

new dictionary of the history of ideas

EDITORIAL BOARD

Editor in Chief

Maryanne Cline Horowitz, *Occidental College*
University of California, Los Angeles

Associate Editors

Jonathan Berkey, *Davidson College*
Zvi Ben-Dor Benite, *New York University*
Benjamin A. Elman, *Princeton University*
George Esenwein, *University of Florida, Gainesville*
Cary J. Nederman, *Texas A&M University*
Vassiliki Betty Smocovitis, *University of Florida, Gainesville*
Neferti Tadiar, *University of California, Santa Cruz*
Mary J. Weismantel, *Northwestern University*
Paul Tiyambe Zeleza, *Pennsylvania State University*

Advisors

Diane Apostolos-Cappadona, *Georgetown University*
Edwina Barvosa-Carter, *University of California, Santa Barbara*
Nupur Chaudhuri, *Texas Southern University*
Kostas Gavroglu, *University of Athens, Greece*
Donald R. Kelley, *Rutgers University*
Zine Magubane, *University of Illinois, Urbana-Champaign*
J. B. Schneewind, *Johns Hopkins University*
Blair Sullivan, *University of California, Los Angeles*
Reed Ueda, *Tufts University*

Librarian Advisory Board

Mary W. George, *Princeton University*
Suzy Szasz Palmer, *University of Louisville*

Editorial Assistant

Lisa Griffin

new dictionary of the history of ideas

maryanne cline horowitz, editor in chief

volume 1

Abolitionism to Common Sense



CHARLES SCRIBNER'S SONS

An imprint of Thomson Gale, a part of The Thomson Corporation

THOMSON
—★—™
GALE



New Dictionary of the History of Ideas
Maryanne Cline Horowitz, Editor in Chief

©2005 Thomson Gale, a part of the Thomson Corporation.

Thomson and Star Logo are trademarks and Gale is a registered trademark used herein under license.

For more information, contact
Thomson Gale
27500 Drake Rd.
Farmington Hills, MI 48331-3535
Or you can visit our Internet site at
<http://www.gale.com>

ALL RIGHTS RESERVED

No part of this work covered by the copyright hereon may be reproduced or used in any form or by any means—graphic, electronic, or mechanical, including photocopying, recording, taping, Web distribution, or information storage retrieval systems—without the written permission of the publisher.

For permission to use material from this product, submit your request via Web at <http://www.gale-edit.com/permissions>, or you may download our Permissions Request form and submit your request by fax or mail to:

Permissions Department
Thomson Gale
27500 Drake Road
Farmington Hills, MI 48331-3535
Permissions Hotline:
248-699-8006 or 800-877-4253, ext. 8006
Fax: 248-699-8074 or 800-762-4058

Since this page cannot legibly accommodate all copyright notices, the acknowledgments constitute an extension of the copyright notice.

While every effort has been made to ensure the reliability of the information presented in this publication, Thomson Gale does not guarantee the accuracy of the data contained herein. Thomson Gale accepts no payment for listing; and inclusion in the publication of any organization, agency, institution, publication, service, or individual does not imply endorsement of the editors or publisher. Errors brought to the attention of the publisher and verified to the satisfaction of the publisher will be corrected in future editions.

LIBRARY OF CONGRESS CATALOGING-IN-PUBLICATION DATA

New dictionary of the history of ideas / edited by Maryanne Cline Horowitz.

p. cm.

Includes bibliographical references and index.

ISBN 0-684-31377-4 (set hardcover : alk. paper) — ISBN 0-684-31378-2 (v. 1) — ISBN 0-684-31379-0 (v. 2) — ISBN 0-684-31380-4 (v. 3) — ISBN 0-684-31381-2 (v. 4) — ISBN 0-684-31382-0 (v. 5) — ISBN 0-684-31383-9 (v. 6) — ISBN 0-684-31452-5 (e-book)

1. Civilization—History—Dictionaries. 2. Intellectual life—History—Dictionaries.

I. Horowitz, Maryanne Cline, 1945—

CB9.N49 2005
903—dc22

2004014731

This title is also available as an e-book.

ISBN 0-684-31452-5

Contact your Thomson Gale sales representative for ordering information.

Printed in the United States of America

10 9 8 7 6 5 4 3 2 1

CONTENTS

Volume 1

List of Articles

Preface

Historiography

Reader's Guide

NEW DICTIONARY OF THE HISTORY OF IDEAS

Abolitionism–Common Sense

Volume 2

Reader's Guide

Communication of Ideas–Futurology

Volume 3

Reader's Guide

Game Theory–Lysenkoism

Volume 4

Reader's Guide

Machiavellism–Phrenology

Volume 5

Reader's Guide

Physics–Syncretism

Volume 6

Reader's Guide

Taste–Zionism

List of Contributors

Index

EDITORIAL AND PRODUCTION STAFF

Project Editors

Mark LaFlaur, Scot Peacock, Jennifer Wisinski

Editorial Support

Kelly Baiseley, Andrew Claps, Alja Collar, Mark Drouillard,
Kenneth Mondschein, Sarah Turner, Ken Wachsberger,
Rachel Widawsky, Christopher Verdesi

Art Editor

Scot Peacock

Chief Manuscript Editor

Georgia S. Maas

Manuscript Editors

Jonathan G. Aretakis, John Barclay, Sylvia Cannizzaro,
Melissa A. Dobson, Ted Gilley, Gretchen Gordon,
Ellen Hawley, Archibald Hobson, Elizabeth B. Inserra,
Jean Fortune Kaplan, Christine Kelley, John Krol,
Julia Penelope, Richard Rothschild, David E. Salame,
Linda Sanders, Alan Thwaites, Jane Marie Todd

Proofreaders

Beth Fhaner, Carol Holmes, Melodie Monahan,
Laura Specht Patchkofsky, Hilary White

Cartographer

XNR Productions, Madison, Wisconsin

Caption Writer

Shannon Kelly

Indexer

Cynthia Crippen, AEIOU, Inc.

Design

Jennifer Wah

Imaging

Dean Dauphinais, Lezlie Light, Mary Grimes

Permissions

Margaret Abendroth, Peggie Ashlevitz, Lori Hines

Composer

GGIS Information Services, York, Pennsylvania

Manager, Composition

Mary Beth Trimper

Assistant Manager, Composition

Evi Seoud

Manufacturing

Wendy Blurton

Senior Development Editor

Nathalie Duval

Editorial Director

John Fitzpatrick

Publisher

Frank Menchaca

LIST OF ARTICLES

A

ABOLITIONISM

Cassandra R. Veney

ABSOLUTE MUSIC

Raymond Knapp

AESTHETICS

Africa

Mary Nooter Roberts

Asia

Mara Miller

Europe and the Americas

Peter Lamarque

AFRICA, IDEA OF

Paul Tiyambe Zeleza

AFRICAN-AMERICAN IDEAS

Sundiata Keita Cha-Jua

AFROCENTRICITY

Ama Mazama

AFROPESSIMISM

Ebere Onwudiwe

AGNOSTICISM

Thomas Dixon

ALCHEMY

China

Fabrizio Pregadio

Europe and the Middle East

Tara E. Nummedal

ALGEBRAS

I. Grattan-Guinness

ALIENATION

David Graeber

ALTRUISM

Thomas Dixon

AMBIGUITY

Giuseppe Caglioti

AMERICA

Alan Mitchell Levine

AMERICANIZATION, U.S.

Michael R. Olneck

ANALYTICAL PHILOSOPHY

Thomas Baldwin

ANARCHISM

George Esenwein

ANCESTOR WORSHIP

Stephen M. Fabian

ANIMISM

Norman E. Whitten Jr.

ANTHROPOLOGY

C. Scott Littleton

ANTICOLONIALISM

Africa

W. O. Maloba

Latin America

Marc Becker

Middle East

Peter Sluglett

Southeast Asia

Maitrii Aung-Thwin

ANTIFEMINISM

Thomas J. Mertz

ANTI-SEMITISM

Overview

Arthur Hertzberg

Islamic Anti-Semitism

Norman A. Stillman

APARTHEID

Betty J. Harris

ARCHITECTURE

Overview

Leland M. Roth

Africa

Nnamdi Elleh

Asia

Leland M. Roth

LIST OF ARTICLES

ARISTOTELIANISM
Charles H. Lohr

ARTS
Overview
Henry M. Sayre

Africa
Babatunde Lawal

ASCETICISM
Hindu and Buddhist Asceticism
Brian Smith

Western Asceticism
Peter Dinzelbacher

ASIAN-AMERICAN IDEAS (CULTURAL MIGRATION)
Haiming Liu

ASSIMILATION
Leonard Dinnerstein

ASTROLOGY
Overview
William E. Burns

China
David W. Pankenier

ASTRONOMY, PRE-COLUMBIAN AND LATIN AMERICAN
Anthony F. Aveni

ATHEISM
Michael Martin

AUTHENTICITY: AFRICA
Kwadwo Osei-Nyame Jr.

AUTHORITARIANISM
Overview
Dirk Berg-Schlösser

East Asia
Soek-Fang Sim

Latin America
Marc Becker

AUTHORITY
Gregory W. Streich

AUTOBIOGRAPHY
Theresa A. Kulbaga
Wendy S. Hesford

AUTONOMY
Kenneth Seeskin

AVANT-GARDE
Overview
Tyrus Miller

Militancy
Rosalind Krauss

AZTLÁN
Luis Leal

B
BARBARISM AND CIVILIZATION
Jay Goulding

BEAUTY AND UGLINESS
Ruth Lorand

BEHAVIORISM
Nadine Weidman

BILINGUALISM AND MULTILINGUALISM
Reynaldo F. Macías

BIOETHICS
Arthur Caplan
Autumn Fiester

BIOGRAPHY
Frederick Liers

BIOLOGY
Vassiliki Betty Smocovitis

BLACK ATLANTIC
Zine Magubane

BLACK CONSCIOUSNESS
Gregory H. Maddox

BODY, THE
Susan Bordo
Monica Udvardy

BORDERS, BORDERLANDS, AND FRONTIERS, GLOBAL
Thomas D. Hall

BUDDHISM
Brian Smith

BUREAUCRACY
Sara Jordan

BUSHIDO
Diane Skoss

C
CALCULATION AND COMPUTATION
Aristotle Tympas

CALENDAR
Stephen M. Fabian

CANNIBALISM
Beth A. Conklin

- CAPITALISM
Overview
 Cary J. Nederman
Africa
 Jeff D. Grischow
- CARTESIANISM
 Stephen Gaukroger
- CASUISTRY
 M. W. F. Stone
- CAUSALITY
 Stathis Psillos
- CAUSATION
 Richard Scheines
- CAUSATION IN EAST ASIAN AND SOUTHEAST ASIAN
 PHILOSOPHY
 Q. Edward Wang
- CENSORSHIP
 John Christian Laursen
- CHANGE
 Daniel W. Graham
- CHARACTER
 Rachana Kamtekar
- CHEMISTRY
 Bernadette Bensaude-Vincent
- CHICANO MOVEMENT
 Juan Gómez Quiñones
 Irene Vasquez Morris
- CHILDHOOD AND CHILD REARING
 Margaret L. King
- CHINESE THOUGHT
 Xinzhong Yao
- CHINESE WARLORDISM
 Yu Shen
- CHRISTIANITY
Overview
 G. R. Evans
Asia
 D. E. Mungello
- CINEMA
 Sean Cubitt
- CITIZENSHIP
Overview
 Ronald Beiner
 Rebecca Kingston
- Cultural Citizenship*
 Adelaida R. Del Castillo
Naturalization
 Patrick Weil
- CITY, THE
The City as Cultural Center
 Patrick Le Galès
The City as Political Center
 Margaret E. Farrar
The Islamic and Byzantine City
 Janet L. Abu-Lughod
Latin America
 Ellen T. Baird
- CIVIL DISOBEDIENCE
 Anthony Parel
- CIVIL SOCIETY
Europe and the United States
 John Ehrenberg
Responses in Africa and the Middle East
 Ebenezer Obadare
- CLASS
 Cary J. Nederman
- CLASSICISM
 Gwen W. Brewer
- CLASSIFICATION OF ARTS AND SCIENCES, EARLY MODERN
 Marc A. Hight
- COLONIALISM
Africa
 Paul Tiyambe Zeleza
Latin America
 Susan Elizabeth Ramirez
Southeast Asia
 Maitrii Aung-Thwin
- COMMON SENSE
 Elisabeth Ellis
- COMMUNICATION OF IDEAS
Africa and Its Influence
 Paul Tiyambe Zeleza
The Americas and Their Influence
 Paul Heyer
Asia and Its Influence
 John Powers
Europe and Its Influence
 Paul Heyer

LIST OF ARTICLES

- Middle East and Abroad*
Thomas F. Glick
- Orality and the Advent of Writing*
Jack Goody
- Southeast Asia and Its Influence*
Janet E. Benson
- COMMUNISM
- Europe*
Tim Rees
- Latin America*
Howard J. Wiarda
Esther M. Skelley
- COMMUNITARIANISM IN AFRICAN THOUGHT
Elias K. Bongmba
- COMPOSITION, MUSICAL
Kathryn Pisaro
- COMPUTER SCIENCE
Ellis Horowitz
- CONFUCIANISM
Jerry Dennerline
- CONSCIOUSNESS
- Overview*
Aviezer Tucker
- Chinese Thought*
Chung-ying Cheng
- Indian Thought*
John Powers
- CONSERVATISM
Arthur Aughey
- CONSILIENCE
Michael Ruse
- CONSTITUTIONALISM
Takashi Shogimen
- CONSUMERISM
Mary Rizzo
- CONTEXT
Peter Burke
- CONTINENTAL PHILOSOPHY
Franz Mayr
- CORRUPTION
Andrew R. Murphy
- CORRUPTION IN DEVELOPED AND DEVELOPING COUNTRIES
John Mukum Mbaku
- COSMOLOGY
- Asia*
Robert Smid
- Cosmology and Astronomy*
Norriss Hetherington
- COSMOPOLITANISM
Kevin James Houk
- CREATIONISM
Michael Ruse
- CREATIVITY IN THE ARTS AND SCIENCES
Dean Keith Simonton
- CREOLIZATION, CARIBBEAN
H. Adlai Murdoch
- CRISIS
Randolph Starn
- CRITICAL RACE THEORY
Richard Delgado
Jean Stefancic
- CRITICAL THEORY
Douglas Kellner
- CULTURAL CAPITAL
Ivan Light
- CULTURAL HISTORY
Donald R. Kelley
- CULTURAL REVIVALS
Margaret Werry
- CULTURAL STUDIES
Lawrence Grossberg
- CYCLES
Frederick Liers
- CYNICISM
L. E. Navia
- D**
- DADA
Willard Bohn
- DANCE
DonnaLee Dox
- DAOISM
Fabrizio Pregadio

- DEATH
 John DeFrain
 Alyssa DeFrain
 Joanne Cacciatore-Garard
- DEATH AND AFTERLIFE, ISLAMIC UNDERSTANDING OF
 Paul R. Powers
- DEISM
 Matthew Kadane
- DEMOCRACY
 Benedetto Fontana
- DEMOCRACY, AFRICA
 Paul Tiyambe Zeleza
- DEMOGRAPHY
 Ramdas Menon
- DEMONOLOGY
 C. Scott Littleton
- DEPENDENCY
 Jane L. Parpart
- DETERMINISM
 Ted Honderich
- DEVELOPMENT
 Manfred D. Laubichler
 Jane Maienschein
- DIALOGUE AND DIALECTICS
Socratic
 Diskin Clay

Talmudic
 Jacob Neusner
- DIASPORAS
African Diaspora
 Paul Tiyambe Zeleza

Jewish Diaspora
 Holly Snyder
- DICTATORSHIP IN LATIN AMERICA
 Marc Becker
- DIFFUSION, CULTURAL
 Victor H. Mair
- DISCRIMINATION
 Howard Winant
- DIVERSITY
 Nathan Glazer
- DREAM
 Marc Michael Epstein
- DRESS
 Lou Taylor
- DUALISM
 Peter Machamer
 Francesca di Poppa
- DYSTOPIA
 David W. Sisk
- E**
- ECLECTICISM
 Donald R. Kelley
- ECOLOGY
 Robert P. McIntosh
- ECONOMICS
 Emmanuel Nnadozie
- ECUMENISM
 Joseph A. Loya
- EDUCATION
Asia, Traditional and Modern
 Q. Edward Wang

China
 Benjamin A. Elman

Europe
 Paul F. Grendler

Global Education
 John A. Xanthopoulos

India
 Michelle Maskiell

Islamic Education
 Sebastian Günther

Japan
 Hideki Takemura
 Genzo Yamamoto

North America
 Theodore R. Mitchell
- EMOTIONS
 Robert C. Solomon
- EMPIRE AND IMPERIALISM
Overview
 James Muldoon

Americas
 Susan Elizabeth Ramirez

Asia
 Wellington K. K. Chan

LIST OF ARTICLES

- Europe*
Martin Lynn
- Middle East*
Charles D. Smith
- United States*
Howard J. Wiarda
- EMPIRICISM
Thomas Nickles
- ENCYCLOPEDIISM
Richard Yeo
- ENLIGHTENMENT
Michael C. Carhart
- ENVIRONMENT
Alain Touwaide
- ENVIRONMENTAL ETHICS
Douglas Maclean
- ENVIRONMENTAL HISTORY
Thomas Pyke Johnson
- EPICUREANISM
Tim Duvall
- EPISTEMOLOGY
Ancient
Richard Bett
Early Modern
Melissa McBay Merritt
Modern
Matthias Steup
- EQUALITY
Overview
Alexandra Kogl
David K. Moore
Gender Equality
Jane Flax
Racial Equality
Gregory W. Streich
- ESCHATOLOGY
Matthias Riedl
- ESSENTIALISM
Jane Flax
- ETHNICITY AND RACE
Africa
Fred Hendricks
- Anthropology*
Ann M. Kakaliouras
- Islamic Views*
James Jankowski
- ETHNOCENTRISM
David Theo Goldberg
- ETHNOGRAPHY
Jean Comaroff
- ETHNOHISTORY, U.S.
Glen Anthony Harris
- ETIQUETTE
Sarah Covington
- EUGENICS
Garland E. Allen
- EUROCENTRISM
Colin Mackerras
- EUROPE, IDEA OF
Heikki Mikkeli
- EVERYDAY LIFE
Peter Burke
- EVIL
Mark Larrimore
- EVOLUTION
Vassiliki Betty Smocovitis
- EXAMINATION SYSTEMS, CHINA
Benjamin A. Elman
- EXISTENTIALISM
Robert C. Solomon
- EXPERIMENT
Theodore Arabatzis
- EXPRESSIONISM
Shulamith Behr
- EXTIRPATION
Marc Becker
- F**
- FALLACY, LOGICAL
David J. Stump
- FALSIFIABILITY
Thomas Nickles
- FAMILY
Modernist Anthropological Theory
Mary J. Weismantel

- Family in Anthropology since 1980*
Cynthia E. Foor
Ann Miles
- FAMILY PLANNING
Asoka Bandarage
- FASCISM
Roger Griffin
- FATALISM
Mark H. Bernstein
- FEMINISM
Overview
Maina Chawla Singh
Africa and African Diaspora
Amina Mama
Chicana Feminisms
Aída Hurtado
Jessica M. Roa
Islamic Feminism
Miriam Cooke
Third World U.S. Movement
Alma M. Garcia
- FETISHISM
Overview
Rosalind C. Morris
Fetishism in Literature and Cultural Studies
Carla Freccero
- FEUDALISM, EUROPEAN
Fredric L. Cheyette
- FIELD THEORIES
Alberto A Martínez
Silvan S. Schweber
- FORM, METAPHYSICAL, IN ANCIENT AND MEDIEVAL
THOUGHT
Gyula Klima
- FORMALISM
Andrzej Karcz
- FOUNDATIONALISM
Paul K. Moser
- FREE WILL, DETERMINISM, AND PREDESTINATION
Thomas M. Osborne Jr.
- FRIENDSHIP
Heather Devere
- FUNDAMENTALISM
Jeffrey T. Kenney
- FUTUROLOGY
Paramanonda Mahanta
- G**
- GAME THEORY
Robert W. Dimand
- GARDEN
Mara Miller
- GAY STUDIES
Andrew Grossman
- GENDER
Overview
Vern L. Bullough
Gender in the Middle East
D. A. Spellberg
- GENDER IN ART
Anat Gilboa
- GENDER STUDIES: ANTHROPOLOGY
Rosalind C. Morris
- GENERAL WILL
John T. Scott
- GENERATION
Steven P. Remy
- GENETICS
History of
Robert Olby
Contemporary
Garland E. Allen
- GENIUS
Valerie Holliday
- GENOCIDE
Mark Kramer
- GENRE
William Hughes
- GEOGRAPHY
Norman J. W. Thrower
- GEOMETRY
Jeremy Gray
- GESTURE
Moshe Barasch
- GHETTO
Arthur M. Lesley

LIST OF ARTICLES

GIFT, THE
Natalie Zemon Davis

GLOBALIZATION
Africa
Kidane Mengisteab

Asia
Jay Goulding

General
Kidane Mengisteab

GNOSTICISM
Giovanni Filoramo

GOOD
James A. Montmarquet

GREEK SCIENCE
Karin Tybjerg

H

HAPPINESS AND PLEASURE IN EUROPEAN THOUGHT
Tim Duvall
Jeffrey Miller

HARMONY
Blair Sullivan

HATE
Jess Maghan

HEALTH AND DISEASE
W. F. Bynum

HEAVEN AND HELL
Alan E. Bernstein

HEAVEN AND HELL (ASIAN FOCUS)
Ning Qiang

HEDONISM IN EUROPEAN THOUGHT
Giulia Sissa

HEGELIANISM
Yitzhak Y. Melamed
Peter Thielke

HEGEMONY
Benedetto Fontana

HERESY AND APOSTASY
Takashi Shogimen

HERMENEUTICS
Jean Grondin

HIERARCHY AND ORDER
Maxim Khomiakov

HINDUISM
Brian Smith

HISTORICAL AND DIALECTICAL MATERIALISM
Terrell Carver

HISTORICISM
Donald R. Kelley

HISTORIOGRAPHY
Daniel Woolf

HISTORY, ECONOMIC
Paul Tiyambe Zeleza

HISTORY, IDEA OF
Donald R. Kelley

HONOR
Sonya Lipsett-Rivera

HONOR, MIDDLE EASTERN NOTIONS OF
Sherifa Zuhur

HUMAN CAPITAL
Philip L. Martin

HUMAN RIGHTS
Overview
Cary J. Nederman
Women's Rights
Christine Min Wotipka

HUMANISM
Africa
Lewis R. Gordon
Chinese Conception of
Jiyuan Yu
Europe and the Middle East
Cary J. Nederman
Renaissance
Albert Rabil Jr.
Secular Humanism in the United States
Stephen Weldon

HUMANITY
African Thought
D. A. Masolo
Asian Thought
John Powers

European Thought
Maryanne Cline Horowitz

HUMANITY IN THE ARTS
Diane Apostolos-Cappadona

- HUMOR
Alleen Pace Nilsen
Don L. F. Nilsen
- HYGIENE
Claire Hooker
- I**
- ICONOGRAPHY
Colum Hourihane
- IDEALISM
Michael Baur
- IDEAS, HISTORY OF
Donald R. Kelley
- IDENTITY
Identity of Persons
Udo Thiel
Personal and Social Identity
Russell Spears
- IDENTITY, MULTIPLE
Overview
Edwina Barvosa-Carter
Asian-Americans
Laura Uba
Jewish Multiple Identity
Jonathan Boyarin
- IMAGES, ICONS, AND IDOLS
David J. Goa
- IMAGINATION
J. Robert Barth
- IMMORTALITY AND THE AFTERLIFE
Tim Duvall
- IMPRESSIONISM
James H. Rubin
- INDIGENISMO
Jorge F. Coronado
- INDIVIDUALISM
Cary J. Nederman
- INTELLIGENTSIA
Mamadou Diouf
- INTENTIONALITY
John R. Searle
- INTERCESSION IN MIDDLE EASTERN SOCIETY
Sherifa Zuhur
- INTERDISCIPLINARITY
David Theo Goldberg
Cathy N. Davidson
- INTERNAL COLONIALISM
Deena J. González
- INTERNATIONAL ORDER
James Muldoon
- INTERPRETATION
Jon Cruz
- ISLAM
Africa
Eltigani Abdelgadir Hamid
Shii
Devin J. Stewart
Southeast Asia
M.B. Hooker
Sunni
Christopher S. Taylor
- ISLAMIC SCIENCE
Sonja Brentjes
- J**
- JAINISM
Lawrence A. Babb
- JAPANESE PHILOSOPHY, JAPANESE THOUGHT
Thierry Jean Robouam
- JIHAD
Michael Bonner
- JOUISSANCE
Brenda L. Bethman
- JUDAISM
Judaism to 1800
Moshe Idel
Modern Judaism
Kalman P. Bland
- JUSTICE
Overview
James P. Sterba
Justice in American Thought
Roberto Alejandro
Justice in East Asian Thought
Lauren F. Pfister
Fèi Lèrén

LIST OF ARTICLES

K

KANTIANISM

Paul Guyer

KINSHIP

Rosa De Jorio

KNOWLEDGE

Barry Allen

L

LANDSCAPE IN THE ARTS

Diane Apostolos-Cappadona

LANGUAGE AND LINGUISTICS

Victor H. Mair

LANGUAGE, LINGUISTICS, AND LITERACY

E. J. W. Barber

LANGUAGE, PHILOSOPHY OF

Ancient and Medieval

John Marenbon

Modern

Meredith Williams

LAW

Winston P. Nagan

LAW, ISLAMIC

Devin J. Stewart

LEADERSHIP

Steven B. Sample

LEARNING AND MEMORY, CONTEMPORARY VIEWS

Ian Neath

LEGALISM, ANCIENT CHINA

Yuri Pines

LIBERALISM

John Charvet

LIBERATION THEOLOGY

Elina Vuola

LIBERTY

Takashi Shogimen

LIFE

Garland E. Allen

LIFE CYCLE

Overview

Mary J. Weismantel

Adolescence

Ann Miles

Elders/Old Age

Samantha Solimeo

LINGUISTIC TURN

Donald R. Kelley

LITERARY CRITICISM

Hortense J. Spillers

LITERARY HISTORY

Paul Newman

LITERATURE

Overview

Vincent P. Pecora

African Literature

Pius Adesanmi

LOGIC

John Marenbon

LOGIC AND PHILOSOPHY OF MATHEMATICS, MODERN

I. Grattan-Guinness

LOVE, WESTERN NOTIONS OF

Vern L. Bullough

Kenneth Mondschein

LOYALTIES, DUAL

Caryn E. Neumann

LYSENKOISM

David Joravsky

M

MACHIAVELLISM

Ben-Ami Scharfstein

MACHISMO

Gloria González-López

Matthew C. Gutmann

MAGIC

Diane Ciekawy

MANICHAISM

Jason David BeDuhn

MAOISM

Chen Jian

MAPS AND THE IDEAS THEY EXPRESS

Norman J. W. Thrower

MARRIAGE AND FERTILITY, EUROPEAN VIEWS

David Levine

MARXISM

Overview

Allan Megill

- Asia*
Maurice Meisner
- Latin America*
Michael Werner
- MASKS
John Nunley
- MATERIALISM IN EIGHTEENTH-CENTURY EUROPEAN
THOUGHT
Peter Machamer
Francesca di Poppa
- MATHEMATICS
I. Grattan-Guinness
- MATRIARCHY
Janet Hoskins
- MECHANICAL PHILOSOPHY
Margaret J. Osler
- MEDIA, HISTORY OF
Sean Cubitt
- MEDICINE
China
Nathan Sivin
Europe and the United States
Harry W. Paul
India
Dominik Wujastyk
Islamic Medicine
Miri Shefer
- MEDITATION, EASTERN
Brian Smith
- MEME
Kenneth Mondschein
- MEMORY
Patrick H. Hutton
- MEN AND MASCULINITY
R.W. Connell
- MESTIZAJE
Karen Mary Davalos
- METAPHOR
Christopher Hollingsworth
- METAPHYSICS
Ancient and Medieval
John Marenbon
- Renaissance to the Present*
Michael LeBuffe
- MICROCOSM AND MACROCOSM
Robert Ziolkowski
- MIGRATION
Africa
Sola Akinrinade
Migration in World History
Dirk Hoerder
United States
Dirk Hoerder
- MILLENARIANISM
Overview
Michael St. Clair
Islamic
David Cook
Latin America and Native North America
Ward Stavig
- MIND
Carl Zimmer
- MINORITY
John E. Farley
- MIRACLES
Kenneth L. Woodward
- MODERNISM
Overview
Michael Levenson
Latin America
David Craven
- MODERNITY
Overview
Elisabeth Ellis
Africa
Mamadou Diouf
East Asia
Chaohua Wang
- MODERNIZATION
Dickson Eyoh
- MODERNIZATION THEORY
Gilbert Rozman
- MOHISM
Yuri Pines

LIST OF ARTICLES

MONARCHY

Overview

Cary J. Nederman

Islamic Monarchy

Anne F. Broadbridge

MONASTICISM

William M. Johnston

MONISM

Peter Machamer

Francesca di Poppa

MORAL SENSE

Charlotte R. Brown

MOTHERHOOD AND MATERNITY

Maina Chawla Singh

MOTIF

Motif in Literature

Kristen Lee Over

Motif in Music

Alyson McLamore

MULTICULTURALISM, AFRICA

Fred Hendricks

MUSEUMS

Julian Spalding

MUSIC, ANTHROPOLOGY OF

Thomas Turino

MUSICAL PERFORMANCE AND AUDIENCES

Alyson McLamore

MUSICOLOGY

Blair Sullivan

MYSTICISM

Chinese Mysticism

Howard L. Goodman

Christian Mysticism

Matthias Riedl

Islamic Mysticism

Richard McGregor

Islamic Mysticism in Asia

Jamal J. Elias

Kabbalah

Moshe Idel

Mysticism in African Thought

Jerusha T. Lamprey

MYTH

Robert A. Segal

N

NARRATIVE

James Phelan

NATION

John Breuilly

NATIONAL HISTORY

Kevin Passmore

NATIONALISM

Overview

Timothy Baycroft

Africa

Toyin Falola

Tyler Fleming

Cultural Nationalism

Elizabeth Bishop

Middle East

James Jankowski

Nationalism in Music, Europe and the United States

Raymond Knapp

NATIVE POLICY

Les W. Field

NATURAL HISTORY

Paul Farber

NATURALISM

Jonathan P. Hunt

NATURALISM IN ART AND LITERATURE

Gabriel P. Weisberg

NATURAL LAW

T. J. Hochstrasser

NATURAL THEOLOGY

Thomas Dixon

NATURE

Max Oelschlaeger

NATURPHILOSOPHIE

Frederick Gregory

NEGRITUDE

H. Adlai Murdoch

NEOCOLONIALISM

Toyin Falola

Matthew Heaton

NEOLIBERALISM

Guy C. Z. Mhone

- NEOPLATONISM
Robert Ziolkowski
- NEW CRITICISM
Amit Ray
- NEWTONIANISM
Manolis Patiniotis
- NIHLISM
Steven Cassedy
- NOMADISM
William A. Wood
- NONVIOLENCE
Anthony Parel
- NUCLEAR AGE
Mark Kramer
- NUDE, THE
Diane Apostolos-Cappadona
- O**
- OBJECTIVITY
Aviezer Tucker
- OBLIGATION
Robert N. Johnson
- OCCIDENTALISM
Q. Edward Wang
- ORAL TRADITIONS
Overview
Sola Akinrinade
Telling, Sharing
Gregory H. Maddox
- ORGANICISM
Cary J. Nederman
- ORIENTALISM
Overview
Allen Douglas
Fedwa Malti-Douglas
African and Black Orientalism
Ahmed S. Bangura
- ORTHODOXY
Earle H. Waugh
- ORTHOPRAXY
Asia
Robert Smid
Western Orthopraxy
Steven Cassedy
- OTHER, THE, EUROPEAN VIEWS OF
Albrecht Classen
- P**
- PACIFISM
Nigel Young
- PAN-AFRICANISM
Marc Matera
- PAN-ARABISM
James Jankowski
- PAN-ASIANISM
Noriko Kamachi
- PAN-ISLAMISM
Jeffrey T. Kenney
- PAN-TURKISM
M. Şükrü Hanioglu
- PARADIGM
David J. Stump
- PARADISE ON EARTH
Walter B. Denny
- PATRIOTISM
Andrew Vincent
- PEACE
Ben Lowe
- PEASANTS AND PEASANTRY
Alois Mlambo
- PERIODIZATION
Donald R. Kelley
- PERIODIZATION OF THE ARTS
Kaylee Spencer-Ahrens
Linnea Wren
- PERSON, IDEA OF THE
Robert Launay
- PERSONHOOD IN AFRICAN THOUGHT
Kwasi Wiredu
- PERSPECTIVE
Samuel Y. Edgerton
- PHENOMENOLOGY
Robert C. Solomon
- PHILANTHROPY
Kevin C. Robbins

LIST OF ARTICLES

PHILOSOPHIES

African

Souleymane Bachir Diagne

American

Stephen Barnes

Feminist, Twentieth-Century

Nancy Tuana

Islamic

Richard C. Taylor

PHILOSOPHY

Historical Overview and Recent Developments

Robert C. Solomon

Relations to Other Intellectual Realms

M. W. F. Stone

PHILOSOPHY, HISTORY OF

Justin E. H. Smith

PHILOSOPHY, MORAL

Africa

Kwasi Wiredu

Ancient

Charles M. Young

Medieval and Renaissance

Jill Kraye

Modern

Jeffrey Edwards

Michael Hughes

PHILOSOPHY AND RELIGION IN WESTERN THOUGHT

M. W. F. Stone

PHILOSOPHY OF MIND

Overview

Anita Avramides

Ancient and Medieval

Jack Zupko

PHILOSOPHY OF RELIGION

M. W. F. Stone

PHRENOLOGY

Nadine Weidman

PHYSICS

G.J. Weisel

PIETISM

Ulrich Groetsch

PLATONISM

Kimberly Sims

PLURALISM

Everett Helmut Akam

POETRY AND POETICS

John T. Hamilton

POLITICAL, THE

Dwight D. Allman

POLITICAL PROTEST, U.S.

Laura R. Woliver

POLITICAL SCIENCE

Tim Duvall

POLYTHEISM

Robert Launay

POPULATION

Malcolm Potts

Martha M. Campbell

POPULISM

Latin America

Robert Albro

United States

Stephen Barnes

POSITIVISM

Thomas Nickles

POSTCOLONIAL STUDIES

Laura Chrisman

POSTCOLONIAL THEORY AND LITERATURE

Gayatri Chakravorty Spivak

POSTMODERNISM

Paula E. Geyh

POVERTY

Christopher J. Berry

POWER

Richard Schmitt

PRACTICES

Heather Levi

PRAGMATISM

Stephen Barnes

PRE-COLUMBIAN CIVILIZATION

Susan Elizabeth Ramirez

PREHISTORY, RISE OF

Donald R. Kelley

PREJUDICE

John Duckitt

- PRESENTISM
Patrick H. Hutton
- PRIVACY
Bonnie McDougall
- PRIVATIZATION
Guy C. Z. Mhone
- PROBABILITY
Alan Hájek
- PROGRESS, IDEA OF
Jerry Weinberger
- PROPAGANDA
David Welch
- PROPERTY
Leif Wenar
- PROPHECY
Marion Leathers Kuntz
- PROTEST, POLITICAL
David Kunzle
- PSEUDOSCIENCE
David J. Stump
- PSYCHOANALYSIS
Matthew F. von Unwerth
- PSYCHOLOGY AND PSYCHIATRY
Joel T. Braslow
Sarah Linsley Starks
- PUBLIC SPHERE
Thomas F. Murphy III
- PUNISHMENT
Douglas C. Dow
- PURITANISM
David Randall
- PYTHAGOREANISM
David Fidler
- Q**
- QUANTUM
Laurie M. Brown
- QUEER THEORY
Annamarie Jagose
- R**
- RACE AND RACISM
Overview
Howard Winant
- Asia*
Genzo Yamamoto
- Europe*
Joshua Goode
- Reception of Asians to the United States*
Haiming Liu
- RADICALS/RADICALISM
Valerae M. Hurley
- RATIONAL CHOICE
Chris Swoyer
Stephen Ellis
- RATIONALISM
Sean Greenberg
- READING
Jonathan Rose
- REALISM
James H. Rubin
- REALISM, AFRICA
Mpalive-Hangson Msiska
- REASON, PRACTICAL AND THEORETICAL
Eugene Garver
- REFLEXIVITY
Heather Levi
- REFORM
Europe and the United States
Erika Rummel
- Islamic Reform*
Charles Kurzman
- REFORMATION
Robert M. Kingdon
- REGIONS AND REGIONALISM, EASTERN EUROPE
Steven Cassedy
- RELATIVISM
Robert N. Johnson
- RELATIVITY
Michel Janssen
- RELIGION
Overview
Russell T. McCutcheon
- Africa*
Elias K. Bongmba
- African Diaspora*
Elias K. Bongmba

LIST OF ARTICLES

- East and Southeast Asia*
Jay Goulding
- Indigenous Peoples' View, South America*
Norman E. Whitten Jr.
- Latin America*
Susan Elizabeth Ramirez
- Middle East*
William E. Shepard
- RELIGION AND SCIENCE
Christopher Southgate
- RELIGION AND THE STATE
- Africa*
Austin Metumara Ahanotu
- Europe*
Cary J. Nederman
- Latin America*
William H. Beezley
- Middle East*
Cyrus Masroori
- United States*
Martin E. Marty
- RENAISSANCE
Maryanne Cline Horowitz
- REPRESENTATION
- Mental Representation*
Whit Schonbein
- Political Representation*
Hans von Rautenfeld
- REPUBLICANISM
- Latin America*
Marc Becker
- Republic*
Cary J. Nederman
- RESISTANCE
Stephen Duncombe
- RESISTANCE AND ACCOMMODATION
Clifton Crais
- RESPONSIBILITY
Michael J. Zimmerman
- REVOLUTION
Krishan Kumar
- RHETORIC
- Overview*
Jean-Claude Carron
- Ancient and Medieval*
John Ward
- RITUAL
- Public Ritual*
Elizabeth McCartney
- Religion*
Robert Launay
- ROMANTICISM IN LITERATURE AND POLITICS
Gerald N. Izenberg
- S**
- SACRED AND PROFANE
Robert Launay
- SACRED PLACES
C. Scott Littleton
- SACRED TEXTS
- Asia*
John Powers
- Koran*
Daniel A. Madigan
- SAGE PHILOSOPHY
D. A. Masolo
- SCARCITY AND ABUNDANCE, LATIN AMERICA
Josiah McC. Heyman
- SCHOLASTICISM
Philipp W. Rosemann
- SCIENCE
- Overview*
Helge Kragh
- East Asia*
Nathan Sivin
- SCIENCE, HISTORY OF
Pat Munday
- SCIENCE FICTION
Marleen S. Barr
- SCIENTIFIC REVOLUTION
H. Floris Cohen
- SECULARIZATION AND SECULARISM
Nikki R. Keddie
- SEGREGATION
Cassandra Rachel Veney
- SEXUAL HARASSMENT
Catharine MacKinnon

- SEXUALITY
Overview
 Jeffrey Weeks
Islamic Views
 Fedwa Malti-Douglas
Sexual Orientation
 Vern L. Bullough
- SHINTO
 Genzo Yamamoto
- SKEPTICISM
 John Christian Laursen
- SLAVERY
 Stanley L. Engerman
- SOCIABILITY IN AFRICAN THOUGHT
 D. A. Masolo
- SOCIAL CAPITAL
 Sean Hawkins
- SOCIAL CONTRACT
 Melissa Lane
- SOCIAL DARWINISM
 Peter Dickens
- SOCIAL HISTORY, U.S.
 Martin J. Burke
- SOCIALISM
 George Esenwein
- SOCIALISMS, AFRICAN
 Pablo L.E. Idahosa
- SOCIETY
 Jay Goulding
- SOPHISTS, THE
 David D. Corey
- SOVEREIGNTY
 Cary J. Nederman
- SPORT
 Mark Dyreson
- STATE, THE
Overview
 Clyde W. Barrow
The Postcolonial State
 Charmaine Pereira
- STATE OF NATURE
 George Klosko
- STOICISM
 Christopher Gill
- STRUCTURALISM AND POSTSTRUCTURALISM
Overview
 Michael Ryan
Anthropology
 Robert Launay
- SUBJECTIVISM
 Chris Swoyer
- SUFISM
 Ousmane Kane
- SUICIDE
 Alexander Murray
- SUPERSTITION
 William E. Burns
- SURREALISM
 Willard Bohn
- SYMBOLISM
 Jennifer L. Shaw
- SYNCRETISM
 C. Scott Littleton
- T**
- TASTE
 David E. W. Fenner
- TECHNOLOGY
 Aristotle Tympas
- TEMPERANCE
 Jack S. Blocker Jr.
- TERROR
 Paul Newman
- TERRORISM, MIDDLE EAST
 Stephen Zunes
- TEXT/TEXTUALITY
 John Mowitt
- TEXTILES AND FIBER ARTS AS CATALYSTS FOR IDEAS
 E. J. W. Barber
- THEATER AND PERFORMANCE
 Margaret Werry
- THEODICY
 Mark Larrimore
- THIRD CINEMA
 Jonathan Beller

LIST OF ARTICLES

THIRD WORLD

Francis B. Nyamnjoh

THIRD WORLD LITERATURE

Neil Larsen

TIME

China

Howard L. Goodman

India

Brian Smith

Traditional and Utilitarian

Richard K. Fenn

TOLERATION

John Christian Laursen

TOTALITARIANISM

Peter Baehr

TOTEMS

Robert Launay

TRADE

Peter N. Peregrine

TRADITION

Hylton White

TRAGEDY AND COMEDY

Henry Ansgar Kelly

TRANSLATION

Naoki Sakai

TRAVEL FROM EUROPE AND THE MIDDLE EAST

James P. Helfers

TREATY

Costas M. Constantinou

TRIBALISM, MIDDLE EAST

Dale F. Eickelman

TROPE

James W. Fernandez

TRUTH

Frederick F. Schmitt

U

UNIVERSALISM

Drucilla Cornell

UNIVERSITY

Overview

Paul F. Grendler

Postcolonial

Yann Lebeau

UNTOUCHABILITY

Overview

Eleanor Zelliot

Menstrual Taboos

Sarah Covington

Taboos

Robert Delième

UTILITARIANISM

R. G. Frey

UTOPIA

Lyman Tower Sargent

V

VICTORIANISM

Donald M. MacRaild

VIRTUAL REALITY

Randall Packer

VIRTUE ETHICS

Rosalind Hursthouse

VISUAL CULTURE

Jonathan Beller

VISUAL ORDER TO ORGANIZING COLLECTIONS

Maryanne Cline Horowitz

VOLKSGEIST

Woodruff D. Smith

VOLUNTEERISM, U.S.

Peter Dobkin Hall

W

WAR

Movindri Reddy

WAR AND PEACE IN THE ARTS

David M. Hart

WEALTH

Christopher J. Berry

WESTERNIZATION

Africa

F. Abiola Irele

Middle East

Ellen Amster

Southeast Asia

Mairii Aung-Thwin

- WILDLIFE
Max Oelschlaeger
- WISDOM, HUMAN
Jack Goody
- WITCHCRAFT
Diane Ciekawy
- WITCHCRAFT, AFRICAN STUDIES OF
Diane Ciekawy
- WOMANISM
Obioma Nnaemeka
- WOMEN AND FEMININITY IN U.S. POPULAR CULTURE
Susan Grayson
- WOMEN'S HISTORY
Africa
Kathleen Sheldon
Asia
Sharon Sievers
- WOMEN'S STUDIES
Margaret H. McFadden
- WORK
Josiah McC. Heyman
- WORLD SYSTEMS THEORY, LATIN AMERICA
David Craven
- YZ**
- YIN AND YANG
Fabrizio Pregadio
- YOGA
Brian Smith
- ZEN
Jay Goulding
- ZIONISM
Arthur Hertzberg

PREFACE

Seeking to present a comprehensive work that discusses pivotal topics of human concern, the editors at Charles Scribner's Sons and a multidisciplinary editorial board of nineteen professors and two librarians designed the *New Dictionary of the History of Ideas (NDHI)* with an emphasis on the diverse perspectives of thinkers around the globe. This six-volume set, which contains all new and original entries, addresses topics in the fields of history, anthropology, and women's studies; philosophy and religion; politics, law and economics; area studies and ethnic studies; literature, performance, music, and the visual arts; communication studies and cultural studies; and science, engineering and medicine. The first *Dictionary of the History of Ideas* was published by Scribner's in 1973–1974 and swiftly became a landmark of scholarship on European thought primarily. The *NDHI* extends this legacy into the twenty-first century with entirely new content on Africa, Asia, Europe, Latin America, North America, and the Middle East. With many more articles than the original edition, hundreds of illustrations, as well as profusely illustrated visual entries, the *NDHI* provides an expansive cross-cultural and global outlook on the history of ideas.

The first *Dictionary of the History of Ideas* is known especially for the history of influential texts. Most significantly, while all articles of *NDHI* discuss influential texts and provide an up-to-date bibliography, there are very few articles in the *NDHI* that are primarily the history of texts. Articles may give evidence of oral communication, such as in a public debate of politicians or in a religious person sharing beliefs and sacred practices with another individual; furthermore, articles on contemporary culture analyze the impact of high technology communication such as the cinema and the Internet. Some authors evocatively describe a thinker's vision of an idea, while others reenact conversational philosophical exchanges. Articles may also depict the experiential expression of ideas in such practices as a social science survey of voter attitudes, patriotic ritual of flag-waving, or political protest.

The field of the history of ideas, in the mid-twentieth century, served as a trendsetter in establishing "interdisciplinarity" in academia, encouraging the pursuit of ideas across the borders of academic disciplines. Perhaps the greatest accomplishment of the *NDHI* is its focus on the most influential multidisciplinary practices, such as "Mysticism," "Mathematics," and "Reading," which have ancient origins, and "Representation: Mental Representation" and "Bioethics," which are creations of our own times. The *NDHI* aims to assist the reader to participate in a wide range of methods and practices of scholarly and popular inquiry.

The Organization of the *NDHI*

From "Abolitionism" and "Absolute Music" to "Zen" and "Zionism," the *NDHI* is arranged alphabetically. Following this introduction is an entry on global historiography that introduces the traditions of history-writing in specific geographical areas. The start of each volume also contains the multifaceted "Reader's Guide," a guide to help high school students, general readers, college and university students, and scholars organize their reading systematically according to their preferences: media of communication of ideas (whether visual images, oral traditions or high technology media, practices or rituals, or mainly texts), geographical area, chronological period, disciplinary or interdisciplinary field. For further reference there is an index at the close of the sixth volume.

Chronological Length and Area-Studies Breadth

The *NDHI* is designed to introduce a general audience to the main ideas and movements of global cultural history from antiquity to the twenty-first century. The chronological scope of the *NDHI* permits examination of a topic over centuries and millennia of development. For example, article

range chronologically from ideas created by humanity several millennia ago, such as “Animism” and “Textiles and Fiber Arts as Catalysts for Ideas,” to such contemporary concepts as “Computer Science,” “Critical Race Theory,” and “Media, History of.” Articles also analyze newly conceived ideas, such as “Sexual Harassment,” a recent label for an age-old phenomenon, as well ideas labeled long ago such as “Untouchability,” “Yin and Yang,” and “Cycles.”

The *NDHI* focuses not only on the ideas themselves (as tends to be the case in companions, dictionaries, and encyclopedias of philosophy), but also on the cultural environments within which those ideas arose, on the transformations and intermingling of the ideas, and on their influence far in time or place from site of origin. The editorial board, which included specialists on Africa, Asia, Europe, Latin America, the Middle East, and North America, invited hundreds of distinguished scholars from around the globe to explore the impact of ideas from their particular areas of expertise. The editorial board also utilized a variety of rubrics to ensure that the alphabetically arranged volumes contain a balance of approaches to the exchange of ideas between individuals and between peoples.

Transformations in Communication

The *NDHI* aims to explore the oral, visual, participatory, and textual processes by which communities communicated, instilled, and ritualized their ideas. A cluster of articles by area specialists on “Communication of Ideas”—which appears in the Reader’s Guide under the headings Geographical Areas and Communication of Ideas—introduces the changing means of communication across the centuries in Africa, the Americas, Asia, Europe, the Middle East, and Southeast Asia, respectively. The authors of these entries discuss the continuation of oral techniques after the emergence of literate elites, as well as the growing importance of the mass media today. The authors consider the impact of the printing press and of journalism on the distribution of ideas, and discuss the trade routes and electronic media that spread ideas from one continent to another. The cluster on “Communication of Ideas” describes the practices of religious leaders, educators, and governing officials who instill religious, disciplinary, and civic rituals and approaches into daily life. The Reader’s Guide suggests “Cinema” and “Third Cinema” as well as the visual essay “Protest, Political” as articles for further reading on communication. The *NDHI* vividly narrates and illustrates the multiple ways in which cultures communicate ideas.

Eight authors contributed to a cluster on education, focusing on the role of diverse forms of education in the transmission and transformation of ideas in Asia, China, Japan, India, Europe, Islam, and North America, respectively; there is also an article on the contemporary movement to which the *NDHI* aims to contribute, “Global Education.” One will find all these articles listed under Education in the Reader’s Guide section on Liberal Arts Disciplines. For developments in higher education, “University: Overview” concentrates on Europe and “University: Postcolonial” on Africa. “Childhood and Child Rearing” discusses the history of childhood, the education of children, and the changing views of what it means to be a child. Two related articles on “Dialogue and Dialectics” focus on the methods for student learning taught by Greek “Socratic” education and by Jewish “Talmudic” education. The practices of evaluation are the focus of “Experiment” and “Examinations Systems, China.” In “Pan-Africanism,” “Pan-Arabism,” “Pan-Asianism,” “Pan-Islamism,” and “Pan-Turkism,” five experts explain the recent rapid development, across wide geographical areas, of unifying cultural and educational movements of identity politics.

Focus on a Geographical Area or Global Chronological Period

Readers may choose to focus on the cultural and intellectual history of a specific area of the globe. For this reason, articles are categorized by geographical focus in the Reader’s Guide under the heading Geographical Areas.

Example of Area Studies. For the study of sub-Saharan Africa, the Reader’s Guide recommends the entries “Communication of Ideas: Africa and its Influence” and “Communication of Ideas: Orality and the Advent of Writing.” For anthropological approaches on sub-Saharan Africa, the reader is advised to turn to “Ethnography.” The visual arts of Africa are discussed in “Arts: Africa” and “Architecture: Africa.” For sacred texts and the practices that accompanied them, see “Islam: Africa” and “Religion and the State: Africa.” Among contemporary movements, consider “Feminism: Africa and African Diaspora” and “Postcolonial Studies.” For political philosophies and governmental practices, see “Socialisms, African” and “Democracy, Africa.” “Philosophies:

African” is a text-based history of African philosophical ideas. For African responses to external influences, see “Westernization: Africa.” For further influences of African thought on other continents, see “Black Atlantic,” “Diasporas: African Diaspora,” “Religion: African Diaspora,” and “African-American Ideas.” As one will find in looking into the index under “Africa,” as well as in the Reader’s Guide under “Africa,” many of the global entries discuss African intellectual history.

Example of Period Studies. Readers choosing to focus on a chronological period are encouraged to consider the period globally. The category Chronological Periods in the Reader’s Guide is divided into the broad periods Ancient, Dynastic, Early Modern, Modern, and Contemporary; the chronology at the back of Volume 6 shows events in the global history of ideas. For example, if one seeks out modern and contemporary intellectual discourse on politics, there are several clusters of articles by area studies specialists in the Modern and Contemporary categories. The series of articles on “Nationalism,” “Empire and Imperialism,” “Colonialism,” and “Anticolonialism” provide a multifaceted introduction to the political and cultural turmoil of the nineteenth and twentieth centuries. To consider discourse on economics, see “Economics,” “Scarcity and Abundance, Latin America,” “Capitalism,” “Consumerism,” “Work,” and the composite article “Globalization.” For an introduction to postcolonial ideas from twentieth- and twenty-first-century authors around the globe, see “Postcolonial Theory and Literature.”

Disciplines and Interdisciplinary Studies

The comprehensive entries on specific disciplines (e.g., “Historiography” and “Education”) and interdisciplinary studies (e.g., “Ecology” and “Cultural Studies”) provide cross-references to relevant articles on ideas, ideologies, movements, and methods in the A–Z volumes (the disciplines are listed in the Reader’s Guide under Liberal Arts Disciplines). Let us consider the field of religious studies.

Organization of religious studies. The world religions receive an introductory composite entry in “Religion,” which is organized globally and concerned with the transmission of religion by both text and oral tradition. Readers might consider also “Sacred Texts” and “Prophecy.” One will find composite entries on “Christianity,” “Judaism,” and “Islam,” as well as individual entries on “Buddhism,” “Hinduism,” “Jainism,” and “Pre-Columbian Civilization.” Relevant to philosophy, as well as to religion, are the articles on “Agnosticism,” “Atheism,” “Deism,” and “Confucianism.” For Asian religions, it is important to also look at “Chinese Thought,” “Japanese Philosophy, Japanese Thought,” and “Meditation, Eastern.” The practices of religion are the focus of “Ritual: Religion,” “Monasticism,” and “Fundamentalism” and are also a concern of the six-part composite on “Mysticism.” “Orthopraxy” explicitly focuses on strict rules for religious practices, in contrast to the focus on strict rules for religious belief in “Orthodoxy.” The physical locations that provide a geographical center to religious rites are the focus of the visual essay “Sacred Places.”

The reader thus might learn how religion in its multitude of variations has been spread orally, by text, by disciplined practices, and by sacred objects and sacred locations. The impact of cultural history, cultural studies, and anthropology on current practices in the history of ideas is very evident in many articles in this encyclopedia.

Oral, Visual, Experiential, and Textual Transmission of Ideas

The section titled “Communication of Ideas” in the Reader’s Guide indicates articles about oral communication, articles showing visual expression, articles discussing the spread of ideas through practices and rituals, and articles based mainly on history of important texts. The aim of this categorization is to feature the main types of historical evidence the author used in the writing of the entry.

Oral ideas. For further exploration of oral communication, one might consider “Everyday Life,” “Oral Traditions,” and “Myth.” The entry “Language, Linguistics, and Literacy” further enhances understanding of the oral traditions underlying language development. The entry “Wisdom, Human” focuses on global examples of popular wisdom traditions, in contrast to the entry “Knowledge,” which highlights the learning of books. “Theater and Performance” and “Musicology” focus on those liberal arts that rely on communication by sound waves.

Visual ideas. People often express their thoughts and their ideas visually. There are more than 400 illustrations throughout the *NDHI* to make that point, to visibly show the correspondence

between ideas expressed in images and ideas spoken or written. Readers are encouraged to thumb through the volumes and allow the images to pique their curiosity. In addition, there are fifteen special visual essays in which the images are the focus of the entry. The illustrations are offered with meaningful commentary to explain their context and analyze their content. For example, the visual essay “Gesture” shows human communication by hand and face, while the entry “Maps and the Ideas They Express” analyzes the conceptual mapping processes of diverse historical cultures. “Gender in Art” is one of several “gender” articles that together help the reader to see and understand the concerns of academic programs in Women’s Studies and Gender Studies.

Experiential ideas. Practices are explored in articles on controversial and easily misunderstood topics, such as “Ancestor Worship” and “Jihad.” Military and civic practices are discussed in “Bushido,” “Cannibalism,” “Terror,” “Nihilism,” “Civil Disobedience,” and “Nonviolence.” The political practices of “Apartheid” and “Segregation” contrast with those of “Diversity” and “Multiculturalism, Africa.” Practices related to human exploration of nature and the power of humans to influence nature are considered in “Witchcraft,” “Astrology,” and “Alchemy,” as well as in “Scientific Revolution” and “Physics.” The experiential aspects of performance arts are discussed in “Masks,” “Dance,” “Theater and Performance,” and “Tragedy and Comedy.” Authors consider music from around the globe, with attention to both performer and audience, in “Music, Anthropology of” and in the visual essay “Musical Performance and Audiences.” The experiential dimension of ideas ranges from the pain inferred in “Punishment” to the joy and reciprocity in “Gift.”

The Reader’s Guide category Communication of Ideas: Practices lists entries focused on practices and experiences, as well as on schools of thought, religions, and political movements. The combined listing encourages readers to consider how the practices overlap among those seeking to spread viewpoints and lifestyles. Schools of thought, such as “Stoicism,” “Confucianism,” and “Existentialism,” are movements of ideas, generally in the humanities; many of these have pre-modern origins and educated disciples into particular schools of thought that adapted to new times. Schools of thought are in fact schools of thought and practices, which contend with religions. Focusing on the human relationship with the divine, religions tend to create popular movements as well as new schools of thought; scholars who emphasize the pantheism of the Stoics consider Stoicism to be a religion. Political movements such as “Temperance,” “Anti-Semitism,” and “Chicano Movement” are movements of ideas in the fine arts, humanities, and social sciences expressed in socioeconomic and political movements. These movements usually have modern developments associated with ideologies.

Textual ideas. Anyone looking at this six-volume encyclopedia in which every article has a bibliography would notice that the written word is one of the major sources for the authors’ evidence and in some cases the exclusive source. Some authors selected primary source passages to quote in sidebars, which are set along side their articles. The bibliographies exhibit the primary sources—the historical texts, images, and transcriptions of oral communication—by which we become familiar with thought from ancient or faraway societies, or with the latest contemporary thought. The bibliographies also exhibit the secondary sources, recent authorities’ accounts of the topic at hand. Many *NDHI* authors are among the authorities cited in the bibliographies of other authors.

Example of political philosophy. Political philosophy is a good example of a field that traditionally has relied on interpreting major texts of history, law, and philosophy. One may learn about political philosophy from the introductory articles “Political Science” and “Power.” Or one might look at specific concepts that have been elaborated in texts for use by governments and citizens such as “Citizenship,” “Democracy,” “Sovereignty,” “Utopia,” “Liberty,” and “Justice.” Political movements that have involved personal experiential participation are well represented in “Fascism,” “Capitalism,” “Machiavellism,” and “Volunteerism, U.S.” Visual display and practices are important for “Ritual: Public Ritual,” “Public Sphere,” and “Resistance.” Oratory abounds in “Liberation Theology.”

Ideas and their accompanying practices that provoked controversies are enhanced by the cross-references in each article, guiding the reader to antonyms and to alternative scholars’ viewpoints; for example, see “Terror” as well as “Human Rights,” “Atheism” as well as “Religion,” or “Evil” as well as “Good.” Likewise, to treat independent developments, diffusion and differentiation of ideas, movements, and practices around the globe, we have provided composite articles for topics such as “Medicine” and “Marxism.”

Reader's Guide to the Liberal Arts

The entries on specific disciplines and on interdisciplinary studies are intended to introduce the reader to a field of study. These introductions to the disciplines are listed for convenience under the university liberal arts classifications of divisions or schools of Fine Arts, Humanities, Social Sciences, and Sciences. In addition, there are listings under three professions: Medicine, Law, and Engineering. The divisions or schools of a university are historically based on the exploration of related topics, as well as an apprenticeship in distinctive crafts and methodologies. We live in an age of crossing "Borders, Borderlands, and Frontiers," yet it is helpful to recognize the whereabouts of the border one is crossing. Generally, fine arts is concerned with creative artistic production; it relies on both the philosophical field of aesthetics and apprenticeship in distinctive crafts. Humanities, increasingly influenced by studies of communication and language, evaluates the traditions and texts at the foundation of distinctive cultures and fosters the expression of philosophical, religious, and literary ideas. Social sciences (or, in recognition of its humanities traits in secondary education, "Social Studies") investigates human societies from the points of view of both observer and observed to find general societal patterns and variations, and contributes to such professions as law. The sciences, seeking to understand nature, have acquired many humanities topics considered in philosophical and religious texts. Scientists analyze aspects of nature (including human perception) through the tools of theory, experiment, and mathematics, and applications of science abound in engineering and in medicine.

Aside from the major differences of academic divisions, the *NDHI* attests to contemporary trends internalized within each discipline. These trends pervade inquiry at the beginning of the twenty-first century: respect for individual creativity, heart-and-mind concern for ethical issues of human and societal relations, and honest consideration of the specific societal position of the inquirer and the inquirer's impact on the investigation.

Combining Approaches of Fine Arts, Humanities, Social Sciences, and Sciences

The multiple sections of the Reader's Guide aim to prevent the reader from treating any listing location as rigid. Each article in the *NDHI* cross-references many other articles. The growth of interdisciplinary programs reflects the increasing overlap among topics listed under the labels of Fine Arts, Humanities, Social Sciences, and Sciences. Specific disciplinary practices include the very multifaceted approaches of biology and history and interdisciplinary programs that are even more difficult to classify in one of the four classifications, such as the earth sciences of ecology and geology or the performance studies exhibited in oratory, drama, ceremony, and dance.

The Liberal Arts Disciplines category has been designed with awareness that the relationship of disciplines to one another has changed over time, and that there is a benefit to studying a topic from several angles. To help encourage cross-fertilization in the fields of knowledge, articles are often listed under the several disciplines or interdisciplinary studies to which they contribute. An important development in the *NDHI* is the listing of entries that overlap the four divisions and of entries that overlap three or two divisions; these listings are designed to help the reader understand how scholars from diverse fields have problematized subjects in new ways, contributed the results of their approaches, and thus added to the comprehension of a multifaceted topic of human concern. The reader will observe that all four divisions of Fine Arts, Humanities, Social Sciences, and Sciences are confronted with issues of "Objectivity" and "Subjectivism," topics within the rubric Multidisciplinary Practices in the Reader's Guide under Liberal Arts Disciplines and Professions.

Example of Interdisciplinary Discipline: History

We might consider the field of history, which utilizes methods of both social science and humanities and considers topics historically from all four classifications of the arts and sciences. For convenience, history is listed here as a discipline under the social sciences. As most of the articles in the *NDHI* are historical, the list of articles under the discipline history concerns historiography and interpretative methods. One will find terms such as "Hermeneutics" and "Volksgeist" and debates on historical periodization, as in "Periodization of the Arts," "Renaissance," and "Reformation," as well as "Modernity" and "Postmodernism." There are specific types of history, such as "Social History, U.S.," "Cultural History," "History, Idea of," "Iconography," and "Science, History of" ("Iconography" is also in "Visual Studies"). The discipline of the history of science appears in the Sciences, where it has numerous articles. The listing separates those articles in the

History of Science focused on the origins of modern or contemporary ideas in the physical, chemical, biological, mathematical, or earth sciences from articles focused on early ideas about nature and the human relationship with nature.

Listing of Each Article under Its Multiple Disciplines

The Liberal Arts Disciplines section of the Reader's Guide allows for duplication of entries in an attempt to provide the student with a full list of relevant articles for the discipline to which the student inquires. One would find "Narrative" and "Trope" under Literature as well as under History. The topic of "Family" is under Anthropology and Sociology and under Women's Studies and Gender Studies. The topic of "Virtual Reality" occurs under Visual Studies and Computer Science. The student and the public are encouraged to perform interdisciplinary inquiries and to freely examine ideas wherever they lead.

An Encyclopedia of, by, and for Humanity

The focus of the *NDHI* is the main ideas that humans have created, expressed, described, visualized, experienced, and proclaimed. What idea might be more important than the idea of "Humanity," yet only recently has a scholarship been accumulating on the history of the idea of "humanity" (rather than the idea of "man"). A cluster of articles treats the abstract idea and the visual imaging of "Humanity" and another cluster addresses the movements around the globe associated with the term "Humanism."

Nevertheless, there are numerous articles on movements that hierarchically categorized humans and deemphasized the commonality, as in the series of articles on "Ethnicity and Race" and on "Race and Racism," as well as in articles on "Ethnocentrism" and "Eurocentrism." Articles on "Sexuality," "Women's Studies," "Universalism," and "Essentialism" add further sophistication to inquiries into the idea of humanity (humans of diverse races, color, and ethnicities; sexes, sexualities, and gender; religions, cultures, and nationalities).

Entries on "Individualism," "Person, Idea of the," and "Personhood in African Thought" focus attention on self-definition. The bridge between studies of particularity and studies of humanity is represented in the series of articles on "Identity," particularly "Multiple Identity," brought about by trends of "Migration" and of "Globalization." The *NDHI*, available in print and electronic versions to readers of English around the globe, challenges readers within the multiplicity of their individual identities to personally identify with humanity and with humanity's more humanitarian ideals.

Charles Scribner's Sons: Continuity and Commitment

Charles Scribner's Sons published the *Dictionary of the History of Ideas: Studies of Selected Pivotal Ideas* (edited by Philip P. Wiener) in five volumes in 1973-1974 and in 2003 approved its free release online through a subsidy by the *Journal of the History of Ideas* to the University of Virginia Library Electronic Text Center (<http://www.historyofideas.org>). Readers are encouraged to utilize that resource for its outstanding entries by prominent historians of an earlier decade. In this brand-new sequel by leading contemporary scholars of cultural history, the title *Dictionary of the History of Ideas* has been retained. As in a dictionary, entries do typically begin with a definition or clarification of a concept, yet the heart of each article lies in the detailed contextual narrative of the changes of meaning over time. Each entry's bibliography further clarifies the discourse and debate concerning the concept. The treatment is therefore encyclopedic in the truest sense.

The *NDHI* is an entirely new publication with many more articles. Area specialists on Africa, the Middle East, Asia, Latin America, Europe, and North America, and specialists on women's studies and ethnic studies advised on the ideas most important to include. Seeking to present cross-cultural perspectives on the history of ideas, the new edition encourages scholarship that is gender-inclusive and global. It focuses on topics of interest today and features developments in scholarship since 1970; it appraises new thinking on some topics in the *NDHI* (communism, linguistics, physics), but mostly addresses entirely new topics (structuralism and poststructuralism, genetics, paradigm, queer theory, text/textuality). While the *DHI* entries were to a great extent the history of texts, the *NDHI* entries are generally the cultural history of ideas, utilizing the records of oral communication, visual communication, communication through practices, as well as the history of texts, in order to emphasize the impact of the idea on a wide variety of people. There are articles on disciplines and interdisciplinary studies, on multidisciplinary scholarly practices, on

genres in the fine arts, on movements, on ideas and the controversies they provoked, and on ethnic traditions. The content is appropriate for assignment in class and for educating a general public. With its generous illustrations and lively entries, the *NDHI* visibly reaches out to communicate ideas.

Acknowledgments

I have greatly appreciated the enthusiasm for and commitment to this project of the publisher Frank Menchaca of Charles Scribner's Sons, an imprint that resides within the publishing offices of Thomson Gale. Nathalie Duval and Jennifer Wisinski supervised the editorial and production staff magnificently. Nathalie Duval, John Fitzpatrick, Mark LaFlaur, and Sarah Turner were instrumental in working with me and the first members of the editorial board on the design of the project at meetings held in New York City in November 2002 and at the American Historical Association in Chicago in January 2003. Jennifer Wisinski, assisted by Scot Peacock who arranged for the illustrations, produced the volumes in Farmington Hills, Michigan, at the main offices of Thomson Gale. I would like to thank also Kelly Baiseley and Kenneth Mondschein for their communication via email to prospective authors, as well as the numerous others noted on the editorial and production staff page.

Each faculty member listed on the editorial board page contributed expertise in area studies, in a historical specialty, and in specific other disciplines and interdisciplinary studies. I thank each of my eighteen colleagues, and their universities and colleges, for the commitment, intelligence, and attention they gave to writing scopes for articles, suggesting authors, and reviewing and improving article content. Occidental College also deserves our appreciation, not only for their encouragement of my commitment to history of ideas, and the *NDHI* in particular, but also for Occidental College graduate Lisa Griffin, assistant to the editorial board. At Occidental College I have experienced first-hand the importance of recruiting a diverse community of faculty and students in order to participate in and experience a multicultural, gender-inclusive global curriculum. My research into authors, images, and bibliography for the *NDHI* took place mainly in Los Angeles: at Occidental College, at the University of California, Los Angeles, at the Getty Research Institute, and in e-mail correspondence with the editorial board and with numerous authors.

I contracted for this project in August 2002, and thanks to a very hard-working editorial board of professors and librarians, excellent authors who fulfilled our invitations, and a very efficient publisher providing clear procedures and practices for a quality production, readers may now enjoy fresh, up-to-date entries on some of the major ideas that have concerned and influenced humanity. Might these volumes help contribute to the global liberal arts appropriate for the twenty-first century!

Maryanne Cline Horowitz

HISTORIOGRAPHY

Since very early times, human beings have had some sense of the past, both their own and that of their community or people. This is something that has distinguished us from other species. Having said that, historiography in the narrower sense of “intentional attempts to recover knowledge of and represent in writing true descriptions or narratives of past events” has had a rather briefer career throughout the world, though one more complex and variegated than most accounts allow. It is not possible in the space of a brief essay such as this to convey the entire richness of the human effort to recapture the past, but an effort must be made to summarize the historiographical traditions of many different regions.

At least three major (in terms of their international scope, longevity, and influence) and a variety of minor independent traditions of historical thought and writing can be identified. The major ones are the Western (descended jointly from the classical Greek and Roman and, via the Old Testament, from the Hebraic), the Islamic (originating in the seventh century C.E.), and the Chinese. Minor ones include the various indigenous traditions of thinking about the past (not all of which involved writing), including ancient Indian, precolonial Latin American, African, and those arising in certain parts of east and Southeast Asia. The Western form (which would include modern Marxist Chinese writing) has predominated for a century or more in most of the world, but it would be a mistake to see that as either inevitable or as based on an innate intellectual superiority of method. Its hegemony springs much more from the great influence of Western colonial powers in various parts of the world during the nineteenth and early twentieth centuries, and perhaps even more from the profound effect in the last hundred years of Western, and especially North American, cultural, linguistic, and economic influences.

A consequence of the global dominance of Western academic historical practices is that not just history, but historiography, has been “written by the victors.” None of the major histories of historical writing produced in the last century addresses other historiographical traditions, undoubtedly in part owing to linguistic difficulties. This has produced a thoroughly decontextualized and celebratory grand narrative of the rise of modern method that has only been challenged in recent years. It is thus critical that any new survey of historical writing not only pay serious attention to non-Western types of historical writing (and indeed to nonliterary ways in which the past was recorded and transmitted), but that it also steer clear of assuming that these were simply inferior forms awaiting the enlightenment of modern European-American methodology.

Early Ideas of History in the Western Tradition

Arguments can certainly be made for a sense of the past in ancient Egypt, and in particular an effort to memorialize the successive dynasties of the Old, Middle, and New Kingdoms. An early specimen is the so-called Palermo stone, a fragmentary stele inscribed with king lists from predynastic times to the fifth dynasty (mid-third millennium B.C.E.); this was probably used by the much later Hellenized Egyptian Manetho in his own *Aegyptiaca*, very little of which has survived. The later Turin papyrus (c. 1300 B.C.E.) extends to the sixteenth century B.C.E. However, the lack of a written alphabet imposed limits on the capacity to convey the past; nor is it clear that Egyptian efforts at record keeping, though certainly serious, were deliberately aimed at constructing accounts of the past for the benefit of present and future generations. Elsewhere in the ancient Near East, various historical inscriptions and texts are attributable to the Hittites, Syrians, and Phoenicians. It is in Mesopotamia, however, that one finds the clearest early evidence of a deliberate human intention to write about the past.

The successive peoples that inhabited the land between the Tigris and Euphrates, especially the Sumerians, Akkadians, Babylonians, and Assyrians, generated the first type of writing in

cuneiform and developed rudimentary forms for the representation of the past, such as king lists, annals, and chronicles. The oldest extant epic, that of the Uruk king Gilgamesh, though it recounts largely legendary episodes, probably has some connection to historicity. Closer to a recognizable historical document is the Sumerian King List probably initiated in the twenty-second century B.C.E., and existing in several recensions. It stretches back into mythical antiquity but goes beyond a mere list in later times to indicate inquisitive uncertainty about the historicity of some rulers expressed in the utterance “Who was king? Who was not king?” It is also a deliberate attempt to present the historical record in a particular light, necessitated by the circumstances of the author’s own time. Various other forms of Sumero-Babylonian historical record exist, including building inscriptions, stele, and other durable media. Other genres, such as astronomical diaries, played a part in establishing a precise chronological grid against which to record events, and both the Babylonians of the second millennium and their neo-Babylonian or Chaldean successors of the middle of the first millennium were keen astronomers and devoted listmakers.

Other ancient peoples in the region authored historiographic documents of some variety. There are significant differences between these writings, but the focus of most was on maintaining a proper record of kings and their achievements—the Assyrian *Eponymous Chronicle*, for example, relays the annual military campaigns of its kings down to Sennacherib (r. 704–681 B.C.E.). While it would be foolish to impose modern Western standards of “objectivity” (themselves highly contested today) in assessing ancient forms of historical writing, subtle differences in this regard have been noted between Assyrian and Babylonian approaches. Assyrian royal annals are largely written in first-person bombastic prose, allegedly by the kings themselves. And whereas the *Synchronous History* of the Assyrians, in describing boundary disputes in the late second to early first millennium invariably blames the Babylonians, those accounts written by the Babylonians themselves are often more neutral. The neo-Babylonian and Chaldean periods produced further works such as the Babylonian Chronicle Series. The Persians, successors to Babylonian power in the sixth century B.C.E., would continue this historiographical activity, for instance in the multilingual Behistun Inscription erected by Darius I (r. 521–486 B.C.E.). The latest Babylonian work is that of Berossus, a contemporary of the Egyptian Manetho in the third century B.C.E.; nothing of Berossus’s original work has survived though it was well known in Hellenistic and Roman times.

What truly puts these writings into the realm of the historical is the evidence that successive works had to be based on what we would now call research—the examination, selection from, and collation of multiple earlier sources—rather than on any tradition of continuous record keeping. Many went beyond that to aspire to provide advice, counsel, or cautionary tales, a recurring motive through much of the global history of historical writing. One of the best-known examples of early Mesopotamian history is the Old Babylonian *Weidner Chronicle*, reaching back to early times but largely devoted to the Sargonic dynasty of Akkad in the twenty-fourth century B.C.E. This is one of the first historical works clearly designed with a didactic purpose, to recover and preserve the past for the edification of present and future, with a lesson attached, in this case the propagation of the cult of the god Marduk. The *Weidner Chronicle*’s account of Sargon I and his grandson Naram-Sin contrasts the godliness of the former with the disobedience to Marduk of the latter, with the consequence of the downfall of Akkad at the hands of Gutian barbarians. The alternation of divine favor and punishment, another frequent theme in historical writing, thus had an early start. It turned up again in the early seventh century B.C.E. when the later Assyrian defeat of Babylon was ascribed to Marduk’s displeasure at recent kings, and it appears frequently throughout the travails of the children of Israel at the hands of foreign hosts depicted in the Hebrew Bible.

The Israelites (or Jews as they later became) were the other major people in the ancient Near East to develop historiography. The Old Testament or Hebrew Bible is now known to have been the work of several hands, and much of it originates from later periods such as the Davidic kingship (tenth century B.C.E.) and the Babylonian Exile (late seventh–early sixth centuries B.C.E.). But in the early genealogies of Genesis and in the more chronological accounts of the Books of Samuel, Kings, and Chronicles, one finds both an effort to memorialize the past accurately as a written record and a strong sense of the divine destiny of the Israelites as a chosen people, a linear progress through which oscillates a recurrent cycle of triumph and misery as God chastises an erring people for disobedience, sin, or idolatry, and then delivers them from oppressors such as the Egyptians, Philistines, Assyrians, and Babylonians. The Hebrew-Judaic view of history and of time is one of the foundation stones of Christian historiography of the past two millennia. It is

an achievement all the more striking when one contrasts it with the relative dearth of Jewish secular historical writing during the millennium-and-a-half of Diaspora between Flavius Josephus (c. 37–c. 100 C.E.) and the sixteenth century when Jews, still stateless, began to rediscover the formal study of the past.

Many Western accounts of historical writing begin with the ancient Greeks rather than the Mesopotamians or the Hebrews, in part because the very word *history* is itself of Hellenic origin. The Greeks developed several different genres of writing about the past, including genealogy or mythography; ethnography; history “proper” or a continuous narrative of sequential events with their causal connections; horography, the year-by-year history of a particular city; and chronography, a system of time-reckoning. Moreover, it is in fifth-century Athens that one first encounters both the word *history* and two historians whose works have survived largely intact and who are known to us by name. Herodotus (c. 484–c. 420 B.C.E.), the first of these, certainly had his predecessors. Among these are numbered the mythographers Hesiod (fl. c. 700 B.C.E.) and (contemporary with Herodotus himself) Hellanicus of Lesbos, who was notable for his attention to the problem of reconciling multiple chronologies; and the murky ninth-century figure of Homer (to whom are ascribed the great epics the *Odyssey* and *Iliad*, first written down several centuries after the heroic events they purport to relate). More directly, these precursors also included the Ionic writer Hecataeus of Miletus (fl. c. 500 B.C.E.), one of a group of geographical writers and recounters of stories collectively known as the “logographers.” Borrowing from Hecataeus, who first distinguished between mythical, genealogical, and “historic” times, and using something of the poetic force of the Homeric epics, Herodotus linked ethnography with history, coining the term *historia* in the sense of “inquiry,” “discovery,” or, in some renderings, “inventory” (the Greek verb *historein* means “to investigate”). His focus was the recent events of the Persian Wars, the origins of which he sought to explain. Herodotus relied to a considerable degree on oral information (although the veracity of that has often been called into question from antiquity to modern times), and in his ethnographic attention to other, non-Greek peoples and their customs he is often held to be the West’s “father” of history in its broader, more inclusive, and nonpolitical sense. Herodotus’s younger contemporary Thucydides (d. c. 401 B.C.E.), in his account of a particular event over a shorter period, namely the thirty-year struggle between Athens and Sparta known as the Peloponnesian War (431–404 B.C.E.), can similarly be regarded as the progenitor of a narrower, politically focused history, though this dichotomy can be overemphasized. Thucydides also fully developed a device employed by Herodotus that would become a convention of much later historical writing, namely the semifictitious speech ascribed to a major figure (Pericles’ funeral oration being a famous example). Zealous in his efforts to represent both sides in the conflict fairly and impartially, Thucydides’ account of the arrogance and fall of Athens goes far beyond ascriptions to Olympian whims—it identifies actual and proximate causes of the Athenians’ eventual humiliation by a city regarded as its cultural inferior; the arrogance of the Athenians, their flaw, is a more fundamental cause of their downfall drawn from Greek tragedy. Finally, unlike Herodotus, Thucydides proclaimed his own intention of writing for the edification of future ages as much as for those living in his own time.

For all the importance that we now assign to these two Greek masters, history did not enjoy a high stature in the Hellenic world, in part because the Greeks were philosophically rather less interested in the past per se than in the realms of nature, ethics, and the mind. Historians nonetheless there certainly were: the authors of *Hellenika* that followed Thucydides focused, like him, on contemporary or recent history. The list of later Greek historians includes Ephorus (c. 405–330 B.C.E.), the first writer of “universal history”; the memorialist Xenophon (c. 431–c. 352 B.C.E.); Theopompus (b. c. 380 B.C.E.); Dionysius of Halicarnassus (fl. c. 20 B.C.E.); and the highly regarded Polybius (c. 200–118 B.C.E.). A Romanized Greek, Polybius is especially significant for articulating a theory of predictable constitutional cycles among three pure and three corresponding perverted forms of government and for postulating the stability of “mixed” regimes consisting of all three pure forms. This was to prove a powerful tool of historical analysis in later centuries.

It was the Romans, however, who produced the next substantial corpus of European historical writing. They were initially much influenced by Greek models, turning such genres as the horography into official *annales* kept by the *pontifex maximus*, a religious figure. The earliest Roman historians such as Quintus Fabius Pictor (fl. 225 B.C.E.) were especially affected by Greek non-annalistic history, though eventually annalistic models were to predominate in a way that had not been true in Greece. The Romans would also introduce a close association of the act of history

writing with the experienced politician or general. This became prized in later times (and was frequently used as an argument to exclude women from writing history), despite having been only sporadically evident (Thucydides and Xenophon) among the Greeks. It signaled the priority of rhetoric and experience over research, with the result that the Herodotean association of history with inquiry now slipped into a Latin notion of *historia* as a “story” in the sense of a narrative, true or not. The Romans also celebrated the laudatory and exemplary value of history, and especially the lives of great men, a concept largely absent among most of the early Greek historians.

Among mature Roman historians, the outstanding figures include Sallust (86–35 or 34 B.C.E.), who described the Catilinian conspiracy that had ominous consequences for the republic; Julius Caesar (c. 100–44 B.C.E.), memorialist of his own campaigns; and Livy (59 B.C.E.–17 C.E.), the great Augustan narrator of Rome’s history from its legendary foundation—*ab urbe condita* (c. 753 B.C.E.). “Universal” history along Ephorus’s lines, eventually an all-purpose model for many medieval and Reformation historians, would find practitioners in the Sicilian Greek Diodorus Siculus (c. 90–c. 21 B.C.E.) and, much later, the imperial pagan Ammianus Marcellinus (c. 330–395 C.E.). No extant Roman historian, however, has been more praised by subsequent ages than Cornelius Tacitus (c. 56 C.E.–120 C.E.), narrator of the reigns of the Julio-Claudian emperors in his *Annales* and of the troubles leading to the accession of the Flavians in his *Histories*. An admirer of German tribal simplicity, as compared in his *Germania* with the luxury and corruption of imperial Rome, Tacitus continued the moral-decay theme detectable in Polybius, Sallust, and Livy; he also established a common motif of later historiography, the juxtaposition of the virtuous and hardy barbarian with the decadent city-dweller. This, along with his terse style, political acuity and epigrammatic comments on events would make Tacitus’s works very popular in much later centuries.

The Romans had a strong sense of the divine destiny of their city and its expanding empire, which provided a horizon for their history writing in the way that the known world as a whole had done for the Greeks. They also injected a teleological and progressive element that was lacking in Greek historiography. Where cycles of rise and fall and the random hand of *Tyche* (fortune) appear in many of the Greek historians, history becomes more purposeful and almost providential among the Romans: Livy, much of whose history has not survived, is both the celebrant of Rome’s seemingly divine expansion and conquests over time, and among the mourners of the dissipation of its republican virtues and loss of liberty. Beginning in the first century B.C.E., a number of Romans also considered, as few Greeks had done, what we would call theoretical—or at least rhetorical—issues of historiography, including the question of what actually constituted history, what were its best models, and what pitfalls ought to be avoided in its composition. The great rhetorician and politician Marcus Tullius Cicero (106–43 B.C.E.), who had an enormous influence on the Renaissance fifteen centuries later, wrote in *De oratore* (55 B.C.E.) about the uses of history, stressing again its utilitarian function. Cicero was not himself a historian. Nor was Lucian (c. 129–after 180 C.E.), who two centuries later penned a tract on *How to Write History*, thereby initiating a historiographical-method genre that would reappear with vigor in the sixteenth century.

Early Chinese Historical Thought and Writing

The second major tradition of thinking and writing about the past is the Chinese. It has been neglected or at best patronized in many modern accounts of historical writing. Despite the triumph in the twentieth century of Western approaches to the past, Chinese historical writing has a longer continuous tradition, and it developed much earlier than the West a clear and consistent set of rules and practices for the recovery and representation of the past. History was a major category of knowledge (along with philosophy, literature, and the “classics”) from as early as the fourth century C.E., a status it would not acquire in Europe before the late seventeenth century. With some important modifications, Chinese historiography was to influence the historical thought and writing of neighboring nations such as Japan, Vietnam, and Korea. Significant Chinese thinking about the past can be dated back to ancient canonical texts such as the *I Ching* (Book of changes), which reached a definitive form about the end of the second millennium B.C.E.

Earliest Chinese thought evinced the notion that there were discernible patterns in the flow of human affairs from which one could learn to govern oneself and navigate a world of continuous change. As this suggests, Chinese thought about the past was very quickly linked to philosophy and the search for the Dao (the “path” or moral order). The first significant independent work of

history, the *Chunqiu* or *Spring and Autumn Annals*, is an account of events from 722 to 479 B.C.E. It is generally associated with the enormously influential philosopher Confucius or Master Kong (551–479 B.C.E.), though he may only have authored a commentary upon this work. Various collections such as the *Zuozhuan* and *Guoyu*, both sometimes attributed to a Confucian contemporary called Zuo Qiuming, drew on the *Chunqiu* and other early chronicles to present historical anecdotes and speeches in support of a Confucian outlook which, like the Buddhist, tended to a cyclical view of time that dominated Chinese historical thought until the nineteenth century. Other philosophical schools departed from the dominant Confucianism. The Daoists, pursuing harmony with nature and retreat from a world of cyclical but unpredictable change, did not accept that history had any discernible pattern or didactic value. The Mohists (followers of Mozi or Mo Di) and Legalists both saw discernible patterns of progress, though the latter, adherents of a totalitarian philosophy adopted by the brutal Qin dynasty (221–206 B.C.E.), asserted that such progress, enforced by state control over naturally evil individuals, made the past largely irrelevant.

The most important early figure in Chinese historical thought and writing, however, was the Han dynasty figure Sima Qian (145–86 B.C.E.). After the unification of various “Warring States” into a single empire by the violent but short-lived Qin (whose first emperor ordered an infamous book-burning and mass execution of scholars, virtually eliminating records of the conquered kingdoms), the succeeding Han emperors (206 B.C.E.–220 C.E.) created the stable conditions under which historiography could mature. Sima Qian, often known as the Grand Historian, did far more than write in his *Shiji* (Historical Records) a comprehensive account of Chinese history. He also evinced a clear sense of the historian’s purpose: to record major and minor occurrences accurately in order to counsel the present and to bestow fame on the good and infamy on evildoers. Perhaps most important, his model for the compilation of facts about the past with its clearly worked out format, a combination of year-by-year annals and individual biographical treatments, influenced the next two millennia of Chinese historical writing. No Western historian, not even Herodotus or Thucydides, can claim that kind of influence, nor does Western historical writing display the continuity of a systematic and eventually institutionalized approach to the past that is exemplified by China. Sima Qian created various categories for the representation of the past that would be developed and augmented by subsequent writers. By the time he finished the *Shiji* that his father had begun, it was nearly four times the size of Thucydides’ *Peloponnesian War*. The *Shiji* would come to be regarded as the first in a long series of twenty-four “Standard Histories” (*zhengshi*), the official history of a dynasty written under its successor dynasty. (The *Shiji* itself, since it covered both the Han and their predecessors, is an exception to the rule that Standard Histories cover only one dynasty and are written after its fall). Sima Qian would most immediately be followed by the historian of the Former or Western Han dynasty, Ban Gu (fl. 1st century C.E.) and his sister and successor, Ban Zhao; their *Hanshu* set the pattern for a history covering only a single dynasty, followed three centuries later by Fan Ye’s *Hou-Hanshu* (History of the Later or Eastern Han), which was left unfinished at its author’s beheading for political conspiracy in 445 C.E.

Over the course of the twelve centuries from the end of the Later Han to the advent of the Ming (the last indigenous Chinese dynasty) in 1368, the basic genres of historical writing were set. In addition to the Standard Histories, one finds that various works in the chronicle format (originated in the *Chunqiu*) or *Biannian shi*, and the Standard Histories themselves, following Sima Qian, continued to combine annalistic sections with biographical accounts, along with accompanying sections such as chronological tables to establish common years for events in different areas (a practice that soon spread to other parts of Asia). A particularly notable example of writing outside the *zhengshi* model is Sima Guang’s (c. 1085 C.E.) *Zizhi tongjian* (Comprehensive mirror for aid in government), which recounts history from the late fifth century B.C.E. to the tenth century C.E., a work that in turn inspired numerous commentaries. Finally, universal histories (in the mode established by Sima Qian) were also compiled, in particular during the Song dynasty (960–1279 C.E.).

Exact analogies between Chinese and Western historiography should be drawn with a high degree of caution since certain fundamental assumptions were quite different. Chronology was based in frequently changed era names (the practice used in many Asian countries until the twentieth century) rather than the single chronology *ab orbe condito* (from the founding of the world), *ab urbe condita* (from the founding of the city), or (especially since the seventeenth century), B.C. (B.C.E.) and A.D. (C.E.)—this accounts for the much earlier development of synchronous chronological tables in China than in Europe. Moreover, where “annals” in the European tradition have

usually been seen as the most rudimentary form of historical record, Chinese historiography regarded the annal as the highest form, the distillation of knowledge from other sources. Grant Hardy has further argued that the Western preference since the Renaissance for the single-voiced omniscient narrator and an internally self-consistent story fits ill with the multiple voices and often competing accounts of a single event included by Sima Qian in the *Shiji*. Perhaps most important, Western historiography places high value upon the independence of the historian from outside interference, though in fact that arms' length relationship has really only occurred in a minority of countries and in relatively recent times; official history, courtly history, and other variants have not fared well in the estimation of modern European-American historiographers.

Yet the Chinese experience testifies to the vigor and achievement of a historiographical enterprise under official sponsorship. Under the Tang dynasty (618–907), historiography became elaborately bureaucratized and even more closely linked to the official civil service; it was also “promoted” within the four categories of learning to second place, behind the classics and before philosophy and literature. Under the Tang, seven new Standard Histories were produced, and by the end of the dynasty the Bureau of Historiography had become virtually an independent arm of government, with a fully worked out system of compilation. From a set of court diaries kept during the reign of an incumbent emperor, a recording of his sayings and actions, and an administrative record, a set of “Veritable Records” (*shilu*) would be developed at the end of the reign. These in turn, after the final eclipse of the dynasty, would form the basis of the Standard History of that dynasty. The latter was intended, at least in theory, to be the official and unchallengeable truth, not subject to rival versions or interpretations. This strategy did not always succeed—a new history of the Mongol Yuan dynasty (1279–1368) was composed in 1920, over five centuries after Ming historians had written an earlier version. Some dynasties such as the Tang and “Five Dynasties” (907–960) each have two Standard Histories. It was customary to destroy the earlier sources once the Standard History had been composed, which accounts for the rarity of surviving examples of Veritable Records, those of the Ming being a notable exception. The writing of Standard Histories would continue for every dynasty up to the final composition of the *Draft History of Qing* in 1927 and its 1962 Taiwanese counterpart, which are sometimes counted as a twenty-fifth and twenty-sixth *zhengshi*. All share the annals-biography form first adumbrated by Sima Qian two millennia earlier, often accompanied (as in the *Shiji*) by other elements such as chronological tables and treatments of hereditary houses.

In addition to the Standard Histories and chronicles, a further major category of historical writing, closer to continuous narrative, was developed under the Song dynasty, the *Jishi benmo* (Histories of beginnings and ends of events). The first example, by Yuan Shu (1131–1205), was completed and published in 1174. This genre would later flourish under the Ming and Qing dynasties. Its specimens largely consisted of rearrangements of existing histories—Yuan's, for instance, built on Sima Guang's *Comprehensive Mirror*—but their attention to the cause and effect of particular occurrences was a significant development in Chinese thinking about the past.

The European Middle Ages

Following the foundation of the Eastern Roman Empire in the fourth century at Constantinople (the former Byzantium) and the establishment of Christianity as the official religion of Europe, western and eastern European historical writing evolved in rather different directions. The continuity of the Byzantine Empire for another millennium facilitated the further evolution of classical historiography written to a high standard of accuracy, primarily in Greek. It comprised both secular history—represented initially by Eutropius, Zosimus, and Procopius—and, beginning with Eusebius of Caesarea (c. 260–c. 339), ecclesiastical history.

The separation of ecclesiastical from secular history, though not absolute, proved fundamental to medieval and early modern historical writing and to later Renaissance divisions among historical genres. Late antique ecclesiastical writers, before the sixth century, included Socrates, Rufinus, Sozomen, Theodoret, and Evagrius and, as the religious inspiration suggests, their work was often highly polemical. But ecclesiastical history (borrowing wholesale the sense of divinely guided destiny immanent in Old Testament historiography and turning it into a more explicit eschatology) had a strong focus on the foundation, growth, and triumph of the Christian religion, and a steady eye toward the eventual return of Christ and the ultimate end of history. This helped its Byzantine writers to develop, quite early, an attention to precise chronology and periodization. Ecclesiastical history was also, significantly, generally devoid of set speeches, its authors preferring

to insert original documents and letters, which had not been a characteristic of most classical histories. The parallel line of Byzantine political historians and chroniclers was just as significant, though it dried up temporarily in the seventh century. A significant revival occurred in the eleventh century with Michael Constantine Psellus's memoirs of court life, and Byzantine historiography is widely regarded to have peaked in the next quarter-millennium under the Komnenian and Palaiologan dynasties. Notable authors included Anna Comnena (1083–c. 1153), one of the first great female writers of history, who composed an account of the reign of her father, the fourteenth-century emperor John VI Cantacuzenus (1292–1383), and the scholars George Pachymeres (1242–c. 1310) and Nicephorus Gregoras (c. 1295–c. 1359); Pachymeres is also significant as the earliest historical source for the rise of the Ottomans in nearby Anatolia.

Historical writing developed much less smoothly elsewhere in Europe. The collapse of the Western Roman Empire and its displacement by various barbarian kingdoms strained and obscured, but did not wholly break, the continuity with ancient models: a writer like Gildas, who recounts the last days of Roman Britain, sounds like an Old Testament prophet or a latter-day Tacitus in his moralizing criticism of British kings. The so-called Dark Ages from the fifth to the ninth centuries were no historiographic vacuum, for historians wrote significant accounts about the various Germanic peoples. Each was quite different in scope and content and each transcended the limits of annals, variously drawing on Eusebius and certain Roman and Byzantine historians. The most important of these “barbarian” works included histories of the Goths (Jordanes, summarizing a lost history by Cassiodorus), the Franks (Gregory of Tours, whose work is more accurately described as a history of his own times), the Lombards (Paul the Deacon), and the Anglo-Saxons (the Latin *Ecclesiastical History of the English People* by the early-eighth-century monk, Bede). Among these, Bede (d. 735) was arguably the greatest historian of the period. The author of several other historical works, he is also credited with first introducing into historical writing the chronological scheme whereby events were dated *anno domini*, from the birth of Jesus Christ, a system previously developed in the form of “Easter Tables” by scholars such as the sixth-century monk Dionysius Exiguus.

Even more than in the Byzantine East, Christianity proved, despite internecine theological disputes, the closest thing to a unifying force in the development of a common vocabulary and shared set of standard themes for history-writing. Eusebius had been translated into Latin. Beginning with Saint Augustine of Hippo and his disciple Orosius (active 414–418), the author of a wide-ranging and much-read universal history, the *Seven Books of History against the Pagans*, a Western scheme emerged for narrating the unfolding of the divine will through history. Accompanying it was the Neoplatonic juxtaposition of “Two Cities,” a heavenly and an earthly, a theme that would be revisited in the twelfth century by the pro-imperial Otto, bishop of Freising, (c. 1111–1158), who used it as the title of his major historical work. It was Otto who provided the classic formulation of a historical continuity argument in the *translatio imperii*, the thesis that the Roman empire had not, in fact fallen, but merely been “translated” from Rome to the Byzantine Greeks and thence, in 800, to the Frankish king Charlemagne, whose ultimate heirs were the Hohenstaufen emperors such as Otto's own nephew Frederick I, called Barbarossa. (The Ottoman conquerors of Constantinople would in turn appropriate this notion, stripped of its Christian association, in the fifteenth century).

There are several other types of medieval historical literature, of which the Norse (Norwegian and Icelandic) sagas of the twelfth to fourteenth centuries (initially an oral record but committed to writing after about 1150) present an especially interesting departure from the prose chronicle and form a link between the world of the annalist and that of the heroic poet; they are the major source for Norway's medieval past. Culminating in Snorri Sturluson's (1179–1241) compendious *Heimskringla* (History of the kings of Norway), itself a reference point for Norwegian national consciousness in much later centuries, the sagas existed alongside Latin prose works such as Saxo Grammaticus's (c. 1150–after 1216) *Gesta Danorum* (Deeds of the Danes), and vernacular chronicles such as Aelnoth's *Krönike* (c. 1120), and Sweden's series of rhymed royal chronicles. Ultimately, however, prose annals and chronicles, and the occasional verse chronicle, would prove the most common form of historical writing through much of the Middle Ages, with the constraints that year-by-year accounts (without the Chinese convention of accompanying biographies) impose on representing the past as a series of continuous events. A good vernacular instance of this would be the *Anglo-Saxon Chronicle*, initiated late in the ninth century and continued by successive writers until the mid-twelfth century.

This does not of course mean, as some later writers supposed, that historiography was simply frozen between classical antiquity and its Renaissance recovery. Historical writing matured considerably beyond simple annals during the twelfth and thirteenth centuries. Monasteries such as Saint Albans in England and Saint-Denis in France developed traditions of multigenerational continuous historical writing (the only Western analogy to the contemporary Chinese experience), in which a summary universal history was often affixed before a contemporary account, which in turn was extended forward by subsequent writers. A separate class of chronicles, more aristocratic in flavor, was influenced by earlier chivalric literature, especially the tales of King Arthur and the *chansons* of figures like Roland, and the biographical *gesta* of deeds of emperors and other rulers. The writing of aristocratic chronicles was stimulated by foreign events and especially by wars such as the ongoing Crusades in the Holy Land, generating such works as the history of the Fourth Crusade by Geoffroi de Villehardouin (c. 1150–c. 1213). Such writing appealed to both rulers and their fighting nobility and was often expressed in languages outside the learned Latin of clerical chronicles. Gabrielle Spiegel has even suggested that the aristocrats of thirteenth-century France, for instance, evolved a vernacular prose historiography in response to concerns about social change and the aggrandizement of royal power. Perhaps the most widely read aristocratic works both at that time and since have been the narrative by Jean Froissart (1333?–c. 1405) of the first phases of the Anglo-French Hundred Years' War (1337–1453) and the various vernacular Scots accounts, in verse and prose, of the Scottish wars of independence against the English. Finally, semifictional works in Latin providing elaborate accounts of the foundations of kingdoms and theories of racial descent were also produced, such as Simon of Kéza's (fl. late 13th century) *Gesta Hungarorum*, which celebrated the deeds of Attila and the supposedly ancestral Huns. The most notorious work of this sort was the *History of the Kings of Britain* by Geoffrey of Monmouth (c. 1100–1154), a major source for subsequent Arthurian literature, and already attacked as an imaginative fabrication by its author's younger contemporary, William of Newburgh (1136–c. 1198).

By the fifteenth century, in the context of the struggles of the French crown with English power and with Burgundian independence, one can discern a sharper political analysis in certain historians such as Thomas Basin (1412–1491) and especially Philippe de Commines (c. 1447–1511), who anticipates in many ways the flavor of Renaissance humanist historiography already unfolding to the east in Italy. In an unrelated but parallel development, relatively late in the European Middle Ages, the growth of towns in Italy and in northern Europe (especially Germany, the Low Countries, and England) produced a distinct vernacular tradition of urban chronicle-writing. Often developing from lists of civic officials, and written by laity, these annals recorded local events in varying degrees of detail and were an important counterpart, for the emerging middling sort of merchants and townsmen, to the more learned Latin chronicles of the monastic and secular clergy, and the aristocratic works by the likes of Villehardouin and Froissart.

The Rise and Growth of Islamic Historiography

Mention of the Crusader chroniclers brings us directly to the third great independent historiographical tradition, the Islamic. There are indigenous examples of historiography, genealogy, and oral traditions among both Arabs and Persians, such as popular stories about battles (*Ayyam*); and Julie Scott Meisami points out that the Sasanian dynasty of Persia (224 C.E.–651 C.E.) is known to have had both royal and priestly historical narratives. Islamic historiography, a highly elaborate and systematic development of historical writing and thought about the past, begins in the seventh century, its first subject being the life and deeds or expeditions (*maghazi*) of Muhammad himself, whose *Hegira* to Medina in 622 C.E. provided a firm date on which to anchor an Islamic chronology. From the very beginning, a zealous effort to record only true statements about or by the Prophet from authoritative testimony, beginning with eyewitnesses, led to careful attention to the chain of transmission (*isnad*) whereby one successive authority passed information, often orally, down to the next: a hadith or report of the words of the Prophet generally consisted of an *isnad* followed by a *matn* (the actual text).

The earliest Muslim historians, many of whose works are only known to us fragmentarily or as part of subsequent works, include Ibn al-Zubayr and his successor, al-Zuhri (d. 742), who was probably the first to combine several accounts into one continuous narrative committed to writing. They were quickly followed by the first great and fully intact biography (*sira*) of the Prophet, by Ibn Ishaq (c. 704–767), and by the more critically and chronologically rigorous treatment of al-Waqidi (747–823), who also wrote several further works on Islamic history. In the early or “for-

mative” period of Islamic historical writing (from the death of Muhammad to the early ninth century), one can identify subbranches respectively associated with the Western Arabian, Syrian, and Iraqi regions; the outstanding works of this period include the genealogical histories of al-Baladhuri (d. c. 892), the historical geography of al-Ya‘qubi (d. 897) and especially the universal chronicle of al-Tabari (c. 839–923), *Ta‘rikh al-Rusul wa al-Muluk* (History of prophets and kings), which was translated into Persian (the *lingua franca* in much of the region) during the mid-tenth century. By the advent of the Baghdad-based Abbasid dynasty in the mid-eighth century, terminology to express the idea of an account of the past had also developed. A *khabar* (plural, *akhbar*, literally “information”) was an account of the past composed for historical interest rather than to shed light on Islamic law, and often devoted to the relation of a single event. The term *Ta‘rikh*, which first appeared about 644 C.E. and is the modern Arabic word for history, was initially used to describe various sorts of writing organized chronologically (it literally means “dating”) whether by annals or by the reigns of caliphs. Both terms were used, often interchangeably, up to the mid-nineteenth century.

By the ninth century, though Islamic history was still written principally in Arabic, the religion’s learned language, Islam had ceased to be predominantly a religion of the Arabs alone. The classical period of Islamic historiography, from the tenth century to the fourteenth, would see a great deal of historical writing by ethnic Persians, particularly under the Ghaznavid dynasty of the eleventh and twelfth centuries. This succeeded a pre-Islamic Persian tradition of verse epic that culminated in the post-conquest *Shahnama* (Book of kings) by Firdawsi, which was completed in 1010 C.E. Persian Muslim historiography would also witness a departure from strict attention to the tradition of hadith and the adoption by many historians of rather more secular intellectual outlook characterized by *adab*, a moral and intellectual education for the elites beginning in the eighth century that is comparable in ambition to later European humanism. This proved liberating in the sense that it permitted departure from strict adherence to the narrowness of the *isnad*, which was never easily able to absorb foreign history; and histories written under the influence of *adab* provide more information as to the author’s intentions in writing them. Historical thought was also influenced by philosophical concerns derived from the notion of *hikmah* (judgment or wisdom) and by a concept of research or inquiry (*bahth*). The work of the tenth-century historian al-Mas‘udi reflects these tendencies and is notable both for its critical apparatus and its author’s bald assertion of the superiority of history to all other sciences. The prolific scientist and polymath al-Biruni (973–1048), much of whose life was spent in India, deployed his mathematical and philological knowledge to the resolution of calendrical and chronological conflicts between the world’s nations.

As Islam spread into other regions, including its Western European beachhead in Spain, as well as sub-Saharan Africa and India, Muslim-authored histories of those regions appeared; the earliest history of Islamic Spain dates from the tenth century and was followed by others over the next half-millennium. Muslims in this period produced a great quantity of historical writing, most of which compares very favorably with the best chroniclers of the West and exceeds it in attentiveness to detail and accuracy, for instance the great biographical dictionary of Ibn Khallikan (1211–1282) and the travel writings (themselves a major source for Muslim social history) of the peripatetic Ibn Battuta (1304–1368 or 1369). Like the European invaders, Arabs such as the Damascene mayor Ibn al Qalanisi (1073–1160) and Saladin’s minister ‘Imad al-Din (d. 1201) also wrote about the Crusades, though it has been observed that most did not regard them as anything other than the latest in a series of struggles against the infidel. Ibn al-Athir (1160–1233), another chronicler of the Crusades, wrote his world history, the *Al-Kamil fil-Ta‘rikh* in the wake of the Mongol invasions of the Muslim world during the early 1220s, an event that had a significant impact on history-writing. Half a century later, another Islamic historian, the Persian ‘Ala’ al-Din ‘Ata-Malik b. Muhammad Djuwayni (or al-Juvayni, 1226–1283) served in the capital of the Great Khan before returning to Baghdad as governor and composing an incomplete *History of the World Conqueror* about Genghis Khan. Rashid al-Din, a Persian converted from Judaism to Islam, also served Persia’s Mongol rulers until his execution in 1318; his *Complete Collection of Histories* is a vast world history especially full of details on the Mongol regime. The Mongols, a nomadic and warlike non-Muslim people who came into conflict with Islam to the West and China to the East in the course of the thirteenth century, developed their own tradition of historical writing, which includes the thirteenth-century epic known as the *Secret History of the Mongols*. There is little sign of historical writing among them for three centuries following, during a period of great internecine turmoil and division among the various descendants of the Khan, but

the early seventeenth century witnessed a revival and produced several specimens of chronicles. These included the *Altan Tobči* (Golden Summary) which begins with the death of Genghis Khan and continues to the early seventeenth century, and the collection of chronicles known as *Erdeni-yin Tobči* (Precious Summary).

At least one Muslim author, the fourteenth-century Tunisian Ibn Khaldun (1332–1406), stands as among the most significant historical thinkers of that or any age, and as the culmination of the philosophical tendencies previously observed in al-Mas‘udi. Although he was the author of a long history, Ibn Khaldun has become better known for that work’s prolegomenon or *Muqaddimah*, an ambitious attempt to work out the many factors underlying historical change including customs, manners, climate, and economics; it has often led to his being considered the first sociologist of history. “It should be known that history, in matter of fact, is information about human social organization, which itself is identical with world civilization.” So begins the *Muqaddimah*. “It deals with such conditions affecting the nature of civilization as, for instance, savagery and sociability, group feelings, and the different ways by which one group of human beings achieves superiority over another.” Ibn Khaldun’s idea that individuals and groups that come to power are animated by a group spirit or *asabiyya* has counterparts in much later Western writers such as Johann Gottfried von Herder (1744–1803), while his belief that regimes once consolidated will almost inevitably become divided or corrupted and fall echoes the cyclical politics of the Greek Polybius.

Beginning in the early fifteenth century, the newly rising Islamic power, the Ottoman Turks, produced significant historical works, commencing with ‘Abdu’l-vasi Celebi’s (fl. 1414) account of the accession of Mehmed I, and continuing with chronicles by Asikpasazade or Asiki (1400–after 1484) and the obscure Nesri (d. c. 1520), who synthesized many of the sources up to his own time. These “chronicles of the house of Osman,” many more of which remain anonymous, are distinguished by having largely been written by authors who lived through many of the events they described. The chronicles are supplemented and in some cases overlaid by other sources. These include royal calendars (starting in the 1440s) containing historical lists, and poems and oral traditional accounts reaching back to an earlier heroic age of Islamic warriors, which provide a backdrop of legend, folklore, and pseudohistory. Examples of such works include the *Iskendername* by Ahmedi (c. 1334–1413), parts of which amount to a world history, the *Danismendname* and the later, more historically specific *Dusturname* (completed 1465 and attributed to one Enveri, about whom little is known). Sultan Bayezid II (r. 1481–1512) commissioned the first two histories devoted specifically to the Ottomans, one in Persian and the other in Turkish (Persian influences were especially potent on early Ottoman literature).

In an interesting parallel with China’s mandarin-dominated historical writing, as well as with the civic courtly historiography of many contemporary Italian states, the major Turkish historical works produced for the next two centuries were sponsored by the Sultan or composed by ministers or functionaries such as the grand vizier Karamani Mehmed Pasha (d. 1481), the secretary Tursun Beg (fl. 1453–1499), the chancellor Mustafa Çelebi Celalzade (c. 1490–1567), the poet and tutor to Sultan Murad, Hoca Efendi (or Sa‘duddin bin Hasan Can, 1535–1599), and the provincial functionary Ibrahim Peçevi (1574–1650). The Istanbul bureaucrat Mustafa Naima (1655–1716) wrote an important history of the empire in the first half of the seventeenth century, which remains today one of the most cited sources for that period.

Renaissance and Seventeenth-Century Europe

A recurring theme in several of the traditions we have discussed is that history should be a useful guide to behavior, the past itself a vast ocean of examples from which the present could fish, often without much attention to the water itself. In the West, the classic exposition of this idea came from the Roman orator Marcus Tullius Cicero (106–43 B.C.E.), who defined history as the *magistra vitae* or mistress of life. Cicero was among the classical authors known in part during the Middle Ages but rediscovered in full by the humanists of the Renaissance, who appropriated the authors of Greece and especially Rome as their models of style, genre, and suitable content. This was true across many areas of intellectual activity from the mid-fourteenth century on, but the rediscovery of classical texts and categories would have wide-ranging effects on historical thought and writing, not least because from the mid-fifteenth century, the advent of printing permitted the easy replication of texts in large numbers. Within two centuries this would create a larger reading public for historical writing than had ever existed previously anywhere in the world.

First, more generally, a sense of remoteness from classical times and an accompanying aspiration to reconnect with them bestowed a temporal perspective that was largely (though not as completely as is often supposed) absent from much medieval writing. This took longer to mature than is usually acknowledged, but by the early seventeenth century this “sense of anachronism” is regularly discernible in various media, for instance in art and in drama: it was increasingly difficult to conceive of Julius Caesar or Alexander the Great as medieval Crusaders or Renaissance *condottieri*. A more period-specific visual sense of the past was slower to develop, though archaeological discoveries, especially the ruins of Rome and of former Roman encampments across Europe soon stimulated this too. Much more quickly, however, there developed a sense of linguistic change. The humanists of the fifteenth century were devoted above all to the restoration of Latin to its classical form after centuries of “barbarism,” though the notion that a “pure” language could be transplanted in frozen form on to a different era actually negated 1500 years of change and introduced a different sort of anachronism.

Second, the rediscovery of particular historians, and ebbs and flows in popularity among them (the notable rise of Tacitus’s popularity at the end of the sixteenth century being a good illustration), served to restore the writing of biography and history as continuous narrative, in neoclassical Latin and vernacular languages, in place of the religious and secular chronicles, annalistically organized, that had dominated for the past millennium or more. Leonardo Bruni, the early-fifteenth-century chancellor of the Florentine Republic, was one member of a long line of learned civic officials who would combine public life with scholarly activity and in particular with the writing of history. His sixteenth-century successors, far too many to enumerate, included two who were also outstanding political thinkers, Francesco Guicciardini (1483–1540) and the more famous Niccolò Machiavelli (1469–1527), both of whom wrote full-length histories. Each also authored works of political wisdom, in Machiavelli’s case drawing inspiration directly from Livy (and, more ambiguously, from Polybius and Tacitus), and yoking together examples from the recent and remote past in *The Prince* and *Discourses*. Guicciardini, his more pessimistic contemporary, had as a young man written a history of Florence; but he grew less interested than Machiavelli in pursuing the history of his city back to barbarian times than in narrating the unfolding of its and all Italy’s current troubles (the invasions by French and Spanish armies and the erosion and collapse of republican independence). Perhaps as a consequence of this Thucydidean focus on the very recent past, he was more attentive to detail (in particular the complexity of contemporary international relations among states), and, unusually for his day, more skeptical about the capacity of past examples to serve the present, owing to variations of circumstance between superficially similar historical situations. This latter point is an important insight that anticipates much later thinking on the uniqueness of discrete historical events and the incommensurability of different historical epochs, and it is no coincidence that Guicciardini eventually found a modern disciple (albeit a critical one) in the great nineteenth-century German historian Leopold von Ranke.

Third, the above-mentioned discovery of physical ruins, statuary, coins, and buildings in Italy and elsewhere nurtured an ancillary branch of historical study often referred to by the generic title “antiquarianism.” This took various forms in different countries, but beginning with Flavio Biondo (1392–1463) in the mid-fifteenth century and continuing through most of western Europe in the sixteenth and seventeenth, the antiquaries engaged in inquiries into what might be called the non-narrative past. Not bound by classical exemplars (there were no ancient antiquarian works extant except fragments of the late republican Roman Marcus Terentius Varro) they turned for a literary model to geography, as exemplified by Pliny the Elder (23–79 C.E.), rather than to history, and many of their works are thus organized by place rather than time. They were also considerably less concerned with using the past as a source of advice for the present, though a keen interest in great families and especially genealogy permitted many of these works to include extensive memorials of the great and their deeds. Among the most significant works in this genre outside Italy was William Camden’s (1551–1623) *Britannia* (1586). This was a pathbreaking account, built on extensive personal travel around Britain (and on unpublished work by the early-sixteenth-century antiquary John Leland), of Roman and medieval British antiquities. Expanded and reprinted several times over the next century, *Britannia* became a virtual *vade mecum* for subsequent generations of antiquaries and for interested country squires. Bound by classical notions of form and genre, Camden was reluctant to consider such a descriptive, non-narrative survey as “history” (unlike the later *Annales* that he wrote about the reign of Queen Elizabeth), so he defined the *Britannia* as a “chorography,” a term adopted by his many imitators in ensuing decades.

Not all of this erudite work was chorographical and peripatetic. In France, where the study of Roman legal tradition was especially sophisticated, philologists and antiquaries from Guillaume Budé in the early sixteenth century to Jacques Cujas and François Hotman a generation further on studied language and law, developing a “French school of historical study.” There was a philosophical aspect to this too, in the belief of certain writers—contrary to the view of contemporary skeptics or “pyrrhonists” that the past could indeed be restored and represented accurately. One of these, Henri de la Popelinière, even wrote a complete “History of histories, with the idea of perfect history.” Another, Jean Bodin (1530–1596), perhaps the most subtle of late-sixteenth-century European intellectuals, and a voice of secular moderation at a time of vicious religious warfare, wrote a widely read *Methodus* (Method) for the reading of history. This was intended to guide the reader through the thickets of past historians and in particular to dispel certain timeworn notions such as the “Four Monarchies” scheme of periodization, inherited from the Middle Ages and reappropriated by writers of apocalyptic literature (the notion that the return of Christ would follow the end of the four successive secular empires of Babylonians, Persians, Greeks, and Romans). Bodin was the most politically astute and philosophical among a number of writers determined to impose order on the proliferating species of writing about the past, which were threatening to bolt from their classical cages, and to offer guidance to bewildered readers. Describing the genres and forms of history according to well-defined categories, these late-sixteenth-century authors of *artes historicae* (arts of history) hearken back to Lucian’s *How to Write History* in the second century.

Historical thought and scholarship was not, of course, invariably or even mainly devoted to the recovery of knowledge for its own sake. Propaganda has always been a significant part of historical writing, both in the sense of mining the past for evidence in support of current ideologies, practices, and regimes, and the use of formal accounts of the past to disseminate such support widely. As the anthropologist Arjun Appadurai has commented, the past can be regarded as a “scarce resource,” control over which must be fought for or negotiated. We have seen a variant of this in the Chinese approach to establishing Standard Histories, and it was true in different ways in the West. Much medieval historical writing had been undertaken as propaganda for one side or the other in disputes such as the long-running papal-imperial or Anglo-French rivalries. Various Renaissance courts had employed humanists to write elegant Latin histories explicitly favorable to their regimes and intended to cast their achievements in the best possible light to ensure that their positive image would be passed down as fame to posterity. Protonationalist sentiments stimulated the propagation of elaborate national myths of descent from Trojans, Gauls and Scythians. (Making the wrong assertion about one of these peoples or their modern heirs could have serious consequences. In Sweden, newly independent of Denmark, Gustav I Vasa condemned the historian Olaus Petrei [Olof Petersson] for apparent criticism in the latter’s *En Svensk Crönika* [Swedish Chronicle]; asserting French descent from Germanic Franks as opposed to Trojans landed Nicolas Fréret in prison in 1714). Spanish historians from the time of Ferdinand II of Aragon and Isabella I of Castile to the twentieth century have periodically sought a basis for Iberian solidarity in a remote and imagined Visigothic past. In central and eastern Europe, subject ethnic groups such as Hungarians, Bohemians, Moldavians, and Croats developed historical writing in an effort to preserve and promote a sense of national identity, for instance in István Szamosközy’s (1565–1612) history of his native Transylvania, Miklós Istvánffy’s (1538–1615) treatment of Habsburg-controlled Hungary in the fifteenth and sixteenth centuries, and Pavao Ritter Vitezović’s Latin history of Dalmatia and Croatia (1666).

With the religious Reformation in Europe this polemical dimension of historical writing reached new levels as not just particular perspectives but the beginnings of what we would now call “ideology” began for the first time to splinter historical writing into conflicting camps, now able to conduct their campaigns with print, the powerful new weapon of mass instruction. Early Protestant reformers, needing to blacken the papacy and the medieval church generally as one long decline from apostolic purity, provided histories such as the *Magdeburg Centuries*, directed by the Croat reformer Matija Vlačić (Matthias Flacius), which recounted the survival of the true church over centuries of papist decay. While much of this work continued to be composed in Latin, historians were increasingly using local vernaculars in order to reach a wider domestic audience. Thus, notes P. K. Hämäläinen, sixteenth-century Finnish clerics, for instance, began for virtually the first time to write history in that tongue rather than the Latin or Swedish used in medieval annals and chronicles. The propaganda potential of such works, even in an era of restricted lay literacy, was enormous, and was maximized, in the age of religious persecution and intolerance, by a subset of

historians who focused on collecting the stories of early and more recent martyrs, as did the Englishman John Foxe, Huguenot Jean Crespin, and the Dutchman Adrian Cornelis van Haemstede. Catholic Europe responded in kind, for instance in the *Ecclesiastical Annals* of Cardinal Cesare Baronio, intended as an antidote to the Protestant version of the past. Partisanship would become virtually routine in historical writing during the religious wars across Europe and Britain during the late sixteenth and seventeenth centuries, although any individual author continued to stress his own impartiality and the bias or falsity of his opponents.

While it is easy to look back at such works and recognize their obvious slant, it would be a gross error to dismiss them as the worthless detritus of religious bigotry. Although openly hostile to alternative views, and often naively supposing (in the manner of la Popelinière or, somewhat later, England's Francis Bacon), that a correct or "perfect" version of the past was achievable, the strength of their convictions led many of these authors to undertake careful research in order to buttress their cases. Nor were the battle lines exclusively confessional, since a broad Latin republic of letters connecting Catholics and Protestants would develop through the late sixteenth and seventeenth centuries. The savagery with which two Protestant chronologers, Thomas Lydiat and Joseph Scaliger, treated each other's works, or the scorn heaped by the great English lawyer and antiquary John Selden (1584–1654) on the Protestant critics of *Historie Titbes* (1618) illustrate this point well, as do the papacy's hostile reactions to the renegade Venetian priest Paolo Sarpi (1552–1623) for his critical *History of the Council of Trent*.

Moreover, ecclesiastical erudition in the cause of belief continued to drive some of the best scholarship of the late sixteenth and seventeenth centuries, as a defense against both alternative faiths and the potentially more serious threat posed by general "pyrrhonism" or skepticism towards the possibility of recovering the past. An intense search for a firm chronology for events before and since Christ climaxed in the sophisticated work of the French Huguenot philologist Joseph Scaliger (1540–1609) and his Jesuit successor, Denis Pétau (or Dionysius Petavius, 1583–1652), as well as in more notorious attempts to fix with certitude dates such as the first day of Creation—most famously assigned by the Irish archbishop James Ussher (1581–1656) to Sunday, 23 October 4004 B.C.E. Building on this chronological corpus, the Maurists, French Benedictines at Saint-Germain-des-Prés and other houses, produced editions of church fathers, based on original sources, but their principal contribution was in the development of systematic paleography (interpretation of historical scripts and hands) and diplomatic (knowledge of the structure, layout, and conventional formulae of documents) for the analysis of sources. This is best summed up by one of their leading figures, Jean Mabillon (1632–1707), in his treatise *De re diplomatica libri VI* (Six books on diplomatics), which focused on the authenticity of medieval charters. The Bollandists—Belgian Jesuits—commenced the *Acta Sanctorum* (Acts of the saints), organized as a month-by-month calendar of feast days, in order to set the lives and deeds of the historical saints on a sounder scholarly footing. Their project continues today and significantly improved the level of source editing then practiced.

Such tendencies in evidentiary criticism could have unintended consequences in nurturing unbelief. The same skepticism that appears in earlier antiquaries' doubts about such myths as the Trojan descent, or in Jean Bodin's dismissal of the Four Monarchies periodization, soon produced doubts about the literal truth of the Old Testament as a historical source, and deistic views of rational religion. The skeptical tendency first notable in the later sixteenth century produced in the seventeenth both reactive affirmations of received traditions (the *Discourse on Universal History*, Bishop Jacques-Bénigne Bossuet's splendid effort to rehabilitate medieval world history in a Christian context being a famous example), and more thoughtful attempts to address what was now an urgent problem, the very reliability of not just specific traditions, but of *any* historical knowledge. Some of these efforts had a secular focus: Francis Bacon's (1561–1626) empirical attempt to build truths from individually verified "facts" (it was in this period that the word "fact" acquired something like its modern meaning) applied in his judgment both to the realm of the past and the realm of nature, both of which were best represented by "histories"—echoes of the old Herodotean notion of a discovery or inventory can here be heard. Bacon also enumerated the various genres of history in a manner directly derived from the sixteenth-century *artes historicae* (although his only significant effort at history-writing, on the reign of England's King Henry VII (r. 1485–1509), was a rather conventional humanist "politic" history in the style of Tacitus and Machiavelli, intended to provide advice to the crown). The French philosopher René Descartes (1596–1650) addressed the problem of knowledge from the interior to the exterior world, through deduction, but

his solution to pyrrhonism in areas like mathematics and religion did little to buttress confidence that knowledge of the past could be similarly verified. In ensuing decades, others (such as Bacon's fellow Englishmen, Edward, Lord Herbert of Cherbury, Joseph Glanvill, and William Chillingworth) sought to reaffirm the historical foundations of religious truth.

Skepticism about received knowledge, and the belief that reason (we might say "common sense") must take precedence over the revealed truth in Scripture, is perhaps most famously represented in the *Dictionnaire historique et critique* by the exiled French *érudit* Pierre Bayle (1647–1706). The *Dictionnaire*, which appeared in several editions beginning in 1697, was enormously influential in the eighteenth century, but Bayle was scarcely alone in his doubts, especially with respect to the status of scripture as a historical source. Another Frenchman, Isaac de la Peyrère, had anticipated this position in 1655 (the very time at which Archbishop Ussher was confidently working out the date of Creation), after concluding that the Old Testament chronologies were irreconcilable with the existence of non-biblical peoples. The Dutch philosopher Baruch or Benedict Spinoza (1632–1677) espoused the notion that the Pentateuch was the work not of Moses but of a much later, post-Exilic author. Churchmen were active participants in these discussions. The French priest Richard Simon (1638–1712) advanced Spinozan doubts as to Mosaic authorship in his *Histoire critique du Vieux Testament*, published at Paris in 1678 and soon seized by authorities. The English cleric Thomas Burnet (c. 1635–1715) authored works of criticism in a similar vein, two centuries of philological refinement having now been reinforced by the physical evidence of fossils, bones and other artifacts collected by the "curious," the virtuoso assemblers of cabinets of marvels during the previous century. When Burnet later suggested that Genesis could be read "metaphorically," he was quickly dismissed from the office he held at court.

Others, however, continued to build new foundations for historical knowledge (in some cases literally) from the ground up, using erudition as the key to decoding and verifying the obscurities of the past. This was not strictly a Christian perquisite. Jewish historical writing, largely a vacuum since the first century C.E., experienced its own renaissance in the sixteenth century with the Iberian exiles Solomon ibn Verga (1460–1554) of Seville and Samuel Usque (fl. 1540–1555) and the messianic world historian Joseph ha-Kohen. But it was the Mantuan-born Azariah de' Rossi (c. 1511–1578) who most resembled the great Christian antiquaries in his attention to the sources of ancient Jewish history. Azariah's *Me'or 'Einayim* (Enlightenment of the Eyes) was roundly rejected by contemporary rabbinical scholars, but it pointed ahead to the more secure revival of Jewish secular historiography in the early nineteenth century.

By 1700, there was considerable overlap between the study of the erudite side of the past (numismatics, epigraphy, papyrology, paleography, and chronology) and the natural philosophy and natural history of the day. Leading intellectuals in other arenas such as Sir Isaac Newton (1642–1727), who was keenly interested in chronology, and Gottfried Wilhelm von Leibniz (1646–1716) participated in these erudite activities and corresponded with the antiquarian *savants* of the day. The atmospheric pressure and velocity of knowledge is well captured in the letters between scholars, and in the interconnected activities of the great many European academies and societies that were founded at this time, as well as in the earliest journals that circulated knowledge in print. There was also intense activity in the area of source publication and criticism. This included both ancient materials and (with an interest not shown previously) those from the Middle Ages, such as the sources of French history begun by the Maurists as *Rerum Gallicarum et Franciscarum Scriptorum*, or the scholarship in hagiography and imperial Roman history by Louis-Sébastien Le Nain de Tillemont (1637–1698). Perhaps the outstanding examples of this Baroque source publication are provided by the works of the Modenese Lodovico Antonio Muratori (1672–1750), including the *Rerum Italicarum Scriptorum* and *Annali d'Italia*.

The tremors affecting thinking about the past, chronology, and history were undoubtedly magnified by two centuries of explorations overseas, for this was also the era of European expansion to the East and the West. The discovery of other peoples, especially primitive indigenous cultures, also complicated inherited schemes for the periodization of history and the Creation story, as la Peyrère had demonstrated. The conquistadors and the more learned clerical missionaries who followed them discovered advanced non-Christian civilizations in the Aztecs, Mayans, and Incas. Many of these had developed their own sense of the past and non-alphabetic means to represent it—the Incas used the *quipu* or knotted cords combined with memorized traditions, and Mayan glyphs record a dynastic history for the period 250–900 C.E. This was also the first period at which

Western modes of history began to spread outside their European confines and exercise influence elsewhere, as both natives and missionaries constructed chronicles of the preconquest and conquest eras. By the seventeenth century, an Indian, Felipe Guamán Poma de Ayala (fl. 1613), and a Mestizo, Garcilaso de la Vega, *El Inca* (1539–1616), both of whom were influenced by the Dominican Bartolomé de Las Casas (1474–1566), could be relatively comfortable writing history in the mode of the Spanish conquerors, as did the Texcocan Fernando de Alva Ixtlilxóchitl (1578–1650). European expansion also moved east, and other missionaries contributed histories of China and Japan in the late sixteenth and seventeenth centuries. They were uninfluenced by very different Chinese historical genres of the late Ming period. Nor, in contrast to their rapid subjugation of indigenous American traditions, did they exercise much immediate impact on the Chinese and Japanese. The great period of Western influence on Asian historical writing lay several centuries ahead.

India in the Pre-Islamic and Mughal Periods

Among indigenous forms of historical writing that differ from those of the West, none is as hard to grasp as, or more contentious than, those of pre-Islamic India. The values and style of Islamic and Chinese historiography differ from the European, but their products are nonetheless clearly recognizable as histories, and they share common concerns with matters such as chronology and the memorialization of particular facts about the past. For this reason, even the respect accorded to these traditions in most Western histories of history is often completely withheld from other modes of apprehending the past that seem much more remote. Early Indian historical writing is among these. India's very capacity to generate thought and writing about the past has often been rejected—al-Biruni commented on the Hindu lack of interest in “the historical order of things” as early as the 1020s; Edward Gibbon commented on general “Asiatic” lack of history in the eighteenth century; and the indictment was echoed by James Mill and by Georg Wilhelm Friedrich Hegel in the nineteenth century. This is a view that modern scholars of ancient India have fought hard to dispel, though from two very different directions. Some, like Romila Thapar, have argued that there is a historicity or at least historical consciousness in early Indian texts. More recently, scholars such as Vinay Lal have denied this but argued that the very notion of the importance of history is a Western imposition upon a colonized South Asia, an epistemological privileging of a category that should *not* be applied to other cultures such as the Indian. Certainly the complexity of ethnic groups and languages, and the rigidities of the caste system, did not permit anything like Western historiography to develop. Nor was there the central government apparatus that stimulated and systematized Chinese historiography, or the religious imperative underlying classical Islamic histories. It is arguable that Indian philosophy paid no special heed to history (though this was also true of the ancient Greeks) in part because the Hindu outlook is thought to have rejected the notion of individual causality and denied the significance of short-term events in favor of much longer epochs or periods. The most frequently cited exception, a twelfth-century text that actually resembles a chronological “history” is the Sanskrit-language *Rajatarangini* (c. 1148–1149) by Kalhana. This verse composition covered the history of Kashmir from remote antiquity to the author's own time and was derived from legends, oral traditions, written records, and inscriptions. Kalhana was followed by four other Sanskrit-language historians: Jonaraja (early fifteenth century), Srivara (later fifteenth century), Prajyabhatta (early sixteenth century), and Suka (early seventeenth century).

But historical forms *of some sort* assuredly did exist in ancient India, indicating a sense of the past quite different from that in the West, but scarcely the happy ignorance suggested by James Mill. Much more typical than Kalhana's work was the combined tradition known as *itihasa-purana*, which by the mid-first millennium C.E. had become an authoritative source for the ruling Brahman caste. *Itihasa* translates as “thus it was” while *purana* refers to “that which pertains to ancient times” or “old lore.” Early Indian historical tradition contains origin myths and extensive genealogical material on the descents of major families (which generally do not place the figures chronologically). There are also some biographies of individual rulers, beginning in the seventh century C.E. and peaking from the tenth to thirteenth centuries, as well as chronicles of ruling families (*Vamsavalis*, literally, “path to succession”) in inscription or textual form, of which Kalhana's text is the best example and the one most familiar in its use of multiple sources, critically evaluated. An additional category is the collection of historical narratives or *Prabandha*, which again have a biographical orientation.

Pre-Islamic India also developed other traditions of writing about the past, distinct from *itihasa-purana*, especially Buddhist and Jaina, both centered in monastic institutions; the Pali-language chronicles from Sri Lanka for instance focus on the history of a particular Buddhist order or monastery but also stray into secular history and the history of earlier times. Writings such as the *Rajavaliya*, compiled by several hands between the fourteenth and nineteenth centuries, and the *Mahavamsa*, a sixth-century work continued in the tripartite *Culavamsa* of the twelfth, fourteenth, and late eighteenth centuries, together represent a cumulative history of nearly two millennia. To India's north, in Tibet, Buddhist scholarship produced (in Tibetan and Sanskrit) the large history known as the *Deb-ther sngon-po* (*Blue Annals*, the work of the translator and compiler 'Gos lot-sa-ba gzhon-nu-dpal (1392–1491) who used and frequently simply copied earlier sources such as *mnam-thar* (lives) by religious teachers, not all of which are still extant. The chronology of this work and the names of Tibetan rulers can be verified by comparison with events described in earlier Chinese annals from the Tang dynasty. Together with the slightly earlier "History of Buddhism" by Buston (composed c. 1322), the *Blue Annals* has become the source of information for most later histories of Tibet. Apart from language variations (Pali and Tibetan as opposed to Sanskrit), South Asian Buddhist historical writing parted from the Brahmanic in at least one important respect, its dating of events from a single point, the death of the Buddha c. 483 B.C.E. (a controverted date also used by some, but not all, Buddhist-influenced countries). There is an obvious analogy with Christian and Muslim dates A.D. and A.H., and the greater sense of time that one finds in a work like Kalhana's may well be attributable to Buddhist influences, though a comparably Buddhist "era" never achieved historiographical usage in either South or East Asia.

Various regions developed historiographic forms during India's "medieval" or Muslim-ruled period, which ended in the mid-eighteenth century. In the Rajput state, Mughal-inspired official chronicles or *khyats* (some of which contained information from earlier Hindu bardic literature) first appeared in the late sixteenth century. In the early eighteenth century a king of Assam, Siva Singha, ordered a history of his predecessors to be written, and a century later, Ramram Basu, at the behest of a British missionary, authored a vernacular history of the government of Bengal. There exists also a distinct tradition of historical writing among the Maratha people of Western India, including *bakbars* (chronicles and biographies) that continued to be written into the period of British imperial governance. While the reliability of some of these works as chronological sources for the periods they depict has been questioned by modern scholars, they nevertheless constitute intentional attempts to capture the past. It is thus important to recognize that the absence of the usual Western forms of historical writing through much of this period does not entail a lack of any such activity, much less the complete absence of historical *thinking*. However, European traditions would eventually prove effective in bringing the indigenous Indian tradition to a close, following its earlier encounters with Islamic historical thought introduced by Arabic and Persian visitors and Mughal conquerors.

These previous contacts date from the eleventh century, when al-Biruni had traveled into India and reported back on its culture. The newcomers brought with them what was by then a mature Muslim historiography, and in the fourteenth-century, the Bengali official Ziya'ud-Din Barani would remark of historians that they must be truthful and provide insight into virtuous behavior but also inquire into the reasons underlying change in human affairs, injunctions that would not have arisen in the context of *itihasa-purana*. By the sixteenth century, when Mongol-descended Islamic rulers from Turkestan (the Mughals) ruled much of India, Islamic and especially Persian, cultural influences on historiography became more widespread: the Sanskrit-language Kashmir chronicles were superseded by Persian-language works such as the anonymous *Baharistan-i-Shahi* (1614), or the sixteenth-century autobiographical history of the Central Asian Mughals, *Tarikh-i-Rashidi* (comp. c. 1541–1544) by the warrior Mirza Muhammad Haidar (c. 1500–1551). The latter's cousin, the Mughal conqueror Zahir-ud-Din Muhammad, known as Babur (1483–1530), composed or dictated a detailed autobiographical history of his times, the *Baburnama*. Abu'l Fazl 'Allami (1551–1602), the minister of Babur's grandson Akbar, authored the *Akbarnama*, which brought together a variety of sources; it also contains many interesting reflections on the nature of history, which he conceived of as both rational and as a source of solace for grief in the present. At precisely the same period that court-sponsored histories were in vogue in Renaissance Europe, the same feature can be observed in Mughal India, and Akbar inaugurated with Abu'l Fazl the Persian-influenced practice of having an official historiographer write the history of the empire, a practice that was maintained until the last great Mughal emperor, or Aurangzeb 'Alamgir, in the following century. During the next two hundred years, Islam continued to dominate

historical writing in India, producing works on various regions and localities, such as Ali Muhammad Khan's mid-eighteenth-century history of Gujrat over the previous seven hundred years.

Early Japanese and Korean Historical Thought

The story of Japanese historical writing begins with the influence of China and Korea and appears to have concluded in our own time with the impact of the West. History developed considerably later in Japan than in China, and then not in the same forms, despite the frequent use of Chinese as the language of composition. Historical writing can be found in the Japanese archipelago from the seventh century C.E. The emperor Temmu had ordered compilation of a chronicle in 681 in order to correct errors in and conflicts between imperial genealogies and the traditional origin tales of various great families. The earliest extant texts are two official historical works, the *Kojiki* (Record of ancient matters, completed 712 C.E.) and *Nihon shoki* or *Nihongi* (Chronicles of Japan [Nihon], comp. 720 C.E.). These were both commissioned in 711, ostensibly by the empress Gemmei, as the preface to the *Kojiki* stated. Both texts relayed a powerful mythology of the creation of the world and the subsequent foundation of the empire by the first human monarch, Jimmu or Jinmu, a direct descendant of the sun goddess—belief in the emperor's divine ancestry would continue to be taught in twentieth-century Japanese schools. The *Nihon shoki* was composed in Chinese in an attempt to imitate Chinese historiography. The *Kojiki* was written in a commonly used mixture of Chinese and Japanese that grew unfamiliar to readers in later centuries, which led in part to the work's being neglected until the 1700s. By 901 C.E. the *Nihon shoki* had been augmented by five other Chinese-language works that with it form the Six National Histories (*Rikkokushi*).

In some ways, however, the Chinese system of historical writing, and in particular the use of the dynasty as the basic unit of the Standard History, was ill-suited to Japan. From the Japanese point of view, all emperors belonged to the same dynasty, being directly descended from the sun goddess via Jimmu—the *Kojiki* in particular stresses the continuity of the imperial line rather than the cycle of dynastic rise and decay immanent in the Chinese Standard Histories. This linealism, and a degree of resistance to Chinese cultural dominance in spite of the influence of Confucianism, ensured that while its language was initially borrowed, the edifice of Chinese historical writing was not reconstructed wholesale, even in officially sponsored chronicles such as the *Azuma kagami*, a late-thirteenth-century product of the first, Kamakura, shogunate or military government, which is presented as if it were a diary compiled as events occurred. Moreover, beginning in the eleventh century during the Heian period, a different type of history, written in Japanese, began to appear in the *Rekishi monogatari* or historical tales, which were composed by independent scholars and departed considerably from the national histories; at least one of these, the *Eiga monogatari* (c. 1100), was composed by a woman. Many works in this genre were biographically organized; a number, such as the *Gunki monogatari*, dealt principally with war and were often recited orally (not unlike the Homeric epics, which they resemble in military values) before being committed to writing. Examples include the fourteenth-century *Taiheiki* (Chronicle of great peace). Most widely read among medieval Japanese historical writings were the *Gukansho* by the priest Jien (c. 1220), the *Eiga monogatari* and the twelfth-century *Okagami* or Great Mirror.

Following several centuries of imperial decline, the Tokugawa Bakufu (1603–1868) was established whereby shoguns ruled the country on behalf of a figurehead emperor through regional *daimyo* or warlords. During this era, Japan was kept rigidly secluded from outside influences. Historical thinking achieved higher intellectual prominence to the extent that Ogyu Sorai (1667–1728) could confidently proclaim that history was “the ultimate form of scholarly knowledge.” Official history-writing in the mode of the Six National Histories continued to flourish, often tied to a particular shogunal “domain” or feudal territory—the pro-imperial *Dai Nihon Shi* (Great history of Japan, begun in 1657 and only completed in 1906) was, for example, initiated in the Mito domain. Much of this work began to depart from the imperial mythology of Jimmu since it did nothing to support the case for shogunal primacy over a puppet emperor. Among shogunal officials, Arai Hakuseki (1657–1725) stands out for his *Tokushi yoron* (Essays on history), a series of lectures on the past intended to instruct the shogun through example while making use of a wide variety of sources and largely ignoring the early origin myths. Arai painted a progressive picture of Japanese history that validated noncentralized governance; it also subordinated individual action and choice to inevitable historical trends. Two generations earlier, Hayashi Razan (1583–1657), an unabashed admirer of Chinese historical texts, had set the stage for a Neo-Confucian philosophy of history strongly allied to the shogunate. A number of private scholars were also

writing about the past, often from non-Confucian perspectives. Motoori Norinaga (1730–1801), an exponent of the “National Learning” school of history, rejected Chinese-influenced accounts of the past in favor of the earlier record of the *Kojiki*, which now achieved a status it had not enjoyed for a millennium. (Motoori conveniently overlooked the fact that it, too, was heavily indebted to Chinese histories).

Like Japan (which it in turn influenced), Korea was strongly affected by Chinese historiography through much of the premodern period. Unlike Japan, Korea had distinct dynasties, and the annals of each reign (*sillok*) are analogous to Chinese Veritable Records. The *chongsa* or dynastic histories of early Korea are similarly comparable to the Chinese Standard Histories (which in fact provide the earliest source material for Korean history). Historical records were maintained from the fourth century C.E., and a history was compiled in 600 C.E. by Yi Mun-jin of the Koguryo kingdom, but these have not survived; Korean writings may even have influenced the Japanese *Nihon shoki* in the eighth century. The earliest example still extant of Korean history-writing, compiled in the Koryo period, is Kim Pu-sik’s *Samguk Sagi* (History of three kingdoms) (1145 C.E.); this used both now-lost Korean sources and Chinese writings, and is clearly modeled on Chinese Standard Histories. The Koryo dynasty (918–1392), following earlier Tang Chinese practice, established a History Office in the tenth century; this bureaucracy was considerably expanded during the ensuing Yi or Choson dynasty (1392–1910), and in the fifteenth century a group of scholars led by Chong In-ji (1418–1450) completed the *Koryosa* (a dynastic history of the Koryo). Choson historians would eventually produce a whole series of *sillok* for each reign covering nearly five centuries up to 1863. As with the Chinese Veritable Records, *sillok* were carefully guarded so that even the reigning monarch was denied access to them in order to protect against interference. Again as with China, the presence of an official bureaucracy could not prevent alternate or private interpretations of the past from being written. A more Korean-focused tradition of historical writing also sprang from this Confucianism, for instance the thirteenth-century monk Iryon’s *Samguk Yusa* (Memorials of three kingdoms). In the eighteenth century, a school of “practical learning” or *sirhak* developed that produced such works as An Chong-bok’s distillation and analysis of Korean history, *Tongsa kangmok*, one of the first histories to be written by a private scholar independent of government support. Beginning in the late nineteenth century, both Western and Meiji Japanese historical scholarship would displace Chinese influences in Korean historiography.

Enlightenment in the West

With the close of the era of religious wars that had marked the sixteenth and much of the seventeenth century, European historiography expanded its scope considerably beyond the political and ecclesiastical topics that had predominated since the Renaissance and Reformation. This does not mean that Enlightenment historiography was a radical departure from what came previously. To the contrary, it relied very heavily on many of the historiographical accomplishments of the previous two centuries, and in particular on the enormous corpus of erudite knowledge in the form of printed documents and texts, engravings of archaeological and architectural remains, and especially the study of different legal systems. Two centuries of travel and expansion also encouraged many of the historians of the late seventeenth and eighteenth centuries to undertake a comparative approach to the study of the past.

A major goal of Enlightenment historiography may be described as the search for a synthesis and balance between erudite knowledge and philosophy. Some of the best examples show a turn away from the narration and description of political events toward the consideration of civilization, customs, and especially *moeurs* (the French word for “manners”). Having said that, it should immediately be admitted that the term *Enlightenment* is itself loaded and complex, and there exists a wide range of views of history and historical writing among the historians who subscribed to its principles. Moreover, far from every historian during the Enlightenment can be described as a practitioner of what J. G. A. Pocock has referred to as “enlightened historiography.”

Two significant Italian contemporaries stand out at the beginning. The younger, Pietro Giannone (1676–1748), was a Neapolitan jurist who authored a *Civil History of the Kingdom of Naples* (1723). This blended detailed knowledge of documents (often derived at second hand from the erudite works of earlier generations) with a focus on social history and a reform-minded and specifically anticlerical outlook that would characterize much later Enlightenment thinking. The older and ultimately—though not immediately—more important was Giambattista Vico (1668–1744), like Giannone a jurist. The influence of Vico on subsequent European thought—

by no means limited to historiography—has been profound, though it was to fall on deaf ears for a century. Vico's *Scienza Nuova* (1725; *New science*), which has aptly been called a virtual Newton's *Principia* for history, espoused an erudite synthesis of the human past—including the non-Western. Vico erected this edifice on a postulated series of cycles of progress and decline, dividing the past into a series of recurring ages: of gods, of heroes, and of men (the historical age)—there had been two such cycles (*corso e ricorso*) up to his own time. Each age was characterized by distinctive modes of speech, thought, law, and government, and all unfolded against the imagined horizon of an "Ideal Eternal History." An admirer of Plato and Tacitus, of the empiricism of Francis Bacon and the legal scholarship of the Dutchman Hugo Grotius, Vico's application of philology and jurisprudence to the study of the past both echoes the Renaissance humanists and presages the work of later anthropologists, linguists, and comparative religion scholars. His ingenious insight that myths were an expression of an earlier mode of consciousness and of a language rooted in poetry, and that they needed to be understood metaphorically, was a powerful tool. It permitted him to embrace the biblical account of man's early history rather than dismiss or query it in the manner of French skeptics such as Bayle. He also provided an apparent answer to Cartesian skepticism in the notion that men *can* understand with certainty the things that they make, which include nations and their history. For Vico, *verum* (truth) was equivalent to *factum* (that which is made—or, we might add, *done*).

The anticlericalism that appears in Giannone would be taken up by one of the period's most well-known figures, Voltaire (the pseudonym of François-Marie Arouet, 1694–1778), whose *Essai sur les mœurs et l'esprit des nations* was an overview and critique of several centuries' worth of institutions and customs, including those of non-Western civilizations such as the Chinese. Less erudite than many other historians of the era, unsympathetically critical of the errors and folly of past ages, and at times positively hostile to "pedantic" scholarship and "useless obscurities," Voltaire praised features in other civilizations while still arriving at the conclusion that Western culture represented the triumph of human reason. He nevertheless contributed to public knowledge of other past societies, often employing contemporary travel accounts as sources; and in *Le siècle de Louis XIV* (1751) he offered a brilliant if uncritical analysis of civilization during the age of Louis XIV, which he aspired to establish as a benchmark for reform in his own time. The notion that there is a cumulative progress in human events had been a recurring theme in history for centuries, though typically ascribed to a divine plan as in the Judeo-Christian eschatological view of time. In the eighteenth century, progress as an organizing principle really came into its own, with the most optimistic views being espoused by the likes of Voltaire and especially his Revolutionary-era successor, Marie-Jean Caritat, marquis de Condorcet (1743–1794). The latter, an ill-fated aristocratic philosophe, left at his death the introduction to a *Sketch for a Historical Picture of the Progress of the Human Mind*, a book that adumbrated a nine-stage history of humanity's progress, with a culminating tenth stage of reason and achievement to follow the Revolution.

In Britain, Enlightenment historiography took a rather different turn. William Robertson (1721–1793) was influenced by Voltaire (though critical of the latter's errors) in his *History of Charles V*. His fellow Scot David Hume (1711–1776)—who was better known as a historian than as a philosopher in his own time—tried to apply his own skeptical theory of causation (and an admiration of ancient historians, especially Thucydides) to England's past. Hume's multivolume *History of England from the Invasion of Julius Caesar to the Abdication of James II* struck a chord with contemporary audiences, and he is also noteworthy for having developed a "sentimental" approach to historical writing that he hoped would appeal to female readers, who found much of historical writing dry and unappealing. The outstanding figure of British historiography during the period, still read frequently today, was Edward Gibbon (1737–1794), whose *The History of the Decline and Fall of the Roman Empire* (1776–1788) was a towering masterpiece synthesizing enormous erudition in literary, numismatic, and other antiquarian sources (albeit often at second-hand) with a philosophical and critical outlook. Gibbon was the late Enlightenment heir to two thousand years of thinking about historical problems such as the relationship between empire and liberty, virtue and power, citizenship and wealth, simplicity and luxury, and the nature and reasons underlying historical decline, themes that can be traced back, in different forms, through Renaissance humanists to post-Eusebian ecclesiastical history and beyond, back to Tacitus and Sallust. Gibbon was just as much the beneficiary of a hundred more recent years of enlightened history and erudition in the different modes of Tillemont, Muratori, Giannone, Voltaire, and Robertson. Though he was by no means an anticlerical in the style of Voltaire, Gibbon has become celebrated for his famous ascription of the fall of Rome to the triumph of "barbarism and

religion,” meaning, respectively, the various migratory tribes and the Christian Church. It is less widely recognized that the majority of his famous book in fact dealt with the Eastern, Byzantine half of the empire, and thus is properly considered a work of medieval, not ancient, history.

Eastern Europe first began to develop a substantive corpus of historiography at this time, often under foreign influence. The Hungarian-Slovak pastor Mátyás Bél (Matthias Belius; 1684–1749) established the first learned society in Austria while publishing an extensive collection of the sources of Hungarian history. Russia had produced a sporadic tradition of chronicle writing, including its *Primary Chronicle* (early twelfth century) since the later Middle Ages. Beginning with the late-seventeenth-century Westernization under Peter the Great, a new national historiography emerged, first with Vasilii Nikitich Tatischev’s (1686–1750) compilation from older chronicles into a *Russian History from Most Ancient Times*, and then with two national histories by Mikhail Vasilyevich Lomonosov (1711–1765) on the earliest periods, and the seven-volume survey of Prince Mikhail Mikhailovich Shcherbatov (1733–1790). Eighteenth-century Russian historical writing reached its highest achievement just after the Napoleonic struggles in the multi-volume synthesis, based on a wide variety of sources, of Nikolai Mikhailovich Karamzin (1766–1826). Western European philological scholarship had also arrived in Russia with two Germans, Gerhard Müller and his literary assistant August Schlözer, the latter of whom edited and published the *Primary Chronicle*.

The German *Aufklärung* contribution to historical thought and writing may have had the most profound and lasting effects on the next century. In contrast to the gentlemanly tradition of a Gibbon or the journalism of a Voltaire, German historical thought and writing was intimately linked to the educational system, and especially to universities such as Göttingen. The list of achievements is considerable. Schlözer (1735–1809) returned from Russia to Göttingen and a prolific career as a historian in 1767. Johann Christoph Gatterer (1727–1799) pursued the development of a “universal history” and promoted erudite scholarship at Göttingen. Elsewhere, at Halle, Friedrich August Wolf (1759–1824) revolutionized Homeric studies and created a new term for the interdisciplinary study of antiquity, *Altertumswissenschaft*. Others worked without university appointments. Johann Winckelmann (1717–1768), a librarian at Dresden, put art history, and especially the study of Greek sculpture, on a new footing, refocusing attention away from artists’ biographies and on to changing styles and their periods. Johann Gottfried Herder (1744–1833), a schoolmaster and clerical official, anticipated the historicism and nationalism of the next century with his notion that a *Volk*, or people, exhibited cultural characteristics, the product of language, climate, and experience, that transcended political boundaries. His *Ideen zur Philosophie der Geschichte der Menschheit* (1784–1791), in some ways a synthesis of the previous century’s work, nonetheless marked a significant departure from the standard early Enlightenment rationalist view of an unchanging nature common to all humans at all times. Herder directed attention away from political and military history (the edificatory value of which he doubted) toward the “inner life” of humans discernible from art, music, and literature, an approach that would ultimately evolve into the later German idea of *Kulturgeschichte*.

Chinese Scholarship under the Qing

Allowing for its very different circumstances, China under the late Ming and succeeding Qing dynasties experienced many of the same historiographical developments as the West. One leading authority on the period, Benjamin Elman, has characterized it as a transition “from philosophy to philology,” as the Neo-Confucianism that had marked most of the previous half-millennium of Chinese historical writing, especially under the Song and Ming, was challenged and a new emphasis placed on evidentiary research—itsself anticipated by many Song scholars centuries previously. Despite the strictures and quotas on civil service careers imposed by the Manchu Qing dynasty, which by and large adopted Chinese language and cultural practices, a higher degree of professionalization occurred in the eighteenth century. Philology and ancillary disciplines such as epigraphy, paleography, manuscript collation, and phonology were developed against the backdrop of an argument within Confucianism between Qing advocates of “Han Learning” (who had a preference for the texts and methods of Han-era scholars in studying the earlier Chinese classics) and their Neo-Confucian “Song Learning” opponents—an interesting if inexact analog to the slightly earlier European *querelle* of ancients and moderns. During this period, official academies supplanted the private schools of earlier years. Ming-era survivors such as Gu Yanwu (1613–1682) epitomized the careful attention to research among a wide range of sources of the

physical as well as the textual, especially in his *Rizhilu* (Record of daily knowledge). As so often in historiography, contemporary issues proved a powerful stimulus for detailed and accurate research that could transcend polemical positions and, a century after Gu, Wang Mingsheng (1722–1798) would assert the responsibility of the historian to examine all available evidence. Together with Zhao Yi (1727–1814) and the respected teacher Qian Daxin (1728–1804), Wang was a member of a great trio of mid-Qing historical scholars who brought historical scholarship to a new level.

Western influences were increasingly felt during this period, albeit inconsistently, and indeed the parallels with Renaissance humanism three centuries earlier are striking, including the considerable expansion of woodblock printing that began late in the Ming era, the frequent exchange of correspondence among scholars, and the particularly high valuation of ancient learning. A consequence of this was that certain venerable texts were held up to the kind of critical scrutiny that Renaissance philologists had applied to forgeries like the Donation of Constantine or the pseudo-histories of Annius of Viterbo. And, as the humanism of the Renaissance had preceded the rationalist skepticism of the Enlightenment, so the Han Learning revival eventually produced a decline in the status of Confucianism. Methodologically, the “School of Evidentiary Research” (*kaozheng* or *k’ao-cheng*) as it is often called, is exemplified in works such as Yan Ruoqu’s (1636–1704) exposure of selected chapters of the *Shujing* (the “Book of Documents,” both a classic and a history) as a piece of later, post-Confucian authorship. This iconoclastic pursuit of truth had effected momentous changes in scholarship before the School itself declined in the nineteenth century. It would clear the way by the end of the Qing era in 1911 for Liang Qichao’s (1873–1929) now Western-influenced call for a “new historiography” and for his associate Xia Zengyu’s general history of China, itself affected by Western-style Japanese histories of China.

A number of other important genres of historical writing appeared during the period. Histories of institutions (*Zhi guan*), previously annexed to the Standard Histories and other works, were now presented as independent reference books. A preexisting form of local history or “gazetteer” dating back to the Song dynasty or earlier, the *Fangzhi* also proliferated, initially as a guide to local administrators who were often strangers to their region, intending to provide a complete history of all phenomena, natural and human, within a particular administrative area. Nearly one thousand Ming and five thousand Qing-era *Fangzhi* survive; although they have no exact Western counterpart, their local focus and emphasis on multiple sources bears comparison with the natural histories and “surveys” of late-seventeenth-century Britain, and, more remotely, with an outstanding German work of local history, Justus Möser’s *History of Osnabrück* (1768).

Romanticism, Historicism, and Nationalism

Möser’s *Osnabrückische Geschichte* has been praised by modern historians such as Friedrich Meinecke for its sensitivity to the uniqueness of the local community. When combined with Herder’s understanding of the cultural differences among various peoples and the integrity of the *Volk*, and with the enormous influence of a cultural icon such as Johann Wolfgang von Goethe, late-Enlightenment Germans had anticipated a number of coming trends in European historical thought. In the political aftermath of the French Revolution and Napoleonic wars, and amid the intellectual wake of the Romantic reaction to Enlightenment rationalism, the nineteenth century saw a turn away from grand theories (philosophers such as Hegel being notable exceptions) and world histories and an increased focus on the individual—especially the heroic individual—and the nation. Early-nineteenth-century French historians such as François Guizot (1787–1874) and Adolphe Thiers (1797–1877) postulated a unified past for their nation, while the more radical Jules Michelet (1798–1874) directed readers to the history of *le peuple* (the common people). Both the interest in individuals and the intuitive sympathy for the unique and distinctive contributions of past ages to modernity (the latter traceable to Herder and as far back as Vico) are hallmarks of a mode of apprehending the past that subsequent ages have called “historicism” (or, following Meinecke, “historism”).

But Romanticism had more immediate outcomes. Initially a conservative or even reactionary movement that privileged nature over reason and revalued neglected periods such as the Middle Ages, it proved adaptable for many in the next generations into a creed for the advancement of liberty and for the promotion of the rising tide of nationalism that threatened the stability of post-Napoleonic Europe. Romantic nationalism was often linked to a sense of identity built upon a shared sense of a people’s ethnic or even political past—for an example one need only think of

Lord Byron's fatal sortie into the Greek war against the Turks in 1824. The impact of nationalist historical consciousness was magnified, following the revolutions of 1848 and the return of progressive ideas in liberal or even radical political clothing, by national unification movements such as the Italian Risorgimento, and in the emerging independence of former satellites in Europe from imperial rule (already anticipated in the American Revolution sixty years previously) and that of other former colonies in North and South America.

Though there had certainly been eminent historians in newly established kingdoms like Belgium prior to their independence, sovereignty or the drive toward it provided an urgent need to establish both the shape of a national past and the capacity to write about it. Even those regions such as Bohemia that did not achieve political autonomy during the period still celebrated their separate identity and marked out a distinctive past. Thus František Palacký's (1798–1876) five-volume history of the Czech nation from earliest times to the Habsburg union of 1526 espoused a highly romantic and nationalist view of the Czech heritage, celebrating the Hussite religious reformers of the fifteenth century, for instance, as exponents of Slavic liberty against Germanic authoritarianism. European Jews, after centuries of rabbinically dominated treatments of their past, acquired a modern national history for the first time in the successive works of Isaac Marcus Jost (1793–1860) and Heinrich Graetz (1817–1891). The latter was a German whose *Geschichte der Juden* put Jewish history on a firm archival and philological basis while not losing sight of the connecting theme of endurance through centuries of exiles, persecutions, and massacres.

The pattern is similar elsewhere. In Hungary, Romantic historians such as István Horvat (1784–1846) created a popular if highly fictionalized remote past for the Hungarian people. The unsuccessful revolt of 1848–1849 was followed by nationalist histories (often authored by exiled liberals such as Mihály Horváth [1809–1878]) and by the foundation of the Historical Commission of the Hungarian Academy of Sciences (1854) and the Hungarian Historical Association (1867), as well as by the extensive publication of source material in the *Monumenta Hungariae Historica* (initiated 1857). Polish aspirations for independence and political reform are likewise reflected in the great quantity of sources published in the early nineteenth century, and in the liberal, pro-peasant multivolume history of Poland by Joachim Lelewel (1786–1861). The proto-Romantic nationalism of the historian Father Paisiy of Hilendar (1722–1773) set his native Bulgaria on a century of historical nation-building leading up to independence in 1878, at first affirming in an uncritical manner the nation's Slavic affiliations and ancient descent from remote nomadic progenitors like the Scythians—a time-honored convention going back to medieval and Renaissance theories of mythical national descent from peoples like the Trojans. Romania, which achieved independence in 1877, established a national academy shortly thereafter, and history was introduced at its newly founded universities.

In northern Europe, Norway acquired a university in 1811, just prior to its establishment (1814) of a semi-independent state in union with Sweden. Most historical activity remained for a time the work of politicians, jurists and poets, such as Henrik Wegeland (1808–1845), author of *Norges Konstitutions Historie* (1841–1843). An academic historiography first emerged in the 1830s with Peter Andreas Munch (1810–1863) and Rudolf Keyser (1803–1864); it retained the romantic outlook of earlier writers, but made significant advances in source-editing. French liberal historiography (Michelet and Guizot) as well as Darwinian-Spencerian notions of progress introduced a more positivist climate in the next generation, which was dominated by the radical proponent of complete independence, Ernst Sars (1835–1917). In Finland, academic historiography had existed since the foundation of the University of Turku in 1640, and had flourished in the Enlightenment with historians such as Henrik Gabriel Porthan (1739–1804), who had mainly written in international Latin. The new nationalist impulse (Finland became an autonomous state in 1809) ensured that vernacular-language works eventually overtook in volume those written in Swedish; the first full-length Finnish-language history of Finland would be produced by Yrjö Sakari Yrjö-Koskinen (1830–1903). Historical consciousness was further stimulated by authors such as the journalist, educator, and novelist Zacharias Topelius (1818–1898), a Finnish Sir Walter Scott, while foreign-authored histories from the south were also widely read. As in Norway, positivist historiography found an audience: England's Henry Thomas Buckle would have one of his strongest followings in Finland.

South of Finland in the Baltic region, nationalist sentiments were much slower to develop. The history of Estonia and Latvia was written almost entirely by their Baltic German intellectual elites prior to their independence in 1918, national sentiments from the 1860s producing relatively lit-

tle by way of historiography. Lithuanian historiography has been more fully documented thanks to Virgil Krapauskas, though its story is similar. Tied to Poland through much of the late medieval and early modern periods and dominated by Russia in the nineteenth century, Lithuania had actually lacked a written language prior to the late fourteenth century—early historical sources emanated from Russian, German, or Polish writers. Unlike other ethnic groups, Lithuanians thus had little by way of historiographical tradition prior to the romantic-era historian Simonas Daukantas (1793–1864), who wrote in Lithuanian and created a dubious pedigree for his people in a remote barbarian tribe. Earlier histories were rare. The “Bychovko chronicle,” the long version of a pro-Lithuanian sixteenth-century text generally known as the *Lithuanian Chronicle* was not available till 1846, when it was published by Daukantas’s contemporary, Teodor Narbutt (1784–1864). Another sixteenth-century Lithuanian chronicle, by Augustine Rotundus (c. 1520–1582), had long been lost. Daukantas had no immediate followers. As Krapauskas notes, between 1832, when the Russians closed the University of Vilnius, and the early twentieth century, Lithuania produced no academically trained historians of its own, though distinguished Poles such as Lelewel wrote about the Lithuanian past. The creation of a sense of national identity where none had existed fell to non-professionals: minor noblemen, poets and linguists, who were more interested in creating a heroic past than in following the canons of western historical scholarship; and the occasional part-time scholar like Bishop Motiejus Valančius (1801–75), whose historical work on his Samogitian diocese more closely approximates mainstream European critical historiography. Collectively, their work provided an essential ingredient for the establishment in 1918 of Lithuania’s own short-lived independence. Beginning in 1883, with the publication of the nationalist newspaper *Ausra*, Lithuanian intellectuals increasingly took an anti-Polish tack. While they traced their linguistic and cultural heritage back, rather tenuously, to the remote centuries of the once-powerful Grand Duchy of Lithuania, they repudiated connections to that state’s association with Poland in favor of a Herderian-style concept of the nation.

Russian historical writing continued to be influenced by Western European traditions in the late eighteenth and nineteenth centuries as it had in the time of Schlözer. As elsewhere, considerable activity was devoted in the post-Napoleonic era to the collection and publication of source materials, especially government documents, under the leadership of the Chancellor Nikolai P. Rumiantsev (1754–1826). An “Archeographic Commission” undertook a nationwide survey of archives and repositories analogous to Britain’s Victorian-founded Historical Manuscripts Commission. Various other archaeological and historical societies were established, such as the Russian Historical Society of Petersburg, whose *Russian Biographical Dictionary* (publication of which was interrupted by the October Revolution in 1917 and the society’s dissolution), is again a counterpart of a British publication, the *Dictionary of National Biography*. Influenced by the German classicist B. G. Niebuhr, M. T. Kachenovskii (1775–1842) adopted a highly skeptical approach to the early, Kievan period of Russian history. Hegel’s philosophy of history and the works of Friedrich Wilhelm Joseph von Schelling (1775–1854) were widely read among the intelligentsia of the 1830s and 1840s, influencing a “slavophilic” school of historians, but the general trend was toward Westernization of practical historical methodology in a “scientific” vein. The two outstanding historians of the second half of the nineteenth century were S. M. Soloviev (1820–1879) and V. O. Kliuchevskii (1841–1911). Soloviev had traveled in the West and heard lectures by the German Leopold von Ranke (see further below), as well as by Guizot and Michelet; he was personally acquainted with the great Czech Palacký. Soloviev’s prodigious *History of Russia since Ancient Times* appeared in twenty-nine annual volumes beginning in 1851, accompanied by numerous monographs. Rather like Ranke, he had a vision of history as a unified and continuous story of organic development. In the following generation Kliuchevskii, Soloviev’s pupil and successor, assigned a new prominence to the analysis of economic and social history, which would establish the groundwork for post-revolutionary Marxist historiography.

In North America, the British colonies diverged historiographically following the American Revolution. The northern colonies—the future Canada—remained firmly within the British imperial orb (despite the existence of a distinctive Francophone Catholic majority within the colony of Lower Canada, subsequently Quebec). A consciousness of Canada as a nation, historically, did not begin to mature until Confederation (1867) brought political unity and semiautonomous status within the empire, and even then Francophone historiography remained apart from its Anglophone counterpart, with recurrent sovereignty movements still building today on the belief in a historically separate Quebecois nation awaiting its rightful autonomy. To the south, the experience was very different. The prototype for a nationalist historiography had been established in

colonial-era writings that acknowledged the colonies' place in the empire but also celebrated aspects of their differences—for instance, in Puritan writings marking New England colonists as reformed “saints” who had voluntarily separated themselves from the ungodliness of the Old World. A distinctive nationalist historiography (admittedly fragmented by ideological and sectional differences for a century or more) thus emerged quite quickly following the independence of the new United States. Early postindependence American historians such as Mercy Otis Warren (1728–1814) provided a history of the Revolution emphasizing democratic values, while the biographers of major figures such as George Washington helped establish a pantheon of national heroes. Historical novels on the model of Britain's Sir Walter Scott were emulated by the likes of James Fenimore Cooper (1789–1851). Both American and world history were enormously popular among readers during the first half of the nineteenth century, but their writing remained the domain of gentlemen of leisure (and the occasional woman like Warren) or of journalists. Famous examples (both blind through most of their careers) include William Prescott (1796–1859), narrator of the Latin American conquests, and Francis Parkman (1823–1893), historian of the frontier. Internationally, the most widely recognized American historian was George Bancroft (1800–1891), a former professor turned diplomat and one of the first of his country to earn a Ph.D. from a German university, a trend that would increase in the second half of the century.

In Latin America, there had been a steady flow of historical writing in both Spanish and Portuguese areas since the conquests of the sixteenth century, a good deal of it by expatriate Spaniards such as the Jesuit historian of Paraguay, Pedro Lozano (1697–1752). The liberal values of the late Enlightenment dominated the writing of history during the nineteenth century, first in the form of constitutionalist historians who focused on the European-inherited legal institutions underlying independence, and later in a more independent and romantic kind of writing that, following Herder and Michelet, emphasized instead the importance of the spirit of the people itself in establishing well-functioning new societies in a postcolonial era: the Chilean Literary Society of the 1830s, for instance, had regular meetings in which selections from Herder and other eighteenth-century historians were read. A third and later group emulated the positivism of writers like Auguste Comte (1798–1857), Henry Thomas Buckle (1821–1862), and Herbert Spencer (1820–1903) to advocate a history that demonstrated the economic and scientific progress of the region along European industrial lines—knowledge of the past, said Vicente Fidel López in the 1840s, would allow planning for the future. The Chilean José Victorino Lastarria, who did not read Comte until the 1860s, nonetheless found in the Frenchman an endorsement of his own ideas from two decades earlier.

In Mexico, conquistadors and missionaries had documented the past since the sixteenth century, including the precolonial histories of the subjugated peoples, derived from native codices and oral information: the Franciscan Bernardino de Sahagún (d. 1590) presented his own survey in both Spanish and the Aztec Nahuatl tongue. Following independence from Spain in 1810, and during the political vicissitudes of the next hundred years, distinctive nationalist and liberal schools of history emerged. Portuguese Brazil, a nation of multiple ethnic groups, followed a similar pattern, as independence in 1822 produced a need for a national history. Early feeble efforts in this direction were transformed in 1838 by the foundation of the Instituto Histórico e Geográfico Brasileiro, which staged a competition in 1840 on the theme of how best to write a Brazilian history—a contest ironically won by the German naturalist Karl Friedrich Philip von Martius. The acknowledged founder of modern Brazilian history during this period was Francisco Adolfo de Varnhagen (1816–1878). Author of both a *General History of Brazil* and a history of Brazilian independence, Varnhagen made pioneering use of documents in European archives and opened up unstudied new subject areas, such as the relationship between Portuguese and native populations. Elsewhere in South America, as Allen Woll has shown, an intense debate concerning the proper method of history-writing followed the publication of Claude Gay's (1800–1873) political history of Chile. Gay, a French botanist, was commissioned by the Chilean government to write this work, and despite its endorsement by the respected Latin American academic and man of letters Andrés Bello, younger writers (including Bello's own one-time pupil, Lastarria) found its recitation of facts without a search for meaning unsatisfactory. Finally, there were those who sought meaning and instruction in the patriots of the South American past, drawing literary inspiration from across the Atlantic. Bartolomé Mitre (1821–1906), for instance, was initially enamored of H. T. Buckle's erudition. In the end, he gravitated toward Thomas Carlyle's “great man” interpretation of history, and Mitre's account of Argentine independence focused on the careers of its leaders, the revolutionary heroes Manuel Belgrano and José de San Martín.

The “Professionalization” of History

If the first half of the West’s nineteenth century is characterized by literary historical writing in a romantic and nationalist vein, the second half may be noted for a rapid growth in what may, with due caution, be loosely called “professionalization.” Although this too has nationalist origins, it is associated less with the “nation” in any ethnic, linguistic, or cultural sense than with the political “state” and its bureaucratic apparatus. The romantic liberalism of national independence and unity rapidly transformed itself in much of Europe into the institutional conservatism of preservation and social stability. Changes were signaled by a number of developments: the expansion of university systems and the turning of many of them by the century’s end to advanced training in historical scholarship; the systematization of public record systems in many countries; the advent of several new professional associations, frequently accompanied by a new style of high-standard periodical or journal; a further development of the longstanding trend to publish archival documents, often under government sponsorship and now with a considerably higher standard of accuracy than previously applied; and the systematic convergence of the erudite skills evolved over the previous three centuries (paleography, diplomatic, numismatics, and epigraphy) within an overarching science of the criticism of sources, for which the German term *Quellenkritik* provides the best shorthand descriptor. This is also significant as the period during which Western-style historiography first began seriously to have a lasting effect on its rival traditions in the Orient and the Middle East, starting it down a road to eventual hegemony in the twentieth-century world.

Any account of nineteenth-century professionalization must begin with a colossus: the imposing figure of the German Leopold von Ranke (1795–1886). Initially a student of ancient history and philology (which were themselves making considerable advances under the older contemporary whom Ranke admired, the philologist Barthold Georg Niebuhr), Ranke wrote a doctoral dissertation on Thucydides. He quickly expanded his interests to include the medieval and modern history of much of the world, beginning in *The Histories of the Latin and Germanic Peoples from 1494 to 1514* with the period tackled by Francesco Guicciardini three centuries earlier. Subsequent works traced the emergence of the European state system that this good German public servant much admired as the source of modern civilization and individual freedom; and with a gaze wandering steadily outward in expanding circles, his life closed with an unfinished multivolume *Weltgeschichte*. Staggeringly prolific as he was, however, Ranke is less important for any of his individual histories than for what he came to symbolize. Over his long career at the University of Berlin, which had displaced Göttingen as the epicenter of German scholarship, he thoroughly transformed the training of young historians (many of them foreigners), by focusing his research seminars on primary sources and their criticism. Among his pupils and associates, Ranke could include many of the great names of the mid- to late nineteenth century, such as Georg Waitz (1813–1886) and Heinrich von Sybel (1817–1895); the latter deserves much of the credit for having converted Ranke’s ideas into institutional form throughout Prussia and then Germany as a whole. Some of Ranke’s students, to be sure, departed from the master’s model. The Swiss historian Jacob Burckhardt (1818–1897), for instance, was an unusual apprentice whose great *Kulturgeschichte, The Civilization of the Renaissance in Italy* (1860) remains one of the most-read historical works of the entire century and is a forerunner of modern cultural history. The conservative Heinrich von Treitschke (1834–1896), who was not a student of Ranke but succeeded him in the chair of history at the University of Berlin (an opportunity Burckhardt had declined), deviated in a different direction. Treitschke’s multivolume history of early-nineteenth-century Germany (1879–1894) provided a celebration of the Bismarckian state and a script for later German imperialism—a development that Ranke, a European rather than a strict nationalist, would not have embraced.

Willingness to subject to criticism documents and texts, and the received notions that derive from them, has often been taken as a sign of secularism or impiety by contemporary critics and later admirers alike: one recalls John Selden’s experience in seventeenth-century England and the reaction to the Han Learning scholars of early Qing China, discussed above. The adulation now paid to earlier critics of Old Testament texts such as Richard Simon and Baruch Spinoza as heralds of modern secularism is not necessarily more accurate than the scorn heaped upon those scholars by conservatives of their own day. With Ranke we find a devoutly religious man, with intellectual debts to German idealist philosophers such as Johann Gottlieb Fichte, attempting to find God’s handiwork in history, as had so many historians before him, but with a focus on the mechanics of human action on the earthly stage to the degree that these could be recovered through careful criticism of sources. Ranke had a strong belief in divinely dictated progress, but also in the distinctive

value and contribution of each historical era and people, all “equal before God.” He promoted a historiography that as far as possible could tell the story of the past *wie es eigentlich gewesen*. This famous phrase translates most accurately as “the past as it essentially was”—not, as some later students thought, “the past as it actually happened.” Later admirers wrongly believed that this meant the complete avoidance of anything not based on a specific fact and the absolute repudiation of conjecture or interpretation, thereby ignoring the moral and philosophical side of Ranke’s work.

Thanks to Ranke, his immediate disciples, and the celebrated German university seminar environment, German scholarship loomed large over many of Europe’s nations in the second half of the nineteenth century and beyond; the Sorbonne historian Ernest Lavisse (1842–1922) was so impressed by Ranke’s successes that he introduced the historical seminar into French higher education. In truth, many of the methodological practices were already practiced elsewhere in Europe. The real appeal of the German approach to historiography was its emphasis on the historian’s calling as a professional (with the high status that it accorded in German society) rather than an amateur or “gentleman scholar.”

If anything, German influence was stronger outside western and central Europe than within. To the east, for instance, several generations of early-twentieth-century Romanian historians derived inspiration from Germany, including the archaeologist Vasile Pârvan (1882–1927) and the methodologist Alexandru Xenopol (1847–1920). To the north, the Dane Kristian Erslev (1852–1930) and the Norwegian Gustav Storm (1845–1903) both spent extended periods in German seminars. Although some British and French historians trained in Germany (Lord Acton [1834–1902], for instance, with the Catholic scholar Johann Joseph Ignaz von Döllinger), it was American students who most frequently flocked to Germany, returning home to staff departments of history and new graduate schools at U.S. universities. Of those historians working at American universities in the 1880s and 1890s, roughly half had spent some period of time studying in Germany, though frequently too short a period to permit them really to absorb German historical method—much less the whole philosophy behind it—in detail. The “objectivity” mantra chanted in American historiography for many decades may be ascribed in large measure to the importation of a naïve version of Rankeanism that upheld Ranke himself as an idol while largely misunderstanding the more subtle aspects of his thought. Indeed, the myth of Ranke was far more influential in America than his methods, and Gabriele Lingelbach has argued persuasively that the concrete influence of German historiography among U.S. historians at this time has been overstated. Many American scholars, such as Henry Adams, who introduced a seminar at Harvard, even held the German university system in low esteem. Again, it was the aura of the “professional” that was most appealing. Professional standards that upheld a creed of “scientific history” were policed by influential academics like J. Franklin Jameson (1859–1937), editor of the *American Historical Review* (est. 1895) and upheld by the newly founded (1884) American Historical Association. The brief assault on the supremacy of political history by James Harvey Robinson (1863–1936) and the “New Historians” before and after World War I, and the work of the Progressive historians such as Carl Becker (1873–1945) and Charles Beard (1874–1948), did not endure, but it opened the door to the advent of social history in the 1960s. Becker and Beard’s “relativist” doubts about objectivity were also rejected in the conservative search for certainties after World War II. The arrival of postmodernism has given them a new relevance in recent decades, though probably not one that either man would have welcomed.

European methods began to penetrate elsewhere in the world. Late Victorian notions of “scientific history” migrated into India during the first third of the twentieth century through British-trained Indian historians returning home to teach. In part owing to the influence of scholars such as the Sanskrit philologist Sir R. G. Bhandarkar (1837–1925), his son, D. R. Bhandarkar (1875–1950, an epigrapher and numismatist), and the Mughal-period scholar Sir Jadunath Sarkar (1870–1958), the institutional apparatus of Western historiography gradually emerged, beginning with the Historical Records Commission of 1919 and the Indian History Congress established in 1937–1938. Early attempts at multivolume histories of India were aborted, but advocates such as the novelist Kanaiyalal Maneklal Munshi promoted Hindu rediscovery of their ancestral, pre-Islamic past. Following independence in 1947, Munshi called for a new history of India which, on this occasion, under the direction of the prolific historian Ramesh Chandra Majumdar, resulted in *The History and Culture of the Indian People* (11 vols., 1951–1969). In recent decades, India has continued to produce outstanding scholars of international reputation such as the historian of early India, Romila Thapar (b. 1931), and the social historian Sumit Sarkar (b. 1939).

Perhaps the most interesting example of direct importation from the West and the profound change it could occasion is provided by Japan. Long closed to the West during the Tokugawa era, Japan rapidly opened up to international influence in the years running up to and following the Meiji Restoration of 1868, which brought an end to the age of the Bakufu. History had enjoyed considerable popularity through much of the nineteenth century, and the new regime established an official department of history and then, in 1875, an expanded Office of Historiography. Its initial purpose was to organize the compilation of the *Dainihon hennenshi*, a new history along the lines of the Six National Histories, and from a pro-Imperial perspective. A rival official history, the *Taisei Kiyo* (Outline of the Imperial Rule), to be written in Japanese, was also initiated by more conservative members of the new regime.

Following a series of renamings and reorganizations, the Office of Historiography was transferred to the Tokyo Imperial University in 1888, and a department of Japanese history founded there in the following year. Closed in 1893 when the government disapproved of its research agenda, the Historiographical Institute, as it had become, was briefly closed. It reopened in 1895, by which time the plans to write a new national history had been all but abandoned: attention now focused on the narrower mandate of recovering and publishing documents.

Any residual Chinese traditional influences on historiography were soon overwhelmed by Western scholarship, for in the meantime, the director of the office, Shigeno Yasutsugu (1827–1910) had arranged for one of Ranke's later disciples, the German Jew Ludwig Riess (1861–1928), to come to Japan in 1887 and teach at Tokyo Imperial University; he remained there until 1902. At the same time, reform-minded and pro-Western scholars such as Fukuzawa Yukichi (1835–1901), a reader of Alexis de Tocqueville, Buckle, Spencer, and Guizot, formulated a theory of civilization espousing the superiority of the West and the need for Japan to catch up with the rest of the world after centuries of isolation. Others practiced the equivalent of British "Whig history," describing the restoration as a major milestone on the road to progress. The popular historian Taguchi Ukichi, another admirer of Western liberals and social theorists, epitomized this outlook in his multivolume *Nihon kaika shoshi* (Brief history of Japanese civilization, 1877–1882). As in Europe, not everyone accepted the value of academic historiography: Yamaji Aizan (1864–1917), an outsider and popular historian highly critical of the sterility of scholarship at Tokyo Imperial, and of "dead history." Moreover, the consequences of the kind of source criticism that Riess's Japanese friends espoused were by no means always welcome, especially among conservative nationalists determined to maintain the tradition of a social and moral function in historiography. Shigeno (who was also president of the Historical Society established in 1889) was himself reviled as "Dr. Obliterator" for his attacks on historical verities. Another historian, Kume Kunitake (1839–1931) was forced to resign from his position in 1892 for using scholarly methods to undermine the historical basis of Shinto and thereby calling into question the historicity of the early myths; this in part occasioned the temporary closing of the Institute in the following year. In her authoritative study of the period, Margaret Mehl has argued (Mehl, p. 14) that in comparison with their German counterparts, scholars at the Historiographical Institute had scant influence on the national interpretation of the Japanese past.

By the end of the nineteenth century, Japanese historians had divided themselves into three formal fields: national (Japanese) history (*kokushi* or *Nihonshi*), oriental history (*Toyoshi*), and Western history (*Seiyoshi*). As the Kume affair illustrates, there was an uneasy tension in the application of what the Japanese themselves called "scientific history" to the construction of a national and Imperial-focused account of the past; in the decade leading up to World War II, the so-called "Imperial view of history" seriously constricted freedom of interpretation. Though actual incidents of government interference were not numerous, they have become well-known: for instance, the historian Tsuda Sokichi (1873–1961) was convicted in 1942 for undermining the still-revered national mythology of the *Kojiki* in work he had published nearly three decades earlier on the ancient imperial court. His doubts about the historicity of Jimmu and his immediate successors were entirely unacceptable in an aggressively militaristic state that had marked the founding emperor's 2600th anniversary in 1940 with national celebrations.

History as Philosophy and as Science

Although the general thrust of nineteenth-century historiography was toward critical scholarship and away from philosophical speculation, the period nevertheless gave birth to a number of schemes for the explanation of all of history, often by nonhistorians. Many of these had origins in German

idealism, especially Hegel's philosophy of history as the gradual self-realization of mind in history through a process of "dialectic." His views, while distinctive, had roots in earlier Enlightenment thinkers, but Hegel firmly rejected—as Herder had earlier questioned—the longstanding classical notion that history was "philosophy teaching by examples." For Hegel, history was a process and simultaneously a coherent narrative of that process, rather than a well from which useful guides to morality and behavior could endlessly be drawn.

The most significant consequence of Hegel's philosophy of history and its dialectic engine was its inversion by the socialist Karl Marx (1818–1883) into a historical materialist philosophy of economic and social change leading from primitive times, through feudal and capitalist phases, to the triumph of the proletariat. With less obvious debts to the philosophy of Ludwig Feuerbach (whom he severely criticized), the scientific positivism of Auguste Comte (whom he viewed with contempt), and more remotely to such a theorist as Vico, Marx developed his views of history piecemeal through several theoretical works, beginning with *The German Ideology* (1846). He wrote at least one work that can be considered a political history, the *18th Brumaire of Louis Napoleon* (1852). Without exception, no theory of history in modern times has had more influence, in terms of sheer numbers of adherents, especially among Marx's Soviet, Eastern European, and Chinese admirers, and the citizens of their states.

Germany also produced other versions of thought about the unfolding of history, and about the nature of the historical discipline. The historian turned theoretician Johann Gustav Droysen (1838–1908), though a believer in the possibility of improved historical knowledge, argued in his *Grundriss der Historik* and elsewhere for a less naive view of the historian's relationship to sources. Droysen placed particular emphasis on the creative role of interpretation as guided by present-day circumstances and values and the need for firm and consistent methodological rules. He was just as hard on historical positivists like Britain's H. T. Buckle for their reduction of human actions and institutions to the categories of the natural world. A further late-nineteenth-century turning away from the post-Rankean fetish of the document can be seen in Wilhelm Dilthey's (1833–1911) assertion that history is a mental act of understanding (*Verstehen*) whereby the meaning of events must be intuited from our own inner experience, not simply narrowly read from the sources. Like Droysen's, Dilthey's position was antipositivist because it assumed historical acts could be apprehended in a way that did not apply to the natural world of science, owing to our essential human similarity with historical figures. Wilhelm Windelband (1848–1915) similarly poured doubt on the modish tendency across Western Europe to see history as a "science" (in a positivist mode that went well beyond anything that Ranke would have advocated) by defending its status as an "ideographic" (representative of the unique and singular) rather than a "nomothetic" (law-generating) practice.

The notorious *Methodenstreit* or "dispute about method" set off in 1891 by Karl Lamprecht (1856–1915) presaged some of the uncertainties of the twentieth century. Critical of the neo-Rankeans of his day, but more sympathetic to positivism than Droysen or Dilthey, Lamprecht cast doubt on the usefulness of history conceived as the account of leaders and particular events, as opposed to larger groups, and invoked the need for an alliance with the incipient social sciences, including psychology. Though roundly denounced at the time, Lamprecht was not without adherents. His students included the leading Romanian historian of the next generation, Nicolae Iorga (1871–1940), and he was seen by a number of East German historians, following World War II, as having provided an "alternative to Ranke" (Chickering, p. xiii). At the same time, Lamprecht's historically minded contemporaries, the philosopher Georg Simmel (1858–1918), the political economist Max Weber (1864–1920), and a French former history student, Émile Durkheim (1858–1917), were pushing the study of the past toward the emerging discipline of sociology, which has enjoyed a steady if troubled relationship with its parent discipline in the century since.

German philosophy and German practice were powerful, and traveled well, but were not in the end omnipotent. The great French ancient historian of the mid-nineteenth century, Numa Denis Fustel de Coulanges (1830–1889), remained quite immune to Niebuhrian *Altertumswissenschaft*. In Britain, which has never highly valued speculative history (Arnold Toynbee being a notable, and oft-criticized, twentieth-century exception), little attention was paid to the philosophy of history. More surprisingly, even the reception of German scholarship and pedagogy was at best mixed. It was perhaps most influential in the area of the history of law, which enjoyed its

closest association with history since the days of John Selden in the seventeenth century. The legal historical scholarship of earlier jurists such as Friedrich Carl von Savigny (1779–1861) on Roman civil law proved useful in the historical debate at the turn of the century regarding the origins of English law and of medieval land-holding practices. Lawyers played a similar role in Germany, Britain, and the United States in related arguments about the degree to which medieval villeinage (and by extension, more modern Anglo-American institutions) was descended principally from Roman colonial origins, as suggested by the lawyer Frederic Seebohm (1833–1912), in pioneering work on agrarian and economic history, or from Anglo-Saxon freemen whose liberties were disrupted before and after the Norman Conquest, as maintained by another lawyer-historian, the émigré Russian Sir Paul Vinogradoff (1854–1925). This was an old debate, going back to the seventeenth century, but it was now investigated through a much wider array of sources. Perhaps the greatest British historian of the beginning of the twentieth century was also a lawyer. The Cambridge scholar Frederic William Maitland (1850–1906), who in 1887 founded the Selden Society to publish medieval legal documents, held a professorship of law rather than history, continuing the long connection between those disciplines that had produced the sixteenth-century French *érudits*, Vico, and Maitland's immediate model, Savigny.

In other contexts, German practices were less influential. England evolved independently a system for training historians (still based on the individual tutorial and without, as yet, the American emphasis on the Ph.D.), a professional journal in the *English Historical Review*, and a series of systematic publications or calendarings of documents such as the *State Papers* and the *Rolls Series* of chronicles, the last-mentioned essentially a counterpart to the German *Monumenta Germaniae Historica*. The most widely read historians, however, remained those of a more literary bent, outside the universities, such as Thomas Babington Macaulay (1800–1859) and the positivist speculator on the history of civilization, Buckle. Despite the eventual impact of educational reformers such as Cambridge's Sir John Seeley (1834–1895) on the curriculum, the British university until near the end of the century occupied a much less important role in historical scholarship than in either Germany or the United States. Celebrated historians such as the medievalist William Stubbs (1825–1901), the exponent of Teutonism Edward Augustus Freeman (1823–1892), and the Reformation historian James Anthony Froude (1818–1894), spent significant periods of their careers in church, journalism, or government rather than in a university setting (Stubbs resigned the Regius professorship of history at Oxford to become a bishop; Freeman became his successor after several unsuccessful attempts at a chair; Froude abandoned the university early in his career and only returned as Freeman's successor late in life, after most of his work had been written). The author of scholarly and popular works on this history of the English people, John Richard Green (1837–1883), was a sickly parish curate turned Episcopal librarian, and never held a university appointment at all.

German historical thought was under duress from other directions in the years leading up to World War I. The historical agency of “spirit,” “providence,” “mind,” and even God, so important for Hegel's or Ranke's predecessors and contemporaries, was fading fast in the age of the iconoclastic philosopher Friedrich Nietzsche (1844–1900), of Marxism, and of modern science. The nineteenth century ended on a quasi-positivist or at least “scientific” note with a variety of “method” books. Ernst Bernheim's (1850–1942) massive *Lehrbuch der historischen Methode: Mit Nachweis der wichtigsten Quellen und Hülfsmittel zum Studium der Geschichte* (1889), which was quickly translated into languages such as Japanese, confidently avowed that many facts of history could be known with certainty, though he conceived that others could only be surmised as “probable.” This trend toward a rather narrow preoccupation with method was also observable in fin-de-siècle France. Earlier French historians such as Jules Michelet and Edgar Quinet (1803–1875) had indeed been affected by speculative philosophy, the latter by Herder and the former by Vico (for whose rediscovery Michelet was largely responsible); the Hebraist and religious scholar Ernest Renan (1823–1892), who developed his own Herderesque theory of nationhood as a “spirit,” also flirted with materialism as a substitute for shaken faith. But as in Germany, this was increasingly a minority position. The apparatus of modern French historiography was established with the founding of the famous graduate research center, the *École pratique des Hautes Études*, in 1868 and of the major journal, *Revue historique* in 1876. Perhaps the most naïve expression of the evidentiary positivism at the root of scientific history—a belief in the methodological improbability and rock-solid documentary foundation of historical knowledge, without the Comtean reduction of all human knowledge to the natural sciences—can be found in a more concise French counterpart to Bernheim. A hugely successful manual on method, the *Introduction aux études historiques*

(1897) by Charles Victor Langlois (1863–1929) and Charles Seignobos (1854–1942) was soon translated or adapted into several other languages. The apparent confidence of some historians in the canons of historical method—soon to be seriously shaken—is best captured in the famous declaration of the Cambridge professor J. B. Bury (1861–1927) that history was a “science . . . nothing more and nothing less.”

The later nineteenth century also witnessed something else not seen before historiographically, namely the far greater involvement of women in historical writing in Europe and North America. Women had been readers of history for three centuries or more, and there had been a handful of notable female historians such as Ban Zhao, Anna Comnena, Catharine Sawbridge Macaulay (1731–1791), and Mercy Otis Warren, as well as numerous women authors of popular histories and biographies such as England’s Agnes Strickland (1796–1874) in the mid-1800s; Germaine de Staël (1766–1817) offered an iconic figure of female “genius” and historical imagination outside the realm of scholarly research. J. R. Green’s widow and collaborator, Alice Stopford Green (1847–1929), outlived her husband by nearly half a century, during which time she published several works on Irish history in her own right. Mary Anne Everett Wood (later Green; 1818–1895) abandoned an early career as a Strickland-like biographer of princesses to spend her life as a full-time editor of documents at England’s Public Record Office. With their admission to some universities women began to make even more significant contributions to scholarship: one of the most formidable economic historians of the first half of the twentieth century, Eileen Power (1889–1940) would proceed from Girton (a women’s college at Cambridge) to postgraduate study at the *École des Chartes*. In the United States, late-nineteenth-century feminists such as Elizabeth Cady Stanton, Susan B. Anthony, and Matilda Joslyn Gage compiled a *History of Woman Suffrage*, while Mary Ritter Beard (1876–1958) published what became the most important English-language survey of female agency and power, *Woman as Force in History* (1946). With all that, the career barriers to women in academic historiography remained daunting until at least the 1970s; the American Historical Association elected only one female president in its first hundred years of existence, although a number have been chosen since then.

Twentieth-Century Developments and New Paths

Historiography has changed enormously during the past hundred years, in ways that merit much fuller treatment than can be afforded here. This final section will be devoted to exploring some of these, including significant transformations in European-American and East Asian historical writing, and developments in other parts of the globe (for instance Africa and Southeast Asia) not treated in earlier sections. It is not the case—contrary to views once confidently held—that these regions had no forms of historiography prior to the arrival of Western imperial powers (any more than this is true of China or Japan). For convenience, however, the earlier history of historical writing in these understudied areas is included in the present section.

The African Past. In order to appreciate twentieth-century African historiography, it is first necessary to examine earlier forms of history on the continent. It was once commonplace to assert that Africa had no past prior to colonial times—it was one of those regions, like the New World or India, that Hegel dismissed as “without history,” a pronouncement that the late Hugh Trevor-Roper (1914–2003) notoriously repeated in the 1960s. In recent decades, this myth has been exploded, largely owing to the considerable efforts of historians to recover and compare oral traditions and to establish reasonably reliable chronologies of events, but also because of growing knowledge of the existence of writing outside Islamic North Africa before the arrival of Europeans. Poetry and folk tales from many regions have been demonstrated to possess a sense of the past and of historical events, with or without the presence of literacy. The oral tales of the Dinka of southern Sudan, for example, frequently begin with the standard assertion, “This is an ancient event.” In some regions hieroglyphics also preserved a record of the early past. Writing was introduced not by European colonizers, but by Arab and Berber invaders in the centuries following the rise of Islam, and a number of west African non-Arabic writing systems appeared in later centuries.

The Islamic influence was especially strong in the north, the region known as Maghreb, Ibn Khaldun’s *Muqaddimah* being its most famous historiographical product. Many indigenous tongues were represented with Arabic script (a practice known as *adjami*), for instance those of the Hausa of Sudan and the nomadic Fulani who conquered much of the Hausa territory in the nineteenth century. Historiographically, the Hausa were especially influenced by the *Ta’rikh al-*

khulafa (History of the caliphs) by the prolific Jalal al-Din al-Suyuti (1445–1505): as late as the early twentieth century, for instance, Abubakar dan Atiku's *Chronicle of Sokoto* imitated the form and style of al-Suyuti. The Hausa also evolved a courtly tradition of contemporary historical writing, exemplified in Ahmad b. Fartua of Bornu's chronicle of the reign of the Sultan Idris III (1570–1602). In more recent times, Hausa communities have developed local chronicles written in either Hausa or Arabic and have focused on maintaining chronological lists of rulers; that of the town of Kano, to give one example, goes back to a legendary founder and ends with a late-nineteenth-century emir, Mahammadu Bello.

In East Africa, *Kitāb al-Sulwa fi-akhbar Kilwa* (The history of the town of Kilwa, in modern Tanzania) was recounted in an anonymous early-sixteenth-century work commissioned by the Sultan Muhammad b. al-Husayn. Royal chronicles in the ancient Ethiopian Ge'ez tongue first appear in the thirteenth century (at the very same time that secular chronicle writing was increasing in medieval Europe) and continue (sometimes in Amharic) into the twentieth. Other Ethiopian historical literature in Amharic appears in the sixteenth century, such as the *History of the Galla*, composed in the 1590s. Further south, the language of Swahili includes a preponderance of narrative poems (*utendi*), of which the earliest written example, *Utendi wa Tambuk* (1728), is a historical epic set during the life of Muhammed. At the other end of the Sahara, west African kingdoms developed an Arabic-language historical literature, such as the *Ta'rikh-as-Sudan* (Chronicle of the blacks) by 'Abd al-Rahman al-Sa'di (fl. 1596–1656) and *Ta'rikh al-Fattash* (Chronicle of the researcher), initiated by Mahmud al-Ka'ti of Timbuktu, which was completed by a descendant about 1665.

Modern Western-style historical writing per se appears first in nineteenth-century colonial times—not a great deal later than its establishment in Europe. Initially, Western historical writing was largely the domain of the colonizers, especially missionaries, who were concerned to integrate African schoolchildren into a Christian and European past. There were some notable indigenous exceptions, such as Samuel Johnson (1846–1901), the Yoruba son of a Sierra Leone freedman who returned to his parents' home in Nigeria as a missionary. Johnson, strongly affected by classical historians such as Xenophon, authored a *History of the Yorubas from the Earliest Times to the Beginning of the British Protectorate* (published posthumously in 1921). This was based largely on Yorubaland oral historical narratives (*itan*) and eyewitness accounts, in addition to colonial documents; Johnson's purpose, as he announced at the start of his book, was to ensure “that the history of our fatherland might not be lost in oblivion, especially as our old sires are fast dying out.” Carl Christian Reindorf (1834–1917), another African cleric, used both oral and written evidence for his 1895 *History of the Gold Coast and Asante*, and the Buganda (part of Uganda) politician Sir Apolo Kagwa (c. 1869–1927) provided an orally based history of *The Kings of Buganda* (1901). In the West Central African territory of the Bamum (modern Cameroon), its local sultan, Njoya (c. 1880–1933), created his own ideographic script, modeled on European writing, and then commissioned the writing of a 548-page manuscript on the history and customs of his people.

All of these works were ethnically based, that is devoted to recovering and telling the past of a particular tribe. Unsurprisingly, given the clerical careers of most authors except Kagwa, they were also Christian-influenced, and most were heavily reliant on European sources, as was the somewhat later work of the Xhosa missionary John H. Soga, *The Southeastern Bantu* (1930). In the areas colonized by Germans, such as Tanganyika (part of modern Tanzania), Swahili historical works in Roman script, as well as verse chronicles in *adjami* appeared in the early twentieth century, beginning with Abdallah bin Hemedi 'Ajjemy's (c. 1835–1912) *Habari za Wakilindi* (Chronicles of the Kilindi, completed in 1906); this was an extensive record of the Kilindi dynasty that ruled the area in the nineteenth century, derived from oral traditions of the Shambala, a non-Swahili-speaking tribe. A reminder that the traffic between spoken tradition and written history can run in both directions is provided by Kenya's *Chronicle of the Kings of Pate*. The original manuscript of this work, which covers the town's history from the thirteenth to the late nineteenth century, was destroyed in 1890, but knowledge of its contents was so vivid that several writers were able to produce new written versions in the decades thereafter.

In South Africa, an indigenous black African oral tradition included Xhosa oral narratives, a subset of which, *amibali* (sing. *ibali*), dealt specifically with historical events and genealogical details. These were marginalized in the late nineteenth century by the “Settler School” of white historians and by white imperially focused historians (principally British though including the

occasional Afrikaner like Henry Cloete). Both of these groups advanced a negative view of the subordinated black culture. The earliest examples of colonial historical writing, in English, Dutch, or Afrikaans, appeared in the first third of the nineteenth century, but the Settler School really only consolidated with the work of the Canadian-born George McCall Theal (1837–1919), who, ironically, had compiled one of the earliest collections of Xhosa narratives. Although criticized for defects of scholarship such as a refusal to cite his sources and a reluctance to do more than recount events without analysis—like many of his contemporaries, he was not a professional historian—Theal proved hugely influential on subsequent historiography. The racist theme of European supremacy in his eleven-volume *History of South Africa* would be accentuated in the distinctive Afrikaner nationalist tradition after 1910, albeit with the center of gravity provided by events such as the Great Trek (the 1830s migration northward of Afrikaners in search of freedom from British Cape colony rule) rather than British imperial expansion.

The almost total neglect or disparagement of the black population continued into the apartheid era. Liberal historians such as W. M. Macmillan and C. W. de Kiewiet, beginning in the 1920s, began to integrate black and white experience, and to attend to social and economic history; they evinced concern for the treatment of indigenous blacks while maintaining the assumption of European civilized superiority. The writing of missionary-trained black historians, such as Soga, of the first half of the century, was notably inclined to a favorable view of the British. In the 1970s, however, more radical scholars, many of them Marxists, advanced a more serious attack on past historiography, likening colonialism and its apartheid aftermath to the class system. The works of British Marxist historians such as Eric Hobsbawm and E. P. Thompson and of the American Eugene Genovese seemed transplantable to Africa. Social theories such as André Gunder-Frank's "underdevelopment" thesis (originally developed with Latin America in mind) were similarly adapted by Africanists.

European-American historiography on Africa began in the nineteenth century—the celebrated American historian and civil rights activist W. E. B. DuBois (1868–1963) had provided inspiration for an early generation of black American scholars. Most early efforts were devoted to countering racist assumptions about the inferiority of Africans. These in turn were often derived from the so-called "Hamitic hypothesis" (the Bible-derived view that Africans were descended from Ham, son of Noah, or alternatively that only the "civilized" cultures of Egypt and North Africa sprung from European peoples such as the Phoenicians). It was not until after World War II, however, that the subject began to make its way, slowly, on to mainstream history curricula. Beginning in the late 1940s with the retreat of the European colonial powers and the establishment of independent nations in ensuing decades, a deeper interest in exploring their own past quickly emerged among African populations, stimulated by reaction to decades of education in an alien imperial historiography. With this came an urgent need to recast the historical record and to recover evidence of many lost precolonial civilizations. At the same time, European intellectuals' (especially British, Belgian, and French) own discomfort with the Eurocentrism of previous scholarship provided for the intensive academic study of African history, an innovation that had spread to North America by the 1960s. Foundational research was done at the School of Oriental and African Studies (SOAS) in London by scholars such as Roland Oliver (cofounder in 1960 of the *Journal of African History*), by the American economic historian Philip Curtin, and by the Belgian Jan Vansina (an authority on oral tradition). Francophone scholars have been as influential as Anglophones, in particular the Parisian social historian, Catherine Coquery-Vidrovitch (b. 1935). But African historiography has not been the sole creation of interested Europeans. African universities have, despite the instabilities of politics and civil war in many areas, trained their own scholars and sent many others overseas for doctoral training (South Africa has been rather exceptional in having a number of powerful research-intensive universities). The pioneering Nigerian historian Kenneth Onwuka Dike (1917–1983) studied at Durham, Aberdeen, and London, and SOAS alone has produced several African-born scholars, including the Ghanaian Albert Adu Boahen (b. 1932). Boahen in turn participated in the important early summary work of postcolonial historical writing, the UNESCO *General History of Africa*, directed by a "scientific committee" two-thirds of whom were Africans and written by over three hundred authors including the Kenyans Ali Mazrui (b. 1933) and Bethwell Allan Ogot (b. 1933), Joseph Ki-Zerbo (b. 1922) of Burkina Faso (formerly Upper Volta), and the Nigerian J. F. A. Ajayi (b. 1929). Francophone African historians had until recently an especially close relationship with French universities, notes Matthias Middell, though African history generally is less prominent within France than in the English-speaking world.

African historiography has also proved a fertile field for the application of various interdisciplinary approaches, including archaeology and linguistics. In particular, it has welcomed the application of social science theories such as “modernization,” “dependency,” and the above-mentioned “underdevelopment.” It has also provided a forum for Marxist concepts such as “modes of production” and “capital”; the work of Walter Rodney (a black radical historian assassinated in Guyana in 1980) has been especially significant in this regard. At the same time, the early focus on political history and the establishment of chronology has been displaced to a considerable degree by an interest in social, economic, and cultural issues, reflecting historiographic trends elsewhere in the world. In recent decades, “Africa” has proved too unwieldy an umbrella term, and the field has segmented into thematic subfields such as slavery and gender; postmodernism has also begun to make itself felt as the colonial and early postcolonial periods are revisited by a fresh generation. The popularity of African history has waned somewhat among North American students, but it remains firmly established as an area of research, sometimes conjoined with Afro-American studies.

China, Japan, and Korea. Western historiographical practices, often derived at second hand via Japan, began to influence late Qing scholars by the end of the nineteenth century. Chinese historical analysis had long been inclined to cyclical views of history as a series of alternating periods of order and disorder, throughout which individual dynasties rose and fell. In the face of rapid change, historians would turn instead to an explanation of the past as linear development over a series of periods. Liang Qichao, as Luke Kwong has shown, built on the previous generation’s works and on the thought of Britain’s Thomas Huxley in developing a five-stage, progressive theory of history (though he would express doubts as to progress and insist on the need for both cyclical and linear views). Liang and Zhang Taiyan advocated a general history (*tongshi*) based on Western practices (largely absorbed through Japanese and Chinese translations). Liang’s own *Xin shixue* (New history) appeared in 1902, citing Edward Gibbon as an exemplary model. A few years further on, in the wake of the republican overthrow of the Qing, and the “May Fourth” New Culture movement that began in 1919, American-style academic history arrived with the translation of the Columbia University historian James Harvey Robinson’s (1863–1936) *The New History* (advocating a broader inquiry into the past that went beyond politics) into Chinese by one of his admirers, He Bingsong (1890–1946). He, who had studied at Wisconsin and Princeton, also adapted Langlois and Seignobos into Chinese as a work on the writing of general history, *Tongshi xinyi* (1928). Another American-trained historian, Hu Shi (1891–1962) authored a history of Chinese philosophy, while Gu Jiegang (1895–1980) published a popular school textbook situating China in world history. At the same time, other Chinese scholars who were German-trained were introducing the very Rankean type of historical writing of which Robinson’s New Historians had been critical, a fine distinction that seems to have mattered little to the Chinese readers of both.

The early twentieth century would see some extensive reconsideration of the Chinese past. Archaeology produced alternative sources such as oracle bone inscriptions for the study of the most ancient dynasties, especially the Shang. Gu Jiegang authored a fundamental reevaluation of ancient Chinese history that was so strong in its dismissal of some received myths that his works were declared unsuitable for students in the late 1920s. In the 1930s an extensive debate arose over the periodization of Chinese history; the outcome of this “Social History Controversy” was the adaptation of the Chinese past into European and especially Marxist period categories such as “feudalism.” Even more than May Fourth scholarship, early Chinese Marxist historical thought, initially derived from Russian sources, produced a fundamental break with the Confucian didactic and moralizing practices that had dominated two-and-a-half millennia of history writing.

With the advent of the People’s Republic after the chaotic period of the Japanese occupation and the ensuing Communist-Nationalist civil war, Marxist historiography became state-sponsored orthodoxy. Fan Wenlan (1893–1969), whose *Zhongguo Tongshi* (General history of China) is a landmark of Chinese Marxist history, had been a Communist since the 1920s and was eventually appointed to head the Institute of Modern History—his close relationship with Chairman Mao Zedong probably saved his life during the Cultural Revolution. Early historiographical efforts were often Soviet-inspired, with textbooks translated directly from Russian. Beginning in the early 1950s and continuing into the 1970s, the focus of scholarship was the history of the peasantry and of capitalism, with the triumph of Communism depicted as inevitable. “Party” historiography became a significant subject in its own right, the texts produced by scholars carefully controlled and

orchestrated from above in a manner that makes the bureaucrat-historians of the Tang era seem positively independent by comparison.

Since 1949, historians at various times have suffered persecution for heterodox statements, while within the Communist Party itself, different factions have sought historical support for contending political positions. The Great Leap Forward (1959–1961) opened a rift among older and younger Marxist scholars and pressured academic historians toward a militant repudiation of “feudal” or “bourgeois” dynastic history, along with the construction of general histories on Marxist principles, and purged of reference to former dynasties, emperors, and events. This was accompanied by directives to subordinate past to present, history to theory, in a simplistic manner resisted by moderate academics such as Beijing University’s Jian Bozan (1898–1968). The Cultural Revolution had an even more terrible impact a few years later, virtually beginning with an attack on the respected historian of the Ming era, Wu Han (1909–1969), who would die in prison. Wu was the first of many historians whose careers were destroyed in these years, including Jian Bozan, who was hounded into suicide (both Jian’s and Wu’s reputations were subsequently rehabilitated under Deng Xiaoping). Following Mao’s death in 1976, the extremist Gang of Four even appealed to the memory of the despotic first Qin emperor in support of autocracy, while liberal critics looked to the ancient Zhou dynasty (eleventh to third centuries B.C.E.) for a model of democratic city-states along the lines of fifth-century Athens. Since the 1980s, entire eras have been rehabilitated, though a Party resolution of 1981 attempted to cut off ongoing historical discussions of the Maoist period in the name of unity. In the last quarter of the twentieth century, Chinese historiography opened up again to the West, and many Chinese academicians have been trained in Western graduate schools and Western books translated into Chinese. This liberalization has largely continued, despite brief setbacks such as the 1989 Tiananmen Square reaction.

The Westernization of Japanese historiography in the late nineteenth century has been recounted above. The early twentieth century saw a considerable expansion of this trend after World War I, with Marxist and social science influences gathering momentum in the 1920s and 1930s; economic history of Japan was practiced by scholars such as Honjo Eijiro (1888–1973) and Otsubuka Hisao (1907–1996), and local history by Yanagita Kunio (1875–1962). Extensive publication of sources also occurred. As we have seen, the period of the late 1930s and the war years marked a disastrous period for historiography, either silencing or co-opting those on the left. During the American occupation and after, Marxist interpretations would rebound, and an enormous effort was directed in the first postwar decades to the support of democracy by identifying the historic weaknesses in the imperial system that had brought the country to the brink of destruction: Maruyama Masao’s (1914–1996) studies of Japanese political thought, for instance, exposed the roots of “ultranationalism” and fascism. The 1960s would see a reaction against “elitist” history (including the Marxist version) and the creation of a “people’s history” (*Minsushi*). Although national devotion to the imperial past has never disappeared entirely, much of postwar Japanese scholarship reflects historiographical trends elsewhere, including the awareness of Eurocentrism. Since the 1970s, the same multiplication of subfields experienced in the West has also occurred in Japan.

Modern Korean historiography acquired a Western face through the intermediary of Meiji Japan, and Japanese scholarship dominated the study of Korea in the early twentieth century, during the period of occupation (1910–1945). One of the early consequences was a reactive rewriting of early Korean history on liberal, progressivist, and nationalist rather than dynastic lines by historians such as Sin Ch’ae-ho (1880–1936) and Ch’oe Nam-sŏn (1890–1957). Beginning in the 1930s and culminating in his acquisition of political influence in the north following World War II, the Marxist Paek Nam-un (1895–1974) featured prominently in the construction of a historical materialist past that integrated Korea within Marxist periodization. When Soviet de-Stalinization spread to allied countries in the mid-1950s, strictly deterministic materialism began to fall from favor among a younger generation of historians; beginning in the late 1960s, traditional international Marxism was largely abandoned in favor of a nationalist historiography of “self-reliance” (*Juch’ŏ*) devoted especially to celebration of the personality and family of Kim Il Sung. To the south, in the Republic of Korea, a central thrust of historiography since World War II has been to dispel foreign and especially Japanese views of Korea as backward and servile. The most influential recent members of the nationalist school have been specialists on ancient history, who have used archaeology as well as history to promote the notion of the Koreans as an independent and homogeneous ethnic group (*minjok*). According to this view, which continues to be taught

in school curricula, the Korean people and state can be traced back over four millennia to a mythic ancestor and state founder, Tan'gun (whose importance was first championed by Sin Ch'ae-ho in the 1930s), their unity having successfully endured generations of suffering from Chinese and Japanese oppressors. The various parallels with the oppression theme of European Romantic-era nationalist historical writing (Poland's Lelewel and Bulgaria's Paisiy, for instance), with modern Jewish historiography since Heinrich Graetz, and with the earlier foundation myths of late medieval and Renaissance Europe, would be worth further exploration.

South East Asia. Our account has so far neglected much of Asia outside India, the Middle East, China, and Japan. Yet there exists a variety of historiographical traditions in other parts of the continent that deserve mention and which for ease of reference are summarized here in one section devoted to Southeast Asia. The region as a whole has been studied extensively by Western scholars (in particular Dutch, British, and French) since colonial times, but we will address our attention to select indigenous forms of history writing, and to those authors the Thai-American historian Thongchai Winichakul usefully calls “home” scholars. In nearly every part of Southeast Asia, local forms of history have arisen, most of which have been influenced at some point by Islamic, Chinese, or Western ideas. The perceptions of the past in most Southeast Asian countries are complicated by the multitude of languages and by the thorny heritage of regional conquests and foreign colonization; they are virtually invisible in standard histories of historical writing, even those that pay heed to China and Islam.

From the perspective of the West, it is often easy to lump subregions such as Indochina together and assume that proximity will have produced similar cultural developments. This can be a mistake, as the examples of Cambodia and Vietnam illustrate. Cambodia, despite over a millennium of literacy, developed relatively little that could be called historiography prior to the establishment of French colonial rule since the *pangsavatar* (sometimes rendered as *bangsavatar*), or chronicle texts of the medieval period, did not survive; there are a few specimens from the nineteenth century such as the 1818 *Nong Chronicle*, which covers the years 1414–1800 and refers to an earlier chronicle that had by then been lost. Late exemplars of this form survive from the end of the colonial regime, under King Sisowath Monivong (d. 1941) and his grandson Norodom Sihanouk. Such histories or palace chronicles (*rajabangsavatar*) as did exist were generally deemed unpublishable regalia, and the royal monopoly discouraged scholarship prior to the country's independence. Much of the earlier material they contain is of questionable accuracy and may in fact have been copied wholesale from Thai chronicles. The major work from the early twentieth century is the *Tiounn Chronicle* (so-named for Monivong's principal minister, who directed its compilation) composed from 1903 to 1907 and then from 1928 to 1934, which was based on a range of earlier materials. Under the French, European methods were introduced, but Cambodian history was given low curricular priority; the brief and terrible rule of the Khmer Rouge in the late 1970s would pronounce an “end to 2000 years of history.”

In contrast, Vietnam has a much longer and richer experience of historical writing dating back nearly a millennium, with a great deal of genealogical activity occurring at the family level from the fifteenth century. Much of the early historical writing was Chinese-influenced (either Confucian or Buddhist) and written in now-archaic Sino-Vietnamese characters. Although successive Chinese invasions and domestic struggles are thought to have destroyed many early sources, an interest in the past extended down to local communities and clans that scrupulously maintained genealogical and biographical information (*gia pha*). Chinese-style dynastic histories or imperial annals, the *Chanb-Su*, record major events reign by reign, and were intended to celebrate the current ruling house, often at the expense of its predecessor. Vietnamese kings strenuously enforced an “authentic history” during the precolonial period. The most noteworthy distinctive historical texts include the *Viet su luoc* (Historical annals of Viet) from the fourteenth century, itself based on a thirteenth-century text by Le Van Hu'u, and the 1479 *Dai Viet su ky toan thu* (Complete historical annals of Great Viet) by Ngo Si Lien.

The eighteenth and nineteenth centuries also produced major historical works, such as Le Quy Don's (c. 1726–1784) *Dai Viet thong su* (Complete history of Dai Viet, also known as the complete history of the Le Dynasty). Traditional Vietnamese historiography would survive the advent of Europeans, especially the French, from the mid-nineteenth century, although it was subject to official censorship: a popular general history was Tran Tron Kim's (1882–1953) *Viet-nam su-luoc* (1929–1930). However, French scholars working on the area (and French-educated Vietnamese

returning home) gradually succeeded in introducing Western models of historiography during the 1900s, along with potent concepts such as nationalism and Marxism, with formidable effects on the country's subsequent development. The advent of the printing press in turn gave history a much wider public currency. Patriotic and anti-French historians like Phan Boi Chau (1867–1940), one of many Vietnamese intellectuals either jailed or exiled from 1908 until the 1920s, abandoned dynastic history and adopted Western historical categories, together with a concept of progress and social development derived from Sino-Japanese interpreters of Darwin and Spencer. The flurry of publishing in the 1920s, 1930s, and 1940s included a significant proportion of historical and biographical books and pamphlets, and Ho Chi Minh himself, after his 1941 return to Vietnam, authored a poetic history of the country. New histories, written by Vietnamese, followed the French withdrawal in the 1950s and signaled a further turn in scholarly historiography in the partitioned country. During the extended period of war prior to 1975, state-enforced Marxist interpretations in the north were met with equally fervent anticommunist historiography in the south, seriously constraining the range of topics that could be addressed. Since the introduction of an official policy of “renovation” in the late 1980s, some liberalization has occurred, including better exchanges of information with the rest of the world. However, an official history, subordinate to political ends, is still conveyed in textbooks, and certain subjects remain proscribed.

Myanmar (Burma before 1989) and Thailand (Siam prior to 1939) also have distinctive historiographies although there are some common points in Tai-language areas of Burma. The study of Burmese historiography is complicated by the powerful influence of myths and stories upon historical writing during relatively recent times rather than in older indigenous sources. Research by Michael Aung-Thwin has demonstrated that a number of so-called historical events rest not on primary sources but on “retroactive myths” or misinterpretations, principally of modern and colonial rather than ancient and indigenous creation. Early Burmese sources include nonroyal historical records, generally concerning particular kingdoms, places, or towns and known as *thamaing*, which is also the modern Burmese word for history. Monastic chronicles such as the *Padaeng Chronicle* recount the arrival of Theravada Buddhism in the Shan states bordering on Siam and Laos during the fifteenth century and the establishment of the Padaeng Vat (Red Forest monastery) itself. The *Jengtung State Chronicle* begins with a legendary or semilegendary section before covering the history of that Shan state from the fourteenth to the early twentieth centuries. Much Burmese historical writing is devoted to specific dynasties and particular kings, in particular the prose chronicles collectively called *Yazawin* (literally, “genealogies of kings”), which are based on written and oral sources and employ literary devices not unlike the classical set speech. According to Aung-Thwin, the *Yazawin* date back at least as far as 1520, when the monk Shin Thilawuntha produced his *Yazawinkyaw* (Celebrated chronicle of kings); only a few such chronicles are extant.

The great age of Burmese historical writing was the eighteenth century, beginning with the *Mahayazawingyi* written by the wealthy independent author U Kala (the first Burmese history thought to be sole-authored) during the first quarter of the eighteenth century. U Kala was followed in the late eighteenth century by an anonymous work, probably by a monk, the *New Pagan Chronicle*, devoted to the Pagan dynasty (1044 C.E.–1287 C.E.). The *Twinthin Myanma Yazawinbit* (The new history of Myanma, or Burma), written at the end of the eighteenth century by Twinthintawun Mahasithu, was the first to use inscriptions to verify facts in earlier chronicles such as U Kala's and to expand the meaning of *Yazawin* beyond the deeds of kings. This practice was not maintained in a series of nineteenth-century writings, generally under official sponsorship, which reverted to the older meaning. These included the *Hmannan Mahayazawindawgyi* (Great royal chronicle of the Glass Palace, so named after the meeting place of its authors), the collective work of a group of selected intellectuals. Essentially an updated version of U Kala's *Mahayazawingyi*, the Glass Palace chronicle was extended in subsequent chronicles up to 1905. These works focused almost entirely on royalty and were intended to present a clear and uncontested record of events accompanied by moral lessons—the *Maniyadanabon* of the late-eighteenth-century monk Shin Sandalinka is a repository of historical examples illustrating pragmatic political principles worthy of Machiavelli.

From 1947 to the 1960s, nationalist histories predominated in Burmese writing, accompanied by a few scholarly local histories and by an increase in biographical writing. The Burma Historical Commission was created in 1955, but has yet to generate the official national history with which it was charged. As Ni Ni Myint observes, *thamaing* displaced *yazawin* as the preferred term for a new kind of non-dynastic history in the years following World War II.

To the southeast, in Thailand, the premodern Siamese elite, who valued history from a very early period, produced historical poetry (for example, the fifteenth-century *Yuan Pài* or “Defeat of the Yuan”), and generated an extensive series of chronicles in various forms. The Buddhist-oriented *tamnan* (stories or legends), often written in Pali, the learned language of South Asian Buddhist culture, were composed from the fifteenth to the twentieth century. Thai-language *phongsawadan* (annals or dynastic chronicles) superseded them in the seventeenth century. The earliest and best, if briefest, example of the latter—which are more secular in interest though they still reflect Buddhist values—is the *Luang Prasert* (also spelled *Prasoet*) chronicle of Ayutthaya (or Ayudhya), the Siamese capital and associated dynasty destroyed by the Burmese in 1767. This work covers Siamese history from the fourteenth century and was composed about 1680; its name derives not from its author, who is unknown, but from its manuscript owner. Subsequent recensions of the chronicles of Ayutthaya, written in the late eighteenth century, extend its history to that time. Chronicle-writing was at its peak during a prolonged period of struggles with Siam’s neighbors, especially Burma, from 1760 to 1828.

The kings of the Chakri dynasty continued to support historical writing. King Rama I (d. 1809) commanded the revision of a number of *phongsawadan*, and his famous later successor, the Buddhist monk-turned-monarch Rama IV or Mongkut ([d. 1868] of *Anna and the King of Siam*) authorized the definitive Royal Autograph edition of the chronicles of Ayutthaya. Keenly interested in history, Mongkut also pursued the study of epigraphy. He and his heir, Rama V (d. 1910), commissioned the last in this tradition, a series of chronicles of his four Chakri predecessors by their long-serving administrator Chaophraya Thiphakorawong (1813–1870). Outside Bangkok, a particularly vigorous tradition of local chronicle-writing developed in northern Thai communities and subsidiary kingdoms. That of Chiang Mai (capital of the old kingdom of Lan Na), the work of an anonymous author who borrowed selectively and carefully from earlier sources, recounts its history from the thirteenth to the nineteenth century. Usually written on palm-leaf manuscripts or bark-paper, these chronicles peaked in the early nineteenth century, although there are well-known later examples such as the *Nan Chronicle*, compiled in 1894 by Saenluang Ratchasomphan, an official of the Nan king. Similar chronicles were written in Tai-language regions of Burma and what is now Laos.

Western non-chronicle histories and school textbooks first began to appear in the late 1920s. At the same time, the introduction of printing expanded the circulation of historical works, including many from abroad, among the Thai learned class. History-teaching at a university level also commenced in the 1920s, at which time a Westernized Thai historiography (*prawatsat*) emerged. A tradition of royalist-nationalist historiography was established by Mongkut’s younger son Prince Damrong Rajanubhab (1862–1943). A prolific author and educational reformer, Damrong was also an admirer of Ranke and Western scholarship in general. His historical work embodied a use of source criticism while retaining the dynastic focus of the older *phongsawadan*. The long-serving Thai official Luang Wichit Wathakan (1898–1962) developed the nationalist view of the past in a twelve-volume history, *Prawattisat Sakon*, which appeared opportunely in 1931, just before the overthrow of the monarchy. This veered away from dynastic history in favor of an account of the Thai nation. At the other end of the ideological spectrum, left-wing historiography has been represented in recent decades by a number of economic historians who have built on a seminal study of Thai “feudalism” by Jit Phumisak (1930–1966), a Marxist who was killed while fighting with a guerilla movement. The 1973 overthrow of Thailand’s military regime, and the recurrent instability of the next two decades, opened up historical scholarship to a range of new interpretations and to sources far beyond the traditional chronicles. Although the royalist-nationalist tradition established by Damrong has remained intact (especially in school textbooks), it has been challenged in recent years by scholars such as Nidhi Eoseewong, in works of local history, and through mass media such as television and magazines.

Malay-language historical genres, long influenced by Indian, Persian, and Arabic sources, have been well studied though most of their exemplars remain in manuscript. Originating in oral traditions, the first Malay writings about the past tended to be a mix of history and fiction intended principally for didactic purposes and to be orally performed rather than read in silence. The earliest surviving historical work is the *Hikayat Raja-Raja Pasai*, which dates from the later fourteenth to the very early sixteenth centuries and begins with the reign of a thirteenth-century Sumatran ruler, Malik al-Salih. The quantity of verifiable material proliferates somewhat after the seventeenth century. Islamic ideas of historiography, present from two centuries earlier, can be observed

more clearly from that point on. The chronological fixity and sense of causality in histories after this date distinguish them from other varieties of Malay literature, though these too contain historical material, most of which is of courtly origin and is organized around dynasties, often beginning with an origin myth. The best-known Malay historical work is the *Sulalat'us-Salatin* (Genealogy of kings) which exists in plural versions, the earliest of which dates from 1612 and which may be a revision of a sixteenth-century text. It is most often attributed to an early editor, the obscure prime minister of the kingdom of Johor, Tun Seri Lanang, and was extended forward by subsequent writers. This work is more often known by the title *Sejarah Melayu* (rendered rather misleadingly as “Malay Annals”) and reaches back several centuries. As with other such “palace” chronicles, its function is not to establish accurate dates in the Western style but to make a case, in this instance for the descent of the fifteenth-century Malaccan sultanate, predecessor of the Johor empire, from Iskandar Zulkarnain (Alexander the Great). The *Hikayat Marong Mahawangsa* (or *Kedah Annals*), from the Thai-influenced northwest Malay peninsula, is a didactic text relaying the arrival and triumph of Islam in that area, and its events are much less verifiable from external sources than those in the *Sejarah Melayu*. Other *Hikayats* vary considerably in the degree to which they contain verifiable historical events as opposed to myths and legends, and modern Malay scholars such as Sir Richard Winstedt subdivided them formally into historical and romance categories. (This now seems an artificial division, and we must once again guard against applying modern Western divisions of fact and fiction to other cultures’ perceptions of their pasts. The anthropologist Shelly Errington has even commented that genres like the *hikayat* ought not be considered history at all since they appear not to arise from “an impulse to write history,” cannot be assumed to relate events in chronological order, and rarely contain events that can be explicitly identified as having occurred). Examples include an anonymous eighteenth-century chronicle, the *Hikayat Negeri Johor*, which covers events in parts of the Malay peninsula since 1672, and the *Hikayat Bandjar*, a product of the south Borneo coastal Malay kingdom of Bandjar.

Modern Malay historical writing began in the early twentieth century, when *tawarikh* (a modern, Muslim-derived term for history) was introduced into schools and a distinction made between it and the more literary content of the *hikayats* (though it maintained the preoccupation with dynasties and political elites). Abdul Hadi bin Haji Hasan published the three-volume *Sejarah Alam Melayu*, the first modern national history, during the 1920s, and a significant number of state and local histories appeared in the years leading up to and following Malaysia’s acquisition of statehood in 1957. More recently, academic historiography has expanded considerably in Malaysia owing to the mandatory study of history in secondary schools since 1987.

Though it shares the Malay language with Malaysia as its modern lingua franca, the case of Indonesia is especially complex, because of its many constituent peoples and languages. Javanese historiographical forms, for instance, include the genre known as *babad*, historical poems generally relating the foundation and subsequent history of Java, or the relation of a particular event, usually a war. These *babad*, also featured in the literature of Java’s neighbor, Bali, were often composed by court poets. They are generally of recent (eighteenth-century and after) origin, and scholars differ on the degree to which they may be relied upon for factual accuracy—though it has been argued that the Western dichotomy between fact and fiction is simply irrelevant since the concept of fiction does not exist, only a notion of degrees of veracity. Examples include the *Babad Tanah Jawi* (Chronicle of the land of Java), a group of texts covering the era from mythical times to the late eighteenth century, *Babad ing Sakhala* (written 1738), a two-thousand-line verse chronicle running from 1478 to 1720, and *Babad Jaka Tingkir*, a mid-nineteenth-century account in seven thousand lines of events that occurred in the sixteenth century, drawn in part from Dutch texts. There are also much earlier Javanese works like the fourteenth-century poem by Mpu Prapanca, the *Desawarnana* and the fifteenth-century (approx.) *Pararaton* (Book of kings), which covers thirteenth-century events.

In northern Sumatra, historical narratives imported from Malay and other languages circulated orally before being written down in verse forms; the eighteenth-century Acehese-language epic *Hikajat Pötjoet Moehamat* describes an earlier civil war, and provides an indigenous history quite in contrast to the official versions of successive Dutch and Indonesian rulers. Oral traditional historical narratives, or *tutui teteek* (“true tales”), circulated widely on the southeast Indonesian island of Roti, as did oral dynastic genealogies of the Rotinese lord or *manek*; many of these traditions have been independently verified by reference to Dutch colonial documents. On Sulawesi, Bugis, and Makasar, historical works date from the seventeenth century and include chronicles or nar-

ratives called *attoriolong* (Bugis for “that which concerns people of the past”) which use lengths of reigns and elapsed times rather than dates to fix chronology.

As these few examples illustrate, a proper survey of Indonesia’s historiography must examine several distinctive literatures and traditions. The construction of a national sense of the past in the face of multiple ethnicities has been no less daunting than the establishment of the nation itself. In the first half of the twentieth century, Dutch-trained Indonesian historians concentrated on providing a background to support aspirations for Indonesian national independence. With the backing of Japanese occupiers at war with Western colonial powers, a nationalist-anticolonial historiography was introduced during the early 1940s. This was largely the work of the nationalist leader and future president Sukarno, the textbook writer Sanusi Pane (1905–1968), and especially the lawyer Muhammad Yamin (1903–1962). Yamin, an admirer of the Malay Tun Seri Lanang and a reader of the French historian Ernest Renan, popularized a romantic vision of history centered on Java. A number of academics such as Muhammad Ali criticized the nationalist bent in historiography in the late 1950s and early 1960s, but it acquired new teeth with the advent of the Suharto regime after 1965. A more militaristic official nationalist history emerged under the direction of the historian, soldier, and minister of education, Nugroho Notokusanto; a virulently anticommunist and “patriotic” multivolume history of Indonesia prepared in the 1970s, *Sejarah Nasional Indonesia*, was an uneasy amalgam of official history with the work of university-based historians. During Suharto’s “New Order,” the nationalist tradition was strictly enforced on schools, even in outlying and problematic territories such as East Timor. Since Suharto’s 1998 resignation, nationalist historiography has been openly challenged by a number of alternative visions of the past, including those representing different localities and submerged ethnic groups such as the Acehnese.

To the northeast of Borneo lie the Philippine islands. Long under Spanish and then American rule, the peoples of the Philippines adapted early on to the historical interests of the conquerors, to the great detriment of pre-existing historical memory. Tagalog *awits* or metrical poems include the *Historia famosa ni Bernardo Carpio*, a romance derived from older stories of medieval Spanish-Moorish conflict. Having largely eradicated precolonial forms of literature, Spanish missionaries used the *awit* as a tool of colonization; the *awits* became so familiar in both written and oral form that, Reynaldo C. Ileto notes, the average Filipino by the nineteenth century “knew more about Emperor Charlemagne, the Seven Peers of France and the destruction of Troy than of pre-Spanish Philippine rajahs and the destruction of Manila by the conquistadores” (Ileto in Reid and Marr, p. 381). Ironically, the chivalric and heroic figures in the *awits* would prove inspirational to Tagalogs dreaming of emancipation from Spanish rule at the end of the nineteenth century, as they transformed the legendary Spaniard Bernardo into a nationalist hero.

According to John N. Schumacher, there appears not to have been any formal historiography in the Philippines prior to the Spanish, despite the existence of writing. The first post-Conquest example is the *Sucesos de las Islas Filipinas*, written by the Spanish official and unsuccessful warrior Antonio de Morga (1559–1636) and published in Mexico in 1609—the only early history to be written by a layman. Throughout the seventeenth and eighteenth centuries, the various resident religious orders produced chronicles largely focused on their own missionary activities. As with the *awits*, however, western histories proved eventually an incitement to nationalism, particularly in the hands of young Filipino secular priests sent back to Europe for higher education in the 1860s. Published work on Filipino folklore and customs began to appear, along with previously unpublished chronicles put out in the *Biblioteca Historica Filipina* series in the 1880s; the journalist Isabelo de los Reyes would establish a Filipino identity in a number of historically-oriented newspaper articles and books. A more sophisticated appeal to history would emerge from José Rizal (1861–1896), who had visited Germany and become aware of western historical methods. During an exile in London in 1887–1888, he provided a carefully annotated edition of Morga’s work, stressing the achievements of pre-Spanish Filipinos and their moral decline under foreign rule. In this form, Rizal’s views would both contribute to revolutionary sentiment following his execution, and ultimately to the continuation of historical study through the ensuing decades of American rule.

This very short survey of a small selection of Southeast Asian historical traditions is far from exhaustive (we have said nothing of the South Sea Islands, for example, where a great deal of ethnographic work on historical memory has been done in recent years by anthropologists), but

it provides a warning against assuming that history is exclusively the perquisite of Western nations, or even of highly bureaucratized Asian countries like Imperial China. It is perhaps worth offering the further cautionary observation that the types of recent political repression of historians, and attempts by governments to enforce a particular perspective on the past, are conversely not restricted to Indochinese totalitarian regimes or island military dictatorships (nor to older authorities like the Catholic Church and the ancient Qin emperors). In the world's largest democracy, India, the advent in 1998 of the BJP-led government (defeated in elections as this essay was going to press) posed a serious threat to historiography and historical pedagogy as the Hindu nationalist regime undertook measures that included the excision of material in school textbooks (a measure publicly condemned by historians such as Sumit Sarkar) and the encouragement of attacks upon distinguished scholars such as Romila Thapar who were deemed to hold disloyal views of the nation's past. Other examples can be found in the West, such as the controversy in the United States in 1995 over an exhibition to commemorate the fiftieth anniversary of the dropping of the Hiroshima atomic bomb, the virulent public reaction in Canada to a 1991 television series perceived as critical of the Canadian forces during World War II, or the ongoing "history wars" in Australia, turning in 2004 on sharp right-left disagreements over the past treatment of the aboriginal population by colonists and imperial authorities. Even more odious monthly additions to the list of historians suffering persecution of one sort or another across the globe make for uncomfortable reading.

The Middle East. After an eighteenth-century decline in Ottoman historical writing, and the temporary displacement of Arabic by Turkish as the dominant elite language of much of the Islamic world, Islamic historiography written in Arabic began to recover in the mid-nineteenth century. This occurred in the wake both of European expansion into the Middle East and Africa and of reforms within the Ottoman Empire itself, which gave rise to incipient Arab nationalism. Many areas had enjoyed some autonomy from Istanbul for a century, with the result that there were already some examples of Arabic-language histories focused on pan-Arab national identity. This was true in Tunisia and Lebanon as well as in Morocco, which historically lay outside Ottoman control. Arab intellectuals in the second half of the nineteenth century began to write histories as continuous narratives, rather than annals, devoted to establishing national pasts, which now also included the pre-Islamic periods. Older pan-Islamic cultural and religious impulses remained as important as newer Arab nationalism, as Muslims confronted the dilemma of how to coexist with Western infidel powers, and as modern Islamic thought, influenced by Western science and technology, itself began to take shape in the hands of activist-reformers like Sayyid Jamal al-Din Afghani (1838–1897), the author of a history of Afghanistan.

During this period, efforts were made to print historical sources, and a number of learned societies were founded with historical interests. The Egyptian 'Abd al-Rahman al-Djabbart (1753–1825) anticipated this revival of historiography with his compelling account of the French occupation of Egypt, and a philosophy of history that echoed Ibn Khaldun's. Al-Djabbart's countryman Rifa'ah Rafi' al-Tahtawi (1801–1873), who had spent five years in Paris, became the channel through which modern European historiography began to enter the Arab world. He translated several French works into Arabic and authored a history of ancient Egypt that consciously emulated modern rather than classical Islamic historical forms; he was also instrumental in reforming the Egyptian school curriculum, which by the 1870s routinely included history. During the era of British rule in Egypt, the influential politician Mustafa Kamil further encouraged nationalist views of his country's past; this trend cut across and in many ways contradicted the Islamic views of most historical writing in the previous millennium.

Most of the historians in this period tended to be non-academics: the Syrian Ilyas Matar (1857–1910) was an Ottoman official, physician, and lawyer, and his compatriot Jurji Yanni (1856–1941) an Orthodox Christian journalist and intellectual. The Lebanese-Egyptian Jurji Zaydan (1861–1914) was a journalist and a prolific author of historical novels in addition to a multivolume history of Islamic civilization (1902–1906). Academic historiography began slowly in the post-Ottoman era starting in the 1920s, initially in the hands of North American- and European-trained scholars, thus extending the dominance of Western-style academic history over the Islamic world's long distinct historiographic traditions. Asad Rustum, a historian of Syria, published an Arabic-language manual on Western historical method in 1939, largely drawn from Langlois and Seignobos's famous textbook, a work that was already fast losing ground in its homeland in the face of the emerging *Annaliste* (see below) historical revolution. A Lebanese Maronite, Philip Hitti,

published a survey of *Lebanon in History* in 1957; more recently, Kamal Salibi (b. 1929) has revised the history of Lebanon and made a close study of its earlier, medieval historiography.

In Turkey itself, the collapse of the Ottoman regime and the institution of Kemal Atatürk's republic in 1923 occasioned a significant rupture with the recent past and with the longer tradition of Ottoman official historiography whose last great representative, Ahmed Cevdet Pasa (1822–1895), a remote disciple of Ibn Khaldun, had produced an enormous annalistic account of events from 1774 to 1826 (continued by Cevdet Pasa's successor Ahmed Lutfi up to the 1860s). Western scholarly methods had, however, begun to appear in Turkey, along with European texts, in the mid-nineteenth century; at the same time, new historical genres such as memoirs also appeared. The study of numismatics and sigillography arrived in Turkey about the same time, and the newer methods began to influence reference books, school texts, and popular histories. The Faculty of Letters at the University of Istanbul, established in 1900, became a training ground for historians, and institutions such as the Imperial Museum of Antiquities (1891, now the Archaeological Museums) provided the infrastructure.

These developments provided a backdrop to the writings of the first generation of republican historians. Unsympathetic to the decay of the later Ottoman Empire in the previous two hundred years, the republicans nevertheless embraced the successes of the empire's glory days from the thirteenth to the seventeenth centuries. As Cemal Kafadar notes, the founder of modern Turkish historiography, Mehmet Fuat Köprülü (1890–1966), began to articulate this vision in the 1930s in a series of lectures at the Sorbonne, soon published as *The Origins of the Ottoman Empire* in French and Turkish. Köprülü focused on Osman (the eponymous founder of the Ottoman house) and the rise of the Turks in thirteenth-century Anatolia; his theories would be elaborated and revised by the Austrian Paul Wittek (1894–1978). The task of this generation of historians, sorting out legend from fact, and balancing ethnicity, religion, and other influences, is in some ways redolent of the romantic nationalist historiographies of the early and middle years of the nineteenth century and, more remotely, of Renaissance debates about national origins, albeit now approached with the tools of modern scholarship. The new work, to which non-Turks such as Wittek and the Greek George Arnakis (a severe critic of Köprülü) contributed, was carried out against a long-standing Western European historiography of the Ottomans dating back to the Englishmen Richard Knolles (c. 1550–1610) and Paul Rycaut (1628–1700) and including more recently the early-nineteenth-century Viennese Joseph von Hammer-Purgstall (1774–1856), and the American Herbert Gibbons (1880–1934). The opening of Ottoman archives in the 1940s redirected scholarship in newer directions of social and economic history, and since the mid-twentieth century, Turkey has continued to produce academic historians such as the left-leaning economic historian Mustafa Akdağ (1913–1972) and his critic, the distinguished historian Halil İnalcik (b. 1916), a student of Köprülü.

As in other regions, since the 1960s social and economic history have emerged in the Middle East as serious rivals to an older, politically focused narrative history. Islamic-focused women's history (which can be traced back to entries on women in an older form, the biographical dictionary or *tabaqat*) has also developed, with newer feminist approaches strongest in Egypt; the male-oriented and restrictive practices of the Muslim fundamentalist regimes have themselves become the subject of study. As Judith E. Tucker notes, recent feminist historians of Islam, some working outside the region, have restored women to roles of significant influence in the longer Muslim past, for instance in Leila Ahmed's *Women and Gender in Islam* and numerous works by the Moroccan sociologist Fatima Mernissi, such as *Women and Islam* (1991). Recent collections of essays such as Guity Nashat and Lois Beck's *Women in Iran from the Rise of Islam to 1800* have also explored the historical place of women in Islamic societies from very early times.

Europe and the Americas. The myriad developments of Western historiography over the past century could easily merit an article in their own right, but since they are readily accessible in other works, the principal developments will only be summarized briefly here. Broadly speaking, the trends outlined for the nineteenth century continued into the first half of the twentieth, though the Einstein-Planck challenges to Newtonian physics, closely followed by the horrors of World War I and the end of the old empires, severely shook whatever remained of the late-nineteenth-century faith in progress and in science. The pessimism following the war's unprecedented slaughter produced some gems of *Kulturgeschichte*, built on the themes of civilization's decadence and decline, such as the Dutch historian Johan Huizinga's (1872–1945) brilliant and Burckhardtian

aesthetic excavation of *The Autumn of the Middle Ages* (1919), which could be read as an allegory for pre-war cultural decadence. A longer and much less subtle example is the German Oswald Spengler's (1880–1936) multivolume speculative analysis of distinctive cultures through history. Harkening back to Nietzsche, and at least superficially anticipatory of Nazism, *The Decline of the West* was a work of reactionary generalization and extreme intellectual relativism; largely completed before the beginning of World War I, it appeared to great fanfare just at its end. Among other things, Spengler's *Decline* would help to inspire the very different (if equally speculative and relativist) British take on comparative civilizations, Arnold Toynbee's (1889–1975) *A Study of History* (12 vols., 1934–1961), which its author began in earnest in 1920, after reading Spengler.

Meanwhile, academic reactions to strict scientific history in the more narrow, positivist sense, echoing Dilthey's earlier qualifications, can be seen in the enormously influential Italian philosopher and historian, Benedetto Croce (1866–1952). Like Dilthey, Croce rejected both Rankean historical method and scientific positivism, arguing instead the autonomy of history from science, and the inseparability of history and life—records and documents only have significance insofar as living humans can reflect upon them and, indeed, relive them; conversely, we only make sense of life by thinking historically. A pronounced antifascist, he also held to a view of “history as the story of liberty.” Croce's views appealed to many, including his younger British contemporary, the archaeologist turned philosopher R. G. Collingwood (1889–1943). Collingwood's posthumously published *The Idea of History* advanced the notion that “all history—is the history of thought” and suggested that the historian must empathize with his or her subjects, enter into the “interior” of a historical event (the thought of the agent behind the event), and mentally “re-enact” it in order to retell it. His book remains very widely read, and its concept of historical imagination has come back into vogue with the advent of postmodernism in the past twenty years. The Brazilian-born Spanish literary scholar and historian, Américo Castro (1885–1972) echoed both Collingwood and the American Carl Becker in his assertion that “To write history demands a historian willing (and able) to enter into the living consciousness of others through the door of his own life and consciousness” (p. 305). Castro, who fled to the United States following the Spanish Civil War further reflected historicist sentiments in his views upon the inseparability of a people and its history, and of the relationship between individual and general histories. In a very different focus on the human interior, the later works of Sigmund Freud, especially *Moses and Monotheism* (1939), applied his own psychoanalytic theories and clinical experience to the “diagnosis” of history. The process of civilization Freud envisaged as an endless struggle of love and hate, sex and death, arising from primal patricide, and carried forward by leader-figures such as Moses in conflict with the mobs whom they dominated—the irony of the similarity in this regard between a Viennese Jew and aspects of the thought of both Nietzsche and Hitler is difficult to escape. The European scholarly tradition had without doubt put some distance between itself and Ranke's history *wie es eigentlich gewesen*.

If irrationalism, skepticism, and pessimism were the dominant chords struck in Western Europe and, to a lesser degree, in North America, the dissonant sound from further east came in the form of Marxism. Just prior to the Bolshevik Revolution, Kliuchevskii's former pupil, Mikhail Nikolaevich Pokrovskii (1868–1932), developed a Marxist version of Russian history in his multivolume study *History of Russia from the Earliest Times to the Rise of Commercial Capitalism* (1910–1914; English trans. 1931). This was endorsed by Lenin and for a time Pokrovskii was the dominant force in early Soviet historiography; after his death, however, he was condemned by Stalin and abandoned by Party historians for his lack of nationalist sentiment. Initial tolerance of intellectual autonomy in the 1920s gave way to rigid Party control in the 1930s, and the state would have an overbearing influence on history-writing from the purges of scholars in the 1930s to the collapse of the Soviet Union seven decades later. This control spread far beyond the borders of the USSR to include the various Soviet satellite states and Warsaw Pact allies in Romania, Poland, Bulgaria, East Germany, Hungary and Czechoslovakia.

Without state sanctions to support it, academic Marxism never attained a dominant position in the West, but had a profound influence nonetheless through the 1980s. Marxist, socialist, or left-leaning historiography began to appear in the Western democracies relatively early in the twentieth century; the leading Norwegian historian of the first half of the twentieth century, Halvdan Koht (1873–1965), for instance was an early self-avowed Marxist. The attraction of Marxism increased in the aftermath of the financial collapse of 1929 and the ensuing Great Depression, which seemed to bear out Marx's views of the inevitable collapse of capitalism. The dalliance of many

interwar British and some American intellectuals with communism provided the earliest examples of historiography that, in the 1960s, would evolve into Labor history, “radical history,” and what is sometimes called “history from below.” Several classics of late twentieth-century historical writing such as E. P. Thompson’s (1924–1993) *The Making of the English Working Class* (1963) and Georges Lefebvre’s (1874–1959) many books on the French revolution were written from an explicitly Marxist, albeit more humanistic, perspective that emphasized the daily lives of the history’s underclasses. A modified version of Marxism articulated by the Italian socialist Antonio Gramsci (1891–1937), with its concept of cultural “hegemony,” has retained an influence in much non-Marxist historical scholarship and literary history.

A very different creation of the interwar period was what has become known as the *Annales* school in France, so called after the journal that began publication in 1929 at the University of Strasbourg under the guidance of Marc Bloch (1886–1944) and Lucien Febvre (1878–1956), two French scholars much influenced by the earlier work of the sociologist Durkheim and the geographer Henri Berr, and with close ties to the Belgian medievalist Henri Pirenne (1862–1935). The journal and the “school” (rather a misnomer, albeit useful as a shorthand) have evolved considerably through successive generations but remain an influential force in France and much admired elsewhere, particularly in North America. The *Annalistes*’ repudiation of the political history of previous decades—Febvre condemned Charles Seignobos for an obsession with events—in favor of an *histoire totale* that examined geography, climate, economy, and agricultural and trade patterns, as well as manners, still seems fresh after seventy-five years. It is, however, a further reminder of the recurrent swing of the pendulum of European historiographical taste between the social and the political, the broad and the particular, dating back to the Enlightenment—and beyond, as far back as Herodotus and Thucydides.

The *Annales* historians also advocated a new *modus vivendi* between history and the social sciences, with Fernand Braudel (1902–1985) calling for the subjugation of *histoire événementielle* (short-term human actions, for instance in the political world) to the study of longer periods of social, material, and economic *conjonctures* and the much slower geographical and climatological changes that occurred over the *longue durée* of centuries; the classic expression of this layered periodization is Braudel’s own study of *The Mediterranean and the Mediterranean World in the Age of Philip II*. The statistical tendencies of many members of Braudel’s generation of *Annalistes* are most clearly evident in the work of Pierre Chaunu (whose history of Seville and the Atlantic established a subgenre often called “serial history” because of its attention to establishing continuous series of historical data on such matters as food prices). Intellectual historians such as Robert Mandrou and François Furet pioneered a quantitative approach to the history of *mentalités*, opening up what has since evolved into *histoire du livre*, the history of the book. In more recent decades, however, the *Annales* historians have veered away from quantification to the study of *mentalités* in Bloch and Febvre’s mode, with considerably more emphasis being placed on individual and collective beliefs, and on life experienced in local settings. The “microhistory” genre of the late 1970s, 1980s, and 1990s, including works like Emmanuel Le Roy Ladurie’s *Montaillou: The Promised Land of Error* (a study of a medieval Cathar village) and Carlo Ginzburg’s *The Cheese and the Worms: The Cosmos of a Sixteenth Century Miller*, has proved highly saleable in the academic and even popular book market and has spawned numerous European and North American imitators.

If any word most characterizes twentieth-century and especially post-1945 historiography, it would have to be *fragmentation* (a more optimistic descriptor might be *diversity*). Historians are now political, military, family, gender, women’s, economic, social, environmental, intellectual or cultural, and the expansion of university history departments especially in the 1960s has encouraged a high degree of subspecialization, together with a proliferation of journals and book series (which the relatively recent introduction of the Internet shows no sign of slowing down given its capacity to offer cheap alternatives to conventional print). Although Marxism has by and large faded from most North American history departments, social history has been maintained, albeit now often dissolved into various components. Among these, women’s history and its offshoot, the history of gender (now including masculinity studies) have perhaps been the most successful in reshaping the recent agenda of the entire discipline. The history of particular ethnicities and religions or sexual orientations has also become more firmly established in departments and often in specialty journals. Interdisciplinary approaches to history began seriously in the 1960s with historians looking to the social sciences, especially sociology and economics, for the theoretical

underpinnings that appeared to be lacking from history itself (it is remarkable how often in the history of historical writing a great cataclysm has been followed by a search for new certitudes, a pronounced skepticism toward old ones, or both in combination). Among the more interesting if controversial experiments one must include psychohistory (best represented by Erik H. Erikson). Equally debatable has been the use of “counterfactuals” (the supposition that events in history occurred in ways other than they actually did, and the attempt to model mathematically a hypothetical projected course of events from that alternate starting point), especially in the “Cliometric” or New Economic History of American academics such as Robert W. Fogel. In the 1980s and 1990s, as the stock of sociology and economics began to fall in the judgment of historians, many turned instead to the work of cultural anthropologists such as Clifford Geertz, Marshall Sahlins, and Victor Turner. (In contrast, social scientists, as Eric H. Monkkonen and others have argued, maintain a steadfast claim to the appropriation of history across their various disciplines, without necessarily intending by “history” the discipline that historians actually practice). Meanwhile, the “history of ideas” has been transformed at one end into cultural history (including most recently the history of the book), and at the other into the pursuit of the meaning of terms and of texts in their linguistic and/or social contexts. The latter stream is in turn divisible into a so-called Cambridge School of the history of political thought, associated with Quentin Skinner in Britain and J. G. A. Pocock in the United States, the *Begriffsgeschichte* (history of political and social concepts) approach associated with the German Reinhart Koselleck, and the “New Historicist” and “cultural materialist” movements in literary criticism.

One trend that began in the mid-1970s but has roots in literary theory and in continental philosophy (especially the French figures Michel Foucault and Jacques Derrida, and the Germans Hans-Georg Gadamer, Martin Heidegger and, more remotely, Friedrich Nietzsche) is the so-called linguistic turn in historiography, often identified with the broader theoretical shift known as postmodernism. Influenced by cultural theorists such as Roland Barthes, Foucault, Jacques Lacan, and Paul Ricoeur, and by the prewar German intellectual Walter Benjamin, postmodernism also draws extensively, if often superficially, from cultural anthropology. The thrust of this has been seriously to challenge conventional boundaries between history and literature, leading American exponents of this view being the Americans Hayden White and Dominick LaCapra. It has also, as the historical theorist F. R. Ankersmit suggests, had the effect of “de-disciplining” and “privatizing” history—restoring the individual author, as opposed to the institutional structures erected in the nineteenth and twentieth centuries, to the center of historical writing. In its most extreme version (which is articulated less frequently than postmodernism’s most severe critics would have us believe), it hearkens back to Renaissance pyrrhonism in its radical denial of the fixity of any historical meaning, the existence of any external reality beyond language (there are only infinite floating “signifiers,” and no definable or recoverable “signifieds”), and the impossibility of making “true” statements about the past. The position derived from this—that any version of history is no more or less valid than another—while seemingly liberal, also opens the door to the legitimation of morally repugnant positions such as Holocaust denial. This issue has come to the fore in recent years through a number of celebrated cases, most notoriously the 1990s libel suit brought by Holocaust denier David Irving against the American historian Deborah Lipstadt, who had charged him with gross fabrication and distortion of evidence to support his theories. A spectacle followed around the globe. The trial involved the historian Richard Evans and a team of graduate students scrutinizing David Irving’s research intensively, the consequences of which were the utter demolition of his arguments and an overwhelming legal victory in the year 2000 for Lipstadt and her publisher.

It is tempting to dismiss much postmodern theorizing, historiographically, as chaotic and intellectually anarchistic nonsense, perhaps even a sign of fin-de-siècle cultural decadence. There has recently been an extreme conservative reaction to it, epitomized in the work of the late British historian Sir Geoffrey Elton, and in the critiques of those who lament the loss of any sense of master-narrative. But the postmodern trend has been highly influential in academic settings (especially literature departments); and, while still a minority influence in history departments, it has found a receptive audience among historians of gender and many social and cultural historians for whom it has provided a set of codes and categories to replace those once derived from Marxism. While some of its arguments are virtually self-discrediting, postmodernism has at least provided a salutary reminder to all historians (if one were really needed) that, Ranke notwithstanding, documents and texts never “speak for themselves” but are interpreted by historians, and, more important, that even the most “neutral” document was ultimately the creation of a human being driven by the assumptions, social pressures, and linguistic conventions of his or her own time.

Few historians would now endorse the French ancient historian Fustel de Coulanges' optimistic admonition to group of applauding students that it was not he who spoke to them but "history, who speaks through me."

A related variant, postcolonial studies, often associated with the literary theorists Edward Said (1935–2003), Gayatri Spivak, and Homi K. Bhabha, has refocused scholarship concerned with former colonies such as India on the subjected masses rather than on the imperial rulers and their indigenous elite allies or political successors. The Subaltern School of Indian historiography (the term derives from Marx and from Antonio Gramsci's theory of hegemony) founded by Ranajit Guha is a prominent example, the academic foundation against which it rebels having been established with the rapid increase of university history departments following independence in 1947, and the development of social-science-influenced South Asian studies. Guha in particular has argued that the Renaissance assignment of non-Europeans to the realm of "peoples without history" was compounded by the subsequent imposition of Enlightenment ideas upon the various colonized areas of the world, in particular the notion that statehood, as well as writing, was essential for a people to achieve historical standing. The colonizers, using their control of language, education, and writing, subjected the Indian past, for example, to Western (and especially Hegelian) notions of "world-history," limited by European standards of chronology and narrative. In other words, they imposed a kind of imperial "dominance without hegemony" over a nation's true sense of its own history. "History" in the Western sense (projected backwards onto indigenous *itihasa* in an effort to make these seem protohistorical) thus permanently completed the displacement, commenced by the Persian-influenced histories of the Mughal era, of the ancient tradition and "old lore," as well as the sense of everyday experience, embodied in the poetic myths contained in *purana* and in epics such as the Ramayana. Vinay Lal, a critic of Subaltern Studies has adopted an even more radical position, asserting that the accommodation of Indian scholars to the very value of history, not simply adoption of its Western forms, is an acceptance of servitude. Sumit Sarkar, an early participant in the Subaltern project, has criticized it for a growing loss of focus on the very groups it was designed to rescue from oblivion and for its swing in the direction of cultural studies, while endorsing a microhistorical approach analogous to the practice of Europeans such as Carlo Ginzburg.

The Latin American experience reflects both European and, more recently, North American trends, while some of its historical concerns have for decades anticipated the very issues raised in the 1960s by European Marxists such as E. P. Thompson and Eric Hobsbawm, and more recently in South Asia by Subaltern scholars. Academic historiography was firmly established with the foundation of public archives at the end of the nineteenth century, and the creation of history departments at universities. The longest-standing graduate programs date back to the 1950s and include El Colegio de México, Universidad Nacional Autónoma de México, Universidad San Marcos in Lima, and the Universidad de Chile, but a significant proportion of academics with doctorates have acquired them abroad at European (especially Oxford, Cambridge, and Madrid) and major American universities, many of which (the University of Texas and the University of California, Berkeley, for example) have first-rate library collections and strong graduate programs in Latin American studies.

By the end of the nineteenth century, the liberalism and positivism that had marked the first decades of postindependence historiography were under duress, in part owing to a growing alienation from America and Europe. The Mexican Revolution of 1910–1920, with its populist and agrarian origins, suggested that the historical role of Latin American masses and especially indigenous and mestizo populations had been seriously underestimated; moreover, the political and economic success of many of the liberal states had been mixed at best. Efforts turned to revisiting the history of Central and South America from a less Eurocentric perspective. Historians and ethnohistorians began to pay special attention to the role of the indigenous peoples and to the ethnic intermixture of populations that had produced a distinctive set of postcolonial societies. The kinds of anthropological excavation of native perceptions of the past applied in the South Pacific have also been employed in Latin America in recent decades. Some of the features of African historiography can also be observed here, in particular the application of Marxist and social science paradigms such as "dependency" and "modernization" theory. And, as with India, an anti-imperialist scholarship has developed (encouraged by the ideologically controversial five hundredth anniversary celebrations of Columbus's 1492 expedition) that insists on the role of European and especially Iberian colonizers in the "invention" of historical categories such as "America."

Conclusion

This article has necessarily been selective, summary, and in places even cursory, in its treatment of the history of history around the planet. While the differences between various forms of historical writing—and different traditions—have deliberately been emphasized, some connecting points also exist. There has been a close relationship between the historical record and the exercise of power for much of the past four thousand years, power being taken in the ethnic, social, and economic as well as narrowly political sense. This is perhaps another way of putting the old saw, mentioned at the very beginning of the essay, that “history is written by the victors,” although in fact it has just as often been written by the losers (consider Thucydides, the Indian Felipe Guamán Poma de Ayala, or the poet and historian John Milton, a failed revolutionary) and those bewildered by the specter of sudden or unwelcome change. There has been an ongoing, dialectic, and much-changing relationship between literature, legend, myth, and history, and firm and categorical divisions between these are by no means the hallmark of all historical cultures. One may also observe the recurrent influence of various forms of present-day self-identification in the construction of pasts, ranging from the Greek city-states through Renaissance debates about racial origins, through Spanish discussions of Visigothic foundations, to the competing global nationalisms of the nineteenth and twentieth centuries. Now as then, current problems and perspectives often drive the most intense and searching investigation of the past: Where French and Spanish invasions of Italy drove Machiavelli and Guicciardini to the past for explanation, similar calamities inspired many of the chroniclers of Burma and Thailand in the late eighteenth and early nineteenth centuries. Where the Reformation ignited a European debate over the history of the church, modern German historians have had to wrestle since 1945 with the problem of the country’s aggressive twentieth-century past and the horror of the Holocaust.

At the start of the twenty-first century, there is a high degree of disintegration and remarkably little consensus as to what a “proper” historical method is, what phenomena constitute legitimate subjects of historical inquiry or whether any historical narrative merits “privileging” (a favored term of literary criticism) as true—or at least more true—over any other. But in facing our own postmodern confusion, we would be entirely wrong to project a nostalgic, supposititious, and comfortable uniformity of opinion onto the historical thought of earlier times. Let us in closing recall the differences between Babylonian, Assyrian, and Hebrew historical writing; Thucydides’ quick departure from the model established by Herodotus; the contemporary medieval critics of Geoffrey of Monmouth’s invented British past; the Qing evidentiary debates; the pyrrhonist challenge to historical knowledge in early modern Europe; and the German quarrels about method in the late nineteenth century. These are but a few reminders that there have always been many mansions in the house of history and an almost infinite number of windows, each providing a fresh perspective on to the past.

BIBLIOGRAPHY

GENERAL AND COMPARATIVE

- Appadurai, Arjun. “The Past as a Scarce Resource.” *Man* 16, no. 2 (1981): 201–219.
- Black, Jeremy. *Maps and History: Constructing Images of the Past*. New Haven and London: Yale University Press, 1997. Valuable study of maps and atlases, and their role in the shaping of perceptions of history.
- Breisach, Ernst. *Historiography: Ancient, Medieval, and Modern*. 2nd ed. Chicago: University of Chicago Press, 1994. Useful survey, confined to western traditions, but full of shrewd judgments and connections.
- Brown, Donald E. *Hierarchy, History, and Human Nature: The Social Origins of Historical Consciousness*. Tucson: University of Arizona Press, 1988. Perceptive commentary on a variety of world traditions, regrettably marred by author’s Eurocentric assumption that there are “sound” historiographies against which others fall short.
- Burke, Peter. *History and Social Theory*. Ithaca, N.Y.: Cornell University Press, 1993.
- Butterfield, Herbert. *Man on his Past: The Study of the History of Historical Scholarship*. Cambridge, U.K.: Cambridge University Press, 1955.
- Castro, Américo. *An Idea of History: Selected Essays of Américo Castro*. Translated and edited by Stephen Gilman and Edmund L. King. Columbus: Ohio State University Press, 1977.
- Collingwood, R. G. *The Idea of History*. Oxford: Oxford University Press, 1946. Classic exposition of philosophy of history also contains a good history of western historical thought.
- Elton, G. R. *Return to Essentials: Some Reflections on the Present State of Historical Study*. Cambridge, U.K., and New York: Cambridge University Press, 1991.

- Kelley, Donald R. *Faces of History: Historical Enquiry from Herodotus to Herder*. New Haven: Yale University Press, 1998. Excellent interpretive chapters on major aspects of European historiography.
- Kochan, Lionel. *The Jew and His History*. London: Macmillan, 1977.
- Lefebvre, Georges. *La naissance de l'historiographie moderne*. Paris: Flammarion 1971.
- Lorenz, Chris. "Comparative Historiography: Problems and Perspectives." *History and Theory* 38 (1999): 25–39.
- Maciu, Vasile, et al. *Outline of Rumanian Historiography until the Beginning of the Twentieth Century*. Bucharest: Academy of the Rumanian People's Republic, 1964.
- Monkkonen, Eric H., ed. *Engaging the Past: The Uses of History across the Social Sciences*. Durham, N.C.: Duke University Press, 1994.
- Orr, Linda. "The Revenge of Literature: A History of History." *New Literary History* 18 (1986–1987): 1–21.
- Sato, Masayuki. "Comparative Ideas of Chronology." *History and Theory* 30 (1991): 275–301.
- Woolf, D. R., ed. *A Global Encyclopedia of Historical Writing*. 2 vols. New York: Garland, 1998. Covers most regions and traditions of the world. See especially articles by Romila Thapar, David K. Wyatt, David Chandler, Anthony Reid, Judith Tucker, Shawn McHale, Ian Copland, Stuart Robson, Ulrich Kratz, and Somkiat Wanthana on less accessible areas such as Southeast Asia, early India, and Islamic women's history, as well as Toivo U. Raun, Andrejs Plakans and P. K. Hämäläinen on understudied European countries such as Estonia, Latvia, and Finland. All have provided information used in the present account.
- Zagorin, Perez. "History, the Referent, and Narrative: Reflections on Postmodernism Now." *History and Theory*. 38 (1999): 1–24. A recent critique of the relevance of postmodernism to historiography.

EARLIEST FORMS OF HISTORICAL WRITING

- Brundage, Burr C. "Historiographic Traditions: The Birth of Clío: A Résumé and Interpretation of Ancient Near Eastern Historiography." In *Teachers of History: Essays in Honor of Laurence Bradford Packard*, edited by H. Stuart Hughes. Ithaca, N.Y.: Cornell University Press, 1954.
- Cogan, Mordechai, and Israel Eph'al, eds. *Ab, Assyria . . . Studies in Assyrian History and Ancient Near Eastern Historiography Presented to Hayim Tadmor*. Vol. 33 of *Scripta Hierosolymitana*. Jerusalem: Magnes Press, Hebrew University, 1991.
- Dentan, Robert, ed. *The Idea of History in the Ancient Near East*. New Haven: Yale University Press, 1955.
- Grayson, A. K. *Assyrian and Babylonian Chronicles*. Locust Valley, New York: J. J. Augustin, 1975.
- Kraus, Christina Shuttleworth. *The Limits of Historiography: Genre and Narrative in Ancient Historical Texts*. Leiden: Brill, 1999.
- Pocock, J. G. A. "The Origins of Study of the Past: A Comparative Approach." *Comparative Studies in Society and History* 4 (1961–1962): 209–246.
- Van Seters, John. *In Search of History: Historiography in the Ancient World and the Origins of Biblical History*. New Haven and London: Yale University Press, 1983. Detailed comparative analysis of various Mesopotamian and Jewish historical texts; not for the beginner.

AFRICA

- Fage, J. D., ed. *Africa Discovers her Past*. London: Oxford University Press, 1970.
- Falola, Toyin, ed. *African Historiography: Essays in Honour of Jacob Ade Ajayi*. Harlow: Longman, 1993.
- Gérard, Albert S. *African Language Literatures*. Washington, D.C.: Three Continents Press, 1981.
- Harneit-Sievers, Axel, ed. *A Place in the World: New Local Historiographies from Africa and South-Asia*. Leiden: Brill, 2002.
- Henige, David. *The Chronology of Oral Tradition: The Quest for a Chimera*. Oxford: Clarendon, 1974.
- Hiskett, Mervyn. *A History of Hausa Islamic Verse*. London: School of Oriental and African Studies, University of London, 1975.
- History in Africa: A Journal of Method*. Contains many useful articles on aspects of African historiography, both indigenous and Western.
- Jewsiewicki, Bogumil and David S. Newbury, eds. *African Historiographies: What History for Which Africa?* Beverly Hills, Calif.: Sage, 1986.
- Middell, Matthias. "Transfer and Interaction: France and Francophone African Historiography." In *Across Cultural Borders: Historiography in Global Perspective*, edited by Eckhardt Fuchs and Benedikt Stuchtey, 163–182. Lanham, Md.: Rowman and Littlefield, 2002.
- Miller, Joseph C. "History and Africa/Africa and History." *American Historical Review* 104, no. 1 (February 1999): 1–32. Useful excursus into the beginnings and major developments within African historiography.
- Pankhurst, Richard K. P., ed. *The Ethiopian Royal Chronicles [Extracts]*. Addis Ababa: Oxford University Press, 1967.

- Prins, Adrian. "On Swahili Historiography." *Journal of the East African Swahili Committee* 28 (1958): 26–40.
- Saunders, Christopher. *The Making of the South African Past: Major Historians on Race and Class*. Capetown and Johannesburg: David Philip, 1988.
- Scheub, Harold. "Xhosa Oral and Literary Traditions." In B. W. Andrzejewski, S. Piłaszewicz, and W. Tyloch, eds. *Literatures in African Languages: Theoretical Issues and Sample Surveys*. Warsaw: Cambridge University Press, 1985, 529–609.
- Smith, Ken. *The Changing Past: Trends in South African Historical Writing*. Athens, Ohio: Ohio University Press, 1988.
- Van Jaarsveld, Floris Albertus. *The Afrikaner's Interpretation of South African History*. Capetown: Simondium Publishers, 1964. Dated account that should be read in conjunction with more recent studies by Smith, Saunders, and Wright listed above and below.
- Vansina, Jan, Raymond Mauny, and L. V. Thomas. *The Historian in Tropical Africa: Studies Presented and Discussed*. London: Oxford University Press, 1964.
- Vansina, Jan. *Oral Tradition as History*. Madison: University of Wisconsin Press, 1985.
- Wright, Harrison M. *The Burden of the Present: Liberal-Radical Controversy over Southern African History*. Cape Town: David Philip, 1977.

EAST ASIA

- Beasley, W. G., and E. G. Pulleyblank. *Historians of China and Japan*. London: Oxford University Press, 1961.
- Brownlee, John S. *Japanese Historians and the National Myths, 1600–1945: The Age of the Gods and Emperor Jimmu*. Vancouver: UBC Press; Tokyo: University of Tokyo Press, 1997.
- Brownlee, John S., ed. *History in the Service of the Japanese Nation*. Toronto: University of Toronto-York University Joint Centre on Modern East Asia, 1983.
- Ch'oe Yōng-ho. "An Outline History of Korean Historiography." *Korean Studies* 4 (1980): 1–28.
- Dirlík, Arif. *Revolution and History: the Origins of Marxist Historiography in China, 1919–1937*. Berkeley: University of California Press, 1978. Especially good on pre-1949 materialist historiography.
- Duus, Peter. "Whig History, Japanese Style: The Min'yūsha Historians and the Meiji Restoration." *Journal of Asian Studies* 33 (1974): 415–436.
- Edmunds, Clifford. "The Politics of Historiography: Jian Bozan's Historicism." In *China's Intellectuals and the State: In Search of a New Relationship*, edited by Merle Goldman, 65–106. Cambridge, Mass: Harvard University Press, 1987.
- Elman, Benjamin A. *From Philosophy to Philology: Intellectual and Social Aspects of Change in Late Imperial China*. Cambridge, Mass.: Harvard University Press, 1984.
- Feuerwerker, Albert, ed. *History in Communist China*. Cambridge, Mass: MIT Press, 1968.
- Gardner, Charles S. *Chinese Traditional Historiography*. Cambridge, Mass: Harvard University Press, 1938. Should be read in concert with more recent studies in Unger, 1993, below and Dirlík, 1978, above.
- Hardy, Grant. "Can an Ancient Chinese Historian Contribute to Modern Western Theory? The Multiple Narratives of Ssu-ma Ch'ien." *History and Theory* 33 (1994): 20–38.
- Kwong, Luke S. K. "The Rise of the Linear Perspective on History and Time in Late Qing China." *Past and Present* 173 (2001): 157–190.
- Leslie, Donald D., Colin Mackerras, and Wang Gungwu, eds. *Essays on the Sources for Chinese History*. Canberra: Australian National University Press, 1973.
- Mass, Jeffrey P. *Antiquity and Anachronism in Japanese History*. Stanford: Stanford University Press, 1992.
- Mehl, Margaret. *History and the State in Nineteenth-Century Japan*. Basingstoke: Macmillan, 1998. Excellent study of its subject.
- Najita, Tesua. "History and Nature in Eighteenth-Century Tokugawa Thought." In *The Cambridge History of Japan*. Vol. 4: *Early Modern Japan*, edited by John W. Hall et al., 596–659. Cambridge, U.K.: Cambridge University Press, 1988–1999.
- Pai, Hyung Il. *Constructing "Korean" Origins: A Critical Review of Archaeology, Historiography, and Racial Myth in Korean State-Formation Theories*. Cambridge, Mass: Harvard University Press, 2000.
- Petrov, Leonid A. "North Korean Historiography in Crisis (1956–1967)." In *Korean Studies at the Dawn of the Millennium: Proceedings of the Second Biennial Conference, Korean Studies Association of Australia*, edited by Young-A Cho, 374–383. Monash: Monash University, 2002.
- Schaberg, David. *A Patterned Past: Form and Thought in Early Chinese Historiography*. Cambridge, Mass., and London: Harvard University Press for Harvard University Asia Center, 2001.
- Schwartz, Benjamin. "History in Chinese Culture: Some Comparative Reflections." *History and Theory* 35 (1996): 23–33.

- Tanaka, Stefan. "Alternative National Histories in Japan: Yamaji Aizan and Academic Historiography." In *Across Cultural Borders: Historiography in Global Perspective*, edited by Eckhardt Fuchs and Benedikt Stuchtey, 119–138. Lanham, Md.: Rowman and Littlefield, 2002.
- . *Japan's Orient: Rendering Pasts into History*. Berkeley: University of California Press, 1993.
- Twitchett, Denis Crispin. *The Writing of Official History under the Tang*. Cambridge, U.K., and New York: Cambridge University Press, 1992.
- Unger, Jonathan, ed. *Using the Past to Serve the Present: Historiography and Politics in Contemporary China*. Armonk, N.Y.: M. E. Sharpe, 1993. See especially chapters by Lawrence R. Sullivan, Geremie Barmé, and Tom Fisher.
- Wang, Q. Edward. *Inventing China through History: The May Fourth Approach to Historiography*. Albany: State University of New York Press, 2001.

EUROPE: ANCIENT AND MEDIEVAL

- Archambault, Paul. *Seven French Chroniclers: Witnesses to History*. Syracuse, N.Y.: Syracuse University Press, 1974.
- Dalven, Rae. *Anna Comnena*. New York: Twayne, 1972.
- Dorey, T. A., ed. *Latin Historians: Chapters by E. A. Thompson [and Others]*. London: Routledge and Kegan Paul, 1966.
- Fornara, Charles W. *The Nature of History in Ancient Greece and Rome*. Berkeley: University of California Press, 1983.
- Goffart, Walter A. *The Narrators of Barbarian History (AD 550–800: Jordanes, Gregory of Tours, Bede, and Paul the Deacon)*. Princeton: Princeton University Press, 1988.
- Gransden, Antonia. *Historical Writing in England*. 2 vols. Ithaca, N.Y.: Cornell University Press, 1974–1982.
- Hartog, François. "The Invention of History: The Pre-History of a Concept from Homer to Herodotus." *History and Theory* 39 (2000): 384–395.
- Hay, Denys. *Annalists and Historians*. London: Methuen, 1977.
- Hillgarth, J. N. "Spanish Historiography and Iberian Reality." *History and Theory* 24 (1985): 23–43.
- Linehan, Peter. *History and the Historians of Medieval Spain*. Oxford: Clarendon, 1993. Long and definitive treatment of its subject.
- Momigliano, Arnaldo. *The Classical Foundations of Modern Historiography*. Berkeley: University of California Press, 1990.
- . *Essays in Ancient and Modern Historiography*. Middletown, Conn.: Wesleyan University Press, 1977.
- Rohrbacher, David. *The Historians of Late Antiquity*. London and New York: Routledge, 2002.
- Smalley, Beryl. *Historians in the Middle Ages*. London: Thames and Hudson, 1974.
- Spiegel, Gabrielle. *Romancing the Past: The Rise of Vernacular Prose Historiography in Thirteenth-Century France*. Berkeley: University of California Press, 1993.
- Syme, Ronald. *Tacitus*. 2 vols. 1958. Reprint, Oxford: Clarendon, 1989.

EUROPE: RENAISSANCE THROUGH EIGHTEENTH CENTURY

- Allan, David. *Virtue, Learning and the Scottish Enlightenment*. Edinburgh: Edinburgh University Press, 1993.
- Barret-Kriegel, Blandine. *Les historiens et la monarchie*. 4 vols. Paris: Presses universitaires de France, 1988.
- Burke, Peter. *The Renaissance Sense of the Past*. London: Edward Arnold, 1969.
- Cochrane, Eric. *Historians and Historiography in the Italian Renaissance*. Chicago: University of Chicago Press, 1981.
- Chickering, Roger. *Karl Lamprecht: a German Academic Life (1856–1915)*. Atlantic Highlands, N.J.: Humanities Press, 1993.
- Huppert, George. *The Idea of Perfect History: Historical Erudition and Historical Philosophy in Renaissance France*. Urbana: University of Illinois Press, 1970.
- Johannesson, Kurt. *The Renaissance of the Goths in Sixteenth-Century Sweden: Johannes and Olaus Magnus as Politicians and Historians*. Translated and edited by James Larson. Berkeley: University of California Press, 1991.
- Kelley, Donald R. *Foundations of Modern Historical Scholarship: Language, Law, and History in the French Renaissance*. New York: Columbia University Press, 1970.
- Knowles, David. *Great Historical Enterprises: Problems in Monastic History*. London: Nelson, 1963.
- O'Brien, Karen. *Narratives of Enlightenment: Cosmopolitan History from Voltaire to Gibbon*. Cambridge, U.K., and New York: Cambridge University Press, 1997.
- Pocock, J. G. A. *The Ancient Constitution and the Feudal Law: A Study of English Historical Thought in the Seventeenth Century: A Reissue with a Retrospect*. Cambridge, U.K.: Cambridge University Press, 1987.

- Pocock, J. G. A. *Barbarism and Religion*. 3 vols. to date. Cambridge, U.K.: Cambridge University Press, 1999–. Brilliant exposition of Gibbon's intellectual environment; far wider-ranging than the title suggests. Vol. 3 is especially good as an interpretive history of European historiography and key concepts such as "decline and fall."
- Segal, Lester A. *Historical Consciousness and Religious Tradition in Azariah de' Rossi's Me'or 'Einayim*. Philadelphia, New York, and Jerusalem: Jewish Publication Society, 1989.
- Skovgaard-Petersen, Karen. *Historiography at the Court of Christian IV (1588–1648): Studies in the Latin Histories of Johannes Portanus and Johannes Meursius*. Copenhagen: Museum Tusulanum Press, 2002.
- Wilcox, Donald. *The Development of Florentine Humanist Historiography in the Fifteenth Century*. Cambridge, Mass.: Harvard University Press, 1969.
- Woolf, D. R. *The Social Circulation of the Past: English Historical Culture 1500–1730*. Oxford: Oxford University Press, 2003.

EUROPE AND NORTH AMERICA: NINETEENTH AND TWENTIETH CENTURIES

- Ahokas, Jaakko. *A History of Finnish Literature*. Bloomington: Indiana University Press, 1973.
- Ankersmit, F. R. "The Postmodernist Privatization of the Past." In the author's *Historical Representation*, 149–175. Stanford, Calif.: Stanford University Press, 2001.
- Baets, Antoon de. *Censorship of Historical Thought: A World Guide, 1945–2000*. Westport, Conn.: Greenwood Press, 2002.
- Bromke, Adam. *The Meaning and Uses of Polish History*. Boulder, Colo.: East European Monographs, 1987.
- Burke, Peter. *The French Historical Revolution: The Annales School, 1929–1989*. Stanford, Calif.: Stanford University Press, 1990.
- Burrow, J. W. *A Liberal Descent: Victorian Historians and the English Past*. Cambridge, U.K.: Cambridge University Press, 1981.
- Dorpalen, Andreas. *German History in Marxist Perspective: The East German Approach*. Detroit, Mich.: Wayne State University Press, 1985.
- Enteen, George M. *The Soviet Scholar-Bureaucrat: M. N. Pokrovskii and the Society of Marxist Historians*. University Park, Pa.: Penn State University Press, 1978.
- Evans, Richard J. *Telling Lies about Hitler: The Holocaust, History and the David Irving Trial*. London: Verso, 2002.
- Gooch, G. P. *History and Historians in the Nineteenth Century*. 2nd ed., revised. London and New York: Longmans, Green, 1952. First published in 1913 and revised by its author, an Acton-influenced historian, in 1952; though dated, it remains useful as an index of pre-World War I attitudes to the nineteenth century's historiographic achievements.
- Hasquin, Hervé, ed. *Histoire et historiens depuis 1830 en Belgique*. Brussels: Éditions de l'Université de Bruxelles, 1981.
- Herbst, Jürgen. *The German Historical School in American Scholarship: A Study in the Transfer of Culture*. Ithaca, N.Y.: Cornell University Press, 1965.
- Hiemstra, Paul A. *Alexandru D. Xenopol and the Development of Romanian Historiography*. New York and London: Garland, 1987.
- Hofstadter, Richard. *The Progressive Historians: Turner, Beard, Parrington*. Reprint of 1968 edition. Chicago: University of Chicago Press, 1979.
- Hubbard, William H., et al., eds. *Making a Historical Culture: Historiography in Norway*. Oslo: Scandinavian University Press, 1995.
- Iggers, Georg G. *The German Conception of History: The National Tradition of Historical Thought from Herder to the Present*. Rev. ed. Middletown, Conn.: Wesleyan University Press, 1983.
- Iggers, Georg G., and James M. Powell, eds. *Leopold von Ranke and the Shaping of the Historical Discipline*. Syracuse: Syracuse University Press, 1990.
- Jacobitti, Edmund E. *Revolutionary Humanism and Historicism in Modern Italy*. New Haven: Yale University Press, 1981.
- Krapauskas, Virgil. *Nationalism and Historiography: The Case of Nineteenth-Century Lithuanian Historicism*. Boulder, Colo.: East European Monographs, 2000.
- Krieger, Leonard. *Ranke: The Meaning of History*. Chicago: University of Chicago Press, 1977.
- Lehmann, Hartmut, and James Van Horn Melton, eds. *Paths of Continuity: Central European Historiography from the 1930s to the 1950s*. Washington, D.C.: German Historical Institute and Cambridge, U.K.: Cambridge University Press, 1994.
- Linenthal, Edward Tabor, and Tom Engelhardt, eds. *History Wars: The Enola Gay and Other Battles for the American Past*. New York: Metropolitan Books, 1996.
- Lingelbach, Gabriele. "The Historical Discipline in the United States: Following the German Model?" In *Across Cultural Borders: Historiography in Global Perspective*, edited by Eckhardt Fuchs and Benedikt Stuchtey, 182–204. Lanham, Md.: Rowman and Littlefield, 2002.

- Mazlish, Bruce. *The Riddle of History: The Great Speculators from Vico to Freud*. New York and London: Harper and Row, 1966. A still useful and entertaining general introduction to select thinkers, somewhat prone to judgmental criticism.
- Mazour, Anatole G. *Modern Russian Historiography*. Rev. ed. Westport, Conn.: Greenwood Press, 1975.
- Meinecke, Friedrich. *Historism: The Rise of a New Historical Outlook*. Translated by J. E. Anderson. Translation revised by H. D. Schmidt. 2nd ed. London: Routledge, 1972.
- Novick, Peter. *That Noble Dream: The "Objectivity" Question and the American Historical Profession*. Cambridge, U.K.: Cambridge University Press, 1988.
- Pók, Attila. "Scholarly and Non-Scholarly Functions of Historical Research Institutes: An Outline of the Case of Hungary in International Context." In *History-Making: The Intellectual and Social Formation of a Discipline. Proceedings of an International Conference, Uppsala, September, 1994*, edited by Rolf Torstendahl and Irmline Veit-Brause, 169–177. Stockholm: Kungl. Vitterhets, historie och antikvitets akademien, 1996.
- Raphael, Lutz. "Organizational Frameworks of University Life and their Impact on Historiographical Practice." In *History-Making: The Intellectual and Social Formation of a Discipline. Proceedings of an International Conference, Uppsala, September, 1994*, edited by Rolf Torstendahl and Irmline Veit-Brause, 151–167. Stockholm: Kungl. Vitterhets, historie och antikvitets akademien, 1996.
- Riis, Carsten. *Religion, Politics, and Historiography in Bulgaria*. Boulder, Colo.: East European Monographs, 2002.
- Shelton, Anita K. *The Democratic Idea in Polish History and Historiography: Franciszek Bujak (1875–1953)*. Boulder, Colo.: East European Monographs, 1989.
- Shtepa, Konstantin F. *Russian Historians and the Soviet State*. New Brunswick, N.J.: Rutgers University Press, 1962.
- Smith, Bonnie G. *The Gender of History: Men, Women, and Historical Practice*. Cambridge, Mass: Harvard University Press, 1998.
- Smith, Leslie F. *Modern Norwegian Historiography*. Oslo: Norwegian Universities Press, 1962.
- Stieg, Margaret F. *The Origin and Development of Scholarly Historical Periodicals*. University: University of Alabama Press, 1986.
- Taylor, M. Brook. *Promoters, Patriots, and Partisans: Historiography in Nineteenth-Century English Canada*. Toronto and Buffalo: University of Toronto Press, 1989.
- Torstendahl, Rolf, ed. *An Assessment of Twentieth-Century Historiography: Professionalism, Methodologies, Writings*. Stockholm: Kungl. Vitterhets, historie och antikvitets akademien, 2000.
- . "Fact, Truth, and Text: The Quest for a Firm Basis for Historical Knowledge around 1900." *History and Theory* 42 (2003): 305–331. Interesting evaluation of nineteenth-century methodology treatises, demonstrating significant differences among a number of them.
- Vardy, Steven Bela. *Modern Hungarian Historiography*. Boulder, Colo: East European Monographs, 1976.
- Vernadsky, George. *Russian Historiography: A History*. Edited by Sergei Pushkarev. Translated by Nickolas Lupinin. Belmont, Mass.: Norland Publishing, 1978.
- White, Hayden. *Metahistory: The Historical Imagination in Nineteenth-Century Europe*. Baltimore: Johns Hopkins University Press, 1973.

LATIN AMERICA

- Adorno, Rolena. *Guaman Poma: Writing and Resistance in Colonial Peru*. 2nd ed. Austin: University of Texas Press, 1986.
- Burns, E. Bradford, ed. *Perspectives on Brazilian History*. New York and London: Columbia University Press, 1967.
- Carey, David, Jr. *Our Elders Teach Us: Maya-Kaqchikel Historical Perspectives*. Tuscaloosa: University of Alabama Press, 2001. Fascinating analysis of indigenous Guatemalan oral traditions and memories, by a historian rather than an anthropologist.
- Cline, Howard F., ed. *Latin American History: Essays on its Study and Teaching, 1898–1965*. 2 vols. Austin: University of Texas Press, 1967. Somewhat dated but still useful collection of essays, principally on U.S. approaches rather than indigenous ones.
- Cormier, Loretta. "Decolonizing History: Ritual Transformation of the Past among the Guajá of Eastern Amazonia." In *Histories and Historicities in Amazonia*, edited by Neil L. Whitehead, 123–139. Lincoln and London: University of Nebraska Press, 2003. Recent example of the ethnohistorical approach (informed by postcolonial discourse) to one variety of the Latin American sense of the past, among indigenous peoples.
- Griffin, Charles C., ed. *Latin America: A Guide to the Historical Literature*. Austin: University of Texas Press, 1971.
- Hill, Jonathan D., ed. *Rethinking History and Myth: Indigenous South American Perspectives on the Past*. Urbana: University of Illinois Press, 1988. Relations between myth, legend, history, and consciousness among various native populations.

- Robinson, John L. *Bartolomé Mitre: Historian of the Americas*. Washington, D.C.: University Press of America, 1982.
- Rabasa, José. *Inventing America: Spanish Historiography and the Formation of Eurocentrism*. Norman and London: University of Oklahoma Press, 1993.
- Thomas, Jack Ray. *Biographical Dictionary of Latin American Historians and Historiography*. Westport, Conn.: Greenwood Press, 1984. Brief entries; useful as a reference tool.
- Wilgus, A. Curtis. *The Historiography of Latin America: A Guide to Historical Writing, 1500-1800*. Metuchen, N.J.: Scarecrow Press, 1975.
- Woll, Allen. *A Functional Past: The Uses of History in Nineteenth-Century Chile*. Baton Rouge and London: Louisiana State University Press, 1982. Excellent study of relations between history and politics in a newly-independent nation.

THE OTTOMAN EMPIRE AND THE MIDDLE EAST

- Ahmed, Leila. *Women and Gender in Islam: Historical Roots of a Modern Debate*. New Haven, Conn.: Yale University Press, 1992.
- Chejne, Anwar G. "The Concept of History in the Modern Arab World." *Studies in Islam: Quarterly Journal of Indian Institute of Islamic Studies* 4 (1967): 1–31.
- Choueiri, Youssef M. *Arab History and the Nation-State: A Study in Modern Arab Historiography 1820-1980*. London and New York: Routledge, 1989.
- Crabbs, Jack A., Jr. *The Writing of History in Nineteenth-Century Egypt*. Detroit: Wayne State University Press; Cairo: American University in Cairo Press, 1984.
- Dengler, Ian C. "Turkish Women in the Ottoman Empire: the Classical Age." In *Women in the Muslim World*, edited by Lois Beck and Nikki Keddie, 229-244. Cambridge, Mass.: Harvard University Press, 1978.
- Duri, A. A. *The Rise of Historical Writing Among the Arabs*. Edited and translated by Lawrence I. Conrad. Introduction by Fred M. Donner. Princeton: Princeton University Press, 1983.
- Kafadar, Cemal. *Between Two Worlds: The Construction of the Ottoman State*. Berkeley: University of California Press, 1995. Useful summary of the sources and modern historiography of the empire.
- Keddie, Nikki R., and Beth Baron. *Women in Middle Eastern History: Shifting Boundaries in Sex and Gender*. New Haven, Conn.: Yale University Press, 1991. See especially introduction by Keddie.
- Khalidi, Tarif. *Arab Historical Thought in the Classical Period*. Cambridge, U.K., and New York: Cambridge University Press, 1994.
- . *Islamic Historiography: The Histories of Mas'ūdi*. Albany: SUNY Press, 1975.
- Lewis, Bernard, and P. M. Holt, eds. *Historians of the Middle East*. London: Oxford University Press, 1962.
- Mahdi, Muhsin. *Ibn Khaldūn's Philosophy of History: A Study in the Philosophic Foundation of the Science of Culture*. Chicago: University of Chicago Press, 1964.
- Meisami, Julie Scott. *Persian Historiography to the End of the Twelfth Century*. Edinburgh: Edinburgh University Press, 1999.
- Mernissi, Fatima. *Women and Islam: An Historical and Theological Enquiry*. Translated by Mary Jo Lake-land. Oxford: Basil Blackwell, 1991.
- Nashat, Guity, and Lois Beck, eds. *Women in Iran from the Rise of Islam to 1800*. Urbana: University of Illinois Press, 2003.
- Robinson, Chase F. *Islamic Historiography*. Cambridge, U.K., and New York: Cambridge University Press, 2003. Invaluable introduction with useful glossary of terms.
- Rosenthal, Franz. *A History of Muslim Historiography*. 2nd rev. ed. Leiden, Netherlands: Brill, 1968.
- Taher, Mohamed, ed. *Medieval Muslim Historiography*. Vol. 5 of *Encyclopaedic Survey of Islamic Culture*. New Delhi: Anmol Publications, 1997.

SOUTH AND CENTRAL ASIA

- Bahāristān-i-Shāhī: A Chronicle of Mediaeval Kashmir*. Translated and edited by K. N. Pandit. Calcutta: Firma KLM, 1991.
- Ganguly, Dilip Kumar. *History and Historians in Ancient India*. New Delhi: Abhinav Publications, 1984.
- Guha, Ranajit. *History at the Limit of World-History*. New York: Columbia University Press, 2002.
- . *An Indian Historiography of India: A Nineteenth-Century Agenda and Its Implications*. Calcutta and New Delhi: K. P. Bagchi, 1988.
- Hardy, Peter. *Historians of Medieval India: Studies in Indo-Muslim Historical Writing*. London: Luzac and Co., 1960.
- Hasan, Mohibbul, and Muhammad Mujeeb, eds. *Historians of Medieval India*. Meerut: Meenakshi Prakashan, 1968.
- Lal, Vinay. *The History of History: Politics and Scholarship in Modern India*. Oxford and New Delhi: Oxford University Press, 2003. See especially chapter 1 on "the history of ahistoricity."

- Pargiter, F. E. *Ancient Indian Historical Tradition*. London: Oxford University Press, 1922. Reprint, Delhi: M. Banarsidass, 1962.
- Perrett, Roy W. "History, Time, and Knowledge in Ancient India." *History and Theory* 38 (1999): 307–321.
- Philips, C. H., ed. *Historians of India, Pakistan, and Ceylon*. London and New York: Oxford University Press, 1961.
- Prakash, Buddha. "The Hindu Philosophy of History." *Journal of the History of Ideas* 16 (1955): 494–505.
- Sarkar, Jagadish Narayan. *History of History-writing in Medieval India: Contemporary Historians: An Introduction to Medieval Indian Historiography*. Calcutta: Ratna Prakashan, 1977.
- Sarkar, Sumit. "The Decline of the Subaltern in Subaltern Studies." In his *Writing Social History*. New Delhi: Oxford University Press, 1997.
- Sen, S. P., ed. *Historians and Historiography in Modern India*. Calcutta: Institute of Historical Studies, 1973.
- Singh, G. P. *Ancient Indian Historiography: Sources and Interpretations*. New Delhi: D.K. Printworld, 2003.
- Thapar, Romila. *History and Beyond*. New York and New Delhi: Oxford University Press, 2000.
- . "Some Reflections on Early Indian Historical Thinking." In *Western Historical Thinking: an Intercultural Debate*, edited by Jörn Rüsen. New York and Oxford: Bergahn Books, 2002.
- Warder, A. K. *An Introduction to Indian Historiography*. Bombay: Popular Prakshan, 1972.
- Waseem, Shah Mohammed, ed. *Development of Persian Historiography in India from the Second Half of the Seventeenth Century to the First Half of the Eighteenth Century*. New Delhi: Iran Culture House, 2003.
- Žamcarano, C. Ž. *The Mongol Chronicles of the Seventeenth Century*. Translated by Rudolf Loewenthal. Wiesbaden: Otto Harrassowitz, 1955.

SOUTHEAST ASIA, PACIFIC ISLANDS, AND AUSTRALASIA

- Ahmad, Abu Talid, and Tan Liok Ee, eds., *New Terrains in Southeast Asian History*. Athens, Ohio: Ohio University Press; Singapore: Singapore National University Press, 2003. Excellent collection; see especially essays by Ni Ni Myint on Burma/Myanmar, and Kobkua Suwannathat-Pian for an introduction to several southeast Asian historical genres and comparison of Thai and Malay writings.
- Aung-Thwin, Michael. "The 'Classical' in Southeast Asia: the Present in the Past." *Journal of Southeast Asian Studies* 26, no. 1 (1995): 75–91.
- . *Myth and History in the Historiography of Early Burma: Paradigms, Primary Sources, and Prejudices*. Athens, Ohio: Ohio University Press; Singapore: Singapore National University Press, 1998.
- Cowan, C. D., and O. W. Wolters, eds. *Southeast Asian History and Historiography: Essays Presented to D. G. E. Hall*. Ithaca, N.Y., and London: Cornell University Press, 1976.
- Errington, Shelly. "Some Comments on Style in the Meanings of the Past." *Journal of Asian Studies* 38, no. 2 (1979): 231–244.
- Florida, Nancy K. *Writing the Past, Inscribing the Future: History as Prophecy in Colonial Java*. Durham, N.C., and London: Duke University Press, 1995.
- Hall, D. G. E., ed. *Historians of South East Asia*. London: Oxford University Press, 1961.
- Jory, Patrick. "Problems in Contemporary Thai Nationalist Historiography." *Kyoto Review of Southeast Asia* 3 (March 2003). Available at <http://kyotoreview.cseas.kyoto-u.ac.jp/issue/issue4/index.html>.
- Larkin, John A., ed. *Perspectives on Philippine Historiography: A Symposium*. New Haven, Conn.: Yale University Southeast Asian Studies, 1979.
- Macintyre, Stuart, and Anna Clark. *The History Wars*. Carlton, Australia: Melbourne University Press, 2003.
- Marr, David. "Vietnamese Historiography, Past and Present." *Nordic Newsletter of Asian Studies* 4 (2002): 1–3. Available at <http://eurasia.nias.ku.dk/activities/publications/niasnytt/2002-4/vietnamese.htm>.
- Moses, John A., ed. *Historical Disciplines and Culture in Australasia: An Assessment*. St. Lucia, Queensland: University of Queensland Press, 1979. Valuable collection of essays covering New Zealand and Papua New Guinea as well as Australia.
- Nguyêñ Thê Anh. "Historical Research in Vietnam: A Tentative Survey." *Journal of Southeast Asian Studies* 26, no. 1 (1995): 121–132.
- Pascoe, Rob. *The Manufacture of Australian History*. Melbourne and Oxford: Oxford University Press, 1979.
- Pelley, Patricia M. *Postcolonial Vietnam: New Histories of the National Past*. Durham and London: Duke University Press, 2002.
- Ras, J. J., ed. and trans. *Hikajat Bandjar: A Study in Malay Historiography*. The Hague: Nijhoff, 1968.

HISTORIOGRAPHY

- Reid, Anthony and David Marr, eds. *Perceptions of the Past in Southeast Asia*. Singapore: Published for the Asian Studies Association of Australia by Heinemann Educational Books, 1979. See in particular R. C. Ileto and John N. Schumacher, S.J., on Philippine historiography, which is relatively understudied within the region. A useful appendix lists extant writings by southeast Asians about their own past, including those discussed in the present essay.
- Ricklefs, M. C. *Modern Javanese Historical Tradition: A Study of an Original Kartasura Chronicle and Related Materials*. London: School of Oriental and African Studies, University of London, 1978.
- Sao Sāimōng Mangrāi, ed. *The Pādaeng Chronicle and the Jengtung State Chronicle Translated*. Ann Arbor: University of Michigan Center for South and Southeast Asian Studies, paper no. 19, 1981.
- Siegel, James. *Shadow and Sound: The Historical Thought of a Sumatran People*. Chicago: University of Chicago Press, 1979.
- Soedjatmoko, et al. eds. *An Introduction to Indonesian Historiography*. Ithaca, New York: Cornell University Press, 1965.
- Thongchai Winichakul. "The Changing Landscape of the Past: New Histories in Thailand since 1973." *Journal of Southeast Asian Studies* 26, no.1 (1995): 99–120.
- Van Klinken, Gerry. "The Battle for History after Suharto: Beyond Sacred Dates, Great Men, and Legal Milestones." *Critical Asian Studies*, 33:3 (2001): 323–350.
- Vickers, Adrian, "Balinese Texts and Historiography." *History and Theory* 29 (1990): 158–178.
- Winstedt, Richard. *A History of Classical Malay Literature*. 2nd ed. Kuala Lumpur, Oxford, and New York: Oxford University Press, 1961. Reprint, 1969.
- Wyatt, David K., ed. and trans. *The Nan Chronicle*. Ithaca, N.Y.: Cornell University Southeast Asia program, 1994. Valuable introduction and edition.

Daniel Woolf

READER'S GUIDE

This Reader's Guide was compiled by the editors to provide a systematic outline of the contents of the New Dictionary of the History of Ideas, thereby offering teachers, scholars, and the general reader a way to organize their reading according to their preferences. The Reader's Guide is divided into four sections: Communication of Ideas, Geographical Areas, Chronological Periods, and Liberal Arts Disciplines and Professions, as indicated in the outline below.

COMMUNICATION OF IDEAS

Introduction to History of Communication of Ideas

Communication Media

GEOGRAPHICAL AREAS

Global Entries

Africa

Asia

Europe

Middle East

North America

Latin and South America

CHRONOLOGICAL PERIODS

Ancient

Dynastic (400 C.E.–1400 C.E.)

Early Modern (1400–1800 C.E.)

Modern (1800–1945)

Contemporary

LIBERAL ARTS DISCIPLINES AND PROFESSIONS

Fine Arts

Humanities

Social Sciences

Sciences

Professions

Multidisciplinary Practices

Especially Interdisciplinary Entries

COMMUNICATION OF IDEAS

This category is the newest aspect of the *New Dictionary of the History of Ideas*; cultural studies, communications studies, and cultural history are moving the disciplines in this direction.

Introduction to History of Communication of Ideas

The following entries focus on the media humans have used to communicate with one another.

- Absolute Music
- Aesthetics: Asia
- Architecture: Overview
- Architecture: Asia
- Arts: Overview
- Astronomy, Pre-Columbian and Latin American
- Bilingualism and Multilingualism
- Borders, Borderlands, and Frontiers, Global
- Calendar
- Cinema
- City, The: The City as a Cultural Center
- City, The: The City as Political Center
- Communication of Ideas: Africa and Its Influence
- Communication of Ideas: Asia and Its Influence
- Communication of Ideas: Europe and Its Influence
- Communication of Ideas: Middle East and Abroad
- Communication of Ideas: Orality and Advent of Writing
- Communication of Ideas: Southeast Asia
- Communication of Ideas: The Americas and Their Influence
- Consumerism
- Cultural Revivals
- Cultural Studies
- Dance
- Diffusion, Cultural
- Dress
- Dualism
- Education: Asia, Traditional and Modern
- Education: Global Education
- Emotions
- Experiment
- Garden
- Gesture
- Humor
- Iconography
- Images, Icons, and Idols
- Japanese Philosophy, Japanese Thought
- Language and Linguistics
- Language, Linguistics, and Literacy
- Learning and Memory, Contemporary Views
- Mathematics
- Media, History of
- Metaphor
- Migration: United States
- Modernity: Africa
- Museums
- Music, Anthropology of

READER'S GUIDE

Musical Performance and Audiences
Oral Traditions: Overview
Oral Traditions: Telling, Sharing
Political Protest, U.S.
Practices
Protest, Political
Reading
Realism: Africa
Reflexivity
Relativism
Representation: Mental Representation
Resistance
Resistance and Accommodation
Rhetoric: Overview
Rhetoric: Ancient and Medieval
Ritual: Public Ritual
Ritual: Religion
Sacred Places
Text/Textuality
Textiles and Fiber Arts as Catalysts for Ideas
Theater and Performance
Third Cinema
Totems
Tradition
Translation
Virtual Reality
Visual Culture
Visual Order to Organizing Collections

Communication Media

This is a listing of the types of historical evidence the author used in writing the entry. While entries in the original Dictionary of the History of Ideas were to a great extent the history of texts, the entries in the New Dictionary of the History of Ideas are generally the cultural history of ideas, making use of the records of oral communication, visual communication, and communication through practices, as well as the history of texts, in order to show the impact of the idea on a wide variety of people.

ORAL

The selective list below contains the entries that give the most coverage to historical examples of the oral transmission and transformation of ideas.

Civil Disobedience
Civil Society: Europe and the United States
Communication of Ideas: Orality and Advent of Writing
Cosmopolitanism
Cultural Capital
Determinism
Dialogue and Dialectics: Socratic
Dialogue and Dialectics: Talmudic
Dream
Emotions
Empire and Imperialism: Europe
Equality: Overview
Etiquette
Fascism
Harmony
Magic
Masks
Media, History of
Millenarianism: Latin America and Native North America

Music, Anthropology of
Musical Performance and Audiences
Musicology
Nomadism
Oral Traditions: Overview
Oral Traditions: Telling, Sharing
Populism: United States
Psychoanalysis
Public Sphere
Republicanism: Republic
Rhetoric: Overview
Ritual: Public Ritual
Ritual: Religion
Slavery
Theater and Performance
Tragedy and Comedy
Trope
Wisdom, Human
COMMUNICATION THROUGH HIGH TECHNOLOGY MEDIA (radio, television, film, computer, etc.)
Absolute Music
Africa, Idea of
Alienation
Americanization, U.S.
Anticolonialism: Africa
Anti-Semitism: Islamic Anti-Semitism
Architecture: Overview
Avant-Garde: Overview
Bilingualism and Multilingualism
Bioethics
Calculation and Computation
Capitalism: Overview
Capitalism: Africa
Censorship
Chicano Movement
Cinema
City, The: The City as a Cultural Center
City, The: The City as Political Center
Colonialism: Southeast Asia
Communication of Ideas: Africa and Its Influence
Communication of Ideas: Asia and Its Influence
Communication of Ideas: Europe and Its Influence
Communication of Ideas: Middle East and Abroad
Communication of Ideas: Orality and Advent of Writing
Communication of Ideas: Southeast Asia
Communism: Latin America
Composition, Musical
Computer Science
Consciousness: Overview
Consumerism
Cosmopolitanism
Creativity in the Arts and Sciences
Critical Theory
Cultural Studies
Death
Demography
Development
Dream
Dress
Dystopia
Empire and Imperialism: United States
Environmental History
Expressionism
Fascism
Fetishism: Fetishism in Literature and Cultural Studies

Field Theories
 Futurology
 Game Theory
 Gay Studies
 Gender: Gender in the Middle East
 Gender in Art
 Genetics: Contemporary
 Genetics: History of
 Genocide
 Genre
 Geography
 Globalization: General
 Harmony
 Hinduism
 History, Economic
 Human Capital
 Iconography
 Intelligentsia
 Jihad
 Jouissance
 Judaism: Modern Judaism
 Language and Linguistics
 Law
 Learning and Memory, Contemporary Views
 Life
 Life Cycle: Elders/Old Age
 Literary Criticism
 Literature: Overview
 Literature: African Literature
 Loyalties, Dual
 Lysenkoism
 Maps and the Ideas They Express
 Masks
 Mathematics
 Media, History of
 Medicine: Europe and the United States
 Medicine: Islamic Medicine
 Meme
 Memory
 Modernism: Overview
 Modernism: Latin America
 Modernity: East Asia
 Motherhood and Maternity
 Motif: Motif in Music
 Music, Anthropology of
 Musical Performance and Audiences
 Musicology
 Nuclear Age
 Occidentalism
 Pan-Arabism
 Parties, Political
 Physics
 Political Protest, U.S.
 Political Science
 Postmodernism
 Power
 Presentism
 Privacy
 Probability
 Progress, Idea of
 Propaganda
 Property
 Protest, Political
 Public Sphere
 Quantum

Reading
 Reform: Europe and the United States
 Reform: Islamic Reform
 Relativity
 Representation: Mental Representation
 Resistance
 Rhetoric: Overview
 Science Fiction
 Sexuality: Overview
 Social History, U.S.
 Society
 State, The: Overview
 Symbolism
 Taste
 Technology
 Third Cinema
 Third World
 Totalitarianism
 Victorianism
 Virtual Reality
 Visual Culture
 War and Peace in the Arts
 Westernization: Africa
 Westernization: Middle East
 Women and Femininity in U.S. Popular Culture
 Work
 World Systems Theory, Latin America

VISUAL

Each of the following entries in the *NDHI* either evocatively describes ideas, includes a visual image of an idea, or provides historical examples of societies visually transmitting and transforming ideas.

Abolitionism
 Aesthetics: Africa
 Aesthetics: Asia
 Aesthetics: Europe and the Americas
 Alienation
 Altruism
 Ambiguity
 Americanization, U.S.
 Ancestor Worship
 Animism
 Anti-Semitism: Overview
 Apartheid
 Architecture: Overview
 Architecture: Africa
 Architecture: Asia
 Arts: Overview
 Arts: Africa
 Asceticism: Hindu and Buddhist Asceticism
 Asceticism: Western Asceticism
 Asian-American Ideas (Cultural Migration)
 Assimilation
 Astrology: Overview
 Astronomy, Pre-Columbian and Latin American
 Authoritarianism: Latin America
 Autobiography
 Avant-Garde: Militancy
 Aztlán
 Barbarism and Civilization
 Beauty and Ugliness
 Behaviorism

READER'S GUIDE

Bioethics
Black Atlantic
Black Consciousness
Body, The
Bushido
Calculation and Computation
Calendar
Cannibalism
Capitalism: Overview
Capitalism: Africa
Causation
Censorship
Change
Chemistry
Childhood and Child Rearing
Cinema
City, The: Latin America
City, The: The City as a Cultural Center
City, The: The City as Political Center
City, The: The Islamic and Byzantine City
Civil Disobedience
Classicism
Classification of Arts and Sciences, Early Modern
Colonialism: Southeast Asia
Common Sense
Communication of Ideas: The Americas and Their Influence
Communication of Ideas: Asia and Its Influence
Communication of Ideas: Europe and Its Influence
Communication of Ideas: Orality and Advent of Writing
Communication of Ideas: Southeast Asia
Composition, Musical
Computer Science
Consciousness: Overview
Consumerism
Continental Philosophy
Cosmology: Asia
Cosmopolitanism
Creativity in the Arts and Sciences
Critical Race Theory
Critical Theory
Cultural Capital
Cultural History
Cultural Revivals
Cultural Studies
Cycles
Cynicism
Dada
Dance
Death
Death and Afterlife, Islamic Understanding of
Demography
Demonology
Determinism
Development
Diasporas: African Diaspora
Diasporas: Jewish Diaspora
Dictatorship in Latin America
Discrimination
Diversity
Dream
Dress
Dystopia
Ecology
Education: Europe
Education: Islamic Education
Emotions
Empire and Imperialism: Europe
Empire and Imperialism: United States
Empiricism
Encyclopedism
Enlightenment
Environment
Environmental History
Epistemology: Ancient
Epistemology: Early Modern
Equality: Overview
Equality: Racial Equality
Essentialism
Ethnicity and Race: Anthropology
Ethnicity and Race: Islamic Views
Ethnocentrism
Etiquette
Eugenics
Europe, Idea of
Everyday Life
Evil
Expressionism
Extirpation
Family Planning
Fascism
Fatalism
Feminism: Overview
Feminism: Chicana Feminisms
Feminism: Third World U.S. Movement
Fetishism: Overview
Fetishism: Fetishism in Literature and Cultural Studies
Feudalism, European
Field Theories
Form, Metaphysical, in Ancient and Medieval Thought
Foundationalism
Friendship
Futurology
Game Theory
Garden
Gender: Overview
Gender: Gender in the Middle East
Gender in Art
Genetics: Contemporary
Genetics: History of
Genius
Genocide
Geography
Geometry
Gesture
Ghetto
Globalization: Asia
Globalization: General
Greek Science
Harmony
Hate
Health and Disease
Heaven and Hell
Heaven and Hell (Asian Focus)
Hedonism in European Thought
Heresy and Apostasy
Hinduism
History, Economic
History, Idea of

- Honor
 Honor, Middle Eastern Notions of
 Humanism: Chinese Conception of
 Humanity: African Thought
 Humanity: European Thought
 Humanity in the Arts
 Humor
 Hygiene
 Iconography
 Idealism
 Ideas, History of
 Identity: Identity of Persons
 Identity, Multiple: Overview
 Identity, Multiple: Jewish Multiple Identity
 Images, Icons, and Idols
 Imagination
 Impressionism
 Intentionality
 Interdisciplinarity
 Islam: Shii
 Islamic Science
 Jainism
 Jihad
 Jouissance
 Knowledge
 Landscape in the Arts
 Language, Linguistics, and Literacy
 Law, Islamic
 Leadership
 Learning and Memory, Contemporary Views
 Liberty
 Life Cycle: Overview
 Life Cycle: Elders/Old Age
 Literary History
 Love, Western Notions of
 Machismo
 Magic
 Maps and the Ideas They Express
 Masks
 Mathematics
 Matriarchy
 Mechanical Philosophy
 Media, History of
 Medicine: Europe and the United States
 Medicine: Islamic Medicine
 Memory
 Men and Masculinity
 Mestizaje
 Metaphor
 Microcosm and Macrocosm
 Migration: United States
 Millenarianism: Islamic
 Millenarianism: Latin America and Native North
 America
 Minority
 Miracles
 Modernism: Overview
 Modernism: Latin America
 Modernity: Overview
 Modernity: Africa
 Monarchy: Overview
 Monasticism
 Motherhood and Maternity
 Motif: Motif in Music
 Museums
 Musical Performance and Audiences
 Musicology
 Mysticism: Chinese Mysticism
 Mysticism: Christian Mysticism
 Myth
 Nation
 Nationalism: Overview
 Natural History
 Naturalism
 Naturalism in Art and Literature
 Naturphilosophie
 Negritude
 Newtonianism
 Nomadism
 Nuclear Age
 Nude, The
 Occidentalism
 Organicism
 Orthodoxy
 Pacifism
 Pan-Asianism
 Paradigm
 Paradise on Earth
 Periodization of the Arts
 Person, Idea of the
 Perspective
 Philosophies: American
 Philosophies: Feminist, Twentieth-Century
 Philosophy: Relations to Other Intellectual Realms
 Phrenology
 Physics
 Political Protest, U.S.
 Population
 Postmodernism
 Practices
 Pre-Columbian Civilization
 Prejudice
 Privacy
 Property
 Protest, Political
 Psychoanalysis
 Public Sphere
 Pythagoreanism
 Queer Theory
 Race and Racism: United States
 Reading
 Realism
 Relativism
 Religion: Indigenous Peoples' View, South America
 Religion and Science
 Religion and the State: Latin America
 Renaissance
 Representation: Mental Representation
 Representation: Political Representation
 Republicanism: Republic
 Resistance
 Resistance and Accommodation
 Responsibility
 Ritual: Public Ritual
 Ritual: Religion
 Romanticism in Literature and Politics
 Sacred and Profane
 Sacred Places
 Science, History of
 Science Fiction

READER'S GUIDE

Scientific Revolution
Sexuality: Overview
Sexuality: Sexual Orientation
Shinto
Slavery
Social History, U.S.
Sophists, The
Sport
Subjectivism
Superstition
Surrealism
Symbolism
Syncretism
Taste
Terror
Text/Textuality
Theater and Performance
Theodicy
Third Cinema
Third World Literature
Toleration
Totalitarianism
Totems
Trade
Tragedy and Comedy
Treaty
Untouchability: Menstrual Taboos
Utilitarianism
Utopia
Victorianism
Virtual Reality
Visual Culture
Visual Order to Organizing Collections
Volunteerism, U.S.
War
War and Peace in the Arts
Westernization: Southeast Asia
Witchcraft
Witchcraft, African Studies of
Women and Femininity in U.S. Popular Culture
Women's History: Africa
World Systems Theory, Latin America
Yin and Yang

PRACTICES

Most of the entries in the *NDHI* discuss how specific societies habituated people to specific ideas. This selective list includes the entries on schools of thought and practice, religions, and political movements, as well as the entries on distinctive practices.

Abolitionism
Afropessimism
Agnosticism
Alchemy: China
Alchemy: Europe and the Middle East
Anarchism
Ancestor Worship
Animism
Anticolonialism: Africa
Anticolonialism: Latin America
Anticolonialism: Middle East
Anticolonialism: Southeast Asia
Anticommunism: Latin America
Antifeminism

Anti-Semitism: Overview
Anti-Semitism: Islamic Anti-Semitism
Apartheid
Aristotelianism
Asceticism: Hindu and Buddhist Asceticism
Asceticism: Western Asceticism
Astrology: Overview
Astrology: China
Atheism
Avant-Garde: Militancy
Behaviorism
Black Consciousness
Buddhism
Bureaucracy
Bushido
Cannibalism
Capitalism: Overview
Capitalism: Africa
Cartesianism
Character
Chicano Movement
Chinese Thought
Christianity: Overview
Christianity: Asia
Cinema
Citizenship: Naturalization
Civil Disobedience
Classicism
Classification of Arts and Sciences, Early Modern
Colonialism: Africa
Colonialism: Latin America
Colonialism: Southeast Asia
Communication of Ideas: Orality and Advent of Writing
Communism: Europe
Communism: Latin America
Communitarianism in African Thought
Computer Science
Confucianism
Conservatism
Constitutionalism
Cosmopolitanism
Creationism
Critical Theory
Cultural Capital
Cultural Studies
Cynicism
Dance
Daoism
Deism
Dialogue and Dialectics: Socratic
Dialogue and Dialectics: Talmudic
Discrimination
Diversity
Eclecticism
Ecumenism
Empire and Imperialism: Overview
Empire and Imperialism: Americas
Empire and Imperialism: Asia
Empire and Imperialism: Europe
Empire and Imperialism: Middle East
Empire and Imperialism: United States
Empiricism
Epicureanism
Equality: Overview
Etiquette

- Eugenics
 Everyday Life
 Existentialism
 Extirpation
 Fascism
 Fatalism
 Feminism: Overview
 Feminism: Africa and African Diaspora
 Feminism: Chicana Feminisms
 Feminism: Islamic Feminism
 Feminism: Third World U.S. Movement
 Fetishism: Overview
 Feudalism, European
 Game Theory
 Genocide
 Ghetto
 Gift, The
 Gnosticism
 Health and Disease
 Hegelianism
 Hinduism
 Humanism: Renaissance
 Humanism: Secular Humanism in the United States
 Human Rights: Overview
 Human Rights: Women's Rights
 Interpretation
 Islam: Africa
 Islam: Shii
 Islam: Southeast Asia
 Islam: Sunni
 Jainism
 Japanese Philosophy, Japanese Thought
 Jihad
 Judaism: Judaism to 1800
 Judaism: Modern Judaism
 Kantianism
 Law
 Leadership
 Legalism, Ancient China
 Liberalism
 Liberation Theology
 Machiavellism
 Magic
 Manichaeism
 Maoism
 Marxism: Overview
 Marxism: Asia
 Marxism: Latin America
 Masks
 Mechanical Philosophy
 Medicine: China
 Medicine: Europe and the United States
 Medicine: India
 Medicine: Islamic Medicine
 Migration: Migration in World History
 Monarchy: Overview
 Monasticism
 Multiculturalism, Africa
 Museums
 Music, Anthropology of
 Musical Performance and Audiences
 Musicology
 Myth
 Nationalism: Overview
 Nationalism: Africa
 Nationalism: Cultural Nationalism
 Nationalism: Middle East
 Neoplatonism
 Nihilism
 Nomadism
 Nonviolence
 Orthodoxy
 Orthopraxy: Asia
 Orthopraxy: Western Orthopraxy
 Pacifism
 Pan-Africanism
 Pan-Arabism
 Pan-Asianism
 Pan-Islamism
 Pan-Turkism
 Paradigm
 Phrenology
 Physics
 Platonism
 Political Protest, U.S.
 Polytheism
 Population
 Populism: Latin America
 Positivism
 Practices
 Pragmatism
 Pseudoscience
 Psychoanalysis
 Psychology and Psychiatry
 Public Sphere
 Punishment
 Race and Racism: Asia
 Race and Racism: Europe
 Race and Racism: United States
 Radicals/Radicalism
 Rational Choice
 Reading
 Realism: Africa
 Reflexivity
 Reform: Europe and the United States
 Relativism
 Religion: Overview
 Religion: Africa
 Religion: African Diaspora
 Religion: East and Southeast Asia
 Religion: Indigenous Peoples' View, South America
 Religion: Latin America
 Religion: Middle East
 Republicanism: Latin America
 Republicanism: Republic
 Resistance
 Resistance and Accommodation
 Responsibility
 Revolution
 Ritual: Public Ritual
 Ritual: Religion
 Romanticism in Literature and Politics
 Sacred and Profane
 Scholasticism
 Science: Overview
 Scientific Revolution
 Secularization and Secularism
 Segregation
 Skepticism
 Slavery

READER'S GUIDE

Socialism
Socialisms, African
Sophists, The
Sport
Stoicism
Subjectivism
Suicide
Superstition
Symbolism
Syncretism
Temperance
Terror
Theater and Performance
Time: Traditional and Utilitarian
Totalitarianism
Totems
Trade
Tradition
Tragedy and Comedy
Tribalism, Middle East
Untouchability: Overview
Untouchability: Menstrual Taboos
Untouchability: Taboos
Utilitarianism
Visual Order to Organizing Collections
Volunteerism, U.S.
Westernization: Africa
Westernization: Middle East
Westernization: Southeast Asia
Witchcraft
Witchcraft, African Studies of
Work
Yoga
Zionism

TEXTUAL

Every entry in the *New Dictionary of the History of Ideas* used texts. The following is a list of entries that focused mainly on the history of a succession of texts. Each academic discipline has a succession of major authors with whom later practitioners of the discipline build upon and respond to creatively. The historian of a discipline—such as the history of political philosophy, literary history, or the history of science—considers the responses of thinkers and practitioners of a discipline to the major earlier texts in the discipline. In tracing the origin, development, and transformation of an idea, the historian of ideas considers thinkers' responses to texts from a variety of disciplines.

Agnosticism
Alchemy: Europe and the Middle East
Algebras
Altruism
America
Analytical Philosophy
Aristotelianism
Asceticism: Hindu and Buddhist Asceticism
Autobiography
Autonomy
Biography
Bureaucracy
Capitalism: Overview
Cartesianism
Casuistry

Causality
Censorship
Change
Chinese Thought
Civil Disobedience
Class
Communitarianism in African Thought
Conservatism
Continental Philosophy
Cosmology: Cosmology and Astronomy
Creolization, Caribbean
Crisis
Cycles
Death and Afterlife, Islamic Understanding of
Deism
Dialogue and Dialectics: Socratic
Dialogue and Dialectics: Talmudic
Eclecticism
Encyclopedism
Epistemology: Ancient
Epistemology: Early Modern
Equality: Gender Equality
Eschatology
Essentialism
Existentialism
Experiment
Falsifiability
Fatalism
Fetishism: Fetishism in Literature and Cultural Studies
Form, Metaphysical, in Ancient and Medieval Thought
Free Will, Determinism, and Predestination
General Will
Generation
Genius
Genre
Geometry
Gift, The
Globalization: Asia
Gnosticism
Good
Greek Science
Happiness and Pleasure in European Thought
Heaven and Hell
Hegelianism
Hermeneutics
Hierarchy and Order
Hinduism
Historical and Dialectical Materialism
Historicism
Historiography
History, Idea of
Humanism: Africa
Humanism: Chinese Conception of
Humanism: Renaissance
Humanity: Asian Thought
Human Rights: Overview
Idealism
Ideas, History of
Identity, Multiple: Overview
Identity: Identity of Persons
Imagination
Immortality and the Afterlife
Individualism
Intelligentsia
Jouissance

- Judaism: Judaism to 1800
 Justice: Overview
 Justice: Justice in American Thought
 Justice: Justice in East Asian Thought
 Kantianism
 Knowledge
 Language, Philosophy of: Ancient and Medieval
 Language, Philosophy of: Modern
 Legalism, Ancient China
 Liberalism
 Liberty
 Literature: African Literature
 Materialism in Eighteenth-Century European Thought
 Mechanical Philosophy
 Medicine: China
 Metaphor
 Metaphysics: Ancient and Medieval
 Metaphysics: Renaissance to the Present
 Microcosm and Macrocosm
 Mind
 Modernity: East Asia
 Mohism
 Moral Sense
 Motif: Motif in Literature
 Mysticism: Chinese Mysticism
 Mysticism: Christian Mysticism
 Mysticism: Kabbalah
 Natural Law
 Natural Theology
 Naturalism
 Naturphilosophie
 Negritude
 Neocolonialism
 New Criticism
 Nihilism
 Organicism
 Orientalism: Overview
 Orthopraxy: Western Orthopraxy
 Paradigm
 Phenomenology
 Philosophies: African
 Philosophies: Islamic
 Philosophy: Historical Overview and Recent Developments
 Philosophy, History of
 Philosophy, Moral: Ancient
 Philosophy, Moral: Medieval and Renaissance
 Philosophy, Moral: Modern
 Philosophy and Religion in Western Thought
 Philosophy of Mind: Ancient and Medieval
 Philosophy of Religion
 Pietism
 Platonism
 Poetry and Poetics
 Political, The
 Postcolonial Theory and Literature
 Practices
 Pragmatism
 Prehistory, Rise of
 Progress, Idea of
 Psychoanalysis
 Queer Theory
 Race and Racism: Overview
 Rationalism
 Reading
 Realism: Africa
 Reflexivity
 Relativity
 Religion: Overview
 Representation: Political Representation
 Republicanism: Republic
 Romanticism in Literature and Politics
 Sacred Texts: Asia
 Science: East Asia
 Science, History of
 Science Fiction
 Social Capital
 Social Contract
 State of Nature
 Stoicism
 Structuralism and Poststructuralism: Overview
 Structuralism and Poststructuralism: Anthropology
 Taste
 Text/Textuality
 Toleration
 Treaty
 Truth
 Universalism
 Utopia
 Virtue Ethics
 Wealth
 World Systems Theory, Latin America

GEOGRAPHICAL AREAS

Global Entries

EXEMPLARY GLOBAL ENTRIES

- Anthropology
 Atheism
 Bilingualism and Multilingualism
 Black Atlantic
 Christianity: Overview
 Communication of Ideas: Orality and the Advent of Writing
 Constitutionalism
 Critical Theory
 Dance
 Environmental History
 Eurocentrism
 Feminism: Overview
 Fundamentalism
 Garden
 Historiography
 History, Economic
 Humanity in the Arts
 Identity, Multiple: Jewish Multiple Identity
 International Order
 Islam: Shii
 Islam: Sunni
 Life Cycle: Elders/Old Age
 Magic
 Maps and the Ideas They Express
 Marxism: Overview
 Mathematics
 Migration: Africa
 Migration: Migration in World History
 Migration: United States
 Monasticism
 Music, Anthropology of

READER'S GUIDE

- Musical Performance and Audiences
Nuclear Age
Pan-Africanism
Peasants and Peasantry
Person, Idea of the
Polytheism
Postcolonial Theory and Literature
Property
Protest, Political
Religion and the State: Africa
Resistance and Accommodation
Ritual: Religion
Sacred Places
Secularization and Secularism
Slavery
Sovereignty
Superstition
Syncretism
Temperance
Third Cinema
Third World Literature
Tradition
Treaty
Witchcraft
Women's Studies
- ENTRIES ON AT LEAST THREE GEOGRAPHIC
AREAS OR A GLOBAL TOPIC
- Abolitionism
Aesthetics: Africa
Africa, Idea of
Alchemy: China
Alienation
Animism
Anthropology
Anticolonialism: Africa
Anticolonialism: Latin America
Anticolonialism: Southeast Asia
Antifeminism
Architecture: Overview
Arts: Overview
Arts: Africa
Asceticism: Hindu and Buddhist Asceticism
Astrology: Overview
Atheism
Authoritarianism: Overview
Authority
Autobiography
Barbarism and Civilization
Bilingualism and Multilingualism
Bioethics
Biography
Black Atlantic
Body, The
Borders, Borderlands, and Frontiers, Global
Buddhism
Calculation and Computation
Calendar
Cannibalism
Capitalism: Overview
Capitalism: Africa
Censorship
Childhood and Child Rearing
Cinema
Citizenship: Overview
City, The: The City as a Cultural Center
Civil Disobedience
Civil Society: Europe and the United States
Colonialism: Africa
Colonialism: Southeast Asia
Communication of Ideas: Africa and Its Influence
Communication of Ideas: Middle East and Abroad
Communication of Ideas: Orality and the Advent of
Writing
Computer Science
Consciousness: Overview
Corruption in Developed and Developing Countries
Cosmology: Asia
Cosmopolitanism
Creativity in the Arts and Sciences
Creolization, Caribbean
Critical Theory
Cultural Capital
Cultural Studies
Dance
Death
Deism
Democracy
Demography
Demonology
Dependency
Diasporas: African Diaspora
Diasporas: Jewish Diaspora
Discrimination
Diversity
Dream
Dress
Dualism
Ecology
Economics
Ecumenism
Education: Global Education
Education: Islamic Education
Empire and Imperialism: Overview
Empire and Imperialism: Asia
Empire and Imperialism: Europe
Empire and Imperialism: Middle East
Empire and Imperialism: United States
Environment
Equality: Overview
Equality: Gender Equality
Equality: Racial Equality
Ethnicity and Race: Anthropology
Ethnocentrism
Ethnography
Evil
Family: Family in Anthropology since 1980
Family Planning
Fascism
Feminism: Africa and African Diaspora
Feminism: Islamic Feminism
Feminism: Third World U.S. Movement
Fetishism: Overview
Friendship
Futurology
Gay Studies
Gender: Overview
Gender: Gender in the Middle East
Gender in Art
Gender Studies: Anthropology
Generation

- Genius
 Genocide
 Geography
 Ghetto
 Globalization: General
 Hate
 Heaven and Hell
 Honor
 Human Capital
 Humanism: Chinese Conception of
 Humanity: African Thought
 Human Rights: Overview
 Human Rights: Women's Rights
 Iconography
 Identity, Multiple: Overview
 Images, Icons, and Idols
 Immortality and the Afterlife
 Intelligentsia
 Islam: Africa
 Islamic Science
 Jihad
 Judaism: Modern Judaism
 Justice: Overview
 Kinship
 Landscape in the Arts
 Language, Linguistics, and Literacy
 Law
 Liberation Theology
 Liberty
 Life Cycle: Overview
 Life Cycle: Adolescence
 Literature: Overview
 Machiavellism
 Masks
 Matriarchy
 Media, History of
 Medicine: China
 Meditation: Eastern Meditation
 Men and Masculinity
 Millenarianism: Overview
 Millenarianism: Latin America and Native North America
 Minority
 Miracles
 Modernism: Overview
 Modernism: Latin America
 Modernity: Overview
 Modernity: Africa
 Modernization Theory
 Monarchy: Overview
 Motif: Motif in Music
 Museums
 Musicology
 Mysticism: Chinese Mysticism
 Myth
 Nation
 Nationalism: Overview
 Nationalism: Africa
 Native Policy
 Negritude
 Neocolonialism
 Nihilism
 Nomadism
 Nonviolence
 Occidentalism
 Oral Traditions: Overview
 Organicism
 Orientalism: Overview
 Orientalism: African and Black Orientalism
 Orthodoxy
 Orthopraxy: Asia
 Other, The, European Views of
 Pacifism
 Paradise on Earth
 Peace
 Periodization
 Periodization of the Arts
 Perspective
 Philosophies: African
 Philosophy: Historical Overview and Recent Developments
 Philosophy: Relations to Other Intellectual Realms
 Philosophy, Moral: Africa
 Political Science
 Population
 Postcolonial Studies
 Practices
 Prehistory, Rise of
 Prejudice
 Presentism
 Privatization
 Pseudoscience
 Race and Racism: Overview
 Reading
 Reflexivity
 Religion: Overview
 Religion: East and Southeast Asia
 Religion: Latin America
 Religion and the State: United States
 Representation: Political Representation
 Republicanism: Republic
 Rhetoric: Overview
 Ritual: Public Ritual
 Sacred and Profane
 Scarcity and Abundance, Latin America
 Science: Overview
 Segregation
 Sexuality: Overview
 Social Capital
 Society
 Sport
 State, The: Overview
 Structuralism and Poststructuralism: Anthropology
 Symbolism
 Third World
 Time: China
 Toleration
 Totalitarianism
 Totems
 Trade
 Translation
 Travel: Travel from Europe and the Middle East
 University: Overview
 University: Postcolonial
 Untouchability: Overview
 Untouchability: Menstrual Taboos
 Untouchability: Taboos
 Victorianism
 Visual Order to Organizing Collections
 War

READER'S GUIDE

War and Peace in the Arts
Westernization: Africa
Westernization: Southeast Asia
Wisdom, Human
Work
World Systems Theory, Latin America

Africa

ENTRIES FOCUSING ON AFRICA

Aesthetics: Africa
Anticolonialism: Africa
Architecture: Africa
Arts: Africa
Authenticity: Africa
Black Atlantic
Capitalism: Africa
Colonialism: Africa
Communication of Ideas: Africa and Its Influence
Communitarianism in African Thought
Democracy, Africa
Diasporas: African Diaspora
Ethnicity and Race: Africa
Feminism: Africa and African Diaspora
Globalization: Africa
Humanism: Africa
Humanity: African Thought
Islam: Africa
Literature: African Literature
Migration: Africa
Modernity: Africa
Multiculturalism, Africa
Mysticism: Mysticism in African Thought
Nationalism: Africa
Pan-Africanism
Personhood in African Thought
Philosophies: African
Philosophy, Moral: Africa
Realism: Africa
Religion: Africa
Religion: African Diaspora
Religion and the State: Africa
Sociability in African Thought
Socialisms, African
Sufism
Westernization: Africa
Women's History: Africa
Witchcraft, African Studies of

ENTRIES THAT CONSIDER AFRICA

Abolitionism
Africa, Idea of
African-American Ideas
Afrocentricity
Afropessimism
Ancestor Worship
Anthropology
Apartheid
Arts: Overview
Bilingualism and Multilingualism
Black Consciousness
Buddhism
Christianity: Overview
Civil Disobedience
Civil Society: Responses in Africa and the Middle East
Communication of Ideas: Orality and Advent of Writing

Creolization, Caribbean
Critical Theory
Dance
Demography
Dependency
Diasporas: Jewish Diaspora
Discrimination
Dress
Ecology
Empire and Imperialism: Europe
Empire and Imperialism: Middle East
Environmental History
Equality: Racial Equality
Ethnography
Eurocentrism
Family: Modernist Anthropological Theory
Fascism
Feminism: Overview
Feminism: Islamic Feminism
Fetishism: Overview
Genocide
Globalization: General
Historiography
History, Economic
Humanity in the Arts
Identity, Multiple: Jewish Multiple Identity
International Order
Islam: Shii
Islam: Sunni
Jainism
Kinship
Law
Liberation Theology
Life Cycle: Elders/Old Age
Machiavellism
Magic
Maps and the Ideas They Express
Masks
Mathematics
Men and Masculinity
Migration: Migration in World History
Migration: United States
Minority
Modernism: Overview
Motherhood and Maternity
Museums
Music, Anthropology of
Negritude
Neocolonialism
Nomadism
Oral Traditions: Overview
Orientalism: African and Black Orientalism
Pacifism
Peasants and Peasantry
Person, Idea of the
Philosophies: Islamic
Polytheism
Postcolonial Studies
Postcolonial Theory and Literature
Property
Protest, Political
Race and Racism: Overview
Religion: Latin America
Religion and the State: United States
Resistance and Accommodation

Ritual: Religion
 Sacred and Profane
 Sage Philosophy
 Segregation
 Slavery
 State, The: The Postcolonial State
 Syncretism
 Temperance
 Third Cinema
 Third World
 Third World Literature
 Time: Traditional and Utilitarian
 Toleration
 Totems
 Treaty
 Tribalism, Middle East
 University: Postcolonial
 Untouchability: Menstrual Taboos
 Victorianism
 War
 Wisdom, Human
 Witchcraft
 Womanism
 Women's Studies
 Work
 World Systems Theory, Latin America

Asia

ENTRIES FOCUSING ON ASIA

Aesthetics: Asia
 Alchemy: China
 Anticolonialism: Southeast Asia
 Architecture: Asia
 Authoritarianism: East Asia
 Buddhism
 Causation in East Asian and Southeast Asian Philosophy
 Chinese Thought
 Chinese Warlordism
 Christianity: Asia
 Colonialism: Southeast Asia
 Communication of Ideas: Asia and Its Influence
 Communication of Ideas: Southeast Asia and Its Influence
 Confucianism
 Consciousness: Chinese Thought
 Consciousness: Indian Thought
 Cosmology: Asia
 Daoism
 Education: Asia, Traditional and Modern
 Education: China
 Education: India
 Education: Japan
 Empire and Imperialism: Asia
 Examination Systems, China
 Globalization: Asia
 Heaven and Hell (Asian Focus)
 Hinduism
 Humanism: Chinese Conception of
 Humanity: Asian Thought
 Islam: Southeast Asia
 Jainism
 Japanese Philosophy, Japanese Thought
 Justice: Justice in East Asian Thought
 Landscape in the Arts

Legalism, Ancient China
 Literature: Overview
 Maoism
 Marxism: Asia
 Medicine: China
 Medicine: India
 Meditation: Eastern Meditation
 Modernity: East Asia
 Mysticism: Chinese Mysticism
 Mysticism: Islamic Mysticism in Asia
 Orthopraxy: Asia
 Pan-Asianism
 Pan-Turkism
 Philosophy: Historical Overview and Recent Developments
 Race and Racism: Asia
 Religion: East and Southeast Asia
 Sacred Texts: Asia
 Science: East Asia
 Time: China
 Time: India
 Westernization: Southeast Asia
 Women's History: Asia

ENTRIES THAT CONSIDER ASIA

Algebras
 Ancestor Worship
 Anthropology
 Anticolonialism: Africa
 Architecture: Overview
 Arts: Overview
 Asceticism: Hindu and Buddhist Asceticism
 Asian-American Ideas (Cultural Migration)
 Astrology: China
 Astronomy, Pre-Columbian and Latin American
 Atheism
 Autobiography
 Barbarism and Civilization
 Beauty and Ugliness
 Bilingualism and Multilingualism
 Biography
 Body, The
 Borders, Borderlands, and Frontiers, Global
 Bushido
 Calculation and Computation
 Cannibalism
 Censorship
 Childhood and Child Rearing
 Christianity: Overview
 Cinema
 Civil Disobedience
 Civil Society: Responses in Africa and the Middle East
 Communication of Ideas: Middle East and Abroad
 Communication of Ideas: Orality and the Advent of Writing
 Constitutionalism
 Cosmopolitanism
 Creativity in the Arts and Sciences
 Critical Theory
 Cultural Revivals
 Cycles
 Dance
 Deism
 Demography
 Demonology
 Dependency

READER'S GUIDE

Diasporas: African Diaspora
Diffusion, Cultural
Dream
Dress
Dualism
Ecumenism
Education: Global Education
Education: Islamic Education
Empire and Imperialism: Europe
Empire and Imperialism: Middle East
Empire and Imperialism: United States
Environment
Environmental History
Ethnography
Eurocentrism
Evil
Family: Family in Anthropology since 1980
Family Planning
Fascism
Feminism: Overview
Field Theories
Friendship
Fundamentalism
Garden
Gay Studies
Gender Studies: Anthropology
Generation
Genetics: Contemporary
Genocide
Globalization: General
Health and Disease
Heaven and Hell
Historiography
History, Economic
Human Capital
Humanity in the Arts
Hygiene
Iconography
Identity, Multiple: Asian-Americans
Identity, Multiple: Jewish Multiple Identity
Images, Icons, and Idols
Imagination
Immortality and the Afterlife
Individualism
Intelligentsia
International Order
Islam: Shii
Islam: Sunni
Islamic Science
Kinship
Language, Linguistics, and Literacy
Liberty
Life Cycle: Overview
Life Cycle: Adolescence
Life Cycle: Elders/Old Age
Machiavellism
Magic
Maps and the Ideas They Express
Marxism: Overview
Masks
Mathematics
Matriarchy
Migration: Migration in World History
Migration: United States
Miracles
Modernism: Latin America
Modernity: Africa
Modernization Theory
Mohism
Monarchy: Overview
Monasticism
Monism
Motherhood and Maternity
Motif: Motif in Music
Museums
Musical Performance and Audiences
Musicology
Nation
Neoliberalism
Nomadism
Nonviolence
Nuclear Age
Nude, The
Occidentalism
Organicism
Orientalism: Overview
Orthodoxy
Pacifism
Paradise on Earth
Peace
Peasants and Peasantry
Periodization
Person, Idea of the
Perspective
Philosophy: Relations to Other Intellectual Realms
Political Science
Population
Postcolonial Studies
Postcolonial Theory and Literature
Practices
Prehistory, Rise of
Privacy
Property
Protest, Political
Race and Racism: United States
Reading
Religion: Overview
Religion and the State: United States
Resistance and Accommodation
Revolution
Rhetoric: Overview
Ritual: Public Ritual
Ritual: Religion
Sacred and Profane
Sacred Places
Secularization and Secularism
Sexual Harassment
Sexuality: Sexual Orientation
Shinto
Slavery
Society
Sovereignty
Sport
Suicide
Superstition
Syncretism
Taste
Temperance
Terror
Textiles and Fiber Arts as Catalysts for Ideas

Third Cinema
 Third World
 Third World Literature
 Toleration
 Totems
 Trade
 Translation
 Treaty
 University: Postcolonial
 Untouchability: Overview
 Untouchability: Menstrual Taboos
 Untouchability: Taboos
 Victorianism
 Virtue Ethics
 Visual Order to Organizing Collections
 War and Peace in the Arts
 Wisdom, Human
 Witchcraft
 Women's Studies
 Work
 World Systems Theory, Latin America
 Yin and Yang
 Yoga
 Zen

Europe

ENTRIES FOCUSING ON EUROPE

Architecture: Overview
 Capitalism: Overview
 Christianity: Overview
 Classification of Arts and Sciences, Early Modern
 Colonialism: Africa
 Colonialism: Latin America
 Colonialism: Southeast Asia
 Communication of Ideas: Europe and Its Influence
 Communism: Europe
 Consumerism
 Dada
 Democracy
 Dialogue and Dialectics: Socratic
 Dialogue and Dialectics: Talmudic
 Education: Europe
 Empire and Imperialism: Overview
 Empire and Imperialism: Europe
 Encyclopedism
 Enlightenment
 Epistemology: Ancient
 Epistemology: Early Modern
 Epistemology: Modern
 Eurocentrism
 Europe, Idea of
 Existentialism
 Expressionism
 Fascism
 Feudalism, European
 Greek Science
 Happiness and Pleasure in European Thought
 Hedonism in European Thought
 Historical and Dialectical Materialism
 Humanism: Europe and the Middle East
 Humanism: Renaissance
 Humanity: European Thought
 Judaism: Judaism to 1800
 Judaism: Modern Judaism
 Landscape in the Arts

Literature: Overview
 Love, Western Notions of
 Marxism: Overview
 Materialism in Eighteenth-Century European Thought
 Mechanical Philosophy
 Medicine: Europe and the United States
 Metaphysics: Ancient and Medieval
 Metaphysics: Renaissance to the Present
 Monarchy: Overview
 National History
 Orthopraxy: Western Orthopraxy
 Other, The, European Views of
 Pan-Turkism
 Philosophy: Historical Overview and Recent Developments
 Philosophy, Moral: Ancient
 Philosophy, Moral: Medieval and Renaissance
 Philosophy, Moral: Modern
 Philosophy and Religion in Western Thought
 Philosophy of Mind: Ancient and Medieval
 Pythagoreanism
 Race and Racism: Europe
 Regions and Regionalism, Eastern Europe
 Religion and the State: Europe
 Scientific Revolution
 Victorianism

ENTRIES THAT CONSIDER EUROPE

Abolitionism
 Absolute Music
 Aesthetics: Europe and the Americas
 Africa, Idea of
 Afrocentricity
 Agnosticism
 Alchemy: Europe and the Middle East
 Algebras
 Alienation
 Altruism
 Ambiguity
 America
 Americanization, U.S.
 Analytical Philosophy
 Anarchism
 Animism
 Anthropology
 Anticolonialism: Africa
 Anticolonialism: Latin America
 Anticolonialism: Middle East
 Anticolonialism: Southeast Asia
 Antifeminism
 Anti-Semitism: Overview
 Anti-Semitism: Islamic Anti-Semitism
 Apartheid
 Architecture: Africa
 Aristotelianism
 Arts: Overview
 Arts: Africa
 Asceticism: Western Asceticism
 Assimilation
 Astrology: Overview
 Atheism
 Authoritarianism: Overview
 Authority
 Autobiography
 Autonomy
 Avant-Garde: Overview

READER'S GUIDE

Avant-Garde: Militancy
 Barbarism and Civilization
 Beauty and Ugliness
 Behaviorism
 Bilingualism and Multilingualism
 Biography
 Biology
 Black Atlantic
 Body, The
 Borders, Borderlands, and Frontiers, Global
 Buddhism
 Bureaucracy
 Calculation and Computation
 Calendar
 Cannibalism
 Cartesianism
 Casuistry
 Causality
 Causation
 Censorship
 Change
 Character
 Chemistry
 Childhood and Child Rearing
 Christianity: Asia
 Cinema
 Citizenship: Overview
 Citizenship: Naturalization
 City, The: The City as a Cultural Center
 City, The: The Islamic and Byzantine City
 Civil Disobedience
 Civil Society: Europe and the United States
 Civil Society: Responses in Africa and the Middle East
 Class
 Classicism
 Common Sense
 Communication of Ideas: Africa and Its Influence
 Communication of Ideas: Middle East and Abroad
 Communication of Ideas: Orality and the Advent of Writing
 Communication of Ideas: Southeast Asia
 Composition, Musical
 Computer Science
 Consciousness: Overview
 Conservatism
 Consilience
 Constitutionalism
 Continental Philosophy
 Corruption
 Cosmology: Cosmology and Astronomy
 Cosmopolitanism
 Creationism
 Creativity in the Arts and Sciences
 Creolization, Caribbean
 Crisis
 Critical Theory
 Cultural Capital
 Cultural History
 Cultural Revivals
 Cultural Studies
 Cycles
 Cynicism
 Dance
 Deism
 Demography
 Demonology
 Dependency
 Determinism
 Development
 Diasporas: African Diaspora
 Diasporas: Jewish Diaspora
 Diversity
 Dream
 Dress
 Dystopia
 Eclecticism
 Ecology
 Economics
 Ecumenism
 Education: Global Education
 Education: India
 Education: Islamic Education
 Emotions
 Empire and Imperialism: Asia
 Empire and Imperialism: Middle East
 Empire and Imperialism: United States
 Empiricism
 Environment
 Environmental Ethics
 Environmental History
 Epicureanism
 Equality: Overview
 Equality: Gender Equality
 Equality: Racial Equality
 Essentialism
 Ethnicity and Race: Africa
 Ethnicity and Race: Anthropology
 Ethnocentrism
 Etiquette
 Eugenics
 Everyday Life
 Evil
 Evolution
 Experiment
 Extirpation
 Fallacy, Logical
 Falsifiability
 Family: Modernist Anthropological Theory
 Family: Family in Anthropology since 1980
 Family Planning
 Fatalism
 Feminism: Overview
 Feminism: Africa and African Diaspora
 Feminism: Islamic Feminism
 Fetishism: Overview
 Fetishism: Fetishism in Literature and Cultural Studies
 Field Theories
 Form, Metaphysical, in Ancient and Medieval Thought
 Formalism
 Foundationalism
 Free Will, Determinism, and Predestination
 Friendship
 Fundamentalism
 Garden
 Gay Studies
 Gender: Gender in the Middle East
 Gender in Art
 Gender Studies: Anthropology
 General Will
 Generation

- Genetics: Contemporary
 Genetics: History of
 Genius
 Genocide
 Geography
 Geometry
 Gesture
 Ghetto
 Gift, The
 Globalization: Africa
 Globalization: Asia
 Globalization: General
 Good
 Harmony
 Hate
 Health and Disease
 Heaven and Hell
 Hegelianism
 Hegemony
 Heresy and Apostasy
 Hermeneutics
 Hierarchy and Order
 Hinduism
 Historicism
 Historiography
 History, Economic
 History, Idea of
 Honor
 Human Capital
 Humanity in the Arts
 Human Rights: Overview
 Humor
 Hygiene
 Iconography
 Idealism
 Ideas, History of
 Identity: Identity of Persons
 Identity, Multiple: Overview
 Identity, Multiple: Jewish Multiple Identity
 Images, Icons, and Idols
 Immortality and the Afterlife
 Impressionism
 Individualism
 Intelligentsia
 Intentionality
 Interdisciplinarity
 International Order
 Interpretation
 Islam: Africa
 Islam: Shi'i
 Islam: Sunni
 Islamic Science
 Jainism
 Jouissance
 Justice: Overview
 Kantianism
 Kinship
 Knowledge
 Language and Linguistics
 Language, Linguistics, and Literacy
 Language, Philosophy of: Ancient and Medieval
 Language, Philosophy of: Modern
 Law
 Leadership
 Learning and Memory, Contemporary Views
 Liberalism
 Liberation Theology
 Liberty
 Life
 Life Cycle: Overview
 Life Cycle: Elders/Old Age
 Linguistic Turn
 Literary Criticism
 Literary History
 Logic
 Logic and Philosophy of Mathematics, Modern
 Loyalties, Dual
 Lysenkoism
 Machiavellism
 Magic
 Manichaeism
 Maoism
 Maps and the Ideas They Express
 Masks
 Mathematics
 Matriarchy
 Media, History of
 Medicine: Islamic Medicine
 Meme
 Memory
 Men and Masculinity
 Metaphor
 Microcosm and Macrocosm
 Migration: Africa
 Migration: Migration in World History
 Migration: United States
 Millenarianism: Overview
 Millenarianism: Islamic
 Millenarianism: Latin America and Native North America
 Mind
 Miracles
 Modernism: Overview
 Modernism: Latin America
 Modernity: Overview
 Modernity: Africa
 Modernity: East Asia
 Modernization
 Modernization Theory
 Monasticism
 Monism
 Moral Sense
 Motherhood and Maternity
 Motif: Motif in Literature
 Motif: Motif in Music
 Museums
 Music, Anthropology of
 Musical Performance and Audiences
 Musicology
 Mysticism: Christian Mysticism
 Mysticism: Kabbalah
 Mysticism: Mysticism in African Thought
 Myth
 Narrative
 Nation
 Nationalism: Overview
 Nationalism: Africa
 Nationalism: Cultural Nationalism
 Nationalism: Middle East
 Native Policy

READER'S GUIDE

Natural History
Natural Theology
Naturalism
Naturalism in Art and Literature
Nature
Naturphilosophie
Negritude
Neocolonialism
Neoliberalism
Neoplatonism
New Criticism
Newtonianism
Nihilism
Nonviolence
Nuclear Age
Nude, The
Objectivity
Obligation
Occidentalism
Organicism
Orientalism: Overview
Orthodoxy
Pacifism
Pan-Africanism
Pan-Asianism
Pan-Islamism
Paradigm
Paradise on Earth
Parties, Political
Patriotism
Peace
Peasants and Peasantry
Periodization
Periodization of the Arts
Person, Idea of the
Perspective
Phenomenology
Philosophies: African
Philosophies: Feminist, Twentieth-Century
Philosophies: Islamic
Philosophy: Relations to Other Intellectual Realms
Philosophy, History of
Philosophy, Moral: Africa
Philosophy of Mind: Overview
Phrenology
Physics
Platonism
Pluralism
Poetry and Poetics
Political, The
Political Science
Polytheism
Population
Positivism
Postcolonial Studies
Postcolonial Theory and Literature
Postmodernism
Poverty
Power
Practices
Pragmatism
Pre-Columbian Civilization
Prehistory, Rise of
Prejudice
Presentism
Privacy
Probability
Progress, Idea of
Propaganda
Property
Prophecy
Protest, Political
Pseudoscience
Psychology and Psychiatry
Public Sphere
Punishment
Puritanism
Quantum
Queer Theory
Radicals/Radicalism
Rational Choice
Rationalism
Reading
Realism
Realism: Africa
Reason, Practical and Theoretical
Reform: Europe and the United States
Reform: Islamic Reform
Reformation
Relativism
Relativity
Religion: Overview
Religion: East and Southeast Asia
Religion: Latin America
Religion: Middle East
Religion and Science
Religion and the State: Latin America
Religion and the State: United States
Renaissance
Representation: Mental Representation
Representation: Political Representation
Republicanism: Latin America
Republicanism: Republic
Resistance
Resistance and Accommodation
Responsibility
Revolution
Rhetoric: Overview
Rhetoric: Ancient and Medieval
Ritual: Public Ritual
Ritual: Religion
Romanticism in Literature and Politics
Sacred and Profane
Sacred Places
Sage Philosophy
Scarcity and Abundance, Latin America
Scholasticism
Science: Overview
Science, History of
Science Fiction
Secularization and Secularism
Sexuality: Overview
Skepticism
Slavery
Social Capital
Social Contract
Social Darwinism
Socialism
Socialisms, African
Society

Sophists, The
 Sovereignty
 Sport
 State, The: Overview
 Stoicism
 Structuralism and Poststructuralism: Overview
 Structuralism and Poststructuralism: Anthropology
 Subjectivism
 Suicide
 Superstition
 Surrealism
 Symbolism
 Taste
 Technology
 Temperance
 Terror
 Terrorism, Middle East
 Textiles and Fiber Arts as Catalysts for Ideas
 Theodicy
 Third Cinema
 Time: Traditional and Utilitarian
 Toleration
 Totalitarianism
 Trade
 Tragedy and Comedy
 Translation
 Travel: Travel from Europe and the Middle East
 Treaty
 Trope
 Truth
 Universalism
 University: Overview
 University: Postcolonial
 Untouchability: Overview
 Untouchability: Menstrual Taboos
 Untouchability: Taboos
 Utilitarianism
 Utopia
 Virtue Ethics
 Visual Order to Organizing Collections
 Volksgeist
 Volunteerism, U.S.
 War
 War and Peace in the Arts
 Wealth
 Westernization: Africa
 Westernization: Middle East
 Westernization: Southeast Asia
 Wildlife
 Wisdom, Human
 Witchcraft
 Witchcraft, African Studies of
 Women's History: Africa
 Women's Studies
 Work
 World Systems Theory, Latin America
 Zionism

Middle East

ENTRIES FOCUSING ON THE MIDDLE EAST

Alchemy: Europe and the Middle East
 Anticolonialism: Middle East
 Civil Society: Responses in Africa and the Middle East
 Communication of Ideas: Middle East and Abroad
 Death and Afterlife, Islamic Understanding of

Dialogue and Dialectics: Talmudic
 Education: Islamic Education
 Empire and Imperialism: Middle East
 Feminism: Islamic Feminism
 Gender: Gender in the Middle East
 Honor, Middle Eastern Notions of
 Humanism: Europe and the Middle East
 Intercession in Middle Eastern Society
 Islam: Shii
 Islam: Sunni
 Islamic Science
 Judaism: Judaism to 1800
 Judaism: Modern Judaism
 Law, Islamic
 Literature: Overview
 Medicine: Islamic Medicine
 Monarchy: Islamic Monarchy
 Nationalism: Middle East
 Pan-Arabism
 Pan-Islamism
 Pan-Turkism
 Philosophies: Islamic
 Religion: Middle East
 Religion and the State: Middle East
 Sufism
 Terrorism, Middle East
 Tribalism, Middle East
 Westernization: Middle East
 Zionism

ENTRIES THAT CONSIDER THE MIDDLE EAST

Africa, Idea of
 Algebras
 Anthropology
 Antifeminism
 Anti-Semitism: Overview
 Anti-Semitism: Islamic Anti-Semitism
 Architecture: Overview
 Architecture: Africa
 Aristotelianism
 Arts: Africa
 Astrology: Overview
 Astrology: China
 Atheism
 Authoritarianism: Overview
 Authority
 Barbarism and Civilization
 Bilingualism and Multilingualism
 Biography
 Calendar
 Childhood and Child Rearing
 Christianity: Overview
 City, The: The Islamic and Byzantine City
 Class
 Communication of Ideas: Africa and Its Influence
 Communication of Ideas: Europe and Its Influence
 Communication of Ideas: Orality and the Advent of Writing
 Computer Science
 Constitutionalism
 Cosmopolitanism
 Creativity in the Arts and Sciences
 Critical Theory
 Dance
 Deism
 Demography

READER'S GUIDE

Demonology
 Dependency
 Diasporas: African Diaspora
 Diasporas: Jewish Diaspora
 Dream
 Dualism
 Ecumenism
 Empire and Imperialism: Europe
 Environment
 Ethnicity and Race: Islamic Views
 Eurocentrism
 Evil
 Family Planning
 Feminism: Overview
 Feminism: Africa and African Diaspora
 Free Will, Determinism, and Predestination
 Friendship
 Fundamentalism
 Garden
 Gay Studies
 Gender in Art
 Ghetto
 Gift, The
 Gnosticism
 Hate
 Health and Disease
 Heaven and Hell
 Heresy and Apostasy
 Historiography
 Humanity in the Arts
 Iconography
 Identity, Multiple: Jewish Multiple Identity
 Images, Icons, and Idols
 Imagination
 Immortality and the Afterlife
 Intelligentsia
 International Order
 Islam: Africa
 Jihad
 Language, Linguistics, and Literacy
 Language, Philosophy of: Ancient and Medieval
 Liberty
 Life Cycle: Elders/Old Age
 Literature: African Literature
 Logic
 Manichaeism
 Maps and the Ideas They Express
 Mathematics
 Matriarchy
 Microcosm and Macrocosm
 Migration: Africa
 Migration: Migration in World History
 Millenarianism: Overview
 Millenarianism: Islamic
 Minority
 Miracles
 Monarchy: Overview
 Motherhood and Maternity
 Museums
 Musicology
 Mysticism: Islamic Mysticism
 Mysticism: Islamic Mysticism in Asia
 Mysticism: Kabbalah
 Mysticism: Mysticism in African Thought
 Nation
 Nationalism: Cultural Nationalism
 Nihilism
 Nomadism
 Nonviolence
 Nuclear Age
 Organicism
 Orientalism: Overview
 Orientalism: African and Black Orientalism
 Orthodoxy
 Orthopraxy: Western Orthopraxy
 Pan-Africanism
 Paradise on Earth
 Peace
 Perspective
 Philosophies: African
 Philosophy, Moral: Medieval and Renaissance
 Philosophy of Mind: Ancient and Medieval
 Political Science
 Polytheism
 Postcolonial Studies
 Postcolonial Theory and Literature
 Property
 Prophecy
 Protest, Political
 Pythagoreanism
 Reform: Islamic Reform
 Religion: East and Southeast Asia
 Religion and Science
 Religion and the State: Africa
 Religion and the State: Europe
 Religion and the State: United States
 Resistance and Accommodation
 Rhetoric: Overview
 Sacred Places
 Sacred Texts: Koran
 Science, History of
 Scientific Revolution
 Secularization and Secularism
 Sexual Harassment
 Sexuality: Islamic Views
 Slavery
 Sovereignty
 Suicide
 Superstition
 Syncretism
 Temperance
 Textiles and Fiber Arts as Catalysts for Ideas
 Theodicy
 Third Cinema
 Third World Literature
 Toleration
 Totalitarianism
 Totems
 Travel: Travel from Europe and the Middle East
 Treaty
 University: Overview
 Untouchability: Menstrual Taboos
 Untouchability: Taboos
 Visual Order to Organizing Collections
 Westernization: Africa
 Westernization: Southeast Asia
 Wisdom, Human
 Women's History: Africa
 Women's Studies
 World Systems Theory, Latin America

North America

ENTRIES FOCUSING ON NORTH AMERICA

African-American Ideas
 America
 Asian-American Ideas (Cultural Migration)
 Black Atlantic
 Chicano Movement
 Christianity: Overview
 Civil Society: Europe and the United States
 Communication of Ideas: The Americas and Their Influence
 Consumerism
 Democracy
 Education: North America
 Empire and Imperialism: Americas
 Empire and Imperialism: United States
 Ethnohistory, U.S.
 Feminism: Chicana Feminisms
 Feminism: Third World U.S. Movement
 Humanism: Secular Humanism in the United States
 Identity, Multiple: Asian-Americans
 Judaism: Modern Judaism
 Justice: Justice in American Thought
 Landscape in the Arts
 Medicine: Europe and the United States
 Migration: United States
 Millenarianism: Latin America and Native North America
 Native Policy
 Philosophies: American
 Political Protest, U.S.
 Populism: United States
 Race and Racism: United States
 Reform: Europe and the United States
 Religion and the State: United States
 Volunteerism, U.S.

ENTRIES THAT CONSIDER NORTH AMERICA

Abolitionism
 Aesthetics: Europe and the Americas
 Africa, Idea of
 Afrocentricity
 Altruism
 Americanization, U.S.
 Analytical Philosophy
 Anthropology
 Anticolonialism: Latin America
 Anticolonialism: Southeast Asia
 Antifeminism
 Asceticism: Western Asceticism
 Assimilation
 Astronomy, Pre-Columbian and Latin American
 Atheism
 Authoritarianism: Latin America
 Authority
 Autobiography
 Aztlán
 Beauty and Ugliness
 Behaviorism
 Bilingualism and Multilingualism
 Bioethics
 Biology
 Body, The
 Borders, Borderlands, and Frontiers, Global
 Buddhism
 Calculation and Computation

Cannibalism
 Causation
 Censorship
 Childhood and Child Rearing
 Cinema
 Citizenship: Overview
 Citizenship: Cultural Citizenship
 Citizenship: Naturalization
 City, The: The City as a Cultural Center
 Civil Disobedience
 Colonialism: Latin America
 Communication of Ideas: Africa and Its Influence
 Communism: Latin America
 Computer Science
 Conservatism
 Consilience
 Constitutionalism
 Continental Philosophy
 Cosmopolitanism
 Creationism
 Critical Race Theory
 Critical Theory
 Cultural Capital
 Cultural Revivals
 Cultural Studies
 Dance
 Death
 Deism
 Demography
 Diasporas: African Diaspora
 Diasporas: Jewish Diaspora
 Discrimination
 Diversity
 Dream
 Dress
 Dualism
 Dystopia
 Ecology
 Economics
 Ecumenism
 Education: Global Education
 Emotions
 Empire and Imperialism: Asia
 Empiricism
 Enlightenment
 Environment
 Environmental Ethics
 Environmental History
 Equality: Overview
 Equality: Gender Equality
 Equality: Racial Equality
 Essentialism
 Ethnicity and Race: Anthropology
 Ethnocentrism
 Ethnography
 Eugenics
 Eurocentrism
 Everyday Life
 Evil
 Evolution
 Family: Modernist Anthropological Theory
 Family: Family in Anthropology since 1980
 Family Planning
 Feminism: Overview
 Feminism: Africa and African Diaspora

READER'S GUIDE

Feminism: Islamic Feminism
Fetishism: Overview
Fetishism: Fetishism in Literature and Cultural Studies
Field Theories
Foundationalism
Friendship
Fundamentalism
Game Theory
Garden
Gay Studies
Gender: Overview
Gender: Gender in the Middle East
Gender in Art
Gender Studies: Anthropology
Generation
Genetics: Contemporary
Genetics: History of
Genius
Genocide
Ghetto
Globalization: Asia
Globalization: General
Hate
Hegelianism
Historiography
History, Economic
Human Capital
Humanity: European Thought
Humanity in the Arts
Human Rights: Overview
Ideas, History of
Identity: Identity of Persons
Identity: Personal and Social Identity
Identity, Multiple: Overview
Identity, Multiple: Jewish Multiple Identity
Impressionism
Intentionality
Interdisciplinarity
Internal Colonialism
International Order
Interpretation
Islam: Shii
Jainism
Justice: Overview
Kantianism
Language and Linguistics
Language, Philosophy of: Modern
Law
Leadership
Learning and Memory, Contemporary Views
Liberation Theology
Life
Life Cycle: Adolescence
Life Cycle: Elders/Old Age
Linguistic Turn
Literary Criticism
Literary History
Loyalties, Dual
Machismo
Magic
Maps and the Ideas They Express
Marxism: Overview
Marxism: Latin America
Masks
Mathematics
Matriarchy
Media, History of
Meme
Men and Masculinity
Mestizaje
Migration: Africa
Migration: Migration in World History
Millenarianism: Overview
Mind
Minority
Modernism: Latin America
Modernity: Overview
Monasticism
Motif: Motif in Music
Museums
Music, Anthropology of
Musical Performance and Audiences
Myth
Narrative
Nation
Nationalism: Overview
Nationalism: Africa
Natural History
Natural Theology
Naturalism
Neocolonialism
Neoliberalism
New Criticism
Nihilism
Nuclear Age
Objectivity
Obligation
Occidentalism
Orientalism: African and Black Orientalism
Orthodoxy
Other, The, European Views of
Pacifism
Pan-Africanism
Paradigm
Parties, Political
Periodization
Person, Idea of the
Philosophies: Feminist, Twentieth-Century
Philosophy: Relations to Other Intellectual Realms
Philosophy of Mind: Overview
Pluralism
Political Science
Population
Positivism
Postcolonial Studies
Postcolonial Theory and Literature
Postmodernism
Practices
Pragmatism
Prehistory, Rise of
Prejudice
Presentism
Privacy
Probability
Progress, Idea of
Property
Protest, Political
Pseudoscience
Psychology and Psychiatry
Quantum

Queer Theory
 Race and Racism: Overview
 Rational Choice
 Reading
 Reflexivity
 Relativism
 Relativity
 Religion: Latin America
 Religion and Science
 Renaissance
 Representation: Mental Representation
 Representation: Political Representation
 Resistance
 Resistance and Accommodation
 Responsibility
 Rhetoric: Overview
 Ritual: Religion
 Scarcity and Abundance, Latin America
 Science, History of
 Science Fiction
 Secularization and Secularism
 Segregation
 Sexual Harassment
 Sexuality: Overview
 Sexuality: Sexual Orientation
 Slavery
 Social History, U.S.
 Sovereignty
 Sport
 State, The: Overview
 Subjectivism
 Suicide
 Superstition
 Syncretism
 Taste
 Technology
 Temperance
 Terrorism, Middle East
 Time: Traditional and Utilitarian
 Totems
 Trade
 Treaty
 Trope
 Truth
 University: Postcolonial
 Utilitarianism
 Victorianism
 Visual Culture
 Visual Order to Organizing Collections
 War
 War and Peace in the Arts
 Westernization: Southeast Asia
 Wildlife
 Witchcraft
 Womanism
 Women and Femininity in U.S. Popular Culture
 Women's Studies
 World Systems Theory, Latin America

Latin and South America

ENTRIES FOCUSING ON LATIN AND SOUTH AMERICA

Anticolonialism: Latin America
 Astronomy, Pre-Columbian and Latin American
 Authoritarianism: Latin America

Black Atlantic
 Colonialism: Latin America
 Communication of Ideas: The Americas and Their Influence
 Communism: Latin America
 Creolization, Caribbean
 Empire and Imperialism: Americas
 Marxism: Latin America
 Millenarianism: Latin America and Native North America
 Modernism: Latin America
 Native Policy
 Populism: Latin America
 Pre-Columbian Civilization
 Religion: Indigenous Peoples' View, South America
 Religion: Latin America
 Religion and the State: Latin America
 Republicanism: Latin America
 Scarcity and Abundance, Latin America
 World Systems Theory, Latin America

ENTRIES THAT CONSIDER LATIN AND SOUTH AMERICA

Abolitionism
 Aesthetics: Africa
 Africa, Idea of
 America
 Ancestor Worship
 Animism
 Anthropology
 Arts: Overview
 Atheism
 Authenticity: Africa
 Authoritarianism: Overview
 Autobiography
 Aztlán
 Bilingualism and Multilingualism
 Borders, Borderlands, and Frontiers, Global
 Calculation and Computation
 Cannibalism
 Chicano Movement
 Christianity: Overview
 Cinema
 Citizenship: Overview
 Citizenship: Cultural Citizenship
 Citizenship: Naturalization
 Critical Theory
 Cultural Capital
 Dance
 Demography
 Demonology
 Dependency
 Diasporas: African Diaspora
 Diffusion, Cultural
 Discrimination
 Diversity
 Empire and Imperialism: United States
 Environmental History
 Ethnohistory, U.S.
 Evil
 Extirpation
 Family Planning
 Fascism
 Feminism: Overview
 Feminism: Africa and African Diaspora
 Feminism: Chicana Feminisms

READER'S GUIDE

Fetishism: Overview
Friendship
Gender in Art
Genetics: Contemporary
Historiography
History, Economic
Honor
Humanity in the Arts
Identity, Multiple: Overview
Identity, Multiple: Jewish Multiple Identity
Indigenismo
Internal Colonialism
International Order
Liberation Theology
Life Cycle: Overview
Life Cycle: Elders/Old Age
Machiavellism
Machismo
Magic
Maps and the Ideas They Express
Masks
Mathematics
Matriarchy
Media, History of
Men and Masculinity
Mestizaje
Migration: Africa
Migration: Migration in World History
Migration: United States
Minority
Modernism: Overview
Modernization Theory
Motherhood and Maternity
Motif: Motif in Music
Museums
Music, Anthropology of
Nationalism: Africa
Negritude
Orthopraxy: Western Orthopraxy
Pan-Africanism
Peasants and Peasantry
Periodization of the Arts
Perspective
Phrenology
Political Protest, U.S.
Polytheism
Population
Postcolonial Studies
Postcolonial Theory and Literature
Practices
Prehistory, Rise of
Property
Protest, Political
Race and Racism: Overview
Religion: African Diaspora
Resistance and Accommodation
Revolution
Rhetoric: Overview
Ritual: Public Ritual
Ritual: Religion
Secularization and Secularism
Segregation
Slavery
Sport
State, The: Overview

Structuralism and Poststructuralism: Anthropology
Surrealism
Syncretism
Temperance
Third Cinema
Third World
Third World Literature
Trade
Treaty
University: Overview
University: Postcolonial
Visual Order to Organizing Collections
Witchcraft
Women's Studies
Work

CHRONOLOGICAL PERIODS

This section is divided according to five periods in world history: Ancient, Dynastic, Early Modern, Modern, and Contemporary. Use this section together with the section on Geographical Areas.

Ancient (before 400 C.E.)

ENTRIES FOCUSED ON THE PERIOD

Buddhism
Consciousness: Chinese Thought
Consciousness: Indian Thought
Democracy
Dialogue and Dialectics: Socratic
Epicureanism
Gnosticism
Greek Science
Hinduism
Justice: Justice in East Asian Thought
Language, Linguistics, and Literacy
Microcosm and Macrocosm
Orthopraxy: Asia
Orthopraxy: Western Orthopraxy
Poetry and Poetics
Sacred Places
Sacred Texts: Asia
Sophists, The
Textiles and Fiber Arts as Catalysts for Ideas
Time: China
Time: India
Yin and Yang

ENTRIES WITH EXAMPLES FROM BEFORE 400 C.E.

Generally the examples in this category are from the ancient Middle East, Europe, or Asia.

Aesthetics: Asia
Aesthetics: Europe and the Americas
Africa, Idea of
Alchemy: China
Alchemy: Europe and the Middle East
Algebras
Ambiguity
Anarchism
Anthropology
Anti-Semitism: Overview
Architecture: Overview

- Architecture: Africa
 Architecture: Asia
 Aristotelianism
 Arts: Overview
 Asceticism: Western Asceticism
 Astrology: Overview
 Astrology: China
 Atheism
 Authority
 Autobiography
 Barbarism and Civilization
 Beauty and Ugliness
 Biography
 Biology
 Body, The
 Borders, Borderlands, and Frontiers, Global
 Bureaucracy
 Calendar
 Casuistry
 Causality
 Causation
 Causation in East Asian and Southeast Asian Philosophy
 Censorship
 Change
 Character
 Childhood and Child Rearing
 Chinese Thought
 Christianity: Overview
 Christianity: Asia
 City, The: The City as a Cultural Center
 City, The: The City as Political Center
 City, The: The Islamic and Byzantine City
 Civil Society: Europe and the United States
 Class
 Classicism
 Classification of Arts and Sciences, Early Modern
 Communication of Ideas: Asia and Its Influence
 Communication of Ideas: Europe and Its Influence
 Communication of Ideas: Middle East and Abroad
 Communication of Ideas: Orality and Advent of Writing
 Communication of Ideas: Southeast Asia
 Communication of Ideas: The Americas and Their Influence
 Composition, Musical
 Confucianism
 Constitutionalism
 Corruption
 Cosmology: Asia
 Cosmology: Cosmology and Astronomy
 Cosmopolitanism
 Creationism
 Creativity in the Arts and Sciences
 Creolization, Caribbean
 Cycles
 Cynicism
 Dance
 Daoism
 Death
 Demonology
 Development
 Diasporas: Jewish Diaspora
 Dream
 Dress
 Dualism
 Eclecticism
 Ecumenism
 Education: Asia, Traditional and Modern
 Education: China
 Education: Europe
 Education: India
 Emotions
 Empire and Imperialism: Overview
 Empire and Imperialism: Asia
 Environment
 Epistemology: Ancient
 Equality: Overview
 Eschatology
 Essentialism
 Etiquette
 Eurocentrism
 Europe, Idea of
 Evil
 Evolution
 Experiment
 Fallacy, Logical
 Fatalism
 Form, Metaphysical, in Ancient and Medieval Thought
 Foundationalism
 Free Will, Determinism, and Predestination
 Friendship
 Fundamentalism
 Garden
 Gay Studies
 Gender in Art
 Generation
 Genre
 Geography
 Geometry
 Gesture
 Gift, The
 Good
 Happiness and Pleasure in European Thought
 Harmony
 Health and Disease
 Heaven and Hell
 Heaven and Hell (Asian Focus)
 Hedonism in European Thought
 Hegemony
 Heresy and Apostasy
 Hierarchy and Order
 Historiography
 History, Idea of
 Humanism: Chinese Conception of
 Humanism: Europe and the Middle East
 Humanity: African Thought
 Humanity: Asian Thought
 Humanity: European Thought
 Humanity in the Arts
 Human Rights: Overview
 Humor
 Hygiene
 Ideas, History of
 Identity, Multiple: Jewish Multiple Identity
 Images, Icons, and Idols
 Imagination
 Immortality and the Afterlife
 Individualism
 International Order
 Interpretation

READER'S GUIDE

Jainism
 Judaism: Judaism to 1800
 Justice: Overview
 Knowledge
 Landscape in the Arts
 Language, Philosophy of: Ancient and Medieval
 Leadership
 Legalism, Ancient China
 Liberty
 Life
 Literary History
 Literature: Overview
 Literature: African Literature
 Logic
 Love, Western Notions of
 Loyalties, Dual
 Machiavellism
 Manichaeism
 Maps and the Ideas They Express
 Marriage and Fertility, European Views
 Mathematics
 Matriarchy
 Mechanical Philosophy
 Media, History of
 Medicine: China
 Medicine: Europe and the United States
 Medicine: India
 Medicine: Islamic Medicine
 Meditation: Eastern Meditation
 Memory
 Men and Masculinity
 Metaphor
 Metaphysics: Ancient and Medieval
 Migration: Migration in World History
 Millenarianism: Overview
 Miracles
 Mohism
 Monarchy: Overview
 Monasticism
 Monism
 Motherhood and Maternity
 Museums
 Music, Anthropology of
 Musical Performance and Audiences
 Mysticism: Chinese Mysticism
 Mysticism: Christian Mysticism
 Narrative
 Nation
 Natural Law
 Nature
 Neoplatonism
 Nomadism
 Nonviolence
 Nude, The
 Organicism
 Orthodoxy
 Other, The, European Views of
 Pacifism
 Paradigm
 Paradise on Earth
 Patriotism
 Peace
 Periodization
 Periodization of the Arts
 Perspective
 Philanthropy
 Philosophies: African
 Philosophies: Islamic
 Philosophy: Historical Overview and Recent Developments
 Philosophy: Relations to Other Intellectual Realms
 Philosophy, Moral: Ancient
 Philosophy, Moral: Medieval and Renaissance
 Philosophy and Religion in Western Thought
 Philosophy of Mind: Ancient and Medieval
 Physics
 Platonism
 Pluralism
 Political, The
 Political Science
 Poverty
 Prehistory, Rise of
 Presentism
 Prophecy
 Punishment
 Pythagoreanism
 Rationalism
 Reading
 Reason, Practical and Theoretical
 Reform: Europe and the United States
 Reformation
 Religion: Overview
 Religion: Africa
 Religion: East and Southeast Asia
 Religion and the State: Europe
 Renaissance
 Representation: Political Representation
 Republicanism: Republic
 Resistance
 Responsibility
 Revolution
 Rhetoric: Overview
 Rhetoric: Ancient and Medieval
 Ritual: Public Ritual
 Science: East Asia
 Scientific Revolution
 Shinto
 Skepticism
 Slavery
 Society
 Sovereignty
 Sport
 State of Nature
 Stoicism
 Suicide
 Superstition
 Syncretism
 Taste
 Text/Textuality
 Toleration
 Totalitarianism
 Tragedy and Comedy
 Translation
 Travel: Travel from Europe and the Middle East
 Treaty
 Trope
 Truth
 University: Overview
 Untouchability: Overview
 Untouchability: Menstrual Taboos

Virtual Reality
 Virtue Ethics
 Visual Order to Organizing Collections
 War and Peace in the Arts
 Wealth
 Wildlife
 Witchcraft
 Work
 Yoga
 Zen

Dynastic (400 C.E.–1400 C.E.)

ENTRIES FOCUSED ON THE PERIOD

Astronomy, Pre-Columbian and Latin American
 Buddhism
 Death and Afterlife, Islamic Understanding of
 Dialogue and Dialectics: Talmudic
 Feudalism, European
 Heresy and Apostasy
 Motif: Motif in Literature
 Orthopraxy: Western Orthopraxy
 Sacred Places
 Sacred Texts: Asia
 Sacred Texts: Koran
 Scholasticism
 Textiles and Fiber Arts as Catalysts for Ideas

ENTRIES WITH EXAMPLES FROM THE PERIOD

400 C.E.–1400 C.E.

Aesthetics: Asia
 Africa, Idea of
 Alchemy: China
 Alchemy: Europe and the Middle East
 Algebras
 America
 Anti-Semitism: Overview
 Anti-Semitism: Islamic Anti-Semitism
 Architecture: Overview
 Architecture: Africa
 Architecture: Asia
 Aristotelianism
 Arts: Overview
 Asceticism: Western Asceticism
 Astrology: Overview
 Astrology: China
 Authority
 Autobiography
 Aztlán
 Barbarism and Civilization
 Beauty and Ugliness
 Biography
 Biology
 Body, The
 Borders, Borderlands, and Frontiers, Global
 Bureaucracy
 Bushido
 Calculation and Computation
 Calendar
 Casuistry
 Causality
 Causation in East Asian and Southeast Asian Philosophy
 Change
 Childhood and Child Rearing
 Chinese Thought
 Christianity: Overview
 Christianity: Asia

City, The: The City as a Cultural Center
 City, The: The Islamic and Byzantine City
 Civil Disobedience
 Civil Society: Europe and the United States
 Class
 Classicism
 Classification of Arts and Sciences, Early Modern
 Communication of Ideas: Africa and Its Influence
 Communication of Ideas: Asia and Its Influence
 Communication of Ideas: Europe and Its Influence
 Communication of Ideas: Middle East and Abroad
 Communication of Ideas: Orality and Advent of Writing
 Communication of Ideas: Southeast Asia
 Communication of Ideas: The Americas and Their Influence
 Composition, Musical
 Confucianism
 Consciousness: Indian Thought
 Consilience
 Constitutionalism
 Corruption
 Cosmology: Asia
 Cosmopolitanism
 Creationism
 Creativity in the Arts and Sciences
 Daoism
 Death
 Democracy
 Demonology
 Diasporas: Jewish Diaspora
 Dream
 Dualism
 Eclecticism
 Ecumenism
 Education: Asia, Traditional and Modern
 Education: China
 Education: Europe
 Education: India
 Education: Islamic Education
 Education: Japan
 Empire and Imperialism: Overview
 Empire and Imperialism: Asia
 Encyclopedism
 Equality: Overview
 Eschatology
 Ethnicity and Race: Islamic Views
 Etiquette
 Eurocentrism
 Europe, Idea of
 Evil
 Examination Systems, China
 Experiment
 Fallacy, Logical
 Feminism: Islamic Feminism
 Form, Metaphysical, in Ancient and Medieval Thought
 Free Will, Determinism, and Predestination
 Friendship
 Garden
 Gay Studies
 Gender: Gender in the Middle East
 Gender in Art
 Gesture
 Gift, The
 Globalization: Asia
 Good

READER'S GUIDE

Happiness and Pleasure in European Thought
 Harmony
 Health and Disease
 Heaven and Hell
 Hegemony
 Hierarchy and Order
 Hinduism
 Historiography
 History, Idea of
 Honor, Middle Eastern Notions of
 Humanism: Africa
 Humanism: Chinese Conception of
 Humanism: Europe and the Middle East
 Humanity: Asian Thought
 Humanity: European Thought
 Humanity in the Arts
 Human Rights: Overview
 Hygiene
 Iconography
 Identity, Multiple: Jewish Multiple Identity
 Images, Icons, and Idols
 Imagination
 Immortality and the Afterlife
 Individualism
 Intentionality
 International Order
 Interpretation
 Islam: Africa
 Islam: Shii
 Islam: Sunni
 Islamic Science
 Jainism
 Japanese Philosophy, Japanese Thought
 Jihad
 Judaism: Judaism to 1800
 Knowledge
 Landscape in the Arts
 Language, Philosophy of: Ancient and Medieval
 Law, Islamic
 Liberty
 Literary History
 Literature: Overview
 Logic
 Love, Western Notions of
 Loyalties, Dual
 Manichaeism
 Maps and the Ideas They Express
 Marriage and Fertility, European Views
 Mathematics
 Medicine: China
 Medicine: Europe and the United States
 Medicine: Islamic Medicine
 Metaphor
 Metaphysics: Ancient and Medieval
 Microcosm and Macrocosm
 Migration: Africa
 Migration: Migration in World History
 Millenarianism: Overview
 Millenarianism: Islamic
 Millenarianism: Latin America and Native North America
 Miracles
 Monarchy: Islamic Monarchy
 Monarchy: Overview
 Monasticism
 Monism
 Motif: Motif in Music
 Musical Performance and Audiences
 Mysticism: Chinese Mysticism
 Mysticism: Christian Mysticism
 Mysticism: Islamic Mysticism
 Mysticism: Islamic Mysticism in Asia
 Mysticism: Kabbalah
 Nation
 Natural Law
 Natural Theology
 Neoplatonism
 Nomadism
 Nude, The
 Objectivity
 Organicism
 Orthodoxy
 Other, The, European Views of
 Paradigm
 Paradise on Earth
 Patriotism
 Peace
 Peasants and Peasantry
 Periodization
 Periodization of the Arts
 Perspective
 Philanthropy
 Philosophies: African
 Philosophies: Islamic
 Philosophy: Historical Overview and Recent Developments
 Philosophy, Moral: Medieval and Renaissance
 Philosophy and Religion in Western Thought
 Philosophy of Mind: Ancient and Medieval
 Physics
 Platonism
 Poverty
 Pre-Columbian Civilization
 Prophecy
 Protest, Political
 Race and Racism: Asia
 Reform: Islamic Reform
 Religion: Africa
 Religion: East and Southeast Asia
 Religion: Middle East
 Religion and the State: Europe
 Religion and the State: Middle East
 Religion and the State: United States Renaissance
 Representation: Political Representation
 Republicanism: Republic
 Responsibility
 Revolution
 Rhetoric: Overview
 Rhetoric: Ancient and Medieval
 Ritual: Public Ritual
 Scientific Revolution
 Sexuality: Islamic Views
 Shinto
 Skepticism
 Sophists, The
 Sovereignty
 Stoicism
 Sufism
 Suicide
 Superstition

Syncretism
 Taste
 Terror
 Time: Traditional and Utilitarian
 Toleration
 Totalitarianism
 Tragedy and Comedy
 Translation
 Travel: Travel from Europe and the Middle East
 Tribalism, Middle East
 University: Overview
 Untouchability: Menstrual Taboos
 Virtual Reality
 Virtue Ethics
 Visual Order to Organizing Collections
 War
 War and Peace in the Arts
 Wealth
 Women's History: Asia
 Work
 Yoga
 Zen

Early Modern (1400–1800 C.E.)

ENTRIES FOCUSED ON THE PERIOD

Astronomy, Pre-Columbian and Latin American
 Cartesianism
 Casuistry
 Empiricism
 Humanism: Renaissance
 Idealism
 Identity: Identity of Persons
 Kantianism
 Materialism in Eighteenth-Century European Thought
 Mechanical Philosophy
 Moral Sense
 Naturphilosophie
 Newtonianism
 Phrenology
 Protest, Political
 Reformation
 Renaissance
 Scientific Revolution
 Theodicy
 Time: Traditional and Utilitarian
 Westernization: Middle East

ENTRIES WITH EXAMPLES FROM THE PERIOD

1400–1800 C.E.
 Abolitionism
 Aesthetics: Africa
 Aesthetics: Asia
 Aesthetics: Europe and the Americas
 Africa, Idea of
 African-American Ideas
 Agnosticism
 Alchemy: Europe and the Middle East
 Algebras
 Ambiguity
 America
 Ancestor Worship
 Anticolonialism: Latin America
 Antifeminism
 Anti-Semitism: Overview
 Apartheid
 Architecture: Overview

Architecture: Asia
 Aristotelianism
 Arts: Overview
 Arts: Africa
 Asceticism: Western Asceticism
 Astrology: Overview
 Atheism
 Authoritarianism: Latin America
 Authority
 Autobiography
 Autonomy
 Aztlán
 Barbarism and Civilization
 Beauty and Ugliness
 Biography
 Biology
 Body, The
 Borders, Borderlands, and Frontiers, Global
 Buddhism
 Bureaucracy
 Bushido
 Calculation and Computation
 Calendar
 Cannibalism
 Capitalism: Overview
 Capitalism: Africa
 Causality
 Causation
 Causation in East Asian and Southeast Asian Philosophy
 Censorship
 Change
 Character
 Chemistry
 Childhood and Child Rearing
 Chinese Thought
 Christianity: Asia
 Christianity: Overview
 City, The: The City as a Cultural Center
 City, The: Latin America
 Civil Disobedience
 Civil Society: Europe and the United States
 Civil Society: Responses in Africa and the Middle East
 Class
 Classicism
 Classification of Arts and Sciences, Early Modern
 Colonialism: Africa
 Colonialism: Latin America
 Colonialism: Southeast Asia
 Common Sense
 Communication of Ideas: Africa and Its Influence
 Communication of Ideas: The Americas and Their Influence
 Communication of Ideas: Asia and Its Influence
 Communication of Ideas: Europe and Its Influence
 Communication of Ideas: Middle East and Abroad
 Communication of Ideas: Orality and Advent of Writing
 Communication of Ideas: Southeast Asia
 Communism: Europe
 Composition, Musical
 Computer Science
 Confucianism
 Consciousness: Overview
 Conservatism
 Constitutionalism

READER'S GUIDE

Consumerism
 Context
 Continental Philosophy
 Corruption
 Cosmology: Asia
 Cosmology: Cosmology and Astronomy
 Cosmopolitanism
 Creationism
 Creativity in the Arts and Sciences
 Creolization, Caribbean
 Crisis
 Critical Theory
 Cultural History
 Cycles
 Death and Afterlife, Islamic Understanding of
 Deism
 Democracy
 Dependency
 Determinism
 Development
 Diasporas: African Diaspora
 Diasporas: Jewish Diaspora
 Dictatorship in Latin America
 Dream
 Dress
 Dualism
 Dystopia
 Eclecticism
 Ecology
 Economics
 Education: Asia, Traditional and Modern
 Education: China
 Education: Europe
 Education: India
 Education: Islamic Education
 Education: Japan
 Education: North America
 Empire and Imperialism: Americas
 Empire and Imperialism: Asia
 Empire and Imperialism: Middle East
 Encyclopedism
 Enlightenment
 Epistemology: Early Modern
 Equality: Overview
 Equality: Gender Equality
 Equality: Racial Equality
 Eschatology
 Essentialism
 Etiquette
 Eurocentrism
 Europe, Idea of
 Everyday Life
 Evil
 Evolution
 Examination Systems, China
 Experiment
 Extirpation
 Fascism
 Fetishism: Overview
 Field Theories
 Foundationalism
 Free Will, Determinism, and Predestination
 Friendship
 Garden
 Gay Studies
 Gender in Art
 General Will
 Genius
 Genre
 Geography
 Geometry
 Gesture
 Ghetto
 Gift, The
 Globalization: Africa
 Globalization: Asia
 Globalization: General
 Gnosticism
 Good
 Harmony
 Health and Disease
 Hedonism in European Thought
 Hierarchy and Order
 Historiography
 History, Idea of
 Honor
 Honor, Middle Eastern Notions of
 Human Capital
 Humanism: Africa
 Humanism: Chinese Conception of
 Humanism: Europe and the Middle East
 Humanism: Secular Humanism in the United States
 Humanity: African Thought
 Humanity: Asian Thought
 Humanity: European Thought
 Humanity in the Arts
 Human Rights: Overview
 Humor
 Hygiene
 Iconography
 Identity, Multiple: Overview
 Identity, Multiple: Jewish Multiple Identity
 Imagination
 Immortality and the Afterlife
 Indigenismo
 Individualism
 International Order
 Interpretation
 Islam: Africa
 Islam: Shii
 Islam: Southeast Asia
 Islam: Sunni
 Islamic Science
 Japanese Philosophy, Japanese Thought
 Judaism: Judaism to 1800
 Judaism: Modern Judaism
 Justice: Overview
 Justice: Justice in American Thought
 Knowledge
 Landscape in the Arts
 Language, Linguistics, and Literacy
 Leadership
 Liberalism
 Liberty
 Life
 Life Cycle: Overview
 Literary History
 Literature: Overview
 Logic
 Love, Western Notions of

- Loyalties, Dual
 Machiavellism
 Magic
 Maps and the Ideas They Express
 Marriage and Fertility, European Views
 Mathematics
 Medicine: Europe and the United States
 Medicine: Islamic Medicine
 Men and Masculinity
 Mestizaje
 Metaphor
 Metaphysics: Renaissance to the Present
 Microcosm and Macrocosm
 Migration: Africa
 Migration: Migration in World History
 Migration: United States
 Millenarianism: Overview
 Millenarianism: Islamic
 Millenarianism: Latin America and Native North America
 Mind
 Modernity: Africa
 Monarchy: Overview
 Monarchy: Islamic Monarchy
 Monasticism
 Monism
 Motif: Motif in Literature
 Motif: Motif in Music
 Museums
 Mysticism: Christian Mysticism
 Mysticism: Kabbalah
 Nation
 National History
 Native Policy
 Natural History
 Natural Law
 Natural Theology
 Nature
 Neoplatonism
 Nomadism
 Nude, The
 Objectivity
 Obligation
 Oral Traditions: Overview
 Organicism
 Orientalism: Overview
 Orthodoxy
 Orthopraxy: Western Orthopraxy
 Other, The, European Views of
 Paradigm
 Paradise on Earth
 Patriotism
 Peace
 Periodization
 Periodization of the Arts
 Perspective
 Philanthropy
 Philosophies: American
 Philosophies: Feminist, Twentieth-Century
 Philosophy: Historical Overview and Recent Developments
 Philosophy: Relations to Other Intellectual Realms
 Philosophy, History of
 Philosophy, Moral: Africa
 Philosophy, Moral: Medieval and Renaissance
 Philosophy, Moral: Modern
 Philosophy and Religion in Western Thought
 Philosophy of Mind: Overview
 Philosophy of Religion
 Physics
 Pietism
 Platonism
 Pluralism
 Poetry and Poetics
 Political Protest, U.S.
 Political Science
 Polytheism
 Poverty
 Power
 Pre-Columbian Civilization
 Prehistory, Rise of
 Presentism
 Probability
 Progress, Idea of
 Propaganda
 Property
 Prophecy
 Punishment
 Puritanism
 Pythagoreanism
 Race and Racism: Asia
 Race and Racism: Europe
 Radicals/Radicalism
 Rationalism
 Reason, Practical and Theoretical
 Reform: Europe and the United States
 Reform: Islamic Reform
 Relativity
 Religion: Africa
 Religion: African Diaspora
 Religion: East and Southeast Asia
 Religion: Indigenous Peoples' View, South America
 Religion: Latin America
 Religion and Science
 Religion and the State: Europe
 Religion and the State: Latin America
 Religion and the State: Middle East
 Religion and the State: United States
 Representation: Political Representation
 Republicanism: Latin America
 Republicanism: Republic
 Resistance
 Resistance and Accommodation
 Responsibility
 Revolution
 Rhetoric: Overview
 Ritual: Public Ritual
 Ritual: Religion
 Romanticism in Literature and Politics
 Scarcity and Abundance, Latin America
 Scholasticism
 Science: Overview
 Science, History of
 Secularization and Secularism
 Sexuality: Overview
 Sexuality: Islamic Views
 Shinto
 Skepticism
 Slavery
 Social Contract

READER'S GUIDE

Society
Sovereignty
Sport
State of Nature
Stoicism
Sufism
Suicide
Superstition
Syncretism
Taste
Temperance
Terror
Text/Textuality
Toleration
Totalitarianism
Tradition
Tragedy and Comedy
Translation
Travel: Travel from Europe and the Middle East
Treaty
Tribalism, Middle East
Trope
Truth
Universalism
University: Overview
Untouchability: Taboos
Utopia
Virtue Ethics
Visual Order to Organizing Collections
Volksgeist
Volunteerism, U.S.
War and Peace in the Arts
Wealth
Westernization: Middle East
Westernization: Southeast Asia
Witchcraft
Women's History: Africa
Work
World Systems Theory, Latin America

Modern (1800–1945)

ENTRIES FOCUSED ON THE PERIOD

Alienation
Altruism
Americanization, U.S.
Analytical Philosophy
Avant-Garde: Overview
Avant-Garde: Militancy
Black Atlantic
Bureaucracy
Chicano Movement
City, The: Latin America
Civil Disobedience
Consumerism
Continental Philosophy
Democracy
Empire and Imperialism: Europe
Eugenics
Evolution
Existentialism
Expressionism
Fascism
Field Theories
Fundamentalism
Futurology

Globalization: Africa
Globalization: Asia
Globalization: General
Hegelianism
Hegemony
Historicism
Humanism: Secular Humanism in the United States
Impressionism
Internal Colonialism
Kantianism
Life
Linguistic Turn
Literary History
Logic and Philosophy of Mathematics, Modern
Maoism
Marxism: Overview
Marxism: Asia
Marxism: Latin America
Media, History of
Modernism: Overview
Modernism: Latin America
Modernity: Overview
Modernity: Africa
Modernity: East Asia
Modernization
Modernization Theory
National History
Nationalism: Overview
Nationalism: Africa
Nationalism: Cultural Nationalism
Nationalism: Middle East
Naturalism
Naturalism in Art and Literature
Naturphilosophie
Neocolonialism
Neoliberalism
Orientalism: African and Black Orientalism
Pan-Africanism
Pan-Arabism
Pan-Asianism
Pan-Islamism
Pan-Turkism
Parties, Political
Phenomenology
Philosophies: Feminist, Twentieth-Century
Phrenology
Populism: Latin America
Populism: United States
Positivism
Pragmatism
Protest, Political
Psychoanalysis
Psychology and Psychiatry
Quantum
Realism
Realism: Africa
Relativism
Relativity
Science Fiction
Secularization and Secularism
Segregation
Sexuality: Sexual Orientation
Sociability in African Thought
Social Darwinism
Socialism

- Socialisms, African
 Structuralism and Poststructuralism: Overview
 Structuralism and Poststructuralism: Anthropology
 Subjectivism
 Surrealism
 Technology
 Third World
 Time: Traditional and Utilitarian
 Totalitarianism
 Utilitarianism
 Victorianism
 Westernization: Africa
 Westernization: Middle East
 Westernization: Southeast Asia
 Work
 Zionism
- ENTRIES WITH EXAMPLES FROM THE PERIOD
 1800–1945
- Abolitionism
 Absolute Music
 Aesthetics: Africa
 Aesthetics: Asia
 Aesthetics: Europe and the Americas
 Africa, Idea of
 African-American Ideas
 Agnosticism
 Alchemy: China
 Alchemy: Europe and the Middle East
 Algebras
 Ambiguity
 America
 Anarchism
 Ancestor Worship
 Animism
 Anthropology
 Anticolonialism: Africa
 Anticolonialism: Latin America
 Anticolonialism: Middle East
 Anticolonialism: Southeast Asia
 Antifeminism
 Anti-Semitism: Overview
 Anti-Semitism: Islamic Anti-Semitism
 Apartheid
 Architecture: Overview
 Aristotelianism
 Arts: Overview
 Arts: Africa
 Asceticism: Western Asceticism
 Asian-American Ideas (Cultural Migration)
 Assimilation
 Atheism
 Authenticity: Africa
 Authoritarianism: Overview
 Authoritarianism: East Asia
 Authoritarianism: Latin America
 Authority
 Autobiography
 Barbarism and Civilization
 Beauty and Ugliness
 Behaviorism
 Bilingualism and Multilingualism
 Bioethics
 Biography
 Biology
 Body, The
 Borders, Borderlands, and Frontiers, Global
 Buddhism
 Bushido
 Calculation and Computation
 Capitalism: Overview
 Capitalism: Africa
 Cartesianism
 Casuistry
 Causality
 Censorship
 Change
 Character
 Chemistry
 Childhood and Child Rearing
 Chinese Warlordism
 Christianity: Overview
 Christianity: Asia
 Cinema
 Citizenship: Overview
 Citizenship: Naturalization
 City, The: The City as a Cultural Center
 City, The: The Islamic and Byzantine City
 Civil Society: Europe and the United States
 Civil Society: Responses in Africa and the Middle East
 Class
 Classicism
 Colonialism: Africa
 Colonialism: Latin America
 Colonialism: Southeast Asia
 Common Sense
 Communication of Ideas: Africa and Its Influence
 Communication of Ideas: The Americas and Their Influence
 Communication of Ideas: Asia and Its Influence
 Communication of Ideas: Europe and Its Influence
 Communication of Ideas: Middle East and Abroad
 Communication of Ideas: Orality and Advent of Writing
 Communication of Ideas: Southeast Asia
 Communism: Europe
 Communism: Latin America
 Composition, Musical
 Computer Science
 Confucianism
 Consciousness: Overview
 Conservatism
 Constitutionalism
 Context
 Corruption
 Corruption in Developed and Developing Countries
 Cosmology: Asia
 Cosmology: Cosmology and Astronomy
 Cosmopolitanism
 Creationism
 Creativity in the Arts and Sciences
 Creolization, Caribbean
 Crisis
 Critical Theory
 Cultural Capital
 Cultural History
 Cultural Revivals
 Cycles
 Dada
 Dance
 Death
 Death and Afterlife, Islamic Understanding of

READER'S GUIDE

Deism
 Democracy: Africa
 Dependency
 Determinism
 Development
 Diasporas: African Diaspora
 Diasporas: Jewish Diaspora
 Dictatorship in Latin America
 Diffusion, Cultural
 Discrimination
 Diversity
 Dream
 Dress
 Dystopia
 Ecology
 Economics
 Education: Asia, Traditional and Modern
 Education: China
 Education: Europe
 Education: Global Education
 Education: India
 Education: Islamic Education
 Education: Japan
 Education: North America
 Emotions
 Empire and Imperialism: Asia
 Empire and Imperialism: Middle East
 Empire and Imperialism: United States
 Empiricism
 Environmental Ethics
 Environmental History
 Epistemology: Modern
 Equality: Overview
 Equality: Gender Equality
 Equality: Racial Equality
 Eschatology
 Essentialism
 Ethnicity and Race: Africa
 Ethnicity and Race: Anthropology
 Ethnicity and Race: Islamic Views
 Ethnography
 Etiquette
 Eurocentrism
 Europe, Idea of
 Everyday Life
 Evil
 Examination Systems, China
 Experiment
 Falsifiability
 Family: Modernist Anthropological Theory
 Family Planning
 Feminism: Overview
 Feminism: Africa and African Diaspora
 Feminism: Chicana Feminisms
 Feminism: Third World U.S. Movement
 Fetishism: Overview
 Fetishism: Fetishism in Literature and Cultural Studies
 Formalism
 Foundationalism
 Friendship
 Game Theory
 Gay Studies
 Gender: Gender in the Middle East
 Gender in Art
 Gender Studies: Anthropology
 General Will
 Generation
 Genetics: Contemporary
 Genetics: History of
 Genius
 Genocide
 Genre
 Geography
 Geometry
 Gesture
 Ghetto
 Gift, The
 Gnosticism
 Good
 Happiness and Pleasure in European Thought
 Harmony
 Health and Disease
 Hermeneutics
 Historical and Dialectical Materialism
 Historiography
 History, Economic
 History, Idea of
 Honor, Middle Eastern Notions of
 Human Capital
 Humanism: Africa
 Humanism: Chinese Conception of
 Humanism: Europe and the Middle East
 Humanity: African Thought
 Humanity: Asian Thought
 Humanity: European Thought
 Humanity in the Arts
 Human Rights: Overview
 Humor
 Hygiene
 Iconography
 Idealism
 Ideas, History of
 Identity: Identity of Persons
 Identity, Multiple: Overview
 Identity, Multiple: Asian-Americans
 Identity, Multiple: Jewish Multiple Identity
 Imagination
 Immortality and the Afterlife
 Indigenismo
 Individualism
 Intelligentsia
 Intentionality
 Intercession in Middle Eastern Society
 International Order
 Interpretation
 Islam: Africa
 Islam: Shii
 Islam: Southeast Asia
 Islamic Science
 Japanese Philosophy, Japanese Thought
 Jihad
 Jouissance
 Judaism: Modern Judaism
 Justice: Overview
 Justice: Justice in American Thought
 Justice: Justice in East Asian Thought
 Kinship
 Knowledge
 Landscape in the Arts
 Language and Linguistics

- Language, Linguistics, and Literacy
 Language, Philosophy of: Modern
 Law
 Law, Islamic
 Leadership
 Learning and Memory, Contemporary Views
 Liberalism
 Liberty
 Life Cycle: Adolescence
 Life Cycle: Elders/Old Age
 Literary Criticism
 Literature: Overview
 Literature: African Literature
 Love, Western Notions of
 Loyalties, Dual
 Lysenkoism
 Magic
 Maps and the Ideas They Express
 Marriage and Fertility, European Views
 Masks
 Mathematics
 Matriarchy
 Medicine: Europe and the United States
 Medicine: India
 Medicine: Islamic Medicine
 Memory
 Men and Masculinity
 Mestizaje
 Metaphor
 Metaphysics: Renaissance to the Present
 Microcosm and Macrocosm
 Migration: Africa
 Migration: Migration in World History
 Migration: United States
 Millenarianism: Overview
 Millenarianism: Latin America and Native North America
 Mind
 Minority
 Monarchy: Overview
 Monarchy: Islamic Monarchy
 Monasticism
 Monism
 Motherhood and Maternity
 Motif: Motif in Literature
 Motif: Motif in Music
 Multiculturalism, Africa
 Museums
 Music, Anthropology of
 Musical Performance and Audiences
 Musicology
 Mysticism: Kabbalah
 Mysticism: Mysticism in African Thought
 Myth
 Narrative
 Nation
 Native Policy
 Natural History
 Natural Theology
 Nature
 Negritude
 New Criticism
 Nihilism
 Nonviolence
 Nude, The
 Objectivity
 Obligation
 Occidentalism
 Oral Traditions: Overview
 Organicism
 Orientalism: Overview
 Orthodoxy
 Orthopraxy: Western Orthopraxy
 Other, The, European Views of
 Pacifism
 Paradigm
 Patriotism
 Peace
 Peasants and Peasantry
 Periodization
 Periodization of the Arts
 Person, Idea of the
 Philanthropy
 Philosophies: African
 Philosophies: American
 Philosophy: Historical Overview and Recent Developments
 Philosophy: Relations to Other Intellectual Realms
 Philosophy, History of
 Philosophy, Moral: Africa
 Philosophy, Moral: Modern
 Philosophy and Religion in Western Thought
 Philosophy of Mind: Overview
 Philosophy of Religion
 Physics
 Platonism
 Pluralism
 Poetry and Poetics
 Political Protest, U.S.
 Political Science
 Political, The
 Polytheism
 Population
 Postcolonial Studies
 Poverty
 Power
 Practices
 Prehistory, Rise of
 Prejudice
 Presentism
 Privacy
 Probability
 Progress, Idea of
 Propaganda
 Property
 Pseudoscience
 Punishment
 Puritanism
 Queer Theory
 Race and Racism: Overview
 Race and Racism: Asia
 Race and Racism: Europe
 Race and Racism: United States
 Radicals/Radicalism
 Rational Choice
 Rationalism
 Reading
 Reason, Practical and Theoretical
 Reflexivity
 Reform: Europe and the United States

READER'S GUIDE

Reform: Islamic Reform
Regions and Regionalism, Eastern Europe
Religion: Overview
Religion: Africa
Religion: African Diaspora
Religion: East and Southeast Asia
Religion: Indigenous Peoples' View, South America
Religion: Latin America
Religion: Middle East Religion and the State: Africa
Religion and Science
Religion and the State: Europe
Religion and the State: Latin America
Religion and the State: Middle East
Religion and the State: United States
Renaissance
Republicanism: Latin America
Republicanism: Republic
Resistance
Resistance and Accommodation
Responsibility
Revolution
Rhetoric: Overview
Ritual: Public Ritual
Ritual: Religion
Romanticism in Literature and Politics
Sacred and Profane
Sacred Places
Sage Philosophy
Scarcity and Abundance, Latin America
Science: Overview
Science, History of
Sexuality: Overview
Sexuality: Islamic Views
Shinto
Skepticism
Slavery
Social Capital
Social History, U.S.
Society
Sophists, The
Sovereignty
Sport
State of Nature
State, The: Overview
Sufism
Suicide
Superstition
Symbolism
Syncretism
Temperance
Terror
Text/Textuality
Toleration
Totems
Trade
Tradition
Translation
Travel: Travel from Europe and the Middle East
Treaty
Trope
Truth
Universalism
University: Overview
Untouchability: Overview
Untouchability: Menstrual Taboos

Untouchability: Taboos
Utopia
Virtual Reality
Visual Culture
Visual Order to Organizing Collections
Volkgeist
Volunteerism, U.S.
War
War and Peace in the Arts
Wealth
Wildlife
Wisdom, Human
Witchcraft
Witchcraft, African Studies of
Women's History: Africa
Women's History: Asia
World Systems Theory, Latin America

Contemporary

ENTRIES FOCUSED ON THE PERIOD

African-American Ideas
Americanization, U.S.
Anticolonialism: Africa
Anticolonialism: Latin America
Anticolonialism: Middle East
Anticolonialism: Southeast Asia
Anti-Semitism: Islamic Anti-Semitism
Apartheid
Bioethics
Black Atlantic
Black Consciousness
Buddhism
Bureaucracy
Capitalism: Africa
Chicano Movement
Citizenship: Naturalization
Civil Disobedience
Communitarianism in African Thought
Consumerism
Continental Philosophy
Creationism
Critical Race Theory
Critical Theory
Cultural Studies
Democracy
Dress
Dystopia
Empire and Imperialism: Europe
Empiricism
Eugenics
Field Theories
Fundamentalism
Futurology
Gay Studies
Gender: Overview
Genetics: Contemporary
Globalization: Africa
Globalization: Asia
Globalization: General
Historicism
Humanity: African Thought
Human Rights: Overview
Human Rights: Women's Rights
Internal Colonialism
International Order

Jihad
 Liberation Theology
 Liberty
 Life
 Linguistic Turn
 Literary History
 Logic and Philosophy of Mathematics, Modern
 Maoism
 Marxism: Overview
 Marxism: Asia
 Marxism: Latin America
 Media, History of
 Modernization
 Modernization Theory
 Nationalism: Overview
 Nationalism: Africa
 Nationalism: Cultural Nationalism
 Nationalism: Middle East
 Neocolonialism
 Neoliberalism
 Nuclear Age
 Orientalism: African and Black Orientalism
 Pan-Africanism
 Pan-Arabism
 Pan-Asianism
 Pan-Islamism
 Pan-Turkism
 Paradigm
 Parties, Political
 Personhood in African Thought
 Phenomenology
 Philosophies: Feminist, Twentieth-Century
 Poetry and Poetics
 Populism: Latin America
 Populism: United States
 Positivism
 Postcolonial Studies
 Postcolonial Theory and Literature
 Postmodernism
 Pragmatism
 Presentism
 Privatization
 Protest, Political
 Psychoanalysis
 Psychology and Psychiatry
 Quantum
 Queer Theory
 Realism: Africa
 Relativism
 Relativity
 Science Fiction
 Segregation
 Sexual Harassment
 Sexuality: Sexual Orientation
 Sociability in African Thought
 Social Darwinism
 Socialisms, African
 Structuralism and Poststructuralism: Overview
 Structuralism and Poststructuralism: Anthropology
 Subjectivism
 Technology
 Terrorism, Middle East
 Text/Textuality
 Theater and Performance
 Third Cinema

Third World
 Totalitarianism
 Virtual Reality
 Virtue Ethics
 War
 Westernization: Africa
 Westernization: Southeast Asia
 Witchcraft
 Womanism
 Women and Femininity in U.S. Popular Culture
 Women's Studies
 Zionism

ENTRIES WITH EXAMPLES FROM THE PERIOD
 SINCE 1945 (especially since the 1970s)

Absolute Music
 Aesthetics: Africa
 Aesthetics: Asia
 Aesthetics: Europe and the Americas
 Africa, Idea of
 Afrocentricity
 Afropessimism
 Agnosticism
 Algebras
 Alienation
 Altruism
 Ambiguity
 America
 Analytical Philosophy
 Anarchism
 Animism
 Anthropology
 Antifeminism
 Anti-Semitism: Overview
 Architecture: Overview
 Architecture: Africa
 Arts: Overview
 Arts: Africa
 Asceticism: Western Asceticism
 Asian-American Ideas (Cultural Migration)
 Assimilation
 Atheism
 Authenticity: Africa
 Authoritarianism: Overview
 Authoritarianism: East Asia
 Authoritarianism: Latin America
 Authority
 Autobiography
 Autonomy
 Avant-Garde: Overview
 Aztlán
 Barbarism and Civilization
 Beauty and Ugliness
 Behaviorism
 Bilingualism and Multilingualism
 Biography
 Biology
 Body, The
 Bushido
 Calculation and Computation
 Cannibalism
 Capitalism: Overview
 Cartesianism
 Casuistry
 Causality
 Causation

READER'S GUIDE

Censorship
 Change
 Character
 Childhood and Child Rearing
 Christianity: Overview
 Christianity: Asia
 Cinema
 Citizenship: Overview
 Citizenship: Cultural Citizenship
 City, The: The City as a Cultural Center
 City, The: The City as Political Center
 City, The: The Islamic and Byzantine City
 Civil Society: Europe and the United States
 Civil Society: Responses in Africa and the Middle East
 Classicism
 Colonialism: Africa
 Colonialism: Southeast Asia
 Communication of Ideas: Africa and Its Influence
 Communication of Ideas: Asia and Its Influence
 Communication of Ideas: Southeast Asia
 Communism: Europe
 Communism: Latin America
 Composition, Musical
 Computer Science
 Confucianism
 Consciousness: Overview
 Conservatism
 Consilience
 Context
 Corruption
 Corruption in Developed and Developing Countries
 Cosmopolitanism
 Creolization, Caribbean
 Crisis
 Cultural Capital
 Cultural History
 Cultural Revivals
 Cycles
 Dada
 Dance
 Death
 Death and Afterlife, Islamic Understanding of
 Deism
 Democracy: Africa
 Demography
 Demonology
 Dependency
 Determinism
 Development
 Diasporas: African Diaspora
 Diasporas: Jewish Diaspora
 Dictatorship in Latin America
 Diffusion, Cultural
 Discrimination
 Diversity
 Dream
 Dualism
 Ecology
 Economics
 Ecumenism
 Education: Europe
 Education: Global Education
 Education: Islamic Education
 Education: North America
 Emotions
 Empire and Imperialism: Middle East
 Empire and Imperialism: United States
 Enlightenment
 Environment
 Environmental Ethics
 Environmental History
 Epistemology: Modern
 Equality: Overview
 Equality: Gender Equality
 Equality: Racial Equality
 Essentialism
 Ethnicity and Race: Africa
 Ethnicity and Race: Anthropology
 Ethnicity and Race: Islamic Views
 Ethnocentrism
 Ethnography
 Ethnohistory, U.S.
 Etiquette
 Eurocentrism
 Europe, Idea of
 Evil
 Existentialism
 Experiment
 Falsifiability
 Family: Modernist Anthropological Theory
 Family: Family in Anthropology since 1980
 Family Planning
 Fascism
 Fatalism
 Feminism: Overview
 Feminism: Africa and African Diaspora
 Feminism: Chicana Feminisms
 Feminism: Islamic Feminism
 Feminism: Third World U.S. Movement
 Fetishism: Overview
 Fetishism: Fetishism in Literature and Cultural Studies
 Formalism
 Foundationalism
 Free Will, Determinism, and Predestination
 Friendship
 Game Theory
 Gender: Gender in the Middle East
 Gender in Art
 Gender Studies: Anthropology
 Generation
 Genetics: History of
 Genius
 Genocide
 Geography
 Ghetto
 Gift, The
 Gnosticism
 Good
 Happiness and Pleasure in European Thought
 Harmony
 Hate
 Health and Disease
 Hegelianism
 Hermeneutics
 Hierarchy and Order
 Hinduism
 Historical and Dialectical Materialism
 Historiography
 History, Economic
 History, Idea of

- Honor, Middle Eastern Notions of
 Human Capital
 Humanism: Africa
 Humanism: Europe and the Middle East
 Humanism: Secular Humanism in the United States
 Humanity: European Thought
 Humanity in the Arts
 Humor
 Ideas, History of
 Identity: Identity of Persons
 Identity: Personal and Social Identity
 Identity, Multiple: Overview
 Identity, Multiple: Asian-Americans
 Identity, Multiple: Jewish Multiple Identity
 Imagination
 Immortality and the Afterlife
 Impressionism
 Intelligentsia
 Intentionality
 Intercession in Middle Eastern Society
 Interdisciplinarity
 Islam: Shii
 Islam: Southeast Asia
 Jainism
 Japanese Philosophy, Japanese Thought
 Jouissance
 Judaism: Modern Judaism
 Justice: Overview
 Justice: Justice in American Thought
 Kantianism
 Kinship
 Knowledge
 Landscape in the Arts
 Language and Linguistics
 Language, Philosophy of: Modern
 Law
 Law, Islamic
 Leadership
 Learning and Memory, Contemporary Views
 Liberalism
 Life Cycle: Adolescence
 Life Cycle: Elders/Old Age
 Literary Criticism
 Literature: African Literature
 Lysenkoism
 Machiavellism
 Machismo
 Magic
 Maps and the Ideas They Express
 Marriage and Fertility, European Views
 Masks
 Mathematics
 Matriarchy
 Medicine: China
 Medicine: Europe and the United States
 Medicine: Islamic Medicine
 Meditation: Eastern Meditation
 Meme
 Memory
 Men and Masculinity
 Mestizaje
 Metaphor
 Metaphysics: Renaissance to the Present
 Migration: Africa
 Migration: Migration in World History
 Migration: United States
 Millenarianism: Overview
 Millenarianism: Islamic
 Millenarianism: Latin America and Native North America
 Mind
 Minority
 Modernism: Latin America
 Modernity: Overview
 Modernity: Africa
 Modernity: East Asia
 Monarchy: Overview
 Monasticism
 Monism
 Moral Sense
 Motherhood and Maternity
 Motif: Motif in Literature
 Motif: Motif in Music
 Multiculturalism, Africa
 Museums
 Music, Anthropology of
 Musical Performance and Audiences
 Musicology
 Mysticism: Mysticism in African Thought
 Narrative
 Nation
 Native Policy
 Natural Law
 Natural Theology
 Nature
 Negritude
 New Criticism
 Nihilism
 Nomadism
 Nonviolence
 Objectivity
 Obligation
 Occidentalism
 Oral Traditions: Overview
 Organicism
 Orientalism: Overview
 Orthodoxy
 Pacifism
 Patriotism
 Peace
 Peasants and Peasantry
 Periodization of the Arts
 Person, Idea of the
 Perspective
 Philanthropy
 Philosophies: American
 Philosophy, History of
 Philosophy, Moral: Africa
 Philosophy, Moral: Modern
 Philosophy and Religion in Western Thought
 Philosophy of Mind: Overview
 Philosophy of Religion
 Pluralism
 Political Protest, U.S.
 Political Science
 Population
 Poverty
 Power
 Practices
 Prejudice

READER'S GUIDE

Privacy
Probability
Progress, Idea of
Propaganda
Property
Pseudoscience
Public Sphere
Punishment
Race and Racism: Overview
Race and Racism: Asia
Race and Racism: Europe
Race and Racism: United States
Radicals/Radicalism
Rational Choice
Reading
Reason, Practical and Theoretical
Reflexivity
Reform: Europe and the United States
Reform: Islamic Reform
Regions and Regionalism, Eastern Europe
Religion: Africa
Religion: African Diaspora
Religion: Indigenous Peoples' View, South America
Religion: Latin America
Religion: Middle East
Religion and Science
Religion and the State: Africa
Religion and the State: Latin America
Religion and the State: Middle East
Religion and the State: United States
Renaissance
Representation: Mental Representation
Representation: Political Representation
Resistance
Resistance and Accommodation
Responsibility
Ritual: Public Ritual
Ritual: Religion
Sacred Places
Sacred Texts: Koran
Sage Philosophy
Science: Overview
Science: East Asia
Science, History of
Scientific Revolution
Secularization and Secularism
Sexuality: Overview
Sexuality: Islamic Views
Shinto
Skepticism
Slavery
Social Capital
Social Contract
Social History, U.S.
Society
Sophists, The
Sovereignty
Sport
State, The: Overview
State, The: The Postcolonial State
State of Nature
Superstition
Surrealism
Symbolism
Syncretism

Taste
Terror
Third World Literature
Toleration
Totems
Trade
Tradition
Translation
Treaty
Tribalism, Middle East
Trope
Truth
Universalism
University: Overview
University: Postcolonial
Untouchability: Overview
Untouchability: Menstrual Taboos
Untouchability: Taboos
Utilitarianism
Utopia
Visual Culture
Visual Order to Organizing Collections
War and Peace in the Arts
Wealth
Wildlife
Wisdom, Human
Witchcraft, African Studies of
Women's History: Africa
Women's History: Asia
Work
World Systems Theory, Latin America

LIBERAL ARTS DISCIPLINES AND PROFESSIONS

This section is in accord with the university divisions of the Liberal Arts into Fine Arts, Humanities, Social Sciences, and Sciences and the graduate programs of the professions of Law, Medicine, and Engineering. The sample of Interdisciplinary Programs are listed under their most common university grouping. For example, Fine Arts includes Performance Arts; Social Sciences includes Women's Studies and Gender Studies, as well as Ethnic Studies; Sciences includes Ecology and Geology, as well as Computer Sciences; Humanities includes programs of Communication, Language, and Linguistics. Meanwhile, the growth of interdisciplinary programs reflects the increasing overlap between studies listed under the labels of Fine Arts, Humanities, Social Sciences, and Sciences. A discipline or interdisciplinary program only appears once, but an entry may appear under the several disciplines and interdisciplinary programs that influenced the scholarship of the article. Titles that appear in bold indicate entries that are especially suited as a introduction to the discipline.

Under the category Multidisciplinary Practices, there are entries on the many methods, techniques, theories, and approaches that have spread across the disciplines. The Multidisciplinary Practices help explain the contemporary trend of interdisciplinarity for which the history of ideas has long been known. At the end of this Reader's Guide is a listing of a number of entries that overlap three of the four divisions and a listing of entries that overlap all four divisions.

Fine Arts

VISUAL STUDIES

Absolute Music
Aesthetics: Africa
Aesthetics: Asia
Aesthetics: Europe and the Americas
 Ambiguity
 Anthropology
 Architecture: Overview
 Architecture: Africa
 Architecture: Asia
 Arts: Overview
 Arts: Africa
 Asceticism: Hindu and Buddhist Asceticism
 Asceticism: Western Asceticism
 Avant-Garde: Overview
 Avant-Garde: Militancy
 Aztlán
 Beauty and Ugliness
 Body, The
 Buddhism
 Change
 Chinese Thought
 Cinema
 City, The: Latin America
 City, The: The City as a Cultural Center
 City, The: The Islamic and Byzantine City
 Classicism
 Classification of Arts and Sciences, Early Modern
 Communication of Ideas: Asia and Its Influence
 Composition, Musical
 Consumerism
 Context
 Cosmopolitanism
 Creativity in the Arts and Sciences
 Cultural History
 Dada
 Death
 Dream
 Dress
 Dystopia
 Environmental Ethics
 Environmental History
 Everyday Life
 Expressionism
 Extirpation
 Fascism
 Fetishism: Overview
 Garden
 Gay Studies
 Gender in Art
 Genre
 Geography
 Geometry
 Gesture
 Ghetto
 Globalization: Asia
 Heaven and Hell (Asian Focus)
 Hinduism
 History, Idea of
 Humanity: European Thought
 Humanity in the Arts
 Humor
 Iconography
 Ideas, History of

Images, Icons, and Idols
 Imagination
 Impressionism
 Islamic Science
 Kantianism
 Knowledge
 Landscape in the Arts
 Life Cycle: Overview
 Literary History
 Literature: Overview
 Maps and the Ideas They Express
 Masks
 Matriarchy
Media, History of
 Medicine: Europe and the United States
 Mestizaje
 Modernism: Overview
 Modernism: Latin America
 Modernity: Africa
 Modernity: East Asia
 Monarchy: Overview
 Motherhood and Maternity
 Museums
 Musical Performance and Audiences
 Musicology
 Mysticism: Chinese Mysticism
 Mysticism: Christian Mysticism
 Naturalism in Art and Literature
 Negritude
 Nude, The
 Occidentalism
 Organicism
 Pan-Africanism
 Paradise on Earth
Periodization of the Arts
 Perspective
 Philosophy: Historical Overview and Recent Developments
 Political Protest, U.S.
 Postmodernism
 Pre-Columbian Civilization
 Protest, Political
 Psychoanalysis
 Pythagoreanism
 Realism
 Realism: Africa
 Religion: Africa
 Renaissance
 Representation: Mental Representation
 Ritual: Public Ritual
 Sacred Places
 Sacred Texts: Asia
 Science: East Asia
 Science, History of
 Science Fiction
 Social History, U.S.
 Sport
 Surrealism
 Symbolism
 Syncretism
 Taste
 Text/Textuality
 Textiles and Fiber Arts as Catalysts for Ideas
 Third Cinema
 Victorianism

READER'S GUIDE

Virtual Reality
 Visual Culture
 Visual Order to Organizing Collections
 War and Peace in the Arts
 Westernization: Southeast Asia
 Women and Femininity in U.S. Popular Culture
 Yin and Yang

MUSIC

Absolute Music
 Aesthetics: Africa
 Aesthetics: Asia
 Authenticity: Africa
 Avant-Garde: Overview
 Cinema
 Classicism
 Classification of Arts and Sciences, Early Modern
 Communication of Ideas: Africa and Its Influence
 Composition, Musical
 Context
 Cosmopolitanism
 Dada
 Dance
 Empire and Imperialism: United States
 Formalism
 Generation
 Genre
 Harmony
 Hinduism
 Humanism: Africa
 Humanism: Chinese Conception of
 Humor
 Iconography
 Identity, Multiple: Jewish Multiple Identity
 Judaism: Judaism to 1800
 Knowledge
 Learning and Memory, Contemporary Views
 Love, Western Notions of
 Modernism: Overview
 Motif: Motif in Music
Music, Anthropology of
Musical Performance and Audiences
Musicology
 Mysticism: Chinese Mysticism
 Orientalism: Overview
 Pan-Asianism
 Pietism
 Political Protest, U.S.
 Postmodernism
 Protest, Political
 Pythagoreanism
 Realism: Africa
 Religion: Africa
 Religion: African Diaspora
 Resistance
 Resistance and Accommodation
 Society
 Sophists, The
 Symbolism
 Taste
 Text/Textuality
 Third Cinema
 Virtual Reality
 Visual Order to Organizing Collections
 Westernization: Africa

PERFORMANCE ARTS (includes drama, dance, oratory, ritual, and ceremony)

Absolute Music
 Aesthetics: Africa
 Aesthetics: Asia
 Alienation
 Americanization, U.S.
 Ancestor Worship
 Anthropology
 Arts: Overview
 Asceticism: Hindu and Buddhist Asceticism
 Asceticism: Western Asceticism
 Astronomy, Pre-Columbian and Latin American
 Authenticity: Africa
 Autobiography
 Avant-Garde: Overview
 Body, The
 Cannibalism
 Censorship
 Cinema
 Civil Disobedience
 Civil Society: Europe and the United States
 Communication of Ideas: Africa and Its Influence
 Communication of Ideas: Asia and Its Influence
 Communication of Ideas: Orality and Advent of Writing
 Communication of Ideas: Southeast Asia
 Composition, Musical
 Confucianism
 Context
 Cosmopolitanism
 Creolization, Caribbean
 Cultural Capital
 Cynicism
 Dada
Dance
 Determinism
 Dialogue and Dialectics: Socratic
 Dialogue and Dialectics: Talmudic
 Dictatorship in Latin America
 Dream
 Dress
 Emotions
 Empire and Imperialism: Europe
 Environment
 Equality: Overview
 Ethnicity and Race: Anthropology
 Etiquette
 Everyday Life
 Expressionism
 Extirpation
 Fascism
 Feminism: Chicana Feminisms
 Fetishism: Overview
 Fetishism: Fetishism in Literature and Cultural Studies
 Game Theory
 Gay Studies
 Gender: Overview
 Gender in Art
 Generation
 Genre
 Gesture
 Harmony
 Hinduism
 History, Economic

- History, Idea of
 Honor
 Humanism: Africa
 Humanism: Chinese Conception of
 Humanity: African Thought
 Humor
 Ideas, History of
 Identity, Multiple: Jewish Multiple Identity
 Images, Icons, and Idols
 Intelligentsia
 Islam: Shii
 Islam: Sunni
 Jouissance
 Judaism: Judaism to 1800
 Knowledge
 Language and Linguistics
 Language, Philosophy of: Modern
 Law, Islamic
 Leadership
 Learning and Memory, Contemporary Views
 Life Cycle: Overview
 Literary Criticism
 Literary History
 Literature: African Literature
 Love, Western Notions of
 Magic
 Manichaeism
 Masks
 Media, History of
 Medicine: China
 Medicine: Islamic Medicine
 Meditation: Eastern Meditation
 Men and Masculinity
 Metaphor
 Millenarianism: Islamic
 Millenarianism: Latin America and Native North
 America
 Modernism: Overview
 Modernity: Overview
 Modernity: Africa
 Motif: Motif in Music
 Music, Anthropology of
 Musical Performance and Audiences
 Musicology
 Mysticism: Chinese Mysticism
 Mysticism: Islamic Mysticism in Asia
 Mysticism: Kabbalah
 Myth
 Narrative
 Nation
 Nationalism: Middle East
 New Criticism
 Nomadism
 Nuclear Age
 Oral Traditions: Overview
 Orientalism: Overview
 Orthodoxy
 Orthopraxy: Asia
 Pan-Turkism
 Periodization of the Arts
 Person, Idea of the
 Philosophies: African
 Philosophies: American
 Philosophies: Feminist, Twentieth-Century
 Philosophies: Islamic
 Philosophy: Historical Overview and Recent Develop-
 ments
 Philosophy, Moral: Ancient
 Philosophy of Mind: Ancient and Medieval
 Pietism
 Poetry and Poetics
 Political Protest, U.S.
 Populism: United States
 Postmodernism
 Practices
 Pre-Columbian Civilization
 Propaganda
 Protest, Political
 Psychoanalysis
 Punishment
 Queer Theory
 Reading
 Realism: Africa
 Reflexivity
 Reform: Europe and the United States
 Relativism
 Religion: Africa
 Religion: African Diaspora
 Religion: East and Southeast Asia
 Religion: Indigenous Peoples' View, South America
 Religion: Latin America
 Religion: Middle East
 Religion and the State: United States
 Republicanism: Republic
 Resistance
 Resistance and Accommodation
 Responsibility
Rhetoric: Overview
Rhetoric: Ancient and Medieval
 Ritual: Public Ritual
 Ritual: Religion
 Romanticism in Literature and Politics
 Sacred Places
 Sacred Texts: Asia
 Sexuality: Overview
 Shinto
 Slavery
 Society
 Sophists, The
 Sport
 Stoicism
 Subjectivism
 Superstition
 Surrealism
 Symbolism
 Syncretism
 Taste
 Temperance
 Text/Textuality
Theater and Performance
 Third Cinema
 Third World Literature
 Time: China
 Time: India
 Toleration
 Totalitarianism
 Totems
 Tragedy and Comedy
 Translation
 Trope

READER'S GUIDE

Untouchability: Menstrual Taboos
Utilitarianism
Victorianism
Virtual Reality
Volunteerism, U.S.
Westernization: Middle East
Westernization: Southeast Asia
Wisdom, Human
Witchcraft
Witchcraft, African Studies of
Yin and Yang
Yoga

Humanities

COMMUNICATION, LANGUAGE, AND LINGUISTICS

Aesthetics: Africa
Aesthetics: Asia
Africa, Idea of
Afrocentricity
Agnosticism
Algebras
Americanization, U.S.
Analytical Philosophy
Anthropology
Anticolonialism: Africa
Asceticism: Hindu and Buddhist Asceticism
Asceticism: Western Asceticism
Astronomy, Pre-Columbian and Latin American
Authenticity: Africa
Avant-Garde: Overview
Avant-Garde: Militancy
Aztlán
Barbarism and Civilization
Beauty and Ugliness
Behaviorism
Bilingualism and Multilingualism
Body, The
Borders, Borderlands, and Frontiers, Global
Buddhism
Calculation and Computation
Calendar
Cannibalism
Casuistry
Censorship
Chinese Thought
Cinema
Civil Disobedience
Classification of Arts and Sciences, Early Modern
Colonialism: Southeast Asia
Communication of Ideas: Africa and Its Influence
Communication of Ideas: The Americas and Their Influence
Communication of Ideas: Asia and Its Influence
Communication of Ideas: Europe and Its Influence
Communication of Ideas: Middle East and Abroad
Communication of Ideas: Orality and Advent of Writing
Communication of Ideas: Southeast Asia
Computer Science
Consumerism
Context
Continental Philosophy
Cosmopolitanism
Creolization, Caribbean
Critical Theory
Cultural Capital

Cultural History
Cultural Revivals
Cultural Studies
Cynicism
Dance
Democracy
Determinism
Dialogue and Dialectics: Socratic
Diasporas: Jewish Diaspora
Dictatorship in Latin America
Diffusion, Cultural
Discrimination
Diversity
Dream
Dress
Ecumenism
Education: Asia, Traditional and Modern
Empire and Imperialism: Asia
Empire and Imperialism: Europe
Empire and Imperialism: United States
Empiricism
Encyclopedism
Epistemology: Ancient
Epistemology: Early Modern
Epistemology: Modern
Ethnicity and Race: Africa
Ethnicity and Race: Anthropology
Ethnicity and Race: Islamic Views
Etiquette
Eurocentrism
Everyday Life
Examination Systems, China
Extirpation
Fallacy, Logical
Feminism: Overview
Feminism: Chicana Feminisms
Fetishism: Overview
Fetishism: Fetishism in Literature and Cultural Studies
Feudalism, European
Formalism
Gender: Gender in the Middle East
Gender in Art
Geometry
Gesture
Globalization: Asia
Globalization: General
Greek Science
Harmony
Hegemony
Hermeneutics
Hinduism
History, Economic
History, Idea of
Humanism: Africa
Humanism: Chinese Conception of
Humanism: Europe and the Middle East
Humanism: Renaissance
Humanity: African Thought
Human Rights: Overview
Idealism
Ideas, History of
Identity: Identity of Persons
Identity, Multiple: Overview
Identity, Multiple: Jewish Multiple Identity
Indigenismo

- Intelligentsia
 Interdisciplinarity
 Interpretation
 Islam: Africa
 Islam: Southeast Asia
 Islam: Sunni
 Islamic Science
 Japanese Philosophy, Japanese Thought
 Jihad
 Jouissance
 Judaism: Judaism to 1800
 Kantianism
 Kinship
 Knowledge
Language and Linguistics
Language, Linguistics, and Literacy
 Language, Philosophy of: Ancient and Medieval
 Language, Philosophy of: Modern
 Law
 Liberty
 Life Cycle: Overview
 Linguistic Turn
 Literary Criticism
 Literary History
 Literature: Overview
 Literature: African Literature
 Machismo
 Magic
 Maps and the Ideas They Express
 Masks
 Materialism in Eighteenth-Century European Thought
 Mathematics
 Matriarchy
 Media, History of
 Medicine: Europe and the United States
 Medicine: India
 Meme
 Mestizaje
 Metaphor
 Metaphysics: Renaissance to the Present
 Migration: Africa
 Migration: United States
 Millenarianism: Latin America and Native North America
 Mind
 Minority
Modernism: Overview
 Modernity: Overview
 Modernity: Africa
 Monarchy: Overview
 Motherhood and Maternity
 Motif: Motif in Literature
 Motif: Motif in Music
 Multiculturalism, Africa
 Music, Anthropology of
 Musical Performance and Audiences
 Musicology
 Mysticism: Chinese Mysticism
 Mysticism: Christian Mysticism
 Mysticism: Islamic Mysticism in Asia
 Mysticism: Kabbalah
 Mysticism: Mysticism in African Thought
 Narrative
 Nation
 Nationalism: Overview
 Nationalism: Middle East
 Native Policy
 Natural History
 New Criticism
 Nomadism
 Objectivity
 Occidentalism
Oral Traditions: Overview
 Organicism
 Orientalism: Overview
 Orthodoxy
 Pacifism
 Pan-Africanism
 Pan-Arabism
 Pan-Asianism
 Pan-Turkism
 Paradigm
 Patriotism
 Periodization of the Arts
 Person, Idea of the
 Personhood in African Thought
 Philosophies: African
 Philosophies: American
 Philosophies: Feminist, Twentieth-Century
 Philosophies: Islamic
 Philosophy: Historical Overview and Recent Developments
 Philosophy of Mind: Overview
 Philosophy of Mind: Ancient and Medieval
 Philosophy of Religion
 Poetry and Poetics
 Political Protest, U.S.
 Positivism
 Practices
 Pre-Columbian Civilization
 Prejudice
 Presentism
 Privacy
 Probability
 Progress, Idea of
 Propaganda
 Protest, Political
 Pseudoscience
 Psychology and Psychiatry
 Public Sphere
 Punishment
 Pythagoreanism
 Quantum
 Queer Theory
 Race and Racism: Asia
 Race and Racism: Europe
 Race and Racism: United States
 Reading
 Realism
 Realism: Africa
 Reflexivity
 Relativism
 Relativity
 Religion: Africa
 Religion: African Diaspora
 Religion: East and Southeast Asia
 Religion: Indigenous Peoples' View, South America
 Religion: Latin America
 Religion: Middle East
 Religion and the State: Latin America

READER'S GUIDE

Religion and the State: Middle East
Representation: Mental Representation
Republicanism: Republic
Resistance
Resistance and Accommodation
Responsibility
Rhetoric: Overview
Ritual: Public Ritual
Ritual: Religion
Romanticism in Literature and Politics
Sacred and Profane
Sacred Places
Sacred Texts: Asia
Sacred Texts: Koran
Sage Philosophy
Science: East Asia
Science, History of
Sexual Harassment
Sexuality: Overview
Sexuality: Sexual Orientation
Shinto
Slavery
Social History, U.S.
Society
Sophists, The
Sport
State, The: Overview
Stoicism
Structuralism and Poststructuralism: Overview
Structuralism and Poststructuralism: Anthropology
Subjectivism
Superstition
Surrealism
Symbolism
Syncretism
Technology
Temperance
Text/Textuality
Textiles and Fiber Arts as Catalysts for Ideas
Theater and Performance
Third Cinema
Third World Literature
Time: India
Time: Traditional and Utilitarian
Toleration
Totalitarianism
Totems
Trade
Tragedy and Comedy
Translation
Travel: Travel from Europe and the Middle East
Treaty
Trope
Truth
Untouchability: Taboos
Utilitarianism
Victorianism
Virtual Reality
Visual Culture
Visual Order to Organizing Collections
Westernization: Middle East
Westernization: Southeast Asia
Wisdom, Human
Witchcraft
Witchcraft, African Studies of

Womanism
Women and Femininity in U.S. Popular Culture
Yin and Yang
LITERATURE
Absolute Music
Aesthetics: Africa
Aesthetics: Asia
Aesthetics: Europe and the Americas
Africa, Idea of
African-American Ideas
Alienation
America
Anticolonialism: Africa
Anti-Semitism: Overview
Architecture: Asia
Asceticism: Hindu and Buddhist Asceticism
Authenticity: Africa
Autobiography
Avant-Garde: Overview
Aztlán
Biography
Buddhism
Bushido
Casuistry
Chinese Thought
Cinema
Classicism
Classification of Arts and Sciences, Early Modern
Colonialism: Africa
Communication of Ideas: Africa and Its Influence
Communication of Ideas: Asia and Its Influence
Communication of Ideas: Europe and Its Influence
Communication of Ideas: Middle East and Abroad
Communication of Ideas: Orality and Advent of Writing
Communication of Ideas: Southeast Asia
Consciousness: Overview
Continental Philosophy
Corruption
Cosmopolitanism
Creativity in the Arts and Sciences
Critical Race Theory
Critical Theory
Cultural Studies
Dada
Dialogue and Dialectics: Socratic
Dream
Dystopia
Education: Islamic Education
Empire and Imperialism: Europe
Enlightenment
Etiquette
Europe, Idea of
Evil
Examination Systems, China
Existentialism
Expressionism
Extirpation
Fascism
Feminism: Overview
Feminism: Chicana Feminisms
Feminism: Third World U.S. Movement
Fetishism: Fetishism in Literature and Cultural Studies
Formalism
Friendship
Futurology

- Game Theory
 Gay Studies
 Gender: Overview
 Gender: Gender in the Middle East
 Generation
 Genius
Genre
 Globalization: Asia
 Gnosticism
 Heaven and Hell
 Heaven and Hell (Asian Focus)
 Hedonism in European Thought
 Hermeneutics
 Hinduism
 Historiography
 History, Economic
 History, Idea of
 Honor, Middle Eastern Notions of
 Humanism: Africa
 Humanism: Chinese Conception of
 Humanism: Renaissance
 Humanity: African Thought
 Humor
 Ideas, History of
 Identity, Multiple: Jewish Multiple Identity
 Imagination
 Indigenismo
 Individualism
 Intelligentsia
 Interdisciplinarity
 Interpretation
 Islam: Africa
 Islam: Shii
 Islam: Sunni
 Islamic Science
 Japanese Philosophy, Japanese Thought
 Jouissance
 Judaism: Judaism to 1800
 Judaism: Modern Judaism
 Language and Linguistics
 Language, Philosophy of: Ancient and Medieval
 Language, Philosophy of: Modern
 Law, Islamic
 Leadership
 Life Cycle: Overview
 Linguistic Turn
 Literary Criticism
Literary History
 Literature: Overview
 Literature: African Literature
 Love, Western Notions of
 Magic
 Manichaeism
 Marxism: Overview
 Marxism: Latin America
 Masks
 Matriarchy
 Medicine: China
 Medicine: Islamic Medicine
 Memory
 Men and Masculinity
 Mestizaje
 Metaphor
 Metaphysics: Renaissance to the Present
 Microcosm and Macrocosm
 Millenarianism: Overview
 Millenarianism: Islamic
 Millenarianism: Latin America and Native North America
 Modernism: Overview
 Modernism: Latin America
 Modernity: Overview
 Modernity: East Asia
 Mohism
 Monarchy: Overview
 Motherhood and Maternity
 Motif: Motif in Literature
 Motif: Motif in Music
 Musicology
 Mysticism: Chinese Mysticism
 Mysticism: Christian Mysticism
 Myth
 Narrative
 Nation
 Nationalism: Africa
 Naturalism
 Naturalism in Art and Literature
 Nature
 Negritude
New Criticism
 Occidentalism
 Oral Traditions: Overview
 Organicism
 Orientalism: Overview
 Orientalism: African and Black Orientalism
 Pan-Africanism
 Pan-Asianism
 Person, Idea of the
 Phenomenology
 Philosophies: African
 Philosophies: American
 Philosophies: Feminist, Twentieth-Century
 Philosophies: Islamic
 Philosophy: Historical Overview and Recent Developments
 Philosophy, Moral: Ancient
 Philosophy, Moral: Medieval and Renaissance
 Pietism
 Platonism
Poetry and Poetics
 Political Protest, U.S.
 Postcolonial Studies
 Postcolonial Theory and Literature
 Postmodernism
 Practices
 Privacy
 Property
 Prophecy
 Protest, Political
 Psychoanalysis
 Queer Theory
 Race and Racism: Europe
 Reading
 Realism: Africa
 Religion: Africa
 Religion: African Diaspora
 Religion: East and Southeast Asia
 Religion: Indigenous Peoples' View, South America
 Religion: Latin America
 Religion: Middle East

READER'S GUIDE

Religion and the State: United States
Renaissance
Republicanism: Republic
Resistance and Accommodation
Rhetoric: Overview
Rhetoric: Ancient and Medieval
Ritual: Public Ritual
Romanticism in Literature and Politics
Sacred Texts: Asia
Sacred Texts: Koran
Sage Philosophy
Scholasticism
Science Fiction
Science: Overview
Sexuality: Overview
Slavery
Social History, U.S.
Society
Sophists, The
State of Nature
Stoicism
Structuralism and Poststructuralism: Overview
Surrealism
Symbolism
Syncretism
Text/Textuality
Theater and Performance
Third World Literature
Toleration
Totalitarianism
Tragedy and Comedy
Translation
Travel: Travel from Europe and the Middle East
Trope
Utopia
Victorianism
Virtue Ethics
Visual Order to Organizing Collections
War and Peace in the Arts
Wisdom, Human

RELIGION

Abolitionism
Aesthetics: Africa
Aesthetics: Asia
Africa, Idea of
Agnosticism
Alchemy: China
Alchemy: Europe and the Middle East
Alienation
Altruism
Americanization, U.S.
Ancestor Worship
Animism
Antifeminism
Anti-Semitism: Overview
Anti-Semitism: Islamic Anti-Semitism
Architecture: Overview
Architecture: Asia
Aristotelianism
Arts: Overview
Arts: Africa
Asceticism: Hindu and Buddhist Asceticism
Asceticism: Western Asceticism
Assimilation
Astrology: Overview

Astrology: China
Astronomy, Pre-Columbian and Latin American
Atheism
Authority
Autonomy
Bioethics
Body, The
Buddhism
Calendar
Cannibalism
Capitalism: Overview
Cartesianism
Casuistry
Causality
Causation in East Asian and Southeast Asian Philosophy
Censorship
Change
Chinese Thought
Christianity: Overview
Christianity: Asia
City, The: Latin America
City, The: The Islamic and Byzantine City
Civil Disobedience
Civil Society: Europe and the United States
Classification of Arts and Sciences, Early Modern
Colonialism: Southeast Asia
Communication of Ideas: Africa and Its Influence
Communication of Ideas: Asia and Its Influence
Communication of Ideas: Middle East and Abroad
Communication of Ideas: Orality and Advent of Writing
Communication of Ideas: Southeast Asia
Composition, Musical
Confucianism
Consciousness: Indian Thought
Conservatism
Continental Philosophy
Corruption
Cosmology: Asia
Cosmology: Cosmology and Astronomy
Cosmopolitanism
Creationism
Cultural History
Dance
Daoism
Death
Death and Afterlife, Islamic Understanding of
Deism
Demonology
Dialogue and Dialectics: Talmudic
Diasporas: Jewish Diaspora
Dictatorship in Latin America
Diversity
Dream
Dress
Dualism
Ecology
Ecumenism
Education: Asia, Traditional and Modern
Education: Europe
Education: Islamic Education
Education: Japan
Empire and Imperialism: Overview
Empire and Imperialism: Americas
Empire and Imperialism: Europe
Enlightenment

- Environment
 Environmental Ethics
 Environmental History
 Epicureanism
 Epistemology: Early Modern
 Epistemology: Modern
 Equality: Overview
 Eschatology
 Ethnicity and Race: Islamic Views
 Etiquette
 Europe, Idea of
 Everyday Life
 Evil
 Evolution
 Existentialism
 Expressionism
 Extirpation
 Family: Family in Anthropology since 1980
 Fascism
 Fatalism
 Feminism: Overview
 Feminism: Africa and African Diaspora
 Feminism: Chicana Feminisms
 Feminism: Islamic Feminism
 Fetishism: Overview
 Form, Metaphysical, in Ancient and Medieval Thought
 Free Will, Determinism, and Predestination
 Friendship
 Fundamentalism
 Gay Studies
 Gender: Gender in the Middle East
 Gender in Art
 General Will
 Genetics: Contemporary
 Genocide
 Ghetto
 Gift, The
 Globalization: Asia
 Gnosticism
 Good
 Harmony
 Health and Disease
 Heaven and Hell
 Heaven and Hell (Asian Focus)
 Hedonism in European Thought
 Heresy and Apostasy
 Hermeneutics
 Hierarchy and Order
 Hinduism
 Historicism
 Historiography
 History, Idea of
 Honor
 Honor, Middle Eastern Notions of
 Humanism: Africa
 Humanism: Chinese Conception of
 Humanism: Renaissance
 Humanism: Secular Humanism in the United States
 Humanity: African Thought
 Humanity: Asian Thought
 Humanity: European Thought
 Humanity in the Arts
 Human Rights: Overview
 Iconography
 Ideas, History of
 Identity: Identity of Persons
 Identity, Multiple: Jewish Multiple Identity
 Images, Icons, and Idols
 Imagination
 Immortality and the Afterlife
 Individualism
 Intelligentsia
 Intentionality
 Intercession in Middle Eastern Society
 Interdisciplinarity
 Islam: Africa
 Islam: Shii
 Islam: Southeast Asia
 Islam: Sunni
 Islamic Science
 Jainism
 Japanese Philosophy, Japanese Thought
 Jihad
 Jouissance
 Judaism: Judaism to 1800
 Judaism: Modern Judaism
 Kantianism
 Kinship
 Knowledge
 Language and Linguistics
 Language, Philosophy of: Ancient and Medieval
 Law, Islamic
 Liberation Theology
 Life
 Literary History
 Love, Western Notions of
 Magic
 Manichaeism
 Marriage and Fertility, European Views
 Marxism: Overview
 Marxism: Latin America
 Masks
 Materialism in Eighteenth-Century European Thought
 Matriarchy
 Medicine: Europe and the United States
 Medicine: Islamic Medicine
 Meditation: Eastern Meditation
 Men and Masculinity
 Metaphor
 Millenarianism: Overview
 Millenarianism: Islamic
 Millenarianism: Latin America and Native North America
 Minority
 Miracles
 Modernity: Overview
 Mohism
 Monarchy: Overview
 Monarchy: Islamic Monarchy
 Monasticism
 Monism
 Motherhood and Maternity
 Motif: Motif in Music
 Multiculturalism, Africa
 Museums
 Music, Anthropology of
 Musical Performance and Audiences
 Mysticism: Chinese Mysticism
 Mysticism: Christian Mysticism
 Mysticism: Islamic Mysticism

READER'S GUIDE

- Mysticism: Islamic Mysticism in Asia
 Mysticism: Kabbalah
 Mysticism: Mysticism in African Thought
 Myth
 Nation
 Nationalism: Cultural Nationalism
 Nationalism: Middle East
 Naturalism
 Natural Law
 Natural Theology
 Newtonianism
 Nomadism
 Nonviolence
 Nude, The
 Obligation
 Organicism
 Orientalism: Overview
 Orientalism: African and Black Orientalism
 Orthodoxy
 Orthopraxy: Asia
 Orthopraxy: Western Orthopraxy
 Other, The, European Views of
 Pacifism
 Paradise on Earth
 Parties, Political
 Peace
 Periodization of the Arts
 Person, Idea of the
 Personhood in African Thought
 Perspective
 Philanthropy
 Philosophies: African
 Philosophies: American
 Philosophies: Feminist, Twentieth-Century
 Philosophies: Islamic
 Philosophy: Historical Overview and Recent Developments
 Philosophy: Relations to Other Intellectual Realms
 Philosophy, Moral: Africa
 Philosophy, Moral: Medieval and Renaissance
 Philosophy, Moral: Modern
 Philosophy and Religion in Western Thought
 Philosophy of Mind: Ancient and Medieval
 Philosophy of Religion
 Physics
 Pietism
 Platonism
 Political Protest, U.S.
 Polytheism
 Population
 Poverty
 Practices
 Pre-Columbian Civilization
 Privacy
 Propaganda
 Prophecy
 Protest, Political
 Pseudoscience
 Psychoanalysis
 Punishment
 Puritanism
 Pythagoreanism
 Race and Racism: Europe
 Rationalism
 Reading
 Reflexivity
 Reform: Islamic Reform
 Reformation
 Relativism
 Religion: Overview
 Religion: Africa
 Religion: African Diaspora
 Religion: East and Southeast Asia
 Religion: Latin America
 Religion: Middle East
 Religion and Science
 Religion and the State: Africa
 Religion and the State: Europe
 Religion and the State: Latin America
 Religion and the State: Middle East
 Religion and the State: United States
 Renaissance
 Representation: Political Representation
 Republicanism: Latin America
 Resistance and Accommodation
 Responsibility
 Rhetoric: Ancient and Medieval
 Ritual: Religion
 Romanticism in Literature and Politics
 Sacred and Profane
 Sacred Places
 Sacred Texts: Asia
 Sacred Texts: Koran
 Scholasticism
 Secularization and Secularism
 Sexuality: Islamic Views
 Shinto
 Skepticism
 Slavery
 Sophists, The
 Subjectivism
 Sufism
 Suicide
 Superstition
 Symbolism
 Syncretism
 Temperance
 Theodicy
 Time: China
 Time: India
 Time: Traditional and Utilitarian
 Toleration
 Totalitarianism
 Totems
 University: Overview
 Untouchability: Overview
 Untouchability: Menstrual Taboos
 Untouchability: Taboos
 Utilitarianism
 Victorianism
 Visual Order to Organizing Collections
 Volunteerism, U.S.
 War
 War and Peace in the Arts
 Westernization: Africa
 Westernization: Middle East
 Westernization: Southeast Asia
 Witchcraft
 Witchcraft, African Studies of
 Yin and Yang

- Yoga
 Zen
 Zionism
 PHILOSOPHY
 Absolute Music
 Aesthetics: Asia
 Aesthetics: Europe and the Americas
 Africa, Idea of
 African-American Ideas
 Afrocentricity
 Agnosticism
 Alchemy: China
 Algebras
 Alienation
 Altruism
 Ambiguity
 Analytical Philosophy
 Anticolonialism: Africa
 Antifeminism
 Architecture: Overview
 Architecture: Asia
 Aristotelianism
 Asceticism: Hindu and Buddhist Asceticism
 Asceticism: Western Asceticism
 Astronomy, Pre-Columbian and Latin American
 Atheism
 Authenticity: Africa
 Autonomy
 Avant-Garde: Militancy
 Bioethics
 Black Consciousness
 Body, The
 Buddhism
 Cartesianism
 Casuistry
 Causality
 Causation
 Causation in East Asian and Southeast Asian Philosophy
 Censorship
 Change
 Character
 Chemistry
 Chinese Thought
 Christianity: Overview
 Civil Disobedience
 Civil Society: Europe and the United States
 Civil Society: Responses in Africa and the Middle East
 Class
 Classification of Arts and Sciences, Early Modern
 Common Sense
 Communitarianism in African Thought
 Confucianism
 Consciousness: Overview
 Consciousness: Chinese Thought
 Consciousness: Indian Thought
 Conservatism
 Consilience
 Context
 Continental Philosophy
 Corruption
 Corruption in Developed and Developing Countries
 Cosmology: Asia
 Cosmopolitanism
 Creationism
 Critical Race Theory
 Critical Theory
 Cultural History
 Cycles
 Cynicism
 Dance
 Daoism
 Death
 Deism
 Democracy
 Democracy: Africa
 Determinism
 Dialogue and Dialectics: Socratic
 Dream
 Dress
 Dualism
 Dystopia
 Eclecticism
 Education: China
 Education: Global Education
 Education: Japan
 Emotions
 Empiricism
 Enlightenment
 Environment
 Environmental Ethics
 Environmental History
 Epicureanism
 Epistemology: Ancient
 Epistemology: Early Modern
 Epistemology: Modern
 Equality: Overview
 Equality: Gender Equality
 Equality: Racial Equality
 Essentialism
 Ethnocentrism
 Eugenics
 Everyday Life
 Evil
 Existentialism
 Expressionism
 Fallacy, Logical
 Falsifiability
 Family Planning
 Fascism
 Fatalism
 Feminism: Overview
 Feminism: Africa and African Diaspora
 Feminism: Chicana Feminisms
 Feminism: Islamic Feminism
 Field Theories
 Form, Metaphysical, in Ancient and Medieval Thought
 Foundationalism
 Free Will, Determinism, and Predestination
 Friendship
 Gender: Gender in the Middle East
 Gender in Art
 General Will
 Genetics: Contemporary
 Genetics: History of
 Geometry
 Gift, The
 Globalization: Asia
 Gnosticism
 Good
 Greek Science

READER'S GUIDE

- Happiness and Pleasure in European Thought
 Harmony
 Health and Disease
 Heaven and Hell (Asian Focus)
 Hedonism in European Thought
 Hegelianism
 Hegemony
 Hermeneutics
 Hierarchy and Order
 Hinduism
 Historical and Dialectical Materialism
 Historicism
 Historiography
 History, Idea of
 Humanism: Africa
 Humanism: Chinese Conception of
 Humanism: Europe and the Middle East
 Humanism: Secular Humanism in the United States
 Humanity: African Thought
 Humanity: Asian Thought
 Humanity: European Thought
 Human Rights: Overview
 Human Rights: Women's Rights
 Idealism
 Ideas, History of
 Identity: Identity of Persons
 Identity, Multiple: Overview
 Identity, Multiple: Jewish Multiple Identity
 Immortality and the Afterlife
 Impressionism
 Individualism
 Intelligentsia
 Intentionality
 Interdisciplinarity
 International Order
 Islam: Africa
 Islam: Sunni
 Islamic Science
 Jainism
 Japanese Philosophy, Japanese Thought
 Jouissance
 Judaism: Modern Judaism
 Justice: Overview
 Justice: Justice in American Thought
 Justice: Justice in East Asian Thought
 Kantianism
 Knowledge
 Language and Linguistics
 Language, Philosophy of: Ancient and Medieval
 Language, Philosophy of: Modern
 Law
 Liberalism
 Liberty
 Life
 Linguistic Turn
 Literary Criticism
 Literary History
 Logic
 Logic and Philosophy of Mathematics, Modern
 Magic
 Manichaeism
 Maoism
 Marxism: Overview
 Marxism: Latin America
 Materialism in Eighteenth-Century European Thought
 Mathematics
 Mechanical Philosophy
 Medicine: China
 Medicine: Europe and the United States
 Meditation: Eastern Meditation
 Memory
 Metaphor
 Metaphysics: Ancient and Medieval
 Metaphysics: Renaissance to the Present
 Microcosm and Macrocosm
 Mind
 Modernism: Latin America
 Modernity: Overview
 Mohism
 Monism
 Moral Sense
 Music, Anthropology of
 Musicology
 Mysticism: Chinese Mysticism
 Myth
 Narrative
 Natural History
 Natural Law
 Natural Theology
 Naturalism
 Nature
 Naturphilosophie
 Neoplatonism
 Newtonianism
 Nihilism
 Nonviolence
 Nuclear Age
 Objectivity
 Obligation
 Occidentalism
 Organicism
 Orientalism: Overview
 Orthopraxy: Asia
 Other, The, European Views of
 Pacifism
 Pan-Africanism
 Paradigm
 Parties, Political
 Peace
 Person, Idea of the
 Personhood in African Thought
 Phenomenology
 Philanthropy
 Philosophies: African
 Philosophies: American
 Philosophies: Feminist, Twentieth-Century
 Philosophies: Islamic
 Philosophy: Historical Overview and Recent Developments
Philosophy: Relations to Other Intellectual Realms
 Philosophy, History of
 Philosophy, Moral: Africa
 Philosophy, Moral: Ancient
 Philosophy, Moral: Medieval and Renaissance
 Philosophy, Moral: Modern
 Philosophy and Religion in Western Thought
 Philosophy of Mind: Overview
 Philosophy of Mind: Ancient and Medieval
 Philosophy of Religion
 Physics

- Pietism
 Platonism
 Pluralism
 Poetry and Poetics
 Political Protest, U.S.
 Political Science
 Population
 Populism: United States
 Positivism
 Postcolonial Studies
 Postmodernism
 Poverty
 Practices
 Pragmatism
 Presentism
 Privacy
 Probability
 Progress, Idea of
 Protest, Political
 Pseudoscience
 Punishment
 Pythagoreanism
 Quantum
 Queer Theory
 Race and Racism: Overview
 Radicals/Radicalism
 Rational Choice
 Rationalism
 Reading
 Realism: Africa
 Reason, Practical and Theoretical
 Reflexivity
 Reform: Europe and the United States
 Relativism
 Relativity
 Religion: Overview
 Religion: East and Southeast Asia
 Religion: Middle East
 Religion and Science
 Religion and the State: United States
 Renaissance
 Representation: Political Representation
 Resistance
 Responsibility
 Rhetoric: Overview
 Romanticism in Literature and Politics
 Sacred Texts: Asia
 Sage Philosophy
 Scholasticism
 Science: Overview
 Science: East Asia
 Science, History of
 Scientific Revolution
 Secularization and Secularism
 Sexual Harassment
 Sexuality: Overview
 Skepticism
 Sociability in African Thought
 Social Darwinism
 Socialisms, African
 Society
 Sophists, The
 State of Nature
 Stoicism
 Structuralism and Poststructuralism: Overview
- Subjectivism
 Suicide
 Surrealism
 Symbolism
 Taste
 Text/Textuality
 Theodicy
 Time: China
 Time: India
 Toleration
 Totalitarianism
 Translation
 Truth
 Universalism
 Utilitarianism
 Victorianism
 Virtue Ethics
 Visual Culture
 Visual Order to Organizing Collections
 Volksgeist
 Volunteerism, U.S.
 War
 Wildlife
 Wisdom, Human
 Witchcraft
 Witchcraft, African Studies of
 Womanism
 Yin and Yang
 Yoga
 Zen
- EDUCATION**
 Abolitionism
 Aesthetics: Africa
 Aesthetics: Asia
 Afrocentricity
 Altruism
 Americanization, U.S.
 Anthropology
 Anticolonialism: Africa
 Anticolonialism: Southeast Asia
 Antifeminism
 Anti-Semitism: Overview
 Apartheid
 Architecture: Overview
 Aristotelianism
 Asceticism: Hindu and Buddhist Asceticism
 Authenticity: Africa
 Authoritarianism: Latin America
 Behaviorism
 Bilingualism and Multilingualism
 Biology
 Black Consciousness
 Body, The
 Buddhism
 Bushido
 Calculation and Computation
 Capitalism: Overview
 Capitalism: Africa
 Character
 Childhood and Child Rearing
 Chinese Thought
 Christianity: Asia
 Citizenship: Naturalization
 City, The: The City as a Cultural Center
 Civil Society: Europe and the United States

READER'S GUIDE

Classification of Arts and Sciences, Early Modern
 Communication of Ideas: Africa and Its Influence
 Communication of Ideas: Asia and Its Influence
 Communication of Ideas: Europe and Its Influence
 Communication of Ideas: Southeast Asia
 Composition, Musical
 Confucianism
 Consciousness: Chinese Thought
 Consciousness: Indian Thought
 Cosmopolitanism
 Creationism
 Creolization, Caribbean
 Cultural Capital
 Cultural Revivals
 Cultural Studies
 Dance
 Daoism
 Death and Afterlife, Islamic Understanding of
 Democracy: Africa
 Dialogue and Dialectics: Socratic
 Dialogue and Dialectics: Talmudic
 Diasporas: Jewish Diaspora
 Diffusion, Cultural
 Discrimination
 Diversity
 Dress
 Eclecticism
Education: Asia, Traditional and Modern
Education: China
Education: Europe
Education: Global Education
Education: India
Education: Islamic Education
Education: Japan
Education: North America
 Emotion
 Empire and Imperialism: Asia
 Empire and Imperialism: Europe
 Empire and Imperialism: United States
 Enlightenment
 Environmental Ethics
 Environmental History
 Epicureanism
 Epistemology: Ancient
 Epistemology: Early Modern
 Epistemology: Modern
 Equality: Overview
 Ethnicity and Race: Anthropology
 Etiquette
 Examination Systems, China
 Experiment
 Extirpation
 Family Planning
 Fascism
 Feminism: Overview
 Feminism: Africa and African Diaspora
 Feminism: Chicana Feminisms
 Feminism: Islamic Feminism
 Gender: Gender in the Middle East
 Generation
 Globalization: Asia
 Good
 Greek Science
 Harmony
 Health and Disease
 Hermeneutics
 Hinduism
 Historical and Dialectical Materialism
 Historiography
 History, Economic
 Human Capital
 Humanism: Chinese Conception of
 Humanism: Europe and the Middle East
 Humanism: Renaissance
 Humanity: Asian Thought
 Hygiene
 Ideas, History of
 Identity, Multiple: Jewish Multiple Identity
 Individualism
 Interdisciplinarity
 Interpretation
 Islam: Africa
 Islam: Southeast Asia
 Islam: Sunni
 Islamic Science
 Japanese Philosophy, Japanese Thought
 Jihad
 Jouissance
 Judaism: Judaism to 1800
 Judaism: Modern Judaism
 Justice: Justice in East Asian Thought
 Kantianism
 Kinship
 Knowledge
 Language and Linguistics
 Language, Linguistics, and Literacy
 Learning and Memory, Contemporary Views
 Life Cycle: Overview
 Life Cycle: Adolescence
 Life Cycle: Elders/Old Age
 Literary Criticism
 Loyalties, Dual
 Maoism
 Maps and the Ideas They Express
 Marxism: Overview
 Masks
 Matriarchy
 Medicine: Europe and the United States
 Men and Masculinity
 Mestizaje
 Metaphor
 Minority
 Modernity: Overview
 Modernity: Africa
 Modernity: East Asia
 Modernization Theory
 Mohism
 Motherhood and Maternity
 Multiculturalism, Africa
 Museums
 Music, Anthropology of
 Musical Performance and Audiences
 Musicology
 Mysticism: Chinese Mysticism
 Mysticism: Islamic Mysticism in Asia
 Mysticism: Kabbalah
 Nation
 Nationalism: Africa
 Natural History
 Negritude

- Neoplatonism
 Newtonianism
 Nuclear Age
 Nude, The
 Objectivity
 Occidentalism
 Oral Traditions: Overview
 Organicism
 Orientalism: Overview
 Orthodoxy
 Pan-Arabism
 Pan-Asianism
 Paradigm
 Periodization of the Arts
 Philosophies: American
 Philosophies: Feminist, Twentieth-Century
 Philosophies: Islamic
 Philosophy: Historical Overview and Recent Developments
 Philosophy, History of
 Philosophy, Moral: Ancient
 Philosophy, Moral: Medieval and Renaissance
 Philosophy, Moral: Modern
 Philosophy of Mind: Ancient and Medieval
 Physics
 Platonism
 Political Protest, U.S.
 Population
 Populism: United States
 Practices
 Pragmatism
 Prejudice
 Privacy
 Propaganda
 Protest, Political
 Pseudoscience
 Psychoanalysis
 Punishment
 Queer Theory
 Reading
 Realism: Africa
 Reason, Practical and Theoretical
 Reflexivity
 Reform: Islamic Reform
 Reformation
 Relativism
 Religion: East and Southeast Asia
 Religion: Middle East
 Religion and the State: Europe
 Religion and the State: Latin America
 Religion and the State: Middle East
 Religion and the State: United States
 Renaissance
 Representation: Political Representation
 Republicanism: Republic
 Resistance
 Rhetoric: Overview
 Rhetoric: Ancient and Medieval
 Ritual: Public Ritual
 Sacred Places
 Sacred Texts: Asia
 Sage Philosophy
 Scholasticism
 Science: East Asia
 Segregation
 Sexuality: Overview
 Skepticism
 Slavery
 Sociability in African Thought
 Social Capital
 Social History, U.S.
 Sophists, The
 Sport
 State, The: Overview
 Stoicism
 Subjectivism
 Sufism
 Superstition
 Temperance
 Theater and Performance
 Third Cinema
 Third World Literature
 Time: China
 Totalitarianism
 Tragedy and Comedy
 University: Overview
 University: Postcolonial
 Untouchability: Menstrual Taboos
 Untouchability: Taboos
 Utilitarianism
 Utopia
 Victorianism
 Visual Order to Organizing Collections
 Volunteerism, U.S.
 War and Peace in the Arts
 Westernization: Africa
 Westernization: Middle East
 Westernization: Southeast Asia
 Wisdom, Human
 Women's History: Africa
 Women's Studies
 Yoga
 Zen

Social Sciences

WOMEN'S STUDIES AND GENDER STUDIES

- Abolitionism
 Aesthetics: Asia
 African-American Ideas
 Anarchism
 Anthropology
 Antifeminism
 Asceticism: Western Asceticism
 Autobiography
 Beauty and Ugliness
 Biography
 Black Atlantic
 Body, The
 Capitalism: Africa
 Censorship
 Chicano Movement
 Childhood and Child Rearing
 Christianity: Overview
 Cinema
 Class
 Colonialism: Africa
 Colonialism: Southeast Asia
 Communication of Ideas: Southeast Asia
 Composition, Musical
 Confucianism

READER'S GUIDE

Consumerism
 Continental Philosophy
 Creativity in the Arts and Sciences
 Critical Race Theory
 Critical Theory
 Cultural Studies
 Dance
 Death
 Death and Afterlife, Islamic Understanding of
 Democracy: Africa
 Demography
 Diversity
 Dress
 Dystopia
 Economics
 Education: Asia, Traditional and Modern
 Education: China
 Education: Europe
 Education: Islamic Education
 Education: North America
 Emotions
 Environmental History
 Equality: Overview
 Equality: Gender Equality
 Essentialism
 Etiquette
 Eugenics
 Eurocentrism
 Everyday Life
 Existentialism
 Family: Modernist Anthropological Theory
 Family: Family in Anthropology since 1980
 Family Planning
 Fascism
 Feminism: Overview
 Feminism: Africa and African Diaspora
 Feminism: Chicana Feminisms
 Feminism: Third World U.S. Movement
 Fetishism: Overview
 Fetishism: Fetishism in Literature and Cultural Studies
 Friendship
Gay Studies
 Gender: Overview
 Gender: Gender in the Middle East
 Gender in Art
Gender Studies: Anthropology
 Genius
 Genre
 Hate
 Historiography
 History, Economic
 Honor
 Honor, Middle Eastern Notions of
 Human Capital
 Humanism: Renaissance
 Humanity: Asian Thought
 Humanity: European Thought
 Human Rights: Women's Rights
 Humor
 Iconography
 Identity: Identity of Persons
 Identity, Multiple: Overview
 Impressionism
 Intelligentsia
 Interdisciplinarity
 Internal Colonialism
 Interpretation
 Islam: Shii
 Jouissance
 Justice: Overview
 Kinship
 Knowledge
 Law
 Law, Islamic
 Legalism, Ancient China
 Liberalism
 Liberation Theology
 Life Cycle: Adolescence
 Literary History
 Literature: African Literature
 Love, Western Notions of
 Machismo
 Marriage and Fertility, European Views
 Masks
 Matriarchy
 Medicine: Europe and the United States
 Men and Masculinity
 Mestizaje
 Minority
 Modernism: Overview
 Motherhood and Maternity
 Music, Anthropology of
 Musicology
 Mysticism: Christian Mysticism
 Narrative
 Nude, The
 Orientalism: African and Black Orientalism
 Orthodoxy
 Pan-Africanism
 Periodization of the Arts
 Philosophies: African
 Philosophies: American
 Philosophies: Feminist, Twentieth-Century
 Philosophy: Historical Overview and Recent Developments
 Poetry and Poetics
 Political Protest, U.S.
 Population
 Postcolonial Studies
 Postcolonial Theory and Literature
 Postmodernism
 Pre-Columbian Civilization
 Privacy
 Progress, Idea of
 Propaganda
 Prophecy
 Protest, Political
 Psychoanalysis
 Public Sphere
 Queer Theory
 Radicals/Radicalism
 Reading
 Reflexivity
 Relativism
 Religion: Africa
 Religion: African Diaspora
 Renaissance
 Republicanism: Latin America
 Resistance and Accommodation
 Rhetoric: Ancient and Medieval

- Ritual: Public Ritual
 Ritual: Religion
 Romanticism in Literature and Politics
 Science: Overview
 Science, History of
 Science Fiction
 Scientific Revolution
 Secularization and Secularism
 Sexual Harassment
Sexuality: Overview
Sexuality: Islamic Views
Sexuality: Sexual Orientation
 Shinto
 Slavery
 Social Contract
 Social History, U.S.
 Sport
 State, The: The Postcolonial State
 Structuralism and Poststructuralism: Overview
 Subjectivism
 Symbolism
 Universalism
 University: Overview
 Untouchability: Menstrual Taboos
 Utopia
 Victorianism
 Virtue Ethics
 Visual Culture
 Visual Order to Organizing Collections
 Volunteerism, U.S.
 War
 Witchcraft
 Witchcraft, African Studies of
 Womanism
 Women and Femininity in U.S. Popular Culture
 Women's History: Africa
 Women's History: Asia
Women's Studies
 Work
- ETHNIC STUDIES**
 Abolitionism
 Absolute Music
 Africa, Idea of
 African-American Ideas
 Afrocentricity
 America
 Americanization, U.S.
 Ancestor Worship
 Anthropology
 Anticolonialism: Africa
 Anticolonialism: Southeast Asia
 Anti-Semitism: Overview
 Anti-Semitism: Islamic Anti-Semitism
 Apartheid
 Architecture: Africa
 Arts: Overview
 Assimilation
 Astronomy, Pre-Columbian and Latin American
 Authenticity: Africa
 Autobiography
 Aztlán
 Barbarism and Civilization
 Bilingualism and Multilingualism
 Black Atlantic
 Black Consciousness
- Body, The
 Borders, Borderlands, and Frontiers, Global
 Cannibalism
 Capitalism: Overview
 Capitalism: Africa
 Chicano Movement
 Cinema
 Citizenship: Cultural Citizenship
 City, The: Latin America
 City, The: The City as a Cultural Center
 City, The: The City as Political Center
 Civil Disobedience
 Class
 Colonialism: Africa
 Colonialism: Latin America
 Colonialism: Southeast Asia
 Communication of Ideas: Southeast Asia
 Communitarianism in African Thought
 Composition, Musical
 Consumerism
 Context
 Cosmopolitanism
 Creolization, Caribbean
 Critical Race Theory
 Critical Theory
 Cultural Capital
 Cultural Revivals
 Cultural Studies
 Dance
 Death
 Demography
 Diasporas: African Diaspora
 Diasporas: Jewish Diaspora
 Diffusion, Cultural
 Discrimination
 Diversity
 Dress
 Education: North America
 Empire and Imperialism: Europe
 Empire and Imperialism: Middle East
 Environmental History
 Equality: Overview
 Equality: Racial Equality
 Essentialism
Ethnicity and Race: Africa
Ethnicity and Race: Anthropology
Ethnicity and Race: Islamic Views
 Ethnocentrism
Ethnography
 Ethnohistory, U.S.
 Eugenics
 Eurocentrism
 Extirpation
 Family Planning
 Fascism
 Feminism: Overview
 Feminism: Africa and African Diaspora
 Feminism: Chicana Feminisms
 Feminism: Third World U.S. Movement
 Fetishism: Overview
 Fetishism: Fetishism in Literature and Cultural Studies
 Gender Studies: Anthropology
 Generation
 Genetics: Contemporary
 Genocide

READER'S GUIDE

Gesture
 Ghetto
 Gift, The
 Hate
 Hinduism
 History, Economic
 Honor
 Humanity: European Thought
 Humor
 Hygiene
 Iconography
 Identity, Multiple: Overview
 Identity, Multiple: Asian-Americans
 Identity, Multiple: Jewish Multiple Identity
 Indigenismo
 Intelligentsia
 Interdisciplinarity
 Internal Colonialism
 Islam: Africa
 Jouissance
 Judaism: Modern Judaism
 Kinship
 Law
 Liberation Theology
 Life Cycle: Adolescence
 Literary History
 Literature: African Literature
 Loyalties, Dual
 Machismo
 Marxism: Latin America
 Mathematics
 Matriarchy
 Men and Masculinity
 Mestizaje
 Migration: Africa
 Migration: Migration in World History
 Migration: United States
 Minority
 Modernism: Overview
 Modernity: Africa
 Motherhood and Maternity
 Multiculturalism, Africa
 Music, Anthropology of
 Musical Performance and Audiences
 Mysticism: Kabbalah
 Nation
 Nationalism: Overview
 Nationalism: Africa
 Nationalism: Cultural Nationalism
 Nationalism: Middle East
 Native Policy
 Naturalism
 Negritude
 Nomadism
 Nuclear Age
 Occidentalism
 Orientalism: Overview
 Orientalism: African and Black Orientalism
 Orthodoxy
 Other, The, European Views of
 Pan-Africanism
 Pan-Asianism
 Pan-Islamism
 Pan-Turkism
 Patriotism
 Periodization of the Arts
 Person, Idea of the
 Philosophies: African
 Philosophies: American
 Political Protest, U.S.
 Population
 Populism: United States
 Postcolonial Studies
 Postcolonial Theory and Literature
 Postmodernism
 Practices
 Pre-Columbian Civilization
 Prehistory, Rise of
 Prejudice
 Privacy
 Protest, Political
 Psychoanalysis
 Queer Theory
 Race and Racism: Overview
 Race and Racism: Asia
 Race and Racism: Europe
 Race and Racism: United States
 Reading
 Realism: Africa
 Reflexivity
 Regions and Regionalism, Eastern Europe
 Relativism
 Religion: African Diaspora
 Religion: Indigenous Peoples' View, South America
 Religion: Latin America
 Religion: Middle East
 Republicanism: Latin America
 Resistance and Accommodation
 Ritual: Religion
 Sage Philosophy
 Scarcity and Abundance, Latin America
 Secularization and Secularism
 Segregation
 Sexuality: Overview
 Shinto
 Slavery
 Socialisms, African
 Sport
 State, The: The Postcolonial State
 Superstition
 Symbolism
 Syncretism
 Terror
 Third Cinema
 Third World
 Third World Literature
 Time: Traditional and Utilitarian
 Totalitarianism
 Totems
 Trade
 Translation
 Treaty
 Untouchability: Menstrual Taboos
 Untouchability: Taboos
 Utopia
 Victorianism
 Visual Culture
 Volksgeist
 Volunteerism, U.S.
 War

- Westernization: Africa
 Westernization: Southeast Asia
 Wisdom, Human
 Witchcraft, African Studies of
 Womanism
 Women and Femininity in U.S. Popular Culture
 Women's History: Africa
 Women's Studies
 Work
 World Systems Theory, Latin America
 Zionism
- HISTORY**
- Aesthetics: Europe and the Americas
 Afrocentricity
 Afropessimism
 Altruism
 Americanization, U.S.
 Anthropology
 Anticolonialism: Latin America
 Anticolonialism: Southeast Asia
 Anti-Semitism: Overview
 Architecture: Overview
 Architecture: Africa
 Asceticism: Hindu and Buddhist Asceticism
 Authoritarianism: Latin America
 Autobiography
 Autonomy
 Aztlán
 Barbarism and Civilization
 Biography
 Buddhism
 Capitalism: Overview
 Change
 Childhood and Child Rearing
 Chinese Thought
 City, The: The City as a Cultural Center
 Classification of Arts and Sciences, Early Modern
 Colonialism: Africa
 Colonialism: Latin America
 Colonialism: Southeast Asia
 Consciousness: Overview
 Conservatism
 Context
 Continental Philosophy
 Cosmology: Asia
 Creolization, Caribbean
 Crisis
 Cultural History
 Cultural Revivals
 Cultural Studies
 Cycles
 Dance
 Determinism
 Diasporas: African Diaspora
 Diasporas: Jewish Diaspora
 Dictatorship in Latin America
 Diffusion, Cultural
 Dress
 Ecology
 Economics
 Education: Europe
 Empire and Imperialism: Overview
 Empire and Imperialism: United States
 Enlightenment
 Environmental History
- Ethnography
 Ethnohistory, U.S.
 Eurocentrism
 Everyday Life
 Evil
 Extirpation
 Fascism
 Fatalism
 Feminism: Overview
 Feminism: Third World U.S. Movement
 Feudalism, European
 Futurology
 Gender in Art
 Generation
 Genius
 Genre
 Geography
 Globalization: Asia
 Hegelianism
 Hermeneutics
 Historical and Dialectical Materialism
 Historicism
Historiography
 History, Economic
History, Idea of
 Honor
 Iconography
 Ideas, History of
 Identity, Multiple: Jewish Multiple Identity
 Intelligentsia
 Intentionality
 Interdisciplinarity
 Internal Colonialism
 International Order
 Interpretation
 Islamic Science
 Japanese Philosophy, Japanese Thought
 Jihad
 Judaism: Judaism to 1800
 Knowledge
 Language and Linguistics
 Leadership
 Learning and Memory, Contemporary Views
 Life Cycle: Elders/Old Age
 Linguistic Turn
 Literary Criticism
 Literary History
 Literature: African Literature
 Love, Western Notions of
 Machiavellism
 Maoism
 Marxism: Overview
 Marxism: Asia
 Marxism: Latin America
 Matriarchy
 Media, History of
 Memory
 Mestizaje
 Metaphor
 Migration: Africa
 Migration: Migration in World History
 Millenarianism: Overview
 Millenarianism: Islamic
 Millenarianism: Latin America and Native North America

READER'S GUIDE

- Modernism: Latin America
 Modernity: Overview
 Modernity: Africa
 Modernity: East Asia
 Modernization
 Modernization Theory
 Motif: Motif in Literature
 Music, Anthropology of
 Musicology
 Narrative
 Nation
 Nationalism: Overview
 Nationalism: Africa
 Native Policy
 Negritude
 Nomadism
 Nuclear Age
 Occidentalism
 Oral Traditions: Overview
 Pan-Asianism
 Paradigm
 Patriotism
 Peasants and Peasantry
 Periodization
 Periodization of the Arts
 Philosophies: Feminist, Twentieth-Century
 Philosophy: Historical Overview and Recent Developments
 Philosophy, History of
 Philosophy of Religion
 Poetry and Poetics
 Political Protest, U.S.
 Polytheism
 Postcolonial Theory and Literature
 Postmodernism
 Power
 Practices
 Pragmatism
 Pre-Columbian Civilization
 Presentism
 Privacy
 Progress, Idea of
 Protest, Political
 Public Sphere
 Queer Theory
 Race and Racism: Asia
 Reading
 Realism: Africa
 Reflexivity
 Reform: Europe and the United States
 Reformation
 Regions and Regionalism, Eastern Europe
 Relativism
 Religion: East and Southeast Asia
 Religion: Indigenous Peoples' View, South America
 Religion: Middle East
 Religion and the State: United States
 Renaissance
 Republicanism: Latin America
 Republicanism: Republic
 Resistance
 Responsibility
 Revolution
 Ritual: Public Ritual
 Sacred Texts: Asia
 Scarcity and Abundance, Latin America
 Science: Overview
 Science, History of
 Scientific Revolution
 Sexuality: Overview
 Skepticism
 Slavery
 Social Capital
 Social Darwinism
 Social History, U.S.
 Society
 Sophists, The
 Sport
 State of Nature
 Structuralism and Poststructuralism: Overview
 Subjectivism
 Surrealism
 Syncretism
 Technology
 Theater and Performance
 Theodicy
 Third World
 Time: China
 Time: India
 Time: Traditional and Utilitarian
 Toleration
 Totalitarianism
 Trade
 Treaty
 Trope
 Utopia
 Victorianism
 Visual Order to Organizing Collections
 Volksgeist
 War
 War and Peace in the Arts
 Westernization: Middle East
 Westernization: Southeast Asia
 Witchcraft
 Witchcraft, African Studies of
 Women's History: Africa
 Women's History: Asia
 World Systems Theory, Latin America
- ### ANTHROPOLOGY AND SOCIOLOGY
- Aesthetics: Asia
 Aesthetics: Europe and the Americas
 Africa, Idea of
 Alienation
 Altruism
 Americanization, U.S.
 Ancestor Worship
Anthropology
 Anti-Semitism: Overview
 Architecture: Overview
 Architecture: Africa
 Asceticism: Hindu and Buddhist Asceticism
 Asceticism: Western Asceticism
 Astronomy, Pre-Columbian and Latin American
 Aztlán
 Barbarism and Civilization
 Beauty and Ugliness
 Bilingualism and Multilingualism
 Body, The
 Borders, Borderlands, and Frontiers, Global
 Buddhism

- Calendar
 Cannibalism
 Capitalism: Overview
 Character
 Childhood and Child Rearing
 Chinese Thought
 Cinema
 Citizenship: Cultural Citizenship
 City, The: The City as a Cultural Center
 Civil Society: Europe and the United States
 Colonialism: Latin America
 Colonialism: Southeast Asia
 Communication of Ideas: Orality and Advent of Writing
 Communication of Ideas: Southeast Asia
 Communitarianism in African Thought
 Composition, Musical
 Context
 Continental Philosophy
 Cosmopolitanism
 Creativity in the Arts and Sciences
 Creolization, Caribbean
 Cultural Capital
 Cultural History
 Cultural Revivals
 Cultural Studies
 Dance
 Death
 Death and Afterlife, Islamic Understanding of
 Demography
 Demonology
 Development
 Diasporas: African Diaspora
 Diasporas: Jewish Diaspora
 Diffusion, Cultural
 Discrimination
 Diversity
 Dream
 Dress
 Ecology
 Environment
 Environmental Ethics
 Environmental History
 Ethnicity and Race: Africa
 Ethnicity and Race: Anthropology
 Ethnocentrism
Ethnography
 Ethnohistory, U.S.
 Etiquette
 Eugenics
 Eurocentrism
 Europe, Idea of
 Everyday Life
 Extirpation
 Family: Modernist Anthropological Theory
 Family: Family in Anthropology since 1980
 Family Planning
 Fascism
 Feminism: Overview
 Feminism: Third World U.S. Movement
 Fetishism: Overview
 Gender Studies: Anthropology
 Generation
 Genetics: Contemporary
 Genetics: History of
 Gesture
 Ghetto
 Gift, The
 Globalization: Asia
 Hinduism
 Historiography
 History, Economic
 History, Idea of
 Honor
 Honor, Middle Eastern Notions of
 Humanism: Chinese Conception of
 Humanity: African Thought
 Humanity: European Thought
 Humor
 Ideas, History of
 Identity: Personal and Social Identity
 Identity, Multiple: Asian-Americans
 Identity, Multiple: Jewish Multiple Identity
 Intelligentsia
 Intentionality
 Interdisciplinarity
 Interpretation
 Jouissance
 Judaism: Modern Judaism
 Kinship
 Knowledge
 Language and Linguistics
Life Cycle: Overview
Life Cycle: Adolescence
Life Cycle: Elders/Old Age
 Linguistic Turn
 Literary Criticism
 Machiavellism
 Magic
 Manichaeism
 Marriage and Fertility, European Views
 Marxism: Overview
 Masks
 Matriarchy
 Meditation: Eastern Meditation
 Memory
 Men and Masculinity
 Mestizaje
 Metaphor
 Migration: Migration in World History
 Migration: United States
 Minority
 Motherhood and Maternity
 Motif: Motif in Music
 Music, Anthropology of
 Musical Performance and Audiences
 Musicology
 Mysticism: Chinese Mysticism
 Myth
 Nation
 Native Policy
 Natural History
 Occidentalism
 Oral Traditions: Overview
 Organicism
 Orientalism: African and Black Orientalism
 Orthodoxy
 Orthopraxy: Asia
 Other, The, European Views of
 Peasants and Peasantry
 Person, Idea of the

READER'S GUIDE

- Philosophies: Feminist, Twentieth-Century
 Philosophy, Moral: Africa
 Phrenology
 Pluralism
 Polytheism
 Postcolonial Theory and Literature
 Postmodernism
 Power
 Practices
 Pre-Columbian Civilization
 Prehistory, Rise of
 Prejudice
 Presentism
 Privacy
 Psychoanalysis
 Public Sphere
 Queer Theory
 Race and Racism: Asia
 Reading
 Reflexivity
 Reform: Europe and the United States
 Relativism
 Religion: Overview
 Religion: Africa
 Religion: African Diaspora
 Religion: Latin America
 Religion: Middle East
 Representation: Mental Representation
 Resistance
 Resistance and Accommodation
 Ritual: Public Ritual
 Ritual: Religion
 Sacred and Profane
 Scarcity and Abundance, Latin America
 Sexuality: Overview
 Sexuality: Sexual Orientation
 Social Capital
 Social Darwinism
 Social History, U.S.
 Society
 Sport
 State of Nature
 Structuralism and Poststructuralism: Overview
 Structuralism and Poststructuralism: Anthropology
 Subjectivism
 Superstition
 Surrealism
 Symbolism
 Syncretism
 Textiles and Fiber Arts as Catalysts for Ideas
 Theater and Performance
 Time: Traditional and Utilitarian
 Toleration
 Totalitarianism
 Totems
 Trade
 Tradition
 Tragedy and Comedy
 Tribalism, Middle East
 Trope
 Untouchability: Menstrual Taboos
 Untouchability: Taboos
 Utilitarianism
 Victorianism
 Virtue Ethics
 War and Peace in the Arts
 Westernization: Southeast Asia
 Wisdom, Human
 Witchcraft
 Witchcraft, African Studies of
 Women's History: Africa
 Work
 World Systems Theory, Latin America
 Yin and Yang
POLITICAL SCIENCE (emphasizing political philosophy)
 Abolitionism
 Absolute Music
 Africa, Idea of
 African-American Ideas
 Afrocentricity
 Afropessimism
 Alienation
 Altruism
 America
 Americanization, U.S.
 Anarchism
 Anthropology
 Anticolonialism: Africa
 Anticolonialism: Latin America
 Anticolonialism: Middle East
 Anticolonialism: Southeast Asia
 Anti-Semitism: Overview
 Anti-Semitism: Islamic Anti-Semitism
 Apartheid
 Architecture: Overview
 Architecture: Africa
 Architecture: Asia
 Asceticism: Western Asceticism
 Asian-American Ideas (Cultural Migration)
 Assimilation
 Astronomy, Pre-Columbian and Latin American
 Authoritarianism: Overview
 Authoritarianism: East Asia
 Authoritarianism: Latin America
 Authority
 Autobiography
 Avant-Garde: Militancy
 Aztlán
 Barbarism and Civilization
 Bilingualism and Multilingualism
 Bioethics
 Black Atlantic
 Black Consciousness
 Borders, Borderlands, and Frontiers, Global
 Bureaucracy
 Bushido
 Calculation and Computation
 Cannibalism
 Capitalism: Overview
 Capitalism: Africa
 Casuistry
 Censorship
 Chicano Movement
 Childhood and Child Rearing
 Chinese Warlordism
 Christianity: Overview
 Christianity: Asia
 Citizenship: Overview
 Citizenship: Cultural Citizenship
 Citizenship: Naturalization

- City, The: Latin America
 City, The: The City as a Cultural Center
 City, The: The City as Political Center
 Civil Disobedience
 Civil Society: Europe and the United States
 Civil Society: Responses in Africa and the Middle East
 Class
 Colonialism: Africa
 Colonialism: Latin America
 Colonialism: Southeast Asia
 Common Sense
 Communication of Ideas: Europe and Its Influence
 Communication of Ideas: Middle East and Abroad
 Communication of Ideas: Southeast Asia
 Communication of Ideas: The Americas and Their Influence
 Communism: Latin America
 Communism: Europe
 Communitarianism in African Thought
 Composition, Musical
 Computer Science
 Confucianism
 Consciousness: Overview
 Consciousness: Chinese Thought
 Conservatism
 Constitutionalism
 Continental Philosophy
 Corruption
 Corruption in Developed and Developing Countries
 Cosmopolitanism
 Creolization, Caribbean
 Critical Race Theory
 Cultural Studies
 Cycles
 Cynicism
 Dada
 Dance
 Daoism
Democracy
 Democracy, Africa
 Demography
 Dependency
 Determinism
 Dialogue and Dialectics: Socratic
 Diasporas: African Diaspora
 Diasporas: Jewish Diaspora
 Dictatorship in Latin America
 Discrimination
 Diversity
 Dress
 Dystopia
 Ecology
 Economics
 Education: China
 Education: Global Education
 Education: India
 Education: Japan
 Education: North America
 Empire and Imperialism: Overview
 Empire and Imperialism: Americas
 Empire and Imperialism: Asia
 Empire and Imperialism: Europe
 Empire and Imperialism: Middle East
 Empire and Imperialism: United States
 Environmental Ethics
 Environmental History
 Equality: Overview
 Equality: Gender Equality
 Equality: Racial Equality
 Ethnicity and Race: Africa
 Ethnicity and Race: Anthropology
 Ethnicity and Race: Islamic Views
 Etiquette
 Eugenics
 Eurocentrism
 Europe, Idea of
 Evil
 Examination Systems, China
 Existentialism
 Expressionism
 Extirpation
 Fallacy, Logical
 Family Planning
 Fascism
 Feminism: Overview
 Feminism: Africa and African Diaspora
 Feminism: Chicana Feminisms
 Feminism: Islamic Feminism
 Feminism: Third World U.S. Movement
 Fetishism: Overview
 Feudalism, European
 Friendship
 Fundamentalism
 Futurology
 Game Theory
 Garden
 Gay Studies
 Gender: Gender in the Middle East
 Gender in Art
 General Will
 Generation
 Genetics: Contemporary
 Genocide
 Ghetto
 Globalization: Africa
 Globalization: Asia
 Globalization: General
 Good
 Happiness and Pleasure in European Thought
 Heaven and Hell
 Heaven and Hell (Asian Focus)
 Hegelianism
 Hegemony
 Hinduism
 Historical and Dialectical Materialism
 Historiography
 History, Economic
 History, Idea of
 Honor
 Honor, Middle Eastern Notions of
 Human Capital
 Humanism: Chinese Conception of
 Humanism: Europe and the Middle East
 Humanism: Renaissance
 Humanism: Secular Humanism in the United States
 Humanity: African Thought
 Human Rights: Overview
 Human Rights: Women's Rights
 Hygiene
 Ideas, History of

READER'S GUIDE

Identity, Multiple: Overview
 Identity, Multiple: Asian-Americans
 Identity, Multiple: Jewish Multiple Identity
 Individualism
 Intelligentsia
 Intentionality
 Intercession in Middle Eastern Society
 Interdisciplinarity
 Internal Colonialism
 International Order
 Islam: Africa
 Islam: Shii
 Islam: Southeast Asia
 Islam: Sunni
 Islamic Science
 Japanese Philosophy, Japanese Thought
 Jihad
 Jouissance
 Justice: Overview
 Justice: Justice in American Thought
 Justice: Justice in East Asian Thought
 Kantianism
 Kinship
 Knowledge
 Language and Linguistics
 Law
 Law, Islamic
 Leadership
 Legalism, Ancient China
 Liberalism
 Liberation Theology
 Liberty
 Life Cycle: Elders/Old Age
 Literary Criticism
 Literary History
 Literature: Overview
 Literature: African Literature
 Lysenkoism
 Machiavellism
 Machismo
 Maoism
 Maps and the Ideas They Express
 Marriage and Fertility, European Views
 Marxism: Overview
 Marxism: Asia
 Marxism: Latin America
 Masks
 Mathematics
 Matriarchy
 Medicine: Europe and the United States
 Meme
 Men and Masculinity
 Mestizaje
 Migration: Migration in World History
 Migration: United States
 Millenarianism: Islamic
 Millenarianism: Latin America and Native North America
 Minority
 Modernism: Overview
 Modernism: Latin America
 Modernity: Overview
 Modernity: Africa
 Modernity: East Asia
 Modernization
 Modernization Theory
 Mohism
Monarchy: Overview
 Monarchy: Islamic Monarchy
 Motherhood and Maternity
 Motif: Motif in Literature
 Multiculturalism, Africa
 Music, Anthropology of
 Musical Performance and Audiences
 Musicology
 Mysticism: Chinese Mysticism
 Myth
 Narrative
 Nation
 Nationalism: Overview
 Nationalism: Africa
 Nationalism: Cultural Nationalism
 Nationalism: Middle East
 Native Policy
 Natural Law
 Naturalism
 Negritude
 Neocolonialism
 Neoliberalism
 New Criticism
 Newtonianism
 Nihilism
 Nomadism
 Nonviolence
 Nuclear Age
 Objectivity
 Obligation
 Occidentalism
 Organicism
 Orientalism: Overview
 Orientalism: African and Black Orientalism
 Orthodoxy
 Orthopraxy: Asia
 Pacifism
 Pan-Africanism
 Pan-Arabism
 Pan-Asianism
 Pan-Islamism
 Pan-Turkism
 Paradigm
 Parties, Political
 Patriotism
 Peace
 Periodization of the Arts
 Person, Idea of the
 Personhood in African Thought
 Philanthropy
 Philosophies: American
 Philosophies: Feminist, Twentieth-Century
 Philosophies: Islamic
 Philosophy: Historical Overview and Recent Developments
 Philosophy, History of
 Philosophy, Moral: Africa
 Philosophy, Moral: Ancient
 Philosophy, Moral: Modern
 Philosophy of Religion
 Phrenology
 Pluralism
 Political Protest, U.S.

- Political Science**
 Political, The
 Population
 Populism: Latin America
 Populism: United States
 Postcolonial Studies
 Poverty
 Power
 Practices
 Pre-Columbian Civilization
 Prejudice
 Presentism
 Privacy
 Privatization
 Probability
 Progress, Idea of
 Propaganda
 Property
 Protest, Political
 Pseudoscience
 Psychoanalysis
 Public Sphere
 Punishment
 Puritanism
 Pythagoreanism
 Quantum
 Queer Theory
 Race and Racism: Overview
 Race and Racism: Asia
 Race and Racism: United States
 Radicals/Radicalism
 Rational Choice
 Reading
 Realism
 Realism: Africa
 Reason, Practical and Theoretical
 Reflexivity
 Reform: Europe and the United States
 Reform: Islamic Reform
 Regions and Regionalism, Eastern Europe
 Relativism
 Religion: Africa
 Religion: African Diaspora
 Religion: East and Southeast Asia
 Religion: Latin America
 Religion: Middle East
 Religion and the State: Africa
 Religion and the State: Europe
 Religion and the State: Latin America
 Religion and the State: Middle East
 Religion and the State: United States
 Renaissance
 Representation: Political Representation
 Republicanism: Latin America
 Republicanism: Republic
 Resistance
 Resistance and Accommodation
 Responsibility
 Revolution
 Rhetoric: Ancient and Medieval
 Ritual: Public Ritual
 Romanticism in Literature and Politics
 Sacred and Profane
 Scarcity and Abundance, Latin America
 Science, History of
 Science Fiction
 Secularization and Secularism
 Segregation
 Sexual Harassment
 Sexuality: Overview
 Sexuality: Islamic Views
 Sexuality: Sexual Orientation
 Shinto
 Skepticism
 Slavery
 Sociability in African Thought
 Social Capital
 Social Contract
 Social History, U.S.
 Socialism
 Socialisms, African
 Society
 Sophists, The
 Sovereignty
 Sport
 State, The: Overview
 State, The: The Postcolonial State
 State of Nature
 Stoicism
 Subjectivism
 Sufism
 Suicide
 Superstition
 Surrealism
 Symbolism
 Syncretism
 Technology
 Temperance
 Terror
 Terrorism, Middle East
 Third Cinema
 Third World
 Third World Literature
 Time: China
 Time: Traditional and Utilitarian
 Toleration
 Totalitarianism
 Trade
 Translation
 Treaty
 Tribalism, Middle East
 University: Postcolonial
 Untouchability: Menstrual Taboos
 Untouchability: Taboos
 Utilitarianism
 Utopia
 Victorianism
 Virtue Ethics
 Visual Order to Organizing Collections
 Volksgeist
 Volunteerism, U.S.
 War
 War and Peace in the Arts
 Wealth
 Westernization: Africa
 Westernization: Middle East
 Westernization: Southeast Asia
 Wildlife
 Witchcraft
 Witchcraft, African Studies of

READER'S GUIDE

- Women's History: Africa
 Work
 World Systems Theory, Latin America
 Zionism
ECONOMICS
 Abolitionism
 Africa, Idea of
 African-American Ideas
 Afropessimism
 Alienation
 Altruism
 Anarchism
 Anthropology
 Anticolonialism: Africa
 Anticolonialism: Latin America
 Anticolonialism: Middle East
 Anticolonialism: Southeast Asia
 Anti-Semitism: Islamic Anti-Semitism
 Apartheid
 Architecture: Africa
 Arts: Africa
 Asceticism: Western Asceticism
 Asian-American Ideas (Cultural Migration)
 Assimilation
 Astronomy, Pre-Columbian and Latin American
 Authoritarianism: East Asia
 Authoritarianism: Latin America
 Avant-Garde: Militancy
 Bioethics
 Black Atlantic
 Black Consciousness
 Bureaucracy
 Bushido
 Calculation and Computation
 Capitalism: Overview
 Capitalism: Africa
 Chicano Movement
 Cinema
 City, The: The City as a Cultural Center
 City, The: The City as Political Center
 City, The: The Islamic and Byzantine City
 Civil Society: Europe and the United States
 Civil Society: Responses in Africa and the Middle East
 Class
 Colonialism: Africa
 Colonialism: Southeast Asia
 Communication of Ideas: Africa and Its Influence
 Communication of Ideas: Middle East and Abroad
 Communication of Ideas: Southeast Asia
 Communism: Europe
 Communism: Latin America
 Composition, Musical
 Confucianism
 Consumerism
 Corruption in Developed and Developing Countries
 Critical Race Theory
 Cultural Capital
 Cultural History
 Cultural Studies
 Democracy: Africa
Demography
 Dependency
 Diasporas: African Diaspora
 Diasporas: Jewish Diaspora
 Dictatorship in Latin America
 Diffusion, Cultural
 Discrimination
 Diversity
 Dress
 Dystopia
Economics
 Education: China
 Education: Global Education
 Empire and Imperialism: Americas
 Empire and Imperialism: Asia
 Empire and Imperialism: Europe
 Empire and Imperialism: Middle East
 Empire and Imperialism: United States
 Environmental Ethics
 Environmental History
 Equality: Overview
 Equality: Gender Equality
 Equality: Racial Equality
 Eugenics
 Eurocentrism
 Europe, Idea of
 Everyday Life
 Examination Systems, China
 Family: Modernist Anthropological Theory
 Family Planning
 Fascism
 Feminism: Overview
 Feminism: Africa and African Diaspora
 Feminism: Chicana Feminisms
 Feminism: Islamic Feminism
 Feminism: Third World U.S. Movement
 Fetishism: Overview
 Fetishism: Fetishism in Literature and Cultural Studies
 Feudalism, European
 Futurology
 Game Theory
 Generation
 Genetics: Contemporary
 Ghetto
 Gift, The
Globalization: Africa
Globalization: Asia
Globalization: General
 Good
 Hegelianism
 Hegemony
 Hinduism
 Historical and Dialectical Materialism
 Historicism
 Historiography
 History, Economic
 History, Idea of
 Human Capital
 Human Rights: Women's Rights
 Ideas, History of
 Identity, Multiple: Asian-Americans
 Indigenismo
 Individualism
 Intelligentsia
 Intentionality
 Internal Colonialism
 Interpretation
 Islam: Africa
 Islam: Sunni
 Islamic Science

- Jainism
 Japanese Philosophy, Japanese Thought
 Jihad
 Justice: Overview
 Justice: Justice in American Thought
 Law, Islamic
 Leadership
 Liberalism
 Liberation Theology
 Life Cycle: Elders/Old Age
 Literary Criticism
 Maoism
 Maps and the Ideas They Express
 Marriage and Fertility, European Views
 Marxism: Overview
 Marxism: Asia
 Marxism: Latin America
 Mathematics
 Migration: Africa
 Migration: Migration in World History
 Migration: United States
 Minority
 Modernity: Africa
 Modernity: East Asia
 Modernization
 Modernization Theory
 Motherhood and Maternity
 Nationalism: Africa
 Native Policy
 Naturalism
 Neocolonialism
 Neoliberalism
 Nomadism
 Nuclear Age
 Occidentalism
 Orthopraxy: Asia
 Pan-Africanism
 Pan-Asianism
 Parties, Political
 Peasants and Peasantry
 Philanthropy
 Philosophies: American
 Philosophy, History of
 Political Protest, U.S.
 Political Science
 Population
 Populism: Latin America
 Populism: United States
 Postcolonial Studies
 Poverty
 Practices
 Pre-Columbian Civilization
 Presentism
 Privacy
 Privatization
 Probability
 Progress, Idea of
 Property
 Protest, Political
 Pseudoscience
 Public Sphere
 Punishment
 Puritanism
 Race and Racism: United States
 Radicals/Radicalism
 Reason, Practical and Theoretical
 Reform: Europe and the United States
 Religion and the State: Africa
 Religion and the State: Latin America
 Renaissance
 Representation: Political Representation
 Republicanism: Republic
 Resistance
 Resistance and Accommodation
 Responsibility
 Ritual: Public Ritual
 Ritual: Religion
 Scarcity and Abundance, Latin America
 Secularization and Secularism
 Segregation
 Sexual Harassment
 Sexuality: Islamic Views
 Slavery
 Social Capital
 Social Darwinism
 Social History, U.S.
 Socialism
 Sport
 State, The: Overview
 State, The: The Postcolonial State
 Technology
 Terrorism, Middle East
 Third Cinema
 Third World
 Third World Literature
 Time: China
 Time: Traditional and Utilitarian
 Totalitarianism
 Trade
 Translation
 Travel: Travel from Europe and the Middle East
 Treaty
 Untouchability: Taboos
 Utilitarianism
 Victorianism
 Visual Culture
 Volunteerism, U.S.
 War and Peace in the Arts
 Wealth
 Westernization: Africa
 Westernization: Middle East
 Westernization: Southeast Asia
 Women and Femininity in U.S. Popular Culture
 Women's History: Africa
 Work
 World Systems Theory, Latin America
 Zen
 Zionism
- GEOGRAPHY
- Africa, Idea of
 America
 Anthropology
 Architecture: Overview
 Barbarism and Civilization
 Borders, Borderlands, and Frontiers, Global
 Capitalism: Overview
 Chinese Warlordism
 Cultural Studies
 Diffusion, Cultural
 Economics

READER'S GUIDE

Environment
Environmental History
Ethnicity and Race: Anthropology
Ethnicity and Race: Islamic Views
Eurocentrism
Feudalism, European
Geography
Ghetto
Globalization: Asia
Globalization: General
History, Economic
History, Idea of
Identity, Multiple: Jewish Multiple Identity
Islamic Science
Maps and the Ideas They Express
Mathematics
Migration: Africa
Migration: Migration in World History
Migration: United States
Minority
Nation
Nationalism: Africa
Natural History
Nomadism
Occidentalism
Orientalism: Overview
Pan-Africanism
Pan-Asianism
Perspective
Population
Privacy
Race and Racism: Asia
Race and Racism: United States
Regions and Regionalism, Eastern Europe
Religion: Indigenous Peoples' View, South America
Sacred Places
Scarcity and Abundance, Latin America
Third Cinema
Third World
Travel: Travel from Europe and the Middle East
Victorianism
Westernization: Southeast Asia
World Systems Theory, Latin America

Sciences

HISTORY OF SCIENCE, EARLY (entries focused on early ideas about nature and the human relationship with nature)

Alchemy: China
Alchemy: Europe and the Middle East
Anthropology
Aristotelianism
Asceticism: Hindu and Buddhist Asceticism
Astrology: Overview
Astrology: China
Astronomy, Pre-Columbian and Latin American
Change
Confucianism
Consciousness: Chinese Thought
Cosmology: Asia
Daoism
Ethnicity and Race: Africa
Ethnicity and Race: Anthropology
Ethnicity and Race: Islamic Views
Greek Science

Harmony
Hierarchy and Order
Hinduism
Humanism: Chinese Conception of
Humanity: African Thought
Ideas, History of
Lysenkoism
Magic
Manichaeism
Medicine: China
Medicine: India
Metaphysics: Ancient and Medieval
Mysticism: Chinese Mysticism
Myth
Natural Theology
Naturphilosophie
Organicism
Paradigm
Person, Idea of the
Philosophies: Islamic
Philosophy: Historical Overview and Recent Developments
Philosophy of Religion
Phrenology
Pseudoscience
Race and Racism: Europe
Race and Racism: United States
Religion: Indigenous Peoples' View, South America
Religion and Science
Ritual: Religion
Sacred Places
Science: East Asia
Segregation
Sexuality: Sexual Orientation
Slavery
Superstition
Syncretism
Time: China
Time: India
Untouchability: Menstrual Taboos
Witchcraft
Yin and Yang

HISTORY OF SCIENCE, MODERN AND CONTEMPORARY (entries focused on the origins of modern or contemporary ideas in the physical, chemical, biological, mathematical, or earth sciences)

Agnosticism
Algebras
Behaviorism
Body, The
Calendar
Cartesianism
Causation
Causation in East Asian and Southeast Asian Philosophy
Chemistry
Communication of Ideas: Middle East and Abroad
Computer Science
Context
Continental Philosophy
Cosmology: Cosmology and Astronomy
Creationism
Creativity in the Arts and Sciences
Cultural History
Demonology
Determinism

- Development
 Ecology
 Education: Islamic Education
 Empiricism
 Enlightenment
 Environment
 Environmental History
 Epistemology: Early Modern
 Equality: Racial Equality
 Everyday Life
 Experiment
 Falsifiability
 Free Will, Determinism, and Predestination
 Health and Disease
 History, Economic
 Idealism
 Islamic Science
 Kantianism
 Knowledge
 Life
 Linguistic Turn
 Mathematics
 Mechanical Philosophy
 Medicine: Europe and the United States
 Medicine: Islamic Medicine
 Metaphor
 Museums
 Nature
 Newtonianism
 Nuclear Age
 Objectivity
 Philosophies: African
 Philosophies: Feminist, Twentieth-Century
 Philosophy, History of
 Philosophy of Mind: Overview
 Philosophy of Mind: Ancient and Medieval
 Physics
 Platonism
 Poetry and Poetics
 Positivism
 Prehistory, Rise of
 Probability
 Progress, Idea of
 Pythagoreanism
 Quantum
 Race and Racism: Asia
 Rationalism
 Reason, Practical and Theoretical
 Reflexivity
 Reform: Europe and the United States
 Relativity
 Renaissance
 Scholasticism
 Science: Overview
Science, History of
Scientific Revolution
 Sexuality: Overview
 Social Darwinism
 Social History, U.S.
 Technology
 Victorianism
 Visual Order to Organizing Collections
PSYCHOLOGY
 Absolute Music
 Aesthetics: Asia
 Aesthetics: Europe and the Americas
 Alchemy: Europe and the Middle East
 Alienation
 Altruism
 Ambiguity
 Ancestor Worship
 Animism
 Anthropology
 Anti-Semitism: Overview
 Asceticism: Hindu and Buddhist Asceticism
 Asceticism: Western Asceticism
 Authoritarianism: East Asia
 Beauty and Ugliness
 Behaviorism
 Bioethics
 Biography
 Biology
 Body, The
 Buddhism
 Cartesianism
 Character
 Cinema
 Communitarianism in African Thought
 Composition, Musical
 Computer Science
 Consciousness: Overview
 Consciousness: Chinese Thought
 Consciousness: Indian Thought
 Consumerism
 Context
 Continental Philosophy
 Creativity in the Arts and Sciences
 Cultural Studies
 Dada
 Dance
 Daoism
 Death
 Demonology
 Determinism
 Diffusion, Cultural
 Discrimination
 Dream
 Emotions
 Empiricism
 Epistemology: Early Modern
 Epistemology: Modern
 Ethnicity and Race: Africa
 Eugenics
 Everyday Life
 Existentialism
 Feminism: Overview
 Fetishism: Overview
 Fetishism: Fetishism in Literature and Cultural Studies
 Form, Metaphysical, in Ancient and Medieval Thought
 Foundationalism
 Friendship
 Gay Studies
 Gender: Overview
 Gender: Gender in the Middle East
 Gender in Art
 Gender Studies: Anthropology
 Gesture
 Harmony
 Hate
 Health and Disease

READER'S GUIDE

- Heaven and Hell
Hinduism
Humanism: Secular Humanism in the United States
Humanity: African Thought
Humanity: European Thought
Identity: Identity of Persons
Identity: Personal and Social Identity
Identity, Multiple: Overview
Identity, Multiple: Asian-Americans
Images, Icons, and Idols
Imagination
Immortality and the Afterlife
Impressionism
Indigenismo
Intentionality
Jainism
Jouissance
Kinship
Knowledge
Language and Linguistics
Learning and Memory, Contemporary Views
Life
Life Cycle: Elders/Old Age
Literary Criticism
Love, Western Notions of
Machismo
Magic
Manichaeism
Masks
Medicine: China
Medicine: Europe and the United States
Meditation: Eastern Meditation
Memory
Men and Masculinity
Metaphor
Metaphysics: Renaissance to the Present
Mind
Modernism: Overview
Modernity: Overview
Modernity: Africa
Modernity: East Asia
Monarchy: Overview
Monism
Motherhood and Maternity
Musical Performance and Audiences
Mysticism: Chinese Mysticism
Mysticism: Islamic Mysticism in Asia
Myth
Narrative
National History
Nationalism: Overview
Naturphilosophie
Negritude
Objectivity
Person, Idea of the
Personhood in African Thought
Philosophies: Islamic
Philosophy, Moral: Modern
Philosophy of Mind: Overview
Philosophy of Mind: Ancient and Medieval
Philosophy of Religion
Phrenology
Political Science
Prejudice
Presentism
Privacy
Probability
Progress, Idea of
Protest, Political
Psychoanalysis
Psychology and Psychiatry
Punishment
Queer Theory
Realism: Africa
Reflexivity
Religion: Africa
Religion: African Diaspora
Religion: Indigenous Peoples' View, South America
Religion: Latin America
Religion and Science
Representation: Mental Representation
Resistance and Accommodation
Responsibility
Ritual: Public Ritual
Sexuality: Overview
Sexuality: Sexual Orientation
Slavery
State of Nature
Structuralism and Poststructuralism: Overview
Subjectivism
Superstition
Surrealism
Symbolism
Syncretism
Temperance
Text/Textuality
Third Cinema
Toleration
Totalitarianism
Tragedy and Comedy
Untouchability: Menstrual Taboos
Untouchability: Taboos
Utilitarianism
War and Peace in the Arts
Witchcraft
Witchcraft, African Studies of
Womanism
Women and Femininity in U.S. Popular Culture
- BIOLOGICAL SCIENCES**
Agnosticism
Altruism
Ancestor Worship
Anthropology
Antifeminism
Asceticism: Hindu and Buddhist Asceticism
Asceticism: Western Asceticism
Beauty and Ugliness
Behaviorism
Bioethics
Biology
Body, The
Buddhism
Cannibalism
Cartesianism
Casuistry
Classification of Arts and Sciences, Early Modern
Composition, Musical
Computer Science
Consciousness: Overview
Consilience

- Creationism
 Critical Race Theory
 Death
 Demography
 Determinism
 Development
 Dystopia
 Ecology
 Emotions
 Environmental Ethics
 Environmental History
 Epistemology: Early Modern
 Equality: Racial Equality
 Ethnohistory, U.S.
 Eugenics
Evolution
 Family: Modernist Anthropological Theory
 Family: Family in Anthropology since 1980
 Family Planning
 Feminism: Overview
 Game Theory
 Garden
 Gender: Overview
 Gender: Gender in the Middle East
 Gender in Art
 Gender Studies: Anthropology
Genetics: Contemporary
Genetics: History of
 Genocide
 Gesture
 Greek Science
 Health and Disease
 Heaven and Hell
 History, Idea of
 Humanism: Secular Humanism in the United States
 Humanity: African Thought
 Hygiene
 Identity: Identity of Persons
 Immortality and the Afterlife
 Intentionality
 Islamic Science
 Jainism
 Jouissance
 Kinship
 Learning and Memory, Contemporary Views
 Life
 Life Cycle: Adolescence
 Life Cycle: Elders/Old Age
 Lysenkoism
 Machiavellism
 Marriage and Fertility, European Views
 Masks
 Materialism in Eighteenth-Century European Thought
 Mechanical Philosophy
 Medicine: China
 Medicine: Europe and the United States
 Medicine: Islamic Medicine
 Meme
 Memory
 Men and Masculinity
 Mestizaje
 Monarchy: Overview
 Motherhood and Maternity
 Musical Performance and Audiences
 Natural History
 Naturalism
 Natural Theology
 Nature
 Naturphilosophie
 Negritude
 Organicism
 Other, The, European Views of
 Periodization of the Arts
 Person, Idea of the
 Perspective
 Philosophies: Islamic
 Philosophy of Mind: Ancient and Medieval
 Phrenology
 Population
 Prehistory, Rise of
 Probability
 Progress, Idea of
 Psychoanalysis
 Psychology and Psychiatry
 Punishment
 Queer Theory
 Religion: Indigenous Peoples' View, South America
 Representation: Mental Representation
 Science: East Asia
 Science, History of
 Sexuality: Overview
 Sexuality: Sexual Orientation
 Sociability in African Thought
 Social Darwinism
 Sport
 State of Nature
 Subjectivism
 Superstition
 Temperance
 Terror
 Text/Textuality
 Totems
 Untouchability: Menstrual Taboos
 Utilitarianism
 Victorianism
 Visual Order to Organizing Collections
 War and Peace in the Arts
 Wildlife
 Women and Femininity in U.S. Popular Culture
PHYSICAL SCIENCES
 Agnosticism
 Alchemy: China
 Astrology: China
 Astronomy, Pre-Columbian and Latin American
 Calculation and Computation
 Calendar
 Causality
 Causation
 Causation in East Asian and Southeast Asian Philosophy
 Change
 Chemistry
 Classification of Arts and Sciences, Early Modern
 Computer Science
 Consciousness: Overview
 Consilience
 Cosmology: Asia
 Cosmology: Cosmology and Astronomy
 Creationism
 Cycles

READER'S GUIDE

Ecology
 Empiricism
 Environmental Ethics
 Environmental History
 Epistemology: Early Modern
 Ethnohistory, U.S.
 Experiment
 Falsifiability
 Field Theories
 Form, Metaphysical, in Ancient and Medieval Thought
 Geography
 Geometry
 Greek Science
 Harmony
 Hinduism
 History, Economic
 Islam: Sunni
 Islamic Science
 Japanese Philosophy, Japanese Thought
 Knowledge
 Language, Philosophy of: Modern
 Life
 Literary History
 Logic and Philosophy of Mathematics, Modern
 Maps and the Ideas They Express
 Materialism in Eighteenth-Century European Thought
 Mathematics
 Mechanical Philosophy
 Metaphysics: Renaissance to the Present
 Microcosm and Macrocosm
 Monism
 Myth
 Natural Theology
 Naturalism
 Nature
 Naturphilosophie
 Newtonianism
 Nuclear Age
 Paradigm
 Periodization of the Arts
 Philosophies: Islamic
 Philosophy: Historical Overview and Recent Developments
 Philosophy, History of
Physics
 Positivism
 Power
 Pragmatism
 Probability
 Progress, Idea of
 Psychoanalysis
 Pythagoreanism
 Quantum
 Rationalism
 Realism: Africa
 Reason, Practical and Theoretical
 Relativity
 Religion: East and Southeast Asia
 Religion: Indigenous Peoples' View, South America
 Religion and Science
 Science: Overview
 Science: East Asia
 Science, History of
 Scientific Revolution
 Sophists, The

Stoicism
 Subjectivism
 Superstition
 Time: China
 Time: India
 Victorianism
ECOLOGY AND GEOLOGY
 Aesthetics: Asia
 Anthropology
 Architecture: Overview
 Architecture: Asia
 Astronomy, Pre-Columbian and Latin American
 Authoritarianism: Overview
 Bioethics
 Biology
 Borders, Borderlands, and Frontiers, Global
 Calendar
 Capitalism: Overview
 City, The: Latin America
 City, The: The City as a Cultural Center
 City, The: The Islamic and Byzantine City
 Creationism
 Death
 Dystopia
Ecology
 Education: Global Education
Environment
 Environmental Ethics
 Environmental History
 Evolution
 Feminism: Overview
 Garden
 Genetics: Contemporary
 Genetics: History of
 Genocide
 Geography
 History, Economic
 History, Idea of
 Hygiene
 Impressionism
 Landscape in the Arts
 Life
 Life Cycle: Elders/Old Age
 Lysenkoism
 Machiavellism
 Maps and the Ideas They Express
 Matriarchy
 Medicine: Islamic Medicine
 Memory
 Migration: Migration in World History
Natural History
 Nuclear Age
 Organicism
 Periodization of the Arts
 Political Protest, U.S.
 Prehistory, Rise of
 Presentism
 Protest, Political
 Religion: Latin America
 Ritual: Religion
 Scarcity and Abundance, Latin America
 Science, History of
 Social Darwinism
 Totems
 Untouchability: Menstrual Taboos

- Utopia
- Visual Order to Organizing Collections
- Wildlife
- Witchcraft
- Witchcraft, African Studies of
- World Systems Theory, Latin America
- CHEMISTRY**
 - Alchemy: China
 - Alchemy: Europe and the Middle East
 - Biology
 - Chemistry**
 - Classification of Arts and Sciences, Early Modern
 - Computer Science
 - Consciousness: Overview
 - Development
 - Experiment
 - Genetics: Contemporary
 - Genetics: History of
 - Health and Disease
 - Islamic Science
 - Life
 - Materialism in Eighteenth-Century European Thought
 - Mechanical Philosophy
 - Medicine: Europe and the United States
 - Mysticism: Chinese Mysticism
 - Paradigm
 - Philosophies: Islamic
 - Physics
 - Quantum
 - Science: East Asia
 - Science, History of
- MATHEMATICS**
 - Absolute Music
 - Aesthetics: Europe and the Americas
 - Algebras**
 - Analytical Philosophy
 - Astronomy, Pre-Columbian and Latin American
 - Beauty and Ugliness
 - Calculation and Computation
 - Causation
 - Causation in East Asian and Southeast Asian Philosophy
 - Chemistry
 - Classification of Arts and Sciences, Early Modern
 - Computer Science
 - Cosmology: Cosmology and Astronomy
 - Death
 - Demography
 - Economics
 - Empiricism
 - Environmental History
 - Equality: Overview
 - Experiment
 - Fallacy, Logical
 - Falsifiability
 - Foundationalism
 - Futurology
 - Game Theory
 - Generation
 - Genetics: Contemporary
 - Genetics: History of
 - Genocide
 - Geometry**
 - Harmony
 - History, Economic
 - Humanism: Chinese Conception of
 - Islamic Science
 - Knowledge
 - Language, Philosophy of: Ancient and Medieval
 - Language, Philosophy of: Modern
 - Language and Linguistics
 - Logic and Philosophy of Mathematics, Modern
 - Mathematics**
 - Newtonianism
 - Perspective
 - Philosophies: Islamic
 - Philosophy: Historical Overview and Recent Developments
 - Physics
 - Political Science
 - Positivism
 - Prejudice
 - Probability
 - Pythagoreanism
 - Quantum
 - Rationalism
 - Reading
 - Reason, Practical and Theoretical
 - Relativism
 - Relativity
 - Representation: Mental Representation
 - Scientific Revolution
 - Social History, U.S.
 - Sophists, The
 - Truth
- COMPUTER SCIENCE**
 - Calculation and Computation**
 - Computer Science**
 - Consciousness: Overview
 - Futurology
 - Game Theory
 - Genetics: Contemporary
 - Genetics: History of
 - Geography
 - History, Economic
 - Interdisciplinarity
 - Language and Linguistics
 - Learning and Memory, Contemporary Views
 - Maps and the Ideas They Express
 - Mathematics
 - Privacy
 - Probability
 - Social History, U.S.
 - Virtual Reality
- Professions**
- MEDICINE**
 - Alchemy: China
 - Alchemy: Europe and the Middle East
 - Americanization, U.S.
 - Ancestor Worship
 - Anthropology
 - Asceticism: Hindu and Buddhist Asceticism
 - Asceticism: Western Asceticism
 - Astrology: China
 - Bioethics
 - Biology
 - Body, The
 - Casualty
 - Chemistry
 - Childhood and Child Rearing

READER'S GUIDE

- Computer Science
 Creativity in the Arts and Sciences
 Death
 Demography
 Determinism
 Diversity
 Environment
 Environmental History
 Eugenics
 Feminism: Overview
 Feminism: Third World U.S. Movement
 Gay Studies
 Gender: Overview
 Gender Studies: Anthropology
 Genetics: Contemporary
 Genetics: History of
 Greek Science
Health and Disease
 Hinduism
 Humanity: African Thought
 Humor
 Hygiene
 Iconography
 Islam: Sunni
 Islamic Science
 Life
 Life Cycle: Elders/Old Age
 Literary Criticism
 Magic
 Mathematics
Medicine: China
Medicine: Europe and the United States
Medicine: India
Medicine: Islamic Medicine
 Meditation: Eastern Meditation
 Miracles
 Motherhood and Maternity
 Music, Anthropology of
 Mysticism: Chinese Mysticism
 Narrative
 Naturphilosophie
 Philosophies: Feminist, Twentieth-Century
 Philosophies: Islamic
 Phrenology
 Population
 Privacy
 Psychoanalysis
 Psychology and Psychiatry
 Pythagoreanism
 Queer Theory
 Religion: Africa
 Religion: African Diaspora
 Religion: East and Southeast Asia
 Religion: Indigenous Peoples' View, South America
 Ritual: Religion
 Science: East Asia
 Science, History of
 Sexuality: Overview
 Skepticism
 Superstition
 University: Overview
 Untouchability: Menstrual Taboos
 Utilitarianism
 Victorianism
 Visual Culture
 Visual Order to Organizing Collections
 Volunteerism, U.S.
 Westernization: Africa
 Witchcraft
 Women and Femininity in U.S. Popular Culture
 Yin and Yang
- ### LAW
- Abolitionism
 African-American Ideas
 Altruism
 Anticolonialism: Africa
 Anticolonialism: Latin America
 Anticolonialism: Southeast Asia
 Antifeminism
 Anti-Semitism: Islamic Anti-Semitism
 Apartheid
 Asian-American Ideas (Cultural Migration)
 Assimilation
 Authoritarianism: Overview
 Authoritarianism: East Asia
 Barbarism and Civilization
 Bioethics
 Black Consciousness
 Cannibalism
 Capitalism: Overview
 Capitalism: Africa
 Casuistry
 Censorship
 Citizenship: Overview
 Citizenship: Cultural Citizenship
 Citizenship: Naturalization
 City, The: The Islamic and Byzantine City
 Civil Disobedience
 Civil Society: Europe and the United States
 Colonialism: Southeast Asia
 Consciousness: Chinese Thought
 Constitutionalism
 Context
 Corruption in Developed and Developing Countries
 Creationism
 Critical Race Theory
 Cultural History
 Cultural Revivals
 Deism
 Democracy
 Democracy: Africa
 Dialogue and Dialectics: Socratic
 Dialogue and Dialectics: Talmudic
 Dictatorship in Latin America
 Discrimination
 Diversity
 Education: Islamic Education
 Empire and Imperialism: Overview
 Empire and Imperialism: Europe
 Empire and Imperialism: United States
 Environmental History
 Equality: Overview
 Equality: Racial Equality
 Ethnicity and Race: Anthropology
 Ethnicity and Race: Islamic Views
 Europe, Idea of
 Extirpation
 Fallacy, Logical
 Falsifiability
 Family Planning

- Fascism
 Feminism: Overview
 Feminism: Africa and African Diaspora
 Feminism: Islamic Feminism
 Feudalism, European
 Gender: Gender in the Middle East
 General Will
 Genetics: Contemporary
 Genetics: History of
 Genocide
 Ghetto
 Globalization: Africa
 Good
 Hate
 Heresy and Apostasy
 Hinduism
 Honor, Middle Eastern Notions of
 Human Rights: Overview
 Humanism: Secular Humanism in the United States
 Iconography
 Identity, Multiple: Jewish Multiple Identity
 Indigenismo
 Individualism
 Intentionality
 Interdisciplinarity
 International Order
 Islam: Africa
 Islam: Shii
 Islam: Southeast Asia
 Islam: Sunni
 Jihad
 Judaism: Judaism to 1800
 Justice: Overview
 Justice: Justice in American Thought
 Justice: Justice in East Asian Thought
 Kinship
 Language and Linguistics
Law
Law, Islamic
 Learning and Memory, Contemporary Views
 Legalism, Ancient China
 Liberalism
 Liberty
 Life Cycle: Elders/Old Age
 Literary Criticism
 Loyalties, Dual
 Marriage and Fertility, European Views
 Masks
 Matriarchy
 Migration: United States
 Minority
 Modernity: Overview
 Monarchy: Overview
 Monarchy: Islamic Monarchy
 Motherhood and Maternity
 Mysticism: Islamic Mysticism
 Narrative
 Nation
 Nationalism: Cultural Nationalism
 Nationalism: Middle East
 Native Policy
 Natural Law
 Nonviolence
 Nuclear Age
 Obligation
 Person, Idea of the
 Philanthropy
 Philosophies: American
 Philosophies: Feminist, Twentieth-Century
 Philosophies: Islamic
 Philosophy: Historical Overview and Recent Developments
 Philosophy, Moral: Ancient
 Political Protest, U.S.
 Population
 Postcolonial Studies
 Power
 Privacy
 Progress, Idea of
 Property
 Protest, Political
 Punishment
 Queer Theory
 Race and Racism: United States
 Reason, Practical and Theoretical
 Reform: Europe and the United States
 Regions and Regionalism, Eastern Europe
 Relativism
 Religion: African Diaspora
 Religion: Middle East
 Religion and the State: Africa
 Religion and the State: Europe
 Religion and the State: Middle East
 Religion and the State: United States
 Representation: Political Representation
 Republicanism: Republic
 Resistance
 Responsibility
 Rhetoric: Ancient and Medieval
 Ritual: Public Ritual
 Sacred Texts: Koran
 Segregation
 Sexual Harassment
 Sexuality: Overview
 Sexuality: Islamic Views
 Sexuality: Sexual Orientation
 Skepticism
 Slavery
 Sociability in African Thought
 Social Contract
 Socialisms, African
 Society
 State, The: Overview
 State, The: The Postcolonial State
 State of Nature
 Stoicism
 Subjectivism
 Sufism
 Suicide
 Temperance
 Toleration
 Totalitarianism
 Treaty
 University: Overview
 Untouchability: Taboos
 Utilitarianism
 Victorianism
 Virtue Ethics
 Visual Order to Organizing Collections
 Volunteerism, U.S.
 War and Peace in the Arts

READER'S GUIDE

Westernization: Africa
Westernization: Middle East
Westernization: Southeast Asia
Wildlife
Witchcraft
ENGINEERING
Alchemy: China
Alchemy: Europe and the Middle East
Architecture: Overview
Architecture: Africa
Architecture: Asia
Beauty and Ugliness
Biology
Calculation and Computation
Capitalism: Overview
Capitalism: Africa
Cinema
City, The: Latin America
City, The: The City as a Cultural Center
City, The: The City as Political Center
City, The: The Islamic and Byzantine City
Communication of Ideas: Southeast Asia
Computer Science
Diffusion, Cultural
Dystopia
Ecology
Empire and Imperialism: Europe
Environmental History
Epistemology: Early Modern
Experiment
Futurology
Gender Studies: Anthropology
Genetics: Contemporary
Genetics: History of
Genocide
Geometry
Globalization: General
Greek Science
Harmony
Historical and Dialectical Materialism
History, Economic
Humanism: Secular Humanism in the United States
Interdisciplinarity
Japanese Philosophy, Japanese Thought
Knowledge
Literary Criticism
Maps and the Ideas They Express
Mathematics
Mechanical Philosophy
Meme
Modernity: Overview
Modernity: Africa
Modernity: East Asia
Modernization
Modernization Theory
Motherhood and Maternity
Music, Anthropology of
Musical Performance and Audiences
Mysticism: Chinese Mysticism
Newtonianism
Nomadism
Nuclear Age
Occidentalism
Perspective
Power

Presentism
Privacy
Progress, Idea of
Protest, Political
Reform: Europe and the United States
Relativity
Science, History of
Science Fiction
Technology
Textiles and Fiber Arts as Catalysts for Ideas
Totalitarianism
Victorianism
Virtual Reality
Visual Culture
War and Peace in the Arts
Westernization: Middle East
Westernization: Southeast Asia
World Systems Theory, Latin America

Multidisciplinary Practices

The *New Dictionary of the History of Ideas* has many entries that discuss the methods by which scholars and researchers pursue knowledge. The entries below discuss approaches, methods, and practices that have influenced many disciplines.

ENTRIES ON MULTIDISCIPLINARY PRACTICES THAT ORIGINATED IN ANCIENT TIMES

Aesthetics: Asia
Africa, Idea of
Algebras
Anthropology
Architecture: Overview
Architecture: Asia
Aristotelianism
Astrology: Overview
Biology
Body, The
Buddhism
Casuistry
Causality
Censorship
Classicism
Classification of Arts and Sciences, Early Modern
Composition, Musical
Cosmology: Asia
Creationism
Creativity in the Arts and Sciences
Daoism
Development
Dialogue and Dialectics: Socratic
Dualism
Eclecticism
Education: China
Education: Europe
Epistemology: Ancient
Equality: Overview
Essentialism
Eurocentrism
Experiment
Fallacy, Logical
Fetishism: Fetishism in Literature and Cultural Studies
Form, Metaphysical, in Ancient and Medieval Thought
Fundamentalism
Gender in Art
Genre

- Geometry
 Greek Science
 Harmony
 Health and Disease
 Hierarchy and Order
 Hinduism
 History, Idea of
 Humanism: Europe and the Middle East
 Humor
 Ideas, History of
 Imagination
 Interpretation
 Knowledge
 Language, Philosophy of: Ancient and Medieval
 Life
 Literary History
 Literature: African Literature
 Logic
 Maps and the Ideas They Express
 Mathematics
 Medicine: China
 Medicine: Europe and the United States
 Medicine: India
 Memory
 Metaphor
 Metaphysics: Ancient and Medieval
 Monism
 Museums
 Music, Anthropology of
 Musical Performance and Audiences
 Mysticism: Chinese Mysticism
 Narrative
 Nature
 Orthodoxy
 Orthopraxy: Asia
 Orthopraxy: Western Orthopraxy
 Paradigm
 Periodization
 Perspective
 Philosophies: African
 Philosophies: Islamic
 Philosophy: Historical Overview and Recent Developments
 Philosophy and Religion in Western Thought
 Physics
 Platonism
 Presentism
 Progress, Idea of
 Pythagoreanism
 Rationalism
 Reading
 Reason, Practical and Theoretical
 Religion: Overview
 Responsibility
 Rhetoric: Overview
 Rhetoric: Ancient and Medieval
 Sacred Places
 Sacred Texts: Asia
 Science: East Asia
 Scientific Revolution
 Skepticism
 Sophists, The
 Syncretism
 Taste
 Text/Textuality
 Toleration
 Translation
 Trope
 Truth
 Virtual Reality
 Wisdom, Human
 Yin and Yang
- ENTRIES ON MULTIDISCIPLINARY PRACTICES OF
 MORE RECENT ORIGIN
 Absolute Music
 Aesthetics: Africa
 African-American Ideas
 Afrocentricity
 Analytical Philosophy
 Astronomy, Pre-Columbian and Latin American
 Avant-Garde: Militancy
 Behaviorism
 Bilingualism and Multilingualism
 Bioethics
 Black Atlantic
 Calculation and Computation
 Class
 Conservatism
 Consilience
 Continental Philosophy
 Critical Race Theory
 Critical Theory
 Cultural Studies
 Dada
 Dialogue and Dialectics: Talmudic
 Dream
 Dystopia
 Economics
 Education: Global Education
 Education: Islamic Education
 Empiricism
 Encyclopedism
 Environmental Ethics
 Environmental History
 Epistemology: Early Modern
 Epistemology: Modern
 Ethnicity and Race: Anthropology
 Ethnocentrism
 Ethnography
 Ethnohistory, U.S.
 Examination Systems, China
 Expressionism
 Family: Modernist Anthropological Theory
 Feminism: Overview
 Fetishism: Overview
 Field Theories
 Formalism
 Futurology
 Game Theory
 Gender: Gender in the Middle East
 Generation
 Genetics: Contemporary
 Genetics: History of
 Geography
 Hegelianism
 Hermeneutics
 Historicism
 Humanism: Africa
 Humanism: Renaissance
 Iconography

Idealism
 Identity: Identity of Persons
 Intentionality
 Interdisciplinarity
 Japanese Philosophy, Japanese Thought
 Language, Philosophy of: Modern
 Language and Linguistics
 Law, Islamic
 Learning and Memory, Contemporary Views
 Linguistic Turn
 Literary Criticism
 Logic and Philosophy of Mathematics, Modern
 Masks
 Metaphysics: Renaissance to the Present
 Mind
 Modernism: Overview
 Modernism: Latin America
 Modernization
 Modernization Theory
 Motif: Motif in Literature
 Motif: Motif in Music
 Mysticism: Kabbalah
 Myth
 Naturalism
 Naturalism in Art and Literature
 Naturphilosophie
 Newtonianism
 Objectivity
 Oral Traditions: Overview
 Orientalism: Overview
 Philosophies: Feminist, Twentieth-Century
 Philosophy, Moral: Africa
 Philosophy of Religion
 Phrenology
 Poetry and Poetics
 Polytheism
 Positivism
 Postcolonial Studies
 Postmodernism
 Power
 Practices
 Pragmatism
 Prejudice
 Probability
 Pseudoscience
 Psychoanalysis
 Queer Theory
 Realism
 Realism: Africa
 Reflexivity
 Regions and Regionalism, Eastern Europe
 Relativism
 Relativity
 Religion: Indigenous Peoples' View, South America
 Religion and Science
 Representation: Mental Representation
 Romanticism in Literature and Politics
 Sacred Texts: Koran
 Sage Philosophy
 Scholasticism
 Science: Overview
 Science, History of
 Science Fiction
 Secularization and Secularism
 Social Capital

Social History, U.S.
 State, The: Overview
 Structuralism and Poststructuralism: Overview
 Structuralism and Poststructuralism: Anthropology
 Subjectivism
 Symbolism
 Third Cinema
 Totems
 Tradition
 Universalism
 Utilitarianism
 Visual Culture
 Volksgeist
 Women's Studies

Especially Interdisciplinary Entries

The most interdisciplinary entries synthesized knowledge by using the methods and focusing on the topics of practitioners of several disciplines. Very few entries listed below are in only one division. Common pairs for the history of ideas are social sciences and humanities, social sciences and sciences, and humanities and sciences. In the early twenty-first century there is generally a recognition of the common overlap of the social sciences with the humanities; social scientists may take ethical and literary factors into consideration and humanists may incorporate societal contexts into their work. The presence of psychology in the sciences, as well as the quantitative nature of some social sciences work, creates an overlap of social sciences with sciences. Another interesting overlap is between humanities and sciences—topics that in antiquity were treated as philosophy or religion are now investigated by those following scientific methods.

SOCIAL SCIENCES, SCIENCES, AND FINE ARTS

Architecture: Africa
 Geography
 Phrenology
 Virtual Reality

SCIENCES, FINE ARTS, AND HUMANITIES

Enlightenment
 Epistemology: Early Modern
 Feminism: Third World U.S. Movement
 Field Theories
 Geometry
 Globalization: Asia
 Text/Textuality

FINE ARTS, HUMANITIES, AND SOCIAL SCIENCES

Aesthetics: Africa
 Alienation
 Americanization, U.S.
 Anticolonialism: Africa
 Arts: Overview
 Arts: Africa
 Authenticity: Africa
 Autobiography
 Avant-Garde: Overview
 Aztlán
 Censorship
 Chinese Thought
 City, The: The Islamic and Byzantine City
 Civil Disobedience
 Civil Society: Europe and the United States
 Colonialism: Southeast Asia
 Communication of Ideas: Africa and Its Influence
 Communication of Ideas: The Americas and Their Influence

Communication of Ideas: Asia and Its Influence
 Communication of Ideas: Orality and Advent of Writing
 Cultural Capital
 Cultural History
 Cynicism
 Dialogue and Dialectics: Socratic
 Dialogue and Dialectics: Talmudic
 Diasporas: Jewish Diaspora
 Dictatorship in Latin America
 Etiquette
 Everyday Life
 Expressionism
 Extirpation
 Fascism
 Feminism: Chicana Feminisms
 Gay Studies
 Gender Studies: Anthropology
 Genre
 Ghetto
 Honor
 Humanity in the Arts
 Humor
 Identity, Multiple: Jewish Multiple Identity
 Images, Icons, and Idols
 Islam: Shii
 Landscape in the Arts
 Leadership
 Life Cycle: Overview
 Linguistic Turn
 Literature: African Literature
 Maoism
 Millenarianism: Islamic
 Millenarianism: Latin America and Native North America
 Minority
 Modernism: Latin America
 Musicology
 Mysticism: Christian Mysticism
 Mysticism: Islamic Mysticism in Asia
 Mysticism: Kabbalah
 Mysticism: Mysticism in African Thought
 Nation
 New Criticism
 Nude, The
 Oral Traditions: Overview
 Orientalism: Overview
 Orthodoxy
 Orthopraxy: Asia
 Pan-Africanism
 Pan-Asianism
 Pan-Turkism
 Philosophies: African
 Philosophies: American
 Philosophy, Moral: Ancient
 Populism: United States
 Postmodernism
 Practices
 Pre-Columbian Civilization
 Realism
 Religion: Africa
 Religion: Middle East
 Religion and the State: United States
 Renaissance
 Resistance

Romanticism in Literature and Politics
 Sage Philosophy
 Shinto
 Society
 Taste
 Theater and Performance
 Theodicy
 Third World Literature
 Wisdom, Human
 HUMANITIES, SOCIAL SCIENCES, AND SCIENCES
 Afropessimism
 Alchemy: China
 Alchemy: Europe and the Middle East
 Altruism
 Antifeminism
 Asceticism: Hindu and Buddhist Asceticism
 Asceticism: Western Asceticism
 Astrology: China
 Astrology: Overview
 Borders, Borderlands, and Frontiers, Global
 Calculation and Computation
 Calendar
 Capitalism: Overview
 Capitalism: Africa
 Cartesianism
 Casuistry
 Causality
 Causation
 Causation in East Asian and Southeast Asian Philosophy
 Character
 Chicano Movement
 Childhood and Child Rearing
 Confucianism
 Consciousness: Chinese Thought
 Consciousness: Indian Thought
 Consilience
 Cosmology: Asia
 Cycles
 Daoism
 Demography
 Demonology
 Discrimination
 Dress
 Dualism
 Education: Islamic Education
 Empiricism
 Equality: Racial Equality
 Ethnicity and Race: Africa
 Ethnohistory, U.S.
 Fallacy, Logical
 Foundationalism
 Futurology
 Genetics: Contemporary
 Genetics: History of
 Genocide
 Health and Disease
 Hermeneutics
 Historical and Dialectical Materialism
 Hygiene
 Intelligentsia
 Internal Colonialism
 Islam: Africa
 Jainism
 Japanese Philosophy, Japanese Thought
 Kinship

READER'S GUIDE

- Law, Islamic
 Machiavellism
 Machismo
 Medicine: China
 Medicine: India
 Meme
 Memory
 Mestizaje
 Modernization Theory
 Motif: Motif in Music
 Museums
 Music, Anthropology of
 Nationalism: Africa
 Natural History
 Naturalism
 Negritude
 Objectivity
 Philosophy, History of
 Philosophy, Moral: Modern
 Philosophy of Religion
 Population
 Positivism
 Pragmatism
 Prejudice
 Presentism
 Privacy
 Probability
 Quantum
 Race and Racism: Overview
 Race and Racism: Asia
 Race and Racism: Europe
 Reason, Practical and Theoretical
 Religion: Overview
 Religion and Science
 Science: Overview
 Scientific Revolution
 Segregation
 Sexuality: Islamic Views
 Sexuality: Sexual Orientation
 Skepticism
 State of Nature
 Structuralism and Poststructuralism: Overview
 Time: China
 Time: India
 Truth
 Universalism
 University: Overview
 Wildlife
 World Systems Theory, Latin America
- FINE ARTS, HUMANITIES, SOCIAL SCIENCES, AND SCIENCES**
 Absolute Music
 Aesthetics: Asia
 Aesthetics: Europe and the Americas
 Ancestor Worship
 Anthropology
 Architecture: Overview
 Architecture: Asia
 Astronomy, Pre-Columbian and Latin American
 Beauty and Ugliness
 Bilingualism and Multilingualism
 Bioethics
 Body, The
 Cannibalism
 Change
 Chemistry
 Cinema
 City, The: The City as a Cultural Center
 City, The: The City as Political Center
 Classification of Arts and Sciences, Early Modern
 Communication of Ideas: Southeast Asia
 Composition, Musical
 Computer Science
 Consciousness: Overview
 Consumerism
 Context
 Continental Philosophy
 Cosmopolitanism
 Creationism
 Critical Theory
 Cultural Studies
 Dance
 Death
 Determinism
 Dream
 Dystopia
 Ecology
 Emotions
 Empire and Imperialism: Europe
 Environment
 Environmental Ethics
 Environmental History
 Equality: Overview
 Equality: Gender Equality
 Ethnicity and Race: Islamic Views
 Eugenics
 Examination Systems, China
 Feminism: Overview
 Fetishism: Overview
 Fetishism: Fetishism in Literature and Cultural Studies
 Friendship
 Game Theory
 Gender: Gender in the Middle East
 Gender in Art
 Generation
 Greek Science
 Harmony
 Heaven and Hell
 Hinduism
 History, Economic
 History, Idea of
 Humanity: African Thought
 Ideas, History of
 Identity, Multiple: Overview
 Intentionality
 Interdisciplinarity
 Islam: Sunni
 Islamic Science
 Kantianism
 Knowledge
 Language and Linguistics
 Learning and Memory, Contemporary Views
 Life
 Literary Criticism
 Literary History
 Love, Western Notions of
 Magic
 Manichaeism
 Maps and the Ideas They Express
 Masks

- Mathematics
 Matriarchy
 Medicine: Europe and the United States
 Medicine: Islamic Medicine
 Meditation: Eastern Meditation
 Men and Masculinity
 Metaphor
 Modernism: Overview
 Monarchy: Overview
 Modernity: Africa
 Modernity: East Asia
 Motherhood and Maternity
 Musical Performance and Audiences
 Mysticism: Chinese Mysticism
 Myth
 Narrative
 Newtonianism
 Nomadism
 Nuclear Age
 Occidentalism
 Organicism
 Paradigm
 Periodization of the Arts
 Person, Idea of the
 Philosophies: Feminist, Twentieth-Century
 Philosophies: Islamic
 Philosophy: Historical Overview and Recent Developments
 Poetry and Poetics
 Political Protest, U.S.
 Progress, Idea of
 Property
 Protest, Political
 Pseudoscience
 Psychoanalysis
 Punishment
 Pythagoreanism
 Queer Theory
 Reading
 Realism: Africa
 Reflexivity
 Reform: Europe and the United States
 Relativism
 Religion: East and Southeast Asia
 Religion: Indigenous Peoples' View, South America
 Religion: Latin America
 Representation: Mental Representation
 Resistance and Accommodation
 Responsibility
 Ritual: Public Ritual
 Ritual: Religion
 Sacred Places
 Science: East Asia
 Science, History of
 Science Fiction
 Sexuality: Overview
 Social History, U.S.
 Sophists, The
 Sport
 Stoicism
 Subjectivism
 Superstition
 Surrealism
 Symbolism
 Syncretism
 Temperance
 Third Cinema
 Toleration
 Totalitarianism
 Totems
 Tragedy and Comedy
 Untouchability: Menstrual Taboos
 Untouchability: Taboos
 Utilitarianism
 Utopia
 Victorianism
 Visual Culture
 Visual Order to Organizing Collections
 Volunteerism, U.S.
 War and Peace in the Arts
 Westernization: Middle East
 Westernization: Southeast Asia
 Witchcraft
 Witchcraft, African Studies of
 Yin and Yang



A

ABOLITIONISM. Historical studies of the ideas that gave rise to abolitionism, whether in the Caribbean, Latin and South America, Africa, or the United States, have provided analyses that are variously political, economic, social, demographic, or religious in focus. This entry examines the political, religious, and economic ideas surrounding abolitionism to illustrate that these factors were often intertwined. The role of ideas, ideologies, movements, tactics, and personalities are examined to demonstrate the complexity of this social movement in terms of gender, race, socioeconomic background of the participants, and time and location of the movement.

Political Ideas

The early abolitionist movement in the United States and Great Britain during the late eighteenth century was guided by the ideas of the Age of Enlightenment, the French and American revolutions, and Christian morality. The concept that individuals were created equal and had the right to life, liberty, and the pursuit of happiness led them to advocate abolitionism. The slave revolt in Saint-Domingue (Haiti) in 1791 led by Toussaint Louverture was based on these ideas of universal liberty and freedom. The importance of the Haitian revolution to the idea of abolitionism is important because it demonstrated that slavery could be abolished quickly and violently and that a gradual approach using persuasion and rationality might not be the answer. Moreover, the revolution radically transformed this former French possession, providing the slaves with full emancipation and political control. Although a visible antislavery movement did not emerge in Brazil until 1850, the political movement for abolitionism there can be traced to the early nineteenth century, infused with ideas from the Haitian, American, and French revolutions. The abolition of slavery in the British West Indies during the nineteenth century grew out of a liberal political reform agenda that sought to provide better treatment for slaves with the view that emancipation would occur gradually. Slave uprisings in Martinique, Cuba, Tortola, Trinidad, Grenada, and Dominica convinced colonial authorities that slavery needed to be reevaluated. For example, in Barbados, after slavery was abolished in 1834 the government instituted an apprenticeship program of six (unpaid) years for field workers and four years for household servants. Jamaica freed its slaves in 1833, and Antigua and Bermuda provided slaves with full emancipation in 1834; as in Barbados, apprenticeship programs served as a transitional institution for several years after emancipation. However, colonial offices throughout the Caribbean dealt with the former slaves in a harsh manner, inflicting punishment for various minor offenses, extending the apprenticeship period, and sending house servants into the fields to labor.

Colonization

The ideas of abolitionism were linked to missionary, colonial, and commercial motives and ideologies of the French, British, and Americans. Quakers in the antislavery movement in the United States worked to settle slaves in Africa based on religious beliefs that slaves had the right to be free and that these political ideas only could be achieved through colonization in Liberia and Sierra Leone. The political ideas of justice, equality before the law, liberty, and the rule of law were meant to serve as the foundations of the colonies. It was equally important politically to utilize former slaves and re-captives in this endeavor to prove that people of African descent were capable of understanding laws, social responsibility, and the dignity of labor. The belief that people of African descent were inherently inferior to whites and could not be assimilated into a white society led many to advocate colonization. The connection between French abolitionism and colonization on the African continent were intimately linked according to some scholars. It has been argued that when the French government abolished slavery in 1848, it was merely replaced with colonization, starting with Algeria; therefore the master-slave relationship continued to leave the African in an inferior, subordinate position, and the French continued to gain from its economic exploitation of land and labor. The same argument can be made for Great Britain following its abolition of slavery, especially in Sierra Leone. Former slaves and recaptured Africans who ended up in Sierra Leone, along with indigenous Africans, were not viewed as having the same claim to citizenship and sovereignty as the British—otherwise the former slaves and recaptured Africans would not have been colonized. In sum, some Europeans advocated abolitionism, but they did not support full citizenship, equality, and freedom for Africans, and whenever and wherever the slave trade ended, missionaries and commercial enterprises entered the African continent with the backing of the colonial state.

Religious Ideas

The religious ideas that fueled abolitionism in the eighteenth and nineteenth centuries, especially in the United States and Great Britain, were firmly rooted in the Christian belief that all people are equal in the eyes of God; therefore, the practice of one person owning another was against Christianity. The doctrine of a divine sovereignty that made people accountable only to God was utilized. Under slavery, the slave was accountable to her or his owner and not to God. Another religious idea that served as a catalyst during the 1820s and 1830s included evangelicalism and revivalism, which supported the belief that slave owners and others associated with slavery and its institutions could



Engraving of slave revolt, Saint-Domingue, from a contemporary German report. The 1791 uprising resulted in personal freedom and political control for Haiti's slave population and paved the way for subsequent abolitionist and reform movements in other countries. THE GRANGER COLLECTION

experience personal salvation through instant conversion. The idea of “come-outism” is important in evangelicalism and abolitionism, adopted by American abolitionists who publicly took a stand against slavery by withdrawing from any institution, especially churches, that did not recognize the sinfulness of slavery.

Economic Ideas

Although religious ideas were important to abolitionism in the United States and Great Britain and for colonization, they were not as significant in South American, Latin American, and Caribbean abolitionism, which contained more economic and political ideas. This could be due to the fact that abolitionism operated in these regions within the colonial framework, and abolitionists were often fighting on several fronts—to achieve independence, achieve freedom for the slaves, and achieve citizenship and other rights for free people of African descent. Throughout most of the nineteenth century, abolitionism in Cuba and Puerto Rico was hampered by the civil war and the revolution in Spain. Abolitionists had to contend with the economic interests of Spain, Cuba, and Puerto Rico—mainly wealthy slave owners who were vehemently opposed to the abolition of slavery, especially in Cuba, which had a large slave population vital to its sugar industry in the western part of the island. Puerto Rico had a much smaller slave population, and by 1835 slavery was virtually nonexistent. In addition, the United States had significant economic investments that it wanted to protect in Cuba and Puerto Rico. But at the same time, there were American abolitionists who demanded an end to slavery in colonies controlled by Spain.

The debate among modern historians between the role of economics and the role of humanitarianism in abolishing slavery in British slaveholding colonies in the Caribbean was sparked by Eric Williams's *Capitalism and Slavery* (1944). According to Williams, capitalism, and not Christian humanitarianism, was the driving force to end slavery because the emerging capitalist system that evolved from the Industrial Revolution demanded free trade and more productive labor than slaves provided. Rational business practices were needed, including a literate workforce. The failing British West Indian plantation economies could not compete with industrial capitalism. This deviated sharply from the British imperial historiography that placed moral humanitarianism as the catalyst for abolitionism. However, Williams's analysis of abolitionism was subsequently rejected by several historians, most notably Roger Anstey and Seymour Drescher, who argued that slavery continued to be economically viable in the United States and Brazil, along with capitalism. They contended that in the late eighteenth century slavery and the slave trade were important to the British economy at the same time that abolitionism began. Still others have contended that abolitionism was a social movement that involved a variety of actors and organizations all grounded in the popular culture and trends of the time in their respective societies. Within the American context, this changing historiography over time includes: historians who supported the humanitarian view of abolitionists (that is, the belief that they were guided by moral and religious values); historians who downplayed the moral aspect and emphasized economic factors; historians who viewed abolitionists as one-sided fanatics who led the country into a needless civil war; and, during the 1960s, historians who again portrayed abolitionists in a more positive light as people who were committed to a just and social cause. Additionally, other scholars—most prominently W. E. B. Du Bois, Eugene Genovese, and Herbert Aptheker—have given agency to the slaves themselves in bringing about emancipation.

The idea of free labor was another economic idea behind abolitionism in the Caribbean, South America, and Latin America, primarily the commercialization of agriculture, which made slave labor economically outdated. The urban-based abolitionist movement in Brazil responded to economic changes that included greater integration into the global economy, an increase in the urban population, expansion of its infrastructure, and creation of new industries and businesses in both rural and urban areas. As a result of these changes, a more liberal form of economics developed that supported free labor instead of slave labor. Moreover, as people became urbanized, traveled outside the country, and learned more about world developments, the institution of slavery seemed backward and made Brazilians appear uncivilized and out of step with a world that was developing new ideas based on science and rationality. Abolitionism in Puerto Rico, Brazil, Cuba, and other Caribbean islands did not mean immediate emancipation accompanied by full citizenship rights; rather, as outlined above, the practice of apprenticeships was employed to compensate slave owners. It was feared that ex-slaves would not be willing to work for wages, the economies would plummet, and a race war would ensue. The aim was to make a gradual transition from slavery to freedom that would not destabilize society.

Tactics, Organizations, and Individuals in the Americas

In discussing abolitionism in the United States and Great Britain, it is important to divide the movement into periods because the tactics, organizations, and individuals the movement attracted evolved in response to changing religious and political ideas. Following the Revolutionary War, the Quakers in Pennsylvania were in the forefront of the abolitionist movement; their tactics and organizations reflected the elite status of their members (wealthy white men) and their belief in gradual abolitionism. They believed that slavery could be gradually abolished by pressuring government representatives to enact laws and statutes against slavery, providing legal aid to runaway slaves, petitioning the federal government to end the importation of slaves and halt the westward expansion of slavery, and pressuring state governments to grant slaves rights.

The Quakers were active in Great Britain as well. In 1783 they formed the London Committee to Abolish the Slave Trade. In 1787 they joined the Evangelical Christians led by William Wilberforce and Thomas Clarkson to form the Society for the Abolition of the Slave Trade. They led petition drives and lobbied the government, and in 1807 the British slave trade was abolished. The goal in Britain now shifted to gradual abolition and then to immediate abolition. In 1823 Clarkson, Wilberforce, and Thomas Fowell Buxton formed the British Anti-Slavery Society after British West Indian plantation owners were reluctant to abolish slavery, and in 1833 the Emancipation Act (which applied to the British colonies but not to Great Britain itself) was passed. In France, Jacques-Pierre Brissot formed the Society of the Friends of Blacks in 1788, and in 1834 the French Society for the Abolition of Slavery was established. In the Netherlands, the Réveil movement associated with the Dutch Reform Church was formed in the 1840s after British Quakers convinced them that slavery was against the Bible. The Spanish Abolition Society was founded in Madrid in 1865. The major actors in abolitionism throughout the Caribbean and Latin and South America were the slaves and free people of African descent who staged revolts, work stoppages, and insurrections, and ran away. Significant slave uprisings occurred in the nineteenth century in Brazil in Bahia, Minas Gerais, Espírito Santo, Rio de Janeiro, and São Paulo. Slave revolts and desertions from the plantations led to the emergence of immediatism and the formation in 1880 of the Brazilian Anti-Slavery Society (Joaquim Nabuco was elected president), which started as a small group of abolitionists based in major urban areas. This movement grew in size to include people from various educational and social backgrounds. Other antislavery organizations in Brazil included the Cearense Liberator Society, Bahian Liberator Society, and Abolitionist Confederation.

People of African descent played a critical role in U.S. abolitionism before and after the movement became integrated; some of these include Richard Allen, Prince Hall, James Forten, Harriet Jacobs, and Mary Shadd Carey. Upstate New York had a major community of activists who believed in immediatism, among them Frederick Douglass, Sojourner Truth, Harriet Tubman, Austin Steward, and Thomas James. Because they were kept out of the first wave of abolitionism, they were forced to establish their own organizations, newspapers,

educational institutions, and churches. They realized early on the importance of using moralism and emotionalism as tactics, and the print media served as the vehicle. Some of those who had escaped slavery wrote and published their narratives, lectured, and helped slaves to escape, and many traveled to Europe to gain support (Frederick Douglass, Nathaniel Paul, Robert Purvis, William Wells Brown, Alexander Crummell, and Ellen and William Craft). People of African descent in both abolitionist periods advocated full emancipation and rights for the enslaved and free.

The role of women of African descent in the abolitionist movement was important and different because they had to deal with issues of race, sex, and class within the antislavery movement and the white women's movement. These women included Grace Bustill Douglass, an educator and founder of the Philadelphia Female Anti-Slavery Society, and her daughter Sarah Douglass; Frances Ellen Watkins Harper, who was a teacher and poet; Maria Miller Stewart, Sarah Forten, and Eliza Dixon Day. These women helped to recruit members to the movement, gave public lectures, raised funds, and organized rallies and events.

Abolitionism and Feminism

The history of feminism in the United States is very directly linked to the abolitionist movement. Black and white women in northern cities in the United States were very active in various religious and benevolent organizations before they joined the abolitionist movement in the 1830s. The administrative and leadership skills and experience they had gained in these organizations were then utilized in the abolitionist movement. It is clear why black women were involved in the struggle to end slavery; however, white women from the working class to the upper middle class saw a correlation between the oppression of slaves and their oppression as women in terms of their legal status, which defined them as the property of their husbands and as their inferiors in society. Women found an outlet in the abolitionist movement for expressing their ideas toward marriage, divorce, and domestic violence. Men made up most of the leadership in abolitionist organizations, and their treatment of female members convinced many of these women that both slaves and women needed to be emancipated. Some abolitionist organizations did not allow African-Americans to join, while others curtailed the participation of women, especially in public speaking, voting, and business decisions. Many of these women continued their efforts to transform society through social movements by working on women's rights in the campaign for suffrage and property rights, along with the rights to file lawsuits, obtain a divorce, and obtain custody of children. The intersection of abolitionism and women's rights influenced the ideas and work of Sarah and Angelina Grimké, Abigail Kelley Foster, Lucretia Mott, and Elizabeth Cady Stanton. The Grimké sisters, who were Quakers, believed they had been called to do God's work in the antislavery movement. Moreover, the linkages between abolition and women's rights in the work of black women abolitionists such as Sojourner Truth cannot be overstated. They were fighting for a double victory—one to end slavery and the other to end discrimination based on gender.

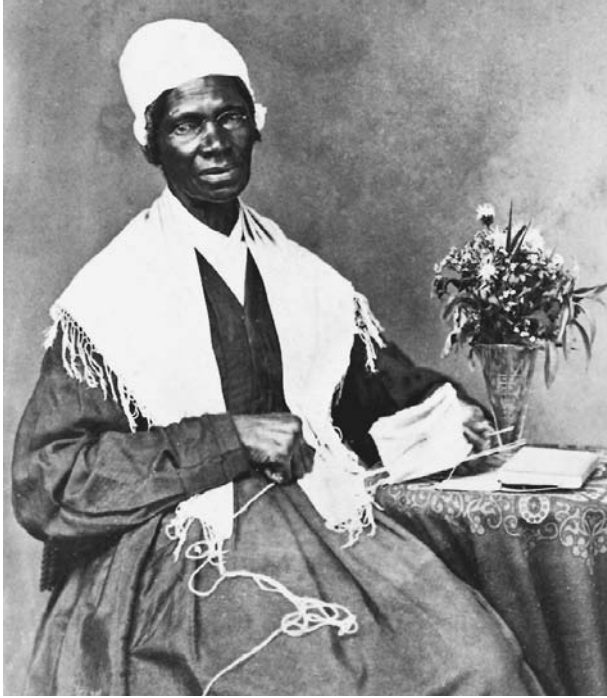

Sojourner Truth (c. 1797–1883). Born into slavery in upstate New York, Isabella Van Wagener gained her freedom when the state abolished the practice in 1827. In the early 1840s she took the name Sojourner Truth and began touring the country to advocate abolition. ARCHIVE PHOTOS, INC.

Tactics, Organizations, and Individuals in Africa

Following the end of the Revolutionary War, many slaves and free people of African descent, as well as some American and British whites, began to question the slaves' future, especially in terms of achieving full citizenship rights and economic independence. Colonization was used as a strategy to end slavery, and Freetown in Sierra Leone was established as a colony in 1787. The American Colonization Society was formed in 1816, followed by the colonization of Liberia in 1847. Individuals of African descent who advocated colonization included Paul Cuffee, who was independently wealthy and free. He made two trips to Sierra Leone with financial backing from the British government—one in 1811 to inquire about the feasibility of African emigration and another in 1815 when he took thirty-eight free Africans with him. Others who shared these beliefs included Joseph Brown Russwurm, Martin Delany, Edward Blyden, and Thomas Peters from Nova Scotia, Canada, who petitioned the British government for assistance. They believed that human dignity, justice, hard work, and the rule of law could be put into practice in the new settlements and that this would prove that these outcasts and marginalized individuals could be given a second chance in life. These philosophical ideas were often intertwined with religious ideas that appealed to ex-slaves because they espoused the importance of God's authority and individual freedom that allowed them to employ petitions, preaching, and the print media as tactics. In addition, a number of Africans, people of African descent, Europeans, and Americans believed that worldwide emancipation would not be

achieved as long as there remained a supply and demand for slaves. Therefore, to contain slavery at its source, the campaign against slavery had to shift from the West to the African continent. To do this, Africans, former slaves, and re-captives were mobilized to advance the idea that if slavery were to end, the antislavery movement had to be based on the African continent and Africans and people of African descent on the continent had to be in the forefront of the antislavery movement.

See also *Capitalism; Liberty; Resistance; Resistance and Accommodation; Slavery.*

BIBLIOGRAPHY

- Azevedo, Celia M. *Abolitionism in the United States and Brazil: A Comparative Perspective*. New York and London: Garland, 1995.
- Baronov, David. *The Abolition of Slavery in Brazil: The "Liberation" of Africans through the Emancipation of Capital*. Westport, Conn.: Greenwood Press, 2000.
- Bender, Thomas, ed. *The Antislavery Debate: Capitalism and Abolitionism as a Problem in Historical Interpretation*. Berkeley: University of California Press, 1992.
- Corwin, Arthur F. *Spain and the Abolition of Slavery in Cuba, 1817–1886*. Austin: University of Texas Press, 1967.
- Eudell, Demetrius L. *The Political Languages of Emancipation in the British Caribbean and the U.S. South*. Chapel Hill: University of North Carolina Press, 2002.
- Newman, Richard S. *The Transformation of American Abolitionism: Fighting Slavery in the Early Republic*. Chapel Hill: University of North Carolina Press, 2002.
- Oostindie, Gert, ed. *Fifty Years Later: Antislavery, Capitalism, and Modernity in the Dutch Orbit*. Pittsburgh: University of Pittsburgh Press, 1996.
- Sanneh, Lamin. *Abolitionists Abroad: American Blacks and the Making of Modern West Africa*. Cambridge, Mass.: Harvard University Press, 1999.
- Schmidt-Nowara, Christopher. *Empire and Antislavery: Spain, Cuba, and Puerto Rico, 1833–1874*. Pittsburgh: University of Pittsburgh Press, 1999.
- Sernett, Milton C. *North Star Country: Upstate New York and the Crusade for African American Freedom*. Syracuse, N.Y.: Syracuse University Press, 2002.
- Temperley, Howard, ed. *After Slavery: Emancipation and Its Discontents*. London: Frank Cass, 2002.
- Williams, Eric. *Capitalism and Slavery*. 1944. Reprint, Chapel Hill: University of North Carolina Press, 1994.

Cassandra R. Veney

ABSOLUTE MUSIC. "Absolute music" is an idea that took root in the writings of early German Romantics such as Wilhelm Heinrich Wackenroder (1773–1798), Ludwig Tieck (1773–1853), and E. T. A. Hoffmann (1776–1822) beginning at the turn of the nineteenth century, and came to dominate musical aesthetics over much of the next two centuries, frequently invoked to argue for music's elevation to a position above the other arts. The term is often allied with such terms as "abstract music," referring to the separation of music from other considerations, and "formalism," referring to the logic



Ludwig van Beethoven (1770–1827). During the eighteenth and nineteenth centuries, the concept of absolute music—exemplified by the works of composers such as Beethoven—played an important role in the development of a nationalistic movement in Germany. THE LIBRARY OF CONGRESS

whereby music makes sense without any accompanying words, drama, or dance. It is most often contrasted with “program music,” whose full sense and purpose depend on a variety of narrative, literary, pictorial, dramatic, or other explanatory bases. In truth, however, the term is much richer, and historically more significant, than these associations would indicate.

The elevation of music to the highest of the arts entailed a shift in the perceived relationship of art to the world around us. As “art for art’s sake” and similar sentiments gained ground in the nineteenth century, music became prized for its very separation from the real world, its lack of precise representational meaning. The symphony became the focal point for a new valorization of music, especially as it developed in the German lands at the hands of Haydn, Mozart, and Beethoven. Beyond its presumed purity, music’s removal from the here and now made it seem a perfect vehicle for expressing the Romantics’ sense of “infinite longing,” which Hoffmann, in an 1810 essay on Beethoven’s Fifth Symphony (1808), called the “essence of Romanticism.” Within this formulation, music could be allied with the sublime, the unattainable, the infinite, and the ineffable, while at the same time expressing and probing profound inner states. Through music, one’s soul could connect, through “longing” or some other deep feeling, to something beyond the everyday world. In this way, as the German musicologist Carl Dahlhaus argues, music could be understood as “absolute” in

two senses, both through its purity, its “absolute” separateness from the reality we can see and touch, and through its capacity to connect us to the “absolute” in the philosophical sense, after Georg Wilhelm Friedrich Hegel (1770–1831).

Beethoven and German Influence

The evolution of the concept proceeded in conjunction with the German Idealist philosophical tradition and figured prominently in the development of German nationalism, as well. Immanuel Kant and Hegel provided the underpinnings, and Arthur Schopenhauer (1788–1860), Richard Wagner (1813–1883), and Friedrich Nietzsche (1844–1900) developed a more specifically musico-philosophical edifice. Ironically, however, while it was Wagner who coined the term “absolute music” around mid-century and thereby embedded it securely within Idealist philosophy, he did so in order to argue against its validity, claiming that music, which he equated with “woman” (thus, essentially sensuous and inchoate), could not flourish in isolation, needing the masculine “poet” (by nature seminal and rational) to thrive. Already, Beethoven’s works, especially his symphonies, were being touted in the second quarter of the century as both the best representative of pure music and the cornerstone of a German musical tradition that represented the highest expression within the highest of the arts, an emblem and indispensable part of what it meant to be German. This elevation of Beethoven was accomplished largely through the writings of Adolf Bernhard Marx (1795–1866), who laid much of the groundwork for formal analysis through his descriptions of sonata form, the basic formal principle for not only Beethoven’s instrumental music, but also of his immediate forebears and principal descendants.

In his landmark *On the Musically Beautiful* (1853), Eduard Hanslick (1825–1904), without using the term “absolute music,” attempted to refute Wagner’s arguments against pure music, arguing that music’s form was identical to its content (thereby effectively divorcing music even from emotion) and claiming for it an eminently masculine rationality based on formalist musical logic. A variety of methods for analyzing music were developed over the century or so following Hanslick’s short book, most notably by Hugo Riemann (1849–1919), an advocate of functional harmonic analysis and phrase-structure analysis; Heinrich Schenker (1868–1935), who introduced layered reductive voice-leading analysis; and Rudolph Réti (1885–1957), who relied on motivic analysis. Since all these systems were developed in large part to validate the logic of Beethoven’s instrumental music, and since Beethoven had become both the figurehead of German music and a supposed universal, the concept of “absolute music” that these methods helped reinforce consolidated the position of German music as the standard of musical value.

Crosscurrents: Program Music and Modernism

From the beginning, there was much resistance to the idea that music is best understood as separate from what soon became known as the “extramusical.” Opera and similar forms, of course, balanced musical logic with and against dramatic necessities (although Wagner argued that Italian opera was essentially “absolute” in its dependence on musical formula). Songs of various types were intimately tied to their texts. Most

significantly opposed to the new concept was the idea of “program music”—instrumental music that relied on a programmatic explanation to orient an audience to its meanings—launched by Hector Berlioz (1803–1869) in the years following Beethoven’s death in 1827. The tradition of program music, to some extent also rooted in Beethoven (especially in his Sixth Symphony, known as the “Pastoral” Symphony, 1808), was continued by Franz Liszt (1811–1886) in his symphonic poems and programmatic symphonies, implicitly disavowed by Johannes Brahms (1833–1897) and Anton Bruckner (1824–1896), but taken up again by both Gustav Mahler (1860–1911) in his first symphonies and Richard Strauss (1864–1949) in his tone poems and programmatic symphonies, beginning in the mid-1880s and continuing through the turn of the twentieth century. Nevertheless, although programmatic music is most readily identified, in musical terms, according to its departures from “musical logic,” there is substantial overlap in the two categories as well, so that they should not simply be viewed as opposite types. Thus, even a programmatic work had to make musical sense and could depend on an underlying sense of music’s absoluteness, while many “absolute” works conveyed implicit programmatic content through their engagement with familiar musical gestures and topics.

During the twentieth century, especially with the advent of high modernism, music’s separateness from other discourses became in some cases more pronounced (by the insistence on sometimes arcane musical logic over what most audiences still perceive as “natural”) and in others virtually eliminated (as when programmatic rationales demanded extreme expressive or descriptive modes at the expense of musical logic). While the latter possibility played a large part in the development of musical modernism, it also led at each turn to the development of new “systems,” such as the concept of *Klangfarbenmelodie* (tone-color melody) proposed by Arnold Schoenberg (1874–1951) in 1911 and the twelve-tone system that he created ten years after that (also known as serialism, which was later developed further by applying it to other elements besides pitch, such as rhythm, meter, and dynamics). In consequence, the former possibility, advancing the principle of music’s absoluteness, was often seen as more fundamental. Thus, in the Soviet Union during the 1930s and 1940s, the charge of “formalism” was used against composers such as Dmitry Shostakovich (1906–1975) when their music was perceived to be too modern. While this charge has been described as little more than a tool for exercising political control, its basis has much in common with Wagner’s insistence on music’s subordination to an exterior logic, and it is based in part on the premise that musical modernism extends the idea of “absolute” music.

Late Twentieth- and Early Twenty-First-Century Perspectives

The last few decades of the twentieth century and the start of the twenty-first century have seen renewed and often highly skeptical interest in the claims of music’s absoluteness alongside an increasingly entrenched advocacy, the latter reinforced by the growth of musical analysis as a discipline. Carl Dahlhaus has historicized the concept, grounding it in Germanic philosophical and musical thought. Many have argued persuasively

that the idea is fundamentally a fiction, that music is always referential to a variety of contexts, some historical and others acquired through reception. Most of these arguments have focused either on a consideration of musical narrative (i.e., the way that music may be understood to tell stories (Anthony Newcomb, Lawrence Kramer, and Susan McClary) or on musical semiotics, of how music has continued to develop an evolving system of referential gestures redolent of the older “doctrine of the affections” (Jean-Jacques Nattiez, Leonard Ratner, and Wye Allanbrook). If “absolute music” has indeed been a fiction, it has been a useful one from many perspectives, helping to enable the experience of music as a uniquely powerful art medium. Under the aegis of its absoluteness, which renders its shapes and gestures officially neutral, music has been capable of reinforcing—but with full deniability—a full array of values and ideas, and of projecting, within its “meaningless” interplay of definiteness and vagueness, phantasmal versions of a re-imagined reality.

See also **Composition, Musical; Harmony; Idealism; Sacred and Profane.**

BIBLIOGRAPHY

- Bent, Ian. *Analysis*. New York: Norton; Basingstoke, U.K.: Macmillan Press, 1987.
- Dahlhaus, Carl. *The Idea of Absolute Music*. Translated by Roger Lustig. Chicago: University of Chicago Press, 1989.
- Hanslick, Eduard. *On the Musically Beautiful: A Contribution towards the Revision of the Aesthetics of Music*. Translated and edited by Geoffrey Payzant. Indianapolis: Hackett Publishing, 1986.
- Kramer, Lawrence. *Musical Meaning: Toward a Critical History*. Berkeley and Los Angeles: University of California Press, 2002.
- McClary, Susan. “Narrative Agendas in ‘Absolute’ Music: Identity and Difference in Brahms’s Third Symphony.” In *Musiology and Difference: Gender and Sexuality in Music Scholarship*, edited by Ruth A. Solie, 326–344. Berkeley and Los Angeles: University of California Press, 1993.
- Newcomb, Anthony. “Once More between Absolute and Program Music: Schumann’s Second Symphony.” *19th-Century Music* 7, no. 3 (April 1984): 233–250.
- Treitler, Leo. “Mozart and the Idea of Absolute Music.” In *Treitler, Music and the Historical Imagination*, 176–214. Cambridge, Mass., and London: Harvard University Press, 1989.

Raymond Knapp

AESTHETICS.

This entry includes three subentries:

- Africa*
- Asia*
- Europe and the Americas*

AFRICA

Africa has more than two thousand languages, representing several thousand cultures, each with its own system of logic. No single aesthetic philosophy characterizes the continent, and

any concept of a coherent “Africa” is arbitrary, given such extraordinary diversity. Furthermore, a given culture may possess several aesthetic discourses, as may any artistic genre. Globalization complicates matters even more, for one cannot discuss the aesthetics of contemporary African artists without considering transnational paradigms and hybrid visions.

Given such complexities, how can one propose any comprehensive notion of African aesthetics? One may consider key aesthetic concepts of a particular group, such as the Yoruba peoples of Nigeria, to demonstrate the specificity of aesthetics. Other revealing themes are aesthetic experiences crossing the boundaries of “traditional” African societies; the efficacy, concealment, and revelations of African arts; a common aesthetic of accumulation and process; and the performativity and polysemy of African expression. Finally, colonial and postcolonial aesthetic encounters are relevant to a discussion of how changing aesthetics shape present concerns.

Aesthetic Discourse

Aesthetics comes from the Greek word for “sense of perception” and can be defined only within particular cultural systems. Cultural insiders must be consulted to ascertain how and why aesthetic concepts come to hold value. African aesthetic concepts reach into moral and spiritual realms. Linguistic exploration of African aesthetic terms finds that words for beauty and goodness often intersect, as Susan Vogel has noted among the Baule peoples of Côte d’Ivoire and others have discerned among the Lega and Songye of the Congo and the Igbo, Edo, and Ibibio of Nigeria, among others. External perfection and internal moral excellence are linked, as are physical perfection and ideal social order. An anti-aesthetic is also common, as in certain satirical masquerades among the Mende of Sierra Leone and the beauty-beast performances of the Igbo and Ibibio of Nigeria.

Most Western knowledge of African aesthetics is derived from research by African scholars and the few ethnographic studies that have carefully examined aesthetic discourse. The most profound knowledge concerns the Yoruba peoples of Nigeria. Yoruba philosophy reveals how and why their varied arts look and do things the ways they do. A compelling concept of Yoruba aesthetics is *ashe*, or life force, possessed and conveyed by all art forms, from visual to narrative to performative. Furthermore, *ashe* provides a tangible contact with the Orisha deities of the Yoruba spiritual pantheon.

Ashe is intrinsically related to the essential nature of creativity called *iwa*, perceptible to those who have “walked with the ancestors” and thus acquired critical and discerning eyes. Important to *iwa* are *oju-inu*, an “inner eye” or the artist’s insight, and *oju-ona*, the external harmony of artworks. For the Yoruba, the beauty of objects, performances, or texts lies not only in what catches the eye but also in the *ashe* derived from the work’s completeness. From these elements one can then discern the artwork’s *iwa*, or essential nature, and finally its *ewa*, or beauty.

Another critical concept of Yoruba aesthetics is *ara*, the “evocative power” of visual, verbal, musical, and performance

arts associated with the ability to amaze (Roberts and Roberts, p. 27). *Ara* bespeaks creativity through departure from norms. Yoruba artists are explorers, and their works reflect new understandings. As the Yoruba philosopher Olabiyi Yai states, art is always “unfinished and generative” (p. 107). Yoruba visual and verbal arts are also linked through *ori*, individuality, and *iyato*, difference and originality, and Yai argues for a definition of art that is “an invitation to infinite . . . difference and departure, and not a summation for sameness and imitation” (p. 113). The tradition-creativity binary posed for so many cultures is thereby dissolved, and “innovation is implied in the Yoruba idea of tradition” (p. 113).

Cross-Cultural Thematics

Through *ashe*, Yoruba arts are highly efficacious—that is, objects *work* and transform peoples’ lives. For many African cultures, how an object looks is related to the way it works, according to strict aesthetic specifications, for protection, healing, communication, mediation, or empowerment. Like aesthetics more generally, each culture has its own concepts of efficacy. For Bantu-speaking peoples of central, eastern, and southern Africa, a power called *nkisi* is manifest in sculpture and other expression, while for Mande-speaking peoples of western Africa, secret and instrumental knowledge is called *nyama*. For African Muslim mystics, *baraka* is a blessing energy emanating from saintly tombs, written and spoken verses, and visual forms. All these terms imply a power-knowledge relationship inhering in works of art, enabling their effectiveness and capacity.

As is true for many other African philosophies, Yoruba aesthetics also privilege knowledge that is allusive, indirect, and enigmatic. Patterns in textiles and scarification; designs on ceramics, houses, and sculpture; graphic inscriptions on walls, masks, and the body; and verbal arts such as proverbs, epics, and songs communicate messages of cultural significance. These can be highly esoteric and understood only by the initiated. For example, geometric patterns on Bamana *bogolanfini* textiles from Mali encode women’s herbal medicinal recipes. In other cases, patterns connote resistance, as did the surreptitious painting of African National Congress colors on homes by southern African women during apartheid.

Another characteristic of many African aesthetic systems is that objects, narratives, songs, and performances are interpreted by audiences in many different ways through intentional semantic variability. African artworks are semantically loaded texts abounding in exegetic richness. For example, among Luba peoples of the southeastern Democratic Republic of the Congo, thrones and staffs embody beauty and royal authority but are also mnemonic devices stimulating the making of history. Polysemy is also the product of a processual and accumulative aesthetic. The process of making art is often more valuable than the final products, and such dynamism is the essence of aesthetic experience. Once created, objects may have ephemeral usage before being destroyed or progressing to the next phases in layered histories.

Aesthetics on the Move

Recent study of African aesthetics includes two critically important thrusts: popular urban arts and diasporic art forms of

the black Atlantic, and an Indian Ocean world linking eastern Africa with South Asia. Again, aesthetic principles of urban arts are contingent upon local use and intent. For instance, urban paintings by the late Congolese artist Tshibumba Kanda Matulu reflect an aesthetic inspired by European comic books while addressing issues of critical historical and political importance. Ghanaian urban arts reflect a vibrant immediacy stemming from subjects of daily life—from soccer to hairstyles to music and film—whereas arts of urban Senegal conform to the aesthetics of a very particular mystical Islam realized through mass-produced images and inspired by photography. As Karin Barber notes, African popular arts fall between the cracks of “traditional” and “elite” or “modern” art. The hybridized forms of Africa’s dynamic popular urban arts reflect not only constant absorption of ideas from the outside but also long-standing adaptive processes through which Africans have always been innovative players in world forums.

Similar dynamism can be witnessed in Africa’s diasporic traditions. Much research, in particular that of Robert Farris Thompson, has shown that some of the most powerful aesthetic carryovers from west Africa to the black Atlantic are based on deeply embedded linguistic concepts such as an “aesthetic of the cool.” Thompson illuminates the origins of slang, gestures, and attitudes by demonstrating how certain aesthetic categories in the African Americas merge moral philosophy, right living, and artistic quality.

One cannot discuss African aesthetics without addressing the effects of colonialism and postcolonialism and modernist and postmodernist expressive trends of the last century. Encounters and entanglements fostered by the colonial experience in Africa have produced complex issues of appropriation and commodification: compelling research reveals close association between aesthetic norms and capitalist incentives (Phillips and Steiner). This has been noticeable since the colonial conquests of the nineteenth century but earlier as well in Portuguese influence upon the late-fifteenth-century kingdoms of Benin in Nigeria and Kongo in Angola and the impact of Christianity in Ethiopia from the fourth century C.E. African styles were adapted to meet changing economic and political circumstances, with a most compelling case among the Mangbetu people of the northeastern Democratic Republic of the Congo and Zaire, whose aesthetics shifted to a European “naturalism” to meet foreign expectations.

Similar dynamics are found on a global scale in the early twenty-first century. Those who study contemporary African arts define modernisms both discrepant from and overlapping with European models. In the early twentieth century, expatriate teachers opened fine arts schools in a number of African cities, introducing new techniques and aesthetics. Often these synthesized existing frameworks produced hybrid forms, as in the workshop of Ulli Beier in Nigeria.

It is safe to say, though, that the most exciting time to study African aesthetics may be the present, for artistic landscapes are extending in many new ways. Scholar-curators such as Okwui Enwezor, artistic director of Documenta 11 in 2002 and the Second Johannesburg Biennale in 1997, and Salah Hassan, editor of *Nka: Journal of Contemporary African Art*,

are transcending the boundaries of aesthetic discourse by introducing riveting work of emerging artists. Africa is a continent of richness, resilience, and diasporic energies because of how its traditions adapt to new circumstances. Whether in the domains of the most traditional rural art forms, such as masquerade or shrines, or in tourist arts, colonial encounters, early workshops, and art movements, African arts defy easy categorization; they simply do not sit still, nor have they ever. Across their huge diversities, African aesthetics can only be appreciated for their very multiplicity and systems of representation that they uphold, accommodate, and transform.

See also Arts: Africa; Literature: African Literature.

BIBLIOGRAPHY

- Abiodun, Rowland, Henry John Drewal, and John Pemberton III. *Yoruba: Art and Aesthetics*. Edited by Lorenz Homberger. New York and Zurich: The Center for African Art and Rietberg Museum, 1991.
- Barber, Karin, ed. *Readings in African Popular Culture*. Bloomington: International African Institute, in association with Indiana University Press, 1997.
- Berlo, Janet Catherine, and Lee Anne Wilson, eds. *Arts of Africa, Oceania, and the Americas: Selected Readings*. Englewood Cliffs, N.J.: Prentice Hall, 1993.
- Hallen, Barry. “Some Observations about Philosophy, Postmodernism, and Art in Contemporary African Studies.” *African Studies Review* 38, no. 1 (April 1995): 69–80.
- Mudimbe, V. Y. *The Invention of Africa: Gnosis, Philosophy, and the Order of Knowledge*. Bloomington: Indiana University Press, 1988.
- Nooter, Mary H. *Secrecy: African Art that Conceals and Reveals*. New York: The Museum for African Art, 1993.
- Oguibe, Olu, and Okwui Enwezor, eds. *Reading the Contemporary: African Art from Theory to Marketplace*. Cambridge, Mass.: MIT Press, 1999.
- Phillips, Ruth B., and Christopher B. Steiner, eds. *Unpacking Culture: Art and Commodity in Colonial and Postcolonial Worlds*. Berkeley: University of California Press, 1999.
- Roberts, Mary Nooter, and Allen F. Roberts. *A Sense of Wonder: African Art from the Faletti Family Collection*. Phoenix, Ariz.: Phoenix Art Museum, 1997.
- Rubin, Arnold. *African Accumulative Sculpture: Power and Display*. New York: Pace Gallery, 1974.
- Thompson, Robert Farris. *African Art in Motion: Icon and Act in the Collection of Katherine Coryton White*. Los Angeles: University of California Press, 1974.
- Viredu, K. “On Defining African Philosophy.” In *Postkoloniales Philosophieren: Afrika*, edited by N. Nagl-Docekal and F. M. Wimmer, 40–62. Vienna and Munich: R. Oldenbourg Verlag.
- Vogel, Susan Mullin. *African Aesthetics: The Carlo Monzino Collection*. Photographs by Mario Carrieri. New York: Center for African Art, 1986.
- Yai, Olabiyi Babalola. “In Praise of Metonymy: The Concepts of ‘Tradition’ and ‘Creativity’ in the Transmission of Yoruba Artistry over Time and Space.” In *The Yoruba Artist: New Theoretical Perspectives on African Arts*, edited by Rowland Abiodun, Henry J. Drewal, and John Pemberton III. Washington and London: Smithsonian Institution Press, 1994.

Mary Nooter Roberts

ASIA

Culturally, Asia encompasses an enormous range of cultural diversity, with philosophical traditions going back 2,500 years. And aesthetics is the philosophical study of art and the elaboration of criteria of value in arts and in nature, as well as how these two notions overlap with the study of nature and being human. In many Asian traditions value focuses on human well-being. In Daoism and Shintoism—and arguably Buddhism and Confucianism—divinity is not transcendent but immanent. Here human beings are at one with divinity and/or the natural world. The division of the various intellectual disciplines is the product of human histories; they developed differently in Asia. For example, throughout Asia there is little dichotomization of mind and body, of spiritual and material. As a result, aesthetic ideas and practices operate very differently, overlapping with the religious in India, helping to constitute the ethical and sociopolitical in East Asia.

Philosophy in the West is thinking, and thinking is done in language. Not so in Asia, where in every tradition the arts are as important as language in grasping ideas. The Japanese Buddhist priest Kukai (774–835) summed up the teachings of his Chinese master Huiguo thus:

The abbot informed me that the Esoteric scriptures are so abstruse that their meaning cannot be conveyed except through art. For this reason he ordered the court artist Li Chen and about a dozen other painters to execute ten scrolls of the Womb and Diamond Mandalas. . . . He also ordered the bronzesmith Chao Wu to cast fifteen ritual implements.” (Tsunoda, p. 141)

Understanding Asian aesthetics thus presupposes bodily experience. For this reason, direct experience with aesthetic values—whether through Japanese tea ceremony or in a Japanese garden—is as crucial to wisdom in the Asian sense as intellectual mastery. This means that for any discussion to do full justice to Asian aesthetics, it must take into consideration the contributions of the arts.

Asian aesthetics has begun to influence European-American philosophy, and both have begun to recognize the importance of situating aesthetics historically and within the contexts of colonialism, cultural hegemony, “race” studies, economics, power, gender politics, and the diasporas.

Buddhism

Early Theravada Buddhism records the importance of aesthetic (Pali, *Samvega*) and distinguishes different kinds of reactions to beauty analogous to reactions to diversity. The Lotus Sutra of Mahayana Buddhism introduced the idea of paradise and encouraged the production of visuals and sounds in honor of the Buddha as meritorious; this later developed into the ideas that art could clarify reality and could make such abstract concepts more concrete. It also provides the earliest example of taking children’s art seriously. Thus began the interest of Mahayana Buddhism in art.

The Japanese priest Kukai (774–835) brought the Shingon Sect of esoteric Buddhism to Japan. Shingon recognized four

main categories of art: (1) painting and sculpture, including mandala painting; (2) music and literature; (3) gestures and acts, including hand positions called *mudras*, ritual, and dance (much of which was ritual); and (4) the implements of civilization and religion.

Kukai was the first Japanese to develop the theoretical dimensions of the visual arts. “For Kukai whatever was beautiful partook of the nature of Buddha. Nature, art and religion were one” (De Bary, 1958, p. 138). This was true of other Japanese Buddhists as well. Summarizing the Shingon view of art, Kukai wrote, “In truth, the esoteric doctrines are so profound as to defy their enunciation in writing. With the help of painting, however, their obscurities may be understood” (Tsunoda, pp. 137–138).

Pure Land Buddhism (10th–13th century) brought enlightenment to the masses through chanting, dancing and singing, and paintings of paradise and hell—practices reflecting new views on enlightenment and who could attain it. The priest Ippen (1239–1289) insisted that the grace of Amida was not confined to the Pure Land Sect or even to Buddhist temples but was everywhere, even in Shinto shrines. Along with this popularization of religion occurred a concurrent popularization of Buddhist art.

The Zen Sect has the most influential aesthetic tradition of all the Buddhist sects. Zen arts attest to the central values of “simplicity, the spirituality of the ordinary, and genuineness of heart,” focusing on the maker’s mind and the process rather than a final product (Kasulis, 1998, pp. 357–371; Suzuki). Painters with a few rough brush strokes convey the mind of the monk and enlightenment itself. In flower arrangement, oddly shaped twigs (only odd numbers are used) convey the simple beauty of the uniquely ordinary. The haiku poet uses a few words to evoke an idea that the reader completes. The gardener helps the rocks find where they want to be and where they fit naturally. In calligraphy, misshapen, oddly arranged characters convey with apparently childlike simplicity a renewed childlike view of the world. In cooking, the Abbot Dogen (1200–1253) insisted monks present the freshest foods beautifully to make meatless menus enticing. Zen arts set up relationships among artist(s), audience, materials, and the environment, as well as express and provoke enlightened mind (Bullen; Kasulis). Zen also countered any distinction between “fine” and “applied” arts and aesthetics, and strengthened, especially for Samurai warriors, the intimate relationship between the arts and martial training.

China

China has a diverse and ancient tradition in aesthetics. Early in the tradition, art was integrally related with metaphysics, social and political philosophy, and ethics. At this stage in the tradition, aesthetics had primacy over rational discourse (Hall and Ames, 1987).

For Confucius (551–479 B.C.E.), ceremony and music, “conducted with style like an artistic performance,” define the behavior of the Confucian gentleman (Graham, p. 11). Music (*yue*) comprises instrumental music, song, and dance, primarily

those of the sacred rites and ceremony (*li*). They both arise from and produce harmony, and, by transforming the heart, transform human relations—and therefore government. For Confucius, “all government can be reduced to ceremony” (Graham, p. 13). The Mohists, in contrast, “condemned music . . . (reconstruing morality) as a set of abstract principles” (Graham, p. 259). Xunzi (300–237 B.C.E.) and his followers developed Confucius’s idea that music was beneficial (or harmful if the wrong kind) into a general theory of the moral efficacy of music. Xunzi was the first to elaborate on the relation between music and ceremony. His “Discourse on Music” begins, “Music is joy, what the authentic man inevitably refuses to do without” (Graham, p. 260). Training in music, therefore, was crucial to education and government. On this view, the sovereign could use music and ritual to enlighten his people and thereby govern well. Yet by 530 C.E. poet-critic Xiao Tong liberated aesthetics from ethics, writing that his selection for his literary anthology had been guided only by aesthetic merit, not moral considerations.

From the fifth century to the present aesthetics was dominated by the arts of the literati class—calligraphy, painting, and poetry, set in the context of natural landscapes or gardens—appreciated in the setting of natural landscapes and gardens. Three characteristics define literati arts: its amateur status as the product of scholar-officials, its function as an expressive outlet, and its style (Bush, 1971, p. 1).

The transition from political-ceremonial aesthetics to literati aesthetics of personal expression is seen in an essay attributed to the scholar Wang Wei (c. 415–443), who situated landscape painting in relation to ceremony and the cosmos:

[According to Wang Wei,] Paintings must correspond to the *ba gua* [the eight trigrams of geomancy], meaning that just as the *ba gua* are a symbolic diagram of the workings of the universe, so must landscape painting be a symbolic language through which the painter may express not a relative, particularized aspect of nature seen at a given moment from a given view point, but a general truth, beyond time and place. Though Wang Wei . . . is full of wonder at the artist’s mysterious power of pictorial compression, he insists that painting is more than the exercise of skill; “the spirit must also exercise control over it; for this is the essence of painting.” (Sullivan, p. 97)

Slightly later, Xie He (fl. 479–501) outlined six principles for judging paintings and painters that have never been superseded: (1) animation through spirit consonance (*qi yun*), (2) structural method (literally *bone means*) in the use of the brush, (3) fidelity to the object in portraying forms, (4) conformity to kind in applying colors, (5) proper planning in placing elements, (6) in copying, perpetuating the ancient models (Soper; Sakanishi; Sullivan, p. 95; Wen). Although Chinese interpretations of principles 3 to 6 diverge, they are roughly equivalent to naturalism, coloring, composition, and training.

Michael Sullivan (p. 96) explains principle 1 as follows:

Qi is that cosmic spirit (literally, breath or vapor) that vitalizes all things, that gives life and growth to the trees,

movement to the water, energy to human beings, and that is exhaled by the mountains as clouds and mist. The artist must attune himself to this cosmic spirit and let it infuse him with energy so that in a moment of inspiration—and no word could be more appropriate—he may become the vehicle for its expression. *Qi* infuses all things, [with] no distinction between animate and inanimate. Seen in this light, the third, fourth and fifth principles involve more than mere visual accuracy; for, as the living forms of nature are the visible manifestations of the workings of the *qi*, only by representing them faithfully can the artist express his awareness of the cosmic principle in action. (Sullivan, 1999, p. 96; Wen, 1963)

During the Southern Song Dynasty (1127–1279), philosophers undertook an intellectual defense of Confucianism against the challenges of Buddhism and Daoism in the Song Synthesis. In the field of aesthetics, this culminated in a synthesis integrating literati arts with ethics, mysticism, and education in the classics that continued till the end of the Qing Dynasty in 1911 (Chan; De Bary, 1960, chaps. 17–19; Koller and Koller, chaps. 21–22; Black).

Mao Zedong (1893–1976) overturned the elitist literati emphasis on the classics and the value of the past. During the Republican Period (1912–1949), Lu Xun (1881–1936)—writer, activist, and founder of the Creative Print Movement—had urged artists to use art in the service of revolution (based on European ideologies). In his 1942 *Talks at the Yan’an Conference on Literature and Art* (the foundation for Communist Chinese aesthetics until 1979), Mao adapted Lu’s thinking to his revolution, acknowledging Lu as a source. Mao argued that the history of art was a product of political-economic structures that must be rejected: Bronze Age art was the product of a slave-based society, while from Han (140 B.C.E.–220 C.E.) to the twentieth century China was feudally unified under an emperor, from whom all value stemmed (McDougall). Yet Mao Zedong adapted aspects of literati aesthetics to revolutionary Communist purposes, including the use of images and texts to teach virtues and a belief in the power of art to transform the human heart and thereby political reality. In 1958 a print by Niu Wen integrated poetry into visual art—a literati concept dating from at least the Song—and peasants were adding poetry to their village murals. By the early 1960s even landscape painting in traditional media (*guo hua*) was adapted to Communist purposes: Huang Peimo’s landscape print *A Distant Source and a Long Stream* (1973) incorporates the deliberate literati archaism and treatment of “empty” space literati aesthetics.

But Mao focused on the masses—both as audience and as agents of their own transformation. This required the masses to be “the sole and inexhaustible source” of subject matter, and it required a new style depicting the masses as inspiring heroes, not as agonized victims (as in Lu Xun’s writings). During this time, setting the framework for aesthetic understanding and debate were praise and criticism in government-published reviews of artworks that the government established as models of art; deviation was dangerous. The impact of Jiang Qing

(1914?–1991), Mao’s wife and deputy director of the Cultural Revolution (1966–1976), is seen in her principles for “model operas” (1961–1965), codified to reform opera and all the visual arts, and in the feminist content of visual art during the Cultural Revolution (1966–1976).

In 1953 Zhou Yang iterated Mao’s advocacy of socialist realism, but declared the enrichment of Chinese tradition to be the objective of using foreign art and aesthetics. He concluded by advocating “free competition of various artistic forms” (Soviet and Chinese) and stated that Mao Zedong’s guiding principle was “Let a hundred flowers bloom and a hundred schools contend.”

The debates over retention of traditional aesthetics and the inclusion of foreign components within Chinese arts continue in the early twenty-first century. Debates focus on the Chinese appropriation and critique of universalizing Euro-American paradigms and meta-narratives, “culture as leisure,” and the resurgence of Mao fever and neo-nationalism.

India

Despite the philosophical diversity within India, there is a surprising degree of consensus about the nature and importance of aesthetics and aesthetic pleasure (*rasa*). Like truth and goodness, *rasa* belongs to reason (*buddhi*); its relation to truth remains a major vein of speculation. Although the specific role that *rasa* plays in the human psyche depends on the metaphysical premises of a given philosophy—whether dualistic or nondualistic, etc.—*rasa* is a highly valued, central part of human experience. It encompasses sexuality, but also takes its place among the spiritual disciplines.

The second basic concept of Indian aesthetics is *kama*, the pursuit of love and enjoyment. *Kama* includes refined aesthetic pleasure, sexual pleasure, and love of the divine (the human search for transcendence). The epitome of *kama* is found in the love of the divine Krishna and Radha, his consort, and in their dance, called the *rasa-lila* (the “playful dance of the god”)—a recurring theme in painting, poetry, and drama. The most famous text of the science of *kama*, Vatsyayana’s *Kama Sutra* (Aphorisms of love) lists sixty-four arts and sciences in which a cultured person or courtesan was educated (Embree, p. 256).

Bharata Muni’s *Natya Sastra* (Treatise on dramaturgy) (written sometime between the 2nd century B.C.E. and the 2nd century C.E.), the first written theory of drama, claims that when humanity began to suffer from pride and the joyful life became full of suffering, the god Brahma created drama—with its attendants music, poetry, and dance—to uplift humanity morally and spiritually by means of aesthetics (*rasa*) (Bharata, 2003).

From Bharata on, emotion (*rasa*, meaning “flavor” or “relish”) is recognized as the heart of drama and all art. *Rasa* thus came to mean the feeling that a poet conveys to a sympathetic reader, aesthetic taste, or aesthetic rapture (Gupta). *Rasa*, the aesthetic rapture accompanying the appreciation of dance and drama, is mentioned in the Upanishads, and some claim that it is even comparable to “the realization of ultimate reality”

(Tripurari, p. 10). The differences between aesthetic *rasa* and Brahman realization of the form of the Absolute became important philosophical issues. Krishna’s *rasa-lila* (his love dance with Radha) provides one answer to these problems and leads to philosophical development of kinds of love (Tripurari, p. 37). This dance, first described in the *Bhagavata Purana* (tenth century?) and set in verse in the twelfth century, inspires poetry and paintings (together called *ragamala*); it forms the kernel for the devotional aesthetic called *bhakti rasa* popular in Vedanti [Tripurari].

Dating from the thirteenth century, the *ragamala* (garland of *ragas*) are painting albums, often with poems, based on *ragas*, the secular musical modes associated with particular feelings/flavors (*rasa*). The paintings depict male or female human heroes or divinities, identified by name and an emblem, in love scenes coordinated with time of day, season, and aesthetic mode, and sometimes a color, deity, planet, or animal. Although conceived within the framework of Hinduism, the *rasa-lila* reaches well beyond it: the Moghuls, who were Muslim, also commissioned pictures of the *rasa-lila*.

Music in India has a similarly long aesthetic tradition. The *Samaveda* treats it as a divine art. Indian philosophers have been particularly interested in the aesthetics of sound (Malik), music and dance (Mittal; Iravati), and chant and storytelling (Kaushal).

Japan

Japanese aesthetics is unique among non-Western traditions in the degree to which it has permeated international awareness. It did this not only through the arts but also by introducing its extensive aesthetic vocabulary—*wabi* (a taste for the simple), *sabi* (quiet simplicity), *shibui* (subdued), *iki* (stylish, elegant), *yugen* (rich or deep beauty), etc. (for explanations, see Miner et al., pt. 4). Saito has reinterpreted *sabi* and *wabi* in terms of an “aesthetics of insufficiency.” This vocabulary has often been interpreted as referring to an “eternal” Japanese spirit, but in fact it has undergone continuous expansion and reinterpretation since medieval times. The political uses served by both the aesthetics and their mythologizing interpretations comprises an important part of Japanese aesthetics in the early twenty-first century. Saito, for instance, reinterprets *sabi* and *wabi* in terms of an “aesthetics of insufficiency.” Perhaps the most important area of current Japanese aesthetics develops the implications of the experience of being bombed and its aftermath(s), which seems to demand utterly new ways of “understanding.”

Several dichotomies are used to organize thinking about the arts in Japan, including the polarities between feminine and masculine, and between native and foreign (originally Chinese; since 1868, American or Western). The earliest Japanese writing on aesthetics, by Kukai (774–835), was deliberately permeated by Chinese Buddhist philosophy. But a native Shinto aesthetic was evident a century earlier in the *Manyoshu* (Collection of ten thousand leaves), an anthology of folk songs and poems. Within the anthology, poems by Kakinomoto no Hitomaro (c. 658–c. 708) exemplify a Shinto aesthetic in which there is a “total unity of world and people, time and

nature, public and private motivations” (Miner et al., p. 176). Concern over what constitutes as Shinto or native aesthetic, often phrased in terms of what is “uniquely Japanese,” continues through Kamo no Mabuchi (1697–1769) and Motoori Norinaga (1730–1801) to the novelists Tanizaki Jun’ichiro and Kawabata Yasunari in the twentieth century, and Emiko Ohunki-Tierney in the twenty-first.

The single most influential figure in the history of Japanese aesthetics (according to Japanese specialists from the twelfth century on) was undoubtedly the Heian poet and diarist Murasaki Shikibu (c. 973–c. 1014). Her explications of the philosophy of literature and painting in her novel *The Tale of Genji* became famous (Tsunoda, vol. 1, pp. 176–179). *Genji* discusses the aesthetics of gardens, calligraphy, nature (especially the moon and the seasons), paper and wrapping, incense, color, fashion, and music; it presents the aesthetic concepts *miyabi* (courtly elegance) and *mono no aware* (awareness of the pathos of things). It exemplifies quintessential Japanese values including the “aesthetics of indirection,” ambiguity, elusiveness, allusion and it developed Buddhist impermanence into an aesthetic virtue.

Subsequent critics extolled *Genji*. An ability to comment intelligently on it became necessary for establishing cultural credentials, although as a woman Murasaki also provoked anxiety. The literary and national-learning scholar Motoori Norinaga (1730–1801) developed the political and social dimensions of the expression frequently found in *Genji* of “the pathos of things” (*mono no aware*) and identified it as fundamental to Japanese culture and national identity (Miner, pp. 95–96; Nishimura). Heian women writers possessed a distinctive sensibility because they wrote in the vernacular rather than Chinese as men did; this allowed them to create their work within a native aesthetic distinct from that of male writers writing in Chinese (Keene).

Murasaki’s contemporary Sei Shonagon (b. c. 967) presented an aesthetics of everyday life (as well as discoursing on more standard topics) in her *Pillow Book*, one of the three great “prose miscellanies” (*zuihitsu*). Her format was used by other medieval aesthetic recluses, notably Kamo no Chomei (1153–1216), *waka* poet and man of letters. His *Hojoki* (Account of my hut) displays an aesthetic distance that typifies this genre.

Fujiwara Shunzei (1114–1204) and Fujiwara Teika (1162–1241)—father and son poets, critics, and anthologists—devised new conceptions of literature and were the first to discern a history of poetry in Japan (Miner et al.). They assessed such matters as the temporalities of *The Tale of Genji* and ways of handling allusion. Shunzei advocated the aesthetic concepts *yugen* and *sabi*, relating them to Buddhist and Shinto values, and outlined a theory of effect in poetry that utilizes the poem’s general configuration (*sugata*), diction (*kotoba*), and spirit (*kokoro*). Teika also wrote instructions to inspire poets.

Saigyō (1118–1190), a poet from a warrior family who became a Shingon priest, wrote a travel diary, a collection with poems on war, and another with poems on Yoshino’s cherry blossoms that “assisted in the gradual shift from the plum to the cherry as the ideal Japanese flower” (Miner et al., p. 223). He helped popularize the aesthetic recluse’s ideal of seclusion

from the world, poetry, and travel. Matsuo Bashō (1644–1695)—poet, critic, diarist, and traveler—brought the lowly and the commonplace into the subject matter and vocabulary for poetry and introduced new elements of humor (Tsunoda).

In theater, Zeami (1363–1443), playwright and theater critic, established a critical vocabulary and aesthetics for No: *yugen*, *monomane* (imitation), *ka* or *hana* (flower)—an allusion both to the transmission of his father’s art and to the traditional aesthetics of Japanese poetry. Chikamatsu Monzaemon (1653–1725), a puppet-theater playwright whose works were adapted for the Kabuki stage, addressed the problem of realism in theater (Tsunoda). Kabuki (like most Asian theater) aims at presentation of an explicitly theatrical reality, unlike Western theater, which aims at representation of everyday life.

Tea ceremony aesthetics of simplicity and austerity creates an appreciation of the ordinary and alternative modes of sociality. Based on Zen, it introduces mindfulness into everyday life.

Several genres of gardens developed distinct aesthetics, specializing in allusion and reference (*katsura*); Zen-like mindfulness, simplicity and austerity, and/or relationships to nature, especially to the seasons, to natural landscape.

By the early twentieth century novelists such as Natsume Soseki, Tanizaki Junichiro, and Kawabata Yasunari explored through fiction ideas from Western aesthetics, such as Kant’s disinterest. Akutagawa’s famous short story “The Hell Screen” (1973) is an instantiation—and an exploration of the ramifications for human life—of the view that realism must be based on experience; the artist can only paint what he or she knows.

Korea

Korea’s contributions to aesthetics and the arts have often been misascribed to China and Japan. The best known are the Choson-Dynasty (1392–1910) debates based on Confucian literati aesthetics (and ethics) that led to the abandonment of elaborate Koryŏ-period (918–1392) incised and inlaid ceramics in favor of simpler forms. Current studies attend especially to the distinctive aesthetics of the many native and folk traditions.

See also Aesthetics: Africa; Aesthetics: Europe and the Americas; Architecture: Asia; Arts.

BIBLIOGRAPHY

- Akutagawa, Ryunosuke. “The Hell Screen.” In *The World of Japanese Fiction*, edited by Yoshinobu Hakutani and Arthur O. Lewis. New York: Dutton, 1973.
- Anesaki, Masaharu. *Art, Life, and Nature in Japan*. New York: Japan Society, 1933; Rutland, Vt., and Tokyo: Charles E. Tuttle Co., 1973.
- Bharata Muni. *Natya Sastra* (Treatise on dramaturgy). Edited by Kapila Katsyayan. New Delhi: Sahitya Akademi, 1996.
- Bush, Susan. *The Chinese Literati on Painting: Su Shih (1037–1101) to Tung Ch’i-ch’ang (1555–1636)*. Cambridge, Mass.: Harvard University Press, 1971.
- Callicott, J. Baird, and Roger T. Ames, eds. *Nature in Asian Traditions of Thought: Essays in Environmental Philosophy*. Albany: State University of New York Press, 1989.

- Chan, Wing-tsit, ed. *Chu Hsi and Neo-Confucianism*. Honolulu: University of Hawaii Press, 1986.
- Chang, Chung-yuan. *Creativity and Taoism: A Study of Chinese Philosophy, Art, and Poetry*. New York: Julian Press, 1963; Harper Colophon Books, 1970.
- Davis, Darrell William. *Picturing Japaneseness: Monumental Style, National Identity, Japanese Film*. New York: Columbia University Press, 1996.
- De Bary, Wm. Theodore, Wing-tsit Chan, and Burton Watson. *Sources of Chinese Tradition*. 2 vols. New York: Columbia University Press, 1960.
- De Bary, Wm. Theodore, et al., eds. *Sources of Japanese Tradition*. 2 vols. New York: Columbia University Press, 1958.
- Embree, Ainslie T. *Sources of Indian Tradition*. Vol. 1: *From the Beginning to 1800*. 2nd ed. New York: Columbia University Press, 1988.
- Gupta, Shyamala. *Art, Beauty, and Creativity: Indian and Western Aesthetics*. New Delhi: D. K. Printworld, 1999.
- Hall, David L., and Roger T. Ames. *Thinking through Confucius*. Albany: State University of New York Press, 1987.
- Iravati. *Performing Artists in Ancient India*. New Delhi: D. K. Printworld, 2003.
- Kamo no Chomei. *Hojoki: Visions of a Torn World*. Translated by Yasuhiko Moriguchi and David Jenkins. Berkeley, Calif.: Stone Bridge Press, 1996.
- Kasulis, Thomas P. "Zen and Artistry." In *Self as Image in Asian Theory and Practice*, edited by Roger T. Ames with Thomas P. Kasulis and Wimal Dissanayake, 357–372. Albany: State University of New York Press, 1998.
- Keene, Donald. "Feminine Sensibility in the Heian Era." In *Japanese Aesthetics and Culture: A Reader*, edited by Nancy G. Hume, 109–123. Albany: State University of New York Press, 1995.
- Ki no Tsurayuki. *Kokin Wakashu: The First Imperial Anthology of Japanese Poetry*. Translated by Helen Craig McCullough. Stanford, Calif.: Stanford University Press, 1985.
- Malik, S. C. *Dhvani: Nature and Culture of Sound*. New Delhi: D. K. Printworld, 1999.
- McDougall, Bonnie S., trans. and ed. *Mao Zedong's "Talks at the Yan'an Conference on Literature and Art": A Translation of the 1943 Text with Commentary*. Ann Arbor: University of Michigan, 1980.
- Miner, Earl, Hiroko Odagiri, and Robert E. Morrell. *The Princeton Companion to Classical Japanese Literature*. Princeton, N.J.: Princeton University Press, 1985.
- Mittal, Anjali. *Hindustani Music and the Aesthetic Concept of Form*. New Delhi: D. K. Printworld, 2000.
- Murasaki Shikibu. *The Tale of Genji*. Translated by Edward G. Seidensticker. New York: Vintage Books, 1976.
- Ohnuki-Tierney, Emiko. *Kamikaze, Cherry Blossoms, and Nationalisms: The Militarization of Aesthetics in Japanese History*. Chicago: University of Chicago Press, 2002.
- Reinhold, Christiana. "Okakura Kakuzo and the Production of the Japan Discourse in the Early Twentieth-Century United States." In *Essays in History*, edited by the Corcoran Department of History at the University of Virginia, vol. 39. Charlottesville: Corcoran Department of History, University of Virginia, 1997.
- Saito, Yuriko. "The Japanese Appreciation of Nature." *British Journal of Aesthetics* 23, no. 3 (1985): 239–251.
- Sei Shonagon. *The Pillow-Book of Sei Shonagon*. Translated by Arthur Waley. London: George Allen and Unwin, 1928.
- Sullivan, Michael. *The Arts of China*. 4th ed. Berkeley and Los Angeles: University of California Press, 1999.
- Teng Gu. *Tang Song huihua shi* (A history of painting during the Tang and Song dynasties). Beijing: Zhongguo gudian yishu chubanshe, 1958.
- Tripurari, B. V. *Aesthetic Vedanta: The Sacred Path of Passionate Love*. Eugene, Oreg.: Mandala Publishing Group, 1998.
- Tsunoda, Ryusaku, William Theodore de Bary, and Donald Keene, eds. *Sources of Japanese Tradition*. 2 vols. New York: Columbia University Press, 1958.
- Wen Fong. "On Hsieh Ho's *Liu-fa*." *Oriental Art* (new series) 9, no. 4 (1963): 3–6.
- Zhou Yang. Report delivered to the Second Congress of Literary and Art Workers, September 1953.

Mara Miller

EUROPE AND THE AMERICAS

Aesthetics is a branch of philosophy concerned with aesthetic experience and the fundamental principles of art and criticism. It is distinct from the history of art and the practice of art criticism, although its own history follows a path parallel to both. It is not an empirical study of the psychology or sociology of art, nor is it the same as *aestheticism*, which names a particular attitude to aesthetic matters, exemplified by the fin-de-siècle "art for art's sake" movement. There is no need to be an "aesthete" to engage in aesthetics. In what follows, a brief history of the subject will be outlined from its eighteenth-century foundations, back through earlier anticipations from the classical period, and on to the modern legacy. Then an analytical survey of contemporary trends and current issues will be offered.

Eighteenth-Century Foundations

Aesthetics in the European tradition, conceived as philosophical inquiry into the experience of beauty, acquired its name and essential nature in the eighteenth century, even though cognate concerns had been debated in Europe for two millennia before that. The term *aesthetics*, from the Greek *aesthēsis* (perception), was coined, in roughly its modern sense, in 1735 by Alexander Baumgarten (1714–1762), a German philosopher who sought to develop a "science of sensitive cognition." Baumgarten's unfinished book *Aesthetica* was the first to bear this new term in its title. In fact the term took some time to catch on and was not established in Great Britain, for example, until the 1830s. Immanuel Kant (1724–1804), perhaps the most influential of all aestheticians, was slow to adopt the new usage, remarking in the second edition of his *Critique of Pure Reason* (1787) that "The Germans are the only people who currently make use of the word 'aesthetic' in order to signify what others call the critique of taste." In that same passage Kant lambastes what he describes as "the abortive attempt made by Baumgarten . . . to bring the critical treatment of the beautiful under rational principles." But whatever its name—*aesthetics* or *critique of taste*—a distinctive inquiry gathered pace through the eighteenth century and came to define what is now universally acknowledged as the field of aesthetics. What are the characteristics of this new inquiry?

Judgments of taste. Several developments in the eighteenth century form the foundations of modern European aesthetics.

One is a growing interest in judgments of taste, notably how attributions of beauty are grounded. Is beauty an objective quality of nature itself or is it merely a projection of the mind? An important impetus for this debate was the writing of Anthony Ashley Cooper (1671–1713), third earl of Shaftesbury, whose Neoplatonist work *Characteristics of Men, Manners, Opinions, Times* (1711) presents the view that beauty, like goodness, resides in the harmony of the natural world, as created by God, and that humans can immediately discern such beauty (or goodness) by an “inward eye” or “moral sense.” Furthermore, the enjoyment of beauty has a disinterested quality distinct from the desire of possession. The Scottish philosopher Francis Hutcheson (1694–1746), in *An Inquiry into the Original of Our Ideas of Beauty and Virtue* (1725), adopted the notion of “moral sense,” including the concomitant sense of beauty, and sought in detail to show how beauty, grounded in “uniformity amidst variety,” could be the object of intersubjectively valid judgments. David Hume’s (1711–1776) influential essay “Of the Standard of Taste,” first published in his *Four Dissertations* (1757), gives explicit focus to “taste” as a capacity for judging beauty, and while emphasizing that beauty “is no quality in things themselves,” nevertheless finds a “standard of taste” in the joint verdict of qualified judges. Hume’s focus is on taste in cultural matters, especially poetry, rather than natural beauty, but judgments about art and nature were seldom at this stage differentiated. In Kant’s definitive contribution to aesthetics, the first part of his *Critique of Judgment* (1790), we find many of the threads of the previous debates subtly interwoven. Kant proposes, in contrast to Shaftesbury and Hutcheson, a clear divide between moral and aesthetic judgments, highlighting the role of disinterestedness in the latter; he steers a path between the avowed subjectivity of beauty and the justifiable aspiration of universality in judgments about beauty; and he distinguishes natural beauty from the beauty of art. For Kant a “pure judgment of taste” rests on a universally communicable, disinterested pleasure in the appearance of an object apart from any conceptualization of that object.

The sublime. A second feature that characterizes the birth of modern aesthetics in the eighteenth century is also closely associated with Kant. This is the interest given to the sublime in addition to the beautiful. Kant’s account of the sublime, in the *Critique of Judgment*, as well as in *Observations on the Feeling of the Beautiful and Sublime* (1763), is again definitive. The sublime rests on the vastness and overwhelming power of nature and the awe that these inspire in humans. Thunder and lightning, hurricanes and volcanoes, towering mountains and crashing waterfalls are judged sublime and induce a mix of fear and pleasure. Kant’s own discussion is complex, distinguishing the “mathematical sublime” (vastness) and the “dynamical sublime” (power), and relating response to the sublime with reflection on the greatness of reason as “a faculty of the mind surpassing every standard of Sense.” The pleasure of the sublime derives from awareness that, in spite of physical frailty in the face of terrifying nature, humans remain superior as rational and moral beings. Interest in the sublime did not originate in the eighteenth century, and discussions often referred back to the literary treatise *On the Sublime*, attributed to “Longinus” from the first century C.E., although the principal

focus in that work is not the awesomeness of nature so much as the sublime style in rhetoric. Edmund Burke’s (1729–1797) *Philosophical Enquiry into the Origin of Our Ideas of the Sublime and Beautiful* (1757) was an important precursor to Kant’s discussion and developed the idea that aesthetic responses stemmed from universal predispositions in human nature.

Fine arts. A third relevant factor in the foundations of aesthetics was the emergence of a conception of the fine arts (*beaux arts*) as belonging to a single category. The seminal work was *Les beaux arts réduits à un même principe* (1746; *Fine arts reduced to a single principle*) by Abbé Charles Batteux (1713–1780). This work listed the fine arts, whose aim is pleasure, as music, poetry, painting, sculpture, and dance. In another category, those arts that combine pleasure and usefulness, he puts eloquence and architecture, while theater is deemed a combination of all the arts. The “single principle” is “the imitation of beautiful nature.” Few followed Batteux in stressing imitation as the definitive element in art, but by the time of Kant’s discussion in the *Critique of Judgment*, the notion of the fine arts was taken for granted. Kant himself offered a quite different common principle of fine art—that of genius—anticipating an aesthetic conception associated with Romanticism. Genius, for Kant, is “a talent for producing that for which no definite rule can be given” and fine art, he insists, “is only possible as a product of genius.”

Conditions in eighteenth-century Europe seemed entirely conducive to the flourishing of aesthetics as an inquiry into the principles of beauty and the fine arts. Marxist historians offer a partial explanation in terms of the rise of a confident and prosperous middle class with the time and inclination to indulge a love of beauty and the display of “sensibility,” “refinement,” and taste. Notions of individuality and subjectivity, central to Enlightenment thought, developed in this century, as did notions of a common human nature on which universal judgments of value might be grounded. It should be emphasized, though, that many aspects of aesthetic inquiry long predate the eighteenth century. A summary survey of these is necessary to map out any adequate history of aesthetics, prior to exploring the legacy of the nineteenth and twentieth centuries.

Classical Anticipations

Both Plato (c. 428–348 or 347 B.C.E.) and Aristotle (384–322 B.C.E.) have extensive and influential discussions of art and beauty, and there is a clear sense that in many cases they were contributing to debates already well established in ancient Greek culture. Plato, for example, famously refers to the “ancient quarrel” between poetry and philosophy. When Batteux, as we have seen, uses the term *imitation* to characterize a feature common to the fine arts he is self-consciously evoking the notion of *mimesis*, central to ancient Greek thought about the arts. The precise meaning of *mimesis*, sometimes translated as “imitation,” sometimes “representation,” is disputed. Undoubtedly Plato often uses the term with negative connotations, as when, in the *Timaeus*, he refers to poets as a “tribe of imitators.” In book ten of the *Republic*, Plato gives an unflattering account of a painter, whose picture of a bed is twice removed from reality being a mere “imitation” of

a carpenter's bed, which itself is a copy of an ideal form. Plato's constant worry about mimetic art, especially poetry, was that it dealt in appearance or illusion, thus being both epistemologically and morally suspect. It was the Neoplatonist Plotinus (205–270 C.E.), writing over five hundred years later, in the *Enneads*, who showed how Plato's metaphysics of forms could be reconciled with a positive conception of artistic mimesis. Plotinus argued that art, by directly imitating the forms themselves, could aspire to an even greater beauty than that found in nature and thus achieve the highest truthfulness.

This debate about the truth of art resonates through the centuries. Plato's pupil Aristotle addressed the matter in his treatise *Poetics*, a discussion of the nature and status of poetic tragedy that has become one of the seminal texts in Western aesthetics. For Aristotle the desire to imitate is both natural and a source of pleasure. Tragedy is an imitation of action and attains, according to Aristotle, thereby contradicting Plato, a status somewhat akin to philosophy in presenting universal truths about what "such and such a kind of man will probably or necessarily say or do." Aristotle went on to argue that mimesis in tragedy had other values as well, including the pleasurable stirring of emotion, notably pity and fear, leading to an ultimate purgation (*katharsis*) or cleansing. The perplexing problem of what makes the viewing of tragedy a pleasurable experience is the subject of a subtle essay by David Hume, "Of Tragedy" (1757).

Although the ancient Greek philosophers had much to say about each of the individual art forms—drama, poetry, music, painting, and sculpture—it seems they possessed no concept equivalent to *fine art*. The term *technē* is sometimes translated as "art" but is closer to "craft" in the modern sense, denoting a specialized skill. For Plato the highest "art" is the statecraft taught to the young guardians in the Republic, which intriguingly he sometimes compares to painting, coloring sculpture, or writing a tragedy. Perhaps, though, the main reason for locating the origins of modern aesthetics in the eighteenth century rather than in ancient Greek philosophy is that there is no systematic attempt in the latter to address interconnected issues about the role of beauty and the arts in human experience. Both Plato and Aristotle write about beauty (*to kalon*) and, although disagreeing on its metaphysical status, broadly agree on the marks of beauty: "measure and proportion" (Plato), "order and symmetry and definiteness" (Aristotle). But such observations are integrated into more general discussions, and neither philosopher felt the need for a distinctive branch of philosophy given over to aesthetic concerns.

In subsequent centuries, up to the eighteenth century, a similar story could be told of isolated, sometimes brilliant, sometimes hugely influential, contributions, but there was no sustained attempt (as epitomized by Kant's *Critique of Judgment*) to establish a philosophy of the beautiful. Often the legacy of debates from the Greeks is in evidence, few more so than Plato's attack on poetry. A deep ambivalence is manifest throughout the history of the Christian Church from the early church fathers through the Middle Ages toward secular poetry and in particular drama. Plato's concerns about the falsehood

and seductiveness of poetry and its antipathy to reason found an analogue in Christian thought in the profane and the sacred. Periodic defenses of poetry were not uncommon. Sir Philip Sidney's (1554–1586) *Defense of Poesie* (1595) takes on the Puritans and is an eloquent argument for the educative and edificatory benefits of poetry. Curiously, in spite of the extraordinary flourishing of the arts in the European Renaissance, the two hundred years between 1400 and 1600 saw little sustained philosophical debate about the arts or beauty. Treatises on individual arts by the likes of Leon Battista Alberti (1404–1472), Leonardo da Vinci (1452–1519), and Albrecht Dürer (1471–1528) were concerned more with theoretical questions about aim and technique than with abstract philosophical investigation. These would not standardly be classified as works in aesthetics, in the stricter sense that emerged after Baumgarten.

The Growth of Modern Aesthetics

A striking development in aesthetics after the eighteenth century was a gradual shift of interest from inquiries into beauty per se and "judgments of taste" to specifically the philosophy of art. Nineteenth- (and late-eighteenth-) century aesthetics was largely dominated by German philosophers, including Johann Christoph Friedrich von Schiller (1759–1805), Friedrich Wilhelm Joseph von Schelling (1775–1854), and Arthur Schopenhauer (1788–1860). A way of writing about art developed that was distinctively philosophical and that contrasted with explorations of art, however theoretical, by artists themselves. Nowhere is this better exemplified than in the magisterial *Lectures on Fine Art*, given in the 1820s by the paramount German aesthetician Georg Friedrich Wilhelm Hegel (1770–1831), a work comparable in importance and influence to Kant's *Critique of Judgment*. Hegel afforded art a central place in his metaphysical system of absolute idealism, locating it, along with religion and philosophy, as one of the modes of "absolute spirit" whereby the mind comes to know itself. Hegel retold the history of art in terms of changing relations between spiritual content (*idea*) and sensuous medium: in symbolic art, characterized by Egyptian and Indian art, the medium dominates the idea; in classical art, from ancient Greece, idea and medium are in perfect balance; in romantic art, from Christian art onward, the idea reaches its ascendancy, manifesting "infinite subjectivity." Hegel proposed a hierarchy of individual arts, from architecture to poetry, and suggested, somewhat obscurely, that the capacity for further development had been exhausted (the "death of art").

Hegel showed par excellence how a philosophy of art could be fully integrated into wider philosophical speculation, and increasingly in the history of aesthetics theories of the arts (or of beauty more generally) would come to be discriminated in terms of the philosophical frameworks within which they are couched. Idealism, either Kantian or Hegelian, had a major impact well into the twentieth century, notably in works like the Italian Benedetto Croce's *Estetica come scienze dell'espressione e linguistica generale* (1902; Aesthetics as science of expression and general linguistics) and the English Robin George Collingwood's *Principles of Art* (1937). Both Collingwood and Croce identified the true work of art not with its physical manifestation but

with an inner state of mind seeking expression. Other philosophical outlooks produced their own distinctive aesthetic theories. Phenomenologists, such as Roman Ingarden (1893–1970) and Mikel Dufrenne (1910–1995), give attention to the properties of an “aesthetic object” in relation to the acts of consciousness of artist and audience. John Dewey (1859–1952), the American pragmatist philosopher, in one of the most important contributions to twentieth-century aesthetics, *Art As Experience* (1934), stresses the origin of art in the everyday world of human action. For Marxist aestheticians, the context in which art must be explained is social and economic, a complete rejection of the premises of the idealist. Contemporary analytical aesthetics, that is, aesthetics influenced by the developments of logic and conceptual analysis in the early to middle parts of the twentieth century, gives less focus to the social or psychological aspects of art as to questions about what kind of entities art works are and what kinds of properties they possess.

Contemporary Trends and Issues

Increasingly from the latter half of the twentieth century into the twenty-first century aesthetics grew in stature as an established branch of philosophy in both the Anglo-American (analytic) and European (Continental) schools of philosophy. The subject was widely taught in universities and learned societies devoted to the subject—the American Society for Aesthetics and societies from the individual European nations—had strong support. Aesthetics was well integrated into mainstream philosophical inquiry with aestheticians drawing on work in, for example, philosophy of language, philosophy of mind, ethics, epistemology, and metaphysics. Indeed the borrowings go both ways, as sometimes technical work in aesthetics—on fictionality, aesthetic properties, ontology of art, interpretation, narrative—has contributed to an advance of understanding in other philosophical fields.

Twenty-first-century concerns in aesthetics might be seen as falling into two broad areas: philosophy of art, on the one hand, and on the other the investigation of aesthetic experience more generally, including experience of the natural world. Philosophy of art encompasses theoretical questions about the nature of art itself, how works of art are distinguished from other artifacts, what values art embodies, and also the special qualities of individual art forms, not only the traditional “fine arts” but other arts such as film, photography, and “mass art.” Inquiries into aesthetic experience go beyond the experience of art and investigate human responses to beauty and other aesthetic qualities wherever they are manifested.

Philosophy of art. When analytic philosophers began to turn their attention to aesthetics in the 1940s, one of their early concerns was to analyze the concept of *art* itself. The idea of providing a definition of art, one that covered all art forms, had not been a central preoccupation of aesthetics in previous centuries. Leo Tolstoy in *What Is Art?* (1898) had proposed that art involves the transmission of feeling from artist to audience; and other kinds of “expression” views, ultimately deriving from romantic conceptions of art, were developed by Croce and Collingwood. More often than not, those who sought an “essence” for art had, implicitly if not explicitly, one particular art form in mind, for example, painting or poetry. Thus the

idea that art is essentially a “representation,” a descendent of classical “mimetic” theories, foundered on “nonrepresentational” arts, including music and all abstract art. Clive Bell’s claim in *Art* (1914) that what is essential to art is “significant form” and the arousing of “aesthetic emotion” was more convincing about modernist painting, which he championed, than about the realist novel. Analytic philosophers felt the need to go back to basics. Could there be any property that all forms of art—painting, music, literature, sculpture, dance, drama—had in common, a property possession of which was both necessary and sufficient for something to be art?

Initially many philosophers were skeptical that art has such an “essence” and indeed that the concept of art lent itself to strict definition. In an influential paper from 1956, “The Role of Theory in Aesthetics,” Morris Weitz (1916–1981) argued that there could be no definition of art because “art” is an “open concept,” allowing for radically new kinds of instantiation. Weitz was one of the first philosophers to recognize the difficulty posed for philosophy of art by the rapid proliferation of art movements in the twentieth century, from modernism to dadaism. If the “readymades” (a urinal, a snow shovel, a bottle rack, etc.) of the avant-garde artist Marcel Duchamp (1887–1968) could count as art, then traditional conceptions would have to be revised. Weitz proposed that all that binds together the disparate products called “art” are loosely connected “family resemblances,” a notion drawn from Ludwig Wittgenstein’s *Philosophical Investigations* (1953).

However, not all philosophers agreed with Weitz’s anti-essentialism, and a swing back toward essentialist accounts was evident in the final quarter of the twentieth century. What is distinctive about these developments is that rather than seeking some *intrinsic* property shared by all works of art—such as “beauty,” “form,” “representation,” “expression”—they highlighted *extrinsic* or *relational* properties of a social, historical, or “institutional” kind. The American philosopher Arthur Danto (b. 1924) was one of the first to develop this line of thought, suggesting that what makes something art is not what it *looks* like but what role it plays in an “artworld.” This is a striking repudiation of a long-standing premise that art must engage aesthetic perception. Following Danto, “institutional” definitions were proposed whereby an object becomes art only by virtue of having that status conferred on it by an institution or artworld or “art circle,” consisting of a loose-knit community of artists, critics, and art appreciators. There is no suggestion that each putative work comes before a panel of experts for authentication but only that there is an essentially social aspect to the existence of art. A related species of art theory makes explicit a historical dimension to art. According to these accounts, to acquire the status of art, an object must be connected in some way with works previously accepted as art: for example, they must be intended to be regarded in ways that earlier works were regarded, or there must be some narrative that links the present with the past.

The immense variety of art forms poses a problem not just for definition but for the more metaphysical question of what *kinds* of entities art works are. It is common to postulate a deep divide between those works that are unique physical

objects, like paintings, carved sculptures, or buildings, and those that allow for multiple instances, like musical and literary works, films, prints, and photographs. While a painting can be destroyed in a fire, it is less easy to see how a symphony might be destroyed (it could, for example, survive the loss of the original score). There is considerable philosophical interest in pursuing the right “ontology” for art, that is, the mode of existence for different kinds of works. Some philosophers are anxious to present a unitary view, in contrast to the binary one just outlined, and it has been suggested that a painting might in principle also be a “type” with multiple instances, the original canvas being no more significant than an original score. Others have argued that the true identity of any work rests not in the final product but in the complex performance that brought it about. This theory recognizes that facts about a work’s provenance are vitally relevant both to what the work is and how it should be appreciated.

A significant trend in contemporary philosophy of art has been to focus on particular art forms. There are recognized branches of aesthetics now labeled philosophy of music, philosophy of literature, philosophy of film, and so on. This tendency has brought aesthetics closer to critics and practitioners within the arts. Often, distinctive issues arise within these more narrowly defined areas. For example, philosophers of music have asked how music can express emotion; whether profundity is possible in music; whether musical works are created or discovered; and what it is to understand music, without assuming that musical understanding is the same as understanding literature or painting. In an important book, *The Aesthetics of Music* (1997), Roger Scruton has argued that music is nonrepresentational, requires a special kind of “intentional” understanding, and yields in its essential musical features only to metaphorical description.

In the philosophy of literature much attention has been given to fictionality, drawing on work in the philosophy of language. How is fictional discourse distinct from nonfictional? Can works of imaginative or fictional literature be bearers of truth (a question familiar from Plato and Aristotle)? One especially persistent problem concerns emotional responses to fiction: on the assumption that to feel, for example, fear and pity, one must believe that the objects of the emotions are real, how can an audience respond in this way (as Aristotle requires for tragedy) when it is known that the objects are mere fictions? Yet another important debate about literature—which extends to all the arts—concerns criteria for interpretation. Is the critic’s role to recover an artist’s intention or is meaning a product of cultural and literary convention?

In the philosophy of the visual arts, a fundamental question is how depiction in two dimensions can represent three-dimensional objects in space. The preliminary thought that pictures must resemble their subject in order to depict them is both difficult to make precise (in some respects anything resembles anything) and open to counterexamples, in the form of caricatures, cubist portraits, and symbolic representations (for example, Christ depicted as a lamb). Some philosophers reject resemblance altogether as an explanation of pictures, preferring to stress the conventional, quasi-linguistic nature of

representation. Kendall Walton, in his influential *Mimesis As Make-Believe* (1990), argues that viewers of pictures play a “game of make-believe” in which they make believe they see objects depicted when in fact they see only paint and canvas. Others have followed Richard Wollheim in supposing that depiction can be explained as a species of “seeing-in” or “seeing-as.” Philosophical explorations of the visual arts have extended to include film and photography, and developments in the aesthetics of film have challenged theoretical approaches based on Marxism and psychoanalysis.

Across all the arts, the issue of what makes art in itself valuable and what criteria are available for evaluating particular works has posed a perennial conundrum. Some aestheticians see value judgments as relative, culture-bound, or “ideological” and have sought to play down their significance. Others have connected the value of art with the very conception of art itself. If art is mimesis, then good art is judged for how well it holds a “mirror to nature,” but if art is expression then it is judged for the depth and sincerity of the artist’s vision. In a subtle treatment of the question, *Values of Art* (1995), Malcolm Budd argues that the value of a work of art as a work of art is the intrinsic value of the experience the work offers. This is a noninstrumental value, and “experience” is left sufficiently wide to include traditional cognitive values such as moral insight.

There are important currents of thought in contemporary aesthetics that are different from, even opposed to, those based in analytic philosophy. The notion of the “death of the author,” promoted by Roland Barthes (1915–1980) and Michel Foucault (1926–1984), has been influential not merely for its impact on literary criticism but also as part of a general post-structuralist skepticism about meaning and subjectivity. In rejecting the notion of a unified autonomous self as the origin of meaning and emphasizing “intertextuality” and the priority of writing over speaking, poststructuralists like Jacques Derrida (b. 1930) present a direct challenge to what they view as the “logocentrism,” or focus on logic and reasoning, of analytic philosophers. Another challenge to core assumptions of traditional aesthetics comes from feminist aesthetics, a growing and influential development in the subject. There are many different, sometimes conflicting, strands to feminist approaches, but central ideas include a reshaping of the artistic canon to include more works by women; an emphasis on gendered responses to art in opposition to notions of universal aesthetic experience; a relocating of art production into its social and personal contexts and a tendency to downplay formalist approaches and concomitant conceptions like “disinterestness”; and the promotion of revised criteria for art evaluation. Marxists, like feminists, roundly reject the notion that art exists in a realm of pure experience or pleasure. Aestheticians like Theodor Adorno (1903–1969), of the Frankfurt School, follow general Marxist precepts in attributing to art deeply social meanings, either reinforcing or resisting prevailing ideologies. Aesthetics itself has been challenged as a set of interests and values inescapably imbued with (bourgeois) ideology.

Aesthetic Experience and Aesthetic Qualities

Aesthetics, as noted earlier, is not always concerned with art. The core of Kant’s theory of aesthetic judgment had little to

do with art but rather with the special kind of pleasure taken in the appearance of things (of any kind). There are longstanding debates over whether there exists a distinctive “aesthetic attitude” or “aesthetic experience” associated with contemplating an object “for its own sake,” without interest or desire. The psychologist Edward Bullough (1880–1934) introduced the idea of *psychical distance* to explain aesthetic response, giving the illustration of someone fogbound at sea enraptured by the beauty of the swirling fog quite apart from the imminent dangers it presents. While recognizing some such phenomenon, philosophers have challenged the idea of an aesthetic attitude either as too narrow to do justice to the many interests, including moral and political ones, properly brought to art appreciation, or even as a “myth,” reducible to other factors.

Setting aside difficulties in how to characterize the psychology of aesthetic appreciation, philosophers have raised questions about the kind of qualities sought in aesthetic experience. Are there distinctive aesthetic qualities? If so, what makes them different from nonaesthetic, physical, structural, or perceptual qualities? The English philosopher Frank Sibley (1923–1996) initiated the contemporary debate and was one of the first to broaden the scope of the inquiry beyond the limited focus on qualities like beauty and the sublime. Words that identify aesthetic qualities, he suggested, include: *unified, balanced, integrated, lifeless, serene, somber, dynamic, powerful, vivid, delicate, moving, trite, sentimental, tragic*, and many more. Some are purely evaluative, some have a descriptive element. Such qualities “emerge” from, but are not logically determined by, nonaesthetic properties like color, configuration, or material constitution. They require “taste” for their apprehension and might be missed by nondiscerning perceivers. A revived form of eighteenth-century debates about the objectivity of beauty addresses the question whether a “realist” or “antirealist” theory of aesthetic qualities is most apt. Those defending the former often postulate specially qualified observers whose judgments are normative.

The most striking reaffirmation that there is more to aesthetics than just philosophy of art comes in the recent renewed interest in the aesthetics of nature and its offshoot “environmental aesthetics.” The dominance of philosophy of art in aesthetics (since Hegel) had distorting effects on philosophical understanding of the appreciation of nature. For one thing, art had become a paradigm for all aesthetic experience, and natural objects or landscapes were viewed as essentially *like* works of art. Even in the eighteenth century there is evidence of such a conception with the pleasure taken in landscaped gardens, scenic views, “prospects,” the “picturesque.” Pioneers in the new aesthetics of nature, including Ronald Hepburn and Allen Carlson, insist that appreciation of nature is *sui generis*. Nature, after all, does not come “framed” or designed by an artist, nor is it static. For Carlson a “true” or appropriate appreciation of the natural world, as it is in itself, does not rest on a merely intuitive response or “innocent eye” but should be informed by knowledge—drawn from geology, biology, and ecology—about the natural processes that brought about the objects perceived. What gives a mountain range its distinctive appearance? Why do landscapes look as they do? To explain our response to the appearance we must go deeper than mere

appearance. The advantage of Carlson’s view is that it relates aesthetics to practical and informed decisions about environmental planning, and it connects to ethical concerns about ecological preservation. But other philosophers prefer a more subjectivist conception and dismiss as too prescriptive the idea of “appropriate” or “inappropriate” responses to nature.

Of course not all environments are “natural,” just as not all “nature” is void of human intervention. Environmental aesthetics goes beyond the aesthetics of nature by considering environments of all kinds, man-made or wilderness, urban or rural. It is hard to see how norms for aesthetic appreciation for such a variety of environments might be established, although extensions of Carlson’s “cognitive” approach have been proposed. Also, it is not clear exactly where the bounds lie between a genuinely aesthetic response to an environment and other more or less pleasurable responses, such as “feeling at home” or sensing a relaxed atmosphere.

Aesthetics has an immensely broad scope both in the objects of its inquiry—from the fine arts to a forest wilderness—and in its methods and underlying principles. A concern for beauty resides deeply in human nature, and inquiring into its sources and characteristics occupies a central place in philosophy. There is, as briefly outlined, a long and rich tradition of debate in Western intellectual history that seeks to explore and clarify the aesthetic dimension of human experience. That tradition continues strongly to this day.

See also Analytical Philosophy; Essentialism; Kantianism; Music, Anthropology of; Musicology; Neoplatonism; Periodization of the Arts; Platonism; Pragmatism.

BIBLIOGRAPHY

- Aristotle. *The Poetics of Aristotle*. Translated by Stephen Halliwell. Chapel Hill: University of North Carolina Press, 1987.
- Beardsley, Monroe C. *Aesthetics: Problems in the Philosophy of Criticism*. 2nd ed. Indianapolis: Hackett, 1981.
- Brand, Peggy, and Carolyn Kormeyer, eds. *Feminism and Tradition in Aesthetics*. University Park: Pennsylvania State University Press, 1995. Useful anthology on feminist responses to historical and contemporary issues in aesthetics.
- Budd, Malcolm. *Values of Art: Pictures, Poetry and Music*. London: Penguin, 1995.
- Carlson, Allen. *Aesthetics and the Environment: The Appreciation of Nature, Art, and Architecture*. London: Routledge, 2000.
- Carroll, Noël. *A Philosophy of Mass Art*. New York: Oxford University Press, 1998.
- Collingwood, Robin George. *The Principles of Art*. Oxford: Oxford University Press, 1938.
- Danto, Arthur. *The Transfiguration of the Commonplace*. Cambridge, Mass.: Harvard University Press, 1981.
- Davies, Stephen. *Definitions of Art*. Ithaca, N.Y.: Cornell University Press, 1991. Useful survey and evaluation of attempts to define art.
- Dewey, John. *Art As Experience*. New York: Putnam, 1934.
- Goodman, Nelson. *Languages of Art*. 2nd ed. Indianapolis: Hackett, 1976.
- Hegel, Georg Wilhelm Friedrich. *Aesthetics: Lectures on Fine Art*. (1835–1838), translated by T. M. Knox. Oxford: Clarendon, 1975.

- Hume, David. "Of the Standard of Taste," "Of Tragedy." (1757). In *Essays, Moral, Political, and Literary*, edited by Eugene Miller. Indianapolis: Liberty Classics, 1985.
- Kant, Immanuel. *Critique of Judgment* (1790). Translated by Werner S. Pluhar. Indianapolis: Hackett, 1987.
- Kearney, Richard, and David Rasmussen, eds. *Continental Aesthetics: Romanticism to Postmodernism: An Anthology*. Malden, Mass.: Blackwell, 2001. Contains important selections from Schiller, Schelling, Schopenhauer, Croce, Heidegger, Adorno, Barthes, Derrida, and others.
- Kelly, Michael, ed. *Encyclopedia of Aesthetics*. 4 vols. Oxford: Oxford University Press, 1998. Contributions by contemporary authors on a wide-ranging array of topics and writers in aesthetics.
- Lamarque, Peter, and Stein Haugom Olsen, eds. *Aesthetics and the Philosophy of Art: The Analytic Tradition: An Anthology*. Malden, Mass.: Blackwell, 2004. Contains important articles from analytic philosophers, including Budd, Carlson, Currie, Danto, Dickie, Hepburn, Kivy, Levinson, Scruton, Sibley, Walton, Weitz, Wollheim, and others.
- Scruton, Roger. *The Aesthetics of Music*. Oxford: Clarendon, 1997.
- Sibley, Frank. *Approach to Aesthetics: Collected Papers on Philosophical Aesthetics*. Edited by John Benson, Betty Redfern, and Jeremy Roxbee Cox. Oxford: Oxford University Press, 2001.
- Walton, Kendall L. *Mimesis As Make-Believe: On the Foundations of the Representational Arts*. Cambridge, Mass.: Harvard University Press, 1990.
- Wollheim, Richard. *Art and Its Objects: With Six Supplementary Essays*. Cambridge, U.K.: Cambridge University Press, 1980.

Peter Lamarque

AFRICA, IDEA OF. The idea of "Africa" is an exceedingly complex one with multiple genealogies and meanings, which make any extrapolations of "African" identity in the singular or plural, any explorations of what makes Africa "Africa," quite difficult. Both Africans and non-Africans have conceived "Africa" differently in various historical and geographical contexts, especially in contemporary times. The descriptions, meanings, images, and discourses of Africa have changed over time as the continent's boundaries—geographical, historical, cultural, and representational—have shifted according to the prevailing conceptions and configurations of global racial identities and power, and African nationalism, including Pan-Africanism. At the beginning of the twenty-first century, the maps and meanings of "Africa" and "Africanness" are being reconfigured by both the processes of contemporary globalization and the projects of African integration.

Discourses about the "idea of Africa" can be framed in various ways. One common approach is to distinguish between Eurocentric and Afrocentric paradigms, between ideas and conceptions of what constitutes "Africa" derived from European as opposed to African perspectives. The difficulty with this method is that it assumes homogeneity within each paradigm and it inscribes an epistemic division between the two approaches that are otherwise deeply implicated with each other. There are other possible typological or taxonomic descriptions of Africa. One can think of religious, ecological, linguistic, and even ethnic taxonomies. This article has chosen

four typologies that seem best able to capture a wide range of constructions of Africa: the racial, representational, geographical, and historical conceptions. As with the Eurocentric–Afrocentric dichotomy, there are no discursive Chinese walls separating the four typologies, nor do they exhaust other possible categorizations, but they do have heuristic value.

Origins of the Name *Africa*

The historical origins of the name *Africa* are in dispute. At least seven origins have been suggested: (1) it is a Roman name for what the Greeks called "Libya," itself perhaps a Latinization of the name of the Berber tribe Aourigha (perhaps pronounced "Afarika"); (2) it is derived from two Phoenician terms either referring to corn or fruit (*pharika*), meaning land of corn or fruit; (3) it comes from a Phoenician root *faraqa*, meaning separation or diaspora; a similar root is apparently found in some African languages such as Bambara; (4) it is drawn from the Latin adjective *aprica* (sunny) or the Greek *aprikē* (free from cold); (5) it might even stem from Sanskrit and Hindi in which the root *Apara* or *Africa* denotes that which, in geographical terms, comes "after"—to the west—in which case Africa is the western continent; (6) it is the name of a Yemenite chief named Africus who invaded North Africa in the second millennium B.C.E. and founded a town called Afrikyah; or (7) it springs from "Afer" who was a grandson of Abraham and a companion of Hercules (Ki-Zerbo; Spivak).

Clearly, there is little agreement on the sources and original meanings of the word *Africa*. The foreignness of the name once prompted Wole Soyinka to demand that it be dropped, and as an act of self-definition he proposed the adoption of terms for *Africa* and *African* rooted in an indigenous language, preferably *Abibirim* and *Abibiman* from Akan. It appears the term *Africa* was used widely from Roman times to refer initially to North Africa, originally called by the Greek or Egyptian word *Libya*, before it was extended to the whole continent from the end of the first century of the common era. The Arabic term *Ifriqiya* most probably represents a transliteration of the word *Africa*. In this sense, then, Africa was a European construct—as much as Europe itself was a construct inflicted by the idea of Africa (and Asia)—whose cartographic application was both gradual and contradictory in that as the name embraced the rest of the continent it increasingly came to be divorced from its original North African coding and became increasingly confined to the regions referred to in Eurocentric and sometimes Afrocentric conceptual mapping as "sub-Saharan Africa," seen as the pristine locus of the "real" Africa or what the German philosopher Georg Wilhelm Friedrich Hegel (1770–1831) called "Africa proper."

The divorce of North Africa may have started with the Arab invasions of the region in the seventh century, but got its epistemic and ideological imprimatur with the emergence of Eurocentricism following the rise of modern Europe, which for Africa entailed, initially and destructively, the Atlantic slave trade, out of which came the forced migration—the largest in human history—of millions of Africans and the formation of African diasporas in the Americas, diasporas that appropriated and popularized the name Africa and through whom Africa became increasingly racialized. For example, the adoption of

“black” as the preferred name of African-Americans from the 1960s, in place of “Negro,” simply reinforced the relabeling of Africa as “black,” a tag that simultaneously rejected and reinscribed the old pejorative appellation of the “dark continent.” For the French, *Afrique noire* served to distinguish the west and central African colonies from the fictive overseas provinces of metropolitan France in North Africa, especially Algeria.

Far less clear is when the appropriation of Africa, as a self-defining identity, occurred in the various regions and among the innumerable societies that make up this vast continent, the second largest in the world. Such an archaeological project has not been undertaken, partly because it is a daunting task to untangle the interpellations and intersections of political and cultural identities for Africa’s peoples—ethnic, national, continental, and global—and partly because African intellectuals, whether nationalist or postcolonial, have been preoccupied with denouncing or deconstructing Eurocentrism.

The Racialization of Africa

The conflation of Africa with “sub-Saharan Africa,” “Africa south of the Sahara” or “Black Africa” so common in discourses about Africa, within and without the continent, ultimately offers us a racialized view of Africa, Africa as the “black” continent. It rests on the metaphysics of difference, a quest for the civilizational and cultural ontology of blackness. For Georg Wilhelm Friedrich Hegel (1770–1831) and his descendants, as Olufemi Taiwo calls purveyors of contemporary Eurocentrism, Africa is the ultimate “undeveloped, unhistorical” other of Europe. Hegel’s “Africa proper” is, in his words, the “land of childhood,” from which North Africa and especially Egypt is excised and attached to Europe, and where history, philosophy, and culture are “enveloped in the dark mantle of night” because its inhabitants, “the Negro exhibits the natural man in his completely wild and untamed state” (Hegel, pp. 91, 93).

Hegel’s ghost still stalks African studies and definitions of Africa. According to some this fragmentation of Africa in African studies has been unproductive intellectually, leaving aside its ideological motivations and effects. To quote John Hunwick:

The compartmentalization of Africa into zones that are treated as ‘Middle East’ and ‘Africa’ is a legacy of Orientalism and colonialism. North Africa, including Egypt, is usually seen as forming part of the Middle East, though Middle East experts are not generally keen to venture farther west than the confines of Egypt. Northwestern Africa—the Maghreb—is generally regarded as peripheral to Middle Eastern Studies and extraneous to African studies. Even the Sahara has been generally viewed as something of a no-go area (especially among anglophone scholars), while the Sudan and Mauritania (which are impossible to label as either ‘sub-Saharan’ or ‘Middle Eastern’) remain in limbo. Northwestern Africa (from Morocco to Libya), despite the area’s close and enduring relationship with West Africa, has been excluded from the concerns of most Africanists. (p. xiii)

This truncated characterization and racialization of Africa is of course not confined to Western scholars. Many African scholars also subscribe to it, as is so evident from their publications on Africa that often omit North Africa. Unlike Hegel and the Eurocentrists, however, African scholars seek to invest, not divest, sub-Saharan Africa with history and intellectual agency. The epistemological fixation with black Africa is so insidious that few remark on it, and when they do they tend to invoke cultural unity for sub-Saharan Africa in which “culture” largely serves as a proxy for race given the fact of cultural diversities within sub-Saharan Africa itself and the cultural affinities between some societies in this region, say the Sahel, with those of North Africa. Take language and religion, two critical attributes of culture: historically the Hausa of West Africa had more in common with their Berber and Arab neighbors to the North than with the Zulu of South Africa. The former traded with each other for centuries, shared religion (Islam) and a script (Arabic), and their languages are part of the Afro-Asiatic family. But this familiar material, moral, and mental universe does not count in the ontology of Africanness confined to the sub-Saharan region.

The separation of North Africa is sometimes based on the question of consciousness and self-representation. It is said people in North Africa perceive themselves to be part of the Arab world and therefore should not be considered a part of Africa. This ignores the simple fact that the vast majority of Arabs actually live in Africa, so that at a minimum Africa has to be considered an Afro-Arab continent. There is no doubt that North Africans have multiple identities and extracontinental affiliations, but so do people in so-called sub-Saharan Africa—ethnic, national, religious, gender, sexual, racial, and so on—in which the identity “African” may not be the primary one. Indeed, the African diaspora was African long before the communities they left behind on the continent developed a consciousness of being African.

Behind these conflicting definitions of Africa, about which regions to include and exclude, lie complex ideological and historical processes that need to be taken into account, for example, the relative decline from the sixteenth century of the trans-Saharan economy following the rise of the Atlantic economy. Another powerful development setting North and West Africa apart, it has been suggested, was the development of an autonomous Sufi Saharan/Sahelian Islam, independent from the North African impulse. Even more crucial, for our purposes, is the need to distinguish between historical knowledge on the one hand, and ideas or imaginings of Africa as intellectual and ideological projects on the other and to ask: who is defining Africa and for what purpose, whose ideas and imaginings predominate, and why? In this regard, it is important to underline the role of institutions from academic institutions to international organizations in this endeavor, to examine both scholarly and popular ideas of Africa and their discursive, spatial, and temporal articulations.

Adebayo Olukoshi and Francis Nyamnjoh remind us that to most ordinary people in Africa, to be African goes beyond making ontological, let alone epistemological, claims. It is a complex and constantly changing and challenging existential and ethical reality.

For the masses of Africans, Africa is above all a lived reality, one that is constantly shaped and reshaped by their toil and sweat as subjected and devalued humanity, even as they struggle to live in dignity and to transform their societies progressively. For these people, the fact of their Africanity is neither in question nor a question. And the least they would expect from concerned scholars is to refrain from adding onto their burdens in the name of a type of scholarship which, in being ahistorical, also trivializes their collective experiences and memories (pp. 1–2).

Representational Discourses of Africa

The notion that there is no racial essence that characterizes Africa and Africans because identities are socially constructed or invented and constantly changing has been the central message of scholars using postcolonial theory. V. Y. Mudimbe's seminal work has sought to map out this discursive process. In *The Invention of Africa* (1988), he interrogates the construction of Africa through Eurocentric categories and conceptual systems, from anthropology and missionary discourses to philosophy, an order of knowledge constituted in the sociohistorical context of colonialism, which produced enduring dichotomies between Europe and Africa, investing the latter's societies, cultures, and bodies with the representational marginalities or even pathologies of alterity (otherness).

In *The Idea of Africa* (1994), he seeks to demonstrate that conquering Western narratives, beginning with Greek stories about Africa, through the colonial library to contemporary postmodernist discourses, have radically silenced or converted African discourses. African intellectuals, he argues, have been reacting to this ethnocentric epistemological order, itself subject to the mutations of Western material, methodological, and moral grids, with varying degrees of epistemic domestication and defiance, in the process of which Africa's identity and difference have been affirmed, denied, inverted, and reconstituted.

For some thinkers one of the most important aspects of Africa's representation lies not in its invention per se, a phenomenon that is by no means confined to the continent, but in the fact that Africa is always represented and performed as a reality or a fiction in relation to something else, mostly Europe (white); Africa is always the Dark Continent (black). The question is precisely what makes the representation of Africa so distinctive and different from the representation of other continents: it is that Africa is always represented and imagined, in ways that Asia, for example, is not necessarily, in relation to master references—Europe, whiteness, Christianity, literacy, development, technology (the comparative and colonizing tropes mutate continuously)—mirrors that reflect, indeed refract Africa in peculiar ways, reducing the continent to particular (negative) images of “lack” and “becoming,” lacking and becoming “Europe.” In short, Africa more than any other continent is the quintessential representational other of Europe; from the moment (historically understood) that the two continents became entangled with each other, the grammar of their self-definitions became distorted mirror images of the other.

From this angle it can be seen why Eurocentric and Afrocentric representations of Africa are so deeply implicated with

each other, why the inclusion or exclusion of North Africa is so crucial to both of them, why their discursive possessiveness centers on Egypt. At stake is the civilizing authority and antiquity of Africa. The contemporary debate about the Africanness, and for some the “blackness,” of ancient Egypt was launched by Cheikh Anta Diop's provocative book, *The African Origin of Civilization: Myth or Reality* (1974). Afrocentric scholars in the United States led by African American scholar Molefi Asante, who coined the term *Afrocentricity*, picked up and popularized Diop's ideas.

But it was not until a European American scholar, Martin Bernal, published his tome *Black Athena* (1987, 1991), affirming the “blackness” of the ancient Egyptians and their enormous contributions to Greek civilization—the cradle of Western civilization—that Afrocentric claims received attention in the mainstream American and international academic media. Among those who were outraged was the classicist Mary Lefkowitz who vehemently attacked Bernal and the Afrocentric movement as a whole for its alleged “myths.”

For many African scholars the debate about the race of the ancient Egyptians seemed rooted more in American preoccupations with race than African history as such. To some of them blackness is less about race and more about representation, a sign not of submission to the Hegelian and colonialist schema of inferior difference, but of subversion and struggle against it. They see black identity as the result of political, social, and cultural negotiations, cooperation, transactions, differences between self and the other that goes beyond skin color; it is about the common experience of pain, exploitation, and suffering shared by an oppressed people and is deployed as a powerful symbol of subversion, struggle, and self-affirmation. It was in this sense that the term *black* was extended to “coloreds” (people of mixed race, Indians, and people of Asian descent) in South Africa in the 1970s and 1980s, and used to refer to people of African and Asian descent in Britain.

Others denounce the use of *race* altogether as a biological determinism that should have no place in Africanist scholarship while affirming the possibilities of (forging) a common African identity. Kwame Anthony Appiah is perhaps the most renowned proponent of this critique in his book *In My Father's House* (1992). Appiah is unsparing in his attack on the dangerous fictions of race and racist thinking and takes direct aim at some of the icons of Pan-Africanism, including W. E. B. Dubois (1868–1963). He seeks to demolish essentialist conceptions of Africa and demonstrate that Africa is not a primordial fixture, but an invented reality, and Africans are not molded from the same clay of racial and cultural homogeneity. This is a celebration of the diversity, complexity, richness, hybridity, and contingency of African identities and social and cultural life, mounted to challenge the totalizing narratives of both African nationalism and European imperialism with their dualistic and polarized representations of Africa and African identities and culture.

Critics of Appiah and Mudimbe and other postcolonial and postmodern African scholars such as Achille Mbembe, who also dismiss “nationalist” or what they sometimes refer to as “nativist” definitions of African identities, have pointed out

that despite these writers' celebratory analyses of the plurality and social construction of African identities, their work is not always sufficiently historicized and is trapped in the "colonial library"—Western episteme—and virtually ignores the "Islamic library"—African writings in Arabic and Arabic script—which would radically shift their conceptions of African thought and ideas of self-representation.

These shortcomings are readily evident in Appiah's book, for example, when he compares the different roles of religion and the modes of thought in what he calls the traditional oral cultures of Africa and the industrialized literate cultures of the West. The comparisons drip with a fundamental tension rooted in a binary conception of African "orality" and European "literacy." This is a problematic formulation, not only because he draws his African examples largely from one culture, Asante, but the conflation of orality with Africa and literacy with Europe is simply false if the "Islamic library" is taken into account. Also, the framing of "traditional" Africa versus "modern" Europe locks both Africa and Europe in a temporal binary that effectively dehistoricizes each. The irony, then, is that despite his best intentions Appiah ends up with an essentialized Africa with an ontological essence—lacking the supposedly European attributes of literacy—and a racialized one as well in that his analysis is confined to sub-Saharan Africa.

Geographical Conceptions of Africa

If we dispense with the racial conceptions of Africa, we are left with geographical and historical notions, Africa as a spatio-temporal construct that is at once a process, product, and a project of a complex and contradictory historical geography. The concept of historical geography, sitting at the intersection of two disciplines, has allowed scholars to combine the spatial and temporal interests of geography and history, to understand that the physical environment and human agency are mutually constitutive, that people's creativity and thought produce places as much as places produce people's cultures and identities, in short, that landscapes are not only important aspects of culture, they are products of historical processes.

Whereas nobody denies that a geographical entity called "Africa" exists, for some this is merely a cartographic reality not a cultural one, an exercise in mapping devoid of experiential meaning for the peoples that have lived within the continent's porous borders. They would be right, some contend, if the argument were that Africa's peoples have always been conscious of living in a place called "Africa." Clearly, they have not, no more than people who in the twenty-first century are called "Asians" or "Europeans" have always had such a spatial consciousness. Historically, local spatial identities, encapsulated and articulated in ethnic, regional, and national terms, have been far more important, while broader (continental) spatial imaginaries have tended to develop as the processes of globalization, understood here to mean the expanding circuits of transregional connectedness, have grown in extensity and intensity.

Thus, in Africa, as elsewhere in the world, there is a hierarchy of spatial identities that are interwoven and interactive in complex ways engendering multiple cultural identities. Space and the spatial stage contextualize cultures, economies,

and politics, and invent and inscribe places and landscapes with ethical, symbolic, and aesthetic meanings. "Space" is created," argues Doreen Massey, "out of the vast intricacies, the incredible complexities, of the interlocking and the non-interlocking, and the networks of relations at every scale from local to global" (pp. 155–156). Space, then, is not a static and passive template of social existence, but an active, constitutive force of the social's very composition and construction.

Seen in this way, then, the multiple mappings of Africa are indeed to be expected. The numerous peoples and societies that have carved out a place of their own across this vast continent have, in a sense, been creating their little Africas, each laying their bricks of African identity across the huge and intricate cartographic, cognitive, and cultural construct known as "Africa." Therefore, a geographical conception of Africa does not need the existence of racial solidarity or the invention of cultural homogeneity. But this is not an empty cartographic vessel either in so far as the diverse cultures and identities that have emerged and have yet to emerge have been and will continue to be shaped by the mapping and materiality of Africa as an ever changing spatial entity and social construct.

The map of Africa, as with all maps, entails many things. Maps are not simply representations of the geographical world. A map is, as David Woodward and Malcom Lewis argue in their massive global history of cartography, simultaneously a cognitive system, a material culture, and a social construction. They speak of "cognitive or mental cartography," "performance or ritual cartography," and "material or artifactual cartography." Recent studies on indigenous cartography in Africa demonstrate that all three have been employed by Africa's various peoples to map, name, and claim their landscapes, stretched over varying scales of expansiveness.

In the nineteenth century, many European explorers solicited and used some of these maps to produce their own maps, which shows cross-cultural intelligibility between African and European maps. To quote Thomas Bassett: "Notwithstanding broad epistemological divides separating Europeans from various African cultural groups, it appears Europeans had little difficulty in reading these maps. Solicited maps demonstrate that Africans had the spatial competence and requisite sign systems to produce maps spontaneously. . . . Indeed, there is evidence that [these] maps were influential in shaping the form and content of European maps of the continent" (p. 37).

Quite clearly African maps influenced European mapmaking in the nineteenth and twentieth centuries in several ways. They enabled European explorers to construct or correct their maps, and were essential for topological determinations, and place-names, which were widely transcribed onto European maps. In turn, European influences also became increasingly discernible in African mapmaking in terms of the materials used, the northerly orientation of some maps (e.g., Ras Makonnen's famous map of Ethiopia of 1899), and the methods employed in their construction (e.g., Cameroonian King Njoya's topographic survey from 1912 to 1916).

For more than fifteen hundred years maps of Africa produced in northern Africa, southern Europe, and western Asia

had reproduced the maps made by Ptolemy in Alexandria in the second century B.C.E., only “altering them slightly to suit their needs” (Mbodji, p. 44). The creation of new and more accurate maps of continental Africa began with the emergence of “scientific” cartography and the beginnings of European global voyages and conquests in the fifteenth and sixteenth centuries, although it was not until the mid-nineteenth century that the broad external and internal contours of the continent were finally filled out as we know them today. The European mapping of Africa was implicated with imperialism both directly and indirectly, directly in that mapmaking facilitated the voyages of exploration and colonization, and indirectly insofar as it was part of the ideological architecture of inscribing European nationalisms at home and forging collective European grandeur globally: from Gerardus Mercator’s (1512–1594) projection, still widely used in the twenty-first century, tiny Europe was inflated in size and massive Africa was dwarfed. It was almost as if Africa’s civilizational diminution had to be accompanied by a cartographic one.

Upon this shriveled “blank darkness” Europe sought to write its cartographic and epistemic will by dividing the continent into colonies, themselves further splintered into allegedly primordial and antagonistic ethnic enclaves, a cognitive mapping sanctioned by the structuralist-functionalist paradigms of anthropology, the premier colonial science. But against the “tribalization” of Africa and African cultures and identities by the colonial administration and colonial anthropology, which were contested by local circuits of exchange, movement, and interaction so that borders served not simply as points of separation and struggle but often as places of convocation and conviviality, there emerged the countervailing elite paradigms, politics and projections of Pan-Africanism, the progenitor of the numerous territorial nationalisms in Africa.

As an ideological, intellectual, and institutional formation Pan-Africanism embodied within itself conflicting tendencies and imaginaries of Africa, premised on racial, spatial, and ideological constructs. While there always existed different versions of Pan-Africanism premised on diverse spatial conceptions of Africa (for example, trans-Atlantic Pan-Africanism embraced the African diaspora in the Americas), the one that received lasting institutional expression for independent African states was continental Pan-Africanism, which was sanctified in 1963 with the formation of the Organization of African Unity (OAU). In 2001 the African Union (AU), a more ambitious project of continental unification, succeeded the OAU.

The formation of the OAU and later the AU entailed a remapping of Africa, the creation and consumption of new national, regional, and continental maps that were produced, performed, and internalized everywhere from schools, the media, and academic and political conferences, to international forums where regional blocs assumed representational identities. In short, “Africa” the map and the place was becoming increasingly “Africa” the idea and the consciousness, buttressed by an intricate web of hundreds of continental institutions covering an ever expanding range of spheres from politics, the economy, environment, health, education, and culture, to technical cooperation and the prosaic world of leisure involving

competitive games and sports and forms of popular entertainment.

By the beginning of the twenty-first century, “Africa” was perhaps more “African” than it had ever been in its history, that is to say, more interconnected through licit and illicit flows of commodities, capital, ideas, and people, not to mention multilateral conflicts and ecological and health panics, and more conscious of its collective identity in the global panorama and hierarchy of regional identities. The historical geography of Africa had been stretched and deepened despite, on the one hand the centrifugal push of spatial and social identities within the continent itself (some of which degenerated into destructive conflicts including civil wars, massive migrations, and state collapse), and on the other the centripetal pull of contemporary globalization and its “glocalization” effects—its tendency to simultaneously internationalize and localize identities and cultures—and the enduring seductions of extracontinental alliances for some regions and countries.

Historical Conceptions of Africa

From the discussion above it is evident that Africa and African identities can be conceived both as states of being and of becoming. In other words, “Africa” is a dynamic historical process, a messy spatio-temporal configuration of agency, structure, and contextuality that is subject to change, which is not always easy to perceive or predict. Africa, in this sense, has emerged out of the complex histories of the continent’s peoples. Indeed, African historians have been in the forefront of constructing Africa as a coherent and complex object of study, investing the continent with a distinctive civilizational identity. They were among the first to take up the Eurocentric lie that Africa was a continent and Africans were a people “without history,” an indictment intended to devalue their humanity.

The pivotal and central role of historians is precisely to propose a space, an axis to locate and make sense of the human experience, politically, socially, culturally, and economically. Needless to say, there are different types of African historians in terms of their training and institutional locations and methodological and theoretical orientations. Academic historians compete with “traditional” and popular historians in public historical discourse, so that there are continuous contestations about space, communities, and histories. But academic historians have tended to dominate in the production of the history of the postcolonial nation and the continental imaginary called Africa.

Once the dominant tendency was to produce linear and celebratory narratives of the nation and the continent, in which colonialism was reduced to a parenthesis or an episode, then the various subalterns wearing the identities of class, gender, or generation joined the historians’ parade, before the postal turn (poststructural, postmodern, and postcolonial theories) that sought to reveal the fictionality of the whole enterprise, that the past is largely imagined, constructed, or invented. The better historians had always seen and constructed history as a series of messy, multiple, complex, and often conflicting processes and discourses about the past, produced simultaneously at local, national, and transnational levels, themselves

connected and constructed in intricate and contradictory and ever changing ways.

By the end of the twentieth century, academic historians had produced a phenomenal amount of scholarship, invented and refined methodologies of research, and excavated the histories of African politics, societies, economies, cultures, and environments from the onerous weight of Eurocentric derision and Afrocentric romanticism. The publication of the UNESCO (1981–1993) and Cambridge (1977–1985) histories of Africa marked the apotheosis of this spectacular scholarly achievement. To be sure, there is much one can criticize about African historiography methodologically and theoretically, but the fact remains historians have written extensively on the development and invention of African cultural traditions and identities over time that make it possible to research, write, and teach about “African” history as a distinctive field, even if complexly connected to other histories, especially of “Europe.”

Despite their prodigious production since independence, African historians, not to mention scholars from other disciplines, have not generally been anxious to propose the defining characteristics of Africa, the essential elements that constitute its development as an idea and a historical geography. The most renowned model is the one proposed by Ali Mazrui, the notion of the “triple heritage,” that the African world is constituted by the confluence of three civilizations: the indigenous (traditional), Western (Christianity), and Arabic (Islam).

The three forces apparently exhibit enormous variations in their spatial and temporal manifestations, some are more dominant in certain regions, countries, and societies, and one could add here among certain classes and genders and at certain times, than in others. But the journey in Mazrui’s gnosis seems not to be toward the harmonious and universal synthesis of the Negritude writers and philosophers, who posited a duality between Africa and Europe, reason and emotion, materialism and morality, humanity and nature, out of whose dialectical encounters and reconciliation a universal civilization would be forged. Rather it is toward a triumphant resurgence and reclamation of Africa’s cultural spaces by tradition and Islam.

Mazrui did not invent the trilateralist view of Africa and its cultures and identities, that contemporary Africa contained an allegedly uneasy mixture of traditional, Western, and Islamic values and practices. The idea can be traced back to the 1887 work of Edward Blyden (1832–1912), the great nineteenth-century Liberian intellectual, for whom the modern “African personality,” as he called it, was formed and would flourish out of the organic integration of the best elements from indigenous culture, Islam, and European science and Christianity. Kwame Nkrumah (1909–1972), the Pan-African activist and intellectual and Ghana’s first president, elaborated on Blyden’s notion of the “African personality” in his concept of consciencism, a cultural and cognitive synthesis between the humanistic and socialist ethos of “traditional” Africa, the acquisitive capitalist values and redemptive Christian hopes of the “West,” and the holistic secular and spiritual precepts of Islam. Forged out of this crucible, the “African personality”

would emerge, modern, assured, and liberated, ready to take its rightful place in the world.

Nkrumah has been faulted for not giving the traditional and Islamic legacies the kind of serious analysis accorded the Western one in his book *Consciencism* (1964). Part of some critics’ unease with Nkrumah’s schema is based on doubts that there indeed exists an exclusive and distinctive African traditional culture or a homogeneous African cultural universe. The same critique has been leveled against Mazrui, who has been attacked for what some regard as his evident partiality to Islam as the more benevolent force than the European-Christian and indigenous parts of the triad. In his withering critique of Mazrui’s television series, *The Africans: A Triple Heritage*, Soyinka accused Mazrui of denigrating indigenous religions and cultures, a charge Mazrui vigorously denied (Mazrui and Mutunga).

The Mazrui-Soyinka debate over Mazrui’s television series underscores the unresolved issues and stakes in contemporary definitions of Africa and Africanness. As noted with reference to Appiah above, both Soyinka and Mazrui do not historicize the moral, societal, and cultural values that constitute African identities. Their ethnographic notions of tradition are problematic; they ignore the sedimentations of exchanges, adaptations, inventions, and changes that the traditions in question, whether seen positively or negatively, have undergone. Often forgotten in these debates are several basic questions, such as how foreign, indeed, are Christianity and Islam to Africa, if we can restrict ourselves to the religious dimensions of the triple heritage for a moment. As histories of both religions clearly indicate, Christianity and Islam were implanted in certain parts of Africa almost at their inception and Africans made significant doctrinal contributions to both religions long before they were introduced to many parts of Europe and Asia where they are considered “indigenous,” “traditional,” or at least their “foreign” pedigree is not always emphasized.

This is to suggest that while the notion of the “triple heritage” highlights the diverse sources of African identities and cultures and seeks to clarify the complex streams that have flowed into their making, it flirts with an essentialized and almost ahistorical notion of a primordial Africa, a “real Africa,” that somehow exists alongside external cultural diffusions, a narrative that is quite reminiscent of the misguided searches for a Hegelian “Africa proper.” The inadequacies of the Blyden-Nkrumah-Mazrui cultural typologies do not mean that all attempts at creating such schemas are mistaken or doomed. Typologies or conceptual categories are essential to intellectual analysis; they are intended to clarify complex social phenomena. Difficulties often arise when the categories cease to be explanatory devices sensitive to human agency, social structure, and spatiotemporal contexts and begin to wallow in their own transcendental magnificence.

Conclusion

It is quite evident that there is no agreement on what “Africa” means, let alone how to define African identities beyond what can only be provisional and partial conceptualizations and categorizations. Yet, we all believe we know what “Africa” is, what

it must be, but when we think we have finally seen it, felt it, touched it, captured and tamed it with our terms of endearment, aversion, or indifference it suddenly melts away into a mirage beyond the assured and unilateral classifications of race, representation, geography, or history. Perhaps wisdom lies in accepting the simple proposition that Africa is indeed many things, a mélange of peoples, places, practices, processes, projects, and possibilities that are both unique and common in their configuration over time and space.

Africa is, in short, a critical site of the human drama, the original homeland, as modern archaeology and genetics tell us, of humanity and it continues to be the continent that hundreds of millions of people in all their marvelous and sometimes bewildering complexities, colors, and cultures still call home. Who can claim the right to divine who belongs or does not belong to its porous boundaries and the histories and memories etched on and eked out of its variegated landscapes? The idea of "Africa," it would seem, will continue to elude any definitive conceptualization that is premised on exclusive claims of race, geography, or history because it is a phenomenon that is always in a state of becoming.

See also Afrocentricity; Afropessimism; Authenticity: Africa; Ethnicity and Race; Ethnocentrism; Eurocentrism; Europe, Idea of; Maps and The Ideas They Express; Multiculturalism, Africa; Other, The, European Views of; Pan-Africanism.

BIBLIOGRAPHY

- Amin, Samir. *Eurocentricism*. Translated by Russell Moore. New York: Monthly Press, 1989.
- Appiah, Kwame Anthony. *In My Father's House. Africa in the Philosophy of Culture*. New York: Oxford University Press, 1992.
- Asante, Molefi Kete. *The Afrocentric Idea*. Philadelphia: Temple University Press, 1987.
- . *Afrocentricity: The Theory of Social Change*. Rev. ed. Trenton, N.J.: Africa World Press, 1988.
- Bassett, Thomas J. "Indigenous Mapmaking in Intertropical Africa." In *The History of Cartography: Cartography in the Traditional African, American, Arctic, Australian, and Pacific Societies*, edited by David Woodward and G. Malcolm Lewis, 24–48. Vol. 2, Book 3. Chicago and London: University of Chicago Press, 1998.
- Bernal, Martin. *Black Athena: The Afroasiatic Roots of Classical Civilization*. 2 vols. New Brunswick, N.J.: Rutgers University Press, 1987–1991.
- Blyden, Edward Wilmot. *Christianity, Islam and the Negro Race*. 1887. Reprint, Edinburgh: Edinburgh University Press, 1967.
- Curtin, Philip D. *The Image of Africa: British Ideas and Action, 1780–1850*. Madison: University of Wisconsin Press, 1964.
- Diop, Cheikh Anta. *The African Origin of Civilization: Myth or Reality*. Translated by Mercer Cook. Chicago: L. Hill, 1974.
- Fage, J. D., and Roland Olivier, eds. *Cambridge History of Africa*. Cambridge, U.K., and New York: Cambridge University Press, 1977–1985.
- Falola, Toyin, and Christian Jennings, eds. *Africanizing Knowledge: African Studies Across the Disciplines*. New Brunswick, N.J.: Transaction, 2002.
- Gyekye, Kwame. *Tradition and Modernity: Philosophical reflections on the African Experience*. New York: Oxford University Press, 1997.
- Hansberry, William Leo. *Africa and Africans as Seen by Classical Writers*. Edited by Joseph E. Harris. Washington, D.C.: Howard University Press, 1977.
- Hegel, G. W. F. *The Philosophy of History*. Translated by S. Sibley. New York: Dover, 1956.
- Hunwick, John. "The Same But Different: Africans in Slavery in the Mediterranean Muslim World." In *The African Diaspora in the Mediterranean Lands of Islam*, edited by John Hunwick and Eve Trout Powell, ix–xxiv. Princeton, N.J.: Markus Wiener, 2002.
- Ki-Zerbo, Joseph. "General Introduction." In *General History of Africa*, edited by J. Ki-Zerbo. Vol. 1: *Methodology and African Prehistory*. London: Heinemann, 1981.
- Lefkowitz, Mary. *Not Out of Africa: How Afrocentrism became an Excuse to Teach Myth as History*. New York: Basic Books, 1996.
- Massey, Doreen. "Politics and Space/Time." In *Place and the Politics of Identity*, edited by Michael Keith and Steve Pile. London and New York: Routledge, 1993.
- Mazrui, Alamin M., and Willy M. Mutunga. *Debating the African Condition: Ali Mazrui and His Critics*. Vol. 1. Trenton, N.J.: Africa World Press, 2003.
- Mazrui, Ali A. *The Africans: A Triple Heritage*. Boston: Little, Brown, 1986.
- Mbembe, Achille. *On the Postcolony*. Berkeley: University of California Press, 2001.
- Mbodji, Mohammed. "'Sop Geographers in Africa Maps with Savage Pictures Fill Their Gaps': Representing Africa in Maps." In *Contested Terrains and Constructed Categories: Contemporary Africa in Focus*, edited by George Clement Bond and Nigel C. Gibson, 37–58. Boulder, Colo., and Oxford: Westview, 2002.
- Miller, Joseph C. "History and Africa/Africa and History." *The American Historical Review* 104, no. 1 (1999): 1–32.
- Mudimbe, V. Y. *The Idea of Africa*. Bloomington and Indianapolis: Indiana University Press, 1994.
- . *The Invention of Africa: Gnosis, Philosophy, and the Order of Knowledge*. Bloomington: Indiana University Press, 1988.
- Nkrumah, Kwame. *Consciencism: Philosophy and Ideology for Decolonization with Particular Reference to the African Revolution*. New York: Monthly Review Press, 1964.
- Olukoshi, Adebayo, and Francis Nyamnjoh. "Editorial." *CODESRIA Bulletin* nos. 1–2 (2004): 1–2.
- Said, Edward W. *Orientalism*. New York: Pantheon, 1978.
- Soyinka, Wole. "The Scholar in African Society." In *Second World Black and African Festival of the Arts and Culture. Colloquium on Black Civilization and Education. Colloquium Proceedings*, edited by A. U. Iwara and E. Mveng, 44–53. Vol. 1. Lagos: Federal Government of Nigeria, 1977.
- Spivak, Gayatri. "Theory in the Margin: Coetzee's *Foe* Reading Defoe's *Crusoe/Roxana*." In *Consequences of Theory*, edited by Jonathan Arac and Barbara Johnson. Baltimore: Johns Hopkins University Press, 1991.
- Taiwo, Olufemi. "Exorcizing Hegel's Ghost: Africa's Challenge to Philosophy." *African Studies Quarterly* 1, no. 4 (1997). Available on the Internet at <http://web.africa.ufl.edu/asq/>.
- UNESCO General History of Africa*. Vols. 1–8. London: Heinemann, 1981–1993.
- Woodward, David, and G. Malcolm Lewis. "Introduction." In *Cartography in the Traditional African, American, Arctic,*

Australian, and Pacific Societies, edited by David Woodward and G. Malcolm Lewis, 1–10. Vol. 2, Book 3. Chicago and London: University of Chicago Press, 1988.

Zezele, Paul Tiyambe. *Manufacturing African Studies and Crises*. Dakar, Senegal: Codesria Book Series, 1997.

Paul Tiyambe Zezele

AFRICAN-AMERICAN IDEAS. For four hundred years, African-Americans have been engaged in a fierce struggle, a struggle for freedom, justice and equality, empowerment and self-determination, or social transformation, depending on one's ideology and its discourses. The lived African-American experience, in its class, gender, generational, and regional specificity, and the struggle against black racial oppression in the form of black social movements, are the soil from which African-American political and social thought are produced. Different social movements—abolition, the nineteenth-century Great Black March West (1879–1910), the protective leagues during the nadir (1877–1917), the New Negro Movement of the early 1900s, the Depression-era struggles, and the civil rights and black power movements of the 1960s—have developed distinct goals and objectives and consequently have evolved quite different strategies, ideologies, and discourses. Contrary to popular opinion, African-American political thought has always been a roiling sea of competing ideological currents. Political scientist Robert C. Smith described ideology as “the enduring dilemma of black politics” because of its variety and vibrancy. The tradition of viewing African-American history through the lens of historical debate underscores the diverse and dynamic character of African-American political discourse. For instance, it is popular to compare and contrast the ideas of Frederick Douglass (1817–1895) and Martin R. Delany (1812–1885), W. E. B. DuBois (1868–1963) and Booker T. Washington (1856–1915), and Marcus Garvey (1887–1940), Ida Wells-Barrett (1862–1931) and Margaret Murray Washington (1863–1953) or, more recently, Martin Luther King (1929–1968) and Malcolm X (1925–1965).

In the popular imagination, African-American political thought has been reduced to two ideological streams, black nationalism and integrationism. Harold Cruse, author of the influential but flawed *Crisis of the Negro Intellectual*, crystallized this binary framework into a Manichean perspective that characterized African-American history as primarily a conflict between proponents of these two ideologies. Cruse did not invent this conceptualization—August Meier had previously asserted it—but he made it the dominant interpretative schema in black political philosophy.

The binary framework has been challenged on two fundamental premises. One group has sought to complicate the categories of black ideologies. Anthropologist Leith Mullings, historian Manning Marable, and political scientists Robert C. Smith and Michael C. Dawson, among others, have offered more comprehensive frameworks. Adding radicalism to nationalism and integrationism, Smith conceives of three major African-American ideologies: black nationalism, integrationism, and radicalism. Mullings and Marable discern three “strategic

visions” in black political thought, which they term *inclusion*, *black nationalism*, and *transformation*. Interestingly, Mullings, Marable, and Smith would acknowledge conservatism as a distinct political perspective; yet, because they do not view it as politically salient before the 1990s, they have not conceptualized it as a major ideology among African-Americans. Dawson's framework, in contrast, includes black conservatism among the six “historically important” black ideologies he identifies: black nationalism, black liberalism, including three streams, black feminism, and black radicalism.

Taking a very different approach, sociologist John Brown Childs eschews the conventional debates over ideology to identify two worldviews, which he argues constitute the “coherent systematic approach” that undergirds political ideologies. Seeking to uncover the “conceptual currents” beneath strategic conflicts among social justice activists, Childs identifies two irreconcilable worldviews, the vanguard and mutuality perspectives. According to Childs, vanguard approaches posit an elite that possesses knowledge of the “way,” which they bestow upon the ignorant and impose on the defiant. In contrast, mutuality approaches advocate praxis built on sociohistorical correspondence, communication, diversity, cooperation, (self-) transformation, and openness, and reject notions of a leading group. Despite the potency of Brown's insights, most scholars of black history and politics have continued to chart African-American social movements and individual activist intellectuals via their ideologies, rather than their worldview or organizing approach.

African-American Ideologies

Several ideologies salient among African-Americans require explication. Here, *ideology* is considered as a systematic theory of society composed of a relatively coherent set of interdependent concepts and values that adherents construct into historical narratives and contemporary discourses to articulate their interpretation of a social groups' economic, political, social interests, and cultural beliefs to rationalize particular public policies. The emergence and salience of African-American ideologies are conditioned by three broad factors: the sociohistorical context, the contemporary discursive matrix, and the black intellectual tradition. It is important to contextualize African-American ideologies historically because they develop during particular historical moments, and their discourses are designed to resolve or, at least, to respond to historically specific problems. Moreover, sociohistorical context not only shapes the emergence of specific ideologies, it also conditions the form and salience an ideology takes at a particular moment. African-American history can usefully be considered as a succession of different racial formations. Black racial formations represent African-Americans' distinct position within the U.S. political economy, polity, and civil society during particular historical periods.

African-American history can be divided into four periods: (1) slavery, 1619–1865; (2) the plantation economy, 1865–1960s; (3) proletarian and urbanization, 1940s–1979; and (4) the new nadir, from 1980 on.

Within the realm of ideation, African-American political thought evidences the dynamic interplay between African-American discourses and the dominant and emergent ideas

circulating during particular historical periods. Contemporary events and discourses present in the United States and the world establish the contemporary examples and discursive matrix with which these African-American ideological discourses engage. Perhaps more pertinent, however, is knowledge of past debates among the black counterpublic and how previous black intellectual traditions have influenced historically specific policy formulations.

Because racial oppression is a system constructed around a matrix of domination, discrimination, and degradation, an appraisal of African-American political and social thought reveals that black activist intellectuals have mainly engaged two issue clusters: those that revolve around questions of *identity* and those concerning questions of *liberation*: “Who are we?” and “What is our present situation, and what should be done about it?” During slavery, the system of racial oppression attempted to destroy African identities, ethnic memories and cultural practices, and the collective and personal identities that derived from them. Since slavery it has sought to make African-Americans nonpersons, requiring, therefore, the search for and (re)assertion of new identities woven from the residue of African survivals and self-interested adaptations, a process that transcends the limits of what is derisively called “identity politics.” Identity questions for oppressed racialized communities are fundamental to the pursuit of liberation. These overarching questions about identity, the present situation, and what should be done to create conditions of freedom, self-determination, and social transformation have elicited different answers from different groups of black activist intellectuals.

Allowing for terminological differences, most scholars of black history and politics would agree that African-American activist intellectuals have justified their political action via an interpretative repertoire drawn from one of the following five interrelated ideological approaches: (1) autonomic, (2) incorporative, (3) black conservatism, (4) black radicalism, and (5) black feminism.

Black Nationalist Ideologies

Black nationalist, or *autonomic*, strategies are the oldest ideological approaches developed by African-Americans. The slave revolts, especially those before the nineteenth century, that aimed to create maroon societies modeled after remembrances of African social organizational patterns perhaps best reflect the anteriority of black nationalism among African-American ideologies. Autonomic approaches are also the most varied and complicated of African-American ideologies, but they can be divided into two broad categories: *protonationalism* and *separatism*. Protonationalism refers to strategic visions that emphasize autonomy in the realm of civil society, the desire to reside in semiautonomous towns and regions, and the preference for preserving distinct cultural practices. Richard Allen’s (1760–1831) creation of the African Episcopal Methodist Church in 1794 and W. E. B. DuBois’s call for blacks to build on their group strengths in the 1930s or the 1960s era campaigns for “community control” of African-American communities are examples of protonationalism.

Separatism has a more delimited terrain, encompassing emigration and efforts to create an independent African-American

nation-state within the United States, such as Martin R. Delany’s and others’ proposals to emigrate to Africa, Canada, or South America during the 1840s and 1850s; Marcus Garvey’s 1920s plan to repatriate to Liberia; or the Republic of New Africa’s 1960s desire to create an African-American nation-state in the U.S. South.

Autonomic discourses are shaped by their sociohistorical context; they tend to surge and ebb in relationship to the economic and political position of blacks in U.S. society. As a rule, black nationalism swells during sustained economic downturns. Autonomic philosophies are also sensitive to the interplay of dominant and emerging ideologies. This is particularly true regarding questions of cultural difference. For instance, between 1850 and 1925, the era historian Wilson Moses terms the golden age of black nationalism, nationalists were ambivalent toward African culture and rejected Africanisms or cultural carryovers. Like the social Darwinists of the day, they often viewed Africans and African-Americans as “underdeveloped” or even “backward,” although they usually ascribed environmental or religious, rather than genetic, causes. Consequently, they preferred European-American high culture. To a large extent, black power, the protonationalism that developed during the “turbulent sixties” (1955–1975) was predicated on *Africanization*, the adoption of actual or imagined African cultural values and practices.

Evidence from several years of the National Black Politics Study from 1979 to 1992 suggests that proto-black nationalism remained the predominant perspective of the majority of African-American people in the late twentieth century. For instance, political scientists Darren W. Davis and Ronald Brown discovered that 84 percent of African-Americans believed blacks should buy from black-owned businesses; 83.3 percent believed blacks should be self-reliant; 73.8 percent wanted blacks to control their communities’ economics; and 68.3 percent believed blacks should govern their communities. Another 70.7 percent thought black children should learn an African language, and 56.5 percent advocated participating only in all-black organizations.

African-American Liberalism

Liberalism is the second oldest black ideology. Scholars often insert “liberal” as an adjective to describe the political values associated with the incorporativist perspective in order to distinguish this set of discourses from conservative and radical approaches, which also advocate incorporation into U.S. society, albeit for radicals into a fundamentally transformed society. And some variants of nationalism and feminism are decidedly liberal in their political social perspectives. Here *incorporative* should be understood as synonymous with *liberal pluralism*.

Smith has argued that liberalism, or incorporativism, is not so much an ideology as a strategy. Applying the logic Anthony Bogues used regarding Quobna Cugoano’s *Thoughts and Sentiments on the Evil of Slavery* to the work of Douglass, DuBois, Charles Johnson, Alain LeRoy Locke (1886–1954), Martin Luther King, Jr., Thurgood Marshall (1908–1993), Mary Frances Berry (b. 1938), and Lani Guiner (b. 1950), among

others, illuminates how their critiques of U.S. society stretched the boundaries of liberal pluralism and provided alternative theories of American democracy.

Incorporative approaches advocate structural integration into the U.S. state and political economy, arguing that the inclusion of African-Americans in traditionally white institutions *in and of itself* constitutes a significant transformation. This is the view that undergirded the legal strategy Charles Hamilton Houston (1895–1950) designed for the National Association for the Advancement of Colored People (NAACP) during the 1930s and of the civil rights movement of the 1960s.

Incorporativists are more ambivalent toward inclusion in European-American civil society: they tend to oppose restrictions barring access to traditionally white institutions, but usually oppose dismantling African-American institutions. For instance, Martin Luther King, Jr. never imagined the dissolution of the black church. Historically a few incorporativists, such as Frederick Douglass, have advocated biological assimilation as well as structural integration. Incorporative approaches generally encourage acceptance of bourgeois European-American cultural values and practices, viewing them as quintessentially “modern,” even though privately many incorporativists often continue to practice the styles and idioms of African-American culture.

While tension exists between the core components of white liberalism and black incorporativism, particularly regarding individualism and notions of equality—equal opportunity versus equality of results—incorporativists generally share their white colleagues’ views on the power of knowledge, the value of diversity, and economic enterprise. Incorporativists are also skeptical of American liberalism’s assertions of pluralism, especially the assertion that the U.S. state is neutral regarding racial and ethnic disputes. Although incorporativists are often critical of the practice of American liberalism, they tend to accept most of its values.

African-American Radicalism

Perhaps more than any other ideology, black radicalism is sensitive to the sociohistorical context. During the slavery period, the radical black perspective advocated the immediate destruction of slavery and the extension of full civil rights to black people. After slavery, as most African-Americans were being incorporated into the semicapitalist plantation economy, things became more complex. Confronting sharecropping, black radicalism required more than the advocacy of black landownership. Circumstances required that black radicals develop a critique of the capitalist system that maintained the plantation economy. Whereas during slavery Frederick Douglass and Martin R. Delany were radicals, during Reconstruction and the first nadir (1877–1917) Douglass became the quintessential black liberal while Delany descended into conservatism. This hypersensitivity to sociohistorical context derives from the general premises of radicalism: transformation of the fundamental structural and ideological elements of a society. Black radicalism has consisted of philosophies and practices that sought the essential transformation of the system of racial oppression and the social system that institutionalized it.

Peter H. Clark, the first modern black radical, joined the Socialist Party in 1877, during the first nadir. Ironically, Clark’s reasons for leaving the socialists probably affected the construction of black radicalism more than his reasons for joining. (Clark left the Socialist Party because it did not confront the specificity of race and racial oppression, preferring to view race as subordinate to class.) The outlines of a distinct black radical perspective, however, did not appear until after World War I, after Hubert H. Harrison (1900–1945), Cyril V. Briggs (1888–1966), and the African Blood Brotherhood (c. 1920s) examined the state of African peoples and the relationship of black and white radicals in the United States. Black radicalism was a unique effort to merge and remake classical Marxist theory and black nationalism into a race-conscious socialist theory. Although Ralph Bunche (1904–1971) and Abram Harris (1899–1963) were radical blacks during the 1930s, unlike W. E. B. DuBois, Langston Hughes (1902–1967), Claudia Jones (1915–1964), and C. L. R. James (1901–1989), their ideas might be too orthodox to be considered foundational for black radicalism. Black radicals, according to Anthony Bogues, are either *heretics* or *prophets*.

Heretics, usually highly educated in European-American radicalism, use subjugated knowledge from black experiences to challenge white radical orthodoxies and to rework them into theories that can accommodate black experiences and perspectives. Bogues’s prophets come from the realm of religion. They are often undereducated by U.S. standards. They tap subjugated knowledge from sources outside the mainstream academy: the Bible, the Koran, particularly esoteric interpretations of both. In addition to derived religious sources, prophets articulate, in Hobsbawm’s terms, an *inherent* ideology, one drawn from the murkier repositories of African survivals and popular culture. Noble Drew Ali (1866–1929) and the Moorish Science Temple, Elijah Muhammad (1897–1975) and the Nation of Islam, and Prince Asiel Ben Israel and the Original Black Hebrew Israelite Nation represent this type of black radicalism. (Note that, by this author’s criterion—opposition to the dominant mode of production—they would not be considered black radicals.)

In more recent times, Huey P. Newton (1942–1989) and the Black Panther Party (1960s), especially their theory of intercommunalism, the Revolutionary Action Movement (late 1960s), and the League of Revolutionary Black Workers (late 1960s) have represented the black radical perspective. Since the late twentieth century, the Black Radical Congress has represented this ideological tendency.

Black Feminism

Like modern black radicalism, black feminism is of comparatively recent origins, although its roots reach back into the nineteenth century. The earliest foreshadowings of this ideology are found in the slave-era speeches and writings of Maria Stewart (1803–1879), Sojourner Truth (c. 1797–1883), and Frances Ellen Watkins (1825–1911). The ideas that would ultimately become the ideology of black feminism developed to a large extent during the first nadir through the speeches, writing, and practices of Ida Wells-Barnett, Mary Church Terrell (1863–1954), and Anna Julia Cooper (1859–1964). While

black women activists, especially women associated with the U.S. Communist Party, such as Esther Cooper Jackson and Claudia Jones, engaged in practices and advocated philosophies that amounted to black feminism, the theory was not formally visible until the 1960s.

According to Linda Burnham, contemporary black feminism, with its emphasis on the simultaneity of overlapping oppressions—race, class, gender, sexuality—is a product of the transition from the civil rights to the black power movement. She locates the origin of this iteration of black feminism with the Student Nonviolent Coordinating Committee's (SNCC) Black Women's Liberation Committee and later the Third World Women's Alliance, in both of which Frances Beal (1900–1987) played a leading role. This stream of black feminism has become a core component of contemporary black radicalism. It can be sharply contrasted with another stream of black feminism, *womanism*, as articulated by Clenora Hudson-Weems, which is more correctly viewed as a tributary of conservative black nationalism.

African-American Conservatism

Black conservatism has a long history and includes a large number of prominent African-Americans. Nevertheless, it has never become a salient ideology for a significant number. Jupiter Hammond (1711–c. 1800) during the slave period, William Hooper Council (1848–1909) during the first nadir, George Schuyler (1895–1977) during the 1940s and 1950s, as well as A. G. Gaston (1892–1996) during the 1960s, represented conservative ideologies. However, none of these individuals shared the virulent antiblack positions of contemporary black conservatives. Black neoconservatives differ from previous generations of black conservatives in that they are often alienated from the black community and divorced from its institutional networks, especially political organizations.

Black conservatism articulates better with its mainstream equivalent than do the other black ideologies. Conservative approaches are premised on white American cultural values, particularly notions of individualism, which advocate *colorblind* individual incorporation into the U.S. political economy, polity, and mainstream white civil society. According to psychologist William Cross, Jr., race and the history and continuing practice of racial oppression are either denied or viewed as not salient by black neoconservatives in constructing their identities. Twenty-first-century black neoconservatives, Thelma Duggin, Clarence Thomas, Gwen Daye Richardson, and Ward Connerly, share the assumptions, interpretations, and goals of the leading white neoconservatives. Black neoconservatives blame the dislocations endemic to poverty on welfare and government subsidies. They claim the Great Society programs, instituted in the 1960s by President Lyndon Johnson, created a “culture of dependency” among the black poor. According to this perspective, instead of providing a social safety net, the Great Society created dependent personalities and an antiachievement culture in the black community. Perhaps more fundamental than the adoption of European-American cultural values is their reduction of African-American culture to a composite of pathological behaviors. Conservatives, including autonomic conservatives, generally reject the African cultural survival thesis.

Summary

The five major ideological expressions of social thought by which African-Americans have sought to reconstruct their racial/ethnic identity, to contemplate the structures, ideologies, and functions of racial oppression, and to envision a future free from that oppression constitute an extraordinarily complex body of evolving political theory. All are shaped by dynamic interaction with their sociohistorical experiences and the dominant and emerging ideologies and discourses in U.S. society and the world, especially pan-African ideas and the black intellectual tradition.

See also Afrocentricity; Assimilation; Black Consciousness; Civil Disobedience; Class; Conservatism; Critical Race Theory; Diasporas: African Diaspora; Discrimination; Diversity; Equality: Racial Equality; Feminism: Africa and African Diaspora; Liberalism; Negritude; Pan-Africanism; Philosophies: Feminist, Twentieth-Century; Political Protest, U.S.; Segregation; Slavery; Womanism.

BIBLIOGRAPHY

- Allen, Robert L. *Black Awakening in Capitalist America: An Analytic History*. New York: Doubleday, 1969.
- Bracey, John H., Jr., August Meier, and Elliott Rudwick, eds. *Black Nationalism in America*. Indianapolis: Bobbs-Merrill, 1970.
- Bogues, Anthony. *Black Heretics, Black Prophets: Radical Political Intellectuals*. New York: Routledge, 2003.
- Burnham, Linda. “The Wellspring of Black Feminist Theory.” *Southern University Law Review* 28, no. 3 (2001): 265–270.
- Bush, Rod. *We Are Not What We Seem: Black Nationalism and Class Struggle in the American Century*. New York: New York University Press, 1999.
- Cha-Jua, Sundiata Keita. *America's First Black Town: Brooklyn, Illinois, 1830–1915*. Urbana: University of Illinois Press, 2000.
- . “Racial Formation and Transformation: Toward a Theory of Black Racial Oppression.” *Souls: A Critical Journal of Black Politics, Culture, and Society* 3 (winter 2001): 25–60.
- Cha-Jua, Sundiata Keita, and Clarence Lang. “Providence, Patriarchy, Pathology: The Rise and Decline of Louis Farrakhan.” *New Politics* 8 (winter 1997): 47–71.
- Childs, John Brown. *Leadership, Conflict, and Cooperation in Afro-American Social Thought*. Philadelphia: Temple University Press, 1989.
- Collins, Patricia Hill. *Black Feminist Thought: Knowledge, Consciousness, and the Politics of Empowerment*. Boston: Unwin Hyman, 1990.
- Cross, Jr., William E. *Shades of Black: Diversity in African-American Identity*. Philadelphia: Temple University Press, 1991.
- Cruse, Harold. *The Crisis of the Negro Intellectual*. New York: Quill, 1984.
- Davis, Darren W., and Ronald E. Brown. “The Antipathy of Black Nationalism: Behavioral and Attitudinal Implications of an African-American Ideology.” *American Journal of Political Science* 46, no. 2 (2002): 239–252.
- Dillard, Angela. *Guess Who's Coming to Dinner Now?: Multicultural Conservatism in America*. New York: New York University Press, 2001.
- Glaude, Eddie S., Jr., ed. *Is It Nation Time?: Contemporary Essays on Black Power and Black Nationalism*. Chicago: University of Chicago Press, 2002.

- Grimshaw, Anna, ed. *The C. L. R. James Reader*. Cambridge, Mass.: Blackwell, 1992.
- Harding, Vincent. *There Is a River: The Black Struggle for Freedom in America*. New York: Harcourt Brace Jovanovich, 1981.
- Hudson-Weems, Clenora. *Africana Womanism: Reclaiming Ourselves*. Troy, Mich.: Bedford, 1993.
- Jeffries, Judson L. *Huey P. Newton: The Radical Theorist*. Jackson: University Press of Mississippi, 2002.
- Marable, Manning, and Leith Mullings. "The Divided Mind of Black America: Race, Ideology, and Politics in the Post-Civil Rights Era." *Race and Class* 36, no. 1 (1994): 61–72.
- McCartney, John T. *Black Power Ideologies: An Essay in African-American Political Thought*. Philadelphia: Temple University Press, 1992.
- Meier, August. *Negro Thought in America, 1880–1915: Racial Ideologies in the Age of Booker T. Washington*. Ann Arbor: University of Michigan Press, 1969.
- Neville, Helen A., and Jennifer Hamer. "'We Make Freedom': An Exploration of Revolutionary Black Feminism." *Journal of Black Studies* 31, no. 4 (March 2001): 437–461.
- Richardson, Marilyn, ed. *Maria W. Stewart, America's First Black Woman Political Writer: Essays and Speeches*. Bloomington: Indiana University Press, 1987.
- Robinson, Cedric. *Black Marxism: The Making of the Black Radical Tradition*. London: Zed, 1983.
- Smith, Robert C. "Ideology as the Enduring Dilemma of Black Politics." In *Dilemmas of Black Politics: Issues of Leadership and Strategy*, edited by Georgia Anne Persons, 200–215. New York: HarperCollins, 1993.
- Stuckey, Sterling. *Slave Culture: Nationalist Theory and the Foundations of Black America*. New York: Oxford University Press, 1987.

Sundiata Keita Cha-Jua

AFROCENTRICITY. Afrocentricity is a theory that emerged in the early 1980s in the United States within the academic context of African-American studies. Afrocentricity was articulated by Molefi Kete Asante, a professor of African-American studies at Temple University and creator of the first Ph.D. program in African-American studies in the nation, in three major essays published between 1980 and 1990.

Like most theories, Afrocentricity has come to be associated with different thrusts, some of which may even be contradictory or incompatible with the original definition of Afrocentricity. However, at its core, Afrocentricity is a theory concerned with African epistemological relevance, also referred to as centeredness or location. The ultimate goal of Afrocentricity is the liberation of African people from the grips of Eurocentrism. The primary and indispensable mechanism to achieve this goal is the fostering of African intellectual agency.

Historical and Intellectual Context

African-American studies academic units came into existence as a result of great political pressure on European institutions of higher learning in a demand for space for the African voice and experience in the late 1960s, during the Black Power movement. No longer satisfied to be culturally disenfranchised and to feel alienated from the classroom (Asante, 1990),

African-American students and community activists brought to the fore of the discussion the question of educational relevance for black people, arguing for a culturally inclusive and sensitive curriculum apt to produce scholars in tune with and committed to the betterment of their communities (Karenga). One of the major characteristics of black studies, therefore, has been a dual concern for academic matters and the life conditions of African-Americans, with African-American studies scholars expected to be scholar-activists.

However, if the political mandate of African-American scholars is clear, their intellectual mission has, on the other hand, been clouded with conceptual confusion since the very beginning. Particularly vexing has been the issue of the relationship between African-American studies and the Western academe, with much debate over the status of African-American studies as a full-fledged independent discipline, or rather a field of studies, devoted to the Black experience and yet operating within the confines of Western intellectual thought. At the core of this issue, however, lies the question of Eurocentrism, with the degree to which one seems willing to challenge European intellectual hegemony determining one's position in the debate over the intellectual status of African-American studies.

Eurocentrism is understood as the interpretation of all reality from the Western perspective, especially as it emerged during the European Age of the Enlightenment. That perspective developed both internally, with the development of a metaparadigm specific and relevant to Europe; and externally, in opposition to "others," especially African people. Hence there are at least four assumptions of that European metaparadigm that have played a major and negative role as far as black people are concerned: (1) all human beings evolve along the same line; (2) the European experience is universal; (3) Europeans are superior; and (4) "others" are defined by their experiences with Europeans. In other words, the European metaparadigm rests among other things on the belief in the superiority and universality of the European experience.

Indeed, in that linear and evolutionary schema of thought, the West claims that when it talks about itself, it is also ipso facto talking about all human beings. The history of all women, men, and children in the world supposedly naturally coincides with that of Europeans. The latter are thus implicitly or explicitly held to be the universal norm by which African intellectual, cultural, and social "progress" will be evaluated. However, if all human beings share a common essence, it is also obvious that they have not all reached the same stage of development. Indeed, it is rather clear, from reading European writers, that Europe precedes the rest of humankind, and time after time it is suggested that Africans must emulate Europeans in order to put an end to their inferior condition.

The expected outcome of such emulation has been a process of mental *conversion* (Mudimbe, 1988), predicated upon the belief that only through a careful imitation of Europeans would Africans improve their lot. While the ontological reduction of the colonized had been well understood as a necessary part of colonialism, the implications of the conversion process, on the other hand, had not been fully appreciated. This may be

precisely because the early African critiques of European colonialism (e.g., Frantz Fanon) still functioned within a fundamentally European conceptual framework, such as Marxism. Hence what was challenged was not Western modernity *per se*, but its abusive practices. Europe's tacit advancement of its own culture as some "no-man's cultural land"—its implicit claims to cultural neutrality and universality—was rarely questioned for it was not construed as problematic.

Such an approach, which was to be expected during those early days, would not allow one to understand the colonization process as the systematic imposition of the European worldview, grounded in a specific time and place yet parading as universal, on people whose cultural and historical experiences were quite different.

Afrocentric Organizing Principle and Concepts

Europe's attempted occupation of practically all human space resulted in Africans being considerably removed from their own cultural base to be relegated to footnote status, to the periphery, the margin of the European experience and consciousness. This mental disenfranchisement is held responsible for Africans often not existing on their own cultural and historical terms but on borrowed European ones. Africans are *dislocated* and, having lost sight of themselves in the midst of social decay, find it exceedingly difficult to orient themselves in a positive and constructive manner, a most difficult plight. *Relocation* is the remedy suggested by Afrocentricity. Only when Africans become *centered*, that is, when they consciously and systematically adopt ways, attitudes, and behaviors that are germane to their own cultural traditions and historical reality, can they hope to achieve freedom. In other words, African freedom is predicated upon the conscious activation of one's Africanness, that is, ultimately, with the exercise by African people of their own *agency*.

Afrocentricity further stresses agency as an African cultural imperative. Indeed, in African culture, ancestral traditions must be preserved and transmitted out of respect for one's personal and collective ancestors. Asante therefore defines Afrocentricity as "a frame of reference" generated by Africans themselves, based on African cosmology, axiology, aesthetic, and epistemology: "Afrocentricity is the study of the ideas and events from the standpoint of Africans as the key players rather than victims. This theory becomes, by virtue of an authentic relationship to the centrality of our own reality, a fundamentally empirical project" (1991, p. 172). Asante further insists that while one may argue over the meaning of Africanness, one cannot argue, as an Afrocentrist, over "the centrality of African ideals and values" for African people (1990, p. 6), thus identifying the notion of cultural, and more specifically, epistemological centeredness as *the Afrocentric organizing principle*. In addition to this major principle, Afrocentricity includes a set of unquestioned propositions that it inherited from its intellectual and ideological antecedents, namely, Garveyism, the negritude movement, Fanonism, Kawaida, and Cheikh Anta Diop's historiography. Those propositions can be listed as follows: African people must be conceived as agents and victors; a Pan-African perspective is essential; a deep commitment to African people and Africa is necessary; there exists an African cultural matrix common to all African people with different

surface manifestations; culture is primary and all-inclusive; Africans must reconnect with African culture for genuine African freedom to be; African cultural rebirth is necessary; the colonizer within the African psyche must be killed; and finally, Nile Valley civilizations (in particular, ancient Egypt, or Kemet) are the foundation of African culture and will serve as a model upon which to elaborate new bodies of thought and action relevant to African contemporary needs. Those principles, which are primary both chronologically and logically, function very much as Afrocentricity's premises.

Afrocentricity as the African-American Studies Metaparadigm

The implications of Afrocentricity for African-American studies have been considerable. Indeed, Asante argues that only when African-American studies scholars center themselves mentally and intellectually in the African cultural and historical experience will genuine African-American studies come into existence. Until then, Asante maintains, Eurocentric studies of African people and phenomena will continue to parade as African-American studies, with the latter existing only as a subfield of European studies. First, Afrocentricity insists, it must be realized that any idea, concept, or theory, no matter how "neutral" it claims to be, is nonetheless a product of a particular cultural and historical matrix. As such, it carries specific cultural assumptions, often of a metaphysical nature. Hence to embrace a European theory or idea is not as innocent an academic exercise as it may seem. In fact, it is Afrocentricity's contention that unless African scholars are willing to reexamine the process of their own intellectual conversion, which takes place under the guise of "formal education," they will continue to be the easy prey of European intellectual hegemony. What is suggested, instead, is that African intellectuals must consciously and systematically relocate themselves in their own cultural and historical matrix, from which they must draw the criteria by which they evaluate the African experience. Their work must be informed by "centrism," that is, "the groundedness of observation and behavior in one's own historical experiences" (Asante, 1990, p. 12). *Africology* is the discipline to which those who study African people and phenomena from an Afrocentric perspective belong.

Thus it can be said that Afrocentricity emerged as a new paradigm to challenge the Eurocentric paradigm responsible for the intellectual disenfranchisement and the making invisible of African people, even to themselves in many cases.

In that respect, Afrocentricity therefore presents itself as *the African-American studies metaparadigm*. As such, it includes three major aspects: cognitive, structural, and functional. The cognitive aspect involves the metaphysical foundations—such as the organizing principle and set of presuppositions that were outlined above, a methodology, methods, concepts, and theories. The structural aspect refers to the existence of an Afrocentric intellectual community, such as is found at Temple University. Finally, the structural aspect of the Afrocentric paradigm refers to the ability of the latter to activate African people's consciousness and to bring them closer to freedom, the ultimate goal of Afrocentricity. Hence Asante concludes that what can be called *the discipline of African-American*

studies itself is intimately linked to the development of Afrocentricity and the establishment in the late eighties of the Temple doctoral program, the first Ph.D. program in African-American studies in the United States.

The Temple Ph.D. program in Africology was immediately successful, as hundreds of national and international applicants sought admission in order to be a part of the Afrocentric epistemological watershed. Although the program has suffered serious setbacks since its inception, there can be little doubt about its influence on African-American studies. Over four hundred dissertations employing the Afrocentric paradigm have been defended, at Temple and at other institutions. Indeed, the Temple Ph.D. program opened the path for the creation of other African-American studies Ph.D. programs in the United States in subsequent years.

Afrocentricity and Its Critics

As could be expected, however, Afrocentricity's growing paradigmatic ascendancy over African-American studies also prompted serious critiques, which fall within five broad categories. First, critics have disagreed with some of Afrocentricity's premises, in particular the notion of an African essence that undergirds the notion of *center*. This criticism is often heard in poststructuralist circles, since the very idea of a *center* is antithetical to the poststructuralist paradigm. Often associated with this criticism is the additional claim that in its search for Africanness, Afrocentricity does not allow for cultural change. In fact, some argue, Afrocentricity's inability to deal adequately with cultural change prevents it from understanding that being African today also means being at least partly European as a result of colonization and widespread Westernization. Afrocentricity, then, is perceived as too restrictive and incapable of grasping the dialectical complexity of modern African identities. While he denies being an "immutabilist," Asante's response has been that Africans need a place to stand in order to challenge oppressive White structures and systems of knowledge and therefore cannot afford postmodern, evanescent, fluid selves. In any case, any discourse on identity is necessarily essentialist. Afrocentrists also point out that far from denying the Westernization of many Africans' consciousness, they recognize it as a destructive force that must be circumvented.

Second, some have taken issue with Afrocentricity's main category, culture. Black feminists and black neo-Marxists advance gender and social class, respectively, as the primary contradiction in African-American life. With regard to feminism, however, Afrocentric scholars who tackle gender issues question the relevance of feminist philosophical and political assumptions for African people, including African women. Concerning the question of class, while it is quite feasible and necessary to articulate an Afrocentric economic theory, Afrocentricity maintains that race/culture remains the most socially relevant category in American society.

Third, Afrocentricity has also been criticized for making untenable historical claims, especially in relation to ancient Egypt. This argument, probably the most publicized, has stemmed from European classicists who, having subscribed to the Greek Miracle theory, became disturbed by two related developments associated with the spread of Afrocentricity: first,

credit was being taken away from Europe for the great civilizations of the Nile Valley (in particular, Egypt); and second, as a consequence the original intellectual achievements of Greece itself were revisited and diminished. For instance, it was pointed out that many Greek philosophers had studied for long periods of time in ancient Africa, and were in reality indebted to their African teachers for many of their ideas. Therefore many European scholars in the United States and Europe proceeded to refute those "Afrocentric" claims. However, it must be noted that the debate over the racial identity of the early Egyptians predates the emergence of Afrocentricity by several decades and is not, therefore, an issue germane to Afrocentricity *per se*. It must be more correctly understood within the context of Diopian historiography, which places Egypt at the beginning, both chronologically and conceptually, of African civilization. In fact, several of the scholars associated with this thrust, such as Martin Bernal, have never claimed to be Afrocentric.

Fourth, Afrocentricity has also been criticized for intellectual bad faith because of wrong attributions and associations. For instance, Afrocentricity has been associated with biological-deterministic arguments (such as that around melanin) that were never part of its premises.

Finally, criticism of an ideological nature has been voiced. In one instance, Afrocentricity has been blamed as reversed Eurocentrism. Some scholars contend that Afrocentricity merely seeks to replace one geopolitical hegemonic center, Europe, with another hegemonic one, Africa. However, as even a cursory reading of Asante's texts would reveal, Afrocentricity is fundamentally nonhegemonic and welcomes the existence of a multiplicity of cultural centers. It is precisely that position that allowed Afrocentricity to challenge Eurocentrism in the first place. Some have also contended that Afrocentricity undermines the very fabric of American society. By emphasizing the Africans' prerogative to be *human as Africans*, Afrocentricity is said to threaten the unity of American society, including the American academe. However, Afrocentrists remark that the unspoken fear is not so much about a shattered national unity (which, given racism, could have never truly existed) but about the threat that Afrocentricity poses to Europe's self-serving monopoly over reason.

While Afrocentricity continues to exercise a significant influence in the United States, it has also been receiving increased attention in Europe and Africa, where a vigorous intellectual movement has emerged informed by Afrocentric tenets and referred to as the "African Renaissance," thus creating the possibility for Afrocentricity to be transformed into a Pan-African school of thought in the years to come.

See also Black Atlantic; Black Consciousness; Eurocentrism; Negritude; Orientalism: African and Black Orientalism; Pan-Africanism; Philosophies: African.

BIBLIOGRAPHY

- Asante, Molefi Kete. *Afrocentricity*. Rev. ed. Trenton, N.J.: Africa World Press, 1988.
- . *Kemet, Afrocentricity, and Knowledge*. Trenton, N.J.: Africa World Press, 1990.

- . *The Afrocentric Idea*. Rev. and expanded ed. Philadelphia: Temple University Press, 1998.
- . “The Afrocentric Idea in Education.” *Journal of Negro Education* 60 (1991): 170–179.
- Conyers, James L., Jr. ed. *Afrocentricity and the Academy*. London: McFarland, 2000.
- Fanon, Frantz. *A Dying Colonialism*. New York: Grove Press, 1967.
- Gray, Cecil Conteen. *Afrocentric Thought and Praxis: An Intellectual History*. Trenton, N.J.: Africa World Press, 2001.
- Karenga, Maulana. *Introduction to Black Studies*. Inglewood, Calif.: Kawaida Publications, 1982.
- Lemelle, Sydney J. “The Politics of Cultural Existence: Pan Africanism, Historical Materialism, and Afrocentricity.” In *Imagining Home: Class, Culture and Nationalism in the African Diaspora*, edited by Sidney J. Lemelle and Robin D. G. Kelley. New York: Verso, 1994. A Marxist critique of Afrocentricity.
- Mazama, Ama, ed. *The Afrocentric Paradigm*. Trenton, N.J.: Africa World Press, 2002.
- Mudimbe, V. Y. *The Invention of Africa: Gnosis, Philosophy, and the Order of Knowledge*. Bloomington: Indiana University Press, 1988.
- Okafor, Victor Oguejiofor. *Towards an Understanding of Africol-ogy*. Dubuque, Iowa: Kendall/Hunt, 2002.

Ama Mazama

AFROPESSIMISM. Afropessimism refers to the perception of sub-Saharan Africa as a region too riddled with problems for good governance and economic development. The term gained currency in the 1980s, when many Africanists in Western creditor countries believed that there was no hope for consolidating democracy and achieving sustainable economic development in the region. The earliest use in print of the word was in a 1988 article from the Xinhua News Agency in which Michel Aurillac, France’s minister of cooperation, criticized the prevailing pessimism in the West about Africa’s economic development and cautioned against what he referred to as an “Afro-pessimism” on the part of some creditors.

Depiction

Many writers have given different expressions to the phenomenon of Afropessimism. Attempts to explain the concept include both cogent studies (Ayittey, 1992, 1998; Jackson and Rosberg; Kaplan, 1994) and polemical and shallow travelogues (Richburg). In general, one virtue of Afropessimist writings is that they do not whitewash Africa’s problems. Further, they correctly refuse to excuse the outrages of some African dictators on the basis of political ideology or racial identity. In particular they refuse to use colonial exploitation to mask postcolonial kleptocracy, the personalization of state power, and the politics of prebendalism. The writers mentioned above (excepting Richburg and Kaplan) do not reject the hope that Africa can develop or that it is capable of overcoming its political and economic problems. In this sense they are not themselves pessimistic about the future of Africa but rather are simply describing the phenomenon of Afropessimism. The real Afropessimists are writers who call for abandoning, or worse,

recolonizing the continent (Johnson; Kaplan, 1992, 1994; Michaels; Hitchens). While generally the writers in the first group merely denounce postcolonial African leadership by pointing out its weaknesses, those in the latter tend to conclude that Africans are incapable of self-rule.

However, a common characteristic of the two modes of Afropessimist writings is imbalance. They all tend to highlight the horrors of a few African countries and ignore the advances of many other countries at various times. The unscientific establishment of doomsday conclusions about Africa characteristic of studies in this genre (see, in particular, Richberg) are usually not warranted by the limited sample of African countries discussed in the narratives. The unintended result is that Africa is given a blanket negative portrayal. (There are, by contrast, prominent works that for the most part decry Africa’s image in the West—see, for instance, Hammond and Jablow; Hawk.) The resultant foreboding and ominous image in Western media and the academy weakens the continent in the global competition for foreign investment and tourism (see Onwujiwe, 1996). This is an economic effect of Afropessimism.

African Rebirth

Still, the conditions that merit pessimism for the future of Africa are not manufactured by Afropessimists; such conditions are empirically verifiable. Since the end of the Cold War, important African leaders such as Presidents Thabo Mbeki of South Africa, Olusegun Obasanjo of Nigeria, and Maître Abdoulaye Wade of Senegal have come to recognize this and have resolved to do something about it. As a result, there has been an honest effort on the continent to address the important issues of good political, economic, and corporate governance and the professionalization of the army in order to diminish chances for destabilizing military coups. These efforts had led the Organization of African Unity (OAU) to found a new institution, the New Partnership for Africa’s Development (NEPAD), charged with the responsibility to provide a vision and strategic framework for Africa’s renewal. NEPAD attempts to provide African interventions with regard to issues of relative underdevelopment and marginalization. NEPAD’s formation and other historic African transformative actions have been referred to as African renaissance.

Impact

In the donor countries of the West in the 1980s, Afropessimists were found in the government, media, and academia. The prevailing view that votes for Africa’s stabilization and development were a waste of scarce resources was fanned by conservative politicians, bureaucrats, journalists, and scholars. This quickly led to an era of strained relationships between Western donor countries and African recipient countries in the late 1980s and early 1990s. Donor countries complained that progress was being slowed by bad governance, corruption, and mismanagement of funds, creating disillusionment and donor (or aid) fatigue. African countries in turn complained of unfulfilled promises and unwarranted intrusiveness in domestic policies by donors. The net result was a reduction in the volume of development aid from Western to African countries.

Explanations

Two explanations have been put forth for the conditions that produced the phenomenon of Afropessimism. One is the apparent inability of postcolonial African leaders to practice good governance. Since the 1960s, when most countries in Africa south of the Sahara regained political independence from European colonialists, the standard of living in Africa has fallen below expectations. The achievement of political self-rule naturally came with raised expectations of the good life for Africans who had been subjected to exploitation and subjugation by colonial tyranny. In the exuberance of the freedom moment, the new indigenous leaders of Africa promised their fellow citizens a brighter future. However, by the 1980s, more than twenty years after independence, the African condition (especially for the masses) had fallen far below the continent's potential. For the most part, bad leadership was responsible for the disappointing performance. Independence ushered in an era of political instability, military dictatorships, and gross mismanagement of natural resources by very corrupt African leaders. By the 1980s all these conspired to drive down the standard of living in most African countries, forcing an otherwise resource-rich continent to become severely dependent on foreign aid and foreign debt.

Another school of thought locates the source of Africa's social and economic downfall on the international political environment. According to this school, Africa regained self-rule during the era of the Cold War, when the relationship between the countries in the Eastern bloc led by the Soviet Union and countries of the Western bloc led by the United States was marked by a state of military competition and political tension. The rivalry stopped short of actual war between the two superpowers, but it forced Africa to become a surrogate terrain for the hot war between the two camps. In the process, African countries, most of them weak and dependent on the Western or Eastern ideological blocs, became little more than client states. Under this new dispensation, Africans lost the power to choose their own leaders. Africa's dependent dictators owed their offices to the economic and military support of Cold War powers. For the most part they put the interests of the foreign powers on which they were dependent ahead of their own national interests. This situation, which was as exploitative and impoverishing as colonialism, became known as neocolonialism and is blamed for the postcolonial impoverishment of Africans that fueled the fires of Afropessimism in the 1980s. Consequently, with the end of the Cold War, some Africanists came to believe that if the detrimental international conditions it imposed were ultimately reversed, then conditions in Africa would improve through good governance. Those who believe in this are known as Afro-optimists. Challenging the view that sub-Saharan Africa has only regressed since independence, they advance examples of postcolonial triumphs achieved by Africa's political leadership despite the prevailing problems identified by Afropessimists. They argue that the energy and perseverance of African peoples portend hope for the future of the continent.

A Middle Ground

The truth about Africa's impoverishment lies somewhere between the analyses of Afropessimists and Afro-optimists. There

is no doubt that corrupt and uncourageous leadership has been the bane of socioeconomic development of sub-Saharan Africa in the postcolonial period. These leaders stunted democratic processes with force in order to preserve a system of one-person rule with no accountability. They awarded overpriced contracts to foreign companies in exchange for large kickbacks deposited in personal accounts in foreign banks. Their conspicuous consumption, cult of personality, nepotism, and naked abuse of political power encouraged a culture of greed, military coups, and instability, which reduced Africa's competitiveness for foreign investment. Governments borrowed billions in the name of the nation and cronies squandered the money, thereby saddling the people with debt.

It is also true that in the same period, global political and economic policies reinforced the legacy of colonialism and exacerbated Africa's problems of self-rule. Apartheid South Africa sponsored destabilizing wars in the southern African region, and a cycle of Cold War-surrogate wars and conflicts ravaged Angola and Mozambique. These wars claimed millions of African lives and devastated the economies of the warring countries. Economic adjustment policies of the World Bank forced African countries to cut spending in health, education, and infrastructure in order to save money to service foreign debts. Low international prices of commodities produced by Africans caused African countries to lose about \$50 billion in the 1980s and early 1990s, the same period of the most virulent Afropessimism. These externally induced problems combined with internal inefficiencies to stunt Africa's political and economic growth and give rise to Afropessimism. However, by the turn of the twenty-first century sub-Saharan Africa's fortunes seemed to have turned markedly for the better.

See also Africa, Idea of; Anticolonialism: Africa; Capitalism: Africa; Colonialism: Africa; Postcolonial Studies; Postcolonial Theory and Literature; Westernization: Africa.

BIBLIOGRAPHY

- Ayittey, George B. N. *Africa Betrayed*. New York: St. Martin's Press, 1992.
- . *Africa In Chaos*. New York: St. Martin's Press, 1998.
- Hammond, Dorothy, and Alta Jablow. *The Africa That Never Was: Four Centuries of British Writing about Africa*. New York: Twayne, 1970.
- Hawk, Beverly G., ed. *Africa's Media Image*. New York: Praeger, 1992.
- Hitchens, Christopher. "Africa without Pity." *Vanity Fair* (November 1994): 43–52.
- Jackson, Robert H., and Carl G. Rosberg. *Personal Rule in Black Africa: Prince, Autocrat, Prophet, Tyrant*. Berkeley: University of California Press, 1982.
- Johnson, Paul. "Colonialism's Back—and Not a Moment Too Soon." *New York Times Magazine* (18 April 1993): 22.
- Kaplan, Robert. "The Coming Anarchy." *Atlantic Monthly* (February 1994): 44–76.
- . "Continental Drift." *New Republic* (28 December 1992): 15.
- Michaels, Marguerite. "Retreat From Africa." *Foreign Affairs* 72, no. 1 (winter 1993): 93–108.
- Onwudiwe, Ebere, "Africa's Other Story." *Current History* 101 (2002): 225–228.

- . “Image and Development: An Exploratory Discussion.” *Journal of African Policy Studies* 1, no. 3 (1995): 85–97.
- Onwudiwe, Ebere, and Minabere Ibelema, eds. *Afro-Optimism: Perspectives on Africa’s Advances*. Westport, Conn., and London: Praeger, 2003.
- Joseph, Richard A. *Democracy and Prebendal Politics in Nigeria: The Rise and Fall of the Second Republic*. New York: Cambridge University Press, 1987.
- Richburg, Keith B. *Out of America: A Black Man Confronts Africa*. New York: Basic Books, 1997.
- Rieff, David. “In Defense of Afropessimism.” *World Policy Journal* 15, no. 4 (winter 1998–1999): 10–22. Also available at <http://www.worldpolicy.org/journal/rieff.html>
- Xinhua News Agency. “France: Creditors Should Do More for Africa’s Debt Problem.” Paris, March 27, 1988, item no. 0327019.

Ebere Onwudiwe

AGNOSTICISM. The heyday of agnosticism was in Victorian Britain between the 1860s and the 1890s. Its leading exponents were Herbert Spencer (1820–1903), Thomas Henry Huxley (1825–1895) (who coined the term), Leslie Stephen (1832–1904), John Tyndall (1820–1893), and William Kingdon Clifford (1845–1879). This group all shared a disillusionment with orthodox Christianity; an opposition to the dominance of British science and education by the Anglican establishment; belief in the theory of evolution and in the importance of science more broadly; and an aspiration to replace dogmatism and superstition with a freethinking, scientific, and ethical religion (see Lightman, 1987, 1989, 2002; Pyle; Turner, 1974, 1993). While agnosticism may have been an antitheological and secularist movement, it was certainly not antireligious. The Victorian agnostics were intensely moralistic people who had a deep sense of the spiritual, especially as evoked by the wonders of the natural world.

The Philosophical Sources of Agnosticism

The term *agnosticism*, as it is used in common parlance, normally refers to a neutral or undecided position on the question of the existence of God. It is shorthand for a rejection of religious faith on the one hand and of outright atheism on the other. The philosophical sources and Victorian expositions of agnosticism, however, reveal it to signify a much broader set of arguments about the limits of human knowledge, whether religious or scientific.

Bernard Lightman’s definitive study, *The Origins of Agnosticism* (1987), places particular emphasis on the concept’s Kantian origins. It is true that Kantian views about the limits of speculative reason, the relativity of knowledge, and the active role of the categories of the mind in constituting that knowledge formed an important part of agnosticism. Lightman argues convincingly for the influence of two writers in particular—William Hamilton (1788–1856) and Henry Longueville Mansel (1820–1871)—on later Victorian agnostics. Hamilton was a Scottish metaphysician who, as well as seeing himself as a defender of the Scottish “common sense” philosophy of Thomas Reid (1710–1796) and Dugald Stewart (1753–1828), was probably the most

important expositor of Kantian philosophy in Britain in the first half of the nineteenth century.

Mansel drew heavily on Hamilton’s particular version of Kantianism in his controversial 1858 Bampton Lectures, entitled *The Limits of Religious Thought*. In these lectures, Mansel argued that speculative reason on its own led to all sorts of contradictions if allowed free rein in the area of theology. His conclusion was that only relative knowledge was possible and that the absolute (or the *unconditioned*, to use Hamilton’s term) was not knowable through the faculties of sense and reason. Mansel’s conclusion was that in the realm of theology, final authority must rest with revelation rather than reason. While Mansel believed that he had used Kant’s philosophy constructively—to demonstrate the necessity of revelation and the authority of the Bible—critics from all sides felt that his arguments constituted, in effect, a complete capitulation in the face of rationalism and modern science and a retreat into an extreme form of fideism.

The idea that Kantian philosophy was at the heart of agnosticism needs to be qualified in a couple of ways (as Lightman himself acknowledges). First, Hamilton and Mansel were far from being simply followers of Kant. They tried to make use of his ideas for their own polemical purposes and certainly did not agree with or reproduce his entire system. The attempt to use philosophy to undermine reason in the realm of theology and establish the necessity and authority of revelation is certainly not “Kantian” in the sense of being a teaching of Kant. Second, a recognition of the influence of Kant on Victorian agnostics should not obscure the very important contributions of David Hume (1711–1776), to whom Kant himself famously acknowledged an important debt, and of other philosophers in the Scottish tradition. These included Reid and Stewart, in whose footsteps Hamilton was following, as well as Hamilton’s principal philosophical antagonist, the empiricist John Stuart Mill (1806–1873). The agnostic philosophy of Thomas Huxley, for instance, was based on a teaching central to the Scottish school, namely that “mind” and “matter” were merely shorthand terms for unknown realities that underlie the world of experience (which is the only domain in which we can have knowledge).

Victorian Agnosticism

Herbert Spencer’s *First Principles* (1862) laid the groundwork for the hugely ambitious, multivolume *Synthetic Philosophy*, finally completed in 1896, which articulated Spencer’s vision of how philosophy, biology, sociology, ethics, religion, and society itself needed to be reconceptualized and transformed in the light of the doctrine of evolution (see Peel). The first part of the *First Principles*, entitled “The Unknowable,” was considered the Bible of agnosticism for the rest of the Victorian period. Spencer argued that science and religion could be reconciled if they recognized that both, ultimately, were concerned with realities whose foundations were beyond the grasp of human knowledge. However, while science could get on with measuring, analyzing, and interpreting observable phenomena, nothing was left for theologians but total silence in the face of the unknowable. There was no role for revelation in Spencer’s proposed scientific and agnostic religion, and Mansel’s conservative critics saw

THOMAS HUXLEY AND THE COINING OF *AGNOSTIC*

Thomas Henry Huxley (1825–1895) rose to prominence in Victorian Britain as a man of science and a brilliant and combative essayist. His polemical defenses of the theory of evolution against its theological detractors, especially in a legendary debate with Samuel Wilberforce (1805–1873), the bishop of Oxford, in 1860, earned him the nickname “Darwin’s Bulldog.” His writings covered topics in philosophy and politics as well as natural science—he was a passionate advocate of better and more widely accessible state education, especially in the sciences. His writings, which included a book on the philosophy of Hume, also reveal the depth and breadth of his learning in the areas of philosophy, religion, and theology. The following excerpt from his 1889 essay “Agnosticism” is Huxley’s own account of how and why he had come to coin the term *agnostic* some twenty years earlier.

When I reached intellectual maturity and began to ask myself whether I was an atheist, a theist, or a pantheist; a materialist or an idealist; Christian or a freethinker; I found that the more I learned and reflected, the less ready was the answer; until, at last, I came to the conclusion that I had neither art nor part with any of these denominations, except the last. The one thing in which most of these good people were agreed was the one thing in which I differed from them. They were quite sure they had attained a certain “gnosis,”—had, more or less successfully, solved the problem of existence; while I was quite sure I had not, and had a pretty strong conviction that the problem was insoluble. And, with Hume and Kant on my side, I could not think myself presumptuous in holding fast by that opinion. Like Dante,

Nel mezzo del cammin di nostra vita
Mi ritrovai per una selva oscura,
but, unlike Dante, I cannot add,
Che la diritta via era smarrita.

On the contrary, I had, and have, the firmest conviction that I never left the “verace via”—the straight road; and that this road led

nowhere else but into the dark depths of a wild and tangled forest. And though I have found leopards and lions in the path; though I have made abundant acquaintance with the hungry wolf, that “with privy paw devours apace and nothing said,” as another great poet says of the ravening beast; and though no friendly spectre has even yet offered his guidance, I was, and am, minded to go straight on, until I either come out on the other side of the wood, or find there is no other side to it, at least, none attainable by me.

This was my situation when I had the good fortune to find a place among the members of that remarkable confraternity of antagonists, long since deceased, but of green and pious memory, the Metaphysical Society. Every variety of philosophical and theological opinion was represented there, and expressed itself with entire openness; most of my colleagues were *-ists* of one sort or another; and, however kind and friendly they might be, I, the man without a rag of a label to cover himself with, could not fail to have some of the uneasy feelings which must have beset the historical fox when, after leaving the trap in which his tail remained, he presented himself to his normally elongated companions. So I took thought, and invented what I conceived to be the appropriate title of “agnostic.” It came into my head as suggestively antithetic to the “gnostic” of Church history, who professed to know so much about the very things of which I was ignorant; and I took the earliest opportunity of parading it at our Society, to show that I, too, had a tail, like the other foxes. To my great satisfaction, the term took; and when the *Spectator* had stood godfather to it, any suspicion in the minds of respectable people, that a knowledge of its parentage might have awakened was, of course, completely lulled.

SOURCE: Thomas Huxley, “Agnosticism,” in his *Collected Essays*, 9 vols. (London: Macmillan, 1893–1894), pp. 237–239.

in Spencer's system exactly the conclusions they had feared would follow from Mansel's teachings on the impotence of human reason in the theological realm.

Although Spencer was later generally considered to be the leading representative of agnosticism, the terms *agnostic* and *agnosticism* did not themselves come into use until about ten years after the publication of the *First Principles*. The terms gained currency through their use by Spencer but also by the theologian and journalist R. H. Hutton, the editor of the *Spectator* in the 1870s, and the lapsed Anglican minister Leslie Stephen, who, after leaving the Church of England, wrote *An Agnostic's Apology* (1876).

Although he made some use of the term in his writings from the 1870s onward, it was only in 1889 that Thomas Huxley revealed himself as the inventor of the terms *agnostic* and *agnosticism* and explained how and why he had come to coin them (Lightman, 2002). One of Huxley's earlier essays that gained him much attention (and much criticism) was entitled "On the Physical Basis of Life" (reprinted in *Collected Essays*, vol. 1). This essay, based on a lecture delivered in Edinburgh in 1868, just a year before he coined the term *agnostic*, is one of the most helpful illustrations of the essence of Huxley's agnosticism. Although the essay was criticized for espousing a materialistic view of life (the idea that all living things are made up of the same substance—"protoplasm"), in fact it defended a nescient or radically empiricist understanding of science as producing nothing more than a set of symbols with which to describe and organize observable phenomena. Huxley rejected materialism on the grounds that it was impossible for empirical science to determine anything at all about the nature of any putative substance or substances underlying the phenomena or of any supposed laws or causes. "In itself," Huxley said, "it is of little moment whether we express the phenomena of matter in terms of spirit; or the phenomena of spirit in terms of matter: matter may be regarded as a form of thought, thought may be regarded as a property of matter—each statement has a certain relative truth" (1893–1894, vol. 1, p. 164). (The materialistic terminology was to be preferred, however, for the pragmatic reason that it connected with other areas of scientific investigation, which were expressed in the same terms, and for the reason that spiritualistic terminology was entirely barren.) Huxley denied that this was a "new philosophy" and especially that it was the invention of the positivist Auguste Comte (1798–1857), as some supposed. Comte, he said, lacked entirely "the vigour of thought and the exquisite clearness of style" of the true author of this philosophy, "the man whom I make bold to term the most acute thinker of the eighteenth century—even though that century produced Kant" (1893–1894, vol. 1, p. 158). The man Huxley had in mind, of course, was Hume.

The closing pages of "On the Physical Basis of Life," then, show several important things about Huxley's agnosticism. They show that Huxley felt the need for a new label—*agnostic*—not in order to distance himself from Christianity (everyone already knew he was an opponent of theological orthodoxy) but primarily in order to repudiate the labels *materialist*, *atheist*, and *positivist*. They also show that Huxley considered Hume to be at least as important as Kant, if not more

important, in the historical pedigree of agnosticism. And finally, they show that agnosticism involved admitting ignorance about the fundamental nature of the physical universe as well as about the existence and attributes of the divine.

Agnosticism in the Twentieth Century

The scientific and religious creed of agnosticism died with Leslie Stephen in 1904. However, the philosophical and theological questions around which it was based, especially about the relationship between the observable and the unobservable, persisted into the twentieth century (although not generally under the banner of agnosticism).

The logical positivism of the earlier twentieth century, along with more recent antirealist philosophies of science (such as Bas van Fraassen's "constructive empiricism" as developed in his 1980 book, *The Scientific Image*), have contained some of the radically empiricist elements of agnosticism as endorsed by Huxley (and derived from Hume and Mill). These philosophers have insisted that all true knowledge must be grounded in experience and that since we cannot have direct experience of unobservable substances, entities, laws, or causes, we must treat them as, at best, useful fictions that serve as shorthand for empirical generalizations. Logical positivists dismissed all "metaphysical" discourse, which claimed to describe underlying realities, as meaningless. In this they agreed both with Comtean positivists and with agnostics.

In the realm of religion and theology, the problems that were central to the agnostics—especially the difficulty of reconciling religion and morality with a scientific worldview—continued to occupy religious thinkers (see Dixon). Some, such as Thomas Huxley's grandson Julian Sorell Huxley (1887–1975), put forward "evolutionary humanism" as a scientific religion based on reason and morality but without revelation. Others took a similar approach but while remaining within the Christian tradition. Don Cupitt, for instance, in books such as *Taking Leave of God* (1980) and *The Sea of Faith* (1984), adopted a "nonrealist" metaphysics and articulated a post-theological version of the Christian religion. For Cupitt, himself a minister in the Church of England, the claims of Christian theology should not be taken to refer to unseen supernatural realities, such as a personal God, but to be expressions of human values and aspirations.

So scientists seeking to give expression to a religious impulse while retaining their intellectual integrity along with theologians looking for an interpretation of the gospel that will resonate in a secular and scientific world have both continued the religious project that the Victorian agnostics had begun.

See also **Atheism; Christianity; Gnosticism; Skepticism.**

BIBLIOGRAPHY

PRIMARY SOURCES

Blinderman, Charles, and David Joyce, eds. "The Huxley File." Available at <http://aleph0.clarku.edu/huxley>. This is an invaluable online resource at Clark University, providing information on Huxley's life and works and access to hundreds of Huxley's published and unpublished writings.

- Cupitt, Don. *Taking Leave of God*. London: SCM, 1980.
- Huxley, Thomas H. "Agnosticism," "Agnosticism: A Rejoinder," and "Agnosticism and Christianity." *Nineteenth Century* 25 (1889): 169–194, 481–504, 937–964. Reprinted in Thomas H. Huxley, *Collected Essays*, vol. 5: *Science and Christian Tradition*. London: Macmillan, 1894.
- . *Collected Essays*. 9 vols. London: Macmillan, 1893–1894.
- Pyle, Andrew, ed. *Agnosticism: Contemporary Responses to Spencer and Huxley*. Bristol: Thoemmes, 1995.
- Spencer, Herbert. *First Principles*. London: Williams and Norgate, 1862. Especially pt. 1.
- Van Fraassen, Bas. *The Scientific Image*. Oxford: Clarendon, 1980.

SECONDARY SOURCES

- Budd, Susan. *Varieties of Unbelief: Atheists and Agnostics in English Society, 1850–1960*. London: Heinemann, 1977.
- Cockshut, A. O. J. *The Unbelievers: English Agnostic Thought, 1840–1890*. London: Collins, 1964.
- Desmond, Adrian. *Huxley: From Devil's Disciple to Evolution's High Priest*. London: Penguin, 1998.
- Dixon, Thomas. "Scientific Atheism as a Faith Tradition." *Studies in History and Philosophy of Biological and Biomedical Sciences* 33 (2002): 337–359.
- Helmstadter, Richard J., and Bernard Lightman, eds. *Victorian Faith in Crisis: Essays on Continuity and Change in Nineteenth-Century Religious Belief*. Stanford, Calif.: Stanford University Press, 1990.
- Lightman, Bernard. "Huxley and Scientific Agnosticism: The Strange History of a Failed Rhetorical Strategy." *British Journal for the History of Science* 35 (2002): 271–289.
- . "Ideology, Evolution, and Late-Victorian Agnostic Popularizers." In *History, Humanity, and Evolution: Essays for John C. Greene*, edited by James Moore. Cambridge, U.K.: Cambridge University Press, 1989.
- . *The Origins of Agnosticism: Victorian Unbelief and the Limits of Knowledge*. Baltimore: Johns Hopkins University Press, 1987.
- Peel, J. D. Y. *Herbert Spencer: The Evolution of a Sociologist*. New York: Basic Books, 1971.
- Turner, Frank M. *Between Science and Religion: The Reaction to Scientific Naturalism in Late Victorian England*. New Haven, Conn.: Yale University Press, 1974.
- . *Contesting Cultural Authority: Essays in Victorian Intellectual Life*. Cambridge, U.K.: Cambridge University Press, 1993.
- White, Paul. *Thomas Huxley: Making the "Man of Science"*. Cambridge, U.K.: Cambridge University Press, 2003.

Thomas Dixon

ALCHEMY.

This entry includes two subentries:

China

Europe and the Middle East

CHINA

Chinese alchemy is based on doctrinal principles, first set out in the founding texts of Daoism, concerning the relation between the domains of the Absolute and the relative, or the Dao and the "ten thousand things" (*wanwu*). Its teachings and

practices focus on the idea of the elixir, frequently referred to as the Golden Elixir (*jindan*), the Reverted Elixir (*huandan*), or the Medicine (*yao*). Lexical analysis shows that the semantic field of the term *dan* (elixir) evolves from a root-meaning of "essence"; its connotations include the reality, principle, or true nature of an entity, or its most basic and significant element or property. The purport of alchemy as a doctrine is to illustrate the nature of this underlying "authentic principle" and to explicate its relation to change and multiplicity.

In the associated practices, compounding the elixir has two primary meanings. In the first sense, the elixir is obtained by heating its ingredients in a crucible. This practice, as well as the branch of alchemy that is associated with it, is known as *waidan*, or "external alchemy" (literally, "outer elixir"). In the second sense, the ingredients of the elixir are the primary components of the cosmos and the human being, and the entire process takes place within the practitioner. This second form of practice (which incorporates some aspects of Daoist meditation methods and of physiological techniques of self-cultivation), as well as the corresponding branch of the alchemical tradition, is known as *neidan*, or "inner alchemy" (literally, "inner elixir"). The Chinese alchemical tradition has therefore three main aspects, namely a doctrinal level and two paradigmatic forms of practice, respectively based on the refining of an "outer" or an "inner" elixir.

The Elixir in External Alchemy

Although the first allusions to alchemy in China date from the second century B.C.E., the combination of doctrines and practices involving the compounding of an elixir, which is necessary to define alchemy as such and to distinguish it from proto-chemistry, is not clearly attested to in extant sources until the third century C.E. The first identifiable tradition, known as Taiqing (Great Clarity; Pregadio, 2005), developed from that time in Jiangnan, the region south of the lower Yangzi River that was also crucial for the history of Daoism during the Six Dynasties (third to sixth centuries). The Taiqing scriptures consist of descriptions of methods for compounding elixirs and of benefits gained from their performance and contain virtually no statements regarding their doctrinal foundations. The emphasis given to certain aspects of the practice and the terminology used in those descriptions, however, show that the central act of the alchemical process consists in causing matter to revert to its state of "essence" (*jing*), or *prima materia*. The main role in this task is played by the crucible, whose function is to provide a medium equivalent to the inchoate state (*hundun*) prior to the formation of the cosmos. In that medium, under the action of fire, the ingredients of the elixir are transmuted, or "reverted" (*huan*), to their original state. A seventh-century commentary to one of the Taiqing scriptures equates this refined matter with the "essence" that, as stated in the *Daode jing* (Scripture of the Way and Its Virtue), gives birth to the world of multiplicity: "Indistinct! Vague! But within it there is something. Dark! Obscure! But within it there is an essence."

In the Taiqing texts, compounding the elixir constitutes the central part of a larger process consisting of several stages, each of which is marked by the performance of rites and ceremonies.

Receiving the scriptures and the oral instructions, building the laboratory, kindling the fire, and ingesting the elixir all require offering pledges to one's master and to the gods, observing rules on seclusion and purification, performing ceremonies to delimit and protect the ritual area, and making invocations to the highest deities. Ingesting the elixir is said to confer transcendence and admission into the celestial bureaucracy. Additionally the elixir grants healing from illnesses and protection from demons, spirits, and several other disturbances. To provide these supplementary benefits, the elixir does not need to be ingested and may simply be kept in one's hand or carried at one's belt as a powerful apotropaic talisman.

The methods of the *Taiqing* texts are characterized by the use of a large number of ingredients. Sources attached to later *waidan* traditions instead describe different varieties of a single exemplary method, consisting of the refining of mercury (Yin) from cinnabar (Yang), its addition to sulfur (Yang), and its further refining. This process, typically repeated seven or nine times, yields an elixir that is deemed to embody the qualities of pure Yang (*chunyang*)—that is, the state of oneness before its differentiation into Yin and Yang.

Role of Cosmology

The doctrinal aspects of alchemy are the main focus of many sources dating from the Tang period (seventh to tenth centuries) onward. These sources formulate their teachings and practices by borrowing the language and the abstract emblems of correlative cosmology, a comprehensive system designed to explicate the nature and properties of different domains—primarily the cosmos and the human being—and the relations that occur among them. The main work that reflects these changes and provides them with textual authority is the *Zhouyi cantong qi* (Token of the Agreement of the Three According to the *Book of Changes*; the “three” mentioned in the title are, according to some commentaries, Daoism, cosmology, and alchemy). Virtually the entire alchemical tradition from the Tang period onward acknowledges this text as its most important scriptural source. Despite this, the *Cantong qi* does not primarily deal with either *waidan* or *neidan* and only occasionally alludes to both of them. Its main purpose is to illustrate the nonduality of the Dao and the cosmos; the task of explicating the details of this doctrinal view, and of applying it to *waidan* and *neidan*, is left to the commentaries and to a large number of related texts.

The emblems of correlative cosmology—typically arranged in patterns that include Yin and Yang, the five agents (*wuxing*), the eight trigrams and the sixty-four hexagrams of the *Book of Changes* (*Yijing*), and so forth—play two main roles closely related to each other. First, they illustrate the relation between unity, duality, and the various other stages of the propagation of Original Pneuma (*yuanyang*) into the “ten thousand things.” In this function, cosmological emblems serve to show how space, time, multiplicity, and change are related to the spacelessness, timelessness, nonduality, and constancy of the Dao. For instance, the *Cantong qi* describes the five agents (which define, in particular, the main spatial and temporal coordinates of the cosmos) as unfolding from the center, which contains them all, runs through them, and “endows them with its efficacy.” In their second role, the emblems of the cosmological system are

used to formulate the relation of the alchemical practice to the doctrinal principles. For instance, the trigrams of the *Book of Changes* illustrate how the alchemical process consists in extracting the pre-cosmic Real Yin (*zhenyin*) and Real Yang (*zhenyang*) from Yang and Yin as they appear in the cosmos, respectively, and in joining them to produce an elixir that represents their original oneness (Pregadio, 2000, pp. 182–184).

In the traditions based on the *Cantong qi*, alchemy is primarily a figurative language to represent doctrinal principles. The *waidan* process loses its ritual features, and the compounding of the elixir is based on two emblematic metals, mercury and lead. The refined states of these metals—respectively obtained from cinnabar and from native lead—represent Yin and Yang in their original, pre-cosmic state, and their conjunction produces an elixir whose properties are said to be equivalent to Pure Yang. The central role played by cosmology in these *waidan* traditions is reflected in two works related to the *Cantong qi*, which respectively state that “compounding the Great Elixir is not a matter of ingredients, but always of the Five Agents,” and even that “you do not use ingredients, you use the Five Agents.”

Doctrines and Practices of Inner Alchemy

Besides a new variety of *waidan*, the *Cantong qi* also influenced the formation of *neidan* (Robinet, 1989, 1995), whose earliest extant texts date from the first half of the eighth century. The authors of several *neidan* treatises refer to their teachings as the Way of the Golden Elixir (*jindan zhi dao*). Their doctrines essentially consist of a reformulation of those enunciated in the early Daoist texts, integrated with language and images drawn from the system of correlative cosmology according to the model provided by the *Cantong qi*. The respective functions of these two major components of the alchemical discourse are clearly distinguished in the doctrinal treatises. Their authors point out that the alchemical teachings can only be understood in the light of those of the *Daode jing* (which they consider to be “the origin of the Way of the Golden Elixir”) and that correlative cosmology provides “images” (*xiang*) that serve, as stated by Li Daochun (fl. 1288–1292), “to give form to the Formless by the word, and thus manifest the authentic and absolute Dao” (*Zhonghe ji*, chapter 3; see Robinet, 1995, p. 75). The alchemical discourse therefore has its roots in metaphysical principles; it uses the language and images of correlative cosmology to explicate the nature of the cosmos and its ultimate unity with the absolute principle that generates and regulates it. Its final purpose, however, is to transcend the cosmic domain, so that the use of images and metaphors involves explaining their relative value and temporary function.

The status attributed to doctrines and practices reflects this view. Some authors emphasize that the inner elixir is possessed by every human being and is a representation of one's own innate realized state. Liu Yiming (1737–1821) expresses this notion as follows:

Human beings receive this Golden Elixir from Heaven. . . . Golden Elixir is another name for one's fundamental nature, formed out of primeval inchoateness [*buncheng*, a term derived from the *Daode jing*]. There is no other

Golden Elixir outside one's fundamental nature. Every human being has this Golden Elixir complete in oneself: it is entirely achieved in everybody. It is neither more in a sage, nor less in an ordinary person. It is the seed of Immortals and Buddhas, and the root of worthies and sages. (*Wuzhen zhizhi*, chapter 1)

Borrowing terms from the *Cantong qi*, which in turn draws them from the *Daode jing*, Liu Yiming calls "superior virtue" (*shangde*) the immediate realization of the original "celestial reality" (*tianzhen*), which is never affected by the change and impermanence that dominate in the cosmos, and "inferior virtue" (*xiade*), the performance of the alchemical process in order to "return to the Dao." He states, however, that the latter way, when it achieves fruition, "becomes a road leading to the same goal as superior virtue" (*Cantong zhizhi*, "Jing," chapter 2).

While the *neidan* practices are codified in ways that differ, sometimes noticeably, from each other, the notion of "inversion" (*ni*) is common to all of them (Robinet, 1992). In the most common codification, the practice is framed as the reintegration of each of the primary components of being, namely essence, pneuma, and spirit (*jing*, *qi*, and *shen*), into the one that precedes it in the ontological hierarchy, culminating in the "reversion" (*huan*) to the state of nonbeing (*wu*) or emptiness (*kong*). The typical formulation of this process is "refining essence and transmuting it into pneuma," "refining pneuma and transmuting it into spirit," and "refining spirit and returning to Emptiness." Li Daochun relates these stages to the passage of the *Daode jing* that states: "The Dao generates the One, the One generates the Two, the Two generate the Three, the Three generate the ten thousand things." According to this passage, the Dao first generates Oneness, which harbors the complementary principles of Yin and Yang. After Yin and Yang differentiate from each other, they rejoin and generate the "Three," which represents the One at the level of the particular entities. The "ten thousand things" are the totality of the entities produced by the continuous reiteration of this process. In Li Daochun's explication, the three stages of the *neidan* practice consist in reverting from the "ten thousand things" to emptiness, or the Dao. In this way, the gradual process that characterizes inner alchemy as a practice is equivalent to the instantaneous realization of the nonduality of the Absolute and the relative.

Just as *waidan* draws many of its basic methods from pharmacology, so *neidan* too shares a significant portion of its notions and methods with classical Chinese medicine and with other bodies of practices, such as meditation and the methods for "nourishing life" (*yangsheng*). What distinguishes alchemy from these related traditions is its unique view of the elixir and a material or immaterial entity that represents the original state of being and the attainment of that state.

See also *Alchemy: Europe and the Middle East; Medicine: China*.

BIBLIOGRAPHY

Needham, Joseph. *Science and Civilisation in China*. Vol. 5, *Chemistry and Chemical Technology*, parts 2–5. Cambridge, U.K.: Cambridge University Press, 1974–1983. Broad overview of

the Chinese alchemical tradition, partly superseded by later studies.

Pregadio, Fabrizio. "Elixirs and Alchemy." In *Daoism Handbook*, edited by Livia Kohn. Leiden: E. J. Brill, 2000. Surveys the history, texts, doctrines, and practices of *waidan*.

———. *Great Clarity: Daoism and Alchemy in Early Medieval China*. Stanford, Calif.: Stanford University Press, 2005. Study of the Taiqing tradition of *waidan* and its relation to Daoism; includes translations of early sources.

Pregadio, Fabrizio, and Lowell Skar. "Inner Alchemy (*Neidan*)." In *Daoism Handbook*, edited by Livia Kohn. Leiden: E. J. Brill, 2000. Survey of history, texts, doctrines, and practices.

Robinet, Isabelle. *Introduction à l'alchimie intérieure taoïste: De l'unité et de la multiplicité. Avec une traduction commentée des Versets de l'éveil à la Vérité*. Paris: Les Éditions du Cerf, 1995. Collection of articles reflecting the best understanding of *neidan* among Western-language studies; includes a translation of a major *neidan* text.

———. "Le monde à l'envers dans l'alchimie intérieure taoïste." *Revue de l'Histoire des Religions* 209 (1992): 239–257. On the notion of "inversion" in *neidan*.

———. "Original Contributions of *Neidan* to Taoism and Chinese Thought." In *Taoist Meditation and Longevity Techniques*, edited by Livia Kohn in cooperation with Yoshinobu Sakade. Ann Arbor: Center for Chinese Studies, University of Michigan, 1989. Focuses on the notions and linguistic expedients used in texts of "inner alchemy" to formulate their doctrines.

Sivin, Nathan. *Chinese Alchemy: Preliminary Studies*. Cambridge, Mass.: Harvard University Press, 1968. Translation of a seventh-century text, with an extensive introduction on *waidan* seen as a branch of the history of Chinese science.

Sivin, Nathan. 1980. "The Theoretical Background of Elixir Alchemy." In Joseph Needham, *Science and Civilisation in China*. Vol. 5, *Chemistry and Chemical Technology*, part 4, *Apparatus, Theories and Gifts*. Cambridge, U.K.: Cambridge University Press. On the role of time in *waidan* and the cosmic correspondences embodied in the apparatus.

Fabrizio Pregadio

EUROPE AND THE MIDDLE EAST

To a modern observer, *alchemy* likely connotes only the transmutation of base metals into gold, or perhaps a more metaphorical transformation of the soul. In its roughly two-thousand-year history, however, alchemy's practices and ideas have ranged much more broadly, encompassing everything from the production of dyes, medicines, precious metals, and gemstones to assaying techniques, matter theory, and spiritual practices linking the manipulation of matter to changes in the alchemist's soul. Although all of these dimensions were present from alchemy's beginnings, practitioners have chosen to highlight particular facets of their art at different times. Any definition of alchemy, therefore, must be both sensitive to its historical permutations and broad enough to include each of its chemical, pharmacological, metallurgical, and spiritual components. To be more precise, one may speak of technical or practical alchemy, spiritual alchemy, natural philosophical alchemy, transmutational alchemy, and medical alchemy (often referred to as iatrochemistry or *chimiatria*). This essay offers an overview of alchemy's changing meaning over its rich and long history.

Practical Origins in Hellenistic Egypt

Although alchemy's roots undoubtedly extend as far back as metallurgy itself, the textual record dates to the first centuries C.E. in the Egyptian city of Alexandria. Immersed in an extraordinary mix of cultures and traditions, Alexandrian alchemists blended Greek matter theory and philosophy, Neoplatonism, Gnosticism, Babylonian astrology, Egyptian mythology, mystery cults, and craft recipes for making cosmetics, beer, precious stones, and gold. Because the few extant texts from this period were written in Greek, this initial period is typically known as Greek alchemy.

The oldest text documenting early alchemy is the *Physika kai mystika* (Of natural and mystical things), purportedly written by the Greek natural philosopher Democritus but likely written by Bolos of Mendes (third century B.C.E.). The *Physika kai mystika* and other similar texts (such as two anonymous Egyptian papyri known as the Leiden Papyrus X and the Stockholm Papyrus) focus on the kind of practical knowledge that would continue to engage alchemists for centuries, providing instructions for how to manufacture and “multiply” gold and silver, as well as how to produce chemically other valuable gemstones, pearls, and dyes. The works of a female alchemist from Hellenistic Egypt named Maria the Jewess (fl. 250 C.E.) contain the oldest descriptions of some of alchemy's most important apparatus, namely alchemical furnaces and stills.

Theoretical Foundations in Antiquity

Such practical alchemical work received theoretical justification in part from Greek natural philosophy. Although Aristotle (384–322 B.C.E) did not write about alchemy per se, he provided a theory of matter that made it possible to conceptualize the transmutation of metals. Aristotle posited the notion that all things were composed of the same formless, passive matter (*materia prima*), which was then transformed into a specific substance by an active, shaping form. For alchemical theory, Aristotle's crucial notion was that, because the four elements—earth, fire, water, and air—were composed of the same basic matter, they could be transmuted into one another by altering their forms. Through the application of heat, for example, water could be transmuted into “air” (steam). From this, alchemists developed the idea of isolating the *materia prima* in metals and transmuting one into another through the use of an agent known as the philosophers' stone or elixir.

The rich cultural resources of the Hellenistic world further developed alchemy's theoretical foundations. From Stoic matter theory, pneuma, or spirits, replaced Aristotelian forms as the active defining force of matter. From Babylonian astrological traditions alchemists adopted the identification of the seven metals (gold, silver, mercury, copper, iron, tin, and lead) with the seven planets (sun, moon, Mercury, Venus, Mars, Jupiter, and Saturn) and the division of both metals and planets into male and female. Finally, the central transmutational process of reducing metals to their *materia prima* before recreating them as gold or silver drew on ideas presented in the Egyptian myth of Isis and Osiris, in which Osiris was killed and dismembered before Isis brought him back to life.

A collection of texts written in the first centuries C.E. known as the *Hermetica* were attributed to Hermes Trismegistos, a

figure identified with the Egyptian god Thoth, the mythical creator of the arts and sciences. Although alchemy was only one topic among many in the *Hermetica*, in the European Middle Ages Hermes came to be known as the legendary first alchemist and alchemy as the “hermetic art.” The *Hermetica* ranged in content from medical, astrological, and magical treatises to much more theosophical ruminations on the redemption of the spirit through gnosis.

This association in the *Hermetica* between practical alchemy and spiritual gnosis found its way into alchemical theory through later authors. The link between spiritual and practical goals of transmutational alchemy is particularly evident in the work of the Alexandrian Zosimos of Panopolis (fl. 300 C.E.; later Latinized as Rosinus). In his compilation of older alchemical writings known as the *Cheirokmeta*, Zosimos wove his practical alchemy into a mystical theoretical framework that would prove just as enduring as alchemy's more technical concerns. Full of secretive language, dream sequences, and allegories, Zosimos's texts describe alchemical processes metaphorically—as sexual generation, for instance—and highlight the role of spirits in transforming matter. With a clear debt to Gnosticism, Zosimos established an enduring connection between practical laboratory work and spiritual perfection.

Medieval Arabic Alchemy

When Islamic empires expanded into centers of Hellenistic culture in the seventh century, Muslim natural philosophers and physicians inherited the Greek alchemical tradition. From the eighth to the tenth centuries, scholars in intellectual centers like Baghdad synthesized the basic elements of the Greek alchemical tradition. The anonymous editor of the *Turba philosophorum* (Crowd of philosophers; c. 900), for instance, assembled excerpts from various Greek alchemical authors into a virtual conversation. Alchemists writing in Arabic also elaborated on the Greek theoretical foundation, contributing a number of key concepts to alchemical matter theory and medicine. The word *alchemy*, a combination of the Arabic definite article *al* with the Greek word *chemeia*, or *chymeia* (likely derived from the word for smelting metals, *cheein*), represents this fusion of Greek and Arabic scholarship, while continued use of Arabic alchemical terms such as *alkalai*, *alcohol*, *alembic*, and *elixir* (*al-iksir*) highlights the legacy of Arabic scholarship.

The translation of Greek alchemical texts into Arabic also underscores a central problem in the history of alchemy: pseudonymous texts. In the first centuries C.E., alchemical texts appeared purportedly authored by figures such as Plato, Socrates, Aristotle, and Cleopatra. Because Arabic and later European translators did not identify these pseudonyms as such, these prominent ancient figures entered the alchemical corpus as legitimate alchemical authors. The authorship of Arabic texts has been equally difficult for scholars to decipher. One of the more influential medieval Arabic texts, for instance, contains a dialogue between King Khalid ibn Yazid (c. 660–704) and a Christian hermit living in Jerusalem, Morienus. Although it is unclear whether Khalid and Morienus actually wrote this text, both figures remained prominent personages in the medieval alchemical tradition.

A collection of thousands of texts dating to the eighth and tenth centuries known in Latin as the *Corpus Gabirianum* and attributed to Jabir ibn Hayaan (c. 721–c. 815) contained fundamental contributions to the medieval Arabic alchemical corpus. Among the innovations of the *Corpus* was the concept of a tripartite division of all things into soul, spirit, and body, a division that would play a central role in European alchemical thought of the sixteenth century. The *Corpus* also introduced the sulfur-mercury theory, which its author had adopted from the ninth-century author Balinus (pseudo-Apollonius of Tyana). This variation on Aristotle's forms and the Stoic pneuma stated that all matter was formed by two qualities, sulfur and mercury, the balance of which existed in varying degrees in different metals. Using the elixir (or philosophers' stone) to shift the balance between these two principles, the alchemist could transmute one metal into another. The *Corpus* also posited that the elixir could be made of plant or animal substances as well as mineral, and that it could be used both as a panacea in medicine and in transmutation. Just as the elixir "cured" base metals of their impurities by transmuting them into silver or gold, so too could it "cure" sick people of their illnesses.

The Persian physician and philosopher Abu Bakr Muhammad ibn Zachariya al-Razi, known in Latin as Rhazes (c. 865–between 923 and 935) is best known for setting out a systematic summary of the "state of the field" of alchemy. Al-Razi added a third quality, salt, to the sulfur-mercury theory, and divided the chemical world into animal, vegetable, and mineral realms. Al-Razi's texts show that he was clearly a practicing alchemist, describing experiments, apparatus, and ingredients, as well as the standard steps of the "great work" of making the elixir.

Although both al-Razi and the *Corpus Gabirianum* provided theoretical justifications of the notion of transmutation, not all Arabic-speaking philosophers supported this idea. The physician Abdallah ibn Sina (Latinized as Avicenna; 980–1037) famously inveighed against the possibility of transmutation in his *Kitab al-shifa* (Book of the remedy), articulating an argument that would prove widely influential in the Latin Middle Ages.

The Latin Middle Ages

In the twelfth century, Europeans such as Gerard of Cremona, Daniel of Morley, and Robert of Ketton began to translate more than seventy Arabic texts into Latin, introducing Europeans for the first time to the alchemical corpus and the Arabic term *al-kimiya*, which became the Latin *alquimia*, *alkimia*, *alchimia*, or *alchemia*. By the end of the century, translations from Morienus, the *Corpus Gabirianum*, and al-Razi, as well as a host of other spurious alchemical texts, acquainted Europeans with the central figures, techniques, and ideas of the Greek and Arabic alchemical traditions. A vibrant European technical literature emerged, dealing with alchemical techniques for dye-making, distilling, metallurgy, mineralogy, and, of course, the transmutation of metals.

Alongside this practical literature, European alchemists writing in Latin also continued to develop the theoretical founda-

tions of their art. Around 1250 the prominent philosopher Albertus Magnus (c. 1200–1280) legitimated scholarly interest in alchemy when he praised alchemists' ability to imitate nature in his *De mineralibus* (On minerals). The late-thirteenth-century *Summa perfectionis magisterii* of Pseudo-Geber (or "the Latin Geber," likely the Italian Franciscan Paul of Taranto) replaced the mercury-sulfur theory with the "mercury alone" theory, which stated that mercury was the fundamental component of metals, while sulfur was a pollutant. Drawing on Aristotle, medieval natural philosophy, and medical theory, Pseudo-Geber also articulated a corpuscular theory of matter, positing that all matter is composed of small particles.

In the thirteenth century a debate emerged around alchemy's legitimacy and its relationship to other fields of knowledge. The central issue was whether alchemy, as a form of human art or technology, was capable of successfully imitating or even surpassing nature. Responding initially to ibn Sina's famous rejection of transmutation (often given greater authority by its erroneous attribution to Aristotle), scholars such as Roger Bacon (c. 1220–1292) and Paul of Taranto forcefully argued that true alchemists could indeed use their knowledge of metals to affect real transmutations. In the late thirteenth and fourteenth centuries Thomas Aquinas, Giles of Rome (Aegidius Romanus), and the inquisitor Nicholas Eymeric formulated theological objections to alchemy, arguing that the power to transmute species was reserved for God alone. This religious critique reached its peak around 1317 with Pope John XXII's condemnation of those alchemists who "promise that which they do not produce." Although this papal bull's primary target was alchemical counterfeiting of metals, it sanctioned the increasingly vociferous backlash against alchemists' claims of power over nature. Still, alchemy continued to flourish in the fourteenth century, as evidenced by the popularity of the Franciscan Johannes de Rupescissa's treatise on the quintessence, or inner essence, of all matter, and a spate of alchemical texts spuriously propagated in the fourteenth century under the name of the thirteenth-century Catalan physician Ramon Lull.

Renaissance Europe

The fifteenth-century rediscovery of the ancient Hermetic corpus and a concurrent revival of Neoplatonism introduced learned Europeans to ancient connections among alchemy, gnosis, and magic. Alchemy's renewed associations with magic and nature's occult forces broadened the primarily technical and natural philosophical discussions of alchemy of the Middle Ages. Hermetic philosophers began to reenvision themselves as operators who might use knowledge of nature to manipulate their world.

At the same time, alchemy's practical utility gained prominence in the sixteenth century, primarily through the work of the Swiss physician and alchemist Paracelsus (1493–1541) and his followers. Although he did not deny the possibility of alchemical transmutation, Paracelsus focused mainly on alchemy's medical applications, advocating a new kind of alchemical medicine, known as *chimiatria* or iatrochemistry, in which practitioners used alchemical distillation and extraction

to isolate the quintessence of matter for medicinal purposes. These powerful (and often controversial) new alchemical drugs were designed to attack the specific disease, in contrast to traditional humoral medicine, which sought to treat the balance of humors within the body as a whole. On the theoretical level, Paracelsus also offered a new understanding of matter, complementing the ancient four elements with the *tria principia* or *tria prima*, adding salt to the two medieval principles of matter (sulfur and mercury). By refining alchemical matter theory and resituating medicine on a new foundation of alchemy, Paracelsus and his followers gave the ancient art a new prominence both in the study of nature and in the practice of medicine.

Transmutation remained a prominent goal for many alchemists, particularly the consumers of a burgeoning trade in printed alchemical books. By the sixteenth century, alchemy had burst the bounds of the world of scholarship and found a much wider audience in Europe. In particular, alchemy's central image of purification and ennoblement resonated with religious reformers such as Desiderius Erasmus, Martin Luther, and the German mystic Jakob Böhme, all of whom drew on alchemical metaphors and imagery in their writings. Alchemical authors also made explicit connections between alchemy and Christianity. Heinrich Khunrath (1560–1605), for instance, specifically articulated such connections, comparing the healing power of the philosophers' stone to the redemptive powers of Christ in the *Ampitheatrum sapientiae aeternae solis verae* of 1595.

Urban readers, literate artisans, and learned ladies also took an interest in alchemy, consuming popular vernacular alchemical literature that tended to focus on the practical benefits of the art, particularly the production of precious metals, gemstones, and medicines. Many self-trained alchemists ultimately found employment among Europe's courts, where many princes generously supported practical and theoretical alchemical work. Faced with an increasingly crowded field of practitioners and no traditional markers of authority such as university degrees, licenses, or guilds, those who consumed alchemical knowledge and products struggled to make their own decisions about what constituted legitimate alchemy. With such a wide variety of people both seeking out knowledge and claiming to be alchemists, new debates emerged in the sixteenth century about what true alchemy was and who could legitimately claim to practice it.

The Scientific Revolution and Beyond

Although it has been assumed that alchemy was inconsistent with new ideas about nature associated with the scientific revolution or that the promoters of the "new science" rejected alchemy, historians now refuse simple narratives associating the scientific revolution with the decline of alchemy. During the seventeenth century, alchemy continued to be a vibrant field of natural philosophical inquiry; most prominent natural philosophers took a mixed view of it. Francis Bacon (1561–1626), for instance, condemned alchemists' tendency toward secrecy, contrasting it with the openness and cooperation that he advocated in reforming the pursuit of natural knowledge. Still, he looked to alchemy as an important source of knowledge about matter and medicine.

Historians have shown that Robert Boyle (1627–1691) and Isaac Newton (1642–1727) were both deeply involved with alchemy both in theory and practice, often in startlingly productive ways. Boyle, for instance, believed in the possibility of transmutation and worked on it for decades, seeking out the knowledge and skills of numerous adepts. Boyle's corpuscular matter theory, for which he is often hailed as a crucial figure in the history of chemistry, bolstered his belief in transmutation and the philosophers' stone. Scholars have shown that Isaac Newton was an avid student of alchemy as well, likely devoting more time to alchemical study and experiments in his lifetime than to physics. Although historians still have a great deal to understand about the exact purpose of Newton's alchemical studies, they clearly played a crucial role in his larger project of understanding God and nature.

By the end of the seventeenth century, alchemy was associated with new medicines, natural magic, ancient wisdom, and popular recipes for making gold as well as the innovations of the scientific revolution. Over the course of the eighteenth century, however, the alchemist's purview came to be more limited. Influenced by Antoine Lavoisier's (1743–1794) efforts to resituate chemical natural philosophy on a foundation of quantitative analysis of matter, a new kind of chemist emerged. Whereas the terms *alchemy* and *chemistry* were used synonymously until the end of the seventeenth century, in the eighteenth century scholars increasingly sought to separate the two, restricting *alchemy* to gold making and spiritual alchemy (activities that natural philosophers began to exclude from science), while also redefining alchemy's scientific and technical dimensions as *chemistry*. As a result, alchemy increasingly lost its long-standing association with science in the eighteenth century, retaining only its ancient links to mysticism and transmutation.

Alchemy continued to flourish among communities of occultists and Romantic natural philosophers in the late eighteenth, nineteenth, and twentieth centuries. Johann Wolfgang von Goethe (1749–1832), for instance, had an enduring interest in alchemy, viewing it as a secret key to the relationships between humans, God, and the cosmos. Nineteenth-century occultists picked up a theosophical thread in the writings of earlier authors such as Paracelsus, Valentin Weigel (1533–1588), Jakob Böhme (1575–1624), and Emanuel Swedenborg (1688–1772), incorporating alchemical study and images into the activities of secret societies. Finally, in the early twentieth century, the psychologist Carl Gustav Jung identified similarities between alchemical symbols and the dreams of his patients, positing that alchemists' descriptions of transmutation were a metaphor for the development of the individual. This view of alchemy, which interprets alchemy as a symbol for deeper psychological processes, has endured in the popular imagination into the twenty-first century.

See also *Chemistry; Magic; Medicine; Islamic Medicine; Neoplatonism; Pseudoscience; Science, History of.*

BIBLIOGRAPHY

Baldwin, Martha. "Alchemy and the Society of Jesus in the Seventeenth Century: Strange Bedfellows." *Ambix* 40 (1993): 41–64.

- Dobbs, Betty Jo Teeter. *The Janus Faces of Genius: The Role of Alchemy in Newton's Thought*. Cambridge, U.K., and New York: Cambridge University Press, 1991.
- Eamon, William. *Science and the Secrets of Nature: Books of Secrets in Medieval and Early Modern Culture*. Princeton, N.J.: Princeton University Press, 1994.
- Harkness, Deborah E. *John Dee's Conversations with Angels: Cabala, Alchemy, and the End of Nature*. Cambridge, U.K., and New York: Cambridge University Press, 1999.
- Lindsay, Jack. *The Origins of Alchemy in Graeco-Roman Egypt*. London and New York: Muller, 1970.
- Moran, Bruce. *The Alchemical World of the German Court: Occult Philosophy and Chemical Medicine in the Circle of Moritz of Hessen (1572–1632)*. Stuttgart, Germany: F. Steiner, 1991.
- Multhauf, Robert P. *The Origins of Chemistry*. Langhorne, Pa.: Gordon and Breach Science Publishers, 1993.
- Newman, William R. *Gebennical Fire: The Lives of George Starkey, an American Alchemist in the Scientific Revolution*. Cambridge, Mass.: Harvard University Press, 1994.
- , ed. *The Summa Perfectionis of Pseudo-Geber: A Critical Edition, Translation, and Study*. Leiden, Netherlands, and New York: Brill, 1991.
- Newman, William R., and Lawrence M. Principe. "Alchemy vs. Chemistry: The Etymological Origins of a Historiographic Mistake." *Early Science and Medicine* 3 (1998): 32–65.
- Patai, Raphael. "Maria the Jewess—Founding Mother of Alchemy." *Ambix* 29, no. 3 (November 1982): 177–197.
- Principe, Lawrence M. *The Aspiring Adept: Robert Boyle and His Alchemical Quest*. Princeton, N.J.: Princeton University Press, 1998.
- Principe, Lawrence M., and William R. Newman. "Some Problems with the Historiography of Alchemy." In *Secrets of Nature: Astrology and Alchemy in Early Modern Europe*, edited by William R. Newman and Anthony Grafton, 385–431. Cambridge, Mass.: MIT Press, 2001.
- Rattansi, Piyo, and Antonio Clericuzio, eds. *Alchemy and Chemistry in the Sixteenth and Seventeenth Centuries*. Dordrecht, Netherlands: Kluwer, 1994.
- Smith, Pamela H. *The Business of Alchemy: Science and Culture in the Holy Roman Empire*. Princeton, N.J.: Princeton University Press, 1994.
- Yates, Frances A. *Giordano Bruno and the Hermetic Tradition*. Chicago: University of Chicago Press, 1964.

Tara E. Nummedal

ALGEBRAS. The word *algebra* refers to a theory, usually mathematical, which is dominated by the use of words (often abbreviated), signs, and symbols to represent the objects under study (such as numbers), means of their combination (such as addition), and relationships between them (such as inequalities or equations). An algebra cannot be characterized solely as the determination of unknowns, for then most mathematics is algebra.

For a long time the only known algebra, which was and is widely taught at school, represented numbers and/or geometrical magnitudes, and was principally concerned with solving polynomial equations; this might be called "common algebra."

But especially during the nineteenth century other algebras were developed.

The discussion below uses a distinction between three modes of algebraic mathematics that was made in 1837 by the great nineteenth-century Irish algebraist W. R. Hamilton (1805–1865): (1) The "practical" is an algebra of some kind, but it only provides a useful set of abbreviations or signs for quantities and operations; (2) In the "theological" mode the algebra furnishes the epistemological basis for the theory involved, which may belong to another branch of mathematics (for example, mechanics); (3) In the "philological" mode the algebra furnishes in some essential way the formal language of the theory.

Lack of space prevents much discussion of the motivations and applications of algebras. The most important were geometries, the differential and integral calculus, and algebraic number theory.

Not Distant Origins?

Several branches of mathematics must have primeval, unknown, origins: for example, arithmetic, geometry, trigonometry, and mechanics. But algebra is not one of them. While Mesopotamian and other ancient cultures show evidence of methods of determining numerical quantities, the means required need only arithmetical calculations; no symbolism is evident, or needed. Concerning the Greeks, the *Elements* of Euclid (fourth century B.C.E.), a discourse on plane and solid geometry with some arithmetic, was often regarded as "geometric algebra"; that is, the theories thought out in algebraic terms. While it can easily be so rendered, this reading has been discredited as historical. For one reason among many, in algebra one takes the square on length a to be a times a but Euclid worked with geometrical magnitudes such as lines, and never multiplied them together. The only extant Greek case of algebraization is the number theory of Diophantus of Alexandria (fl. c. 250 C.E.), who did use symbols for unknowns and means of their combination; however, others did not take up his system.

A similar judgment applies to ancient Chinese ways of solving systems of linear equations. While their brilliant collection of rules can be rendered in terms of the modern manipulation of matrices, they did not create matrix theory.

The Arabic Innovations

Common algebra is a theory of manipulating symbols representing constant and unknown numbers and geometrical magnitudes, and especially of expressing polynomial equations and finding roots by an algorithm that produces a formula. Its founders were the Arabs (that is, mathematicians usually writing in Arabic) from the ninth century, the main culture of the world outside the Far East. Some of the inspiration came from interpreting various Greek or Indian authors, including Euclid. The pioneer was Al-Khwarizmi (fl. c. 800–847) with his work *Al-jabr wa'l-muqabala*, known in English as the *Algebra*, and over the next five centuries followers elaborated his theory.

The problems often came from elsewhere, such as commerce or geometry; solutions usually involved the roots of



Postage stamp bearing the likeness of Al-Khwarizmi. The early-ninth-century Arab librarian and astronomer was a pioneer in the field of mathematics, setting forth theories that were expanded upon for centuries. The term *algebra* was first derived from his groundbreaking work *Al-jabr wa'l-muqabala*. KEITH BAUMAN, TNA ASSOCIATES, FRANKLIN, MICHIGAN

polynomial equations. Algebra was seen as an extension of arithmetic, working with unknowns in the same way as arithmetic works with knowns. The Arabic manner of expression was verbal: the word *shay* denoted the unknown, *mal* its square, *ka'b* its cube, *mal mal* for the fourth power, and so on. Arabs also adopted and adapted the Indian place-value system of numerals, including 0 for zero, that is called Hindu-Arabic. They were suspicious of negative numbers, as not being *pukka* quantities.

European Developments to the Seventeenth Century

Common algebra came into an awakening Europe during the thirteenth century. Among the various sources involved, Latin translations of some Arab authors were important. A significant homegrown source was the Italian Leonardo Fibonacci, who rendered the theory into Latin, with *res*, *census*, and *cubus* denoting the unknown and its powers. He and some translators of Arabic texts also adopted the Indian system of numerals. Communities developed, initially of Italian *abbacists* and later of German *Rechenmeister*, practicing arithmetic and common algebra with applications—some for a living.

The title of al-Khwarizmi's book included the word *al-jabr*, which named the operation of adding terms to each side of an equation when necessary so that all of them were positive. Maybe following his successor Thabit ibn Qurra (836–901), in the sixteenth century Europeans took this word to refer to the entire subject. Its theoretical side principally tackled properties of polynomial equations, especially finding their roots. An early authority was Girolamo Cardano (1501–1576), with his *Ars magna* (1545); successors include François Viète (1540–1601) with *In artem analyticam isagoge* (1591), who applied algebra to both geometry and trigonometry. The Europeans gradually replaced the words for unknowns, their powers, means of combination (including taking roots), and relationships by symbols, either letters of the alphabet or special signs. Apart from the finally chosen symbols for the arithmetic numerals, no system became definitive.

In his book *Algebra* (1572), Rafael Bombelli (1526–1572) gave an extensive treatment on the theory of equations as then known, and puzzled over the mystery that the formula for the (positive) roots of a cubic equation with real coefficients could use complex numbers to determine them even if they were real; for example (one of his), given

$$x^3 = 15x + 4 / \text{root } x = (2 + \sqrt{-1}) + (2 - \sqrt{-1}) = 4.$$

The formula involved had been found early in the century by Scipione del Ferro (1465–1526), and controversially published later by Cardano. It could be adapted to solve the quartic equation, but no formula was found for the quintic.

Developments with Equations from Descartes to Abel

René Descartes's (1596–1650) *Géométrie* (1637) was an important publication in the history algebra. While its title shows his main concern, in it he introduced analytic geometry, representing constants and also variable geometric magnitudes by letters. He even found an algebraic means of determining the normal to a curve. Both this method and the representation of variables were to help in the creation of the calculus by Isaac Newton (1642–1727) in the 1660s and Gottfried Wilhelm Leibniz (1647–1716) a decade later.

During the seventeenth century algebra came to be a staple part of mathematics, with textbooks beginning to be published. The binomial theorem was studied, with Newton extending it to non-integral exponents; and functions were given algebraic expression, including as power series. Algebraic number theory developed further, especially with Pierre de Fermat (1601–1665). Negative and complex numbers found friends, including Newton and Leonhard Euler (1707–1783); but some anxiety continued, especially in Britain.

The theory of polynomial equations and their roots remained prominent. In particular, in Descartes's time "the fundamental theorem of algebra" (a later name) was recognized though not proved: that for any positive integer n a polynomial equation of degree n has n roots, real and/or complex. The Italian mathematician J. L. Lagrange (1736–1813) and others tried to prove it during the eighteenth century, but the real breakthrough came from 1799 by the (young) C. F. Gauss (1777–1855), who was to produce three more difficult and

not always rigorous proofs in 1816 and 1850. He and others also interpreted complex numbers geometrically instead of algebraically, a reading that gradually became popular.

Another major question concerning equations was finding the roots of a quintic: Lagrange tried various procedures, some elaborated by his compatriot Italian Paolo Ruffini (1765–1822). The suspicion developed that there was no algebraic formula for the roots: the young Norwegian Niels Henrik Abel (1802–1829) showed its correctness in 1826 with a proof that was independent of Lagrange’s procedures.

Lagrange was the leading algebraist of the time: from the 1770s he not only worked on problems in algebra but also tried philologically to algebraize other branches of mathematics. He based the calculus upon an infinite power series (the Taylor series); however, his assumption was to be refuted by Augustin-Louis Cauchy (1789–1857) and W. R. Hamilton (1805–1865). He also grounded mechanics upon principles such as that of “least action” because they could be formulated exclusively in algebraic terms: while much mechanics was encompassed, Newtonian and energy mechanics were more pliable in many contexts.

The Nineteenth Century: From Algebra to Algebras

Lagrange’s algebraic ambitions inspired some new algebras from the late eighteenth century onward. The names used below are modern.

Firstly, in differential operators, the process of differentiating a function in the calculus was symbolized by D , with the converse operation of integration taken as $1/D$, with 1 denoting the identity operation; similarly, finite differencing was symbolized by Δ , with summation taken as $1/\Delta$. Much success followed, especially in solving differential and difference equations, though the workings of the method remained mysterious. One earnest practitioner from the 1840s was George Boole (1815–1864), who then imitated it to form another one, today called Boolean algebra, to found logic.

Secondly, in functional equations, the “object” was the function f itself (“sine of,” say) rather than its values. In this context F.-J. Servois (1767–1847) individuated two properties in 1814: “commutative” ($fg = gf$) and “distributive” ($f(g + h) = fg + fh$); they were to be important also in several other algebras.

As part of his effort to extend Lagrange’s algebraization of applied mathematics, Hamilton introduced another new algebra in 1843. He enlarged complex numbers into quaternions q with four units $1, i, j$ and k :

$$q := a + ib + jc + kd, \text{ where } i^2 = j^2 = k^2 = ijk = -1; \\ \text{and } ij = k \text{ and } ji = -k$$

and similar properties. He also individuated the property of associativity (his word), where $i(jk) = (ij)k$.

At that time the German Hermann Grassmann (1809–1877) published *Ausdehnungslehre* (1844), a very general algebra for expressing relationships between geometrical magnitudes. It was capable of several other readings also; for example, later

his brother Robert adapted it to rediscover parts of Boolean algebra. Reception of the Grassmanns was much slower than for Hamilton; but by the 1880s their theories were gaining much attention, with quaternions extended to, for example, the eight-unit “octaves,” and boasting a supporting “International Association.” However, the American J. W. Gibbs (1839–1903) was decomposing quaternions into separate theories of vector algebra and of vector analysis, and this revision came to prevail among mathematicians and physicists.

Another collection of algebras developed to refine means of handling systems of linear equations. The first step (1840s) was to introduce determinants, especially to express the formulae for the roots of systems of linear equations. The more profound move of inventing matrices as a manner of expressing and manipulating systems themselves dates from the 1860s. The Englishmen J. J. Sylvester (1814–1897) and Arthur Cayley (1821–1895) played important roles in developing matrices (Sylvester’s word). An important inspiration was their study of quantics, homogeneous polynomials of some degree in any finite number of variables: the task was to find algebraic expressions that preserved their form under linear transformation of those variables. They and other figures also contributed to the important theory of the “latent roots and vectors” (Sylvester again) of matrices. Determinants and matrices together are known today as linear algebra; the analysis of quantics is part of invariant theory.

On polynomial equations, Lagrange’s study of properties of functions of their roots led especially from the 1840s to a theory of substitution groups with Cauchy and others, where the operation of replacing one root by another one was treated as new algebra. Abel’s even younger French contemporary Évariste Galois (1811–1832) found some remarkable properties of substitutions around 1830.

This theory of substitutions gradually generalized to group theory. In its abstract form, as pioneered by the German Richard Dedekind (1831–1916) in the 1850s, the theory was based upon a given collection of laws obeyed by objects that were not specified: substitutions provided one interpretation, but many others were found, such as their philological intrusion into projective and (non-)Euclidean geometries. The steady accumulation of these applications increased the importance of group theory.

Other algebras also appeared; for example, one to express the basic properties of probability theory. In analysis the Norwegian Sophus Lie (1842–1899) developed in the 1880s a theory of “infinitesimal transformations” as linear differential operators on functions, and formed it as an algebra that is now named after him, including a group version; it has become an important subject in its own right.

Consolidation and Extensions in the Twentieth Century

At the end of the nineteenth century some major review works appeared. The German David Hilbert (1862–1943) published in 1897 a long report on algebraic number theory. The next year the Englishman Alfred North Whitehead (1861–1947)

put out a detailed summary of several of them in his large book *A Treatise on Universal Algebra*, inspired by Grassmann but covering also Boole's logic, aspects of geometries, linear algebra, vectors, and parts of applied mathematics; an abandoned sequel was to have included quaternions. His title, taken from Sylvester, was not happy: no algebra is universal in the sense of embracing all others, and Whitehead did not offer one.

Elsewhere, group theory rose further in status, to be joined by other abstract algebras, such as rings, fields (already recognized by Abel and Galois in their studies of polynomial equations), ideals, integral domains, and lattices, each inspired by applications. German-speaking mathematicians were especially prominent, as was the rising new mathematical nationality, the Americans. Building upon the teaching of Emmy Noether (1882–1935) and Emil Artin (1898–1962), B. L. van der Waerden's (1903–1996) book *Modern Algebra* became a standard text for abstract algebras and several applications, from the first (1930–1931) of its many editions.

This abstract approach solved the mystery of the need for complex numbers when finding real roots of real polynomial equations. The key notion is closure: an algebra A is closed relative to an operation O on its objects a , or to a means of combining a and b , if Oa and $a \cdot b$ always belong to A . Now finding roots involved the operations of taking square, cube, . . . roots and complex but not real numbers are closed relative to them.

One of the most striking features of mathematics in the twentieth century was the massive development of topology. Algebraic topology and topological groups are two of its parts, and algebras of various kinds have informed several others. Both (abstract) algebras and topology featured strongly in the formalization of pure mathematics expounded mainly after World War II by a team of French mathematicians writing under the collective name "Bourbaki."

Reflections

The proliferation of algebras has been nonstop: the classification of mathematics in the early twenty-first century devotes twelve of its sixty-three sections of mathematics to algebras, and they are also present in many other branches, including computer science and cryptography. The presence or absence in an algebra of properties such as commutativity, distributivity, and associativity is routinely emphasized, and (dis)analogies between algebras noted. Meta-properties such as duality (given a theorem about $+$ and \cdot , say, there is also one about \cdot and $+$) have long been exploited, and theologically imitated elsewhere in mathematics. A massive project, recently completed, is the complete classification of finite simple groups. Textbooks abound, especially on linear and abstract algebras.

Abstract algebras bring out the importance of structures in mathematics. A notable metamathematical elaboration, due among others to the American Saunders MacLane (b. 1909), is category theory: a category is a collection of mathematical objects (such as fields or sets) with mappings (such as isomorphisms) between them, and different kinds of category are studied and compared.

Yet this story of widespread success should be somewhat tempered. For example, linear algebra is one of the most widely taught branches of mathematics at undergraduate level; yet such teaching developed appreciably only from the 1930s, and textbooks date in quantity from twenty years later. Further, algebras have not always established their own theological foundations. In particular, operator algebras have been grounded elsewhere in mathematics: even Boole never fixed the foundations of the D -operator algebra, and a similar one proposed from the 1880s by the Englishman Oliver Heaviside (1850–1925) came to be based by others in the Laplace transform, which belongs to complex-variable analysis. However, a revised version of it was proposed in 1950 by the Polish theorist Jan Mikusinski (1913–1987), drawing upon ring theory—that is, one algebra helped another. Algebras have many fans.

See also *Logic; Logic and Philosophy of Mathematics, Modern; Mathematics.*

BIBLIOGRAPHY

- Corry, Leo. *Modern Algebra and the Rise of Mathematical Structures*. Basel, Switzerland, and Boston: Birkhäuser, 1996.
- Cournot, Antoine Augustin. *De l'origine et des limites de la correspondance entre l'algèbre et la géométrie*. Paris and Algiers: Hachette, 1847.
- Crowe, Michael J. *A History of Vector Analysis: The Evolution of the Idea of a Vertical System*. Notre Dame and London: Notre Dame University Press, 1967. Reprint, New York: Dover, 1987.
- Dieudonné, Jean. *A History of Algebraic and Differential Topology 1900–1960*. Basel, Switzerland, Birkhäuser, 1989.
- Grattan-Guinness, I., ed. *Companion Encyclopedia of the History and Philosophy of the Mathematical Sciences*. 2 vols. London: Routledge, 1994. Reprint, Baltimore: Johns Hopkins University Press, 2003. See especially Part 6.
- Hawkins, Thomas W. *Emergence of Lie's Theory of Groups: An Essay in the History of Mathematics, 1869–1926*. Berlin: Springer, 2002.
- Høyrup, Jens. *Lengths, Widths, Surfaces: A Portrait of Old Babylonian Algebra and Its Kin*. Berlin and New York: Springer, 2002.
- Hutton, Charles. "A History of Algebra." In vol. 2 of his *Tracts on Mathematical and Philosophical Subjects*. London: F. C. and R. Rivington, 1812.
- Klein, J. *Greek Mathematical Thought and the Origins of Algebra*. Cambridge, Mass.: MIT Press, 1968.
- Lam, Lay Yong, and T. S. Ang. *Fleeting Footsteps: Tracing the Conception of Arithmetic and Algebra in Ancient China*. Singapore: World Scientific Publishing, 1992.
- Mehrtens, Herbert. *Die Entstehung der Verbandstheorie*. Hildesheim, Germany: Gerstenberg, 1979.
- Nesselmann, G. H. F. *Versuch einer kritischen Geschichte der Algebra*. Reprint, Frankfurt, Germany: Minerva, 1969.
- Novy, Lubos. *The Origins of Modern Algebra*. Translated by Jaroslav Taner. Prague: Academia, 1973.
- Pycior, Helena M. *Symbols, Impossible Numbers, and Geometric Entanglements: British Algebra through the Commentaries on Newton's Universal Arithmetick*. Cambridge, U.K., and New York: Cambridge University Press, 1997.
- Scholz, Erhard, ed. *Geschichte der Algebra: Eine Ausführung*. Mannheim: Wissenschaftsverlag, 1990. Up to Noether, but no algebraic logic, differential operators, or functional equations.

- Sinaceur, Hourya. *Corps et modèles: Essai sur l'histoire de l'algèbre réelle*. Paris: Vrin, 1991. English translation Basel, Switzerland: Birkh.
- Stedall, Jacqueline A. *A Discourse Concerning Algebra: English Algebra to 1685*. Oxford, and New York: Oxford University Press, 2002.
- van der Waerden, B. L. *A History of Algebra: From al-Khwarizmi to Emmy Noether*. Berlin: Springer, 1985. See the remark above on Scholz.
- Vercelloni, Luca. *Filosofia delle strutture*. Florence, Italy: La Nuova Italia, 1988.
- Vuillemin, Jules. *La philosophie de l'algèbre*. Paris: Presses Universitaires de France, 1992.
- Wallis, John. *Treatise of Algebra, Both Historical and Practical*. . . . London: Printed by J. Playford, for R. Davis, 1685. And not a little corrigible.
- Wussing, Hans. *The Genesis of the Abstract Group Concept: A Contribution to the History of the Origin of Abstract Group Theory*. Translated by Abe Shenitzer. Cambridge, Mass.: MIT Press, 1984. German original, Berlin, 1969.
- Zeuthen, H. *Die Lehre von den Kegelschnitten im Altertum*. Copenhagen: Høst, 1886. Influential source on the supposed Greek geometric algebra.

I. Grattan-Guinness

ALIENATION. The notion of alienation is a very unusual one because it is at once an attempt to explain a widespread feeling—a very subjective, somewhat indefinable feeling—and a critique of the nature of any society that regularly produces it.

This was not always so. The feeling that one is not at home in the world, the sense of estrangement from one's surrounding, oneself, and other people, appears to be as old as history; for most world religions (Buddhism, most strains of Christianity and Daoism, Sufi strands in Islam) this feeling was seen mainly as reflecting a profound insight into the truth of the human condition. Hermits, monks, and meditators often actively valued or cultivated feelings of alienation as a way to something higher. Calvinism came closer to the modern conception in seeing feelings of isolation and emptiness as a sign of humanity's fall from grace, but it was really only in the nineteenth century that the modern understanding of the term came into being. This conception was closely tied to the experience of living in a vast, impersonal, industrial city. Feelings of alienation were particularly prone to strike those who in earlier generations might have been considered likely victims of melancholia: intellectuals, artists, and youth. The effects were much the same: depression, anxiety, hopelessness, suicide.

One might distinguish two main strains in the modern alienation literature: one that stressed the experience itself as an unavoidable (though possibly ameliorable) effect of the impersonal, bureaucratized nature of modern life, entailing the loss of any ability to use that experience to attain some deeper, more genuine truth about the world—since with the death of God and traditional structures of authority, most of these truths were considered definitively lost. The other, drawing on older theological traditions, saw alienation as the key to the true, hidden nature of the modern (i.e., capitalist, industrial)

order itself, showing it to be an intolerable situation that could be resolved only by overthrowing that order and replacing it with something profoundly different.

The first tradition can be found in social thinkers such as Alexis de Tocqueville, Émile Durkheim, or Max Weber; novelists such as Fyodor Dostoyevsky or Franz Kafka; and philosophers such as Søren Kierkegaard or Friedrich Nietzsche. Here alienation is the darker underside of all the positive values of modernity, the experience of those sundered from all previous sources of meaning: community, hierarchy, the sacred. It is the point where individualism becomes isolation, freedom becomes rootlessness, egalitarianism becomes the destruction of all value, rationality, an iron cage.

Probably the most famous formulation within this genre was Émile Durkheim's (1858–1917) notion of anomie. Observing that suicide rates tend to go up during times of both economic boom and economic collapse, Durkheim concluded that this could only be because both booms and busts threw ordinary people's expectations so completely in disarray that they ended up in a state of lacking norms, unable to determine what they had a right to expect or even want from life and unable to imagine a time when they could. This kind of analysis could lead either to a resigned pessimism, the assumption (favored by social conservatives) that public life in modern society can never really be anything but alienated, or to a liberal approach that saw alienation as a form of deviance or lack of proper integration that policymakers should ideally be able to ameliorate or even overcome.

The other tradition can be traced to Georg Wilhelm Friedrich Hegel (1770–1831), who drew heavily on theological sources. For Hegel, "alienation" was a technical term, a necessary moment in the process whereby Spirit (which for Hegel was simultaneously God, Mind, Spirit, and Human Self-Consciousness) would achieve true self-knowledge. Human history involved the same story: Mind would project itself out into the world, creating, say, Law, or Art, or Science, or Government; it would then confront its creations as something alien to it and strange; then, finally, coming to understand that these alienated forms are really aspects of itself, would reincorporate them and come to a richer self-conception as a result.

Karl Marx (1818–1883) remained true to this dialectical approach but concentrated on the material creativity of work, emphasizing that under capitalism, not only the products of one's labor but one's labor itself, one's very capacity to create—and for Marx, this is one's very humanity—becomes a commodity that can be bought and sold and hence appears to the worker as an "alien force." Insofar as Marx shares Hegel's optimism, and sees this dilemma as opening the way to a new, revolutionary society, all this is much in line with the older, theological conception in which alienation, however painful, is a realization about the truth of one's relation to the world, so that understanding this becomes the key to transcending it. Twentieth-century Marxists, though, have not been so uniformly optimistic.

While Marxist regimes officially claimed to have eliminated the problem of alienation in their own societies, Western

Marxism, starting with György Lukács (1885–1971) and climaxing with the Frankfurt School, forced to explain the lack of revolutionary change in industrial democracies, gradually became a prolonged meditation on the varied forms of alienation (reification, objectification, fetishism, etc.) in modern life. This emphasis set the tone for an outpouring of literature on the subject in the mid-twentieth century, not all of it Marxist.

France in the 1950s and early 1960s saw the emergence of a particularly rich body of alienation theory, ranging from the Existentialism of Jean-Paul Sartre and Albert Camus, which attempted to formulate an ethics for the isolated individual, to a variety of Marxist approaches, of which the most extravagant—and influential—was developed by the Situationist International, whose members saw modern consumer society as a gigantic “spectacle,” a vast apparatus composed of not only media images but market logic, the rule of experts, and the nature of the commodity form, all combining together to render individuals passive and isolated spectators of their own lives. Like many of the radical art movements from which they emerged, the Situationists were dedicated to imagining ways to revolutionize everyday life itself as a way of overcoming the “living death” of capitalist alienation.

After the failed insurrection of May 1968 in France, this literature on alienation rapidly disappeared in the face of post-structuralist critiques that argued it was impossible to talk about a human subject alienated from society or from itself because the subject was itself an effect of discourse and hence a social construct. Over the course of the 1970s and 1980s, these critiques spread outside France and the theme of alienation has, as a result, largely disappeared from intellectual debate in the early twenty-first century.

There are two main exceptions. First, in its radical, redemptive form, the idea of alienation has remained alive in artistic and revolutionary circles largely outside the academy. Situationism, for example, is still very much at the center of the (increasingly international) anarchist and punk scenes, both of which are largely rebellions against the meaninglessness and alienation of “mainstream” urban, industrial, or postindustrial life. These themes have suddenly reemerged to public attention with the rise of the “antiglobalization” movement, though they have still found almost no echo in the academy.

Second, in its more liberal, ameliorative form, the idea of alienation became ensconced in certain branches of sociology and hence reemerged in what is increasingly called “postmodern” alienation theory. When American sociologists started taking up the theme of alienation systematically in the 1950s and 1960s, they began by making it into a factor that could be quantified. Various questionnaires and techniques of tabulating an individual’s degree of alienation were developed; surveys then revealed, not entirely surprisingly, that aside from students, those who scored highest for alienation were, precisely, aliens, immigrants, or else members of minority groups already defined as marginal to mainstream American life. Over the course of the 1990s and the early twenty-first century, this sociological work has converged with an interest in identity and identity-based social movements to yield a new, “postmodern” body of alienation theory.

On the individual level, alienation is said to occur when there is a clash between one’s own self-definition and the identity assigned one by a larger society. Alienation thus becomes the subjective manner in which various forms of oppression (racism, sexism, ageism, etc.) are actually experienced and internalized by their victims. As a result, where the older revolutionary conception sees alienation as essential to the fundamentally violent, antihuman nature of “the mainstream,” postmodern theories now once again see alienation as a measure of exclusion from the mainstream. On the social level, the postmodern conception of alienation is said to be caused by a surfeit rather than a lack of freedom; a notion that appears almost impossible to distinguish from what were, in the late nineteenth century, called “modern” concepts of alienation. So far, these two traditions have barely come into contact with each other—except, perhaps, in recent environmentalist ideas about “alienation from nature.” How or whether they will make contact remains an open question.

See also **Existentialism; Identity; Person, Idea of the; Society.**

BIBLIOGRAPHY

- Geyer, Felix, ed. *Alienation, Ethnicity, and Postmodernism*. London and Westport, Conn.: Greenwood Press, 1996.
- Ollman, Bertell. *Alienation: Marx’s Conception of Man in Capitalist Society*. Cambridge, U.K., and New York: Cambridge University Press, 1976.
- Schmitt, Richard, and Thomas E. Moody, eds. *Alienation and Social Criticism*. Atlantic Highlands, N.J.: Humanities Press, 1994.
- Schweitzer, David, and Felix Geyer, eds. *Alienation Theories and De-Alienation Strategies: Comparative Perspectives in Philosophy and the Social Sciences*. London: Science Reviews, 1989.

David Graeber

ALTRUISM. The term *altruism* was coined by the French philosopher and sociologist Auguste Comte (1798–1857). Derived from the Italian word *altrui*, meaning “to others” or “of others,” “altruism” was introduced as an antonym for “egoism” to refer to the totality of other-regarding instincts in humans. The new terms *altruism*, *altruist*, and *altruistic* provided nineteenth-century thinkers with a controversial new conceptual framework within which to discuss ancient philosophical, religious, and ethical questions. In the earlier idiom of Enlightenment moralism, these had been expressed as questions about the relationship between particular self-serving passions and benevolent moral sentiments or between the principle of self-love and the authority of the conscience. It was in this earlier idiom that writers such as Thomas Hobbes and Bernard Mandeville expressed their view that all human action was ultimately driven by self-interest and that their critics, including Francis Hutcheson and Joseph Butler, expressed the contrary view that benevolence was as fundamental a principle of human action as self-interest. The conceptual history of “altruism” proper began in the 1850s and has generated its own particular set of scientific, religious, and philosophical questions.

“Altruism” and “altruistic” have been used to refer to at least three different sorts of things: intentions, actions, and ideologies. These three sorts of usage can be grouped under the headings of “psychological altruism,” “behavioral altruism,” and “ethical altruism.” Psychological altruism is any set of inclinations or intentional motivation to help others for their own sakes. Behavioral altruism is defined in terms of consequences rather than intentions: it refers to any action that benefits others (normally with the additional condition that there is some cost to the agent). “Evolutionary altruism” or “biological altruism” is a form of behavioral altruism, since it is defined solely in terms of consequences rather than intentions: it refers to any behavior that reduces the fitness of the organism performing it and increases the fitness of another organism (see Dawkins; Sober and Wilson). Finally, ethical altruism is an ideology stating that the happiness of others should be the principal goal of one’s actions. (Ethical egoism, by contrast, states that what the individual should seek above all else is his or her own happiness.)

A frequent cause of confusion has been equivocation between the first two of these three possible meanings—between claims about psychology and claims about behavior. The claim that there is no such thing as true altruism, for example, might be intended to convey the view that, psychologically, no one’s motives are ever entirely forgetful of self, since we know that we will receive approval and pleasure as a result of our charitable actions. The reply might be that true altruism certainly exists because many people engage in charitable activities at a cost to themselves, but by shifting from the psychological to the behavioral perspective on altruism, this reply fails to rebut the initial claim. Such conceptual confusion and disagreement over the meaning of altruism marked discussions of it from the outset and persist to this day. (Blum provides one useful and concise discussion of some of the definitional and conceptual issues.)

Discussions of altruism also have revolved around fundamental empirical, ethical, and political questions. What are the real roots of human altruism? Are they biological, psychological, social, or cultural? Is altruism really the highest moral good? Are we morally obliged to extend our altruism to strangers just as much as to family and friends? Should we even behave altruistically toward nonhuman animals? In what ways can societies be arranged in order to maximize the amount of altruism? Are the best societies, in any case, really those in which altruism is maximized?

Comte and Sociology

The term *altruism* was coined, in French (*altruisme*), by Auguste Comte (1798–1857) in the first volume of his *Système de politique positive* (1851–1854; *System of positive polity*). The first uses in English followed in the 1850s and 1860s in works by British thinkers sympathetic to Comte, including George Eliot, G. H. Lewes, and John Stuart Mill (see Dixon, 2005). In the Comtean system, “altruism” stood for the totality of other-regarding sentiments. The new cerebral science of phrenology, Comte said, proved that altruistic sentiments were innate. He heralded this as one of the most important discoveries of modern science and contrasted it with what he presented as the Christian view, namely that human beings

are, by nature, entirely selfish (because of the taint of original sin). Comte’s hope was that through the institution of a new humanistic religion based on a scientific understanding of human nature and society, civilized nations would develop to a stage where altruistic sentiments prevailed over egoistic ones. Working out how to bring such a society about, Comte taught, was the greatest problem facing humanity. In his view, one of the keys to increased altruism was a recognition of the fact that women, because of their maternal instincts, were more altruistic than men. They therefore should have supreme moral and religious authority (although only within the domestic sphere). Thus the Religion of Humanity, as he called it, encouraged a particular emphasis on feminine moral virtues and the great sanctity of motherhood (see Wright).

Another important Comtean coinage with which altruism was initially closely associated was “sociology”—the new science of society. Two of the most significant nineteenth-century theoretical treatments of altruism, other than Comte’s own, were also produced by pioneering sociologists, namely Herbert Spencer (1820–1903) and Émile Durkheim (1858–1917). Durkheim, who drew on the sociological theories of both Comte and Spencer while making much greater and more sophisticated use of empirical data than either of them, made a distinction between egoistic, altruistic, and anomic types of suicide in his 1897 study of the subject. Egoistic suicide was most widespread in developed, Western nations (especially strongly Protestant ones), Durkheim said, as a result of the highly developed sense of individual autonomy such nations encouraged. Altruistic suicide, on the other hand, was particularly prevalent among primitive peoples, who had an excessive sense of social integration. The main sorts of altruistic suicide with which Durkheim was concerned were the suicides of men on the threshold of old age or stricken with sickness, suicides of women on their husbands’ deaths, and the suicides of followers or servants on the death of their chief (Durkheim, book 2, chapter 4).

Darwin, Spencer, and Evolution

Charles Darwin did not use the term “altruism,” preferring to use older terms with which he was familiar from his reading of moral philosophy in the 1830s and 1840s, such as “benevolence,” “sympathy,” and “moral sense” (see Darwin; Richards). In his *Descent of Man* (1871), Darwin famously developed a group-selection explanation for the apparent self-sacrificing behavior of neuter insects. According to this view, communities of insects that happen to contain self-sacrificers benefit in the struggle for existence at the expense of communities made up of more selfish individuals with which they are in competition. As a result, contrary to the popular caricature of Darwinian nature as dominated by selfishness and competition, Darwin actually argued that benevolence and cooperation are entirely natural—that they are deeply embedded in our biology. The problem of how to account for altruistic behavior, especially in insects, continued to puzzle biologists (see Lustig) and became a central topic in the new discipline of “sociobiology” founded by the entomologist E. O. Wilson in the 1970s.

In the English-speaking world of the later nineteenth century, however, it was Herbert Spencer (1820–1903) rather

than Charles Darwin (1809–1882) who was celebrated as the leading exponent of the philosophy of evolution. Spencer was also one of the writers most responsible for the spread of the language of altruism (and sociology) from the 1870s onward (see Dixon, 2004). Spencer acknowledged that he had borrowed these terms from Comte. In his *Principles of Psychology* (second edition of 1870–1872) and *Data of Ethics* (1879), he developed his theory of how altruistic instincts could evolve and be inherited and how they would increase as social evolution progressed. He denied, however, that by doing so he endorsed Comte's views on philosophy, science, or religion. Indeed, although Spencer agreed with Comte that altruism would increase as societies evolved further, his vision of the ideal future society was in many ways the opposite of the Comtean vision. Whereas Comte envisaged a hierarchical and, in effect, totalitarian society in which individuals sacrificed personal freedom in the interests of order and progress, Spencer hoped for a society in which individual freedoms (and responsibilities) were maximized (see Richards). Spencer's hope was that people would increasingly act in altruistic ways spontaneously and voluntarily, without state intervention. Although Spencer had a very elevated reputation and a wide sphere of influence in Britain and America in the 1860s and 1870s, the scientific rejection of his belief in the heritability of acquired moral and intellectual characteristics, along with the rise of a political consensus in favor of some kind of state provision of welfare, rendered much of his thought untenable by the early twentieth century.

Utilitarianism

Utilitarianism, as discussed by its most distinguished nineteenth-century advocate, John Stuart Mill (1806–1873), was based on the view that a good act was one that would increase the general prevalence of pleasure over pain in the whole of society. It could thus be construed as a form of ethical altruism. In *Auguste Comte and Positivism* (1865), however, Mill made clear that his utilitarianism did not imply a one-sided commitment to altruism. He believed that a commitment to the general happiness was quite consistent with each individual living a happy life, and he criticized Comte for advocating an extreme sort of altruism. According to Mill's utilitarian principles, Comte's idea of happiness for all, procured by the painful self-sacrifice of each, was a contradiction; a sufficient gratification of "egoistic propensities" was a necessary part of a happy life and was even favorable to the development of benevolent affections toward others. Later in the nineteenth century Henry Sidgwick further developed the utilitarian tradition of philosophical ethics (see Schneewind). In his celebrated *Methods of Ethics* (1874 and several subsequent editions), Sidgwick tried to establish the proper extent of individual altruism and to show how such behavior could be encouraged while also recognizing the legitimate, independent demands of self-interest.

Christianity and Unbelief

At its inception, the concept of altruism resonated widely in a Victorian culture saturated with moral and religious earnestness (see Collini). Some were attracted to Comtean positivism and its worship of humanity as an eminently respectable form of unbelief, one that combined a commitment to the sciences

with a continuing religious sense and with the strong social conscience that the positivist ideology of altruism involved (see Wright). On the other hand, some who were committed to a Christian view of morality and society saw in Comtean altruism a concept of the love of others that was detached both from an understanding of appropriate self-love and from the necessity of a love of God. There were also those who saw in humanistic celebrations of altruism simply a secularized version of the Christian ideology of service to others (see Dixon, 2004, 2005). This last view was held by both proponents and opponents of Christianity. Among the latter, one of the most trenchant was Friedrich Nietzsche (1844–1900). In Nietzsche's vision, Christianity was at the root of all ideologies of altruism, self-sacrifice, and pity—in short, of the "slave morality" that was the exact opposite of the assertive and aristocratic ideals he celebrated (see Nietzsche and the introduction by Ansell-Pearson).

From the twentieth century onward, once the origins of altruism in Comte's atheistic philosophy had largely been forgotten, it was much more common to encounter the assumption that altruism was a term that encapsulated the heart of Christian teaching. The French philosopher Jacques Maritain (1882–1973), however, continued to press the point that Comte's extreme and atheistical concept of altruism differed significantly from Christian love, whether human or divine. The difference between Christian love and altruism that Maritain insisted upon could be summarized as the difference between loving one's neighbor *as oneself* and loving one's neighbor *instead of oneself* (see Maritain). Nonetheless, some Christian writers still consider altruism to be virtually identical to Christian love, or agape.

Socialism and Economics

The 1880s saw a downturn in the economic prosperity of Britain and its empire. The results of this included waning confidence in the inevitability of social and economic progress and increased public awareness of the plight of the urban poor. The economic orthodoxy of *laissez-faire*, which emphasized the freedom and autonomy of the individual and had accompanied the optimism and success of the earlier Victorian period, also increasingly came into question. A renewed interest in altruism was now evident, not only in philosophy and religion but also in economics. A central assumption of classical political economy was that man had benevolent as well as selfish instincts, but when it came to economic activity, the rigorous application of self-interest was the most rational principle. This assumption was now subjected to more serious examination (see Pearson). Altruism became associated with political creeds of cooperation and collectivism. One commune in the United States was even named "Altruria" in recognition of the importance of altruism to this new movement. The concept of altruism was thus redefined as an ideology, in a way that brought it closer to communism than either the Comtean positivism or the Spencerian individualism with which it had earlier been associated. Altruism, for these groups, was a radical and universal denial of self in the pursuit of harmonious and egalitarian community living. In the later twentieth century, the viability of the assumption of self-interest in economics would again be called into question (see Mansbridge; Monroe).

First Half of the Twentieth Century

The closing decades of the nineteenth century, as well as seeing a new interest in “altruism” as an economic and political doctrine, witnessed an accelerated professionalization of intellectual discussions of the subject. Whereas writers like Lewes, Eliot, Mill, and Spencer had pursued their intellectual projects outside the universities (they were, to use Collini’s phrase, “public moralists”), it was increasingly the case by the turn of the twentieth century that rigorous academic discussions of moral philosophy, economics, psychology, and sociology were conducted by university-based experts. The resultant discussions were thus both more detached from public political life and more fragmented. In the first half of the twentieth century the influence of the ethos of logical positivism meant that those working in the human and social sciences were inclined to avoid or even to deny the meaningfulness of questions with ethical and religious overtones. G. E. Moore claimed (in his 1903 work *Principia ethica*) that any system of ethics that tried to draw moral conclusions on the basis of a scientific account of human nature and society (as the systems of both Comte and Spencer had done) committed the “naturalistic fallacy.” (See Maienschein and Ruse’s collection of essays investigating the possibility of founding ethics on biology.) Finally, the success of the neo-Darwinian synthesis in biology and the rejection of the doctrine of the inheritance of acquired characteristics seemed to undermine earlier theories of the gradual evolution of greater altruism. All that was left was a starkly amoral vision of nature as the domain of competition and natural selection. All of these factors meant that even though philosophers, sociologists, and economists continued to discuss concepts of altruism, the first fifty or sixty years of the twentieth century saw a reduction of academic interest in the subject.

Social Psychology, Sociobiology, and Altruism since the 1960s

Scientific research into altruism has markedly increased since the 1960s. During the 1970s, “helping behavior” and the problem of the “unresponsive bystander” were among the most popular topics in social psychology (see Howard and Pillavin; Latané and Darley; Wispé). Later C. Daniel Batson stimulated considerable discussion among social psychologists with a series of experiments trying to establish the genuinely altruistic motivation of some helping behavior, explaining it as the product of empathy (see Batson). Others have preferred more egoistic hypotheses, such as the theory that helping behavior is undertaken in order to alleviate the helper’s own distress at the suffering of the person to be helped.

In the field of evolutionary biology, 1975 saw the publication of E. O. Wilson’s controversial *Sociobiology*, which set out to explain all social phenomena in terms of underlying biological mechanisms. The following year Richard Dawkins’s highly successful popular science book *The Selfish Gene* was published. It was based on mathematical models developed by William D. Hamilton to explain altruistic behaviors in terms of their benefits to genetically related individuals. Absolutely central to both these books was the puzzle of how self-sacrificing individuals could ever have been successful in the merciless struggle for existence. In short, how could Darwinian

evolution produce altruism? Dawkins’s straightforward answer was that it could not. According to Dawkins, human beings and other animals are blind robots programmed by their “selfish genes,” and any actions that on the surface seem to be examples of “altruism” are in fact driven by the interests of the genes. The existence of apparently altruistic impulses could thus be explained by the fact that an individual who acts in the interests of close relatives (who have many of the same genes) is increasing the chances of copies of the individual’s genes persisting into the next generation. Since there is no genuine altruism in nature, Dawkins concluded, the most we can do is to try to teach our children altruism in the hope that they can succeed in rebelling against their genetic inheritance.

Scientific, philosophical, and theological critiques of Dawkins’s ideas have been abundant. Some have argued that the idea that genes can have “interests” or be described as “selfish” is misleadingly anthropomorphic. Dawkins has replied that these are only metaphors, but ones that help to communicate the fact that the real business of evolution goes on at the genetic level. But others have questioned whether it has really been established that selection operates exclusively, or even primarily, at the genetic level rather than at the level of individuals, groups, or species (see Sober and Wilson). And many commentators have found the view of human nature implicit in *The Selfish Gene* to be unacceptably cynical, fatalistic, and pessimistic.

Since the 1990s, although academic discussions have now moved on from the agenda set by sociobiology and *The Selfish Gene*, the topic of “altruism” has continued to attract a great deal of attention from a wide range of disciplines, including theology, philosophy, evolutionary biology, economics, social psychology, and sociology (see Batson; Mansbridge; Monroe; and for a particularly helpful collection, Post et al.). The same central questions about what science, religion, and philosophy each have to contribute to an understanding of human altruism, and about their ethical and political implications, continue to be vigorously debated.

See also **Christianity: Overview; Good; Moral Sense; Philanthropy; Utilitarianism.**

BIBLIOGRAPHY

PRIMARY SOURCES

- Batson, C. Daniel. *The Altruism Question: Toward a Social-Psychological Answer*. Hillsdale, N.J.: Erlbaum, 1991.
- Comte, Auguste. *System of Positive Polity; or, Treatise on Sociology, Instituting the Religion of Humanity*. Translated by Edward Spencer Beesly et al. 4 vols. London: Longmans, Green, 1875–1877.
- Darwin, Charles. *The Descent of Man, and Selection in Relation to Sex*. 1871. Edited and with an introduction by James Moore and Adrian Desmond. London: Penguin, 2004.
- Dawkins, Richard. *The Selfish Gene*. Oxford: Oxford University Press, 1976.
- Durkheim, Emile. *Suicide: A Study in Sociology*, 1897. Translated by John A. Spaulding and George Simpson, edited with an introduction by George Simpson. London: Routledge and Kegan Paul, 1952.

- Latané, Bibb, and John M. Darley. *The Unresponsive Bystander: Why Doesn't He Help?* New York: Appleton-Century Crofts, 1970.
- Mill, John Stuart. *Auguste Comte and Positivism*. London: Trübner, 1865.
- Nietzsche, Friedrich. *On the Genealogy of Morality*, 1887. Translated by Carol Diethe, edited with an introduction by Keith Ansell-Pearson. Cambridge, U.K.: Cambridge University Press, 1994.
- Sober, Elliott, and David Sloan Wilson. *Unto Others: The Evolution and Psychology of Unselfish Behaviour*. Cambridge, Mass., and London: Harvard University Press, 1998.
- Wispé, Lauren, ed. *Altruism, Sympathy, and Helping: Psychological and Sociological Principles*. New York and London: Academic Press, 1978.

SECONDARY SOURCES

- Blum, Lawrence. "Altruism." In *Encyclopedia of Ethics*, edited by Lawrence C. Becker and Charlotte B. Becker. New York and London: Routledge, 2001.
- Collini, Stefan. "The Culture of Altruism." In *Public Moralists: Political Thought and Intellectual Life in Britain, 1850–1930*. Oxford: Clarendon Press, 1991.
- Dixon, Thomas. "Herbert Spencer and Altruism: The Sternness and Kindness of a Victorian Moralist." In *Herbert Spencer, 1820–1903: Founding Father of Modern Sociology*, edited by Greta Jones. London: Galton Institute, 2004.
- . "The Invention of Altruism: Auguste Comte's *Positive Polity* and Respectable Unbelief in Victorian Britain." In *Science and Beliefs: From Natural Philosophy to Natural Science, 1700–1900*, edited by David Knight and Matthew Eddy. Aldershot, U.K.: Ashgate, 2005.
- Lustig, Abigail. "Ants and the Nature of Nature in Auguste Forel, Erich Wasmann, and William Morton Wheeler." In *The Moral Authority of Nature*, edited by Lorraine Daston and Fernando Vidal. Chicago: University of Chicago Press, 2004.
- Maienschein, Jane, and Michael Ruse, eds. *Biology and the Foundation of Ethics*. Cambridge, U.K., and New York: Cambridge University Press, 1999.
- Mansbridge, Jane, ed. *Beyond Self-Interest*. Chicago: University of Chicago Press, 1990.
- Maritain, Jacques. *Moral Philosophy: An Historical and Critical Survey of the Great Systems*. London: Geoffrey Bles, 1964. Chapters 11, 12.
- Monroe, Kristen Renwick. "A Fat Lady in a Corset: Altruism and Social Theory." *American Journal of Political Science* 38 (1994): 861–893.
- Pearson, Heath. "Economics and Altruism at the *Fin de Siècle*." In *Worlds of Political Economy*, edited by Martin J. Daunt and Frank Trentmann. Basingstoke, U.K.: Palgrave Macmillan, 2004.
- Post, Stephen G., et al., eds. *Altruism and Altruistic Love: Science, Philosophy, and Religion in Dialogue*. Oxford and New York: Oxford University Press, 2002.
- Richards, Robert. *Darwin and the Emergence of Evolutionary Theories of Mind and Behavior*. Chicago: University of Chicago Press, 1987. Especially chapters 4–7.
- Schneewind, J. B. *Sidgwick's Ethics and Victorian Moral Philosophy*. Oxford: Clarendon Press, 1977.
- Spencer, Herbert. *The Data of Ethics*. London: Williams and Norgate, 1879.

- Wright, Terence R. *The Religion of Humanity: The Impact of Comtean Positivism on Victorian Britain*. Cambridge, U.K.: Cambridge University Press, 1986.

Thomas Dixon

AMBIGUITY. By instinct humans yearn for reassurance and certainties and dream of an orderly universe where the reasoning process corresponds to external reality. This attitude is reflected by the assumption, authoritatively legitimized by Aristotle (384–322 B.C.E.), that no responsible statement can exhibit internal contradictions. In his *Categories*, Aristotle states that the essential character of a substance seems to be its ability to host opposites. At any instant, however, one can assign either a quality or its opposite to a substance: According to Aristotle, "Nobody can be simultaneously sick and healthy. Similarly, nothing is at the same time white and black. No object exists simultaneously hosting opposites." No alternatives exist besides these two; any third possibility is excluded: *tertium non datur*.

Ambiguity

According to Aristotle, the substitution of opposite qualities hosted by a substance during a transformation has a discontinuous character. His logic seems to imply a step-by-step flow of time and rules out the intervention of a critical situation where opposite qualities can smoothly cooperate and compete together in the same substance. This schematizes evolution as a quasi-static change of objects rather than a continuous course of events.

Aristotle's conception is reflected in the rigid aesthetic canons of the art of antiquity. For instance, in Myron's *Discobolus* (The discus thrower), fifth century B.C.E., Museo nazionale, Rome, time seems to be frozen in the act of launching the discus. Furthermore, throughout two millennia, the *tertium non datur* has influenced Mediterranean culture.

It is only during the twentieth century that, thanks to an attentive evaluation of the nature of time and the adoption of a probabilistic approach to the evolution of natural systems, ambiguity, meaning the coexistence or confluence of two or more incompatible aspects in the same reality, has acquired a non-negative connotation in the Western world.

Probability, Uncertainty, and the Arrow of Time

In the 1680s Isaac Newton's concept of absolute, mathematical time depicted a uniform flow deprived of any psychological aspect, including a propensity to flow only toward the future. In the 1700s Pierre-Simon Laplace's rigid, deterministic viewpoint left no space to uncertainties and contradictions.

In the 1820s, however, Nicolas-Léonard-Sadi Carnot's second principle of thermodynamics and Rudolf Clausius's principle of the increase of entropy or disorder in isolated systems attached a directional arrow to time from past to future. In the 1900s Albert Einstein's theory of relativity assigned time an additional role in the fourth dimension of physical space known as the space-time continuum. In the 1920s the

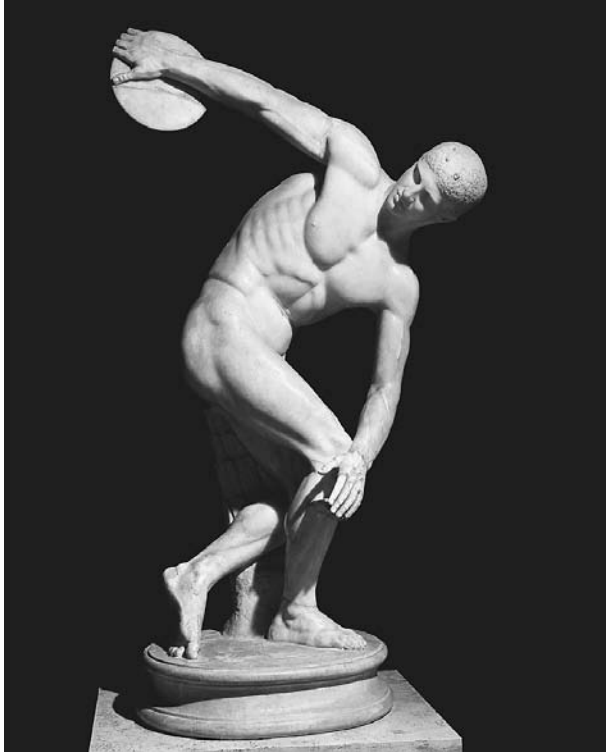

Roman copy of *Discobolus* by Myron, created 2nd century B.C.E. The concept of arrested motion, as seen in Myron's sculpture of a discus thrower, illustrates the substitution of opposite qualities that can sometimes characterize ambiguity. © DAGLI ORTI/CORBIS

probabilistic approach and Werner Karl Heisenberg's uncertainty principle of quantum mechanics brought an end to certainties. In the 1960s, the irreversible thermodynamics of nonlinear systems removed from equilibrium by fluxes of energy, matter, and information regarded time as the creator of spatial, temporal, or functional structural order. These systems include the mind.

Most likely the above breakthroughs in the *Weltanschauung* (worldview), relevant for an analysis ennobling ambiguity, played a role in focusing the attention of eminent philosophers—Immanuel Kant, Georg Wilhelm Friedrich Hegel, Arthur Schopenhauer, Friedrich Nietzsche, Henri-Louis Bergson, and Jean-Paul Sartre, among them—on the dynamics of the processes of transformation rather than on Aristotle's statics of the objects.

Even closer correlations can be conjectured between the scientific and artistic milieus. Look at, for example, Claude Monet's *Waterloo Bridge, Effect of Fog* (1903, Hermitage State Museum). While looking at this painting, the observer, driven by curiosity, correlates his or her sensory stimuli, assembling them in an interiorized pattern. While this mental pattern develops, the fog on the Thames seems to lift slowly, until a critical state is reached where the bridge, the boats on the river, and the urban background merge into the meaning of the painting. This critical state, at a boundary sharing foggy

and meaningless scenery and, at the same time, a meaningful picture, is loaded with ambiguity.

The mental process just described can be viewed as a metaphor of Jean Piaget's statement, "The intelligence organizes the world while it organizes itself." This aphorism leads to self-referentiality. Contextually, ambiguity sneaks in: "Concerning what one cannot talk about, it's necessary to be silent," Ludwig Wittgenstein writes, and yet he talks—and is "silent"—at the same time.

Should one agree in interpreting ambiguity as equivocalness, self-referentiality would make the language totally ambiguous. Rome? A city, a town, and a four-letter word. Again with reference to the above breakthroughs, think of a cubist portrait by Picasso. Its perception lends itself ambiguously to several reconstructions of percepts—front figure, profile, and so forth—and recalls the process of measurement of a quantum structure: a process whose result allows us to access, with different probabilities, the several possible basic modes of being (or behaving) characteristic of the structure.

Similar considerations hold for the ambiguous representation of the fourth dimension on a two-dimensional canvas, seen in several futurist de-structured paintings and in Marcel Duchamp's *Nude Descending a Staircase, No. 2* (1912, Philadelphia Museum of Art), an organization of kinetic elements expressing the space-time continuum through the abstract representation of movement.

The Dynamics of Ambiguity

Open systems, far removed from (thermodynamic) equilibrium by intense fluxes of resources—such as matter, energy, and information—exceeding certain critical thresholds, undergo dynamic instabilities resulting in the emergence of spatial, temporal, or functional order. These instabilities exhibit a critical region where the transformation has not yet occurred and yet, at the same time, has already occurred. This region hosts ambiguity, an ambiguity that can be captured at the critical state marking the onset of convective motions in an initially still fluid heated from below (for example, think to the critical state of the formation of the Giants Causeway, the hexagonal volcanic rocks of Northern Ireland), at the starting of a chromatic chemical clock during the Belousov-Zhabotinsky autocatalytic reactions, or at the arising of a synchronized, ordered applause from a stochastic clapping when the audience in an auditorium, driven by enthusiasm, demands an encore from the soloist.

Dynamic instabilities occur under special critical conditions in nature and in society. They also occur during perception, not seldom but continuously and systematically. Their outcome, at the critical state of the perceptive process, is the emergence of visual thinking.

Vivid examples of ambiguity in the mind can be experienced while looking at an ambiguous structure such as *Fragment of Psychoplastic Structure* (1963, collection of the author). This figure may be conceived as a visual metaphor for a diatomic hydrogen molecule formed by two identical atoms. It helps to visualize both the two lower energy modes of being

three-dimensional space and assign its central region to the right- or to the left-hand cubic modulus. Thereafter, visual thinking cannot get stuck in either of these positions: soon an endless sequence of approximately periodic perceptive alternations of right/left/right prospects sets in.

As anticipated, the process of perception, leading to the dynamics of visual thinking, turns out to resemble closely the process of measurement of a homonuclear diatomic molecule according to quantum mechanics. Both processes share ambiguity.

Ambiguity as a Permanent Cultural Value

In conclusion, complex concepts of quantum physics and the structure of matter are intimately connected with optical illusions, paradoxes, and ambiguity, features usually attributed to the world of art rather than to science. Both art and science are produced, emotionally and rationally, by our thinking. And our thinking proceeds chaotically, on the jagged watershed of a permanent cultural value: ambiguity.

See also Authority; Metaphor; Perspective; Quantum.

BIBLIOGRAPHY

- Arnheim, Rudolf. *Visual Thinking*. Berkeley: University of California Press, 1969.
- Caglioti, Giuseppe. *The Dynamics of Ambiguity*. Berlin: Springer, 1992.
- . "Perception of Ambiguous Figures: A Qualitative Model Based on Synergetics and Quantum Mechanics." In *Ambiguity in Mind and Nature: Multistable Cognitive Phenomena*, edited by Peter Kruse and Michael Stadler. Berlin: Springer, 1995. Psychologists, physicists, neurologists, and chemists analyze multistability in perception.
- Empson, William. *Seven Types of Ambiguity*. London: Chatto and Windus, 1953.
- Haken, Hermann. *Synergetics, an Introduction: Nonequilibrium Phase Transitions and Self-organization in Physics, Chemistry, and Biology*. 2nd ed. Berlin: Springer, 1983.
- Hoffmann, Roald. *The Same and Not the Same*. New York: Columbia University Press, 1995.
- Piaget, Jean. *La construction du réel chez l'enfant*. Neuchâtel, France: Delachaux and Niestlé, 1937.
- Prigogine, Ilya. *La fin des certitudes: temps, chaos et les lois de la nature*. Paris: O. Jacob, 1996.
- Wittgenstein, Ludwig. *Tractatus logico philosophicus*. New York: Harcourt Brace, 1922.

Giuseppe Caglioti

(the so-called stationary states) of this molecule and its resonant behavior during a spectroscopic observation of it.

At first this figure, by construction, could be envisaged superficially as a two-dimensional structure exhibiting a center of symmetry. Keep looking at it as passively as possible. Its central region around the center of symmetry could be described in two ways: (1) as belonging 50 percent to the modulus at left and 50 percent to the modulus at right and, paradoxically, (2) as belonging neither to the modulus at left nor to the modulus at right. These two descriptions, though quite acceptable if considered separately, are incompatible if attributed to the same reality simultaneously, as they should be in this case. Indeed, we react instinctively to the absurdity of the situation and hasten to remove the ambiguity built into the figure by letting the two-dimensional figure invade the

AMERICA. America is one of the greatest political-philosophical symbols in world history. It is equal in importance to Athens representing philosophy, Jerusalem representing biblical religion, Rome representing both its pagan and Catholic manifestations, and Mecca representing the home of Islam. But what is meant by *America*? When people refer to it are they signifying the precise measurements of the landmass that incorporates the territory from Canada's Ellesmere Island above the magnetic pole in the north to Tierra del Fuego off the tip of Argentina in the south? Do they want to call

attention to the area that in the year 2000 was home to forty-five countries and territories with 900 million people, where dozens of languages are spoken, and where can be found people of almost every ethnic origin, religion, and social and economic class? It is unlikely that they are referring to these basic facts. Facts and figures do not begin to touch what *America* represents symbolically. Throughout its history, *America* has stood for two different, almost opposite, things. First, it stands for natural man, the Indians, who are said to represent the world's beginning. Second, it stands for the United States, the great political experiment based on natural rights, which has evoked inspiration and fear and envy. It inspires such strong feelings because the United States is often perceived as the world's future. *America* thus represents both the world's origins and its endpoint. This essay attempts to shed light on the "idea" of *America* by tracing its genealogy from America's discovery by Western man until the twenty-first century.

The Indians

From 1492 until the American Revolution, and in some sense continuing into the twenty-first century, *America* evoked the image of Indians. Archaeologists believe that the American continent was first inhabited by human beings who walked from Siberia to Alaska over the Bering Strait on a frozen land bridge about 30,000 to 40,000 years ago. However, what the Indians represent in the global imagination is a fairly static image informed by media portrayals that starkly depict the Indians either as barbaric savages or as noble stewards of the land living in harmony with nature. These images have a long genealogy.

First attempts to explain America. Although the Americas were undoubtedly visited by the Vikings around the year 1000, the "discovery" of America is attributed to Christopher Columbus, whose voyage to America in 1492 captured the European imagination. Ironically, to Columbus's dying day, he insisted that what he had found was part of Asia. Thus, perceptions of America have been mistaken from the very beginning. (Sixteenth-century mapmakers, recognizing Columbus's mistake, named the New World not after him, but after Amerigo Vespucci—hence the name *America*—whom they credited as the first to realize that the New World was its own continent.)

The Indians of America were misrepresented from the very beginning and ever since their discovery. Not only did Columbus believe America was someplace else—hence the name Indians—but his description of its inhabitants was fanciful, too. He claimed to discover cannibals, Cyclopes, Amazons, Sirens, dog-faced peoples, people with no hair, and people with tails. These bizarre claims were suggested to him by centuries of fanciful tales passed on through medieval times by supposedly reliable authorities. In short, Columbus claimed to find what he was looking for. This began a pattern of preformed opinions dictating what is supposedly found in America. He saw the land as potential wealth and its people as possible converts or slaves. For him, as for most of the early conquistadores and missionaries, the Indians had no independent status, no integrity of their own. They were just to be used.

The Spanish Renaissance philosophers who first reflected on the discovery of the Indians did little better in appreciating

them. Two positions dominated the Spanish debates. The first position, arguing that the Indians did not possess the faculty of reason, went so far as to argue that the Indians were the concrete embodiment of Aristotle's natural slave. According to this view, the Indians could be incorporated into Europe's traditional Christian-Aristotelian worldview but only in its lowest place. God created the Indians as naturally inferior, the argument went, so it was just and right that the Spanish subjugate them. The second view saw the Indians as rational—as evidenced by their languages, economics, and politics—but as underdeveloped and needing Spanish tutelage. Because they were human, the Indians had to be governed by consent—not their formal, explicit consent, but rather what they would consent to after they came to understand the natural law, which of course the Spanish thought they possessed. In short, because the Spanish were so confident in their worldview, it never occurred to them that they might be incorrect or possess only a partial truth. Their cultural confidence led them to reject the Americans as barbaric.

America as the home of natural man. In 1580 the French philosopher Michel de Montaigne (1533–1592) began a path-breaking new way of thinking about the Indians. A skeptic and a keen observer of human diversity, Montaigne argued that "each man calls barbarism whatever is not his own practice; for indeed it seems we have no other test of truth and reason than the example and pattern of the opinions and customs of the country we live in." Unlike the Spanish, Montaigne doubts the standards of his own place and time. In his famous essay "Of Cannibals" (*Essays*) he describes Indian society as the best society that ever was, real or imagined, because they are "still very close to their original naturalness" and thus live in a "state of purity" according to "*les loix naturelles*." He claims their society, held together with "little artifice and human sorder," is as pure and natural as a society can be. His account claims that these Indians do fight and eat their captives, but he says they do so not for economic gain but as a kind of aristocratic struggle for mastery. He describes their warfare as "wholly noble" and "as excusable and beautiful as this human disease can be." This is the origin of the image of the noble savage.

Montaigne knows, however, that his account of the Indians' tranquility and bliss is fictitious. He concedes the barbarous horror of some of their actions, writing, "I am not sorry that we notice the barbarous horror of [their] acts, but I am heartily sorry that, judging their faults rightly, we should be so blind to our own." Here Montaigne reveals his true intentions in describing the Indians: he uses them as an image with which to expose the horrors and cruelty of his own world. This usage of the Indians as a countercultural marker was to become the norm. While Montaigne's account of the Indians is in the end neither anthropologically accurate nor fully desirable, he is the first to misrepresent the Indians in a positive fashion.

After Montaigne, no major philosopher in Europe doubted the Indians' naturalness. To the contrary, the Indians came to represent natural man par excellence. From Montaigne until the end of the Enlightenment, every major philosopher agreed

with John Locke's (1632–1704) famous statement that “in the beginning all the world was America” (*Second Treatise of Government*). America represented Europe's past. In ending one debate, however, Montaigne began a new one. While every major thinker agreed that the Indians represented mankind's natural state, debate arose over the interpretation of the natural state: was it a brutishness to overcome or an innocence to recapture?

Among these philosophers the debate evolved in a single direction. Thomas Hobbes (1588–1679) first argued that mankind's natural state is a horrible state of war to be avoided at all costs. Locke and Charles-Louis de Secondat, baron de Montesquieu (1689–1755), countered that the state of nature is pacific but undesirable. Jean-Jacques Rousseau (1712–1778), François Marie Arouet de Voltaire (1694–1778), and Denis Diderot (1713–1784) later praised the Indians as naturally good and happy, in contrast to European artificiality and corruption. These varied representations, it should be noted, do not correspond to any changes in Indian societies, nor do they respond to new information about the Indians. In truth, the available evidence was barely consulted at all by any of the great thinkers. Rather, these philosophers clearly used their descriptions of the Indians as support for their own ends. As dissatisfaction with Europe increased, so did praise of the Indians grow as an alternative, more desirable and more natural, way of living.

In sum, contemporaneous representations of the American Indians really reflect Europe's own debates, not the reality of America. They have left the legacies of brutishness and of the noble savage, which remain in the twenty-first century. But there is another legacy of these debates. In using the Indians of America to promote their own visions of freedom and legitimate institutions, the philosophers set in motion a train of thought and actions that would lead to revolution. The first of these revolutions took place in America and led to the founding of the United States.

The United States

When people speak about America, they usually are referring not to the Indians, nor to the hemisphere as a whole, but to the United States of America (USA), the world's most powerful nation since World War II. The global obsession with American power revolves around four axes: cultural, economic, political, and military. American popular culture (e.g., blue jeans, rock and roll and jazz music, cinema and television programming, McDonald's restaurants, and Disneyland) is both highly prized for its energy, ease, accessibility, and speed and condemned as an unwanted cultural intrusion that threatens to swamp indigenous ways. Economically, America has for centuries represented the possibility of riches beyond belief (“streets paved with gold”), and as such has been the goal of tens and tens of millions of immigrants. But since the United States became the world's dominant economic power, its material wealth has become both envied and resented. Politically, America has been lauded as a uniquely favorable place (what the American colonist John Winthrop called a “city on a hill”) for the promise of freedom that it offers, and it has been condemned, as in the eyes of the Iranian revolutionary, the Ayatollah Khomeini, as

“the great Satan” for what are perceived to be its heathen and materialistic ways. Militarily, the United States has since World War II been the strongest country on earth, and since the collapse of the Soviet Union, it is universally cited as the world's only superpower. This power is sometimes feared and envied by those without it. Moreover, people throughout the globe paradoxically call for the United States to use its power when they want it to do something and condemn the United States as arrogant when it uses it for a cause of which they disapprove.

These perceptions of the United States are neither new nor unmediated reactions to perceived facts. Each of these praises and complaints can be traced back almost to the founding of the United States itself. Thus, they cannot be explained merely as a reaction to a particular political administration or to the rise of American power. Deeper phenomena are at play.

First reactions to the United States. The United States was formed in a rebellion from England in 1776. Its revolution was the first successful modern revolution in that it was inspired and justified (at least in part) by philosophical doctrine. The United States' Declaration of Independence invokes philosophy when it argues that “all men are created equal” and endowed with “inalienable rights” such as the rights to “life, liberty, and the pursuit of happiness.” Government exists only to secure these rights, and any government that does not secure them is deemed illegitimate. The founders of the United States wrote a Constitution to secure these rights based on limited government and the separation of public and private spheres. At a time when no country on earth was based on the consent of the governed, the success of American democracy proved to the modern world that democratic and representative government could exist.

The relationship between the Old and New Worlds (and the two images of America) is intertwined and reciprocal. The American Revolution marked the first major step in the collapse of the European empires founded after Columbus discovered the New World. This revolution was inspired in part by the European philosophical doctrines based on natural rights, which had themselves been partly inspired by the original inhabitants of America. Ironically, the political experiment in the name of natural rights then helped destroy the “natural” people who helped inspire the United States' philosophical forefathers. The American Revolution then helped inspire the French Revolutionaries and other lovers of liberty throughout the world. The complex nature of this relationship is seen in the following quotation from the essay “On the Influence of the American Revolution on Europe” by the French philosopher Marie-Jean Caritat, marquis de Condorcet (1743–1794):

“The human race had lost its rights. Montesquieu found them and restored them to us” (Voltaire). It is not enough, however, that these rights be written in the philosophers' works and engraved in the heart of virtuous men. It is also necessary that the ignorant or feeble man be able to read them in the example of a great people.

America has given us this example. Its Declaration of Independence is a simple and sublime exposition of

these rights, so sacred and so long forgotten. Among no nation have they been so well known, or preserved in such perfect integrity.

The reciprocal relationship is evident: it moves from Montesquieu and Voltaire, who had been partially inspired by America's original inhabitants, to the Declaration of Independence then back to Condorcet, who authored France's Constitution of 1793.

Condorcet's praise of America was typical of the Enlightenment philosophes. Immediate reaction to the American Revolution by Enlightenment thinkers was one of enthusiastic praise. In his popular pamphlet entitled "Observations on the Importance of the American Revolution and the Means of Making it a Benefit of the World," Richard Price (1723–1791) writes, "I see the revolution in favor of universal liberty which has taken place in America; a revolution which opens a new prospect in human affairs, and begins a new era in the history of mankind." Given the unprecedented liberties guaranteed in America, Price is hopeful, nay certain, that liberty will soon spread throughout the world, if unchecked by tyrannical governments. He says the revolution will "raise the species higher" and compares its effect to "opening a new sense." Indeed, he goes so far as to suggest that "next to the introduction of Christianity among mankind, the American revolution may prove the most important step in the progressive course of human improvement." So many hopes has he pinned on America that "perhaps there never existed a people on whose wisdom and virtue more depended; or to whom a station of more importance in the plan of Providence has been assigned." Similarly, Anne-Robert-Jacques Turgot (1727–1781), whose brief stint as finance minister in France marked the last serious attempt at reform before the French Revolution, says in a "Letter to Price" that America is "the *hope* of the world" and should "become a *model* to it."

The Enlightenment thinkers did not think America was perfect. Slavery was America's greatest flaw. They understood the difficulties in eradicating this execrable institution and argued that America would be judged by the manner of eliminating it as circumstances allowed.

The great strengths of America, however, more than outweighed its imperfections. Enlightenment leaders praised the numerous liberties in the United States, including freedom of the press, speech, conscience, and religion. Moreover, America was seen as an inspiration for the world. As Condorcet writes, it is an example "so useful to all the nations who can contemplate it"; "it teaches them that these rights are everywhere the same"; "the example of a free people submitting peacefully to military, as to civil, laws will doubtless have the power to cure us." Europe developed these Enlightenment ideas, but due to its powerfully entrenched institutions, it could not act on them. The Enlightenment philosophes, however, thought that the example of America would inspire the deeds that their words could not. In fact, they were right. The American Revolution inspired the French Revolutionaries in 1789, and it has continued to inspire revolutionaries throughout the world.

Nineteenth-century views of the United States.

Nineteenth-century views of the United States are seen through the lens of the French Revolution. After the French Revolution devolved into terror, anarchy, and despotism, no major thinker ever again unqualifiedly praised the American Revolution. This is peculiar. Thinkers might have said that the French got it wrong, the Americans right, so let us praise the Americans and further intensify the study of it. Instead, they let the horrors of the French Revolution color their understanding of the American. This shows once again how the perceptions of America were based more on European dynamics than on the reality of America itself.

Despite the failure of the French Revolution, the existence of the United States, coupled with the Enlightenment belief in progress, led to a general feeling that the United States was the future. If the French proved that the path to the future was not simple and smooth, the perception of what the future was to be like, as embodied in the United States, was also ambivalent. Interest in the United States was heightened because everyone had a stake in the future, which the United States seemed to represent.

In the aftermath of the French Revolution, criticism arose about the United States. The substance of this criticism was similar across the ideological spectrum of the nineteenth century and is familiar to anyone aware of contemporary critiques of the United States. What America had become and what critics thought Europe would become—democratic—was regarded as a mixed blessing. The greatest representative of this ambivalence is Alexis de Tocqueville (1805–1859), the great French thinker and statesman. According to Tocqueville, democratic government is inefficient, meandering, and petty. But it has its advantages. It gets more done by energizing the people to do things themselves: "it does that which the most skillful government often cannot do: it spreads throughout the body social a restless activity, superabundant force, and energy never found elsewhere, which, however little favored by circumstance, can do wonders. Those are its true advantages" (*Democracy in America*). Democracy is not conducive, however, to refinement, elevated manners, poetry, glory, or heroic virtues. All of the main political theorists of the nineteenth century agreed with this ambivalent assessment of America—and of the budding liberalism of Europe.

America was seen as epitomizing the self-interested individualism of the new commercial society and as representing the centralization of power by the new middle-class regime. As such, four criticisms were repeatedly leveled at it. First, America was said to embody the disorder caused by collapsing institutions. The authority of all previous standards—experience, age, birth, genius, talent, and virtue—was undercut in America. Second, America represented a growing obsession with money. It was because of this that all other standards of human value were ignored. Third, America represented unchecked equality. The new type of man preferred equality to liberty, as Tocqueville and John Stuart Mill (1806–1873) warned. Finally, the new form of government represented the power of the majority, the "tyranny of the majority" in Tocqueville's famous phrase. This stifled creativity and

individuality. It guaranteed that society would be geared to the mediocre middle at the expense of individual refinement, the cultivation of culture, and the emergence of spiritual sublimity and greatness. These are essentially the same charges leveled against the United States in the late twentieth and early twenty-first centuries by traditional authorities in Africa, Asia, and the Middle East, by the educated elites in Europe and elsewhere, and by the antimodern radicals, such as the Ayatollah Khomeini, Hizbollah, and Al Qaeda.

Twentieth-century views of the United States. The main twentieth-century critiques of America, such as those by Oswald Spengler (1880–1936) and Martin Heidegger (1889–1976) on the right and by the Frankfurt School on the left, argue that America is overly technological and materialistic. Thus, America, once described as the home of nature, became the place where nature is most obscured. Twentieth-century thinkers did not agree on the origins of America's technological morass. For example, the Frankfurt School saw technology as the result of capitalism, whereas Heidegger attributed it to a particular metaphysical way of being. The characteristics that they lamented in America's overtechnicalization, however, are similar. They lament the mechanization of society and the way it alienates human beings from their deeper essences. They deplored the monotonization and leveling of the world and the resulting loss of individuality. They decried the way technology kills the spirit and prevents the attainment of the highest human developments. In short, their substantive list of complaints is very similar to those made during the nineteenth century; but whereas the nineteenth-century thinkers attributed the problems to an array of social, political, and economic factors, twentieth-century thinkers blamed them on technology.

Beyond the technological blame, there is another important divergence between nineteenth- and twentieth-century thinkers' assessments of America. Whereas nineteenth-century thinkers like Tocqueville saw Russia, as well as the United States, as an emerging power, they almost all greatly preferred the American model to the Russian. This was not true in the twentieth century. Many figures on the left, such as Jean-Paul Sartre (1905–1980) and Simone de Beauvoir (1908–1986), ideologically committed to communism, lauded Soviet approaches and condemned American ones. Even among the anticommunist right, many considered the United States and the Soviet Union to be equally bad. Heidegger, for example, says that America and Russia "are metaphysically the same." An abstraction from politics that allows such comparisons is regrettable, but in Heidegger's case it is even worse. While formally arguing that the United States and Russia are the same, when he needs a shorthand label for the phenomena that he describes as a "*Katastrophe*," he calls it "Americanization," not Russianization, implying that the former is closer to the core of the problem.

Critical Reflections

According to its representations, *America* has moved from representing Europe's past to representing Europe's future and from the epitome of nature to the epitome of technology, polar opposite views. Four points might be noted, however, that

raise questions about the validity of these representations. First, descriptions of America have been fantastical from the beginning. They are inaccurate and often intentionally so. Second, although twentieth-century thinkers blame the United States for the technologization of the world, it is apparent that the technological attitude long predates the founding of the United States. Columbus and the conquistadores neither saw the New World for what it was nor had any desire to do so. Rather, they sought to exploit resources and people, and this is the essence of the technological attitude, the attitude that some claim began only with the United States. Third, twentieth-century thinkers miss the mark in blaming America for problems that have to do with modernity itself. Because the United States was created from scratch by colonists with minimal feudal baggage, the United States emerged as perhaps the purest embodiment of modern values. But there are multinational corporations in Europe and other countries around the world, and most people wherever they live in the world desire the standard of living and freedom that the United States—and many modern countries—have. So while there is a certain justification for seeing the United States as embodying modernity, it is not modernity's sole embodiment.

Fourth, there is a fundamental continuity in the views about America. The Indians have been described as on the one hand, naïve, innocent, childlike, and simple, and on the other as brutish, vulgar, shallow, stupid, and lacking spirituality. These are essentially the same charges that Europe and the world leveled at the United States throughout the nineteenth and twentieth centuries. The United States might be all of these things, although probably not more than most countries and possibly less so than many. But the fact that ways of life as opposite as those of the Indians and the United States are described in fundamentally the same terms indicates a problem in the substantive nature of the representations.

As an epilogue, it is worth noting briefly a postmodern view of America. Postmodern thinkers reject the idea of there being any humanly knowable truth and choose to play with images, which they claim is all we are left with. The French postmodern thinker Jean Baudrillard has done this with the United States. In a book entitled *America* (1986; English translation published in 1988), Baudrillard writes contradictorily, "For me there is no truth of America" and, "I knew all about this nuclear form, this future catastrophe when I was still in Paris, of course." He also mixes all of the main images of America, describing the United States both as "the original version of Modernity" and as "the only remaining primitive society." For him, America is the "Primitive society of the future." He combines five hundred years of images of America in a clever fashion.

See also *Enlightenment; Europe, Idea of; Individualism; Natural Law.*

BIBLIOGRAPHY

- Beichman, Arnold. *Anti-American Myths: Their Causes and Consequences*. Rev. ed. New Brunswick, N.J.: Transaction, 1993.
- Ceaser, James W. *Reconstructing America: The Symbol of America in Modern Thought*. New Haven, Conn.: Yale University Press, 1997.

- Chiappelli, Fredi, Michael J. B. Allen, and Robert L. Benson, eds. *First Images of America: The Impact of the New World on the Old*. 2 vols. Berkeley: University of California Press, 1976.
- Chinard, Gilbert. *L'exotisme américain dans la littérature française au XVI siècle*. Geneva: Slatkine Reprints, 1970.
- Dudley, Edward, and Maximillian E. Novak, eds. *The Wild Man Within: An Image in Western Thought from the Renaissance to Romanticism*. Pittsburgh: University of Pittsburgh Press, 1972.
- Echeverria, Durand. *Mirage in the West: A History of the French Image of American Society to 1815*. Princeton, N.J.: Princeton University Press, 1957.
- Elliott, John H. *The Old World and the New: 1492–1650*. Cambridge, U.K.: Cambridge University Press, 1970.
- Gerbi, Antonello. *The Dispute of the New World: The History of a Polemic, 1750–1900*. Rev. and enl. ed. Translated by Jeremy Moyle. Pittsburgh: University of Pittsburgh Press, 1973.
- Hollander, Paul. *Anti-Americanism: Critiques at Home and Abroad, 1965–1990*. New York: Oxford University Press, 1992.
- O'Gorman, Edmundo. *The Invention of America: An Inquiry into the Historical Nature of the New World and the Meaning of Its History*. Bloomington: Indiana University Press, 1961.
- Pagden, Anthony. *The Fall of Natural Man: The American Indian and the Origins of Comparative Ethnology*. New York: Cambridge University Press, 1982.
- Revel, Jean-François. *Anti-Americanism*. Translated by Diarmid Cammell. San Francisco: Encounter Books, 2003.
- Roger, Philippe. *L'ennemi américain: Généalogie de l'antiaméricanisme français*. Paris: Seuil, 2002.
- Rubinstein, Alvin Z., and Donald E. Smith, eds. *Anti-Americanism in the Third World: Implications for U.S. Foreign Policy*. New York: Praeger, 1985.
- Todorov, Tzvetan. *The Conquest of America: The Question of the Other*. Translated by Richard Howard. Norman: University of Oklahoma Press, 1999.
- Woodward, C. Vann. *The Old World's New World*. New York: Oxford University Press, 1991.

Alan Mitchell Levine

AMERICANIZATION, U.S. *Americanization* refers to processes of “becoming American,” and to organized efforts to encourage the transformation of immigrants into “Americans.” The term was in informal use in the United States in the mid-nineteenth century, but it is most prominently associated with the movement of that name during the 1910s and early 1920s. The term is often used interchangeably with *assimilation*.

The “problem” of Americanization arises because American national identity must be constructed in the absence of primordial ethnic mythology, and in the face of exceptional diversity. There is general recognition that the United States is a “civic nation,” rather than an “ethnic nation,” in which devotion to “founding principles” is the source of national identity and community. The creedal nature of American identity carries the implication that anyone may “become American” by committing himself or herself to the nation’s founding principles, and to their expression in distinctively American symbols and ways of living. However, the propositional nature of American identity carries with it the question of who is capable of the necessary understanding of, and commitment to,

American principles, and to the ways of living that they are taken to imply. That seed of doubt has led Americans to scrutinize cultural differences, ethnic consociation, and race as potential indicators of the lack of qualification for trusted membership in the polity, and to insist on outward demonstrations of Americanization by those considered for membership.

American National Identity and Ideologies of Americanization

The definition of American identity in ideological terms was elaborated in the early postindependence period. While the extent to which a new American people would emerge from the fusion of diverse strands of Europeans, as Michel-Guillaume-Jean de Crèvecoeur’s (1735–1813) famous “Letter from an American Farmer” rhapsodized, was questionable, what was firmly established was the association of American identity with individual “transformation.”

Americanization in the nineteenth century. Nineteenth-century Americans expected life in the United States to transform European newcomers into culturally compatible neighbors. While not directing specific “Americanization” efforts toward immigrants, American communities placed faith, in particular, in the common schools to be “culture factories” in which to inculcate principles of republican virtue, and to cultivate American habits and identities. A general pattern of acceptance of diversity and confidence in the workings of America’s natural “melting pot” was not obtained until the 1890s.

The 1890s represent a crucial turning point that intensified the salience of ethnicity as an element of national identity, gave rise to the “Americanization movement,” and, ultimately, resulted in long-lasting restrictions on immigration. A massive influx of new immigrants, primarily from southern and eastern Europe, combined with the perception of the frontier having closed, accelerated industrialization, rural emigration, recurring economic distress, perceptions of urban disorder and disorganization, labor conflict, and radical political agitation diminished Americans’ faith in the naturally absorptive powers of American life and in a laissez-faire approach to immigrant absorption. So, too, did the development of a distinctively racist ideology that identified Anglo-Saxon descent with authentic American identity and placed the new immigrants into inferior classifications.

Americanization in the first quarter of the twentieth century. The resulting effort to “Americanize” immigrant newcomers was part of the Progressive movement’s broader efforts to construct a modern and cohesive social order, and also part of a new purifying national effort to cultivate patriotism among all Americans. As World War I approached, the priorities of immigrant adjustment would yield to the priority of coercively assuring loyalty through insistence on naturalization, quick acquisition and sole use of English, and adherence to “American” cultural norms.

Well before the official birth of the “Americanization movement” in 1915, educators began to grapple with what they determined were the needs of the increasing number of foreign-born adults and their children. Settlement houses and other agencies

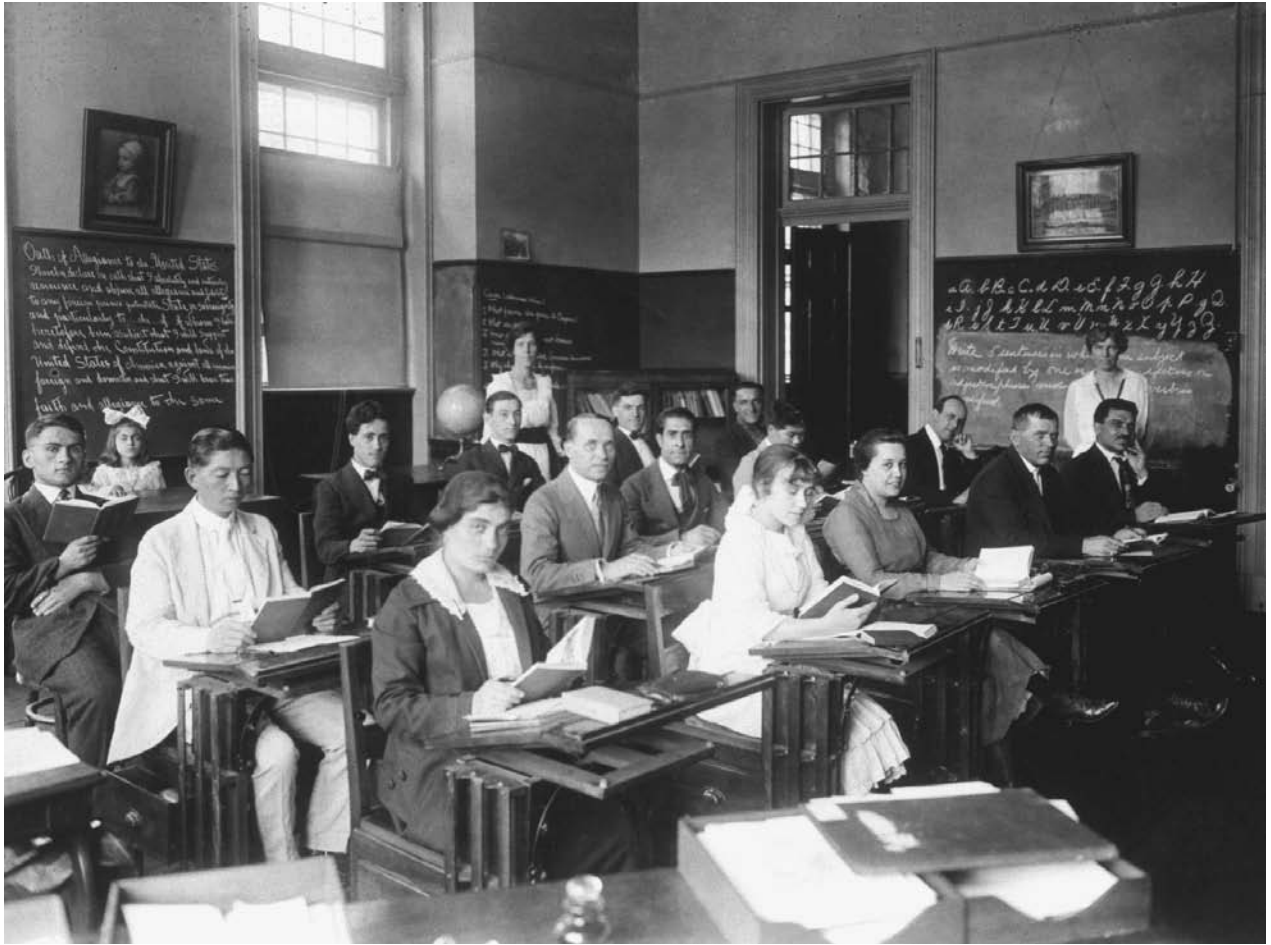

Immigrants in Americanization class. In the early 1900s, citizenship classes such as those conducted by the U.S. Bureau of Naturalization often sought to teach immigrants not only basic civic facts about America, but also how the newcomers could be more “American” in their everyday life. © CORBIS

like the YMCA initiated programs and activities intended to familiarize immigrants with the language and cultural practices of the United States and to smooth the transition from “immigrant” to “American.” Public schools began to adopt distinctive curricular, extracurricular, and disciplinary innovations intended to “Americanize” the children of immigrants. These included, among other measures, kindergartens, instruction in hygiene, manners, and the conduct of daily life, home visitations, and special classes for teaching English. During this phase of “humanitarian” Americanization, professionals sought to integrate immigrants into American life without harshly and rapidly stripping them of their homeland ties and concerns or of their culturally distinct languages, values, beliefs, and customary ways.

The Americanization movement that followed was multifaceted and involved professional, popular, and political elements. Its participants were not of one mind, and some shifted their viewpoints and priorities over time. It is the coercive and strident activities of campaigns of the World War I period against “hyphenation,” and, then, for “100 Percent Americanism” that have left the lasting image of the Americanization movement, and account for its repudiation in the 1920s.

According to John Higham, the Americanization movement represented “nothing less than an alteration in the whole texture of nationalist thought.” One-Hundred Percent Americanism demanded “universal conformity organized through total national loyalty.” The new spirit of nationalism required complete identification with country so as to “permeate and stabilize the rest of [the individual’s] thinking and behavior” (1970, pp. 204–205). In this vein, citizenship classes included lessons not only on civic duties like voting, but also on “American” ways of performing routine tasks like cooking and cleaning, child rearing, and personal hygiene. “Becoming an American, immigrants were taught, involved making yourself over entirely” (McClymer, p. 109).

Perhaps highest on the Americanizers’ agendas for remaking immigrants into Americans was conversion by immigrants from home-language to the use of English. For the most extreme among the “English First” crusaders, language was foremost a matter of loyalty. Professional Americanizers, however, emphasized that only a common language could guarantee the “community of interest” required for national unity. Among professional Americanizers, English was deemed necessary to

facilitate the widespread social intercourse and participation that they so ardently championed.

Historians have not often been kind to the Americanization movement of the 1890–1925 period. Robert Carlson has labeled the Americanization movement a “Quest for Conformity” that demanded an unfair exchange, and, in general, was psychologically damaging to its putative beneficiaries. Gary Gerstle identifies the Americanization movement with coercive nation-building that almost destroyed German Americans as an ethnic group, limited the identities that Americans could adopt, and hardened the racial color-line. John Higham, while recognizing the mixed impulses of the movement, interprets the movement as fundamentally an episode in American nativism.

Not all historians, however, have viewed the Americanization movement in unrelentingly negative terms. The circumstances to which the Americanizers were responding were, given their perspectives, threatening and challenging. In the face of the massive immigration from parts of the world that heretofore had not been large sources of emigration to America, worries over whether democracy could function in the absence of a common language, common culture, and common commitment, were, in Robert Wiebe’s judgment, reasonable. Stephan Brumberg is critical of academic critics of the Americanization movement who fail to appreciate the immigrant’s real needs for structure and direction in an alien, threatening, perplexing, and dehumanizing environment. Moreover, the vocabulary of Americanization, with its proclamations of American symbols and ideals celebrating liberty, democracy, and equal opportunity, could be adopted by immigrant and American workers alike, to help forge an American working-class consciousness in opposition to the rule of capitalist elites.

While most historians have evaluated the Americanization movement by what it did to immigrants, Michael Olneck has questioned the proximate effects of Americanization and has argued that perhaps the largest significance of the movement was to create new “public meanings” rather than to have changed immigrants. Most significantly, the Americanization movement defined subsidiary identities as incompatible with “American” identity, delegitimated collective identities, relegated ethnic identities to the “background,” and demarcated a supraethnic, shared public terrain of “American life” into which all were expected to “enter,” as well as symbolically represented the abstract autonomous individual as the constitutive element of American society.

Americanization between 1930 and 1965. During the 1920s occasional voices were raised against the project of a homogeneous America, and by the 1930s an ideology of “cultural pluralism” gained currency. With the rise of fascism in Europe, concerns over ethnic, racial, and religious tensions in the United States, the ongoing social and political incorporation of second-generation Americans, scholarly discovery of persistent ethnicity in the cities, and anthropological refutations of racialist doctrines, ideas of America as encompassing a potentially harmonious diversity consistent with assimilation took hold, and were reinforced during the mass mobilization for World War II. Cultural diversity would be tolerated within the context of shared national ideas and sentiments that

ensured civic harmony and cooperation. Cultural pluralism in this form represented a powerful reaffirmation of American ideology as a basis of national identity.

Pluralism in the 1950s was “predicated on consensus around the American value system despite seeming to place a premium verbally on diversity” (Gleason, p. 62). Subsequently, American universalistic egalitarian and individualistic civic ideals appeared to triumph in passage of the Civil Rights Act of 1964 and the Immigration Reform Act and Voting Rights Act of 1965. The triumph, in the view of some, was short-lived.

Americanization after 1965. The emergence and legitimacy of Black Power and other ethnic nationalisms in the mid-1960s, anti-Vietnam War critiques and mass protests, and the adoption of policies encouraging ethnic identification, recognition, and rights, was seen by some to have replaced civic nationalism with a strong version of cultural pluralism, later to be termed *multiculturalism*. In the process, *assimilation* joined the already discredited term *Americanization* as a term of opprobrium.

However, reactions against multiculturalism have occasioned calls for the revival of a civic ideology of American identity, and some have attempted to revive a modern ideal of Americanization. Significantly, academic and journalistic critics of multiculturalism rarely claim to seek a return to the demands for homogeneity characteristic of the Americanization movement period, nor do they urge an end to ethnicity. John Higham advocates “pluralistic integration,” in which individual rights and needs for group solidarity are balanced, as are universalistic principles and particularistic needs. David Hollinger propounds a model of “postethnic cosmopolitanism,” which prefers voluntary to prescribed affiliations, appreciates multiple identities and communities of broad scope, and accepts the formation of new groups as part of the normal life of a democratic society. Peter Salins commends “Assimilation, American Style” that requires citizens to accept English as the national language, take pride in American identity, and believe in America’s liberal and democratic egalitarian principles, and to live by a Protestant ethic of self-reliance, hard work, and moral rectitude, but does not demand cultural homogeneity. Even John Miller, who protests “The Unmaking of Americans” and the undermining of an earlier assimilation ethic by multiculturalism, argues not that racial and ethnic identities should be suppressed, but only that their expression remain confined to the private sphere. In its 1997 recommendations, the United States Commission on Immigration Reform recommended “taking back” the word *Americanization*, since it is “our word” that was “stolen” by racists and xenophobes in the 1920s. The Commission defined *Americanization* in ways that are consistent with the ideal of civic nationality. “Americanization,” the Commission wrote, “is the process of integration by which immigrants become part of our communities and by which our communities and the nation learn from and adapt to their presence,” and is “the cultivation of a shared commitment to the American values of liberty, democracy and equal opportunity” (p. 26). “The United States,” the Commission continued,

is a nation founded on the proposition that each individual is born with certain rights and that the purpose

of government is to secure these rights. The United States admits immigrants as individuals. . . . As long as the United States continues to emphasize the rights of individuals over those of groups, we need not fear that the diversity brought by immigrants will lead to ethnic division or disunity. (pp. 28–29)

Whether or not subsequent government action is as attentive as the Commission tried to be to the “cosmopolitan” elements in defining American identity is debatable, but government policies certainly evidence an ongoing commitment to Americanization. In 2001 the Congress replaced the Bilingual Education Act with the English Language Acquisition Act, which included replacing the United States Department of Education’s Office of Bilingual Education and Minority Language Affairs with an Office of English Language Acquisition. In 2003 Congress established the “Office of Citizenship” in the United States Department of Homeland Security. The Office of Citizenship is meant to work to revive and emphasize “the common civic identity and shared values that are essential to citizenship,” according to a government fact sheet. And, despite apparent commitments to multiculturalism in the public schools, actual formal and informal practices, particularly those emphasizing the rapid acquisition of English, suggest that schools continue to regard “Americanization” as a priority, even if they do not use that term. What remains absent from the schools is the civics education component of Americanization that predominated during the 1910s.

Conclusion

At the juncture of the early twenty-first century, those made uneasy by America’s increasing ethnic and linguistic diversity called, through such efforts as attempting to legislate an “official” status for English, for a kind of revived Americanization movement. While a majority supported proposals to make English the “official” language, acceptance of diversity nevertheless appeared embedded in expressed attitudes, and public-opinion studies strongly supported the conclusion that Americans’ “. . . preference for an inclusive nationalism coexists with the widespread acceptance of pluralism in cultural practices” (Citrin et al., p. 266). A “cosmopolitan liberal” view of American identity and polity appeared to predominate over either a multiculturalist or nativist view, and so we would expect coercive Americanization crusades to remain a thing of the past.

See also **Assimilation; Diversity; Ethnicity and Race; Identity: Personal and Social Identity**

BIBLIOGRAPHY

- Carlson, Robert A. *The Americanization Syndrome: A Quest for Conformity*. New York: St. Martin’s, 1987.
- Citrin, Jack, et al. “Multiculturalism in American Public Opinion.” *British Journal of Political Science* 31 (2001): 247–274.
- Gleason, Philip. *Speaking of Diversity: Language and Ethnicity in Twentieth-Century America*. Baltimore: Johns Hopkins University Press, 1992.
- Higham, John. *Send These to Me: Jews and Other Immigrants in Urban America*. New York: Atheneum, 1975.

- . *Strangers in the Land: Patterns of American Nativism, 1860–1925*. 1955. Reprint, New York: Atheneum, 1970.
- Hollinger, David A. *Postethnic America: Beyond Multiculturalism*. New York: Basic Books, 2000.
- McClymer, John F. “The Americanization Movement and the Education of the Foreign-born Adult, 1914–1925.” In *American Education and the European Immigrant, 1840–1940*, edited by Bernard J. Weis, 96–116. Urbana: University of Illinois Press, 1982.
- Miller, John J. *The Unmaking of Americans: How Multiculturalism Has Undermined the Assimilation Ethic*. New York: Free Press, 1998.
- Olneck, Michael R. “Americanization and the Education of Immigrants, 1900–1925: An Analysis of Symbolic Action.” *American Journal of Education* 97 (1989): 398–423.
- Salins, Peter D. *Assimilation, American Style*. New York: Basic Books, 1997.
- Schultz, Stanley K. *The Culture Factory: Boston Public Schools, 1789–1860*. New York: Oxford University Press, 1973.
- United States Commission on Immigration Reform. *Becoming an American: Immigration and Immigrant Policy: 1997 Report to Congress*. Washington, D.C.: United States Commission on Immigrant Reform, 1997.

Michael R. Olneck

ANALYTICAL PHILOSOPHY. It was only in the 1960s that the phrase “analytical philosophy” came into frequent use as a way of describing the kind of philosophy characteristic of much English-language philosophy of the twentieth century. But occasional references to “analytical” (or “analytic”) philosophy as a new kind of philosophy can be found much earlier, where it is primarily used to introduce a contrast with “speculative philosophy.” The thought here is that whereas traditional philosophers have attempted by means of speculative arguments to provide knowledge of a kind that is not otherwise possible, “analytic” philosophers aim to use methods of philosophical analysis to deepen the understanding of things that are already known—for example, concerning the past or concerning mathematics. In doing so analytic philosophers will seek to clarify the significance of essentially uncontentious historical or mathematical truths and to explain the possibility of our knowledge of them. This program does not require that analytic philosophers deny the possibility of speculative philosophy; but many did so, most famously those associated with the Vienna Circle such as Rudolph Carnap (1891–1970), who held that “all statements whatever that assert something are of an empirical nature and belong to factual science” and went to claim that, for philosophy, “What remains is not statements, nor a theory, nor a system, but only a method: the method of logical analysis” (1932; 1959, p. 77).

Methods of philosophical analysis are in fact as old as philosophy, as in Socrates’ dialectic. The method was especially prominent in the theory of ideas characteristic of seventeenth- and eighteenth-century philosophy, which involved the analysis of complex ideas into simple ones. One of Immanuel Kant’s (1724–1804) insights was to recognize the priority of

complete judgments over ideas, or concepts, and this led him to hold that analytic methods of inquiry were subordinate to the elucidation of synthetic unities, such as the unity of consciousness. Kant's successors in the tradition of German idealism took this subordination much further as they sought to articulate the internal relations that hold together ever more encompassing "organic wholes" such as the state and the universe. For them, analysis was only ever a preliminary stage of inquiry, a kind of falsification to be transcended once a relevant organic whole and its relationships had been identified.

Moore

A good place to mark the start of analytical philosophy is therefore with the young G. E. Moore's (1873–1958) emphatic denunciation of this idealist philosophy. Moore rejected internal relations and organic wholes, and in their place he gives priority to individual judgments, or propositions, and their constituent concepts. Since he holds that true propositions are real structures that do not represent facts, but constitute them, it follows that an analysis of a proposition into its constituent concepts is equally an analysis of a fact into its elements: as he puts it "A thing becomes intelligible first when it is analysed into its constituent concepts" (1899; 1993, p. 8). Thus in Moore's early work a method of conceptual analysis is employed to identify the basic properties of things. This is manifest in Moore's *Principia Ethica* (1903), where Moore famously argues that goodness is the basic ethical property and thus that ethical theory is the theory of the good. It should be observed, however, that Moore's method of analysis does not specify the content of his theory of the good, even though this is also supposed to be a priori. Moore's method of metaethical analysis is therefore combined with an appeal to intuitive reflection concerning synthetic a priori ethical truths; and one of the issues that has remained a matter of debate is just what contribution conceptual analysis has to offer to ethical theory.

Russell, Frege, Wittgenstein

The decisive development that gave a distinctive character to analytical philosophy was that whereby the young Bertrand Russell (1872–1970), freshly converted from idealism by Moore, used his new logical theories to enhance the possibilities for philosophical analysis. For what is special about analytical philosophy is the preeminence given to logical analysis. In Russell's early work this development is manifest in his "theory of descriptions," whereby he uses his logical theory to provide an analysis of propositions in which particular things are described. Russell argued that he was thereby able to resolve long-standing metaphysical puzzles about existence and identity, and equally to show how it is possible for us to have knowledge ("by description") of things of which we have no direct experience. Indeed as Russell became increasingly adept at developing and applying his logical theory, he came to think that its use was really the only proper way of doing philosophy. Thus in 1914 he gave some lectures that included one with the title "Logic as the Essence of Philosophy," and he here declares: "every philosophical problem, when it is subjected to the necessary analysis and purification, is found either to be not really philosophical at all, or else to be, in the sense in which we are using the word, logical" (1914, p. 33).

Russell here describes his method as "the logical-analytic method of philosophy" (p. v) and he goes on to add that the first clear example of this method is provided by Gottlob Frege's (1848–1925) writings. Russell has in mind here Frege's development in 1879 of a radically new logical theory (first order predicate logic, as we would now call it) in his *Begriffsschrift* ("Concept-script"). Although Frege does not here apply his logic to philosophical debates, he does offer it as "a useful tool for the philosopher" who seeks to "break the domination of the word over the human spirit by laying bare the misconceptions that through the use of language almost unavoidably arise concerning the relations between concepts" (1879; 1970, p. 7). This contrast between the new logical "concept-script" and the apparent structure of ordinary language brings to the surface a concern with the proper understanding of language that is characteristic of analytical philosophy. The relationship between logic and ordinary language remains a contested matter, but the identification of "logical form" is one enduring strand of analytical philosophy, as in Donald Davidson's theories of action and causation.

As indicated, Russell looked back to Frege when describing his "logical-analytic method of philosophy"; but in truth Russell's philosophy also contained much more besides, in particular a problematic emphasis on the priority of the things that are presented in experience, the things that we "know by acquaintance." One of the achievements of Ludwig Wittgenstein (1889–1951), who had studied with Russell and through him made contact with Frege, was to set aside this aspect of Russell's philosophy and present a purified logical-analytic method in his *Tractatus Logico-Philosophicus* (1922). Wittgenstein maintains here that "Philosophy is not one of the natural sciences"; instead "Philosophy aims at the logical clarification of thoughts. Philosophy is not a body of doctrine but an activity" (4.111–112). There is a sharp disagreement here with Russell, whose philosophy certainly does offer "a body of doctrine" based on his theory of knowledge by acquaintance. By contrast Wittgenstein holds that one should be able to demonstrate to anyone who seeks to advance a philosophical proposition that in doing so they have fallen into talking nonsense (6.53).

The Vienna Circle

Whether Wittgenstein altogether succeeds in explaining his own position without convicting himself of nonsense remains debated. But there is a different element in his position that requires attention: the thesis that logic has a special a priori status because it articulates the rules that make language possible. This thesis is often associated with the claim that logic is "analytic" because logical truth depends only on the definition of logical vocabulary. In fact there is a distinction here: it is one thing to hold that logic is a priori because it is integral to language, it is another to hold that logic is "analytic" in the sense that it is just true by definition. But this distinction was not drawn by the members of the Vienna Circle whose "logical empiricism" constitutes the next phase in the development of analytical philosophy. As indicated by the passage cited earlier from Carnap, a leading member of this group, their starting point was an empiricist presumption that the

understanding of language is rooted in perceptual experience; but they recognized that ordinary experience does not exhibit the complex laws and structures of which the natural sciences speak. So they invoked logic to make the connections between observation and theory. In order to remain true to their empiricism, therefore, they emphasized the “analyticity” of logic, such that logic was not to be thought of as a body of abstract nonempirical doctrine but simply a way of working out the conventions of language.

Ordinary Language Philosophy

Although there was much disagreement among the logical empiricists their position constituted an immensely influential antimetaphysical paradigm for mid-twentieth-century philosophers, especially after the rise of the Nazis had led to the emigration of the leading philosophers of the group from Central Europe to the United States. While traditional philosophers complained, quite rightly, that the antimetaphysical rhetoric of the position concealed its own metaphysical assumptions, two other lines of criticism were especially important for the subsequent development of analytical philosophy. In Britain, especially after 1945, the logical empiricists’ emphasis on logical analysis was felt to be excessively restrictive. It was argued by the defenders of “ordinary language philosophy” such as J. L. Austin and Peter Strawson that formal logic does not adequately capture the complex conceptual structures of our thought and language, and thus that a much more heterogeneous and informal approach to conceptual analysis is required. This work led to the development of a variety of approaches to the study of language, especially speech act theory, which treats speech as a kind of action and therefore conceives of its meaning in the light of the things speakers *do* by means of their speech acts (for example, making a promise or naming a child). At much the same time Wittgenstein’s later *Philosophical Investigations* (1953) were published, with a similar emphasis on the need to understand our ordinary “language-games” instead of relying on formal logic to capture the structure of thought. One of the most challenging features of Wittgenstein’s later investigations was his critical discussion of psychological concepts, and this, together with other work, has helped to direct recent analytical philosophers at least as much to the philosophy of mind as to the philosophy of language.

Quine

The other main criticism of logical empiricism came from the American philosopher Willard Van Orman Quine (1908–2000), who argued that the logical empiricists had been mistaken in regarding logic as “analytic”—that is, true by definition. Quine argued that logic is of the same type as other beliefs: it is an element of the web of belief through which we make sense of our experience as experience of an objective world. Hence logic is not analytic, since it concerns the world, and it is not a priori, since it is revisable in the light of experience. Quine’s arguments remain disputed, but his work has certainly helped to encourage philosophers to address broader disputes in the natural sciences and other areas. There is no enclosed domain for a priori logical and conceptual analysis. Some critics, most notably Richard Rorty, argue that it follows that there is now nothing worth calling “analytical philosophy.” But these claims

are exaggerated. Although Quine was a critic of the analyticity of logic, he was a distinguished logician and used logical analysis throughout his philosophy; so his practice shows that analytical philosophy does not depend on the analyticity of logic. Second, although Quine’s arguments call into question the “linguistic” conception of the a priori as analyticity it is widely accepted that some distinction between the a priori and the empirical has to be made if we are to be able to reason coherently; and as long as that distinction is in place, analytical philosophers can draw on it to characterize the significance of their conclusions. Analytical philosophy today, therefore, continues the tradition captured by Russell and Wittgenstein at the beginning of the twentieth century. It is not “a body of doctrine,” it is a “method,” typically “logical-analytic,” but often informal, of using reasoning to capture and criticize conceptual structures. As such one finds it regularly employed across the whole spectrum of contemporary philosophical debate, by feminists and political philosophers as much as by metaphysicians and epistemologists.

Analytical and Continental Philosophy

Throughout much of the twentieth century analytical philosophy was very different from the approach to philosophy characteristic of “continental” philosophers such as Edmund Husserl, Martin Heidegger, Jean-Paul Sartre, and Maurice Merleau-Ponty. One reason for this was simply their ignorance of logic, which excluded them from any serious understanding of analytical philosophy. Conversely analytical philosophers, by and large, remained uncomprehending of the phenomenological project of recovering the basic structures of intentionality. By the end of the twentieth century, however, with translations of all the main works involved into the relevant languages, a much greater degree of mutual comprehension has been achieved. As a result, while continental philosophers such as Jacques Derrida have sought to appropriate analytical techniques such as speech-act analysis, analytical philosophers have turned their attention to the theme of intentionality, though sometimes with conclusions far removed from those of continental philosophers. Thus the situation is now one of dialogue despite profound disagreements.

See also Continental Philosophy; Idealism; Language, Philosophy of; Modern; Philosophy of Religion; Positivism.

BIBLIOGRAPHY

- Analysis* (1933–). A journal founded to promote analytical philosophy. See the statement in vol. 1, which remains a characteristic expression of this kind of philosophy.
- Austin, John Langshaw. *How to Do Things with Words*. Oxford: Clarendon Press, 1962. Austin here begins to develop speech-act theory.
- Ayer, Alfred J. *Language, Truth, and Logic*. London: Gollancz, 1936. A brilliant statement of the logical empiricist position.
- , ed. *Logical Positivism*. Glencoe, Ill.: Free Press, 1959. An excellent collection of papers.
- Baldwin, Thomas. *Contemporary Philosophy: Philosophy in English since 1945*. Oxford and New York: Oxford University Press, 2001. A book in which the author of this entry discusses the main themes of analytical philosophy since 1945.

- Butler, R. J., ed. *Analytical Philosophy*. 2 vols. Oxford: Blackwell, 1962–1965. Two collections of papers characteristic of mid-twentieth century analytical philosophy.
- Carnap, Rudolph. “The Elimination of Metaphysics through Logical Analysis of Language.” 1932. In *Logical Positivism*, edited by A. J. Ayer, 60–81. Glencoe, Ill.: Free Press, 1959. Originally published in German as “Überwindung der Metaphysik durch logische Analyse der Sprache,” this is Carnap’s classic statement of his logical empiricism.
- . “Empiricism, Semantics and Ontology.” *Revue Internationale de Philosophie* 4 (1950): 20–40. Reprinted in *The Linguistic Turn: Recent Essays in Philosophical Methods*, edited by Richard Rorty. Chicago: University of Chicago Press, 1967. 2nd ed., 1992. Carnap here introduces a distinction between “internal” and “external” questions to clarify his defense of analyticity. Rorty’s collection is a useful resource, and the 2nd ed. contains two interesting skeptical retrospective essays.
- Cohen, G. A. *Karl Marx’s Theory of History: A Defence*. Oxford: Clarendon Press, 1978. A work showing how analytical philosophy can be applied to the study of Marxism; the starting point of “analytical Marxism.”
- Davidson, Donald. *Essays on Actions and Events*. Oxford: Clarendon Press, 1980. This collection includes Davidson’s discussions of “logical form.”
- Derrida, Jacques. “Signature, Event, Context.” In his *Margins of Philosophy*. Translated by Alan Bass. Chicago: University of Chicago Press, 1982. Derrida’s critical discussion of Austin.
- Frege, Gottlob. *Begriffsschrift*. 1879. In *Frege and Godel: Two Fundamental Texts in Mathematical Logic*, edited by J. van Heijenoort. Translated by S. Bauer-Mengelberg. Cambridge, Mass.: Harvard University Press, 1970. Frege’s revolutionary new logical theory.
- Fricker, Miranda, and Jennifer Hornsby. *The Cambridge Companion to Feminism in Philosophy*. Cambridge, U.K., and New York: Cambridge University Press, 2000. A collection of papers showing how issues in feminist philosophy are addressed by analytical philosophers.
- Montefiore, Alan, and Bernard Williams. *British Analytical Philosophy*. London: Routledge, 1966. A useful collection in which the British conception of analytical philosophy is expounded and discussed.
- Moore, G. E. “The Nature of Judgment.” 1899. In *G. E. Moore: Selected Writings*, edited by Thomas Baldwin, 1–19. London and New York: Routledge, 1993. Moore’s early rejection of the idealist theory of judgment.
- . *Principia Ethica*. Cambridge, U.K.: Cambridge University Press, 1903. Rev. ed., edited by Thomas Baldwin. Cambridge, U.K.: Cambridge University Press, 1993. Moore’s classic presentation of his analytical ethics.
- Quine, Willard van Orman. *From a Logical Point of View: 9 Logico-Philosophical Essays*. Cambridge, Mass.: Harvard University Press, 1953. A collection which includes some of Quine’s early papers, especially “Two Dogmas of Empiricism” in which he launches his critique of analyticity.
- . *Ways of Paradox*. New York: Random House, 1966. A collection that includes two of his main papers on logical empiricism, “Truth by Convention” and “Carnap on Logical Truth.”
- Rorty, Richard. *Philosophy and the Mirror of Nature*. Princeton, N.J.: Princeton University Press, 1979. Rorty here sets out his skeptical critique of analytical philosophy.
- Russell, Bertrand. “On Denoting Mind.” 1905. In *Logic and Knowledge: Essays, 1901–1950*, edited by R. Marsh, 41–56. London: G. Allen and Unwin, 1956. Russell’s presentation of his theory of descriptions.
- . *Our Knowledge of the External World as a Field for Scientific Method in Philosophy*. Chicago, Ill.: Open Court, 1914. Russell’s presentation of his logical-analytic method in philosophy.
- Strawson, P. F. *Logico-Linguistic Papers*. London: Methuen, 1971. A collection that includes Strawson’s early criticisms of Russell’s logic and his later reflections on logic and language.
- Wisdom, John. *Problems of Mind and Matter*. Cambridge, U.K.: Cambridge University Press, 1934. An early example of an exposition of “analytic” philosophy as such.
- Wittgenstein, Ludwig. *Philosophical Investigations*. Translated by G. E. M. Anscombe. Oxford: Blackwell, 1953. Wittgenstein’s later discussion of language-games, rule-following, and psychological concepts.
- . *Tractatus Logico-Philosophicus*. Translated by C. K. Ogden. London: K. Paul, Trench, Trubner and Co., 1922. Wittgenstein’s early attempt to present philosophy as logical analysis.

Thomas Baldwin

ANARCHISM. The term *anarchy* comes from an ancient Greek word meaning “without a leader or ruler.” However, proponents of anarchism have most often used the term to refer to a natural state of society in which people are not governed by submission to human-made laws or to any external authority. Anarchism is above all a moral doctrine concerned with maximizing the personal freedom of individuals in society. To achieve this end, leading anarchist social theorists have tended to offer critical analyses of (1) the state and its institutional framework; (2) economics; and (3) religion. Anarchist hostility to the state is reflected in the rejection of the view popularized by contract theorists that a government’s sovereignty is legitimated by the consent of its subjects. Anarchists contend that no contractual arrangement among human beings justifies the establishment of a ruling body (government) that subordinates individuals to its authority. From their observations of the historical development of the state, anarchist thinkers such as Pierre-Joseph Proudhon (1809–1865) and Peter Kropotkin (1842–1921) concluded that all forms of government have been used as instruments for establishing monopolies that favor the propertied and privileged. Anarchists also argue that the all-encompassing authority of the state allows it to exercise undue influence over the lives of its citizens. It is further maintained by anarchists that the state, using laws and the organs of power at its disposal, can control not only citizens’ public and private behavior but also their economic lives. As such, the state, in all its forms, is condemned as an unnecessary evil.

From an economic standpoint, most anarchists have identified themselves as members of the anticapitalist socialist movement. In common with socialists, anarchists see capitalism as a system ruled by elites, one that exploits the working or productive members of society economically and represses them culturally and spiritually. Accordingly, anarchists argue

that the emancipation of the worker will only be achieved by completely destroying the pillars of capitalism.

Anarchists differ as to what form of economic arrangements should replace capitalism. Collectivists and mutualists insist that private ownership of the fruits of individuals' labor is desirable, while anarchist communists maintain that individual freedom can only be achieved in a society where all material goods and natural resources are placed under common ownership. Still another group of anarchists known as individualists have advocated a system of "labor for labor" exchange, which they believe could operate in accordance with natural market forces.

Anticlericalism is another important dimension of anarchist thinking. Though most anarchists are materialists, they are not opposed to spirituality per se: indeed anarcho-pacifists such as Leo Tolstoy (1828–1910) were self-identified as Christians. Rather, anarchists condemn organized religion, which they see as an agent of cultural repression. They have, for example, attacked the Catholic Church among other religious institutions on the grounds that it has historically served as a means of empowering church government and not of enriching the spiritual lives of its adherents. Anarchists further contend that the church has consistently acted as an ally of secular governments and therefore forms part of the general system of state repression that operates against the common person.

Because the heyday of anarchism as an ideological movement was during the nineteenth and early twentieth centuries, the focus here will be on the core beliefs of key anarchist theorists in this period. Thus a discussion of other, less historically significant anarchist strands such as pacifism and individualism will be mentioned only in passing. The impact that classical anarchist theory has had on recent political and social movements will be summarized in the concluding section.

Anarchist Principles in Context

The ideas associated with modern anarchism can be traced to the period of the French Revolution (1789–1799), although they did not crystallize into a formal political doctrine until the middle part of the nineteenth century. The first book that offered the clearest intimation of the anarchist conception of society was William Godwin's *An Enquiry concerning Political Justice and Its Influence upon General Virtue and Happiness* (London, 1793). In this, Godwin identifies the state as the main source of all social ills. In order for humans to live freely and harmoniously, Godwin advocates the establishment of a stateless society in which individuals are no longer subject to the economic exploitation of others. Despite its antistatist message, the ideas found in Godwin's magnum opus belong to a tradition of British political radicalism that cannot be classified as anarchist. In fact his work had its greatest influence on the liberal thinkers of his age as well as on Robert Owen, John Gray, and other early socialist reformers.

Of far greater significance to the development of modern anarchist ideology is the French social philosopher Pierre-Joseph Proudhon, whose indictment of private property

under capitalism was made famous in his book *What is Property?* (1840). Proudhon's main contributions to the anarchist view of society lay in his theories of mutualism and federalism. In the former he argued that the exploitative capitalist system could be undermined by creating economic organizations such as the People's Bank, an institution of mutual credit meant to restore the equilibrium between what individuals produce and what they consume. Because he believed that concentrating political power in the hands of the state militated against the economic forms he was proposing, Proudhon argued for a society in which power radiated from the bottom upward and was distributed along federal or regional lines.

Though he himself never belonged to any party or political organization, Proudhon's writings inspired a substantial following among freethinkers, liberal intellectuals, and workers across Europe, particularly in France and Spain. One of his most famous disciples was the Russian anarchist Mikhail Bakunin (1814–1876). Like Proudhon, Bakunin was an eclectic thinker who was constantly revising and reformulating his views on society. More so than Proudhon, who did not believe that the transition to an anarchist society demanded violent and sweeping changes, Bakunin gave both physical and ideological expression to the view that revolutionary upheaval was a necessary and unavoidable process of social development, a view summed up in his oft-quoted dictum, "The urge to destroy is also a creative urge." At the core of his creed was collectivism, by which he meant that the land and means of production should be collectively owned and that future society should be organized around voluntary associations—such as peasant communes or trade unions—that were not regulated or controlled by any form of government. Too impatient to set forth a systematic exegesis of his antiauthoritarian beliefs, Bakunin tended to express his concepts in tracts that could be used by revolutionary bodies (for example, the Alliance of Social Democracy) with which he was associated. Indeed Bakunin's most enduring legacy to anarchism resides in his conception of revolutionary transformation. According to him, the dispossessed and most repressed elements of society—particularly the working classes and peasantry in economically backward countries such as Spain, Italy, and Russia—were by nature revolutionary and only needed proper leadership to rise up against their oppressors. Because he adamantly rejected the Marxian notion that conquering political power was a precondition for overthrowing capitalism, Bakunin was convinced that the exploited masses should be led into revolt by a small and dedicated group of individuals who were acting in their interests. It was his belief that revolution could not be achieved until the state was completely abolished, which brought him into conflict with Karl Marx and his followers, who insisted that a "dictatorship of the proletariat" was a necessary phase in the transition to a stateless society (communism).

Bakunin's antipolitical conception of revolutionary change as well as his forceful repudiation of the authoritarian communist principles embodied in the Marxism of his day drove a wedge between his adherents in the First International (1864–1876) and those of Karl Marx, thus establishing a divide in the European socialist movement that would never be bridged.

However, not all anarchists were hostile toward the idea of communism. Another Russian aristocrat turned revolutionary, Peter Kropotkin, developed over the course of his lifetime a sociological theory of anarchism that combined the antiauthoritarian beliefs espoused by his predecessors in the anarchist movement with those of communism. Unlike Proudhon and Bakunin, both of whom believed in the right of individual possession of products produced from one's labor, Kropotkin advocated an economic system based on the communal ownership of all goods and services that operated on the socialist principle "from each according to his abilities, to each according to his needs." By distributing society's wealth and resources in this way, Kropotkin and other anarchist communists believed that everyone, including those who were unproductive, would be able to live in relative abundance.

Kropotkin's greatest contributions to anarchist theory, however, were his attempts to present anarchism as an empirically verifiable worldview, one that was based on "a mechanical explanation of world phenomena, embracing the whole of nature." Following in the positivist tradition laid down by Auguste Comte (1798–1857), Herbert Spencer (1820–1903), and other forerunners of modern social science, Kropotkin believed that the study of society was analogous to that of the world of nature. In *Modern Science and Anarchism* (1912), for example, Kropotkin contends that the anarchist method of sociological enquiry is that of the exact natural sciences. "Its aim," he says, "is to construct a synthetic philosophy comprehending in one generalization all the phenomena of nature—and therefore also the life of societies." In developing his views on human nature, Kropotkin went farther in extending the analogy between society and the natural world. Like the Social Darwinists of his era, Kropotkin maintained that all human behavior was a reflection of our biological condition. But while most Social Darwinists argued that a "tooth and nail" impulse in the struggle for existence was the dominant natural law governing the evolution of human behavior, Kropotkin insisted that the instinct of cooperation was an even more important factor in this process. According to him, it is the species in nature that shows the greatest tendency toward mutual aid—not cutthroat competition—that is the one most likely to survive and flourish over time. By arguing in this way, Kropotkin was attempting to demonstrate that anarchism was a highly evolved state of human nature but one that could not be obtained until the state and other coercive institutions were completely abolished.

The relationship between anarchism and violence. The efforts of Kropotkin and other anarchist thinkers to define anarchism as a rational and practicable doctrine were overshadowed by the negative publicity generated by the violence-prone elements of the movement. Beginning with the assassination of Tsar Alexander II in 1881 and continuing up to the turn of the century, when the American president William McKinley was murdered in 1901 by a lone gunman, anarchists everywhere were viewed as sociopaths who terrorized society by throwing bombs and assassinating heads of state. The fact that not all of these public outrages were committed by anarchists (Alexander II was killed by nihilists) or individuals who were representative of the movement as a whole did little to dispel

the exceedingly negative image of anarchists that was being projected by the popular press and government authorities.

The violent practices that were now associated with anarchism were largely the product of an ill-defined tactic known as "propaganda by the deed," a direct-action policy advocated by some anarchists from the late 1870s on. That violent and even criminal deeds were necessary to advance the anarchist movement appealed especially to a small number of disaffected idealists who were convinced that the only way to intimidate the ruling classes and overturn the capitalist system was to disrupt the daily routines of bourgeois society. Killing public figures close to the centers of political and religious power was one way of doing this. Bombing cafés, robbing banks, and destroying churches and similar hierarchical institutions were also seen as justifiable means to a revolutionary end.

A number of the perpetrators of "propaganda by the deed" were influenced by a highly individualistic strain of anarchist thought that became popular among *déclassé* intellectuals and artists around the turn of the twentieth century. A seminal figure in the individualist branch of anarchist thinking was the German philosopher Max Stirner (1806–1856). In his *The Ego and His Own* (1845), Stirner espoused a philosophy that was premised on the belief that all freedom is essentially derived from self-liberation. Because he identified the "ego" or "self" as the sole moral compass of humankind, he condemned government, religion, and any other formal institution that threatened one's personal freedom. It was his abiding concern with the individual's uniqueness and not his views as a social reformer that made Stirner attractive to certain segments of the anarchist community at the end of the nineteenth century. This was particularly true not just of the devotees of violence in Europe but also of the nonrevolutionary individualist anarchists in the United States. For example, the foremost representative of this strand of anarchism in the United States, Benjamin R. Tucker (1854–1939), took from Stirner's philosophy the view that self-interest or egoistic desire was needed to preserve the "sovereignty of the individual."

Spiritual anarchism and anarcho-syndicalism. Parallel to the terrorist acts committed at this time, the Christian pacifist Leo Tolstoy (1828–1910) was developing an antiauthoritarian current of thinking that, in its broadest sense, can be regarded as belonging to the anarchist tradition. Tolstoy promoted a form of religious anarchism that was based on the "law of supreme love" as defined by his personal (anti-doctrinal) reading of the Scriptures. Though he did not see himself as an anarchist, he nevertheless believed that in order for men and women to live in a morally coherent world it was necessary to destroy the state and its institutions. Because of his rejection of the use of force and violence, Tolstoy and his followers advocated civil disobedience, or nonviolent resistance, as a means of achieving the stateless and communally based society they envisioned.

It was also around this time that anarchist doctrine experienced another significant metamorphosis. From the late 1890s until the 1930s, anarchist activity was increasingly centered in working-class cultural and economic organizations,

and the tactics and strategy of the movement were grounded in the theory of revolutionary syndicalism. While not wholly abandoning the use of violence, the anarcho-syndicalists believed that, against the organized forces of big government and monopoly capitalism, the revolutionary élan of the workers could be most effectively channeled through trade union organizations. Using tactics such as the general strike, which was meant to paralyze the economy by linking shutdowns in different industries, the anarcho-syndicalists believed that it would be possible to create the general conditions for a complete collapse of capitalism and the state. Anarcho-syndicalism became an important force in the labor movements in parts of Latin America (Mexico, Argentina) and in European countries such as Italy, France, and Spain. Its greatest impact was felt in Spain. During the Second Republic (1931–1936) and continuing through the civil war period (1936–1939), anarcho-syndicalism developed into a powerful mass movement. At its peak the anarcho-syndicalist organizations known as the CNT-FAI (National Confederation of Workers and Federation of Iberian Anarchists) counted more than 1.5 million adherents. Their influence over the course of events during the civil war was most dramatically illustrated by the fact that they set up and ran thousands of industrial and agricultural collectives throughout the Republican zone. The triumph of Franco's Nationalist forces in 1939, followed by the outbreak of another global world war that same year, sounded the death knell for anarcho-syndicalism not only in Spain but in other Western European countries as well.

It deserves mention here that, by the time World War II began, anarchism's reach extended across the globe. Besides taking root in the Americas, the doctrine had penetrated parts of East Asia and even the subcontinent. In both China and Japan, for example, Western anarchist ideas influenced leading social thinkers such as Mao Zedong and labor organizers who were seeking to establish socialism in those countries. However, the emergence of authoritarian and totalitarian regimes of both the right and left in the 1930s and late 1940s effectively quashed the libertarian tendencies that had been developing up to then. It would take another forty years before anarchist ideas would be resurrected by tiny protest groups (mostly in Japan) that wanted to express their cultural and intellectual dissatisfaction with the status quo.

Contemporary Anarchism

While the Spanish Civil War, World War II (1939–1945), and the rise of totalitarian communist regimes after 1949 were events that effectively ended the further development of the historical anarchist movement, anarchist ideas and sensibilities were not as easily repressed. The political and cultural protest movements of the 1960s and 1970s in Europe and the Americas saw a resurgence of interest in anarchism. Feminists, ecologists, student radicals, pacifists, and others who were eager to question the prevailing social and moral preconceptions of modern society held by both the left and the right were drawn above all to the doctrine's iconoclasm. At this time, elements from a variety of nonlibertarian groups—the Situationists in France, for example—freely borrowed anarchist ideas in developing their own ideological positions.

Anarchism has also been enriched by the thinking of some of the twentieth century's leading philosophers, political activists, artists, and intellectuals. Bertrand Russell, Herbert Read, Mahatma Gandhi, Martin Buber, Albert Camus, Michel Foucault, Paul Goodman, Lewis Mumford, and Noam Chomsky are among the notable figures who have been associated with anarchist beliefs and values.

From the late twentieth century on, anarchism has continued to branch out in different directions. Anarchist ideas have been influential in the development of radical feminism and the Green and antiglobalist movements that have spread across Europe and the Americas. Contemporary anarcho-feminism has its roots in the writings and activism of historically important figures like Emma Goldman, Voltairine de Cleyre, and Federica Montseny. Goldman was among the first female anarchists to emphasize that the emancipation of women in society must begin with psychological change within women themselves. By calling on women to struggle against the repressive and hierarchical structures that dominated their personal lives, Goldman anticipated late-twentieth-century anarcho-feminists, who have insisted that the "personal is political" and have developed a radical critique of everyday life. Anarchist principles also have been adopted by some of the more radical ecological movements of postindustrial societies. Libertarian social ecologists such as Murray Bookchin have attempted to extend the traditional anarchist demand to emancipate society from government rule to our natural environment, calling for an end to human beings' dominating and exploitative relationship with nature.

Perhaps because of its shock value in an age crowded by political neologisms, the anarchist label has also been applied to groups that do not properly belong to the anarchist tradition. For example, the term "anarcho-capitalism" is sometimes used to refer to libertarian economic and social thinkers such as Ayn Rand, David Friedman, and other pro-capitalists who hold strong antistatist views. But even though they share the anarchist's contempt for state authority, their commitment to free enterprise and laissez-faire principles places them completely at odds with classical anarchist thinking and practice.

Ever since the Cold War ended in 1991, small groups of anarchists around the world have been in the forefront of the antiglobalization movement. Like their predecessors, modern anarchist activists seek to expose the adverse power relationships that affect our daily lives. They are particularly concerned with the impact that the global expansion of corporate leviathans has had on society, not least because of the seemingly unlimited ways in which this advanced form of capitalism can manipulate and control the lives of individuals. While a few anarchist groups still resort to direct-action methods to get their revolutionary message across, a growing number are turning to advanced technologies like the Internet to promote their cause. In short, whether one admires or abhors anarchist principles, it cannot be denied that anarchism offers a critical perspective of authority that appears to be endlessly relevant to those who want to sharpen their awareness of the boundaries of personal freedom.

See also Communism; Feminism; Marxism; Protest, Political; Social Darwinism; Socialism.

BIBLIOGRAPHY

PRIMARY SOURCES

- Bakunin, Mikhail. *Michael Bakunin: Selected Writings*. Edited by Arthur Lehning. Translated by Steven Cox and Olive Stevens. New York: Grove Press, 1973.
- Bookchin, Murray. *Post-Scarcity Anarchism*. 1971. 3rd ed., Oakland, Calif.: AK Press, 2004.
- Chomsky, Noam. *Radical Priorities*. 1981. Edited and introduced by Carlos Otero. Exp. 3rd ed. Edinburgh and Oakland, Calif.: AK Press, 2003.
- Cohn-Bendit, Daniel, and Gabriel Cohn-Bendit. *Obsolete Communism: The Leftwing Alternative*. Translated by Arnold Pomerans. Harmondsworth, U.K.: Penguin, 1968.
- Debord, Guy. *The Society of the Spectacle*. 1973. Reprint, New York: Zone Books, 1994.
- De Cleyre, Voltairine. *Anarchism and American Traditions*. Chicago: n.p., 1932.
- Goldman, Emma. *Anarchism, and Other Essays*. 1910. Reprint, with a new introduction by Richard Drinnon, New York: Dover, 1969.
- Goodman, Paul. *Growing Up Absurd*. New York: Random House, 1960.
- Kropotkin, Peter. *The Conquest of Bread*. 1906. In *The Conquest of Bread and Other Writings*, edited by Marshall Shatz. Cambridge, U.K., and New York: Cambridge University Press, 1995.
- . *Modern Science and Anarchism*. Translated from the Russian by David A. Modell. Philadelphia: The Social Club of Philadelphia, 1903. 2nd ed., London: Freedom Press, 1923.
- . *Mutual Aid: A Factor of Evolution*. London: Heinemann, 1902.
- Proudhon, Pierre-Joseph. *What Is Property: An Inquiry into the Principle of Right and Government*. 1890. Translated by Donald R. Kelley and Bonnie G. Smith. Cambridge, U.K.: Cambridge University Press, 1994.
- Puente, Isaac. *Libertarian Communism*. 1932. Sydney: Monty Miller Press, 1985.
- Reclus, Élisée. *An Anarchist on Anarchy*. London: Liberty Press, 1897.
- Rocker, Rudolf. *Anarcho-syndicalism*. London: Secker and Warburg, 1938.
- Stirner, Max. *The Ego and His Own*. Translated by Steven T. Byington. New York: Benj. R. Tucker, 1907.
- Tolstoy, Leo. *What I Believe*. Translated by Constantine Popoff. London: Elliot Stock, 1885.
- Tucker, Benjamin J. *Instead of a Book*. 1893. Reprint, New York: Arno Press, 1972.

SECONDARY SOURCES

- Guérin, Daniel. *Anarchism*. Translated by Mary Klopfer. New York: Monthly Review Press, 1970.
- Joll, James. *The Anarchists*. 2nd ed. Cambridge, Mass.: Harvard University Press, 1980.
- Marshall, Peter H. *Demanding the Impossible*. London: Fontana, 1991.
- Miller, David. *Anarchism*. London: Dent, 1984.
- Pennock, J. Roland, and John W. Chapman, eds. *Anarchism*. New York: New York University Press, 1978.
- Sonn, Richard D. *Anarchism*. New York: Twayne, 1992.
- Woodcock, George. *Anarchism*. New ed. Harmondsworth, U.K.: Penguin.

George Esenwein

ANCESTOR WORSHIP. Ancestor worship is the reverent devotion expressed by descendants for their deceased forebears through a culturally prescribed set of rituals and observances. The prominence of ancestors as a focus of worship within a broader religious tradition is common in many parts of the world, including Asia, Africa, and Native America, but there are few unifying characteristics cross-culturally. Commonalities include:

Only those deceased of appropriate relationship to the living and who have undergone the necessary *rites de passage* are worshiped.

Those that are worshiped usually are recognized by name or title, often a special posthumous one.

Services to the ancestors frequently include offerings and libations.

That ancestor worship is related to the animistic belief in a spirit or soul surviving the body after death, as proposed by early anthropologist Edward Burnett Tylor (1832–1917), is reasonable, since it is this spirit essence of the ancestor that is believed to continue its relationship with descendants. That ancestor worship is related to the earliest stage of religious expression among humans, however, as Tylor's theory further suggested, is certainly debatable. Other controversies in the study of ancestor worship include whether practices in honor of the deceased constitute actual worship; the extent to which linear versus collateral relatives comprise the worshipping group; the ways in which the living are influenced by the dead; and the individual, family, kin group, or regional variability in practice that can be present in a single cultural tradition.

Ancestors in Africa and Asia

In his work among the Tallensi of Ghana, Meyer Fortes emphasizes the significance of ancestor worship to patrilineage unification and lineage or segment differentiation. In particular, the father–oldest surviving son relationship is emphasized, the latter having the primary responsibility for performing the appropriate rituals and service. In general, placement of an African ancestral shrine and the performance of its services can also relate to and influence descendants' genealogical position and seniority.

In China, Daoist, Confucian, Buddhist, and folk concepts have contributed to the practice of ancestor worship in which heads of patrilineages are emphasized but other patrilineal relatives are included. There are three prominent sites for ancestor worship: family shrines, lineage halls, and tombs or graveyards of relatives. Proper placement and orientation of the latter will take geomancy (*feng-shui*) into account. Physical remains of the deceased are laid to rest in the tomb/graveyard, which serves as the site of public rituals; ancestral tablets represent the deceased in shrine and temple, in which their spirits are housed, and for which more private and personal observances are made. While the ancestors wield significant authority and influence in the lives of their living descendants, the latter care for and look after their ancestors—for example, by burning paper money at New Year's to contribute to their ancestors' bounty or prosperity.



Man with mummified remains of ancestor. In certain cultures, ancestors are seen as intermediaries between people and the gods, and it is believed that their involvement in the day-to-day happenings of the family does not end with death. © CHRIS RAINIER/CORBIS

Japanese ancestors are also emphasized on the father's side, and their worship is primarily related to Buddhist beliefs and practices. The deceased receive a posthumous or "Buddhist" name, which is written on a tablet and kept in the family's *butsudan* or Buddhist altar; Buddhist funerary services help purify the corpse from the polluting influences of death. Other services include "death day" memorial services for up to fifty years, New Year's and Bon (or Obon) celebrations, and household prayers. While tradition maintains a differentiation between stem and branch families and a main ancestral altar in the stem house, more modern practice has individual families establishing their own *butsudan* with the death of a household member. Proper care for the ancestors and observance of appropriate services, offerings, and prayers are believed not only to help the ancestors be restful and in peace, but also to result in blessings and good fortune for the descendants.

Among the Inca

In his early chronicle of Inca customs, Felipe Guaman Poma de Ayala pictures a mummy with feathered headdress and fine raiment carried on a litter as illustration of November or *aya marçay quilla* (Quechua for "the month of the dead"). He describes how during the holiday of the dead the deceased were removed from their crypts, adorned with clothing and feathers, given food—through burnt offerings—and drink, and carried dancing and walking through the streets and plazas, then laid to rest with various offerings. Such activities occurred

primarily in the worship of royal mummies, as an extension of the concept of the divine nature of the Inca king. While Inca beliefs included the departure of the soul from the body at death, royal bodies were mummified, served burnt offerings and drinks, and cared for by official attendants. Royal ancestors participated in affairs of state—counseling living rulers and contributing to their decision making, and, either in the guise of their mummified remains or as idols making formal appearances and visitations, receiving obeisance from their living subjects. Such beliefs were common in the Andes, as ancestral idols of subject peoples were held in Cuzco, the Inca capital, as a control mechanism.

Andean and Inca ancestor worship extended beyond that of royalty, and was probably common among all classes in the pre-Columbian era. Padre Bernabé Cobo attests that when the soul departed from the body, members of the deceased's *ayllu* (a corporate kin group) and family took and cared for the body, providing the veneration and care that was possible according to the family's means and status. The bodies were kept in relatives' houses, tombs, or shrines and were regularly paid tribute through sacrifice and prayer. This nonroyal worship was performed only by those descended in a direct line, and usually only by the children and possibly grandchildren of the deceased. Such worship was held to directly affect descendants' vitality and fortune, while its lack or disrespect to the ancestors could result in ill health or other maladies.

Ancestral Ambivalence

Ancestor worship is most likely to be practiced in a society with strong lineages or other consanguineal corporate groups whose continuity, standing, and control of resources extends over generations, and one in which there are strong beliefs in an active spirit world. In such contexts the appropriately related and ritually defined deceased continue to be interactive lineage and family members, cared for and revered by the living and in turn contributing to the prosperity of their succeeding generations as sources of or mediators with divine power. In general, ancestors who are worshiped are perceived as guardian or authority figures who are difficult to please, whose degree of influence on the living usually decreases with increasing genealogical distance from descendants. The power of the ancestors is therefore ambivalent: as likely to punish as to reward, they offer security and comfort while also contributing to uncertainty in an equivocal cosmos.

See also Animism; Religion.

BIBLIOGRAPHY

- Cobo, Bernabé. *Historia del nuevo mundo*. 1653. Madrid: Biblioteca de Autores Españoles, 1964.
- D'Altroy, Terence N. *The Incas*. Malden, Mass.: Blackwell, 2002.
- Fortes, Meyer. *Oedipus and Job in West African Religion*. Cambridge, U.K.: Cambridge University Press, 1959.
- Guaman Poma de Ayala, Felipe. *Nueva corónica y buen gobierno*. 1615. Paris: Institut d'ethnologie, 1936.
- Hsu, Francis L. K. *Under the Ancestors' Shadow: Kinship, Personality, and Social Mobility in China*. Stanford, Calif.: Stanford University Press, 1971.
- Newell, William H., ed. *Ancestors*. The Hague: Mouton, 1976.

Smith, Robert J. *Ancestor Worship in Contemporary Japan*. Stanford, Calif.: Stanford University Press, 1974.

Stephen M. Fabian

ANIMISM. Animism has had a long and important history in anthropology and outside it, as an intellectual concept with important implications not only for the study of religion, but also for the political struggles of indigenous peoples around the world. The anthropological study of animism has been a two-edged sword for indigenous people. It has brought their religious concepts, and thus their rich intellectual and spiritual lives, to the attention of the world, demonstrating the intrinsic value of their cultures. But to the extent that the apparent contrast between monotheistic and animistic religions has been exaggerated and used to create an artificial hierarchy of religious thought, it has also been used against them, to denigrate their beliefs and their intellectual capacities, and thus to deny them full equality with their colonizers.

Concepts

The concept of animism first appeared explicitly in Victorian British anthropology in *Primitive Culture* (1871), by Sir Edward Burnett Tylor (later published as *Religion in Primitive Culture*, 1958). His writings are preceded historically by those of the Greek Lucretius (c. 96–c. 55 B.C.E.) and the Roman Marcus Tullius Cicero (106–43 B.C.E.), among many others. “The doctrine of human and other souls” or “the doctrine of spiritual beings” constitutes the essence of Tylor’s theory. The doctrine of souls is based on the foundational doctrine of “psychic unity,” which affirms that all people, everywhere, for all time (or at least the past fifty thousand years or so), have the same capacity to comprehend all phenomena in the known, observed, and imagined universe by use of their own cultural symbols and languages. Tylor regards *Spiritualism* as a modern cult that lacks panhuman motivations of animism.

The idea of animism is that in all cultural systems people experience phenomena—such as dreams, visions, sudden insights, out-of-body experiences, near-death experiences, and trances—that simultaneously conjoin perceptions of being “elsewhere” with the knowledge of being “here.” Some thinkers explain this experience through a belief in the human soul, which they envision as distinct from but inextricably attached to the body until death do they part, so that animistic belief in the soul becomes part of every cultural system.

Robert Ranulph Marett (1866–1943), Tylor’s successor at Oxford, introduced the concept of *animatism* to that of *animism*, extending the idea of an animating spirit similar to the soul to include many different forces in nature and culture (*The Threshold of Religion*, 1909). Such force is what makes a tree grow from a seed, the rain fall, or the sun shine—that which brings fertility and fecundity to the earth. Loss of such force results in death. People are in awe of such forces as manifest in volcanoes and earthquakes and especially in inert corpses. Out of the observations and awe of force in nature comes the universality of the sacral basis for religious experience, which Marett argued was prior to animism. Animism



African man beside animist figure (sculpted from mud and bone and covered with feathers), Burkina Faso, c. 1979. Many indigenous cultures believe in spiritual beings, a concept first defined as animism by Sir Edward Burnett Tylor in 1871. Tylor proposed that animism derived from an attempt to explain certain phenomenon such as trances, dreams, and visions. © CHARLES LENARS/CORBIS

and animatism are often not clearly distinguished, as many of Marett’s ideas have been blended through time in philosophical and religious literature with those of Tylor and many others.

The Canelos Quichua native people of Amazonian Ecuador illustrate concepts of animism and animatism. Souls and spirits are ubiquitous and even spirits have souls. Those who interact intensively with the souls are the male shamans and the female potters, both of whom influence the conceptual system of one another through mutual symbol revelation. For example, when a shaman in trance dimly “sees” an approaching colorful, noisy spirit, a woman quietly, from the darkened recesses of the room, clarifies his emerging vision and names the actual spirit.

Human souls are acquired through both mother and father. Spirit essences are hierarchized into four essential tiers, easily represented as spheres encompassing one another. Sungui, the master spirit of the rain forest and hydrosphere,

is the apotheosis of androgynous power. This male and female spirit takes many corporeal forms, the most prominent being the giant anaconda. This spiritual superpower must be controlled or it will overwhelm and inundate the world; Amasanga, master spirit of the rain forest, controls the power of Sungui. The corporeal representative of this androgynous being is the great black jaguar. In turn, rainforest dynamics are controlled by Nungüi, a strictly feminine spirit, master of garden soil and pottery clay, whose corporeality is manifest in the deadly black coral snake with a mouth too small to bite humans. The inner sphere is the human household, wherein the souls and spirits come together in a special system of human knowledge, vision, and imagery. Power flows downward through the spheres, and control of power is exercised upward from inner to outer spheres.

Cultural Implications

In Tylor's original formulation, animism was an argument for the universality of human intellectual and spiritual worlds. The universality of concepts of souls, and hence the universality of religion, is a major contribution of Tylor, one that endures into the twenty-first century. Like the Canelos Quichua, humans everywhere, in one way or another, and with very great differences, conceptualize into cultural systems the spiritual dimensions of life, as well as the corporeal aspects of quotidian existence. With this concept of universalism of fundamental religious thought, Victorian England and the rest of the English-lettered world was exposed to cultural relativism.

What constitutes human difference in economy, society, psychology, and religion, then, is cultural, not biological. Although people are very "different" from one another, across space and through time, their mental capacities—cognitive, emotional, and imaginative—are not. As Clifford Geertz puts it: "The doctrine of the psychic unity of mankind, which so far as I am aware, is not seriously questioned by any reputable anthropologist, is but the direct contradictory of the primitive mentality argument" (p. 62).

Tylor, however, very much the Victorian gentleman, began his quest for the bases of animism with what he called the "lower races," whom he also labeled "savages," "rude, non-religious tribes," and "tribes very low in the scale of humanity," among other such figures of speech that link evolutionary biology and culture, thereby enforcing the "primitive mentality argument" later expanded by Lucien Lévi-Bruhl in *Les fonctions mentales dans les sociétés inférieures* (1910; translated in 1996 as *How Natives Think*). The Victorian contradiction of enlightened cultural relativity, attached to a scalar view of humans as evolving from the "lower races" to the "civilized nations," leads to the racist paradox that a few civilizations evolved while the rest of the world's people "remained" animist. Animism, by this reasoning, is evidence of low-level "relics." This contradiction became canonized by the sixteenth century through the emergence of Western modernity and mercantilist capitalism and remains strong in twenty-first-century Western cosmology.

It is, however, a fallacy. Every religious system, including the monotheistic religions such as Christianity and Islam, include representations of the supernatural with strong animistic dimensions. Despite religious scholars' assertions to the

contrary, members of monotheistic religions nonetheless act at times as though there are spiritual beings detached from corporeal beings, manifest concern over the fate of their immortal souls, and make these beliefs part of their traditions, such as the jinn of Middle Eastern folklore, or of the dominant religion itself.

Nonetheless, the enduring Victorian contradiction between cultural relativity and social evolution continues to cast a shadow over the religious beliefs of indigenous peoples, leading many of the world's people with rich beliefs in spirits and noncorporeal essences of animate and inanimate things—but without a "high god" organizer—to resent the concept *animist* because of its connotation of savagery. Among the Canelos Quichua, for example, spokespeople to the outside world often express considerable resentment at the use of the word.

By the same token, animist symbolism does more than establish a template for understanding quotidian life and the universe. It also undergirds the ideological struggles of indigenous people to establish a place and space in nation-state life. In Amazonian Ecuador, for example, animistic concepts were utilized during political uprisings in 1990 and 1992, and again in 2000, when indigenous people rose up as one mighty body to claim—in part successfully—their territory and their rights. Animism as a concept is very powerful in its relativistic dimensions, but is destructive when used to place people in a universal or particular evolutionary scheme that ranges from primitive to civilized.

See also *Polytheism; Religion: Indigenous Peoples' View, South America; Sacred and Profane*.

BIBLIOGRAPHY

- Geertz, Clifford. *The Interpretation of Culture*. New York: Basic Books, 1973.
- Honigmann, John J. *The Development of Anthropological Ideas*. Homewood, Ill.: Dorsey, 1976.
- Stocking, George W., Jr. *After Tylor: British Social Anthropology, 1888–1951*. Madison: University of Wisconsin Press, 1995.
- . *Victorian Anthropology*. New York: Free Press, 1987.
- Swanson, Guy E. *The Birth of the Gods: The Origin of Primitive Beliefs*. Ann Arbor: University of Michigan Press, 1960.

Norman E. Whitten Jr.

ANTHROPOLOGY. As an academic discipline, anthropology is somewhat less than two centuries old, but speculations, if not rigorous scientific theories, about where we human beings came from and how to account for the physical and cultural differences that distinguish our communities and nations from one another probably began during prehistory.

In the United States (but not in most other academic settings, for example, in Europe or Asia), the discipline is conventionally divided into four main subfields: biological (or physical) anthropology, archaeology, linguistics, and sociocultural anthropology. The history and current state of each subfield will be discussed in this entry, as well as how they have

influenced one another during the last two-hundred-odd years. Although they will be described separately, the four subfields form the *logos* of *anthropos*, the broad science that studies the human species.

The concept that unites these four subfields is *culture*. The earliest systematic formulation of the anthropological concept of culture was articulated by Sir Edward Burnett Tylor (1832–1917) in the first sentence of his pioneering book, *Primitive Culture* (1871): “Culture, or Civilization, taken in its wide ethnographic sense, is that complex whole which includes knowledge, belief, art, morals, law custom, and any other capabilities and habits acquired by man as a member of society.” This entry will use an updated version of Tylor’s definition put forth by Daniel G. Bates and Elliot M. Fratkin: “Culture, broadly defined, is a system of shared beliefs, values, customs, and material objects that members of a society use to cope with their world and with one another, and that are transmitted from generation to generation through learning” (1999, p. 5). The work of biological anthropologists seeks—among other things—to discover how, when, and why our remote ancestors evolved the physiological capacity for culture; archaeologists attempt to trace the evolution of culture and seek to reconstruct the nature of prehistoric (as well as historic and contemporary) cultures from the material objects they left behind; linguists describe the principal symbolic system—language—through which cultural learning occurs; and socio-cultural anthropologists are concerned with the nature of culture per se and the myriad factors that shaped (and continue to shape) its contemporary manifestations.

Biological Anthropology

The advent of geology and the study of fossil sequences in the late eighteenth and early nineteenth centuries by pioneer geologists such as James Hutton (1726–1797) and Sir Charles Lyell (1797–1875) who laid the groundwork for the study of human evolution. Two major events in the 1850s loom large in the history of this most basic of the subfields: (1) the accidental discovery in 1856 of the first premodern human being, the prototype of the Neanderthals, in a quarry near Düsseldorf, Germany, and (2) Charles Darwin’s (1809–1882) theory of “natural selection,” articulated in *On the Origin of Species* (1859). This theory gave scholars who wanted to study the course of human evolution systematically a theoretical framework for determining how one species evolved over time into another.

The human fossil evidence in Europe, and eventually throughout the Old World, from Africa to China and Indonesia, mounted rapidly, and by the early twentieth century anthropologists had developed several models of human evolution. At first, there appeared to have been two successive species of genus *Homo*: *Homo sapiens*, including all modern human beings as well as our immediate precursors, the Neanderthals, and the far older *Pithecanthropus erectus*, the earliest example of which was found near Solo on the island of Java in 1895. It had become clear that the human species was at least several hundred thousand years old. As the twentieth century unfolded, new and even older hominid fossils were discovered, primarily in Southern and Eastern Africa, and both

the dates and descriptions of hominid evolution changed markedly. The 1925 discovery of *Australopithecus africanus* in South Africa by Raymond Dart (1893–1988) pushed the origin of the hominids back at least a million years and added a new, pre-*Homo* genus, *Australopithecus*, or “Southern Ape-Man.”

It is impossible here to outline the sequence of major fossil discoveries in Africa and elsewhere that have been made since 1925. The names of anthropologists responsible for these finds include the late Louis S. B. Leakey (1903–1972) and Mary Leakey (1913–1996), who, in the late 1950s and early 1960s, discovered a number of extremely important protohominids at Olduvai Gorge in northeast Tanzania. In 1974 Donald Johanson discovered “Lucy,” an extremely early Australopithecine that lived in what is now southeastern Ethiopia around 3.1 million years ago, the prototype of *Australopithecus afarensis*. In 1994 fossil evidence of an even older genus and species of protohominids, *Ardipithecus ramidus*, more than a million years older than “Lucy” (c. 4.5 million years old), was found in the same region of Africa, and in the last several years fossil fragments found in East Africa push the origin of hominids even farther back, perhaps as much as 5.5 million years. Moreover, it is now suspected that hominid bipedalism evolved as early as 4.5 to 5 million years ago; by freeing our forelimbs, it affected the evolution of the capacity for culture profoundly by enabling our ancestors to use and make tools.

Of course, this did not happen overnight. The earliest evidence for the presence of crude tools, again in East Africa, dates from around 2.5 million years ago. By this time, the earliest species of our genus, *Homo habilis*, had evolved, followed by *Homo ergaster* (c. 1.9–1.5 million years ago), and then *Homo erectus*, which dominated the Old World from c. 1.5 million to about 200,000 years ago, when it began to be replaced, at least in Europe—*Homo erectus* appears to have lingered longer in parts of Asia—by the Neanderthals. They, in turn, were eventually displaced by our own immediate ancestors, anatomically modern hominids (*Homo sapiens*), who are now thought to have evolved around 130,000 years ago near the southern tip of Africa. By 27,000 years ago, *Homo sapiens* had replaced all other hominid species everywhere. Some biological anthropologists still subscribe to the “multiregional hypothesis” that human beings became “modern” simultaneously in several parts of the Old World, from Africa to Europe and East Asia about 40,000 to 50,000 years ago, but consensus in the profession supports the “out of Africa” model, strengthened by the absence of any evidence that Neanderthal mitochondrial DNA exists in modern European populations.

A significant element in this evolutionary journey was the development of our brains to the point that we were able not only to make crude stone tools but to envelope ourselves and the world around us in what cultural anthropologist Clifford Geertz has called “webs of significance,” the capacity for culture. At the same time, it has become abundantly clear that, since the emergence of anatomically modern hominids, no appreciable differences in the capacity for culture have emerged among the several modern human physical types, what are still sometimes erroneously called “races,” and that the behavioral

and technological differences that separate contemporary human communities are cultural rather than biological. One of the most important contributions of biological anthropology to general knowledge has been to dispel the pernicious myths of racial superiority and inferiority.

In addition to tracing the course of human evolution, many biological anthropologists specialize in the comparative study of chimpanzees (e.g., Jane Goodall), gorillas (e.g., the late Dian Fossey [1932–1985]), and other nonhuman primates, hoping to throw additional light on human behavior and the extent to which it is grounded in our primate heritage. Such studies provide a better understanding of the profound biological changes in our ancestors during the last five million years, changes that culminated in *Homo sapiens*.

While biological anthropology is best known for the study of ancient humans and other primates, other branches of the field also make significant contributions. Forensic anthropologists assist law enforcement agencies in gathering and interpreting evidence in cases of homicide, massacres, and genocides; other biological anthropologists study the interaction of culture and biology as it affects our health, longevity, and well-being. Such researchers work on a range of topics including the spread of AIDS (autoimmune deficiency syndrome) and other communicable diseases; the relationship between health and social problems such as poverty, racism, and inequality; stress and rapid social change; diet and maternal well-being; and the long-term effects of violence and warfare. There is a close relationship between this type of biologically focused anthropology and the work of medical anthropologists, cultural anthropologists who study the social contexts of medical practice.

Archaeology

Archaeology's roots lie in the early eighteenth century, when the landed gentry in Britain and elsewhere in Europe began to acquire stone, bronze, and iron implements for display, but it was not until late in that century that serious excavations began, largely inspired by discoveries at Pompeii and Herculaneum.

Two major events in the 1830s moved the fledgling discipline of archaeology to a new level. One was Jacques Boucher de Perthes's (1788–1868) discovery in 1838, near Abbeville, France, of a crude lithic (stone) technology that predated the gentlemen's displayed objects by well over 100,000 years. The second was the Danish scholar Christian Thomsen's (1788–1865) articulation of the "three-age system"—still a fundamental archaeological concept: the Stone, Bronze, and Iron Ages, which appeared in 1836 in the Catalogue of the Danish National Museum's collection (Thomsen was its first curator). Because stone artifacts typically came from the lowest levels of a trench or pit, while bronze objects came from the middle levels, and iron objects were typically found closest to the surface, Thomsen realized that this reflected a universal temporal sequence.

A generation later, in another important book, *Prehistoric Times* (1865), Sir John Lubbock (1834–1913), later Lord

Avebury, not only coined the term *prehistory*, but also divided Thomsen's Stone Age into two successive stages, the Paleolithic, or Old Stone Age, and the Neolithic, or New Stone Age. Subsequent archaeologists added the term *Mesolithic* to refer to the transitional period at the end of the Ice Age between the Paleolithic and the Neolithic, which saw the beginnings of settled life, agriculture, and animal husbandry.

By the early twentieth century, archaeology was an established scholarly discipline. In subsequent decades, archaeologists sought to discover sequences, or stages, in the evolution of culture per se and to reconstruct the trajectory of cultural development in specific regions, such as the ancient Near East, Mexico, the American Southwest, Peru, Africa, India, Oceania, East Asia, and Southeast Asia. In the late twentieth and early twenty-first centuries, a split occurred between *processual* and *postprocessual* archaeologists. Processual archaeology starts from the assumption that all human communities are themselves systems, and need to be viewed as such. Processual archaeologists are primarily concerned with the processes whereby ancient peoples adapted to their ecosystems, and how these processes changed over time as the ecosystems changed. Postprocessual archaeology, on the other hand, focuses on reconstructing the daily lives of the people who lived in prehistoric communities, how their societies were organized, the nature of their religious beliefs and worldviews, their socioeconomic hierarchies, and other elements of culture that sociocultural anthropologists study in living communities. Postprocessualists, for the most part, see themselves as cultural anthropologists who work with artifacts rather than living informants.

Out of processual and postprocessual archaeology have developed branches of contemporary archaeology: urban archaeology, which looks at the nature of urban life in premodern cities, and industrial archaeology, which attempts to reconstruct what life was like for the majority of people in early industrial towns in the Midlands of England, parts of New England, and elsewhere in the emerging industrial regions of Europe and America in the late eighteenth and early nineteenth centuries. A similar approach has been applied to reconstructing the lives of enslaved Africans and African-Americans on antebellum plantations in the Caribbean and the American South, as well as of African-Americans in the urban northeast.

Other trends in contemporary archaeology include a focus on the lives of women, ordinary people, and the poor, rather than the "great men" of history. Scientific developments that make it possible to recover detailed data about diet, farming systems, and other aspects of everyday life have provided the technical impetus for these new research areas. While the study of the most ancient manifestations of human culture, such as the rise of agriculture or the state, remains important to archaeologists, an increasing number have turned to historical projects in which documents and archives and working with historians complement the material remains retrieved during excavations. Such projects promise new insights into many aspects of human history, including medieval Europe, colonial Latin America, and early settlements in the United States.

Linguistics

Linguists study the primary medium by which culture is transmitted, language. The discipline of linguistics—at first called philology—dates from approximately the same period that biological anthropology and archaeology began, the late eighteenth century. Sir William Jones (1746–1794), a jurist and student of Asian languages assigned to the British East India Company’s outpost at modern-day Calcutta, is generally credited with founding the discipline. In 1786, in the course of a speech to the Bengal Asiatic Society, of which he was the founder and president, Jones outlined, for the first time, the family-tree model of linguistic relationships, focusing on what would soon be called the Indo-European language family.

Within a generation, comparative philology (now called historical, or diachronic, linguistics) was an established discipline. Scholars such as Jacob Grimm (1785–1863), Franz Bopp (1791–1867), and August Schleicher (1821–1868) had reconstructed what appeared to be the Proto-Indo-European lexicon. Eventually, other language families, such as Sino-Tibetan (Chinese, Tibetan, Thai, Burmese, etc.) and Hamito-Semitic (Ancient Egyptian, Hebrew, Babylonian, Arabic, and other Near Eastern languages), also began to be studied from this perspective. Franz Boas (1858–1942), in addition to being a pioneer sociocultural anthropologist, was also among the first to apply the comparative method to the study of Native American languages.

In the early decades of that century, thanks primarily to the efforts of a brilliant Swiss linguist, Ferdinand de Saussure (1857–1913), a new structural approach to the study of language emerged, one that emphasized synchronic studies rather than the historical focus that had dominated during the previous century. De Saussure made a basic distinction between what he called *la langue*, the basic rules that govern the grammar of a given language, and *la parole*, the specific speech patterns that occur at any given instant. The linguist’s job is to elicit the nature of *la langue* by recording and analyzing examples of *la parole*. This approach soon led to two concepts that still dominate anthropological linguistics: the *phoneme* and *morpheme*. A phoneme is a minimal sound feature of a language that signals a difference in meaning; a morpheme is an ordered arrangement of such speech sounds that carries an indivisible meaning. Thus, the sounds represented by the English letters *d*, *o*, and *g* are phonemes, while the word *dog* is a morpheme. Combining the same phonemes in reverse order produces a wholly different morpheme, *god*. Structural linguists are also concerned with syntax, the arrangement of morphemes into phrases and sentences, and semantics, how meanings are structured by morphemes and their forms and their position and function in sentences. *Grammar* is the entirety of a language’s phonological, morphological, syntactic, and semantic rules that enable humans to communicate and transmit culture.

In the course of the last few decades, linguists have debated the extent to which there are universal, innate features that form the fundamental structure of all human languages. The U.S. linguist Noam Chomsky has argued in favor of this proposition. In *Syntactic Structures* (1957), Chomsky suggested

that all human beings have the innate ability to generate every possible sentence in their language. This approach to the study of language is called transformational-generative grammar (TG). However, not all linguists accept this model. A great many hold that, like culture, language is infinitely variable and that there are no proven universal features.

The relationship between language and culture has also been a major concern among linguists, especially anthropological linguists. Two pioneers in the study of this relationship were Edward Sapir (1884–1939) and his student Benjamin Lee Whorf (1897–1941), who suggested that there was an intrinsic connection between the fundamental features of a culture and the structure of its language. For example, as Whorf pointed out, the Hopi Indian language does not mark verb tense, a feature that Whorf said is reflected in the absence of a linear time concept in Hopi culture. All events are intrinsically linked to one another, and life simply unfolds. Although by no means universally accepted by contemporary anthropologists—some critics object that his approach is tautological and that there is no evidence to support the priority of language over culture—the Sapir-Whorf Hypothesis continues to influence anthropological thinking.

Early in the twentieth century, after the publication of books such as Sapir’s *Language* (1921) and Leonard Bloomfield’s (1887–1949) book of the same title (1933), linguistics developed into a separate discipline dedicated to the scientific study of language, with connections to the related fields of cognitive science and cognitive psychology, as well as some aspects of computer science (artificial intelligence, machine translation), after the publication of Chomsky’s *Syntactic Structures*. The development of TG grammar produced an explosion of research in both synchronic and diachronic linguistics that continues to extend our understanding of language and mind and how we communicate.

Anthropological linguistics exists as a separate but related discipline that emphasizes the relationship between language and culture, but adopts a more holistic and, often, humanistic approach than, for example, cognitive psychology. Anthropological linguists study a variety of language practices, ranging from the relationship between language and music within specific cultures to children’s use of language in play. A major focus that distinguishes linguistic anthropology from other branches of linguistics is its focus on questions of politics, power, and social inequality, as these aspects of culture affect language. The study of language ideologies emphasizes the different statuses of certain language practices, in contexts ranging from a bank officer turning down a loan applicant, to political speeches, to bilingual and bicultural contexts (for example, the study of “Spanglish,” forms of language developed by Americans who speak both Spanish and English), to the controversies about varieties of English spoken by African Americans.

Sociocultural Anthropology

Sociocultural anthropology, the subfield concerned with culture per se, especially in its many contemporary ethnographic manifestations, commands the attention of the majority of

professional anthropologists. Although there are some excellent examples of ethnographic description in antiquity—Herodotus’s (484?–425 B.C.E.) account of the ancient Scythians in Book 4 of his *History* (c. 440 B.C.E.) and Cornelius Tacitus’s (55? B.C.E.–after 117 C.E.) detailed account of ancient Germanic-speaking culture, *Germania* (c. 98 C.E.)—like the other principal subfields of anthropology, sociocultural anthropology began to take shape in the early nineteenth century and is closely linked to colonialism. As Europeans (or people of European heritage) expanded into India, Southeast Asia, Africa, and Oceania, as well as across North America, they found themselves confronting—and eventually dominating—what they called “primitive” cultures. These encounters led to two fundamental questions that dominate anthropology: (1) Why do cultures differ? and (2) Why are some cultures technologically “simple” societies, while others developed more complex, technologically sophisticated societies? Accounting for the differences found among cultures is problematic. For example, while, in some regions, humans live in small-scale societies with very basic technologies and low population densities—what early anthropologists, influenced by colonialism and scientific racism, called “primitive”—in other places, such as the Valley of Mexico, people began millennia ago to develop complex, energy-intensive agricultural technologies that enabled them to congregate in great numbers, build enormous cities and finance the construction of elaborate buildings and works of art, and, in general, to develop what are called “civilizations.”

This second question has especially been the province of archaeologists, but it underlies cultural anthropology as well. At its best, cultural anthropology has steadfastly argued for the value of the small-scale and the more environmentally wise “primitive” as culturally significant. At its worst, it has functioned as the “handmaiden of imperialism,” either overtly, as when British anthropologists worked for the colonial enterprise in Africa, or indirectly, as purveyors of “exotica” that reinforce the prejudices of urbanites and racial elites regarding the “savagery” of foreigners or of native populations and minorities closer to home.

It is thus no accident that the first great theoretical paradigm in sociocultural anthropology was *unilineal evolutionism*, the idea that all cultures can be ranked along a grand scale that culminated, of course, with nineteenth-century European and American industrial civilization, the “best of all possible worlds.” Darwin’s *The Origin of Species* reinforced this approach to the assessment of cultural differences, in particular the concept of “natural selection.” Unilineal evolutionism was predicated on two fundamental axioms: (1) the idea of *progress*, that the direction of cultural evolution is everywhere from “primitive” to “civilized” and (2) the idea of *psychic unity*, that all human beings, irrespective of their environment or specific history, will necessarily think the same thoughts and, therefore, progress through the *same* series of evolutionary stages. Sir Edward Burnett Tylor, who was the first anthropologist to define the concept of culture, was a major contributor to unilineal evolutionism, suggesting a three-stage model for the evolution of religion: animism (a belief that all phenomena are “animated” by unique spirit beings), polytheism, and monotheism, which, he held, is a prime characteristic of advanced civilizations.

The most influential unilineal evolutionist was Lewis Henry Morgan (1818–1881), a successful American lawyer who practiced anthropology as an avocation. In *Ancient Society* (1877), Morgan posited a three-stage model for the evolution of culture: savagery, barbarism, and civilization. The first two stages, which he labeled, collectively, *societas* (society), as opposed to *civitas* (civilization), were each subdivided into three successive substages: lower, middle, and upper. His prime criterion for assigning cultures to one or another of these stages was the character and complexity of their technology. Because they lacked the bow and arrow, a prime technological criterion, Morgan assigned the ancient Hawaiians to “Middle Savagery,” despite the fact that they practiced agriculture and had a highly complex social organization.

Although Morgan’s emphasis on material culture—tools, weapons, and other artifacts—had a significant influence on a later school of sociocultural anthropology, cultural materialism, he also pioneered the study of kinship systems. By the 1890s, however, the unilineal evolutionists’ rigid adherence to paradigms based on incomplete and questionable ethnographic data (largely collected by missionaries, traders, colonial administrators, and so forth) was called into question by a new generation of anthropologists who had spent time in the field. (Most of the unilineal evolutionists were “armchair scholars,” although both Tylor and Morgan did have some field experience in their youth, the former in Mexico and the latter among the Seneca, an Iroquois tribe that lived near his home in upstate New York.)

In the United States, the chief critic of what was then called the comparative method in anthropology was Franz Boas, the most influential American anthropologist. A rigorous, scientifically trained German-born scholar, he later switched to anthropology and did extensive fieldwork among the Baffin Island (Canada) Eskimo (or Inuit), as well as the Native Americans of British Columbia. He and other critics of the unilineal approach, many of whom were his students, such as Alfred Louis Kroeber (1876–1960) and Robert Lowie (1883–1957), also called into question unilineal evolutionism’s fundamental axioms, seriously questioning whether “progress” was in fact universal or lineal and whether it was possible to rank all human cultures according to a *single* evolutionary scheme. Finally, the Boasians attacked the concept of “psychic unity,” suggesting that all cultures are inherently different from one another and that they should be assessed on their own merits and not comparatively. This approach, which stressed empirical field research over “armchair” theorizing, came to be known as historical particularism, and emphasized cultural relativism and diffusion rather than rigid evolutionary sequences. Anthropologists were enjoined to reconstruct the culture-history of particular tribes and societies, but *not* the evolution of culture per se. Emphasis was also placed on what has been called “salvage ethnography,” gathering ethnographic data before the simpler cultures of the world were overwhelmed by Western culture.

Boas left another important legacy: his work as a public intellectual who used his scholarly knowledge to educate the American public about racial equality. For Boas, who had experienced anti-Semitism in his native Germany, this kind of

work on the part of intellectuals was crucial if America was to realize its democratic ideals. He inspired many of his students, including Ruth Benedict (1887–1948) and Margaret Mead (1901–1978), to their own forms of public work by his example. He also influenced several important African and Native American intellectuals who left anthropology for other pursuits, most notably the novelist Zora Neale Hurston (1891–1960), as well as the Brazilian sociologist Gilberto Freyre (1900–1987), who credits Boas's influence in the preface to his controversial books on race in Brazilian culture.

In Britain, the empirical reaction to Morgan, Tylor, and their colleagues took a different turn. Most early-twentieth-century British anthropologists, such as Bronislaw K. Malinowski (1884–1942), a Polish scholar who immigrated to England to complete his studies, and A. R. Radcliffe-Brown (1881–1955), were largely ahistorical; that is, they advocated a structural–functional, rather than historical, approach to the study of cultures. Their emphasis was primarily, if not in some cases wholly, on the here and now, on the social organization of living human communities and how the elements thereof were functionally interrelated to form integrated wholes. Malinowski, who spent four years (1915–1918) studying the culture of the Trobriand Islanders (near New Guinea), also focused on how social institutions function to serve basic human needs, such as shelter, reproduction, and nourishment. Radcliffe-Brown, who did field work in the Andaman Islands, South Africa, and Australia, drew liberally on the ideas of the French sociologist Émile Durkheim (1858–1917) in his attempts to discover what he called the “social laws” and “structural principles” that govern social organization everywhere. Among them, Boas, Malinowski, and Radcliffe-Brown trained or influenced at least two generations of sociocultural anthropologists on both sides of the Atlantic, from the early 1900s to the threshold of World War II, and, in Radcliffe-Brown's case, for a decade afterward as well.

However, beginning in the late 1930s, a reaction to the essentially antitheoretical stance of the Boasians began to take shape, based on the assumption that all cultures are necessarily adapted to the ecological circumstances in which they exist. The leading advocate of “cultural ecology” was Julian H. Steward (1902–1972), whose book *Theory of Culture Change* (1955) had a major impact on the discipline. Other scholars, such as Leslie A. White (1900–1975) and British archaeologist V. Gordon Childe (1892–1957), drawing on the Marxist assumption that the “means of production” is everywhere crucial in determining the nature of society, emphasized the primacy of material culture. (Indeed, White consistently described himself as a disciple of Lewis Henry Morgan, whose work had, in turn, influenced Marx's collaborator Friedrich Engels [1820–1895].) These early “neo-evolutionists” of the mid-twentieth century all acknowledged a debt to Marx, but the new materialism in anthropology soon split into two camps: one that emphasized historical materialism, political economy, and the study of imperialism and inequality, and another that repudiated Marx and focused on questions of ecological adaptation and evolution. The former include Eric Wolf, Sidney Mintz, Eleanor Leacock, and John Murra. Mintz's study of the history of sugar and Wolf's timely

comparative project on *Peasant Wars of the Twentieth Century* (1999), published in response to U.S. involvement in Vietnam, remain two classic studies from this school. Among the anti-Marxists, the best-known is the late Marvin R. Harris, whose provocative books for the general public argue that apparently “irrational” religious behavior, such as the Hindu refusal to eat meat or Jewish dietary law, can be attributed to biological needs unknown to practitioners.

Neo-evolutionism was not the only post-Boasian development in sociocultural anthropology. Also in the late 1930s, a number of American anthropologists, among them Margaret Mead, Ruth Benedict, and Ralph Linton, drew selectively on Freud and other early twentieth-century psychologists and developed the “culture and personality” school, which emphasized the interface among individual personalities and the cultures they share, as well as the “infant disciplines”—weaning and toilet training—and their effects on both the formation of individual personality structures and the nature of particular cultures. Early and harsh toilet training was held to produce “anal” personalities and authoritarian cultures, whereas relaxed attitudes toward sphincter control and related processes produce relaxed social systems. At the start of the twenty-first century this school has few proponents, but psychological anthropology remains a recognized branch of sociocultural anthropology.

In the 1950s, linguistics began to influence an increasing number of anthropologists. If the cultural ecologists and materialists had come to conceive of culture as essentially an adaptive system, their linguistically oriented colleagues were concerned with cognitive systems and shared symbols, with how people attach meaning to the world around them. Initially known as “ethnoscience,” this approach has come to be called “cognitive anthropology.” Closely related to it are two other approaches also concerned with meaning. One of them, closely identified with the eminent French anthropologist Claude Lévi-Strauss, is *structuralism*. Extremely influential outside of anthropology, especially in France, this school focused on underlying structures of thought based on binary oppositions, like the binary mathematical code used by computers. From simple pairs such as *hot/cold* or *up/down*, cultures construct elaborate systems of myth and meaning that shape everything from cooking to kinship, as well as providing answers to questions about life and death. When initially published, his partially autobiographical *Tristes tropiques* (1955; *The sad tropics*) in which he recounts his flight from Nazi Germany to find refuge among the tribes of Amazonian Brazil, was perhaps more influential than his dense and difficult works of structural analysis. Later, however, it was criticized for its portrayal of Native Americans as seemingly “outside of history.”

In America, a different school of anthropology, “symbolic anthropology,” would ultimately prove more influential than structuralism. This approach, which draws on the same linguistic and cognitive models as structuralism, emphasizes emotion and affect in addition to cognition, and looks back to traditional anthropological studies of magico-religious belief systems, especially Durkheim's work. Among the more important contributors to symbolic anthropology have been

the British scholars Victor W. Turner and Mary Douglas, and the American anthropologist Clifford Geertz. Turner's study of the multivalent symbolic meanings of the "milk-tree" in the life of the Ndembu of northwestern Zambia—its milklike sap stands for everything from semen to mothers' milk—remains a classic. In it, he borrows from Arnold van Gennep's (1873–1957) classic work, *Les rites de passage* (1909; *The Rites of Passage*), the concept of the "transition" stage in a rite of passage, which Turner rechristened "liminality." Douglas studied the symbolic opposition between what she calls "purity and danger," as exemplified in her brilliant analysis of the food taboos in the Old Testament, which, she argues, reflect a fear of anomalous animals, like the pig, which is neither a browser nor a ruminant. Geertz, who has done extensive fieldwork in Indonesia and Morocco, is famous for his in-depth analysis of the symbolism of cockfighting in Bali, as well as for the concept of "webs of significance," the idea that all human beings are necessarily bound together by intricate symbolic "webs" in terms of which they collectively confront external reality.

In the last two decades, sociocultural anthropology has seen the emergence of the "post-isms": postcolonialism, which examines the impact of neoliberal capitalism on recently decolonized states; poststructuralism, which critiques the work of Lévi-Strauss and other classic structuralists; and, most importantly, postmodernism, a manifestation of a broader intellectual movement in architecture, literature, cinema, and the arts predicated in fair measure on the theories of French scholars Jacques Derrida and Michel Foucault. Postmodernists question the validity of externally imposed orders, as well as linear analysis and "essentialist" interpretations, and assert that anthropologists should "deconstruct" the cultures they are attempting to understand. Moreover, postmodern ethnographies often focus as much on the ethnographers as they do the communities they have studied, as any cultural account must necessarily include the impact of the investigator on the investigated, and vice versa. This element in postmodernism has been criticized a great deal, especially by materialists such as Sidney Mintz. Among the more prominent postmodernist anthropologists are Stephen A. Tyler, Vincent Crapanzano, and James A. Boon.

In recent years, sociocultural anthropologists—from a variety of perspectives—have been concerned with globalization, transnational communities, such as the African, Indian, and Chinese diasporas, and borderlands, in which the inhabitants freely share culture traits that are otherwise, for the most part, extremely different and seemingly contradictory and integrate them into new, "hybrid" cultures. There has also been increased concern with feminism, especially what has been labeled "third-wave feminism," and with the heretofore often neglected roles women play in shaping cultural norms, as well as the inequality that persists almost everywhere between the sexes. Finally, gay and lesbian, as well as transsexual, studies form a significant element of contemporary sociocultural anthropology, leading to a major reassessment of the concept of "gender" and the extent to which it is socially constructed rather than innate.

This brief overview of the history and current state of the discipline of anthropology, primarily in the United States, has necessarily omitted mention of many specific developments

and schools of thought, for example, the *Kulturkreis*, or "culture-circle" school, centered on Father Wilhelm Schmidt (1868–1954), that took shape in Vienna in the early years of the last century; the impact of Sir James G. Frazer's (1854–1941) *The Golden Bough* (1890), which seduced Malinowski into completing his studies in England; and the single-diffusionist ideas of G. Elliot Smith (1871–1937). A great many important contributors, to say nothing of specific topical and regional specialties, such as urban anthropology, esthetic anthropology, East Asian anthropology, African anthropology, and so on, have been slighted. Nevertheless, this discussion provides a general description of what anthropology, in its several major dimensions, is about, how it got that way, and the overwhelming importance of the concept of culture to the discipline.

See also Diffusion, Cultural; Ethnography; Eurocentrism; Gender Studies: Anthropology; Interdisciplinarity; Kinship; Language and Linguistics; Oral Traditions; Prehistory, Rise of; Structuralism and Poststructuralism: Anthropology.

BIBLIOGRAPHY

- Bates, Daniel G., and Elliot M. Fratkin. *Cultural Anthropology*. 2nd ed. Boston: Allyn and Bacon, 1999.
- Benedict, Ruth. *Patterns of Culture*. 1934. Reprint, New York: New American Library, 1959.
- Bloomfield, Leonard. *Language*. 1933. Reprint, New York: Holt, Rinehart and Winston, 1961.
- Boas, Franz. "The Limitations of the Comparative Method of Anthropology." In *High Points in Anthropology*, edited by Paul Bohannan and Mark Glazer, 2nd ed., 81–93. New York: Knopf, 1988. Originally published in 1896.
- . *The Mind of Primitive Man*. 1911. Reprint, New York: Free Press, 1963.
- Boon, James A. *Other Tribes, Other Scribes: Symbolic Anthropology in the Comparative Study of Cultures, Histories, Religions, and Texts*. New York: Cambridge University Press, 1982.
- Bopp, Franz. *A Comparative Grammar of the Sanskrit, Zend, Greek, Latin, Lithuanian, Gothic, German, and Slavonic Languages*. Translated principally by Lieutenant Eastwick. London: Madden and Malcolm, 1845–1856, 1867.
- Brandewie, Ernest. *When Giants Walked the Earth: The Life and Times of Wilhelm Schmidt, SVD*. Fribourg, Switzerland: University Press, 1990.
- Campbell, Bernard G., ed. *Humankind Emerging*. New York: HarperCollins, 1992.
- Childe, V. Gordon. *Man Makes Himself*. 1936. Reprint, New York: New American Library, 1951.
- Chomsky, Noam. *Syntactic Structures*. 2nd ed. New York: Mouton de Gruyter, 2002. Originally published in 1957.
- Crapanzano, Vincent. *Hermes' Dilemma and Hamlet's Desire: On the Epistemology of Interpretation*. Cambridge, Mass.: Harvard University Press, 1992.
- Daniel, Glyn. *The Idea of Prehistory*. Harmondsworth, U.K.: Penguin, 1964.
- Darwin, Charles. *On the Origin of Species*. New York: Modern Library, 1936. Originally published in 1859.
- De Saussure, Ferdinand. *Course in General Linguistics*. Translated and annotated by Roy Harris. London: G. Duckworth, 1983. Originally published in 1907.

- Derrida, Jacques. *The Derrida Reader: Writing Performances*. Translated and edited by Julian Wolfreys. Edinburgh: Edinburgh University Press, 1998.
- Douglas, Mary. *Purity and Danger: An Analysis of the Concepts of Pollution and Taboo*. London: Routledge and Kegan Paul, 1966.
- Durkheim, Émile. *The Elementary Forms of the Religious Life*. Translated by Joseph Ward Swain. New York: Collier, 1961. Originally published in 1915.
- Fagan, Brian M. *Archaeology: A Brief Introduction*. 4th ed. New York: HarperCollins, 1991.
- Fossey, Dian. *Gorillas in the Mist*. Boston: Houghton Mifflin, 1983.
- Foucault, Michel. *The Essential Works of Michel Foucault, 1954–1984*. Translated by Robert Hurley, et al. New York: New Press, 1997–2000.
- Frazer, Sir James G. *The Golden Bough: A Study in Magic and Religion*. Abridged ed. New York: Macmillan, 1922.
- Geertz, Clifford. *The Interpretation of Cultures: Selected Essays*. New York: Basic Books, 1973.
- Gennep, Arnold van. *Les rites de passage*. 1909. Reprint, Paris: A. and J. Picard, 1981.
- Goodall, Jane. *Through a Window: My Thirty Years with the Chimpanzees of Gombe*. Boston: Houghton Mifflin, 1990.
- Grimm, Jacob. *On the Origin of Language*. Translated by Raymond A. Wiley. Leiden, Netherlands: E. J. Brill, 1984. Originally published in 1851.
- Harris, Marvin R. *The Rise of Anthropological Theory: A History of Theories of Culture*. New York: Crowell, 1968.
- Herodotus. *The Histories*. Translated by Robin Waterfield. New York: Oxford University Press, 1998.
- Johanson, Donald C., and Maitland A. Edey. *Lucy, the Beginnings of Humankind*. New York: Simon and Schuster, 1990.
- Kroeber, A. L. *The Nature of Culture*. 1952. Reprint, Chicago: University of Chicago Press, 1965.
- Leach, Edmund R. *Claude Lévi-Strauss*. New York: Viking, 1970.
- Lévi-Strauss, Claude. *Structural Anthropology*. Translated by Claire Jacobson and Brooke Grundfest Schoepf. New York: Basic Books, 1963. Originally published in 1958.
- Linton, Ralph. *The Cultural Background of Personality*. New York: Appleton-Century, 1945.
- Littleton, C. Scott. "Anthropology's Moral Cosmos: Reinventing Heisenberg's Wheel and the Need for a Postmodern-Materialist Agenda." *Cosmos* 15 (1999): 111–127.
- Lowie, Robert H. *The Crow Indians*. 1935. Reprint, New York: Holt, Rinehart and Winston, 1956.
- Lubbock, Sir John (Lord Avebury). *Prehistoric Times as Illustrated by Ancient Remains and the Manners and Customs of Modern Savages*. 7th ed. New York: Holt, 1913. Originally published in 1865.
- Malinowski, Bronislaw. *Argonauts of the Western Pacific: An Account of Native Enterprise and Adventure in the Archipelagoes of Melanesian New Guinea*. 1922. Reprint, Prospect Heights, Ill.: Waveland, 1984.
- . *A Scientific Theory of Culture and Other Essays*. 1944. Reprint, New York: Oxford University Press, 1960.
- Mead, Margaret. *Coming of Age in Samoa: A Psychological Study of Primitive Youth for Western Civilization*. 1928. Reprint, New York: Morrow, 1961.
- Mintz, Sydney W. *Sweetness and Power: The Place of Sugar in Modern History*. New York: Viking, 1985.
- More, Jerry D. *Visions of Culture: An Introduction to Anthropological Theories and Theorists*. Walnut Creek, Calif.: Altamira, 1997.
- Morgan, Lewis Henry. *Ancient Society, or Researches in the Lines of Human Progress from Savagery through Barbarism to Civilization*. Chicago: C. H. Kerr, 1877.
- . *Systems of Consanguinity and Affinity of the Human Family*. Washington, D.C.: Smithsonian, 1970.
- Pedersen, Holger. *The Discovery of Language: Linguistic Science in the Nineteenth Century*. Translated by John Webster Spargo. Bloomington: Indiana University Press, 1962. Originally published in 1959.
- Radcliffe-Brown, A. R. *Structure and Function in Primitive Society: Essays and Addresses*. 1952. Reprint, Glencoe, Ill.: Free Press, 1962.
- Sapir, Edward. *Language: An Introduction to the Study of Speech*. 1921. Reprint, New York: Harcourt, Brace, 1957.
- Service, Elman R. *Origins of the State and Civilization: The Process of Cultural Evolution*. New York: Norton, 1975.
- Smith, G. Eliot. *The Diffusion of Culture*. London: Watts, 1933.
- Steward, Julian H. *Theory of Culture Change: The Methodology of Multilinear Evolution*. Urbana: University of Illinois Press, 1972.
- Stocking, George W., Jr. *The Ethnographer's Magic and Other Essays in the History of Anthropology*. Madison: University of Wisconsin Press, 1992.
- Stringer, Chris. *African Exodus: The Origins of Modern Humanity*. New York: Holt, 1997.
- Tacitus, Cornelius. *The Germania of Tacitus*. Translated by Rodney Potter Robinson. Middletown, Conn.: American Philological Association, 1935.
- Turner, Victor W. *The Forest of Symbols: Aspects of Ndembu Ritual*. Ithaca, N.Y.: Cornell University Press, 1967.
- Tyler, Stephen A. "Post-Modern Ethnography: From Document of the Occult to Occult Document." In *Writing Culture: The Poetics and Politics of Ethnography*, edited by James Clifford and George E. Marcus, 122–140. Berkeley: University of California Press, 1986.
- Tylor, Sir Edward Burnett. *Primitive Culture: Researches into the Development of Mythology, Philosophy, Religion, Art, and Custom*. 2 vols. London: John Murray, 1871.
- White, Leslie A. *The Science of Culture: A Study of Man and Civilization*. New York: Grove, 1949.
- Whorf, Benjamin Lee. *Language, Thought, and Reality: Selected Writings*. Edited by John B. Carroll. Cambridge, Mass.: MIT Press, 1956.

C. Scott Littleton

ANTICOLONIALISM.

This entry includes four subentries:

Africa
Latin America
Middle East
Southeast Asia

AFRICA

In post–World War II history, *decolonization* is a term generally employed to describe and explain the struggle for, and attainment of, freedom from colonial rule by most countries in Asia and Africa. This attainment was marked by a transfer of

power; national political elites assumed the administrative responsibilities and duties previously discharged by the colonial authorities. Thus, new sovereign nations were born.

Steadfast struggle through political parties and related movements, in the pursuit of decolonization, marked the era of nationalism in Africa. Nationalism was the indispensable vehicle utilized to achieve the desired goal of decolonization.

It is important to point out that the study and analysis of nationalism in Asia and Africa has been affected by the scholarly and ideological controversies that still surround the “national question,” nationality, and nationalism. While the power and influence of nationalism is undisputed, Benedict Anderson points out that the terms *nation*, *nationality*, and *nationalism* have all “proved notoriously difficult to define, let alone to analyze.” Many scholars, especially in the West, have continued to look at nationalism as an anachronism and therefore as a concept that is not a revealing tool of analysis. Part of the explanation for this scholarly disillusionment is the ill repute nationalism acquired during the era of Nazism and fascism in Europe, when it came to be associated with intolerance and a reactionary chauvinism that was “at odds with the proper destiny of man.”

The study of nationalism has also been a source of intellectual and ideological frustration to Marxists, who have traditionally been troubled by its “chameleon qualities.” Nationalism “takes many different forms, is supported by many different groups and has different political effects.” Unlike Marxism, which places much emphasis on a society’s class structure, economics, and “form of economic organization,” nationalism is basically political and cultural. This explains in part why Marxism and nationalism have had a “difficult dialogue” over the years.

In Asia and Africa, post–World War II nationalism was, above all, a “revolt against the West” (Barracough), its chief characteristic “resistance to alien domination.” This resistance, which led to decolonization, ultimately created a multitude of nations out of lands that had had “little or no national consciousness.” It is fair to conclude that in order to comprehend the centrality and diversity of nationalism in postwar Asian and African history, “European modalities” may not be strictly relevant.

Aims and Objectives

Political freedom from colonial rule was viewed by nationalists and their supporters as the instrument to redress the economic and social neglect and injustices of the colonial era. Kwame Nkrumah of Ghana urged fellow nationalists throughout Africa to “seek first the political kingdom and all else would be added unto” them. There could be no meaningful social and economic progress without political independence. Nationalist activists and their followers expected an improvement in their living conditions. This desire and expectation to live in dignity partly explains the political support given by the masses to the nationalists and nationalism.

In India, Jawaharlal Nehru (1889–1964) argued emphatically that without political freedom, Indians would have no

power to shape their destiny. They would remain “hopeless victims of external forces” that oppressed and exploited them.

In semicolonial China, Mao Zedong (1893–1976) also saw the critical value of national political freedom from external domination. Without this freedom, there could be no advancement of his revolutionary social and economic program. It would have been futile to dream of building a communist society without a nation in which to construct it.

Nationalism identified exploitation as the primary economic mission of colonialism—exploitation of the colonized people and their labor and resources. In Africa, the expansion of cash crop production, land alienation, mineral exploitation, and even limited manufacturing toward the end of colonial rule enriched the Western capitalist countries, and not Africans. In the struggle for decolonization, there was a general outcry by the nationalists against this exploitation. The colonial economic record in Asia, and especially in India, provided nationalists with rich evidence of exploitation. There was the familiar example of British investment in railways that remained quite profitable to the investors but did little for Indian economic advancement. Colonialism had deemphasized the production of food crops while actively promoting the growing of cotton, jute, indigo, and opium, which fetched high prices overseas. The profits that accrued from these exports and other British capital were, to a large extent, invested in “white settler countries,” such as Canada, Australia, and New Zealand, and not in India. In addition, European powers did not encourage, nor support, the industrialization of their colonies. In India, this aggravated economic and social problems on the eve of decolonization.

Socially and culturally, colonialism was a racist system. The era of “modern” nineteenth-century imperialism was also the era of scientific racism. Colonialism, mediated through racism and racist policies, limited and even forbade meaningful cross-cultural dialogue between colonizer and colonized. Throughout most of Africa and Asia, racism was “not an incidental detail, but . . . a consubstantial part of colonialism.” Harsh, brutal, and deliberately discriminatory treatment at the hands of European colonizers was the constant, painful reminder to Africans and Asians that they were a colonized and humiliated people. All nationalists, irrespective of ideological differences, were generally agreed that such treatment was indefensible; it must be ended.

The Development of Nationalism

The development of nationalism was not uniform throughout the countries of Asia and Africa. The majority of nationalist movements, however, roughly followed a distinct pattern. First, there were local protest movements; some were culturally based, while others were created by the local elite to protest against local and specific grievances, usually economic. Second, there was the crucial period of mass nationalism. In most countries of Asia and Africa, this occurred after World War II. In Africa, this rough pattern applies to all the countries that attained their political independence before 1975. The same is true in Asia, except for those countries that secured their freedom after protracted armed struggle led by communist parties.

This constitutes what can be characterized as the first and dominant phase of African and Asian nationalism.

The second phase applies in Africa to the former Portuguese colonies of Guinea-Bissau, Angola, and Mozambique, in addition to Zimbabwe, South Africa, and Namibia. In Asia, it applies to China and Vietnam, even though their wars of liberation had achieved key victories before 1975. In almost every case, political independence in the second phase was achieved after protracted guerrilla warfare. Liberation movements in China, Vietnam, and former Portuguese colonies in Africa moved to be more precise in their definition of national liberation and societal development. Further, they adopted a Marxist ideology as a guide to their struggle, much more deliberately and consistently than had the majority of the nationalist movements in the first phase. Although the nationalist movements in the second phase did not undertake to pursue identical policies, they nonetheless embarked on a far more detailed socioeconomic analysis of colonial and imperial domination.

In Africa, these Marxist-leaning movements were influenced by the revolutionary thought of Frantz Fanon (1925–1961). In his most famous book, *The Wretched of the Earth* (*Les damnés de la terre*, 1961; Eng. trans., 1963), Fanon argued passionately that true decolonization must be the product of violence. Colonialism, “created and maintained by violence,” could be truly uprooted only through “mass participation in violent decolonization.” This violence was to be the product of an organized revolutionary movement composed of urban intellectuals and peasants. Fanon also argued that revolutionary violence against the colonialists was “a cleansing force” for individual participants: “it frees the native from his inferiority complex and his despair and inaction.” The meaning and implications of this observation continue to generate ideological and intellectual controversy. Still, it should be said that Fanon’s formulation was not a “lyrical celebration of violence” (see L. Adele Jinadu) but rather a strategy to be employed by the colonized in pursuit of true liberation.

After World War II, European powers were not eager to liquidate their empires in Asia and Africa. Although drastically weakened by the war, neither Britain nor France (the major imperial powers) seemed anxious to grant political independence to their colonies. Indeed, the dominant postcolonial policies seemed to favor reassertion of imperial authority. To this end, France fought costly wars in Vietnam and Algeria as it tried unsuccessfully to suppress nationalism. Britain fought against a determined anticolonial movement in Malaya, as well as against the Mau Mau nationalist peasant revolt in Kenya. Even in those colonies where there was little or no armed resistance, European powers were quick to employ brutal force to try to stem the tide of nationalism.

Colonial administrators routinely dismissed the legitimacy of Asian and African nationalism. Any stirring of nationalism was seen as an alien, artificial, almost inappropriate creation, imposed by Asian or African elites on unwilling or otherwise ignorant masses. This was a disastrously mistaken claim and belief. It would have been impossible for nationalist activists to achieve any success without the sustained and spirited support

of those masses. The ideological strife of the Cold War, however, led many colonial administrators to mistakenly view nationalist agitation as the unfolding of a global communist conspiracy.

In the end, imperial maneuvers, brutal force, and concessions failed to derail the drive toward decolonization. In the political climate of the postwar years, imperial powers were forced to see that there could be no compromise between direct imperial domination and the basic, nonnegotiable demands of nationalism.

On balance, it is fair to conclude that internal factors in each colony proved the chief determinant in the nature of the struggle for, and attainment of, political independence. Nationalist and revolutionary movements were essentially local in inspiration and objectives. These movements were not “exportable commodities,” says Amílcar Cabral, but rather were “determined and conditioned by the historical reality of each people.” This underscores the vitality and integrity of Asian and African nationalism and amply demonstrates (in Geoffrey Barraclough’s words) that “the will, the courage, the determination, and the deep human motivation” that propelled it forward “owed little, if anything, to Western example.”

After Political Independence: The Struggle Continues

The attainment of political independence by Asian and African countries left several questions unresolved. There was the question of ideology in the postcolonial period. In many countries, successful nationalist movements were essentially coalition parties, representing several ideological positions and tendencies. In Indonesia, President Sukarno (1901–1970) argued that the nationalist movement must be inclusive, and hence he saw “nothing to prevent Nationalists from working together with Moslems and Marxists.” This expedient inclusiveness began to unravel in the postcolonial period. On this matter, it is vital to remember that these ideological questions were debated against the backdrop of the Cold War, which had an indelible impact not only on the texture of decolonization the imperial powers were willing to entertain but also on internal postcolonial ideological tensions.

Closely related is that decolonization did not lead to economic freedom or even sustained economic growth and development in most Asian and African countries. What happened? Asian and African countries rarely, if ever, inherited vibrant, varied, and integrated national economies. What they inherited, says Basil Davidson (1974), was a colonial economic system that for centuries had “developed little save the raw materials needed in the Atlantic world.” In Africa, the imperial powers both before and after independence imposed “an institutionalized relationship between Africans and Europeans,” which facilitated the exploitation of Africans and their resources. As in Asian countries, this system has proved to be very difficult to change. The consequences have been economic stagnation, often regression, and widespread poverty.

These economic problems have seriously compromised the essence of the political freedom won after so much sacrifice and determination. Yet in many of these countries, as in Latin America, the ruling elite lead opulent lifestyles amid grinding

and widespread poverty. This cannot be taken as an indicator of economic development and social progress; it is the product of corruption, patronage, and oppression. Only “true decolonization,” according to Fanon, could prevent the rise of an African national bourgeois eager to strike a self-serving compromise with Western imperialism. The critical point to remember is that in Africa, as in Asia, the inherited “economies remained externally oriented” and did not “provide the basis for a strong national economy.”

The essence of decolonization has also been frequently compromised by the demands and expectations of foreign aid. For Asian and African countries, such aid has been an almost permanent feature of postcolonial history, but has not led to economic independence and progress; quite often, poverty and economic stagnation have persisted. Since the 1950s, aid from the West to African, Asian, and other developing countries has been guided by shifting political and economic paradigms. These have included import substitution, population control, and expansion of exports. “Structural adjustment” in support of globalization is the paradigm that currently guides the dispensation of Western aid. Still, poverty and poor economic performance have persisted in most Asian and African countries.

The formulation and implementation of these development fashions clearly indicate that a conscious effort has been made to sidestep tackling the fundamental and exploitative relationship between imperial powers and former colonies. The result, as described by Mahbub ul-Haq, is that a “poverty curtain” now exists, dividing the world into “two unequal humanities—one embarrassingly rich and the other desperately poor.”

The struggle also continues in cultural affairs—a struggle over respect for Asian and African cultures. Culture is intricately linked to dignity and identity. Dignity, and with it cultural pride, are especially important for a people whose past has been dominated by alien rule and culture, and colonialism was hostile to the vibrant growth and assertion of local culture. This hostility was clearly evident in the propagation of racial stereotypes demeaning to Asians and Africans, characterizations and beliefs that are, sadly, not yet dead. A matter of critical importance to the people in former colonies is the survival of their cultures in the age of globalization, which has facilitated the rapidly expanding marketing of Western entertainment. Films, music, and general attitudes toward lifestyle promote a sort of global homogenization that is Western-derived and -controlled. This has not stimulated the survival or growth of local cultures and values. World culture is thought to be threatened if diversity is lost.

In the postcolonial period, culture has once again been invoked in the West as lying behind the poverty of developing countries. The cultures, values, and attitudes of most Asian, African, and Latin American countries, not their colonial legacy or even their underdevelopment by the West, are said to be at the root of their poverty; their traditional cultures are seen to inescapably impede progress. This is in contrast to Western societies, whose cultural values both inspire and facilitate progress. In the United States, key proponents of this “cultural factor” include Samuel P. Huntington and Lawrence E. Harrison.

The principal contentions advanced in arguing the cultural factor are not new. They formed an integral part of imperialism’s theory and practice in Asia and Africa in the nineteenth century. They now mark the resurrection of a theory of development that has a distinct imperial lineage—cultural imperialism. As in the past, this theory avoids embracing history in its formulation and analysis. Perhaps even more crucial, it avoids discussing the origin and management of the current Western-dominated international political economy. There is no serious attempt made to analyze how this economy makes it particularly difficult for the majority of Asian and African countries to reap the economic and social benefits of decolonization.

The controversial and emotional question of language has emerged as critical in discussions of decolonization. What should be the language of creativity in African and Asian countries newly liberated from Western imperial rule? Many writers in these societies have agonized over this matter, concerned that the continued use of European tongues in literature and sometimes as the national language constitutes “linguistic imperialism.”

In Africa, the foremost critic of what is called linguistic imperialism is Ngugi wa Thiong’o, Kenya’s most eminent writer. In a 1991 interview, Ngugi emphasized the reality that a “very tiny minority, the tip of every nationality, speak French or English or Portuguese.” Since most Africans speak their native languages, an African author who writes in a European language (rather than creating literature in an African language, which would then be translated into other African languages) essentially shuts off the huge majority and instead addresses fellow members of the elite. This is inherently undemocratic and is unlikely to serve as the cornerstone of a national literary tradition. Further, Ngugi holds that “African thought, literary thought, is imprisoned in foreign languages” and that African thinkers and writers, “even at their most radical, even at their most revolutionary are alienated from the majority.” To Ngugi and his supporters, the language question, “is the key, not the only one, but definitely a very, very important key to the decolonization process.”

See also *Colonialism: Africa; Nationalism: Africa; Neocolonialism*.

BIBLIOGRAPHY

- Anderson, Benedict. *Imagined Communities: Reflections on the Origin and Spread of Nationalism*. London and New York: Verso, 1991.
- Barnet, Richard, and John Cavanagh. “Homogenization of Global Culture.” In *The Case against the Global Economy*, edited by Jerry Mander and Edward Goldsmith. San Francisco: Sierra Club Books, 1996.
- Barracough, Geoffrey. *An Introduction to Contemporary History*. New York: Basic Books, 1965.
- Cabral, Amílcar. *Unity and Struggle*. Translated by Michael Wolfers. New York: Monthly Review Press, 1979. Originally published in Portuguese, 1977.
- Cooper, Frederick. *Africa since 1940: The Past of the Present*. Cambridge, U.K., and New York: Cambridge University Press, 2002.

- Das, Manmath N. *The Political Philosophy of Jawaharlal Nehru*. New York: John Day, 1961.
- Davidson, Basil. *Can Africa Survive?* Boston: Little, Brown, 1974.
- . *Which Way Africa? The Search for a New Society*. Baltimore: Penguin, 1964.
- Davis, Horace B. *Toward a Marxist Theory of Nationalism*. New York: Monthly Review Press, 1978.
- Fairchild, Halford H. "Frantz Fanon's *The Wretched of the Earth* in Contemporary Perspective." *Journal of Black Studies* 25, no. 2 (December 1994): 191–199.
- Fanon, Frantz. *The Wretched of the Earth*. New York: Grove Press, 1968.
- Gopal, Sarvepalli, ed. *Jawaharlal Nehru: An Anthology*. New Delhi: Oxford University Press, 1980.
- Han, Suyin. *The Morning Deluge: Mao Tsetung and the Chinese Revolution, 1893–1954*. Boston: Little, Brown, 1972.
- Haq, Mahbub ul-. *The Poverty Curtain*. New York: Columbia University Press, 1976.
- Hargreaves, John D. *Decolonization in Africa*. 2nd ed. London and New York: Longman, 1996.
- Harrison, Lawrence E., and Samuel P. Huntington. *Culture Matters: How Values Shape Human Progress*. New York: Basic Books, 2000.
- Kohn, Hans, and Wallace Sokolsky. *African Nationalism in the Twentieth Century*. Princeton, N. J.: Van Nostrand, 1965.
- Jinadu, L. Adele. "Some Aspects of the Political Philosophy of Frantz Fanon." *African Studies Review* 16, no. 2 (September 1973): 255–289.
- Jussawalla, Feroza. "The Language of Struggle." *Transition* 54 (1991): 142–154.
- Maloba, W. O. "Decolonization: A Theoretical Perspective." In *Decolonization and Independence in Kenya*, edited by B. A. Ogot and W. R. Ochieng. London: J. Currey; Athens: Ohio University Press; Nairobi, Kenya: East African Educational Publishers, 1995.
- Memmi, Albert. *The Colonizer and the Colonized*. 2nd ed. Boston: Beacon, 1991.
- Ngugi wa Thiong'o. *Decolonising the Mind: The Politics of Language in African Literature*. London: J. Currey, 1986.
- . "The Language of Struggle." Interview with Feroza Jussawalla. *Transition*, no. 54 (fall 1991): 142–154.
- . *Moving the Centre: The Struggle for Cultural Freedoms*. London: J. Currey, 1993.
- Soekarno, Achmed. *Nationalism, Islam and Marxism*. Translated by Karel H. Warouw and Peter D. Weldon. Ithaca, N. Y.: Cornell University, Modern Indonesia Project, 1970.

W. O. Maloba

LATIN AMERICA

Over the past five hundred years, Latin America has experienced three and possibly four periods of colonization, all of which gave rise to anticolonial movements. The first period symbolically began with Christopher Columbus's arrival in the Americas on 12 October 1492, launching three centuries of Spanish, Portuguese, and British colonial control over the hemisphere, with the French, Dutch, Danish, and other European powers competing for slices of the action in the Caribbean. In most of Latin America, this period came to an end with the wars of independence from about 1810 to 1825. Political independence ushered in a second period (known as

neocolonialism), in which the countries of Latin America were still subject to foreign economic control—this time largely by the British. During the third period, corresponding to the twentieth century, this economic dependency shifted from the British to the United States, and anticolonial responses increasingly assumed anti-imperialistic characteristics. The twenty-first century arguably introduced a fourth period of neocolonialism, in which Latin America has become subject to control through the maquiladora system to transnational capital not necessarily rooted in one country and in which the export commodity is labor rather than raw materials.

Independence

The Latin American movement most closely associated with anticolonialism corresponds to the period at the beginning of the nineteenth century during which most of the region gained its political independence from European colonial powers. This "postcolonial era began before many territories became colonial," Robert Young notes, and "before some European imperial powers, such as Germany and Italy, had even become nations themselves" (p. 193). As in the United States, independence represented a shift of economic wealth and political power from a colonial elite to a domestic elite. In Latin America, this was expressed as a struggle between *peninsulares* (those born on the Iberian peninsula, i.e., Spain and Portugal) and *creoles* (those born in the New World). Independence did not result in any corresponding shift in social relations, nor did it result in the abolition of slavery or more rights for women. In fact, without the paternalistic protection of the European crowns the position of peasants and Indians actually worsened.

The 1780 Tupac Amaru uprising in the South American Andes is one of the largest, earliest, and most significant anticolonial movements in the history of Latin America. The leader of this uprising, José Gabriel Condorcanqui (d. 1781), a descendant of the Incas, first attempted to petition for the rights of his people through legal channels. When legal attempts failed, he took the name of the last Inca ruler (Tupac Amaru) and led an uprising that quickly spread throughout the southern Andes. The insurgents sacked Spanish haciendas and *obrajes* (textile mills), driven by messianic dreams of a renewed Inca empire that would free the indigenous peoples from hunger, injustice, oppression, and exploitation. The Spanish captured Tupac Amaru and other leaders of the uprising six months later and executed them in Cuzco, the former capital of the Inca empire. This did not end the rebellion but shifted its focus south to Bolivia, where under the leadership of Aymara people it entered a more radical, violent, and explicitly anticolonial phase. In this phase, the insurgents captured and held the city of La Paz for several months and threatened the silver mines at Potosí—a direct challenge to Spanish wealth and power. The Spanish finally captured and executed the leaders and the uprising eventually collapsed. This revolt has sometimes been seen as a forward-looking antecedent to the successful creole independence movements that came forty years later and sometimes as a reactionary messianic movement that sought to return to the time of the Inca empire. Sinclair Thomson positions these uprisings in the context of local struggles against abusive colonial practices and for self-determination



Christopher Columbus coming ashore at San Salvador. Columbus's arrival in the New World in 1492 gave rise to the first period of colonization of Latin America. Spain, Portugal, and Britain proceeded to control the region, which didn't achieve independence until the early nineteenth century. © BETTMANN/CORBIS

and equality. Although the uprising ultimately failed, it reveals a widening gap between the colonial elites and the subaltern masses, as well as a refusal of indigenous peoples to passively accept their marginalized role in society.

The Haitian slave revolt provides another stark contrast to the creole independence movements and in essence underscores the lack of a compelling anticolonial discourse in those events. Haiti was a French colony, and its production of sugar, cotton, and indigo made it one of the most important colonies in the world. Soaring sugar profits for French planters in the eighteenth century led to a dramatic increase in the number of African slaves they imported to work the plantations. By the end of the century, about 80 percent of the Haitian people were overworked and underfed slaves. Nevertheless, Haitian independence movements began in 1789 not as a slave revolt but from the small elite class of planters, who had been influenced by the French Revolution's rhetoric of "liberty, equality, fraternity." For the planters, liberty meant home rule and freedom from French tariff structures. The whites armed the slaves to fight the French, but instead, under the

leadership of Toussaint L'Ouverture (1743–1803), slaves took advantage of the opportunity to revolt and destroyed the old society. The result was perhaps one of the few true social revolutions the world has ever seen, in which members of a mass movement completely obliterated the *ancien régime* and claimed power for itself. By the time Jean-Jacques Dessalines declared Haitian independence in 1804, the sugar economy had disappeared, having been displaced by subsistence agriculture. The example of a black slave republic sent a terrifying chill through creole elites, which had begun to agitate for independence elsewhere in Latin America. The only other independent country in the hemisphere, the United States, refused to recognize the Haitian government. The dangers exemplified by the first successful anticolonial movement in Latin America put the brakes on other independence movements, delaying their completion by perhaps a generation.

Neocolonialism

By the 1820s, most of Latin America had gained political independence from its colonial masters. With Iberian mercantile restrictions gone, northern European (and particularly British)

capital flooded the region. As critics have noted, a legacy of colonization was a blocking of moves toward industrialization, which would have represented little gain for colonial powers. This trend continued with the British (and later the United States) extracting raw materials from and importing finished goods into the region. The infrastructure, such as the railroad systems, was designed to transport products from mines and plantations to seaports rather than to integrate a country. The economic benefits of this trade accrued to foreign powers, with wages and living standards remaining depressed as resources were drained away from the domestic economy. Neocolonialism also led to cultural shifts. For example, predominantly Catholic Latin American countries implemented freedom of religion in order to encourage foreign investment from Protestant powers. Despite formal independence, external economic forces determined many of the domestic policies in Latin America. This irony has come to be known as neocolonialism.

Nineteenth-century examples of neocolonialism include the export of Peruvian guano and Chilean nitrates, which fueled an agricultural boom in Europe. Neocolonialism, and Latin America's subsequent falling behind relative to economic growth in northern industrial economies, was not inevitable nor was it the only possible option. In *The Poverty of Progress*, E. Bradford Burns points to Paraguay as a viable example of autonomous economic development. The country's leaders eliminated large estates and emphasized domestic food production, and they restricted foreign penetration of the economy. Rapid economic development without outside foreign development alarmed the elitist governments in the neighboring countries of Argentina, Brazil, and Uruguay, who feared the model Paraguay offered to the poor in their own countries. Their opposition led to the War of the Triple Alliance (1864–1870), which devastated Paraguay and destroyed this alternative model to neocolonialism.

The concept of formally independent countries that remained economically dependent on outside powers first was articulated in Marxist circles in the 1920s, though the term *neocolonialism* was not introduced until the 1960s. It has always been closely associated with anti-imperialism, as was demonstrated at the 1966 Tricontinental Conference in Havana, Cuba, which linked anticolonial struggles in Asia, Africa, and Latin America. Although U.S. neocolonial control is largely a twentieth-century phenomenon, it is rooted in the 1823 Monroe Doctrine, which declared Latin America to be part of the U.S. imperial sphere of influence.

Anti-Imperialism

When the Haitian sugar economy collapsed with the slave revolt at the end of the eighteenth century, much of this production shifted to the neighboring island of Cuba. As a result, while other colonial economies stagnated, leading to elite discontent with European rule, the Cuban economy took off, undercutting any impetus for a serious anticolonial movement. As a result, the island remained a Spanish colony until the end of the nineteenth century. José Martí (1853–1895) perhaps best represents Cuban anticolonial movements. Born to *peninsular* parents (his father was a Spanish official), he was a teenage rebel who was exiled to Spain for his political activities and later

worked in the United States as a journalist. He was killed in battle on 19 May 1895, when he returned to the island to join the anticolonial struggle. Much of Martí's ideology emerged out of the context of nineteenth-century liberalism, but his contact with radical movements in the United States also imbued his anticolonialism with aspects of social revolution. Rather than seeking to merely change one elite for another, as had happened when colonialism ended in most other American republics, he wanted true social changes. He was an anti-imperialist and a revolutionary nationalist who worked against economic dependency as well as for political independence. Martí, like Venezuelan independence leader Simón Bolívar (1783–1830) before him and Argentine-born guerrilla leader Ernesto "Che" Guevara (1928–1967) after him, called for a unified America to confront the common problems left by a legacy of European colonization.

After Martí's death, with Cuba on the verge of gaining its independence in 1898, the United States intervened in order to control the economic wealth of the colony for its own benefit and to prevent the establishment of another black republic on the Haitian model. Disguising its efforts as altruism, the U.S. Senate passed the Teller Amendment, which declared that the United States would not recolonize the island. Although this legislation thwarted the imperial intent of the United States to annex the island, the 1901 Platt Amendment declared "that the government of Cuba consents that the United States may exercise the right to intervene for the preservation of Cuban independence, the maintenance of a government adequate for the protection of life, property and individual liberty" (Bevans, pp. 116–117). This led to a unique colonial situation, in which Cuba had a civilian government but not one that could be called a democracy. The island became an extension of Miami, and U.S. intervention promoted and perpetuated corruption, violence, and economic stagnation. This set the stage for the successful 1959 Cuban Revolution, which freed the country from economic colonization, much as independence in 1898 had freed it from Spain's political colonization. After the triumph of the revolution, Cuba became a global leader in postcolonial anti-imperialist struggles.

Although the Teller Amendment prohibited the annexation of Cuba to the United States, the legislation stood mute on Spain's few remaining colonial possessions in the Caribbean. Most importantly, this led the United States to occupy the island of Puerto Rico, a territory it continues to hold in the twenty-first century. In fact, after Namibia was freed from South African control in the 1980s, Puerto Rico became the sole remaining item on the agenda of the United Nations's decolonization committee, although anticolonial struggles continue elsewhere, notably in French Polynesia. For the United States, Puerto Rico remains an unresolved and seemingly irresolvable colonial question. In the early twenty-first century the island is an *Estado Libre Asociado* (literally, Associated Free State, but defined by the United States as a commonwealth), which means that it is an unincorporated territory that belongs to, but is not part of, the United States. This leaves Puerto Rico subject to the whims of the United States, and its residents with few legal avenues through which to address offenses committed against them. As an example of the colonial relationship, residents on the island were made

U.S. citizens during World War I so that they could be drafted to fight in Europe, but even in the early twenty-first century they do not have the right to political representation in Washington. However, the economic advantages of their status, including the ability to migrate freely to the United States to work, create a situation where only a small percentage of Puerto Ricans favor independence for the island, but resentment at the island's colonial status is nonetheless widespread and deeply felt.

Anticolonial sentiments in Puerto Rico flourished during the second half of the twentieth century, and in part gained a focus around political campaigns to halt U.S. naval bombing practice at Vieques Island. In 1941, with World War II on the horizon, the United States military acquired most of the land at Vieques as an extension of the Roosevelt Roads Naval Station in order to develop a base like Pearl Harbor for its Atlantic fleet. Noise from bombs and low-flying airplanes engaged in practice maneuvers disturbed inhabitants and disrupted the fishing economy. The later use of napalm, depleted uranium, and other experimental weapons left the area heavily contaminated. The imperialist nature of the military's occupation of Vieques quickly gave rise to popular sentiments against the navy's presence and calls for them to leave. Finally, on 19 April 1999, two off-target bombs destroyed an observation post, killing David Sanes Rodríguez, a local civilian employee. This triggered a massive civil disobedience campaign that finally forced the navy to leave Vieques on 1 May 2003. Independence leaders such as Pedro Albizu Campos and Rubén Berríos Martínez provided leadership to the campaigns, seeing Vieques as an important part of an anticolonial and anti-imperialist struggle. Their slogan became "Today Vieques, tomorrow Puerto Rico."

Non-Spanish Caribbean

European colonization of the Caribbean began with Columbus's arrival in 1492, and the region was so highly valued that it remained under the control of various European empires longer than any other part of the hemisphere. Spain maintained—and then lost—control over the largest and most populous islands of Cuba, Hispaniola, and Puerto Rico, known as the Greater Antilles. Other European powers, including the British, French, and Dutch, intruded into the Spanish domain and established a significant presence, particularly on the smaller islands, known as the Lesser Antilles, where descendants of African slaves and Asian indentured workers imported to replace the decimated indigenous population led many of the anticolonial movements.

As they did in Africa and Asia, modern nationalist anticolonial movements in much of the Caribbean emerged in the aftermath of World War II, with its emphasis on the values of democracy and self-determination. As Cary Fraser argues, independence movements in the Caribbean must be understood in the context of these broader decolonization efforts. During the second half of the twentieth century, some of the islands gained their independence, although the British, French, and Dutch still retained colonial control over several smaller islands. Many of the residents benefited economically from access to European welfare systems, which dampened anticolonial agitation.

Even after independence, many of the colonies maintained close relationships with their mother countries, leaving imprints on their political culture that marked them as significantly different from Latin America. For example, the former British colonies remained part of the Commonwealth and retained the British queen as their monarch.

As the European empires collapsed, U.S. economic, political, and ideological interests gained increased hegemony over the Caribbean. Tourism and providing tax havens for foreign banks and corporations became the area's primary roles in the global economy. An example of the United States' ambiguous commitment to self-determination and its growing neocolonial control was its successful efforts to unseat Cheddi Jagan and his People's Progressive Party from the presidency of British Guiana in the early 1960s. United States opposition to Jagan, who was influenced by Marxist ideology and maintained friendly ties with the communist world, indicated that the Caribbean (as well as Latin America in general) would remain within the U.S. sphere of influence.

See also Anticolonialism: Africa; Anticolonialism: Middle East; Anticolonialism: Southeast Asia; Colonialism; Neocolonialism.

BIBLIOGRAPHY

- Barreto, Amílcar Antonio. *Vieques, the Navy, and Puerto Rican Politics*. Gainesville: University Press of Florida, 2002.
- Bevans, C. I., ed. *Treaties and Other International Agreements of the United States of America, 1776–1949*. Vol. 8. Washington, D.C.: U.S. Government Printing Office, 1971.
- Burns, E. Bradford. *The Poverty of Progress: Latin America in the Nineteenth Century*. Berkeley: University of California Press, 1980.
- Fraser, Cary. *Ambivalent Anti-colonialism: The United States and the Genesis of West Indian Independence, 1940–1964*. Westport, Conn.: Greenwood, 1994.
- Geggus, David Patrick, ed. *The Impact of the Haitian Revolution in the Atlantic World*. Columbia: University of South Carolina, 2001.
- Pérez, Louis A. *The War of 1898: The United States and Cuba in History and Historiography*. Chapel Hill: University of North Carolina Press, 1998.
- Thomson, Sinclair. *We Alone Will Rule: Native Andean Politics in the Age of Insurgency*. Madison: University of Wisconsin Press, 2002.
- Young, Robert J. C. *Postcolonialism: An Historical Introduction*. Oxford and Malden, Mass.: Blackwell, 2001.

Marc Becker

MIDDLE EAST

Between the early nineteenth century and the outbreak of World War I, much of the area between Morocco and what is now Turkey came under different forms of European colonial rule. Thus France began the conquest of Algeria in 1830, took over Tunisia in 1881, and (in partnership with Spain) took over Morocco in 1912. Britain occupied Egypt in 1882, formalizing the occupation by the declaration of a protectorate in 1914, and Italy began its conquest of Libya in 1911.

Ottoman Empire and the Mandate System

With the exception of Morocco, the entire region either had been or still was in the early twentieth century at least nominally part of the Ottoman Empire, a multiethnic geopolitical unit that had been in existence since the late thirteenth century and that came to an end in the 1920s. Although it is misleading to regard the Ottomans as an imperial power, it is nevertheless the case that in spite of the Tanzimat reforms of the nineteenth century, which were generally intended to extend full citizenship to all subjects of the empire, the largely Christian provinces in southeastern Europe had become independent states in the course of the nineteenth century as a consequence of more or less bitter struggles to assert their various ethnolinguistic identities. In contrast, regardless of their ethnicity, the overwhelmingly Muslim population of the Arab provinces continued to regard the (Turkish) Ottomans as the natural defenders of Islam, with the result that most of the Middle East was barely affected by Arab nationalism until the early twentieth century.

On the coasts of the Arabian Peninsula, Britain's concern with keeping the route to India safe and open led to a series of treaties with various local rulers between the 1820s and 1916, under which the rulers generally agreed not to grant or dispose of any part of their territories to any power except Britain. In 1839, Britain annexed Aden and turned it into a naval base. Exclusive treaties were signed with the tribal rulers of the interior, and in 1937 the area was divided into the port and its immediate hinterland (Aden Colony) and the more remote rural/tribal areas (Aden Protectorate). Principally because of their remoteness and their apparent lack of strategic importance, central Arabia and northern Yemen were never colonized.

After the collapse of the Ottoman Empire at the end of the First World War, the empire's remaining Arab provinces were assigned by the newly created League of Nations to Britain and France as mandates, with Britain taking responsibility for Iraq, Palestine, and Transjordan, and France taking responsibility for Lebanon and Syria. The guiding principle of the mandate system was that the states concerned should remain under the tutelage of the mandatory power until such time as they were able to "stand alone," a period that, although not specified, was still understood to be finite. The mandate period was relatively short-lived, ending with the creation of Israel from the former Palestine mandate in 1948.

Islam and Anticolonialism

A number of factors are crucial to understanding the various manifestations of anticolonialism in the Arab world in the nineteenth and twentieth centuries. In the first place, the colonial period coincided with several movements of Islamic renewal; the same phenomenon can also be observed in the Indian subcontinent, West Africa, Central Asia, and Southeast Asia. Some movements clearly were, or became, reactions to colonialism, but one of the most influential, the Wahhabis in the center of the Arabian peninsula, both predated colonialism in the region and originated in an area relatively distant from any direct colonial activity. In the late eighteenth and nineteenth centuries, such renewal or reform movements

spread out over a wide geographical area. Some, such as the Sanusi jihad, based in Saharan Libya, later the backbone of resistance to Italian colonization, exhibited an organizational structure similar to that of the Sufi orders, based on a network of lodges; others were urban-based, often around traditional centers of Islamic learning, while yet others were millenarian. Thus in the 1880s, the Sudanese Mahdi preached that he was the divinely appointed regenerator of Islam and consciously imitated the life and career of the Prophet. The renewal movements were by no means always sympathetic to, or even tolerant of, one another. Muhammad al-Mahdi al-Sanusi (1844–1902), for example, was at pains to point out that the Mahdi was not entitled to claim either the leadership of the universal Islamic community or a transcendental relationship with the Prophet Muhammad, and Wahhabism (if not checked by more prudent political considerations) has often exhibited considerable intolerance toward other manifestations of Islam.

The reform movements fed into anticolonialism in a number of ways. One of their effects was to draw a battle line between those rulers and elites in the Islamic world who were prepared to make accommodations to European colonizers and those sections of the community who were not. Thus 'Abd al-Qadir (1808–1883), the early leader of the resistance to the French, was quick to make use of a fatwa (legal opinion) obtained from the Mufti of Fez stating that those Muslims who cooperated with non-Muslims against other Muslims could be considered apostate and thus could be killed or enslaved if captured. Later in the nineteenth century, Ba Ahmad, the chamberlain of the Moroccan sultan 'Abd al-'Aziz (r. 1894–1908), believed his only recourse was to buy off or otherwise accommodate the French, who were making incursions into southern Morocco from both Algeria and Senegal. This policy alienated many influential religious and tribal leaders, who were bitterly opposed to the Commander of the Faithful giving up "the lands of Islam" to foreign invaders; some of them considered that this made him illegitimate and transferred their allegiance to a more combative leader.

The Economic Impact of Colonialism

An important effect of colonialism was to hasten the disintegration of long-established social and economic relations and to substitute the often harsher dictates of the market. The pre-colonial world was no egalitarian paradise, but, for example, the confiscation or purchase of land in colonial Algeria and mandatory Palestine and the formation of large landed estates in Syria and Iraq as a result of the establishment of regimes of private property under the mandates often resulted in cultivators either being driven off the land or being reduced from free peasants to serfs. Being far more incorporated into the world market than they had been before, with the concomitant pressure to cultivate cash crops, forced peasant households to migrate to slum settlements on the edges of the major cities where they faced an uncertain and often near-destitute existence.

Resistance to Colonialism

Twentieth-century resistance to colonialism inevitably partook of the general experience of its time, including assertions of national and ethnic identity, which were given added meaning

and purpose in the face of alien colonizing. The press, the radio, and political parties and clubs provided new opportunities for disseminating the ideologies of anticolonialism. To these must be added the example first of Germany in the 1930s—a previously fragmented state that had turned its recent unification into a means of challenging the old colonizers, Britain and France; and for much of the 1940s, 1950s, and 1960s the Soviet Union as a new form of social and economic organization, under which a previously feudal regime was being transformed into an egalitarian welfare state. Such visions were especially attractive to those who had not experienced the realities of daily life under such regimes.

Algeria

Provided a certain flexibility is adopted, it is possible to identify the major templates of anticolonial resistance, which vary according to the nature of the colonizing process. The Algerian case is probably the most extreme because of the extent of the devastation caused by the colonization process over a period of some 130 years. In the months after the conquest of the city of Algiers in July 1830, the French military began to encourage the settlement of French *colons* in the city's rural hinterland. At the time, Algeria was, if only nominally, an Ottoman province and had no developed political structures. Local leaders in the west of the country turned first to the Moroccan sultan, but the French warned him not to interfere. The leaders then turned to the Sufi orders, the only bodies with an organizational structure, and Muhi al-Din, the leader of the Qadiriyya order, and his shrewd and energetic son 'Abd al-Qadir were asked to lead a tribal jihad against the French.

Between 1832 and 1844 'Abd al-Qadir managed to keep the French at bay with an army of about ten thousand. Initially, he achieved this by making agreements with the French recognizing his authority over certain parts of the country, but by the 1840s the French had decided on a policy of total subjugation and 'Abd al-Qadir, defeated at Isly in 1844, eventually surrendered in 1847. By this time the European population had reached over 100,000, living mostly in the larger towns. In the 1840s, the French had begun a policy of wholesale land confiscation and appropriation, and a number of local risings took place in protest. The settlers had influential allies in Paris, and throughout the nineteenth century the indigenous population faced the gradual erosion of most of their rights. The last major act of resistance until the war of 1954 to 1962 was the rebellion in Kabylia in 1870 to 1871, led by Muhammad al-Muqrani. For a while, al-Muqrani's army of some 200,000 controlled much of eastern Algeria, but it was no match for the better equipped French troops. After the defeat of al-Muqrani's rebellion (he was killed in battle in May 1871) the local communities involved were fined heavily and lost most of their tribal lands.

The Algerian national movement was slow to develop in the twentieth century. The tribal aristocracy had been defeated and no former indigenous governing class or emerging business bourgeoisie existed (as they did in, for example, Morocco, Tunisia, Syria, and Lebanon). Some Algerians felt that France had brought them into the modern world and wanted to become more French—that is, to enjoy the same rights as the

French in Algeria without having to give up their Islamic identity. This tendency, generally called assimilationist, was represented by Ferhat Abbas, who sought to become a member of the French Chamber of Deputies. The first strictly nationalist movement, the *Étoile Nord-Africaine* (later the *Parti du Peuple Algérien*), which initially had links to the French Communist Party, was founded by Messali Hadj in 1926, recruiting among Algerian workers in France. Yet another tendency was represented by Ahmad Ibn Badis (1889–1940), who sought to reform Algerian popular Islam through the Association of 'Ulama', asserting the Muslim nature of Algeria.

From the 1930s onwards, rapid urbanization fuelled Algerian resistance to France. By the end of World War II there was some hope on the part of moderates both in France and Algeria that compromises could be worked out that might deflect violent nationalism, but the Algerian European community's dogged insistence on maintaining its privileges meant that these hopes soon evaporated. Ferhat Abbas's movement soon became insignificant. Ibn Badis's death meant that the Association of 'Ulama' lacked influence, leaving Messali Hadj dominating the field, with supporters among Algerian workers in France as well as in Algeria. However, his organization was regarded as too moderate, and a splinter group, the *Organisation Secrète*, seceded from it in the mid-1940s. Its members included such major revolutionary figures as Ahmed Ben Bella, Ait Ahmad, Murad Didouche, Mohammed Boudiaf, and Belkacem Krim. This group subsequently launched the Algerian Revolution, or war of national liberation, on 1 November 1954. The war lasted until 1962, when Algeria became independent; over the eight years, between 1 million and 1.5 million Algerians and 27,000 French were killed. The war proved intensely divisive, especially as more Algerian Muslims fought as soldiers or *harkis* on the French side than in the Algerian army.

Tunisia, Egypt, and Morocco

In the case of Tunisia, Egypt, and Morocco, the decision of Britain and France to take over the reins of government (in 1881, 1882, and 1912) was at least partly precipitated by local opposition to the draconian financial measures that the European powers had forced local governments to impose in order to repay the debts they had contracted on the various European money markets. The ruler of Tunisia, Ahmad Bey (1837–1855), made strenuous efforts both to modernize Tunisia and to assert its independence from Istanbul, and he had been substantially aided by France in the latter objective. By the time of his death, Tunisia had a modern army and a modern navy; the Bey's brother-in-law, who survived him by nearly twenty years, was a modernizing finance minister and prime minister, and an Italian family provided the state's foreign ministers until 1878. In 1861, much to the discomfiture of Muhammad al-Sadiq Bey (1859–1882), Tunisia adopted a constitution and a modern (that is, generally secular) legal system under which the Bey's prerogatives were quite limited.

These reforms were better received in the outside world and among the sizeable local European community than within Tunisia, where a rural rising against the new legal system and the new taxes was put down with considerable brutality in 1864.

As happened in Egypt at much the same time, the contracting of substantial foreign debts (generally used to build the infrastructures that made the reforms possible or to pay the European consultants—officers, engineers, and so forth—in charge of putting them into effect) and the general mismanagement and corruption associated with the loans meant that the country found itself increasingly at the mercy of its foreign creditors. Tunisia declared bankruptcy in 1869 and Egypt in 1876. The sterling efforts of the reformer Khayr al-Din (c. 1825–1889) to balance the budget were no match for French colonial ambitions, which eventually forced the Bey to accept a protectorate under the terms of the Treaty of Bardo in May 1881. By 1892, four-fifths of cultivated lands were in French hands.

The situation in Egypt was similar; the additional taxes imposed as a result of British and French administration of the public debt, initiated in 1876 essentially to ensure that the bond-holders got their money back, eventually gave rise to a nationalist movement. Many of its members had the additional grievance that the government of Egypt was conducted by foreigners, that is, a Turco-Circassian aristocracy consisting of the descendants of the viceroy Muhammad 'Ali (1780–1848) and their courtiers, in which native Egyptians constantly encountered a glass ceiling. Another interesting component of the rebellion led by Ahmad 'Urabi (1839–1911) between 1879 and 1882 was the emphasis on restoring Egypt fully to the Ottoman Empire. Although relatively large numbers of foreigners resided in Egypt, they were generally neither settlers nor *colons* in the French North African sense: most were not bureaucrats or farmers and had not lived there for generations; they resided mostly in the cities and engaged in commerce or in service occupations. In addition, most of them were not citizens of the occupying power.

In spite of a succession of strong rulers for much of the nineteenth century, Morocco was also unable to avoid colonial penetration, first economic (imports of tea, sugar, candles, and cotton cloth; exports of wool, cereals, and ostrich feathers) and then military. The first major confrontation between locals and Europeans occurred in 1859 to 1860, when Spain besieged Tetouan. A month later, Spain demanded an indemnity as the price of withdrawal, and although the terms were punitive half the indemnity was paid within two years. This involved great hardship, particularly the imposition of non-traditional agricultural taxation, which caused considerable unrest. A massive devaluation of the currency took place, as did a near-universal switch to foreign coinage. Like Tunisia and Egypt, Morocco gradually moved from a state of general economic self-sufficiency to dependence on the world market. Morocco gradually became dependent on foreign loans and declared bankruptcy in 1903. Largely to preempt German colonial efforts, France and Britain signed the Entente Cordiale in 1904, under which Britain recognized France's pre-eminence in Morocco and France formally accepted the British occupation of Egypt. Franco-Spanish occupation of Morocco was formalized in 1912.

Independence

Some of the anticolonial movements of the twentieth century were urban-based mass movements, often led by charismatic

leaders, perhaps most notably Habib Bourguiba of Tunisia, who led the Neo-Destour Party between 1954 and Tunisian independence in 1956 and who remained his country's leader until 1987. Allal al-Fassi, leader of the Istiqlal party, might have played a similar role in the history of Morocco. However, in 1953 the French exiled the sultan, Muhammad V, to Madagascar, and as a result the rallying cry of the national movement became the sultan's return from exile, which led in its turn to the sultan/king retaining his position as ruler after Morocco's independence in October 1956 and the virtual eclipse of the secular political parties.

In Egypt, a kind of independence was achieved in 1936, but the national movement went through two stages. In the first stage, some but not all powers were handed over to local elites. This arrangement involved some form of power-sharing with the former colonial power, which became increasingly intolerable to wide sections of the population. However, given the balance of forces, it was not possible to break these links by democratic means—that is, by voting in a political party or coalition that would be able to end the relationship. Thus a second stage was necessary, in which a determined group within the military seized power, destroying in the process the fairly rudimentary institutions of parliamentary government that the colonial powers had put in place. In this way, first General Mohamad Neguib (1901–1984) and then Gamel Abdel-Nasser (1918–1970) took power in 1952. Iraq went through a similar process, and 'Abd al-Karim Qasim took power in 1958. A similar but more complex process took place in Syria, although the old social classes still ruling in 1961 had long severed any links they may have had with France.

Palestine

The final and highly anomalous case of anticolonialism in the Middle East is Palestine, unique among its neighbors in that it was a settler state. The text of the Palestine mandate included the terms of the Balfour Declaration (1917), in which Britain as mandatory power undertook to facilitate the setting up of a "national home for the Jewish people." In 1922, there were 93,000 Jews in Palestine and about 700,000 Arabs; in 1936, there were 380,000 Jews and 983,000 Arabs; and in 1946, about 600,000 Jews and 1.3 million Arabs; thus the Jewish population increased from 13 percent to 31 percent over a period of twenty-four years. Anticolonialism took different forms, principally through opposition by both Arabs and Zionists to British policy, which they tried to combat in different ways, and Arab opposition to Zionism. The Palestine rebellion of 1936 to 1939 was mostly a peasant insurrection against colonial rule and the settlers; in 1947 to 1948, the Zionists fought and won against an assortment of Arab armies and the poorly organized Palestinian resistance forces; the colonial power had long indicated that it would withdraw.

Opposition to colonial rule and colonial settlement was fairly widespread throughout the nineteenth and twentieth centuries and took a variety of different forms, rural and urban, organized and spontaneous, religious and political, showing greater or lesser degrees of coherence. In any colonial situation, a wide spectrum of responses existed, with resistance at one end, acquiescence in the middle, and collaboration at

the other end. Some members of the colonized population rebelled and some collaborated, but the majority acquiesced, at least for most of the time. In the nationalist historiography of the colonial period, the struggle for colonial freedom or national independence is often characterized in a way that shows the brave freedom fighters ranged against the brutal colonial authorities. The “achievements” of colonialism have long been open to question, and the divisions and chaos of the post-colonial world make the value of the legacy more questionable as time passes. Nevertheless, it is also important to understand the complexity and multifaceted nature of anticolonialism: the intrigues; the competing and often warring factions; the venality and corruption of many of them. For national maturity, and increasingly for national reconciliation, it will be necessary that such uncomfortable truths are boldly confronted rather than wilfully ignored.

See also *Anticolonialism: Africa*; *Anticolonialism: Latin America*; *Anticolonialism: Southeast Asia*; *Empire and Imperialism: Middle East*.

BIBLIOGRAPHY

- Anderson, Lisa. *The State and Social Transformation in Tunisia and Libya, 1830–1980*. Princeton, N.J.: Princeton University Press, 1986.
- Batatu, Hanna. *The Old Social Classes and the Revolutionary Movements of Iraq: A Study of Iraq's Old Landed Classes and Its Communists, Ba'ithists, and Free Officers*. Princeton, N.J.: Princeton University Press, 1978.
- Botman, Selma. *Egypt from Independence to Revolution, 1919–1952*. Syracuse, N.Y.: Syracuse University Press, 1991.
- Khoury, Philip S. *Syria and the French Mandate: The Politics of Arab Nationalism, 1920–1946*. Princeton, N.J.: Princeton University Press, 1987.
- Morris, Benny. *Righteous Victims: A History of the Zionist-Arab Conflict, 1881–2001*. New York, Vintage, 2001.
- Morsy, Magali. *North Africa 1800–1900: A Survey from the Nile Valley to the Atlantic*. London and New York: Longman, 1984.
- Prochaska, David. *Making Algeria French: Colonialism in Bône, 1870–1920*. Cambridge, U.K.: Cambridge University Press, 1990.
- Sluglett, Peter. *Britain in Iraq, 1914–1932*. London: Ithaca Press, for the Middle East Centre, 1976.
- . “Formal and Informal Empire in the Middle East.” In *Historiography*. Vol. 5 of *The Oxford History of the British Empire*, edited by Robin W. Winks, 416–436. Oxford: Oxford University Press, 1999.

Peter Sluglett

SOUTHEAST ASIA

Anticolonialism in Southeast Asia has been considered from a wide range of perspectives, resulting in deliberation over its character and place in the region's history. Generally, anticolonialism refers to one type of Southeast Asian response to the encounter with Euro-American colonialism. One might then describe anticolonialism as including everything from the personalities, institutions, and resistance movements that arose in direct response to the establishment of colonies in Southeast Asia, to the growth of literary expressions, rituals, history,

and popular culture that emerged within that historical context. More specifically, anticolonialism has also come to represent the ways in which colonized peoples protested, resisted, or expressed dissatisfaction with changes imposed by colonial authorities.

Because of the nature and history of colonialism in Southeast Asia (which occurred over four centuries involving different actors, intensities, locations, and agendas), expressions of anticolonialism in the region tend to reflect the circumstances and characteristics particular to each locality. So the study of anticolonial movements in the Spanish colonies was understood in the context of a “Philippine history” that was different from the historical context in which colonialism (and anticolonialism) would be examined in the case of nineteenth-century Myanmar (then known as Burma), whose history and colonial experience under the British had unfolded in quite a different manner. At the same time, scholars have also done extensive comparative work, demonstrating similarities in the way Southeast Asians articulated protest. In this regard, scholars have concentrated on the different forms of anticolonial expression in order to demonstrate variation and coherency in Southeast Asian cultural history. As a result, a distinctive and uniform “Southeast Asian” response to colonialism has yet to be clearly defined.

Categories and Features of Anticolonialism

In order to make sense of the variety of ways in which Southeast Asians responded to colonialism, expressions of protest and resistance might be approached under three general categories: traditional, synthesis, and radical movements. Although problematic in terminology, traditional movements represent those initial “knee-jerk” reactions to the immediate military and pacification operations of the colonial powers that preceded the establishment of administrative governments. These movements were generally led by elites of the traditional order, using the vocabulary and symbols of leadership to which their followers would associate with precolonial authority. Designed to resurrect the institutions and social networks that were dismantled by the encroaching Europeans, ex-princes, ministers, and priests (or monks) rallied their immediate followers to resist colonial encroachment at locations of significant religious, political, and cultural importance. Because these movements were based on patron–client, village, and locally defined networks of relations, these outbreaks of resistance were limited in scale. These types of responses were generally found throughout the region but were more locally oriented and unsuccessful in realizing the return of precolonial sociopolitical orders.

The second category of anticolonialism, which includes those expressions that exemplify a synthesis of indigenous and European ideals, refers generally to the types of programs championed by educated indigenous elites who wanted to initiate change and reform through the colonial system, using the vocabulary and procedures adopted from European education. These forms of protest were undertaken after colonial administrative and social institutions had already been entrenched in local soil, producing a generation of social reformers who saw the means for change within the apparatus and mechanics of

the colonial system but who hoped to localize Western ideals of civil society and individualism through traditional symbols and belief systems. Unlike earlier responses that aimed to return to precolonial orders, these programs sought to initiate social reform within the parameters of colonial law and convention. Many who initiated such reforms were challenged by the inability to connect with rural populations, whose concerns, experiences, and conceptions of the world were much different from their more urbanized, Western-educated counterparts.

The third type of anticolonial response, which were more radical than the earlier “East-West” attempts to synthesize, describes the initiatives of younger, educated urban students and activists who sought complete independence from colonial authorities using the organizational and sometimes ideological blueprints inherited from Europe, Japan, and America. In contrast to the generation of educated elites who hoped to initiate social reform through the system, the leaders of these movements aimed to uproot the colonial powers using the language of anticolonial nationalism in order to replace the system. Based in cities but able to penetrate the countryside, these movements attempted to bridge the rural–urban gap by making the colonial experience itself the common inspiration to launch popular movements toward independence.

These three categories of analysis offer a preliminary structure to distinguish the different types of social and political protest that might be considered “anticolonial,” while they also take into account the sociopolitical changes that occurred within Southeast Asian colonial society during the late nineteenth and early twentieth centuries as it affected local populations and communities. While anticolonial sentiment developed along these general lines, differences in the methods and natures of the colonial administrations, and the periods in which they were implemented, account for the variations and departures from the stages within this scheme.

One common feature that binds the scholarly understanding of anticolonialism in the region is that it was mainly directed toward institutions, individuals, and policies that had come to represent the way in which colonial authority threatened or affected the lifestyle, worldviews, or identities of local peoples. Symbols of the colonial state (such as infrastructural edifices, district offices, and administrators) were common targets for anticolonial protest, though local indigenous elites who were deemed collaborators or at least sympathetic to the colonial authorities were often subjected to distrust, scorn, and sometimes violence as well. Attacks on local headmen outnumbered attacks on British officials during the initial outbreak of the Saya San Rebellion in Burma in 1930, as these British-appointed headmen were perceived as acting on behalf of the newly formed British village administration.

While rebellions, riots, marches, and boycotts are all illustrative of more obvious forms of resistance, anticolonialism was expressed in a variety of other modes, harnessing local forms of public expression and media to articulate displeasure or disagreement with policies and pressures imposed by the colonial state. The growth of print culture alongside local theater, religious festivals, and other cultural outlets enabled

anticolonialism to be articulated in a wide range of forms, much of which contributed to the scholarly understanding of culture, peasants, and nationalism in Southeast Asia. While these contexts represent more recent scholarly approaches to thinking about anticolonialism, the earliest versions of the idea can be found in the writings of colonial scholar-officials.

Colonial Origins of the Idea

The earliest traces of “anticolonialism” can be found in the documents compiled by scholar-officials working within the various colonial administrations. Specifically, political officers who accompanied the initial military campaigns of conquest and later those within the civil service were among the first to interpret and write about the wide range of responses to colonial operations in the region. Many of these accounts speak of anticolonial resistance as brief interludes or disturbances, mere interruptions to the social order established by the authorities. Within official reports, gazetteers, manuals, and censuses, administrators organized, defined, and made sense of these outbreaks, thereby creating the very categories and perspectives under which “resistance” and “anticolonialism” would eventually be considered. Throughout the region, officials identified key cultural markers such as protective tattooing, charms, and astronomical symbols as part of the “traditional” uniform of resistance, which combined superstitious beliefs and religion in order to appeal to the masses who participated in these movements. Other features included the rebuilding of royal palaces and religious edifices in mountain strongholds that were said to represent cosmological and spiritual power. Case studies demonstrate these similarities in the early *minlaung* (prince) movements of Burma (1885–1890s), the “save-the-emperor” movements of northern Vietnam (1885–1896), and the Java War (1825–1830). Characteristics of anticolonial resistance were first identified, labeled, and codified by officials whose jobs were to affirm colonial policies as much as they were supposed to collect and interpret the societies they were charged with administering.

More importantly, colonial officials were interested in establishing the causal factors for these disturbances and wrote their reports accordingly, influencing scholars who would later use these sources, their approaches, and their descriptions for their own studies. Reports often stated that these brief instances of violence resulted from irrationality, superstition, gullibility, false prophets, religious fanaticism, and other inherent cultural traits that predictably would endure if not for colonial intervention. It was no surprise that initial pockets of resistance that faced the Dutch in Java, the British in Lower Burma, and the French in Vietnam would be considered akin both in character and origin to the anticolonial rebellions in the early twentieth century, though the circumstances would be considerably different. Thus, officials were charged with finding and naming examples of what was “anticolonial” in Southeast Asia partly in hopes of establishing the difference between traditional Asia and modern Europe. In this manner, the idea of anticolonialism began to take shape along a binary framing that placed Southeast Asians and Europeans at opposite ends, structuring the way in which protest, resistance, and revolt would be studied in the years to come.

Nationalism and the Idea of Anticolonialism

With the exception of the Vietnamese and to a lesser extent the Indonesians (who had to endure the return of the colonial powers following World War II), the eventual exit of the European powers from the political scene created an important intellectual vacuum within which scholars of the former colonies could operate. Many of these “home” scholars sought to repair, renovate, or even remove the histories produced under colonial tutelage. Heeding the needs of nationhood, Southeast Asian scholars, many of whom were trained in European schools, began readdressing the histories that were written for them by colonial historians by writing from the perspective of the nation. Where rebels, political activists, and influential religious figures were once marginalized and condemned by colonial historians, they were now transformed into “national” heroes who contributed to the fruition and emergence of the nation-state. Figures such as Java’s Dipanogoro (c. 1785–1855), the Philippines’ José Rizal (1861–1896), Burma’s Saya San (d. 1931), and Vietnam’s Tran Van Tra (1918–1996) became part of a common history of the nation and struggle that contributed to the imagining of the nation. Moreover, the rebellions and incidents first identified by colonial officials as being important were appropriated by home scholars for their narratives, intent on recasting the perspective in which they had originally been presented. So “anticolonial” movements became seen as independence movements, affecting the way in which protest and resistance was interpreted. For instance, the tone of the scholarship and the analysis of the movements were sympathetic rather than critical, shifting the movements’ role and importance in history to demonstrate a national consciousness that was growing during colonial rule. Earlier elements of resistance that colonial writers had highlighted in order to establish the “backward” nature of political expression (such as tattooing, religious symbols, and language) were played down by nationalist historians in favor of more “objective” economic and political origins, although the interest and focus in causal factors as prescribed by colonial documents was nevertheless maintained. Local conceptions of protest and revolt were unintentionally deemed irrelevant, because nationalist scholars were keen on writing a modern narrative of the new nation. The shape and scope of anticolonialism had not changed, only its interpretation and coloring.

While these adjustments were being made by home scholars writing through the lens of the nation, scholars in the West began to reconsider anticolonialism within the context of nation as well, choosing to consider indigenous expressions of protest and revolt (which were ironically being played down by their counterparts in Southeast Asia) as evidence of proto-nationalism. As a result, the major rebellions and revolts (which continued to dominate the attention of scholars) that had taken on a religious or culturally specific character were deemed important to study under the rubric of “Asian” nationalism, which seemed to make these once dismissed ideological influences important and relevant to scholarly study. Consequently, disturbances and outbreaks of violence that demonstrated religious overtones drew attention on the grounds that they were early expressions of nationalism and therefore warranted closer scrutiny. The Saya San Rebellion (1930–1932) in Burma, which made use of Buddhist ideas in its program, was now being considered as a “Buddhist” protonationalist movement,

suggesting that religion and other Southeast Asian ideological sources were important to understanding the growth and expression of Asian nationalism. Similarly, Dipanogoro’s rebellion in Java represented an Islamic nationalism that would precede movements in the twentieth century, while the Filipino revolt launched in 1896 by Andres Bonifacio (1863–1897), which alluded to Christian ideas, seemed to forecast the origins of a national consciousness.

Autonomous History and the Idea of Anticolonialism

In the early 1960s, shifts within Southeast Asian studies began promoting research that sought an alternative approach to the ways in which Southeast Asian culture and history had been conceptualized by earlier scholars. Following the call of John Smail to produce histories of Southeast Asia that were not bound to the European narratives, chronologies, and categories of analysis, scholars began directing their attention to writing about and studying what they perceived as indigenous history, which had finally attained its “autonomy” from the priorities and perspective of European-centered history. This trend affected the way in which anticolonialism came to be understood, in that Southeast Asian conceptions of resistance and protest were now being studied for what they revealed about the region’s cultural heritage and conceptions of the world. Where scholars might have considered how revolts inspired by Islamic, Buddhist, or Christian ideas operated under the rubric of nationalism, emphasis was now directed toward understanding how these mentalities revealed something about the very nature of Southeast Asian culture.

This new direction in thinking led scholars to write some of the most important works about anticolonialism and Southeast Asian culture. For example, Reynaldo C. Ileto, author of the seminal work *Payson and Revolution*, studied the ways in which Filipino-Catholic conceptions of rebellion were articulated through the imagery, scenes, and narratives associated with the Passion story of Christ. It inspired a new interest in millenarianism, or the idea of the coming millennium (or end of the world/cycle), and its relation to religious anticolonial movements. Historians such as Emanuel Sarkisyanz demonstrated how Buddhist conceptions about the end of the world framed the way Burmese made sense of the rapid social and economic changes occurring around them and how the notion of a future Buddha was associated with leaders promising a return to precolonial social norms. Michael Adas would take this paradigm and extend it comparatively within the region and beyond, showing in his *Prophets of Rebellion* that anticolonial movements were forged by the charismatic leadership of men who used religious notions of the millennium in order to gain popular support among the peasantry. Most importantly, these studies and many others began using the idea of anticolonialism in order to flesh out what were perceived as indigenous conceptions of the Southeast Asian world.

Peasant Studies and the Idea of Anticolonialism

With the shift toward an “autonomous” reading of anticolonialism came a connected interest in focusing on peasant society and consciousness. Pathbreaking works, such as James C. Scott’s *The Moral Economy of the Peasant*, applied models for

studying peasants to the anticolonial movements of the 1930s (the Saya San Rebellion in British Burma and the Nghe-Tinh Uprising in French Vietnam) in order to understand not just how “Southeast Asians” might have articulated and understood revolt but also in what specific ways peasants would have expressed and made sense of the new colonial order. The work of Scott and others suggested that the economic conditions of the 1930s directly challenged the peasantry’s locally defined threshold for subsistence, resulting in the widespread rebellions and resistance that occurred throughout the region. Peasant studies tended to also concentrate on economic causal factors, leading scholars to suggest possible connections between the anticolonial rhetoric and new communist influences that were slowly becoming a part of these and other nationalist movements to come. Yet peasant studies also led to the emerging interest in “everyday” forms of resistance and “avoidance” protest that focused on how peasants and communities may have expressed anticolonial sentiment on a daily basis as opposed to the larger and less frequent rebellions that officials and scholars had grown accustomed to study. Anticolonial behavior could be expressed by sabotage, flight, the dragging of one’s feet, and other forms of self-preservation and protest that were directed against authority and/or the colonial state. In a fundamental way, the influence of peasant studies upon the idea of anticolonialism challenged for the first time some of the categories and foci of colonial officials by momentarily shifting attention away from the major rebellions and revolts to the everyday behavior of Southeast Asians. The breadth of scholarship generated by this focus continues to influence the field in the early twenty-first century, by which time the focus on the peasantry had broadened to include minority groups, women, and ethnicities involved in challenges to the state and its apparatus.

Postcolonial Studies and Anticolonialism

Scholars in the early twenty-first century have returned to the idea of anticolonialism, armed with new perspectives and interdisciplinary approaches. As colonialism continues to challenge scholars, many in the academe have been inspired by suggestions that “knowledge” and “power” are closely connected, which have resulted in studies attempting to show how “knowledge” about Southeast Asia reveals something about the contexts in which it was produced. Invariably, attention has returned to those early colonial official-scholars who first began collecting, cataloguing, inventorying, and labeling what they considered Southeast Asia to be. Following Edward Said’s critique of Oriental knowledge production, scholars have demonstrated not only that this construction of Southeast Asian culture by colonial administrators represented European images of the “Orient” but that it also represented an underlying “power” to say what was and what was not “Southeast Asia.” Applying these approaches to the study of resistance and protest, it has become clear that the very categories that define resistance, the rebel, the criminal, and anticolonialism itself were produced in particular contexts that reveal as much about the colonizer as they reveal something about the perceptions of anticolonialism. Research directed at prisons, anticolonial legislation/law, and criminality have become the focus of study in order to demonstrate how colonial administrations

defined Southeast Asian anticolonialism to fit, serve, and respond to the needs of counterinsurgency policies and the maintenance of colonial order. Where once anticolonialism shed light on forms of Southeast Asian culture, it is now redirected to the forms of colonial knowledge and counterinsurgency.

See also *Colonialism: Southeast Asia; Empire and Imperialism: Asia; Nationalism; Westernization: Southeast Asia.*

BIBLIOGRAPHY

- Adas, Michael. *Prophets of Rebellion: Millenarian Protest Movements against the European Colonial Order*. Chapel Hill: University of North Carolina Press, 1979.
- Cooper, Frederick, and Ann Laura Stoler, eds. *Tensions of Empire: Colonial Cultures in a Bourgeois World*. Berkeley and Los Angeles: University of California Press, 1997.
- Dirks, Nicholas B., ed. *Colonialism and Culture*. Ann Arbor: University of Michigan Press, 1992.
- Iletto, Reynaldo C. *Payson and Revolution: Popular Movements in the Philippines, 1840–1910*. Quezon City, Philippines: Ateneo de Manila University Press, 1979.
- McHale, Shawn Frederick. *Print and Power: Confucianism, Communism, and Buddhism in the Making of Modern Vietnam*. Honolulu: University of Hawaii Press, 2004.
- Mrázek, Rudolf. *Engineers of Happy Land: Technology and Nationalism in a Colony*. Princeton, N.J.: Princeton University Press, 2002.
- Rafael, Vicente L., ed. *Figures of Criminality in Indonesia, the Philippines, and Colonial Vietnam*. Ithaca, N.Y.: Cornell University, Southeast Asia Program, 1999.
- Reid, Anthony. *Southeast Asia in the Age of Commerce, 1450–1680*, Vol. 1: *The Lands below the Winds*. New Haven, Conn.: Yale University Press, 1988.
- Scott, James C. *The Moral Economy of the Peasant: Rebellion and Subsistence in Southeast Asia*. New Haven, Conn.: Yale University Press, 1976.
- Sears, Laurie J. *Shadows of Empire: Colonial Discourse and Javanese Tales*. Durham, N.C.: Duke University Press, 1996.
- Steinberg, David Joel, ed. *In Search of Southeast Asia: A Modern History*. Rev. ed. Honolulu: University of Hawaii Press, 1987.
- Stoler, Ann Laura. *Capitalism and Confrontation in Sumatra’s Plantation Belt, 1870–1979*. 2nd ed. Ann Arbor: University of Michigan Press, 1995.
- Tarling, Nicholas, ed. *The Cambridge History of Southeast Asia*, Vol. 2: *The Nineteenth and Twentieth Centuries*. Cambridge, U.K.: Cambridge University Press, 1992.
- Zinoman, Peter. *The Colonial Bastille: A History of Imprisonment in Vietnam, 1862–1940*. Berkeley and Los Angeles: University of California Press, 2001.

Mairii Aung-Thwin

ANTIFEMINISM. Since they became widely used in the late nineteenth century, both *feminism* and *antifeminism* have been hotly contested words, an indication of their politically charged complexity. Activists and thinkers in both camps have sought to control the field of discourse by defining their opponents, while resisting definition themselves. Each camp has adapted to circumstances that change with each victory or setback. The increasing global exchange of ideas and strategies

has produced new local feminisms and antifeminisms. The problem of definition is further complicated by retrospective debates about the relative feminism and antifeminism of historical figures and traditions. Even among self-proclaimed feminists and antifeminists at any given time and place, great philosophical and programmatic diversity is the rule. Under these circumstances, all definitions must be provisional.

Defining Feminism and Antifeminism

Historically and conceptually, feminism precedes antifeminism, which arises as a reaction against and repudiation of feminism and can only be defined on that basis. The definition of *feminism* offered by the historian Linda Gordon has the requisite balance of precision and suppleness to serve as a starting point: “Feminism is a critique of male supremacy, formed and offered in the light of a will to change it, which in turn assumes a conviction that it is changeable” (quoted in Cott, pp. 4–5). Antifeminism, then, repudiates critiques of male supremacy and resists efforts to eliminate it (often accompanied by dismissal of the idea that change is possible). Note that this definition of *antifeminism* limits its reference to reactions against critiques of gender-based hierarchies and efforts to relieve the oppression of women. In this way, antifeminism is distinguished from the related concepts of male chauvinism, sexism, misogyny, patriarchy, and androcentrism, all of which can exist in the absence of feminism.

The origins of modern feminism and antifeminism are primarily found in the European Enlightenment. Among the earliest and most influential works of Enlightenment feminism was Mary Wollstonecraft’s (1759–1797) *A Vindication of the Rights of Women* (1792). Her innovation was to include women in the Enlightenment ideal of autonomous individualism and to extend the critique of rule by divine right to men’s subordination of women. Initially, *A Vindication of the Rights of Women* was praised in the majority of publications that took notice and largely ignored by more conservative journals. The disclosure of Wollstonecraft’s transgressive sexual history in a memoir posthumously published by her husband then brought increased attention from conservative commentators who, in their denunciations, pioneered a common tactic of antifeminist discourse by linking her ideas to her behavior and then labeling both “immoral.”

In a pattern that continues to the present, much of early antifeminism was both an authentic manifestation of opposition to the dismantling of male supremacy and an effective weapon against women and men seeking larger transformations in social, religious, moral, economic, and political relations. Wollstonecraft and the generations of feminists she inspired have most often been affiliated with radical movements such as abolition, free love, Jacobinism, Perfectionism, Communism, temperance, transcendentalism, antimilitarism, and other less-than-popular causes. These associations have provoked and shaped antifeminist reactions. For example, the anticommunist movements following the world wars utilized often tenuous connections between feminists and communists to condemn both. Near the end of the twentieth century, the U.S. radio personality Rush Limbaugh created the term *feminazi* as an all-encompassing epithet to discredit liberal activist

women. In practice, the two functions of antifeminism, as a means and as an end, have complemented and enhanced one another.

Feminism, Antifeminism, and Difference

At the core of the antifeminist program is the preservation (or reestablishment) of social, economic, and political differences based on gender. The most basic tenet of antifeminism is that the differences between men and women are such that inequalities of treatment and status are desirable or necessary. While the antifeminist position has been clear, feminists have been divided in their approaches to the nature and ramifications of gender differences. Individualist, liberal, or equality feminists have asserted an androgynous view of society and have sought to banish gender differentiation from social, political, and economic structures. In this view, equality is achieved by equal treatment without regard to gender. Difference, social, or relational feminists recognize gender differences (both biological and socially constructed) as of continuing significance, and base their claims for equity (in part) on these differences. The argument from difference emphasizes that utility and justice demand that, because men and women are different, women’s interests cannot be represented by men and, therefore, women need to have the opportunity to participate fully in society. Difference feminists have been open, to varying degrees, to differential treatment of men and women in cases where gendered physical or other characteristics are such that equivalence appears more tenable than absolute equality. In practice, many feminists have employed both approaches, basing their opposition to male supremacy on universal human rights as well as uniquely female characteristics or experiences.

Equality feminism and difference feminism have aroused overlapping versions of antifeminism. The antifeminist reactions to equality feminism have mostly been of two types: exclusion and ridicule. By appealing to religion, tradition, science, and nature, antifeminists sought to exclude women from the Enlightenment category of autonomous individuals who should be granted rights. In this view, women lacked the rational capacity and independent nature required of members of society. As the mounting evidence of women’s accomplishments and capabilities has made it increasingly difficult to directly dispute women’s intelligence and rationality, opponents of equality feminism have turned to the other approach: exaggeration and ridicule. In one example, opponents of the Equal Rights Amendment in the United States equated equal rights for women with mandatory unisex toilet facilities in their successful campaign against ratification.

Ridicule has also been employed against difference feminism, often as part of a larger critique of the “feminization” of society. Because antifeminists and difference feminists share a belief in gender differentiation, their disagreements have centered on the nature of this differentiation, claims to superiority of one gender or the other, and appropriate spheres of participation. Although there is a strain of antifeminism that associates women with dangerous, uncontrolled sexuality, most antifeminists and difference feminists have held a common vision of women as more nurturing and less aggressive than men. Extreme antifeminists have presented this difference as

absolute and unalterable, not a matter of degree or environment. On this basis, they have asserted that women are unfit for professions and pursuits demanding an aggressive intellect or personality and, more generally, for the rough-and-tumble of the public spheres of politics and business.

Equality feminists and some difference feminists have countered that gender characteristics vary greatly within each sex, are largely the product of education and opportunity, and that differences will lessen if males and females are treated equally. Other difference feminists, especially those associated with maternalist versions of feminism, have diagnosed the failings of the public sphere as symptoms of aggressive male dominance and prescribed female activism and influence as the cure. Expanded female influence has brought backlash protests against “momism” and the “softening” of individuals, institutions, and cultures informing the men’s movement activities of Robert Bly (b. 1926) and others. Complaints about momism and “feminization” expose the antifeminist dimensions of ideas such as republican or national motherhood that celebrate women’s abilities and contributions within the circumscribed private realm of the family, simultaneously seeking to limit women’s participation in the larger society. When these boundaries have been stretched or broken, the reactionary ridicule has been based on the supposed inappropriateness of female-identified qualities in a shifting array of arenas ranging from education, governance, and the law (primarily in the late nineteenth and early twentieth centuries), to (in the twentieth century) science, police work, and the military.

Nature, Science, Religion, and Antifeminism

Antifeminists have appealed to both religious and scientific authority in defending male supremacy as “natural.” The Abrahamic monotheisms (Judaism, Christianity, and Islam), like many of the world’s religions, contain contradictions: they grew from liberatory roots but were shaped by the hierarchical and patriarchal environments of the societies they matured in. This is manifested in restrictions on women’s actions, movement, contacts, dress, and worship as well as general dictates mandating female obedience. Feminists, ranging from the United States’ Matilda Joslyn Gage (1826–1898) in the nineteenth century to Morocco’s Fatima Mernissi (b. 1940) in the twenty-first, have identified established religion as a primary source of women’s oppression while simultaneously providing feminist interpretations of cardinal religious texts to claim the liberatory traditions for women.

Established religions tend toward antifeminism because they have a vested interest in preserving the status quo. In contrast, religious fundamentalists are generally reactionary outsiders, opposing secular authority as well as conservative and liberal religious practices. Although much scholarship and most popular images portray fundamentalist movements as inherently antifeminist, other scholars and women within these movements have identified ways in which women have used fundamentalism to increase their power and freedom, if not actually to overthrow the male supremacy deeply encoded in most religious traditions. The historical record reveals that fundamentalist regimes, from Puritan Massachusetts to Afghanistan under the Taliban, have imposed severe restrictions on women,

indicating that the feminist potential of religious fundamentalism is limited in practice.

As religion has aided antifeminist appeals to tradition, science and social science have provided more modern justifications for the subjection of women. Scientific antifeminism begins and ends with the assertion that “biology is destiny.” Charles Darwin (1809–1882), the pioneer of evolutionary theory, believed that the female’s primary role and the focus of her evolutionary adaptations was reproduction. The influential nineteenth-century social philosopher and social scientist Herbert Spencer (1820–1903) held an even dimmer view of women’s evolution, asserting that women had not taken part of the final step in human development, the acquisition of the ability to reason. Other scientists and pseudoscientists measured brain size, head bumps, musculature, and other characteristics to delineate women’s supposed inferiority.

The belief that women had primarily (if not exclusively) evolved for reproduction was used to caution against their education and participation in almost all activities not directly connected to procreation and nurture. In this view, women who pursued other avenues were going against their nature, risking serious illness and damage to their reproductive capacity. At a time when “race suicide” anxiety was common among Northern and Western Europeans and the colonial project was underway, antifeminists depicted women’s neglect of their reproductive nature as a selfish betrayal of their race and nation. The common diagnoses of “hysteria” given to a variety of mental, emotional, and physical symptoms drew on this analysis in that the “disease” was confined to women’s child-bearing years and was often portrayed as a product of women’s inferior, childlike nature. Sigmund Freud (1856–1939), the founder of psychology, extended the (pseudo)scientific discourse on female inferiority by positing a phallogocentric view of human nature. These versions of scientific antifeminism have fallen from favor, although echoes of them can still be discerned in discussions of gender difference. More common early in the twenty-first century are utilitarian social science arguments, offering anecdotal and statistical evidence that women who choose not to be wives and mothers are unhappy, that the children of working mothers are damaged, and that society suffers when women pursue any path but motherhood. Intellectual antifeminism in academia ranges from wholesale dismissal of feminist work to less obvious discrimination in publishing and career advancement.

Antifeminism, Patriarchy, Reproduction, and Sexuality

Feminists and antifeminists have staked claims to a range of positions on sexuality and reproduction. It is important to begin with the observation that control of female reproductive labor was the historic object of the establishment of patriarchal forms of male superiority around the globe. In the vast majority of societies, feminism has targeted some form of patriarchal relations, or their vestiges in industrial or industrializing societies. For this reason, control of female reproduction and sexuality have been major antifeminist themes and goals. Patriarchal practices as varied as patrilineal inheritance of property and female genital mutilation have been targeted by

feminists and defended by antifeminists. Early feminist activists challenged direct legal manifestations of patriarchy by agitating for married women's property laws, maternal guardianship rights, and the liberalization of divorce statutes. Feminist success, real and perceived, led to a counter "men's rights" movement in the late twentieth century, largely concerned with the divorce-related issues of alimony, child support, and paternal custody rights.

Although not directly addressing reproductive issues, the struggle for political rights and educational and vocational opportunities sought to provide women with alternatives to patriarchal dependency. In each of these cases, antifeminists claimed that the resulting reforms would render women physically and temperamentally unfit for reproduction and motherhood. In the late nineteenth century, Margaret Sanger (1883–1966) and other birth-control advocates addressed reproduction directly in their promotion of contraception as a means to increase women's autonomy. The battles over access to contraception, like the continuing conflicts over abortion rights, divided women's rights advocates to some degree. At base, contraception and abortion are about control of reproduction, but a complex mélange of issues including religion, freedom of speech, medical authority, and female sexual pleasure have shaped the debates.

In these and other contexts, the antifeminist depictions of female sexuality have been multifaceted. Early feminists were often said to be *unsexed*. The exact meaning of this term varies greatly, but it was never used in a positive manner. The related concept of the "masculine woman" is clearer and equally negative in intent. The rhetoric associating feminists with lesbians—accurately and inaccurately—has been a mainstay of antifeminism. This trope has long coexisted with other conflicting stereotypes of feminists as antisex prudes and free-loving (heterosexual) libertines. Although all three have been present throughout the history of antifeminism, their relative popularity has gone through cycles. Perhaps due to the influence of Wollstonecraft, the depiction of feminism as a gateway to sexual license enjoyed an early popularity, but most feminists of the late nineteenth and early twentieth centuries actively espoused respectability. This, in concert with their involvement in the temperance movement and campaigns for social purity, inspired caricatures of feminists as antisexual. The emergence of the "New Woman" and the flapper ideals in the early twentieth century brought back complaints about the loose (heterosexual and homosexual) morals of feminists. The visibility of lesbians in the women's liberation movements of the 1970s inspired new attacks on feminists as sexually deviant "man-haters." In the late twentieth and early twenty-first centuries all three antifeminist tactics have been common. Prominent women with progressive politics are regularly the subjects of whispering campaigns about their homosexuality. In works such as Katie Roiphe's best-selling *The Morning After*, feminism is blamed for creating a puritanical climate of sexual fear, yet it is commonplace for religious activists to condemn feminists for "undermining" the morals of society. Leading antifeminist Phyllis Schlafly has exploited all three: equating feminism with lesbianism, blaming feminists for creating an overly sexualized culture, and taking them to task for their

work against rape and pornography. The inconsistency in the antifeminist stance on sexuality is both a reflection of the diversity of feminism and a product of political expediency.

Colonialism, Anticolonialism, and Globalization

The colonial project of the eighteenth, nineteenth, and twentieth centuries was freighted with gender ideologies. One important aspect involved attempts to remake the gender relations of the colonized peoples in the image of Western male supremacy. The diverse societies subjected to colonization had developed unique systems of gender, some more egalitarian than Western norms, some less so. An unintended consequence of the colonial project was the contradictory spread of Western feminist ideas. Just as the official policies were based on a lack of understanding of the traditions and needs of the colonized people, Western feminism betrayed a narrowness of vision and arrogance that created distrust, even among those women who were the intended beneficiaries. This distrust and these misunderstandings continue to plague relations among feminists, creating schisms that have been exploited by antifeminists.

Anticolonial movements provided new but often fleeting opportunities for feminists. In many nations, the flux of revolutionary times combined with the need for the widest possible support created revolutionary nationalist movements open to expansive roles for women, if not always feminist ideas. Women's labor and leadership were celebrated, but in a manner that reinforced traditional images of women as wives and mothers, not as revolutionaries on their own terms, and the success of nationalist movements has often brought a backlash against the feminist women who were once comrades-in-arms. In strategic appeals, former revolutionaries and other local authorities have branded feminism as a Western influence. Feminists in the developing world have increasingly rejected Western models in order to create their own ideologies that are both truer to their experiences and less vulnerable to condemnation on nationalistic and anti-Western grounds.

See also Discrimination; Diversity; Enlightenment; Equality; Gender Equality; Feminism; Gender; Gender Studies; Anthropology; Human Rights; Women's Rights; Identity; Personal and Social Identity; Motherhood and Maternity; Philosophies: Feminist, Twentieth-Century; Power; Sexuality; Untouchability; Menstrual Taboos; Witchcraft; Women and Femininity in U.S. Popular Culture; Women's Studies.

BIBLIOGRAPHY

- Chafeta, Janet Saltzman, and Anthony Gary Dworkin. "In the Face of Threat: Organized Antifeminism in a Comparative Perspective." *Gender and Society* 1, no. 1 (March 1987): 33–60.
- Cott, Nancy F. *The Grounding of Modern Feminism*. London and New Haven, Conn.: Yale University Press, 1987.
- Faludi, Susan. *Backlash: The Undeclared War against American Women*. New York: Crown, 1981.
- Freedman, Estelle B. *No Turning Back: The History of Feminism and the Future of Women*. New York: Ballantine, 2002.
- Gordon, Linda. "What's New in Women's History." In *Feminist Studies/Critical Studies*, edited by Teresa de Lauretis, 20–30. Bloomington: Indiana University Press, 1986.

- Howard, Angela, and Sasha Ranae-Adams Tarrant, eds. *Antifeminism in America: A Collection of Readings from the Literature of the Opponents to U.S. Feminism, 1848 to the Present*. 3 vols. New York and London: Garland, 1997.
- Kinnard, Cynthia D. *Antifeminism in American Thought: An Annotated Bibliography*. Boston: G. K. Hall, 1986.
- Morgan, Robin, ed. *Sisterhood Is Global: The International Women's Movement Anthology*. New York: Feminist Press of the City University of New York, 1996.
- Roiphe, Katie. *The Morning After: Sex, Fear, and Feminism on Campus*. New York, Toronto, and London: Little, Brown, 1993.
- Schlafly, Phyllis. *Feminist Fantasies*. Dallas: Spence, 2003.
- Sommers, Christina Hoff. *Who Stole Feminism: How Women Have Betrayed Women*. New York: Touchstone, 1995.

Thomas J. Mertz

ANTI-SEMITISM.

This entry includes two subentries:

Overview

Islamic Anti-Semitism

OVERVIEW

Anti-Semitism is that hatred of the Jews that defines them as a threat to humankind. The most important contemporary quarrel about anti-Semitism is the issue of its very nature. While some scholars have been insisting for decades that there is no continuing phenomenon of anti-Semitism, arguing on the contrary that “Jew hatred” has reinvented itself many times, others adhere to the contrary opinion, seeing a direct line connecting pre-Christian to modern forms of anti-Semitism.

Origins

Throughout the ages, many peoples have fought one another in the hope of conquering the wealth and land of others, but the antagonists do not usually declare that the existence of their enemy is a danger to the future of all of humankind. Anti-Semitism began in the third century before the beginning of the Christian era. It was defined by Manetho (3rd century B.C.E.), an Egyptian priest who had been substantially influenced by Hellenistic culture. Manetho asserted that the Jews are the enemies of the human race and that it is necessary to remove the Jews from human society. Indeed, a line may be drawn straight from this pre-Christian anti-Semitism of Manetho through the Christian anti-Semitism of ancient and medieval times, to the modern era, when the hatred of Jews was redefined but not essentially changed by secular ideologies.

Manetho's main contention, an obvious rebuttal to the biblical account of the exodus of the Jews from Egypt, is that the Jews did not leave Egypt as the victors in a revolt against the pharaoh who oppressed them. On the contrary, the Jews were expelled from Egypt because they were lepers and, on the side, engaged in nefarious and destructive acts. The Egyptians threw them out into the desert because the Jews endangered the existing civilization of Egypt. They were, in fact, a threat to all

other civilizations, as well. The Jews were therefore not like the Hittites, a powerful enemy with whom the Egyptians kept fighting but who were never regarded as a unique and fundamental threat to society. According to Manetho, the Jews ought to be expelled into the desert or quarantined wherever they appeared or, if these means failed, society as a whole had the right to defend itself by destroying the Jews. Thus, Manetho's “Jew hatred” was not a simple justification of a violent and vehement conflict.

There is a fundamental parallel between some anti-Semitic assessments of the Jews and the angriest descriptions in the Bible of the dangers posed by idolatry. This competing faith must be totally isolated and the idol worshippers must be walled off from the Jewish society, or utterly destroyed. So, in earliest times, the enemies of the Jews had no monopoly on the idea that a competing faith or way of life might be defined as so dangerous as not to merit the right to survive.

The Roman Empire

The basic “Jew hatred” as defined by Manetho was expanded by a number of Greek or Roman writers, historians, and statesmen. To be sure, not all Hellenistic literature in its two languages, Greek and Latin, was dominated by anti-Semitism. Some writers admired the steadfastness of the Jews and their continuing search for righteousness and social justice—but the majority of the Hellenistic creative forces were arrayed against the Jews.

Within a century or so, the issues came to a head over the large number of Gentiles who became converts, or who wanted to become converts, to Judaism. The Pharisees insisted that all converts to Judaism were joining “a new and godly commonwealth” (Baron, 1983, vol. 1, p. 181). This definition offered by Philo Judaeus (c. 13 B.C.E.–between 45 and 50 C.E.), the leading Jewish intellectual figure of the first century B.C.E., was accepted to mean that a new convert was classified as a child who was now newly born as a Jew. This conversion meant that he disavowed his previous family, for according to Philo, such proselytes “have left their country, their kinfolk and their friends and their relations for sacred virtue and holiness” (Baron, 1983, vol. 1, p. 181). A generation later Cornelius Tacitus (c. 56–c. 120 C.E.) made the same point but he expressed it in the language of a pronounced distemper with the Jews. Once they became converts to Judaism, they “despised the gods, disowned their own country and regard their parents, children and brothers as of little account” (Baron, 1983, vol. 5, p. 182). As the Jews became more numerous and more powerful throughout the Roman Empire, Tacitus considered the Jews as subversive because they were the enemies of the three main pillars of society: religion, country, and family (Baron, 1983, vol. 5, p. 194).

In this outlook Tacitus was following the Stoic philosopher Lucius Annaeus Seneca (14 B.C.E.–65 C.E.): “The customs of that most criminal nation have gained such strength that they are now received in all lands. The conquered have given laws to the conquerors” (Baron, 1983, vol. 5, p. 191; quoted from *De superstitione* by Augustine in his *City of God*, 6:11). The same point had been argued by Marcus Tullius Cicero

(106–43 B.C.E.), the supreme orator of Rome, a generation earlier:

Even while Jerusalem was standing and the Jews were at peace with us, the practice of their sacred rites was at variance with the glory of our empire, the dignity of our name, the customs of our ancestors. But now it is even more so, when that nation by its armed resistance has shown what it thinks of our rule. (Baron, 1983, vol. 5, p. 192: quoting Cicero's defense in *Pro Flacco*, 28:69)

But the best summary of the anti-Semitism that recurs in major Hellenistic figures is present in the Book of Esther, the biblical account of the victory of the Jews over Haman, their archenemy in the Persian Court. This book was probably composed in the third century B.C.E. or perhaps even a bit later. Haman's arguments against the Jews are addressed to King Ahasuerus:

"There is a certain people, scattered and dispersed among the other peoples in all the provinces of your realm, whose laws are different from those of any other people and who do not obey the king's laws; and it is not in Your Majesty's interest to tolerate them. If it please Your Majesty, let an edict be drawn for their destruction, and I will pay ten thousand talents of silver to the stewards for deposit in the royal treasury." Thereupon the king removed his signet ring from his hand and gave it to Haman son of Hammedatha the Agagite, the foe of the Jews. (Esther 3:8–10)

In these brief verses the essential, classic doctrine of anti-Semitism is summarized: the Jews are different from everybody else; their very existence is an assault on the accepted standards of religion and good conduct. It would be best for the Persian Empire if the Jews were utterly removed. Anti-Semitism has now been defined as the doctrine by which all of the rest of human society can defend itself against the arrogance of Jewish monotheism.

Nonetheless, the question remained very much alive in the consciousness of the Roman Empire in the first century: What is one to do with the Jews? Clearly they would not obey the laws that Rome imposed on all of its own people. Jews refused to participate in civic celebrations because these invariably required worship of the gods and especially of the Roman emperors as gods. The Roman rulers in Alexandria, and even more in Judea, made allowances for the peculiar stubbornness of the Jews, but there were recurring clashes between Jews and the Roman authorities. These issues could not be resolved through negotiation between Jews and imperial officials. On the contrary, the Jews themselves had to find room for living in the larger society. So their traditions had to be changed.

By the middle of the second century after the suppression of the last great Jewish revolt under Bar Kokhba (131–135), the leading rabbis no longer expected a restoration of the Temple in Jerusalem and of Jewish sovereignty in the Holy Land. They made peace with the notion that the Messiah

would come at some future date and redeem the Jews from exile and powerlessness, but the date was unknown and unpredictable. The Jews had to make peace with the notion that they would live as a minority among other religions.

The capital of Palestine was de facto in Caesarea, the port city from which the Roman Empire controlled all of its various subjects in Palestine. Rabbinic Judaism also had its headquarters in Caesarea, where the court of its religious leadership, headed by the descendants of Hillel, was situated. The leader in the last years of the first century and the beginning years of the second century C.E. was Rabban Gamaliel II. He regularly made use of the public bathhouse in Acre, even though entering that building required that he walk under an arch that was adorned at its apex by an image of the goddess Aphrodite. Gamaliel's critics regarded his use of the bathhouse as a form of worship of the pagan goddess. He responded that, of course, he intended no such conduct. The image of the goddess served a purely civic function at the entrance of the bathhouse, which was a facility that belonged equally to all the citizens of the region, including Jews.

Rabban Gamaliel II defended his conduct as religiously neutral, but soon those who defined rabbinic law went further. Later rabbis ruled that Jews were commanded to visit the sick even among the idolaters, to bury their dead together with the Jewish dead, and to support their poor among the Jewish poor. In the Middle Ages, these rabbinic rules were summarized by Moses Ben Maimon (Maimonides; 1135–1204) in his *Code of Jewish Law*, in the section on political law in what is written in the *Hilkhot Melakhim* (10:12). All of this was to be done "for the sake of peace" because it was written in Scripture that "God is good to everyone and His mercy extended to all of His creatures." It was said further that "its ways [that is, the ways of Torah] are the ways of grace and all its paths are peace." To be sure, these are not the only rabbinic opinions. There are many counterviews in the Talmud that Jews must maintain distance from non-Jews, but the more giving rulings suggest that Jews were looking for ways of accommodating themselves to a society that they had little hope of controlling or of converting to the Jewish faith.

Nonetheless, despite the rulings of the more liberal rabbis, the distance between Jews and non-Jews remained. These descendants of the Pharisees could never give up the notion that their religion was God's true teaching and that, at some unpredictable moment, the whole world would come to Mount Zion to be received and converted to the one true faith, the monotheism that Abraham had once proclaimed.

Christianity and Anti-Semitism

How could the Jewish religion be redefined so that it became a possible and even quickly accessible faith for all of humankind? The answer was devised by the first two or three generations of those who had adhered to the person and teaching of an itinerant Jewish preacher, Jesus of Nazareth. Despite centuries of thought and scholarly research, what Jesus himself believed is still not clear. The weight of the evidence is that Jesus regarded himself as a Jew who had come to wrest the leadership of his people from the priests who dominated

in the affairs of the Temple and the Pharisees who had seized the initiative in defining the laws by which Jews were urged to live. In a few decades after his crucifixion, the religious leadership passed to a much more radical Jewish thinker, Saul of Tarsus (St. Paul; d. between 62 and 68 C.E.), who opened Judaism to all the non-Jews of the world without requiring that they accept the rituals and all the many restrictions that the rabbis had defined.

In its very beginnings Christianity could not choose the path that had been suggested by Manetho and elaborated by the pagan Hellenists, that Jews were by their very nature beyond redemption. On the contrary, Saul of Tarsus asserted in Romans 9 that Christianity was a shoot grafted on to the tree of Jesse, that is, that Christianity was the true offshoot of Judaism—if only the Jews would accept the truth of their religion as it was now being expounded by those of them who had become Christian believers.

Even more fundamentally, Christianity could not present itself as a universal religion that was setting out to convert the whole world. It demanded only that those who joined it should include themselves in the transforming faith in Jesus, who had died for sins of humankind. How could anyone be excluded from this transforming faith and the salvation that it offered each individual? And yet, as the church fathers saw with bitter dismay, the Jews did not behave according to the Christian theological plan. Jesus had been born among them, but the Jews were obdurate. Their majority refused to accept the truth that appeared among them. To the church fathers, it was unthinkable that the divine message was unclear or, worse still, that the Jews understood the message but rejected it.

By the middle of the second century, church fathers such as Saint Justin (Justin Martyr, c. 100–c. 165), writing in Greek, and half a century later, Tertullian (c. 155 or 160–after 220 C.E.), writing in Latin, were critical of the Jews for not having accepted Christ. Within a hundred years, especially after Emperor Constantine (ruled 306–337) proclaimed Christianity the state religion of Rome, later church fathers were offering an explanation for the obduracy of the Jews: they were too strongly in the grip of Satan, who had commandeered the synagogues and instructed the rabbis; the Jews could not see the truth of Christianity because they were now led by the enemy of God, the supreme anti-Christ. They were referred to as the “Synagogue of Satan” in *Revelations* 2:9 and 3:9. Two things could be done: Jews could be persecuted as the enemies of truth or the effort to convert them could be redoubled, over and over again, to persuade them to abandon their wrong-headedness. In this very early Christian explanation that the Jews were now “the synagogue of Satan” their otherness was explained, and the path was prepared that could lead to pronouncing the Jews to be totally dangerous to the rest of humankind—and all of this on the basis of Christian theology. Manetho had decided that the Jews were dangerous to the health of humankind because they were lepers; the earliest church fathers defined a different metaphor—the Jews were a threat to the souls of men and women because they were Satan’s disciples in leading them away from divine truth. Thus,

the Christian relationship to Jews was defined as a paradox: the culmination of the triumph of the new faith would be in its conversion of the Jews, but the tasks of achieving this glorious time would be enormously difficult, because it involved direct war with Satan himself.

Early Christianity found a compromise between the two alternatives—that the Jews had to survive until they accepted Jesus and that they were by their very nature the hopelessly wicked “synagogue of Satan”—by asserting both alternatives: the Jews could not be totally obliterated, for there would be no one left to represent them at the end of days when they would finally accept the Christian truth, but society had to be defended against the Jews or it would be hopelessly corrupted. Further elucidations of this basic paradox included the permission to keep Jews alive by allowing them to perform pariah tasks that were forbidden to Christians, such as lending money at interest, but the notion that those who had condemned Christ deserved the most severe punishment was never abandoned.

Since living Jews were the enemies of truth, they could be blamed for everything that went wrong in society. So, early in the fifteenth century, when Europe was swept by the Black Plague, which killed perhaps a quarter of the population, it seemed self-evident that this scourge was brought on the Christian majority by the small Jewish minority, which was full of hate and anger. It also seemed self-evident that the possessions of the Jews had been acquired by deception and by stealing from the Christians. It was, therefore, logical and even lawful to treat them like a kind of sponge; whatever possessions they had could be confiscated by the ruling power. In the course of the Middle Ages, there was hardly a place in Europe that had not expelled the Jews and forced them to leave without any resources with which to live. Nonetheless, the myth remained that in the divine plan Jews or at least some of them needed to be kept alive so their acceptance of the true Christianity would be the dramatic act that would point to the end of days. Some historians call this medieval version of hatred of Jews “anti-Judaism” rather than “anti-Semitism.” It was only late in the Middle Ages that Christian anti-Semitism came close to completing its ideological journey by asserting that the Jews were hopelessly dangerous always, even after they might convert to Christianity.

Conversos

The largest Jewish community in Europe in the fourteenth and fifteenth centuries existed on the Iberian Peninsula, the southern half of which was then controlled and ruled by Muslim states and the central and northern half by Christians. Jews were a significant minority in both these regions of Spain. They were especially important to the Christians who wanted to force them to convert and thus strengthen the Christian majority in the region. At the end of the fourteenth century, the Christians did succeed in forcing Jews to convert by the tens of thousands. In a century or so, the number of such converts grew until the climax in 1492, when the combined kingdom of Aragon and Castile, under the joint rule of Ferdinand and Isabella, confronted the Jews with a stark choice: either convert to Christianity or leave the land of their Christian

majesties. A quarter million Jews then still remained in all the lands of Christian Spain; the larger half accepted conversion, and the rest left, hoping to find some refuge in places where Jews were allowed to live openly, or semiopenly, as Jews.

There were many forces that led to this decree of conversion or expulsion, but the economic motive was dominant. Many of the Jews in Spain had made their way into the middle class and even beyond, so their Christian competitors presumed that the increasingly prominent Jewish role in Iberian commerce could be ended by forcing them to become Christians. The Jews would redistribute themselves in such fashion that they would no longer be dominant in trade and commerce. None of this happened. On the contrary, the “new Christians” used their new privileges to become not only more major figures in banking and the ownership of land; they also intermarried, quite rapidly, with high figures in the nobility and rose to predominant positions in the state, the army, and even in the Church. Some Jews thought it would be safer to move to the Spanish colonies in the New World. In the middle of the seventeenth century, Spain had developed its rule in South America through the viceroyalty of Lima in Peru. At one moment in those years the viceroy and the archbishop were both descendants, at least in part, of “new Christians,” and so, Lima was known mockingly as *La Juderia*. The Inquisition redoubled its efforts in Peru and Mexico, the main centers of Spanish rule, to suppress Marranos (that is, new Christians who actually or supposedly practiced Judaism in secret).

But the “new Christians” remained powerful. The way had to be found to make these converts from Judaism into second-class citizens or worse. At the beginning of the fifteenth century the doctrine was invented of *Limpieza de Sangre* (purity of blood). It first became law in Toledo in 1449 and restrictions were widely adopted: those who could not prove that all four of their grandparents were “old Christians” were denied roles in government or in the Church. The taint that Jewish blood now brought with it was not different from Manetho’s insistence nearly two thousand years earlier that Jews were lepers and thus infectious beings. Anti-Semitism had changed on the surface, but its basic thrust had remained the same. The Jews are a lasting danger to the majority.

Modern Anti-Semitism

The major shift in the definition of anti-Semitism occurred in the eighteenth and nineteenth centuries, when Christianity was largely pushed aside among educated Europeans by the doctrines of the Enlightenment. The dominant cliché since the eighteenth century has been that the Enlightenment ushered in the age of equality of all religions and ethnic identities. This is largely true, but the most ideological wing of the Enlightenment asserted its own version of *Limpieza de Sangre*. The dominant figure in European letters in the second half of the eighteenth century was Voltaire (1694–1778). He paid some lip service to the notion that all people could be perfected including perhaps even the hardest case of all, some Jews, but his basic position was that the Jews were born with fanaticism in their hearts as Bretons were born with blond hair. It was not strange for Voltaire to assert such a view because he had

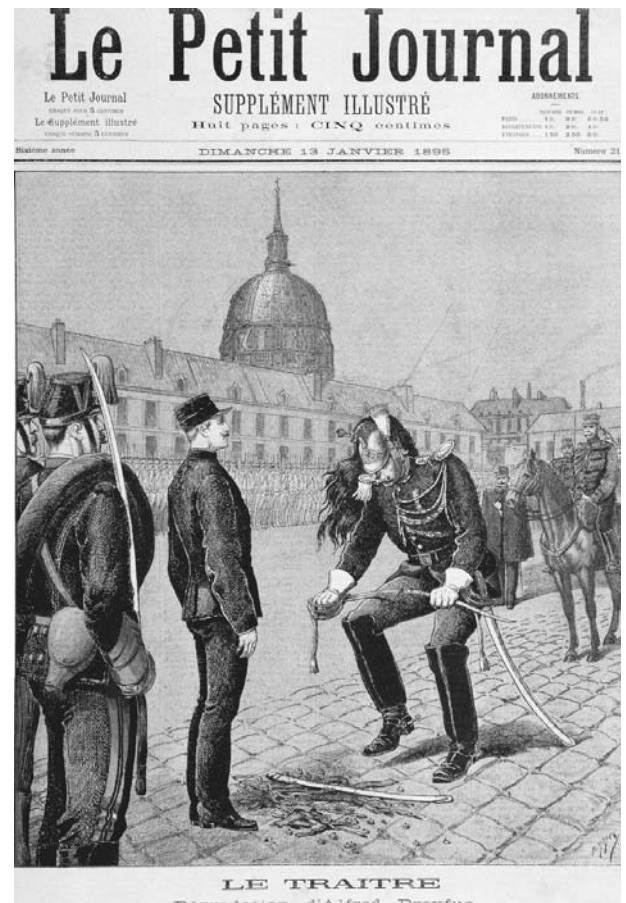

Le Petit Journal illustration of Alfred Dreyfus being stripped of his rank (1895). Dreyfus, a French army captain of Jewish descent, was accused of selling military secrets to the Germans. He was not exonerated and released from incarceration until 1906. © LEONARD DE SELVA/CORBIS

himself defined negroes as not human beings; they were an intermediate stage between humans and monkeys. Voltaire and those who followed after him, such as Paul-Henri-Dietrich d’Holbach (1723–1789) and, to some degree, Denis Diderot (1713–1784), thus solved the problem of what to do about the Jews by declaring it to be a question of how to defend the bulk of humanity against a dangerous infection that was carried by people who looked human but really were alien.

This notion appeared during the debates of the era of the French Revolution in the writings and decisions of the most radical Jacobins who asserted, both in Paris and in eastern France, that giving the Jews equality was simply to make it more possible for them to realize their nefarious plots under more respectable cover. In the next half century or so, after the revolutionary era, some of the greatest figures of the European left (such as Pierre-Joseph Proudhon, Charles Fourier, and even Karl Marx) argued, often quoting Voltaire, that the Jews were a danger and that the Jews themselves had to be saved from their Jewish identity for their own sake and for the sake of humankind.



Jewish man forced by Nazis to ride in open cart, c. 1935. Under Hitler, Jews were legally classified as a separate race and forced to endure many types of public humiliation, such as wearing a yellow Star of David for identification purposes. © HULTON-DEUTSCH COLLECTION/CORBIS

This doctrine of many of the radical Enlightenment thinkers was appropriated by the nationalists who took over European literature and political thought in the middle years of the nineteenth century. Their image of a nation was that it represented the purity of an older culture, and therefore, aliens who had not shared in that history had no role. Jews were certainly viewed as aliens from Asia who did not belong within any of the European nations. With variations, this doctrine became part of the thinking of the pan-Germans and the pan-Slavs, and of other European nationalists.

Toward the end of the nineteenth century at least three versions of anti-Semitism were very virulent in Europe. In tsarist Russia where some six million Jews, at least half of those in the world at the time, lived, the dominant form of anti-Semitism was based on many centuries of Christian hatred. In the last fifty years of its existence, the absolute rule of the tsars found it useful to deflect the angers of the poor by blaming the Jews as the source of all the troubles in Russia. In 1881–1882, pogroms swept through the realm and a mass migration of Jews fled the kingdom. Most of these refugees went west to America, but some were the first founders of the new Zionist settlement in Palestine. But even in tsarist Russia, where the ruling class and especially the tsars themselves were believing Christians of the old school, other, more modern forms of anti-Semitism contributed to the persecution of the Jews. Many of the archenemies of the tsarist regime nonetheless blamed the Jews. The new revolutionaries saw the uprising of the poor against the Jews as a movement to be supported because the Jews—so the revolutionaries argued—were the capitalist

oppressors of the poor of Russia. By the last decades of the nineteenth century, pan-Slavism was also gaining strength and importance in eastern Europe and especially in Russia. The essential doctrine of this movement was that the Slavs had been chosen by history, and probably by God himself, to be the superior people of all of humankind. Obviously, the ancient Jewish claim to closeness had long been nullified, and those who would maintain this claim were troublemakers, or worse.

These various assaults on the Jews were given prominence, and special bitterness, in the last years of the century by the appearance of the book *The Protocols of the Elders of Zion*. This book was, of course, a forgery that was concocted by agents of the tsarist secret police probably working in Paris, which was then the intellectual capital of Europe. In the *Protocols* all the forms of anti-Semitism were combined: Jewish capitalists and Jewish revolutionaries were actually engaged—so the authors of the *Protocols* maintained—in a joint endeavor to undermine the civilization and culture of the European majority. The capitalist, Lord Rothschild, and the socialist Jews, who were trying to assassinate the tsar, pretended to hate each other, but this was not the truth. They were really partners in the immemorial Jewish enterprise, to undermine society in order to control it. The ultimate battle in the world was between those who would defend the majority culture and their immemorial enemies, the Jews. The *Protocols* have been repeatedly discredited as a fantasy, but this book has been reprinted in a variety of languages and continues to be read and believed by anti-Semites all over the world, including the newest recruits to the “great hatred” in the Muslim world and in Japan.

The essence of post-Christian anti-Semitism was a restatement of pre-Christian Hellenistic Jew hatred. In the middle of the eighteenth century, a second-level scholar and leader of the Enlightenment in France, the Count Jean-Baptiste de Mirabaud, had published a book of citations from Greek and Latin authors (*Opinion des anciens sur les Juifs*, 1769) in which the Jews were denounced as alien to European society and a danger to its future. This theme was carried forward in the next century and the one thereafter, to naturalize anti-Semitism in the rhetoric of both pre-Christian and post-Christian times. To be sure these attacks also derived some nourishment from Christian theology but this was not the essence of modern anti-Semitism. It was not necessary to denounce the Jews as Christ-killers; the charge of leprosy in various permutations was more than enough.

Nazi Anti-Semitism

The heyday of anti-Semitism, its ultimate climax, came with the rise of Nazism. Adolf Hitler and those who followed him were certain that they were engaged in a great and unavoidable task, the defense of European civilization against all forms of subversion by the Jews. Hitler's ultimate vision of the world was that it was poised on the verge of an ultimate war in which the Jews had to be destroyed. There was no longer any pretense that some Jews might be redeemable: this was now a war to the death. The results are well known. The overwhelming majority of the Jewish population of Europe, to the number of six million men, women, and children, were systematically murdered. The rest were saved only because Hitler and his allies lost the war. Nonetheless, the Nazis did not entirely lose their fierce war with the Jews.

The assault in the 1940s destroyed the most creative elements of the world Jewish community in the middle of the twentieth century. It changed the face of Europe, which was no longer a main center of Jewish life and creativity. More subtly, the emphasis within Jewish life has for the last half century been more on fighting off the attempt to destroy the Jews than it has centered on recreating the religious and cultural values that were destroyed. In the early twenty-first century those concerns were only beginning to be at the center of Jewish endeavors. Thus, Hitler's greatest success was to make of the Jews a people much more frightened for its future than it had been in the previous century.

After the victory in 1945 in World War II, Jews—and people of good will everywhere—thought that anti-Semitism would fade away. But anti-Semitism has not disappeared and in some parts of the world it is even more powerful than ever before. Society as a whole has not yet accepted the idea that those who will not play by its conventional rules are nonetheless entitled to a life of freedom and dignity. The question that was posed more than three thousand years ago, whether the Jews had a right to survive in a society that did not agree with the premises on which much of Jewish religion and culture is based, is still very much open. Will the societies that remember their pasts as Christians and Muslims make room for Jews? We cannot yet be sure.

See also *Christianity; Judaism; Prejudice; Toleration*.

BIBLIOGRAPHY

- Baron, Salo W. *The Russian Jew under Tsars and Soviets*. 2nd edition, rev. and enl. New York: Schocken, 1987.
- . *A Social and Religious History of the Jews*. 8 vols. 2nd edition, rev. and enl. New York: Columbia University Press, 1983.
- Gager, John G.. *The Origins of Anti-Semitism: Attitudes toward Judaism in Pagan and Christian Antiquity*. New York: Oxford University Press, 1983.
- Hertzberg, Arthur. *The French Enlightenment and the Jews*. New York: Columbia University Press, 1968.
- Katz, Jacob. *Exclusiveness and Tolerance: Studies in Jewish-Gentile Relations in Medieval and Modern Times*. 1961. Reprint, Westport, Conn.: Greenwood Press, 1980.
- Langmuir, Gavin I. *History, Religion, and Antisemitism*. Berkeley: University of California Press, 1990.
- Parkes, James. *The Conflict of the Church and Synagogue*. 1934. Reprint, New York: Hermon Press, 1974.
- Poliakov, León. *The History of Anti-Semitism*. 4 vols. Philadelphia: University of Pennsylvania Press, 2003.
- Pultzer, Peter G. J. *The Rise of Political Anti-Semitism in Germany and Austria*. New York: Wiley, 1964.
- Tcherikover, Victor. *Hellenistic Civilization and the Jews*. 1959. Translated by S. Applebaum. Reprint, Peabody, Mass.: Hendrickson, 1999.
- Trachtenberg, Joshua. *The Devil and the Jews: The Medieval Conception of the Jew and its Relation to Modern Antisemitism*. 1943. Reprint, Philadelphia: Jewish Publication Society, 1993.
- Zimmerman, Moshe. *Wilhelm Marr, the Patriarch of Antisemitism*. New York: Oxford University Press, 1986.

Arthur Hertzberg

ISLAMIC ANTI-SEMITISM

Anti-Semitism became in the late twentieth century an integral part of Islamic and, particularly, Arab cultural discourse. Like other modern intellectual and political movements, such as nationalism, socialism, and fascism, anti-Semitism is a European import of fairly recent vintage into the Muslim world.

Traditional Islamic Attitudes

As in the case of Christianity, fundamental Islamic attitudes toward Jews and Judaism go back to the historical circumstances surrounding the founding of the new faith and are sanctioned by scripture and tradition. Jews figure into traditional Islam's theological worldview, and Jews lived as a subject population under Muslim rule, sometimes under better, sometimes under worse conditions. However, because Islam did not begin as a sect within Judaism or claim to be *verus* Israel (or the "true" Israel), as did Christianity, the Koran and later theological writings (with the exception of the Sira, or canonical biography of the Prophet Muhammad) do not exhibit anything comparable to the overwhelming preoccupation with the Jews that one finds in the New Testament, patristic literature, and later Christian theological writings.

Traditional Islamic thought had its own store of negative stereotypes of Jews. According to the Koran (Sura 2:61), "wretchedness and baseness were stamped upon them, and they were visited with wrath from Allah." The Koran, exegetical,



Edition of *Mein Kampf* translated into Arabic. In the late nineteenth century, anti-Semitic tracts and books began to appear, many of which were translations of existing works. Adolf Hitler's *Mein Kampf* was translated into Arabic in 1935, after careful editing removed the anti-Arabic sentiments within. © HULTON-DEUTSCH COLLECTION/CORBIS

and hagiographic literature brand the Jews of Medina as having been the principal opponents of the Prophet along with the idolaters and as a treacherous lot. But they were also people who had received a genuine divine revelation, like the Christians and Zoroastrians, and like the latter deserved tolerance as long as they accepted the status of humble tributary *dhimmis* ("protected peoples"). Though the image of Jews was on the whole even more negative and condescending than that of Christians, they shared the same legal status within the traditional Islamic social system, and throughout most of the fourteen hundred years of Islamic history were rarely singled out for greater discrimination than other non-Muslims. The relatively rare instances of specifically anti-Jewish violence often occurred when a Jew was perceived to have egregiously transgressed the boundaries of proper conduct by rising too high in the bureaucracy. Anti-Jewish rioting only became a more frequent phenomenon in the twentieth century in the Arab parts of the Muslim world with the anti-Jewish sentiments generated by Zionism and European colonialism.

Introduction of European Anti-Semitic Ideas in the Nineteenth Century

Modern anti-Semitic ideas made their first appearance in the Middle East among the Arabic-speaking Christians of Syria, who maintained commercial, educational, and cultural ties with the European nations making ever stronger inroads into the region during the nineteenth century. French merchants and missionaries seem to have played a principal role in this process. The classic European notion of the blood libel gained widespread circulation in the Levant after the notorious Damascus Affair of 1840 when the French consul, Count Benoît Ulysse de Ratti-Menton, accused the Damascene Jewish community of having kidnapped and murdered a Capuchin friar for the Passover ritual. The case became an international cause célèbre, and for several months Ratti-Menton received support

from the local Muslim authorities. The memory of the Damascus Affair was preserved by local Christians, but for a long time thereafter, anti-Semitic ideas, whether of the medieval or modern, post-Enlightenment varieties, made little or no headway among the vast majority of Arab and non-Arab Muslims. Anti-Semitic articles appeared occasionally in the late-nineteenth-century Syrian and Egyptian Arabic press in which Christians were prominent. Arabic anti-Semitic books and pamphlets also made their appearance at this time. Again, these were mainly by Christian authors and were frequently translations or adaptations of European works such as August Rohling's *The Talmudic Jew*, which was published in Egypt in 1899 under the title *al-Kanz al-Marsud fi Qawaid al-Talmud* (The guarded treasure of the principles of the Talmud). These early works laid the foundations for a very extensive literature in the twentieth century when the attitudes of the Muslim majority toward Jews became radically altered. Rohling's *The Talmudic Jew* has enjoyed enduring popularity in Arabic, has been reprinted a number of times, and has inspired numerous other books, as for example, Muhammad abri's *al-Talmud: Shari'at al-Yahud* (The Talmud: The religious law of the Jews).

Evolution of Islamic Anti-Semitism in the Twentieth Century

The Axis gained widespread sympathy in the Islamic world during the 1930s and 1940s because they were the enemies of the Western colonial powers and Western democratic values. Turkish, Arab, and Iranian nationalists admired German militarism. Nazi and Fascist propaganda helped familiarize educated Muslims with the vocabulary of modern anti-Semitism. *Mein Kampf* appeared in an Arabic translation in 1935 with its anti-Arab statements expunged. However, most of the Arabic literature that imitates Nazi Jew-baiting tracts dates from the postwar period.

No work has had a more profound impact upon modern Muslim anti-Semitism than the *Protocols of the Elders of Zion*, written in Paris at the end of the nineteenth century for the tsarist secret police and allegedly the secret minutes of a Jewish conspiracy for world domination. Although it was already being cited by Arab nationalists in Iraq and Palestine in the early 1920s, the complete text first appeared in Cairo in 1925 as *Mu'amarat al-yahudiyya 'ala'l-Shu'ub* (The Jewish conspiracy against the nations), translated by Antun Yamin, a Lebanese Maronite. This was the first of a long line of Arabic editions and translations, and the book has been a continual bestseller throughout the entire Arab and Muslim world. The *Protocols* have been quoted, praised, and recommended by politicians, academics, and religious leaders. The principal idea of the *Protocols* about an international Zionist-Jewish conspiracy is repeated in everything from television series to religious literature and has become a fundamental tenet of the Islamic fundamentalist worldview, both Sunni and Shiite. Ayatollah Khomeini, for example, writes in his *Vilayet-i Faqih: Hukumat-i Islami* (1971; The trusteeship of the jurisconsult: Islamic governance) that the true aim of the Jews "is to establish a world Jewish government." This and other notions from the *Protocols* may be found in the writings of Moroccan Islamist Sheikh Abdessalam Yassine, the Tunisian theologian Rached

Ghannouchi, and in the publications of the Muslim Brotherhood, Hamas, Hizbollah, al-Jama'at al-Islamiyya, and Al Qaeda.

Contemporary Islamists cite proof texts from the Koran and hadith to corroborate the *Protocols*. The widely disseminated writings of the Egyptian philosopher Sayyid Qub probably played an influential role in the spread of this harmonization of the *Protocols* and Islamic traditional texts.

The numerous humiliating defeats of Arab armies at the hands of tiny Israel, the strong relationship between the Jewish State and the United States, and the general social, technological, and political weakness of the Islamic world as a whole, despite the great oil wealth of some Islamic nations, have all contributed to the credence given by many Muslims to the notion of the invisible hand of a Zionist-Jewish cabal as depicted in the *Protocols*.

Though less a general belief among contemporary Muslims than the Jewish conspiracy for world domination, the blood libel has come to have wide circulation in the late twentieth and early twenty-first centuries, especially in the Arab world. Even ostensibly scholarly treatments of Judaism such as 'Ala 'Abd al-Wahid Wafi's *al-Yahudiyya wa'l-Yahud* (1970; Judaism and the Jews) and Hasan Zaza in his *al-Fikr al-Dini al-Isra'ili: At-waruhu wa Madhabihuhu* (1971; Israelite religious thought: Its phases and schools) present the blood libel as fact. Zaza devotes a learned discussion to the blood libel observing that such a practice is forbidden by Jewish law, but then notes that the accusation has followed the Jews throughout history, that people often act contrarily to their religious teachings, and finally cites the confessions of one of the accused murderers in the Damascus Affair as proof of the veracity of charge. Blood libel stories appear from time to time in the mainstream Arabic press as both features and news items. Syrian defense minister Mustafa Tlas has written one of the best selling books promoting the blood libel, *Fatir Sahyun* (The matzah of Zion). The book went into eight editions between 1983 and 2002, with the last alone selling over twenty thousand copies. As with the conspiracy of the *Protocols*, blood libel stories have been featured in Arabic television dramatizations during the nights of Ramadan in 2003.

See also **Anti-Semitism: Overview; Fundamentalism; Jihad; Law, Islamic.**

BIBLIOGRAPHY

- Kepel, Gilles. *Muslim Extremism in Egypt: The Prophet and Pharaoh*. Translated by Jon Rothschild. Berkeley and Los Angeles: University of California Press, 1985.
- Lewis, Bernard. *Semites and Anti-Semites: An Inquiry into Conflict and Prejudice*. New York and London: Norton, 1986.
- Stillman, Norman A. "Antisemitism in the Contemporary Arab World." In *Antisemitism in the Contemporary World*, edited by Michael Curtis. Boulder, Colo., and London: Westview Press, 1986.
- . *The Jews of Arab Lands: A History and Source Book*. Philadelphia: The Jewish Publication Society, 1979.
- . *The Jews of Arab Lands in Modern Times*. Philadelphia: The Jewish Publication Society, 1991.

Norman A. Stillman

APARTHEID. *Apartheid*, an Afrikaans word meaning "apartness," describes an ideology of racial segregation that served as the basis for white domination of the South African state from 1948 to 1994. Apartheid represented the codification of the racial segregation that had been practiced in South Africa from the time of the Cape Colony's founding by the Dutch East India Company in 1652. Its emergence in 1948 was antithetical to the decolonization process begun in sub-Saharan Africa after World War II. Widely perceived internationally as one of the most abhorrent human rights issues from the 1970s to the 1990s, apartheid conjured up images of white privilege and black marginalization implemented by a police state that strictly enforced black subordination.

Historical Background

The Dutch East India Company occupied the Cape Colony uninterruptedly from 1652 until the British takeover in 1795. The company's conflict with the indigenous Khoisan was exacerbated by its granting of farmland to company members who had completed their term of service. The Khoisan, who became indentured servants, were landless by the time of the British occupation. Slaves were imported from Asia and elsewhere in Africa throughout the eighteenth century. Briefly restored to Dutch rule in 1803, the colony was again brought under British control in 1806. Two events to which Dutch settlers reacted negatively were the British abolition of the slave trade in 1806 and of slavery in 1833. The latter precipitated the Great Trek, in which many Dutch (Afrikaner) farmers migrated outside the Cape Colony.

A "mineral revolution," financed by British capital, began in South Africa with the discovery of diamonds in Kimberley in 1868 and gold in Johannesburg in 1886. Later the British victory in the Boer War (1899–1902) brought the Transvaal and the Orange Free State under British rule. Natal was already a British colony. Collectively the four colonies formed the Union of South Africa in 1910.

Afrikaners, who suffered military defeat in the war, displayed intense anti-British sentiment as many of their farms were destroyed and their wives and children placed in concentration camps, resulting in a high mortality rate. Their efforts to increase their population contributed to proletarianization, precipitating their migration to cities for employment. They often became squatters alongside poor blacks. In 1928–1932 the Carnegie Corporation conducted a study of the "poor white problem" and made recommendations for improving the status of working-class Afrikaners. During that period, Afrikaans, a Dutch variant, became a written language. Members of the emerging Afrikaner bourgeoisie opened the first Afrikaner bank and insurance company.

Rise of Afrikaner Nationalism

After the Boer War, two Afrikaner generals, Jan Smuts and Louis Botha, sought conciliation with the British in forming the South African Party. Supporters also included enfranchised blacks. The South African Party defeated the Unionist Party in the 1910 elections. Cognizant of eroding political rights, members of the black educated elite formed the South African Native National Congress (later the African National Congress) in 1912. Racist legislation enacted during this period of "fusion" included the



1913 Land Act, which prohibited a type of sharecropping called farming-on-the-half, in which black sharecroppers negotiated with white farmers to farm part of the latter's land. Furthermore, blacks could not own land outside of designated areas.

Another Afrikaner general, J. B. M. Hertzog, led dissidents against a South African alliance with the British in World War I. A schism developed between Smuts and Hertzog over South African involvement in World War II, signaling the end of fusion. It was then that Hertzog advocated a South African republic outside the British Commonwealth. Further racist legislation included:

The Urban Areas Act of 1923, which legislated urban racial segregation, discouraging blacks from becoming town-rooted.

The Industrial Reconciliation Act of 1926, which introduced job protections for poor whites.

The 1936 Land Act, which reinforced the 1913 Land Act and designated homelands as areas for African land ownership.

A 1936 decree that struck Africans in the Cape Province from the common voters' roll.

The historian T. Dunbar Moodie has suggested that Afrikaner nationalism was a civil religion representing the integration of key symbolic elements. These include major events in Afrikaner history, the Afrikaans language, and Dutch Calvinism. From Moodie's perspective, Afrikaners viewed their history in terms of a repeating suffering-and-death cycle at the hands of the British through major events such as the Great Trek and the Boer War. The Broederbond, a secret society composed of Afrikaner professionals, formed the Federation of Afrikaner Cultural Organizations (FAK), affiliating cultural and language associations as well as church councils, youth groups, and scientific study circles in 1929.



Segregated bathrooms in Johannesburg, South Africa, 1984.

When the National Party came to power in 1948, many laws were passed to segregate the population, one of which banned blacks and Indians from using the same public facilities as whites. © IAN BERRY/MAGNUM PHOTOS

Black Resistance

Black activism increased after World War II in South Africa as elsewhere in Africa. When A. B. Xuma became president-general of the African National Congress (ANC) in 1940, he attempted to unify the organization ideologically, regulate its finances, and conduct a propaganda campaign. A major schism developed when Xuma and a few middle-class members advocated negotiation through African representative bodies, while more militant members leaned toward the Communist Party and more assertive political activism.

In the mid-1940s a group of young professionals, including Nelson Mandela and Robert Sobukwe, banded together to form the ANC Youth League. They made overtures to Coloured and Indian political organizations in their call for majority rule. Coloureds were descendants of “miscegenation” that occurred in the Cape after the Dutch East India Company’s occupation. Indians were recruited as indentured servants to work on Natal’s sugar plantations in the 1860s.

Apartheid Legislation

After the National Party victory in 1948, a battery of laws was enacted to strictly segregate South African society by race, ethnicity, and class. The Prohibition of Mixed Marriages Act of 1949 outlawed marriages between whites and blacks. The Population Registration Act of 1950 required that each adult South African be classified by ethnic group as follows: white (Afrikaners and English), Coloured (mixed race, Asian [mostly Indian]), and African (Xhosa, Zulu, Ndebele, Swazi, Basotho, Batswana, Bapedi, Venda, and Tsonga). In 1951 South Africa’s “African” population was approximately 8.5 million, nearly four-fifths of the entire population.

The Group Areas Act of 1950 enforced the residential segregation of Coloureds and Indians. These groups could not use public facilities outside residential boundaries.

The Suppression of Communism Act of 1950 forced the disbandment of the South African Communist Party and a

diplomatic break with the Soviet Union. The Bantu Authorities Act of 1951 abolished the Natives Representative Council, replacing it with indirect rule. The Natives (Abolition of Passes and Coordination of Documents) Act of 1952 required the assignment of detailed reference books to all pass holders detailing their background, employment, and residential rights outside the reserves.

Parliament also passed the Bantu Education Act of 1953, providing for state control of African schools, which had mostly been founded by missionary societies, at the primary, secondary, and tertiary levels. The Ministry of Native Affairs planned a curriculum to prepare the “Bantu” (South African blacks) to occupy a servile position in South African society. Undocumented Africans were removed from urban areas to rural homelands under the provisions of the Native Resettlement Act of 1954. Cape Coloureds were removed from the common voters’ roll in the Cape Province in 1956.

When Hendrik F. Verwoerd, minister of native affairs from 1950, became prime minister in 1958, he continued to initiate apartheid legislation compatible with his views regarding “separate development.” The Promotion of Bantu Self-Government Act of 1959 provided for the creation of eight national units for African self-government supposedly reflective of African ethnic groupings. Since urban blacks had no political representation, it devolved upon chiefs to act as roving ambassadors between African subjects in the urban areas and those resident in homelands. Homelands or reserve areas represented 13.7 percent of the land.

The Bantu Homelands Act of 1970 required that all Africans be given exclusive citizenship in a homeland, disregarding place of birth and current residence. In 1972 Zululand and Bophuthatswana were granted self-governing status, while Transkei, self-governing since 1963, was given more autonomy as the model homeland. Transkei’s “independence” in 1976 was followed by Bophuthatswana in 1977, Venda in 1979, and Ciskei in 1981.

The Western Cape was declared a Coloured labor preference area in the 1950s. Indians, granted citizenship in 1963, experienced racial discrimination in residential and trading rights.

Gender Issues

Helen Suzman (1993), a long-term antiapartheid member of parliament (MP), observed that in 1953, her first year, there were actually four women in parliament. Two were fellow United Party members, and one was a member of the Liberal Party. Suzman, a liberal, dealt primarily with racial issues, although she also advocated equal rights for women regarding marriage, divorce, abortion, and employment. White women had been enfranchised in 1930 to counter the nonwhite male vote. In general racial and gender issues were not intertwined. However, in 1955 liberal white women founded the Black Sash to protest the proposed disenfranchisement of Coloured men. Members argued for respect for the South African constitution. In the 1970s the Black Sash set up “advice offices” in major cities to assist blacks with problems regarding “influx

NELSON MANDELA



Nelson Mandela. Mandela was elected South Africa's first black president in 1994 after having spent over twenty years in prison. A well-known political activist, Mandela was arrested in 1962 and charged shortly thereafter with sabotage and conspiring against the government. © DAVID TURNLEY/CORBIS

Nelson Rolihlahla Mandela, South Africa's first black president, was born on 18 July 1918, to Chief Gadla Henry Mphakanyiswa, of Thembu royalty, and Noselkeni Fanny in the Eastern Cape village of Mveso, Transkei. After his father's death when Mandela was nine, the acting tribal chief, Jongintaba, assumed Mandela's guardianship. Mandela had access to the best education a black youth could have, attending Clarksbury Boarding Institute, Healdtown College, and University College of Fort Hare. He eventually left Transkei to avoid an arranged marriage and moved to Johannesburg.

Mandela became politicized while living in Alexandra Township by attending African National Congress (ANC) and South African Communist Party (SACP) meetings. After receiving his B.A. in 1942, he entered law school at the University of Witwatersrand. His autobiography, *Long Walk to Freedom*, includes many names

famous in the antiapartheid struggle—Walter Sisulu, A. B. Xuma, George Bizos, Bram Fischer, Robert Sobukwe, Joe Slovo, Ruth First, Oliver Tambo, and Z. K. Matthews.

Viewing the ANC leadership as too conservative, Mandela in 1943 became a founding member of the ANC Youth League, which sought to motivate the leadership to action. Shocked by the National Party victory in 1948, he and other leaders of the ANC organized a "defiance campaign," employing a variety of passive-resistance tactics against apartheid legislation. Because of these activities, ANC activists were put under government surveillance, and Mandela was eventually served with a two-year banning order (1953–1955). A banning order restricted an individual to a magisterial district. He or she was expected to report regularly to the police and was under constant police surveillance. A banned individual could not be quoted in the press, could

(continued on the next page)

NELSON MANDELA

(continued from previous page)

not work, and could not meet with more than one person at a time.

Mandela and 155 other ANC leaders were arrested during the defiance campaign. In 1956 ninety-one people were accused, and sixty-one charges were dropped due to lack of evidence (Saunders; Davenport). Thirty people were tried for treason, and all but one were acquitted, including Mandela, in 1961.

After the treason trial and the banning of the ANC and PAC, Mandela went underground in the newly formed military wing of the ANC, Umkhonto we Sizwe (Spear of the Nation), as chair of the high command. This office planned sabotage, guerrilla warfare, and open revolution. Mandela based his underground operations at a farm in the Johannesburg suburb of Rivonia. Upon his return from the Pan-African Freedom Movement of East and Central Africa meeting in Ethiopia, he was arrested near Pietermaritzburg and charged with inciting a strike and leaving the country without a passport. He received a three-year prison sentence for the former charge and a two-year sentence for the latter. While in prison, he discovered that many members of the ANC high command were arrested in Rivonia in July 1963. They were charged under the Sabotage Act of 1962, with the onus being on the accused to prove their innocence. The state had requested the death penalty. The accused were given life imprisonment on 12 June 1964. International pressure had a great impact on sparing their lives. The nine-month trial ended in June 1963 with Mandela sentenced to life imprisonment. Mandela was incarcerated on Robben Island, off Cape Town, for nearly three decades. In his

autobiography he wrote of this experience, remarking about the degree to which apartheid permeated every aspect of life in South Africa, even for those in prison, where clothing and food were differentiated according to a prisoner's race.

There were a number of attempts to free Mandela, including a major campaign in 1980. He was transferred to Pollsmoor Prison in 1982 and to Victor Vester Prison in Paarl in 1988. During this time he was allowed increasing contact with his wife, Winnie Mandela, and their two daughters. Mandela began negotiations with the South African government for his freedom and the end of apartheid while at Pollsmoor. That continued in earnest at Victor Vester Prison in May 1988. Government representatives preferred to negotiate with Mandela alone and vetoed his request to discuss the first meeting with his ANC comrades. Mandela outlined the negotiated issues as "the armed struggle, the ANC's alliance with the Communist Party, the goal of majority rule, and the idea of racial reconciliation." The government representatives were concerned that the ANC might attempt "blanket nationalization of the South African economy" as stated in the ANC's Freedom Charter. The secret talks occurred against the backdrop of internal protests by the United Democratic Alliance and the Mass Democratic Movement, a state of emergency, and international economic sanctions.

The ANC, PAC, and SACP were legalized on 2 February 1990, and Nelson Mandela was released from Victor Vester Prison on 11 February 1990. When elected president in 1994, Mandela sought to create a "Rainbow Nation," and the ANC collaborated with other political parties to form a "Government of National Unity."

control, unemployment, contracts, housing, and pensions" (Saunders).

Black women were particularly discriminated against with influx control and pass laws, extended to women in 1956. Influx control was a policy designed to direct the flow of black labor to "white" urban areas for employment and to rural

farms. With the Nationalist victory in 1948, influx control regulations were enhanced. Pass laws regulated document requirements for black people. Jacklyn Cock examined their status as domestic servants in suburban white households. In *Maids and Madams*, Cock reports on a study of 800,000 black domestic servants. She examines their status as workers and mothers and their dependency relationships with their white

HENDRIK FRENCH VERWOERD

Hendrik Frensch Verwoerd, often considered the architect of apartheid, was born in Amsterdam on 8 September 1901, six months before his parents moved to Wynberg, near Cape Town, South Africa. As a lay missionary in South Africa, Verwoerd's father received an assignment in Bulawayo, Zimbabwe, where the family lived for five years. Young Verwoerd performed well academically there and in Brandfort, Free State, South Africa, his next home. Developing a strongly anti-British political orientation in Zimbabwe, he immersed himself in Afrikaner life in Brandfort. Verwoerd completed secondary school in 1918 and proceeded to the University of Stellenbosch.

At Stellenbosch, Verwoerd was elected chair of the Students' Representative Council in 1923. He majored in sociology, psychology, and logic. After receiving his B.A., he was appointed to a position in the Psychology Department, completing his master's in 1923 and his doctorate in 1924. In 1925 Verwoerd traveled to Germany for study at Leipzig, Hamburg, and Berlin. In 1927 he and his wife, Betsie Verwoerd, returned to Stellenbosch, where he assumed a position as professor of applied sociology. Becoming chair of the Department of Sociology and Social Work in 1933 at Stellenbosch, he began to work with social welfare organizations and undertook a committee assignment on housing and unemployment focusing on the plight of poor Afrikaner whites.

Verwoerd joined the Purified Nationalist Party in 1935 as Afrikaners were attempting to unite politically and also became a member of the nativist Broederbond. He left academia to establish the Nationalist paper *Die Transvaler* in 1937. The major objective of *Die Transvaler* was to lure Afrikaners away from the British-oriented United Party and foster the idea of a Christian-National republic. During World War II, *Die Transvaler* adopted a pro-German stance and was opposed to South African involvement with the Allies. That stance became more explicitly

anti-Semitic when Nationalists sought to limit Jewish immigration, deny Jewish citizens party membership, and discourage support for their businesses.

Despite the party's national victory in parliament, Verwoerd lost his local election by a narrow margin in 1948. However, the new prime minister, Daniel F. Malan, appointed him to the senate, and in 1950 Verwoerd became minister of native affairs. In this role, which he described to his wife as the "Great Induna," or great chief, Verwoerd reviewed and restructured the entire ministry, considered the most important in the South African cabinet, and formulated a body of apartheid legislation. On the death of J. G. Strijdom, Malan's successor, Verwoerd became prime minister in 1958.

After organizing a successful whites-only referendum to create a South African republic, Verwoerd attended the Commonwealth Prime Ministers' Conference in London in 1961. There he explored the possibility of South Africa remaining a member of the British Commonwealth. Although rebuffed by the British, Canadians, and Afro-Asian bloc because of apartheid, the prime minister received a hero's welcome when he returned to South Africa in early 1961. He had hoped for commonwealth approval of South Africa's apartheid policy given the pro-British sentiment of English-speakers in the white electorate. Afrikaner Nationalists applauded South Africa's removal from the commonwealth.

Verwoerd was assassinated on 6 September 1966, before a parliamentary session in the presence of about four hundred people. The assassin, Demetrio Tsafendas, was later tried and incarcerated in mental institutions until his death in 1999. Officially classified white, he had been born in Mozambique to a Greek father and a Coloured mother. In a 2001 book Henk van Woerden argued convincingly that the assassination was politically motivated.



madams. Black domestic workers neglected their own families to be at the beck and call of the white madams and often lived in servants' quarters near the madams' houses. This enabled the madam to engage in leisure activities or to pursue employment to enhance her family's income. Cock illuminates gradations of female exploitation in the South African context in focusing on the relationship between maid and madam.

Increasing Black Nationalism

In 1952 the African National Congress, whose membership was estimated at 100,000, organized a campaign of defiance to protest racially discriminatory laws, burning passes and defying regulations concerning segregated facilities. Eighty-five hundred people were arrested during the four-month campaign, which resulted in a treason trial and the eventual acquittal of the accused. In 1955 the African National Congress and similar political organizations met and drafted the Freedom Charter, which embraced the tenets of a nonracial,

democratic society in which major capitalist enterprises would be nationalized.

Ideological differences within the ANC resulted in Robert Sobukwe breaking away to form the Pan-Africanist Congress (PAC) in 1959. In 1960 the PAC organized a campaign to protest pass laws and low wages. At Sharpeville, near Johannesburg, in March 1960, police opened fire on a crowd of demonstrators, killing 69 and injuring some 180. The government declared a state of emergency and arrested 1,600 people. The massacre precipitated international condemnation of the South African government, diminished investor confidence, and threw the economy into recession.

After Sharpeville, the ANC and PAC were banned, initiating underground political activity. Nelson Mandela, who had already been imprisoned on other charges, and his compatriots, taken into custody at a farm in the Johannesburg suburb of Rivonia, site of the ANC's underground headquarters, were

HELEN GAVRONSKY

Helen Gavronsky was born to Lithuanian Jewish immigrant parents near Johannesburg in 1917. She married Moses Suzman in 1937 and had two daughters. Later she returned to the University of the Witwatersrand to complete her B.A. Then she was hired as a lecturer in economic history. The United Party invited her to run for a seat in Houghton, a northern suburb of Johannesburg, in 1952. With the support of her husband, she successfully ran for the seat, which required her absence from her family while residing in Cape Town half a year. In parliament Suzman was a proponent of racial equality, South Africa's return to the commonwealth, rule of law, and the administration of justice. During her tenure in parliament she visited prisons, townships, and "resettlement areas" in the rural homelands. She was in parliament when Hendrik Verwoerd was assassinated and visited Nelson Mandela on Robben Island and in Pollsmoor Prison.

Often at odds with the United Party over apartheid legislation, she formed the Progressive Party in 1959 and became its sole representative. After fourteen years, six colleagues joined her in 1974. Although it was unpopular to participate in an increasingly oppressive apartheid parliament, Suzman was a vigorous advocate of racial equality. Despite their admiration, many black South Africans were critical of her antisansctions stance in the 1980s.

Suzman received many international honors, including honorary degrees from Oxford, Cambridge, and Harvard; the United Nations Human Rights Award (1978) and Medallion of Heroism (1980); and the Liberal International Prize for Freedom (2002). Suzman left parliament in 1989 but continued her activities in the Helen Suzman Foundation, which is devoted to liberal causes.

charged with sabotage and conspiracy to overthrow the government. In 1964 all but one of the codefendants were sentenced to life imprisonment. The Rivonia trial signaled the cessation of black nationalist resistance in South Africa. Many members of banned organizations sought refuge in other countries. Neighboring colonies provided South Africa a protective buffer against guerrilla insurgency, investor confidence was restored, and the country embarked on a period of economic prosperity. Meanwhile, after an all-white referendum, South Africa was declared a republic outside the commonwealth in 1961.

Dismantling of Apartheid

The outbreak of the Soweto riots in 1976 marked the denouement in the South African struggle. Students in the Johannesburg township rioted when the government made Afrikaans the language of school instruction in science subjects. Combating police bullets with sticks and stones, hundreds of students were killed. Others fled the country. The ANC set up recruitment stations in Mozambique from which refugees were transferred for military training. Coloured students in Cape Town intensified their activism. Unrest continued around the country and lasted well into 1977, having a deleterious effect on the economy. Refugees, both male and female, began to infiltrate the country to conduct acts of sabotage.

South Africa's protective buffers began to erode in 1975 with the independence of Angola and Mozambique, followed by that of Zimbabwe in 1980, allowing for increasing guerrilla infiltration into the country. After the Muldergate information

scandal, P. W. Botha, minister of defense, became prime minister in 1978. Muldergate was an information scandal in which substantial sums of money allocated to buy international media support for apartheid was funneled to the *Citizen*, a pro-government newspaper in Johannesburg (Saunders, p. 116). The disclosure and attempted cover-up precipitated dissension within the ranks of the National Party. Botha's total strategy combined militarism and reform.

Recognizing the potential for a racial bloodbath, the Nationalists sought a "consociational democracy" in which no racial group would dominate. In an effort to bring legitimate leaders to the negotiating table, a campaign began to free the long-imprisoned ANC leader Nelson Mandela in the early 1980s. The president (formerly prime minister) proposed a tricameral parliament with chambers for Asians, Coloureds, and whites. The exclusion of those classified African led to the formation of the United Democratic Front to coordinate activism within the country.

In the mid-1980s major Western powers initiated economic sanctions against apartheid South Africa. Governmental negotiations began in 1990, when Mandela was released from prison. The ANC and other liberation organizations were "unbanned," or legitimized. An interim constitution was written, and elections were held in 1994. The ANC was victorious nationally.

Conclusion

When South Africa celebrated its first decade of postapartheid government, it had rejoined the commonwealth and a number

of international bodies. The ANC was returned to power for a third term in April 2004 with 70 percent of the vote. Some progress had been made toward racial equality despite inequities in the distribution of wealth. However, South Africa continued to grapple with the legacy of apartheid—high unemployment, low literacy rates, inadequate housing, the HIV/AIDS pandemic, and the dynamics of globalization. In the early twenty-first century the unemployment rate was estimated at 38 to 40 percent. According to the South African Survey 1999, one-third of South Africans needed adequate housing. The HIV rate in prenatal clinics was 22.8 percent in 1998.

South Africa is not viewed as competitive in global production due to high labor costs. A number of mining and manufacturing enterprises have established branches in other African countries. The government seeks to attract new investment and to enhance the skills of its black labor force. With regard to the Internet, in the early twenty-first century South Africa was the best-wired country in Africa.

See also *Prejudice; Race and Racism; Segregation*.

BIBLIOGRAPHY

- Adam, Heribert. *Modernizing Racial Domination: South Africa's Political Dynamics*. Berkeley: University of California Press, 1971.
- Ballinger, Margaret. *From Union to Apartheid: A Trek to Isolation*. Cape Town: Juta, 1969.
- Bernstein, Hilda. *For Their Triumphs and for Their Tears: Conditions and Resistance of Women in Apartheid South Africa*. London: International Defence and Aid Fund, 1978.
- Biko, Steve. *I Write What I Like*. Edited by Aelred Stubbs. New York: Harper and Row, 1979.
- Cock, Jacklyn. *Maids and Madams: A Study in the Politics of Exploitation*. Johannesburg: Ravan, 1980.
- Davenport, T. R. H., and Christopher Saunders. *South Africa: A Modern History*. 5th ed. New York: St. Martin's, 2000.
- Davis, Stephen M. *Apartheid's Rebels: Inside South Africa's Hidden War*. New Haven, Conn.: Yale University Press, 1987.
- De Klerk, F. W. *The Last Trek: A New Beginning*. London: Macmillan, 1998.
- Desmond, Cosmos. *The Discarded People: An Account of African Resettlement in South Africa*. Harmondsworth, U.K.: Penguin, 1970.
- Doxey, G. V. *The Industrial Colour Bar in South Africa*. Cape Town and New York: Oxford University Press, 1961.
- Forgey, Herma, et al. *South African Survey 1999/2000*. Johannesburg: South African Institute of Race Relations, 2000.
- Gregory, T. E. *Ernest Oppenheimer and the Economic Development of Southern Africa*. Cape Town and New York: Oxford University Press, 1962.
- Hepple, Alexander. *Verwoerd*. Harmondsworth, U.K.: Penguin, 1967.
- Hirson, Baruch. *Year of Fire, Year of Ash: The Soweto Revolt, Roots of a Revolution?* London: Zed, 1979.
- James, Wilmot G., ed. *The State of Apartheid*. Boulder, Colo.: L. Rienner, 1987.
- Johnstone, Frederick A. *Class, Race, and Gold: A Study of Class Relations and Racial Discrimination in South Africa*. London and Boston: Routledge and Kegan Paul, 1976.
- Kadali, Clements. *My Life and the ICU: The Autobiography of a Black Trade Unionist in South Africa*. New York: Humanities, 1970.
- Kuzwayo, Ellen. *Call Me Woman*. San Francisco: Spinster's Ink, 1985.
- La Guma, Alex, ed. *Apartheid: A Collection of Writings on South African Racism by South Africans*. New York: International, 1971.
- Lambley, Peter. *The Psychology of Apartheid*. Athens: University of Georgia Press, 1980.
- Le May, G. H. L. *Black and White in South Africa: The Politics of Survival*. New York: American Heritage, 1971.
- Lerumo, A. *Fifty Fighting Years: The Communist Party of South Africa, 1921–1971*. London: Inkululeko, 1971.
- Luthuli, A. J. *Let My People Go*. New York: McGraw-Hill, 1962.
- Magubane, Bernard. *The Political Economy of Race and Class in South Africa*. New York: Monthly Review, 1979.
- Mandela, Nelson. *Long Walk to Freedom: The Autobiography of Nelson Mandela*. Boston: Little, Brown, 1994.
- . *No Easy Walk to Freedom: Articles, Speeches, and Trial Addresses of Nelson Mandela*. London: Heinemann, 1973.
- Mbeki, Govan. *South Africa: The Peasants' Revolt*. Baltimore: Penguin, 1964.
- Michelman, Cherry. *The Black Sash of South Africa: A Case Study in Liberalism*. Oxford and New York: Oxford University Press, 1975.
- Moodie, T. Dunbar. *The Rise of Afrikanerdom: Power, Apartheid, and the Afrikaner Civil Religion*. Berkeley: University of California Press, 1975.
- Murray, Martin. *South Africa: Time of Agony, Time of Destiny: The Upsurge of Popular Protest*. London: Verso, 1987.
- Nkomo, Mokubung. *Student Culture and Activism in Black South African Universities: The Roots of Resistance*. Westport, Conn.: Greenwood, 1984.
- Ramphele, Mamphela. *A Bed Called Home: Life in the Migrant Labour Hostels of Cape Town*. Cape Town: David Philip; Athens: Ohio University Press, 1993.
- Rees, Mervyn, and Chris Day. *Muldergate: The Story of the Info Scandal*. Johannesburg: Macmillan, 1980.
- Saunders, Christopher. *Historical Dictionary of South Africa*. Metuchen, N.J., and London: Scarecrow Press, 1983.
- Seidman, Ann, and Neva Seidman. *South Africa and U.S. Multinational Corporations*. Westport, Conn.: L. Hill, 1978.
- Shimoni, Gideon. *Jews and Zionism: The South African Experience (1910–1967)*. Cape Town: Oxford University Press, 1980.
- Slabbert, F. van Zyl, and David Welsh. *South Africa's Options: Strategies for Sharing Power*. New York: St. Martin's, 1979.
- Stultz, Newell M. *Afrikaner Politics in South Africa, 1934–1948*. Berkeley: University of California Press, 1974.
- Suzman, Helen. *In No Uncertain Terms: A South African Memoir*. New York: Knopf, 1993.
- Thompson, Leonard. *The Political Mythology of Apartheid*. New Haven, Conn.: Yale University Press, 1985.
- Troup, Freda. *Forbidden Pastures: Education under Apartheid*. London: International Defence and Aid Fund, 1976.
- Tutu, Desmond. *Crying in the Wilderness: The Struggle for Justice in South Africa*. Grand Rapids, Mich.: W. B. Eerdmans, 1982.
- Walshe, Peter. *The Rise of African Nationalism in South Africa: The African National Congress, 1912–1952*. Berkeley: University of California Press, 1971.
- Wilson, Frances. "Farming 1866–1966." In *The Oxford History of South Africa*, vol. 2, edited by Monica Wilson and Leonard Thompson. New York: Oxford University Press, 1971.
- Woerden, Henk van. *The Assassin: A Story of Race and Rage in the Land of Apartheid*. New York: Metropolitan, 2001.

Betty J. Harris

APOCALYPSE. See *Dystopia; Eschatology; Nuclear Age.*

APPEARANCE AND REALITY. See *Metaphysics.*

ARCHITECTURE.

This entry includes three subentries:

Overview

Africa

Asia

OVERVIEW

Architecture is the crystallization of ideas. Architecture has been defined many ways—as shelter in the form of art, as a blossoming in stone and a flowering of geometry (Ralph Waldo Emerson), as frozen music (Johann Wolfgang von Goethe), man’s triumph over gravitation and his will to power (Friedrich Nietzsche), the will of an epoch translated into space (architect Mies van der Rohe), the magnificent play of forms in light (architect Le Corbusier), a cultural instrument (architect Louis I. Kahn), or inhabited sculpture (sculptor Constantin Brancusi). The architectural critic Ada Louise Huxtable framed a rather clinical definition, saying architecture is a “balance of structural science and aesthetic expression for the satisfaction of needs far beyond the utilitarian.” Most people in the early twenty-first century—users, that is, as opposed to designers and critics—seldom think of architecture as anything more than a mute utilitarian container. Yet architecture is a form of nonverbal communication, as was recognized by many builders in centuries past. Architecture speaks volumes about the values and priorities of the designer or architect, and of those who built it. This view of architecture has been voiced by many commentators but was expressed particularly well by the nineteenth-century critic John Ruskin, who pointed out in his preface to *St. Mark’s Rest* (1877) that nations “write their autobiographies in three manuscripts—the book of their deeds, the book of their words, and the book of their art. Not one of these books can be understood unless we read the other two; but of the three, the only quite trustworthy one is the last.”

Accounts of military exploits and written expressions of theory and practice are records of ideas often subtly worded to shade the values of a time and culture; architecture, in contrast, is fundamentally driven by the most essential economic pressures. Architecture therefore is a truly revealing cultural artifact. In contrast to all the other durable visual arts, architecture comes into being only through the coordinated efforts of client, architect, builder, and scores of workers, and therefore—since it requires such a formidable financial investment—caprice and personal whimsy are normally restricted, replaced by the pressures of what is truly important in the culture of client, architect, and builder. Architecture is a “bottom line” art form. Moreover, who people are and what they do is influenced, if not determined, by the architecture around them. As Winston Churchill suggested in speaking to Parliament in 1944, “we shape our buildings, and afterwards our buildings shape us.”

Early Humans in Europe

Buildings or shelters were being constructed by early human ancestors as early as 400,000 to 300,000 years ago, judging from the traces found at a site called Terra Amata, near Nice, France. The remains of the oldest human dwellings found so far do not suggest anything other than protection from the elements, but that must have changed with the rise of thinking in terms of symbols and metaphors between 50,000 and 30,000 years ago among Neanderthal people in Europe and certainly their Cro-Magnon *homo sapiens* successors. How symbolic thinking may have found expression in shelters so far has been impossible to determine, for all that survives from the infancy of modern humans are nonorganic materials; whatever else they may have built of timbers and hides, or carved in wood, long ago disappeared. The tantalizing evidence that does endure is found in the skilled paintings of animals and cryptic symbols created deep in the caves of Spain and France, in Australia, and at other locations.

Also suggesting a complex system of spiritual belief is the evidence of careful and thoughtful burial given some Neanderthal individuals, which became more customary for the Cro-Magnon. Reverence and respect for the remains of the dead as departed members of the human community seems to have developed about 250,000 years ago, along with ideas concerning some persistence of life after death, or at least the notion that the remains of dead parents, elders, and children merited care and reverence. Megalithic stone burial chambers were built in France and Ireland as early as 6,700 years ago (4700 B.C.E.). Cut into the limestone hill of Hal Saflieni, Malta, is a tomb called the “hypogeum,” carved perhaps 5,500 years ago (3500 B.C.E.). Because it was excavated long ago, much of its chronological evidence was destroyed, but another semisubterranean burial site on the Maltese island of Gozo, called the Brochtorff Circle, was excavated in the 1990s and more accurately dated as having been built roughly 6,000 years ago.

Built evidence suggests that around 5,500 years ago the notion of time as a continual cycle of recurring celestial events was well developed in northern Europe, as the technically sophisticated construction of such sites as the Newgrange tomb in the Boyne Valley of Ireland (constructed 5,200 years ago) and the first phases of construction at Stonehenge in the plain of Salisbury, Wiltshire, England (started about 4,950 years ago) demonstrate. The enormous well-known megalithic stones at Stonehenge were put in place much later, between 4,000 and 3,500 years ago. These sites were carefully constructed to mark critical points in the cycle of the year, such as the day of the winter solstice sunrise and the summer solstice sunrise and sunset.

Antiquity: Egypt, Greece, Rome

Egypt. In ancient Egypt, Greece, and Rome architecture reflected the worldviews and underlying concepts of each society itself. The culture of ancient Egypt was rooted in chronometric concepts—the cycle of the year, the notion of time extending endlessly from the past toward an unfathomable future, the human spirit continuing in existence into this future. As Herodotus (c. 484–c. 420 B.C.E.) observed in his *Histories*,



Aerial view of Stonehenge, Wiltshire, England. Some early constructions, such as that of Stonehenge, which was constructed in three phases between 2950–1500 B.C.E., were dedicated to marking time and the cycle of seasons throughout the year. © JASON HAWKES/CORBIS

Egypt is the gift of the Nile, a long linear oasis extending from the south to the north, where the river expands into its delta and empties into the Mediterranean. Across this south-north line lies the east-west path of the sun. These two orthogonal lines and the cycles of what define them—the daily passage of the sun and the yearly rising flood and lowering of the river—also define the human life cycles of ancient Egypt. Geometry and symmetry were fundamental to this life, both in remeasuring the fields after inundation and in laying out the ancient temples, the houses of the gods where endless ceremonies were carried out during the course of the year. The linear, rigorously ordered grid of the temple layout exemplified the idea of *ma'at*, a concept that combines the ideas of truth, justice, order, stability, security, harmony—the total of the right order of things that was established by the gods at the creation of the world.

For artisans, scribes, officials, and others who served the bureaucracies, life could be very pleasant in the valley of the

Nile, at least during the politically settled periods that lasted hundreds of years. So the ancient Egyptians came to think that following death, an individual's soul passed into an afterlife where—properly provided for with a preserved physical body and stores of food and drink, and assisted by statue-substitute servants—life could be enjoyed forever. It was for this reason that so much of the Egyptians' creative effort and energies went into the building of their temples, tombs, and (for the Pharaoh god-kings) the pyramids that were their ascent stairs to join the gods. Their focus was on the life to come.

Greece. The Greeks, for whom daily life was a much more arduous and risky affair, focused not on an unverifiable spiritual life after death but on achieving knowable excellence of human achievement in this world. Their term for this was *aretē*, that quality of excellence that comes from studied refinement, skill, and testing, demonstrated by achievement through valor in war or athletic competition or contest, *agōn*. Excellence could be

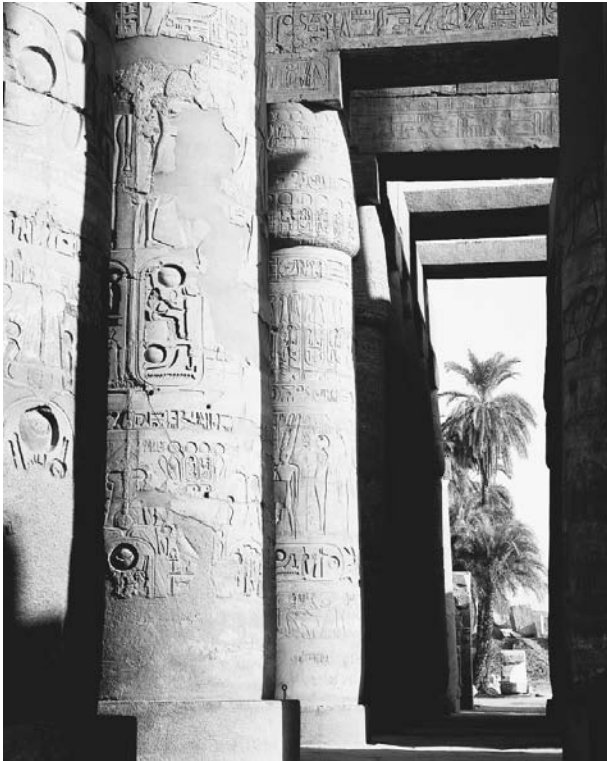

Columns at the Hypostyle Hall of The Temple of Amon, Al Karnak, Egypt. Constructed c. 1315–1235 B.C.E. Ancient Egyptian society gradually came to ascribe special significance to the afterlife, and thus much care and detail was given to the design of temples and tombs. © ROYALTY-FREE/CORBIS

represented in poetry, music, and athletic skill—all of which were the subject of contests—as well as in sculpture and architecture. Through such contests individuals learned their abilities and limitations, what the priests of Apollo meant when they said “know thyself.” In all things the ancient Greeks sought *logos*, a concept that encompasses reason, logic, generating idea, conception, a natural order that existed in the world, the opposite of *chaos*. The Greeks strove to realize this ideal of balance and symmetry (from *symmetria*, meaning “of like measure”). Heraclitus (c. 540–c. 480 B.C.E.) described this concept of symmetry, saying “measure and logos are firm in a changing world,” and describing how cold is balanced by hot, day by night, health by disease. The risk was that such mental constructs might venture into the realm of mystic speculation, as was somewhat the case with Pythagoras of Samos (c. 580–c. 500 B.C.E.), who asserted that the universe was governed by a symmetry of numbers, demonstrated by the harmonic sounds created by vibrating strings of proportional lengths. Out of this theorizing, however, came such highly useful mathematical demonstrations as the Pythagorean theory describing how the areas of the squares drawn on the two sides of a right triangle are together equal to the area of the larger square drawn on the side of the connecting side, or hypotenuse.

This perfection of mathematical proportions and excellence in construction was embodied in the Greek temples, buildings erected in durable permanent materials such as marble, with

blocks having sides ground to perfect planes that fitted together so tightly that a knife blade could not be inserted between them. In particular, the temple dedicated to Athena Parthenos (the Parthenon), built atop the Athenian acropolis in 447–438 B.C.E., in addition to having this precision of assembly, also incorporated in its design numerous interrelated proportional systems governing such dimensions as the ratio of building length to width to height, and the thickness and spacing of the outer ring of marble columns, among many other dimensions and relationships. Moreover, it incorporated a subtle inward slant to the columns, especially a diagonal inward slant to the corner columns, as well as optical corrections, such as the upward swelling curvature of the base repeated in the upward curve of all the parallel horizontal lines of the building. These nearly imperceptible optical corrections make the building appear to be straighter and lighter, more perfect, than is physically the case. What the eye actually sees, then, and what the mind expects to see, are not in exact agreement. The result is that the building constantly shimmers and shifts in the viewer’s perception between these two subtly conflicting mental activities, giving it a visual stimulation that has excited comment since the time of its construction.

Rome. Greek architecture is not particularly concerned with the enclosure of interior public spaces. Most activities in the Greek city-state polis took place in outdoor spaces such as the agora (marketplace) or the open precincts around temples. The Romans, however, developed numerous kinds of public buildings to house groups of people—law courts (basilicas), markets, and baths, among others—as cities across their empire grew in size and density of population. To certain abstract constructs of Greek culture and learning, the Romans added a practical mind-set that enabled them to solve technical problems such as supplying water to their cities and carrying away waste products. They adopted arch and vault construction for a wide variety of buildings. To this they added the use of readily available volcanically modified materials to make a form of natural concrete. Using this concrete enabled Romans to vault spans of unprecedented size in their public buildings.

All these social programs and architectural developments come together in the Roman public baths, versions of which were built in cities the length and breadth of the empire, including Bath, in England, and Paris among countless other settlements. Aqueducts, carried aloft on stacked arches, brought water into the baths, where it was heated and distributed to the various bathing areas, with cold, tepid, and warm pools. In the warm bath areas the rooms themselves were heated by means of hollow passages under the floor and running up through the walls, acting as so many chimney flues for fires kept burning in side furnaces. In the early 2000s the great public baths of the city of Rome stand, mostly in fragmented unroofed portions, as testaments to the engineering skill of the Romans, but a better sense of the majesty of these vast spaces can still be glimpsed in the church of Santa Maria degli Angeli, originally the baths built by the emperor Diocletian in 298–306 C.E., but sufficiently intact to be converted into a huge church with monastery by Michelangelo in the mid-sixteenth century.

Romans, for the most part, were concerned with the here and now. During the republican period Romans embraced the



The Parthenon (Temple of Athena Parthenos), Athens, Greece. The focus of ancient Greek architecture was symmetry and harmonious proportions. The design of the Parthenon, which was constructed 447–438 B.C.E., displays the precision and exacting detail to construction common to the period. © HECTOR WILLIAMS

quality of *gravitas*, a sense of the importance of matters at hand, combined with ingrained discipline, patriotic responsibility, and seriousness of purpose, austerity, conservatism, and a deep respect for tradition. A good Roman citizen upheld a rigid morality, served the state, maintained unimpeachable honor, and strove for a physical and spiritual asceticism—all qualities discernable in the first Roman emperor, Augustus (r. 27 B.C.E.–14 C.E.) himself. It is all too easy to think of Romans comporting themselves as commonly depicted in novels and films, devoted to depravity and sensual excess, but this was more the case during the later empire. The goal of many earnest Romans in the first centuries after Augustus was to reestablish the moral standards of the republican past. In many ways, the best representative of the Roman personal values of probity and self-discipline can be found in the emperor Marcus Aurelius (r. 161–180), trained in the tradition of the Greek Stoics. His *Meditations*, intended for his personal reflection—with their repeated admonitions to uphold personal honor because of its basic practicality—are a tribute to the persistence of republican virtues.

Middle Ages

Even around 175 C.E., as Marcus Aurelius was writing his *Meditations*, Christianity was spreading across the empire. Of the various cults and religions that vied for converts during the early years of what has come to be called the common era,

Christianity was the most persuasive for several reasons. Unlike the impersonal state religion of Rome, with its removed and depersonalized rituals to placate Jupiter and the deified emperors, Christianity offered direct communication with a personalized deity, embodied in the crucified Christ. The present world, with all of its shortcomings and disappointments, was seen as only the preparation ground for a subsequent eternal life. The classical focus on the practicalities of the here and now faded in importance. In the West, the old Roman Empire was transformed, through invasion after invasion from the north and east, as well as through the rise of Christianity, whose strong vertical bureaucratic structure took on much of the character of the fading Roman government. The old position of the Roman emperor as chief priest (*pontifex maximus*) was taken over by the bishop of Rome as head of all bishops, and therefore head of the church.

Although Christianity maintained that all humans are born in original sin, and are destined to persist in this fallen state, doomed to spend eternity in Hell, doctrine held out the hope of Heaven. This consuming aspiration, directed away from the present world in favor of the next, is embodied in the abundant and mutually reinforcing vertical motifs in Gothic architecture, developed in France and other areas of Europe around 1150. Every line of the Gothic cathedral seems to point toward heaven. Moreover, the architecture is covered across its entire



Baths of Diocletian, Rome, Italy (built 298–306 B.C.E.), refurbished as the Church of Santa Maria degli Angeli (interior). In ancient Rome, the use of modified concrete led to buildings that were large and spacious, as can be seen in this church, which was converted in the mid-sixteenth century from a public bath house. © ELIO CIOL/CORBIS

surface with sculpted images drawn from Scripture and the lives of the saints. Influenced by the writings of the abbé Suger of St.-Denis, architects opened up ever larger clerestory windows in the upper ranges of the churches and cathedrals. The windows were filled with highly colorful stained glass, an allegory of divine light, with images amplifying the stories told in the stone carvings. The churches became veritable Bibles in stone and colored glass, inculcating scriptural lessons in the faithful.

The later High Gothic urban cathedrals, for the most part dedicated to the Virgin Mother—Our Lady, or Notre Dame,

in French-speaking regions—were not only ecclesiastical buildings commissioned and paid for in part by the church, but also municipal undertakings raised to celebrate the status and power of the cities. Often the naves of these cathedrals were owned by the city, while the transept and crossing area as well as the choir were church property.

Renaissance. The culture of the so-called Middle Ages in Europe, focused on the life of the church, was bolstered by Scholasticism and the infusion of Aristotelian logic through the writing of St. Thomas Aquinas (c. 1224–1274). By the



Cathedral of Saint-Pierre, Beauvais, France. Constructed 1125–1548. The architecture of cathedrals built during the Gothic period focused on soaring lines and arches. Light was abundant, and facades were decorated with religious imagery. © PAUL ALMASY/CORBIS

fourteenth century, with the growth of merchant cities in Italy and the development of banking, wealthy merchants began to underwrite the new scholarly study of Roman and Greek literature and history, not so much to augment religious doctrine but for its own inherent merit and political implications. In fact, in Florence, where the powerful and enormously wealthy Medici family supported scholars and artists, the qualities of humanism were seen as demonstrating how the self-governing Florentines were superior to the autocratic rulers of other Italian states. Thus was set in motion a rebirth of ancient classical learning, a Renaissance.

The challenge of the time was to link humanist study with religious doctrine, to uncover how the knowledge of the ancients paralleled and thus supported church doctrine; the means for this was a reinvigorated Neoplatonism. Just as Scripture maintained that Adam had been made in the physical image of an all-perfect god, so too did the pagan Roman architect Vitruvius (1st cent. B.C.E.) declare that within the form of the human body could be found the modules of the most perfect geometric forms, the circle and the square. His written description was beautifully depicted in the well-known drawing by Renaissance artist/architect Leonardo da Vinci, planned as



Santa Maria delle Carceri Church, Prato, Italy. Constructed 1485–1506. In Italy during the Middle Ages, most religious architecture was simple and clean in design, comprised of balanced combinations of circles and squares. © DENNIS MARSICO/CORBIS

an illustration for a new edition of Vitruvius's *Ten Books on Architecture*: a man with outstretched arms just touches the edges of a circle and square.

The circle and square became the measure of perfect architectural form as well in scores of new churches and chapels built in Italy. Of the many examples, the small church of Santa Maria delle Carceri in Prato, designed by Giuliano da Sangallo in 1485, shows this modular perfection well. Its basic plan is a square of about 38 feet, extended upward to the top of the main cornice to form a cube. Short half-square arms project on the four sides. Atop the internal cube span four semicircular arches (half the height of the cube), and these define four curved pendentives that carry the topmost dome, circular in plan and nearly a perfect hemisphere in section. Circles and squares, and their three-dimensional counterparts, define the edges and perimeters of this idealized building.

The Renaissance emphasis on the ability of the human mind to grasp the rational structure of the universe led Martin Luther (1483–1546) to analyze the New Testament in search of support of papal practices, particularly the sale of indulgences. Instead, Luther uncovered in the letters of St. Paul the assertion that salvation was God's gift through faith and repentance, not something to be parceled out by, much less purchased from, an established church and clerical hierarchy. Coupled with the desire of numerous German princes to shed the political yoke imposed by the Roman Church, Luther's church reforms led to a splintering of the church universal. Delayed in reacting to this attack, the Roman Church convened the Council of Trent (1545–1563) to draft responses to the Reformation split in the church. Whereas the Reformationists, to varying degrees, shunned the use of sensory aids in worship—and in certain

regions of Northern Europe engaged in the wholesale destruction of paintings and statuary—the Council of Trent decreed that, on the contrary, the ordinary worshiper can only grasp the mysteries of faith with difficulty and so highly evocative painted and sculpted imagery were to be emphatically employed. A superb illustration of this dictum can be found in the highly emotive and mysteriously illuminated sculpted figure of St. Theresa found at the end of the right transept arm of the church of Santa Maria della Vittoria, Rome, built by Gian Lorenzo Bernini in 1645–1652. Here in a total work of art, fusing painting, sculpture, and architectural enframement, the ecstatic divine experience of St. Theresa is shown to the common worshiper in terms of seemingly carnal ecstasy, an analogy easily understood. Architecture, merged with painting and sculpture, was to serve as an instrument of propaganda in bringing the strayed faithful back into the protective arms of Mother Church (exactly the image Bernini said he was after in the curved encircling colonnade of his new piazza in front of the huge basilica of St. Peter's in Rome).

Modern Era

The emphasis on the place of human understanding and reason, on rational analysis, initiated by the Renaissance and Reformation, reemerged in the eighteenth century.

Enlightenment. During the so-called Age of Reason, or Age of Enlightenment, scientific analysis of the structural forces at work in a building began to be modeled mathematically, and the strength of building materials such as different woods and stones were tested and recorded in statistical tables. A good example in which the Age of Faith and the Age of Reason overlap can be seen in the Church of Saint Geneviève in Paris, begun in 1755 by architect Jacques-Germain Soufflot. Returning to the perfected forms of the Renaissance, Soufflot used a plan based on a Greek cross, with four arms of equal length extending from a central rotunda capped with a dome. Heavily influenced by what he had learned on a recent trip to southern Italy to inspect and study the ruined Greek temples at Paestum, near Naples, Soufflot used rows of structural Corinthian columns inside the church, balancing the weight of the smaller domes over the arms of the building directly on these columns. Seldom in the preceding three centuries had free-standing columns been used—as in ancient Greek architecture—for true structural support. Moreover, the great central dome was supported by slender piers. Using his knowledge of the strength of materials, Soufflot made the entire building much more delicate and lighter in appearance than had been the accepted norm. When cracks began to appear in the dome piers, construction was ordered halted while Soufflot's computations were subjected to scrutiny. Overall, Soufflot's calculations were proven to be correct, although some strengthening of the building took place. The building was finished in 1790 after Soufflot's death, but such was the shift in ideology and patronage in those tumultuous years of the French Revolution that the church was desacralized and converted to become the Panthéon, a memorial to great deceased French military and literary heroes.

United States. The nascent utilitarianism incorporated into the design of the Panthéon was carried to the newly formed



Nineteenth-century drawing of the Panthéon (originally Church of Saint Geneviève), Paris, France. Constructed 1755–1790. During the Age of Enlightenment, attention began to be paid to different methods of structural support, one example being the freestanding columns Jacques-Germain Soufflot used in his design for the Panthéon. © ARCHIVO ICONOGRAFICO, S.A./CORBIS

United States of America where the demands of commerce became the driving cultural force. The greatest and most innovative achievements made by American architects were not in churches, nor even in buildings to house representative government; in these they borrowed heavily from Greek and Roman and even Renaissance models. Instead their most innovative achievements were made in the design of the freestanding single family residence (as in the work of McKim, Mead & White in their early years, and in the career of Frank Lloyd Wright) but most recognizably in soaring office skyscraper towers. The first accomplishments were made in Chicago in the 1880s and 1890s in ten- and twenty-story office towers, but the lead soon passed to New York architects, who piled floor upon floor to create spires of forty and fifty stories. In an effort to attach a measure of culture and time-honored respectability to his world headquarters, Frank W. Woolworth instructed his architect Cass Gilbert to model his new fifty-five-story office building, to be named the Woolworth Building, on northern Gothic European guild halls. Although a marvel of applied engineering—from its massive caisson foundations extending to bedrock, to its steel frame clad in terra

cotta panels, to its innovative elevator system, among scores of other technical innovations—externally the building is Gothic in style, artfully composed, like Gothic churches, with every line straining heavenward. Here, however, the aspiration is not for heaven, but for self-advertisement, aggrandizement, and profits. Woolworth called it a “Cathedral of Commerce.” The apotheosis of the American office tower was reached in the soaring 102-story Empire State Building, 1929–1931, begun just months before the onset of the Great Depression. The tallest building in the world, it was not surpassed in height for thirty years.

American office skyscrapers became ever taller by the mid-twentieth century—sixty, eighty, and finally a hundred stories. These were proud towers, often showing little real concern on the part of patrons or architects for the impact on urban scale. They became symbols of American enterprise, and were first exported by American corporations around the world, and then embraced by developing countries around the globe in the late twentieth century. Even where the concentration of activities into narrow soaring towers made no practical sense—most



The Empire State Building, New York City. Constructed 1929–1931. In the United States, most advancements in architecture were based on the societal need for copious office space, leading to structures that reached over a hundred stories into the air. The Empire State Building held the record for world’s tallest office building for thirty years. © BETTMANN/CORBIS

notably in the twin Petronas towers designed for Kuala Lumpur, Malaysia, in 1996, by the American architect Cesar Pelli, to rise 1,476 feet or 450 meters—towers they became nonetheless, as symbols of national power and pride. Such dramatic symbols, proud, standing free in the open air, inescapable emblems of American cultural imperialism (in some viewers’ eyes), proved irresistible targets for terrorists at the dawn of the twenty-first century. Damaged in 1993 by a bomb, the twin World Trade Center towers (1,368 ft., 417 m) were brought crashing to the ground on 11 September 2001, after terrorists used commercial aircraft as flying bombs. For the terrorists, the ideas represented by the towers were too loathsome to let stand.

Postmodernism

As the twenty-first century opened, new architectural paradigms emerged. One building type that gained new cachet as the embodiment of urban identity and cultural striving was the art museum. Such commissions came to represent the pinnacle of an architect’s career, particularly after Frank Gehry made the small city of Bilbao, Spain, a cultural destination with his Guggenheim Museum on the waterfront there.

Gehry’s free-form undulating buildings are only one representation of postmodernism, a multifaceted philosophical



MBF Tower, Penang, Malaysia. Constructed 1990–1993. In designing the MBF Tower, architect Ken Yeang utilized construction methods that allowed for natural light and ventilation, a technique seen more and more frequently in the twenty-first century. PABLO ZIEGLER / EMPORIS.COM

and artistic expression derived from literary analysis. In many instances the drive of late-twentieth-century architects to break the strictures of conventional mid-twentieth-century modernism rendered their efforts both disjointed and self-absorbed. The counterpart to this kind of postmodernism is found in so-called developing countries around the globe. Since roughly 1950 there has been a growing reawakening in these areas to long-standing regional building cultures and building methods. This “critical regionalism” encourages architects to draw once again on the wisdom gained in centuries of construction in their regions, in preference to the imported European and American building forms and methods, with the accompanying reliance on high energy consumption for lighting, heating, and cooling buildings. This regionalism began with the work of Hasan Fathy in Egypt and his advocacy of adobe brick in vaulted and domed construction, a time-honored building method in that land, and one that used building materials available at minimal cost. More recently in Egypt, Saudi Arabia, numerous Middle Eastern countries, and generally in the Third World nations, there has been a return to traditional building forms (but often using twentieth-century materials) for various public buildings but especially for mosques because of their strong symbolic importance. In Sri Lanka, architect Geoffrey Bawa drew on imagery associated with traditional small-scale village meeting houses for his expansive Sri Lanka



Parliament of Sri Lanka, Kotte (near Colombo). Constructed 1980–1983. Beginning in the mid-twentieth century, some architects advocated a return to traditional designs that drew upon the resources readily available in the area. Drawing internally on the British House of Commons, the external forms are inspired by ancestral local buildings of assembly. © 2004 LANDOV LLC. ALL RIGHTS RESERVED. REPRODUCED BY PERMISSION

Parliament building complex; its recognizable broad overhanging eaves and open pavilion-like structures providing shade and free movement of air in this tropical country.

Around the globe, as the twenty-first century began there was rising interest in sustainable building design and construction, in using materials in ways that minimize toxic production methods, and in using natural sunlight for energy and natural air movement and water for cooling. In this way, over time, the impact of such architecture on public resources will be limited and the total social and economic cost minimized. Among many late-twentieth-century architects who drew on this design philosophy, one whose work is particularly interesting is Ken Yeang of Malaysia. His thirty-two-story MBF Tower in Penang employs the skyscraper tower form, a symbol of progressive modernity, but also uses traditional ideas such as curved external terraces and separation of elements to promote natural ventilation in place of massive cooling machinery.

These examples demonstrate that there need be no elemental conflict between the use of modern materials such as concrete, glass, steel, and aluminum in the creation of traditional forms that reflect long-established ways of living and also make accommodation to local climatic conditions.

See also Aesthetics; Arts; Modernism; Postmodernism; Sacred Places.

BIBLIOGRAPHY

- Bergdoll, Barry. *European Architecture, 1750–1890*. New York: Oxford University Press, 2000.
- Bony, Jean. *French Gothic Architecture of the Twelfth and Thirteenth Centuries*. Berkeley: University of California Press, 1983.
- Braham, Allan. *The Architecture of the French Enlightenment*. Berkeley: University of California Press, 1980.
- Burenhult, Gören, ed. *People of the Past: The Epic Story of Human Origins and Development*. San Francisco: Fog City, 2003. A global treatment of human origins and the earliest cultures, drawing on the expertise of scores of expert contributors and the results of recent archaeological discoveries.
- Collins, Peter. *Changing Ideals in Modern Architecture, 1750–1950*. 2nd ed. Montreal: McGill-Queens University Press, 1998.
- Curtis, William J. R. *Modern Architecture since 1900*. 3rd ed. Upper Saddle River, N.J.: Prentice Hall, 1996.
- Heydenreich, Ludwig Heinrich. *Architecture in Italy, 1400–1600*. 2 vols. 1903. Reprint, New Haven, Conn.: Yale University Press, 1995–1996.
- Hurwit, Jeffrey M. *The Athenian Acropolis: History, Mythology, and Archaeology from the Neolithic Era to the Present*. New York: Cambridge University Press, 1999.
- Jencks, Charles. *The Language of Post-Modern Architecture*. 6th ed. New York: Rizzoli, 1991.
- Kalnein, Wend von. *Architecture in France in the Eighteenth Century*. New Haven, Conn.: Yale University Press, 1995.
- Klotz, Heinrich. *The History of Postmodern Architecture*. Cambridge, Mass.: MIT Press, 1988.

- Lewis-Williams, David. *The Mind in the Cave: Consciousness and The Origins of Art*. London and New York: Thames and Hudson, 2002.
- Moffett, Marian, Michael Fazio, and Lawrence Wodehouse. *Buildings across Time: An Introduction to World Architecture*. Boston: McGraw-Hill, 2004.
- Rhodes, Robin F. *Architecture and Meaning on the Athenian Acropolis*. Cambridge, U.K.: Cambridge University Press, 1995.
- Roth, Leland M. *American Architecture: A History*. Boulder, Colo.: Westview Press, 2001.
- . *Understanding Architecture: Its Elements, History, and Meaning*. New York: Icon Editions, 1993.
- Smith, William S. *The Art and Architecture of Ancient Egypt*. 3rd ed., rev. New Haven, Conn.: Yale University Press, 1998.
- Steele, James. *Architecture Today*. London: Phaidon, 1997.
- Trachtenberg, Marvin, and Isabelle Hyman. *Architecture from Prehistory to Postmodernity*. 2nd ed. New York: Abrams, 2002.
- Ward-Perkins, J. B. *Roman Imperial Architecture*. Harmondsworth, U.K.: Penguin, 1981.
- Wittkower, Rudolf. *Architectural Principles in the Age of Humanism*. 4th ed. London: St. Martin's, 1988.

Leland M. Roth

AFRICA

Sketching a comprehensive history of African architecture remains a daunting task because of the enormous size of the continent, the thousands of distinct ethnic groups that inhabit the vast lands, the differences in climate, and the various colonial, economic, political, and religious experiences. Yet, African geography, characterized by the large size of the continent, which encompasses multiple population and cultural distributions, can provide the methodological and temporal means for studying and understanding the continent's architectural history, practices, and scholarship.

The "Triple Heritage" Architectural Concept

Looking at the floor plan of a family dwelling in Africa, one needs to ask: Who lives there? Is it a Muslim family, a Christian family, or a family that believes in ancestor worship? Is there an extended family ancestors' shrine? Is the dwelling laid out as an extended family compound or as a single-family bungalow in an exclusive wealthy section of the city? When examining the tectonics—that is, the construction methods by which the structures of the house, the styles of decorations on the façade and elevations (fronts), roof, openings, and columns, are held together in harmony—of a built object in Africa, one is bound to reflect on what the walls are made of. Are they constructed from grass, branches of trees, reeds, raffia palm fronds, timber, coral shells and sands, clay, or stones? Regarding more recently built structures, one must ask: Are the walls built with concrete materials, zinc, plywood, synthetic materials, engineered wood, or cardboard boxes? What about climatic control and protection from the elements such as the sun and rain? Is the roof of the dwelling high-pitched, low-pitched, sloping to one side, or flat? What material(s) is it made of? Slate, zinc, shingles, clay, thatch, or grass? How are cooling, heating, and humidity controlled? Furthermore, because one of the most important aspects of buildings is the elevation, and many traditional African compounds have portals, one is bound to ask questions regarding

the relationships between the portals and the elevations of the houses in the compound, such as: What styles and motifs articulate the portal's surrounding elements, and how are the doors and windows decorated? Are they painted with clay or other pigments? Do they display specific symbols that can be recognized by the members of the community? These are questions that can be addressed with a clear understanding of Africa's geography.

The distribution of climatic zones and vegetation types, along with the availability of building materials, influences the manner in which people build in different parts of the continent. While the coastal tips of northern and southern Africa are covered by Mediterranean vegetation, further inland one encounters semiarid wooded steppe lands that border the deserts—the Sahara Desert in the North, the Kalahari Desert in the South. Both regions are buffered by vast Sahel and savanna grasslands and forests that stretch to West Africa and parts of East Africa. Heading north from the West African Atlantic, mangrove forests, dense tropical rain forests, and evergreen forests gradually transition into Sahel and savanna woodlands and then into the desert proper—the Sahara.

The distribution of cultural groups and political experiences across different parts of the continent from ancient times through the present also underscores the importance of understanding the geography of the continent when studying its architectural heritage. The northern parts of the continent, comprised of the countries of Morocco, Algeria, Tunisia, Libya, and Egypt, are inhabited by populations that are predominantly Muslim, and certain cultural buildings and edifices from the past and present reflect this way of life. The Muslim population in northern Africa extends to West Africa in countries such as Mauritania, Senegal, Guinea, Mali, Burkina Faso, Niger, and Chad, although these nations contain pockets of Christian communities. Similarly, building techniques reflect these religious cultural affinities as well as responses to specific regional, vernacular, and climatic needs.

Moving eastward toward the Atlantic coast from the northwestern African coastal countries, a great change in religious affiliations and cultural identifications can be observed among citizens of the same country. For example, in Sierra Leon, Liberia, Côte d'Ivoire, Ghana, Togo, Benin, Nigeria, and Cameroon, the populations in the northern parts of these countries are predominantly Muslim, whereas the southern populations are predominantly Christian. The middle parts, often identified as middle belts, seem to have balanced numbers of Christians and Muslims. In the Central African Republic, Gabon, the Democratic Republic of Congo (formerly Zaire), and Angola, large Catholic and other Christian denominations reside side by side with large Muslim populations. With the exception of Ethiopia, a Christian country with a predominantly Coptic sect as well as a minority Muslim population, many East African countries are predominantly populated by Muslims with fairly large number of citizens affiliated with the Christian faith. The Republic of Sudan, Djibouti, Somalia, Kenya, Uganda, and Tanzania have large Muslim and minority Christian populations. As in West Africa, northern Sudan is predominantly Muslim, whereas the southern part

is principally Christian. Mozambique, Zambia, Zimbabwe, Namibia, Botswana, and the Republic of South Africa are inhabited by populations that are predominantly Christian with significant populations of Muslims. Once again, the architecture of these regions of Africa reflects the cultural and climatic variations.

It is important to emphasize that the West did not introduce Christianity to all parts of Africa. Certain North African territories and East African countries such as Ethiopia adopted the Christian faith in the middle of the fourth century C.E.—that is, about the same time that Imperial Rome adopted Christianity as its official state religion. One cannot ignore, however, the proselytization of the Christian faith to Africans by later colonizing European missionaries. Also, keeping in mind that the Islamic religion began to spread on the continent in the seventh century C.E., one is left with the inevitable question: What form(s) of cultural affiliations were on the African continent before the coming of Islam and Christianity? The answer is that there has always been indigenous African culture; in fact, one has to speak in the plural by stating that there have always been indigenous cultures that were generated and propagated by the peoples of the continent and that varied greatly from place to place. Indigenous African cultures have had the greatest impact on the continent's architecture(s).

When discussing African architectural practices, the most important thing to keep in mind about the indigenous, Western, and Islamic aspects of African cultures is that they are broad concepts that vary from place to place and region to region. Nevertheless, these concepts lay solid foundations for studying the continent's architecture across time and space in different regions of the continent. For that reason, Nnamdi Elleh, in his book *African Architecture: Evolution and Transformation* (1997), summed up the original sources of African architecture as indigenous, Western, and Islamic in what he called the "triple heritage architectural concept." The formation of this theory followed years of research exploring the works of architectural historians such as Udo Kultermann, Peter Garlake, Susan Denyer, and Susan B. Aradeon, and it took into consideration the geography, anthropology, sociology, history, and political systems of Africa, especially as reflected in the works of such scholars as Ali A. Mazrui, who first coined the phrase "triple heritage" in his book titled *The Africans: A Triple Heritage* (1986).

It is obvious that for a continent as large as Africa, such a sweeping proposition can be problematic. The triple heritage concept needs to be clarified, because when examined from cultural, functional, stylistic, and tectonic perspectives, there are gray areas in which it is difficult to separate indigenous from Western architectural motifs, or indigenous from Islamic architecture. Conversely, there are several cases in which motifs that help identify Western and Islamic architecture cannot be completely isolated from one another. Issues of regionalism and vernacular articulations that are inspired by climatic necessities and available building technologies can compound this problem. This is where history and archaeology can help sort out how these three large building cultures came together and provided the continent its architectural heritage. The aim in

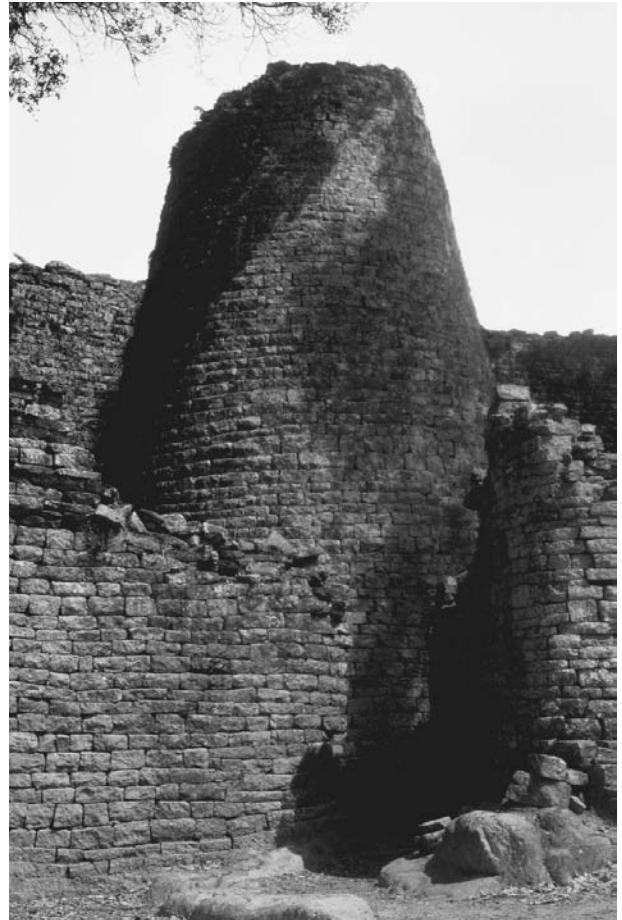

Ruins of a conical stone tower of a convent in Zimbabwe. The religion of a region and other cultural variations can play an important role in African architecture, affecting such choices as elevation, construction style, building materials, and decoration or ornamentation. © CHARLES & JOSETTE LENARS/CORBIS

adopting this historical approach is not necessarily to achieve a total level of cultural separation asserting in absolute terms that this is indigenous, that is Western, and that is Islamic—as desirable as that may be; it would be hard to reach a level of absolute certainty regarding which tectonic and stylistic motifs could be identified and separated from one another in all cases. Nevertheless, understanding the mechanisms in which architectural fusion took place among the three cultures places one in a better position to determine the functions, styles, and systems of the continent's architectural practices. Hence, the next three sections provide synopses of the indigenous, Western, and Islamic aspects of the triple heritage architectural concept.

The Roots of Indigenous African Architecture

The most challenging task for scholars of African architecture is determining its historical sources. This task is compounded by the nuances of intellectual historiography that bifurcate the continent into two parts comprising an "uncivilized" black Africa occupying sub-Saharan regions and an Arab North Africa

fairly “civilized” because of its proximity to the Western civilizations of the Mediterranean region and southern Europe. Gaining currency from the middle of the eighteenth century, the early history of Africa, which was constructed primarily by European explorers, has been an obstacle to scholars who work on the architectural history of the continent because it favors the advancement of the concept of a “primitive” architecture for sub-Saharan Africa in opposition to a mature Islamic architectural civilization for northern Africa. As such, when looking at the history of sub-Saharan African architecture, early scholars of the subject ignored its historical, geographical, and regional variations. Often, the published titles on African architectural history were classified under “primitive” architecture. This method of exploring African history has a major consequence because it denies the reality that Africans also produced monumental architecture during ancient times.

The evidence from archaeological sites in different parts of the continent contradicts the notion that Africans were unable to produce monumental architecture. So far, there are only two main texts that ground traditional African architecture in antiquity and make a strong case for exploring what the archaeological evidence reveals about the continent’s architectural history: Elleh’s aforementioned *African Architecture* and Labelle Prussin’s *African Nomadic Architecture: Space, Place, and Gender* (1995). Both books strongly argue that scholars should look at the archaeological records in the Sahara, especially from the regions of Tassili and Fezzan, in order to gain insights into how different architectural elements evolved on the continent. Prussin’s contribution is particularly interesting in that it traces the origins of the tent structure and the role of women in its construction and perpetuation from prehistoric to contemporary times. Prussin’s propositions help buttress Elleh’s concept of the triple heritage when it comes to the relationships between ancient Egyptian architecture and traditional architecture in sub-Saharan Africa. In *Art History in Africa: An Introduction to Method* (1984), Jan Vansina makes the point that ancient Egyptian art and architecture cannot be fully understood without recognizing that it inherited most of its traditions from the Saharan cultures that predate it by more than three thousand years.

Usually, when people think of ancient Egyptian architecture the image that comes to mind is great pyramids and temples that were built by people whose skin color was lighter than the complexion of people who reside in sub-Saharan Africa. The implication is that, culturally speaking, these people with lighter skin color are entirely distinct from those with very dark skin, and, as such, those with very dark skin produced nothing in antiquity. On the contrary, and backed by strong archaeological evidence, Elleh argues that early Egyptian dynasties and their monumental architecture were built by ancient African kings. Thus, indigenous African architecture includes pyramids, temples, clay (adobe) structures, tent structures, huts made of grass and reeds, and a combination of multiple building materials, and the tectonics of each structure depended on its geographical location and the time in which it was conceived and produced.

For example, Elleh emphasizes that monumental architecture such as the pyramids did not just develop in ancient Egypt overnight. It evolved slowly following the desiccation of the

Sahara Desert, whereupon certain building traditions from the Sahara were transferred to the newly founded kingdom of Egypt by Menes (fl. c. 2925 B.C.E.), the pharaoh whom archeologists identify as Narmer. By the third and fourth dynasties, when Djoser’s Step Pyramid and the Great Pyramid of Khufu (Cheops) were built, the pharaohs were African kings, and their monumental productions were indigenous African productions. This proposition could be extended to the Middle Kingdom (2000–1786 B.C.E.) when most of the powerful pharaohs ruled Egypt. The evolution of ancient Egyptian dynastic architecture shows that long before the conquest of Egypt by Alexander the Great, king of Macedonia, in 332 B.C.E., the Assyrians had taken over around 670 B.C.E., followed by the Persians in 525 B.C.E. This leads one to recognize that the early structures built before the invasions were all proposed and constructed by indigenous African monarchs. J. C. Moughtin’s book *Hausa Architecture* (1985) sheds light on the relationships between certain ancient Egyptian architectural motifs and the motifs that are used by Hausa adobe builders. The relationships between Hausa building traditions and Islamic building traditions within the West African region was studied by Prussin in *Hatumere: Islamic Design in West Africa* (1986). Also important are Peter Garlake’s contributions on the architecture of Great Zimbabwe, the site of ruins within Zimbabwe dating from as early as the eleventh century C.E.

Western (European Colonial) Influences on African Architecture

It has been suggested that the relationships among the three strands of the African architectural heritage cannot be completely isolated from one another in many cases because the cultures have intermixed over time. Yet there are two clearly defined phases during which Western-inspired architectural styles were imported into Africa. The first phase began with the Roman conquest of the North African city-state of Carthage in 146 B.C.E. at the end of the Third Punic War. This conquest brought with it Roman building cultures and architectural traditions that can be found throughout most of North Africa, especially in sites such as El Djem, Tunisia, where a Roman coliseum dating to 300 C.E. can be found.

The second phase began much later, during the fifteenth century, when European explorers began to look for a sea route to the Orient. Pioneered by the Spaniards and the Portuguese, who sailed around the West African Atlantic coasts on their journey to India and the Far East, numerous trading fortresses began to dot the West African coastal landscapes as trade between Europe, Africa, and the Orient became more lucrative. These large structures also heralded the arrival of people from other European countries, such as the Belgians, Dutch, English, French, and Germans, who began to settle along the African coastal territories. Among the first and largest of the European structures was Fort Elmina, built by Diogo d’Azambuja, a Portuguese captain, in 1482, in what was then called the Gold Coast (today’s Ghana). The booming trade between Africa, Europe, and the Orient expanded to the Americas as the slave trade brought from Europe new seekers of treasures in Africa.

In 1820 about five thousand English settlers moved to the Cape in southern Africa. In 1830 France invaded and occu-



The Great Mosque in Djenne, Mali. Built in the thirteenth and fourteenth centuries, the mud-brick mosque at Djenne is an example of the influence of Islamic tradition upon African architecture. The Djenne mosque is the largest mud structure in the world. © ROBERT VAN DER HILST/CORBIS

pied Algiers. In 1867 the availability of diamonds in the Griqualand West region of southern Africa was brought to the attention of the European settlers. Likewise, gold was brought to the attention of Europeans at Lydenberg, in Transvaal, in 1873. The Berlin Conference of 1884–1885 set in motion the “Scramble for Africa” in which the European powers subdivided the continent into spheres of influences. Cecil Rhodes, who would become prime minister of the Cape Colony in 1890, founded De Beers Consolidated Mines in 1888 and the British South Africa Company one year later. This synopsis of nineteenth-century colonial African history mirrors the manner in which Western architecture was spread on the continent from the turn of the nineteenth century through most of the twentieth century. Because of the manner in which the continent was settled by later European economic immigrants, it is not surprising that South Africa was the area most greatly influenced by Western architecture.

The Arrival and the Sources of Islamic Architecture in Africa

Coupled with Islamic architectural influence in Africa are the processes of Arabization in northern Africa spawned by

migrating and conquering Muslims who were spreading the faith and the new forms of political leadership that Islam inspired from the early part of the seventh century C.E. The religion founded by the prophet Muhammad (c. 570–632 C.E.) spread rapidly throughout most of the Arabian Peninsula into northern Africa. By 641 Egypt had fallen to the Muslim conquerors, and it was only a matter of time before the remaining parts of Byzantine North Africa fell. The rapid spread of Islam and its new building traditions, which incorporated traditions from Byzantine Rome, helped inspire various styles of Islamic architecture in northern Africa. The Great Mosque of Kairouan, Tunisia, started around 670 and completed in the ninth century, is one of the great mosques that set the pace for the new building traditions that emerged in northern Africa. The evidence that Islam had spread to most of West and East Africa before the tenth century is abundant, and Islamic-inspired architectural structures dating to the fourteenth century can be located in Mali, such as the Great Mosque of Djinguere Ber, and Tanzania, such as the Palace of Husuni Kubwa at Kilwa. It is important to keep in mind that the styles of Islamic architecture varied greatly between northern, western, and eastern Africa.

Conclusion

While the triple heritage concept is an important starting point for understanding African architectural history, scholars have to look beyond the traditional sources by exploring the influences of late-twentieth-century capitalism in order to understand the forces that are propelling contemporary African architectural practices. Following the independence movements of the 1960s, leaders of the newly independent African states sent many students to Europe and the Americas to study architecture. Also, a number of schools of architecture were established in Africa, and several postcolonial cities, such as Dodoma, Tanzania; Yamoussoukro, Côte d'Ivoire; and Abuja, Nigeria's new federal capital, which was designed for three million inhabitants, were built. These twentieth-century modernist projects remain to be studied and documented.

See also *Architecture: Overview*; *Arts: Africa*.

BIBLIOGRAPHY

- Aradeon, Susan B. "Al-Sahili: The Historians' Myth of Architectural Technology Transfer from North Africa." *Journal des Africanistes* 59, nos. 1–2 (1989): 99–131.
- Davidson, Basil. *African Civilization Revisited: From Antiquity to Modern Times*. Trenton, N.J.: African World Press, 1991.
- Denyer, Susan. *African Traditional Architecture: An Historical and Geographical Perspective*. London: Heinemann, 1978.
- Elleh, Nnamdi. *African Architecture: Evolution and Transformation*. New York: McGraw-Hill, 1997.
- Garlake, Peter. *Early Art and Architecture of Africa*. Oxford: Oxford University Press, 2002.
- . *Great Zimbabwe*. London: Thames and Hudson, 1973.
- Hoag, John D. *Islamic Architecture*. New York: Harry N. Abrams, 1977.
- Kultermann, Udo. *New Architecture in Africa*. Translated by Ernst Fleisch. New York: Universe Books, 1963.
- . *New Directions in African Architecture*. Translated by John Maass. New York: George Braziller, 1969.
- Mazrui, Ali A. *The Africans: A Triple Heritage*. Boston: Little, Brown, 1986.
- Moughtin, J. C. *Hausa Architecture*. London: Ethnographica, 1985.
- Prussin, Labelle. *African Nomadic Architecture: Space, Place, and Gender*. Washington, D.C.: Smithsonian Institution Press, 1995.
- . *Hatumere: Islamic Design in West Africa*. Berkeley and Los Angeles: University of California Press, 1986.
- Vansina, Jan. *Art History in Africa: An Introduction to Method*. New York: Longman, 1984.

Nnamdi Elleh

ASIA

Parallel to cultural developments in the West during the centuries around the start of the common era—and in essential isolation from the West—completely separate developments were occurring in southern and eastern Asia, shaping civilizations and cultures that continue to this day, and whose fundamental philosophical views continue with little change, despite long contact with the West.

Indian Architecture

The first of these cultures to be treated, and in some ways those that had the most important influence on other Asian cultures, were those that developed in what is now India. As early as 5,000 years ago several cities flourished along the Indus River in northeastern India, producing remarkable artwork and forms of writing still debated as to methods of decipherment. A native Dravidian religion later developed in this area, with emphasis on male and female fertility imagery. About 3,500 years ago groups of Aryan invaders moved in from the north, bringing more ascetic religious practices. These two ancient belief systems underlie Indian temple architecture to this day, combining abstract diagrammatic and symbolic plan arrangements overlaid with a profusion of luxuriant carvings portraying the numerous gods, shown in episodes from their many stories, including depictions of transcendental male and female physical union.

Around 2,600 years ago three major religions developed in India—Hinduism, Jainism, and Buddhism—each with a variant belief in the transmigration of souls, reborn in new bodily form after death. In Hinduism, with its pantheon of numerous deities largely associated with natural elements and events, the ancient emphasis on the individual and the universal, male and female, the phallic *lingam* form and the corresponding female *yoni* imagery, was strongly developed. Hinduism, with its many elaborate rituals carried out by Brahmin priests, was rejected by Jainism, and also by Buddhism, started by Siddhartha Gautama (c. 563–c. 483 B.C.E.), who, through meditation directed at release from human desire, achieved the state of “enlightened one,” or Buddha. Spread throughout India and far beyond by disciples and monks who emulated the Buddha's example, Buddhism rejected the elaborate Hindu rituals in favor of seeking release from self with the extinction of desire, leading ultimately to a state of *nirvana*.

Hindu architecture. In Hindu belief the primordial world floated in a vast ocean, with a sacred mountain at its center consisting of five or six ascending levels or terraces. From this idea developed the concept of the gods residing in the mountains or in sacred caves; this led to the creation of temples as caves carved into the solid rock of cliff sides, the carved elements of the shaped space inside recalling more ancient forms once carved in wood. A good example is the Vishnu cave-temple carved out in the sixth century at Badami in Karnataka, southern India, a hall with many square columnar piers, oriented on a north-facing axis.

Two axes typically govern Hindu temple architecture: a horizontal ground-plane axial system oriented to the cardinal directions, most often facing east; and a towering mass marking a vertical axis. This vertical mass, the *shikhara*, represents the sacred mountain, and rises in massed layers, gently rounded at the top. The enormously thick masonry walls of the base enclose a small internal chamber, the sacred cave-womb space, *garbhagriha*. Leading up to the *garbhagriha* are several chambers, aligned on the principal east-facing axis, surrounded by columnar porches, the entire complex set on a tall plinth or base, the *mandapa*. The type of the northern Indian temple is well represented by the Khandariya Mahadeva temple at Khajuraho, built about 1030 in

the Madhya Pradesh region of north central India, whose rising, slightly parabolically curved *shikhara*, in the quintessential mountain profile, is composed of bundled layers.

Buddhist architecture. Ironically, Buddhist architecture in India is comparatively rare, surviving better in examples based on Indian prototypes but built in places to which Buddhism was carried, such as Sri Lanka and Cambodia, and in wooden framed temples built in China and Japan. The building type mostly closely related to Indian sources is the *stupa*. Following the Buddha's death, his ashes were divided into ten parts, which were carried to places associated with his life and teaching. These portions of his remains were buried in mounds inspired by the small mounded village memorials or *chaityas* traditionally built over the remains of deceased leaders. The Buddhist stupa, a large domed mound covered with stone, represents the dome of heaven; it is enclosed by circular walkways for meditation, and defined by encircling stone fences punctuated by large gates in the cardinal directions representing the winds. A splendid example (remaining in India) is the Great Stupa at Sanchi in the Madhya Pradesh, begun by the Indian ruler Asoka sometime between 273 and 236 B.C.E. The broad dome, 120 feet (36.5 meters) in diameter and rising 54 feet (16.5 meters) in height, is capped with a square railing (*harmika*) and a spire-like form (*chatra*) resembling superimposed umbrellas representing the stages of enlightenment achieved by Buddha as well as symbolizing the bodhi tree under which he achieved his final enlightenment. As Buddhism spread eastward, this *chatra* form is believed to have inspired the development of the Chinese pagoda tower (the name for which derives from the Sanskrit *dagoba* for stupa).

Islamic Architecture

The religious landscape of India, and indeed large portions of southeast Asia, was dramatically changed with the spread of



Detail of the sculptured gate of the Great Stupa at Sanchi, India. Constructed sometime between 273 and 236 B.C.E., the Great Stupa is one of the few surviving examples of original Buddhist architecture. Stupas were built to commemorate the deeds of Buddha, and some are said to enshrine his mortal remains. © ARCHIVO ICONOGRAFICO, S.A./CORBIS

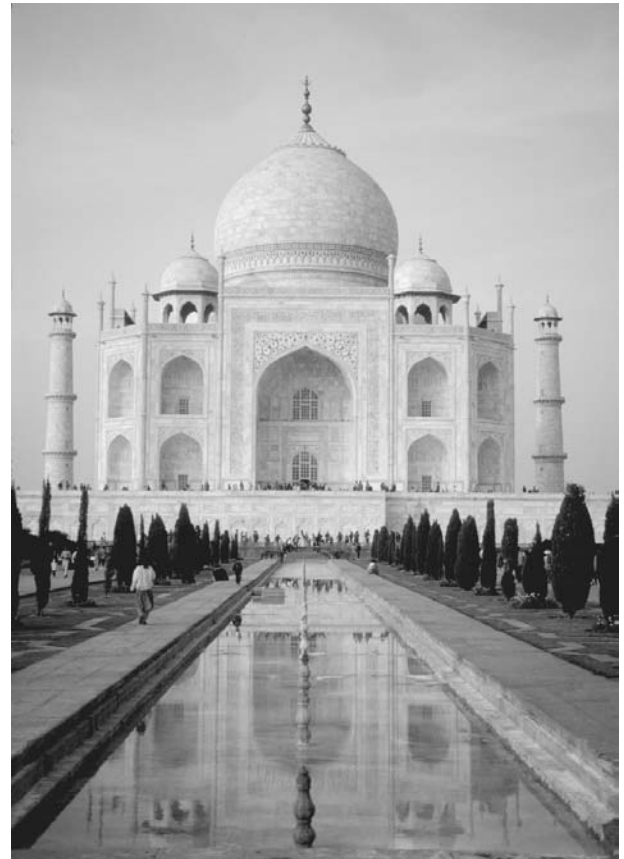

India's Taj Mahal. The Taj Mahal in Agra, Uttar Pradesh, represents a shining example of Asian architecture during the Mughal dynasty. Constructed as a tomb to honor Shah Jahan's deceased wife, the building displays harmonious proportions and a purity of design. © SUSAN D. ROCK

Islam from the west. Islamic armies of the Turks and Afghans conquered northern India in the late twelfth century, and an independent Islamic state was declared there in 1206. Mosque building now took the place of temple building, revealing a fundamental difference in the concept of the religious building. Whereas the Hindu temple was a vertical point marker in space, its interior densely enclosed, dark, mysteriously introvert, the mosque in contrast (inspired by the court of the prophet Muhammad's house in Mecca) was open to the sky, a public gathering place for prayer, extrovert. The introduction of Islam in Hindu India set up a fundamental conflict that still continues, after eight centuries, to generate intense clashes and to cause bloodshed.

By about 1500 this Islamic empire was enlarged by Babur, founder of the Mughal dynasty, to extend from Afghanistan to Bengal. By this time a distinctive north Indian Islamic culture had emerged, with Islam established as the official religion, but with later Mughal emperors such as Akbar and Shah Jahan fostering a broader cultural tolerance. Where the teaching of Islam held firm, however, was in the elimination of figural sculpture from sacred buildings (although figural painting

was practiced separately). Gardens, mirroring the Koranic descriptions of paradise, became a design specialty of the Mughals.

For many observers, the pinnacle of Mughal architecture was reached with the creation of a striking white marble tomb, the Taj Mahal, built by the bereft emperor Shah Jahan on the banks of Jumna River near Agra, Uttar Pradesh, to honor his beloved wife Mumtaz Mahal, who died in childbirth. Begun around 1631, the building itself was finished in six years, while the garden and adjoining buildings were completed in 1643. Bounded by a wall punctuated by a large entry gate on the southern edge is a broad square garden laid out in a precise grid, with channels of water on the axes (symbolic of the rivers of paradise) converging on a slightly elevated pool in the center. Lawns and planted beds fill the four quadrangles; originally intended to have different plants producing flowers continuously during the cycle of the seasons, the flower beds were framed by fruit trees. No literate Mughal entering the garden could fail to appreciate the images of paradise that informed every aspect of the design, for over the entry gate, written out in black marble inlay in a white marble band, is this passage from the Koran:

But Oh thou soul at peace,
Return thou unto thy Lord, well-pleased, and well-pleasing unto Him,
Enter thou among thy servants,
And enter thou My paradise.

At the northern edge, on a raised platform is the white domed tomb, a masterwork conceived by the Shah's architects, Ustad Ahmed Lahori and 'Ahb al-Karim Ma'mur Kahn, aided by the court calligrapher Amanat Khan. The square mass of the central building is a symbol of calm and harmony, for it is exactly as high as it is wide, and the height of the dome is exactly the same as that of the arched entry block. The white marble mass of the building is embellished everywhere with representations of the flowers of paradise, crafted of inlays of jade, lapis, amber, carnelian, jasper, amethyst, agate, heliotrope, and green beryl. In addition to the flower and geometrical ornamental inlays, black marble inlay everywhere presents passages from the Koran that relate to paradise on the Day of Judgment. In its purity of material and its balance of proportions, the Taj Mahal serves as a fitting representation of paradise.

Chinese Temples and Residences

Buddhism was introduced to China around the first century B.C.E. Buddhist temples there were built in the wood-frame tradition that had developed in China around the second millennium B.C.E. A good example, because constrained in size, is one of the oldest surviving wood buildings in China, the Nanchan Temple on Wutai Mountain in Shaanxi province, begun 782 C.E. Stupas in China were replaced by pagodas, inspired not only by the multilevel *chakra* but also drawing on the tradition of local watchtowers. The horizontal layers of the stacked parasols were modified as encircling projecting roof bands (as in the brick pagoda of the Song Yue temples at Song Mountain, Henan province, built in 523). From this evolved

the timber-framed pagoda, with superimposed broad eaves carried by the densely stacked brackets, as seen in the Fogong temple at Yingxian, Shaanxi province, built in 1056.

Before the onslaught of Western influence in the nineteenth century, China's social structure had long been shaped by two philosophical systems resulting from the writings of two sages of the fifth century B.C.E.—Laozi and Confucius (Kong fuzi). These two systems fit nicely with the Chinese concept of *yin* and *yang*, the necessary presence of basic dualities or polarities in the universe, such as male and female. The system of Laozi, called Daoism (from *Dao*, "the way"), in comparison with Confucianism, is nonrational or naturalistic, and nonauthoritarian, embracing the spontaneous variation of nature. Confucianism, in contrast, originally developed as a system to ensure logical orderly governance, was rooted in a sense of underlying order, obedience to authority, veneration of ancestors, and respect for one's elders. These two philosophical systems were brought into alignment with the religious tenets of Buddhism, which flourished in China (prior to the Communist Revolution in the mid-twentieth century).

Confucian ideas of an orderly system intended to promote and maintain social order are well illustrated by one of the oldest manuscripts to survive in China, *Kao gong ji* (The artificer's record), from the fifth century. This remarkable document is a guide for laying out cities, outlining general principles that hold true in large measure for modest residential compounds as well as for the sprawling complex of the imperial household and governmental center of Ming and Qing China—the Forbidden City, Beijing. Chinese culture is about containment—the nation is bounded by a wall (the Great Wall to keep out the barbarians); the city is bounded by a wall (indeed, the word for city and wall is the same, *cheng*); and the individual household compound is bounded by a closed wall. The *Kao gong ji* instructs that a capital city should be a square 4,000 feet to a side, oriented to the cardinal directions, with three gates to a side. The main gate should face south, and the principal street runs north-south, leading to the governmental center. Each of the cardinal axes and directions is associated with one of the five elements, with attributes and colors associated with each of the cardinal directions. East is linked with spring, wood, and the color green. South is associated with summer, fire, and red. West is associated with autumn, metal (in particular gold), and white. North is connected with winter, night, and the color black. Where the axes of the city intersect in the center, *zhong*, is the location of the ruler's residence and place of administration, associated with a vertical *axis mundi*, earth, and the royal color yellow (the central imperial palace buildings—and only these buildings—were covered with yellow glazed roof tiles). There, in a room facing southward toward a court sat the emperor, likewise facing south, at the center of all things.

Residences were walled family compounds, ruled by the male master, with lesser authority associated with his wife and several consorts. The walled house was made up of a series of inward-focused courtyards, and the "good wife" was one who never ventured outside the walls. Ideally laid out on a north-south axis, the house had a simple door opening to the street,



Entrance to Phoenix Hall, Byōdōin Temple, Honshū, Japan. Previously the site of aristocrat Fujiwara Yorimichi's country villa, Byōdōin was converted into a Buddhist monastery in the mid-eleventh century. Phoenix Hall was built at the time of this conversion and was named for its resemblance to the outstretched wings of the mythical bird. © ARCHIVO ICONOGRAFICO, S.A./CORBIS

leading to a first inner service court, lined by kitchen and service rooms to the south, with children's and guest rooms east and west. A door in the northern wall of this court led to a second inner court, lined with children's suites east and west, but on the axis on the north side of this court would be the parents' suite of rooms, often in the very center of which was a large room, the ancestral hall, with an altar on its north side for the veneration of ancestors and the gods.

In contrast to this ordered regularity and the straight axial lines of the house itself was the studied and felicitous irregularity of the adjoining garden in compounds of the more well-to-do. In a *yin* (feminine) and *yang* (male) balance, the house was seen as Confucian while the garden was Daoist. While some gardens could be large, such as the famous ones in Suzhou, even a small court could be made a symbol of nature by the adroit use of a small lagoon or pond, a few selected trees, a selected unusually irregular rock. Paths were made of curved or broken and bent lines, since inauspicious or malevolent spirits could only move along straight lines. Gardens were considered more difficult to design than houses, and they were intended to look as if they had grown entirely out of nature. Hence, the intellectual study of garden design and the making of gardens was a discipline associated with highly educated

poets, philosophers, and men who had distinguished themselves in government service.

Japanese Architecture and Gardens

Japanese architecture, like Japanese culture, is distinct and unique but at the same time incorporates elements imported from China, notably Buddhism. The native religion of Japan, Shinto, is described as a form of nature's idealization, and was largely responsible (some scholars have suggested) for Japan's being able to retain a distinct cultural identity in the face of the strong Chinese influence. The "way of the gods" (the literal meaning of *Shinto*) is based on deep respect for *kami*, an eternal superconsciousness believed to be inherent throughout nature, in ancient trees, in remarkable boulders, in streams, and other natural manifestations, provoking profound awe. Shinto as a religion is itself unique, having neither dogma, scriptures, nor form. The religious content of Shinto, reflected in a native focus on purity of form, material, and construction in objects and architecture, is thought to have been formulated during the Yayoi period (c. 300 B.C.E. to c. 300 C.E.). *Kami* is considered present also in human constructions of utmost simplicity of form and purity of construction. This is demonstrated by the ritual reconstruction, every twenty years,

of the most sacred Shinto shrines, as at the Ise Jingu precinct or shrine on the eastern coast. There, since the reign of Emperor Temmu (672–686), now some sixty times, on identical adjoining sites, the complex of buildings has been meticulously duplicated and rebuilt with new carefully prepared cypress timbers and thick perfectly trimmed thatch roofs, leaving only the most sacred central pole covered and protected on the adjoining site, awaiting the next rebuilding.

Beauty as a principle pervading all nature and, ideally human construction, reshaped Buddhist architecture, introduced from China after 552 C.E. Factions of the imperial family, early converts to Buddhism, strongly endorsed this new religion that was seemingly so contradictory to native Shinto, and supported the building of a temple and monastery complex that became the Horuji temple complex, marked by its tall five-storied pagoda. Other larger temple and monastery compounds followed elsewhere, but perhaps the perfection of Sino-Nipponese Buddhist architecture was reached in a private residential compound converted by its owner, Fujiwara Yorimichi (994–1074) into a realization of the Pure Land Buddhist Paradise as illustrated in the Taima Mandala brought from China in the late ninth century. Built in 1053 in Uji, near Kyoto, the Byodoin contains the regent's private chapel, the Amida Hall, called the Hodo (Phoenix Hall) because its plan with central tail and outstretched wings is said to resemble the phoenix, and also because of the ceramic phoenix images crowning its roof. Reflected in the waters of the lake, the outstretched wings might be seen to suggest flight. Inside sits a gilded wooden image of the Buddha, seated on an open lotus, hands serenely folded in meditation.

An exceptionally ascetic form of Buddhism—Chan (Zen) Buddhism—was introduced from China around 1200. Emphasizing pragmatism while shunning elaborate external rituals, Zen Buddhism held strong appeal for the ruling samurai warriors. Replacing perfunctory ritual with highly focused meditation and stern self-discipline, Zen Buddhism proposed a different path to enlightenment, and its reduction to pure essence is well illustrated by the austere meditative rock gardens of Zen monasteries, most notably in the rock garden at Ryoanji, built in the 1480s in Kyoto. Within this temple courtyard, five groups of judiciously placed rocks are set into a broad bed of carefully raked white pebbles, presenting an image resembling islands in a shimmering sea or mountain tops poking through layers of clouds.

A fine residential example showing the Zen Buddhist focus on essentials and on refinement of detail can be found in the Katsura Villa, built from c. 1616 to 1660 in stages by Prince Hachijo Toshihito and his son Noritada on the Katsura River southwest of Kyoto. The plain-frame construction of now-darkened unlacquered cedar, contrasted with white plastered walls and white paper screens, the studied angles of its gentle gable roofs, and its internal spaces governed in their proportions by the standardized *tatami* floor mats measuring roughly 3 by 6 feet, perfectly realize Zen ideals. But as part of the villa complex itself, the purest manifestation of Zen artlessness, painstaking attention to detail, and careful balance of differing textures in building materials and garden elements

is found in the five dispersed teahouses placed with subtle precision in the surrounding garden. With absolute simplicity of building materials and intimate human scale, the Japanese teahouse is the perfect setting for the austere, stylized, slowly choreographed quasi-religious tea ceremony in which partaking a beverage can be considered a Zen meditation.

See also Aesthetics: Asia; Buddhism; Confucianism; Daoism; Garden; Religion: East and Southeast Asia; Sacred Places; Shinto.

BIBLIOGRAPHY

- Boyd, Andrew. *Chinese Architecture and Town Planning, 1500 B.C.–A.D. 1911*. Chicago: University of Chicago Press, 1962.
- Chinese Academy of Sciences, Institute of the History of Natural Sciences. *History and Development of Ancient Chinese Architecture*. Beijing: Science, 1986.
- Dehejia, Vidya. *Indian Art*. London: Phaidon, 1997.
- Huntington, Susan L. *The Art of Ancient India: Buddhist, Hindu, Jain*. New York: Weatherhill, 1985.
- Isozaki, Arata. *Katsura Villa: Space and Form*. New York: Rizzoli, 1987.
- Liu, Laurence G. *Chinese Architecture*. New York: Rizzoli, 1989.
- Mason, Penelope. *History of Japanese Art*. New York: Abrams, 1993.
- Mitchell, George. *Hindu Art and Architecture*. London and New York: Thames and Hudson, 2000.
- . *The Hindu Temple: An Introduction to Its Meaning and Forms*. 2nd ed. Chicago: University of Chicago Press, 1988.
- Rowland, Benjamin. *The Art and Architecture of India: Buddhist, Hindu, Jain*. 3rd ed. Baltimore: Penguin, 1967.
- Stanley-Baker, Joan. *Japanese Art*. London and New York: Thames and Hudson, 2000.
- Tange, Kenzo, and Nooru Kawazoe. *Ise: Prototype of Japanese Architecture*. Cambridge, Mass.: MIT Press, 1965.

Leland M. Roth

ARISTOTELIANISM. Aristotelianism is the tradition that stressed the theoretical “sciences” rather than the practical disciplines in Aristotle’s encyclopedia of the disciplines, and within the theoretical disciplines the systematic presentation of “true and certain” knowledge rather than the inductive search for its principles.

Greek Aristotelianism

The edition of Aristotle’s works made by Andronicus of Rhodes (fl. c. 70–c. 50 B.C.E.) established the knowledge of a comprehensive, structured body of demonstrated conclusions as Aristotle’s ideal of science. The works of Alexander of Aphrodisias (fl. c. 200), the first great commentator on Aristotle, complemented this view of the philosopher’s scientific corpus. The Neoplatonic movement attempted to harmonize the thought of Plato and Aristotle as the two great representatives of the Greek tradition. The tradition of commentary on Aristotle as an introduction to the higher wisdom of Plato was represented at Athens by two works that transformed Aristotle’s encyclopedia into an idealistic system. The *Elementatio theologica* (Rudiments of theology) and the *Elementatio physica* (Rudiments of physics)

of Proclus (410?–485) exhibit all forms of substance as deriving from a single first principle, the Platonic One.

Alexandrian exegesis of Aristotle's text, following Ammonius Hermiae, a pagan (fl. c.550), was more independent. John Philoponus, a Christian (fl. c. 529), even contested various Aristotelian notions. His introduction of the Judeo-Christian idea of creation into philosophy rendered Proclus's entire system questionable. These Alexandrian developments determined, in large measure, the approach to Aristotle's philosophy in the Byzantine world. Plato and Aristotle were regarded as representatives of "Hellenic philosophy," as part of a pagan tradition, generally opposed to "our (Christian) philosophy." The interest of Christian theologians in Aristotle was mostly limited to the parts of his logic necessary in theology, although under the dynasty of the Komnenoi (11th–12th century), Aristotle's practical philosophy enjoyed a rebirth with the commentary on the *Ethics* put together by Eustratius of Nicaea (1054–c. 1117). After the fall of Constantinople to the Crusaders in 1204, the necessity of answering the challenge of an increasingly sophisticated Latin theology led to the composition of compendia of Aristotelian doctrine, although the debate regarding Aristotelian methods of proof continued.

Arabic Aristotelianism

By the ninth century practically the entire corpus of Aristotle's works, together with those of his Greek commentators, had been made available in Islam. Aristotle's classification of the natural sciences supplied the structure for an encyclopedia in which classical authors like Hippocrates (c. 460–c. 377 B.C.E.) and Galen (129–c. 199), Euclid (fl. c. 300 B.C.E.) and Ptolemy (second century C.E.) also found a place. The understanding of science as a body of strictly demonstrated conclusions was decisive for Islamic Aristotelianism. In their commentaries on this enormous body of new doctrine, Arabic philosophers tended to comment on the logic, metaphysics, and natural philosophy as parts of a philosophical encyclopedia; few commentaries on the practical philosophy were written. Muslim thinkers opposed studies concerned with their own way of life, called the "Arabic or traditional sciences" (the Koran; traditions; kalam, or dialectical theology; and the like), to the "Greek or rational sciences," associated for the most part with Aristotle's name. Kalam's task was to supply the faithful with logical proofs for their belief, but its methods of proof forced the Aristotelian philosophers to refine their idea of scientific methodology.

In his *Catalogue of the Sciences*, the Persian philosopher, al-Farabi (c. 878–c. 950) attempted to fit the "traditional sciences of the Arabs" into the Aristotelian division of the sciences. The doctrine of God is taken up under the theoretical science of metaphysics, whereas kalam is regarded as a part of politics, with the function of defending the articles of faith. Al-Farabi demanded that the theologians provide strict demonstrations in defense of Muslim doctrine. About a century later, another Persian philosopher, the famous physician Avicenna (980–1037), undertook to reform kalam in accordance with the Aristotelian theory of demonstrative science and understood kalam not as a part of politics, but rather as metaphysics. Through the Persian theologian al-Ghazali (1058–1111),

Avicenna's conception of logical proof was influential in Muslim theology. Averroës (1126–1198), writing in Muslim Spain, also confronted the theologians with Aristotle's idea of demonstrative science, stressing the truth and certainty of Aristotle's presentation of theoretical science.

Medieval Jewish Materialism

Medieval Judaism also needed Aristotelian science and the logic that went with it. Where conflicts between philosophy and the Jewish faith appeared, some thinkers—of whom Moses Maimonides (1135–1204) was the most significant—held that philosophical speculation must proceed according to the theory of demonstrative science, without regard for theological doctrine. Only when the philosophical and theological doctrines have been clearly defined can one ask how the two realms are related. In spite of this view, an increasingly critical evaluation of Aristotle's doctrines in the light of the Jewish faith appeared in the fourteenth century.

Medieval Latin Aristotelianism

The works of Aristotle were made available in the Latin West in three clearly distinguishable stages. The first stage opened in the sixth century with Boethius's (c. 480–c. 524) translations of Aristotle's treatises on logic, along with some notions transmitted by Cicero (106–43 B.C.E.). Such works had but little effect upon the monastic life of the early Middle Ages. The second stage began in the twelfth century with the gradual translation of the entire corpus of Aristotle's works. Working in the tradition of the *concordia discordantium* (reconciliation of disagreements), Scholastic teachers made the epoch-making decision not to try to separate—as the Byzantines and Muslims before them had done—their own religious disciplines from the profane sciences inherited from the ancients. They attempted rather to situate theological teaching within the Aristotelian classification of the sciences. The masters were guided at first by Boethius and then by Euclid. In his *De hebdomadibus* (Concerning the weekly conferences), Boethius described the organization of scientific knowledge much as Aristotle had done, and early authors sought to develop a general theory of scientific method from it. Gilbert de La Porrée (1076–1154) maintained, for example, that first principles can be established for all the liberal arts and in the same way for theology itself. Nicholas of Amiens (fl. c. 1190) in his *Ars fidei catholicae* (Art of the Catholic faith) attempted to present theological doctrine in accordance with Euclid's geometrical model.

The condemnation in 1210 and 1215 of Aristotle's *libri naturales* (books of natural philosophy) at Paris was followed by an intense effort to axiomatize the quadrivial sciences. The attempt was most successful in the science of optics, a science subalternate to geometry. But the philosophers also turned their attention to Aristotle's theory of science. Robert Grosseteste (c. 1175–1253) commented on Aristotle's *Posterior Analytics*, explaining that "science" means true and certain knowledge derived by syllogistic demonstration from first principles. Accordingly, the theologians undertook to transform their discipline into an Aristotelian science. In his *Summa aurea* (Golden compendium), William of Auxerre (c. 1150–1231) proposed taking the articles of faith as the principles of theological demonstration, on the basis of which Catholic theology could be presented as a structured

body of strictly demonstrated conclusions. This lead was followed in particular by the Dominican theologians of the early part of the century.

By about 1230 the Latins had at their disposal the complete body of Aristotelian teaching together with Averroës's commentaries. The Aristotelian paradigm for science was established institutionally in the year 1255, when Aristotle's works were prescribed for the lectures in the Paris arts faculty. Working within this paradigm, the Latins made, in the course of the next two centuries, enormous progress not only in mathematics and the physical sciences, but also in the Aristotelian practical philosophy, following new translations of the *Ethics* and *Politics*. Albert the Great (c. 1200–1280) was among the first to turn his attention to the complete Aristotelian encyclopedia. His paraphrases of all of the fundamental works in Aristotle's encyclopedia prepared the way for the vast commentary literature through which the Middle Ages assimilated Aristotelian science.

The Aristotelian paradigm was also taken up by the theologians, most prominently by Thomas Aquinas (1225–1274). At this period the theologians were faced with the same problem as that which confronted the masters of arts—the systematic presentation of a body of traditional knowledge. In Thomas's view, theology should present the teaching of Scripture and the church fathers deductively, taking its departure from the indemonstrable, but to the Christian evident, articles of faith. Thomas sought to establish a concord between Aristotle's conclusions and revealed doctrine. While Christian doctrines could not be proved, their acceptance was thought to be able to be shown at least reasonable because congruent with basic philosophical conclusions that Aristotle was thought to have demonstrated.

Anomalies in this paradigm appeared even in the thirteenth century. About the year 1250, as Averroës's real position on the immortality of the human soul became known, the Latins came increasingly to distinguish between the teaching of Aristotle and that of Averroës. But in the year 1277 the bishop of Paris condemned 219 propositions—of which the majority represented Aristotelian positions—because they entailed consequences contrary to revealed doctrine. In the light of the condemnation, John Duns Scotus (1266?–1308) proposed a new conception of the theoretical sciences. His claim that the first object of the intellect is not sensible reality, but, rather, being as such, made it possible to study corporeal reality in a metaphysical way in contradistinction to the corporeal reality studied by the Aristotelian physics. The fact that many of Aristotle's doctrines were in apparent conflict with Christian teaching helped the philosophers to adjust the metaphysical assumptions that lay behind many of his positions, especially in astronomy. Aided by the Aristotelian idea that the individual sciences are autonomous in their own realm, philosophers like John Buridan (c. 1295–c. 1358) were able to develop theories in physics that were independent of Aristotle's treatment, while mathematicians like Nicole d'Oresme (c. 1325–1382) turned to areas that Aristotle had neglected.

Renaissance Aristotelianisms

During the third and final stage in the evolution of Latin Aristotelianism, the traditional conception of the Aristotelian

encyclopedia of the sciences became increasingly untenable. This period began in the year 1438 with the arrival of the Greeks at the Council of Florence. The aged philosopher George Gemistus Plethon (c. 1355–1450 or 1455) charged the Latins not only with being unacquainted with Platonic philosophy, but also with misunderstanding Aristotle's teaching. These misunderstandings arose because the Latins had been misled by Averroës to believe that the philosopher's works contained a demonstrative summary of scientific truth. Nevertheless, the Renaissance witnessed a vast increase in the literature of commentary on Aristotle's works. But at the same time Aristotelianism became but one among many philosophies, with Platonism, Stoicism, and Epicureanism also claiming attention. And the hierarchically unified worldview offered by Scholastic Aristotelianism had by the sixteenth century broken down, so that we must speak, in this period, not of one, but of several Aristotelianisms.

Catholic Aristotelianism. The encounter of the Christian Aristotelianism adumbrated by Thomas Aquinas with a secular Aristotelianism that had arisen in the Italian medical faculties resulted in the radical transformation of the Aristotelian speculative sciences in the sixteenth century. The Scholastic understanding of Aristotle's science of human nature was challenged in particular by Pietro Pomponazzi (1462–1525), who maintained that according to Aristotle the doctrine of the soul belongs to physics as a part of the doctrine dealing with *corpus animatum* (animated physical bodies). Because the soul is a material form, it is impossible to prove its immortality. The proponents of Christian Aristotelianism took up this challenge. They sought to retain Aristotle's deductive theory of science but were forced to modify radically Aristotle's ideas of the subject matter of natural philosophy. Their efforts were based on the search for metaphysical rather than physical proofs for the soul's immortality. Dominicans like Tommaso de Vio (Cajetan, 1469–1534) and Crisostomo Javelli (d. c. 1538) and Jesuits like Benito Perera (c. 1535–1610) and Francisco Suárez (1548–1617) constructed a new science of metaphysics based on the revealed idea of creation. The high point of this development was reached with the publication of Suárez's *Disputationes metaphysicae* (Metaphysical disputations) at Salamanca in 1597. Suárez retained the Aristotelian–Scholastic understanding of science and used the Scotist distinction of reality into *ens infinitum*, *ens creatum immateriale*, and *ens creatum materiale* (infinite being, immaterial created being, and material created being) to render the growing crisis of the Aristotelian physics as the science of *corpus mobile* (changeable physical bodies) irrelevant to Scholastics.

Italian secular Aristotelianism. Constrained by the immense amount of scientific material that the Renaissance had recovered, Aristotelian authors in Italy wrote increasingly during the sixteenth century about the teaching of this new body of doctrine and sought to situate Aristotle's theory of science within a broader context. Jacopo Zabarella (1533–1589), professor at Padua, was the author who brought these developments together most successfully in his tract *De methodis* (On method) of 1578. He distinguished scientific "method" from "orders" of presentation. There are two "methods" of discovery: (1) the compositive or synthetic method, which is the

demonstrative method of “science,” as Aristotle had conceived it; and (2) the resolute or analytic method belonging to the operative disciplines or “arts,” which begin with the end of an action and seek to discover the means and principles by which this end may be attained. “Orders” of presentation are simply ways of presenting the available material clearly. There are two “orders” corresponding to the two “methods” described above.

Lutheran Aristotelianism. Despite Luther’s rejection of Aristotle, the Aristotelian conception of science gained a central place in Protestant universities. Lutheran authors of the late sixteenth century tended to regard theology as a practical science and, following Zabarella, came to think that theological doctrine should be presented according to the analytic “order.” In his *Epitome theologiae* (Epitome of theology) of 1619, Georg Calixt (1586–1656) first applied Zabarella’s idea of the analytic method to theology. But the *Formula concordiae* (Formula of concord) of 1577 established a Lutheran orthodoxy, and philosophical textbooks, like the *Exercitationes metaphysicae* (1603–1604; Metaphysical exercises) of the Wittenberg professor Jacob Martini (1570–1649) and the *Metaphysica commentatio* (1605; A metaphysical commentary) of Cornelius Martini (1568–1621) of Helmstedt, turned to the metaphysics proposed by Suárez, which all those who admitted the idea of creation could accept. Their understanding of the relationship between philosophy and theology opened the way for the free development in Lutheranism of a natural theology as a theoretical science, presented in accordance with Zabarella’s synthetic order. The first independent treatise on *Theologia naturalis* (Natural theology) was published by Christoph Scheibler (1589–1653) at Giessen in 1621.

Calvinist Aristotelianism. Reformed theologians of the early seventeenth century regarded their science as essentially theoretical. In the works of authors like Bartholomew Keckermann (1571/73–1609) of Heidelberg and Danzig, Clemens Timpler (1567–1624) of Heidelberg and Steinfurt, and Johann Heinrich Alsted (1588–1638) of Herborn, the idea of a synthetic presentation of doctrine was maintained, but the encyclopedia of the disciplines was enlarged and transformed by a theory of the arts, a “technology.” Reformed theologians began to use the term “system” for ordered compilations of Christian teaching. For the Marburg professor Rudolph Goclenius (1547–1628), who used the word for the first time in his *Lexicon philosophicum* (1613; A philosophical lexicon), “ontology” has the role of assigning to each of the scientific disciplines its proper place in this new encyclopedia of the practical, productive disciplines.

Neo-Scholasticism. The last edition of the Latin text of Aristotle’s works was published by the Jesuit Silvester Maurus (1619–1687) in the year 1668. After the Thirty Years’ War, Protestant Aristotelianism generally disappeared. But Catholic Scholasticism continued to enjoy a shadowy existence in the seminaries decreed by the Council of Trent (1545–1563). A new literary form appeared, the *cursus philosophicus*, a summary of Scholastic teaching in philosophy, generally written in the form of disputations on the works of Aristotle. The purpose of the *cursus* was to provide the basic philosophical knowledge necessary for the study of Catholic theology, and it tended

increasingly to return to the teaching of one of the great thirteenth-century doctors, like Thomas Aquinas (Thomism) and Duns Scotus (Scotism).

Modern Study of Aristotle

The Neo-Scholasticism of the nineteenth century thought of Aristotle’s philosophy as a response to the Enlightenment’s rejection of a worldview in which revelation appeared necessary and its acceptance reasonable. The *cursus* found the support of the Catholic Church in Pope Leo XIII’s encyclical *Aeterni Patris* of 1879 and various pieces of legislation concerning the instruction in seminaries. The Dominican and Jesuit orders followed the doctrine of Thomas Aquinas, while the Franciscan order followed that of Duns Scotus, both emphasizing Aristotle’s metaphysics, even for cosmological and psychological questions.

The publication by the Berlin Academy of the *Aristotelis opera* between 1831 and 1870 and of the *Commentaria in Aristotelem graeca* between 1882 and 1909 has supplied the basis for the modern study of Aristotle and the Greek tradition of his philosophy. The *Aristoteles latinus*, undertaken by the Union Académique Internationale in 1939 for the edition of the medieval Latin translations, two collections of the Latin translations of the Greek commentaries, as well as a series of English translations of them, have contributed to a new understanding of Aristotelianism in the twentieth century.

See also **Greek Science; Islamic Science; Logic; Metaphysics; Natural History; Natural Law; Natural Theology; Philosophy and Religion in Western Thought; Platonism; Scholasticism.**

BIBLIOGRAPHY

- Gottschalk, Hans B. “Aristotelian Philosophy in the Roman World from the Time of Cicero to the End of the Second Century AD.” In *Aufstieg und Niedergang der römischen Welt*, edited by W. Haase. Berlin: Walter de Gruyter, 1987.
- Lohr, Charles H. *Latin Aristotle Commentaries: II. Renaissance Authors*. Florence, Italy: Olschki, 1988.
- . “Medieval Latin Aristotle Commentaries.” *Traditio* 23–30 (1967–1974).
- . “Metaphysics.” In *The Cambridge History of Renaissance Philosophy*, edited by C. B. Schmitt et al., 535–638. Cambridge, U.K.: Cambridge University Press, 1988.
- , ed. *Commentaria in Aristotelem graeca: Versiones Latinae temporis resuscitatarum litterarum*. 12 vols. Frankfurt, Germany: Minerva, and Stuttgart, Germany: Frommann-Holzboog, 1978.
- Mikkeli, Heikki. *An Aristotelian Response to Renaissance Humanism: Jacopo Zabarella on the Nature of Arts and Sciences*. Helsinki: Finnish Historical Society, 1992.
- Peters, F. E. *Aristoteles arabus: The Oriental Translations and Commentaries on the Aristotelian Corpus*. Leiden, Netherlands: Brill, 1968.
- Schmitt, Charles B. *Aristotle and the Renaissance*. Cambridge, Mass.: Harvard University Press, 1983.
- Sorabji, Richard, ed. *The Ancient Commentators on Aristotle: A Series of English Translations*. London and Ithaca, N.Y.: Duckworth, 1987.
- . *Aristotle Transformed: The Ancient Commentators and Their Influence*. London: Duckworth, 1990.

Verbeke, Gerard, et al., eds. *Corpus latinum commentariorum in Aristotelem graecorum*. 12 vols. Louvain, Belgium: University of Louvain, 1957; Leiden, Netherlands: Brill, 1973–1981.

Charles H. Lohr

ARTIFICIAL INTELLIGENCE. See **Computer Science.**

ARTS.

This entry includes two subentries:

Overview
Africa

OVERVIEW

While people have always made objects that are rightly considered works of art, the *idea* of the arts is a separate category of human endeavor—distinct, that is, from other kinds of human activity such as hunting or food gathering or making in general—is a relatively modern construction.

The “Era of Art”

In the forward to his monumental study of the medieval icon, *Bild und Kult*, translated *Likeness and Presence* in the American edition, Hans Belting explains the book’s rather curious subtitle—*A History of the Image before the Era of Art*—in terms that immediately focus on the issues surrounding the idea of the visual arts, especially just what they are and how they function in culture as a whole:

Art, as it is studied by the discipline of Art History today, existed in the Middle Ages no less than it did afterwards. After the Middle Ages, however, art took on a different meaning and became acknowledged for its own sake—art as invented by a famous artist and defined by a proper theory. While the images from olden times were destroyed by iconoclasts in the Reformation period, images of a new kind began to fill the art collections which were just then being formed. The era of art, which is rooted in these events, lasts until this present day. From the very beginning, it has been characterized by a particular kind of historiography which, although called the history of art, in fact deals with the history of artists. (p. xxi)

The historiography to which Belting refers is exemplified by the work of Giorgio Vasari (1511–1574). A painter in his own right, he was by all accounts the first serious collector of drawings—he believed that they revealed the very moment of artistic inspiration. His passion for drawing also led him to found the Accademia del Disegno (Academy of Design) in Florence in 1562. He theorized that *disegno* (meaning both “drawing” and “design”) was superior to *colorito* (“painting in color”) because the former was an exercise of the intellect, while the latter appealed only to the sensual appetites. At the



Reliquary effigy of St. Foy (gold and silver over a wooden core, studded with precious stones and cameos), mostly 983–1013, with later additions. Created to contain the skull of a martyred child who was put to death for refuting pagan worship, the artistic power of the effigy lies not in its resemblance to the actual child, but in its purpose as the vessel that houses the sacred remains. © GIRAUDON / ART RESOURCE, NY

Accademia he encouraged artists to develop their talents unfettered by the constraints of tradition and convention, arguing that genius was most readily realized in invention.

All of Vasari’s preoccupations are reflected in his *Lives of the Most Eminent Painters, Sculptors, and Architects*, first published in 1550 and then greatly revised and expanded in 1568.

Vasari's book marks the historical moment when what people today so readily think of as the visual arts were transformed from objects reflecting the manual skills of the individual craftsman to reflections of the intellectual and creative powers of the artist. Before the "era of art," the image, however artistically made, served specific cultural, religious, or political functions. It was required, quite literally, to perform. As Belting puts it, "Authentic images seemed capable of action, seemed to possess *dynamis*, or supernatural power" (p. 6). They performed miracles, warded off danger, and healed the sick. If in the "era of art" images lost this power, they gained a considerable expressive dimension. They became the medium through which artists—in the era of art, they are called "artists"—express their own ideas and feelings and make manifest their own individual talent or genius.

The difference between the image before the era of art and the image after is readily apparent if we compare the reliquary effigy of St. Foy at Conques in France and Leonardo da Vinci's (1452–1519) famous *Mona Lisa*. St. Foy was a pilgrimage church built in 1050–1120 to accommodate pilgrims on their way to Santiago de Compostela, in the northwest corner of present-day Spain, a favorite pilgrimage destination because the body of the apostle St. James the Greater, which lay at rest there, had a reputation for repeated miracles. St. Foy housed the relics of St. Foy ("Saint Faith" in English), a child who was martyred when she was burned to death in 303 for refusing to worship pagan gods. Her skull was contained in this elaborate jeweled reliquary, which stood in the choir of the church where pilgrims could view it from the ambulatory that circles the space. The head of the reliquary was salvaged from a late Roman face guard and parade helmet and reused here. Many of the precious stones that decorate the reliquary were the gifts of pilgrims themselves. The saint's actual skull was housed in a recess carved into the back of the reliquary, and below it, on the back of her throne, was an engraving of the Crucifixion, indicating the connection between St. Foy's martyrdom and Christ's own.

Now, the St. Foy effigy, fashioned out of the antique Roman mask, bears no real resemblance to the saint herself. Its value resides not in any likeness, but in its contiguity with the skull housed within. It literally "touches" the physical remains of a child burned to death, at least symbolically, by the soldier whose face this mask once guarded. The Roman artifact has thus been completely transformed—from the pagan to the Christian, from male ornament symbolic of war to a female form symbolic of faith. And it symbolizes, further, the transformation that awaits the faithful, from the physical confines of the body to the spiritual realm of the soul. Pilgrims decorated the reliquary not merely in penitence for their sins but because they felt, in its presence, the need to sacrifice their material wealth in symbolic repetition of the saint's sacrifice of her person. In one of the most important first-hand accounts of the relationship between the cult statue and the pilgrims who came to venerate it, Bernard of Angers, who made three trips to Conques beginning in 1013, describes how he was at first skeptical of the reliquary's power: "I looked with a mocking smile at [his companion] Bernier, since so many people were thoughtlessly directing their prayers at an object

without language or soul, . . . and their senseless talk did not come from an enlightened mind." But he soon changed his mind:

Today I regret my foolishness toward this friend of God. . . . Her image is not an impure idol but a holy momento that invites pious devotion. . . . To be more precise, it is nothing but a casket that holds the venerable relics of the virgin. The goldsmith has given it a human form in his own way. The statue is as famous as once was the ark of the covenant but has a still more precious content in the form of the complete skull of the martyr. This is one of the finest pearls in the heavenly Jerusalem, and like no other person in our century it brings about the most astonishing miracles through its intercession with God.

It is as if, he says, "the people could read from the luster of these eyes whether their pleas had been heard" (pp. 536–537). It is the efficacy of the relics within that the people read into the statue's outward gaze.

The relationship between the image and its beholder is entirely different in Leonardo's *Mona Lisa* (1503–1506). In the first place, the image is, above all, a likeness. Vasari was the first to use the name by which the painting is now known, leading to speculation that the sitter is Lisa Gherardini, who married the Florentine merchant Francesco Bartolomeo del Giocondo in 1495, but other testimony contradicts this thesis, and her identity remains a mystery. This mystery, of course, lends the painting much of its fame, for without any relevant biographical knowledge, any clues as to what she might be thinking are pure speculation. As David Summers put it in his important contribution to global and intercultural art history, *Real Spaces* (2003), "She is the individual mask of her own inwardness, of the mind and heart suggested to us by her famous smile." Leonardo's purpose, Summers reminds us, was to make "the invisible (the movements of the soul) visible in the movements of the body," even in such a small movement as the upward turn of the sitter's lips. But Leonardo himself recognized

that artists run the risk of making images look like themselves because the same individual soul that shaped the artist's physical appearance also judges the beauty and rightness of the figures the artist makes. Leonardo recommended that artists study proportion, which will give them the means to counteract this distorting narcissistic tendency. His argument assumes coincidence between individual appearance and individual soul, outwardness and inwardness. It also suggests the difficulty of distinguishing the perception of another from oneself. (p. 331)

Thus the enduring myth that *Mona Lisa* is in fact a self-portrait, Leonardo's revelation of his "feminine side." But more important, Summers makes clear here the way in which the visual arts, in the era of art, are removed from the cultural dynamic that informs the medieval icon. Just as surely as the meaning of the reliquary statue at St. Foy resides "inside" its mask, so the meaning of the *Mona Lisa* resides beneath her

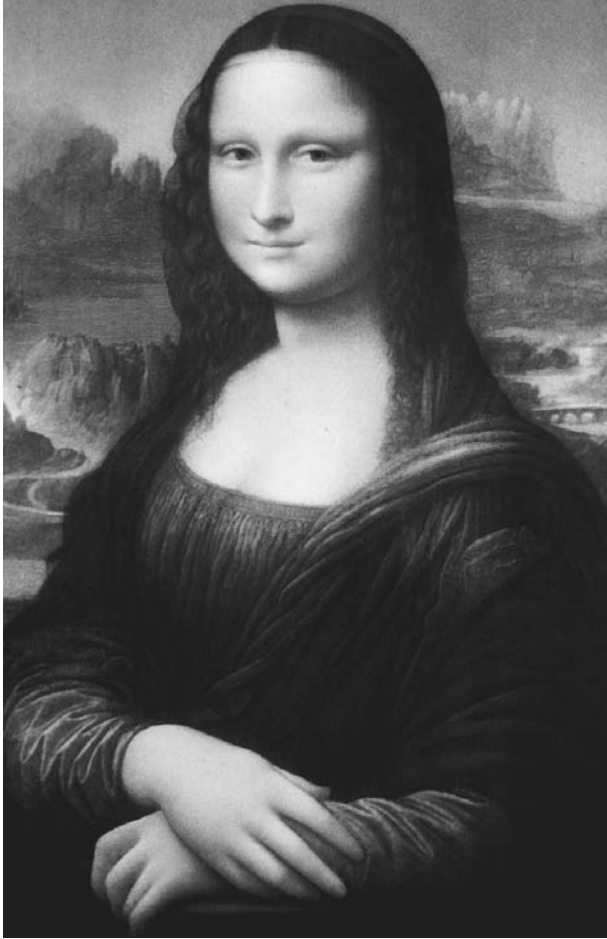

Mona Lisa (1503–1506) by Leonardo da Vinci. Oil on wood. Da Vinci's masterpiece is a study in inwardness and what exists just below the surface, and admirers have spent centuries trying to decipher the subtle clues in the subject's face for an indication of what thoughts are in her head. © THE BETTMANN ARCHIVE

superficial appearance. But her meaning is private, personal, immaterial. She is forever meditative, forever a mystery, a self-reflective soul. People visit the Louvre in the early twenty-first century, in a procession not so unlike that of the medieval pilgrims, because, in the space between image and beholder, the self-reflection that the image portrays is recreated in one's reflections upon it. As Denis Donoghue has put it, "The mysteriousness of art is in all art; . . . it suffuses the space between the image and its reference" (p. 32).

From *Ars* to *Arte* to *Beaux-Arts*

The transformation of the image from an efficacious to a reflective space is coincident with the rise of the very idea of the "arts." Before the era of art, the word *art* had much broader meaning than it does today. The Latin *ars* (and the Greek *technē*) referred to almost any branch of human endeavor—the work of the farmer, the shipwright, the military commander, the magician, the cobbler, the poet, the flute player, the vase painter, all were included in the general category of the "arts" so long as their endeavors were executed with a certain

degree of skill. In the *Ethics* (book 6), Aristotle distinguished between two spheres of action—*praxis*, doing, or moral or political conduct, and *poiesis*, making, producing, or performing. The intellectual virtue attendant to *poiesis* is *technē*—art, technique, skill, and know-how—"the trained ability of making something under the guidance of rational thought" (1140.9–10). Aristotle further distinguishes between the liberal and servile arts. The liberal arts are those that work with the intellect, including the verbal arts of grammar and rhetoric and the mathematical arts of arithmetic, geometry, astronomy, and music. The servile arts are those associated with physical labor and, generally, work for pay. Thus the work of the farmer and the cook were more or less equivalent to that of the architect, the sculptor, and the painter. As John Boardman puts it in his *Greek Art*, "Art for Art's sake" was virtually an unknown concept; there was neither a real Art Market nor Collectors; all art had a function and artists were suppliers of a commodity on a par with shoemakers" (p. 16).

Even by Vasari's time, things had hardly changed. He does not use the Italian *artista* to refer to "the artist," but rather *artifice*, "artificer." "What a happy age we live in!" he wrote, reacting to the sight of Michelangelo's Sistine Chapel frescoes. "And how fortunate are our artists [*artifice*] who have been given light and vision by Michelangelo and whose difficulties have been smoothed away by this marvelous and incomparable artist [*artifice*]." Indeed, the word *artista* was more generally used to refer to those who studied the more intellectual liberal arts, particularly rhetoricians. Furthermore, the Italian word *arte*, which in modern usage means simply "art," was in medieval times and throughout the Renaissance, the word for "guild," including, in Florence, the *Arte della Lana*, the wool guild; the *Arte di Seta*, the silk guild; and the *Arte di Calimala*, the cloth merchants' guild. Thus *art* remained simply making, skill, and know-how. The bankers had their *arte*, and so did the lawyers—perhaps because of their rhetorical skill the lawyers' was the most prestigious of all.

Not until the middle of the eighteenth century did the arts separate themselves off from other fields of endeavor into their own exclusive area of expertise. In what is one of the best surveys of the history of the *arts* as an idea, Larry Shiner points to two crucial texts—Charles Batteux's *Les beaux arts réduit à un même principe* (The fine arts reduced to a single principle), published in 1746 in France and translated into English three years later as *The Polite Arts; or, A Dissertation on Poetry, Painting, Musick, Architecture, and Eloquence*, and the 1751 edition of Denis Diderot and Jean Le Rond d'Alembert's *Encyclopédie*.

Batteux claimed there are actually three classes of arts: those that simply minister to our needs (the mechanical arts); those whose aim is pleasure (the beaux-arts par excellence); and those that combine utility and pleasure (eloquence and architecture). Batteux also used two other criteria for separating the beaux-arts from the rest: genius, which he calls "the father of the arts," because it imitates beautiful nature, and taste, which judges how well beautiful nature has been imitated. . . . The *Encyclopédie* now grouped all five fine arts (poetry, painting, sculpture, engraving, and music) under the faculty of

* SYSTÈME FIGURÉ DES CONNOISSANCES HUMAINES.

ENTENDEMENT.

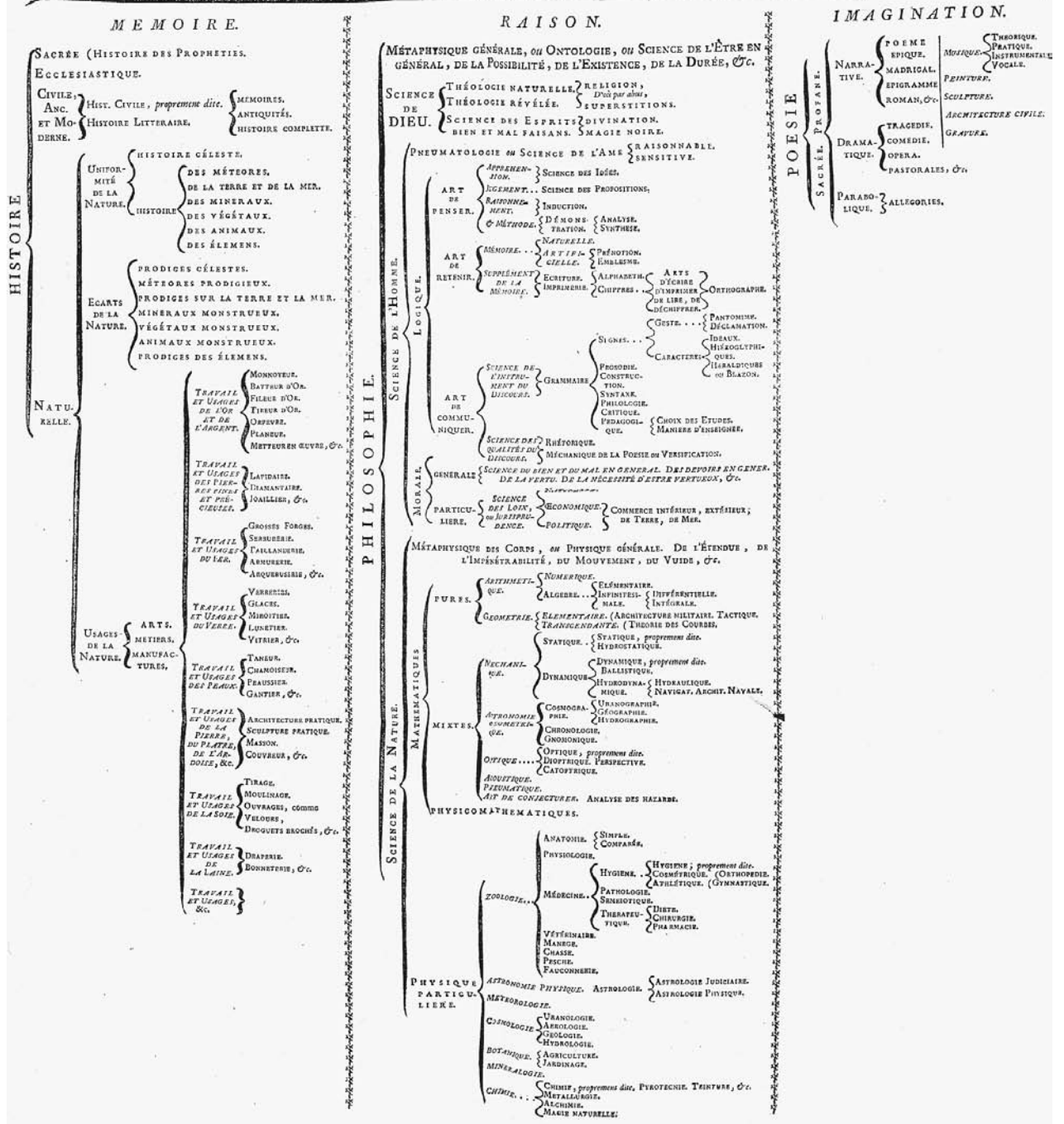

Système Figuré des Connoissances Humaines (Table of Human Knowledge; 1751), a diagram of the arts by Denis Diderot and Jean le Rond d'Alembert. Researchers did not begin to classify the arts into their own separate field of study until the eighteenth century, when several groundbreaking texts on the subject were published. ANNENBERG RARE BOOK AND MANUSCRIPT LIBRARY, UNIVERSITY OF PENNSYLVANIA

imagination as one of three main divisions of knowledge, splendidly isolated from all other arts, disciplines, and sciences. (pp. 83–84)

Nevertheless, as Shiner points out, Diderot's article "Art" in the *Encyclopédie* ignores the new category of "beaux-arts" altogether and concentrates exclusively on the mechanical arts, representations of which constitute almost the entirety of the *Encyclopédie's* illustrations. It would be another twenty-five years before an article on the "beaux-arts" would finally find its way into a supplement to the *Encyclopédie*. According to d'Alembert, the category of the *beaux-arts*—the term that the English world would translate first as the "polite arts" and then as the "fine arts"—consisted of any works that have pleasure for their aim and that rely on the imagination (inventive genius) as opposed to memory (history) or reason (philosophy). The cult of originality and imagination inaugurated by Vasari in his *Lives* reached its ultimate conclusion here.

The "Arts" and Other Cultures

Shiner makes a convincing case that the arts are a modern invention, "not an essence or a fate but something we have made . . . [an] invention barely two hundred years old" (p. 3). One of the first to convincingly argue the point was Paul Oskar Kristeller in his 1950 essay "The Modern System of the Arts," but Shiner's argument is distinguished by its awareness that the category of the "arts" is a markedly European construct, one that in recent years has come under increasing scrutiny as the (Western) art world has "opened" itself to works made in other cultures. In the process, the very idea of the "arts" has begun to change once again.

One of the key moments in this process happened in the summer of 1989, with the opening of an exhibition in Paris that announced itself as "the first world-wide exhibition of contemporary art." Called *Magiciens de la terre*, or *Magicians of the Earth*, the show consisted of works by one hundred artists, fifty from the traditional "centers" of Western culture (Europe and America) and fifty from the so-called Third World, from Asia, South America, Australia, Africa, and, incidentally, Native American art from North America. The show's curator, Jean-Hubert Martin, conceived of the exhibition as a way to show the real differences between and specificity of different cultures. But the exhibition raised many questions of the kind articulated by Eleanor Heartney in her extended review of the show in *Art in America*:

Can there really, one wonders, be any continuum between a Kiefer painting and a Benin ceremonial mask? How does one make judgments of "quality" about objects completely foreign to our culture and experience? Is there any "politically correct" way to present artifacts from another culture, or does the museological enterprise inevitably smack of cultural exploitation? Wary of the tendency to romanticize the lost purity of vanished worlds, the organizers have emphasized societies in transition, in many cases choosing Western and non-Western artists who represent an exchange of influences between their respective cultures. Still, one wonders if

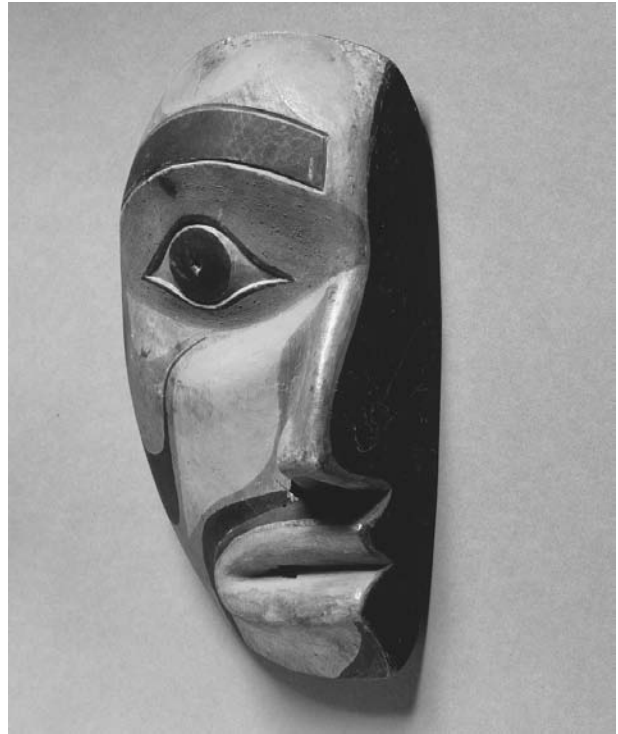

Kwakiutl mask from British Columbia, Canada, 1887. Painted wood. The Kwakiutls, a native American tribe found along the northwest coast of Canada, utilized masks for virtually every occasion in their culture. William Rubin, director emeritus of New York's Museum of Modern Art, attempted to compare Kwakiutl art to that of Picasso to prove that abstraction is a universal concept. © BILDARCHIV PREUSSISCHER KULTURBESITZ / ART RESOURCE, NY

such exchanges are really equivalent. Is the same thing going on when an artisan from Madagascar incorporates airplanes and buses within the traditional tomb decorations of Madagascar and Mario Merz appropriates the igloo or hut form into his sculptures? (pp. 91–92)

In order to treat all the show's exhibitors on equal terms, the curators included only the names of each work's creator and its geographical origin in identifying the pieces. As a result, the average Western viewer was encouraged, as Heartley says, "to apply preexisting Western esthetic standards to objects where such standards are irrelevant" (p. 92).

Nevertheless, in its recognition of the growing impact of Western culture and modern technology on "evolving" cultures, and its refusal to romanticize the originary purity of the artifacts on display, the show marked a distinct advance over the Museum of Modern Art's 1984 exhibition *'Primitivism' in 20th-century Art: Affinity of the Tribal and Modern*. Curator William S. Rubin tried to show that abstraction was a universal language by comparing, for instance, Pablo Picasso's *Girl before a Mirror* to a Kwakiutl mask from British Columbia the likes of which Picasso had almost certainly never seen and arguing that what "led artists to be receptive to tribal art" in the twentieth century

The greatest gifts are often seen, in the course of nature, rained by celestial influences on human creatures; and sometimes, in supernatural fashion, beauty, grace, and talent are united beyond measure in one single person, in a manner that to whatever such a one turns his attention, his every action is so divine, that, surpassing all other men, it makes itself clearly known as a thing bestowed by God (as it is), and not acquired by human art. This was seen by all mankind in Leonardo da Vinci, in whom, besides a beauty of body never sufficiently extolled, there was an infinite grace in all his actions; and so great was his genius, and such its growth, that to whatever difficulties he turned his mind, he solved them with ease. . . . In learning and in the rudiments of letters he would have made great proficience, if he had not been so variable and unstable, for he set himself to learn many things, and then, after having begun them, abandoned them. Thus, in arithmetic, during the few months that he studied it, he made so much progress, that, by continually suggesting doubts and difficulties to the master who was teaching him, he would very often bewilder him. He gave some little attention to music, and quickly resolved to learn to play the lyre, as one who had by nature a spirit most lofty and full of refinement: wherefore he sang divinely to that instrument, improvising upon it. . . . He practised not one branch of art only, but all those in which drawing played a part; and having an intellect so

divine and marvellous that he was also an excellent geometrician, he not only worked in sculpture, making in his youth, in clay, some heads of women that are smiling, of which plaster casts are still taken, and likewise some heads of boys which appeared to have issued from the hand of a master; but in architecture, also, he made many drawings both of ground-plans and of other designs of buildings; and he was the first, although but a youth, who suggested the plan of reducing the river Arno to a navigable canal from Pisa to Florence. . . . And there was infused in that brain such grace from God, and a power of expression in such sublime accord with the intellect and memory that served it, and he knew so well how to express his conceptions by draughtmanship, that he vanquished with his discourse, and confuted with his reasoning, every valiant wit. . . . It is clear that Leonardo, through his comprehension of art, began many things and never finished one of them, since it seemed to him that the hand was not able to attain to the perfection of art in carrying out the things which he imagined; for the reason that he conceived in idea difficulties so subtle and so marvellous, that they could never be expressed by the hands, be they ever so excellent.

SOURCE: Giorgio Vasari, "Life of Leonardo Da Vinci: Painter and Sculptor of Florence." In *The Lives of the Most Eminent Painters, Sculptors, and Architects*, pp. 89–92.

had "to do with a fundamental shift in the nature of most vanguard art from styles rooted in visual perception to others based on conception"—that is, abstraction (p. 11). The reaction to Rubin's show was dramatic—and negative. Many critics believed that Rubin unwittingly outlined the terms by which so-called tribal cultures had traditionally been appropriated—that is, colonized and consumed—by Western culture. Others pointed out that Rubin's so-called tribal art was not, to the cultures that produced it, art at all. In a particularly severe review in *Artforum*, Thomas McEvelley took Rubin to task for insisting that the specific function and significance of each of the objects in the show was irrelevant. "But it is also true," McEvelley points out, "that he attributes a general function to all the objects together, namely, the esthetic function, the function of giving esthetic satisfaction. In other words, the function of Modernist works is tacitly but constantly attributed to the primitive works. . . . Religious objects . . . are misleadingly presented as art objects" (pp. 58–59).

In other words, most of the works in this exhibition were produced before their particular cultures had entered the "era of art," and Rubin proceeded as if Western historiography determines global historiography. There was long-standing precedent for Rubin's position, one of the most notable of which was Paul Guillaume and Thomas Munro's ground-breaking *Primitive Negro Sculpture*, first published in 1926 but still current enough in 1968 to be reprinted by Hacker Art Books. As Christa Clarke has summarized the book's ground-breaking principles: "*Primitive Negro Sculpture* . . . differs from earlier publications in providing clearly developed aesthetic criteria for an evaluation of African sculpture. The text not only makes distinctions between 'art' and 'artifact,' but also specifies ideal formal properties and delineates cultural 'style regions' based on shared stylistic characteristics" (p. 41). All the illustrations in the book were from the collection of the Barnes Foundation, collected by Albert C. Barnes in order to demonstrate his own aesthetic theory,



Quetzal feather headdress of Aztec emperor Montezuma II, c. 1520. Fashioned from beads, shells, and over four hundred iridescent quetzal feathers, this elaborate headdress was presented to Holy Roman Emperor Charles V by Cortés. Quetzals were considered sacred by the Aztecs, who believed the birds represented wisdom and peace. © ERICH LESSING / ART RESOURCE, NY

which was founded on the belief in ideal form. In Clark's summary:

Great art does not imitate nature but interprets the experience of seeing nature through "plastic means"—that is, through color, line, light, and space. This exclusive focus on "plastic form" provided a critical framework that encompassed all visual material, regardless of cultural origin or subject matter. Barnes's aesthetic studies led him to consider African sculpture as the purest expression of three-dimensional form. (pp. 42–43)

Thus Guillaume and Munro, working at Barnes's behest, not only differentiate African "art"—sculptures and masks (i.e., religious objects and fetishes)—from African "artifacts"—cups, utensils, musical instruments—but they emphasize the formal qualities of the "art" in particular:

To the eye, to the hand, to both together moving over the surface, the statue is like music in its succession of repeated and contrasting sensuous forms, its continuities and subtle alterations of a theme. Or rather it is the material for music that one may compose at will,

proceeding always in a new order from line to line and mass to mass, singling out and reorganizing the elements, perceiving always some new relationship that had never presented itself before. (p. 33)

Guillaume and Munro may as well be writing about the art of Picasso or Henri Matisse (1869–1954), both of whose work, of course, Barnes admired and collected.

In fact, one of the most notable aspects of modern art historiography in the West is its refusal to see the artifacts of other cultures in terms other than the formalist aesthetic of modernism. McEvilley underscores the fact with a telling example:

In New Guinea in the '30s, Western food containers were highly prized as clothing ornaments—a Kellogg's cereal box became a hat, a tin can ornamented a belt, and so on. Passed down to us in photographs, the practice looks not only absurd but pathetic. We know that the tribal people have done something so inappropriate as to be absurd, and without even beginning to realize it. Our sense of the smallness and quirkiness of their world view encourages our sense of the larger scope and greater clarity of ours. Yet the way Westerners have related to the primitive objects that have floated through their consciousness

would look to the tribal peoples much the way their use of our food containers looks to us: they would perceive at once that we had done something childish in appropriate and ignorant, and without even realizing it. Many primitive groups, when they have used an object ritually (sometimes only once) desecralize it and discard it as garbage. We then show it in our museums. In other words: our garbage is their art, their garbage is our art. (p. 59)

In sum, the category “art” is by no means universal.

In *The Invention of Art*, Larry Shiner points out that “the Japanese language had no collective noun for ‘art’ in our sense until the nineteenth century” nor before the nineteenth century had anyone in China “grouped painting, sculpture, ceramics, and calligraphy together as objects” sharing any qualities in common (p. 15). Indeed, there is, among non-Western peoples and those cultures that exist on Western culture’s margins, a growing antipathy to the appropriation of their “crafts” into the art context. Shiner cites a statement by Michael Lacapa, an “artisan” of mixed Apache, Hopi, and Tewa heritage, that he encountered at the Museum of Indian Arts and Culture in Santa Fe in 1997:

What do we call a piece of work created by the hands of my family? In my home we call it pottery painted with designs to tell us a story. In my mother’s house, we call it a wedding basket to hold blue corn meal for the groom’s family. In my grandma’s place we call it a Kachina doll, a carved image of a life force that holds the Hopi world in place. We make pieces of life to see, touch, and feel. Shall we call it “Art?” I hope not. It may lose its soul. Its life. Its people. (p. 273)

Quite clearly, the process that would transform Lacapa’s pottery, basket, or Kachina doll is not so much their appearance in the Museum of Indian Arts and Culture (where they apparently fall on the “culture” side of things), but the fact that they were to be purchased, collected, and commodified by agencies outside the culture and “life” in which they were produced.

Homi Bhaba, one of the great students of contemporary “global” culture, has reminded us of the “artificial” consequences of Western colonization. “The great remains of the Inca or Aztec world are the debris,” he writes, “of the Culture of Discovery. Their presence in the museum should reflect the devastation that has turned them from being signs in a powerful cultural system to becoming the symbols of a destroyed culture” (p. 321). The headdress of Montezuma II (in Nahuatl, Motecuhzoma; r. 1502–1520), presented to the Habsburg emperor Charles V (r. 1519–1556) by Hernán Cortés and now in the Museum of Ethnology in Vienna, is a case in point. Consisting of 450 green tail feathers of the quetzal bird, blue feathers from the cotinga bird, beads, and gold, it is a treasure of extraordinary beauty. But the historical moment is being approached, if not already here, when such objects will be allowed to give up their status as “art,” except insofar, perhaps, the recognition that the “arts” are a historically constructed phenomenon that conveniently serves to mask social history. “It seems appropriate,” Homi Bhaba says, “[to make] present in the

display of art what is so often rendered unrepresentable or left unrepresented—violence, trauma, dispossession” (p. 321). It seems likewise appropriate to let the arts, which in the early twenty-first century have neither pleasure nor the revelation of genius as their principal aims, represent these things.

See also Aesthetics; Classification of Arts and Sciences, Early Modern; Creativity in the Arts and Sciences; Gender in Art; Humanity in the Arts; Landscape in the Arts; Periodization of the Arts; War and Peace in the Arts.

BIBLIOGRAPHY

- Belting, Hans. *Likeness and Presence: A History of the Image before the Era of Art*. Translated by Edmund Jephcott. Chicago: University of Chicago Press, 1994.
- Bernard of Angers. *Book of the Miracles of St. Faith (Liber miraculorum S. Fides)*. Text 34 in the “Appendix: Texts on the History and Use of Images and Relics,” in Belting, *Likeness and Presence*, pp. 536–537. Chicago: University of Chicago Press, 1994.
- Bhabha, Homi K. “Postmodernism/Postcolonialism.” In *Critical Terms for Art History*, edited by Robert S. Nelson and Richard Shiff. Chicago and London: University of Chicago Press, 1966.
- Boardman, John. *Greek Art*. London: Thames and Hudson, 1996.
- Clarke, Christa. “Defining African Art: Primitive Negro Sculpture and the Aesthetic Philosophy of Albert Barnes.” *African Arts* 36, no. 1 (spring 2003): 40–51, 92–93.
- Donoghue, Denis. *The Arts without Mystery*. Boston: Little, Brown, 1983. Contrary to the sense of its title, Donoghue’s book is a meditation on the place of mystery in the arts widely defined to include painting, sculpture, literature, music, dance, and theater.
- Guillaume, Paul, and Thomas Munro. *Primitive Negro Sculpture*. New York: Harcourt Brace, 1926.
- Heartney, Eleanor. “The Whole Earth Show: Part II.” *Art in America* 77, no. 7 (July 1989): 90–97.
- McEvelley, Thomas. “Doctor Lawyer Indian Chief: *Primitivism in Twentieth-Century Art* at the Museum of Modern Art.” *Artforum* 23, no. 3 (November 1984): 54–61.
- Rubin, William S. “*Primitivism in Twentieth-Century Art: Affinity of the Tribal and the Modern*.” New York: Museum of Modern Art, 1984.
- Shiner, Larry. *The Invention of Art: A Cultural History*. Chicago: University of Chicago Press, 2001.
- Summers, David. *Real Spaces: World Art History and the Rise of Western Modernism*. New York: Phaidon, 2003.
- Vasari, Giorgio. *The Lives of the Most Eminent Painters, Sculptors, and Architects*. 2 vols. Translated by Gaston du C. de Vere. New York: Knopf, Everyman’s Library, 1996.

Henry M. Sayre

AFRICA

Between 1520 and 1521, the famous German painter and engraver Albrecht Dürer (1471–1528) purchased two African ivory carvings in the Netherlands. He was so impressed by their craftsmanship that he noted in his diary:

all sorts of marvelous objects for human use much more beautiful to behold than things spoken of in fairy tales.

. . . And in all the days of my life, I have seen nothing which rejoiced my heart as these things—for I saw among them wondrous artful things and I wondered over the subtle genius of these men in strange countries. (Fagg, p. 9)

The Myth of Primitivism

Although stylized carvings from the kingdoms of Sapi, Benin, and Kongo were popular in Europe in the sixteenth century, scholarly interest in African art in general did not begin until the nineteenth century, when European colonization of Africa increased the number of examples arriving in European museums. But by this time the European attitude to the arts of other cultures had changed drastically, having been influenced by ideas of Enlightenment and evolution. Both ideas placed European culture at the apex of human development, using its naturalistic representations as the benchmark for the arts of other cultures. And since most of the sculptures and masks from Africa were stylized or conceptual in form, European scholars looked down on them as “primitive” and a failed attempt to imitate nature.

Although naturalistic representation turned up as early as 1910 in Africa, such as the terra cotta and brass figures of Ife, Nigeria, they were dismissed as the works of foreigners. In fact, Leo Frobenius, the German anthropologist who first brought Ife art to world attention, attributed the portraits to the ancient Greeks, who, he speculated, might have settled among the Yoruba before the Christian era. According to him, if a full figure in the Ife style were to be found, it would almost certainly reflect a proportion similar to that of classical Greek art. Fortunately, a full figure has been found and dated to the twelfth and sixteenth centuries of the Christian era. Contrary to expectation, its proportion is completely different from that of Greek art but closer to what is found in the generality of African figure sculpture—the head being about a quarter of the whole body, notwithstanding the naturalistic treatment of body parts.

By and large the myth of primitivism is no longer taken seriously. First, its assumption that naturalism was a late stage in the progressive evolution of art from the conceptual to the lifelike has been debunked by the occurrence of naturalistic images in the prehistoric rock art of Africa, Europe, and Australia. Some of the examples from Africa were created about twenty-five thousand years ago. Second, from a close study it is now known that the disregard for naturalism in African art is deliberate, not the result of a technical deficiency. It has been influenced by different cosmologies that not only trace the origin of art to supernatural beings but also identify the human body as a piece of sculpture animated by a vital force or soul. In other words, art makes the spirit manifest in the physical world. The time-honored ritual still associated with the creation of sculptures and masks today clearly shows that art in precolonial Africa was not so much concerned with imitating reality as with evoking its essence. Thus stylization hints at the interrelatedness of the physical and metaphysical. Ironically, the same so-called primitive art of Africa contributed significantly to the birth of modern European art at the beginning of the twentieth century, inspiring prominent artists such as

André Derain, Maurice Vlaminck, and Pablo Picasso, among others, to abandon naturalism in favor of stylization and abstraction.

Functionalism, Structuralism, and “One Tribe, One Style”

The pre-nineteenth-century European distinction between “art” (the nonutilitarian) and “craft” (the utilitarian) also contributed to the prejudice against African art, given its use in ritual ceremonies. This distinction turned African sculptures and masks into ethnological specimens and a gold mine for anthropologists interested in the relationship between art and society. Some applied the functional theory developed in the 1920s by the French sociologist Émile Durkheim (1858–1917) and his followers, emphasizing the interconnection of ritual, religion, language, social practices, and symbolic expressions. Others employed the structuralist model popularized in the 1950s and 1960s by Claude Lévi-Strauss (b. 1908) to search for deeper meanings or a concealed order in symbolic or language systems. In both approaches—often combined in the same study—art was treated as part of an organic whole and as an aspect of myth, religion, or kinship system. Little attention was paid to aesthetic factors, individual creativity, and the historical factors affecting form and style (for a comprehensive review of the literature, see Gerbrands).

Between 1935 and 1946, the Museum of Modern Art in New York organized major exhibitions of African and Oceanic art to familiarize the public with their influence on European and American modernism. By the 1950s some American art historians such as Robert Goldwater (New York University) and Paul Wingert (Columbia University) had started offering courses in African art. The emergence of many newly independent African states from the 1960s onward resulted in a worldwide increase of scholarly interest in African affairs.

Most of the early surveys of African art focused on style areas, inaugurating what Sidney Kasfir (1984) calls the “one tribe, one style” conceptual model. Its underlying assumption was that the styles and iconographical elements that define the art of a given group had been fixed for centuries, untouched by outside influences. It thus encouraged the study of African art in the “ethnographic present.” A sea change occurred in the late 1960s and early 1970s with the arrival in the field of new scholars who combined art-historical and anthropological methods in a more critical way. Apart from focusing on the art of specific African cultures, they took cognizance of individual and regional variations within a major style area. In addition, they documented artistic exchanges between contiguous and distant groups due to military conquest or centuries of trade, migration, and/or social interaction.

Unlike their predecessors, who focused mainly on art objects and ignored the artists who created them, the new scholars and their students recorded names of artists, possible dates of objects, and contexts of use, among other data. Since then there has been a shift from an emphasis on the religious significance of art to its implications in the realm of politics, psychology, gender, mass communication, and performance. Such was the involvement of art in all phases of life in precolonial

Africa that scholars began to use the term *art for life's sake* to distinguish African art from the European idea of art for art's sake.

In the early twenty-first century the more rigorous approach of a new generation of scholars is shedding new light on old problems and assumptions. For example, previous scholars paid little attention to the interaction between Islam and African art or simply concluded that Islam had had a totally negative impact on African sculpture, given its injunction against image-making. Late twentieth and early twenty-first century scholarship provides evidence to the contrary. Field studies by René Bravmann (1974), Labelle Prussin, Frederick Lamp, and other scholars demonstrate that Muslims in some areas of West Africa have not totally abandoned their ancestral art and religion. By emphasizing the recreational function of African masking, they have succeeded in preserving it in an Islamic context. It is therefore not unusual (among the Baga of Guinea and the Dyula of Mali, Côte d'Ivoire, and Ghana) to see masked performers in the early twenty-first century during important Islamic holiday celebrations, such as the end of Ramadan or the birthday of Prophet Mohammed. Non-Muslims are also known to attach Islamic talismans to altar sculptures so as to make them more efficacious. Arabesque motifs also abound in masks, wood carvings, and fabrics all over Africa. Thus the idea of "tradition" in African art has been modified. Whereas it was once regarded as a strict conformity to forms handed down from the past, in the early twenty-first century the idea is understood as a process of continuity and change (for an overview of the major paradigms in the study of African art up to the 1980s, see *African Art Studies* [1987], Adams, and Ben-Amos).

Beyond Sub-Saharan African Art

Admittedly, the influence of African sculpture on modern art has virtually eliminated the evolutionist prejudice against its conceptual form. Yet it has encouraged a scholarly bias for figure sculpture and masks from West, Central, and Equatorial Africa, marginalizing the equally significant artistic expressions in other media within and outside the region. Until the turn of the twenty-first century, this bias isolated the study of sub-Saharan African art from those of northern, northeastern, and southern parts of the continent, where the decorative arts predominate.

It is gratifying to note, however, that in the early twenty-first century scholars are beginning to correct this anomaly. Surveys cover not only the entire continent (including Ancient Egypt, Nubia, and the Swahili civilizations of East Africa) but also previously neglected art forms such as body adornment, weaving, pottery, calabash decoration, leatherwork, beadwork, and architecture. Thanks to new data from archaeology, prehistoric rock art, various eyewitness accounts by Arab and European visitors to the continent between the eleventh and nineteenth centuries, and works of African origin that found their way to Europe from the fifteenth century onward, it has become possible to attempt a more comprehensive and reliable overview of the artistic developments in the continent from the earliest times to the present, though there are still gaps in knowledge.

The Paradox of Modernism

As is well known, European colonization of a good part of Africa between the late nineteenth century and the mid-1970s resulted in the imposition of European values. It also disrupted the social order, precipitating metamorphic changes. Having discredited African art as "primitive" and as "fetishes," colonial administrators introduced a new art education program, stressing naturalism and art for art's sake. At first talented Africans were encouraged to go to Europe for further training, but by the late 1930s European-type art departments had been established at Achimota College, Gold Coast (now Ghana), and Makarere College, Uganda. Others were introduced in the 1940s and 1950s in Senegal, Nigeria, Republic of Sudan, and Congo-Leopoldville (now the Democratic Republic of Congo). The paradox is that colonialism foisted European-type naturalism on Africa, touting it as "modern art" at the same time as the leading modern European artists were being inspired by African stylization. Conversely, "modernism" had different implications in Africa and Europe during the colonial period, denoting naturalism in the former and stylization/abstraction in the latter.

Dissatisfied with this paradox, some European expatriates in Africa initiated an alternative modernism—a conceptual art that would evoke the spirit of African art without necessarily imitating its forms. They established informal art workshops where individuals without previous art training could create freely, emphasizing genre and folkloric themes. These workshops include L'Academie de l'Art Populaire Congolais, Elizabethville (now Lubumbashi), Democratic Republic of Congo (founded in 1946 by Pierre Romain Desfosses); the Poto-Poto School of Art, Brazzaville, Peoples Republic of Congo (founded in 1951 by Pierre Lods); the Central African Workshop, Salisbury, Southern Rhodesia (now Zimbabwe) (founded in the late 1950s by Frank McEwen); the Lourenço Marques Workshop, Mozambique (founded in 1960 by Amancio Guedes); and the Oshogbo Workshop, Oshogbo, Nigeria (founded in 1962 by Ulli Beier). The graduates of these workshops created images ranging from the realistic and surrealist to the expressionistic and abstract. Some were very original while others were derivative, reflecting influences from European modernism, or what Marshall Mount describes as "a rather condescending Western stereotype of what African painting should be" (p. 75).

The Traditional, Neotraditional, and Authentic

As mentioned above, many Africans have not totally abandoned their cultural heritage despite conversion to Islam. This is also the case with Christianity. During the colonial period, many converts venerated their ancestors secretly. Those living in the urban areas frequently returned to their villages to participate in initiation ceremonies and annual festivals featuring masks. Thus artists trained in the traditional or the so-called classical styles continued to receive commissions, though the number of their local clients had declined considerably.

However, these artists found new clients in the international market created by the interest in African sculptures and masks as a result of their influence on modern European art. The huge demand led some artists to move from rural to urban areas,

forming cooperatives such as those of the Bamana (Bamako, Mali), Senufo (Abidjan, Côte d'Ivoire), Edo (Benin City and Lagos, Nigeria), Ibibio (Ikot Ekpene, Nigeria), Okavango (Rundu, Namibia), Wakamba (Nairobi, Kenya), and Makonde (Dar es Salaam, Tanzania). These cooperatives were still flourishing in the early twenty-first century, creating what is popularly known as “neotraditional,” “tourist,” or “souvenir” art. They specialize in copying and mass-producing the art of the ethnic groups to which they belong, in addition to occasionally replicating popular images in exhibition catalogs from other groups. Their products are sold wholesale to traders who then distribute them across Africa and overseas, making them available at hotel lobbies, supermarkets, boutiques, and duty-free shops in local and international airports. Other artists specialize in beadwork, leatherwork, jewelry, weaving, dyeing, pottery, and calabash decoration, among other arts.

This revival of interest in African art during the colonial period encouraged the Catholic Church in Nigeria to explore the possibility of adapting the art to a Christian context. So between 1947 and 1953 the church established an experimental art workshop in the Yoruba town of Oye Ekiti, Western Nigeria, where it employed the services of Yoruba artists. Two young British priests, Kevin Carroll and Sean O'Mahoney, supervised the project. They supplied the themes and encouraged the artists to render biblical characters in the Yoruba style, though without the rituals that sometimes preceded or accompanied the production of images destined for local shrines. The workshop produced madonnas, crucifixes, nativity sets, altarpieces, baptismal fonts, carved doors, and other works with Christian motifs. The finished objects replaced imported artworks in Catholic churches within and outside Oye Ekiti. The reception of the images, however, varied; it was positive in some areas but so negative in others that they had to be removed because they reminded some Yoruba Catholics of the “pagan” shrines of their ancestors (Carroll; Picton, 2002, pp. 100–101).

Thus a distinction is now made between “traditional” and “neotraditional” African art. The former refers to a work in the so-called classical style originally created for and actually used in private rituals or public ceremonies by the same society to which the artist belongs. The “neotraditional,” on the other hand, refers to a similar work created outside its time-honored context for the tourist/souvenir market or to function as “art for art's sake.” And because most Western scholars and curators regard the used image as “authentic” and the unused as “fake,” the carving cooperatives in the urban and rural areas have devised various ways of artificially aging replicas to enable them to make the grade. In fact, such is the demand in the early 2000s for “old” or “authentic” art that a well-executed contemporary work may be passed over in favor of a damaged mediocre piece if the latter appears to be much older.

Sidney Kasfir (1992) has criticized this Western “antiquarianist mind-set” because it tends to ignore formal quality, an important yardstick for judging a work of art. According to Christopher Steiner, because “authenticity” is defined by Western patrons, those who sell both ancient and recent African art “are not only moving a set of objects through the world economic system, they are also exchanging information—mediating,

modifying, and commenting on a broad spectrum of cultural knowledge” (Steiner, p. 2).

Pan-Africanism, Negritude, Decolonization, and the Search for a New Identity

It is easy to understand why art historians ignored modern and contemporary African art for a long time. First, they were preoccupied with the so-called classical African art, which had influenced the birth of modern European art. Second, some of them assumed that the belief system that inspired the best of African creativity was on the wane due to the negative impact of colonialism, Western education, industrialization, urbanization, and mass conversion to Islam and Christianity. That African creativity has not only recovered from the ordeals of colonialism but has in fact been rejuvenated is apparent in the early-twenty-first-century rise in the number of mainstream museums and galleries collecting contemporary African art as well as in the spate of publications on it.

Although it is customary to trace the beginnings of this recovery to the period after World War II when the products of the colonial art schools used their art to critique the colonialism as part of local agitation for political independence, the roots lie much deeper in the Pan-African movement of the nineteenth century. Spearheaded by George Padmore (1902–1959) and Henry Sylvester Williams (1869–1911) of Trinidad, Edward Wilmot Blyden (1832–1912) of the Danish West Indies, and W. E. B. DuBois (1868–1963) of the United States, among others, the movement organized a number of international conferences of black leaders from Africa and the Americas between the early 1900s and the 1940s. There were two principal objectives. The first was to inspire all blacks within and outside Africa to be proud of their color, history, and cultural heritage; and the second, to unite all blacks in their struggle against racial discrimination and toward the decolonization of Africa.

These conferences—along with Marcus Garvey's (1887–1940) ideology of “Africa for Africans,” which promoted a millennial vision of decolonized Africa as a future superpower—generated many debates and publications on different aspects of black history and culture as well as the political, economic, and creative potentials of blacks. In the United States, the quest for a distinct black identity in the arts gave birth to the Harlem Renaissance of the 1920s and 1930s during which African-American artists, writers, musicians, dancers, and intellectuals experimented with their African heritage. In France, Pan-Africanism, along with the Harlem Renaissance, inspired the Negritude movement in the 1930s among a group of African and Caribbean students.

Apart from celebrating the richness of their African past in their works, the Negritude writers and poets also questioned the “civilizing mission” of Europe in Africa, in view of the impact of African art on European modernism. Besides, they claimed that black people all over the world share certain cultural and emotional characteristics that constitute the essence of blackness and called on artists to capture this essence in their creations. The journal *Presence Africaine* was founded in Paris in 1947 to serve as an organ for disseminating the Negritude manifesto to the black world.

In short, these black-consciousness movements culminated in the political agitation that spread across Africa after World War II, motivating artists to explore the potentials of their African heritage and synthesize them with Western elements. The situation varied from one country to another, however, depending on the degree of the artistic commitment of the political leadership. For example, when Ghana gained political independence from Britain in 1957, Kwame Nkrumah (1909–1972), an active member of the Pan-African movement, became its first prime minister and, later, president. He urged contemporary Ghanaian artists to research into their ancestral legacy and to cultivate an “African personality” in their works. To this end, he made funds available for public art projects.

Léopold Sédar Senghor (1906–2001), one of the founders of negritude along with Aimé Césaire of Martinique and Léon Damas of Guyana, became the first Senegalese president when Senegal became independent from France in 1960. During his twenty years in office, he promoted negritude as a national artistic philosophy, becoming the patron of the “École de Dakar,” a group of artists manifesting this philosophy in their works. Having been influenced by negritude while studying in Europe, the Nigerian artist Ben Enwonwu (1921–1994) returned home to become his country’s flag bearer in the search for a national identity in the visual arts, especially after Nigeria gained independence from Britain in 1960. As the special art adviser to the government, he received a lot of commissions to decorate public buildings.

However, the most significant attempt to decolonize the visual arts in the country was initiated by the Zaria Art Society formed in 1958 by a group of students at the Nigerian College of Arts, Science and Technology in Zaria, whose art department was dominated by expatriate art teachers. To counter the naturalism being forced upon them by their teachers, these students (now known as the “Zaria Rebels”) organized private sessions to formulate strategies for evolving a Nigerian identity in their works. Space limitations will not allow a survey of artistic developments in all African countries. Suffice it to say that political independence inspired a cultural and artistic reawakening throughout sub-Saharan Africa. It led to a drastic review of the colonial art education program. New art schools, museums, and national galleries have since been created to promote an African consciousness in the arts, although not everybody agrees with the premise of Negritude that all black people share a common emotional characteristic.

There were similar post-emancipation reactions in northern and northeastern Africa (Mauritania, Morocco, Algeria, Tunisia, Libya and Egypt, and the Republic of Sudan) where there are large Arab populations, although Egypt and Libya attained political independence before World War II. The academic realism introduced to these countries during the colonial period has been modified. In the early twenty-first century, their contemporary artists experiment with different materials, forms, and ideas, seeking inspiration from diverse sources ranging from Islamic calligraphy and crafts to Pan-Africanism and different Euro-American styles. In Egypt some artists also draw on ancient Egyptian and Coptic sources in an attempt to relate the past to the present.

While Ethiopia has been exposed to Orthodox Christianity since the fourth century, it was never colonized except for a brief period of Italian occupation between 1936 and 1941. For a long time, the Ethiopian Church was the chief patron of the arts, commissioning metal crosses, illuminated manuscripts, paintings, and murals. Most of the artists were priests trained to work in the Coptic-Byzantine or modified Italian Renaissance style. But in the early nineteenth century, the nobility and members of the royal family started commissioning secular paintings from freelance artists. Modernization commenced in the 1920s with the introduction of European-type art education. Some Ethiopians later studied in Europe, returning in the 1930s to popularize new forms and styles. A school of fine arts was created in 1958; initially the school encouraged students to focus on Ethiopian history, culture, and political aspiration, but by the start of the twenty-first century the school’s program stressed experimentation and individual creativity.

South Africa became a Dutch colony in the seventeenth century. The British took it over in the nineteenth century, granting it political independence under white minority rule in 1910. The notorious apartheid system that disenfranchised the black majority was introduced in 1948. Until recently, most of the well-equipped and state-sponsored art institutions were reserved for whites. Blacks had to be content with informal art workshops or craft centers run by churches and philanthropists. Black art focused mainly on black suffering under the oppressive apartheid regime between 1948 and 1994. Much of white South African art, in contrast, reflected the prevailing trends in Europe. However, by the 1980s some concerned white artists, no longer willing to be silent while the rest of the world condemned apartheid, had started using their art overtly or covertly to critique it. Since the end of the apartheid system in 1994, contemporary South African art has been charting a new course, reflecting on the past and projecting the collective aspirations of a new nation now ruled by a black majority.

The Postcolonial, Postmodern, and Transnational

In the early twenty-first century contemporary African art is no longer confined to the works of black artists; it now includes those produced by artists of European, Arab, and Asian descent. That it has come of age is evident in the creative ways it often combines ancient African elements with new and frequently Western materials, forms, and techniques to reflect the peculiarity of the continent’s history and the complexity of its encounters with other cultures. No wonder that contemporary African artists have been receiving more invitations to participate in international exhibitions and biennials. Africa itself has become the site of major expositions such as the Cairo International Biennial in Egypt, first held in 1984; the Dakar Biennial (Dak’Art) in Senegal, first held in 1992; and the Johannesburg Biennale, South Africa, first held in 1995.

The strong visibility of contemporary African art on the world stage was reflected in the inclusion for the first time in a 1996 major textbook on world art (Stokstad) the works of two contemporary African artists, Magdalene Odundo of Kenya and Ouattara of Côte d’Ivoire. In 1998 curator Okwui Enwezor of Nigeria, the founder of *Nka: Journal of Contemporary African Art*, was appointed the artistic director of

Documenta 11 in Kassel, Germany—the first time an African would be trusted with such a major responsibility. A year later, the Egyptian artist Ghada Amer won the UNESCO Prize at the Forty-Eighth Venice Biennial in Italy. As Barbara Pollack aptly observes in the April 2001 issue of *Art News*: “While the political upheavals in . . . [African] . . . countries serve as a backdrop to their work, many of these artists struggle to make individual statements that transcend politics and nationality. By so doing, they are transforming our very definition of African art” (p. 124).

As the postcolonial period in Africa coincided with the post-modernist deconstruction of the Eurocentric hegemony in the visual arts, the question has been raised as to whether the two phenomena are related. They are, insofar as the multiculturalism promoted by the postmodern movement has opened new doors for contemporary African art, enabling it show the world that the creativity formerly associated with its past has been rejuvenated. Yet, and as Kwame Anthony Appiah points out, much of the so-called postcolonial African art is not as independent as implied in the rhetoric of decolonization. For despite an increase in local patronage, contemporary African art still depends largely on the European-American market, which in turn exerts a considerable influence on its materials, techniques, form, and content as well as on what is produced and where it is exhibited overseas. In other words, elements of the colonial—now neo-colonial—still lurk in the postcolonial like an old masquerade in a new costume. No wonder some critics see a kind of “neo-primitivism” in the emphasis on self-taught art in major exhibitions such as “Magiciens de la Terre,” organized in 1989 by the Centre Pompidou in Paris, and “Africa Explores,” organized in 1991 by the Center for African Art and the New Museum of Contemporary Art in New York (Oguibe and Enwezor, p. 9; Picton, 1999, pp. 120–125; Hassan, 1999, pp. 218–219).

Lastly, it is significant to note that many African artists have been living permanently abroad since the middle of the twentieth century, if not earlier. Many have become naturalized English, French, Belgian, or American citizens, yet they retained strong ties with Africa. This has produced a “double consciousness” that often resonates in their work, transcending racial, geographical, and national boundaries while at the same time identifying the black self in a largely Caucasian ambience—a new home away from home in the global village that the world has become.

See also *Aesthetics: Africa; Ancestor Worship; Masks; Modernism; Negritude; Pan-Africanism*.

BIBLIOGRAPHY

- Adams, Monni. “African Visual Arts from an Art Historical Perspective.” *African Studies Review* 32, no. 2 (1989): 55–103.
- A comprehensive overview of the literature up to the 1980s. *African Art Studies: The State of the Discipline. Papers Presented at a Symposium Organized by the National Museum of African Art, Smithsonian Institution*. Washington, D.C.: National Museum of African Art, 1990.
- Appiah, Kwame A. “Is the Post- in Postmodern the Post- in Post-colonial?” *Critical Inquiry* 17 (1991): 336–357.
- Ben-Amos, Paula. “African Visual Arts from a Social Perspective.” *African Studies Review* 32, no. 2 (1989): 1–53. A review of anthropological literature.
- Bravmann, René A. *Islam and Tribal Art in West Africa*. Cambridge, U.K., and New York: Cambridge University Press, 1974.
- . *Open Frontiers: The Mobility of Art in Black Africa*. Seattle: University of Washington Press, 1973.
- Carroll, Kevin. *Yoruba Religious Carving: Pagan and Christian Sculpture in Nigeria and Dahomey*. Foreword by William Fagg. London and Dublin: G. Chapman, 1967.
- Deliss, Clémentine, gen. ed., and Jane Havell, ed. *Seven Stories about Modern Art in Africa*. London: Whitechapel, 1995.
- Enwezor, Okwui, ed. *The Short Century: Independence and Liberation Movements in Africa, 1945–1994*. Munich and New York: Prestel, 2001.
- Fagg, William. *African Majesty: From Grassland and Forest: The Barbara and Murray Frum Collection, May 22–July 12, 1981*. Introduction by Alan G. Wilkinson. Toronto: Art Gallery of Ontario, 1981.
- Fall, N’Goné, and Jean Loup Pivin, eds. *An Anthology of African Art: The Twentieth Century*. New York: Distributed Art Publishers, 2002. A collection on the transition from traditional to contemporary African Art.
- Geiss, Imanuel. *The Pan-African Movement: A History of Pan-Africanism in America, Europe, and Africa*. Translated by Ann Keep. New York: Africana, 1974.
- Gerbrands, A. A. *Art as an Element of Culture, Especially in Negro-Africa*. Leiden, Netherlands: Brill, 1957.
- Hassan, Salah M. “The Khartoum and Addis Connections.” In *Seven Stories about Modern Art in Africa*, edited by Jane Havell; general editor Clémentine Deliss, 105–125. London: Whitechapel, 1995.
- . “The Modernist Experience in African Art: Visual Expressions of the Self and Cross-Cultural Aesthetics.” In *Reading the Contemporary: African Art from Theory to the Marketplace*, edited by Olu Oguibe and Okwui Enwezor Oguibe, 215–235. London: Institute of International Visual Arts, 1999.
- Hassan, Salah M., and Achamyeleh Debela. “Addis Connections: The Making of Modern Ethiopian Art Movement.” In *Seven Stories about Modern Art in Africa*, edited by Jane Havell, general editor Clémentine Deliss, 127–139. London: Whitechapel, 1995.
- Kasfir, Sidney L. “African Art and Authenticity: A Text with a Shadow.” *African Arts* 25, no. 2 (1992): 41–53, 96–97.
- . “One Tribe, One Style: Paradigms in the Historiography of African Art.” *History in Africa* 11 (1984): 163–193.
- Lamp, Frederick. *Art of the Baga: A Drama of Cultural Invention*. Forewords by Simon Ottenberg and Djibril Tamsir Niane. New York: Museum for African Art, 1996.
- Mount, Marshall W. *African Art: The Years since 1920*. Bloomington: Indiana University Press, 1973. Reviews contemporary art schools, workshops, and styles up to the early 1970s.
- Oguibe, Olu, and Okwui Enwezor, eds. *Reading the Contemporary: African Art from Theory to the Marketplace*. London: Institute of International Visual Arts, 1999.
- Perani, Judith, and Fred T. Smith. *The Visual Arts of Africa: Gender, Power, and Life Cycle Rituals*. Upper Saddle River, N.J.: Prentice-Hall, 1998.
- Phillips, Tom, ed. *Africa: The Art of a Continent*. New York: Prestel, 1995.
- Picton, John. “In Vogue, or The Flavour of the Month: The New Way to Wear Black.” In *Reading the Contemporary: African Art from Theory to the Marketplace*, edited by Olu Oguibe and Okwui Enwezor, 115–126. London: International Institute of Visual Arts, 1999.

- . “Neo-Traditional Sculpture in Nigeria.” In *An Anthology of African Art: The Twentieth Century*, edited by N’Goné Fall and Jean Loup Pivin, 98–101. New York: Distributed Art Publishers, 2002.
- Pollack, Barbara. “The Newest Avant-Garde.” *Art News* 100, no. 4 (2001): 124–129.
- Prussin, Labelle. *Hatumere: Islamic Design in West Africa*. Berkeley: University of California Press, 1986.
- Sieber, Roy, and Arnold Rubin. *Sculpture of Black Africa: The Paul Tishman Collection*. Los Angeles: Los Angeles County Museum of Art, 1968.
- Steiner, Christopher B. *African Art in Transit*. Cambridge, U.K., and New York: Cambridge University Press, 1994.
- Visonà, Monica Blackmun, Robin Poynor, Herbert M. Cole, and Michael D. Harris. *A History of Art in Africa*. New York: Harry N. Abrams, 2001.
- Williamson, Sue. *Resistance Art in South Africa*. New York: St. Martin’s Press, 1989.

Babatunde Lawal

ARTS, PERIODIZATION OF. See **Periodization of the Arts.**

ASCETICISM.

This entry includes two subentries:

Hindu and Buddhist Asceticism
Western Asceticism

HINDU AND BUDDHIST ASCETICISM

The English term *asceticism* derives from the Greek *askesis*, originally meaning “to train” or “to exercise,” specifically in the sense of the training and self-denial that an athlete undergoes to attain physical skill and mastery over the body. The Stoics adapted the word to refer to the moral discipline of the sage who learns, through self-mastery, how to act freely—how to choose or refuse a desired object or an act of physical pleasure at will and how to control the emotions with reason. Plato and the neo-Platonic philosophers also used the term in the sense of the denial of “lower” sensual desires in order to cultivate “higher” spiritual traits.

The word was then passed on from the Greeks to early Christians in this sense of self-control over physical and psychological desires in favor of spiritual ideals or goals. Asceticism has come to function cross-culturally to refer to a whole host of activities in the religions of the world. Most religions have at least some practices that can be deemed ascetic: fasting, celibacy, seclusion, voluntary infliction of pain, bodily mutilation, temperance or complete abstinence from intoxicants, renunciation of worldly goods and possessions, and, in some cases, religious suicide. Asceticism can also include the cultivation of moral qualities requiring self-restraint and discipline, such as patience and forbearance. One sometimes reads of an “inner asceticism,” which involves various practices where one learns to be “in the world, but not of it.”

Ascetic practices are engaged in for a variety of ends. Many traditions encourage or demand asceticism at periodic or designated times of the religious calendar, usually for purification or preparation for a significant ritual event. Fasting and celibacy are particularly common practices used to this end. Most rites of passage or life-cycle rites also require some form of self-denial and self-discipline on the part of the person undergoing the ritual. Ascetic practices as forms of penance are also very frequently prescribed for expiation of sin or impurity. In some cases, ascetic practices are employed as a sort of sacrifice to the deity or powers one is trying to influence to obtain fulfillment of a request, while in other instances asceticism is seen as meritorious in general, leading to or ensuring a good result in this world or the next.

Many religions have within them an elite group of specialists, renunciators or monastics, who maintain an ascetic lifestyle more or less continuously. These “permanent” ascetics may be marked by their special appearance (distinctive clothes or robes, or no clothes at all; long, uncut hair or heads completely shorn of hair; the possession of certain characteristic implements or items, such as a begging bowl or staff; or in some extreme cases, signs in the form of physical mutilation, such as castration). They may be associated with particular locales (monasteries or other isolated and secluded areas, such as forests, deserts, jungles, or caves; or a mandate to wander homeless) to further indicate that they have separated themselves from ordinary society. Ascetic techniques in many traditions are said to bring magical or supernatural powers.

While asceticism is a feature of virtually every religion, it plays an especially prominent role in the three principal Indian religions: Hinduism, Buddhism, and Jainism. All three of these traditions originated at more or less the same time and out of the same religious and philosophical milieu. In the middle centuries of the first millennium B.C.E., many individuals and groups known collectively as “wanderers” (*śramanas*) arose in India to oppose certain features of the older Vedic religion and to advocate new ideas, methods, and goals. Most wanderer groups—especially those responsible for the formation of the new religions of Hinduism, Buddhism, and Jainism—shared the belief that this world has suffering and potentially endless rebirth. This negative evaluation of the world came to be called *samsara*. All three religions also posited the new religious goal of an escape or release from this cycle, variously called *moksha* (“liberation”), *nirvana* (“extinguishing” of suffering and rebirth), or *kevala* (“isolation” or “perfection”).

Samsara is believed to be perpetuated by desire, *karma*, and worldly life in general. The quest for liberation from *samsara* thus entailed asceticism and renunciation, and such practices became central to all three of these Indian religions. Meditation techniques, yoga, austerities of various sorts all were developed to further the end of disengaging from the world of sensual desires, and this in turn led to the final goal of release.

Asceticism in Hinduism

Asceticism in the form of yoga and meditation possibly goes back to the earliest period of Indian history. Seals depicting a figure sitting in what looks like a yogic pose have been found at sites

of the Indus Valley Civilization dating to the second millennium B.C.E. In the texts of the early Vedas (c. 1500–c. 1000 B.C.E.), ascetic practices appear in a variety of contexts. References are made to long-haired silent sages (*munis*), clad in soiled yellow garments or naked, who are depicted as having supernatural powers, acquired perhaps as a result of their ascetic practices. The early texts also tell of the shadowy wandering ascetics (*vratyas*), who seem to have also practiced physical austerities.

The Vedas in some places say that the deities gained their status, or even created the entire universe, through the power of their inner, ascetic heat (*tapas*), acquired through the rigorous practice of physical and spiritual self-discipline and mortification of the body. The term *tapas* derives from a Sanskrit root meaning to heat up or burn, and refers to any one of a variety of ascetic methods for achieving religious power. In the Rig Veda, Indra is said to have achieved his divine place through the practice of asceticism and the generation of this powerful “heat,” while elsewhere in that ancient work are encountered cosmogonic hymns that attribute the origins of the universe to the Primal One who creates by “heating up ascetic heat.” The metaphysical qualities of both truth and order are said to have derived from ascetic heat, and the ancient Indian seers (*rishis*) also were supposed to have achieved their powers through ascetic heat.

This notion of ascetic heat as a creative, or even coercive, religious force was to persist in Indian religious thinking through subsequent centuries to the present. One may gain ascetic heat through a variety of ascetic techniques, including fasting, chastity, and various yogic techniques such as breath control (*pranayama*), and through it the adept can procure tremendous supernatural powers and even the status of a god. In the Upanishads, epics, and other Sanskrit texts one often learns of various ascetics who force their way into heaven and become gods through the power of their ascetic heat. Deities such as Shiva were especially associated with this power of ascetic heat, derived from proficiency in yoga, meditation, and extreme austerities.

Various classes of ascetics (*tapasvins*, “specialists in the practice of *tapas*”) eventually arose in Hindu India and are sometimes enumerated. They are mainly differentiated by the form of austerities they engage in. Some ascetics, for example, stay totally stationary for years at a time or remain standing or in water for weeks on end. Some ascetics subsist solely on fruits, wild plants, and roots, or they live only on grain left in the fields. Among the most famous are ascetics who practice the “five fires” ritual (building four fires around themselves, with the sun as the fifth) and “spike-lying” ascetics who sleep on beds of nails.

A second strand of asceticism within the Hindu tradition might better be termed “renunciation.” Such renunciation can be either *tyaga* (relinquishing a desire for actions to produce effects) or *sannyasa* (abandoning family, social, economic life, and the ritual activity associated with the householder’s way of life), in order to pursue single-mindedly the ultimate goals of religion. World renouncers seem to have been a feature of Indian religious life since very early times. Already mentioned above are the silent sages and wandering ascetics discussed in the Vedas. Later texts depict a wide variety of renouncers, hermits, and ascetic “orders” living in the jungles and forests.

Among such ascetics were those who, with or without their wives, live on wild fruits and plants and maintain a ritual sacrificial fire; those who are “god-possessed” but perform the Vedic rituals; those with matted hair who wear bark clothing; those who sleep on the ground, eat only what drops from trees and plants, and regulate their meals according to the waxing and waning of the moon; those who wander from one monastery to another, eating only eight mouthfuls of food per day; those who remain naked, live under trees or in graveyards, and remain indifferent to what they eat or receive from others; renouncers who wear red and beg only at the homes of high-caste Brahmins; and radical ascetics who do not remain more than a day in any one place and live on cow urine and feces.

Renunciation (and the values and practices associated with it, especially nonviolence [*ahimsa*], vegetarianism, lack of possessions, and begging for a living) came to play an enormously influential role in Hinduism from the time of the Upanishads onwards. Not only were there dedicated ascetics and renunciates who committed their lives to this kind of religious practice; even those who chose to remain householders were influenced by renunciatory values. From a very early date, then, Hinduism was shaped by asceticism and renunciation.

Yet the Hindu tradition also had dissenting voices. The religion was somewhat divided about the value and necessity of asceticism and the renunciatory lifestyle. Some ancient texts condemn renunciation in general. (In the Hindu epic *Mahabharata*, one of the heroes of the epic goes so far as to say that renunciation is only for those who have failed in worldly affairs.) More often, texts condemn renunciation by householders—those with families to support and occupations to fulfill.

Indeed, Hindu texts written in the wake of the wanderer movement often extolled the householder’s life of marriage, reproducing, and raising children. In the *Dharma Sutras* the householder stage is sometimes said to be the only legitimate or best stage of life—better even than the stage of pursuing the ultimate religious goal of final liberation from rebirth. Those in all other stages of life (the student, forest dweller, and world renouncer) depend on the householder, in part because it is the householder who feeds or donates to them when they beg from him:

A householder alone offers sacrifices. A householder afflicts himself with austerities. Of the four stages of life, therefore, the householder is the best. As all rivers and rivulets ultimately end up in the ocean, so people of all stages of life ultimately end up with the householder. As all creatures depend on their mothers for their survival, so all mendicants depend on householders for their survival. (*Vasishtha Dharma Sutra*, 10.14–16, quoted in Olivelle, p. 93)

As another text puts it, when “carried out with zeal,” the householder stage of life procures both happiness in this life and heaven in the next:

Just as all living creatures depend on air in order to live, so do members of the other stages of life subsist by depending on householders. Since people in the other

three stages of life are supported every day by the knowledge and food of the householder, therefore the householder stage of life is the best. It must be carried out with zeal by the man who wants to win an incorruptible heaven [after death] and endless happiness here on earth. (*Manu*, 3.77–79)

Nevertheless, one also finds ascetic and renunciatory values—especially nonviolence (*ahimsa*), but also nonpossession and ascetic heat—included in ethical lists that seem generally applicable to all, no matter what stage of life they are in. Indeed, even the householder's life came to include certain kinds of austerities, especially as a way of penance and cleansing one's conscience: "If his mind-and-heart is heavy because of some act that he has committed, he should generate the inner heat [*tapas*] [prescribed] for it until he is satisfied. . . . Those who have committed major crimes and all the rest who have done what should not be done are freed from that guilt by well-generated inner heat" (*Manu*, 11.234, 240).

From an early age in the history of Hinduism there was also a recognition that one could live two basic kinds of religious lives within the boundaries of the religion: a life of engagement and a life of disengagement. Both were usually regarded as legitimate (although some texts do weight one or the other more heavily), and both were accorded Vedic authority and pedigree. Both were also generally regarded as efficacious—according to the following text, engagement leading to a state of equality with the gods, and disengagement to a transcendent condition beyond the world of *samsara*:

There are two kinds of Vedic activity: the one that brings about engagement [in worldly action] and the rise of happiness, and the one that brings about disengagement [from worldly action] and the supreme good. The activity of engagement is said to be driven by desire in this world and the world beyond; but the activity of disengagement is said to be free of desire and motivated by knowledge. The man who is thoroughly dedicated to the activity of engagement becomes equal to the gods; but the man who is dedicated to disengagement passes beyond the five elements. (*Manu*, 12.88–90)

Reconciling these two apparently different modes of religious life was not always easy, however. On the face of it, the life of engagement and the life of disengagement appear to be incompatible—the one involved in the world of activity and *karma*, and the other attempting to renounce such activity and free oneself of *karma*.

One of the principal methods for synthesizing the two was the system of the four stages of life (*ashramas*)—perpetual student, householder, forest dweller, and world renouncer—developed especially in the *Dharma Sutras*. In some texts the four states of life seem to have been regarded as four different types of life that a student could pursue after study with a teacher. In other cases, however, the early authorities insisted that there is only one legitimate stage of life, that of the householder. Finally, however, the tradition settled into conceptualizing the system of

stages of life as progressive and more or less incumbent upon all upper-caste Hindus. This framework of stages of life could then be used to affirm life in the world (by emphasizing that all must pass through the householder stage of life before renunciation) while still incorporating the values and practices of asceticism into the ideal life of the Hindu practitioner. Three of the four classical stages of life emphasized ascetic practices, as will be seen, while the system also validated, and indeed insisted upon, the legitimacy of and need for the nonrenunciatory householder stage.

In the ideal structure laid out in Hindu texts, the first stage of life is that of a student. A young boy is given over to a teacher (*guru*), whom he lives with and serves for many years while studying the sacred Vedas under the teacher's guidance. The lifestyle assigned to this stage of life is one of austerity, asceticism, and discipline. Not only should the student remain chaste for the duration of this period; he should also observe a variety of other restraints and avoidances:

The chaste student of the Veda who lives with his guru should obey these restraints, completely restraining the cluster of his sensory powers to increase his own inner heat. . . . He should avoid honey, meat perfume, garlands, spices, women, anything that has gone sour, and violence to creatures that have the breath of life; anointing [his body with oil], putting make-up on his eyes, wearing shoes, and carrying an umbrella; desire, anger, and greed; dancing, singing, and playing musical instruments; gambling, group arguments, gossip, telling lies, looking at women or touching them, and striking another person. He should always sleep alone and never shed his semen, for by shedding his semen out of lust he breaks his vow. (*Manu*, 2.175–80)

Another text gives a slightly different list of observances, vows, and practices, but similarly emphasizes the importance of an austere life dedicated to self-restraint, the cultivation of virtue, and obedience to the teacher:

Now the rules for the studentship. He shall obey his teacher, except when ordered to commit crimes which cause loss of caste. He shall do what is serviceable to his teacher, he shall not contradict him. He shall always occupy a couch or seat lower than that of his teacher. He shall not eat food offered at a sacrifice to the gods or the ancestors, nor pungent condiments, salt, honey, or meat. He shall not sleep in the daytime. He shall not use perfumes. He shall preserve chastity. He shall not embellish himself by using ointments and the like. He shall not wash his body with hot water for pleasure. But, if it is soiled by unclean things, he shall clean it with earth or water, in a place where he is not seen by a guru. Let him not sport in the water whilst bathing; let him swim motionless like a stick. . . . Let him not look at dancing. Let him not go to assemblies for gambling, etc., nor to crowds assembled at festivals. Let him not be addicted to gossiping. Let him be discreet. Let him not do anything for his own pleasure in places which his teacher frequents. Let him talk with women so much only as his purpose

requires. Let him be forgiving. Let him restrain his organs from seeking illicit objects. Let him be untired in fulfilling his duties; modest; possessed of self-command; energetic; free from anger; and free from envy. (*Apastamba Dharma Sutra*, quoted in Embree, pp. 84–86)

Also among the duties laid out for those in the student stage of life is begging for a living—more precisely, begging and then turning over the proceeds to the teacher. Begging, for the religious student and other renunciates who legitimately live by such means, was said to be like fasting:

He should fetch a pot of water, flowers, cow dung, clay, and sacrificial grass, as much as are needed, and go begging every day. A chaste student of the Veda, purified, should beg every day from the houses of people who do not fail to perform Vedic sacrifices and who are approved of for carrying out their own innate activities. He should not beg from his guru's family nor from the relatives of his mother or father, but if he cannot get to the houses of others he should avoid each of these more than the one that precedes it. And if there are none of the people mentioned above, he should beg from the whole village, purified and restrained in his speech, but he should avoid those who have been indicted. . . . When he is under the vow [of a chaste student] he should make his living by begging, nor should he eat the food of just one person; when begging is the livelihood of a person under a vow it is traditionally regarded as equal to fasting. (*Manu*, 2.182–85, 188)

When the student reaches marriageable age, he should take a wife and start a family, eschewing, by and large, renunciatory and ascetic practices in favor of the pursuit of private gain (*artha*)—understood as material prosperity, self-interest, political advantage, and in general getting ahead in the world. Hinduism thus recognizes making a good living (in an acceptable occupation) and taking care of one's family as important and indeed religiously enjoined goals of life. Private gain is listed as one of the three “ends of life” in Hindu texts, the other two being the pursuit of religious duty (*dharma*) and the pursuit of pleasure (*kama*). And while following the dictates of religious duty is obviously of great importance for one's spiritual well-being and can involve certain ascetic practices, especially for purification and penance, the pursuit of pleasure and creature comforts is to be fully embraced in the householder stage of life. In some texts, private gain is in fact the most important of these ends of life: “Of the three ends of human life, material gain is truly the most important. . . . For the realization of religious duty and pleasure depend on material gain” (*Artha Sastra*, 1.7).

But, according to the scheme of the ideal stages of life, when the householder has completed this stage of life (upon the birth of grandchildren), he should begin to withdraw from the world and once more cultivate a more ascetic lifestyle. After finishing the life of a student and after marrying and raising a family as a householder, a man may enter the third stage of life, that of the forest dweller. This stage of life, like that of the student, is characterized by ascetic practices and detachment from the

world, including the renunciation of cultivated food (in favor of wild food that grows in the jungle) and of all possessions:

After he has lived in the householder's stage of life in accordance with the rules in this way, a twice-born Vedic graduate should live in the forest, properly restrained and with his sensory powers conquered. But when a householder sees that he is wrinkled and gray, and [when he sees] the children of his children, then he should take himself to the wilderness. Renouncing all food cultivated in the village and all possessions, he should hand his wife over to his sons and go to the forest—or take her along. . . . He should eat vegetables that grow on land or in water, flowers, roots, and fruits, the products of pure trees, and the oils from fruits. . . . He should not eat anything grown from land tilled with a plough, even if someone has thrown it out, nor roots and fruits grown in a village, even if he is in distress [from hunger]. (*Manu*, 6.1–3, 13, 16)

Subsistence on gathered food that grows naturally and spontaneously in the wild can be supplemented with food obtained by begging. The begged food, however, should be only enough for “bare subsistence” and should be obtained from the right donors:

He should get food for bare subsistence by begging from priests who are ascetics themselves, from householders, and from other twice-born forest-dwellers. Or a man who lives in the forest may get [food] from a village, receiving it in the hollow of a leaf or in his hand or in a broken clay dish, and eat [only] eight mouthfuls of it. To perfect himself, a priest who lives in the forest must follow these and other preparations for consecration, as well as the various revealed canonical texts of the Upanishads, and those that sages and priestly householders have followed, to increase learning and inner heat and to clean the body. (*Manu*, 6.27–30)

The final stage of life is that of the world renouncer, who continues and furthers the ascetic practices of the forest dweller: “And when he has spent the third part of his lifespan in the forests in this way, he may abandon all attachments and wander as an ascetic for the fourth part of his lifespan” (*Manu*, 6.33). In this stage, the renouncer sends his wife away to live with his sons and performs a ceremony equivalent to his own funeral, stating that from this time on “no one belongs to me, and I belong to no one.” Dying to his social persona, the wandering hermit from this time forth may no longer return to his previous home and should live entirely detached from the things of this world, owning nothing, alone and without companions, perfectly content and indifferent. He should beg but once a day, and he should not be “addicted to food” or hope for lots of alms or be disappointed should he receive nothing.

He should always go all alone, with no companion, to achieve success; realizing that success is for the man who is alone, he neither deserts nor is deserted. The hermit should have no fire and no home, but should go to a

village to get food, silent, indifferent, unwavering and deep in concentration. A skull-bowl, the roots of trees, poor clothing, no companionship, and equanimity to everything—this is the distinguishing mark of one who is Freed. He should not welcome dying, nor should he welcome living, but wait for the right time as a servant waits for orders. . . . He should live here on earth seated in ecstatic contemplation of the soul, indifferent, without any carnal desires, with the soul as his only companion and happiness as his goal. . . . He should go begging once a day and not be eager to get a great quantity, for an ascetic who is addicted to food becomes attached to sensory objects, too. . . . He should not be sad when he does not get anything nor delighted when he gets something, but take only what will daily sustain his vital breath, transcending any attachment to material things. (*Manu*, 6.42–45, 49, 55, 57)

The system of stages of life was the principal way in which Hinduism reconciled the apparently contradictory pulls of its life-affirming and world-renouncing strains. But there was also another way of reconciling the householder and renunciatory ways of life in the classical texts of Hinduism. This is the yoga of action (*karma yoga*) in the *Bhagavad Gita*. As opposed to the renunciation of action characteristic of ascetics and world renouncers, the *Bhagavad Gita* advocates a renunciation in action: one performs one's duties in society but dedicates the fruits of all action to God.

Asceticism in Buddhism

According to Buddhist texts, Siddhartha Gautama (c. 563–c. 483 B.C.E.), the founder of Buddhism, was born into a royal family and raised in the lap of luxury. Upon learning of the true nature of the world outside his insulated life—a world full of suffering, sickness, old age, and death—Gautama immediately renounced his privileged life, left his family, and joined a group of ascetics in the jungle.

The time of the Buddha seems to have been one in which many different renunciatory groups in the uninhabited regions of north India experimented with various techniques—ascetic, yogic, philosophical, and meditational—to attain release from suffering and rebirth. Early Buddhist texts are replete with references to ascetics of various types. One such text depicts the typical ascetic (*tapasvin*) of the time as one who

goes naked, is of certain loose habits, licks his hands, respects no approach nor stop; accepts nothing expressly brought, nor expressly prepared, nor any invitations. . . . He takes food once a day, or once every two days, or once every seven days. . . . He feeds on herbs, or on the powder of rice husks, on rice-scum, on flour of oil seeds, on grasses, on cowdung, or on fruits and roots from the woods. . . . He wears coarse hempen cloths, discarded corpse cloths, discarded rags, or antelope hide, or bark garments. (*Digha Nikaya*, quoted in Bhagat, p. 151)

According to hagiographies of the life of the Buddha, Gautama hooked up with such a group and practiced and

mastered the radical ascetic regimen they advocated, to such an extent that he ate virtually nothing and shriveled to nothing more than skin and bones. Finding that he had not achieved his goal through such austerities, Gautama rejected the ascetic path and pursued what he called the “middle way” between the poles of sensuality and asceticism: “There are two extremes, O monks, which he who has given up the world ought to avoid. What are these two extremes? A life given to pleasure, devoted to pleasures and lust; this is degrading, sensual, vulgar, ignoble and profitless. And a life given to mortifications; this is painful, ignoble and profitless” (*Mahavagga*, quoted in Bhagat, p. 161).

Buddhism in its origins is thus somewhat ambivalent about the usefulness of asceticism. On the one hand, it rejects the extreme forms of physical abnegation and self-torture that appear in the other Indian religions it grew up with. Buddhism denies that such physical asceticism alone can procure for the practitioner the highest spiritual goals. On the other hand, however, there can be no question that Buddhism requires its more serious practitioners not only to renounce worldly life but also to train diligently in self-discipline and self-control through the “eightfold path” (right views, intention, speech, action, livelihood, effort, mindfulness, and concentration). Attaining the permanent peace and happiness known as *nirvana* also requires the elimination of desire and aversion through ascetic self-discipline and abnegation. If one can eliminate desire, selfishness, and egotism by more moderate means, the more radical physical austerities are unnecessary: “All mortification is vain so long as selfishness leads to lust after pleasures in this world or in another world. But he in whom egotism has become extinct is free from lust; he will desire neither worldly nor heavenly pleasures, and the satisfaction of his natural wants will not defile him. He may eat and drink to satisfy the needs of life” (*Mahavagga*, quoted in Bhagat, p. 162).

While the Buddha rejected the extreme forms of physical asceticism recommended by others, he did allow for a number of ascetic practices called the *dhutangas*. These practices are said not to be the path itself but only preparatory for the path; they help the seeker eliminate all forms of attachment. The *dhutangas* include wearing only monastic robes made from discarded fabric, living only on alms begged for indiscriminately, eating only once a day, living in the forest or at the foot of a tree or in a cemetery, and sleeping only while sitting upright (and never while lying down).

The main form that asceticism took in Buddhism was monastic renunciation of the world. In stark contrast to the Hindu system of the four stages of life, in which renunciation was relegated to the end of life after the householder stage, Buddhists insisted that as soon as one recognized that this world is like a “house on fire,” one should give up the worldly life and join the monastery. There, in the company of other monks or nuns, one could pursue a regulated life of study, meditation, and self-discipline similar to the monastic lifestyle pursued in other religious traditions.

Asceticism in Jainism

The founder of the religion of Jainism was, like the Buddha, a world renouncer. Unlike the Buddha, however, Mahavira (599–527 B.C.E.) embraced a program of extreme austerities

to reach his religious goal. Having left the social world, Mahavira adopted the life of a naked wandering mendicant and for twelve years practiced the most severe of physical austerities until he reached perfection.

The life of Mahavira set the tone for the development of the Jain tradition. Jainism is perhaps the most ascetically oriented of all the world's religions. Most Jains are and have always been householders, but even householders are urged to live lives of self-restraint and especially nonviolence. Jain monks pursue lives of even greater austerities, following the five "great vows" (no killing living beings, truthfulness, no stealing, chastity, and renunciation of possessions) and, in some sects, not wearing any clothing. Jains seek ascetic heat in both its "external" and "internal" forms—the former entailing fasting, begging, and mortification of the body; the latter requiring penance, modesty, service to others, study, meditation, and nonattachment to the body. The epitome of asceticism is found in the Jain tradition of religious suicide by starvation.

Conclusion

While renunciation of the world and asceticism have had a huge influence on Indian religions, it must be remembered that the more extreme practices have always been limited to the very few, the religious virtuosi. Also, these world-denying and self-abnegating practices have always coexisted with equally or more powerful strains in these traditions valorizing a worldly life and, to some extent, material goals. The ascetic quality of Indian religions has often been exaggerated, even caricatured, at the expense of a more realistic portrait—one that admits the impact of asceticism on these traditions while contextualizing such practices and values within what have always been complex and varied religious traditions.

See also *Asceticism: Western Asceticism; Buddhism; Hinduism*.

BIBLIOGRAPHY

- Bhagar, M. G. *Ancient Indian Asceticism*. New Delhi: Munshiram Manoharlal, 1976.
- Bronkhorst, Johannes. *The Two Sources of Indian Asceticism*. New York: Peter Lang, 1993.
- Chakraborti, Haripada. *Asceticism in Ancient India in Brahmanical, Buddhist, Jaina, and Ajivika Societies, from the Earliest Times to the Period of Śaṅkarācārya*. Calcutta: Punthi Pusak, 1973.
- Doniger, Wendy. *Asceticism and Eroticism in the Mythology of Siva*. New York: Oxford University Press, 1973.
- Dutt, Sukumar. *Buddhist Monks and Monasteries of India: Their History and Their Contribution to Indian Culture*. London: George Allen and Unwin, 1962.
- Eliade, Mircea. *Yoga: Immortality and Freedom*. 2nd ed. Princeton, N.J.: Princeton University Press, 1969.
- Embree, Ainslie T., ed. *The Hindu Tradition: Readings in Oriental Thought*. New York: Vintage, 1972.
- Manu. *The Laws of Manu*. Translated by Wendy Doniger, with Brian K. Smith. London: Penguin Books, 1991.
- Olivelle, Patrick. *The Āśrama System: The History and Hermeneutics of a Religious Institution*. New York: Oxford University Press, 1993.

Brian Smith

WESTERN ASCETICISM

Asceticism, defined for our purposes within the context of the premodern tradition, refers to specific passive and active practices that are engaged in out of ideological motives: on the one hand, abstinence from nourishment, sleep, sexuality, social communication, and social ties—thus from natural human expression—and from other components of civilization, such as bodily cleanliness; on the other hand, the active cultivation of physical revulsion, whether through intentional exhaustion or bloody self-mutilation. As long as the passive practice is performed in a balanced manner, it may bring positive physical and spiritual results. More common, however, are examples wherein this sort of practice leads to abiding physical and spiritual damage; with the active sort this is generally the case. While technically similar, certain therapeutic practices, engaged in for medical reasons, are not to be considered asceticism in this context. Asceticism, although grounded in metaphysical motivations, is decidedly a concept concerned with practical realization; thus the following will discuss both theory and practice.

The Ancients

The ancient Greek word *askesis* referred at first to the physical practices of soldiers and athletes, and only later to intellectual exercises such as philosophizing, training of the will, or morality. Religious asceticism only played a role with small groups (cultish chastity of the priestesses of the Roman goddess Vesta, castration of the priests of the Egyptian god Attis), or during specific times (yearly abstinence for several days in honor of Ceres) or activities (especially magic).

The main arguments for asceticism lay, on the one hand, in the realm of a cult's purity codes and, on the other, in the philosopher's requirement for ethical strengthening of will and nonattachment: marriage and children would only disrupt the thinker's conduct of life. Thus retreat from the world was recommended by philosophers such as Plato, and many wise men, like Apollonius of Tyana in the first century C.E., took vows of chastity. Related is the philosophical ideal of imperviousness to all earthly circumstances (apathy, ataraxy). Within Orphicism, Pythagoreanism, Stoicism, and Cynicism there were strains that viewed the physical as far inferior to the spiritual. The essential ancient conception (the *soma sema* doctrine, for example, in Plato's *Gorgias*) was that the soul, caught in the "grave" of the body, should be liberated through a weakening of precisely this body. Examples of this idea occurred in the Eleusian fasts, in Neoplatonism, and—most clearly delineated—in Manichaeism. Passive asceticism was considered the best means to attain this liberation. Ascetic tendencies supported, furthermore, a strand of ancient medicine that energetically recommended abstinence from sexuality, as the discharge of semen was thought to weaken the body and soul of both men and women.

In Old Testament Judaism, asceticism only appeared in the form of cultish abstention, or fasting, as practiced by the Nazareans or John the Baptist, or more strictly in sects such as the Therapeutae. The Celts utilized fasting as a coercive method for deciding disputes: they fasted at their enemy's door, thereby compelling him to fast as well, on pain of loss of honor.

Early Christianity

The most important early Christian ascetic forms were fasting and sexual abstinence. The former, as habitual practice, cannot be traced back to Jesus—his disciples did not even fast on the Sabbath. He said of himself, “The son of man came eating and drinking,” wherefore he was criticized as a “glutton and drunkard” (Matt. 11:19). His apparently exceptional forty-day fast in the desert (like Moses and Elias) became, nevertheless, the paradigm whereby this practice later became part of the permanent *imitatio Christi*. The basis for the ideal of chastity was in Jesus’s saying “And there are eunuchs who have made themselves eunuchs for the kingdom of heaven’s sake” (Matt. 19:12). Yet this was practiced very rarely (according to the most important theologian of the third century, Origen of Alexandria), in order to avoid comparison with the priests of Attis. Paul was more influential, teaching, in the face of the imminent coming of the end of the world, that he who has a wife shall behave as if he has none (1 Cor. 7:29). He only allowed for physical love reluctantly, as a concession; it was far preferable that all believers would be as chaste as he. For how else could one concentrate oneself entirely upon Christ? The doctors of the church built upon these elements enthusiastically and combined them with misogynist components of the Judaic creation doctrine and ancient philosophy. St. Jerome (c. 347–419 or 420), who devalued marriage in favor of chastity, and St. Augustine (354–430), who argued that original sin is reenacted through the sex act, laid the foundations of the Christian sexual ethic that are still with us today. Doubts about the eschatological salvation of married people (as in the ascetic sect of the Encratites) were, however, consistently refuted as heresies.

Christian asceticism, as a movement that truly shaped the conduct of life, found its most emphatic expression in the monastic fathers in the deserts of Egypt and Syria, who were also paradigms for the ideal of *contemptus mundi* and self-mortification. The spread of asceticism throughout the Western world paralleled that of monasticism, which based itself consistently upon vows of chastity, poverty, and obedience. The following aspects contributed to its ideological background:

1. The wish to imitate the religious founder (*imitatio Christi*), a consequence of a (hardly authentic) saying of Jesus, “And anyone who does not take up his cross and follow me is unworthy of me” (Matt. 10:38).
2. The reception of the pagan *soma sema* doctrine: spiritualized, this led to the commandment, in harmony with a dualistic belief system, to “leave” all pleasurable earthly things in order not to sully oneself with material goods (*contemptus mundi*).
3. The monastic ideal of the *angelikos bios*, the angelic life, which implied wakefulness, fasting, and sexual abstinence, since angels neither sleep, nor eat, nor love.
4. Self-punishment during earthly existence in order to avoid the incomparably more horrific divine revenge in the beyond; also, taking on penance

for another’s sins (with the same intention) as atonement toward the Godhead.

5. Presentation of an immaterial oblation.
6. Weakening of the body with the aim of rendering it less susceptible to sinful practices.

The Middle Ages

The high and late Middle Ages were the epochs of the widest proliferation of ascetic ideals in European history. Up to the turn of the first century, self-mortification was almost exclusively the duty of the “virtuosos” of this religion, the monks; it was only after the church reform of the high Middle Ages that an outbreak of lay piety initiated this ideal for every truly engaged Christian in the world. A maxim of St. Bartholomew of Farne (d. 1193) can be taken as paradigmatic of the wide proliferation of the *soma sema* doctrine: “We must inflict our body with all kinds of adversity if we want to deliver it to perfect purity of soul!” The mendicant orders, founded in the thirteenth century, were especially important for the spread of ascetic ideals among the laity. Their basic tenets, grounded in asceticism, were traditional: contempt of the world as well as weakening and chastisement of the body as an instrument of sin. In addition to these goals of self-salvation, and in contrast to older monasticism, the goal of brotherly love fostered the attempt to atone for the sins of other believers, both living and deceased. The founders of the Minorites and the preaching orders created a precedent as well. St. Francis of Assisi (1181 or 1182–1226) taught, “I have no greater enemy than my body,” arguing that “We should feel hatred towards our body for its vices and sinning!” For St. Francis this attitude entailed fasting and self-flagellation for the disciplining of the body, which he called “brother donkey.” This metaphor, beloved by the ascetics, expresses the idea of the body as a beast of burden that, according to *Legenda maior*, the life of St. Francis by St. Bonaventure (c. 1217–1274), “should be weighed down by hard work, often scourged with the whip, and nourished with poor fodder.” As for St. Dominic (c. 1170–1221), aside from the usual waking and fasting, three times every night he would “whip himself with an iron chain: once for himself, once for the sinners in the world, and one for the sinners who are suffering in purgatory.”

The most common ascetic practices of the Middle Ages and the early modern period were poverty, self-flagellation, fasting, waking, hunger, and other works of penitence.

Self-flagellation (*disciplina*), previously rare, spread first with the teachings of the doctor of the church Pier Damiani (1007–1072): he recommended that one flagellate oneself for the duration of forty psalms daily, on high holy days one-half more again. His treatise *De laude flagellorum* (In praise of flagellation) established this idea: participation in the sufferings of Christ promises a part in his glory (self-punishment and reward). Many saints of the late Middle Ages individually practiced similar self-punishments; as a collective practice, self-flagellation was institutionalized in convents such as those of the Dominicans in southern Germany. This ascetic act was practiced collectively by the laity as well, at least since the advent of

the many flagellant movements from 1260 to 1348, which were reactions against plague and apocalyptic fears; there sprang up, in Italy above all, numerous penitential brotherhoods (*penitenti*) with the popular name Battuti. A practice initially developed as a reaction against a particularly terrifying crisis situation became thereby an abiding institution that existed into modern times. Self-flagellation was, as a rule, practiced along with meditations on the Passion, with the aim of imitating Christ's sufferings. Ludolf of Saxony (c. 1295–1377), for example, demanded in his widely read *Vita Christi* that the reader should whip himself, at least in his imagination, to perfect the scourging, and should stretch his arms out in the form of a cross, to imitate the Crucifixion.

Genuflection (*veniae*) was one of the most common methods of prayer, practiced already in ancient times. The prayer position became, in the ancient church, a penitential practice and, at least from the high Middle Ages on, an ascetic achievement: St. Maria of Oignies (c. 1177–1213), for example, managed up to six hundred genuflections without interruption.

Wakefulness (*vigiliae*) found its theological justification in Luke 6:12, when Jesus kept a vigil before calling the twelve apostles. Here too the monks of the Middle Ages attempted to outdo their religious leader: some, for example, such as the beatified Benevenuta of Bojanis, bathed their eyes in vinegar. Sleep deprivation was a given in any case, since sleep was constantly interrupted by the cloister's prayer rhythm; it was further assured by hard beds.

Penitential robes (*cilicium*) and girdles (*cingulum, catena*) were often worn by those living in the world, even under everyday clothing. The beatified father confessor Wilbirg of St. Florian (c. 1230–1289), who chastised himself with an iron girdle that inflamed the skin egregiously, outlined their typical rationale: "In this way I have afflicted my flesh hardly and through this affliction have I won a reward which is not small."

Fasting (*ieiunum*) was not only prescribed during certain times in the church year (Holy Week) but was, beyond this, the most frequently practiced ascetic achievement. The two female doctors of the church, St. Catherine of Siena (1347–1380) and St. Teresa of Avila (1515–1582), followed this practice: in order to force themselves to regurgitate, they inserted, amid great pain, plant stems or branches down their throats to their stomachs. Catherine called this act "retribution" and introduced it with the words "And now we will deliver retribution to this most wretched sinner!" In 1380 she died of thirst, following an ascetic trial. According to themselves and the reports of their contemporaries, many late medieval ascetics took their holy anorexia to the point that they were able to live entirely without nourishment: these included Benevenuta of Bojanis, Elsbeth Achlerin, St. Lidwina of Schiedam, and the Swiss national saint, Nicholas of Flüe.

Total chastity (*castimonia*), in accordance with the above-mentioned ideal of Paul and the church fathers, was a matter of course for all who took their priestly role or monasticism seriously. It is not surprising that numerous visions by celibate men and women have come down to us that openly or subliminally incorporate sexuality, be it in the form of sadistic

punishment fantasies in purgatory or hell or as the mystical love union of bride and Christ. As many married lay people began, following the eleventh- and twelfth-century church reforms, to strive for monastic ideals, the problem of accommodating asceticism and the *debitum maritum* came sharply to the fore. Some couples, like the count and countess St. Eleazar and St. Delphina of Sabran (fourteenth century), carried on a chaste marriage. Women with less pious husbands, like St. Dorothy of Montau (1347–1394) or St. Francesca of Rome (1384–1440), made every sexual coupling into a torture through self-mutilation.

Ascetic practices of this kind were not generally intended to be private matters; they were supposed to be public, as part of a contemporary worldview that saw the ascetic's suffering body as a sign written for God—a visible demonstration of election and an exhortation to imitation. The contemporary paintings and sculptures of, for example, St. Bernardino of Siena, John of Capistrano, and Nicholas of Flüe, document this clearly.

Asceticism gained, from the high Middle Ages on, a further function that had not previously been present—the mystical inducement of trancelike or ecstatic states. In this function—which fully parallels the preparation for the soul's journey of shamanism, excepting that Christianity does not employ drugs—asceticism was practiced by almost all experiential mystics from the late Middle Ages to the present, although it evoked criticism from some theoretical mystics, such as Meister Eckehart (c. 1260–?1327).

Extreme ascetic trials were often demanded as tests of obedience or as punishments by father confessors or cloister leaders; the disciplining of the individual therefore served the interests of the churchly authority's exercise of power. The internalization of asceticism as an ideal could also, seen from a sociological perspective, subconsciously serve this same goal.

Western Christianity did not consist only of Catholics, of course, but included, with increasing frequency toward the turn of the first millennium, alternative sects as well. Heresies, developed as a result of intensive theological and philosophical reflection, such as Amalric of Bena's doctrines in the late twelfth and early thirteenth centuries, but also, in time, Protestantism, show a particular tendency toward asceticism. Sects that leaned toward libertine ideas, however, such as the Adamites, the Free Spirit Brotherhood, and the Luciferians, were naturally opposed to asceticism. Asceticism, however, took on an enormous significance in the dualistic heresy of the Manichaean tradition. According to its teachings, the material world was evil, especially anything that was related to sexuality and its accompanying animal satisfactions. The "light soul" needed to be freed from the prison of "dark materiality." Thus the Cathars (Albigensians) fasted three days in every week and an additional forty days every year. Marriage was forbidden. An extreme form of nutritional deprivation, the *endura*, was practiced as well, whereby terribly ill sect members would fast themselves to death; sick babies would be deprived of their milk, a practice that was called "preparing a good end." The intensification of Catholic asceticism since the twelfth century was, to a large extent, a reaction to these practices, an attempt, in other words, to outdo these heretical dualists.

The Early Modern Period

In Catholic lands the medieval ascetic forms were continued in principle, especially in the Latin countries, aided by the development of a thorough theoretical collection of texts on asceticism and mysticism systematizing the abovementioned theological foundations. St. Veronica Giuliani (1660–1727), who, among other things, used her tongue to lick half of her cloister clean of dust and spiders, may be taken as a practical example; the most widespread theoretical example of a *direttio ascetica* (ascetic instruction) was the *Direttorio ascetico* by the Jesuit Giovanni Scaramelli (1687–1752).

Sects like the Jansenists had strands who practiced extreme forms of asceticism: in Paris, after 1730, there appeared the female Convulsionists, who swallowed burning coals or pebbles, suffered under the body weight of other members, and voluntarily underwent crucifixion for hours at a time. This was a mass movement that spread through the energy of group dynamics and evolved during communal religious services.



Twiggy modeling a dress, 1968. By the mid-twentieth century, asceticism had been diluted to a concept practiced primarily by those seeking to attain personal satisfaction in sports, political or financial gain, or, as in the case of a fashion model, a desirable physical appearance. © BETTMANN/CORBIS

The Protestant reformers, more emphatically even than the humanists, rejected the asceticism that had previously been quite well known because they counted it as an act of “good works” and a mark of monasticism. With the exception of Methodists and Anglicans, Protestant piety recognized retreat from the world but no active asceticism. Max Weber and Ernst Troeltsch have seen this attitude as a strict work ethic and a denial of the earned pleasures of an upwardly mobile life of production and consumption; in other words, Calvinism is an “internal asceticism,” or a secularized equivalent of monastic asceticism (implying, naturally, a considerable expansion of the term’s meaning). To the Enlightenment philosophers, asceticism was no longer comprehensible and became merely a cause to mock Catholicism.

Modernity

Since the Enlightenment, even the Catholic Church has come, more and more, to reject the above-described ascetic forms—at a distance from an approximately eighteen-hundred-year tradition—as aberrations and “exaggerations.” In the early twenty-first century, Catholic theologians of this denomination define asceticism as balanced, consisting of harmless penances like moderation in alcohol and nicotine intake or separation from the entertainment industry, as components of a lifetime of striving for perfection. In twenty-first-century monastic life, ascetic achievements are limited to a daily practice regulated by prayer times and reduced to a mild fast before the holy days. Often asceticism is just a synonym for morality—practices that manifest a striving toward God (avoidance of sin, practice of the virtues, or concentration on God). Even Pope Pius XII’s teaching that a Christian should wish to seek physical pain in order to take part in the sufferings of Christ, should reject sensual satisfaction and debase his flesh, has not altered the general watering down of the ascetic ideal. That ideal has more in common now with the (Protestant) philosophy of the eighteenth and nineteenth centuries, which reached back to the original meaning of the word: Immanuel Kant saw in asceticism a cheerful fulfillment of duty, Friedrich Nietzsche an exercise of the will. In the modern age, asceticism, thus secularized, is practiced for purely personal purposes: in sports (painful training and sexual abstinence in order to attain ultimate achievement), for the realization of aesthetic norms (fasting to attain an ideal figure, sometimes to the extent of a striving for gauntness), or for the attainment of social and lucrative ends. In 2004, for example, the English television station Channel 4 aired a reality show in which the contestants competed to see who could go without sleep the longest—a week of sleep deprivation brought the winner 140,000 euros.

Another ascetic form, grounded in subjective ethics—not religious as a rule—is fasting for the implementation of an ideological stance (as in ancient Ireland). In modern times it has become a common method (hunger strike) to appeal through the media for the sympathy of the public.

Conclusion

As a widespread phenomenon, asceticism was historically significant only within the religious realm. Self-discipline and self-infliction of pain, as voluntary practices of piety, primarily

functioned as part of a predetermined contract with the Godhead in the sense of a religious *do ut* (principle of reciprocity) that anticipated a reward in this and the other world. Asceticism was therefore always commonly seen as a means to an end, although it may have been, for those with corresponding psychosomatic dispositions, a goal in itself. Remarkably, no other religion besides Christianity so positively values suffering and pain. This value begins with voluntary participation in the Passion of the religious leader, attains a decided accent with Paul, the martyrs, and monasticism, and reaches its high point in the era between the thirteenth and the eighteenth centuries. And Christianity alone uses, as its most important symbol, a physical body that has been pierced with nails to an instrument of torture and left there to die. In the third chapter of her major work, *Il dialogo*, Catherine of Siena emphasizes the foundations of Catholic asceticism: "For God, who is infinite, wants infinite love—and infinite suffering."

With the advent of Protestantism and, above all, through the Catholic Church's own reception of the Enlightenment, such roads to the heavenly realm became obsolete. Behind this change was also a fundamental transformation of the historical perspective on the body, which manifested itself in law with the elimination of torture and capital punishment. From a social psychology perspective, asceticism is defined as an elite organization of conduct of life that critically rejects the general cultural values of the "masses"; psychologically, asceticism is seen as a socially accepted and rewarded overcompensation for guilt feelings, as in masochism and the death instinct. In the Western world of the early twenty-first century, traditional Christian asceticism, with very few exceptions, no longer exists; asceticism only exists in purely personal, secularized, analogous forms, which inspire more criticism than admiration.

See also *Body, The; Christianity; Enlightenment; Manichaeism; Monasticism; Neoplatonism.*

BIBLIOGRAPHY

- Auer, Albert. *Die philosophischen Grundlagen der Askese*. Salzburg, Austria: Jgonta, 1946.
- Deth, Ron van, and Walter Vandereycken. *From Fasting Saints to Anorexic Girls*. New York: New York University Press, 1994.
- Dinzelbacher, Peter. "Über die Körperlichkeit in der mittelalterlichen Frömmigkeit." In *Bild und Abbild vom Menschen im Mittelalter*, edited by Elisabeth Vavra, 49–87. Klagenfurt, Austria: Wieser, 1999.
- Gougaud, Louis. *Devotional and Ascetic Practices in the Middle Ages*. Translated by G. G. Bateman. London: Burns, Oates and Washbourne, 1927.
- Lehmann, Hartmut. "Asketischer Protestantismus und ökonomischer Rationalismus." In *Max Webers Sicht des okzidentalen Christentums*, edited by Wolfgang Schluchter, 529–553. Frankfurt, Germany: Suhrkamp, 1988.
- Ranke-Heinemann, Uta. *Eunuchs for the Kingdom of Heaven*. Translated by Peter Heinegg. New York: Penguin, 1991.
- Schjelderup, Kristian. *Die Askese*. Berlin: de Gruyter, 1928.
- Vaage, Leif E., and Vincent L. Wimbush, eds. *Asceticism and the New Testament*. New York: Routledge, 1999.
- Viller, Marcel, ed. *Dictionnaire de spiritualité ascétique et mystique*. 16 vols. Paris: Beauchesne, 1932–.

Viller, Marcel, and Karl Rahner. *Ascese und Mystik in der Väterzeit*. 2nd ed. Freiburg, Germany: Herder, 1990.

Wimbush, Vincent L., and Richard Valantasis, eds. *Asceticism*. New York: Oxford University Press, 1995.

Zöckler, Otto. *Ascese und Mönchtum*. Frankfurt, Germany: Heyder and Zimmer, 1897.

Peter Dinzelbacher

ASIAN-AMERICAN IDEAS (CULTURAL MIGRATION). Asian migration to the United States is a trans-Pacific flow of people, social networks, and cultural values. Asian immigrants arrived in America with their own lifestyles, labor and vocational skills, business expertise and capital, family rituals and traditions, religious and philosophical beliefs. As Asians have adapted to American society, some of their home cultures have remained, others have disappeared, and still others have changed. Migration is often a process of negotiation over cultures during which Asian immigrants and their descendants construct new identities, community structure, and cultural sensibilities. Race and ethnicity play important roles in such processes. The formation of Asian-American culture is not a simple blending of Western and Asian cultures. (This entry will not cover immigrants from South Asia.)

The Migration of Values: Religion and Education

Asian experience in America illustrates how cultural values are transplanted, transformed, and developed. In Asia, Confucianism, Buddhism, and Daoism play important roles in people's spiritual life. Confucianism is a philosophical doctrine that guides Asians in human relationships, such as the relationship between the rulers and the ruled or between parents and children. Although Buddhism is a religion, Buddhist teaching is more psychological than theological. When monks pray for deceased family members at a funeral, they help people relieve pain. Daoism advises people to live a simple life and to pursue tranquility and harmony with nature. Those belief systems accompanied Asian immigrants to America. The respect for elders and filial piety advocated by Confucianism have influenced family relationships in both early and contemporary Chinese-American families. Family and district associations of early Chinese communities made sure that a joss house for ancestry worship was available for immigrants and sometimes built temples for prayers. Hsi Lai Temple, completed in 1988 in Hacienda Heights, Los Angeles County, is the largest Buddhist temple in North America. A high percentage of early Japanese immigrants were Buddhists as well, since the Jodo Shinshu (True Pure Land) branches of Amida Buddhism were prevalent in the southwestern part of Japan where immigrants came from. Once rooted in American society, Asian cultural institutions have adapted themselves to local settings. In the early twentieth century, Japanese Buddhist priests often prayed in both Japanese and English, referred to their temples as "churches," installed pews in the temples, and even used hymnals in prayer activities.

Influenced by Confucianism in China, education is the most important social mobility path in Asia. Asian immigrants

have brought their belief in the value of education to the United States. Children are expected to compete vigorously at school and earn good grades, and parents often feel obliged to see children through college. Ethnic-language schools have existed in Asian communities since the nineteenth century. Asian children often go to ethnic-language school after attending regular American public schools, though many of them dislike the arrangement. However, language class is only part of the curriculum, as ethnic-language schools often provide Asian cultural classes as well as classes supplementary to public school education. Ethnic-language schools in the early Japanese community offered English-language classes to assist the second generation to do well at American public schools. Contemporary Chinese-language schools often provide SAT or other college entrance preparation classes. Education is an important agenda in the Asian-American family. The value of education has been transmitted to the second generation as Asian parents send their children to attend ethnic-language schools.

Media and Festivals

Other cultural components of Asian-American communities include ethnic-language newspapers, journals, and Web sites, as well as radio and TV stations. Ethnic mass media are instrumental in allowing immigrants to receive news about both America and their home country and to obtain information on job and business opportunities. It also gives them a sense of community. Ethnic festival celebrations are the most visible community events to provide Asian-Americans with a collective cultural identity. Nisei Week in Los Angeles is the largest ethnic festival for Japanese-Americans. Created in the 1930s, the Nisei Week festival aimed to rejuvenate Little Tokyo's economy and reach out to mainstream American society. More importantly, the *issei* (immigrant) generation was concerned about rapid assimilation of the *nisei* (second) generation and wanted to use this occasion to promote ethnic pride among the American-born Japanese. *Nisei* were often advised that buying in Little Tokyo demonstrated their loyalty to Japanese culture. During Nisei Week, stores were colorfully decorated, fashion and talent shows were performed, and a grand parade was organized. The Nisei Week queen often rode together with local government officials in the parade. Under the festival atmosphere, however, lay conflicts between generations, racial tensions, and the struggle of Asian small-business owners.

Lunar New Year is the most important festival for Chinese-Americans. In China, it is essentially a family celebration. Family members clean the house, pay off debts, cook a rich family dinner, give red envelopes containing money to children, and use firecrackers to scare away evil spirits. In America, however, it becomes a public event. Chinese community organizations sponsor the Lunar New Year banquet, organize a dragon or lion dance parade, and decorate the community with red lanterns and bright banners. Before the Chinese Exclusion Acts were repealed in 1943, many Chinese immigrants were separated from their wives and children in China. Clan association banquets replaced the family feast in order to give the single males a sense of family life. Merchants allowed their employees a couple of days off from work to express ethnic solidarity. The Lunar New Year festival was also an occasion to reach

out to mainstream America. While most stores were closed in China during the holidays, decorated Chinatown welcomed visitors as merchants commercialized it to attract tourists. Modeled after the Rose Bowl Parade on New Year's Day in Los Angeles, the Golden Dragon Parade tradition originated in the San Francisco Chinese community in the 1950s. Local celebrities, government officials, famous Chinese professionals and artists, and Miss Chinatown U.S.A. all rode on the floats during the parade. As the Chinese take this occasion to show their ethnic pride, the Lunar New Year gains new meanings in America.

Influences on Mainstream Society

Asian-American culture has influenced American society at large. Grocery chains such as 99 Ranch Market attract both Asian and non-Asian clients. Many Americans consult acupuncture specialists or feng shui masters. Asian food is probably the most visible transplanted culture in America. Wherever they went, immigrants brought their cookery with them. A business directory in 1856 listed five restaurants and thirty-eight grocery stores among eighty-eight Chinese businesses in San Francisco. Obviously Chinese immigrants cooked their own meals and visited Chinese restaurants during their leisure time. However, as racial discrimination gradually forced the Chinese out of other occupations and channeled them into menial service jobs such as the restaurant or laundry business, many Chinese picked up cooking skills and worked as professional cooks. With numerous Chinese restaurants and laundry shops in metropolitan areas during the exclusion years, cooking and laundry became an ethnic label for Chinese-Americans. To adapt Chinese cuisine to American society, Chinese immigrants created "sweet and sour pork" or "chop suey" as "authentic" Chinese dishes in America and invented the "fortune cookie" as an additional incentive to American customers. Restaurants in China had no such thing as a "fortune cookie." Original "chop suey" consisted of intestines and giblets, as ordinary Chinese did not want to waste any part of butchered livestock. Hundreds of "chop suey houses" appeared in New York, Boston, Washington, Philadelphia, and Chicago in the 1900s after Li Hongzhang, a senior Chinese official, visited the United States in 1896. Chinese restaurant operators capitalized on the visit and marketed "chop suey" as Li's favorite dish. Being an authentic Chinese food in America, chop suey is defined in Webster's dictionary as "a dish prepared chiefly from bean sprouts, bamboo shoots, water chestnuts, onions, mushrooms, and meat or fish and served with rice and soy sauce." While the Chinese restaurant has become popular in America society, cooking is a false trademark of Chinese ethnicity.

Herbal medicine, on the other hand, is a true ethnic skill of the Chinese. Like Chinese restaurants, herbal stores began to appear as soon as the Chinese arrived in America. With the growth of Chinese immigrants, more and more herbal doctors arrived to serve the needs of the community. Soon the herbalists began to serve non-Chinese patients as well. By the 1930s, many Chinese herbal doctors had more Caucasian patients than Chinese. Unlike Chinese cuisine, herbal medicine could not change its ingredients, flavor, or dispensation to suit the taste of mainstream Americans. As a transplanted culture, it

had to remain distinctively Chinese for its effectiveness. Herbal medicinal formulations were made from hundreds of indigenous herbs gathered in the mountains and valleys of China. The supply of medicine relied on the constant importation of herbs from China. In their efforts to bypass unfair restrictions and cross ethnic boundaries to serve a larger community, Chinese herbalists developed and expanded an ethnic career and business in a Western society where most of their patients were not familiar with Chinese culture and where the medical profession was becoming increasingly standardized and regulated. Acceptance of and respect for Chinese herbal medicine demonstrate how mainstream American patients adapted themselves to an Asian medical therapy. The history of Chinese herbal medicine is a case of reverse assimilation and an expression of ethnic resilience in cultural migration.

See also *Confucianism; Identity, Multiple: Asian-Americans; Race and Racism: Reception of Asians to the United States; Religion: East and Southeast Asia.*

BIBLIOGRAPHY

- Chan, Sucheng. *Asian Americans: An Interpretive History*. Boston: Twayne, 1991.
- Ichioka, Yuji. *The Issei: The World of the First Generation Japanese Immigrants, 1885–1924*. New York: Free Press, 1988.
- Kurashige, Lon. *Japanese American Celebration and Conflict: A History of Ethnic Identity and Festival in Los Angeles, 1934–1990*. Berkeley: University of California Press, 2002.
- Liu, Haiming. “The Resilience of Ethnic Culture: Chinese Herbalists in the American Medical Profession.” *Journal of Asian American Studies* 1, no. 2 (June 1998): 173–191.
- Takaki, Ronald. *Strangers from a Different Shore: A History of Asian Americans*. Rev. ed. Boston: Little, Brown, 1998.
- Tong, Benson. *The Chinese Americans*. Rev. ed. Boulder: University of Colorado Press, 2003.
- Tsai, Shih-shan Henry. *The Chinese Experience in America*. Bloomington: Indiana University Press, 1986.
- Yin, Xiao-huang. *Chinese American Literature since the 1850s*. Urbana: University of Illinois Press, 2000.
- Yu, Renqiu. “Chop Suey: From Chinese Food to Chinese American Food.” *Chinese America: History and Perspectives* 1 (1987): 87–100.
- Zhou, Min. *Chinatown: The Socioeconomic Potential of an Urban Enclave*. Philadelphia: Temple University Press, 1992.

Haiming Liu

ASSIMILATION. In 1964 Milton M. Gordon (b. 1918) produced a groundbreaking book called *Assimilation in American Life*. He informed readers that three different theories of assimilation existed in the United States: “Anglo-Conformity,” the “Melting Pot,” and “Cultural Pluralism.” Gordon acknowledged, though, that Anglo-Conformity was “the most prevalent ideology of assimilation in America throughout the nation’s history” (p. 89). The other two theories, proposed by members of minority groups who wanted to “fit in” but who were unwilling to accept the cultural demands of the dominant society, suggested that all people who came to the United States ultimately mixed together and formed a “new American,” or

that individuals could “assimilate” while maintaining aspects of their own culture. History has shown, however, as Gordon himself noted, that to be accepted by others as an American, one had to conform totally to the values of Anglos in the United States. (“Anglo” values are sometimes referred to as WASP—white, Anglo-Saxon, Protestant—characteristics.)

Colonial Period

No one questions, of course, that the United States, and the British colonies before the formation of the American government, almost always welcomed European Caucasians as future citizens. In the colonial era there was an incessant call for additional laborers. And although much of the need was filled by black Africans, white people had no desire to intermingle with them socially or on an equal basis. Since the way to assimilate in American society requires marriage with a member of the dominant culture, and adoption of the folkways and mores of that culture, any non-Caucasian could not be considered. Nonwhites could not become white, and prejudice prevented most white people from marrying people of any other skin color.

Starting in colonial America, however, the standards for assimilation included adoption of the religion and language of the community. Most of the Pilgrims, Puritans, and others who traveled to the southern part of what is now the United States were Protestants. Catholics were feared because they were viewed as subject to the “tyrannical dictates” of the pope in Rome. The epithet “Jews, Turks, and Infidels” assumed inferiority, non-Protestant faiths, and lack of the attitudes and characteristics required of all Americans.

These views did not prevent Catholics and Jews from coming to the colonies, but these groups were rarely accepted as equals by members of the dominant culture. It is true, also, that some Protestant denominations, such as Quakers and Huguenots (French Protestants), were also looked down upon. Once they changed their denominations, however, they had the option of blending with members of the dominant culture. Some accepted the colonial demand for assimilation into a more mainstream Protestant denomination. This choice, however, was usually made by their children or grandchildren. Moreover, other European immigrants could either conform to American values or choose to remain with people of similar backgrounds. The latter was not acceptable to the colonists; it concerned members of the dominant culture. Benjamin Franklin (1706–1790) warned fellow Pennsylvanians in the eighteenth century about the Germans in their midst:

Why should the *Palentine Boors* be suffered to swarm into our Settlements, and by herding together, establish their Language and Manners, to the Exclusion of ours? Why should *Pennsylvania*, founded by the *English*, become a Colony of *Aliens*, who will shortly be so numerous as to Germanize us instead of our Anglyfying them? (Dinnerstein et al., 1999, p. 7)

Franklin’s thoughts reflect not only the values of people of his own time but also those of Americans throughout the centuries. As a result of their anxiety about maintaining the

dominant culture, colonists feared new immigrants who might undermine it with their own preferences. Often individuals, some of whom had been here perhaps for less than one generation, expressed the most hostile feelings about the new immigrants. Subsequent generations in the United States also frowned on newcomers with different backgrounds. Only foreign-born Protestants who spoke English were easily accepted without criticism by Americans.

From the colonial era stereotypical impressions of almost every group became part of the thought and expression of members of the Anglo-American culture. Descendants of the English regarded Germans as fat, stupid, and drunk; Jews and Quakers as clever and wealthy; Scots-Irish as violent and drunk; and French, Spaniards, and other “papists” as “hot-blooded lovers” and “slaves” of tyrannical rulers in the Catholic Church. Nineteenth- and twentieth-century immigrants like the Irish, the Poles, and the Jews were similarly branded with epithets Americans fantasized.

Responses to Crisis

Whenever a crisis occurred in American society, some ethnic group was usually targeted as the culprit. In the 1790s, at the time that the English and French were battling for control of the Atlantic Ocean, French “radicalism” supposedly undermined American society. Fears of the French led to the passage in 1798 of the Alien and Sedition Acts, which gave the president unilateral power to jail and/or force people back to where they came from if they criticized the government. During World War I, Americans denounced people of German ancestry; during World War II, the U.S. government incarcerated Japanese-Americans; and after the attack on the World Trade Center and the Pentagon, on September 11, 2001, legislation quickly passed through Congress calling for the “registration” of Muslims from several Middle Eastern and Asian nations. In each of these periods, most other Americans regarded members of these groups as threats to the security of the nation.

Throughout American history, once crises had passed, Caucasians could engage in whichever economic endeavors they chose. Members of society who had not married people of the dominant culture, however, had a more difficult time functioning in the United States. Some, who were even prohibited from having equality by state laws or customs, such as Asians and Mexican-Americans, nonetheless found their niche in a variety of endeavors. The Irish, in the nineteenth and twentieth centuries, could buy saloons, join the army, or attend law school. Civil-service positions were generally open to them as well as to others of different backgrounds who passed qualifying examinations. Through the middle of the twentieth century many political “bosses” were of Irish ancestry. Given the opportunities for independent entrepreneurs, Jews as well as Japanese rose in society. After World War II, where educational opportunity existed, everyone who partook of it fully moved up a notch or two on the socioeconomic scale.

Nonetheless, many newcomers and their children still retained traditional values and refused to marry outside of their cultures. Although almost everyone acculturated in stages, that

is, adopted the characteristics, attributes, and behavior of members of American society, it sometimes took three or four generations before they actually assimilated. For these people and their descendants, “success,” but not total acceptance, was also possible. Thus, in tracing the evolution of people in American history, one notes that while wealth or accomplishments were always signs of having succeeded in the dominant culture, such attributes were not enough to be considered “one of us.” An athlete or an entertainer might be extremely skillful, popular, and appealing in his or her field of endeavor, but still not accepted as an “equal” by members of the dominant culture. At one time a Jewish actor or an Italian baseball player might be universally applauded, but that did not make Jews or Italians part of the mainstream.

In general, Americans welcomed all Caucasian immigrants until approximately the 1920s. There were always concerns, though, that non-Protestants could not fit into American society. Thus, when the tide of European immigration turned overwhelmingly Catholic and Jewish in the late nineteenth and early twentieth centuries, Congress passed laws curbing their influx. In the 1920s new immigration legislation favored people whose compatriots had predominated in the settlement of the United States. Laws establishing quotas for different nationalities passed in 1921 and 1924, respectively. These bills set low quotas for southern and eastern Europeans but much more generous ones for the British, Germans, and Irish. In the 1930s American consular officials placed more stringent restrictions on Jewish people trying to emigrate from Germany than they did on non-Jews. Similarly, after World War II, legislation to bring in displaced persons from Europe favored non-Jews over Jews, and former fascists over Communists. Not until 1965 did Congress pass immigration legislation favoring family unification.

The opportunities for assimilation in American society have always been greater for Caucasian Protestants than for people of other backgrounds. Before World War II sociologists noted that people of different national heritages had begun marrying members of other ethnic groups who shared their religion. In the 1960s, the nation witnessed a rise in the rates of intermarriage by people of European descent who had had different religious and ethnic backgrounds. The United States Supreme Court then declared, in *Loving v. Virginia* (1967), that states could not ban interracial marriage. Immediately the prohibition of interracial marriage, which still existed in twenty-two states, mostly in the South and the West, ceased.

Since that time, Americans of all stripes have witnessed increasing numbers of marriages based on individual choices and characteristics. Demographers and statisticians, moreover, have concluded that more than 50 percent of all Americans have chosen life partners based on individual characteristics rather than religious, ethnic, or legal considerations. As one boy put it in 1993, “I’m half Italian, half Japanese, and all American.”

Class, rather than any other factor in the twenty-first century, should be examined before making assessments about intermarriage as well as ease of assimilation. In the twenty-first century, in countries such as Germany and England, both class and heritage play a more significant aspect in acceptance than

ASTROLOGY

they do in the United States. But unlike the United States, where place of birth determines citizenship, in some European countries—for example, Switzerland—one is never automatically a citizen, regardless of birthplace.

See also *Americanization, U.S.; Asian-American Ideas (Cultural Migration); Identity, Multiple; Loyalties, Dual; Migration.*

BIBLIOGRAPHY

- Alba, Richard. *Remaking the American Mainstream: Assimilation and Contemporary Immigration*. Cambridge, Mass.: Harvard University Press, 2003.
- Dinnerstein, Leonard, Roger L. Nichols, and David M. Reimers. *Ethnic Americans: A History of Immigration*. 4th ed. New York: Columbia University Press, 1999.
- . *Natives and Strangers: A Multicultural History of Americans*. 4th ed. New York: Oxford University Press, 2003.
- Gordon, Milton M. *Assimilation in American Life: The Role of Race, Religion, and National Origins*. New York: Oxford University Press, 1964.
- Jacoby, Tamar. *Reinventing the Melting Pot: The New Immigrants and What It Means to Be American*. New York: Basic Books, 2003.
- Portes, Alejandro, and Rubén A. Rumbaut. *Legacies: The Story of the Immigrant Second Generation*. Berkeley: University of California Press, 2001.

Leonard Dinnerstein

ASTROLOGY.

This entry includes two subentries:

Overview
China

OVERVIEW

Astrology, the effort to relate earthly occurrences to the stars and planets, is one of the oldest known intellectual endeavors. The oldest evidence for the Western tradition of astrology comes from Mesopotamia in the late third millennium B.C.E. Mesopotamian astronomical documents correlated celestial phenomena like eclipses with public events, including political changes and natural catastrophes. The first surviving “natal” horoscope, recounting the position of the planets at an individual’s birth, is also Mesopotamian and dates from the late fifth century B.C.E. One Mesopotamian people, the Babylonians or Chaldeans, long remained famed for their astrological ability. Astrologers generally were called Chaldeans as early as the first century B.C.E. in Rome.

Greek interest in astrology began in the Hellenistic period, as Alexander the Great’s (r. 336–323) conquests exposed Greek thinkers to Mesopotamian culture. The Greeks put astronomy in a cosmological framework, emphasizing the motions of the planets rather than static correlations. Hellenistic Alexandria was a center of astrology, and the Hermetic texts that originated there incorporated astrology into their magical and religious system. The Hellenistic period also saw the first evidence

of Jews embracing astrology, a practice traditional Judaism condemned.

The Roman upper classes also initially condemned astrology, which they associated with popular divination and superstition. This position is reflected in Marcus Tullius Cicero’s (106–43 B.C.E.) *On Divination*. Following the Roman conquest of the Hellenistic east in the first century B.C.E., Roman interest in astrology increased. The earliest evidence for Roman astrologers dates from this period. The Stoic school of philosophy, popular among the Roman elite, endorsed astrology along with other forms of divination. (The Epicureans, great rivals of the Stoics, condemned it.) Astrology became particularly prominent in the Roman Empire, as Augustus Caesar (63 B.C.E.–14 C.E.) employed it in his propaganda, subsequent emperors employed court astrologers, and rebels and aspirants to the imperial throne consulted astrologers to estimate their chances for success.

The imperial period saw the first surviving Latin astrological work, the Roman poet Manlius’s Stoic-influenced *Astronomica*. Manlius had little astronomical or mathematical skill, however, and the most important astrological writer in the Roman Empire was the Greek astronomer Claudius Ptolemy (2nd century C.E.), author of the most influential ancient astrological book, *Tetrabiblos*. Ptolemy, more a codifier than an innovator in astrology, defended it as a science of the influence of the stars on the terrestrial world based on conjecture rather than certainty. The early Christians attacked astrology, associating it with determinism and Gnosticism. St. Augustine of Hippo’s (354–430) denunciation of astrology in *The City of God* was particularly influential in the Latin West. The Christian Roman Empire included astrology in its strong antidyvination laws, which were however only sporadically enforced.

Medieval Astrology

During the early Middle Ages, astrology, like many ancient disciplines, languished in the Latin West less because of the church’s condemnation than because few Westerners were able to draw an astrological chart or read Greek astrological works. The most important theoreticians and practitioners in the early Middle Ages were Arabic speakers in the Islamic world. Arabs developed several astrological ideas later accepted in the West, such as the correlation of patterns in human history with the conjunctions of Jupiter and Saturn, the so-called great conjunctions. Greek and Arabic works of astrological theory were translated into Latin only in the twelfth and thirteenth centuries. Medieval intellectuals like Albertus Magnus (c. 1200–1280) and Roger Bacon (c. 1220–1292) endorsed astrology but faced the problem of reconciling astrological determinism with the Christian doctrine of free will. They claimed that the stars influenced only the body, and not the soul. St. Thomas Aquinas (c. 1224–1274) conceded that the stars influenced human passions, and that many astrological predictions were correct because most people were ruled by their passions. He claimed, however, that the wise man could resist his passions, and thus the stars could not determine his actions. The medieval emphasis on the power of the stars over the body helped astrology become closely allied with medicine. Charles V of France (r. 1364–1380), whose library contained many books

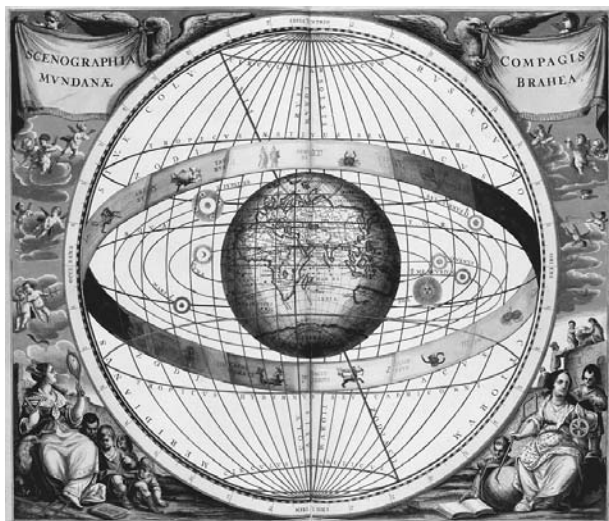

Map of Tycho Brahe's system of planetary orbits around the earth, with signs of the horoscope (1660–1661), by Andreas Cellarius. Danish astronomer Brahe, who calculated the measurements of the solar system in the sixteenth century, was one of the last major Western astronomers to practice astrology. © STAPLETON COLLECTION/CORBIS

on astrology, contributed to the foundation of a college of astrological medicine in the 1360s.

Not all late medieval intellectuals accepted the new astrology. Six propositions of Bishop Étienne Tempier's famous prohibition of 1277 condemned astrology, mostly on the grounds of its determinism. The Scholastic philosopher Nicole d'Oresme (c. 1325–1382) vigorously opposed astrology. He reiterated the Christian attack on astrological determinism and added a new argument, that the velocities of the heavenly bodies were mathematically irrational and incommensurable, and thus it was impossible to know them exactly enough for astrology to work.

Astrology in the Renaissance and Reformation

As in other ancient sciences, Renaissance humanists claimed to be recovering the true, ancient astronomy from corruption by Arab and medieval Latin writers (although Arab-derived great conjunction theory remained very popular.) Renaissance philosophers, particularly those influenced by Neoplatonism, also extended the discipline's scope. The third book of Marsilio Ficino's (1433–1499) *Three Books on Life* (1489) treated the planets as a guide to all aspects of human life. Girolamo Cardano (1501–1576), who wrote a commentary on the *Tetrabiblos*, scandalized many by drawing a natal horoscope of Jesus Christ. While Martin Luther (1483–1546) and John Calvin (1509–1564) both condemned astrology, many of their Protestant followers (including Philipp Melancthon; 1497–1560) practiced it. Protestant astrologers were particularly interested in reconciling astrology with the apocalyptic interpretation of the Bible, using the stars and great conjunctions to help predict the date of the end of the world.

Astrology was an important support for professional astronomers in the late Middle Ages and Renaissance, as many

patrons were interested in astronomical data principally for its astrological uses. The leaders of the scientific revolution differed in their opinions of astrology. The last major Western astronomers to seriously practice astrology were Tycho Brahe (1546–1601) and Johannes Kepler (1571–1630), both of whom drew horoscopes for the monarchs they served. Mechanical philosophers like Marin Mersenne (1588–1648) and the “Christian Epicurean” Pierre Gassendi (1592–1655) denied the doctrine of the influence of the stars on the Earth that astrology was based on, as it had no mechanical explanation. Although several of the founding members of the Royal Society practiced astrology, it lost its central intellectual role in the late seventeenth century. Astronomers increasingly justified their science as useful in navigation and cartography rather than astrology. Copernican astronomy did not “disprove” astrology, but the shift from an earth-centered to a sun-centered cosmos did call into question traditional geocentric astrological interpretation. Astrology also suffered from the general decline of magical thinking as Europe entered the eighteenth century. Although many ordinary people continued to believe in astrology, it was not taken seriously by most scientists and intellectuals.

See also *Magic; Pseudoscience; Science.*

BIBLIOGRAPHY

- Barton, Tamsyn. *Ancient Astrology*. New York: Routledge, 1994.
 Grafton, Anthony. *Cardano's Cosmos: The Worlds and Works of a Renaissance Astrologer*. Cambridge, Mass.: Harvard University Press, 1999.
 Tester, S. Jim. *A History of Western Astrology*. Woodbridge, Suffolk, U.K.: Boydell, 1987.
 Zambelli, Paola, ed. *"Astrologi Hallucinati": Stars and the End of the World in Luther's Time*. New York: de Gruyter, 1986.

William E. Burns

CHINA

In China, coordination of human activity with the sun, moon, and stars, including the cardinal orientation of structures in the landscape, can be traced back to the Neolithic cultures of the fifth millennium B.C.E. In the words of Sima Qian (fl. 100 B.C.E.), “Ever since the people have existed, when have successive rulers not systematically followed the movements of sun, moon, stars, and asterisms?” By the early Bronze Age, around the beginning of the second millennium, attention had already begun to focus on the circumpolar region as the abode of the sky god *di*, and from this time forward the North Pole increasingly became a locus of practical and spiritual significance. The polar-equatorial emphasis of Chinese astronomy began to take shape, which meant that the ancient Chinese remained largely indifferent to heliacal phenomena and the ecliptic (the sun's apparent path through the skies). A prominent feature of this polar focus was the use of the handle of the constellation Northern Dipper (Ursa Major) as a celestial clock-hand and the identification of certain cardinal constellations with the seasons and their unique characteristics—the green dragon with spring, the red bird with summer, the white tiger with autumn, the dark turtle

with winter. As Sima Qian would later say: “The 28 lunar lodges govern the 12 provinces, and the handle of the Dipper seconds them; the origin [of these conceptions] is ancient.” Massings of the five planets, *di*’s “Minister-Regulators,” solar and lunar eclipses, and other astronomical and atmospheric phenomena were seen as portents of imminent, usually ominous events. Astronomical records are not abundant in the earliest written documents, the oracle-bone divinations of the late Shang dynasty (c. 13th to mid-11th B.C.E.); however, a theory of reciprocity prefiguring later Chinese astrological thinking is already in evidence. What transpired in the heavens could and did profoundly influence human affairs, and conversely, human behavior could and did provoke a response from the numinous realm beyond the limits of human perception. Astral divination was reactive and opportunistic and, as elsewhere, never focused on individuals beyond the royal person, but only on affairs of state such as the sacrifices to the royal ancestors, the harvest, warfare, and the like.

By the late Zhou dynasty (1046–256 B.C.E.) *tianwen*, “sky-pattern reading” or astrological prognostication, took as its frame of reference the twenty-eight lunar mansions or equatorial hour-angle segments into which the sky was by then divided. In classical “field allocation” astrology of mid to late Zhou, these twenty-eight segments of uneven angular dimensions were correlated with terrestrial domains according to different schemes. Allocated among the astral fields for purposes of prognostication were either the nine provinces into which China proper was traditionally thought to have been divided, or the twelve warring kingdoms of the late Zhou, whose successive annihilation by Qin led to the establishment of the unified empire in 221 B.C.E. The classical job description of the post of astrologer royal is found in the third century B.C.E. canonical text *The Rites of Zhou*:

[The *Bao zhang shi*] concerns himself with the stars in the heavens, keeping a record of the changes and movements of the stars and planets, sun and moon, in order to discern [corresponding] trends in the terrestrial world, with the object of distinguishing (prognosticating) good and bad fortune. He divides the territories of the nine regions of the empire in accordance with their dependence on particular celestial bodies; all the fiefs and territories are connected with distinct stars, based on which their prosperity or misfortune can be ascertained. He makes prognostications, according to the twelve years [of the Jupiter cycle], of good and evil in the terrestrial world. (trans. Needham, p. 190; modified by the author)

In this scheme, movements of the sun, moon, and planets formed the basis of prognostication, taking also into account their correlations with the five elemental phases (Mercury-Water; Venus-Metal; Mars-Fire; Jupiter-Wood; Saturn-Earth), as well as *yin* and *yang*. While sparsely documented in contemporary sources, probably as a result of the hermetic nature of the practice, evidence suggests the influence of astrological considerations was pervasive. As a common aphorism put it not long after the founding of the empire, “astute though

the Son of Heaven may be, one must still see where Mars is located.” Although Babylonian influence on Chinese astrology has occasionally been claimed, and a few suggestive parallels between specific late planetary prognostications (c. 100 B.C.E.) have been drawn, on the whole the evidence in favor is unpersuasive. Ancient Chinese cosmology and astrology are distinctive in essential respects, and any parallels are so circumstantial that it is more likely that throughout its formative period Chinese astrology developed in isolation from significant external influences. When it comes to China’s immediate neighbors, the flow of ideas has been overwhelmingly outward from the center.

Early Imperial Period

In the early imperial period, Han dynasty (206 B.C.E.–220 C.E.) cosmologists amalgamated field-allocation astrology with hemerological concepts (lucky and unlucky days for various activities), yin-yang and five phases correlative cosmology, as well as the symbolic trigrams of the *Book of Changes*, to develop the systematic and highly complex method of divination embodied in the *shi* or diviner’s board so representative of that period. Examples of the latter excavated from Han tombs typically consist of a round heaven plate with the Northern Dipper inscribed at the center as if seen from above, and with the twenty-eight lunar mansions, months of the year, or solar chronograms inscribed in bands around the circumference. The pivot of the heaven plate is conventionally placed in or near the handle of the Dipper in recognition of its symbolic centrality and numinous power, while the square earth plate underneath is graduated around its exposed perimeter in concentric bands showing the twenty-eight lunar mansions, the twelve earthly branches and ten heavenly stems marking the cardinal and intercardinal directions, the twenty-four seasonal nodes, and so on. Some examples substitute for the heaven plate an actual ladle fashioned from magnetic lodestone and designed to rotate within a highly polished circular enclosure representing the circumpolar region.

As originally conceived, the twenty-eight lunar mansions did not technically constitute a zodiac, since, with the exception of comets, novae, and the like, the sun, moon, and planets did not actually appear among their constituent stars: many of the latter in ancient times actually lay closer to the equator than to the ecliptic. Rather, astronomical phenomena occurring within a given astral field were connected with noteworthy events in the corresponding terrestrial region. In terms of classical resonance theory this was because the astral and terrestrial realms were continuous and composed of the same quasi-matter, quasi-*pneuma* called *qi*. Theory held that disequilibrium at any point in the system could potentially provoke imbalance throughout by a mysterious process somewhat analogous to magnetism or sympathetic resonance. In case of disruption it was essential to identify the cause and to take corrective action, based on yin-yang and five phases phenomenological correlations, to remedy the situation and restore harmony to the system. Unlike the Ptolemaic scheme, which has aptly been dubbed “astrological ethnology,” despite modifications designed to take account of historical changes in political boundaries and the relative balance of power between

the empire and its non-Chinese neighbors, from the outset field-allocation astrology was resolutely sinocentric. The non-Chinese world remained essentially unrepresented in the heavens and in astrology except as a reflex of Chinese concerns.

Though individualized horoscopic astrology did not figure in the repertoire, the increasing complexity of astrological theory in Han times was accompanied by a proliferation of prognostication methods and devotions directed toward astral deities. The ancient cult of *Tai yi*, the supreme ultimate or numinous cosmic force resident at the pole, rose to prominence even in the imperial sacrifices, being imaginatively linked in contemporary iconography with the image of the celestial thearch driving his astral carriage (Ursa Major) around the pole.

The Dipper is the Celestial Thearch *di's* carriage. It revolves about the center, visiting and regulating each of the four regions. It divides *yin* from *yang*, establishes the four seasons, equalizes the Five Elemental Phases, deploys the seasonal junctures and angular measures, and determines the various periodicities: all these are tied to the Dipper. (Sima Qian, *Shi ji*, "Treatise on the Heavenly Offices")

The protection of *Tai yi* and lesser astral spirits was invoked both in local cults led by magicians and by imperial officials, in the latter case especially before initiating major military campaigns, when

a banner decorated with images of the sun, moon, Northern Dipper, and rampant dragons was mounted on a shaft made from the wood of the thorn tree, to symbolize the Supreme Ultimate and its three stars. . . . The banner was called 'Numinous Flag.' When one prayed for military success, the Astrologer Royal would hold it aloft and point in the direction of the country to be attacked. (Sima Qian, *Shi ji*, "Basic Annals 12: The Filial and Martial Emperor")

Prognostication based on the appearance of the stars of the Dipper appeared, as well as that based on the color, brightness, movements, and so forth, of comets, "guest stars" or supernovae, eclipses, occultations of planets by the moon, and a variety of atmospheric phenomena. Ancient precedent dating from the Three Dynasties (Xia, Shang, Zhou) of the Bronze Age in the second millennium led to the establishment by Han times of certain astrological resonance periods, especially dense clusters of the five visible planets at roughly 500-year intervals, as the preeminent sign of Heaven's conferral of the "mandate" to rule on the new dynasty. Other alignments of the five planets, or simply their simultaneous appearance in the sky, were popularly held to be "beneficial for China," in an indirect allusion to the existence of a non-Chinese world. Not surprisingly, given the close theoretical link in Han imperial ideology between portents, anomalies, and the conduct of state affairs, the popularization of prognostication by omens led to a politicization of astrology, and the fabrication of all manner of portents for political ends, especially during succession

crises, reached a level unmatched in later imperial history. Because of the connection between astrological omens and state security, in time only imperial officials were allowed to make observations and study the records, and by imperial decree unauthorized dabbling in astrological matters became a capital offense.

Six Dynasties Period and After

Along with the gradual spread of Buddhism in the centuries following the collapse of the Han dynasty, efforts were made by Buddhist writers during the Three Kingdoms and Six Dynasties period (220–589 C.E.) to integrate Indian Buddhist cosmological and astrological concepts and to reconcile incommensurate numerological categories—for example, matching the Buddhist *mahābhūtas* (four elements) with the Chinese five phases. Subsequently, attempts were made to establish even more complex correspondences between Chinese and Indian astrological sets such as the twenty-eight lunar mansions with the twelve Indian zodiacal signs derived from Hellenistic astrology, the nine planets of Indian astronomy with the seven astral deities of the Northern Dipper, and so on. During the Six Dynasties era and the early Tang dynasty (618–906) in particular, China's most influential translators of Buddhist astrological works and compilers of astrological treatises were Indians such as Qutan Xida (Gautama Siddhārta, fl. 718), author of the *Kaiyuan zhanjing* (Kaiyuan reign-period treatise on astrology), the greatest compendium of ancient and medieval Chinese astrological fragments. On the whole, however, these efforts at syncretism exerted surprisingly little influence on long-established Chinese astrological theory, especially given the drastic decline of Buddhism following the Tang dynasty proscriptions in the mid-ninth century and the subsequent resurgence of Neo-Confucianism. Assimilation was also hindered by the difficulty of rendering the foreign concepts and terminology into Chinese, which was often accomplished by means of bizarre or idiosyncratic transliterations.

At the popular level Chinese astrology continued to absorb influences (Iranian, Islamic, Sogdian) via the Central Asian trade routes, and although certain Western numerological categories (such as the seven-day week) are represented in the enormously popular and widely circulated *lishu* or almanacs (documented from the ninth century), and individualized horoscopic astrology appears in later horoscopes (from the fourteenth century), Hellenistic concepts apparently had little discernible impact on the practice of astrology at the imperial court. Until modern times the most common popular forms of divination employed ancient prognostication techniques connected with lucky and unlucky denary and duodenary cyclical characters (paired to generate the sequence of sixty unique designations used to enumerate the days since at least the Shang dynasty), fate-calculation based on the eight characters *bazi* designating the exact time of birth, and so forth.

During the Song dynasty (960–1279) astrology entered a period of routinization and gradual decline, in part as a result of overexploitation by sycophants and careerists as a means of enhancing their status or prospects at court, and in part because of the resurgence of Neo-Confucianism and a return to a more anthropocentric outlook. Along with an increasing emphasis on

human affairs and moral self-cultivation, which was philosophically antithetical to superstition, the archaic belief in an interventionist Heaven that communicated by means of signs in the heavens faded into the background, and *tianwen* or “sky-pattern reading” shifted focus from the ever-precarious genre of prediction to a safer and more manageable interpretive mode. As a consequence, the objective status of natural phenomena declined, and the practice of astrology by imperial officials on the whole reverted to routine observing and recording of observations, focusing on the anomalous.

Henceforth, the interpretation of “sky-patterns” was Confucianized—one might even say domesticated—and only isolated instances of inductive generalization from observation are to be found, rather than interpretation more or less tentatively based on historical precedent. Given its subservience to the state ideology, Chinese astrology was incapable of growing into an independent body of learning or science of the heavens, but remained throughout imperial history the handmaiden of politics when not dismissed as mere superstition, which humble status is confirmed by the traditionally low rank of the post of court astrologer.

See also *Astrology: Overview; Cosmology*.

BIBLIOGRAPHY

Henderson, John B. *The Development and Decline of Chinese Cosmology*. New York: Columbia University Press, 1984.

Major, John S. *Heaven and Earth in Early Han Thought: Chapters Three, Four, and Five of the Huainanzi*. Albany: State University of New York Press, 1993.

Needham, Joseph, et al. *Science and Civilisation in China*. Vol. 2: *History of Scientific Thought*. Cambridge, U.K.: Cambridge University Press, 1956.

———. *Science and Civilisation in China*. Vol. 3: *Mathematics and the Sciences of the Heavens and the Earth*. Cambridge, U.K.: Cambridge University Press, 1959.

Pankenier, David W. “Applied Field Allocation Astrology in Zhou China: Duke Wen of Jin and the Battle of Chengpu (632 B.C.E.).” *Journal of the American Oriental Society* (1999): 261–279.

———. “The Cosmo-Political Background to Heaven’s Mandate.” *Early China* 20 (1995): 121–176.

———. “Popular Astrology and Border Affairs in Early Imperial China: An Archaeological Confirmation.” *Sino-Platonic Papers* 104 (July 2000): 1–19.

Schafer, Edward H. *Pacing the Void: T’ang Approaches to the Stars*. Berkeley: University of California Press, 1977.

Wu, Yiyi. “Auspicious Omens and Their Consequences: Zhenren (1006–1066) Literati’s Perception of Astral Anomalies.” Ph.D. dissertation, Princeton University, 1990.

David W. Pankenier

ASTRONOMY, PRE-COLUMBIAN AND LATIN AMERICAN. The sun and the moon, the planets and the stars are the same the world over. One might hypothesize, therefore, that diverse cultures of the world would think the same of them. The two American continents, having been cut

off from the Old World from the time of the Asian migration across the Bering land bridge more than ten thousand years ago up to European contact in the fifteenth century, provide an excellent laboratory to test such a hypothesis. One does find some remarkable Old–New World parallels. For example, ancient Maya divisions of the movement of the planet Venus inscribed on bark paper are practically identical to those written in cuneiform by the Babylonians. Moreover, in both of these highly urbanized cultures, planetary sightings were employed to the same end by a class of astronomer-astrologers situated very close to royalty: to cast omens.

This essay is divided into two parts. It begins by reviewing the astronomies of the so-called high cultures of the New World: the Maya, the Aztecs, and the Incas, those must often compared with the classical world, Egypt, and the Middle East, from whom are inherited the roots of modern scientific astronomy. Then follows a brief examination of astronomical practices by less complex societies of North and South America.

“High Cultures” of the New World

Of all the Pre-Columbian civilizations none has received as much attention both by scholars and the media as the ancient Maya. The reason is very simple: at its pinnacle, between 200 and 900 C.E., the classical Maya civilization created great art, sculpture, and architecture; they devised a complex religious pantheon; and they developed syllabic writing and numerical systems on a par with the West.

Maya. Maya math was directed largely toward timekeeping (indeed the priest in charge of the calendar was—and still is—called the keeper of the day, *ah kin*). They counted their days in a base-20 system. Like the Babylonians (who used a different base) they dealt with time uniquely, by changing the scheme so as to identify the third position with 360 (18 × 20 rather than 20 × 20). Here was a way of handily reckoning the approximate length of the year. By the beginning of the Christian era they were writing inscriptions in “long count” that reckoned the number of days lapsed since the most recent cycle of creation. Maya mathematicians fixed the great event, which we would transcribe as 0.0.0.0.0 on their temporal odometer, to a date that corresponds in the Christian calendar to 12 August 3114 B.C.E. Though the reasons why they did so remain elusive, this deep-time setting of the commencement of creation is relatively common in highly stratified societies. But Maya time was enmeshed with other cycles that suggest a belief in a sensate universe, with all of its components interconnected—a universe that did not operate apart from human concern.

A shorter cycle, called the *tzol kin* (count of days), which the Maya still employ in the early 2000s, predated the long count by several centuries. Widespread throughout Mesoamerica yet unknown in the Old World, this 260-day round consisted of a series of twenty day-names preceded by numerical coefficients ranging from one to thirteen. Thirteen was the number of layers of heaven in Maya cosmology, while the bodily origin of twenty already is obvious. But other reasons may underlie the popularity of the number 260. In contemporary

Guatemala, there is evidence linking this basic time cycle to the human gestation period. This convenient round number approximates nine lunar months (265.77 days) in the same way that 360 approximates the length of the seasonal year (365.2422 days). The *tzol kin* is also a close approximation to the mean interval of appearance of Venus as evening or morning star, and it beats harmoniously in the ratio of 2:3 with the eclipse reckoning period of 173.32 days. Such approximations offer the advantage to the calendar keeper of assigning particular sets of dates in the *tzol kin* to eclipse or Venus warnings.

Astronomers, along with the mathematicians and scribes who worked with them during the Classic period (c. 200–900 C.E.), were members of a courtly class. Excavations of an eighth-century elite burial at the Maya ruins of Copán, Honduras, revealed the remains of a scribe, his paint pot and brushes still intact. These specialists were required to know with meticulous accuracy every celestial cycle that might conceivably guide human destiny. Control over these time periods by the Maya lords, their superiors, enabled them to appropriately schedule their own affairs as well as those of the state. As in China, such court professionals advised the ruler about the proper time to make decisions. When should they enter into armed conflict, set a date for a royal marriage, or an ascent to the throne? When ought they to conduct a ritual, or make an offering to pay the debt to the gods for their assistance in producing a good crop or a healthy newborn child? One can imagine royal appointees going from town to town, their codices filled with detailed planetary calculations and agricultural almanacs tucked under their arms, ready and willing to advise the local rulers on such issues. Likewise can be imagined their subordinates advising commoners in the marketplace.

Inscriptions on carved monuments (*stelae*) at the Maya ruins of Copán, Yaxchilán, Palenque, and elsewhere connect seminal events in the lives of the rulers with key sky events such as eclipses and planetary conjunctions. These suggest that the ruler may have achieved cosmic status, there being an implied descent of royalty from ancestor deities who resided in the sky. Outdoor rites held in the open spaces that front the temples served to legitimize heaven-ordained actions by the ruler. Cosmic hierophanies, the interplay of timed light and shadow to manifest the sacred, were likely staged in the architecture of Palenque and Yaxchilán. The shadow of a descending serpent on Chichén Itzá's largest pyramid is still witnessed today on the spring equinox.

There exists little evidence regarding Mesoamerican observational technology. Pictographs from Central Mexican codices depict men peering over what could be sighting devices that consist of pairs of crossed sticks. Often these characters are portrayed in the recesses of temples, which suggests that such edifices might have been preferentially aligned toward events that took place at the local horizon. A few oddly skewed misshapen structures and buildings with narrow slots or windows do seem to align astronomically. For example, the cylindrically shaped Caracol of Chichén Itzá, Yucatan, possesses built-in sighting shafts oriented to key positions of Venus, the Mayan god representing the recycling of creation.

Aztecs. At the time of European contact, the Aztecs controlled a vast empire centered on their capital of Tenochtitlan on the site of modern Mexico City. While their well-described practice of human sacrifice might tend to divert one's attention from pursuits so esoteric as astronomy, it must be remembered that the Aztecs offered the blood of their captives to the sun god Tonatiuh to keep the heavens in motion, lest eternal darkness befall them. Politically such a policy may be thought of as a mechanism of control and domination exerted by the Aztec rulers over their newly conquered tributaries all around the lake basin that surrounded their island capital. But from a religious perspective these sacrificial acts might be better regarded as mandatory rites of renewal of cyclic time in the life of the Aztec city paired with its dedication to cosmically sanctioned military conquest. The shape of Aztec time is also manifest in their documents. The Aztec historical record is rife with pictorialized events of nature, among them eclipses and smoking stars (comets and/or meteors). These books tell the reader that the sky is very much a part of civic life, for the pictures are juxtaposed alongside events of social importance, such as deaths, conquests, and accessions.

The Templo Mayor, largest of all Aztec buildings, exhibits a celestial alignment. One informant told a sixteenth-century Spanish friar that a certain festival took place at the temple when the equinox sun stood at its midpoint, but because it was a bit misaligned, Moctezuma needed to pull the temple down and straighten it. The temple's orientation is just what it would have had to be to permit the rising equinox sun to fall into the notch between the twin temples that once surmounted the flat-topped forty-meter-high pyramid. When the sun arrived there, Spanish chroniclers relate, a royal observer situated in the plaza fronting the bottom of the stairs carefully watched it. Like a town crier he would signal the time to begin the ritual of human sacrifice that attended that particular month of the year. The Aztec 52-year calendar round (the meshing of 260- and 365-day cycles) was cosmically timed as well. It began with the precise sighting of the Pleiades in the overhead position at midnight. When the time approached, one chronicler says, the priests ascended the Hill of the Star to affirm that the movements of the heavens had not ceased and that the end of the world was not imminent. Thus, one thinks of the sky as part of the background set for the effective performance of religious rites.

Inca. The Inca, whose even larger empire thrived in the Andes while the Aztecs ruled much of Mesoamerica, embedded the sky in a unique scheme that united ideas about religion, social organization, and hydrology. The *ceque* system was conceived as a giant mnemonic map built into the capital city Cuzco's natural and artificial topography. Likely used elsewhere, the system is best known from descriptions by Spanish chroniclers, who state that ceques were imaginary radial lines grouped like spokes on a wheel, dividing the city into sections much like a pie graph. The wheel's hub was the Coricancha, the navel of the world and the temple of ancestor worship.

Each of the Cuzco's forty-one *ceques* was traced by a line of *huacas*, or sacred shrines, that extended outward along irrigation canals and natural water sources across the landscape.

The Inca believed the 328 *huacas* to be openings in the mountain body of Pachamama, or Mother Earth, and there specific Xin groups left her offerings at specified times of the year. Some huacas were temples, others intricately carved rock formations, natural springs, and other landscape features. Still others were astronomical markers involved with the establishment of a calendar.

While not all investigators agree on the precise placement of astronomical *huacas*, it seems clear that they were part of a horizon-based solar calendar. In one instance, the northernmost pillar of a set of four on a hillside overlooking the capital served as a warning device. When the sun reached there the planting season in the Cuzco valley was approaching. People who cultivated crops at higher altitudes, where growth occurred at a slower pace, therefore would be allowed sufficient additional time to sow their seeds before planting commenced in lower levels of the valley. These dates were marked by the other pillars. The *ceque* system also indicated the various kin and ethnic groups that made up the population by designating certain *huacas* to their care. In this sense the order of worship of the *ceques* and their *huacas* constituted a mnemonic scheme that incorporated information, including astronomy, considered vital to the operation of the state.

Less Complex Societies

Other great indigenous cities of the Americas also used the pristine order evident in the sky to establish social order on earth. For example, the same general kind of sky symmetry found in Cuzco is apparent at Cahokia, located near where the Mississippi and Missouri Rivers join. Built one thousand years ago, Cahokia was truly a significant economic and political center of great proportions: it controlled the distribution of maize and exotic trade items over a very wide area. Though no chroniclers ever wrote about it and no indigenous writing system survives it, its axis of orientation is cardinal, and mound alignments imply that the sun was a major object of attention. Following and marking out the annual solar path along the horizon, rulers of this economic hub regulated the seasonal flow of goods and services and scheduled the holidays. Their accompanying solar rituals would take place when the local populace and the tributaries of the state turned out in the plaza in front of the great Monks Mound. The same can be said of Ohio's Hopewell, who erected large geometrical earthworks in the first millennium C.E. The axes of these structures, the interior spaces of which, like Great Britain's Stonehenge, were used as places of assembly, are aligned to the solstices and possibly to the stationary points of the moon at the horizon.

North America's Hopi of Arizona were among the many Native American skywatchers. The Hopi marked the solstices, which the elders referred to as "houses" where the sun stops in his travels along the horizon. At these places along the high mesa the priests erected small shrines. There a sun priest in charge of the calendar would deposit prayer sticks as offerings to welcome the sun and to encourage him along on his celestial journey. Some of these shrines have special openings that allow shafts of sunlight to penetrate particular directions, thus serving as another way to mark time. Sometimes the sun priest would gesture to the sun, whirling a shield on which was painted a sun

design, to imitate the sun's turning motion, hastening away any malevolent spirits who might impede the great luminary.

Though archaeoastronomers and historians of pre-Columbian astronomy suffer a lack of data relative to their Old World counterparts (the entire corpus of pre-Columbian Mesoamerican texts can easily be accommodated by a coffee table), they are offered some distinct advantages. First, some cultures survive and remain isolated enough from the domination of the West, so that authentic astronomical customs and beliefs can still be retrieved. Second, these living cultures are not so distant in time from their predecessors. Data from these cultures offer inroads into understanding the more complex systems of the past. For example, present-day Quechua-speaking people of South America still chart constellations that date all the way back to Inca times, if not earlier. They still call the Pleiades *collica*, or "storehouse," as the Inca named them; and alpha and beta Centauri, which are among the few bright stars that may figure in alignments tied to the *huacas* of Cuzco's *ceque* system, represent the "Eyes of the Llama." They are part of a parade of dark cloud animal constellations that, along with star-to-star constellations like our own, comprise the Milky Way, which is so much more prominent in the southern than in the northern hemisphere.

What once was a cosmic temple lives on in the early twenty-first century's cosmic house. The Pawnee lodge of the Midwest United States has a smoke-hole through which can be observed certain groups of stars used in storytelling. Likewise, the bell-shaped quarters of the Warao of Venezuela's Orinoco Delta consist of a zenith pole marked out with a yearly calendar calibrated by following the ascension of the solar image at noon. The difference between house and city is but one of size and social complexity. If the home incorporates a design for life and the calendar regulates activity, it is easy to understand why cities such as Cuzco and Tenochtitlan would have been imbued with similar cosmic imagery.

Whether ancient or contemporary, what is striking about pre-Columbian astronomy is that, in stark contrast with the West, all of the sky observations seem to have been acquired with either low technology or no technology. These societies used neither wheel nor gear, and few of them employed metals. Moreover, their mental devices diverge from those of Western astronomy. One hears mention neither of fractions nor of Euclidean geometry. Nor did indigenous Americans raise questions about the rotundity of the earth, or speculate on whether the Sun or any distant celestial body might lie at the center of the universe. This is because the spatial view of the universe—the concept of orbits, maps, deep space—is one of the gifts of the Greeks. Such concepts are culture-bound, and one ought not anticipate that pre-Columbian people would have entertained questions that appear to be common sense to the Westerner. This does not mean that Native Americans did not philosophize or theorize about the world around them. Their speculations were basically human centered. There was not a mechanistic universe that operated as an entity apart from what is thought of as human consciousness.

In sum, studying pre-Columbian skies helps enable a realization of the uniqueness, rather than superiority, of the

Western worldview. The sky offered Native Americans a means of solving some of life's basic problems: how to regulate human activity, how to understand and worship the gods, and above all how to know what it means to be a member of society.

See also *Calendar*; *Cosmology*; *Philosophies: American*.

BIBLIOGRAPHY

- Aventi, Anthony. *Ancient Astronomers*. Washington, D.C.: Smithsonian Books, 1993.
- . *Stairways to the Stars: Skywatching in Three Great Ancient Cultures*. New York: Wiley, 1997.
- Bauer, Brian, and David Dearborn. *Astronomy and Empire in the Ancient Andes*. Austin: University of Texas Press, 1995.
- Krupp, Edwin. *Skywatchers, Shamans, and Kings: Astronomy and the Archaeology of Power*. New York: Wiley, 1997.
- Ruggles, Clive, and Nicholas Saunders, eds. *Astronomies and Cultures: Papers Derived from the Third "Oxford" International Symposium on Archaeoastronomy*. Niwot: University Press of Colorado, 1993.
- Tedlock, Barbara. *Time and the Highland Maya*. Albuquerque: University of New Mexico Press, 1992.
- Urton, Gary. *At the Crossroads of the Earth and the Sky: An Andean Cosmology*. Austin: University of Texas Press, 1981.
- Williamson, Ray A. *Living the Sky: The Cosmos of the American Indian*. Boston: Houghton-Mifflin, 1984.

Anthony F. Aveni

ATHEISM. The term *atheism* usually refers to the belief that there is no God or are no gods. This position has been called *positive atheism*, since it involves an actual belief and not just the absence of belief. In contrast, *negative atheism* involves the absence of belief in a God or gods. Atheism is typically contrasted with agnosticism, the view that one cannot know if a deity exists. Negative atheism, however, is compatible with agnosticism, for in the name of rationality one who does not know if God exists should suspend belief in God.

In Western and Near Eastern societies the term *atheism* has sometimes been used narrowly to refer to the denial of theism, in particular Judeo-Christian and Islamic theism. According to theism, God is a personal being, an all-powerful, all-knowing, and all-good creator of the universe who takes an active interest in human concerns and guides creatures by revelation. Positive atheists disbelieve that this God exists and reject concomitants including an afterlife, a cosmic destiny, the supernatural origin of the universe, an immortal soul, the revealed nature of texts such as the Bible and the Koran, and a religious foundation of morality. Negative atheists, in the narrow sense, simply do not have a belief in the theistic God and what that entails.

Theism is not a characteristic of all religions, however. For example, although the theistic tradition is found in Hinduism in the Bhagavad Gita, the earlier Upanishads teach that ultimate reality, Brahma, is an impersonal and pantheistic god. Positive atheism in its broadest sense would advocate disbelief in the pantheistic as well as the theistic aspects of Hinduism. Indeed, there are skeptical and atheistic schools of thought

within the Hindu tradition itself. Theravada Buddhism and Jainism are commonly believed to be atheistic, but this interpretation holds only for the narrow sense of disbelieving in a creator God. For although these religions reject a theistic creator God, they accept numerous lesser deities.

In the Western world, nonbelief in the existence of God is a pervasive phenomenon with a long and illustrious history. Ancient philosophers such as Lucretius were nonbelievers, and important thinkers of the Enlightenment such as the Baron d' Holbach (1723–1789) and Denis Diderot (1713–1784) were outspoken atheists. In the nineteenth century the most articulate and best-known atheists and critics of religion were Ludwig Feuerbach, Karl Marx, Arthur Schopenhauer, and Friedrich Nietzsche. Bertrand Russell, Sigmund Freud, and Jean-Paul Sartre were among the twentieth century's most influential atheists. In contemporary philosophical thought atheism has been defended by, among others, Paul Edwards, Antony Flew, Paul Kurtz, John Mackie, Michael Martin, Kai Nielsen, Michael Scriven, and J. J. C. Smart. In the United States, many contemporary atheists are also self-identified as humanists, secular humanists, or rationalists.

At the beginning of the twenty-first century atheism can be found from the Netherlands to New Zealand, from Canada to China, from Spain to South America. State atheism prevailed in the U.S.S.R. until the breakup of the Soviet Union. It was estimated in the 2002 *New York Times Almanac* that there are in the world about 222 million atheists (4 percent of the total population) and 887 million agnostics (negative atheists).

Popular misunderstandings of atheism abound. Thus, for example, it has been claimed that atheists are immoral, that morality cannot be justified without belief in God, and that life has no meaning without belief in God. There are, however, no grounds for supposing that atheists are any less moral than believers; many ethical systems have been developed that do not assume the existence of supernatural beings, and the meaning of life can be based on secular purposes such as the betterment of humankind.

Philosophically, atheism has been justified in differing ways. Negative atheists attempt to establish their position either by showing that the standard arguments for the existence of God—for instance the argument from first cause, the argument from design, the ontological argument, and the argument from religious experience—are unsound, or by demonstrating that statements about God are meaningless. Positive atheists argue in turn that the concept of God is inconsistent and that the existence of evil makes the existence of God improbable.

In particular, positive atheists have maintained that theism does not provide an adequate explanation of the existence of seemingly gratuitous evil such as the suffering of innocent children. Rejecting the standard defenses given by theists, they argue that justifications in terms of human free will leave unexplained why, for example, children suffer because of genetic diseases. Positive atheists hold that arguments that God allows much pain and suffering in order to build human character fail,

in turn, to explain why there was suffering among animals before human beings ever evolved and why human character could not be developed with less suffering than in fact there is. They argue that an explanation of evil better than the explanation that God has given us free will or the chance to develop character is that God does not exist.

Atheism has wide-ranging implications for the human condition. Among other things it entails that ethical goals must be determined by secular aims and concerns, that human beings must take charge of their own destiny, and that death is the end of human existence.

Although it is sometimes associated with materialism, communism, rationalism, existentialism, or anarchism, there is no necessary relation between atheism and any of these other positions. Some atheists, for example the objectivist writer Ayn Rand (1905–1982), have been opposed to communism, and some—for example, Bertrand Russell—have rejected materialism. Although all contemporary materialists are atheists, the ancient materialist Epicurus believed that the gods were made of atoms. And although rationalists such as René Descartes have believed in God, many contemporary atheists consider themselves rationalists. Jean-Paul Sartre was an atheist and an existentialist; Søren Kierkegaard was an existentialist who accepted God. In turn, Karl Marx was an atheist who rejected anarchism, but Leo Tolstoy was a Christian who embraced it.

In sum, atheism is a complex phenomenon with a rich history, brilliant defenders, and a wide following. It is often unjustly maligned and confused with other positions.

See also *Agnosticism; Creationism; Evil; Religion; Religion and the State.*

BIBLIOGRAPHY

- Hiorth, Finngeir. *Atheism in India*. Mumbai, India: Indian Secular Society, 1998.
- . *Atheism in the World*. Oslo, Norway: Human-Etisk Forbund, 2003.
- Joshi, S. T., ed. *Atheism: A Reader*. New York: Prometheus Books, 2000.
- Martin, Michael. *Atheism: A Philosophical Justification*. Philadelphia: Temple University Press, 1990.

Michael Martin

AUTHENTICITY, AFRICA. Ideologies of authenticity within African thought are self-affirming and counterideological positions adopted by individuals, groups, and communities of resistance who have all had their identities traumatically impacted upon or disrupted by forces of imperialism and conquest—namely slavery, colonialism, and neocolonialism. African authenticity is in this sense fundamentally an ongoing cultural, socioeconomic, and political process of self-definition. Particularly noteworthy are the theoretical and philosophical commonalities between these discourses, which enable their collective identification and characterization as movements seeking self-affirmation and self-legitimation as part of a vital project of self-rehabilitation.

The African oral tradition, a very significant part of African epistemology and knowledge production, has been vital to this project. One thinks immediately, for example, of the Jamaican-Caribbean–West Indian reggae group Culture, which, espousing the old “Back to Africa” philosophy and vision of Marcus Mosiah Garvey (1887–1940), consistently critiques and confronts “the West,” or Babylon (a historical and geographical referent for England and other imperial powers), in its music as a way of combating the dominance and hegemony of an ever-pervasive Western imperialism. The powerful and invigorating lyrics of Culture and the melodious spiritual chanting of Rastafari worldviews are deployed as a critical counterdiscursive ideology that continually reminds Africans and black people generally of the “agony and pain” of slavery, whose effects, as is constantly affirmed, are being felt even in the early twenty-first century.

Culture espouses an ideology of authenticity—nostalgically articulated around the idea of Africa as “home,” or the homeland to which all black people must return one day. With this recurrent theme, the world-famous group not only connects Caribbean cultural identity with Africa but also blames the dispersal of Africans in the diaspora on an inhumane imperialist system, the oppressive entity of Babylon, which from the days of slavery until the present has bequeathed a debilitating legacy of brutal racist exploitation on Africans and peoples of African descent. As a sign that Africa (as against the Caribbean or the New World) remains the authentic home for Black people, the members of Culture indict the slave master and sing of “travelling from home to Jamaica” (in the track “Still Rest My Heart,” of the album *Three Sides to My Story*) while yearning for liberation and affirming black humanity. African displacement and dispersal within the diaspora therefore become emblematic of a historical abnormality necessitating redress. Retribution is envisaged in the form of “fire,” which the prophetic voice of lead vocalist Joseph Hill calls upon to “burn” Babylon or the West as a means of ensuring restitution.

African authenticity would also be unimaginable without Cheik Anta Diop’s *The African Origin of Civilization*, a classic work with an interdisciplinary fusion of historical, anthropological, sociological, and linguistic material that, together with such accompanying texts as *Precolonial Black Africa* and *Civilization or Barbarism*, redefines the historical contribution of black people to world civilization by staking a claim for perceiving Ethiopia-Nubia and ancient Egypt as historical sources of present-day civilization. Diop’s comprehensive assemblage of evidence on the black race contests the epistemological dominance of Western civilization in contemporary knowledge production by contending that European civilization, which posits itself as evolutionarily and universally superior and as a global model, is derived from Greek civilization, which in turn “stole,” or borrowed, largely from black Egyptian and African civilization.

In literature, authenticity has found expression in *Muntu* and *Two Thousand Seasons*, two historical narratives by Ghanaians Joe de Graft (1924–1978), a playwright and theater practitioner, and Ayi Kwei Armah (b. 1939), a novelist and critic. Reconstructing precolonial African history, *Muntu* proposes that Africans inhabited a state of innocence devoid of

materialistic greed, exploitation, and corruption before the advent of European colonialism and the transatlantic slave trade. The nostalgic precolonial world of *Two Thousand Seasons* similarly narrativizes the vicissitudes of a pan-African community whose hospitality before the dawn of Arab and Western slavery and colonialism was encapsulated in a humane philosophy articulated simply as “the way.” The gruesome images of imperialist gluttony and excess and the portrait of the corruption of precolonial traditional institutions of governance in Africa in both works also, however, encode a rhetorical idealism that has led to accusations of racial essentialism, a critical charge indiscriminately applied to other discourses of African authenticity.

Relevant in this regard is Negritude, the literary movement of the 1930s developed by French-educated African and Caribbean students and intellectuals in France and founded upon a politics of racial solidarity among mutually oppressed African, Caribbean, and other black people in response to the alienating and suffocating ambience of French colonialism and culture. Led by poets Aimé Césaire (b. 1913) of Martinique and Léopold Sédar Senghor (1906–2001) of Senegal, Negritude harked back to an old and authentic Africa whose identity Negritudists identified with in the face of the inequalities they experienced within the failed French colonial policy of assimilation. Although the racialist discourse of Negritude was justifiable, it did not always state its case properly.

Similarly, *Toward the Decolonization of African Literature*, a work that claims to be exorcising African literature of domination by aesthetic and critical Eurocentrism, has come to be equated with a deeply conservative endeavor to retain a purist form of African identity in an impractical and regressive manner. In this polemical work of soul-searching that advocates a return to African sources within literature and cultural theory and clamors for deep immersion in African aesthetics as central to the project of reinventing an authentic African identity in the aftermath of colonialism, authors Chinweizu (b. 1943), Onwuchekwa Jemie (b. 1940), and Ihechukwu Madubuike (b. 1943) also present exoticized notions of African culture and African tradition, thereby diminishing the force of their argument. Critics have, however, never addressed the deeper question of Eurocentrism that Chinweizu and colleagues raise and have instead gleefully exploited the glaring simplification of African identity in *Toward the Decolonization*. However, the prevailing contradictions in no way invalidate the urgent need for a counterdiscursive and oppositional critique of the Western aesthetic and critical domination of African literature.

The ideological project of African authenticity is in the final event a critical counterculture that self-consciously contests all oppressive ideologies. Such a project informs *I Write What I Like*, the radical and defiant work by the famous political activist and black South African Steve Biko (1946–1977), whose resistance to the vicious and inhuman system of apartheid in South Africa led to his incarceration, brutalization, and subsequent murder. While Biko’s text has been acclaimed as the definitive work of the black consciousness movement, which he founded and led, it is also an individuated work locatable outside the strict parameters and confines of the black consciousness movement.

Biko’s quest for authentic liberation for black people was unique in contending that self-emancipation derived foremost from within a person’s psychological makeup. Biko was the first singularly and vociferously to contend that liberation from the structures and strictures of apartheid could in no proper sense be spearheaded by, for example, the white liberal establishment in South Africa. Biko therefore encouraged black South Africans as an oppressed group to adopt a strategy of liberation in which their self-worth necessitated a calculated disavowal of the patronizing contribution of members of the oppressor group.

Reactionary and reductionist attempts to deny the historical realities that works of African authenticity speak about have often engendered some willfully gross misinterpretations and simplistic trivializations of what are essentially and in reality existentially rooted quests for freedom and liberation. While African authenticity is often misconceptualized as a puritanist discourse, it is an ambivalent creative process and a miscellaneous philosophy or approach to life that inevitably closely relate to other forms of African thought and practice. Thus one might, for instance, find the concept being expressed in different kinds of material artifacts that may simultaneously be referred to as African art, African culture, and so on.

See also *Africa, Idea of; Afrocentricity; Black Consciousness; Negritude; Philosophies: African.*

BIBLIOGRAPHY

- Arham, Ayi Kwe. *Two Thousand Seasons*. Nairobi: East African Publishing House, 1973.
- Biko, Steve. *I Write What I Like: A Selection of His Writings*. Edited with a personal memoir by Aelred Stubbs. London: Bowerdean Press, 1978.
- Césaire, Aimé. *Notebook of a Return to My Native Land*. Translated by Mireille Rosello with Annie Pritchard; introduction by Mireille Rosello. Newcastle upon Tyne, U.K.: Bloodaxe, 1995.
- Chinweizu, Onwuchekwa Jemie, and Ihechukwu Madubuike. *Toward the Decolonization of African Literature*. Vol. 1: *African Fiction and Poetry and Their Critics*. Enugu, Nigeria: Fourth Dimension, 1980.
- Culture. “Rolling Stone.” In the album *Humble African*. Jamaica, N.Y.: Heartbeat, 2000.
- . *Three Sides to My Story*. New York: Shanachie Records, 1991.
- de Graft, Joe. *Muntu*. Nairobi: Heinemann Educational Books, 1977.
- Diop, Cheikh Anta. *The African Origin of Civilization: Myth or Reality*. Translated by Mercer Cook. New York: Lawrence Hill, 1974.
- . *Civilization or Barbarism: An Authentic Anthropology*. Translated by Yaa-Lengi Meema Ngemi, edited by Harold J. Salemson and Marjolijn de Jager. Brooklyn, N.Y.: Lawrence Hill, 1981.
- . *Precolonial Black Africa: A Comparative Study of the Political and Social Systems of Europe and Black Africa from Antiquity to the Formation of Modern States*. Translated by Harold J. Salemson. Westport, Conn.: Lawrence Hill, 1987.
- Irele, Abiola, ed. *Selected Poems of Léopold Sédar Senghor*. Cambridge, U.K., and New York: Cambridge University Press, 1977.

AUTHORITARIANISM

Jack, Belinda Elizabeth. *Negritude and Literary Criticism: The History and Theory of "Negro-African" Literature in French*. Westport, Conn.: Greenwood Press, 1996.

Kesteloot, Lilyan. *Black Writers in French: A Literary History of Negritude*. Translated by Ellen Conroy Kennedy. Washington, D.C.: Howard University Press, 1991.

wa Thiong'o, Ngugi. *Decolonising the Mind: The Politics of Language in African Literature*. London: Currey, 1986.

Kwadwo Osei-Nyame Jr.

AUTHORITARIANISM.

This entry includes three subentries:

Overview

East Asia

Latin America

OVERVIEW

The term *authoritarianism* can be applied to a great variety of contexts. It can refer to authoritarian behavior, leadership styles, or personality types in families, industrial enterprises, bureaucracies, and other forms of organizations. Here, it refers to political regimes that fall under this broad label. The major characteristics of authoritarian regimes include a limited political pluralism with restrictions on the activities of interest groups and parties, a low level of social mobilization and popular political participation, a dominantly "subject" or "parochial" political culture, and usually a personalized form of leadership.

The term came into use in the nineteenth and twentieth centuries when it became necessary to distinguish hierarchically structured, traditional monarchical or more recent "bonapartist" autocratic regimes from liberal democracies, on the one hand, and all-encompassing "totalitarian" systems, on the other. Liberal democracies can be defined with regard to three major dimensions: an open and competitive political pluralism (usually in a multiparty system), a high level of political participation (as in fair and free elections, referenda, etc.), and political institutions that guarantee a certain separation of powers, the rule of law, and basic human rights (such as freedom of expression, information, organization, religion, etc.). Totalitarian systems, at the other extreme, are characterized by monistic, all-encompassing social and political organizations (such as a single party; dependent unions; organizations for women, youth, etc.), a high level of social mobilization (as in political rallies, high election turnouts), an explicit, monolithic, absolutist ideology, and a strong repressive apparatus. In fact, however, these distinctions cannot always be drawn precisely and some "gray" areas exist between these types. In common usage, all nondemocratic systems are lumped together as "dictatorships." Whereas the original use of this term in the Roman republic referred to emergency powers for a limited period, today it implies all kinds of arbitrary rule and political repression. Nevertheless, important qualitative differences can be found among such nondemocratic regimes.

Dominant Characteristics of Political Systems

Among the most important dimensions of political systems are the basis of legitimacy, the party system, the pattern of

recruitment of the executive, the actual power structure, the scope of political control, the ideological orientation of the system, and the formal vertical and horizontal separations of power. Legitimacy can be based on strong attachment to a political leader (charismatic), on elective procedures (legal-rational), or on a customary or informal acceptance (traditional) of political incumbents or a regime. Party systems are distinguished according to their degree of competitiveness, ranging from one-party states without any competitive elements, through semicompetitive single-party structures and restricted multiparty systems, to fully competitive ones. The recruitment of the executive can be achieved by inheritance, direct election by the population, a majority vote by parliament, or through forceful usurpation. The actual power structure within the executive can be strongly personalized and clientelistic or have a small collective group at its base (e.g., a military junta or a politburo of a centralized party), or it can be broadly composed to incorporate the most important plural elements of society.

The scope of control can range from limited to totalitarian. Ideological orientation is considered in relation to its respective social basis. This can consist of a "communalistic" (e.g., ethnic or religious) group, or of the lower, middle, or upper classes of society, corresponding to the political continuum of "left," "center," and "right." Finally, in a constitutional sense, the vertical separation of power can be viewed as complete, as limited but with an independent judiciary, or as nonexistent. Similarly, the horizontal separation of power can be federal or centralized. These dimensions and their discrete expressions are listed on the left-hand side in Table 1.

Specific Forms of Authoritarian Rule

Based on the characteristics outlined above, we can differentiate six forms of authoritarian rule.

Authoritarian monarchy. The most traditional political system in the world today is the authoritarian monarchy. Its basis of legitimacy is customary and is often linked to mythical assumptions regarding the foundation of the respective dynasty. Examples of this type are Ethiopia (until 1974) and Saudi Arabia. Accession to the throne is generally regulated by heredity, and there is little, if any, open political competition. Formal separation of powers is nonexistent, the power structures are personalistic and reinforced by an aristocratic upper-class ideology. In former times, most regimes of this kind were built upon feudal agrarian structures. Today they tend to have centralized and absolutist characteristics.

"Old" oligarchy. Another type of authoritarianism, which has been prevalent in Latin America, is the "old" oligarchy or, to use Howard J. Wiarda's term, the *traditional-authoritarian* regime. Such a regime receives its support from feudalistic or "neofeudalistic" rural structures and, since the late twentieth century, from segments of the urban upper classes. In the old oligarchy's extreme forms (e.g., in Nicaragua until 1979), a small number of leading families exercise almost exclusive control over political and economic life. In this system, a leader may be replaced relatively easily by another, sometimes through holding manipulated elections that do not alter the power structure.

Table 1. Dominant characteristics of political system types

Characteristics:	Types:											
	Authoritarian Monarchy	"Old" Oligarchy	"New" Oligarchy	Semicompetitive	Personalistic military	Corporatistic military	Socialistic military	Socialist	Communist	Fascist	Theocratic	Democracy
Legitimacy:												
weak or none		X	X	(X)	X	X	X	X	X			
traditional or customary	X							(X)	(X)		X	
personalistic (charismatic)				(X)			(X)	(X)	(X)	X	(X)	
elective (legal-rational)				X								X
Party System:												
no party	X	X			X	X					X	
one party without competitive elements			X									
one party with competitive elements or restricted multiparty							X	X	X	X		
multiparty		(X)		X		(X)		(X)				X
Head of Executive:												
monarch	X											
president or prime minister		X	X	X				X	X	X		X
military ruler					X	X	X					
religious leader											X	
Power Structure:												
personalistic	X	X	X	X	X		(X)		X	(X)		
collective group						X	X	X		X		
representative				(X)								X

Note: Marks in brackets indicate the possibility of certain variations among subtypes.

SOURCE: Courtesy of the author

Political leadership in these states has been connected with the traditional elements of the Catholic Church and the military. Antonio de Oliveira Salazar's (1889–1970) Portugal, and to some extent Francisco Franco's (1917–1989) Spain, also can be placed in this category. Political activities and the media are usually controlled by the regime's repressive apparatus. Other elements that constitute a separation of powers, such as an independent judiciary or a federal structure, are equally lacking.

"New" oligarchy. The "new" oligarchy receives its support from the dominant urban groups in a contemporary context. In this "hegemonic" regime, open competition for public office does not occur. Usually, there is a single-party structure, which, however, is predominantly formal and not very effective. Instead, great emphasis is placed on the bureaucracy. Public opinion and the media are controlled, while leadership is centralized and highly personalistic. In this respect, some charismatic elements of legitimacy may exist. Compliance is established either in terms of passive acceptance or by repressive measures. Both the social base and "inclusiveness" vary in ethnic and class terms. In a majority of cases, a relatively wide ethnic base is combined with more restricted class interests that

favor the prosperous groups in society. Countries such as Cameroon, Tunisia, and the Philippines (under Ferdinand Marcos; 1917–1989) are cases in point.

Semicompetitive authoritarianism. Another type can be termed "semicompetitive." In Latin America this system was also based on the traditionally dominant classes, but there is a greater balance between the rural and urban elements. This type also comes close to what Wiarda calls an "open corporatist" system. The contending elements are often institutionalized in "conservative" and "liberal" parties such as those found in nineteenth-century Chile, Colombia, or Uruguay. The "dominant one-party" system in postrevolutionary Mexico is a special case in point. Active participation remains restricted to the middle and upper segments of the population, while mass mobilization is largely prevented or restricted to more symbolic functions. In a different social context, one-party systems embodying competitive elements (e.g., that of Kenya until 1992) and states in which "regulated competition" prevails (e.g., Singapore, Lebanon until 1975) can also be subsumed under this category. Semicompetitive regimes tend to follow established constitutional rules within a presidential or

parliamentary system. Regular transfers of power occur within the set framework. They are generally less repressive than “oligarchic” systems. The media often enjoy greater freedom as well.

Socialist authoritarianism. “Socialist” regimes reveal another pattern. They are characterized by an effective single-party organization, a centralized system of government, and an ideology directed toward an egalitarian social order and a “non-capitalist” and “self-reliant” development. Freedom of expression and pluralistic forms of organization are curtailed. There is, however, a great deal of variation. One group (e.g., Tanzania and Guinea after independence) attempted to found their specific type of socialism upon their societies’ egalitarian traditions and culture. Another group (e.g., Algeria, Mozambique) advocated a Marxist-oriented “scientific” brand of socialism. In both groups, there may exist some semicompetitive elements in the intraparty and parliamentary spheres. Socialist regimes must be distinguished from their totalitarian “communist” counterparts, if only because of their generally “underdeveloped” condition and the relative lack of effective social control.

Military regimes. In addition to civilian regimes, there are systems that are controlled by “men on horseback” (Janowitz). These military rulers come to power through a coup d’état after the previous civilian institutions fail. In the absence of significant countervailing powers, the military’s monopoly over the physical means of coercion makes less efficient civilian governments an easy prey for armed groups. The social bases of these regimes are usually rather narrow. Some military rulers act as temporary caretakers and make genuine attempts to return their countries to civilian rule (as Olusegun Obasanjo in Nigeria in 1980). Others, on the contrary, seek to establish their power permanently. Three subtypes can be distinguished.

The first is personal military authoritarianism. These regimes center around a “strong man” and his most immediate following. Because there are few, if any, formalized input structures, they rely heavily on their centralized output apparatus. In many Latin American countries, this type of rule was exercised by the characteristic “caudillo” in the nineteenth century. Although the caudillo’s ascent to power was largely due to his personal qualities (i.e., his military prowess and perhaps charismatic appeal), his rule cannot be understood without reference to the established landed oligarchy. The large haciendas remained one of the stable elements in turbulent times, and caudillos often were (or became) *hacendados* as well. In cases where a caudillo managed to establish a durable regime, this was often accomplished through a system of regional and local subpatrons, the “caciques.” Since this type of rule is highly personalistic, it remained inherently unstable. Caudillos were often overthrown by successful rivals.

A second subtype is corporate military authoritarianism. In the 1960s some Latin American states, such as Brazil and Argentina, witnessed the emergence of more “modern” military regimes. In these countries, power had been assumed by the military on a corporate basis. Within the leading ranks of the armed forces, a certain institutionalized transfer of power was established. Although the political orientation of these regimes was “national” and favorable to “modernization,” they nonetheless

have left older social structures essentially intact. Formal interest groups and parties were strongly regulated, and the repressive nature of the regime was often particularly blatant.

A third subtype is that of socialist military authoritarianism, which establishes its authority on a permanent basis through the creation of a single-party system. In contrast to the other forms of military rule, these regimes have a socialist and lower-class orientation. In such cases (e.g., Gamal Abdel Nasser’s Egypt, or Peru after 1968), the power of the military was directed toward social reforms. The long-term success of such reforms depends, however, upon the government’s ability to secure participation from below. If these efforts fail, a shift to a semicompetitive type of regime (e.g., Anwar as-Sadat’s Egypt), a polyarchic system (in Peru after 1980), or a return to personalistic military rule may take place.

Outlook

After the dramatic events in Eastern Europe in 1989–1990 and their repercussions in other parts of the world, many of these authoritarian regimes disappeared. To a large extent, they were replaced by liberal democracies. Nevertheless, in some regions, most conspicuously in the Middle East, nondemocratic regimes persisted (e.g., the monarchies and sheikdoms in the Arabian peninsula, the personalistic military dictatorships in Iraq, Lybia, and Syria, or the “semicompetitive” systems in Egypt and Tunisia). In other areas, as in parts of the former Soviet Union, communist regimes were transformed into “post-totalitarian” but still harshly authoritarian and personalistic “new oligarchic” or “sultanistic” ones. In other cases, the newly established democratic forms of government remained defective with respect to important aspects such as truly “free and fair” elections, meaningful popular participation, and the guarantee of the rule of law and basic human rights. Some authors termed these regimes purely “electoral,” “illiberal,” or “delegative” democracies. In most cases, they resemble the former “semicompetitive” or even “new oligarchic” types.

Thus, at the beginning of the twenty-first century authoritarianism has been on the decline and at least the worst totalitarian forms of rule, with the possible exception of some fundamentalist “theocratic” ones, seem to be over. New variants, however, may yet occur and there remain certain authoritarian and populist dangers in some of the longer-established democracies as well.

See also Communism; Democracy; Socialism; Totalitarianism.

BIBLIOGRAPHY

- Altemeyer, Bob. *Right-Wing Authoritarianism*. Winnipeg: University of Manitoba Press, 1981.
- Berg-Schlosser, Dirk. “Typologies of Third World Political Systems.” In *Contemporary Political Systems: Classification and Typologies*, edited by Anton Bebler and Jim Seroka, 173–201. Boulder, Colo.: Lynne Rienner, 1990.
- Chehabi, Houchang E., and Juan J. Linz. *Sultanistic Regimes*. Baltimore: Johns Hopkins University Press, 1998.
- Collier, David, ed. *The New Authoritarianism in Latin America*. Princeton, N.J.: Princeton University Press, 1979.

- Dahl, Robert A. *Polyarchy: Participation and Opposition*. New Haven, Conn.: Yale University Press, 1971.
- Hermet, Guy, Richard Rose, and Alain Rouquié, eds. *Elections without Choice*. New York: Macmillan, 1978.
- Linz, Juan J. "Totalitarian and Authoritarian Regimes." In *Handbook of Political Science*, vol. 3: *Macropolitical Theory*, edited by Fred I. Greenstein and Nelson W. Polsby. Reading, Mass.: Addison-Wesley, 1975.
- Linz, Juan J., and Alfred C. Stepan. *Problems of Democratic Transition and Consolidation: Southern Europe, South America, and Post-Communist Europe*. Baltimore: Johns Hopkins University Press, 1996.
- O'Donnell, Guillermo A. *Modernization and Bureaucratic-Authoritarianism: Studies in South American Politics*. Berkeley: Institute of International Studies, University of California, 1973.
- Rosberg, Carl G., and Thomas M. Callaghy, eds. *Socialism in Sub-Saharan Africa*. Berkeley: Institute of International Studies, University of California, 1979.
- Wiarda, Howard J. "The Political Systems of Latin America: Developmental Models and a Typology of Regimes." In *Latin America*, edited by J. W. Hopkins. New York: Holmes and Meier, 1985.

Dirk Berg-Schlosser

EAST ASIA

Grand claims have been made about the superiority and inevitability of liberal democracy. Do they hold true for East Asian countries? According to typologies in political science, most East Asian countries are considered authoritarian. Japan, Philippines, Taiwan, Thailand, and South Korea are considered democracies; Indonesia is considered ambiguous while all other East Asian governments (Brunei, Cambodia, China, Laos, Malaysia, Myanmar, North Korea, Singapore, and Vietnam) are seen as authoritarian. While this way of organizing and talking about the world is dominant in political, academic, and even popular discourses, its persuasiveness is often compromised upon closer scrutiny.

First, this classification system is confusing because its analytical categories are heavily infused with normative overtones; not only do governments involve scholars in their international programs (e.g., Alliance For Progress), students of politics are also often politically invested and concerned with social change. This conflation of the scientific and the ideological has been criticized by Jeanne Kirkpatrick. She observed that regimes were not classified only by their political form (e.g., regular elections, civil and political liberties) but by their ideologies and economic organization. Totalitarian regimes were exclusively communist regimes with command economies while authoritarian regimes were typically market-driven and seen as more benign despite being equally repressive.

Second, mediating the dichotomous categories of democratic/authoritarian are various theories of democratization whose predictions about East Asian regimes are, at best, as often inaccurate as they are accurate. Democratization and its absence were explained by a variety of factors tied to modernization, such as, in order of theoretical importance, socioeconomic development (measured by the Human Development Index), the rate of pop-

Southeast Asian countries	Freedom House rating (2000)	Average annual GDP per capita (1975–2000)
Un-free countries (Rating 5.5–7)		
Myanmar	7.7	1.3%
Vietnam	7.7	4.8%
Laos	7.6	3.2%
Brunei	7.5	unavailable
Cambodia	6.6	1.9%
Partly free countries (Rating 3–5.5)		
Malaysia	5.5	4.1%
Singapore	5.5	5.2%
Indonesia	4.4	4.4%
Free countries (Rating 1–2.5)		
Philippines	2.3	0.1%
Thailand	2.3	5.5%

SOURCE: freedomhouse.org, nationmaster.com

ulation growth, and the vigor of civil society. Conversely, it was believed that with economic and social development, or modernization, authoritarian regimes would transition to democracy. The strongest formulation of this modernization theory is perhaps Francis Fukuyama's "end of history" thesis, in which he predicted the triumph of liberal democracy over all other political forms in late capitalism through increasing institutional and ideological convergence globally.

Among East Asian countries, evidence against the thesis outweighs evidence for it. In Northeast Asia, economic development in Japan, Taiwan, and South Korea appeared to have triggered a transition to democracy while its absence in Mongolia and North Korea correctly predicts nondemocratization. With the exception of China, which remains staunchly nondemocratic despite impressive economic growth (8.1 percent average annual GDP per capita from 1975 to 2000), the thesis appears to hold true.

In Southeast Asia, there are ample instances where economic growth induces the reverse. As a region, despite the fact that Southeast Asia has a higher average income than South Asia (considered "partly free"), it is rated as the least free region in Asia by Freedom House and remains the only region in the world that has not established a regional system of human rights.

Among the five Southeast Asian countries rated as "unfree," only three support the thesis that economic stagnation inhibits democratization. In prosperous Brunei and in Vietnam (which has the second highest average annual GDP among the ten countries), there appears to be no correlation between economic development and democracy.

The most significant counterevidence to the theory comes from the "free" and "partly free" countries, with Singapore and the Philippines being especially significant counterevidence to the thesis. Singapore was able to forestall democratization despite impressive economic development (considering the devastation of the recent Asian economic crisis that significantly lowered these figures). Singapore's average annual GDP per capita from 1965 to 1990 was a stunning 6.5 percent. In the case of the Philippines, the absence of economic development did not appear to handicap political development; it is the most free despite being worst off economically.

Empirically, the reality of political regimes in East Asia offers mixed evidence to the thesis that economic growth would trigger democratization. In trying to understand why and how they are perpetuated, we obviously need more than modernization theory. Modernization theorists themselves are cognizant of the problems and have attempted to repair the theory without relinquishing the essential paradigm, its dichotomies, or categories.

Revised Modernization Theories

Concerned with the persistence of authoritarianism despite strong and sustained economic growth in East Asia, revised modernization theorists began to argue that authoritarianism was necessary for late-industrializing countries to kick-start their economies, but continue to subscribe to the transition paradigm by pointing out that after the initial phase of growth, contradictions between authoritarianism and capitalism would trigger what is seen as the natural evolution to democracy. In this sense, revised modernization theorists merely redefine authoritarianism as a necessary evil and as a steppingstone; they do not deviate significantly from the modernist view of authoritarianism as transitory and democracy as the end point.

Another revisionist group criticized the economic determinism of modernization theorists but continues to frame the question of authoritarianism within the transition paradigm. For instance, O'Donnell, Schmitter, and Whitehead turned to more voluntaristic explanations by focusing on the role of civil society in triggering a transition to democracy. Theorizing about political opposition in East Asia, Rodan criticized these approaches for romanticizing civil society as "the locus of free-minded and mutually cooperative groups and individuals beyond the state's purvey" (p. 3). Because civil societies cannot exist as alternatives to states but only in relation to them, the notion of civil society not only presupposes the state, but its autonomy crucially depends on and can only be guaranteed by the state. In East Asia, the relationship between civil society (if it exists) and the state is often one of co-option. Depending on how scholars perceive the state, studies of East Asian societies often refer to this political arrangement as paternalistic or guardian states if authority is perceived to be benevolent, or clientelist or nepotist states if authority is deemed corrupt.

A third attempt at revising modernization theory clusters around the concept of "modern authoritarianism." Within modernization theory, authoritarianism had been understood as a premodern phase, and it was believed that with modernization, societies develop into either totalitarian or democratic polities. Rejecting this typology, Linz elaborated on regimes that were authoritarian and modern and proposed a definition of authoritarianism that has become classic:

Authoritarian regimes are political systems with limited, not responsible, political pluralism; without elaborate and guiding ideology (but with distinctive mentalities); without intensive nor extensive political mobilization (except some points in their developments); and in which a leader (or occasionally a small group) exercises

power within formally ill-defined limits but actually quite predictable ones. (p. 255)

The applicability of this theory to East Asia should be obvious, even if actual empirical studies were few and far between. While much of theorization on authoritarianism focused on Spain and Latin American countries, it should be recalled that among developing countries, few regions were modernizing (and leaving feudalism behind) as quickly as East Asia.

As with other revisionist attempts, this theory continues to operate within the modernization paradigm. First, it continues to subscribe to the authoritarian-democratic dichotomy; liberal democracy remains the point of reference while authoritarianism appears to be a residual category into which all nondemocratic countries are shoved. Because authoritarianism is seen as a crisis of governance within a democracy, it continues to be seen as unstable and lacking in legitimacy.

Second, what (revised) modernization cannot afford to acknowledge (without having to undergo a paradigm shift) is that even in the most coercive of states, authoritarian governments have always attempted to justify their policies and to acquire legitimacy for their governance. Especially with the global hegemony of democratic values, authoritarian governments in East Asia are devoting more and more attention to the articulation of national ideologies and are less willing to rely on sporadic justifications or sheer coercion. From Vietnam's exhortation to citizens to become "cultural soldiers" to Indonesia's Pancasila democracy to the variants of Asian Values discourse articulated by Cambodia, China, Malaysia, Myanmar, and Singapore, the reality in East Asia challenged the "modern authoritarianism" thesis that regards authoritarianism regimes as ideologically weak, unable to secure consent, and thus illegitimate and unstable.

Legitimate(d) Authoritarianism

While (revised) modernization theorists focused on the transitory nature of authoritarianism, there were other theorists who were interested in the internal logic and staying power of authoritarianism in East Asia. Focused on the question of legitimacy, these approaches typically developed in dialogue with Max Weber's (1864–1920) theory of the three modes of legitimacy (traditional, charismatic, legal-rational). We will review Karl Wittfogel's (1896–1988) exploration of bureaucratic centralization (legal-rational legitimacy) and Lucian and Mary Pye's investigation of Asian culture (traditional legitimacy) before considering how recent theoretical developments such as hegemony theory may contribute to the further understanding of authoritarianism in East Asia.

Wittfogel's *Oriental Despotism* argues that water control and distribution (especially the management of extensive system of canals) spawned hydraulic civilizations with authoritarian centralized empires and sprawling bureaucracies both deeply hostile to change. Critiques of this thesis range from observations that irrigation is often organized locally rather than by centralized bureaucracies to highlights of counterevi-

dence from the West such as the rise and fall of ancient Greece and the chronic backwardness of eastern Europe.

Resonating with other studies of the cultural-psychological studies of authoritarianism (such as studies of fascism in Germany), the Pyes' study of cultural psychology focused on values of frugality, hard work, family values, respect for authority, and Asians' understanding of power. Critiquing the imposition of Western notions of power in understanding Asian societies, they argued that power should not be understood as "participation in the making of significant decisions" or in terms of choice but as status and, indeed, the freedom from having to decide at all. To the Pyes, this Asian sense of power generates authoritarian regimes: "When power implies the security of status, there can be no political process. Contention and strife cease" (p. 22). Insofar as power derives from morality, any challenge to the system or democratic competition is necessarily an affront to the leader and is thus responded to with a heavy hand.

This thesis has been criticized for its culturalism (using culture as an explanation rather than as something to be explained), which in this case generates the tautological thesis that "authoritarian cultures produce authoritarianism." Exactly what is Asian or Confucian culture, and is culture destiny? While the Pyes focused on hierarchical features, others rediscover alternative trajectories to argue that Asian cultures have democratic roots. For instance, William Theodore de Bary and Wei-ming Tu demonstrate the affinities between Confucianism and liberalism while Chu and Winberg Chai argue that current authoritarian regimes distort Confucian values and that if implemented correctly, Confucianism would produce democracy. Furthermore, even if there is agreement on the nature of Asia's values and historical roots, its future—what to preserve and what to change—remains something hotly debated by East Asian leaders (e.g., Singapore's Lee Kwan-Yew versus South Korea's Kim Dae-Jung).

Whatever the mode of legitimacy—legal-rational, charismatic, or traditional—contemporary theorists are increasingly acknowledging that authoritarianism can be legitimate(d) and that the distinction between democracy and authoritarianism is more blurred than modernization theories suggest. Given the problems with modernization theories, the question of why authoritarianism in East Asia is sometimes seen as legitimate by its subjects and the question of why it endures despite development need to be broached from the perspective of legitimacy rather than in terms of modernization. Because legitimacy is a subjective concept pegged to the perceptions of the ruled, the question of why authoritarian regimes (especially prosperous ones) endure is necessarily a question of ideology and research in this direction necessitates close examination of cultural and historical conditions within a regime rather than the broad socioeconomic comparisons associated with modernization theory.

One useful perspective comes from cultural studies, especially the concepts of hegemony and popular authoritarianism. Instead of the dichotomy of democratic/authoritarian, Antonio Gramsci (1891–1937) postulated the categories of consent/coercion—the latter categories do not correspond

with the former because they are not mutually exclusive. Following Weber's definition of the state as an organ with a legitimate monopoly over coercion, Gramsci distinguished between this "outer ditch" of coercion and an "inner ditch" of consensus and commonsense. To the extent that there is consensus, it becomes unnecessary to mobilize repressive state apparatuses to discipline society; political alternatives are sufficiently de-legitimized through the molding of commonsense. Since the 1990s, some applications of this theory to Asia have included John Girling's analysis of middle-class hegemony in Thailand, John Hilley's analysis of Mahathirism in Malaysia, and Soek-Fang Sim's analysis of the Asian Values project in Singapore.

The various theories outlined here can combine to offer a sophisticated understanding of authoritarianism in East Asia. Modernization theory, although flawed, offers effective descriptions of the democratization pressures confronted by rapidly developing countries. What it fails to do, and what is advantageous about localized theories, is the focus on how history, geography, culture, and ideology can come together to engender countervailing forces that stabilize the regime and arrest the drift toward democracy.

See also Authority; Democracy; Pluralism.

BIBLIOGRAPHY

- Chai, Chu, and Winberg Chai. *Confucianism*. Woodbury, N.Y.: Barron's, 1973.
- De Bary, Wm. Theodore. *The Liberal Tradition in China*. New York: Columbia University Press, 1983.
- Diamond, Larry. "Thinking about Hybrid Regimes." *Journal of Democracy* 13, no. 2 (2002): 5–21.
- Fukuyama, Francis. *The End of History and the Last Man*. New York: The Free Press, 1992.
- Girling, John. *Interpreting Development: Capitalism, Democracy, and the Middle Class in Thailand*. Ithaca, N.Y.: Cornell University Press, 1996.
- Gramsci, Antonio. *Selections from the Prison Notebooks*. Edited and translated by Quinton Hoare and Geoffrey Nowell Smith. London: Lawrence and Wishart, 1971.
- Hilley, John. *Malaysia: Mahathirism, Hegemony and the New Opposition*. London and New York: Zed Books, 2001.
- Kirkpatrick, Jeanne. "Dictatorships and Double Standards." *Commentary* 68, no. 2 (1979): 34–35.
- Linz, Juan J. "An Authoritarian Regime: The Case of Spain." In *Mass Politics: Studies in Political Sociology*, edited by Erik Allardt and Stein Rokkan. New York: Free Press, 1970.
- Lipset, Seymour Martin. "Some Social Requisites of Democracy." *American Political Science Review* 53, no. 1 (1959): 69–105.
- O'Donnell, Guillermo, Phillipe Schmitter, and Laurence Whitehead. *Transitions from Authoritarian Rule: Latin America*. Baltimore: John Hopkins University Press, 1986.
- Pye, Lucian W., and Mary W. Pye. *Asian Power and Politics: The Cultural Dimensions of Authority*. London: Belknap Press, 1985.
- Rodan, Garry. "Theorizing Political Opposition in East and Southeast Asia." In *Political Oppositions in Industrializing Asia*, edited by Garry Rodan. London and New York: Routledge, 1996.
- Sim, Soek-Fang. "Asian Values, Authoritarianism and Capitalism." *The Public* 8, no. 2 (2001): 45–66.

Tu, Wei-ming. *Way, Learning and Politics: Essays on the Confucian Intellectual*. Albany: State University of New York, 1993.

Wittfogel, Karl. *Oriental Despotism: A Comparative Study of Total Power*. New Haven, Conn.: Yale University Press, 1957.

Soek-Fang Sim

LATIN AMERICA

Traditional interpretations of authoritarianism in Latin America root this phenomenon in the style of Iberian colonization in the region. The Hispanic world, this argument alleges, was naturally more authoritarian than Anglo-Saxon cultures. Furthermore, the cultures they encountered in the New World (particularly the Aztec and Inca Empires) were themselves very hierarchical, which further facilitated authoritarian forms of governance. Subsequent interpretations have generally rejected the racist implications of these theories in favor of more sophisticated and nuanced explanations. Nevertheless, debates continued on how best to confront authoritarian tendencies.

Authoritarianism is related to, but distinct from, dictatorship and totalitarianism. Unlike totalitarianism, authoritarian regimes sometimes allow limited political pluralism (though, unlike in a democracy, that opposition is limited and often not legitimate). In addition, authoritarianism lacks a defined ideology, which characterizes totalitarian regimes. Furthermore, authoritarianism tends to rely on apathy rather than a mobilized and engaged population. George Philip notes how rising inequality under democratic government leads to disenchantment, with significant minorities preferring authoritarian over democratic leadership. Some scholars contend that democratic systems can be strengthened through a reformation of political institutions, such as political parties and electoral processes. Others maintain that prolonged socioeconomic crises are a larger threat to stability and that economic growth is necessary to prevent a lapse back into authoritarianism. These economic policies, however, often take the form of neoliberal reforms that are profoundly antidemocratic and lead back to an authoritarian style of governance.

Caudillos

During the nineteenth century, authoritarian political structures were expressed in the form of caudillo styles of leadership. A lack of a functioning democratic system that allowed for peaceful transfers of power from one civilian government to another led to a series of palace coups and military governments. Facing a power vacuum after the disappearance of patriarchal monarchies at independence, leaders sought legitimacy through charisma and appeals to tradition rather than expressing a coherent ideology. A caudillo, which broadly means a “strongman,” style of government represents the use of charisma rather than military force to keep political forces under control through promotion of allegiance to a central leader. These caudillos were not necessarily of a specific ideological orientation, could be associated with liberal or conservative politicians, and could take a military or civilian form; in addition, they might be rooted in either urban or rural populations and be oriented toward either modernizing or tradi-

tional forces. Perhaps the most common unifying thread among caudillos was their appeal to nationalism. Caudillos sometimes relied on legal means, including elections and plebiscites, to legitimate their control but once in office tolerated no dissent to their authority. Representative of this in Mexico are both Benito Juárez (r. 1861–1872) and Porfirio Díaz (r. 1877–1880; 1884–1911) who came into power claiming to support freely contested elections but then became deeply entrenched in power. Both caudillos were liberals from the poor and largely indigenous southern state of Oaxaca. They relied on this home base of support to maintain themselves in power even as their policies increasingly served elite interests. Juárez is commonly regarded as Mexico’s first “Indian” president though he implemented legislation that took land away from rural villages. Díaz ruled using the strategy of *pan o palo* (carrot or the stick) to reward lavishly his supporters and repress brutally his opponents. It took the Mexican Revolution (1910–1920) to remove Díaz from power after thirty-four years, one of the longest-running dictatorships in the history of Latin America.

One of the most noted and resilient examples of Latin American authoritarian regimes is that of General Antonio López de Santa Anna (1794–1876) during the first half century after Mexico’s independence in 1821. Santa Anna held power eleven different times with catastrophic results perhaps unequaled in Latin America’s history, including the loss of half of Mexico’s territory to the United States. Seemingly contradictory ideological principles, including adhering to federalism, centralism, liberalism, conservatism, and even monarchism, characterized his different times in office. When liberals held the upper hand, he ruled Mexico as a liberal. Later Santa Anna became a conservative and passed some of the most reactionary legislation in Mexico’s history. Historians often point to his charisma and political opportunism as explaining his success in holding onto (or, more accurately, repeatedly returning to) power. Will Fowler, however, finds such interpretations to be unsatisfactorily simplistic in explaining Santa Anna’s resilience. Rather, his success is a result of elite support, motivated by the desire to preserve hegemonic class interests. Santa Anna’s promises to deliver political stability and prevent social dissolution were more important than differences in ideology. A subsequent long tradition of casting the ruler as a villain is what has made it “difficult to understand why he was so successful” (Fowler, p. 13). Santa Anna perhaps was no worse or no more opportunistic a leader than his contemporaries, just perhaps more successful in riding out political changes. In Fowler’s assessment, his commitment to elite privilege and detachment from partisan politics ultimately made him an arbitrator of competing ideological interests. Whichever group currently held the upper hand courted his support in order to consolidate its control over the country.

Caudillos were not necessarily a negative force and have sometimes been divided into the categories of “cultured caudillos” and “barbarous caudillos” (Hamill, p. 5). Mariano Malgarejo from Bolivia is often considered to be a classic representation of the later. He abrogated land titles of Indian peasants and sold off large slices of Bolivian territory as if it were



Tanks in Santiago during the Chilean coup. In 1973 Chilean military forces overthrew the democratic government of President Salvador Allende, supplanting it with a dictatorship that widely repressed basic human rights and banned any political opposition. © HORACIO VILLALOBOS/CORBIS

his own personal property in order to generate funds to put down chronic revolts against his government. As a result, Bolivia lost to neighboring countries half of its territory as well as its outlet to the sea. Like Santa Anna, Magarejo was perhaps no worse than any other caudillo but just more active and successful at this style of government.

Corporatism

Traditional interpretations of authoritarianism argue that after independence in the early nineteenth century, the Latin American republics had difficulties in shaking their Iberian heritage. Although they drafted constitutions that borrowed heavily on liberal ideals and institutions, leaders proved ineffective at governing. As a result, many Latin American countries soon shifted to dictatorial forms of government, marked with elite rule, political instability, militarism, and authoritarianism. This led some leaders to argue that the new republics needed strong, centralized governments more than social and economic equality. Fowler points to these as common reasons throughout Latin American history for the “longevity, resilience, and endurance” of authoritarian regimes, including “the consummate political skills of the dictators, their pragmatism, flexibility and timely opportunism, their use of clientelism, patronage and cooption, their personalist politics, prestige or charisma, and effective repression.” Authoritarian leaders supplemented these characteristics with the use of military forces, a manipulation of political parties, and expression of “a certain ideological vagueness” (Fowler, p. xiii). This au-

thoritarian tradition hindered the emergence of Western-style democratic forms of government.

Corporatist theories, which gained popularity in the 1950s, emphasized this Iberian heritage of authoritarianism to explain underdevelopment in Latin America. This authoritarianism expressed itself politically through a patriarchal monarchy, economically in feudalistic landholding systems, militarily with elitist structures, and religiously with the Catholic hierarchy. During its colonization of the Americas, Iberia transferred these authoritarian institutions to the New World. Corporatist interpretations blamed a failure of democracy and economic development on the persistence of hierarchical structures in modern institutions, with power flowing vertically from the top down. Jan Knippers Black summarized corporatist theories as “blaming the Iberians” (p. 4). Critics of corporatist theories have noted that countries like Chile that were subject to authoritarian military rule toward the end of the twentieth century were on the fringes of Spanish colonization and emerged out of a long democratic tradition. Given this reality, many aspects of corporatist theories begin to break down, as do interpretations that place blame on the legacy of hereditary absolute monarchies for the persistence of strong, centralized authoritarian structures.

Bureaucratic Authoritarianism

In the second half of the twentieth century, personalist dictators such as Manuel Noriega (r. 1983–1989) in Panama gave

way to authoritarian military regimes, particularly in the South American countries of Argentina, Chile, Brazil, and Uruguay. These authoritarian regimes were unparalleled in their brutality and suppression of civil society and political movements. Fearing a rising leftist threat, both from electoral coalitions as well as armed guerrilla movements, these authoritarian regimes sought to redraw the structure of their countries along more traditional lines. Rather than relying on the personal power of an individual dictator, these regimes used military institutions to maintain control over society. The resulting bureaucratic-authoritarian regimes fundamentally restructured political and economic institutions to remake their countries along neoliberal lines that dramatically widened the gap between the rich and the poor. Critics claimed that these economic reforms were so unpopular that they could only be imposed through undemocratic means. Popular reactions to structural adjustments that sharply reduced living standards led authoritarian regimes to crack down even more viciously on their opponents.

The Argentine political scientist Guillermo O'Donnell introduced the concept of *bureaucratic authoritarianism* to describe institutional dictatorships that were not a legacy of Iberian rule but used coercion to respond to what they viewed as threats to the capitalist system. While the revolutionary left condemned these dictatorships as fascist and turned to armed struggle as a means to overthrow them, O'Donnell argued "that the appropriate way to oppose them was through an unconditional commitment to democracy" (O'Donnell, p. xiii). These regimes resulted from a failure of democracy to extend the protections of citizenship to an entire population. A notable gap between liberal principles and exclusionary economic practices led to what O'Donnell terms "low-intensity citizenship" (p. 143). Unfortunately, economic inequalities persisted and even grew as part of neoliberal policies that were retained even after O'Donnell's long-desired return to democratic governance in Latin America.

Alberto Fujimori's (r. 1990–2000) government in Peru in the 1990s provides another important variation on the authoritarian tradition in Latin America. In what came to be known as an *autogolpe* (self-coup) or "fujicoup," Fujimori launched a coup against himself in April 1992 to shut down the congress and rewrite the country's constitution. Using what George Philip calls "semi-authoritarianism," Fujimori realized some significant policy achievements, including stopping inflation and ending the bloody Shining Path guerrilla insurgency (p. 169). More significantly, his violation of Peru's constitutional order did not lead to a fall in his popularity. Rather, many people believed that the country's crisis legitimized authoritarian measures. By 2000, however, the crisis had passed, and public opinion swung away from support for his abuses of power. His fall from power was neither a triumph of democracy nor a blow against authoritarianism but a result of popular responses to a changing political situation.

In an interesting twist on condemnations of authoritarian traditions in Latin America, James F. Petras and Frank T. Fitzgerald argue that sometimes democratic governments are not authoritarian enough to defend positive social reforms. Pointing specifically to Salvador Allende's (r. 1970–1973) gov-

ernment in Chile in the early 1970s and the Sandinista government in Nicaragua in the 1980s, they note that the ruling classes do not give up their elite privileges without a struggle. This argument contrasts these failed attempts at social, economic, and political transformation to that of Cuba. If the Cuban government had not taken the drastic authoritarian measures that it did in the early 1960s, the revolution's attempts to redistribute wealth to the lower classes and extend education and health care throughout the country would have failed. Because the bourgeoisie and their international allies are not ideologically committed to democratic rule, they do not hesitate to use whatever tactics might be necessary to undermine social reforms when they are implemented through democratic means. Ironically, Petras and Fitzgerald argue, social reformers need to utilize authoritarian tactics to defend democratic processes or risk total failure.

The fall of Salvador Allende's government in Chile is the most noted example in Latin America of a fall of a democratic government to an authoritarian regime. Rooted in a long history of civilian institutions, Allende pledged to put the country on a "Chilean Road to Socialism" that would utilize existing democratic structures to redistribute wealth in an attempt to end extreme economic and social inequalities. When his reforms led to nationalization of U.S.-owned copper mines and other industries, the U.S. Central Intelligence Agency (CIA) helped engineer a bloody military coup on 11 September 1973 that overthrew his government. General Augusto Pinochet (r. 1974–1990) then implemented one of the most savage military dictatorships in the history of Latin America. A country that had one of the longest democratic traditions in Latin America now became a prime example of an authoritarian regime that suppressed the basic principles of liberal democracy, including values of individual freedom, civil liberties, social and economic equality, and free elections. At the same time, these regimes embraced *laissez-faire* economic systems that critics subsequently termed "savage capitalism." As a type of dictatorship, they outlawed political opposition and greatly restricted individual freedoms.

As relations with the Pinochet dictatorship illustrate, the U.S. government "supported authoritarian regimes that promised stability, anticommunism, and economic trade and investment opportunities." David F. Schmitz notes how this policy conflicted with a theoretical embrace of the principles of liberal democracy and human rights. U.S. officials viewed Latin Americans as racially inferior and strong authoritarian leadership as necessary to maintain order, prevent social and political chaos, and implement neoliberal policies necessary for economic modernization (Schmitz, p. 304). Rather than fostering democratic institutions, U.S. support for authoritarian regimes often led to political polarization, instability, and radical nationalist movements. Critics constantly charge that such support conflicts with U.S. interests, virtually no matter how those interests are conceptualized. "Equating dictators with freedom," Schmitz maintained, "blinded American leaders to the contradictions and failures of their policy" (p. 7). Authoritarian regimes often performed poorly in terms of economic development and, together with extensive human rights viola-

tions, lost legitimacy internally. Democracy emerged and economies grew in Latin America in spite of, rather than because of, U.S. policies.

By the end of the twentieth century, with a reemergence of democratic governments throughout Latin America, authoritarianism appeared to be safely buried in the past. Nevertheless, Leigh Payne points to the persistence of an authoritarian tradition in right-wing threats to democratic structures. These “uncivil movements” that use political violence to promote exclusionary objectives do not necessarily seek to overthrow democratic systems, but nevertheless they are able to shape the discourse and practices of democratic institutions. A search for social justice and equality all too often continues to be an elusive goal. In subtle, and sometimes not so subtle, ways, authoritarianism is still a force to be reckoned with in Latin America.

See also *Democracy; Dictatorship in Latin America; Nationalism; Pluralism; Populism; Totalitarianism.*

BIBLIOGRAPHY

- Black, Jan Knippers. “Introduction: The Evolution of Latin American Studies.” In *Latin America, Its Problems and Its Promise: A Multidisciplinary Introduction*, 3rd ed., edited by Jan Knippers Black, 1–17. Boulder, Colo.: Westview, 1998.
- Domínguez, Jorge I., ed. *Authoritarian and Democratic Regimes in Latin America*. New York: Garland, 1994.
- Fowler, Will, ed. *Authoritarianism in Latin America since Independence*. Westport, Conn: Greenwood, 1996.
- Hamill, Hugh M., ed. *Caudillos: Dictators in Spanish America*. Norman: University of Oklahoma Press, 1992.
- Mainwaring, Scott, and Arturo Valenzuela, eds. *Politics, Society, and Democracy: Latin America*. Boulder, Colo.: Westview, 1998.
- O’Donnell, Guillermo A. *Counterpoints: Selected Essays on Authoritarianism and Democratization*. Notre Dame, Ind.: University of Notre Dame Press, 1999.
- Payne, Leigh A. *Uncivil Movements: The Armed Right Wing and Democracy in Latin America*. Baltimore: Johns Hopkins University Press, 2000.
- Petras, James F., and Frank T. Fitzgerald. “Authoritarianism and Democracy in the Transition to Socialism.” *Latin American Perspectives* 15, no. 1 (winter 1988): 93–111.
- Philip, George. *Democracy in Latin America: Surviving Conflict and Crisis?* Malden, Mass.: Polity, 2003.
- Schmitz, David F. *Thank God They’re on Our Side: The United States and Right-Wing Dictatorships, 1921–1965*. Chapel Hill: University of North Carolina Press, 1999.

Marc Becker

AUTHORITY. The conceptual history of *authority* reveals it to be an essentially contested concept because of the many debates about its sources, purposes, and limits, as well as its proximity to the concept of power.

Since Plato’s critique of Athenian democracy, physical force and rhetorical persuasion have been viewed as types of power but not authority. Hannah Arendt observes that “[i]f author-

ity is to be defined at all, then it must be in contradistinction to both coercion by force and persuasion through arguments” (p. 93). Indeed, it is only when authority fails that force or persuasion is used to elicit compliance. This distinction is reflected in Jean-Jacques Rousseau’s (1712–1778) discussion of what a legislator must do to form a political community guided by the general will:

Since, then, the legislator can use neither force nor argument, he must, of necessity, have recourse to authority of a different kind which can lead without violence and persuade without convincing. That is why, in all periods, the Fathers of their country have been driven to seek the intervention of Heaven, attributing to the Gods a Wisdom that was really their own. (pp. 207–208)

In this passage, religious authority is so widely accepted and unquestioned by the people that, if it is appealed to, no force or persuasion is necessary.

Rousseau’s legislator, however, might be engaging in deception by invoking religious authority as a proxy. To be authoritative, the legislator’s statement should be accepted or rejected on its merits. As Richard Friedman states, “[i]f there is no way of telling whether an utterance is authoritative, except by evaluating its contents to see whether it deserves to be accepted in its own right, then the distinction between an authoritative utterance and advice or rational persuasion will have collapsed” (p. 132). Deference toward authority may not be automatic, as those affected by it evaluate its statements to judge whether they are, in fact, authoritative.

Given this, it may be said that if power is the ability of some individual, group, or institution to control, coerce, or regulate others, authority is the recognition of the right of that individual, group, or institution to exercise power. In short, those over whom power is exercised recognize that whoever or whatever is exercising that power is doing so legitimately. There is an element of trust, faith, and recognition on the part of those following authority that the person exercising it possesses some quality (for example, wisdom, expertise, or the fact that the person was elected by the people) that ought to be deferred to. If this is the case, then authority, rather than simple power, exists and must be followed, adhered to, and, within limits, obeyed.

The Sources of Authority

One approach to authority focuses on the question of who has a right to rule, and on what this right rests. Early notions of authority based it on the right of the strongest, the many, or the wisest to make laws. For example, while Pericles (c. 495–429 B.C.E.) praises Athenian democracy as the rule of the many according to the rule of law, Plato (c. 428–348 or 347 B.C.E.) views it as an unstable form of government that rests on the opinion and force of the majority. Instead, he prefers authority be given to those who possess reason and wisdom. Also, from antiquity to the Middle Ages, authority is often related to the divine, with rulers seen as “gods” themselves or as receiving authority from a divine power. In the European Middle Ages, the notion of civil and religious authority was

clearly tied to the Catholic Church. For example, papalism asserted that the pope had final authority over both ecclesiastical and civil realms. Also, the notion of divine right monarchy, promoted by Robert Filmer (c. 1588–1653), asserted that the absolute authority of monarchs rests on Adam's patriarchal authority in the Garden of Eden.

In the latter part of the Middle Ages, the intellectual flourishing of the Renaissance led to the rediscovery of the notion of self-government in the form of republican city-states such as Florence, Italy. In turn, this influenced the emergence of the social-contract theory of John Locke (1632–1704) and Rousseau that rests legitimate government on the consent of the citizens of a political community. Locke's theory of consent and the right to revolt helped shape the Declaration of Independence and the republican character of the U.S. Constitution. However, the social-contract theory was criticized as resting on abstract notions of consent, reason, equality, and liberty. Edmund Burke (1729–1797), for instance, favored moderate reforms of existing institutions, and stressed that members of each generation must respect their entailed inheritance that obliged them to follow traditions established by previous generations. Furthermore, Joseph-Marie de Maistre (1753–1821) saw the abstract ideas that inspired the French Revolution as undermining the “throne and altar,” which were the traditional authorities that held society together.

Authority and Legitimacy

Another approach to authority focuses more on the question of whether those who are ruled accept authority as legitimate regardless of its source. This approach originated with Max Weber (1864–1920), who distinguished three ideal types of authority: traditional authority that rests on history and tradition; charismatic authority that rests on the personality of the leader; and legal-rational authority that rests on impersonal rules and powers and is associated with the office rather than the personal characteristics of the office holder. If those affected think that power is exercised legitimately, then any of these three types of authority is legitimate, regardless of its moral justification.

Weber suggested that as societies modernize, authority transforms from traditional, to charismatic, to legal-rational. This implies that only one type of authority exists at a time, or that authority is a linear sequence from traditional to charismatic to legal-rational. Clearly, these three types of authority coexist. This is illustrated by distinguishing between the notions of “an authority” and “in authority.” For example, the U.S. Congress possesses legal-rational authority, and representatives and senators have certain powers that derive from their office. Representatives and senators are “in authority” but are often influenced by individuals called to testify before committee hearings who, because of their charisma or expertise, are “an authority.”

The Purposes of Authority

The purposes of political authority are as contested as its sources. For some, authority should promote a virtuous society. The desired virtues differ depending on whether one looks to Aristotle's (384–322 B.C.E.) discussion of the golden mean, Niccolò Machiavelli's (1469–1527) discussion of republican

virtue, religiously inspired notions of Christian or Islamic virtue, or the emphasis on character as evident in Bill Bennett's *Book of Virtues*. For some, authority should promote a just society. Similarly, the definition of justice differs depending on whether one looks to Plato's ideal republic or John Rawls's (1921–2002) view that justice is the fair distribution of resources and opportunities in a society. And for some, authority is needed to provide stability and order. Here too are found differences ranging from Thomas Hobbes's (1588–1679) emphasis on an absolutist government created by the consent of the people who simply desire protection and order, or the republican tradition that suggests that stability comes from dividing authority among different branches of government that check and balance each other.

Since authority is valued but exists in tension with other social values, there is a debate about its limits. Some, like Filmer and Jean Bodin (1530–1596), defend absolute authority in the hands of one person, and oppose the separation of its powers, on grounds that absolutism alone can provide stability and order. Others, such as Locke and James Madison (1751–1836), suggest that absolute authority in the hands of one person or group of persons inevitably leads to arbitrary and excessive power that squelches political and civil liberties. Thus, authority must be divided among separate branches that can check and balance each other, and operate within certain constitutionally prescribed limits such as the Bill of Rights. Furthermore, the authority of government can conflict with the demands of conscience or standards of justice that transcend government. Thus, civil disobedience, as Henry David Thoreau (1817–1862) suggests, can be justified on grounds that individuals should not be coerced into supporting an evil they otherwise oppose.

Several controversies continue to surround authority in the early 2000s. Issues such as identifying the origin of the social-contract tradition and delineating the limits of obedience continued to attract scholarly attention. Other debates are both scholarly and politically important. For example, the proper relationship between religious and secular authority remains controversial in the United States, France, and in some predominantly Islamic countries debating democratic reforms. There are also ongoing concerns that all types of authority are not respected or deferred to as much as in the past. Cultural conservatives in the United States especially bemoan the loss of respect for and faith in authority, and point to a culture that promotes relativism, cynicism, and irony as the culprit. Finally, the U.S. government's reaction to the terrorist attacks of September 11, 2001, the invasions of Afghanistan and Iraq, and the Patriot Act have each, in different ways, sparked controversy. For example, there continues a global discussion about the appropriate use of unilateral or multilateral military force. And, within the United States, the tension between governmental authority and civil liberties remains controversial. From these examples, one can see that the historical debates regarding the sources, purposes, and limits of authority remain important in this era.

See also **Civil Disobedience; Democracy; Liberty; Power; Republicanism; Republic.**

SOME DEFINITIONS OF AUTOBIOGRAPHY

Philippe Lejeune: “A retrospective account in prose that a real person makes of his own existence stressing his individual life and especially the history of his personality” (“The Autobiographical Pact”).

Sidonie Smith and Julia Watson: “Our working definition of autobiographical or life narrative, rather than specifying its rules as a genre or form, understands it as a historically situated practice of self-representation. In such texts, narrators selectively engage their lived experience through personal storytelling” (*Reading Autobiography*).

Leigh Gilmore: “As a genre, autobiography is characterized less by a set of formal elements than by a rhetorical setting in which a person places herself or himself within testimonial contexts as seemingly diverse as the Christian confession, the scandalous memoirs of the rogue, and the coming-out story in order to achieve as proximate a relation as possible to what constitutes truth in that discourse” (*The Limits of Autobiography*).

BIBLIOGRAPHY

- Arendt, Hannah. “What Is Authority?” In *Between Past and Future: Eight Exercises in Political Thought*. Enl. ed. New York: Penguin, 1977.
- Friedman, Richard. “On the Concept of Authority in Political Philosophy.” In *Concepts in Social and Political Philosophy*, edited by Richard Flathman. New York: Macmillan, 1973.
- Rousseau, Jean-Jacques. “The Social Contract.” In *Social Contract: Essays by Locke, Hume, and Rousseau*, edited by Sir Ernest Barker. London: Oxford University Press, 1947.

Gregory W. Streich

AUTOBIOGRAPHY. Growing scholarly interest in the relationship between truth and fiction, along with popular interest in personal life-narratives and the “culture of confession,” have brought new prominence to the genre of autobiography. Indeed, according to Leigh Gilmore, the number of English-language autobiographies and memoirs roughly tripled from the 1940s to the 1990s (p. 1, n. 1), and scholarly attention to life writing has followed this trend. Paradoxically, however, as interest in autobiography has risen, debates over the nature and definition of the genre have become increasingly prevalent. Etymologically the word “autobiography” is a compound of the Greek terms *autos* (self), *bios* (life), and *graphe* (writing). At its simplest, then, autobiography can be defined as “self-life-writing.” But, as illustrated by debates over what counts as autobiography—and indeed, over what counts as “truth” in the postmodern world—the apparently simple act of writing one’s own life is much more complex than this definition suggests. In fact, autobiography is as diverse and as protean as any literary genre, and attempts to define it have always been troubled.

Scholars of autobiography have long theorized the genre not as a discrete set of characteristics but as a literary and cultural practice informed by diverse cultural, rhetorical, and institutional contexts (see especially Bruss; Butterfield; Eakin; Egan; Gilmore; Hesford; Lionnet; Smith and Watson). This way of thinking resonates with postmodern theories of language, subjectivity, identity, and power that have reshaped how we think about autobiography and other “true” stories. “Self-life-writing,” then, involves more than simply writing or reading a life story; it also requires attention to the rhetorical situation in which that story is embedded and to the cultural narratives that shape what counts as “truth” in a particular time and place.

Culture and Identity: Narrative Strategies

Contemporary philosophers and cultural critics have convincingly argued that identity and experience are themselves socially constructed, shifting according to historical and cultural ideas about personhood and everyday life. Despite this postmodern turn to thinking about how identity is made, not born, scholars of autobiography nevertheless insist on the materiality of identity in theorizing life writing, particularly the material consequences of race, ethnicity, class, gender, sexuality, and ability, and how autobiographical narratives are affected by culturally available identity categories and narratives. From Sei Shōnagon’s *The Pillow Book* (Japan, c. 1000 C.E.) to Margery Kempe’s *The Book of Margery Kempe* (England, 1436) to Benjamin Franklin’s *The Autobiography of Benjamin Franklin* (United States, 1771–1789) to Richard Rodriguez’s immigration memoir *Hunger for Memory* (United States, 1982), identity and narrative provide key frames through which autobiographers negotiate their life stories. For example, Shōnagon’s notebooks, containing observations, poems, and stories written by a tenth-century Japanese woman, differ in many ways from

AUTOBIOGRAPHY AND TRAUMA

Given the culture of confession that infuses contemporary life in the United States, it may not come as a surprise that trauma memoirs have become remarkably popular with both autobiographers and audiences alike. Trauma memoirs often narrate state-sponsored and human rights violations, such as Elie Wiesel's *Night* (1960) and Loung Ung's *First They Killed My Father: A Daughter of Cambodia Remembers* (2000), but they also often narrate acts of individual violence, such as rape, domestic violence, and incest, such as Mary Karr's *The Liar's Club* (1995) and Michael Ryan's *Secret Life* (1995). Autobiographies that attempt to narrate traumatic experiences, such as child abuse, rape, and war, are caught within a paradox: trauma is often understood to be defined by a radical unrepresentability, since it is that which shatters the self and makes language and narrative impossible. In this context, narrative, argues Arthur W. Frank in *The Wounded Storyteller: Body, Illness, and Ethics* (1995), is an ethical as well as an aesthetic imperative, testifying to the narrator's continuing presence in the world in spite of injury, illness, and even imminent death. Indeed contemporary scholars of trauma autobiographies have become increasingly interested in the process

and the politics of articulating pain and injury through life narrative. For example, Marianne Hirsch's *Family Frames: Photography, Narrative, and Postmemory* (1997), Annette Kuhn's *Family Secrets: Acts of Memory and Imagination* (1995), and Nancy Miller and Jason Tougaw's collection *Extremities: Trauma, Testimony, and Community* (2002), explore the difficulty of representing trauma. Significantly Leigh Gilmore's *The Limits of Autobiography: Trauma and Testimony* argues that trauma is a key site at which to deconstruct the generic boundaries between fiction and non-fiction, the imagined and the real. Many authors of trauma narratives, such as Mikal Gilmore, Dorothy Allison, and Jamaica Kincaid, strategically choose to turn away from the autobiographical label and instead to embrace fiction as a genre that can achieve the project of self-representation without putting the author in the position of being scrutinized and judged by readers and critics. As these theorists suggest, turning one's life into a story is laden with difficult representational and political choices concerning which stories to tell, which culturally available narratives to draw upon, and which generic categories to affix to the final product.

Franklin's archetypal autobiography, which reveals his investment in white male privilege in the early U.S. republic. Nevertheless both autobiographies show that "self-life-writing" is a process that is historically and culturally situated, and through which identity and experience are negotiated, materialized, and refashioned.

Significantly Franklin's *Autobiography* relies on a larger cultural narrative, the bildungsroman, which has widely accepted currency in the United States. The bildungsroman follows a classic narrative trajectory of conversion in which the individual hero embarks on a long journey that ends with his resolution with the larger social community—in Franklin's case, the national community as represented by Philadelphia. The bildungsroman provides narrative shape and truth-value to a wide range of mainstream and marginal autobiographies published in the United States, from Franklin's to Mary Antin's *The Promised Land* (1912), Jade Snow Wong's *Fifth Chinese Daughter* (1950), Malcolm X and Alex Haley's *The Autobiography of Malcolm X* (1965), and Rodriguez's *Hunger for Memory*. The fact that several immigrant, ethnic, and women

autobiographers have relied on the bildungsroman to give their stories a recognizable trajectory and broad cultural currency is no accident. Indeed many autobiographers have used this form deliberately and strategically in order to persuade their readers that they too deserve a place of privilege in the United States and that their achievement of the "American Dream" is a result of individual hard work and intelligence. Therefore many autobiographies that are shaped by the bildungsroman narrative downplay structural inequities such as gender, ethnicity, race, class, sexuality, and ability. Wong and Rodriguez, for example, openly dispute the assumption that gender or ethnicity has served as a barrier in their lives, even when their autobiographies clearly show otherwise. The bildungsroman, then, is a form that both enables and constrains the kinds of life stories that can be told by particular autobiographers.

Narratives of mobility and/or immobility structure a wide variety of autobiographies that bring into view questions concerning the representation of the racialized, gendered, and classed body. Unlike the heroic journey narrative of the bildungsroman, which relies on an individualized story of social

mobility, many autobiographical narratives of mobility and immobility engage questions of community, belonging, and citizenship and their relationship to how the freedoms of particular bodies are granted or restricted. For example, the slave narrative articulates the broad cultural, economic, and historical forces that compelled racialized subjects into slavery in the United States, Britain, and the British colonies. Frederick Douglass's *The Narrative of the Life of Frederick Douglass, an American Slave* (1845) gained wide influence in the United States in the nineteenth century for its indictment of white slave owners whose personal and political freedom depended upon the forced servitude of an entire class of people. Slave narratives by female slaves, such as Harriet Jacobs's *Incidents in the Life of a Slave Girl* (1861) and Mary Prince's *The History of Mary Prince, a West Indian Slave* (1831), added to this an exploration of how gender also operated to the advantage of white men in the slave economy. An examination of slave narratives, then, exposes the abstract narrative of individual social mobility in bildungsroman narratives to be a patent fiction and shows instead how race, gender, and class privilege operate to enable or constrain particular bodies and particular life narratives.

Likewise other autobiographical narratives structured by the dynamics of immobility or restricted mobility provide key insights into how society is constructed around gender, race, ethnicity, class, sexuality, and ability. For example, early American captivity narratives told the story of American Indians' supposed savagery and white women's supposed civility. For example, Mary Rowlandson's *A True History of the Captivity and Restoration of Mrs. Mary Rowlandson* (1682), perhaps the most famous of the captivity narratives, creates a solid opposition between white settlers and native "savages," arguing in the process that the settlers, not the natives, have God-given authority over the American wilderness. In contrast, prison memoirs and Japanese-American internment narratives illustrate the racial and class dynamics that constrain the movement of individuals who are deemed by the state to be a danger to the citizenry. In one of the most famous internment narratives, Jeanne Wakatsuki Houston and James D. Houston's *Farewell to Manzanar* (1973), the narrator describes the racialization process by which Japanese immigrants and citizens were reconstructed as enemies of the state solely on the basis of their ethnicity and without regard to their citizenship status or national loyalties. Similarly prison memoirs such as Alexander Berkman's *Prison Memoirs of an Anarchist* (1912) and *Against All Hope: The Prison Memoirs of Armando Valladares* (1986) expose how race and class factor into a supposedly impartial criminal justice system. As these autobiographies illustrate, mobility and immobility are intricately tied to social constructions of race, ethnicity, class, gender, and citizenship status and differ radically depending upon one's privilege or lack thereof. The choice to write an autobiography shaped by the form of the slave narrative, the captivity narrative, the prison narrative, or the internment narrative is likewise a choice with a range of political and rhetorical effects and is not simply a neutral or self-evident choice. Likewise immigration narratives provide a culturally intelligible form for many autobiographies and call attention to the ways in which "citizen," "alien," and "immigrant" are shifting and socially constructed categories. Immigration narratives some-

times draw on other culturally available narratives such as the bildungsroman, as we have seen with Jade Snow Wong and Richard Rodriguez. But other immigration autobiographies resist the individualist trajectory of the bildungsroman by explicitly challenging the terms by which the nation-state defines "citizen" and "Other." For example, in Judith Ortiz Cofer's *Silent Dancing: A Partial Remembrance of a Puerto Rican Childhood* (1990), the concept of *La Tristeza*, "the sadness that only place induces and only place cures" (p. 14), functions as a poignant way to theorize the pain of immigration and displacement. In Ernesto Galarza's *Barrio Boy: The Story of a Boy's Acculturation* (1971), the narrator constructs his life as a series of lessons in coming to gender, ethnic, and class consciousness. Self-consciously portraying his life as historically and psychologically representative of all Mexican immigrants to the United States, Galarza resists the psychological characterization of Chicanos as lacking "self-image" (p. 2) and insists that his identity, like his autobiography, is profoundly affected both by his childhood in Jalcoctán and by his participation in the U.S. Chicano labor movement of the 1960s.

The case of immigrant and ethnic autobiography brings up another issue that informs the study of self-life-writing: namely, the question of who can speak for whom. The politics of collaboration, editing, and translation inform much ethnic life writing throughout U.S. history as well as earlier and non-U.S. autobiographies such as Margery Kempe's *Book*, over which questions about the author's literacy continue to throw her status as autobiographer into doubt. In the U.S. context, a primary example of the politics of who can speak for whom is the history of nineteenth- and early-twentieth-century Native-American autobiographies, many of which were produced collaboratively between the native subject and a white ethnographer. For example, *The Life of Ma-ka-tai-me-she-kia-kiak, or Black Hawk* (1833), transcribed and edited by J. B. Patterson, and *Black Elk Speaks* (1932), transcribed and edited by John G. Neihardt, are both as-told-to autobiographies that call attention to the politics of cross-cultural representation, translation, and authorial agency. But the collaborative autobiography continues into the late twentieth century and on to the present day with classics such as *The Autobiography of Malcolm X* and the contemporary *testimonio* of Rigoberta Menchú, *I, Rigoberta Menchú: An Indian Woman in Guatemala* (1984), transcribed and edited by Elisabeth Burgos-Debray.

Menchú's *testimonio*, published and circulated in North America, calls for attention to the contemporary politics of globalization and the transnational production, circulation, and reception of life narratives in the "First World" about "Third World" subjects. But *testimonio* also differs from conventional autobiography. As Doris Sommer argues, whereas autobiography generally tells the story of an individualized "I" and its unique experiences, in *testimonio* the "I" becomes plural and stands in for a community of people who share a common identity and representative, rather than unique, experiences. In Menchú's case, this plural "I" has renewed public and scholarly interest in the question of "truth" in autobiography, as she has been accused of misrepresenting "her" experiences for aesthetic and political gain.

“Outlaw” Genres

Debates such as these over the slipperiness of autobiography as a genre have led contemporary scholars to turn to the increasingly complex production and reception of autobiographical “outlaw genres,” which call attention to how generic distinctions have always been troubled, fluid, and contestable. In “Resisting Autobiography: Out-Law Genres and Transnational Feminist Subjects” (1992), Caren Kaplan argues that hybrid autobiographical forms constitute strategic political moves for women, ethnic, and immigrant authors who do not wish to write their lives according to culturally available scripts. Moreover, Sidonie Smith and Julia Watson’s edited collection *Getting a Life: Everyday Uses of Autobiography* (1996), broadens conceptions of autobiography past purely written forms into everyday cultural practices that are in fact identity practices. These scholars point out that contemporary “autobiographical” texts call into question the generic boundaries between fiction, autobiography, biography, ethnography, myth, and performance. Authors are increasingly labeling their works “biomythography” (Audre Lorde’s *Zami: A New Spelling of My Name*, 1982), “fictional autobioethnography” (Norma Elia Cantú’s *Canícula: Snapshots of a Girlhood en la Frontera*, 1995), and other generic hybrids, and many authors are combining text with images and drawings that call attention to the visual as a self-representational practice. For example, Art Spiegelman’s two-volume *Maus: A Survivor’s Tale* (1986 and 1991) uses a comic book or “graphic novel” form in order to explore Spiegelman’s troubled relationship with his father, a survivor of Auschwitz, and his life story. Cherríe Moraga’s *Loving in the War Years: lo que nunca pasó por sus labios* (1983) and Gloria Anzaldúa’s *Borderlands/La Frontera: The New Mestiza* (1987) combine personal essays and poems with history and feminist theory in English and Spanish to create hybrid forms that are both autobiographical and academic. And Theresa Hak Kyung Cha’s multimedia *Dictee* (1982) draws on autobiography, biography, photographs, drawings, and cinema in order to explore the challenges of immigration for the Korean-American narrator and her mother.

Outlaw genres suggest that autobiography is moving from a generally textual narrative form into a range of complex oral, textual, visual, and performative cultural practices that explore the challenges of identity and self-representation in diverse ways and through diverse media. Coco Fusco and Guillermo Gómez-Peña’s autobiographical performance art is one striking example of contemporary attempts to expand self-representation beyond textual forms. In *Year of the White Bear: Two Undiscovered Amerindians Visit the West* (1992), Fusco and Gómez-Peña, dressed up as exotic tribal figures from an unnamed and “undiscovered” island, displayed themselves in a cage in London, Madrid, and New York. Counting on their audiences’ familiarity with the colonial practice of putting native peoples on display for Western audiences, Fusco and Gómez-Peña were surprised by the extent to which their performance, intended as a satire of popular nineteenth-century cultural expositions that presented cultural tribes as specimens, was taken literally and as truth by audiences. This ironic performance of racialized identity goes to the heart of questions of truth, authenticity, and audience

expectations in “nonfictional” self-representational acts. It also illustrates the continuing need for autobiography to be theorized complexly and rhetorically, especially in the contemporary global landscape in which texts cross national, cultural, and language boundaries with ever-increasing frequency.

See also *Biography; Identity; Memory; Narrative; Person; Idea of the; Representation.*

BIBLIOGRAPHY

- Bruss, Elizabeth W. *Autobiographical Acts: The Changing Situation of a Literary Genre*. Baltimore and London: Johns Hopkins University Press, 1976.
- Butterfield, Stephen. *Black Autobiography in America*. Amherst: University of Massachusetts Press, 1974.
- Eakin, Paul John. *How Our Lives Become Stories: Making Selves*. Ithaca, N.Y.: Cornell University Press, 1999.
- Gilmore, Leigh. *The Limits of Autobiography: Trauma and Testimony*. Ithaca, N.Y.: Cornell University Press, 2001.
- Hesford, Wendy S. *Framing Identities: Autobiography and the Politics of Pedagogy*. Minneapolis: University of Minnesota Press, 1999.
- Kaplan, Caren. “Resisting Autobiography: Out-law Genres and Transnational Feminist Subjects.” In *De/Colonizing the Subject: The Politics of Gender in Women’s Autobiography*, edited by Sidonie Smith and Julia Watson, 115–138. Minneapolis: University of Minnesota Press, 1992.
- Lejeune, Philippe. “The Autobiographical Pact.” In *On Autobiography*, edited by Paul John Eakin. Translated by Katherine Leary. Minneapolis: University of Minnesota Press, 1989.
- Lionnet, Françoise. *Autobiographical Voices: Race, Gender, Self-Portraiture*. Ithaca, N.Y.: Cornell University Press, 1989.
- Smith, Sidonie, and Julia Watson. *Getting a Life: Everyday Uses of Autobiography*. Minneapolis: University of Minnesota Press, 1996.
- . *Reading Autobiography: A Guide to Interpreting Life Narratives*. Minneapolis: University of Minnesota Press, 2001.
- Sommer, Doris. “‘Not Just a Personal Story’: Women’s Testimonios and the Plural Self.” In *Life Lines: Theorizing Women’s Autobiography*, edited by Bella Brodzki and Celeste Schenck, 107–130. Ithaca, N.Y.: Cornell University Press, 1988.

Theresa A. Kulbaga
Wendy S. Hesford

AUTONOMY. *Autonomy* was first used by the ancient Greeks to describe city-states that had the power to legislate their own laws and direct the course of their own affairs. The etymology (*auto* [self] + *nomos* [law]) suggests self-governance or the imposition of law on oneself. The original implication of autonomy was pejorative when applied to the individual. When, for example, in Sophocles’ tragedy, the chorus uses the word *autonomos* to describe the actions of Antigone, the audience is meant to understand that she has placed her own judgments above the laws of the city—a clear violation of Greek norms.

By the seventeenth or eighteenth century, however, people as well as governments came to be viewed as autonomous agents. If human reason is able to discern the difference be-

tween right and wrong, each person can formulate his or her own conception of how to live without relying on religious or secular authorities.

This idea had a decisive impact on liberal political philosophies, which claimed that each person is sovereign over himself, so that the only way governments can exercise control over their citizens is on the basis of consent, implicit or actual. In this way, authority flows not from the ruler downwards but from the citizens—conceived as free rational agents with an equal share in society—upwards. Along these lines, Jean-Jacques Rousseau (1712–1778) argues that freedom for the individual consists in obedience to self-imposed law, and the sovereignty of the state derives from laws that the people, as expressed in the general will, impose on themselves.

It is generally agreed that the classic formulation of the doctrine of autonomy occurs in Immanuel Kant (1724–1804). While God or a national leader can command certain actions and threaten punishment if we do not obey, each person is responsible for the actions he performs. In fact, Kant took this idea to its logical conclusion: every moral agent is both an end *in* itself and a being capable of legislating morality *for* itself.

Suppose God or a political leader orders us to do something. Why should we obey? No one doubts that life will be uncomfortable if we do not. But the question is not “What is it in our interest to do?” but “What are we obliged to do?” Kant’s point is that obligation must derive from within: no external source can create obligation *for* us. Rather than say, “Do this” and “Don’t do that,” a person in authority must allow us to see for ourselves what is right. Not to do so is patronizing or degrading.

Kant therefore proclaims: “The will is thus not merely subject to the law but is subject in such a way that it must be regarded also as legislating for itself and only on this account as being subject to the law, of which it can regard itself as the author” (p. 38). Once we can regard ourselves as authors, reward and punishment no longer matter. The only thing that matters is whether we are convinced our action is right.

Even for as vocal a critic of Kant as John Stuart Mill (1806–1873), autonomy plays a central role. The best way to maximize the happiness of the greatest segment of society is to restrict the authority society can exercise over the individual and grant the individual sovereignty over his thought and person. The only warrant society has for interfering with this sovereignty is if the actions of one person impinge on the rights of another. Barring that, each person has the right to pursue his own happiness in whatever way he judges best.

Finally, one can find the doctrine of autonomy in the thought of John Rawls (1921–2002), for whom a just society is one which free and equal agents would choose for themselves if they had to take a place in that society but did not know what place they would be assigned—rich or poor, gifted or challenged, religious believer or atheist. This is simply a modern way of expressing the idea of implicit consent and saying that each person has the right to formulate and pursue his or her own conception of the good life.

Common Misconceptions

It is worth noting that, for Kant, autonomy does not permit me to do as I please. If it is degrading for someone to deny me the status of a moral agent, it is equally degrading to deny someone else that status. In Kant’s view, the only law I can impose on myself in a coherent fashion is one that simultaneously upholds the dignity of others.

A second misconception concerns authorship. To say that I must *regard* myself as the author of something is not to say that I am the author in fact. Consider the Fifth Amendment to the U.S. Constitution. Although I was not present when the founders drafted it, by prohibiting torture it articulates a principle to which I am strongly committed. So I can take responsibility for it even if I had to learn about it in a civics class.

Finally, there is the question of scope. Although Kant defines autonomy as rational self-legislation, this does not mean it is based on an intelligence test. By rationality he simply means the ability to recognize that moral agents have obligations; as such, autonomy applies to all of humanity regardless of education or social standing.

Objections

Though it is often said that Kant’s conception of autonomy leads to atheism, there is no reason why this has to be so. I can obey God as long as my reason for doing so is that the commandment to obey is morally valid; what I cannot do is obey blindly. The same is true of the government. Rather than urging obedience to legitimate authority, autonomy rejects the claim that legitimacy is irrelevant to authority: “Right or wrong, it’s my country, my religion, my family, and so on.”

Another objection claims that emphasizing individual sovereignty undermines virtues like trust, friendship, and cooperation. It does—if that means it is possible, in principle, for one person to be right and the rest of society wrong. But it hardly follows that one should go through life disregarding the advice of others and avoiding intimate relationships. To say that I should take responsibility for my actions is not to say that I must become a citadel. To live up to my obligations and fulfill myself as a person, I need the help of family, friends, and a host of institutions. All autonomy demands is that these groups or institutions respect my dignity as a free and rational agent (as well as respecting the dignity of others). At bottom, what autonomy denies is any form of political, religious, or moral tyranny.

See also *Enlightenment; Kantianism; Reason, Practical and Theoretical; Responsibility*.

BIBLIOGRAPHY

- Allison, Henry E. *Kant’s Theory of Freedom*. Cambridge, U.K.: Cambridge University Press, 1990.
- Dworkin, Gerald. *The Theory and Practice of Autonomy*. Cambridge, U.K.: Cambridge University Press, 1988.
- Kant, Immanuel. *Grounding for the Metaphysics of Morals*. 3rd ed. Translated by James W. Ellington. Indianapolis: Hackett, 1993.
- Korsgaard, Christine M. *The Sources of Normativity*. Cambridge, U.K.: Cambridge University Press, 1996.

- Mill, John Stuart. *On Liberty*. Indianapolis: Hackett, 1978.
- Rousseau, Jean-Jacques. *Discourse on Political Economy and the Social Contract*. Translated by Christopher Betts. Oxford and New York: Oxford University Press, 1994.
- Schneewind, J. B. *The Invention of Autonomy*. Cambridge, U.K.: Cambridge University Press, 1998.

Kenneth Seeskin

AVANT-GARDE.

This entry includes two subentries:

Overview
Militancy

OVERVIEW

Beginning in the nineteenth century, the term *avant-garde* has been applied to a wide range of social activities, from military to political to artistic. Since the early twentieth century, however, it has most commonly been used to designate those artists who, in making works of art, knowingly transgress aesthetic and social norms, seeking thus to scandalize, to disrupt established canons of taste, and to criticize the limits of society and project utopian alternatives.

In the common viewer or reader, avant-garde art often provokes indignation, uproar, outrage, puzzlement, or even violent rejection. Still, these audience responses, which have accompanied the artistic avant-garde throughout its history, do not lead back to a common set of stylistic and attitudinal traits that would allow for a clear, exhaustive conceptual analysis of avant-gardism. As an art-criticism term, *avant-garde* has been applied equally to the extremist subjectivism of the expressionists and the geometrical rationalism of Russian suprematism and constructivism; in music, to the serialism of Karlheinz Stockhausen (b. 1928) and the chance-operational compositions of John Cage (1912–1992); in literature, to the “transrational” pure-sound poetry of the Russian futurists, the densely allusive modernist epic of Ezra Pound (1885–1972), and the graphic and grammatical minimalism of concrete poets; in film, to the lush romanticism of Stan Brakhage’s (1933–2003) handmade films and to the self-reflexive, analytical bent of Malcolm Le Grice (b. 1940); in architecture, to the exuberant utopianism of El Lissitzky (1890–1941) and the icy rationality of Mies van der Rohe (1886–1969); and in performance, to the minimalist, disciplined stage images of Samuel Beckett (1906–1989) and the Dionysian spontaneity of the Living Theater. Similarly, the political affiliations of the avant-garde offer no unitary picture: ranging from the tormented anarchism of the early expressionists to the studied political indifference of Marcel Duchamp (1887–1968), from the fascist partisanship of Italian futurism to the communist and Trotskyite engagements of the surrealists, from John Cage’s playful antiauthoritarianism to the more regimented left-wing politics of many American artists of the later 1960s and the 1970s.

The term’s conceptual blurriness, however, has hardly hampered its successful career in the arts. On the contrary, its indeterminate content and constantly shifting, constantly expanding application points to essential features of “avant-garde” dynamics in the art world. Less a coherent concept than a highly effective ideological metaphor, the term and the ideas surrounding it have proven a convenient vehicle for unsettling artistic conventions and canons of value, for proliferating technical innovations from one medium to another, and for communicating new aesthetic ideas across disciplinary as well as national borders.

Avant-Garde as Ideological Metaphor

The ideological components of avant-garde as a metaphor can be grouped under three headings: political, formal, and temporal-historical. The avant-garde artist, often a self-conscious member of a sectarian group or movement, creates artworks that at once lay claim to formal innovativeness and to their effective quality as social criticism. “Avant-garde” connotes precisely this implication of social criticism in acts of formal innovation and the artist’s corollary struggle to find new artistic expressions—new figures and forms—to probe imaginatively beyond the strictures of a given social order. But this conflation of form and political meaning carries only two dimensions of avant-garde as metaphor. A further, temporal dimension gives that ideology its peculiar depth. “Avant-garde” also suggests an historical measure that lies in the future, a goal toward which artists are leading, while others merely follow. Through its artistic practice and products, the avant-garde adumbrates this end toward which the whole of a society is—or at least *should be*—heading. Where the avant-garde was, it is implied, there the social mainstream must inevitably find itself.

At first glance, the ideology is patently absurd. How could an abstract painting, a dadaist collage, an aleatory musical composition, or a film composed of mere patches of light and color be an anticipation of a new social norm, when it cannot even appeal to the present taste or understanding of a majority of citizens? At this point, however, the political and formal dimensions of the metaphor come to the ideological rescue of the avant-garde artist, by investing this estrangement of the artist from the audience with a paradoxical surplus value. The interpretative gap between the artist and his or her audience is taken by the artist (or by his or her critical champions) to represent the difference between the transfigured future, which the artist anticipates figurally, and the unredeemed present, which the audience literally embodies and from which the artist must break free. The audience’s lack of understanding with respect to the avant-garde work thus in no way discredits or devalues the work in the artist’s eyes. On the contrary, from the perspective of the avant-garde, this incomprehension indicates that the artist has authentically broken with the present and now stands in secret league with the future. The audience must be directed, perhaps even forced to catch up over time, to that which the artist has already discovered freely, through acts of artistic intuition and creation. But of course by that time the artist will have already moved on to new terrain, in perpetual revolt even against those utopian orders that presently can hardly be imagined.

Theories and Historiographies of the Avant-Garde

Theories and historiographies of the avant-garde have tended to emphasize one of the three dimensions of this basic ideological metaphor—political, formal, and temporal-historical—while downplaying or even excluding the others.

Examples of important formally-based theories and histories include the work of the art critic Clement Greenberg, who conceived of avant-gardism as the intensified focus of artworks on the essential properties of their media and attacked prominent avant-garde multimedial experimentation (such as minimalist sculpture) as leading to a bad theatricality akin to kitsch; Umberto Eco, who in his study *The Open Work* discussed the avant-garde's construction of works that require participatory completion by performers and audience; Julia Kristeva, who in *Revolution in Poetic Language*, sought to show how avant-garde poets such as Rimbaud and Mallarmé disrupted the grammatical means by which language functions as a vehicle of normal communication and ideology; and Marjorie Perloff, who traced out in a series of books the landmarks of a "poetics of indeterminacy," a futurist legacy, and a Wittgensteinian poetics.

Theorists of particular importance for the illumination of the political dimension of the avant-garde include Peter Bürger, whose *Theory of the Avant-Garde* focuses on the institutional status of art as autonomous from social life and the avant-garde's attempt to break down that autonomy and return art to its effective place in society; the urban historian Manfredo Tafuri, who considers the unanticipated role that avant-garde radicalism played in subordinating modern architecture and urbanism to big business, socialist planning, or the capitalist state; Fredric Jameson, who views the avant-garde as an intense site in which the contradictions of late capitalism were given aesthetic and experiential form; and the poststructuralist philosophers Jean-François Lyotard and Gilles Deleuze, who interpret avant-garde art as postconceptual models of embodied thinking in which mind, body, and technology merge in novel, free ways.

Theories focused on the temporal and historiographic dimension of the avant-garde are rarer than the other two, more dominant orientations, but these include the writings of the Frankfurt school philosopher Theodor Adorno, especially in his studies of modern music; the poet Octavio Paz's Harvard lectures, *Children of the Mire: Modern Poetry from Romanticism to the Avant-Garde*; Peter Osborne's *The Politics of Time: Modernity and Avant-Garde*; and Fredric Jameson's *A Singular Modernity*.

In the early years of the twenty-first century, however, a theory that accounts holistically for the interactions of all three dimensions of the avant-garde's basic metaphor—its constitutive identification of the formal with the political and the temporal-historical—had yet to appear.

See also *Arts: Overview; Avant-Garde: Militancy; Dada*.

BIBLIOGRAPHY

Adorno, Theodor W. *Philosophy of Modern Music*. Translated by Anne G. Mitchell and Wesley V. Blomster. New York: Continuum, 2003.

- Bürger, Peter. *Theory of the Avant-Garde*. Translated by Michael Shaw. Minneapolis: University of Minnesota Press, 1984.
- Deleuze, Gilles. *Francis Bacon: The Logic of Sensation*. Translated by Daniel W. Smith. Minneapolis: University of Minnesota Press, 2003.
- Eco, Umberto. *The Open Work*. Translated by Anna Cancogni. Cambridge, Mass.: Harvard University Press, 1989.
- Greenberg, Clement. "Avant-Garde and Kitsch." *Partisan Review* 6, no. 5 (1939): 34–49.
- . "Toward a Newer Laocoon." *Partisan Review* 7, no. 4 (1940): 296–310.
- Jameson, Fredric. *Postmodernism; or, The Cultural Logic of Late Capitalism*. Durham, N.C.: Duke University Press, 1991.
- . *A Singular Modernity: Essay on the Ontology of the Present*. London and New York: Verso, 2002.
- Kristeva, Julia. *Revolution in Poetic Language*. Translated by Margaret Waller. New York: Columbia University Press, 1984.
- Lyotard, Jean-François. *Duchamp's Transformers*. Translated by Ian MacLeod. Venice, Calif.: Lapis, 1990.
- Osborne, Peter. *The Politics of Time: Modernity and Avant-Garde*. London and New York: Verso, 1995.
- Paz, Octavio. *Children of the Mire: Modern Poetry from Romanticism to the Avant-Garde*. Translated by Rachel Phillips. Cambridge, Mass.: Harvard University Press, 1974.
- Perloff, Marjorie. *The Futurist Moment: Avant-Garde, Avant-Guerre, and the Language of Rupture*. Chicago: University of Chicago Press, 1986.
- . *The Poetics of Indeterminacy: Rimbaud to Cage*. Princeton, N.J.: Princeton University Press, 1981.
- . *Wittgenstein's Ladder: Poetic Language and the strangeness of the Ordinary*. Chicago: University of Chicago Press, 1996.
- Tafuri, Manfredo. *Architecture and Utopia: Design and Capitalist Development*. Translated by Barbara Luigia La Penta. Cambridge, Mass.: MIT Press, 1976.
- . *The Sphere and the Labyrinth: Avant-Gardes and Architecture from Piranesi to the 1970s*. Translated by Pellegrino d'Acerno and Robert Connolly. Cambridge, Mass.: MIT Press, 1987.

Tyrus Miller

MILITANCY

Gustave Courbet (1819–1877) was the first artist to assume the mantle of the avant-garde, savoring its military associations from within his outpost in the Pavillon du Réalisme he had constructed to exhibit his paintings that had been rejected by the official salon of the 1855 World's Fair. While the largest of these works—*Studio of the Painter: A Real Allegory* (1855)—could be thought to constitute a manifesto of Courbet's beliefs, he issued a written manifesto as well, in which he stated his determination to be "nothing but a painter."

Courbet's rejection from officialdom was institutionalized in 1863 by the Salon des Refusés, which France had been forced to set up next to the recognized salon in the Palais des Beaux-Arts. It was to this salon of the refused artists that Édouard Manet (1832–1883) was consigned, showing his *Déjeuner sur l'herbe* and *Olympia* to the shrieks of laughter of the scandalized visitors. Indeed, it was Manet's own determination to be "nothing but a painter" that incensed his viewers,



Dancers perform *The Rite of Spring*, English National Ballet, 2003. At the ballet's premiere in Paris in 1913, Igor Stravinsky's dissonant composition and the distinctly unusual choreography sparked outrage in the audience, which raised such an uproar that the dancers were unable to hear the music. © ROBBIE JACK/CORBIS

since his maintenance of the painterly qualities of his works led him to suppress the half-tones of representational shading and to flaunt wide expanses of percussive white paint in the eyes of his audience. "Nothing but a painter" was soon endowed with the epithet "*l'art pour l'art*" or art for art's sake, another mantle willingly assumed by the growing numbers of the self-professed avant-garde.

It is the position of Peter Bürger, whose *Theory of the Avant-Garde* (1984) remains the best treatment of this subject, that the withdrawal of the artist into the sanctuary of art for art's sake was the necessary condition for the formation of what he terms the "historical avant-garde," or the first wave of intensely militant activity that characterized the movements of futurism, cubism, dada, and surrealism during the opening decades of the twentieth century. Because their militancy was aimed at breaking down the barriers separating art from the life around it, it was necessary, Bürger maintains, that these barriers really existed. By incorporating the columns they cut from their daily newspapers into works now called *collage* (or gluing), the cubists transgressed the sanctity of the special province of the work of art. This same principle of transgression was practiced by the dada *photomonteurs*, such as John Heartfield and Hannah Hoch, who extended the collage technique to include photographic reproductions from

illustrated magazines in order to wage political battle against the mounting powers of fascism.

Another obvious example of this avant-garde indifference to the separation of art and life is the readymade, introduced by Marcel Duchamp (1887–1963) in the form of the urinal he entered into the New York Salon des Independents in 1917. For Bürger, these transgressive modes of operation constituted specific paradigms of avant-garde attack against the boundaries of *l'art pour l'art*. Further, he argued, after the historic avant-garde had come to an end during World War II, the postwar avant-garde had no ground on which to maneuver except that of repeating the already-explored paradigms of the earlier avant-garde: the readymade, the photo-montage, the monochrome painting, the assemblage. Bürger's designation for this state of affairs and the artists consigned to it is "neo-avant-garde," which would include the photo-montage canvases of Robert Rauschenberg (b. 1925), the readymades of Andy Warhol (1928–1987), the monochromes of Lucio Fontana (1899–1968), and so forth.

The cries of rage that greeted Manet's *Olympia* soon became the hallmark of the avant-garde as each new transgression elicited its own storm of protest, such as the audience that stormed out of the theater during Igor Stravinsky's (1882–1971) *Rite of*

Spring or the thunder of catcalls hurled at *Parade*, scored by Erik Satie (1866–1925) for typewriters and other machines.

The philosopher Stanley Cavell posits that these expressions of anger, triggered by the fear of being hoodwinked by a fraudulent work, are what characterizes modernism itself, such that “the dangers of fraudulence, and of trust, are essential to the experience of art” (pp. 188–189). In relation to the avant-garde, he writes, “What looks like ‘breaking with tradition,’ in the successions of art is not really that; or is that only after the fact, looking historically or critically; or is that only as a result not as a motive: the unheard of appearance of the modern in art is an effort not to break, but to keep faith with tradition. It is perhaps fully true of Pop Art that its motive is to break with the tradition of painting and sculpture; and the result is not that the tradition is broken, but that these works are irrelevant to that tradition, i.e., they are not paintings, whatever their pleasures” (pp. 206–207).

The scholar and critic Leo Steinberg has also emphasized this problem of fraudulence dogging the most important works of modernism and striking not just the outsider or layperson, but the inner circle of artists as well. In “Contemporary Art and the Plight of Its Public,” he reports Henri Matisse’s anger at Pablo Picasso’s *Les Femmes d’Alger* (1907), which he called “Picasso’s hoax,” and Georges Braque’s refusal of the picture with: “It is as though we were supposed to exchange our usual diet for one of tow and paraffin.”

Two important essays by the critic Clement Greenberg analyze the relation between the avant-garde and modernism: “Avant-Garde and Kitsch” (1939) and “Modernist Painting” (1960). As Greenberg defines it, in the 1939 essay, “Kitsch is a product of the industrial revolution which urbanized the masses of Western Europe and America and established what is called universal literacy” (1986, p. 11). He gives as its examples: “popular, commercial art and literature with their chromeotypes, magazine covers, illustrations, ads, slick and pulp fiction, comics, Tin Pan Alley music tap dancing, Hollywood movies, etc., etc.” (p. 11). If, as he puts it, “Kitsch is vicarious experience and faked sensations” (p. 12), there were artists who felt the need to resist this fraudulence. These, to which are given the name “avant-garde,” “sought to maintain the high level of [their] art by both narrowing it and raising it to the expectation of an absolute in which all relationships would be either resolved or beside the point. ‘Art for art’s sake’ and ‘pure poetry’ appear, and subject matter or content becomes something to be avoided like a plague” (p. 8). In order to pursue this “purity” the avant-garde artist detaches himself from bourgeois society to which he is nonetheless attached, as Greenberg puts it, “by an umbilical cord of gold.”

“Modernist Painting,” assuming the existence of the avant-garde, gives an account of how the “narrowing and raising” of a given art began historically, and what its new logic consists of. Defining modernism as an Enlightenment phenomenon, Greenberg locates its onset with Kant who “used logic to establish the limits of logic” (1993, p. 85). What then follows is that “the essence of Modernism lies . . . in the use of characteristic methods of a discipline to criticize the discipline itself, not in order to subvert it but in order to entrench it more firmly

in its area of competence” (p. 85). What each art sought, Greenberg argued, was to exhibit “not only that which was unique and irreducible in art in general, but also that which was unique and irreducible in each particular art” (p. 86). What follows from this is that “the enterprise of self-criticism in the arts become one of self-definition with a vengeance” (p. 86).

For painting itself, self-criticism produced as defining features: the flat surface, the shape of the support, and the properties of the pigment, all of which needed, under Modernism, to be acknowledged openly. “Manet’s,” Greenberg explains, “became the first Modernist pictures by virtue of the frankness with which they declared the flat surfaces on which they were painted” (1993, p. 86).

Greenberg’s avant-garde continues through the twentieth century, picking up ever-new strength and certainty. For him, Bürger’s “neo-avant-garde” could only be a version of Kitsch, the triumph of not-art in place of the real thing.

See also Avant-Garde: Overview; Dada; Modernism; Surrealism.

BIBLIOGRAPHY

- Bürger, Peter. *Theory of the Avant-Garde*. Translated by Michael Shaw. Minneapolis: University of Minnesota Press, 1984.
- Cavell, Stanley. “Music Discomposed.” In his *Must We Mean What We Say? A Book of Essays*. New York: Scribners, 1969.
- Greenberg, Clement. *The Collected Essays and Criticism*. Edited by John O’Brian. Vol. 1. Chicago: University of Chicago Press, 1986.
- . *The Collected Essays and Criticism*. Edited by John O’Brian. Vol. 4. Chicago: University of Chicago Press, 1993.
- Poggioli, Renato. *The Theory of the Avant-Garde*. Translated by Michael Shaw. Minneapolis: University of Minnesota Press, 1984.
- Steinberg, Leo. “Contemporary Art and the Plight of Its Public.” In his *Other Criteria: Confrontations with Twentieth-Century Art*. New York: Oxford University Press, 1972.

Rosalind Krauss

AZTLÁN. As a region in mythical geography, Aztlán (the land of the [white] herons) has a long history. According to the Náhuatl myth, the Aztecs (whose name is derived from Aztlán) were the last remaining tribe of seven, and they were advised by their god Huitzilopochtli to leave Aztlán in search of the promised land, which they would know by an eagle sitting on a cactus, devouring a serpent. They found it, and there they built Tenochtitlan, now Mexico City. Later the Aztecs remembered the region of their origin as an earthly paradise. Wanting to know more about it, Moctezuma Ilhuicamina (r. 1440–1469) sent his priests in search of Aztlán. They found it and gave the ruler a hyperbolic description of the place, as told by Diego Durán (1537–1588) in his *Historia de las Indias de Nueva-España y Islas de Tierra Firme*, a work finished in 1581 and translated into English in 1964 as *The Aztecs*. Although other early historians mention Aztlán, Durán presents the most elaborated description of the utopian nature of the city.

With few exceptions, the topic of mythical Aztlán was forgotten until the 1960s, when the rebirth of the myth flourished in Chicano thought. The cultural nationalists—one of the most important branches of the Chicano movement—appropriated the term *Aztlán* to establish the indigenous nature of their culture, a characteristic central to their philosophy. The appropriation of the myth took place during the “Crusade for Justice Youth Conference,” held in Denver in March 1969. It was there that for the first time the myth of Aztlán was mentioned in a Chicano document, “El Plan Espiritual de Aztlán.”

“El Plan,” which owes its creation to the poet Alurista, became the cultural nationalists’ manifesto. First, it establishes the unique nature of Chicano culture, since La Raza (the Bronze race) has an Aztec origin. The Spanish word *raza* means “the people,” and *raza de bronce* means “the brown people,” who claim to be descendants of the Aztecs. Second, it identifies Aztlán as the Mexican territory ceded to the United States in 1848—that is, present-day California, Arizona, New Mexico, and parts of Colorado. Third, following one of the basic ideas of the Mexican Revolution, it recognizes that the land belongs to those who work it. And fourth, it identifies the Chicano nation with Aztlán.

Aztlán became the symbol most used by Chicanos and Chicanas—activists as well as authors—writing about the history, the culture, or the destiny of their people. In April 1969 a group of concerned activists met in Santa Barbara and drafted *El Plan de Santa Barbara: A Chicano Plan for Higher Education*. Recommendation number nine deals with students’ organizations: “The various students groups, MAYA, MASC, UMAS, adopt a united name as symbol and promise; such as CAUSA (Chicano Alliance for United Student Action) or MECHA (Movimiento Estudiantil Chicano de Azatlán)” (p. 22). The name MECHA was adopted and is much in the news, as during the 2003 elections for governor of California one of the candidates, Cruz Bustamante, was attacked for having belonged to MECHA during his student days.

During the spring of 1970 the first number of the journal *Aztlán* (still in existence) was published, and in it the plan was reproduced in both English and Spanish. The prologue consists of a piece by the Chicano poet Alurista (b. 1947), “Poem in Lieu of Preface,” in which he unites the mythical Aztec past with the present. From that year on books based on the concept of Aztlán multiplied. The myth of Aztlán was popular not only among academics, but also among the common people. According to Michael Pina:

A cultural renaissance inspired by the powerful ideological thrust of cultural nationalism swept through the barrios of the Southwest. . . . Chicanos turned to pre-Hispanic myths and symbols. . . . The most outstanding example of this practice is illustrated by the vital role that the Aztec myth of Aztlán played in the development of Chicano nationalism. (Anaya and Lomelí, p. 40)

Artists and dramatists also took up the concept. In 1971 Luis Valdez (b. 1940), who had helped César Chávez organize

the farm workers, published his collection *Actos* (one-act plays). In the preliminary piece, “Notes on Chicano Theater,” Valdez states, “The concept for a national theatre for La Raza is intimately related to our evolving nationalism in Aztlán” (p. 3).

The myth has been utilized with advantage for political purposes. The novels of Miguel Méndez (b. 1930) and Rudolfo Anaya (b. 1937) are examples representative of two aspects of cultural nationalism based on the concept of Aztlán. In *Peregrinos de Aztlán* (1974) Méndez depicts the plight of the Yaqui Indians of the border in their peregrination back to Aztlán. The narrator, the old Yaqui Loreto Maldonado, tormented by the memories of his fallen and abused people, wants to take them back to Aztlán, the lost paradise.

Anaya’s *Heart of Aztlán* (1976) is also a novel about the search for Aztlán. Clemente Chávez, a man of some years, goes to the mountains, guided by the blind minstrel Crispín, on a truly imaginary pilgrimage: “They walked to the land where the sun rises, and . . . they found new signs, and the signs pointed them back to the center, back to Aztlán” (Anaya, pp. 129–130). For Anaya, Aztlán is not a political concept but a personal one. Clemente finds Aztlán in his own heart. “Time stood still, and in that enduring moment he felt the rhythm of the heart of Aztlán beat to the measure of his own heart. . . . A joyful power coursed from the dark womb-heart of the earth into his soul and he cried out I AM AZTLAN!” (Anaya, p. 131). This spiritual interpretation of Aztlán has been criticized by writers who believe that Chicano literature should be social, that literature of this type “didn’t contribute to that movement, or to bettering the life of the people in any way” (Johnson and Apodaca, p. 424).

For Clemente the search for Aztlán has ended. In a similar way it has also ended for the followers of cultural nationalism, as the movement—like the social movements of other ethnic groups—came to an end in the early 1980s. Even Alurista, the creator of the nationalist concept of Aztlán, in an interview with Wolfgang Binder agreed about the danger of idealizing the Aztecs and their myths. “Yes, without question, and I see it now” he said in 1981. “At the moment we are talking of a period during which the call of arms was the cry for self determination. So it was very important to be proud of everything we had been” (p. 4). In the early 2000s younger Chicanos and Chicanas considered the idealization of Aztec mythology as belonging to a romantic period in the history of their culture. While the symbolism of Aztlán still resonated in the literature, art, and political legacies that it helped inspire, few idealized that aspect of their historical past.

See also *Chicano Movement; Nationalism: Cultural Nationalism*.

BIBLIOGRAPHY

- Anaya, Rudolfo. *Heart of Aztlán*. Berkeley, Calif.: Justa, 1976.
 Anaya, Rudolfo, and Francisco Lomelí, eds. *Aztlán: Essays on the Chicano Homeland*. Albuquerque, N. Mex.: El Norte, 1989.
 See especially Michael Pina, “The Archaic, Historical, and Mythicized Dimensions of Aztlán,” 14–48, and “El Plan Espiritual de Aztlán,” 1–5.

Binder, Wolfgang, ed. *Partial Autobiographies: Interviews with Twenty Chicano Poets*. Erlangen, Germany: Palm and Enke, 1985.

Johnson, David, and David Apodaca. "Myth and the Writer: A Conversation with Rudolfo Anaya." In *Rudolfo A. Anaya: Focus on Criticism*, edited by César A. Gonzalez, 414–438. La

Jolla, Calif.: Lalo, 1990.

Plan de Santa Barbara: A Chicano Plan for Higher Education. Oakland, Calif.: La Causa Publications, 1969.

Valdez, Luis. *Actos: By Luis Valdez y El Teatro Campesino*. San Juan Bautista, Calif.: Cucaracha, 1971.

Luis Leal



B

BARBARISM AND CIVILIZATION. Barbarism and civilization are salt and pepper concepts that are inextricably interlinked. In the Western world, “barbarism” is derived from the classical Greek word *barbaros* (barbarian) that referred originally to foreigners who did not speak Greek. In the modern world, barbarism carries a negative connotation of unrefined and savage. “Civilization” is derived from the Latin word *civis* (citizen) that referred originally to those living in a Roman city. In the modern world, civilization carries a positive connotation of education and sophistication.

Although “barbarians” and “barbarism” come from the ancient world, “civilization” does not. Fernand Braudel maintains that “civilization” first appeared in 1732 in regard to French jurisprudence that “denoted an act of justice or a judgment which turned a criminal trial into civil proceedings” (p. 3). In 1752 the statesman Anne Robert Jacques Turgot used “civilization” to describe a process of being civilized. “Civilization” stood firmly against its opposite of “barbarism.” By 1772 “civilization” and its mate “culture” replaced “civility” in England and fostered *Zivilization* (civilization) alongside the older *Bildung* (culture) in Germany (see Braudel, p. 4).

Friedrich Engels: Barbarism and Civilization

Against this backdrop, the dual concepts of barbarism and civilization emerged in the works of Friedrich Engels (1820–1895), who was influenced by Lewis H. Morgan’s (1818–1881) pathbreaking study *Ancient Society* (1878). Engels writes: “Barbarism—the period during which man learns to breed domestic animals and to practice agriculture, and acquires methods of increasing the supply of natural products by human activity. Civilization—the period in which man learns a more advanced application of work to the products of nature, the period of industry and of art” (1972, p. 93). Homeric Greeks, native Italian tribes, Germanic tribes of Caesar’s time, and the Vikings represent the upper stages of barbarism. Citing descriptions in Homer’s *Iliad*, Engels continues: “Fully developed iron tools, the bellows, the hand mill, the potter’s wheel, the making of oil and wine, metal work . . . the wagon and the war chariot, shipbuilding with beams and planks, the beginnings of architecture as art, walled cities with towers and battlements, the Homeric epic and a complete mythology—these are the chief legacy brought by the Greeks from barbarism into civilization” (p. 92).

It is evident that modern Western ideas of barbarism and civilization have a hierarchy built in. On the one hand, barbarians are seen as belligerent precursors of civilization. On the other hand, civilization is considered a culturally advanced

stage of human development. Many of these ideas begin in ancient Greece.

Herodotus and the Barbarians

The Greek historian Herodotus (c. 484–420 B.C.E.) divides the world into those who speak Greek and those who do not. Barbarians are the latter. Herodotus writes: “But the Greek stock, since ever it was, has always used the Greek language, in my judgment. But though it was weak when it split off from the Pelasgians [originary Greek tribes], it has grown from something small to be a multitude of peoples by the accretion chiefly of the Pelasgians but of many other barbarian peoples as well” (p. 57). Herodotus further punctuates the Greek language: “But before that, it seems to me, the Pelasgian people, so long as it spoke a language other than Greek, never grew great anywhere” (p. 57). The Greeks saw the barbarians as fascinating enemies whose “natural status” was that of the slave (see Harrison, p. 3). Herodotus scrutinizes two “barbarian” cultures on the opposite ends of the spectrum: the Egyptians and the Scythians. In Egypt, the sky rarely rains while the river always rises when others fall; in Scythia, the sky rains in summer but not in winter while the river never changes; in Egypt, the Nile unites the land while in Scythia, the Danube divides the land into many districts; in Egypt there is one king while in Scythia there are many; in Egypt, they believe themselves to be the oldest of peoples while the Scythians believe themselves to be the youngest; in Egypt, culture is marked by strict religious rituals that rarely change while the Scythian culture illustrates constant change and varying rituals (see Herodotus, pp. 138–290, cf. Redfield, pp. 35–37). As Herodotus claims, the Egyptians know many things while the Scythians know one great thing, “how no invader who comes against them can ever escape and how none can catch them if they do not wish to be caught. For this people has no cities or settled forts; they carry their houses with them and shoot with bows from horseback; they live off herds of cattle, not from tillage, and their dwellings are on their wagons” (p. 298). At the time of Alexander the Great (356–323 B.C.E.), the Persians were the main barbarian adversaries. Fighting his way through Asia, he arrived at Maracanda (Samarkand, Uzbekistan) in Sogdiana, the first meeting point of Eastern and Western civilizations (see Arrian, pp. 351–537). Although Alexander occupied the fortified citadel, he was unable to secure it because of counterattacks by Scythian coalitions. A major city on the Silk Road, Samarkand was the site for Chinese paper mills established in the early eighth century (see Gernet, p. 288) and the center of a Turkic-Mongol empire under Tamerlane in the fourteenth century (see Nicolle). Tamerlane’s grandson, Ulugh-Beg (1394–1449), was an astronomer who built



Attila Burning Townships during the Invasion of Italy, woodcut, c. 19th century. Embodying the barbarian threat to Western civilization, Attila the Hun (406?–453) conquered much of Central Europe. Although tribes such as the Huns were all overthrown by stronger forces of civilization, they represented what Arnold J. Toynbee termed a barbarian “heroic age.” © BETTMANN/CORBIS

an observatory at Samarkand and was the first since Ptolemy to compile a star chart.

Toynbee’s Rhythm of History

Paying close attention to the ancient Greeks and Romans, Arnold Toynbee did not subscribe to a linear, hierarchical view of civilization. Even Karl Marx and Friedrich Engels’s dialectical approach to history resulted in successive stages of development toward a desired end (see Marx and Engels, pp. 23–40). Although Toynbee’s own vision of human history was nostalgic for the lost past and pessimistic for the future, his comparative theory of civilizations (East and West) was linked to an acute understanding of Greek philosophy and an essentialist view of Chinese philosophy. Toynbee concentrates on the idea of a “rhythm” of history. On the one hand, Empedocles’ ancient Greek philosophy sees the universe caught in the ebb and flow of a rhythmic alternation of the “integrating force” of love and the “disintegrating force” of hate, a unity arising from plurality and a plurality arising from unity (see Toynbee, 1935, pp. 200–201). On the other hand, Chinese philosophy sees the universe caught in the ebb and flow of a rhythmic alternation of the “shadow” force of yin and the “sunshine” force of yang: “Each in turn comes into

the ascendant at the other’s expense; yet even at the high tide of its expansion it never quite submerges the other, so that, when its tide ebbs, as it always does after reaching high-water mark, there is still a nucleus of the other element left free to expand, as its perpetual rival and partner contracts” (p. 202). Toynbee’s assessment of the growth and breakdown of civilizations is a yin-yang beating out of “the song of creation” through challenge and response, withdrawal and return, and rout and rally (Toynbee, 1939, p. 324).

Through this rhythm of history, tensions between state and church are disrupted by an interregnum of barbarians that Toynbee calls collectively the *Völkerwanderung* (the wandering peoples). In the Western world, this refers to Germanic and Slavic tribes from the north on the borders of the Greco-Roman civilization as well as Sarmatians and Huns from the Steppes of Eastern Europe. Although they were all overthrown by stronger forces of civilization, these wandering tribes represent a barbarian “heroic age” (Toynbee, 1939). The Vandals and Ostrogoths were destroyed by Roman counteroffensives, while Visigoths succumbed to both Frankish and Arabian assaults. In the long run, Toynbee felt the barbarians had little impact on Western civilization because the church was more powerful in regard to cultural and philosophical transmissions (see 1935, pp. 58–63, cf. Bury, pp. 177–230).

Toynbee could not apply his yin-yang theory of history in any great detail to China itself. In *Reconsiderations*, he laments the lack of a classical Chinese upbringing: “I should, of course, have taken Chinese, not Hellenic, history as my model, and I should have seen Chinese history as a series of successive realizations of the ideal of a universal state, punctuated by intermediate lapses into disunion and disorder . . . the Yin-Yang rhythm would be cyclical without having any regular periodicity” (1960, p. 188).

China’s Yin-Yang Polarities

A closer look at China validates Toynbee’s suspicions. China had ancient words for both “civilization” and “barbarism” that are still in use today. *Wenming* refers literally to a bright and clear culture that possesses writing, art, and literature. In China’s classical world, the most used term for barbarian was *hu* (beard), which gave rise to expressions such as *huche* (talk nonsense) (see Wilkinson, p. 724). The Chinese word for barbarian combined both the Roman idea of *barbarus* (“the bearded one”) and the Greek idea of *barbar* (“talk nonsense”). The Han dynasty expression *yiyi gong yi* (“use barbarians to attack barbarians”) (see Wilkinson, p. 723) is reminiscent of Julius Caesar’s deployment of subdued Germanic and Gallic cavalry at Alesia against Vercingetorix’s Gallic horsemen (see Caesar, pp. 186, 218, 221).

Although the Greeks, Romans, and Japanese share a centralized view of their own respective civilizations, it is only the Chinese who name theirs as such. In the Wei and Jin periods (220–420 C.E.), Zhongguo (Middle Kingdom) and Huaxia (Cathay) were syncopated into Zhonghua (Central Cultural Florescence) (see Smith, p. 3), making civilization both a geographic and cultural entity for all under heaven. Even today, the term for “middle kingdom” is retained in the name of the People’s

Republic of China (*Zhonghua renmin gongheguo*). As Richard Smith, a renowned historian of China, maintains: “Barbarian conquest affirmed and reinforced this Sinocentric world view rather than shattering it” (p. 3). Like Toynbee, Smith sees every aspect of Chinese civilization, including barbarian intrusion, as following the polarities of yin and yang. He writes: “Yin and yang were, then (1) cosmic forces that produced and animated all natural phenomena; (2) terms used to identify recurrent, cyclical patterns of rise and decline, waxing and waning; (3) comparative categories, describing dualistic relationships that were inherently unequal but almost invariably complementary” (p. 4). Hence, yin and yang are mutually conditioning linked opposites that are co-constitutive of Chinese cosmology. When Smith writes that “the boundaries of China waxed and waned in response to periodic bursts of either Chinese expansion or ‘barbarian’ invasion” (p. 11), he echoes Toynbee’s universal rhythm for civilizations as “the perpetual alternation of a Yin state of quiescence with a Yang burst of activity” (1960, p. 188).

Mongols and Manchu Emperors

Non-Han peoples as “outsiders” were “dynamically and inextricably intertwined” with Chinese civilization (Smith, p. 11). Confucians felt that barbarians could adopt Chinese culture and become Chinese (see Ebrey, p. 179). Therefore, the history of China is the history of barbarian withdrawal and return. The pressure of the Ruzhen (Jurchen descendants of the Xiongnu) invasion in the Jin dynasty and the Mongol attacks of the thirteenth century forced the southern courts to establish strict civil service examinations. As the Mongols Genghis Khan (c. 1162–1227) and his grandson Kublai Khan (r. 1260–1294) adapted to Chinese culture, Confucian-style civil service examinations were reestablished. In 1313 the commentaries of the neo-Confucian Zhu Xi were included in these examinations, where they lasted until 1904 (see Smith, p. 37). The overthrow of the Mongols by Chinese patriots in the Ming dynasty saw the reinstatement of a Qin-Han structure of civil, military, and despotic reign. In turn, the Ming were ousted by the Manchu (Tungusic descendants of the Ruzhen), who marked the beginning of the Qing dynasty. The Manchu were organized under banners or civil-military units distinguished by colored flags. Before 1644, their administrative units for conscription and taxation recruited Chinese and Mongols. By 1648, the “multi-ethnic army” of bannermen included less than 16 percent Manchu (see Naquin and Rawski, pp. 4–5). Like the Mongols, the Manchu adopted Chinese culture, allowing for a renaissance of ancient philosophy and literature (see Goulding). While the first emperor of China burned most of the books in the known world, the Manchu established the largest known library that included literature and philosophy of China’s classical age (see Smith, p. 3; cf. Wilkinson, pp. 273–277, 485). Although censorship saw the destruction of many Ming books, the Complete Library of the Four Treasuries (1772–1782) resulted in seven sets of thirty-six thousand volumes (see Naquin and Rawski, p. 66). Whereas the Western world annihilated barbarians in a quest for civilization, the Eastern world accommodated them as co-constitutive elements of its yin-yang cosmology.

See also *Confucianism; History, Idea of; Marxism; Yin and Yang*.

BIBLIOGRAPHY

- Arrian. *History of Alexander and Indica*. Vol. 1. Translated by P. A. Brunt. Cambridge, Mass.: Harvard University Press, 1976.
- Braudel, Fernand. *A History of Civilizations*. Translated by Richard Mayne. New York: Penguin Books, 1995.
- Bury, J. B. *The Invasion of Europe by the Barbarians*. New York: W. W. Norton and Company, 2000. First published in 1928.
- Caesar, Julius. *The Conquest of Gaul*. Translated by S. A. Handford. London: Penguin Books, 1951.
- Curtin, Jeremiah. *The Mongols: A History*. Boston: Little, Brown, 1908. Reprint, Cambridge, Mass.: Da Capo Press, 2003.
- Ebrey, Patricia Buckley. *Cambridge Illustrated History of China*. Cambridge, U.K.: Cambridge University Press, 1999.
- Engels, Friedrich. *The Origin of the Family, Private Property, and the State*. Edited by Eleanor Burke Leacock. Translated by Alec West. New York: International Publishers, 1972.
- Gernet, Jacques. *A History of Chinese Civilization*. 2nd ed. Translated by J. R. Foster and Charles Hartman. Cambridge, U.K.: Cambridge University Press, 1996.
- Goulding, Jay. “‘Three Teachings Are One’: The Ethical Intertwinings of Buddhism, Confucianism, and Daoism.” In *The Examined Life—Chinese Perspectives: Essays on Chinese Ethical Traditions*, edited by Xinyan Jiang. Binghamton, N.Y.: Global Academic Publishing, Binghamton University, 2002.
- Harrison, Thomas. “General Introduction.” In *Greeks and Barbarians*, edited by Thomas Harrison. London: Routledge, 2002.
- Herodotus. *The History*. Translated by David Grene. Chicago: University of Chicago Press, 1987.
- Marx, Karl, and Friedrich Engels. *The Communist Manifesto*. Edited by Samuel H. Beer. Northbrook, Ill.: AHM Publishing, 1955.
- Morgan, David. *The Mongols*. Oxford, and New York: Blackwell, 1986.
- Morgan, Lewis Henry. *Ancient Society*. New York: Henry Holt, 1878. Reprint, Tucson: University of Arizona Press, 1985.
- Naquin, Susan, and Evelyn S. Rawski. *Chinese Society in the Eighteenth Century*. New Haven, Conn.: Yale University Press, 1987.
- Nicolle, David. *The Age of Tamerlane*. Oxford: Osprey Publishing, 1990.
- Redfield, James. “Herodotus the Tourist.” In *Greeks and Barbarians*, edited by Thomas Harrison. London: Routledge, 2002.
- Smith, Richard J. *China’s Cultural Heritage: The Qing Dynasty, 1644–1912*. 2nd ed. Boulder, Colo.: Westview Press, 1994.
- Toynbee, Arnold J. *A Study of History*. Vol. 1. 2nd ed. London: Oxford University Press, 1935.
- . *A Study of History*. Vol. 6. London: Oxford University Press, 1939.
- . *A Study of History*. Vol. 12: *Reconsiderations*. London: Oxford University Press, 1960.
- Wilkinson, Endymion. *Chinese History: A Manual*. Rev. and enlarged. Cambridge, Mass.: Harvard University Asia Center, 2000.

Jay Goulding

BAROQUE. See *Periodization of the Arts*.

BELIEF. See *Religion*.

BEAUTY AND UGLINESS. Beauty is a vital and central element of human experience. It is associated with pleasure, which influences personal choices and cultural developments. Poets praise it, artists strive to capture it in their works, moralists warn against its deceiving influence, scientists seek to uncover its secrets, and philosophers reflect on its illusive nature. Expressions of the vitality of beauty in its role in everyday life are found in any culture. The attraction of beauty, the desire to be beautiful and obtain beautiful objects, is universal, although the manifestations of this desire vary across cultures and ages. Classical Western philosophy has regarded beauty as one of the three fundamental concepts of human understanding: truth (and falsehood), good (and evil), beauty (and ugliness). However, in the seventeenth century beauty was considered a marginal concept, while in the twentieth century it came to be regarded as dispensable altogether.

Beauty is typically related to the visual field, but is not limited to it. The Hebrew Bible attributes beauty mainly to human appearance and natural scenery, but also to the voice (Ezekiel, 33:32), to wisdom (Ezekiel, 28:7), and to God (Psalms, 50:2). The ancient Greeks ascribed beauty to things that are morally good, appropriate, and pleasing, be they natural objects or artifacts, tangible and concrete or abstract, personal deeds, or social institutions. In China beauty refers to wealth, longevity, talent, good reputation, and behavior. There appears to be a cross-cultural agreement that beauty is relevant to all aspects of life, but the nature of the concept and its actual applications are a matter of constant dispute. The variety of tastes and their suppleness, the difficulties in justifying judgments of beauty (and in determining their common ground) indicate that the idea of beauty is far more complicated than the way it appears in everyday experience.

Theories of beauty typically focus on two aspects: defining beauty, and determining its function and significance.

Definitions of Beauty

In the *Greater Hippias*, Plato (c. 428–348 or 347 B.C.E.) ascribes to Socrates the viewpoint that knowledge of beauty is a prerequisite for actual applications: one cannot properly distinguish between beautiful and ugly objects without knowing what beauty is. On the other hand, in the *Symposium*, Plato has Diotima argue that knowledge of beauty begins with direct experience of particular cases and knowledge of the abstract form of beauty is the highest and final stage, distilled from everyday experience.

Direct experience, Socrates claims, is unreliable. It reveals a complex of contradicting qualities that cohabit in the same object: any beautiful object is at the same time not beautiful when compared with a higher beauty. Appearance can be misleading. A person may appear beautiful when wearing suitable clothes, although he is not truly beautiful. Socrates in fact dismisses all expressions of physical beauty as untrustworthy. The ultimate beauty that contains no contradicting elements is beyond earthly experience. Plato portrays such absolute beauty in the *Phaedo*, where Socrates sees its heavenly form. Socrates rejects further the idea that beauty is that which functions properly: an object may function well, but if its purpose is evil,

the object is not beautiful. He also disagrees that beauty should be defined as a cause of delight. The good, Socrates argues, also causes delight, and the two should be kept distinct.

Socrates concludes in the *Greater Hippias* that beauty is difficult to define. Voltaire (1694–1778) goes further to argue that beauty, due to its relativist nature, is not just difficult but impossible to define. In his *Philosophical Dictionary* (1764) Voltaire writes that the toad sees beauty in large round eyes and a flat snout, and the devil sees beauty in a pair of horns and four claws. Epicharmus (c. 530–c. 440 B.C.E.), the comic dramatist, similarly remarks that a dog considers a dog the most beautiful creature, and equally an ox prefers an ox, a donkey a donkey, and a pig a pig. Realizing that beauty has no common core, Voltaire believes that one had better save oneself the trouble of attempting to study its nature.

Neither the difficulties presented by Socrates nor Voltaire's reservations have discouraged philosophers, artists, critics, and scientists from reflecting upon the nature of beauty throughout the centuries. Attempts to define beauty can be divided into two main groups: theories that regard beauty as a form of order and theories that regard beauty as a kind of pleasure. Theories of beauty may be divided further according to the logical status assigned to beauty: objective, subjective, relative, and relational. The objective approach asserts that beauty inheres in the object, and that judgments of beauty have objective validity. The subjective approach maintains that beauty is not a quality of the object but rather a creation of the mind. Relativism tends to associate beauty with cultural values, and the relational approach regards beauty as a product of both the object and the contemplative mind.

Beauty as a form of order. The Pythagoreans believed that beauty is a manifestation of harmonious, mathematical relations such as the golden section. In this proportion a straight line, c , is divided by two unequal parts, a and b , in such a way that the ratio of the smaller, a , to the greater part, b , is the same as that of the greater part, b , to the whole, c . Ugliness is the expression of disorder and a lack of rational proportions. Beauty was thus considered an objective expression of cosmic truth. The ancient Egyptians were probably the first to use the golden section in the design of the Pyramids, but it was Pythagoras of Samos (c. 580–c. 500 B.C.E.) who first presented its mathematical formulation.

Many have followed the Pythagorean notion of order. Plato writes that proportions constitute beauty (*Philebus*). Aristotle (384–322 B.C.E.) associates beauty with order and size in *Poetics*, and with symmetry and definiteness in *Metaphysics*. St. Augustine of Hippo (354–430) holds that beauty is based on numbers (*De libero arbitrio*). St. Thomas Aquinas (c. 1224–1274) mentions proportion and harmony among the three requirements of beauty (*Summa theologica*). Gottfried Wilhelm von Leibniz (1646–1716) describes beauty as an obscure, sensual perception of mathematical configurations (*Principles of Nature and Grace Based on Reason*, 1714), and the painter William Hogarth (1697–1764) formulates principles of beauty applicable to art (*The Analysis of Beauty*, 1753). Many other authors expressed similar views.

Plotinus (205–270) is an exception. In *Enneades* (I, 6) he rejects the idea that beauty consists of order and proportion. His main points are: (1) Proportions, order, symmetry, and harmony apply to compound objects, while beauty is also found in simple elements like sunlight or gold. (2) The parts of a beautiful object must be beautiful, too, because beauty cannot consist of ugly elements. However, the parts themselves are simple and cannot convey order. (3) A beautiful face may look ugly when it expresses anger or wickedness, yet its proportions are the same. (4) Physical beauty is a reflection of the divine beauty, which unifies the formless multiplicity of matter. Thus, unity, not complexity, is essential to beauty.

Notwithstanding Plotinus's criticism, the Pythagorean notion of beauty became influential in Western philosophy for two principal reasons: The association of beauty with order was appealing to the rational mind, and experience suggests that the parts of a beautiful object are well situated, complement each other, and create a unified whole. This understanding generated the notion of unity in variety: Beauty resides in complexity that is unified by order. Accepting the fact that order is the key concept for understanding beauty, the question arises whether there are unifying laws of beauty that apply to all cases of beautiful objects, in the same way that the laws of nature apply to all physical phenomena.

Alexander Baumgarten (1714–1762) believed that the laws of beauty, like the laws of nature, could be uncovered by systematic, empirical investigations. He called for the establishment of a new science, which he named *aesthetics*. This science was intended to investigate direct perception in which particular representations are combined into a whole. Baumgarten was not influential among philosophers, but psychologists and mathematicians from the nineteenth century onward pursued his vision, seeking to translate the traditional formula—unity in variety—into measurable variables. In the field of psychology, the investigation of beauty is associated mainly with Gestalt theory and experimental aesthetics. Ernst H. Weber (1795–1878) and Gustav T. Fechner (1801–1887) investigated sensual perceptions and the relation between the intensity of the stimulus and the responsive sensation it causes. Fechner founded experimental aesthetics and made it a branch of psychology. Max Wertheimer (1880–1943), Wolfgang Köhler (1887–1967), and Kurt Koffka (1886–1941) defined the principles of the “good gestalt” (*Prägnanz*) and examined its application in various fields. A good gestalt expresses order, regularity, simplicity, stability, and continuity. According to Hans J. Eysenck (1916–1997), the fundamental law of aesthetics derives from the law of the good gestalt while, conversely, the law of aesthetics determines the properties of the good gestalt (1942).

In the mathematical realm we find George D. Birkhoff (1884–1944), who analyzed polygons and vases in order to formulate a concept of beauty. Birkhoff's conclusion is that the pleasure derived from any work of art or object of beauty depends on two variables: order (O), which expresses the unity of the object, and complexity (C), or the diversity exhibited by the object. The resulting measure of the aesthetic pleasure (M) derived from an object is then expressed mathematically:

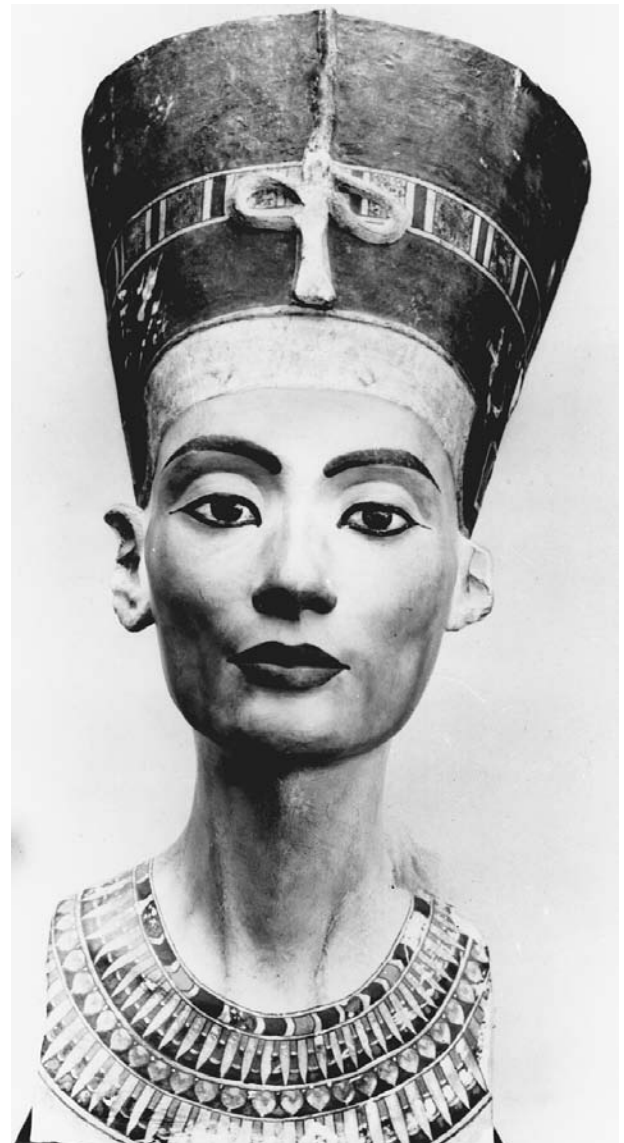

Statue head of Queen Nefertiti, Egypt, 14th century B.C.E. Beauty has long been considered by many to play a prominent role in sexual selection among both animals and humans. Noted feminist Camille Paglia believes this theory can be traced back as far as ancient Egypt. © CORBIS-BETTMANN

$M = O/C$ —that is, aesthetic pleasure is equal to the ratio of order to complexity (*Aesthetic Measure*, 1933).

From a different perspective, information theory inspired the idea that beauty is a measurable informative value. This theory offers a mathematical apparatus that describes, analyzes, and measures the transmission of information in communication systems. A clear message—namely, a highly ordered message—is a message of low informative value, high redundancy, and high predictability. Since the elements of a beautiful object are obviously neither redundant nor predictable, beauty in this context is regarded not as a form of high order, but rather as a happy medium, a balance between high order and disorder. Sir Fran-



The Parthenon on the Acropolis, Athens, Greece. One of the many definitions of beauty focuses on order and symmetry. Philosophers such as Plato, Aristotle, and the Pythagoreans considered harmonious proportions—often based on mathematical formulas—as an indication of beauty. © BETTMANN/CORBIS

cis Galton (1822–1911) demonstrates this idea of averages by superimposing photographs of convicted murderers and distilling a single photograph out of the many images. According to the viewers who examined the photos, this composite photograph was the best-looking face of all the original ones. Galton concluded that the average (composite) face is free from the irregularities that variously blemish each of the individual faces (1878).

Daniel E. Berlyne (1924–1976), one of the leading figures of experimental aesthetics in the twentieth century, sets the idea of happy medium in a psychological perspective. He describes the pleasure derived from beauty and good art as a reduction of arousal. The complexity of the object generates arousal in tension, and subsequently, when the unified whole is perceived, tension is reduced. According to Berlyne, experiments tend to confirm that some intermediate degree of complexity produces the most pleasing effect and that extremes of simplicity or complexity are distasteful (*Conflict, Arousal, and Curiosity*, 1960).

Monroe C. Beardsley (1915–1985), one of the most influential aestheticians of the last century, criticizes attempts to render beauty or good art in terms of a happy medium or an

average. He maintains that the identification of complexity with disorder fails to explain the fact that complexity is a relevant ground for praise, and that the degree of informative value is not high enough to establish the aesthetic worth of an object. Beardsley agrees that beauty is a form of order, but argues that the beauty formula inspired by information theory leads to absurdities. Aesthetic order, according to Beardsley, escapes mechanical patterns and is marked by freedom, diversity, and uniqueness (1968). Abraham Moles (1920–1992) similarly acknowledges the limitations of information theory. He distinguishes between semantic information and aesthetic information. Semantic information has a universal logic and can be expressed in different languages. Aesthetic information cannot be translated into any other language or system of logic; it refers to particular objects apprehended by particular spectators (1966).

The notion of organic form or an organic whole suggests that beauty expresses a nonmechanical order consisting of inner forces or structures. In an organic form the whole precedes the differentiation of the parts, and the various parts are interdependent. Plato is the first to offer a formulation of art as an organic form (*Phaedrus*) in relation to literary works of art. Samuel T. Coleridge (1772–1834) turns to organic form in his

defense of Shakespeare's works against the claim that they are formless. He emphasizes the harmony required in such works, not only between parts but also between matter and form. George E. Moore (1873–1958) adds that the value of an organic whole is different from the sum of its parts (*Principia Ethica*, 1903). Harold Osborne (1905–1987) defines aesthetic order in terms of an organic whole that cannot be reduced to its parts and is, therefore, directly apprehended as a whole. Beauty is an emergent property of a whole that reflects upon the parts, although each of the parts on its own is aesthetically neutral (1982). Heinrich Wölfflin (1864–1945), an influential art historian, describes good art as an organism in which nothing could be changed or moved from its place, but in which all must be as it is (*Principles of Art History*, 1915). Ruth Lorand, however, argues that the concept of an organic whole ignores, in most of its variants, the quantitative aspect of beauty. Some objects are more beautiful than others, and absolute beauty of the kind described by Wölfflin and others is hardly ever found. Aesthetic order, according to Lorand, is quantitative, highly informative, unpredictable, and, paradoxically, an order without laws (2000).

Beauty as a kind of pleasure. The immediate connection between beauty and feeling, and the difficulties inherent in defining beauty as a quality of the object, have given rise to the idea that beauty is not a quality of the object, but rather an emotion evoked by the object. St. Augustine asks whether an object is beautiful because it pleases or pleases because it is beautiful, and answers that the object pleases because it is beautiful. That is, beauty is the cause of pleasure and not identical with it (*De vera religione*). By contrast, Thomas Aquinas does not separate beauty from pleasure; he calls that beautiful whose apprehension pleases us. The definition of beauty as an expression of emotion usually renders judgments of beauty individual and subjective. René Descartes (1596–1650) regards beauty as totally subjective and dependent on individual conditions (letter to Marin Mersenne, 1630). Baruch Spinoza (1632–1677) dismisses beauty as mere sensual content. He mocks those who believe that beauty is objective, and that God, too, finds delight in beautiful things. (*Ethics*, I, appendix, 1667).

Empiricists of the eighteenth century, however, regarded this subjective aspect of beauty as an informative indication of human nature. Taste, the capacity for appreciating beauty, became a key concept. Francis Hutcheson (1694–1746) defines beauty as a source of pleasure that indicates not only qualities found in the object, but also the character of the spectator's sense of beauty (*Inquiry into the Original of Our Ideas of Beauty and Virtue*, 1725). Joseph Addison (1672–1719) writes that perhaps there is no real beauty, only certain modifications of matter that the mind pronounces beautiful (*The Spectator*, 1712). In his *Essays on the Intellectual Powers of Man* (1785), Thomas Reid (1710–1796) describes beauty as an occult quality: we know how it affects our senses, but not what it is in itself. According to Edmund Burke (1729–1797), beauty is the quality that causes love or passion and is not an objective quality like proportion (*A Philosophical Enquiry into the Origin of Our Ideas on the Sublime and Beautiful*, 1757). Archibald

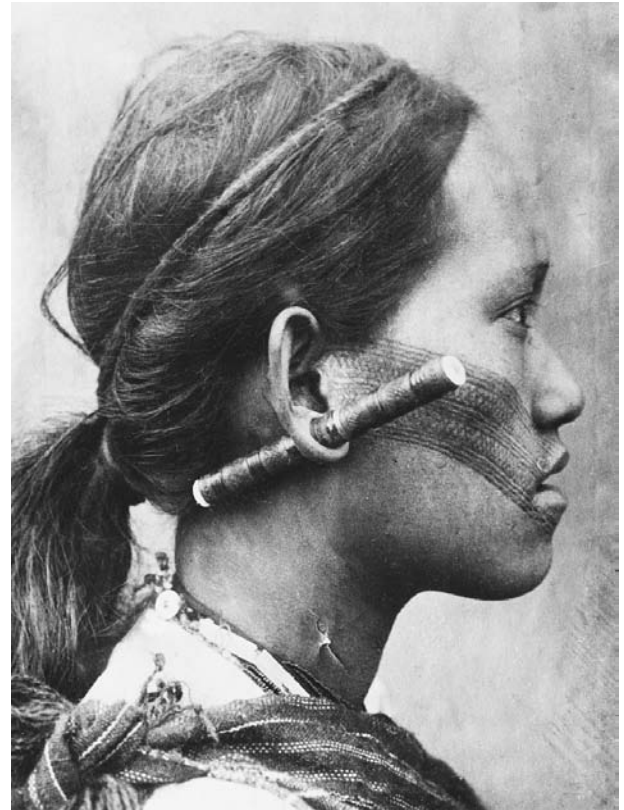

Woman with tattooed face, China, c. 1900. The concept of beauty often varies from culture to culture. Physical enhancements such as tattoos, elaborate piercings, and facial hair may be considered beautiful among some societies but ugly among others. © MICHAEL MASLAN HISTORIC PHOTOGRAPHS/CORBIS

Alison (1757–1839) goes further, arguing that it is impossible to imagine an object of taste that is not an object of emotion (*Essays on the Nature and Principles of Taste*, 1790).

David Hume (1711–1776) writes in the same spirit that Euclid did not mention the beauty of the circle in any of the relevant propositions because beauty belongs to the sentiment of the spectator and is not a quality of the circle (*Enquiry Concerning the Principles of Morals*, 1751). He defines beauty as an expression of a subjective order that reflects our nature, customs, or capricious inclinations (*A Treatise of Human Nature*, 1739). In his influential essay *Of the Standard of Taste* (1757), Hume observes that different spectators equally praising the beauty of the same object does not necessarily indicate that they refer to the same features, or that they find delight for the same reasons.

Immanuel Kant (1724–1804), regarded as the most influential figure in modern philosophy, sought to bridge the gap between rationalism and empiricism. His account of beauty in *Critique of Judgment* (1790) is the first systematic analysis of the aesthetic phenomenon in modern philosophy. Kant rejects Baumgarten's vision of aesthetics as a science and holds that genuine judgments of beauty do not convey knowledge; they are individual judgments that cannot be generalized. Like Burke, he distinguishes between the beautiful and the sublime: Beauty



Illustration from *Beauty and the Beast* (1874) by Walter Crane. Freud believed that humans found beauty in that which inspired sexual feelings. Darwin concurred with this theory, claiming that beauty played a role in the courting habits of many diverse cultures. © HISTORICAL PICTURE ARCHIVE/CORBIS

pleases through the free play of imagination and understanding and sustains the mind in restful contemplation. The sublime presents a disharmony between sensual capacities and reason. Thus, the feeling of the sublime carries with it a mental agitation: it is a pleasure compounded with displeasure. Kant defines beauty in terms of a peculiar kind of pleasure that consists in paradoxical features. He formulates four elements of the pleasure evoked by beauty: (1) Unlike the pleasures of the good and the pleasant, the pleasure of the beautiful is devoid of all interest. It is a disinterested pleasure. (2) Unlike other pleasures, the pleasure of the beautiful is not based on concepts. It is a non-conceptual pleasure. (3) The pleasure of the beautiful is a form of purposiveness without the presentation of a purpose. That is, the beautiful object demonstrates an inner order that is not subordinated to any external purpose. (4) The pleasure of the beautiful raises expectations for universal agreement. It is cognized as the object of a necessary liking. The necessity of universal assent that we associate with judgment of taste is a subjective necessity that we present as objective by presupposing a common sense. Kant, therefore, defines beauty as subjective-objective.

Many authors after Kant, however, preferred to deny the objective aspect of beauty and defined it as essentially subjective. Edgar Allan Poe (1809–1849) writes in *The Philosophy of Composition* (1846) that when men speak of beauty, they do not mean a quality but an affect—an intense and pure elevation of the soul. George Santayana (1863–1952) follows Hume by stating that beauty is not a property of an object. It is an emotion, a pleasure that is erroneously regarded as a quality of the object, such as color, proportion, or size. In this view, beauty is a value that reflects the beholder's position, and therefore is

entirely subjective. The tendency to relate beauty to objects and expect other people to experience the same beauty is, according to Santayana, a strange psychological phenomenon that calls for psychological investigation (*The Sense of Beauty*, 1896).

However, not all of those who explain beauty in terms of pleasure consider it subjective. Clarence I. Lewis (1883–1964), for instance, regards all evaluations, including aesthetic evaluation, as forms of empirical knowledge. In *An Analysis of Knowledge and Valuation* (1946), he states that all forms of empirical knowledge are relational—that is, they depend equally on both the qualities of the object in question and the contribution of the contemplating mind. Viewing beauty as a relational quality bypasses the subjective-objective conflict and draws similarities between perception of beauty and relational perception of other qualities. Samuel Alexander (1859–1938) maintains that beauty is a kind of illusion that depends on the viewer's perspective. The perceived beauty is a result of a mutual contribution of the genuine qualities of the object as well as the mind that apprehends it (*Space, Time and Deity*, 1920).

John Locke (1632–1704) differentiates between objective and relational qualities. The former are primary qualities independent of the spectator's apprehension; the latter are secondary and tertiary qualities that reflect sensual perceptions and emotional reactions (*An Essay Concerning Human Understanding*, 1690). Following this understanding, David W. Prall (1886–1940) maintains that beauty is constituted in pleasurable apprehension and is therefore a tertiary quality that reflects the spectator's reaction to the object's qualities (*Aesthetic Judgment*, 1929). Beauty, as a tertiary quality, is most sensitive to individual differences

among spectators. Individuality is also central in Mary Mothersill's definition of beauty. According to Mothersill, an object is beautiful if it causes pleasure by virtue of its aesthetic properties. Aesthetic properties are the properties that define the individuality of the object and distinguish it from others. The measure of beauty, so Mothersill holds, demands a reliable affect theory, since the measure of beauty is in fact the measure of the emotion it causes (1983).

Opposites of beauty. Examining the opposites of beauty illuminates the nature of beauty from a different angle. Although ugliness seems to be the immediate opposite of beauty, the complexity and peculiarity of the concept generates more than one opposite, each contrasting beauty in a different way.

The ugly. George E. Moore defines beauty in terms of the good—that of which the admiring contemplation is good in itself—and, accordingly, ugliness in terms of evil—that of which the admiring contemplation is evil in itself (1903). Understanding beauty in terms of order renders ugliness as a form of disorder. Rudolf Arnheim defines it as a struggle of conflicting, uncoordinated orders (1966). Conflicts express trends and values and therefore ugliness, like beauty, is a matter of cultural conceptions. For example, in the 1939 film *Gone with the Wind*, hair dyed shocking red is associated with prostitution and is thus considered ugly; it created a conflict with the prevailing standards of decency. Contemporary Western notions of decency are different; as a result, the sight of colored hair is no longer shocking or perceived as irregular, as it used to be.

The boring. Boredom indicates a failure to maintain a sufficient degree of novelty or a failure to deal with materials that interest the observer. This may partly explain the phenomenon of fashion: an oft-repeated style gradually loses its charm and fails to evoke the pleasure it generated before. When set in opposition to beauty, boredom indicates that beauty is stimulating as long as it maintains some degree of novelty.

The insignificant. An insignificant object, even if well-crafted, may be cute, pretty, lovely, or decorative, but not startlingly beautiful. The boring is not equivalent to the insignificant. We may be bored by something we hold significant and be attracted by trivial, insignificant objects.

The meaningless. A meaningless object is neither beautiful nor ugly. A meaningless object cannot be beautiful, since one cannot grasp any integration of its parts or be moved by it. A person who is unable to recognize the category within which the particular object falls (and is unable to make sense of it) is unable to appreciate its beauty.

Kitsch. Kitsch consists of beautiful elements, but it is not beautiful in a strict sense. Thomas Kulka holds that a prerequisite of kitsch is that it should employ familiar and well-tested elements that evoke positive responses (1988). Kitsch uses images—such as a bouquet of red roses or a red-roofed hut on the edge of a breathtaking lake—that appeal to many in order to manipulate sentiments and desires for commercial or political purposes. Kitsch is not a failure to create good art; it is, rather, a form of deception that requires “know-how.” Seeing kitsch in opposition to beauty suggests that the genuine expe-

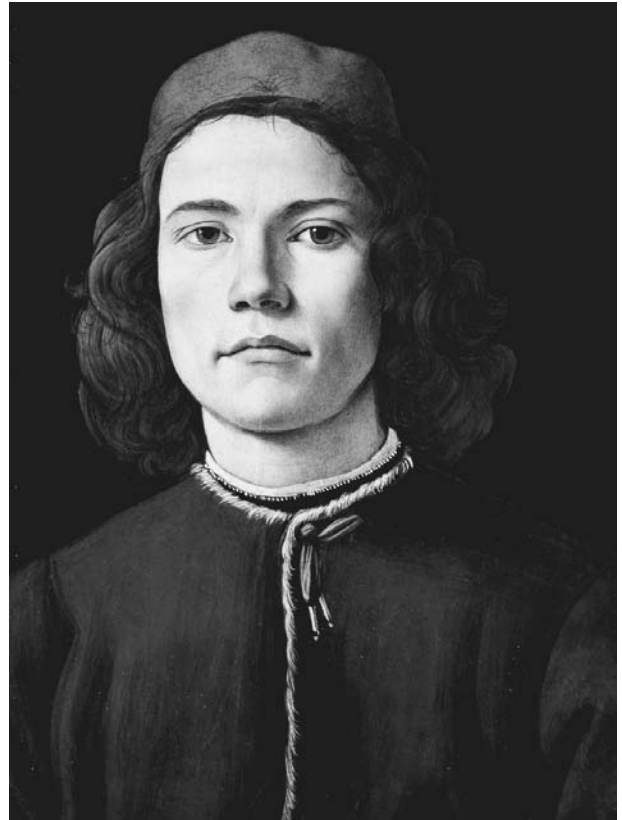

Portrait of a Young Man (1487) by Sandro Botticelli. Tempera on panel. Theories about the relationship between art and beauty have varied throughout time. Plato saw art as a deception that was a separate concept from beauty, while many contemporary philosophers considered art itself to be beautiful. © NATIONAL GALLERY COLLECTION. REPRODUCED BY KIND PERMISSION OF THE TRUSTEES OF THE NATIONAL GALLERY, LONDON/CORBIS

rience of beauty is sincere, and that it is not constituted by well-tested effective formulae.

The Function of Beauty

According to Kant, beauty has no function beyond the pleasure it generates. As much as this view influenced philosophical discourse, it did not satisfy natural scientists and social and cultural researchers.

Beauty and sexual selection. Charles Darwin (1809–1882) sought to answer the question: how has natural beauty been acquired and what is its purpose? He rejects the idea that beauty in nature is a merely arbitrary outcome of physical forces. Darwin believed that the beautiful colors and diversified patterns we see in butterflies, moths, fish, birds, and other creatures must be beneficial in some way. In *The Descent of Man and Selection in Relation to Sex* (1871), he presents the theory that beauty is a result of accumulative sexual selection. Studying mating rituals among various species, Darwin concludes that the animals' splendid decorations, their pomp and display, could not be inconsequential, and that it is impossible to doubt that the female admires the beauty of her male

partner. This contrasts with the traditional view expressed by Burke (1767) that beauty is feminine, while the sublime is masculine.

Kant states that only humans are capable of appreciating beauty. Darwin insists that the origin of the ability to notice beauty (and appreciate it as such) is the same for animals and humans. Yet he agrees that humans' perception of beauty is far more complex than that of animals and involves cultural values and traditions. He examined courting customs in different cultures and confirmed that beauty plays an equally central role in choosing mates, in spite of cultural differences.

Sigmund Freud (1856–1939) concurs with Darwin as to the origin and role of beauty in human life. In *Civilization and Its Discontents* (1930), Freud asserts that there is no doubt that beauty originates in sexual feelings, and that all forms of pleasure are related to sexual love. According to Darwin and Freud, the function of beauty is universal, but the variety of its manifestations coheres with cultural relativism. Tattoos serve as a beautifying means in one culture and are condemned in another. The Makalalo women used to pierce their upper lips and place a ring in it. Piercing, until recently regarded as esoteric in Western culture, is now commonplace in Western society. Facial hair (beard or mustache) is thought to enhance masculine beauty in Western culture. While the American Indians considered facial hair vulgar, they appreciated long hair for men. However, the passion for beauty and the readiness to suffer to achieve it are similar in all cultures.

Naomi Wolf, an active feminist, denies that this is true. She rejects the idea that beauty answers genuine, universal needs. Beauty, according to Wolf, is a myth created during the industrial revolution and used ever since by men to manipulate women for their own interest. Beauty, she holds, is not universal and is not a function of evolution. The readiness of women to suffer in order to achieve the false ideal of beauty indicates the dominance of men and confirms male manipulation. Thus, according to Wolf, the female suffering for beauty is not a genuine product of evolutionary forces (1991). Camille Paglia criticizes this kind of feminist approach for concentrating on images of beauty of the last century and for failing to encompass a broad historical view. Paglia places the origin of beauty in ancient Egypt (1991).

In contrast to Wolf's position, Nancy Etkoff argues that beauty is a powerful and genuine element in everyday life. She agrees with Darwin that beauty influences sexual choice, but she goes on to argue that it influences all aspects of life from early childhood on. Beauty is not the result of political or economical manipulation, but rather the other way around: due to its strong impact, beauty is used as a means of achieving political and economic ends. Beauty, according to Etkoff, is not a product of a certain period in history; its origin, rather, lies in human nature itself (1999).

Beauty and art. Art was traditionally considered a source of beauty; some even argued that natural beauty is subordinated to artistic beauty. Plato, however, separated art and beauty into two independent concepts: real beauty reflects truth, while art is a deceiving imitation of nature. Aristotle, by

contrast, held that good art is beautiful and that, therefore, the two are inseparable: a good work of art is a beautiful work. The Aristotelian aesthetic tradition prevailed for centuries, but it was the eighteenth century that gave rise to the idea that creating beauty is the essential purpose of art.

Kant holds that good art is beautiful, although it differs significantly from natural beauty: a good work of art is a beautiful representation. A representation can be beautiful even if its subject matter is not beautiful. Georg Wilhelm Friedrich Hegel (1770–1831) argues that beauty is the essential feature of art, and natural beauty is a reflection of artistic beauty (*Aesthetics*, 1835). In this view, beauty reflects intentional creation, not incidental results of blind, natural forces. The poet Friedrich von Schiller (1759–1805) associates art with freedom and beauty: we arrive at freedom through artistic beauty, since it is a product of intentional, free choice (*Letters on the Aesthetic Education of Man*, 1795). The comparison between artistic and natural beauty led Oscar Wilde (1854–1900) to the observation that life and nature imitate art far more than art imitates life or nature. Art is the creation of beauty; life and nature constitute its raw materials (*The Decay of Lying*, 1894). Benedetto Croce (1866–1952) similarly states that the sense of natural beauty is a derivative of artistic beauty. Beauty of nature cannot be explained unless one regards it as the work of a divine creator. Beauty, according to Croce, is a synonym of intuition and expression, and these refer to the artistic form. The content of the work is beautiful only when wrought into form.

Robin G. Collingwood (1889–1943) defines art as an attempt to achieve beauty (*Outlines of a Philosophy of Art*, 1925). However, his viewpoint did not gain influence in the twentieth century. The prevailing analytical trend preferred, it would seem, clear-cut, definable notions and has not been conducive to the study of the paradoxical nature of beauty, its ambiguous logical status, and the endless disputes over matters of taste. Thus, beauty has been dismissed as a vague and insignificant concept and considered irrelevant to art. Ludwig Wittgenstein (1889–1951) remarks in this analytical vein that beauty is an odd word that is hardly ever used (*Lectures and Conversations on Aesthetics*, 1938). John A. Passmore states that there is something suspicious about the notion of beauty, and that artists seem to get along quite well without it. He associates beauty with kitsch and bourgeois art (1954).

The association of beauty with superficiality and tranquil bourgeois life stood in contrast to the revolutionary spirit of modern art and the general atmosphere between the two world wars and after. Detaching beauty from art became common practice. According to Curt J. Ducasse (1881–1969), there is no essential connection between art and beauty. Art is an attempt to express feelings, and artists may intend to create or express ugliness in their work (*The Philosophy of Art*, 1966). Nelson Goodman (1906–1998) argued that many of the best paintings are, in the most obvious sense, ugly. Beauty, according to Goodman, is a vague and deceptive concept, while art is a kind of language that has no essential bond with beauty (*Languages of Art*, 1968). The influential and much-discussed institutional definition of art presented by George Dickie (1974) similarly bypasses the notion of beauty.

Mary Mothersill strongly criticizes the wide neglect of beauty and its detachment from art. She argues that the idea of beauty is indispensable and taken for granted in art criticism, because although critics do not explicitly refer to beauty, the idea is implicit in their criticism (1984). Mothersill's analysis of beauty reflects a change in approach. By the turn of the century we witness the growth of a renewed interest in various aspects of beauty. Wilfried Van Damme examines the anthropological perspective of beauty (1996). Eddy M. Zemach defends the objectivity of aesthetic properties and their empirical testability (1997). James Kirwan studies the history of the concept in order to illuminate the experience of beauty (1999). Peg Zeglin Brand examines the role and significance of beauty in social life and in relation to gender (2000). Lorand offers a theory of aesthetic order that revives the connection between beauty and art (2000), and Nick Zangwill rethinks the metaphysics of beauty (2001). These and other contemporary studies confirm that beauty is central to human experience in spite of its neglect in the discourse of the last century. The genuine vitality of beauty is bound to intrigue the reflective mind and inspire further investigations of its nature.

See also *Aesthetics; Arts; Emotions; Evolution; Feminism; Imagination; Platonism; Taste; Truth.*

BIBLIOGRAPHY

- Arnheim, Rudolf. *Toward a Psychology of Art*. Berkeley: University of California Press, 1966.
- Beardsley, Monroe C. "Order and Disorder." In *The Concept of Order*, edited by Paul G. Kuntz. Seattle and London: University of Washington Press, 1968.
- Dickie, George. *Art and the Aesthetic: An Institutional Analysis*. Ithaca, N.Y.: Cornell University Press, 1974.
- . *The Century of Taste: The Philosophical Odyssey of Taste in the Eighteenth Century*. Oxford: Oxford University Press, 1996.
- Etcoff, Nancy. *Survival of the Prettiest: The Science of Beauty*. New York: Doubleday, 1999.
- Eysenck, Hans J. "The Experimental Study of the 'Good Gestalt,' a New Approach." *Psychological Review* 49 (1942): 344–364.
- Galton, Francis. "Composite Portraits." *Nature* 18 (1878): 97–100.
- Lorand, Ruth. *Aesthetic Order: A Philosophy of Order, Beauty, and Art*. London: Routledge, 2000.
- Moles, Abraham. *Information Theory and Esthetic Perception*. Translated by Joel E. Cohen. Urbana: University of Illinois Press, 1966.
- Mothersill, Mary. *Beauty Restored*. Oxford: Clarendon, 1984.
- Osborne, Harold. "Aesthetics and Other Forms of Order." *British Journal of Aesthetics* 22 (1982): 3–16.
- Paglia, Camille. *Sexual Personae: Art and Decadence from Nefertiti to Emily Dickinson*. New York: Vintage, 1991.
- Passmore, John A. "The Dreariness of Aesthetics." In *Aesthetics and Language*, edited by William Elton, 36–55. Oxford: B. Blackwell, 1954.
- Stolnitz, Jerome. "'Beauty': Some Stages in the History of an Idea." *Journal of the History of Ideas* 22 (1961): 185–204.
- Tatarkiewicz, Wladyslaw. *History of Aesthetics*. The Hague: Mouton, 1970–74.
- Van Damme, Wilfried. *Beauty in Context*. Leiden, Netherlands, and New York: Brill, 1996.
- Wolf, Naomi. *The Beauty Myth*. New York: Anchor, 1992.
- Zangwill, Nick. *The Metaphysics of Beauty*. Ithaca, N.Y.: Cornell University Press, 2001.
- Zeglin Brand, Peg, ed. *Beauty Matters*. Bloomington: Indiana University Press, 2000.
- Zemach, Eddy M. *Real Beauty*. University Park: Pennsylvania State University Press, 1997.

Ruth Lorand

BEHAVIORISM. Behaviorism is a theoretical approach in psychology that emphasizes the study of behavior—that is, the outwardly observable reactions to a stimulus of an organism, whether animal or human—rather than the content of the mind or the physiological correlates of behavior. Largely centered in the United States, behaviorism had an early stage (1910–1930) that was dominated by the work of the comparative psychologist John B. Watson, and a later stage, neo-behaviorism (1930–1955), defined by the psychologists Edward C. Tolman, Clark Hull, and B. F. Skinner.

Behaviorism has its roots in the work of Ivan Pavlov (1849–1936), a Russian physiologist who studied medicine in St. Petersburg and physiology at the University of Breslau in Germany. Pavlov designed a series of experiments to understand learning, a psychological process, in terms of the physiological process of conditioning, or training, reflex responses. His experimental animal of choice was the dog, though he expected that his results could apply to humans as well. Dogs normally display a salivation reflex at the sight of food. Pavlov's experiment involved ringing a bell at the same moment that the dog was presented with food. After presenting both stimuli in this joint manner, Pavlov simply rang the bell without also presenting the food—and found that the dog salivated. The normal reflex had been conditioned to appear in response to an unconventional stimulus. An organism's innate responses could thus be trained by this conditioning method to be elicited by a range of stimuli that did not normally produce them, and Pavlov used the method to examine the ways in which responses could be excited and inhibited. The method of conditioning reflexes could, according to Pavlov, replace a mentalistic language about what animals see or hear or feel with a physicalistic, materialist language about responses to stimuli. The conditioning method focused on outward, objective observation of animal behavior, rather than on guessing about the content of an animal's mind. In Pavlov's interpretation, seemingly purposeful behavior on the part of the animal could be reduced to the training of reflexes, or the formation and breaking of habits. Such a view bears a strong similarity to that of the behaviorists who followed, but in an important respect Pavlov differed from them. He never abandoned the idea that he was basically a physiologist and that there could be no science of psychology independent of physiology. Pavlov intended that the acts comprising an animal's behavior should eventually be explained in terms of the workings of its brain. He had no patience with the American behaviorists' belief that behavior formed its own autonomous branch of scientific study.

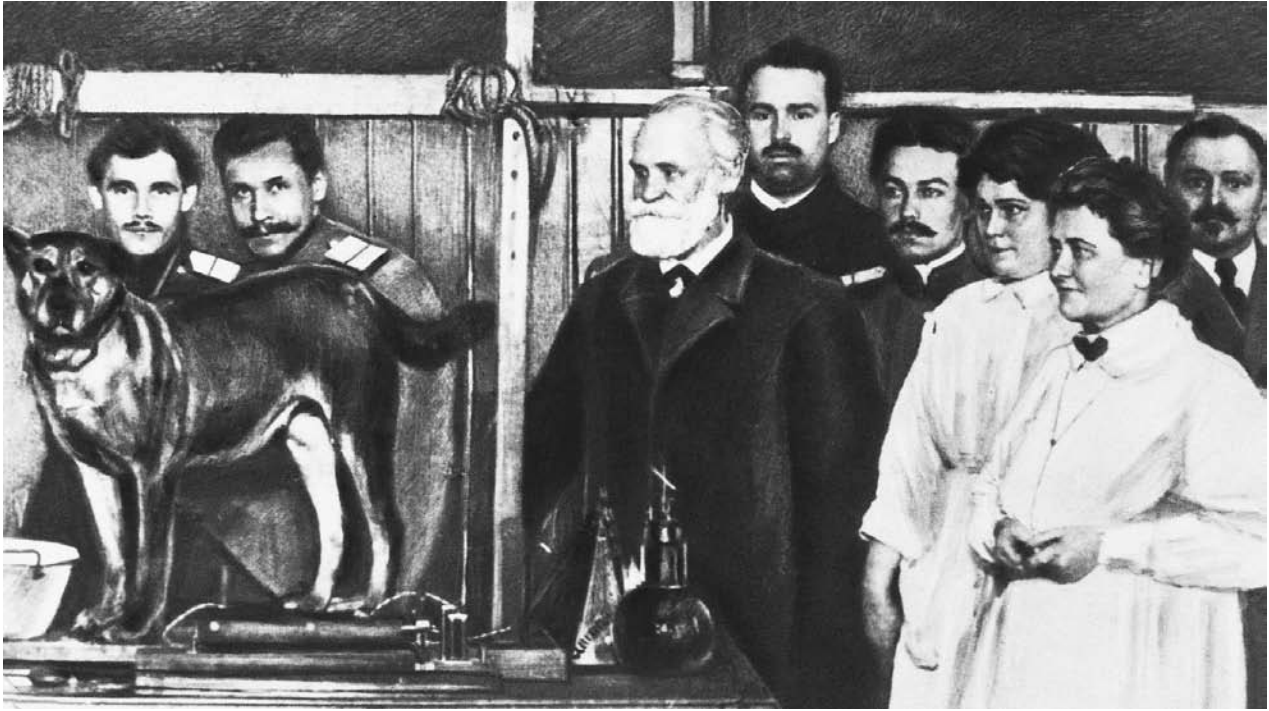

An airbrushed photograph of Russian physiologist Ivan Pavlov and his staff, c. 1925–1936. Pavlov, whose views formed the foundation of Behaviorism, believed that learning consisted of a series of conditioned responses. His experimental animal of choice was the dog, though he expected that his results could apply to humans as well. © BETTMANN/CORBIS

Behaviorism (1910–1930)

Pavlov's experiments in classical conditioning were familiar to Western psychologists from 1906 on and formed the heart of the behaviorist method. In 1913 John B. Watson (1878–1958) systematically and provocatively set out the principles of behaviorism in a manifesto entitled "Psychology As the Behaviorist Views It." Watson was a comparative psychologist interested in making psychology a real science by defining it as the study of outwardly observable behavior, rather than of thought, imagery, consciousness, or mind. In doing so he intended to break psychology's ties with philosophy. As a comparative psychologist with interests also in developmental psychology—the study of how the mind develops in childhood, as well as over the course of evolution—Watson knew that the conventional psychological method of introspection was inapplicable to the subjects of his science. Children and animals could not be asked to introspect, to divulge the contents of their minds, and guessing at what they were thinking Watson judged to be unscientific. Focusing instead on behavior rather than on consciousness was therefore the only way to proceed. Watson also had a practical motivation for his behaviorism—he wanted to make it the science of how people act.

Watson was born in Greenville, South Carolina. He attended college at Furman University and graduate school in the department of philosophy at the University of Chicago, where he was trained in comparative psychology by the neurologist Henry Herbert Donaldson and the psychologist James Rowland Angell. Watson was interested in the work of Jacques

Loeb (1859–1924), a German-trained materialist physiologist at Chicago who studied tropisms, or movements in plants and animals, that he interpreted in solely physico-chemical terms. Donaldson and Angell, however, dissuaded Watson from working with the radical Loeb, and Watson instead wrote his dissertation on the correlation between brain growth and learning ability in rats.

In 1908 Watson became professor of psychology at the Johns Hopkins University, but as a comparative psychologist felt marginalized in the department. In his 1913 manifesto he devised a way to bring comparative psychology to center stage. A truly scientific psychology, he wrote, would abandon talk of mental states or conscious content of minds and instead focus on prediction and control of behavior. By focusing on objectively observable behavior, by getting away from mind, consciousness, and introspection and examining physical variables instead, psychology would become a legitimate science. Like Pavlov, Watson believed in observing and training physical responses to stimuli, making no reference to mind, and thereby treating animal and human behavior on the same level. In his 1919 book, *Psychology From the Standpoint of a Behaviorist*, Watson rejected the concept of mind completely, interpreting even imagery, thought, and language all in terms of behavior accessible to an objective observer.

At Johns Hopkins, Watson was associated with the psychiatrist Adolf Meyer, the head of the Phipps Clinic, where Watson applied behaviorist conditioning methods to children. In a famous series of experiments conducted with his gradu-

ate assistant Rosalie Rayner, Watson trained a child by the name of Little Albert (aged 9–13 months) to fear a rat, a response the child then produced in reaction to the sight of any furry creature. Watson's evident success in training even such a deep-seated reaction as fear led him to believe that all of a person's behavior could be altered, any habit could be formed or broken, by the engineering of stimuli—that is, by the control of the person's immediate environment. In his 1924 book *Behaviorism* Watson expressed this environmentalist view in its most extreme terms. But by then Watson had been forced to resign his position at Hopkins because of his involvement in an extramarital love affair with Rayner. He and Rayner moved to New York City, where Watson joined the John Walter Thompson advertising agency, and where both Watson and Rayner became popular authorities on child-rearing according to behaviorist principles. Their *Psychological Care of Infant and Child* appeared in 1928.

Watson was not the only psychologist during the 1910s to advocate behaviorism. At Columbia University Teachers College, Edward L. Thorndike (1874–1949), experimenting with cats learning their way around puzzle-boxes, similarly argued that the study of objectively observable changes in behavior, and their correlation with changes in stimuli, formed the heart of a legitimately scientific psychology. Thorndike formulated the law of effect, which held that pleasure or reward will reinforce a certain behavior, while pain will extinguish it: thus the animal's experience has important consequences for its behavior.

Neobehaviorism (1930–1955)

The second phase of behaviorism, neobehaviorism, was associated with Edward C. Tolman (1886–1959), Clark Hull (1884–1952), and B. F. Skinner (1904–1990). Like Thorndike, Watson, and Pavlov, the neobehaviorists believed that the study of learning and a focus on rigorously objective observational methods were the keys to a scientific psychology. Unlike their predecessors, however, the neobehaviorists were more self-consciously trying to formalize the laws of behavior. They were also influenced by the Vienna Circle of logical positivists, a group of philosophers led by Rudolph Carnap (1891–1970), Otto Neurath (1882–1945), and Herbert Feigl (1902–1988), who argued that meaningful statements about the world had to be cast as statements about physical observations. Anything else was metaphysics or nonsense, not science, and had to be rejected. Knowledge, according to the logical positivists, had to be built on an observational base, and could be verified to the extent that it was in keeping with observation.

A professor of psychology at the University of California at Berkeley, Tolman focused his experimental work largely on white rats learning their way through mazes. He differed from his behaviorist predecessors by taking a more holistic approach to behavior than they had. Rather than talking in terms of atomistic, isolated stimuli and responses, Tolman emphasized their integration with the environment by referring to them as “stimulating agencies” and “behavior acts.” In his 1932 *Purposive Behavior in Animals and Men*, Tolman argued that purpose and cognition were essential to behavior and should be



Yvonne Skinner and daughter with experimental psychologist B. F. Skinner's invention, the “baby box,” 1945. The “baby box” was a glassed-in playpen in which temperature and humidity were automatically controlled. Skinner's youngest daughter spent her infancy in one. Controversial and misunderstood by the general public, the box was intended by Skinner to serve in the same capacity as a crib, but with an enhanced environment to keep a child safe and healthy. © BETTMANN/CORBIS

interpreted not as mentalistic entities but as outwardly observable features of behavior describable in objective language. He also defined the notion of the intervening variable, a link between stimulus and response that helps to determine behavior. As many as ten intervening variables could exist between a stimulating agency and a rat's decision to move in a certain direction at a choice-point in a maze.

Of the three neobehaviorists, Hull was the most ambitious about constructing a formal theory of behavior. He believed he had found the fundamental law of learning or habit-formation—the law of stimulus generalization—and that this law not only underlay all behavior in animals and humans, but was a principle basic enough to unify all the social sciences. According to the law, a response could be called forth by an unconventional stimulus as long as that stimulus was associated, either temporally or in character, with the stimulus that usually called forth the response. As long as the unconventional stimulus was similar enough to the usual one, it could elicit the response. Pavlov had noted this effect when his dogs salivated at the ringing of a bell. Hull further theorized that learning was continuous—that is, when an animal was trained to respond to a particular positive stimulus (or avoid a negative stimulus), all aspects of that stimulus impinging on the animal's sensorium were gradually associated with that response. Thus the animal learns in an incremental way, not in an all-or-nothing burst, and thus engineering the appearance of stimuli could precisely control the animal's ability to form habits. These laws of behavior explained how all learning took place without resorting to immaterial notions like soul or free will. Hull, who had originally intended to become an engineer, even designed a variety of machines that worked on the principles of conditioning reflexes, in order to demonstrate

that learning was a wholly mechanistic process. He expressed his laws of behavior in mathematical terms, filling his 1943 *Principles of Behavior: An Introduction to Behavior Theory* with complex equations.

The rigor for which Hull strove in his science was evident both in his exclusion of any nonmaterial entity and in his formulation of laws. It was also evident in the hypothetico-deductive method by which he believed psychologists must work. Here Hull's inspiration was the certainty of scientific knowledge achieved by the natural philosopher Isaac Newton (1642–1727). In Hull's method, the theorist began with the observation of a certain behavior, derived axioms from that observation, deduced consequences from the axioms, tested the consequences through experiment, and then refined the axioms, ultimately establishing the laws of behavior on a firm observational and experimental footing. In 1929 Hull moved from his teaching position at the University of Wisconsin at Madison to a prestigious post at the Rockefeller Foundation–funded Institute of Human Relations at Yale, where he remained until his death in 1952. Hull's laws of behavior and his rigorous scientific method became central to the Institute's mission to unify the social sciences. Hull's theory of behavior integrated psychology, psychiatry, sociology, and anthropology by describing learning as the forging of connections between stimulus and response, and then envisioning this mechanism as the mediator of all social and cultural activity. The build-up and breakdown of habit was thus interpreted as the key to all behavior. Hull and his work formed the focal points of the Institute of Human Relations, which lasted only as long as Hull lived and was dissolved after his death. His approach was, however, continued by his friend and supporter Kenneth Spence (1907–1967), a psychologist at the University of Iowa.

The Harvard psychologist B. F. Skinner, the third of the important neobehaviorists, rejected Hull's attempts at formal theory building and returned to the Watsonian project of founding a science entirely on the observation of behavior. Skinner devised an experimental set-up, the so-called Skinner box, in which a pigeon or a rat would be rewarded for accomplishing an act, such as raising its head above a certain line, or pressing a lever, by the release of food pellets. In his 1938 *Behavior of Organisms*, Skinner explained that a movement rewarded in this way was reinforced—that is, made more likely to occur—while one that was punished was stamped out. A behavior that was followed by the repetition of that behavior—a movement selected and maintained by its positive consequences—Skinner called the operant. His approach therefore was referred to as operant conditioning. Both animals and people behave the way they do because of the positive consequences produced by past behavior. For Skinner, all learning was a matter of such reinforcement, and his method consisted of recording sequences of movements that revealed the patterns by which behavior was reinforced. He avoided talking about habit formation, and even about stimuli, restricting his science to the observation of these movement patterns.

In his 1953 *Science and Human Behavior*, Skinner explained the principles that underlay his psychology. First, he argued that his science was entirely based in observation, and that theories

and hypotheses played a limited role in it: his approach was radically inductivist and empiricist. Second, since psychology was supposed to be restricted to the level of behavioral observation, it had no need of being reduced to or explained in terms of physiology. Physiology was not more fundamental than psychology—it was either unobservable, hence unscientific, or part of behavior itself. Third, for Skinner, mental processes or states were to be interpreted as behavior—memory, knowledge, imagery, and other such mentalistic entities he dismissed as metaphors or fictions. Past consequences of behavior, not mental states, motivated future action. Skinner's 1957 *Verbal Behavior* was his attempt to deal with thought and language in terms of reinforced movements. Finally, Skinner believed that biological adaptation was the ultimate criterion for the persistence of a behavior: if an action aided survival, it persisted.

Skinner argued that behavior could be shaped, or controlled, by controlling the rewards or reinforcements meted out in response to them—that is, by controlling the environment. In the mid 1950s and 1960s, some penal and psychiatric institutions adopted this method of behavior modification to shape the behavior of their inmates. In his 1948 book *Walden Two*, Skinner had prepared the ground for such application of his science by imagining a utopian community led according to behaviorist principles. In his 1971 *Beyond Freedom and Dignity*, Skinner argued that such ethical principles as free will and individual responsibility are simply illusions, and what will make us truly free is the realization that behavior is instead controlled by the past and by the environment.

Neobehaviorism came in for strong criticism in the late 1950s and 1960s. Philosophers of science questioned the claim that any science could be theory-neutral and based solely in observation; observations were themselves seen to be theory-laden. Psychologists questioned the idea that learning was a singular entity that could form the basis for all of psychology. In particular, cognitive psychology, drawing on insights from computer science, redefined mental processes such as problem solving, learning, and memory in terms of information processing, a development that gave a new autonomy and a new respectability to the study of internal mental states. Influenced by this cognitivist turn, the psycholinguist Noam Chomsky (b. 1928) published a scathing review of Skinner's *Verbal Behavior*, arguing that language had to be understood in terms of universal and innate mental structures, not as behavior shaped by the environment. Behaviorism is currently regarded by psychologists as one approach among many; both cognitivism and neuroscience are arguably as influential in understanding mind and behavior.

See also **Biology; Determinism; Education: North America; Psychology and Psychiatry.**

BIBLIOGRAPHY

- Amsel, Abram. *Behaviorism, Neobehaviorism, and Cognitivism in Learning Theory: Historical and Contemporary Perspectives*. Hillsdale, N.J.: Erlbaum, 1989.
- Boakes, Robert. *From Darwin to Behaviorism: Psychology and the Minds of Animals*. New York: Cambridge University Press, 1984.

- Buckley, Kerry. *Mechanical Man: John Broadus Watson and the Beginnings of Behaviorism*. New York: Guilford Press, 1989.
- Harris, Benjamin. "Whatever Happened to Little Albert?" *American Psychologist* 34 (1979): 151–160.
- Hull, Clark L. *Principles of Behavior: An Introduction to Behavior Theory*. New York: Appleton Century Crofts, 1943.
- Mills, John A. *Control: A History of Behavioral Psychology*. New York: New York University Press, 1998.
- Morawski, J. G. "Organizing Knowledge and Behavior at Yale's Institute of Human Relations." *Isis* 77 (1986): 219–242.
- O'Donnell, John M. *The Origins of Behaviorism: American Psychology, 1870–1920*. New York: New York University Press, 1985.
- Pavlov, Ivan P. *Conditioned Reflexes*. Translated by G. Anrep. Oxford: Oxford University Press, 1927.
- Samelson, Franz. "Struggle for Scientific Authority: The Reception of Watson's Behaviorism, 1913–1920." *JHBS* 17 (1981): 399–425.
- Skinner, B. F. *The Behavior of Organisms*. New York: Appleton Century Crofts, 1938.
- Smith, Laurence D. *Behaviorism and Logical Positivism: A Re-assessment of the Alliance*. Stanford, Calif.: Stanford University Press, 1986.
- Tolman, Edward C. "A New Formula for Behaviorism." *Psychological Review* 29 (1922): 44–53.
- Watson, John B. "Psychology as the Behaviorist Views It." *Psychological Review* 20 (1913): 158–178.
- Weidman, Nadine M. *Constructing Scientific Psychology: Karl Lashley's Mind-Brain Debates*. New York: Cambridge University Press, 1999.

Nadine Weidman

BELIEF. See **Religion**.

BILINGUALISM AND MULTILINGUALISM. A bilingual individual, generally, is someone who speaks two languages. An ideal or balanced bilingual speaks each language as proficiently as an educated native speaker. This is often referred to as an ideal type since few people are regarded as being able to reach this standard. Otherwise, a bilingual may be anywhere on a continuum of skills.

Literacy abilities may be an additional dimension to bilingualism, but they are often referred to separately as *biliteracy*, leaving *bilingualism* to carry the weight of oral language abilities. Bilingualism is a specific case of multilingualism, which has no ceiling on the number of languages a speaker may dominate. The timing and sequence in which one learns each of the languages has led to other distinctions between kinds of multilingualism. Much of the linguistics literature, for example, identifies native language or mother tongue as a first language, ignoring the possibility or diminishing the value of having more than one native language or mother tongue. Such a person is often referred to as a simultaneous bilingual, while someone who acquires the second language after the first one is often referred to as a sequential bilingual ("early" if between early childhood and puberty, and "late" if after puberty). The context of

language acquisition leads naturally to distinguishing between "informal" bilinguals, who acquire their languages outside of formal settings like schools, imitating the natural processes of acquiring the mother tongue, and "formal" bilinguals, who generally learn the language in schools or similar settings.

When these terms apply to groups, one speaks of bilingual or multilingual communities or nations. The aggregate enumeration of the speakers in these groups (also referred to as language diversity or demography) will often profile the number of monolingual and bilingual speakers of each language. For example, there may be a multilingual community in which speakers are monolingual in each of three languages. This would be rare, and the language groups would probably be isolated from each other. More often than not, a multilingual community or nation has multilingual individuals. If the situation involves social or political power, then a language group may be referred to as a language minority (minority-language) group or a language majority (majority-language) group, reflecting the power relationship to other groups in the society or political unit.

Language Diversity

The linguistic diversity of the world has depended on the world population and the number of languages in the world. The world population grew from about 300 million at the time of Christ to an estimated 1 billion in 1804, 2 billion in 1927, and 6 billion at the end of 1999, and is projected to reach 10 billion around 2183. In 1950 there were only four countries with a national population greater than 100 million persons. In 2003 the number of such countries had grown to eleven. The United Nations projects that in 2050 such countries will number eighteen. India, China, and the United States were the top three countries at each of these points in time.

The twentieth century was the highest growth period in the history of humanity, almost quadrupling the world population. The highest rate of growth occurred between 1965 and 1970 (2 percent per annum), and the largest annual increases in population occurred in the late 1980s, with 86 million people added to the world population annually.

One should keep in mind as well that the distribution of the population and its languages around the world is uneven, have changed over time, and are expected to continue such changes, at least into the near future. In 1750, for example, 64 percent of the estimated world population was located in Asia, while 21 percent was in Europe, 13 percent in Africa, and 2 percent in the Americas. By 1950, Asia had lost almost 10 percentage points and Africa about 4 percent; Europe remained steady at 22 percent, but the Americas grew to 14 percent of the total equally between the northern and southern countries. The United Nations Population Division projects that in 2150, Europe and North America will shrink in percentage from 22 percent to 7 percent and from 7 percent to 4 percent, respectively; Asia will remain steady at 60 percent, but Africa will more than double its proportion from 9 percent to 24 percent, and Latin America will increase slightly its portion of the world population from 7 percent to 9 percent. These changing distributions of the human population across

Table 1. Top languages by number of speakers, 2000

(in millions)

Language	Countries		First Language
	Hub	Number	
Chinese (Mandarin)	China	16	874
Hindi	India	17	366
English	United Kingdom	104	341
Spanish	Spain	43	322–358
Bengali	Bangladesh	9	207
Arabic			207
Portuguese	Portugal	33	176
Russian	Russia	30	167
Japanese	Japan	26	125
German	Germany	40	100

SOURCE: Data from McGeeveran, pp. 626–627

the world have had and will continue to have an impact on the numbers of speakers of specific languages in those regions, and urbanism and migrations will increase the probability of language contact between speakers of different languages. By the middle of the twentieth century, more than half of the world’s population was considered urban. By the end of the twentieth century, about 4 percent of the world’s population did not live in their country of birth.

The world’s language diversity is only now being better understood and described. The sources of estimating the number of languages in the world vary in the quality of their data and methods, not the least of which is their varying definitions of language. Some authors estimate that somewhere between 30,000 and 500,000 languages have been created and died in the course of human history, indicating that languages usually have a short life span as well as a very high death rate. Only a few (such as Basque, Egyptian, Chinese, Greek, Hebrew, Latin, Persian, Sanskrit, and Tamil) have lasted more than two thousand years.

One of the more widely cited and consistent sources on the number of languages and speakers of those languages estimates that there were approximately 6,800 oral languages in the world at the beginning of the twenty-first century. Some experts argue that the inclusion of manually signed languages would increase the estimate to 12,000 human languages. Chinese Mandarin, English, Hindi, Spanish, and Arabic have been identified as the languages with the greatest number of native speakers in the world in 2000 (see Table 1).

More often than not, the enumeration of speakers through government or organizational surveys only takes into account a single language per person, despite the normative multilingualism around the world. This current multilingualism has been promoted by the greater language contact of the twentieth century, in part the legacy of colonialism and the postcolonial practice of establishing new nation-states with populations that belonged to different ethno-language communities.

In many areas of the imperial colonial language (such as English, French, Spanish, Dutch) was spread as a second or

replacement language among the colonized population, albeit with a wide range in the language proficiencies of these speakers. In some instances, the number of native speakers of these colonial languages is greater outside the metropole of the colonizing nation, and even the second-language speakers of these colonial languages may be larger than the native speakers of the same language. In 1999, for example, English was estimated to have 341 million native speakers around the world and 508 million second-language speakers; Spanish was estimated to have 358 million native speakers globally and 417 million second-language speakers.

In 2000, the enumerated languages were unevenly divided across the world in the various continents. Africa had 30 percent of the oral languages but 13 percent of the world’s population; Asia had about 33 percent of the world’s languages and 61 percent of the world’s population. The Pacific Oceanic area had about 19 percent of the languages, the Americas 15 percent, and Europe had approximately 3 percent of the oral languages and about 12 percent of the world’s population. The two most linguistically diverse countries, Papua New Guinea and Indonesia, together had more than 22 percent (1,500) of the world’s oral languages, most of which are not spoken in any other country. An overwhelming 83 to 84 percent of the world’s languages are spoken in only one country.

The range in the numbers of speakers of a particular language is large, from several hundred to hundreds of millions. The median number of speakers of a language was probably around 5,000 to 6,000 at the turn of the twenty-first century. More than 95 percent of the world’s spoken languages have fewer than 1 million native users, while some 5,000 (83 percent) spoken languages have fewer than 100,000 speakers, and more than 3,000 spoken languages have fewer than 10,000 users. About 1,500 spoken languages and most of the sign languages have fewer than 1,000 users. In 1999, some 500 languages had fewer than 100 speakers.

Ranka Bjeljac-Babic proposed that no language could survive unless 100,000 people speak it, and so estimated that at the beginning of the twenty-first century, ten languages were dying each year. Michael Krause projected that 50 to 90 percent of the spoken languages would disappear during the twenty-first century. From one perspective these languages will “wither” by a “voluntary” failure to transmit the language from one generation to another. From another perspective, many of these languages are threatened and “murdered” by repressive nation-state policies and language majoritarian practices, not unlike what has been seen in the past. European colonial conquests, for example, eliminated at least 15 percent of all languages spoken at the outset of the colonial period. According to Bjeljac-Babic, “Over the last 300 years, Europe has lost a dozen [languages], and Australia has only 20 left of the 250 spoken at the outset of the colonial period. According to I, about 540 (three-quarters of the total) have died out since Portuguese colonization began in 1530” (p. 18).

These “heritage” languages will be replaced by another language, adding to the numbers of native speakers of that second language, which may be a regional language or a language

of wider communication (an international or world language). If size is a significant factor in the robustness and continuity of a language, then the growth of some of the medium-sized languages with the addition of persons who otherwise would have spoken their heritage language might retard their demise.

It is more difficult to estimate the number of new languages created during any particular period, either from the “splitting” of a natural language into mutually not understandable varieties, the transformation of pidgins (reduced-language contact speech) into elaborated creoles by the acquisition of native speakers who complexify it for all required purposes, or the revival of “dead” languages, such as Hebrew’s revival by the new state of Israel, which developed its vocabulary to reflect a modern and more complete range of functions.

Language Diversity in Civil Society

The core sense of “civil” society is generally understood as the societal interaction, organization, and activity that takes place outside of government or the state. From this standpoint, the role of language diversity in civil society has varied across time and settings. Factors such as whether a group of people or a society is primarily rural or urban, sedentary or migratory, will often influence language diversity and individual bilingualism. The social and political relations between groups often determine how it is perceived, treated, or utilized within the society as a resource, problem, or even as a part of the civil and human rights of individuals or groups.

For example, Sue Wright describes the elite in Europe for much of the Middle Ages and the Renaissance as “multicultural and multilingual” because of their need to interact and collaborate with each other despite the different native languages in the region. Acquiring other languages was seen as an expected and normal activity for these mobile elites. Most of the population, however, were sedentary farmers, serfs, or peasants, living in small, monolingual villages and having no contact with or need to learn other languages. They spoke a variety of one of the language “continua” of Romance, Germanic, Celtic, Slavic, or Baltic. The dominant Christian Church operated across kingdoms and “nations” with a common language of wider communication—Latin. In general, villagers attempted to accommodate “others” who did not speak the village language, who were often travelers or soldiers, but otherwise people understood each other from one village to the next, even if their vernaculars were slightly different.

According to Eduardo Ruiz Vietez, three activities caused changes in this situation: the consolidation of national kingdoms, the reformation of the church, and the development of the printing press. The consolidation of kingdoms into more fixed territories meant that the royals governed a multilingual population at the same time that the vernacular language of the capital was promoted as a standard. The first grammar of such a vernacular was presented to the king and queen of Castille, Spain, in 1492, as an instrument of nation building along with the sword and the Bible. The Reformation promoted the translation of the Bible into vernacular languages, establishing a need for literacy and standardization of the text in various lan-

guages. Wright describes the emerging relationship between language and the printing press: “Printers adopted standardized languages with enthusiasm. Print capitalism profited from the standardisation of national languages, because the process delivered bigger markets than the splintered linguistic landscape of the dialect continua” (p. 2).

By the eighteenth and nineteenth centuries in Europe, *nation* was understood in civic terms and in ethnic or cultural terms. Within the civic, fixed territorial states, nation-building pressure was placed on disparate groups. Within the ethnic states, the boundaries were fixed around the single group, with other ethnolinguistic groups often pushed out. Single-language standardization and its association with the state developed a single concept of the nation as a single, unified cultural body, even while in reality, many of these nations contained regional, historically rooted, language minorities (such as the Catalans or Basques), and even migratory or nomadic language groups (such as the Romani) that continue into the early twenty-first century.

For another pattern of language diversity and civil society, one can turn to the Mexican Aztec Empire during the fifteenth century. In the fourteenth and fifteenth centuries, the Aztec Empire was organized into a tributary system, where the Nahuatl language was used in the metropole and throughout the empire. In the subjugated areas of the empire, bilingual administrators, such as “tax” collectors and local governors, were the brokers in local towns and villages and would mediate the tributes and administrative interactions with the central government. Beyond these interactions, the need for Nahuatl was minimal among the local populations, who continued to use their local languages. The language of the empire was highly valued and its value provided an incentive for individual bilingualism among the population, although individual bilingualism was not widespread.

The situation changed after contact with the Spanish and, later, other Europeans. With the imposition of the Spanish colonial structures, Spanish became the “instrument” of empire building, not just nation building. It became the prestige language and was imposed through the process of evangelization and conversion. The libraries of the Aztec Empire were

Table 2. Countries by number of languages, 2000

Country	Languages	Population (2003)
Papua New Guinea	850	5,500,000
Indonesia	670	220,500,000
Nigeria	410	133,900,000
India	380	1,068,600,000
Cameroon	270	15,700,000
Australia	250	19,900,000
Mexico	240	104,900,000
Zaire (Democratic Republic of the Congo)	210	56,600,000
Brazil	210	176,500,000
Philippines	172	81,600,000

SOURCE: Data from Skutnabb-Kangas (2000), p. 34; Population Research Bureau web site

burned and destroyed by the Spanish. Religious leaders, colonial administrators, and indigenous elites, who learned each other's languages, became bilingual and brokered the creation of revised local histories and knowledge. Over time, Spanish was promoted as a single substitute for the indigenous languages, increasing its number of speakers, even while many indigenous languages survive into the early twenty-first century.

In these and other ways, communication in language-diverse settings has been promoted through bilingual brokers. Travelers, soldiers, missionaries, and immigrants often learned new languages to facilitate these communications. Certainly in language contact situations individual bilinguals in the various languages played key roles in the civic interactions between peoples. If the language situation was more complex, involving three languages, a pidgin as "common" language often arose to broker communication between groups.

In the twentieth century, the development of popular schooling in multilingual situations often was organized with bilingual or multilingual instruction. Early primary grades were often taught in the native language of the community, with the regional and/or the national languages added as the student matured. The integration of countries into regional economic, political, and civil societies, such as the European Union, has put social pressures on groups to maintain their national languages at the same time they are to learn other regional languages and some languages for wider communication, such as English. This results in the promotion of at least a trilingualism among the population.

The transnational movement of people (as immigrants, refugees, and international workers) has also created the need for learning the host country's language(s), and for addressing the language needs of their children in schools. When there are substantial numbers of speakers of these (immigrant) languages concentrated in one place over a sufficient time to establish local organizations and institutions, such as local ethnic economy or independent community mother-tongue schools, then there are other local accommodations that often follow, with and without the support of the host society and the dominant language majority.

Government Policies to Accommodate Language Diversity

Official statements or policies about language can be made by governments at any level. These official statements about language may also be made at an institutional level, such as a church, labor union, or school. In general, the statements are about the *status* of a language, designating it as an official or national language; its form or structure (*corpus*), elaborating the language lexicon, or morphology; or its *functions* or use (including domains of use), as in the media of instruction in schools.

Government or official positions regarding language policies may be designed to *promote* a language through its recognition, use, or resource allocation; to *tolerate* the language, by not making any policies with regard to it; to *restrict* it, by conditioning societal benefits, rights, or services on knowledge of

the language; or to *repress* it (sometimes referred to as *linguicide*), by actively prohibiting its use and its transmission from one generation to another. Very often these approaches or designs are influenced by whether the language is seen as a resource (promoting foreign-language learning, for example), a problem, or a right (human or civil). Language policies of promotion and repression may be justified in several ways, sometimes ideologically similar, such as by national unification. Their means, however, are drastically different. These approaches to language policies may favor single or multiple languages. India, for example, has two official languages—Hindi and English—and more than fifteen national languages, reflecting the status of other languages within the component states of the nation.

The juridical concept of human rights has developed over the last hundred-plus years. Language has often been considered an important aspect of these rights. Two international standards are developing: the right to be free from discrimination based on language, and the right to access (acquire and use) one's mother tongue and the languages of the community and state if they are different. In some countries these rights are tied to "individual" freedoms of expression and speech (as in some Western countries); in other countries, they are seen as part of the right to cultural integrity and identity (some socialist countries, for example, recognize clearly identified national minorities as nations with inherent rights and protections).

Evaluation of Language Policies

The success of language policies and planning by governments is not uniform across time and place. Neither is success measured in the same ways. Any such evaluation of language policies would need to take into account the goal, its justification, and the means to achieve it.

L. F. Bosnahan reviewed four cases of language imposition, of which three were successful in seeding and developing the imposed common language of empire—Latin during the Roman Empire, Greek during the Greek Empire, Arabic during the rise of Islam, and Turkish during the Ottoman Empire. The first three cases were successful in having the imposed language become the exclusive or principal speech of the population, replacing the preexisting vernaculars. Bosnahan cites four features he believes made this success possible, if not determinative, where all four cases shared the first two features and were differentiated by the third and fourth: (1) each language was imposed by military authority, resulting in a political unity that increased commercial, political, economic, and/or cultural contact among different sections of the united area; (2) once imposed, it was maintained for at least several centuries by similar authority, allowing the adoption and then transmission of the language across several generations and the spread across the population; (3) the area of language imposition was already multilingual, making the imposed language one for wider communication; and (4) knowledge of the imposed language conferred material advantages and benefits widely recognized among the population, including employment, citizenship and its attendant rights and privileges, acquisition or grants of land, and trade opportunities. Bosnahan identifies another characteristic to which he does not attribute

a share of the language imposition but which seems, nonetheless, important: a group that acquires the imposed language more quickly or readily than the rest of the subjugated population becomes an elite or intelligentsia that functions in the first stages of the military invasion and pacification as the interpreters and minor officials of the new authority, and subsequently as the medium through which the new language is transmitted to the subjugated general population.

One can look to other goals or situations, such as group co-existence, democratic pluralism, national integration, or the amelioration of group conflict. Each might require a different type and method of assessment. Some of these might be guided by principles of language diversity that have been borne out by research: (1) language conflict is usually related to other conflicts; (2) individual bilingualism in language contact situations is generally a normal result; (3) language conflict most often arises when one group attempts to impose its language on another; and (4) no two languages will be used by the same group of speakers for all of the same functions at the same time.

Whether there are 6,800 languages in the world, or 3,000, or less than 1,000, globalization is making the globe an ever smaller village. Communication will continue to be humanity's most important task. Addressing language diversity by encouraging individual multilingualism seems to be a continuing, viable strategy for success.

See also *Demography; Language and Linguistics; Language, Linguistics, and Literacy; Population.*

BIBLIOGRAPHY

- Andresen, Julie T. *Linguistics in America, 1769–1924: A Critical History*. London: Routledge, 1990.
- Bjeljac-Babic, Ranka. "6,000 Languages: An Embattled Heritage." *UNESCO Courier* 53 (April 2000): 18–19.
- Brosnahan, L. F. "Some Historical Cases of Language Imposition." In *Varieties of Present-Day English*, edited by Richard W. Bailey and Jay L. Robinson, 40–55. New York: Macmillan, 1973.
- Crystal, David. *Cambridge Encyclopedia of Language*. 2nd ed. Cambridge, U.K.: Cambridge University Press, 1997.
- Dixon, R. M. W. *The Rise and Fall of Languages*. Cambridge, U.K.: Cambridge University Press, 1997.
- Eco, Umberto. *The Search for the Perfect Language*. Oxford: Blackwell, 1995.
- Gray, Edward G., and Norman Fiering, eds. *The Language Encounter in the Americas, 1492–1800: A Collection of Essays*. New York: Berghahn, 2000.
- Grimes, Barbara, ed. *Languages of the World*. Vol. 1 of *Ethnologue*. 14th ed. Dallas: Summer Institute of Linguistics International, 2000.
- Hymes, Dell. "Speech and Language: On the Origins and Foundations of Inequality Among Speakers." Chap. 3 in *Ethnography, Linguistics, Narrative Inequality*. London: Taylor and Francis, 1996.
- Krauss, Michael. "The World's Languages in Crisis." *Language* 68, no. 1 (1992): 4–10.
- McGeveran, William A. *World Almanac and Book of Facts 2004*. New York: World Almanac Books, 2003.
- Phillipson, Robert. *English-Only Europe?: Challenging Language Policy*. London: Routledge, 2003.
- Population Research Bureau. *World Population: More than Just Numbers*. Washington, D.C.: Population Research Bureau, 1999. Also available at <http://www.prb.org>.
- Ruiz Vieyetz, Eduardo Javier. "The Protection of Linguistic Minorities: A Historical Approach." *MOST Journal on Multicultural Societies* 3, no. 1 (2001). Available at <http://www.unesco.org/most/vl31vie.htm>.
- Skutnabb-Kangas, Tove. "Language Policies and Education: The Role of Education in Destroying or Supporting the World's Linguistic Diversity." Available at <http://www.linguapax.org/congres/plenaries/skutnabb.html>.
- . *Linguistic Genocide in Education, or Worldwide Diversity and Human Rights?* Mahwah, N.J.: Lawrence Erlbaum, 2000.
- Thomason, Sarah. *Language Contact*. Washington, D.C.: Georgetown University Press, 2001.
- United Nations Population Division. *The World at Six Billion*. New York: United Nations Population Division, 1999. Also available at <http://www.un.org/esa/population/publications/sixbillion/sixbillion.htm>.
- Wright, Sue. "Language and Power: Background to the Debate on Linguistic Rights." *MOST Journal on Multicultural Societies* 3, no. 1 (2001). Available at <http://www.unesco.org/most.vl3n1wri.htm>.

Reynaldo F. Macías

BIODIVERSITY. See **Ecology; Evolution; Nature; Wildlife.**

BIOETHICS. Bioethics as a field is relatively new, emerging only in the late 1960s, though many of the questions it addresses are as old as medicine itself. When Hippocrates wrote his now famous dictum *Primum non nocere* (First, do no harm), he was grappling with one of the core issues still facing human medicine, namely, the role and duty of the physician. With the advent of late-twentieth-century science, an academic field emerged to reflect not only on the important and age-old issues raised by the practice of medicine, but also on the ethical problems generated by rapid progress in technology and science. Forty years after the emergence of this field, bioethics now reflects the profound changes in medicine and the life sciences.

Nature and Scope of Bioethics

Against the backdrop of advances in the life sciences, the field of bioethics has a threefold mission: (1) to raise important questions about the general practice of medicine and the institutions of health care in the United States and other economically advanced nations, (2) to wrestle with the novel bioethical dilemmas constantly being generated by new biomedical technologies, and (3) to challenge the presumptions of international and population-based efforts in public health and the delivery of health care in economically underdeveloped parts of the globe. While attention to the ethical dilemmas accompanying the appearance of new technologies such as stem cell research or nanotechnology can command much

of the popular attention devoted to the field, the other missions are of equal importance.

At the core of bioethics are questions about medical professionalism, such as: What are the obligations of physicians to their patients? and What are the virtues of the “good doctor”? Bioethics explores critical issues in clinical and research medicine, including truth telling, informed consent, confidentiality, end-of-life care, conflict of interest, nonabandonment, euthanasia, substituted judgment, rationing of and access to health care, and the withdrawal and withholding of care. Only minimally affected by advances in technology and science, these core bioethical concerns remain the so-called bread-and-butter issues of the field.

The second mission of bioethics is to enable ethical reflection to keep pace with scientific and medical breakthroughs. With each new technology or medical breakthrough, the public finds itself in uncharted ethical terrain it does not know how to navigate. In the twenty-first century—what is very likely to be the “century of biology”—there will be a constant stream of moral quandaries as scientific reach exceeds ethical grasp. As a response to these monumental strides in science and technology, the scope of bioethics has expanded to include the ethical questions raised by the Human Genome Project, stem cell research, artificial reproductive technologies, the genetic engineering of plants and animals, the synthesis of new life-forms, the possibility of successful reproductive cloning, preimplantation genetic diagnosis, nanotechnology, and xenotransplantation—to name only some of the key advances.

Bioethics has also begun to engage with the challenges posed by delivering care in underdeveloped nations. Whose moral standards should govern the conduct of research to find therapies or preventive vaccines useful against malaria, HIV, or Ebola—local standards or Western principles? And to what extent is manipulation or even coercion justified in pursuing such goals as the reduction of risks to health care in children or the advancement of national security? This population-based focus raises new sorts of ethical challenges both for health care providers who seek to improve overall health indicators in populations and for researchers who are trying to conduct research against fatal diseases that are at epidemic levels in some parts of the world.

As no realm of academic or public life remains untouched by pressing bioethical issues, the field of bioethics has broadened to include representation from scholars in disciplines as diverse as philosophy, religion, medicine, law, social science, public policy, disability studies, nursing, and literature.

History of Bioethics

Bioethics as a distinct field of academic study has existed only since the early 1960s, and its history can be traced back to a cluster of scientific and cultural developments in the United States during that decade. The catalysts for the creation of this interdisciplinary field were the extraordinary advances in American medicine during this period coupled simultaneously with radical cultural changes. Organ transplantation, kidney dialysis, respirators, and intensive care units (ICUs) made pos-

sible a level of medical care never before attainable, but these breakthroughs also raised daunting ethical dilemmas the public had never previously been forced to face, such as when to initiate admission to an ICU or when treatments such as dialysis could be withdrawn. The advent of the contraceptive pill and safe techniques for performing abortions added to the ethical quandaries of the “new medicine.” At the same time, cultural changes placed a new emphasis on individual autonomy and rights, setting the stage for greater public involvement and control over medical care and treatment. Public debates about abortion, contraceptive freedom, and patient rights were gaining momentum. In response, academics began to write about these thorny issues, and scholars were beginning to view these “applied ethics” questions as the purview of philosophy and theology. “Bioethics”—or, at the time, “medical ethics”—had become a legitimate area of scholarly attention.

In its early years, the study of bioethical questions was undertaken by a handful of scholars whose academic home was traditional university departments of religion or philosophy. These scholars wrote about the problems generated by the new medicine and technologies of the time, but they were not part of a discourse community that could be called an academic field or subject area. Individual scholars, working in isolation, began to legitimize bioethical issues as questions deserving rigorous academic study. But bioethics solidified itself as a field only when it became housed in institutions dedicated to the study of these questions. Academic bioethics was born with the creation of the first “Bioethics center.”

Ironically, academic bioethics came into existence through the creation of an institution that was not part of the traditional academy. The first institution devoted to the study of bioethical questions was a freestanding bioethics center, purposely removed from the academy with its rigid demarcations of academic study. The institution was the Hastings Center, originally called The Institute of Society, Ethics and the Life Sciences, which opened its doors in September 1970. Its founder, Daniel Callahan, along with the psychiatrist Willard Gaylin, M.D., created the center to be an interdisciplinary institute solely dedicated to the serious study of bioethical questions. Callahan, a recently graduated Ph.D. in philosophy, had been one of the isolated scholars working on an issue in applied ethics, and he had found himself mired in complex questions that took him far afield from the traditional boundaries of philosophy. His topic, abortion, required engagement with the disciplines of law, medicine, and social science, which he felt himself unprepared to navigate. With academic departments functioning as islands within a university, it seemed that truly interdisciplinary work was impossible. The Hastings Center was founded to create an intellectual space for the study of these important questions from multiple perspectives and academic areas.

The second institution that helped solidify the field of bioethics was the Kennedy Institute of Ethics, which opened at Georgetown University in 1971. The founders had similar goals to those of Hastings, though they placed their center inside the traditional academy. While housed outside of any particular academic departments, the Kennedy Institute came to look more like a traditional department, offering degree pro-

grams and establishing faculty appointments along a university model.

From these modest beginnings, the field of bioethics exploded, with dozens of universities following suit, creating institutions whose sole function was the study of bioethical issues. Its growth was fueled by the appearance both of new technologies such as the artificial heart and in vitro fertilization and new challenges such as HIV. Bioethics was now permanently on the academic map and central to public discourse.

Institutions of Bioethics

Since the early 1970s, as bioethics has gained legitimacy, there has been an increasing trend of bioethics centers becoming academic departments. Originally modeled on the structure of an independent “think tank,” the bioethics centers of the early twenty-first century are often housed within either a medical school or school of arts and sciences, indistinguishable in structure from any other departments in those schools. The professionalization of bioethics has taken it from the academic margins to the center, and with this development has come all of the trappings of traditional academics, such as tenure, degree programs, professional conferences, and academic journals.

Beginning in the 1980s, medical schools began housing bioethics institutes either as departments of medical ethics or departments of medical humanities. Located within an undergraduate medical school, the duties of these departments include the ethics education of the M.D. students. Whereas the original bioethics centers had as their primary focus the production of scholarly research, departments of bioethics have pedagogical obligations and are viewed as institutions designed to serve the narrower educational mission of the school. Bioethics institutions that are instead housed within a school of arts and sciences have the same type of pedagogical obligations, though perhaps serving a different student population, namely, university undergraduates or graduate students. Departments of bioethics, depending on their configuration, offer traditional undergraduate or graduate courses, undergraduate majors or concentrations, graduate degrees (usually master's degrees), undergraduate medical school ethics training, and/or residency ethics training. By the early twenty-first century, there were more than sixty master of bioethics programs in the United States, attracting a diverse student population including recent undergraduates; students pursuing joint J.D., M.D., and Ph.D. degrees; and midcareer professionals from the fields of law, medicine, and public policy whose work requires specialty training in the field of bioethics.

Another result of the professionalization of bioethics was the pressure to publish in traditional scholarly venues, such as academic journals. But the formation of a new academic field of study necessitated the creation of academic journals in which to publish these novel scholarly works. Journals emerged that were designed solely for works in the field of bioethics, including the *Hastings Center Report*, the *Kennedy Institute of Ethics Journal*, the *American Journal of Bioethics*, and *Bioethics*. But the mainstreaming of bioethics into the academy also opened up space within traditional medical and scientific jour-

nals for scholarly works in bioethics. Research in bioethics is now routinely published in the likes of the *Journal of the American Medical Association*, the *New England Journal of Medicine*, *Science*, and *Nature*.

Perhaps the institution most effectively used within the field of bioethics is the Internet. All major bioethics institutes, centers, and departments (and some journals) have elaborate Web sites, not only offering information about the specific institution, faculty, and degree programs, but also undertaking an educational mission to raise the level of public debate about current bioethical issues. These Web sites offer substantive information for individuals seeking to become better informed about these issues. One of the most developed Web sites is the companion site to the *American Journal of Bioethics* (www.bioethics.net). This Web site not only offers actual scholarly works in the field but also includes a high school bioethics project, job placement information, a “Bioethics for Beginners” section, and a collection of bioethics news stories from the popular press, updated daily, with direct links to the original news articles.

The Methods of Bioethics

The founders of the field of bioethics and its first leaders were largely theologians or philosophers. Reflecting the scholarly conventions of their home disciplines, the first works in bioethics centered on a normative analysis of bioethical issues, arguing for or against the moral permissibility of a particular technology, practice, or policy. Starting in the 1970s, these philosophers and theologians were joined by physicians and lawyers, who too made normative claims about bioethical problems. But by the mid-1990s, bioethics was attracting populations of scholars who had not previously been well represented in the field, namely, social scientists and empirically trained clinicians, both physicians and nurses. With the entry of these new groups of scholars, the “methods” of bioethics began to shift, mirroring the methodologies of the new disciplines becoming central to the field. With this change, bioethics included not only normative analysis but also the empirical study of bioethical questions, what Arthur Caplan has called “empiricized bioethics.”

Empiricized bioethics takes one of two forms: either it seeks to collect empirical data needed to shed light on a bioethical problem, or it attempts to stand outside the discipline in order to study the field itself. Projects taking the first form use either qualitative or quantitative social science methodology to collect data needed to make persuasive bioethical arguments. These empirical studies might explore, for example, patient comprehension of medical information, patient and family experience with medical care, the ability of children or incompetent adults to give consent for research participation, or the frequency with which practitioners face particular ethical dilemmas.

Projects taking the second form explore the way in which the field of bioethics is evolving, the influence it has had on policy formation, the methods and strategies it employs, the field's understanding of itself, and its place in public life and contemporary academia. One very prominent contemporary

method employing this strategy is narrative bioethics, or what might be called “deconstructionist bioethics.” Using the insights of literary criticism, these bioethicists examine the discourse of the field to reveal its biases, conventions, and assumptions, making the field more self-reflective about its motives and goals. Along the same line, the field has seen the development of feminist bioethics and disability bioethics, both of which focus on issues of inclusion and exclusion, voice, and their confluence on particular substantive issues. Altogether, the empirical methods of bioethics have been so well received in the field that by the early twenty-first century, all bioethics centers and departments had representation from the social sciences or clinical medicine, and in many cases the empiricists constituted the majority of center or department membership.

One final methodology that has had a significant presence in medical humanities departments is literary analysis, in which literary texts are used as a vehicle for the ethics education of clinicians in training. These medical humanists use first-person illness narratives or first-person testimonies from clinicians, as well as important works in fiction, to teach health care professionals about the ethical issues involved in being both patient and practitioner.

Current Issues in the Field: Bioethics in the Early Twenty-First Century

The bioethical issues being addressed by the field are too numerous to count, but the flavor of bioethics in the early twenty-first century can be conveyed by an exploration of the bioethical implications of genetic research, health care access reform, and stem cell research, arguably the most pressing issue in the field to date.

Advances in the science of genetics, including the Human Genome Project and the ability to find genetic markers for particular diseases, have raised difficult ethical dilemmas. Two of the most pressing issues are preimplantation genetic diagnosis and the genetic testing of adults. With the technology to identify inherited diseases in the early embryo comes questions about which embryos ought to be implanted, which diseases constitute a legitimate moral reason to discard an embryo or become the criterion for embryo selection, which traits ought parents be allowed to select or test for, and who ought to have access to this technology and on what grounds. For example, while there might be widespread support for testing embryos that might carry the trait for Tay-Sachs disease or cystic fibrosis, there are troubling questions about selecting embryos on the basis of sex, nonlethal trisomes (such as Down’s syndrome), or aesthetic or character traits that technology may someday be able to screen for. In adult medicine, genetic tests already exist to detect mutations leading to some forms of inherited breast cancer and to Huntington’s disease. Here, questions arise about privacy of health care information, psychological impact, stigmatization, lack of informed consent, health insurance access, and familial disclosure. With the advent of commercial genetic testing centers, patients will soon have easy access to genetic tests independent of the practice of clinical medicine, without the benefit of genetic counseling services, professional psychological support, or adequate, and possibly accurate, clinical information.

The Internet, for example, will likely bring universal access to any genetic test as it becomes available.

Emerging Issues for the Future

As the twenty-first century unfolds, new and expanding areas of research will require increasing attention to their related ethical aspects.

Neuroethics. Knowledge about the human brain holds much promise and offers much needed hope to those who suffer from disorders of the brain and mind. The relative accessibility of the brain through biochemical, electrical, and magnetic stimulation, as well as surgery, makes neurological interventions tempting as knowledge of brain structure, wiring, and chemistry grows. Nevertheless, there has been little systematic analysis of the ethical implications of the revolution in the brain sciences. This revolution raises numerous ethical questions and issues:

- The “essence” of personhood and identity
- The relation between physiological structures and higher functioning (“mind” or “self”)
- The ways in which abnormalities in the brain might account for atypical or antisocial human behavior
- The acceptability of using pharmaceuticals, implants, or other interventions to enhance innate traits such as memory, attention span, or musical ability
- The legitimacy of intervening to alter aspects of personality, mood, or emotion; to assess the effectiveness of treatments or incarceration in modifying criminal behavior; or to detect predispositions to both desirable and undesirable behavior in persons who cannot themselves consent

New knowledge of the brain will soon have an enormous impact on the legal and penal systems. How to integrate knowledge of the brain into the practice of forensics, the prosecution of persons accused of crime, and the screening of those seeking parole are all issues likely to become pressing in the not-too-distant future. Equally controversial will be the use of new knowledge about the brain in the detection and prevention of the onset of undesirable behavior in adolescents and children and in trying to improve or enhance their capabilities and skills.

Eugenics. While there has been much attention in bioethics to the mapping of the human genome and to the nuclear transfer techniques used to clone Dolly the sheep and other animals, the most provocative genetics-related issue facing society during the first half of the twenty-first century is likely to be to what extent ought humans design their children. Rudimentary steps toward making eugenics a reality are all around us.

The finalization of a crude map of the human genome and other animal and plant genomes means that medicine will soon have at its disposal a huge amount of information about the contribution genetics makes to a wide variety of traits, behav-

iors, and phenotypic properties. In addition primitive efforts to introduce genes into the cells of the human body through gene therapy will be refined to the point at which genetic surgeons should be able to introduce targeted genes with specific functions into both somatic cells (cells in a person's body) and germ-line cells such as the stem cells in the testicles that create sperm in a man's body. And the ability to analyze the genetic makeup of sperm, eggs, and embryos has already led to some infertility clinics offering genetic testing for diseases as a part of their standard care for their clients. This means that parents of tomorrow, both infertile and fertile, will increasingly look to medicine to diagnose potential problems and risks before babies and children are created. The issue will not be whether humans should design their children but to what extent and with what if any limits on how far one may go to improve, enhance, and optimize them.

When should a person die? Another fascinating emerging ethical issue is whether humanity should seek to control the time of death. It is one thing to agree that individuals who are dying have the right to withdraw or not initiate medical treatments. It is quite a different matter to say that someone who is not terminally ill but is suffering from a terribly disabling chronic condition, a severely diminished quality of life, or the prospect of decades of life in a state of dementia or extreme frailty should have the right to medical or technological assistance in dying as is already the case in the Netherlands, the state of Oregon, and Colombia. The focus of these debates, however, has been almost exclusively the terminally ill. As the population of the world ages over the course of the twenty-first century, more and more persons may begin to ask or demand the right to control the timing of their death, whether they are deemed terminally ill or not.

See also **Biology; Death; Eugenics; Life; Medicine: Europe and the United States.**

BIBLIOGRAPHY

- Callahan, Daniel. "Bioethics as a Discipline." *Hastings Center Studies* 1, no. 1 (1973): 66–73.
- Caplan, Arthur L. *Am I My Brother's Keeper? The Ethical Frontiers of Biomedicine*. Bloomington: Indiana University Press, 1997.
- Jonsen, Albert R. *The Birth of Bioethics*. New York: Oxford University Press, 1998.
- Reich, Warren T. "The Word 'Bioethics': Its Birth and the Legacies of Those Who Shaped Its Meaning." *Kennedy Institute of Ethics Journal* 4, no. 4 (1994): 319–336.
- Rothman, David J. *Strangers at the Bedside: A History of How Law and Bioethics Transformed Medical Decision Making*. 2nd ed. New York: Aldine de Gruyter, 2003.
- Stevens, M. L. Tina. *Bioethics in America: Origins and Cultural Politics*. Baltimore: Johns Hopkins University Press, 2000.

Arthur Caplan
Autumn Fiester

BIOGRAPHY. One of the oldest genres of literature, biography is a written account of a person's life. It is also known as "life writing," a broader term that encompasses autobiogra-

phy and other narrative forms such as letters, memoirs, journals, and diaries. The term *biography* derives from the Greek *bios* (life) and *graphein* (to write). Latin and Greek terms for biography were used in antiquity. Before the adoption of the word *biography* into English in the seventeenth century, common terms for biography were *life* and the Latin *biographia*.

Many of the earliest "histories" were biographical accounts of the lives of important historical figures. Biography often has been associated with the field of history (and at times has been considered a branch of it), but distinctions between them were drawn beginning in ancient times. Whereas the writers of histories always have purported to present the truth accurately, biographers more obviously have praised their subjects or have presented them as exemplars for moral or didactic (educational) purposes.

Although formal definitions of biography vary, biographical literature includes such forms as character sketches, single biography, serial biography, literary biography, ethical (or didactic) biography, critical biography, and hagiography (sacred biography). In addition, biography shares many features with other literary genres, including travel writing and epistolary literature (that is, literature based on letters), and certain novelistic forms, such as the biographical novel and the bildungsroman that follows the development of a young character. The mixture of fiction with fact in biography means that it has much in common with imaginative literature. For example, the emergence of the novel as a genre paralleled developments in biography. Many early novels adopted a biographical form. In contemporary literature, a novelized biography may be nearly indistinguishable from a biographical novel.

Some commentators have indicated that biography, as an independent form, has been predominantly a product of Western civilization. In particular, they have pointed to the comparatively greater focus on the individual personality in Western biographical literature. If one follows a narrowly construed definition of biography, and adopts Western forms as standards, then this conclusion may seem plausible. Yet while the development of biography in the West has followed a unique trajectory, the production of biographical literature (and likely the biographical impulse witnessed in oral cultures) appears to be universal. Nevertheless, some differences between Western and non-Western traditions must be considered. In China, for example, biographical literature has been largely contained within a historiographic tradition and has been primarily related to the literature of the art of government. In India, biographical writings (such as fragments regarding the Buddha) have been contained within a larger body of spiritual literature.

Just as it is difficult to find an unbiased historical narrative (and many histories have been written for political purposes), biography long has been written for political, moral, or didactic purposes. The origins of biography in epideictic rhetoric (panegyric, or elaborate praise) means that biographers (whether of kings or revolutionaries) have been more interested in praising their subjects' actions or characters than in presenting historically accurate accounts. For this reason, the genre has lent itself to politicized narratives (including political histories or political romances) and narratives that define personal

identity. Although biography traditionally has centered on rulers, philosophers, or literati, modern biographers have taken a wide variety of persons for their subjects, including women and individuals from underrepresented or persecuted groups.

Ancient Biography

Biographies have evolved from short narratives that commemorate the deeds of illustrious figures to more complex forms that present the life of an individual in considerable detail. The earliest biographical records include the hieroglyphic inscriptions on Egyptian monuments (c. 1300 B.C.E.) and cuneiform inscriptions found in Assyria (c. 720 B.C.E.) and Persia (c. 520 B.C.E.). These quasi-biographical works commemorated the deeds of kings. Similarly, the oldest biographical writings in England were runic inscriptions that related the lives of heroes. Apart from Western quasi-biographical works, the earliest biographies appeared in the second century B.C.E. in China. The *Shih-chih* (Historical records) by Sima Qian (formerly transliterated as Ssu-ma Ch'ien, c. 145–c. 85 B.C.E.) included short character sketches, anecdotes, and dialogue between archetypal subjects. The historian Ban Gu (formerly transliterated as Pan Ku, 31–92 C.E.) continued this tradition in the *Han shu* (History of the former Han dynasty).

While biographical literature existed in the West as early as the fifth century B.C.E., a more defined notion of biography did not appear there until the Hellenistic age. Ion of Chios (c. 490–c. 421 B.C.E.) wrote quasi-biographical character sketches of eminent figures such as Pericles and Sophocles. Xenophon (c. 431–c. 352 B.C.E.) wrote a life of Cyrus (c. 365 B.C.E.) that praised the king. He also commemorated Socrates in the *Memorabilia*. Other quasi-biographical works include Plato's dialogues on Socrates, the *Apology* and the *Phaedo*.

Among the earliest surviving biographies are those contained in *De viris illustribus* (On illustrious men), by Cornelius Nepos (c. 100–c. 25 B.C.E.). This work became a model for subsequent serial biography, a form that consisted of the collected lives of one or more categories of illustrious persons. Plutarch (c. 46–after 119 C.E.) is perhaps the most famous ancient biographer. His *Parallel Lives* comprised forty-six biographies assembled in pairs. This work was an early example of a collection of single, autonomous lives. Plutarch showed a greater interest in revealing a subject's moral character than in documenting historical details, a feature that is typical of panegyric literature. He also praised his subjects in many anecdotes and digressions.

Other early biographers included Cornelius Tacitus (c. 56–c. 120 C.E.) and Suetonius (c. 69–after 122 C.E.). Suetonius presented the life of Julius Caesar and the lives of the first eleven emperors in his *De vita Caesarum* (c. 110 C.E.; English trans. *The Twelve Caesars*, 2003). Following Plutarch, he emphasized the personal lives of the emperors rather than historical details in his collection of single lives. Suetonius also wrote *De viris illustribus* (c. 106–113; On illustrious men), a series of biographies of illustrious figures (philosophers, orators, and literati) that became a model for serial biography.

Diogenes Laertius (3rd century B.C.E.) wrote the *Lives of Eminent Philosophers*, a series of biographies of Greek philosophers.

This work is the most complete surviving example of the ancient genre of philosophers' lives (the revival of which in the fifteenth century had a major impact on early modern biography). Diogenes notably indicates in his accounts that the actions and behaviors of the philosophers serve to exemplify their teachings. Although he focused on the private lives of his subjects, he also was known for his meticulous documentation of sources. His serial *Lives* were instructive to later biographers because he arranged them by the relations of masters to disciples and by individuals' contributions in their fields. St. Jerome (c. 347–419 or 420) wrote the exemplary serial biography in late antiquity. His *De viris illustribus* (c. 392; English trans. *On Illustrious Men*, 1999) was an elaboration on Suetonius's notes on the lives of the philosophers. It was widely imitated for three centuries and revived as a model in the twelfth century. He also incorporated elements of classical biography in his lives of saints, which greatly influenced medieval biographers.

Medieval and Renaissance Biography

The works of Plutarch, Suetonius, and St. Jerome remained models for biographers in the medieval and Renaissance periods. The characteristic biographical form of the medieval period was the life of the saint (the sacred life or hagiography). Although many collections of saints' lives or acts (martyrologies) were compiled, there was often little differentiation between the characteristics of individual saints. While medieval hagiographers heavily drew on classic biographies, they focused on praising the spiritual virtues of their subjects and offered evidence for their canonization. Hagiography consequently developed unique conventions, such as the preservation of miracles and the martyrdom of saints. Exemplary lives of this period include Adamnan's *Life of St. Columba* (c. 690), Bede's *Life of St. Cuthbert* (c. 731), Eadmer's *Life of St. Anselm* (c. 1124), and Jean de Joinville's *History of St. Louis* (c. 1309). Other important biographical works include the *Lives of the Fathers* and the *History of the Franks* by Gregory of Tours (538–594), Bede's *Ecclesiastical History of the English People* (c. 731), and later Einhard's *Life of Charlemagne* (c. 829–836; based on Suetonius's *The Twelve Caesars*).

Humanist biographers in the Renaissance were influenced by classical lives and the lives of saints. Petrarch's incomplete *De viris illustribus* (begun c. 1337; On illustrious men) is in the tradition of single biographies of eminent ancient figures (following Suetonius and Plutarch). Giovanni Boccaccio's *Trattatello in laude di Dante* (1354–1355; English trans. *Life of Dante*, 1990) exemplifies the revival of the single life of a subject presented as an ideal. Influenced by Petrarch, Boccaccio assembled two collections of single lives concerning illustrious ancient figures, *De casibus virorum illustrium* (1355–1374; On the fall of illustrious men) and *De claris mulieribus* (1360–1374; On famous women), the first collection of women's lives. Partly in response to Boccaccio's *De claris mulieribus*, Christine de Pisan (1364–c. 1430) wrote her vernacular *Le livre de la cité des dames* (1405; English trans. *The Book of the City of Ladies*, 1998), often considered the first work of feminist literature. Notably, the earliest modern English autobiography is *The Book of Margery Kempe* (c. 1432–1436), by Margery Kempe (c. 1373–c. 1440), a work that largely follows the conventions of medieval sacred biography.

Renaissance biographers borrowed extensively from the works of Diogenes Laertius and St. Jerome, especially in developing new serial lives assembled according to notions of cultural progress. In *De origine civitatis Florentiae et de eiusdem famosis civibus* (c. 1381–1382; On the origins of the Florentine state and her most famous citizens), Filippo Villani presented short sketches of a wide variety of Florentine citizens, including poets, musicians, and painters. Later, Giorgio Vasari wrote his *Lives of the Painters, Sculptors, and Architects* (1550, rev. ed. 1568), following progressive developments in art through a series of biographies that culminated in Michelangelo. In England, William Roper (1496–1578) wrote the *Life of Sir Thomas More* and George Cavendish (1500–1561?) wrote the *Life of Cardinal Wolsey*. Other biographical writings were the *Lives of Famous Ladies* and the *Lives of Famous Men* by Pierre de Bourdeille, seigneur de Brantôme (c. 1540–1614) and Macarius's *Stepennaya Kniga* (1563; Book of degrees) in Russia.

The Seventeenth and Eighteenth Centuries

The English term *biography* was first used by John Dryden in 1683. The seventeenth century and the early eighteenth century witnessed expanded production of many types of life writing, including diaries, letters, and memoirs. Biographies by women appeared in this period, such as *Memoirs of the Life of Colonel Hutchinson* by Lucy Hutchinson (1620–after 1675) and *The Life of William Cavendish* (1667) by Margaret Cavendish (1623–1673). Some important biographical works were the five lives of eminent figures by Izaak Walton (1593–1683), the *Lives of Eminent Men* by John Aubrey (1626–1697), the diary of Samuel Pepys (1633–1703), and Roger North's *Lives of the Norths* (1742–1744). The most influential English biography was James Boswell's *Life of Samuel Johnson* (1791). Boswell adopted the methods of earlier biographers, but artfully combined letters, personal documents, conversation, anecdotes, and his own observations to present a vivid portrait of Johnson. His in-depth treatment had a major impact on biography throughout the world.

The Nineteenth and Twentieth Centuries

Early-nineteenth-century biography was influenced by Boswell's *Life of Samuel Johnson* as well as by the writers within the Romantic movement. The primary biographical form in this period was the Victorian "life and letters" (or "life and times"). It was characterized by relatively great length, sobriety, and concern with social propriety. Some biographies of this period were Thomas Moore's *Life of Sheridan* (1825) and his *Letters and Journals of Lord Byron* (1830), John Lockhart's *Life of Sir Walter Scott* (1837–1838), Elizabeth Gaskell's *Life of Charlotte Brontë* (1857), G. O. Trevelyan's *Life and Letters of Lord Macaulay* (1876), and David Mason's *Life of John Milton: Narrated in Connection with the Political, Ecclesiastical, and Literary History of His Time* (7 vols., London, 1859–1894). Popular literary genres of the later nineteenth and early twentieth centuries that were influenced by biography included the realistic novel and the historical novel.

Biography in the twentieth century reflected the rise of modernism in the arts. There was a reaction against the Vic-

torian style of biography that resulted in shorter, less studious lives. Works of modernist biography include Lytton Strachey's *Eminent Victorians* (1918) and *Queen Victoria* (1921) and the numerous lives by André Maurois (1885–1967). Changes in style also were reflected in biographers' adoption of a scientific outlook. The influence of psychology (especially Freudian and Jungian) eventually led to the development of psychobiography. Experimental forms and methods were explored in works as diverse as Virginia Woolf's mock biography *Orlando* (1928), Lord David Cecil's two-volume work on Lord Melbourne (1939 and 1954), and A. J. A. Symon's *The Quest for Corvo* (1934). Postmodern forms of life writing emerged after World War II. Although more represented in autobiography than biography, postmodern lives have been characterized by further experimentation and the broad use of nontraditional methods. Postmodern biography in many ways reacts against modernist biography but is also an extension of it. It contains elements that are antiheroic, antihistorical, and absurd, or that consciously undermine conventional forms.

There were other major developments in the late twentieth century. One was the widespread appearance of biographies by and about women, and in particular, the establishment of feminist life writing as a literary form. Feminist biography had appeared in the fifteenth century, and feminists' writings had flourished at times, especially in the late eighteenth century (for example, Mary Wollstonecraft's *A Vindication of the Rights of Woman*, 1792). The late twentieth century, however, saw the rise of feminism as a major cultural movement and a rapid increase in feminist life writings. Late-twentieth-century feminist biographies were numerous and included several lives of Woolf. Feminist biographers have drawn inspiration from the works of earlier feminists, including the writings of Charlotte Perkins Gilman (1860–1935) and Woolf's essays *A Room of One's Own* (1929) and *Three Guineas* (1938). In addition to the establishment of feminist biography and the increase in biographies written by women (with women as subjects), lesbian and gay biography also became independent forms in the late twentieth century (such as Elizabeth Mavor's *The Ladies of Llangollen*, 1971).

The late twentieth century witnessed the emergence of traditionally underrepresented groups in biography, both as subjects and as biographers. In the United States, for example, subjects were increasingly African-American, Asian-American, Hispanic, and Native American (or were members of other underrepresented or immigrant groups). Some of these biographies built on earlier traditions (for example, African-American lives range from pre-Civil War slave narratives to Alex Haley's *Roots*, 1976). Biographers working in various postcolonial literatures also produced many lives of subjects from underrepresented groups.

Another major development has been the globalization of biography. As biographical forms have become diffused around the world, they have encompassed subjects from cultures in Africa, the Americas, East and Southeast Asia, Australia, the Middle East, the Indian subcontinent, and other regions. It is notable that while biographical forms have spread worldwide, biographers have continued to draw on forms established in earlier times

(both oral and written). In the early twenty-first century, as a result of these trends, biography is an increasingly global art, evidenced by the diversity in its subjects and forms.

See also *Autobiography; Genre; Literature*.

BIBLIOGRAPHY

PRIMARY SOURCES

- Ban Gu (Pan Ku). *The History of the Former Han Dynasty*. 3 vols. Translated by Homer H. Dubs. Baltimore, Md.: Waverly Press; and Ithaca, N.Y.: Spoken Language Services, Inc., 1938–1955. Translation of the *Han shu*.
- Boccaccio, Giovanni. *Life of Dante*. 1354–1355. Translated by Vincenzo Zin Bollettino. New York: Garland, 1990. Translation of *Trattatello in laude di Dante*.
- Boswell, James. *The Life of Johnson*. 1791. Reprint, edited by George Birbeck Hill and L. F. Powell, Oxford: Clarendon, 1971. 4 vols.
- Christine de Pisan. *The Book of the City of Ladies*. 1405. Translated by Earl Jeffrey Richards. New York: Persea, 1998. Translation of *Le livre de la cité des dames*.
- Jerome, St. *On Illustrious Men*. c. 392. Translated by Thomas P. Halton. Washington, D.C.: Catholic University of America Press, 1999. Translation of *De viris illustribus*.
- Nanamoll, Bhikku. *The Life of the Buddha*. Seattle: Buddhist Publication Society, 2001. Translated from the Pali Canon.
- Plutarch. *Lives*. Edited by Arthur Hugh Clough and translated by John Dryden. New York: Modern Library, 2001. 2 vols. Clough's 1864 revision of Dryden's 1683 translation.
- Sima Quan (Su-ma Ch'ien). *The Records of the Grand Historian of China*. 2 vols. Translated by Burton Watson. New York: Columbia University Press, 1961. Translations from the *Shih-chih*.
- Strachey, Lytton. *The Eminent Victorians: Cardinal Manning, Florence Nightingale, Dr. Arnold, General Gordon*. 1918. Reprint, London: Continuum, 2002.
- Suetonius. *The Twelve Caesars*. c. 110 C.E. Translated by Robert Graves. London: Penguin, 2003.
- Sylvester, Richard S., and Davis P. Harding, eds. *Two Early Tudor Lives: "The Life and Death of Cardinal Wolsey," by George Cavendish [and] "The Life of Sir Thomas More," by William Roper*. New Haven, Conn.: Yale University Press, 1962.
- Vasari, Giorgio. *Lives of the Painters, Sculptors, and Architects*. Rev. ed. 1568. Translated by Gaston du C. de Vere. New York: Knopf, 1996.

SECONDARY SOURCES

- Edel, Leon. *Literary Biography*. Toronto: University of Toronto Press, 1957.

Frederick Liers

BIOLOGY. *Biology* comes from the Greek word for life, *bios*, and the Greek word for thought or reasoning, *logos*. It denotes the science that studies life, the properties and processes that sustain life, the evolutionary history of life, and particular living organisms. It is a science of enormous diversity, breadth, and heterogeneity unified only by the conceptual framework provided by the theory of evolution. Indeed, as famously noted in 1973 by the Russian evolutionary geneticist Theodosius

Dobzhansky (1900–1975), “Nothing in biology makes sense except in the light of evolution”—a quote now replicated in so many university-level textbooks that it is almost a dictum in modern biology.

One reason for the diversity of biology comes from the staggering diversity of organisms that can be considered living. These range from viruses, bacteria, and fungi to plants and animals, including humans. Another reason is that life can be studied on various levels in a hierarchy that ranges from the organic-macromolecular level to genes, cells, tissues, organs, and entire organisms. Furthermore, organisms interact in, and can be organized into, families, communities, societies, species, populations, biomes or biota, and perhaps even the global systems (as in the controversial Gaia hypothesis, which postulates that the earth itself is a living organism). To a large extent, biological subdisciplines are organized around each of these levels of activity or organization. Thus, for example, cellular biology, or cytology (coming from the Greek word *cyto* for cell), deals specifically with the study of cells, while ecology (coming from the Greek word *oikos* for habitat) deals with interactions between populations, species, communities, and biomes and the processes that sustain them. Since biology deals immediately with living organisms and processes, it has a large applied component. It touches on medical and health-related areas, pharmacy, agriculture, forestry, and biological oceanography. In contemporary society, the promises and problems associated with applications of biology are staggering. They range from stem-cell research, the development and use of genetically modified organisms, and the use of biological tools as identity markers (as in DNA “fingerprinting”) to the possibility of designer babies and human cloning. Whereas the physical sciences and their applications dominated science for much of the history of science, the biological sciences now dominate both popular and scientific discussions, especially after the discovery of the structure of DNA in 1953. Viewing the revolution precipitated by the applications of biology to society at the closing of the twentieth century, many commentators anticipate that the new century will be the century of biology.

The Origins of Biology

Though biology is generally regarded as a modern science with late origins in the early to mid-nineteenth century, it drew on varied traditions, practices, and areas of inquiry beginning in antiquity. Traditional histories of biology generally target two areas that merged into modern biological science: medicine and natural history. The tradition of medicine dates back to the work of ancient Greek medical practitioners such as Hippocrates of Kos (b. 460 B.C.E.) and to figures such as Galen of Pergamum (c. 130–c. 200), who contributed much to early understanding of anatomy and physiology. The tradition of natural history dates back to the work of Aristotle (384–322 B.C.E.). Especially important are his *History of Animals* and other works where he showed naturalist leanings. Also important is the work of Aristotle's student Theophrastus (d. 287 B.C.E.), who contributed to an understanding of plants. Aristotle and Theophrastus contributed not only to zoology and botany, respectively, but also to comparative biology, ecology, and especially taxonomy (the science of classification).

Both natural history and medicine flourished in the middle ages, though work in these areas often proceeded independently. Medicine was especially well studied by Islamic scholars working in the Galenic and Aristotelian traditions, while natural history drew heavily on Aristotelian philosophy, especially in upholding a fixed hierarchy of life. The Roman naturalist Caius Plinius Secundus (23–79), known as Pliny, also had a major influence on natural history during the middle ages, notably through his compendium *Natural History* (later shown to be rife with errors of fact). Without doubt the most outstanding contributor to natural history in the middle ages is Albertus Magnus (1206–1280), recognized for his superb botanical studies and for his work in physiology and zoology. A lesser known figure is Holy Roman Emperor Frederick II (1194–1250), whose treatise *The Art of Falconry* is one of the first serious accounts of ornithology.

Though animals traditionally drew the attention of many naturalists, the study of zoology remained underdeveloped during the middle ages, relying heavily on illustrated books of animals modeled on medieval bestiaries. Botany, on the other hand, flourished in the Renaissance and early modern period. The study of plants was important in medicine, as well as natural history (and in fact constituted one of the few early points of common focus in the two areas), because plants were regarded as *materia medica*, substances with noted medicinal properties. These medicinal properties drew medical attention to plants. Hence it became standard practice to plant gardens next to primary centers of medical instruction, and professors of medicine were very often experts in *materia medica* and served as garden curators. Indeed, noted taxonomists of the early modern period—individuals such as Andrea Cesalpino (1519–1603) and Carl Linnaeus (1707–1778), both of whom are considered fathers of modern botany for their work in reforming taxonomy—were simultaneously physicians and botanists. An exception was John Ray (1627–1705), an English taxonomist who also worked with animals.

Also leading to the growing interest in and need for taxonomy and to an unprecedented development of natural history were the voyages of exploration associated with the establishment of colonies from the late fifteenth century. Largely to meet the demand to classify the collections made by explorers and travelers in order to exploit these natural commodities, gardens and museums of natural history were created in European centers associated with colonial conquests, especially Madrid, Paris, and London. A new period of scientific exploration dawned with the first voyage of Captain James Cook, whose expeditions included not only astronomers and artists but also botanists, such as Joseph Banks (1743–1820). On returning to London, Banks was instrumental in helping to found the Royal Institution of Great Britain, as well as in continuing to expand Kew Garden and the Royal Society. He also encouraged these institutions to serve the interests of both natural history and the expanding British Empire in the late eighteenth and early nineteenth centuries.

While botany and medicine were closely linked, anatomy and physiology followed other trajectories. After Galen, the next major figure in the history of anatomy is Andreas Vesalius

(1514–1564) of Belgium. Unlike many anatomists (such as Galen, who relied on dissections of animals such as pigs and Barbary apes), Vesalius drew his knowledge of the human body from detailed dissections on human cadavers. He was unusual for his time in believing that the authority of nature should supercede the authority of ancient texts. His seven-volume atlas of human anatomy, *De Humani Corporis Fabrica* (On the fabric of the human body), covered skeletal and muscular anatomy as well as the major organ systems of the body. Skillfully illustrated by some of the leading Renaissance artists, the atlas was considered a work of art as well as of anatomical science. Although Vesalius challenged many of tenets held by Galen and his numerous commentators, he nonetheless retained some erroneous conventions present in Galen's anatomy, such as the existence of pores in the septum of the heart and "horned" appendages in the uterus (present in the pig uterus but not in the human uterus). Vesalius's work was shortly followed by the work of anatomical specialists such as Bartolomeo Eustachio (1510–1574) and Gabriele Falloppio (1523–1562). Eustachio specialized in the anatomy of the ear, and Falloppio specialized in the female reproductive tract.

Developments in anatomy that turned interest to the parts and organs of the body were accompanied by questions dealing with organ function. In the sixteenth century, physiology, the science that deals specifically with the functioning of living bodies, began to flourish. The major animal physiologist of this period was William Harvey (1578–1657). Harvey performed numerous dissections and vivisections on a range of animals to determine that blood circulates through the body and is not manufactured *de novo*, as Galenic tradition had dictated. Harvey's influence was felt not only in medicine, but also in comparative physiology and comparative biology, since he performed his experiments on diverse animal systems. His experiments and major treatise, *An Anatomical Disputation concerning the Movement of the Heart and Blood in Living Creatures* (1628), are considered one of the first demonstrations of the method of hypothesis testing and experimentation. While Harvey frequently drew analogies between the pumping action of the heart and mechanical pumps, he resisted the idea that the body entirely obeyed mechanistic principles. Unlike his contemporary René Descartes (1596–1650), who held mechanistic theories of the functioning of animal bodies, Harvey maintained that some kind of nonmechanistic special forces, later called "vitalistic," were responsible for the life processes of animate matter.

The mechanical philosophy—the belief that the universe and its constituent parts obeyed mechanical principles that could be understood and determined through reasoned observation and the new scientific method—thus made its way into the history of biology. This engendered a lively discussion between mechanism and vitalism, between the idea that life obeyed mechanistic principles and the idea that life depended on nonmechanistic "vital" principles or somehow acquired "emergent properties." The debate cycled on and off for much of the subsequent history of biology, up to the middle decades of the twentieth century.

During the Renaissance, the mechanical philosophy did gain some proponents in anatomy and physiology, the most no-

table figure being Giovanni Borelli (1608–1679), who sought to understand muscle action in animal bodies in terms of levers and pulleys. Some early embryologists, as followers of Descartes, espoused the belief that development too followed mechanistic principles. In what came to be known as preformation theory or “emboitement,” the seeds of mature but miniaturized mature adult forms or *homunculi* were thought to be embedded entirely intact in mature organisms (as though they were encased in a box within a box, hence the name “emboitement”). Prominent advocates of this view included Marcello Malpighi (1628–1694) and Jan Swammerdam (1637–1680). This stood in contrast to the idea of “epigenesis,” the belief dating back to Aristotle and his commentators that development began from initially undifferentiated material (usually the ovum) and then followed an epigenetically determined path of development after fertilization. One of the more prominent proponents of this theory was Pierre Louis Maupertuis (1698–1759), who argued that preformationist theories could not explain why offspring bore characteristics of both parents.

In the seventeenth and eighteenth centuries, theories of embryology and development were superimposed with theories of sexual reproduction, along with a number of theories on the origins of life, most of which upheld the idea of spontaneous generation. During this period debates raged over spontaneous generation, the idea that life was spontaneously created out of inanimate matter. The popular belief that living organisms propagated from mud in streams, dirt and detritus, or environments such as rotting meat was supported by a number of scholars from antiquity on. William Harvey’s research into reproduction, published in 1651 as *Exercitationes de Generatione Animalium* (Essays on the generation of animals), began to cast doubt on spontaneous generation. Harvey believed that all life reproduced sexually, a view he pithily stated with his famous dictum *Ex ovo omnia* (“Everything comes from the egg”). In 1668 the Italian physician Francesco Redi (1626–1697) performed a famous experiment that further detracted from the theory of spontaneous generation. By carefully covering rotting meat so that it was not accessible to flies, he showed that maggots did not spontaneously emerge. The idea that sexual reproduction characterized much of life was further reinforced when Nehemiah Grew (1641–1711) demonstrated sexuality in plants in 1682. Later, in 1768, the Italian physiologist Lazzaro Spallanzani (1729–1799) offered additional evidence disproving spontaneous generation, and in 1779 he gave an account of the sexual function of ovum and sperm. Despite this accumulating experimental evidence against spontaneous generation, new developments continued to fuel belief in spontaneous generation. In 1740, for example, Charles Bonnet (1720–1793) discovered parthenogenesis (“virgin birth”—an asexual form of reproduction) in aphids, and in 1748 John Turberville Needham (1731–1781) offered evidence of what he thought were spontaneously generated microbes in a sealed flask of broth (this was later challenged by Pierre-Louis Moreau de Maupertuis [1698–1759]). Finally, the discovery of microbial life supported the idea that living organisms spontaneously emerged from natural environments such as pond water. The seventeenth and eighteenth centuries thus witnessed a number of debates that were only resolved

much later in the late nineteenth century when distinctions were made between the very different processes associated with reproduction, the origins of life, and embryological or developmental unfolding. Belief in spontaneous generation was finally put to rest in 1860 by the celebrated “swan-necked flask” experiments of Louis Pasteur (1822–1895).

Other notable developments in the origins of biology came as the result of new instruments and technologies, the most important of which was the microscope. Developed independently by Robert Hooke (1635–1703) in England and Antony Van Leeuwenhoek (1632–1723) in the Netherlands, the microscope revealed a previously unseen and entirely unimagined universe of life. Robert Hooke first observed repeating units he described as “cells” in his *Micrographia* (1665), while Leeuwenhoek observed varied motile organisms he described as “animalcules.” While the microscope opened up cytological and microbiological explorations, it also shattered Aristotle’s notion that life is organized along a *scala naturae* (ladder of nature), since new and minute animal forms were not easily located on the ladder of creation. It also fueled the belief in spontaneous generation. Pioneering the use of the microscope and its application to anatomy, Marcello Malpighi (1628–1694), Italian professor of medicine and personal physician to Pope Innocent XII, drawing on the previous work of Andrea Cesalpino and William Harvey, studied the circulatory and respiratory systems of a range of animals (especially insects). He was one of the first to study major organ groups such as the brain, lungs, and kidneys in diverse organisms.

Modern Biology

Though there is some disagreement among historians of biology about the precise origins, the transition to modern biology appears to have occurred from the late eighteenth century to the early nineteenth century. A confluence of developments brought about this transition. In France naturalists reformed taxonomy and began to recognize the extinction of life forms. This progress resulted from the work of natural historians such as the Comte de Buffon (1707–1788), Georges Cuvier (1769–1832), Étienne Geoffroy de Saint Hilaire (1772–1844), and Jean-Baptiste de Lamarck (1744–1829) at institutions such as the Jardin du Roi. New sciences emerged, including comparative anatomy and paleontology, areas in which Cuvier is still recognized as the founding father. French anatomists such as Xavier Bichat (1771–1802) and physiologists such as François Magendie (1783–1855), by experimenting on animal systems (sometimes to questionable excess in the case of Magendie), refined and enhanced understanding of fundamental physiological processes, and thereby revolutionized physiological understanding of life. In Germany the insights of natural philosophers such as Johann Wolfgang von Goethe (1749–1832) and Lorenz Oken (1779–1851) began to generate a serious interest in a unified science of life.

All of this activity was echoed by a number of early references to biology in a number of obscure German contexts beginning in the late eighteenth century. Traditional histories generally pinpoint the first general use of the term *biology* at 1800 in the medical treatise *Prapädeutik zum Studium der gesammten Heilkunst* (Propaedeutic to the study of general medicine) by Karl Friedrich Burdach (1776–1847), who used

it mostly for the study of human morphology, physiology, and psychology. It appeared again in 1802 in the work of the German naturalist Gottfried Treviranus (1776–1837) and in the work of Jean-Baptiste de Lamarck, the French botanist and early proponent of transmutationism. Although the word gained some currency by the 1820s, especially in the English language, it was largely through the efforts of August Comte (1798–1857), the French social philosopher, that the term gained its most widespread currency. For Comte, biology, one of the “higher sciences” in his philosophy of positivism, was the discipline of knowledge that organized the study of life and sought the principles of life.

Especially critical to the development of modern biology was the period between 1828, when Friedrich Wöhler (1800–1882) artificially synthesized the organic compound urea in the laboratory (fueling the debate between mechanism and vitalism), and 1866, the year Gregor Mendel (1822–1884) published his theory of heredity. During this time the conceptual foundations of the new science were laid, and many of the defining criteria of nearly all the major subdisciplines of biology were established.

The first areas for which groundwork was laid were cytology (now part of the more general discipline of cell biology) and histology (the study of tissues). Advances in optics in the 1830s by workers such as Giovanni Battista Amici (1784–1863) significantly enhanced the resolving power of the microscope and diminished or entirely eliminated such disruptive phenomena as chromatic aberration. Techniques for selectively dyeing and staining cellular components and enhancements in sectioning that led to thinner and thinner sections further enabled researchers to see more clearly increasingly finer structures. As a result of improvements in microscope technology, a series of plant and animal observations from 1833 led to recognition of a number of cellular structures, beginning with the nucleus, first observed in orchid cells by the English microscopist Robert Brown (1773–1858). Observations on the cells of plants and animals culminated in the establishment of the cell theory in the late 1830s, the recognition that cells were the basic unit of organization in all living tissues. The establishment of the cell theory resulted from observational work by the botanist Matthias Schleiden (1804–1881) and by the animal physiologist Theodor Schwann (1810–1882). Rudolf Virchow (1821–1902) extended this theory in 1840 to include the observation that all cells come from cells, and in 1858, in his *Cellular Pathology*, he provided new foundations for understanding disease in terms of cellular disruption. The germ theory of disease, a theory that Louis Pasteur proposed in the 1860s as a result of his work in microscopy, suggested that microorganisms were the causes of infectious diseases. Advances in microscopy in the nineteenth century thus laid the foundations not only of cytology and histology but also of the new science of microbiology (the study of microbial life), which continued to explore smaller and smaller life forms well into the twentieth century.

Yet another area that drew heavily on microscopy was knowledge of heredity (later designated as the science of genetics), especially in the late nineteenth century after structures such as chromosomes were first observed and cellular reproduction

was understood in terms of meiosis and mitosis. The chromosome theory of heredity, first proposed by Walter Sutton (1877–1916) and Theodor Boveri (1862–1915), largely integrated knowledge of the fine structure and behavior of chromosomes with Mendelian genetics to suggest that chromosomes were the material carriers of heredity. This theory was not articulated until early in the twentieth century, between 1902 and 1903. This development occurred so late because Gregor Mendel’s experimental insights into the process of heredity, which had been published in 1866, was not appreciated until its rediscovery in 1900. The modern science of heredity, which William Bateson (1861–1926) designated as genetics, began in the early years of the twentieth century, with initial inquiry determining the extent to which Mendelian principles operated in the natural world. The second area of interest sprung from the pioneering research of the American geneticist Thomas Hunt Morgan (1866–1945) and his laboratory on Mendelian genetics in the fruit fly, *Drosophila melanogaster*. Beginning roughly in the 1910s and peaking in the 1930s, this classic school of genetics worked on the transmission of a number of characteristics by studying mutant forms of *Drosophila*.

Microscopic techniques also played an active role in other important areas of nineteenth-century biology, areas such as embryology, and brought into relief the interplay between heredity, development, cytology, and evolution. By the late nineteenth century, persistent questions of biological development were being tackled with techniques and insights gleaned from cytology and cellular physiology, leading to a renewal of the debate between mechanism and vitalism. Just when figures such as August Weismann (1834–1914) had articulated mechanistic theories linking heredity with development and evolution, leading to movements such as developmental mechanics, individuals such as Hans Driesch (1867–1961) challenged strict mechanism in biology by experimentally demonstrating that almost any part of the cellular constituents of embryonic tissues had the potential to develop into mature forms. Driesch’s experimental efforts were rivaled by those of Wilhelm Roux (1850–1924), the leading advocate of developmental mechanics.

The middle decades of the nineteenth century also witnessed improvements in animal physiology, especially through the efforts of the German school associated with Johannes Müller (1801–1858) and later through the pioneering efforts of Hermann von Helmholtz (1821–1894). Increasingly, work in physiology, especially that of Helmholtz, drew heavily on the physical sciences. This research further supported the view that life obeys mechanistic principles and is reducible to such sciences as chemistry and physics. Proponents of this view increasingly dominated physiology, an arch example being Jacques Loeb (1859–1924), the German-American biologist most associated with mechanistic and reductionistic approaches to biology. His essays in *The Mechanistic Conception of Life* (1912) summarized this point of view.

Unquestionably, a major development in the critical early period of modern biology was the articulation and acceptance of evolution as based largely on the mechanistic process of natural selection. Drawing on a number of transmutation theories

PROPERTIES OF LIVING ORGANISMS

- A capacity for evolution
- A capacity for self-replication
- A capacity for growth and differentiation via a genetic program
- A capacity for self-regulation, to keep the complex system in a steady state (homeostasis, feedback)
- A capacity (through perception and sense organs) for response to stimuli from the environment
- A capacity for change at the level of phenotype and of genotype

SOURCE: Ernst Mayr, *This is Biology: The Science of the Living World* (1997).

(especially those of Buffon, Lamarck, and Robert Chambers [1802–1871]), Charles Darwin (1809–1882) and Alfred Russel Wallace (1823–1913) independently formulated similar theories of species change through the mechanism of natural selection, jointly publishing their insights in a paper read to the Linnaean Society in 1858. Darwin articulated his theory more fully in his celebrated work *On the Origin of Species by Means of Natural Selection, or the Preservation of Favoured Races in the Struggle for Life* (1859). Though the mechanism of evolutionary change continued to resist full understanding by scientists, the fact that life on earth had had an evolutionary history became widely accepted by the late nineteenth century. Because the mechanism remained uncertain, evolutionary theory remained controversial in the closing decades of the nineteenth century. Suggested alternative mechanisms included neo-Lamarckism, directed evolution, aristogenesis, and mutation theory—an entirely new theoretical formulation that drew on the new experimental science of genetics. The turn of the twentieth century is frequently known as the “eclipse of Darwin,” not so much because he fell into disfavor, but because alternatives to his theory of natural selection were being favored instead.

Between 1930 and 1950 scientists became certain about the mechanism of natural selection by integrating insights into heredity from Mendelian genetics with insights from traditional natural-history-oriented areas such as systematics, botany, and paleontology to formulate what has been called the “synthetic theory of evolution.” At this time evolutionary biology was organized as a discipline, in order to study the process of evolution from a range of perspectives. This “evolutionary synthesis”—an integration of Darwinian selection theory with the newer Mendelian genetics—is generally recognized as a major event in the history of twentieth-century biology. With the establishment of the synthetic theory of evolution, scientists began to feel that a mature, unified, modern science of biology had emerged. Theodosius Dobzhansky, whose own work in evolutionary genetics served as catalyst for this syn-

thesis, has maintained that evolution went a long way toward unifying biology.

Much of the work of twentieth-century biologists served to integrate biology. In addition, new technologies (such as the first electron microscopes in the 1930s), as well as developments and refinements in existing technologies, led to a staggering range of new discoveries in the twentieth century. In 1895 the Dutch biologist Martinus Beijerinck (1851–1931) designated what is known now as viruses—tiny living aggregations of protein and nucleic acid—as “filterable agents” because they passed through fine filters that could contain bacteria. It was known that these filterable agents could induce disease, but their structure was unknown until 1935, when W. M. Stanley (1904–1981) first crystallized the tobacco mosaic virus. This opened up further inquiry into viruses as disease-causing agents, into proteins and nucleic acids as the sole components of this very simple form of life, and into biochemical techniques instrumental for carrying out this research. By the late 1930s molecular biology and biochemistry were gaining traction. The reductionistic, mechanistic approaches of these sciences further pushed biological thinking about life in those directions. There was acute interest in the molecular structure of important proteins such as insulin, whose structure was determined in 1955 by Frederick Sanger (b. 1918), and in the role played by proteins and nucleic acids in reproduction and genetics.

In 1953 vitalistic approaches and philosophies received two body blows. First, the discovery of the structure of DNA (deoxyribonucleic acid), by Rosalind Franklin (1920–1958), Maurice Wilkins (b. 1916), James D. Watson (b. 1928), and Francis Crick (1916–2004) made the mechanism of the replication of genetic material understandable at the macromolecular level and moved genetics in the direction of molecular genetics. More than any discovery in recent biology, the discovery of the structure of DNA brought forth a revolution in biology, not just because of the theoretical knowledge gleaned, but also because of the potential applications of this knowledge.

EARLY DEFINITIONS OF BIOLOGY

From Lamarck, 1802: Biology: this is one of the three divisions of terrestrial physics; it includes all which pertains to living bodies and particularly to their organization, their developmental processes, the structural complexity resulting from prolonged action of vital movements, the tendency to create special organs and to isolate them by focusing activity in a center, and so on.

From Treviranus, 1802: The objects of our research will be the different forms and phenomena of life, the conditions and laws under which they occur and the causes whereby they are brought into being. The science which concerns itself with these objects we shall designate Biology or the Science of Life.

SOURCE: As translated by William Coleman in *Biology in the Nineteenth Century: Problems of Form, Function, and Transformation* (1971), p. 2.

The second body blow to vitalism was delivered in the same year by news of the celebrated experiment simulating the origins of life under early conditions on earth by Stanley Miller (b. 1930) and Harold C. Urey (1893–1981) at the University of Chicago. Miller and Urey enclosed the constituents of the early atmosphere of earth (methane, ammonia, and hydrogen gas) in a glass vessel and applied a high-energy electrical discharge to it, “sparkling” it to simulate lightning. A container of boiling water constantly supplied water vapor and heat. The cooling and condensing water vapor simulated rain. After letting the apparatus run for a number of hours and eventually weeks, Miller and Urey collected a brown-red pasty substance and chemically analyzed it to reveal a number of amino acids, the building blocks of proteins, and other macromolecules usually associated only with living organisms. The Miller-Urey experiment thus provided evidence that the basic building blocks for life could be generated by the kinds of conditions present in the early atmosphere of the earth. Subsequent experiments simulating conditions on other planets supported the view that life may also have originated in space, on other planets, or wherever similar conditions are found. For this area of study integrating research on the origins of life on earth with research on the existence and specific character of life on other planets, the molecular geneticist Joshua Lederberg (b. 1925) coined the term “exobiology,” the biology of organisms outside earth. Its sibling science is esobiology, or earth-based biology.

After World War II, biology boomed, and with it emerged new societies and institutions to organize the growing science. In 1947 the first umbrella organization for the biological sciences, the American Institute of Biological Sciences, was created in the United States. Other institutions, such as the National Science Foundation in the United States, established large divisions (and budgets) to fund research in the biological sciences. Both trends helped shape the direction and character of subsequent biological research. As with many other sciences in the

postwar period, the dominant site of activity in the biological sciences had shifted from its older European centers in Germany, France, and England to the United States. At the height of the Cold War, the Soviet launch of the Sputnik satellite drove a panicked U.S. government to offer even stronger support of scientific research. The biological sciences, too, benefited from this turn of events and received generous funding for research and biological instruction. Textbooks such as the popular Biological Sciences Curriculum Study drew on a virtual industry of biologists and educators to produce a series of widely read and influential textbooks for American high school students. Research in the United States continued at specialized research centers such as that at Cold Spring Harbor (in 2004 a center for molecular biology) and more traditional research settings including public and private universities, land-grant colleges, hospitals and medical centers, museums and gardens. In university education, biology as a subject area is considered so vital that it has become a requirement for general education programs. It is rapidly becoming one of the most popular majors for university students not just in the United States but worldwide.

Despite arguments for the unity of the increasingly diverse biological sciences, controversies and debates erupt between biologists about fundamental concepts in the biological sciences. Differences are especially pronounced between more reductionistic, physicalist, laboratory-driven, and experimental sciences such as molecular biology and biochemistry and more integrative, field-oriented, observational, and historical sciences such as evolutionary biology and ecology. In the mid-1960s, university biology departments became divided over differences in conceptual foundations, goals, methodology, philosophy, and scientific style. As a result, at locations such as Harvard University, departments of biology formally divided into departments of molecular biology and organismic biology, an area defined as an integrative approach to the biological sciences that includes a strong historical and ecological component. Roughly at this time ecology—a science of enormous

heterogeneity drawing on a range of approaches, practices, and methodologies and rooted in questions pertaining to adaptive responses to varying environments—became integrated with evolutionary approaches and instituted in departments of ecology and evolution. Often located within ecology and evolution departments are systematics and biodiversity studies, a newer area concerned with biodiversity, including classification and conservation.

In 1961 the evolutionary biologist, historian, and philosopher Ernst Mayr, reflecting on some of these growing differences between biologists, provocatively suggested that biology in fact comprises two sciences. The first is a biology based on proximate causes that answers questions of function (molecular biology, biochemistry, and physiology). The second is a biology based on ultimate causes that seeks historical explanation (evolutionary biology, systematics, and the larger discipline of organismic biology). While the biology of proximate causes is reductionistic and physicalist, the biology of ultimate causes is historical and is characterized by emergent properties. Much of Mayr's reflections on the structure of the biological sciences has formed the backbone of the history and philosophy of biology and has made its way into some textbooks in the biological sciences. While vitalism is no longer tenable in biology, there is considerable support for the belief that complex properties emerge from simpler strata in biology and for the idea that such emergent properties are useful in explaining life.

See also *Evolution; Genetics; Life*.

BIBLIOGRAPHY

- Allen, Garland. *Life Science in the Twentieth Century*. New York: Wiley, 1975.
- Appel, Toby. *Shaping Biology: The National Science Foundation and American Biological Research, 1945–1975*. Baltimore: Johns Hopkins University Press, 2000.
- Caron, Joseph. "Biology' in the Life Sciences: A Historiographical Contribution." *History of Science* 26 (1988): 223–268.
- Coleman, William. *Biology in the Nineteenth Century: Problems of Form, Function, and Transformation*. New York: Wiley, 1971.
- Dobzhansky, Theodosius. "Nothing in Biology Makes Sense Except in the Light of Evolution." *American Biology Teacher* 35 (1973): 125–129.
- Farley, John. *Gametes and Spores: Ideas about Sexual Reproduction, 1750–1914*. Baltimore: Johns Hopkins University Press, 1982.
- . *The Spontaneous Generation Controversy from Descartes to Oparin*. Baltimore: Johns Hopkins University Press, 1977.
- Lenoir, Timothy. *Strategy of Life*. Chicago: University of Chicago Press, 1989.
- Loeb, Jacques. *The Mechanistic Conception of Life*. Chicago: University of Chicago Press, 1912.
- Lovelock, James. *The Ages of Gaia: A Biography of Our Living Earth*. New York: Norton, 1988.
- Mayr, Ernst. "Cause and Effect in Biology." *Science* 134 (1961): 1501–1506.
- . *The Growth of Biological Thought: Diversity, Evolution, and Inheritance*. Cambridge, Mass.: Harvard University Press, 1982.
- . *This Is Biology: The Science of the Living World*. Cambridge, Mass.: Harvard University Press, 1997.
- Moore, John A. *Science as a Way of Knowing: The Foundations of Modern Biology*. Cambridge, Mass.: Harvard University Press, 1993.
- Morton, A. G. *History of Botanical Science: An Account of the Development of Botany from Ancient Times to the Present Day*. New York: Academic Press, 1981.
- Nordenskiöld, Erik. *The History of Biology*. New York: Tudor, 1936.
- Nyhart, Lynn. *Biology Takes Form: Animal Morphology and German Universities, 1800–1900*. Chicago: University of Chicago Press, 1995.
- Pauly, Philip J. *Biologists and the Promise of American Life*. Princeton, N.J.: Princeton University Press, 2000.
- . *Controlling Life: Jacques Loeb and the Engineering Ideal in Biology*. Berkeley: University of California Press, 1987.
- Pinto-Correia, Clara. *The Ovary of Eve: Egg and Sperm and Preformation*. Chicago: University of Chicago Press, 1997.
- Richards, Robert J. *The Romantic Conception of Life*. Chicago: University of Chicago Press, 2002.
- Smocovitis, Vassiliki Betty. *Unifying Biology: The Evolutionary Synthesis and Evolutionary Biology*. Princeton, N.J.: Princeton University Press, 1996.
- Sterelny, Kim, and Paul E. Griffiths. *Sex and Death: An Introduction to the Philosophy of Biology*. Chicago: University of Chicago Press, 1999.
- Strick, James E. *Sparks of Life: Darwinism and the Victorian Debates over Spontaneous Generation*. Cambridge, Mass.: Harvard University Press, 2000.

Vassiliki Betty Smocovitis

BIOMETRY. See *Evolution*.

BIRTH CONTROL AND ABORTION. See *Family Planning*.

BLACK ATLANTIC. In writing *The Black Atlantic: Modernity and Double Consciousness* (1993), Paul Gilroy sought to devise a theoretical approach to understanding race that encompassed three crucial elements. First, the idea of race as fluid and ever-changing, rather than static; second, the idea of race as a transnational and intercultural, rather than strictly national, phenomenon; third, the focus on analyzing resistance to racism as a phenomenon that emerged transnationally and diasporically.

Gilroy seeks to provide a theoretical rendering of race that bridges the hemispheres. To this end he takes the Atlantic as his preferred unit of analysis and uses it to ground his transnational perspective on race. In Gilroy's analysis the black Atlantic represents the history of the movements of people of African descent from Africa to Europe, the Caribbean, and the Americas and provides a lens through which to view the ways that ideas about nationality and identity were formed. Thus, in *Black Atlantic* the focus is on intercontinental trade and travel as well as on processes of conversion and conquest and the resultant forms of creolization and hybridization that occur.

The author maps the Atlantic Ocean as a way to catalogue a whole series of transoceanic transactions and exchanges in the past and in the present and in so doing seeks to move beyond racially essentialist ways of thinking which posit an unvarying, pure, and singular black (or African) culture. In positing the syncretic and hybrid nature of black culture and the deep connections between the formation of modernity and the formation of black culture, Gilroy points to the fact that modernity is itself a profoundly hybrid phenomenon.

The idea of movement is central to Gilroy's argument. Hence, the image of a ship forms a central metaphor in the text. Gilroy describes ships as micropolitical and microsocial systems that focus one's attention on the circulation of ideas as well as identifying them as cultural and political artifacts. Slave ships are particularly central to Gilroy's argument as he posits slavery as a pivotal moment for the emergence of modernity, modern ideas of race, and the *Black Atlantic* as, in his words, "a counterculture of modernity." By a counterculture of modernity, Gilroy refers to the varied ways in which people of African descent responded to and resisted the fact that, in the modern West, racial terror and reason were so deeply connected. It was this yoking together of racism and modernity that led people of African descent across the globe to search for ways to construct oppositional identities, particularly through music, which Gilroy identifies as being the preeminent nontextual form through which African people not only confronted racially repressive social systems but also retained a sense of cultural integrity and forged common cultural memories.

Intellectual Antecedents

Gilroy was not the first scholar to stress the importance of understanding race as a phenomenon that both emerged and was resisted transnationally. Scholars like W. E. B. Du Bois, Eric Williams, and C. L. R. James and Frantz Fanon examined the ways in which slavery and racism were pivotal to the formation of Western modernity. These scholars focused not only on the economic importance of Atlantic slavery to the formation of the West but also on the ways in which blackness was absolutely necessary for the construction of whiteness as an identity. Du Bois and James were also concerned to document the myriad ways in which the black diaspora communities, in their attempts to construct artistic and aesthetic responses to racism, played a critical part in developing the cultural institutions of the West.

Scholars connected with the negritude movement echoed their efforts, focusing on the unique cultural contributions that they attributed to the so-called African personality. Leroi Jones (Amiri Baraka) likewise pioneered the study of the music of the African diaspora, documenting the various ways in which it allowed for the articulation of a complex, albeit nontextual, response to racism. Scholars like Stuart Hall, who brought the insights of Du Bois and Williams to bear on British cultural studies, further developed these ideas. Hall was particularly instrumental in developing an approach to the study of race and culture which sought to understand race as an ideological system which should be analyzed in its political, social, and economic dimensions and black culture as simultaneously heterogeneous and connected.

Intellectual Impact

The concept of the *Black Atlantic* has been enormously influential. Gilroy's focus on the heterogeneous nature of black expressive culture has significantly broadened the field of cultural studies, forcing it beyond its parochial concern with either the cultures of working class Anglo-Saxons or European high culture. The manner in which Gilroy places slavery at the center of Western modernity, racializing and thus fundamentally transforming Georg Wilhelm Friedrich Hegel's rendering of the master-slave dialectic has, likewise, been enormously influential in the field of philosophy.

Gilroy's particular focus on the revolutionary struggles of African-descended peoples has also been enormously influential in the field of labor history, broadening it to examine the histories of the struggles of those other than white European or American working people. His focus on music as a modality through which cultural memories are retained and passed on (in form if not in content) has also been influential in the field of history, opening up new possibilities for uncovering the histories of cultures that place a higher priority on oral, rather than written, forms of communication.

The ideas that underlie the notion of the *Black Atlantic* have also been enormously important in the emerging field of transnational cultural studies. Scholars like Arjun Appadurai, George Lipsitz, and Donna Haraway have furthered Gilroy's emphasis on the intersections between local and global cultural dynamics, examining the global circulation of ideologies, people, technology, capital, and culture. Gilroy's work also played an important role in the emergence of postcolonial studies, much of which took a transnational analysis of the idea of race as its central theoretical concern. Thus, the influence of Gilroy can be seen in the work of scholars like Anne McClintock, David Theo Goldberg, Jean and John Comaroff, Catherine Hall, and Anne Laura Stoler, whose work examines the intertwined histories of colony and metropole and the ways in which ideas about gender, race, and class emerged both transnationally and dialectically. Gilroy has also provided an important challenge to dominant ways of thinking within the field of African-American studies. His critique of essentialist thinking about race has proved to be particularly challenging to devotees of Afrocentrism.

Critiques

Although widely applauded for his intellectual innovations, Gilroy is not without his critics. Some African-Americanists have accused Gilroy of failing to understand the complexities of the African-American experience and, thus, of having underplayed the unique and enduring historical connections between Africans and African-Americans in his effort to highlight flows, indeterminacy, and contingency. The work of feminist scholars has also highlighted the androcentric nature of Gilroy's inquiry; men exemplify the Atlantic experience. Yet, the work of scholars like Vron Ware and Catherine Hall indicates that the women within the abolitionist movement, such as Ida B. Wells Barnett and Charlotte Grimké, were equally important exemplars of precisely those processes of exchange that Gilroy highlights in his text. Gilroy talks about the abolitionist movement as an example of the counterculture of

modernity as well as a transnational movement organized around race struggle. Although Gilroy provides many insightful observations about how gender was implicated in the production of both blackness and modernity, these insights are not central to his thesis and oftentimes remain unexplored. Robert Reid-Pharr notes, for example, that Gilroy fails to examine the ways in which thinkers like W. E. B. Du Bois, Martin Delaney, and Frederick Douglass conflated the regeneration of the black nation with the regeneration of the patriarchal black family.

Yet another criticism of Gilroy's work has been that the concept of the *Black Atlantic* is too narrowly focused on the experiences of blacks as minorities in the United States and Great Britain. Thus, the *Black Atlantic* proceeds from the assumption that diasporic black communities are necessarily minority communities. This assumption does not, however, hold true for people in the Caribbean. Furthermore, as Nadi Edwards points out, the ways in which Gilroy makes Afrocentric nationalism (which he opposes) the polar opposite of cultural syncretism (which he celebrates) ignores cultural developments such as negritude, which, although essentialist, also celebrated syncretism and hybridity.

Other scholars have pointed out that a narrow focus on the traffic that occurred across the Atlantic Ocean makes it impossible to understand the totality of the black experience. Françoise Vergès has pointed out that the islands of the Indian Ocean also offer important insights for understanding intercontinental trade and migration, as well as for understanding processes of conquest, conversion, and creolization. The Indian Ocean, like the Atlantic, offers a space for exploring various types of seaborne transactions and exchanges and opens up a space for thinking about the ways in which Africa interfaced not only with the Americas and Europe but also with India and South and East Asia. It also provides an opening for exploring how Africa interacted not only with the Christian, but also with the Islamic, world.

See also Aesthetics: Africa; Africa, Idea of; African-American Ideas; Afrocentricity; Black Consciousness; Creolization, Caribbean; Diasporas: African Diaspora; Feminism: Africa and African Diaspora; Modernity: Africa; Post-colonial Theory and Literature; Race and Racism.

BIBLIOGRAPHY

- Baraka, Imamu Amiri. *Blues People: Negro Music in White America*. New York: Morrow, 1963.
- Comaroff, Jean, and John Comaroff. *Of Revelation and Revolution*. Vol. 1. Chicago: University of Chicago Press, 1993.
- Edwards, Nadi. "Roots, and Some Routes Not Taken." *Found Object* 4 (1994): 27–34.
- Goldberg, David T. *Racist Culture: Philosophy and the Politics of Meaning*. Oxford: Blackwell, 1993.
- Hall, Catherine. *White, Male, and Middle-Class: Explorations in Feminism and History*. London: Routledge, 1992.
- Lipsitz, George. *Dangerous Crossroads: Popular Music, Postmodernism, and the Poetics of Place*. London: Verso, 1994.
- Reid-Pharr, Robert. "Engendering *The Black Atlantic*." *Found Object* 4 (1994): 11–16.

Vergès, Françoise. *Monsters and Revolutionaries: Colonial Family Romance and Métissage*. Durham, N.C.: Duke University Press, 1999.

Ware, Vron. *Beyond the Pale: White Women, Racism, and History*. London: Verso, 1992.

Zine Magubane

BLACK CONSCIOUSNESS. Black consciousness is the name of a black nationalist political movement originating in South Africa during the 1960s and 1970s. It proclaimed the necessity of black South Africans to rely on themselves for liberation and to claim South Africa as an African nation. Black consciousness drew on a tradition of black nationalist thought in South Africa associated with Africanist political movements and emerged during a time when the older antiapartheid movements, especially the African National Congress and Pan-African Congress, had been driven deep underground by state repression. It also drew on the rhetoric and ideology of black power and black theology coming out of the United States in the 1960s.

Stephen Biko (1946–1977), a former medical student, served as its most important leader and philosophical guide. The movement emphasized black self-reliance in the struggle against the racist apartheid system in South Africa. Many of the participants in the Soweto uprisings of 1976 espoused support for black consciousness. The suppression of that movement and especially Biko's death while in police custody in 1977 weakened the organizational base of the movement. Many of its supporters went into exile, where they mostly joined the larger African National Congress (ANC), the biggest of the movements fighting for majority rule in South Africa. Those that remained in South Africa became active in civic organizations that made up the United Democratic Front during the 1970s and 1980s. Biko himself became an international icon in the struggle against apartheid, and was celebrated in popular music, a best-selling book, and a motion picture. While the movement left little long-term institutional impact, its message of black empowerment helped mobilize the younger generation in the struggle. Its popularity forced the ANC to adopt a more populist approach to the struggle and helped create the basis for the mobilization of the 1980s, which succeeded in forcing the Apartheid regime to free ANC leader Nelson Mandela (b. 1918) and negotiate a relatively peaceful transfer of power. Likewise, the term *black consciousness* entered the lexicon of Pan-African political discourse.

Black consciousness developed out of a long tradition of racial nationalism in South Africa. Liberation movements in South Africa operated within a tension between a liberal and multiracial or nonracial view of the struggle against white domination and a more "Africanist" conception of the struggle. The former emphasized solidarity among all the peoples of South Africa, including progressive whites as well as Asians and "coloreds." The oldest and largest liberation movement, the African National Congress, generally espoused this philosophy even as it became more radically socialist in its politics after World War II. Nonracialism was enshrined in the Freedom Charter of 1955

(along with socialism), giving the movement its alternate name of Charterist. Africanist critiques emerged by the 1920s. They argued that South Africa was an African nation occupied by colonial settlers who had no inherent right to be there. Activists such as Anton Lembede (1914–1947), founder of the Congress Youth League (CYL), often called on the communal traditions of African societies as well as external advocates of black autonomy such as Marcus Garvey (1887–1940) and Booker T. Washington (1856–1915), as their inspirations. The Congress Youth League movement of the ANC in the 1940s brought together young activists who promoted a more Africanist view of the struggle, often pitted against an older ANC leadership that sought allies among liberal whites in South Africa and socialist governments abroad. The CYL movement eventually led to a split in the ANC. One faction, led by Robert Sobukwe, broke off and formed the Pan-African Congress. The rest, led by Nelson Mandela, Walter Sisulu, and Oliver Tambo, gradually took control of the ANC and pushed it to more active resistance in the face of the tightening of Apartheid. They, however, converted to (or remained loyal to) the general Charterist position on nonracialism. The smaller Pan-African Congress (PAC) during the 1950s tried to press for even more direct mobilization against apartheid. The massacre of at least sixty unarmed PAC protesters in 1960 at Sharpeville resulted in the suppression of both the ANC and PAC in South Africa, imprisoning or driving into exile most of the leaders and activists of those organizations.

The early 1960s saw a period of relative quiet in black activism in South Africa. Biko and other black students developed the concept of black consciousness in the later 1960s on the segregated university of campuses of South Africa. By the mid-1960s, the National Union of South African Students (NUSAS) was one of the few national institutions still integrated and engaged in activism for change. However, NUSAS's leaders came primarily from the English-speaking white universities of South Africa and followed a liberal, moderate anti-apartheid program. Black students, including students from Indian and coloured campuses, felt the organization was becoming less concerned with political change and more with narrow university issues. In 1967, at a meeting of NUSAS at Rhodes University in Grahamstown, the university administration required the students to use segregated facilities. In response, black students led by Biko, Barney Pityana, and Harry Nengwekulu helped found the all-black South African Students' Organisation (SASO). Biko emerged as the leading spokesman of the group. He was a medical student at the University of Natal Medical School, Black Section.

After 1969, the black consciousness movement called for blacks to liberate themselves psychologically first. It claimed many black people had internalized ideas of inferiority and dependency from the racism of apartheid. Once black people had come to believe that they had the right and power to stand up for themselves, they would then be able to take power in their own hands. One of the principle targets of the movement was the perceived dependence of blacks on white liberals to speak for them. Biko stated, "Merely by describing yourself as black, you have started on a road towards emancipation, you have

committed yourself to fight against all forces that seek to use your blackness as a stamp that marks you out as a subservient being." Biko argued that only blacks (and he included the non-African peoples of color in South Africa in this definition) were truly oppressed in South Africa and that white liberals generally sought to play the role of gatekeepers toward blacks. The movement drew to some extent on the ideas of "Africanist" critics of the nonracialism of the ANC such as Sobukwe of the PAC as well as the ideas of black power and the black theology movement in the United States. Like the PAC, the black consciousness movement also criticized the close alignment of the ANC with the South African Communist Party and the Soviet bloc.

After 1969, the black consciousness movement began to gain at least nominal adherents throughout the black population of South Africa. Black consciousness adherents created a number of organizations dedicated to political mobilization and community service. They operated in an environment where the South African government kept a close watch on black organizations and had to be careful about both their words and their actions lest they call down the repressive state apparatus on themselves. In addition to SASO, the Black People's Convention, founded in 1972, created an alliance of over seventy organizations dedicated to black consciousness, including new, often unrecognized, labor unions and the South African Student Movement that included secondary school students. Biko became the head of the organization, and the South African government promptly "banned" him, a sentence that restricted him to his hometown of King William's Town in what is now the Eastern Cape Province and severely limited his ability to remain in contact with other members and organizations in the movement. The University of Natal also expelled him from medical school.

The resonance of black consciousness's call for pride and self-reliance helped create the conditions that led to a wave of anti-apartheid unrest by 1976, despite the absence from the active political stage of leaders like Biko. A wave of strikes by black workers swept through the country in 1975 and 1976, and they were often led by "unofficial" unions affiliated with the black consciousness movement. In 1976, the government announced that henceforth it would require the teaching of Afrikaans, the Dutch-based language of white Afrikaners, instead of English in many black schools. Many blacks saw this as an effort to keep them isolated. Students in the township (a suburb designated for blacks only) of Soweto outside Johannesburg began a boycott of classes. Confrontations with the police led to a broader mobilization in favor of school and work stay-aways. Between 16 June and October of 1976, violence spread to townships in many parts of South Africa. Even though the government dropped its requirements on the use of Afrikaans, the movement took on the air of a general uprising. By the end of 1976, the South African government reported over 500 people had died in the violence, a figure many think is much too low to be accurate. Regarded as the guiding light of the uprising, although due to the banning order not particularly involved in its planning, Biko himself was arrested four times during this period, the final time in August

1977. Then, he was beaten repeatedly, suffered head injuries, taken in the back of a Land Rover to Pretoria, and died on 11 September 1977. The government denied responsibility for his death. Only with the work of the postapartheid Truth and Reconciliation Commission in South Africa almost twenty years later was formal responsibility for Biko's death laid at the feet of the police.

Black consciousness organizations and supporters came under extreme pressure after the 1976 uprisings. Many went to prison; many others went into exile. In both places, they began to drift into ANC-led circles. The ANC, for its part, adopted a more populist attitude toward mobilization. In South Africa, organizations affiliated with the black consciousness movement provided the basis for community organizations that continued the struggle against apartheid. Tensions remained between the ANC's commitment to the Freedom Charter, which called for a socialist and nonracial future for South Africa and these organizations and adherents. Some supporters of black consciousness created the Azanian People's Organization (AZAPO), which claims to be the main heir to the black consciousness movement. This movement in the 1980s and political party in the 1990s remained small.

Black consciousness represented a South African response to the conditions of 1960s apartheid. Its leaders drew on a range of ideas from abroad and from the past to shape their version of racial nationalism. Yet the influences of black power and black theology in the United States, the African nationalist movements that brought independence to much of the rest of Africa, revolutionary theorists such as Frantz Fanon (1925–1961) and Amílcar Cabral (1924–1973) merely contributed a language to what was an indigenous development. In its successful mobilization of mass protest, it forced the more widely recognized liberation movements to adopt a more populist and less rigidly ideological approach to the struggle. Likewise, its success at grassroots organizing, which again mirrored the efforts of some black power organizations in the United States, helped change the political landscape of South Africa. The main legacy of the movement remains its mobilization, especially of young people, in the 1970s as a prelude to the struggles of the 1980s that led to the end of apartheid. Nelson Mandela said at the twentieth anniversary of Biko's death, "The driving thrust of black consciousness was to forge pride and unity amongst all the oppressed, to foil the strategy of divide-and-rule, to engender pride amongst the mass of our people and confidence in their ability to throw off their oppression."

See also *Afrocentricity; Apartheid; Authenticity: Africa; Black Atlantic; Internal Colonialism; Nationalism; Pan-Africanism.*

BIBLIOGRAPHY

- Biko, Stephen. *Black Consciousness in South Africa*. Edited by Millard Arnold. New York: Vintage, 1979.
- . "The Definition of Black Consciousness." 1971. Available at <http://www.azapo.org.za/documents/bcc.htm>.
- . *I Write What I Like: A Selection of His Writings*. Edited by Aelred Stubbs. London: Bowerdean Press, 1996.

Frederickson, George M. *Black Liberation: A Comparative History of Black Ideologies in the United States and South Africa*. New York: Oxford University Press, 1995.

Mandela, Nelson. "Address by President Nelson Mandela at the Commemoration of the Twentieth Anniversary of Steve Biko's Death," East London, 12 September 1997. Available at <http://www.anc.org.za/ancdocs/history/mandela/1997/sp970912.html>.

Mark, Anthony W. *Lessons of the Struggle: South African Internal Opposition, 1960–1990*. New York: Oxford University Press, 1992.

Moodley, Kogila. "The Continued Impact of Black Consciousness in South Africa." *Journal of Modern African Studies* 29, no. 2 (June 1991): 237–252.

Gregory H. Maddox

BLACK ORIENTALISM. See **Orientalism: African and Black Orientalism.**

BODY, THE. What is "the body"? If the question seems ridiculous to you, you are undoubtedly not alone. At any given time, in any given culture, most people have an intuitive, if not always easy to articulate, notion of what the body is, and probably regard that notion as shared by all human beings. The fact is, however, that human cultures have not only done an amazing variety of things to human bodies, but have imagined and experienced the nature, limits, and capacities of the human body—and its relation to the self—in extremely diverse ways.

For example, most people living in the early-twenty-first century West believe the body to be a border between the self and the external world, and one that houses only one individual self. Those whose experience departs from this are treated as suffering from a personality disorder. Many non-Western cultures, in contrast, do not regard the skin as an impermeable border between the individual and the natural world, and believe that the physical body may host multiple selves. Another example is the relationship of mind and body. Many cultural systems—Zen Buddhism is one—do not mark a radical distinction between mind and body. In contrast, mind/body dualism has been so thoroughly integrated into the fabric of Western culture that some may have difficulty imagining an experience of the self that does not partake of it.

From the significance of body parts to contemporary theory of the body, different conceptions abound. Neither "race," nor gender, nor sexuality is a universally uniform category. Different cultures imagine different organs as the center of bodily functioning, and privilege different senses; among the Suya of Brazil, for example, hearing is equated with understanding, as seeing is for Europeans and North Americans. And while contemporary biologists attempt to map a basic genetic blueprint, poststructuralists argue that the very notion of a biological body is a human invention.

From a philosophical and anthropological perspective—and to establish limits to an exceedingly broad topic—this ar-

ticle focuses on the intellectual, cultural, and political developments that various disciplines have regarded as landmarks in the history of the idea of the body.

A Brief Tour of Western Dualism from Plato to Plastic Surgery

Despite its familiarity, the notion that human minds or souls are fundamentally different from human bodies is a cultural construction that took many centuries to build. Arguably all human cultures, including prehistoric peoples, have had some concept of spirit residing *in* the body. But this does not yet imply belief in an immaterial substance distinct *from* the body. For many cultures, spirit is simply “aliveness,” the vital principle that animates all living things, from plants to humans, and is itself conceived as a kind of material substance. In both Homer and the Hebrew Scriptures, for example, the words *spirit* and *breath* are used interchangeably.

The notion of an immaterial substance that is separable from the body emerges in historical documents first as part of ancient Egyptian and Chinese beliefs in a “dual soul,” one aspect of which is joined to the body, while the other travels, after death, to the realm of the ancestors. Greek philosophers visited Egypt and were aware of such notions; their influence is especially striking in Plato (c. 428–347 B.C.E.), who believed that the soul exists both before the birth and after the death of the body. With Plato, however, it is no longer the realm of the ancestors in which the disembodied soul resides, but the world of true knowledge—the Forms. With this innovation, Plato introduces what was to become a central ingredient in later versions of dualism: the elevation of the life of the soul (or mind, or reason, depending upon the system) to the pinnacle of human achievement, with the body imagined as the enemy of its aspirations.

The body as enemy. For Plato, the body is the enemy of the soul primarily because it apprehends things through the senses—and the senses, notoriously, can lie, can deceive one into mistaking imperfect and transient versions—of love, beauty, and justice—for enduring realities. Reality, for Plato, is composed of eternal, universal Ideas that can only be seen with the mind’s eye, and so can only be known by human beings after death (or before life—Plato believed in reincarnation) when they are liberated from their bodily prison. But although Plato mistrusted the body’s perceptions, he revered the beauty of the human form and did not view the desires of the body, sexual or otherwise, as sinful. In the *Symposium* (360 B.C.E.), in fact, it is desire for another human being that first touches the philosopher with a passion for beauty, and initiates him into a quest for its timeless essence. The desires of the body, for the Greeks, are only a problem when they are permitted to overrule reason (as they were imagined, for example, to function in women). The Greek ideal was management of the desires of the body in the interests of self-mastery, not, as for Christian thought, denial of the desires of the body in the interests of purity.

Plato’s ideas about the body do not constitute a theory but must be patched together from remarks and arguments in various dialogues. For that very reason, however, they could be se-

lectively recruited—and significantly retooled—to serve later systems of Christian thought, where they have exerted a powerful historical influence. Saint Augustine (354–430) was a key architect of such ideas, which have shaped the theory and practice of many strains of Christianity, particularly Catholicism. In Augustine’s hands, Plato’s prison of the senses becomes the home of “the slimy desires of the flesh,” and the judicious management of sexual desire is replaced with the requirement to totally subdue the body’s “law of lust.” Judaic, African, Eastern, and Greek systems of thought had not viewed sexual desire as an impediment to spirituality, except with regard to an elite, ascetic caste of philosophers or priests, or when indulged in without restraint. Now what had been regarded as a natural human need became, at best, a necessary (to procreation) evil.

The body as machine. Despite their differences, the dualism of Plato and Augustine shared the ancient view of the living body—and the natural world—as permeated with spirit. René Descartes (1596–1650) was to decisively change that, in a reformulation of mind/body dualism that would herald the birth of modern science. For Descartes, the body is a mechanically functioning system with nothing conscious about it—simply the interaction of fluids, organs, and fleshly matter. Mind, in contrast, became pure consciousness—the famous “I think, therefore I am.” This was a separation far more decisive than anything imagined before, as mind and body became defined as mutually exclusive substances.

These abstract reformulations had enormous cultural consequences. For one, the human intellect became elevated to almost God-like status, as it could be imagined as capable—given the right methods of reasoning—of seeing through the illusions of the senses to the underlying reality of things. At the same time, the notion of the body as an intricate but soulless machine made radical experimentation and intervention less troubling to religious-minded scientists and doctors, and liberated human ambitions to explore, dissect, and correct the defects of nature.

In the early-twenty-first century, the body-as-machine is no longer just a guiding metaphysics or metaphor; it has become a material realization. Every day, in hospitals throughout the world, human body parts are being repaired, reconditioned, and replaced, sometimes by the organs of other humans, sometimes by machines. Normally automatic respiratory functioning, the cessation of which used to be a marker of the death of the body, now can be prolonged indefinitely by sophisticated life-support machinery. The domain of cosmetic surgery not only includes the correction of disfiguring accidents and birth defects, but prevention and repair of the physical effects of aging, the rearranging and contouring of face and body to particular beauty ideals, and even—very recently—the promotion of extreme makeovers, composed of multiple surgeries designed to produce wholly new physical selves.

Whatever one’s attitude toward such developments, what is clear is arrival of a “cyborg culture.” It is not only through the achievements of science that a cyborg culture has been established—or, as others would emphasize, the marriage of medical technology and consumer capitalism—but by virtue

of a conception of self for which the body is mere matter to be manipulated at the will of the true “I,” the “thinking thing.” Such living, historical connections between theory and practice make studying ideas about the body more than a scholarly exercise.

The Mind Embodied

From Plato to Descartes, the body has been imagined as merely attached to—and decidedly inferior to—an idealized intellectual or spiritual essence in which all hope of human accomplishment lies. In the background of this denigration of the body is the virtually obsessive need of Western philosophy and religion, until the nineteenth century, to distinguish “man” from “the animals.” Descartes is explicit: Animals have no soul, cannot think, and are mere bundles of instincts, prepackaged by God. The man/animal distinction was already there, however, in remarks strewn throughout philosophy and religion, and (with a few exceptions—for example, Thomas Hobbes and other early materialists) it gathered momentum after Descartes.

In the second half of the nineteenth century, however, the human being begins to be naturalized, imagined more as a complex animal than a potential God unfortunately trapped within a mindlessly craving material body. The foundational contribution to this transformation was Charles Darwin’s (1809–1882) theory of evolution, which demoted the human being from a fallen angel to a species that had evolved from other forms of animal life. Evolution not only placed human beings on a continuum with the “mindless” creatures from whom philosophers and theologians had struggled to distinguish them, but suggested that their vaunted, God-like intellect was merely the result of a larger brain, itself the product of environmental contingencies that had allowed certain biological features to “survive” over (that is, outproduce) others.

Not a Darwinian *per se*, Frederick Nietzsche (1844–1900) insisted forcefully on the instinctual nature of the human being, and far from regarding it as base or evil, viewed it as a force for life and an essential dimension of creativity. He mocked the notion that humans can attain disembodied existence or pure spirit, and mounted a fierce attack on those philosophers and priests who (as Nietzsche viewed it) had made life-denying, ascetic values the standard of human perfection, all the while seeking their own earthly power. For Nietzsche, such “will to power” was a positive thing, so long as it was joyously embraced in oneself and allowed to flourish in others; what he despised about the priestly caste—those “despisers of the body,” as he called them—was their professed humility and meekness, even as they dictated the terms of existence for their followers.

With this critique, Nietzsche introduced two themes concerning the body that were to become increasingly prominent in modern and postmodern thought. For many intellectuals, both before and after Nietzsche, the history of philosophy and religion has been imagined as a conversation between disembodied minds (or, more colloquially, talking heads); not only are the class, race, gender, and historical period of participants considered irrelevant to their ideas, but so are emotional attachments, self-interest, and personal history. The seeker of

Truth is supposed to be above all that. Nietzsche was the first to insist that such transcendence of embodied existence is impossible, “The eye that is turned in no particular direction,” he wrote, “is an absurdity and a nonsense. . . . There is only a perspectival seeing, only a perspectival knowing” (p. 119). Such notions have played a central role in twentieth-century critiques of Western culture mounted by feminists, deconstructionists, and Foucauldians.

The instinctual body. The second body theme Nietzsche introduced, which Sigmund Freud (1856–1939), the father of psychoanalysis, was to elaborate and systematize, is the high price human beings have paid in the process of becoming “civilized.” For Nietzsche, a decisive historical moment was the banishing of the Dionysian element—ecstatic surrender to the body, the unconscious, and the erotic—from Greek culture. Freud, unlike Nietzsche, viewed the repression of (sexual and aggressive) instinct as necessary to the preservation of human community and order. But he agreed with Nietzsche that the cost of instinctual repression in the interests of civilization was “discontent”—neurosis, depression, phobias, psychosomatic conversions, and just plain “ordinary unhappiness” (as he termed the usual condition of modern man). Much of Freud’s writing describes the developmental stages—both in the individual and in the species—that inevitably take the human being from an instinctual existence devoted to “the pleasure principle” through stages of renunciation and accommodation to the demands of reality (which Freud believed were unable to gratify all human needs, even in the most permissive society) and morality (first experienced through parental authority, later internalized as the super-ego).

Freud represents, in many ways, a synthesis of several of the trends outlined in this article so far. In the tradition of Judaic and Greek thought (and unlike Augustine), he did not regard the desires of the body as sinful. Like Darwin, he looked to nature, not God, to understand the design of the human being, and described what he believed he had found with the dedicated detachment of the Cartesian scientist. Like Plato, he believed the “higher” accomplishments of humanity—art, music, literature, philosophy—require the sublimation (or redirection) of the body, from the original aim of sexual fulfillment to the less intense gratifications of art and intellect. But like Nietzsche, he was continually drawn to the exploration of the underside of progress—the unconscious drives and desires, never fully banished from human life, and a constant reminder of the primacy of the body.

The lived body. Another philosophical spokesperson for the primacy of the body—but with a very different understanding of that primacy than Darwin, Nietzsche, or Freud—was Maurice Merleau-Ponty (1908–1961). Merleau-Ponty, in the tradition of philosophical phenomenology, did not believe the human body could be reduced to a scientific or social object of study. What such perspectives left out, he argued, was what phenomenologists call “the lived body.” From the perspective of the lived body, human beings do not *have* bodies (as they might possess hats or coats), they *are* bodies; and as bodies, are more than physically encased minds or collections of instinct. Rather, bodies are the medium of human experience,

first called into question the universality, not just of Freudian theory, but of the Western tendency to regard the body—sexuality in particular—as a source of unruly impulses that are fundamentally in tension with the need for human order.

Mead and Mauss. Margaret Mead's (1901–1978) pioneering research in Samoa and New Guinea, for example, was concerned with debunking Western ethnocentrism, including with regard to sexuality. In Samoa, Mead (1928) found that adolescence was not a period of rebellion from parents, nor was adolescent sexuality fraught with the moral constrictions of the West. By revealing the more relaxed child-rearing practices and less rigid sex roles in Samoa and New Guinea, Mead critiqued American patterns and called for their modification.

Marcel Mauss's (1872–1950) reflections on cross-cultural variations in what he called “techniques of the body” constituted another important moment in the development of anthropological thinking about the body. Mauss noted (1934) that while, universally, people successfully hold themselves upright, walk, gesture, talk, and eat, the precise renderings of these activities varies from one society to the next. Later (1938), he formulated the important distinction between the self (*moi*) and the social or culturally constructed person (*la personne*). The former refers to individuals' private, personal sense of themselves; the latter to the cross-culturally variable ways in which societies define the contours of individuals, such as expectations and rights varying by gender and life stage; the degree to which cultural members are perceived to be connected to one another and to nature; and beliefs about the human soul, its essence and location, and how it and the souls of deceased relatives influence the affairs of the living.

Personhood has been the realm of rich sociocultural research, yielding cross-cultural data with myriad implications. For example, in preindustrial societies, where perceptions of the demarcation between nature and culture, and between the living, deceased, and yet-to-be-born, are more gradual than in the postindustrial West, the proper or improper actions of humans are perceived to directly influence the well-being of entire communities (including the spirits of the dead and future generations), and nature's bounty and benevolence as well. A closer connectedness to the suprahuman world is expressed through the greater homage paid to its deceased, to widely varying burial practices centered on the corpse, and to a host of prescriptions and proscriptions concerning the bodies of the bereaved, which vary by gender and kinship status.

Biology and culture. With Mauss, Mead, Bronislaw Malinowski, Ruth Benedict, and others leading the way, anthropologists began to accumulate a storehouse of knowledge concerning the tremendous cultural variation that exists in ideas about the body and their corresponding implications for attitudes toward and practices of sexuality, reproduction, abortion, infanticide, child mortality, breast-feeding, child-raising, pawnship and slavery, and gender roles. It was from such cross-cultural knowledge that anthropology's concept of the body emerged. It is one that sees the corporeal body and its con-

through which they engage with their surroundings. Merleau-Ponty, unlike Plato or Descartes, was not concerned with some reality beyond or behind the way things appear, but with the way the world is given to embodied beings. For many twentieth-century continental philosophers, this was the definitive rejection of dualism; by doing away with “two worlds” and concentrating on the world as it appears to us, already saturated with the meaning that bodies give it, Merleau-Ponty reunited mind and body and made them natural allies in the quest for understanding.

Culturally Variable Bodies

Freud drew his conclusions about the inevitable struggle between ego and id from his own psychiatric practice, largely composed of well-to-do Victorians whose problems, arguably, were more the product of the culture they lived in than universal forms of human discontent. The point seems obvious in the early twenty-first century, after half a century of criticism of the many questionable assumptions about gender, class, and sexuality contained in classical Freudian theory. Many people associate such criticism with feminism—and indeed, feminism played a major role in placing Freudian theory in historical perspective. But it was anthropologists who

THE SOCIAL SKIN

Mary Douglas's work, as well as feminist deconstructions of the meanings contained in representations of the female body, inspired a generation of anthropologists and cultural theorists to explore the human body as a text that can be read to reveal a great deal of cultural information. This symbolic function of the body applies not only to the taboos and rituals described by Douglas, but to parts of the body, to representations of the human body—in artworks, medical texts, racial ideology, and advertisements—and to decorations and modifications of the flesh, from ornaments, hair fashion, cosmetics, masking, costuming, tattooing, piercing, and scarification, to body fattening or thinning, muscular development, and cosmetic surgery. However extreme or seemingly whimsical the practice, it always has meaning, always is shaped by the sociocultural context in and through which people act. Anthropologist Terence Turner called this dimension of the body the “social skin,” a concept that applies just as aptly to the nineteenth-century corset and twentieth-century implants as to the traditional neck rings of the Karen peoples of Burma or lip plugs of the Amazonian Kayapo.

A key difference between the body modifications of traditional societies and those of post-modern culture is that the former are dictated by group membership and are nonnegotiable by individuals. The status-significance of the size of Ethiopian lip-plates among brides-to-be is set by custom, as is who may engage in such modification. In contrast, many contemporary body modifications based on traditional practices—piercing, scarification, and tattooing—are freely adopted for their potential to express an

individual's choice of alternative values or group identifications. Other contemporary modifications—for example, exercising to change the shape or fat composition of the body, or having one's face lifted to achieve the appearance of youth—are freely engaged in and (in principle) open to members of all social groups, but reflect norms of beauty to which there is considerable pressure to conform. Those who resist or cannot afford to conform pay a stiff price, in lesser access to jobs, mates, and social power.

Whether traditional or contemporary, all body modifications carry meaning, expressing cultural ideals (and anxieties), racial biases, social status, and membership in particular groups. Those meanings may be complex—both female slenderness and male muscularity, for example, are arguably overdetermined to be attractive in the late twentieth and early twenty-first-century context for reasons having to do with anxiety over changing gender roles, the increasing association of bodily discipline with self-control and power, and the moral valuation of leanness in a “super-sized” culture of indulgence (Bordo, 1993, 1999). Bodily meanings are also unstable and highly context-dependent, raising questions about the changing politics of the body: Does hair straightening by blacks, for example, have the same significance in 2004 as it did when “natural” styles were an expression of racial pride? There is no one answer to a question such as this; different analysts will interpret such practices differently. But however controversial or layered, no bodily style can be considered to be “just fashion,” the expression of meaningless or arbitrary taste.

stituent parts, as well as its movements, gestures, needs, and desires as inextricably both physical and sociocultural. While language, social interaction, eating, drinking, and sexual activity are primary needs for which human bodies contain intrinsically biological capacities, none of these primary needs can be undertaken apart from culture. Thus the physical body is never just a biological organism. It cannot be, because human beings, as Clifford Geertz has observed, “are caught in the webs of significance that they themselves weave” (p. 5).

So, for example, while human differences in skin color, hair texture, and body size and shape have been variably selected by the pressure of different environmental conditions, there is no biological basis for the racial classifications that have been built upon those differences. Such classifications arbitrarily abstract particular phenotypical traits from a human array that is both much more varied and much more continuous than the concept of race allows. Race is not a biological “fact” but an idea—an idea around which an elaborate web of signifi-

cance, with enormous and destructive consequences for the treatment of human beings, has been woven.

The classification and regulation of sexuality and gender, too, always involve the mediation of meaning, of human ideas, in the physical or biological realm. For example, as Malinowski first showed through his groundbreaking ethnographic research among the Melanesian Trobriand Islanders, ideas about conception affect patterns of sexual control. In matrilineal societies, in which the female is believed to contribute the blood—commonly thought to be the substance that ties lineal descendants to one another—to the fetus, female sexuality is not as strictly controlled as in patrilineal societies, where descent is believed to pass through males. In patrilineal societies, female sexuality tends to be closely monitored to insure that the line remains pure of foreign male intrusion. Depending upon the multitude of ways in which patriliney is interpreted, this monitoring may range from the moral sanction that sexual intercourse be confined to marriage, to the female bodily coverings of Muslim societies, to sharply segregating the sexes, or to various forms of female circumcision that, while often performed as a rite of passage, have the effect of decreasing sexual pleasure.

Research on male same-sex intercourse also highlights how similar physical acts can have widely differing social meanings. In some Latin American cultures, males may perform same-sex acts, but according to machismo ideology, it is only if a male plays the role of the passive partner that he is considered to be a homosexual. Among the Sambia of Papua New Guinea, on the other hand, where the conception of the human body is rooted in bodily fluids, same-sex intercourse isn't even considered sexual but is a ritual of maturation. Within this system, as Gilbert Herdt's research demonstrates, adult men are believed to be created through male elders' constant insemination of boys.

The cross-cultural evidence produced by anthropologists is a powerful argument against the notion that there is a single human body whose blueprint is invariant across history and culture. Evolutionary psychologists may argue that patterns of mate selection, gender differences, and even ideals of beauty are universally inscribed in human genes, but most contemporary biological and social scientists believe that whatever the role of biology—and many consider that role significant—it never manifests itself in pure form, untouched by the guiding, shaping, and disciplining hand of culture. Even such phenotypical results of the genetic code as human height, stature, weight, as well as physiological processes such as sexual orgasm and the onset and cessation of menstruation are more responsive to the socioculturally determined physical environment than was previously thought.

Many psychologists and biologists, too, now believe that genetic determinism does not square with the facts of human physiology. The human brain is extremely large; thus if humans are to squeeze out of their mothers while it is still possible to get through, most of the neural maturation must occur after birth. In the first two years of life, the brain fixes countless synapses it didn't have at birth, while weeding out many

others. Which connections are reinforced and which atrophy is the result of the infant's (unavoidably cultural) experience, not inalterable hardwiring that maintains its timeless demands regardless of the particularities of environment and upbringing.

Politics Re-Conceives the Body

Environment and upbringing, of course, include patterns of social inequality. A new attention, not merely to the shaping and disciplining hand of culture, but to the body's role in the maintenance of (and resistance to) the inequalities of gender, race, class, and sexuality was a keynote of the political, social, and intellectual movements of the 1960s and 1970s.

Black Power, Women's Liberation, and the politics of the body. For example, Black Power, a movement that raised consciousness of racist aesthetics and ignited the "Black is Beautiful" philosophy, extended the conception of racial politics to include the body. Until the emergence of Black Power, the struggle for civil rights in the United States had focused on legal obstacles to equality. But Stokely Carmichael and others insisted that this was not sufficient, that blacks must reclaim the cultural heritage and pride that slavery had robbed from them, that they must decolonize their bodies and souls. As people became aware that racism had left its imprints on the body as well as on social institutions, that then-dominant standards of beauty—light skin, blue eyes, straight hair, narrow noses—were as much an expression of white dominance as "whites only" drinking fountains and bathrooms, allowing one's hair to go "natural" began to be seen as a political act.

Taking their cue from Black Power, early second-wave feminists (or women's liberationists, as they were then called) began to redefine the gendered body in political rather than biological terms. The 1950s had been rife with ideology about woman's nature, true femininity, and the horrible consequences of deviance from them. In the late-1960s, these notions, and their bodily accoutrements—speaking softly, moving gracefully, deodorizing, plucking, shaving, and decorating the body to appeal to men—began to be seen as training in subservience and central to the social production of gender. "In our culture," wrote Andrea Dworkin in 1974, "not one part of a woman's body is left untouched, unaltered. No feature or extremity is spared the art, or pain, of improvement." This constant requirement to modify and enhance one's body, she went on to argue, is not merely cosmetic, but disciplinary, as it prescribes "the relationship that an individual will have to her own body . . . her motility, spontaneity, posture, gait, the uses to which she can put her body." Anticipating both Foucault's description of "docile" bodies and later feminist arguments about the "performative" nature of gender, she described "the experience of being a woman" as a "construct" and a "caricature" created not by nature, but arising out of the habitual practices of femininity (pp. 113–114).

This was a pivotal moment in the history of the idea of the body, and hardly confined to Dworkin's work. Plato, Aristotle, and Hobbes had collectively created the metaphor of "the body politic," comparing the state to a human body, with different organs symbolizing different functions, forces, and so on. Authors such as Dworkin, Germaine Greer (whose

book *The Female Eunuch* [1970] was the first systematic exploration of the social construction of the female body), Anne Koedt, Shulamith Firestone, Angela Davis, Mary Daly, Barbara Omolade, and Adrienne Rich collectively inverted the metaphor, imagining the female body as itself a politically inscribed entity, its physiology and morphology shaped by histories and practices of containment and control—from foot-binding and corseting to rape and battering to compulsory heterosexuality, forced sterilization, unwanted pregnancy, and the gender-specific abuses of racism and slavery. The “politics of the body” was born.

Gender and the body: from Beauvoir to Butler. Simone de Beauvoir (1908–1986) was the first philosopher to insert gender into discussions about the body, connecting the social subordination of woman to the cultural associations and practices that tie women to the body, weighed down and imprisoned by her physiology (while men imagine they can transcend their own biology and physicality to commune with pure ideas). The association of woman with nature and body—particularly reproductive processes—became an important theme of early feminist theory throughout the disciplines. Some of the most influential contributions include Susan Griffith’s *Woman and Nature* (1978), Dorothy Dinnerstein’s *The Mermaid and the Minotaur* (1976), and anthropologist Sherry Ortner’s “Is Woman to Man as Nature Is to Culture?” (1974). Ortner argued that menstruation, pregnancy, childbirth, lactation, and breastfeeding are biological processes that everywhere in the world tie women to nature in ways that male biology and physiology do not. Hence cultures everywhere interpret women as closer to nature than men. Because people universally value culture over nature, men are thereby awarded more prestige than women.

Ultimately such notions were challenged in the 1980s and 1990s, as feminist anthropologists turned their attention to the myriad ways that women’s (and men’s) reproductive biology and physiology have been interpreted through different “webs of significance” (to use Geertz’s phrase) throughout the world. Their projects reflected an “anti-essentializing” turn in feminist thought that became a unifying project among postmodern feminist scholars throughout the disciplines, skeptical of generalizations about gender and more attuned to the variable cultural structures and assumptions through which human bodies are perceived, experienced, and socially organized.

“One is not born, but rather becomes, a woman,” wrote Simone de Beauvoir in 1952 (p. 301). In retrospect, one can see much of feminist thought since the early 1970s as an elaboration of this idea, from early-second-wave writings on the socialization of Western women—Vivian Gornick and Barbara Moran’s path-breaking *Woman in Sexist Society: Studies in Power and Powerlessness* (1971)—to feminist anthropologists’ more global perspectives on gender symbolism and sex-role organization, to bell hooks’s protests against white-biased assumptions about womanhood, to Iris Young’s studies on the phenomenology of female embodiment, to Judith Butler’s enormously influential work on the performative nature of gender.

Butler’s work was not entirely original. Both Erving Goffman and other feminists had articulated what were essen-

tially performative theories of gender—the notion that there is no stable, essential reality behind the (culturally constructed) acts that constitute gender identities. But by crystallizing, elaborately theorizing, and attaching a set of specific technical terms to ideas that had been in the air for some time, Butler seized a moment that was ripe for being marked as a new turn in feminist and postmodern theory. She also pushed anti-essentialism and social constructionism one step further than others, arguing that not just gender but biological sex has no “core” reality. For Butler, the illusion of such a core—the belief that sexual bodies have a “natural” heterosexual configuration—is itself produced by constant repetition of the bodily gestures and practices that create sexual identity. For Butler, not only are man and woman “made” by cultural discourse and practice, but so, too, is the illusion of their biological reality.

The body as symbol of society: Mary Douglas. Until the 1960s, philosophers, cultural theorists, and anthropologists had incorporated observations, perspectives on, and ideas about the body in their work. But it is only in the 1960s and 1970s that the body itself became a focus of systematic theorizing. A foundational figure in this development was Mary Douglas, who introduced the notion of the body as a system of “natural symbols” that metaphorically reproduce social categories and concerns—an “image of society” (1970, p. 98). So, for example, when societies are under external attack, the maintenance of rules governing what belongs inside and outside the body becomes especially strict. Or—a different kind of example—“a natural way of investing a social occasion with dignity is to hide organic processes” (1970, p. 12). Hence important social occasions dictate that the body be held stiffly, the limbs and hands under careful control. And in general, manners and etiquette require the conscious withholding of bodily excreta: It is impolite to spit, fart, burp, laugh out loud, or to interrupt conversation with such involuntary expulsions as sneezing, coughing, and runny noses.

Underlying the use of the body as a social metaphor, Douglas argued, is a pan-human need for order, achieved by culturally classifying and systematizing objects, including persons, events, and activities, and by instituting routines. Having established those classifications and routines, people avoid all ambiguous or anomalous objects, states, events, and activities because they interpret them as disorderly and polluting. Douglas coined the phrase, “dirt is matter out of place” to mean that “dirt is a by-product of a systematic ordering and classification of matter” (1966, p. 35). Thus what any human culture considers to be dirt is a function of that culture’s particular system and what is considered to be outside and inside its established boundaries.

The theory has broad application, not least of which is to human bodies. An excellent example is the application of her general theory of pollution to the margins of the human body. Douglas argues that everywhere, the boundaries of the body are imbued with heightened metaphorical potency—people react to them intensely; they are “loaded.” This includes hair, the bodily lining itself, the skin, as well as all the bodily orifices—the mouth, nose, tear ducts, anus, vagina, and others—and all the bodily wastes that pass through that bodily lining or boundary—such as sweat, tears, saliva, menstrual blood, and semen.

In her earlier work, Douglas concluded that all such bodily marginal phenomena are universally interpreted as defiling. Later (1970) she revised this to a more neutral position, maintaining that they contain enhanced metaphorical potential, but, depending on sociocultural context, they are either heightened to sacred valuation or else denigrated as polluting. It is this latter, more versatile position that has proved most attractive to later anthropologists. For example, feminists later pointed out that the widespread taboos segregating menstruating women may in some cultures be due to an interpretation of menstrual blood as signifying the power of fertility, rather than a polluting substance (see especially Buckley and Gottlieb).

The social management of bodies: Bourdieu and Foucault. By viewing the body as a text on which societal taboos and values are symbolically inscribed, Douglas's symbolic structuralism focuses on the reproduction of static rules rather than the production of human subjects whose bodies are experienced, trained, and regulated in very particular, practical ways. In the 1970s and 1980s, this emphasis changed, as anthropologist Pierre Bourdieu (1930–2002) and philosopher Michel Foucault (1926–1984), systematizing what in many ways was already implied in feminist body politics, shifted attention to the social “disciplining” of the body.

Bourdieu's emphasis was on what he called “practice”—the everyday habits by means of which the body is inculcated with cultural knowledge. Banally through “the seemingly most insignificant details of dress, bearing, physical and verbal manners,” culture is “made body,” as Bourdieu puts it—converted into automatic, habitual activity. As such, it is put “beyond the grasp of consciousness,” where it exercises “the hidden persuasion of an implicit pedagogy . . . through injunctions as insignificant as ‘stand up straight’” (p. 94).

Michel Foucault brought both practice and power onto center stage in contemporary theory. His work on sexuality, gender deviance, madness, and punishment historicizes the changing ways in which people are disciplined to conform to their culture, from the public torture and gallows of the middle ages, to today's largely unconscious self-monitoring and policing of one's own body. Foucault emphasizes that in the modern and post-modern world, people no longer need physical manipulation by centralized authorities in order to create socially disciplined bodies. Rather the spatial and temporal organization of institutions such as prisons, hospitals, and schools, and the practices and categories of knowledge—for example, ideas about what constitutes sickness and health—create norms (gender and sexuality among them) that work on individuals “from below”: not chiefly through coercion, but through individual self-surveillance and self-correction. Thus, as Foucault writes, “there is no need for arms, physical violence, material constraints. Just a gaze. An inspecting gaze . . . which each individual under its weight will end by interiorizing to the point where he is his own overseer” (Foucault, 1977, p. 155).

Foucault's model has been influential throughout the disciplines, inspiring many writers to perform their own genealogies of various historical discourses and practices relating to the regulation of sexuality and health. Queer theory has developed, in

large part, from his historicization and denaturalization of heterosexual norms. Feminist cultural theorists such as Sandra Bartky and Susan Bordo find Foucault's model of self-surveillance useful for the analysis of femininity, so much of which is reproduced “from below,” through self-normalization to cultural ideals of the perfect face and body. For Bordo, Foucault's notion of power was an ally, too, in the development of a model of gender that discards the notion of men as oppressors in favor of an emphasis on systems of power within which people are all enmeshed. This rejection of an oppressor/oppressed model has been salient in the emergence of third-wave feminist theory, as well as recent attention to the male body and masculine acculturation. Post-modern theorists have seized on Foucault's ideas about resistance—“where there is power, there is also resistance,” he wrote in his later work (1978, p. 95)—to support studies in the instability of culture and the role of human agency.

The Body in the Early Twenty-First Century

Bodily life in the early twenty-first century is full of contradictions. On the one hand, people appear freer than ever to become individual artisans of the physicality that they present to the world; virtually everything, from the shape of one's noses to one's sexual morphology, can be changed. On the other hand, as Western imagery and surgical technology, deployed throughout the world, makes slender, youthful beauty a global ideal, the choices seem less expressions of individuality than self-correction to standardized (and often racialized) cultural norms.

Increasingly medical technology has become an extension of human bodies, which are now subject to extensive intervention in order to repair malfunctioning organs, to prolong male sexual functioning, to facilitate conception, to determine fetal sex and to avoid genetic defects, to ensure pregnancy to term, and to determine when and how birth and death takes place. The benefits of this technology to alleviate human suffering and extend human choice seem undeniable. However the sweeping dominion of what Foucault called “biopower” has raised questions for which there are not yet clear answers, as many fundamental assumptions about the body are being physically, metaphorically, and ethically challenged.

When adults insist on gender reassignment surgery, are they realizing long-sought-for gendered identities or are they falling victim to the tyranny of genitalia as gender designation? When hearts, livers, and kidneys are implanted in needy persons from brain-dead donors, are some essences of the latter thereby perpetuated? How does such organ transfer influence Western constructions of the body as the sharply bounded sanctuary of the highly individuated self? When a child today can have five parents—genetic mother, surrogate mother, nurturing mother, genetic father and nurturing father—how is kinship relatedness constructed? When bodies can be perpetuated indefinitely on life-support machinery, where and when does life, and by extension one's body, end? The body, clearly, will always be an unfinished concept in the history of ideas.

See also Biology; Death; Dress; Feminism; Fetishism; Gender; Life; Life Cycle; Person, Idea of the; Sexuality.

BIBLIOGRAPHY

- Augustine, Saint. *The Confessions*. Translated by R. S. Pine-Coffin. New York: Penguin, 1991.
- Bartky, Sandra. *Femininity and Domination*. New York: Routledge, 1990.
- Beauvoir, Simone de. *The Second Sex*. New York: Alfred A. Knopf, 1952. Reprint, New York: Vintage, 1974.
- Bordo, Susan. *The Male Body: A New Look at Men in Public and in Private*. New York: Farrar, Straus, and Giroux, 1999.
- . *Unbearable Weight: Feminism, Western Culture, and the Body*. Berkeley: University of California Press, 1993. Reprint, Berkeley: University of California Press, 2003.
- Bourdieu, Pierre. *Outline of a Theory of Practice*. Translated by Richard Nice. Cambridge, U.K.: Cambridge University Press, 1977.
- Buckley, Thomas, and Alma Gottlieb, eds. *Blood Magic: The Anthropology of Menstruation*. Berkeley: University of California Press, 1988.
- Butler, Judith. *Bodies That Matter: On the Discursive Limits of "Sex."* New York: Routledge, 1993.
- Darwin, Charles. *The Origin of Species by Means of Natural Selection*. London: John Murray, 1859. Reprint, New York: Penguin, 1968.
- Descartes, René. "Meditations." In *The Philosophical Works of Descartes*, edited and translated by Elizabeth Haldane and G. R. T. Ross. 1911. Reprint, London: Cambridge University Press, 1967.
- Douglas, Mary. *Natural Symbols: Explorations in Cosmology*. New York: Pantheon, 1970. Reprint, New York: Routledge, 2003.
- . *Purity and Danger: An Analysis of the Concepts of Pollution and Taboo*. New York: Praeger, 1966. Reprint, New York: Routledge, 2002.
- Dworkin, Andrea. *Woman-Hating*. New York: Dutton, 1974.
- Foucault, Michel. *Discipline and Punish: The Birth of the Prison*. Translated by Alan Sheridan. New York: Vintage, 1977. Reprint, New York: Vintage, 1995.
- . "The Eye of Power." In *Power/Knowledge: Selected Interviews and Other Writings 1972–1977*, edited and translated by Colin Gordo. New York: Pantheon, 1980.
- . *The History of Sexuality*. Vol. 1: *An Introduction*. New York: Vintage, 1978.
- Freud, Sigmund. *Civilization and its Discontents*. Translated by James Strachey. New York: W. W. Norton, 1961.
- Geertz, Clifford. *The Interpretation of Cultures*. New York: Basic Books, 1973.
- Goffman, Erving. *The Presentation of Self in Everyday Life*. Garden City, N.Y.: Doubleday, 1959.
- Gornick, Vivian. *Woman in Sexist Society: Studies in Power and Powerlessness*. New York: Basic Books, 1971.
- Herdt, Gilbert, ed. *Ritualized Homosexuality in Melanesia*. Berkeley: University of California Press, 1984.
- Laqueur, Thomas. *Making Sex: Body and Gender from the Greeks to Freud*. Cambridge, Mass.: Harvard University Press, 1990.
- Malinowski, Bronislaw. *The Sexual Life of Savages in North-western Melanesia*. New York: Eugenics Publishing Company, 1929. Reprint, Boston: Beacon Press, 1987.
- Mauss, Marcel. "A Category of the Human Mind: The Notion of Person, the Notion of 'Self.'" In his *Sociology and Psychology: Essays*. Translated by Ben Brewster. London and Boston: Routledge and Kegan Paul, 1979.
- Mauss, Marcel. "Techniques of the Body." *Economy and Society* 2 (1973): 70–88.
- Mead, Margaret. *Coming of Age in Samoa: A Psychological Study of Primitive Youth for Western Civilisation*. New York: William Morrow, 1928. Reprint, New York: Perennial Classics, 2001.
- Merleau-Ponty, Maurice. *Phenomenology of Perception*. London: Routledge and Kegan Paul, 1962.
- Nietzsche, Frederick. *The Birth of Tragedy and the Case of Wagner*. Translated with a commentary by Walter Kaufmann. New York: Random House, 1967.
- . *On the Genealogy of Morals*. New York: Vintage, 1969.
- Omolade, Barbara. "Hearts of Darkness." In *Powers of Desire: The Politics of Sexuality*, edited by Ann Snitow, Christine Stansell, and Sharon Thompson. New York: Monthly Review Press, 1983.
- Ortner, Sherry. "Is Female to Male as Nature is to Culture?" In *Woman, Culture and Society*, edited by Michelle Rosaldo and Louise Lamphere. Stanford, Calif.: Stanford University Press, 1974.
- Pitts, Victoria. *In the Flesh: The Cultural Politics of Body Modification*. New York: Palgrave Macmillan, 2003.
- Plato. *Phaedo. The Dialogues of Plato*. Translated by G. M. A. Grube. Indianapolis: Hackett, 1977.
- . *Symposium*. Translated by Alexander Nehamas and Paul Woodruff. Indianapolis: Hackett, 1989.
- Turner, Terence. "The Social Skin." In *Not Work Alone: A Cross-Cultural View of Activities Superfluous to Survival*, edited by Jeremy Cherfas and Roger Levin. Thousand Oaks, Calif.: Sage Publications, 1980.
- Young, Iris. *Throwing Like a Girl and Other Essays in Feminist Philosophy and Social Theory*. Bloomington: Indiana University Press, 1990.

Susan Bordo
Monica Udvardy

BORDERS, BORDERLANDS, AND FRONTIERS, GLOBAL. At first glance the concept of borders, borderlands, or frontiers would seem to be straightforward. A border or boundary is a line on a map delineating a territorial boundary or the limit of a political jurisdiction. Borders are primarily, but far from exclusively, seen as properties of and under the control of states. Nevertheless, this has generally not always been the case. Even in the contemporary world where such an interpretation often does apply, the concept of borders frequently becomes much more complicated.

Complications of a Seemingly Simple Concept

The first complication is semantic. In many European languages, including British English, the term *frontier* is a synonym for border. In the Americas, and especially in the United States, *border* means boundary, between countries, between the states of the United States, or between provinces in Mexico or Canada. *Frontier*, typically but not exclusively, refers to a historical boundary between expanding European settlements and indigenous settlements. Thus in English usage in the United States, frontiers and borders are very different concepts and refer to quite distinct social markers. This usage has often been generalized to any sort of border zone or borderland between different sets of peoples coming into contact. It is frequently

extended metaphorically to refer to any boundary between known and unknown, an extension discussed further at the end of this entry.

The second complication is historical. Since the founding of the first states in human history in Mesopotamia some five thousand years ago, boundaries or borders have generally been vague, imprecise zones in which political—and to a lesser extent economic, social, and cultural—control fades away. That is, borders, boundaries, borderlands, and frontiers are zones or regions with some dimension, where there is a shift, more or less gradual, from control by one state to another or to an absence of state control. An important corollary of this complication is that the lack of precision is not necessarily a problem in semantics or conceptualization. Rather, it is often an accurate reflection of an actual fuzziness of boundary zones.

A third complication is that at different times and in different places these concepts have had different meanings, and they have been implemented in different ways. Often a word translated as *border* from one language to another had behind it a different meaning, a different concept of markers, and even different ethical and political implications of what that “border” entailed.

A fourth complication is that the meanings of these terms and how they have been implemented have changed over many millennia. Throughout these changes there have often been disconnects or divergences between their social reality and what various actors (individuals or states) thought they should be.

Finally, there is a problem of scale. Almost any border or boundary zone, when viewed from a sufficient distance, appears as a sharp line. When viewed up close, however, it becomes a zone having some width and often having blurry edges. So from a central capital, a border or frontier may seem precise. Yet from the perspectives of those living on or near the boundary or frontier, or even from the perspectives of those charged with administering or controlling it, it can be quite vague and often contentious.

Defining Borders, Borderlands, and Frontiers

In order to discuss these issues it is useful to present somewhat general definitions of these terms. The following definitions carry two caveats or cautions. First, as with any generalized concepts, they will not be precise for all uses. Second, these terms shift meaning over time and through space. Still, the following are useful for further discussion:

boundary—a demarcation indicating some division in spatial terms

border—an international boundary line; when a border is seen as a zone it is often called a borderland or the borderlands

frontier—a zone of contact with or without a specified boundary line

The term *borderlands* straddles the distinction between frontier and border and is often used as a synonym for frontier as a zone.

The contemporary concept of a border as a sharp, precise line stems from two sources. First is the Peace of Westphalia (1648), which established the modern nation-state system under which a state had full sovereign control of the lands and peoples within its borders. The second source is the development of private property as a concept, in which one individual, or state, had exclusive rights to land or territory. While in the early twenty-first century these conditions are taken as “normal” or “natural,” they are neither. Rather, the idea of a border as a precise line grew out of the needs of states to define boundaries. The idea of exclusive control of land developed from the transformation of control of land from a matter of use rights to a concept of land as an economic commodity, that is, something that can be bought and sold. In other words, these contemporary conceptualizations, which are often seen as a part of the process of modernization, were themselves socially constructed under very specific historical, political, and economic conditions.

In premodern times, that is, approximately before the sixteenth century C.E., land was most often thought of as a resource to which individuals, or more typically groups, had rights to use. In many nonstate societies, if the individual or group did not use the land—usually for a considerable time—then they lost their use rights. This is almost always distinctly different, however, from the European concept of *terra nullius*, which means “empty or unused land.” For those groups who foraged for a livelihood or who practiced shifting agriculture, “use” of land often included long fallow periods. To groups that practiced intensive agriculture—from classic civilizations to modern states—such fallow land appeared empty, hence unclaimed and available for settlement. These differences in how rights to land are conceptualized have been the source of much conflict over many millennia between agricultural states and nonstate peoples. For example, such conflicting viewpoints are at the root of the myth that the island of Manhattan was “purchased.” Dutch occupiers presumed that they were buying a commodity with exclusive rights. Indigenous peoples thought that in consideration for a gift marking friendship they were granting rights to joint use of common lands.

At least two caveats are in order in regard to such conflicts. First, nonstate peoples could and did come into conflict over use of land. Indeed, one of the major mechanisms of the spread of humans derives from such conflicts. Although they were sometimes resolved through fighting, such conflicts were more often resolved by one group moving deeper into unoccupied land, which over time led to the spread of humans over most of the earth. Second, many claims by civilizations or states that land was unused, or was *terra nullius*, were in fact veiled rationalizations for seizing land from peoples who had less complex social or political organization and who did not use the land as intensively.

From the development of the first states some five thousand years ago until the early twenty-first century, though abating somewhat since the Peace of Westphalia (1648), land could be, and often was, seized by conquest. To be ethical, such seizures often needed some sort of justification, such as a “just

war,” reparation for previous harm done, or evidence of illegitimate use by those from whom the land was seized. Obviously, such claims could, and often were, readily invented and rationalized. Still, states did develop a territorial sense and became concerned with boundaries, borders, borderlands, and frontiers. A primary concern, however, was control, mainly political and economic but sometimes also social and cultural. Even constructed barriers, such as the Great Wall of China or Hadrian’s Wall in northern Scotland that marked the edge of the Roman Empire, barriers that did constitute explicit boundaries, were primarily used to control movements of peoples and goods. They were seldom intended as absolute barriers.

Such walls and other barriers were often constructed with military and control functions in mind. They served to regulate interactions between the state or empire and the surrounding groups, whether those were other empires, states, or nonstate peoples. They were constructed to keep members within the state or empire, to keep others out, and to regulate which individuals, groups, or objects could cross the barrier as well as why, when, and under what circumstances such crossings could take place. Such barriers often marked a shift from direct control to indirect control, wherein local leaders controlled the area, but via assorted agreements with the state or empire. In essence, such barriers were not sharp or precise lines but rather the visible centerlines of zones of transition. Some people tried to avoid these controls. Such avoidance is typically defined as “criminal.” Thus borders give rise to smuggling and smugglers.

Frontier as Membrane

These sorts of considerations led the historian Richard W. Slatta to describe frontiers as membranes. This is a singularly appropriate metaphor for frontiers and to somewhat lesser extent for borders, borderlands, and boundaries. Membranes are differentially permeable with respect to what may pass through them and what is blocked. Their permeability often is different for opposite directions. That is, some goods are allowed to pass, say horses entering China from the central Asian steppes and silk leaving. Other things, such as armies, are not allowed to pass. Horses came into China but seldom left, unless mounted by soldiers seeking retribution for raids; silk left China but seldom came in. Membranes have thickness. When viewed from a distance they seem thin, almost like lines. When viewed up close they are zones through which objects, people, and ideas may pass.

Borderlands and Frontiers as Zones of Ethnic Change

Because borderlands and frontiers are zones between different human organizations, they are also zones of intense interactions of objects, peoples, and ideas. These interactions can range from very peaceful, mutually beneficial relationships to incessant warfare. Oftentimes, several types of interactions along the range from peaceful to warlike can occur simultaneously. For instance, along the northern frontier of New Spain (what is now the southwestern United States) various indigenous groups would have peaceful trading relationships with some Spanish villages while they were raiding others. This also occurred among various indigenous groups. Indeed, at

times these opposite relations were not between different indigenous groups and villages but varied from family group to family group on both sides. In short, frontiers are zones of intense interactions, often of several types at the same time. These interactions can change rapidly with local circumstances. This locally variable volatility is a special characteristic of frontiers and borderlands.

These were and are zones where different products and processes mixed and intermingled, often leading to the development of new products and processes. On frontiers one process of this sort, called ethnogenesis, is especially salient. Ethnogenesis is the formation of a new ethnic group via the amalgamation of two or more previously distinct groups.

With the interactions of different peoples, interbreeding and intermarriage were not rare, even in cases in which one or both sides tried to prevent such mixing. When the mixing became sufficiently regular and frequent, it could give rise to an entirely new group. The Metis in Canada and Genizaros in northern New Spain are examples. The Metis grew from unions between French fur traders—typically males—and indigenous women. These long-term relations were mutually beneficial. French fur traders gained access to furs collected and processed through their wives’ groups (such unions were frequently polygynous, with the trader having more than one wife, often from different groups). The indigenous groups gained access to European trade goods acquired through traders who were relatives and hence under considerable kinship obligation to trade fairly. In the early twenty-first century the Metis are still negotiating with the Canadian government for recognition as a people distinct from both indigenous or first nations and from European immigrants.

In northern New Spain there was an active trade in captives, both indigenous peoples captured by Spaniards during fighting and Spaniards captured by indigenous peoples; in both cases, the captives were typically women or children. Indigenous children raised in Spanish communities developed a separate identity that was neither fully Spanish nor fully of their natal indigenous group. If an individual Genízaro or his family rose to prominence, typically as a frontier soldier or sometimes through economic success, he or they could be assimilated into Hispanic society. When the United States annexed the region, the trade in captives rapidly ceased, and the Genízaro population gradually assimilated into either Hispanic or indigenous societies.

The anthropologist Frederick Barth describes another role for boundaries with respect to ethnic identity. Barth argues that ethnicity is not defined by its content but rather by the boundary or boundaries that separate one group from another. This seemingly counterintuitive view developed from studies showing that when individuals or families crossed ethnic boundaries (which may or may not coincide with political boundaries), they often changed identity. Such events are not all that rare in the ethnographic record. Furthermore, some individuals and families made such changes more than once in a single lifetime. Typically, such changes are associated with changes in ecological adaptation. Chinese farmers who moved onto the steppe and

became pastoralists typically joined a nomad group and took up that group's culture. If or when they moved back and again took up farming, they again became Chinese. In such cases, not only is the border or frontier a membrane, but it also is a catalyst for identity change. As noted, such ethnic boundaries seem most common where local ecology forces changes in productive strategies. Changes in climate and especially the development of new technologies allow such borders to shift over time.

Recent research by the biologist Mark Pagei and the anthropologist Ruth Mace supports Barth's interpretation. Pagei and Mace argue that boundaries help maintain a sense of group and enhance social solidarity and cooperation, but often at the cost of promoting conflict with other groups. Thus boundaries and borders play an important role in group formation, even while generating conflict between groups.

The Puzzle of Borderlands and Frontiers

These complications give rise to yet another, enduring aspect of borders, borderlands, and frontiers. On first glance they all seem the same or certainly similar. But with closer examination, each border region seems unique. This puzzling aspect of frontiers has fascinated and frustrated scholars who study frontiers comparatively. The sociologist Thomas D. Hall argues that this puzzling quality derives from the complex way in which frontiers are formed. In a nutshell, frontiers are constructed by the interaction of two or more different groups. The location, extent, duration, and changes in any specific frontier zone entail a complex mixture of factors external to the frontier zone and local factors, all mediated by the actions of the peoples who live in the frontier zone.

The broad similarity among frontiers derives from the small number of factors, in the following example numbering five, that shape most frontiers:

- the types of groups that come into interaction (three types: nonstate, tributary [or ancient] states or empires, or capitalist [or modern] states);
- the type of boundary involved (four types: local economic, political or military, long-distance economic, and cultural);
- the types of nonstate groups (three types, such as those conventionally labeled bands, tribes, or chiefdoms);
- the type of frontier (four types: buffer, barrier, internal, or external); and
- the type of ecological environment (four types: steppe, sown, hill, or valley).

These few factors, when divided into only a few basic categories, will generate 576 different types of frontiers. This immense variety—which could easily be expanded with finer categorization—explains why each specific frontier seems unique. The point of this example is *not* the specific list of factors *nor* the number of specific categories into which they are divided. Rather, it is that with only a few factors divided into a small number of categories an immense variety of frontiers or

borderlands can be described. This then “solves” the puzzle of how and why all frontiers seem similar at first glance but on closer examination seem unique. The similarity derives from the small number of factors involved; the uniqueness from the large number of ways they can be combined.

Borders, Borderlands, and Frontiers as Sites of Social Change

Because of the various complex interactions that occur along borders, in borderlands, and on frontiers, such places are very fertile areas for studying how social, political, economic, and cultural changes occur and how individuals and groups both shape and are shaped by those changes. They are zones where the local and the global interact very intensely and hence exhibit processes that are rarely, if ever, seen in more central areas. This is another reason why the study of borderlands and frontiers is often so fascinating to scholars.

Frontiers are often seen as sources of change, as in the famous frontier thesis of the American historian Frederick Jackson Turner (1861–1932): that the frontier zones of the United States shaped the country's national character. Turner has often been criticized for having the causality backwards: It was the central areas that shaped the frontier. The literature of these debates is enormous, even leading some U.S. historians to question the utility of the concept of “the frontier.” A major problem here is in the definite article: “the frontier” was in reality many, highly fluid, and changeable frontiers.

One very positive result of these debates has been the development of a growing body of writings on comparative frontiers. By comparing different frontiers, scholars have begun to uncover both common, underlying factors and their various unique constellations. Such studies have done much to further blur the distinctions between history and sociology, anthropology, and geography. A conventional, if caricatured, view of these disciplines is that history is idiographic, concerned with painting detailed pictures, whereas sociology, anthropology, and geography are nomothetic or seeking lawlike regular patterns. This conventional view is flawed in at least two ways. First, it sees the two approaches as opposites or as in conflict rather than complementary. Second, it fails to recognize that there is a vast array of possibilities of combining both types of explanations and descriptions. Studies of frontiers or borderlands, especially comparative studies, must combine both approaches in ways that often render disciplinary distinctions unrecognizable. Phrased alternatively, comparative studies of frontiers are inherently multi- and interdisciplinary. Thus the comparative study of frontiers itself forms a kind of intellectual borderland.

Borderlands and Frontiers as Metaphors

No discussion of borders, borderlands, and frontiers would be complete without some attention to the metaphorical use of these terms. Most readers of English are familiar with such phrases as “the frontiers of medicine,” “the frontiers of science,” and “space, the final frontier.” Behind these metaphors is a state-centered view of borders, borderlands, and frontiers in which such areas mark a zone of transition from well-known territory under control of the state to little-known territory not

under control of the state. This metaphor breaks down, however, if pushed too far. Spatial frontiers most often had residents on the other side who were obviously not unknown to themselves. Indeed, at first contact, from each side (and there often are or were borders or frontiers with more than two sides) the other side(s) seemed unknown and were seen as strange or mysterious by the other side(s).

The unknown quality of the “other side of the border or frontier” simultaneously generates curiosity, promise, threat, and fear. It is this combination of reactions brought on by approaching unknown and often uncontrolled territory, peoples, or ideas that is the key difference between frontiers and borderlands on the one hand and a border or boundary in the conventional sense on the other. Presumably with a conventional border, what is on the other side is known but is held separate and distinct by the border. The combination of mystery and danger accompanied by promise and curiosity seems to be at the root of the popularity of the use of frontier (and less frequently borderlands) as a metaphor. In that sense, of course, it is singularly apt for describing or labeling a transition from the known to the unknown.

Thus concepts of borders, borderlands, and frontiers seem at first glance straightforward, simple, and clear. Yet when examined more closely, they are mysterious, complex, and murky. This is why they are often regions of such fascination to scholars and thinkers in many disciplines. Also because of their transitional qualities, they are often excellent sites to study a wide variety of social, cultural, political, and economic change.

See also *Ethnicity and Race; Migration; State, The; World Systems Theory, Latin America.*

BIBLIOGRAPHY

- Barth, Frederick, ed. *Ethnic Groups and Boundaries*. Boston: Little, Brown, 1969.
- Bentley, Jerry H. *Old World Encounters: Cross-Cultural Contacts and Exchanges in Pre-Modern Times*. Oxford: Oxford University Press, 1993.
- Brooks, James F. *Captives and Cousins: Slavery, Kinship, and Community in the Southwest Borderlands*. Chapel Hill: University of North Carolina Press, 2002.
- Chase-Dunn, Christopher, and Thomas D. Hall. *Rise and Demise: Comparing World-Systems*. Boulder, Colo.: Westview Press, 1997.
- Donnan, Hastings, and Thomas M. Wilson. *Borders: Frontiers of Identity, Nation, and State*. Oxford: Berg, 1999.
- Guy, Donna J., and Thomas E. Sheridan, eds. *Contested Ground: Comparative Frontiers on the Northern and Southern Edges of the Spanish Empire*. Tucson: University of Arizona Press, 1998.
- Hall, Thomas D. “Frontiers, Ethnogenesis, and World-Systems: Rethinking the Theories.” In *A World-Systems Reader: New Perspectives on Gender, Urbanism, Cultures, Indigenous Peoples, and Ecology*, edited by Thomas D. Hall, 237–270. Lanham, Md.: Rowman and Littlefield, 2000.
- Hofstadter, Richard, and Seymour Martin Lipset, eds. *Turner and the Sociology of the Frontier*. New York: Basic, 1968.
- Lattimore, Owen. *Studies in Frontier History: Collected Papers, 1928–1958*. London: Oxford University Press, 1962.

Mikesell, Marvin W. “Comparative Studies in Frontier History.” *Annals of the American Association of Geographers* 50 (1960): 62–74.

Pagei, Mark, and Ruth Mace. “The Cultural Wealth of Nations.” *Nature* 428 (March 18, 2004): 275–278.

Slatta, Richard W. *Comparing Cowboys and Frontiers*. Norman: University of Oklahoma Press, 1997.

Taylor, George Rogers, ed. *The Turner Thesis concerning the Role of the Frontier in American History*. 3rd ed. Lexington, Mass.: Heath, 1972.

Weber, David J. *The Spanish Frontier in North America*. New Haven, Conn.: Yale University Press, 1992.

Weber, David J., and Jane M. Rausch, eds. *Where Cultures Meet: Frontiers in Latin American History*. Wilmington, Del.: Scholarly Resources, 1994.

Thomas D. Hall

BRAIN DRAIN. See *Migration*.

BUDDHISM Buddhism, the only truly “world” religion of Asia, was founded in the fifth century B.C.E. in northwest India by a prince named Gautama, who was also called Siddhartha (“He who has reached his goal”), Shakyamuni (“Silent sage of the Shakya clan”), and eventually the Buddha, or “Enlightened One.” The religion spread throughout northern India during the next centuries, becoming a major competitor with Hinduism for popular support and royal favor. The traditions of Hinduism and Buddhism mutually influenced each other, sharing many of the same assumptions but also differentiating themselves doctrinally and, to a lesser degree, socially and ritually.

The three major forms of Buddhism—Theravada (“The Speech of the Elders”), Mahayana (“The Great Vehicle”), and Vajrayana (“The Diamond Vehicle”)—all were born in India and were given their characteristic stamp in that country. By the end of the first millennium C.E., however, Buddhism was more or less defunct in the land of its origin, in part as a result of invading Muslims who especially targeted Buddhist temples and monasteries and in part because Buddhist doctrines and deities were increasingly assimilated into Hinduism.

Long before it ceased to be a religion of India, however, Buddhism had become a pan-Asian religion. By the middle of the third century B.C.E. the great Mauryan emperor Ashoka consolidated most of the Indian subcontinent under his rule. While Ashoka may or may not have been himself a Buddhist convert, tradition gives him credit for spreading the religion not only throughout India (his “edicts” posted on pillars throughout the subcontinent are often read for their Buddhist or crypto-Buddhist messages) but also into Sri Lanka to the south, where it soon became the state religion. From there Buddhist monks brought the religion to Burma, Thailand, and other parts of Southeast Asia, where it has survived as the predominant faith of that region.

Other monks, starting from points in northern India, followed the trade routes into Central Asia and eventually into China, where Buddhism entered by the first century C.E. Although initially regarded with suspicion as a foreign and “barbarian” faith, over the course of several centuries Buddhism was gradually blended with Chinese culture until it joined Confucianism and Taoism as one of the principal religions of that region. By the middle centuries of the first millennium C.E., Buddhism had become the religion of choice of the newly reunified Chinese empire, and indigenous doctrinal and philosophical schools of Buddhism arose. By the seventh century, Buddhism had converts in China from all strata of society, from the imperial family down to the peasantry, and monasteries flourished throughout the empire. The popularity of Buddhism in China would not last, however, and by the ninth century the religion began to decline.

From China, Buddhism entered Korea by the third century C.E. Missionaries from Korea brought the religion to Japan in the sixth century, where it developed into the dominant religion of that country and exerted a huge influence on Japanese national culture. It was not until the seventh century that Buddhism came from India to remote Tibet where, after a few centuries of ups and downs, it became firmly entrenched by the eleventh century and was the state religion until the Chinese invasions in the 1950s. Tibetan Buddhism was exported to Mongolia originally as a result of the close relations between one of the ruling khans and the first Dalai Lama.

Buddhism has been known in the West since at least the time of Alexander the Great and possibly influenced some forms of Greek philosophy, the Gnostics, and early Christians. In modern times, as a result initially of immigration of Asians to Western countries in the nineteenth and twentieth centuries and increasingly because of interest among Westerners themselves, Buddhism can no longer be regarded as an exclusively Asian religion.

The Buddha and the Fundamental Doctrines of Buddhism

The historical details of the life of the Buddha, like those of the lives of many of the world’s religious founders and saints, are probably unrecoverable, buried under layers and layers of mythology and doctrinal revisionism. While there is little doubt that at the origin of Buddhism lies a strong, charismatic founder, the particular contours of the person and life of that founder can only be purely speculative. The oldest Pali and Sanskrit texts do not relay a sustained narrative about the Buddha’s life but rather give only snippets and fragmentary references that seem to emphasize his human features. This has led some to argue that Buddhism is fundamentally an “atheistic” religion, although for a variety of reasons this is a distortion of Buddhist belief. There are indications that even in his lifetime Gautama was accorded great respect and veneration and soon after his death was worshipped in the form of relics, pilgrimages to sites of significance in the Buddha’s life, and eventually in images that became the centerpieces of devotion.

The first known formal biography or hagiography of Gautama Buddha was the *Buddhacarita*, written in Sanskrit probably around the first century C.E. by Ashvaghosha. Over subsequent centuries other life stories were produced in India and Sri Lanka incorporating more and more legendary and mythical materials. The later texts in the hagiographical tradition in Buddhism increasingly stress the miraculous and supernatural elements of the founder. Indeed, in many of them Shakyamuni is portrayed as this era’s Buddha, the latest in a string of many prior Buddhas and the forerunner of a future Buddha known as Maitreya. By the time of the rise of Mahayana Buddhism in the early centuries C.E. the historical Gautama was wholly eclipsed by a complex “Buddhology” that elevates the Buddha to cosmic and, for most ordinary Buddhists, divine stature.

While there are a variety of understandings of who the Buddha was among the various adherents and sects of Buddhism, all are agreed on the basic outline of his life story. He was supposed to have lived sometime during the period from the sixth to the fourth centuries B.C.E., born into a family of the Kshatriya, or warrior-king, class in the clan called the Shakyas in northeastern India. Many accounts say his birth was attended by miracles and that he was born with signs on his body indicating a destiny either as an enlightened Buddha or as a world-conquering emperor. His parents, preferring the latter career path, kept him isolated from the outside world and educated him to be a prince. Gautama grew up under these pampered circumstances, married, and had a son he named Rahula (“Fetter”).

This sheltered life of royal luxury came to an end when the young prince was taken by his charioteer on four excursions outside the confines of the castle. On these trips he saw, for the first time, the suffering nature of a life where sickness, old age, and death are inevitable. On his last tour he also saw a mendicant who was attempting to find an alternative to such a life. These “four sights” provided the impetus for the future Buddha to immediately leave the householder way of life and go in search of the means to liberation from suffering.

The middle centuries B.C.E. in North India were a time of great religious and intellectual ferment and experimentation. Many of the religious assumptions prevailing at that time were integrated into the Buddha’s teaching and subsequent Buddhism, including the belief in karma and rebirth, the cyclical nature of time, the pervasiveness of suffering, and the positing of an alternative to suffering and rebirth.

Upon leaving his previous life as a prince, Gautama is said to have joined several of the many different groups of world renouncers living in the wilderness areas of India, including one group of radical ascetics. The future Buddha perfected the methods taught in this group, learning how to live on but a grain of rice a day, until he became skeletal and weak—but not enlightened. According to legend, Gautama abandoned the way of radical asceticism, just as he had early renounced the life of hedonistic pleasure in the castle, and soon discovered a “middle way” between these two extremes. In deep meditation under a “tree of enlightenment,” the Buddha reached

his own enlightenment and nirvana, the “extinguishing” of ignorance, suffering, and rebirth.

The first sermon or teaching of the newly enlightened Buddha was, according to the legends, given at the Deer Park in Sarnath in northeast India to members of the group of ascetics with whom Gautama had associated earlier. This first “turning of the wheel of dharma” encapsulates the fundamental tenets of all forms of Buddhism and consists of what are called the Four Noble Truths.

The first of these is the universal fact of suffering and dissatisfaction (*dukkha*). A standard formula declares that “birth is suffering, aging is suffering, sickness is suffering, death is suffering; sorrow, lamentation, pain, grief, and despair are suffering; association with what one dislikes is suffering; separation from what one likes is suffering; not getting what one wants is suffering.” Such unhappy circumstances are sometimes called “obvious suffering” and are also bound up in another central doctrine of all forms of Buddhism: the insistence that there is no “self” or “essence” to things and beings (*an-atman*). This belief directly contradicts the concept in Hinduism of an *atman*, or fundamental and underlying self (which was not conceived of, however, as the ego or temporary persona that undergoes rebirth). In the Hindu texts known as the Upanishads, realization of one’s true nature, one’s true self or *atman*, as identical to the ultimate ground of the cosmos (the Brahman), was the end of the mystical pursuit. In contrast, the positing of *an-atman* became one of the distinctive, even unique, features of the Buddhist religion. Suffering occurs in part by grasping and clinging to a self that does not, according to Buddhism, exist.

According to Buddhist doctrine, what we call the “self” is merely a composite of five “aggregates” or “heaps” (*skandhas*). These are “form” (the body in particular and physical and material form in general), feelings (pleasant, unpleasant, and neutral), discrimination (that which processes and categorizes sensory and mental information), karmic predispositions (including, among many other mental factors, will or volition), and consciousness (meaning not only mental awareness but also the “consciousnesses” associated with the five senses). The “self” is but an ever-changing conglomeration of these five aggregates—a process rather than an essential entity.

Another dimension of the first Noble Truth of universal suffering is called the “suffering of change.” Even the pleasant things and circumstances of life are not lasting, and when they are lost we suffer. Thus a second central concept of Buddhist metaphysics also tied up with the truth of suffering is that of impermanence, or *anitya*. Buddhism posits the impermanence and changing nature of all caused and compounded or composite things and beings. Suffering occurs when one mistakes impermanence for permanence and, again, becomes ignorantly attached to things and beings in the false belief that they will last.

A third dimension of suffering is sometimes identified: the “pervasive” suffering that accompanies birth in “samsara”—a word that literally means “to wander or pass through a series of states or conditions.” Samsara describes the beginningless cycle of cosmic or universal death and rebirth and the fact that phenomenal existence is transient and ever-changing. “Perva-

sive” suffering points to the recurring experience of birth, life, death, and rebirth in such a universe.

The second Noble Truth states that suffering has a cause and is not therefore eternally and hopelessly hard-wired into the nature of things. Suffering, according to Buddhism, is created by our own ignorant and habitual responses to life. The chief cause of suffering is variously identified as “thirst” (*tanha*), “craving” (*trishna*), or the “three poisons”: “desire” or “attraction” (*raga*), “aversion” or “hatred” (*pratigha*), and “ignorance” (*avidya*).

Suffering occurs because of a series of interrelated causal factors that are summarized in another important Buddhist doctrine, that of “dependent origination.” In essence this doctrine declares “that being, this comes to be; from the arising of that, this arises; that being absent, this is not; from the cessation of that, this ceases” (*Samyuttanikaya* 2.28). In its classical form, dependent origination consists of twelve conditioned and conditioning links: (1) ignorance, (2) formations (the construction of new karma), (3) consciousness, (4) mind and body, (5) the six sense fields, (6) contact of the senses with the sense fields, (7) feeling, (8) craving, (9) grasping, (10) becoming, (11) birth (i.e., rebirth), and (12) aging and death. Each link depends on the one before it. Aging and death (12) depend on birth (11), for if one were not perpetually reborn one would not repeatedly grow old and die. Birth depends on becoming (10, in the sense of the ripening of karma created in the past); becoming depends on grasping or clinging (9), which in turn depends on craving (8). Craving arises due to pleasant and unpleasant feelings (7), which depend on the contact of the senses (6) with the objects or “fields” of the senses (5), which could not exist without a mind and body (4). Mind and body depend on the consciousness of the six sense fields (3, the five senses with the mind as the sixth), which are determined by the volitional forces (2) that come into play due to ignorance (1). When ignorance ceases, karma is no longer produced, and all other links in the chain are stopped, right up through old age and death.

This brings us to the third Noble Truth, which declares that there is an alternative to suffering, the state called *nirvana*. The term literally means an “extinguishing” or “blowing out” and has sometimes been misunderstood as some kind of nihilism. Nirvana is indeed often described in negative terms: the permanent cessation or extinction of suffering and its causes (craving and the three poisons), of the false idea of and attachment to self, of mistaking the impermanent for the permanent, and of rebirth in the world of samsara. But nirvana is also depicted in positive form, as a state of absolute peace, serenity, tranquility, happiness, and bliss. One who achieves such a state is known as an arhat, or “worthy one,” and various important milestones along the way are also delineated. One who has had the experience of penetrating into the true nature of reality is called an *arya* (noble one) and a “stream-enterer,” for he or she is from that time forward moving inexorably toward nirvana. A “once-returner” has only one more lifetime before achieving the goal, and a “non-returner” will attain nirvana in this lifetime. A distinction is also sometimes made between “nirvana with remainder” (indi-

cating that the person has reached the goal but is still embodied) and “nirvana without remainder,” or “final nirvana” (*parinirvana*), which the arhat enters after the death of the body.

The fourth Noble Truth is the declaration that there is a path or method for achieving the state of nirvana. Just as suffering has its causes, so too can the end of suffering be brought about by entering and perfecting the “Eightfold Path,” which are sometimes also grouped into what are called the “Three Trainings.” The first “training” is in wisdom and covers the first two steps of the Eightfold Path: (1) right view (meaning, among other things, a proper understanding of the Four Noble Truths) and (2) right resolve (the determination to end one’s suffering). The second training is in ethics and includes (3) right speech (abstaining from lying, divisive speech, harsh speech, and idle speech), (4) right action (abstaining from killing, stealing, and sexual misconduct), and (5) right livelihood (abstaining from professions that involve harming other beings). The third training is in meditative concentration and covers (6) right effort (persistence in the training of meditation), (7) right mindfulness, and (8) right concentration. Given the crucial importance and centrality of meditation to the Buddhist path, texts go into great detail about the increasingly subtle states of mind associated with right mindfulness and right concentration.

After the first sermon at the Deer Park, the Buddha is said to have traveled and taught in India for many decades. During the Buddha’s lifetime, he also apparently inaugurated one of the central institutions of Buddhism, monasticism, the most ancient continuous institution in history. From the earliest period of Buddhism, the community, or *sangha*, consisted of laymen and laywomen on the one hand and monks and nuns on the other. But it was especially the monastics who were encompassed in the term *sangha*. The monastic rules of discipline, or *vinaya*, may go back to the Buddha himself but were in any case codified in a series of councils held after the Buddha’s passing away. Being a Buddhist traditionally means that one “takes refuge” in what are called the three jewels—the Buddha, the dharma (i.e., the teachings and the attainments those teachings lead to), and the *sangha* (sometimes meaning exclusively the monastics and sometimes meaning the whole of the Buddhist community).

The Buddha was said to have lived to the age of about eighty, at which time he “passed into his *parinirvana*.” According to the texts, relics from his body were distributed and subsequently buried at the base of distinctively Buddhist places of worship called stupas, which, together with the monasteries and pilgrimage sites, formed the spatial centers of the new religion.

Formation of Theravada Buddhism

According to legend, the first of the Buddhist councils, where monks from all over North India met to collate the Buddha’s teachings, occurred just after the Buddha’s passing away, and several more were held in the years following. In these councils, the earliest forms of the Buddhist canon were developed. Texts, originally orally recited by monks, were divided into three main divisions or “baskets” (*pitakas*): *vinaya* (rules for monas-

tics), *sutra* (discourses), and *abhidharma* (metaphysics). While different traditions have different recensions (in different languages) and even different texts in their canon, all follow this basic division of the sacred scripture into the “three baskets.”

It was in the second of these councils, held some one hundred years after the Buddha’s *parinirvana*, that sectarian differences led to a division between a group of monks called the “Elders” (Sthaviras) and a breakaway set of groups known collectively as the “Great Assemblists” (Mahasanghikas). While the exact reason for the schism is not known with certainty, it seems as though the Mahasanghikas were the more liberal of the two groups while the Sthaviras were the more conservative, preserving what they regarded as the original purity of the Buddha’s teachings. Other schisms and divisions into schools and subschools also occurred, but the Sthaviravadins survived as the “Theravadins” (the Pali name for “teachings of the elders”) in South India, especially Sri Lanka, and from there into Southeast Asia.

Prior to the eleventh century, Theravada was but one of the several forms of Buddhism practiced in Sri Lanka. While it, like all other forms of Buddhism, represents itself as “pure” and “original,” it is in fact a syncretistic blend of a variety of elements and practices. Various reforms sponsored by royal patrons have attempted to recover the “original purity” of Theravada, and among the monastics movements of conservative “forest monks” have at various times insisted on going back to the meditative base of the tradition. As the form of Buddhism that came to predominate in Sri Lanka and Southeast Asia, Theravada is sometimes also called “southern” Buddhism.

Mahayana Buddhist Doctrines and Traditions

The origins of the second major division within Buddhism are shrouded in uncertainty. What was to be called Mahayana, or the “Great Vehicle,” did not originate with any one reforming individual or emerge at any specific time. It at least partially had its roots in a pan-Indian devotional movement (bhakti) that also had a dramatic impact on the Hindu traditions of India around 150 B.C.E. and in the centuries following. Mahayana is also sometimes traced back to the “Great Assemblists,” or Mahasanghikas, but it seems that for many years, even centuries, monks who eventually became Mahayana lived and studied in the same monasteries as others. Perhaps the best way to envision Mahayana Buddhism in its earliest years was as a set of new texts that introduced new doctrinal elements into Buddhism. Those who accepted the canonical legitimacy of these new texts were Mahayana.

The doctrines put forward in these new texts were not, however, represented as new. Rather, they too were supposed to originate with the Buddha; they were regarded as “turnings of the wheel of dharma” that taught the deeper meanings of the Buddha’s message for disciples who were more capable.

Chief among the distinctive teachings of Mahayana was a new conceptualization of the goal of Buddhism. In early Buddhism as well as in the subsequent Theravada tradition, the attainment of nirvana was theoretically possible for anyone. But Buddhahood itself remained the unique feature of Gautama. The Mahayana Buddhists posited enlightenment

and Buddhahood itself as the ultimate goal for all practitioners and regarded nirvana as a lower attainment for those of a “lesser vehicle” (Hinayana).

With this new idea regarding the goal of Buddhism came a radically different understanding of Buddhology. Gautama, for the Mahayana Buddhists, was but one of an innumerable set of Buddhas who populated the cosmos. Each Buddha ruled a region, or “heaven” or “pure land,” which was also populated with highly evolved spiritual beings known as Bodhisattvas. These Buddhas and Bodhisattvas were thought to be filled with compassion and with certain abilities and powers to help those who asked for it. One of the chief features of Mahayana Buddhism is its devotional quality, consisting of the worship of and prayers to these celestial Buddhas and Bodhisattvas.

Integral to the new Buddhology that distinguishes the Mahayana is the doctrine of the “three bodies” or “three forms” (*rupas*) of the Buddha. The first is the “transformation body” (*nirmana kaya*), which refers to the physical emanations the Buddha sends out to this and other worlds. The historical Buddha, Gautama, was one such emanation according to Mahayana Buddhism—a notion that also assumes that Gautama was always and already enlightened, being merely an earthly incarnation of a previously enlightened cosmic Buddha. Under this conception, Buddhas have the capability of sending out virtually infinite numbers of transformation bodies out of their compassion and urge to help all sentient beings everywhere.

Each Buddha also has what is called an “enjoyment body” (*sambhoga kaya*), a subtle body of light that appears in that Buddha’s heaven or pure land, a paradisiacal world populated with advanced practitioners and Bodhisattvas. Conditions in such a land are highly conducive for the attainment of Buddhahood; one form of Mahayana Buddhist practice is to pray and perform other devotional activities in the hopes that one or another of the Buddhas will admit the devotee into his or her pure land after death.

Finally there is what is called the “dharma body” of the Buddha, which refers to the ultimate nature of the Buddha’s mind and to reality itself in its ultimate form. The dharma body includes the omniscience or perfect realization of wisdom in a Buddha’s mind. It also includes the ultimate nature of reality itself, its “thusness” or “suchness.”

Another innovation in Mahayana Buddhism was the superseding of the Eightfold Path with a new method (leading to a newly reconceived goal). This was what became known as the “Path of the Bodhisattva.” The first step on this path was to attain what was termed *bodhicitta*, the “mind of enlightenment” or the motivating wish to attain Buddhahood out of compassion for all sentient beings. A key ingredient to *bodhicitta* and, indeed, a virtue that takes center stage in Mahayana Buddhism, is compassion (*karuna*), which, together with “loving kindness” (*maitri*) and wisdom (*prajna*), form a triad of the distinctive virtues characteristic of the Bodhisattvas (“beings of enlightenment,” the ones who have attained *bodhicitta*) and the Buddhas as conceived by Mahayana.

Out of this driving wish for enlightenment, impelled by the altruistic intention to help end the suffering of others, the Mahayana practitioner takes various vows, swearing to live a life guided by compassion, and then engages in the “six perfections,” each associated with a progressively higher stage of the Bodhisattva path. The first of these “perfections” (*paramitas*) is generosity, including the giving of material things, protection from fear, and the giving of dharma teachings themselves. In its most advanced form, the perfection of giving includes the willingness of the Bodhisattva to give up his or her own body if necessary. Also included under this perfection is giving in the form of what is known as “transfer of merit” (*pari-namana*), the perpetual turning over to the benefit of others any karmic merit done by any meritorious act.

The second perfection is ethics (*shila*) and consists largely of avoidance of the ten basic misdeeds of body, speech, and mind (killing, stealing, sexual misconduct, lying, divisive speech, harsh speech, idle speech, coveting, ill will, and wrong views). Third is the perfection of patience (*kshanti*), specifically combating anger with compassion and loving kindness. The fourth perfection is joyful effort or “vigor” (*virya*), defined as taking joy in doing meritorious and compassionate acts. Fifth comes meditative concentration (*dhyaana*) followed by the sixth perfection, wisdom (*prajna*).

The “perfection of wisdom” consists of realizing the truths of the distinctive metaphysics that also defines Mahayana Buddhism. Especially associated with the great philosopher Nagarjuna (c. 150–250 C.E.) is the important doctrine of “emptiness,” or *shunyata*. Nagarjuna argued that, as a sort of universal extension of the earlier doctrine of “no-self,” all phenomena are “empty” of inherent nature or self-existence. Persons and phenomena exist only dependently, not independently. Emptiness is thus not the ultimate ground of being but rather the insistence that there is no such ultimate, irreducible ground. Emptiness is not some thing but the absence of intrinsic existence to all things. But neither, argued Nagarjuna, does this mean that “nothing exists.” Things do exist, but only dependently. The philosophical school associated with Nagarjuna’s thought was called the “Middle Way” school (*Madhyamika*), positing neither nihilism nor eternalism but a median between the two.

Another important philosophical tenet of Mahayana Buddhism is the identity of samsara and nirvana. Liberation is not “outside” or “apart from” a world of suffering; they are not two separate realities. Both are equally “empty” of self-nature and exist, as all things, only dependently.

While other traditions and schools of Buddhism also went from India to China, Korea, and Japan, it was Mahayana Buddhism that flourished and was further developed in those regions. Mahayana is thus sometimes called “northern Buddhism” in contrast to the predominantly Theravada traditions of “southern Buddhism.”

Mahayana Buddhism in China was heavily influenced by the preexisting religious philosophies of Confucianism and Taoism and by the presuppositions of a culture already ancient, literate, and sophisticated by the time Buddhism was brought to it in the early centuries C.E. Among the difficulties Buddhism faced

in China were monasticism and celibacy, which were understood to be in opposition to the Chinese emphasis on filial piety and ancestor worship. Conversely, the Chinese readily embraced and further elaborated the Mahayana concept of all beings having a “Buddha nature,” or the potential to achieve Buddhahood and enlightenment.

By the fifth century C.E. different schools of Buddhism arose in China. Some of these were simply Chinese equivalents of Indian Buddhist schools. San-lun, or the “Three Treatises” school, was the Chinese version of Madhyamika, and Fa-hsiang, or “Characteristics of the Dharma” school, was the equivalent of the Indian philosophical tradition known as Yogacara. But also at about this time, distinctively Chinese schools of Buddhism arose that reflected indigenous cultural and religious emphases. The importance of harmony, for example, produced schools like the T’ien-t’ai (“Heavenly Terrace”; Tendai, in Japan), which placed one text (in this case the Lotus Sutra) above all others and then organized the rest of the diverse Buddhist tradition into a hierarchically ordered synthesis. The T’ien-t’ai philosophy embraced the idea that Buddha nature exists in all things and that the absolute and phenomenal world are not ultimately different. Another school that attempted to harmonize the teachings of Buddhism into a syncretistic whole was the Hua-yan (Kegon, in Japan) school, which elevated the Avatamsaka Sutra to the highest place and oriented the rest of Buddhist texts and teachings around it.

Of special importance, however, were two other schools that arose in China, spread to neighboring regions from there, and survive to the present. The first of these was the “Pure Land” school (Ch’ing-t’u), a devotional and faith-based sect centering on the figure of Amitabha Buddha. Pure Land became the most popular form of the religion in China, Korea, and Japan, especially among the laity. Pure Land promises an easy path to salvation in the guise of rebirth into the heaven or pure land of Amitabha, where one will quickly become enlightened. The principal practice of this form of Buddhism has been to call upon the grace of this Buddha through repeating a formula known as *nien-fō* (*nembutsu* in Japanese). In its more radical forms, Pure Land has insisted that one must rely totally on the “other-power” of the Buddha and not at all on one’s own efforts.

The second of the two most important schools that arose initially in China was that known as Ch’an, or Zen as it was termed in Japan. Deriving from a Sanskrit word for “meditation,” the Ch’an/Zen tradition offers a stark contrast to the devotionalism of Pure Land. Traced back to an Indian monk-missionary named Bodhidharma, whose radical and uncompromising meditational techniques become legendary, the Ch’an/Zen tradition developed a simple but disciplined and demanding set of methods for directly intuiting one’s own Buddha nature and achieving various levels of awakening (*wu*, or *satori* in Japanese). These methods included meditation, the “direct transmission” of wisdom from the mind of the enlightened teacher to that of the student, and the contemplation of riddles known as koans.

Vajrayana or “Tantric” Buddhism

The third major form of Buddhism, like that of Mahayana, was the particular Buddhist expression of a pan-Indian religious movement. Whereas Mahayana became the Buddhist form of the bhakti, or devotional movement, Vajrayana (“Diamond Vehicle”) was the Buddhist expression of what has been called Tantrism, an esoteric, sometimes antinomian, and often controversial form of religious belief and practice that became influential throughout India beginning in the middle centuries of the first millennium C.E.

Here too, as with Mahayana, this apparently new form of Buddhism is not represented as new at all. Vajrayana claims to be the secret doctrines and practices taught by the Buddha in his guise as Vajradhara (the “Holder of the diamond”) to only his most advanced disciples. It also portrays itself as the quick way to enlightenment in this very lifetime through the attainment of “accomplishments,” or powers (*siddhis*), that speed up the process. The tantric master (*mahasiddha*) appropriates to him- or herself the powers of one or another of the Buddhas, who is invoked through the practice of meditative visualizations, symbolic gestures (mudras), and the recitation of sacred words called mantras (indeed, such is the importance of the latter that sometimes this form of Buddhism is called Mantrayana or the “Vehicle of the Mantra”).

One key to this form of Buddhism is the emphasis on initiation and the important place of the tantric master, or guru. It is the teacher who is the gateway to the powers of the tantric deity or Buddha and their secret world, or mandala. The techniques and wisdom are to be scrupulously guarded from the uninitiated, and as a result the texts of Vajrayana Buddhism are often encoded in a symbolic or metaphorical language (sometimes called “twilight speech”) not easily decipherable by outsiders. Once initiated, the practitioner forms a special connection, even identity, with the tantric deity or Buddha into whose sphere one has entered. By attempting to recognize the union with that deity through meditation and, in more advanced cases, ritual and yogic practices involving a partner of the opposite sex, the practitioner tries to “short-circuit” the mind into a realization of enlightenment and the perception of all things and beings as pure.

Tantric forms of Buddhism perhaps originated among the laity but by the eighth century had been taken up by monastic scholars and brought increasingly into the mainstream of Buddhist thought and practice. By and large the great tantric practitioners who brought this form of Buddhism to Tibet had originally been trained in the monasteries. And while Vajrayana Buddhism spread also to Southeast Asia, Japan, and elsewhere, it was primarily in Tibet and Nepal where this form of Buddhism was preserved after it was extinguished in India.

Later Developments: Modern Buddhism in Asia and Buddhism in the West

Buddhism, like all other religions, has been influenced by the forces of modernity. These forces—including scientific materialism, secularism, technological advances, and the ideologies of democracy, equality, Marxism, and so on—arrived in the traditionally Buddhist Asian countries in the forms of Western

imperialism and colonialism and the Christian missionary movement that often accompanied them. In Sri Lanka, Southeast Asia, China, and Japan, the coming of Western influences disrupted the traditional structural alliances between Buddhist monastic institutions and the government. Buddhist revivals in places like Sri Lanka and Thailand resulted in what has been called a new "Protestant" form of Buddhism that emphasizes rationality and deemphasizes the split between monastics and laity. Buddhism also often became associated with cultural and emerging national pride in the battle against the colonial powers and their impact. In Japan and Korea, Buddhist influences combined with modern concepts and in some cases Christian influences to give rise to a slew of new religious movements. And in China and Tibet, where Chinese Communist regimes have not often been favorably disposed to Buddhism, the religion survives in a much-weakened condition in comparison to its earlier influence.

Buddhism in the modern West comprises two very different kinds of groups. On the one hand, it has come to North America and Europe as the religion of Asian immigrants. For these new arrivals, Buddhism provides a sense of cultural community, continuity, and tradition in new and often challenging circumstances. Often over time the Buddhism practiced in these immigrant communities increasingly takes on the shape of Christian church worship, with the introduction of scripture reading, sermons, and youth education ("Sunday school").

The other form of Buddhism in the West is made up of Western converts who are almost always attracted not to the devotional or even the communal element of Buddhist religion as much as to the philosophical and especially meditative component. For these Western lay practitioners (there are at present very few Western Buddhist monastics), the practice of Buddhism means first and foremost meditation, a dimension of the religion formerly in Asian contexts confined almost exclusively to the monastics.

See also Asceticism: Hindu and Buddhist Asceticism; Chinese Thought; Communication of Ideas: Asia and Its Influence; Consciousness: Chinese Thought; Cosmology: Asia; Daoism; Heaven and Hell (Asian Focus); Hinduism; Meditation, Eastern; Mysticism: Chinese Mysticism; Religion: East and Southeast Asia; Sacred Texts: Asia; Yin and Yang; Zen.

BIBLIOGRAPHY

- Conze, Edward. *A Short History of Buddhism*. London and Boston: Unwin, 1980.
- Harvey, Peter. *An Introduction to Buddhism: Teachings, History, and Practices*. Cambridge, U.K., and New York: Cambridge University Press, 1990.
- Lopez, Donald S., Jr., ed. *Buddhism in Practice*. Princeton, N.J.: Princeton University Press, 1995.
- , ed. *Buddhist Hermeneutics*. Honolulu: University of Hawaii Press, 1988.
- Robinson, Richard H., and Willard L. Johnson. *The Buddhist Religion: A Historical Introduction*. 4th ed. Belmont, Calif.: Wadsworth, 1997.
- Strong, John. *The Experience of Buddhism: Sources and Interpretations*. Belmont, Calif.: Wadsworth, 1995.

Takakusu, Junjiro. *The Essentials of Buddhist Philosophy*. 3rd ed. Edited by by Wing-tsit Chan and Charles A. Moore. Honolulu: University of Hawaii Press, 1956.

Tambiah, Stanley J. *World Conqueror and World Renouncer*. Cambridge and New York: Cambridge University Press, 1976.

Walpole, Rahula. *What the Buddha Taught*. Rev. ed. New York: Grove Press, 1974.

Williams, Paul. *Buddhist Thought: A Complete Introduction to the Indian Tradition*. London and New York: Routledge, 2000.

Brian Smith

BUREAUCRACY. The idea of bureaucracy formally begins with Max Weber (1864–1920); indeed, the *idea* of bureaucracy ends with Weber as well. Prior to Weber's explication of the "ideal type" of rational, efficient organization of public or private business as a bureaucracy, the idea was simply a commonsense, practical method for the organization of economic or government action. While the original idea of bureaucracy was a prescription for social organization for both public and private organizations, the contemporary usage of the term is limited nearly exclusively to public organizations.

The association between Weber and the concept of bureaucracy is readily apparent; however, Weber himself did not explicate a definition of bureaucracy as such. Rather, he simply elaborated on a form of social organization according to specific characteristics and suggested that these were the elements of what would become bureaucracy. It is important to note that Weber was a sociologist committed to explaining the organizational forms within the world around him; bureaucratic forms of social organization were certainly in existence before Weber's ideal typology came to light.

The Practical Form of Social Organization Later Known as Bureaucracy

Prior to the coinage of the term *bureaucracy* in the nineteenth century, organizations that functioned essentially as bureaucracies had long existed throughout the world. As early as the Han Dynasty (206 B.C.E.–220 C.E.), Chinese bureaucracy was taking on the form of a merit-based, centralized administrative apparatus of the state. Other early civilizations, including the Egyptians and the Greeks, included active administrative arms, but unlike the Chinese, were not selected primarily on criteria of merit. The early practice of bureaucracy was nominally a system of individuals employed (often permanently) in court advisership, tax collection, and the implementation of imperial/monarchical policy. This form of bureaucratic social organization dates back to the early Chinese dynasties as well as the early Egyptians, Phoenicians, Romans, Greeks, and other ancient societies, all of whom employed a designated body of loyal officials to implement the various policies of the ruling classes. Throughout the early common era, bureaucracy remained an arm of the ruling powers and the aristocracy; imperial, monarchical, and feudal systems employed bureaucratic-type organizations primarily to implement taxation and land-use policies.

The Middle Ages saw the expansion of another form of public bureaucracy. The ecclesiastic bureaucracy was designed

to implement policies and maintain the hierarchy of the Catholic Church. The church was certainly not alone in its use of formal hierarchical structures for the purpose of efficient implementation of policy: early Protestant faiths and the Islamic faith also employed bureaucratized structures for the coordination of their ever-growing populations of clerics and faithful. The bureaucratization of modern life is intimately tied to religion, in Weber's case, Protestantism. The alliance between ecclesiastic and secular bureaucracies would dominate the greater part of the millennium. For example, the Crusades to the Holy Land were in many ways marvels of imperialist-expansionist uses of both bureaucratic structures. The use of the two bureaucratic forms in the foreign occupation and domination of foreign lands would be an important idea in the late-twentieth-century rejection of colonialism. As Rodney argues, the church was also a colonizing force, "[meant] primarily to preserve the social relations of colonialism . . ." (p. 253), and had to be dealt with as a colonizing bureaucratic power.

The key elements of the early practical bureaucracies (from the early Han Dynasty bureaucracy to the nascent Prussian state administration) included significant loyalty to the court, (very) limited policy discretion, frequent abuses of government power for organizational and individual gain, and the erection and maintenance of significant barriers to entry into the public service. The earliest practicing bureaucrats were rightfully accused of coveting and vehemently defending their titles as well as unduly influencing court decisions in favor of maintenance of the bureaucratic structure. This tendency of bureaucratic officials would be a perennial argument against the use of bureaucracy, particularly for the organization of government business. Later, within the early modern era (particularly the time of the prerevolutionary French administration) bureaucracy was used primarily as an aristocratic tool of domination of the many by the few. However, the inefficiencies and graft of rational-legal and formalistic bureaucratic systems are unlikely to be noted as particularly heinous compared to earlier, traditional forms of imperial and aristocratic abuses.

Max Weber and the Idea of Bureaucracy

What is notable about the very idea of bureaucracy is its severe rational modernism. Political modernity and bureaucracy are largely symbiotic; the rise of the state paralleled the rise of the bureaucracy. One of the philosophers of the modern economizing state and the modern bureaucratic idea is Adam Smith (1723–1790), whose defense of the division of labor promoted the bureaucratization of the early Westphalian state. Indeed, Smith's ideas are elemental to Weber's core tenets of bureaucracy: the rigid division of responsibilities and tasks and the economization of organizational forms. Whereas Smith advocated the division of labor in order to promote efficient economic growth, Weber suggests the division of labor for the efficient production of goods or services. Inevitably, bureaucracy was conceived as, and has become, an economizing tool for the rationalization of complex and ambiguous environments.

The rationality of bureaucracy is a central idea within Weber's ideal type. In fact, Weber himself suggests that bureaucracy be a rational-legal form designed to promote the rationalization of organizational tasks and goals. The rational-

izing tendency of bureaucracy, while being one of the elements most open to contemporary criticism, was also its most attractive quality for the architects of Enlightenment-guided governance, who sought alternatives to earlier forms of despotic and aristocratic dominance. The adoption of the bureaucratic form by theorists of liberal government has its roots in the legal protection of natural (rational) rights for all. In fact, embedded in the rationalization structure of bureaucracy is the elimination of particularism—the diminishment of universal individual rights for the sake of traditional forms of class or ethnic domination. Those responsible for the French Revolution pined, within their writings, for the rational nonexceptionalism of the bureaucratic form. Indeed, as Maximilien de Robespierre (1758–1794) and later Alexis de Tocqueville (1805–1859) identified, the *ancien régime* was epitomized by the irrational occupation of power by a centralized bureaucracy of the ruling class.

The products of mid-modern European thought on the liberalizing and economizing role of government produced the context in which Weber penned his essay "Bureaucracy." Within the essay he establishes the criteria elemental to the ideal bureaucracy. Foremost, he recommends that bureaucracy be the instrument of rational-legal authority, which he defines as that manner of authority "resting on a belief in the 'legality' of patterns of normative rules and the right of those elevated to authority under such rules to issue commands" (Scott, p. 44). This supplanted traditional forms of authority such as the sanctity of hereditary rule or charismatic authority such as the leadership of Napoleon. The bureaucratic organization of rational-legal authority involves the following necessary criteria: the specification of jurisdictional areas, the hierarchical organization of roles, a clear and intentionally established system of decision-making rules, the restriction of bureau property to use by the bureau, the compensation by salary (not spoils) of appointed officials, and the professionalization of the bureaucratic role into a tenured lifelong career. The idea of bureaucracy suggests that rules, norms, merit, regulations, and stability are paramount to the operation of government. The rule-bound nature of bureaucracy has been widely critiqued in modern political and sociological analyses; however, the number of alternative forms of organization that have received as much consideration is limited.

Criticism of and Advancements in the Idea of Bureaucracy

Critics primarily attack the practice of bureaucracy, but a few notable scholars attack or enhance the very idea of a bureaucracy and/or a bureaucratic state. Oddly, Georg Wilhelm Friedrich Hegel (1770–1831) was a reformer of the idea of bureaucracy without being an outright critic of the form. The Hegelian notion of the neutral universalizing civil service devoted to the common good contradicts Weber's notion of the bureaucracy that unquestioningly serves the rational-legal authority of the state. Hegel expands the role of bureaucracy beyond simply the implementation of rules to a universalizing and constitutive, productive artifact of modern society. This notion of the constitutive and productive bureaucracy is picked up by later political scientists such as Brian J. Cook. Despite the positive contribution that Hegelian philosophy has upon the idea of bureaucracy, followers of Hegel, such as Karl Marx and

Hannah Arendt, have damned the practice of bureaucracy as a dominating instrument of rationalized capitalist will. However, they have not notably expanded upon the idea of bureaucracy but have rather simply recast the rules already understood to be elemental to the idea and defined them as ills of modernity.

One avenue of expansion upon the idea comes from the criticism that postcolonial and postmodern theorists have directed toward bureaucracy. Weber initially argued for bureaucracy to be a tool for internal organization of offices that served to legitimate the power of the organization's authority through rationalization and rules. What postcolonial and postmodern theorists have charged is that bureaucracy is also designed for domination of the organization by those external to it. Weber's idea was, according to later critics, formed within a social vacuum and neglected the role of environment and context upon bureaucratic behavior. However, Weber likely did not intend to explicate a form of social organization void of social context; rather, he espoused one that could potentially work within a multitude of situations with or without being extensively tailored to individual societies. As such, Weber's original idea is decidedly impersonal and lacks space for exceptionalism. Consequently the organizational form is also ideal for discipline and domination; as an organizational tool within the public, bureaucracy has, as Hegel suspected, a tendency toward projection of a universal standard (of rationality, in this case). As Robert K. Merton suggests, the "formalism, even ritualism [of bureaucracy], ensues with an unchallenged insistence upon punctilious adherence to formalized procedures" (p. 106). The bureaucratic insistence upon rule-based formality codifies conformance, the primary tool of bureaucratic dominance.

Bureaucracies, particularly in modern democratic societies, have significant roles to play as channels of representation. Theorists of representative bureaucracy have expanded upon the idea itself to suggest that the practice be a conduit of effective and well-rounded governance. Similarly, as suggested by Michael Lipsky, lower-level bureaucrats can serve as advocates for citizen needs within their official capacities. Theorists of representative or advocative bureaucracy clearly reject the Weberian characteristic of neutral servants of authority and by doing so expand the idea of bureaucracy from a micro-level instrument of social organization to a macro-level system of social responsibility.

Criticisms of the Practice of Bureaucracy

The speculation that bureaucracy will bear bad fruit within society began with criticisms of government practice across history. These criticisms came from various philosophical schools as well as from the rapidly decolonized nations, particularly following World War II. However, many of the philosophical criticisms of bureaucracy are leveled against the practice rather than the idea. As Charles T. Goodsell notes, there are three broad typologies of antibureaucratic criticism within academia. These are a focus on unacceptable performance, the fear of bureaucracies serving elite interests over the interests of the entire polity, and the fear of bureaucratic oppression through formalism and a general lack of concern for particular needs of clientele. Of these criticisms, the focus on the unacceptable

performance and antihumanitarianism of bureaucracies seems to dominate the majority of the literature. For example, Thorstein Veblen, James Dewey, and D. Warnotte identify ills in bureaucratic practice that include, respectively, "trained incapacity," "occupational psychosis," and "professional deformation" (Merton, p. 104). However, each of these criticisms is lodged against practical states of bureaucratic employment rather than the idea of bureaucracy itself. Additional critical thought on the practice comes largely from contemporary organization theorists who have concerned themselves with the impact of bureaucratic structure on employees' motivation and attitudes. Additionally, theorists of public administration have speculated upon the role of bureaucracy within other organizational forms such as democratic governance. While these criticisms are decidedly useful as a pedagogical tool for understanding the nature of bureaucracy, they represent neither a critical reflection upon nor notable additions to the idea itself.

Goodsell's third typology has been largely taken up by postmodernists, critical theorists, and postcolonial critics of bureaucracy. The use of government bureaucratic domination as well as ecclesiastic bureaucratic domination was highly effective in the overtaking of colonial properties. However, bureaucratization was an ineffective tool for the reformation of decolonized states. Perhaps Weber was correct in his assertion that "bureaucracy, thus understood, is fully developed in political and ecclesiastical communities only in the modern state, and, in the private economy, only in the most advanced institutions of capitalism" (p. 73). The bureaucratization of juridical states and the rise of capitalist economy are inextricably related; the bureaucratic form is unnatural in societies where charismatic or traditional authority still dominates. The modernist preference for rational-legal authority suggests that bureaucracy should be the natural form of organization, but for decolonizing states in a situation of authoritative flux, bureaucracy may be an unnatural and in many cases falsely dominating form of organization.

Another form of critique against the practice of bureaucracy has come from scholars of gender relations. These critiques center primarily upon the rejection of the rationalist-modern form of organization as decidedly male-centered. Feminist scholars have argued that bureaucratic structures privilege male forms of communication, deemphasize intuitive and experiential knowledge, diminish the creative capacities of employees, and encourage conformity with historically male institutions, such as government. Again, while these critiques address some structures of bureaucracy as suggested by Weber, the idea itself is not augmented in the address.

Contrary to the thesis that bureaucratic organizations are consistently dominating is the thesis that bureaucracies (as Hegel supposes) can be neutral civil services devoted to the benefit of all in the society. Particularly because of its rational character and nonparticularistic method of organizing client needs, the bureaucracy can ideally serve all within a given community at an equally efficient level. However, according to some critical theorists, Jürgen Habermas being the most notable, the current conditions of social interaction within society are prohibitive of appreciative discourse between equal parties capable of reaching mutually acceptable and operable conclusions. Whether the bu-

reaucracy offers itself as a neutral public servant or not, the social structure of government in capitalist societies in particular unconsciously promotes unequal dialogue and domination by bureaucracies.

Summary of the History of the Idea of Bureaucracy

The history of the idea of bureaucracy is also marked by changes in the public perception of the term. Prior to Weber's defining the idea of bureaucracy, the practice of rational organization of government services according to neutral merit-based qualifications was viewed as a positive antidote to the nepotism and hereditary domination of traditional monarchical or ethnocentric forms of government. However, across most of the globe, the recent history of the term suggests that it has had a largely negative influence upon society. Indeed, the term *bureaucracy* now evokes epithetical connotations that refer exclusively to perceived inadequacies in government policy implementation.

One final characteristic of the history of the idea of bureaucracy is the multitude of synonyms that have evolved to describe the practice or the idea of bureaucracy in more neutral or passive terms, particularly within the past century. These synonyms include public administration, public management, public service, and governance or policy implementation. In fact, within much of the contemporary literature on bureaucracy, or public administration in particular, the two concepts are used coterminously. This tendency to conflate the idea of bureaucracy with the idea of public service, management, or administration demonstrates that the term has expanded from its original sociological implications. However, this is not to suggest that the idea of bureaucracy as the social organization of complex tasks according to rational-legal authority has lost any of its original appeal. It merely suggests that changing public preferences have altered the disciplinary significance of historical ideas and distorted them to reflect current social contexts, even if it leads to the incorrect hijacking of what once was a neutral academic term.

See also *Democracy; Liberalism; State, The.*

BIBLIOGRAPHY

- Arendt, Hannah. *Crises of the Republic*. New York: Harcourt Brace Jovanovitch, 1972.
- . *Eichmann in Jerusalem: A Report on the Banality of Evil*. Rev. and enl. ed. New York: Viking, 1964.
- Blau, Peter M. *The Dynamics of Bureaucracy*. 2nd ed. Chicago: University of Chicago Press, 1973.
- Cook, Brian J. *Bureaucracy and Self-Government: Reconsidering the Role of Public Administration in American Politics*. Baltimore: Johns Hopkins University Press, 1996.
- Creel, H. G. "The Beginnings of Bureaucracy in China: The Origin of the Hsien." *Journal of Asian Studies* 23, no. 2 (1964): 155–184.
- Eisenstadt, S. N. *The Political Systems of Empires*. London: Free Press of Glencoe, 1963.
- Goodsell, Charles T. *The Case for Bureaucracy: A Public Administration Polemic*. 3rd ed. Chatham, N.J.: Chatham House, 1994.
- Habermas, Jürgen. *The Inclusion of the Other: Studies in Political Theory*. Edited by Ciaran Cronin and Pablo de Greiff. Cambridge, Mass.: MIT Press, 1997.
- Hegel, G. W. F. *Elements of the Philosophy of Right*. Edited by Allen W. Wood; translated by H. B. Nisbet. Cambridge, U.K., and New York: Cambridge University Press, 1991.
- Lipsky, Michael. *Street Level Bureaucracy: Dilemmas of the Individual in Public Services*. New York: Russell Sage Foundation, 1980.
- Marx, Karl. *Critique of Hegel's "Philosophy of Right"*. Edited by Joseph O'Malley; translated by Annette Jolin and Joseph O'Malley. Cambridge, U.K.: Cambridge University Press, 1970.
- . *Marx's Eighteenth Brumaire: (Post) modern Interpretations*. Edited by Mark Cowling and James Martin. London: Pluto Press, 2002.
- Mbembe, Achille. *On the Postcolony*. Berkeley: University of California Press, 2001.
- Meier, Kenneth J. "Representative Bureaucracy: An Empirical Analysis." *American Political Science Review* 69, no. 2 (1975): 526–542.
- Merton, Robert K. "Bureaucratic Structure and Personality." In his *Social Theory and Social Structure*. Rev. and enl. ed. New York: Free Press, 1957.
- Perrow, Charles. "Why Bureaucracy?" In his *Complex Organizations: A Critical Essay*. 3rd ed. New York: McGraw-Hill, 1986.
- Reese, Thomas J. *Inside the Vatican: The Politics and Organization of the Catholic Church*. Cambridge, Mass.: Harvard University Press, 1996.
- Rodney, Walter. *How Europe Underdeveloped Africa*. Washington, D.C.: Howard University Press, 1981.
- Scott, W. Richard. *Organizations: Rational, Natural, and Open Systems*. 5th ed. Upper Saddle River, N.J.: Prentice Hall, 2003.
- Skocpol, Theda. *States and Social Revolutions: A Comparative Analysis of France, Russia, and China*. Cambridge, U.K., and New York: Cambridge University Press, 1979.
- Smith, Adam. 1776. "Of the Division of Labour." In *Classics of Organization Theory*, edited by Jay M. Schafritz and J. Steven Ott. 5th ed. Fort Worth, Tex.: Harcourt College Publishers, 2001.
- Stivers, Camilla. *Bureau Men, Settlement Women: Constructing Public Administration in the Progressive Era*. Lawrence: University of Kansas Press, 2000.
- . *Gender Images in Public Administration: Legitimacy and the Administrative State*. 2nd ed. Thousand Oaks, Calif.: Sage, 2002.
- Weber, Max. *From Max Weber: Essays in Sociology*. Edited and translated by H. H. Gerth and C. Wright Mills. Oxford and New York: Oxford University Press, 1946.
- Wenke, Robert J. "Egypt: Origins of Complex Societies." *Annual Review of Anthropology* 18 (1989): 129–155.
- Wilson, Woodrow. "The Study of Administration." *Political Science Quarterly* 2, no. 2 (1887): 197–222.
- Witz, Anne, and Mike Savage, eds. *Gender and Bureaucracy*. Cambridge, Mass.: Blackwell, 1992.

Sara Jordan

BUSHIDO. Literally translated as "way of the warrior," Bushido evolved into a clearly defined ethical system of the *bushi*, or warrior class of Japan, during the seventeenth and eighteenth centuries; the term first appeared in the *Kōyō gunkan* in about 1625. In his 1899 *Bushido: The Soul of Japan*, Nitobe Inazō, the first to articulate the concept in English, enumerated seven essential values of the warrior class: justice, courage, benevolence, politeness, veracity and sincerity, honor, and loyalty. More re-



Samurai warrior, photographed c. 1860 by Felice Beato. Bushido, the samurai code of ethics, was formalized in writing in the sixteenth century and adhered to for some three hundred years. Bushido placed emphasis on certain chivalrous virtues such as loyalty, courage, and courtesy. © HISTORICAL PICTURE ARCHIVE/CORBIS

cently, Bushido has been credited with fueling Japanese atrocities in World War II, through “the unassailable rule that death is preferable to dishonour” (Edwards, p. 5). In fact, neither of these popular conceptions accurately represents the codes of warrior behavior that developed over the course of six centuries.

The Warrior Governments of Japan

In 1192 Minamoto Yoritomo established the first *bakufu*, or “tent government,” to counter the growing inability of the imperial family and aristocracy to control the provinces. From that time until the Meiji Restoration of 1868 Japan was governed by its warrior class.

Yoritomo’s Kamakura government was later idealized as the warrior’s “Golden Age,” when “selfless loyalty unto death” characterized relations between warlords and their samurai retainers. Modern scholarship has uncovered a different picture, however. According to Dr. Karl Friday, “From the beginnings of the samurai class and the lord/vassal bond in the eighth century to at least the onset of the early modern age in the seventeenth, the ties between master and retainer were contractual, based on mutual interest and advantage, and were heavily conditioned by the demands of self-interest” (p. 342). There was no single prescriptive code of behavior; instead each warrior clan had its own behavioral norms, sometimes listed in formal “house pre-

cepts,” or *kakun*, or in admonitory epistles to a lord’s heirs and retainers.

These early warrior documents varied considerably—some had a decidedly Buddhist cast, others insisted on a thorough education in the arts, while still others advised a single-minded focus on strategy and skills for battle. Some were written in a highly stylized Chinese form; others were composed in a more natural Japanese manner. The Chinese-influenced theme of balance between *bun* (literature) and *bu* (martial skills), *bunbu ryōdō*, appears frequently. So do the reciprocal admonitions of loyalty to the lord and benevolence toward retainers. Maintaining martial skills is so important that Shiba Yoshimasa writes, “Insofar as martial arts are concerned, it goes without saying that one should practice . . .” (Hurst, p. 218).

From War to Peace

Prior to the Edo period (1600–1868), the primary function of a warrior was to fight. Writing about how to behave as warriors was of less immediate concern than actual battlefield skills. Tokugawa Ieyasu changed all that, through the unification of the country and his establishment of the third and final bakufu in 1603. Suddenly the *bushi*, who had been engaged in almost continual warfare for one hundred years, were left without any battles to fight. By the eighteenth century, the gap between name and role had widened to the point that the *bushi* experienced a full-fledged identity crisis. The samurai were now primarily administrators and bureaucrats searching for an understanding of their proper role in a warless age.

Unlike their predecessors, who had been writing for fighting men and clan leaders, thinkers such as Yamaga Sokō and his student Daidōji Yūzan wrote about Bushido in an attempt to define and encourage behaviors that would distinguish warriors from the other classes of farmers, artisans, and merchants. Incorporating a more traditional Confucianism than the state-favored Neo-Confucianism, Yamaga argued that the primary duty of the warrior was to serve as an exemplar for the rest of society, through deeply cultivated sincerity of action.

Yamamoto Tsunetomo, in the *Hagakure*, saw a very different purpose for the eighteenth-century warrior—“The Way of the Samurai is found in death” (p. 17). This anachronistic view—warriors had not died in battle for more than a century—is frequently misunderstood. In order to control the armed warriors, Tokugawa Ieyasu established a series of inviolable laws; these at times came into conflict with the warrior’s individual loyalties or sense of honor. In particular, both parties in any conflict between samurai were to be punished equally; in this context, Yamamoto urged that if warriors were forced to break the Shogun’s law they might as well fight to the death.

Modern Legacy

The values of the *bushi*, both actual and idealized, have permeated all levels of Japanese society. In the Edo period, members of the merchant class deliberately adopted samurai standards of behavior to identify themselves more closely with

**PRECEPTS OF THE FIGHTING MAN (KAMAKURA, MUROMACHI,
AZUCHI-MOMOYAMA PERIODS, 1185–1600)**

Rokuhara-dono gokakun (The precepts of the lord of Rokuhara, 1247), by Hōjō Shigetoki
Gokurakuji-dono goshōsoku (The message of the master of Gokurakuji, 1256), by Hōjō Shigetoki
Tōjiin goisho (Last testament from the Tōjiin Temple, 1357), attributed to Ashikaga Takauji
Chikubashō (Bamboo stilt anthology, 1383), by Shiba Yoshimasa
Imagawa kabegaki (Imagawa's wall inscriptions, 1395–1409), by Imagawa Ryōshun
Yoshisadaki (The records of Yoshisada, c. 1338), attributed to Nitta Yoshisada
Jūshichikajō (The seventeen articles, c. 1479), by Asakura Takakage
Nijūikkajō (Twenty-one precepts, c. 1495), by Hōjō Sōun
Soteki waki (The recorded words of Asakura Soteki, c. 1553), by Asakura Soteki
Kyūjūkyū kakun (Ninety-nine precepts, 1558), by Takeda Nobushige; collected in the *Kōyō gunkan*. Redefining the Warrior: the Tokugawa peace (1600–1868)
Kōyō gunkan (A military history of the great men of Kai, c. 1625), compiled by Kōsaka Danjō and Obata Kagenori
Bukyō yōroku (Essentials of military studies, 1656), by Yamaga Sokō
Budō shoshinshū (Introduction to the way of the warrior, 1716), by Daidōji Yūzan
Hagakure (In the shadow of leaves, 1716), by Yamamoto Tsunetomo

the ruling class. After the Meiji Restoration, unemployed samurai became doctors and educators, and brought their written codes with them. The *Imagawa kabegaki*, by the fourteenth-century poet-warlord Imagawa Ryōshun, was even used as a textbook in Edo-period schools. During the years prior to the Meiji Restoration, the samurai's spirit of sincerity in action, loyalty, and self-sacrifice allowed them to take leadership in the revolt that would lead to the abolition of their class.

Bushido's most tragic legacy is the warped version ultranationalists used in formulating propaganda to encourage and sustain the Japanese soldier before and during World War II. The spirit of the *Hagakure* incited young Japanese men to become kamikaze suicide pilots; death was promoted as preferable to surrender.

In the early twenty-first century the term *Bushido* appeared more frequently in English-language martial arts publications than it ever did in early warrior texts. And even though Nitobe's list of virtues was not directly derived from actual warrior codes, it did reflect romanticized warrior ideals that the rapidly modernized Japanese recognized as noble and found comforting to call their own.

See also *Chinese Warlordism*.

BIBLIOGRAPHY

- Edwards, Bernard. *Blood and Bushido: Japanese Atrocities at Sea 1941–1945*. New York: Brick Tower Press, 1991.
- Friday, Karl F. "Bushido or Bull? A Medieval Historian's Perspective on the Imperial Army and the Japanese Warrior Tradition." *The History Teacher* 27, no. 3 (1994): 339–349.
- Hurst, G. Cameron III. "The Warrior As Ideal for a New Age." In *The Origins of Japan's Medieval World: Courtiers, Clerics, Warriors, and Peasants in the Fourteenth Century*, edited by Jeffrey P. Mass, 209–233. Stanford, Calif.: Stanford University Press, 1997.
- Wilson, William Scott, trans. *Ideals of the Samurai: Writings of Japanese Warriors*. Edited by Gregory N. Lee. Burbank, Calif.: Ohara, 1982.
- Yamamoto Tsunetomo. *Hagakure: The Book of the Samurai*. Translated by William Scott Wilson. Tokyo and New York: Kodansha International, 1983.

Diane Skoss



C

CALCULATION AND COMPUTATION. Words containing the roots *calcul-* and *comput-* have existed since antiquity. The study of concepts used to indicate actions, professions, and (mental and material) artifacts suggests that *calculation* and *computation* have not been, as canonically assumed, an exclusive concern of modern times. The mere existence of both word clusters throughout the decades (and centuries) prior to World War II also suggests that it may be problematic to assume that the relationship between calculation and computation has been simple—that is, computation existing as an exclusive postwar phenomenon brought about by a technical revolution that left calculation behind. For both Charles Steinmetz (1865–1923) and Vannevar Bush (1890–1974), celebrated pioneers of the prewar and interwar generation of electrical engineering, respectively, both calculation and computation were of constitutional importance to all their technical work. Their writings indicate a belief that the computing revolution started long before the 1940s. Steinmetz and Bush employed both concepts contemporaneously in their pervasive engineering textbooks in order to differentiate between high-skill analysis and low-skill application, between creative mental design and routine manual implementation, between that which was subject to the least and to the most of mechanization.

Steinmetz and Bush perceived themselves as analysts, in the tradition of Gottfried Wilhelm von Leibnitz (1646–1716) and Isaac Newton (1642–1727), the early modern founders of calculus. With the dynamic expansion of the division of labor that has been part and parcel of the expanding capitalist mode of production, the progress of calculation was a prerequisite for the advance of computation. Successful calculation from the top by the well-paid few would, first, routinize the work performed by the multitudes in the base of the pyramid; second, it would minimize the skill required by them; third, it would subject their work to mechanization; and fourth, it would lower their salary expectations. Computation was the job for a low-paid clerk known as the “computer” or “computor.” These human computers were usually women, who produced computations for the state and the military, for insurance companies and other businesses, and for analysts within the engineering and scientific community. While human computers worked with a rich variety of artifacts, it was the mass employment of mechanical desktop “calculating machines” that determined their history. By contrast, the engineering graduate, almost exclusively a male, was trying to distance himself from the ranks of the human computers by passionately defending the accuracy of his inexpensive slide rule, which he could own individually and skillfully use to “calculate.”

After the 1950s, amid popular expectation that full mechanization had finally arrived, the concept of “computer” connoted a machine rather than a human, thereby signifying the ideological hegemony that pointed to full separation of production from skilled labor, of accumulated (or dead) labor from living labor, and of fixed from variable capital. Instead of disappearing, the dated engineering differentiation between “analysts” and “computors” resurfaced in the system analysts versus coders struggle that marked the emergence of the programmers, computation’s new professionals. The difference between computation and calculation resonates throughout the fierce competition between the digital and analog computer (1940s–1950s), followed by the juxtaposition of digital computer hardware to software (1960s–1970s), which, in turn, was succeeded by the contrast between digital computer software operating systems from software for special purposes (i.e., application software) in the 1980s and 1990s.

Premodern, Early Modern, Non-Western

The difference in the meaning of “calculation” and “computation” that are found in Steinmetz and Bush seems to have been built on the precapitalist use of terms formed by the roots *calcul-* and *comput-*, respectively. Historiographically, the late medieval period offers an example when one compares the interest shown in quantifying the heterogeneity of motion by the Merton College theorists known as the “Oxford calculatores” to the practice shown by the ecclesiastical community toward homogenizing the standardization of time through a technique known as *computus*. During the late medieval and early modern period, the attack by the algorists upon the abacists—that is, the promoters of computing who relied upon previous and private memorization of tables of numerical relationships versus the defenders of the ancient tradition who placed emphasis on live calculations performed in public by moving pebbles (that is, calculi) along designated lines—compares favorably to the conflict between the digital (programming) and the analog (living labor) of the recent decades.

The physical embodiment of complex numerical relationships through interconnected mechanical parts that were concealed by a case, hence masking the motion of the gears, displayed only the input and output numbers. Some celebrated early modern examples were Blaise Pascal’s (1623–1662) adding machine (1642) and Leibniz’s adding and multiplication machine (1685). Earlier in the same century (1623), the German mathematician and linguist Wilhelm Schickard (1592–1635) had mechanized the set of numbered sliding rods that John Napier (1550–1617) had devised in 1617 to simplify astronomical calculations. Both Pascal and Leibniz sought to

profit selling their machines to merchants and natural philosophers. Galileo Galilei (1564–1642) tried the same with his improved computing dividers. Many of the early modern natural philosophers were heavily involved in calculating innovations. Additional contributions include “calculation by analysis” to the coordinates of René Descartes (1596–1650), by differentiation and integration in the calculus tradition that prefigures in Simon Stevin (1548–1620) and materializes in Newton and Leibniz, and by the analysis of multiplication and division into addition and subtraction through the logarithms that Napier introduced in 1614.

As with the method of algorists, the speed in calculation by logarithms assumed the availability of relevant tables. The transformation of these tables into scales inscribed in, first, circles sharing a fixed center and, soon after, scales that slid beside each other while sharing a fixed framework, found its ultimate presentation in the logarithmic slide rule, configured by William Oughtred (1574–1660) as early as 1621. The interactive proliferation of both tables of logarithms and logarithmic slide rules determined the history of calculation from the early modern period until the very recent decades. The dilemmas of computation in the recent decades have prefigured in the construction and worldwide use of tens (if not hundreds) of millions of slide rules, linear, circular, cylindrical, or hybrid, wooden, metal, or plastic, handmade or mass produced, cheap or expensive, with accessories such as cursors and magnifying glasses to increase the accuracy without increasing the size. The recent debates over special versus general purpose software and over competing software operating systems was long rehearsed in debates over choice of general or special purpose slide rule scales and scale system standards. Moreover, as scales of all sorts slid beside each other or within each other, the logarithmic slide rule turned out to be only one of innumerable versions of slide rules. Material culture scholars see no end to collection of calculation wheels devised to compute phenomena ranging from a menstrual cycle to a baseball season.

The coevolution of logarithmic slide rules and tables of logarithms is no different from the codevelopment of Leibniz’s “calculus” and his “calculating machine.” Taken together they point to the paired constitution of the scientific and the technical since earlier modernity. If Leibniz sought to sell his machine to merchants, Charles Babbage (1792–1871), a Cambridge mathematics professor, was interested in a calculating engine organized internally according to the symbolic efficiency and rationality of the nascent industrial order emerging within the first half of the nineteenth century in Great Britain. Partially funded by the government, Babbage failed for economic reasons to have his “difference engine” constructed because he was forced to depend on one of the most skillful workers of the period, Joseph Clement (1779–1844), in the workshop of whom the engine to calculate as if powered by “steam” was to be constructed. While the construction of the difference engine encountered the problem of skilled labor, Babbage realized that the use of the engine itself would be limited to special purposes, which would not eliminate calculation’s dependence on skilled labor. In 1833, he started drafting sketches of a second engine, the “analytical engine,” which he sought to be

independent of labor skill. He kept making modifications to the plans until his death in 1871 without ever managing to advance beyond programmatic descriptions of such an engine.

In Babbage’s *The Exposition of 1851; or, Views of Industry, the Science and the Government of England*, published in London in 1851 following his review of the panorama of industrial capitalism staged at the Crystal Palace World Fair, he repeatedly touched on the ideal of an engine that would render laborers mere “attendants,” unable to influence the production of calculation. Although Babbage’s calculating engines matched his promotion of a version of continental analysis that he thought to be more appropriate to a calculation to sustain further industrial growth, he became known for his emphasis on the mechanization rather than the organization of work. The organization of work has been the pursuit of the division-of-labor scheme that the French engineer Gaspard Clair Prony (1755–1839) devised in 1792 to have a new set of logarithmic and trigonometric tables produced as a monument to the new French Republic. Six eminent mathematicians who selected the appropriate equations formed the peak of his pyramid, a layer of ten mathematicians below them advanced the analysis to the point where everything was converted to simple arithmetic, and a group of one hundred humans, recruited even from hairdressers, performed simple operations on a part of a problem before passing it to the next person.

The expansive reproduction of this scheme by setting smaller or larger groups during the nineteenth and the twentieth century, after taking advantage of sources available both within and outside the Western society, resulted in the formation of an army of “computers.” By the introduction of commercial calculating machines such as Thomas de Colmar’s (1785–1870) Arithmometer, exhibited at the 1855 Paris Exposition, references to “human computers” are found from as near as a British male scientist’s environment of female friends and as far as male Indians working in British engineering initiatives in their country. The relative continuity between Leibniz’s calculating machine and the Arithmometer—the most widely available calculating machine based on improvements on Leibniz’s machine by 1871—is an index of the relative continuity between merchant and industrial capitalism. Leibniz had promoted his machine to a society marked by the dynamic appearance of merchants by stating that “it is unworthy of excellent men to lose hours like slaves in the labor of calculation, which could safely be relegated to anyone else if the machine were used” (Leibniz, quoted in David Eugene Smith, *A Source Book in Mathematics* [1929], pp. 180–181). Babbage’s “attendants” were the industrial version of Leibniz’s slaves. Babbage wanted his calculating engines used for the production of general and special purpose tables, including tables for the navigational pursuits of the British empire. Batteries of human computers—along with other implements such as calculating machines and slide rules—produced numerous tables and charts for an assortment of military and civilian purposes (scientific, engineering, and commercial).

The lack of a synthesis of scholarly studies limits scholars’ ability to compare the modern European experience with calculation and computation to those of non-European societies. What is known about the Inca knotted strings known as *quipu*

and the Chinese knotted cords suggests that societies paradigmatic of civilization in other continents relied heavily on what is now identified as calculation and computation. Ongoing historical interpretation of archaeological findings from ancient Mesopotamia point to the few who knew how to connect computations routinely produced by the many to a calculating coefficient that could make the abstract concrete. Projecting Western conceptual demarcations to non-Western societies may prove problematic, especially considering the parallel dead ends from having projected late modern Western demarcations to ancient and early modern histories. Interpretation, for example, of the Hellenistic Antikythera mechanism as “analog,” and accordingly, a technically inferior computer, has blocked historians from taking into account the digitalization introduced by the complicated geared structure underneath the disk representing analogically the universe. As a result, the search for how the technical accuracy of the artifact matched with social interests of the period has been replaced by the assumption of limits in the accuracy due to inferiority from belonging to an essentialist inaccurate technical genre. Similarly, a historiography aiming at interpreting the analog motion of the pebbles on ancient and early modern abacuses has been blocked by the late modern emphasis on the resting pebbles—that is, on the perception of pebbles as digits. The tradition of the Chinese and the Western abacus, therefore, has been flatly situated under the “digital,” thereby making it impossible to acknowledge differences in the employment of abacus analogies between and within traditions.

Late Modern Period

Abacuses and artifacts from the associated tradition of counting boards with pebbles or beads share the honor of being ancestors of the digital computer along with the various mechanical and electromechanical desktop calculating machines produced from 1850 to 1950. They are joined by an ensemble of mechanical and (later) electromechanical tools and machines used for punching holes into cards, which represent computable variables, for sorting these cards according to the variable to be computed, and for tabulating and printing the results. They are best known as punched card machines, based on the part of the process that was least subjected to mechanization. Going back to the end of the nineteenth century, punched card machines were rented by companies that were ancestors to IBM (International Business Machines) to, first, the United States Census Bureau, and, subsequently, censuses for nations around the world. Calculating and punched card machines were extensively used for filing, accounting, and related activities that involved the processing of large amounts of data in larger enterprises, which have ranged from railroads to insurance companies. The U.S. Social Security Administration also used hundreds of punched card mechanisms and machines to implement a social security system that, in 1935, had to handle information about the wages paid by three million employers to their twenty-six million employees.

In addition to the slide rule, the list of what has been a posteriori placed under analog computers includes calendars, sundials, orreries, astrolabes, planetariums, material models of all kinds (including scale models), mathematical and other

mental models, graphs that could be as complex as the nomograms of Maurice D’Ocagne (1862–1938) and his followers (used from the late nineteenth century until the recent decades), computing linkages, artifacts with mechanical integrators and differentiators, curve tracers and kinematic mechanisms in the tradition of planimeters and associated artifacts, harmonic analyzers and synthesizers like the one that Lord Kelvin had built as a tide predictor, mechanical, electromechanical, and electrical analyzers for general (e.g., Bush’s differential analyzer) and special purposes (e.g., Bush’s electric power network analyzers), electrolytic tanks, resistive papers and elastic membranes used as models, and countless mechanisms and machines produced and used in fire control (internal, external, and terminal ballistics). Case studies have retrieved the histories of many other cases of unique tools and machines, including those used for crucial tidal calculations in the Netherlands.

Changes in calculating machinery were coupled with changes to make the calculus correspondingly operational. Remembered more as the author of the state-of-the-art calculating machines during the interwar period, Bush was also the author of influential writings on the “operational calculus,” which capitalized on a tradition of modifications of the calculus that adjusted it to the ever-changing needs of engineers who thought of themselves as equal to any scientist. In the 1930s and in the 1940s, punched card machines were reconfigured to be useful in scientific calculations. Bush’s differential and network analyzers were also used in the scientific calculations of the period immediately before and after World War II. Calculating machines were used in scientific calculations even earlier and so were slide rules.

The various branches of the state have had an organic role in fostering technological change. To the examples of the extensive use of digital punched card machinery by civilian apparatuses such as the census should be added the involvement by the military in purchasing analog fire control mechanisms and machines; of the state’s exclusive involvement in cryptography-related calculation and computation even less is known, with the exception of the celebrated Colossus machine during World War II. Using the Colossus machine, a British team that included in its members the mathematician Alan Turing (1912–1954) broke the code produced by a German machine known as the Enigma. The military had actually used hundreds of punched card machines in World War I for materiel inventory and for medical record keeping. Interwar support for military needs changed so remarkably that the computing bombsight and the anti-aircraft director were by World War II extremely complex artifacts with thousands of mechanical, electrical, and electronic parts. The competing development of the computing bombsight, which increased the target reach for a bomber, and the anti-aircraft director, which increased the reach of ground-based fire targeting the bomber itself, has formed a vicious circle that exemplifies the contradiction of modern technology. In the United States, the development of accurate bombsights during World War II was a secret second only to the construction of the atomic bomb. The extreme technological contradiction to date may have been that the most accurate computing bombsight was used

to drop the first atomic bomb, a lethal weapon like none before it, the efficient release of which required the least accuracy.

Contemporary Period

The demand for ballistics tables beyond what available human computers could supply in World War II resulted in the construction of ENIAC (Electronic Numerical Integrator and Computer), considered by many to have been the first digital electronic computer. It was constructed by employing 18,000 vacuum tubes between 1943 and 1945 at the Moore School of Pennsylvania by a team led by John Mauchly (1907–1980) and J. Presper Eckert (1919–1995) with funds from the U.S. Army's Ballistics Research Laboratory. Under the direction of Howard Aiken (1900–1973), a physics instructor at Harvard University, IBM completed in 1944 the construction of the Automatic Sequence Controlled Calculator (Harvard Mark I), used to produce the U.S. Navy's ballistic tables. A wealth of detail exists about the 1940s and the 1950s, the period of the heroes of electronic computation, which has attracted the disproportionate attention of historians. At the very least, this attention has made it clear that the electronic computer was a "multiple invention," which means that it came by a social cause, not an individual genius.

The construction of ENIAC was roughly contemporaneous to several other projects. Aiken's efforts at reconfiguring IBM's accounting machines for the purpose of solving nonlinear differential equations went back to 1937. The Bell Labs employee George Stibitz constructed a series of machines based on relays and other telephonic equipment, including the Complex Number Calculator, which was used successfully by the military between 1940 and 1949. In Germany, starting in 1938 and continuing through the war, Conrad Zuse (1910–1995) constructed a series of machines that were also based on electromechanical relays. Iowa State College physics professor John Atanasoff (1903–1995) and his graduate student Clifford Berry (1918–1963) built a special purpose electronic computer, the ABC (Atanasoff-Berry Computer) between 1939 and 1942. Ranging from the big to the gigantic, these machines inaugurated experimentation with correspondence between electronic circuitry and numerical computational relationships, in the decimal or the binary system. Claude Shannon is the most recognizable of those who were arguing for such correspondence theoretically by showing that the design of electronic circuits and the reduction of reasoning to a series of simple algebraic operations (as proposed by the Boolean algebra) could be used to push each other forward.

Having been a participant of the Moore School team, the Princeton mathematician John von Neumann (1903–1957) shaped the following generation of electronic computers by setting the standard of a computer architecture based on an internal division of labor between a control unit that interacted with the memory to check the flow of data between the memory and the arithmetic unit while controlling the input and output. His division between an arithmetic unit, which is where any future calculation was to take place (by taking into account selected past computations from a stock accumulated in the memory) imported the living-dead labor dynamic balance of the whole of the capitalist economy into the

workings of the machine—the balance during the dynamic self-accumulation of past computations in the memory was to be provided by the control unit. The accumulation of data and instructions in the memory unit became known as the "stored program technique." It represented an economy of flexible allocation of resources that was opposite to the brute-force approach of the previous generation of electronic computers. Von Neumann presented his architecture in a 1945 report on EDVAC, a computer to follow ENIAC. The architecture was rehearsed in the construction of the IAS (named after Princeton's Institute for Advanced Study) by a team led by von Neumann at Princeton. It was completed in 1952. Like most experimental computers of the period, IAS was funded by sources such as the military and the Atomic Energy Commission. Similar machines were constructed at seventeen other research centers in the United States and several more in various other countries.

Interested in commercial rather than scientific computers, Eckert and Mauchly tried a series of intermediate computer configurations and business schemes before authorizing the production of the Remington-Rand UNIVAC (Universal Automatic Computer), the first of which was delivered to the Census Bureau in 1951. The first UNIVAC for business use was installed at the General Electric Appliance Division, for payroll computations in 1954. By 1957, the number of UNIVACs sold was up to forty-six. Along with several other manufacturers, IBM entered the electronic computer business in the early 1950s. It started with the 1951 IAS-type Defense Calculator, which was renamed IBM 701. IBM constructed and rented nineteen such machines. By 1960, IBM had dominated the market with machines such as the IBM 650, usually rented to universities under attractive terms, which subsequently tied university computations to IBM. IBM's dominance was solidified by its introduction in the mid-1960s of the standard-setting System/360 family of computers.

By then, the analog-digital debate, which has started in the late 1940s and escalated in the early 1950s, was practically over. The evolution of the MIT Project Whirlwind between 1945 and 1953, under the direction of Jay Forrester, captured the emergence of the analog-digital demarcation. Intended to be used in real-time aircraft flight simulation, it started as an analog machine. Upon learning about the EDVAC, Forrester decided to attempt to construct a digital computer. His costly change was supported, initially, by the U.S. Office of Naval Research with approximately one million dollars per year. When the Navy gave up, the Air Force stepped into the void hoping that the digital Whirlwind computer could lead into a machine suitable to the needs of SAGE (Semi-Automatic Ground Environment), a system to coordinate the detection of and response to the Soviet Union's strategic bombers. The pursuit of SAGE brought about enormous demands for programming, thereby revealing the dependence on computer software. It started to become apparent that the analog-digital contrast was succeeded by a contrast between software and hardware.

There is no record of thinkers who foresaw a market for more than a few mainframes in the 1940s. There is also no record of thinkers who predicted that the future of computation was not

in the formation of computer utilities, according to the direction suggested by the time-sharing of mainframes during the 1960s. Patented in 1959 by Jack Kilby of Texas Instruments, the integrated circuit contained all the elements of an electronic circuit in a chip of silicon. The microprocessor appeared a decade later as a general-purpose programmable integrated circuit. The cheapening of the hardware and the miniaturization of electronic components made possible the decrease of the size of the mainframes to that of minicomputers. The potential of reducing the size of the computer further to that of a home appliance was realized in the subsequent decades, resulting in the mass production and use of personal computers during the 1980s and the mass interconnection of personal computers that led to the formation of the Internet and the World Wide Web during the 1990s. In the meantime, microprocessors have been installed everywhere from home appliances to automobiles.

The decrease of the value of hardware accentuated the increase in the value of software. What concluded as a “software crisis” started as a problem of “programmer shortage.” Generations of general and special-purpose programming languages, and, by now, software operating systems have yet to provide a stable solution. Attempts at computer-aided programming (machine self-programming) and software engineering (mass production of software) have met with limited success if not complete failure. From eliminating the “programming bugs” that clogged the early electronic computers to blocking the so-called spam that plugs contemporary e-mailing, computation seemed to have increased rather than decreased the dependence on skilled labor. In its absence, all sorts of computer viruses threaten the contemporary world with catastrophe. Many of the world’s habitants anxiously anticipated living through the completion of a millennium in the transition from year 1999 to year 2000, which became known as Y2K. Their recollection of the event is marked by the memory of anxiety surrounding Y2K, a concern that stemmed from decades of labor-saving yet short-sighted use of two digits for the purpose of making electronic computations economical.

See also **Computer Science; Mathematics; Technology.**

BIBLIOGRAPHY

- Abbate, Janet. *Inventing the Internet*. Cambridge, Mass.: MIT Press, 1999.
- Aspray, William, ed. *Computing before Computers*. Ames: Iowa State University Press, 1990.
- Beniger, James, R. *The Control Revolution: Technological and Economic Origins of the Information Society*. Cambridge, Mass.: Harvard University Press, 1986.
- Black, Edwin. *IBM and the Holocaust: The Strategic Alliance between Nazi Germany and America’s Most Powerful Corporation*. New York: Crown, 2001.
- Blok, Aad, and Greg Downey, eds. *Uncovering Labour in Information Revolutions, 1750–2000*. Cambridge, U.K., and New York: Cambridge University Press, 2003.
- Borst, Arno. *The Ordering of Time: From the Ancient Computus to the Modern Computer*. Translated by Andrew Winnard. Chicago: University of Chicago Press, 1994.
- Campbell-Kelly, Martin. *From Airline Reservations to Sonic the Hedgehog: A History of the Software Industry*. Cambridge, Mass.: MIT Press, 2003.

- Campbell-Kelly, Martin, et al. *The History of Mathematical Tables: From Sumer to Spreadsheets*. Oxford and New York: Oxford University Press, 2003.
- Campbell-Kelly, Martin, and William Aspray. *Computer: A History of the Information Machine*. New York: Basic Books, 1996.
- Ceruzzi, Paul. *A History of Modern Computing*. 2nd ed. London and Cambridge, Mass.: MIT Press, 2003.
- Cortada, James. *IBM, NCR, Burroughs, and Remington Rand and the Industry They Created, 1865–1956*. Princeton, N.J.: Princeton University Press, 1993.
- Edwards, Paul. *The Closed World: Computer and the Politics of Discourse in Cold War America*. Cambridge, Mass.: MIT Press, 1996.
- Hopp, Peter M. *Slide Rules: Their History, Models and Makers*. Mendham, N.J.: Astragal Press, 1999.
- Jeziński, Dieter von. *Slide Rule: A Journey through the Centuries*. Translated by Rodger Shepherd. Mendham, N.J.: Astragal Press, 2000.
- Kline, Ronald. *Steinmetz: Engineer and Socialist*. Baltimore: Johns Hopkins University Press, 1992.
- Lubar, Steven. *InfoCulture: The Smithsonian Book of Information Age Inventions*. Boston, Mass.: Houghton Mifflin, 1993.
- MacKenzie, Donald. *Knowing Machines: Essays on Technical Change*. Cambridge, Mass.: MIT Press, 1996.
- McFarland, Stephen L. *America’s Pursuit of Precision Bombing, 1910–1945*. Washington, D.C.: Smithsonian Institution Press, 1995.
- Menninger, Karl. *Number Words and Number Symbols: A Cultural History of Numbers*. Translated by Paul Bronner. Cambridge, Mass.: MIT Press, 1969.
- Mindell, David A. *Between Human and Machine: Feedback, Control, and Computing Before Cybernetics*. Baltimore: Johns Hopkins University Press, 2002.
- Nebeker, Frederik. *Calculating the Weather: Metrology in the 20th Century*. San Diego, Calif.: Academic Press, 1995.
- Small, James S. *The Analogue Alternative: The Electronic Analogue Computer in Britain and the USA, 1930–1975*. London and New York: Routledge, 2001.
- Spufford, Francis, and Jenny Uglow, eds. *Cultural Babbage: Technology, Time and Invention*. London: Faber, 1996.
- Williams, Michael R. *A History of Computing Technology*. 2nd ed. Los Alamitos, Calif.: IEEE Computer Society, 1997.
- Yates, JoAnne. *Control Through Communication: The Rise of American System in Management*. Baltimore: Johns Hopkins University Press, 1989.
- Zachary, G. Pascal. *Endless Frontier: Vannevar Bush, Engineer of the American Century*. New York: Free Press, 1997.

Aristotle Tympas

CALENDAR. A calendar is a system of reckoning and ordering time beyond the period of a day in a repetitive, usually annual, cycle. A calendar’s primary function is regulating and organizing human activities; the word derives from the Latin *calendarium* or *calendra*, “account book,” and *kalendae* or “calends,” the new moon and first day of the Roman month, when Romans paid their debts. Calendars may have derived from the human penchant for imposing order; however, the most efficient exploitation of natural resources implies synchronizing productive efforts with nature’s cycles. Sensitivity to such

cycles is biologically programmed into humans as circadian rhythms, including the twenty-four-hour cycle of sleep and wakefulness and fluctuating body temperature; and in the female menstrual cycle, which approximates a lunar period.

Calendric periodicities are traced ultimately to the Sun and the Moon. The daily apparent rising and setting of the Sun is due to the rotation of the Earth, while the annual cycle of the seasons is related to the revolution of the Earth around the Sun, and the tilt of the Earth relevant to its plane of revolution. The most commonly reckoned calendrical period beyond day and night is the synodical lunar month (the cycle of lunar phases) of 29.5 days. Incommensurability between this period and the seasonal cycle based on the solar year of 365.24 days and the need to process fractions of days in the astronomical cycles with whole-day counts have been among the most difficult challenges for calendar specialists.

Early, Nonliterate, and Folk Calendars

Alexander Marshack sees in the scorings and tally marks on Paleolithic fossils and artifacts the beginnings of time recording. With Neolithic domestication, systematic time reckoning allowed farming practices to fit local moisture and temperature patterns. Such concerns and efforts are suggested at Stonehenge in England, where, beginning about five thousand years ago, massive stones were arranged in geometric patterns. While interpretations of the site vary, its main axis includes an alignment to the June solstice sunrise, the day of longest sunlight.

Small-scale and nonliterate societies such as the Nuer of Africa emphasize a sensitivity and responsiveness to seasonal cycles that E. E. Evans-Pritchard calls “ecological time.” Such calendars are characterized by:

1. space-time (the fusing of concepts of time with the space accessed and occupied in that time);
2. fuzzy-bordered seasons (increasing rains gradually transform dry season to wet);
3. “layered” observations of synchronous events at different ecological levels (for example, the bloom of plant species coincident with the movement of fish or game); and
4. diachronic sequences, such as episodic faunal or floral changes or consecutive astronomical observations (for example, advancing stellar positions, changes in the Moon’s position and shape, or the movement of the Sun on the horizon).

Calendar Codification and Civilization

Awareness of the astronomical significance behind seasonal phenomena allowed human communities to coordinate their activities seasonally for strategic and productive ends. Once a reliable system of recording such information was devised, calendar refinement and codification were possible. Calendar codification and the enhanced utilization of energy and other resources that this enabled are a significant factor in the process of civilization—a topic deserving additional study. The earliest centers of civilization in Mesopotamia, the Indus and Nile

valleys, eastern China, Mesoamerica, and the Andes all have information recording systems and codified calendars, which were probably overseen by high-ranking astronomer-priests who also likely oversaw timely rituals relating human endeavors to cosmic powers.

Varieties of Calendars

The prominence of the Moon in premodern societies with limited lighting and the regularity of its phases resulted in the synodical lunar month being basic to many traditional calendars. In the Muslim calendar, twelve lunar months of twenty-nine or thirty days are reckoned in a year of 354 days, or a leap year of 355, in a thirty-year cycle. The approximately eleven-day difference between such a synodical lunar calendar and the solar year, however, results in a slippage of months through the seasons. In order to maintain synchrony between lunar months and the seasons, an intercalated month is necessary, a strategy employed in the Jewish calendar with influence from Babylonia: seven leap years intersperse with twelve common years in a nineteen-year cycle.

Ancient Egyptians used the annual heliacal rise (predawn reappearance) of Sirius to help coordinate their lunar months with the seasons and solar year. While maintaining this system for religious observance, they later developed a civil year of 365 days comprising twelve fixed months of thirty days with five additional days. The ancient Maya had a similar five-day end-of-year, but divided the other 360 days into eighteen named periods of twenty days. This yearly calendar intermeshed every fifty-two years with a divinatory cycle of 260 days. Maintaining separate calendars for civic and religious (and/or regional and ethnic) functions is a common practice, useful in the twenty-first century for the retention of local traditions amidst the spread of the Gregorian calendar.

The Gregorian Calendar and Globalization

The Gregorian calendar spread through European colonialism and later through international relations, exchange, and commerce. It developed from the first-century B.C.E. Julian calendar, named after Julius Caesar, who commissioned its development and approved the reckoning of months no longer determined by lunar observations in a year that averaged 365.25 days. The Gregorian gets its name from Pope Gregory XIII, by whose election in the year 1572 C.E. the day marking the vernal equinox had strayed ten days from its occurrence. His papal bull in 1582 set out the mechanisms by which:

1. the spring equinox would occur on its actual date;
2. Easter—which depends on calculations from the vernal equinox—would be determined; and
3. a leap year system would be implemented, allowing for prolonged congruency between the calendar and its astronomical underpinnings.

Since the sixteenth century, countries around the world have adopted the Gregorian calendar, including its twelve fixed months, seven-day weeks, and beginning date. However, day and month names usually occur in the vernacular, and

traditional reckonings may be kept for local, ethnic, and religious observances.

Through calendars, humans impose culturally significant rhythms on the perception of time. Across human cultures two primary perceptions of the character of time predominate:

1. time as recursive or cyclic, observed in the recurrence of day and night, lunar waxing and waning, and the return of the seasons; and
2. time as linear, an ongoing process, observed in the maturation of vegetation, decay, and the transition of a human life from birth to death.

Specially marked dates and periodicities are the human, cultural cadence in the infinitude of time. While unable to control the passage of time, humans with calendars have increasingly ordered their relationship to and utilization of it.

See also *Astronomy, Pre-Columbian and Latin American; Time.*

BIBLIOGRAPHY

- Aveni, Anthony. *Empires of Time: Calendars, Clocks, and Cultures*. Boulder: University Press of Colorado, 2002.
- Evans-Pritchard, E. E. *The Nuer: A Description of the Modes of Livelihood and Political Institutions of a Nilotic People*. Oxford: Oxford University Press, 1940. Reprint, 1969.
- Fabian, Stephen Michael. *Space-Time of the Bororo of Brazil*. Gainesville: University Press of Florida, 1992.
- Marshack, Alexander. *The Roots of Civilization: The Cognitive Beginnings of Man's First Art, Symbol and Notation*. London: Weidenfeld and Nicolson, 1972.
- Richards, Edward G. *Mapping Time: The Calendar and Its History*. Oxford: Oxford University Press, 1998.
- Westheim, Margo. *Calendars of the World: A Look at Calendars and the Ways We Celebrate*. Oxford: Oneworld Publications, 1994.

Stephen M. Fabian

CANNIBALISM. The possibility of cannibalism has been an object of thought and imagination in virtually every society. The idea of consuming human body substance as food or for symbolic purposes invokes emotionally charged cultural and psychological concerns with boundaries between self and other, persons and nonpersons, the meanings of food and ingestion, and the limits of a moral community. Many societies, both Western and non-Western, have seen cannibalism as a marker of negative difference between peoples, a quintessential symbol of otherness, savagery, and subhumanity. Others have treated it as a form of exchange or as a mechanism of transformation, regeneration, or reproduction through transactions between ontological categories such as kin and enemy, mortals and deities, human and animal.

In Western thought, two uses of the idea of cannibalism have been recurring themes: as a negative stereotype of exotic "others," and as a metaphor for reflexive questioning, critique,

and parody of Western culture. Especially in the politics of colonialism, accusations of cannibalism have been deployed to denigrate non-Western peoples, assert colonizers' moral superiority, and legitimize the takeover of native lives and lands. Only recently have scholars called attention to socially approved cannibal practices in Western history, such as the tradition of using human body substances as medicines, which flourished in Europe until the eighteenth century.

The stigma associated with cannibalism in Western thought makes any assertion that certain people engaged in it politically sensitive. Since the 1970s, especially in the United States, anthropologists and historians have debated where and to what extent cannibalism was an institutionalized, socially accepted practice (as distinguished from its occurrence as an aberrant, individual act motivated by starvation or psychological deviance). These arguments mostly involved historical and retrospective evidence, since under the impact of colonialism and modernity, any former practices of institutionalized flesh-eating had largely disappeared by the 1970s. Major controversies focused on Michael Harner's and Marvin Harris's interpretation of human sacrifice as a response to dietary shortages among the Aztecs of fifteenth-century Mexico; the role of funerary cannibalism in epidemics of the neurological disease *kuru* in the New Guinea highlands; the ongoing debate between Marshall Sahlins and Gananath Obeyesekere over allegations of cannibalism among South Pacific islanders and after the death of Captain James Cook; and the interpretation of archaeological finds from Europe and the southwestern United States that show dismemberment, mutilation, and cooking of body parts.

A major impetus to debates over the reality of cannibalism came from William Arens's *The Man-Eating Myth* (1979), which examined selected accounts from some non-Western societies. Finding a lack of hard evidence and no credible eyewitness accounts by Western experts, Arens expressed doubt that cannibalism ever existed anywhere as a socially approved practice. He argued that cannibalism is best understood not as a cultural practice but as a projection of Western fantasies, racism, and political propaganda. Although presented as a critique of Orientalist prejudices, the argument reified negative colonial stereotypes with its implicit assumption that the act of ingesting human substance is in all cases repulsive and morally indefensible. Arens's critique of the supposed bias and credulity of those who have written about cannibalism as social practice found some scholarly receptivity, particularly within cultural studies.

In anthropology, Arens's book drew criticism for its methodology, sensational rhetoric, and unreasonable and inconsistent empirical standards. The controversy had the positive effect of stimulating ethnographers and historians to reassess historical and ethnographic evidence. While debates continue over the evidence in specific cases, most anthropologists accept the idea that normative, institutionalized practices of consuming human body substances did occur in some times and places in the past.

Recent anthropological work has sought to contextualize local cultural practices by elucidating their social, symbolic,

religious, and ritual significance. A few scholars, such as Eli Sagan and I. M. Lewis, have proposed universal explanations interpreting flesh-eating in all contexts, from warfare to funeral rites, as expressions of similar impulses such as hostility, ambivalence, or desires for dominance. The stronger trend has been to recognize diversity and the many different kinds of practices with distinctive cultural meanings that have been lumped together under the rubric of “cannibalism.” Ethnographies from Melanesia and the South Pacific have highlighted how cannibalism, as practice or idea, was linked to cultural ideas about ethnicity and gender, the uses of flesh and food to define spheres of morality and exchange, and human reproduction and the circulation of vital energies or substances contained in the body. Lowland South American ethnography has emphasized cannibalism’s role in the production of personhood and alterity and indigenous notions of its role in metaphysical transformations and exchanges between enemies and between the living and the dead, humans and animal, mortals and immortals. There has also been new attention directed to native peoples’ images of Europeans or other foreigners and their descendants as “white cannibals.” An implicit agenda in much recent scholarship is to undermine negative stereotypes and deexoticize the subject of cannibalism by expanding humanistic understandings of how, within local systems of cultural meaning, some peoples may have felt that consuming human flesh or bones was a positive, morally acceptable thing to do.

Over the past five centuries, numerous writers, from Michel de Montaigne to Jonathan Swift and Ruth Benedict, have used cannibal imagery to express critical perspectives on Western culture and as a rhetorical device for inverting conventional boundaries of civilization and morality. In Brazil in 1928, Oswald de Andrade’s “Cannibal Manifesto” launched the avant-garde Antropofagia movement, which reclaimed cannibal imagery from native Brazilians’ early encounters with Europeans and asserted that the key principle of Brazilian modernity is assimilation of foreign influences. Latin American artists and intellectuals continue to find cannibalism a fertile metaphor for Euro-American culture and exploitative political economic relations.

Since the 1970s, there has been a trend among scholars, artists, and culture critics in the United States and elsewhere to deploy cannibalism as a metaphor for Western civilization itself. Globalization, capitalist consumer culture, and cross-cultural appropriation in tourism, art, media, and museums have been portrayed as forms of cannibalism. Richard King criticizes the Occidentalism in analyses that treat “the West” as a single, undifferentiated entity while perpetuating negative stereotypes, trivializing cannibalism as a real experience and embodied cultural practice, and deflecting attention from its meanings in specific social-historical contexts. As one of the last real taboos in contemporary cosmopolitan society, cannibalism’s attention-getting power to shock ensures that it will continue to be a theme and source of fascination in popular culture and scholarship.

See also *Colonialism; Ethnography; Eurocentrism; Occidentalism; Orientalism.*

BIBLIOGRAPHY

- Arens, William. *The Man-Eating Myth: Anthropology and Anthropology*. Oxford: Oxford University Press, 1979.
- Barker, Francis, Peter Hulme, and Margaret Iversen, eds. *Cannibalism and the Colonial World*. New York: Cambridge University Press, 1998.
- Brown, Paula, and Donald Tuzin, eds. *The Ethnography of Cannibalism*. Washington, D.C.: Society for Psychological Anthropology, 1983.
- Conklin, Beth A. *Consuming Grief: Compassionate Cannibalism in an Amazonian Society*. Austin: University of Texas Press, 2001.
- Goldman, Laurence, ed. *The Anthropology of Cannibalism*. Westport, Conn.: Bergin and Garvey, 1999.
- Harner, Michael. “The Ecological Basis for Aztec Sacrifice.” *American Ethnologist* 4 (1977): 117–135.
- Harris, Marvin. “People Eating.” In his *The Sacred Cow and the Abominable Pig: Riddles of Food and Culture*, 199–234. New York: Simon and Schuster, 1985.
- King, Richard. “The (Mis)Uses of Cannibalism in Contemporary Cultural Critique.” *Diacritics* 30, no. 1 (2000): 106–123.
- Lestringant, Frank. *Cannibals: The Discovery and Representation of the Cannibal from Columbus to Jules Verne*. Translated by Rosemary Morris. Berkeley: University of California Press, 1997.
- Obeyesekere, Gananath. “Cannibal Feasts in Nineteenth-Century Fiji: Seamen’s Yarns and the Ethnographic Imagination.” In *Cannibalism and the Colonial World*, edited by Francis Barker, Peter Hulme, and Margaret Iversen, 63–86. Cambridge, U.K., and New York: Cambridge University Press.
- Sagan, Eli. *Cannibalism: Human Aggression and Cultural Form*. New York: Harper and Row, 1974.
- Sahlins, Marshall. *How “Natives” Think: About Captain Cook, for Example*. Chicago: University of Chicago Press, 1995.
- Sanday, Peggy Reeves. *Divine Hunger: Cannibalism as a Cultural System*. New York: Cambridge University Press, 1986.

Beth A. Conklin

CAPITALISM.

This entry includes two subentries:

Overview
Africa

OVERVIEW

Capitalism has been the dominant economic system in the West since the nineteenth century and has increasingly spread across the globe. Characterized by unfettered markets in labor and natural resources, commodity production, and the reinvestment of profit, capitalism must be distinguished from other forms of commercial society that existed in early times or outside of the West, in which market-oriented activity remained ultimately subservient to political or moral goals. (Examples of such non-capitalist market society include the so-called mercantilism that preceded full-fledged capitalism in Europe and the city-state empires of the ancient Mediterranean world, which actively engaged in commerce yet did not generate capitalist socioeconomic relations.) Throughout its history—even before it took

root—capitalism was a controversial idea that posed serious issues for philosophers, moralists, and social scientists alike.

Early Advocates

Perhaps the best-known and most important early exponent of capitalism was the Scottish economist Adam Smith (1723–1790). Smith employed the term *capital* in technical economic discussions contained in *An Inquiry into the Nature and Causes of the Wealth of Nations* (1776), but he did not describe his economic system as “capitalism.” Rather, the latter term seems to have arisen only in the nineteenth century. Smith preferred to speak about natural liberty, by which he meant simply that if everyone acts freely as they see fit in their own interests, then the welfare of the whole society will be best served. For Smith, the system of natural liberty constitutes a sort of automatic or homeostatic mechanism of self-adjustment (which he sometimes calls the “invisible hand”), so that any attempt (on the part of government or some other agent) to interfere in its operation will lead to greater inefficiency and hence less total welfare. The doctrine of natural liberty thus yields the founding principles of capitalism as an economic system. In turn, Smith applied this discovery not only to the operation of the marketplace but also to all aspects of society, including its educational, religious, and judicial institutions. He narrowly confines the role of government to those functions consistent with natural liberty: foreign defense, regulation of criminal activity, and provision of “public goods” too expensive for any single segment of the private economy to undertake.

The sources for Smith’s insight about maximized individual liberty, unconstrained by coercive externalities, have been debated. Certainly, an earlier group of French economic theorists, known collectively as the Physiocrats, may have played a role in the formulation of this idea. Perhaps more importantly, as Albert O. Hirschman and others have argued, many influential political and moral theorists writing in the seventeenth and eighteenth centuries had promoted doctrines of human psychology and action that comported well with Smithian natural liberty. So-called heroic virtues were replaced with more mundane values in the writings of a wide range of early modern thinkers, including Niccolò Machiavelli (1469–1527), Thomas Hobbes (1588–1679), François de La Rochefoucauld (1613–1680), Anthony Ashley Cooper, third earl of Shaftesbury (1671–1713), and Bernard Mandeville (c.1670–1733).

The work of Smith inspired a school of thought known broadly as classical political economy. Its leading members in the nineteenth century, such as David Ricardo (1772–1823) and Thomas Malthus (1766–1834), extended and refined Smith’s insights, often drawing in addition on the work of the utilitarian philosopher and social reformer Jeremy Bentham (1748–1832). In its most ruthless form, this position was combined with a reading of Darwinian biology to make the argument that capitalism, as a system of the survival of the fittest, was sanctioned by evolution, as in the Social Darwinism of Herbert Spencer (1820–1903). Nor were devotees of unlimited capitalism limited to the earliest stages of capitalist development. The neoclassical school of economic theory, exemplified

by the work of Friedrich von Hayek (1899–1992) and Milton Friedman (b. 1912), continues to exercise considerable influence on all dimensions of social thought into the twenty-first century. The so-called rational choice or public choice economists persist in their belief that the free market relations realized only under capitalism constitute the single legitimate model of all social order.

Foes

Capitalism has by no means lacked for criticism from many different quarters. Communitarians, such as Henri de Saint-Simon (1760–1825), asserted that capitalists’ concentration on competition and individual self-interest at the expense of social solidarity would ultimately corrupt and corrode communal order. Utopians, such as Charles Fourier (1772–1837), sought to replace capitalism’s exploitation of labor with a free and creative socioeconomic system in which human potential could flourish. The anarchist Pierre-Joseph Proudhon (1809–1865), proclaiming that “private property is theft,” denounced the collusion of state and capitalist enterprise and proposed to level the unequal distribution of the material benefits of work and to liberate workers to collaborate freely in their chosen activities. What all of these essentially left-wing responses to capitalism shared was a belief that cooperation rather than competition was the key to the improvement of human society and the amelioration of psychological as well as material misery.

The most famous nineteenth-century opponent of capitalism was Karl Marx (1818–1883), who, with his collaborator Friedrich Engels (1820–1895), offered far-reaching and systematic criticism based on a careful study of the inner operations of the capitalist economy. It is too seldom acknowledged that Marx shared more with the classical political economists than with capitalism’s moralistic antagonists. In his unfinished masterwork, *Capital* (volume 1 published in 1867), Marx viewed himself as engaging in the “scientific” analysis of capitalism, borrowing heavily from Smith and his successors, while pointing out the structural weaknesses and limitations that the capitalist apologists had overlooked. In particular, Marx believed that the intense conflicts between capitalists and workers, as well as among capitalists themselves, would produce recurrent and ever-deepening economic, social, and political crises. Eventually the growing body of exploited industrial laborers, whom Marx labeled the proletariat, would recognize the source of its exploitation in the market-engendered condition of “wage slavery” and would revolt against the capitalist system as a whole.

Yet Marx did not dismiss lightly the accomplishments of capitalism. He maintained, instead, that the technological achievement of capitalism in constantly revolutionizing the means of production should be harnessed by any future communist society. Indeed, one of the inherent contradictions of capitalism was its inability to utilize fully its own productive capacity, a situation that would be rectified under communism. In sum, what singled out Marx’s criticism of capitalism was its immanent character, in comparison to communitarians, utopians, and anarchists, whose critiques were based on standards external to capitalist economics.

Origins

One of the central issues in the conceptualization of capitalism has been the explanation of its emergence in the first place. Both classical political economists and orthodox Marxists provide essentially materialistic accounts rooted internally in the economic realm, whether arising from technological innovation, class conflict, urbanization, or demographic pressures. In the late nineteenth century, the endogenous position was challenged by the German sociologist Max Weber (1864–1920), who, in a series of studies ultimately published as *The Protestant Ethic and the Spirit of Capitalism*, argued against the validity of all such internal explanations for the growth of capitalism. Rather, Weber proposed that the emergence of a Calvinist version of Reformed Christian theology during the sixteenth and seventeenth centuries constituted the necessary and sufficient condition for capitalism's origins. According to Weber, the Calvinist Protestant was impelled to demonstrate to his community his worthiness for salvation (the certainty of which was by no means earned by external merit, as in Catholicism) by working hard and leading an ascetic life. Such hard work, however, produced economic gains and the temptation for leisure and luxury. What was the Calvinist to do with the deserved profits of his labors? The answer was to rid himself of his riches by investing them in further economic enterprises, which in turn yielded additional wealth. As an unintended consequence of the Calvinist renunciation of worldliness, the circulation of capital was born and with it the pattern of capitalist development. Weber's antimaterialistic explanation of capitalism directly challenged the primacy of the economic realm upheld by classical political economists and Marxists alike.

The response to Weber's thesis was loud and shrill on all sides, and there is good reason to believe that in its initial statement it misrepresents history. Yet the question of why capitalism emerged when and where it did—or indeed at all—remains a widely debated topic. One dimension of this discussion has been a debate raging since the 1940s, centered mainly within differing schools of economic history, concerning the transition from feudalism to capitalism. Scholars such as Paul Sweezy and Immanuel Wallerstein, elaborating on the earlier work of Henri Pirenne (1862–1935), postulated that a commercially stimulated push toward exchange relations, centered in the growing late medieval towns, undermined feudalism and introduced the basic principles of economic rationality. Other historians, such as J. A. Raftis, considering the radical depopulation of Europe at the end of the Middle Ages caused by recurrent and severe plagues, point to purely demographic factors among the laboring masses to account for disruptions in long-established patterns of land tenure that occasioned the decline of feudalism. Still another body of literature, represented by the research of R. H. Hilton and Robert Brenner, places local political factors arising from conflicts between peasant producers and seigniorial appropriators at the center of the transition to capitalist social relations. All of these views, however, share the conviction that material factors endogenous to economic life are adequate to explain the decline of feudalism and the emergence of capitalism.

By contrast, some later scholars, mindful of the pitfalls of the Weberian analysis, have nonetheless sought to proffer an

“exogamous” account of the origins of capitalism. For example, Liah Greenfeld has posited a certain version of “nationalism” as the explanatory metric for the spread of the “spirit of capitalism.” According to Greenfeld, England in the sixteenth and seventeenth centuries generated a form of nationalism that promoted the common wealth through the pursuit of individual profit, hence leading to the accumulation and circulation of private capital. In turn, the initial success of this nationalism pushed other European countries and regions to pursue similar nationalistic programs, with varied rates of success. As with Weber, Greenfeld maintains that “cultural” or “ideological” factors are required to explain the expansion of the capitalist economy.

Globalization

With the demise of communism as an economic and ideological alternative to capitalism, many thinkers have proclaimed the final and ultimate victory of the capitalist system and its supposedly attendant sociopolitical values of democratic rights and individual liberty. According to Francis Fukuyama, for instance, history has proven that capitalism constitutes the best way of arranging the basic production and distribution of human goods. The global spread of capitalism signals an end to the contention between the fundamentally incommensurable economic ideas and doctrines; all that remains to be done is a fine-tuning of the balance between the private profit economy and those public goods that government is better qualified to provide. The process of capitalist globalization, then, represents nothing less than the civilizing of the human species.

Yet critics of capitalism persist, even in the face of optimism that capitalism will bring prosperity and well-being around the globe “in the long run.” (The economist John Maynard Keynes [1883–1946] once famously quipped that “of course, in the long run, we're all dead.”) Feminists point out that capitalism has done little to erase the economic and social disparities that exist between men and women. Authors concerned with race relations make a similar point about the market's failure to break down inequalities between people of differing skin colors and ethnicities. Environmentalists charge that capitalism's emphasis on unlimited growth as the only sustainable form of economy has led and will continue to lead to the ruin of the planet and, eventually, to the extinction of the human species. Latter-day communitarians and republicans hold that contempt for legal authority and civic virtue stems from the capitalist-inspired glorification of leisure and luxury. And religious authorities worldwide (including leaders of major Western churches, such as Pope John Paul II) have sternly criticized capitalism for eroding spiritual and moral values in favor of unrestrained accumulation and consumption. Capitalist ideas appear destined to remain controversial even, or perhaps especially, in the age of economic globalization.

See also *Communism; Economics; Marxism*.

BIBLIOGRAPHY

Engelmann, Stephen G. *Imagining Interest in Political Thought: Origins of Economic Rationality*. Durham, N.C.: Duke University Press, 2003.

- Fukuyama, Francis. *The End of History and the Last Man*. New York: Free Press, 1992.
- Greenfeld, Liah. *The Spirit of Capitalism: Nationalism and Economic Growth*. Cambridge, Mass.: Harvard University Press, 2001.
- Hirschman, Albert O. *The Passions and the Interests: Political Arguments for Capitalism before Its Triumph*. Princeton, N.J.: Princeton University Press, 1977.
- Holton, Robert J. *Cities, Capitalism, and Civilization*. London and Boston: Allen and Unwin, 1986.
- . *The Transition from Feudalism to Capitalism*. New York: St. Martin's, 1985.
- Marx, Karl. *Capital*. Vol. 1. Translated by Samuel Moore and Edward Aveling. London: Lawrence and Wishart, 1974.
- Smith, Adam. *An Inquiry into the Nature and Causes of the Wealth of Nations*. Edited by R. H. Campbell and A. S. Skinner. Oxford: Clarendon; New York: Oxford University Press, 1976.
- Weber, Max. *The Protestant Ethic and the Spirit of Capitalism*. Translated by Talcott Parsons. New York: Charles Scribner's Sons, 1958.
- Wood, Ellen Meiksins. *The Origin of Capitalism: A Longer View*. 2nd ed. London: Verso, 2002.

Cary J. Nederman

AFRICA

Debates over capitalism in Africa revolve around the best means to rescue the continent from a prolonged period of stagnation and decline. Observers agree that the program, in the absence of a socialist alternative, must focus on capitalist development. There is disagreement, however, over the role of the African state in this process, as well as over whether to make raw materials exports or industrialization the main engines of growth. On the one side stand the Bretton Woods Institutions (the World Bank and International Monetary Fund, hereinafter the BWIs), who advocate a neoliberal approach based on freeing up markets for cash crop exports and reducing the state's control over national development. On the other side stand African scholars, mainly those representing the United Nations Economic Commission for Africa (UNECA), who argue for more industrialization and a much stronger role for the state. As the debate has continued, African leaders have moved closer to the BWI position with the establishment of the New Partnership for Africa's Development (NEPAD). Still, NEPAD has its critics, and the debate persists over the relative roles of the state and the market.

The Colonial Legacy and Uneven Capitalist Development

These debates have not unfolded in a vacuum; they are rooted in the colonial legacy and the response to that legacy by the first generation of African leaders. The Atlantic slave trade and colonialism blocked the conditions for the development of capitalism in Africa. In dwarfing all other commerce, the slave trade interrupted the accumulation process necessary for capitalist development. Its abolition reversed this trend by creating an opening for "legitimate" commerce, which African producers pursued by increasing their production of raw materials (such as gum, hides, and palm oil) for expanding European markets. Most of the production, however, was based on noncapitalist

labor regimes such as family and household labor or forced labor of various kinds. Colonialism did not alter this structure appreciably, because the colonial powers tended to block the development of private property and of wage labor—with the exception of migrant labor in the mining and plantation sectors. Although African industries appeared in the major cities, especially after World War II, the absence of land markets and the predominance of migrant labor ensured that capitalism did not develop fully during the colonial period. To make matters worse, the colonial powers discriminated against African capitalists in favor of nonindigenous entrepreneurs, and against women, the main agricultural producers. In sum, capitalism did take root during the colonial era, but its development was uneven, halting, and incomplete.

Independence, State-Led Development, and Import-Substitution Industrialization

Between 1960 and 1975, the new African leaders pursued industrialization in order to overcome the colonial inheritance. Rooted in the anticolonial struggle, some of their programs were socialist (as in Ghana and Algeria), some more explicitly capitalist (as in Kenya). Others, such as that in Ethiopia, were more difficult to define. In practice, however, most African countries shared a commitment to modernization and industrialization. Many followed the model of Import-Substitution Industrialization (ISI), in which governments took control over national industrialization by protecting domestic industries from foreign competition. Rooted in modernization theory, the goal was for the state to mobilize enough investment in domestic industry to achieve the "big push" thought necessary for self-sustaining economic growth. State-led development became the norm in the 1960s.

Ghana and Algeria provide two examples of the socialist variant of ISI, with a high percentage of state-owned enterprises and a professed commitment to labor rather than capital. In Ghana, Kwame Nkrumah implemented a Seven-Year Development Plan (1957–1966) designed to develop domestic industry, infrastructure, and social welfare. Nkrumah mobilized investment capital export taxes, foreign borrowing, and the sale of electricity produced by the new Volta hydroelectric dam. Nkrumah's government took control of the country's major industries as well as the agricultural sector, but he also provided state-sponsored social services such as education and health care. In Algeria, after a nationalist revolution between 1954 and 1962, the country's first leader, Ahmed Ben Bella, pursued an orthodox Marxist program, setting out to smash the middle-class traders and bureaucrats. A military coup in 1965 brought a new leader (Houari Boumédiène), who declared a fusion of socialism, Islam, and Arabic culture. Although Boumédiène left education and cultural matters in the hands of politicians who emphasized Algeria's Islamic heritage, his economic vision was secular, technocratic, and socialist. Between 1966 and 1971, the state nationalized 90 percent of the country's industries, beginning with oil and gas and then extending to industrial production. The idea was to nationalize Algeria's natural resources and use the profits to develop state-owned industrial enterprises. Ultimately this vision failed to achieve its goals, and Boumédiène's socialist program gave way to the increasing "Islamicization" of Algeria.

Kenya and South Africa provide illustrations of a more capitalist road to national development. In Kenya between 1963 and 1978, President Jomo Kenyatta supported the African bourgeoisie with government intervention into agriculture, trade, and production. This program was not uncontested; a number of prominent trade unionists, including Bildad Kaggia and Fred Kubai, argued for a radical socialist alternative. Kenyatta purged these elements from the ruling party (the Kenyan African National Union, or KANU) and pushed ahead with a program of state-managed capitalism, although one of its most famous architects, Tom Mboya, referred to it as “African socialism.” While there was an element of redistribution, the core of the Kenyatta-Mboya program is better understood as corporate capitalism, under which the state partnered with labor and capital (domestic and foreign) in the pursuit of capital formation and industrialization. Import-Substitution Industrialization provided the model, with protected home markets for consumer goods and agreements with foreign firms to import essential capital-goods inputs. By the late 1970s, Kenyatta had built up strong agricultural and industrial sectors. South Africa pursued capitalist development through ISI from an early date (the 1940s), with impressive economic results. Industrialization there, however, was racialized, and the post-1948 apartheid state ruthlessly exploited the black population, stripping them of the most basic human and political rights. This strategy worked economically until the 1970s, when the economy faltered and African resistance intensified. International sanctions exacerbated the downward trend in the 1980s, and apartheid finally met its end in 1994, when national elections brought the African National Congress to power under Nelson Mandela. Thirty years after Kenyatta had set out to Africanize the Kenyan economy, South Africa’s black majority government faced pressures for similar Africanization, but the state-led option was no longer on the table.

In Ethiopia, the emperor Haile Selassie presided after 1935 over the conversion of feudal lands into private holdings, especially in the southern part of the country. Land sales accelerated between 1960 and 1974, producing concentration in the south, with farms as big as 200,000 acres. Using ISI as a model, the state invested in agricultural commercialization along capitalist lines; in industry the government attempted to develop textile and beverage production. These policies triggered the development of an agrarian bourgeoisie during the 1960s, as well as a small industrial sector, but these were dependent on foreign capital and insignificant in relation to subsistence agriculture, which remained under the domination of the big landlords. Peasant and student resistance to the landlords emerged during the 1970s under the slogan “land to the tiller.” Grievances paralleled a wave of army mutinies, resulting in a revolution that swept away the emperor’s government in favor of a Soviet-backed regime that ruled between 1974 and 1977. In the end, the ruling military council gave way to an authoritarian regime under Haile Meriam Mengistu, which allied with the Soviets in 1977 and pushed through a collectivization program in the countryside. This program succeeded in revolutionizing the social basis of power in the rural areas, but Mengistu’s authoritarianism produced widespread resistance, and the regime finally fell in 1991.

Selassie’s state-led development programs produced some significant successes during the 1960s, with growth in gross domestic product and comprehensive social welfare programs. As the decade progressed, however, it became clear that the gains would not be sustainable and that Africa had entered a period of economic stagnation. The oil shocks of 1973 and 1979, and a wave of drought in 1975 and 1976, worsened the crisis considerably. Flagging economic performance fed into a wave of unrest and military coups, including those in Algeria (1965), Ghana (1966), and Ethiopia (1974). As the 1970s progressed, stagnation worsened and African governments became less democratic; the decade witnessed the rise of one-party states presiding over a deteriorating economic climate.

During the 1970s, it seemed that “the African state had not been up to its ‘historic mission’ of ensuring capitalist accumulation”; as Thandika Mkandwire noted, the question for African analysts was whether this was a temporary phenomenon, which could be solved while retaining Africa’s links to the world economy, or a permanent structural problem solvable only by delinking from the global system. In the 1970s several prominent dependency theorists, including Egypt’s Samir Amin and Nigeria’s Bade Onimode, took up the latter position in arguing for a radical program of African autonomy and self-sufficiency.

In the late 1970s the dependency school lost ground to a more reform-minded version of structuralism, which argued that developing nations could achieve capitalist development while retaining their links to a reformed world economy. UNECA exemplified this stance with its 1976 report entitled the *Revised Framework for the Implementation of the New International Order for Africa*. The *Revised Framework* led to the Lagos Plan of Action (LPA) of 1980, which emphasized external factors—especially the continent’s reliance on raw materials exports—as the main causes of Africa’s economic stagnation. On this issue the LPA agreed with the dependency argument that declining terms of trade, which reflected the neocolonialist exploitation of the continent, posed a serious threat to African economic development. As a result, the LPA’s goals for Africa emphasized regional and continental self-reliance and self-sustaining development, to be achieved through a greater focus on industrialization and economic cooperation. Exports would be pursued, but they would be subordinated to domestic industrial development.

The Lagos Plan of Action also placed gender on the development agenda, arguing that women were central to the development process and that their interests had to be considered in the design and implementation of development programs. This stance provided a welcome corrective to modernization theory, which insisted that women were impediments to development and should be confined to the domestic sphere. This view had been challenged in the 1970s by the Women in Development (WID) paradigm and the proclamation of the UN’s International Decade for Women (1975–1985). In 1976, the Association of African Women for Development called for the integration of women into development programs. The LPA took up this call by demanding more support for women in agriculture and industry. Although they praised the LPA’s stance as a step in the right direction, critics argued that the

plan did little to facilitate a significant shift in African women's economic and political power. This criticism formed part of a larger movement during the 1980s to recognize issues of gender inequality in the design and implementation of development programs. This approach argued that development must address issues such as the sexual division of labor and power over reproduction if African women were to benefit from economic growth.

Neoliberalism, Structural Adjustment, and the African Reaction

African recommendations between 1976 and 1980 set the scene for a protracted debate between African intellectuals and the Bretton Woods Institutions over the terms of capitalist development on the continent. In 1981, the World Bank rejected the LPA in its famous Berg Report (*Towards Accelerated Development in Sub-Saharan Africa*), which attributed economic stagnation to poor government policies rather than external factors. In pursuing Import-Substitution Industrialization, Africa's leaders had turned their backs on the continent's comparative advantage in raw materials, in favor of propping up inefficient domestic industries and a bloated public sector. The Berg Report recommended returning to an outward-oriented program of raw materials exports, to be accomplished by rolling back state intervention and freeing up market forces. Specific recommendations promoted under the rubric of Structural Adjustment Programs (SAPs) included eliminating subsidies and controls (on imports, wages, and prices), devaluing local currencies, and letting the market determine the prices for raw materials exports.

In 1989 UNECA responded to the Berg Report by reaffirming the Lagos Plan through the African Alternative Framework to Structural Adjustment (AAF-SAP). This rejected the outward-oriented, market-based strategy of structural adjustment in favor of an inward-looking, state-led program of African self-reliance. The report also recommended subsidies for exports, bilateral and multilateral trade agreements, and debt forgiveness. Finally, the AAF-SAP stressed the importance of human development, especially the provision of basic social services and education. In short, it advocated a modified version of ISI, with a greater emphasis on the export sector.

The World Bank accepted the need for human-centered development in its 1989 report, *Sub-Saharan Africa: From Crisis to Sustainable Growth*. Citing the LPA and UNECA, this accepted the need to consider human-centered development in creating an environment to enable sustainable economic growth in Africa. The report, however, clung to the bank's commitment to structural adjustment and export-led development. A subsequent bank report emphasized SAPs even more strongly, claiming that "adjustment is working" in countries that followed its prescriptions, in agriculture as well as industry. In 1999, African critics countered once again with a systematic critique of structural adjustment entitled *Our Continent, Our Future: African Perspectives on Structural Adjustment*, which modified earlier calls for African self-reliance by accepting the need to compete in the global economy on the basis of comparative advantage. This was not to be achieved, however, through SAPs and raw materials exports; instead, the

study recommended a modified version of ISI in which African governments would nurture high-value-added, labor-intensive industries producing manufactured exports for the world market. Thandika Mkandawire, coeditor of *Our Continent, Our Future*, subsequently argued for the creation of developmental states in Africa—along Asian lines—which he believed could be socially engineered by political actors and civil society within the context of African democratization.

The World Bank has not accepted ISI in the early twenty-first century, but recent bank initiatives have made more concessions to African participation and social development, particularly through the new Comprehensive Development Framework (CDF). This moves beyond structural adjustment to focus on poverty reduction and social development; it also emphasizes local ownership of the development process. African leaders have responded to this shift by creating the New Partnership for Africa's Development (NEPAD), led by Thabo Mbeki of South Africa. NEPAD accepts the BWIs' neoliberal program for capitalist development as well as the need for peace, security, and good governance. To guarantee that Africa will benefit from globalization, however, NEPAD also seeks to reform the rules of globalization to guarantee equity as well as economic growth, by reducing Western protectionism and providing for African social needs. Separating itself from UNECA, the OAU (now reconstituted as the African Union) came out in support of NEPAD in 2001.

Several prominent African scholars have criticized NEPAD for rejecting the programs proposed by UNECA in favor of the neoliberal model of the Bretton Woods Institutions. This acceptance of neoliberalism threatens to reproduce African dependence on Western donors, which is especially dangerous in an age of shrinking Official Development Assistance. African critics of NEPAD argue that any concessions to Western donors must not compromise the principles of the LPA. Some of these critics call for a return of the developmental state. Other African scholars, such as Claude Ake, have tried to find a middle ground between this position and the neoliberal program. Ake proposes a populist alternative, drawing on "the energy of ordinary people" and geared toward the development of smallholder agriculture underwritten by popular democracy. Driven by farmer participation, this approach would increase the efficiency and productivity of small farmers and provide the basis for rural industries such as food processing and packaging. The result would be a bottom-up process of endogenous economic and human development. This process would have to involve African women, who appear to have been left out of the NEPAD blueprint, in what some critics consider a step backward from the LPA on the issue of gender and development.

Claude Ake's work illustrates that the debate over capitalism in Africa in the early 2000s revolves around three poles—the market, the state, and the community—rather than two. It remains an open question, however, which of these will emerge as the preferred trustee over African capitalism in the twenty-first century.

See also Anticolonialism; Colonialism; Development; Economics; Modernization; Modernization Theory; Neocolonialism; Neoliberalism; Socialisms, African.

BIBLIOGRAPHY

- Ake, Claude. *Democracy and Development in Africa*. Washington, D.C.: Brookings Institution, 1996.
- Amin, Samir. *Delinking: Towards a Polycentric World*. London: Zed, 1990.
- . *Neo-colonialism in West Africa*. Harmondsworth, U.K.: Penguin, 1973.
- Berman, Bruce, and Colin Leys, eds. *African Capitalists in African Development*. Boulder, Colo.: Lynne Rienner, 1994.
- Goldsworthy, David. *Tom Mboya: The Man Kenya Wanted to Forget*. New York: Africana, 1982.
- Kennedy, Paul. *African Capitalism: The Struggle for Ascendancy*. Cambridge, U.K., and New York: Cambridge University Press, 1988.
- Leys, Colin. *Underdevelopment in Kenya*. London: Heinemann, 1975.
- Mkandawire, Thandika. "Thinking about Developmental States in Africa." *Cambridge Journal of Economics* 25 (2001): 289–313.
- Mkandawire, Thandika, and Charles C. Soludo. *Our Continent, Our Future: African Perspectives on Structural Adjustment*. Dakar, Senegal: CODESRIA; Trenton, N.J.: Africa World Press, 1999.
- Onimode, Bade. *A Future for Africa: Beyond the Politics of Adjustment*. London: Earthscan, 1992.
- . *Imperialism and Underdevelopment in Nigeria: The Dialectic of Mass Poverty*. London: Zed, 1982.
- Organization of African Unity. *Lagos Plan of Action for the Economic Development of Africa, 1980–2000*. Addis Ababa, Ethiopia: OAU; Geneva, Switzerland: International Institute for Labour Studies, 1981.
- Owusu, Francis. "Pragmatism and the Gradual Shift from Dependency to Neoliberalism: The World Bank, African Leaders and Development Policy in Africa." *World Development* 31, no. 10 (2003): 1655–1672.
- Parpart, Jane. *African Women and Development: Gender in the Lagos Plan of Action*. East Lansing: Michigan State University Press, 1985.
- Sender, John, and Sheila Smith. *The Development of Capitalism in Africa*. London and New York: Methuen, 1986.
- Shenton, Robert W. *The Development of Capitalism in Northern Nigeria*. London: J. Currey; Toronto: University of Toronto Press, 1986.
- Women Waging Peace. "African Women Respond: Summary Report on G8 and Nepad Plan and the Impact on Women in Africa." *Women and Developments International Magazine*, no. 58/59 (spring 2003).
- World Bank. *Accelerated Development in Sub-Saharan Africa: An Agenda for Action*. Washington, D.C.: World Bank, 1981.
- . *Adjustment in Africa: Reforms, Results, and the Road Ahead*. New York: Oxford University Press, 1994.
- Young, Crawford. *Ideology and Development in Africa*. New Haven Conn.: Yale University Press, 1982.

Jeff D. Grischow

CARTESIANISM. When René Descartes died in 1650, his work had already attracted both critics and followers. In 1632 Cartesian philosophy was being taught in the Netherlands by his disciple Henri Reneri (1593–1639), and by the mid-1630s

the far more independently minded Henri Regius (1598–1679) was setting out his own version of Cartesianism in a less guarded and more polemical way than had Descartes himself. Indeed it was Regius who attracted the first condemnation of Cartesianism, from the Dutch theologian Gisbert Voetius (1589–1676), in 1641, and in 1642 Voetius turned on Descartes himself, drawing him into a very public controversy. Cartesianism first flourished as a movement in the Netherlands, being established as early as the 1650s at Leiden and Utrecht—where there was a Cartesian club, the College der Savanten—as well as at other Dutch universities. It was through a member of one of these Dutch groups, Johannes Clauberg (1622–1665), that Cartesianism came to be established in Germany: he took up the chair of theology and philosophy at the University of Duisberg in 1651, a new university set up by the cousin of Princess Elizabeth, Descartes's correspondent and staunch defender.

Responses to Descartes

In England there was less enthusiasm. In 1644 Kenelm Digby (1603–1665) set out his own eclectic version of Descartes's philosophy (and invited Descartes to come and live in England), and later in the decade Henry More (1614–1687), the Cambridge Platonist, explored various features of Cartesianism in his correspondence with Descartes. But Cartesianism soon developed a reputation for heterodoxy in England, above all because of his rejection of any aims or ends acting in nature, and his writings were widely attacked in the second half of the seventeenth century. In France, Louis XIV banned the teaching of Cartesian philosophy, and Cartesians were excluded from the Académie des Sciences. While these attacks were directed at the perceived radical nature of Cartesianism, others such as Daniel Huet (1630–1721), a patron of the Jesuits, were charging him with plagiarism: Huet claimed he took his epistemology from the Greek skeptics, the *cogito* from Augustine, and the ontological argument from Anselm.

However, Descartes had disciples in France, including Claude Clerselier (1614–1684), who oversaw the publication of his letters and other hitherto unpublished works (a laborious undertaking, which included retrieving the trunk containing them from the sea and drying them out), establishing a vital resource for scholars all over Europe and in the New World. Moreover, there was a strong French Cartesian movement in natural philosophy, centered on Jacques Rohault (1620–1672) and Pierre-Sylvain Régis (1632–1707), in the second half of the century, and by the 1670s there was a movement applying the Cartesian principle of "clear and distinct ideas" to social and political questions, with radical consequences: François Poulain de la Barre (1647–1723) was defending the equality of the sexes on this basis, and Descartes's niece, Catherine, was proposing Cartesianism as an alternative (with women particularly in mind) to the philosophy of the universities. The peculiar political circumstances in France—Louis in effect brought a delayed Counter-Reformation to France—resulted in a radicalization of Cartesianism in the late seventeenth century. By the early decades of the eighteenth century, there were Cartesians in painting (Charles Le Brun), architecture (the Perrault brothers), and music (Jean-Philippe

Rameau), and Descartes had become almost an establishment figure in France, as the famous attack on him by Voltaire indicates, where he was castigated for being out of date in comparison with developments in English philosophy. Yet by the 1770s he was radicalized again, as the Enlightenment *philosophes* claimed him as a corevolutionary.

Descartes had a deep concern for orthodoxy—even his advocacy of mechanism, in the form of the doctrine of the inertness of nature, can be seen as a response to the heterodox naturalism of the Renaissance, where the powers attributed to nature leave little room for a divine role—and had written his *Principles of Philosophy* with a view to having it adopted as a textbook in Jesuit colleges. Nevertheless, much of his work was bitterly condemned by the Catholic Church after his death. His writings were placed on the *Index of Prohibited Books* in 1663, primarily it would seem because of his heterodox account of transubstantiation, but his view that ours is not the only solar system also elicited explicit condemnations from religious authorities throughout the remainder of the seventeenth century.

Aspects of Cartesianism

In some areas, Descartes's work was accepted as pathbreaking: above all his geometrical optics and his algebra (Isaac Newton learned his advanced mathematics in the first instance from Descartes's *Geometry*). But other areas attracted a more partisan response. We can distinguish three different kinds of concern in the Cartesian corpus in this respect: epistemology and metaphysics, cosmology, and physiology.

Although the *Meditations* is for modern readers the canonical text by Descartes, this focus is really a nineteenth-century development, and the most widely read and discussed of his works in the eighteenth century were the *Discourse on Method*, *Principles of Philosophy*, and the posthumously published *Treatise on Man*. Moreover, Descartes himself had played down the epistemological and metaphysical concerns that characterize the *Meditations*. Two themes dominate the *Meditations*—a skeptically driven epistemology and the mind/body problem—and the fortunes of these differ radically among later philosophers. Neither Baruch Spinoza (1632–1677) nor Gottfried Wilhelm von Leibniz (1646–1716) could see any value or legitimacy in beginning epistemology by answering radical skeptical problems (and Blaise Pascal [1623–1662] referred to Descartes's philosophy as “useless and uncertain”), and they abandoned the idea of a skeptically driven epistemology. Nicolas Malebranche (1638–1715) was a little closer to Descartes, although still at variance with him on key doctrines, and he was not so dismissive of skeptical beginnings for epistemology, but they work in a rather different way in his philosophy than they do in Descartes. Malebranche's philosophy vied with that of John Locke (1632–1794) at the end of the seventeenth century, and his influence on George Berkeley (1685–1753) and David Hume (1711–1776) was at least as great as that of Locke, putting skeptical issues to the fore. On the mind/body question, no one was satisfied with Cartesian dualism. Spinoza, Malebranche, and Leibniz each saw the question as being the key to success, and each offered their own distinctive solution to the question: neutral monism, occasionalism, and preestablished harmony, respectively. By the eighteenth century,

epistemologically oriented issues of mind had receded from the philosophical arena to some extent, and Cartesianism was less associated with dualism.

Two natural-philosophical topics on which Descartes's views had caused immense controversy were his account of the solar system in book 3 of the *Principles of Philosophy* and his account of the formation of the earth in book 4. Descartes's response to the Copernicanism problem was not to make the sun the center of the cosmos, as Copernicus had done, but to make the sun one of an indefinite (perhaps infinite) number of solar systems, each containing planets like ours that may harbor beings with souls. The idea that our sun was simply one star among many and could not be held to be the center of the cosmos gained credence in the course of the later seventeenth century (for those who held that the universe was infinite there was no issue, of course, since something infinite cannot have a center since every point is equidistant from an infinitely remote boundary). Even more radical was his view of the formation of the earth. The Bible had presented a creation story in which the fabric of the earth, plants, and animals, had a function in a unique, highly designed system. Descartes, by contrast, has a general theory of planet formation: planets derive from stars that have formed a coating of hard matter around their periphery and are squeezed out by surrounding solar systems, in effect becoming massive pieces of refuse that find a home in other solar systems in orbits that depend on their size and speed. No exception is made for the Earth in Descartes's account, which completely robs the formation of earth of any teleology. The account was the first nonmythological treatment of the formation of the earth and was of great influence in the eighteenth century, not least in Georges-Louis Buffon's (1707–1778) account.

More generally, Descartes's cosmology—in which planets were carried around their suns by means of the vortical motion of a swiftly circulating medium in which they were immersed—was taken very seriously, and was the dominant cosmological system before Newton's *Principia*. Indeed, in continental Europe, it was not abandoned in favor of Newtonianism for some time, primarily because it did not involve any appeal to action at a distance, which was universally perceived to be the most problematic general feature of Newton's system. Moreover, Descartes's system was far more comprehensive than Newton's, tying his vortex theory of planetary motion in with phenomena such as magnetism and static electricity.

Descartes's rejection of teleology was also manifest in his account of embryology, set out in the *Treatise on Man* and in more detail in *The Description of the Human Body*. There he insists on a radically mechanistic approach, denying that the fetus strives to realize an end or goal in the development process. The inert and initially undifferentiated matter making up the horse fetus, for example, develops into a horse not because it somehow contains “horseness” or because it is able to shape itself into a horse but because the distinctive mechanical and physio-chemical processes in the womb of a horse cause the matter to develop in a certain way. In this way, Descartes opened up the question of the physiology of fetal development. Embryology is in fact just one topic in Descartes's comprehensive attempt to mechanize physiology, and in the

Treatise on Man a variety of physiological processes are construed in such a way that we need only postulate inert matter being acted upon by mechanical forces. From this derives his infamous doctrine of *bêtes machines* (animal machines), whereby the behavior of animals, who lack minds (in the sense of awareness of their “cognitive” states) in Descartes’s account, can be accounted for fully in terms of the mechanically describable interaction between their constituent parts. In 1747 Julien Offray de La Mettrie (1709–1751) published his *Man Machine*, in which he purported to apply the Cartesian theory of animal machines to human beings (actually his materialism was different from Cartesian mechanism), claiming that this could be done successfully, so that it was unnecessary to postulate a human soul to account for human thoughts and behavior. This solidified the image of Descartes as a dangerous materialist, and it was only in the nineteenth century that the idea of Descartes as a dualist was generally revived.

By the twentieth century, interest in Descartes in Anglophone philosophy was largely confined to his skeptically driven epistemology and his dualist account of mind. The revival of interest in empiricist epistemology, helped by the rise of positivism, resulted in skepticism being taken much more seriously as a philosophical problem (for example, in A. J. Ayer). In the philosophy of mind, various alternatives to dualism—such as epiphenomenalism, behaviorism, and materialism—were devised, with the effect that Cartesian dualism was often set up as a straw man by which to contrast one’s own theory (as in Gilbert Ryle’s defense of behaviorism). By contrast, in French and German philosophy, interest centered rather on Descartes’s idea of a self as independent of the world in which it finds itself, as a locus of subjectivity that is given prior to any interactions that it has with other subjects. The ethical and political aspects of this understanding have been explored either in their own right (by Jean-Paul Sartre, for example) or in combination with a Kantian account of ethical autonomy (such as by Jürgen Habermas).

See also *Dualism; Epistemology; Materialism in Eighteenth-Century European Thought; Newtonianism; Philosophy, History of; Skepticism*.

BIBLIOGRAPHY

- Balz, Albert G. A. *Cartesian Studies*. New York: Columbia University Press, 1951.
- Clarke, Desmond M. *Occult Powers and Hypotheses: Cartesian Natural Philosophy under Louis XIV*. Oxford: Clarendon Press, 1989.
- Gaukroger, Stephen, John Schuster, and John Sutton, eds. *Descartes’ Natural Philosophy*. London: Routledge, 2000.
- Harth, Erica. *Cartesian Women: Versions and Subversions of Rational Discourse in the Old Regime*. Ithaca, N.Y.: Cornell University Press, 1992.
- Mouy, Paul. *Le développement de la physique cartésienne, 1646–1712*. Paris: Vrin, 1934. Reprint, New York: Arno, 1981.
- Tournadre, Gérard. *L’orientation de la science cartésienne*. Paris: Vrin, 1982.
- Verbeek, Theo. *Descartes and the Dutch: Early Reactions to Cartesian Philosophy*. Carbondale: Southern Illinois University Press, 1992.

Stephen Gaukroger

CASUISTRY. From the Latin *casūs* (cases), casuistry is a method of practical reasoning that aims to identify the scope and force of moral obligations in the varied contexts of human action. While the golden era of casuistry belongs to the period 1450–1660, its origins as an intellectual outlook on moral decision-making can be traced back to ancient philosophy and to the legal traditions of medieval Europe. Aristotle, for instance, stressed the importance of an irreducibly practical method of moral reasoning that would be attentive to “the particulars” (*ta kath’ hekasta*) of cases. The Stoics also sought to provide detailed reasons as to how universal principles could be applied to particular cases. In addition to this, they bequeathed the idea of a natural law and a set of stock “casuistical examples,” such as “Murderer at the Door” and “the Merchant of Rhodes,” which would command the attention of European moralists for many centuries.

The development of a casuistical ethics would await the emergence of medieval canon law as set down by Gratian of Bologna (d. before 1159) and his interpreters, as well as the analysis by Scholastic theologians of the problems of human life as they affected the Christian conscience. Alongside canon lawyers, Scholastic thinkers considered cases of conscience (*casūs conscientiae*) that required a sensitive analysis of their conflicting options. The casuistical tendencies inherent in medieval theology and law were further fortified by the stipulation of the Fourth Lateran Council (1215) that all members of the faithful undergo auricular confession before a priest at least once a year. As a result of this development, medieval thought witnessed the advancement of a new genre of theological writing: the *summa confessorum*. These tracts were written for pastors hearing confession and contain detailed recommendations on the types of sin as well as their appropriate penitential tariffs. Well-known fifteenth-century manuals written by Angelo Carletti di Chivasso (1411–1495) and Sylvester Mazzolini (1460–1523) helped to condition the method adopted by later casuistical treatises.

Casuistry came of age in the sixteenth century. Building on the legacy of medieval moral thought, it sought to address the complexities of early modern life by means of restating the verities of the Christian tradition, while developing new theories of moral decision-making. There is a great diversity among the varieties of casuistical writing. On the one hand, there are speculative treatments of the practical problems of natural law and moral theology. An example of this tendency can be witnessed in the writings of Jesuit theologians Gabriel Vásquez (1549 or 1551–1604), Francisco Suárez (1548–1617), and Leonardus Lessius (1554–1623). This, however, might be said to contrast with other types of casuistical writing, where the intention of the author is wholly pastoral. Here the aim was to provide pithy and more accessible treatments of the basic problems of conscience, either for the benefit of those involved in the training of priests—a need that became pressing with the establishment of seminaries after the Council of Trent (1545–1563)—or else for priests engaged in parochial work or missionary activity. Examples of this type of manual can be found in the writings of the Jesuits Franciscus Toletus (1534–1596) and Antonio Escobar y Mendoza (1589–1669).

Probabilism

A distinctive innovation of early modern casuistry was probabilism. Originally advanced by a Dominican theologian, Bartolomé de Medina (1527 or 1528–1580), the theory was later taken up by an assortment of Jesuit theologians. Put briefly, probabilism states that in a case of conscience, provided that both options for a course of action are “probable”—that is, they can be justified by right reason, good argument, and sound authority—and that one alternative is more probable than the other, one is permitted to choose the “least probable” (*minus probabilis*) alternative and is not required to act on the more probable option. Although upheld by many luminaries of early modern Scholastic theology, probabilism failed to convince the vast majority of sixteenth- and seventeenth-century thinkers that it could avoid laxism. Later confessions of probabilism, especially those developed by the Cistercian Juan Caramuel Lobkowitz (1606–1682) and the Theatine cleric Antonino Diana (1586–1663), were held to be reprehensible theories that served to endow immoral acts with the token appearance of morality.

The close association of the Jesuit order with probabilism and a residual anti-Jesuit feeling in many quarters of Catholicism and Protestantism conspired to make the terms *Jesuit*, *probabilist*, and *casuist* synonymous in the European mind from the mid-seventeenth century onward. It was, however, powerful critiques of Jesuit moral theology that did most to alter the fortunes of casuistry and condemn it to years of decline. One of the best-known broadsides was advanced by Blaise Pascal (1623–1662), whose merciless *Les lettres provinciales* (1656–1657) dealt a near fatal blow to casuistry. Pascal’s brilliant yet highly rhetorical tirade against the Jesuits sought to expose the putative inconsistencies and errors in their probabilistic method and its application to a wide range of moral questions.

Although Pascal’s critique was largely judged to have been a success, it would be wrong to think that the production of works of casuistical ethics or an interest in its issues abruptly terminated after 1657. Even when attacked by an impressive array of detractors, ranging from Dominican supporters of “probabiliorism” (the view that one should always choose the more probable alternative in a case of conscience), Jansenist rigorists, and a hodgepodge of Anglican theologians and Puritan divines to secular moral philosophers, casuistry was still a noticeable feature of the eighteenth-century intellectual landscape, especially in Roman Catholic countries. During a time when European culture and philosophy were being changed as a result of the Enlightenment, the old casuistical methods were similarly refreshed and refashioned by thinkers such as St. Alfonso Maria de’ Liguori (1696–1787), who sought to recast theories such as probabilism in order to take account of the preceding century of debate. Liguori’s efforts ensured the continuation of vestiges of the casuistical tradition in Roman Catholic moral theology up to the Second Vatican Council (1962–1965).

Decline

While a case-method approach to moral theology can be found in some Anglican writers like Robert Sanderson (1587–1663) and Jeremy Taylor (1613–1667), it is noticeable that most

philosophers and theologians in English-speaking countries eschewed probabilism and other theories of Roman Catholic casuistry. Their hostility to these ideas, however, did not prevent them from developing a Christian ethics that addressed its own understanding of cases of conscience. Puritan moralists like William Ames (1576–1633), William Perkins (1558–1602), and Richard Baxter (1615–1691) discussed the vagaries of conscience as they pertained to the practices of piety, while the aforementioned Anglicans, Sanderson and Taylor, and Joseph Hall (1574–1656), were at pains to stress the gulf that separated their treatment of the problems of morality from “papists” and other such undesirables. The effect of these developments was to sideline casuistical ethics within English-speaking moral theology for most of the late seventeenth and eighteenth centuries, with the consequence that it had become invisible by the advent of the nineteenth.

The continuing decline of casuistry can also be witnessed in modern moral philosophy. As they began to express their independence from religion and theology, moral philosophers began to doubt the relevance of a theory of practical conduct indebted to religious values and principles. Further to this, the appeal to authority inherent in a theory like probabilism was now deemed to be authoritarian in an age smitten with ideas of individual autonomy and inalienable rights. For these reasons, traditional casuistry found little favor among philosophers. Thinkers such as Adam Smith (1723–1790) expressed their hostility with aplomb, while Immanuel Kant’s (1724–1804) treatment of certain “Casuistical Questions” at the end of his *Metaphysik der Sitten* (1797) reveals the extent of the changes that had occurred within the discussion of casuistry from the mid-seventeenth century onward. For Kant, casuistry could only mean “applied ethics”; the method of the theologians had been debunked and abandoned.

This more neutral sense of casuistry as the “application of moral principles to particular cases” persisted up until the early 2000s, as can be witnessed in the isolated remarks on the subject by William Paley (1743–1805), Henry Sidgwick (1838–1900), and George Edward Moore (1873–1958). Apart from several historical studies that invariably upheld the critique of Pascal, twentieth-century thinkers were rarely inclined to study the claims of the casuistical tradition. This changed, however, with the publication in 1988 of the *Abuse of Casuistry* by Albert Jonsen and Stephen Toulmin. They argued that, notwithstanding its colorful past, the old casuistical methods of the theologians could be transposed with great benefit to ongoing debates in bioethics. Jonsen and Toulmin offered a redescription of casuistry in terms of reasoning about “paradigm cases,” a method that they deemed sufficient to fashion a viable notion of moral consensus. If not in moral philosophy, certainly in bioethics their work has been favorably received and continues to stimulate further work on a host of practical issues. Here, “casuistry” is deemed to be an important tool for making decisions of principle while respecting the requirements of particular cases. While Jonsen and Toulmin’s portrayal of the casuistical tradition is controversial—not least in its eschewal of probabilism and readiness to concur with the basic ingredients of Pascal’s questionable critique—it is interesting that as a new century begins, the much maligned

method of the theologians is enjoying something of a modest revival.

See also *Philosophy, Moral; Scholasticism*.

BIBLIOGRAPHY

- Jonsen, Albert, and Stephen Toulmin. *The Abuse of Casuistry: A History of Moral Reasoning*. Berkeley: University of California Press, 1988.
- Keenan, James F., and Thomas A. Shannon, eds. *The Context of Casuistry*. Washington, D.C.: Georgetown University Press, 1995.
- Leites, Edmund, ed. *Conscience and Casuistry in Early Modern Europe*. Cambridge, U.K.: Cambridge University Press, 1988.
- Vallance, Edward, and Harald Braun, eds. *Contexts of Conscience in Early Modern Europe, 1500–1700*. London: Palgrave Macmillan, 2004.

M. W. F. Stone

CAUSALITY. The causality debate has been centered on two issues, one metaphysical, the other epistemic. The metaphysical issue concerns the nature of the connection between cause and effect: How and in virtue of what does the cause bring about the effect? The epistemic issue concerns the possibility of causal knowledge: How, if at all, can causal knowledge be obtained?

Aristotle

Aristotle (384–322 B.C.E.) claimed a sharp distinction between understanding the fact and understanding the reason why (*dioti; aitia*). Though both types of understanding proceed via deductive syllogism, only the latter is characteristic of science because only the latter is tied to the knowledge of causes. In his *Posterior Analytics*, Aristotle contrasted the following two instances of deductive syllogism:

- A. Planets do not twinkle; what does not twinkle is near; therefore, planets are near.
- B. Planets are near; what is near does not twinkle; therefore, planets do not twinkle.

Syllogism A demonstrates the fact that planets are near but does not explain it because it does not state its causes. On the contrary, syllogism B is explanatory because it gives the reason why planets do not twinkle: because they are near. Explanatory syllogisms like B are formally similar to nonexplanatory syllogisms like A. Both are demonstrative arguments of the form: all Fs are Gs; all Gs are Hs; therefore, all Fs are Hs. The difference between them lies in the “middle term” G. In B, but not in A, the middle term states a cause. As Aristotle said: “The middle term is the cause, and in all cases it is the cause that is being sought” (90a5–10). To ask why F is H is to look for a causal link joining F and H. Aristotle’s key observation was that, besides being demonstrative, explanatory arguments should also be asymmetric: the asymmetric relation between causes and effects should be reflected in an explanatory asymmetry between the premises and the conclusion of

the explanatory arguments—the premises should explain the conclusion and not the other way around.

Aristotle took scientific knowledge to form a tight deductive-axiomatic system whose axioms are first principles, being “true and primary and immediate, and more known than and prior to and causes of the conclusion” (71b20–25). Being an empiricist, he thought that knowledge of causes has experience as its source. But experience on its own cannot lead, through induction, to the first principles: these are universal and necessary and state the ultimate causes. On pain of either circularity or infinite regress, the first principles cannot be demonstrated either. So, something besides experience and demonstration is necessary for the knowledge of first principles. This is a process of abstraction based on intuition, a process that reveals the essences of things—that is, the properties by virtue of which the thing is what it is. In the example B above, it is of the essence of something’s being near that it does not twinkle. In the rich Aristotelian ontology, causes are essential properties of their subjects and necessitate their effects. He thought that the logical necessity by which the conclusion follows from the premises of an explanatory argument mirrors the physical necessity by which causes produce their effects.

In his *Physics*, Aristotle distinguishes between four types of causes. The material cause is “that out of which a thing comes to be”; the formal cause is “the definition of its essence”; the efficient cause is “the primary source of the change or rest”; and the final cause is “that for the sake of which a thing is done” (194b23–195a3). For instance, the material cause of a statue is its material; its formal cause is its form or shape; its efficient cause is its maker; and its final cause is the purpose for which the statue was made. Aristotle thought that a complete causal explanation has to cite all four causes: the efficient cause is the active agent that puts the form on matter for a purpose.

Aristotle’s Legacy

Most of Aristotle’s views were accepted by the Scholastics. Aristotle thought that the chains of efficient causes must stop at some “unmoved movers”—that is, things that are themselves unmoved but produce motion to other things. The Scholastics thought that the only proper efficient cause was God, being the ultimate unmoved mover. Later thinkers revolted against all but efficient causality. Efficient causality, what Aristotle called “the source of motion” (195a10), was taken to be the only type of causality by all those who advocated, in one form or another, the mechanical philosophy: in their hands, efficient causality became tantamount to pushings and pullings. Final causes, in particular, were cast to the winds. Where Aristotle saw goals and purposes in nature, mechanical philosophers either excised purpose from nature (Hobbes, Hume) or placed it firmly in the hands of God (Descartes, Leibniz). The moderns also revolted, to varying degrees, against the rich ontological landscape that Aristotle had painted: essences, substantial forms, activities, and so on. However, two key Aristotelian ideas, that there is necessity in nature and that this necessity is the same as the logical necessity of a demonstrative argument, were to become part of the mainstream philosophical thinking about causality until David Hume (1711–1776) subjected them to severe criticism and undermined them.

Descartes

René Descartes (1596–1650) distinguished all substances into two sorts: thinking things (*res cogitans*) and extended things (*res extensa*). He took the essence of mind to be thought and that of matter extension. Unlike Aristotle, he thought that matter was inert (since its essence is that it occupies space). Yet, there are causal connections between bodies (bits of matter) and between minds and bodies (bits of different substances). So, two big questions emerge within Cartesianism. The first is: how is body-body interaction possible? The second is: how is mind-matter interaction possible? Descartes's answer to the first question is the so-called transference model of causality: when x causes y , a property of x is communicated to y . He thought that this view is an obvious consequence of the principle "Nothing comes from nothing." As he put it: "For if we admit that there is something in the effect that was not previously present in the cause, we shall also have to admit that this something was produced by nothing" (vol. 1, p. 97). But Descartes failed to explain how this communication is possible. Indeed, by taking matter to be an inert extended substance, he had to retreat to some external cause of motion and change. Descartes treated forces with suspicion since they did not quite fit within his tight scheme of the two distinct substances and their two essential attributes. So in his *Principles of Philosophy* (1644) he retreated to God, whom he took to be "the efficient cause of all things" (vol. 1, p. 202). But this retreat to God cannot save the transference model. Besides, the transference model of causality makes an answer to the second question above (how do mind and matter interact?) metaphysically impossible. Being distinct substances, they have nothing in common that can be communicated between them. Descartes was a rationalist. He thought that Reason alone can, by a priori reflection, discover the basic casual laws of nature, which, Descartes thought, stem directly from God.

Descartes's Successors

Descartes's successors were divided into two groups: the occasionalists and those who reintroduced activity into nature. Occasionalism is the view that the only real cause of everything is God and that all causal talk that refers to worldly substances is a sham. Nicolas Malebranche (1638–1715) drew a distinction between real causes and natural causes (or occasions). As he put it: "A true cause as I understand it is one such that the mind perceives a necessary connection between it and its effect. Now the mind perceives a necessary connection between the will of an infinite being and its effect. Therefore, it is only God who is the true cause and who truly has the power to move bodies" (1997, p. 450). Natural causes are then merely the occasions on which God causes something to happen. Malebranche pushed Cartesianism to its extremes: since a body's nature is exhausted by its extension, bodies cannot have the power to move anything, and hence to cause anything to happen. What Malebranche also added was that since causality involves a necessary connection between the cause and the effect (a view that Descartes accepted too), and since no such necessary connection is perceived in cases of alleged worldly causality (where, for instance, it is said that a billiard ball causes another one to move), there is no worldly causality: all there is in the world is regular sequences of events, which strictly

speaking are not causal. Gottfried Wilhelm Leibniz (1646–1716), on the other hand, aimed to reintroduce forces and active powers into nature. As he said: "activity is the essence of substance" (1981, p. 65). Each substance is sustained by an internal "primitive active force," which causes its subsequent states. Yet, in a rather puzzling move, he also thought that there is no real causality in nature, since Leibnizian substances (what he called "the monads") do not interact. Rather, they are coordinated with each other by God's act of preestablished harmony, which confers on them the natural agreement of exact clocks.

There is an irony to be noted at this point. Most early modern philosophers tried to solve the metaphysical issue of causality. They devised elaborate theories to explain how the cause brings about the effect. But in the end, they excised causality from nature. More mildly put, insofar as there was causality in nature it was taken to be the product of divine impulse (Descartes) or of mysterious primitive forces (Leibniz).

Hume

In his ground-breaking *A Treatise of Human Nature* (1739–1740), David Hume made the scientific hunt for causes possible, by freeing the concept of causality from the metaphysical chains that his predecessors had used to pin it down. For Hume, causality, as it is in the world, is a regular succession of event-types: one thing invariably following another. His famous first definition of causality runs as follows: "We may define a CAUSE to be 'An object precedent and contiguous to another, and where all the objects resembling the former are plac'd in like relations of precedency and contiguity to those objects, that resemble the latter'" (1978 ed., p. 170).

Taking a cue from Malebranche, Hume argued that there was no perception of the supposed necessary connection between the cause and the effect. When a sequence of events that is considered causal is observed—for example, two billiard balls hitting each other and flying apart—there are impressions of the two balls, of their motions, of their collision, and of their flying apart, but there is no impression of any alleged necessity by which the cause brings about the effect. Hume went one step further. He found worthless his predecessors' appeals to the power of God to cause things to happen, since, as he said, such claims give us "no insight into the nature of this power or connection" (p. 249). So, Hume secularized completely the notion of causality. He also found inadequate, because circular, his predecessors' attempts to explain the link between causes and effects in terms of powers, active forces, and so on. As he put it: "[T]he terms *efficacy, agency, power, force, energy, necessity, connexion, and productive quality*, are all nearly synonymous; and therefore 'tis an absurdity to employ any of them in defining the rest" (p. 157).

Yet Hume faced a puzzle. According to his empiricist theory of ideas, there are no ideas in the mind unless there were prior impressions (perceptions). He did, however, recognize that the concept of causality involved the idea of necessary connection. Where does this idea come from, if there is no perception of necessity in causal sequences? Hume argued that the source of this idea is the perception of "a new relation

betwixt cause and effect”: a “constant conjunction” such that “like objects have always been plac’d in like relations of contiguity and succession” (p. 88). The perception of this constant conjunction leads the mind to form a certain habit or custom: to make a “customary transition” from cause to effect. It is this felt determination of the mind that affords us the idea of necessity.

So instead of ascribing the idea of necessity to a feature of the natural world, Hume took it to arise from within the human mind, when the latter is conditioned by the observation of a regularity in nature to form an expectation of the effect, when the cause is present. Indeed, Hume offered a second definition of causality: “A CAUSE is an object precedent and contiguous to another, and so united with it, that the idea of the one determines the mind to form the idea of the other, and the impression of the one to form a more lively idea of the other” (p. 170). Hume thought that he had unpacked the “essence of necessity”: it “is something that exists in the mind, not in the objects” (p. 165). He claimed that the supposed objective necessity in nature is spread by the mind onto the world. Hume can be seen as offering an objective theory of causality in the world (since causation amounts to regular succession), which was however accompanied by a mind-dependent view of necessity. This dual aspect of Hume’s account of causality is reflected in his two definitions.

Being an empiricist, Hume argued that all causal knowledge stems from experience. He revolted against the traditional view that the necessity that links cause and effect is the same as the logical necessity of a demonstrative argument. He argued that there can be no a priori demonstration of any causal connection, since the cause can be conceived without its effect and conversely. His far-reaching observation was that the alleged necessity of causal connection cannot be proved empirically either. As he famously argued, any attempt to show, based on experience, that a regularity that has held in the past will or must continue to hold in the future will be circular and question-begging. It will presuppose a principle of uniformity of nature. But this principle is not a priori true. Nor can it be proved empirically without circularity. For any attempt to prove it empirically will have to assume what needs to be proved—namely, that since nature has been uniform in the past it will or must continue to be uniform in the future. This Humean challenge to any attempt to establish the necessity of causal connections on empirical grounds has become known as his skepticism about induction. But it should be noted that Hume never doubted that people think and reason inductively. He just took this to be a fundamental psychological fact about human beings that cannot be accommodated within the confines of the traditional conception of Reason. Indeed, Hume went on to describe in detail some basic “rules by which to judge of causes and effects” (p. 173).

Kant

It was Hume’s critique of necessity in nature that awoke Immanuel Kant (1724–1804) from his “dogmatic slumber,” as he himself famously stated. In his *Critique of Pure Reason* (1787), Kant tried to demonstrate that the principle of causality—namely, “everything that happens, that is, begins to

be, presupposes something upon which it follows by rule,” (1965 ed., p. 218)—is a precondition for the very possibility of objective experience. He took the principle of causality to be required for the mind to make sense of the temporal irreversibility that there is in certain sequences of impressions. So, whereas we can have the sequence of impressions that correspond to the sides of a house in any order we please, the sequence of impressions that correspond to a ship going downstream cannot be reversed: it exhibits a certain temporal order (or direction). This temporal order by which certain impressions appear can be taken to constitute an objective happening only if the later event is taken to be necessarily determined by the earlier one (i.e., to follow by rule from its cause). For Kant, objective events are not “given”: they are constituted by the organizing activity of the mind and in particular by the imposition of the principle of causality on the phenomena. Consequently, the principle of causality is, for Kant, a synthetic a priori principle.

Ingenious though Kant’s answer to Hume was, it was ironic in three respects. Firstly, Kant safeguarded the concept of causality but at the price of making it applicable only to the phenomena and not to the unknowable things-in-themselves (noumena). Secondly, recall that Hume argued that the supposed necessity of causal sequences cannot be observed in the sequences themselves, but is projected by the mind onto the world. Kant agreed with all this, but took this projection by the mind onto the world to be presupposed for the distinction between causal and noncausal sequences. Thirdly, Kant identified causality with the rule of natural law: causal sequences of events are lawful sequences of events. This became the main plank of the Humean philosophical tradition. Stripped from objective necessity, natural laws boil down to worldly regularities.

The Regularity View of Causality

Arthur Schopenhauer (1788–1860) charged Kant with showing the absurd result that all sequence is consequence. As he noted, the tones of a musical composition follow each other in a certain objective order and yet it would be absurd to say that they follow each other according to the law of causality. This has also been a major objection to Hume’s views. Hume left the metaphysics of causality behind, but like Kant, he ended up with a loose notion of causality. On the one hand, it seems that there can be causality without regularity. This is the case of the so-called singular causality, where one event causes another to happen without this particular (singular) sequence of events falling under a regularity. On the other hand, there can be regularity without causality. There are cases in which events regularly follow each other (like the night always follows the day) without being the cause of each other. Once more, the metaphysical and the epistemological issues of causality come to the fore. We might not be able to know that a sequence of events is causal unless we see it repeat itself many times. But this does not imply that, metaphysically speaking, causality consists in regular sequence. On the Humean view, whether or not a sequence of events is causal depends on things that happen elsewhere and elsewhere in the universe, and in particular on whether or not this particular sequence instantiates a regularity. The Humean

view may be entitled the Regularity View of Causality. But an opposite view that became prominent in the twentieth century, due mostly to the work of Curt John Ducasse (1881–1969), is that what makes a sequence of events causal is something that happens there and then: a local tie between the cause and the effect, or an intrinsic feature of the particular sequence. Ducasse's (1968) single-difference account, roughly that an event *c* causes an event *e* if and only if *c* was the last—or, the only—difference in *e*'s environment before *e* occurred, takes causality to link individual events independently of any regular association that there may or may not be between events like the cause and events like the effect. Causality, non-Humeans argue, is essentially singular: a matter of this causing that.

Most advocates of singular causation argue that, contra Hume, causality is observable. A central claim is that causal relations are embodied in language by causal verbs, such as “to bend,” “to corrode,” “to push,” “to break,” and so on. So, we are told, when one asserts that, for instance, the vase broke after being struck with a hammer, by the very use of the verb “to break,” one makes a causal claim, and one has thereby directly perceived the vase being caused to break. Elizabeth Anscombe (b. 1919) argued that since our language is infested with causal verbs, there is no mystery in the claim that we directly perceive causings: when we learn to report such things as pushings, pullings, breakings, and the like from having observed them, we have thereby learned to report causings from having observed them.

Mill

In his monumental *A System of Logic Ratiocinative and Inductive* (1843), John Stuart Mill (1806–1873) defended the Regularity View of Causality, with the sophisticated addition that in claiming that an effect invariably follows from the cause, the cause should be taken to be the whole conjunction of the conditions that are sufficient and necessary for the effect. For Mill, regular association is not, on its own, enough for causality. A regular association of events is causal only if it is “unconditional”—that is, only if its occurrence does not depend on the presence of further factors which are such that, given their presence, the effect would occur even if its putative cause was not present. A clear case in which unconditionality fails is when the events that are invariably conjoined are effects of a common cause. Ultimately, Mill took to be causal those invariable successions that constitute laws of nature.

Mill is also famous for his methods by which causes can be discovered. These are known as the Method of Agreement and the Method of Difference. According to the first, the cause is the common factor in a number of otherwise different cases in which the effect occurs. According to the second, the cause is the factor that is different in two cases, which are similar except that in the one the effect occurs, while in the other it does not. In effect, Mill's methods encapsulate what is going on in controlled experiments: we find causes by creating circumstances in which the presence (or the absence) of a factor makes the only difference to the production (or the absence) of an effect. Mill, however, was adamant that his methods work only if certain metaphysical assumptions are in place. It must be

the case that: (a) events have causes; (b) events have a limited number of possible causes; and (c) same causes have same effects, and conversely.

Logical Positivism

Bertrand Russell (1872–1970), in his “On the Notion of Cause” (1918), argued that the concept of causality was incoherent. But this was just as well for him, since, as he claimed, physics has stopped looking for causes: for “there are no such things.” Here is his famous dictum: “The law of causality, I believe, like much that passes muster among philosophers, is a relic of a bygone age, surviving, like the monarchy, only because it is erroneously supposed to do no harm” (1918, p. 180). His suspicion of the concept of causality was inherited by the movement of logical positivism (the Vienna Circle), which set the agenda for most of the philosophy of science in the twentieth century. They took to heart Hume's critique of the supposed necessary connection between cause and effect. The twist they gave to this critique was based on their verificationist criterion of meaning. As the leader of the Circle, Moritz Schlick (1882–1936), stressed, positing a “linkage” between two events would be tantamount to “committing a kind of nonsense” since all attempts to verify it would be necessarily futile (1979, p. 245). Rudolf Carnap (1891–1970) thought that insofar as the concept of causality is useful to science, it should be understood by reference to the notion of laws of nature. He insisted that the only meaningful content that causal talk can have is when we call “cause” the event, or the physical magnitude, or the physical state, which temporally precedes another one nomologically dependent on the former. The logical positivists took the laws to be exceptionless regularities that are expressed by true universal statements of the form “all Fs are Gs” (e.g., all planets move in ellipses).

Deductive-Nomological Explanation

A central element of the empiricist project was to legitimize—and demystify—the concept of causality by subsuming it under the concept of lawful explanation, which, in turn, was modeled on deductive arguments. This project culminated in Carl Hempel (1905–1977) and Paul Oppenheim's Deductive-Nomological model of explanation. According to this, to offer an explanation of an event *e* is to construct a valid deductive argument of the following form:

Antecedent/Initial Conditions

Statements of Laws

Therefore, *e* (event/fact to be explained)

So, when the claim is made that event *c* causes event *e* (e.g., that the sugar cube dissolved because it was immersed in water), it should be understood as follows: there are relevant laws in virtue of which the occurrence of the antecedent condition *c* (putting the sugar in water) is nomologically sufficient for the occurrence of the event *e* (the dissolving of the sugar). It has been a standard criticism of the Deductive-Nomological (DN) model that, insofar as it aims to offer sufficient and necessary conditions for an argument to count as a bona fide explanation, it fails. For, there are arguments that satisfy the

There are some philosophers who assert that secondary causes act through their matter, figure, and motion . . . others assert that they do so through a substantial form; others through accidents or qualities, and some through matter and form; of these some through form and accidents, others through certain virtues or faculties different from the above. . . . Philosophers do not even agree about the action by which secondary causes produce their effects. Some of them claim that causality must not be produced, for it is what produces. Others would have them truly act through their action; but they find such great difficulty in explaining precisely what this action is, and there are so many different views on the matter that I cannot bring myself to relate to them.

SOURCE: Nicolas Malebranche, *The Search After Truth (Recherche de la Vérité)* (1674–1675), trans. Thomas M. Lennon and Paul J. Olscamp. Cambridge, U.K., and New York: Cambridge University Press, 1997, p. 659.

structure of the DN-model, and yet fail to be bona fide explanations of a certain event. For instance, one can construct a deductive-nomological “explanation” of the height of a flagpole having as premises (a statement of) the length of its shadow and (statements of) relevant laws of optics, but this is not an explanation of why the flagpole has the height it does. In a sense, this counterexample repeats a point that we saw already made by Aristotle—namely, that good explanations are asymmetric: they explain effects in terms of causes and not conversely. Conversely, there are bona fide explanations that fail to instantiate the DN-model. For instance, one can construct an explanation of why there was a car crash (by telling a causal story of how it happened) without referring to any law at all. The joined message of these counterexamples is that the DN-model fails precisely because it ignores the role of causality in explanation. In other words, the moral of the counterexamples is there is more to the concept of causality than what can be captured by DN-explanations.

Laws of Nature

Be that as it may, the Deductive-Nomological model, as well as any attempt to tie causality to laws, faces a rather central conceptual difficulty: the problem of how to characterize the laws of nature. Most Humeans have come to adopt the Regularity View of Laws: laws of nature are regularities. Yet, they have a hurdle to jump: not all regularities are causal. Nor can all regularities be deemed laws of nature. The night always follows the day, but it is not caused by the day. And, though a regularity, it is not a law of nature that all coins in my pocket are euros. So, the Humeans have to draw a distinction between the good regularities (those that constitute the laws of nature) and the bad ones—that is, those that are, as Mill put it, “conjunctions in some sense accidental.” Only the former can underpin causality and play a role in explanation. Among the many attempts to distinguish between laws and accidents, the most promising is what may be called the web of laws view. According to this, the regularities that constitute the laws of nature are those that are expressed by the axioms and

theorems of an ideal deductive system of our knowledge of the world, which strikes the best balance between simplicity and strength. Whatever regularity is not part of this best system is merely accidental: it fails to be a genuine law of nature. The gist of this approach, which has been advocated by Mill, Frank Ramsey (1903–1930), and David Lewis (1941–2001), is that no regularity, taken in isolation, can be deemed a law of nature. The regularities that constitute laws of nature are determined in a kind of holistic fashion by being parts of a structure. But despite its many attractions, this view does not offer a purely objective account of laws of nature.

A contrary view that has been defended by David Armstrong (b. 1926) is that lawhood cannot be reduced to regularity. Lawhood is said to be a certain necessitating relation among natural properties. An attraction of this view is that it makes clear how laws can cause anything to happen: they do so because they embody causal relations among properties. But the central concept of nomic necessitation is still not sufficiently clear.

Inus Conditions

Among the more recent attempts to develop more defensible versions of the Regularity View of Causality, J. L. Mackie’s (1917–1981) inus-conditions approach stands out. Mackie stressed that effects have, typically, a “plurality of causes” (p. 61). That is, a certain effect can be brought about by a number of distinct clusters of factors. Each cluster is sufficient to bring about the effect, but none of them is necessary. So, he takes the regularities in nature to have a complex form ($A \& B \& C$ or $D \& E \& F$ or $G \& H \& I$) \leftrightarrow E , which should be read as: all ($A \& B \& C$ or $D \& E \& F$ or $G \& H \& I$) are followed by E , and all E are preceded by ($A \& B \& C$ or $D \& E \& F$ or $G \& H \& I$). How do we pick out the cause of an event in this setting? Each single factor of $A \& B \& C$ (e.g., A) is related to the effect E in an important way. It is an *insufficient* but *nonredundant* part of an *unnecessary* but *sufficient* condition for E . Using the first letters of the italicized words, Mackie has called

such a factor an inus condition. Causes, then, are inus conditions. So to say that short circuits cause house fires is to say that the short circuit is an inus condition for house fires. It is an insufficient part because it cannot cause the fire on its own (other conditions such as oxygen, inflammable material, etc. should be present). It is, nonetheless, a nonredundant part because, without it, the rest of the conditions are not sufficient for the fire. It is just a part, and not the whole, of a sufficient condition (which includes oxygen, the presence of inflammable material, etc.), but this whole sufficient condition is not necessary, since some other cluster of conditions, for example, an arsonist with gasoline, can produce the fire.

Counterfactual Dependence

In his *Enquiry Concerning Human Understanding* (1748) Hume stated briefly another way to view causality. He said that an object is the cause of another when “if the first object had not been, the second never had existed” (1975 ed., p. 146). This view has been articulated into a theory of causality by David Lewis. Lewis (1986) defined causality in terms of the counterfactual dependence of the effect on the cause: the cause is rendered counterfactually necessary for the effect. For instance, to say that the short-circuit caused the fire is to say that if the short-circuit had not happened, the fire would not have ensued. To be more precise, Lewis defined causality by reference to a *causal chain* of counterfactually dependent events, where a sequence of events (C, E, E', \dots) is a chain of counterfactual dependence if and only if E counterfactually depends on C , E' counterfactually depends on E , and so on. This move is meant to enforce that causation is a transitive relation among events (that is, if C causes E and E causes E' , then C causes E'). As Lewis put it: “one event is a cause of another if and only if there exists a causal chain leading from the first to second” (p. 167). Statements such as “if C had happened, then E would have happened” are called counterfactual conditionals (another example, “if this sugar cube had been in water, it would have dissolved”) for they state what could or could not have happened, under certain circumstances. But it has been notoriously difficult to specify the conditions under which counterfactual conditionals are true or false. Lewis articulated a rather complicated logic of counterfactual conditionals, which was based on the idea that, besides the actual world, there are also other possible worlds, which can be deemed more or less similar to the actual. A chief but not inviolable criterion for judging the similarity among worlds was taken to be whether the same laws of nature govern the worlds under comparison.

Though it is still one of the main contestants, this view of causality faces important difficulties. A chief among them comes from cases of causal overdetermination, where there are two factors each of which is sufficient to bring about the effect, but none of them is necessary, since even if the one was not present, the other factor would ensure the occurrence of the effect. For instance, two rocks are simultaneously thrown at a bottle and they shatter it. They both caused the shattering, but the effect is not counterfactually dependent on either of them, since if the first rock had missed the bottle, the other would have still shattered it. So there is causality without the cause being counterfactually dependent on the effect.

Here is a billiard-ball lying on the table, and another ball moving towards it with rapidity. They strike; and the ball, which was formerly at rest, now acquires a motion. This is as perfect an instance of the relation of cause and effect as any which we know, either by sensation or by reflection. Let us therefore examine it. 'Tis evident, that the two balls touched one another before the motion was communicated, and that there was no interval betwixt the shock and the motion. *Contiguity* in time and place is therefore a requisite circumstance to the operation of all causes. 'Tis evident likewise, that the motion, which was the cause, is prior to the motion, which was the effect. *Priority* in time, is therefore another requisite circumstance in every cause. But this is not all. Let us try any other balls of the same kind in a like situation, and we shall always find, that the impulse of the one produces motion in the other. Here therefore is a *third* circumstance, viz., that is a constant conjunction betwixt the cause and effect. Every object like the cause, produces always some object like the effect. Beyond these three circumstances of contiguity, priority, and *constant conjunction*, I can discover nothing in this cause. The first ball is in motion; touches the second; immediately the second is in motion: and when I try the experiment with the same or like balls, in the same or like circumstances, I find that upon the motion and touch of the one ball, motion always follows in the other. In whatever shape I turn this matter, and however I examine it, I can find nothing farther. (pp. 649–650)

SOURCE: David Hume, *Abstract to A Treatise of Human Nature*. Published by Hume anonymously in 1739.

Probabilistic Causality

No matter how one thinks about causality, there are certain platitudes that this concept should satisfy. One of them may be called the difference platitude: causes make a difference—namely, things would be different if the causes of some effects were absent. This platitude is normally cast in two ways. We

[W]e derived the principle that everything that happens has a cause from the condition under which alone a concept of happening in general is objectively possible—namely, by showing that the determination of an event in time, and therefore the event as belonging to experience, would be impossible save as standing under such a dynamical rule.

SOURCE: Immanuel Kant, *Critique of Pure Reason* (1787), trans. Norman Kemp Smith. New York: St. Martin's Press, 1965, p. 624.

have already seen the first, the counterfactual way: if the cause had not been, the effect would not have been either. The other is a probabilistic way: causes raise the chances of their effects—namely, the probability that a certain event happens is higher if we take into account its cause than if we do not. This thought has led to the development of theories of probabilistic causality. We do rightly claim that smoking causes lung cancer, even though there is no regular association (or deterministic connection) between smoking and lung cancer. Some philosophers, most notably Patrick Suppes (1984) and Nancy Cartwright (1983), think that this is already a good argument against the view that causality is connected with invariable sequences or regularities. They then analyze causal claims in terms of probabilistic relations among magnitudes, capitalizing on the intuition that causes (mostly, but not invariably) raise the probabilities of their effects. Some think that there are good empirical reasons to jettison determinism (roughly, that each and every event has a fully sufficient set of causes) in favor of indeterminism (roughly, that there are genuinely chancy events). They then try to show that indeterminism and causality mix well, given the thought that a certain event can be caused to happen even though its cause made only a difference to its chance to happen. Interestingly, these ideas are extended to deterministic causality as well, with the prime thought being that an effect is deterministically caused to happen if its probability, given its cause, is unity.

Causes as Recipes

Another central platitude of the concept of causality may be called the recipe platitude: causes are recipes for producing or preventing their effects. This platitude is normally cast in terms of manipulability: causes can be manipulated to bring about certain effects. G. H. von Wright (1906–2003) developed this thought into a full-blown theory of causality. He took it that what confers on a sequence of events the character of causal connection is “the possibility of subjecting cause-factors to experimental test by interfering with the ‘natural’ course of events” (1993, p. 117). Since manipulation is a distinctively human action, he concluded that the causal relation is dependent upon the concept of human action. But his views were

taken to be too anthropomorphic. For, do we not think that there would be causal relations, even if there would not be any humans around capable of manipulating anything? Yet, recently, there have been important attempts to give a more objective gloss to the idea of manipulation. James Woodward (2003) introduces a notion of intervention that is not restricted to human action and argues that a relationship among some magnitudes X and Y is causal if, were one to intervene to change the value of X appropriately, the relationship between X and Y would remain invariant but the value of Y would change, as a result of the intervention on X . This interventionist account has been developed by Judea Pearl (2001) into a rather powerful mathematical tool, known as Bayesian probabilistic networks, for discovering and establishing causal relations from relations of probabilistic dependence among variables. An attraction of the interventionist approach is that it is not so much concerned with the metaphysics of causality as with the epistemological and methodological circumstances under which causal facts can be ascertained.

Physical Causality

Lately, there have been a number of attempts to show that there is more to causality than regular succession by positing a physical mechanism that links cause and effect. In his *Scientific Explanation and the Causal Structure of the World* (1984), Wesley Salmon (1925–2001) advanced a mechanistic approach, roughly that an event c causes an event e if and only if there is a causal process that connects c and e . Borrowing an idea of Hans Reichenbach's (1956), Salmon characterized “causal” those processes that are capable of transmitting a mark, where a mark is a modification of the structure of a process. Later on, Salmon (1997) and Phil Dowe (2000) took causality to consist in the exchange or transfer of some conserved quantity, such as energy-momentum or charge. Such accounts may be called transference models because they claim that causality consists in the transfer of something (some physical quantity) between the cause and its effect. They claim that causality need not involve regularities or laws. Rather, it consists in a local physical tie between cause and effect. But there is a drawback. Even if it is granted that these models offer neat accounts of causality at the level of physical events or processes, they can be generalized as accounts of causality *simpliciter* only if they are married to strong reductionistic views that all worldly phenomena (be they social or psychological or biological) are, ultimately, reducible to physical phenomena. We saw earlier that Descartes, too, advanced a transference model of causality and that he stumbled on the issue of mental causality: how can the mental cause anything physical to happen, as it manifestly does? The irony is that the very same hurdle might have to be jumped by the advocates of the modern transference models.

Neo-Aristotelianism

Hume found any appeal to causal powers suspect, since he thought there were no impressions of them. Hume's views were dominant until the last quarter of the twentieth century, when there was a resurgence of Aristotelianism. A few contemporary philosophers think that causation should be best understood in terms of causal powers—that is, powers, dispositions, and

capacities things have to cause other things to happen. These powers are supposed to stem from the nature or essence of a thing and they determine what a thing is and what it can do. The causal laws that govern the world are supposed to stem from these causal powers. According to Brian Ellis (2001), a chief defender of this view, causal laws state necessary truths about how things are intrinsically disposed to behave. But many philosophers find these views unappealing, not least because they fail to explain the fundamental notion of causal power.

See also **Aristotelianism; Cartesianism; Determinism; Dualism; Empiricism; Neoplatonism; Probability.**

BIBLIOGRAPHY

PRIMARY SOURCES

- Anscombe, G. E. M. *Causality and Determination*. London: Cambridge University Press, 1971.
- Aristotle. *Physics*. In vol. 1 of *The Complete Works of Aristotle*, 2 vols., edited by Jonathan Barnes. Princeton N.J.: Princeton University Press, 1984.
- . *Posterior Analytics*. 2nd ed. Translated by Jonathan Barnes. Oxford: Clarendon, 1993.
- Armstrong, D. M. *What Is a Law of Nature?* Cambridge, U.K., and New York: Cambridge University Press, 1983. Classic defense of the view that natural laws embody necessitating relations among properties.
- Carnap, Rudolf. *An Introduction to the Philosophy of Science*. Edited by Martin Gardner. New York: Dover, 1995. A classic late statement of the positivist philosophy of science.
- Cartwright, Nancy. *How the Laws of Physics Lie*. Oxford and New York: Clarendon, 1983. A thorough critique of the Regularity Views of Causation and Laws.
- Descartes, René. *The Philosophical Writings of Descartes*. 3 vols. Translated by John Cottingham, Robert Stoothoff, and Dugald Murdoch. Cambridge, U.K., and New York: Cambridge University Press, 1985. Vol. 1 includes *Principles of Philosophy* (1644), Descartes's classic presentation of his philosophy of nature.
- Dowe, Phil. *Physical Causation*. Cambridge, U.K., and New York: Cambridge University Press, 2000. The standard rendition of the conserved-quantity theory of causation.
- Ducasse, C. J. *Causation and the Types of Necessity*. New York: Dover, 1969. Defends singular causation against Hume and Mill.
- Ellis, B. D. *Scientific Essentialism*. Cambridge, U.K., and New York: Cambridge University Press, 2001. A thorough defense of neo-Aristotelianism.
- Hempel, Carl G. *Aspects of Scientific Explanation, and Other Essays in the Philosophy of Science*. New York: Free Press, 1965.
- Hume, David. *An Enquiry Concerning Human Understanding* (1748). Edited by L. A. Selby-Bigge from the posthumous edition of 1777. 3rd ed., edited by P. H. Nidditch, published as *Enquiries Concerning Human Understanding and Concerning the Principles of Morals*. Oxford: Clarendon, 1975. A less skeptical version of Hume's critique of causality.
- . *A Treatise of Human Nature*. 1739. Edited by L. A. Selby-Bigge, 1888. 2nd ed., with text revisions by P. H. Nidditch. Oxford: Clarendon, 1978.
- Kant, Immanuel. *Critique of Pure Reason*. 1787. Translated by Norman Kemp Smith. New York: St. Martin's Press, 1965. A classic of Western philosophy.
- Leibniz, Gottfried Wilhelm. *New Essays on Human Understanding*. 1765. Translated and edited by Peter Remnant and Jonathan Bennett. Cambridge, U.K., and New York: Cambridge University Press, 1981. Posthumously published defense of rationalism against John Locke's empiricism.
- Lewis, David. "Causation." In his *Philosophical Papers*, vol. 2. Oxford: Oxford University Press, 1986.
- Mackie, J. L. *The Cement of the Universe: A Study of Causation*. Oxford: Clarendon, 1974. One of the most comprehensive and original books on causality.
- Malebranche, Nicolas. *The Search After Truth* (1674–1675). Translated by Thomas M. Lennon and Paul J. Olscamp. Cambridge, U.K., and New York: Cambridge University Press, 1997.
- Mill, J. S. *A System of Logic: Ratiocinative and Inductive* (1843). 8th ed. London: Longmans, Green and Co., 1911. Wide-ranging treatment of the methodology of science.
- Pearl, Judea. *Causality: Models, Reasoning, and Inference*. Cambridge, U.K.: Cambridge University Press, 2001. Technical but insightful.
- Ramsey, F. P. "Universals of Law and of Fact." 1928. In *Foundations: Essays in Philosophy, Logic, Mathematics and Economic*, edited by D. H. Mellor. London: Routledge and Kegan Paul, 1978.
- Reichenbach, Hans. *The Direction of Time*. Edited by Maria Reichenbach. Berkeley and Los Angeles: University of California Press, 1956. A defense of the view that the direction of time stems from the direction of causation.
- Russell, Bertrand. "On the Notion of Cause." In his *Mysticism and Logic, and Other Essays*. London: George Allen and Unwin, 1932. First published in 1918.
- Salmon, Wesley. *Causality and Explanation*. New York: Oxford University Press, 1998.
- . *Scientific Explanation and the Causal Structure of the World*. Princeton, N.J.: Princeton University Press, 1984. The most systematic contemporary mechanistic account of causality.
- Schlick, Moritz. "Causation in Everyday Life and in Recent Science." 1932. In *Moritz Schlick Philosophical Papers, Vol. 2 (1925–1936)*. Edited by Henk L. Mudler and Barbara F. B. De Velde-Schlick. Dordrecht, Netherlands: D. Reidel, 1979.
- Suppes, Patrick. *Probabilistic Metaphysics*. Oxford: Blackwell, 1984.
- von Wright, G. H. "On the Logic of the Causal Relations." In *Causation*, edited by Ernst Sosa and Michael Tooley. Oxford: Oxford University Press, 1993.
- Woodward, James. *Making Things Happen: A Theory of Causal Explanation*. New York: Oxford University Press, 2003. The standard development of the interventionist approach.

SECONDARY SOURCES

- Clatterbaugh, Kenneth. *The Causation Debate in Modern Philosophy, 1637–1739*. New York: Routledge, 1999. Excellent survey of the main theories of causality from Descartes to Hume.
- Eells, Ellery. *Probabilistic Causality*. Cambridge, U.K.: Cambridge University Press, 1991. A thorough treatment of theories of probabilistic causality.
- Psillos, Stathis. *Causation and Explanation*. Chesham: Acumen and Montreal: McGill-Queens University Press, 2002. Detailed discussion of the main philosophical theories of causality.

Sosa, Ernest, and Michael Tooley, eds. *Causation*. Oxford: Oxford University Press, 1993. A collection of the most influential philosophical papers on causation in the second half of the twentieth century.

Stroud, Barry. *Hume*. London: Routledge and Kegan Paul, 1977. Still the best presentation of Hume's philosophy.

Stathis Psillos

CAUSATION. Philosophers have theorized about causation since well before Aristotle, who distinguished several types of causation: efficient, material, final, and formal. For example, a wood carving is made by an artist (the efficient cause) by chiseling a piece of wood (the material cause) for the purpose of creating a beautiful object (the final cause), arriving at something that has the properties of a wood carving (the formal cause).

Although Aristotle's typology framed discussions of causation until the scientific revolution and in some circles even until David Hume, the focus settled onto analyzing efficient causation and in particular on understanding the kinds of substances that might interact causally. René Descartes, for example, separated material and mental substances and wrote extensively on how cross-substance causation might happen. Discussions of causation thus became entangled with the metaphysics of substance, and positions ranged all the way from Baruch Spinoza, who claimed there is only one type of substance, to Gottfried Wilhelm Leibniz, who claimed there was an infinity of unique substances, one per monad. Everyone wanted to understand causation as involving some "power" to produce change, and different substances possess different sorts of powers over their own and other substances. For example, the empiricist Bishop George Berkeley argued that our ideas (sensations) cannot be caused by other ideas or matter, because ideas and matter are "inert" and do not have the sort of causal "power" necessary for efficient causation. Only an agent like God or a willful person possesses such power. John Locke, in *An Essay concerning Human Understanding*, wrote voluminously trying to explicate the idea of causal power in empiricist terms. David Hume, the brilliant eighteenth-century Scottish philosopher, finally rejected the notion of causal power as being beyond direct observation, and he recast the problem of understanding the connection between a cause and its effect as another version of the problem of induction. Although causes always seem to be followed by their effects, the bond between them might well be nothing more than a psychological habit we develop as a result of regularly perceiving the idea of one type of object or event (e.g., thunder) just after the idea of another (e.g., lightning). Hume's challenge was to find compelling reasons for believing that when an object similar to one we have seen previously occurs, then the effect must necessarily occur. No one has succeeded in answering Hume's challenge, but his effect on the debate was as powerful as Aristotle's. All modern theories of causation begin with something like Hume's story: there are objects or events that we can group as similar, like the events of walking in the rain with no coat and developing a cold. They all ask what does it mean to assert that the relation between these events is causal.

Modern Theories of Causation

Practically, causation matters. Juries must decide, for example, whether a pregnant mother's refusal to give birth by cesarean section was the cause of the death of one of her twins. Policy makers must decide whether violence on TV causes violence in life. Neither question can be coherently debated without some theory of causation. Fortunately (or not, depending on where one sits), a virtual plethora of theories of causation have been championed in the third of a century between 1970 and 2004.

Before the sketch of a few of the major theories, however, consider what one might want out of a theory of causation. First, although one can agree that causation is a relation, what are the relata? Are causes and effects *objects*, like moving billiard balls? Are they *particular events*, like the *Titanic* hitting an iceberg in 1912? Or are they *kinds of events*, like smoking cigarettes and getting lung cancer? As it turns out, trying to understand causation as a relation between particular objects or events is quite a different task than trying to understand it as relation between *kinds* of occurrences or events.

Second, one wants a theory to clarify, explain, or illuminate those properties of causation that one can agree are central. For example, whatever causation is, it has a direction. Warm weather causes people to wear lighter clothing, but wearing lighter clothing does not cause warm weather. A theory that fails to capture the *asymmetry of causation* will be unsatisfying.

Third, one knows that in many cases one thing can occur regularly *before* another, and thus appear to be related as cause and effect, but is in fact the effect of a common cause, a phenomenon called *spurious causation*. For example, flashes of lightning appear just before and seem to cause the thunderclaps that follow them, but in reality both are effects of a common cause: the superheating of air molecules from the massive static electric discharge between the earth and the atmosphere. A good theory of causation ought to successfully separate cases of real from spurious causation.

The history of thinking on causation from 1970 to 2004 can be organized in many ways, but the one that separates matters best, both temporally and conceptually, is captured eloquently by Clark Glymour:

Philosophical theories come chiefly in two flavors, Socratic and Euclidean. Socratic philosophical theories, whose paradigm is *The Meno*, advance an analysis (sometimes called an "explication"), a set of purportedly necessary and sufficient conditions for some concept, giving its meaning; in justification they consider examples, putative counterexamples, alternative analyses and relations to other concepts. Euclidean philosophical theories, whose paradigm is *The Elements*, advance assumptions, considerations taken to warrant them, and investigate the consequences of the assumptions. Socratic theories have the form of definitions. Analyses of "virtue," "cause," "knowledge," "confirmation," "explanation," are ancient and recent examples. Euclidian theories have the form of formal or informal axiomatic systems and are often essentially mathematical: Euclid's geometry, Frege's

EVENT CAUSATION VERSUS CAUSAL GENERALIZATIONS

Legal cases and accident investigations usually deal with a particular event and ask what caused it. For example, when in February 2003 the space shuttle *Columbia* burned up during reentry, investigators looked for the cause of the disaster. In the end, they concluded that a chunk of foam insulation that had broken off and hit the wing during launch was the cause of a rupture in the insulating tiles, which was the cause of the shuttle's demise during reentry. Philosophers call this *event causation*, or *actual causation*, or *token-causation*.

Policy makers, statisticians, and social scientists usually deal with *kinds* of events, like graduating from college, or becoming a smoker, or playing lots of violent video games. For example, epidemiologists in the 1950s and 1960s looked for the kind of event that was causing a large number of people to get lung cancer, and they identified smoking as a primary cause. Philosophers call this *type-causation*, or *causal generalization*, or *causation among variables*.

The properties of causal relationships are different for actual causation and for causal generalizations. Actual causation is typically considered transitive, antisymmetrical, and irreflexive. If we are willing to say that one event A, say the *Titanic* hitting an iceberg on 12 April 1912,

caused another event B, its hull ripping open below the water line and taking on water moments later, which in turn caused a third event C, its sinking a few hours later, then surely we should be willing to say that event A (hitting the iceberg) caused event C (sinking). So actual causation is transitive. (Plenty of philosophers disagree, for example, see the work of Christopher Hitchcock.) It is antisymmetrical because of how we view time. If a particular event A caused a later event B, then B did not cause A. Finally, single events do not cause themselves, so causation between particular events is irreflexive.

Causal generalizations, however, are usually but not always transitive, definitely not antisymmetrical, and definitely not irreflexive. In some cases causal generalizations *are* symmetrical, for example, confidence causes success, and success causes confidence, but in others they are not, for example, warm weather causes people to wear less clothing, but wearing less clothing does not cause the weather to warm. So causal generalizations are *asymmetrical*, not antisymmetrical, like actual causation. When they are symmetrical, causal generalizations are reflexive. Success breeds more success and so forth.

logic, Kolmogorov's probabilities, That of course does not mean that Euclidean theories do not also contain definitions, but their definitions are not philosophical analyses of concepts. Nor does it mean that the work of Euclidean theories is confined to theorem proving: axioms may be reformulated to separate and illuminate their contents or to provide justifications (n.p.).

For causation, Socratic-style analyses dominated from approximately 1970 to the mid-1980s. By then, it had become apparent that all such theories either invoked noncausal primitives that were more metaphysically mysterious than causation itself, or were circular, or were simply unable to account for the asymmetry of causation or to separate spurious from real causation. Slowly, Euclidean style theories replaced Socratic ones, and by the early 1990s a rich axiomatic theory of causation had emerged that combined insights from statisticians, computer scientists, philosophers, economists, psychologists, social scientists, biologists, and even epidemiologists.

The 1970s and Early 1980s: The Age of Causal Analyses

Several different analyses of causation were given serious attention in the 1970s. One school gave an account based on counterfactuals, another used Hume's idea of regularity or constant conjunction, still another attempted to reduce causation to probabilistic relations and another to physical processes interacting spatiotemporally, and yet another was founded on the idea of manipulability.

The counterfactual theory. In the late 1960s Robert Stalnaker began the rigorous study of sentences that assert what are called *contrary-to-fact conditionals*. For example, "If the September 11, 2001, terrorist attacks on the United States had not happened, then the United States would not have invaded Afghanistan shortly thereafter." In his classic 1973 book *Counterfactuals*, David Lewis produced what has become the most popular account of such statements. Lewis's theory rests on two ideas: the existence of alternative "possible worlds" and a similarity metric over these worlds. For example, it is intuitive

OVERDETERMINATION AND PREEMPTION

A spy, setting out to cross the desert with some key intelligence, fills his canteen with just enough water for the crossing and settles down for a quick nap. While he is asleep, Enemy A sneaks into his tent and pokes a very small hole in the canteen, and a short while later enemy B sneaks in and adds a tasteless poison. The spy awakes, forges ahead into the desert, and when he goes to drink from his canteen discovers it is empty and dies of thirst before he can get water. What was the cause of the spy's death? According to the counterfactual theory, neither enemy's action caused the death. If enemy A had not poked a hole in the canteen, then the spy still would have died by poison. If enemy B had not put poison into the canteen, then he still would have died from thirst. Their actions overdetermined the spy's death, and the pinprick from enemy A preempted the poison from enemy B.

In the beginning of the movie *Magnolia*, a classic causal conundrum is dramatized. A

fifteen-year-old boy goes up to the roof of his ten-story apartment building, ponders the abyss, and jumps to his death. Did he commit suicide? It turns out that construction workers had installed netting the day before that would have saved him from the fall, but as he is falling past the fifth story, a gun is shot from inside the building by his mother, and the bullet kills the boy instantly. Did his mother murder her son? As it turns out, his mother fired the family rifle at his drunk stepfather but missed and shot her son by mistake. She fired the gun every week at approximately that time after their horrific regular argument, which the boy cited as his reason for attempting suicide, but the gun was usually not loaded. This week the boy secretly loaded the gun without telling his parents, presumably with the intent of causing the death of his stepfather. Did he, then, in fact commit suicide, albeit unintentionally?

that the possible world identical to our own in all details except for the spelling of my wife's middle name ("Anne" instead of "Ann") is closer to the actual world than one in which the asteroid that killed the dinosaurs missed the earth and primates never evolved from mammals.

For Lewis, the meaning and truth of counterfactuals depend on our similarity metric over possible worlds. When we say "if A had not happened, then B would not have happened either," we mean that for each possible world W_1 in which A did not happen and B did happen, there is at least one world W_2 in which A did not happen and B did not happen that is closer to the actual world than W_1 . Lewis represents counterfactual dependence with the symbol: $\square \rightarrow$, so $P \square \rightarrow Q$ means that, among all the worlds in which P happens, there is a world in which Q also happens that is closer to the actual world than all the worlds in which Q does not.

That there is some connection between counterfactuals and causation seems obvious. We see one event A followed by another B. What do we mean when we say A caused B? We might well mean that if A had not happened, then B would not have happened either. If the *Titanic* had not hit an iceberg, it would not have sunk. Formalizing this intuition in 1973, Lewis analyzed causation as a relation between two events A and B that both occurred such that two counterfactuals hold:

1. $A \square \rightarrow B$, and
2. $\sim A \square \rightarrow \sim B$

Because both A and B already occurred, the first is trivially true, so we need only assess the second in order to assess whether A caused B.

Is this analysis satisfactory? Even if possible worlds and a similarity metric among them are clearer and less metaphysically mysterious than causal claims, which many dispute, there are two major problems with this account of causation. First, in its original version it just misses cases of overdetermination or preemption, that is, cases in which more than one cause was present and could in fact have produced the effect.

Even more importantly, Lewis's counterfactual theory has a very hard time with the asymmetry of causality and only a slightly better time with the problem of spurious causation. Consider a man George who jumps off the Brooklyn Bridge and plunges into the East River. (This example is originally from Horacio Arlo-Costa and is discussed in Hausman, 1998, pp. 116–117.) On Lewis's theory, it is clear that it was jumping that caused George to plunge into the river, because had George not jumped, the world in which he did not plunge is closer to the actual one than any in which he just happened to plunge for some other reason at approximately the same time. Fair enough. But consider the opposite direction: if George had not plunged, then he would not have jumped. Should we assent to this counterfactual? Is a world in which George did not plunge into the river and did not jump closer to the real one than any in which he did not plunge but did jump? Most everyone except Lewis and his followers would

say yes. Thus on Lewis's account jumping off the bridge caused George to plunge into the river, but plunging into the river (as distinct from the idea or goal of plunging into the river) also caused George to jump. (Lewis and many others have amended the counterfactual account of causation to handle problems of overdetermination and preemption, but no account has yet satisfactorily handled the asymmetry of causality.)

For the problem of spurious causation, consider Johnny, who gets infected with the measles virus, runs a fever, and shortly thereafter gets a rash. Is it reasonable to assert that if Johnny had not gotten a fever, he would not have gotten a rash? Yes, but it was not the fever that caused the rash, it was the measles virus. Lewis later responded to this problem by prohibiting "backtracking" and to the problem of overdetermination and preemption with an analysis of "influence," but the details are beyond our scope.

Mackie's regularity account. Where David Lewis tried to base causation on counterfactuals, John Mackie tried to extend Hume's idea that causes and effects are "constantly conjoined" and to use the logical idea of necessary and sufficient conditions to make things clear. In 1974 Mackie published an analysis of causation in some part aimed at solving the problems that plagued Lewis's counterfactual analysis, namely overdetermination and preemption. Mackie realized that *many* factors combine to produce an effect, and it is only our idiosyncratic sense of what is "normal" that draws our attention to one particular feature of the situation, such as hitting the iceberg. It is a set of factors, for example, A: air with sufficient oxygen, B: a dry pile of combustible newspaper and kindling, and C: a lit match that *combine* to cause D: a fire. Together the *set* of factors A, B, and C are *sufficient* for D, but there might be other sets that would work just as well, for example A, B, and F: a bolt of lightning. If there were a fire caused by a lit match, but a bolt of lightning occurred that also would have started the fire, then Lewis's account has trouble saying that the lit match caused the fire, because the fire would have started without the lit match; or put another way, the match was not necessary for starting the fire. Mackie embraces this idea and says that X is a cause of Y just in case X is an Insufficient but Necessary part of an Unnecessary but Sufficient *set* of conditions for Y, that is, an INUS condition. The set of conditions that produced Y need not be the only sufficient set, thus the set is not necessary, but X should be an essential part of a set that is sufficient for Y.

Again, however, the asymmetry of causality and the problem of spurious causation wreak havoc with Mackie's INUS account of causation. Before penicillin, approximately 10 percent of those people who contracted syphilis eventually developed a debilitating disease called paresis, and nothing doctors could measure seemed to tell them anything about which syphilitics developed paresis and which did not. As far as is known, paresis can result only from syphilis, so having paresis is by itself sufficient for having syphilis. Consider applying Mackie's account to this case. Paresis *is* an INUS condition of syphilis, because it is sufficient by itself for having syphilis, but it is surely not a cause of it.

Consider the measles. If we suppose that when people are infected they either show both symptoms (the fever and rash) or their immune system controls it and they show neither, then the INUS theory gets things wrong. The fever is a necessary part of a set that is sufficient for the rash: {fever, infected with measles virus}, and for that matter the rash is a necessary part of a set that is sufficient for fever: {rash, infected with measles virus}. So, unfortunately, on this analysis fever is an INUS cause of rash and rash is also a cause of fever.

Probabilistic causality. Twentieth-century physics has had a profound effect on a wide range of ideas, including theories of causation. In the years between about 1930 and 1970 the astounding and unabated success of quantum mechanics forced most physicists to accept the idea that, at bedrock, the material universe unfolds probabilistically. Past states of subatomic particles, no matter how finely described, do not determine their future states, they merely determine the probability of such future states. Embracing this brave new world in 1970, Patrick Suppes published a theory of causality that attempted to reduce causation to probability. Whereas electrons have only a propensity, that is, an objective physical probability to be measured at a particular location at a particular time, perhaps macroscopic events like developing lung cancer have only a probability as well. We observe that some events seem to quite dramatically change the probability of other events, however, so perhaps causes *change the probability* of their effects. If $\Pr(E)$, the probability of an event E, changes given that another event C has occurred, notated $\Pr(E | C)$, then we say E and C are *associated*. If not, then we say they are *independent*. Suppes was quite familiar with the problem of asymmetry, and he was well aware that association and independence are perfectly symmetrical, that is, $\Pr(E) = \Pr(E | C) \Leftrightarrow \Pr(C) = \Pr(C | E)$. He was also familiar with the problem of spurious causation and knew that two effects of a common cause could appear associated. To handle asymmetry and spurious causation, he used time and the idea of *conditional* independence. His theory of probabilistic causation is simple and elegant:

1. C is a *prima facie* cause of E if C occurs before E in time, and C and E are associated, that is, $\Pr(E) < \Pr(E | C)$.
2. C is a *genuine cause* of E if C is a *prima facie* cause of E, and there is *no* event Z prior to C such that C and E are independent conditional on Z, that is, there is *no* Z such that $\Pr(E | Z) = \Pr(E | Z, C)$.

Without doubt, the idea of handling the problem of spurious causation by looking for other events Z that *screen off* C and E, although anticipated by Hans Reichenbach, Irving John Good, and others, was a real breakthrough and remains a key feature of any metaphysical or epistemological account that connects causation to probability. Many other writers have elaborated a probabilistic theory of causation with metaphysical aspirations, for example, Ellery Eells, David Papineau, Brian Skyrms, and Wolfgang Spohn.

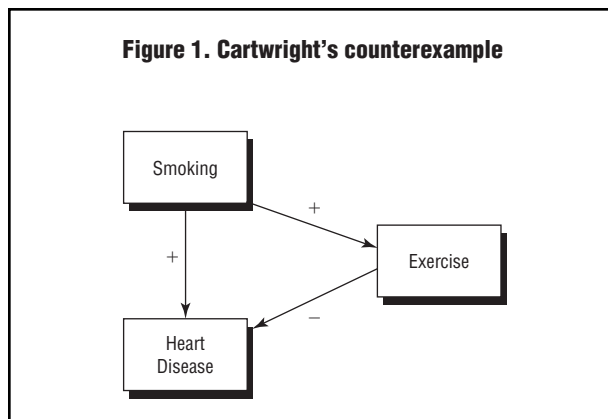

SOURCE: Courtesy of the author

Probabilistic accounts have drawn criticism on several fronts. First, defining causation in terms of probability just replaces one mystery with another. Although we have managed to produce a mathematically rigorous theory of probability, the core of which is now widely accepted, we have not managed to produce a reductive metaphysics of probability. It is still as much a mystery as causation. Second, there is something unsatisfying about using time explicitly to handle the asymmetry of causation and at least part of the problem of spurious causation (we can only screen off spurious causes with a *Z* that is prior in time to *C*).

Third, as Nancy Cartwright persuasively argued in 1979, we cannot define causation with probabilities alone, we need causal concepts in the definiens (definition) as well as the definiendum (expression being defined). Consider her famous (even if implausible) hypothetical example, shown in Figure 1: smoking might cause more heart disease, but it might also cause exercise, which in turn might cause *less* heart disease. If the negative effect of exercise on heart disease is stronger than the positive effect of smoking and the association between smoking and exercise is high enough, then the probability of heart disease given smoking could be *lower* than the probability of heart disease given not smoking, making it appear as though smoking prevents heart disease instead of causing it.

The two effects could also exactly cancel, making smoking and heart disease look independent. Cartwright's solution is to look at the relationship between smoking and heart disease within groups that are doing the same amount of exercise, that is, to look at the relationship between smoking and heart disease *conditional* on exercise, even though exercise does not in this example come before smoking, as Suppes insists it should. Why does Suppes not allow *Z*s that are prior to *E* but after *C* in time? Because that would allow situations in which although *C* really does cause *E*, its influence was entirely mediated by *Z*, and by conditioning on *Z* it appears as if *C* is *not* a genuine cause of *E*, even though it is (Fig. 2).

In Cartwright's language: Smoking should increase the probability of heart disease in *all causally homogeneous situations* for heart disease. The problem is circularity. By

referring to the causally homogeneous situations, we invoke causation in our definition. The moral Cartwright drew, and one that is now widely accepted, is that causation is *connected* to probability but cannot be *defined* in terms of it.

Salmon's physical process theory. A wholly different account of causation comes from Wes Salmon, one of the pre-eminent philosophers of science in the later half of the twentieth century. In the 1970s Salmon developed a theory of scientific explanation that foundered partly on an asymmetry very similar to the asymmetry of causation. Realizing that causes explain their effects but not vice versa, Salmon made the connection between explanation and causation explicit. He then went on to characterize causation as an interaction between two *physical processes*, not a probabilistic or logical or counterfactual relationship between events. A *causal interaction*, according to Salmon, is the intersection of two *causal processes* and the exchange of some invariant quantity, like momentum. For example, two pool balls that collide each change direction (and perhaps speed), but their total momentum after the collision is (ideally) no different than before. An interaction has taken place, but momentum is conserved. Explaining the features of a causal process is beyond the scope of such a short review article, but Phil Dowe has made them quite accessible and extremely clear in a 2000 review article in the *British Journal for Philosophy of Science*.

It turns out to be very difficult to distinguish real causal processes from pseudo-processes, but even accepting Salmon's and Dowe's criteria, the theory uses time to handle the asymmetry of causation and has big trouble with the problem of spurious causation. Again, see Dowe's excellent review article for details.

Manipulability theories. Perhaps the most tempting strategy for understanding causation is to conceive of it as how the world responds to an intervention or manipulation. Consider a well-insulated, closed room containing two people. The room temperature is 58 degrees Fahrenheit, and each person has a sweater on. Later the room temperature is 78 degrees Fahrenheit and each person has taken his or her sweater off. If we ask whether it was the rise in room temperature that caused the people to peel off their sweaters or the peeling off of sweaters that caused the room temperature to rise, then unless there was some strange signal between the taking off of sweaters and turning up a thermostat somewhere, the answer is obvious. Manipulating the room temperature from 58 to 78 degrees will cause people to take off their sweaters, but manipulating them to take off their sweaters will not make the room heat up.

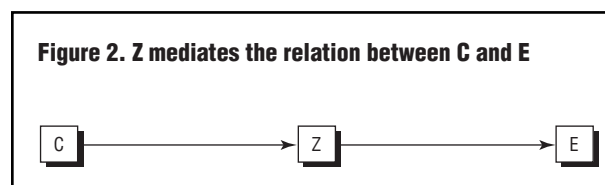

SOURCE: Courtesy of the author

In general, causes can be used to control their effects, but effects cannot be used to control their causes. Further, there is an invariance between a cause and its effects that does not hold between an effect and its causes. It does not seem to matter *how* we change the temperature in the room from 58 to 78 degrees or from 78 to 58, the co-occurrence between room temperature and sweaters remains. When the temperature is 58, people have sweaters on. When the temperature is 78, they do not. The opposite is not true for the relationship between the effect and its causes. It *does* matter how they come to have their sweaters on. If we let them decide for themselves naturally, then the co-occurrence between sweaters and temperature will remain, but if we intervene to make them take their sweaters off or put them on, then we will annihilate any co-occurrence between wearing sweaters and the room temperature precisely because the room temperature will not *respond* to whether or not people are wearing sweaters. Thus manipulability accounts handle the asymmetry problem.

They do the same for the problem of spurious causation. Tar-stained fingers and lung cancer are both effects of a common cause—smoking. Intervening to remove the stains from one’s fingers will not in any way change the probability of getting lung cancer, however.

The philosophical problem with manipulability accounts is circularity, for what is it to “intervene” and “manipulate” other than to “cause”? Intervening to set the thermostat to 78 is just to cause it to be set at 78. Manipulation is causation, so defining causation in terms of manipulation is, at least on the surface of it, circular.

Perhaps we can escape from this circularity by separating human actions from natural ones. Perhaps forming an intention and then acting to execute it *is* special, and *could* be used as a noncausal primitive in a reductive theory of causation. Writers like George Henrik von Wright have pursued this line. Others, like Paul Holland, have gone so far as to say that we have no causation without human manipulation. But is this reasonable or desirable? Virtually all physicists would agree that it is the moon’s gravity that causes the tides. Yet we cannot manipulate the moon’s position or its gravity. Are we to abandon all instances of causation where human manipulation was not involved? If a painting falls off the wall and hits the thermostat, bumping it up from 58 to 78 degrees, and a half hour later sweaters come off, are we satisfied saying that the sequence: thermostat goes up, room temperature goes up, sweaters come off was not causal?

Because they failed as reductive theories of causation, manipulability theories drew much less attention than perhaps they should have. As James Woodward elegantly puts it:

Philosophical discussion has been unsympathetic to manipulability theories: it is claimed both that they are unilluminatingly circular and that they lead to an implausibly anthropocentric and subjectivist conception of causation. This negative assessment among philosophers contrasts sharply with the widespread view among statisticians, theorists of experimental design, and many social and natural scientists that an appreciation of the

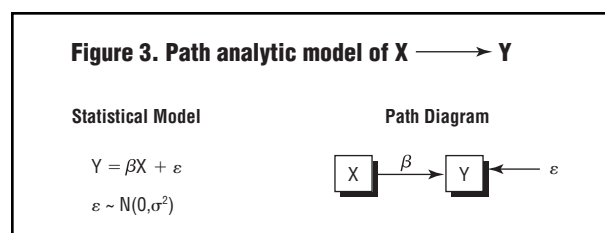

SOURCE: Courtesy of the author

connection between causation and manipulation can play an important role in clarifying the meaning of causal claims and understanding their distinctive features. (p. 25)

The Axiomatic and Epistemological Turn: 1985–2004

Although there will always be those unwilling to give up on a reductive analysis of causation, by the mid-1980s it was reasonably clear that such an account was not forthcoming. What has emerged as an alternative, however, is a rich axiomatic theory that clarifies the role of manipulation in much the way Woodward wants and connects rather than reduces causation to probabilistic independence, as Nancy Cartwright insisted. The modern theory of causation is truly interdisciplinary and fundamentally epistemological in focus. That is, it allows a rigorous and systematic investigation of what can and cannot be learned about causation from statistical evidence. Its intellectual beginnings go back to at least the early twentieth century.

Path analysis. Sometime around 1920 the brilliant geneticist Sewall Wright realized that standard statistical tools were too thin to represent the causal mechanisms he wanted to model. He invented “path analysis” to fill the gap. Path analytic models are causal graphs (like those shown in Figs. 1 and 2) that quantify the strength of each arrow, or direct cause, which allowed Wright to quantify and estimate from data the relative strength of two or more mechanisms by which one quantity might affect another. By midcentury prominent economists (e.g., Herbert Simon and Herman Wold) and sociologists (e.g., Hubert Blalock and Otis Dudley Duncan) had adopted this representation. In several instances they made important contributions, either by expanding the representational power of path models or by articulating how one might distinguish one causal model from another with statistical evidence.

Path models, however, did nothing much to help model the asymmetry of causation.

In the simplest possible path model representing that X is a cause of Y (Fig. 3), we write Y as a linear function of X and an “error” term (that represents all other unobserved causes of Y besides X. The real-valued coefficient β quantifies X’s effect on Y. Nothing save convention, however, prevents us from inverting the equation and rewriting the statistical model as:

$$X = \alpha Y + \delta, \text{ where } \alpha = 1/\beta \text{ and } \delta = -1/\beta \varepsilon$$

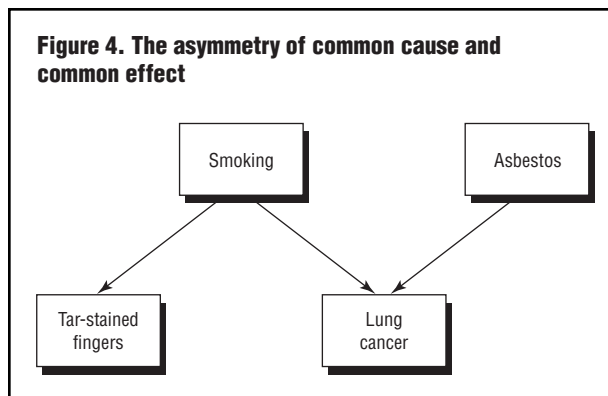

SOURCE: Courtesy of the author

This algebraically equivalent model makes it appear as if Y is the cause of X instead of vice versa. Equations are symmetrical, but causation is not.

Philosophy. In the early 1980s two philosophers of causation, David Papineau and Daniel Hausman, paying no real attention to path analysis, nevertheless provided major insights into how to incorporate causal asymmetry into path models and probabilistic accounts of causation. Papineau, in a 1985 article titled “Causal Asymmetry,” considered the difference between (1) two effects of a common cause and (2) two causes of a common effect (Fig. 4). He argued that two effects of a common cause (tar-stained fingers and lung cancer) are *associated* in virtue of having a common cause (smoking) but that two causes of a common effect (smoking and asbestos) are not associated in virtue of having a common effect (lung cancer). In fact he could have argued that the two effects of a common cause C are associated in virtue of C , but are *independent* conditional on C , whereas the two causes of a common effect E are *not* associated in virtue of E but are *associated* conditional on E .

Daniel Hausman, in a 1984 article (and more fully in a 1998 book *Causal Asymmetries*), generalized this insight still further by developing a theory of causal asymmetry based on “causal connection.” X and Y are *causally connected* if and only if X is a cause of Y , Y a cause of X , or there is some common cause of both X and Y . Hausman connects causation to probability by assuming that two quantities are associated if they are causally connected and independent if they are not. How does he get the asymmetry of causation? By showing that when X is a cause of Y , anything else causally connected to X is also connected to Y but not vice versa.

Papineau and Hausman handle the asymmetry of causation by considering not just the relationship between the cause and effect but rather by considering the way a cause and effect relate to other quantities in an expanded system. How does this help locate the asymmetry in the path analytic representation of causation? First, consider the apparent symmetry in the statistical model in Figure 3. X and ε are not causally connected and have Y as a common effect. Thus following both Papineau and Hausman, we will assume that X and ε are independent and that in any path model properly representing

a direct causal relation $C \rightarrow E$, C and the error term for E will be independent. But now consider the equation $X = \alpha Y + \delta$, which we used to make it appear that $Y \rightarrow X$. Because of the way δ is defined, Y and δ will be associated, except for extremely rare cases.

Statistics and computer science. Path analytic models have two parts, a path diagram and a statistical model. A path diagram is just a directed graph, a mathematical object very familiar to computer scientists and somewhat familiar to statisticians. As we have seen, association and independence are intimately connected to causation, and they happen to be one of the fundamental topics in probability and statistics.

Paying little attention to causation, in the 1970s and early 1980s the statisticians Phil Dawid, David Spiegelhalter, Nanny Wermuth, David Cox, Steffen Lauritzen, and others developed a branch of statistics called *graphical models* that represented the independence relationships among a set of random variables with undirected and directed graphs. Computer scientists interested in studying how robots might learn began to use graphical models to represent and selectively update their uncertainty about the world, especially Judea Pearl and his colleagues at the University of California, Los Angeles (UCLA). By the late 1980s Pearl had developed a very powerful theory of reasoning with uncertainty using Bayesian Networks and the Directed Acyclic Graphs (DAGs) attached to them. Although in 1988 he eschewed interpreting Bayesian Networks causally, Pearl made a major epistemological breakthrough by beginning the study of indistinguishability. He and Thomas Verma characterized when two Bayesian Networks with different DAGs entail the same independencies and are thus empirically indistinguishable on evidence consisting of independence relations.

Philosophy again. In the mid-1980s Peter Spirtes, Clark Glymour, and Richard Scheines (SGS hereafter), philosophers working at Carnegie Mellon, recognized that path analysis was a special case of Pearl’s theory of DAGs. Following Hausman, Papineau, Cartwright, and others trying to connect rather than reduce causation to probabilistic independence, they explicitly axiomatized the connection between causation and probabilistic independence in accord with Pearl’s theory and work by the statisticians Harry Kiiveri and Terrence Speed. Their theory of causation is explicitly nonreductionist. Instead of trying to define causation in terms of probability, counterfactuals, or some other relation, they are intentionally agnostic about the metaphysics of the subject. Instead, their focus is on the epistemology of causation, in particular on exploring what can and cannot be learned about causal structure from statistics concerning independence and association. SGS formulate several axioms connecting causal structure to probability, but one is central:

Causal Markov Axiom: Every variable is probabilistically independent of all of its noneffects (direct or indirect), conditional on its immediate causes.

The axiom has been the source of a vigorous debate (see the *British Journal for the Philosophy of Science* between 1999

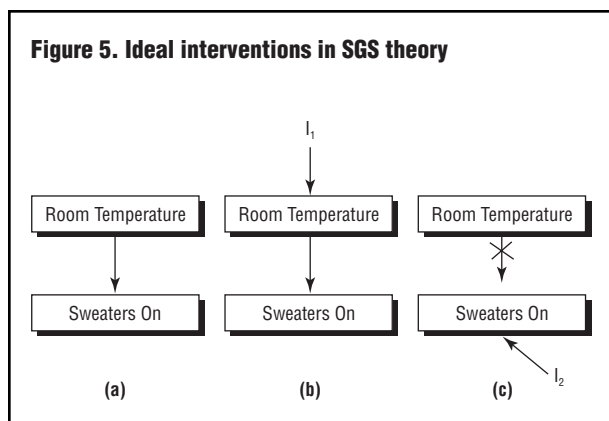

SOURCE: Courtesy of the author

and 2002), but it is only half of the SGS theory. The second half involves explicitly modeling the idea of a manipulation or intervention. All manipulability theories conceive of interventions as coming from outside the system. SGS model an intervention by adding a new variable external to the system that

1. is a direct cause of exactly the variable it targets and
2. is the effect of no variable in the system

and by assuming that the resulting system still satisfies the Causal Markov Axiom.

If the intervention completely determines the variable it targets, then the intervention is *ideal*. Since an ideal intervention determines its target and thus overrides any influence the variable might have gotten from its other causes, SGS model the intervened system by “x-ing out” the arrows into the variable ideally intervened upon. In Figure 5a, for example, we show the causal graph relating room temperature and wearing sweaters. In Figure 5b we show the system in which we have intervened upon room temperature with I_1 and in Figure 5c the system after an ideal intervention I_2 on sweaters on.

This basic perspective on causation, elaborated powerfully and presented elegantly by Judea Pearl (2000), has also been adopted by other prominent computer scientists (David Heckerman and Greg Cooper), psychologists (Alison Gopnik and Patricia Cheng), economists (David Bessler, Clive Granger, and Kevin Hoover), epidemiologists (Sander Greenland and Jamie Robins), biologists (William Shipley), statisticians (Steffen Lauritzen, Thomas Richardson, and Larry Wasserman), and philosophers (James Woodward and Daniel Hausman).

How is the theory epistemological? Researchers have been able to characterize precisely, for many different sets of assumptions above and beyond the Causal Markov Axiom, the class of causal systems that is empirically indistinguishable, and they have also been able to automate discovery procedures that can efficiently search for such indistinguishable classes of models, including models with hidden common causes. Even in

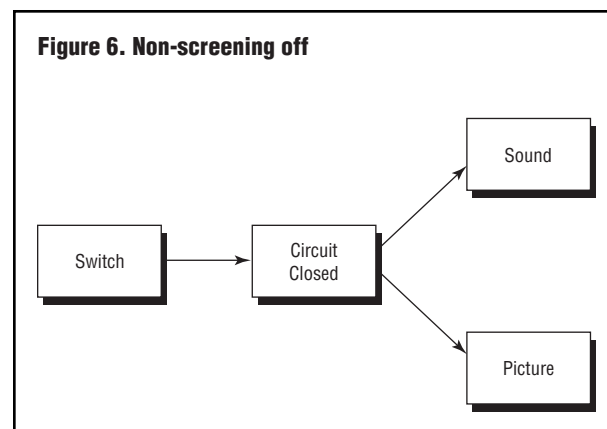

SOURCE: Courtesy of the author

such cases, we can still sometimes tell just from the independencies and associations among the variables measured that one variable is not a cause of another, that two variables are effects of an unmeasured common cause, or that one variable is a definite cause of another. We even have an algorithm for deciding, from data and the class of models that are indistinguishable on these data, when the effect of an intervention *can* be predicted and when it cannot.

Like anything new, the theory has its detractors. The philosopher Nancy Cartwright, although having herself contributed heavily to the axiomatic theory, has been a vocal critic of its core axiom, the Causal Markov Axiom. Cartwright maintains that common causes do not always screen off their effects. Her chief counterexample involves a chemical factory, but the example is formally identical to another that is easier to understand. Consider a TV with a balky on/off switch. When turned to “on,” the switch does not always make the picture and sound come on, but whenever it makes the sound come on, it also makes the picture come on (Fig. 6). The problem is this: knowing the state of the switch does not make the sound and the picture independent. Even having been told that the switch is on, for example, also being told that the sound is on adds information about whether the picture is also on.

The response of SGS and many others (e.g., Hausman and Woodward) is that it only appears as if we do not have screening off because we are not conditioning on *all* the common causes, especially those more proximate to the effects in question. They argue that we must condition on the Circuit Closed, and not just on the Switch, in order to screen off Sound and Picture.

A deeper puzzle along these same lines arises from quantum mechanics. A famous thought experiment, called the Einstein-Podolsky-Rosen experiment, considered a coupled system of quantum particles that are separated gently and allowed to diverge. Each particle is in superposition, that is, it *has no definite spin until it is measured*. J. S. Bell’s famous inequality shows that no matter how far apart we allow them to drift, the measurements on one particle will be highly correlated with

THE ASYMMETRY OF CAUSATION THROUGH CAUSAL CONNECTION

Two variables A and B are “causally connected” if either A is a cause of B, B a cause of A, or a third variable causes them both. If causation is transitive, then it turns out that everything causally connected to X is connected to its effects, but not everything connected to Y is connected to its causes. When $X \rightarrow Y$, everything causally connected to X is causally connected to Y (Fig. 7a), but something causally connected to Y is *not* necessarily causally connected to X (Fig. 7b).

Figure 7. The asymmetry in the transitivity of causal connection

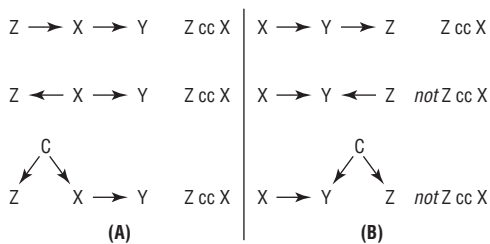

SOURCE: Courtesy of the author

the other, even after we condition on the state of the original coupled system. There are no extra hidden variables (common causes) we could introduce to screen off the measurements of the distant particles. Although the details are quite important and nothing if not controversial, it looks as if the Causal Markov Axiom might not hold in quantum mechanical systems. Why it should hold in macroscopic systems when it might not hold for their constituents is a mystery.

The SGS model of an intervention incorporates many controversial assumptions. In a 2003 tour de force, however, James Woodward works through all the philosophical reasons why the basic model of intervention adopted by the interdisciplinary view is reasonable. For example, Woodward considers why a manipulation must be modeled as a direct cause of only the variable it targets. Not just *any* manipulation of our roomful of sweater-wearing people will settle the question of whether sweater wearing causes the room temperature. If we make people take off their sweaters by blowing super-hot air on them—sufficient to also heat the room—then we have not *independently* manipulated just the sweaters. Similarly, if we are testing to see if confidence improves athletic performance, we cannot intervene to improve confidence with a muscle relaxant that also reduces motor coordination. These manipula-

tions are “fat hand”—they directly cause more than they should.

Woodward covers many issues like this one and develops a rich philosophical theory of intervention that is not reductive but is illuminating and rigorously connects the wide range of ideas that have been associated with causation. For example, the idea of an independent manipulation illuminates and solves the problems we pointed out earlier when discussing the counterfactual theory of causation. Instead of assessing counterfactuals like (1) George would not have plunged into the East River had he not jumped off the Brooklyn Bridge and (2) George would not have jumped off the bridge had he not plunged into the East River, we should assess counterfactuals about manipulations: (1′) George would not have plunged into the East River had he been independently manipulated to not jump off the Brooklyn Bridge and (2′) George would not have jumped off the bridge had he been independently manipulated not to have plunged into the East River. The difference is in how we interpret “independently manipulated.” In the case of 2′ we mean if we assign George to not plunging but leave everything else as it was, for example, if we catch George just before he dunks. In this way of conceiving of the counterfactual, George *would* have jumped off the bridge, and so we can recover the asymmetry of causation once we augment the counterfactual theory with the idea of an independent manipulation, as Woodward argues.

Conclusion

Although the whirlwind tour in this short article is woefully inadequate, the references below (and especially their bibliographies) should be sufficient to point interested readers to the voluminous literature on causation produced in the late twentieth century and early twenty-first century. Although the literature is vast and somewhat inchoate, it is safe to say that no reductive analysis of causation has emerged still afloat and basically seaworthy. What has been described here as the interdisciplinary theory of causation takes direct causation as a primitive, defines intervention from direct causation, and then connects causal systems to probabilities and statistical evidence through axioms, including the Causal Markov Axiom. Although it provides little comfort for those hoping to analyze causation Socratically, the theory does open the topic of causal epistemology in a way that has affected statistical and scientific practice, hopefully for the better. Surely that is some progress.

See also Empiricism; Epistemology; Logic; Quantum; Rationalism.

BIBLIOGRAPHY

Bell, J. “On the Einstein-Podolsky-Rosen Paradox.” *Physics* 1 (1964): 195–200.

Cartwright, Nancy. “Against Modularity, the Causal Markov Condition, and Any Link between the Two.” *British Journal for Philosophy of Science* 53 (2002): 411–453.

———. “Causal Laws and Effective Strategies.” *Noûs* 13 (1979).

———. *How the Laws of Physics Lie*. New York: Oxford University Press, 1983.

———. *Nature’s Capacities and Their Measurement*. New York: Oxford University Press, 1989.

- Dowe, Phil. "Causality and Explanation." *British Journal for Philosophy of Science* 51 (2000): 165–174.
- Glymour, Clark. "Review of James Woodward, *Making Things Happen: A Theory of Causal Explanation*." *British Journal for Philosophy of Science*. Forthcoming.
- Hausman, Daniel. *Causal Asymmetries*. New York: Cambridge University Press, 1998.
- . "Causal Priority." *Noûs* 18 (1984): 261–279.
- Halpern, J., and Judea Pearl. "Actual Causality." *IJCAI Proceedings*. 2002.
- Hitchcock, C. "The Intransitivity of Causation Revealed in Equations and Graphs." *Journal of Philosophy* 98 (2001): 273–299.
- . "Of Humean Bondage." *British Journal for Philosophy of Science* 54 (2003): 1–25.
- Holland, Paul. "Statistics and Causal Inference." *Journal of the American Statistical Association* 81 (1986): 945–960.
- Kiiveri, H., and T. Speed. "Structural Analysis of Multivariate Data: A Review." In *Sociological Methodology*, edited by S. Leinhardt. San Francisco: Jossey-Bass, 1982.
- Lauritzen, Steffen. *Graphical Models*. New York: Oxford University Press, 1996.
- Lewis, David. "Causation as Influence." *Journal of Philosophy* 97 (2000): 182–197.
- . *Counterfactuals*. Cambridge, Mass.: Harvard University Press, 1973.
- Mackie, John. *The Cement of the Universe*. New York: Oxford University Press, 1974.
- McKim, S., and S. Turner. *Causality in Crisis? Statistical Methods and the Search for Causal Knowledge in the Social Sciences*. Notre Dame, Ind.: University of Notre Dame Press, 1997.
- Meek, C., and C. Glymour. "Conditioning and Intervening." *British Journal for Philosophy of Science* 45 (1994): 1001–1021.
- Papineau, David. "Causal Asymmetry." *British Journal for Philosophy of Science* 36 (1985): 273–289.
- Pearl, Judea. *Causality: Models, Reasoning, and Inference*. New York: Cambridge University Press, 2000.
- . *Probabilistic Reasoning in Intelligent Systems*. San Mateo, Calif.: Morgan and Kaufman, 1988.
- Reichenbach, Hans. *The Direction of Time*. Berkeley: University of California Press, 1956.
- Salmon, Wes. *Scientific Explanation and the Causal Structure of the World*. Princeton, N.J.: Princeton University Press, 1984.
- Simon, Herbert. "Spurious Correlation: A Causal Interpretation." *JASA* 49 (1954): 467–479.
- Spirites, Peter, Clark Glymour, and Richard Scheines. *Causation, Prediction, and Search*. 2nd ed. Cambridge, Mass.: MIT Press, 2000.
- Spohn, Wolfgang. "Deterministic and Probabilistic Reasons and Causes." *Erkenntnis* 19 (1983): 371–396.
- Suppes, Patrick. *A Probabilistic Theory of Causality*. Amsterdam: North-Holland, 1970.
- Woodward, James. *Making Things Happen: A Theory of Causal Explanation*. Oxford: Oxford University Press, 2003.
- Wright, Sewall. "The Method of Path Coefficients." *Annals of Mathematical Statistics* 5 (1934): 161–215.

Richard Scheines

CAUSATION IN EAST ASIAN AND SOUTHEAST ASIAN PHILOSOPHY. Causation is defined most commonly as a relationship between two events or two states of

affairs in which the first brings about the second. The idea of causation has long existed among the peoples in South and East Asia, but as a historical notion, it has taken different forms of expression in these regions.

The Influence of Buddhism in South Asia

In South Asia, where the belief in reincarnation constituted an important philosophical base for both Hinduism and Buddhism, the concept of causation played a vital role in shaping one's outlook on life and history. According to Buddhism, all forms of existence are related one way or another in an infinite and endless causal web. Thus the creation theory, which is crucial to some religions, finds no place in Buddhism. Drawing on the incarnation belief, Buddhism also connects the life of this world to the next, in which the rise or fall of one's status leading to either salvation or condemnation is dependent on the karma one accumulates in this life. Ironically, however, this causal connection between this world and the next is not necessarily conducive to the development of historical consciousness because it dwells on the mutability, fluidity, and temporality of life, which breeds an extreme relativism that negates the meaning of life itself. Indeed, while Buddhism urges one to improve one's karma in life, it also stresses, extending the broad-based belief in eschatology in South Asia, that life is merely a fleeting bubble and that the world is extinguishable ablaze. Moreover, because everything is causally related in an infinite and endless web, nothing is constant or specifically consequential to anything else. Explanation for change also becomes unnecessary.

In its later development, however, Buddhism began to value life and history, which in turn translated its idea of causation into an important contribution to the development of historical thinking. In Theravada Buddhism, hagiological need led to the development of a scholastic trend. The same need also gave rise to a new concept of time, in which the birth of Buddha became a watershed in the otherwise completely cyclical flow of time. More important, the appearance of Buddha was not considered an accidental event, but a result of the work of an inexorable, omnipresent rule or norm. All this renders the Buddhist theory of causation germane to the study of history. Buddhists continue to situate the change of history in an infinite causal relation, or an "iron chain of causality," which leads them to a multilateral and simultaneous consideration of historical causation. In the meantime, they also seek to identify the specific causes for each event. They argue that even if the result is the same, the causal relation between the result and its causes remains unique. Historical change thus is regarded as an outcome of the concatenation of a number of divergent factors coming together in a unique circumstance and relationship.

The Influence of Confucianism in East Asia

In East Asia, the conception of causation was also characterized by relativism, or by a correlative way of thinking that, in both ontology and cosmology, took what Joseph Needham called "an organicist" approach to describing the relationship between humans and their environment. This correlative thought originated from speculations on the possible impact

of what happened in nature, or in Heaven, on human lives on Earth. But in its later development, particularly in the theoretical formations of yin and yang and the Five Elements/Phases (*wuxing*), it exerted a fundamental and pervasive influence on shaping the notion of causality in ancient China. Instead of searching for a linear, particulate cause, ancient Chinese approached causation in a circumambient (all-encompassing) manner, which allowed them to note an organic web of causal connection.

Out of its worldly interest and moral concerns, Confucianism appears more assertive in defining causal relations in human affairs, although it was by no means immune to the idea of a Heaven–humanity correlation in developing historical explanations. Confucius (551–479 B.C.E.), for example, believed that the rise and fall of political powers depended on the Mandate of Heaven. But dismayed by the decline of central government of his time, he nevertheless set out, after seeing the unicorn that to him suggested a mission charged by Heaven, to revise the *Spring and Autumn Annals*, hoping to bring about a punitive consequence for the unruly behaviors of officials and princes. Mencius (c. 371–c. 289 B.C.E.), devout follower of Confucius, claimed that Confucius’s effort was not in vain, indicating a belief in historical causation among the Confucians in that immoral behavior is to be condemned through the course of history. Throughout early imperial China, the idea of a Heaven–humanity correlation represented a major expression of historical causation, subscribed to by Dong Zhongshu (c. 194–c. 114 B.C.E.), a political theorist, as well as by Sima Qian (c. 145–86 B.C.E.), a court historian. Dong used it to forge a theory on dynastic succession for legitimizing the reigning Han dynasty (206 B.C.E.–220 C.E.), whereas Sima used it to help structure his interpretative framework of history. While a main framework, the correlative idea did not stop Sima from searching for other temporal and coincidental causes in explaining historical change. In fact, Sima was both commended and chided for demonstrating great curiosity for the “wonders” of history in his *Shiji* (The records of history). By comparison, Ban Gu (32–92 C.E.), also a Han historian, was narrower in his interest and more rigid in his method in seeking causal explanations for history, focusing on the bond between morality and history.

Diversifying Tradition in Post-Han Era

After the fall of the Han dynasty, China’s cultural tradition diversified as a result of the entrance of Buddhism, which gave rise to the expansion of Daoism and the resurgence of Confucianism. The theories of historical causation also flourished. Yet a general tendency remained identifiable, marked by the decline of the notion of a Heaven–humanity correlation. This decline was shown in the tradition, established in the seventh century, of writing official dynastic histories, which, following Ban Gu’s model, purported to draw analogies from the history of previous dynasties for the benefit of the reigning dynasty. Hence the writing of dynastic historiography amounted to a serious effort to find specific causal relations in history, rather than to apply the mysterious and superstitious correlative idea. In his *Zizhi tongjian* (A comprehensive mirror of aid for government), Sima Guang (1019–1086) made a valiant at-

tempt to generalize the causes for the successes and failures of the previous rulers. Of the important ones identified by him, few were attributed to the will of Heaven.

Yet the notion of Heaven remained important. Influenced by the metaphysics of Buddhism, the Neo-Confucians of the Song period (960–1279), such as Zhu Xi (1130–1200), averred that *li* (principle), or *tianli* (heavenly principle), was the ultimate cause for the change of history, commanding the ebb and flow of good and evil times. At the same time, they searched for *tianli*’s various worldly manifestations in order to demonstrate and explain the mutability and temporality of life and history. This effort was continued by Wang Fuzhi (1619–1692) in late imperial China and Arai Hakuseki (1657–1725) of Tokugawa Japan (1603–1867). Wang and Arai discussed the concept *shi* (circumstance), which they used to underscore the uniqueness of the causal relations of historical events, an emphasis also readily identifiable in the Buddhist construction of historical causation.

See also **Buddhism; Causation; Confucianism; Hinduism.**

BIBLIOGRAPHY

- Gokhale, B. G. “The Theravada-Buddhist View of History.” *Journal of the American Oriental Society* 85, no. 3 (1965): 354–360.
- Needham, Joseph. *History of Scientific Thought*. Vol. 2 of *Science and Civilisation in China*. Cambridge, U.K.: Cambridge University Press, 1956.
- Wu, Huaqi. *Zhongguo shixue sixiangshi*. Hefei, China: Anhui renmin chubanshe, 1996.

Q. Edward Wang

CENSORSHIP. Censorship comprises many methods of preventing the publication or dissemination of speech, printed matter, art, theater, music, electronic media, or other forms of expression. The most common subjects that are censored are religion, politics, and sex. The usual justification is that such expression is subversive, blasphemous, heretical, obscene, pornographic, or otherwise offensive or harmful. Censorship can take place before publication, known as prior restraint, in the form of requirements such as licensing and prior review. It can also take place after publication in such forms as banning, burning, or boycotting of the published product and fining, imprisonment, or the death penalty for the author or publisher.

The English term is derived from the ancient Roman institution of the censors, two elected magistrates responsible for overseeing the morals of the Roman people and who could warn or ban certain people or behavior at will. In later times censorship has often been carried out by individuals or committees appointed by religious or political authorities, but it can also be carried out by self-appointed vigilantes. The term has been expanded to include self-censorship, in which one does not express something for fear of the consequences, and market censorship, in which suppression of a publication is caused by the refusal of advertisers to advertise in it or of the public to buy it.

The political ideology of modern liberalism is generally against censorship on the ground that it limits freedom unnecessarily. By far the largest body of reflection on censorship has been written by its opponents. Those who are in a position to impose censorship have usually done it without articulating their reasons in any depth. Communitarian and autocratic ideologies such as socialism, national socialism, communism, absolute monarchism, and theocracy have generally done little more than assert that censorship protects the community and its leaders against perceived threats. In the late twentieth and early twenty-first centuries, there has been an upsurge in articulation of justifications for censorship. Radical feminists and spokespersons for ethnic, religious, or formerly colonized groups have supported censorship of pornography, “hate speech,” and criticism of themselves, pointing to the harm that uncensored expression can do.

Sex has been the target of much censorship. Objectionable sexual material is variously labeled obscene, pornographic, indecent, or degrading. Obscenity has been defined as having a tendency to deprave or corrupt; as appealing to prurient interest; or as being offensive to prevailing moral standards. Pornography has been defined as explicit depiction of sexual behavior intended to cause arousal. Censorship of these matters is sometimes limited to shielding younger age-groups, and it is sometimes claimed that this type of censorship should only be applied if there is no redeeming scientific, artistic, or political value to sexual materials. Since the 1980s, censorship has been justified by the argument that pornography is equivalent to rape.

Almost no one believes in absolute freedom of expression. Libel, slander, and defamation are prohibited by nearly every legal code. These prohibitions are not usually considered to be censorship, but rather a part of tort law.

It is widely accepted that prior restraint is more effective at preventing expression than postpublication censorship. The requirement to submit items for approval may intimidate someone into not submitting something that might actually be approved or that might not attract negative attention if it were published. Postpublication punishment is rarely fully effective: the censors might miss a few items entirely, and when books or recordings that have already been published are destroyed, a few copies can often be saved surreptitiously.

Blasphemy, Heresy, and Atheism

Socrates (c. 470–399 B.C.E.) was put to death in ancient Greece for introducing new gods, among other charges. Later, the main religions introduced doctrines of blasphemy and heresy as justifications for censorship. For the Jews blasphemy meant insult to God and was closely related to idolatry. The Christians expanded the meaning to include insult to Christ, and they tended to confuse blasphemy with heresy, or theological error. There is little evidence that blasphemy was a major concern in early Islam, but in 1989 a *fatwa* in Iran called for the death penalty against the author Salman Rushdie (1947–) for blasphemy. The same year, Hindu fundamentalists issued a death threat against the historian M. M. Kalburgi for blasphemy.

In the widest meaning of heresy, the beliefs of every sect are heresies to every other sect, but it is usually the dominant orthodoxy that gets to define the heretical for practical purposes. Censorship of heresies can begin with prohibition of expression and develop through excommunication and punishment up to the death penalty. Atheism is a heresy to most religions and is sometimes considered worse than mere adherence to a mistaken religion. In ancient Greece, Anaxagoras (c. 500–c. 428 B.C.E.) was prosecuted for denying the existence of the gods.

The Catholic Church developed the most sophisticated early censoring apparatus in the form of the Inquisitions and *Index*. In 1231 the Dominican and Franciscan orders were charged with inquiry into the spread of heresy, an undertaking later known as the Inquisition. The Spanish Inquisition was instituted in 1478, and after various experiments with local inquisitions, a centralized Roman Inquisition was set up in 1542 to root out heresy. Lists of banned books were published in Paris (1544), Lucca (1545), Louvain (1546), and Venice (1549). In 1559 the first *Index of Prohibited Books* was issued at the Council of Trent, and a separate papal Congregation of the Index, set up in 1571, continued to issue an *Index* every few decades until it was abolished in 1966. Enforcement of such efforts at censorship depends in part on the climate of public opinion: in the eighteenth century, for example, sale of the *Index* was banned in Austria because people were buying it to use as a guide to reading.

Political Subversion

Because his pupils were closely allied to the oligarchy, it is arguable that the real reason for the persecution of Socrates was his political stance. Plato's *Laws* (c. 350 B.C.E.) makes the case for wide powers of censorship in order to prevent innovation: If no new songs and books are allowed and few people are allowed to travel, there will be no new ideas and no pressure for harmful political change.

In the Roman Empire, censorship of writers was often provoked by political satires of the emperors. In later times, political authorities have often censored expressions that they perceived to be threatening to their power and social stability, even claiming that any opposition to their persons or policies is treason.

The Netherlands and England

The first two countries to have substantial freedom from censorship were the Netherlands and England. At the time of the Dutch Revolt (1568–1648), the chaos of civil war, an extreme federalism consisting of numerous jurisdictions, and the growing economic importance of the commercial book market meant that the Dutch civil authorities were too exhausted to initiate effective censorship, that what was banned in one jurisdiction could be published in another, and that economic interests opposed censorship in the Netherlands. Protestant criticism of the Catholic Inquisition and *Index* also made it difficult to justify Protestant censorship. Similar reasons encouraged effective limits on censorship during the English Civil War and Commonwealth (1642–1660).



Postal Censorship Office in England, 1939. During World Wars I and II, mail in the participating countries was frequently censored to ensure that specifics about military strengths or weaknesses were not being leaked or that propaganda was not being spread. © HULTON-DEUTSCH COLLECTION/CORBIS

The English philosopher Thomas Hobbes articulated the case for censorship in his *Leviathan* (1651). A philosophical nominalist, Hobbes believed very much in the importance of words and even claimed that the English Civil War was caused by too much reading of ancient republican authors. Therefore, he argued, the prince should have control over all forms of expression, a position frequently emulated by political authorities elsewhere. But even Hobbes did not articulate a full case for censorship with no exceptions. He warned princes against wasting valuable power trying to control people's minds when unnecessary.

The first major articulation of opposition to censorship was John Milton's (1608–1674) *Areopagitica* of 1644. He associated licensing with the infamous Inquisition of the Catholic Church and argued that knowledge of errors helps confirm the truth. Also among his arguments were that books cannot be suppressed without great harm to learning, and most people do not learn their evil ways from books. The censors

are not infallible, he said, and the attempt to regulate all forms of expression would be both exhausting and futile. Furthermore, he said, criticism of magistrates helps keep them informed. As usual, there were limits to Milton's tolerance: he approved of suppression of Catholics and the impious as threats to society. In the same period, Henry Robinson argued in *Liberty of Conscience* (1644) for liberty of the press on the ground that it was good for business.

The Dutch writer Benedictus de Spinoza (1632–1677) wrote provocative historical criticism of the Bible in his *Theological-Political Treatise* (1670), which also called for the freedom of every person to think what he wanted and to say what he thought. Spinoza's posthumously published *Ethics* (1677) argued for materialism, which was widely interpreted as atheism, and also asserted that part of the definition of a free man is one who can say what he thinks. Even though he wrote in Latin to avoid attention from anybody but the most educated, Spinoza's work was widely banned, and his followers were persecuted and censored throughout the following century.

Charles Blount (1654–1693) published *A Just Vindication of Learning* in 1679, and in *Miracles, No Violation of the Laws of Nature* (1683), he offered the first translation of part of Spinoza's work into English. His *Reasons Humbly Offered for the Liberty of Unlicens'd Printing* (1693) retailed Milton's reasoning and may have influenced Parliament's decision not to renew the Licensing Act in 1695. Like Milton, the English philosopher John Locke (1632–1704) opposed toleration of atheists and Catholics, and he also wrote several memoranda in the 1690s against the renewal of the Licensing Act. "I know not why a man should not have liberty to print what ever he would speake, and to be answerable for the one just as he is for the other if he transgresses the law in either," he wrote. When the Licensing Act expired in 1695 without renewal, England had de facto press freedom.

The deist John Toland (1670–1722) was responsible for the widespread distribution of Milton's *Areopagitica* in his 1698 edition of Milton's complete works, and he attacked censorship in several later publications. Other English deists from Anthony Collins to Matthew Tindal also defended freedom of expression. Both Spinoza and the deists are examples of radical philosophers in opposition to censorship.

James Mill (1773–1836) and his son John Stuart Mill (1806–1873) updated many of the arguments against censorship that had circulated in English, French, and German before them. James Mill argued that true statements about individuals should never be censored and that only direct obstruction of government operations should be censored, not general objections to policy. John Stuart Mill insisted that we do not really know anything unless we have considered the alternatives to it and that there is some truth in every opinion.

From Bayle to Constant

In the francophone world, the Huguenot refugee Pierre Bayle (1647–1706) penned the first general justification of the publication of obscenity. His "An Explanation Concerning Obscenities" (1702) argued that outright recommendation of lewdness and debauchery should be punished, but anything less than that should be left to the people to judge for themselves. The works of great authors such as Giovanni Boccaccio are protected by a "right" of the republic of letters, he argued, and even the Bible contains accounts of lewdness. Finally, he said that historians can report obscene things as mere facts of history, and no one is forced to read them. Bayle also wrote against censorship of atheists.

In 1747 Elie Luzac (1723–1796) published the atheistic *Man a Machine* by J. O. de La Mettrie, which resulted in much scandal. He was forced to turn over most copies for burning. Luzac then wrote his *Essay on Freedom of Expression* (1749) in order to defend freedom of the press. He relied on the tradition of natural law and claimed that the expression of ideas can never be harmful to society: false ideas will be refuted, and even true ideas will not be fully convincing unless we have seen the false alternatives. Luzac also pointed out that prohibited books will circulate underground anyway. He was no social or political radical, and his work demonstrates that conservatives can oppose censorship.

When her work was attacked in the press, Germaine de Staël (1766–1817) wrote in favor of censorship. Her intellectual companion, Benjamin Constant (1767–1830), countered with the case against censorship in many writings, including *Principles of Government Applicable to All Representative Governments* (1815). He agreed that writers who preach murder, theft, and pillage should be punished, but he argued that most pamphlets are harmless.

From Schmidt to Bahrdr

In the German-speaking world, substantial freedom of the press emerged from the multiple jurisdictions in the region, but authors were still imprisoned for their publications. Johann Lorenz Schmidt's (1702–1749) rationalist translation of the Bible in 1735 was outlawed in 1737, and he was imprisoned but escaped. The introduction to his German translation (1741) of Matthew Tindal's *Christianity as Old as the Creation* included a 130-page prefatory essay on freedom of the press, which may have been the first extended critique of censorship in German. Schmidt also translated Spinoza's *Ethics* into German in 1744.

Joseph II (1741–1790) relaxed press controls in the Habsburg Empire, and Frederick II of Prussia (1712–1786) generally limited censorship to political matters, not attacks on religion. In the decades of ferment after about 1770, many German writers called for press freedom. Christoph Martin Wieland's periodical *German Mercury* called press freedom the palladium of humanity in 1784; August Ludwig von Schlözer's *Letters to Eichstädt in Vindication of Publicity* (1785) rejected a bishop's censorship; and Johannes Kern's *Letters on Freedom of Thought, Belief, Speech, and the Press* (1786) based such freedoms on the social nature of mankind. The philosopher Immanuel Kant (1724–1804) elevated press freedom into the transcendental principle of public law.

Carl Friedrich Bahrdr's *On Freedom of the Press and Its Limits* (1787) consolidated much of the foregoing German material into an extended critique of censorship. He labeled freedom of the press a human right and argued that people only really believe truths they have found for ourselves. He opposed suppression of atheism and claimed that all human progress depends on mutual communication. Bahrdr was willing to condone censorship of state secrets and private matters and spelled out what later became known as the public figure doctrine. His satire of the Prussian king Frederick William II, *The Edict of Religion* (1788), landed him in prison for more than a year.

Pushkin and Solzhenitsyn

In the nineteenth and twentieth centuries, two Russian writers penned brilliant critiques of censorship. Aleksandr Pushkin's (1799–1837) long poems "Epistle to the Censor" (1822) and "Second Epistle to the Censor" (1824) could not be published in his lifetime. They described censors as gloomy, "meddling eunuchs." Aleksandr Solzhenitsyn's (1918–) "Letter to the Fourth Writers Congress" (1967) called censorship a survival from the Middle Ages and complained about the power of ignorant censors over literature.

Legal Declarations

In 1767 Sweden became the first country in the world to declare official freedom of the press, although a number of countries already had de facto freedom from censorship by then. However, Sweden's law specifically excepted matters of religion, one of the most common matters censored. In 1770 Denmark became the first to end censorship of all subjects. The decree was the work of Prime Minister Johann Friedrich Struensee (1737–1772), whose publications had been censored in Hamburg a decade before. He was overthrown and executed in 1772, but prior restraint of the press was not reimposed.

The fledgling United States was the site of several declarations of freedom of the press. The Virginia Declaration of Rights (1776) asserted that freedom of the press is one of the bulwarks of freedom itself, and declarations and constitutions in Pennsylvania (1776), Delaware (1776), North Carolina (1776), Vermont (1777), South Carolina (1778), and other states contained similar provisions. These provisions were precedents for the First Amendment to the United States Constitution (1791), which holds that "Congress shall make no law . . . abridging the freedom of speech, or of the press." How these words would be interpreted, of course, would have a great effect on censorship in the United States. Thomas Jefferson, for example, was highly in favor of freedom of the press until he became president, when he prosecuted newspapers that criticized his policies.

Article 11 of the French Declaration of the Rights of Man of 1789 provided that "Every citizen may freely speak, write, and print, subject to accountability for abuse of this freedom."

Many European constitutions of the nineteenth century abolished censorship. Article 19 of the United Nations Universal Declaration of Human Rights (1948) provides that "Everyone has the right to freedom of opinion and expression; this right includes freedom to . . . seek, receive and impart information and ideas through any media."

Sites of Censorship

Public libraries, museums, and schools are common sites of efforts to censor. The financing of libraries and museums by the public is alleged to confer a different standard than the open market, and protection of children from harmful materials is the usual justification for censorship of schoolbooks.

The development of each new medium of communication has brought with it efforts to censor that medium. Internet censorship is the latest in that line, with authorities around the world trying more or less effectively to limit access to certain Web sites and information.

Another late-twentieth-century phenomenon is the spread of "hate speech" codes on academic campuses. Intended to protect the vulnerable against speech that is alleged to express hate, the codes are open to wide-ranging interpretation and amount to imposition of judgments by whomever controls the censoring apparatus. Wherever anyone alleges that the expressions of others are insulting, offensive, or degrading, presumably those others could assert that the former's allegations are insulting, offensive, or degrading to them.

China has been a particularly active site for censorship and protests against it since the 1990s, but few observers from other countries can indulge in complacency. Derek Jones's *Censorship* (2001) details numerous cases of censorship of writers, directors, and artists on every continent and in almost every country in the twentieth century.

Censorship is not always an unmitigated bane for writers, artists, and publishers. One advantage is that it draws attention to works and causes. Authors have actively sought book burnings for the publicity value, and some books that have been taken off prohibited lists have seen their sales drop. Artistic careers have been made from the martyr value of censorship.

See also Arts; Democracy; Liberty; Power.

BIBLIOGRAPHY

PRIMARY SOURCES

- Bahrdr, Carl Friedrich. *On Freedom of the Press and Its Limits*. In *Early French and German Defenses of Freedom of the Press*, edited by John Christian Laursen and Johan van der Zande. Leiden, Netherlands: Brill, 2003. Originally published in 1787.
- Bayle, Pierre. "An Explanation Concerning Obscenities." In *Bayle: Political Writings*, edited by Sally L. Jenkinson. Cambridge, U.K., and New York: Cambridge University Press, 2000.
- Locke, John. "Appendix: Documents Relating to the Termination of the Licensing Act, 1695." In *The Correspondence of John Locke*, edited by E. S. De Beer. Vol. 8. Oxford: Clarendon, 1979.
- Luzac, Elie. *Essay on Freedom of Expression*. In *Early French and German Defenses of Freedom of the Press*, edited by John Christian Laursen and Johan van der Zande. Leiden, Netherlands: Brill, 2003. Originally published in 1749.
- Milton, John. *Areopagitica*. In *Areopagitica, and Other Political Writings of John Milton*, edited by John Alvis. Indianapolis: Liberty Fund, 1999. Originally published in 1644.
- Spinoza, Benedictus de [Baruch]. *Theological-Political Treatise*. Translated by Samuel Shirley. 2nd ed. Indianapolis: Hackett, 2001. Originally published in 1670.

SECONDARY SOURCES

- Coetzee, J. M. *Giving Offense: Essays on Censorship*. Chicago: University of Chicago Press, 1996.
- Foerstel, Herbert N. *Free Expression and Censorship in America: An Encyclopedia*. Westport, Conn.: Greenwood, 1997.
- Goldstein, Robert Justin, ed. *The War for the Public Mind: Political Censorship in Nineteenth-Century Europe*. Westport, Conn.: Praeger, 2000.
- Harrison, Nicholas. *Circles of Censorship: Censorship and its Metaphors in French History, Literature, and Theory*. Oxford: Clarendon, 1995.
- Index on Censorship* (spring 1972–). Quarterly magazine.
- Israel, Jonathan. "The Intellectual Debate about Toleration in the Dutch Republic." In *The Emergence of Tolerance in the Dutch Republic*, edited by C. Berkvens-Stevelinck, J. Israel, and G. H. M. Posthumus Meyjes. Leiden, Netherlands: Brill, 1997.
- Jones, Derek, ed. *Censorship: A World Encyclopedia*. 4 vols. London and Chicago: Fitzroy Dearborn, 2001.

Spalding, Paul. *Seize the Book, Jail the Author: Johann Lorenz Schmidt and Censorship in Eighteenth-Century Germany*. West Lafayette, Ind.: Purdue University Press, 1998.

John Christian Laursen

CELL THEORY. See **Biology; Genetics: History of; Science, History of.**

CHAIN OF BEING. See **Hierarchy and Order.**

CHANGE. “Cold things warm up, the hot cools off, wet becomes dry, dry becomes wet,” observes Heraclitus (fr. 126), as if to state an obvious fact. Yet this fact became highly troublesome to early philosophers.

Antiquity

Although his predecessors had theories to account for natural changes, Heraclitus (c. 540–c. 480 b.c.e.) seems to be the first Western thinker to raise philosophical questions about change itself. According to Plato, Heraclitus held that (1) all things are changing, and (2) comparing life to a river, he claimed that one could not step twice into the same river (Cratylus 402a). On the basis of these two theses Plato draws the conclusion that (3) Heraclitus maintained that contradictory propositions were true (Theaetetus 182–183). In fact, Heraclitus seems to have held a more defensible, if still radical, view. Plato probably derives (1) and (2) directly from Heraclitus fr. 12: “On those stepping into the same rivers, other and other waters flow.” Instead of saying the rivers are different, Heraclitus says they are the same—in contrast to the waters that comprise them. From this and other fragments we can extract a theory that although there is constant change in the materials of the world, stable structures supervene on them. Indeed, Heraclitus seems to imply that if there were not constant exchanges of matter, the structures would not exist; for instance, if the water ceased to flow, the river would cease to be.

The Eleatic challenge. In contrast to Heraclitus, Parmenides (b. c. 515 B.C.E.) of Elea (possibly reacting to Heraclitus, though this is controversial) denies the possibility of change. Rejecting the way “that it is not” because what-is-not could not be uttered (fr. 2), Parmenides rules out whatever properties rely on not-being. Since coming to be or perishing presuppose a time when something is not, they are not allowed, and similarly motion (in place?) is to be rejected (fr. 8). Parmenides enumerates several kinds of change: “coming to be and perishing, being and not being, changing place and exchanging bright color” (fr. 8.40–41). He seems to reject all of these as impossible. Parmenides’ argument presents a problem often called the “Eleatic challenge”: how can what-is come from what-is-not? The challenge poses a direct threat to cosmogony, the standard kind of pre-Socratic theory. After Parmenides, most cosmological theories posited the existence of a plurality of continuing materials that were individually supposed to be everlasting, for instance the four elements of

Empedocles (c. 490–c. 430 B.C.E.): earth, water, air, and fire. Thus cosmologists could claim that they did not allow coming to be or perishing of the ultimate realities, but only a harmless rearrangement of them. Nonetheless, Parmenides’ argument seems to rule out not only coming to be and perishing, but all other kinds of change as well, and also to preclude a plurality of existences. Reinforced and sharpened by Zeno of Elea (c. 495–c. 430 B.C.E.) and Melissus of Samos (5th c. B.C.E.), the Eleatic challenge seems to have gone unanswered for more than a century.

Plato’s response. Perhaps influenced by the lectures of Cratylus (a follower of Heraclitus), Plato (c. 428–348 or 347 B.C.E.) attributes a radical flux to the world of sensible things: they are always changing and never completely stable. If sensible things were the only existing things, knowledge and even discourse about the world would be impossible. But there is another world of changeless realities, the Forms, which provide a stable structure for sensible things, referents for language, and objects for knowledge. Forms, such as Justice and Equality, and perhaps *Being*, have Parmenidean properties but no Heraclitean properties. Thus Plato creates a two-world theory, in which Heraclitean change of sensible things is tempered by Parmenidean constancy of ideal things. In his later work, Plato even posits a Form of Motion and another of Rest as ultimate kinds in which all sensible things participate (*Sophist* 254d). Unfortunately, a Form of Motion does not allow for any analysis of different kinds of motion or of different stages within a motion. Plato claims that the ultimate source of orderly motion is soul, which is immortal and self-moving (*Phaedrus* 245c–e).

Aristotle. Aristotle (384–322 B.C.E.) provides the first systematic study of change. He maintains that only primary substances can survive a change of one property to its opposite, implying that changes are variations in properties over time (*Categories* 5). He distinguishes several types of change by the kind of entity involved: coming-to-be and its opposite perishing (change in the category of substance), alteration (change of quality), increase and decrease (change of quantity), and locomotion (change of place) (*ibid.* 14). In *Physics* I, he sets out to answer the Eleatic challenge. Observing that changes always involve a subject changing from one opposite state to another, he generalizes this scheme to the most problematic case: that of change in substance. Even in this case there is some continuing subject for a change from one state to its opposite, as in the case of bronze, which goes from being unformed to being formed (in a statue). Similarly, there is some continuing substratum for something going from being not-human to human; the substratum for substantial change can be called matter (e.g., bronze), the negative state the privation (e.g., not-formed), the positive state the form (e.g., formed). On this model, though the final object comes from what-is-not, it does not come from nothing: the negative state is not nonexistence, but characterizes something that is, e.g., the bronze. “What-is-not” is seen to pick out not-*F*, and to presuppose a matter *m*, and not to refer to nothing at all. The Eleatic challenge rests on a mistake.

Aristotle sets out the circumstances of change as follows: a cause of motion *M* causes an object *O* to change from condition

(place, property, etc.) C_1 to C_2 between times t_1 and t_2 (*Physics* V 1). In those cases in which O does not come to be or perish (undergo change of substance), the change is a *motion*. We may identify the circumstances with identity conditions: two changes are the same just in case they have the same mover, object, initial and final conditions, and beginning and ending times.

Not satisfied with a general definition and defense of change, Aristotle seeks to identify its place in the cosmos. Some things are always in motion (e.g., the heavenly bodies), some always at rest (e.g., the earth), and some things are at different times in motion and at rest (e.g., animals). Because there can be no beginning of time, but time is only the measure of regular motion, there must always have been cosmic motion. The only kind of motion that can be everlasting is locomotion in a circle (seen in the heavenly bodies). Such everlasting motion is only possible if there is some unmoved entity that causes the motion (*Physics* VIII). This is the first unmoved mover, which acts as a final cause, so that the heavenly bodies try to imitate its perfect (but motionless) actuality. Aristotle assumes that motion needs some sort of explanation, and everlasting motion needs an everlasting cause.

Christian Platonism. Throughout late antiquity and the Middle Ages, Platonic and Aristotelian concepts of change continued to provide the standard account. There is, however, one important departure from classical theories that early Christian thinkers made: beginning in the second century C.E. they began to claim that God created the world *ex nihilo* (out of nothing), contrary to the classical notion expressed by Parmenides that what-is could not come from what-is-not. The Creation was a miraculous event caused by an omnipotent God.

Later Platonists interpreted Plato as saying that there was a simple and perfect One from which Mind (including the Platonic Forms) emanated; from Mind, Soul emanated, and from Soul, matter. Emanation was a kind of ontological overflowing according to which one being gave of its fullness to produce a lower-level being; the lower being proceeds from the higher in a timeless way such that the lower is always in existence, but dependent on the higher. Temporal distinctions are found only in the lower beings, so that the One and Mind are not in time and hence not subject to change.

In Christian Platonism, both *ex nihilo* creation and a changeless deity are combined with a historical account of God's interaction with the world, as in St. Augustine of Hippo's (354–430) *City of God*. Paradoxically, a changeless God interacts with changeable mortals to produce the drama of human salvation.

Modern Era

In the modern era a fundamental reorientation in the theory of motion occurred when the principle of inertia was recognized. Put forth first by René Descartes (1596–1650) and Pierre Gassendi (1592–1655), and canonized by Isaac Newton (1642–1727) as his first law, the principle stated that a body in uniform straight motion tends to stay in motion, and a body at rest tends to stay at rest. Thus the physicist did not need to explain continued motion. Moreover, since Newton's

law of gravity could account for elliptical motions of satellites around a massive body, there was no longer any need for an unmoved mover to maintain the cosmic order. The kind of kinetic change that needed to be explained was acceleration, which depended on the application of a force to the moving body. John Locke (1632–1704) identified motion and rest as primary qualities whose ideas resembled the originals; colors and the like were secondary qualities whose ideas did not resemble the originals. Increasingly, motion in place came to be seen as the fundamental kind of change, which accounted for all other kinds.

History and physics. Up until the nineteenth century, the study of history had been of little interest to philosophers. Aristotle had said that history was less philosophical than poetry, because it dealt with the particular rather than the universal. But when Georg Wilhelm Friedrich Hegel (1770–1831) explained the development of consciousness as a dialectical progression leading to ever more comprehensive concepts, he made history vitally important to philosophy. In particular the history of thought seemed to reflect the growth of spirit, exemplifying the realization of freedom and self-consciousness. An understanding of the development of culture and human institutions was now indispensable for philosophy. Historical change was essential to human self-realization. Becoming was the fulfillment of the concepts of *being* and *not-being*.

Although the historicist idealism launched by Hegel was highly influential, it eventually occasioned a strong reaction in England. One of the leading critics of idealism, Bertrand Russell (1872–1970), argued against “internal relations” by which every event was necessarily connected with every other. Instead, he proposed that the world consisted of a set of independent facts. Change itself could be defined in terms of propositions: “Change is the difference, in respect of truth or falsehood, between a proposition concerning an entity and a time T , and a proposition concerning the same entity and another time T' , provided that the two propositions differ only by the fact that T occurs in one where T' occurs in the other” (sec. 442). Thus if “Socrates is literate at T ” is false and “Socrates is literate at T' ” is true for the times 465 B.C.E. and 450 B.C.E., respectively, we can infer a change. Against Russell, John M. E. M'Taggart (1866–1925) has argued that we should distinguish between an “A series” of events ordered with respect to past, present, and future, and a “B series” ordered with respect to before and after; only the former entails the existence (the flow) of time, since the latter involves only a fixed sequence of determinate events. But the A series produces contradiction, since every event is allegedly past, present, and future, that is, has incompatible predicates. Thus the A series is incoherent, and consequently there is no time and hence no change. Yet one can reply that the B series provides an adequate basis for time and change, and that the predicates *past*, *present*, and *future* are no more incompatible than *taller* and *shorter*: they are incomplete predicates, which, when properly completed for a given subject, would not produce a contradiction: “past with respect to time T_3 [or event E_3 , etc.],” “present with respect to T_2 ,” “future with respect to T_1 .” The kinds of changes described by Russell's and M'Taggart's accounts (sometimes called “Cambridge changes”) have been criticized

as too weak: a statement about a subject can change truth value with the subject's undergoing any alteration. For instance, I become shorter than my son when he grows taller than I, even though my stature does not change. Russell could reply that his account is meant only to identify some change in the world, not to analyze the subject of that change. In any case, we seem to need a richer account than Russell's to analyze the structure of change itself.

Advances in physics have affected views of the place of change in the world. Whereas Newtonian physics saw motion and rest as interchangeable phenomena seen from different frames of reference, the Theory of Relativity puts a limit on speed (the speed of light) and makes time a fourth dimension on a par with the three dimensions of space. Space, time, and mass all became relative quantities, and acceleration ceased to provide a necessary condition of change. At a quantum level, some particles have properties of both bodies and waves, and subatomic particles seem to be packets of energy. New theories such as String Theory suggest that subatomic particles are states of multidimensional strings of energy. Alfred North Whitehead (1861–1947) drew on early-twentieth-century physics to develop a speculative metaphysics positing processes rather than things as the ultimate realities. His style of philosophy, however, has gone out of favor, and in the late twentieth century philosophers tended to study change in trying to specify identity conditions for events.

See also *Cycles; History, Idea of; Physics; Relativity; Time.*

BIBLIOGRAPHY

- Gill, Mary Louise, and James G. Lennox, eds. *Self-Motion: From Aristotle to Newton*. Princeton, N.J.: Princeton University Press, 1994.
- Lombard, Lawrence Brian. *Events: A Metaphysical Study*. London: Routledge and Kegan Paul, 1986.
- McTaggart, John McTaggart Ellis. *The Nature of Existence*. 2 vols. Edited by C. D. Broad. Cambridge, U.K.: Cambridge University Press, 1921–1927.
- Russell, Bertrand. *The Principles of Mathematics*. 2nd ed. London: Allen and Unwin, 1937.
- Sorabji, Richard. *Matter, Space, and Motion: Theories in Antiquity and Their Sequel*. Ithaca, N.Y.: Cornell University Press, 1988.
- Waterlow, Sarah. *Nature, Change, and Agency in Aristotle's Physics: A Philosophical Study*. Oxford: Clarendon, 1982.
- Whitehead, Alfred North. *Process and Reality: An Essay in Cosmology*. New York: Macmillan, 1929.

Daniel W. Graham

CHARACTER. The word *character*, when applied to persons, has two sources, distinguished lexically in ancient Greek by the terms *ethos* and *charaktēr*. *Ēthos*, originally referring to a disposition or custom, from Aristotle on refers to the stable dispositions that guide a person's actions and that are suitable objects of moral praise and blame. The earliest uses of *charaktēr* in Greek, like the earliest uses of *character* in English, refer to an impression such as would be carved or stamped onto a coin or tablet; metaphorically, "characters" are signs (actions, facial features, social positions) that reveal something about a person's soul. Dur-

ing the seventeenth century, the sense of "character" in English came to include a person's psychological traits themselves.

Aristotle and Virtue Ethics

The fourth-century B.C.E. philosopher Aristotle, in *Nicomachean Ethics*, understands character (*ēthos*, or *hexis ēthikē*, "moral disposition") to be a disposition of the appetitive and emotional faculties, which leads its possessor to act and feel in particular ways. This disposition is acquired through habituation, a process that develops the intellectual as well as the appetitive and emotional faculties. Aristotelian virtues are such dispositions informed by practical wisdom—a capacity for judgment developed through experience and reflection, which guides conduct where technical knowledge cannot. This is one point of convergence between Aristotle's ethics and the thinking of contemporary virtue theorists, for as Aristotle rejects the claims of his teacher Plato (c. 428–348 or 347 B.C.E.) and Sophists such as Protagoras (c. 485–410 B.C.E.) that there is some art or science that can guide conduct, contemporary virtue theorists reject the claims of deontological ethics that conduct is well-guided by rules, such as "maximize utility" or "act only upon a maxim you could without contradiction will to be a universal maxim." Aristotle and contemporary virtue theorists also share the view that characters are appropriate objects of moral praise and blame; Aristotle reasons that this requires that our characters be voluntary, and argues that this is so on the grounds that our actions are voluntary and our characters are the products of our actions.

Aristotle's *Ethics* focuses on the cultivation (or acquisition or promotion in others) of virtuous character. When Aristotle describes the courageous or liberal person, he does so from the inside, showing us the person's concerns so that we see how, given the person's values, it makes sense for him to do as he does. But Aristotle's *Rhetoric* uses characterization to dispose audiences to trust a speaker, and his *Poetics*, to effect an appropriate fit between a person and his words and deeds; here, words and actions are signs by which we may know someone's character. Subsequently, Aristotle's student Theophrastus (c. 372–c. 287 B.C.E.) sketched representative vicious types by enumerating their typical words and deeds, in a work that came to be known as the *Ēthikoi Charaktēres* (English trans. *Characters of Theophrastus*, or Moral signs), which was much imitated in English literature from the seventeenth century on. In *Characters of Vertues and Vices* (1608), by the English prelate Joseph Hall (1574–1656), "character" for the first time refers to a type of person, rather than just to the signs that reveal that type. A "character" genre evolved in various directions in the seventeenth and eighteenth centuries, adding to moral types, types of men and women in various stations of life (perhaps influenced by the Stoic notion that human beings are given *personae*, or roles to play in this world), and using their sketches to satirize individuals and societies. Although this literature interacts richly with popular ideas about character, it has generally not been taken up in philosophical ethics.

Kantian Ethics

An ancient tradition in natural philosophy, and particularly medicine, sought to explain an individual's character (*ēthos*) in

terms of the four humors, or bodily fluids—namely the melancholy, phlegmatic, sanguine, and choleric. In his *Anthropology from a Pragmatic Point of View*, the eighteenth-century philosopher Immanuel Kant (1724–1804) sweeps such speculation to one side by distinguishing character from temperament: Temperament is given one by nature or habituation. People may vary in their temperaments, and indeed be classified by their dominant humors; however, character, which one either has or lacks, is the property of the will by which one binds oneself to self-prescribed rational practical principles. Kant's most influential ethical work, *The Groundwork for the Metaphysics of Morals*, identifies character with the good will, a will motivated solely by duty or principles of practical reason that it legislates to itself; Kant gives character the role of making use of such qualities as courage, resolution, and perseverance—which belong to temperament and might be bad if not in the control of a good will, the only thing good without qualification. In the *Metaphysics of Morals*, Kant likewise describes virtue as self-constraint, a power to withstand those of our inclinations that oppose morality—not merely some habit of morally good actions, virtue requires acting on “considered, firm and continually purified principles.”

Neo-Aristotelian critics have charged that Kant's emphasis on acting on principle results in his neglecting the roles character and virtue play in both a good ethical life and morally praiseworthy action, and Kantian defenders often reply by pointing to Kant's doctrine of virtue. But the criticism can be raised anew with respect to Kant's conception of character and virtue itself, for these replace appropriate feeling and the sensitivity it affords with a commitment to acting on principle. One source of apparent disagreement between Kant and Aristotle is terminological: Aristotle defines moral character as a disposition of appetite and emotion, but he insists that it cannot exist without practical wisdom. So Aristotle does not consider an act or person guided solely by appetite and emotion, however well trained these may be, to be virtuous or praiseworthy. For Aristotle, practical wisdom is necessary for appetitive and emotional dispositions to be good (this is what distinguishes virtue proper from natural virtue), just as for Kant, the good will is necessary for courage, resolution, and perseverance to be good. Still, principle is not practical wisdom, and Kant has less faith in the ability of developed capacities of judgment and feeling to result in right action, and more faith in the ability of principles to do so, than does Aristotle. This may be one reason for Kant's restriction of character to one's commitment to the ends that practical reason prescribes itself; presumably another is that, to the extent that character is the appropriate object of praise and blame, it ought to be voluntary, and Kant takes only our resolutions, but not our natural and habituated inclinations, to be voluntary.

Utilitarianism

Not himself a utilitarian, the eighteenth-century philosopher David Hume (1711–1776) characterizes virtuous character traits as those that tend to the good, of mankind or at least of their possessor, and vicious ones as those that tend to the bad. Hume thus shares with utilitarians the view that the moral value of a character trait depends on its nonmoral value for

people. Given its first widely influential formulation by Jeremy Bentham (1748–1832) in the nineteenth century in *The Principles of Morals and Legislation*, utilitarianism focuses on the rightness or wrongness of actions: the principle of utility deems that action right that, of the available alternatives in any given situation, tends to maximize the happiness of those affected. Utilitarianism's critics fault it for being insensitive to the importance of character evaluation for moral evaluation, but John Stuart Mill (1806–1873), a second-generation utilitarian, already stresses that acts ought to be evaluated for their consequences on character and character formation and includes as ingredients of happiness or utility such diverse intrinsic goods as friendship and virtue. A utilitarian may also subject character-traits and rules, and not only acts, to utilitarian assessment.

Challenges

In the twentieth and twenty-first centuries, questions have been raised about whether there is such a thing as character at all. The existentialist philosopher Jean-Paul Sartre (1905–1980) charged that to explain a person's (one's own or someone else's) action in terms of his or her character is to assimilate the action to an event in the natural world (for which the character is an ad hoc explanation), denying the person's freedom and refusing the rational understanding that human action demands. In a separate development, a research tradition in experimental social psychology, “situationism,” holds that people's behavior is not distinctive or consistent across a range of situations. These criticisms may apply more to the conception of character as revealed in signs than to the conception put forth in philosophical ethics.

See also *Aristotelianism; Good; Kantianism; Moral Sense; Person, Idea of the; Utilitarianism; Virtue Ethics.*

BIBLIOGRAPHY

- Aristotle. *Nicomachean Ethics*. Translated by Christopher Rowe. Oxford and New York: Oxford University Press, 2002.
- Bentham, Jeremy. *The Principles of Morals and Legislation*. Buffalo, N.Y.: Prometheus, 1988.
- Boyce, Benjamin. *The Theophrastan Character in England to 1642*. Cambridge, Mass.: Harvard University Press, 1947.
- Hume, David. *A Treatise of Human Nature*. Edited by L. A. Selby-Bigge. 2nd ed. Oxford: Clarendon; New York: Oxford University Press, 1978.
- Kant, Immanuel. *Anthropology from a Pragmatic Point of View*. Translated by Mary J. Gregor. The Hague, Netherlands: M. Nijhoff, 1974.
- . *Practical Philosophy*. Translated by Mary J. Gregor. Cambridge, U.K., and New York: Cambridge University Press, 1996. Includes *Metaphysics of Morals* and *Groundwork for the Metaphysics of Morals*.
- Klibansky, Raymond, Erwin Panofsky, and Fritz Saxl. *Saturn and Melancholy: Studies in the History of Natural Philosophy, Religion, and Art*. New York: Basic Books, 1964.
- Liddell, Henry George, and Robert Scott, comps. *Greek-English Lexicon*. Oxford: Clarendon; New York: Oxford University Press, 1996.
- Mill, John Stuart. *Essays on Politics and Culture*. Edited by Gertrude Himmelfarb. Garden City, N.Y.: Doubleday, 1962.

- . *Utilitarianism*. Edited by George Sher. Indianapolis: Hackett, 1979.
- Railton, Peter. “How Thinking about Character and Utilitarianism Might Lead to Rethinking the Character of Utilitarianism.” *Midwest Studies in Philosophy* 13 (1988): 398–416.
- Ross, Lee, and Richard E. Nisbett. *The Person and the Situation: Perspectives of Social Psychology*. Philadelphia: Temple University Press, 1991.
- Sartre, Jean-Paul. *Anti-Semite and Jew*. Translated by George J. Becker. New York: Schocken, 1948.
- Theophrastus. *The Characters of Theophrastus: An English Translation from a Revised Text*. Translated by J. E. Sandys. London: Macmillan, 1909.

Rachana Kamtekar

CHEMISTRY. Where and when did chemistry originate? Some chemists would identify ancient Egypt as the birthplace of chemistry because of that culture’s glassworks, cosmetics, and mummification techniques. Advocates of this theory might also refer to a possible etymology of the word *chemistry* from the Egyptian word for *black*. Other historians place the origins of chemistry amid ancient Greek theories of matter that formulated the basic concepts—principles, elements, and atoms—for understanding the individuality of material substances and their transformations. Others would argue that chemistry emerged in medieval alchemy: alchemists invented the laboratory that is still the site for the production of chemical knowledge, and they established and transmitted techniques and instruments that are still at work in many chemical processes. Meanwhile, historians of institutional life would assert that chemistry emerged in seventeenth-century Europe when public lectures and chairs of chemistry were created.

The variety of answers to the question of origins points to the multiple identities of chemistry. A posteriori it seems natural to consider chemistry as an autonomous academic science with technological applications in a variety of domains. However, this is only one face of chemistry. Whether we consider chemistry as a set of technological practices—such as metal reduction, dyeing, glass-making—or as a theory of matter transformations, or as a teachable and public knowledge enjoying an academic status, the chronological marks change dramatically.

The question of origin cannot be settled not only because chemistry is multifaceted, but also because the answer depends heavily on the image of chemistry one wants to convey. For instance, eighteenth-century chemists strongly denied any connection between chemistry and alchemy. The kind of useful and reliable discipline they wanted to promote on the academic stage was contrasted with the obscurity and fraudulent practices of alchemists, although this is a discontinuity seriously questioned by historians of alchemy at the turn of the twenty-first century.

Alchemy in the Scientific Revolution

First, historians of alchemy note that there was no linguistic distinction between chemistry and alchemy in the seventeenth century—both disciplines being named “chymistry.” Second,

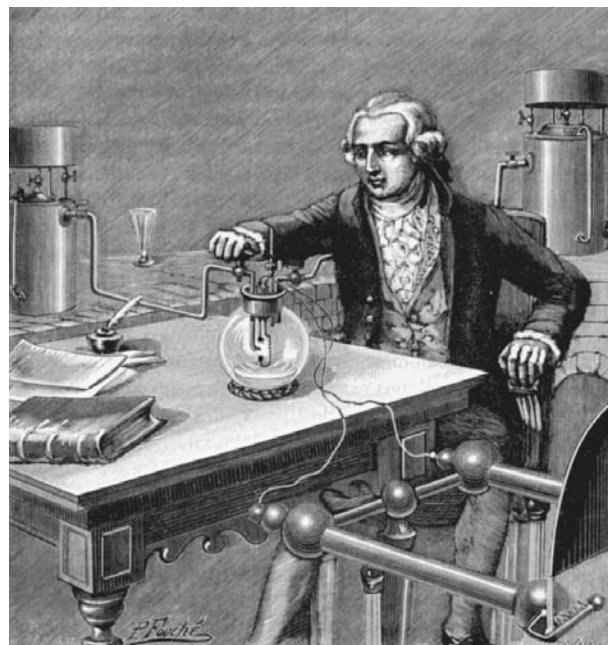

Eighteenth-century illustration depicting Antoine-Laurent Lavoisier in his laboratory, by P. Fouche. Regarded as the founder of modern chemistry, Lavoisier (1743–1794) conducted groundbreaking quantitative experiments that led to the formulation of the law of the conservation of matter. © LEONARD DE SELVA/CORBIS

against the popular view of alchemy as a spiritual quest based on religious symbolism, historians such as Lawrence Principe and William Newman claim that “chymists” did actually manipulate and transform matter. While the religious interpretation of alchemy served to distance it from chemistry, they emphasize the continuity and argue that medieval alchemists already had developed experimental methods often considered as chief characteristics of modern science. They established a number of tests to identify substances; they used analysis and synthesis in order to demonstrate the similarity between substances extracted from nature and substances artificially produced in the laboratory; and they used weight measurements and the balance-sheet method traditionally credited to Antoine-Laurent de Lavoisier (1743–1794) to determine the identity of substances.

Early modern “chymistry” also questions the grand narrative of the scientific revolution, with Galileo Galilei’s (1564–1642) and Robert Boyle’s (1627–1691) mechanical philosophy whisking away the alchemical tradition. Boyle’s view of material phenomena as being produced by the interaction of small particles that have only primary qualities (size, shape, and motion) by no means implied a rejection of the alchemical tradition. Since Jabir ibn Hayyan (c. 721–c. 851), whose work was spread and discussed in the West in the thirteenth century, the discipline of alchemy had fostered a corpuscular view of matter that was later developed by Daniel Sennert (1572–1657), an early seventeenth-century chemist. Sennert managed to reconfigure the Aristotelian theory of matter by combining the

four principles with Democritean atomism. In order to provide experimental demonstration that matter at the microlevel is made by the juxtaposition of atoms, he performed a *reductio in pristinum statum* (reduction into the pristine state). Although Boyle positioned himself as a “natural philosopher” against “chymical philosophers, he was in debt to Sennert, since he tacitly used his experiments and his theoretical framework in his early essays as well as in *The Sceptical Chymist* (1680).

In addition, Boyle’s skepticism did not apply to alchemical transmutations. Until his death, he kept seeking the philosopher’s stone, using the knowledge he had learned in his youth from the American chymist George Starkey (1627–1665), who also initiated Sir Isaac Newton (1642–1727). Boyle, the advocate of public knowledge at the Royal Society, concealed his transmutational processes in secret language.

Thus, two of the celebrated founding fathers of modern science, Boyle and Newton, were dedicated believers in alchemical transmutation. Since Betty Dobbs’s 1975 work, *The Foundations of Newton’s Alchemy: or, “The Hunting of the Greene Lyon,”* historians of chemistry have reconsidered the impact of Newton’s bold chemical hypothesis at the end of his *Opticks* (1704). In the famous Query 31, Newton ventured an interpretation of chemical reactions in terms of attraction between the smallest particles of matter. A uniform attractive force allowed the smallest particles to cohere and form aggregates whose “virtue” gradually decreased as the aggregates became bigger and bigger. Whereas this hypothesis has been read as an extrapolation of gravitational physics to chemistry, it is possible to view it as a way to rationalize chemical practices that was impossible in Cartesian mechanism. Newton allowed chemists to understand and measure affinities in purely chemical terms.

Eighteenth-Century Cultures of Chemistry

Such was the program initiated by Etienne-François Geoffroy (Geoffroy the Elder; 1672–1731), who published a “Table des rapports” (table of affinities) in 1718. The substance at the head of a column is followed by all the substances that could combine with it in order of decreasing affinity—the degree of affinity being indicated by the place in the column. A substance C that displaces B from a combination AB to form AC will be located above B in the column because of its stronger affinity for A. Displacement reactions thus provided a qualitative measure of affinities and allowed predicting the outcome of reactions. Thus, chemistry came to be seen as a predictive and useful science in the eighteenth century.

It is important to stress that long before Lavoisier, chemistry had conquered the status of an autonomous academic discipline. A chemistry class had been established at the Paris Academy of Science in the late seventeenth century, whereas the physics class was only created in 1785. The chemistry class conducted systematic research programs in plant analysis and mineralogy. Not only were chemistry chairs established in a number of European universities, but also innumerable public and private courses of chemistry opened up with experimental demonstrations. They were attended by a variety of

audiences: pharmacists, metallurgists, as well as gentlemen and “philosophes” who practiced chemistry as enlightened amateurs. Chemistry was promoted alongside Enlightenment values as a rational and useful knowledge that would be of benefit to economy and society. A key strategy for winning political support was the introduction of the distinction between “pure” and “applied” chemistry by Johan Gottschalk Wallerius (1709–1785), who took the chair of chemistry in Uppsala in 1753. This distinction asserted the dignity of pure chemistry while transforming the chronological priority of chemical arts into a logical dependence upon “pure” knowledge. Chemistry could thus be perceived as a legitimate academic discipline in university curricula and highly valued for its usefulness in various applications. At the same time in France, chemistry was celebrated in the context of the *Encyclopédie* as a model science based on empirical data rather than on a priori speculations, a science requiring craft and labor, cultivated by skilled “artists” working hard in their laboratories unlike those lazy philosophers who never took off the academic gown.

However, chemistry was more than a fashionable science. So decisive was the success of Lavoisier’s revolution in the 1780s that most chemists and historians of science, according to Frederic Holmes, “viewed eighteenth-century chemistry as the stage on which the drama of the chemical revolution was performed” (Holmes, 1989, p. 3). They once described it as an obscure and inconsistent set of practical rules based on the erroneous phlogiston theory. This theory, shaped by Georg-Ernst Stahl in the early eighteenth century, explained a number of phenomena such as combustion, as well as properties such as metals or acids, by the action of an invisible principle or fire named phlogiston (from the Greek term for “burnt”). The canonical story thus culminated in Lavoisier’s questioning the existence of phlogiston and its alleged presence in metals, in acids, in combustion and respiration, and consequently overthrowing the old paradigm.

When historians resist the temptation to read eighteenth-century chemistry backward, waiting for Lavoisier to arrive on the stage, they quickly realize that this standard picture was only one aspect among numerous diverse cultures of chemistry in the eighteenth century, many of which were extremely innovative. In workshops and firms, the invention of continuous processes led to what historians of industry described as “the chemical revolution.” In more academic spaces, laboratory practices were also deeply changed by the study of salt solutions when wet analysis was added to the traditional fire analysis and color indicators were systematically applied to acids and alkalis. This change, especially visible in the research program conducted at the Paris Academy of Science on plant and mineral analysis, had a theoretical impact: chemists gave up the old concept of salt as a universal principle, in favor of the notion of middle salt—a substance resulting from the combination of volatile and nonvolatile salts or of alkali and acid. This redefinition subverted the traditional notion of principles as material entities as bearers of properties. Substances could present similar properties and belong to the same class despite their different constituent principles. The idea of interchangeability was reinforced by the displacement reactions that

allowed the construction of affinity tables. Affinity tables favored the view that the behavior of a “mixt” (compound) depends less upon the nature of its constituent principles than on its relations with other substances. The relational identity of chemical substances minimized the importance of principles—whether they be three, four, or five—that chemists used to oppose to the mechanistic view of a “catholic matter.” Moreover in a number of eighteenth-century chemistry courses—for instance in Hermann Boerhaave’s (1668–1738) textbook and Guillaume-François Rouelle’s (1703–1770) lectures—elements were often redefined as “agents” of chemical reactions rather than as constituent principles. Elements were consequently presented as “natural instruments” together with “artificial instruments” such as laboratory vessels, furnaces, and alembics. This pragmatic notion of elements accompanied their redefinition in operational terms as substances that could not be further decomposed by available analytic techniques.

From Phlogiston to Oxygen

In addition, the phlogiston theory was neither an overarching nor a rigid framework. The notion, which was first forged by Georg Ernst Stahl (c. 1660–1734) around 1700, was most often mixed either with Newton’s views of matter that inspired salt and affinity chemistry or with various notions inspired by local mining or pharmaceutical traditions. It is therefore difficult to identify a unitary phlogiston theory that would define eighteenth-century chemistry. Rather, two distinct phlogiston theories prevailed in two different contexts. In mid-eighteenth-century France, Stahl was considered as the founder of chemistry when Rouelle and his pupils redefined Stahl’s “inflammable earth” as fire. The fire principle, always invisible because it circulated from one combination to another one, imparted combustibility or metallic properties when it was “fixed.” It was released during combustion and metals calcination. Indeed, there was a difficulty here: if phlogiston was released when metals calcinated, how would one explain their increase of weight? The anomaly had been known for decades and had not prevented the success of this powerful theoretical framework since, as Immanuel Kant and Lavoisier himself acknowledged, it was Stahl’s merit to realize that combustion and reduction were two inverse reactions and that calcination and combustion were one and the same process despite their phenomenological dissimilarities. Lavoisier cast doubts on phlogiston when he addressed the question of weight increase in 1772. After conducting experiments of combustion of phosphorus and lead calcination with careful weighing of each ingredient and each piece of apparatus before and after the reaction took place, he concluded that the weight gain could be due to a combination with part of the air contained under the flask. Although Lavoisier was convinced that his discovery was about to cause a revolutionary change in physics and chemistry, he could not yet refute that combustion released phlogiston. Unsurprisingly many contemporary chemists adopted a compromise between the two interpretations, and Pierre-Joseph Macquer (1718–1784) redefined phlogiston as the principle of light distinct from heat. Meanwhile an “English phlogiston” emerged from pneumatic studies that gained a sound phenomenological reality through its assimilation with hydrogen.

The study of gases so much changed the landscape of chemistry in the 1770s that some contemporary chemists used the phrase “the pneumatic revolution.” Although air had been considered as one of the four elements, it was considered as a mechanical agent rather than as a chemical reactant until Stephen Hales (1677–1761), a British plant physiologist, built a “pneumatic chest” for collecting gases released by physiological processes. With this apparatus chemists were able to collect the gases given off by chemical reactions, to measure their volume, and to submit them to various tests. Joseph Black (1728–1799) identified “fixed air” (carbon dioxide) in 1756; in 1766, Henry Cavendish (1731–1810) isolated “inflammable air” (hydrogen); in 1772 Joseph Priestley (1733–1804) described a dozen new airs in his *Experiments and Observations on Different Kinds of Air*. In 1774 Karl Wilhelm Scheele (1742–1786), a Swedish pharmacist, isolated and described a new air that made a candle flame brighter and facilitated respiration. By the same time, Priestley had also produced a similar air by the reduction of the “red precipitate of mercury,” a result that he communicated to Lavoisier when he visited him in Paris in October 1774.

Lavoisier was a latecomer in the crowd of chemists “hunting” airs, his earlier interest in chemistry being related to geology. His attention was drawn to the mechanisms of fixation and release of gases when he discovered the role of air in combustion. He consequently became aware of the British works—with the help of his wife Marie-Anne-Pierrette Paulze-Lavoisier (1758–1836), who translated foreign publications for him. He conducted systematic experiments on “elastic fluids” that were published in his *Opuscules physiques et chimiques* in 1774. He repeated Priestley’s reduction of the red precipitate of mercury and performed the reverse operation of calcining mercury. Whereas Priestley characterized the gas released as “dephlogisticated air” Lavoisier concluded in 1778 that this gas was “the purest part of the air.”

Two alternative views of gases were in competition. For the British pneumatists, the various gases isolated were composed of one single air differentiated according to the proportion of phlogiston they contained. In other terms, they fit nicely into the phlogiston paradigm. They even reinforced it because a pneumatic science, whose unquestioned leader was Priestley and which allowed a better understanding of physiological processes in plants and animals as well as medical applications, emerged. By contrast, Lavoisier came to see atmospheric air as a compound and developed a theory of gaseous state. All solid or liquid substances could be in a gaseous state depending on the quantity of caloric (or heat) they fix. Thanks to his caloric theory of gases, Lavoisier was in a better position to refute the phlogiston theory of combustion. He could account for the release of heat once he admitted that combustion consisted in a combination with a portion of atmospheric air that released its caloric. This portion of air that he first named “vital air”—later renamed oxygen—would play a key role in Lavoisier’s chemistry. Not only did it explain combustion and calcinations but it was also the principle of acidity. Therefore, during the controversy that followed, Lavoisier’s theory was referred to as “oxygen theory” or sometimes “antiphlogistic

theory.” Phlogiston was condemned as a useless chimerical entity, only to be replaced by another enigmatic principle of heat, “caloric,” while the omnipresent element oxygen’s being a bearer of properties was an echo of the older chemistry.

Revolution or Foundation?

Lavoisier’s revolution did not condemn the old notion of elements common to all substances, although he destroyed three of the traditional four elements, fire, air, and water. The demonstration that water was not an element but a compound of two gases was made in a solemn experiment of analysis and synthesis of water set up in February 1785. It required heavy and expensive equipment designed with the help of a military engineer and with the support of an academic Commission of Study for the Improvement of Balloons. With this spectacular experiment Lavoisier won his first allies. Together they were able to take advantage of the opportunity to reform the chemical language as outlined by Louis Bernard Guyton de Morveau (1737–1816) and build up a new “Method of Chymical Nomenclature” that reflected Lavoisier’s theory and eliminated phlogiston. The new system, published in 1777, was seen as a coup d’état and sparked a fierce controversy. The anti-phlogisticians mobilized all resources, including the creation of a new journal, *Annales de chimie*, in order to convince European chemists. Moreover, to defeat the last and attractive British version of phlogiston as inflammable air (hydrogen), which was articulated by Richard Kirwan (1732–1812), Madame Lavoisier translated into French his *Essai sur le phlogistique* (1788; Essay on phlogiston), while the anti-phlogisticians criticized the author’s view in footnotes. Beyond the issue of phlogiston, numerous objections to the new language were raised by contemporary chemists concerning the choice of terms, such as “oxygen” (an acid generator according to Lavoisier’s theory of acids) and “azote” (improper for animal life and a property of many other gases). Although the French “nomenclators” did not change any term, their system was finally adopted throughout Europe by 1800. But this victory did not always mean conversion to all facets of Lavoisier’s chemistry. The reform of language fulfilled a long-felt need among the chemical community and it came at the right moment: textbooks were needed to train pharmacists as well as chemists for burgeoning industries. The new systematic language and Lavoisier’s *Elements of Chemistry* (1789) facilitated the teaching of chemistry.

In the context of the French Revolution, which resulted in Lavoisier’s death on the guillotine and the creation of a new educational system, Lavoisier’s revolution has been perceived as the destruction of premodern chemistry and the foundation of modern chemistry on a tabula rasa. However, the celebration of the founding hero overemphasizes the impact of his contribution to chemistry. Lavoisier did not overthrow the whole of chemistry. The tradition of salt and affinity chemistry remained untouched. Rather, the latter was revised and integrated in a grandiose “Newtonian dream” by Claude-Louis Berthollet (1748–1822) in his *Essai de statique chimique* (1803). Lavoisier invented neither the “law of conservation of matter”—a kind of axiomatic principle tacitly assumed by all natural scientists long before him—nor the laws of chemical

proportions that inspired the chemical atomism developed by the next generation of chemists.

Nineteenth-Century Chemical Atoms

Nineteenth-century chemistry has often been described as a smooth sequence of discoveries that gradually established modern chemistry. Positivist historians were content with reporting landmark events such as John Dalton’s atomic theory, Amedeo Avogadro’s law, Dmitry Ivanovich Mendeleev’s periodic system, and so on. In thus conveying a cumulative process, they not only distorted history but also tended to deprive past scientists of inner consistency because they failed to accept many of these “great discoveries.”

One major feature of nineteenth-century chemistry is that the history of ideas did not follow the pathway that seems logical from a present-day perspective. For instance, the laws of chemical proportions did not follow from Lavoisier’s program. Instead, they emerged from salt chemistry, more precisely from attempts to determine the weight or ponderous quantity of a base that could neutralize a definite quantity of acid. While the chemical revolution was drawing all attention toward Paris, two German chemists, Karl Friedrich Wenzel (1740–1793) and Jeremias Richter (1762–1807), were initiating a quantitative chemistry that they named *stöichiometrie* or stoichiometry (from the Greek *stoicheion*, or element). The main assumption that the properties of any substance depend upon the nature and proportion of its constituent elements opened up a research program for chemists whose key words were *analysis* and *quantification* (titration or dosage).

The field of stoichiometry was extended in 1802 when Joseph Louis Proust (1754–1826) applied Richter’s notion of “equivalent,” so far limited to reactions between acids and bases, to all combinations and formulated a general law: the relationships of the masses according to which two or several elements combine are fixed and not susceptible of continuous variations. While Berthollet questioned the generality of Proust’s law of definite proportions, John Dalton (1766–1844), a professor at Manchester, made it the basis for his atomic hypothesis. He assumed that chemical combinations take place unit by unit, or atom by atom. He added a law of multiple proportions: when two elements form more than one compound, the weight proportions of the element that combines with a fixed proportion of another one are in a simple numerical ratio. Dalton’s hypothesis rested on the assumption that atoms were solid and indivisible, that they were surrounded by an atmosphere of heat, that there were as many kinds of atoms as there were elements. Dalton’s atoms were not the uniform and minute discrete units that structured all material bodies of ancient atomism. Rather, they were minimum and discrete units of chemical combination. And Dalton assumed that atoms would combine in the simplest way, that is, two atoms formed a binary compound. The main advantage of Dalton’s hypothesis was that it allowed simple formulas. Instead of determining the composition of a body by percentages, chemists could express it in terms of constituent atoms thanks to the determination of atomic weights. Of course it was impossible to weigh individual atoms. Since Dalton could not determine this weight

by using the neutrality of the compound like Richter, he elected a conventional standard. He chose hydrogen as the unit of reference. For instance, hydrogen and oxygen were known to form water, whose analysis gave the ratio 87.4 parts by weight of oxygen for 12.6 of hydrogen. If hydrogen has a weight equal to 1, the relative atomic weight of an atom of oxygen will be roughly 7. Shortly after Dalton's *New System of Chemical Philosophy* (1808), Joseph Gay-Lussac (1778–1850) announced that volumes of gas that combine with each other were in direct proportion and that the volume of the compound thus formed was also in direct proportion with the volume of the constituent gases. The volumetric proportions thus seemed to confirm Dalton's weight ratios.

To explain the convergence, both Amedeo Avogadro (1776–1856) in 1811 and André-Marie Ampère (1775–1836) in 1814 suggested that in the same conditions of temperature and pressure, equal volumes of gases contain the same number of molecules. In order to admit this simple hypothesis, however, both men had to admit a second hypothesis: that when two gases joined to form a compound, the integrating molecules should divide into two parts.

From a modern perspective this hypothesis was a big step forward because it suggested the distinction between atoms and molecules. Why, then, was it rejected in the 1830s and for several decades afterward by the most prominent chemists? The rejection of Avogadro's law is a classical topos for illustrating the opposition between presentist and historicist approaches. The alleged "blindness" of nineteenth-century chemists appears as a perfectly consistent attitude once one considers that Avogadro's hypothesis of molecules formed of two atoms of the same element stood in contradiction to the theoretical framework of chemical atomism. In Dalton's theory, such diatomic molecules were physically impossible because of the repulsion between the atmospheres of heat of two identical atoms, and they were theoretically impossible in the new electrochemical paradigm set up by Jöns Jacob Berzelius (1779–1848) on the basis of his experiments on electrolytic decomposition. Elements were defined by their electric polarity, and the intensity of the positive or negative charge determined the affinity between them. Molecules of two atoms of the same element were impossible because of the repulsion between two identical electrical charges.

The distinction between atom and molecule did not directly follow from Avogadro's law. Rather it was formulated by a young chemist, Auguste Laurent (1807–1853), trained in mineralogy and crystallography. He challenged Berzelius's electrochemical view. For Berzelius all compounds resulted from the electric attraction between two elements. This dualistic view was extended to organic compounds thanks to the notion of radical—for instance the benzoyl radical discovered by Leibig—a group of atoms that, like elements, persisted through reactions. In the 1830s Jean-Baptiste-André Dumas (1800–1884) prepared trichloroacetic acid by the substitution of three atoms of chlorine to three atoms of hydrogen in acetic acid. His student Laurent noticed the similarity of properties between the two acids. Electronegative atoms of chlorine could replace electropositive atoms of hydrogen without changing

the properties too much. He consequently developed a unitary theory that Dumas called "type theory" in 1838: in organic compounds there exist types that persist when elements are changed. This suggested that the properties of compounds depended more on the architecture of molecules than on the nature of constituent atoms. Type theory applied to the increasing crowd of organic compounds while inorganic chemistry was still ruled by dualism.

Charles Frédéric Gerhardt (1816–1856) attempted to reunify chemistry by extending the type theory to all compounds, using analogy as a guide. Although he admitted that we do not know anything about the actual arrangement of atoms in a molecule, he defined three types—hydrogen, water, and ammonia—as an ideal taxonomic scheme. According to Gerhardt, all compounds derived from these three types.

The theory of type implicitly indicated that atoms of different elements had different combining powers or valences. Hydrogen, for example, has a valence of one, while oxygen has two and nitrogen three. It is worth emphasizing that although nineteenth-century organic chemists such as Gerhardt and August Kekulé (1829–1896) did not believe in the actual existence of atoms and molecules, they were able to invent structural formulas that allowed them to predict and create new compounds.

The Construction of the Periodic System

Gerhardt's unitary perspective also provided the foundation for the construction of the periodic system. Dmitry Ivanovich Mendeleev (1834–1907) was certainly not the first chemist who tried to classify elements on the basis of atomic weights. Van Spronsen reasonably argued that the periodic system was codiscovered by six chemists in the 1860s. However, Mendeleev adopted a different strategy. He pointed to the Karlsruhe Conference, held in 1860, as the first step toward the periodic law. This first international meeting of chemists adopted atomic weights based on Avogadro's and Gerhardt's views. From the general agreement on the distinction between atoms and molecules, Mendeleev derived another crucial distinction, between simple body and element. Since Lavoisier's famous definition of elements as nondecomposed bodies, most chemists did not distinguish between the two terms. Mendeleev, on the contrary, stressed the difference between the simple substances, empirical residues of decomposition characterized by their physical properties and molecular weights, and the abstract element defined as an invisible ingredient and characterized by its atomic weight. Mendeleev chose to classify elements rather than simple bodies because he considered them as responsible for the properties of simple and compound substances. Mendeleev was thus the first chemist who really worried about a clear definition of what was to be classified. Although abstract and unobservable, Mendeleev's elements were material entities and true individuals. Mendeleev was a staunch opponent of the hypothesis formulated by William Prout (1785–1850), which asserted that the multitude of simple substances derived from one single primary element, usually identified as hydrogen. Throughout the

nineteenth century this reductionist mainstream stimulated attempts at classifying elements. Classifications were mainly aimed at tracing genealogical relations or families by grouping analogous elements in triads or families according to the numerical ratios of their atomic weights. Starting from the assumption that elements would never be divided or transmuted into one another, Mendeleev took an opposite direction. He sought unity in a natural law ruling the multiple elements, rather than in matter itself. He compared the most dissimilar elements and firmly relied on the order of increasing atomic weights. Whereas grouping elements on the basis of valences always faced the difficulty of multiple valences, Mendeleev strictly relied on the order of increasing atomic weight, which he regarded as the constant criterion of the individuality of chemical elements.

Indeed, this criterion revealed some deficiencies. It sometimes blurred strong chemical analogies (for instance between Li and Mg, Be and Al, B and Si) or induced unexpected proximities (for example, in Mendeleev's eighth group). Mendeleev struggled with these difficulties and published thirty different tables in order to better suit his system with chemical analogies. However, his abstract notion of elements allowed predictions of unknown elements. Many of these elements were confirmed during Mendeleev's lifetime and served to validate his system while guarding it from further challenges. The discovery of a dozen rare earth elements in the late nineteenth century created difficulties because they lack individual properties and have strong mutual analogies. The inert gases were not welcomed either, first, because they had not been predicted, but mainly because they did not exhibit chemical properties. The atomic weights determined by William Ramsay (1852–1916) and Lord Rayleigh (John William Strutt; 1842–1919) for helium (4) and argon (40) would result in the placement of the latter between potassium and calcium according to its atomic weight. This was impossible, and the whole periodic system was in danger to collapse. Mendeleev raised doubts about the elemental nature of argon. Thanks to their sound belief in the periodic law, Ramsay and Rayleigh found a place for them at the cost of a new reversal of increasing atomic weight values and a new prediction of an intermediate element between neon and argon. A zero group was opened up that first undermined Mendeleev's notion of individual elements defined by their atomic weight. A second blow came from the discovery of electrons and radioactivity. Mendeleev desperately tried to explain this apparent anomaly with the hypothesis of confused movements of ether around heavy atoms. In this grandiose attempt to unify mechanics and chemistry, Mendeleev admitted ether in the periodic system in the 0 group. This error is instructive because it reveals the intellectual roots of Mendeleev's system. It is thus impossible to consider Mendeleev's system as a kind of precursor of quantum chemistry. Mendeleev dealt with elements and not with atoms.

Chemistry and Quantum Theory

The periodic system nevertheless served as a guide in the emergence of atomic physics, especially for Niels Bohr's (1885–1962) quantum model of the atom. Atoms of successive elements in the periodic system present an additional electron on the outermost shell. When a shell becomes full, a new shell

begins to fill. Exceptions to this rule are reflected in the uneven length of periods in the periodic system.

The autonomy of chemistry thus seemed to be deeply questioned in the mid-twentieth century. If individual properties of chemical elements can be deduced from quantum theory, the theoretical foundations of chemistry lie in physics. Chemistry would be a reduced science. Many chemistry teachers struggle against these reductionist tendencies and claim that all the properties of chemical elements and compounds cannot be predicted by quantum calculus, even with the help of computer simulation. The bottom-up approach that prevails in recent materials chemistry and pharmaceutical research places great expectations in the control of individual atoms. However, those nanotechnologies also reveal that the chemist's ability to synthesize new products relies on a good deal of know-how and astute rules as much as on the fundamental laws of nature. Furthermore, recent synthetic strategies are more and more inspired by living organisms. For instance, supramolecular chemistry aims to design chemical processes that mimic the selectivity of biological processes to obtain molecular recognition without the help of genetic code. Thus, chemistry is renewing its old alliance with life science.

See also Alchemy; Physics; Science, History of; Quantum.

BIBLIOGRAPHY

- Bensaude-Vincent, Bernadette. *Lavoisier: Mémoires d'une révolution*. Paris: Flammarion, 1993.
- . "L'éther, élément chimique: Un essai malheureux de Mendeleev en 1904." *British Journal for the History of Science* 15 (1982): 183–187.
- . "Mendeleev's Periodic System of Chemical Elements." *British Journal for the History of Science* 19 (1986): 3–17.
- Bensaude-Vincent Bernadette, and Isabelle Stengers. *A History of Chemistry*. Translated by Deborah van Dam. Cambridge, Mass., and London: Harvard University Press, 1996.
- Bensaude-Vincent, Bernadette, and Ferdinando Abbri, eds. *Lavoisier in European Context: Negotiating a New Language for Chemistry*. Canton, Mass.: Science History Publications/USA, 1995.
- Beretta, Marco. *The Enlightenment of Matter: The Definition of Chemistry from Agricola to Lavoisier*. Canton, Mass.: Science History Publications/USA, 1993.
- Brock, William H. *The Fontana History of Chemistry*. London: Fontana Press, 1992. Also published as *The Norton History of Chemistry*. New York: Norton, 1994.
- Donovan, Arthur. *Antoine Lavoisier: Science, Administration, and Revolution*. Cambridge, Mass., and Oxford: Blackwell, 1993.
- , ed. *The Chemical Revolution: Essays in Reinterpretation*. *Osiris*, 2nd ser. 4 (1988). A special issue of the journal *Osiris*.
- Holmes, Frederic Lawrence. *Antoine Lavoisier: The Next Crucial Year, or the Sources of His Quantitative Method in Chemistry*. Princeton, N.J.: Princeton University Press, 1998.
- . *Eighteenth-Century Chemistry as an Investigative Enterprise*. Berkeley: Office for the History of Science and Technology, University of California at Berkeley, 1989.
- . *Lavoisier and the Chemistry of Life: An Exploration of Scientific Creativity*. Madison: University of Wisconsin Press, 1985.
- Knight, David M. *Ideas in Chemistry: A History of the Science*. New Brunswick, N.J.: Rutgers University Press, 1992.

- Levere, Trevor H. *Transforming Matter: A History of Chemistry from Alchemy to the Buckyball*. Baltimore: Johns Hopkins University Press, 2001.
- Newman, William R., and Lawrence M. Principe. *Alchemy Tried in the Fire: Starkey, Boyle, and the Fate of Helmontian Chymistry*. Chicago: University of Chicago Press, 2002.
- Nye, Mary Jo. *Before Big Science: The Pursuit of Modern Chemistry and Physics, 1800–1940*. New York and London: Twayne, 1996.
- . *From Chemical Philosophy to Theoretical Chemistry: Dynamics of Matter and Dynamics of Disciplines, 1800–1950*. Berkeley and London: University of California Press, 1993.
- Principe, Lawrence M. *The Aspiring Adept: Robert Boyle and His Alchemical Quest*. Princeton, N.J.: Princeton University Press, 1998.
- Rocke, Alan J. *Chemical Atomism in the Nineteenth Century: From Dalton to Cannizzaro*. Columbus: Ohio State University Press, 1984.
- . *The Quiet Revolution: Hermann Kolbe and the Science of Organic Chemistry*. Berkeley and London: University of California Press, 1993.
- Van Spronsen, J. W. *The Periodic System of the Chemical Elements: A History of the First Hundred Years*. Amsterdam, London, and New York: Elsevier, 1969.

Bernadette Bensaude-Vincent

CHICANO MOVEMENT. Between 1966 and 1977, members of the Mexican-American community engaged in a period of widespread political activism akin to other civil rights and antiwar movements of the 1960s. The resulting challenges and concurrent mentalities became the Chicano movement, or as it is now known in recognition of the equally important participation of Chicanas, the Chicana/o movement. During this period large-scale political organizing occurred among the Mexican-American community with a hitherto unprecedented urban energy. For those involved in the Chicana/o movement, the experience was characterized by a remarkable intensity at the personal and local collective levels. This rise in political engagement was the consequence of an interaction between a specific cultural context and contending, contentious social efforts, civic events, and ideological beliefs. It challenged the ineffectiveness of liberalism and the increasing economic and human cost of an armed interventionist foreign policy in the third world and this, combined with urban youth dissidence and ethnic protests, encouraged growing social and political militancy among Mexican-Americans.

A series of changes and continuities took place across Mexamerica in regard to the position and status of Mexican-Americans. Even though Mexicans slowly entered the skilled labor market, larger numbers remained poor due to discrimination and exploitation, and their social and educational possibilities were inhibited by social controls and economic immobility. At the same time, a very modest, educated, and political middle class burgeoned. During the 1950s and 1960s, the number of Mexican-Americans elected to office slowly increased, but electoral underrepresentation remained the rule. In comparison with the preceding periods, the number of

Mexican-American union participants slightly increased in industries accessible to unions. However, far more people were barred from, rather than included in, these unions. Basic workers and farm laborers remained the most visibly excluded.

While explicit anti-Mexican discrimination receded in some areas of employment and housing, overall discrimination continued. Mexicans held the least desirable and worst-paying jobs in the economy and lagged behind the income and schooling levels of both Anglos and blacks. Despite this, the Mexican community grew numerically, including both citizens and immigrants, and this was reflected in the increase of Mexican high school and college graduates. Growth continued into the following decades. Women's participative access to heretofore enclosed social and economic sectors was particularly noticeable, yet some exclusion persisted. The number of Mexican female college graduates increased relative to years past, as did female business ownership. Still, most Mexican women did not attend college and continued to figure prominently in the minimum-wage labor sectors. They were variously oppressed by diverse institutions including the state, their neighborhoods, and their family circles. Immigrant single mothers were most vulnerable to forms of brutality and violence, which included forced sterilizations. These multiple oppressions continued to limit the opportunities for Mexican women, as well as Mexican men and children, over generations.

Selecting chronological dates is always an arguable procedure, but there are two events that, because of their public resonance, could be used to chart the rise and decline of the national Chicana/o movement. The 1966 farmworkers' march to Sacramento, California, is often acknowledged as a visible sign of rising, proactive Mexican-American public sentiment. This could be considered the beginning of notable political ferment. Ten years or so later, the 1977 San Antonio, Texas, Immigrant Rights Conference, which was prefaced by growing anti-Mexican outlooks, signaled an acknowledged decline of Chicano militant effectiveness since the attempt at coordinated pro-immigrant rights failed on this occasion. This was soon followed by the anti-affirmative action backlash stimulated by the Supreme Court's "reverse discrimination" decision in *Bakke v. Regents of the University of California* (1978).

The view of some Chicana/o activists from the mid-1960s to the mid-1970s was that civic matters compelled a reevaluation of earlier ideological tenets (a trend emphasizing gradualism known as Mexican-Americanism), and required the development of a new "in your face" style of politics. There was much insistence upon democratic rights, and high-volume addresses were full of heightened cultural and ethnic references. These trends were effectively legitimated by relatively wide mobilizations. Advocacy reform practices previously local became increasingly regional and tentatively national. In short, the Chicana/o movement flourished as an ethnic revivalist movement of the 1960s and 1970s and was anchored in new, specifically charged politics. It involved thousands and spread from Galveston to Chicago, from Seattle to Brownsville.

Contents

Central to the movement phenomena, ad hoc organizations that focused on specific local crises or sector needs sprang up across the Southwest and Midwest. These groups centered on issues such as education reforms, service inequities, undesired urban changes, biases in war on poverty programs, drug impact, welfare rights, child care and ex-felon needs. Title II of the Economic Opportunity Act of 1964, which stipulates participation by the “client” (that is, the poor), encouraged local group mobilization either through a positive outreach facilitating participation or as a consequence of negative reactions to the perceived malfunctioning or exclusivity of certain programs. Self-help organizations advocating individual determination developed in many localities and placed stress on individual rights and access to services, particularly for women and children. Many urban Mexican-Americans increasingly came to participate in public civic activities that involved direct interaction with officials and program personnel. The youth and women stepped forward as the primary participants in these efforts. Although Chicana/o politics in the early 1960s remained overwhelmingly liberal and reformist in content, more radical currents insisted on civic equities and plural participation within areas often controlled by electoral or patronage cliques. However, the dynamic leadership initiators often voiced a distrust of known older electoral *políticos*. By the late 1960s, certain currents encompassed procommunity autonomy and pluralist tendencies vis-à-vis constituted civic arrangements that were perceived as exclusionary and manipulated. Importantly, movement spokespersons established relations with groups, organizations, educational institutions, and political leaders not only across the Mexican border but also in other countries.

Cultural Context

At times, Chicana/o political energy flowed from cultural circumstances. On other occasions, political conditions encouraged cultural happenings. Culture, history, and arts resonated in every discourse. Community affairs became increasingly varied and complex, reflecting nearly all hues of the social spectrum from center to left. To oppose the movement, its cultural rhetoric, professed priorities, or stressed styles could be interpreted as a confession of rightist sympathies. To be sure, older organizations and electoral politics continued as the new politics emerged. The origins of this energized cultural ideological activity lie in the demographic and material circumstances of the early 1960s as well as in subjective conditions. Certainly, contrasting opinions on politics and history—of complacency versus insurgency—contributed to ideological growth. Mexicans were increasingly recognized by the media as the nation’s second-largest minority, but their protest movement was not defined in the way that those of white and black dissidents were, and the media did not actively shape their leadership and rhetoric. The widespread social and economic conditions of laboring people heightened the political consciousness of Chicana/o activists. The movement drew inspirational and ideological reinforcements from a variety of sources, including those common to other social movements. But it also uniquely derived many of its beliefs from the historical heritage of Mexican-Americans themselves and in particular the ideological legacy of Mexico and Latin America. Significantly, Chicana/o activists also explored and deployed nativist

Mesoamerican heritages, and this was particularly evident in the arts. After politicized arts hammered on doors, commercially expressive cultural activities eventually flowed to the public domain.

Sharing the upheaval that grew out of changes in the ideological climate and material conditions of the early 1960s, individuals of Mexican descent engaged in a variegated burst of activity loosely identified as the “Chicano movement.” Among the seminal organizing and strategic forces were student organizations, defense groups, and artists’ coalitions; the United Farm Workers Union; the Alianza Federal de Mercedes, or land rights movement; the Crusade for Justice, a political rights organization; and eventually, La Raza Unida Party. These were followed by church associations and women’s and immigrants’ rights organizations. Most of these forces were comprised of working-class people, and women often provided the membership base. The movement had a range of concurrent fronts, which were noticeably secured in local bases where individuals chose priorities and the levels of their participation. Whatever the particular goals and methods of the political activism, the underlying motivation was always a general dissatisfaction over the Mexican’s political, economic, and social status in an Anglo-dominated society. Focus was increasingly placed on questions of exploitation, repression, exclusion, alienation, ethnicity, identity, class, gender, and chauvinism. History was privileged, perhaps more than in other social movements. Understanding the dynamics of the Mexican-American experience became a paramount motif, a voiced ideological necessity in the struggle to assess the present and envision a future for Mexican-Americans. These particular issues were sharply expressed in the arts; poets and muralists served as ideologues.

Ideology

Although *Chicanismo* often seemed a loosely expressed concept, in specific situations it could translate as a radical political and affirmative ethnic populism. The issue of identity linked to political demands jumped to the forefront. The term *Chicano* itself, used among the youth in particular regions, denoted the person and the group. *Chicanismo* referred to a set of beliefs and, more importantly, to a political practice. Its emphasis on dignity, self-worth, pride, uniqueness, and a feeling of cultural rebirth made the term attractive to many people of Mexican origin, as well as some of Latin American descent, in a way that cut across class, gender, regional, and generational lines. Negative past experiences regarding the denial of cultural heritage increased the appeal of *Chicanismo*, which emphasized Mexican cultural consciousness and social and linguistic tradition as well as economic and occupational opportunities. The Chicana/o movement became a challenge to the assumptions, politics, and principles of the established systems within and outside the community. However, even though it marked a progressive step in the struggle for identity by denying the grosser aspects of deculturalization, the designation also became a subterfuge for avoiding a critique of identity and Mexican “singularity.” The widespread appeal of *Chicanismo* without explicit ideological class content shows, in large part, how often heterogeneous political elements could identify with the “Chicano movement.” In practice, people expressed *Chicanismo* in a variety of ways.

In hindsight, one can ask whether *Chicanismo*, if seen through a militant conceptualization and in the context of its identity and ideological notions, was not simply one more effort to subsume Mexican identity and all of its implications in a dominant social context of covert anti-Mexicanism. Indeed, the term was a necessary referent for a distinct social group that could be differentiated from others in the United States by virtue of its ethnic and national roots. Other designations continued to be used, and the tension between *Chicano* and *Mexican* evolved rather than disappeared. In the initial cultural and political discourse, *Chicano* was clearly an abbreviated form for Mexicans north of the Rio Bravo, and *Chicanismo* meant a politically asserted *Mexicanidad*. Curiously, many middle-class people rejected the term as pejorative, while the lower classes preferred the appellation of *Mexicano*. Yet, to many of the young, *Chicano* was *the* term; for activists it was *the* litmus test for a political frame of mind. Furthermore, the *Chicano* denotation not only emphasized an unconventional “lifestyle” stressing *Chicanismo* but also stressed the more widely noted features of emphatic public cultural practices and radical personal values of the late 1960s embodied in the attitude, “*Soy Chicano y qué!*” (“*I am Chicano and what of it!*”).

Gender

The gender issue was sharply raised by individuals, organizations, and community activists in several Chicana/o movement areas starting in the late 1960s. Particularly noticeable were matters related to women in community settings and youth and student circles and on the perceived subordination of women and gender issues within the movement itself. Nonetheless, women obviously participated in all efforts associated with the Chicano movement. Any reference to its subsumed activities objectively implied female participation even as some pointed out that traditional gender roles were enforced, meaning that women could only occasionally assume leadership roles in many movement organizations. Inspired by militant women, Chicanas integrated Mexican and Latin American feminist heritages and drew from the contemporary radical feminist programs. Increasingly, women’s organizations grew out of community actions, political campaigns, union groups, campus activities, and inmate and ex-felon concerns. The late 1960s and the 1970s witnessed an increasing emphasis on full female participation in all aspects of community civic efforts as well as on the development of activities specific to women. At the same time, movement newspapers and journals increased their coverage on issues pertinent to gender issues.

Chicanas believed in Chicana solutions to Chicana problems the same way that Chicanos upheld Chicano solutions to Chicano problems. The initial impetus was for a critique of stereotypes impeding gender equality. This thrust grew organizationally, and its edge reflected the internal dynamics within movement organizations. Eventually a view of Chicanas as the victims of multiple oppressions (as women, ethnics, and workers) evolved. Female activity remained strongest in community arenas such as those of unionization and public services. The majority of Chicana activists participated in organizations that were not exclusively female, but gender issues arose in all groups and circumstances and were dealt with in one way or

another. Over time Chicana/o organizations have had prominent female members. In fact, MALDEF (Mexican American Legal Defense and Educational Fund), a highly visible civil rights organization, has had two long-term national women leaders. Women in higher education circles had advantaged access to forums from the 1980s onward and publicized their views and priorities. Despite resistance and controversy, veteran militants did not ultimately defer the feminist concerns, and eventually a persistent strain of efforts addressed the needs and concerns of lesbian and bisexual women.

Universalism

From the late 1960s through the 1970s, the tendencies of utopian indigenismo, cultural nationalism, and Saul Alinsky-style civil rights activism seemingly spread. These spoke only partially to the more structurally oriented economic critiques of the Mexican-American reality being raised. These criticisms were condensed into a modestly growing Marxist current within the Mexican-American community containing many of the various Marxist tendencies found in the United States. For some Marxism remained an intellectual fad, and a few considered it a philosophical critique of the capitalist society and capitalist “hegemonic culture” in particular. For others Marxism became a conceptual framework for examining the Mexican experience in a more specific and extensive manner, particularly as related to labor and gender. And some took it as an ideology combining analysis and guidance in political action and organizational structure. In this renovation, members of the 1960s and 1970s generations joined Marxists from the 1940s and 1950s. Despite the Chicana/o left wing’s ideological commonality, this sector’s social makeup was varied. Moreover, a substantial part of the Mexican Left had no specific organizational allegiance. And the part that did drew a distinction between those groups stemming from the community, such as CASA (Court Appointed Special Advocates), and those outside of it.

Problems and Achievements

As the events of the 1960s and 1970s unfolded, a presently unmeasurable element impacted political development, organization, and leadership. Police surveillance presumably occurred throughout the Southwest among Chicana/o efforts. Targets were determined, strategies devised, and tactics conducted to weaken militancy and political organizations of all types. This covert procedure was concurrent with the more visible and understood overt activities of incitements, arrests, and beatings. Police provocation to commit violent acts and, more frequently, display counterproductive behavior, was a fact. This of course led to dissension within or between groups, as well as among individuals. Police control remained constant throughout the 1970s, perhaps negatively affecting achievements.

By stressing self-determination, pride, and even aggression, the spokespersons of the Chicana/o movement achieved reasonable successes during the 1960s and 1970s: they made the larger social majority acknowledge the discrepancy between the democratic stance professed by the state and the reality in the barrios. Moreover, leaders undertook the strong actions needed to enable the more moderate elements to enter governmental,

academic, and labor institutions. Significantly, several movement thrusts continued: unionization, Chicano studies, civil rights litigation, and immigrant rights are some examples.

Clear limitations stand out when reviewing the accomplishments of the movement. Token reforms, limited representation, and personal mobility were often achieved. But Chicano self-determination, though espoused, was not accomplished. The problems confronting the movement were several: the lack of a coherent, broad, radical program for a convinced constituency; a lack of adequate material resources; and a lack of structured disciplined organizations with stable leadership mechanisms.

Conclusion

The Chicana/o movement reflected a broad and deep range of activities, most of which proved seminal to the debates, issues, and forms of later years. By the late 1970s, activists and goals diffused, and priorities and means were transformed. The intensity of the movement's momentum diminished somewhat, and activism too often became a consciously delimited activity for individuals. Mexican-American political players were no longer easily identifiable as stemming from two or three sectors within the community, nor did they share the same ethnic fervor or radical perspective as the militant Chicanas/os who had first created the context and opportunity for empowerment. Rather, spokespersons and leaders, women and men, became a complex amalgam of backgrounds, interests, ways, and goals. A growing number of professional politicians surfaced from a variety of Mexican communities, each of them espousing the concerns of a unique political constituency, and were increasingly acknowledged or tolerated as public "leadership." Many young Mexicans had explored the forbearance of the establishment and, in every way accessible, pursued what the system offered and accepted pragmatic ways of achieving reformist results. Almost bereft of resources, activists transmuted their energy into assets for their community. In that turnabout, young Chicanas/os motivated a large percentage of their community leaders to exhibit a stronger public image. In effect, they demanded that society at large receive a new message about what it meant to be of Mexican descent. They also generated support for educational, political, and economic advancements.

Public officials began addressing issues of concern to Mexican-Americans in a more considerate manner. Finally, and perhaps most importantly, the Chicana/o movement forced certain concessions from the Anglo institutional mainstream, and some of these concessions—voting and representational rights, partial bilingual education, meagerly funded Chicano studies programs and unenthusiastic affirmative-action employment practices—created a setting from which a viable Mexican middle class could expand to local prominence. The 1960s and 1970s activists also laid the groundwork for a series of economic advancements, so that by the 1980s a Mexican middle class had indeed effectively consolidated within the community. The short-term occupational gains of the 1970s were perhaps magnified by the economic setbacks of the 1980s and the consequences of 1990s globalism. Mexican-Americans suffered the effects of drastic federal policy changes lessening government support for affirmative action and civil rights affirmations. But as with other U.S. constituencies, some Mexican-American

analysts in the late 1980s totaled the score card. The score was short but the game was still on.

In retrospect, the late twentieth century looms as a time of cultural revitalization within the community. This was evident in the energies directed toward education, unions, the arts, the media, and religious institutions, as well as in a period of increased efforts at social integration. In a whip of that cultural whirlwind, the Chicana/o community remains tempered by a uniquely Mexican-American concern for both cultural continuity and political affirmation while testing how pluralistic the allegedly diverse system is. In the 1990s, dominant social elites put forth two overarching responses: promulgate the belief that civil rights gains had consolidated, and propagandize the notion that Mexican aliens subverted the society by their presence. In this context, the master narrative of the Chicana/o movement is still being elaborated.

See also Bilingualism and Multilingualism; Ethnohistory, U.S.; Feminism: Chicana Feminisms; Indigenismo; Political Protest, U.S.

BIBLIOGRAPHY

- Acuña, Rodolfo. *A Community under Siege: A Chronicle of Chicanos East of the Los Angeles River, 1945–1975*. Los Angeles: Chicano Studies Research Center, University of California, Los Angeles, 1984.
- . *Occupied America: A History of the Chicanos*. 5th ed. New York: Pearson Longman, 2004.
- Chavez, Ernesto. *Mi Raza Primero! (My people first!): Nationalism, Identity, and Insurgency in the Chicano Movement in Los Angeles*. Berkeley: University of California Press, 2002.
- Delgado Bernal, Dolores. *Chicana School Resistance*. Ph.D. dissertation, University of California, Los Angeles, 1999.
- García, Alma M., ed. *Chicana Feminist Thought: The Basic Historical Writings*. New York: Routledge, 1997.
- García, Ignacio. *United We Win: The Rise and Fall of La Raza Unida Party*. Tucson: University of Arizona Press, 1989.
- Gómez-Quinones, Juan. *Mexican Students Por La Raza: The Chicano Student Movement in Southern California, 1967–1977*. Santa Barbara, Calif.: Editorial La Causa, 1978.
- Gonzales Berry, Erlinda, and David Maciel, eds. *The Contested Homeland: A Chicano History of New Mexico*. Albuquerque: University of New Mexico Press, 2001.
- Gutierrez, Jose Angel. *The Making of a Chicano Militant*. Madison: University of Wisconsin Press, 1998.
- Mora, Magdalena, and Adelaida del Castillo, eds. *Mexican Women in the United States: Struggles Past and Present*. Los Angeles: Chicano Studies Research Center, University of California, Los Angeles, 1980.
- Muñoz, Carlos. *Youth, Identity, Power: The Chicano Movement*. London and New York: Verso, 1989.
- Navarro, Armando. *Mexican American Youth Organization: Avant-Garde of the Chicano Movement in Texas*. Austin: University of Texas Press, 1985.
- Rosales, Francisco Arturo. *Chicano! The History of the Mexican American Civil Rights Movement*. Houston: Arte Público Press, 1996.
- Sanchez, David. *Expedition through Aztlan*. Los Angeles: Perspectiva Press, 1996.

Vigil, Ernesto. *The Crusade for Justice: Chicano Militancy and the Government's War on Dissent*. Madison: University of Wisconsin Press, 1969.

Juan Gómez-Quiñones
Irene Vasquez Morris

CHILDHOOD AND CHILD REARING. During the last two centuries, even amid poverty and war, more children have had the opportunity for successful lives than ever before. The modern concern for child health, education, and well-being, however, emerged only after long millennia in which children's welfare was subordinated to the needs and goals of caretakers and communities—a pattern also encountered today in developing regions of the world. In recent decades, scholars have gained considerable understanding of the experience of children, as well as attitudes toward childhood in the premodern world.

The Child-Centered Modern Age

Since the nineteenth century, scholars, scientists, and writers, along with lawyers, statesmen, and philanthropists, have concerned themselves with the nature and welfare of the child as at no previous time. Triggering that interest were the ideas of John Locke (1632–1704), Jean-Jacques Rousseau (1712–1778), and later authors of the Romantic movement.

Elaborated in his *Essay on Human Understanding* (1690), Locke's notion that the human infant's brain is a tabula rasa, free of innate ideas but subject to the formative stresses of the environment, made the earliest stage of human development seem critical. In his *Émile* (1762), Rousseau understood the child as a noble savage, best able to gather knowledge as he pursued his natural interests and instincts long before he needed to master the artificial skills of the schoolroom. Soon afterwards, Romantic writers and artists idealized childhood innocence and empathized with childhood experience, as did William Blake (1757–1827) in his *Songs of Innocence* (1789) and William Wordsworth (1770–1850) in his *Ode: Intimations of Immortality from Recollections of Early Childhood* (1807).

The exploration of childhood proceeded as new “social sciences” of the human condition developed. Charles Darwin's (1809–1882) theory of evolution by the process of natural selection, described in his seminal works *The Origin of Species* (1859) and *The Descent of Man* (1871), envisioned the creation of new species as the product of individual acts of procreation by millions of genetically privileged individuals—a vision of biological change, that is, centered on the birth of new infant generations. In a series of works published from the 1890s through the 1930s, the Austrian psychoanalyst Sigmund Freud (1856–1939) explored the role of childhood trauma on later adulthood and mapped the struggles toward autonomy of the developing infant personality. In *The School and Society* (1899), among other works, the American philosopher John Dewey (1859–1952) redefined the purpose of education: its aim was not to instill the accumulation of adult learning but to prepare future citizens and workers.

Practitioners of the new science of anthropology traveled the globe to study pre-state human societies, including their child-rearing concepts and practices, an interest exhibited in, among others, Margaret Mead's (1901–1978) *Coming of Age in Samoa* (1928). Sociologists investigated the situation of youth in modern societies, looking at peer groups, youth gangs, adolescent drug use, and teen pregnancy, among many other topics. Psychologists explored early childhood learning and development, a topic they share more recently with biologists, philosophers, and linguists in the interdisciplinary pursuit of “cognitive science.”

Social reformers, philanthropists, and journalists, meanwhile, took up the cause of child welfare, as did Danish-born Jacob Riis (1849–1914) and Lewis Hine (1874–1940), for instance, who depicted in photographs and prose the condition of “street Arabs” and child workers at the turn of the twentieth century in America. While advocating women's civil rights, the early feminist movement highlighted women's maternal capacities and duties, an orientation that culminated in the publication in 1900 of the Swedish feminist Ellen Key's (1849–1926) influential book, *The Century of the Child*.

In the twentieth century, both communist and fascist governments targeted the child. Soviet Communism promoted collective childcare so as to free women to become workers, while Italian Fascists and German Nazis adopted maternalist and pro-natalist policies. Totalitarian states of both persuasions promoted youth societies that indoctrinated adolescents in official ideology. Reeling from the slaughter of World War I, meanwhile, democratic states instituted welfare policies that supported mothers, families, and children. Among the free and the unfree, twentieth century wars and genocidal projects resulted in the slaughter, starvation, displacement, and militarization of children. The United Nations Convention on the Rights of the Child (1989) addresses these, among other abuses of children that have survived in the modern world.

At the same time, the twentieth century has also seen great progress in the medical care of the child. The modern practice of childbirth put traditional midwives out of business by about 1900. Whereas vaccination for smallpox had been known since the eighteenth century, the twentieth century brought new vaccinations against diseases dangerous specifically for children, such as diphtheria. In addition, the availability of pasteurization, refrigeration, and devices for artificial feeding dramatically improved survival rates of abandoned and orphaned children. Funded by public and private monies, social workers tended to the needs of the children of the poor and immigrant populations. Experts on child rearing flooded the market with advice books for middle-class readers, a flood epitomized by the popular work of Dr. Benjamin Spock (1903–1998), whose *Common Sense Book of Baby and Child Care*, first published in 1946, reached its seventh edition before the author's death in 1998.

A generation before Spock's death, however, a new book appeared in France that shook the scholarly world: Philippe Ariès's *Centuries of Childhood* (1960; English trans., 1962). So careful of children had citizens of the modern West become that they had forgotten the lost world of not so very long ago:



The Virgin and Child Before a Firescreen by Robert Campin, c. 1430. Oil on wood. The many artistic depictions of Mary and the baby Jesus created throughout the centuries have served to focus attention on the symbiotic relationship that exists between mother and child. © THE ART ARCHIVE / NATIONAL GALLERY LONDON / EILEEN TWEEDY

the premodern world, where children perhaps counted not so much as in the present era, or at least not in the same way.

The Historicity of Childhood

Centuries of Childhood presents the thesis that the “concept of childhood” itself is modern: a creation of the seventeenth and eighteenth centuries. This thesis has been disputed and defended by later scholars. As a product of that controversy, the historicity of childhood has been established indisputably. The concept of childhood, along with childhood itself, is subject to change in changing historical circumstances.

In earlier times, Ariès argued, children were perceived as participants in adult society. They shared the same amusements as adults and did not have distinctive occupations or adornments. Even at school, children, adolescents, and adults intermingled, without distinction of age. The important boundary was not between child and elder, but dependent and master. Sentimental relations between parents and children were weakened, moreover, by the frequency of child death. Attitudes began to shift in the seventeenth century as smaller, coherent family groups supported the experience of individual children. Literary works evinced a newfound affection for children, while families willingly invested in child accessories and

education and grieved at child deaths. Ariès based his arguments mainly on literary texts and artistic representations, mostly from France and England between 1500 and 1750.

Ariès’s work evoked responses that critiqued and confirmed his hypotheses. In 1965 the British historian Peter Laslett published *The World We Have Lost* echoing some of Ariès’s conclusions. Laslett was reporting on the project of empirical research on the history of the family centered at Cambridge University, which studied such archival sources as baptismal records for evidence of family structure, ages of baptism, marriage, and death. Using different sources, Laslett, like Ariès, concluded that the experience of past childhood was unlike that in the modern age: such children lived in a world we have lost.

Also affirming Ariès’s hypothesis, Lawrence Stone’s massive *Family, Sex, and Marriage in England, 1500–1800* (1977) focused on elite households and utilized literary evidence such as diaries, autobiographies, and letters. Over three stages of development ranging from large, authoritarian households to smaller, more egalitarian ones, the family became increasingly “affective,” Stone argued, characterized by strong sentimental ties and abundant investment in child welfare.

The American psychohistorian Lloyd de Mause, agreeing with Ariès and Stone on the greater importance of the child in modern times, proposed a model of the history of childhood that unfolded in five stages from the horrors of antiquity to the enlightened childrearing practices of the present day. Declaring in his seminal 1973 essay “The Evolution of Childhood” that the history of childhood was a “nightmare from which we have just begun to awaken,” de Mause credited modern psychoanalytic theory with persuading adults to abandon age-old practices of abuse and consciously to further the child’s autonomy and creativity. Also highlighting recent shifts in child-rearing attitudes, Edward Shorter’s *Making of the Modern Family* (1975) argued that warmer, sentimental relations between men and women encouraged a stronger bond between mother and child.

Historians of the Italian Renaissance, examining a period (principally the fifteenth century) well before the kind of turning point in perceptions of children identified by Ariès, Stone, de Mause, or Shorter, found a trove of empirical data that permitted the mapping of household structures of Florence and its surrounding countryside. The work of David Herlihy and Christiane Klapisch-Zuber, first published in 1978, yielded important insights about family size and ethos in different social groups. In essays collected and republished in 1993, Richard Trexler further explored both the dependency of children in Florence and their capacity as innocents as agents of salvation. Turning from Florence, Margaret King studied childhood death and adult bereavement in a noble Venetian family (1994).

While not aligning themselves as supporters or opponents of Ariès, Renaissance historians added to the evidence pointing to the difference between modern and past childhoods. In the wake of Stone’s study, however, historians of England plunged into the controversy, generally to defend past parents and childhoods. Clarissa Atkinson’s study of medieval moth-

erhood, and Barbara Hanawalt's of children in fourteenth-century London, pointed to the complexity of past family relationships in contradiction to Ariès's notion of a premodern "indifference." More heatedly, Linda Pollock plowed through hundreds of diaries (mostly seventeenth century) to support her claim that parents cared deeply about their children. Alan Macfarlane, in studies of the origins of English individualism (1978) and of love and marriage in the early modern era (1986), proposed that familial relationships in England had long exhibited supposedly "modern" qualities of profound sentiment.

Examining Puritan communities in England and colonial Anglo-America, John Sommerville and John Demos each found attitudes toward children that were surprisingly modern. Examining family documents from Reformation-era Germany in several studies between 1983 and 2001, Steven Ozment argued (as had Macfarlane for England) that modern sentiments of family intimacy were well-established long before the modern age. Historians of ancient Greece and Rome such as Mark Golden and Suzanne Dixon, similarly, did not detect, as Ariès had suggested, any lack of a "concept" of childhood. Anthropologists note that in the Americas, early documents about the Aztec and Inca civilizations reveal a very structured picture of the life course, in which phases of childhood play an important role; in tribal societies of Africa and the Americas, too, initiation rituals divide a life into discrete phases associated with childhood, adolescence, parenthood, and grandparenthood. Hugh Cunningham, finally, focusing on children in the industrial era, placed the break between older and modern perceptions of children not in the early modern era, as had Ariès and Stone, but in the nineteenth century.

This brief overview shows that Ariès's pioneering hypothesis did not win universal acceptance from scholars. On one point agreement has been general: childhood is not the unchanging phenomenon contemporary experts often assume it is, but it varies according to time, setting, social context, gender, and culture. Ariès's great achievement was to establish the historicity of childhood as something no longer capable of refutation.

That established, it is clear that scholars have moved beyond the issues of the Ariès debate to explore a broader range of issues. These include issues concerning the child in the context of the mother-child relationship; those concerning the child in the context of the father-headed household; and those related to the training and education of children. This survey concludes with a consideration of the impact of industrialization on childhood, ushering us into the modern world.

Mother and Child: The First Dyad

Women alone give birth to children, although in the simplest band-level societies, child rearing is a more collective enterprise than among later agriculturalists, and even among agricultural peoples, social structures such as kin groups (clans and lineages) and polygynous marriages often lead to families in which children acknowledge multiple adults who raise them, and adults correspondingly recognize their responsibilities to-

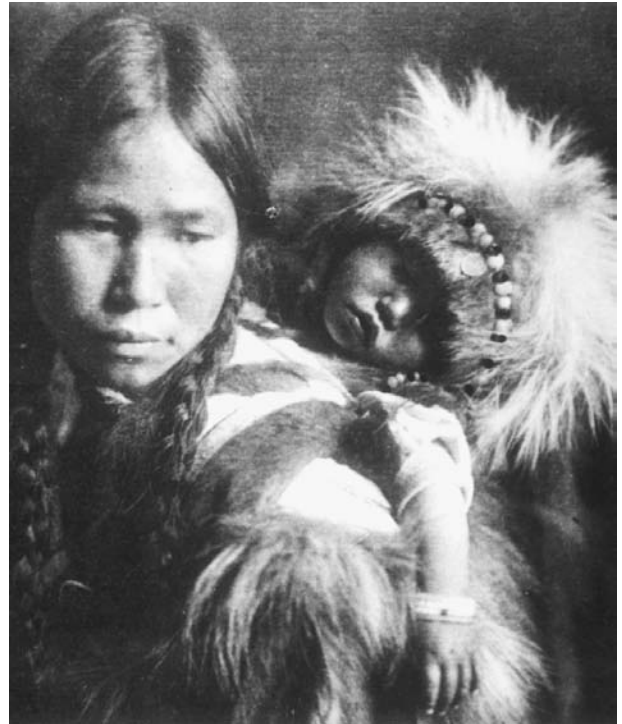

Eskimo mother and child, c. 1915, photographed by H. G. Kaiser. The ultimate human bond has long been believed to be that between mother and child, and many cultures possess myths and legends centering on avenging mothers and mother goddesses. NATIONAL ARCHIVES AND RECORDS ADMINISTRATION

ward children other than their own birth children. In history, those children who survived were reared by mothers or mother surrogates. Even in advanced societies, the most powerful of human bonds has been that between mother and child, and the metaphor of motherhood is often used by other adults in expressing their bond with a child, as Gracia Clark has shown in her studies of West African motherhood. The dependency of the child on the mother, and the implication of the mother in the life of the child, is expressed in artistic representations of the mother-child dyad that appear in many different cultural settings—most famously, for Western civilization, in the image of Mary, the virgin mother, and the child Jesus. In recent years, however, African-American and Chicana scholars, while emphasizing the significance of motherhood within their cultural traditions, have used concepts such as "Othermothering" to underscore that mothering is typically a task shared among kinswomen, in contrast to the isolated white mother of the middle-class Euro-American nuclear family.

The importance of motherhood is further expressed in mythologies and cult objects: mother goddesses, fierce and gentle, the consorts of their sons, the guarantors of the fertility of the fields or of safety in childbirth, conspirators at times against the power of men. The fantasies of maternal power are also expressed in fantasies of matriarchal societies—although scholars now generally agree that there were none truly such—such as that of the Amazons.

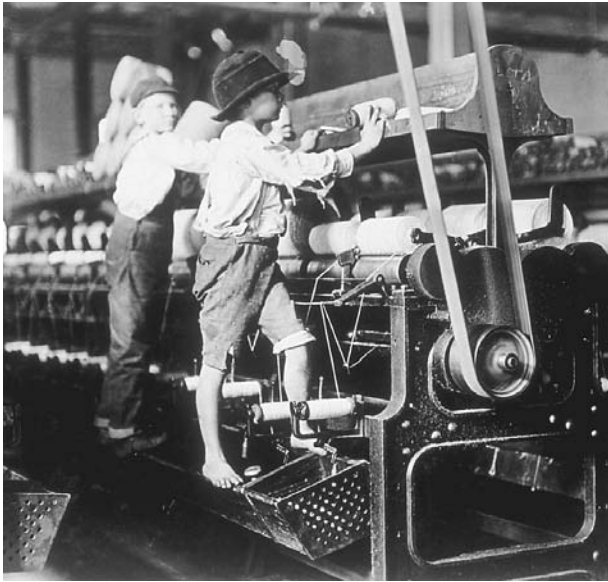

Children working in a textile mill. During the early years of the industrial era, children were frequently employed to work long hours under dangerous conditions in factories and mills. By the end of the nineteenth century, inquests into child safety resulted in protective laws being passed. THE LIBRARY OF CONGRESS

Although anthropologists, linguists, and literary critics have been the primary observers of the ancient figure of the mother, real and mythic, historians have also examined the circles of women who surround the mother. These were the women who, across cultures, gathered to assist mothers in childbirth—female kin, friends, servants, and neighbors—while the skilled expert among them, the midwife, took charge. (Male physicians retained control of the theoretical literature about childbirth until the eighteenth century, when they took on the obstetrical role as well.) The same communities of women gathered to mourn the dead, or to provide advice at times of crisis and illness. John Riddle has shown in his works on abortion and herbalism that these informal women’s groups wordlessly transmitted medical and physiological information across generations.

In some societies, such female communities lived in physical isolation within larger households, as in the *gynaecium* of the ancient Greeks, or the “inner quarters” of elite Chinese families. Here children of both sexes were raised until about age seven, and girls remained until they were wed. The harems of the Chinese emperors and Ottoman sultans constituted more formalized versions of such female communities. In these separate worlds, women gave birth, raised children, tended the sick, spun thread, and mourned the dead.

Supported by female networks, mothers faced that first essential task after childbirth itself: breastfeeding. The health and survival chances of all children before modern times depended on the availability of a lactating mother or mother-surrogate, as Valerie Fildes has shown in her comprehensive history of nursing. The alternatives that were attempted, including arti-

ficial feeding of nonhuman milk and nursing from animal teats, often resulted in infant death. In societies such as ancient Rome and the Americas, slave nurses nourished and reared the children of their masters. In the premodern West and later colonial and postcolonial settings, paid wetnurses were hired to feed the children of the nobility, and later of urban, colonial, and racial elites. Gilberto Freyre’s classic psychosocial analysis of Brazilian society, *The Masters and the Slaves* (English trans., 1947), dissects the effects of this infantile closeness with the black female body, and concomitant distance from the white mother, on the sexual development of Brazil’s upper classes. This practice was commonplace in premodern Europe despite the universal advice of expert physicians, theologians, and philosophers. In the West, as in China and the Islamic world, injunctions to mothers to nurse their children account for a large part of all advice literature pertaining to children.

Mothers regularly experienced the deaths of their offspring in childbirth, in infancy, and in early childhood, an experience that is still common today for the world’s poor, as documented in Nancy Scheper-Hughes’s penetrating analysis of motherhood in urban Brazil, *Death without Weeping* (1992). The toll of infant death prior to modernization was in the range of 20 to 50 percent of live births, statistics that remain all too common in impoverished areas of the developing world. In the near-absence of birth control, fertility was high, and women commonly gave birth to many children, with totals of more than twenty not uncommon; yet mothers often saw only a few children reach adulthood. The high rate of infant and child mortality is the single most important fact to be culled from the history of childhood; as Scheper-Hughes documents, childhood signifies differently when few children reach adulthood.

Most babies died of disease or malnutrition, from which perils their mothers could not protect them, as they still cannot today. Others died also from accidents, neglect, or infanticide, the last of these an act most often perpetrated by mothers—and sometimes by salaried or servile nurses. Impoverished mothers, often servants, slaves, or prostitutes, or others whose conception and parturition was deemed “illegitimate,” were often, and disproportionately, infanticidal. Enslaved Africans and American Indian mothers often chose to terminate their infants’ lives rather than see them grow up under the tragic circumstances in which their mothers lived; for slave women, this horror was compounded by the knowledge that the children belonged to the master, and not to their own parents.

Mothering varies, of course, according to economic status. Among working families, the labor of absent mothers earning cash to support their children counted as material symbols of maternal love, whereas in middle-class, mid-twentieth-century American families, it was the presence of the mother inside the home rather than in the workplace that demonstrated her commitment to her children. In wealthy households, mothers are often freed from the constant demands of children by the services provided by hired help—nannies, babysitters, and tutors. In contemporary American and European societies, this

labor is provided by immigrant women whose own children are often a continent away, cared for by grandparents or other female kin.

In Western society, the profound detestation of maternal, and more broadly female, endangerment of children is witnessed by the condemnation and, sporadically, prosecution of abortion and infanticide. The idea of the evil mother appears to have triggered profound passions expressed in the fantasies of the evil deeds done by witches (in Europe, especially the fifteenth to seventeenth centuries); by Christians (as perceived by the Romans during the late-ancient era of persecution); or by Jews (as perceived by Christians during anti-Semitic outbursts). All of these persecuted malefactors were believed to have sickened, killed, and cannibalized children.

The vulnerability of children was thus a source of great anxiety to the adults who, nevertheless, sacrificed children to divine forces in a practice that was once nearly universal—as Martin Bergmann, among others, informs us. Although mothers were not the only agents of child sacrifice, the connection already seen of women with death and mourning, with the often fatal event of childbirth, and with frequent child death, indicates that connection.

Successful mothers of child survivors were, in addition, the primary educators of children. Modern social science has established that mothers and mother substitutes are the first teachers of language—in the Western world, a fact reflected in the term used for the natal language as the “mother tongue” (*lingua materna*, *Muttersprache*). In the United States, the notion of “mother language” took on special poignancy for the young children of immigrants. Warm childhood memories of the smells and sounds of their monolingual mother’s kitchens contrasted with life at school and workplaces, where they struggled to master the language and customs of an alien and sometimes racially and ethnically hostile world. Throughout history, male suspicion of mothers and nurses as shapers of language also testifies to their important role: the ancient Roman statesman and author Cato the Elder (234–149 B.C.E.) would not have his children spoken to by nurses, and the Dutch humanist Desiderius Erasmus (1466?–1536) disdained the linguistic environment of the nursery and urged the swift conveyance of the child to a qualified tutor. In contrast, Chinese theorists celebrated those heroic mothers who prepared their sons from infancy to study for the civil service examinations.

The maternal role was probably more potent than these experts feared. Before written texts, the values and traditions of a culture were probably transmitted in story and, even more likely, in song, sung by mothers and nurses to generations of infants. In more developed societies, mothers and mother-surrogates were the first agents of religious instruction, a powerful welder of civilizational loyalties.

The Household: The Father’s Domain

In premodern times, a child’s chances of survival depended on her mother’s availability to nurture; but so, too, on her father’s benevolence. For once human beings joined together in sedentary communities to engage in agricultural production, the

father-headed household made an appearance. Fathers were the gatekeepers of households, and the guardians of the children he admitted to them. Those fortunate children were generally the offspring of approved women: those considered to be “legitimate.” A bright line divided the spheres of legitimacy and illegitimacy, with great consequence for the lives of children (even though, in many societies, the illegitimate children of concubines lived under the same roof as their preferred half-siblings).

In Greek and Roman society, the master of the household had the power to welcome or reject a newborn child. Children not so welcomed would be “exposed,” or placed outside the household in a place where they might perhaps perish, or possibly be retrieved by other families seeking a servant or by slavedealers interested in exploiting the child as a laborer or prostitute. As John Boswell carefully noted, exposure was not necessarily coterminous with infanticide; but certainly, a child’s destiny was more assured if he remained in the household into which he was born.

The “exposure,” abandonment, or killing of unwanted infants was commonplace in ancient civilizations, including China as well as those of the Mediterranean world. The aim was to limit population and conserve household resources, purposes achieved in modern times by contraception and abortion. Another form of abandonment practiced in medieval Europe, which may also have been caused by demographic factors, had at least superficially a religious motivation as well. Children given to a monastery, as “oblates” (offerings), would not only disburden a family of too many children, but would enhance their parents’ chances of salvation. Yet the oblation of a child had ancient roots as well and approaches the phenomenon of child sacrifice as much as that of abandonment.

When fathers kept or exposed children, gender issues came into play. Boys were generally preferred to girls, as skewed sex ratios in different communities of the ancient world inform us; indeed, they still do so inform us, as sex preference by abortion is widely practiced today in Asia. When girls were raised in the household, the status of males remained higher. In ancient Rome, for instance, when boys received distinctive personal names at birth, girls bore their fathers’ name with a feminine ending: the daughter of Julius, for instance, was Julia. In Italian Renaissance genealogies, daughters were often anonymous, designated only as “filia” (daughter). In contrast, in some pre-state societies, such as those of the American Iroquois or Hopi, the birth of a female child was celebrated.

In Western and Asian civilizations, boys were generally preferred to girls as heirs, whether they were valued as the keepers of the family rites, as in China and Rome, or as the inheritors of property, as they were nearly everywhere. The dowry was a common device—prevalent among the Hebrews and Babylonians, the Chinese and Indians, the Greeks and Romans, and premodern Europeans—used to give a limited portion of a patrimony to daughters upon marriage (or entry to a convent, in Christendom) so that the bulk of it was preserved for one or more sons.

The concern with inheritance, resulting in the devaluation of daughters relative to sons, characterizes societies organized

by father-dominated households. The organization of those households, however, varies enormously according to region, era, and social rank. In China, India, and Islamic society, the young tended to marry early and remain within or closely related to the bridegroom's male kin. In Islam, endogamous marriage, principally to first cousins, was and remains common, and polygamy, although never universal, is permitted. In China, young brides often suffered under the hand of their powerful mothers-in-law.

European society, in a pattern especially characteristic of northwestern Europe, tended toward late marriage and the establishment of autonomous households, and truly nuclear families, by the newly married. As Alan Macfarlane has argued (1978, and again in 1985), the latter pattern, which prevailed in England, was conducive to the development of behavioral autonomy and the sense of individualism that was to manifest itself in the theoretical products of the Renaissance and Enlightenment. Certainly, in monogamous, nuclear families, it may be assumed that individual children received greater parental attention, with a consequent enhancement of their life chances.

The iron reality of high mortality meant that, whether the family was more or less extended, all children in premodern times experienced a different type of household than is common in contemporary society. Women generally gave birth to children over the whole span of their fertile years. Their first-born children might be twenty or more years older than their last. Sibling relationships would be greatly complicated by this fact: late-born children would find themselves subject to the authority of early children, if those remained at home; or early-born children might be ejected early from the household in favor of late-born dependents. As women's lives were often cut short by death in childbirth, moreover, husbands tended to remarry, and more than once. Their second and subsequent wives continued to bear children, who were half-children of the first wife, occasioning even more intense sibling rivalries and the often-hostile presence of the stepmother.

When the father of the household died, patterns of widow remarriage differed. In China, India, and the West, the preference was that they should not remarry—and in traditional India, some widows died on their husbands' funeral pyres, in the Hindu custom of *suttee*. In Europe, although chaste widowhood was theoretically preferred, widow remarriage was common. Young widows who remarried might surrender their children to their husband's kin. Widows who did not remarry might continue to rear their children in the households of their husbands, or form one of the few woman-headed households.

A child's life chances in history depended even more than today on the nature of her mother, her father, and her household. So too did the kind of training or education that children received.

Training and Education: The Circulation of Children

Maternal rearing lasted until the age of seven, approximately, in most societies. Thereafter, although some girls continued under their mothers' care until marriage, most children learned

the tasks of adulthood elsewhere: from tutors, at work, in school, or by apprenticeship.

Almost universally, the age of seven (sometimes six or eight) is the point at which children were thought to reach an age of competence. At that point, they could perform tasks responsibly, understand religious instruction, or begin formal education. At this point, too, boys were generally transferred from maternal to paternal oversight. In some tribal societies, as in such settings as ancient Sparta, the Ottoman Janissary Corps, and the nineteenth-century English public school, boys have been removed from the care of their mothers at an early age and raised in exclusively male groups—a kind of collective extension of paternal care.

If there was general agreement on the approximate age of seven as demarcating a stage of childhood, other demarcations were variable. Weaning (around eighteen months to two years was typical in the Western world) marked for some the boundary between infancy and early childhood. Later childhood was often seen to begin somewhere after age ten, when children were seen working outside the home, although some did so as early as age eight or nine as well. Some societies, like the Jews and the Romans, ritually marked the entry of boys into adulthood at age thirteen or fourteen. Minimum ages of marriage for girls clustered around age twelve.

No consensus, therefore, existed on the stages of childhood after age seven, or about the length of childhood. The child who was trained to peasant labor, or apprenticed to a master, or sent into service, or swept up in the experience of war, had only a brief childhood. In those peasant societies where household structures were extended, as in China, sons lived in the natal household even after marriage, still subordinate to paternal authority, while girls often married young, to be raised by the parents of their young husbands. In Western society, where it was common for young couples to begin their own separate households, adulthood began with marriage.

After regional and cultural factors, the boundaries of childhood depended most on the social standing of the child. In Western society, many children were in a process of circulation from ages as young as eight or nine. The poor were sent from home to labor as servants; nobles to acquire the skills of knighthood (if male) or household management (if female); those of artisan origin to apprenticeships lasting five, seven, or even ten years. Children circulated for purposes other than work or training. Wealthy households took in the surplus or orphaned children of their kin, while the children of an unwed or widowed mother would follow her on a tedious journey in search of shelter or employment.

In contrast, those children privileged enough to remain at home, supported by their bourgeois or aristocratic parents, were the real prototype of modern children. Dressed in special clothing, and endowed with specialized objects—known to us as toys—to enhance their play, they would be perceived as uniquely innocent. They would be protected from exposure to adult sexuality and violence; they would be tended in illness and mourned in death; and they might be given tutors and teachers and provided a liberal educa-

tion. An interesting comparison is provided by Bronislaw Malinowski's famous description of childhood in the Trobriand Islands off the coast of Papua New Guinea, where children spent their days in a separate "nation of children," similarly freed from adult responsibility, but also from adult supervision to a degree unthinkable in the upper- and middle-class West.

Until recent times, schooling has been an opportunity limited to the fortunate few. One of the hallmarks of civilization, literacy was initially the property of an esoteric elite of priests and scribes. In Mesopotamia, Egypt, and China, writing consisted of numerous and intricate characters that were learned with difficulty and reproduced slowly. That pattern persisted in imperial China, where the literary arts were highly esteemed, and families sacrificed so that their sons could be educated and compete, and sometimes qualify for office, in strenuous state-run examinations. In tribal societies, sex-specific education could last for years, but usually took place in sex-segregated contexts and depended upon the oral and ritual transmission of knowledge.

Alphabetic writing systems made literacy easier to achieve. As merchants and artisans gained access to writing skills, schooling became more generalized. In Greek, Hellenistic, and Roman society, literacy was relatively widespread among urban elites. Islamic civilization, as well, esteemed literacy. Significant numbers of Muslims from the straits of Gibraltar into south Asia and Oceania learned to read Arabic, the language of the Koran.

In the wake of the Germanic invasions of the fifth and sixth centuries, the level of civilization in Europe dropped dramatically from Roman days. For centuries, literacy was limited to members of the Christian church hierarchy: priests and monks. Schools were appendages of monasteries and cathedrals, their prime purpose to supply the minimal knowledge of Latin necessary to perform the liturgy. As scholastic (school-based) learning developed in the twelfth and thirteenth century, stimulated by the incorporation of ancient Greek (especially Aristotelian) texts, universities took form. In these institutions of higher learning—the world's first—students in their teens and twenties gained degrees in philosophy, theology, medicine, and law. In the Americas, Aztec and Inca noble youth entered priest-run schools where they received education in the forms of knowledge; only among the Maya, however, would this include literacy in the Western sense.

The humanists of the Italian Renaissance created a form of schooling beyond the church-based system, whose purpose was to enlighten and develop the individual rather than to instill specific systems of knowledge. The Protestant and Catholic Reformations each adopted the Renaissance notion of elementary and secondary schools that now proliferated, serving to prepare not only a priestly class, but male elites from the middle classes and the nobility, and even girls at elementary levels. These educational initiatives, together with revolutions in economics and science that made backward Europe the dominant world power, greatly enhanced the chances children would have for their own advancement.

Schooling came at a cost for young students—the cost of corporal punishment. From antiquity, the symbol of a teacher was the rod that he wielded to "correct" the unruly or unresponsive student. In medieval Europe, it was understood that Latin was literally to be beaten into the young. Although humanist pedagogues deplored the use of the rod, corporal punishment remained a feature of the schoolroom into modern times. Such abuse was only an extension of norms outside the classroom. Those with power could visit physical chastisement on their dependents: masters over apprentices, householders over servants, the state over malefactors, and fathers over children. Perhaps the world has seen, over the last century, along with those consumed by Holocaust, world war, and state-sponsored famine, the first children to escape the rod.

The Advent of Modernity: School and Work

The twin processes of Enlightenment and industrialization mark the division between premodern and modern for childhood and concepts of childhood. Whereas the Enlightenment introduced the ideas with which this article began, leading to the modern disciplines that specialize in the condition and care of the child, industrialization introduced new forms of exploitation of children, but also, in time, new opportunities for family life as standards of living eventually rose. In the two areas of work and schooling, the lives of children changed most dramatically during the industrial era.

Industrialization meant, above all, the factory organization of labor. Children, notoriously, labored in the early factories, to the great detriment of their health and well-being. As industrialization progressed, an inquest into the welfare of children workers resulted in Britain's Factory Act of 1833, which set hour limits for child workdays. Following suit, most advanced nations introduced the regulation of child labor, beginning with France in 1841, and culminating in the first decades of the next century with Japan, Russia, and the United States. Today, child labor is found in developing regions of the world and is the subject of investigation and censure by many activists and policy-makers in the developed world.

As policy-makers, employers, and parents came to understand that children must not spend their lives in factory labor, they established instead the goal of sending all children to school. Beginning with France by 1878 and Britain by 1891, secular, free, and compulsory mass public education was the norm for the wealthiest nations of Europe and the Americas, as well as rapidly modernized Japan. At the same time, the kindergarten movement created by central European pedagogical theorists Johann Heinrich Pestalozzi (1746–1827) and Friedrich W. A. Froebel (1782–1852) swept the Western world, encouraging the establishment of kindergartens supported by fee-paying elite parents and charitable institutions. In the early twentieth century, Maria Montessori (1870–1952) introduced the concept of a nursery school for the very young, featuring child-friendly spaces and materials and a structured but individualized and child-appropriate curriculum. In the more privileged countries, these opportunities for young children have become increasingly commonplace. In poor countries, in contrast, even children over age seven, especially girls, lack the opportunity for a basic education.

Laslett's depiction of *The World We Have Lost* poignantly alerted modern readers to the unbridgeable distance between their own reality and that of children of premodern times. More recently, we have learned that the distance is not so very great. In the developing nations of the modern world, millions of children live in conditions strikingly like those of the times we thought we had left behind: among them, continual maternal childbearing without possibility of contraception; high rates of infant and child mortality; abandonment, infanticide, and abuse; absent or tyrannical fathers; child labor; and the cataclysm of war.

See also *Education; Family; Motherhood and Maternity.*

BIBLIOGRAPHY

- Ariès, Philippe. *Centuries of Childhood: A Social History of Family Life*. Translated by Robert Baldick. New York: Vintage, 1962.
- Atkinson, Clarissa W. *The Oldest Vocation: Christian Motherhood in the Middle Ages*. Ithaca, N.Y.: Cornell University Press, 1991.
- Bergmann, Martin S. *In the Shadow of Moloch: The Sacrifice of Children and Its Impact on Western Religions*. New York: Columbia University Press, 1992.
- Boswell, John Eastburn. *The Kindness of Strangers: The Abandonment of Children in Western Europe from Late Antiquity to the Renaissance*. New York: Pantheon, 1988.
- Clark, Gracia. *Onions Are My Husband: Survival and Accumulation by West African Market Women*. Chicago: University of Chicago Press, 1994.
- Cunningham, Hugh. *Children and Childhood in Western Society since 1500*. London: Longman, 1995.
- Demos, John. *A Little Commonwealth: Family Life in Plymouth Colony*. Oxford and New York: Oxford University Press, 1970.
- Dixon, Suzanne. *The Roman Family*. Baltimore: Johns Hopkins University Press, 1992.
- Ebrey, Patricia Buckley. *The Inner Quarters: Marriage and the Lives of Chinese Women in the Sung Period*. Berkeley: University of California Press, 1993.
- Fildes, Valerie A. *Breasts, Bottles and Babies: A History of Infant Feeding*. Edinburgh: Edinburgh University Press, 1986.
- Freyre, Gilberto. *The Masters and the Slaves (Casa-grande & Senzala): A Study in the Development of Brazilian Civilization*. Translated by Samuel Putnam. New York: Knopf, 1947.
- Golden, Mark. *Children and Childhood in Classical Athens*. Baltimore: Johns Hopkins University Press, 1990.
- Goody, Jack. *The Development of the Family and Marriage in Europe*. Cambridge, U.K., and New York: Cambridge University Press, 1983.
- Grendler, Paul. *Schooling in Renaissance Italy: Literacy and Learning, 1300–1600*. Baltimore: Johns Hopkins University Press, 1989.
- Hanawalt, Barbara A. *Growing Up in Medieval London: The Experience of Childhood in History*. Oxford and New York: Oxford University Press, 1993.
- Herlihy, David. *Medieval Households*. Cambridge, Mass.: Harvard University Press, 1985.
- Herlihy, David, and Christiane Klapisch-Zuber. *Tuscans and Their Families: The Florentine Catasto of 1427*. Abridged translation. New Haven, Conn.: Yale University Press, 1985.
- Hoffer, Peter C., and N. E. H. Hull. *Murdering Mothers: Infanticide in England and New England, 1558–1803*. New York: New York University Press, 1981.
- King, Margaret. *The Death of the Child Valerio Marcellus*. Chicago: University of Chicago Press, 1994.
- Klapisch-Zuber, Christiane. *Women, Family and Ritual in Renaissance Italy*. Translated by Lydia Cochrane. Chicago: Chicago University Press, 1985.
- Laslett, Peter. *The World We Have Lost*. New York: Scribners, 1965.
- Macfarlane, Alan. *Marriage and Love in England: Modes of Reproduction, 1300–1840*. Oxford, and New York: Blackwell, 1985.
- . *The Origins of English Individualism: The Family, Property, and Social Transition*. Oxford: Blackwell, 1978.
- de Mause, Lloyd. "The Evolution of Childhood." In *The History of Childhood*, edited by Lloyd de Mause. New York: Psychohistory Press, 1976.
- Mitterauer, Michael. *A History of Youth*. Oxford and New York: Blackwell, 1992.
- Ozment, Steven. *Ancestors: The Loving Family in Old Europe*. Cambridge, Mass.: Harvard University Press, 2001.
- Pollock, Linda. *Forgotten Children: Parent-Child Relations from 1500 to 1900*. Cambridge, U.K., and New York: Cambridge University Press, 1983.
- Riddle, John M. *Eve's Herbs: A History of Contraception and Abortion in the West*. Cambridge, Mass.: Harvard University Press, 1997.
- Scheper-Hughes, Nancy. *Death without Weeping: The Violence of Everyday Life in Brazil*. Berkeley: University of California Press, 1992.
- Sommerville, C. John. *The Discovery of Childhood in Puritan England*. Athens: University of Georgia Press, 1992.
- Stone, Lawrence. *The Family, Sex, and Marriage in England, 1500–1800*. London and New York: Weidenfeld and Nicolson, 1977.
- Trexler, Richard C. *Power and Dependence in Renaissance Florence*. Vol. 1, *The Children of Florence*. Binghamton: State University of New York Press, 1993.
- Zelizer, Viviana A. *Pricing the Priceless Child: The Changing Social Value of Children*. Reprint, Princeton, N.J.: Princeton University Press, 1994.

Margaret L. King

CHINESE THOUGHT. *Chinese thought* is a generic term, referring to the ideas produced, expanded, and transmitted in the history of China. First, these ideas are not simply general opinions, but the philosophical views of the world, life, and society that have been commonly accepted as concepts or systematic theories. These ideas or theories are the end-products of logical reasoning—in Chinese, the two characters *si xiang* (thought) both contain a radical *xin* (heart/mind), the faculty of which is defined as "thinking" (Mengzi, 6A:15, p. 168). Secondly, these concepts or theories are primarily transmitted through words or writings, conveyable to and understandable by the people of later generations, although other means can also be used to pass on ideas; for example, symbolic form and structure of excavated artifacts and architectures have been correctly "understood" or interpreted as the meaningful ideas that underlie, and are integrated with, the history and culture of China. Thirdly, these concepts or theories are "typical" of the Chinese, who have employed them as tools to explore the inner and the external world, and to recapture the interaction

between human activities and the natural and/or the supernatural realms. What is meant by “typical” here is in practice the formalization of philosophical opinions characteristic of the process of thinking by major Chinese philosophers.

The Origin

There is no consensus among modern scholars as to when Chinese thought started and whether or not the philosophical ideas of Chinese people originated from a single source. According to traditional beliefs, Chinese culture started with the invention of the diagrams or ideographical symbols by a legendary figure Fu Xi, and was continually shaped through the working of cultural heroes and legendary sage kings, particularly the Yellow Emperor (Huang di), Yao, Shun, and Yu, who are believed to have been the leaders of China in the fourth to third millennia B.C.E. It is traditionally believed that the period of cultural heroes was followed by the three dynasties—Xia (c. 2205–c. 1600 B.C.E.), Shang (c. 1600–c. 1045 B.C.E.), and Zhou (c. 1045–256 B.C.E.)—in which a reasonably comprehensive system of thought about the philosophical foundation of the world developed and that the earliest writings discovered so far as presented in “oracle bone inscriptions,” recording royal divinations and major natural and political events in the early part of the Shang dynasty, mark the beginning of systematic thinking concerning political, religious, and philosophical matters. Modern scholarship on ancient China and new findings of regional centers of civilization, however, have challenged the traditional convictions about the actual existence and functioning of the Xia dynasty and about a single line of development in early Chinese thought. Symbols and preliminary pictographs on potteries and jades discovered in East and South China (Longshan culture), and jade wares and bronze figures and masks found in Southwest China (Shu culture), have shed a new light on the multi-originary sources of Chinese thought, and on the ways these sources were integrated into a single culture through a long and gradual process. Archaeological excavations of houses, cities, and sacrificial sites dated to the prehistorical period also prove that well before using characters to record their thinking of the world and life, the people who lived in the land of China had started to reflect on the physical and the metaphysical world, search for the harmonious interaction between the spiritual and the mundane, and implement these ideas in construction, decoration, and in a variety of economic, political, and religious activities.

The Rise of Rational Thinking

Having said this, we are fully aware of the importance of written language, without which it would be impossible to form abstract concepts, and to preserve and transmit systematic ideas. The ideas as presented in the oracle bones inscriptions of the Shang and the bronze inscriptions of the early Zhou represented an attempt to rationalize, albeit in a preliminary way, the Chinese understanding about cosmic change, the nature and function of social institutions, life and death, and so on. These ideas were later reflected and expanded upon in the *Book of Documents* (*Shu*), the *Book of Poetry* (*Shi*), and the *Book of Changes* (*Yi*), part of which can be dated to the western Zhou dynasty (1045?–771 B.C.E.). However, the rationalization of Chinese thought did not come into full play until

the Spring and Autumn period (770–476 B.C.E.), when the early theological view of the world was challenged, modified, and transformed by new thinkers. Since the moving of the capital to Luoyang in 770 B.C.E., the Zhou kings gradually lost control over the states, while the lords of large states became powerful and competed with each other for the domination of the smaller ones. Natural disasters and administrative abuses had fundamentally shaken the political and economic foundation of the feudal system, and society experienced dramatic change and transformation. Substantially weakened were the force of the beliefs that the power of the Zhou king was endowed in the name of the Mandate of Heaven (*tian ming*) and that the ritual (*li*) binding people and states to the king was part of the cosmic order. The official ideology under the royal patronage and control was gradually torn apart: “The arts of the Way in time comes to be rent and torn apart by the world” (Zhuangzi, p. 364), and Chinese thought came to the stage where several distinct ways of thinking were pioneered as responses to the social and political reality, either negatively deconstructing or positively reconstructing. These thinking streams led to the final formation of a number of major schools, the so-called “a hundred schools” (*bai jia*), during the Warring States period (475–221 B.C.E.), whose rational calling found representative voices in Confucianism (*Ru*), Daoism (*Dao*), Mohism (*Mo*), Legalism (*Fa*), Logicians (*Ming*), Yin-yang School, School of Military Strategies (*Bing*), School of Agriculture (*Nong*), and so on. The competition and mutual criticism between these schools was substantial and productive, in which they developed and extended the boundaries of their own thought. Of these schools Confucianism, Daoism, Mohism, and Legalism were of the greatest significance for the formation and development of Chinese thought.

Confucianism. The early *ru* tradition became a school of thought that bears the name of Confucianism in the West today, mainly through the educational efforts of Confucius (Kong fuzi, 551–479 B.C.E.), who, although claiming only to be a transmitter of ancient culture, attempted to rectify political chaos and social disruption by transmitting and transforming the ritual and learning of the past. Employing “controlling one’s selfish desires” (*ke ji*) and “re-establishing the ethical codes of conduct” (*fu li*) as two major tools, Confucius was devoted to the realization of a humane and righteous society in which people followed the good example of rulers and treated each other in accord with the rules of propriety or moral codes. Confucius trained his students to become conscious moral agents or “gentlemen” (*jun zi*), who sincerely upheld the Way (*dao*), were grounded firmly on virtues (*de*), behaved in accord with humaneness (*ren*), and took recreation in the arts (Confucius 7:6, p. 86). In practice he required them to be filial to their parents, respectful to the elders in community, earnest in action and trustful in words, and to love all the people, have the friendship of the good, and cultivate themselves through studying traditional culture (Confucius 1:6, pp. 59–60). The ideas and ideals Confucius illustrated in his conversations that were later compiled into a book entitled *Lun yu* (*The Analects*) and were further expanded by his followers during the Warring States period, among whom Mengzi (372?–289? B.C.E.) and Xunzi (330?–227? B.C.E.) took a lead. Mengzi believed in the religious, ethical, and political vision contained in the Confucian classics, and devel-

oped the Confucian doctrine in a religio-ethical direction, while Xunzi was inclined toward the naturalistic and ritualistic vision, and cultivated it in the spirit of humanistic rationalism. Both honored Confucius and believed that everybody was able to attain the ideal—that is, to become a sage (*sheng*) through learning and practicing—but Mengzi and Xunzi differed dramatically in their views of Heaven (*tian*) and human nature (*xing*): while the former held that Heaven is the supreme moral authority and humans are born with a good nature, the latter argued that Heaven is natural and human instincts would lead to evil and chaos if not checked by rituals, moral rules, and sagely teachings. New discoveries of writings on bamboo strips at Guodian and other parts of south China dating to about 300 B.C.E. provided certain evidence that between Confucius and Mengzi there were active a number of Confucian “sub-schools” that developed Confucius’s thinking about the Way of Heaven, human nature, and moral and political applications.

Daoism. In contrast to Confucian ideals, many Daoist ideas were propagated as an alternative route to social harmony, as evidenced in the following passage: “Exterminate the sage, discard the wise; and the people will benefit a hundredfold; exterminate benevolence, discard rectitude, and the people again will be filial” (Laozi, 1963 p. 75). A variety of sources have been identified showing the rise of the Daoist thought during the end of the Spring and Autumn period and the beginning of the Warring States period, but no definitive dates for the Daoist masters Laozi (traditional dates c. 571–c. 480 B.C.E.) and Zhuangzi (360?–280? B.C.E.) have been agreed on. The majority of modern scholars have refuted the traditional beliefs, arguing that the two most important Daoist philosophical books, *Daode jing* (or *Laozi*) and *Zhuangzi*, might not have come into existence until the fourth to third centuries B.C.E. However, the two silk texts of the *Laozi* discovered in 1973 at a Han tomb in Mawangdui dated to 168 B.C.E. and the bamboo version of part of the *Laozi* excavated in 1993 from a Chu tomb at Guodian were testimony that this Daoist work had already had different lines of textual transmission by the fourth century B.C.E. It is clear that the *Laozi* and the *Zhuangzi* were representative of the way of life for those people who withdrew themselves from social and political controversies. Central to them are the concepts of *dao*, the Way, and *de*, its power. As the mystic origin and principle of the world, we are told, *dao* cannot be known unless we have reduced our sensational experience and knowledge to the minimum, which is described either as a process of “polishing the mystic mirror” (Laozi, 1963, p. 66) and/or as “driving out perception and intellect” and “doing away with understanding” (*Zhuangzi*, p. 90). To live peacefully in a chaotic society, we are advised to take water as our guide: staying lower, withdrawing from politics, and not contending with others. In defining the nature of Dao as *yin* or yielding, the *Laozi* openly opted for a “feministic approach” and took “the mystic female” as the model for humanity. Withdrawing from the corrupted and chaotic society, the Daoist masters propagated a natural way of life in which there was no competition and purposeful action (*wu wei*). Apart from these philosophical collections, other strings of Daoist ideas and practices, such as the so-called Learning of Huang (the Yellow Emperor)-Lao (Laozi), also played an important part in the formation of Daoism.

Mohism. Mohism (also spelled Moism) was virtually created in the activities and thought of Mo Di or Mozi (Master Mo, 468?–376? B.C.E.). Differing from Confucians who presented a humanistic system that defined and redefined the moral-political-religious code by way of a “virtue ethic,” Mohists went for a utilitarian way to improve people’s material welfare, maintaining that a theory was good only if it was able to bring benefits to the people, order to society, and an increase in population to the state. For Mozi, what brought the greatest harm to the world was partiality (*bie*) that caused people to love their own parents, families, and states while hating and attacking the parents, families, and states of others. He called for the abandonment of partiality and replaced it with universal love (*jian ai*), regarding the states of others as our own, and loving the families of others as our own. By this, it was claimed, the ideal society of the great unity would be realized. Based on utilitarian principles, Mozi was strongly against all activities that did not contribute to the material welfare of the people, and called for the abandonment of Confucian ritual and music. Unlike Daoists who simply withdrew themselves, Mohists were constantly on peace missions, strongly condemning aggressive wars and selflessly aiding the defense of the state attacked. Against the tide of pragmatism, rationalism, and agnosticism, Mozi and his followers reconfirmed the authority of the spirits and spiritual powers, arguing that the righteous way we must follow was to worship Heaven above, to provide services to the spirits in the middle realm, and to bring benefits to the people below. In politics they called for “honoring the worthies”—namely, selecting and promoting the most qualified to governmental posts. In order to increase the welfare of the state and the people, they put forward as important policies “identifying with the superior” and exercising the control of thought as the tool for social order. Having a particular appeal to artisans, merchants, and small property owners, Mohism occupied a distinguished and influential position in the philosophical arena during that time, which can be seen from the fact that Mengzi listed the school of Mo as one of the two most dangerous rivals (Menzi, 3B:9, p. 114), while Han Fei (280?–233 B.C.E.), a Legalist thinker, described Mohism as one of the two most important schools (Han Fei, p. 118). After the death of Master Mo, however, Mohists disintegrated into three sub-schools, each claiming to be “true Mohism” and accusing others of being “false Mohism.” They developed Mohist thought in the areas of epistemology and formal logics, which together with many of earlier Mohist ideas and ideals had a lasting effect on the development of Chinese thought, although Mohism as a school had died out by the time of the Han dynasty.

Legalism. Listed under “Legalism” (*fa jia*) by later historians or catalogs are such politicians and thinkers as Guang Zhong or Guanzi (d. c. 645 B.C.E.), Shang Yang (390?–338 B.C.E.), Shen Buhai (401?–337 B.C.E.), Shen Dao (350?–275? B.C.E.), and Han Fei (280?–233 B.C.E.). According to the authors of *Han shu* (History of the former Han dynasty), Legalists originated with administrative officials (*li guan*), who put into practice realizable codes of rewards and penalties in order to support rites and institutions (Ban Gu, p. 1736). However, the formation of the so-called Legalism school followed a route quite different from that of other schools, since these men were

not united by loyalty to a master, nor by an organization, nor through their commitment to specific books. They were grouped together as a single school on the grounds that they all asserted that the only way to save the world from collapse and to strengthen the power of the state was to govern it by penal codes and restrain it with clearly defined law (*fǎ*). All Legalists attempted to justify the universality of law, and to identify law not only with the codes of punishment, but also with the “standardized” patterns of behavior, including administrative and military planning and statecraft. Taking law as the most important tool for governance, some Legalists deliberately associated law (*fǎ*) with the arts of rulership (*shu*) and the authoritative power (*shi*). Entwined with administrative techniques, Legalism demonstrated a tendency toward ideological authoritarianism, encouraging the ruler of the state to exercise control over people’s thinking, constantly disciplining as well as stimulating individuals to avoid punishment and to seek benefits. Differing from the other schools of the time that engaged in scholarly debates and argument as the way to prevail, some Legalists held a negative attitude towards the so-called “useless and harmful” philosophies and encouraged the ruler to suppress them if at all possible. Hostile to Confucians who took the past as the moral and political model for today, Legalists argued that the times had changed and the past must not be used to guide today’s activities, and some went even further to attack the so-called sage kings as the culprits of an immoral society. Despising the reclusive Daoists who refrained from engaging in politics, Legalists positively took part in the state administration; also, ignoring Mohists who opposed aggressive war and championed for peace, Legalists took war as a necessary tool to strengthen the power of the ruler, expand the state, and make the people strong, disciplined, and submissive. Effective means as many Legalist ideas were in increasing the power and wealth of a state, Legalism virtually elevated the state of Qin in West China above all other states and was instrumental to the final establishment of a unified empire in 221 B.C.E.

Heaven and Humans

Divergent as these schools are in terms of metaphysical views and political vision, they developed their ideas and theories around a certain number of key themes, such as Heaven and humans, the Way and changes, the past and today, knowledge and the criteria of truth, the internal and the external realms, and so on. Of these themes the relation between Heaven and humans stands at the center, underlying almost all the important ideas and ideals propagated by the major thinkers, and functioning as the core of Chinese thought in later history. Heaven is a convenient translation of *tian*, which, originally meaning “sky” above us, contains multidimensional meanings, such as the natural order, the religious ultimate (the Lord of Heaven), the source of the political order (the Mandate of Heaven), and the moral order. In search of the Way of Heaven and its relation to the way of humans, Chinese thinkers of the Axial era (800–200 B.C.E.) raised a number of questions such as whether or not Heaven or the Will of Heaven could be known, whether or not Heaven would intervene in human affairs, and what attitude humans should have toward Heaven.

The majority of the early philosophers came to the understanding that harmonious interaction between Heaven and humans was the key to the solving of all social, political, and philosophical problems.

In its metaphysical and physical connotation, Heaven refers to the cosmos, the material world, the Natural Law, or simply Nature, in which humans live, act, and regenerate, and to which humans conform. When asked why he did not speak, Confucius pointed out that silent Heaven ran its course by its law rather than by its words: “What does Heaven ever say? Yet there are the four seasons going round and there are the hundred things coming into being” (Confucius 17:19, p. 146). Major Daoist masters took Dao (the Way) as the original substance of Heaven, and regarded the returning to Heaven as a necessary step for the unity with Dao: “Humans follow the way of Earth; Earth follows the way of Heaven; Heaven follows Dao, and Dao follows its own nature” (*Laozi*, chapter 25; see Laozi, 1963, p. 82). Xunzi understood Heaven as the natural order operating according to unchanging principles, arguing that Heaven ran its courses constantly and did not change along with the events in the human society. Against the religious and moralist teaching that Heaven would bless the good and punish evil, Xunzi believed that Heaven did not intervene in human affairs but provided the environment in which all living things exist. Differing from the ideas that humans could do nothing in relation to the natural order, however, Xunzi defends the position of humans in the world that while performing their duties in accord with seasonal changes, humans should not simply glorify and obey Heaven, but rather must “regulate what Heaven has mandated and use it” (*Xunzi*, vol. 3, p. 21). The texts of *The Book of Changes (Yi jing)* provided many insights into the nature and function of the universal order (Heaven and Earth) that underlies the myriad phenomena and defines the natural law of Heaven as the foundation of human existence. Represented by the sage, humans are equipped with the power and intelligence to stay in tune with the natural order.

Applied in the spiritual realm, Heaven signifies an anthropomorphic Lord (*huang tian*) who presides above, and rules over or governs directly, the spiritual and material worlds, by which humans fulfill their destiny. In the Confucian classics, particularly the *Book of Poetry*, the *Book of Documents*, and the *Book of Rites*, Heaven and humans are locked in a mandate giver and receiver relation: while the king rules the world by the Mandate of Heaven (*tian ming*), he must be responsible to Heaven above him. It is a fundamental belief that as the spiritual power, Heaven awards virtuous people with the right to govern and punishes those who depart from the Way, which will definitively lead to the collapse of the dynasty. Succeeding to this tradition, Confucius claimed that “Heaven alone is great!” (Confucius 8:19, p. 94), believing that whether or not the Way prevailed in the world was predetermined by Heaven, and that his mission to transmit the ancient culture was endowed by the power of Heaven. However, Confucius admitted that it was not easy for ordinary people to understand the will of Heaven, and that the only path to this kind of knowledge was through learning and practice (Confucius 2:4, p. 63). This theme is further illustrated in the *Mengzi*, where humans

are required to know their heart/mind first: by extending the heart/mind, we are able to know the will of Heaven and to serve Heaven (*Mencius* 7 A:1, p. 182). The spiritual relationship between Heaven and humans is clearly explained in Mohism: Heaven is like the watchdog above us and nobody would be able to evade Heaven's eyes. For Mozi, Heaven desires righteousness and hates unrighteousness, and if we devote ourselves to righteousness then we are doing what Heaven desires, and if we disobey the will of Heaven then we are bringing misfortune and calamity upon ourselves (Mozi, p. 79).

For a majority of Confucian followers, Heaven is the source of virtues, the prototype of the moral order that guides humans in their social life, and the supreme sanction of human behavior. Confucius claimed that "Heaven has given birth to virtues that are in me" (Confucius 7:23, p. 89). Mengzi believed that there are two kinds of honors, the honors bestowed by Heaven (for example, humaneness, righteousness, sincerity, and the like) and the honors bestowed by humans (for example, positions and ranks in the government). He believed that the former should be sought after first and the latter would follow as a matter of course (Mengzi 6A:16, pp. 168–169). Even Xunzi, who attempted to separate the natural order and the moral order, defining the three roots of rituals as serving Heaven above and Earth below, paying honor to one's forebears and exalting rulers and teachers, drew much from the moral significance of Heaven (Xunzi, vol. 3, p. 58). Later Confucians in general took Heaven and Earth as the model of moral rules and principles; for example, just as Heaven is above and the earth below, so too the sovereign is placed over his ministers and subjects, parents over their children, and a husband over his wife. Although other schools did not emphasize as much the moral nature of Heaven as the Confucians did, they argued from different perspectives that the Way of Heaven was the foundation of moral virtues. Mozi drew upon his understanding that Heaven has its will, and argued that humans must follow Heaven's will, devoting themselves to the good fortune and prosperity of the people (Mozi, p. 79). Regarding Heaven as a natural process revolving ceaselessly, the *Zhuangzi* nevertheless requires the virtue of emperors and kings to take Heaven and Earth as its ancestor, the Way and its virtue as its master, and to take nonaction as its constant rule (Zhuangzi, p. 144). Han Fei believed that the Way was the beginning of all beings and the measures of right and wrong, although under Daoist influence he argued that only by being empty and still could the ruler hold fast to the Way (Han Fei, p. 16).

Syncretic Philosophies

The so-called philosophical schools were never clear-cut in their heritages and boundaries. It has been argued that diverse as they were, these schools actually sprang from the unified tradition of an earlier time and shared a common root in their teachings. The commonality in theoretical deliberation and the practical needs for communication between different schools paved the way for a philosophical syncretism. Toward the end of the Warring States period syncretic writings became dominant, in which mutual accommodation between seemingly divergent theories and inter-philosophical dialogue were enthusiastically engaged. Qin (221–206 B.C.E.) and Han (206

B.C.E.–220 C.E.) thinkers went even further by drawing upon a variety of cultural and literary lineages, and constructed or reconstructed a grand philosophy of cosmological, religious, political, and ethical theories, which is evidenced in such eclectic collections as *The Spring and Autumn Annals of Mr. Lü*, *The Book of Guan Zhong*, and *The Book of Master Huainan*. Yin-yang, the Five Elements or Five Agents (*wu xing*), the Way, Heaven, the spiritual realm and the mundane world, political ideals, and ethical norms were all woven into a structure in which Heaven, Earth, and humanity stood as the three interrelated pillars of the universe, and resonances between human society, government administration, and natural processes were intensively sought after. In the powerful current of syncretism, the earlier teachings of the philosophical schools were transformed and regenerated, and became constituent elements of a new phase in the development of Chinese thought.

Confucian ethics and the Confucian orthodoxy. Confucian thinkers and politicians led the way of syncretism and pushed the boundaries of their own teachings far beyond the recognition of early Confucian masters. Confucian ethics and the Confucian political blueprint were replanted in the rich soil of syncretic ideas and values, embodied in such popular texts as *Xiao jing* (The book of filial piety), as well as *Da xue* (The great learning), *Zhong yong* (The doctrine of the mean) and *Li yun* (The evolution of rites), three of the essays on ritual and rites in an anthology entitled *Li ji* (The book of rites). The transmission of the mainstream Confucian learning was focused on the commentary lineages of *Chun qiu* (The spring and autumn annals), a work believed to be composed by Confucius himself. Dong Zhongshu (195?–105? B.C.E.), a leading thinker of the Han period, drew upon the earlier resources, Confucian, Daoist, Legalist, and particularly that of Yin-yang and the Five Elements, and constructed Confucian doctrines in line with the new thinking of the Han. He reinterpreted the relationship between Heaven and humans into the backbone of a new integrated system of ethics, politics, religion, and education. Eclectic as he was in the book attributed to him, *The Luxurious Dew of the Spring and Autumn Annals* (*Chunqiu Fanlu*), Dong was nevertheless faithful to Confucian ideals, according to which harmony between the three realms, Heaven, Earth, and humans, is central to the peace of the world, while the king or emperor is described as the agent of Heaven who ruled over the world by the mandate from above. In holding the vital and immense responsibility for the moral guidance of the people, the ruler's authority must be spiritually disciplined and practically based on the advice of the enlightened scholar-officials and support by the people. It was this kind of Confucian thought that was eventually elevated to be the state orthodoxy during the reign of Emperor Wu (r. 141–87 B.C.E.), to which all other schools of thought were required to conform.

Daoist religion and Neo-Daoist philosophy. The wisdom in Lao-Zhuang Daoism was particularly appealing to thinkers with a creative mind, and its leaning to the concepts of *xuan* (mystery), *wu wei* (nonaction or no purposeful action), *wu* (nothingness), *kong* (emptiness), and *jing* (tranquil-

ity) opened up the imaginary vision of philosophers and religious practitioners as well. The other branch of the broadly defined Daoism, the teachings of the Yellow Emperor and Laozi (Huang-Lao) was also particularly popular at the time and penetrated all layers of social life through medical and shamanic practices that, extended and put into political practices, underlay the imperial policies during the first few decades of the Han dynasty. Through synthesizing Confucian ethics, Lao-Zhuang philosophy, and Huang-Lao teaching, Daoism developed in two directions: religio-political movements aimed at purifying the world, prolonging the life, and overthrowing the Han dynasty, and a kind of Mysterious Learning (*xuan xue*) emerging during the Wei-Jing period (256–420 C.E.). In the former, Dao was mystified as the divine source and Laozi the philosopher as the Savior of the world, while in the latter the heavily politicized relation between Heaven and humans was reinterpreted as that between social norms and human naturalness, and the philosophers Confucius and Laozi were transformed into the moral ideals who had embodied Dao and had reached very high stages in self-cultivation. Religious Daoism and Neo-Daoist philosophy were combined and integrated into the Daoist tradition that exercised a powerful influence over the way of life in Chinese history.

Buddhism and the interaction of “the three teachings.”

By the first century of the common era, if not earlier, Buddhism had been introduced to China via Central Asia. Different but innovative, Buddhist teachings on ignorance, suffering, and Buddhahood were met both with enthusiasm and suspicion, welcomed by those who were preoccupied with issues of longevity, metaphysical speculation, and superhuman achievements, while resisted by those who attempted to secure the integrity of Chinese culture in relation to the state and family. In debates with Confucians and Daoists, Buddhists skillfully accommodated their teachings to the cultural requirements and spiritual needs of Chinese society, soon seizing the minds of the people and becoming powerful in the reshaping of the political and religious landscape. Based on the study of particular texts and the synthesis of Indian and Chinese understandings, distinguished Buddhist thinkers and their followers created various schools of Buddhist doctrine, of which Tiantai, Huayan, Chan, and Pure Land were particularly important and influential. In search of harmony and unity between the three teachings, Confucian, Daoist, and Buddhist theorists and practitioners consciously explored and justified the rationality of the one body of the three teachings (*san jiao yi ti*). Confucius, Laozi, and the Buddha were recognized as the fountainheads of three religio-ethical traditions, distinctive from each other and yet being the same in essence. It was held that in their mutual supplementation, the three teachings were all needed to meet the political, ethical, personal, social, and spiritual needs of the society. The interaction between Confucianism, Daoism, and Buddhism became the major subject matter and the mainstream current in the later development of Chinese thought.

Neo-Confucianism. Well embedded in the integral development of the “three traditions,” the Confucians of the Song (906–1279) and Ming (1368–1644) dynasties revived the traditional Confucian teachings in response to the challenges

from a variety of philosophical lineages, particularly those of Buddhism and Daoism. Their works or commentaries on earlier Confucian texts revealed new horizons for Confucian philosophy, innovating its ethical understandings, and placing moral and political principles on the ground of metaphysical and metaethical rethinking about the Supreme Ultimate (*Tai ji*), Heaven (*tian*), Principles of Heaven (*Tian li*), material force (*qi*), and the heart/mind (*xin*). Of the seminal thinkers of this period, Cheng Yi (1033–1107) and Zhu Xi (1130–1200) led the way to a rational reasoning about the reality of Confucian principles and norms, while Lu Jiuyuan (1139–1193) and Wang Shouren (1472–1523) preferred an idealistic identification between human heart/mind and social virtues and between knowledge and action. Common to both types of Confucian learning, however, was the emphasis on humanity and self-cultivation, pointing to the direction of the attainability of sagehood by all. Reshaped as the new learning of the Confucian Way, known as Neo-Confucianism in the West, Confucian thought became the state ideology and the philosophical basis of Chinese life and thinking until the beginning of the nineteenth century.

However, Neo-Confucianism did not go without significant challenges. Dissatisfied with the stereotypes of Zhu Xi’s authoritarian scholarship, a number of independent thinkers in the Qing dynasty (1644–1911) branded Song scholars as “unfaithful followers” of the Confucian Way, proposing to return to the learning of the Han dynasty (*Han Xue*) and to take studies of Confucian classics rather than philosophical reinterpretations as the path to Confucian values. Other scholars engaged in “evidential studies” of ancient texts and commentaries (*Kao Zheng Xue*) against speculations, and explored new ways by which Confucian learning could be used to improve people’s lives and to strengthen the state. Although these currents did not change the overall landscape of Qing learning, they in one way or another prepared Confucian intellectuals for a new stage that was looming large with the incoming of “Western learning” (*Xi Xue*), in which the further development of Chinese thought would be fundamentally influenced by the conflict and interaction between the Chinese and the Western cultures.

See also Confucianism; Consciousness: Chinese Thought; Daoism; Humanism: Chinese Conception of; Justice: Justice in East Asian Thought; Legalism, Ancient China; Maoism; Mohism; Mysticism: Chinese Mysticism; Religion: East and Southeast Asia; Time: China.

BIBLIOGRAPHY

PRIMARY SOURCES

- Ban Gu. *Han Shu*. 12 vols. Hong Kong: Zhonghua Shuju, 1970.
 Confucius. *The Analects*. Translated with an introduction by D. C. Lau. Harmondsworth, U.K., and New York: Penguin, 1979.
 Han Fei. *Han Fei Tzu Basic Writings*. Translated by Burton Watson. New York: Columbia University Press, 1964.
 Laozi. *The Classic of the Way and Virtue: A New Translation of the Tao-te Ching of Laozi As Interpreted by Wang Bi*. Translated by Richard John Lynn. New York: Columbia University Press, 1999.

- . *Lao Tzu: Tao Te Ching*. Translated with an introduction by D. C. Lau. Harmondsworth, U.K.: Penguin, 1963.
- . *Lao Tzu's Tao Te Ching—A Translation of the Startling New Documents Found at Guodian*. Translated by Robert G. Henricks. New York: Columbia University Press, 2000.
- Lau, D. C., trans. *Mencius*. Harmondsworth, U.K.: Penguin, 1970.
- Mozi. *Mo Tzu Basic Writings*. Translated by Burton Watson. New York: Columbia University Press, 1963.
- Shang Yang. *The Book of Lord Shang: A Classic of the Chinese School of Law*. Translated by J. J. L. Duyvendak. London: Arthur Probsthain, 1928.
- Xunzi. *Xunzi: A Translation and Study of the Complete Works*. Translated by John Knoblock, 3 vols. Stanford, Calif.: Stanford University Press, 1988–1994.
- Zhuangzi. *The Complete Words of Chuang Tzu*. Translated by Burton Watson. New York: Columbia University Press, 1968.

SECONDARY SOURCES

- Bloom, Irene, and Wm. Theodore de Bary, eds. *Principle and Practicality: Essays in Neo-Confucianism and Practical Learning*. New York: Columbia University Press, 1979.
- Chan, Wing-tsit, ed. *Chu Hsi and Neo-Confucianism*. Honolulu: University of Hawaii Press, 1986.
- De Bary, Wm. Theodore. *The Message of the Mind in Neo-Confucianism*. New York: Columbia University Press, 1989.
- De Bary, Wm. Theodore, and Irene Bloom, comps. *Sources of Chinese Tradition*, vol. 1. 2nd ed. New York: Columbia University Press, 1999.
- Eno, Robert. *The Confucian Creation of Heaven: Philosophy and the Defense of Ritual Mastery*. Albany: State University of New York, 1989.
- Graham, A. C. *Disputers of the Tao: Philosophical Argument in Ancient China*. La Salle, Ill.: Open Court, 1989.
- Hall, David L., and Roger T. Ames. *Thinking from the Han: Self, Truth, and Transcendence in Chinese and Western Culture*. Albany: State University of New York Press, 1998.
- Hansen, Chad. *A Daoist Theory of Chinese Thought: A Philosophical Interpretation*. New York and Oxford: Oxford University Press, 1992.
- Kohn, Livia. *Daoism and Chinese Culture*. Cambridge, Mass: Three Pines Press, 2001.
- . *Laughing at the Tao: Debates among Buddhists and Taoists in Medieval China*. Princeton, N.J.: Princeton University Press, 1995.
- Loewe, Michael, and Edward L. Shaughnessy, eds. *The Cambridge History of Ancient China*. Cambridge, U.K., and New York: Cambridge University Press, 1999.
- Queen, Sarah A. *From Chronicle to Canon—The Hermeneutics of the Spring and Autumn according to Tung Chung-shu*. Cambridge, U.K., and New York: Cambridge University Press, 1996.
- Schwartz, Benjamin I. *The World of Thought in Ancient China*. Cambridge, Mass.: Belknap Press of Harvard University, 1985.
- Yao, Xinzhong. *An Introduction to Confucianism*. New York: Cambridge University Press, 2000.
- Zhang, Dainian. *Key Concepts in Chinese Philosophy*. Translated and edited by Edmund Ryden. New Haven, Conn., and London: Yale University Press, 2002.

Xinzhong Yao

CHINESE WARLORDISM. The term *junfa* became part of the Chinese vocabulary in the 1910s and gained popularity in the 1920s to describe the phenomenon of militarism that dominated the Chinese political scene between 1916 and 1928. While both characters, *jun* (military) and *fa* (as in *menfa*, prominent lineage), are ancient Chinese words, it was in Japan that *fa* as a suffix was paired with other words to mean “a clique of” or “a faction of.” *Zaibatsu*, for example, means financial combines (*caifa* in Chinese); and *gumbatsu*, meaning military clique, helped the Chinese define the emerging situation of militarism in China.

Before *junfa*, there were other Chinese terms to refer to individual military governors. *Zongdu*—viceroy, for example—was used in the Qing text. In the early twentieth century, the character *du*, “to supervise,” appeared in such compounds as *dudu*, *dujun*, and *duban*—all referring to a military governor.

Junfa, or its English equivalents *warlords* and *warlordism*, when used in the context of Chinese polity and society during the first part of the twentieth century, are pejorative expressions, evoking brutality, chaos, and the plundering of the civilian population. The warlord era was marked by constant warfare, thrusting China into perpetual economic and political instability. Typically, modern warlordism in China applies to the years between 1916 and 1928, but its impact and legacy, with its residual influence, lasted well into the 1940s. Official history in Beijing and Taipei denounces warlords and characterizes the era as reactionary to China’s endeavor toward national unity and progress. Both Chinese and English scholarship describe the warlords as regional militarists, possessing personal armies that they constantly strove to expand and heavily relied on to advance their own interests in power and money. Backed by their military power, they maintained virtual territorial autonomy over the regions under their control. They relied heavily on taxes of the local population for revenue. While petty warlords depended more on local sources, including the domestic opium traffic, more significant ones had established ties with the foreign powers present in China from whom they gained financial and military support.

However, it would be a mistake to think of warlords as being under the thumb of the foreign powers. Between 1916 and 1928, when the warlords held sway in China, they numbered in the hundreds if not in the thousands. Their strengths varied tremendously, from a force composed of no more than a handful of men to well-armed troops of several hundred thousand strong. Numerous as they were, there were fewer than a dozen major factions, among which were three infamous cliques in North China. The Anhui clique (Wan) was headed by Duan Qirui, the premier of the Beijing government between 1912 and 1920. The Zhili (Zhi) faction was commanded by Feng Guozhang, who, after his death, was succeeded by Cao Kun. The Fengtian (Feng) clique was led by Zhang Zuolin. Members of all warlord coalitions, big and small, shifted their allegiance constantly as was the nature of the warlord alliances; but the three northern factions stood out and commanded more attention than the southern warlord groupings because they fought for national power represented by the Beijing government.

Warlordism in modern China had its origin in the last decades of the nineteenth century, when the Qing government was losing control of the empire under the pressure of domestic unrest and foreign intervention. Though not the hereditary descendants of the regionally originated Xiang and Huai armies that aided the imperial government in defeating the Taiping rebels in the mid-1800s, the later warlord troops were nourished by the same political crisis that had challenged the Qing's power. A more immediate model followed by the twentieth-century warlord system was the New Army that the Qing established in the 1890s as part of its attempt to revamp the imperial power. Unfortunately for the central government, the reform effort failed, and the New Army, comparatively modern in training and equipment, acquired the quality of a personal army loyal to its commander, Yuan Shikai.

With this army at his command, Yuan emerged as a power to be reckoned with at a time when China was undergoing its most fundamental historical transformation. Oscillating between the Qing and the anti-Qing forces, but finally leaning toward the latter, Yuan used his military power to gain the highest political position in the new government, becoming the first president of the Republic of China in 1912. During his reign, Yuan more than once resorted to force in implementing his policies. His opponents also turned to military power in their effort to block and defeat Yuan's political agenda, as in the anti-monarchical war in 1915, touched off by Yuan's scheme of putting himself on the dragon throne. Military force, thus politicized and empowered by political leaders, established its legitimate authority in political struggles.

China was well on the road toward rule by the gun during Yuan's presidency. But his regime was not a military regime; it represented a central authority supported by provincial leaders, a structure not fundamentally different from the Qing bureaucracy. However, more than the Qing monarchy, Yuan's government was plagued by the perennial tension between centralization and local autonomy. Yuan's death in 1916 left the weak and antiquated civil institutions in the hands of his less capable successors, plunging the country into complete fragmentation.

What also contributed to the rise of the system of warlords was the absence of an institutional passage to power. The civil service examination had long channeled the talented and ambitious to the service of the imperial bureaucracy. No longer in use, it left one with nothing to follow but one's own ability to survive. Consequently, military power became the assurance of success in a society without a clearly defined code of conduct.

Instead of an aberration, twentieth-century warlordism was a manifestation of a recurrent theme in Chinese history—a history that alternated between political integration and fragmentation and a history filled with struggles of local powers challenging the central authority. During times of disintegration, soldiers dominated politics. The backgrounds of the modern warlords were diverse: some were bandits with little education; others had training in Confucianist classics. A few

may even have received some Western education. While many deserved the reputation of being a breed of gross and unscrupulous men, there were also those who succeeded in presenting themselves as men of idealism and altruism, steeped in Confucianist morality and Christian benevolence. Provincial warlords such as those in Sichuan were notoriously corrupt and cruel; Yan Xishan, who overlorded Shanxi, was mostly noted for his effective control of the province. Nationally known figures such as Wu Peifu and Feng Yuxiang, on the other hand, maintained a façade of being honest and high-minded. Though some of them displayed modern attitudes and used rhetoric of patriotic nationalism, and in fact many of them adopted modern organization and technology to their forces, they were not men of ideology. Their political and military maneuvering at various levels, confusing and conflicting but ultimately in accordance with their own interests, only prolonged and deepened China's political crisis.

Though the warlords dominated Chinese politics during the early years of the Republic of China, they did not come to power suddenly in the wake of the fall of the Qing dynasty. The system evolved over a period of time. In contrast, the end of the warlords' rule came rather suddenly. After two years between 1926 and 1928, the Northern Expedition claimed victory over the warlords when its troops entered Beijing, signifying the reunification of the whole of China. The defeat of the warlords was more than a military victory. Built on the rising nationalistic desire for a strong and unified China and a strong antiwarlordist sentiment, the nationalist government was finally able to wage a successful war against the warlords.

However, this was not a complete victory, as political and military expediency forced the newly established nationalist government to negotiate with some of the warlords, allowing their troops to be absorbed en masse into its own army in exchange for their allegiance. These "residual warlords" continued to contest the central power and made China's unification only a nominal reality. The Communist victory in 1949 ultimately put an end to the influence of the warlords who had survived throughout the Republican era.

See also **Bushido**.

BIBLIOGRAPHY

- Ch'i, Hsi-sheng. *Warlord Politics in China, 1916–1928*. Stanford, Calif.: Stanford University Press, 1976. A classic, offering a comprehensive analysis of warlord politics.
- Lary, Diana. *Warlord Soldiers: Chinese Common Soldiers, 1911–1937*. Cambridge, U.K.: Cambridge University Press, 1985. An extraordinary study of common soldiers in warlord troops.
- McCord, Edward A. *The Power of the Gun: The Emergence of Modern Chinese Warlordism*. Berkeley and Los Angeles: University of California Press, 1993. An in-depth study of the origins of warlords in two provinces of Hunan and Hubei.
- Wou, Odoric Y. K. *Militarism in Modern China: The Career of Wu Pei-fu, 1916–1939*. Folkestone, U.K.: Dawson, 1978. An example of many studies on individual warlords.

Yu Shen

CHRISTIANITY.

This entry includes two subentries:

Overview

Asia

OVERVIEW

According to the writers of the Gospels, Jesus of Nazareth gathered a small group of disciples and went about for three years in first century Galilee, preaching a message of hope to the poor and healing the sick. John the “Baptist” had gone before him, calling people to repent and be baptized, promising the imminent coming of the Kingdom of Heaven. He recognized in Jesus a far greater preacher than himself, sent from God. Jesus and his disciples eventually set out for Jerusalem. He threw out those who were trading in the temple precincts. He prophesied that the temple would be destroyed. The Jewish leaders pressed for his punishment and the Roman authorities authorized his crucifixion, with a mocking title nailed to the Cross: “Jesus of Nazareth, King of the Jews.” Three days after Jesus’s body was buried it was discovered to be missing from the tomb where it had been laid. Some of the disciples said they had seen and spoken to the Risen Lord and later that they had seen him ascend into heaven. They began to declare him to be the Son of God.

The spread of Christianity toward the West, through the Roman Empire and eventually the whole world, began with the conversion of the Saul of Tarsus, known after his conversion as Paul. He had been determined to eradicate this new sect until he had a vision on the road to Damascus that took him from an energetic Judaism to missionary zeal for Christianity. It was he who persuaded Peter and the other disciples that it was God’s will that they should preach the gospel of Jesus to everyone and not just the Jews.

Jesus wrote nothing, and the lack of contemporary accounts of his ministry makes the “historical Jesus” hard to be sure of. The Holy Scriptures of the Christian faith were composed after his death. The four Gospels, accounts of the life of Jesus, the Acts of the Apostles (a history of the early church), a series of pastoral letters to young churches by Paul and others, and an Apocalypse describing the end of all things came to be accepted by the end of the fourth century as a divinely inspired “New Testament” to be added to the Old Testament of the Jewish Scriptures to form the Bible. The Bible has always been used as authority, taken literally by fundamentalists but in most centuries figuratively interpreted as a means of resolving apparent contradictions within it and using it to answer questions it does not directly address.

Christianity and Secular Thought

A series of Christian authors during the first centuries C.E., later known as “the Fathers,” defended the faith to contemporary philosophers. Roman imperial religion was syncretistic. Apart from the Christians only the Jews refused to mingle their God with the gods of the pagans. Christians claimed that Jesus of Nazareth was the Son of God and had promised to

send the Holy Spirit, or Paraclete, into the world to be “with” his people. Contemporary philosophy described a Trinity in descending order: a Supreme Being, a Logos, a “Soul of the World.” Christians insisted that the three “Persons” in one God in their Trinity were equal and coeternal. There were long-running debates about the manner in which God could have “become man.” The definitive creed of the council of the whole church held at Nicaea in 325 provided an “official” statement of the approved faith.

With the fall of the Roman Empire, the arena of debate changed. In the Eastern, Greek-speaking half of the old Roman Empire, Christian learning survived in deeply conservative monasteries and focused on a mystical spirituality colored by late Platonism. Christian thought and learning in the West moved into the new Christian monasteries, the cathedral schools, and eventually, from the end of the twelfth century, into the newly created universities. Islamic scholarship had preserved and developed Greek thought and was absorbed in its turn by the Christian scholars of the thirteenth century.

Thinkers of the Middle Ages such as Peter Lombard (c. 1095–1160) and Thomas Aquinas (c. 1224–1274) worked out a “systematic theology” covering the existence and nature of God, Unity, and Trinity; the way in which God became man and why; a doctrine of the church and the sacraments; and the relationship of human free will to the foreknowledge and predestination and grace of an omniscient and omnipotent God. For most of fifteen hundred years in the West the church dominated intellectual endeavor to the point where philosophy and science were subsumed in theology.

Division

Christians, despite their schismatic tendencies, always put a premium on unity of faith. Yet the Christological debates of the third to fifth centuries ultimately led to the separation of the Monophysite Churches after the Council of Chalcedon (451). In 1054 the Orthodox Church and the Western Roman Church divided, partly over the Western addition to the creed of the assertion that the Holy Spirit proceeded from both the Father and the Son.

The Reformation of the sixteenth century in western Europe divided the Roman Catholic Church from the Lutherans, Calvinists, Anglicans, and other “reforming” communities. In dispute at this period were the claims of the institutional church to provide the only route to salvation and the reformers’ claim that the individual needed only a justifying faith and the Bible to read, and the grace of the Holy Spirit would do the rest. In the eighteenth century the Methodist Church separated from the Church of England (Anglican) over the validity of its ministry and in due course itself became a worldwide “communion.”

Ecumenism

From the second half of the twentieth century there have been serious attempts to restore Christian unity. From 1948, the World Council of Churches, which influenced the whole of the twentieth century with its work on “faith and order” as

well as on “peace and justice,” excluded the Roman Catholic Church. The Second Vatican Council of the early 1960s put the Roman Catholic Church’s stamp of approval on the modern ecumenical movement and allowed it to enter into bilateral and multilateral dialogues with other Christian communities.

Christianity and Modern Thought

The eighteenth-century Age of Enlightenment returned to “natural” religion, those “truths” that can be arrived at by rational observation of the “created world.” This was a first step in allowing changes of fashion in modern secular philosophy and political assumption to drive new thinking in Christian theology. Theologians were prompted to fresh thinking by philosophers such as Immanuel Kant. Friedrich Schleiermacher continued the challenge into the nineteenth century. Søren Kierkegaard called for a move away from believing “propositions” to living the Christian life. Charles Darwin’s work on the *Origin of Species* forced Christians to think radically about the story of the Creation told in Genesis. Karl Barth, Rudolf Bultmann, Dietrich Bonhoeffer, Reinhold Niebuhr, Paul Tillich, and Karl Rahner are leading theologians of the twentieth century who have attempted modern restatements of the faith that allow for the changed philosophical infrastructure. “Process theology” (Alfred Whitehead and Charles Hartshorne) postulated that God is changeable and challengeable—a process, not a substance. Don Cupitt and others have experimented with the idea of the “death” of God. Postmodernism, a multiple and shapeless movement emerging after World War II, and the “deconstruction” of language and forms (Michel Foucault and Jacques Derrida) have undermined old certainties.

Christianity and Secular Politics

The Gospels say that Jesus taught his disciples to be compliant citizens, “rendering to Caesar” what the law required. The Roman Empire became officially Christian with the conversion of the emperor Constantine the Great in the early fourth century. Modern manifestations of the resulting long-term tension in relations of church and state include liberation theology in South America in the late twentieth century, which pressed for recognition of the dignity of the poor. Liberal feminism, especially vigorous in the United States in the late twentieth century, called for inclusiveness of language and an end to the assumption that God is a “he.” Women are ordained to the Anglican, though not the Roman Catholic or Orthodox, priesthood and episcopate in the early twenty-first century. The old debate about the relationship of science and religion has moved partly into the political arena and is now preoccupied with the ethics of the mapping of the human genome, genetically modified food, and the means now available to achieve live births of human children not conceived by ordinary sexual intercourse.

Mission and Interfaith Relations

The Gospels relate that Jesus charged his disciples with spreading the Gospel, and the first generations took it throughout the Roman Empire. Gregory the Great sent a mis-

sion of Augustine of Canterbury to England in 597, and from there Boniface in the eighth century took missions into continental Europe. Christianity was still spreading east and north in the tenth and eleventh centuries. The crusading period from the late eleventh to the thirteenth century brought Christianity into contact with Islam in the Middle East and the first translation of the Koran was made in the West in the mid-twelfth century. With world explorations and discovery of the Americas in the sixteenth century it was carried to the New World. There the Roman Catholic tradition dominated Latin America and the colonies established by the Spanish and French in North America, with the future United States predominantly colonized by Protestant exiles from Northern Europe. The nineteenth century saw a somewhat “imperialist” spreading of the faith into the Far East and Africa and the Pacific. Much of this later missionary endeavor has been “denominational”; American Baptist missionaries entered Orthodox Russia after the fall of communism. Throughout the Middle Ages and early modern period the Jews had lived in Europe alongside the Christian communities. During World War II the Roman Catholic Church did not protest about the Holocaust, and Pope John Paul II eventually apologized for the silence of the Church. Interfaith dialogue in the early twenty-first century seeks to establish a basis of mutual respect on which adherents of different faiths may live.

Conclusion

Christianity remains numerically probably the largest world religion, with Islam close behind. About a third of the population of the world was Christian in the 1990s, and the majority of the non-Christian population knew of Christianity or had some opportunity of contact with it. The largest number of Christians resided in Latin America, with Europe second and Africa third, then North America, then South Asia. Post-colonialism and globalization pose major challenges as to how far the faith can absorb local culture without itself being essentially changed. But paradoxically the loss of heritage makes for conservatism. The fastest-growing Christian community is in Africa, where the intellectual history of the patristic and medieval West is often unfamiliar. Conservative fundamentalism is making the ordination of homosexuals as priests and bishops in the West a church-dividing matter in parts of Africa. The altered balance of the Christian populations worldwide has begun to throw into question the continuance of an intellectual tradition now culturally remote from many Christians while it continues to privilege the Bible as the foundation text and ultimate authority.

See also Christianity: Asia; Free Will, Determinism, and Predestination; Heaven and Hell; Heresy and Apostasy; Philosophy and Religion in Western Thought; Philosophy of Religion; Pietism; Puritanism; Religion and Science; Religion and the State; Ritual: Religion; Sacred and Profane.

BIBLIOGRAPHY

Evans, G. R., ed. *The Early Christian Theologians*. Oxford: Blackwell, 2004.

- , ed. *The Medieval Theologians*. Oxford: Blackwell, 2001.
- Ford, David, ed. *The Modern Theologians*. 2nd ed. Oxford: Blackwell, 1997.
- Gascoigne, Bamber. *A Brief History of Christianity*. London: Robinson, 2003.
- Lindberg, Carter, ed. *The Reformation Theologians*. Oxford: Blackwell, 2002.
- McBrien, Richard P. *Catholicism*. 3rd ed. London: Geoffrey Chapman, 1994.
- Piepkorn, Arthur Carl. *Profiles in Belief: The Religious Bodies of the United States and Canada*. 4 vols. New York: Harper and Row, 1977–1979. Covers all the main Christian denominations with an account of their differences.
- Sanders, E. P. *The Historical Figure of Jesus*. London: Penguin, 1995.
- . *Paul*. Oxford: Oxford University Press, 1991.
- Ward, Keith. *Christianity: A Short Introduction*. Oxford: Oneworld, 2000.
- Ware, Timothy. *The Orthodox Church*. New ed. London: Penguin, 1993.

G. R. Evans

ASIA

Since the 1970s, the study of Christianity in Asia has been transformed by new approaches in which the scholarly perspective has become less Eurocentric and more Asian. Particularly in regard to China, Western missionary sources have given way to Chinese sources while the meaning of Christianity has been broadened beyond a narrow religious content to include Asian cultural elements.

The history of Christianity in Asia begins with the unconfirmed legend that St. Thomas, one of the original Twelve Disciples, carried the teaching as a missionary to the southwest coast of India. By the third century, Nestorian Christians of the Syrian church were well established in the Malabar Coast region of India. When the Portuguese began landing in India in 1498, they encountered a group of approximately 100,000 St. Thomas Christians.

Christianity in East Asia dates from the arrival of the missionary Aluoben in the Tang capital of Changan in 635. This Nestorian church in China grew with imperial support until it peaked in 781 and then was destroyed in the anti-Buddhist persecution of 845. The period of continuous and sustained development of Christianity in China dates from the entry of Jesuit missionaries in 1580. It was the result of European global voyages, Catholic Reformation fervor, and Chinese receptivity in the syncretic cultural atmosphere of the Ming dynasty (1368–1644).

Jesuit Accommodation

The newly formed Society of Jesus led the way in missionizing Asia in the early modern period. The Jesuits cultivated regional Asian elites in an effort to accommodate Christianity with indigenous cultural elements. While Jesuit accommodation was criticized by other missionaries, it is clear that some process of inculturation (assimilation) was necessary for the long-term viability of Christianity in Asia.

In China, led by the pioneering Father Matteo Ricci (1552–1610), the Jesuits developed a mission strategy focusing on the scholar-officials. A number of prominent literati were converted in the early seventeenth century, including the famous Three Pillars of the Early Christian Church: Xu Guangqi (1562–1633), Li Zhizao (1565–1630), and Yang Tingyun (1557–1627). Instead of syncretizing the traditional Three Teachings (Buddhism, Confucianism, and Daoism), Xu proposed to “supplement Confucianism and displace Buddhism” by blending Confucianism and Christianity. This formula influenced later literati, such as Shang Huqing (b. 1619) and Zhang Xingyao (b. 1633). However, with the Manchu conquest of 1644, Chinese culture became more conservative and less open to creative synthesizing, causing the literati converts to decrease both in numbers and eminence.

In south India, a Jesuit named Robert de Nobili (1577–1656) studied the languages of ancient India (Sanskrit and classical Tamil) to develop a new and fruitful approach to inculturating Christianity into Tamil culture in the years 1605–1656. However, the Hindu and Muslim cultures of this region resisted Christianity, making South Asia far less fertile territory than East Asia. In southeast Asia, Buddhist cultures resisted the penetration of Christianity, with the notable exception of Vietnam. The French Jesuit Alexandre de Rhodes (1593–1660) developed a remarkably effective missionary method by creating a Vietnamese group of catechists who were trained in basic medicine and who lived as a celibate brotherhood. This led to the creation of a thriving Catholic Church. In more recent times, evangelical Protestants in Vietnam have grown to an estimated 700,000 in number.

In Japan, missionaries met with striking initial success followed by rejection. The Jesuit Francis Xavier arrived in 1549 while Japan was emerging from a period of warring feudal chaos, which provided a brief window of opportunity for the missionaries. Within sixty-five years, there were 300,000 Christians in a Japanese population of twenty million. However, fears of subversion by this foreign religion led to a harsh persecution of Christians that culminated in the death of 3,125 Christian martyrs in the years 1597–1660. Christianity was exterminated in Japan, except for a small group of underground Christians in the area of Nagasaki. Christianity never again rekindled the interest that it had in the late sixteenth century in spite of the extensive investment of American missionaries and church funds made in Japan in the aftermath of World War II.

The isolation of Korea, which was controlled by China, delayed the development of Christianity by denying access to missionaries. However, Jesuit publications in Chinese did reach China and these stimulated a young Korean named Lee Sung-hun (1751–1801) to travel to Beijing and be baptized in 1784. Lee returned to Korea and converted other Koreans. The first Protestant missionaries entered Korea in 1885 and in the twentieth century, Korea became a leading area of Christian growth in Asia.

The entire population of the Philippines was converted within one century after the arrival of Spanish missionaries in

1565. Protestant missionaries first entered the Philippines when the Americans replaced the Spaniards as colonizers in 1898. The Philippines remain today the only Asian country where Christianity is a majority religion, although there has been rapid growth in China, Indonesia, Singapore, and South Korea.

Asian Inculturation

In China, the acceptance of Christianity was made more difficult by the Rites Controversy and related Eurocentric rulings from Rome that were inflexible in dealing with rites to ancestors and to Confucius. This produced an untenable situation in which conversion to Christianity forced one to be unfilial to one's ancestors. Rome later reversed these rulings in 1939 in a case involving Japanese Shinto rites. With the Jesuits losing favor at the court in Beijing, most of the conversions made in the late seventeenth and eighteenth centuries were made by non-Jesuit missionaries working in the provincial cities and rural areas of China. Although magistrates were increasingly harsh in their treatment of Christians, the Catholic rural converts remained faithful.

The first Protestant missionary to work in China was Robert Morrison (1782–1834) of the London Missionary Society who served in Macau and Canton from 1807 to 1834. The missionaries working out of Canton distributed religious tracts that were instrumental in stimulating mystical visions in a frustrated examination candidate named Hong Xiuquan who became convinced that he was the younger brother of Jesus. The result was a powerful blending of Christian and native Chinese folk beliefs in a Taiping movement that nearly toppled the Qing dynasty in 1853–1864. Whereas Catholics emphasized the development of Chinese catechisms, Protestants concentrated on translating the Bible into Chinese. The Delegates Version appeared in 1852–1854 and the Union Version in 1919.

After the Treaty of Nanjing (1842), other treaty ports were opened up to Christian missionaries. However, the missionaries were tainted in the eyes of many Chinese by their association with foreign imperialist pressures. When the Communists took over in 1949 and expelled both the imperialists and the missionaries, there were three million Catholics and 1.5 million Protestants. Because the Chinese communist government and the Vatican refused to normalize relations, Catholic churches split into those registered with the government (Chinese Catholic Patriotic Association) and underground Catholic churches loyal to Rome. Distrust of the government caused a similar split of Protestants into registered churches (Three-Self Patriotic Movement) and unregistered house churches.

Many observers believed that Christian churches were nearly exterminated in China during the antireligious activities of the Cultural Revolution (1966–1976). Actually, religious persecution and in more recent times, the spiritual thirst generated by a rapidly changing society, have fostered strong growth in the numbers of Christians, particularly in native Chinese churches. The emergence of these indigenous movements indicates that Christianity is taking root in China, although it is likely to remain, like Buddhism, a minority religion. Estimates today place the number of Catholics at ten million and the number of Protestants at thirty million. This would

mean that 3 percent of the Chinese population is Christian. Of the three billion people in Asia today, 8 percent are estimated to be Christians.

See also Confucianism; Religion: East and Southeast Asia.

BIBLIOGRAPHY

- Eber, Irene, Sze-kar Wan, and Knut Wulf, eds. *Bible in Modern China: The Literary and Intellectual Impact*. Nettetal, Germany: Steyler, 1999.
- Elison, George. *Deus Destroyed: the Image of Christianity in Early Modern Japan*. Cambridge, Mass.: Harvard University Press, 1974.
- Gernet, Jacques. *China and the Christian Impact: A Conflict of Cultures*. Translated by Janet Lloyd. Cambridge, U.K., and New York: Cambridge University Press, 1985.
- Mungello, D. E. *The Spirit and the Flesh in Shandong, 1650–1785*. Lanham, Md.: Rowman and Littlefield, 2001.
- Neill, Stephen. *A History of Christian Missions*. Hammondsworth, U.K.: Penguin, 1964. Revised 2nd ed., 1986.
- Ricci, Matteo, S.J. *The True Meaning of the Lord of Heaven (T'ien-chu Shih-i)*. Translated by Douglas Lancashire and Peter Hu Kuo-chen, S.J. St. Louis: Institute of Jesuit Sources, 1985.
- Spence, Jonathan. *God's Chinese Son: The Taiping Heavenly Kingdom of Hong Xiuquan*. New York: Norton, 1996.
- Standaert, Nicolas, ed. *Handbook of Christianity in China*. Vol. 1, 635–1800. Leiden, Netherlands: Brill, 2001.

D. E. Mungello

CHURCH AND STATE. *See Religion and the State.*

CINEMA. The latter half of the twentieth century witnessed a swift decline in the popularity and significance of cinemagoing in the West, associated with suburbanization and the rise of competitor media like rock and roll and television. From the 1990s, cinema release was repositioned as a cornerstone of multimedia-themed product lines, including alternative forms of distribution and exhibition (in-flight entertainment, video, broadcast, DVD, and Webstreaming) and spin-offs such as soundtrack albums, novelizations, comic books, franchised toys, board and computer games, and fast-food branding. Moribund profit centers like celebrity gossip magazines were revived, and new ones like product placement inaugurated. Integration of print, TV, theme parks, and Internet companies into massive corporations allowed for an increasing cross-marketing of products in cycles of which film was only one instance. In this transition from mass spectacle to integrated media product, it might have been difficult to retain respect for cinema as “the seventh art.” Nonetheless, during this period and into the early twenty-first century, there has been vigorous interest in the medium of film.

The Language of Cinema

As a broad generalization, the development of cinema studies since 1970 has been shaped by a debate between the search for a medium-specific “language” of cinema and inquiries into the ways cinema reflects, reproduces, or otherwise expresses

THE LORD OF THE RINGS



Ian McKellen as Gandalf in *Lord of the Rings: The Fellowship of the Ring* (2001). The massive production of the *Lord of the Rings* trilogy was aided by shooting outside the U.S. to take advantage of cheaper labor costs and flexible working arrangements. THE KOBAL COLLECTION

The Lord of the Rings: The Fellowship of the Ring, directed by Peter Jackson, New Line/Wingnut, New Zealand/USA, 2001, 178 mins.

The Lord of the Rings: The Two Towers, directed by Peter Jackson, New Line/Wingnut, New Zealand/USA, 2002, 179 mins.

The Lord of the Rings: The Return of the King, directed by Peter Jackson, New Line/Wingnut, New Zealand/USA, 2003, 201 mins.

Based on the best-selling novel of the twentieth century, the first major blockbuster of the twenty-first could base its innovations on a significant preexisting fan base. The trilogy format, already opened up as a possibility by the highly successful 1999 release of *The Matrix*, differed from the better established “franchise” model of comic-book superhero and horror cycles in the 1980s and 1990s by promising to tell a complete narrative, rather than an open-ended series of discrete tales. Though large, the production budget

was comparable to similarly ambitious blockbuster films of the period. The risk of spending such budgets on fantasy, a genre notoriously difficult to sell to mass audiences, was spread across the fame of the original “property,” J. R. R. Tolkien’s novel, the use of overseas labor, and an innovative marketing campaign.

The Lord of the Rings, though frequently marketed as a triumph of the New Zealand film industry, is an example of a “runaway” production—that is, a Hollywood project filmed in a foreign territory to benefit not only from location scenery but from tax breaks offered by national governments to entice high-spending studio productions, cheaper labor costs than the highly unionized U.S. industry, and flexible working arrangements often unavailable in the United States. Unusually for a big-budget production, the film employed relatively unknown actors at cheaper rates, concentrating spending instead on props, stunts, locations, and digital effects. Without a star, the film then needed to be sold on its look and its story. (The 1977 blockbuster *Star Wars* is a comparable example.)

During the 1990s, a low-budget student film achieved significant box-office success through judicious use of word-of-mouth advertising on the then-new Worldwide Web. The marketing of *The Lord of the Rings*, while also using the familiar channels for preselling blockbusters, used carefully leaked and later carefully timed releases of teasers, interviews, backstage footage, trailers, stills, and production details to fan sites, even inviting fan Webmasters to attend significant film festivals and to report on them. In contrast to the Disney Company, which had set lawyers onto fans running Harry Potter sites, New Line, the AOL–Time-Warner branch company responsible for the film, used the fans as a medium for publicity before, during, and after the release of the films.

The trilogy extended and systematized a number of developments in the blockbuster film
(continued on the next page)

THE LORD OF THE RINGS

(continued from previous page)

that may now be referred to as event movies. The theatrical release of the film is the trigger for a raft of related products including books, toys, computer games, soundtrack albums, and, very significantly, DVD release. Unusually, *The Lord of the Rings* could not benefit from the lucrative market in “product placement” (the sale of screen time within the film to automobile, computer, hotel and food companies, among others). Instead it capitalized on the very authenticity of a fantastic world without commercial products. The international touring exhibition of props from the films helped build this aura of authenticity. The planning and filming of substantial extra scenes so that the theatrical release of the film could be supplemented with up to an hour of extra storytime on the extended DVD release

allowed an innovative release pattern for the films stretching over a five- to six-year period. This in turn required a loyal fan base, whose interest could be maintained over the extended period of the release strategy.

The films’ budget also required that the movies, like *The Matrix* and *Crouching Tiger, Hidden Dragon* (2000), should be especially palatable to East Asian audiences. Action sequences quoting both Hong Kong fight films and Japanese anime graphic style have become key components in large-budget films destined for a cosmopolitan marketplace. Cinema theory now needs to undertake explorations of such global cultural phenomena, their relationship with both the United States and the country of production, and the future status of cultural specificity in the global circulation of audiovisual materials.

the cultures it derives from or seeks to change. Initial work of the later 1960s emphasized the linguistic structures that appeared to govern cinema. In the later 1970s, two backlashes came in the form first of a film-specific criticism antipathetic to the idea that “bourgeois” forms like the novel and the feature film shared similar structures, and second, of a move away from “theory” toward more traditional forms of humanistic and sociological scholarship. The 1980s witnessed a powerful burst of interest in the cultural dimensions of cinema as an expression of macro- and microcultures—African-American, queer, and third cinema theories privileging the role of cinema as communicator of distinct and differentiated cultural values. In the 1990s, additional emphases were placed on ostensibly marginalized techniques like sound and animation, while the struggle over theory was renewed in the arrival of new theoretical paradigms, notably from phenomenology and the philosophy of desire.

Earlier criticism (commonly referred to as “classical film theory”) often celebrated cinema’s capacity for realism (see Andrew, 1976). After 1968 the French journal *Cahiers du cinéma*, in common with much of French culture, was rapidly and radically politicized and began to critique the illusion of reality in cinema. In the person of Christian Metz, the new criticism articulated an influential mix of Marxism, psychoanalysis, and semiotics, the “science of signs.” In the 1970s, critics associated with the U.K. journal *Screen* began to translate much of this work, and to develop an indigenous theoretical practice, today often referred to as *Screen* theory. The addition of a powerful strand of feminist criticism was the most significant new development, especially as presented in Laura

Mulvey’s 1975 essay “Visual Pleasure and Narrative Cinema” and in the work of Stephen Heath, while Paul Willemen added political commitment and polemic. Rejecting the realist proposals of André Bazin and Siegfried Kracauer, the *Screen* critics proposed that cinema acted as an ideological apparatus, a term borrowed in part from the French Communist Party’s leading philosopher of the day, Louis Althusser. Rather than transmitting ideological messages, as earlier political critics had assumed, cinema’s technical apparatus of camera and projector lenses and screens recreated a model in which the audience member was constructed as the subject of ideology. Interpellated (or “hailed”) by the apparatus and positioned by it, the cinematic subject became a willing participant in the construction of illusion. (It is interesting to note that the two leading political theorists of working-class collusion in their own oppression, Louis Althusser and Antonio Gramsci, were both translated by editors of *Screen*.)

In Mulvey’s version, this process recapitulated the mirror phase of early childhood development proposed by the French psychoanalyst Jacques Lacan. For Lacan, the child’s first recognition of itself in the mirror was both a traumatic discovery of separation from the maternal body and the first identification with an ideal version of itself—more distinct, more capable than it feels itself to be. This dialectic between the loss and idealization of the self Mulvey holds to be the origin of identification with human figures on screen, a fundamental identification that is then articulated with the differing representations of men and women (the one typically looking, the other typically being looked at) to produce the effect of gendered subjectivity in the cinema apparatus. *Screen* critics prized especially the works

PRINCESS MONONOKE

Princess Mononoke (Mononoke-hime, 1997). A product of the Japanese animation industry, *Princess Mononoke* depicts the struggle between the natural world and technology. REUTERS NEWMEDIA INC./CORBIS

Princess Mononoke, directed by Hayao Miyazake, Tokuma Shoten/Nippon Television Network/Dentsu/Studio Ghibli/Miramax, Japan, 1999 (U.S. version), 128 mins.

Hayao Miyazake's *Mononoke-hime* (1997; released in the United States in 1999 as *Princess Mononoke*), the sixth feature film for his Studio Ghibli, built on the success of his child-oriented anime, extending back more than a decade. The Japanese animation industry, powered in part by its close relations with the export of television shows for children and the toys and games crazes of the 1980s, had turned in the late 1980s to themes more suited to young adults. The international success of Katsuhiro Otomo's *Akira* in 1988 and Mamoru Oshii and Masamune Shirow's *Ghost in the Shell* of 1995 had paved the way for higher production values, the assimilation of digital technologies into traditional hand-painted cel animation, and increasingly convoluted narrative lines.

Immensely successful in Japan, where it was only outgrossed by *Titanic*, the film raises special

challenges for the theory of cinema. The animation form has traditionally been seen as childish and has received proportionately little critical attention, while Japanese product aimed at television sales had acquired a reputation for shoddy technique, often due to the practice of farming large proportions of the handcraft out to overseas animation factories, notably in Thailand. Miyazake's film is extremely well crafted throughout, essential if the film was to succeed on the big screen. Several innovations helped, including the use of specially-written software to make three-dimensional digital animation look more like traditional cartoons.

Princess Mononoke's themes of struggle between environmental and mechanistic forces at a formative moment in Japanese history seem not only to have chimed with audiences, but to have echoed in the cartoon form the dialectics of technology and nature. Evoking the environmental ethics of first peoples, the film seeks to reconcile
(continued on the next page)

*PRINCESS MONONOKE**(continued from previous page)*

technological progress with a mystical understanding of the forest as stronghold of nature. The very unnaturalness of the medium, including the necessity to invent sounds for the various cartoon creatures that inhabit the film, give the movie a greater depth and deeper conflicts than the wishful ending would suggest. And the success of the film challenges cinema theory to address two of its major weaknesses: the first being the audio component of audiovisual media and its articulation with the visual; the second,

the distance between photographic and graphic depiction.

Digital theorist Lev Manovich observes that the rise of digital cinema makes contemporary audiences aware that cinematography is a brief excursion in the history of animated pictures. From such specialized formal analyses, cinema studies can hope to derive new paradigms for understanding relations between recording, inventing, representing, and communicating in an increasingly global media society.

of the avant-garde, deploying the semiotic theory of signs to advance the theory that avant-garde cinema freed signifiers (the materials of light and shade for example) from their bondage to the signified (to the illusory representation of an always already ideological reality). At the same time, they sought out more popular films that exemplified the contradictory and dialectical tendencies within the dominant ideology, such as the 1950s melodramas of Douglas Sirk with their clash of wealthy lifestyles and emotional catastrophe. Technical work in film semiotics continues with the work of Warren Buckland, and *Screen* theory has retained its position since the 1970s, especially among feminist critics like Kaja Silverman, but it has never been uncontroversial.

The Specificity of Cinema

The most influential critic of the *Screen* agenda has been David Bordwell. Accusing the *Screen* critics of blindness to the specificity of film, Bordwell and his co-author Kristin Thompson developed a “neoformalist” analysis. Combining inspiration from Russian formalism with cognitive psychology, they proposed a rigorous film scholarship grounded in archive work and extensive as well as intensive film viewing. They also argued for what appeared to be a more commonsense approach to audience activity. Using cognitive theories, Bordwell argued that audiences were actively engaged in constructing meaning, guessing what will happen next, forming hypotheses and mental maps, and piecing together the action of the plot from the fragments of edited film narration. Criticized for their normative and apolitical account of the cinema experience, and despite the sometimes strident protestations of their later work, Thompson and Bordwell have been influential in establishing close analysis of filmic technique and high levels of historical scholarship as necessary prerequisites of film study.

New historicism (rather confusingly referred to as “revisionist” in some accounts) has been especially effective in the

renewal of film studies, focusing attention on the specificity of film’s evolution as technology, industry, and culture. In the 1980s and 1990s scholars such as Barry Salt, Tom Gunning, Roberta Pearson, Janet Staiger, Miriam Hansen, Kevin Brownlow, and Robert Allen and Douglas Gomery on U.S. cinema; Michael Chanan, Pam Cook, Andrew Higson, John Hill, and Robert Murphy on the United Kingdom; Thomas Elsaesser on Germany; Richard Abel on France; Yuri Tsivian on Russia; and others have radically rewritten the glib accounts of journalistic film history. The new cinema historicism diminishes the importance of individuals and denies the apparent linear progress from silent to sound, monochrome to color. Instead the new historicists emphasize the importance of institutional forces and economic trends in the innovation and dissemination of technologies and techniques, seeking reasons why certain promising technologies are delayed or abandoned, assessing the reactions of audiences and exhibitors to emerging technologies, focusing on the institutional histories of studios and government agencies, and tracing links between cinema and cognate industries. In the process some key beliefs of even recent film criticism have been undermined, as when Rick Altman argued, on evidence from D. W. Griffith’s involvement with the stage, that melodrama was a formative component of classical Hollywood, thus critiquing both the belief that U.S. cinema was realist in essence and that melodrama was an effective antidote to its dominance.

Since the 1990s film historians have turned to oral history and documentary accounts of audience activity in the cinema. A major element of television studies throughout its life, audience studies have had a weaker position in film studies, perhaps because of the relative difficulty and social impropriety of staring at audience members in the dark. Early accounts from the 1930s by participants in the British Mass Observation project, even Hugo Münsterberg’s pioneering psychological study of 1916, failed to establish a strong tradition of reception studies. Distinguishing themselves from market

THE RULES OF THE GAME

Scene from *La Règle du jeu* (*The Rules of the Game*), 1939. France has produced many films that have proven to possess cross-cultural appeal. One of these is Jean Renoir's classic *La Règle du jeu*. The original negative was damaged during the German occupation of World War II but was restored in 1956. NOUVELLE EDITION FRANCAISE / THE KOBAL COLLECTION

La Règle du jeu, directed by Jean Renoir, Nouvelle Editions Françaises, France, 1939, 110 mins.

Hated or ignored on its release in 1939, Jean Renoir's *La Règle du jeu* is one of the most consistently admired of all films. An ensemble cast in an upstairs-downstairs country weekend enact the rituals of a dying civilization on the brink of war. With its deep staging and deep-focus cinematography, its long takes, and a fluid camera that seems to track the actors (rather than construct the action for the camera), the film became a touchstone of realist criticism.

In a widely read essay, "S/Z and *Rules of the Game*" (in the film journal *Jump Cut*, nos. 12–13,

winter 1976–1977, pp. 45–51), Julia Lesage argued that in fact the film was constructed through the types of code identified by Roland Barthes and that its realism was merely the effect of cinematic and narrative technique. This formalist analysis would also inspire readings by, among others, Kristin Thompson, for whom the film is an elaborately constructed artifice. That Renoir appears in the film as the character Octave, caught between the aristocrats and the servants, inspired a number of *auteur* critics to single out the film as an account of the artist's role in society and in cinema. In his 1990s *His-*

(continued on the next page)

THE RULES OF THE GAME

(continued from previous page)

toire du cinéma, the cinéaste Jean-Luc Godard returns many times to *The Rules of the Game* as if to an exemplary combination of formal innovation and political commitment.

Phenomenological and psychoanalytic critics have focused on the role of illusion in the film, the series of mistaken identities that propel the plot, and the ethos of “keeping up appearances” that leads to the final tragedy. Still baffling for

textual analysts is the charm and the comedy that have kept the film popular not only with critics but with film buffs for more than sixty years. Compellingly humanist in outlook—Renoir’s direction rarely if ever seems to dislike his characters—the film’s narrative nonetheless enacts a damning satire on a rigidly stratified society that prides itself on the appearances through which it lies to itself. This paradox of a realist cinema portraying an unreal society maintains the film’s interest long after that society has faded away.

research by their interest in emotional, inventive, ironic, and resistant attitudes, and in the extremities of fan culture, such studies of necessity emphasize the depth rather than the breadth of their findings, giving more attention to highly specific audiences than to the standard aggregate measure of film audience, box-office returns. At least one international project attempted to do both deep and broad research, investigating cross-cultural meanings of fantasy through an Internet-based survey of responses to the twenty-first century blockbuster *The Lord of the Rings*. Both historical and contemporary reception studies focus on the cultural construction of audiences, the determinations of race, class, gender, and other formations on the ways audiences read and react to movies, disputing both the *Screen* concept of an apparatus that determines response, and Bordwell’s idea of the audience’s work of textual reconstruction.

Cultures and Economies of Cinema

Cross-cultural dimensions of cinema, initially discussed mostly in terms of the textual properties and ideological concerns of national cinemas, are now the object of much work in reception, political economy, and postcolonial research. Summed up in Ella Shohat and Robert Stam’s 1994 title “Unthinking Eurocentrism,” cross-cultural studies result in several kinds of work that dispute the normative tendency of neoformalism and the blindness to cultural difference of the apparatus theory espoused by the *Screen* critics. Some scholars have been at pains to emphasize the creativity or political significance of previously marginalized cinemas and directors. Others apply rigorous theoretical critique to such art house favorites as the Chinese fifth-generation filmmakers. Still more radical was the movement in filmmaking and film theory known as *third cinema*, after an influential 1976 essay by Cuban cinéastes Fernando Solanas and Octavio Gettino, which argued that the first and second cinemas—mass entertainment and bourgeois psychodramas, respectively—had failed the revolution and that a third cinema based in popular forms and addressing popular struggles was the best way forward. This spirit was echoed across the world, in the films of Haile Gerima

in Ethiopia, Sembene Ousmane in Senegal, and Anand Patwardhan in India, and in the critical writings of Teshome Gabriel, Trinh Minh-Ha, and others (for example, Jim Pines, Paul Willemsen, Coco Fusco, and John Downing). Since a central tenet of third cinema was that cultural specificity was integral to a cinema that was genuinely popular in the sense of belonging to and acting with the people, the term acted as an umbrella for a wide range of practice. Another early Cuban proponent, Julio Garcia Espinoza, called for an imperfect cinema; in Brazil, Glauber Rocha called for a cinema of hunger. For some proponents, the third cinema demanded a break with the technical wealth as well as the techniques of the first and second cinemas, while for others the resultant formally challenging films were merely reversions to the self-important antics of art house cinema and of no interest or use to the oppressed. This debate became especially vibrant in North America and in Europe where a new and intensely articulate generation of filmmakers and critics from African- and Hispanic-American, black British, and British-Asian backgrounds began to give voice to their artistic and political demands.

A second effect of this global consciousness has been a reappraisal of the old Marxist political economy espoused by *Screen* theory, updating the analysis to take account of globalization on the film business, its working practices, and its use of international free trade agreements to maintain and develop monopolistic corporate cartels. Janet Wasko, Andrew Higson, and Richard Maltby, among others, have addressed the impact of information technologies and the increasing integration of entertainment industries in guiding the development of new industrial practices as well as strategic policy on global media flows, intellectual property rights legislation, and the potential impacts of North American dominance of film distribution on the cultural lives of smaller nations. Increasingly, studies of auteurs are articulating the creative process with the industrial, and the best of them are also informed by theoretical paradigms that explain the dependence of creation in film on industrial and technical processes over which an individual director has little control.

Such studies of the development of film industries merge with analytical concerns in the study of cinema's relationships with modernity. A number of scholars, among them Anne Friedberg and Friedrich Kittler, trace cinema's roots back to related developments of the late nineteenth century such as department stores, electric streetlights, railways, and advertising, and argue forward to the digital era that cinema has always integrated with a range of other media into a broad process of modernization. In this context the study of entertainment has developed rapidly, with increasing awareness of the cross-media appeal of stardom, movie soundtracks, and animation. Film sound has benefited especially from the work of Michel Chion, Rick Altman, and Philip Brophy, who listen not only to music but to sound effects, to the construction of off-screen space, thematic constructions of gender and race, and the shifting hierarchy of recorded sound and recorded image. Like stardom, which is governed by a dialectical relation between on-screen presence and real absence, the study of film sound reveals complex interactions of space and time, sometimes reinforcing and sometimes undermining the coherence of a film's imaginary world. The sense of modernity as a complex process of homogenization and fragmentation is also common to studies of popular genres like horror, action movies, and science fiction, genres that frequently evoke both utopian and dystopian alternatives to dominant conceptions of embodiment, agency, and the necessity of current social arrangements.

Technologies of Cinema

The arrival of digital technologies in cinema has provoked debate over the degree of continuity between this process of modernization in the predigital cinema and the potential postmodernity of digital film. Critics like Lev Manovich believe in the continuity of the two, and in cinema's powerful determination of such key factors of digital media as the use of screens. Others derive from digital media new paradigms for reviewing the historical data, rediscovering such typically digital techniques as motion capture in the pre-cinematic chronophotography of Étienne-Jules Marey, or digital compositing of layers in the trompe-l'oeil sets of Georges Méliès' early fantasy films. Scholars of special effects, such as Vivian Sobchack, Scott Bukatman, and Timothy Murray, have begun to analyze the diminishing dependence of cinema on what can be enacted in front of a camera, tracing, in Michelle Pearson's work, a transition from spectacle for its own sake to a more embedded expectation of near-photographic illusion seamlessly wedded to cinematographic imagery, as in James Cameron's *Titanic* (1997), a case argued by Angela Ndalani, for whom spectacle is, if anything, a more significant element of contemporary entertainment than at any time since the Baroque.

At certain points, this discussion of the transition from photo-mechanical to electronic cinema replicates the long-running debate between culturalist and medium-specific accounts of film. If such vast currents as modernity or globalization run through the transition to digital, then there will be continuity. But if the deep-seated alterations to cinematic technique take precedence, then the experience of

cinema, and to some extent of cultural activity at large, can be expected to change equally. This hypothesis has been tested especially by a generation of phenomenological critics like Vivian Sobchack and Laura U. Marks, for whom the object of inquiry is the physical embodiment of the spectator and the ways this relates to the richness of the felt experience of cinema. This type of work, instigated by Dudley Andrew, is extended in Marks's work into a consideration of the emulation of touching in certain modes of cinema practice. The theme of embodiment also runs through the rapid rise of interest in Gilles Deleuze's two-volume analysis of cinema, remarkable for its espousal of a philosophy of desire grounded in Henri Bergson (rather than the ubiquitous Heideggerianism, in themes of loss, lack, and the fading of reality, of poststructural criticism) and for its meticulous readings of individual films. Deleuze envisages a shift from the "movement-image" pre-1945 toward a "direct time image" in postwar cinema. Informed by the semiotic pragmatism of Charles Sanders Peirce, Deleuze deploys an idiosyncratic vocabulary to argue for cinema's gradual liberation from a mechanistic dependence on the image of the human body toward a more metaphysical engagement with the pure dimensionality of time and its flows.

Challenges of Cinema

The tumultuous history of cinema studies since the mid twentieth century has concentrated several core debates in the history of ideas. Should the study of film deploy traditional hermeneutic and humanistic techniques, or should it abandon them for a more rigorous analysis grounded in linguistics? Or was such grappling with continental theory an alibi for a failure to address the realities of political economy, actual rather than textually determined readers, and the operations of oppression and exploitation disguised or denied by filmic representations? Or was cinema in any case an entirely symbolic activity, a simulacrum with no relation to any reality, physical or social? In institutions where cinema has been taught, there have been the additional claims that the analysis of film is mere carping, all too often negative and destructive, and of no use to those who wish to move into filmmaking as a career. Such claims have led to the rise of major literatures in script analysis and structure, in the technical aspects of filmmaking, and in elements of creative industries literature devoted to film financing, marketing, and policy, many of which have been subsumed into the canon of cinema studies teaching.

Looking to cinema's specific contributions to the history of ideas, among the most significant has been its meticulous attention to the specificities of cultural difference and the contemporaneous splitting and differentiation of subjectivity, in the admission of transcultural cinemas and in queer cinema, for example. At its best, the affirmation of camp, for example in Richard Dyer's work on queer cinema, is valuable not only for film studies but for better understanding of the rich emotional life of the culture.

Indeed, if anything distinguishes the cinema theory among media studies, it is its readiness to engage with the emotional life. Alongside the cool analysis of finance, technique, and box office, it is difficult to sidestep the intense emotive power of

film, from haunting abstraction to political passion, and in physiological reactions of tears, shrieks, and laughter. While some advances have been made in the study of the erotic (by Linda Williams) and the horrific (by Barbara Creed), both comedy and tearjerkers have resisted analysis and remain in many ways the most difficult emotional technologies to account for, partially because they are among the least esteemed in intellectual circles.

There is too the contradictory fascination of cinema captured in the phrase *the dream factory*. Flagship of the consciousness industries, cinema figures as both escape and utopia, flight from oppression or flight toward its alternative. It is both a device for replenishing the exhausted with meaningless entertainment and a technology for demanding the impossible. Its illusions may be seen as lies and ideology, or as evocations of emotional and spiritual satisfactions denied and destroyed by consumerism. Its darkness, serried ranks of seating, and clockwork rhythms of projection can appear as both a continuation of factory discipline into leisure time and as an expression of solidarity, community, and sociability.

Meanwhile, despite (and, in some resistant political sense, perhaps because of) the dominance of Hollywood on world screens, cinema has proved remarkably successful at translating cultural difference across the world: one thinks of the mix of kung fu, spaghetti western, and U.S. gangster in Perry Henzell's Jamaican *The Harder They Come* (1973). The films of Rainer Werner Fassbinder, John Woo, Akira Kurosawa, and Satyajit Ray have reached far more people than equivalent literary or even musical creations. Nonetheless, there remain huge difficulties in securing distribution for non-Hollywood films, a challenge that film studies shows signs of addressing in the early twenty-first century, along with the issues of cross-cultural transmission, emotion, and identification, and the utopian as well as the industrial capabilities of the medium.

See also *Media, History of; Third Cinema; Visual Culture*.

BIBLIOGRAPHY

- Andrew, J. Dudley. *Concepts in Film Theory*. Oxford and New York: Oxford University Press, 1984.
- . *The Major Film Theories: An Introduction*. London and New York: Oxford University Press, 1976.
- Gledhill, Christine, and Linda Williams, eds. *Reinventing Film Studies*. London: Arnold, 2000.
- Metz, Christian. *Film Language: A Semiotics of the Cinema*. Translated by Michael Taylor. New York: Oxford University Press, 1974.
- . *The Imaginary Signifier: Psychoanalysis and Cinema*. Translated by Celia Britton et al. Bloomington: Indiana University Press, 1982.
- . *Language and Cinema*. Translated by Donna Jean Umiker-Seboek. The Hague: Mouton, 1974.
- Miller, Toby, and Robert Stam, eds. *A Companion to Film Theory*. Malden, Mass.: Blackwell, 1999.
- Mulvey, Laura. "Visual Pleasure and Narrative Cinema." *Screen* 16, no. 3 (autumn 1975): 6–18. Reprinted in her *Visual and Other Pleasures*. Bloomington: Indiana University Press, 1989.
- Nichols, Bill, ed. *Movies and Methods*. 2 vols. Berkeley: University of California Press, 1976–1985.

Shohat, Ella, and Robert Stam. *Unthinking Eurocentrism: Multiculturalism and the Media*. London and New York: Routledge, 1994.

Solanas, Fernando, and Octavio Getino. "Towards a Third Cinema." In *Movies and Methods*, Vol. 1, edited by Bill Nichols. Berkeley: University of California Press, 1976. Revised translation in *25 Years of Latin American Cinema*, edited by Michael Chanan. London: BFI/Channel 4, 1984.

Stam, Robert, and Toby Miller, eds. *Film and Theory: An Anthology*. Malden, Mass.: Blackwell, 2000.

Sean Cubitt

CITIZENSHIP.

This entry includes three subentries:

Overview
Cultural Citizenship
Naturalization

OVERVIEW

Citizenship consists in sharing a political community, and enjoying the benefits and assuming the political responsibilities that give effect to this experience of shared political community. If the purpose of political philosophy is to provide a principled account of the nature and appropriate boundaries of political community, then it makes sense to say that the tradition of political philosophy from Aristotle to the present is more or less defined by a tradition of reflection on the normative foundations of citizenship. In an important sense, then, the whole history of political philosophy offers a continuing reflection on and dialogue about the nature of citizenship, and it is not clear that one can give a full report on the history of reflection about citizenship with anything less than a thorough and comprehensive account of the history of political philosophy in its totality. This is impossible here, and therefore a short summary of basic themes in the tradition of political philosophy, and its relation to thinking concerning the meaning of citizenship, will have to suffice.

Citizenship in the History of Political Philosophy

Book three of *The Politics* by Aristotle (384–322 B.C.E.) is the first treatise on citizenship, and it remains an essential reference point for all subsequent reflection on what it means to be a citizen: "The citizen in an unqualified sense is defined by no other thing so much as by sharing in decision and office. . . . Whoever is entitled to participate in an office involving deliberation or decision is . . . a citizen in this city; and the city is the multitude of such persons that is adequate with a view to a self-sufficient life" (p. 87). Aristotle's definition of citizenship sounds modest enough, but in fact it encapsulates an awesomely ambitious account of what is required in order for human nature truly to flourish. Aristotle's account of what it means to be a citizen is intended to be a conceptualization of the experience of free, native-born males in the polis as a unique site for the development of properly human capacities. What the definition affirms is that only a very small number of human

beings in the history of humankind (and only a minority of the inhabitants of Athens even during the age of the polis) have been in a position to realize their full humanity because they happen to be members of the kind of political community that uniquely gives play to their properly human (political or polis-based) capacities.

In republican Rome the idea of citizen virtue was detached from the robust theory of moral development offered by Aristotle, and saw its crowning ideal in a practice of courageous military heroism in defense of the free state. Still, the Roman drive for glory, honor, and power to defend the liberties of collective, aristocratic self-rule was regarded as double-edged by one of the great Christian fathers, St. Augustine of Hippo (354–430). While praising the Romans in his *City of God* for such a long-lasting and glorious state, Augustine called upon Christian believers (and those who felt themselves to be future citizens of heaven) to recognize the pride residing in these Roman ideals of citizenship, and to see the ultimate futility of all earthly ambitions. Christians, as pilgrims in this world, should adopt a stance of submission, disengaging themselves from the ideals of active participation. Augustine saw in the ultimate failure of human enterprises an opportunity to cultivate humility and acceptance of God's will.

It has long been thought that, following Augustine, the ideals of citizenship were largely absent from medieval thinking and only reappeared in the Western tradition in the Italian Renaissance. However, more recent research has shown the deep historical roots of the links between the language of citizenship and the struggle for communal independence throughout Europe (see Höfert). The lingering presence of Roman law, along with the emergence of a class of burghers who sought new forms of political influence, gave rise to political struggles in which the language of citizenship became, once again, salient.

Niccolò Machiavelli (1469–1527), particularly in his *Discourses on Livy*, is regarded as the most famous—as well as the most controversial—defender of citizen liberties. Inspired by the ideal of civic virtue as practiced by the Romans, he called for a new ethos of devotion to the political community sealed by a practice of collective self-rule and self-defense. Needless to say, Machiavelli's conception of the citizen-body remains emphatically patriarchal, as is the case, with rare exceptions, for the entire political theory tradition until recent times. Understanding of the internal and external challenges to the survival of the free state led him to recognize that the duties of successful leadership of a free state would necessitate actions that would, at times, contravene the precepts of conventional morality. Nonetheless, he praised republics over principalities, for it was only through collective self-rule that the greatest number could guarantee their personal autonomy and independence and thereby achieve a more lasting and glorious state.

Post-Reformation religious struggles in Europe gave rise to new accounts of the proper relation between rulers and their peoples, especially in matters of religious practice. While these debates were initially more relevant to individuals as subjects of absolute rulers, they brought about broader reflection on

the concept of natural individual rights, which would later become a powerful tool in the struggle against absolutist rule. *The Second Treatise of Government*, by John Locke (1632–1704), is the best-known account, harnessing the idea of individual rights to a notion of collective sovereignty even though Locke does not reject monarchy. Still, with the advent of commercial society, the possibility of fusing the promotion of individual liberties with a form of government that would require very limited participation on the part of all citizens was increasingly regarded as an attractive alternative. It has meant that in the modern era the quality of citizenship has often been judged more by the accountability of liberal democratic governments toward their citizenry than by the actual forms and degrees of popular participation. But this new synthesis has not been without its critics: modern theorists, notably Jean-Jacques Rousseau (1712–1778), have drawn on more ancient accounts of citizen virtue to decry the lack of active participation in collective self-rule as an ongoing assault upon true popular liberties.

On the Social Contract, by Rousseau, and *The Philosophy of Right*, by Georg Wilhelm Friedrich Hegel (1770–1831), remain the two most important modern treatises on citizenship. At the core of Rousseau's political philosophy is the idea that modern human beings should be judged by the (suitably high) standard of the ancient experience of citizenship. When Rousseau claims, in a note to *Social Contract* (Book one, chap. 6), that modern men know only what it means to be bourgeois and have no notion of what it means to be a *citoyen* (citizen), he makes perfectly clear how deficient he regards modern human beings in relation to this standard. This celebration (mythicization?) of ancient citizenship has of course not gone uncontested within modern political thought: just as Rousseau challenged the Lockean synthesis outlined above, so Rousseau's account of citizenship in turn was challenged vigorously by subsequent liberals. Hence it has been one of the chief theoretical purposes defining liberal political theory going back to Charles de Montesquieu (1689–1755)—or perhaps going back to Thomas Hobbes (1588–1679) if one considers Hobbes part of the liberal tradition—precisely to challenge the normative superiority of classical republicanism. This has been nicely summarized by J. G. A. Pocock: “[Thinkers such as Montesquieu, David Hume (1711–1776), and Adam Smith (1723–1790)] argued that the virtuous man of antiquity was obliged by the lack of a free market to live off the labour of slaves who worked his land and gave him the leisure to serve the republic. His ‘virtue’ made him harsh and barbaric; even his moral personality was impoverished by his inability to exchange goods with his fellows. . . . [With the development of the market, the] rigid and fragile virtue of antique man was replaced by the greater flexibility of ‘manners’” (Pocock, p. xxi). Hegel, with his huge debt to the vindication of modernity contained in the classical political economy tradition (see Plant), represents perhaps the crowning expression of the thought that citizenship in the modern liberal state cannot be exhausted by the notion of citizens unwaveringly committed to the exertions of civic virtue. Hegel, in common with other liberals, believed that consciousness of rightful membership in the modern state must incorporate a clear acknowledgment of the legitimacy and, indeed, moral necessity of the energies that individuals invest in their private lives.

Reading Rousseau gives one the impression that the most powerful theorizing about citizenship is located outside of, and in polemical opposition to, the liberal tradition. But students of the history of political philosophy should never forget that there is at the same time a decisively important tradition of reflection about citizenship and civic virtue *within* liberalism. Alexis de Tocqueville (1805–1859) and John Stuart Mill (1806–1873) are two great exemplars of civic theorizing within the liberal tradition. For all Mill's apprehensions about an unrestricted franchise, and for all Tocqueville's anxieties about the unwelcome consequences of the culture of democracy, both of them were strongly committed to enhancing the civic dimension of liberalism, and in that sense, both are important modern theorists of citizenship.

Citizenship in Contemporary Debates

Not surprisingly, the problem of citizenship has continued to shape contemporary debates in political philosophy. Communitarianism, at least as expressed in the work of Charles Taylor and Michael Sandel, presented itself as a new vocabulary for articulating an old complaint about the attenuated character of liberal citizenship. (This is emphatically not the case with the communitarianism of Alasdair MacIntyre, who fundamentally rejects modern nation-state-based citizenship as a site for moral community.) In the case of Sandel, for example, the more he has continued to develop his theoretical concerns, the clearer it has become that his real concern is not with community per se, but rather with the eclipse of richer possibilities of civic engagement and civic identity in an age dominated by liberal-proceduralist conceptions of politics. This basically civic-republican critique of liberalism should be set within a broader resurgence of civic-republican theorizing. Civic republicanism has surged back to life, philosophically, in the influential work of Hannah Arendt and, in a more historical vein, in the work of John Pocock, Quentin Skinner, and Philip Pettit.

More recently, new challenges to liberal citizenship have arisen in the debates about feminism and multiculturalism. As regards the latter, important arguments have been mounted to the effect that civic norms defined within the horizon of liberalism cannot do justice to the profound forms of cultural diversity ("deep diversity") that characterize virtually all political communities today. The basic multiculturalist idea is that liberal societies cannot fully honor the citizenship of their members if essential aspects of the identity of those members are slighted or treated as irrelevant to citizenship. Like any doctrine in political theory, multiculturalism comes in strikingly different versions. In Iris Young's view, liberal citizenship must be radically reconstructed so as to acknowledge an emphatic "politics of difference." In Will Kymlicka's more moderate view, accommodations to cultural difference are themselves required by liberal justice, rightly understood. According to the latter view, multiculturalism is merely a more effective (and more just) vehicle for the integration of minorities into a liberal civic regime, whereas according to the former view, the liberal vision of citizenship is intrinsically flawed, since liberal universalism is simply a mask for the hegemony of a majority culture.

At the same time, one can say that the powerful challenges to liberal understandings of citizenship generated by communitarian, civic-republican, and multiculturalist theorists have provoked, in response, more robust and more philosophical theories of citizenship from the liberal side. Jürgen Habermas's theory of communicative action can be interpreted as a new liberal (or post-liberal) doctrine of citizenship, and John Rawls's ambitious meditation on the notion of "public reason" in the latter phase of his intellectual career offers another such doctrine. The fundamental issue is posed by Rawls in relation to what he calls "civic humanism" ("classical republicanism" he regards as a more modest doctrine): "[Civic humanists believe that] the activity in which human beings achieve their fullest realization, their greatest good, is in the activities of political life. . . . [Liberal justice as Rawls understands it] rejects any such declaration; and to make the good of civil society subordinate to that of public life it views as mistaken" (Rawls, pp. 420–421; cf. pp. 205–206).

The opposing side is represented by Hannah Arendt when, at the conclusion of *On Revolution*, she endorses the ancient Greek solution to the problem, posed by Sophocles, of how "to bear life's burden": "It was the polis, the space of men's free deeds and living words, which could endow life with splendor" (Arendt, p. 285). The issue here, as it was originally in Aristotle's doctrine of citizenship, is whether civic life constitutes a privileged location for the expression of our proper humanity, or whether it ought merely to furnish a procedural framework for more diverse, privately defined activities in which we express our humanity. So we see that one of the core debates that has animated political philosophy throughout its history—for instance, in the argument between Rousseau, with his uncompromising republicanism, and his liberal critics such as Adam Smith (see Ignatieff) and Benjamin Constant (1767–1830)—continues to be a living question in contemporary thought.

See also Civil Society; Democracy; Nation; Political, The; Social Contract.

BIBLIOGRAPHY

- Arendt, Hannah. *On Revolution*. New York: Viking, 1965.
- Aristotle. *The Politics*. Translated by Carnes Lord. Chicago: University of Chicago Press, 1984.
- Beiner, Ronald, ed. *Theorizing Citizenship*. Albany: State University of New York Press, 1995.
- Hegel, G. W. F. *Elements of the Philosophy of Right*. Edited by Allen W. Wood. Translated by H. B. Nisbet. Cambridge, U.K.: Cambridge University Press, 1991.
- Höfert, Almut. "States, Cities, and Citizens in the Later Middle Ages." In *States and Citizens: History, Theory, Prospects*, edited by Quentin Skinner and Bo Stråth, 63–75. Cambridge, U.K.: Cambridge University Press, 2003.
- Ignatieff, Michael. *The Needs of Strangers: An Essay on Privacy, Solidarity, and the Politics of Being Human*. New York: Viking, 1984. See chapter four.
- Machiavelli, Niccolò. *Discourses on Livy*. Translated by Harvey C. Mansfield and Nathan Tarcov. Chicago: University of Chicago Press, 1996.

JUAN GÓMEZ-QUIÑONES

Born of Mexican parents in 1940 in Parral, Chihuahua, Juan Gómez-Quíñones has been active in the articulation and political negotiation of cultural citizenship since the 1960s. His experience in the United States' Chicano civil rights movement led to his authoring of foundational papers on the history and identity of Chicano peoples of the southwestern United States. Soon after, he expressed the importance of and developed an epistemology for Chicano studies as a new interdisciplinary field. Such efforts helped to establish Chicano studies in institutions of higher education throughout the nation. Among his published works are *Chicano Politics: Reality and Promise, 1940–1990* (1990); *Mexican American Labor, 1790–1990* (1994); and *Roots of Chicano Politics, 1600–1940* (1994). In 1971 he helped found *Aztlan: International Journal of Chicano Studies Research*, the United States' premier journal of Chicana and Chicano studies. He is professor of history at the University of California at Los Angeles (UCLA) and lives with his family in Santa Monica, California. In 2003 UCLA presented him with the Rosenfield Distinguished Community Partnership Prize for community service.

- Plant, Raymond. "Hegel and Political Economy." *New Left Review* no. 103 (May/June 1977) and no. 104 (July/August 1977).
- Pocock, J. G. A. "Introduction." In Edmund Burke, *Reflections on the Revolution in France*. Indianapolis: Hackett, 1987.
- Rawls, John. *Political Liberalism*. New York: Columbia University Press, 1993.
- Riesenberg, Peter. *Citizenship in the Western Tradition: Plato to Rousseau*. Chapel Hill: University of North Carolina Press, 1992.
- Rousseau, Jean-Jacques. *On the Social Contract*. Edited by Roger D. Masters. Translated by Judith R. Masters. New York: St. Martin's, 1978.

Ronald Beiner
Rebecca Kingston

CULTURAL CITIZENSHIP

Cultural citizenship has been part of a broader discussion on cultural pluralism that began in the United States at the beginning of the twentieth century. Since then pluralism has undergone at least three noteworthy transformations, beginning with, during the first quarter of the twentieth century, attempts to preserve primarily European immigrant cultures vis-à-vis the state, followed by the integrationist civil rights movements of the 1960s and 1970s, and lastly, the mainstreaming of "difference" and a multiculturalism that began in the 1980s. Never intended to destabilize the authority of the nation-state or its ideology, these "politics of difference" have helped give voice to American democratic citizenship.

Cultural Citizenship and Latinos

The notion of cultural citizenship initially developed in the 1980s, in part to bring greater multicultural emphasis to dis-

courses of race in the United States that stressed black and white dichotomies. It is both a theoretical perspective and methodological approach with which to examine the socio-cultural identity, political will, and cultural creation of primarily Latino populations in the United States. Theoretically, the notion acknowledges the cultural resiliency, social reproduction (the class, cultural, and linguistic knowledge and skills that establish the cultural capital of social groups), and rights-claiming agency of ethnic communities and other marginalized groups as viable and worthy outcomes of social injustice and alienation. Methodologically, cultural citizenship requires that social scientists approach their studies from the perspective of subordinate groups in order to understand the latter's goals, perceptions, and purposes. The term appears to have been coined by the anthropologist Renato Rosaldo, who first used it in the late 1980s to make a case for the democratization of institutions of higher education through diversity in the classroom, curricula, decision making, and society at large; a call not unlike that made by Chicano civil rights leaders of a generation before. In the 1980s and 1990s a Latino cohort of social scientists, among them Rosaldo, used the concept to examine Latino civic participation in the voicing, claiming, and negotiating of cultural space. Importantly, these studies speak to cultural phenomena as the aesthetic and force behind the empowerment of groups to civic action. As such, cultural citizenship examines the colloquial meanings of alienation and belonging as they apply to marginalized groups with respect to the national community. In this context, claims to rights made against the state by subordinate communities arise as a consequence of degradation and exclusion in their daily environments but may also result from acts of self-definition, representation, affirmation, sensibility, and aesthetics. Specifically, these may be expressed as desires and aspirations for

equality, respect, and dignity. In the early years of the twenty-first century, cultural citizenship has been applied to modernizing efforts in an international context.

Sociocultural Agents of Citizenship

It is clear from the literature on cultural citizenship that cultural phenomena and issues of identity are privileged over theoretical considerations having to do with membership in the polity, except for its emphasis on the group. Unlike traditional concepts of citizenship in which the individual is the rights holder, the agents and subjects of cultural citizenship are undeniably the group. In concert with the literature on cultural pluralism, cultural citizenship too presents rights claiming as the prerogative of the group and, as such, calls attention to an ongoing broader debate between cultural pluralism and universal citizenship in the nation-state.

For much of the studies on Latino cultural citizenship, membership in the nation-state is implicitly ambiguous as if yet to be determined or in the process of becoming, as must be the case for illegal immigrant populations in the nation-state. Others describe a kind of citizenship practiced by Latino communities before the nation-state as “social citizenship,” specifically using T. H. Marshall’s meaning of *social* as entitlement to benefits deriving from the largesse of the welfare state. Similarly, social rights to citizenship have been used to describe a “citizenship without consent” practiced by communities of Mexican illegal immigrants in a postnational context inclusive of as well as beyond the nation-state.

Group-differentiated citizenship has been criticized on several counts, among them its reverting to premodern ways of using religious, ethnic, or class membership to determine the political status of people; its discouraging the integration of ethnoracial groups into mainstream society; and its undermining of a greater fraternity between all Americans and a common sense of purpose. The historian David Hollinger argues that group-differentiated citizenship is provincial and given to insularity when the need is for cosmopolitanism and “freedom of affiliation” embodied by the exceptional growth (compared with other nations) of mixed-raced people in the United States.

In response, cultural pluralists point out that citizenship rights as originally conceived by the nation’s founding fathers are oblivious to the needs and differences of multicultural groups. Indeed, the philosopher Iris M. Young argues, the American liberal concept of equal citizenship plays no part in the notion of universal citizenship, nor is it meant to, since the latter assumes and upholds a homogeneous collective community at the expense and suppression of group difference. For this reason, Juan Gómez-Quíñones believes, Chicano/Latino cultural identity is vital to membership in a political community precisely because citizenship rights and responsibilities do not encompass multicultural rights. “Though there has been a great stress on voting qua voting as a measure of political achievement and influence,” he writes, “the act of voting does not promise the achievement of full equities, much less direct and full democracy” (p. 211).

Defenders of differentiated group representation believe that citizenship should recognize and accommodate sociocultural difference to compensate for past injustices. For Young, any conception of equal citizenship must include historically excluded groups in the political community both as individuals and as members of the group. Young questions an ideal that in practice reinforces the power of the privileged in “this unified public” (of universal citizenship) while marginalizing others. An alternative approach to membership in the polity is “differentiated citizenship,” which allows for group-based claims or distinct group rights for what Young calls “social-cultural” groups but which the philosopher Will Kymlicka distinguishes as national and ethnic minorities and underrepresented groups. According to Kymlicka, some form of differentiated group rights for the latter comprise part of citizenship rights in most, if not all, modern democracies.

See also *Assimilation; Citizenship; Naturalization; Identity; Multiple; Nation*.

BIBLIOGRAPHY

- Flores, William V. “Citizens vs. Citizenry: Undocumented Immigrants and Latino Cultural Citizenship.” In *Latino Cultural Citizenship: Claiming Identity, Space, and Rights*, edited by William V. Flores and Rina Benmayor. Boston: Beacon Press, 1997.
- Gómez-Quíñones, Juan. *Chicano Politics: Reality and Promise, 1940–1990*. Albuquerque: University of New Mexico Press, 1990.
- Hollinger, David A. *Postethnic America: Beyond Multiculturalism*. New York: Basic Books, 1995.
- Kymlicka, Will. *Multicultural Citizenship: A Liberal Theory of Minority Rights*. Oxford: Clarendon; New York: Oxford University Press, 1995.
- Rosaldo, Renato. “Cultural Citizenship, Inequality, and Multiculturalism.” In *Race, Identity, and Citizenship: A Reader*, edited by Rodolfo D. Torres, Louis F. Mirón, and Jonathan X. Inda. Malden, Mass.: Blackwell, 1999.
- . *Culture and Truth: The Remaking of Social Analysis*. Rev. ed. Boston: Beacon Press, 1993.
- Rosaldo, Renato, ed. *Cultural Citizenship in Island Southeast Asia: Nation and Belonging in the Hinterlands*. Berkeley: University of California Press, 2003.
- Walzer, Michael. “Pluralism: A Political Perspective.” In *Harvard Encyclopedia of American Ethnic Groups*, edited by Stephan Thernstrom. Cambridge, Mass.: Belknap Press of Harvard University, 1980.
- Young, Iris M. “Polity and Group Difference: A Critique of the Ideal of Universal Citizenship.” In *Theorizing Citizenship*, edited by Ronald Beiner. Albany: State University of New York Press, 1995.

Adelaida R. Del Castillo

NATURALIZATION

Citizenship rests with territory at the heart of the definition of *nation-state*. If territory determines the geographical limits of state sovereignty, citizenship determines a state’s population. Beyond these limits one finds foreign land, foreign sovereignty, and foreigners. Drawing the boundary within which some human beings are included and others excluded as foreigners, permitting

some of them to acquire citizenship with certain conditions and others to lose citizenship, is a state prerogative that requires legal tools. In citizenship law, the two most important legal tools traditionally used to determine citizenship are:

1. *Birthplace*, or *jus soli*, the fact of being born in a territory over which the state maintains, has maintained, or wishes to extend its sovereignty.
2. *Bloodline*, or *jus sanguinis*, citizenship as a result of the nationality of one parent or of other, more distant ancestors.

All nations use *jus soli* and *jus sanguinis* in defining attribution of citizenship at birth. However, two other tools are used in citizenship law, attributing citizenship after birth through naturalization:

1. *Marital status*, in that marriage to a citizen of another country can lead to the acquisition of the spouse's citizenship.
2. Past, present, or future *residence* within the country's past, present, future, or intended borders (including colonial borders).

In eighteenth-century Europe, *jus soli* was the dominant criterion of nationality in the two most powerful kingdoms: France and the United Kingdom. The state simply inherited feudal tradition: human beings were linked to the lord who held the land where they were born. The French Revolution broke with this feudal tradition. Against Napoléon Bonaparte's wish, the new civil code of 1804 granted French nationality at birth only to a child born to a French father, either in France or abroad. This policy of *jus sanguinis*, representing a modern innovation, was not ethnically motivated; it simply reflected the fact that individual rights and family had become more important than subjecthood and state power. This French innovation was borrowed extensively and became the law in Austria (1811), Belgium (1831), Spain (1837), Prussia (1842), Russia (1864), Italy (1865), Netherlands (1888), Norway (1892), and Sweden (1894).

The British tradition of *jus soli*, on the contrary, was transplanted, unamended and unbroken, to Britain's colonies in North America (the United States and Canada), Europe (Ireland), Africa (South Africa), and Australia. It also influenced Portugal and Denmark until the Nordic countries adopted a common nationality regime in the 1920s.

Were a population and territory to match one another exactly, attributing citizenship on the basis of *jus sanguinis*, *jus soli* or residence would not make any difference. Citizenship law would concern the same population and would have the same juridical effects. Further, naturalization would be irrelevant. It is the case, of course, that the population and territory of a nation-state do not coincide. People migrate and, with respect to migration, one can distinguish broadly between two different types of countries:

1. "Countries of emigration" are countries where part of the core population resides outside the

national boundaries, a characteristic applying to the majority of European countries before World War II (with the exception of France), and Mexico since the 1930s.

2. "Countries of immigration" are those in which the majority of citizens are immigrants or descendants of immigrants, or whose foreign populations have settled as permanent residents alongside a majority population that is perceived to have existed since time immemorial and is not descended from immigrants. The United States, Canada, and Australia and countries of South America are examples of the former, while the latter category includes France since the mid-nineteenth century and all other western European countries since World War II.

The legal traditions of *jus soli* and *jus sanguinis* were maintained with consistency and relative ease in the majority of these different countries until World War II. In countries of immigration such as the United States, *jus soli* allows the children of immigrants to acquire citizenship automatically. For continental European countries that were countries of emigration, *jus sanguinis* allowed citizens abroad to maintain links until their descendants lost touch.

Since World War II, however, citizenship laws have converged across all democratic states, due to the large increase in the scale of migrations across the world. In many continental European states, large-scale postwar immigration led to legislative changes so as to permit increasingly large segments of the population born in their territories, namely second- and third-generation immigrants, to access citizenship more easily. Elements of *jus soli* have been included in their *jus sanguinis* tradition that extends citizenship automatically at birth to third-generation immigrants (France since 1889, the Netherlands since 1953, Spain since 1990, and Belgium since 1992). For the second generation, in many countries, children born to immigrants on national territory are entitled to citizenship if the child (Belgium, Denmark, Finland, France, Italy, Netherlands, Spain, Sweden) or one of the child's parents (Germany) has lawfully resided there for a period of years.

Countries with nationality laws based upon automatic *jus soli* often attracted a number of immigrants into their territory, encouraging these countries to become more restrictive. For example, the United Kingdom's imperial and expansive conception of territory, combined with its *jus soli* tradition, involuntarily encouraged immigration. Just after World War II, all subjects of the British Empire had access to British citizenship simply by residing in the territory of the United Kingdom proper. Since that time, British legislation on nationality has undergone a swift and silent revolution away from the extended and automatic *jus soli* to a 1981 law that attributes citizenship only to children born in U.K. territory to parents with legal residence status. The legal residence of parents has also been included as a requirement in the Portuguese and South African laws.

The trend toward convergence in nationality laws concerns almost all advanced industrial countries, insofar as they share

three basic characteristics: democratic values, stable borders, and a self-perception as countries of immigration rather than of emigration. The importance of these three conditions is confirmed when considering exceptions to this rule, such as Israel and Russia. In both countries, there is a dominant perception that many of their citizens reside outside their borders, and that the borders—indispensable for the definition of the *sol*—are not stable. *Jus sanguinis* thus remains at the center of both of their citizenship laws. But for all countries, regardless of their situation concerning migration or their level of development, there are two distinct lines of convergence in nationality laws. First, there has been a notable trend since the mid-twentieth century toward repealing provisions for the automatic acquisition of citizenship through marriage, a move motivated at the same time by the development of equal rights between men and women in nationality laws and by worries about fraudulent marriages with illegal aliens. Second, equal rights between men and women to transmit their citizenship to their children has produced the development of dual citizenship and more toleration of this phenomenon in many countries that formerly refused it (for example, Switzerland since 1990). What remains divergent are the rules for naturalization; that is, the processes by which foreign residents of the first generation access citizenship in a host country. States generally require a period of residence and knowledge of the language, and take into account a criminal record, but the details of these requirements still vary greatly, both in the formal requirements of nationality laws and in the practices through which these laws are enforced.

See also *Americanization, U.S.; Citizenship: Cultural Citizenship*.

BIBLIOGRAPHY

- Aleinikoff, T. Alexander, and Douglas Klusmeyer. *Citizenship Policies for an Age of Migration*. Washington, D.C.: Carnegie Endowment for International Peace, 2002.
- Aleinikoff, T. Alexander, and Douglas Klusmeyer, eds. *Citizenship Today: Global Perspectives and Practices*. Washington, D.C.: Carnegie Endowment for International Peace, 2001.
- Hansen, Randall, and Patrick Weil, eds. *Dual Nationality, Social Rights, and Federal Citizenship in the U.S. and Europe: The Reinvention of Citizenship*. New York: Berghahn, 2002.
- . *Towards a European Nationality: Citizenship, Immigration and Nationality Law in the EU*. Houndsmills, U.K., and New York: Palgrave, 2001.
- Weil, Patrick. *Qu'est ce qu'un français? Histoire de la nationalité française depuis la Révolution*. Paris: Grasset, 2002.

Patrick Weil

CITY, THE.

This entry includes four subentries.

The City as Cultural Center
The City as Political Center
The Islamic and Byzantine City
Latin America

THE CITY AS CULTURAL CENTER

In the modern conception of the word *city*—characterized by the size, the aggregation of housing, differentiated division of labor, and the density of interaction—the first cities appeared in Mesopotamia around 10,000 B.C.E. and most clearly by 3,000 B.C.E. The great city of Babylon marked the coming of age of civilization, characterized by an urban culture that highlighted sophisticated arts and crafts, rare products, a multiplicity of material objects introduced through trade, the emergence of new ideas and modes of domination, and a more complex social structure.

From the early days of urbanization, several often competing conceptions of cities were evident:

- the material city of walls, squares, houses, roads, light, utilities, buildings, waste, and physical infrastructure;
- the cultural city in terms of imaginations, differences, representations, ideas, symbols, arts, texts, senses, religion, aesthetics;
- the politics and policies of the city in terms of domination, power, government, mobilization, public policies, welfare, education;
- the social city of riots, ethnic, economic, or gender inequalities, everyday life, and social movements;
- the economy of the city: division of labor, scale, production, consumption, and trade.

As a unit of analysis the city is often characterized through the emphasis on diversity, fragmentation, strangeness, encounters with strangers, the mosaic of variety, contingent interactions, moving borders, everyday life and events, and the multitude of interactions. However, another perspective focuses upon integration, domination, assimilation, social order, control, inequalities, unity, models, patterns of economic development, structures, and systems. From Babylon, Athens, Rome, and later Florence, to the present era's so-called global cities comes the idea that cities are places where culture flourishes, where civilization reaches its highest point of complexity and sophistication. The density and diversity of interactions are supposed to stimulate innovations in all sorts of ways, to free urban inhabitants from traditional cultural constraint. Cities are therefore presented by social scientists, historians, and writers in a progressive way as centers of innovation and culture even if civilizations first developed without or beyond cities, as, for instance, in the case of Egypt. By contrast, the city is also portrayed as the place of darkness, chaos, violence, riots, exploitation, marginal life and deviance, destruction, and oppression.

Those categories were for the most part derived from the division of labor between disciplines put forward at the end of the nineteenth century. The study of the city as a cultural center evoked passionate debates at the start of the twentieth century when the German sociologists Max Weber, Werner Sombart, and Georg Simmel discussed the relationship between cities, culture, arts, technological developments, and

domination. They asked questions about the influence of a particular set of structural social, economic, political, and cultural conditions such as capitalism on the effect of cities or on individual and collective behavior, modes of thinking, ways of life, cultural creation, and imagination.

The City as an Integrated Political and Social Structure

In the Western world, cities emerged at the turn of the first millennium, insinuating themselves into the gaps of the feudal system. In a section titled “The City” in his 1925 study, *Economy and Society*, Max Weber portrays the medieval Western city as having the following characteristic features: fortifications, a market, and a specifically urban economy of consumption, exchange, and production; a court of law and the ability to ordain a set of rules and laws; rules relating to landed property (since cities were not subject to the taxes and constraints of feudalism); a structure based on associations of guilds; and—at least partial—political autonomy, expressed in particular through the existence of an administrative body and the participation of the burghers in local government, and sometimes even through the existence of an army and an actual policy of foreign expansion; and a citizenship with relative freedom often associated with affiliation to a guild.

The medieval city was the crucible of European society, a place in which new cultural and political models developed, along with new social relations and cultural and organizational innovations, furthered by interactions between the various populations thus promoting mechanisms for learning a collective way of life, for innovation and spreading innovation, rapid accumulation, transformation of behaviors, interplay of competition and cooperation, and processes of social differentiation engendered by proximity. The Europe of cities was not just the Europe of early capitalism and of merchants, but also the Europe of intellectuals, universities, and culture that launched the Renaissance.

In analytical terms, this sketches out a research perspective in terms of local societies and governance that is crucial for the analysis of contemporary cities, in Europe in particular. The city is conceived as an integrated local society (most of

the time, incomplete), and as a complex social formation, sometimes a local society. Cities may be more or less structured in their economic and cultural exchanges, and the different actors may be related to each other in the same local context with long-term strategies, investing their resources in a coordinated way and adding to the social capital riches. In this case the urban society appears as well structured and visible, and one can detect forms of (relative) integration. If not, the city reveals itself as less structured and as such no longer a significant subject for study: somewhere where decisions are made externally by separate actors. Such an analysis examines the interplay and conflicts of social groups, interests, and institutions, and the way in which, to some extent, regulations have been put in place through conflicts and the logics of integration. Cities do not develop solely according to interactions and contingencies: groups, actors, and organizations oppose one another, enter into conflict, coordinate, produce representations in order to institutionalize collective forms of action, implement policies, structure inequalities, and defend their interests. This perspective on cities highlights the informal economy, the dynamism of localized family relations, the interplay of associations, reciprocity, culture and ways of life, the density of localized horizontal relations, and local social formations.

The Industrial City

The industrial revolution led to a new wave of urbanization. Concentration in great metropolises and large industrial areas lent a different dynamic to cities, changing them both socially and physically: a new type of industrial city emerged in the nineteenth century—most often around coal mining, textiles, or iron and steel, then later chemicals, electricity, and mechanical engineering—enjoying an extraordinarily rapid growth fueled by immigration and leading to the formation of dense industrial regions and centers as in Britain, the German Ruhr, or the northeast of France—“Coketowns” as Lewis Mumford put it. The “tyranny of fixed cost” (transport) also supported the rise of industrial ports and the pace of concentration in large industrial cities such as Calcutta and, most decisively, in large U.S. cities of the Northeast and Midwest—New York and Chicago in particular. Cities became places



Ideal City, c. 1470, by Piero della Francesca. Although cities are almost inevitably prone to incidents of violence and oppression, they have also historically been centers of progress and innovation where diversity, knowledge, and culture are celebrated concepts. © ARTE & IMMAGINI SRL/CORBIS

where capital was tied up in major fixed assets, with labor forces that varied in composition and size, and with a high level of internal diversity.

The industrial city is first and foremost a place of social conflicts, inequalities, urban poverty, social segregation, and speculation. Karl Marx and his followers sketched a view of the city organized by capitalism, a place of class struggle determined to a large extent by the economy. The Marxist analysis was “urbanized” by David Harvey, who stressed the role of land and property for capital accumulation, investment together with the contradictions of capitalism in cities. He underlined both the role of the built environment in capitalism and the social struggle of social groups to prevent the disinvestment in industrial cities, which fed the dynamics of deindustrialization and urban crisis. Others have developed the role of class struggle to analyze the dynamics and culture of cities in different parts of the world. Changing forms of capitalism after 1945 gave rise to the analysis of the “Fordist city”—that is, the city organized around and for the needs of the large industry.

Industrial cities are characterized by their social structure and by their form and organization. Although U.S. cities had large firms and major entrepreneurs, they were above all workers’ cities, sites of immense poverty and exploitation, and crucibles for working-class organization. The industrial city took the form of this combination of industries, workers’ housing (slums, social housing, suburban houses), minimal communal amenities, transportation infrastructure, and, later, social democratic forms of urban government. Overpopulated working-class districts mixed with factories in city centers, driving out the bourgeoisie (in a configuration that reversed that of the old European cities, where industrial activities and working populations had most often been pushed out to the periphery) into what became the suburbs. Social surveys were initiated in Britain, France, and Germany to assess poverty and the terrible conditions of public health. Working-class culture was organized around work, clubs, cafés, dances, and sport, although with considerable variations from one city to another. Even beyond the structural opposition between the bourgeoisie and the newly forming working class, these industrial cities were socially diverse places: artisans continued to exist and to develop, and the number of shops increased, if only to feed the abundant populations of vagrants, prostitutes, and white-collar office workers.

After the 1960s, the most industrialized cities declined in the United States and Western Europe, leading to a postindustrial landscape, a mix of derelict land and buildings and new cultural or housing activities. By contrast, other cities in the world—for instance, in rapidly urbanizing China—have become the new workshops of the world, comprising a high concentration of the working class in the manufacturing sector.

The Rise of the Metropolis: Centers of Experiment for Modern Social Life

For observers of the late nineteenth and early twentieth century (Simmel in particular), the development of the large metropolis is a major phenomenon, both in Europe and in the United States.

Capital cities benefited from the consolidation of states, the shift of political life onto the national level, and the strengthening of the states’—and therefore the bureaucracies’ (including the army’s)—capacity for control, as well as from industrial development and colonization. These major cities absorbed a large part of the flow of migration, thus providing sizeable reserves of labor. They were the first beneficiaries of the transport revolution, from tramways to road and rail networks. Open to the world in an era that saw increasing numbers of different kinds of exchanges, discoveries, and technical innovations, they established their role by organizing universal exhibitions and great fairs. Concerned with public health and safety, governments organized major improvement works, created wide avenues, and constructed new public buildings: stations, squares, and monuments that symbolized their dynamism and technical progress. These cities were also places of speculation, of public and private investment in housing, and of financial capital. Their cultural influence changed scale because of more rapid diffusion, transports, and colonial empires. In particular, London, Paris, Berlin, and Vienna were the theaters of extraordinary physical and cultural transformations. As university cities and cultural centers, they were the focus of unrest and the sites of the political and social revolts that punctuated the nineteenth century. The great metropolis became the site of consumption, of department stores and wide avenues, of overstimulation that changed the urban cultural experience. This led also to physical transformation with the ever-increasing diffusion of urbanization around those large metropolises, hence the rise of suburbs, either working-class ones such as the red belt in Paris or bourgeois suburbs where the middle class abandoned the center.

The rise of the large metropolis became an American feature: New York and Chicago and later Los Angeles in particular gradually replaced European cities in the urban imagination of the modernist metropolis. They grew thanks to stunning economic development and massive immigration. In the 1920s both the American and European metropolis became a place of strong inequalities, anti-Semitism, violence against foreigners, racism, anticommunist movements, and flamboyant cultural creativity. The U.S. model is constructed around the industrial city with its low-income neighborhoods linked to manufacturing districts and close to commercial cores and its middle-income neighborhoods beyond. Out of the suburban migration of the middle classes accentuated after World War II emerged the prototypical metropolis with its central city ringed by suburban enclaves. In the best case, the commercial core became dominant. In the worst cases it, along with the manufacturing district, was in decline. The dynamics of development was horizontal, with activities deconcentrated and decentralized.

The metropolis and the neighborhood are associated with the Chicago school of urban sociology, which for several decades developed ethnographic studies on different ethnic communities and neighborhoods, and also—in research such as that by Robert Ezra Park, Ernest W. Burgess, and Roderick D. McKenzie—on groups such as hobos, gangs, and the like. Such work concentrates on interaction and on the density of

interactions within the city, leading to an ecological model of the urban process based upon the dynamics of competition and conflict between different groups and their evolution in terms of social and spatial mobility. The city is the place of dense interaction, of mobility, within a context of rapid social change, industrialization, and immigration, a “social laboratory” of modernity where more classic social structures are eroded.

The issue of immigration and the presence of ghettos became central, and racism was quickly established as the leading cultural divide within cities. The question of race and relations between ethnic groups, particularly in U.S. cities, became the cornerstone of American sociology and urban sociology. Ghetto formation, competition between ethnic and racial groups, and assimilation remain the main lenses through which cities are analyzed.

Related debates concerning the integration of diverse ethnic groups took place in European cities during the period of mass migration to industrial cities in the 1960s and 1970s, and the urban-ethnic issue also became central in the political and social dynamics of cities: suburbanization and the rise of xenophobic organizations.

Cities of Difference: Globalization in Progress

Urbanization was reaching new highs in the contemporary world with the rise of mega cities whose greater metropolitan populations exceeded 15 million, such as Calcutta, Cairo, Tokyo, Bombay, and Seoul. Beyond the modern metropolis, researchers try to make sense of those large urban areas with terms such as “postmetropolis,” “global cities,” and “global city-regions.” The processes of globalization, including transnational migration, architecture, financial transactions, transport flux, and dissemination of technological innovations contribute to the rise of mega cities in different parts of the globe.

In contrast to the modernist view of the metropolis, cities have been a major subject of the cultural turn in the social sciences suggesting that culture orients our behavior and shapes what we are able to know about the world. According to cultural studies that have taken place within cities, the question of identity and culture has become a central paradigm. Immigration and the pluralization of identity pave the way for the image of the city as fragmented mosaics. The city is about “the other,” and the risks associated with diversity.

The first impact of the cultural turn is about the questioning of classic Western categories such as cities, gender, ethnic, militarism, surveillance, and colonialism. A body of research has made visible issues of sexual, racial, age, religious, gender, and ethnic minorities, together with class, stressing the fluidity of cities, the role of informal organizations and social movements in social conflicts; it has raised issues of justice and the pluralization of identity formation beyond the state. The city is therefore analyzed through representation, discourse, objects, arts. Cultural studies scholars now take up goods as texts that signal the important social processes of their time and context. They look at cities as worked out through perception, memories, and imagination, everyday life and practices, interactions and events, a space simultaneously real and imagined,

material and metaphorical, ordered and disordered: from gay enclaves to fortress cities and postcolonial environments. The city is seen as a fluid process, constantly reshaped, chaotic and indeterminate, subject to rival and contradictory claims.

Culture is now a major determinant of migration and the dynamics of cities. From the studios of Los Angeles and Hong Kong to the old neighborhood of Istanbul or Bombay and the cultural clusters of Florence and Prague, all places have culture industries from museums to choirs, county fairs to religious buildings, galleries to theaters. Each city is unique, and its uniqueness relies both upon the interactions within the city, a place for spectacles, and upon interactions with other cities. Tourism, migration, economic development, and urban regeneration seem to rely now, at least in part, upon culture.

“Fantasy cities” are on the rise (as documented by John Hannigan) and one exemplar, Las Vegas, is the fastest growing city in the United States. Surveillance technologies, marketing, standardized entertainment, and culture give a new boost to cities as places of cultural consumption under strict surveillance, at the expense of local groups, social conflicts, and local culture.

The traditional ideas of the city, the modern metropolis or the industrial city, are now associated or replaced by contradictory images of those mega cities where one either emphasizes cultural diversity and the infinite range of interactions or the strength of control and capital accumulation by dominant groups. The rise of mobility and transnational flux within more globalized capitalist cities raise new issues about assimilation, social order, politics, and culture in cities. Cities are reshaped by local groups and culture interacting, adapting, or protesting against globalized flows.

See also *Civil Society; Cultural History; Globalization; Social Capital*.

BIBLIOGRAPHY

- Bagnasco, Arnaldo, and Patrick Le Galès, eds. *Cities in Contemporary Europe*. Cambridge, U.K., and New York: Cambridge University Press, 2000.
- Briggs, Asa. *Victorian Cities*. London: Penguin, 1962.
- Davis, Mike. *City of Quartz: Excavating the Future in Los Angeles*. London and New York: Verso, 1990.
- Eade, John, and Christopher Mele, eds. *Understanding the City, Contemporary and Future Perspectives*. Oxford and Malden, Mass.: Blackwell, 2002.
- Fincher, Ruth, and Jane M. Jacobs, eds. *Cities of Difference*. New York: Guilford Press, 1998.
- Hannigan, John. *Fantasy City: Pleasure and Profit in the Post-modern Metropolis*. London and New York: Routledge, 1998.
- Harvey, David. *The Urbanization of Capital: Studies in the History and Theory of Capital Urbanization*. Baltimore: Johns Hopkins University Press, 1985.
- King, Anthony D., ed. *Re-presenting the City: Ethnicity, Capital, and Cultural in the Twenty-first-Century Metropolis*. New York: New York University Press, 1996.
- Logan, John R., ed. *The New Chinese City: Globalization and Market Reform*. Oxford: Blackwell, 2002.

- Massey, Douglas S., and Nancy Denton. *American Apartheid: Segregation and the Making of the Underclass*. Cambridge, Mass.: Harvard University Press, 1993.
- Mingione, Enzo, ed. *Urban Poverty and the Underclass*. Oxford and Cambridge, Mass.: Blackwell, 1996.
- Mumford, Lewis. *The City in History: Its Origin, Its Transformations, and Its Prospects*. New York: Harcourt, Brace and World, 1961.
- Park, Robert Ezra, Ernest W. Burgess, and Roderick D. McKenzie. *The City*. Chicago: University of Chicago Press, 1967.
- Sassen, Saskia. *The Global City: London, New York, Tokyo*. Princeton, N.J.: Princeton University Press, 2001.
- Scott, Allen J., and Edward W. Soja, eds. *The City: Los Angeles and Urban Theory at the End of the Twentieth Century*. Berkeley: University of California Press, 1996.
- Sennett, Richard. *The Conscience of the Eye: The Design and Social Life of Cities*. New York: Knopf, 1990.
- Smith, Michael Peter. *Transnational Urbanism: Locating Globalization*. Oxford: Blackwell, 2001.
- Storper, Michael. *The Regional World: Territorial Development in a Global Economy*. New York: Guilford Press, 1997.
- Walton, John, and David Seldon. *Free Markets and Food Riots: The Politics of Global Adjustment*. Oxford: Blackwell, 1994.
- Weber, Max. *Economy and Society: An Outline of Interpretive Sociology*, 2 vols., edited by Guenther Roth and Claus Wittich. Berkeley: University of California Press, 1978. Originally published as *Wirtschaft und gesellschaft*, 1925.
- Zukin, Sharon. *The Cultures of Cities*. Oxford: Blackwell, 1995.

Patrick Le Galès

THE CITY AS POLITICAL CENTER

In Western political thought, ideas about cities, citizenship, and democracy have always been inextricably linked. Since Socrates suggested in *The Republic* that his interlocutors help him to create a city in speech, the city has functioned as a real and metaphorical center for struggles over what it means to be political. Ideas about civilization and barbarism, egalitarianism and exclusion, virtue and vice, civic participation and social unrest, all find expression in discussions of the city. Yet the city is and has always been an ambiguous achievement; its success (or failure) as a form of political organization rests on its citizens' dubious abilities to govern themselves, deliberate with strangers, act on principles beyond narrow self-interest, and collectively determine their future. Thus the state of a nation's cities is often used as a barometer to judge the quality of its political life.

City as Democratic Ideal

In its most utopian incarnations, the city is common ground, a space where the democratic values of equality, heterogeneity, public life, and creative expression might be freely lived. In the United States the roots of its democratic heritage are routinely traced to ancient Greece, where in Athens in the fifth century B.C.E. the vision of the "good life" was concomitant with city life. As Pericles famously argued:

Our constitution is called a democracy because power is in the hands not of a minority but of the whole people.

When it is a question of settling private disputes, everyone is equal before the law. . . . [J]ust as our political life is free and open, so is our day-to-day life in our relations with each other. We do not get in a state with our next door neighbor if he enjoys himself in his own way. . . . We are free and tolerant in our private lives, but in public affairs we keep to the law. . . . Here each individual is interested not only in his own affairs but in the affairs of the state as well: even those who are mostly occupied with their own business are extremely well-informed on general politics—this is a peculiarity of ours: we do not say that a man who takes no interest in politics is a man who minds his own business; we say that he has no business here at all. (Pericles' Funeral Oration, in Thucydides, pp. 145–147)

Equality before the law, tolerance of difference, and civic participation—these are the qualities of city life that are found desirable and worthy of imitation.

In the modern context, the ideal of metropolitan democracy is grounded in the potential found in these three aspects of city life originally articulated in Pericles' speech. First, as Max Weber argued, modern city life—as characterized by economic and bureaucratic rationalization and autonomous law and administration—disrupted feudal and paternalistic forms of governance. Traditional and often immutable hierarchies (such as tribe, religion, or kinship) thus were replaced by more egalitarian political associations.

Second, democratic urbanists exalt the city's inherent heterogeneity as democracy's greatest good. The city is a place where citizens are required to negotiate many different axes of identity and difference (for example, race, class, gender, and sexual orientation), so city life cultivates an appreciation of diverse groups without necessarily assuming either assimilation or exclusion. While in ancient Athens the boundaries for demarcating "citizen" and "other" were considerably narrower than they are in the early twenty-first century, the principles of toleration and noninterference are cornerstones of democratic urbanism. The city functions as a place where persons unknown to each other and often without shared familial, religious, ethnic, or cultural ties have the opportunity to act in concert to achieve mutual good; a certain kind of cosmopolitanism (or an ability to "move comfortably in diversity") is intrinsic to discussions of democratic urbanism (Sennett, p. 17).

Third, because political life is not based on private relationships but on the whole body of citizens deliberating among themselves (the public's business is everyone's business), the presence of truly public spaces—boulevards, parks, and plazas—is a requirement for collective action. In fact such places serve as stages for political activity, facilitating interaction among diverse groups with different interests and creating the necessary conditions for collective decision-making. This very material public sphere both presupposes and cultivates political imagination by encouraging citizens to think and act in ways that transcend their particular experiences.

The City as Democratic Menace

From its inception, however, the city's equality and diversity have also signified its instability—the threat it poses to moral, social, and political order. The city has been regarded as the site of sinful excess and moral turpitude, where upstanding citizens may risk succumbing to the depravity of the mob. Despite (or because of) its status as the rationalized center of Western political and economic life, the city has also been the site of its revolutions; from Europe in 1848 to the United States and Paris in 1968, cities have been recognized as the epicenters of democratic upheaval.

Attempts to secure the city as a political and cultural center have historically often sought to contain, control, or eliminate many of the very elements urban democrats find so promising. Efforts to create meaningful, modern urban life have varied greatly, ranging from the reinvention of Paris by Baron Georges-Eugène Haussmann (1809–1891), the Garden City of Ebenezer Howard (1850–1928), the City Beautiful of Daniel Burnham (1846–1912), and the Radiant City of Le Corbusier (1887–1965), to numerous public housing projects across the United States and Europe. But as Elizabeth Wilson notes, what these efforts have in common is the desire to replace chaos with order, heterogeneity with uniformity, and the noise and commotion inevitable in lively public places with placidity and good behavior.

Contemporary Challenges to the City's Democratic Potential

One of the widely debated issues regarding cities in the early twenty-first century is how their democratic possibilities might be realized in practice. While (at least implicitly) remaining sympathetic to the ideal of the city as a democratic space, important contributions in critical urban thought examine the inequalities woven into the urban fabric that delimit the amount and quality of freedom allowed to citizens, especially through residential segregation and the privatization of public space.

Residential segregation is caused by any number of factors. In the American context, typical examples of these include the use of racially restrictive covenants and redlining up through the 1960s; the priority placed on the federal highway system rather than public transit; federal tax incentives offered to homeowners (via deductions for mortgage interest) rather than to renters; and the use of local property taxes to fund public schools. These practices are not accidental but institutional and political, and they work to create, sustain, and embed economic and racial inequalities in the urban landscape. All result in widely divergent experiences for living, working, and pursuing educational opportunities in the context of modern city life.

As a result of these practices the inner city and inner-ring suburban areas are increasingly racially segregated and economically isolated. The results of this are myriad. First, the economically privileged have less and less contact with working-class and poor people, especially persons of color. Second, geographic segregation often produces serious spatial mismatches, where jobs and workers move in opposite directions; as more companies move to areas outside the central city, low-

wage workers have more difficulty finding jobs and then commuting to them, since they often cannot afford to work, live, and find child care in the same areas. Finally, residents in poor and working-class neighborhoods often pay more for basic goods and services, such as groceries (Dreier et al., pp. 41–77).

These costs are not only directed at the economically underprivileged, however. Instead, what is commonly referred to as “urban sprawl” (low-density development at the edges of an existing city) is the other side of concentrated poverty and has its own burdens: complete car dependency and longer commutes, shrinking green space and loss of farmland, increased pollution and flooding, and higher taxes to support new infrastructure (roads, schools, water and sewer, and power lines). Furthermore, these sprawling, redundant netherworlds between city and suburb defy Kevin Lynch's (1960) aesthetic prescriptions for memorable, livable cities: a legible city, he suggested, would be one whose physical features and landmarks are easily identifiable. As a result of sprawl, urban peripheries look more and more similar (freeways and off-ramps, chain stores and traffic), while also looking less and less like traditional urban centers.

Intensifying residential segregation finds its apotheosis in gated communities, which not only include elite suburban housing developments but also increasingly many inner-city, middle-income apartment buildings. While scholars stress numerous reasons for Americans' affinity for living behind walls (ranging from fear of falling property values to craving privacy, security, and/or like-minded neighbors), they generally agree that such arrangements inhibit, rather than promote, democracy. In gated communities, typically public spaces such as streets, sidewalks, and green spaces are walled off and “forted up” (in Blakely and Snyder's evocative phrase), privatizing not only individual residences but community space as well. Gated communities also are often racially homogenous. According to the U.S. Census Bureau's 2001 American housing survey, while the white and Hispanic middle classes are embracing gated communities in greater numbers, African Americans are much less likely to live in such areas. Although gated communities take a variety of forms and serve myriad functions (from retirement communities to inner-city security zones), spaces that promote homogeneity and exclusivity can only have a chilling effect on democracy. Their net result, then, is division rather than diversification, thus “undermin[ing] the very concept of civitas, organized community life” (Blakely and Snyder in Ellin, ed., p. 85). Residential segregation—especially as exemplified in gated communities—thus undermines the city's potential to foster tolerance of and political alliances across class and racial differences.

In part gated communities are symptomatic of the second challenge to urban democracy: the rapid privatization of public space. In *City of Quartz*, Mike Davis observes that “the American city . . . is being systematically turned inside out—or, rather, outside in. The valorized spaces of the new megastructures and super-malls are concentrated in the center, street frontage is denuded, public activity is sorted into strictly functional compartments, and circulation is internalized in corridors under the gaze of private police” (p. 226). Boundaries between public and private spaces are consciously constructed through the use of walls, landscapes, and police or

private security guards, but they are also marked through less tangible (though no less real) obstructions: commodities some cannot purchase, real estate that some cannot afford, a history and traditions that are not commonly shared. Davis argues that while architectural critics (often members of the dominant racial group and economic class) are often oblivious to these sorts of spatial segregation, marginalized groups recognize these borders immediately (p. 226).

This is all to say that urban space is no longer exemplified by truly public places. Instead, urban space at the millennium is increasingly contained, sanitized, monitored and defended; its goal is not to promote democracy (as in the Athenian polis) but rather to provide safe spaces for (predominantly white) middle-class suburbanites to work, shop, and play (Davis, p. 227).

Whither the City Center?

Many predictions for the future of urban democracy are dire. As Elizabeth Wilson plainly states, “The result is that today in many cities we have the worst of all worlds: danger without pleasure, safety without stimulation, consumerism without choice, monumentality without diversity. At the same time, larger and larger numbers of people inhabit zones that are no longer really either town or countryside” (p. 9).

These indeterminate zones that are not “town or countryside” indicate a final challenge for the city as political center: a new kind of urbanism typified by exurbs or edge cities that are no longer economically dependent on an urban center and defy the “core-periphery” model of the twentieth-century city. In fact, some would argue, casting the “city as political center” at the new millennium is entirely misguided. Rather, as Robert Fishman contends, “the true centre of this new city is not in some downtown business district but in each residential unit. From that central starting point, the members of the household create their own city from the multitude of destinations that are within suitable driving distance” (p. 185).

The “city” as it exists for most people, then, no longer matches the traditional picture of centrally concentrated economic and cultural life but rather comprises travel routes and endpoints, transportation and communications networks that together form weblike metropolitan regions that often include more than one urban center and frequently span several states. Edge cities and exurbs, some commentators assert, are almost entirely disconnected from their nearest urban centers, containing within themselves all the necessities of life: opportunities not only to live (as in traditional suburbs) but also for commerce and leisure, functions previously delegated to cities. Faced with the dilution of urban public life, the “city on a hill” is replaced by the “dream home” as the site of utopian possibilities.

The diminishment of the city as political center raises the question of whether or not the city has declined in importance as an economic center. Some theorists of the global city argue that industrial restructuring and the development of sophisticated communications networks have rendered city space less crucial than what Manuel Castells calls “the space of flows,” or the continual movement of people, goods, technology, and information over large distances, and the material infrastructure

that makes this movement possible. For Castells, what is important is no longer centers but networks, which allows real-time interaction between dispersed actors. Others, most notably Saskia Sassen, contend that the past few decades have seen the emergence of truly global cities, which provide an immense telecommunications, design, and service infrastructure for transnational corporations. This has created an unprecedented concentration of wealth and labor power in these cities while at the same time forging even greater disparities of wealth.

Throughout history people have staked claims to better lives in better cities, knowing that this particular spatial form of organization carries with it the potential both for hegemony and equality, disenfranchisement and deliberation. The question for advocates of urban democracy is how to correct some of the egregious inequalities rendered by twenty-first-century urban planning practices and globalization and how to best modify governance systems to take into account the changing shape of metropolitan democracy. The shapes presently given to cities and towns, the lines drawn with concrete and steel or building codes and zoning ordinances—or the connections forged with digital communications networks—enable citizens to make material their ideas about assimilation, stratification, and segregation. Uncritically adopting the city as a normative ideal, however, ignores the ways in which the built environment can legitimate and perpetuate exclusion, inequality, and even disenfranchisement from the ranks of proper citizenship.

See also City, The: The City as a Cultural Center; Democracy; Public Sphere.

BIBLIOGRAPHY

- Blakely, Edward J., and Mary Gail Snyder. “Divided We Fall: Gated and Walled Communities in the United States.” In *Architecture of Fear*, edited by Nan Ellin, 85–99. New York: Princeton Architectural Press, 1997.
- Blakely, Edward J. and Mary Gail Snyder. *Fortress America: Gated Communities in the United States*. Washington, D.C.: Brookings Institution, 1997.
- Castells, Manuel. *The Informational City*. Oxford: Blackwell, 1989.
- Davis, Mike. *City of Quartz: Excavating the Future in Los Angeles*. London: Verso, 1990.
- Dreier, Peter, John Mollenkopf, and Todd Swanstrom. *Place Matters: Metropolitcs for the Twenty-first Century*. Lawrence: University Press of Kansas, 2001.
- Fishman, Robert. *Bourgeois Utopias: The Rise and Fall of Suburbia*. New York: Basic Books, 1987.
- Jacobs, Jane. *The Death and Life of Great American Cities*. 1961. Reprint, New York: Vintage, 1993.
- Lynch, Kevin. *The Image of the City*. Cambridge, Mass.: Technology Press, 1960.
- Plato. *The Republic*. Translated by Allan Bloom. 2nd ed. 1968. Reprint, New York: Basic Books, 1991.
- Sassen, Saskia. *The Global City: New York, London, Tokyo*. 2nd ed. 1991. Reprint, Princeton, N.J.: Princeton University Press, 2001.
- Sennett, Richard. *The Fall of Public Man*. 1974. Reprint, New York: Norton, 1992.
- Thucydides. *The Peloponnesian War*. Harmondsworth, U.K.: Penguin, 1972.

Weber, Max. *Economy and Society: An Outline of Interpretive Sociology*. 1921. Reprint, Berkeley and Los Angeles: University of California Press, 1978.

Wilson, Elizabeth. *The Sphinx in the City: Urban Life, the Control of Disorder, and Women*. Berkeley: University of California Press, 1991.

Young, Iris Marion. *Justice and the Politics of Difference*. Princeton, N.J.: Princeton University Press, 1990.

Margaret E. Farrar

THE ISLAMIC AND BYZANTINE CITY

Islam first developed and spread in a region of the world where urban civilizations had originated. Caravan routes crisscrossed the Fertile Crescent and the Arabian peninsula several millennia prior to the birth of Christianity, linking the urban-centered civilizations of Mesopotamia, the Nile Valley, and the Indian subcontinent. Overland routes were supplemented by water transit via the Red Sea and the Persian (Arab) Gulf, with transshipping ports in what is now Yemen. Arabia was then more fertile than it is in the early 2000s, and its products (including frankincense and myrrh) were in much demand.

The lands through which the desert caravans passed were divided into the territories of seminomadic tribes that controlled and protected passage. The islands in the narrow gulfs harbored “pirates” who could block passage, pillage, and even sink sailing dhows. If there was not to be a war of all against

all, the neighboring communities, whether urban, transhumant, or nomadic, had to develop rules of trust, hospitality, and fair exchange of goods. And there needed to be centers of safety in which members of diverse tribes and communities could mingle without fear.

Mecca: A Place of Safety

Long before the message of Muhammad initiated the religion of Islam, the thriving city of Mecca was just such a place of safety. It was considered “sacred;” its Ka’ba (an enormous, cubicle black stone) was endowed with holy significance (Esin). In much the same way that the polytheism of Greek mythology derived from the unification of various city-states, each with its own deity, so the Ka’ba was host to the gods of various tribes and peoples who, at least there, could coexist. In this context, “sacred” meant safe. As early as the first millennium B.C.E., Mecca had been established as a place of pilgrimage, where traders could meet without fear. Greco-Roman influences and the monotheistic cults of Judaism and, later, Christianity, were already present in Mecca when Muhammad was born in Arabia in about 570 C.E. He eventually settled in Mecca where he lived with his first wife, Khadijah, serving as commercial agent for her long-distance caravan trade. When he was about forty years old, revelations began to appear to him, in which the text of the Koran was revealed in a series of retreats.

Thus began the formulation of a new monotheism called Islam, considered seditious by the residents of Mecca. In 622, when Muhammad was fifty-three and in declining health, he

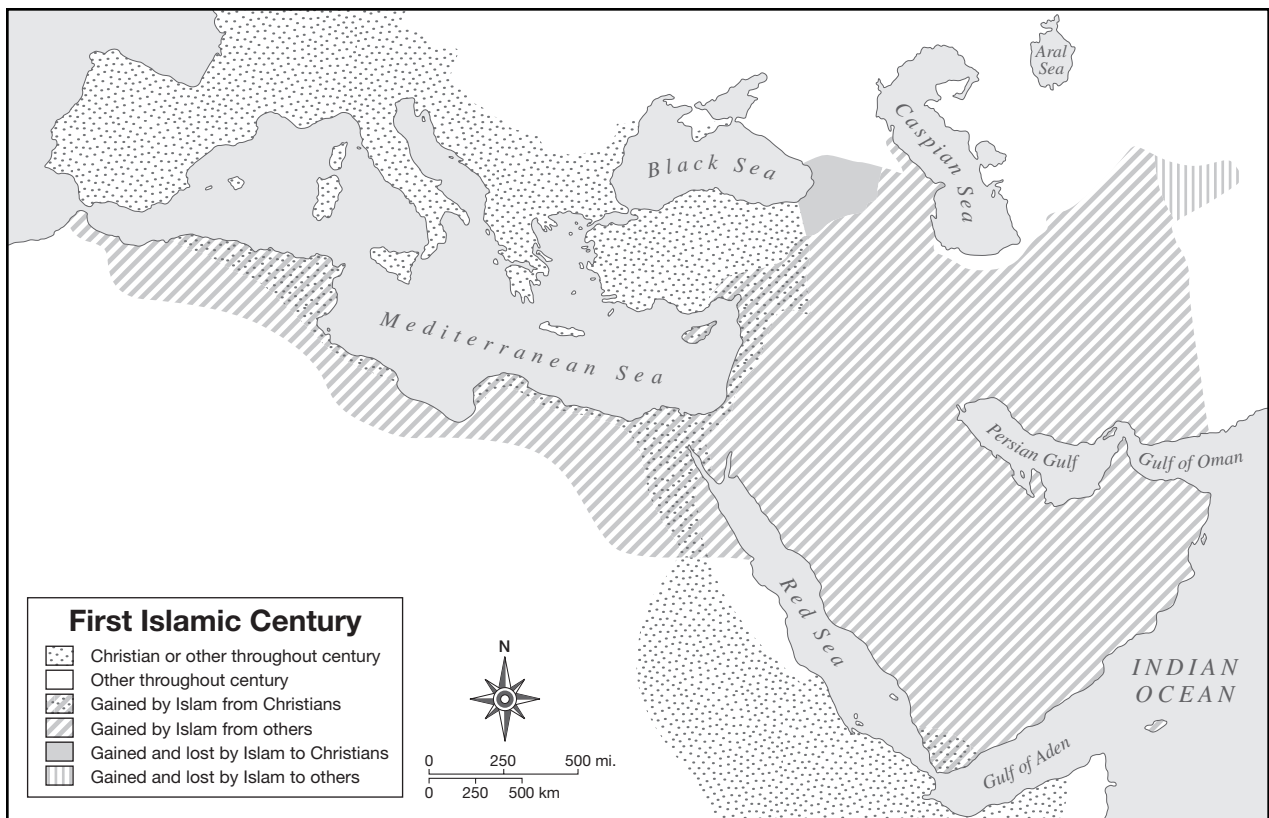

was forced to escape with his followers to the city of Yathrib (later renamed Al-Medina, meaning “The City”) and gained the support of the local tribe there and his first converts to the new religion. The date of the Hegira (flight to Yathrib) is accepted as the founding date of Islam and the first year in the Muslim calendar. The first mosque, a simple unroofed walled square with the prayer direction oriented toward the Ka’ba in Mecca, was built in the desert outside Medina, to which followers were summoned to gather five times per day by a call to communal prayer. Resisting recurring attacks from Meccans, Muhammad finally returned to Mecca in 630 at the head of a powerful army of his followers, accepted the keys to the Ka’ba, destroyed the idols and other signs of polytheism, and dedicated the structure (and the city) to the worship of one God and as the destination of prayer and pilgrimage. Two years later the Messenger of God was dead.

The Rapid Spread of the New Religion

Within one century of the death of the Prophet, Islam had spread to a vast area that included, in addition to the Arabian peninsula, Sassanid Persia as far north as the Caucasus and including Mesopotamia, the Fertile Crescent, and a thin coastal layer along North Africa that stretched from northern Egypt up the Nile to Cairo and had reached the westernmost tip of Morocco. The Byzantine Empire, defenders of Orthodox Christianity, controlled much of the northern edge of the Mediterranean, from its base in Anatolia and its capital, the New Rome, in Constantinople. While it is impossible to estimate what proportion of the populations in these two juxtaposed “empires” actually lived in urban centers (and that would depend upon the demographic definition of a city one accepted), it must be acknowledged that, for its time, the region was, along with the Indian subcontinent and China, certainly one of the most “urbanized” in the world.

Over the ensuing centuries, the Arab Conquest increased the levels of urbanization in three ways: by establishing temporary encampments for its troops and their accompanying dependents, by founding new “princely” cities for the successive ruling dynasties that came to power in various subregions of western Islam, and by occupying preexisting cities that would grow larger under conditions of increased prosperity.

The New Garrison Towns

The early days of expansion saw the founding of armed camps, often outside existing settlements, where troops were quartered, mosques were constructed, captive populations administered, and conversions encouraged. Basra and Kufa were the first “garrison towns” (*amsar*) set up by the Arab conquerors in the Persian-ruled region of lower Mesopotamia. *Fustat*, which means “tent city,” was an army camp set up beyond the limits of an existing Greco-Roman bishopric seat of Babylon, near present-day Cairo, by the Arab general who in 640 C.E. conquered Egypt. Another variety was the *ribat* or fort. Rabat in Morocco began as just such a walled fortress in which the ruler and his troops were quartered. “The term *Amsar* . . . as later used . . . to designate those *fustats* and *ribats* that were selected as centers to manage the conquered territories and as bases from which further military campaigns could be launched” (Al-

Sayyad, p. 45). Their regular gridiron arrangements revealed their military origins, just as the bastide towns in Gaul revealed their origins in the Roman conquests. Gradually, as the lines between conquerors and converts grew more permeable, these army camps blended with existing settlements and were transformed into cities endowed with schools and mosques, palaces, and offices of the rulers, and took on unified commercial functions.

New Princely Capitals for Dynasties

Although fewer in number and developed later, these served significant symbolic purposes, since the “royal cities” established in the emerging Islamic world were often accompanied by regime changes: the movement of the caliphate or shifts between Sunni and Shiite sects. Two notable examples were the planned princely cities of Baghdad (properly *Madinat al-Salam*, the “City of Peace,” or *Madinat al-Mansur*, the “City of the [Caliph] Mansur”) founded during the second half of the eighth century by the Abbasids who displaced the Umayyad caliphate, formerly located in Damascus, and Cairo (*Al-Qahirah*, “the Victorious”), founded in 969 by the Fatimids, a Shiite dynasty coming from Tunisia that displaced the former Sunni rulers. Both were new cities, located on level and well-irrigated land some distance from existing settlements; they were carefully designed as walled protected enclaves for new rulers. But they differed radically in terms of conceptions and plans.

The royal city of Baghdad was a circular city on the opposite bank of the Tigris from the village of Baghdad, intended to house the newly victorious Abbasid caliphate. Surrounded by a pair of formidable walls and a moat, with entry restricted to four gateways and commoners forbidden admittance, the round city held at its center the palace of the caliph with its attached cathedral mosque. Around this most protected focus were the palaces for the princes and their armed defenders. Inside the peripheral walls were arranged governmental offices to administer the empire. Gradually, population gathered on the outskirts of this city, of which only archaeological traces remain. Within a short time Baghdad had grown into a large capital in which Islamic learning and scientific and intellectual development reached a medieval peak—at least until it was sacked by the Mongols in 1258.

Cairo, in contrast, would eventually grow from imperial enclave into the greatest capital in the Islamic world until Ottoman times, filled with architectural and artistic treasures, many of which are preserved to this day. Laid out in the form of a walled rectangle with a regular street pattern of two major streets intersecting at right angles and leading to four impressive gateways, it contained the palaces of Mu’izz al-Din, the newly installed Fatimid caliph, the major mosque, and quarters assigned to various ethnic groups that made up his army. The ordinary citizens of Fustat, by then grown into a prosperous commercial city to its south, were at first enjoined from entering. Only after Fustat was burned (in 1169) to protect the princely city from invading Crusaders, were the gates to Al-Qahirah opened to the “masses.” But this marked the rise of Salah al-Din Yusuf al-Ayyub (Saladin; 1137/8–1193),

the demise of the Fatimids, and the establishment of the Ayyubid dynasty. Thereafter, the history of the city's development approximated that of the third category.

Conversions of Existing Cities into Cities of the Dar al-Islam

Constantinople, the Christian capital of Byzantium until its conquest by Muslim forces in 1453 (officially renamed Istanbul in 1930), and the Roman-patterned cities of Aleppo and Damascus in Syria and of Tunis in North Africa, are noteworthy examples of existing cities whose plans were transformed by Islamic occupation. These walled cities had inherited from the pre-Islamic period regular streets and processions, churches, covered markets, and a clear division, according to principles of Roman property law, between public (both secular and religious) and private space. Over time, the major changes were to create, from those regular divisions, the narrow labyrinthian paths and dead-ends that are associated with the Islamic city.

Sauvaget, in his pathbreaking studies of the transformation of Damascus (1934) and Aleppo (1941), traced these changes, attributing them to the substitution of Islamic law for Roman law, a theory more fully explicated by Hakim (1986), who examined Islamic legal precedents as they developed primarily in the Maghreb (western North Africa). In Islamic property law, responsibilities to one's neighbors, including the protection of their visual privacy, took precedence over a priori protection of the public way. As a result, buildings began to infringe on the streets, unless neighbors objected in the courts, and the residential neighborhoods became honeycombed into cells of semipublic space. Given the greater segregation between male and female space in Islamic codes of modesty, markets and residential zones became more spatially differentiated, with markets, courts, mosques, and industrial districts more specialized. These changes, which occurred over time in both preexisting "Christian" cities and in formally planned army camps and princely towns, gave rise to many of the characteristics now associated with the Islamic city.

Relation of Islam to the Idea of the City

This brief history is sufficient to establish several principles of Islamic expansion and its urban and social roots.

1. First, cities and commerce were central to the new religion, and many of the developments in Islamic law and jurisprudence dealt with densely settled urban places.
2. Islam was initially tolerant of other religions but welcoming to converts, extending to them equality in the *umma* (community of believers).
3. Property laws differed substantially from Roman law.
4. The religion stressed rules to police business practices and ensure trust and credit in trade.
5. Laws reformed social relations, regularizing and liberalizing relations between masters and slaves,

husbands and wives, albeit while increasing gender separation.

6. Religious duties were incumbent on all members of the community of believers, including declaring belief in one God (Allah), accepting the prophetic message of Muhammad, praying five times daily, tithing to charity and sharing wealth with the poor, observing the dawn to dusk fast during the month of Ramadan, and make the pilgrimage to Mecca.

Common Consequences of these Distinguishing Features

The *amsar*, the *ribats*, the converted Greco-Roman settlements, and the new princely capitals, while differing in origins and original plans, eventually evolved into communities that had much in common. Most were walled. The center of the city usually contained the main mosque, next to which were linear market streets specializing in books, candles, and other religious items. Nearby were the hostels for long-distance merchants and high value, low bulk items such as gold, other precious metals and minerals, and the officer whose duties included policing honest trade in the markets. Another main thoroughfare held the workshops of artisans and their shops, other mosques, hospitals, and schools, with the judicial courts and other government offices nearby. Outside or just inside the major gates to the walls were the markets for live animals and bulk agricultural products, on which taxes were imposed. But what was particularly noticeable in developed towns of Islam, attributable to Islamic property law, was the tendency of regular plans to be transformed into cellular structures of what might be called "defensible space." Religious charitable endowments (called *awaqf*, sing., *waqf*) and the largesse of rulers provided material support for many of the "public" functions, such as hospitals, schools, mosques, and water fountains, that Westerners associate with municipal government. Unlike the West, however, private users were held collectively responsible for cleaning, sprinkling, and lighting the streets in their own neighborhoods, as well as for protecting the safety of their residents. It was a workable system of governance so long as the empires remained prosperous but, as in all cities, in times of economic, political, and epidemic troubles, urban decay could set in.

The Consequences of Ottoman Rule and Subsequent Colonialism

The conquest by the Ottoman Turks of Constantinople in the mid-fifteenth century and the expansion of the Ottoman Empire to the Arab provinces in the Fertile Crescent and North Africa in the sixteenth century led to a period when the wealth of empire was concentrated in their capital Konstantiniyee (Constantinople), known by its popular Turkish name as Istanbul. Istanbul grew to become one of the largest cities in the world, whereas former major metropolitan centers such as Cairo were demoted to mere provincial capitals, losing population and economic vigor. Severely weakened, province after province fell victim to European colonial incursions in the course of the nineteenth century, and the remaining remnants

of the Ottoman Empire, with the exception of Anatolia, were lost to the victorious Allies after World War I.

While twentieth-century decolonization movements, with few exceptions, succeeded in liberating the countries of western Islam, the region was fragmented into many small states, in contrast to the unities in religion and law the region had enjoyed during the heights of earlier empires, and the poor economic conditions due to subservience to the industrialized West left a heritage of underdevelopment. Although urban populations increased, from both higher rates of natural increase and immigration from the countryside (Istanbul in the early 2000s has a population of eleven million and the greater Cairo region houses perhaps sixteen million), economic development lagged behind, creating conditions typical in Third World cities. In most countries, although Islam remains the official religion, governing laws mostly derive from the Napoleonic Code. Many of the older forms of urban property law, charity, and personal behavior no longer sustain vital urban functions.

See also *Law, Islamic; Religion and the State: Middle East*.

BIBLIOGRAPHY

- Abu-Lughod, Janet L. *Cairo: 1001 Years of the City Victorious*. Princeton, N.J.: Princeton University Press, 1971.
- . "The Islamic City—The Historic Myth, Islamic Essence and Contemporary Relevance." *International Journal of Middle East Studies* 19, no. 2 (May 1987): 155–176.
- . *Rabat: Urban Apartheid in Morocco*. Princeton, N.J.: Princeton University Press, 1980.
- AlSayyad, Nezar. *Cities and Caliphs: On the Genesis of Arab Muslim Urbanism*. New York: Greenwood Press, 1991.
- Celik, Zeynep. *The Remaking of Istanbul: Portrait of an Ottoman City in the Nineteenth Century*. Seattle and London: University of Washington Press, 1986.
- Esin, Emil. *Mecca the Blessed/Medina the Radiant*. New York: Crown; Novato, Italy: Paul Elek Ltd., 1963.
- Hakim, Besim Selim. *Arabic-Islamic Cities: Building and Planning Principles*. London and New York: KPI, 1986.
- Hitti, Philip K. *Capital Cities of Arab Islam*. Minneapolis: University of Minnesota Press, 1973.
- Sauvaget, Jean. *Alep: Essai sur le développement d'une grande ville Syrienne*. Paris: Librairie Orientaliste, 1941.
- . "Esquisse d'une histoire de la ville de Damas." *Revue Etudes Islamiques* 3 (1934): 421–480.

Janet L. Abu-Lughod

LATIN AMERICA

The history of the city in Latin America stretches over three thousand years and a vast geographic area. The cities vary considerably over space and time. Prior to the coming of the Spaniards, many pre-Columbian cities are thought to have been cosmograms or cosmologically conceived—the cities' buildings and plans emulated the cosmos as their leaders conceived of it. After the conquest, the Spanish Crown sought to impose order on the new lands in its possession and based planning on a grid that had a centrally located church fronting on a plaza. The checkerboard grid plan persisted throughout

the colonial period. After independence from Spain, Latin-American countries sought out new forms of city planning in Europe, especially France, that would make visible their status as newly formed republics.

Ancient Indigenous America: Mesoamerican and Andean Civilization

Ancient indigenous cities in the Western Hemisphere were prominent, complex centers of economic, cultural, political, and religious power and authority. As administrative centers, cities functioned variously as city-states, centers of regional states, and centers of empire. Political life and religious life were intertwined and overseen by divine and semidivine rulers or the ruling elite. At the heart of most cities were palaces, monumental civic-religious structures, and the ceremonial plazas where public rituals took place. Cities were also frequently cosmopolitan, with enclaves of resident foreigners who are identified as such by cultural practices and material goods consistent with their culture of origin.

The city as cosmogram. City plans are many and varied; in some regions, such as the central Mexican urban center at Teotihuacan, planners imposed a consistent grid plan on every structure, from central temples and palaces to small outlying barrios. In contrast, the Chimú capital of Chan Chan in Peru was comprised of large walled palatial compounds that loosely shared the same orientation. Elsewhere, notably in the clusters of buildings and temples organized around plazas among the Maya and the capital city of Cuzco (Peru), site plans are irregular in shape, their form dictated by the local topography and inherent processes of agglutination, yet still organized according to an internal logic, albeit a more organic one. The organizing plan of Cuzco has been the subject of lively debate, with some scholars suggesting that it represents a puma, while others note its grid plan tempered by topographic irregularities. Of particular interest are the forty-two sacred *ceque* (pathways) radiating from a central node outward, linking the sacred city to all corners of the Inka empire.

Regardless of these differences, common shared features among these pre-Columbian centers include the cosmological alignment of major buildings and of the city itself with the passage of the Sun, the movement of significant planets and stars, and the cardinal directions; the alignment of buildings with significant features of the surrounding topography such as sacred places, caves, and mountains; built statements of politico-religious power and authority such as large pyramids and walled precincts; as well as the pragmatic concerns of dense, urban life (workshops, urban housing of workers, water, food, and disposal of waste, for example). The indigenous city harmonized with its environment even as it shaped that environment and gave focus and significance to elements of the environment that were held to be important. Natural features of the landscape, such as the rivers at Teotihuacan and Cuzco, were even made to conform to the planning principles employed. As symbolic texts, indigenous cities gave visible form to collective belief and shared identity. Through the powerful intersection of cosmological time and space, the city functioned as both axis mundi and cosmogram.

Colonial Spanish America

From its inception, Spanish urban planning in the Western hemisphere was based on the grid plan, with its characteristic large central plaza dominated by a church. The earliest royal instructions (1513) and government decrees indicated that a geometric grid was to be used, but not until 1573 did King Philip II's ordinances explicitly direct that the grid be used in city planning, thereby codifying practices long in effect. Scholars have cited gridded prototypes ranging from indigenous city planning; the Roman *castrum*; the French *bastide*; the ideal city of the Renaissance architectural theorist, Leon Battista Alberti; Santa Fe (1491), the military encampment of Ferdinand and Isabella at the siege of Granada; and the apocalyptic New Jerusalem in the Book of Revelation. It is probable that some or all of these multiple indigenous and European urban sources were precursors to the colonial Spanish-American urban grid and converged to serve complementary economic, social, political, and religious goals.

The ordered city. In Mexico, the typical grid plan came into being in urban developments in the 1520s and 1530s as new towns were built and the destroyed Aztec capital Tenochtitlan, an indigenous gridded city, was rebuilt as the administrative capital of New Spain. These geometrically ordered, regularized towns met the needs of the army, church, and state bureaucracy as they provided a framework for administrative efficiency, political control, and Christian indoctrination. The urban landscape was radically altered as the multiple cultural expressions of preconquest cities were supplanted by the uniformity of the grid extended across space and time in what had become Spanish America. The grid physically and symbolically established and confirmed the desired social order and clearly marked both the land and its people as being under the well-ordered, administrative, and Christian control of the Spanish.

Republican and Contemporary Latin America

Latin-American countries, with the exception of Cuba and Puerto Rico, won their political independence from Spain and Portugal between 1808 and 1826. As newly independent countries, they sought to express national identity, progress, and modernity and take their place among the metropolises of the Western world. To do so and to refashion its capital cities, Latin America looked to Paris, which was itself undergoing modern transformation under the direction of Georges-Eugène Haussmann. France's economic connections to Latin America and its position as a champion of independence and republicanism and a center of the arts and urbanity made it a natural model for the new Latin-American republics. Large public parks and grand, tree-lined, diagonal boulevards (such as the Paseo de la Reforma in Mexico City) followed the Haussmann model and reshaped Latin-American cities, freeing them from the colonial grid.

From metropolis to megalopolis. In the second half of the nineteenth century and the beginning of the twentieth, many urban populations grew exponentially as foreign investments and overseas immigrants poured into Latin America. Capitals were enlarged to accommodate their growing populations, and the ideas of the early-twentieth-century Swiss architect and planner, Charles-Édouard Jeanneret, known as Le Corbusier, and his followers in the Congrès International d'Architecture Mod-

erne (CIAM) became influential. Le Corbusier's ideas focused on high-rise buildings to increase living density and relieve overcrowding, new highways to relieve traffic congestion, and urban space zoned according to function; in short, an attempt to bring order and efficiency to cities that had grown rapidly. Although Brasília, the new, disembedded capital city of Brazil planned by Lúcio Costa and inaugurated in 1960, incorporated some of Le Corbusier's ideas, his urban plans and those of his followers were rarely implemented. Le Corbusier's legacy is more clearly to be seen in high-rise buildings of cement, glass, and steel and in the peripheral highways encircling many of Latin America's major cities.

See also City, The: The City as Cultural Center; City, The: The City as Political Center.

BIBLIOGRAPHY

- Almadoz, Arturo, ed. *Planning Latin America's Capital Cities, 1850–1950*. New York and London: Routledge, 2002.
- Fraser, Valerie. *Building the New World: Studies in the Modern Architecture of Latin America, 1930–1960*. London: Verso, 2000.
- Hardoy, Jorge E. "Theory and Practice of Urban Planning in Europe, 1850–1930: Its Transfer to Latin America." In *Rethinking the Latin American City*, edited by Richard M. Morse and Jorge E. Hardoy, 20–49. Washington, D.C.: Woodrow Wilson Center Press, 1992.
- Schaedel, Richard P., Jorge E. Hardoy, and Nora Scott Kinzer, eds. *Urbanization in the Americas from Its Beginnings to the Present*. The Hague, Netherlands: Mouton, 1978.
- Smith, Monica L., ed. *The Social Construction of Ancient Cities*. Washington, D.C.: Smithsonian Institution Press, 2003.
- Townsend, Richard F., ed. *Ancient Americas: Art from Sacred Landscapes*. Chicago: Art Institute of Chicago, 1992.

Ellen T. Baird

CIVIL DISOBEDIENCE. Civil disobedience is an illegal act performed publicly in contravention of a law or laws of the government for the short-term purpose of bringing about a change in the law or laws and for the long-term purpose of improving society as a whole. It is a political act because its underlying principles are the principles of political justice that regulate the state and its institutions, and not those of private conduct. The act is called "civil" because it is courteous in the manner of its performance, not criminal in its methods or revolutionary in its effects. It presupposes the legitimacy of the state and the constitutional order, and its aim is the preservation of an improved state, not its overthrow.

Civil disobedience may be carried out by individuals or by masses of people. Its acts may be symbolic, as in the case of fasts, vigils, the burning of official documents, and so forth, or they may be substantial, as in the case of boycotts, strikes, marches, mass meetings, withdrawal of cooperation with the government and its institutions, sit-ins, occupation of public buildings, and the like.

In the late twentieth century, the idea of civil disobedience acquired a legal standing in international jurisprudence thanks

especially to the Nuremberg trials. The latter established the legal norm according to which individuals may be held responsible for not disobeying domestic laws that grossly violate fundamental human rights.

The History of the Concept

The concept of civil disobedience has evolved over a long period of time. Ideas drawn from different periods of history and from different cultures have contributed to its evolution. The idea that there is a law that transcends the laws of the state is found in Socrates (c. 470–399 B.C.E.), in some of the classical Greek tragedies, and in the Indian concept of dharma (duty). In these traditions, should the higher law and the laws of the state come into conflict, the individual had the obligation to disobey the laws of the state. In the Middle Ages, St. Thomas Aquinas (1225–1274) defended the natural-law view that unjust laws did not bind the citizen in conscience. John Locke (1632–1704) taught that the government derived its authority from the people, that one of the purposes of the government was the protection of the natural rights of the people, and that the people had the right to alter the government should it fail to discharge its fundamental duties.

Thoreau. The writer who made the theory famous, put it into practice, and gave the practice the name “civil disobedience” was Henry David Thoreau (1817–1862). His ideas on the subject are found in the celebrated lecture that he delivered in 1848 to the Concord Lyceum in Massachusetts, under the title “On the Relation of the Individual to the State.” It was first published in printed form in 1849 under a different title, “Resistance to Civil Government,” in *Aesthetic Papers*, a volume edited by Elizabeth Peabody. It first appeared under the title “Civil Disobedience” only in 1866, four years after Thoreau’s death, in a volume of his writings entitled *A Yankee in Canada with Anti-Slavery and Reform Papers*.

Two principles underlie Thoreau’s conception of civil disobedience. The first is that the authority of the government depends on the consent of the governed. The second is that justice is superior to the laws enacted by the government, and the individual has the right to judge whether a given law reflects or flouts justice. In the latter case the individual has the duty to disobey the law and accept the consequences of the disobedience nonviolently. In Thoreau’s case, he judged that the laws upholding slavery and supporting the Mexican War (1846–1848) were unjust. He chose to spend a night in jail rather than submit to the unjust laws.

Gandhi. Mahatma Gandhi (1869–1948) broadened the scope of civil disobedience and internationalized its practice. Gandhian civil disobedience originated in 1906, in South Africa, as part of his campaign for the defense of the civil rights of the disenfranchised Indian immigrants. On his return to India in 1915, he made civil disobedience the primary moral force behind his leadership of the Indian nationalist movement.

His idea of civil disobedience drew from a wide variety of intellectual sources. Plato’s *Apology of Socrates* was one of them. In 1908 he published a paraphrase of it under the title *The Story of a Soldier of Truth*. The Sermon on the Mount had a

profound influence on him, especially as interpreted by Leo Tolstoy in his *The Kingdom of God Is within You* (1893). Patanjali’s *Yogasutra* and the *Bhagavad Gita* also guided the development of his thoughts on nonviolence as it applied to civil disobedience.

When in 1906 he started the civil rights campaign in South Africa, Gandhi did not know what term to use to describe it. (He read Thoreau only in 1907). Some called the new campaign passive resistance, in comparison with the British Passive Resistance Movement against the Education Act of 1902. But he was unhappy with the comparison for two reasons. The first was that British passive resistance did not forbid violence as a means of achieving its goal; the second was that it did not require that its practitioners be free from hatred of their political opponents.

Gandhi called his practice “satyagraha,” a Gujarati word meaning “firmness in adhering to truth.” Satyagraha, free of the defects of passive resistance, introduced six elements into the theory and practice of civil disobedience:

- First, its moral basis was grounded in truth, a basis much deeper than that provided by the theory of consent. To be binding, laws had to be truthful. All untruthful laws had to be resisted, though civilly—that is, by truthful means.
- Second, civil disobedience presupposed the obligation to obey the state: only those had the right to practice civil disobedience who knew “how to offer voluntary and deliberate obedience” to the laws of the state.
- Third, commitment to nonviolence was an essential component of civil disobedience. The commitment in question could be either moral or tactical, depending on the moral aptitude of the practitioner.
- Fourth, the practice of civil disobedience required a minimum degree of moral fitness, to be acquired by the exercise of such virtues as truthfulness, nonviolence, temperance, courage, fearlessness, and freedom from greed.
- Fifth, a practitioner of civil disobedience had to accept the punishment consequent to the disobedience voluntarily, and without complaint.
- Finally, engagement in civil disobedience had to be complemented by engagement in organized social work.

For Gandhi, it was not enough to seek to improve the state; it was equally necessary to seek to improve civil society. To assist Indians to combine civil disobedience with voluntary social work, he wrote *Constructive Programme* (1941, revised in 1945). It identified the major social evils prevalent in Indian society, such as religious intolerance, caste violence, and discrimination against the untouchables, minorities, and women. The removal of these social evils by voluntary work was as important as the removal of unjust laws by civil disobedience. According to

Gandhi, “civil disobedience without the constructive program will be like a paralyzed hand attempting to lift a spoon.”

Martin Luther King Jr. The third major figure who contributed greatly to the development of the practice of civil disobedience was Martin Luther King Jr. (1929–1968). He made civil disobedience the distinguishing feature of the civil rights movement in the United States. In this he was deeply influenced by Gandhi’s methods. But he was also influenced by Christian humanism, as is evident in his “Letter from Birmingham Jail” (1963). The letter has been called the most widely read and discussed manifesto on civil disobedience since Thoreau’s essay. Addressed to his fellow African-American clergymen, it explained why immediate, direct, nonviolent action was a duty incumbent upon every American who wished to rid the nation of segregationist laws. Here King faced a dilemma. On the one hand, the law had by 1954 declared segregation to be unconstitutional, yet on the other it also tolerated segregationist practices in certain states. How then could one advocate breaking some laws while obeying others?

One could do both, he contended, because one had the right to judge each law on its own merit. And the criterion he recommended for making such judgement was drawn from Christian humanism. According to St. Augustine of Hippo (354–430), an unjust law was no law at all. And according to Aquinas, an unjust law was a human law that was not rooted in eternal and natural law. Just laws uplifted human beings, while unjust ones degraded them. The segregationist laws were unjust and dehumanizing and therefore had to be disobeyed. King contributed greatly to making civil disobedience a respected tradition of American politics. In this he marks an advance on Thoreau, who seemed to appeal, hitherto, mostly to New England intellectuals. King actualized the potential that was in Thoreau.

In the late twentieth century, civil disobedience became a tactic adopted by various protest movements worldwide. The anti-nuclear weapons movement, the green movement, and the movement against globalization have adopted it with varying degrees of enthusiasm.

Philosophic Status Today

Thoreau, Gandhi, and King were primarily practitioners rather than philosophers of civil disobedience. Even though a philosophy did underlie their practice, they themselves did not elaborate it in any systematic fashion. From the last quarter of the twentieth century onward, however, philosophers and political theorists have taken a keen interest in the philosophic aspects of civil disobedience. The most significant of these philosophers is John Rawls (1921–2002). His *Theory of Justice* (1971) integrates civil disobedience into the liberal-contractarian philosophy of justice. It grounds civil disobedience in the two principles of Rawlsian justice—namely, those of equal basic liberty of the citizens and equality of opportunity. However, a society built on these principles is not a “perfectly just society,” but only “a nearly just society.” Though it is a well-ordered society, “serious violations” of justice can and do occur in it. This imperfect character of the justice of the liberal society places the citizen in a moral quandary. There is on the one

hand the obligation to obey laws enacted under an agreed upon constitution, yet on the other there is the duty to oppose the injustices of particular laws and the right to defend the basic liberty of citizens. That is to say, the obligation to obey in a liberal society is relative, not absolute—relative to the prior right to defend one’s basic liberty and the duty to oppose injustice.

It is here that civil disobedience comes to the rescue of the embattled citizen. It permits the citizen to disobey an unjust law, but only within the bounds of fidelity to the constitutional order. In this way civil disobedience helps test the moral basis of liberal democracy. It also points to the limits of the majority principle. If the majority fails to respect the basic liberty of citizens and equality of opportunity, the grieved citizen or citizens have the right to disobey the law, irrespective of the position of the majority.

However, for Rawls, civil disobedience may not be violent in its methods; it has to be nonviolent for two reasons. First, in a liberal democratic society civil disobedience is a mode of appealing to the latent sense of fundamental justice that the majority is presumed to possess. This appeal can succeed only if the means of civil disobedience remains nonviolent. The civilly disobedient may warn and admonish, but not threaten. Second, nonviolence is a method of expressing disobedience within the limits of fidelity to the constitutional order, and of accepting voluntarily the legal consequences of disobedience. Thus, though contrary to a given law, civil disobedience is a morally correct way of maintaining the constitutional order in an admittedly imperfect society. It becomes part of free government. It gives stability to the constitutional order and helps actualize the capacity for self-correction.

Rawls’s theory has the merit of explaining why civil disobedience works only in certain societies and not in others. It works in societies whose contending members can agree on what constitutes justice. Because of this they are able to compose their differences. Civil disobedience tests the solidity of this consensus. In societies whose contending members cannot agree on what constitutes justice, there is no room for civil disobedience, but only for civil war or something close to it. Thus, Rawls’s theory can also explain why civil disobedience succeeded the way it did in unjust colonial societies such as South Africa and India. It succeeded because, paradoxically, the higher colonial administration and the civilly disobedient citizens were able to agree on the basic principles of liberal justice.

There is one major difference, however, between Rawls’s theory and that of Gandhi and King. Rawls grounds his theory in the principles of liberty and equality, without asking whether they need grounding in some other principle. Gandhi and King ground their conceptions of liberty and equality in the higher principle of the spiritual personality of human beings—atman (the spiritual self) in the case of Gandhi and the immortal soul in that of King. It is because humans have a spiritual personality that they ought to be free and equal in society. Their theory of disobedience has deeper roots than does Rawls’s. The latter operates within the limits of European Enlightenment, whereas the other two operate within a broader framework.

Disputed Questions

Although the theory of civil disobedience has achieved philosophic maturity, there are two questions that still remain unresolved. One has to do with the place of violence in civil disobedience. Theorists such as Christian Bay do not rule out the use of limited physical violence. The problem here is where to draw the line between limited physical violence and revolutionary violence. The other question has to do with the acceptance of punishment due to civil disobedience. Some, including Rawls, accept it for prudential reasons, while others such as Gandhi do so for moral reasons. Gandhi believes that the suffering of the innocent victim has a unique moral force, which civil disobedience should integrate into its moral theory.

See also *Protest, Political; Reform; Resistance and Accommodation; Revolution.*

BIBLIOGRAPHY

- Bass, Jonathan, S. *Blessed Are the Peacemakers: Martin Luther King Jr., Eight White Religious Leaders, and the "Letter From Birmingham Jail."* Baton Rouge: Louisiana State University Press, 2001.
- Bay, Christian, and Charles C. Walker. *Civil Disobedience: Theory and Practice.* Montreal: Black Rose, 1975.
- Bedau, H. A., comp. *Civil Disobedience: Theory and Practice.* Indianapolis: Pegasus, 1969.
- Gandhi, Mahatma. *Hind Swaraj and Other Writings.* Edited by Anthony J. Parel. Cambridge, U.K.: Cambridge University Press, 1997.
- . *Satyagraha in South Africa.* Ahmedabad: Navajivan, 1972.
- Gans, Chaim. *Philosophical Anarchism and Political Disobedience.* Cambridge, U.K.: Cambridge University Press, 1992.
- Haksar, Vinit. *Rights, Communities, and Disobedience: Liberalism and Gandhi.* New York: Oxford University Press, 2001.
- Rawls, John. *A Theory of Justice.* Cambridge, Mass.: Harvard University Press, 1971.
- Thoreau, Henry David. *Political Writings.* Edited by Nancy L. Rosenblum. New York: Cambridge University Press, 1996.

Anthony Parel

CIVIL SOCIETY.

This entry includes two subentries:

Europe and the United States

Responses in Africa and the Middle East

EUROPE AND THE UNITED STATES

An ancient term of Western political and social theory, *civil society* has enjoyed enormous popularity in recent years and has outstripped its geographic origins to spread all over the world. Public leaders, newspaper writers, religious figures, social theorists, political activists, and commentators from many different perspectives now use the term on a regular basis. The term's meaning has shifted dramatically over the centuries, and different historical periods have understood it in distinct ways.

Three distinct usages can be delineated. *Civil society* first appears in classical Greek and Roman thought, which considered it to be synonymous with a politically organized commonwealth—a view that was modified by the medieval church's distaste for purely political categories and came to describe a society organized around the primacy of religion. As powerful markets and centralized states began to erode medieval institutions, a second, and characteristically modern, liberal understanding arose that conceived of civil society as the arena of economic relations and institutions. Frightened by the consequences of the French Revolution and the advent of mass political activity, a third conception developed during the middle of the nineteenth century to describe civil society as a sphere of voluntary intermediate organizations that stand between the state and the citizen. Pioneered by Alexis de Tocqueville (1805–1859), this is the way *civil society* is understood in contemporary usage. Although chronologically distinct, each of these understandings contributes important insights to political and social life and sheds light on contemporary issues of democracy and equality.

Political and Religious Commonwealths

When Cicero (106–43 B.C.E.) equated civil society with a politically constituted commonwealth, he expressed a powerful tendency to understand "civility" as the requirements of citizenship. His effort represented the most complete development of classical thinking about civil society. Plato (c. 428–348 or 347 B.C.E.) had attempted to articulate an invariant ethical center for public life, an effort that Aristotle (c. 384–322 B.C.E.) tried to correct by recognizing that people live their lives in different spheres and in multiple associations. Aristotle's respect for variation and distinction underlay a political theory that understood civil society as a moral-political association that improved the life of its citizens, but the Roman recognition of a legally protected private realm made it possible to equate civil society with republican virtues and political life. Imperial collapse led to St. Augustine of Hippo's (354–430 C.E.) devastating attack on the classical tradition's effort to organize a self-reliant public sphere, but Christian insistence that civil society could be understood only in terms of the requirements of faith and church made it difficult to organize human affairs with such depraved material as fallen man. St. Thomas Aquinas (c. 1224–1274) was more willing than Augustine to recognize that politics could sustain a measure of moral action and constitute civil society, but the corrosive effects of markets and the pressure of centralizing kings brought the first period of theorizing to a halt.

Markets, Individuals, and Interests

Niccolò Machiavelli's (1469–1527) rediscovery of classical republicanism and Thomas Hobbes's (1588–1679) insistence that only a single point of sovereign power could protect the calculating individual and his interests pointed the way toward a fully modern conception of civil society. It was not long before those interests became expressed as property, production, and acquisition. John Locke's (1632–1704) civil society was made possible by the sovereign power of states, but it was really the pursuit of private interest that made political liberty

worthwhile. Locke's clear preference for economic activity anchored many later conceptions, and Adam Smith (1723–1790) articulated the first fully bourgeois theory of civil society as a sphere of production and competition that was driven by the self-interested calculations of isolated individuals. The state played an organizing and protecting role, but Smith's conviction that economic processes could organize social life expressed liberalism's suspicion of centralized political power and its assumption that civil society is constituted by the market. Jean-Jacques Rousseau (1712–1778), Immanuel Kant (1724–1804), and Georg Wilhelm Friedrich Hegel (1770–1831) would try to infuse civil society—now equated with “civilization”—with solidarity and moral purpose, but it was plain that this tradition of thought understood civil society as a law-governed sphere where property, civil liberties, and political equality would enable self-serving individuals to make private decisions in conditions of freedom and security. If the classical view of civil society had been shaped by the ancient traditions of civil republicanism and came to an end with the fall of the Roman Empire, the second view was clearly related to the early framework of capitalism. Karl Marx's (1818–1883) desire to overcome civil society's foundation in the class relations of bourgeois society looked to a socialist state to democratize civil society itself and seemed to recapture a moment of the classical heritage. It also shed light on an important weakness in liberal theory by calling for democratic supervision of civil society's chaos and instability.

Intermediate Associations and the State

Drawing on Aristotle, Cicero, and Machiavelli for the theory of the mixed constitution, Baron de Montesquieu (1689–1755) located intermediate bodies at the heart of his aristocratic theory of civil society. His fear of royal power fed Edmund Burke's (1729–1797) defense of local privilege against the leveling and centralizing French Revolution, but it was Tocqueville's claim that voluntary activity connected individualistic, self-serving Americans to the common good that proved particularly powerful. Tocqueville's insight has fed most of the contemporary interest in civil society, in large measure because of his desire to limit the thrust of the democratic state by preserving local freedom, protecting pockets of local privilege, and nurturing traditions of self-organization. His assumption of widespread equality of condition meant that he did not have to examine how inequality and voluntary activity might reinforce one another—a matter that has become vitally important, given contemporary economic and political trends. Nevertheless, powerful American traditions of suspicion of the state and a history of local volunteerism have all but guaranteed that Tocqueville finds a ready audience in this country—particularly in politically conservative periods.

Contemporary Issues

Interest in civil society was largely confined to academic circles until the early 1980s, when dissident Polish intellectuals and journalists began talking of “the rebellion of civil society against the state.” It wasn't long before an influential body of Eastern European thought began to understand civil society as constitutional republics and intermediate associations. As Soviet-style socialism continued to be hostile to almost all

spontaneous social initiatives, it made sense that dissidents would be interested in limiting state power and would be indifferent to the market's threat to freedom and equality. But their sunny optimism would soon fade away. As the East European civic forums, underground newspapers, student leagues, “flying universities,” and other groupings began to yield to the logic of economics and the imperatives of politics, it became practically and theoretically imperative to understand how civil society can serve democracy in conditions of powerful markets and bureaucratized states. Voluntary organizations and social movements have contributed to freedom and equality in important ways, but the naive assumption that they constitute a democratic sphere of action in their own right has begun to yield to more sober questions of how local voluntary activity can serve democracy in an environment that is constituted by widening inequality and dominated by large, powerful institutions. It is important to understand how the local and the small can serve freedom and democracy with, not against, the universal and the large. Further intellectual and practical activity will be compelled to investigate how inequality and bureaucracy affect the ability to organize on the one hand, and how local activity can mitigate the effects of inequality and hold political structures to account on the other.

See also *Citizenship; Democracy; Equality; Society.*

BIBLIOGRAPHY

- Eberly, Don E., ed. *The Essential Civil Society Reader: Classic Essays in the American Civil Society Debate*. Lanham, Md.: Rowman and Littlefield, 2000.
- Ehrenberg, John. *Civil Society: The Critical History of an Idea*. New York: New York University Press, 1999.
- Putnam, Robert D. *Bowling Alone: The Collapse and Revival of American Community*. New York: Simon and Schuster, 2000.
- Seligman, Adam. *The Idea of Civil Society*. Princeton, N.J.: Princeton University Press, 1995.
- Skocpol, Theda, and Morris P. Fiorina, eds. *Civic Engagement in American Democracy*. Washington, D.C.: Brookings Institution Press, 1999.
- Verba, Sidney, Kay Lehman Schlozman, and Henry E. Brady. *Voice and Equality: Civic Voluntarism in American Politics*. Cambridge, Mass.: Harvard University Press, 1995.

John Ehrenberg

RESPONSES IN AFRICA AND THE MIDDLE EAST

“All vogue words tend to share a similar fate,” observes Zygmunt Bauman. “The more experiences they pretend to make apparent, the more they themselves become opaque. The more numerous are the orthodox truths they elbow out and supplant, the faster they turn into no-questions-asked canons” (p. 1). Bauman's specific subject was globalization, but he may well have been alluding to civil society. Ever since it made a blazing entry into mainstream political theory in the mid 1980s, *civil society* has had a quite remarkable career as a buzzword, both in policy and scholarly circles. Rare is that academic without a perspective on civil society. For all this analytic intensity however, civil society continues to evade the critical gaze, and seemingly definitive statements about its meaning or origin have merely given rise to even knottier dilemmas.

Ironically, history has been of little help. In most cases, historical excursion has only complicated the riddle, for civil society has not one but many genealogies. Its complex story traces back to a tangle of understandings, and scholars generally tend to privilege whatever genealogy best suits their purposes.

Apparently, many of the hurdles encountered in grappling with the idea of civil society could be scaled easily. One is the problem of definition, which, Iris Marion Young contends, has persisted simply because many scholars stubbornly hanker after a one-sentence definition. The implicit suggestion here is that deeper understanding of civil society might be gained if the inquirer were to take for granted its conceptual diversity. This may not be the vehicle that transports one to definitional nirvana, but there is at least the precognition of the inherent plurality of the subject. A second problem is the popular conflation of civil society as an idea, an ideal, and a device for the attainment of a vaguely defined “good society.” Again, as Michael Edwards suggests, the problem comes not from this trifurcation, but rather from imagining that civil society cannot be all three at the same time.

Different Understandings

This definitional problem is not new, and one way of illustrating this is to briefly explore some of the several ways in which civil society has been historically understood. We deal with a dense and richly conflicted narrative, and the distinctions made here are, of necessity, a guide. The first understanding is that of civil society as the opposite of the state of nature. In this view, civil society points to a condition of refinement, a departure from a state in which humanity was slave to its instincts and passions, to one in which it is governed by reason and rationality. This is a mere prototype of course, as many who have sadly contemplated the horrors of the past century might readily attest, but it should help in underscoring the point that most times, civil society is merely that to which groups or peoples aspire. Even more important, implicit in this definition is an undeniable gender bias, especially given that women were often described as being closer to a state of nature than men. Therefore, civil society, at least within the framework of this understanding, is profoundly patriarchal. However, scholars like Adam Seligman have provided a more historically rooted picture. For him, the state of nature could be taken as the immediate post-Enlightenment seventeenth- and eighteenth-century Europe in which there was a clear need to tame the demon of unfeeling individuation, which had been an unexpected concomitant of the new era of rapid industrialization. According to this account, the accent on rationality as opposed to feelings that was the immediate by-product of the European Enlightenment, and the emergence of the market as the arena where the new individual could realize his newly found “freedom” had to be checked by something much larger than the private individual himself, hence “civil” society; a society, in Keith Tester’s words, of “less barbarous manners.” If nothing at all, it is this “civil” or “polite” society that defines and imposes the parameters of social conduct, “reestablishing some public (and perforce communal) space to mediate what are seen as the adverse effects of the ideology of individualism” (p. 28).

A second understanding is the envisioning of civil society as connoting the possession of certain values (privacy, individual-

ism, and the market, say) that are present in and actually define the West but are, alas, in short supply or completely absent from other societies. Scholars generally trace the intellectual pedigree of this controversial formulation to Adam Ferguson (1723–1816) and Georg Wilhelm Friedrich Hegel (1770–1831), but its most forceful affirmation could be seen in the writings of Ernest Gellner. According to this view, civil society is what his “Atlantic society” has that “others” do not; “others” here signifies either other cultures or sociopolitical systems, or a combination of both. Thus, civil society becomes, “like human rights, what authoritarian regimes lack by definition. It is what the Greeks, the Enlightenment and we today have; it is what despotic governments, whether in the past or the present, the here or the elsewhere, do not have” (Goody, p. 150).

Other conceptualizations certainly exist, and admittedly, it is well nigh impossible to scour the fastnesses of the history of political thought and philosophy for every analysis of the subject of civil society. One of the more influential formulations, in reality a conceptual first, has been the Hegelian delineation of civil society as that which is separate from the state. Drawing partly on the work of the Scottish chaplain Adam Ferguson, Hegel defines civil society as “the realm of difference, intermediate between the family and the state.” His conception of civil society makes clearer sense within the ambit of his rather abstruse philosophy of history, which, mindful of the risks inherent in simplification, can be articulated thus: History is the evolution of consciousness and the modern world is the highest demonstration of that evolution. For Hegel then, civil society is “the achievement of modernity,” one *moment* (the other two being the family and the state), in which the movement of the objective spirit (*Geist*) can be analyzed (Schechter, 2000). Even though in sharp contrast to Ferguson he insisted on the ontological integrity of the state as having a “concrete existence” (Schechter, p. 38) of its own, Hegel shared Ferguson’s derision for the state-of-nature construct. His case for its rejection is based on his appreciation of historical developments, particularly in the economic sphere. While the dichotomy that the state of nature/state of civilization presumed might have possibly made some sense at a historical moment, Hegel believed that profound changes in the economic realm had made this binary otiose, or useless. The indelible consequences of this economic revolution, he thought, were to be seen in the specific transformation of what was regarded as the private sphere. More specifically, the expansion of the economy, Hegel argued, had incorporated and dominated civil society, leaving the state to emerge more clearly as a “separate political sphere.” The family, for its own part, is relegated to what is left of the by now “emaciated” public sphere.

Skeptics usually seize on this extensive mesh of meanings and nuances to assert that civil society is nothing more than a “plastic concept,” one whose shelf life will come to an abrupt halt sooner rather than later. Optimists disagree. Indeed, they argue that the hermeneutic elasticity of civil society is good both for the subject and for the various political projects in whose cause it is usually invoked. Mary Kaldor, for example, thinks that the changing meaning arises from several factors: “the changing content and coverage of the term—what it was not; the tension between normative and descriptive, idealistic

and empiricist, subjective and objective implications of the concept; and the relative emphasis on the private and the public or the individual and the social" (p. 16).

Be that as it may, policy and scholarly infatuation with civil society has shown little sign of waning. To be sure, the immediate backcloth for the contemporary revival was lent by events in former Eastern Europe, where the idea inspired dissident groups intent on rolling back the authoritarian communist state. In this specific context, civil society was the social culture, one framed by the rule of law and an institutional civility that was lacking from the social system that the dissidents sought to destabilize and disestablish. Particular inspiration for the dissidents' challenge to the state had come from the prison writings of Antonio Gramsci (1891–1937), the atypical Italian Marxist who posited, contra Karl Marx, that civil society, being the sphere of culture, ideology, and associations, is equally that of contestation. While Marx reduces civil society to the market economy, arguing that it is basically a bourgeois lie, Gramsci contends that it (that is, civil society) "offers the popular classes an opportunity to deny the ruling classes hegemony in the realm of ideas, values and culture, as a basis for the ultimate seizure of power and the transformation of capitalist property relations and the state" (quoted in Bangura, pp. 45–46). This, together with the work of Alexis de Tocqueville (1805–1859), who had speculated on the bountiful social capital accruing from Americans' "habit of association," had informed the quite successful invocation of the idea in Eastern Europe.

From Eastern Europe, the idea diffused to the rest of the world, where, fortuitously, it fed into the existing disenchantment with the welfare state across the Western world, the search for an ethical force in the wake of the perceived global slide into moral decay, the explosion in the number of NGOs (non-governmental organizations), and the anticipation of greater civility amid the rampant surge of religious and other kinds of fundamentalism. Outside the West, particularly in the developing countries, the idea of civil society emerged in the thick of the struggle for democratic liberalization and social inclusion for marginalized groups. To be sure, this idea of civil society as a useful tool in the resistance to hegemony by dispossessed groups owes much to early feminist and suffragist movements in Britain. These movements drew heavily on the postulations of John Stuart Mill (among others) regarding civil society, while at the same time seeking to make the concept more inclusive. Across Africa in the late 1980s and early 1990s, the association of civil society with democracy, or at least the possibility of its achievement, was common indeed. Many freely conflated the two, and the popular media treated them as though they were synonyms.

Alternative Genealogies

The embrace of the idea of civil society in non-Western contexts was always going to be difficult. First, there was the problem posed by the specifically Western origin of the idea, one that automatically generated the poser: Is civil society applicable or "thinkable" outside its specific Western cultural and geographic provenance, and might it be compatible with societies denounced by Gellner as "non-modular," "ritual-

pervaded," and "segmentary"? Second, if civil society actually exists outside the West, in places like Africa, Asia, and the Middle East, what might it mean, and with what unit will scholars analyze it? Contrary to general belief, these dilemmas have not been raised by scholars in the West alone. Both Africans and Africanists, like Mahmood Mamdani, Peter Ekeh, Emmanuel Gyimah-Boadi, Eboe Hutchful, Thomas Callaghy, and Stephen Orvis, have expressed deep skepticism about the usefulness of the idea of civil society ("a vague, often confusing and ever-shifting concept") in explicating non-Western or, specifically African, realities; although in the process they have generated insights that have enriched the relevant literature considerably. This has also been the case in the Middle East and Asia, where thinkers like Sudipta Kaviraj, Sunil Khilnani, Neera Chandhoke, Farhad Kazemi, and Masoud Kamali have picked up the gauntlet.

As a result, issues surrounding the so-called alien nativity of civil society have led to the emergence of a critical and fascinating oeuvre. So powerful and diverse is this emergent corpus that Jude Howell and Jenny Pearce think that it forms the core of what might well be called an "alternative genealogy" of civil society. But what are its arguments? The first is to stress the crucial fact that, its Western origins notwithstanding, civil society has over the past decade become a useful tool in the resistance to hegemony by dispossessed groups. Howell and Pearce note that if there is a common thread in the non-Western application of civil society, it is its use to legitimize citizens' right to resist the prevailing development paradigm, thus showing how truly contested the liberal meanings of the concept are. In the process, "civil society has enabled critical voices to occupy an intellectual space where an alternative set of values and propositions on how societies ought to develop and change can be put forward, challenging those that would otherwise dominate" (Howell and Pearce, p. 36).

A second argument of the emergent alternative genealogy is to say that it does not serve any purpose to lay emphasis on the rash of possible meanings of civil society outside the West, especially as even in the West itself, it is impossible to point to a single coherent narrative of civil society. This position has been seemingly corroborated by the plethora of meanings of civil society advanced by different Western scholars. Examples are the imagination of civil society as: "the natural condition of freedom" (Keane); "a condition of education, refinement and sophistication as opposed to a condition of barbarism" (Tester); a "point of refuge from the dangerous totalising systems of state and economy that threatened the life-world" (Habermas); a "metaphor for Western liberalism" (Seckinelgin), and "the anchorage of liberty" (Dahrendorf).

Afro-Arab Discourses

For obvious reasons, the debate on the possibility and meanings of civil society outside the West has elicited a more spirited discourse in Africa and the Islamic world. Gellner, we recall, had vilified Islamic societies for "exemplifying a social order which seems to lack much capacity to provide political countervailing institutions, which is atomised without much individualism, and operates effectively without pluralism"

(p. 29). The denial of civil society in Africa is inspired by a similar characterization.

In both cases, the challenge has been to postulate a theory of civil society that simultaneously recognizes the idea's Western origin and usefulness to the Afro-Arab world. This cannot be done without redefining the term, a cause that has been helped by its unique lack of a commonly agreed definition. Thus, formulating civil society as the "values of mutual support and solidarity [which] exist in the history of human sociability" (Howell and Pearce, p. 36), scholars in Africa and the Middle East argue that civil society has always existed in different forms in other societies. Not surprisingly, a wealth of literature has emerged on African and Islamic civil societies.

One outcome of these attempts, coupled with the ever-increasing policy focus on civil society is the emergence of the idea in a form that is not "civilizationally circumscribed" (Hefner, p. 221). There may be some residual skepticism about the applicability of civil society outside the West, but at least nobody seems to be saying that anymore. The global "professionalization of the third sector," to borrow the words of Michael Edwards, has led to the increased popularity of civil society, and these days the international aid industry seems to be more bothered about empowering civil society than defining it. While this ought to give cause for a pause, it seems more important to observe that in tandem with the "professionalization" of civil society, different local meanings are being created around the concept as part of an increasingly universal negotiation between citizens, states, and markets. This is the real future of the idea, and it would seem to be the next subject for scholarly research.

See also *Civil Society: Europe and the United States; Democracy; Third World.*

BIBLIOGRAPHY

- Bangura, Yusuf. "Authoritarian Rule and Democracy in Africa: A Theoretical Discourse." In *Authoritarianism, Democracy, and Adjustment: The Politics of Economic Reform in Africa*, edited by Peter Gibbon, Yusuf Bangura, and Arve Ofstad. Uppsala: Scandinavian Institute of African Studies, 1992.
- Bauman, Zygmunt. *Globalization: The Human Consequences*. New York: Columbia University Press, 1998.
- Dahrendorf, Ralf. *Reflections on the Revolution in Europe: In a Letter Intended to Have Been Sent to a Gentleman in Warsaw*. London: Chatto and Windus, 1990.
- Edwards, Michael. *Civil Society*. Malden, Mass.: Polity, 2004.
- Gellner, Ernest. *Conditions of Liberty: Civil Society and Its Rivals*. New York: Lane, 1994.
- Goody, J. R. "Civil Society in an Extra-European Perspective." In *Civil Society History and Possibilities*, edited by Sudipta Kaviraj and Sunil Khilnani. Cambridge, U.K.: Cambridge University Press, 2001.
- Habermas, Jürgen. *Between Facts and Norms: Contributions to a Discourse Theory of Law and Democracy*. Translated by William Rehg. Cambridge, Mass.: MIT Press, 1996.
- Hefner, Robert W. *Civil Islam: Muslims and Democratization in Indonesia*. Princeton, N.J.: Princeton University Press, 2000.

- Howell, Jude, and Jenny Pearce. *Civil Society and Development: A Critical Exploration*. Boulder, Colo.: Lynne Rienner, 2001.
- Kaldor, Mary. *Global Civil Society: An Answer to War*. Cambridge, U.K.: Polity, 2003.
- Keane, John. *Civil Society: Old Images, New Visions*. Stanford, Calif.: Stanford University Press, 1998.
- Lewis, David. "Civil Society in African Contexts: Reflections on the Usefulness of a Concept." *Development and Change* 33, no. 4 (2002): 569–586.
- Seckinelgin, Hakan. *Civil Society as a Metaphor for Western Liberalism*. London: London School of Economics and Political Science, 2002.
- Seligman, Adam B. *The Idea of Civil Society*. New York: Free Press, 1992.
- Schecter, Darrow. *Sovereign States or Political Communities?: Civil Society and Contemporary Politics*. Manchester, U.K.: Manchester University Press, 2000.
- Tester, Keith. *Civil Society*. London and New York: Routledge, 1992.

Ebenezer Obadare

CLASS. The term *class* is used in a wide range of intellectual discourses, including logic, the natural sciences, and pedagogy. At its Latin origins, however, *classis* was first and foremost a social term, denoting the division of the Roman people attributed to King Servius Tullius (r. 578–534 B.C.E.). In early Rome, class connoted a distinction in rank between those who paid tribute (property tax) and those who did not, as well as the system of divisions between types of military service. In particular, *classis* often seems to have been reserved to describe citizens on the lower social and economic rungs. Only after the principate of Augustus (31 B.C.E.–14 A.D.) did *classis* come to be employed in a more general sense to mean a division of all sorts of things into groups.

Early Histories

The Latin genesis of class nomenclature does not mean that the idea behind it (in either a social or general sense) did not exist prior to the rise of the Roman Republic. Aristotle's *Organon* proposed a logical system of classification of natural and linguistic types into genus and species according to categorical criteria. For the ancient Greeks, the Few and the Many constituted a central measure of division within the social order. Both Plato and Aristotle divided social groups into functional classes whose status and power was graded according to the contributions each made to the purposes of the civil community as a whole. Plato's *Republic* famously identified within the city three parts—rulers, soldiers, and laborers—while Aristotle distinguished six socioeconomic classes—soldiers, priests, judges, farmers, artisans, and traders—of whom only the first three were deemed fully qualified to exercise the rights associated with citizenship, at least in the best political system.

Class thus has generally been associated with systems of social exclusion. Indeed, elaborate mythologies have been generated to support or justify class divisions. The tale of Noah's curse on the descendants of his son Ham, in Genesis 9:20–27, has been taken as an explanation for class inequality. Likewise,

the Koran (Sura 43:31) declares that social differentiation arises from Allah's will that the inferior should be subjected to the superior. The caste system that long governed social organization and relations in India and elsewhere in Asia purported to reflect the disparate origins of the various groups as described in the Vedas: the Brahmans from the lips of Brahma, the Kshatriya from the shoulders, the Vaisya from the thighs, and the Sudra from the feet.

During the European Middle Ages, the idea behind class distinctions was popularly captured by various forms of organic unities. Many medieval thinkers, quite possibly under the indirect influence of Plato, divided society into the three-fold functional ordering of those who fight, those who work, and those who pray. In the High Middle Ages, this was gradually replaced by the more developed organic doctrine of the body politic, the most influential exponent of which was John of Salisbury (1115 or 1120–1180). His *Policraticus* (completed 1159) contained an extensive account of how each of the organs and limbs of the human body—from the head to the toes—had a direct counterpart in society, from the king, his advisors, soldiers, and diverse magistrates all the way down to the peasants and artisans. Class divisions were natural and necessary in order to maintain justice and the common good. Essentially this view enjoyed wide currency in Europe well into early modern times.

The Renewal of Class

For the first millennium and more of European history, the term *class* was not invoked in order to describe the distinctions between and identities of social groups. Rather, *class* was invoked through what we might call “status language,” such as *gradus* in Latin, *état* in French, *Stand* in German, and “orders” or “estates” in English. At the end of the eighteenth century, however, a notable linguistic shift that renewed the nomenclature of class appeared in most major European languages. This change seems to have accompanied the transformations wrought by the industrial revolution and the rise of political economy: class conveyed an essential economic overtone that was not fully captured by the status language of earlier times. The work of authors such as Thomas Malthus (1766–1834) and David Ricardo (1772–1823) did much to disseminate class discourse, and especially phrases such as “the laboring classes” and “the working class.”

The nineteenth century was the heyday of discussions about class in this updated economic sense. Class divisions were upheld by classical political economy on the grounds that the division of labor and the competition implied therein were necessary for the efficient use of productive resources. Critics of capitalism, whether communitarians such as Claude-Henri de Rouvroy, comte de Saint-Simon (1760–1825) or utopians such as Charles Fourier (1772–1837) or anarchists such as Pierre-Joseph Proudhon (1809–1865), remained convinced that the sources of exploitation were not inherent in class divisions per se so much as in unequal distribution of property or wages or the material benefits of work. Differentiation in the contributions made by laborers thus did not excuse their subordination in economic, political, or social standing.

The Marxist Transformation

Without doubt, the most famous promulgator of the idea of class in the modern world was also its most profound critic: Karl Marx (1818–1883). Marx treated class distinction as a universal characteristic of human history from the earliest times of social organization until his own day. For Marx, classes were economic groups constituted by differential access to the means of production—that is, the technologies and natural resources necessary for human beings to reproduce their physical existence. In every social formation, there were two essential and contending classes: a working class, which used, but did not directly own or control, the means of production; and an appropriating class, which lived directly or indirectly from the labor of workers. In different economic systems, the type and nature of technology, and of the social relationships employed in organizing labor and maintaining domination over it, might vary considerably. Hence, tribal societies met the physical and extraphysical needs of their members differently than did subsequent ancient slave or feudal systems. But the fundamental clash of interests between workers and appropriators was a permanent feature of history up to the present day.

In previous social systems, Marx held, the struggle between the classes had wound up with the replacement of one exploitative mode of production (the material and social elements of the economy) with another, culminating in capitalism. On the one hand, capitalism, with its veneer of freedom and equality, produced the most intense exploitation of the worker ever achieved. Yet, on the other hand, just because the condition of the capitalist working class, termed the proletariat, was so degraded, Marx believed that it formed a “universal class,” capable of releasing and realizing all of the untapped potential of a truly liberated humanity. For this reason, Marx held that the proletariat, once it became conscious of its own circumstances and the source of its immiseration, would revolt against its capitalist oppressors and would generate a qualitatively different kind of society. The future society, which Marx called communism, would be classless, since the proletariat, as the most completely exploited class in history, would have no remaining object to exploit. Communism would see the end of human history as a dynamic series of class struggles and would instead herald a new beginning of history in which each and every individual as a full human being would have the opportunity to pursue and attain his or her freely chosen needs.

The Weberian Reply

The primary response to Marx's conception of class was proposed by the German sociological thinker Max Weber (1864–1920). Weber's main insight was to recognize the empirical faults of an exclusive emphasis on class as an economic phenomenon. Rather, Weber saw society—in particular, in the modern world—as far too complex in its stratification to fit into the straightjacket of economic determinism. It should be noted that Weber's critique was directed not just at Marx and other radical critics of capitalism, but also at the classical political economists, who shared with Marxism a stridently economic orientation.

In one sense, Weber does adopt an economic conception of *class*; it is the term he employs to designate social differentiation based on occupation and function as defined by the market. But class is simply one form of distinction. Equally important are status and power. Status denotes the factors of honor and reputation that attach to specific ways of life and are accorded deference by others. Thus, individuals of certain status (say, from a landed nobility) may enjoy greater repute than those of a given class who are wealthier but whose sources of income (say, commerce) are generally held to be debased or ignoble. Power applies to the capability of a group to impose its collective will on others, even in the face of their resistance. Weber points out how, in the modern world, those with the greatest class position or status often do not occupy the positions of administrative or bureaucratic authority. In turn, bureaucrats can and do enact policies that run contrary to the real or perceived interests of economic and reputational elites. This demonstrates that their social position depends on a source—power—that cannot be entirely assimilated to class or status.

Later social scientists have extended and enlarged the factors that influence social differentiation well beyond Weber's original triad. Such elements as kinship, occupation, race and ethnicity, and education have been added to the basic dimensions of class, status, and power. But it seems safe to say that the dominant perspective on social stratification both normatively and empirically during the last century remained Weberian in orientation.

Marxist Rejoinders

Somewhat ironically, many of the fiercest critics of the classical Marxist doctrine of class would consider themselves to fall into the Marxist camp. The failure of the proletariat to rise up against and to crush capitalism even as the conditions of its exploitation worsened led some Marxists, especially in Western Europe, to revisit Marx's conception of class struggle. The so-called Frankfurt School of Critical Social Theory renounced the crass economism of classical Marxism in favor of an analysis that emphasized the cultural sources of working-class conservatism, including the mass media, out-group scapegoating (anti-Semitism and other forms of ethnic and racial hatred), and the predominance of so-called technological rationality. Members of the Frankfurt School embraced, alternately, pessimism about the possibility of successful class struggle (as in the work of Max Horkheimer [1895–1973] and Theodor W. Adorno [1903–1969]) or optimism that other marginalized groups, such as racial minorities, students, denizens of Third World nations, women, and environmentalists, might become the bearers of the revolutionary subjectivity of Marx's proletariat (as Herbert Marcuse [1898–1979] asserted). In either instance, traditional Marxian class analysis leading to proletarian revolution was set aside as an unrealistic and unrealizable expectation.

Another school of Marxist thought, drawing upon the rigorous methodological principles of modern economics and the other social sciences, sought to wed so-called rational choice doctrines of economic behavior to a radical worldview. Authors such as Jon Elster (b. 1940) and John Roemer (b. 1938)

argue that class should be reinterpreted according to the standards of methodological individualism, so that a class is not greater than the sum of its parts, but a coordinated body of similarly positioned individual agents. Known as “rational choice” or “analytical” Marxism, this approach attempts to strip class of perceived metaphysical accretions—for example, the holism criticized by Sir Karl Popper (1902–1994)—without eliminating it as a workable foundation for a viable theory of economic exploitation.

Still other thinkers within a Marxist vein have set out to restore the “political” dimension to Marx's conception of class struggle. Historians such as Robert Brenner (b. 1943) and political theorists such as Ellen Meiksins Wood (b. 1939) stress the contingency of class relations depending on political context, and thus they foreground local juridical-coercive institutions in understanding the constitution of class identities. This perspective insists on the wholly illusory nature of the supposed separation of the economic and the political under capitalism. Political power shapes class conflict, and thus the state itself is the prime site for class struggle and opposition.

Beyond Class

An important trend in the late twentieth and early twenty-first century has been to resist both Marxian and Weberian theories of social differentiation in favor of other fundamental sources of division among human beings. Feminism provides an example of one such line of reasoning. Feminist theory claims that gender, rather than class, constitutes the defining division in human historical dynamics. Broadly stated, feminists assert that reproduction trumps production as the organizing principle around which human social institutions are fixed. Thus, it is the gender divide, emerging from the male oppression of women, that drives social processes throughout history. Patriarchalism, not classism, constitutes the major division among human beings, and the obsession with class is itself a patriarchal trick to divert attention from the fundamental struggle between the sexes.

Class-oriented conceptions of social power and dynamic have also come under attack from proponents of critical race theory. The orientation of critical race theory raises questions quite similar to those of traditional Marxism concerning the ways in which state power (in its legal-judicial and coercive applications) reinscribes and reinforces racial divides. Thus, just as gender is foregrounded in feminist analysis, so race becomes the central focus of analysis among proponents of the critical race school.

The Future of Class?

Class has become anathema in political discourse in the West. Politicians are able to silence their opponents with the mere assertion that “class war” is being invoked. Liberalism—democracy's insistence that equality constitutes the salient feature of social life—even in spite of the evident social, economic, racial, and political disparities that exist in liberal-democratic regimes—suggests that class is effectively dead as a category of social analysis and critique. Yet the discourse of class seems to reappear regularly among the intellectual categories with which



Sandro Botticelli's *Birth of Venus* (1482). Tempera on canvas. Botticelli painted his masterpiece during the Renaissance, the period in which classicism bloomed. A member of Lorenzo de' Medici's intellectual circle, Botticelli strove to reconcile Christian beliefs with classical concerns in his work. GALLERIA DEGLI UFFIZI, FLORENCE, ITALY. © THE ART ARCHIVE/DAGLI ORTI

social thinkers, and social movements, narrate their self-understandings. May class yet outlive those whose interests prescribe its obsolescence?

See also **Communism; Critical Race Theory; Marxism; Power.**

BIBLIOGRAPHY

- Brennan, Catherine. *Max Weber on Power and Social Stratification: An Introduction and Critique*. Aldershot, U.K.: Ashgate, 1997.
- Brown, Donald E. *Hierarchy, History, and Human Nature: The Social Origins of Historical Consciousness*. Tucson: University of Arizona Press, 1988.
- Calvert, Peter. *The Concept of Class: An Historical Introduction*. New York: St. Martin's, 1982.
- Carling, Alan H. *Social Division*. London: Verso, 1991.
- Clark, Terry Nichols, and Seymour Martin Lipset, eds. *The Breakdown of Class Politics: A Debate on Post-Industrial Stratification*. Baltimore: Johns Hopkins University Press, 2001.
- Crenshaw, Kimberlé, ed. *Critical Race Theory: The Key Writings That Formed the Movement*. New York: Norton, 1995.
- Horkheimer, Max, and Theodor W. Adorno. *Dialectic of Enlightenment*. Translated by John Cumming. New York: Herder and Herder, 1972.
- Horowitz, Maryanne C., ed. *Race, Class, and Gender in Nineteenth-Century Culture*. Rochester, N.Y.: University of Rochester Press, 1991.

Marcuse, Herbert. *An Essay on Liberation*. Boston: Beacon, 1969.

McNall, Scott G., Rhonda F. Levine, and Rick Fantasia, eds. *Bringing Class Back in Contemporary and Historical Perspectives*. Boulder, Colo.: Westview, 1991.

Moravcsik, J. M. E., ed. *Aristotle: A Collection of Critical Essays*. London: Macmillan, 1968.

Roemer, John, ed. *Analytical Marxism*. Cambridge, U.K.: Cambridge University Press, 1986.

Russ, Joanna. *What Are We Fighting For? Sex, Race, Class, and the Future of Feminism*. New York: St. Martin's, 1998.

Skeggs, Beverley. *Formations of Class and Gender: Becoming Respectable*. London: Sage, 1997.

Wood, Ellen Meiksins. *Democracy against Capitalism: Renewing Historical Materialism*. Cambridge, U.K., Cambridge University Press, 1995.

Cary J. Nederman

CLASSICISM. Classicism has two dominant meanings in the West. The first concerns the Greeks of the sixth and fifth centuries B.C.E. and their influence, first on the Romans and then on Western cultures from the Renaissance on. The second meaning, evolved from the first, concerns the quality of a work—its style, its structure, and to some extent its content,

always with the quality of the Greek models in mind. The *Oxford English Dictionary* definition, “The principles of classic literature or art; adherence to . . . a classical style,” comprehends both meanings. The word *classicism* has become a common term since its first use in the nineteenth century. Classicism spread across Europe from Italy to Germany, to France, to Russia, to England, with the place and the time of its usage shading its meaning. It remains a useful term, with contextual clues indicating its intended meaning.

The intellectual and aesthetic outflow of the Greeks was prodigious and the extant aesthetic, philosophical, historical, and political writings have had a phenomenal impact on Western culture. Homer’s epics (c. 800 B.C.E.), the poetry of Sappho (seventh century B.C.E.) and Pindar (sixth century B.C.E.); the dramas of Aeschylus, Sophocles, Euripedes, and Aristophanes (fifth century B.C.E.); the sculptures of Phidias; the oratory of Pericles and the writings of Plato and Aristotle (fifth and fourth centuries B.C.E.) are but some of the most prominent Greek contributions to Western culture. In the works of these and other Greeks, future generations have found what has come to be understood as the features of classicism: beauty, balance, proportion, formal structure, intellectual vigor and depth, rational content supported by symmetrical form, often accompanied by a sense of humor and skillful satire. All of these characteristics are manifested in a humanist context. Unfortunately, much of our knowledge of this great outpouring comes to us secondhand because the originals no longer exist, although we have some fragments of the writings—a few poems of Sappho and some works of Aristotle, for example—and some remains of aesthetic works, such as the Elgin Marbles, the sculpture of Hera, friezes of the battle of the centurians, and drawings on pottery. These remains have been studied for centuries.

Much of what we know of Greek contributions comes from two sources: writings about them and copies of them. Aristotle in his *Poetics* analyzed and commented on Greek drama, vastly amplifying the evidence from the few extant dramas. Longinus illuminated the style and purpose of art. Much of what we know of Greek sculpture comes from Roman copies, and much of what we know of Greek and Roman architecture comes from Vitruvius, the Roman architect who wrote about architecture in *De re architectura* (first century C.E.), the manuscript of which was found in the fifteenth century and translated into many languages.

The Romans and Medieval Europe

The Romans, conscious of Greek art and thought, intentionally copied the Greeks. The first neoclassical age was really the Roman one between about the first century C.E. and the fifth century C.E. A good deal of what we now call classicism is a Roman continuation and expansion of Greek thought and aesthetic ideas and values. Fortunately, most of the Roman works are extant, and the writings of the poets Horace, Ovid, and Virgil, as well as the orators and prose writers including Cicero, Cato, Pliny the Elder, and Quintilian, have greatly enriched the classical tradition. Latin had a vigorous life all through the medieval period. It was the lingua franca not only



Queen’s House, Greenwich, England, constructed in 1616. Architect Inigo Jones drew upon the work of the celebrated Andrea Palladio in his design for Queen’s House. The spare, symmetrical appearance of the structure recalls ancient Greek architecture. EDIFICE/CORBIS

of the church but of the universities, which started in the twelfth and thirteenth centuries, as well as most serious writing.

The Renaissance

The next neoclassical period, which we call the Renaissance, exploded in Italy under the patronage of such personages as the Medicis and Pope Leo X. The Renaissance with its focus on secular life, fortified by the availability of the important literary works of the Romans and by translations of the Greeks into Latin, sometimes via Arabic, and then by the study of Greek, enabling educated people to read Greek originals, created the great flowering of classicism. Fortified by copious commentary on the ancients from such scholars as Pico della Mirandola and Ficino and stimulated by such scholars as the humanist Erasmus, educated people across Europe talked about classical language, art, architecture, and ideas. Petrarch wrote sonnets in the vernacular. Botticelli painted the beautiful *Birth of Venus*. Great works of poetry, painting, architecture, and sculpture appeared first in Italy in the mid-fourteenth century, and then surged across Europe, into France, Germany, the Netherlands, England, and elsewhere.

An excellent illustration of this sweep of classicism across Europe and into America is in architecture. Andrea Palladio (1508–1580), probably the most influential architect in Western history, rejected the medieval Gothic structures, turning instead to classical antiquity for models. He not only created beautiful classical buildings in northern Italy, but he published his ideas, complete with goals, models, dimensions, materials, and methods of construction. Designers such as the English architect Inigo Jones read Palladio’s books and went to see his buildings, then went back home to construct Palladian architecture, the most famous being the classic Queen’s House in Greenwich (1616). Its simple, clean, symmetrical elegance contrasted strongly with Tudor architecture. Over a century

later, Alexander Pope wrote a 204-line poem on English architecture ("Moral Essays: Epistle IV, Of the Use of Riches," 1734), praising the good taste of Lord Burlington, who indiscriminately applied Palladian ideas, and satirizing noblemen who built expensive mansions lacking in harmony and proportion. Palladian architecture moved across Europe, into parts of Asia, and especially to the Americas, dominating colonial architecture in the United States. Buildings across the world illustrate Palladio's influence: symmetrical structures with balanced vertical and horizontal lines, grand staircases, Greek pillars and Roman arches, porticoes and frescoes, pediments and loggias, statues in the Greek style. In each building, every part contributes to a harmonious, unified whole.

Neoclassicism

As with architecture, almost all fields were affected by classicism, especially literature. The rich collection of Greek and Roman writings, the theories of Aristotle and Longinus, and the considerable body of accumulating Italian and French literary criticism inspired many to write in imitation (mimesis) of the ancients, observing the "rules" they thought inherent in the ancient writings. The flourishing literary criticism included, for example, long discussions of the unities of time, place, and action, of decorum, and of high moral quality. France for a time became the artistic center of this new neoclassicism. Although Racine, Corneille, Molière, Boileau, and others were successful in espousing and observing the rules of classicism, an individual genius elevated their writing. The rules were followed less successfully in Joseph Addison's correct and popular, though stiff *Cato*, but Dryden and Pope in England, and Goethe and Schiller in Germany wrote many inspired classical works.

In the twenty-first century we speak of many creators prior to the early nineteenth century as being classical or neoclassical. Classicism has a recognizable core of ideas that draws creators and critics to it again and again. Behind classicism is the innate desire to make accessible the civilizing influence of great art, music, literature, and architecture. The painters Jacques-Louis David in France (1748–1825) and Joshua Reynolds in Britain (1723–1792) were influential classicists who not only painted but also put their theories into print. Even music, which has no extant models from the ancients, produced classicists: The music of Haydn, Mozart, and the early Beethoven has a strong, clear structure. Their dominant sonata form—orderly, complete, balanced—gives shape and purpose to the chaos of sound.

By the late eighteenth century the neoclassical movement began to burn itself out as artists turned elsewhere for inspiration. In a sense, classicism is an ideal not a reality, since humans almost compulsively veer into irregularities or even rebel against ideals. Classicism tried to give answers, but multitudinous questions remained. Hence countermovements arose, which critics have termed Romantic, with its concern for self-expression, and baroque, with its intentional rejection of balance and harmony. Classicism's closed form, with its completeness, balanced proportion, solid repose, and clean structure, often became a more open form, with restless parts and unstressed edges. The classical *The Ambassadors* (1533) of Hans Holbein (1497–1543), for

example, has a symmetrical structure with clear, distinct figures. In contrast, in the baroque *Christ Washing the Feet of His Disciples* (1556) of Tintoretto (Jacopo Robusti, 1518–1594), Christ at the center right of the picture is smaller than the figures on the left, and the colors and shapes blend into one another.

Though theoretically classicism aspires to produce the best art, in reality much of the best art veers from the classical or outright rebels against it. The classical critic Samuel Johnson has pointed out the many deviations from classicism of William Shakespeare's plays but still recognized their greatness. Much art has elements of classicism. Mary Cassatt's (1844–1926) many paintings, for example, have classical beauty, balance, and repose, but contiguous mothers and daughters blend. The much-admired works of Paul Klee (1879–1940) or Jackson Pollock (1912–1956) demonstrate rejection of classicism. Note the restless parts and unstressed edges of Klee's *Remembrance of a Garden* or Pollock's *Moon Woman*.

Conclusion

Still, during the many centuries of admiring and imitating the Greeks, the term *classicism* has evolved to describe an ideal, a set of aspirations that humans keep returning to. The style of classicism tends to be clear, elegant, precise, rational; the structure, to be formal, balanced, cohesive, closed; the content, to be uplifting, idealized, humanist. Classicism does not have as strong a pull as it used to, in part because it can be pushed into absolutism, and humans are increasingly seeing the world in relative terms. Classical artists from the past—Phidias, Virgil, Raphael, Michelangelo, Titian—will always be with us. But there are also modern exponents of classicism ranging from poets such as T. S. Eliot and W. H. Auden to literary critics including Irving Babbitt and Jacques Barzun, from artists such as Paul Cézanne and William Bailey to musicians like Sergey Prokofiev, Igor Stravinsky, and Béla Bartók. So ingrained is the term *classicism* that many critics use it to describe contemporary forms of art, such as jazz, or even cuisine. It implies a standard of excellence only rarely achieved. Post-modernism saw an almost total rejection of classicism in the late twentieth century, but reaction might well lead to a revival of classicism in some form or another.

See also Aesthetics; Arts; Periodization of the Arts.

BIBLIOGRAPHY

- Aristotle. *Poetics*. Translated by George Whalley. Edited by John Baxter and Patrick Atherton. Montreal: McGill-Queen's University Press, 1997.
- Avery, Catherine B., ed. *The New Century Italian Renaissance Encyclopedia*. New York: Appleton-Century-Crofts, 1972.
- Eliot, T. S. *What Is a Classic? An Address Delivered before the Virgil Society on the 16th of October 1944*. London: Faber and Faber, 1946.
- Fletcher, Banister. *A History of Architecture on the Comparative Method*. Rev. by R. A. Cordingley. 17th ed. rev. New York: Scribners, 1975.

- Hornblower, Simon, and Antony Spawforth, eds. *The Oxford Classical Dictionary*. 3rd ed. Oxford and New York: Oxford University Press, 1996.
- Murphy, Bruce, ed. *Benet's Reader's Encyclopedia*. 4th ed. New York: HarperCollins, 1996.
- Preminger, Alex, ed. *Princeton Encyclopedia of Poetry and Poetics*. Enl. ed. Princeton, N.J.: Princeton University Press, 1974.
- Rosen, Charles. *The Classical Style: Haydn, Mozart, Beethoven*. New York: Viking, 1971.
- Sadie, Stanley, ed. *The New Grove Dictionary of Music and Musicians*. 20 vols. London: Macmillan; Washington, D.C.: Groves Dictionaries of Music, 1980.
- Secrétan, Dominique. *Classicism*. London: Methuen, 1973.
- Speake, Graham, ed. *Encyclopedia of Greece and the Hellenic Tradition*. 2 vols. London and Chicago: Fitzroy Dearborn, 2000.
- Summerson, John. *The Classical Language of Architecture*. Cambridge, Mass.: MIT Press, 1980.
- Turner, Jane, ed. *The Dictionary of Art*. 34 vols. New York: Grove, 1996.
- Wellek, René. "Classicism in Literature." In *Dictionary of the History of Ideas; Studies of Selected Pivotal Ideas*, edited by Philip P. Wiener. 5 vols. New York: Scribners, 1973–1974.
- Wölfflin, Heinrich. *Principles of Art History: The Problem of the Development of Style in Later Art*. Translated by M. D. Hottinger. 7th ed. New York: Dover, 1950.

Gwen W. Brewer

CLASSIFICATION OF ARTS AND SCIENCES, EARLY MODERN. The concept of *classification* seems obvious and benign. To classify is to arrange or distribute according to a system or method, a sense of the word that has not altered since its inception in antiquity. The significance of classification lies not in what it means, but in how it is applied. How people classify—according to what principles—has evolved and altered over time as their understanding of the world has altered. How people classify also bears directly on important issues in metaphysics. Does the world come “pre-carved” into natural kinds, or is classification merely an arbitrary exercise of human volition? If natural kinds exist, then classification reveals truths about the external world. The development of ideas about classification (and the things classified) has paralleled both scientific and artistic developments in the early modern period.

Aristotelian Background

To understand the concept of classification in the early modern period, it is necessary to first understand the conceptual framework the early moderns inherited from their predecessors. The world prior to 1600 was still largely Aristotelian. Aristotle (384–322 B.C.E.) provided a classification scheme based on matching a basic kind (species) with a set of distinguishing characteristics (differentia) in order to sort things in the world. Thus a human individual is a rational animal. That is, a human is of the kind “animal” but is distinguished from all other animals by rationality. This example reveals an underlying assumption of Aristotle’s system: genuine classification provides definitions. When a thing is properly classified, it is defined. Definition, in turn, relies on the concept of essences. An essence is a property

I do not deny but nature, in the constant production of particular beings, makes them not always new and various, but very much alike and of kin one to another. But I think it nevertheless true, that the boundaries of the species whereby men sort them, are made by men; since the essences of the species, distinguished by different names, are, as has been proved, of man’s making, and seldom adequate to the internal nature of the things they are taken from. So that we may truly say, such a manner of sorting things is the workmanship of men.

SOURCE: John Locke, *An Essay concerning Human Understanding*, III.6.37, p. 462.

a thing must have to be what it is. Thus one might say that being rational is essential to being human; an individual thing is simply not a human if it lacks rationality.

In Aristotle is also found the first division between the arts and sciences. The distinction is modeled on the natural/artificial divide. *Scientia* concerns demonstrable and certain knowledge derived from nature. In nature, things develop according to natural internal principles of change (entelechies). Something is artificial if it changes because of an external source—like some clay becoming a sculpture because of a craftsman’s work. Sculptures are artificial because they do not possess internal principles of change. They are what they are because someone or something else altered them. This distinction led Aristotle to characterize science as an enterprise whose goal is to account for the internal causes or explanatory principles we find in nature. Since this goal is reached by definition (asserting the essences of things), one discovers that appropriate classification is in fact *the* scientific enterprise—the process of acquiring knowledge. (See *Posterior Analytics*, in *Complete Works*, book 2, especially 93a1–10).

Medieval Academia

Building on this Aristotelian foundation, medieval thinkers developed the core distinction between nature and artifice into an academic edifice. The sciences concerned nature. Since God is the author of nature, it follows that not only should people study nature, they also should expect to find regular order and well-defined kinds within it, as would be consonant with the perfection of the deity. Science is the practice of proper classification by definition. The arts more properly concern skills, whether mental or physical. The Latin root *artes* refers to the technical skills needed to produce something, a fact more apparent in the Greek root *techne*, as in the word “technology.” For the medieval period there is no sense of the “fine

I do not know why you and your associates always want to make virtues, truths and species depend upon our opinion as knowledge. They are present in nature, whether or not we know it or like it.

SOURCE: Gottfried Wilhelm Leibniz, *New Essays on Human Understanding*, p. 327.

arts.” All art is craft. A painter or sculptor is as much a craftsman as a carpenter or shipwright. The goal of the artist is the technical perfection of their work or trade.

Although the sciences were broadly treated and classified in the same way, some innovation occurred in the classification of the arts. In the medieval period is seen the division of the arts into those that are “liberal” (meaning that they are suitable for free citizens) and those that are “servile” (work that was typically manual and done by slaves). Hence a liberal arts curriculum is first found in the early universities. Students who completed courses of study in grammar, rhetoric, logic, arithmetic, geometry, music, and astronomy were awarded a bachelor of arts. This already implies a division in the arts, since these fields were thought to have redeeming features, whether beauty or intellectual stimulation. Interestingly, many of the fields now routinely called arts were excluded. Poetry and the visual arts, for instance, were not considered suitable subjects for inclusion. Unlike the other fields, these (and others) were not judged to be intellectual arts; competences in these areas were thought to depend on the practice of bodily skills and not on the deepening of mental skills.

Early Modern Context

In many ways the early moderns were still in the grips of the Aristotelian worldview. René Descartes (1596–1650), like the Cartesians who followed him, assumed that knowledge is a mathematical mapping of the system or structure of nature. As humanity comes to grips with the order of nature and learns to sort it into kinds, it gains knowledge about nature.

Descartes and most of the early moderns preserve the traditional distinction between the arts and the sciences. Science is acquired by the mind; art is a bodily aptitude appropriate to craftsmen. Thus Descartes notes that oratory and poetry are “gifts of the mind” and hence not properly arts at all (*Philosophical Writings*, vol. 1, p. 114). It was not until the eighteenth century that a robust separation between the fine and useful arts emerged. Parallel with this core difference between conceptions of science and art, classification within each underwent an increasingly divergent development. This development occurred although one key characteristic of early modern theory of art is that art possesses an essentially intellectual character. Perhaps in response to Cartesian and me-

dieval thinking, advocates sought to establish a place for the arts within the mental realm.

This new development generated some interesting thinking about classification. In both the arts and sciences, classification frequently depended on subject matter. Descartes did not like this method for the sciences, since it emphasized material particularity over mental universality. Thus one finds a significant point of departure for classification in the arts and sciences. Genuine knowledge comes from the application of a unified methodology. Hence Descartes argues that it is inappropriate to separate the sciences on the basis of subject matter, since quality scientists should be applying a single method of thought in all scientific matters. The arts, however, comprise separate and distinct skills. As a result, the arts should be distinguished, studied and mastered individually. Skilled craftsmen specialize; skilled intellects universalize. The arts are those intellectual enterprises that also require a practical component, but the latter should not diminish the fact of the former.

Yet as the eighteenth century unfolds there occurs a startling series of innovations in both the arts and the sciences. As the sciences mature, an understanding of what it means to classify comes into focus. The arts develop an independent character, and theories of art push thinking about the nature of classification in the arts in new directions.

Early Modern Classification in the Arts

A number of transformations in the arts took place during the early modern period. What constitutes art, how one ought to classify its various subfields, and even how one ought to judge works of art all underwent bold revisions. The nature and number of the changes is considerable, but it is worth sampling some of the more significant developments.

The concept of invention in art (in the sense of a creative process) altered in the period and would ultimately change how people think about what constitutes art. The old view (even espoused by Leon Battista Alberti, an important Italian theorist of art, as late as the fifteenth century) is that an inventive artist is one that preserves tradition, communal values, and accepted ways of thinking. By the eighteenth century, however, the artist as a solitary figure committed to breaking or superseding traditional norms and artistic methodologies was firmly entrenched. Thus a new intellectual tool developed for categorizing within art and for what counts as art. As the humanist movement took root, artists increasingly redefined their discipline and the standards of quality within their work.

How one identifies and classifies beauty also underwent substantial change as the early modern period unfolded. Prior to the eighteenth century beauty was an objective feature of things in the world. For the followers of Plato beauty was a transcendental property, a “Form” in which beautiful things participated. For others beauty was more immanent and empirical but nonetheless present *in a thing*. Thus classifying things as beautiful depended on isolating features in the objective world. In this sense, classifying objects in the world of art was similar to classifying things in the sciences. The world comes pre-jointed, and peoples’ task as aesthetes is to learn to recognize those divisions.

Beauty is no quality in things themselves: It exists merely in the mind which contemplates them; and each mind perceives a different beauty. One person may even perceive deformity, where another is sensible of beauty; and every individual ought to acquiesce in his own sentiment, without pretending to regulate those of others. To seek the real beauty, or real deformity, is as fruitless an enquiry, as to pretend to ascertain the real sweet or real bitter.

SOURCE: David Hume, *Essays Moral*. . . section 23, "Of the Standard of Taste."

Starting with the work of Francis Hutcheson (1694–1746) in the early 1700s and best displayed in the work of David Hume (1711–1776) later in the century, theorists of art shifted the concept of beauty away from an external objective standard to an internal standard. This shift did not necessarily signal the abandonment of objectivity in beauty, but it moved the focus of attention away from the natural world to the person making aesthetic judgments. Both Hutcheson and Hume developed theories of "taste," theories of artistic sensibilities that classify on the basis of perceiving subjects and not objects.

In a similar vein, the concept of the sublime became elevated as an independent kind of experience. The sublime (roughly a lofty, elated feeling), especially in the work of Edmund Burke (1729–1797), now becomes a separate class quite distinct from beauty. Interestingly, earlier seventeenth-century discussions of the sublime apply the concept only to certain arts such as rhetoric and poetry; no mention is made of the sublime with respect to the visual arts. Jonathan Richardson (1665–1745) was one of the first to apply sublimity explicitly to the visual arts, marking yet another important step in the increasing stratification and complication of artistic categories.

In general the middle of the eighteenth century witnessed the birth of modern theory of art. In 1750 Alexander Baumgarten (1714–1762) published *Aesthetica* and established aesthetics as an independent field studying sensual cognition. Later in the same decade Denis Diderot began publishing his biennial critical reviews of the salons, effectively launching serious art criticism. With criticism comes classification, not only of quality but of many other features. It should thus be expected that during this time there would be a conceptual explosion of classification in the arts to support all of this innovation in theory of art. The expectation is not disappointed.

Perhaps the most prominent example of this classificatory explosion is seen in the work of Gérard de Lairesse (1641–1711), a Dutch painter and author who published several lengthy volumes at the inception of the eighteenth century about the vi-

sual arts. After distinguishing art (a production of the mind) from manner (a manual execution of a skill), he divides the arts into various kinds. Though divisions based on the content of what is painted had been already present for centuries, Lairesse is important because he shifted his classificatory scheme from content to modes of representation. Instead of sorting paintings and painters by their pictorial genres (landscapes, still lifes, portraits, and so forth), he advocated a system based on how the artist seeks to represent the content of the work. Kinds of brush strokes and implicit symbolizations became at least as important as the superficial object depicted. Even still lifes could have allegorical meaning, thus altering how the nature and kind of the work ought to be viewed.

Early Modern Classification in the Sciences

The core problem for the sciences regarding classification during the period concerned was how to carve the world into kinds. For instance, while natural philosophers were engaged in debates over how to classify organisms, metaphysicians asked more foundational questions, such as whether there were natural kinds. Did nature come predivided into kinds? If so, then the task of science was merely to reveal these ultimate classes. And how might this task best be done? Was it even possible to ascertain nature's "joints"? Alternatively, if nature does not come already divided, what are the implications for the sciences? Independently of whether there are natural kinds, there remains the question as to whether there is an ideal system for sorting individuals. In the history of science are found the key foundational theories for the contemporary system of scientific nomenclature being developed in this period.

The problem of natural kinds remains in the early twenty-first century. The philosopher John Locke (1632–1704), an antirealist about species (he did not believe that the world came antecedently divided into distinct species/kinds), argued that in principle one can have no access to the "real essences" of things and as a result cannot ever hope to know how reality is "really" divided. Instead, the most for which one can hope is to develop an empirical system of classification based on nominal essences—the names or appearances of things: "the sorting of things is the workmanship of the understanding" (*Essay*, p. 415). A particular lump of matter is classified as gold because it appears to have the set of properties that have been assigned to the concept of the kind gold. This view was deeply unsatisfying to many, Wilhelm Leibniz (1646–1716) in particular. Leibniz argued that nature *had* to come prepackaged into kinds and furthermore that there existed some empirical (perhaps even a priori) evidence as to what those kinds in fact are. What is important about this debate is not its resolution—philosophers continue to argue whether there is one yet—but its impact on thinking about classification generally. This debate helped to liberate scientific thinking from the Aristotelian view of classification as definition. It was no longer deemed sufficient to classify the world by simply positing one or several definitions. How the world may be classified into scientific kinds has to obey certain empirical and analytical restrictions.

Much of the work came in response to the practical issue of how best to classify in the emerging sciences. A great deal

of urgency was attached to developing coherent systems of classification, especially as human knowledge about the natural world and the variety therein continued to grow. Early modern scientific systems tended to be either artificial (classifying on the basis of convenience for identification) or natural (classifying according to natural kinds). Most of the classification systems in biology during the period were by the “habit” of the kind. So plants were categorized by whether they flower or whether they produce fruit. Animals were classified by whether they lay eggs or are nocturnal, and so on. The most important development, however, was the application of new rational systems of naming kinds. Carolus Linnaeus (1707–1778), a Swedish botanist, devised the precursor to the present system of nomenclature in the eighteenth century (although there were some, such as Jean Bauhin in the sixteenth century, who anticipated this system). His system of binomial nomenclature relied on the division between male and female as one of its fundamental kind distinctions (which is no longer used), but his basic methodology has been adopted as the standard for classification in the biological sciences.

Robert Boyle (1627–1691) is an exemplar of early modern thinkers who helped define “scientific” theories as rational and ordered methodologies. Boyle, now famous for his development of early chemical theories, argued passionately that chemical kinds had to be subject to empirical experimentation. The old chemical categories were deficient precisely because they were not subject to verifiable tests. Boyle further developed the distinction between primary and secondary qualities (though he coined the terms, the concepts can be traced back at least to Galileo), thus preparing the ground for additional scientific inquiry based on a classification of things in nature that were in principle subject to empirical testing. Thus in the debate over how to carve up nature into kinds, new meta-insights emerged that provided constraints on what sorts of classificatory schemes were acceptable. Even if one cannot know whether the particular details about the kinds one picks out in the world are accurate, there nonetheless emerges a theory of classification that indicates that how one classifies is not purely arbitrary.

It is worth noting an issue not addressed by the early moderns but that was fast approaching. All of the reasoning about classification in this period was pre-Darwinian. Phylogenetic systems of classification (those that classify according to evolutionary sequences) did not emerge until later and hence there was no pressure to suppose that there are deep connections *between* the kinds that are picked out in nature. Thus one of the constraints that would appear after the development of the theory of evolution (that species-kinds might be interrelated in definable ways) was not yet present. But one might speculate that the innovations in theory of classification in the previous century were part of what made evolutionary theory possible. That there are constraints on what could count as a good system of classification prepares one for additional deep connections in certain fields of inquiry.

Emerging into the Nineteenth Century

By the end of the eighteenth century one can detect a clear separation between theorizing about classification in the arts and

in the sciences. Thinkers preserved in the sciences the ideal of external objectivity but grappled with whether this ideal could be achieved. Most importantly, the scientific community developed theories that preserved the ideal in the face of epistemological shortcomings by positing meta-constraints on what could count as a satisfactory theory of kinds. In the arts, classification shifted away from external objectivity to more subjective and intersubjective forms of classification. This shift was facilitated by the distinction between the fine arts and useful arts and more generally by the development of new and separate theories of art. Aesthetics emerged as an independent field of inquiry with its own set of kinds and categories. The early modern period witnessed the development of separate and new ways of classifying in the arts distinct from the sciences.

By the nineteenth century the arts and the sciences were conceived of as separate disciplines with distinct classificatory systems. And as such a new question arose: How is it determined whether some activity or thing should be classified as science or as art, as scientific or as artistic? Separating art and science by how they classify does not entail that they use different conceptions of what it means more broadly to classify at all. In fact, this article has assumed the contrary. Furthermore, separating art and science does not imply that the two domains are utterly distinct. As Leo Tolstoy wrote at the close of the nineteenth century, “Science and art are as closely bound together as the lungs and the heart, so that if the one organ is vitiated the other cannot act rightly” (p. 277).

See also Aesthetics; Arts; Science, History of.

BIBLIOGRAPHY

PRIMARY SOURCES

- Aristotle. *The Complete Works of Aristotle*. Edited by Jonathan Barnes. Princeton, N.J.: Princeton University Press, 1984.
- Baumgarten, Alexander. *Aesthetica*. 1750. Hildesheim, Germany: G. Olms, 1961.
- Boyle, Robert. *Selected Philosophical Papers of Robert Boyle*. Edited by M. A. Stewart. Manchester, U.K.: Manchester University Press, 1979.
- Burke, Edmund. *A Philosophical Enquiry into the Origin of Our Ideas of the Sublime and Beautiful*. Edited by James T. Boulton. London: Routledge and Kegan Paul, 1958.
- Descartes, René. *The Philosophical Writings of Descartes*. Translated by John Cottingham et al. 3 vols. New York: Cambridge University Press, 1985–1991.
- Hume, David. *Essays Moral, Political and Literary*. Edited by Eugene F. Miller. Indianapolis: Liberty Classics, 1985.
- Hutcheson, Francis. *An Inquiry concerning Beauty, Order, Harmony, Design*. Edited by Peter Kivy. The Hague: Martinus Nijhoff, 1973.
- Kant, Immanuel. *Critique of Judgment*. Translated by Werner S. Pluhar. Indianapolis: Hackett, 1987.
- Leibniz, Gottfried Wilhelm. *New Essays on Human Understanding*. Translated and edited by Peter Remnant and Jonathan Bennett. Cambridge, U.K., and New York: Cambridge University Press, 1981.
- Locke, John. *An Essay concerning Human Understanding*. Edited by Peter H. Nidditch. New York: Oxford University Press, 1975.

Tolstoy, Leo. *What Is Art?* Translated by Aylmer Maude. London: Oxford University Press, 1930.

SECONDARY SOURCES

Barasch, Moshe. *Modern Theories of Art*. Vol. 1: *From Winckelmann to Baudelaire*. New York: New York University Press, 1990. Excellent historical approach to developments in theory of art.

Gaut, Berys, and Lopes, Dominic, eds. *The Routledge Companion to Aesthetics*. London and New York: Routledge, 2001. Excellent general resource, including separate articles on key historical figures in the philosophy of art.

Lawrence, George. *Taxonomy of Vascular Plants*. New York: Macmillan, 1951. Although dated, this text contains an excellent history of classificatory systems in the sciences.

Wittkower, Rudolf, and Margot Wittkower. *Born under Saturn*. New York: Norton, 1963. A history of artists and how they have been viewed from antiquity to the end of the early modern period.

Marc A. Hight

CLEANLINESS. See *Hygiene*.

COGNITIVE SCIENCE. See *Philosophy of Mind*.

COLONIALISM.

This entry includes three subentries:

Africa

Latin America

Southeast Asia

AFRICA

Conceptions and characterizations of colonialism vary considerably among scholars of Africa. Differences and debates center on four sets of interrelated issues: first, the place and importance of the colonial period in African history; second, the nature of the colonial encounter and its driving force; third, the typologies of African colonialism; and fourth, the legacies of colonialism for postcolonial Africa. These questions have been addressed from a wide variety of disciplinary and analytical traditions. In general, the historiography of colonialism in Africa has been dominated at different moments by four paradigms: the imperialist, nationalist, radical, and postcolonial.

Imperialist approaches, which prevailed in the early twentieth century, emphasized the civilizing mission and impact of colonialism. Critiques against this tradition, combined with nationalist struggles that led to decolonization, culminated in the rise of nationalist historiography, which emphasized African activities and agency. From the 1970s, influenced by a growing sense of pessimism about the developmental and democratic capacities of the postcolonial state and the rise of militant ide-

ologies and social movements, “radical” approaches emerged, centered on dependency and Marxist ideas that highlighted the economic depredations and effects of colonialism. In the 1990s, following the demise of socialist regimes and ideologies and the spread of poststructuralism and postmodernism, postcolonial perspectives were increasingly used to reinterpret the cultural and discursive dynamics and complexities of colonialism. Additional paradigms on colonialism arose, most critically those informed by feminist and environmental studies, which stress the role of gender and ecology in the construction of colonial identities, societies, and political economies.

Colonialism in African History

Imperialist and nationalist historiographies represent almost diametrically opposed views of the place and impact of colonialism in African history, with one regarding it as a decisive moment, the other, as a parenthesis. To the imperialists, colonialism in fact brought Africa into history, for in their view, Africa “proper,” to use Hegel’s moniker—from which North Africa was excised—was the land of the “Unhistorical, Undeveloped Spirit,” exhibiting “the natural man in his completely wild and untamed state” (pp. 91, 93). European colonialism, therefore, was depicted as a civilizing mission undertaken to historicize and humanize Africans.

Consequently, imperialist historians mostly discussed in positive light the policies of colonial governments and the activities of colonial auxiliaries, from European merchants to missionaries. When their narratives mentioned Africans, it was to condemn their societies and cultures or to chronicle their Westernization or modernization. Those who resisted colonial conquest or colonial rule were depicted as atavistic, while those who collaborated or accepted the colonial regime were praised for their foresight and wisdom. In fact, in-depth study of African societies was largely left to anthropology, which, with its functionalist-positivist paradigms and ethnographic present, exonerated, if not extolled, colonialism.

Nationalist historians offered an ideological and methodological revolt against imperialist historiography. Using new sources, including oral tradition, historical linguistics, and historical anthropology, together with written and archaeological sources, they chronicled the histories of African states and societies before the European colonial conquest and celebrated the growth and eventual triumph of nationalism during the colonial era. They sought to unravel painstakingly African activity, adaptations, choice, and initiative. Led by J. F. Ade Ajayi (1968) in Anglophone Africa and Cheikh Anta Diop (1974) in Francophone Africa, they emphasized continuity in Africa’s long history and reduced colonialism to a parenthesis, an episode, a digression, a footnote that had altered African cultures and societies only slightly. In this narrative, independence marked a moment of historical recovery in which the agency of the precolonial past was restored and reconnected to the postcolonial future. The linear and celebratory tales of nationalist historiography were later found wanting by numerous critics.

While both the dependency and the Marxist scholars focused on the exploitative economic structures and processes of colonialism, the former were more interested in explaining the

external forces that produced and reproduced Africa's underdevelopment; the latter preferred to concentrate on the internal dynamics. To the *dependentistas*, colonialism marked a second stage in Africa's incorporation into an unequal world capitalist system that was ushered in during the fifteenth century with the onset of the Atlantic slave trade. Marxist scholars sought to transcend the ubiquitous and homogeneous capitalism of dependency theory. Colonialism, they argued, entails the articulation of modes of production whereby precapitalist modes are articulated in their diverse relations with the capitalist mode. Hence the introduction of capitalism by colonialism does not eliminate the precapitalist modes but reshapes them; the latter are progressively subordinated to capital through a contradictory process of destruction, preservation, and transformation.

Unlike the nationalists, the imperialist, dependency, and Marxist historians share the view that the colonial period was decisive in African history. But they differ in their characterization and conceptualization of the place and impact of colonialism. Like the nationalists and unlike the imperialists, the *dependentistas* and Marxists see colonialism as an intrusive moment in the *longue durée* of African history. Insofar as dependency analyses concentrate on the external determinations of underdevelopment, they diminish African agency and echo imperialist accounts of African history, whereas the Marxist focus on internal production processes and social relations resonates with nationalist historiography.

The nationalist periodization of African history, in which the colonial moment occupies limited space, was sanctified in the Cambridge (*History of Africa*, 1977–1985) and UNESCO (*General History of Africa*, 1981–1993) histories, each in eight thick volumes, only two of which were on the colonial and postcolonial periods. Yet far more African historians currently work on the colonial period than on the precolonial period.

The Nature of the Colonial Encounter

Colonialism in Africa entailed an encounter between the continent and Europe. This encounter encompassed multiple spheres (from politics, economy, and culture to sexuality, psychology, and representations), spatial scales (from local and individual colonial territories to subregions and the continent as a whole), and social groups and inscriptions (from the colonizers and colonized to class, gender, and generation). Analyzing the nature of the colonial encounter, therefore, has proved exceedingly complex and contentious, given the range of possible analytical categories and conceptions of what indeed “Europe” and “Africa” mean. Different readings informed by disparate disciplinary or theoretical orientations emphasize the political, economic, cultural, or representational import of the colonial encounter.

Overall, some regard this encounter as essentially antagonistic while others depict it as ambivalent or even accommodative. Until recently, especially before the rise of postcolonial theory, colonialism was largely conceived in antagonistic terms as a series of encounters between the seemingly enduring and impermeable binaries of colonizer and colonized, Western and non-Western, domination and resistance, modernity and tradition, destruction and preservation, and universal and local. Post-

colonialists insist on the ambivalent nature of colonialism, its contingency and decenteredness, and the hybridities and pluralities of the identities it produced. If colonialism is primarily viewed as a political encounter among imperialist and nationalist scholars and as an economic one among the radicals, the postcolonialists emphasize its cultural and discursive dimensions.

The Bifurcated Colonial State

Studies on colonialism as politics and the politics of colonialism have tended to focus on two main issues: the nature of the colonial state and African resistance. Discussion and debate on the colonial state have centered on its specificities and construction, how to classify African colonial states and administrations, the dynamics of colonial power and civil society, and the demise or reconstitution of the colonial state into the postcolonial state. Crawford Young has argued quite forcefully that the African colonial state derives its peculiarity from the fact that it enjoyed only some of the crucial attributes of the modern state (territory, population, sovereignty, power, law, and the state as nation, an international actor, and an idea) and could not exercise some of its imperatives (hegemony, autonomy, security, legitimacy, revenue, and accumulation).

This is because the colonial state in Africa was created in the late nineteenth century, long after both the modern metropolitan state and the generic colonial state had been formed, which allowed for no experimentation. Also, as a conquest state imposed by force, its hegemony was excessively coercive, so that it enjoyed little legitimacy. Moreover, its territoriality was ambiguous, its sovereignty and institutions of rule were extraverred and resided in the imperial metropole, and its revenue base was weak. Charged with the onerous tasks of consolidating colonial rule, linking the colony to the metropole, and establishing or promoting colonial capitalism, the result was that the colonial state was both interventionist and fragile, authoritarian and weak, and exercised domination without hegemony, all of which ensured its eventual downfall.

All colonial states, irrespective of their ideologies and administrative systems, justified themselves in the names of civilization and pacification. Economic motivations of colonialism were assiduously downplayed. Moreover, all colonial powers used African intermediaries in their administrative systems because they lacked personnel and local knowledge and in order to minimize African resistance and administrative costs. They also used chartered companies in some of their colonies in the early years.

In imperialist historiography, colonial power was portrayed as unassailable because it was for Africa's good. For the opposite reason it was decried in nationalist historiography, which stressed its oppressiveness and incapacity to withstand the full might of nationalist struggle. Dependency writers tended to disregard the importance of politics because they believed that neither the colonial state nor African resistance could stop the ineluctable juggernaut of the world capitalist system, while Marxists subsumed colonial politics to either local class struggles (waged by the numerically small working classes, and only reluctantly and later were struggles by the much larger peas-

antries considered) or anti-imperialist struggles mediated by communist parties in the imperial metropolises themselves or the Soviet Union. Many of the early studies failed to examine the ways that colonial power was specifically deployed, engaged, contested, deflected, or appropriated.

It was not until Peter Ekeh published his influential essay “Colonialism and the Two Publics in Africa” that colonial civil society began to receive serious scholarly attention. He argued that colonialism created two publics that he called the primordial and civic publics, whose dialectical relationships accounted for the political problems of postcolonial Africa. The first public is associated with primordial groupings, sentiments, and activities; the second is associated with the colonial administration and is amoral, lacking the generalized moral imperatives operative in the private realm and in the primordial public. The two publics emerged because colonial ideologies of legitimation denigrated African societies and cultures and glorified European colonial rule, while African bourgeois ideologies of legitimation accepted colonial ideas and principles to justify the leadership of the elites in the fight against colonialism and the inheritance of the postcolonial state. Both ideologies envisaged and sought to separate the indigenous and colonial publics, in which different conceptions of citizenship, morality, and material expectations prevailed. Thus colonial civil society was characterized by the bifurcation of the public realm, which accounts for the centrality of ethnicity in African politics and the disjunction between the state and society that has bedeviled postcolonial Africa.

Others saw the bifurcation and ethnicization of colonial civil society differently. In his award-winning book *Citizen and Subject*, Mahmood Mamdani argued that the bifurcation of power in Africa results from the continent’s distinctive colonial experience. The configuration of colonial rule in Africa led first to the institutionalization of two systems of power under a single authority: one urban, based on civil power and rights, excluding the colonized on the basis of race, the other rural, where tradition and culture incorporated the colonized into the rule of custom. Second, colonial rule in Africa led to the privileging of state-ordained and state-enforced traditions that had least historical depth and were monarchical, authoritarian, and patriarchal, so that customary power and law became an integral part of a decentralized despotism. Finally, with custom becoming the language of force, colonial rule led to rationalizing the appropriation and management of land and the mobilization of labor under the colonial rubric.

This bifurcated state power, civil and customary, first crystallized in equatorial Africa—as “indirect rule” in British colonies and “association” in French colonies—and later spread to older colonies to the north and south, including South Africa, where apartheid represented the last attempt at reorganizing the state structure to incorporate the “native” population in a world of enforced tradition. The challenges confronting African countries in the struggles for independence and after were to democratize the state and particularly customary power, deracialize civil society, and restructure unequal external relations of dependency.

Dependent Colonial Capitalism

To many scholars, economics, not politics, is central to the colonial project. In the 1970s systematic studies began to appear on African colonial economies. Three dominant approaches emerged. The first was rooted in neoclassical economic theory and focused largely on market processes and the problems of resource allocation. Anthony Hopkins has provided the most famous neoclassical treatment of African economic history. Using vent-for-plus theory (that colonialism provided a “vent,” or an “opening”), he argues that colonialism inaugurated an “open economy” of increased market opportunities, which West Africans seized with alacrity by mobilizing previously underutilized resources. Hopkins’s economic history walked a fine line between the imperialist approaches that stressed the modernizing impact of colonialism and the nationalist emphasis on African initiatives.

The second approach was dependency, which was born out of dissatisfaction with prevailing neoclassical descriptions, analyses, and prescriptions for Third World development. Using the concepts of “incorporation,” “unequal exchange,” “development of underdevelopment,” and “center-periphery,” dependency writers emphasized external economic linkages and exchange relations, often at the expense of internal and production processes. Walter Rodney’s influential text *How Europe Underdeveloped Africa* portrayed colonialism simply as a new stage in Africa’s unrelenting slide into structural internal underdevelopment and external dependency.

Marxist scholars attacked both neoclassical and dependency writers for alleged theoretical inadequacies, empirical shortcomings, and ideological biases. They sought to employ concepts of dialectical and historical materialism—which seek to examine how specific systems originate, develop, function, and change in given historical epochs—to unravel Africa’s historical realities. For the precolonial era, it proved difficult to fit Africa into the traditional Marxian modes or to construct specific African ones. As far as the colonial economy was concerned, many Marxists found the concept of the articulation of modes of production useful and produced interesting studies on labor and workers, agriculture and peasants, and the changing structures of Africa’s incorporation into the world economy.

Despite the different emphases of the three approaches, it is possible to outline the common features shared by African colonial economies: they were all expected to provide raw materials and markets for the imperial economies and to be financially self-supporting. The colonial economy was characteristically export-oriented and monocultural and suffered from uneven productivity between sectors and outside domination in terms of markets, technology, and capital. It developed in three phases: first, the period up to World War I, when coercion—forced labor, cultivation, and taxation—predominated; second, the interwar years, characterized by regulation of the colonial economy and the disruptions of the Great Depression, which exposed its vulnerabilities and fostered new economic policies of development planning; and third, the post-World War II period, when “colonial development and welfare” policies took hold, characterized by increased state intervention and investment in “economic development.”

Typologies of Colonialism

A key challenge in analyzing African colonial economies, as with other spheres of colonialism, is their sheer diversity. The temporal division between precolonial and colonial economies and politics and their spatial development during the colonial period were manifested quite unevenly. The growth and structure of colonial economies, for example, were determined by the level of development of the precolonial economies themselves, the nature of precolonial relations with Europe, the modes of conquest and resistance, the level of development of the colonizing powers, the resource endowment of each territory, and the presence or absence of European settlers.

Several attempts have been made to construct typologies of African economies and colonialism more broadly. Three can be identified. First is the renowned tripartite division of Africa developed by Samir Amin (1972): the Africa of the labor reserves (Algeria, Kenya, and much of southern Africa), where Africans were primarily expected to provide labor for European colonial enterprises; the Africa of trade (West Africa, Uganda, Morocco, and Tunisia), where Africa produced the bulk of commodities traded by colonial companies; and the Africa of concession companies (central and equatorial Africa and the Portuguese colonies), where chartered companies enjoyed economic and administrative control over African labor and produce. Second is Thandika Mkandawire's typology distinguishing between rentier and merchant economies, in which surpluses are extracted from rents from mining and trade and taxes from agriculture, respectively. Third is the distinction often drawn between settler and peasant economies or modes of production.

The concept of peasants has a rich and controversial literature in African studies. Debate has focused on the historical origins of African peasantries, their relations with capital and the state, internal differentiations, the changing organization of peasant work—especially its complex articulations with gender and generational relations and divisions—the impact of environmental conditions and changes, the complex patterns of rural cultural construction, peasant knowledge systems, and the intricacies of peasant politics and struggles at various levels, from the household and the local community to the national and global system. In this context, not only did colonialism alter the lives of African peasantries, but the latter also profoundly shaped the terrain of colonialism in Africa.

The concept of the settler mode of production sought to capture the specificities of settler colonies. Settler colonialism was characterized by several features: the exclusion of competition (settler control of key economic resources, including land, allocation of infrastructure, banking, and marketing, at the expense of the indigenous people); the predominance of the migrant labor system (which allowed the costs of reproducing labor power to be borne in the rural reserves); generalized repression whereby direct and brutal force was used regularly; and the close intersection of race and class.

Linked to the concept of settler colonialism is the concept of internal colonialism, in which the colonizing “nation” or “race” occupies the same territory as the colonized people. This

concept found favor among some academics and liberation movements in South Africa who saw the hierarchical, exploitative, and separatist structures of segregation and apartheid as analogous to the relationship of domination and subjection between an imperialist state and its racialized colonies. Harold Wolpe attacked the concept for positing an unexplained autonomy of racial, ethnic, and cultural groups and obscuring the relationships between them, akin to the theory of plural society widely used by liberal scholars to describe South African society.

The Ambivalences of Colonial Society

The pluralist approach was widely applied by social anthropologies to explain many other African colonial societies, which were depicted as “plural societies” in which different ethnic groups and races lived in close proximity; colonial social change was attributed to “culture contact” and “acculturation.” To the pluralists, colonialism provided an arena for the acculturation of African ethnic groups to European culture and values, and so they were preoccupied with recording the patterns of what they called “detribalization” as indicated by changes in clothes, occupations, education, family forms, and leisure activities.

Marxist critics such as Bernard Magubane attacked the indices used by the pluralists and the fact that the specifics of European life and culture in Africa and their own “acculturation” or “Africanization” were ignored. Above all, in their view, the pluralists mystified the real social relations for they failed to place colonial social change in the context of colonialism as a global system of economic relations. The Marxists demonstrated that behind the processes of “acculturation” lay widespread practices of resistance. For example, the leisure activities of workers, as exhibited in work songs, often articulated African popular resistance against colonial rule. Similarly, it was demonstrated that transformations of cultural practices in the rural areas reflected peasant attempts to resist and remake the colonial situation. The Marxists maintained that religious conversions, whether to Christianity or Islam, represented not simply “acculturation” and the renunciation of the old religions but also translations of the old religions into new terms as filtered through the complex mediations of class and social consciousness.

Preoccupied as they were to show African agency, nationalist scholars were perhaps the loudest in refusing to see the processes of colonial social and cultural change simply as a product of “Westernization.” In a famous essay on the invention of tradition in colonial Africa, Terence Ranger insisted that social and cultural traditions were invented and manipulated by both Europeans and Africans to serve their own interests. Specifically, elders, men, ruling aristocracies, and indigenous people appealed to “tradition.” The elders did so in order to defend their dominance over the rural means of production against challenges from the youth; men wanted to retain control against women, who were playing an increasingly important role in the rural areas, especially in regions dominated by male migrant labor; ruling aristocracies sought to maintain or extend their control over their subjects; and in-

digenous people were anxious to ensure that migrants who settled among them did not achieve political or economic rights. This model became popular for analyzing the contexts in which various cultural and social practices in colonial Africa developed—from music and dance to law and marriage.

This constructivist approach was to be fully developed by postcolonial scholars, for whom colonialism was a regime of material and cultural relations as well as discursive and symbolic representations that affected both Africans and Europeans profoundly, although in different ways. The postcolonialists sought to dismantle the image of colonialism as a coherent and monolithic process, to transcend the dichotomy of colonizer and colonized by problematizing, differentiating, and pluralizing each group and mapping out their complex and shifting relations, and to specify the cultural configurations and discourses fashioned out of their changing identities, consciousness, interactions, and negotiations.

Postcolonialists brought into sharper focus issues previously ignored or misconstrued in structuralist and social scientific analyses of colonialism, especially those concerning sexuality, subjectivity, psychology, and language. Besides the textual notions and readings of colonial culture, analyses have increasingly come to stress the nonverbal, tactile dimensions of social practice and the corporeal regimes of bodies, clothing, and performances. Particularly influential have been Frantz Fanon's acclaimed work on the psychology of colonialism and his crucial insights that "blackness" and "whiteness" were mutually constitutive ideological constructions. Building on Fanon's insights, scholars of Africa have highlighted the construction of colonial mentalities, madness, and medicine as mechanisms for inscribing and policing racial and sexual boundaries. Kwame Appiah has shown how the ideas of race in Africa were socially constructed and how colonial and anticolonial discourses reinforced each other to fix racial essences on bodies.

The Feminist Intervention

Many of the approaches used to analyze African colonial politics, economies, societies, and cultures were often gender-blind and tended to ignore women's lives, experiences, contributions, voices, perceptions, representations, and struggles. This began to change following the rise of the feminist movement, which emerged out of both localized and transnational trajectories and intellectual and political struggles within and outside the academy. While the struggles to mainstream women and gender are far from over, African women have become increasingly more visible in histories of colonialism, which has disrupted the binaries and chronologies that tend to frame colonialism in Africa.

As the field of women's studies has expanded, African women have become more differentiated in terms of class, culture, and status, and their complex engagements, encounters, and negotiations with and contestations against the wide range of forces described as colonial are now clearer. From the large and diverse body of theoretical, methodological, and pedagogical literature that has been generated in the last three decades, vigorous debates are evident. One of the most intriguing is on the validity of the term *gender* itself, with writ-

ers such as Ifi Amadiume stressing the relative flexibility of sex/gender relations in precolonial Africa, and Oyèrónké Oyewùmí denying the existence of gender categories altogether.

In the early twenty-first century it has become well established that colonialism had a contradictory impact on different groups of women, although the dominant tendency was to undermine the position of women as a whole. Colonialism combined European and African patriarchal ideologies to create new practices, relations, and ideologies. Earlier work on colonial gender regimes focused on women in productive and commercial activities in the rural and urban areas and the acute tensions in gender relations that were created, to which the colonial state responded by tightening already restrictive customary law, leading to important changes in family structure and new forms of patriarchal power. The topic that attracted by far the most attention was that of women's resistance to colonial rule. Studies ranged from those that examined specific activists and events to general analyses of women's involvement in nationalist struggles in various countries that demonstrated conclusively women's political engagements and contributions.

More recent work has focused on issues of sexuality, constructions of gender identities, and colonial representations. According to Zine Magubane, African sexuality and its control and representations were central to ideologies of colonial domination. In colonial discourse, female bodies symbolized Africa as the conquered land, and the alleged hyperfecundity and sexual profligacy of African men and women made Africa an object of colonial desire and derision, a wild space of pornographic pleasures in need of sexual policing. Sexuality was implicated in all forms of colonial rule as an intimate encounter that could be used simultaneously to maintain and to erode racial difference and as a process essential for the reproduction of human labor power for the colonial economy, both of which demanded close surveillance and control, especially of African female sexuality.

Feminist studies on the construction of gender identities and relations have helped spawn a growing literature on the creation and transformation of colonial masculinities. Writing on Southern Africa, Robert Morrell argues that the colonial divisions of class and race produced different masculinities, some of which were dominant and hegemonic, and others, subordinate and subversive, although the latter received a patriarchal dividend over women of their class and race. These masculinities were produced and performed in different institutional contexts, each with its own gender regime and power relations, from the state, church, and school to the workplace and the home. Needless to say, masculinities changed over time and manifested themselves differently in rural and urban areas, where different gender and associational systems existed and patterns of political, social, and political change took place.

The Demise of Colonialism

Conceptions and analyses of colonialism in Africa have been affected quite considerably by how the demise of colonialism is understood. This in turn has centered on how two processes are examined—namely, decolonization, and African nationalism or

resistance—and the connections between the two. Nationalist historians contend that nationalism was primarily responsible for the dismantling of the colonial empires, while to imperialist historians decolonization was largely a product of metropolitan policy and planning. Others seek to place decolonization in the context of changes in the international relations system. Clearly, a process as complex as decolonization was a product of many factors. It involved a complex interplay of the prevailing international situation, the policies of the colonial powers, and the nature and strength of the nationalist movements, which in turn reflected internal conditions both in the metropolises and the colonies and the ideologies and visions of the postcolonial world. There were also variations in the patterns of decolonization among regions and colonies, conditioned by the way in which these factors coalesced and manifested themselves. Furthermore, decolonization was affected by the relative presence and power of European settlers and the perceived geopolitical strategic importance of each colony.

Similarly, the nature and dynamics of African nationalism were exceedingly complex. Not only were the spatial locus and social referent of the “nation” imagined by the nationalists fluid (they could be ethnic, national, regional, and continental), but multiple secular and religious visions of the postcolonial state vied for supremacy. Moreover, nationalism was articulated and fought on many fronts (political, economic, social, cultural, religious, and artistic) through different organizational forms (from political and civic organizations to cultural and religious movements) and in different terrains (rural and urban). The development and impact of nationalism also varied between different colonies even among those under the same imperial power, depending on such factors as the way the colony had been acquired and administered, the presence or absence of settlers, the traditions of resistance, and the social composition of the nationalist movement and its type of leadership.

Two key questions dominate African scholarship on decolonization and nationalism. The first is the social content and composition of anticolonial resistance. By the 1980s the old accounts of elite politics and heroic resistance had been abandoned in favor of analyses of resistance by peasants, workers, and women, and from the early 1990s more attention was paid to everyday forms of resistance by various subaltern groups, including youth. In short, the challenge was to write resistance with a small “r” rather than a capital “R” without losing, as Frederick Cooper (1994) insisted, the connections between the subaltern resistances and the larger and fluid constructs of colonialism. The second question centers on the continuities and discontinuities marked by decolonization. In the 1960s, nationalist scholars were inclined to see decolonization as ushering a radical break with colonialism. From the 1970s, the revolutionary pessimism of Fanon, who had pronounced decolonization false in his searing treatise of 1963, *The Wretched of the Earth*, gained adherents among radical scholars who stressed the structural continuities of colonialism. For their part, the postcolonialists, with their fixation on colonialism, recentered colonialism in African history.

See also Africa, Idea of; Anticolonialism: Africa; Empire and Imperialism; Internal Colonialism; Nationalism.

BIBLIOGRAPHY

- Ajayi, J. F. Ade. “The Continuity of African Institutions under Colonialism.” In *Emerging Themes of African History: Proceedings*, edited by T. O. Ranger, 189–200. Nairobi, Kenya: East African Publishing House, 1968.
- Allman, Jean, Susan Geiger, and Nakanyike Musisi, eds. *Women in African Colonial Histories*. Bloomington: Indiana University Press, 2002.
- Amadiume, Ifi. *Male Daughters, Female Husbands*. London and Atlantic Highlands, N.J.: Zed Books, 1987.
- Amin, Samir. “Underdevelopment and Dependence in Black Africa: Historical Origins.” *Journal of Modern African Studies* 10, no. 4 (1972): 503–524.
- Appiah, Kwame Anthony. *In My Father’s House: Africa in the Philosophy of Culture*. New York: Oxford University Press, 1992.
- Cooper, Frederick. “Conflict and Colonialism: Rethinking Colonial African History.” *American Historical Review* 99, no. 5 (1994): 1516–1545.
- Cooper, Frederick, and Ann Laura Stoler. *Tensions of Empire: Colonial Cultures in a Bourgeois World*. Berkeley: University of California Press, 1997.
- Diop, Cheikh Anta. *The African Origin of Civilization: Myth or Reality*. Translated by Mercer Cook. New York: L. Hill, 1974.
- Diouf, Mamadou. *Historians and Histories: What For? African Historiography between State and the Communities*. Amsterdam and Calcutta: Sepsis and CSSSC, 2003.
- Ekeh, Peter P. “Colonialism and the Two Publics in Africa: A Theoretical Statement.” *Comparative Studies in Society and History* 17, no. 1 (1975): 91–112.
- Fanon, Frantz. *The Wretched of the Earth*. Preface by Jean-Paul Sartre. Translated by Constance Farrington. New York: Grove, 1963.
- Hegel, G. W. F. *The Philosophy of History*. Translated by J. Sibree with a new introduction by C. J. Friedrich. New York: Dover Publications, 1956.
- Hopkins, Anthony G. *An Economic History of West Africa*. London: Longman, 1973.
- Jewsiewicki, Bogumil. “African Historical Studies: Academic Knowledge as ‘Usable Past’ and Radical Scholarship.” *African Studies Review* 32, no. 3 (1989): 1–76.
- Lomba, Ania. *Colonialism/Postcolonialism*. London and New York: Routledge, 1998.
- Magubane, Bernard. “A Critical Look at Indices in the Study of Social Change in Colonial Africa.” *Current Anthropology* 12, nos. 4/5 (1971): 419–445.
- Magubane, Zine. *Bringing the Empire Home: Race, Class, and Gender in Britain and Colonial South Africa*. Chicago: University of Chicago Press, 2004.
- Mamdani, Mahmood. *Citizen and Subject: Contemporary Africa and the Legacy of Late Colonialism*. Princeton, N.J.: Princeton University Press, 1996.
- Mazrui, A. A., ed., and C. Wondji, assistant. ed. *Africa Since 1935*. Vol. 8 of *General History of Africa*, UNESCO International Scientific Committee for the Drafting of a General History of Africa. Berkeley: University of California Press, 1993.
- McClintock, Anne. *Imperial Leather: Race, Gender, and Sexuality in the Colonial Contest*. New York: Routledge, 1995.
- Mkandawire, Thandika. “The State and Agriculture in Africa: Introductory Remarks.” In *The State and Agriculture in Africa*, edited by Naceur Bourenane and Thandika Mkandawire. Dakar, Senegal: Codesria, 1987.

- Morrell, Robert. "Of Boys and Men: Masculinity and Gender in Southern African Studies." *Journal of Southern African Studies* 24, no. 4 (1998): 605–630.
- Oyewùmí, Oyèrónké. *The Invention of Women: Making an African Sense of Western Gender Discourses*. Minneapolis: University of Minnesota Press, 1997.
- Ranger, Terence O. "The Invention of Tradition in Colonial Africa." In *The Invention of Tradition*, edited by Eric Hobsbawm and Terence Ranger. Cambridge, U.K., and New York: Cambridge University Press, 1983.
- Rodney, Walter. *How Europe Underdeveloped Africa*. Rev. ed. Postscript by A. M. Babu. Washington, D.C.: Howard University Press, 1981.
- Wolpe, Harold. "The Theory of Internal Colonialism: The South African Case." In *Beyond the Sociology of Development: Economy and Society in Latin America and Africa*, edited by Ivar Oxaal, Tony Barnett, and David Booth, 229–252. London and Boston: Routledge and Kegan Paul, 1975.
- Young, Crawford. *The African Colonial State in Comparative Perspective*. New Haven, Conn.: Yale University Press, 1994.
- Zezeza, Paul Tiyambe. *Manufacturing African Studies and Crises*. Dakar, Senegal: Codesria, 1997.

Paul Tiyambe Zezeza

LATIN AMERICA

Colonialism is all about the exercise of power and its consequences. Theoretically, the exercise of power entails the interaction of at least two parties negotiating (by various means or practices) their wills on one or more issues, as shown by their various actions or statements. This definition holds for interactions of both individuals and institutions. The imposition of one state's will over another is the essence of colonialism. This phenomenon can be observed in a formal sense, when, for example, a mother country dominates a colony, as Spain and Portugal controlled their kingdoms in the Americas. It can also be seen in an informal sense, when the British government pressured Argentine representatives to repay the Baring Brothers' loan in the nineteenth century.

The history of colonialism, which has been a ubiquitous part of the history of the Americas for centuries, can be divided into four parts: pre-Columbian native imperialism; early modern European colonialism; new colonialism (in the nineteenth and early twentieth centuries); and neocolonialism, which came to dominate especially after World War II. Archaeologists and historians have described two major pre-Columbian empires in this hemisphere. In the first, the Nahuatl-speaking people, who called themselves the Mexica, dominated the far-flung "Aztec" empire, which was akin to a loose confederation of city-states under one dominant power. The second great indigenous imperial regime was that of the Inca in South America. Because the Inca required all peoples newly incorporated into the empire to add the Inca Sun god to their religious hierarchy, to learn to communicate in the Quechua language, and to serve the Inca state as requested, they established an empire that was more unified and homogeneous than their counterparts in Mexico.

The age of modern colonialism began in the fifteenth century with the rise of modern nation-states and the beginning of European exploration and discovery. Both of the pre-Columbian empires of the Americas were subsequently conquered and colonized by the Spanish. Representatives of the Spanish crown quickly reorganized the indigenous population to facilitate their rule. To anchor Spaniards in place, colonial authorities—beginning with Hernando Cortez in North America and Francisco Pizarro in South America—gave to their followers grants of native peoples and the rights to their labor—called *encomiendas*. Thus imperial fiat created a new Spanish elite. The grantees or *encomenderos* ruled the native population at will until reports of misuse, exploitation, and the attendant demographic catastrophe motivated the king to establish a government to implement his law and will.

In Spain, the Council of the Indies (Consejo de Indias) was created to study and make policy for the New World, advise the king, and settle important court cases on appeal. The crown created the House of Trade (Casa de la Contratación) in Seville to regulate commerce, collect taxes, and license immigrants. In America, viceroys represented the monarch's person. Supreme courts (*real audiencias*) and treasury departments (*real haciendas*) were also established. Local representation of the king was entrusted to district governors, or *corregidores*. Each Spanish city had a town council (*cabildo*) that was entrusted with overseeing the urban population, planning and growth, sanitation, and law and order. Because the overseas state remained relatively unelaborated and weak under the Habsburgs, the Spanish king relied on the church to help rule. The church provided education to a select few; kept the baptismal, marriage, and burial records; served as a source of capital; provided the moral underpinnings of order; oversaw charity; and proved a ready channel of communication for royal mandates.

Under the Habsburg kings, the colonies provided the mother country with agricultural commodities, precious metals, and exotic products, and proved a ready and profitable market for manufactured goods, which were increasingly made elsewhere in Europe but shipped in Spanish ships in exchange for Spanish civilization and culture (language, religion, and lifeways), manufactured goods, and law and governance. Because Habsburg bureaucratic jurisdictions remained blurred and overlapping, this partnership between church and state resulted in a flexible and long-lasting system of rule that, because of the distances and difficulties in communication, gave many American districts a measure of local autonomy.

In 1700, the Bourbons inherited the Spanish kingdoms. They realized that Spain's global power had waned since the late sixteenth century and that the American kingdoms were deficient in supplying the mother country with sufficient revenues to justify their new designation as colonies. Therefore the Bourbons set about reforming the colonial structure and its personnel (1) to defend the overseas kingdoms from the encroachment of the Dutch, the French, and the British, who all wanted footholds in the Americas and access to their raw materials and markets; (2) to rationalize the administration of the New World kingdoms; and (3) to maximize the revenues flowing into the royal treasury of Spain. The Bourbons did

this in stages—working on the reforms first at home in the peninsula, then in the Caribbean, next in New Spain, and finally in Peru. Among the reforms were (1) the expulsion of the Jesuit order on charges of disloyalty and sedition (teaching new and prohibited treasonous ideas associated with Enlightenment philosophers such as Locke and Montesquieu); (2) the creation of the two new viceroalties of New Granada (1717, 1739) and La Plata (1776) from the viceroyalty of Peru, ostensibly to bring justice closer to the settlers; (3) the replacement of the creole *corregidor* system of local administration with that of an *intendente* system of peninsular-born royal officials who enjoyed higher status and broader jurisdiction; (4) the renewal of the tax system to increase some levies (e.g., the sales tax) and create new ones (e.g., the tobacco monopoly); (5) the creation of the first true military organization (for defense); (6) the promotion of new technology (for example, pumps and the Born process to increase the productivity of the mines); and (7) the passage of legislation opening up trade.

These reforms alienated (1) the church, because of the monarch's growing anticlericalism; (2) creole families, because the Jesuits had been the favored educators of elite sons; (3) creole *corregidores*, who were replaced with peninsular-born *intendentes*; (4) people of mixed blood (i.e., the *castas*), who were particularly hard hit by increasing taxes; (5) creole militiamen, who resented the fact that the new military organization allowed persons of mixed blood to join; (6) miners, who wondered why it had taken the crown so long to send them the pump that could solve their flooding problems; (7) large wholesale merchants, who lost their monopoly on import supply; and (8) provincial towns that lost the business from overland traffic of mule teams and llama caravans in the Andes as new seaports were opened up for freer trade.

In the short run, the reforms did improve security, administrative expediency, and tax revenues. But in the long run, the imposition of the will of the mother country stifled local autonomy and was interpreted as a threat to the sociopolitical and economic interests of the creoles, causing enough resentment to heighten the desire for independence. Independence, which split the Spanish-American colonies into more than twenty separate countries in the first three decades of the nineteenth century, ended the formal unequal exchange between Spain and its American colonies.

Portuguese colonization followed the same general outlines, with some notable differences. The Portuguese overseas government in Brazil was established in the middle of the sixteenth century in part to prevent the French and other foreign interlopers from taking control of selected areas. The flight of the royal family and its court from Napoleon in 1807 and arrival in Brazil in 1808 and the presence of the royal family in the early nineteenth century resulted in a controlled independence and rule by members of the royal family, Pedro I and Pedro II, as kings of a separate Portuguese kingdom. Pedro II ruled in a relatively enlightened way, but resentment mounted nonetheless, culminating with the issuance in 1888 of the "Golden Law," freeing the slaves, that fatally undermined support for his rule and led to his exile in 1889.

Independence, which foreshadowed the age of new imperialism, however, did not bring the new republican governments total control over their own affairs. The new nations were politically independent but became subject to foreign invasions and state-to-state pressures over debts and the maintenance of law and order. Europe's industries were eager to find sources of raw materials and new markets. Investors willingly exported capital. As mentioned above, the Argentine government defaulted on its first loan, subjecting it to years of informal British diplomatic pressure for repayment. Further north, Mexico, Central America, and the Caribbean nations faced invasion to collect similar debts, as when the Spanish, French, and British governments sent troops into Mexico during the rule of the constitutionally elected presidency of Benito Juárez to collect overdue moneys.

In the twentieth century, the term "neocolonialism" referred to informal economic ties and the growing predominance of the cultures and values of the former colonial powers by which they continued to influence the cultures and outlooks of Latin-American states. Unequal terms of trade exacerbated Latin America's relations with the rest of the world as more and more products (such as bananas, coffee, sugar, and tin) were needed to buy the same or equivalent imported products. Resentment at this situation stimulated a rich intellectual life across the continent in the twentieth century; in fields as varied as economics, political philosophy, literature, and art, anti-imperialism was a hallmark of a distinctively Latin American form of modernism.

Deteriorating terms of trade and dependency on other world powers have split the populations of the various countries. The elites support the foreign loans, aid, and close trading relations because they are importers and exporters who profit from such relations or the bankers, lawyers, and politicians who negotiate the loans, write the contracts, and collect the fees for their efforts. Nationalists, in contrast, are against such dealings, arguing that their nations export low-priced products to buy relatively high-cost manufactured goods that are often inappropriate technologically to the needs of the majority of their people. These nations also pay out more in principal, interest, fees, and patent and licensing costs than they take in, thus exacerbating inequality between countries and within their own nations, perpetuating their subordinate status, inequality, and poverty.

In addition, nationalists claim that the ruling elites colonize their own compatriots, in that provincial producers sell their local products—be it oranges or potatoes—at low prices and buy high-priced manufactured goods in return. In addition, the provinces send taxes to the capital and get much less back in the form of public works and services (such as schools)—a form of internal colonialism.

Such unequal relations have left a legacy of inequality and growing suspicion of and covert and overt resistance to the rule-makers at home and abroad. Under the Habsburgs, colonial populations resisted, saying, "*obedescio pero no cumpló*" (I obey but will not comply), implying that they recognized that the king had the right to issue the law but that if he had been

better informed, he would not have done so. While they informed him of their circumstances and the reasons why the decree is not wise, it was not locally enforced. Increasingly this practice has been replaced by the attitude summarized as “*hecho la ley, hecho la trampa*” (a law passed is a law bypassed [by cheating, trickery, cleverness, or deceit]). This shows the growing cynicism and intolerance of the general population to their governments, international agencies, and unequal relations with the more developed world.

At the beginning of the twenty-first century, the picture is mixed. The fall of the Soviet Union has undermined the sense of any alternative to U.S. capitalism; at the same time, however, the disastrous economic situation that has resulted from neoliberal reforms—the latest set of policies imposed by international creditors on Latin-American nations—has fueled a new sense of resentment. At the same time, a militant desire for functioning democracy, transparency, and an end to corruption has fostered the growth of a wide variety of grassroots political movements. But for many, the only solution is to migrate, legally or illegally, north—into what a previous generation of anticolonialist Latin Americans called “the belly of the beast.”

See also *Anticolonialism: Latin America; Empire and Imperialism: Americas*.

BIBLIOGRAPHY

- Bernecker, Walther L., and Hans Werner Tobler, eds. *Development and Underdevelopment in America: Contrasts of Economic Growth in North and Latin America in Historical Perspective*. New York: Walter de Gruyter, 1993.
- Felix, David, ed. *Debt and Transfiguration? Prospects for Latin America's Economic Revival*. Armonk, N.Y.: M. E. Sharpe, 1990.
- Frank, Andre Gunder. *Latin America: Underdevelopment or Revolution: Essays on the Development of Underdevelopment and the Immediate Enemy*. New York: Monthly Review Press, 1969.
- Galeano, Eduardo. *Open Veins of Latin America: Five Centuries of the Pillage of a Continent*. Translated by Cedric Belfrage. New York: Monthly Review Press, 1973.
- Johnson, John J. *Latin America in Caricature*. Austin: University of Texas Press, 1980.
- Keen, Benjamin. *A History of Latin America*. 4th edition. 2 vols. Boston: Houghton Mifflin, 1991.

Susan Elizabeth Ramirez

SOUTHEAST ASIA

Studies detailing the nature of colonial policy and practice in Southeast Asia have all acknowledged its disparate nature and overwhelming range of characteristics. While many European powers shared the desire to establish colonies overseas, the manner in which this was accomplished was more random than regular. Factors contributing to this variance include differing philosophies of administrative governance, differing levels of indigenous resistance, and differing periods of influence in the region. For instance, Spanish colonial projects in Southeast Asia began in the 1560s, nearly two hundred years earlier than the efforts of the British, French, and Dutch, resulting

in a much longer and more enduring history of colonialism in the Philippines (originally a Spanish colony) than in Malaya (a British colony). The Dutch employed a more indirectly ruled system (using indigenous elites to initiate their policies) than the British, who in Burma, for example, deposed the sitting monarchy in favor of ruling more directly through an impersonal civil service administration. In French Vietnam, there was a mixture of both systems, resulting in corresponding levels of resistance in areas more intensively encroached upon by colonial authorities. In general, polities that had achieved sophisticated levels of cultural, political, and economic integration tended to resist European powers more vigorously than polities in more decentralized areas. Some polities in insular Southeast Asia, whose political relations were more tenuous because of geographical constraints, competitive economies, and personal ties, offered less sustained, organized, or intensive resistance than in the mainland kingdoms whose populations were linked by common religious, economic, and historical worldviews. Simply put, the shape of colonialism in Southeast Asia was in large part determined by the nature of precolonial regional dynamics and the ability of the local communities to interact and respond to the differing policies, attractions, and challenges of colonial governance. Yet the idea of colonialism in Southeast Asia has also been understood and considered through approaches suggested by scholars of both Southeast Asian and colonial studies. This entry, after first providing a brief historical overview of colonialism in the region, discusses the ways in which Southeast Asian studies was constructed and shaped by scholars who were writing about or reacting to colonialism, producing works that revealed the complexities of that encounter as well as the epistemological links between the two branches of study.

Historical Overview

While this article is not concerned with the history of the colonialism in Southeast Asia per se, a brief overview highlighting some of its key points is necessary. The history of Southeast Asia's encounter with Europe begins as early as the first decades of the sixteenth century, an occurrence that is indeed one of the earliest episodes in the history of colonialism as a global phenomenon. In many respects, some of the “classical” features of colonialism—such as territorial conquest; the intervention and disruption of local socioeconomic networks; and the introduction of new cultural regimes and models through various missionary and educational activity—first came into play in Southeast Asia before they appeared later elsewhere. All major colonial European powers (as well as, later, the United States and Japan) took part in the long history of colonialism in the region: In the twentieth century the Netherlands was in control of Indonesia; Portugal, of East Timor; the United States, of the Philippines (taken from Spain after 1898); France, of Vietnam, Laos, and Cambodia (so-called French Indochina); and Great Britain, of Malaya and Myanmar (Burma). The region also provides the unique example of Thailand (Siam), which was never colonized, though institutional and cultural changes were significantly connected to European diplomatic pressures along its borders. During World War II most of these territories were occupied by Japan, whose imperial designs, cultural sensibilities, and economic initiatives

disconnected Europe and America's hold on the region, which indirectly contributed to the tensions of a nationalist sentiment and Cold War competitions within the former colonies. Most of the European powers, weakened by the war, would lose their colonies after the war, though attempts were made (in varying degrees) to regain their original foothold within the region.

As the cases of the Mayla Emergency, the Indonesian Revolution, the Indochinese War, and, later, the Vietnam War show, the response to colonialism in Southeast Asia continued in the form of anticolonial resistance movements, though external observers tended to regard these wars in the context of the Cold War.

Trends in the Study of Colonialism

The story of Southeast Asia's encounter with Europe spans several centuries, leaving a long and complex record of exchange, negotiation, and domination. Colonialism in Southeast Asia might be considered one important chapter in that much larger story of global interaction. Within the region's early colonial historiography, colonialism pertained to the transformation of "traditionally" defined polities into dependent states modeled along European definitions of organization and administration. Because this approach to colonialism was significantly linked to the perspective of those who were immersed within the colonial service, it was no surprise that this understanding of colonialism was expressed through studies of administrative changes and their effects on local societies, economies, and cultures. Equally important was the overarching representation of the colonial encounter in binary terms: all that was "modern" was inherently European and became the standard to which Southeast Asian culture and history would be measured. Interestingly enough, these studies formed the foundations for the area studies disciplines, as many of the earliest doyens in the fields were from the ranks of the scholar-administrator. Early linguists, anthropologists, and historians, working within the colonial administrations, set the paradigms and agendas that later scholars would either confirm or contest, creating important but imposing discussions that would dominate the course of scholarship. Their views of the peoples and cultures they encountered set into motion a whole genealogy of scholarship that responded in various ways to their findings. For example, reports that discussed the despotic nature of Southeast Asian leadership not only reveal the way in which colonial agendas colored early documentation, they also identify why writing about "Southeast Asian kingship" was important in the first place. While these early writings relate something about Southeast Asia, they also reveal important insight into how colonialism was perceived by those working within it. Thus, the propagation of colonialism in Southeast Asia by these officials was partially responsible for the emergence of Southeast Asian studies as a field of study.

Thematically, colonialism has come to refer to a variety of processes that contributed to a fundamental change in identity, worldview, and consciousness. These institutional and cultural transformations were initiated at different levels and in varying intensities by many groups within the European com-

munity, indigenous elites, and rural populations. The complicated and complex nature of this interaction has been decoded by a variety of interpretations, affecting the many understandings and forms of colonialism. Colonial administrator-scholars referred to colonialism in terms of its policies and practices that contributed to the administrative formation of the colonies, whereas nationalist historians treated the subject as the processes of interaction, subjugation, and control that enabled the peoples and societies of Southeast Asia to come under colonial authority. Another manifestation of colonialism took its shape (although indirectly) through studies of indigenous forms of resistance and protest, whereas others explored colonialism through the multitude of indigenous social institutions it encountered and affected. More recent trends position colonialism through its relationship to the nation and the forming of national cultures; criminality, counterinsurgency, and prisons; and its forms of knowledge and various modes of representation. In addition, it has also been illustrated through technology, literature, and film. In short, the shape of colonialism has been fashioned through a variety of approaches, reflecting trends in the study of colonialism as a thematic category and through the interdisciplinary guilds within area studies.

Colonialism since 1970

Conceptions of colonialism in Southeast Asia have developed significantly since 1970, though scholarship began widening its historical gaze of the region's history and colonialism's place in it nearly a decade earlier. In response to colonial and nationalist-oriented histories of the colonial past, in which the attention was directed toward colonial administrators, policies, and interests in the region, scholars began shifting their focus, creating histories that told the same stories from internal, local, or indigenous perspectives. One of the most significant interventions was offered by John Smail, who saw a lingering problem in the historiography of modern Southeast Asian history. He concluded that both colonial and nationalist scholarship seemed to privilege the same European contexts, events, and narratives about the "colonial period" even when their political sympathies tended to diverge in analysis. In addition, the very conception of "modernity" in the region's history was automatically being associated with the trends, institutions, and ideas that emerged during the colonial period. According to Smail, modern history tended to focus on colonial narratives, concerns, and priorities that signaled a deep disjuncture with the precolonial past, whose own narratives, cultural forms, and terminology were being neglected by the grand narratives of empire, development, and modernity. In order to challenge the prevailing fixtures of colonial and nationalist historiography, Smail called for a writing and periodization of modern Southeast Asian history that applied indigenous categories of analysis, reconstituting the way in which modernity and colonialism would be defined, interpreted, and chronicled. Identifying these cultural forms that could structure the writing of an "autonomous" history of Southeast Asia during this period of intense Eurasian exchange became the overarching paradigm for scholars of the late 1960s and 1970s. This approach aimed to

address the imbalance in scholarship, which had tended strongly toward European-oriented histories (which emphasize fundamental changes in society), by favoring histories that engaged the possibility of regional cultural continuities. To Smail, colonialism would no longer mark the arrival of modernity; it would merely mark a stage within the long-term patterns and processes of the region's history.

These adjustments lifted the idea of colonialism from the confines of European studies and placed it within the framework of Southeast Asian studies, which shifted attention that previously privileged the study of history through colonial categories to studies that investigated the nature of indigenous culture during the colonial encounter. While early studies might have explored the ways in which ideas of leadership, agriculture patterns, community organization, and kinship relations were affected by colonial policies and practices, the new interest in an "autonomous" perspective urged scholars to prioritize local institutions, patterns, and terms as the main subject of inquiry, so that the study of colonialism would become integrated into the cultural history and anthropology of Southeast Asia. One example could be found in the work of Emanuel Sarkisyanz, who demonstrated through his study of Burmese Buddhism that Southeast Asians reacted and responded to colonialism through local terms and concepts inherent to their worldview. The dismantling of the monarchy, subsequent rebellions, and nationalism were all considered through the prism of Buddhism in Burma, suggesting that it was possible to view the colonial period from a more Southeast Asian perspective. At the same time, effort was directed toward the ways in which global, regional, and local forces bound and interacted with peasant societies outside state or religious institutions, shifting the terms of engagement of colonialism to everyday life and practices. Seminal works such as James C. Scott's *The Moral Economy of the Peasant* directed attention to the ways in which global market economies affected the everyday life of the peasant in Southeast Asia, fundamentally challenging local conceptions of legitimacy, economy, and authority. In addition, such approaches stretched the legacy of precolonial traditions, which were often labeled as "traditional," into an epistemological space that previously scholarship had neglected to consider. Indigenous religion, ritual, and customary laws, and other modes of the precolonial conceptual world, became categories of analysis that were now used to study the role and nature of colonialism in Southeast Asia.

Colonial Dichotomies

While the terms of the colonial encounter were being reconfigured and though scholars were seemingly decolonizing the epistemology of Southeast Asia, others began to question the direction the field had taken and the perspective in which colonialism was being discussed. Smail's "autonomous" history had fundamentally edged the scholarship toward a fresh course of research, but there were still some lingering issues that needed to be resolved. The field's leanings toward supposed indigenous categories as modes of analyses might have fallen a bit short in providing a total picture of colonialism in Southeast Asia by underestimating the impact of colonial influences on society. Scholars had merely swung the pendulum from one

end of the spectrum to the other, extending a little too much enthusiasm for the continuities and unchanging nature of Southeast Asian cultural forms.

Following the important arguments in Edward Said's *Orientalism*, scholars such as Ann Laura Stoler questioned the essential nature of these categories while at the same time challenging the "European versus Southeast Asian" perspective upon which studies of colonialism continued to rest. Although important writers such as Franz Fanon and Albert Memmi had developed their seminal arguments about those who lay between the "colonized" and "colonizer," applying these types of questions to the study of colonial society in Southeast Asia remained in its infancy. With these new callings, the study of "mixed-bloods" in Dutch Indonesia, the "métisse" in French Vietnam, "mestizos" in the Spanish Philippines, and "Eurasians" became an important challenge to the idea that colonial society and its study could be divided into simple binary categories of analysis. These studies also suggested that colonialism in Southeast Asia (and beyond) was much more complex than previously imagined, pointing to a variety of situations and scenarios in which ideas, institutions, and technology were exchanged in different and often complicated ways. Colonialism in Southeast Asia could no longer be viewed as a neat and simple process, the colonial encounter could no longer be approached through binary framings, and it became clear that the categories that had been considered intrinsically "European" or "Southeast Asian" were no longer tenable.

The realization that colonialism was a much more complicated process that occurred at different intensities, at different times, and in different places also inspired scholars to look at other domains in Southeast Asia where such mixing and blurring of ideas might occur. Many scholars had been pondering this idea for some time, outside the contours of colonial studies but within the framework of Asian nationalism. Benedict Anderson's seminal *Imagined Communities* set the agenda by demonstrating that the nation-state was articulated through cultural forms that enabled peoples to bridge the conceptual gap between kin and citizen. Many of these forms of community bonding were those introduced by colonial authorities, adopted by urban nationalists, and localized by grassroots leaders. These patterns of exchange were shown to have occurred at every level of society, and consequently colonialism's shape became influenced by the concerns and mechanics of nationalism.

Colonialism's relationship to Southeast Asian nationalism developed significantly following the important insights of Anderson. One of his students, Thongchai Winichakul, extended the connections between colonial statecraft and nationalist identity by demonstrating the influence of map-making and the creation of Thai identity in his exceptional work, *Siam Mapped*. Though his emphasis was on the notion of "Thainess" and its relationship to boundaries, Winichakul's study reinforced the idea that colonial notions of space, measurement, ethnicity, and history were being actively engaged by Southeast Asian elites—even from those who were not formally colonized. Colonial knowledge was not something that was strictly part of the European conceptual world, it was constantly being reshaped, modified, and localized to fit the needs of Southeast Asians, who in many cases

used these new ideas to emulate as well as resist European hegemony. Along the same lines, Maurizio Peleggi's *Lords of Things* demonstrates how the Thai monarchy embraced different forms of European material culture in an effort to redefine itself in the style of European monarchies, changing its public image through colonial ideas of modernization. Studies exploring the nature and origins of Southeast Asian nationalism indirectly contributed to the changing understanding of colonialism by continuing to challenge the terms and situations that characterized that encounter. Writing against the pervasive grain that had kept Southeast Asians locked in their temporal and spatial limbo, scholars began to investigate the ways in which technologies were disseminated and more often appropriated to transform the Southeast Asian conceptual world. Print culture, education, social engineering, and advancements in communication were actively being adopted to fit the needs of new and old elites alike, while at the same time these modes of colonialism were also being used to reify and remake "traditional" forms of Southeast Asian culture.

Trends in the Late 1990s and Early 2000s

Scholarship from the late 1990s and early 2000s has made provocative connections between the history of colonialism and the production of knowledge in Southeast Asia. Many of the categories and approaches used to conceptualize the region's contours—its cultures, institutions, languages, ethnicities, and histories—have been shown to be largely conceived, organized, and textualized by colonial administrator-scholars seeking to make legible the vast territories, societies, and peoples that had come under their authority. This legacy has not always been recognized, though active measures were taken by scholars in the 1960s and 1970s hoping to decolonize the epistemology of Southeast Asia by referring to categories and terms thought to be "autonomous" to the region. Although this scholarship produced the bulk of Southeast Asian knowledge, research from the late 1990s and beyond is noticing that some of these studies relied on categories and perspectives that emerged through colonial understandings of Southeast Asia. Turning to indigenous language sources or traditional perspectives was not enough—the evidence for what was considered traditional, indigenous, or autonomous was often based on the documents of officials who wrote into these sources their own agendas, concerns, and priorities.

One such example might be found in Laurie J. Sears's path-breaking study *Shadows of Empire*, which reconstructs the way in which Dutch views of traditional *wayang kulit* (shadow-puppet theater) were adopted by scholars and Javanese alike. Not only is the role of the Dutch in the "inventing" of tradition explored, but Sears also charts the way in which the meanings of these cultural symbols were contested by officials, scholars, and performers throughout history. This approach recast the way in which colonialism was being considered: Elements thought to be distinctly Southeast Asian were now being reevaluated as products of colonialism, revealing the unsettled nature of "traditional" culture and revisiting European influence on the epistemological landscape of the region.

The picture of colonialism was that its reach was far more penetrating than once held and that through the study of more benign forms of authority, the actual extent of that influence might be perceived. Leading scholars such as Vicente L. Rafael, author of *White Love and Other Events in Filipino History*, and Rudolf Mrázek, author of *Engineers of Happy Land*, have revealed how colonial photography, roads, language policy, architecture, electricity, and travel literature reflect the relationship between colonial technology, knowledge, and power. Moreover, Mrázek's work employs an important and provocative approach by suggesting that it is possible to "read" colonial society and its forms like a text. In a sense, his unique "translation" of Dutch buildings, roads, and magazines applies approaches to colonial society that are usually reserved for studying Southeast Asia's deep past. Panivong Norindr's *Phantasmatic Indochina* addresses the ways in which French colonial ideology can be gleaned from its films, exhibitions, and architecture. More importantly, the studies contained within this work address how the very idea of "Indochine" was a concept that was invented, reified, and articulated to justify political-economic policies on the one hand and how cultural forms contributed to that imagining on the other. Ironically, colonial studies has gone from one end of the spectrum to the other; while early colonial administrators tried hard to textualize the boundaries and contents of their imagined colony, scholars today are disassembling those constructs by relying on the very sources those early officials produced.

Finally, advancement in gender and identity studies has also reworked the manner in which scholars have approached the relationship between colonialism and social policies. Just as the categories of colonizer and colonized were once problematized to reveal those communities lying "in-between," approaching colonialism through gender-inspired scholars to consider how European notions of womanhood transformed sexual relations and expectations of "native" women within colonial communities. These studies have explored the role and symbol of European motherhood in the colony and the manner in which this image affected policy toward the maintenance of white communities. By doing so, they have directly confronted the image of the colony as a site for "unfettered economic and sexual opportunity" through policies that attempted to curb men from racial intermixing and "going native."

Conclusion

Scholars continue to add to this discursive body of colonial knowledge, which has only recently and sporadically been problematized. Exploring the contexts in which much of this knowledge was produced has led to new questions about what is actually known about the region and new perspectives in which the scholarly understanding of colonialism in Southeast Asia might be expanded. These sentiments suggest that colonialism and colonial society can be studied from colonialism's cultural forms—its institutions, languages, ideas, economies, and literary representations—to reveal new perspectives about the processes of change and continuity. Proponents for this anthropology of colonialism suggest that by understanding how Southeast Asia was made through "scholarship," one can

get a sense of colonialism and the effects of that encounter with the peoples and cultures of the region.

At the same time, considerable effort has been spent on delineating the actual conditions on the ground, which were much more complicated than perhaps official documents or earlier studies attempted to convey. Scholars have shifted their emphasis on rebellions as the sole sign of protest to show that resistance, subversion, and circumvention was occurring in an everyday fashion in everyday settings. Inconsistent policies toward Southeast Asians in rural and urban settings intensified incoherency, mismanagement, and competition among colonial officials while exacerbating tensions between metropole (European capitals) and colonial capitals. It is with this last trend where the idea of colonialism has taken its most current shape. Scholars within Southeast Asian studies are beginning to examine how competing interests, agendas, and concerns within colonial communities produced different boundaries in colonial society, while the contestation of categories has led to the understanding that the differences between European and Southeast Asian were created, defined, and maintained. Hybridity has not hidden the scholarly reemphasis on European colonialism within a Southeast Asian world, but if historiography repeats itself as much as history seems to, one can anticipate further studies of “Southeast Asian” hybridity in the colonial setting to emerge in the future.

See also *Anticolonialism: Southeast Asia; Empire and Imperialism: Asia; Westernization: Southeast Asia.*

BIBLIOGRAPHY

- Anderson, Benedict. *Imagined Communities: Reflections on the Origin and Spread of Nationalism*. Rev. ed. London: Verso, 1991.
- Cohn, Bernard S. *Colonialism and Its Forms of Knowledge: The British in India*. Princeton, N.J.: Princeton University Press, 1996.
- Cooper, Frederick, and Ann Laura Stoler, eds. *Tensions of Empire: Colonial Cultures in a Bourgeois World*. Berkeley and Los Angeles: University of California Press, 1997.
- Dirks, Nicholas B., ed. *Colonialism and Culture*. Ann Arbor: University of Michigan Press, 1992.
- McHale, Shawn Frederick. *Print and Power: Confucianism, Communism, and Buddhism in the Making of Modern Vietnam*. Honolulu: University of Hawaii Press, 2004.
- Mrázek, Rudolf. *Engineers of Happy Land: Technology and Nationalism in a Colony*. Princeton, N.J.: Princeton University Press, 2002.
- Norindr, Panivong. *Phantasmatic Indochina: French Colonial Ideology in Architecture, Film, and Literature*. Durham, N.C.: Duke University Press, 1996.
- Peleggi, Maurizio. *Lords of Things: The Fashioning of the Siamese Monarchy's Modern Image*. Honolulu: University of Hawaii Press, 2002.
- Rafael, Vicente L. *White Love and Other Events in Filipino History*. Durham, N.C.: Duke University Press, 2000.
- Reid, Anthony. *Southeast Asia in the Age of Commerce, 1450–1680*, Vol. 1: *The Lands below the Winds*. New Haven, Conn.: Yale University Press, 1988.

- . *Southeast Asia in the Age of Commerce, 1450–1680*, Vol. 2: *Expansion and Crisis*. New Haven, Conn.: Yale University Press, 1993.
- Sears, Laurie J. *Shadows of Empire: Colonial Discourse and Javanese Tales*. Durham, N.C.: Duke University Press, 1996.
- Stoler, Ann Laura. *Capitalism and Confrontation in Sumatra's Plantation Belt, 1870–1979*. 2nd ed. Ann Arbor: University of Michigan Press, 1995.
- Tarling, Nicholas, ed. *The Cambridge History of Southeast Asia*, Vol. 2: *The Nineteenth and Twentieth Centuries*. Cambridge, U.K.: Cambridge University Press, 1992.
- Thongchai Winichakul. *Siam Mapped: A History of the Geo-body of a Nation*. Honolulu: University of Hawaii Press, 1994.
- Zinoman, Peter. *The Colonial Bastille: A History of Imprisonment in Vietnam, 1862–1940*. Berkeley and Los Angeles: University of California Press, 2001.

Maitrii Aung-Thwin

COMEDY. See **Humor; Tragedy and Comedy.**

COMMON SENSE. The common-sense philosophers of the Scottish school—including Thomas Reid, Dugald Stewart, James Beattie, George Campbell, and James Oswald—argued against George Berkeley and David Hume that ordinary human perception and moral judgment need not be defended against skeptical inquiry but ought to be taken as self-evident. As Campbell put it, “to maintain propositions the reverse of the primary truths of common sense, doth not imply a contradiction, it only implies insanity” (*The Philosophy of Rhetoric*, 1776). The common-sense school was criticized by Immanuel Kant for its “appeal to the opinion of the multitude” (*Prolegomena*, 1783); Joseph Priestley, for example, wrote in his “examination” of Reid, Beattie, and Oswald (1774) that common sense is for persons of “middling” capacities. Nevertheless, their ideas enjoyed immense influence, not only in Great Britain but also in Germany and elsewhere. The idea that ordinary language can express principles of common sense, emphasized in the works of the Scottish school and also present in the work of the Italian jurist Giambattista Vico, led to interest in common sense on the part of later philosophers, including Henry Sidgwick, G. E. Moore, Hans-Georg Gadamer, J. L. Austin, and Hannah Arendt.

While most members of the Scottish school are read today primarily for historical interest, the work of the Presbyterian minister and professor of moral philosophy, Thomas Reid, has undergone a revival in recent years. Reid began his career at Marischal College in Aberdeen, where he founded the Aberdeen Philosophical Society, or “Wise Club.” The group concentrated much of its energy on the work of fellow Scot David Hume. While the poet, zealous Christian, and anti-Humean polemicist, James Beattie, joined the society some nine years after its founding, most of its members were more concerned with establishing an empirical foundation for British learning than with combating potential heresy. Hume called Beattie’s *Essay on the Nature and Immutability of Truth* (1770) “a horrible large lie in octavo”; though Hume disagreed with Reid’s criticism of

his work and once suggested in a letter to a mutual friend that pastors ought to stick to “worrying” each other and leave the philosophers to their arguments, he generally treated Reid with respect.

Hume’s work was of great interest to the Aberdeen philosophers—and to members of the Scottish common-sense school in general—because it brings Cartesian skepticism to conclusions that, for them, are so contrary to ordinary human experience that they demonstrate the futility of all such philosophizing. In his *Inquiry* (1764), Reid writes that “since we cannot get rid of the vulgar notion and belief of an external world, [we ought] to reconcile our reason to it as well we can.” Half a century earlier, Anthony Ashley Cooper, third earl of Shaftesbury, had argued in a commonsensical vein that it would be easier to imagine half of mankind mad than to deny the conclusions of “natural knowledge, fundamental reason, and common sense” (“Sensus Communis,” 1710). For Shaftesbury, human beings have a natural faculty of moral sense.

One difficulty with tracing the influence of the idea of common sense is the variety of meanings attached to it even by thinkers in close geographical and historical proximity. Reid’s commonsense access to moral judgment is much more like reasoned appeal to a self-evident principle than Shaftesbury’s combination of feeling and thinking, and Francis Hutcheson’s use of the term “moral sense” implies still less reason and still more immediate sensation than Shaftesbury’s. Reid’s realism is starkly opposed to Berkeleyan idealism, yet both authors appeal directly to the authority of common sense.

These difficulties aside, however, it is possible to specify several important views that set the Scottish common-sense school apart. First, common-sense philosophy criticized both moral and epistemological skepticism from the point of view of ordinary reason. This argument sometimes took the form of ad hominem attack on Hume: “Even the author of the *Treatise of human nature*, though he saw no reason for this belief [in hardness of bodies in nature], but many against it, could hardly conquer it in his speculative and solitary moments; at other times he fairly yielded to it, and confesses that he found it necessary to do so” (Reid, *Inquiry*, 1764).

Second, philosophy takes its starting point from the self-evident principles of common sense. For Oswald, these self-evident principles included many Christian religious doctrines, and indeed a good bit of the common-sense school’s subsequent popularity lay in its claim to defend the religious views of ordinary British citizens from the perceived incursions of system-building philosophers. Reid’s position on religion and self-evidence is more complex and interesting; for example, he argues that it makes no sense to deny the validity of perception while accepting that of reason because both faculties “come out of the same shop.”

Third, not only does common sense furnish pragmatic certainty about the evidence of our senses and the existence of our selves, but it also provides natural insight into moral questions. Along with commonsense views of right and wrong comes the conviction of one’s own human agency. Reid developed this idea into what contemporary philosophers would call an in-

compatibilist defense of freedom: for Reid, free human agents begin causal chains of events independent of natural causes.

The German reception of the Scottish common-sense philosophers is frequently described by commentators as a “misreception.” Generally, while German readers were enthusiastic about the contributions of the Scots, they tended to empty the idea of “common sense” of the moral and social elements present in Reid’s and others’ work. The “popular philosophy” movement of the mid-eighteenth century in Germany shared the commonsense zeal of the Scottish school, and members of both groups criticized the absurdities of academic philosophizing. As Christian Garve put it (writing, in 1798, his observations on the most common principles of ethics), common sense is not “common because it is contemptible, but because it is, or should be, the common property of all human beings.” Unlike the popular philosophers, Kant was highly critical of the Scottish common-sense school and its reading of Hume in his *Prolegomena* (1783); however, he took the concept of common sense itself seriously in his *Critique of Judgment* (1790). There Kant distinguished between “*sensus communis*,” considered as an idea of a comparative sense, and “common human understanding,” which includes qualities exhibited by all normal human reason.

Of course Kant, unlike the Scottish school, denies that either *sensus communis* or common sense frees us from the need to justify our sensations and beliefs. However, Kant did provide some intriguing suggestions about both concepts’ functions; each, in a different way, serves to replace unavailable certainty in judgment with an approximation of collective judgment. This aspect of Kant’s treatment of common sense inspired Hannah Arendt’s interesting independent reflections on the topic, which include the suggestion that when it comes to choosing between moral approbation and disapprobation, the “criterion . . . is communicability, and the standard of deciding about it is common sense.”

See also **Enlightenment; Knowledge; Moral Sense; Skepticism.**

BIBLIOGRAPHY

- Arendt, Hannah. *Lectures on Kant’s Political Philosophy*, edited by Ronald Beiner. Chicago: University of Chicago Press, 1982.
- Beattie, James. *An Essay on the Nature and Immutability of Truth: In Opposition to Sophistry and Skepticism*. 1770. Reprint, Bristol: Thoemmes Press, 1999.
- Broadie, Alexander, ed. *The Cambridge Companion to the Scottish Enlightenment*. Cambridge, U.K.: Cambridge University Press, 2003.
- Campbell, George. *The Philosophy of Rhetoric*. 1776. Reprint, edited by Lloyd F. Bitzer. Carbondale: Southern Illinois University Press, 1988.
- Garve, Christian. *Einige Betrachtungen über die allgemeinsten Grundsätze der Sittenlehre*. Wroclaw, Poland: W. G. Korn, 1798.
- Kant, Immanuel. *Prolegomena to Any Future Metaphysics*. 1783. Rev. ed., translated and edited by Gary Hatfield. Cambridge, U.K.: Cambridge University Press, 2004.
- Oz-Salzberger, Fania. *Translating the Enlightenment: Scottish Civic Discourse in Eighteenth-Century Germany*. Oxford: Clarendon, 1995.

Priestley, Joseph. *An Examination of Dr. Reid's Inquiry into the Human Mind on the Principles of Common Sense, Dr. Beattie's Essay on the Nature and Immutability of Truth, and Dr. Oswald's Appeal to Common Sense in Behalf of Religion*. London: J. Johnson, 1774.

Reid, Thomas. *An Inquiry into the Human Mind: On the Principles of Common Sense*, edited by Derek Brookes. University Park: Pennsylvania State University Press, 1997. Authoritative, new critical edition.

Shaftesbury, Anthony Ashley Cooper, Earl of. "Sensus Communis, an Essay on the Freedom of Wit and Humour in a Letter to a Friend." 1710. Reprinted in Shaftesbury, *Characteristics of Men, Manners, Opinions, Times*, edited by Lawrence E. Klein. Cambridge, U.K.: Cambridge University Press, 1999.

Yaffe, Gideon. *Manifest Activity: Thomas Reid's Theory of Action*. Oxford: Clarendon, 2004.

Elisabeth Ellis

new dictionary of the history of ideas

EDITORIAL BOARD

Editor in Chief

Maryanne Cline Horowitz, *Occidental College*
University of California, Los Angeles

Associate Editors

Jonathan Berkey, *Davidson College*
Zvi Ben-Dor Benite, *New York University*
Benjamin A. Elman, *Princeton University*
George Esenwein, *University of Florida, Gainesville*
Cary J. Nederman, *Texas A&M University*
Vassiliki Betty Smocovitis, *University of Florida, Gainesville*
Neferti Tadiar, *University of California, Santa Cruz*
Mary J. Weismantel, *Northwestern University*
Paul Tiyambe Zeleza, *Pennsylvania State University*

Advisors

Diane Apostolos-Cappadona, *Georgetown University*
Edwina Barvosa-Carter, *University of California, Santa Barbara*
Nupur Chaudhuri, *Texas Southern University*
Kostas Gavroglu, *University of Athens, Greece*
Donald R. Kelley, *Rutgers University*
Zine Magubane, *University of Illinois, Urbana-Champaign*
J. B. Schneewind, *Johns Hopkins University*
Blair Sullivan, *University of California, Los Angeles*
Reed Ueda, *Tufts University*

Librarian Advisory Board

Mary W. George, *Princeton University*
Suzy Szasz Palmer, *University of Louisville*

Editorial Assistant

Lisa Griffin

new dictionary of the history of ideas

maryanne cline horowitz, editor in chief

volume 2

Communication of Ideas to Futurology



CHARLES SCRIBNER'S SONS

An imprint of Thomson Gale, a part of The Thomson Corporation

THOMSON
—★—™
GALE



New Dictionary of the History of Ideas
Maryanne Cline Horowitz, Editor in Chief

©2005 Thomson Gale, a part of the Thomson Corporation.

Thomson and Star Logo are trademarks and Gale is a registered trademark used herein under license.

For more information, contact
Thomson Gale
27500 Drake Rd.
Farmington Hills, MI 48331-3535
Or you can visit our Internet site at
<http://www.gale.com>

ALL RIGHTS RESERVED

No part of this work covered by the copyright hereon may be reproduced or used in any form or by any means—graphic, electronic, or mechanical, including photocopying, recording, taping, Web distribution, or information storage retrieval systems—without the written permission of the publisher.

For permission to use material from this product, submit your request via Web at <http://www.gale-edit.com/permissions>, or you may download our Permissions Request form and submit your request by fax or mail to:

Permissions Department
Thomson Gale
27500 Drake Road
Farmington Hills, MI 48331-3535
Permissions Hotline:
248-699-8006 or 800-877-4253, ext. 8006
Fax: 248-699-8074 or 800-762-4058

Since this page cannot legibly accommodate all copyright notices, the acknowledgments constitute an extension of the copyright notice.

While every effort has been made to ensure the reliability of the information presented in this publication, Thomson Gale does not guarantee the accuracy of the data contained herein. Thomson Gale accepts no payment for listing; and inclusion in the publication of any organization, agency, institution, publication, service, or individual does not imply endorsement of the editors or publisher. Errors brought to the attention of the publisher and verified to the satisfaction of the publisher will be corrected in future editions.

LIBRARY OF CONGRESS CATALOGING-IN-PUBLICATION DATA

New dictionary of the history of ideas / edited by Maryanne Cline Horowitz.

p. cm.

Includes bibliographical references and index.

ISBN 0-684-31377-4 (set hardcover : alk. paper) — ISBN 0-684-31378-2 (v. 1) — ISBN 0-684-31379-0 (v. 2) — ISBN 0-684-31380-4 (v. 3) — ISBN 0-684-31381-2 (v. 4) — ISBN 0-684-31382-0 (v. 5) — ISBN 0-684-31383-9 (v. 6) — ISBN 0-684-31452-5 (e-book)

1. Civilization—History—Dictionaries. 2. Intellectual life—History—Dictionaries.

I. Horowitz, Maryanne Cline, 1945–

CB9.N49 2005
903—dc22

2004014731

This title is also available as an e-book.

ISBN 0-684-31452-5

Contact your Thomson Gale sales representative for ordering information.

Printed in the United States of America

10 9 8 7 6 5 4 3 2 1

CONTENTS

Volume 1

List of Articles

Preface

Historiography

Reader's Guide

NEW DICTIONARY OF THE HISTORY OF IDEAS

Abolitionism–Common Sense

Volume 2

Reader's Guide

Communication of Ideas–Futurology

Volume 3

Reader's Guide

Game Theory–Lysenkoism

Volume 4

Reader's Guide

Machiavellism–Phrenology

Volume 5

Reader's Guide

Physics–Syncretism

Volume 6

Reader's Guide

Taste–Zionism

List of Contributors

Index

EDITORIAL AND PRODUCTION STAFF

Project Editors

Mark LaFlaur, Scot Peacock, Jennifer Wisinski

Editorial Support

Kelly Baiseley, Andrew Claps, Alja Collar, Mark Drouillard,
Kenneth Mondschein, Sarah Turner, Ken Wachsberger,
Rachel Widawsky, Christopher Verdesi

Art Editor

Scot Peacock

Chief Manuscript Editor

Georgia S. Maas

Manuscript Editors

Jonathan G. Aretakis, John Barclay, Sylvia Cannizzaro,
Melissa A. Dobson, Ted Gilley, Gretchen Gordon,
Ellen Hawley, Archibald Hobson, Elizabeth B. Inserra,
Jean Fortune Kaplan, Christine Kelley, John Krol,
Julia Penelope, Richard Rothschild, David E. Salamie,
Linda Sanders, Alan Thwaites, Jane Marie Todd

Proofreaders

Beth Phaner, Carol Holmes, Melodie Monahan,
Laura Specht Patchkofsky, Hilary White

Cartographer

XNR Productions, Madison, Wisconsin

Caption Writer

Shannon Kelly

Indexer

Cynthia Crippen, AEIOU, Inc.

Design

Jennifer Wahj

Imaging

Dean Dauphinais, Lezlie Light, Mary Grimes

Permissions

Margaret Abendroth, Peggie Ashlevitz, Lori Hines

Composer

GGG Information Services, York, Pennsylvania

Manager, Composition

Mary Beth Trimper

Assistant Manager, Composition

Evi Seoud

Manufacturing

Wendy Blurton

Senior Development Editor

Nathalie Duval

Editorial Director

John Fitzpatrick

Publisher

Frank Menchaca

READER'S GUIDE

This Reader's Guide was compiled by the editors to provide a systematic outline of the contents of the New Dictionary of the History of Ideas, thereby offering teachers, scholars, and the general reader a way to organize their reading according to their preferences. The Reader's Guide is divided into four sections: Communication of Ideas, Geographical Areas, Chronological Periods, and Liberal Arts Disciplines and Professions, as indicated in the outline below.

COMMUNICATION OF IDEAS

Introduction to History of Communication of Ideas

Communication Media

GEOGRAPHICAL AREAS

Global Entries

Africa

Asia

Europe

Middle East

North America

Latin and South America

CHRONOLOGICAL PERIODS

Ancient

Dynastic (400 C.E.–1400 C.E.)

Early Modern (1400–1800 C.E.)

Modern (1800–1945)

Contemporary

LIBERAL ARTS DISCIPLINES AND PROFESSIONS

Fine Arts

Humanities

Social Sciences

Sciences

Professions

Multidisciplinary Practices

Especially Interdisciplinary Entries

COMMUNICATION OF IDEAS

This category is the newest aspect of the *New Dictionary of the History of Ideas*; cultural studies, communications studies, and cultural history are moving the disciplines in this direction.

Introduction to History of Communication of Ideas

The following entries focus on the media humans have used to communicate with one another.

Absolute Music
Aesthetics: Asia
Architecture: Overview
Architecture: Asia
Arts: Overview
Astronomy, Pre-Columbian and Latin American
Bilingualism and Multilingualism
Borders, Borderlands, and Frontiers, Global
Calendar
Cinema
City, The: The City as a Cultural Center
City, The: The City as Political Center
Communication of Ideas: Africa and Its Influence
Communication of Ideas: Asia and Its Influence
Communication of Ideas: Europe and Its Influence
Communication of Ideas: Middle East and Abroad
Communication of Ideas: Orality and Advent of Writing
Communication of Ideas: Southeast Asia
Communication of Ideas: The Americas and Their Influence
Consumerism
Cultural Revivals
Cultural Studies
Dance
Diffusion, Cultural
Dress
Dualism
Education: Asia, Traditional and Modern
Education: Global Education
Emotions
Experiment
Garden
Gesture
Humor
Iconography
Images, Icons, and Idols
Japanese Philosophy, Japanese Thought
Language and Linguistics
Language, Linguistics, and Literacy
Learning and Memory, Contemporary Views
Mathematics
Media, History of
Metaphor
Migration: United States
Modernity: Africa
Museums
Music, Anthropology of

READER'S GUIDE

Musical Performance and Audiences
Oral Traditions: Overview
Oral Traditions: Telling, Sharing
Political Protest, U.S.
Practices
Protest, Political
Reading
Realism: Africa
Reflexivity
Relativism
Representation: Mental Representation
Resistance
Resistance and Accommodation
Rhetoric: Overview
Rhetoric: Ancient and Medieval
Ritual: Public Ritual
Ritual: Religion
Sacred Places
Text/Textuality
Textiles and Fiber Arts as Catalysts for Ideas
Theater and Performance
Third Cinema
Totems
Tradition
Translation
Virtual Reality
Visual Culture
Visual Order to Organizing Collections

Communication Media

This is a listing of the types of historical evidence the author used in writing the entry. While entries in the original Dictionary of the History of Ideas were to a great extent the history of texts, the entries in the New Dictionary of the History of Ideas are generally the cultural history of ideas, making use of the records of oral communication, visual communication, and communication through practices, as well as the history of texts, in order to show the impact of the idea on a wide variety of people.

ORAL

The selective list below contains the entries that give the most coverage to historical examples of the oral transmission and transformation of ideas.

Civil Disobedience
Civil Society: Europe and the United States
Communication of Ideas: Orality and Advent of Writing
Cosmopolitanism
Cultural Capital
Determinism
Dialogue and Dialectics: Socratic
Dialogue and Dialectics: Talmudic
Dream
Emotions
Empire and Imperialism: Europe
Equality: Overview
Etiquette
Fascism
Harmony
Magic
Masks
Media, History of
Millenarianism: Latin America and Native North America

Music, Anthropology of
Musical Performance and Audiences
Musicology
Nomadism
Oral Traditions: Overview
Oral Traditions: Telling, Sharing
Populism: United States
Psychoanalysis
Public Sphere
Republicanism: Republic
Rhetoric: Overview
Ritual: Public Ritual
Ritual: Religion
Slavery
Theater and Performance
Tragedy and Comedy
Trope
Wisdom, Human
COMMUNICATION THROUGH HIGH TECHNOLOGY MEDIA (radio, television, film, computer, etc.)
Absolute Music
Africa, Idea of
Alienation
Americanization, U.S.
Anticolonialism: Africa
Anti-Semitism: Islamic Anti-Semitism
Architecture: Overview
Avant-Garde: Overview
Bilingualism and Multilingualism
Bioethics
Calculation and Computation
Capitalism: Overview
Capitalism: Africa
Censorship
Chicano Movement
Cinema
City, The: The City as a Cultural Center
City, The: The City as Political Center
Colonialism: Southeast Asia
Communication of Ideas: Africa and Its Influence
Communication of Ideas: Asia and Its Influence
Communication of Ideas: Europe and Its Influence
Communication of Ideas: Middle East and Abroad
Communication of Ideas: Orality and Advent of Writing
Communication of Ideas: Southeast Asia
Communism: Latin America
Composition, Musical
Computer Science
Consciousness: Overview
Consumerism
Cosmopolitanism
Creativity in the Arts and Sciences
Critical Theory
Cultural Studies
Death
Demography
Development
Dream
Dress
Dystopia
Empire and Imperialism: United States
Environmental History
Expressionism
Fascism
Fetishism: Fetishism in Literature and Cultural Studies

Field Theories
 Futurology
 Game Theory
 Gay Studies
 Gender: Gender in the Middle East
 Gender in Art
 Genetics: Contemporary
 Genetics: History of
 Genocide
 Genre
 Geography
 Globalization: General
 Harmony
 Hinduism
 History, Economic
 Human Capital
 Iconography
 Intelligentsia
 Jihad
 Jouissance
 Judaism: Modern Judaism
 Language and Linguistics
 Law
 Learning and Memory, Contemporary Views
 Life
 Life Cycle: Elders/Old Age
 Literary Criticism
 Literature: Overview
 Literature: African Literature
 Loyalties, Dual
 Lysenkoism
 Maps and the Ideas They Express
 Masks
 Mathematics
 Media, History of
 Medicine: Europe and the United States
 Medicine: Islamic Medicine
 Meme
 Memory
 Modernism: Overview
 Modernism: Latin America
 Modernity: East Asia
 Motherhood and Maternity
 Motif: Motif in Music
 Music, Anthropology of
 Musical Performance and Audiences
 Musicology
 Nuclear Age
 Occidentalism
 Pan-Arabism
 Parties, Political
 Physics
 Political Protest, U.S.
 Political Science
 Postmodernism
 Power
 Presentism
 Privacy
 Probability
 Progress, Idea of
 Propaganda
 Property
 Protest, Political
 Public Sphere
 Quantum

Reading
 Reform: Europe and the United States
 Reform: Islamic Reform
 Relativity
 Representation: Mental Representation
 Resistance
 Rhetoric: Overview
 Science Fiction
 Sexuality: Overview
 Social History, U.S.
 Society
 State, The: Overview
 Symbolism
 Taste
 Technology
 Third Cinema
 Third World
 Totalitarianism
 Victorianism
 Virtual Reality
 Visual Culture
 War and Peace in the Arts
 Westernization: Africa
 Westernization: Middle East
 Women and Femininity in U.S. Popular Culture
 Work
 World Systems Theory, Latin America

VISUAL

Each of the following entries in the *NDHI* either evocatively describes ideas, includes a visual image of an idea, or provides historical examples of societies visually transmitting and transforming ideas.

Abolitionism
 Aesthetics: Africa
 Aesthetics: Asia
 Aesthetics: Europe and the Americas
 Alienation
 Altruism
 Ambiguity
 Americanization, U.S.
 Ancestor Worship
 Animism
 Anti-Semitism: Overview
 Apartheid
 Architecture: Overview
 Architecture: Africa
 Architecture: Asia
 Arts: Overview
 Arts: Africa
 Asceticism: Hindu and Buddhist Asceticism
 Asceticism: Western Asceticism
 Asian-American Ideas (Cultural Migration)
 Assimilation
 Astrology: Overview
 Astronomy, Pre-Columbian and Latin American
 Authoritarianism: Latin America
 Autobiography
 Avant-Garde: Militancy
 Aztlán
 Barbarism and Civilization
 Beauty and Ugliness
 Behaviorism

READER'S GUIDE

- Bioethics
 Black Atlantic
 Black Consciousness
 Body, The
 Bushido
 Calculation and Computation
 Calendar
 Cannibalism
 Capitalism: Overview
 Capitalism: Africa
 Causation
 Censorship
 Change
 Chemistry
 Childhood and Child Rearing
 Cinema
 City, The: Latin America
 City, The: The City as a Cultural Center
 City, The: The City as Political Center
 City, The: The Islamic and Byzantine City
 Civil Disobedience
 Classicism
 Classification of Arts and Sciences, Early Modern
 Colonialism: Southeast Asia
 Common Sense
 Communication of Ideas: The Americas and Their Influence
 Communication of Ideas: Asia and Its Influence
 Communication of Ideas: Europe and Its Influence
 Communication of Ideas: Orality and Advent of Writing
 Communication of Ideas: Southeast Asia
 Composition, Musical
 Computer Science
 Consciousness: Overview
 Consumerism
 Continental Philosophy
 Cosmology: Asia
 Cosmopolitanism
 Creativity in the Arts and Sciences
 Critical Race Theory
 Critical Theory
 Cultural Capital
 Cultural History
 Cultural Revivals
 Cultural Studies
 Cycles
 Cynicism
 Dada
 Dance
 Death
 Death and Afterlife, Islamic Understanding of
 Demography
 Demonology
 Determinism
 Development
 Diasporas: African Diaspora
 Diasporas: Jewish Diaspora
 Dictatorship in Latin America
 Discrimination
 Diversity
 Dream
 Dress
 Dystopia
 Ecology
 Education: Europe
 Education: Islamic Education
 Emotions
 Empire and Imperialism: Europe
 Empire and Imperialism: United States
 Empiricism
 Encyclopedism
 Enlightenment
 Environment
 Environmental History
 Epistemology: Ancient
 Epistemology: Early Modern
 Equality: Overview
 Equality: Racial Equality
 Essentialism
 Ethnicity and Race: Anthropology
 Ethnicity and Race: Islamic Views
 Ethnocentrism
 Etiquette
 Eugenics
 Europe, Idea of
 Everyday Life
 Evil
 Expressionism
 Extirpation
 Family Planning
 Fascism
 Fatalism
 Feminism: Overview
 Feminism: Chicana Feminisms
 Feminism: Third World U.S. Movement
 Fetishism: Overview
 Fetishism: Fetishism in Literature and Cultural Studies
 Feudalism, European
 Field Theories
 Form, Metaphysical, in Ancient and Medieval Thought
 Foundationalism
 Friendship
 Futurology
 Game Theory
 Garden
 Gender: Overview
 Gender: Gender in the Middle East
 Gender in Art
 Genetics: Contemporary
 Genetics: History of
 Genius
 Genocide
 Geography
 Geometry
 Gesture
 Ghetto
 Globalization: Asia
 Globalization: General
 Greek Science
 Harmony
 Hate
 Health and Disease
 Heaven and Hell
 Heaven and Hell (Asian Focus)
 Hedonism in European Thought
 Heresy and Apostasy
 Hinduism
 History, Economic
 History, Idea of

- Honor
 Honor, Middle Eastern Notions of
 Humanism: Chinese Conception of
 Humanity: African Thought
 Humanity: European Thought
 Humanity in the Arts
 Humor
 Hygiene
 Iconography
 Idealism
 Ideas, History of
 Identity: Identity of Persons
 Identity, Multiple: Overview
 Identity, Multiple: Jewish Multiple Identity
 Images, Icons, and Idols
 Imagination
 Impressionism
 Intentionality
 Interdisciplinarity
 Islam: Shii
 Islamic Science
 Jainism
 Jihad
 Jouissance
 Knowledge
 Landscape in the Arts
 Language, Linguistics, and Literacy
 Law, Islamic
 Leadership
 Learning and Memory, Contemporary Views
 Liberty
 Life Cycle: Overview
 Life Cycle: Elders/Old Age
 Literary History
 Love, Western Notions of
 Machismo
 Magic
 Maps and the Ideas They Express
 Masks
 Mathematics
 Matriarchy
 Mechanical Philosophy
 Media, History of
 Medicine: Europe and the United States
 Medicine: Islamic Medicine
 Memory
 Men and Masculinity
 Mestizaje
 Metaphor
 Microcosm and Macrocosm
 Migration: United States
 Millenarianism: Islamic
 Millenarianism: Latin America and Native North
 America
 Minority
 Miracles
 Modernism: Overview
 Modernism: Latin America
 Modernity: Overview
 Modernity: Africa
 Monarchy: Overview
 Monasticism
 Motherhood and Maternity
 Motif: Motif in Music
 Museums
 Musical Performance and Audiences
 Musicology
 Mysticism: Chinese Mysticism
 Mysticism: Christian Mysticism
 Myth
 Nation
 Nationalism: Overview
 Natural History
 Naturalism
 Naturalism in Art and Literature
 Naturphilosophie
 Negritude
 Newtonianism
 Nomadism
 Nuclear Age
 Nude, The
 Occidentalism
 Organicism
 Orthodoxy
 Pacifism
 Pan-Asianism
 Paradigm
 Paradise on Earth
 Periodization of the Arts
 Person, Idea of the
 Perspective
 Philosophies: American
 Philosophies: Feminist, Twentieth-Century
 Philosophy: Relations to Other Intellectual Realms
 Phrenology
 Physics
 Political Protest, U.S.
 Population
 Postmodernism
 Practices
 Pre-Columbian Civilization
 Prejudice
 Privacy
 Property
 Protest, Political
 Psychoanalysis
 Public Sphere
 Pythagoreanism
 Queer Theory
 Race and Racism: United States
 Reading
 Realism
 Relativism
 Religion: Indigenous Peoples' View, South America
 Religion and Science
 Religion and the State: Latin America
 Renaissance
 Representation: Mental Representation
 Representation: Political Representation
 Republicanism: Republic
 Resistance
 Resistance and Accommodation
 Responsibility
 Ritual: Public Ritual
 Ritual: Religion
 Romanticism in Literature and Politics
 Sacred and Profane
 Sacred Places
 Science, History of
 Science Fiction

READER'S GUIDE

Scientific Revolution
Sexuality: Overview
Sexuality: Sexual Orientation
Shinto
Slavery
Social History, U.S.
Sophists, The
Sport
Subjectivism
Superstition
Surrealism
Symbolism
Syncretism
Taste
Terror
Text/Textuality
Theater and Performance
Theodicy
Third Cinema
Third World Literature
Toleration
Totalitarianism
Totems
Trade
Tragedy and Comedy
Treaty
Untouchability: Menstrual Taboos
Utilitarianism
Utopia
Victorianism
Virtual Reality
Visual Culture
Visual Order to Organizing Collections
Volunteerism, U.S.
War
War and Peace in the Arts
Westernization: Southeast Asia
Witchcraft
Witchcraft, African Studies of
Women and Femininity in U.S. Popular Culture
Women's History: Africa
World Systems Theory, Latin America
Yin and Yang

PRACTICES

Most of the entries in the *NDHI* discuss how specific societies habituated people to specific ideas. This selective list includes the entries on schools of thought and practice, religions, and political movements, as well as the entries on distinctive practices.

Abolitionism
Afropessimism
Agnosticism
Alchemy: China
Alchemy: Europe and the Middle East
Anarchism
Ancestor Worship
Animism
Anticolonialism: Africa
Anticolonialism: Latin America
Anticolonialism: Middle East
Anticolonialism: Southeast Asia
Anticommunism: Latin America
Antifeminism

Anti-Semitism: Overview
Anti-Semitism: Islamic Anti-Semitism
Apartheid
Aristotelianism
Asceticism: Hindu and Buddhist Asceticism
Asceticism: Western Asceticism
Astrology: Overview
Astrology: China
Atheism
Avant-Garde: Militancy
Behaviorism
Black Consciousness
Buddhism
Bureaucracy
Bushido
Cannibalism
Capitalism: Overview
Capitalism: Africa
Cartesianism
Character
Chicano Movement
Chinese Thought
Christianity: Overview
Christianity: Asia
Cinema
Citizenship: Naturalization
Civil Disobedience
Classicism
Classification of Arts and Sciences, Early Modern
Colonialism: Africa
Colonialism: Latin America
Colonialism: Southeast Asia
Communication of Ideas: Orality and Advent of Writing
Communism: Europe
Communism: Latin America
Communitarianism in African Thought
Computer Science
Confucianism
Conservatism
Constitutionalism
Cosmopolitanism
Creationism
Critical Theory
Cultural Capital
Cultural Studies
Cynicism
Dance
Daoism
Deism
Dialogue and Dialectics: Socratic
Dialogue and Dialectics: Talmudic
Discrimination
Diversity
Eclecticism
Ecumenism
Empire and Imperialism: Overview
Empire and Imperialism: Americas
Empire and Imperialism: Asia
Empire and Imperialism: Europe
Empire and Imperialism: Middle East
Empire and Imperialism: United States
Empiricism
Epicureanism
Equality: Overview
Etiquette

- Eugenics
 Everyday Life
 Existentialism
 Extirpation
 Fascism
 Fatalism
 Feminism: Overview
 Feminism: Africa and African Diaspora
 Feminism: Chicana Feminisms
 Feminism: Islamic Feminism
 Feminism: Third World U.S. Movement
 Fetishism: Overview
 Feudalism, European
 Game Theory
 Genocide
 Ghetto
 Gift, The
 Gnosticism
 Health and Disease
 Hegelianism
 Hinduism
 Humanism: Renaissance
 Humanism: Secular Humanism in the United States
 Human Rights: Overview
 Human Rights: Women's Rights
 Interpretation
 Islam: Africa
 Islam: Shii
 Islam: Southeast Asia
 Islam: Sunni
 Jainism
 Japanese Philosophy, Japanese Thought
 Jihad
 Judaism: Judaism to 1800
 Judaism: Modern Judaism
 Kantianism
 Law
 Leadership
 Legalism, Ancient China
 Liberalism
 Liberation Theology
 Machiavellism
 Magic
 Manichaeism
 Maoism
 Marxism: Overview
 Marxism: Asia
 Marxism: Latin America
 Masks
 Mechanical Philosophy
 Medicine: China
 Medicine: Europe and the United States
 Medicine: India
 Medicine: Islamic Medicine
 Migration: Migration in World History
 Monarchy: Overview
 Monasticism
 Multiculturalism, Africa
 Museums
 Music, Anthropology of
 Musical Performance and Audiences
 Musicology
 Myth
 Nationalism: Overview
 Nationalism: Africa
 Nationalism: Cultural Nationalism
 Nationalism: Middle East
 Neoplatonism
 Nihilism
 Nomadism
 Nonviolence
 Orthodoxy
 Orthopraxy: Asia
 Orthopraxy: Western Orthopraxy
 Pacifism
 Pan-Africanism
 Pan-Arabism
 Pan-Asianism
 Pan-Islamism
 Pan-Turkism
 Paradigm
 Phrenology
 Physics
 Platonism
 Political Protest, U.S.
 Polytheism
 Population
 Populism: Latin America
 Positivism
 Practices
 Pragmatism
 Pseudoscience
 Psychoanalysis
 Psychology and Psychiatry
 Public Sphere
 Punishment
 Race and Racism: Asia
 Race and Racism: Europe
 Race and Racism: United States
 Radicals/Radicalism
 Rational Choice
 Reading
 Realism: Africa
 Reflexivity
 Reform: Europe and the United States
 Relativism
 Religion: Overview
 Religion: Africa
 Religion: African Diaspora
 Religion: East and Southeast Asia
 Religion: Indigenous Peoples' View, South America
 Religion: Latin America
 Religion: Middle East
 Republicanism: Latin America
 Republicanism: Republic
 Resistance
 Resistance and Accommodation
 Responsibility
 Revolution
 Ritual: Public Ritual
 Ritual: Religion
 Romanticism in Literature and Politics
 Sacred and Profane
 Scholasticism
 Science: Overview
 Scientific Revolution
 Secularization and Secularism
 Segregation
 Skepticism
 Slavery

READER'S GUIDE

Socialism
Socialisms, African
Sophists, The
Sport
Stoicism
Subjectivism
Suicide
Superstition
Symbolism
Syncretism
Temperance
Terror
Theater and Performance
Time: Traditional and Utilitarian
Totalitarianism
Totems
Trade
Tradition
Tragedy and Comedy
Tribalism, Middle East
Untouchability: Overview
Untouchability: Menstrual Taboos
Untouchability: Taboos
Utilitarianism
Visual Order to Organizing Collections
Volunteerism, U.S.
Westernization: Africa
Westernization: Middle East
Westernization: Southeast Asia
Witchcraft
Witchcraft, African Studies of
Work
Yoga
Zionism

TEXTUAL

Every entry in the *New Dictionary of the History of Ideas* used texts. The following is a list of entries that focused mainly on the history of a succession of texts. Each academic discipline has a succession of major authors with whom later practitioners of the discipline build upon and respond to creatively. The historian of a discipline—such as the history of political philosophy, literary history, or the history of science—considers the responses of thinkers and practitioners of a discipline to the major earlier texts in the discipline. In tracing the origin, development, and transformation of an idea, the historian of ideas considers thinkers' responses to texts from a variety of disciplines.

Agnosticism
Alchemy: Europe and the Middle East
Algebras
Altruism
America
Analytical Philosophy
Aristotelianism
Asceticism: Hindu and Buddhist Asceticism
Autobiography
Autonomy
Biography
Bureaucracy
Capitalism: Overview
Cartesianism
Casuistry

Causality
Censorship
Change
Chinese Thought
Civil Disobedience
Class
Communitarianism in African Thought
Conservatism
Continental Philosophy
Cosmology: Cosmology and Astronomy
Creolization, Caribbean
Crisis
Cycles
Death and Afterlife, Islamic Understanding of
Deism
Dialogue and Dialectics: Socratic
Dialogue and Dialectics: Talmudic
Eclecticism
Encyclopedism
Epistemology: Ancient
Epistemology: Early Modern
Equality: Gender Equality
Eschatology
Essentialism
Existentialism
Experiment
Falsifiability
Fatalism
Fetishism: Fetishism in Literature and Cultural Studies
Form, Metaphysical, in Ancient and Medieval Thought
Free Will, Determinism, and Predestination
General Will
Generation
Genius
Genre
Geometry
Gift, The
Globalization: Asia
Gnosticism
Good
Greek Science
Happiness and Pleasure in European Thought
Heaven and Hell
Hegelianism
Hermeneutics
Hierarchy and Order
Hinduism
Historical and Dialectical Materialism
Historicism
Historiography
History, Idea of
Humanism: Africa
Humanism: Chinese Conception of
Humanism: Renaissance
Humanity: Asian Thought
Human Rights: Overview
Idealism
Ideas, History of
Identity, Multiple: Overview
Identity: Identity of Persons
Imagination
Immortality and the Afterlife
Individualism
Intelligentsia
Jouissance

Judaism: Judaism to 1800
 Justice: Overview
 Justice: Justice in American Thought
 Justice: Justice in East Asian Thought
 Kantianism
 Knowledge
 Language, Philosophy of: Ancient and Medieval
 Language, Philosophy of: Modern
 Legalism, Ancient China
 Liberalism
 Liberty
 Literature: African Literature
 Materialism in Eighteenth-Century European Thought
 Mechanical Philosophy
 Medicine: China
 Metaphor
 Metaphysics: Ancient and Medieval
 Metaphysics: Renaissance to the Present
 Microcosm and Macrocosm
 Mind
 Modernity: East Asia
 Mohism
 Moral Sense
 Motif: Motif in Literature
 Mysticism: Chinese Mysticism
 Mysticism: Christian Mysticism
 Mysticism: Kabbalah
 Natural Law
 Natural Theology
 Naturalism
 Naturphilosophie
 Negritude
 Neocolonialism
 New Criticism
 Nihilism
 Organicism
 Orientalism: Overview
 Orthopraxy: Western Orthopraxy
 Paradigm
 Phenomenology
 Philosophies: African
 Philosophies: Islamic
 Philosophy: Historical Overview and Recent Developments
 Philosophy, History of
 Philosophy, Moral: Ancient
 Philosophy, Moral: Medieval and Renaissance
 Philosophy, Moral: Modern
 Philosophy and Religion in Western Thought
 Philosophy of Mind: Ancient and Medieval
 Philosophy of Religion
 Pietism
 Platonism
 Poetry and Poetics
 Political, The
 Postcolonial Theory and Literature
 Practices
 Pragmatism
 Prehistory, Rise of
 Progress, Idea of
 Psychoanalysis
 Queer Theory
 Race and Racism: Overview
 Rationalism
 Reading

Realism: Africa
 Reflexivity
 Relativity
 Religion: Overview
 Representation: Political Representation
 Republicanism: Republic
 Romanticism in Literature and Politics
 Sacred Texts: Asia
 Science: East Asia
 Science, History of
 Science Fiction
 Social Capital
 Social Contract
 State of Nature
 Stoicism
 Structuralism and Poststructuralism: Overview
 Structuralism and Poststructuralism: Anthropology
 Taste
 Text/Textuality
 Toleration
 Treaty
 Truth
 Universalism
 Utopia
 Virtue Ethics
 Wealth
 World Systems Theory, Latin America

GEOGRAPHICAL AREAS

Global Entries

EXEMPLARY GLOBAL ENTRIES

Anthropology
 Atheism
 Bilingualism and Multilingualism
 Black Atlantic
 Christianity: Overview
 Communication of Ideas: Orality and the Advent of Writing
 Constitutionalism
 Critical Theory
 Dance
 Environmental History
 Eurocentrism
 Feminism: Overview
 Fundamentalism
 Garden
 Historiography
 History, Economic
 Humanity in the Arts
 Identity, Multiple: Jewish Multiple Identity
 International Order
 Islam: Shii
 Islam: Sunni
 Life Cycle: Elders/Old Age
 Magic
 Maps and the Ideas They Express
 Marxism: Overview
 Mathematics
 Migration: Africa
 Migration: Migration in World History
 Migration: United States
 Monasticism
 Music, Anthropology of

READER'S GUIDE

- Musical Performance and Audiences
Nuclear Age
Pan-Africanism
Peasants and Peasantry
Person, Idea of the
Polytheism
Postcolonial Theory and Literature
Property
Protest, Political
Religion and the State: Africa
Resistance and Accommodation
Ritual: Religion
Sacred Places
Secularization and Secularism
Slavery
Sovereignty
Superstition
Syncretism
Temperance
Third Cinema
Third World Literature
Tradition
Treaty
Witchcraft
Women's Studies
- ENTRIES ON AT LEAST THREE GEOGRAPHIC
AREAS OR A GLOBAL TOPIC
- Abolitionism
Aesthetics: Africa
Africa, Idea of
Alchemy: China
Alienation
Animism
Anthropology
Anticolonialism: Africa
Anticolonialism: Latin America
Anticolonialism: Southeast Asia
Antifeminism
Architecture: Overview
Arts: Overview
Arts: Africa
Asceticism: Hindu and Buddhist Asceticism
Astrology: Overview
Atheism
Authoritarianism: Overview
Authority
Autobiography
Barbarism and Civilization
Bilingualism and Multilingualism
Bioethics
Biography
Black Atlantic
Body, The
Borders, Borderlands, and Frontiers, Global
Buddhism
Calculation and Computation
Calendar
Cannibalism
Capitalism: Overview
Capitalism: Africa
Censorship
Childhood and Child Rearing
Cinema
Citizenship: Overview
City, The: The City as a Cultural Center
Civil Disobedience
Civil Society: Europe and the United States
Colonialism: Africa
Colonialism: Southeast Asia
Communication of Ideas: Africa and Its Influence
Communication of Ideas: Middle East and Abroad
Communication of Ideas: Orality and the Advent of
Writing
Computer Science
Consciousness: Overview
Corruption in Developed and Developing Countries
Cosmology: Asia
Cosmopolitanism
Creativity in the Arts and Sciences
Creolization, Caribbean
Critical Theory
Cultural Capital
Cultural Studies
Dance
Death
Deism
Democracy
Demography
Demonology
Dependency
Diasporas: African Diaspora
Diasporas: Jewish Diaspora
Discrimination
Diversity
Dream
Dress
Dualism
Ecology
Economics
Ecumenism
Education: Global Education
Education: Islamic Education
Empire and Imperialism: Overview
Empire and Imperialism: Asia
Empire and Imperialism: Europe
Empire and Imperialism: Middle East
Empire and Imperialism: United States
Environment
Equality: Overview
Equality: Gender Equality
Equality: Racial Equality
Ethnicity and Race: Anthropology
Ethnocentrism
Ethnography
Evil
Family: Family in Anthropology since 1980
Family Planning
Fascism
Feminism: Africa and African Diaspora
Feminism: Islamic Feminism
Feminism: Third World U.S. Movement
Fetishism: Overview
Friendship
Futurology
Gay Studies
Gender: Overview
Gender: Gender in the Middle East
Gender in Art
Gender Studies: Anthropology
Generation

- Genius
 Genocide
 Geography
 Ghetto
 Globalization: General
 Hate
 Heaven and Hell
 Honor
 Human Capital
 Humanism: Chinese Conception of
 Humanity: African Thought
 Human Rights: Overview
 Human Rights: Women's Rights
 Iconography
 Identity, Multiple: Overview
 Images, Icons, and Idols
 Immortality and the Afterlife
 Intelligentsia
 Islam: Africa
 Islamic Science
 Jihad
 Judaism: Modern Judaism
 Justice: Overview
 Kinship
 Landscape in the Arts
 Language, Linguistics, and Literacy
 Law
 Liberation Theology
 Liberty
 Life Cycle: Overview
 Life Cycle: Adolescence
 Literature: Overview
 Machiavellism
 Masks
 Matriarchy
 Media, History of
 Medicine: China
 Meditation: Eastern Meditation
 Men and Masculinity
 Millenarianism: Overview
 Millenarianism: Latin America and Native North America
 Minority
 Miracles
 Modernism: Overview
 Modernism: Latin America
 Modernity: Overview
 Modernity: Africa
 Modernization Theory
 Monarchy: Overview
 Motif: Motif in Music
 Museums
 Musicology
 Mysticism: Chinese Mysticism
 Myth
 Nation
 Nationalism: Overview
 Nationalism: Africa
 Native Policy
 Negritude
 Neocolonialism
 Nihilism
 Nomadism
 Nonviolence
 Occidentalism
 Oral Traditions: Overview
 Organicism
 Orientalism: Overview
 Orientalism: African and Black Orientalism
 Orthodoxy
 Orthopraxy: Asia
 Other, The, European Views of
 Pacifism
 Paradise on Earth
 Peace
 Periodization
 Periodization of the Arts
 Perspective
 Philosophies: African
 Philosophy: Historical Overview and Recent Developments
 Philosophy: Relations to Other Intellectual Realms
 Philosophy, Moral: Africa
 Political Science
 Population
 Postcolonial Studies
 Practices
 Prehistory, Rise of
 Prejudice
 Presentism
 Privatization
 Pseudoscience
 Race and Racism: Overview
 Reading
 Reflexivity
 Religion: Overview
 Religion: East and Southeast Asia
 Religion: Latin America
 Religion and the State: United States
 Representation: Political Representation
 Republicanism: Republic
 Rhetoric: Overview
 Ritual: Public Ritual
 Sacred and Profane
 Scarcity and Abundance, Latin America
 Science: Overview
 Segregation
 Sexuality: Overview
 Social Capital
 Society
 Sport
 State, The: Overview
 Structuralism and Poststructuralism: Anthropology
 Symbolism
 Third World
 Time: China
 Toleration
 Totalitarianism
 Totems
 Trade
 Translation
 Travel: Travel from Europe and the Middle East
 University: Overview
 University: Postcolonial
 Untouchability: Overview
 Untouchability: Menstrual Taboos
 Untouchability: Taboos
 Victorianism
 Visual Order to Organizing Collections
 War

READER'S GUIDE

War and Peace in the Arts
Westernization: Africa
Westernization: Southeast Asia
Wisdom, Human
Work
World Systems Theory, Latin America

Africa

ENTRIES FOCUSING ON AFRICA

Aesthetics: Africa
Anticolonialism: Africa
Architecture: Africa
Arts: Africa
Authenticity: Africa
Black Atlantic
Capitalism: Africa
Colonialism: Africa
Communication of Ideas: Africa and Its Influence
Communitarianism in African Thought
Democracy, Africa
Diasporas: African Diaspora
Ethnicity and Race: Africa
Feminism: Africa and African Diaspora
Globalization: Africa
Humanism: Africa
Humanity: African Thought
Islam: Africa
Literature: African Literature
Migration: Africa
Modernity: Africa
Multiculturalism, Africa
Mysticism: Mysticism in African Thought
Nationalism: Africa
Pan-Africanism
Personhood in African Thought
Philosophies: African
Philosophy, Moral: Africa
Realism: Africa
Religion: Africa
Religion: African Diaspora
Religion and the State: Africa
Sociability in African Thought
Socialisms, African
Sufism
Westernization: Africa
Women's History: Africa
Witchcraft, African Studies of

ENTRIES THAT CONSIDER AFRICA

Abolitionism
Africa, Idea of
African-American Ideas
Afrocentricity
Afropessimism
Ancestor Worship
Anthropology
Apartheid
Arts: Overview
Bilingualism and Multilingualism
Black Consciousness
Buddhism
Christianity: Overview
Civil Disobedience
Civil Society: Responses in Africa and the Middle East
Communication of Ideas: Orality and Advent of Writing

Creolization, Caribbean
Critical Theory
Dance
Demography
Dependency
Diasporas: Jewish Diaspora
Discrimination
Dress
Ecology
Empire and Imperialism: Europe
Empire and Imperialism: Middle East
Environmental History
Equality: Racial Equality
Ethnography
Eurocentrism
Family: Modernist Anthropological Theory
Fascism
Feminism: Overview
Feminism: Islamic Feminism
Fetishism: Overview
Genocide
Globalization: General
Historiography
History, Economic
Humanity in the Arts
Identity, Multiple: Jewish Multiple Identity
International Order
Islam: Shii
Islam: Sunni
Jainism
Kinship
Law
Liberation Theology
Life Cycle: Elders/Old Age
Machiavellism
Magic
Maps and the Ideas They Express
Masks
Mathematics
Men and Masculinity
Migration: Migration in World History
Migration: United States
Minority
Modernism: Overview
Motherhood and Maternity
Museums
Music, Anthropology of
Negritude
Neocolonialism
Nomadism
Oral Traditions: Overview
Orientalism: African and Black Orientalism
Pacifism
Peasants and Peasantry
Person, Idea of the
Philosophies: Islamic
Polytheism
Postcolonial Studies
Postcolonial Theory and Literature
Property
Protest, Political
Race and Racism: Overview
Religion: Latin America
Religion and the State: United States
Resistance and Accommodation

Ritual: Religion
 Sacred and Profane
 Sage Philosophy
 Segregation
 Slavery
 State, The: The Postcolonial State
 Syncretism
 Temperance
 Third Cinema
 Third World
 Third World Literature
 Time: Traditional and Utilitarian
 Toleration
 Totems
 Treaty
 Tribalism, Middle East
 University: Postcolonial
 Untouchability: Menstrual Taboos
 Victorianism
 War
 Wisdom, Human
 Witchcraft
 Womanism
 Women's Studies
 Work
 World Systems Theory, Latin America

Asia

ENTRIES FOCUSING ON ASIA

Aesthetics: Asia
 Alchemy: China
 Anticolonialism: Southeast Asia
 Architecture: Asia
 Authoritarianism: East Asia
 Buddhism
 Causation in East Asian and Southeast Asian Philosophy
 Chinese Thought
 Chinese Warlordism
 Christianity: Asia
 Colonialism: Southeast Asia
 Communication of Ideas: Asia and Its Influence
 Communication of Ideas: Southeast Asia and Its Influence
 Confucianism
 Consciousness: Chinese Thought
 Consciousness: Indian Thought
 Cosmology: Asia
 Daoism
 Education: Asia, Traditional and Modern
 Education: China
 Education: India
 Education: Japan
 Empire and Imperialism: Asia
 Examination Systems, China
 Globalization: Asia
 Heaven and Hell (Asian Focus)
 Hinduism
 Humanism: Chinese Conception of
 Humanity: Asian Thought
 Islam: Southeast Asia
 Jainism
 Japanese Philosophy, Japanese Thought
 Justice: Justice in East Asian Thought
 Landscape in the Arts

Legalism, Ancient China
 Literature: Overview
 Maoism
 Marxism: Asia
 Medicine: China
 Medicine: India
 Meditation: Eastern Meditation
 Modernity: East Asia
 Mysticism: Chinese Mysticism
 Mysticism: Islamic Mysticism in Asia
 Orthopraxy: Asia
 Pan-Asianism
 Pan-Turkism
 Philosophy: Historical Overview and Recent Developments
 Race and Racism: Asia
 Religion: East and Southeast Asia
 Sacred Texts: Asia
 Science: East Asia
 Time: China
 Time: India
 Westernization: Southeast Asia
 Women's History: Asia

ENTRIES THAT CONSIDER ASIA

Algebras
 Ancestor Worship
 Anthropology
 Anticolonialism: Africa
 Architecture: Overview
 Arts: Overview
 Asceticism: Hindu and Buddhist Asceticism
 Asian-American Ideas (Cultural Migration)
 Astrology: China
 Astronomy, Pre-Columbian and Latin American
 Atheism
 Autobiography
 Barbarism and Civilization
 Beauty and Ugliness
 Bilingualism and Multilingualism
 Biography
 Body, The
 Borders, Borderlands, and Frontiers, Global
 Bushido
 Calculation and Computation
 Cannibalism
 Censorship
 Childhood and Child Rearing
 Christianity: Overview
 Cinema
 Civil Disobedience
 Civil Society: Responses in Africa and the Middle East
 Communication of Ideas: Middle East and Abroad
 Communication of Ideas: Orality and the Advent of Writing
 Constitutionalism
 Cosmopolitanism
 Creativity in the Arts and Sciences
 Critical Theory
 Cultural Revivals
 Cycles
 Dance
 Deism
 Demography
 Demonology
 Dependency

READER'S GUIDE

Diasporas: African Diaspora
Diffusion, Cultural
Dream
Dress
Dualism
Ecumenism
Education: Global Education
Education: Islamic Education
Empire and Imperialism: Europe
Empire and Imperialism: Middle East
Empire and Imperialism: United States
Environment
Environmental History
Ethnography
Eurocentrism
Evil
Family: Family in Anthropology since 1980
Family Planning
Fascism
Feminism: Overview
Field Theories
Friendship
Fundamentalism
Garden
Gay Studies
Gender Studies: Anthropology
Generation
Genetics: Contemporary
Genocide
Globalization: General
Health and Disease
Heaven and Hell
Historiography
History, Economic
Human Capital
Humanity in the Arts
Hygiene
Iconography
Identity, Multiple: Asian-Americans
Identity, Multiple: Jewish Multiple Identity
Images, Icons, and Idols
Imagination
Immortality and the Afterlife
Individualism
Intelligentsia
International Order
Islam: Shii
Islam: Sunni
Islamic Science
Kinship
Language, Linguistics, and Literacy
Liberty
Life Cycle: Overview
Life Cycle: Adolescence
Life Cycle: Elders/Old Age
Machiavellism
Magic
Maps and the Ideas They Express
Marxism: Overview
Masks
Mathematics
Matriarchy
Migration: Migration in World History
Migration: United States
Miracles
Modernism: Latin America
Modernity: Africa
Modernization Theory
Mohism
Monarchy: Overview
Monasticism
Monism
Motherhood and Maternity
Motif: Motif in Music
Museums
Musical Performance and Audiences
Musicology
Nation
Neoliberalism
Nomadism
Nonviolence
Nuclear Age
Nude, The
Occidentalism
Organicism
Orientalism: Overview
Orthodoxy
Pacifism
Paradise on Earth
Peace
Peasants and Peasantry
Periodization
Person, Idea of the
Perspective
Philosophy: Relations to Other Intellectual Realms
Political Science
Population
Postcolonial Studies
Postcolonial Theory and Literature
Practices
Prehistory, Rise of
Privacy
Property
Protest, Political
Race and Racism: United States
Reading
Religion: Overview
Religion and the State: United States
Resistance and Accommodation
Revolution
Rhetoric: Overview
Ritual: Public Ritual
Ritual: Religion
Sacred and Profane
Sacred Places
Secularization and Secularism
Sexual Harassment
Sexuality: Sexual Orientation
Shinto
Slavery
Society
Sovereignty
Sport
Suicide
Superstition
Syncretism
Taste
Temperance
Terror
Textiles and Fiber Arts as Catalysts for Ideas

Third Cinema
 Third World
 Third World Literature
 Toleration
 Totems
 Trade
 Translation
 Treaty
 University: Postcolonial
 Untouchability: Overview
 Untouchability: Menstrual Taboos
 Untouchability: Taboos
 Victorianism
 Virtue Ethics
 Visual Order to Organizing Collections
 War and Peace in the Arts
 Wisdom, Human
 Witchcraft
 Women's Studies
 Work
 World Systems Theory, Latin America
 Yin and Yang
 Yoga
 Zen

Europe

ENTRIES FOCUSING ON EUROPE

Architecture: Overview
 Capitalism: Overview
 Christianity: Overview
 Classification of Arts and Sciences, Early Modern
 Colonialism: Africa
 Colonialism: Latin America
 Colonialism: Southeast Asia
 Communication of Ideas: Europe and Its Influence
 Communism: Europe
 Consumerism
 Dada
 Democracy
 Dialogue and Dialectics: Socratic
 Dialogue and Dialectics: Talmudic
 Education: Europe
 Empire and Imperialism: Overview
 Empire and Imperialism: Europe
 Encyclopedism
 Enlightenment
 Epistemology: Ancient
 Epistemology: Early Modern
 Epistemology: Modern
 Eurocentrism
 Europe, Idea of
 Existentialism
 Expressionism
 Fascism
 Feudalism, European
 Greek Science
 Happiness and Pleasure in European Thought
 Hedonism in European Thought
 Historical and Dialectical Materialism
 Humanism: Europe and the Middle East
 Humanism: Renaissance
 Humanity: European Thought
 Judaism: Judaism to 1800
 Judaism: Modern Judaism
 Landscape in the Arts

Literature: Overview
 Love, Western Notions of
 Marxism: Overview
 Materialism in Eighteenth-Century European Thought
 Mechanical Philosophy
 Medicine: Europe and the United States
 Metaphysics: Ancient and Medieval
 Metaphysics: Renaissance to the Present
 Monarchy: Overview
 National History
 Orthopraxy: Western Orthopraxy
 Other, The, European Views of
 Pan-Turkism
 Philosophy: Historical Overview and Recent Developments
 Philosophy, Moral: Ancient
 Philosophy, Moral: Medieval and Renaissance
 Philosophy, Moral: Modern
 Philosophy and Religion in Western Thought
 Philosophy of Mind: Ancient and Medieval
 Pythagoreanism
 Race and Racism: Europe
 Regions and Regionalism, Eastern Europe
 Religion and the State: Europe
 Scientific Revolution
 Victorianism

ENTRIES THAT CONSIDER EUROPE

Abolitionism
 Absolute Music
 Aesthetics: Europe and the Americas
 Africa, Idea of
 Afrocentricity
 Agnosticism
 Alchemy: Europe and the Middle East
 Algebras
 Alienation
 Altruism
 Ambiguity
 America
 Americanization, U.S.
 Analytical Philosophy
 Anarchism
 Animism
 Anthropology
 Anticolonialism: Africa
 Anticolonialism: Latin America
 Anticolonialism: Middle East
 Anticolonialism: Southeast Asia
 Antifeminism
 Anti-Semitism: Overview
 Anti-Semitism: Islamic Anti-Semitism
 Apartheid
 Architecture: Africa
 Aristotelianism
 Arts: Overview
 Arts: Africa
 Asceticism: Western Asceticism
 Assimilation
 Astrology: Overview
 Atheism
 Authoritarianism: Overview
 Authority
 Autobiography
 Autonomy
 Avant-Garde: Overview

READER'S GUIDE

- Avant-Garde: Militancy
 Barbarism and Civilization
 Beauty and Ugliness
 Behaviorism
 Bilingualism and Multilingualism
 Biography
 Biology
 Black Atlantic
 Body, The
 Borders, Borderlands, and Frontiers, Global
 Buddhism
 Bureaucracy
 Calculation and Computation
 Calendar
 Cannibalism
 Cartesianism
 Casuistry
 Causality
 Causation
 Censorship
 Change
 Character
 Chemistry
 Childhood and Child Rearing
 Christianity: Asia
 Cinema
 Citizenship: Overview
 Citizenship: Naturalization
 City, The: The City as a Cultural Center
 City, The: The Islamic and Byzantine City
 Civil Disobedience
 Civil Society: Europe and the United States
 Civil Society: Responses in Africa and the Middle East
 Class
 Classicism
 Common Sense
 Communication of Ideas: Africa and Its Influence
 Communication of Ideas: Middle East and Abroad
 Communication of Ideas: Orality and the Advent of Writing
 Communication of Ideas: Southeast Asia
 Composition, Musical
 Computer Science
 Consciousness: Overview
 Conservatism
 Consilience
 Constitutionalism
 Continental Philosophy
 Corruption
 Cosmology: Cosmology and Astronomy
 Cosmopolitanism
 Creationism
 Creativity in the Arts and Sciences
 Creolization, Caribbean
 Crisis
 Critical Theory
 Cultural Capital
 Cultural History
 Cultural Revivals
 Cultural Studies
 Cycles
 Cynicism
 Dance
 Deism
 Demography
 Demonology
 Dependency
 Determinism
 Development
 Diasporas: African Diaspora
 Diasporas: Jewish Diaspora
 Diversity
 Dream
 Dress
 Dystopia
 Eclecticism
 Ecology
 Economics
 Ecumenism
 Education: Global Education
 Education: India
 Education: Islamic Education
 Emotions
 Empire and Imperialism: Asia
 Empire and Imperialism: Middle East
 Empire and Imperialism: United States
 Empiricism
 Environment
 Environmental Ethics
 Environmental History
 Epicureanism
 Equality: Overview
 Equality: Gender Equality
 Equality: Racial Equality
 Essentialism
 Ethnicity and Race: Africa
 Ethnicity and Race: Anthropology
 Ethnocentrism
 Etiquette
 Eugenics
 Everyday Life
 Evil
 Evolution
 Experiment
 Extirpation
 Fallacy, Logical
 Falsifiability
 Family: Modernist Anthropological Theory
 Family: Family in Anthropology since 1980
 Family Planning
 Fatalism
 Feminism: Overview
 Feminism: Africa and African Diaspora
 Feminism: Islamic Feminism
 Fetishism: Overview
 Fetishism: Fetishism in Literature and Cultural Studies
 Field Theories
 Form, Metaphysical, in Ancient and Medieval Thought
 Formalism
 Foundationalism
 Free Will, Determinism, and Predestination
 Friendship
 Fundamentalism
 Garden
 Gay Studies
 Gender: Gender in the Middle East
 Gender in Art
 Gender Studies: Anthropology
 General Will
 Generation

- Genetics: Contemporary
 Genetics: History of
 Genius
 Genocide
 Geography
 Geometry
 Gesture
 Ghetto
 Gift, The
 Globalization: Africa
 Globalization: Asia
 Globalization: General
 Good
 Harmony
 Hate
 Health and Disease
 Heaven and Hell
 Hegelianism
 Hegemony
 Heresy and Apostasy
 Hermeneutics
 Hierarchy and Order
 Hinduism
 Historicism
 Historiography
 History, Economic
 History, Idea of
 Honor
 Human Capital
 Humanity in the Arts
 Human Rights: Overview
 Humor
 Hygiene
 Iconography
 Idealism
 Ideas, History of
 Identity: Identity of Persons
 Identity, Multiple: Overview
 Identity, Multiple: Jewish Multiple Identity
 Images, Icons, and Idols
 Immortality and the Afterlife
 Impressionism
 Individualism
 Intelligentsia
 Intentionality
 Interdisciplinarity
 International Order
 Interpretation
 Islam: Africa
 Islam: Shii
 Islam: Sunni
 Islamic Science
 Jainism
 Jouissance
 Justice: Overview
 Kantianism
 Kinship
 Knowledge
 Language and Linguistics
 Language, Linguistics, and Literacy
 Language, Philosophy of: Ancient and Medieval
 Language, Philosophy of: Modern
 Law
 Leadership
 Learning and Memory, Contemporary Views
 Liberalism
 Liberation Theology
 Liberty
 Life
 Life Cycle: Overview
 Life Cycle: Elders/Old Age
 Linguistic Turn
 Literary Criticism
 Literary History
 Logic
 Logic and Philosophy of Mathematics, Modern
 Loyalties, Dual
 Lysenkoism
 Machiavellism
 Magic
 Manichaeism
 Maoism
 Maps and the Ideas They Express
 Masks
 Mathematics
 Matriarchy
 Media, History of
 Medicine: Islamic Medicine
 Meme
 Memory
 Men and Masculinity
 Metaphor
 Microcosm and Macrocosm
 Migration: Africa
 Migration: Migration in World History
 Migration: United States
 Millenarianism: Overview
 Millenarianism: Islamic
 Millenarianism: Latin America and Native North America
 Mind
 Miracles
 Modernism: Overview
 Modernism: Latin America
 Modernity: Overview
 Modernity: Africa
 Modernity: East Asia
 Modernization
 Modernization Theory
 Monasticism
 Monism
 Moral Sense
 Motherhood and Maternity
 Motif: Motif in Literature
 Motif: Motif in Music
 Museums
 Music, Anthropology of
 Musical Performance and Audiences
 Musicology
 Mysticism: Christian Mysticism
 Mysticism: Kabbalah
 Mysticism: Mysticism in African Thought
 Myth
 Narrative
 Nation
 Nationalism: Overview
 Nationalism: Africa
 Nationalism: Cultural Nationalism
 Nationalism: Middle East
 Native Policy

READER'S GUIDE

Natural History
 Natural Theology
 Naturalism
 Naturalism in Art and Literature
 Nature
 Naturphilosophie
 Negritude
 Neocolonialism
 Neoliberalism
 Neoplatonism
 New Criticism
 Newtonianism
 Nihilism
 Nonviolence
 Nuclear Age
 Nude, The
 Objectivity
 Obligation
 Occidentalism
 Organicism
 Orientalism: Overview
 Orthodoxy
 Pacifism
 Pan-Africanism
 Pan-Asianism
 Pan-Islamism
 Paradigm
 Paradise on Earth
 Parties, Political
 Patriotism
 Peace
 Peasants and Peasantry
 Periodization
 Periodization of the Arts
 Person, Idea of the
 Perspective
 Phenomenology
 Philosophies: African
 Philosophies: Feminist, Twentieth-Century
 Philosophies: Islamic
 Philosophy: Relations to Other Intellectual Realms
 Philosophy, History of
 Philosophy, Moral: Africa
 Philosophy of Mind: Overview
 Phrenology
 Physics
 Platonism
 Pluralism
 Poetry and Poetics
 Political, The
 Political Science
 Polytheism
 Population
 Positivism
 Postcolonial Studies
 Postcolonial Theory and Literature
 Postmodernism
 Poverty
 Power
 Practices
 Pragmatism
 Pre-Columbian Civilization
 Prehistory, Rise of
 Prejudice
 Presentism
 Privacy
 Probability
 Progress, Idea of
 Propaganda
 Property
 Prophecy
 Protest, Political
 Pseudoscience
 Psychology and Psychiatry
 Public Sphere
 Punishment
 Puritanism
 Quantum
 Queer Theory
 Radicals/Radicalism
 Rational Choice
 Rationalism
 Reading
 Realism
 Realism: Africa
 Reason, Practical and Theoretical
 Reform: Europe and the United States
 Reform: Islamic Reform
 Reformation
 Relativism
 Relativity
 Religion: Overview
 Religion: East and Southeast Asia
 Religion: Latin America
 Religion: Middle East
 Religion and Science
 Religion and the State: Latin America
 Religion and the State: United States
 Renaissance
 Representation: Mental Representation
 Representation: Political Representation
 Republicanism: Latin America
 Republicanism: Republic
 Resistance
 Resistance and Accommodation
 Responsibility
 Revolution
 Rhetoric: Overview
 Rhetoric: Ancient and Medieval
 Ritual: Public Ritual
 Ritual: Religion
 Romanticism in Literature and Politics
 Sacred and Profane
 Sacred Places
 Sage Philosophy
 Scarcity and Abundance, Latin America
 Scholasticism
 Science: Overview
 Science, History of
 Science Fiction
 Secularization and Secularism
 Sexuality: Overview
 Skepticism
 Slavery
 Social Capital
 Social Contract
 Social Darwinism
 Socialism
 Socialisms, African
 Society

Sophists, The
 Sovereignty
 Sport
 State, The: Overview
 Stoicism
 Structuralism and Poststructuralism: Overview
 Structuralism and Poststructuralism: Anthropology
 Subjectivism
 Suicide
 Superstition
 Surrealism
 Symbolism
 Taste
 Technology
 Temperance
 Terror
 Terrorism, Middle East
 Textiles and Fiber Arts as Catalysts for Ideas
 Theodicy
 Third Cinema
 Time: Traditional and Utilitarian
 Toleration
 Totalitarianism
 Trade
 Tragedy and Comedy
 Translation
 Travel: Travel from Europe and the Middle East
 Treaty
 Trope
 Truth
 Universalism
 University: Overview
 University: Postcolonial
 Untouchability: Overview
 Untouchability: Menstrual Taboos
 Untouchability: Taboos
 Utilitarianism
 Utopia
 Virtue Ethics
 Visual Order to Organizing Collections
 Volksgeist
 Volunteerism, U.S.
 War
 War and Peace in the Arts
 Wealth
 Westernization: Africa
 Westernization: Middle East
 Westernization: Southeast Asia
 Wildlife
 Wisdom, Human
 Witchcraft
 Witchcraft, African Studies of
 Women's History: Africa
 Women's Studies
 Work
 World Systems Theory, Latin America
 Zionism

Middle East

ENTRIES FOCUSING ON THE MIDDLE EAST

Alchemy: Europe and the Middle East
 Anticolonialism: Middle East
 Civil Society: Responses in Africa and the Middle East
 Communication of Ideas: Middle East and Abroad
 Death and Afterlife, Islamic Understanding of

Dialogue and Dialectics: Talmudic
 Education: Islamic Education
 Empire and Imperialism: Middle East
 Feminism: Islamic Feminism
 Gender: Gender in the Middle East
 Honor, Middle Eastern Notions of
 Humanism: Europe and the Middle East
 Intercession in Middle Eastern Society
 Islam: Shii
 Islam: Sunni
 Islamic Science
 Judaism: Judaism to 1800
 Judaism: Modern Judaism
 Law, Islamic
 Literature: Overview
 Medicine: Islamic Medicine
 Monarchy: Islamic Monarchy
 Nationalism: Middle East
 Pan-Arabism
 Pan-Islamism
 Pan-Turkism
 Philosophies: Islamic
 Religion: Middle East
 Religion and the State: Middle East
 Sufism
 Terrorism, Middle East
 Tribalism, Middle East
 Westernization: Middle East
 Zionism

ENTRIES THAT CONSIDER THE MIDDLE EAST

Africa, Idea of
 Algebras
 Anthropology
 Antifeminism
 Anti-Semitism: Overview
 Anti-Semitism: Islamic Anti-Semitism
 Architecture: Overview
 Architecture: Africa
 Aristotelianism
 Arts: Africa
 Astrology: Overview
 Astrology: China
 Atheism
 Authoritarianism: Overview
 Authority
 Barbarism and Civilization
 Bilingualism and Multilingualism
 Biography
 Calendar
 Childhood and Child Rearing
 Christianity: Overview
 City, The: The Islamic and Byzantine City
 Class
 Communication of Ideas: Africa and Its Influence
 Communication of Ideas: Europe and Its Influence
 Communication of Ideas: Orality and the Advent of Writing
 Computer Science
 Constitutionalism
 Cosmopolitanism
 Creativity in the Arts and Sciences
 Critical Theory
 Dance
 Deism
 Demography

READER'S GUIDE

Demonology
Dependency
Diasporas: African Diaspora
Diasporas: Jewish Diaspora
Dream
Dualism
Ecumenism
Empire and Imperialism: Europe
Environment
Ethnicity and Race: Islamic Views
Eurocentrism
Evil
Family Planning
Feminism: Overview
Feminism: Africa and African Diaspora
Free Will, Determinism, and Predestination
Friendship
Fundamentalism
Garden
Gay Studies
Gender in Art
Ghetto
Gift, The
Gnosticism
Hate
Health and Disease
Heaven and Hell
Heresy and Apostasy
Historiography
Humanity in the Arts
Iconography
Identity, Multiple: Jewish Multiple Identity
Images, Icons, and Idols
Imagination
Immortality and the Afterlife
Intelligentsia
International Order
Islam: Africa
Jihad
Language, Linguistics, and Literacy
Language, Philosophy of: Ancient and Medieval
Liberty
Life Cycle: Elders/Old Age
Literature: African Literature
Logic
Manichaeism
Maps and the Ideas They Express
Mathematics
Matriarchy
Microcosm and Macrocosm
Migration: Africa
Migration: Migration in World History
Millenarianism: Overview
Millenarianism: Islamic
Minority
Miracles
Monarchy: Overview
Motherhood and Maternity
Museums
Musicology
Mysticism: Islamic Mysticism
Mysticism: Islamic Mysticism in Asia
Mysticism: Kabbalah
Mysticism: Mysticism in African Thought
Nation
Nationalism: Cultural Nationalism
Nihilism
Nomadism
Nonviolence
Nuclear Age
Organicism
Orientalism: Overview
Orientalism: African and Black Orientalism
Orthodoxy
Orthopraxy: Western Orthopraxy
Pan-Africanism
Paradise on Earth
Peace
Perspective
Philosophies: African
Philosophy, Moral: Medieval and Renaissance
Philosophy of Mind: Ancient and Medieval
Political Science
Polytheism
Postcolonial Studies
Postcolonial Theory and Literature
Property
Prophecy
Protest, Political
Pythagoreanism
Reform: Islamic Reform
Religion: East and Southeast Asia
Religion and Science
Religion and the State: Africa
Religion and the State: Europe
Religion and the State: United States
Resistance and Accommodation
Rhetoric: Overview
Sacred Places
Sacred Texts: Koran
Science, History of
Scientific Revolution
Secularization and Secularism
Sexual Harassment
Sexuality: Islamic Views
Slavery
Sovereignty
Suicide
Superstition
Syncretism
Temperance
Textiles and Fiber Arts as Catalysts for Ideas
Theodicy
Third Cinema
Third World Literature
Toleration
Totalitarianism
Totems
Travel: Travel from Europe and the Middle East
Treaty
University: Overview
Untouchability: Menstrual Taboos
Untouchability: Taboos
Visual Order to Organizing Collections
Westernization: Africa
Westernization: Southeast Asia
Wisdom, Human
Women's History: Africa
Women's Studies
World Systems Theory, Latin America

North America

ENTRIES FOCUSING ON NORTH AMERICA

African-American Ideas
 America
 Asian-American Ideas (Cultural Migration)
 Black Atlantic
 Chicano Movement
 Christianity: Overview
 Civil Society: Europe and the United States
 Communication of Ideas: The Americas and Their Influence
 Consumerism
 Democracy
 Education: North America
 Empire and Imperialism: Americas
 Empire and Imperialism: United States
 Ethnohistory, U.S.
 Feminism: Chicana Feminisms
 Feminism: Third World U.S. Movement
 Humanism: Secular Humanism in the United States
 Identity, Multiple: Asian-Americans
 Judaism: Modern Judaism
 Justice: Justice in American Thought
 Landscape in the Arts
 Medicine: Europe and the United States
 Migration: United States
 Millenarianism: Latin America and Native North America
 Native Policy
 Philosophies: American
 Political Protest, U.S.
 Populism: United States
 Race and Racism: United States
 Reform: Europe and the United States
 Religion and the State: United States
 Volunteerism, U.S.

ENTRIES THAT CONSIDER NORTH AMERICA

Abolitionism
 Aesthetics: Europe and the Americas
 Africa, Idea of
 Afrocentricity
 Altruism
 Americanization, U.S.
 Analytical Philosophy
 Anthropology
 Anticolonialism: Latin America
 Anticolonialism: Southeast Asia
 Antifeminism
 Asceticism: Western Asceticism
 Assimilation
 Astronomy, Pre-Columbian and Latin American
 Atheism
 Authoritarianism: Latin America
 Authority
 Autobiography
 Aztlán
 Beauty and Ugliness
 Behaviorism
 Bilingualism and Multilingualism
 Bioethics
 Biology
 Body, The
 Borders, Borderlands, and Frontiers, Global
 Buddhism
 Calculation and Computation

Cannibalism
 Causation
 Censorship
 Childhood and Child Rearing
 Cinema
 Citizenship: Overview
 Citizenship: Cultural Citizenship
 Citizenship: Naturalization
 City, The: The City as a Cultural Center
 Civil Disobedience
 Colonialism: Latin America
 Communication of Ideas: Africa and Its Influence
 Communism: Latin America
 Computer Science
 Conservatism
 Consilience
 Constitutionalism
 Continental Philosophy
 Cosmopolitanism
 Creationism
 Critical Race Theory
 Critical Theory
 Cultural Capital
 Cultural Revivals
 Cultural Studies
 Dance
 Death
 Deism
 Demography
 Diasporas: African Diaspora
 Diasporas: Jewish Diaspora
 Discrimination
 Diversity
 Dream
 Dress
 Dualism
 Dystopia
 Ecology
 Economics
 Ecumenism
 Education: Global Education
 Emotions
 Empire and Imperialism: Asia
 Empiricism
 Enlightenment
 Environment
 Environmental Ethics
 Environmental History
 Equality: Overview
 Equality: Gender Equality
 Equality: Racial Equality
 Essentialism
 Ethnicity and Race: Anthropology
 Ethnocentrism
 Ethnography
 Eugenics
 Eurocentrism
 Everyday Life
 Evil
 Evolution
 Family: Modernist Anthropological Theory
 Family: Family in Anthropology since 1980
 Family Planning
 Feminism: Overview
 Feminism: Africa and African Diaspora

READER'S GUIDE

Feminism: Islamic Feminism
Fetishism: Overview
Fetishism: Fetishism in Literature and Cultural Studies
Field Theories
Foundationalism
Friendship
Fundamentalism
Game Theory
Garden
Gay Studies
Gender: Overview
Gender: Gender in the Middle East
Gender in Art
Gender Studies: Anthropology
Generation
Genetics: Contemporary
Genetics: History of
Genius
Genocide
Ghetto
Globalization: Asia
Globalization: General
Hate
Hegelianism
Historiography
History, Economic
Human Capital
Humanity: European Thought
Humanity in the Arts
Human Rights: Overview
Ideas, History of
Identity: Identity of Persons
Identity: Personal and Social Identity
Identity, Multiple: Overview
Identity, Multiple: Jewish Multiple Identity
Impressionism
Intentionality
Interdisciplinarity
Internal Colonialism
International Order
Interpretation
Islam: Shii
Jainism
Justice: Overview
Kantianism
Language and Linguistics
Language, Philosophy of: Modern
Law
Leadership
Learning and Memory, Contemporary Views
Liberation Theology
Life
Life Cycle: Adolescence
Life Cycle: Elders/Old Age
Linguistic Turn
Literary Criticism
Literary History
Loyalties, Dual
Machismo
Magic
Maps and the Ideas They Express
Marxism: Overview
Marxism: Latin America
Masks
Mathematics
Matriarchy
Media, History of
Meme
Men and Masculinity
Mestizaje
Migration: Africa
Migration: Migration in World History
Millenarianism: Overview
Mind
Minority
Modernism: Latin America
Modernity: Overview
Monasticism
Motif: Motif in Music
Museums
Music, Anthropology of
Musical Performance and Audiences
Myth
Narrative
Nation
Nationalism: Overview
Nationalism: Africa
Natural History
Natural Theology
Naturalism
Neocolonialism
Neoliberalism
New Criticism
Nihilism
Nuclear Age
Objectivity
Obligation
Occidentalism
Orientalism: African and Black Orientalism
Orthodoxy
Other, The, European Views of
Pacifism
Pan-Africanism
Paradigm
Parties, Political
Periodization
Person, Idea of the
Philosophies: Feminist, Twentieth-Century
Philosophy: Relations to Other Intellectual Realms
Philosophy of Mind: Overview
Pluralism
Political Science
Population
Positivism
Postcolonial Studies
Postcolonial Theory and Literature
Postmodernism
Practices
Pragmatism
Prehistory, Rise of
Prejudice
Presentism
Privacy
Probability
Progress, Idea of
Property
Protest, Political
Pseudoscience
Psychology and Psychiatry
Quantum

Queer Theory
 Race and Racism: Overview
 Rational Choice
 Reading
 Reflexivity
 Relativism
 Relativity
 Religion: Latin America
 Religion and Science
 Renaissance
 Representation: Mental Representation
 Representation: Political Representation
 Resistance
 Resistance and Accommodation
 Responsibility
 Rhetoric: Overview
 Ritual: Religion
 Scarcity and Abundance, Latin America
 Science, History of
 Science Fiction
 Secularization and Secularism
 Segregation
 Sexual Harassment
 Sexuality: Overview
 Sexuality: Sexual Orientation
 Slavery
 Social History, U.S.
 Sovereignty
 Sport
 State, The: Overview
 Subjectivism
 Suicide
 Superstition
 Syncretism
 Taste
 Technology
 Temperance
 Terrorism, Middle East
 Time: Traditional and Utilitarian
 Totems
 Trade
 Treaty
 Trope
 Truth
 University: Postcolonial
 Utilitarianism
 Victorianism
 Visual Culture
 Visual Order to Organizing Collections
 War
 War and Peace in the Arts
 Westernization: Southeast Asia
 Wildlife
 Witchcraft
 Womanism
 Women and Femininity in U.S. Popular Culture
 Women's Studies
 World Systems Theory, Latin America

Latin and South America

ENTRIES FOCUSING ON LATIN AND SOUTH AMERICA

Anticolonialism: Latin America
 Astronomy, Pre-Columbian and Latin American
 Authoritarianism: Latin America

Black Atlantic
 Colonialism: Latin America
 Communication of Ideas: The Americas and Their Influence
 Communism: Latin America
 Creolization, Caribbean
 Empire and Imperialism: Americas
 Marxism: Latin America
 Millenarianism: Latin America and Native North America
 Modernism: Latin America
 Native Policy
 Populism: Latin America
 Pre-Columbian Civilization
 Religion: Indigenous Peoples' View, South America
 Religion: Latin America
 Religion and the State: Latin America
 Republicanism: Latin America
 Scarcity and Abundance, Latin America
 World Systems Theory, Latin America

ENTRIES THAT CONSIDER LATIN AND SOUTH AMERICA

Abolitionism
 Aesthetics: Africa
 Africa, Idea of
 America
 Ancestor Worship
 Animism
 Anthropology
 Arts: Overview
 Atheism
 Authenticity: Africa
 Authoritarianism: Overview
 Autobiography
 Aztlán
 Bilingualism and Multilingualism
 Borders, Borderlands, and Frontiers, Global
 Calculation and Computation
 Cannibalism
 Chicano Movement
 Christianity: Overview
 Cinema
 Citizenship: Overview
 Citizenship: Cultural Citizenship
 Citizenship: Naturalization
 Critical Theory
 Cultural Capital
 Dance
 Demography
 Demonology
 Dependency
 Diasporas: African Diaspora
 Diffusion, Cultural
 Discrimination
 Diversity
 Empire and Imperialism: United States
 Environmental History
 Ethnohistory, U.S.
 Evil
 Extirpation
 Family Planning
 Fascism
 Feminism: Overview
 Feminism: Africa and African Diaspora
 Feminism: Chicana Feminisms

READER'S GUIDE

Fetishism: Overview
Friendship
Gender in Art
Genetics: Contemporary
Historiography
History, Economic
Honor
Humanity in the Arts
Identity, Multiple: Overview
Identity, Multiple: Jewish Multiple Identity
Indigenismo
Internal Colonialism
International Order
Liberation Theology
Life Cycle: Overview
Life Cycle: Elders/Old Age
Machiavellism
Machismo
Magic
Maps and the Ideas They Express
Masks
Mathematics
Matriarchy
Media, History of
Men and Masculinity
Mestizaje
Migration: Africa
Migration: Migration in World History
Migration: United States
Minority
Modernism: Overview
Modernization Theory
Motherhood and Maternity
Motif: Motif in Music
Museums
Music, Anthropology of
Nationalism: Africa
Negritude
Orthopraxy: Western Orthopraxy
Pan-Africanism
Peasants and Peasantry
Periodization of the Arts
Perspective
Phrenology
Political Protest, U.S.
Polytheism
Population
Postcolonial Studies
Postcolonial Theory and Literature
Practices
Prehistory, Rise of
Property
Protest, Political
Race and Racism: Overview
Religion: African Diaspora
Resistance and Accommodation
Revolution
Rhetoric: Overview
Ritual: Public Ritual
Ritual: Religion
Secularization and Secularism
Segregation
Slavery
Sport
State, The: Overview

Structuralism and Poststructuralism: Anthropology
Surrealism
Syncretism
Temperance
Third Cinema
Third World
Third World Literature
Trade
Treaty
University: Overview
University: Postcolonial
Visual Order to Organizing Collections
Witchcraft
Women's Studies
Work

CHRONOLOGICAL PERIODS

This section is divided according to five periods in world history: Ancient, Dynastic, Early Modern, Modern, and Contemporary. Use this section together with the section on Geographical Areas.

Ancient (before 400 C.E.)

ENTRIES FOCUSED ON THE PERIOD

Buddhism
Consciousness: Chinese Thought
Consciousness: Indian Thought
Democracy
Dialogue and Dialectics: Socratic
Epicureanism
Gnosticism
Greek Science
Hinduism
Justice: Justice in East Asian Thought
Language, Linguistics, and Literacy
Microcosm and Macrocosm
Orthopraxy: Asia
Orthopraxy: Western Orthopraxy
Poetry and Poetics
Sacred Places
Sacred Texts: Asia
Sophists, The
Textiles and Fiber Arts as Catalysts for Ideas
Time: China
Time: India
Yin and Yang

ENTRIES WITH EXAMPLES FROM BEFORE 400 C.E.

Generally the examples in this category are from the ancient Middle East, Europe, or Asia.

Aesthetics: Asia
Aesthetics: Europe and the Americas
Africa, Idea of
Alchemy: China
Alchemy: Europe and the Middle East
Algebras
Ambiguity
Anarchism
Anthropology
Anti-Semitism: Overview
Architecture: Overview

- Architecture: Africa
 Architecture: Asia
 Aristotelianism
 Arts: Overview
 Asceticism: Western Asceticism
 Astrology: Overview
 Astrology: China
 Atheism
 Authority
 Autobiography
 Barbarism and Civilization
 Beauty and Ugliness
 Biography
 Biology
 Body, The
 Borders, Borderlands, and Frontiers, Global
 Bureaucracy
 Calendar
 Casuistry
 Causality
 Causation
 Causation in East Asian and Southeast Asian Philosophy
 Censorship
 Change
 Character
 Childhood and Child Rearing
 Chinese Thought
 Christianity: Overview
 Christianity: Asia
 City, The: The City as a Cultural Center
 City, The: The City as Political Center
 City, The: The Islamic and Byzantine City
 Civil Society: Europe and the United States
 Class
 Classicism
 Classification of Arts and Sciences, Early Modern
 Communication of Ideas: Asia and Its Influence
 Communication of Ideas: Europe and Its Influence
 Communication of Ideas: Middle East and Abroad
 Communication of Ideas: Orality and Advent of Writing
 Communication of Ideas: Southeast Asia
 Communication of Ideas: The Americas and Their Influence
 Composition, Musical
 Confucianism
 Constitutionalism
 Corruption
 Cosmology: Asia
 Cosmology: Cosmology and Astronomy
 Cosmopolitanism
 Creationism
 Creativity in the Arts and Sciences
 Creolization, Caribbean
 Cycles
 Cynicism
 Dance
 Daoism
 Death
 Demonology
 Development
 Diasporas: Jewish Diaspora
 Dream
 Dress
 Dualism
 Eclecticism
 Ecumenism
 Education: Asia, Traditional and Modern
 Education: China
 Education: Europe
 Education: India
 Emotions
 Empire and Imperialism: Overview
 Empire and Imperialism: Asia
 Environment
 Epistemology: Ancient
 Equality: Overview
 Eschatology
 Essentialism
 Etiquette
 Eurocentrism
 Europe, Idea of
 Evil
 Evolution
 Experiment
 Fallacy, Logical
 Fatalism
 Form, Metaphysical, in Ancient and Medieval Thought
 Foundationalism
 Free Will, Determinism, and Predestination
 Friendship
 Fundamentalism
 Garden
 Gay Studies
 Gender in Art
 Generation
 Genre
 Geography
 Geometry
 Gesture
 Gift, The
 Good
 Happiness and Pleasure in European Thought
 Harmony
 Health and Disease
 Heaven and Hell
 Heaven and Hell (Asian Focus)
 Hedonism in European Thought
 Hegemony
 Heresy and Apostasy
 Hierarchy and Order
 Historiography
 History, Idea of
 Humanism: Chinese Conception of
 Humanism: Europe and the Middle East
 Humanity: African Thought
 Humanity: Asian Thought
 Humanity: European Thought
 Humanity in the Arts
 Human Rights: Overview
 Humor
 Hygiene
 Ideas, History of
 Identity, Multiple: Jewish Multiple Identity
 Images, Icons, and Idols
 Imagination
 Immortality and the Afterlife
 Individualism
 International Order
 Interpretation

READER'S GUIDE

- Jainism
 Judaism: Judaism to 1800
 Justice: Overview
 Knowledge
 Landscape in the Arts
 Language, Philosophy of: Ancient and Medieval
 Leadership
 Legalism, Ancient China
 Liberty
 Life
 Literary History
 Literature: Overview
 Literature: African Literature
 Logic
 Love, Western Notions of
 Loyalties, Dual
 Machiavellism
 Manichaeism
 Maps and the Ideas They Express
 Marriage and Fertility, European Views
 Mathematics
 Matriarchy
 Mechanical Philosophy
 Media, History of
 Medicine: China
 Medicine: Europe and the United States
 Medicine: India
 Medicine: Islamic Medicine
 Meditation: Eastern Meditation
 Memory
 Men and Masculinity
 Metaphor
 Metaphysics: Ancient and Medieval
 Migration: Migration in World History
 Millenarianism: Overview
 Miracles
 Mohism
 Monarchy: Overview
 Monasticism
 Monism
 Motherhood and Maternity
 Museums
 Music, Anthropology of
 Musical Performance and Audiences
 Mysticism: Chinese Mysticism
 Mysticism: Christian Mysticism
 Narrative
 Nation
 Natural Law
 Nature
 Neoplatonism
 Nomadism
 Nonviolence
 Nude, The
 Organicism
 Orthodoxy
 Other, The, European Views of
 Pacifism
 Paradigm
 Paradise on Earth
 Patriotism
 Peace
 Periodization
 Periodization of the Arts
 Perspective
 Philanthropy
 Philosophies: African
 Philosophies: Islamic
 Philosophy: Historical Overview and Recent Developments
 Philosophy: Relations to Other Intellectual Realms
 Philosophy, Moral: Ancient
 Philosophy, Moral: Medieval and Renaissance
 Philosophy and Religion in Western Thought
 Philosophy of Mind: Ancient and Medieval
 Physics
 Platonism
 Pluralism
 Political, The
 Political Science
 Poverty
 Prehistory, Rise of
 Presentism
 Prophecy
 Punishment
 Pythagoreanism
 Rationalism
 Reading
 Reason, Practical and Theoretical
 Reform: Europe and the United States
 Reformation
 Religion: Overview
 Religion: Africa
 Religion: East and Southeast Asia
 Religion and the State: Europe
 Renaissance
 Representation: Political Representation
 Republicanism: Republic
 Resistance
 Responsibility
 Revolution
 Rhetoric: Overview
 Rhetoric: Ancient and Medieval
 Ritual: Public Ritual
 Science: East Asia
 Scientific Revolution
 Shinto
 Skepticism
 Slavery
 Society
 Sovereignty
 Sport
 State of Nature
 Stoicism
 Suicide
 Superstition
 Syncretism
 Taste
 Text/Textuality
 Toleration
 Totalitarianism
 Tragedy and Comedy
 Translation
 Travel: Travel from Europe and the Middle East
 Treaty
 Trope
 Truth
 University: Overview
 Untouchability: Overview
 Untouchability: Menstrual Taboos

Virtual Reality
 Virtue Ethics
 Visual Order to Organizing Collections
 War and Peace in the Arts
 Wealth
 Wildlife
 Witchcraft
 Work
 Yoga
 Zen

Dynastic (400 C.E.–1400 C.E.)

ENTRIES FOCUSED ON THE PERIOD

Astronomy, Pre-Columbian and Latin American
 Buddhism
 Death and Afterlife, Islamic Understanding of
 Dialogue and Dialectics: Talmudic
 Feudalism, European
 Heresy and Apostasy
 Motif: Motif in Literature
 Orthopraxy: Western Orthopraxy
 Sacred Places
 Sacred Texts: Asia
 Sacred Texts: Koran
 Scholasticism
 Textiles and Fiber Arts as Catalysts for Ideas

ENTRIES WITH EXAMPLES FROM THE PERIOD

400 C.E.–1400 C.E.
 Aesthetics: Asia
 Africa, Idea of
 Alchemy: China
 Alchemy: Europe and the Middle East
 Algebras
 America
 Anti-Semitism: Overview
 Anti-Semitism: Islamic Anti-Semitism
 Architecture: Overview
 Architecture: Africa
 Architecture: Asia
 Aristotelianism
 Arts: Overview
 Asceticism: Western Asceticism
 Astrology: Overview
 Astrology: China
 Authority
 Autobiography
 Aztlán
 Barbarism and Civilization
 Beauty and Ugliness
 Biography
 Biology
 Body, The
 Borders, Borderlands, and Frontiers, Global
 Bureaucracy
 Bushido
 Calculation and Computation
 Calendar
 Casuistry
 Causality
 Causation in East Asian and Southeast Asian Philosophy
 Change
 Childhood and Child Rearing
 Chinese Thought
 Christianity: Overview
 Christianity: Asia

City, The: The City as a Cultural Center
 City, The: The Islamic and Byzantine City
 Civil Disobedience
 Civil Society: Europe and the United States
 Class
 Classicism
 Classification of Arts and Sciences, Early Modern
 Communication of Ideas: Africa and Its Influence
 Communication of Ideas: Asia and Its Influence
 Communication of Ideas: Europe and Its Influence
 Communication of Ideas: Middle East and Abroad
 Communication of Ideas: Orality and Advent of Writing
 Communication of Ideas: Southeast Asia
 Communication of Ideas: The Americas and Their Influence
 Composition, Musical
 Confucianism
 Consciousness: Indian Thought
 Consilience
 Constitutionalism
 Corruption
 Cosmology: Asia
 Cosmopolitanism
 Creationism
 Creativity in the Arts and Sciences
 Daoism
 Death
 Democracy
 Demonology
 Diasporas: Jewish Diaspora
 Dream
 Dualism
 Eclecticism
 Ecumenism
 Education: Asia, Traditional and Modern
 Education: China
 Education: Europe
 Education: India
 Education: Islamic Education
 Education: Japan
 Empire and Imperialism: Overview
 Empire and Imperialism: Asia
 Encyclopedism
 Equality: Overview
 Eschatology
 Ethnicity and Race: Islamic Views
 Etiquette
 Eurocentrism
 Europe, Idea of
 Evil
 Examination Systems, China
 Experiment
 Fallacy, Logical
 Feminism: Islamic Feminism
 Form, Metaphysical, in Ancient and Medieval Thought
 Free Will, Determinism, and Predestination
 Friendship
 Garden
 Gay Studies
 Gender: Gender in the Middle East
 Gender in Art
 Gesture
 Gift, The
 Globalization: Asia
 Good

READER'S GUIDE

- Happiness and Pleasure in European Thought
 Harmony
 Health and Disease
 Heaven and Hell
 Hegemony
 Hierarchy and Order
 Hinduism
 Historiography
 History, Idea of
 Honor, Middle Eastern Notions of
 Humanism: Africa
 Humanism: Chinese Conception of
 Humanism: Europe and the Middle East
 Humanity: Asian Thought
 Humanity: European Thought
 Humanity in the Arts
 Human Rights: Overview
 Hygiene
 Iconography
 Identity, Multiple: Jewish Multiple Identity
 Images, Icons, and Idols
 Imagination
 Immortality and the Afterlife
 Individualism
 Intentionality
 International Order
 Interpretation
 Islam: Africa
 Islam: Shii
 Islam: Sunni
 Islamic Science
 Jainism
 Japanese Philosophy, Japanese Thought
 Jihad
 Judaism: Judaism to 1800
 Knowledge
 Landscape in the Arts
 Language, Philosophy of: Ancient and Medieval
 Law, Islamic
 Liberty
 Literary History
 Literature: Overview
 Logic
 Love, Western Notions of
 Loyalties, Dual
 Manichaeism
 Maps and the Ideas They Express
 Marriage and Fertility, European Views
 Mathematics
 Medicine: China
 Medicine: Europe and the United States
 Medicine: Islamic Medicine
 Metaphor
 Metaphysics: Ancient and Medieval
 Microcosm and Macrocosm
 Migration: Africa
 Migration: Migration in World History
 Millenarianism: Overview
 Millenarianism: Islamic
 Millenarianism: Latin America and Native North America
 Miracles
 Monarchy: Islamic Monarchy
 Monarchy: Overview
 Monasticism
 Monism
 Motif: Motif in Music
 Musical Performance and Audiences
 Mysticism: Chinese Mysticism
 Mysticism: Christian Mysticism
 Mysticism: Islamic Mysticism
 Mysticism: Islamic Mysticism in Asia
 Mysticism: Kabbalah
 Nation
 Natural Law
 Natural Theology
 Neoplatonism
 Nomadism
 Nude, The
 Objectivity
 Organicism
 Orthodoxy
 Other, The, European Views of
 Paradigm
 Paradise on Earth
 Patriotism
 Peace
 Peasants and Peasantry
 Periodization
 Periodization of the Arts
 Perspective
 Philanthropy
 Philosophies: African
 Philosophies: Islamic
 Philosophy: Historical Overview and Recent Developments
 Philosophy, Moral: Medieval and Renaissance
 Philosophy and Religion in Western Thought
 Philosophy of Mind: Ancient and Medieval
 Physics
 Platonism
 Poverty
 Pre-Columbian Civilization
 Prophecy
 Protest, Political
 Race and Racism: Asia
 Reform: Islamic Reform
 Religion: Africa
 Religion: East and Southeast Asia
 Religion: Middle East
 Religion and the State: Europe
 Religion and the State: Middle East
 Religion and the State: United States Renaissance
 Representation: Political Representation
 Republicanism: Republic
 Responsibility
 Revolution
 Rhetoric: Overview
 Rhetoric: Ancient and Medieval
 Ritual: Public Ritual
 Scientific Revolution
 Sexuality: Islamic Views
 Shinto
 Skepticism
 Sophists, The
 Sovereignty
 Stoicism
 Sufism
 Suicide
 Superstition

Syncretism
 Taste
 Terror
 Time: Traditional and Utilitarian
 Toleration
 Totalitarianism
 Tragedy and Comedy
 Translation
 Travel: Travel from Europe and the Middle East
 Tribalism, Middle East
 University: Overview
 Untouchability: Menstrual Taboos
 Virtual Reality
 Virtue Ethics
 Visual Order to Organizing Collections
 War
 War and Peace in the Arts
 Wealth
 Women's History: Asia
 Work
 Yoga
 Zen

Early Modern (1400–1800 C.E.)

ENTRIES FOCUSED ON THE PERIOD

Astronomy, Pre-Columbian and Latin American
 Cartesianism
 Casuistry
 Empiricism
 Humanism: Renaissance
 Idealism
 Identity: Identity of Persons
 Kantianism
 Materialism in Eighteenth-Century European Thought
 Mechanical Philosophy
 Moral Sense
 Naturphilosophie
 Newtonianism
 Phrenology
 Protest, Political
 Reformation
 Renaissance
 Scientific Revolution
 Theodicy
 Time: Traditional and Utilitarian
 Westernization: Middle East

ENTRIES WITH EXAMPLES FROM THE PERIOD

1400–1800 C.E.
 Abolitionism
 Aesthetics: Africa
 Aesthetics: Asia
 Aesthetics: Europe and the Americas
 Africa, Idea of
 African-American Ideas
 Agnosticism
 Alchemy: Europe and the Middle East
 Algebras
 Ambiguity
 America
 Ancestor Worship
 Anticolonialism: Latin America
 Antifeminism
 Anti-Semitism: Overview
 Apartheid
 Architecture: Overview

Architecture: Asia
 Aristotelianism
 Arts: Overview
 Arts: Africa
 Asceticism: Western Asceticism
 Astrology: Overview
 Atheism
 Authoritarianism: Latin America
 Authority
 Autobiography
 Autonomy
 Aztlán
 Barbarism and Civilization
 Beauty and Ugliness
 Biography
 Biology
 Body, The
 Borders, Borderlands, and Frontiers, Global
 Buddhism
 Bureaucracy
 Bushido
 Calculation and Computation
 Calendar
 Cannibalism
 Capitalism: Overview
 Capitalism: Africa
 Causality
 Causation
 Causation in East Asian and Southeast Asian Philosophy
 Censorship
 Change
 Character
 Chemistry
 Childhood and Child Rearing
 Chinese Thought
 Christianity: Asia
 Christianity: Overview
 City, The: The City as a Cultural Center
 City, The: Latin America
 Civil Disobedience
 Civil Society: Europe and the United States
 Civil Society: Responses in Africa and the Middle East
 Class
 Classicism
 Classification of Arts and Sciences, Early Modern
 Colonialism: Africa
 Colonialism: Latin America
 Colonialism: Southeast Asia
 Common Sense
 Communication of Ideas: Africa and Its Influence
 Communication of Ideas: The Americas and Their Influence
 Communication of Ideas: Asia and Its Influence
 Communication of Ideas: Europe and Its Influence
 Communication of Ideas: Middle East and Abroad
 Communication of Ideas: Orality and Advent of Writing
 Communication of Ideas: Southeast Asia
 Communism: Europe
 Composition, Musical
 Computer Science
 Confucianism
 Consciousness: Overview
 Conservatism
 Constitutionalism

READER'S GUIDE

- Consumerism
- Context
- Continental Philosophy
- Corruption
- Cosmology: Asia
- Cosmology: Cosmology and Astronomy
- Cosmopolitanism
- Creationism
- Creativity in the Arts and Sciences
- Creolization, Caribbean
- Crisis
- Critical Theory
- Cultural History
- Cycles
- Death and Afterlife, Islamic Understanding of
- Deism
- Democracy
- Dependency
- Determinism
- Development
- Diasporas: African Diaspora
- Diasporas: Jewish Diaspora
- Dictatorship in Latin America
- Dream
- Dress
- Dualism
- Dystopia
- Eclecticism
- Ecology
- Economics
- Education: Asia, Traditional and Modern
- Education: China
- Education: Europe
- Education: India
- Education: Islamic Education
- Education: Japan
- Education: North America
- Empire and Imperialism: Americas
- Empire and Imperialism: Asia
- Empire and Imperialism: Middle East
- Encyclopedism
- Enlightenment
- Epistemology: Early Modern
- Equality: Overview
- Equality: Gender Equality
- Equality: Racial Equality
- Eschatology
- Essentialism
- Etiquette
- Eurocentrism
- Europe, Idea of
- Everyday Life
- Evil
- Evolution
- Examination Systems, China
- Experiment
- Extirpation
- Fascism
- Fetishism: Overview
- Field Theories
- Foundationalism
- Free Will, Determinism, and Predestination
- Friendship
- Garden
- Gay Studies
- Gender in Art
- General Will
- Genius
- Genre
- Geography
- Geometry
- Gesture
- Ghetto
- Gift, The
- Globalization: Africa
- Globalization: Asia
- Globalization: General
- Gnosticism
- Good
- Harmony
- Health and Disease
- Hedonism in European Thought
- Hierarchy and Order
- Historiography
- History, Idea of
- Honor
- Honor, Middle Eastern Notions of
- Human Capital
- Humanism: Africa
- Humanism: Chinese Conception of
- Humanism: Europe and the Middle East
- Humanism: Secular Humanism in the United States
- Humanity: African Thought
- Humanity: Asian Thought
- Humanity: European Thought
- Humanity in the Arts
- Human Rights: Overview
- Humor
- Hygiene
- Iconography
- Identity, Multiple: Overview
- Identity, Multiple: Jewish Multiple Identity
- Imagination
- Immortality and the Afterlife
- Indigenismo
- Individualism
- International Order
- Interpretation
- Islam: Africa
- Islam: Shii
- Islam: Southeast Asia
- Islam: Sunni
- Islamic Science
- Japanese Philosophy, Japanese Thought
- Judaism: Judaism to 1800
- Judaism: Modern Judaism
- Justice: Overview
- Justice: Justice in American Thought
- Knowledge
- Landscape in the Arts
- Language, Linguistics, and Literacy
- Leadership
- Liberalism
- Liberty
- Life
- Life Cycle: Overview
- Literary History
- Literature: Overview
- Logic
- Love, Western Notions of

- Loyalties, Dual
 Machiavellism
 Magic
 Maps and the Ideas They Express
 Marriage and Fertility, European Views
 Mathematics
 Medicine: Europe and the United States
 Medicine: Islamic Medicine
 Men and Masculinity
 Mestizaje
 Metaphor
 Metaphysics: Renaissance to the Present
 Microcosm and Macrocosm
 Migration: Africa
 Migration: Migration in World History
 Migration: United States
 Millenarianism: Overview
 Millenarianism: Islamic
 Millenarianism: Latin America and Native North America
 Mind
 Modernity: Africa
 Monarchy: Overview
 Monarchy: Islamic Monarchy
 Monasticism
 Monism
 Motif: Motif in Literature
 Motif: Motif in Music
 Museums
 Mysticism: Christian Mysticism
 Mysticism: Kabbalah
 Nation
 National History
 Native Policy
 Natural History
 Natural Law
 Natural Theology
 Nature
 Neoplatonism
 Nomadism
 Nude, The
 Objectivity
 Obligation
 Oral Traditions: Overview
 Organicism
 Orientalism: Overview
 Orthodoxy
 Orthopraxy: Western Orthopraxy
 Other, The, European Views of
 Paradigm
 Paradise on Earth
 Patriotism
 Peace
 Periodization
 Periodization of the Arts
 Perspective
 Philanthropy
 Philosophies: American
 Philosophies: Feminist, Twentieth-Century
 Philosophy: Historical Overview and Recent Developments
 Philosophy: Relations to Other Intellectual Realms
 Philosophy, History of
 Philosophy, Moral: Africa
 Philosophy, Moral: Medieval and Renaissance
 Philosophy, Moral: Modern
 Philosophy and Religion in Western Thought
 Philosophy of Mind: Overview
 Philosophy of Religion
 Physics
 Pietism
 Platonism
 Pluralism
 Poetry and Poetics
 Political Protest, U.S.
 Political Science
 Polytheism
 Poverty
 Power
 Pre-Columbian Civilization
 Prehistory, Rise of
 Presentism
 Probability
 Progress, Idea of
 Propaganda
 Property
 Prophecy
 Punishment
 Puritanism
 Pythagoreanism
 Race and Racism: Asia
 Race and Racism: Europe
 Radicals/Radicalism
 Rationalism
 Reason, Practical and Theoretical
 Reform: Europe and the United States
 Reform: Islamic Reform
 Relativity
 Religion: Africa
 Religion: African Diaspora
 Religion: East and Southeast Asia
 Religion: Indigenous Peoples' View, South America
 Religion: Latin America
 Religion and Science
 Religion and the State: Europe
 Religion and the State: Latin America
 Religion and the State: Middle East
 Religion and the State: United States
 Representation: Political Representation
 Republicanism: Latin America
 Republicanism: Republic
 Resistance
 Resistance and Accommodation
 Responsibility
 Revolution
 Rhetoric: Overview
 Ritual: Public Ritual
 Ritual: Religion
 Romanticism in Literature and Politics
 Scarcity and Abundance, Latin America
 Scholasticism
 Science: Overview
 Science, History of
 Secularization and Secularism
 Sexuality: Overview
 Sexuality: Islamic Views
 Shinto
 Skepticism
 Slavery
 Social Contract

READER'S GUIDE

Society
Sovereignty
Sport
State of Nature
Stoicism
Sufism
Suicide
Superstition
Syncretism
Taste
Temperance
Terror
Text/Textuality
Toleration
Totalitarianism
Tradition
Tragedy and Comedy
Translation
Travel: Travel from Europe and the Middle East
Treaty
Tribalism, Middle East
Trope
Truth
Universalism
University: Overview
Untouchability: Taboos
Utopia
Virtue Ethics
Visual Order to Organizing Collections
Volkgeist
Volunteerism, U.S.
War and Peace in the Arts
Wealth
Westernization: Middle East
Westernization: Southeast Asia
Witchcraft
Women's History: Africa
Work
World Systems Theory, Latin America

Modern (1800–1945)

ENTRIES FOCUSED ON THE PERIOD

Alienation
Altruism
Americanization, U.S.
Analytical Philosophy
Avant-Garde: Overview
Avant-Garde: Militancy
Black Atlantic
Bureaucracy
Chicano Movement
City, The: Latin America
Civil Disobedience
Consumerism
Continental Philosophy
Democracy
Empire and Imperialism: Europe
Eugenics
Evolution
Existentialism
Expressionism
Fascism
Field Theories
Fundamentalism
Futurology

Globalization: Africa
Globalization: Asia
Globalization: General
Hegelianism
Hegemony
Historicism
Humanism: Secular Humanism in the United States
Impressionism
Internal Colonialism
Kantianism
Life
Linguistic Turn
Literary History
Logic and Philosophy of Mathematics, Modern
Maoism
Marxism: Overview
Marxism: Asia
Marxism: Latin America
Media, History of
Modernism: Overview
Modernism: Latin America
Modernity: Overview
Modernity: Africa
Modernity: East Asia
Modernization
Modernization Theory
National History
Nationalism: Overview
Nationalism: Africa
Nationalism: Cultural Nationalism
Nationalism: Middle East
Naturalism
Naturalism in Art and Literature
Naturphilosophie
Neocolonialism
Neoliberalism
Orientalism: African and Black Orientalism
Pan-Africanism
Pan-Arabism
Pan-Asianism
Pan-Islamism
Pan-Turkism
Parties, Political
Phenomenology
Philosophies: Feminist, Twentieth-Century
Phrenology
Populism: Latin America
Populism: United States
Positivism
Pragmatism
Protest, Political
Psychoanalysis
Psychology and Psychiatry
Quantum
Realism
Realism: Africa
Relativism
Relativity
Science Fiction
Secularization and Secularism
Segregation
Sexuality: Sexual Orientation
Sociability in African Thought
Social Darwinism
Socialism

- Socialisms, African
- Structuralism and Poststructuralism: Overview
- Structuralism and Poststructuralism: Anthropology
- Subjectivism
- Surrealism
- Technology
- Third World
- Time: Traditional and Utilitarian
- Totalitarianism
- Utilitarianism
- Victorianism
- Westernization: Africa
- Westernization: Middle East
- Westernization: Southeast Asia
- Work
- Zionism
- ENTRIES WITH EXAMPLES FROM THE PERIOD
1800–1945
- Abolitionism
- Absolute Music
- Aesthetics: Africa
- Aesthetics: Asia
- Aesthetics: Europe and the Americas
- Africa, Idea of
- African-American Ideas
- Agnosticism
- Alchemy: China
- Alchemy: Europe and the Middle East
- Algebras
- Ambiguity
- America
- Anarchism
- Ancestor Worship
- Animism
- Anthropology
- Anticolonialism: Africa
- Anticolonialism: Latin America
- Anticolonialism: Middle East
- Anticolonialism: Southeast Asia
- Antifeminism
- Anti-Semitism: Overview
- Anti-Semitism: Islamic Anti-Semitism
- Apartheid
- Architecture: Overview
- Aristotelianism
- Arts: Overview
- Arts: Africa
- Asceticism: Western Asceticism
- Asian-American Ideas (Cultural Migration)
- Assimilation
- Atheism
- Authenticity: Africa
- Authoritarianism: Overview
- Authoritarianism: East Asia
- Authoritarianism: Latin America
- Authority
- Autobiography
- Barbarism and Civilization
- Beauty and Ugliness
- Behaviorism
- Bilingualism and Multilingualism
- Bioethics
- Biography
- Biology
- Body, The
- Borders, Borderlands, and Frontiers, Global
- Buddhism
- Bushido
- Calculation and Computation
- Capitalism: Overview
- Capitalism: Africa
- Cartesianism
- Casuistry
- Causality
- Censorship
- Change
- Character
- Chemistry
- Childhood and Child Rearing
- Chinese Warlordism
- Christianity: Overview
- Christianity: Asia
- Cinema
- Citizenship: Overview
- Citizenship: Naturalization
- City, The: The City as a Cultural Center
- City, The: The Islamic and Byzantine City
- Civil Society: Europe and the United States
- Civil Society: Responses in Africa and the Middle East
- Class
- Classicism
- Colonialism: Africa
- Colonialism: Latin America
- Colonialism: Southeast Asia
- Common Sense
- Communication of Ideas: Africa and Its Influence
- Communication of Ideas: The Americas and Their Influence
- Communication of Ideas: Asia and Its Influence
- Communication of Ideas: Europe and Its Influence
- Communication of Ideas: Middle East and Abroad
- Communication of Ideas: Orality and Advent of Writing
- Communication of Ideas: Southeast Asia
- Communism: Europe
- Communism: Latin America
- Composition, Musical
- Computer Science
- Confucianism
- Consciousness: Overview
- Conservatism
- Constitutionalism
- Context
- Corruption
- Corruption in Developed and Developing Countries
- Cosmology: Asia
- Cosmology: Cosmology and Astronomy
- Cosmopolitanism
- Creationism
- Creativity in the Arts and Sciences
- Creolization, Caribbean
- Crisis
- Critical Theory
- Cultural Capital
- Cultural History
- Cultural Revivals
- Cycles
- Dada
- Dance
- Death
- Death and Afterlife, Islamic Understanding of

READER'S GUIDE

Deism
 Democracy: Africa
 Dependency
 Determinism
 Development
 Diasporas: African Diaspora
 Diasporas: Jewish Diaspora
 Dictatorship in Latin America
 Diffusion, Cultural
 Discrimination
 Diversity
 Dream
 Dress
 Dystopia
 Ecology
 Economics
 Education: Asia, Traditional and Modern
 Education: China
 Education: Europe
 Education: Global Education
 Education: India
 Education: Islamic Education
 Education: Japan
 Education: North America
 Emotions
 Empire and Imperialism: Asia
 Empire and Imperialism: Middle East
 Empire and Imperialism: United States
 Empiricism
 Environmental Ethics
 Environmental History
 Epistemology: Modern
 Equality: Overview
 Equality: Gender Equality
 Equality: Racial Equality
 Eschatology
 Essentialism
 Ethnicity and Race: Africa
 Ethnicity and Race: Anthropology
 Ethnicity and Race: Islamic Views
 Ethnography
 Etiquette
 Eurocentrism
 Europe, Idea of
 Everyday Life
 Evil
 Examination Systems, China
 Experiment
 Falsifiability
 Family: Modernist Anthropological Theory
 Family Planning
 Feminism: Overview
 Feminism: Africa and African Diaspora
 Feminism: Chicana Feminisms
 Feminism: Third World U.S. Movement
 Fetishism: Overview
 Fetishism: Fetishism in Literature and Cultural Studies
 Formalism
 Foundationalism
 Friendship
 Game Theory
 Gay Studies
 Gender: Gender in the Middle East
 Gender in Art
 Gender Studies: Anthropology
 General Will
 Generation
 Genetics: Contemporary
 Genetics: History of
 Genius
 Genocide
 Genre
 Geography
 Geometry
 Gesture
 Ghetto
 Gift, The
 Gnosticism
 Good
 Happiness and Pleasure in European Thought
 Harmony
 Health and Disease
 Hermeneutics
 Historical and Dialectical Materialism
 Historiography
 History, Economic
 History, Idea of
 Honor, Middle Eastern Notions of
 Human Capital
 Humanism: Africa
 Humanism: Chinese Conception of
 Humanism: Europe and the Middle East
 Humanity: African Thought
 Humanity: Asian Thought
 Humanity: European Thought
 Humanity in the Arts
 Human Rights: Overview
 Humor
 Hygiene
 Iconography
 Idealism
 Ideas, History of
 Identity: Identity of Persons
 Identity, Multiple: Overview
 Identity, Multiple: Asian-Americans
 Identity, Multiple: Jewish Multiple Identity
 Imagination
 Immortality and the Afterlife
 Indigenismo
 Individualism
 Intelligentsia
 Intentionality
 Intercession in Middle Eastern Society
 International Order
 Interpretation
 Islam: Africa
 Islam: Shii
 Islam: Southeast Asia
 Islamic Science
 Japanese Philosophy, Japanese Thought
 Jihad
 Jouissance
 Judaism: Modern Judaism
 Justice: Overview
 Justice: Justice in American Thought
 Justice: Justice in East Asian Thought
 Kinship
 Knowledge
 Landscape in the Arts
 Language and Linguistics

- Language, Linguistics, and Literacy
 Language, Philosophy of: Modern
 Law
 Law, Islamic
 Leadership
 Learning and Memory, Contemporary Views
 Liberalism
 Liberty
 Life Cycle: Adolescence
 Life Cycle: Elders/Old Age
 Literary Criticism
 Literature: Overview
 Literature: African Literature
 Love, Western Notions of
 Loyalties, Dual
 Lysenkoism
 Magic
 Maps and the Ideas They Express
 Marriage and Fertility, European Views
 Masks
 Mathematics
 Matriarchy
 Medicine: Europe and the United States
 Medicine: India
 Medicine: Islamic Medicine
 Memory
 Men and Masculinity
 Mestizaje
 Metaphor
 Metaphysics: Renaissance to the Present
 Microcosm and Macrocosm
 Migration: Africa
 Migration: Migration in World History
 Migration: United States
 Millenarianism: Overview
 Millenarianism: Latin America and Native North America
 Mind
 Minority
 Monarchy: Overview
 Monarchy: Islamic Monarchy
 Monasticism
 Monism
 Motherhood and Maternity
 Motif: Motif in Literature
 Motif: Motif in Music
 Multiculturalism, Africa
 Museums
 Music, Anthropology of
 Musical Performance and Audiences
 Musicology
 Mysticism: Kabbalah
 Mysticism: Mysticism in African Thought
 Myth
 Narrative
 Nation
 Native Policy
 Natural History
 Natural Theology
 Nature
 Negritude
 New Criticism
 Nihilism
 Nonviolence
 Nude, The
 Objectivity
 Obligation
 Occidentalism
 Oral Traditions: Overview
 Organicism
 Orientalism: Overview
 Orthodoxy
 Orthopraxy: Western Orthopraxy
 Other, The, European Views of
 Pacifism
 Paradigm
 Patriotism
 Peace
 Peasants and Peasantry
 Periodization
 Periodization of the Arts
 Person, Idea of the
 Philanthropy
 Philosophies: African
 Philosophies: American
 Philosophy: Historical Overview and Recent Developments
 Philosophy: Relations to Other Intellectual Realms
 Philosophy, History of
 Philosophy, Moral: Africa
 Philosophy, Moral: Modern
 Philosophy and Religion in Western Thought
 Philosophy of Mind: Overview
 Philosophy of Religion
 Physics
 Platonism
 Pluralism
 Poetry and Poetics
 Political Protest, U.S.
 Political Science
 Political, The
 Polytheism
 Population
 Postcolonial Studies
 Poverty
 Power
 Practices
 Prehistory, Rise of
 Prejudice
 Presentism
 Privacy
 Probability
 Progress, Idea of
 Propaganda
 Property
 Pseudoscience
 Punishment
 Puritanism
 Queer Theory
 Race and Racism: Overview
 Race and Racism: Asia
 Race and Racism: Europe
 Race and Racism: United States
 Radicals/Radicalism
 Rational Choice
 Rationalism
 Reading
 Reason, Practical and Theoretical
 Reflexivity
 Reform: Europe and the United States

READER'S GUIDE

Reform: Islamic Reform
Regions and Regionalism, Eastern Europe
Religion: Overview
Religion: Africa
Religion: African Diaspora
Religion: East and Southeast Asia
Religion: Indigenous Peoples' View, South America
Religion: Latin America
Religion: Middle East Religion and the State: Africa
Religion and Science
Religion and the State: Europe
Religion and the State: Latin America
Religion and the State: Middle East
Religion and the State: United States
Renaissance
Republicanism: Latin America
Republicanism: Republic
Resistance
Resistance and Accommodation
Responsibility
Revolution
Rhetoric: Overview
Ritual: Public Ritual
Ritual: Religion
Romanticism in Literature and Politics
Sacred and Profane
Sacred Places
Sage Philosophy
Scarcity and Abundance, Latin America
Science: Overview
Science, History of
Sexuality: Overview
Sexuality: Islamic Views
Shinto
Skepticism
Slavery
Social Capital
Social History, U.S.
Society
Sophists, The
Sovereignty
Sport
State of Nature
State, The: Overview
Sufism
Suicide
Superstition
Symbolism
Syncretism
Temperance
Terror
Text/Textuality
Toleration
Totems
Trade
Tradition
Translation
Travel: Travel from Europe and the Middle East
Treaty
Trope
Truth
Universalism
University: Overview
Untouchability: Overview
Untouchability: Menstrual Taboos

Untouchability: Taboos
Utopia
Virtual Reality
Visual Culture
Visual Order to Organizing Collections
Volksgeist
Volunteerism, U.S.
War
War and Peace in the Arts
Wealth
Wildlife
Wisdom, Human
Witchcraft
Witchcraft, African Studies of
Women's History: Africa
Women's History: Asia
World Systems Theory, Latin America

Contemporary

ENTRIES FOCUSED ON THE PERIOD

African-American Ideas
Americanization, U.S.
Anticolonialism: Africa
Anticolonialism: Latin America
Anticolonialism: Middle East
Anticolonialism: Southeast Asia
Anti-Semitism: Islamic Anti-Semitism
Apartheid
Bioethics
Black Atlantic
Black Consciousness
Buddhism
Bureaucracy
Capitalism: Africa
Chicano Movement
Citizenship: Naturalization
Civil Disobedience
Communitarianism in African Thought
Consumerism
Continental Philosophy
Creationism
Critical Race Theory
Critical Theory
Cultural Studies
Democracy
Dress
Dystopia
Empire and Imperialism: Europe
Empiricism
Eugenics
Field Theories
Fundamentalism
Futurology
Gay Studies
Gender: Overview
Genetics: Contemporary
Globalization: Africa
Globalization: Asia
Globalization: General
Historicism
Humanity: African Thought
Human Rights: Overview
Human Rights: Women's Rights
Internal Colonialism
International Order

Jihad
 Liberation Theology
 Liberty
 Life
 Linguistic Turn
 Literary History
 Logic and Philosophy of Mathematics, Modern
 Maoism
 Marxism: Overview
 Marxism: Asia
 Marxism: Latin America
 Media, History of
 Modernization
 Modernization Theory
 Nationalism: Overview
 Nationalism: Africa
 Nationalism: Cultural Nationalism
 Nationalism: Middle East
 Neocolonialism
 Neoliberalism
 Nuclear Age
 Orientalism: African and Black Orientalism
 Pan-Africanism
 Pan-Arabism
 Pan-Asianism
 Pan-Islamism
 Pan-Turkism
 Paradigm
 Parties, Political
 Personhood in African Thought
 Phenomenology
 Philosophies: Feminist, Twentieth-Century
 Poetry and Poetics
 Populism: Latin America
 Populism: United States
 Positivism
 Postcolonial Studies
 Postcolonial Theory and Literature
 Postmodernism
 Pragmatism
 Presentism
 Privatization
 Protest, Political
 Psychoanalysis
 Psychology and Psychiatry
 Quantum
 Queer Theory
 Realism: Africa
 Relativism
 Relativity
 Science Fiction
 Segregation
 Sexual Harassment
 Sexuality: Sexual Orientation
 Sociability in African Thought
 Social Darwinism
 Socialisms, African
 Structuralism and Poststructuralism: Overview
 Structuralism and Poststructuralism: Anthropology
 Subjectivism
 Technology
 Terrorism, Middle East
 Text/Textuality
 Theater and Performance
 Third Cinema

Third World
 Totalitarianism
 Virtual Reality
 Virtue Ethics
 War
 Westernization: Africa
 Westernization: Southeast Asia
 Witchcraft
 Womanism
 Women and Femininity in U.S. Popular Culture
 Women's Studies
 Zionism

ENTRIES WITH EXAMPLES FROM THE PERIOD
 SINCE 1945 (especially since the 1970s)

Absolute Music
 Aesthetics: Africa
 Aesthetics: Asia
 Aesthetics: Europe and the Americas
 Africa, Idea of
 Afrocentricity
 Afropessimism
 Agnosticism
 Algebras
 Alienation
 Altruism
 Ambiguity
 America
 Analytical Philosophy
 Anarchism
 Animism
 Anthropology
 Antifeminism
 Anti-Semitism: Overview
 Architecture: Overview
 Architecture: Africa
 Arts: Overview
 Arts: Africa
 Asceticism: Western Asceticism
 Asian-American Ideas (Cultural Migration)
 Assimilation
 Atheism
 Authenticity: Africa
 Authoritarianism: Overview
 Authoritarianism: East Asia
 Authoritarianism: Latin America
 Authority
 Autobiography
 Autonomy
 Avant-Garde: Overview
 Aztlán
 Barbarism and Civilization
 Beauty and Ugliness
 Behaviorism
 Bilingualism and Multilingualism
 Biography
 Biology
 Body, The
 Bushido
 Calculation and Computation
 Cannibalism
 Capitalism: Overview
 Cartesianism
 Casuistry
 Causality
 Causation

READER'S GUIDE

- Censorship
- Change
- Character
- Childhood and Child Rearing
- Christianity: Overview
- Christianity: Asia
- Cinema
- Citizenship: Overview
- Citizenship: Cultural Citizenship
- City, The: The City as a Cultural Center
- City, The: The City as Political Center
- City, The: The Islamic and Byzantine City
- Civil Society: Europe and the United States
- Civil Society: Responses in Africa and the Middle East
- Classicism
- Colonialism: Africa
- Colonialism: Southeast Asia
- Communication of Ideas: Africa and Its Influence
- Communication of Ideas: Asia and Its Influence
- Communication of Ideas: Southeast Asia
- Communism: Europe
- Communism: Latin America
- Composition, Musical
- Computer Science
- Confucianism
- Consciousness: Overview
- Conservatism
- Consilience
- Context
- Corruption
- Corruption in Developed and Developing Countries
- Cosmopolitanism
- Creolization, Caribbean
- Crisis
- Cultural Capital
- Cultural History
- Cultural Revivals
- Cycles
- Dada
- Dance
- Death
- Death and Afterlife, Islamic Understanding of
- Deism
- Democracy: Africa
- Demography
- Demonology
- Dependency
- Determinism
- Development
- Diasporas: African Diaspora
- Diasporas: Jewish Diaspora
- Dictatorship in Latin America
- Diffusion, Cultural
- Discrimination
- Diversity
- Dream
- Dualism
- Ecology
- Economics
- Ecumenism
- Education: Europe
- Education: Global Education
- Education: Islamic Education
- Education: North America
- Emotions
- Empire and Imperialism: Middle East
- Empire and Imperialism: United States
- Enlightenment
- Environment
- Environmental Ethics
- Environmental History
- Epistemology: Modern
- Equality: Overview
- Equality: Gender Equality
- Equality: Racial Equality
- Essentialism
- Ethnicity and Race: Africa
- Ethnicity and Race: Anthropology
- Ethnicity and Race: Islamic Views
- Ethnocentrism
- Ethnography
- Ethnohistory, U.S.
- Etiquette
- Eurocentrism
- Europe, Idea of
- Evil
- Existentialism
- Experiment
- Falsifiability
- Family: Modernist Anthropological Theory
- Family: Family in Anthropology since 1980
- Family Planning
- Fascism
- Fatalism
- Feminism: Overview
- Feminism: Africa and African Diaspora
- Feminism: Chicana Feminisms
- Feminism: Islamic Feminism
- Feminism: Third World U.S. Movement
- Fetishism: Overview
- Fetishism: Fetishism in Literature and Cultural Studies
- Formalism
- Foundationalism
- Free Will, Determinism, and Predestination
- Friendship
- Game Theory
- Gender: Gender in the Middle East
- Gender in Art
- Gender Studies: Anthropology
- Generation
- Genetics: History of
- Genius
- Genocide
- Geography
- Ghetto
- Gift, The
- Gnosticism
- Good
- Happiness and Pleasure in European Thought
- Harmony
- Hate
- Health and Disease
- Hegelianism
- Hermeneutics
- Hierarchy and Order
- Hinduism
- Historical and Dialectical Materialism
- Historiography
- History, Economic
- History, Idea of

- Honor, Middle Eastern Notions of
 Human Capital
 Humanism: Africa
 Humanism: Europe and the Middle East
 Humanism: Secular Humanism in the United States
 Humanity: European Thought
 Humanity in the Arts
 Humor
 Ideas, History of
 Identity: Identity of Persons
 Identity: Personal and Social Identity
 Identity, Multiple: Overview
 Identity, Multiple: Asian-Americans
 Identity, Multiple: Jewish Multiple Identity
 Imagination
 Immortality and the Afterlife
 Impressionism
 Intelligentsia
 Intentionality
 Intercession in Middle Eastern Society
 Interdisciplinarity
 Islam: Shii
 Islam: Southeast Asia
 Jainism
 Japanese Philosophy, Japanese Thought
 Jouissance
 Judaism: Modern Judaism
 Justice: Overview
 Justice: Justice in American Thought
 Kantianism
 Kinship
 Knowledge
 Landscape in the Arts
 Language and Linguistics
 Language, Philosophy of: Modern
 Law
 Law, Islamic
 Leadership
 Learning and Memory, Contemporary Views
 Liberalism
 Life Cycle: Adolescence
 Life Cycle: Elders/Old Age
 Literary Criticism
 Literature: African Literature
 Lysenkoism
 Machiavellism
 Machismo
 Magic
 Maps and the Ideas They Express
 Marriage and Fertility, European Views
 Masks
 Mathematics
 Matriarchy
 Medicine: China
 Medicine: Europe and the United States
 Medicine: Islamic Medicine
 Meditation: Eastern Meditation
 Meme
 Memory
 Men and Masculinity
 Mestizaje
 Metaphor
 Metaphysics: Renaissance to the Present
 Migration: Africa
 Migration: Migration in World History
 Migration: United States
 Millenarianism: Overview
 Millenarianism: Islamic
 Millenarianism: Latin America and Native North America
 Mind
 Minority
 Modernism: Latin America
 Modernity: Overview
 Modernity: Africa
 Modernity: East Asia
 Monarchy: Overview
 Monasticism
 Monism
 Moral Sense
 Motherhood and Maternity
 Motif: Motif in Literature
 Motif: Motif in Music
 Multiculturalism, Africa
 Museums
 Music, Anthropology of
 Musical Performance and Audiences
 Musicology
 Mysticism: Mysticism in African Thought
 Narrative
 Nation
 Native Policy
 Natural Law
 Natural Theology
 Nature
 Negritude
 New Criticism
 Nihilism
 Nomadism
 Nonviolence
 Objectivity
 Obligation
 Occidentalism
 Oral Traditions: Overview
 Organicism
 Orientalism: Overview
 Orthodoxy
 Pacifism
 Patriotism
 Peace
 Peasants and Peasantry
 Periodization of the Arts
 Person, Idea of the
 Perspective
 Philanthropy
 Philosophies: American
 Philosophy, History of
 Philosophy, Moral: Africa
 Philosophy, Moral: Modern
 Philosophy and Religion in Western Thought
 Philosophy of Mind: Overview
 Philosophy of Religion
 Pluralism
 Political Protest, U.S.
 Political Science
 Population
 Poverty
 Power
 Practices
 Prejudice

READER'S GUIDE

Privacy
Probability
Progress, Idea of
Propaganda
Property
Pseudoscience
Public Sphere
Punishment
Race and Racism: Overview
Race and Racism: Asia
Race and Racism: Europe
Race and Racism: United States
Radicals/Radicalism
Rational Choice
Reading
Reason, Practical and Theoretical
Reflexivity
Reform: Europe and the United States
Reform: Islamic Reform
Regions and Regionalism, Eastern Europe
Religion: Africa
Religion: African Diaspora
Religion: Indigenous Peoples' View, South America
Religion: Latin America
Religion: Middle East
Religion and Science
Religion and the State: Africa
Religion and the State: Latin America
Religion and the State: Middle East
Religion and the State: United States
Renaissance
Representation: Mental Representation
Representation: Political Representation
Resistance
Resistance and Accommodation
Responsibility
Ritual: Public Ritual
Ritual: Religion
Sacred Places
Sacred Texts: Koran
Sage Philosophy
Science: Overview
Science: East Asia
Science, History of
Scientific Revolution
Secularization and Secularism
Sexuality: Overview
Sexuality: Islamic Views
Shinto
Skepticism
Slavery
Social Capital
Social Contract
Social History, U.S.
Society
Sophists, The
Sovereignty
Sport
State, The: Overview
State, The: The Postcolonial State
State of Nature
Superstition
Surrealism
Symbolism
Syncretism

Taste
Terror
Third World Literature
Toleration
Totems
Trade
Tradition
Translation
Treaty
Tribalism, Middle East
Trope
Truth
Universalism
University: Overview
University: Postcolonial
Untouchability: Overview
Untouchability: Menstrual Taboos
Untouchability: Taboos
Utilitarianism
Utopia
Visual Culture
Visual Order to Organizing Collections
War and Peace in the Arts
Wealth
Wildlife
Wisdom, Human
Witchcraft, African Studies of
Women's History: Africa
Women's History: Asia
Work
World Systems Theory, Latin America

LIBERAL ARTS DISCIPLINES AND PROFESSIONS

This section is in accord with the university divisions of the Liberal Arts into Fine Arts, Humanities, Social Sciences, and Sciences and the graduate programs of the professions of Law, Medicine, and Engineering. The sample of Interdisciplinary Programs are listed under their most common university grouping. For example, Fine Arts includes Performance Arts; Social Sciences includes Women's Studies and Gender Studies, as well as Ethnic Studies; Sciences includes Ecology and Geology, as well as Computer Sciences; Humanities includes programs of Communication, Language, and Linguistics. Meanwhile, the growth of interdisciplinary programs reflects the increasing overlap between studies listed under the labels of Fine Arts, Humanities, Social Sciences, and Sciences. A discipline or interdisciplinary program only appears once, but an entry may appear under the several disciplines and interdisciplinary programs that influenced the scholarship of the article. Titles that appear in bold indicate entries that are especially suited as a introduction to the discipline.

Under the category Multidisciplinary Practices, there are entries on the many methods, techniques, theories, and approaches that have spread across the disciplines. The Multidisciplinary Practices help explain the contemporary trend of interdisciplinarity for which the history of ideas has long been known. At the end of this Reader's Guide is a listing of a number of entries that overlap three of the four divisions and a listing of entries that overlap all four divisions.

Fine Arts

VISUAL STUDIES

Absolute Music
Aesthetics: Africa
Aesthetics: Asia
Aesthetics: Europe and the Americas
 Ambiguity
 Anthropology
 Architecture: Overview
 Architecture: Africa
 Architecture: Asia
 Arts: Overview
 Arts: Africa
 Asceticism: Hindu and Buddhist Asceticism
 Asceticism: Western Asceticism
 Avant-Garde: Overview
 Avant-Garde: Militancy
 Aztlán
 Beauty and Ugliness
 Body, The
 Buddhism
 Change
 Chinese Thought
 Cinema
 City, The: Latin America
 City, The: The City as a Cultural Center
 City, The: The Islamic and Byzantine City
 Classicism
 Classification of Arts and Sciences, Early Modern
 Communication of Ideas: Asia and Its Influence
 Composition, Musical
 Consumerism
 Context
 Cosmopolitanism
 Creativity in the Arts and Sciences
 Cultural History
 Dada
 Death
 Dream
 Dress
 Dystopia
 Environmental Ethics
 Environmental History
 Everyday Life
 Expressionism
 Extirpation
 Fascism
 Fetishism: Overview
 Garden
 Gay Studies
 Gender in Art
 Genre
 Geography
 Geometry
 Gesture
 Ghetto
 Globalization: Asia
 Heaven and Hell (Asian Focus)
 Hinduism
 History, Idea of
 Humanity: European Thought
 Humanity in the Arts
 Humor
 Iconography
 Ideas, History of

Images, Icons, and Idols
 Imagination
 Impressionism
 Islamic Science
 Kantianism
 Knowledge
 Landscape in the Arts
 Life Cycle: Overview
 Literary History
 Literature: Overview
 Maps and the Ideas They Express
 Masks
 Matriarchy
Media, History of
 Medicine: Europe and the United States
 Mestizaje
 Modernism: Overview
 Modernism: Latin America
 Modernity: Africa
 Modernity: East Asia
 Monarchy: Overview
 Motherhood and Maternity
 Museums
 Musical Performance and Audiences
 Musicology
 Mysticism: Chinese Mysticism
 Mysticism: Christian Mysticism
 Naturalism in Art and Literature
 Negritude
 Nude, The
 Occidentalism
 Organicism
 Pan-Africanism
 Paradise on Earth
Periodization of the Arts
 Perspective
 Philosophy: Historical Overview and Recent Developments
 Political Protest, U.S.
 Postmodernism
 Pre-Columbian Civilization
 Protest, Political
 Psychoanalysis
 Pythagoreanism
 Realism
 Realism: Africa
 Religion: Africa
 Renaissance
 Representation: Mental Representation
 Ritual: Public Ritual
 Sacred Places
 Sacred Texts: Asia
 Science: East Asia
 Science, History of
 Science Fiction
 Social History, U.S.
 Sport
 Surrealism
 Symbolism
 Syncretism
 Taste
 Text/Textuality
 Textiles and Fiber Arts as Catalysts for Ideas
 Third Cinema
 Victorianism

READER'S GUIDE

Virtual Reality
 Visual Culture
 Visual Order to Organizing Collections
 War and Peace in the Arts
 Westernization: Southeast Asia
 Women and Femininity in U.S. Popular Culture
 Yin and Yang

MUSIC

Absolute Music
 Aesthetics: Africa
 Aesthetics: Asia
 Authenticity: Africa
 Avant-Garde: Overview
 Cinema
 Classicism
 Classification of Arts and Sciences, Early Modern
 Communication of Ideas: Africa and Its Influence
 Composition, Musical
 Context
 Cosmopolitanism
 Dada
 Dance
 Empire and Imperialism: United States
 Formalism
 Generation
 Genre
 Harmony
 Hinduism
 Humanism: Africa
 Humanism: Chinese Conception of
 Humor
 Iconography
 Identity, Multiple: Jewish Multiple Identity
 Judaism: Judaism to 1800
 Knowledge
 Learning and Memory, Contemporary Views
 Love, Western Notions of
 Modernism: Overview
 Motif: Motif in Music
Music, Anthropology of
Musical Performance and Audiences
Musicology
 Mysticism: Chinese Mysticism
 Orientalism: Overview
 Pan-Asianism
 Pietism
 Political Protest, U.S.
 Postmodernism
 Protest, Political
 Pythagoreanism
 Realism: Africa
 Religion: Africa
 Religion: African Diaspora
 Resistance
 Resistance and Accommodation
 Society
 Sophists, The
 Symbolism
 Taste
 Text/Textuality
 Third Cinema
 Virtual Reality
 Visual Order to Organizing Collections
 Westernization: Africa

PERFORMANCE ARTS (includes drama, dance, oratory, ritual, and ceremony)

Absolute Music
 Aesthetics: Africa
 Aesthetics: Asia
 Alienation
 Americanization, U.S.
 Ancestor Worship
 Anthropology
 Arts: Overview
 Asceticism: Hindu and Buddhist Asceticism
 Asceticism: Western Asceticism
 Astronomy, Pre-Columbian and Latin American
 Authenticity: Africa
 Autobiography
 Avant-Garde: Overview
 Body, The
 Cannibalism
 Censorship
 Cinema
 Civil Disobedience
 Civil Society: Europe and the United States
 Communication of Ideas: Africa and Its Influence
 Communication of Ideas: Asia and Its Influence
 Communication of Ideas: Orality and Advent of Writing
 Communication of Ideas: Southeast Asia
 Composition, Musical
 Confucianism
 Context
 Cosmopolitanism
 Creolization, Caribbean
 Cultural Capital
 Cynicism
 Dada
Dance
 Determinism
 Dialogue and Dialectics: Socratic
 Dialogue and Dialectics: Talmudic
 Dictatorship in Latin America
 Dream
 Dress
 Emotions
 Empire and Imperialism: Europe
 Environment
 Equality: Overview
 Ethnicity and Race: Anthropology
 Etiquette
 Everyday Life
 Expressionism
 Extirpation
 Fascism
 Feminism: Chicana Feminisms
 Fetishism: Overview
 Fetishism: Fetishism in Literature and Cultural Studies
 Game Theory
 Gay Studies
 Gender: Overview
 Gender in Art
 Generation
 Genre
 Gesture
 Harmony
 Hinduism
 History, Economic

- History, Idea of
 Honor
 Humanism: Africa
 Humanism: Chinese Conception of
 Humanity: African Thought
 Humor
 Ideas, History of
 Identity, Multiple: Jewish Multiple Identity
 Images, Icons, and Idols
 Intelligentsia
 Islam: Shii
 Islam: Sunni
 Jouissance
 Judaism: Judaism to 1800
 Knowledge
 Language and Linguistics
 Language, Philosophy of: Modern
 Law, Islamic
 Leadership
 Learning and Memory, Contemporary Views
 Life Cycle: Overview
 Literary Criticism
 Literary History
 Literature: African Literature
 Love, Western Notions of
 Magic
 Manichaeism
 Masks
 Media, History of
 Medicine: China
 Medicine: Islamic Medicine
 Meditation: Eastern Meditation
 Men and Masculinity
 Metaphor
 Millenarianism: Islamic
 Millenarianism: Latin America and Native North America
 Modernism: Overview
 Modernity: Overview
 Modernity: Africa
 Motif: Motif in Music
 Music, Anthropology of
 Musical Performance and Audiences
 Musicology
 Mysticism: Chinese Mysticism
 Mysticism: Islamic Mysticism in Asia
 Mysticism: Kabbalah
 Myth
 Narrative
 Nation
 Nationalism: Middle East
 New Criticism
 Nomadism
 Nuclear Age
 Oral Traditions: Overview
 Orientalism: Overview
 Orthodoxy
 Orthopraxy: Asia
 Pan-Turkism
 Periodization of the Arts
 Person, Idea of the
 Philosophies: African
 Philosophies: American
 Philosophies: Feminist, Twentieth-Century
 Philosophies: Islamic
 Philosophy: Historical Overview and Recent Developments
 Philosophy, Moral: Ancient
 Philosophy of Mind: Ancient and Medieval
 Pietism
 Poetry and Poetics
 Political Protest, U.S.
 Populism: United States
 Postmodernism
 Practices
 Pre-Columbian Civilization
 Propaganda
 Protest, Political
 Psychoanalysis
 Punishment
 Queer Theory
 Reading
 Realism: Africa
 Reflexivity
 Reform: Europe and the United States
 Relativism
 Religion: Africa
 Religion: African Diaspora
 Religion: East and Southeast Asia
 Religion: Indigenous Peoples' View, South America
 Religion: Latin America
 Religion: Middle East
 Religion and the State: United States
 Republicanism: Republic
 Resistance
 Resistance and Accommodation
 Responsibility
Rhetoric: Overview
Rhetoric: Ancient and Medieval
 Ritual: Public Ritual
 Ritual: Religion
 Romanticism in Literature and Politics
 Sacred Places
 Sacred Texts: Asia
 Sexuality: Overview
 Shinto
 Slavery
 Society
 Sophists, The
 Sport
 Stoicism
 Subjectivism
 Superstition
 Surrealism
 Symbolism
 Syncretism
 Taste
 Temperance
 Text/Textuality
Theater and Performance
 Third Cinema
 Third World Literature
 Time: China
 Time: India
 Toleration
 Totalitarianism
 Totems
 Tragedy and Comedy
 Translation
 Trope

READER'S GUIDE

Untouchability: Menstrual Taboos
Utilitarianism
Victorianism
Virtual Reality
Volunteerism, U.S.
Westernization: Middle East
Westernization: Southeast Asia
Wisdom, Human
Witchcraft
Witchcraft, African Studies of
Yin and Yang
Yoga

Humanities

COMMUNICATION, LANGUAGE, AND LINGUISTICS

Aesthetics: Africa
Aesthetics: Asia
Africa, Idea of
Afrocentricity
Agnosticism
Algebras
Americanization, U.S.
Analytical Philosophy
Anthropology
Anticolonialism: Africa
Asceticism: Hindu and Buddhist Asceticism
Asceticism: Western Asceticism
Astronomy, Pre-Columbian and Latin American
Authenticity: Africa
Avant-Garde: Overview
Avant-Garde: Militancy
Aztlán
Barbarism and Civilization
Beauty and Ugliness
Behaviorism
Bilingualism and Multilingualism
Body, The
Borders, Borderlands, and Frontiers, Global
Buddhism
Calculation and Computation
Calendar
Cannibalism
Casuistry
Censorship
Chinese Thought
Cinema
Civil Disobedience
Classification of Arts and Sciences, Early Modern
Colonialism: Southeast Asia
Communication of Ideas: Africa and Its Influence
Communication of Ideas: The Americas and Their Influence
Communication of Ideas: Asia and Its Influence
Communication of Ideas: Europe and Its Influence
Communication of Ideas: Middle East and Abroad
Communication of Ideas: Orality and Advent of Writing
Communication of Ideas: Southeast Asia
Computer Science
Consumerism
Context
Continental Philosophy
Cosmopolitanism
Creolization, Caribbean
Critical Theory
Cultural Capital

Cultural History
Cultural Revivals
Cultural Studies
Cynicism
Dance
Democracy
Determinism
Dialogue and Dialectics: Socratic
Diasporas: Jewish Diaspora
Dictatorship in Latin America
Diffusion, Cultural
Discrimination
Diversity
Dream
Dress
Ecumenism
Education: Asia, Traditional and Modern
Empire and Imperialism: Asia
Empire and Imperialism: Europe
Empire and Imperialism: United States
Empiricism
Encyclopedism
Epistemology: Ancient
Epistemology: Early Modern
Epistemology: Modern
Ethnicity and Race: Africa
Ethnicity and Race: Anthropology
Ethnicity and Race: Islamic Views
Etiquette
Eurocentrism
Everyday Life
Examination Systems, China
Extirpation
Fallacy, Logical
Feminism: Overview
Feminism: Chicana Feminisms
Fetishism: Overview
Fetishism: Fetishism in Literature and Cultural Studies
Feudalism, European
Formalism
Gender: Gender in the Middle East
Gender in Art
Geometry
Gesture
Globalization: Asia
Globalization: General
Greek Science
Harmony
Hegemony
Hermeneutics
Hinduism
History, Economic
History, Idea of
Humanism: Africa
Humanism: Chinese Conception of
Humanism: Europe and the Middle East
Humanism: Renaissance
Humanity: African Thought
Human Rights: Overview
Idealism
Ideas, History of
Identity: Identity of Persons
Identity, Multiple: Overview
Identity, Multiple: Jewish Multiple Identity
Indigenismo

- Intelligentsia
 Interdisciplinarity
 Interpretation
 Islam: Africa
 Islam: Southeast Asia
 Islam: Sunni
 Islamic Science
 Japanese Philosophy, Japanese Thought
 Jihad
 Jouissance
 Judaism: Judaism to 1800
 Kantianism
 Kinship
 Knowledge
Language and Linguistics
Language, Linguistics, and Literacy
 Language, Philosophy of: Ancient and Medieval
 Language, Philosophy of: Modern
 Law
 Liberty
 Life Cycle: Overview
 Linguistic Turn
 Literary Criticism
 Literary History
 Literature: Overview
 Literature: African Literature
 Machismo
 Magic
 Maps and the Ideas They Express
 Masks
 Materialism in Eighteenth-Century European Thought
 Mathematics
 Matriarchy
 Media, History of
 Medicine: Europe and the United States
 Medicine: India
 Meme
 Mestizaje
 Metaphor
 Metaphysics: Renaissance to the Present
 Migration: Africa
 Migration: United States
 Millenarianism: Latin America and Native North America
 Mind
 Minority
Modernism: Overview
 Modernity: Overview
 Modernity: Africa
 Monarchy: Overview
 Motherhood and Maternity
 Motif: Motif in Literature
 Motif: Motif in Music
 Multiculturalism, Africa
 Music, Anthropology of
 Musical Performance and Audiences
 Musicology
 Mysticism: Chinese Mysticism
 Mysticism: Christian Mysticism
 Mysticism: Islamic Mysticism in Asia
 Mysticism: Kabbalah
 Mysticism: Mysticism in African Thought
 Narrative
 Nation
 Nationalism: Overview
 Nationalism: Middle East
 Native Policy
 Natural History
 New Criticism
 Nomadism
 Objectivity
 Occidentalism
Oral Traditions: Overview
 Organicism
 Orientalism: Overview
 Orthodoxy
 Pacifism
 Pan-Africanism
 Pan-Arabism
 Pan-Asianism
 Pan-Turkism
 Paradigm
 Patriotism
 Periodization of the Arts
 Person, Idea of the
 Personhood in African Thought
 Philosophies: African
 Philosophies: American
 Philosophies: Feminist, Twentieth-Century
 Philosophies: Islamic
 Philosophy: Historical Overview and Recent Developments
 Philosophy of Mind: Overview
 Philosophy of Mind: Ancient and Medieval
 Philosophy of Religion
 Poetry and Poetics
 Political Protest, U.S.
 Positivism
 Practices
 Pre-Columbian Civilization
 Prejudice
 Presentism
 Privacy
 Probability
 Progress, Idea of
 Propaganda
 Protest, Political
 Pseudoscience
 Psychology and Psychiatry
 Public Sphere
 Punishment
 Pythagoreanism
 Quantum
 Queer Theory
 Race and Racism: Asia
 Race and Racism: Europe
 Race and Racism: United States
 Reading
 Realism
 Realism: Africa
 Reflexivity
 Relativism
 Relativity
 Religion: Africa
 Religion: African Diaspora
 Religion: East and Southeast Asia
 Religion: Indigenous Peoples' View, South America
 Religion: Latin America
 Religion: Middle East
 Religion and the State: Latin America

READER'S GUIDE

Religion and the State: Middle East
Representation: Mental Representation
Republicanism: Republic
Resistance
Resistance and Accommodation
Responsibility
Rhetoric: Overview
Ritual: Public Ritual
Ritual: Religion
Romanticism in Literature and Politics
Sacred and Profane
Sacred Places
Sacred Texts: Asia
Sacred Texts: Koran
Sage Philosophy
Science: East Asia
Science, History of
Sexual Harassment
Sexuality: Overview
Sexuality: Sexual Orientation
Shinto
Slavery
Social History, U.S.
Society
Sophists, The
Sport
State, The: Overview
Stoicism
Structuralism and Poststructuralism: Overview
Structuralism and Poststructuralism: Anthropology
Subjectivism
Superstition
Surrealism
Symbolism
Syncretism
Technology
Temperance
Text/Textuality
Textiles and Fiber Arts as Catalysts for Ideas
Theater and Performance
Third Cinema
Third World Literature
Time: India
Time: Traditional and Utilitarian
Toleration
Totalitarianism
Totems
Trade
Tragedy and Comedy
Translation
Travel: Travel from Europe and the Middle East
Treaty
Trope
Truth
Untouchability: Taboos
Utilitarianism
Victorianism
Virtual Reality
Visual Culture
Visual Order to Organizing Collections
Westernization: Middle East
Westernization: Southeast Asia
Wisdom, Human
Witchcraft
Witchcraft, African Studies of

Womanism
Women and Femininity in U.S. Popular Culture
Yin and Yang
LITERATURE
Absolute Music
Aesthetics: Africa
Aesthetics: Asia
Aesthetics: Europe and the Americas
Africa, Idea of
African-American Ideas
Alienation
America
Anticolonialism: Africa
Anti-Semitism: Overview
Architecture: Asia
Asceticism: Hindu and Buddhist Asceticism
Authenticity: Africa
Autobiography
Avant-Garde: Overview
Aztlán
Biography
Buddhism
Bushido
Casuistry
Chinese Thought
Cinema
Classicism
Classification of Arts and Sciences, Early Modern
Colonialism: Africa
Communication of Ideas: Africa and Its Influence
Communication of Ideas: Asia and Its Influence
Communication of Ideas: Europe and Its Influence
Communication of Ideas: Middle East and Abroad
Communication of Ideas: Orality and Advent of Writing
Communication of Ideas: Southeast Asia
Consciousness: Overview
Continental Philosophy
Corruption
Cosmopolitanism
Creativity in the Arts and Sciences
Critical Race Theory
Critical Theory
Cultural Studies
Dada
Dialogue and Dialectics: Socratic
Dream
Dystopia
Education: Islamic Education
Empire and Imperialism: Europe
Enlightenment
Etiquette
Europe, Idea of
Evil
Examination Systems, China
Existentialism
Expressionism
Extirpation
Fascism
Feminism: Overview
Feminism: Chicana Feminisms
Feminism: Third World U.S. Movement
Fetishism: Fetishism in Literature and Cultural Studies
Formalism
Friendship
Futurology

- Game Theory
 Gay Studies
 Gender: Overview
 Gender: Gender in the Middle East
 Generation
 Genius
Genre
 Globalization: Asia
 Gnosticism
 Heaven and Hell
 Heaven and Hell (Asian Focus)
 Hedonism in European Thought
 Hermeneutics
 Hinduism
 Historiography
 History, Economic
 History, Idea of
 Honor, Middle Eastern Notions of
 Humanism: Africa
 Humanism: Chinese Conception of
 Humanism: Renaissance
 Humanity: African Thought
 Humor
 Ideas, History of
 Identity, Multiple: Jewish Multiple Identity
 Imagination
 Indigenismo
 Individualism
 Intelligentsia
 Interdisciplinarity
 Interpretation
 Islam: Africa
 Islam: Shii
 Islam: Sunni
 Islamic Science
 Japanese Philosophy, Japanese Thought
 Jouissance
 Judaism: Judaism to 1800
 Judaism: Modern Judaism
 Language and Linguistics
 Language, Philosophy of: Ancient and Medieval
 Language, Philosophy of: Modern
 Law, Islamic
 Leadership
 Life Cycle: Overview
 Linguistic Turn
 Literary Criticism
Literary History
 Literature: Overview
 Literature: African Literature
 Love, Western Notions of
 Magic
 Manichaeism
 Marxism: Overview
 Marxism: Latin America
 Masks
 Matriarchy
 Medicine: China
 Medicine: Islamic Medicine
 Memory
 Men and Masculinity
 Mestizaje
 Metaphor
 Metaphysics: Renaissance to the Present
 Microcosm and Macrocosm
 Millenarianism: Overview
 Millenarianism: Islamic
 Millenarianism: Latin America and Native North America
 Modernism: Overview
 Modernism: Latin America
 Modernity: Overview
 Modernity: East Asia
 Mohism
 Monarchy: Overview
 Motherhood and Maternity
 Motif: Motif in Literature
 Motif: Motif in Music
 Musicology
 Mysticism: Chinese Mysticism
 Mysticism: Christian Mysticism
 Myth
 Narrative
 Nation
 Nationalism: Africa
 Naturalism
 Naturalism in Art and Literature
 Nature
 Negritude
New Criticism
 Occidentalism
 Oral Traditions: Overview
 Organicism
 Orientalism: Overview
 Orientalism: African and Black Orientalism
 Pan-Africanism
 Pan-Asianism
 Person, Idea of the
 Phenomenology
 Philosophies: African
 Philosophies: American
 Philosophies: Feminist, Twentieth-Century
 Philosophies: Islamic
 Philosophy: Historical Overview and Recent Developments
 Philosophy, Moral: Ancient
 Philosophy, Moral: Medieval and Renaissance
 Pietism
 Platonism
Poetry and Poetics
 Political Protest, U.S.
 Postcolonial Studies
 Postcolonial Theory and Literature
 Postmodernism
 Practices
 Privacy
 Property
 Prophecy
 Protest, Political
 Psychoanalysis
 Queer Theory
 Race and Racism: Europe
 Reading
 Realism: Africa
 Religion: Africa
 Religion: African Diaspora
 Religion: East and Southeast Asia
 Religion: Indigenous Peoples' View, South America
 Religion: Latin America
 Religion: Middle East

READER'S GUIDE

- Religion and the State: United States
Renaissance
Republicanism: Republic
Resistance and Accommodation
Rhetoric: Overview
Rhetoric: Ancient and Medieval
Ritual: Public Ritual
Romanticism in Literature and Politics
Sacred Texts: Asia
Sacred Texts: Koran
Sage Philosophy
Scholasticism
Science Fiction
Science: Overview
Sexuality: Overview
Slavery
Social History, U.S.
Society
Sophists, The
State of Nature
Stoicism
Structuralism and Poststructuralism: Overview
Surrealism
Symbolism
Syncretism
Text/Textuality
Theater and Performance
Third World Literature
Toleration
Totalitarianism
Tragedy and Comedy
Translation
Travel: Travel from Europe and the Middle East
Trope
Utopia
Victorianism
Virtue Ethics
Visual Order to Organizing Collections
War and Peace in the Arts
Wisdom, Human
- RELIGION**
- Abolitionism
Aesthetics: Africa
Aesthetics: Asia
Africa, Idea of
Agnosticism
Alchemy: China
Alchemy: Europe and the Middle East
Alienation
Altruism
Americanization, U.S.
Ancestor Worship
Animism
Antifeminism
Anti-Semitism: Overview
Anti-Semitism: Islamic Anti-Semitism
Architecture: Overview
Architecture: Asia
Aristotelianism
Arts: Overview
Arts: Africa
Asceticism: Hindu and Buddhist Asceticism
Asceticism: Western Asceticism
Assimilation
Astrology: Overview
- Astrology: China
Astronomy, Pre-Columbian and Latin American
Atheism
Authority
Autonomy
Bioethics
Body, The
Buddhism
Calendar
Cannibalism
Capitalism: Overview
Cartesianism
Casuistry
Causality
Causation in East Asian and Southeast Asian Philosophy
Censorship
Change
Chinese Thought
Christianity: Overview
Christianity: Asia
City, The: Latin America
City, The: The Islamic and Byzantine City
Civil Disobedience
Civil Society: Europe and the United States
Classification of Arts and Sciences, Early Modern
Colonialism: Southeast Asia
Communication of Ideas: Africa and Its Influence
Communication of Ideas: Asia and Its Influence
Communication of Ideas: Middle East and Abroad
Communication of Ideas: Orality and Advent of Writing
Communication of Ideas: Southeast Asia
Composition, Musical
Confucianism
Consciousness: Indian Thought
Conservatism
Continental Philosophy
Corruption
Cosmology: Asia
Cosmology: Cosmology and Astronomy
Cosmopolitanism
Creationism
Cultural History
Dance
Daoism
Death
Death and Afterlife, Islamic Understanding of
Deism
Demonology
Dialogue and Dialectics: Talmudic
Diasporas: Jewish Diaspora
Dictatorship in Latin America
Diversity
Dream
Dress
Dualism
Ecology
Ecumenism
Education: Asia, Traditional and Modern
Education: Europe
Education: Islamic Education
Education: Japan
Empire and Imperialism: Overview
Empire and Imperialism: Americas
Empire and Imperialism: Europe
Enlightenment

- Environment
 Environmental Ethics
 Environmental History
 Epicureanism
 Epistemology: Early Modern
 Epistemology: Modern
 Equality: Overview
 Eschatology
 Ethnicity and Race: Islamic Views
 Etiquette
 Europe, Idea of
 Everyday Life
 Evil
 Evolution
 Existentialism
 Expressionism
 Extirpation
 Family: Family in Anthropology since 1980
 Fascism
 Fatalism
 Feminism: Overview
 Feminism: Africa and African Diaspora
 Feminism: Chicana Feminisms
 Feminism: Islamic Feminism
 Fetishism: Overview
 Form, Metaphysical, in Ancient and Medieval Thought
 Free Will, Determinism, and Predestination
 Friendship
 Fundamentalism
 Gay Studies
 Gender: Gender in the Middle East
 Gender in Art
 General Will
 Genetics: Contemporary
 Genocide
 Ghetto
 Gift, The
 Globalization: Asia
 Gnosticism
 Good
 Harmony
 Health and Disease
 Heaven and Hell
 Heaven and Hell (Asian Focus)
 Hedonism in European Thought
 Heresy and Apostasy
 Hermeneutics
 Hierarchy and Order
 Hinduism
 Historicism
 Historiography
 History, Idea of
 Honor
 Honor, Middle Eastern Notions of
 Humanism: Africa
 Humanism: Chinese Conception of
 Humanism: Renaissance
 Humanism: Secular Humanism in the United States
 Humanity: African Thought
 Humanity: Asian Thought
 Humanity: European Thought
 Humanity in the Arts
 Human Rights: Overview
 Iconography
 Ideas, History of
 Identity: Identity of Persons
 Identity, Multiple: Jewish Multiple Identity
 Images, Icons, and Idols
 Imagination
 Immortality and the Afterlife
 Individualism
 Intelligentsia
 Intentionality
 Intercession in Middle Eastern Society
 Interdisciplinarity
 Islam: Africa
 Islam: Shii
 Islam: Southeast Asia
 Islam: Sunni
 Islamic Science
 Jainism
 Japanese Philosophy, Japanese Thought
 Jihad
 Jouissance
 Judaism: Judaism to 1800
 Judaism: Modern Judaism
 Kantianism
 Kinship
 Knowledge
 Language and Linguistics
 Language, Philosophy of: Ancient and Medieval
 Law, Islamic
 Liberation Theology
 Life
 Literary History
 Love, Western Notions of
 Magic
 Manichaeism
 Marriage and Fertility, European Views
 Marxism: Overview
 Marxism: Latin America
 Masks
 Materialism in Eighteenth-Century European Thought
 Matriarchy
 Medicine: Europe and the United States
 Medicine: Islamic Medicine
 Meditation: Eastern Meditation
 Men and Masculinity
 Metaphor
 Millenarianism: Overview
 Millenarianism: Islamic
 Millenarianism: Latin America and Native North America
 Minority
 Miracles
 Modernity: Overview
 Mohism
 Monarchy: Overview
 Monarchy: Islamic Monarchy
 Monasticism
 Monism
 Motherhood and Maternity
 Motif: Motif in Music
 Multiculturalism, Africa
 Museums
 Music, Anthropology of
 Musical Performance and Audiences
 Mysticism: Chinese Mysticism
 Mysticism: Christian Mysticism
 Mysticism: Islamic Mysticism

READER'S GUIDE

- Mysticism: Islamic Mysticism in Asia
 Mysticism: Kabbalah
 Mysticism: Mysticism in African Thought
 Myth
 Nation
 Nationalism: Cultural Nationalism
 Nationalism: Middle East
 Naturalism
 Natural Law
 Natural Theology
 Newtonianism
 Nomadism
 Nonviolence
 Nude, The
 Obligation
 Organicism
 Orientalism: Overview
 Orientalism: African and Black Orientalism
 Orthodoxy
 Orthopraxy: Asia
 Orthopraxy: Western Orthopraxy
 Other, The, European Views of
 Pacifism
 Paradise on Earth
 Parties, Political
 Peace
 Periodization of the Arts
 Person, Idea of the
 Personhood in African Thought
 Perspective
 Philanthropy
 Philosophies: African
 Philosophies: American
 Philosophies: Feminist, Twentieth-Century
 Philosophies: Islamic
 Philosophy: Historical Overview and Recent Developments
 Philosophy: Relations to Other Intellectual Realms
 Philosophy, Moral: Africa
 Philosophy, Moral: Medieval and Renaissance
 Philosophy, Moral: Modern
 Philosophy and Religion in Western Thought
 Philosophy of Mind: Ancient and Medieval
 Philosophy of Religion
 Physics
 Pietism
 Platonism
 Political Protest, U.S.
 Polytheism
 Population
 Poverty
 Practices
 Pre-Columbian Civilization
 Privacy
 Propaganda
 Prophecy
 Protest, Political
 Pseudoscience
 Psychoanalysis
 Punishment
 Puritanism
 Pythagoreanism
 Race and Racism: Europe
 Rationalism
 Reading
 Reflexivity
 Reform: Islamic Reform
 Reformation
 Relativism
 Religion: Overview
 Religion: Africa
 Religion: African Diaspora
 Religion: East and Southeast Asia
 Religion: Latin America
 Religion: Middle East
 Religion and Science
 Religion and the State: Africa
 Religion and the State: Europe
 Religion and the State: Latin America
 Religion and the State: Middle East
 Religion and the State: United States
 Renaissance
 Representation: Political Representation
 Republicanism: Latin America
 Resistance and Accommodation
 Responsibility
 Rhetoric: Ancient and Medieval
 Ritual: Religion
 Romanticism in Literature and Politics
 Sacred and Profane
 Sacred Places
 Sacred Texts: Asia
 Sacred Texts: Koran
 Scholasticism
 Secularization and Secularism
 Sexuality: Islamic Views
 Shinto
 Skepticism
 Slavery
 Sophists, The
 Subjectivism
 Sufism
 Suicide
 Superstition
 Symbolism
 Syncretism
 Temperance
 Theodicy
 Time: China
 Time: India
 Time: Traditional and Utilitarian
 Toleration
 Totalitarianism
 Totems
 University: Overview
 Untouchability: Overview
 Untouchability: Menstrual Taboos
 Untouchability: Taboos
 Utilitarianism
 Victorianism
 Visual Order to Organizing Collections
 Volunteerism, U.S.
 War
 War and Peace in the Arts
 Westernization: Africa
 Westernization: Middle East
 Westernization: Southeast Asia
 Witchcraft
 Witchcraft, African Studies of
 Yin and Yang

- Yoga
 Zen
 Zionism
 PHILOSOPHY
 Absolute Music
 Aesthetics: Asia
 Aesthetics: Europe and the Americas
 Africa, Idea of
 African-American Ideas
 Afrocentricity
 Agnosticism
 Alchemy: China
 Algebras
 Alienation
 Altruism
 Ambiguity
 Analytical Philosophy
 Anticolonialism: Africa
 Antifeminism
 Architecture: Overview
 Architecture: Asia
 Aristotelianism
 Asceticism: Hindu and Buddhist Asceticism
 Asceticism: Western Asceticism
 Astronomy, Pre-Columbian and Latin American
 Atheism
 Authenticity: Africa
 Autonomy
 Avant-Garde: Militancy
 Bioethics
 Black Consciousness
 Body, The
 Buddhism
 Cartesianism
 Casuistry
 Causality
 Causation
 Causation in East Asian and Southeast Asian Philosophy
 Censorship
 Change
 Character
 Chemistry
 Chinese Thought
 Christianity: Overview
 Civil Disobedience
 Civil Society: Europe and the United States
 Civil Society: Responses in Africa and the Middle East
 Class
 Classification of Arts and Sciences, Early Modern
 Common Sense
 Communitarianism in African Thought
 Confucianism
 Consciousness: Overview
 Consciousness: Chinese Thought
 Consciousness: Indian Thought
 Conservatism
 Consilience
 Context
 Continental Philosophy
 Corruption
 Corruption in Developed and Developing Countries
 Cosmology: Asia
 Cosmopolitanism
 Creationism
 Critical Race Theory
 Critical Theory
 Cultural History
 Cycles
 Cynicism
 Dance
 Daoism
 Death
 Deism
 Democracy
 Democracy: Africa
 Determinism
 Dialogue and Dialectics: Socratic
 Dream
 Dress
 Dualism
 Dystopia
 Eclecticism
 Education: China
 Education: Global Education
 Education: Japan
 Emotions
 Empiricism
 Enlightenment
 Environment
 Environmental Ethics
 Environmental History
 Epicureanism
 Epistemology: Ancient
 Epistemology: Early Modern
 Epistemology: Modern
 Equality: Overview
 Equality: Gender Equality
 Equality: Racial Equality
 Essentialism
 Ethnocentrism
 Eugenics
 Everyday Life
 Evil
 Existentialism
 Expressionism
 Fallacy, Logical
 Falsifiability
 Family Planning
 Fascism
 Fatalism
 Feminism: Overview
 Feminism: Africa and African Diaspora
 Feminism: Chicana Feminisms
 Feminism: Islamic Feminism
 Field Theories
 Form, Metaphysical, in Ancient and Medieval Thought
 Foundationalism
 Free Will, Determinism, and Predestination
 Friendship
 Gender: Gender in the Middle East
 Gender in Art
 General Will
 Genetics: Contemporary
 Genetics: History of
 Geometry
 Gift, The
 Globalization: Asia
 Gnosticism
 Good
 Greek Science

READER'S GUIDE

- Happiness and Pleasure in European Thought
 Harmony
 Health and Disease
 Heaven and Hell (Asian Focus)
 Hedonism in European Thought
 Hegelianism
 Hegemony
 Hermeneutics
 Hierarchy and Order
 Hinduism
 Historical and Dialectical Materialism
 Historicism
 Historiography
 History, Idea of
 Humanism: Africa
 Humanism: Chinese Conception of
 Humanism: Europe and the Middle East
 Humanism: Secular Humanism in the United States
 Humanity: African Thought
 Humanity: Asian Thought
 Humanity: European Thought
 Human Rights: Overview
 Human Rights: Women's Rights
 Idealism
 Ideas, History of
 Identity: Identity of Persons
 Identity, Multiple: Overview
 Identity, Multiple: Jewish Multiple Identity
 Immortality and the Afterlife
 Impressionism
 Individualism
 Intelligentsia
 Intentionality
 Interdisciplinarity
 International Order
 Islam: Africa
 Islam: Sunni
 Islamic Science
 Jainism
 Japanese Philosophy, Japanese Thought
 Jouissance
 Judaism: Modern Judaism
 Justice: Overview
 Justice: Justice in American Thought
 Justice: Justice in East Asian Thought
 Kantianism
 Knowledge
 Language and Linguistics
 Language, Philosophy of: Ancient and Medieval
 Language, Philosophy of: Modern
 Law
 Liberalism
 Liberty
 Life
 Linguistic Turn
 Literary Criticism
 Literary History
 Logic
 Logic and Philosophy of Mathematics, Modern
 Magic
 Manichaeism
 Maoism
 Marxism: Overview
 Marxism: Latin America
 Materialism in Eighteenth-Century European Thought
 Mathematics
 Mechanical Philosophy
 Medicine: China
 Medicine: Europe and the United States
 Meditation: Eastern Meditation
 Memory
 Metaphor
 Metaphysics: Ancient and Medieval
 Metaphysics: Renaissance to the Present
 Microcosm and Macrocosm
 Mind
 Modernism: Latin America
 Modernity: Overview
 Mohism
 Monism
 Moral Sense
 Music, Anthropology of
 Musicology
 Mysticism: Chinese Mysticism
 Myth
 Narrative
 Natural History
 Natural Law
 Natural Theology
 Naturalism
 Nature
 Naturphilosophie
 Neoplatonism
 Newtonianism
 Nihilism
 Nonviolence
 Nuclear Age
 Objectivity
 Obligation
 Occidentalism
 Organicism
 Orientalism: Overview
 Orthopraxy: Asia
 Other, The, European Views of
 Pacifism
 Pan-Africanism
 Paradigm
 Parties, Political
 Peace
 Person, Idea of the
 Personhood in African Thought
 Phenomenology
 Philanthropy
 Philosophies: African
 Philosophies: American
 Philosophies: Feminist, Twentieth-Century
 Philosophies: Islamic
 Philosophy: Historical Overview and Recent Developments
Philosophy: Relations to Other Intellectual Realms
 Philosophy, History of
 Philosophy, Moral: Africa
 Philosophy, Moral: Ancient
 Philosophy, Moral: Medieval and Renaissance
 Philosophy, Moral: Modern
 Philosophy and Religion in Western Thought
 Philosophy of Mind: Overview
 Philosophy of Mind: Ancient and Medieval
 Philosophy of Religion
 Physics

- Pietism
 Platonism
 Pluralism
 Poetry and Poetics
 Political Protest, U.S.
 Political Science
 Population
 Populism: United States
 Positivism
 Postcolonial Studies
 Postmodernism
 Poverty
 Practices
 Pragmatism
 Presentism
 Privacy
 Probability
 Progress, Idea of
 Protest, Political
 Pseudoscience
 Punishment
 Pythagoreanism
 Quantum
 Queer Theory
 Race and Racism: Overview
 Radicals/Radicalism
 Rational Choice
 Rationalism
 Reading
 Realism: Africa
 Reason, Practical and Theoretical
 Reflexivity
 Reform: Europe and the United States
 Relativism
 Relativity
 Religion: Overview
 Religion: East and Southeast Asia
 Religion: Middle East
 Religion and Science
 Religion and the State: United States
 Renaissance
 Representation: Political Representation
 Resistance
 Responsibility
 Rhetoric: Overview
 Romanticism in Literature and Politics
 Sacred Texts: Asia
 Sage Philosophy
 Scholasticism
 Science: Overview
 Science: East Asia
 Science, History of
 Scientific Revolution
 Secularization and Secularism
 Sexual Harassment
 Sexuality: Overview
 Skepticism
 Sociability in African Thought
 Social Darwinism
 Socialisms, African
 Society
 Sophists, The
 State of Nature
 Stoicism
 Structuralism and Poststructuralism: Overview
 Subjectivism
 Suicide
 Surrealism
 Symbolism
 Taste
 Text/Textuality
 Theodicy
 Time: China
 Time: India
 Toleration
 Totalitarianism
 Translation
 Truth
 Universalism
 Utilitarianism
 Victorianism
 Virtue Ethics
 Visual Culture
 Visual Order to Organizing Collections
 Volksgeist
 Volunteerism, U.S.
 War
 Wildlife
 Wisdom, Human
 Witchcraft
 Witchcraft, African Studies of
 Womanism
 Yin and Yang
 Yoga
 Zen
- EDUCATION
 Abolitionism
 Aesthetics: Africa
 Aesthetics: Asia
 Afrocentricity
 Altruism
 Americanization, U.S.
 Anthropology
 Anticolonialism: Africa
 Anticolonialism: Southeast Asia
 Antifeminism
 Anti-Semitism: Overview
 Apartheid
 Architecture: Overview
 Aristotelianism
 Asceticism: Hindu and Buddhist Asceticism
 Authenticity: Africa
 Authoritarianism: Latin America
 Behaviorism
 Bilingualism and Multilingualism
 Biology
 Black Consciousness
 Body, The
 Buddhism
 Bushido
 Calculation and Computation
 Capitalism: Overview
 Capitalism: Africa
 Character
 Childhood and Child Rearing
 Chinese Thought
 Christianity: Asia
 Citizenship: Naturalization
 City, The: The City as a Cultural Center
 Civil Society: Europe and the United States

READER'S GUIDE

- Classification of Arts and Sciences, Early Modern
 Communication of Ideas: Africa and Its Influence
 Communication of Ideas: Asia and Its Influence
 Communication of Ideas: Europe and Its Influence
 Communication of Ideas: Southeast Asia
 Composition, Musical
 Confucianism
 Consciousness: Chinese Thought
 Consciousness: Indian Thought
 Cosmopolitanism
 Creationism
 Creolization, Caribbean
 Cultural Capital
 Cultural Revivals
 Cultural Studies
 Dance
 Daoism
 Death and Afterlife, Islamic Understanding of
 Democracy: Africa
 Dialogue and Dialectics: Socratic
 Dialogue and Dialectics: Talmudic
 Diasporas: Jewish Diaspora
 Diffusion, Cultural
 Discrimination
 Diversity
 Dress
 Eclecticism
Education: Asia, Traditional and Modern
Education: China
Education: Europe
Education: Global Education
Education: India
Education: Islamic Education
Education: Japan
Education: North America
 Emotion
 Empire and Imperialism: Asia
 Empire and Imperialism: Europe
 Empire and Imperialism: United States
 Enlightenment
 Environmental Ethics
 Environmental History
 Epicureanism
 Epistemology: Ancient
 Epistemology: Early Modern
 Epistemology: Modern
 Equality: Overview
 Ethnicity and Race: Anthropology
 Etiquette
 Examination Systems, China
 Experiment
 Extirpation
 Family Planning
 Fascism
 Feminism: Overview
 Feminism: Africa and African Diaspora
 Feminism: Chicana Feminisms
 Feminism: Islamic Feminism
 Gender: Gender in the Middle East
 Generation
 Globalization: Asia
 Good
 Greek Science
 Harmony
 Health and Disease
 Hermeneutics
 Hinduism
 Historical and Dialectical Materialism
 Historiography
 History, Economic
 Human Capital
 Humanism: Chinese Conception of
 Humanism: Europe and the Middle East
 Humanism: Renaissance
 Humanity: Asian Thought
 Hygiene
 Ideas, History of
 Identity, Multiple: Jewish Multiple Identity
 Individualism
 Interdisciplinarity
 Interpretation
 Islam: Africa
 Islam: Southeast Asia
 Islam: Sunni
 Islamic Science
 Japanese Philosophy, Japanese Thought
 Jihad
 Jouissance
 Judaism: Judaism to 1800
 Judaism: Modern Judaism
 Justice: Justice in East Asian Thought
 Kantianism
 Kinship
 Knowledge
 Language and Linguistics
 Language, Linguistics, and Literacy
 Learning and Memory, Contemporary Views
 Life Cycle: Overview
 Life Cycle: Adolescence
 Life Cycle: Elders/Old Age
 Literary Criticism
 Loyalties, Dual
 Maoism
 Maps and the Ideas They Express
 Marxism: Overview
 Masks
 Matriarchy
 Medicine: Europe and the United States
 Men and Masculinity
 Mestizaje
 Metaphor
 Minority
 Modernity: Overview
 Modernity: Africa
 Modernity: East Asia
 Modernization Theory
 Mohism
 Motherhood and Maternity
 Multiculturalism, Africa
 Museums
 Music, Anthropology of
 Musical Performance and Audiences
 Musicology
 Mysticism: Chinese Mysticism
 Mysticism: Islamic Mysticism in Asia
 Mysticism: Kabbalah
 Nation
 Nationalism: Africa
 Natural History
 Negritude

Neoplatonism
 Newtonianism
 Nuclear Age
 Nude, The
 Objectivity
 Occidentalism
 Oral Traditions: Overview
 Organicism
 Orientalism: Overview
 Orthodoxy
 Pan-Arabism
 Pan-Asianism
 Paradigm
 Periodization of the Arts
 Philosophies: American
 Philosophies: Feminist, Twentieth-Century
 Philosophies: Islamic
 Philosophy: Historical Overview and Recent Developments
 Philosophy, History of
 Philosophy, Moral: Ancient
 Philosophy, Moral: Medieval and Renaissance
 Philosophy, Moral: Modern
 Philosophy of Mind: Ancient and Medieval
 Physics
 Platonism
 Political Protest, U.S.
 Population
 Populism: United States
 Practices
 Pragmatism
 Prejudice
 Privacy
 Propaganda
 Protest, Political
 Pseudoscience
 Psychoanalysis
 Punishment
 Queer Theory
 Reading
 Realism: Africa
 Reason, Practical and Theoretical
 Reflexivity
 Reform: Islamic Reform
 Reformation
 Relativism
 Religion: East and Southeast Asia
 Religion: Middle East
 Religion and the State: Europe
 Religion and the State: Latin America
 Religion and the State: Middle East
 Religion and the State: United States
 Renaissance
 Representation: Political Representation
 Republicanism: Republic
 Resistance
 Rhetoric: Overview
 Rhetoric: Ancient and Medieval
 Ritual: Public Ritual
 Sacred Places
 Sacred Texts: Asia
 Sage Philosophy
 Scholasticism
 Science: East Asia
 Segregation

Sexuality: Overview
 Skepticism
 Slavery
 Sociability in African Thought
 Social Capital
 Social History, U.S.
 Sophists, The
 Sport
 State, The: Overview
 Stoicism
 Subjectivism
 Sufism
 Superstition
 Temperance
 Theater and Performance
 Third Cinema
 Third World Literature
 Time: China
 Totalitarianism
 Tragedy and Comedy
 University: Overview
 University: Postcolonial
 Untouchability: Menstrual Taboos
 Untouchability: Taboos
 Utilitarianism
 Utopia
 Victorianism
 Visual Order to Organizing Collections
 Volunteerism, U.S.
 War and Peace in the Arts
 Westernization: Africa
 Westernization: Middle East
 Westernization: Southeast Asia
 Wisdom, Human
 Women's History: Africa
 Women's Studies
 Yoga
 Zen

Social Sciences

WOMEN'S STUDIES AND GENDER STUDIES

Abolitionism
 Aesthetics: Asia
 African-American Ideas
 Anarchism
 Anthropology
 Antifeminism
 Asceticism: Western Asceticism
 Autobiography
 Beauty and Ugliness
 Biography
 Black Atlantic
 Body, The
 Capitalism: Africa
 Censorship
 Chicano Movement
 Childhood and Child Rearing
 Christianity: Overview
 Cinema
 Class
 Colonialism: Africa
 Colonialism: Southeast Asia
 Communication of Ideas: Southeast Asia
 Composition, Musical
 Confucianism

READER'S GUIDE

Consumerism
 Continental Philosophy
 Creativity in the Arts and Sciences
 Critical Race Theory
 Critical Theory
 Cultural Studies
 Dance
 Death
 Death and Afterlife, Islamic Understanding of
 Democracy: Africa
 Demography
 Diversity
 Dress
 Dystopia
 Economics
 Education: Asia, Traditional and Modern
 Education: China
 Education: Europe
 Education: Islamic Education
 Education: North America
 Emotions
 Environmental History
 Equality: Overview
 Equality: Gender Equality
 Essentialism
 Etiquette
 Eugenics
 Eurocentrism
 Everyday Life
 Existentialism
 Family: Modernist Anthropological Theory
 Family: Family in Anthropology since 1980
 Family Planning
 Fascism
 Feminism: Overview
 Feminism: Africa and African Diaspora
 Feminism: Chicana Feminisms
 Feminism: Third World U.S. Movement
 Fetishism: Overview
 Fetishism: Fetishism in Literature and Cultural Studies
 Friendship
Gay Studies
 Gender: Overview
 Gender: Gender in the Middle East
 Gender in Art
Gender Studies: Anthropology
 Genius
 Genre
 Hate
 Historiography
 History, Economic
 Honor
 Honor, Middle Eastern Notions of
 Human Capital
 Humanism: Renaissance
 Humanity: Asian Thought
 Humanity: European Thought
 Human Rights: Women's Rights
 Humor
 Iconography
 Identity: Identity of Persons
 Identity, Multiple: Overview
 Impressionism
 Intelligentsia
 Interdisciplinarity
 Internal Colonialism
 Interpretation
 Islam: Shii
 Jouissance
 Justice: Overview
 Kinship
 Knowledge
 Law
 Law, Islamic
 Legalism, Ancient China
 Liberalism
 Liberation Theology
 Life Cycle: Adolescence
 Literary History
 Literature: African Literature
 Love, Western Notions of
 Machismo
 Marriage and Fertility, European Views
 Masks
 Matriarchy
 Medicine: Europe and the United States
 Men and Masculinity
 Mestizaje
 Minority
 Modernism: Overview
 Motherhood and Maternity
 Music, Anthropology of
 Musicology
 Mysticism: Christian Mysticism
 Narrative
 Nude, The
 Orientalism: African and Black Orientalism
 Orthodoxy
 Pan-Africanism
 Periodization of the Arts
 Philosophies: African
 Philosophies: American
 Philosophies: Feminist, Twentieth-Century
 Philosophy: Historical Overview and Recent Developments
 Poetry and Poetics
 Political Protest, U.S.
 Population
 Postcolonial Studies
 Postcolonial Theory and Literature
 Postmodernism
 Pre-Columbian Civilization
 Privacy
 Progress, Idea of
 Propaganda
 Prophecy
 Protest, Political
 Psychoanalysis
 Public Sphere
 Queer Theory
 Radicals/Radicalism
 Reading
 Reflexivity
 Relativism
 Religion: Africa
 Religion: African Diaspora
 Renaissance
 Republicanism: Latin America
 Resistance and Accommodation
 Rhetoric: Ancient and Medieval

- Ritual: Public Ritual
 Ritual: Religion
 Romanticism in Literature and Politics
 Science: Overview
 Science, History of
 Science Fiction
 Scientific Revolution
 Secularization and Secularism
 Sexual Harassment
Sexuality: Overview
Sexuality: Islamic Views
Sexuality: Sexual Orientation
 Shinto
 Slavery
 Social Contract
 Social History, U.S.
 Sport
 State, The: The Postcolonial State
 Structuralism and Poststructuralism: Overview
 Subjectivism
 Symbolism
 Universalism
 University: Overview
 Untouchability: Menstrual Taboos
 Utopia
 Victorianism
 Virtue Ethics
 Visual Culture
 Visual Order to Organizing Collections
 Volunteerism, U.S.
 War
 Witchcraft
 Witchcraft, African Studies of
 Womanism
 Women and Femininity in U.S. Popular Culture
 Women's History: Africa
 Women's History: Asia
Women's Studies
 Work
ETHNIC STUDIES
 Abolitionism
 Absolute Music
 Africa, Idea of
 African-American Ideas
 Afrocentricity
 America
 Americanization, U.S.
 Ancestor Worship
 Anthropology
 Anticolonialism: Africa
 Anticolonialism: Southeast Asia
 Anti-Semitism: Overview
 Anti-Semitism: Islamic Anti-Semitism
 Apartheid
 Architecture: Africa
 Arts: Overview
 Assimilation
 Astronomy, Pre-Columbian and Latin American
 Authenticity: Africa
 Autobiography
 Aztlán
 Barbarism and Civilization
 Bilingualism and Multilingualism
 Black Atlantic
 Black Consciousness
 Body, The
 Borders, Borderlands, and Frontiers, Global
 Cannibalism
 Capitalism: Overview
 Capitalism: Africa
 Chicano Movement
 Cinema
 Citizenship: Cultural Citizenship
 City, The: Latin America
 City, The: The City as a Cultural Center
 City, The: The City as Political Center
 Civil Disobedience
 Class
 Colonialism: Africa
 Colonialism: Latin America
 Colonialism: Southeast Asia
 Communication of Ideas: Southeast Asia
 Communitarianism in African Thought
 Composition, Musical
 Consumerism
 Context
 Cosmopolitanism
 Creolization, Caribbean
 Critical Race Theory
 Critical Theory
 Cultural Capital
 Cultural Revivals
 Cultural Studies
 Dance
 Death
 Demography
 Diasporas: African Diaspora
 Diasporas: Jewish Diaspora
 Diffusion, Cultural
 Discrimination
 Diversity
 Dress
 Education: North America
 Empire and Imperialism: Europe
 Empire and Imperialism: Middle East
 Environmental History
 Equality: Overview
 Equality: Racial Equality
 Essentialism
Ethnicity and Race: Africa
Ethnicity and Race: Anthropology
Ethnicity and Race: Islamic Views
 Ethnocentrism
Ethnography
 Ethnohistory, U.S.
 Eugenics
 Eurocentrism
 Extirpation
 Family Planning
 Fascism
 Feminism: Overview
 Feminism: Africa and African Diaspora
 Feminism: Chicana Feminisms
 Feminism: Third World U.S. Movement
 Fetishism: Overview
 Fetishism: Fetishism in Literature and Cultural Studies
 Gender Studies: Anthropology
 Generation
 Genetics: Contemporary
 Genocide

READER'S GUIDE

- Gesture
 Ghetto
 Gift, The
 Hate
 Hinduism
 History, Economic
 Honor
 Humanity: European Thought
 Humor
 Hygiene
 Iconography
 Identity, Multiple: Overview
 Identity, Multiple: Asian-Americans
 Identity, Multiple: Jewish Multiple Identity
 Indigenismo
 Intelligentsia
 Interdisciplinarity
 Internal Colonialism
 Islam: Africa
 Jouissance
 Judaism: Modern Judaism
 Kinship
 Law
 Liberation Theology
 Life Cycle: Adolescence
 Literary History
 Literature: African Literature
 Loyalties, Dual
 Machismo
 Marxism: Latin America
 Mathematics
 Matriarchy
 Men and Masculinity
 Mestizaje
 Migration: Africa
 Migration: Migration in World History
 Migration: United States
 Minority
 Modernism: Overview
 Modernity: Africa
 Motherhood and Maternity
 Multiculturalism, Africa
 Music, Anthropology of
 Musical Performance and Audiences
 Mysticism: Kabbalah
 Nation
 Nationalism: Overview
 Nationalism: Africa
 Nationalism: Cultural Nationalism
 Nationalism: Middle East
 Native Policy
 Naturalism
 Negritude
 Nomadism
 Nuclear Age
 Occidentalism
 Orientalism: Overview
 Orientalism: African and Black Orientalism
 Orthodoxy
 Other, The, European Views of
 Pan-Africanism
 Pan-Asianism
 Pan-Islamism
 Pan-Turkism
 Patriotism
 Periodization of the Arts
 Person, Idea of the
 Philosophies: African
 Philosophies: American
 Political Protest, U.S.
 Population
 Populism: United States
 Postcolonial Studies
 Postcolonial Theory and Literature
 Postmodernism
 Practices
 Pre-Columbian Civilization
 Prehistory, Rise of
 Prejudice
 Privacy
 Protest, Political
 Psychoanalysis
 Queer Theory
 Race and Racism: Overview
 Race and Racism: Asia
 Race and Racism: Europe
 Race and Racism: United States
 Reading
 Realism: Africa
 Reflexivity
 Regions and Regionalism, Eastern Europe
 Relativism
 Religion: African Diaspora
 Religion: Indigenous Peoples' View, South America
 Religion: Latin America
 Religion: Middle East
 Republicanism: Latin America
 Resistance and Accommodation
 Ritual: Religion
 Sage Philosophy
 Scarcity and Abundance, Latin America
 Secularization and Secularism
 Segregation
 Sexuality: Overview
 Shinto
 Slavery
 Socialisms, African
 Sport
 State, The: The Postcolonial State
 Superstition
 Symbolism
 Syncretism
 Terror
 Third Cinema
 Third World
 Third World Literature
 Time: Traditional and Utilitarian
 Totalitarianism
 Totems
 Trade
 Translation
 Treaty
 Untouchability: Menstrual Taboos
 Untouchability: Taboos
 Utopia
 Victorianism
 Visual Culture
 Volksgeist
 Volunteerism, U.S.
 War

- Westernization: Africa
 Westernization: Southeast Asia
 Wisdom, Human
 Witchcraft, African Studies of
 Womanism
 Women and Femininity in U.S. Popular Culture
 Women's History: Africa
 Women's Studies
 Work
 World Systems Theory, Latin America
 Zionism
- HISTORY**
- Aesthetics: Europe and the Americas
 Afrocentricity
 Afropessimism
 Altruism
 Americanization, U.S.
 Anthropology
 Anticolonialism: Latin America
 Anticolonialism: Southeast Asia
 Anti-Semitism: Overview
 Architecture: Overview
 Architecture: Africa
 Asceticism: Hindu and Buddhist Asceticism
 Authoritarianism: Latin America
 Autobiography
 Autonomy
 Aztlán
 Barbarism and Civilization
 Biography
 Buddhism
 Capitalism: Overview
 Change
 Childhood and Child Rearing
 Chinese Thought
 City, The: The City as a Cultural Center
 Classification of Arts and Sciences, Early Modern
 Colonialism: Africa
 Colonialism: Latin America
 Colonialism: Southeast Asia
 Consciousness: Overview
 Conservatism
 Context
 Continental Philosophy
 Cosmology: Asia
 Creolization, Caribbean
 Crisis
 Cultural History
 Cultural Revivals
 Cultural Studies
 Cycles
 Dance
 Determinism
 Diasporas: African Diaspora
 Diasporas: Jewish Diaspora
 Dictatorship in Latin America
 Diffusion, Cultural
 Dress
 Ecology
 Economics
 Education: Europe
 Empire and Imperialism: Overview
 Empire and Imperialism: United States
 Enlightenment
 Environmental History
- Ethnography
 Ethnohistory, U.S.
 Eurocentrism
 Everyday Life
 Evil
 Extirpation
 Fascism
 Fatalism
 Feminism: Overview
 Feminism: Third World U.S. Movement
 Feudalism, European
 Futurology
 Gender in Art
 Generation
 Genius
 Genre
 Geography
 Globalization: Asia
 Hegelianism
 Hermeneutics
 Historical and Dialectical Materialism
 Historicism
Historiography
 History, Economic
History, Idea of
 Honor
 Iconography
 Ideas, History of
 Identity, Multiple: Jewish Multiple Identity
 Intelligentsia
 Intentionality
 Interdisciplinarity
 Internal Colonialism
 International Order
 Interpretation
 Islamic Science
 Japanese Philosophy, Japanese Thought
 Jihad
 Judaism: Judaism to 1800
 Knowledge
 Language and Linguistics
 Leadership
 Learning and Memory, Contemporary Views
 Life Cycle: Elders/Old Age
 Linguistic Turn
 Literary Criticism
 Literary History
 Literature: African Literature
 Love, Western Notions of
 Machiavellism
 Maoism
 Marxism: Overview
 Marxism: Asia
 Marxism: Latin America
 Matriarchy
 Media, History of
 Memory
 Mestizaje
 Metaphor
 Migration: Africa
 Migration: Migration in World History
 Millenarianism: Overview
 Millenarianism: Islamic
 Millenarianism: Latin America and Native North America

READER'S GUIDE

Modernism: Latin America
Modernity: Overview
Modernity: Africa
Modernity: East Asia
Modernization
Modernization Theory
Motif: Motif in Literature
Music, Anthropology of
Musicology
Narrative
Nation
Nationalism: Overview
Nationalism: Africa
Native Policy
Negritude
Nomadism
Nuclear Age
Occidentalism
Oral Traditions: Overview
Pan-Asianism
Paradigm
Patriotism
Peasants and Peasantry
Periodization
Periodization of the Arts
Philosophies: Feminist, Twentieth-Century
Philosophy: Historical Overview and Recent Developments
Philosophy, History of
Philosophy of Religion
Poetry and Poetics
Political Protest, U.S.
Polytheism
Postcolonial Theory and Literature
Postmodernism
Power
Practices
Pragmatism
Pre-Columbian Civilization
Presentism
Privacy
Progress, Idea of
Protest, Political
Public Sphere
Queer Theory
Race and Racism: Asia
Reading
Realism: Africa
Reflexivity
Reform: Europe and the United States
Reformation
Regions and Regionalism, Eastern Europe
Relativism
Religion: East and Southeast Asia
Religion: Indigenous Peoples' View, South America
Religion: Middle East
Religion and the State: United States
Renaissance
Republicanism: Latin America
Republicanism: Republic
Resistance
Responsibility
Revolution
Ritual: Public Ritual
Sacred Texts: Asia
Scarcity and Abundance, Latin America
Science: Overview
Science, History of
Scientific Revolution
Sexuality: Overview
Skepticism
Slavery
Social Capital
Social Darwinism
Social History, U.S.
Society
Sophists, The
Sport
State of Nature
Structuralism and Poststructuralism: Overview
Subjectivism
Surrealism
Syncretism
Technology
Theater and Performance
Theodicy
Third World
Time: China
Time: India
Time: Traditional and Utilitarian
Toleration
Totalitarianism
Trade
Treaty
Trope
Utopia
Victorianism
Visual Order to Organizing Collections
Volkgeist
War
War and Peace in the Arts
Westernization: Middle East
Westernization: Southeast Asia
Witchcraft
Witchcraft, African Studies of
Women's History: Africa
Women's History: Asia
World Systems Theory, Latin America

ANTHROPOLOGY AND SOCIOLOGY

Aesthetics: Asia
Aesthetics: Europe and the Americas
Africa, Idea of
Alienation
Altruism
Americanization, U.S.
Ancestor Worship
Anthropology
Anti-Semitism: Overview
Architecture: Overview
Architecture: Africa
Asceticism: Hindu and Buddhist Asceticism
Asceticism: Western Asceticism
Astronomy, Pre-Columbian and Latin American
Aztlán
Barbarism and Civilization
Beauty and Ugliness
Bilingualism and Multilingualism
Body, The
Borders, Borderlands, and Frontiers, Global
Buddhism

- Calendar
 Cannibalism
 Capitalism: Overview
 Character
 Childhood and Child Rearing
 Chinese Thought
 Cinema
 Citizenship: Cultural Citizenship
 City, The: The City as a Cultural Center
 Civil Society: Europe and the United States
 Colonialism: Latin America
 Colonialism: Southeast Asia
 Communication of Ideas: Orality and Advent of Writing
 Communication of Ideas: Southeast Asia
 Communitarianism in African Thought
 Composition, Musical
 Context
 Continental Philosophy
 Cosmopolitanism
 Creativity in the Arts and Sciences
 Creolization, Caribbean
 Cultural Capital
 Cultural History
 Cultural Revivals
 Cultural Studies
 Dance
 Death
 Death and Afterlife, Islamic Understanding of
 Demography
 Demonology
 Development
 Diasporas: African Diaspora
 Diasporas: Jewish Diaspora
 Diffusion, Cultural
 Discrimination
 Diversity
 Dream
 Dress
 Ecology
 Environment
 Environmental Ethics
 Environmental History
 Ethnicity and Race: Africa
 Ethnicity and Race: Anthropology
 Ethnocentrism
Ethnography
 Ethnohistory, U.S.
 Etiquette
 Eugenics
 Eurocentrism
 Europe, Idea of
 Everyday Life
 Extirpation
 Family: Modernist Anthropological Theory
 Family: Family in Anthropology since 1980
 Family Planning
 Fascism
 Feminism: Overview
 Feminism: Third World U.S. Movement
 Fetishism: Overview
 Gender Studies: Anthropology
 Generation
 Genetics: Contemporary
 Genetics: History of
 Gesture
 Ghetto
 Gift, The
 Globalization: Asia
 Hinduism
 Historiography
 History, Economic
 History, Idea of
 Honor
 Honor, Middle Eastern Notions of
 Humanism: Chinese Conception of
 Humanity: African Thought
 Humanity: European Thought
 Humor
 Ideas, History of
 Identity: Personal and Social Identity
 Identity, Multiple: Asian-Americans
 Identity, Multiple: Jewish Multiple Identity
 Intelligentsia
 Intentionality
 Interdisciplinarity
 Interpretation
 Jouissance
 Judaism: Modern Judaism
 Kinship
 Knowledge
 Language and Linguistics
Life Cycle: Overview
Life Cycle: Adolescence
Life Cycle: Elders/Old Age
 Linguistic Turn
 Literary Criticism
 Machiavellism
 Magic
 Manichaeism
 Marriage and Fertility, European Views
 Marxism: Overview
 Masks
 Matriarchy
 Meditation: Eastern Meditation
 Memory
 Men and Masculinity
 Mestizaje
 Metaphor
 Migration: Migration in World History
 Migration: United States
 Minority
 Motherhood and Maternity
 Motif: Motif in Music
 Music, Anthropology of
 Musical Performance and Audiences
 Musicology
 Mysticism: Chinese Mysticism
 Myth
 Nation
 Native Policy
 Natural History
 Occidentalism
 Oral Traditions: Overview
 Organicism
 Orientalism: African and Black Orientalism
 Orthodoxy
 Orthopraxy: Asia
 Other, The, European Views of
 Peasants and Peasantry
 Person, Idea of the

READER'S GUIDE

Philosophies: Feminist, Twentieth-Century
 Philosophy, Moral: Africa
 Phrenology
 Pluralism
 Polytheism
 Postcolonial Theory and Literature
 Postmodernism
 Power
 Practices
 Pre-Columbian Civilization
 Prehistory, Rise of
 Prejudice
 Presentism
 Privacy
 Psychoanalysis
 Public Sphere
 Queer Theory
 Race and Racism: Asia
 Reading
 Reflexivity
 Reform: Europe and the United States
 Relativism
 Religion: Overview
 Religion: Africa
 Religion: African Diaspora
 Religion: Latin America
 Religion: Middle East
 Representation: Mental Representation
 Resistance
 Resistance and Accommodation
 Ritual: Public Ritual
 Ritual: Religion
 Sacred and Profane
 Scarcity and Abundance, Latin America
 Sexuality: Overview
 Sexuality: Sexual Orientation
 Social Capital
 Social Darwinism
 Social History, U.S.
 Society
 Sport
 State of Nature
 Structuralism and Poststructuralism: Overview
 Structuralism and Poststructuralism: Anthropology
 Subjectivism
 Superstition
 Surrealism
 Symbolism
 Syncretism
 Textiles and Fiber Arts as Catalysts for Ideas
 Theater and Performance
 Time: Traditional and Utilitarian
 Toleration
 Totalitarianism
 Totems
 Trade
 Tradition
 Tragedy and Comedy
 Tribalism, Middle East
 Trope
 Untouchability: Menstrual Taboos
 Untouchability: Taboos
 Utilitarianism
 Victorianism
 Virtue Ethics

War and Peace in the Arts
 Westernization: Southeast Asia
 Wisdom, Human
 Witchcraft
 Witchcraft, African Studies of
 Women's History: Africa
 Work
 World Systems Theory, Latin America
 Yin and Yang
 POLITICAL SCIENCE (emphasizing political philosophy)
 Abolitionism
 Absolute Music
 Africa, Idea of
 African-American Ideas
 Afrocentricity
 Afropessimism
 Alienation
 Altruism
 America
 Americanization, U.S.
 Anarchism
 Anthropology
 Anticolonialism: Africa
 Anticolonialism: Latin America
 Anticolonialism: Middle East
 Anticolonialism: Southeast Asia
 Anti-Semitism: Overview
 Anti-Semitism: Islamic Anti-Semitism
 Apartheid
 Architecture: Overview
 Architecture: Africa
 Architecture: Asia
 Asceticism: Western Asceticism
 Asian-American Ideas (Cultural Migration)
 Assimilation
 Astronomy, Pre-Columbian and Latin American
 Authoritarianism: Overview
 Authoritarianism: East Asia
 Authoritarianism: Latin America
 Authority
 Autobiography
 Avant-Garde: Militancy
 Aztlán
 Barbarism and Civilization
 Bilingualism and Multilingualism
 Bioethics
 Black Atlantic
 Black Consciousness
 Borders, Borderlands, and Frontiers, Global
 Bureaucracy
 Bushido
 Calculation and Computation
 Cannibalism
 Capitalism: Overview
 Capitalism: Africa
 Casuistry
 Censorship
 Chicano Movement
 Childhood and Child Rearing
 Chinese Warlordism
 Christianity: Overview
 Christianity: Asia
 Citizenship: Overview
 Citizenship: Cultural Citizenship
 Citizenship: Naturalization

- City, The: Latin America
 City, The: The City as a Cultural Center
 City, The: The City as Political Center
 Civil Disobedience
 Civil Society: Europe and the United States
 Civil Society: Responses in Africa and the Middle East
 Class
 Colonialism: Africa
 Colonialism: Latin America
 Colonialism: Southeast Asia
 Common Sense
 Communication of Ideas: Europe and Its Influence
 Communication of Ideas: Middle East and Abroad
 Communication of Ideas: Southeast Asia
 Communication of Ideas: The Americas and Their Influence
 Communism: Latin America
 Communism: Europe
 Communitarianism in African Thought
 Composition, Musical
 Computer Science
 Confucianism
 Consciousness: Overview
 Consciousness: Chinese Thought
 Conservatism
 Constitutionalism
 Continental Philosophy
 Corruption
 Corruption in Developed and Developing Countries
 Cosmopolitanism
 Creolization, Caribbean
 Critical Race Theory
 Cultural Studies
 Cycles
 Cynicism
 Dada
 Dance
 Daoism
Democracy
 Democracy, Africa
 Demography
 Dependency
 Determinism
 Dialogue and Dialectics: Socratic
 Diasporas: African Diaspora
 Diasporas: Jewish Diaspora
 Dictatorship in Latin America
 Discrimination
 Diversity
 Dress
 Dystopia
 Ecology
 Economics
 Education: China
 Education: Global Education
 Education: India
 Education: Japan
 Education: North America
 Empire and Imperialism: Overview
 Empire and Imperialism: Americas
 Empire and Imperialism: Asia
 Empire and Imperialism: Europe
 Empire and Imperialism: Middle East
 Empire and Imperialism: United States
 Environmental Ethics
 Environmental History
 Equality: Overview
 Equality: Gender Equality
 Equality: Racial Equality
 Ethnicity and Race: Africa
 Ethnicity and Race: Anthropology
 Ethnicity and Race: Islamic Views
 Etiquette
 Eugenics
 Eurocentrism
 Europe, Idea of
 Evil
 Examination Systems, China
 Existentialism
 Expressionism
 Extirpation
 Fallacy, Logical
 Family Planning
 Fascism
 Feminism: Overview
 Feminism: Africa and African Diaspora
 Feminism: Chicana Feminisms
 Feminism: Islamic Feminism
 Feminism: Third World U.S. Movement
 Fetishism: Overview
 Feudalism, European
 Friendship
 Fundamentalism
 Futurology
 Game Theory
 Garden
 Gay Studies
 Gender: Gender in the Middle East
 Gender in Art
 General Will
 Generation
 Genetics: Contemporary
 Genocide
 Ghetto
 Globalization: Africa
 Globalization: Asia
 Globalization: General
 Good
 Happiness and Pleasure in European Thought
 Heaven and Hell
 Heaven and Hell (Asian Focus)
 Hegelianism
 Hegemony
 Hinduism
 Historical and Dialectical Materialism
 Historiography
 History, Economic
 History, Idea of
 Honor
 Honor, Middle Eastern Notions of
 Human Capital
 Humanism: Chinese Conception of
 Humanism: Europe and the Middle East
 Humanism: Renaissance
 Humanism: Secular Humanism in the United States
 Humanity: African Thought
 Human Rights: Overview
 Human Rights: Women's Rights
 Hygiene
 Ideas, History of

READER'S GUIDE

- Identity, Multiple: Overview
 Identity, Multiple: Asian-Americans
 Identity, Multiple: Jewish Multiple Identity
 Individualism
 Intelligentsia
 Intentionality
 Intercession in Middle Eastern Society
 Interdisciplinarity
 Internal Colonialism
 International Order
 Islam: Africa
 Islam: Shii
 Islam: Southeast Asia
 Islam: Sunni
 Islamic Science
 Japanese Philosophy, Japanese Thought
 Jihad
 Jouissance
 Justice: Overview
 Justice: Justice in American Thought
 Justice: Justice in East Asian Thought
 Kantianism
 Kinship
 Knowledge
 Language and Linguistics
 Law
 Law, Islamic
 Leadership
 Legalism, Ancient China
 Liberalism
 Liberation Theology
 Liberty
 Life Cycle: Elders/Old Age
 Literary Criticism
 Literary History
 Literature: Overview
 Literature: African Literature
 Lysenkoism
 Machiavellism
 Machismo
 Maoism
 Maps and the Ideas They Express
 Marriage and Fertility, European Views
 Marxism: Overview
 Marxism: Asia
 Marxism: Latin America
 Masks
 Mathematics
 Matriarchy
 Medicine: Europe and the United States
 Meme
 Men and Masculinity
 Mestizaje
 Migration: Migration in World History
 Migration: United States
 Millenarianism: Islamic
 Millenarianism: Latin America and Native North America
 Minority
 Modernism: Overview
 Modernism: Latin America
 Modernity: Overview
 Modernity: Africa
 Modernity: East Asia
 Modernization
 Modernization Theory
 Mohism
Monarchy: Overview
 Monarchy: Islamic Monarchy
 Motherhood and Maternity
 Motif: Motif in Literature
 Multiculturalism, Africa
 Music, Anthropology of
 Musical Performance and Audiences
 Musicology
 Mysticism: Chinese Mysticism
 Myth
 Narrative
 Nation
 Nationalism: Overview
 Nationalism: Africa
 Nationalism: Cultural Nationalism
 Nationalism: Middle East
 Native Policy
 Natural Law
 Naturalism
 Negritude
 Neocolonialism
 Neoliberalism
 New Criticism
 Newtonianism
 Nihilism
 Nomadism
 Nonviolence
 Nuclear Age
 Objectivity
 Obligation
 Occidentalism
 Organicism
 Orientalism: Overview
 Orientalism: African and Black Orientalism
 Orthodoxy
 Orthopraxy: Asia
 Pacifism
 Pan-Africanism
 Pan-Arabism
 Pan-Asianism
 Pan-Islamism
 Pan-Turkism
 Paradigm
 Parties, Political
 Patriotism
 Peace
 Periodization of the Arts
 Person, Idea of the
 Personhood in African Thought
 Philanthropy
 Philosophies: American
 Philosophies: Feminist, Twentieth-Century
 Philosophies: Islamic
 Philosophy: Historical Overview and Recent Developments
 Philosophy, History of
 Philosophy, Moral: Africa
 Philosophy, Moral: Ancient
 Philosophy, Moral: Modern
 Philosophy of Religion
 Phrenology
 Pluralism
 Political Protest, U.S.

- Political Science**
 Political, The
 Population
 Populism: Latin America
 Populism: United States
 Postcolonial Studies
 Poverty
 Power
 Practices
 Pre-Columbian Civilization
 Prejudice
 Presentism
 Privacy
 Privatization
 Probability
 Progress, Idea of
 Propaganda
 Property
 Protest, Political
 Pseudoscience
 Psychoanalysis
 Public Sphere
 Punishment
 Puritanism
 Pythagoreanism
 Quantum
 Queer Theory
 Race and Racism: Overview
 Race and Racism: Asia
 Race and Racism: United States
 Radicals/Radicalism
 Rational Choice
 Reading
 Realism
 Realism: Africa
 Reason, Practical and Theoretical
 Reflexivity
 Reform: Europe and the United States
 Reform: Islamic Reform
 Regions and Regionalism, Eastern Europe
 Relativism
 Religion: Africa
 Religion: African Diaspora
 Religion: East and Southeast Asia
 Religion: Latin America
 Religion: Middle East
 Religion and the State: Africa
 Religion and the State: Europe
 Religion and the State: Latin America
 Religion and the State: Middle East
 Religion and the State: United States
 Renaissance
 Representation: Political Representation
 Republicanism: Latin America
 Republicanism: Republic
 Resistance
 Resistance and Accommodation
 Responsibility
 Revolution
 Rhetoric: Ancient and Medieval
 Ritual: Public Ritual
 Romanticism in Literature and Politics
 Sacred and Profane
 Scarcity and Abundance, Latin America
 Science, History of
 Science Fiction
 Secularization and Secularism
 Segregation
 Sexual Harassment
 Sexuality: Overview
 Sexuality: Islamic Views
 Sexuality: Sexual Orientation
 Shinto
 Skepticism
 Slavery
 Sociability in African Thought
 Social Capital
 Social Contract
 Social History, U.S.
 Socialism
 Socialisms, African
 Society
 Sophists, The
 Sovereignty
 Sport
 State, The: Overview
 State, The: The Postcolonial State
 State of Nature
 Stoicism
 Subjectivism
 Sufism
 Suicide
 Superstition
 Surrealism
 Symbolism
 Syncretism
 Technology
 Temperance
 Terror
 Terrorism, Middle East
 Third Cinema
 Third World
 Third World Literature
 Time: China
 Time: Traditional and Utilitarian
 Toleration
 Totalitarianism
 Trade
 Translation
 Treaty
 Tribalism, Middle East
 University: Postcolonial
 Untouchability: Menstrual Taboos
 Untouchability: Taboos
 Utilitarianism
 Utopia
 Victorianism
 Virtue Ethics
 Visual Order to Organizing Collections
 Volksgeist
 Volunteerism, U.S.
 War
 War and Peace in the Arts
 Wealth
 Westernization: Africa
 Westernization: Middle East
 Westernization: Southeast Asia
 Wildlife
 Witchcraft
 Witchcraft, African Studies of

READER'S GUIDE

Women's History: Africa
 Work
 World Systems Theory, Latin America
 Zionism
ECONOMICS
 Abolitionism
 Africa, Idea of
 African-American Ideas
 Afropessimism
 Alienation
 Altruism
 Anarchism
 Anthropology
 Anticolonialism: Africa
 Anticolonialism: Latin America
 Anticolonialism: Middle East
 Anticolonialism: Southeast Asia
 Anti-Semitism: Islamic Anti-Semitism
 Apartheid
 Architecture: Africa
 Arts: Africa
 Asceticism: Western Asceticism
 Asian-American Ideas (Cultural Migration)
 Assimilation
 Astronomy, Pre-Columbian and Latin American
 Authoritarianism: East Asia
 Authoritarianism: Latin America
 Avant-Garde: Militancy
 Bioethics
 Black Atlantic
 Black Consciousness
 Bureaucracy
 Bushido
 Calculation and Computation
 Capitalism: Overview
 Capitalism: Africa
 Chicano Movement
 Cinema
 City, The: The City as a Cultural Center
 City, The: The City as Political Center
 City, The: The Islamic and Byzantine City
 Civil Society: Europe and the United States
 Civil Society: Responses in Africa and the Middle East
 Class
 Colonialism: Africa
 Colonialism: Southeast Asia
 Communication of Ideas: Africa and Its Influence
 Communication of Ideas: Middle East and Abroad
 Communication of Ideas: Southeast Asia
 Communism: Europe
 Communism: Latin America
 Composition, Musical
 Confucianism
 Consumerism
 Corruption in Developed and Developing Countries
 Critical Race Theory
 Cultural Capital
 Cultural History
 Cultural Studies
 Democracy: Africa
Demography
 Dependency
 Diasporas: African Diaspora
 Diasporas: Jewish Diaspora
 Dictatorship in Latin America

Diffusion, Cultural
 Discrimination
 Diversity
 Dress
 Dystopia
Economics
 Education: China
 Education: Global Education
 Empire and Imperialism: Americas
 Empire and Imperialism: Asia
 Empire and Imperialism: Europe
 Empire and Imperialism: Middle East
 Empire and Imperialism: United States
 Environmental Ethics
 Environmental History
 Equality: Overview
 Equality: Gender Equality
 Equality: Racial Equality
 Eugenics
 Eurocentrism
 Europe, Idea of
 Everyday Life
 Examination Systems, China
 Family: Modernist Anthropological Theory
 Family Planning
 Fascism
 Feminism: Overview
 Feminism: Africa and African Diaspora
 Feminism: Chicana Feminisms
 Feminism: Islamic Feminism
 Feminism: Third World U.S. Movement
 Fetishism: Overview
 Fetishism: Fetishism in Literature and Cultural Studies
 Feudalism, European
 Futurology
 Game Theory
 Generation
 Genetics: Contemporary
 Ghetto
 Gift, The
Globalization: Africa
Globalization: Asia
Globalization: General
 Good
 Hegelianism
 Hegemony
 Hinduism
 Historical and Dialectical Materialism
 Historicism
 Historiography
 History, Economic
 History, Idea of
 Human Capital
 Human Rights: Women's Rights
 Ideas, History of
 Identity, Multiple: Asian-Americans
 Indigenismo
 Individualism
 Intelligentsia
 Intentionality
 Internal Colonialism
 Interpretation
 Islam: Africa
 Islam: Sunni
 Islamic Science

- Jainism
 Japanese Philosophy, Japanese Thought
 Jihad
 Justice: Overview
 Justice: Justice in American Thought
 Law, Islamic
 Leadership
 Liberalism
 Liberation Theology
 Life Cycle: Elders/Old Age
 Literary Criticism
 Maoism
 Maps and the Ideas They Express
 Marriage and Fertility, European Views
 Marxism: Overview
 Marxism: Asia
 Marxism: Latin America
 Mathematics
 Migration: Africa
 Migration: Migration in World History
 Migration: United States
 Minority
 Modernity: Africa
 Modernity: East Asia
 Modernization
 Modernization Theory
 Motherhood and Maternity
 Nationalism: Africa
 Native Policy
 Naturalism
 Neocolonialism
 Neoliberalism
 Nomadism
 Nuclear Age
 Occidentalism
 Orthopraxy: Asia
 Pan-Africanism
 Pan-Asianism
 Parties, Political
 Peasants and Peasantry
 Philanthropy
 Philosophies: American
 Philosophy, History of
 Political Protest, U.S.
 Political Science
 Population
 Populism: Latin America
 Populism: United States
 Postcolonial Studies
 Poverty
 Practices
 Pre-Columbian Civilization
 Presentism
 Privacy
 Privatization
 Probability
 Progress, Idea of
 Property
 Protest, Political
 Pseudoscience
 Public Sphere
 Punishment
 Puritanism
 Race and Racism: United States
 Radicals/Radicalism
 Reason, Practical and Theoretical
 Reform: Europe and the United States
 Religion and the State: Africa
 Religion and the State: Latin America
 Renaissance
 Representation: Political Representation
 Republicanism: Republic
 Resistance
 Resistance and Accommodation
 Responsibility
 Ritual: Public Ritual
 Ritual: Religion
 Scarcity and Abundance, Latin America
 Secularization and Secularism
 Segregation
 Sexual Harassment
 Sexuality: Islamic Views
 Slavery
 Social Capital
 Social Darwinism
 Social History, U.S.
 Socialism
 Sport
 State, The: Overview
 State, The: The Postcolonial State
 Technology
 Terrorism, Middle East
 Third Cinema
 Third World
 Third World Literature
 Time: China
 Time: Traditional and Utilitarian
 Totalitarianism
 Trade
 Translation
 Travel: Travel from Europe and the Middle East
 Treaty
 Untouchability: Taboos
 Utilitarianism
 Victorianism
 Visual Culture
 Volunteerism, U.S.
 War and Peace in the Arts
 Wealth
 Westernization: Africa
 Westernization: Middle East
 Westernization: Southeast Asia
 Women and Femininity in U.S. Popular Culture
 Women's History: Africa
 Work
 World Systems Theory, Latin America
 Zen
 Zionism
- GEOGRAPHY**
 Africa, Idea of
 America
 Anthropology
 Architecture: Overview
 Barbarism and Civilization
 Borders, Borderlands, and Frontiers, Global
 Capitalism: Overview
 Chinese Warlordism
 Cultural Studies
 Diffusion, Cultural
 Economics

READER'S GUIDE

Environment
Environmental History
Ethnicity and Race: Anthropology
Ethnicity and Race: Islamic Views
Eurocentrism
Feudalism, European
Geography
Ghetto
Globalization: Asia
Globalization: General
History, Economic
History, Idea of
Identity, Multiple: Jewish Multiple Identity
Islamic Science
Maps and the Ideas They Express
Mathematics
Migration: Africa
Migration: Migration in World History
Migration: United States
Minority
Nation
Nationalism: Africa
Natural History
Nomadism
Occidentalism
Orientalism: Overview
Pan-Africanism
Pan-Asianism
Perspective
Population
Privacy
Race and Racism: Asia
Race and Racism: United States
Regions and Regionalism, Eastern Europe
Religion: Indigenous Peoples' View, South America
Sacred Places
Scarcity and Abundance, Latin America
Third Cinema
Third World
Travel: Travel from Europe and the Middle East
Victorianism
Westernization: Southeast Asia
World Systems Theory, Latin America

Sciences

HISTORY OF SCIENCE, EARLY (entries focused on early ideas about nature and the human relationship with nature)
Alchemy: China
Alchemy: Europe and the Middle East
Anthropology
Aristotelianism
Asceticism: Hindu and Buddhist Asceticism
Astrology: Overview
Astrology: China
Astronomy, Pre-Columbian and Latin American
Change
Confucianism
Consciousness: Chinese Thought
Cosmology: Asia
Daoism
Ethnicity and Race: Africa
Ethnicity and Race: Anthropology
Ethnicity and Race: Islamic Views
Greek Science

Harmony
Hierarchy and Order
Hinduism
Humanism: Chinese Conception of
Humanity: African Thought
Ideas, History of
Lysenkoism
Magic
Manichaeism
Medicine: China
Medicine: India
Metaphysics: Ancient and Medieval
Mysticism: Chinese Mysticism
Myth
Natural Theology
Naturphilosophie
Organicism
Paradigm
Person, Idea of the
Philosophies: Islamic
Philosophy: Historical Overview and Recent Developments
Philosophy of Religion
Phrenology
Pseudoscience
Race and Racism: Europe
Race and Racism: United States
Religion: Indigenous Peoples' View, South America
Religion and Science
Ritual: Religion
Sacred Places
Science: East Asia
Segregation
Sexuality: Sexual Orientation
Slavery
Superstition
Syncretism
Time: China
Time: India
Untouchability: Menstrual Taboos
Witchcraft
Yin and Yang

HISTORY OF SCIENCE, MODERN AND CONTEMPORARY (entries focused on the origins of modern or contemporary ideas in the physical, chemical, biological, mathematical, or earth sciences)

Agnosticism
Algebras
Behaviorism
Body, The
Calendar
Cartesianism
Causation
Causation in East Asian and Southeast Asian Philosophy
Chemistry
Communication of Ideas: Middle East and Abroad
Computer Science
Context
Continental Philosophy
Cosmology: Cosmology and Astronomy
Creationism
Creativity in the Arts and Sciences
Cultural History
Demonology
Determinism

- Development
 Ecology
 Education: Islamic Education
 Empiricism
 Enlightenment
 Environment
 Environmental History
 Epistemology: Early Modern
 Equality: Racial Equality
 Everyday Life
 Experiment
 Falsifiability
 Free Will, Determinism, and Predestination
 Health and Disease
 History, Economic
 Idealism
 Islamic Science
 Kantianism
 Knowledge
 Life
 Linguistic Turn
 Mathematics
 Mechanical Philosophy
 Medicine: Europe and the United States
 Medicine: Islamic Medicine
 Metaphor
 Museums
 Nature
 Newtonianism
 Nuclear Age
 Objectivity
 Philosophies: African
 Philosophies: Feminist, Twentieth-Century
 Philosophy, History of
 Philosophy of Mind: Overview
 Philosophy of Mind: Ancient and Medieval
 Physics
 Platonism
 Poetry and Poetics
 Positivism
 Prehistory, Rise of
 Probability
 Progress, Idea of
 Pythagoreanism
 Quantum
 Race and Racism: Asia
 Rationalism
 Reason, Practical and Theoretical
 Reflexivity
 Reform: Europe and the United States
 Relativity
 Renaissance
 Scholasticism
 Science: Overview
Science, History of
Scientific Revolution
 Sexuality: Overview
 Social Darwinism
 Social History, U.S.
 Technology
 Victorianism
 Visual Order to Organizing Collections
PSYCHOLOGY
 Absolute Music
 Aesthetics: Asia
 Aesthetics: Europe and the Americas
 Alchemy: Europe and the Middle East
 Alienation
 Altruism
 Ambiguity
 Ancestor Worship
 Animism
 Anthropology
 Anti-Semitism: Overview
 Asceticism: Hindu and Buddhist Asceticism
 Asceticism: Western Asceticism
 Authoritarianism: East Asia
 Beauty and Ugliness
 Behaviorism
 Bioethics
 Biography
 Biology
 Body, The
 Buddhism
 Cartesianism
 Character
 Cinema
 Communitarianism in African Thought
 Composition, Musical
 Computer Science
 Consciousness: Overview
 Consciousness: Chinese Thought
 Consciousness: Indian Thought
 Consumerism
 Context
 Continental Philosophy
 Creativity in the Arts and Sciences
 Cultural Studies
 Dada
 Dance
 Daoism
 Death
 Demonology
 Determinism
 Diffusion, Cultural
 Discrimination
 Dream
 Emotions
 Empiricism
 Epistemology: Early Modern
 Epistemology: Modern
 Ethnicity and Race: Africa
 Eugenics
 Everyday Life
 Existentialism
 Feminism: Overview
 Fetishism: Overview
 Fetishism: Fetishism in Literature and Cultural Studies
 Form, Metaphysical, in Ancient and Medieval Thought
 Foundationalism
 Friendship
 Gay Studies
 Gender: Overview
 Gender: Gender in the Middle East
 Gender in Art
 Gender Studies: Anthropology
 Gesture
 Harmony
 Hate
 Health and Disease

READER'S GUIDE

Heaven and Hell
Hinduism
Humanism: Secular Humanism in the United States
Humanity: African Thought
Humanity: European Thought
Identity: Identity of Persons
Identity: Personal and Social Identity
Identity, Multiple: Overview
Identity, Multiple: Asian-Americans
Images, Icons, and Idols
Imagination
Immortality and the Afterlife
Impressionism
Indigenismo
Intentionality
Jainism
Jouissance
Kinship
Knowledge
Language and Linguistics
Learning and Memory, Contemporary Views
Life
Life Cycle: Elders/Old Age
Literary Criticism
Love, Western Notions of
Machismo
Magic
Manichaeism
Masks
Medicine: China
Medicine: Europe and the United States
Meditation: Eastern Meditation
Memory
Men and Masculinity
Metaphor
Metaphysics: Renaissance to the Present
Mind
Modernism: Overview
Modernity: Overview
Modernity: Africa
Modernity: East Asia
Monarchy: Overview
Monism
Motherhood and Maternity
Musical Performance and Audiences
Mysticism: Chinese Mysticism
Mysticism: Islamic Mysticism in Asia
Myth
Narrative
National History
Nationalism: Overview
Naturphilosophie
Negritude
Objectivity
Person, Idea of the
Personhood in African Thought
Philosophies: Islamic
Philosophy, Moral: Modern
Philosophy of Mind: Overview
Philosophy of Mind: Ancient and Medieval
Philosophy of Religion
Phrenology
Political Science
Prejudice
Presentism

Privacy
Probability
Progress, Idea of
Protest, Political
Psychoanalysis
Psychology and Psychiatry
Punishment
Queer Theory
Realism: Africa
Reflexivity
Religion: Africa
Religion: African Diaspora
Religion: Indigenous Peoples' View, South America
Religion: Latin America
Religion and Science
Representation: Mental Representation
Resistance and Accommodation
Responsibility
Ritual: Public Ritual
Sexuality: Overview
Sexuality: Sexual Orientation
Slavery
State of Nature
Structuralism and Poststructuralism: Overview
Subjectivism
Superstition
Surrealism
Symbolism
Syncretism
Temperance
Text/Textuality
Third Cinema
Toleration
Totalitarianism
Tragedy and Comedy
Untouchability: Menstrual Taboos
Untouchability: Taboos
Utilitarianism
War and Peace in the Arts
Witchcraft
Witchcraft, African Studies of
Womanism
Women and Femininity in U.S. Popular Culture

BIOLOGICAL SCIENCES
Agnosticism
Altruism
Ancestor Worship
Anthropology
Antifeminism
Asceticism: Hindu and Buddhist Asceticism
Asceticism: Western Asceticism
Beauty and Ugliness
Behaviorism
Bioethics
Biology
Body, The
Buddhism
Cannibalism
Cartesianism
Casuistry
Classification of Arts and Sciences, Early Modern
Composition, Musical
Computer Science
Consciousness: Overview
Consilience

- Creationism
 Critical Race Theory
 Death
 Demography
 Determinism
 Development
 Dystopia
 Ecology
 Emotions
 Environmental Ethics
 Environmental History
 Epistemology: Early Modern
 Equality: Racial Equality
 Ethnohistory, U.S.
 Eugenics
Evolution
 Family: Modernist Anthropological Theory
 Family: Family in Anthropology since 1980
 Family Planning
 Feminism: Overview
 Game Theory
 Garden
 Gender: Overview
 Gender: Gender in the Middle East
 Gender in Art
 Gender Studies: Anthropology
Genetics: Contemporary
Genetics: History of
 Genocide
 Gesture
 Greek Science
 Health and Disease
 Heaven and Hell
 History, Idea of
 Humanism: Secular Humanism in the United States
 Humanity: African Thought
 Hygiene
 Identity: Identity of Persons
 Immortality and the Afterlife
 Intentionality
 Islamic Science
 Jainism
 Jouissance
 Kinship
 Learning and Memory, Contemporary Views
 Life
 Life Cycle: Adolescence
 Life Cycle: Elders/Old Age
 Lysenkoism
 Machiavellism
 Marriage and Fertility, European Views
 Masks
 Materialism in Eighteenth-Century European Thought
 Mechanical Philosophy
 Medicine: China
 Medicine: Europe and the United States
 Medicine: Islamic Medicine
 Meme
 Memory
 Men and Masculinity
 Mestizaje
 Monarchy: Overview
 Motherhood and Maternity
 Musical Performance and Audiences
 Natural History
 Naturalism
 Natural Theology
 Nature
 Naturphilosophie
 Negritude
 Organicism
 Other, The, European Views of
 Periodization of the Arts
 Person, Idea of the
 Perspective
 Philosophies: Islamic
 Philosophy of Mind: Ancient and Medieval
 Phrenology
 Population
 Prehistory, Rise of
 Probability
 Progress, Idea of
 Psychoanalysis
 Psychology and Psychiatry
 Punishment
 Queer Theory
 Religion: Indigenous Peoples' View, South America
 Representation: Mental Representation
 Science: East Asia
 Science, History of
 Sexuality: Overview
 Sexuality: Sexual Orientation
 Sociability in African Thought
 Social Darwinism
 Sport
 State of Nature
 Subjectivism
 Superstition
 Temperance
 Terror
 Text/Textuality
 Totems
 Untouchability: Menstrual Taboos
 Utilitarianism
 Victorianism
 Visual Order to Organizing Collections
 War and Peace in the Arts
 Wildlife
 Women and Femininity in U.S. Popular Culture
- PHYSICAL SCIENCES**
- Agnosticism
 Alchemy: China
 Astrology: China
 Astronomy, Pre-Columbian and Latin American
 Calculation and Computation
 Calendar
 Causality
 Causation
 Causation in East Asian and Southeast Asian Philosophy
 Change
 Chemistry
 Classification of Arts and Sciences, Early Modern
 Computer Science
 Consciousness: Overview
 Consilience
 Cosmology: Asia
 Cosmology: Cosmology and Astronomy
 Creationism
 Cycles

READER'S GUIDE

Ecology
 Empiricism
 Environmental Ethics
 Environmental History
 Epistemology: Early Modern
 Ethnohistory, U.S.
 Experiment
 Falsifiability
 Field Theories
 Form, Metaphysical, in Ancient and Medieval Thought
 Geography
 Geometry
 Greek Science
 Harmony
 Hinduism
 History, Economic
 Islam: Sunni
 Islamic Science
 Japanese Philosophy, Japanese Thought
 Knowledge
 Language, Philosophy of: Modern
 Life
 Literary History
 Logic and Philosophy of Mathematics, Modern
 Maps and the Ideas They Express
 Materialism in Eighteenth-Century European Thought
 Mathematics
 Mechanical Philosophy
 Metaphysics: Renaissance to the Present
 Microcosm and Macocosm
 Monism
 Myth
 Natural Theology
 Naturalism
 Nature
 Naturphilosophie
 Newtonianism
 Nuclear Age
 Paradigm
 Periodization of the Arts
 Philosophies: Islamic
 Philosophy: Historical Overview and Recent Developments
 Philosophy, History of
Physics
 Positivism
 Power
 Pragmatism
 Probability
 Progress, Idea of
 Psychoanalysis
 Pythagoreanism
 Quantum
 Rationalism
 Realism: Africa
 Reason, Practical and Theoretical
 Relativity
 Religion: East and Southeast Asia
 Religion: Indigenous Peoples' View, South America
 Religion and Science
 Science: Overview
 Science: East Asia
 Science, History of
 Scientific Revolution
 Sophists, The

Stoicism
 Subjectivism
 Superstition
 Time: China
 Time: India
 Victorianism
ECOLOGY AND GEOLOGY
 Aesthetics: Asia
 Anthropology
 Architecture: Overview
 Architecture: Asia
 Astronomy, Pre-Columbian and Latin American
 Authoritarianism: Overview
 Bioethics
 Biology
 Borders, Borderlands, and Frontiers, Global
 Calendar
 Capitalism: Overview
 City, The: Latin America
 City, The: The City as a Cultural Center
 City, The: The Islamic and Byzantine City
 Creationism
 Death
 Dystopia
Ecology
 Education: Global Education
Environment
 Environmental Ethics
 Environmental History
 Evolution
 Feminism: Overview
 Garden
 Genetics: Contemporary
 Genetics: History of
 Genocide
 Geography
 History, Economic
 History, Idea of
 Hygiene
 Impressionism
 Landscape in the Arts
 Life
 Life Cycle: Elders/Old Age
 Lysenkoism
 Machiavellism
 Maps and the Ideas They Express
 Matriarchy
 Medicine: Islamic Medicine
 Memory
 Migration: Migration in World History
Natural History
 Nuclear Age
 Organicism
 Periodization of the Arts
 Political Protest, U.S.
 Prehistory, Rise of
 Presentism
 Protest, Political
 Religion: Latin America
 Ritual: Religion
 Scarcity and Abundance, Latin America
 Science, History of
 Social Darwinism
 Totems
 Untouchability: Menstrual Taboos

- Utopia
 Visual Order to Organizing Collections
 Wildlife
 Witchcraft
 Witchcraft, African Studies of
 World Systems Theory, Latin America
- CHEMISTRY**
 Alchemy: China
 Alchemy: Europe and the Middle East
 Biology
Chemistry
 Classification of Arts and Sciences, Early Modern
 Computer Science
 Consciousness: Overview
 Development
 Experiment
 Genetics: Contemporary
 Genetics: History of
 Health and Disease
 Islamic Science
 Life
 Materialism in Eighteenth-Century European Thought
 Mechanical Philosophy
 Medicine: Europe and the United States
 Mysticism: Chinese Mysticism
 Paradigm
 Philosophies: Islamic
 Physics
 Quantum
 Science: East Asia
 Science, History of
- MATHEMATICS**
 Absolute Music
 Aesthetics: Europe and the Americas
Algebras
 Analytical Philosophy
 Astronomy, Pre-Columbian and Latin American
 Beauty and Ugliness
 Calculation and Computation
 Causation
 Causation in East Asian and Southeast Asian Philosophy
 Chemistry
 Classification of Arts and Sciences, Early Modern
 Computer Science
 Cosmology: Cosmology and Astronomy
 Death
 Demography
 Economics
 Empiricism
 Environmental History
 Equality: Overview
 Experiment
 Fallacy, Logical
 Falsifiability
 Foundationalism
 Futurology
 Game Theory
 Generation
 Genetics: Contemporary
 Genetics: History of
 Genocide
Geometry
 Harmony
 History, Economic
 Humanism: Chinese Conception of
- Islamic Science
 Knowledge
 Language, Philosophy of: Ancient and Medieval
 Language, Philosophy of: Modern
 Language and Linguistics
 Logic and Philosophy of Mathematics, Modern
Mathematics
 Newtonianism
 Perspective
 Philosophies: Islamic
 Philosophy: Historical Overview and Recent Developments
 Physics
 Political Science
 Positivism
 Prejudice
 Probability
 Pythagoreanism
 Quantum
 Rationalism
 Reading
 Reason, Practical and Theoretical
 Relativism
 Relativity
 Representation: Mental Representation
 Scientific Revolution
 Social History, U.S.
 Sophists, The
 Truth
- COMPUTER SCIENCE**
Calculation and Computation
Computer Science
 Consciousness: Overview
 Futurology
 Game Theory
 Genetics: Contemporary
 Genetics: History of
 Geography
 History, Economic
 Interdisciplinarity
 Language and Linguistics
 Learning and Memory, Contemporary Views
 Maps and the Ideas They Express
 Mathematics
 Privacy
 Probability
 Social History, U.S.
 Virtual Reality
- Professions**
- MEDICINE**
 Alchemy: China
 Alchemy: Europe and the Middle East
 Americanization, U.S.
 Ancestor Worship
 Anthropology
 Asceticism: Hindu and Buddhist Asceticism
 Asceticism: Western Asceticism
 Astrology: China
 Bioethics
 Biology
 Body, The
 Casuistry
 Chemistry
 Childhood and Child Rearing

READER'S GUIDE

Computer Science
 Creativity in the Arts and Sciences
 Death
 Demography
 Determinism
 Diversity
 Environment
 Environmental History
 Eugenics
 Feminism: Overview
 Feminism: Third World U.S. Movement
 Gay Studies
 Gender: Overview
 Gender Studies: Anthropology
 Genetics: Contemporary
 Genetics: History of
 Greek Science
Health and Disease
 Hinduism
 Humanity: African Thought
 Humor
 Hygiene
 Iconography
 Islam: Sunni
 Islamic Science
 Life
 Life Cycle: Elders/Old Age
 Literary Criticism
 Magic
 Mathematics
Medicine: China
Medicine: Europe and the United States
Medicine: India
Medicine: Islamic Medicine
 Meditation: Eastern Meditation
 Miracles
 Motherhood and Maternity
 Music, Anthropology of
 Mysticism: Chinese Mysticism
 Narrative
 Naturphilosophie
 Philosophies: Feminist, Twentieth-Century
 Philosophies: Islamic
 Phrenology
 Population
 Privacy
 Psychoanalysis
 Psychology and Psychiatry
 Pythagoreanism
 Queer Theory
 Religion: Africa
 Religion: African Diaspora
 Religion: East and Southeast Asia
 Religion: Indigenous Peoples' View, South America
 Ritual: Religion
 Science: East Asia
 Science, History of
 Sexuality: Overview
 Skepticism
 Superstition
 University: Overview
 Untouchability: Menstrual Taboos
 Utilitarianism
 Victorianism
 Visual Culture

Visual Order to Organizing Collections
 Volunteerism, U.S.
 Westernization: Africa
 Witchcraft
 Women and Femininity in U.S. Popular Culture
 Yin and Yang

LAW

Abolitionism
 African-American Ideas
 Altruism
 Anticolonialism: Africa
 Anticolonialism: Latin America
 Anticolonialism: Southeast Asia
 Antifeminism
 Anti-Semitism: Islamic Anti-Semitism
 Apartheid
 Asian-American Ideas (Cultural Migration)
 Assimilation
 Authoritarianism: Overview
 Authoritarianism: East Asia
 Barbarism and Civilization
 Bioethics
 Black Consciousness
 Cannibalism
 Capitalism: Overview
 Capitalism: Africa
 Casuistry
 Censorship
 Citizenship: Overview
 Citizenship: Cultural Citizenship
 Citizenship: Naturalization
 City, The: The Islamic and Byzantine City
 Civil Disobedience
 Civil Society: Europe and the United States
 Colonialism: Southeast Asia
 Consciousness: Chinese Thought
 Constitutionalism
 Context
 Corruption in Developed and Developing Countries
 Creationism
 Critical Race Theory
 Cultural History
 Cultural Revivals
 Deism
 Democracy
 Democracy: Africa
 Dialogue and Dialectics: Socratic
 Dialogue and Dialectics: Talmudic
 Dictatorship in Latin America
 Discrimination
 Diversity
 Education: Islamic Education
 Empire and Imperialism: Overview
 Empire and Imperialism: Europe
 Empire and Imperialism: United States
 Environmental History
 Equality: Overview
 Equality: Racial Equality
 Ethnicity and Race: Anthropology
 Ethnicity and Race: Islamic Views
 Europe, Idea of
 Extirpation
 Fallacy, Logical
 Falsifiability
 Family Planning

- Fascism
 Feminism: Overview
 Feminism: Africa and African Diaspora
 Feminism: Islamic Feminism
 Feudalism, European
 Gender: Gender in the Middle East
 General Will
 Genetics: Contemporary
 Genetics: History of
 Genocide
 Ghetto
 Globalization: Africa
 Good
 Hate
 Heresy and Apostasy
 Hinduism
 Honor, Middle Eastern Notions of
 Human Rights: Overview
 Humanism: Secular Humanism in the United States
 Iconography
 Identity, Multiple: Jewish Multiple Identity
 Indigenismo
 Individualism
 Intentionality
 Interdisciplinarity
 International Order
 Islam: Africa
 Islam: Shii
 Islam: Southeast Asia
 Islam: Sunni
 Jihad
 Judaism: Judaism to 1800
 Justice: Overview
 Justice: Justice in American Thought
 Justice: Justice in East Asian Thought
 Kinship
 Language and Linguistics
Law
Law, Islamic
 Learning and Memory, Contemporary Views
 Legalism, Ancient China
 Liberalism
 Liberty
 Life Cycle: Elders/Old Age
 Literary Criticism
 Loyalties, Dual
 Marriage and Fertility, European Views
 Masks
 Matriarchy
 Migration: United States
 Minority
 Modernity: Overview
 Monarchy: Overview
 Monarchy: Islamic Monarchy
 Motherhood and Maternity
 Mysticism: Islamic Mysticism
 Narrative
 Nation
 Nationalism: Cultural Nationalism
 Nationalism: Middle East
 Native Policy
 Natural Law
 Nonviolence
 Nuclear Age
 Obligation
 Person, Idea of the
 Philanthropy
 Philosophies: American
 Philosophies: Feminist, Twentieth-Century
 Philosophies: Islamic
 Philosophy: Historical Overview and Recent Developments
 Philosophy, Moral: Ancient
 Political Protest, U.S.
 Population
 Postcolonial Studies
 Power
 Privacy
 Progress, Idea of
 Property
 Protest, Political
 Punishment
 Queer Theory
 Race and Racism: United States
 Reason, Practical and Theoretical
 Reform: Europe and the United States
 Regions and Regionalism, Eastern Europe
 Relativism
 Religion: African Diaspora
 Religion: Middle East
 Religion and the State: Africa
 Religion and the State: Europe
 Religion and the State: Middle East
 Religion and the State: United States
 Representation: Political Representation
 Republicanism: Republic
 Resistance
 Responsibility
 Rhetoric: Ancient and Medieval
 Ritual: Public Ritual
 Sacred Texts: Koran
 Segregation
 Sexual Harassment
 Sexuality: Overview
 Sexuality: Islamic Views
 Sexuality: Sexual Orientation
 Skepticism
 Slavery
 Sociability in African Thought
 Social Contract
 Socialisms, African
 Society
 State, The: Overview
 State, The: The Postcolonial State
 State of Nature
 Stoicism
 Subjectivism
 Sufism
 Suicide
 Temperance
 Toleration
 Totalitarianism
 Treaty
 University: Overview
 Untouchability: Taboos
 Utilitarianism
 Victorianism
 Virtue Ethics
 Visual Order to Organizing Collections
 Volunteerism, U.S.
 War and Peace in the Arts

READER'S GUIDE

Westernization: Africa
Westernization: Middle East
Westernization: Southeast Asia
Wildlife
Witchcraft
ENGINEERING
Alchemy: China
Alchemy: Europe and the Middle East
Architecture: Overview
Architecture: Africa
Architecture: Asia
Beauty and Ugliness
Biology
Calculation and Computation
Capitalism: Overview
Capitalism: Africa
Cinema
City, The: Latin America
City, The: The City as a Cultural Center
City, The: The City as Political Center
City, The: The Islamic and Byzantine City
Communication of Ideas: Southeast Asia
Computer Science
Diffusion, Cultural
Dystopia
Ecology
Empire and Imperialism: Europe
Environmental History
Epistemology: Early Modern
Experiment
Futurology
Gender Studies: Anthropology
Genetics: Contemporary
Genetics: History of
Genocide
Geometry
Globalization: General
Greek Science
Harmony
Historical and Dialectical Materialism
History, Economic
Humanism: Secular Humanism in the United States
Interdisciplinarity
Japanese Philosophy, Japanese Thought
Knowledge
Literary Criticism
Maps and the Ideas They Express
Mathematics
Mechanical Philosophy
Meme
Modernity: Overview
Modernity: Africa
Modernity: East Asia
Modernization
Modernization Theory
Motherhood and Maternity
Music, Anthropology of
Musical Performance and Audiences
Mysticism: Chinese Mysticism
Newtonianism
Nomadism
Nuclear Age
Occidentalism
Perspective
Power

Presentism
Privacy
Progress, Idea of
Protest, Political
Reform: Europe and the United States
Relativity
Science, History of
Science Fiction
Technology
Textiles and Fiber Arts as Catalysts for Ideas
Totalitarianism
Victorianism
Virtual Reality
Visual Culture
War and Peace in the Arts
Westernization: Middle East
Westernization: Southeast Asia
World Systems Theory, Latin America

Multidisciplinary Practices

The *New Dictionary of the History of Ideas* has many entries that discuss the methods by which scholars and researchers pursue knowledge. The entries below discuss approaches, methods, and practices that have influenced many disciplines.

ENTRIES ON MULTIDISCIPLINARY PRACTICES THAT ORIGINATED IN ANCIENT TIMES

Aesthetics: Asia
Africa, Idea of
Algebras
Anthropology
Architecture: Overview
Architecture: Asia
Aristotelianism
Astrology: Overview
Biology
Body, The
Buddhism
Casuistry
Causality
Censorship
Classicism
Classification of Arts and Sciences, Early Modern
Composition, Musical
Cosmology: Asia
Creationism
Creativity in the Arts and Sciences
Daoism
Development
Dialogue and Dialectics: Socratic
Dualism
Eclecticism
Education: China
Education: Europe
Epistemology: Ancient
Equality: Overview
Essentialism
Eurocentrism
Experiment
Fallacy, Logical
Fetishism: Fetishism in Literature and Cultural Studies
Form, Metaphysical, in Ancient and Medieval Thought
Fundamentalism
Gender in Art
Genre

- Geometry
 Greek Science
 Harmony
 Health and Disease
 Hierarchy and Order
 Hinduism
 History, Idea of
 Humanism: Europe and the Middle East
 Humor
 Ideas, History of
 Imagination
 Interpretation
 Knowledge
 Language, Philosophy of: Ancient and Medieval
 Life
 Literary History
 Literature: African Literature
 Logic
 Maps and the Ideas They Express
 Mathematics
 Medicine: China
 Medicine: Europe and the United States
 Medicine: India
 Memory
 Metaphor
 Metaphysics: Ancient and Medieval
 Monism
 Museums
 Music, Anthropology of
 Musical Performance and Audiences
 Mysticism: Chinese Mysticism
 Narrative
 Nature
 Orthodoxy
 Orthopraxy: Asia
 Orthopraxy: Western Orthopraxy
 Paradigm
 Periodization
 Perspective
 Philosophies: African
 Philosophies: Islamic
 Philosophy: Historical Overview and Recent Developments
 Philosophy and Religion in Western Thought
 Physics
 Platonism
 Presentism
 Progress, Idea of
 Pythagoreanism
 Rationalism
 Reading
 Reason, Practical and Theoretical
 Religion: Overview
 Responsibility
 Rhetoric: Overview
 Rhetoric: Ancient and Medieval
 Sacred Places
 Sacred Texts: Asia
 Science: East Asia
 Scientific Revolution
 Skepticism
 Sophists, The
 Syncretism
 Taste
 Text/Textuality
 Toleration
 Translation
 Trope
 Truth
 Virtual Reality
 Wisdom, Human
 Yin and Yang
- ENTRIES ON MULTIDISCIPLINARY PRACTICES OF
 MORE RECENT ORIGIN
 Absolute Music
 Aesthetics: Africa
 African-American Ideas
 Afrocentricity
 Analytical Philosophy
 Astronomy, Pre-Columbian and Latin American
 Avant-Garde: Militancy
 Behaviorism
 Bilingualism and Multilingualism
 Bioethics
 Black Atlantic
 Calculation and Computation
 Class
 Conservatism
 Consilience
 Continental Philosophy
 Critical Race Theory
 Critical Theory
 Cultural Studies
 Dada
 Dialogue and Dialectics: Talmudic
 Dream
 Dystopia
 Economics
 Education: Global Education
 Education: Islamic Education
 Empiricism
 Encyclopedism
 Environmental Ethics
 Environmental History
 Epistemology: Early Modern
 Epistemology: Modern
 Ethnicity and Race: Anthropology
 Ethnocentrism
 Ethnography
 Ethnohistory, U.S.
 Examination Systems, China
 Expressionism
 Family: Modernist Anthropological Theory
 Feminism: Overview
 Fetishism: Overview
 Field Theories
 Formalism
 Futurology
 Game Theory
 Gender: Gender in the Middle East
 Generation
 Genetics: Contemporary
 Genetics: History of
 Geography
 Hegelianism
 Hermeneutics
 Historicism
 Humanism: Africa
 Humanism: Renaissance
 Iconography

Idealism
 Identity: Identity of Persons
 Intentionality
 Interdisciplinarity
 Japanese Philosophy, Japanese Thought
 Language, Philosophy of: Modern
 Language and Linguistics
 Law, Islamic
 Learning and Memory, Contemporary Views
 Linguistic Turn
 Literary Criticism
 Logic and Philosophy of Mathematics, Modern
 Masks
 Metaphysics: Renaissance to the Present
 Mind
 Modernism: Overview
 Modernism: Latin America
 Modernization
 Modernization Theory
 Motif: Motif in Literature
 Motif: Motif in Music
 Mysticism: Kabbalah
 Myth
 Naturalism
 Naturalism in Art and Literature
 Naturphilosophie
 Newtonianism
 Objectivity
 Oral Traditions: Overview
 Orientalism: Overview
 Philosophies: Feminist, Twentieth-Century
 Philosophy, Moral: Africa
 Philosophy of Religion
 Phrenology
 Poetry and Poetics
 Polytheism
 Positivism
 Postcolonial Studies
 Postmodernism
 Power
 Practices
 Pragmatism
 Prejudice
 Probability
 Pseudoscience
 Psychoanalysis
 Queer Theory
 Realism
 Realism: Africa
 Reflexivity
 Regions and Regionalism, Eastern Europe
 Relativism
 Relativity
 Religion: Indigenous Peoples' View, South America
 Religion and Science
 Representation: Mental Representation
 Romanticism in Literature and Politics
 Sacred Texts: Koran
 Sage Philosophy
 Scholasticism
 Science: Overview
 Science, History of
 Science Fiction
 Secularization and Secularism
 Social Capital

Social History, U.S.
 State, The: Overview
 Structuralism and Poststructuralism: Overview
 Structuralism and Poststructuralism: Anthropology
 Subjectivism
 Symbolism
 Third Cinema
 Totems
 Tradition
 Universalism
 Utilitarianism
 Visual Culture
 Volksgeist
 Women's Studies

Especially Interdisciplinary Entries

The most interdisciplinary entries synthesized knowledge by using the methods and focusing on the topics of practitioners of several disciplines. Very few entries listed below are in only one division. Common pairs for the history of ideas are social sciences and humanities, social sciences and sciences, and humanities and sciences. In the early twenty-first century there is generally a recognition of the common overlap of the social sciences with the humanities; social scientists may take ethical and literary factors into consideration and humanists may incorporate societal contexts into their work. The presence of psychology in the sciences, as well as the quantitative nature of some social sciences work, creates an overlap of social sciences with sciences. Another interesting overlap is between humanities and sciences—topics that in antiquity were treated as philosophy or religion are now investigated by those following scientific methods.

SOCIAL SCIENCES, SCIENCES, AND FINE ARTS

Architecture: Africa
 Geography
 Phrenology
 Virtual Reality

SCIENCES, FINE ARTS, AND HUMANITIES

Enlightenment
 Epistemology: Early Modern
 Feminism: Third World U.S. Movement
 Field Theories
 Geometry
 Globalization: Asia
 Text/Textuality

FINE ARTS, HUMANITIES, AND SOCIAL SCIENCES

Aesthetics: Africa
 Alienation
 Americanization, U.S.
 Anticolonialism: Africa
 Arts: Overview
 Arts: Africa
 Authenticity: Africa
 Autobiography
 Avant-Garde: Overview
 Aztlán
 Censorship
 Chinese Thought
 City, The: The Islamic and Byzantine City
 Civil Disobedience
 Civil Society: Europe and the United States
 Colonialism: Southeast Asia
 Communication of Ideas: Africa and Its Influence
 Communication of Ideas: The Americas and Their Influence

- Communication of Ideas: Asia and Its Influence
 Communication of Ideas: Orality and Advent of Writing
 Cultural Capital
 Cultural History
 Cynicism
 Dialogue and Dialectics: Socratic
 Dialogue and Dialectics: Talmudic
 Diasporas: Jewish Diaspora
 Dictatorship in Latin America
 Etiquette
 Everyday Life
 Expressionism
 Extirpation
 Fascism
 Feminism: Chicana Feminisms
 Gay Studies
 Gender Studies: Anthropology
 Genre
 Ghetto
 Honor
 Humanity in the Arts
 Humor
 Identity, Multiple: Jewish Multiple Identity
 Images, Icons, and Idols
 Islam: Shii
 Landscape in the Arts
 Leadership
 Life Cycle: Overview
 Linguistic Turn
 Literature: African Literature
 Maoism
 Millenarianism: Islamic
 Millenarianism: Latin America and Native North America
 Minority
 Modernism: Latin America
 Musicology
 Mysticism: Christian Mysticism
 Mysticism: Islamic Mysticism in Asia
 Mysticism: Kabbalah
 Mysticism: Mysticism in African Thought
 Nation
 New Criticism
 Nude, The
 Oral Traditions: Overview
 Orientalism: Overview
 Orthodoxy
 Orthopraxy: Asia
 Pan-Africanism
 Pan-Asianism
 Pan-Turkism
 Philosophies: African
 Philosophies: American
 Philosophy, Moral: Ancient
 Populism: United States
 Postmodernism
 Practices
 Pre-Columbian Civilization
 Realism
 Religion: Africa
 Religion: Middle East
 Religion and the State: United States
 Renaissance
 Resistance
 Romanticism in Literature and Politics
 Sage Philosophy
 Shinto
 Society
 Taste
 Theater and Performance
 Theodicy
 Third World Literature
 Wisdom, Human
HUMANITIES, SOCIAL SCIENCES, AND SCIENCES
 Afropessimism
 Alchemy: China
 Alchemy: Europe and the Middle East
 Altruism
 Antifeminism
 Asceticism: Hindu and Buddhist Asceticism
 Asceticism: Western Asceticism
 Astrology: China
 Astrology: Overview
 Borders, Borderlands, and Frontiers, Global
 Calculation and Computation
 Calendar
 Capitalism: Overview
 Capitalism: Africa
 Cartesianism
 Casuistry
 Causality
 Causation
 Causation in East Asian and Southeast Asian Philosophy
 Character
 Chicano Movement
 Childhood and Child Rearing
 Confucianism
 Consciousness: Chinese Thought
 Consciousness: Indian Thought
 Consilience
 Cosmology: Asia
 Cycles
 Daoism
 Demography
 Demonology
 Discrimination
 Dress
 Dualism
 Education: Islamic Education
 Empiricism
 Equality: Racial Equality
 Ethnicity and Race: Africa
 Ethnohistory, U.S.
 Fallacy, Logical
 Foundationalism
 Futurology
 Genetics: Contemporary
 Genetics: History of
 Genocide
 Health and Disease
 Hermeneutics
 Historical and Dialectical Materialism
 Hygiene
 Intelligentsia
 Internal Colonialism
 Islam: Africa
 Jainism
 Japanese Philosophy, Japanese Thought
 Kinship

READER'S GUIDE

- Law, Islamic
 Machiavellism
 Machismo
 Medicine: China
 Medicine: India
 Meme
 Memory
 Mestizaje
 Modernization Theory
 Motif: Motif in Music
 Museums
 Music, Anthropology of
 Nationalism: Africa
 Natural History
 Naturalism
 Negritude
 Objectivity
 Philosophy, History of
 Philosophy, Moral: Modern
 Philosophy of Religion
 Population
 Positivism
 Pragmatism
 Prejudice
 Presentism
 Privacy
 Probability
 Quantum
 Race and Racism: Overview
 Race and Racism: Asia
 Race and Racism: Europe
 Reason, Practical and Theoretical
 Religion: Overview
 Religion and Science
 Science: Overview
 Scientific Revolution
 Segregation
 Sexuality: Islamic Views
 Sexuality: Sexual Orientation
 Skepticism
 State of Nature
 Structuralism and Poststructuralism: Overview
 Time: China
 Time: India
 Truth
 Universalism
 University: Overview
 Wildlife
 World Systems Theory, Latin America
- FINE ARTS, HUMANITIES, SOCIAL SCIENCES, AND SCIENCES**
 Absolute Music
 Aesthetics: Asia
 Aesthetics: Europe and the Americas
 Ancestor Worship
 Anthropology
 Architecture: Overview
 Architecture: Asia
 Astronomy, Pre-Columbian and Latin American
 Beauty and Ugliness
 Bilingualism and Multilingualism
 Bioethics
 Body, The
 Cannibalism
 Change
 Chemistry
 Cinema
 City, The: The City as a Cultural Center
 City, The: The City as Political Center
 Classification of Arts and Sciences, Early Modern
 Communication of Ideas: Southeast Asia
 Composition, Musical
 Computer Science
 Consciousness: Overview
 Consumerism
 Context
 Continental Philosophy
 Cosmopolitanism
 Creationism
 Critical Theory
 Cultural Studies
 Dance
 Death
 Determinism
 Dream
 Dystopia
 Ecology
 Emotions
 Empire and Imperialism: Europe
 Environment
 Environmental Ethics
 Environmental History
 Equality: Overview
 Equality: Gender Equality
 Ethnicity and Race: Islamic Views
 Eugenics
 Examination Systems, China
 Feminism: Overview
 Fetishism: Overview
 Fetishism: Fetishism in Literature and Cultural Studies
 Friendship
 Game Theory
 Gender: Gender in the Middle East
 Gender in Art
 Generation
 Greek Science
 Harmony
 Heaven and Hell
 Hinduism
 History, Economic
 History, Idea of
 Humanity: African Thought
 Ideas, History of
 Identity, Multiple: Overview
 Intentionality
 Interdisciplinarity
 Islam: Sunni
 Islamic Science
 Kantianism
 Knowledge
 Language and Linguistics
 Learning and Memory, Contemporary Views
 Life
 Literary Criticism
 Literary History
 Love, Western Notions of
 Magic
 Manichaeism
 Maps and the Ideas They Express
 Masks

- Mathematics
 Matriarchy
 Medicine: Europe and the United States
 Medicine: Islamic Medicine
 Meditation: Eastern Meditation
 Men and Masculinity
 Metaphor
 Modernism: Overview
 Monarchy: Overview
 Modernity: Africa
 Modernity: East Asia
 Motherhood and Maternity
 Musical Performance and Audiences
 Mysticism: Chinese Mysticism
 Myth
 Narrative
 Newtonianism
 Nomadism
 Nuclear Age
 Occidentalism
 Organicism
 Paradigm
 Periodization of the Arts
 Person, Idea of the
 Philosophies: Feminist, Twentieth-Century
 Philosophies: Islamic
 Philosophy: Historical Overview and Recent Developments
 Poetry and Poetics
 Political Protest, U.S.
 Progress, Idea of
 Property
 Protest, Political
 Pseudoscience
 Psychoanalysis
 Punishment
 Pythagoreanism
 Queer Theory
 Reading
 Realism: Africa
 Reflexivity
 Reform: Europe and the United States
 Relativism
 Religion: East and Southeast Asia
 Religion: Indigenous Peoples' View, South America
 Religion: Latin America
 Representation: Mental Representation
 Resistance and Accommodation
 Responsibility
 Ritual: Public Ritual
 Ritual: Religion
 Sacred Places
 Science: East Asia
 Science, History of
 Science Fiction
 Sexuality: Overview
 Social History, U.S.
 Sophists, The
 Sport
 Stoicism
 Subjectivism
 Superstition
 Surrealism
 Symbolism
 Syncretism
 Temperance
 Third Cinema
 Toleration
 Totalitarianism
 Totems
 Tragedy and Comedy
 Untouchability: Menstrual Taboos
 Untouchability: Taboos
 Utilitarianism
 Utopia
 Victorianism
 Visual Culture
 Visual Order to Organizing Collections
 Volunteerism, U.S.
 War and Peace in the Arts
 Westernization: Middle East
 Westernization: Southeast Asia
 Witchcraft
 Witchcraft, African Studies of
 Yin and Yang



C

CONTINUED

COMMUNICATION OF IDEAS.

This entry includes seven subentries:

Africa and Its Influence

The Americas and Their Influence

Asia and Its Influence

Europe and Its Influence

Middle East and Abroad

Orality and the Advent of Writing

Southeast Asia and Its Influence

AFRICA AND ITS INFLUENCE

The communication of ideas in and from Africa is characterized by enormous changes over time and variations among societies. Historically, as might be expected for such a large and ancient continent—the second largest in the world and the one where humanity originated—African societies have exhibited high levels of cultural diversity, uneven patterns of political and socioeconomic development, and different forms of engagement with other world regions. Africa is home to hundreds of cultural groups and languages that have influenced each other in complex ways. It has given rise to advanced societies, such as the ancient civilizations of Egypt and West Africa, which existed alongside simpler societies. Many parts of the continent in the northern and northeastern subregions, and later the western coastal regions, were integrated into extracontinental cultural and commercial traffic, while some parts in the interior were relatively isolated. It was in the zones of intensive intercultural communication that ideas from Africa were transmitted to the outside world and ideas from other regions entered Africa. Needless to say, modern African countries are at different stages of industrialization and development, and unequally integrated into the global circuits of ideas and information.

Understanding these disparities is crucial to analyzing and mapping out the changing processes and patterns in the communication of ideas in and from Africa. For one thing, it underscores the difficulty of, indeed the need to avoid, simple generalizations. The development and connections between the various modes of communication—oral, textual, visual, and performance—have manifested themselves in multiple ways across the continent at different times. Similarly diverse are the institutional forms, and their patterns of growth, through which ideas have been expressed, ranging from educational and religious institutions to civic and professional bodies and mass media outlets. As an interactive process, the communication of ideas has a spatial dynamic that entails not

only the travel of the ideas themselves from one place to another through several media, but also their transmission by human agents who move and settle in different places.

In this context, for example, the conquest of Spain by the Moors from northwestern Africa, which they ruled for nearly eight centuries, was crucial to the diffusion of ideas from Africa and other parts of the ancient world to Western Europe. So was the forced migration of enslaved Africans across the Atlantic important for the spread of countless African ideas to the Americas. Likewise, European invasions of Africa, most crucially colonization (both the ancient Roman colonization of North Africa and the nineteenth-century European colonization of the continent as a whole), played a profound role in the spread of ideas from Europe, some of which were, as is true of Christianity, ideas that previous generations of African thinkers, such as the Egyptian Gnostics and St. Augustine from the Maghreb, had contributed to their development, and that the newly converted Africans proceeded to further transform. This back-and-forth process typifies the complex flows of ideas in world history and the dangers of ethnocentric claims of exclusive cultural authorship.

Orality and Performance

Looking at the span of human history in its entirety, orality clearly antedates literacy, so deciphering the origins and development of oral and textual forms of communication in Africa, and their relationships, is not an easy task. Many Africanists used to claim that Africa, by which they often meant “sub-Saharan Africa,” was defined by oral modes of expression and communication before the intrusion of European influences from the fifteenth century and especially following colonization in the nineteenth. The contention that Africa was ontologically oral and Europe literary had both positive and negative implications. On the positive side, it led to the valorization of oral sources in reconstructions of African history and of oral narratives—what came to be known as oral literature, or orature—in African literature. On the negative side, it oversimplified both African histories and narrative traditions and reinforced the age-old analytical dichotomies in the conceptualization of African and European phenomena.

Undoubtedly, oral communication and traditions have been important modes of social dialogue and transmitting history in African societies for a long time. Oral traditions include oral narratives (epics, legends, and explanatory tales), poetry (praise poetry, chants, and songs), and epigrams (proverbs, riddles, puns, and tongue twisters). Combined, they served to link the past and the present, construct collective worldviews

and identity, educate the youth, express political views, and provide entertainment and aesthetic pleasure. The production of oral traditions often involved performance based on a participatory ethic. In many societies, there were highly trained and esteemed custodians of oral tradition. Among the Mande of West Africa, for example, they were known as *griots*, a word that acquired popularity in the United States following the 1977 airing of the acclaimed television miniseries *Roots*, based on the 1976 book in which Haley reputedly traced his African ancestry to a village in the Gambia with the help of a griot.

From Thomas Hale's fascinating history, it is clear that griots had many other functions besides being genealogists. They were historians, advisers to rulers, patrons, and other members of society, spokespersons, diplomats, mediators, interpreters and translators, musicians, composers, teachers, exhorters, warriors, witnesses, praise-singers, and ceremony participants during namings, initiations, courtship, marriages, installations, and funerals. Griots first emerged at least a thousand years ago; since then their role has changed, and so have interpretations of their history in the oral accounts themselves and in written accounts by locals and outsiders. In more recent times, the griots have taken advantage of twentieth-century technologies including radio, television, audiocassettes, and CDs to spread their knowledge to new audiences locally and globally. Also, many griot epics, such as the renowned *Epic of Sundiata*, about the legendary king of the Mali Empire, have been committed to print. While the literature has mostly discussed male griots, recent scholarship has demonstrated that there were female griots, or *griottes*, as Hale refers to them.

The case of the griots demonstrates the intricate connections between orality and performance. As a medium for the construction, dissemination, and consumption of ideas, performance in the forms of drama and music and dance were particularly important in African societies. According to Modupe Olaogun, African drama dates back to ancient times and includes pantomimes, dance-drama, mask, shadow, and court theaters, heroic recitations, praise-poetry, and market comedy by itinerant troupes, which use, in various combinations and with different degrees of sophistication, role-playing, dialogue, mime, movement, dance, song, puppetry, costume, and scenic spectacle. In the late eighteenth century, African theater entered a new era as contacts with Europe increased and European theater motifs and practices were introduced, elements of which were creatively appropriated and used to further diversify African theatrical expression. Most important was the incorporation of scripted text and reorganization of the theatrical space to separate performers and spectators. In Egypt, Ya'qub Sannu (1839–1912) founded modern Egyptian theater with distinct European influences.

Syncretized performances emerged. For example, the black township music theater of South Africa combined the indigenous dramatic modes of storytelling (the isiZulu's *ingoma* or the isiXhosa's *ntsomi*) with Western choral and vaudeville forms to create a popular theater, which from the 1930s became a powerful vehicle for antiapartheid resistance. In West Africa, where European settler influence was negligible, new theatrical practices were largely developed through educational institutions. In the 1920s, there emerged in countries such as Ghana

and Nigeria itinerant indigenous language theater. By the mid-twentieth century, European influences had waned and Africa's vibrant theater could be divided into distinct forms: literary, popular, and theater for development, each with its own styles, aesthetics, themes, messages, languages, and audiences.

Similarly, music as a mode of cultural production and communication underwent significant changes over the centuries. As with theater, different musical forms developed across the continent, depending on the performance contexts of location and audience, the nature of the performers (spontaneous groups, popular musicians, or specialized musicians), the instruments used (ranging from idiophones to membranophones including drums, aerophones, and chordophones), and their functions (whether entertainment, political, religious, and educational, work-related, or mnemonically to recall past events). According to Turino (2003), despite their obvious differences, music in African societies tended to share a participatory ethic rather than a presentational one (except for music specialists at royal courts), and music and dance were conceptualized as part of the same art form and as social processes rather than as set items or products.

Dance not only included music, but was a complex interactive affair involving movement, theater, sculpture, and religion, whose styles and organization served as social metaphors that communicated aesthetic preferences, issues of kinship, gender, status, and age. Different African societies influenced each other, and from the nineteenth century they began to feel European influences, not least missionary attacks against African dance as "lewd" or "lascivious." In the course of the twentieth century, numerous old dances were reconfigured and recontextualized and new ones emerged. In the 1950s and 1960s, formal dance companies and national dance ensembles practicing traditional dance were created in many countries. In the meantime, new dances such as highlife and rumba had emerged in Africa's rapidly expanding cities. All this demonstrates, argues Oforiwa, the continent's remarkable cultural flexibility, capability, and creativity.

Many of the new music and dance styles were adapted from the African diaspora in the Americas. Rumba, for example, was an Afro-Cuban dance genre created by slaves after emancipation in the 1880s. While African music was exported to the Americas during the era of the Atlantic slave trade, where it was further developed and transformed, as cultural contacts between Africa and the African diaspora grew from the late nineteenth-century diasporan music—from jazz, rumba, and reggae to pop music and hip hop—it was re-exported back to Africa, where it was reappropriated and converted. In the twentieth century, African music and dance became a powerful medium to express Pan-African, cosmopolitan, and nationalist consciousness, in addition to performing gender, class, and religious ideas and identities.

Written Communication

It is quite evident that African "traditional" cultures and modes of communication have demonstrated a capacity to use new communication technologies and, in the process, to transform both themselves and those technologies. This challenges many

of the simplistic generalizations and dichotomies about African cultural and intellectual history. Writing specifically about literacy and orality, Eileen Julien is critical of those who regard orality and writing as exclusive domains and successive moments in which the oral represents Africa's authentic expressive form. She argues that there is nothing intrinsically oral about Africa, that orality and writing have continually influenced each other for a long time, as Albert Gérard (1981) and Harold Scheub have shown in their exhaustive studies. This intertextuality can be seen in the works of contemporary African writers who deliberately appropriate oral forms to serve literary artistic ends.

Among the earliest African societies to develop writing as a method of recording and transmitting knowledge and information were Egypt, Nubia (whose Meroitic script [2nd century B.C.E.–5th century C.E.] has yet to be deciphered), and Ethiopia. In these early literary traditions, writing and reading were confined to a tiny religious and political elite. In Egypt, hieroglyphic writing began about 3000 B.C.E. The literature of the Old Kingdom (2650–2152 B.C.E.) was largely didactic, dominated by the “wisdom” genre. Literary genres multiplied during the Middle Kingdom (2040–1640 B.C.E.) to include more intricate literary forms such as novels, satires, and autobiographies, as well as political and social commentaries and philosophical discourses. During the New Kingdom (1539–1069 B.C.E.) a new literary genre emerged—the love poem—and writers began to abandon classical language and to write in the colloquial language of their time. Later, a new literature known as Demotic (meaning “of the people”) developed, and, after large numbers of Egyptians had converted to Christianity, a Coptic literature emerged emphasizing religious themes.

Ethiopian writing (in a language called Ge'ez) began in about 500 B.C.E. It grew when the Kingdom of Axum became Christianized (c. 400 C.E.), following the conversion of King Ezana in 330 C.E. The Bible was translated from Greek into Ge'ez and other religious translations were produced. The “golden age” of Ge'ez literature, according to Gérard (1981), was between 1270 and 1520, during which both religious and secular writing flourished. Between 1314 and 1322, the clergy, in support of a new dynasty, wrote the *Kabra Nagast* (Glory of Kings), reportedly the most venerated book in Ethiopian history. Royal chronicles, in fact, were an important genre of Ethiopian writing until the beginning of the twentieth century. In the fifteenth century, local hagiographies began to appear as nationalist homage to the holy men of the Ethiopian Church. Ge'ez writing waned from the sixteenth century, to be followed three centuries later by the development of writing in Amharic, the commonly spoken language in Ethiopia, which flowered in the twentieth century, incorporating new literary and intellectual trends.

The Arab conquest of North Africa (661–750 C.E.) ushered in a new period in African political, religious, and cultural history. It brought Islam and the Arabic language and script, which altered the modes of communication of ideas and Africa's links to the wider world. Muslim North Africa gave the continent and the world its first universities, the mosque universities of Ez-Zitouna in Tunis (founded in 732),

Quaraouiyine in Fez (founded in 859), and Al-Azhar (founded in Cairo in 969). Lulat argues that these universities influenced the development of the modern European university, which acquired five elements from the Muslims: (1) a large corpus of knowledge; (2) rationalism and the secular investigative approach of natural science; (3) division of knowledge into academic subjects; (4) the notion of the university as a community of individual scholars; and (5) the idea of the college. He concludes that “the modern university that was brought to Africa by the colonial powers is as much Western in origin as it is Islamic” (p. 16).

North African intellectuals produced a vast body of scholarship in a wide range of fields, from the natural sciences to poetry and history, and some of the world's most renowned minds including Ibn Batuta of Tangier (1304?–1377?), the traveler who visited numerous countries in Asia, Europe, and Africa and wrote extensively on his explorations, and Ibn Khaldun of Tunis (1332–1406), the historian who pioneered secular history in his monumental *Kitab-al-'Ibar* (Universal History) and three-volume *Muqaddimah* (Introduction to History).

Through trans-Saharan trade, Islam spread from North Africa to West Africa, where it began to make significant inroads in the eleventh century. Centers of Islamic learning emerged, including the mosque university of Tombouctou established in the twelfth century, where numerous works were produced, such as *Ta'rikh al-Fattash* (Chronicle of the Researcher) and *Ta'rikh al-Sudan* (History of the Sudan), written by Mahmud Ka'ti (b. 1468) and Abd al-Rahman al-Sa'di (1596–1656), respectively. In addition to writing in Arabic, West African scholars also wrote in African languages using Arabic script, writings that are called *Ajami*. Examples include the *Kano Chronicle* and the *Gonja Chronicle*, produced in modern-day Ghana in the eighteenth century. Arabic and *ajami* writing flourished in nineteenth-century Hausaland. Usman dan Fodio (1754–1817), the leader of the Islamic reform movement that created the Sokoto Caliphate, the largest state in nineteenth-century West Africa, and his brother and daughter, wrote hundreds of books and treatises on law, theology, politics, finance, history, and poetry. Senegal also produced illustrious scholars and religious leaders, among them the legendary Amadou Bamba (1850–1927), whose works remain popular to this day.

Arabic and *ajami* writing also spread to the east African coast and Madagascar. Malagasy *ajami* writing was well established by the time the first Europeans arrived in the early seventeenth century, although it did not achieve the status it did in West Africa or among the Swahili along the east African coast. *Ajami* was gradually supplanted by Roman script from the 1820s as part of the Merina kingdom's (1787–1896) ambitious modernization drive. Swahili writing, whose origins have been dated to the thirteenth century (if not earlier), produced a vigorous literature, mostly poetry and historical chronicles, such as the sixteenth-century *Kilwa Chronicle*. Classical Swahili literature entered its golden age between the mid-eighteenth and mid-nineteenth centuries, during which the work of several writers stands out: Saiyid Abdallah b. Nassar (1720–1820), Muyaka bin Haji al-Ghassaniy (1776–1840), Muhyi 'l-Din

(1789–1869), and Umar b. Amin (1798–1870), who wrote religious and epic poetry. From the second half of the nineteenth century, Swahili writing was confronted with a new challenge in the form of European imperialism.

The vast corpus of African writings in Arabic and *ajami* (much of the latter is scattered in private holdings) across the continent contains important records of African contributions to human knowledge in general and Islamic scholarship in particular. As with early and contemporary Christianity, Africans have made significant contributions to Islamic thought almost from its emergence in the Arabian peninsula in the seventh century.

The coming of Europeans in the fifteenth century, during the infamous Atlantic slave trade, crystallizing into colonization from the mid-nineteenth century, marked yet another watershed in the development of African writing and in the technologies of the communication of ideas. European Christianity was especially critical in the introduction of new cultural practices and writing to many languages that had previously had no written tradition. In Southern Africa, for example, the written literature of the Zulu and Xhosa dates to the early nineteenth century, and most of the works were initially religious in tone, including translations of the Bible and books such as *Pilgrim's Progress*. Later, a more secular and anticolonial literature emerged, especially in journals and newspapers. Dictionaries and historical works were also produced. A vibrant local language literature also developed in West Africa, especially in Ghana and Nigeria. Particularly impressive was writing in Yoruba, consisting mostly of fiction, drama, poetry, journalism, and historical works, such as Samuel Johnson's (1846–1901) landmark *History of the Yorubas* (1921).

The nineteenth century also witnessed the development of new African scripts, especially in West Africa, the most famous being the Vai script invented by Duwalu Bukele (1810–1850). Even more consequential in the long run was the development of African writing in the European languages, especially English and French, a subject that is exhaustively discussed in the edited collections by Albert Gérard (1986) and Oyekan Owomoyela (1993), among others. Initially, African writings in the European languages concentrated on autobiographies such as Olaudah Equiano's (1745–1797) *The Interesting Narrative of the Life of Olaudah Equiano, or, Gustavus Vassa, the African* (1789). In the nineteenth century, scholarly works began to be produced by such intellectuals as Edward William Blyden (1832–1912), author of tomes like *A Vindication of the African Race* (1857) and *Christianity, Islam, and the Negro Race* (1887), which had a permanent influence on African thought.

In the twentieth century, as colonialism became entrenched, European language writing and communication spread to all aspects of African cultural and social life and became a definitive part of African literature, scholarship, education, and public discourse. The use of European languages continued after independence, a period that saw an explosion in education at all levels. For example, the number of universities increased from forty-two in 1960 (many of which were in North Africa and in South Africa) to more than four hundred, enrolling about five million students, by the beginning of the new cen-

tury. Although a vast improvement compared to the colonial era, this still represented a relatively low enrollment ratio of less than 5 percent.

The mastery of the European languages by Africans can be seen in the fact that several have won the Nobel Prize for Literature and other prestigious international awards, and many African academics are among the leading figures in their respective fields. In fact, claim the authors of *Africa and the Disciplines*, “research in Africa has shaped the disciplines and thereby shaped our convictions as to what may be universally true” (Bates, Mudimbe, and O'Barr, p. xiv). Some see the European languages as a force for cultural unification, national integration, administrative efficiency, modernization, and globalization, while others contend that the dominance of these languages erodes Africa's linguistic and epistemic autonomy and its ability to define itself, pursue development, and entrench democratic rights in a situation where the languages of tuition, government, and business are not indigenous and spoken by the masses in daily life.

The Development of Modern Media

Besides educational institutions and religious institutions, the modern media have been critical channels for spreading ideas. The modern printed press dates to the turn of the nineteenth century. The first newspapers, in both African and European languages, appeared in Egypt in 1798, in South Africa in 1800, in Sierra Leone in 1801, in Ghana in 1822, in Liberia in 1826, and in Nigeria in 1859. The most important Egyptian paper in the first half of the nineteenth century was *al-Waqa'ie Al-Misriyya* (Egyptian events), founded in 1828, and from the second half of the nineteenth century until the twentieth century it was *al-Ahram* (The pyramids), founded in 1875. After the British occupation of 1882, Egyptian newspapers became vehicles of nationalist protest. Between 1900 and 1914, 250 newspapers appeared, although many did not survive. The Egyptian press entered its “golden age” after independence in 1922, and by 1937, according to Amy Ayalon, there were 250 Arabic and 65 foreign-language papers.

In West Africa, members of the Western educated elite established newspapers as vehicles to express incipient nationalism in the face of European colonial encroachment. Among the most influential papers were the *Accra Herald*, later renamed the *West Africa Herald*, established by Charles Bannerman in 1858, and the *Iwe Iborin*, founded in 1859 by African missionaries in Abeokuta, Nigeria, and written in Yoruba. During the first half of the twentieth century, when colonialism was firmly entrenched, a host of private newspapers were established by African businessmen and nationalists, from Herbert Macaulay (1864–1946), who founded the *Lagos Daily News* in 1925, to Nnandi Azikiwe (b. 1904), the first president of independent Nigeria, who founded *West African Pilot* in 1937, and whose party, the National Council of Nigeria and the Cameroons, came to control ten newspapers by the 1950s.

In the French colonies, the first African-run papers did not emerge until the 1920s, although before 1900 Senegal had three settler papers. The press expanded rapidly after World

War II: some 365 newspapers were established between 1945 and 1960, when the French colonies attained their independence. In Southern, Central, and Eastern Africa, the press was largely a European creation to serve the information, education, and entertainment needs of the European settler communities, leaving the African readership in search of alternative channels of communication. After World War II some nationalists founded their own papers—for example, *Muigwithania* (Work and play) and *Nyanza Times*, established by Jomo Kenyatta and Oginga Odinga, who later became independent Kenya's first president and vice president, respectively.

After independence the print media faced new opportunities and challenges. The growth of education and literacy levels expanded their readership base, but the emergence of authoritarian one-party states and military regimes undermined press freedom and led to the closure or imprisonment and harassment of many journalists. National news agencies were established and many of the new governments either bought existing papers or established new ones. A few governments were more concerned about the role of foreign ownership and tried to encourage local private media ownership, as was the case, for example, in Nigeria, where Moshood Abiola (1955–1998), later elected president in the annulled elections of 1992, and the Ibru Group established vast media empires. Concerns about the role of the international media—its excessive control of global news flows and misrepresentations of events in the global South—soon translated into international demands in the 1970s by African, Asian, and Latin American countries for the establishment of a New World Information Order (NWIO).

The demands for NWIO were not heeded. In any case, the prodemocracy movement that arose across Africa in the mid-1980s soon transformed Africa's media landscape. These movements were fueled by, and in turn facilitated, the rapid growth of newspapers, so that countries that had a handful of tightly controlled papers suddenly had several dozen vociferous tabloids. Another development was the creation of the Internet, which opened new possibilities for the African press to reach new audiences at home and abroad. By 2000, all African countries had access to the Internet and hundreds of African newspapers were available online.

The Internet is the latest in a long line of telecommunication technologies to be appropriated by African countries. Previously there had been the telegraph, then telephony, cinema, radio, and television, all of which, except radio, grew relatively slowly during the colonial period. The transistor radio played a major role as a vehicle of nationalist mobilization during the struggle for independence. But many countries did not have direct telephone connections with each other and it often took years to get a phone installation, a situation that persisted well after independence. Colonial Africa was generally excluded from the international agencies that regulate global telecommunications, a situation that changed as independent governments joined these organizations, such as the International Telecommunication Union and the International Telecommunications Satellite Organization, and tried to make up for lost time.

The emergence of the so-called information society and knowledge economies, fueled by the forces of global market integration and the emergence and convergence of new information technologies—what came to be known collectively as “globalization”—compelled African governments to accelerate the pace of telecommunications infrastructure development and to liberalize that sector. In pursuit of this agenda, attempts were made to forge more effective government policies, create regional telecommunication initiatives, and leapfrog old technologies by acquiring the latest technologies such as cell phones and satellites. The use of cell phones across the continent skyrocketed. In 1998, the Afristar satellite was launched, the first of its kind in the world designed to broadcast directly to consumer radio receivers.

These initiatives have borne some fruit. Numerous African institutions from governments to universities use Internet services and Africa is more connected to the rest of the world than it has ever been. Yet, many challenges remain. While the number of Internet users on the continent more than quadrupled in the 1990s, reaching 3.1 million by the beginning of 2001, this represented less than 1 percent of worldwide users, which then numbered 407.1 million. The challenge is not only to close the digital divides—within Africa and between Africa and the developed world—but also for Africa to increase its production of the technologies themselves and the content of information on the global information highway.

Thus, by the beginning of the twenty-first century, Africa's postcolonial mediascape was a dynamic and multifaceted blend of traditions, influences, and technologies. The most modern forms of communications technologies coexisted with the indigenous media, electronic outlets lived side by side with street information and rumor mills, known under various names in different regions such as *radio trottoir* in Francophone Africa, *radio boca a boca* in Lusophone (Portuguese-speaking) Africa, and *bush telegraph*, or *pavement radio*, in Anglophone Africa.

Africa and Its Influence

Through the various modes of communication identified above, ideas have been and continue to be transmitted within, from, and into Africa—ideas about religion, culture, politics, and the arts, as well as ideologies, iconographies, and images, not to mention academic theories, concepts, and methodologies. Discourses on African influences tend to be dominated by the tropes of origination, contestation, reciprocity, hybridity, and agency. *Origination* emphasizes Africa's authenticity and as the source of Western civilization associated with the work of Cheikh Anta Diop and the Afrocentricists. *Contestation* refers to Ali Mazrui's notion of counterpenetration or counterconquest, celebrating Africa's capacities to contest other civilizations at home and abroad (2002).

Reciprocity portrays Africa largely as a recipient of external influences, whether negatively, as in Walter Rodney's *How Europe Underdeveloped Africa*, or positively as in the numerous works that discuss the benefits of external interventions for Africa from colonialism and Christianity to foreign aid and globalization. *Hybridity* is inspired by postcolonial theory and, as in Kwame Anthony Appiah's *In My Father's House*, dismisses any African

essence and sees Africa as a constellation of hybrid cultures and identities. The *agency* paradigm is beloved by nationalist and radical historians who seek to show how Africans have actively fashioned their material, mental, and moral lives from the complex ebbs and flows of internal and external forces and influences.

In reality, Africa has not been constituted only from within but also from without. Indeed, it is fair to say that Africa has been constituted by the world as much as it has constituted the world in all its ramifications—historical, demographic, cultural, economic, political, and discursive.

See also African-American Ideas; Afrocentricity; Arts: Africa; Colonialism: Africa; Diasporas: African Diaspora; Diffusion, Cultural; Humanism: Africa; Humanity: African Thought; Literature: African Literature; Modernity: Africa; Mysticism: Mysticism in African Thought; Negritude; Orientalism: African and Black Orientalism; Pan-Africanism; Personhood in African Thought; Philosophies: African; Philosophy, Moral: Africa; Realism, Africa; Sociability in African Thought; University: Postcolonial; Westernization: Africa; Women's History: Africa.

BIBLIOGRAPHY

- Ajayi, Omofolabo S. *Yoruba Dance: The Semiotics of Movement and Body Attitude in Nigerian Culture*. Trenton, N.J.: Africa World Press, 1998.
- Al-Khozai, Mohamed A. *The Development of Early Arabic Drama (1847–1900)*. London and New York: Longman, 1984.
- Amanze, J. N. *A History of the Ecumenical Movement in Africa*. Gaborone, Botswana: Pula Press, 1999.
- Appiah, Kwame Anthony. *In My Father's House: Africa in the Philosophy of Culture*. New York: Oxford University Press, 1992.
- Asante, Molefi Kete. *The Afrocentric Idea*. Rev. ed. Philadelphia: Temple University Press, 1998.
- Ayalon, Ami. *The Press in the Arab Middle East: A History*. New York: Oxford University Press, 1995.
- Ayegboyin, Deji, and S. Ademola Ishola. *African Indigenous Churches: An Historical Perspective*. Lagos, Nigeria: Greater Heights, 1997.
- Banham, Martin, James Gibbs, and Femi Osofisan, eds. *African Theater in Development*. Oxford: James Currey; Bloomington: Indiana University Press, 1999.
- Barber, Karin, John Collins, and Alain Ricard. *West African Popular Theater*. Bloomington: Indiana University Press; Oxford: James Currey, 1997.
- Bates, Robert H., V. Y. Mudimbe, and Jean O'Barr, eds. *Africa and the Disciplines: The Contribution of African Research in Africa to the Social Sciences and Humanities*. Chicago: University of Chicago Press, 1993.
- Beebe, Maria, K. Kouakou, and Banji Magliore. *Africa Dot Edu: IT Opportunities and Higher Education in Africa*. New Delhi: Tata McGraw-Hill, 2003.
- Bernal, Martin. *Black Athena: The Afroasiatic Roots of Classical Civilization*. 2 vols. New Brunswick, N.J.: Rutgers University Press, 1987.
- Blyden, Edward Wilmot. *Christianity, Islam, and the Negro Race*. London: W. B. Whittingham, 1887.
- . *A Vindication of the African Race; Being a Brief Examination of the Arguments in Favor of African Inferiority*. Monrovia, Liberia: G. Killian, 1857.
- Bourgault, Louise M. *Mass Media in Sub-Saharan Africa*. Bloomington: Indiana University Press, 1995.
- Charry, Eric S. *Mande Music: Traditional and Modern Music of the Maninka and Mandinka of Western Africa*. Chicago: University of Chicago Press, 2000.
- Chernoff, John H. *African Rhythm and African Sensibility: Aesthetics and Social Action in African Musical Idioms*. Chicago: University of Chicago Press, 1979.
- Conteh-Morgan, John. *Theater and Drama in Francophone Africa: A Critical Introduction*. Cambridge, U.K.: Cambridge University Press, 1994.
- Diop, Cheikh Anta. *The African Origin of Civilization: Myth or Reality*. Translated by Mercer Cook. Chicago: L. Hill, 1974.
- Ejiaga, Romanus, and Paul Tiyambe Zeleza. "Education: Postindependence." In *Encyclopedia of Twentieth-Century African History*, edited by Paul T. Zeleza and Dickson Eyoh. London and New York: Routledge, 2003.
- Equiano, Olaudah. *The Interesting Narrative of the Life of Olaudah Equiano, or, Gustavus Vassa, the African*, edited by Werner Sollors. New York: Norton, 2001. Originally published in 1789.
- Falola, Toyin, and Christian Jennings. *Sources and Methods in African History: Spoken, Written, Unearthed*. Rochester, N.Y.: University of Rochester Press, 2003.
- Gérard, Albert S. *African Language Literatures: An Introduction to the Literary History of Sub-Saharan Africa*. Harlow, U.K.: Longman, 1981.
- , ed. *European-Language Writing in Sub-Saharan Africa*. 2 vols. Budapest: Akadémiai Kiadó, 1986.
- Hale, Thomas A. *Griots and Griottes: Masters of Words and Music*. Bloomington: Indiana University Press, 1998.
- Hyden, Goran, Michael Leslie, and Foulu F. Ogundimu, eds. *Media and Democracy in Africa*. New Brunswick, N.J., and London: Transaction, 2002.
- Isichei, Elizabeth A. *A History of Christianity in Africa: From Antiquity to the Present*. Lawrenceville, N.J.: Africa World Press, 1995.
- Jeyifo, Biodun. *The Truthful Lie: Essays in a Sociology of African Drama*. London: New Beacon Books, 1985.
- Julien, Eileen. *African Novels and the Question of Orality*. Bloomington: Indiana University Press, 1992.
- Kruger, Loren. *The Drama of South Africa: Plays, Pageants, and Publics since 1910*. London and New York: Routledge, 1999.
- Levtzion, Nehemia, and L. Randall Pouwels, eds. *The History of Islam in Africa*. Athens: Ohio University Press, 2000.
- Lulat, Y. G.-M. "The Development of Higher Education in Africa: A Historical Survey." In *African Higher Education: An International Handbook*, edited by Damtew Teferra and Philip Altbach, 15–31. Bloomington: Indiana University Press, 2003.
- Magubane, Zine. "The Influence of African-American Cultural Practices on South Africa, 1890–1990." In *Leisure in Urban Africa*, edited by Paul Tiyambe Zeleza and Cassandra Rachel Veney. Trenton, N.J.: Africa World Press, 2003.
- Martin, Phyllis. *Leisure and Society in Colonial Brazzaville*. New York: Cambridge University Press, 1995.
- Mazrui, Alamin. "Globalization and Some Linguistic Dimensions of Human Rights in Africa." In *Human Rights, the Rule of Law and Development in Africa*, edited by Paul T. Zeleza and Philip J. McConaughay, 52–70. Philadelphia: University of Pennsylvania Press, 2004.
- Mazrui, Ali A. *Africa and Other Civilizations: Conquest and Counter-Conquest*. Edited by Ricardo René Laremont and Fouad Kalouche. Trenton, N.J.: Africa World Press, 2002.

- Mazrui, Ali A., and Alamin Mazrui. *The Power of Babel: Language and Governance in the African Experience*. Chicago: University of Chicago Press, 1998.
- Miller, Ivor L. "A Secret Society Goes Public: The Relationship between Abakua and Cuban Popular Culture." *African Studies Review* 43, no. 1 (2000): 161–188.
- Modupe, Olaogun. "Theater." In *Encyclopedia of Twentieth-Century African History*, edited by Paul T. Zeleza and Dickson Eyoh, 548–555. London and New York: Routledge, 2003.
- Monson, Ingrid T., ed. *The African Diaspora: A Musical Perspective*. New York: Garland, 2000.
- Mudimbe, Valentin Y. *The Invention of Africa: Gnosis, Philosophy, and the Order of Knowledge*. Bloomington: Indiana University Press, 1988.
- Ngugi wa Thiong'o. *Decolonising the Mind: The Politics of Language in African Literature*. Nairobi, Kenya: Heinemann, 1986.
- Nketia, J. H. Kwabena. *The Music of Africa*. New York: Norton, 1974.
- Noam, Eli M., ed. *Telecommunications in Africa*. New York: Oxford University Press, 1999.
- Oforiwa, Aduonum. "Dance." In *Encyclopedia of Twentieth-Century African History*, edited by Paul T. Zeleza and Dickson Eyoh, 124–130. London and New York: Routledge, 2003.
- Okpewho, Isidore. *African Oral Literature: Backgrounds, Character, and Continuity*. Bloomington: Indiana University Press, 1992.
- Owomoyela, Oyekan, ed. *A History of Twentieth-Century African Literatures*. Lincoln: University of Nebraska Press, 1993.
- Ranger, Terence O. *Dance and Society in Eastern Africa, 1890–1970: The Beni Ngoma*. London: Heinemann, 1975.
- Riverson, L. Kwabena. *Telecommunications Development: The Case of Africa*. Lanham, Md.: University Press of America, 1993.
- Robinson, David. *Muslim Societies in African History*. Cambridge, U.K.: Cambridge University Press, 2004.
- Rodney, Walter. *How Europe Underdeveloped Africa*. Washington, D.C.: Howard University Press, 1982.
- Rosander, Eva E., and David Westerlund, eds. *African Islam and Islam in Africa: Encounters between Sufis and Islamists*. Athens: Ohio University Press, 1997.
- Sanneh, Lamin O. *The African Transformation of Christianity: Comparative Reflections on Ethnicity and Religious Mobilization in Africa*. Tempe: Arizona State University Press, 1998.
- Scheub, Harold. "A Review of African Oral Traditions and Literature." *African Studies Review* 28, nos. 2/3 (1985): 1–72.
- Teferra, Damte, and Philip Altbach. "Trends and Perspectives in African Higher Education." In *African Higher Education: An International Reference Book*, edited by Damte Teferra and Philip Altbach, 3–14. Bloomington: Indiana University Press, 2003.
- Turino, Thomas. "Music." In *Encyclopedia of Twentieth-Century African History*, edited by Paul T. Zeleza and Dickson Eyoh, 371–378. London and New York: Routledge, 2003.
- . *Nationalists, Cosmopolitans, and Popular Music in Zimbabwe*. Chicago: University of Chicago Press, 2000.
- Vansina, Jan. *Oral Tradition as History*. Madison: University of Wisconsin Press, 1985.
- Warren, Lee. *The Dance of Africa: An Introduction*. Englewood Cliffs, N.J.: Prentice-Hall, 1972.
- Waterman, Christopher A. *Juju: A Social History and Ethnography of an African Popular Music*. Chicago: University of Chicago Press, 1990.
- White, Luise, Stephan F. Miescher, and David William Cohen. *African Words, African Words: Critical Practices in Oral History*. Bloomington: Indiana University Press, 2001.
- Zeleza, Paul T., and Ibulaimu Kakoma, eds. *In Search of Modernity: Science and Technology in Africa*. Trenton, N.J.: Africa World Press, 2003.

Paul Tiyambe Zeleza

THE AMERICAS AND THEIR INFLUENCE

The Americas were first settled from Asia by successive waves of migrants who crossed the Bering Sea from Siberia to Alaska during the last Ice Age using a land bridge, the frozen sea, and possibly open boats. Estimates as to when this began range from twenty thousand to one hundred thousand years ago. By 8000 B.C.E. settlements had reached the southern tip of South America. The new arrivals came as hunter-gatherers, but over the millennia many adopted agriculture and a few groups built civilizations comparable to what had developed earlier in ancient Mesopotamia, Egypt, and the Indus Valley.

Pre-European Communication

Anthropological research suggests a rich and historically deep tradition of oral communication among early Amerindian people in which linguistic diversity appears to have been considerable. Even within the usually accepted language groupings of North America—Eskimo-Aleut; Athabaskan, or Na-Dene; Algonquian-Wakashan; Aztec-Tanoan; Hoka-Siouan; Penutian; and Arawakan—many dialects existed, a consequence of regional diversity and the linguistic fluidity of primary oral cultures.

The communication of ideas among the first Americans, however, was not limited to spoken language. Smoke signals and the tom-toms, immortalized in Hollywood film, actually existed. The latter could transmit a variety of messages via rhythmic signatures in ways that resemble how bugle calls have been used by military groups in more recent history. The result was a form of communication over distance whereby messages could travel faster than messengers, an accomplishment often first attributed to telegraphy. Another form of long-distance communication developed by Native Americans, although they were probably not the first to come up with the idea, emerged in the nineteenth century when mirrors acquired in trade were used to flash messages across the plains. This practice inspired the United States Army to develop the heliograph, in which the signal mirrors were adapted to transmit Morse code.

One of the more remarkable achievements in communication developed by Native Americans is Plains Sign Language (PSL). It served as a lingua franca, enabling communication between tribes speaking different dialects and in some cases completely different languages. PSL is not a series of rudimentary gestures, but a full-fledged semantically open system capable of sending a virtually infinite variety of messages—it has even been used to recount episodes from the Bible. Most PSL signs are, to use the classic semiotic categories, either iconic (resembling what they represent, such as crossed fingers standing for a tepee) or indexical (where, metonymically, a part stands for the whole, as when a continuous circular motion of the index finger represents a wagon). Although the third semiotic category, the symbolic or arbitrary sign (the dominant

one for spoken language), is rare in PSL, it is not altogether absent; we find it, for example, when a part of the body such as the knee or elbow is used to represent a concept. PSL's exploration of the interface between spoken language and the nonverbal communication of gestures has prompted wide and enduring fascination—it has been studied by philosophers of language and appropriated by Boy Scouts.

New World Civilizations

It was once believed that to have civilization—a political state with a centralized government, ruling bureaucracy, complex division of labor, agricultural surplus, and monumental public works—writing had to be in use. The Americas have yielded a major exception to this rule: the empire of the Incas. Centered in Peru, this extended in a north-south direction from Ecuador to Chile, and eastward into part of the Amazon Basin. Keeping track of this enormous social experiment depended not on writing but on a communication medium capable of doing some of the same things. The Incas used the quipu, a series of woolen or cotton cords of different length, thickness, and color that could be braided and knotted in various ways. Each of these elements represented information. This enabled the quipu to be used for a variety of complex tasks, such as the recording of a census or the calculation of economic output, tribute obligations, and taxes. In conjunction with the Incan oral tradition, quipus were even used as mnemonic devices, to assist in recounting aspects of historical succession.

In contrast to the Incas, the two great Mesoamerican civilizations, the Aztecs and the Maya, developed writing. More specifically, they created a form of writing similar to, but not as elaborate as, Egyptian hieroglyphics. Numerous images and occasionally abstract signs (as opposed to the more streamlined and economical characters of an alphabet) were used to represent parts of speech rather than—as is the case with Chinese script, for example—objects and concepts. It could be argued that precursors of writing in the Americas can be found in rock art (petroglyphs) and in images (pictograms) drawn on animal skins; several buffalo hide inscriptions actually tell a story. However, the possibilities inherent in freeing writing from purely iconic representation allowed it to be used for much more elaborate forms of communication. Nowhere in the Americas has this been demonstrated more than in the case of the Maya.

Mayan history spans roughly the first millennium C.E. The Maya wrote on durable media—stone and parchment (animal skins). Although lacking metal tools, the wheel, or domestic draft animals, Mayan culture nonetheless developed ideas of considerable sophistication. Their mathematical and astronomical knowledge rivaled that of the Babylonians and surpassed that of the Egyptians. One result is a calendar of staggering complexity and accuracy. The lunar month was calculated at 29.53020 days, which compares favorably with our current reckoning of 29.53059 days. Mayans viewed world history in terms of cycles of creation and destruction. (The current cycle, or long count, places the next destruction of the world on 23 December 2012.)

For reasons that remain a source for much archaeological speculation, classic Mayan civilization collapsed dramatically

in the ninth century, whereas the fall of the Incas and Aztecs did not occur until the Spanish conquest. Although this appears to have been a case of self-destruction—an environmental degradation hypothesis has gained increasing support—the Spanish did administer a coup de grace of sorts. Under the auspices of the Catholic Church, almost all the surviving Mayan codices (parchment books) were destroyed. The few that remain, such as the famous Dresden Codex, provide a revealing, if only partial, view of Mayan thought and culture.

Colonial America

Whether the quest was for riches, as in the Spanish incursion into the New World, or for a life free from the constraints of the homeland, which motivated the settlement of most of Anglophone North America, religion played an important role. When the Spanish decided to follow plunder with colonization, taming the indigenous peoples through religious conversion became an imperative. In 1539, less than one hundred years after Gutenberg's invention of moveable-type printing, the bishop of Mexico established the first printing office in the New World. Books of religious instruction helped Franciscans and Jesuits spread Catholicism. They made religious conversions at a rate that far surpassed the later efforts of Protestants in North America, largely because of Catholicism's greater capacity to accommodate indigenous beliefs. The teaching of literacy was not a high priority in Catholic proselytizing at this time, except for those natives destined for ordination.

The seventeenth-century Puritans, in contrast, attempted to teach peoples under their purview to read various religious texts translated into the languages of the tribes in question, but the project was eventually abandoned. The Latin alphabet has only limited phonetic utility when used to transcribe non-Indo-European languages. In 1821, however, the Cherokee Sequoyia devised an indigenous writing system by modifying the Latin alphabet to represent syllables of the Cherokee language. Often referred to as an alphabet, this eighty-five-character script is, technically speaking, a syllabary. At one point it was even used for newspapers; after falling into disuse, it is now enjoying renewed interest. Other Native American groups, such as the Cree and Inuit, have also developed syllabaries.

Whether brought by Puritans, Quakers, Mennonites, or any of the other Protestant groups that settled North America, the influence of the Reformation was profound. Idolatry was rejected and vernacular literacy was encouraged so that all could have direct access to the word of God. Imported Epistles were soon supplanted by Bibles, psalm books, and catechisms minted in America after print shops were set up (1640) in Boston and Cambridge. The literacy rate in colonial New England at this time has been estimated at about 60 percent for adult males, with a figure of about half that for women. It was somewhat less in the southern colonies—50 percent for males and 25 percent for females—given the more agrarian (and, in some places, Catholic) nature of the South, where the education system tended, apart from the segment that catered to the elite, to be less well developed.

The eighteenth century saw a gradual rise in colonial literacy, along with the publication of texts besides those relating

to religion—schoolbooks, professional and technical manuals, and eventually the political tracts that would inspire the American Revolution. By 1790 American editions of English works began to appear, to be followed in several decades by a national tradition of fiction and poetry. Throughout the eighteenth century, books were relatively costly. Access to them was abetted by the establishment of subscription libraries, the prototype being the Philadelphia Library Company, established in 1731, largely through the efforts of Benjamin Franklin. Newspapers also facilitated the dissemination of ideas throughout the century, beginning in 1700 with Boston postmaster John Campbell's hand-copied news sheet, which went to print in 1704 as the *Boston News-Letter*. Within a generation a dozen such publications were available, and throughout the remainder of the century growth would be exponential.

In the decades leading up to 1776, a growing volume of printed matter urged resistance to British authority. Perhaps the most notorious document in this regard is Thomas Paine's *Common Sense*, published as the revolution began, on 9 January 1776. Although the ideals of those advocating independence included free speech and a free press, pro-British newspapers expressing Loyalist sentiments were often suppressed. By the time of the revolution there was near universal literacy in the northern colonies. Nevertheless, the importance of the oral tradition cannot be discounted. What was read was discussed and augmented by speeches in taverns, meeting halls, and other public places.

The Penny Press

In the 1830s American newspapers began their emergence as a true mass medium—one that disseminates the same information to large numbers of people. In the colonies or early republic a successful newspaper attracted only a few thousand readers at most. After the revolution, advertising helped finance newspapers, and many, if not most, had the word *Advertiser* in their title. Circulation was dependent on subscription. Early in the nineteenth century, partisan politics began to play an increasingly important role as papers aligned themselves with political parties in response to the debate between Federalists and Anti-Federalists. No matter what political constituency these journals served, the associated business interests determined their emphasis. Subscribers were generally well-off and had to sign on for a year at a cost of six cents an issue.

The arrival of the penny papers changed the industry. The idea began in New York and within a decade had spread to other metropolitan areas. Benjamin Day's *New York Sun* (1833), James Gordon Bennett's *New York Herald* (1835), and Horace Greeley's *New York Tribune* (1841) were sold on the street for a penny and reached a readership many times that of the partisan press. Many readers were immigrants, members of the traditional middle class, or from a nascent literate working class. These papers were not without political leanings, but they were not party-funded (advertising revenue helped defray costs) and were quite capable of shifting an allegiance if a candidate's platform displeased them. Local news, along with crime—the more sensational the better—human interest stories, and coverage of late-breaking events such as the war with Mexico made the penny papers immediate as well

as informative. Journalistic practice shifted from the interpretation of an event, in some cases long after the fact, to speedy, descriptive reporting. Eventually the penny papers added coverage of the arts, theater, sports, and general entertainment.

Several theories have been put forth to explain the success of the penny press. On the technological side, steam power and the rotary press facilitated mass production. The use of steam in rail and ship transportation and improved roads speeded the movement of news. By the mid-1840s that movement was no longer limited to the available means of transportation, given the advent of the electric telegraph, which prompted the formation of news agencies such as the Associated Press (1849). News was becoming a commodity—the fresher the better. Nevertheless, it must be noted that the advent of the penny press itself preceded technological influences that contributed so greatly to its success. On the human side, a literate urban population was expanding and was feeling a greater sense of empowerment through the electoral process. Being informed through regular access to news helped give direction to that empowerment.

Yellow Journalism

Penny papers dominated news reporting until the end of the nineteenth century, when they were outdone at their own game by the journalistic innovations of Joseph Pulitzer and William Randolph Hearst. Beginning in midcentury, though, there were alternative visions of what a newspaper should be. The most notable such experiment was Henry Raymond's *New York Times*, sometimes referred to as an example of the "information press." Beginning in 1851, the *Times* eschewed the base populism of the penny press and used a matter-of-fact style to report urban news, public-interest stories, and business activities. On the eve of the Civil War the *Times* became associated with the Republican Party and its antislavery position. Perhaps the paper's finest hour in its first half-century of operation occurred in the 1870s, when it helped expose the infamous New York municipal corruption ring headed by William Marcy "Boss" Tweed.

The challenge to the penny press and the information press posed by Pulitzer and Hearst gave rise to what became known as "yellow journalism." The term itself, which evokes notions of sensationalism and scandal mongering, derives from a cartoon character bent on exposing corruption, the Yellow Kid, drawn by Richard Outcault for Pulitzer's *New York World*. Pulitzer, a Hungarian immigrant, took over the paper in 1885. His numerous innovations included a populist, pro-labor and pro-union position; campaigns to expose municipal corruption and injustice; advocacy of an increased tax burden for the wealthy; investigative journalism that tackled everything from phony psychics to the dire conditions in a mental hospital; and publicity-seeking stunts to improve circulation, such as sending Nellie Bly on her legendary seventy-two-day trip around the world in 1888–1889.

Pulitzer also streamlined the prose style of his papers (he would acquire a chain of them) by avoiding colloquial and esoteric terms and shortening paragraphs and sentences. Headlines, barely discernible in the penny papers, now spanned columns. Visuals—diagrams, cartoons, along with the reproduction

of photographs using the new halftone process—earned a prominent place. This helped make Pulitzer’s papers appealing, especially to immigrants for whom English was a second language.

Hearst admired these innovations but believed they could and should be extended further. In 1895 he took over the *New York Journal* and began a battle for circulation supremacy with Pulitzer that has been described as fiercer than the Spanish-American War that both papers would cover three years later. Hearst’s moneyed background allowed him to hire away part of Pulitzer’s staff, including Outcault and his Yellow Kid.

Hearst’s journalistic exposés were not always limited to stories relating to the public interest. Sensationalism was omnipresent. Lurid scandals that we associate today with tabloid journalism sometimes made the front page, accompanied by massive, attention-getting headlines. Hearst also had a reputation for newsmaking when mere reporting would not suffice. His most famous foray in this direction occurred when he drummed up sentiment for a reluctant U.S. government to declare war on Spain. Hearst’s quip to artist Frederick Remington, who had cabled from Cuba that there was little fighting to report—“You furnish the pictures and I’ll furnish the war”—is humorously dramatized in Orson Welles’s 1941 film based on Hearst’s life, *Citizen Kane*.

Book Publishing

In addition to religious publications, a major type of book emerging from the colonial press was the almanac. Benjamin Franklin’s *Poor Richard’s Almanac* (1732), blending self-help advice with humor, became a best-seller. Book production was centered at first in Boston and Cambridge, but by the early eighteenth century Philadelphia (where Franklin was based) became a major player. Censorship limited the variety of books that could be published, and there was no enforcement of copyright. By the early nineteenth century the industry had diversified its output, and the burgeoning commercial center of the new nation, New York, had become the center of publishing as well.

In the United States, modern book publishing—featuring a diverse general list and home-grown authors—began in 1817, when James and John Harper established the firm bearing their name. They were soon followed by John Wiley, who took over his father’s fledgling business in 1826. The house scored a major coup when it signed a then-unknown James Fenimore Cooper—later referred to as “America’s Sir Walter Scott”—who went on to become the country’s first literary celebrity. In 1840 Wiley went into partnership with George Putnam, who would eventually leave to establish his own firm in 1849. In 1846 Wiley and Putnam published Herman Melville’s first novel, *Typee*, which in turn passed to Harper’s in 1849. (Melville was never a big seller during his lifetime.)

Harper’s went on to become the largest publisher in America, earning considerable sums from pirating English favorites including the Brontës, Thackeray, and Dickens. The house also produced textbooks and a magazine that bore its name, which emerged as the medium to which many people turned

for Civil War coverage, especially owing to impressive visuals (woodcut illustrations). Other well-known firms that emerged during this time include Appleton (1831), Scribner’s (1846), and D. Van Nostrand (1848). However, it was a small Boston publisher, John P. Jewett, working in the shadow of Little, Brown (1847) and Houghton (1848), who scored the century’s biggest publishing coup. After Phillips, Sampson and Company (1850) turned down the novel rights to Harriet Beecher Stowe’s serialized (in the *National Era*) story *Uncle Tom’s Cabin*, Jewett published it in 1852. The book became the biggest-selling hardcover in nineteenth-century America and had an enormous impact on the (northern) public’s attitude toward slavery and its rising antipathy toward the South.

The second half of the century saw the country secure, both in its publishing industry and in the literary ability of American authors. The old houses grew and new ones sprang up as reading tastes diversified. Harper’s even signed the once-pirated Dickens in 1867. In 1895, during a decade that saw a boom in American fiction publishing, Harper’s secured the rights to sixteen books by Mark Twain (Samuel Clemens). Twain and several other prominent writers successfully promoted their work through a series of highly entertaining public readings—performances, in the case of Twain—that recaptured, at least in spirit, the oral tradition of storytelling that had been so integral to the cultural life of both Native Americans and African-Americans.

See also **Censorship; Literature; Media, History of.**

BIBLIOGRAPHY

- Amory, Hugh, and David D. Hall, eds. *The History of the Book in America*. Vol. 1: *The Colonial Book in the Atlantic World*. New York: Cambridge University Press, 2000.
- Ascher, Marcia, and Robert Ascher. *Code of the Quipu: A Study in Media, Mathematics, and Culture*. Ann Arbor: University of Michigan Press, 1981.
- Carey, James W. *Communication as Culture: Essays on Media and Society*. Boston: Unwin Hyman, 1989.
- Coe, Michael D. *The Maya*. London: Thames and Hudson, 1980.
- Crowley, David, and Paul Heyer, eds. *Communication in History: Technology, Culture, Society*. Boston: Allyn and Bacon, 2003.
- Czitrom, Daniel. *Media and the American Mind: From Morse to McLuhan*. Chapel Hill: University of North Carolina Press, 1982.
- Peters, John Durham. *Speaking into the Air: A History of the Idea of Communication*. Chicago: University of Chicago Press, 1999.
- Pfeiffer, John E. *The Emergence of Society: A Pre-history of the Establishment*. New York: McGraw-Hill, 1977.
- Robinson, Andrew. *The Story of Writing: Alphabets, Hieroglyphics, and Pictograms*. London and New York: Thames and Hudson, 1995.
- Ruhlen, Merritt. *The Origin of Language: Tracing the Evolution of the Mother Tongue*. New York: Wiley, 1994.
- Schudson, Michael. *Discovering the News: A Social History of American Newspapers*. New York: Basic Books, 1978.
- Stephens, Mitchell. *A History of News: From the Drum to the Satellite*. New York: Viking, 1988.
- Tebbel, John. *Between Covers: The Rise and Transformation of Book Publishing in America*. New York: Oxford University Press, 1987.

Tebbel, John, and Mary Ellen Zuckerman. *The Magazine in America: 1741–1990*. New York: Oxford University Press, 1991.

Umiker-Sebeok, D. Jean. “Aboriginal Sign ‘Languages’ from a Semiotic Point of View.” In *The Sign and its Masters*, by Thomas A. Sebeok. Lanham, Md.: University Press of America, 1989.

Paul Heyer

ASIA AND ITS INFLUENCE

Asia comprises a vast amount of land divided into numerous countries, many of which have civilizations dating back thousands of years. Due to the huge scope of this topic, this entry will focus on India as an important hub for the transmission of ideas throughout Asia and how other Asian countries influenced the development of Indian civilization.

When India became independent in 1947, the new government faced the daunting task of convincing a large and highly disparate population that the various peoples of India constituted one nation. The populace was divided among a variety of religious groups, the majority of whom were Hindus (more than 80 percent). Hindus are divided into more than two thousand endogamous castes (*jati*), each of which considers itself to be different from all the others. In the early twenty-first century there are over 800 million Hindus, 81 million Muslims, 20 million Christians, 14 million Sikhs, 6 million Buddhists, 3 million Jains, and about 600,000 Zoroastrians in India. In addition, there is enormous linguistic diversity: the 1971 census (the most recent containing a survey of languages) listed thirty-three languages with more than one million speakers, and there are numerous smaller languages and dialects, many of which are mutually incomprehensible. Since independence, the government has made great strides in promoting education, but more than half of the population remains illiterate.

In this situation, oral and visual texts play a central role in communicating ideas among India’s population, which currently numbers over one billion. The ideals of nationhood and government initiatives are often disseminated orally or symbolically, and this is also true of religious ideas. Public performances of religious tales are widely popular all over India, and the annual Ramlila (“Sport of Rama”) plays generally draw huge crowds. These are based on Tulsidas’s (1543?–1623) version of the Hindu epic *Ramayana*, which tells the story of the mythical king Rama, an incarnation of the god Vishnu. When the *Ramayana* was serialized on television in the 1980s, it became a major national event, and the country came to a standstill every week when it was showing. This was followed by serialization of the *Mahabharata*, the other major religious epic of India, which was equally well received. Due to the continuing popularity of public performances and mass media presentations of religious themes, religious narratives and the ideas they convey are widely diffused in India. The spread of Internet access and growing expertise in software development in India have increased this process, at least among those who are able to use computers. It is now possible to make virtual pilgrimages to Hindu holy sites and to perform virtual *puja* (offerings and prayers) at several popular Hindu cultural Internet sites. These generally use English, the language of elite communication in India, and they appeal particularly to Indians living overseas.

Language Issues

Even after fifty years as an independent country, there is no real national language, despite government attempts to promote Hindi, which is spoken in the northern part of the country. Linguistically related to Sanskrit, Hindi is the single most spoken language in India, but even so it falls well short of a majority. In 1971 there were 153,792,062 Hindi speakers listed, but even though it is widely spoken (and linguistically related to other languages in the so-called Hindi Belt of north India), there was significant resistance to a government proposal to make it the national language.

The main opposition came from speakers of the Dravidian languages of the south and tribal groups, who felt that they would be disadvantaged if Hindi became the language of government examinations, higher education, and interstate communication. People in the north who speak either Hindi or a linguistically related language would have a significant edge, while speakers of other languages would have to become proficient in Hindi to compete. In response to these concerns, the Indian government first mandated that both English and Hindi would be national languages until 1965, after which English would be dropped, but continued pressure forced the government to retain English for an indefinite period until it could be replaced by Hindi. Many Indian nationalists deplore this situation and feel that the continued use of the language of India’s colonizers is an affront to national dignity, but the situation seems likely to continue for the foreseeable future.

A complex system of center-state communication has been devised. Most of India’s states are organized along linguistic lines, and those states in which Hindi is dominant must communicate with the central government in Hindi. Others may communicate in either Hindi or English. In India, language is closely linked to cultural identity, and there are concerted efforts in many parts of India to ensure that traditional tongues are maintained.

English and Sanskrit

The use of English as a national medium proved to be an important aspect of India’s rise to prominence in science and technology in the late twentieth century, particularly the development of computer software. Hindi and other Indian languages are poorly suited to communication of modern scientific ideas and terminology. The development of vernacular equivalents is still in its infancy, and so the widespread use of English in elite education, tertiary institutions, and the government-sponsored Indian Institutes of Technology (IITs)—which turn out the majority of Indian information technology workers—has helped India to become an international powerhouse in software technology. English also functions as a marker of elite status in India and is seen as a sign of education and upward mobility among the middle classes. Despite this, according to government estimates, only 11 percent of Indians are fluent in English, and its use is mainly confined to the educated elite.

The use of English as an elite lingua franca has parallels to the position of Sanskrit in ancient and classical India. As with Latin in medieval Europe, Sanskrit was the language of

philosophers, writers, and religious teachers, who used it to bridge the linguistic diversity of the subcontinent. The Vedas, the earliest sacred texts of Hinduism, were composed in Sanskrit, probably between 2000 and 400 B.C.E. Most of India's great classical literature, philosophy, and religious works were written in Sanskrit, and it functioned as a means for communicating ideas across the subcontinent for millennia. Despite the widespread use of writing, oral transmission has always been predominant. The main religious duty of the priestly caste of Brahmins is to memorize and transmit the Vedas to their descendants, a process that continues in the early 2000s.

The use of Sanskrit by the elite facilitated the communication of ideas within the areas that adopted it as the lingua franca. One example of its use in communication of ideas was the tradition of public philosophical debate (*vadavidya*) among rival philosophical factions. From at least the time of the Buddha (c. 563–c. 483 B.C.E.) and Mahavira (c. 599–527 B.C.E.) such debates were common. Reports of the time indicate that they were generally sponsored by rulers and often attracted large crowds. The stakes were quite high in these contests: the winners received financial rewards, government patronage, and increased status, but the losers had to publicly acknowledge their defeat and leave the area. Thus it is not surprising that underhanded techniques were commonly used to win debates, and by the first century C.E. there were several manuals outlining the rules and proper conduct for philosophical disputes. According to Akshapada, there are three types of debate: (1) honest debate (*vada*), in which both sides seek the truth and try to establish the correct view; (2) sneaky debate (*jalpa*), in which one tries to win by any means; and (3) destructive debate (*vitanda*), in which one side merely tries to demolish the opponent's position without putting forward an alternative. The most famous practitioner of the third type was the Buddhist philosopher Nagarjuna (fl. c. 150–250 C.E.). By all accounts, because the stakes were so high, the first type of debate generally was confined to members of the same philosophical school, and the primary objective in encounters with rival traditions was to defeat them and establish one's own school as dominant.

Some of the common concerns of oral philosophical debates were: What is the meaning or purpose of life? Should one pursue sensual pleasures, or does asceticism lead to better results? Is the world eternal? Is there an individual soul, and if so, is it eternal? In ancient India there was an enormous diversity of philosophical schools, and one of the key focal points of debate concerned what should function as valid means of knowledge (*pramana*). There were a number of commonly accepted *pramanas*, such as direct perception (*pratyaksa*), inference (*anumana*), verbal testimony (or scripture, *abda*), and analogy (*upamana*). Some of the most vigorous intersectorial debates centered on issues of validity; some schools accepted all of the *pramanas*, some orthodox Brahmanical schools relied ultimately on scriptural testimony, and the Buddhists only accepted direct perception and inference. These philosophical debates were waged for millennia between rival philosophical factions, and the interchange of ideas they fostered led to significant developments within all major philosophical traditions.

Trade and the Exchange of Ideas

Because India was a major cultural and commercial center, it had widespread influence in the region. Sanskrit was not only the language of ruling elites in India but also extended into neighboring countries. Sanskrit was adopted as the language of statecraft and a symbol of royal legitimacy in Angkor (whose name derives from the Sanskrit word *nagara*, city), and was used by ruling elites ranging from Prambanam in central Java to Annam (modern-day Vietnam) to Peshawar in Gandhara (modern-day Pakistan). The languages of neighboring countries such as Ceylon (Sri Lanka), Thailand, Indonesia, and Malaysia are strongly influenced by Sanskrit and contain many cognate words. Versions of the *Ramayana* and *Mahabharata* are found all over South and Southeast Asia and continue to be widely performed, and Indian thought, myth, and cultural themes pervade the region.

In addition to being a hub of ideas and technology, India was the nexus of trade in the region. Early records indicate that guilds run by Brahmins dominated regional commerce and document commercial interactions with Thailand, Alexandria, Lebanon, Burma, island and mainland Southeast Asia, China, Vietnam, and the Philippines. India's major international trade routes began at Patna in the north and went on to Taxila, through the Hindu Kush mountains to Bactria and Seleucia, and west toward Damascus and the seaports of Ionia. Trade with China is documented as early as the first century C.E., when embassies were sent between the two countries, and a major expansion of trade took place during the Tang dynasty (618–907). The most important avenues of trade were the silk routes, which brought goods and technology by sea and overland through Central Asia. The overland trade routes from northern India went to the north and south of the Tarim Basin and met at the Chinese frontier at the Jade Gate near the oasis city of Dunhuang. The famous caves of Dunhuang were constructed between the fifth and eighth centuries and were used to store texts and images. Dunhuang became a major center of interchange between Indian and Chinese culture, and during the period that it was annexed by the expanding Tibetan empire (ninth century) it also served as a conduit for Buddhist learning and literature from Tibet, Central Asia, and China.

Beginning in the second century C.E., Buddhist missionaries began to follow the trade routes through Central Asia and made their way into China. In 142 a group of monks led by An Shigao established a translation bureau in Loyang to render Sanskrit Buddhist texts into Chinese. For several centuries interest in Buddhism was largely confined to émigrés from Central Asia, but in the fourth century significant numbers of Chinese began to convert. This led to increased importation of texts and ideas from India as well as increased pilgrimage by Chinese Buddhists to India. Among the most famous of these intrepid travelers was Faxian, who traveled overland to India in 399, and Xuanzang, who journeyed overland through Central Asia to India. Xuanzang spent a total of sixteen years there (629–645) and traveled all over the subcontinent, chronicling Buddhist institutions and schools. He brought back numerous texts and spent most of the rest of his life translating and interpreting them.

During the Tang dynasty there were reportedly thousands of Indians in China's major cities. Some were traders and others were Buddhist missionaries. Some, such as Bodhiruchi (fl. 508–537), brought more than just Buddhist learning: Bodhiruchi was born into a Brahman family and was learned in Samkhya philosophy, astrology, mathematics, medicine, and grammar. He translated fifty-three volumes of the Buddhist canon under the patronage of the emperor and was also influential in introducing the court to other aspects of Indian learning and technology. Pilgrims and traders who returned to India brought peaches, pears, vermilion, and Chinese silk with them, and many also studied Chinese medicine, astrology, and mathematics during their stay.

Conquest, Invasion, and Emigration

In addition to these generally amicable trade relations, conquest and invasion played major roles in the transmission of ideas into India. India is geologically separated from the rest of Asia; the Himalayas—the world's highest mountains—constitute its northern border, but their passes have been crossed by innumerable invaders, migrants, and travelers. One important early group of migrants was the Aryans, who probably originated in Europe and arrived in India in the second millennium B.C.E. They spoke a proto-Sanskrit language and brought their sacred texts, the Vedas. Over the course of centuries they became predominant in northern India, but their culture probably absorbed elements from India's indigenous inhabitants.

Alexander the Great crossed the Indus River in 326 B.C.E. and easily conquered the divided kingdoms of northern India, but his troops revolted at the Beas River and refused to advance, so his expansion into the subcontinent was halted. In the political vacuum left by Alexander's withdrawal, an Indian dynasty, the Mauryas (321–185 B.C.E.), conquered the Gangetic plain and the Indus River valley, but the dynasty fell apart several decades after the death of the great emperor Ashoka (r. 269–232 B.C.E.). After this there were some small dynasties, such as the Shungas and Kanvas, but none were able to match the Mauryas' power. In the following centuries there were invasions by several groups of foreigners, including Bactrian military commanders of Alexander's frontier provinces. They were followed by Persians, Scythians, and Central Asian barbarian tribes.

The Bactrians carved out small kingdoms in the northern parts of the subcontinent, and their rule was a time of cultural exchange between the Greek cultural world and India. There is evidence of transmission of technology and literature as well as medical and astrological knowledge. The works of Plato were brought to India, and the *Mahabharata* was read by some Greeks. In one famous example of intercultural exchange, the Bactrian king Menander (fl. 160–135 B.C.E.) reportedly had a series of philosophical dialogues with the Buddhist sage Nagasena, which are preserved in the *Questions of King Milinda* (*Milindapanho*). This became one of the classics of Buddhist philosophy and was translated into Chinese as early as the fourth century C.E. In this text, Menander poses questions from the perspective of classical Greek philosophy, and Nagasena answers from a Buddhist perspective. Menander is presented as

an admirer of the Buddha and his doctrine, and he seems to be familiar with Buddhist philosophy.

Buddhist thought and culture were also spread into Southeast Asia beginning in the third century B.C.E. The first successful Buddhist mission was reportedly sponsored by Ashoka, who sent his son Mahinda, a Theravada Buddhist monk, to Ceylon. After becoming established there, Theravada spread to other areas of Southeast Asia and became the dominant religion in Thailand, Burma, Cambodia, and Laos. Beginning in the seventh century, Mahayana Buddhism was adopted by the kings of Tibet, who began a process of importation of Indian Buddhist culture and learning. They sponsored Tibetan scholars to study in the great monastic universities of north India, and Indian scholars were brought to Tibet to spread their religion and to translate the Buddhist canon into Tibetan.

Beginning in the eighth century, a series of Islamic invaders penetrated into India from the north. One of these, Mahmud of Ghazni (971–1030), conquered large areas of northern India and also engaged in widespread destruction and looting of religious sites. As a result of the depredations of his armies and later Muslim invaders, the Buddhist monastic universities were destroyed, and by the thirteenth century Buddhism had largely disappeared in India. In the thirteenth century, the Ghurids from Central Asia established the Delhi sultanate, which ruled much of northern India until 1526. They in turn were defeated by the armies of Babur (1483–1530), a descendant of Genghis Khan and Timur, who established the Mughal dynasty, which ruled most of India until 1856. The Delhi Sultanate and the Mughal Empire established a prolific trade in both ideas and commerce between India and the Islamic world. Persian was the language of the Mughal court, which patronized the arts and philosophy. The height of the Mughal dynasty was a period of cultural flourishing in India, and ideas, literature, and technology circulated among India, Persia, and the Middle East as well as the rest of Asia.

In 1656 the Mughal emperor Dara Shukoh had sections of the Upanishads translated into Persian, believing that they were secret scriptures referred to in the Koran. Sufi writings and teachers also exercised significant influence in India, and this continues in the early twenty-first century. The great emperor Akbar (r. 1556–1605) was highly influential in the interchange of ideas in India and is reported to have held philosophical and religious discussions with representatives of a range of religions and traditions. Following an expansion of the empire under Aurangzeb (r. 1658–1707), internal pressures weakened it, and local hegemonies began to carve out small states.

European traders began to arrive in the sixteenth century. The first were the Portuguese, who established Goa as their trading base in 1510. In 1608 the British East India Company founded its first trade headquarters in Surat, followed by Madras in 1641 and Calcutta in 1691. During the next century, the East India Company gradually extended its control and by the eighteenth century had overcome most of its rivals. Following General Robert Clive's defeat of French forces at Plassey in Bengal 1757, Britain became the dominant power in the subcontinent and began to create rail and communications networks. In the early 1850s the East India Company

spent £110,250 on telegraph lines linking the presidencies of India (the areas under direct British rule), which along with the railways and a postal service created by the British allowed for transport of goods and ideas all over the subcontinent. In 1865 a cable link was established between Britain and India.

Indians at first perceived the British as low-caste invaders, but gradually elites began to recognize the benefits of British education and started sending their children to study abroad. At the same time, the British established English-medium schools in India for their children and those of Indian elites. As British scholars began to explore India, interest in its classical literature increased dramatically. Chairs for the study of Sanskrit and Indian culture were established at leading British universities, and religious, philosophical, and literary classics were translated into European languages. Initially the main emphasis was on classical studies, and German scholars were at the forefront of this movement. The pioneering Indologist Max Müller published the first printed versions of the Vedas in Oxford between 1849 and 1873. A French translation of the Upanishads (from the Persian translation sponsored by Dara Shukhoh) was published in 1801–1802.

At the same time, European humanism and political philosophy were widely disseminated among British-educated Indians. The most influential leader of India's independence movement, Mohandas K. (Mahatma) Gandhi (1869–1948), first read the *Bhagavad Gita* in Sir Edwin Arnold's English translation after joining the London Vegetarian Society while studying law in London. His writings indicate that in addition to the *Gita*, he was profoundly influenced by Leo Tolstoy, the Sermon on the Mount, and Henry David Thoreau. As with many other Indians educated in British schools, his thought was a mixture of traditional Hinduism and Western thought.

During their study in British schools, India's independence leaders learned about Western notions of democracy and used these against their colonizers. In addition, the British-built railroads enabled activists to travel all over the subcontinent and to speak with like-minded people in distant areas. This, along with the availability of instant communications via telegraph and, later, telephone and wireless, facilitated the process of learning to imagine themselves as constituting one people belonging to a unified nation.

Because of India's diversity, the process of nation-building and the task of fostering nationalist consciousness among its various religious, linguistic, racial, and tribal groups continues in the early twenty-first century. The growing penetration of telephone service, television, radio, and other forms of mass communication is part of this process. Probably the most pervasive and influential medium for the dissemination of ideas is "Bollywood" films, which are produced en masse and are widely popular not only in India but also Nepal, Tibet, and Southeast Asia. Most of these use a simplified version of Hindi (often referred to as Hindustani), and they function as cultural markers that contain lessons about morality, behavioral norms, courtship and marriage, political issues, and religious themes. The plots are generally thin, characters tend to be stereotypical, and the acting is mediocre at best, but they are enormously

popular and are important texts for both Indians and outsiders in regard to popular attitudes and current ideas. They also have helped to spread oral comprehension of Hindi throughout the subcontinent and even beyond, which may in time aid the government's goal of making it the national language. As it continues to define itself in the aftermath of its colonial period, India is once again emerging as a major center for the development and dissemination of ideas in Asia, and Indian thought and technology have become part of the global inheritance of humanity.

See also Aesthetics: Asia; Asceticism: Hindu and Buddhist Asceticism; Chinese Thought; Consciousness: Indian Thought; Cosmology: Asia; Education: Asia, Traditional and Modern; Empire and Imperialism: Asia; Hinduism; Jainism; Sufism.

BIBLIOGRAPHY

- Brass, Paul R. *Language, Religion, and Politics in North India*. London and New York: Cambridge University Press, 1974.
- Goody, Jack. *The East in the West*. Cambridge, U.K., and New York: Cambridge University Press, 1996.
- Hartmann, Paul, B. R. Patil, and Anita Dighe. *The Mass Media and Village Life: An Indian Study*. New Delhi: Sage, 1989.
- Hein, Norvin. *The Miracle Plays of Mathurā*. New Haven, Conn., and London: Yale University Press, 1972.
- Kersenboom, Saskia. *Word, Sound, Image: The Life of a Tamil Text*. Oxford and Washington, D.C.: Berg, 1995.
- Kuppuswamy, B. *Communication and Social Development in India*. New Delhi: Sterling, 1976.
- Lopez, Donald S., Jr., ed. *Curators of the Buddha: The Study of Buddhism under Colonialism*. Chicago: University of Chicago Press, 1995.
- Matilal, Bimal Krishna. *The Character of Logic in India*. Edited by Jonardon Ganerit and Heeraman Tiwari. Oxford: Oxford University Press, 1998.
- Pollock, Sheldon. "The Sanskrit Cosmopolis, A.D. 300–1300: Transculturation, Vernacularization, and the Question of Ideology." In *Ideology and Status of Sanskrit*, edited by Jan E. M. Houben, 197–248. Leiden, Netherlands, and New York: E. J. Brill, 1996.
- Pollock, Sheldon, ed. *Literary Cultures in History: Reconstructions from South Asia*. Berkeley: University of California Press, 2003.
- Smith, David. *Hinduism and Modernity*. Oxford: Blackwell, 2003.
- Wang, Georgette, ed. *Treading Different Paths: Informatization in Asian Nations*. Norwood, N.J.: Ablex, 1994.
- Yadava, J. S., and Vinayshil Gautam, eds. *The Communication of Ideas*. New Delhi: Concept, 1980.

John Powers

EUROPE AND ITS INFLUENCE

By the first millennium B.C.E., major world civilizations were flourishing in Mesopotamia, Egypt, the Indus Valley, and China. Each had developed a distinct form of writing, along with urban centers for administration and record keeping. In contrast, Europe was largely a series of diverse nonliterate village farming communities steeped in the conventions of primary oral communication. The eventual emergence of a literate tradition in Europe took place in Greece—at its cusp,

one of the most celebrated works in the history of Western civilization.

Orality and Literacy in Greece

Homer's *Iliad* and *Odyssey* occupy an important early niche in the history of European literature. It has been argued, however, that the Homeric epics, strictly speaking, are not even literature. In *An Essay of the Original Genius and Writings of Homer* (1775), the English diplomat and archaeologist Robert Wood initiated a continuing debate by arguing that Homer could not read or write and that the poetic character of the epics facilitated memorization and therefore oral transmission. More recent research has shown that these narratives share important characteristics with the oral histories of nonliterate societies around the world. Their aural resonance results from the use of devices such as hyperbolic turns of phrase, metrically patterned formulae, and extensive clichés.

Sometime between 700 and 550 B.C.E., the Homeric epics were committed to writing, using an alphabet the Greeks had recently adapted from the twenty-two-character Phoenician consonantal alphabet, which some scholars insist should be called rather a syllabary or consonantal syllabary. The Greek variant modified the original characters and added several new ones in order to represent a series of independent vowel sounds. This made writing easier to learn, a more complete approximation of speech, and a medium capable of transcribing different dialects and even other languages—such as Coptic, an Egyptian language recorded using modified Greek characters. Within a hundred years the convention of writing left to right displaced the right-to-left Phoenician (and Semitic) tradition. Before this conversion the Greeks briefly experimented with boustrophedon, the seemingly logical but ultimately impractical style of alternating the direction of the script in each line.

The literacy revolution in Greece had significant cultural consequences, but it must be remembered that at first what was transcribed reflected the extant oral tradition, as in the poetics of Homer. Over the next several centuries, writing would gradually take a less flowery and more prosaic turn. This evolution, in which the content of a new medium is at first that of the previous mode of communication, is a central tenet in the communication theory of Marshall McLuhan. It recurs throughout the cultural history of Europe. In the fifteenth century, for example, the incunabula, or first wave of printed books, replicated not only the content but the calligraphic style of the earlier manuscripts—the Gutenberg Bible was even printed on parchment, the preferred medium for manuscripts—and before the rise of newspapers in the seventeenth century, during the period when reports of major news events were printed in pamphlets and broadsides, they were often written in verse. Eventually, more efficacious ways of using a new medium change the forms of discourse conveyed by that medium, and so it was with alphabetic literacy in Greece.

Until the fifth century B.C.E., a teacher in Greece taught from transcribed texts that were steeped in the conventions of the spoken word. Students were expected to commit the information conveyed to memory (similarly, in the Middle Ages, a scribe might read a manuscript passage aloud in order to

ensconce it in auditory memory). By the end of the fifth century, in the period coinciding with Plato's early education, what had been recited was now read by students schooled in the new mode of communication. How widespread literacy was at this time—it was limited in theory to free male citizens—is still subject to debate. Nevertheless, its influence on institutions, such as the law, as well as on philosophy and knowledge in general, was profound. Learning the new alphabetic script was facilitated through the use of several easily accessible media—sand, slate, and waxed tablets. More permanent texts were inscribed on papyrus (imported from Egypt) and parchment (obtained from the skins of domestic animals).

Plato's Critique

Standing on the cusp of this information revolution, Plato saw benefits and liabilities in the transformation. In the utopian vision of his *Republic*, he has harsh words for both the oral tradition of Homeric verse and the later legacy of dramatists such as Aeschylus, whose writings have poetic overtones. Their emotionality, heavy reliance on sensory experience in describing the world (a signature trait of primary oral languages), imprecise use of language, and ambivalent portraits of the world and the gods Plato saw as exerting a corrupting influence on youth. On the other hand, he did not hold the new literate education, capable of circumventing these conceits, to be without its own limitations. In his *Phaedrus*, Plato uses a dialogue with Socrates—not a recorded conversation but literary prose imitating speech—to lament the attenuation of memory that is a consequence of literacy. He argues that dependency on an external source, such as writing, will diminish the internal resources of thought and memory and thereby weaken the mind. Also, since the written text is passive, a dialogic give-and-take is not possible. Yet despite these reservations it was writing—phonetic literacy, to be precise—that would facilitate the type of abstractions underlying Plato's philosophy and much of subsequent Western thought.

Alphabetic literacy fostered the gathering of a wide variety of data that would be difficult to retain using the relevance structure of primary oral communication. That this data could be analyzed and preserved for posterity is attested to by numerous texts that have come to us from ancient Greece, among them the geography of Anaximander (610–547 B.C.E.), characterized by a visionary cartographic impulse; the histories of Herodotus (c. 484–c. 420 B.C.E.); Hippocrates' (fl. c. 600 B.C.E.) treatises on medicine; the philosophy of Aristotle (384–322 B.C.E.); and the geometry of Euclid (fl. c. 300 B.C.E.), with its verbal arguments as well as figures. To this list must be added the imperial legacy of Alexander the Great (ruled 336–323 B.C.E.), abetted as it was by literate administrators.

Rome

The legacy of Hellenic culture would eventually and selectively pass to Rome. It was preceded by the art of writing itself. The Roman alphabet, nearly identical to the one we employ but limited at the time to block capitals, resulted from the modification of a Greek variant sometimes known as the Euboean or Western Greek alphabet. This diffused into the Italian peninsula under the auspices of the Etruscans, who eventually

ceded it to Rome, where it was modified into the alphabet used in most of western Europe, sub-Saharan Africa, Australasia, and the Americas. The contrasting Ionian or Eastern Greek alphabet became the standard for written communication in the fifth-century B.C.E. Athens and the model for the modern Greek alphabet; it also provided inspiration for the later Cyrillic alphabet, used to write Russian and several other Slavic languages.

Many historians contend that the intellectual and artistic achievements of Rome failed to surpass the legacy of Hellenic civilization. However, it appears that in both the Roman Republic (fifth to first centuries B.C.E.) and Roman Empire (first century B.C.E. to fifth century C.E.) the literacy rate was higher—yet oratorical eloquence was just as prized and cultivated as it had been in Greece. Earlier views suggesting that mass literacy might have existed in Rome have been tempered by recent estimates restricting it to anywhere from 5 to 20 percent of the population. Nevertheless, writing, in the form of signage and inscriptions on altars and monuments, was widespread. The ruins of Pompeii even reveal electoral posters, along with graffiti drawing on the poetry of Ovid and Propertius, which suggests that even some members of the underclass must have been able to read and write. In wealthier homes slaves were sometimes taught to be household scribes. Literacy was also not unknown among the gladiators.

The book trade, in the form of papyrus scrolls, flourished under the empire. Teams of scribes were able to produce hundreds of copies and occasionally revised “editions” of a given work—a feat usually linked with the printing revolution. Bookstores were established, and even advertised. Papyrus was, however, expensive (ordinary correspondence usually employed wax tablets) and many private libraries accumulated written materials more for status—conspicuous consumption, to use Thorstein Veblen’s term—than for the sake of having a repository of knowledge.

More so than in Greece, the communication of ideas in Rome emphasized practical arts such as the building of roads, aqueducts, bridges, and mills. Literacy also served administration and law, especially in rationalizing the transition from republic to empire. The growing body of law regarding contract and property rights and other legal obligations further inflated a growing bureaucracy. Communication over distance was accomplished through an efficient imperial postal system and an early forerunner of the newspaper, the *acta*—a sheet of relevant news that would be distributed, copied, redistributed, and when necessary, read aloud to those who were not literate. Coordinating events in time was expedited through the calendrical reforms overseen by Julius Caesar (100–44 B.C.E.), which laid the foundations of the calendar we use today. The variable (against the solar year) 12-month lunar calendar, in which the year starts in March, was displaced by a 365.2-day, (366 every fourth year), 12-month year starting in January, with the number of days in each month adjusted accordingly.

The Middle Ages

The usually accepted date for the fall of the Roman Empire and dawn of the Middle Ages is 476 C.E., when the Teutonic

prince Odoacer deposed the youthful figurehead Romulus Augustulus, thus ending the imperial succession. However, as the historian Henri-Jean Martin insists, the death throes of classical culture had begun before and continued for several centuries after that date. Earlier barbarian invasions, crippling taxes, corrupt administration, and, most likely, food shortages and epidemics all contributed to the collapse of Rome. In the fourth century, in the face of growing instability, the emperor Constantine had adopted Christianity, and Rome had eventually followed suit. Constantine had also established Constantinople as the capital of the Eastern (Byzantine) Empire, which would outlast the Western Empire by almost a thousand years.

The Middle Ages saw a more limited and ecclesiastical form of written communication than was the case in classical antiquity. The parchment codex, or *pergamenum*, displaced the papyrus scroll. Its form resembles that of the modern book, with facing pages written on both sides. The codex manuscript began appearing in the first century C.E., became common in the third and fourth centuries, and then established itself as the dominant medium for written knowledge until the advent of the printed book in the fifteenth century. The codex could compress more information into a smaller space than the scroll. Parchment is also far more durable than papyrus and has the advantage of reusability when washed, resulting in a palimpsest that often reveals traces of the original text; and although costly, it could be produced locally at a time when trade with Egypt was being curtailed.

The Roman Catholic Church assumed administrative leadership in postimperial Rome, with popes replacing emperors. Europe became a decentralized, largely nonliterate patchwork of feudal estates based on rural agriculture. The centuries that followed are usually seen as a period of cultural decline, often referred to as the Dark Ages—a term now dismissed, however, by many historians; Lynn White, for example, has argued that while classical learning may have been eclipsed, significant developments were occurring in agricultural practice (the plow and crop rotation), the mechanical arts (accurate clocks), and technology (multipurpose water-powered mills).

Monastic Expansion

By the end of the sixth century, under the auspices of Pope Gregory the Great (reigned 590–604), another invasion of Europe from Rome began. The monastic tradition, founded by St. Benedict (c. 480–547) and originally dedicated to prayer and asceticism, now formed itself into a proselytizing militia. When the churchmen moved north they were met with accommodation more than resistance as local rulers availed themselves of the literacy-based administrative skills the monks could provide. None were more appreciative or proactive in accepting what the newcomers brought than the Frankish king Charlemagne (742–814). Although his capacity to read and write is debated by historians—apparently he sought to acquire the skill as an adult—he promoted the cause assiduously, overseeing the creation of written legal charters and of schools for the teaching and standardizing of Latin, which had become plagued with inconsistent usage. This Carolingian Renaissance, as it is called, although short-lived (his empire fragmented in

the ninth century), left a profound imprint on subsequent European communication. It also yielded a new script, Carolingian miniscule, using lower-case characters with clean lines and improved punctuation.

Written knowledge became ensconced in monastic libraries that might contain several hundred to a thousand manuscripts. In contrast, however, libraries in Damascus, Cairo, and Córdoba, when Spain came under Moorish occupation in the tenth century, had upward of one hundred thousand volumes. These collections, fully employing the new medium of paper, evidenced far greater intellectual diversity than was permitted in Christendom, where the Catholic Church aggressively censored what was copied and knowledge was steeped in theological assumptions. When the church did allow secular classics from antiquity to become available, they were subject to revisionist interpretation—thus, for example, Plato was appreciated for the otherworldliness of his philosophy and his disavowal of sensory experience. Medieval texts were usually read aloud; although silent reading would begin to appear in the later Middle Ages and became the norm after printing, for most of the era it was the exception. In his *Confessions* (c. 400), St. Augustine of Hippo expresses both bewilderment and admiration when he observes St. Ambrose reading silently.

Sacred vs. Secular

The worldview of the churchmen, sometimes referred to as a cosmography, regarded nature as a book to be interpreted, not a domain amenable to empirical discovery or rational analysis. However, with new ideas entering Europe from the Crusades and through the Islamic presence in Spain, as well as from the newly emergent church-founded universities, some accommodation became necessary. In response, Thomas Aquinas (1225–1274) argued for a partial application of rational methods to an understanding of the world, provided scriptural revelation remained the final arbiter. The Franciscan Roger Bacon (1214–1294) abused this license with a series of experiments, most notably in optics, that resulted in his imprisonment. The fate of others who transgressed Catholic ideology is chronicled in the history of the Inquisition.

In communicating its teachings to the mostly nonliterate masses, the church employed a rich iconography. Cathedrals were texts to be read; each image told a story. By the thirteenth century, clerics, drafting voluminous contracts, charters, and wills, began to increasingly serve the needs of both secular rulers and a merchant class that had been growing since the emergence of towns two centuries earlier. Still, in this mostly oral world, the language of everyday life remained poetic. Rhymes were used to remember everything from agricultural practice to accountancy, and newsworthy events were conveyed in song by traveling troubadours. The period also saw the beginnings of writing in local languages, or vernaculars, facilitated through the spread of paper, which had initially entered Europe via trade and by the fourteenth century was increasingly being manufactured there. Vernacular literatures emerged, as evidenced in the writings of Dante (1265–1321), Petrarch (1304–1374), and Chaucer (c. 1342–1400).

The Print Revolution

Although few scholars would argue that any single technology merits the label “historical prime mover,” moveable-type printing is certainly one of the few likely candidates. It gave new impetus to the Renaissance already underway, opened the door to modernity, and offered a technique for mass production that would proliferate during the industrial revolution. Johannes Gutenberg, a goldsmith from Mainz whose forty-two-line Bible was printed in 1455, is usually deemed the creator of the new medium. It must be remembered, however, that printing from wooden blocks had begun seven hundred years earlier in China, and that by the eleventh century the Chinese were experimenting with moveable type using baked clay characters. Since Chinese print shops required thousands of such characters, given China’s nonalphabetic script, and since the results were less aesthetically appealing than block books, the experiment had not endured. By the late fourteenth century Korea had developed both an alphabetic script and moveable-type printing using bronze characters. This remained a temporary development. It was the European variant of the technology that would eventually sweep the world.

By 1501, European printers had turned out twenty-seven thousand known publications totaling over ten million copies. Further growth would be exponential. Early print runs produced from two hundred to a thousand copies of a book at a cost far below that of scribal labor, not to mention the greater affordability of paper versus parchment. Although literacy rates rose steadily, nothing approaching mass literacy would emerge until the nineteenth century. Churchmen and scholars were the first to avail themselves of the new printed texts, with Bibles, prayer books, and the Latin and Greek classics having priority. By the sixteenth and seventeenth centuries, however, dictionaries and treatises on philosophy, science, and medicine, often with woodcut illustrations, became widespread. Practical manuals in the technological arts also proliferated, diminishing a dependency on face-to-face apprenticeship in a number of fields.

The printed book assumed a look that was clearly different from that of the medieval manuscript. Printers such as the Venetian Aldus Manutius (Aldo Mannucci; 1449–1515) reduced its size (his Aldine editions prefigure the contemporary pocket book), streamlined the font, and made many Greco-Roman classics available in translation at a relatively low cost to the Renaissance consumer. Other features that we often take for granted began to appear: a regularized title page indicating the date and place of publication, improved punctuation, and layouts that made silent reading the norm. The index, once an oddity in manuscript culture, was now often used to make reference works easier to use.

The spread of knowledge brought about through printing increasingly drove a wedge between the world of the theologians and the views of both secular scholars and an emerging bourgeoisie with vested commercial interests. Print also abetted a schism within the church itself, when religious leaders saw it as a way of expediting the reproduction and sale of papal indulgences. This, along with other church “indulgences,” led a German theologian, Martin Luther, to nail to a Wittenberg

church door ninety-five theses (1517) advocating reform. His grievances were soon printed and the church responded in kind, resulting in a full-scale war of words and, ultimately, the Protestant Reformation.

Philosophy and Literature

Although Luther oversaw the first vernacular edition of the Bible, in German—only to be perturbed by how some in his flock interpreted various passages—the first two centuries of the print revolution saw Latin still used for most scholarly publications. But it was a language on the wane, as was the influence of theology on both natural science and the newly emerging human sciences. Nicolaus Copernicus (1473–1543) and Galileo Galilei (1564–1642), the former somewhat reluctantly (he was averse to seeing his work in print) and the latter stridently, challenged theological orthodoxy in scientific matters. By the eighteenth century in France, the Enlightenment philosophes demanded the removal of theological explanations from the realm of history. They also sought a science of man based on the models and methods of the natural sciences. Many were inspired by and participated in one of the great book publishing ventures in history, the French *Encyclopédie*, edited (1751–1772) by Denis Diderot and Jean d’Alembert. The seventeen volumes (eleven volumes of plates) identified its contributors, defied government and church attempts at censorship, and symbolized the age more than any other writing project.

Print also brought into wider circulation the vernacular literatures of Europe. At first this did not require widespread literacy, as broadsheet ballads and chapbooks could be read aloud to the nonliterate. Authors were usually funded by a patron. The eighteenth century also saw an increase in the literacy rate, though, with writers now becoming dependent on the whims of the marketplace. Book purchase was often beyond the means of an expanding audience of readers; rental from a growing number of circulating libraries, however, became a viable option.

The nineteenth century, sometimes referred to as “the age of the novel,” saw a series of changes that made books less costly and would by its end usher in nearly universal literacy. The making of linen rag paper moved into the world of industrial mass production as waterpower replaced manpower, and was in turn replaced by steam. Early beneficiaries included Walter Scott, whose *Waverley* (1814) became a best-seller, as did Charles Dickens’s *Pickwick Papers* (1836). The last quarter of the century witnessed a further drop in the cost of books resulting from the process of manufacturing paper from wood pulp rather than rag. This served to make not only novels but also works dealing with travel, adventure, and popular science affordable. Small personal libraries, once the preserve of the aristocracy, gentry, and later the bourgeoisie, now became an aspect of many working-class homes.

News

Orators in antiquity, the Roman *acta*, medieval troubadours, and handwritten and early printed broadsides were some of the ways through which news had circulated in premodern Europe. The first true newspapers, defined by a regular publication schedule, were weeklies that began in Germany in the

first decade of the seventeenth century. Other countries quickly embraced the idea. Written in the vernacular, these publications were in part a response to the rise of nation-states and their growing economic interdependence. Freedom of the press was virtually nonexistent. In most countries a government license was required to publish newspapers as well as books, which meant submitting to censorship and high taxes. Circulation was limited to a few thousand readers at best. Domestic news was minimal and any critique of the government could lead to a charge of treasonous libel, for which several printer/publishers were executed. “Safe” domestic stories included the occasional and usually sensationalized account of a gruesome murder—an intriguing link with contemporary tabloids.

Beginning in London in the first decade of the eighteenth century, the daily newspaper became a fact of life in many large European cities. Greater public access to information, coupled with the ideals of the Enlightenment, especially free speech, led to laws guaranteeing freedom of the press. The first of these was passed in Sweden in 1766, and by the end of the next century most European countries had followed suit. During this period newspapers became a true mass medium. Contributing factors included the rotary steam-driven press, which reduced production time; the viability of engraved illustrations, a feature popularized by the *Illustrated London News* when it began in 1842; and the spectacular increase in the speed of information movement the electric telegraph brought to news gathering—demonstrated dramatically in coverage of the Crimean War (1853–1856). By the turn of the century, wood-pulp paper, the linotype machine (invented in the United States), the half-tone process for reproducing photographs, and increased advertising allowed newspapers to expand their size and scope without a substantial increase in price. These changes also helped give them a look that would endure well into the twentieth century.

See also Censorship; Education; Encyclopedism; Literature; Maps and the Ideas They Express; Media, History of; Propaganda.

BIBLIOGRAPHY

- Burke, James. *The Day the Universe Changed*. Boston: Little, Brown, 1985.
- Clanchy, Michael. *From Memory to Written Record in England, 1066–1307*. Cambridge, Mass.: Harvard University Press, 1979.
- Crowley, David, and Paul Heyer, eds. *Communication in History: Technology, Culture, Society*. Boston: Allyn and Bacon, 2003.
- Drucker, Johanna. *The Alphabetic Labyrinth*. New York: Thames and Hudson, 1995.
- Eisenstein, Elizabeth. *The Printing Press as an Agent of Change: Communications and Cultural Transformations in Early Modern Europe*. New York: Cambridge University Press, 1979.
- Feather, John. *A History of British Publishing*. London and New York: Routledge, 1991.
- Harris, William V. *Ancient Literacy*. Cambridge, Mass.: Harvard University Press, 1989.
- Havelock, Eric, and Jackson P. Hershbell, eds. *Communication Arts in the Ancient World*. New York: Hastings House, 1978.
- Illich, Ivan, and Barry Sanders. *A B C: The Alphabetization of the Popular Mind*. New York: Vintage, 1989.

- Le Goff, Jacques, ed. *Medieval Callings*. Chicago: University of Chicago Press, 1990.
- Logan, Robert. *The Alphabet Effect*. New York: Morrow, 1986.
- Lovejoy, Arthur O. *The Great Chain of Being*. New York: Harper and Row, 1960.
- McLuhan, Marshall. *The Gutenberg Galaxy*. New York: Signet, 1969.
- Manguel, Alberto. *A History of Reading*. New York: Viking, 1996.
- Martin, Henri-Jean. *The History and Power of Writing*. Chicago: University of Chicago Press, 1994.
- Menache, Sophia. *The Vox Dei: Communication in the Middle Ages*. New York: Oxford University Press, 1990.
- Ong, Walter J. *Orality and Literacy: The Technologizing of the Word*. London and New York: Methuen, 1982.
- Peters, John Durham. *Speaking into the Air: A History of the Idea of Communication*. Chicago: University of Chicago Press, 1999.
- Stephens, Mitchell. *A History of News: From the Drum to the Satellite*. New York: Viking, 1988.
- White, Lynn Townsend, Jr. *Medieval Technology and Social Change*. New York: Oxford University Press, 1978.

Paul Heyer

MIDDLE EAST AND ABROAD

The great continental Eurasian landmass, with its vast steppes stretching east to west in a more or less uniform climatic belt, has been a useful path for the transit of ideas and techniques throughout history, with what is now the Arab world as the fulcrum of the exchange between China and Europe. Over roughly the first thirteen or fourteen centuries of the Common Era, there was a slow, steady diffusion of ideas and, particularly, technology from East to West.

The Ancient Near East

The administration of large political entities, whether kingdoms or empires, required skills in writing and numeracy for administrative purposes, so that the ruler's writ could be understood by his officials and communicated throughout the land. In ancient empires there was a priestly monopoly on secular, as well as esoteric, knowledge. In societies whose cultural "memory" was limited by their inability to store large quantities of data in archives, the centralization of all knowledge was no doubt functional. Monopoly of knowledge was based on stone (later papyrus) and pictographs in Egypt, clay tablets and cuneiform in Mesopotamia. Difficult scripts were ultimately a constraint on both governance and trade, so expanding empires required conventionalization of the written language.

Conquest, in turn, involved the mixing of languages and writing systems. The Sumerians had a word-value writing system, while that of the Akkadians was based on syllable values. Simplification of writing was paired with the adoption of the sexagesimal counting system in the centralized bureaucracy established by Hammurabi (1792–1750 B.C.E.; Old Assyrian Empire, 1800–1375 B.C.E.). The sexagesimal system had been passed on after 2000 B.C.E. from the Sumerians to the Babylonians and Assyrians, "together with their cuneiform script, which they adapted to their Semitic languages" (van der Waerden, p. 667).

The alphabet was invented by Semitic peoples, possibly in Palestine, on the fringes of the Babylonian and Egyptian

empires before 1500 B.C.E., and perfected along the Phoenician coast. The alphabet formed part of an integrated writing system that came to include papyrus and the reed pen. Two families of script emerged: one Phoenician (reflecting demands of maritime trade and an alphabet that could be used with papyrus), the other Aramaic (responding to demands of land-based trade and, possibly, the use of parchment). The alphabet was flexible, and it favored the growth of trade and the rise of cities. Extensive oral traditions of the ancient Jews and Egyptians now could be written down. The written letter replaced the graven image. The ban on graven images in Judaism (and, later, in Islam) may well reflect ancient rivalries with peoples whose writing systems were based on pictographs.

The centralization of power (Assyrians, then Persians) involved problems of communication and transportation, both of which were reflected in administrative capacity (the ability to move documents over space) and continuity (the ability to store documents over time). Laws and edicts had to be delivered to provincial governors and also stored over time in a central archive to promote continuity and stability, both in administration and in law.

Conquest has always been a powerful means of cultural diffusion. When the Persians conquered Egypt in 525 B.C.E., they set off a century of intense cultural exchange. Babylonian astrology may have first reached Egypt then (Parker, p. 723). Conquest also had systemic effects on language use. The Roman conquest (and doubtless that of the Arabs later on) had the effect of destroying oral cultures and replacing them by a more standardized written one. This has been a constant of Middle Eastern history.

Ease of communication meant that there were continuous or intermittent cultural exchanges over long periods of time between the same places, in both directions. Thus, Indian mathematical astronomy received a constant infusion of new ideas from the West: in the fifth century B.C.E. from Mesopotamia via Persia; in the second and third century C.E. from Mesopotamia via Greece; in the fourth century C.E. directly from Greece; in the tenth through the eighteenth centuries from Persia; in the nineteenth century from England. In the first three transmissions, the Indians got theory that was either out-of-date in its country of origin or else was deviant, so there was virtually no reflection of Ptolemaic astronomy in India until the seventeenth century (Pingree, p. 533). At the same time that elements of Greek astronomy reached India, the Arabs introduced Indian astronomical tables in the Middle East and adopted their format.

Medieval Communication and Transportation

The East-to-West process of diffusion picked up pace subsequent to the Islamic conquests, when the Islamic world acquired (in the words of Joseph Needham) "a focal character in the process of diffusion." The innovations diffused included a package of Indian crops and the irrigation technologies needed to grow them in arid or semiarid environments that the Arabs recognized as comprising a distinctively Indian style of agriculture, which they called *filaha hindiyya* (Indian agriculture). The package included the *norra* (an animal-powered

water-lifting wheel), and a whole roster of crops including sugar cane, rice, citrus trees, and the watermelon. From Persia came the *qanat* or filtration gallery (a way of tapping water for irrigation that became attached to the Indian package), perhaps the windmill, the artichoke, and the eggplant. China was the most fecund source of technological innovation (paper, block printing with a press, the compass, gunpowder, to name only the most salient). The agents of diffusion were varied, mostly merchants and soldiers fulfilling their characteristic historical role as bearers of new ideas, but agricultural innovations were typically borne by folk migrations of tribal segments or clans, such as those who left Arabia in the seventh century and whose children and grandchildren settled in Islamic Spain, where they introduced Indian-style agriculture.

The Silk Road was an overland caravan system (with a number of auxiliary sea routes via India) that brought silk from China to Mesopotamia or the Roman frontier around the first century C.E., and to Baghdad after the Arab conquests. Not much merchandise besides silk was carried because there was little demand in China for Western products, with some exceptions such as Roman glassware. However, once established, the route became a conduit for the spread of ideas and techniques. Medieval Arab and European travelers (for example, ibn Battuta [1304–1365] and Marco Polo [1254–1324]) used it, as did merchants, and some specific Chinese techniques, such as textile machinery, are known to have reached Europe via the Silk Road. Chess is thought to have been a diversion perfected by Muslim Silk Road merchants. Persian merchants bore ideas to and from China to Persia from the fifth through the tenth centuries.

Richard Bulliet describes a reciprocal relationship between the decline of Roman roads and the introduction of the camel. Camels do not need paved roads. The Muslim conquest represented, in its early centuries, the dominance of nomads over settled areas, made possible by the adoption of the North Arabian camel saddle. Once the dominance was established, a decisive cost factor (20 percent) over shipping by wagon quickly led to the disappearance of wheeled vehicles in most areas of the Islamic world. Roman roads were already in decline and the caravan routes that replaced them were shortened long-distance overland trade routes because wheeled vehicles required fairly gentle gradients (following the crest lines of ridges rather than heading straight across valleys). With respect to trade, caravan routes were linked to overseas trading networks, forming a great web for the transportation of goods that knit together the “world economy” of the Islamic Empire. Trade over long distances led to the invention in the Islamic world of methods of business organization and credit that later were adopted, first in Italian commercial ventures, then those of other European countries: the partnership among merchants, called *commenda* in medieval Europe, was known in the Arab world of Muhammad (Arabic, *shirka*, “partnership”) and the European bill of exchange was modeled on the Arabic *sufiyya*, the check on Arabic *sakk* (both conceptually and etymologically). The Muslim world economy functioned as a kind of free-trade zone (propitious as well for the transfer of ideas and techniques), powered by the gold *dinar* and the silver *dirham*.

Medieval Translation Movements

The great translation movement that began in ninth-century Baghdad displays an overall pattern quite similar to that of the westward movement of technology from China, India, and Persia. The movement began through an internal mechanism: the Sassanid kings of Persia (224–651 C.E.), whose mantle of authority and legitimation the Arab Abbasid caliphs (750–1256 C.E.) sought, had maintained a palace library and manuscript copying office whose task was to carry out an ideological precept of the Sassanid state, which was that Persian and other ancient lore should be preserved in a central place. One of Persian kingship’s claims to legitimation was that it was the guardian of knowledge. Under Arab rule, this palace library, with the same task, was known as the Dar al-Hikma (House of Wisdom). The Abbasids clothed this preexisting rationale with a geopolitical cloak: its message to both the Persian elites to the East of Baghdad and the Greek-speaking masses to the West was that the caliphate was the only legitimate heir to their respective cultural traditions. Thus did the entire extant corpus of Greek wisdom come to be translated into Arabic; to it were added, in particular, Persian and Indian components. Among the latter was a family of celestial charts that, when coupled with Ptolemy’s theoretical astronomy, laid the basis for medieval Arab, and later Latin, astronomy, which, along with Indian numerals (including the zero) and the place-value system, formed the core of the medieval scientific achievement.

This scientific movement, based at first on translation and the retrieval of ancient lore, was an epiphenomenon of the ease of communication within the Eurasian landmass, facilitated by the political unity provided by the Islamic empire of the early Middle Ages. Travel for the sake of knowledge (Arabic, *al-rihla fi-talab al-ilm*) was characteristic of both Muslim and Jewish scholars, who traveled from one end of the Islamic world to the other in order to study the religious and secular sciences with famous teachers.

The assimilation of knowledge originating in cultures different from that of the core society always involves not only a range of linguistic problems associated with translation but also culturally rooted conceptual problems. Among all the peoples involved in medieval “translation movements” (Greek and Persian into Arabic, Arabic into Latin, Hebrew, Chinese, and European vernacular languages), there was a fairly standard debate about the relative merits of literal versus free translation (Latin, *ad verbum* and *ad sensum*, respectively). In some cases, defective texts bearing alien conceptions were passed along in the most literal fashion possible in order to preserve what sense there was. Such was the case of Aristotle’s *Posterior Analytics* (350 B.C.E.), which survived in the form of student notes and which, having passed through an Arabic translation, became one of the keystones of scientific method in both medieval Islam and Europe. The Arabs also had conceptual difficulties with Aristotle’s *Poetics* (350 B.C.E.), much of which presumes familiarity with drama, because there was no such literary tradition in their culture. In the case of alchemy, a series of translation errors that confused the color gold with the metal, dating to classical antiquity, led to an increasingly esoteric body of knowledge that, at each successive step, compounded the error.

Once a core of science existed in Arabic, it was then diffused again in both directions from Islamic civilization through the Eurasian plain, eastward to China and westward, through Sicily and Spain, to Latin Europe. Arab astronomy (and its practical side, astrology) reached Latin Europe in the early twelfth century, several decades after the Christian conquest of Toledo (1085), and reached China about a century later. The Chinese founded observatories and staffed them with Muslim personnel. Interest in both East and West was pre-eminently practical: astronomical calculation of calendars and the practice of “political astrology,” the assessment of favorable times for military, political, and economic activities.

When one considers the relative importance of oral versus written culture in the communication of knowledge, perhaps one can profitably begin with the case of mathematics (which has the advantage of reducing ideological issues to a minimum). Even after the reception of Indian calculation (*hisab al-hind*) in the Arabic-speaking world, calculation (among merchants, for example) continued to utilize hand signals. If the intermediate steps were written, a dust board (the original sense of *abacus*) was used, then erased, and the results were often written down in alphanumeric form. So in mathematics and commerce there was always a range of media available and, in practice, they were mixed according to various utilitarian principles. Similar mixes of oral and written culture were probably equally useful in other areas of human experience.

The game of chess originated in India, and was then cultivated in Persia, the immediate sources of the Arabic game *al-Shatranj*. It followed the same path of diffusion westward as did Indian astronomy and mathematics and had the same audience, namely educated people attracted to mathematics and logic. The first technical treatises on chess in Arabic appeared in the ninth century. There was also a popular variant of the game that was astronomical in nature, played on a round board divided into the twelve houses of the zodiac. Part of the reason that chess was popular among Muslims and Jews is that gambling was forbidden by both religions, an example of a cultural stimulus to the adoption of an innovation.

Paper and Literacy

The culturewide significance of media of communication can be appreciated from the example of paper. Paper reached the Arabs in 751 C.E. when they conquered Turkistan and found Chinese papermakers there: “It is stated that craftsmen from China made [paper] in Khurasan like the form of Chinese paper” (Ibn al-Nadim, I, 39–40). The technique reached Iraq in the precise moment that the Abbasids were consolidating power, with administrative as well as cultural consequences. The caliph Harun al-Rashid (r. 786–809 C.E.) instituted the first of several bureaucratic reforms based on the use of paper. The chemistry associated with the fabrication and use of paper and inks reflects a characteristic mix of Indian, Persian, Greek, and Babylonian elements that appears in the movement of translation, especially early Arab alchemy. With an administrative reform of the early tenth century, all Abbasid edicts had to be copied on paper for provincial governors and for preservation in registers. Thus, paper was crucial to administrative expansion and bureaucratic consolidation, giving the

Abbasids an augmented capacity for governing far-flung provinces effectively.

Paper was associated with a vertical mill, whereby a water wheel turns a horizontal axis fitted with hammers. Paper was one element in a unified set of Chinese technologies that diffused simultaneously westward along with the mill type: preparation of different kinds of oil, paper, sugar, indigo, lacquer, and tea—all of which require pounding or maceration (Daniels, pp. 30–39)—bringing the paper and sugar industries to the Middle East simultaneously. The names *al-Warraq* (papermaker) and *al-Sukkari* (sugar maker) appear in ninth-century Iraq.

It is thought that, because of the democratizing effect of paper, literacy was more widespread in the Islamic world than in medieval Europe, where both writing (on parchment) and reading were the province of a small, mainly clerical elite. But the definition of literacy has recently broadened somewhat: a person may well have a piece of paper (a deed, a horoscope, a prescription) that cannot be completely read, but the contents are generally understood. There was a great deal of what might be called partial literacy, and many people who could read (at whatever level) could not write. The two skills were not as tightly linked as they have been in recent centuries. Among Muslims and Jews, reading in particular and, to a lesser degree, writing, were skills that were required for an ordinary religious life, dependent on mastery of scriptural and other religious texts (hadith, Talmud). The Cairo *Geniza* (a repository of tenth-century documents written in Hebrew and Judeo-Arabic) shows a certain democratization of ideas: almanacs, amulets, horoscopes, prescriptions, and other such quasi-scientific paraphernalia were widely circulated.

Sacred objects were visualized in different ways. Judaism and Islam were iconoclastic, the Persians less so, thus human figures adorn their manuscripts. But the Muslims liked other kinds of representations such as huge, ornately lettered Korans.

The Ottomans and Early Modernization

There was an eastward reflux of technological diffusion when Jews and Muslims were expelled from Spain, the Jews in 1492 and the Moriscos, in a steady flow of emigrants from 1492 through the definitive expulsion of 1610. The Moriscos took back to North Africa a version of Indian agriculture (Arabic, *filaha hindiyya*) updated especially with New World crops (maize, tomatoes, American beans, chili pepper, *opuntia* [cactus], and tobacco). The Ottomans (and the Mamlukes before them) received firearms from different sources, but the Moriscos diffused the Spanish approach to artillery. Ibrahim ibn Ahmad ibn Ghanim, a Morisco who had been an artilleryman in Spain, arrived in Tunis in 1609–1610 and wrote an influential artillery manual in Arabic, in great part paraphrased or translated from Luis Collado’s *Plática manual de artillería*.

Spanish Jews introduced a new, modern textile industry, that of broadcloth, into the Ottoman Empire, the new cloth being the result of the introduction, from Spain, of a fulling mill that made for a stronger, cheaper brand of textile. A French traveler in Istanbul in the mid-sixteenth century remarked that the Marranos “were the men who have taught the

Turks how to trade and to deal with those things that we use mechanically.” In Cristóbal de Villalón’s pseudonymous sixteenth-century *Viaje de Turquía*, the author explains that the Turkish artillery corps

had no masters to teach them (particularly how to mount pieces on carriages) until the Jews were thrown out of Spain. They showed them how, as well as how to fire muskets, to make forts and trenches, and whatever devices and strategies there are in war, because before they [the Turks] were no better than animals.

The report is exaggerated, but all the crafts of the Renaissance military engineer are represented. Giovanni Soranzo (doge of Venice, r. 1312–28) is said to have prevented the expulsion of the Jews from Venice in 1571 on the grounds that Jewish refugees from Spain had taught the Turks how to make cannons, cannonballs, and other armaments. That Jews had modernized medicine in the Ottoman Empire had become a cliché in European commentary by the eighteenth century. Villalón, referring to Jewish physicians in the Ottoman court, says they practiced there “almost by inheritance.” Those physicians diffused a kind of compendium of late medieval European medicine.

The traditional culture of the Middle East also offered ample resistance to innovations: some opposed the telegraph because they supposed that spirits inhabited the wires. Jews or Christians generally established the first printing presses in the Ottoman Empire or Islamic world because Muslims had long opposed printing on religious grounds. The first government gazette in the Ottoman Empire appeared in Turkish and Arabic in 1867, the first newspaper, the following year (the first newspaper did not appear in Persia until 1935).

Modernization

The predominant pattern of innovation in the nineteenth century was that the Ottomans filtered the European model of modernization and diffused specific techniques to selected sites in their empire. Centralization was the dominant political ideal associated with modernization. In terms of Arab society, this translated into bringing tribes under central control, which, in turn, involved a stepped-up military capacity and favored spatially unifying technologies such as the telegraph and the railroad. Bedouins realistically viewed the telegraph as an unwelcome government intrusion. The first Ottoman telegraph lines were built in 1855. Beirut was linked to Damascus in 1861 and to Istanbul two years later. Then Iraq was linked by telegraph to Istanbul, but also to India, a move that was thought to enhance the economic stability of the country (England pushed for this to enhance its control over India after the Mutiny of 1857–1859). Istanbul was linked to Arabia in 1901, complementing the Hijaz railroad, which linked Syria to Arabia. The telegraph and railroads were a unifying force economically (because they increased the volume of commerce in the towns and districts along their routes and in their termini) and politically. Because the Hijaz railroad carried pilgrims, it became a visible, material symbol of Pan-Islamism.

The telegraph and railroad were designed to reduce the time and distance factors across the great Eurasian landmass.

Ottoman imperial administration differed in places that had the telegraph, where communication was instantaneous, and those that didn’t, where it took days for dispatches to arrive, with palpable results in law enforcement, tax collection, price and wage regulation, and so forth. The telegraph was also a spur to democratization, as citizens used telegrams to petition the central government directly. As a result, the pace of innovation may have quickened, at least in cities, and selected rural economies certainly benefited. However, the deeper cultural manifestations of such technologies have yet to be explored.

Darwinian evolution illustrates how acceptance or resistance to modern scientific ideas was channeled along religious lines. The Syrian Protestant College in Beirut (later American University of Beirut) was famously a node of diffusion of Darwinism. The chief backer of Darwin there, Edwin Lewis, was fired for his efforts, but not before having passed the idea to students, mostly secular writers of Christian origin who continued their advocacy of Darwin in Lebanon and Egypt. Among Muslims, interestingly, Shiite theologians tended to have a more moderate view of evolution than did their Sunni counterparts. Religious opposition was uniformly based on scriptural authority, although moderate (generally Shiite) commentators stressed that there was no specific Koranic warrant to oppose the theory.

What explains the receptivity to innovation in the early Islamic world and the rejection of innovation in the modern Islamic world? Under what circumstances did Islam itself become a barrier to the diffusion of ideas and techniques? In the broadest possible terms, so long as a minority of Muslims ruled a majority of non-Muslims (a garrison state model), it was to the advantage of the rulers to be open to whatever innovations might increase their power and augment their prestige. Once Muslims were in a majority, a kind of cultural self-sufficiency set in, which turned the interests of the elite inward, toward refining the Islamic system, which was (in theory, at least) a kind of theocracy in which no distinction was made between religious and civil (legal) spheres and in which religious law regulated all aspects of daily life. Innovation was viewed as arbitrary, having no basis in recognized tenets of Islam. The traditional education system, mosque-based schools (*madrasas*), never evolved into a system that could encompass exogenous elements. In such a cultural system, innovation is irrelevant. *Bid’a* (Arabic, “innovation”) was held to be both good and bad, betraying ambivalence (at the least) toward innovation, and was invoked selectively against, for example, tobacco, coffee, and various aspects of modern science.

See also *Diffusion, Cultural; Education: Islamic Education; Empire and Imperialism: Middle East; Islam; Islamic Science; Trade.*

BIBLIOGRAPHY

- Allsen, Thomas T. *Culture and Conquest in Mongol Eurasia*. Cambridge, U.K.: Cambridge University Press, 2001.
- Bloom, Jonathan M. *Paper before Print: The History and Impact of Paper in the Islamic World*. New Haven, Conn.: Yale University Press, 2001.
- Bulliet, Richard W. *The Camel and the Wheel*. Cambridge, Mass.: Harvard University Press, 1975.

- Daniels, Christian. "Sugarcane Technology." In *Science and Civilization in China*, edited by Joseph Needham, vol. 6, part 3, 5–539. Cambridge, U.K.: Cambridge University Press, 1996.
- Diamond, Jared M. *Guns, Germs, and Steel: The Fates of Human Societies*. New York: Norton, 1997.
- Glick, Thomas F. "Moriscos and Marranos as Agents of Technological Diffusion." *History of Technology* 17 (1995): 113–125.
- Glick, Thomas F., and Helena Kirchner. "Hydraulic Systems and Technologies of Islamic Spain: History and Archeology." In *Working with Water in Medieval Europe: Technology and Resource-Use*, edited by P. Squatriti, 267–329. Leiden, Netherlands: Brill, 2000.
- Gutas, Dmitri. *Greek Thought, Arabic Culture: The Graeco-Arabic Translation Movement in Baghdad and Early Abbasid Society*. New York: Routledge, 1998.
- Ibn al-Nadim. *The Fibrist of al-Nadim: A Tenth-Century Survey of Muslim Culture*. 2 vols. Edited by Bayard Dodge. New York: Columbia University Press, 1970.
- Innis, Harold A. *The Bias of Communication*. Toronto: University of Toronto Press, 1964.
- Issawi, Charles. *The Fertile Crescent, 1800–1914: A Documentary Economic History*. New York: Oxford University Press, 1988.
- Needham, Joseph. *Science and Civilization in China, Volume 1: Introductory Orientations*. Cambridge, U.K.: Cambridge University Press, 1954.
- Parker, Richard A. "Egyptian Astronomy, Astrology, and Calendrical Reckoning." In *Dictionary of Scientific Biography*, edited by Charles C. Gillespie, vol. 15, 706–727. New York: Scribners, 1970–1978.
- Pingree, David. "History of Mathematical Astronomy in India." In *Dictionary of Scientific Biography*, edited by Charles C. Gillespie, vol. 15, 531–633. New York: Scribners, 1970–1978.
- Rogan, Eugene. "Instant Communication: The Impact of the Telegraph in Ottoman Syria." In *The Syrian Land: Processes of Integration and Fragmentation*, edited by Thomas Philipp and Birgit Schaebler, 113–128. Stuttgart: F. Steiner, 1998.
- van der Waerden, B. L. "Mathematics and Astronomy in Mesopotamia." In *Dictionary of Scientific Biography*, edited by Charles C. Gillespie, vol. 15, 667–680. New York: Scribners, 1970–1978.
- Ziadet, Adel A. *Western Science in the Arab World: The Impact of Darwinism, 1860–1930*. New York: St. Martin's, 1986.

Thomas F. Glick

ORALITY AND THE ADVENT OF WRITING

The communication of ideas is not basically different from any other type of human communication. It is founded on the unique human skill of speech, a highly developed and formalized system of audio communication, which links with animal sounds and other forms of the communicative act but is infinitely more sophisticated. The jury is still out on the question of the genetic component in spoken language, but that need not affect this analysis of its consequences.

Communication of Ideas in Oral Cultures

The development of human society over the long term is affected by the speed and accuracy with which ideas are transferred from one individual or group to another. In the Old Stone Age, or Paleolithic period, such a process was slow since

communication in the sense of physical movement was slow. And with oral communication, virtually all transfer had to be face-to-face, a matter of constant conversations over time. Nevertheless, ideas were exchanged and human life slowly changed, for example, from using one type of stone tool to another in parallel ways throughout the world. Of course, one reason for this commonality could be the intrinsic logic of development, in which intergenerational communication would also be important, but the intergroup transfer of ideas has been of overwhelming significance in much of human history.

How is it that nonutilitarian ideas, for example, even about witchcraft and sorcery, about mystical aggression, are so similar in preindustrial societies in many parts of the world? The standard answer would be phrased by reference to some version of the idea of "primitive mentality," that these ideas were appropriate to "primitive societies." At a very general level, such a contention may be valid but circular. It follows a line of thinking that sees similar environmental conditions (for example, in hunting and gathering economies) as producing similar sets of ideas. That is a tenable position. But the degree of similarity is the crucial issue. These ideas of witchcraft, like the idea of the alphabet, seem very close to one another in contexts where the possibility of alternative conceptions seems to be wide open. So there is not simply the question of the general appropriateness of ideas to a particular set of socioeconomic circumstances but of the communication of more specific notions over time, possibly in this case internally from a common source.

A clearer case is that of the folktale. The collections of Stith Thompson trace distinct thematic similarities over many parts of the world, some of which, like the Cinderella stories, show considerable resemblances over wide areas. It is highly unlikely that such tales have emerged independently, given the common features, nor yet that their distribution reflects some early wanderings of peoples. Rather it is surmised that they represent the transmission of particular stories from one community to another by travelers or by itinerant storytellers, who provide a precise mechanism for their circulation. Naturally such stories have to be "acceptable" to the recipients, but acceptability does not mean that they have to reflect in any precise way the sociocultural conditions of those who listen and adapt the stories. In northern Ghana, folktales incorporated the notion of chiefship (*nalo*) even among chiefless groups who had never had, or had rejected, the institution but who knew that it existed in neighboring states. One aspect of the folktale was therefore "imaginary" in some communities, embodying ideas of authority that they did not accept as part of their own way of life. So such tales were unlikely to have arisen independently but rather by some process of intergroup communication since their thematic content was not functionally or structurally integrated with the cultures themselves. In this case intercultural communication occurred in oral cultures by means of a specific mechanism, the traveler or the wandering "teller of tales."

That process continues to be of great significance in the spread of ideas and information even in written cultures, where wandering scholars, past and present, are important elements

in the process of communication. Physical movement is still of great significance in the early twenty-first century. Despite electronic means of communication that supplement and could perhaps eliminate them, conferences proliferate, not simply as an excuse for academic tourism; in certain fields at least they are seen as ways of gaining access to the latest ideas, or perhaps to the creators of those ideas. In other words they are seen as contributing to the exchange of knowledge. Above all they serve to set up personalized networks that have the function of leading to collaboration between individuals and groups working on similar topics, contacts that serve to facilitate the flow of ideas by establishing informal (oral) communication to supplement the more formal and more widespread type made possible by the use of the written word.

Such international conferences, involving an increased tempo and range of contact, depend upon the development of new modes of transport, especially relatively cheap air travel that is changing ways of life in other less formal ways. Whatever doubts may be expressed about travel broadening the mind, it has certainly led to some shifts in terms of everyday behavior, such as food and drink. Even if mass tourism has not led to any very evident changes of a more conceptual kind, it seems likely that the opportunities for the youth of Europe to travel to India or Nepal has resulted in an increased interest in the religions of those areas, and hence in Buddhist, Islamic, or Hindu philosophical notions. Vegetarianism and a different attitude toward the slaughter of animals, and to the nature of the boundary between “us” and “them,” becomes an important part of the belief systems of the Western world that had hitherto been largely characterized by its addiction to the eating of meat. For such persons the notion of animal rights includes their right to stay alive.

Written Communication of Ideas

The communication of ideas took on somewhat greater possibilities when humankind moved into the graphic age in the Upper Paleolithic, with the elaboration of cave art and the use of signs, such as the palms of hands and what have been called “traces” by Jacques Derrida, though under this rubric he includes not only graphic marks but also the memory traces of speech. However, these were not “writing” in the full sense since they did not systematically represent the spoken word externally, but they did mean that visual signs with restricted meanings, as in the North American wampum belts, could be communicated to others at a distant destination. Obviously there had to be some community of understanding, for example, that an arrow meant danger, but a full linguistic code came only with the invention of writing in the Fertile Crescent of the Near East around 3000 B.C.E. Then a whole sentence or conversation could be transferred over space and over time with greater speed and accuracy given that it was preserved in a relatively permanent form, on tablets or on papyrus, as “visible language.” As a result, ideas could be transmitted from the past, from earlier civilizations (in the strict sense of that word) without any human intermediaries. The works of Aristotle might be forgotten, lost for a while, by Europeans and then brought back into circulation by way of Arabic translations some thousand years later. So his ideas never disappeared in the way they

did in oral cultures of which the Senegalese author Amadou Hampaté Bâ wrote that “when an old man dies, a whole library is burnt.” With writing, the previous generation is no longer the only or main source of cultural ideas. They can now be bypassed by reference to books that form a quite independent source of knowledge. One is no longer limited to folk wisdom, to the sayings of the elders; one can refer to the works of Plato, of Moses ben Maimon (Maimonides), of Mencius, or of Indian philosophers, which one’s teacher, either in the family or outside, may have never read or possibly even heard of. Intellectually and in other ways, the relationship with one’s family is dramatically changed. The death of an old man is of less account since his ideas are already recorded or irrelevant. The educational process takes on a totally different character.

Turning speech into a visual, material object also makes possible the communication of ideas and information at a distance. An individual can send a message far away without being involved face-to-face. That has had disadvantages as well as advantages. The former mean that verbal messages became divorced from the wider context of speech, so that one misses the accompanying gestures and tonality and moves to a great decontextualization of language and a certain depersonalization of the process of communication. But the great advantage lay not only in giving linguistic communication a permanent frame but at the same time in making it more “abstract.” It did not, of course, introduce abstraction but it did increase the resort to more abstract notions; nouns were often preferred to verbs; what had been implicit speech became more explicit in the written register. The latter, being visible, enabled a more detailed examination of linguistic expressions by the eye, which could range back and forth over the page, reappraising and reviewing the ideas that had been formulated there. Once again such a considered approach to what was being said was not impossible in oral intercourse, but it was not easy and inevitable as it became with the written word, which then saw the virtual birth of activities that were later to be named “philosophy” or “theology.” Both the “sophia” and the “logos” were stimulated by the use of writing, subsequently giving birth to a whole range of topics that had remained only implicit in purely oral cultures. It is true that then one can speak of ethnoscience such as ethnogeography or ethnobotany. All societies have concepts of space and time, and all resort to some classification of the animals and plants that surround them. But those fields of enquiry are significantly advanced by the use of written lists that impose a beginning and an end on particular sequences and hence give rise to explicit questions of inclusion and exclusion that probe the nature of categories.

In some written languages, the category is even shown in the way a word is constructed. In Mesopotamian cuneiform, for example, a certain suffix may indicate whether one is referring to a god or a town to which the god is attached. That is one of the advantages of nonphonetic scripts; they can point to the range of phenomena or ideas in which one can search whereas phonetic scripts such as alphabets are necessarily limited to the information contained in the oral forms.

This attempt to classify ideas and information was promoted by the development of schools, which were necessary to teach

the techniques of reading and writing, so that the system could be passed down from one generation to the next. Unlike other innovations, that transfer could not be achieved within the family. It was now useful for pupils to be segregated from the family and to have lists of plants and animals as exercises, a process that led to the consolidation of lists in encyclopedias, such as the *Onomastica* of Egypt, as well as to the emergence of distinct fields of enquiry, such as zoology, and to the development of more integrated, more precise, more “scientific” sets of ideas, which became more readily communicated to those who had studied a particular field than to the public in general. As such sets of ideas developed, they were more readily communicated to a specialist audience, except in a watered-down, “popular” form. Since some ideas became more difficult to communicate unless to an “educated” audience, the relative unity of knowledge in oral cultures with memory storage became shattered into particular spheres with writing.

Literate and Illiterate Communication

The greatest division of this kind was between those who could read and those who could not, a division that applied not only to cultures, literate and nonliterate, but to individuals within societies, literate and illiterate. For the first five thousand years of the history of writing until the end of the nineteenth century, writing was (with a few, marginal exceptions) acquired only by a minority of the population. In many ways, the literate minority made most of the running intellectually. They were responsible for the written religion, for the schools, the administration, the written works of literature, drama, music, and poetry, producing and communicating many of the dominant ideas. The rest of the population were, of course, affected by these developments, for example, by way of the “Bible of the Poor,” through images; their intellectual apparatus was also influenced by techniques such as “oral arithmetic,” which it took writing to invent. And they had their own, often vigorous, “popular” culture that was in turn affected by the narratives produced by the literates and in turn impinged upon the latter’s achievements. But as far as most literate activities were concerned, they played very much a subordinate role. Only with the gradual extension of education, based on learning to read and write, was this situation largely changed.

It has been claimed by some recent writers, unwilling to accept the absence of writing in, for example, Africa, that any visual signs, even memory traces, represent writing. Such a position is held by certain well-meaning persons who wish to play down intellectual differences of the kind that are embodied in Levy-Bruhl’s notion of a “primitive mentality” that failed to perceive contradiction, were prelogical, and resorted to mystical participation. Such notions need to be set aside, as was done by the anthropologist Evans-Pritchard in the work on Azande witchcraft where he tried to demonstrate that their ideas about witchcraft were in fact “logical.” One specific case he took was the Azande explanation for why a man was killed by a brick falling off a wall as he passed underneath; the Azande would not accept the notion of an accident, insisting that some person or force had mystically caused the brick to drop at that particular time.

Certainly his position could not be considered “prelogical” in Levy-Bruhl’s terms. On the other hand, that logic had in turn to be differentiated from the “logic” of Greek philosophers and others, which depended critically on developments in the written sphere, in the formality that characterizes the treatment and composition of written statements such as the syllogism. While embryonic forms may exist in oral discourse, the syllogism itself, *a* is to *b* and so on, must be considered as a product of writing that in this way extends and elaborates the range of “technologies of the intellect” available to humans. Equally one can posit that many notions of mathematics, anything except simple multiplication and division, are, unlike addition and subtraction, dependent upon the written mode. So the advent of writing does not simply allow the communication of ideas but strongly influences the nature of the ideas to be communicated.

Paper and Communication

Not only the advent of writing but the use of cheaper and more flexible writing materials helped the communication of ideas and the democratization of knowledge through the spread of education. An important stage was reached with the use of paper. Previously the media for visible language consisted of clay tablets (as in Mesopotamia), of other solid materials, of wax tablets, of papyrus, and in the West of parchment (of skins). Papyrus gave Egypt a considerable advantage for the sending of messages and recording of information, but in the West that material had to be imported at considerable expense and the local use of parchment meant that a manuscript of 150 pages required the skins of a dozen sheep, only possible in a “carnivorous society” (Braudel, p. 497). Paper was cheap and could be manufactured out of local vegetable or waste material. But it was a long time coming to the West and when it did so, like writing and later printing, represented “the conquest of the East.” Invented in China at the beginning of the common era, it was adopted throughout the Islamic world from Central Asia, to Baghdad around 1000 C.E., to Spain where paper mills were turning in the twelfth century. In Christian Europe, paper was first manufactured in Italy two hundred years later. The enormous advantage this gave to Islamic cultures in the communication of ideas is illustrated by the fact that the library of the caliph of Cordoba in the twelfth century consisted of 400,000 volumes, while the number in the monastery of St. Gall in Switzerland, one of the largest in the north, was six hundred. The discrepancy was enormous and represented the great lag in Western knowledge systems before the Renaissance and the advent of the printing press, also probably from China, at the end of the fifteenth century.

In Asia, the expense of communication was in copying (and creation) rather than materials; the use of paper enabled ideas and information to be communicated rapidly from East to West. The notion of zero and Arabic numerals that made such a difference to mathematical calculation were just part of a transfer that paved the way for the Renaissance and the “scientific revolution,” including the revival of interest in the classical civilizations. Hence the rush of Western scholars to Palermo (such as Adelard of Bath) or to Toledo (the mathematician Gerbert of Aurillac) in search of what the Islamic world had to offer.



Gutenberg printing press. Johannes Gutenberg (c. 1395–1468) invented the printing press sometime in the mid-fifteenth century. The moveable printing blocks it employed made it far simpler to operate than the complicated machinery of the Far East, allowing Europe to gain an intellectual foothold in the world. © ERICH LESSING / ART RESOURCE, NY

Printing

The balance of intellectual power partly shifted to Europe with the advent of printing following Gutenberg. Its success was partly due to the great advantage of the alphabet, which enabled movable type to be used with a minimum number of units, unlike the more complex logographic scripts of the Far East. Paper was essential in this shift since it provided a flexible, smooth, and inexpensive surface for the press; it was then that the milling of paper really took off in the West. In the Islamic world, which had diffused the production of paper from China to Europe, the acceptance of printing was very different; scriptures sacred to Muslims had at first to be written, not printed. In contrast to earlier times, with the mechanization of writing, the circulation of ideas and information became much less costly and more rapid in Europe than elsewhere. The value of rapid exchange of ideas at a distance can be seen in the correspondence of members of the Royal Society in Britain, where the impetus of the scientific revolution was certainly supported by such communication between scholars in various fields and countries, in the same

way, but much faster than had earlier happened in the vast Islamic world as a result of the use of paper as a writing material. Now it was possible to send printed versions of scientific papers to a wide range of people known to be interested in the same topic.

Mass Media

The speed and openness of the communication of ideas and information generally is increased even more by the appearance of the mass media, including electronic ones. In a sense mass media began in the early days of printing with broadsheets and newsletters. Indeed printing itself eventually enabled the large-scale production of almanacs as well as of textbooks for schools, as the price decreased. That process developed yet further with the coming of the roller press in the nineteenth century, which ensured the wider distribution of newspapers and magazines whose contents ranged from the sports and leisure activities to more serious ideas of a popular kind; but academic discussion, too, increasingly took place in journals that were taken by the growing number of libraries,

established earlier in monasteries, and later in universities, colleges, schools, and eventually in towns and even villages.

Electronic media further speeded up the process of transmissions, through the telephone from the 1880s for brief individual messages, to more substantial broadcasts through the radio, the cinema, and television. But for scholarly purposes the great breakthrough came with the development of communication by means of interconnected computers that enable immediate access to huge stores of information throughout the world. Those living in remote areas, away from libraries, can download material from the latest journals worldwide and keep up with the most recent developments in their topic. Indeed in some scientific fields, research workers are expected to post their findings without waiting for formal publication. The rapidity of the access to and the flow of scientific ideas promotes their application and hence the “innovativeness” of human society. The problem then becomes one of finding a way around this mass of information, for which purpose a number of “search engines” have appeared to assist with enquiries.

See also *Diffusion, Cultural; Language, Linguistics, and Literacy; Oral Traditions.*

BIBLIOGRAPHY

- Ballestini, Simon. *Ecriture et texte: contribution africaine*. Quebec: Presses de l'Université Laval, 1997.
- Braudel, Fernand. *The Structures of Everyday Life*. Vol. 1: *Civilization and Capitalism 15th–18th Century*. Berkeley: University of California Press, 1992.
- Cox, Marian Roalfe. *Cinderella: Three Hundred and Forty-Five Variants of Cinderella*. Folklore Society Monograph 31. London: Folklore Society, 1893.
- Derrida, Jacques. *Of Grammatology*. Translated by Gayatri Chakravorty Spivak. Baltimore: Johns Hopkins University Press, 1977. First published in 1967.
- Evans-Pritchard, E. E. *Witchcraft, Oracles, and Magic among the Azande*. Oxford: Clarendon, 1976.
- Goody, Jack. “Animals, Men and Gods in Northern Ghana.” *Cambridge Anthropology* 16, no. 3 (1992–1993): 46–60.
- . *The Domestication of the Savage Mind*. Cambridge, U.K.: Cambridge University Press, 1977.
- Lévy-Bruhl, Lucien. *L'Âme primitive*. Paris: Presses Universitaires de France, 1963.
- Thompson, Stith A. *Motif-Index of Folk-Literature*. 6 vols. Rev. and enlarged ed. Bloomington: Indiana University Press, 1955–1958.
- Tsien, Tsuen-hsuein. *Science and Civilization in China*. Vol. 5: *Chemistry and Chemical Technology*. Part 1: Paper and Printing. Cambridge, U.K.: Cambridge University Press, 1988.

Jack Goody

SOUTHEAST ASIA AND ITS INFLUENCE

Trade has always accompanied the spread of knowledge throughout Southeast Asia. From ancient times, exchange networks linked the mainland's coast with the Red, Mekong, and Chao Phraya Rivers, while by the second half of the first millennium B.C.E. Indian traders had arrived with goods and religiously based concepts of government.

Precolonial Southeast Asia

The Lao-Thai culture area, encompassing modern Thailand, Laos, Cambodia, and Burma (present-day Myanmar), has a common history of Hinduized states and Theravada Buddhism. Pali (the language of early Buddhist texts) and Sanskrit (the language of early Hinduism) are also Indian in origin. Vietnam, while sharing aspects of mainland Southeast Asian culture and society, represents the cultural influence of Han Chinese and Confucianism overlying indigenous traditions.

The major language groups of Southeast Asia include Austronesian (Cham on the mainland and many languages throughout the islands of contemporary Malaysia and Indonesia), Mon-Khmer, Burman, Tai (Thai/Lao), and Vietnamese. Of these, Mon-Khmer, Burman, Thai, and Lao have Indian-derived writing systems. In the case of societies influenced by Hindu and Buddhist cultures, the primary purpose of text was to convey religious knowledge. However, the role of written text and its use in everyday life varied significantly among Southeast Asian societies, as discussed below. The Hindu-Buddhist states possessed rich oral traditions, passed down through dramatic performances and shadow-puppet plays featuring the *Ramayana* and other Indian epics, with the *Ramayana* in particular presenting models not only of the ideal ruler but of ideal male and female roles in society. Buddhism is an important religious tradition throughout much of Southeast Asia in the early twenty-first century.

The Age of Commerce

With the advent of Muslim traders in the thirteenth century and Europeans in the sixteenth, Southeast Asia encountered a new set of cultures and languages as Islam and Christianity exerted their influence. Europeans came seeking Asia's fabled wealth, particularly spices essential for preserving meat, but later trade gave way to conquest and settlement. By 1900 Europeans had divided the region among themselves, introducing a new set of languages: Spanish in the Philippines, French in Indochina (present-day Laos, Cambodia, and Vietnam), English in Burma, and Dutch in the Dutch East Indies. Spanish control of the Philippines effectively ended the eastward spread of Muslim influence. Many English loanwords from Southeast Asian languages (e.g., godown, gong) date from this period.

Anthony Reid suggests that despite ideas of male superiority entrenched among courts and urban elites due to the male-dominated written traditions of Hinduism, Buddhism, Confucianism, and Islam, women played a surprisingly influential role in society during the period of early European exploration. Because they were heavily involved in trade, including long-distance and wholesale marketing, women often knew multiple languages. European visitors left numerous accounts of female merchants who translated for them and acted as diplomats and negotiators for indigenous governments.

European traders also reported a high level of literacy among women as well as men in several locations. Reid suggests that literacy in Southeast Asia may actually have declined between the sixteenth century and the early twentieth century as Islamic and Christian education systems displaced a different, older



Hindu temple of Angkor Wat, erected in the twelfth century in Cambodia. Much of the communication in Hindu and Buddhist cultures involved the sharing of religious or historical knowledge. The facade of the temple at Angkor Wat depicts scenes from Hindu epics and events in the life of King Suryavarman II. © DAVID BALL/CORBIS

type of literacy. In the Lampung districts of southern Sumatra, the Philippines, southern Sulawesi, and the island of Sumbawa, the old Indonesian *ka-ga-nga* alphabet was written on bamboo or palm leaf, and women actively perpetuated the writing tradition by teaching it to household members. Literacy in these areas apparently existed for the sole purpose of courtship, that is, the composition of love poetry. Visitors also noted high literacy in Java and Bali. When Muslims began to dominate a region, the traditions were quickly stamped out, and women's literacy was discouraged. In contrast to these early reports, recent accounts of Southeast Asian Buddhist societies describe a disadvantaged position for women with regard to literacy. Because Buddhist texts were written in the Pali language and only males became monks and received their education in temples, women's education during the last century lagged behind that of men. In Laos, for example, which received little in the way of development resources from its French occupiers, few women became literate in Lao until the late-twentieth-century generation.

Colonial Society

By the late nineteenth century and early twentieth century, colonial rulers in Malaya, Burma, Indochina, and the Dutch East Indies were introducing formal Western education. Colonial governments established schools, teacher-training institutions, medical colleges, and universities. Where colonizers wanted to develop a class of indigenous civil servants, instruction was given in European languages. In the Dutch East Indies, for example, Malay and Dutch were both taught in Roman characters, and in Vietnam instruction was in French. In Laos, however, which had already been staffed with French-speaking Vietnamese ad-

ministrators, the colonial government of 1941 to 1945 actively encouraged Lao language standardization and the creation of a distinct Lao identity to enlist local support for French rule.

Daniel Marr notes that "among all the countries of Southeast Asia, Vietnam probably enjoyed the most favorable conditions for meaningful intellectual activity" (pp. 32–33). For one thing, 85 percent of Vietnamese spoke the same language. Literacy, however, was a major issue. At the beginning of the twentieth century, four different writing systems were available: (1) Chinese characters; (2) nom (demotic characters); (3) French; and (4) *quoc-ngu* (romanized script developed by seventeenth-century French missionaries). Chinese knowledge had been important for civil exams in the nineteenth century but declined in the twentieth. Although only about 5 percent of the Vietnamese population could read by the mid-1920s, school enrollment increased, and people learned *quoc-ngu* informally after that. The French established the University of Indochina (now the University of Hanoi) and upgraded it in the 1930s because too many Vietnamese were going to France and learning anticolonial ideas. Both government and private Vietnamese schools expanded in the 1930s, while French works were translated into *quoc-ngu*.

The French conquerors brought the first modern printing press to Vietnam, and French-language bulletins were published in Saigon as early as 1861; the first Vietnamese (French-language) newspaper went to press in 1917. By the 1930s, however, both Vietnamese nationalism and *quoc-ngu* were developing together. Intellectuals sought to use the script as a vehicle to modernize Vietnamese culture, while revolutionaries, particularly after the founding of the Democratic Republic of Vietnam in 1945, made the elimination of illiteracy a top priority. Vietnamese publication was remarkably prolific, unparalleled by any other Southeast Asian country: roughly fifteen million bound publications were produced in the two decades before the August 1945 revolution (about eight or nine books or pamphlets per literate individual).

The most important European concepts to influence Southeast Asia were probably nationalism and the idea of the nation-state, made possible by growing literacy in indigenous languages and the development of the local press. Prenationalist movements grew not only because of direct experience with colonial injustice but also as the result of influences from abroad, including the Meiji Revolution in Japan and the 1911 Chinese Revolution of Sun Yat-sen. The 1917 Russian Revolution led to the establishment of Communist Parties in Southeast Asia. Young men (including the Vietnamese leader Ho Chi Minh) were attracted to the Communist Party abroad because of its anticolonialism. Marxist ideas, such as nationalization and state-controlled economies, kept their popularity in several Southeast Asian countries after independence.

Postcolonial Society

The introduction of secular education and a Western curriculum in the twentieth century had profound effects on Southeast Asian language and culture. Necessary skills for preserving and transcribing old texts have been lost, while Western cultural traits have become a source of status. After publishing houses were es-

TIMELINE—SOUTHEAST ASIA

Mainland Southeast Asia consists of the present-day states of Myanmar (Burma), Thailand, Cambodia, Laos, and Vietnam. Maritime or island Southeast Asia includes the Malay part of the peninsula and a large archipelago divided between Indonesia and the Philippines.

PRECOLONIAL ERA

- c. 500 B.C.E. Indian trade with mainland Southeast Asia begins, leading to the spread of Hindu-Buddhist ideology and the influence of Sanskrit and Pali on local languages.
- c. 1 C.E. With the spread of trade into the islands, west and central maritime Southeast Asia comes under the influence of Hindu and Buddhist traditions.
- 1st millennium C.E. Mon-Khmer people settle Irawaddy Valley, Bangkok Plain, and Mekong Delta; Khmer site of Angkor Wat (ninth century) typifies court of Hinduized Southeast Asian state. Red River Valley (southernmost extent of Chinese Empire) occupied by Vietnamese. Chams (Malayo-Polynesian language group) inhabit coast from the Red River Valley to the Mekong Delta.
- Early 2nd millennium C.E. Burmans move into the Shan Hills from the eastern Himalayas; conquer Mon-dominated Irawaddy River Valley. Thai and related Lao move into what is now Laos and Thailand from Southeast China.
- 1300 C.E. Islam expands into island Southeast Asia from the Indian Ocean, following trade routes; Muslims introduce Arabic as they convert local populations.
- 14th–18th centuries. Vietnamese push south, dominating Chams and taking the Mekong Delta from the Khmers.
- 16th century. Spain annexes the Philippines, bringing Christianity and Spanish and blocking the eastward spread of Muslim conversions. Portuguese and then the Dutch occupy the Spice Islands.
- 18th century. Four ethnic groups dominate mainland Southeast Asia by this time: Burmans (Irawaddy River Valley), Thais (Bangkok Plain), Lao (northern and central Mekong Valley), and Vietnamese (eastern lowlands). The contemporary states of Myanmar

(Burma), Thailand, Laos, and Vietnam take their names from these ethnic groups.

COLONIAL ERA

- 1824–1885. British acquire Burma, which becomes an Indian province in 1885.
- 1858–1885. French take over the Nguyen dynasty of Vietnam; French becomes the language of administration in French Indochina (present-day Vietnam, Laos, and Cambodia). French introduce the printing press to Vietnam; the first French-language bulletins appear in 1861. Malay (later the Indonesian national language) develops a popular literature, spreading ideas of modernization and nationalism from the late nineteenth century on.
- 1885–1945. Western schools rapidly expand by the early twentieth century. First Vietnamese (French-language) newspaper is printed in 1917. First Thai publishing houses are established in the 1930s. In Vietnam a remarkable expansion of literacy in *quoc-ngu*, romanized Vietnamese script, takes place between the 1920s and 1940s. Early nationalist movements develop throughout Southeast Asia in response to colonialism and the introduction of Western thought.
- 1945–1954. Most of Southeast Asia is decolonized in the aftermath of World War II.

POSTCOLONIAL ERA

- 1954–1975. The expansion of radio in the 1960s and 1970s creates a community of listeners in Southeast Asian countries for the first time. The Vietnam War, ending in 1975 with the fall of Saigon, results in massive devastation, population loss, and displacement within mainland Southeast Asia as well as an unprecedented international refugee flow.
- Mid-1980s. Television is introduced to Laos and Bali. The refugee diaspora stimulates use of new media, such as video. Literary analysis and the first women scholars emerge in Laos during the late twentieth century.
- 1990s. Television viewing greatly expands with the advent of satellite television.
- 2000. Cell phones, fax machines, computers, and cybercafes permeate city life. The Thai language, in both spoken and written forms, increasingly dominates neighboring Laos.

tablished in Laos and Northeast Thailand in the 1930s, writing on palm leaves became obsolete. In the late twentieth century a new field of Lao literary analysis emerged in which female as well as male Lao scholars participate.

The last two decades of the twentieth century brought modern mass media within reach of most Southeast Asians, though access varies. Television first appeared in Thailand during the 1950s but was not available outside the capital until rural electrification took place in the late 1970s. During the 1980s color television sets and then videocassette recorders became common, and by the next decade television viewing had greatly increased. In Bali (Indonesia), famous for its popular theater, the effect of television on live theater was so great that eight out of ten theater troupes vanished during the 1980s. Siam's (present-day Thailand) confrontation with Western colonialism in the nineteenth century led to a concern with boundaries and remodeling of the Siamese administration system after the model of Dutch and British colonial practice. One of the first Asian countries to use new media to further national development, Thailand has promoted an "official" national cultural identity for at least ninety years through its public education system and mass literacy in Central Thai. By the late 1980s television programming was used to introduce new, nonindigenous patterns of consumption, such as the presentation of Christmas gifts. Due to Thai control of modern mass media, the Thai language in both spoken and written forms increasingly dominates neighboring Laos. Whereas Thai and Lao are closely related, the Thai language modernized more rapidly; Lao scholars are still debating the standardization of its writing system.

Communication of ideas on the popular level in mainland Southeast Asia in the early twenty-first century is largely within an Asian sphere of influence; for example, Thai boxing and beauty contests, Hong Kong dramas dubbed into Vietnamese or Thai. Foreign ideas and the English language have begun to enter Thailand to some extent as a result of the increase in tourism after 1987. The influence of Southeast Asian refugees on both their host countries and countries of origin should not be ignored, particularly now that former refugees can visit or even return permanently to Southeast Asia; new ideas include more rights for women, increased individualism, and democracy. The political legacy of the Vietnam War remains a part of global, particularly U.S., consciousness.

See also **Colonialism: Southeast Asia; Globalization: Asia; Westernization: Southeast Asia.**

BIBLIOGRAPHY

- Bellwood, Peter. "The Prehistory of Island Southeast Asia: A Multidisciplinary Review of Recent Research." *Journal of World History* 1 (1987): 171–224. Useful background on prehistory of region.
- Chandler, David P. *A History of Cambodia*. 2nd ed. Boulder, Colo.: Westview, 1992.
- Christie, Clive J. *A Modern History of Southeast Asia: Decolonization, Nationalism, and Separatism*. London and New York: Tauris Academic Studies, 1996.
- Ebihara, May M., Carol A. Mortland, and Judy Ledgerwood. *Cambodian Culture since 1975: Homeland and Exile*. Ithaca, N.Y.: Cornell University Press, 1994.

- Evans, Grant, ed. *Laos: Culture and Society*. Chiang Mai, Thailand: Silksworm Books, 1999. This is a useful collection of essays on Lao language and culture.
- Ginsburg, Faye D., Lila Abu-Lughod, and Brian Larkin, eds. *Media Worlds: Anthropology on New Terrain*. Berkeley: University of California Press, 2002. See particularly essays by Annette Hamilton, Mark Hobart, Rosalind C. Morris, and Louisa Schein.
- Higham, Charles. "The Later Prehistory of Mainland Southeast Asia." *Journal of World Prehistory* 3 (1989): 235–282. Useful for overview of ethnic groups and languages.
- Marr, David G. *Vietnamese Tradition on Trial, 1920–1945*. Berkeley: University of California Press, 1981. Fascinating discussion of how romanized Vietnamese script became the vehicle for literacy and popular debate between the 1920s and the 1940s, developing along with the nationalist movement. Has an excellent chapter on women.
- McDaniel, Drew. *Electronic Tigers of Southeast Asia: The Politics of Media, Technology, and National Development*. Ames: Iowa State University Press, 2002.
- Reid, Anthony. *Southeast Asia in the Age of Commerce, 1450–1680*. 2 vols. New Haven, Conn.: Yale University Press, 1988–1993.
- Somers Heidhues, Mary. *Southeast Asia: A Concise History*. New York: Thames and Hudson, 2000.

Janet E. Benson

COMMUNISM.

This entry includes two subentries:

Europe
Latin America

EUROPE

"A spectre is haunting Europe—the spectre of Communism." The famous opening line to *The Communist Manifesto* evokes the expectations and fears that have been associated with European communism. Published in 1848 amid a tumultuous period of political unrest across the continent, this polemical pamphlet was an idealistic call to arms directed at an emerging male working class ("the proletariat") that was identified with the growth of industrial capitalism. The authors, Karl Marx and Friedrich Engels, predicted that this new class would become the agent of a revolutionary transformation of the existing social order and that they would in turn create a new form of society in their own image: communism. This they foresaw would be an egalitarian proletarian civilization that abolished divisions based upon private property and the market and in which oppressive states would disappear to be replaced by "an association, in which the free development of each is the condition for the free development of all." All other social groups would disappear, in particular the industrial middle class ("the bourgeoisie"), which they identified as the dominant force in the modern world. The struggle to create this new form of equal society, as close to perfect freedom as possible, would be one of the most titanic and final in human history.

Karl Marx and the Origins of Modern Communism

In articulating this powerful vision of a future society, the authors of the *Manifesto* appropriated the concept of communism to themselves—so much so that communism and Marxism have often been taken as inseparable, if not synonymous, establishing a line of political thinkers and activists from Marx onward who contributed to the development of both. This link was strengthened further after the Bolshevik revolution of 1917 and the establishment of the Soviet regime (U.S.S.R.) in Russia, which claimed to be creating an authentic communist society in direct connection with Marx's ideas, and by political movements that sought to spread that revolution worldwide. Communism seemed to become an established feature of European political culture and conflict. Its significant impact on European societies was deepened yet further by the spread of Soviet-style regimes to most of Eastern Europe after 1945, which suggested that the most significant political choice of modern times was between accepting and rejecting communism. However, the reality of life under these dictatorships was increasingly at odds with the ideals that they supposedly stood for. Any sense of permanence was then shattered in the period from 1989 to 1991 by the complete collapse of these states and of most of the communist movements elsewhere in Europe. From the perspective of the early twenty-first century the whole conception of Marxist communism in its European context appears redundant as a form of political theory and practice.

The above description serves as a useful starting point, reflecting an image of communism that has dominated current understanding of it. But not all communists have been Marxists, and not all Marxists have been communists. In reality communism has been a more complex and contested doctrine, as was evident even when *The Communist Manifesto* was written.

In fact, hardly any single element of the *Manifesto's* conceptualization of communism was truly novel—including the use of the term itself. It was already used by a variety of minority groups across Europe, religious as well as political, to indicate an egalitarian, communally organized society. Marx and Engels took it from socialism, which developed from Enlightenment thinking as a rejection of liberalism and in reaction to the failure of the French Revolution of 1789 to produce a more complete social transformation. From Gracchus Babeuf's ill-fated *Conspiracy of the Equals* in 1796 and his attempt to produce a "commune," *communism* became a term indicating the most extreme end of the spectrum of French socialist thought. It indicated those groups most committed to the complete rejection of existing society and a belief that violent means were needed to achieve this goal. As such Marx and Engels's use of *communist* derived from their attempt to identify their own particular brand of thinking within the socialist market. More particularly, the *Manifesto* was published as the badge of a tiny organization they had founded, the German Communist League. At the same time, other groups, such as that of Louis-Auguste Blanqui, also described themselves as communist.

Other ideas in the *Manifesto* also predated Marx and Engels in socialist thinking: that industrialization was transforming human relations; the identification of the working

class as agents of change; the idea of a class struggle and that a "dictatorship of the proletariat" would be required before communism could be achieved. Nor was their very brief and generalized description of the nature of a future communist society particularly novel. They also included a series of immediate demands made by the league, including universal male suffrage, that were even less unusual. As it turned out, Marx and Engels had misread the immediate prospects for revolutions of the type they predicted. The year 1848 did not mark the start of the final crisis of capitalism as they conceived of it; in fact capitalism was only just developing, and that crisis was to be endlessly postponed.

What made Marx's version of communism distinctive was his bold claim that it embraced a "scientific" worldview and the fact that he placed his analysis of communism in a much broader context. The latter reflected his major preoccupation in life, which was the analysis of contemporary society and of trends in its development. He engaged with the most significant intellectual movements of his age. In addition to French socialism, he brought German philosophy, British political economy, and above all the new methods and language of the natural sciences into a brilliant synthesis. Marx described the result as "scientific socialism," which he distinguished from the "utopianism" of his many forebears and rivals. His aim was to unify theory and practice, to marry the analysis of society to political action. This was what made Marx and Engels's analysis of the coming communist society so powerful: their brand of socialism would succeed not because of mere striving and wishful thinking but because it was based in scientific study and represented the culmination of an inevitable trend in the modern world. Accordingly the *Manifesto* contained little discussion of political organization or revolutionary activity. Instead it presented communism as the direct product of a process of historical change involving a class struggle that was rooted in the effects of industrialization. The working class was destined to become a majority in society, and it would be bound, in the face of obvious economic oppression, to demand change, which could only be achieved by seizing economic and political power. In this view societies passed through great epochs: as feudalism had given way to capitalism, so capitalism would give way to communism. It was this faith in the inevitability of communism, as predicted by scientific socialism, that was Marx's great contribution. From it the possibility of communism as a political ideology in its own right and as a secular religion could be fashioned, but this did not happen immediately.

Non-Marxist Communism

Ironically, after the collapse of the German Communist League in 1850 *The Communist Manifesto* remained largely unread until rediscovered later as a prophetic work. No new political creed and form of political organization followed its publication, nor did Marx or Engels wish to separate themselves from other revolutionary currents. In fact, no other movements describing themselves as "communist" appeared again for seventy years. Nevertheless, the use of the term *communism* did resurface, but it was largely used by individuals and movements that were

unconnected with Marx's ideas. The Russian anarchist thinker Mikhail Bakunin had used the term as part of his early political lexicon. Again he used *communism* rather loosely to indicate a future form of egalitarian society; decentralized and communally organized, it would be free from domination by the propertied classes and above all from a dictatorial state. Bakunin argued that the peasantry, and not just the working class, could be revolutionary agents and that communism could be based on peasant institutions. However, by the time the International Working Men's Association (IWMA, 1864–1876) was formed, Bakunin had changed his views. The First International, as it became known, was an attempt to create cooperation between all the European political groups that claimed to speak on behalf of the working class, but within a few years the organization foundered in a welter of internal disputes.

By the 1880s, however, a fully fledged version of anarchist or "libertarian" communism had appeared that was most closely associated with another Russian revolutionary, Peter Kropotkin. As well as expanding the theoretical basis of anarchist thinking, Kropotkin also provided a critique of the state-centered approach of socialist communism to revolution. He argued that the state must be destroyed for a communist society to exist, as the state in any form was always an oppressive force. In contrast, Marx and Engels, and their later followers, asserted that the state needed to be captured and used by the workers in the "dictatorship of the proletariat" of the revolution. It would then "wither away" as the emergence of communism made it either completely or partly redundant. Other non-Marxist socialist movements also espoused forms of communism, most notably the Socialist Revolutionaries (SRs), who appeared in Russia in 1902. Following in the footsteps of the Russian Populists of the 1860s and 1870s and writers such as Alexander Herzen, who had again argued that the peasantry could be the basis of a revolutionary society, the SRs proposed an agrarian form of socialism that would be based upon village communes. Once again, a perfect society was the aim, though the nature of that society and the means to achieve it were quite distinct from Marxist communism.

Marxism and European Socialism

If not all communists were Marxists by the 1880s, more strangely, hardly any Marxists actually called themselves communists at this time. Most mainstream socialists began to describe themselves as Marxists, but hardly any labeled themselves as "communists." From 1850 until his death in 1883, Marx himself never again felt the need to distinguish his notion of socialism as communist. This reflected the passing of a particular moment in the late 1840s but also the way in which socialism was developing. Though falsely welcomed, by Marx as well as many others, as the first genuinely "proletarian revolution," the horrific aftermath of the Paris Commune of 1871 largely dealt a death blow to the idea of "spontaneous" insurrection as a path to socialism. There was also the realization that the vaguely defined working class would not automatically opt for socialism and that organization was required to win over workers to a cause previously espoused by small groups of intellectuals. Accordingly European socialists created permanent political bodies that could attract mass support and cam-

paign for change. By the late 1880s the most influential model was provided by the German Social Democratic Party (SPD), first formed in 1875. And by the 1890s social democrat movements had appeared in every major European country. Although formed on national lines—reflecting the consolidation of nation-states and of national economies in Europe—they also joined together in the Second International. This was formed in 1889, during a conference to celebrate and examine the achievements of the French Revolution of 1789, as a confederation of socialist parties. Every party was officially committed to a revolutionary Marxist analysis and theoretically to the notion that socialism would lead to a society without classes, private property, and the oppressive state. Whatever appearances might suggest, however, this did not represent the triumph of a communist version of socialism.

Marxist orthodoxy in the International was adapted for everyday purposes by a series of interpreters and popularizers, the most prominent of whom were Engels (until his death in 1895), August Bebel, G. V. Plekhanov, and Karl Kautsky. Indeed Kautsky's *The Class Struggle* was the bible for social democrat activity, though it is doubtful to what degree the rank and file of these movements was really aware of the nuances of even this version of Marxism. The analysis of capitalist society, the revolutionary mission of the proletariat, the role of class struggle in causing change, and the inevitable triumph of socialism were all there, as was the language of science in which the whole was couched. Also present was the "stages" view of historical and economic development, but here Marx's essentially economic analysis was qualified by a more practical political approach. The leading spokesmen of the Second International believed that not just a capitalist society but a liberal democratic ("bourgeois democratic") political system was required before real socialism could be achieved. Within such a system the workers' movement could develop and gain influence and eventually power. The state could be conquered by essentially peaceful means, using the growing numerical superiority of the working class, and the socialist stage could then be attempted. This downplayed the need for a seizure of power by force and reformulated the notion of a dictatorship of the proletariat. The aim was still a socialist revolution and eventually a communist society, but these were now longer-term aims that awaited a crisis of capitalism. The immediate priority was to organize politically and economically, to campaign for liberal democratic reforms, and to obtain immediate improvements in the lives of workers. The centrality of class struggle was further qualified by other issues. European imperialism and the threat of war became major preoccupations. In fact, the desire to prevent war through working-class solidarity across national boundaries became the major preoccupation of the Second International. And for the first time, equality between the sexes also became a significant issue for mainstream Marxists. Both August Bebel and Engels wrote tracts on the "woman question," and an increasing number of socialist-feminist women followed suit. In 1907 Clara Zetkin, the leading socialist-feminist of the SPD, organized the Socialist Women's International to campaign for working women's rights and female suffrage. However, insistence on the primacy of class over gender also divided social democrats. Some parties, led by the Austrians, rejected separate organizations for women and resisted the call for women to receive the vote. Many female activists,

such as Rosa Luxemburg, also argued that revolution would automatically bring gender equality and that campaigns on women's issues were simply a diversion.

Small groups of dissenters within social democracy took different elements of Kautsky's ideas and pursued them to different conclusions. Revisionists within the SPD, particularly Eduard Bernstein, questioned the very possibility of revolution, let alone its inevitability in modern industrial capitalism, proposing as a consequence that socialists should abandon the rhetoric of a revolutionary transformation, accept the permanence of capitalism, seek legality, and participate in existing institutions with the aim of securing democracy and improvements for workers. Socialism would come through the success of capitalism, as a means to redistribute its products more fairly, rather than through its collapse. These were still radical aims for the time, and the growth of social democrat representation in western European countries with parliamentary institutions and a working-class franchise lent plausibility to this strategy. Even so, revisionism was rejected by the mainstream as a heresy and even more vigorously by other factions that took seriously the revolutionary rhetoric of social democracy. For them, socialists should make revolution a reality by taking more active immediate steps to take power and overturn capitalist society. What they really rejected was the deterministic idea that revolution would come about through a process of inevitable historical change; instead it had to be made by revolutionary activists. A variety of factions and leaders became associated with this more forceful approach, the best known being the German Spartacists led by Rosa Luxemburg and Karl Liebknecht and the Russian Bolsheviks headed by Vladimir Ilich Lenin. But none designated themselves as "Communists" or sought separation from social democracy. Even in Russia, where the social democrats divided into two separate Bolshevik and Menshevik factions in 1903, both groups maintained their adherence to the International, and the ideological differences between them were far less than they were later to be presented. What was distinctive was the Bolsheviks' approach to organization and revolutionary activity. Lenin believed that conventional parties, particularly in the conditions of the tsarist autocracy, were futile and that workers had to be led by a "revolutionary vanguard" of tightly organized revolutionary professionals—the conspiratorial and military overtones were striking and prophetic.

In 1902 Lenin published *What Is To Be Done*, in which he laid out his ideas relating to the role of the party and party organization in the revolutionary movement. Little read at the time, it was to become a founding work of Leninism, the most significant ideological expression of twentieth-century communism. But while social democracy remained united, it served to constrain these more radical and revolutionary voices on the fringe of European socialism.

Splits in the European Social Democratic Movement

World War I and its aftermath shattered the delicate unity of the International. With the outbreak of war the overwhelming majority of socialists abandoned their pacifist and antinationalist stance. With the exception of the Serbian and both

Russian movements, all the parties pledged themselves to their respective war efforts and in many cases joined governments of national unity. They gained respectability, a new status, and shared responsibility for government actions. But as the war progressed and antiwar sentiment grew, they also faced growing dissent from within their own ranks. War deprivation, inflation, labor disputes, and growing social and political unrest in many European states divided socialists. In Germany an antiwar group broke away from the SPD to form the Independent Social Democratic Party (USPD, 1916). As the war dragged on to its close in late 1918, uncoordinated social and political unrest broke out in much of Europe, starting in Russia in February 1917 when the tsar abdicated and was replaced by a weak liberal government supported by the Mensheviks. Governments also collapsed in much of central and eastern Europe and were weakened elsewhere, including in states such as Spain that had been neutral in the war, creating power vacuums that were often filled by a plethora of ad hoc committees. Many of those involved in this so-called council communism in countries such as Austria, Germany, Hungary, and Italy were dissident socialists, but militants from other political movements, radicalized soldiers, and the previously uncommitted also participated. Women were also prominent in many of the activities of these committees, which challenged state authority and became a chief feature of the revolutionary unrest that gripped parts of Europe until 1921. They were heterogeneous in both their participants and in their political outlook, taking different forms in different places and at different times. In Austria, Germany, and Hungary during 1919 to 1921 workers and soldiers' councils became the basis for revolutionary insurrections that were suppressed by counter-revolutionary force. Elsewhere protest was essentially syndicalist in nature, with workplace committees formed as part of economic activities. These were significant in Britain, France, and Belgium and most widespread in northern Italy, where a wave of factory occupations spread across northern cities in late 1920. Revolutionary activists were galvanized by these events, even where they fell far short of an outright seizure of power. Once again the long-awaited crisis of capitalism seemed at hand. It was out of this chaotic situation that self-proclaimed communist movements and ideas appeared once more.

Bolshevism and the Emergence of the Communist International

It was Bolshevism that self-consciously promoted itself as a model for a new kind of revolutionary Marxist party and ideology. After February 1917 and considerable discussion within the movement, the Bolsheviks declared their opposition to the liberal government. While the Mensheviks concentrated on the liberal-democratic phase of revolution, Lenin declared that this could be skipped and that a "workers and peasants state" could be established. In an agrarian country, the Bolsheviks substituted the revolutionary party for the working class as the agent of revolutionary change. Never a mass movement, the Bolsheviks gathered support among soldiers and civilians disillusioned with the war and, crucially, in the committees (soviets) that sprang up in the major cities. Converts to the Bolshevik cause included the

Menshevik leader Leon Trotsky. With less success they also tried to extend their influence into those parts of the countryside where peasants had seized control of the land and their localities. By October 1917, with the government discredited by its own failures to end the war and carry out social reforms, the Bolsheviks were able to seize control in the main cities by force.

This was really only the beginning of the Bolsheviks' struggle to secure power, let alone to fulfilling their declared aim of creating a communist society and a world revolution. This process was accompanied by the creation of a mythology that legitimized the violent revolutionary methods of the Bolsheviks as the only path to communism. Lenin's main theoretical contribution was laid out in two works, *The April Theses* and *The State and Revolution*, both published in 1917. Once again theory and practice were unified. Bolshevik leaders, particularly Lenin, were lauded as the only true revolutionaries and interpreters of Marxist thought, farsighted and infallible in their judgments. In that sense successful revolution represented the triumph of the will of these leaders, and an authentic socialist revolution leading to communism could be carried out only by Bolsheviks. Similarly the party they led was the only representative of the interests of the working class. Indeed the party was needed to make up for the deficiencies of workers, who, left to their own devices, would not develop a "revolutionary consciousness." The path to true communism was through true bolshevism, and all other claims to revolutionary status were therefore fraudulent. Bolshevism's minority status and tenuous links to mainstream Marxism and socialism were glossed over, as was the fact that other groups within Russia—as elsewhere—also claimed revolutionary status as "communists": particularly the Socialist Revolutionaries and anarchist communists who rejected a centralized state and were supported by sections of the peasantry. By March 1918 the Bolsheviks began to describe themselves as the Communist Party.

In fact, the real route to power came through pragmatic compromises and a bloody civil war that lasted until 1921 in which the real instrument that established Bolshevik rule was not the party but the Red Army. The result was that opponents of all political persuasions, from the ultraleft to the tsarist right, were either crushed or marginalized. The main claim to the primacy of what after Lenin's death in 1924 became called the Marxist-Leninist approach to revolutionary communism came from the success of the Bolsheviks in seizing power in Russia and retaining it. Not surprisingly, all interpretations of communism had to contend with Lenin's ideas and the Soviet regime. However, there was no unquestioning acceptance of Bolshevik ideology and practice; far from it. From the start, questions abounded as to whether Leninism was Marxism or even socialism, and whether the Soviet Union was evolving as a communist society. For a majority of European Marxists, who continued to call themselves socialists, and for many who called themselves communists, the answers to these questions were negative. Kautsky, for example, was quick to condemn both Leninism and the Soviet Union as perversions of Marxism and socialism. Likewise, as a witness to the destruction of Russian anarchist communism at the hands of the Bolsheviks, Kropotkin wrote to Lenin denouncing the regime as a betrayal of communist ideas of free-

dom and humanity. Lenin's response to these critics, at home and abroad, was to denounce them as utopians in "*Left-Wing Communism: An Infantile Disorder*," published in 1920.

Paradoxically, the international attractions of Leninism as a universal ideology were increased by the fact that the Bolshevik revolution proved to be an exception. Short-lived Soviet governments were proclaimed in Munich and Hungary, but Bolshevik-style revolution was defeated everywhere outside Russia. Mainstream social democrats often played a pivotal role in this process, eschewing violence and opting instead to secure liberal-democratic regimes in power. The result was a deep and enduring division between the majority of social democrats and the dissenters. It was institutionalized in 1919 by the formation of a new Communist International (Comintern) based in Moscow. Its creation was based on the notion that Bolshevik-style revolution had failed not because developments in Russia were a peculiar case but because other countries lacked a proper Bolshevik party. Therefore the Comintern was to be a world Communist Party organized on Bolshevik lines, with different sections in each country, which aimed to spread Bolshevism beyond the borders of Soviet Russia. Adherents in each country were required to agree to a twenty-one-point charter based on Leninist principles of organization and activity. Between 1919 and 1921 Communist Parties of this "new type" were created in most European countries, drawing in mostly dissident socialists but also others who saw Bolshevism as the path to revolution.

Leninism offered a path to power, but what to do with it was a more difficult matter. The formulations of Lenin and other leading Bolsheviks such as Leon Trotsky on how communism was to be created or what it would look like in practice had been as vague as those of all the preceding generations of Marxists who assumed that it would emerge out of an advanced industrial society rather than a rural one. In reality, they had no blueprint. The regime that emerged in Russia called itself a Soviet democracy with a constitutional apparatus. Significantly, neither the U.S.S.R. nor later Communist states actually claimed to be communist societies. Their governments argued that they were living through a socialist stage, "the dictatorship of the proletariat" again, and were in the process of building communism. In practice this meant the permanent dictatorship of the party and the creation of a party-bureaucratic state that, in theory if not in practice, subsumed all aspects of society to it. Nor could any rivals—not just political but also religious—be tolerated. Throughout all the considerable changes, conflicts, and real debates about policy that took place in Soviet society and government, this was to be the constant reality that inhibited pluralism and independence, even during the genuinely radical early phase of Bolshevism, with its cultural and social experimentation. Symptomatic of the trend that set in was the case of Alexandra Kollontai, a strong advocate of the equality that the Soviet regime promised to women. Though initially prominent in the party and government, she and her writings were gradually marginalized, as was the question of real equality.

After Lenin's death in 1924 the question of how to create a communist society in a country that lacked an industrial working class was at the heart of the struggle for the party

leadership. Although a political and personality dispute as well, the three main contenders—Nikolai Bukharin, Leon Trotsky, and Joseph Stalin—all shared this basic goal but differed over how it was to be achieved. Bukharin favored a gradualist approach, while Trotsky argued that a “permanent revolution” was required—a swift transformation and a determined effort to secure the spread of the revolution worldwide. Rather than contributing wholly new ideas to these disputes, Stalin maneuvered between them and emerged triumphant. His approach was domestic and sought to create a specifically Russian version of communism, “socialism in one country.” However, the second revolution that he announced in 1928 borrowed heavily from Trotsky’s ideas in terms of the elimination of the peasantry through the collectivization of agriculture and rapid industrialization. The application of state power to centralize economic and social control that followed could only be achieved through considerable force and at the cost of millions of lives and was accompanied by a Stalinist terror that eliminated political enemies both real and imagined. Ideological conformity to Marxism-Leninism, as now defined by Stalin, became a prerequisite for survival. Nonconformist communists were accordingly particular targets, usually labeled as “Trotskyists” whether they were followers of Trotsky or not. This created a permanent division among Marxist communists, all of whom saw themselves as the heirs of Lenin and Bolshevism, between those who accepted the Soviet Union as it developed under Stalin and those who did not.

These disputes and developments in the Soviet Union inevitably impacted on the wider international communist movement. Stalin was mostly contemptuous of the Comintern, seeing foreign communists as inadequate and other communist parties as failures and sources of dissent. And in terms of recreating Bolshevik success this was a correct assessment, as no other successful revolution occurred in Europe despite some serious efforts in the early 1920s. The International went through various strategic twists and turns until it was finally dissolved in 1943, all of which proved futile and, for Stalin, simply proved his point. Individual parties did often play a prominent political role, particularly in liberal-democratic conditions. But for the most part international communism provided a threat and a justification for the authoritarian and Fascist movements that rose in Europe in the 1920s and 1930s—a threat that was without any real substance. After 1928, developments in the Soviet Union increasingly divided communists. On the one hand, many were appalled at the excesses of Stalinism and either became dissenters or abandoned communism completely. But on the other hand, the apparent achievements of collectivization and industrialization could also be a matter of pride and an example that communism offered a real alternative to the unemployment and economic depression that gripped Europe after 1929. As a result, and encouraged by the Comintern, Communist Parties turned in on themselves in pursuit of dissidents—many of whom were expelled as Trotskyists. Some formed small rival Communist groups, and Trotsky himself, in exile until his murder by Soviet agents in 1940, attempted to form a rival International.

For non-Russian communists questions about why the Bolshevik revolution could not be repeated and of the direction

taken by Soviet communism became central preoccupations. Most of the discourse of the orthodox Communist Parties simply aped that of the Soviet government and the International. In particular, the idea that the Bolshevik path was simply unrepeatable in the conditions in the more economically and socially advanced societies in the rest of Europe was officially unacceptable. Even so, some creative intellectuals, often called the Western Marxists, did flourish. Chief among them were Antonio Gramsci, Karl Korsch, György Lukács, and some members of the so-called Frankfurt School (particularly Herbert Marcuse). They were active in the first flood of revolutionary enthusiasm for the Soviet experiment, when there was more space for creative thinking within communist movements. Questions about the significance of culture and aesthetics in Marxist analysis concerned them as much as, if not more than, economics and politics. They were aware that cultural and social circumstances often conditioned political possibilities. Often implicitly, rather than explicitly, they offered a critique of Leninism in all its variations (including Trotsky’s). Gramsci in particular, without ever rejecting the Soviet model, suggested a path to revolution that contained the same sense of human agency as Lenin’s views but rejected its insurrectionary and conspiratorial strategy as well as the primacy placed on the material conditions necessary for revolutionary change. In complex Western societies, Gramsci argued, revolution was intimately bound up with a competition or struggle for cultural dominance (*egemonia*). In order for socialism to be established it had to be as consensual as possible—more akin to the triumph of the Italian Renaissance. Such thinking remained a minority concern and was decisively marginalized after 1928 in the drive to impose Stalinist orthodoxy on all communists. Either purged from their parties, recanting their views, exiled or imprisoned by their governments, they were silenced and their writings ignored by contemporaries.

In many respects, the fund of genuinely new ideas about communism, in Europe at least, began to dry up by the 1940s. The consolidation of Soviet rule under Stalin and the failure of communism outside of Russia contributed to that feeling. But once again a world war transformed the fortunes of communism in Europe. The war effort allowed Stalin to combine Soviet rule and Russian nationalism—a potent combination that was also to be successful outside of Europe after 1945. The isolation of the Soviet Union was also ended between 1945 and 1949, when Soviet rule spread to Eastern Europe under military occupation by the Red Army, and Yugoslavia was liberated by Communist partisans under Marshall Tito. In Western Europe as well, Communists also gained greater respectability and popularity as a result of the prominent role they played in the civilian resistance movements in parts of occupied Europe. Powerful and popular parties developed in France, Greece, and Italy. After 1945 Communists even participated in governments, though they were ejected by 1947 as the Cold War developed and political divisions hardened. Increasingly, political choices were dominated by attitudes toward communism, both domestically and internationally. This was, in fact, to mark the highpoint of communist success and, though not clearly perceivable at the time, the trend was from then on to be decline. Both within the Soviet-style regime and

within the Western Communist Parties, as well as in the wider world of communist thinking, communism ossified. And the search for renewal, and the recycling of old ideas, began to dominate.

Without World War II it is extremely unlikely that Soviet-style regimes would ever have emerged in this region. Even so, communism was not established overnight. By 1949, however, Communist Party rule prevailed throughout Eastern and Central Europe. At first many elements of Stalinist policies were imposed on the newly formed regimes: collectivization of agriculture, state economic control, the suppression of religion and class differences. But by the time of Stalin's death in 1953 it had become apparent that, due to the distinctive social, economic, and cultural conditions that existed in each of these countries, attempts to create systems in the likeness of the Soviet Union could never be completely successful. Yugoslavia was the one country in the communized part of Europe that completely escaped Soviet domination. Thanks in large measure to the partisan leader, Josip Broz, or Tito, from 1948 on Yugoslavia followed an independent course of Communist development. However, this extension of Communist rule also marked the beginnings of decline and the eventual destruction of communism as a state ideology in Europe. Following Stalin's death the problems of cultural, economic, and social stagnation steadily mounted. Opposition to Communist dictatorship also grew, including from intellectuals within party ranks who used the tools of official Marxism to dissect the failings of their own societies. The growth of dissent and the rejection of the regimes by many of their own supporters were to be key features of decline.

The central, unsolvable problem for all the Communist states became how to liberalize and renew themselves without rejecting party rule. The first serious attempt to do so came in the Soviet Union during the mid-1950s when a new premier, Nikita Khrushchev, surprised the world by denouncing the crimes of Stalinism and promising a renewal of communist ideals. The slogan "communism within a generation" was accompanied by attempts at economic reform and political liberalization. However, a conservative backlash unseated Khrushchev and destroyed the drive for reform. Similar experiments under Imre Nagy in Hungary in late 1956 and in Czechoslovakia under Alexander Dubcek in the spring of 1968 resulted in military intervention by the Soviet Union and Warsaw Pact countries. By the 1980s all the Communist states suffered from "stagnation" (*zastoy*), the term used by Russians to describe conditions under the leadership of Leonid Brezhnev. Any serious belief that communism could renew itself as a state ideology had finally passed. In Poland a powerful independent trade union organization, Solidarity, emerged in the early 1980s and soon posed a serious challenge to the regime. It contained a coalition of ideas ranging from Catholicism to dissident Marxism. Only direct military rule was able temporarily to contain it.

The End of Communism

What would turn out to be a significant shift in Soviet leadership occurred in 1985, when the reform-minded and relatively youthful Mikhail Gorbachev became head of state. His plans for more open debate (*glasnost*) about new ideas and policies

were accompanied by an attempt at restructuring (*perestroika*) the Soviet economic system. Gorbachev also made waves on the foreign policy front. Early in his administration he made it clear that the Soviet Union was no longer going to impose its policies over Communist regimes in Eastern and Central Europe, which set in motion the dissolution of the political, economic, and military ties that had formerly bound these countries to the Soviet Union. By 1989 nearly all the Communist regimes had imploded, and the fall of the Berlin Wall reunited Germany, effectively ending the Cold War. The Soviet Union was, once again, isolated as the only Communist state. However, in 1991 a failed military coup by conservative hard-liners, dismayed at Gorbachev's reforms and the loss of the Eastern European regimes, precipitated a final crisis. Gorbachev was sidelined, and more radical groups within the Soviet Communist Party, led by Boris Yeltsin, announced the dissolution of the regime.

Developments in Western communism took a parallel but distinctive course. After 1949 the hopes of spreading revolution to the West became ever more remote, confirmed by the defeat of the Greek Communists in the civil war of 1944–1949. Though still linked to the Soviet Union, the trend in Western parties was for increasing independence and a search for a more distinctively "Western" approach to communism. During the 1940s and 1950s, the atmosphere of the Cold War and the political restrictions it brought about inhibited free discussion of Marxist ideas in Europe—ironically paralleling the situation in the Soviet bloc. But by the late 1950s and 1960s, when de-Stalinization in the Soviet Union eased the Cold War, many Western parties adopted a policy of National Communism in an attempt to adapt themselves to specific conditions in different countries. This was due to a number of reasons, including rejection of many of the tenets of Leninism as unsuitable, and a reaction to many of the aspects of Soviet rule and to the failure of liberalization. Western parties also faced competition from dissenting communist movements—Trotskyites and also new models derived from the Third World (Maoism, Castroism). Communists also found themselves radically out of step with the long economic boom that transformed Western European capitalism from the early 1960s onwards. Many orthodox Communists embraced Eurocommunism, which broke entirely with the Soviets and was particularly influential in Italy and Spain. This involved the frantic rediscovery of many of the Western Marxists of the 1920s, particularly Antonio Gramsci, who was particularly promoted by the leader of the Italian Communist Party, Palmiro Togliatti, in a search for distinctive ideas. However, these developments came too late and only tended to divide Western Communists. By the 1980s the trend in all parties was toward decline and, in many cases, eventual disappearance.

Beyond some very basic ideas, there has never been a consensus about communism, nor a fixed body of doctrine that has underpinned it. Historically it has been a concept in a constant state of redefinition, used and interpreted in a diversity of ways. Even the appropriation of the term by Soviet-style regimes was but one definition of what communism could mean. It would now seem to have exhausted the possibilities for further renewal. The remaining standard-bearers for communism in Europe re-

flect this eclectic heritage. So-called unreconstructed Stalinists remain as a dying breed. Where communist parties remain they have tended to downplay their Marxist-Leninist credentials and have embraced the broader agendas of the feminist, ecological, and antiglobalization movements. It has been their erstwhile opponents on the dissident Far Left, anarchist communists, and “Trotskyites” who have retained their revolutionary purity on their own terms. All these are vestiges of the past. Whether a new form of thought that calls itself “communist” can ever emerge in Europe remains an unknown.

See also Anarchism; Authoritarianism; Communism: Latin America; Marxism.

BIBLIOGRAPHY

PRIMARY SOURCES

- Alexander, Robert J. *International Trotskyism 1929–1985: A Documentary Analysis of the Movement*. Durham, N.C.: Duke University Press, 1991.
- Bebel, August. *Women and Socialism*. London: Zwan Books, 1988.
- Gramsci, Antonio. *Selections from the Prison Notebooks*. Edited and translated by Quinton Hoare and Geoffrey Nowell Smith. London: Lawrence and Wishart, 1971.
- Kautsky, Karl. *The Class Struggle (Erfut Program)*. New York: Norton, 1971.
- Kollantai, Alexandra. *Selected Writings*. Translated by Alix Holt. London: Alison and Busby, 1977.
- Korsch, Karl. *Karl Korsch: Revolutionary Theory*, edited by Douglas Kellner. Austin: University of Texas Press, 1977.
- Kropotkin, Peter. *Anarchist Communism*, edited by Nicolas Walter. London: Freedom Press, 1987.
- Lenin, Vladimir I. *Selected Works*. 3 vols. Moscow: Progress, 1977.
- Lukács, György. *Political Writings, 1919–1929*. Translated by Michael McColgan. London: New Left Books, 1972.
- Marx, Karl, and Friedrich Engels. *The Communist Manifesto*. New York: St. Martin's Press, 1999.
- Marxists Internet Archive. Available from www.marxists.org. A wide range of texts in English translation and other information.
- Stalin, Joseph. *Selected Works*. Edited by Lightning Source Inc. Honolulu: University Press of the Pacific, 2002.

SECONDARY SOURCES

- Berger, Stefan, and David Broughton, eds. *The Force of Labour: The Western European Labour Movement and the Working Class in the Twentieth Century*. Oxford: Berg, 1995.
- Blackburn, Robin. *After the Fall: The Failure of Communism and the Future of Socialism*. London: Verso, 1991.
- Bull, Martin J., and Paul Heywood, eds. *West European Communist Parties after the Revolutions of 1989*. London: Macmillan, 1994.
- Cahm, Caroline. *Kropotkin and the Rise of Revolutionary Anarchism, 1872–86*. Cambridge, U.K., and New York: Cambridge University Press, 1989.
- Carey Hunt, R. N. *The Theory and Practice of Communism*. Rev. ed. London: Penguin, 1963.
- Claudin, Fernando. *The Communist Movement: From Comintern to Cominform*. London: Cox and Wyman, 1975.
- Cowling, Mark, ed. *The Communist Manifesto: New Interpretations*. Edinburgh: Edinburgh University Press, 1998.

- Donald, Moira, and Tim Rees, eds. *Reinterpreting Revolution in Twentieth Century Europe*. New York: St. Martin's Press, 2001.
- Eley, Geoff. *Forging Democracy: The History of the Left in Europe, 1850–2000*. Oxford: Oxford University Press, 2002.
- Fowkes, Ben. *The Rise and Fall of Communism in Eastern Europe*. London: Macmillan, 1983.
- Furet, François. *The Passing of an Illusion: The Idea of Communism in the Twentieth Century*. Translated by Deborah Furet. Chicago: University of Chicago Press, 1999.
- Harding, Neil. *Leninism*. London: Macmillan, 1996.
- Haupt, Georges. *Aspects of International Socialism, 1871–1914*. Cambridge, U.K., and New York: Cambridge University Press, 1986.
- Joll, James. *The Second International, 1889–1914*. 2nd ed. London: Routledge, 1974.
- Kindersley, Richard, ed. *In Search of Eurocommunism*. London: Macmillan, 1981.
- Laqueur, Walter. *The Dream That Failed: Reflections on the Soviet Union*. Oxford and New York: Oxford University Press, 1994.
- Lichtheim, George. *A Short History of Socialism*. London: Weidenfeld and Nicholson, 1980.
- McDermott, Kevin, and Jeremy Agnew. *The Comintern: A History of International Communism from Lenin to Stalin*. New York: St. Martin's Press, 1996.
- Millar, James R., and Sharon L. Wolchik, eds. *The Social Legacy of Communism*. Cambridge, U.K., and New York: Cambridge University Press, 1994.
- Naimark, Norman, and Leonid Gibianskii, eds. *The Establishment of Communist Regimes in Eastern Europe, 1944–1949*. Boulder, Colo.: Westview Press, 1997.
- Rose, R. B. Rose. *Gracchus Babeuf: The First Revolutionary Communist*. Stanford, Calif.: Stanford University Press, 1978.
- Sassoon, Donald. *One Hundred Years of Socialism: The West European Left in the Twentieth Century*. New York: I. B. Tauris, 1996.
- Stern, Geoffrey. *The Rise and Decline of International Communism*. Aldershot, U.K.: Edward Elgar, 1990.
- Westoby, Adam. *The Evolution of Communism*. Cambridge, U.K.: Polity Press, 1989.
- Woodcock, George, and Ivan Avakumovic. *The Anarchist Prince: A Biographical Study of Peter Kropotkin*. New York: Schocken, 1971.

Tim Rees

LATIN AMERICA

Latin America in the 1890s was a society primed for the dissemination of socialist ideologies. It was ruled by autocrats and oligarchs who were exploiting an increasingly discontented peasant populace and perpetuating a sharply divided two-class social structure. During this time, increased productivity and foreign investment ushered in the earlier stages of exploitative capitalism as well as a wave of European immigrants advocating the Marxist philosophies upon which socialist and communist movements were being built in Europe. The spread of this ideology was acutely evidenced by its recurrent presence in Latin American literature and art, most notably in the Mexican mural movement in the 1920s and 1930s. Led by famous artists such as Diego Rivera (1886–1957), José Clemente Orozco (1883–1949), and David Alfaro Siqueiros (1896–1974), the mural movement initiated decades of controversial

ANTICOMMUNISM IN LATIN AMERICA

A period of increased productivity and foreign investment in Latin America during the latter part of the nineteenth century attracted a wave of Italian, German, and Spanish immigrants who spread Marxist ideas throughout Latin America. This feudal, medieval, Catholic, and patrimonial region translated these ideas into a movement against its hierarchical two-class agrarian-based system. Following the Great Depression of the 1930s, leftist political parties emerged that promoted a strong role for the state in directing change, a leftist ideology, and anti-American nationalism. The next two decades were marked by instability and conflict as authoritarian, democratic, and communist groups vied for power.

In 1954 the United States intervened in Guatemala to overthrow a leftist regime that the United States said was communist. Four years later Fidel Castro led the successful Cuban Revolution. Cuba became the first openly socialist country in Latin America, the first to ally itself with the Soviet Union, and the first to openly turn its back on the United States. As a result, anticommunism in the region gained powerful U.S. military, political, and covert backing. Cuba added a new Marxist-Leninist “model” for Latin America and consequently made the prevention of “another Cuba” the central focus of United States policy. The United States chose time and again to support anticommunist military regimes over unstable democracies that believed in freedom for leftists. As workers, peasants, and guerrillas mobilized throughout the region, the traditional elite power-holders turned to their armies for support and received the backing of the United States, thereby ushering in twenty years of conflict and military–authoritarian rule.

The most famous U.S. anticommunist engagements in Latin America included the 1961 Bay of

Pigs fiasco, in which the CIA trained and financed 1,400 Cuban exiles who were supposed to incite a popular revolt against Castro, but were instead arrested upon arrival. In 1962, the Cuban Missile Crisis brought the world to the brink of nuclear war, when the United States discovered that the Soviet Union was attempting to assemble nuclear missiles in Cuba. In 1965, the United States intervened in the Dominican Republic to prevent what it thought was a communist uprising.

Internal anticommunist movements also emerged throughout the region. One notable example of this was in Chile. In 1973 General Augusto Pinochet, head of the Chilean army, overthrew democratically elected, but Marxist, Salvador Allende in an attempt to save the country from communism. Leftist parties were banned and their supporters exiled, tortured, or killed. Pinochet subsequently shut down the old political system and established a personalist dictatorship that maintained power through violent repression for more than a decade.

In Nicaragua, a Marxist guerrilla movement known as the Sandinista Liberation Front gained much domestic and international support by the late 1970s. It forced the powerful Somoza family from power and established the second openly socialist regime in Latin America. The *contras* emerged as an armed anti-Sandinista resistance movement and were strongly supported by the United States. The *contras*’ resistance, combined with a U.S. boycott that devastated the economy, undermined Sandinista control. Internationally supervised elections were held in 1991. As in the majority of Latin American states that had democratized since the 1970s, the Marxists did not win a majority of the vote in Nicaragua but continued to participate as a significant player in the democratic political process.

socialist and revolutionary expressions in art and culture throughout the continent.

Revolutionary socialism seemed to “fit” Latin America’s two-class society, but it was strongly opposed by the Roman Catholic Church, the armed forces, and the oligarchy.

Meanwhile, the Great Depression ushered in a series of revolutions that placed power in the hands of the middle class, began an era of organized labor’s political influence, and fostered the emergence of Marxist-socialist political movements and parties. The twenty years that followed were plagued with

instability as communist, authoritarian, and democratic groups vied for power.

The Cuban Model

In 1959 the Cuban Revolution, led by Fidel Castro, established the first Marxist-Leninist regime in Latin America and set an example for like-minded movements throughout the region. Cuba became an active participant in regional politics and engaged in extensive revolutionary activism abroad. Its alliance with the Soviet Union led to the Cuban Missile Crisis of 1962, with the American discovery of Soviet nuclear missiles being assembled in Cuba leading to the brink of nuclear war.

Like other Latin strongman leaders (caudillos) of his generation, Castro, a socialist caudillo, claimed to personify his country, led through repression, and had no tolerance for political dissidence. He ushered in attractive changes in health, education, and social mobilization, but his administrative mistakes, combined with the fall of communism abroad and a continued American boycott, have left Cuba's increasingly declining economy with little prospects for recovery. What began as a popular revolution deteriorated into the last communist dictatorship in the region, one mired in poverty and oppression.

Guerrilla Insurgents

However, in the 1960s, at the height of its regional influence and revolutionary appeal, Cuba joined with the Soviet Union in funding and training Marxist guerrilla groups throughout Latin America. Following Cuba's lead, these movements chose armed conflict over electoral competition as a means to their deliverance from exploitation. What followed in many countries were two decades of civil wars and military-authoritarian rule as powerful elites turned to their armies, as well as to the anticommunist strategies of the United States, to repress the guerrilla insurgents. The most successful guerrilla insurrection was the Sandinista Liberation Front in Nicaragua, which eventually established the second officially socialist regime in Latin America. Although this regime was ousted through elections in 1991 with the help of an economic boycott and support of anticommunist Contra forces by the United States, Marxists remained a powerful force in the newly democratic system. As a wave of democracy began to overtake the continent by the late 1970s, many communist and guerrilla movements transitioned into political parties and contested for power through the democratic process.

Diverse forms of Marxism and communism developed in other countries, reflecting their diverse histories, sociologies, and levels of development. Indeed that was a major problem for Marxist movements, how to adapt a quite rigid ideological formula to different nations and circumstances. In Peru the socialist Aprista movement and the more rigid communist groups were bitter enemies for decades. Nicaragua had Christian socialists as well as independent Marxists and Leninists. Colombia has four different Marxist and guerrilla movements. Throughout the continent, rivalries between socialists and communists, and various types of each, have been intense.

Democratic Transition

As the twentieth century came to a close, a phenomenal shift occurred in Latin America from authoritarian and—in the case of Nicaragua but not yet Cuba—communist regimes to incomplete democracies. With the fall of the Soviet Union and the poor economic and social conditions of the four remaining communist states in the world (China, North Korea, Vietnam, and Cuba), the Marxist-Leninist model was less appealing than ever. The nineteen Latin American democratic states, with Cuba remaining the only nondemocratic one, each had a unique experience with a liberal transition, but the region as a whole changed from a rural peasant-agricultural society to a modern, urban, industrial, and diversified one. While it experienced improved economic conditions, better human rights records, and political liberalization after its transition from authoritarianism, Latin America was still far from stable in the early 2000s.

The gap between rich and poor was the largest in the world and still widening. Economic development was continuing at a slow pace, with major collapses in several states. Political participation and civic engagement were not entirely free; patrimonialism, cronyism, and corruption continued, with most governments closely monitoring and regulating political parties and associational life. In the view of most Latin Americans, democracy had yet to deliver on its promises, and polls indicated declining support for it. This disillusionment, exacerbated by the continued two-class system and the dire straits of the poverty-stricken masses, made a return to authoritarianism increasingly appealing to many Latin Americans and led to a revival of Marxist language, but a resurgence of communism or communist parties is highly unlikely. With globalization, new openings in free trade, and numerous successful models of liberal economic and political systems worldwide, it is unlikely that Marxism-Leninism will be revived or that even the Cuban regime will remain communist for long after the eventual passing of the resilient Fidel Castro.

Conclusion

While the turn of the nineteenth century ushered in a wave of socialist ideology that gained much momentum in the art, culture, and politics of Latin America, with the new millennium came a waning tide for socialist ideals and movements. The twentieth century witnessed varieties of communist movements in Latin America, including international Marxists, Fidelistas, guerrilla insurgents, and communist parties participating in the political process. Although democracy seems to have outlasted the alternatives, the book is not closed on the future of the partially consolidated and still transitioning democratic regimes of the region. With continued economic and political instability and an exceptionally large income gap, Latin America might be ripe for renewed Marxist appeals, as it was in the late nineteenth century. Although guerrilla insurgents and socialist parties remain and leftist coalitions may be securing power in states such as El Salvador, the future may likely see a rise in new forms of statism and authoritarianism, but a return to the failed model of Marxist-Leninism or even a resurgence of strong Marxist movements is unlikely.

See also Authoritarianism; Democracy; Dictatorship in Latin America; Marxism.

BIBLIOGRAPHY

- Alexiev, Alexander A. *Marxism and Resistance in the Third World*. Santa Monica, Calif.: Rand Corporation, 1989.
- Huntington, Samuel P. *The Third Wave: Democratization in the Late Twentieth Century*. Norman: University of Oklahoma Press, 1991.
- Kryzaneck, Michael J. *U.S.–Latin American Relations*. Westport, Conn.: Praeger, 1996.
- Löwy, Michael, ed. *Marxism in Latin America from 1909 to the Present: An Anthology*. Atlantic Highlands, N.J.: Humanities Press, 1992.
- Wiarda, Howard J. *Comparative Democracy and Democratization*. Fort Worth, Tex.: Harcourt College Publishers, 2002.
- Wiarda, Howard J., and Harvey F. Kline, eds. *Latin American Politics and Development*. Boulder, Colo.: Westview, 2000.

Howard J. Wiarda
Esther M. Skelley

COMMUNITARIANISM IN AFRICAN THOUGHT.

This essay explores representative Africanist thought on personhood and community, highlighting especially the debate between Ifeanyi Menkiti and Kwame Gyekye on communitarianism, defined generally as relating to social organization in small, cooperative, partially collectivist communities. The general debate on these issues in Africa can be traced to important studies of personhood and psychology in African life and thought championed by French ethnologists and British and American social anthropologists as well as African scholars in different fields. The groundbreaking work, *La notion de personne en Afrique noire*, edited by Germaine Dieterlen (1973), which grew out of the French ethnological tradition, inaugurated a vigorous debate on personhood that has bearing on questions of individualism and communitarianism. In his insightful 1986 essay, “The Person and the Life Cycle in African Social Life and Thought,” Paul Riesman explored Africanist literature relevant to personhood, individuality, and community. Riesman argued that the Marcel Griaule school developed interest in personhood and community and that scholars such as Griaule and Dieterlen underscored concepts of individuality and community. In British social anthropology, Meyer Fortes grounded his studies of personhood in customs, behavior, and personality. Other scholars focused on the powers of a person’s obligations and social roles as well as on conflicts, legal systems, and individual responsibility.

The 1987 Uppsala symposium “African Folk Models and Their Application” also addressed personhood and personal experiences. Introducing the book published after this conference, Ivan Karp argued: “Quite simply, persons sometimes experience themselves in a human way, sometimes in a Lockean way, and sometimes, as in the case of positivist social scientists, as Kantian transcendentalists. However, these modalities of experience should not be reified and then debated as competing epistemologies. Rather they should be seen as descriptive of the varying ways human beings experience the world according to widely varying needs and interests” (Jackson and Karp, p. 17). Victor Turner’s studies also called attention to individuality. Jean Comaroff argued that there was widespread

conception of an “essence” of the person, whose soul was not a privatized interiority but a being-in-the-world. Ellen Corin argued that societies do not always overshadow individuals because certain modalities allowed an individual to particularize to defend himself or herself from “‘collectivizing’ pressure of the clanic image” (p. 146). Michael Jackson also highlighted individuality in the phenomenological approaches, and V. Y. Mudimbe approached the subject from the viewpoint of inequality of power.

Since 1950 the Africanists Elinore Bowen, Mary Smith, Sarah LeVine, and Marjorie Shostak have articulated personhood, individuality, self-consciousness, and self-identity in community. Philosophers Ifeanyi Menkiti of Nigeria and Kwame Gyekye of Ghana have brought the debate into sharp relief by articulating positions on individualism and communitarianism. Menkiti has articulated a communitarian ethos, while Gyekye has defended a balanced perspective, which he calls moderate communitarianism. Gyekye has pointed out that the debate on individualism and the community in Africa affects the way people think of philosophical and moral issues. Philosophically, the debate probes whether an individual stands on his or her own and does not depend on the community or the individual is naturally embedded in social relations and a community. The moral concerns explore whether individual rights are primary and cannot be violated for any reason or people should instead pursue the common good.

Menkiti on Communitarianism

In “Person and Community in African Traditional Thought” (1984), Menkiti argued that, in Africa, the community had priority over the individual. He distinguished between Western views, which generally hold that a person is a lone individual, and African views, in which a person is defined “by reference to the enviroing community,” quoting John Mbiti’s statement, “I am because we are, and since we are, therefore I am,” to support his thesis (p. 171). According to Menkiti, “as far as Africans are concerned, the reality of the communal world takes precedence over the reality of individual life histories” (p. 171). Thus the communal ethos has ontological and epistemological precedence. Menkiti also defended the communitarian view on biological and social grounds because the individual comes from a common gene pool and belongs to a linguistic community: “Just as the navel points men to umbilical linkage with generations preceding them, so also does language and its associated social rules point them to a mental commonwealth with others whose life histories encompass the past, present, and future” (p. 172). Menkiti stated emphatically that personhood is defined by community and not by qualities such as rationality, will, or memory.

Menkiti underscored his views of personhood by affirming a *processual*, or procedural, mode of being in African thought in which an individual becomes a person through social and ritual incorporation. Menkiti conflates the facticity of personhood with quality. He does this by distinguishing between *muntu mutupu* (a man of middling importance) and *muntu mukulumpe* (a powerful man, a man with a great deal of force). It is not clear why both persons cannot hold the status of “person,” even though one is “middling” and the other is already great. Menkiti

rejects the Western minimalist definition of a person, “whoever has a soul, or rationality, or will, or memory; the African view is ‘maximal.’” Menkiti uses the word *maximal* to indicate that the African view of personhood includes other criteria and is not limited to soul, rationality, or will. Since personhood is achieved, not endowed, in Africa, one could fail at achieving it. There are rules governing social rituals of incorporation that are designed to help the individual attain selfhood. The older an individual becomes, the more of a person that individual becomes. Menkiti quoted an Igbo proverb, “What an old man sees sitting down, a young man cannot see standing up,” to support his claim that personhood is a quality acquired as one gets older. While this proverb hints at differences of perspective between older and younger individuals, it is not implicit that personhood is an acquired quality. Opponents might agree with Menkiti that a youth has a different point of view from that of an older individual but might also affirm, in contrast with Menkiti’s views, that both are persons.

Menkiti defended the communitarian ethos by arguing that people use the neuter pronoun *it* to refer to a child rather than the personal pronouns *him* or *her* because the child has not yet attained personhood. He also stated that when a child dies, the funeral ceremonies are brief. However, when an older person dies, elaborate funeral celebrations take place because the older individual has achieved personhood and has now become an ancestor who lives among the people. In general, when one dies, he or she ceases to be a person. At the beginning of life, an individual who has no name will work toward personhood, and at the end of life, that individual loses personhood because he or she has departed for the next world. The departed ones may be referred to with the neuter pronoun *it* because their contact with the human community has been severed.

Thus it is clear that people at both ends of life are not persons because the young have yet to attain personhood while the dead have completed their development. “It is the carrying out . . . [of] obligations that transforms one from the “it”-status of early childhood, marked by an absence of moral function, into the person-status of later years, marked by a widened maturity of ethical sense—an ethical maturity without which personhood is conceived as eluding one” (Menkiti, p. 176). Meyer Fortes also argued that, among the Tallensi, “No one can be certainly known to have been a full human person until he is shown, at the time of his death, to have been slain by his ancestors and therefore to deserve a proper funeral” (1987, p. 257).

But Menkiti’s view that brief mourning periods indicate the degree of personhood of the deceased is contested. Elias Bongmba has argued that funeral rites of children among the Wimbun are brief and sad for reasons that do not reflect a child’s status as a person but because the Wimbun people mourn the fact that the young person has not lived life fully. They take personhood for granted but consider the death of a young person *rkwi bipsi shu*, meaning “death that has spoiled the mouth.” This means that the death of a young person shocks and numbs the appetite for food or drink, which people consume when an elderly person dies (Bongmba).

Menkiti cited John Rawls, who argued that justice is owed a moral personality, “a potentiality that is ordinarily realized in due course,” to support his claims that individuals acquire personhood as they carry out their obligations (Rawls, pp. 505–506). However, one could argue that Rawls emphasized moral potential and not personality. Whereas for Menkiti personhood is acquired when one develops and carries out moral acts, Rawls’s position is that an individual who is already a person has the potential of becoming a moral person. Menkiti rejected Jean-Paul Sartre’s definition of individualism because it stipulated unconditioned freedom and choice, which Sartre assumed was available to all. The African view is that such an idea of freedom is wrong because it ignores the community, which plays an important role in the life of the individual. According to the Africanist view, Sartre was wrong to place children and adults on the same level of choice. Finally, Menkiti rejected Western views that the community is a collectivity of self-interested individuals. This makes the community an aggregation of separate individuals. In Mbiti’s phrase “I am because we are,” the “we” is not additive “but a thoroughly fused collective we” (Menkiti, p. 179). African societies thus emphasize duty, while Western societies emphasize rights.

Gyekye on Moderate Communitarianism

Gyekye has argued that Menkiti overstated claims and that his views are misleading. Other factors, such as rationality, virtue, evaluation of moral judgments, and choice are important in determining personhood in Africa. People are born into community and have an orientation toward others. The Akan proverb, “A person is not a palm tree to survive alone,” summarizes human interdependence. Individual capacities, talents, dispositions, goals, and needs are met in interaction with others in society. Gyekye has also argued that it is a mistake to conclude that there are no individual dimensions to personhood in Africa. He cites another Akan proverb in which the view that individuals exist prior to community is implicit: “One tree does not make a forest.” “Community existentially derives from the individual and the relationships that would exist between them” (Gyekye, p. 38). Thus the reality of the community is derivative, not primary, and individuals choose whether they want to belong to a community or not. The community allows an individual to actualize his or her potential and develop personality in the social world without destroying his or her own will.

Gyekye quoted another Akan proverb to support his views of individuality. “A clan is like a cluster of trees which, when seen from afar, appear huddled together, but which would seem to stand individually when closely approached.” Two other Akan proverbs underscore individuality: “One does not fan [the hot food] that another may eat,” and “The lizard does not eat pepper for the frog to sweat.” Individuals have particular attributes, which they often exercise in contrast to the community. In opposition to Menkiti’s position that one earns personhood, Gyekye has argued that the term *person* is ambiguous. For example, what is implied in the expression *onye onipa*—“He is not a person”—is that the person does not display the norms of human behavior such as kindness, generosity, compassion, benevolence, and respect for other people. The Akan also say of someone, “He is a person,” meaning the

person fulfills his or her obligations. Personhood also involves responsible action that leads to success.

Exercising one's potential cannot be seen as the process of becoming a person in the sense in which Menkiti describes it. Individuals have a rational, moral sense and a capacity for virtue and judgment that the community nurtures. Individuals can also question what they do not agree with. Individuals are self-directing and self-determining and for that reason possess autonomy. Individual autonomy should not be equated with morality; instead, a moral agent must have the capacity to distinguish between good and evil. Although there is no conceptual link between autonomy and morality, there is a link between autonomy and freedom. Actions that result from a person's vision (visionary acts) concretize individuality because visionaries are always ahead of the public. Individuals who have visions can come up with innovative things to do even though such innovation might draw from the past history and narrative of the community.

Gyekye also has advocated moderate communitarianism because communities are more than associations of individuals; communities share values and obligations, and members of the community often express a desire to promote communal interests. Thus members of the community often invest intellectual, ideological, and emotional attachment to the community and engage in reciprocal social relations within the family, clan, village, ethnic group, neighborhood, city, and nation. Community, in this sense, refers to a cultural community, one that shares values and practices, not simply to a language group. The idea of community implies a common good, which is not merely the combination of individual interests but shared values, working together to meet the necessities of life and a common humanity, and not merely a surrogate of total individual goods. Thus "the common good" refers to all the values a community shares: peace, freedom, respect, dignity, security, and satisfaction.

Gyekye has argued that Western communitarians like Alasdair MacIntyre and Michael Sandel, who argue that individuals are only part of a community because they inherit their narratives from the community in which they are embedded, have overstated their case. One may indeed start from a certain narrative, but the fact that one can also reject sections of the narrative or practice one finds immoral is an indication that an individual person is not entirely constituted by the social. Radical communitarians thus exaggerate the impact of history and communal structures on individual autonomy. Furthermore, communitarians have rejected the construction of political thought solely from a foundation of individual rights. According to MacIntyre, "the truth is plain: there are no such rights, and belief in them is one with the belief in witches and in unicorns" (1984, p. 69). Communitarians would want to replace the politics of right with the idea of common good. By contrast, Gyekye has argued that rights are indispensable to self-assertion and the evaluative process. The idea of rights strengthens human dignity. Advocates of rights anchor their beliefs in the theistic perspective that human beings have intrinsic value because God created them.

Finally, rights can also be derived from nature because an individual has a rational faculty that allows him or her to strive

to be the best he or she can be. Therefore a community cannot disregard individual rights. Moderate communitarianism, however, is not obsessed with rights alone but also emphasizes, according to Gyekye, social values such as peace, harmony, stability, solidarity, mutuality, and reciprocity. Individual rights should be matched with responsibility. A sense of responsibility implies that supererogation is not necessary to morality, but that morality should be open, with no limits placed on individual self-sacrifice.

This view of personhood allows for consideration of, among other things, human rights in the African context. Postcolonial leaders stressed communitarian views, assuming that this kind of communal spirit would easily translate into the more complex needs of a nation-state. Politicians were eager to champion socialism and communal essentialism, and their preference for a communitarian ethos has compromised the debate on human rights in Africa. The human rights question suggests and implies that individuals have certain rights and should therefore possess self-determination. Strengthening individuality cannot be seen then as a concession to Western values because the Western tradition also supports communitarian perspectives. Moderate communitarianism is appealing because a radical communal thesis paints only a partial portrait of the dialectic between individualism and communitarianism.

See also Africa, Idea of; Humanity: African Thought; Identity: Personal and Social Identity; Life Cycle: Overview; Person, Idea of the.

BIBLIOGRAPHY

- Bongmba, Elias Kifon. *African Witchcraft and Otherness: A Philosophical and Theological Critique of Intersubjective Relations*. Albany: State University of New York Press, 2001.
- Comaroff, Jean. *Body of Power, Spirit of Resistance: The Culture and History of a South African People*. Chicago: University of Chicago Press, 1985.
- Corin, Ellen. "Vers une réappropriation de la dimension individuelle en psychologie africaine." *Revue canadienne des études africaines* 14, no. 1 (1980): 135–156.
- Dieterlen, Germaine. *Les âmes des dogon*. Paris: Institut d'ethnologie, 1941.
- Dieterlen, Germaine, ed. *La notion de personne en Afrique noire*. Paris: Éditions du centre national de la recherche scientifique, 1973.
- Donnelly, Jack. "Human Rights and Western Liberalism." In *Human Rights in Africa: Cross-Cultural Perspectives*, edited by Abdullahi Ahmed An-Nai'im and Francis Deng. Washington, D.C.: Brookings Institution, 1990.
- Evans-Pritchard, E. E. *Witchcraft, Oracles and Magic among the Azande*. Oxford: Clarendon, 1937.
- Fortes, Meyer. *The Dynamics of Clanship among the Tallensi*. London: Oxford University Press, 1945.
- . *Religion, Morality, and the Person: Essays on Tallensi Religion*. Cambridge, U.K.: Cambridge University Press, 1987.
- . *The Web of Kinship among the Tallensi*. London: Oxford University Press, 1949.
- Gluckman, Max, ed. *The Allocation of Responsibility*. Manchester, U.K.: Manchester University Press, 1972.
- Griaule, Marcel. *Dieu d'eau: Entretiens avec Ogotemmêli*. Paris: Éditions du Chêne, 1948.

- Gyekye, Kwame. *Tradition and Modernity: Philosophical Reflections on the African Experience*. New York: Oxford University Press, 1997.
- Hallen, Barry, and J. O. Sodipo. *Knowledge, Belief, and Witchcraft: Analytic Experiments in African Philosophy*. London: Ethnographica, 1986.
- Jackson, Michael, and Ivan Karp, eds. *Personhood and Agency: The Experience of Self and Other in African Cultures*. Washington, D.C.: Smithsonian Institution Press, 1990.
- Jacobson-Widding, Anita. "The Shadow as an Expression of Individuality in Congolese Conceptions of Personhood." In *Personhood and Agency: The Experience of Self and Other in African Cultures*, edited by Michael Jackson and Ivan Karp, 31–58. Washington, D.C.: Smithsonian Institution Press, 1990.
- LeVine, Sarah. *Mothers and Wives: Gusi Women of East Africa*. Chicago: University of Chicago Press, 1979.
- MacIntyre, Alasdair. *After Virtue: A Study in Moral Theory*. Notre Dame, Ind.: University of Notre Dame Press, 1984.
- . *Whose Justice? Which Rationality?* Notre Dame, Ind.: University of Notre Dame Press, 1988.
- Menkiti, Ifeanyi A. "Person and Community in African Traditional Thought." In *African Philosophy, an Introduction*, edited by Richard Wright, 171–182. Lanham, Md.: University Press of America, 1984.
- Rawls, John. *A Theory of Justice*. Cambridge, Mass.: Harvard University Press, 1971.
- Riesman, Paul. *Freedom in Fulani Social Life: An Introspective Ethnography*. Translated by Martha Fuller. Chicago: University of Chicago Press, 1977.
- . "The Person and the Life Cycle in African Social Life and Thought." *African Studies Review* 29, no. 3 (June 1986): 71–138.
- Senghor, Léopold S. *On African Socialism*. Translated by Mercer Cook. New York: Praeger, 1964.
- Shostak, Marjorie. *Nisa: The Life and Words of a Kung Woman*. Cambridge, Mass.: Harvard University Press, 1981.
- Smith, Mary. *Baba of Karo [Kro]*. Introduction and notes by M. G. Smith. New York: Philosophical Library, 1955.
- Turner, Victor. *The Forest of Symbols: Aspects of Ndembu Ritual*. Ithaca, N.Y.: Cornell University Press, 1957.
- Wiredu, Kwasi. *Cultural Universals and Particulars: An African Perspective*. Bloomington: Indiana University Press, 1996.
- . "Person and Community in Akan Thought." In *Person and Community*, edited by Kwasi Wiredu and Kwame Gyekye. Washington, D.C.: Council for Research in Values and Philosophy, 1992.
- Wiredu, Kwasi, and Kwame Gyekye, eds. *Person and Community*. Washington, D.C.: Council for Research in Values and Philosophy, 1992.

Elias K. Bongmba

COMMUNITY. See **Society**.

COMPLEMENTARITY. See **Quantum**.

COMPOSITION, MUSICAL. The term *composition* (from the Latin *com*, together, and *ponere*, to put) is commonly applied in Western music to a notated work, and

in non-Western systems to a consistently united progression or organization of sounds. Although Western music compositions have been defined by their narrative structure (i.e., progression toward a climax, etc.) a more accurate definition, encompassing modern Western experimental music and much non-Western music, is that of music composition as an alteration of a listener's "normal" acoustic environment through the creation of an artificially created acoustic environment by the joint activities of a composer and performer—movement through time rather than specifically narrative. In the field of music perception, composition is described scientifically, as a combination of linguistic elements (grammar, syntax, communication), the brain's bias toward finding pattern and regularity, and psychoacoustic factors (the physical limitations of the human senses). The details of this article on music composition will largely focus on Western classical music, but as necessary with such a wide-ranging term, other countries and styles are included in a limited form as well.

Cultural Roles

Music compositions are not constructed in a vacuum, but fill a cultural role in society. Composers provide music for many activities, including entertainment, social ritual, religious enlightenment, educational study, accompaniment to drama, and healing, both emotional and physical. These artificial social divisions are of course not inflexible, as music written for entertainment can be used in a learning environment and religious music has entered the concert hall. Entertainment music includes the immense diversity of Western art music composed for the concert performance, from Gustav Mahler's (1860–1911) *Symphony of a Thousand* to John Cage's short silent work *4'33"*, and also incorporates the many uses of background music. Music compositions used for religious purposes are diverse, including chant from all religions (most without attribution), hymns, spirituals (also without attribution), complex polyphony for Christian services, both Catholic and Protestant, and the mbira compositions improvised upon by Shona performers to aid in spirit possession ceremonies, or *bira*. Educational music is seldom attributed to specific composers, despite its universal nature and scope—from nursery chants and simple teaching songs to the extensive historical sagas found in eastern Europe consisting of thousands of stanzas. Music for drama is subsidiary to text and plot, and includes incidental music for plays, Broadway show tunes, opera, and Japanese Noh theater. Composition is often altered through improvisation during performances of folk music, jazz, many types of non-Western music, and Western art music of the Baroque and Classical periods.

Composers have a societal function as well. In many eras and cultures, composers have a well-defined job—providing music to those who can pay within the limitations set by the occasion. The importance of a composer's work, however, is directly dependent on the distinction between composer and performer, so in cultures that focus on improvisation, composers have little to no place. For example, in religious chant and much folk music, composers are unspecified and therefore receive no recognition. In the twenty-first century, however, composers have a clear and important place in Western

society—Beethoven’s name makes the comic pages in *Peanuts*, and Mozart is the subject of the award-winning movie and musical *Amadeus*.

Despite the common perception that musical skill or talent is the major factor in their success, composers have attained high positions as artists because of social factors such as rank, race, political connections, heredity, and gender. Until the twentieth century, for example, women were not accepted as major composers of Western art music. In south India, the Brahman caste is traditionally associated with music. Composers’ financial status in the West is determined by payments from performers and organizations for new works, sales of music of existing works and fees from concert performances, and royalties from recordings and broadcasts on radio. Composers also teach and perform music—passing on the ability to compose and perform their works to the next generation.

Changing Definitions

The transformation of the definition of composition can be seen through a study of changes in music over time. Although musical composition was obviously a part of earlier Greek, Egyptian, and Roman society, based on evidence from the visual arts and literature, the lack of musical notation makes it impossible to reconstruct the works, as only texts survive to earlier compositions. The earliest pitch notation in Western compositions is found in the eighth century, in notation for Gregorian chant. Gregorian chant, however, did not have composer attribution; Pope Gregory I (r. 590–604) received it from heaven, according to legend. As the medieval period drew to a close, composer’s names became attached to works and compositions became more elaborate, incorporating greater rhythmic complexity (syncopation, hocket, meter changes) and harmonic subtlety (use of modes, polyphony, use of *cantus firmus*, greater use of triads, thirds, and dissonance).

In late-medieval and Renaissance music (1500–1650) compositional rules and techniques became codified. The enormous outpouring of musical composition based on these rules included lively dance works, simple songs, and complex vocal works organized by strict pitch rules (counterpoint). Renaissance composers such as Josquin des Prez (c. 1440–1521) and Giovanni da Palestrina (c. 1525–1594) were respected members of the art world of the Renaissance just as their counterparts Shakespeare, Rembrandt, and Leonardo da Vinci were. As a reaction to the complexity of music from the high Renaissance, works in the Baroque period (1600–1750), such as Claudio Monteverdi’s (1567–1643) *Orfeo* (1607), focused on the relative simplicity of solo lines accompanied by clearly stated harmonic progressions. These harmonies were delineated by realizations of a “figured bass” by two instruments, one low melodic instrument (cello, trombone, bassoon) playing the bass line, and the other chordal instrument (harpsichord, guitar, lute, harp, organ) presenting harmonic realizations. This method of composition—open for improvisation in the harmony part and closely linked to the emotions of a specific text—was so controversial it became known as the “second practice.” Balancing the freedom and textual expression of the early Baroque with tightly structured counterpoint was an achievement of late Baroque (1700–1750) composers such as

Johann Sebastian Bach (1685–1750) and George Frideric Handel (1685–1759).

In the Classical period (1750–1820), Wolfgang Amadeus Mozart (1756–1791) and Franz Joseph Haydn (1732–1809) explored abstraction and the expression of Enlightenment ideals in music through a combination of carefully balanced structures with graceful expression. Ludwig van Beethoven’s (1770–1827) early works are in the simpler, balanced style of the Classical period, but the power, intensity, emotionalism, and unconstrained attitude toward Classical-era forms place much of his work closer to the Romantic style. Extramusical inspirations from such sources as patriotic fervor, literature, and the visual arts became tools for Romantic period (1820–1900) composers to use in mining emotional depths. They sought extremes in emotions expressed through extended dissonances, and unique structures such as the tone poem.

Tonality was still used in a large part of music in the Modern epoch; as the basis of pop, rock, film, and jazz music as well as many works of Western art music by composers such as Aaron Copland (1900–1990), Leonard Bernstein (1918–1990), Dmitry Shostakovich (1906–1975), Sergey Prokofiev (1891–1953), and Igor Stravinsky (1882–1971). Those composers using tonality in the twentieth century, however, did so with a strong awareness of historical precedent. In the late Romantic–early Modern environment, tonality had become so extended as to seem, to Arnold Schoenberg (1874–1951) and his students Alban Berg (1885–1935) and Anton Webern (1883–1945), irrelevant as an organizational system, especially in the explorations of atonality. In Schoenberg’s alternative to tonality, serialism, each piece begins with a series—a group of equally important tones. This system, dependent on mathematics and democracy instead of tonality’s traditions and hierarchy, was a complete break with part pitch organization and musical traditions. Serialism became one of the predominant compositional forces of the twentieth century, expanded after World War II to include the organization of rhythms, dynamics, and note length as well and as reviled by audiences as it was embraced in academic environments. The twentieth century also fostered a strong community of compositional rebels, including Charles Ives (1874–1954) and John Cage (1912–1992), as composers experimented with unusual combinations of sounds, extended silences, and chance procedures as compositional tools.

Throughout the twentieth century and continuing in the twenty-first century, the music world has splintered into factions with contradictory compositional outlooks. Although Western music focuses largely on pitch distinctions, as seen above, distinguishing features of compositions can vary. In other cultures, folk, pop, and jazz, text changes, phrase alterations, or changes in usage also can be seen as defining features for distinguishing individual compositions.

Conclusion

Musical compositions all have a common foundation—the acoustic and physiological realities of the human body. Composers combine these physical realities with an awareness of the sociocultural context and the emotional and aesthetic

ramifications of patterns, acoustics, and language. The inability of defining such a complex process, a delicate balancing act between the physical, emotional, spiritual, and intellectual is at the heart of Frederic Rzewski's description of composition as seen by a composer: "Composition is a constant search for reproducible patterns in the sound-universe and for rational symbols to describe them. It is a mystery how deep unconscious processes can somehow be expressed in a symbolic form, which makes them comprehensible to other minds" (Lecture at the Hochschule der Künste Berlin, 21 June 1994).

See also *Absolute Music; Music, Anthropology of; Musical Performance and Audiences; Musicology*.

BIBLIOGRAPHY

- Becker, Howard S. *Art Worlds*. Berkeley: University of California Press, 1982.
- Berry, Wallace. *Structural Functions in Music*. Englewood Cliffs, N.J.: Prentice-Hall, 1976.
- Hindemith, Paul. *The Craft of Musical Composition*. Vol. 1. New York: Associated Music, 1945.
- Kerman, Joseph. *Contemplating Music: Challenges to Musicology*. Cambridge, Mass.: Harvard University Press, 1985.
- Kunst, Jos. *Making Sense in Music: An Enquiry into the Formal Pragmatics of Art*. Ghent, Belgium: Communication and Cognition XVI, 1978.
- Shelemay, Kay Kaufman, ed. *Ethnomusicology: History, Definition, and Scope*. Garland, 1992.

Kathryn Pisaro

COMPUTER SCIENCE. Computer science is often defined as "the systematic study of algorithmic processes, their theory, design, analysis, implementation and application." An algorithm is a precise method usable by a computer for the solution of a problem. The term *algorithm* comes from the last name of a Persian author, Abu Ja'far Mohammed ibn Musa al Khwarizmi (c. 825 C.E.), who wrote an early textbook on mathematics. Some computer scientists study broad classes of algorithms, while others study algorithms for a specific task. Algorithms must be written down in some notation. Often the notation used is a programming language, as algorithms written in a programming language can be transformed and executed on a digital computer. Such algorithms are called computer software. Computer science is also concerned with large software systems, collections of thousands of algorithms, whose combination produces a significantly complex application. For these systems new issues become prominent: reliability, security, dependability, scalability, and modifiability of both the computer software and hardware. Another aspect of computer science is the impact it has had on other disciplines. Computer science "thinking," namely the modeling of processes by algorithms, has had a major impact on researchers in other fields.

Early History

The field called computer science was born in the 1940s, though its roots extend back to the nineteenth century and even earlier. One of the early founders of the field was Alan

Turing (1912–1954), a citizen of Great Britain, who in 1937 published his famous paper entitled "On Computable Numbers with an Application to the Entscheidungsproblem." In this paper he introduced the concept of an abstract computing device, later dubbed a Turing machine. It was precisely the simplicity of his model that permitted scientists to ask, and answer, fundamental questions about the nature of computation. Any computer can be simulated by a Turing machine, and the converse is also true. Moreover, the complexity of Turing machine computations yields insights into the efficiency of computations on real computers. Two other famous mathematical logicians who made early contributions to computer science were Alonzo Church (1903–1995) and Kurt Gödel (1906–1978). Church developed a system called the lambda calculus, which makes possible logically precise expressions of mathematical propositions. The lambda calculus proved to be a model for functional programming, and the popular LISP programming language used the lambda calculus as its theoretical base. Of equal import was the so-called Church thesis, which states that every effectively calculable number-theoretic function is lambda-definable. The importance of this result is that it ties numerical computation to string manipulation, an initially surprising result. Kurt Gödel is best known for his proof of "Gödel's Incompleteness Theorems." As early as 1931 he proved fundamental results about axiomatic systems, showing that in any axiomatic mathematical system there are propositions that cannot be proved or disproved within the axioms of the system. In particular the consistency of the axioms cannot be proved.

Computer science was not founded solely by mathematicians. An equally important group was electrical engineers, who focused on actually building a computing machine. World War II identified and spurred a need for computing devices, machines that could help carry on the mechanics of war. Enlisted into this cause were some of the greatest scientists of the day. One of these was Howard Aiken (1900–1973), who in 1944 built the Automatic Sequence Control Calculator (Mark I) at Harvard University. Another groundbreaking effort was the development of the ENIAC computer by John Mauchly and John Presper Eckert at the Moore School of Electrical Engineering of the University of Pennsylvania. Mauchly and Eckert were in turn influenced by John Vincent Atanasoff (1903–1995), who is now widely recognized as the inventor of the world's first electronic computer, the so-called Atanasoff-Berry computer (ABC machine). The ABC machine employed all of the basic units of a modern digital computer, including binary arithmetic, a separate arithmetic unit, and vacuum tubes for emulating logical switching circuits such as adders. The mathematician-turned-computer-scientist John von Neumann (1903–1957) worked closely with Mauchly and Eckert, and among many results he is usually credited with the idea of the stored program computer, the idea that a computer would contain within it both a program for processing the data as well as the data itself.

Computer Science Chronology

During the early period (1950s–1960s), a great deal of computer science work focused on understanding and refining

essential elements of a computer system. Operating-systems software was developed to facilitate the control of the functional units of a computer: the processor and the input and output devices. Programming languages were devised so programmers could more easily express the computations they wished to accomplish. FORTRAN (Formula Translation), developed by John Backus and a team at IBM around 1954, was the first popular, high-level programming language. Its focus was on efficient numerical calculation. LISP (LISt Processor), developed by John McCarthy at MIT around 1956, focused on symbolic programming. Both languages had major impacts and, though less popular, were still in use in the early twenty-first century.

The study of algorithms. As the definition of computer science is the systematic study of algorithms, it is not surprising that the decade of the 1970s was a period when the study of algorithms was dominant. One aspect of this research was the development of a theory of algorithms. Building on the theories of Church and Turing, computer scientists asked questions such as “Is there an algorithm for any Turing machine such that it decides whether or not the machine eventually stops if it is started in some initial state?” This is termed the Halting Problem. The Halting Problem has been shown to be unsolvable. Another aspect of the theory of algorithms has to do with problem reducibility. For example, it has been shown that if an algorithm did exist for the Halting Problem, then it would be possible to solve Hilbert’s “tenth problem”—namely, given a Diophantine equation, determine a procedure that decides in a finite number of steps if the equation has an integer solution. Computer scientists have shown that Hilbert’s problem is reducible to the Halting Problem and is therefore unsolvable.

A second aspect of algorithm studies concerns the development of new algorithmic solutions for specific problems. Topics such as sorting, searching, and graph theory were closely studied from an algorithmic point of view. Many new and efficient algorithms for these topics have been produced—for example, Hoare’s Quicksort algorithm for sorting, hashing as a technique for searching, and Tarjan’s algorithm for determining graph planarity, to name just a few. As the search for new algorithms proceeded, new techniques for analyzing the performance of these algorithms were developed. Methodologically, worst-case, best-case, and average-case analysis have become standard questions to address when presenting an algorithm. There are standard mathematical notations for presenting these results. Algorithm design techniques were identified, for example, divide-and-conquer, depth-first search, greedy method, and dynamic programming.

No discussion of computer science would be complete without a discussion of its most famous problem, “Does $P = NP$?” P is the set of problems that can be solved in deterministic polynomial time. That means that for a problem with inputs of size N , there must be some way to solve the problem in $F(N)$ steps for some polynomial F . F can be any polynomial, even N to a very high power. For example, sorting a set of N numbers can be done in polynomial time. This problem is in the set P . NP is the set of problems one can solve in

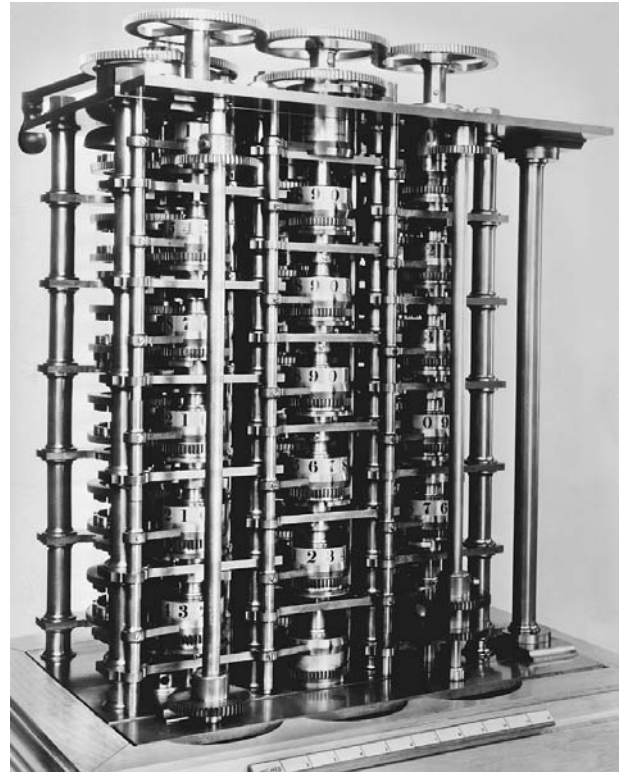

Difference Engine No. 1, a differential calculating machine invented by Charles Babbage (1792–1871). In the early nineteenth century, British mathematician Babbage constructed machines to perform basic numerical computations. True computer science, however, did not exist until the mid-twentieth century. © BETTMANN/CORBIS

nondeterministic polynomial time. That means for a problem with inputs of size N , there must be some way to solve the problem in $F(N)$ steps for some polynomial F just as before. In NP , however, the program is allowed to make lucky guesses, though it must prove the solution is correct. Many problems are in NP —for example, the traveling salesman, finding a Hamiltonian cycle, satisfiability of propositional expressions, finding a maximum clique, integer knapsack problem, and the optimal scheduling problem.

All problems in P are also in NP . You do not need to use nondeterministic guesses in an NP program if you do not want to. But does $P = NP$? This problem was first posed by Steven Cook (1971). No one has ever proven that they are equal and no one has ever proven they are not. But despite this failure, the “ $P = NP$?” problem has contributed a great deal to our understanding of algorithms. This has come about because computer scientists have been able to identify a large class of problems, all of which are reducible to each other, that is, solving one of these problems will immediately lead to a solution for the others. This class is called the NP -complete problems. The fact that NP -complete problems are (intuitively) the most difficult in NP follows from the fact that we may prove P equals NP if and only if some NP -complete problem has a polynomial-time algorithm. In his original formulation of the “ $P = NP$?”

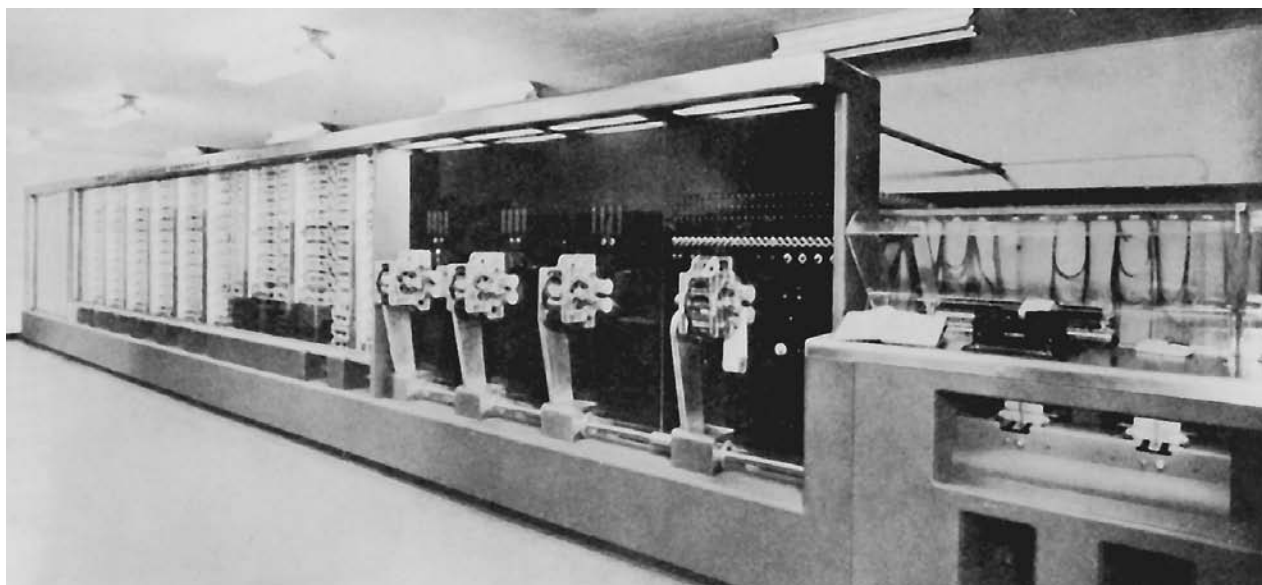

Mark I computer, built in 1944 by Howard Aiken (1900–1973). Aiken's calculator replaced mechanical components with electromagnetic ones and responded to instructions it was fed from punched cards. Aiken later introduced a computer science program to Harvard University, the first of its kind. THE LIBRARY OF CONGRESS

problem, Cook showed that the satisfiability problem (find an assignment of values to Boolean variables in a logical statement to make it true) was a member of the NP-complete problems (this is called Cook's Theorem). However, despite many efforts, no one has ever shown that an NP-complete problem is also in P. Because no one has found such an example, many researchers believe that P is not equal to NP. And yet computer science is relatively new, and lots of other difficult problems have remained unsolved for centuries before someone came up with a solution, so perhaps this one just needs more time.

Artificial intelligence. The 1980s saw a great deal of work in the field of artificial intelligence (AI). AI is the subfield of computer science that is concerned with the computational understanding of intelligent behavior and with the creation of systems that produce such behaviors. One approach has been to develop computer programs that mimic the way humans behave. A second approach is to produce a computational model of some intelligent behavior, regardless of whether the model imitates human processes or not. One of the earliest examples of the latter approach was James Slagle's SAINT program for performing symbolic integration at the level of a college freshman. AI researchers early on emphasized heuristics as a problem-solving approach. Heuristics differ from algorithms in that they may not converge (or produce) the correct or exact answer, but experience shows that they often produce acceptable answers. For example, computers that play chess must evaluate the worth of their position at every step. Since it is computationally infeasible to work out the worth of all of the possible moves, researchers have developed heuristics that return a numerical assessment of the worth of a future move.

Returning to Alan Turing, in an article he published in 1950 he described a game in which a human interrogator

attempts to determine, solely on the basis of a written interrogation, whether the identity of the "person" answering his questions is in fact a person or a computer. This has come to be known as the Turing test. This challenge inspired a great deal of AI research. Of special mention is the ELIZA program developed by Joseph Weizenbaum, which appears to emulate a nondirective therapist. If the person being interrogated says "I am very happy," ELIZA might respond with "Why are you very happy?" and so it goes. Other researchers attempted to develop computer programs that would exhibit behaviors that were believed to be signs of human intelligence. Playing chess or proving mathematical theorems were two such areas of intense study. There are many subareas of artificial intelligence, including natural language understanding, general problem solving, knowledge representation and reasoning, learning, machine vision, robotics, and autonomous agents.

Personal computers and the Internet. An important phenomenon of the 1980s was the success of industry in producing a low-cost, miniaturized computer processor. This brought about the personal computer. Initially these machines might include 640,000 bytes of memory, no disk (only a floppy drive), and a processor whose speed might be 1 KHz (kilohertz) or less. The cost of such a machine was approximately \$5,000. As technology improved, prices steadily dropped while capabilities were enhanced, and computers moved from the exclusive domain of the government and large corporations into the home and small business arena. A personal computer in 2004 might have 1 billion bytes of memory, a disk with a capacity of 100 gigabytes, and a processor whose speed is 10 MHz (megahertz) and might cost less than \$2,000. Word processing and accounting (spreadsheets) became dominant applications. But this had little effect on computer science per se.

SOME EXAMPLES OF COMPUTER SCIENCE MERGING WITH OTHER FIELDS

Library science, which is concerned with the archiving of texts into digital libraries so the information can be efficiently and accurately retrieved. With the advent of the Internet, digital libraries are causing major changes to the traditional bricks-and-mortar library.

Management science, which is concerned with the development of computer models to help businesses perform their planning and forecasting functions. It also uses computer databases to store business transactions and to mine those transactions to better understand the critical elements of the company.

Economics, which uses computer models to forecast economic conditions and to evaluate the effects of varying strategies.

Medicine and biology, which use computer models to diagnose and treat disease. Modern imaging methods such as magnetic resonance imaging (MRI) critically rely on computers, graphics algorithms, and software.

Psychology and cognitive science, which are concerned with understanding human thought and emotion. Computer models are used to gain insight into the operation of the human mind and nervous system.

Linguistics, which is concerned with the use of computers for speech recognition and synthesis and for machine translation between languages.

In the 1990s research that had started back in 1969 with the U.S. Department of Defense, and that led to the digital network of computers called the ARPAnet, became accessible to everyone as the Internet. Research on packet switching and network protocols led to the development of TCP/IP (transmission control protocol/Internet protocol), the standard that now enables any pair of connected computers to communicate. As the number of Internet users grew, computer scientists began to study how best to exchange information between them. This culminated in the development of the World Wide Web by Tim Berners-Lee (c. 1990).

In the early twenty-first century new issues challenged computer researchers. People studied how digital sensors by the thousands can be coordinated to do things like predict the weather. Others developed methods for connecting thousands of idle personal computers together to work on a single problem (GRID computing). And simulations of physical processes down to the atomic level could be achieved, as digital computer speeds reached Teraflop level (a thousand billion instructions per second).

Basic Methodologies of the Field

The digital computer is the center of computer science. Abstract models are developed in the hope of capturing essential elements, but the models need sufficient accuracy so conclusions reflect what will actually occur on a real digital computer. Algorithmic thinking requires one to express solutions to problems as a sequence of steps, each one sufficiently precise

that it could be translated into the elemental steps of a digital computer, and then to analyze the efficiency of these steps.

Another fundamental mode of thinking for a computer scientist is representation—namely, the way in which data is stored so that algorithms making use of the data will compute efficiently. For example, a phone book is organized alphabetically so we can easily locate a person's phone number if we know his or her name. On the other hand, if we know a phone number and want to know the name of the person who has that number, the phone book is useless. Organizing the data so questions can be answered efficiently is the end goal of data representation. Representation does not only refer to ways to organize data but also ways to encode data. For example, how does one represent a mathematical expression that needs to be differentiated or integrated, or how should one encode speech, sound, or a movie so that it is compact yet is able to be faithfully rendered? Compression algorithms have succeeded in reducing the size of popular songs to approximately 3 megabytes (3 million characters), but a full-length feature movie, using the best encoding scheme of the day, requires approximately 1,000 megabytes. The former can be transferred across the Internet in a matter of minutes, while the latter requires several hours or more. Computer scientists are researching both sides of the problem, studying how to increase the bandwidth of the network while also improving the degree to which compression algorithms work.

Computer scientists have differing approaches to problems. Theoreticians aim to bring order to rapidly emerging subfields.

They attempt to develop models or analytic methods to help understand what is going on. In some computer science areas formal models exist, such as automata theory, switching theory, graph theory, and formal languages. However, for some fields, such as operating systems, programming languages, and compilers, theory has had a limited impact. Experimenters build systems and then use them to test out a variety of questions. Performance analysis and comparisons of different architectures are often the results of such experimentation.

Relationships to Other Disciplines

Computer science originated within mathematics, mainly through mathematical logic, and through electrical engineering with the use of Boolean algebra and switching theory to describe electronic circuitry. Conversely, computer science has strongly influenced mathematics. In some cases computers have been used to help prove theorems. One example is the question of whether four colors are sufficient for coloring any planar map, called the Four Color problem. This problem remained unsolved for more than one hundred years until the Four Color Theorem was proven by Kenneth Appel and Wolfgang Haken in 1976. As part of the Appel-Haken proof that four colors are sufficient, they use a computer to investigate a large but finite number of potential counterexamples.

Computer science has an equally strong connection with engineering, and in many ways the connection is much stronger than with mathematics. Computers are now indispensable when it comes to designing and building any complex structure, from a skyscraper or submarine to a computer. CAD/CAM systems (computer-aided design/computer-aided manufacturing) rely on a combination of computer graphics, specialized algorithms, and a complex of supporting software to provide the engineer with a set of tools by which one can master the complexity involved.

In the late 1990s and early 2000s a new bond grew between the physical sciences and computer science. The fields of physics, chemistry, biology, geology, and astronomy posed grand challenge experiments, problems that require massive high-speed computations. Human-genome sequencing is one such problem. Biologists view DNA as an encoding of information needed to generate a unique organism. The international effort to sequence the 3 billion DNA letters in the human genome, accomplished on 14 April 2003, was considered by many to be one of the most ambitious scientific undertakings of all time. Computer science played a pivotal role. All of the sequence data generated by the Human Genome Project has been deposited into public databases and made freely available to scientists around the world. Assembling and interpreting this data has required new levels of coordination and collaboration of computer scientists and biologists to formulate the necessary computing algorithms, data-management approaches, and visualization systems. In short, high-performance computing has fundamentally changed the way biologists do science; parallel computing systems have enabled high-throughput genome analysis; and modern search engines are allowing access to unprecedented amounts of biological data.

Another grand challenge is the Human Brain Project. This is a broad-based effort involving neuroscientists and information

scientists (computer scientists, engineers, physicists, and mathematicians). The goal is to produce new digital capabilities providing a World Wide Web (WWW)-based information management system in the form of interoperable databases and associated data management tools. Tools include graphical interfaces, information retrieval and data analysis, visualization and manipulation, and biological modeling and simulation. It is expected that the neuroscience databases will be interoperable with other databases, such as genomic and protein databases. From these two examples and many more one sees that researchers from many fields are now regarding computation as a third paradigm of scientific investigation, alongside theory and experimentation.

See also *Calculation and Computation; Logic; Mathematics.*

BIBLIOGRAPHY

- Barr, Avron, and Edward A. Feigenbaum, eds. *The Handbook of Artificial Intelligence*. Vol. 4. Reading, Mass.: Addison Wesley, 1990.
- Denning, Peter J., et al. "Computing as a Discipline." *Communications of the ACM* 32, no. 1 (January 1989): 9–23.
- Denning, Peter J., and Robert M. Metcalfe, eds. *Beyond Calculation: The Next Fifty Years of Computing*. New York: Copernicus, 1997.
- Hartmanis, Juris, and Herbert Lin, eds. *Computing the Future: A Broader Agenda for Computer Science and Engineering*. Washington, D.C.: National Academy, 1992.
- Knuth, Donald E. *The Art of Computer Programming*. 3 vols. Reading, Mass.: Addison Wesley, 1997–1998.
- Ralston, Anthony, Edwin D. Reilly, and David Hemmendinger, eds. *Encyclopedia of Computer Science*. 4th ed. London: Nature Publishing Group, 2000.

Ellis Horowitz

CONFUCIANISM. The word *Confucianism* implies the existence of a philosophy, a religion, or a worldview that goes by the name. "Confucian" ideas or attributes are assumed to have roots in ancient China, to be part of the common heritage of people of Chinese ancestry in other parts of the world, and to be shared by the peoples of Korea, Japan, and Vietnam, who have been heavily influenced by Chinese culture. *Confucianism* has been used to identify an ideology of benevolent kingship used by empires to legitimize themselves in various parts of eastern Asia. It is often applied to the practice of ancestor worship or simple respect for family elders. Yet, although there was an ancient Chinese word for "scholar" (*ru*), referring to those who studied ancient texts, the term *Confucianism* has no precise equivalent in Chinese. In order to understand why so many different phenomena have gotten lumped together in this fashion, we had better start with Confucius, or "the master," whose name was Kong (551–479 B.C.E.).

Confucius

The master speaks to us in the *Lunyu* (Analects), which contains brief, disconnected sayings attributed to him, conversations he had with disciples, and additional sayings or comments by some of those disciples. The text portrays Confucius as mentor and patron to a group of younger men who

sought to serve in the government of a small state called Lu between 510 and 479 B.C.E. It is from their questions and answers that the notion of Confucian “learning” derives. Confucius describes himself simply as one who loves to learn and as a transmitter of wisdom from the ancient past. That he also learns from his students demonstrates that learning, knowing, and holding to the truth were considered parts of a continuous process, which was at once intellectual, practical, and spiritual. Learning was essential to knowing, knowing was essential to doing, doing was essential to spiritual fulfillment, and spiritual fulfillment was essential to learning. This process was held up as a standard against which the corrupting influences of wealth and power could be measured. After his death, it was the learning of Confucius that his disciples sought to emulate, and the standards he set were what students in later times struggled to achieve.

The concepts the learners used were appropriated from the pre-Confucian discourse of a broad class of warriors across the North China Plain. In this discourse power and virtue ideally were one (*de*). The worlds of men and of spirits (*gui* or *shen*) were separate but communication between the two was possible, and so was mutual intervention. Shamans and oracles were the agents of communication, while the warriors’ sacrificial rites (*li*) were intended to mollify the spirits and to prevent their capricious intervention in the affairs of men. Five hundred years before the time of Confucius, astrologers in the service of a particular coalition of warrior clans called Zhou had interpreted the movements of stars and planets as signs of the movement of spiritual forces in an ordered cosmos. From this they had extrapolated the overarching idea of a Mandate of Heaven (*Tian Ming*), which legitimated the Zhou claim to order the world under heaven (*tianxia*) with a clarification of the ritual duties of all the warrior clans, in accordance with their rank. At the apex of this ritual hierarchy was the head of the house of Zhou, who alone among men bore the title of king (*wang*), but who by the time of Confucius no longer had any real political power.

The wisdom that Confucius sought to transmit was expressed in the language of Zhou texts and embodied in the performance of the rites as codified by the original Zhou patriarchs. But in the absence of Zhou power, the wisdom of the ancients with respect to bringing peace and order to the world could only be validated by the conscience, or benevolence (*ren*), of especially virtuous “gentlemen” (*junzi*) who rejoiced in the prospect of placing duty, or righteousness (*yi*), above personal gain. Resisting the temptation to validate the Mandate of Heaven by appealing to revealed truth, the early Confucians held that human virtue, without reference to spiritual intervention, was both necessary and sufficient for bringing order to a world fraught with conflicts over wealth and power.

Warring States Confucianism

Until the time of Mencius (Mengzi; c. 371–c. 289 B.C.E.) the principal proponents of Confucian learning resided in Lu, where they studied and taught the ancient texts and proper performance of the rites. The text that bears the name Mencius confirms historians’ judgments that this era, the height of

the Warring States period, witnessed a rapid change in the ethos of the ruling class. The rulers of the larger states all appropriated the title of king for themselves. They accelerated the development of institutions of direct taxation and conscription within their borders and belligerently applied new technologies in their efforts to expand beyond these borders. They actively sought advice on how to develop, defend, and expand their states, inviting scholars from throughout the known world to participate. Two opposing tendencies appear to have defined a new discourse involving a “Hundred Schools of Thought.” On the one side were ideas that reflected and further encouraged the standardization of institutions and laws, the simplification and clarification of administrative methods, and the realistic pursuit of political goals. On the other side were ideas that reflected and further encouraged belief in divine retribution, spiritual intervention, and the Mandate of Heaven. Mencius revived the early Confucians’ concepts of conscience, duty, ritual performance, and wisdom within this discourse.

The Confucius of the *Analects* answered a question about the meaning of wisdom by advising the questioner to “revere the spirits but keep them at a distance.” He had very little to say about heaven. The Warring States discourse defines the domain of man as the space between heaven and earth. In this domain there is a Way (*dao*)—a set of principles and/or activities—that parallels, follows, approximates, resonates with, or reflects the “Way of Heaven and Earth.” In Mencius the “Way of Man” is moral and the “gentleman” is its agent. The Warring States discourse also anticipates a reappearance of the spiritual forces that were manifest in the Zhou Mandate of Heaven. In Mencius the Mandate of Heaven appears at two levels. At one level Mencius advises kings and lesser rulers as to how they must act if they expect to receive the mandate and become a “true” king. At another level the text defines the “gentleman” as one who is able to grasp and hold onto the original moral “mind,” or “heart” (*xin*), which was heaven’s mandate to each individual human, and thereby to “transform the environment through which he passes and invest with spirituality (*shen*) the place in which he resides.” At both levels, the idea of the Mandate of Heaven is inseparable from the idea that in the mind of every person originally there are the seeds both of benevolence and of the duty to spread it in the domain of humanity.

In political thinking the idea of a world ordered by ritual was being displaced by the idea of a world ordered by law, or rewards and punishments. Yet proper performance of the rites remained important to the ruling elite, who still sought to legitimize their status by showing respect for their dead parents and ancestors as well as reverence for the gods of local communities over which they ruled. Mencius included the rites among the four virtues that were seeded by heaven in the human mind, but the Legalists—those who would reform the world by enforcing new laws—dismissed them as artifacts of a world that was no more, while the Daoists, for whom the Way was not moral but natural, regarded them as the last means of moral suasion before a ruler resorted to force. In the middle of the next century, as the powerful state of Qin mounted its conquest of the world, Xunzi (c. 298–c. 230 B.C.E.)—the last of the great Warring States scholars to ap-

ply the early Confucians' concepts—revived the concept of ritual with a stunning attack on the Legalists, the Daoists, and Mencius alike.

Xunzi argued that in the absence of benevolent rulers, it was the principles inherent in the performance of the rites that preserved the wisdom of the ancients and provided the means by which the “gentleman” could transform the world. The Daoists were right about heaven; it was neither moral nor responsive to human pleas for help. But, in addition, it was the origin of all life, and it provided man with a mind capable of learning by observing nature and by moderating the natural drive toward self-gratification. Human nature could not be distinguished from animal nature by its goodness, as Mencius had argued. Humans could understand the meaning of the word “good” because humans had invented it to contrast with the natural urge to gratify their desires. This natural urge was enhanced by emotions that, if allowed to prevail, led to ever increasing conflict and ultimate self-destruction. Social order, in short, was invented by the sages, and the rites were their means of channeling the emotions between the extremes that would destroy that order. For Xunzi, ordinary men find benevolence unattractive because they are naturally inclined to pursue pleasure and profit, leaving benevolence to the sages, but everyone benefits from a social order that keeps our angry and acquisitive urges at bay.

Xunzi replaces the moral mind of Mencius with a mind that is “empty, unified, and still.” Like the Daoists, Xunzi argues that reasoning—moving the mind, filling it with things, and analyzing them—forces us to make distinctions that lead us away from first principles and into petty disputes. Because the “gentleman” understands the principles behind the rites, an understanding that guides him to the middle ground between keeping to form and releasing the feelings, he finds comfort in carrying them out. Officials only maintain them, while ordinary people perform them because they are customary and believe they have something to do with spirits. As for laws and regulations, or rewards and punishments, these are necessary but not sufficient tools for governing. “Although there can be disorder where the laws are good, I have never heard of a case of disorder where the ruler was a ‘gentleman.’”

Han Confucianism

With the successful completion of the Qin conquest (221 B.C.E.) and gradual development of imperial rule under the Han by the time of the emperor Wudi (141–86 B.C.E.) came another shift in political and cosmological discourse within the ruling class. The unique title of the emperor (august lord; *huangdi*) placed him above the warriors, scholars, magistrates, and economic managers who ran the state, and also above the complex array of magicians, shamans, and religious cults that made up the spiritual landscape. The ruler now occupied the position of cosmic pivot. The cosmos was explained as constantly changing, its primordial energy, or the psychophysical stuff of which all things are made (*qi*), being differentiated by the complementary interaction of bipolar valences (yin and yang). Every part of the cosmos resonated with the changes occurring in the others. Small changes in climate, ecology, production, and administrative policy were related to a larger process that moved in grand cycles through five phases. Scholars gathered at the imperial academy

and many lesser academies across the realm to improve their understanding of heaven, earth, and human sciences based on this cosmology. Dong Zhongshu (c. 179–c. 104) is credited with the revival of early Confucian textual studies and the Mencian idea of “moral mind” within this context.

What modern scholars have called “Han Confucianism” comprised a broad spectrum of beliefs, social practices, and textual scholarship. The Five Classics on which imperial academy scholars based their interpretations were the *Changes*, *Documents*, *Odes*, and *Rites*—all purported to be Zhou classics—and *Spring and Autumn Annals of Lu*, an extremely spare text attributed to Confucius. Dong Zhongshu used the *Spring and Autumn Annals* as a prophetic text, giving it more power in imperial academic discussions. One commentary on this text, the *Gongyang zhuan*, imagined in it cryptic references to a past and future age of “great peace,” which readily fit into the discussions of continuous cycles of change and cosmic resonance. Dong advocated studying the past to prepare for the future. He interpreted specific natural disasters that damaged symbolic imperial structures as warnings to the emperor that corruption and dishonesty at court were moving the human world away from the “great peace” and toward cosmic disorder. Although contemporary scholars increasingly conclude that this version of “Han Confucianism” never subsumed the larger cosmology of which these moral arguments were a part, the image of Confucius as a sage continued and the idea of a Confucian vision of a utopian future reappeared in the nineteenth century. The radical reformer Kang Youwei (1858–1927) applied it to the modern world.

As the male educated elite of the Later Han period (25–220 C.E.) found themselves dependent more on large landed estates, inherited titles, and marriage ties than on official positions with the Han state, they found other uses for the texts. The families of the titled elite used the *Rites* as their guide to social relations. Confucius had become something like a patron saint of scholars (*ru*), and education in the classics had become a necessary part of elite status. An early Han text called *Filial Piety* preached devotion to parents and ancestors. If education for men had carried with it the obligation to serve both one's parents and the public good, education for women entailed the obligation to serve both the family of one's birth and the family of one's marriage in their roles as daughters, wives, and mothers. The rituals of ancestor worship distinguished elite male lines of descent, while the rituals of marriage and childbirth defined the passage of women from one line to another. Ban Zhao (c. 48–c. 119), an educated woman of the highest status during this period, has been celebrated for her literary talents and exemplary role in further propagating these family values in her essays *Admonitions to Women*. With this text also begins a discussion of gender using Confucian concepts, as the author reminds her male readers that if a “gentleman” owes his status not to conditions of birth but to “Confucian” learning, then the same must be true of the exemplary woman.

Neo-Confucianism

For nearly a thousand years after the disintegration of the Han empire, the maintenance of elite family rituals and repeated invocation of filial duty were the only distinctively “Confucian”

markers of the political elite in China. The classics, now labeled “New Texts,” were replaced by more recently discovered “Old Texts,” which joined Buddhist scriptures and imperial institutions as the eclectic markers of civilization. This was the civilization that spread to the Korean Peninsula and the Yamato Plain of Japan. The great Tang state of the seventh century left the elite families and their self-defined hierarchy in place. The Tang model resonated with the interests of great families in Korea and Japan. But not until the eleventh century, in an East Asian world that was divided among shifting imperial states but increasingly integrated by an expanding commercial economy, did another new ethos invite the recasting of early Confucian ideas.

The recasting, which has led Western scholars to coin the term “Neo-Confucianism” in an effort to define it, developed at the intersection of three social-intellectual trends. First, in the great Song empire of the eleventh century an emergent scholar-official elite, in their discussions of statecraft, tended to support their arguments on all sides with appeals to “native” precedents and values, in contrast to “imported” religious values and the imputed values of a rising commercial class. This nativist trend produced “moral learning” (*daoxue*), which centered on early Confucian ideas of the Way and self-cultivation. Second, with the development of woodblock printing, the growth of unprecedentedly large commercial urban centers, and the appearance of private academies, there emerged a new metaphysical discussion that subsumed Buddhist and Daoist philosophy. This metaphysical trend was labeled “principle learning” (*lixue*). Third, as an increasing number of scholar-official families relocated in rural areas in central, eastern, and southern China where they could invest in land and form strategic alliances with other locally prominent families, they began to appropriate the genealogical rules, forms of record keeping, contracts for incorporating property, and family rituals of the old hereditary elite as part of their localist social strategies. This localist trend led to the reinvention of the rites to suit their needs, while raising new problems for those scholar-officials who were engaged in “moral learning.”

Zhu Xi (1130–1200), the great master of Song “principle learning,” brought these three trends together in his copious writings on learning, statecraft, family rituals, cosmology, and the sciences. Philosophers of the previous century, especially Cheng Yi (1033–1107), had challenged the Buddhist view that prior to something (i.e., prior to the mind’s effort to distinguish one thing from another) there is nothing (*wu*). They turned to the cosmology of the *Changes*, according to which all things come into being with the movement of the complementary valences of yin and yang. Their movement is limited only by the finite amount of *qi* in the cosmos, and this limit (*ji*) is called the “great ultimate” (*taiji*). In other words, they argued, prior to something there is a principle (*li*), which is best understood as both the ultimate limit and that which has no limit (*wuji*). The mind’s awareness of principles in things is not, as the Buddhists argued, something that it invents and confuses with reality but, rather, the completion of the process by which something simultaneously comes to exist and becomes knowable as principle. In the words of Zhu Xi, the “investigation of things,” which, according to one ancient

text, the *Great Learning*, was the first step in the process of learning that led to self-cultivation and world peace, meant the “exhaustive comprehension of principle.” Drawing on this and another ancient text called the *Doctrine of the Mean*, he also argued that the unity of principle and mind was a manifestation of the Mandate of Heaven, which could only be understood as good, thereby merging the moralist with the metaphysical trend. He wrote commentaries on these two texts along with the *Analects* and *Mencius*, supplementing the commentaries by Cheng Yi, and advocated their study as a unit called the Four Books.

The moralist trend intersected the localist trend as the rites of upwardly mobile families began to change and the value of women in marriage arrangements began to rise. In the commercial world, especially in the households of urban and geographically mobile small traders and shopkeepers, a woman’s value could easily depend more on the talents and abilities she brought to the trade than on her conformity to Ban Zhao’s model. For a landowning scholar-official family, on the other hand, a woman’s value was determined primarily by the family’s rank, wealth, and local status. As daughters tended to marry upward on the social scale, dowries rose to a level that moralists regarded as grotesque. Concurrently, scholar-official families began to perform ceremonies at gravesites and to include in their ancestral rites greater generational depth. To further enhance their pedigrees, they began compiling genealogical records, which then became the currency of social relations locally, regionally, and empire-wide as time went on. When appeals to moral principles proved insufficient to counter these trends, scholars adapted the ancient texts and traditions to the setting of official standards for the new practices. Zhu Xi himself wrote copiously on issues of the family rituals that were the tools, or the cultural capital, of this class. Marriages, deaths, burials, ancestral rites, genealogical record keeping, and patterns of descent group formation were all contributing to a new discussion, the vocabulary of which derived from ancient ritual texts and concurrent discussions of learning and morality among the scholar-official elite.

After the Mongol expansion and domination of Asia, the texts and commentaries of Song “Neo-Confucianism” emerged as the orthodoxy on which success in the examination system of the Ming and Qing imperial civil service depended. A broadening stratum of educated elites in rural and urban communities throughout China drew on this tradition of learning to construct the nexus of power between the imperial state and local society. At the same time, the tradition’s dual focus on self-cultivation and public duty defined a new debate on the role of individuals quite apart from the state. By the mid-sixteenth century a newly vibrant urban culture, based in part on global trade and silver flows, challenged the scholar-officials’ nexus of power. An alternative reading of the ancient texts proposed by Wang Yangming (1472–1529) produced an array of new traditions that differed from the Song moralist trend. Wang argued that the “exhaustive comprehension of principle” could not occur in the first stage of learning because knowledge of principles was inseparable from the act of knowing. Learning entailed the “unity of knowledge and action,” so that only when the mind actively applied itself to something could the principle be

According to Confucius, the point of “learning” was to attain confidence in one’s own understanding of the Way, which also entailed the duty to restore virtue to power through benevolence and the use of ritual. One who understood this was called a “gentleman,” to be distinguished from a “petty man,” who did not. The core of this teaching can be found in a few pithy quotations from book 4 of the *Analects*:

The benevolent man is attracted to benevolence because he feels at home in it; the wise man is attracted to benevolence because he finds it to his advantage (4:2).

There is no point in seeking the counsel of an officer who sets his mind on the Way, if he is ashamed of poor food and poor clothes (4:9).

The gentleman cherishes virtue in power; the petty man cherishes his native land. The gentleman cherishes justice; the petty man cherishes mercy (4:11).

The gentleman understands what is right; the petty man understands what is profitable (4:16).

When you meet someone better than yourself, turn your thoughts to becoming his equal. When you meet someone not as good as you are, look within and examine your own self (4:17).

If one is able to run the state with rites and deference, then what is the difficulty? If one is unable to run the state with rites and deference, then what good are the rites? (4:13).

Mencius believed that humans were inclined to goodness by nature and that this original goodness could be found by looking into one’s heart (or mind), which heaven had made sensitive to the suffering of others: “Suppose one were, all of a sudden, to see a young child on the verge of falling into a well. One would certainly be moved to compassion. . . . The heart of compassion is the germ of benevolence; the heart of shame is the germ of duty; the heart of deference is the germ of the rites; the heart of right and wrong is the germ of wisdom. Having these four germs is like having four limbs. To say that one cannot use them is to cripple oneself; to say that one’s ruler cannot use them is to cripple one’s ruler.”

Mencius also counseled rulers of states on how to recover and apply the compassion that was in their hearts. The key was to “take this very heart here and apply it to what is over there. . . . Why is it that your bounty is sufficient to reach animals yet the benefits of your government fail to reach the people? . . . The people will not have constant hearts if they are without constant means. Lacking constant hearts, they will go astray and fall into excesses, stopping at nothing. To punish them after they have fallen foul of the law is to set a trap for the people. How can a benevolent man in authority allow himself to set a trap for the people?”

Xunzi believed that humans were inclined to selfishness and that goodness was the result of the conscious activity of the mind (or heart). Neither “goodness” nor the rites were mandated by heaven; both were created by men who understood that ritual and deference were necessary for social order and the collective good. “The former kings looked up and took their model from Heaven, looked down and took their model from the earth, looked about and took their rules from mankind. Such rules represent the ultimate principle of community harmony and unity. . . . Hence the sacrificial rites originate in the emotions of remembrance and longing, express the highest degree of loyalty, love, and reverence, and embody what is finest in ritual conduct and formal bearing.” Man shares energy, life, and intelligence with the animals; why is man superior? “Because he is able to organize himself in society and they are not. Why is he able to organize himself in society? Because he sets up hierarchical divisions. And how is he able to set up hierarchical divisions? Because he has a sense of duty.”

Zhu Xi believed that one could be said to have learned something only when the principle in a text had revealed to one the principle that was buried in one’s mind: “When one’s original mind has been submerged for a long time, and the moral principle in it hasn’t been fully penetrated, it’s best to read books and probe principle without any interruption; then the mind of human desire will naturally be incapable of winning out, and the moral
(continued on the next page)

(continued from previous page)

principle in the original mind will naturally become safe and secure. . . . In reading, we cannot seek moral principle solely from the text. We must turn the process around and look for it in ourselves. . . . We have yet to discover for ourselves what the sages previously explained in their texts—only through their words will we find it in ourselves.”

Wang Yangming believed that “learning” required both knowing and acting, and it was not

necessarily aided by reading books. “In all the world, nothing can be considered learning that does not involve action. Thus the very beginning of learning is already action. To be earnest in practice means to be genuine and sincere. This is already action.” “In the basic structure of mind there is neither good nor evil; when the mind moves purposively, then there is good and evil; knowing good and evil is what is meant by ‘moral knowledge’; doing good and destroying evil is what is meant by ‘the investigation of things.’”

known. By the same token, insofar as the substance of mind was empty and still, it was neither good nor evil, but a clarified mind in action “naturally” or “intuitively” conformed to what was “good.” This, he argued, is what Mencius had meant by “moral knowledge” (*liang zhi*). Some of the new traditions developed closer affinities with Buddhist and Daoist enlightenment. Some gave a much higher priority to individual enlightenment than to educational status. Some made it a duty to convert wealth into charity or to spread the enlightenment attained through self-cultivation to women and to social classes that were outside the nexus of power. Some even pointed out the ways in which the structures of family, lineage, and state impeded the learning process for men and women alike.

Ming challenges to Song Neo-Confucian orthodoxy continued to influence the personal moral choices of educated Chinese during the Ming decline and Qing conquest in the seventeenth century, but they did not displace that orthodoxy in the examination system. Nor did they prevent the Qing from using Confucian state ideology, demanding loyalty and compliance with prescribed norms in regular readings of the emperor’s “Sacred Edict,” or providing official support for patriarchal lineage institutions throughout the empire. On the other hand, a new trend of “evidential scholarship” (*kaozheng*) emerged to challenge the antiquity of the pre-Han texts on which the orthodox commentaries depended. By the mid-eighteenth century, philological studies of ancient texts had developed into a science known as “Han learning” that complemented the learning imported by Jesuits into the Qing court’s bureau of astronomy, weakening the cosmological underpinnings of the imperial state without challenging its political dominance. As Han learning gradually eroded the validity of the “Old Texts” of the Confucian tradition, new champions of the early Han “New Texts” also appeared. When alternative cosmologies and political philosophies arrived along with British gunboats and opium in the early nineteenth century, Chinese scholars and reformers responded not simply by reinforcing imperial Confucian ideology, but by drawing on current evidential scholarship and renewed debates over ethics that were strikingly relevant to the modern age.

In Korea the Chosŏn dynasty officially implemented Confucian rituals for local control using texts propagated by Zhu Xi, whose commentaries also remained orthodoxy in imperial examinations. By the eighteenth century Chosŏn state power had declined but a thoroughly ensconced local elite maintained a strict social hierarchy using Confucian family and community rituals, prescribed by law. In Tokugawa Japan, on the other hand, Confucian scholars found it difficult to reconcile Neo-Confucian ideas with *bakufu* military governance, as distinct from imperial authority, and the strict social distinction between a *samurai* class and common folks. Ogyū Sorai (1666–1728) and his successors in “Ancient studies” (*kogaku*) challenged the Neo-Confucian worldview with observations akin to Xunzi’s about the need to implement rites that are appropriate in time and place. A school of “National learning” (*koku-gaku*) arose and went even further, blaming Chinese learning in general for corrupting the native traditions of Shinto and the idea of imperial power. In response, Japanese “Han learning” promoted the study of the literary products of Chinese civilization as a valuable tradition in its own right. In the nineteenth century the Mito school devised a new formula, according to which the Chinese sages, as understood by the Duke of Zhou and Confucius, had formulated for China a philosophy whose principles were intrinsic in the Japanese imperial cult and original Shinto practice. Holding to the idea that Chinese civilization reflected universally true ideas, they concluded that the Way of the sages and the Way of the gods (Shinto) were actually one.

Modern Confucianism

After 1868 the Meiji leaders of Japan reinvented Shinto as a state religion in the effort to create a Japanese nation that could compete in a world dominated by modern imperialist powers. In its new imperial discourse it would also claim righteousness and demand loyalty of Korean and Chinese subjects in Confucian terms. In China, moderate reformers tried to combine Confucian traditions of education, political unity, and social order with modern technology and institutional reforms to enable the Qing empire to compete as well. With its capture of Taiwan in 1895 the Japanese empire emerged as both the greatest threat to China and the most obvious model for inventing

a Chinese nation. Kang Youwei, a visionary who captured the imagination of a younger generation of reformers, drew on the “New Text” tradition to reinvent the image of Confucius himself as a radical reformer who envisioned an egalitarian world without political or cultural borders. The eras of “great peace” and, eventually, “great unity” would be China’s contribution to a world that would eventually emerge from this era of imperialist expansion. At the same time, Kang and the other radical reformers hoped to place the young Guangxu emperor in a position analogous to that of the Meiji emperor in Japan, as the symbolic head of an empire strong enough to resist demotion at the hands of foreign powers.

In the revolutionary tide that engulfed China over the century after the failure of the Qing reforms, Kang’s vision was dismissed as an artifact of a world swept away by modern change. But the very way in which it was dismissed demonstrates the role Confucianism has played in revolutionary discourse. The reformers’ adaptation of ideals of self-cultivation, family loyalty, and Confucian education to a modern national identity galvanized support for the effort to save China among overseas Chinese in Southeast Asia and elsewhere, contributing to a culturally specific style of engaging the modern world that is still thriving. As educated Japanese increasingly distanced themselves from the “backward” cultures of East Asia, blaming the failures of Neo-Confucian idealism in large part, educated Chinese increasingly identified themselves with humanistic Confucian traditions to combat the rampant “superstition” of popular religious culture and the “backwardness” of the imperial state. Liang Qichao (1873–1929), who was the most influential of Kang Youwei’s followers, forced into exile in 1898 after the failed reform effort, tried to meld Xunzi’s realistic concepts of a social order based on group obligations with German authoritarian notions of law in order to overcome both the impractical idealism of the Song tradition and the disintegrative effects that a more liberal political philosophy would likely have had on China. By the 1920s he was urging politically dispossessed students to learn from Wang Yangming’s philosophy of *liang zhi* and the unity of knowledge and action. The Communist revolutionary leader Liu Shaoqi, on the other hand, urged the educated cadre to apply the unflagging selflessness of Confucian learning to the socialist cause. To combat Communism, the Nationalist regime appropriated the image of Confucius as authoritative teacher, lover of tradition, and counselor of respect for parents, elders, and rulers—the very opposite of the radical, visionary Confucius imagined by Kang Youwei.

More recently Confucian cultural norms have been credited for the Asian “economic miracle,” the political stability and unprecedented economic development of China since the fall of the Soviet Union, and the educational success of East Asians in general. The same norms have been shamelessly invoked by dictators and blamed for the relative weakness of opposition politics, cronyism, and persistent gender inequality. Samuel Huntington has claimed that “Confucian civilization” provides a set of norms and symbols that opponents of the progressive ideas and institutions of “Western civilization” can use to maintain power in their own countries. Such a view represents a powerful position on the geopolitical struggles of the post–Cold War world, but it does not re-

flect the complex history or diversity of the ideas and practices associated with the Confucian tradition.

Other scholars have tried to understand the ways in which new traditions of Confucian learning appeared over time as economic and social conditions changed. Much postwar Japanese scholarship on Confucianism has focused on the libertarian and communitarian tendencies in China and Japan since the time of Wang Yangming. The same tendencies have led others to focus on tensions related to social mobility, increasing literacy, and shifting gender roles. Tu Wei-ming has argued that Chinese on the intellectual and geographic periphery have been the most creative in adapting Confucian learning to modern change. He believes that others will benefit from the lessons learned by those on the periphery and continue to develop new modern identities while renewing their Confucian roots. Chinese scholars of Confucianism in Hong Kong, Singapore, and more recently Taiwan and China have turned their focus to arguments about the balance between human rights and political authority, pressing politicians and entrepreneurs to attend to grievances, provide for education and welfare, value the law, and share the wealth. In a postcolonial, postrevolutionary world, the future of Confucian learning can hardly be predicted, but it seems unlikely that it will cease.

See also Chinese Thought; Daoism; Education: China; Legalism, Ancient China.

BIBLIOGRAPHY

PRIMARY SOURCES

- Confucius. *Confucius: The Analects (Lun Yü)*. Translated with an introduction by D. C. Lau. Harmondsworth, U.K., and New York: Penguin, 1979.
- . *The Original Analects: Sayings of Confucius and His Successors*. Translated with commentary by E. Bruce Brooks and A. Taeko Brooks. New York: Columbia University Press, c. 1998.
- Mencius. *Mencius*. Translated with an introduction by D. C. Lau. Harmondsworth, U.K.: Penguin Books, 1970.
- Wang Yang-ming. *Instructions for Practical Living, and Other Neo-Confucian Writing*. Translated by Wing-tsit Chan. New York: Columbia University Press, 1963.
- Xunzi. *Xunzi: Basic Writings*. Translated by Burton Watson. New York: Columbia University Press, 1963.
- . *Xunzi*. Translated by John Knoblock. 3 vols. Stanford, Calif.: Stanford University Press, 1988–1994.
- Zhu, Xi. *Chu Hsi’s Family Rituals: A Twelfth-Century Chinese Manual for the Performance of Cappings, Weddings, Funerals, and Ancestral Rites*. Translated by Patricia Buckley Ebrey. Princeton, N.J.: Princeton University Press, 1991.
- . *Learning to Be a Sage: Selections from the Conversations of Master Chu, Arranged Topically*. Translated with a commentary by Daniel K. Gardner. Berkeley: University of California Press, 1990.

SECONDARY SOURCES

- Chang, Hao. *Liang Ch’i-ch’ao and Intellectual Transition in China, 1890–1907*. Cambridge, Mass.: Harvard University Press, 1971.

- Ching, Julia. *To Acquire Wisdom: The Way of Wang Yang-ming*. New York: Columbia University Press, 1976.
- Chow, Kai-wing. *The Rise of Confucian Ritualism in Late Imperial China: Ethics, Classics, and Lineage Discourse*. Stanford, Calif.: Stanford University Press, 1994.
- De Bary, William Theodore, and John W. Chaffee, eds. *Neo-Confucian Education: The Formative Stage*. Berkeley: University of California Press, 1989.
- De Bary, William Theodore, and Tu Wei-ming, eds. *Confucianism and Human Rights*. New York: Columbia University Press, 1998.
- Ebrey, Patricia Buckley. *Confucianism and Family Rituals in Imperial China: A Social History of Writing about Rites*. Princeton, N.J.: Princeton University Press, 1991.
- Elman, Benjamin A. *Classicism, Politics, and Kinship: The Ch'ang-chou School of New Text Confucianism in Late Imperial China*. Berkeley: University of California Press, 1990.
- Elman, Benjamin A., John B. Duncan, and Herman Ooms, eds. *Rethinking Confucianism: Past and Present in China, Japan, Korea, and Vietnam*. Los Angeles: University of California Press, 2002.
- Goldin, Paul Rakita. *Rituals of the Way: The Philosophy of Xunzi*. Chicago: Open Court, 1999.
- Hsiao, Kung Chuan. *A Modern China and a New World: Kang Yu-wei, Reformer and Utopian, 1858–1927*. Seattle: University of Washington Press, 1975.
- Queen, Sarah A. *From Chronicle to Canon: The Hermeneutics of the Spring and Autumn, According to Tung Chung-shu*. Cambridge, U.K.: Cambridge University Press, 1996.
- Tillman, Hoyt Cleveland. *Confucian Discourse and Chu Hsi's Ascendancy*. Honolulu: University of Hawaii Press, 1992.
- Tu, Wei-ming. *Centrality and Commonality: An Essay on Confucian Religiousness*. Albany: State University of New York Press, 1989.
- . *Neo-Confucian Thought in Action: Wang Yang-ming's Youth (1472–1509)*. Berkeley: University of California Press, 1976.
- Tu, Wei-ming, ed. *Confucian Traditions in East Asian Modernity: Moral Education and Economic Culture in Japan and the Four Mini-dragons*. Cambridge, Mass.: Harvard University Press, 1996.
- Yao, Xinzhong. *An Introduction to Confucianism*. Cambridge, U.K., and New York: Cambridge University Press, 2000.

Jerry Dennerline

CONSCIOUSNESS.

This entry includes three subentries:

Overview
Chinese Thought
Indian Thought

OVERVIEW

Consciousness has three distinct meanings in the modern world. First it refers to immediate subjective experience. Second, it is the source of immediate and certain knowledge of mental states. For example, if I am in pain, I am conscious of pain and certain of this knowledge of my mental state. Third, it is

self-consciousness, a concept of the self that answers the question “Who am I”?

From the seventeenth to the later part of the nineteenth century, the first two meanings of *consciousness* were indistinguishable and often joined by the third meaning: The presence of immediate private experience was assumed, and infallible truths about states of mind and personal or collective identities were derived from it. Since the later nineteenth century, these three ideas of consciousness have been distinguished from each other and subjected separately to criticisms and doubts.

The etymology of *consciousness* is derived from the Latin *con* (with, together) and *scire* (to know). When Romans shared particular knowledge, they had con-sciousness. Sharing knowledge with oneself is the etymological source of *conscience*. In medieval Latin, for example in the works of St. Thomas Aquinas (c. 1224–1274), *consciousness* came to mean a knowing subject, as distinct from an unconscious person or a plant. However, the first two modern senses of *consciousness* were introduced largely by René Descartes (1596–1650).

Consciousness in Modern Philosophy

Since its inception in the seventeenth century, the history of the modern idea of consciousness is intertwined with the history of the idea of science and the scientific worldview. Consciousness has been on the rims of the scientific worldview, at once a challenge to the applicability of the scientific method for understanding consciousness, and an alternative possible source of knowledge, more certain than scientific empirical knowledge that must rely on the senses.

The Cartesian revolution. When Descartes initiated the discussion of consciousness in Europe, it was against the backdrop of the scientific revolution of the seventeenth century. Science presented then a materialist and mechanistic worldview. Pre-Newtonian science considered the universe to be composed of material particles that generate motion and change by direct physical interaction and transmission of force, much like clockwork or a billiard game. Descartes proposed to distinguish humans from artificial or organic machines (brutes) by the presence of mind, language, reason, and consciousness. Descartes believed that consciousness provides an intimate and certain source of knowledge, superior to empirical knowledge that is founded on the fallible and often misleading evidence of the senses. What we take as our sensory input may be a dream; we may be “brains in a vat,” as later epistemologists put it. But conscious introspection can provide sure knowledge about ourselves that is independent of the senses. For example, Descartes’s famous saying, *cogito ergo sum*, “I think, therefore I am,” suggests that any act of thinking implies the presence of a thinker, a person, and therefore self-knowledge of personal existence is certain. Descartes then divided the universe into material things, *res extensa*, that exist in space, and *res cogitas*, consciousness, a mind that thinks but has no material extension. The resulting duality of mind and body came to be known as dualism. Dualists must explain how mind and body interact in the person despite their qualitative differences, and respond to attempts to reunify mind and body in monistic philosophic systems that consider everything

to be either ideal, part of immaterial consciousness, or material, so that consciousness is part of the material world that science describes—brain states, for example.

The phenomenological tradition. Immanuel Kant (1724–1804) revolutionized philosophy by distinguishing the introspective study of the structure of pure consciousness as the subject matter of philosophy, distinct from the study of nature, the subject matter of science. Kant studied how any sensory input must appear in consciousness, in what he called the categories such as time, space, and causal order. However, Kant also concluded that while philosophical introspection may offer an infallible knowledge of the structure of consciousness, there could never be knowledge of the world as it is independent of consciousness.

Georg Wilhelm Friedrich Hegel (1770–1831) attempted to reunify consciousness with the world in an idealist monistic scheme according to which the world is a spirit, and our consciousness is that part of the world that can achieve self-consciousness. Consciousness, then, is what determines being, what happens to exist materially at any moment.

In his 1874 *Psychology from an Empirical Standpoint*, Franz Brentano (1838–1917) introduced the thesis that all conscious states are intentional. We experience the world against the background of our intentions, manifested in a sense of meaningfulness or meaninglessness. For example, my current conscious state includes my thoughts about this entry, vision of a computer screen, the sounds of a Mahler symphony in the background, and so forth. All these experiences are imbued with meaning against my intentions, to write a comprehensive and informative entry, to enjoy listening to my favorite composer, and so on. Had my intentions been different, say to earn a lot of money and to become better acquainted with contemporary rap, my state of consciousness, though including the same sights and sounds, would have been different and the experience much less meaningful.

Brentano taught at the University of Vienna. Among his most remarkable students were both Edmund Husserl (1859–1938) and Sigmund Freud (1856–1939). The first founded the philosophical school of phenomenology, the culmination of the tradition that considered consciousness to be the subject matter of philosophy and direct introspection the sure method. The second extended intentionality to unconscious states, but also shifted the focus of intellectual discourse from consciousness to the unconscious.

Husserl's phenomenology is the last great school of philosophy to attempt to found certain knowledge on introspection of our consciousness. Husserl thought that with the scientific revolution, people lost awareness of pristine and immediate consciousness, which has been emptied of meaning because they objectify, abstract, and conceptualize. Husserl sought to recapture and philosophically analyze this immediate consciousness. Husserl called his method *epoché*, the suspension of belief in the distinction between subjective and objective phenomena that allows immediate consciousness to "appear." Within *epoché*, consciousness appears full of meaning, prior to conceptualization, and so the philosopher who

follows Husserl's method will be able to analyze the universal aspects of consciousness. Husserl called what should appear to anybody who goes through *epoché* the "life-world." Husserl's description of the life-world he discovered may be interpreted as a reaction against increasing modernity, urbanization, and loss of traditions and security in Europe in the early twentieth century; against the loss of a pristine bucolic world of farmers rooted in their land; and against the growing gap between the scientific worldview of matter and energy, galaxies and atoms, and the human perspective on the world of earth and sky, flowers and friends. Husserl's method of *epoché* proved susceptible to personal biases and so generated accounts as different from each other as those of Martin Heidegger and Emmanuel Levinas (1906–1995). Husserl was also criticized for not considering possible differences between human consciousness in different historical eras or cultures, though such philosophical anthropology has never been his purpose.

The gap between the modern scientific worldview and human point of view also spurred the explorations of the French philosopher Henri-Louis Bergson (1859–1941). Bergson was particularly interested in our consciousness of time. Physics (except for Newton's law of entropy, which stipulates increasing disorder in the universe in the direction of time) is indifferent to the direction of time from past to future. Einsteinian relativity considers time as a dimension that can be stretched or compressed in relation to gravity and velocity. Our conscious experience of time is quite different. Bergson attempted to distinguish our conscious experience of time as a continuous duration from its scientific divisibility into moments.

At the same time, "stream of consciousness" novelists such as Henry James, Arthur Schnitzler, Virginia Woolf, and especially James Joyce in *Ulysses* explored consciousness and time through a narrative method that attempted to record everything that goes through their protagonist's minds.

The Unconscious

Freud broke with the philosophic tradition that had identified the mental, the mind, with consciousness and consequently considered the introspective study of consciousness as the source of certain knowledge. Freud divided our mental lives into the conscious and the unconscious. Freud's unconscious is composed of desires that are suppressed, expelled from the conscious self because they are unacceptable or too painful especially in connection with suppressed memories of traumas suffered especially during early childhood. Still, though unconscious, these motives and memories express themselves in dreams, neurotic obsessive symptoms, phobias, slips, jokes, sublimated art, and under hypnosis. It is impossible to learn of the content of the unconscious by direct introspection, but indirectly, through free association and the symbolic interpretation of dreams.

Freudian psychoanalysis offered to cure neurotics through recollection of the suppressed memories of the events that caused the suppression of desires. This "catharsis" should increase consciousness at the expense of the unconscious. Since the suppressed memories are painful, people devise a variety of defense mechanisms to avoid confronting them consciously.

Consequently, the Cartesian tradition of gaining certain knowledge through introspection collapsed: introspection is useless for gaining access to the unconscious, indeed it may be misleading because of defense mechanisms. The correspondence between one's thought and thoughts about thoughts (self-consciousness) has come under even greater criticism since Freud. For example, Gilbert Ryle in his *Concept of Mind* (1949) argued that introspection, inward perception of mental entities, is fallible and incomplete.

In a larger historical context, Freud responded to the rise of irrational political forces in Europe that appealed to unconscious, uncontrolled, and ultimately destructive mental forces that eventually dominated the middle of the twentieth century in Europe. Freud wished to devise a method that would bring the unconscious under the control of the rational conscious. Other trends within depth psychology, art, and politics sought quite on the contrary to release the unconscious powers, dreams, and nightmares and allow them to dominate the conscious. Younger psychoanalysts like Carl Jung (1875–1961) and Jacques Lacan (1901–1981) offered alternative characterizations of the conscious and the unconscious.

Contemporary Philosophy of Mind

The middle of the twentieth century witnessed a decline in discussion of consciousness. The research programs associated with the chief intellectual trends of the time had no fruitful implications for our understanding of consciousness: Martin Heidegger (1889–1976) directed phenomenology toward ontology and hermeneutics; structuralism and poststructuralism studied texts and languages; Marxism considered subjective consciousness to be derived from the more basic and objective material relations of production; in psychology, behaviorism ignored consciousness, while in philosophy logical positivism ignored in principle what cannot have immediate operational, empirical, effects. Behaviorism and positivism, the dominant schools respectively in academic psychology and philosophy until the sixties, ignored the study of consciousness because it could not be reduced to observable behavior or empirically verified. Since the study of private consciousness was beyond the methods associated with the research programs of either school, it was left to literature and mysticism.

In the last few decades of the twentieth century several intellectual developments led to refocusing of philosophy, especially in English-speaking countries, on the problem of consciousness. The failure of philosophical positivism to explain actual scientific theories that contain nonobservable concepts such as *energy*, and the uselessness of behaviorism for the solution of many problems in psychology in comparison with alternative research programs, spurred an academic search for more fruitful research programs and a return to the problem of consciousness.

Advances in neurology; the physical study of the brain, using brain scanning, rare cases of localized brain damage, and so forth; the discovery of genetic causes for a variety of mental illnesses; and research into the effects of drugs on the brain allowed scientists for the first time to offer physiological, ma-

terial explanations to a variety of states of consciousness. At the same time, advances in computer technology generated advanced forms of artificial intelligence. For the first time, humans created artifacts that appeared more intelligent than themselves. This led to a reexamination of popular conceptions of the distinctive essence of humanity. If not intelligence, perhaps consciousness could distinguish us from our machines?

Philosophers, scientists, and writers wondered about the prospects for conscious artificial intelligence, and hence about the meaning of consciousness. The knowledge acquired about complex information processing through the analysis of systems, such as those of artificial intelligence, prepared expectations for attempting to understand the mind as a complex information-processing system, and consciousness in those terms. These developments have led to the founding of the new, yet controversial, “cognitive science”—“cognitive science” for its detractors.

The discussion of consciousness in recent philosophy of mind may be traced to Thomas Nagel's (1974) groundbreaking reformulation of the mind-body problem, the relation between the physical and the mental. Nagel asked whether the physical-material external description of brain states could ever explain the mental internal experience of consciousness. Nagel argued that there is and always will be an “explanatory gap” between our consciousnesses and what a science of the mind may explain, however sophisticated it becomes. It will never be able to explain “what it is like” to have specific points of view, for example, what it is like to be a bat, hang upside down from the ceiling, and sense radar rays.

Much of the subsequent debate centered on reasons for affirming or denying the existence of the explanatory gap. Dualists like Nagel and John Searle suggested that though consciousness is a natural phenomenon, we lack the concepts and theories to close the explanatory gap. Eliminativism claims that there is no explanatory gap because consciousness does not exist; it “eliminates” the explanatory gap by eliminating consciousness. Daniel C. Dennett (1991), following Julian Jaynes (1976), claimed that consciousness is a cultural construct that emerged in ancient Greece.

Functionalists such as Australian philosopher D. M. Armstrong and Hilary Putnam proposed to characterize states of consciousness by their causes and effects, rather than by their internal properties. Physicalists claim that ultimate reality is material and described by physics. Both consider the explanatory gap as a problem of reduction of the mental to the physical. They recognize that there is at present an explanatory gap, but they believe that it may be possible to close it through a successful scientific reduction of the mental to physical theories. Some advocated that such a reduction will prove that a type of conscious state such as being in love or seeing red will be reduced to a physical or chemical description of a brain state. Others, such as Patricia and Paul Churchland, envisioned the reduction of what they call “folk psychology” to an advanced neuroscience along the lines of the reduction by chemical theories of ordinary descriptions of chemical interactions to a small number of types of basic elements and the laws that govern their interactions. Such a reduction may demonstrate correspondence between several types of physical interac-

tion and the same conscious state, as the same tune may be played by a variety of different orchestral arrangements.

Frank Jackson (1982) and David Chalmers (1996) argued that scientific material external explanations cannot explain consciousness, since it is possible to conceive of a universe where the descriptions of material states of affairs that explain consciousness are true, but people do not develop consciousness, a world of zombies that act in response to stimuli without being conscious. For example, people may react to hunger by eating and to danger by defending themselves without being conscious of dining or fighting. Such a problem does not exist when scientists reduce water to two atoms of hydrogen and one atom of oxygen. Colin McGinn (1991) went further by suggesting that human beings are forever blocked from knowing the link between physical brain states and consciousness because introspective consciousness provides no immediate knowledge of brains, while neuroscientific knowledge of brains provides no access to consciousness.

Frank Jackson (1982) further attacked physicalism by demonstrating that some qualia, the subjective qualities of conscious experience, cannot be reduced to physical facts. Jackson introduced the following thought experiment: Suppose that a scientist named Mary was locked all her life in a room where everything was in black and white but had access to the world outside through black and white books and television. Mary could learn everything that science can teach us about colors, optics, and wavelengths, how they interact with the eye and transmitted to the brain, and so forth. Still, though Mary would be familiar with the physicalist-scientific explanation of color, it would not prepare her for anything like the actual experience of red, because it is irreducible to scientific physical descriptions.

Physicalist responses to Jackson's thought experiment claimed that Mary's new experience of red would not add to the number of facts she knows, rather it would represent knowledge of old facts in a new way, or a broadening of Mary's imagination. The description and explanation of mental causation of physical effects is a major problem for dualists like Jackson. Eliminativists do not think there is consciousness, only perceptions of it, no qualia, properties of experience, but perceptions of qualia "as if" there were mental objects. So, mental causation of physical events is not a problem for them because they deny the mental. Jackson advocated epiphenomenalism; he considers consciousness to be a side effect of physical processes that connects physical causes with effects. Consciousness is irrelevant for the generation of physical events. Consciousness emerges then from physical interactions, has properties that are irreducible to those of a physical lower level, and so is more than the sum of its parts. A related question is whether the emergence of consciousness may be explained by Darwinian evolution as conveying some sort of adaptationist advantage.

Historical Self-Consciousness

Self-conscious introspection was presented as a source for certain knowledge of history as well as the person. Philosophies of history presented themselves as that part of the historical process

that is conscious of itself. As Nathan Rotenstreich has suggested, Giambattista Vico (1668–1744), Hegel, Marx, Benedetto Croce (1866–1952), and Robin George Collingwood (1889–1943) tried to base the very possibility of historical knowledge on the identity of subject and object. They constructed metaphysical entities like "ideal eternal history," "the spirit," "organic civilizations," "clashing civilizations," and so forth, to designate what they took to be the essence of history. If a philosophy of history is the self-consciousness of history, not just a consciousness of history, how history appeared to people who lived at a place and time, philosophers of history must occupy a privileged position within the historical process, at its end, the end of history. From the temporal vantage point of the end of a process, whether it is linear or cyclical, it is possible to discern its direction and meaning. Therefore philosophies of history from Vico to Francis Fukuyama, through Hegel, Marx, and Arnold Joseph Toynbee, have had to include apocalyptic themes in their philosophy to justify their claim to be conscious of the whole historical process. Still, mutually inconsistent philosophies of history seem to have been reflecting the consciousnesses of their particular eras rather than of the whole of history.

Self-Consciousness and Identity

Consciousness may refer to self-identity. As Locke put it in his *Essay Concerning Human Understanding*, "as far as . . . consciousness can be extended backwards to any past action or thought, so far reaches the identity of that person."

Hegel, Marx, György Lukács, Heidegger, and Jean-Paul Sartre (1905–1980) elaborated on the extent to which one's self-consciousness may not depend on introspection, but on how others conceive of oneself. Hegel introduced the master-slave dialectics, where the master's consciousness depends on the slave, since without the recognition of the slave, the master is not a master. Marx interpreted ideology as false consciousness, self-identity that does not conform to objective class interests, derived of relations to the means of production as owners or laborers. The Hungarian György Lukács (1885–1971) combined Hegel's phenomenology with Marx's materialism to present a theory of class-consciousness that became influential among European Marxists and emphasized reification and alienation. Heidegger analyzed alienation in modern mass societies where self-consciousness is imposed from without by the mass media and mass society, molding all people to become identical and anonymous. Sartre criticized the reduction of persons to roles, the promotion of essence above existence.

Under these influences, especially through the writings of Michel Foucault (1926–1984), historians have been tracing the history of such constructed and imposed self-consciousnesses, of sexual identities, madness, deviance and crime, ethnic and national identities, and so forth. These contributions to the history of consciousness have an emancipatory as well as a scholarly purpose, they intend to discover the history of self-consciousness as well as liberate groups from identities that were imposed on them from without to control and dominate.

Another debate within the writing of history and social sciences is about the primacy of consciousness and human intel-

lect over being, material conditions and especially economic structures, in history. Materialists attempt to explain historical changes in consciousness including scientific theories and new religions and artistic styles, as resulting from economic changes, whereas idealists attempt to show the opposite. As the new president of free Czechoslovakia and a former political prisoner, playwright Václav Havel put it in his speech to the joint houses of Congress in February 1990: "The experience [of totalitarianism] has given me one great certainty: Consciousness precedes Being!"

See also *Cartesianism; Dualism; Idealism; Materialism in Eighteenth-Century European Thought; Monism.*

BIBLIOGRAPHY

- Brentano, Franz Clemens. *Psychology from an Empirical Standpoint*. Translated by Antos C. Rancurello, D. B. Terrell, and Linda L. McAlister. London: Routledge, 1973.
- Chalmers, David. *The Conscious Mind*. Oxford: Oxford University Press, 1996.
- Churchland, Patricia Smith. *Neurophilosophy: Toward a Unified Science of the Mind-Brain*. Cambridge, Mass.: MIT Press, 1986.
- Churchland, Paul M. *The Engine of Reason, the Seat of the Soul: A Philosophical Journey into the Brain*. Cambridge, Mass.: MIT Press, 1995.
- Dennett, Daniel C. *Consciousness Explained*. Boston: Little, Brown, 1991.
- Jackson, Frank. "Epiphenomenal Qualia." *The Philosophical Quarterly* 32 (1982): 127–136.
- Jaynes, Julian. *The Origin of Consciousness in the Breakdown of the Bicameral Mind*. Boston: Houghton Mifflin, 1982.
- Lukács, Gregor. *History and Class Consciousness: Studies in Marxist Dialectics*. Translated by Rodney Livingstone. Cambridge, Mass.: MIT Press, 1971.
- McGinn, Colin. *The Problem of Consciousness*. Cambridge, U.K.: Blackwell, 1991.
- Nagel, Thomas. "What Is It Like to Be a Bat?" *The Philosophical Review* 83 (1974): 435–450.
- Rotenstreich, Nathan. *Between Past and Presence: An Essay on History*. New Haven, Conn.: Yale University Press, 1958.
- Velmans, Max. *Understanding Consciousness*. Philadelphia: Routledge, 2000.

Aviezer Tucker

CHINESE THOUGHT

Human consciousness in Chinese thought may be seen in three layers, each of which requires the other two for both development and understanding. While these three layers of consciousness are constructed for analytical purposes, in reality they are interconnected. Psychologically, they represent different frames of reference, but they are also different dimensions of the same individual and/or collective human consciousness. The first layer, cosmological consciousness, defines the objective world of being and becoming for the human person. The second layer, consciousness of the human self, provides a world of human distinction based on the self-reflection of the human mind and heart in which a human self can be uniquely identified in the life-world of humanity. The third layer, po-

litical consciousness, is where the human self projects or reconstructs an ideal political and practical world of reality in which the human self could realize its desires for power, creativity, and freedom of action. Hence we may regard the three layers as forming an integral part of each other so that any human action and human language could impart and receive meaning relative to these three layers.

Cosmological Consciousness

Chinese cosmological consciousness was first described in the texts of *Zhouyi* (also called *Yijing*). The symbolic realism of the *Zhouyi* presents a world of changes that are embodied in symbolic forms of what may be called an onto-cosmological consciousness. Later, in the sixth to fifth century B.C.E., the Daoist text *Dao de jing* presented the development of a cosmogony from the reality as void.

The Chinese metaphysical tradition is distinguished from the Western tradition by a dialectical understanding of reality as a dynamic presentation of events and things in a context of universal and profound interconnectedness. The central idea is creative change (*yi, shengsheng*), which manifests itself in the generation of life, in the transformation of states of being, and in the two modes of becoming referred to as yin and yang, the invisible and the visible, the formless and the formed, the soft and the firm, the creative and the receptive. Transformation (*hua*) of things in these two modes of becoming is the subtle creative movement of reality in growth and decline, in an interchange of vital forces (*qi*), which also embodies relevant forms and principles (*li*). Hence any event-thing in reality is both concrete and principled, both phenomenal and noumenal. The phenomenal and the noumenal cannot be separated and their unity is realized in a cosmological process that is also ontologically understood. There is no way to speak of the ontological except by referring to it as the ultimate creative source and origin of the cosmological, the *taiji*. Based on this understanding, we may observe several features of this onto-cosmological consciousness.

Onto-cosmological reality as a process. Onto-cosmological reality is a process that has a primordial origin and source of abundant creativity because all the ten thousand things are generated from it by way of yin-yang interaction. This reality is exhibited in the phenomenon of heaven and earth and forms a space-time in which all things take place in the contexts or in the form of a situation: all situations are portents of future development and embody a history. The development of situations follows an implicit ordering of yin-yang interaction, difference, conflict, balance, and harmony.

In this process of onto-cosmology, the human person is conceived to be generated as arising from the best spirits of heaven and earth and thus embodies a nature of goodness of cosmic creativity, which matches heaven and earth by development of culture and morality. The thesis of unity of heaven and man (*tianren heyi*) is given an actual meaning and an ideal meaning: a human being is endowed with a nature and a function from heaven and earth in his birth and thus is capable of producing and creating like heaven and earth on the higher level of mind and intelligence. The ultimate goal of human life is to strive for

self-realization in moral cultural creativity derived from the onto-cosmological creativity of heaven and earth.

Indeterminate and boundless creativity. It should be noted that the onto-cosmology of *yi* (change) is not theological. Unlike the Greeks, who sought a creative force and a motivating value ending in a transcendent deity or power, the Chinese view of reality is creation from an internal creative source called the *taiji* or the Dao, not an external God. It is also unlike the Hebrew religion, which conceived God as personal and spiritual and absolutely transcendent over and above the human person, in that the ultimate reality is conceived as a spontaneous process called the Dao, and its creative indeterminateness is not confined to any personal qualities.

Perhaps it is because of the early presence of this notion of the indeterminate and boundless creativity that no personalistic religion ever came to predominate. The Chinese believer may take any and all religions as compatible and contributing to a whole of human goodness. It is also due to the early presence of this onto-cosmology that there is a lack of mythology in the early history of Chinese consciousness. This is indeed noteworthy, because almost all main cultural traditions in the world have a rich repertoire of mythological figures.

Although the Chinese onto-cosmological consciousness is not about a god, it can be described as a divine consciousness in so far as the divine (*shen*) suggests creativity from what is given to what is not given and from what is not to what is. It is in this sense that the Chinese notion of heaven and the *taiji* could also be said to be transcendent, either continuously or noncontinuously. Continuous transcendence is creativity based on what is given to produce what is not given, without excluding what is given in the new states of being. As it always links the created to the source of the creative, it is both internal and inclusive. Noncontinuous transcendence is external and exclusive in the sense that it creates things from a prior unrelated source and supervises what is created without being an integral part of it.

This may lead to the question of creation from the non-being and void, which is explicitly developed in the Daoist texts. It must be pointed out that the development of the Daoist cosmo-ontology in the *Dao de jing* is not separable from the *Yijing* onto-cosmology. In so far as the *Yijing* stresses the movement from the internal ontology of creativity to a dynamic and harmonious cosmology of universe, the Daoist sees the process of creative change as a comprehensive way of balancing all things and forces and as a process of return to the origin. This process and totality is called the Way (the Dao). The first Daoists were motivated by a desire to seek peace and tranquility of mind and spirit in the human person after witnessing the corruption of human cultures and morality and the destructiveness of wars. They wished to go back to a starting point where desires and greed in the human person had not yet been provoked and where people could appreciate the value in taking no action. For them, natural and spontaneous action embodied a morality, which is creative and harmonious for human life. It is in this light that they came to see the importance of understanding the void (*wu*). The void is without determinateness of being and is yet full of creativity of being.

It is also the formless source from which all things will return. With this notion of the void, we can see how the void gives rise to being by nonaction or spontaneous action (*ziran*) in so far as being can be seen to arise out of spontaneity.

We must of course distinguish this view of nonbeing giving rise to being from the argument *creatio ex nihilo* in Christian theology on one hand and from the argument of dependent co-origination (*yuangqi*) from emptiness (*sunyata*) in Buddhist philosophy. The *nihilo* is absolute nothingness, and God simply creates everything from this absolute nothingness by his powerful act of creation. The *sunyata* is not absolute nothingness but a state of nonclinging and no-desires in the human mind. The formation of mind is from delusion of mind, so that all things we come to know come from a co-origination, which needs to be dissolved in *sunyata*.

Natural realism. Compared with these two forms of creation, we must recognize in the *Yijing* and in Daoism a sense of natural realism that stresses different aspects of the creativity of a natural reality. The Chinese concept of consciousness is radically different from the Western scientific materialism, which reduces mind to matter, and from the Western transcendent dualism, which bifurcates the human from the divine and which separates the bodily from the spiritual. In the Chinese onto-cosmology there is no reduction but holistic correlation, no dualism but comprehensive organicism. The cosmic consciousness is not separable from the human consciousness but exists as a part of it. There is a sense of the origin and a sense of the way of development and return. There is also a sense of a potentiality for creative development from internal creativity that is both transcending and inclusive, both transforming and harmonizing. This natural realism is to be experienced as a result of comprehensive experience based on both observation and reflection. This experience is also practical and pragmatic, as what one has experienced could be applied for furthering one's life and enhancing one's pragmatic and moral actions.

Consciousness of Human Self

The development of morality in Confucianism and Mohism heightened the development of human consciousness of humanity as both individual and community. We can explain this first in terms of the formation of the *li* (ritual) as an institution that links the human individual development to the development of a society or community and to the state.

Li serves to maintain a social order founded on family relations. It is therefore a particularistic and concrete practice of relating people so that the society not only becomes ordered but also becomes affectively consolidated. In a deeper sense *li* is the sentiment showing practical care for concrete people in particular contexts and thus becomes a matter of *ren* (benevolence, humanity, human-heartedness, human goodness). But when *li* becomes merely a form without the concern or the feeling, it loses its meaning. This is the background against which the Confucian *Analects* and *Records of Li* (*Liji*) called for the reform of *li* and an awakening to *ren*.

Ren is the deep feeling of a person beyond desires, a feeling of the unity of humanity, and a consciousness of an underlying

bond among human persons that would lead to the love, care, and regard of one for the other. This deep feeling of unity is experienced as inherent in human existence. Confucius (551–479 B.C.E.) believed that the practice of *li* based on the feeling of *ren* would render *li* a meaningful and living force that would both regulate oneself inside and harmonize human relationships outside. On this basis, the world would be ordered, and the well-being of people would be secured.

Confucius thus suggests that *li* can be restored and instituted as part of social and community life. With *ren*, old forms could be modified and new forms of conduct could be adjusted and made to fit particular relationships and situations. The individuating principle of *yi* (righteousness/rightness) enables us to see how differences in situations and relationships exhibit a need for relating, which is only fulfilled by the formation of the concrete rules of *li*.

Hence, Confucius proposed three sets of virtuous relationships: the relationship between *ren* and *yi* is one of generalization and particularization; the relationship between *ren* practice and *li* is one of a general content and general form; the relationship between *li* and *yi* is one of concrete form and particular content. These three relationships represent a challenge to the old order of morality that depended exclusively on the particular forms of *li*. The principles of these relationships also form an endowment for the human mind to define its own forms of understanding and conduct. The power of seeing right and acting right is wisdom (*zhi*), which is native but which needs to be refined by practice and experience. Having attained *zhi*, a person will not be perplexed, just as having attained *ren*, a person will not have anxiety. Confucius also speaks of moral courage (*yong*) as absence of fear. When one acts right with genuine heart for *ren*, there is natural absence of fear, and there is moral courage.

Ethics and morality. Confucius takes *ren* as the basis of both ethics and morality. If *ethics* means norms governing human relationships, it is clearly founded on *ren* in consideration of human relationships. It is *ren* embodied in *yi* (righteousness) and *li* (propriety) as guided by *zhi* (wisdom). There is a dimension of *ren* that reveals the deep bond of universal humanity with heaven conceived as the ultimate metaphysical source of humanity. Confucius says the ultimate truth, or Dao, may be found in light of the experience of this ultimate source.

This deepened and heightened sense of *ren* as a vertical and uplifting force contrasts with the horizontal and expanding sense of *ren*, which includes a family, a clan, a community, and a whole world of people. We can see *ren* in either sense as a form of transcendence, a transcendence of inclusion and absorption as earlier described. In the ideal state the vertical uplifting sense of *ren* may even include the horizontal and expanding sense of *ren* (while the latter may not include the former). It is in this ideal state that we can see how the moral consciousness in Confucianism comes to a full realization of the humanity in a person.

Mencius and Zhongyong, Daxue and Xunxi. Confucianism developed in two distinct ways: Mencius (Mengzi;

c. 371–c. 289 B.C.E.) and Zhongyong emphatically expounded the upward-transcending aspect of *ren* (or *ren* in a vertical uplifting sense), while Daxue and Xunxi (c. 298–c. 230) expounded the across-transcending aspect of the Confucian *ren* (or *ren* in a horizontal expanding sense).

The uplifting sense of *ren* leads Mencius to explicitly define the essence of a human being as a moral being, with four root feelings of morality: sympathetic care, self-restraint, reverence, and distinction between the right and wrong. Zhongyong explicitly recognizes human nature as derived from heaven or from the mandate of heaven (*tianming*) and hence capable of participating in the creative and ceaseless creation and preservation of being. Zhongyong further identifies the uplifting sense of *ren* as a sense of reality by holding that if one is sincere (in the sense of having full reflection of oneself without self-deception and without withholding oneself to the openness to reality) one's mind will become illuminated.

Unlike Zhongyong, who relates the self to ultimate reality, Daxue confronts the self with the extended world of things, so that the self has to have an experiential understanding of the real world before one can relate to things and then relate to other people. Whereas the bright virtue (*mingde*) of Daxue focuses on one's ability to love and renovate people with one's self-cultivation and the cultivation of moral relations, the *daqingming* (great purity and clarity) of Xunzi focuses on renovating people with institutional design for education and governmental organization. In other words, Xunzi's approach to renovation of the people is political and economical rather than merely moral and moralistic.

It is obvious that classical Confucianism developed a system of morality that integrates humanities, education, and even religion. It is a unique system based not on a single idea of value, but on a unity of principles and ideas of *ren* and *li*. This system is truly both knowledge and value. It includes both the theoretical and the practical. As this system is continuous and coterminous with the onto-cosmology described in the first section, it can be regarded as a human development of the onto-cosmology, which leads to the unity of the heaven and the human (*tianren heyi*) through a unified process of self-reflection, self-cultivation, and self-practice (*zhixing heyi*).

Philosophical Daoism and Mohism. Two alternative systems exhibit equivalent consciousness of totality and human action. Both are critical of the Confucian system: the Daoist system rejects the practice of *li* and together the invention and development of culture and knowledge. The Mohist philosophy sought to redefine *yi* in order to achieve a standard of social justice.

Two great classical Daoists who respectively represent the initiation and development of the school of philosophical Daoism were Laozi and Zhuangzi. Laozi presents the Dao as a source of being from which things rise and to which they would return. He urges a simple style of living that is consistent with the primordial dao. His vision of reality is in fact a partial adaptation from the *Yijing's* onto-cosmology with an emphasis on the principle of receptivity and passivity as the ground and as reason for the natural creation of the world. Hence he

sees human culture as a blocking of the Dao. But for Zhuangzi (c. 369–c. 286 B.C.E.), the emphasis is not on a variant of onto-cosmology, but on how one may practice the nonseparation between oneself and the Dao where the Dao is to be embodied in all things in the world, large or small. The whole world of being is to be understood by an open and creative mind, which would link the out-world of nature to the inner world of human spirit.

The Mohist philosophy as represented by Mozi (468?–376 B.C.E.) criticizes Confucianism for its excessive engagement with *li* and thus for lacking a sense of universality and a sense of productivity. In the spirit of *li*, the Confucians practice *ren* as self-control and graded love, which Mozi sees as leading to a society of hierarchy of difference and circles of dissension. Further, Mozi sees Confucianism as dividing social classes into the ruled and the ruling, which lack a common base for solidarity. He sees the continuous wars of his time as an inevitable result of an inequitable society that lacks a sense of social justice. What then is social justice? According to Mozi, social justice must be founded on one identical standard. He uses the same word, *yi*, that Confucius used, but he intends a meaning that is objective. To establish this identity and objectivity of *yi*, Mozi appeals to the will of the heaven (*tianzhi*), with which everyone should comply. But his doctrine of identity compliance (*shangtong*) is also hierarchical, as he assumes a hierarchy of ranks that enforce the compliance. This would amount to enforcing the ideology of those upper-class leaders in the name of the *tianzhi* and this no doubt assumes or leads to a political dictatorship or totalitarianism that Mozi would build on the foundation of selection/election of the talented who are devoted to the government and consequent meritocracy.

Mozi diagnoses the cause of continuous wars as the lack of love among people. In order to reach peace among warring states, he advocates the doctrine of universal love (*jian-ai*). Love is universal (*jian*) if it can be shared on an equal basis. Thus one should love other people's family as one loves one's own family. The point is that we should not love our own family to the exclusion of other families in consideration of benefits to be shared. (But later Mencius misinterprets this as meaning treating another's father as one's own father and thus denies the unique status of one's own father). The doctrine of universal love if universally practiced would eliminate wars because it allows each group of people or state to care for its own land and property without trying to ravage lands of other states and other groups of people. There is also the more desirable consequence of this doctrine: namely the mutual benefit of states and peoples. This leads to the ultimate ideal of Mozi: every person, every people, and every state would live on an equitable basis, and a society of human life would flourish just as a society of natural life flourishes under the compassionate will of heaven.

This social idealism of Mozi is criticized for its unrealistic and utopian projections. But a more serious difficulty is the contradiction between his prescription for social justice on the basis of identity compliance and his argument for equitable love of mutual benefit. The problem results from his lack of consideration of the feelings and moral freedom of the individual,

which the Confucians make great efforts to evince as the natural basis of society and government.

Political Consciousness

Since the Daoist and the Mohist philosophies did not become the guiding principles for the development of political governance in Chinese history after the Warring States period (475–221 B.C.E.), one may ask why Confucianism became the dominating and received political ideology in the early Han period, and hence the mainstream moral and political axiology in post-Qin Chinese history. In order to answer this question, we have to understand how Legalism (*fajia*) and legalist politics failed during the Qin period, which preceded the Han. *Legalism* refers to a trend of thought focused on administrative power and punitive laws and regulations that culminated in Han Fei Zi (c. 280–233 B.C.E.). In this system the notion of law (*fa*) as a tool of punishment is too narrow a representation of the actual use of law, which was generally to the exclusion and at the expense of social morality. Legalism was based on an understanding and manipulation of human desire for reward and fear of punishment, with total disregard for human needs for freedom and trust. Because of this narrow instrumentation of the law, Legalism is identified with strict authoritarianism, which is couched in laws and regulations set by the ruler's own desire for power and wealth. Its failure to address equally fundamental and important needs in human nature doomed the Qin power to a short span despite its great work in unifying China. It also laid the foundation for a need and desire to return to Confucianism as a tradition of human nature in the trust of moral virtues.

Return to Confucianism. The return to Confucianism and especially to the political consciousness of Confucianism in the early Han period thus is not surprising, especially as there were no better alternatives as far as political governance is concerned. Confucianism more than any system presented an axiology of well-related and integrated values that were rooted in history and that could be defined or redefined as norms of a political ideology to be used to regulate the behavior of the people. Dong Zhongshu (179–104 B.C.E.) developed the Confucian justification and promotion of political ideology for political rule. Dong speaks of the harmonization and preservation of humanity and community as the primary concern of a ruler, who should extend his *ren* from the moral to the political domain. Thus Dong transforms the values of five virtuous relationships into three basic norms of organization and leadership: the people obey the ruler, the son obeys the father, and the wife obeys the husband.

This set of norms, based on Confucian virtues and a vision of a grand unity and harmony among different groups of people, worked in Chinese society for the next 2,000 years but collapsed confronting the demands for openness, equality, and individual freedom in the beginning of the twentieth century. Yet, the rejection of the three norms did not lead to the rejection of the five virtuous relationships among people. Instead there arose the opportunity to examine the political significance of the primordial Confucian proposition on the unity of inner sageliness (*neisheng*) and outer kingliness (*waiwang*) as a core of political consciousness in Confucianism and hence as the everlasting feature in Chinese philosophy.

Righteousness and the ability to rule. To rule or to govern (*zhi*) is to have power to cause others to follow or obey an order. To be aware of and practice *ren* is the first and foremost requirement for a self-cultivating person to be able to rule or to govern. A good ruler must know both what the people want and what is really good for them, and he must be worthy of their trust. The second requirement is that a ruler be led by *zhi* (wisdom) to make enlightened decisions and policies and avoid mistakes of ignorance and short-sightedness. A man of *ren* of course further requires ritual (*li*) to make his action sustainable, but this must be made on the basis of the presence of *ren*. To have *ren* and to conduct oneself right in terms of wisdom and the moral form of appropriateness, one can be said to set a good example for people to follow and emulate so that people can be satisfied with their leaders.

Rectification of names. Another essential requirement of successful governance is the Confucian doctrine of rectification of names. In the Zilu chapter of the *Analects* Confucius says:

If names are not rectified, then language will not be smooth, if language is not smooth, things will not be done. If things are not done, then rituals and music will not flourish. If rituals and music will not flourish, then punishments will not meet their target. If punishments will not meet their targets, then people do not know what to do.

Thus, names and language reflect reality but they also determine what reality is, particularly with regard to social and political matters. One may interpret this observation of Confucius as requiring a system of correct names and language that would order social and political relationships as the basis for political administration.

Once basic moral and social relationships among people are set in order, a political order should ensue. In order to reach such a state, the ruler has to set things right beginning with himself as a moral example. This does not preclude the institution of laws of punishment to ensure the moral order. However, the Confucian vision is that once basic order is established, then political order will be easily implemented without necessarily appealing to laws of punishment.

This point needs to be made clear: Confucius is not opposed to laws for any state. Rather, he holds that we should aim at going above the requirement of law and reach for the Dao. The political consciousness of a moral ruler is to hold oneself to the standard of the Dao so that one would not deviate from the Dao. Of course, one could still find that what one does with the intention to do good may still be wrongdoing. Rather than an intentional wrong, that would be a factual mistake, which one must conscientiously be willing to correct.

Compatibility with democracy. It has often been asked whether Confucianism is compatible with the modern Western concept of democracy, or rule by the people. The answer can be ambiguous depending on what is perceived as the goal of political rule. If the goal is social and moral order, in so far

as modern democracy will lead to such a desirable state of society, democracy is compatible with the Confucian moral patriarchy. On the other hand, if democracy is geared toward achievement of basic freedom of the people to decide how to rule themselves, then the moral patriarchy of Confucian political consciousness is indeed a problem. The basic assumption of Confucianism is often that people are incapable of making such decisions and therefore require a wise and benevolent leader to take care of them and to put their lives in order. Hence the ruler is given the whole and sole responsibility to take care of the people for the benefit of the people. On the other hand, it is believed that people can tell a good ruler from a bad ruler and that people could complain about their rule and even rise up to remove a ruler, as Mencius makes clear.

This implies that the people can also rise to choose a new ruler. The morally superior person (*junzi*) can be said to be a potential candidate for becoming a ruler. It may be argued that if he continues to develop himself in moral superiority by acquiring all the moral powers of relating to all people, he could be elected to the position of ruler. Since Confucius urges and educates all people to be morally superior persons, it logically follows that everyone can become a candidate for political rulership and could be considered engaged in a competition for successful development of oneself as a moral person in order to be eventually selected or elected to be the ruler. We must note that for the implicit mandate of the people to develop into the democratic consciousness of a modern nation-state, the major step of entrusting people to make a popular election must be made.

We may also note that the Confucian idea of the moral cultivation of a *junzi* suggests the presence of a potential democracy, because the *junzi* must win the people's trust as a good ruler. The moral requirement for political rectitude suggests that a rational understanding is needed to transform the implicit moral democracy into an explicit political practice. This transformation would represent a new development of the moral-political philosophy of Confucianism. This would amount to a revolution in the Confucian political consciousness by way of a deep rational reflection.

Two further observations of the Confucian political consciousness can be made. First, in comparison with the Greek city-state, where people were more actively concerned with the political affairs of the community, the Chinese society was primarily based on agriculture, and the people, having little time for self-governance, relied on their leaders to impose order. Once China became industrialized and people became better educated, the demand for democratic government was greater, and democracy will eventually prevail. Historically, China as a political entity has been involved in a process of consolidation of political power and integration of large groups of people for purposes of defense, so that the demand for democracy did not even arise. There is also a lack of rational reflection and understanding on the process of succession of political power to the extent that the inevitability of dynastic cycling by way of intrigue or force has become a historically conditioned belief among the large mass of people.

Second, when Confucius wrote his historical *Annals of Lu* (*Lu Chunjiu*) in which he praises moral and condemns immoral actions of dukes and ministers, he established a tradition of moral critique of political figures in light of their individual actions instead of their institutional practice. This suggests that the political consciousness of Confucianism subjected a rational consideration of institutions to a moral consideration of personal action. But we do, however, see in Confucius a critical awareness of a need for adaptiveness of a ritual system and hence a critical awareness of the question of appropriateness and timeliness of a given ritual system or institution in the governance and personal action of a ruler.

Conclusion

We have dealt with the mainstream schools of Chinese philosophy in the classical period and their contributions to human consciousness in a threefold structure. In the development of these schools a fundamental consciousness of reality emerges as the leading force of influence, namely the consciousness of the ultimate reality that is the incessant source and foundation for the building of a system of morality and a system of politics in later times. But this consciousness of the ultimate that is rooted in a human person can also be described as an original consciousness of reality as a body of truths or a system of truths (*benti*) as experienced by self-conscious individuals. This idea of *benti* has its own inner logic of development as described on the three levels of human consciousness in Chinese philosophy. In later history we see projects of realizing emptiness and achieving enlightenment in Chinese Buddhism. We also witness efforts to incorporate Buddhist insight into a Confucian framework as well as efforts to integrate various strains of thought in new syntheses and formulations of the world and the self. These efforts have continued into the twenty-first century while facing a still larger challenge: the integration of the Chinese and the Western.

See also *Chinese Thought; Confucianism; Cosmology: Asia; Daoism; Humanism: Chinese Conception of; Humanity: Asian Thought; Justice: Justice in East Asian Thought; Legalism, Ancient China; Mysticism: Chinese Mysticism; Religion: East and Southeast Asia.*

BIBLIOGRAPHY

- Chan, Wing-tsit, trans. and ed. *A Source Book in Chinese Philosophy*. Princeton, N.J.: Princeton University Press, 1963.
- Cheng, Chung-ying, and Nick Bunnin, eds. *Contemporary Chinese Philosophy*. Malden, Mass.: Blackwell, 2002.
- Cua, Antonio S., ed. *Encyclopedia of Chinese Philosophy*. New York and London: Routledge, 2003.
- Feng, Youlan. *A History of Chinese Philosophy by Fung Yu-lan*. 2 vols. Translated by Derk Bodde. Princeton, N.J.: Princeton University Press, 1983.
- Hsiao, Kung-chuan. *History of Chinese Political Thought*. Translated by F. W. Mote. Princeton, N.J.: Princeton University Press, 1979.

Chung-ying Cheng

INDIAN THOUGHT

There is enormous diversity among the various traditions of classical Indian philosophy concerning the nature of

consciousness and the place of humanity in the cosmos, but there are a number of presuppositions that are shared by many of India's great thinkers. Most classical Indian philosophical schools agree, for example, that living beings are reborn over and over again in a beginningless cycle (*samsara*) and that one's present situation is determined by past actions (*karma*). The final goal of most of these systems is also the same: liberation (*moksa*) from the cycle of birth, death, and rebirth.

Brahmanical Systems

In the Brahmanical systems, karmic actions are closely related to one's social duty (*dharma*), which is determined by the endogamous group (*varna*) into which one is born. Morality is not individual, but collective, and in making decisions one is not expected to decide for oneself what is and is not moral; rather, one determines what people of one's type ought to do in particular situations, and one group's morality might differ significantly from another's. For example, while killing is characterized as immoral for most groups, it is the duty of a member of the warrior caste (*ksatriya*) to slay enemies in a just war. The tension between the demands of dharma and the dictates of conventional morality is highlighted in the *Song of God* (*Bhagavad Gita*) in which the warrior Arjuna balks at the idea that in an immanent battle he will be required to kill relatives and teachers—people with whom he has intimate karmic obligations—and he decides to escape his dharma by becoming a world renouncer (*sannyasin*). The god Krishna informs him that this is not a viable option and that it would lead to ridicule from his fellow *ksatriyas* in this life and negative karmic consequences in future lives.

Atman. The *Bhagavad Gita* upholds a notion that is found in most Brahmanical systems: that every being has a permanent, unchanging essence or soul (*atman*) that transmigrates from life to life, appropriating bodies and life situations that are directly concordant with past karma. According to the *Upanishads*, however, the atman is not directly affected by the vicissitudes of one's rebirths; although in some texts it is described as being pure consciousness, it is not directly aware of, or affected by, change. It moves from body to body, but the individual is normally unaware of it. All beings have an intellect (*buddhi*), which when trained leads one toward direct understanding of the atman, but actual perception of it is the result of yogic training, in which one learns to control the senses and look within, differentiating the apparently real phenomena of perception and the truly real atman.

The search for the atman figures prominently in several *Upanishads*. In the *Katha Upanishad*, for example, a Brahman boy named Naciketas asks Yama, the lord of death, to reveal the truth of what becomes of the individual after the body dies. Yama first tests him to see if he is psychologically ready to learn the truth and, after Naciketas rejects offers of riches and fame as merely transitory, Yama decides that he has no interest in the material world and tells him of the eternal, unchanging atman. At the culmination of his speech, Yama pronounces the famous "great statement" (*mahavakya*), "You are that" (*tat tvam asi*), indicating that the individual atman is the same as the ultimate reality, referred to as *Brahman*. Brahman is described in the *Upanishads* as pure being (*sat*); it never

changes, and it is the sole reality. All the phenomena of existence are merely projections of Brahman, and when a sage learns to perceive reality as it is, everything other than Brahman is revealed as illusion.

According to the *Katha Upanishad*, the sufferings of ordinary beings are due to their lack of control over their senses (*indriya*). Yama states that the intellect is like the reins of a chariot, which the charioteer uses to control his horses. The horses are compared to the senses. Without the restraint of a firm charioteer, the horses will run rampant, just as unrestrained senses pursue fleeting sense objects. A skilled charioteer gains control over his horses in the same way that a yogi restrains his senses through meditation. The chariot is compared to the body, which is motivated to pursue attractive things by unrestrained senses but attains a state of peace through meditative practice. The atman is like a passenger who travels along with the chariot, but exercises no control over it. Liberation is attained by those who directly perceive the atman. When one recognizes that individual existence is merely illusion, all sense of separateness from Brahman is transcended, and the individual atman is merged with it, like a wave that is absorbed into the ocean.

The world of appearances. In the Non-dualist (*Advaita*) Vedanta system of Shankara (c. 8th century C.E.), the world of appearances is said to be merely the sport of Brahman (*brahmalila*). Brahman projects the illusion of ordinary reality for its own enjoyment, but ultimately none of it is real. On the conventional level, phenomena operate according to laws, and so conventionally Shankara accepts the validity of direct perception (*pratyakṣa*). From the ultimate perspective the multiplicity of appearance is false, however, and so in seeking the truth one should learn to overlook the evidence of one's senses and initially rely on the Vedic scriptures (of which the Upanishads are a part), which reveal the way things really are. Scriptural statements are later confirmed by introspective meditation.

Arguments regarding valid means of knowledge (*pramana*) figure prominently in intersectarian disputes among Indian philosophers. Most schools of classical Indian philosophy accept the primacy of direct perception, as well as inference (*anumāna*) based on sense experience. For Shankara, however, the evidence of the senses is false, and so ultimately only scriptural testimony (*śabda*) is valid. The scriptures themselves require no validation, because they “are like the sun which reveals itself while revealing colors.” The Vedas are part of the very fabric of reality and are eternally true. They have no author (*apauruṣeya*) and are directly perceived by “seers” (*ṛṣi*), who reveal them, but do not alter their content.

The Nyaya school—which like Vedanta is regarded as one of the six “orthodox” (*astika*) traditions of Brahmanical philosophy—takes issue with several of these ideas. According to Nyaya, it is ridiculous to claim that the Vedic texts have no author; instead, the Naiyayikas hold that they are composed by God, who is omniscient. God's position as the being who knows all things serves to validate the truth of Vedic statements. In addition, God is also the author of the medical texts of the *ayurveda*, and the fact of their effectiveness serves as an analogical proof that Vedic statements that cannot be verified

by ordinary humans are also true. They are further corroborated by the testimony of trustworthy persons (*apta*), and so ordinary humans can accept them with confidence.

Like the Advaita Vedantins, the Naiyayikas assert the existence of an eternal atman, which is the locus of each individual's karma, but unlike Shankara, they claim that the atman is able to acquire knowledge, feeling, and volition. It is not the sort of spiritual entity postulated by Advaita Vedanta, and each atman has its own mind (*manas*), which is connected with it until it reaches liberation. At that point, the atman becomes completely liberated from everything, including mind. The path to liberation for Nyaya begins with reasoning, which brings correct knowledge.

In common with other Indian classical philosophical systems, the Nyaya asserts that living beings are caught up in transmigration as a result of ignorance (*avidya*), which manifests in the form of mistaken ideas. Correct reasoning, guided by scripture, is an essential prerequisite for liberation. It eliminates wrong ideas and reveals the truth of things, and thus serves to overcome ignorance. One does not engage in argument for its own sake; correct reasoning leads to certainty, and is in accord with Vedic statements. On this basis, one can engage in introspective meditation, by means of which one is able to directly validate the truth of scripture. Liberation in this system is not conceived of as bliss, as in some other Indian traditions, but rather as absence of pain. Bliss requires its opposite, but in the liberated state one transcends all qualities and dichotomies. In liberation the atman is separated from the physical body—and all other physicality—and attains a state of absolute neutrality.

Buddhist Systems

The Buddhists, while accepting the notions of *karma*, *samsara*, and *mokṣa* (or *nirvana* in common Buddhist parlance), reject many of the core assumptions of the Naiyayikas, as well as important doctrines of the Upanishads and Advaita Vedanta. One of the cornerstones of Indian Buddhist schools is the doctrine of “no-self” (*anatman*), which rejects the Brahmanical belief in a permanent, unchanging soul. The Buddhists rely mainly on the *pramanas* of direct perception and inference, and reject the atman as a conceptual construct that is unfindable either by the senses or by reasoning. The Buddha pointed out that the central reality of all existence is change. All phenomena come into being as a result of causes and conditions, they change in every moment, and eventually they pass away. If there were some disembodied, unchanging entity, it would have no relation to any individual, and because it lies beyond the world of the senses it could never be perceived.

Epistemological tradition. The “Epistemological” (*Pramana*) tradition, whose most influential exponent was Dharmakīrti (c. 530–600), further contends that an unchanging entity would have no causal efficacy, and so it would be entirely unrelated to the world. Dharmakīrti's approach is pragmatic and empirical: he asserts that there is no point in discussing things that can never be verified by sense experience and that have no impact on the physical world. In his

pragmatist system, all statements and cognitions are subject to falsifiability: a statement is true only as long as subsequent perceptions and analysis do not show it to be false. In addition, Dharmakīrti believes that there is no point in discussing merely theoretical topics (such as the atman) and that an essential test of validity is the possibility of effective activity (*artha-kriya*). Practical application is one of the conditions of valid knowledge. In his system, statements become true through a process of verification: they must be able to withstand subsequent analysis and be corroborated by relevant perceptions. Those that meet this test may be accepted as true, while others (even statements contained in Buddhist scriptures) should be rejected.

In his major work, the *Commentary on [Dignaga's] Compendium of Valid Cognition (Pramana-varttika)*, Dharmakīrti only accepts the *pramanas* of direct perception and inference, and rejects others that are accepted by the Naiyayikas, such as comparison (*upamana*) and scriptural testimony. The former is unreliable because it is not based on direct experience, and the latter only convinces those who already accept the cited scriptures as normative. Dharmakīrti asserts that any truth claim must be verifiable by analytical reasoning and direct perception. Direct perception is defined as being “free from conceptuality and incontrovertible.” In his system, only the first moment of perception counts as direct perception, and subsequent moments are overlaid with conceptuality. They are not produced by cognition of a directly perceived sign, but instead are merely based on the initial perception and interpreted by the mind.

The epistemological tradition also claims that the nonexistence of the atman can be confirmed by developing a special cognitive capacity called “yogic direct perception” (*yogi-pratyaksa*), which allows meditators to directly perceive truths that are hidden from ordinary beings. In most Indian philosophical traditions, there is a close link between meditative practice and philosophy, and the training regimens of the various schools begin with study of doctrine, which is reinforced by yoga. The paths of Indian philosophical/religious traditions are intended to ensure that meditators directly perceive the tenets of the system in which they are training, and philosophy is often a reflexive exercise that uses reasoning to argue for the insights gained in meditation. Doctrine is derived from practice, and those whose experiences differ from the tradition's doctrines are either brought into line or expelled (and sometimes they become founders of new schools).

Transmigration and liberation. In rejecting the atman, the Buddhists were widely seen as being vulnerable on the question of what transmigrates from life to life. The Buddha is said to have taught that the belief in a permanent self is shared by all ordinary people, but despite its universality it is a false concept, and one that leads to grasping after material things and mistaken notions about reality. Those who seek liberation must overcome the innate belief in a self, and this requires meditative training. In searching for the atman through introspective meditation, Buddhists find that there is no enduring essence (either atman or Brahman), and that instead individuals are composites of five “aggregates” (*skandha*): form,

feelings, discriminations, consciousness, and compositional factors. The first refers to physical form, and the second comprises one's emotional responses to phenomena. These are discriminated into positive, negative, and neutral, and this process leads to desire for certain phenomena and aversion toward others. The aggregate of consciousness encompasses one's mental events and includes phenomena that are generally regarded as part of the unconscious in Western psychology. Compositional factors are other elements that are part of the innate sense of self, and mainly consist of karmic factors.

According to most Buddhist schools, consciousness is the aggregate that transmigrates from life to life. It is commonly described as being of the nature of “clear light” (*prabhavarā*), and all defilements are said to be adventitious (*agantuka*). One's volitional actions produce karmas, which move consciousness in certain directions and determine the nature of one's rebirth, but consciousness, unlike the atman, changes in every moment and is directly affected by the vicissitudes of one's life. Meditative training aims to remove mental defilements like anger, desire, and obscuration, while simultaneously cultivating good qualities like patience, morality, and wisdom.

In classical Indian philosophy, Buddhism was one of the main “heterodox” (*nastika*) systems. The Buddhists rejected the authoritativeness of the Vedas and claimed that their own scriptures contained correct doctrines and the only truly effective path to liberation. They asserted that the core existential problem is suffering (*dukkha*) and that it is caused by ignorance. Because beings misunderstand the true nature of reality, they make choices that lead to suffering and result in continuing transmigration. Since the problem is a cognitive one, the solution is also cognitive: liberation requires that one overcome mistaken ideas and acquire correct understanding. One of the most basic misconceptions, according to the Buddhists, is the notion of the atman. They assert that anyone who clings to a permanent self or to an ultimate reality (whether conceived as God or Brahman) will inevitably continue to transmigrate from life to life, and they hold that only those who free themselves from such false notions are able to attain liberation.

For all of the traditions discussed in this essay, the central concern of philosophy should be liberation. Indian philosophical texts commonly state in their introductions that the purpose of composition is to aid others in the pursuit of *moksa*, which indicates that philosophy is not viewed as an exercise in discussing semantic problems, but ideally should be a matter of profound concern for anyone seeking to comprehend reality as it is and thus attain the ultimate goal.

See also Cosmology: Asia; Philosophy; Religion: East and Southeast Asia.

BIBLIOGRAPHY

- Chakrabarti, Kisor K. *Classical Indian Philosophy of Mind: The Nyaya Dualist Tradition*. Albany: State University of New York Press, 1999.
- Dreyfus, Georges B. J. *Recognizing Reality: Dharmakīrti's Philosophy and Its Tibetan Interpretations*. Albany: State University of New York Press, 1997.

- Griffiths, Paul J. "Pure Consciousness and Indian Buddhism." In *The Problem of Pure Consciousness: Mysticism and Philosophy*, edited by Robert K. C. Forman, 71–97. New York: Oxford University Press, 1990.
- Gupta, Bina. *CIT: Consciousness*. New Delhi: Oxford University Press, 2003.
- Matilal, Bimal K. *Perception: An Essay on Classical Indian Theories of Knowledge*. Oxford: Clarendon, 1986.
- Mohanty, J. N. "Understanding Some Ontological Differences in Indian Philosophy." *Journal of Indian Philosophy* 8, no. 3 (1980): 205–217.
- Potter, Karl H. *Presuppositions of India's Philosophies*. Westport, Conn.: Greenwood, 1972.

John Powers

CONSERVATISM. *Conservatism* lends itself to misunderstanding because its political designation is easily confused with popular usage. To be conservative in the sense of preferring the familiar to the unfamiliar is a common form of behavior. Since this attitude toward life is universal, it issues from no necessary political commitment. For any person, even the most bohemian, not to develop a settled habit or a lingering attachment would be almost inconceivable. However, it is possible to conceive of persons having such habits and attachments and yet being radical in his or her politics. That would have been true, for instance, of Adolf Hitler. Equally, to be conservative in the sense of wishing to maintain a position of authority, privilege, reverence, or wealth is another universally recognizable form of behavior that issues from no necessary political commitment. It would be exceptional for someone who has achieved or inherited such powerful status not to want to secure it. This would have been true, for instance, of Joseph Stalin. Both of these popular meanings of conservatism—as shorthand for individual or social characteristics—are inadequate to understanding conservatism in politics. Both of them are primordial in their instincts, general in their applications, and empty of content.

Conservatism in politics, on the other hand, is a relatively recent historical phenomenon, particular in its significance, and as a consequence has a distinctive, if differentiated, character. Conservatism is best understood as a set of propositions about the activity of governing, defined against those radical ideologies with roots in eighteenth-century speculation, like liberalism and socialism, that were to have such a profound effect on world history in the course of the nineteenth and twentieth centuries. It is opposed to grand schemes for the political emancipation or salvation of humankind to which such radical speculation can lead. Conservatism advocates limited ambitions in politics, argues that the aspiration of government should be modest, and emphasizes the value of continuity in the state. Conservatives believe that government can be authoritative only when it is limited, modest, and continuous. If it were possible to identify a distinctive desire uniting all forms of conservatism, it would be the desire to be left alone to enjoy the benefits of a well-ordered society. As the nineteenth-century British prime minister Lord Salisbury (Robert Arthur Talbot Gascoyne-Cecil) once put it, conservatism is like a

policeman: if there were no (radical) criminals to protect against, there would be no need for it. However, conservatives will not be left alone.

Origins of Conservatism: Britain, France, and Germany

Restricting the scope of politics in this manner has made conservatism appear at odds with the promise of modernity. Certainly, any political project to remove evil from the world is for the religious conservative an act of impiety, just as any project to perfect humankind is for the secular conservative an act of dangerous folly. The difficulty remains that these fundamental criticisms of modern hubris are easily dismissed as nostalgic, self-interested, and most damning of all, irrationally prejudiced. If conservative irrationalism can be ascribed to any particular failing, it is thought to be the presumption of resisting historical progress. In this view, conservatism and modernization are antithetical, since to be modern is to assume history to be linear and its meaning to be emancipation from ignorant custom. That is an audacious concept of politics that understands traditional restraints to be obstacles to manifest destiny.

Conventional historical wisdom has been that the event that transformed these terms of political argument was the French Revolution. That convention is a sound one. The main currents of European intellectual life were drawn into the revolution, and out of it emerged the modern narrative of progress versus reaction, improvement versus obstruction, and reason versus tradition that was to shape political reflection in the course of the following two centuries. This has been an influential narrative and a persuasive one. In its light, conservatism at best serves as a prudential brake on the wheels of change, at worst as an insufferable denial of human development. In neither case is it thought to involve anything of substantial value or intellectual significance. Nevertheless, the temptation to interpret conservatism as "antimodern" should be resisted, for to be conservative does not entail a passive acceptance of the status quo. Rather it involves a critical encounter with what exists. *Conservatism* was itself a nineteenth-century neologism for a modern, novel, self-conscious disposition in politics and as such is a contemporary of *socialism*, *liberalism*, and *nationalism*. Its meaning has been given by modern experience and its content by the recurring expression of certain principles in the work of thinkers alarmed into reflection by revolutionary activity. Conservatism, in other words, has a history, not a nature, and that is an insight owed to the Irish "philosopher in action," Edmund Burke (1729–1797).

Britain. If Burke is taken to be paradigmatic of conservative thought, it is by attribution rather than by design. Burke drew on a large repertoire of ideas, such as the social-contract tradition of Thomas Hobbes (1588–1679) and John Locke (1632–1704) and the skeptical conventionalism of David Hume (1711–1776), and marshaled them like a great melodist to challenge the abstract "speculatism" of the French revolutionaries. Writing from within a culture of constitutional monarchy that had only recently and precariously secured its legitimacy (albeit with the loss of the American colonies), Burke's intent in *Reflections on the Revolution in France* (1790) is to warn against

the implications of revolutionary principles, which he thinks are as subversive of good government as they are of bad. If society is indeed a social contract, it is a contract “between those who are living, those who are dead, and those who are to be born,” and in that formulation Burke tries to make safe two of the potentially radical loose ends bequeathed by Locke. Political society, Burke argues, is not dissolvable according to demands made by the present generation, and the “tacit” consent of contemporaries is assumed because of their inherited obligations and future responsibilities. Burke does refer these obligations and responsibilities to laws of nature, but he is aware that nature can be a false friend. It is those very “natural” rights, so beloved by revolutionaries in France, that he dismisses as being incompatible with the “real” rights of political society. For Burke, to “follow nature” is not a radical invitation to rebel against society but an injunction to accept one’s “second nature” as a dutiful member of a historically achieved political order. Since history is a record of experience and since all practical knowledge is a product of experience, history supplies a sufficient guide to political activity. From that empiricist rather than natural-law premise, Burke proposes that prudence, circumstance, utility, convenience, and respect for order provide the proper conditions for liberty, while abstract theorizing delivers the condition of “rational despotism.”

For some, this committed Burke (and conservatism) to an “organic” theory of society. That is an understandable interpretation, but a degree of caution is required because the argument is more subtle and the content less mysterious than the expression “organic” sometimes implies. Burke’s notion of the constitution assumes an arrangement in which order and liberty presuppose one another. It assumes that the individual is part of and has meaning within a social order of classes or estates and that the state is an authoritative expression of that social order. The “little platoons” of immediate identity are functional to stability because their education in local and social affection forms the basis of patriotism. On the one hand, the state cannot be absolute, for its existence depends on the life of its parts and it has a duty to secure them. On the other hand, reasons of state cannot be reduced alone to the protection of the rights of individuals. If revolutionary theorizing would dissolve these historical associations into dust and make social relationships as evanescent as the “flies of summer,” Burke’s model was not an alternative blueprint. Unlike the revolutionary’s vision of France as “nothing but *carte blanche*, upon which he may scribble anything he pleases,” Burke is defending what he takes to be the actual life of the British state, monarchical, aristocratic, and constitutional.

The paradigmatic conservatism of Burke’s thought lies in its evocation of sympathy for what is enduring in a political association. While revolutionary politics proclaim a profound incompatibility between the values of the people and the principles of traditional structures of government, Burke proclaims a deep congruence. Tradition, which is shorthand for a politics of congruence, emerges from his work as an important value in conservative politics. Conservatism puts the idea of tradition to work in defense of the political order. It seeks to encourage people to accept the world around them, for it just

happens to be the world in which we do live and it is one that sets limits to political change. In the British case, the ability of the political order to secure its authority through prolonged periods of economic and social change appeared to confirm Burke’s maxim that a state without the means of reform is without the means of its own conservation. It also appeared to confirm his assumption that the advancement of civilization owes more to the advantages of stability than it does to the pursuit of abstract rights. In the conduct of reform, continuity is secured because improvements are never wholly new and what is retained is never wholly obsolete. Of course, the reconciled condition that conservatism proposes is reconciliation within the ideology itself and not necessarily reconciliation in experience. It is possible to conceive of reality as being seriously at odds with the ideology.

France. This was the case for conservatives in France, where, unlike the happy condition of Britain, the experience and effect of revolution had disconnected the state from what they believed to be the true spirit of society. This compelled thinking through with passionate intensity questions of order and legitimacy, and it fostered a politics that made fundamental distinctions between what is true and what exists. In this case what mattered was the fractured rather than the coherent relationship between political structures and spiritual truth. The legitimacy of those who had usurped power in the name of reason could never be secure against the consecrated authority they had displaced. The task of conservative political argument was to recall people to their true allegiance by clarifying the principles that had been forsaken.

For Joseph-Marie de Maistre (1753–1821), the French Revolution represents divine retribution for the sins of the godless Enlightenment and the “century of blasphemy” that had preceded it. One consequence of that blasphemy is the rationalist misconception involved in the creation of a written constitution. The true constitution is not to be found in the fine words of such a document but in the public spirit that should animate it. For de Maistre, “what is written is nothing.” The constitution is divine in origin, and only when one acts in harmony with God can his or her actions be creative. Once separated from the Creator, people’s actions are rendered negative and destructive. The rule of number, implied by popular sovereignty, has nothing to do with the rule of justice and would ultimately prove to be self-destructive. This is what the course of revolutionary history reveals to conservatives—a succession of failed constitutions of increasing perniciousness and impiety. That disastrous history is as much the fault of the internal corruption of the ancien régime as of the arguments of the philosophes. Ironically then, the revolution will serve as a necessary purgative and will lead to the inevitable, because divinely ordained, restoration of monarchy, religion, and nation. That dissociation between the social and the political as well as the theocratic justification for the restoration of the ancien régime is also found in the work of Louis de Bonald (1754–1840). Monarchy and church, throne and altar, will together bring back into harmony the body and spirit of the nation that the French political revolution had willfully divided. It will, moreover, defeat secular nationalism and replace it with ultramontane Catholicism.

Like Burke, de Maistre and de Bonald associated the terror and the chaos in France with the new, rapacious, self-seeking, revolutionary elite, and they formulated a sociology as well as a pathology of revolution to account for it. They recall to attention the monstrosity of humankind when liberals may prefer to flatter humanity, and they remind one that original sin may be a better guide to modern history than natural goodness. Nevertheless, there are a number of problems with their denunciation of revolutionary presumption. Like radicalism, their thought conveys a profound alienation between what is and what ought to be and, like radicalism, presents itself as a science of politics with a blueprint of restoration as grandiose as the Declaration of the Rights of Man and Citizen. Moreover, de Maistre's celebrated recommendation that if "you wish to *conserve* all, *consecrate* all" is a proposition that transforms the sacred into human artifice, as impious to the true faith as the revolutionary consecration of the cult of the Supreme Being. The intelligent reflection necessary to make the case for conserving all tends to corrode the myths upon which traditions depend and collapses conservatism into very unconservative reaction.

Germany. If conservatism in Britain defended the congruence and conservatism in France demanded the restoration of harmony between the social and political orders, then conservatism in nineteenth-century Germany aspired to bring together an idea of the social and an idea of the political. Here revolutionary France in all its horrible fascination was instructive, demonstrating not only the radical dangers of popular sovereignty but also the military effectiveness of national unity. A romantic evocation of the cultural and racial characteristics of the *Volk* existed alongside a statist philosophy of *realpolitik*. Both were to contribute to an aggressive nationalism favored by those who thought German culture threatened by alien influences and by those who thought its state insufficiently powerful. If these tendencies are present in some measure in all conservative politics, they were to take a radical and racist turn in twentieth-century German history when combined in the detraditionalized, de-Christianized, alienated, genocidal (and so unconservative) shape of National Socialism.

A very different sort of reconciliation is provided by Georg Wilhelm Friedrich Hegel (1770–1831), whose philosophy courageously addresses the central problem of modernity—the idea of progress—that conservative thought either chose to veil (like Burke) or to deny (like de Maistre). The conservative suspicion of progress is that it denies the present in pursuit of the future. A restless and limitless ambition for change, based on an abstract model of human experience, makes modernity into a political *project* to be implemented rather than a *process* (for good and ill) to be understood. The French Revolution was such a political project, and Hegel attempts to map the lineage and the lineaments of the modern state in order to contain the destructive potential of the ideal of emancipation (that Hegelianism was not the *project* of modernity, the fulfillment of which demanded a new science of revolution, was well understood by that most insightful student, Karl Marx). On the conviction that the rational is actual and the actual is rational, Hegel argues in *The Philosophy of Right* (1821), the "plain man like the philosopher takes his stand." The task of the philosopher is to reveal

the rationality of the common-sense intuition of the plain person. Hegel does not approve an institution on the basis of Burkean prescription—that its survival alone is sufficient justification of its rationality—but on the basis of its conformity with the rational self-understanding of the age. Such rationalism and historicism sit uneasily with conservative traditionalism, which often despises the self-understanding of the age and believes that the best reason for a practice is that no reason need be given. Despite his philosophical ambivalence, Hegel's appeal to the conservative is twofold. His reflections satisfy the need to feel that the enjoyment of present liberties is meaningful and should not be sacrificed to some abstract "ought to be." They also satisfy that deep desire to arrest the disturbing uncertainties of modern life within stable political institutions. Ironically, it has been these emotional satisfactions rather than his rational metaphysical system that constitute Hegel's enduring attraction to conservative thinkers.

The Challenge of the Modern

If there has been a specter haunting conservatism in modern times, it is the specter of "mass society." The fear of mass society is a product of two related possibilities. The first is the disintegration of traditional allegiances in the name of liberation and personal freedom. Since conservatives hold that such allegiances are the condition of identity, the consequence would be the loss of individuality. Liberalism, ironically, promotes the death of liberty. The second fear concerns the manipulation of that disintegration by ideologies that promise material satisfaction in return for absolute political power. Having destroyed individuality, mass society would demand abasement before the secular image of its collective power, the state. Socialism, ironically, promotes the death of the social.

In the nineteenth century and for much of the twentieth century, conservatism defended property, religion, and family as bulwarks against the feared drift to "mass" society in which the decencies of civilized life would be subverted by popular barbarism. This disposition helps to capture what is distinctive about the conservative idea of the nation, the one form of popular politics to which it not only adapted but which it also helped to define. For conservatives, the nation is understood as a political community united in acceptance of the legitimacy of traditional political arrangements. The "people" is not some abstract category but the historic nation in its regional and social variety, with its traditional beliefs, particular affections, and long-standing prejudices. To be conservative is another way of professing one's sympathy for the "real" character of the nation, and like de Maistre, conservatives would agree that they have met the French, English, Germans, or Americans but have yet to meet "Humanity."

In rejecting the universal claims of radical politics, conservatism has been compelled to identify exactly what it is that makes the nation distinctive. What differentiates conservatism from right-wing ideologies is the nature of that distinctiveness. In right-wing thought the idea of the nation serves to mobilize the people in order to assert its distinctive purity, honor, and greatness. In conservative thought, the idea of the nation serves to foster piety toward its distinctive social and political

institutions. This differentiation has nothing to do with the intensity of national feeling. It has to do with the source of national feeling. Right-wing thought locates it in the will of the people. Conservatism locates it in the inherited practices of a way of life and has been concerned to limit the popular will in the name of tradition and order. In Europe between the two world wars, conservatism was outflanked by radical right-wing movements because an appeal to tradition and order appeared irrelevant in conditions of economic collapse and social disintegration. The sense of political decadence made an ideology of popular salvation, like fascism, a powerful alternative to traditional conservative patriotism. Britain was the exception, and the experience of British conservatism was thought to illustrate the distinction between the politics of the moderate right and the politics of the extreme right.

While the drama of modern European history has been taken to be exemplary of this difference, an American illustration is more appropriate. Harvey C. Mansfield Jr. considered that the great achievement of American politics has been the replacement of the idea of the sovereign people with the idea of the constitutional people. "The warmth of their republican genius must somehow be cooled; the confidence in their own sovereignty, which is responsible for the factiousness of democratic majorities, must be restrained" (Mansfield, p. 57). The practice of constitutional politics educates democracy in the responsibilities of government, in particular the need to limit power in order to enjoy life, liberty, and happiness. All elements of government "are derived *from* the people but none of them *is* the people," and populism, with its tendency to deny limit and constitutional constraint, is just as subversive of good government as any other species of radicalism (Mansfield, p. 55). This does not imply that there are no elements of populism in conservatism or that conservative politics has not appealed to its prejudices against innovation. However, conservatism's suspicion of political enthusiasm of all kinds makes it uncomfortable with the fickleness as well as the hubris of popular opinion, especially when it proclaims itself to be "the moral majority."

Resisting democracy, defending tradition. Of course, resisting the claims of democracy in the name of limited constitutional politics can be interpreted as an offense to modern sensibility, and defending tradition in a world of rapid change can be seen as either irrelevant or willfully ignorant. Conservatism always faces an enormous challenge in making these ideas persuasive in a world of programmatic politics. It appears insufficiently purposeful to those who are seeking a political faith and insufficiently principled to those who are seeking an alternative to radicalism. To such critics, conservatism is always right, but its inability to be proactive also means that it is always wrong. For example, Friedrich Hayek (1899–1992) thought conservatism incapable of offering "an alternative to the direction in which we are moving" because it does not and cannot indicate another direction (p. 398). Since Hayek famously believed that the socialistic path along which society was moving was the road to serfdom, then clearly conservatism, for all its useful maxims, would not do. This attitude helps to distinguish conservatism from that other species of recent politics, the New Right.

What Hayek assumes is the modernist belief in history-as-project, and this makes politics into an engagement between

projects, either a capitalist one or a socialist one. That modernist assumption, at the heart of New Right dogmatics about liberty and choice, finds systematic expression in neoconservatism. Indeed, some of the leading neoconservatives, like Irving Kristol, have radical political backgrounds. Their contribution in the last half of the twentieth century was to provide a systematic critique of "big government" and its policy failures and to show that the market was not only compatible with moral values but also more efficient in the delivery of social goods. Neoconservative arguments helped transform the political climate in the 1970s and 1980s and contributed to the intellectual defeat of socialism. However, there does exist a tension in neoconservatism between market fundamentalism and conservative skepticism. As Michael Oakeshott (1901–1990) once argued, a plan like Hayek's to end all planning is still a species of rationalism and one with which conservatives can only feel uncomfortable. It abstracts the market from the institutional and cultural traditions necessary for its flourishing, and for the skeptic, conservatism does not have a project to realize. That is its strength and not its weakness, for it properly designates the restricted competence in human affairs of such projects like market liberalization. If conservatism has an attitude toward capitalism, it is the endeavor to sustain those conditions that favor the political economy of freedom, a very different notion from the minimal state.

Postmodernism, human rights, and multiculturalism.

If in the early twenty-first century revolutionary ideologies like communism no longer threaten, arguments in favor of egalitarianism and the aggrandizing state have taken a new shape. As a result, conservatism has been obliged to engage with new discourses, such as postmodernism, human rights, and multiculturalism. In 1959 Hannah Arendt (1906–1975) wrote that distinction and difference had become private matters of the individual and that simple insight, with its contradictory effects, continues to have profound implications for conservatism. Traditionally, of course, conservatism held distinction and difference not to be private matters at all but to be ones of public significance. According to Robert Nisbet, this is the key to understanding the conservative sociological imagination, where such differences, articulated in social institutions like Burke's "little platoons," mediate the relationship between the state and the individual.

The trend toward privatization has disordered that notion in two ways. First, the contemporary state has come either to absorb many of the functions of these institutions, like the educational responsibilities of churches, or to incorporate them into centrally determined policy networks. Second, it has become attractive for the individual to retire into a private world and to cede public duties to the care of professionals. The consequence of both aspects is an expansion of state influence that many conservatives do believe is inimical to individual freedom and social autonomy. For the conservative, the old radical dynamic that required a straightforward faith in state-fostered egalitarianism to be achieved through the redistribution of wealth between social classes has been replaced by a politics of inclusion that requires a rather contradictory faith not only in cultural "difference" but also in the redistribution of "worth" between social groups. The dynamic in this case is toward

the removal of all obstacles in the way of social inclusion, and the motor is a refurbished language of abstract rights.

This new politics is understood to be yet another strategy to achieve the utopian objective of radical democracy, and conservatives believe that the only way it can be realized is by calling on the state to implement an ever-expanding body of entitlements. The influential neoconservative critique of modern liberalism has its roots here, and the concern is that the emphasis on rights will weaken the informal bonds of society and permit the state to become dangerously intrusive in the lives of citizens, destroying the distinction between public and private. Diversity is officially “celebrated,” but what is fostered is a culture suspicious of independent thought or behavior or “political incorrectness.” This is reminiscent of what George Santayana (1863–1952) once called “vacant liberty.” Santayana’s problem with the prescriptions of liberalism is its high-minded egalitarianism of respect, which he believes to be at odds with the very pluralism it seeks to promote. For Santayana, unlimited toleration would achieve the “euthanasia of differences,” and as a consequence everybody “would be free to be what he liked, and no one would care to be anything but what pleased everybody” (p. 449). This anticipates a common, two-pronged, conservative criticism of contemporary liberalism. First, liberalism defends difference only in theory but cannot really come to terms with it in practice when it discovers that goodwill alone is not enough. Second, it is actually intolerant of dissent from political correctness and seeks to impose a modern version of “rational despotism.” Two strands of conservatism, the civil and the cultural, can be identified in response to contemporary political trends.

Conservatism: Civil and Cultural

Civil conservatism draws on a recognizable tradition of limited politics. On the one hand, it proposes that government should not plan the lives of citizens or be an instrument of their collective enlightenment but should uphold a framework of law. On the other hand, it argues that the rights of civil society should not be translated into claims on public expenditure but should be valued as the condition of self-reliance and creativity. Limited but authoritative government remains the proper complement to a society of “difference.”

This understanding owes much to the work of Oakeshott, who in turn owes much to Hobbes. Indeed, Oakeshott’s celebrated essay “On Being Conservative” draws its inspiration from a distinctive reading of Hobbes’s *Leviathan*. Commentators seduced by his poetic description of conservatism as a preference for “the tried to the untried, fact to mystery, the actual to the possible, the limited to the unbounded, the near to the distant, the sufficient to the superabundant, the convenient to the perfect, present laughter to utopian bliss” (Oakeshott, 1991, p. 408) sometimes fail to note that Oakeshott believes this disposition to be inappropriate “in respect of human conduct in general” (p. 415). However, conservatism does remain appropriate in respect of government, all the more so indeed in a modern society that puts so much store by its individualism.

Governing, for Oakeshott, “is recognized as a specific and limited activity; not the management of an enterprise, but the

rule of those engaged in a great diversity of self-chosen enterprises” (1991, p. 429). The philosophic basis of this view of government is explored in *On Human Conduct* (1975). This text has provided fruitful reflection for a diverse range of thinkers seeking a method to secure political legitimacy in contemporary multicultural societies and who identify a common threat to civility in utopian liberalism. Noël O’Sullivan, for example, has attempted to develop a vision of “formal politics” where the bond of association “is neither an agreed end, nor personal approval of the ruler and his actions, but acknowledgement of the procedural considerations which confer authority” (pp. 204–205). He argues that formal politics does not mean a commitment to liberalism but rather a rejection of the sort of “programmatically politics” with which modern liberal politics has become associated. The problem with the formal politics favored by civil conservatives is that it may be (ironically) too abstract and too detached from public sentiment to engage the loyalty of citizens. Certainly, it appears very distant from that sympathy for a traditional way of life normally associated with conservative politics.

Cultural conservatism, by contrast, assumes that a sense of unity rather than diversity is the foundation of political legitimacy. As Roger Scruton argues, the civil vision discounts “prejudices,” and for Scruton (as for Burke), prejudices are those prepolitical affections, such as a sense of national belonging, upon which a stable political order depends. As he succinctly expresses it, “Unity is, in the normal instance, social rather than political, and ought also to be national” (1990, p. 54). This sets out a clear skeptical agenda for conservatism on issues—such as immigration, feminism, multiculturalism, and human rights—that are thought to present challenges to the substance of national identity. This cultural conservative agenda can be distinguished from that of the extreme right because of its respect for the conventions of established institutions. The great difficulty with it is that the social unity it assumes is a contentious one and, far from being self-evident, presents an easy target for those who would dismiss conservatism as nostalgic and elegiac. Contemporary conservatism, then, remains an ambiguous identity, a hybrid of civil and cultural elements.

Conclusion

In a century of ideological extremism like the twentieth century, conservatism often appeared something of an affectation and marginal to the march of history in which the advancing forces of modernization were thought certain to rout the retreating forces of conservatism. Insofar as many people have lost faith in the “grand narratives” of the nineteenth and twentieth centuries, like Marxism and other emancipatory ideals, then the conservative disposition may no longer appear so reactionary. Since conservatism never subscribed to the grosser forms of the modernist faith, contemporary skepticism comes as no surprise to it. However, as befits a philosophy of modesty and imperfection, conservatism cannot assume a final victory.

See also *Authoritarianism; Change; Fascism; Liberalism; Monarchy; Radicals/Radicalism; Totalitarianism.*

BIBLIOGRAPHY

- Arendt, Hannah. *The Human Condition*. Garden City, N.Y.: Doubleday, 1959.
- Aughey, Arthur, Greta Jones, and W. T. M. Riches. *The Conservative Political Tradition in Britain and the United States*. London: Pinter, 1992.
- Aveneri, Shlomo. *Hegel's Theory of the Modern State*. London: Cambridge University Press, 1972.
- Devigne, Robert. *Recasting Conservatism: Oakeshott, Strauss, and the Response to Postmodernism*. 2nd ed. New Haven, Conn.: Yale University Press, 1994.
- Eatwell, Roger, and Noël O'Sullivan, eds. *The Nature of the Right*. London: Pinter, 1989.
- Franco, Paul. *The Political Philosophy of Michael Oakeshott*. New Haven, Conn.: Yale University Press, 1990.
- Hayek, Friedrich A. *The Constitution of Liberty*. London: Routledge and Kegan Paul, 1976.
- Honderich, Ted. *Conservatism*. London: H. Hamilton, 1990.
- Kirk, Russell, ed. *The Portable Conservative Reader*. New York: Viking, 1982.
- Kristol, Irving. *Confessions of a Neo-Conservative*. New York: Basic Books, 1983.
- Mansfield, Harvey C., Jr. "Constitutional Government: The Soul of Modern Democracy." *Public Interest* 86 (1987): 53–64.
- Muller, Jerry Z., ed. *Conservatism: An Anthology of Social and Political Thought from David Hume to the Present*. Princeton, N.J.: Princeton University Press, 1997.
- Nisbet, Robert. *Conservatism: Dream and Reality*. Milton Keynes, U.K.: Open University Press, 1986.
- Oakeshott, Michael. "On Being Conservative." In his *Rationalism in Politics and Other Essays*. New and expanded ed. Indianapolis: Liberty Press, 1991.
- . *On Human Conduct*. Oxford: Clarendon, 1975.
- O'Sullivan, Noël. *Conservatism*. London: Dent, 1976.
- . "The Politics of Ideology." In *The Structure of Modern Ideology*, edited by Noël O'Sullivan, 188–212. London: Edward Elgar, 1989.
- Santayana, George. *Dominations and Powers*. New York: Charles Scribner's Sons, 1951.
- Scruton, Roger. "In Defence of the Nation." In *Ideas and Politics in Modern Britain*, edited by John C. D. Clark, 53–87. London: Macmillan, 1990.
- . *The Meaning of Conservatism*. South Bend, Ind.: St. Augustine's, 2002.
- , ed. *Conservative Texts: An Anthology*. New York: St. Martin's, 1991.

Arthur Aughey

CONSILIENCE. "Consilience of inductions" is a phrase that was invented by the nineteenth-century English historian and philosopher of science William Whewell (1794–1866; pronounced "Hule"), and introduced in his *Philosophy of the Inductive Sciences* (1840). Whewell was trying to capture the notion of what Isaac Newton (1642–1727) had labeled a "true cause," or *vera causa*, the kind of cause that supposedly lies at the center of the very best kinds of scientific theories. Whewell's friend, the astronomer and philosopher John F. W. Herschel (1792–1871), had argued (in an empiricist fashion) that a true cause is something that we ourselves experience

directly or analogically. We know for instance that a force is pulling the moon toward the earth, because we have had direct experience of the tug of a string as we are whirling around with a stone tied to its end.

Whewell, to the contrary, in a rationalist fashion, wanted to characterize a true cause as something that is not necessarily experienced at all, but that is adequate to explain the empirical facts as we know them. He argued therefore that such a cause must be at the center of a scientific explanation, explaining all of the disparate facts and in turn being explained by them. If such a cause can predict and explain new and excitingly unexpected facts, then so much the better. Such a fan-like construction, with the cause at the apex, Whewell labeled a consilience of inductions. He argued also that such a situation is as simple as it is possible for a theory to be, and hence a true cause is also marked by the fact that it is the most economical of explanatory forces, with many parts being reduced to one fundamental mechanism.

For Whewell and Herschel, the paradigmatic example of a true cause was Newtonian mechanics, which used the one force—gravitational attraction—to explain not just the heavenly motions of the planets but also the earth-bound motions of such things as cannonballs. Johannes Kepler's (1571–1630) laws of celestial motion and Galileo Galilei's (1564–1642) laws of terrestrial motion were brought beneath one force. But Whewell and Herschel themselves were arguing over the science of their day, most particularly the nature and causes of light. The beginning of the nineteenth century was the time when the wave theory of Christiaan Huygens (1629–1695) was conquering the particle theory of Isaac Newton. The problem is that no one sees waves. Herschel argued that we have experienced analogous phenomena to light waves, for instance the waves of water in a pond. Hence it is reasonable to suppose that light waves produce such things as interference patterns. Whewell replied that there is no need of analogies—it is enough that the wave theory explains many phenomena that are impossible to explain with the particle theory. The patterns produced by something such as Thomas Young's (1773–1829) double-slit experiment are themselves enough to confirm that light travels in waves and not in particles.

Also dividing Whewell and Herschel was the true nature of geology, with Whewell arguing that it is permissible—even obligatory—to invoke unseen upheavals (catastrophes), and with Herschel agreeing with the uniformitarian geologist Charles Lyell (1797–1875) that unlimited time is enough to produce all changes, given the kinds of causes (rain, sleet, earthquakes, and so forth) that we see around us today. A young scientist who took deep note of Whewell's arguments was Charles Darwin (1809–1882), who, realizing that no one can ever see evolution actually occurring, consciously modeled his *Origin of Species* (1859) on Whewell's thinking. Having introduced his mechanism of natural selection, Darwin then spent the rest of the work showing how selection explains so many different areas—instinct, biogeography, paleontology, embryology, morphology, classification, and more—and how these areas in turn confirm natural selection as a true cause. When challenged, Darwin always referred to this strategy, even though, somewhat

paradoxically, Whewell himself never became an evolutionist and supposedly would not allow the book on the shelves of the Cambridge college of which he was principal.

Consilience in Modern Science

The consilience of inductions figures high in modern science. Its broad explanatory power was the main reason that so many geologists were so quickly converted to the theory of plate tectonics. Supposing that the continents move explains so much—the shape of the continents, the position of earthquakes and volcanoes, the trenches in the middle of oceans, the magnetic lines, and much more. In recent years the idea has been extended into philosophy and to thinking about science and knowledge generally. The Harvard student of the ants and of social behavior (sociobiology), Edward O. Wilson, argues that all of human knowledge is heading toward a consilience—a consilience where evolution will be the all-powerful joining and explaining idea. We have a kind of gene-culture coevolution, where culture tries to impose its ways and norms on human behavior and thought, but where the genes always constrain the flights of fancy and make sure that human nature never strays too far from the basic biological.

Wilson argues that morality for instance cannot exist as a disembodied ethereal enterprise, but must be rooted firmly in our evolutionary background—morality exists because and only because it was and is of use to us as creatures struggling to survive and reproduce. Those humans who worked together did better than those who did not. Likewise, religion serves to bind humans together in well-functioning units. It has no correspondence to reality but serves as an adaptation toward the greater success of *Homo sapiens*. Wilson argues that we must strive to achieve ever-greater consiliences between disparate parts of human knowledge until all is bound together in one big super-picture. Only then will we humans recognize the extent to which we are part of this big picture—a picture that includes all of natural diversity. Only then will we humans be truly motivated to the preservation of the living world around us, something from which we emerged and something without which we can never hope to survive. Consilience has therefore moved from the epistemological norm of William Whewell to the moral imperative of Edward O. Wilson.

See also *Causation; Science, Philosophy of.*

BIBLIOGRAPHY

- Ruse, Michael. *The Darwinian Revolution: Science Red in Tooth and Claw*. 2nd ed. Chicago: University of Chicago Press, 1999. Originally published in 1979.
- Whewell, William. *The Philosophy of the Inductive Sciences*. 2 vols. London: Parker, 1840.
- Wilson, Edward O. *Consilience*. New York: Knopf, 1998.

Michael Ruse

CONSTITUTIONALISM. Constitutionalism is commonplace in modern political discourse in the West and beyond, yet it remains an elusive concept. Some have considered it impossible (and unnecessary) to give a definition of it.

Nonetheless, one can discern several common features of the concept: the rule of law, not of men; limitations of political authority; the protection of civic rights and liberties; and rule based on the free consent of the ruled. Placing limitations on the exercise of political power is central to the notion of constitutionalism, and measures for that end include admonition to the deviant ruler; the assertion of the people's right to resist, punish, or depose a tyrant; the division of sovereignty via federalism; and the separation of powers, or other checks and balances.

Paradoxical as it may seem, the presence of a constitution is not necessarily a manifestation of constitutionalism. A constitutionalistic constitution forms a political entity, establishes its fundamental structure, and determines the limits within which power can be exercised politically. But some constitutions in the modern world, like those of the former Soviet Union and the People's Republic of China, do not limit the exercise of political power. A constitution of this sort is designed to constitute and empower the state, but not to control it.

Ancient Conceptions

The idea of controlling political power goes back to ancient Athens, where all state officials were accountable to the citizens who sat on the jury court. This jury-court system is the hallmark of the Athenian constitutionalism based on popular participation, yet it was never conceptualized by the leading Greek philosophers, including Plato (c. 428–348 or 347 B.C.E.) and Aristotle (384–322 B.C.E.). For Plato, democracy—rule by the ignorant masses—was fundamentally flawed. His vision of the ideal state, therefore, allows no space for an assembly or a court: a countervail to the contemporary practice of Athenian politics. Aristotle's tripartite conception of the just political structure—monarchy, aristocracy, and *politeia*—resulted in the idea of the mixed constitution combining the virtues of three. This idea, ill defined by Aristotle, was often confused with the idea of the ideal constitution. The political practice of Republican Rome was described and celebrated by Cicero (106–43 B.C.E.) as the “mixed constitution,” which was, however, a pure aristocracy according to his own description. The nature of Republican Rome's political institutions remains elusive: in contrast with Cicero, Polybius (c. 200–c. 118 B.C.E.) depicted them as part of a constitutionalist system, with the popular assembly controlling legislation and the election of magistrates.

Medieval Conceptions

The medieval model of constitutionalism is often associated with Magna Carta (1215); in it, the constitutionalistic idea that personal liberties should be protected from the authority of the prince by established legal procedures was already present. But the medieval contributions to constitutional theory may be found in the sphere of ecclesiology under the label of conciliarism. Conciliarism was the idea that the pope was not an absolute ruler but a constitutional monarch whose authority was ministerial and delegated to him for the common good of the church. The ultimate authority in the church, then, resides in the whole body of the believers or their representatives—namely, the general council. According to twelfth-century canonists, who

grappled with the questions surrounding the possible abuse of power by the pope, the pope was an intrinsic part of a general council and the authority of the pope with a general council was greater than without: an argument parallel to the secular idea of the supremacy of the king-in-parliament. The divine nature of papal authority did not necessarily result in theocratic absolutism because of the idea that the power of jurisdiction came from God through the people; the power of the papal office originates from God, but the choice of a person who assumes the office depends on the consent of human cooperation.

The exaltation of papal sovereignty in thirteenth-century mendicant ecclesiology was countered by secular masters' "episcopal" view: Christ conferred supreme authority not to Peter and his successors alone but equally to the twelve apostles and their successors; thereby ecclesiastical sovereignty was divided. All these elements of thought constituted conciliarism in the later Middle Ages, represented by such thinkers as Pierre d'Ailly (1350–1420) and Jean de Gerson (Jean Charlier; 1363–1429). The historian J. N. Figgis describes early modern constitutionalism as "the last effort of medieval constitutionalism," but the extent to which medieval constitutional thought influenced its modern counterpart remains debatable.

Early Modern Conceptions

Widespread administrative abuses and ecclesiastical corruption in late-sixteenth-century France generated a number of polemical pamphlets, which asserted the rights of the people to depose a tyrant. Huguenot political writers including François Hotman (1524–1590; *Francogallia*), Théodore de Bèze, (Theodorus Beza; 1519–1605; *The Rights of Magistrates*), and Duplessis-Mornay (Philippe de Mornay, Seigneur du Plessis-Marly; 1549–1623; *Vindiciae contra tyrannos*; A defense of liberty against tyrants) made important contributions to early modern constitutionalism by defining the right to resist and depose a tyrannical monarch as the ultimate guarantee of a set of particular controls on political authority. Their works rejected resistance by private individuals but asserted the right of resistance by constituted public power, especially of the Estates and lesser magistrates. Huguenot political thinkers upheld the doctrine of the division of sovereignty between the monarch, representative institutions, and lesser magistrates, whilst their contemporary Jean Bodin (1530–1596), a powerful proponent of the indivisibility of sovereignty, saw anarchy as the alternative to monarchy (just as Thomas Hobbes would do in the following century). Jean Bodin's theory of sovereignty circulated widely in seventeenth-century England, and served to bolster the idea of unlimited monarchical sovereignty manifested by James I (ruled 1603–1625) and Charles I (ruled 1625–1649). Sir Robert Filmer (c. 1588–1653) and Thomas Hobbes (1588–1679) conceptualized the doctrine of monarchical authority. But political authority in England had already been pluralistic, and this reality was crystallized in Sir Edward Coke's (1552–1634) idea that the English judiciary was independent from the crown as well as from Parliament. A more direct reaction to the Bodinian doctrine came from Johannes Althusius (Joachim Althaus; 1557–1638), who attributed indivisible sovereignty, unlike Bodin, to the people as a collective entity.

The people as individuals are under the ruler, and yet the people as a collectivity is superior to the ruler. Althusius's novelty lies in his vision of federalism: he conceived a political community as a hierarchy of corporations, and took care to specify the way in which smaller communities are associated together in larger political entities, which resulted in a system of checks and balances.

Perhaps one of the most important sources for the authors of the American constitution was the epoch-making *L'esprit des lois* (1748; *The spirit of the laws*) written by Charles-Louis de Secondat, baron de Montesquieu (1689–1755). This eminent lawyer was deeply inspired by the English system of government that, in his view, had effectively secured what he called "political liberty." Montesquieu observed that the highest expression of political liberty was to be found in England. English constitutional practice had protected each citizen from each other, from foreign enemies of the state, and from the state itself. The key to this success, according to Montesquieu, was the functional separation of powers: legislative, executive, and judicial. The institutional separation of powers secured effective control of the coercive authority of the state: a significant departure from the "mixed constitution" model.

The late eighteenth century was the age of constitutions; the first modern written constitution was enacted in the United States of America (1787), followed by the French Declaration of the Rights of Man and the Citizen (1789). *The Federalist*, eighty-five papers written by Alexander Hamilton (1755–1804), James Madison (1751–1836), and John Jay (1745–1829), vindicated the theoretical foundations of the U.S. Constitution that underlined the limits on federal power by means of federalism, separation of powers, and the effective independence of political institutions. These institutional constraints were designed to augment the citizen's exercise of civic virtues to prevent monarchical despotism and to maintain liberty.

What constituted an important intellectual backdrop was republican constitutional ideas. Republicanism, upheld by influential figures such as Montesquieu, Jean-Jacques Rousseau (1712–1778), and Immanuel Kant (1724–1804), distinguished the people as a legislator (constituent power) from the people as a legislative power (constituted power) and envisioned the "good order" of society—that is, the fundamental principles of the working of a political society, or the means by which good laws and good rulers should be made. On the other hand, the U.S. Constitution was initially criticized for the omission of a specific statement concerning basic citizen rights. This was later drawn up as the Bill of Rights, now considered an integral part of the constitution.

Modern Conceptions

The U.S. Constitution generated reaction from British constitutionalists, and at the heart of the debate was the idea of sovereignty. Walter Bagehot (1826–1877), the author of *The English Constitution*, criticized the ambiguity of the locus of sovereignty in it, whereas Albert Venn Dicey (1826–1877) thought highly of the federal system of government that divided legislative powers between national and state authorities. The nightmare of totalitarianism in the first half of the

twentieth century, on the other hand, demanded the vindication of constitutionalism, which was quintessentially crystallized in Charles H. McIlwain's *Constitutionalism, Ancient and Modern*.

In the early twenty-first century, issues over constitutionalism became ever more complex. Constitutionalism did not grow out of democratic thought, yet most contemporary states with a constitution are constitutional democracies. This demands that the relationship between constitutionalism and democracy be defined more precisely. The reconciliation between liberal right-based constitutionalism and republican democratic constitutionalism has also been sought. Furthermore, there exists a plurality of constitutions. The British model, for example, manifests parliamentary sovereignty, whereas the American model locates sovereignty in the people. The wide reception of constitutionalism beyond the West has created new varieties of constitutionalism (transformative constitutionalism). The emerging European Union after World War II, followed by the post-1989 developments in Eastern Europe in particular, has brought the debate over constitutionalism to an entirely new phase: constitutionalism beyond the framework of the nation state, and even the possibility of global constitutionalism.

Islamic Conceptions

The idea of limited government was not unknown in early Islamic political thought; the Muslim ruler was more limited than Christian princes in the sense that he had no power to legislate. The Holy Law (*shari'a*) however, was not effective in limiting political power due to the dearth of institutional machinery that imposed the limitations.

In Persia (Iran) in the 1850s, the government reformed the legal system to limit the power of the *'ulama* (scholar-teachers), and introduced the Western notion of constitutionalism. The promoters of constitutionalism, such as Malkom Khan (1833–1908) and Mirza Yusef Khan Mostashar od-Dowle (d. 1895), endeavored to demonstrate that the new idea was anchored in Islamic law and tradition. Mirza Yusef Khan's treatise, *Yek Kalameh* (n.d.; One word), contrasted Western prosperity with Persian stagnation and saw the solution of this problem in *yek kalameh*, a political structure based on law. He highlighted the virtues of the French constitution and demonstrated its compatibility with Islamic ideas. Such endeavors contributed to incorporating the Shiite religious group successfully into the constitutionalist movement, thereby paving the way to the Constitutional Revolution (1905–1911). Similarly, the young Ottomans, including Namik Kemal (1840–1888), who admired the constitution of the French Third Republic, reinterpreted passages in the Koran as arguments for constitutional democracy. Khayr al-Din al-Tunisi (1822/23–1890), who dreamed of the independence of the Islamic world community, was, like the Ottoman and Persian reformers, receptive to the Western constitutional idea that personal liberty and justice should be achieved by the rule of law. But his constitutionalism also echoed the Islamic intellectual tradition, especially the political ideas of Ibn Khaldūn (1332–1406).

Chinese Conception

The term that signifies “constitutional law” is of ancient origin in the Chinese language, and yet it denoted none of the

Western ideas associated with modern Western constitutionalism. For the Chinese, constitutionalism was a Western import, dating back to the early nineteenth century. But the idea was not seriously assimilated until Japan established the first constitutional law in East Asia in 1889.

K'ang Yu-wei (1858–1927) was the leader of the Hundred Days of Reform, the movement for constitutional reform. He embraced the evolutionist view that constitutional change from monarchy to democracy was a historical necessity. His 1898 reform program, which included the creation of a parliament and the adoption of a constitution, was welcomed by the Emperor Kuang-hsü, (ruled 1875–1908), but its translation into practice was aborted by the coup d'état under the initiative of the Empress Dowager Tz'u-hsi (1835–1908).

Japan's victory in the war against the Russian Empire in 1905 demonstrated, in the eyes of the Chinese constitutional reformists, the victory of constitutionalism; this gave added momentum to the reception of the idea in China. The Ch'ing government drew up an “Outline of Constitution” modeled on the Japanese constitution, which never took effect, however, due to the 1911 revolution led by Sun Yat-sen (1866–1925) and the downfall of the Ch'ing dynasty. The Republic of China, established in 1912, promulgated a Provisional Constitution, the first modern constitution, modeled on the U.S. Constitution. Sun Yat-sen's *Sanminzhuyi* (1924; The three principles of the people)—the Principle of Nationalism, the Principle of Democracy, and the Principle of People's Livelihood—was inspired by Abraham Lincoln's (1809–1865) Gettysburg Address (1863), and his guiding principle of constitution-making known as the separation of five powers—the powers of administration, legislation, judiciary, examination, and impeachment, the last two being uniquely Chinese—was built upon Montesquieu's notion of the separation of powers.

Japanese Conceptions

The Japanese reception of Western constitutionalism, following the collapse of the Tokugawa Shogunal regime (1603–1867), was motivated by the diplomatic and military needs of national independence. The strengthening of the military needed to be augmented by “the concord of the People's mind (*jinwa* or *jinmin kyōwa*),” which could be achieved through the introduction of Western constitutional government. One of the pressing tasks in domestic politics was to settle the conflict between powers by entrusting supreme authority to parliament. Hence, in his *Tonarigusa* (1861; Grass next door), the first treatise on constitutionalism in Japan, Katō Hiroyuki (1836–1916) proclaimed the establishment of parliamentary politics. The perception of a constitution as the symbol of a modern Western-style state was widely shared by the political leaders of the new Meiji government, which led to the speedy creation of the Meiji Constitution, the first constitutional law in East Asia. Yet, the adoption of a “Westernized” constitution, officially an imperial gift to the Japanese subjects, was not accompanied by wide acceptance of the idea of controlling the power of the state. The prevalent Confucian language that equated the private with the evil and the public (namely, the state, not the civil society) with justice undercut the constitutional idea of the protection of individual liberties.

After Japan's defeat in World War II, constitutionalism, which had experienced a serious setback during the war, was rehabilitated under the new Constitution of Japan. This Constitution, however, was created not by popular demand, but by the initiative of the occupation authority. Ever since, Article 9, which proscribes the use of military means in diplomatic conflict, has been the focal point of post-war constitutional debate.

See also *Democracy; Republicanism; State, The*.

BIBLIOGRAPHY

- Beer, Laurence Ward, ed. *Constitutionalism in Asia: Asian Views of the American Influence*. Berkeley: University of California Press, 1979.
- Bellamy, Richard, ed. *Constitutionalism, Democracy, and Sovereignty: American and European Perspectives*. Aldershot, U.K.: Avebury, 1996.
- Black, Antony. *The History of Islamic Political Thought: From the Prophet to the Present*. Edinburgh: Edinburgh University Press, 2001.
- Castiglione, Dario, and Richard Bellamy, eds. *Constitutionalism in Transformation: European and Theoretical Perspectives*. Oxford: Blackwell, 1996.
- Figgis, J. N. *Political Thought from Gerson to Grotius, 1414–1625*. 2nd ed. Cambridge, U.K.: Cambridge University Press, 1916.
- Franklin, Julian, trans. and ed. *Constitutionalism and Resistance in the Sixteenth Century: Three Treatises by Hotman, Beza, and Mornay*. New York: Pegasus, 1969.
- Gordon, Scott. *Controlling the State: Constitutionalism from Ancient Athens to Today*. Cambridge, Mass.: Harvard University Press, 1999.
- Lloyd, Howell, A. "Constitutionalism." In *The Cambridge History of Political Thought, 1450–1700*, edited by J. H. Burns and Mark Goldie, 254–297. Cambridge: Cambridge University Press, 1991.
- McIlwain, Charles H. *Constitutionalism, Ancient and Modern*. Rev. ed. Ithaca, N.Y.: Cornell University Press, 1947.
- Tierney, Brian. *Religion, Law, and the Growth of Constitutional Thought, 1150–1650*. Cambridge, U.K.: Cambridge University Press, 1982.

Takashi Shogimen

CONSUMERISM. Consumerism, the central economic and social policy of contemporary capitalism, is a doctrine of growing the economy through constantly increasing the consumption of commodities and services. The term *consumerism* is also used to describe movements to protect the rights and interests of consumers.

Consumerism and Mass Production

While the consumption of commodities has always been an aspect of human society, consumerism was not possible until after the first and second industrial revolutions (1760–1840 and late nineteenth and early twentieth centuries, respectively). The industrial revolutions, led by Great Britain and the United States, gradually caused the replacement of the artisan system, in which goods were produced locally by skilled workers on a

small scale. Technological innovations, like the spinning jenny (1764), allowed fewer and less-skilled workers the ability to produce more goods, while the creation of national transportation networks, such as railroads, allowed for their wide dissemination. The factory system, in which labor was organized by specific tasks, rose into prominence, leading to the growth of cities, rising immigration, and the depletion of natural resources.

As the labor process was divided into separate tasks, laborers became estranged from the products of their labor, destroying the pride in craftsmanship they had experienced in the artisan system. Karl Marx (1818–1883), political economist and theorist of capitalism, described this disconnection as "alienation." Alienation allowed commodities to be seen not as the products of labor, which was hidden from consumers, but as fetishes, things imbued with an almost animate power in the world. A commodity's usefulness, or, in Marx's terms, use-value, became increasingly subordinated to its exchange value, or its social worth (generally its price or monetary value). As commodities lost any connection with objective value, they became fetishized. Advertising has aided and exploited commodity fetishism by suggesting that commodities have magical properties—that is, that buying a product will increase the consumer's social status or attractiveness. As the commodity has become the central aspect of social life, areas that were once outside of the economic sphere, such as the family or religion, are recreated as commodities for sale in the market.

While the industrial revolutions allowed for mass production, it was not until Henry Ford (1863–1947) introduced his assembly-line system for automobile production that goods could be produced in huge quantities cheaply enough to be widely accessible. Using Frederick Taylor's scientific-management principles, Ford assigned workers small, repetitive tasks that by 1913 allowed a car to be produced every ninety-three minutes. While the nature of this work was potentially unfulfilling for workers, Ford paid them well—his legendary five-dollar-per-day minimum wage—as a means of ensuring that he would have a mass of people able to afford the Ford Model T. The success of Ford's venture so changed the American economy and capitalism in general that the Italian Marxist Antonio Gramsci (1891–1937) coined the term *Fordism* to describe it. Fordism is defined by an economy dominated by centralized mass production, state welfare, unionized workers, and consumption of standardized commodities, of which the Model T is the ideal example. This car was designed to appeal to all consumers regardless of class, race, gender, and so on. Under Fordism, yearly or seasonal product changes are minimal or nonexistent.

While advertising had existed previously—from town criers to handbills—advertising as a rationalized, scientific profession began only in the 1850s. In the mid-nineteenth century a variety of products, such as patent medicines, had come to be widely consumed in the national marketplace. Advertising became important as a means of creating desire for new, standardized products and especially of proving to consumers that these products were superior to homemade or local ones. In their search for status as professionals and experts, advertisers

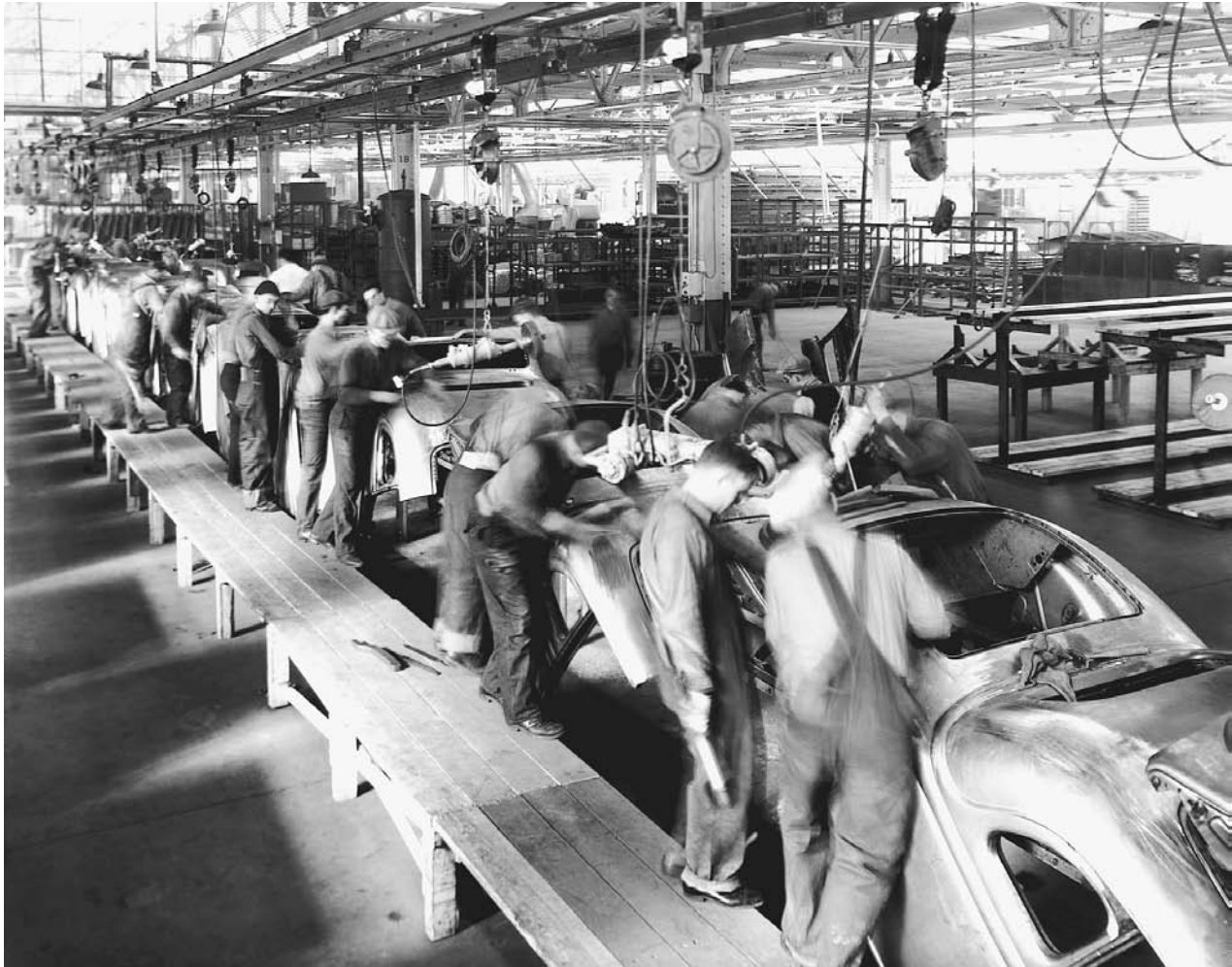

Assembly line at Ford Motor Company factory, Minnesota, 1935. Industrial advancements such as Henry Ford's assembly line, which was instituted in the early twentieth century, allowed products to be available to consumers in mass quantities and at affordable prices. © BETTMANN/CORBIS

sought to distance their practice from the carnivalesque methods of peddlers, snake-oil salesmen, and other hucksters by relying on factual information soberly offered. Yet the carnival tradition never entirely disappeared, and even in this era, pictorial advertisements using magical and sensual imagery continued to appear in mass periodicals, though they were managed by the new national advertising agencies and therefore became increasingly standardized.

By the 1880s and 1890s the modern advertising system was in place. Instead of simply serving as middlemen between businesses and media outlets, advertisers sold their services as designers of campaigns, promoters of products, and experts on the media. Branding, in which products came to be known by a specific brand name, became increasingly important in differentiating essentially similar products from each other in the market. As these brand-name products were distributed across formerly insurmountable barriers of geography by steamships and trains, people in diverse regions could consume the same products, inculcating a sense of nationalism. In this way, the

Fordist era promoted a nation founded on the “democracy of goods” in which everyone used the same consumer products, collapsing consumerism with national identity. Yet this “imagined community” was highly stratified by race, gender, ethnicity, and class. While the Fordist era of mass production shifted the United States, as well as other nations, from a country of artisan production, regional cultures, and individualized commodities to one of national brands, this nationalism came at the expense of many members of the nation itself, particularly people of color, the working class, and women. Blacks, for example, were portrayed in advertisements of this era almost exclusively as happy servants or as icons of slavery, such as Aunt Jemima and Uncle Ben. Working-class people were also rarely seen in advertisements, which presented a relentlessly middle- or upper-class world.

Consumerism and Post-Fordism

The term *post-Fordist* has been used to describe the shift from an economy based on mass production and mass consumption

SOAP

Soap was first sold under a brand name in Great Britain in 1884, placing it indelibly within the history of British imperialism and Victorian notions of gender and race. Soap advertisements portrayed soap as a fetish, imbued with the power to cleanse and bring civilization. As Reverend Henry Ward Beecher (1813–1887) argued in an 1885 testimonial for Pears soap, “If Cleanliness is next to Godliness, then surely SOAP is a means of GRACE.” Soap advertisements consistently used magical imagery to hide the intense labor performed by working-class maids employed in middle-class homes. Middle-class women were never shown as laborers, creating a gendered ideology where middle-class women were “angels of the household” whose major role was that of consumer.

Soap advertisements also offered a racial ideology, described as “commodity racism” by Anne McClintock. A Pears soap advertisement of 1899 argued that “The first step toward lightening THE WHITE MAN’S BURDEN is through teaching the virtues of cleanliness. PEARS’ SOAP is a potent fact in brightening the dark corners of the earth as civilization advances.” The scientific racism that posited evolutionary notions of biology and history came to be projected onto commodities, which would do the work of empire. Soap became the symbolic carrier of whiteness, imperialism, and Victorian gender roles.

of identical goods to one distinguished by “flexible specialization.” Production is specialized through the use of technology. The post-Fordist labor force is multiskilled and global, which has eroded the class consciousness of Fordist labor movements. Importantly, consumption has become specialized as well. No longer is there one product designed for the mass of consumers. Instead, products are target marketed to particular niches, using demographics, psychographics, and other marketing techniques. At this point, style becomes the major method of differentiating products. Advertisers encourage consumer desire to become more volatile and individualized. Products are not marketed by extolling their utilitarian value but by proving to the consumer how he or she can use them to display a particular identity to the world. The development of a post-Fordist economy is difficult to pinpoint, though scholars suggest that the 1970s in the industrial West was a turning point. Even within one economy, such as the United States, the development of post-Fordism did not occur unilaterally through all industries. While current Western economies can be described as post-Fordist, Third World economies are not necessarily so, though First World post-Fordism relies on the exploitation of labor, resources, and markets within the Third World.

Scholars agree, however, that one of the most significant aspects of the post-Fordist economy is the reliance on market segmentation as opposed to mass consumption. Market segmentation emphasizes particular aspects of a product or creates a particular product to appeal to specific market segments, which are differentiated by income, gender, race, ethnicity, age, geography, and so on. This marketing para-

digm developed out of the baby boom of the post-World War II era and the social and identity movements of the 1960s that became the predominant paradigm by the 1970s and 1980s.

The social and identity movements of the 1960s suggested that people understood their identities as differentiated by a number of characteristics. In response, advertisers and marketers explored the potential for “breaking up America” and the world into an ever-increasing number of segments of people who had “lifestyles” that were defined by the particular commodities they consumed. The development of cable television is an ideal example. Beginning in the late 1970s, cable networks were designed to appeal to particular types of viewers, whether women (Lifetime), African-Americans (Black Entertainment Television [BET]), and youth (Music Television [MTV]), through the content of their programs as well as the flow of shows and commercials. As important as “signaling” or attracting the desired type of viewers, however, was ensuring that unwanted types of viewers were not watching.

Race and ethnicity are becoming increasingly critical market segments. In 1994, according to *Brandweek*, at least half of all Fortune 500 companies were using ethnic or racial marketing techniques. Latinos, for example, are one of the fastest-growing ethnic minorities in the United States, and corporations are searching for ways to appeal to this segment, which is divided into a variety of subsegments (Mexican-American, Puerto Rican-American, Cuban-American).

PSYCHOGRAPHICS

Psychographics is a method of market segmentation based on personality, lifestyle, and geodemographics. These techniques promise to offer marketers the ability to define their target buyers by their beliefs, values, and self-perception. This allows for micromarketing, or marketing tailored to the level of very small segments, such as neighborhoods. For example, a department store that serves a neighborhood of young unmarried people may not carry children's products, while the same department store in a different but nearby neighborhood, with a different geodemographic profile, might do so. Psychographics also allows marketers to appeal to consumers based on their perceived self-perceptions. Does this consumer generally make decisions based on status? Beliefs? The online service "You Are Where You Live" offered by the marketing analysis company Claritas in the early 2000s is an example of the use of psychographics and geodemographics.

An important corollary of these developments is that as style becomes central in product differentiation, it is necessary for styles to change rapidly. What has been described as the essentially postmodern practice of pastiche is an outgrowth of these marketing and economic changes, in which capital recycles old styles in a desperate attempt to create products that seem "new and improved." As the commodity becomes even more divorced from use- or exchange-value, it becomes a sign, able to be given a variety of possible and mutable meanings depending on the particular market segment. Price fluctuates not according to actual production costs but according to how much a particular consumer will pay. Cultural intermediaries, or those members of the professional-managerial class that work in cultural industries such as advertising or public relations, serve as cultural guides for the middle class, helping these consumers navigate the array of potential commodities available for consumption and offering their lifestyles as models of how to live successfully in this new world of constant consumption.

The Politics of Consumerism

As consumerism has become the fundamental doctrine of contemporary capitalism, individuals have been encouraged to consider themselves primarily as *consumers* rather than as citizens, workers, or members of religious denominations. While in many ways this ideological shift has been spurred by capital as a means of ensuring a continual increase in consumer spending as a means of growing the economy, numerous individuals and organizations have used this consumer identity as a way to encourage government control over business and to protest social, racial, political, and economic injustice. For example, during the Great Depression of the 1930s women's organizations such as the General Federation of Women's Clubs and the League of Women Shoppers led consumer protests for food legislation and against rising meat prices. Dr. Kathryn McHale, the general director of the American Association of University Women, summarized the consumer

movement's philosophy in 1935 when she said "there is no interest which is more fundamental than that of consumers. All residents of our nation are consumers in large or limited way. No matter what our other interests, we have in common one function—that of consumption" (Cohen, p. 34).

Even the civil rights movement of the 1950s and 1960s utilized consumer identity to justify its claim for equal rights. The first and most-remembered protests were the Montgomery bus boycott, when African Americans refused to consume public transportation as a protest against their inferior treatment in the transit system, and the lunch-counter sit-ins, when protesters refused to move from whites-only dining areas. These tactics showed the government and the American public the correlation between citizenship and the right to consume—in the consumerist world of post-World War II America, being banned from consumption demonstrated second-class status.

While consumer movements have been successful to a degree in protecting certain rights, they can be faulted for accepting the overwhelming ideology of consumerism and, more widely, capitalism. Instead, other individuals and organizations have sought to protest the ideology of consumerism through a variety of methods and means. While consumerism relies on the creation of desire, anticonsumerist movements focus on "need." Religious sects such as the Amish and the Shakers adapted the Christian idea of voluntary poverty, for example, to create a more godly existence based on need, while the counterculture of the 1960s used voluntary poverty to justify its renunciation of material goods and capitalism. However, even voluntary poverty or its secular corollary, "voluntary simplicity," created by Duane Elgin in the 1980s, have been adapted by the mass media and business. In the 1970s the Stanford Research Institute, a nonprofit corporation that offers corporate clients advice on emerging trends, estimated that almost 75 million Americans had "simple" sympathies that business should utilize (Kleiner, 1996). Still, many people advocate voluntary simplicity as necessary to limit the negative environmental

impact of a consumer-driven economy, which produces huge amounts of waste and uses resources at an ever-quicken pace.

Another central critique of consumerism is related to globalization. Multinational corporations are cited for destroying local and indigenous resources and cultures in order to make way for their products. The term *McDonaldization* has been coined to describe the phenomenon of local cultures being stamped out by multinational corporations spreading a homogenous Western (usually American) culture. However, scholars dispute the effects of McDonaldization. While many see local cultures being destroyed by the forces of globalizing popular culture, others assert that local cultures incorporate and adapt these forces, creating a syncretized culture. Still, either side must acknowledge the uneven power relationships that exist between a cultural behemoth like the United States and Third World markets.

See also *Capitalism; Globalization; Marxism*.

BIBLIOGRAPHY

- Baudrillard, Jean. *The Consumer Society: Myths and Structures*. Thousand Oaks, Calif.: Sage, 1998.
- Campbell, Colin. *The Romantic Ethic and the Spirit of Modern Consumerism*. New York: Blackwell, 1987.
- Cohen, Elizabeth. *A Consumers' Republic: The Politics of Mass Consumption in Postwar America*. New York: Knopf, 2003.
- Ewen, Stuart. *Captains of Consciousness: Advertising and the Social Roots of the Consumer Culture*. New York: McGraw-Hill, 1976.
- . *All Consuming Images: The Politics of Style in Contemporary Culture*. New York: Basic Books, 1988.
- Ewen, Stuart, and Elizabeth Ewen. *Channels of Desire: Mass Images and the Shaping of American Consciousness*. Minneapolis: University of Minnesota Press, 1992.
- Frank, Thomas. *The Conquest of Cool: Business Culture, Counter-culture, and the Rise of Hip Consumerism*. Chicago: University of Chicago Press, 1997.
- Kleiner, Art. *The Age of Heretics: Heroes, Outlaws, and the Forerunners of Corporate Change*. New York: Currency/Doubleday, 1996.
- Lears, T. J. Jackson. *Fables of Abundance: A Cultural History of Advertising in America*. New York: Basic Books, 1994.
- Lury, Celia. *Consumer Culture*. New Brunswick, N.J.: Rutgers University Press, 1996.
- Marchand, Roland. *Advertising the American Dream: Making Way for Modernity, 1920–1940*. Berkeley: University of California Press, 1985.
- Marx, Karl. *Capital: A Critique of Political Economy*. New York: Vintage Books, 1977.
- McClintock, Anne. *Imperial Leather: Race, Gender, and Sexuality in the Colonial Conquest*. New York: Routledge, 1995.
- Ritzer, George. *The McDonaldization of Society: An Investigation into the Changing Character of Contemporary Social Life*. Newbury Park, Calif.: Pine Forge Press, 1993.
- Turov, Joseph. *Breaking up America: Advertisers and the New Media World*. Chicago: University of Chicago Press, 1997.
- Williams, Raymond. "Advertising: The Magic System." In his *Problems in Materialism and Culture: Selected Essays*. London: Verso, 1980.
- Witt, Doris. *Black Hunger: Food and the Politics of U.S. Identity*. New York: Oxford University Press, 1999.

Mary Rizzo

CONTEXT. Like "text," the word "context" is a metaphor derived from the Latin *texere*, "to weave." In the fourth century C.E. the Latin noun *contextio* described the text surrounding a given passage. In the Middle Ages, *contextio* came to mean "literary composition," but an interest in what we call "context," especially in biblical exegesis, was expressed through the term *circumstantiae*. In the ninth century, Sedulius Scotus enunciated the rule of "seven circumstances"—person, fact, cause, time, place, mode, and topic.

Texts in Context

It was in the sixteenth and seventeenth centuries, especially in Italian, French, English, and German, that the term "context" (*contesto*, *contexture*, *Kontext*) began to be used with frequency. From the sentences before and after the passage to be interpreted, "context" came to refer to the coherence of a text, the relation of the parts and the whole. The term was also extended to include the intention (*scopus*) of the writer.

"Circumstances" remained a key term. Jurists discussed circumstantial evidence. Moralists studied "cases of conscience," the ethical equivalent of case law. Interpretations of the Bible invoked the need to take circumstances into consideration. The sixteenth-century Florentine historian Francesco Guicciardini offers an example of contextual thinking in early modern style. Guicciardini's *Considerations* on the *Discourses* of his friend Niccolò Machiavelli criticized the generalizations because they were "advanced too absolutely" (*posto troppo assolutamente*), since human affairs "differ according to the times and the other events" (*si varia secondo la condizione de' tempi ed altre occorrenzie*).

The thrust of the movements we call the "scientific revolution" and the "Enlightenment" was anticontextual in the sense that participants were concerned with formulating generalizations that would be valid whatever the circumstances. By the late eighteenth century, however, these "enlightened" attitudes were coming to be viewed as part of an intellectual old regime against which a more "historicist" generation revolted around the year 1800, stressing differences between individuals and cultures at the expense of general laws.

The Rise of Cultural Context

This "Counter-Enlightenment" was associated with a further expansion in the meaning of the term "context," increasingly concerned not only with local circumstances but also with the "historical context" of an entire culture, society, or age. A famous example is Madame de Staël's essay *De la littérature considérée dans ses rapports avec les institutions sociales* (1800; The influence of literature upon society). Within the German tradition of hermeneutics, the classical scholar Friedrich Ast distinguished in 1808 between the literal or grammatical level of interpretation, the historical level (concerned with meaning), and the cultural level, concerned with grasping the "spirit" (*Geist*) of antiquity or other periods.

Karl Marx was a contextualist in another sense, concerned to locate consciousness and its expressions within "life," especially social life. Marxists and non-Marxists alike were increasingly concerned with *Zusammenhang*, the connection between the parts and the whole.

Material context was also taken more seriously in the early nineteenth century than before. In archaeology, the increasing concern with stratigraphy in the early nineteenth century implied a concern with context or location. Antoine Quatremère de Quincy denounced the looting of Italian works of art by Napoleon, Lord Elgin, and others on the grounds that this uprooting or *déplacement* deprived the objects of their cultural value. Later in the century, the German anthropologist Franz Boas caused a sensation in museum circles by arguing that artifacts should be arranged by “culture area” rather than evolutionary sequence because an object could not be understood “outside of its surroundings.”

The Discovery of Situation

In a number of disciplines in the 1920s and 1930s, especially sociology, psychology, history, and anthropology, the term “situation” came to play a central role. Karl Mannheim, for instance, one of the pioneers of the sociology of knowledge, treated ideas as socially situated (literally “tied to the situation,” *Situationsgebunden*). At much the same time the sociologist William I. Thomas was stressing the importance of what he called “the definition of the situation” for social action. In psychology, Lev Vygotsky and Aleksandr Luria argued that the mentality of illiterates was characterized by “concrete or situational thinking.”

In the case of history, we might contrast the French with the British approach. Marc Bloch’s famous study *Les rois thaumaturges* (1924) attempted to make the belief in the supernatural power of the royal touch intelligible by presenting it as part of a system of “collective representations,” while R. G. Collingwood and Herbert Butterfield concerned themselves with contexts and situations at the individual level. For Butterfield, the historian’s task was to place an individual action “in its historical context.” For his part, Collingwood declared that “every event . . . is a conscious reaction to a situation, not the effect of a cause.”

Anthropology is sometimes perceived as the contextual discipline par excellence. More exactly, it became this kind of discipline in the 1920s, thanks to Bronislaw Malinowski. Meaning, he argued, is dependent on the “context of situation.” In a famous example he referred to a stick that might be used for digging, punting, walking, or fighting. “In each of these specific uses,” he claimed, “the stick is embedded in a different cultural context.” Malinowski’s ideas about context were taken further by his pupil Edward Evans-Pritchard, in a study of witchcraft, oracles, and magic among the Azande in which the author argued that “an individual in one situation will employ a notion he excludes in a different situation.”

The Contextual Turn

In the last generation we have seen what might be called a “contextual turn,” on the analogy of so many other turns in intellectual history. One sign of change is the increasing use of terms such as “contextualism,” “contextualization,” and “de-contextualization.” In the case of theology, the “contextual reinterpretation” of religion has been under discussion. In ethics, a movement known as “situationism” has effectively revived casuistry under another name. In philosophy, John Austin’s analysis

of the “occasion” and “context” of utterances remains influential. In educational sociology and psychology, the work of Basil Bernstein and Jerome Bruner on “context-dependent” and “context-independent” learning illustrates the trend.

In literary criticism the idea of placing a poem “in context,” or even “in total context,” was defended by the Cambridge critic F. W. Bateson and denounced by F. R. Leavis, who argued that “social context” meant merely “one’s personal living.”

In the 1950s and 1960s, sociolinguists such as Dell Hymes and William Labov noted that the same people speak differently according to the context or situation. Even in the case of the law, concerned with general rules, the rise of “context sensitivity” has been noted. In sociology, Anthony Giddens described “locale” as essential to what he calls the “contextuality” of social interaction, while feminists such as Donna Haraway revived and revised Mannheim’s concept of “situated knowledge.”

A concern with situation and performance has become increasingly visible in recent decades in musicology and art history. Thus the phrase “performative context” has come into use to refer to the adaptation of music to suit a certain place, occasion, and audience. In art history, where an artist’s style was once taken to be an expression of his or her personality, it is now interpreted as a kind of performance. A movement for a “contextual archaeology” has made its appearance.

In intellectual history the concern with context is even more explicit, above all at Cambridge University. In the 1950s, Peter Laslett argued the case for placing Locke’s *Second Treatise of Government* in a “revised historical context.” In his *Barbarism and Religion* (1999) J. G. A. Pocock, a student of Butterfield’s, set out “to effect a series of contextualizations” of Edward Gibbon’s *Decline and Fall of the Roman Empire* (1776–1788). Quentin Skinner’s work relies still more on the idea of context, whether linguistic, intellectual, or political. In the philosophy and history of science, the foundation of the journal *Science in Context*, in 1987, offers another example of context-consciousness, at once an attempt to emulate the historians of political thought and a response to a continuing debate over the status of scientific knowledge, universal or local.

See also **Cultural Studies; Historiography.**

BIBLIOGRAPHY

- Boas, Franz. “Museums of Ethnology and Their Classification.” *Science* 9 (1887): 587–589.
- Burke, Peter. “Context in Context.” *Common Knowledge* 8, no. 1 (2002): 152–177.
- Collingwood, R. G. “Outlines of a Philosophy of History.” In *The Idea of History*, edited by Jan van der Dussen, 426–496. Oxford: Clarendon, 1993.
- Giglioli, Pier Paolo, comp. *Language and Social Context*. Harmondsworth, U.K.: Penguin, 1972.
- Leites, Edmund, ed. *Conscience and Casuistry in Early Modern Europe*. Cambridge, U.K., and New York: Cambridge University Press, 1988.
- Mannheim, Karl. *Conservatism: A Contribution to the Sociology of Knowledge*. Edited by David Kettler, Volker Meja, and Nico

- Stehr. London and New York: Routledge and Kegan Paul, 1986. Translation of *Das Konservative Denken*.
- Thomas, William I. "Situational Analysis" In *W. I. Thomas on Social Organisation and Social Personality*, edited by Morris Janowitz, 154–167. Chicago: University of Chicago Press, 1966.
- Toulmin, Stephen. *Cosmopolis: The Hidden Agenda of Modernity*. New York, 1990.
- Tully, James, ed. *Meaning and Context: Quentin Skinner and His Critics*. Cambridge, U.K.: Polity Press, 1988.

Peter Burke

CONTINENTAL PHILOSOPHY. The term *continental philosophy* was coined by English-speaking analytic philosophers in Great Britain and the United States shortly after World War II. Since then, the term has been used primarily by English-speaking philosophers but not by western European philosophers, who see no need to call themselves "continental."

The differences between analytic and continental philosophy are rooted in eighteenth-century European Enlightenment. Generally speaking, analytic philosophers tended to view the Enlightenment positively, while continental philosophers viewed it critically. Taking different stances toward the German philosopher Immanuel Kant (1724–1804), analytic philosophers focused primarily on Kant's epistemological work, *Critique of Pure Reason*, while continental philosophers stressed Kant's ethical and aesthetic works, the *Critique of Practical Reason* and the *Critique of Judgment*. The final divide between analytic and continental philosophy occurred in their respective stances toward post-Kantian German idealism and Romanticism, especially toward the dialectical system of the "Absolute Spirit" posited by Georg Wilhelm Friedrich Hegel (1770–1831). Deeply influenced by Hegel and by the critique of religion devised by Hegel's former student Ludwig Feuerbach (1804–1872), Karl Marx (1818–1883) and Friedrich Engels (1820–1895) transformed Hegel's dialectical idealism into dialectical and historical materialism. In keeping with this post-Kantian philosophy, contemporary continental philosophers are concerned primarily with man's history and culture and with religious, moral, and social issues.

Wittgenstein and Analytic Philosophy

In order to understand continental philosophy, one has to refer indirectly to analytic philosophy, which originated in Germany and Austria through the work of Gottlob Frege (1848–1925) and the Austrian-born British philosopher Ludwig Wittgenstein (1889–1951), its most famous representative. Analytic philosophy was preceded by the logical positivism of the "Vienna Circle" of the 1930s and drew its name from its logical "analysis" of language. Analytic philosophy soon became the mainstream philosophical movement in the English-speaking world, especially after the publication of Wittgenstein's *Tractatus logico-philosophicus* in 1921. With great originality, the later Wittgenstein overshadowed almost all of analytic philosophy with his posthumous book *Philosophische Untersuchungen* (1953; *Philosophical Investigations*), which brought

about a new "linguistic turn," wherein language came to be understood in terms of cultural diversity, or "language games," including ordinary, religious, moral, and aesthetic language. In his later years Wittgenstein criticized his own *Tractatus* and its one-sided, representational "picture theory" of language. The later Wittgenstein reinterpreted language as embedded in the action-oriented, social context of historical "forms of life." In addition, Wittgenstein was deeply concerned with the foundations of religious faith, the nature of religious language, fideism, and ethical and aesthetic issues, which brought him closer to the European, "continental" philosophy of Kant, Arthur Schopenhauer (1788–1860), and even Martin Heidegger (1889–1976).

Wittgenstein opened the way to encounters with continental philosophy. In spite of ongoing differences in subjects and methods, in the late twentieth and early twenty-first centuries continental and analytic philosophers have opened promising new dialogues as exemplified by Richard Rorty, Herbert Dreyfus, Charles Taylor, John McDowell, Hilary Putnam, Stanley Cavell, Alistair McIntyre, Hans-Georg Gadamer, and Jean-François Lyotard, among others. Contemporary philosophy of science, with its historical and sociological sensibility, has also been influenced by continental philosophy as exemplified by Thomas Kuhn, Gaston Bachelard, Jürgen Habermas, Karl-Otto Appel, Ernst Tugendhat, Ian Hacking, Paul Feyerabend, Patrick Heelan, Joseph J. Kockelmans, Ted Kiesel, and Thomas M. Seebohm. Continental philosophy has especially impacted Heidegger-influenced existential psychoanalysis as exemplified by the work of Jean Piaget, Ludwig Binswanger, Medard Boss, Erich Fromm, William J. Richardson, and Jacques Lacan.

With its roots in the Enlightenment, the analytic tradition, for the most part, stresses clarity and precision in thought and language, an ahistorical view of truth, reason, and human nature. It tends to critique traditional religion, morality, and metaphysics. With the exception of the more conservative Wittgenstein, analytic philosophers, for the most part, adhere to a progressive, liberal, and democratic worldview. In contrast, heavily influenced by Hegel's ideas about the intrinsic historicity of human thought and action, continental tradition, for the most part, is concerned with the historical, cultural, and social conditions of human life and tends to be focused on issues of liberation and "emancipation" from individual and social injustice. Some continental philosophers are critical of modernism and liberal democracy, especially Heidegger and some postmodernists. There are many exceptions, including the liberal Western Marxists György Lukács (1885–1971), Ernst Bloch (1885–1977), and Antonio Gramsci (1891–1937), as well as the Frankfurt School. In the twenty-first century, continental philosophy is strongly represented by French philosophers.

Because of the great impact of nineteenth-century German idealism and European Romanticism on continental philosophy, some continental philosophers, in the footsteps of Schopenhauer, Max Weber (1864–1920), Max Scheler (1874–1928), and Oswald Spengler (1880–1936), have been critical of modern, urbanized, and industrialized society. Haunted by

the loss of a mostly idealized ancient, medieval world of agricultural and hierarchical life forms, they have sought to recover a holistic view of human life as adumbrated in the “philosophies of life” of Friedrich Nietzsche (1844–1900), Wilhelm Dilthey (1833–1911), and Henri-Louis Bergson (1859–1941). Some continental philosophers, especially feminist philosophers, have emphasized the dimensions of the aesthetic life, the emotional, imaginative, creative, and “unconscious” aspects of human existence.

Freud and the Unconscious

The pioneering work of Sigmund Freud (1856–1939) on the unconscious had a deep influence on modern literature, literary criticism, and on continental philosophy. When continental philosophy rediscovered the unconscious, it inspired a deeper appreciation of the human body and of human sexuality and also supported the rejection of the dualism of René Descartes (1596–1650). Concerned with issues presented by Freud’s work, French philosophers such as Jean-Paul Sartre (1905–1980), Simone de Beauvoir (1908–1986), Maurice Merleau-Ponty, Jean Baudrillard, Michel Foucault, Jacques Lacan, and the feminist philosophers Luce Irigaray (b. 1930), Julia Kristeva (b. 1941), Sarah Kofman (1934–1994), Michele Le Doeuff (b. 1948) and Helene Cixous (b. 1937) are now at the forefront of the crossroads between philosophy, linguistic theory, Marxism, psychoanalysis, and literature. For example, Irigaray writes: “Sexual difference is one of the major philosophical issues, if not the issue, of our age” (*Ethique de la différence sexuelle*, 1984; *An Ethics of Sexual Difference*, p. 19).

Phenomenology of Consciousness

In eighteenth-century Germany, Johann Heinrich Lambert (1728–1777), Kant, and Hegel, who wrote *Die Phänomenologie des Geistes* (1807; *Phenomenology of Spirit*), used the term *phenomenology* in different contexts. Edmund Husserl (1859–1938), the founder of contemporary phenomenology, used the term as a pre-suppositionless description of human consciousness in constituting meaning. From his teacher Franz Brentano (1838–1917), Husserl adopted the theory of “intentionality,” the notion that every mental act is directed toward something. According to Husserl, phenomenology describes the essential contents (*noema*) of our intentional acts (*noesis*), not objects in the world. The content of consciousness is neutral as to its reality or nonreality.

In his famous *Logische Untersuchungen* (1900–1901; *Logical Investigations*), Husserl sought to go “back to the things themselves” (*Zu den Sachen selbst*) as they appeared to pure consciousness in perceptual and “categorical intuition.” Husserl maintained that “being” is given to “categorical intuition” like any other ideal essence. Heidegger critiqued Husserl, maintaining that being is not an “object” of intuition but is understood from the pretheoretical context of man’s concrete, factual life. Heidegger transformed Husserl’s phenomenology of consciousness into a hermeneutical and existential phenomenology of “being.”

Husserl’s first work, *Philosophie der Arithmetik* (1891; *Philosophy of Arithmetic*), was written in terms of “psychologism,”

according to which “logical meaning” could be reduced to “psychological acts.” When Frege criticized “psychologism,” Husserl discarded it and developed a new method, which attempted to gain access to the data of “pure” consciousness by taking a step back (“reduction”) from the “natural attitude” of common sense and the sciences. In his new method, Husserl described two different “reductions”: (1) *phenomenological reduction*, or *epoché* (suspension), which “brackets” the ordinary, natural world, that is, the “existence” of things, and (2) *eidetic reduction*, which describes the *eidos*, the “essence” of noematic content. Husserl called the intentional activity of consciousness “object-constituting subjectivity” by which all meanings are “constituted,” that is, disclosed and made manifest. Although Husserl remained within the Cartesian tradition of subject-object dualism, he consigned this dualism to the noetic-noematic structure of the intentional act. Thus, he undermined the modern “epistemological” problem of an isolated subject and an “external world.”

In his early work *Ideen zu einer reinen phänomenologie* (1913; *Ideas: General Introduction to Pure Phenomenology*), Husserl and his students held a “realist” position, focusing on the contents of consciousness, whereas the later Husserl changed to a more “idealist” position, which he called “transcendental,” that is, that the world is always “for” a mind. According to Husserl, transcendental consciousness “bestows” meaning upon everything, including its own functioning. In some respects, the later Husserl paralleled Heidegger by turning his phenomenological investigations to questions of “temporality,” that is, the temporal flow of transcendental consciousness, and to “intersubjectivity” or social existence. In his later years, Husserl also focused on a “genetic” phenomenology in which the original “genesis” of intentional acts and objects is something passive for consciousness (“passive synthesis”), prior to any voluntary activity of transcendental consciousness. Husserl also became interested in the historical character of science and in the problem of the constitution of the “life-world” (*Lebenswelt*) upon which science is based. Ironically, the later Husserl believed that phenomenology could even constitute the “essence” of the life-world.

Merleau-Ponty was one of the most famous French phenomenologists. Influenced by Husserl and Heidegger, opposed to Cartesian subject-object dualism, he developed an “ontology of the flesh,” which centered on the primacy of perceptual experience and the role of the lived and living body as the primary access to a spatio-temporal world (*Phénoménologie de la perception* (1945; *Phenomenology of Perception*). One’s perceptions, which are always connected with the flesh of the living body, are historically situated interpretations of the world. Perceptions cannot be reduced to pure “source-data” of intentional consciousness.

Heidegger and the Phenomenology of Being

Heidegger studied Scholastic philosophy and theology at the University of Freiburg, where he became acquainted with Husserl’s new phenomenological movement. In 1927 he published his most famous work, *Sein und Zeit* (*Being and Time*). In 1933 he served briefly as the rector of the University of Freiburg but was stripped of his professorship in 1945 because

of his personal involvement with the national socialist movement and his membership in the Nazi Party. After the war, his stubborn silence about Nazi atrocities and the Holocaust cast a dark shadow over his otherwise brilliant career. He died in 1976, and in accordance with his wishes, he had a Catholic funeral.

In his student days, when he read Brentano's *On the Manifold Meaning of Being since Aristotle* (1862), Heidegger became absorbed with the question of time as experienced by human beings and with the question of the meaning of being (*Seinsfrage*); that is, what it means "to be." He gradually came to the conclusion that all Western philosophy, beginning with Plato's theory of suprasensible Forms, had conceived *being* and *time* as opposites, mutually exclusive of each other. Even Aristotle had interpreted time as constant "presence" and as a "now," without reference to being and past and future horizons. Western metaphysics had described God too as eternal "Now" (*Nunc stans*), beyond all time. Heidegger called attention to this "onto-theological" character of metaphysics and maintained that the actual, unitary relationship between being and time in human existence had been "forgotten" in lieu of dualisms such as time and eternity.

In addition to Heidegger's existential interpretation of such terms as *techné*, *phronesis*, and *sophia* in Aristotle's *Ethics*, his studies of time in early Christianity, Augustin, Luther, and Kierkegaard had a great influence on *Being and Time*. In turn, Heidegger had a deep impact on contemporary Protestant and Catholic theology.

Reevaluating the relationship between being and time, Heidegger argued that human existence must be understood from three dimensions of "ec-static" (i.e., existential) time: past, present, and future in their intimate, ontological interdependence. He used the German word *Dasein* to describe the human being with his/her implicit understanding of being. The "Da" or "there" of *Dasein* expresses that the human being is not a thing-like "substance" (Aristotle) or an enclosed "subject" (Descartes). Rather, the human being is an open realm, a "clearing" (*Lichtung*) as in a forest, wherein the understanding of being, of other human beings and things, and of man's own self takes place simultaneously. *Dasein* is always already a "being-with-others" in a shared, communal way of life. For Heidegger, *Dasein* is ontologically gender neutral. Because of its temporal character, *Dasein* is not a static entity but a "potentiality-for-being" (*Seinkönnen*), a temporal movement of possible ways of being, which the individual chooses or lets others choose for him. *Dasein* is always a projecting of oneself into the future toward death, its "authentic" acceptance or its "inauthentic" denial.

Another related term for *Dasein* is *existence*, from the Latin *ec-sistere*, meaning "standing out" into the openness of being. Existence applies only to human beings and is characterized by "mineness," which can be "authentic" or "inauthentic." Still another relational word for *Dasein* is "*being-in-the-world*," which negates the subject-object dualism of Descartes and Husserl, and articulates *Dasein's* holistic and practical involvement with, and comportment toward, the world. *Dasein* is not disclosed to us through "categories" of things, but rather

through its prescientific characteristics, which Heidegger called "existentials" such as *disposition* (*Befindlichkeit*), existential *understanding* (*Verstehen*), and *speech* (*Rede*).

According to Heidegger, in *Identität und Differenz* (1957; *Identity and Difference*), Western metaphysics erred in its inadequate understanding of time as pure "presence" for a subject. Furthermore, Western metaphysics forgot the primordial "ontological difference" between "being" and "beings" in favor of only "ontical differences" between beings such as God, world, and humanity. Heidegger maintained that metaphysics had to be "deconstructed" in order to positively unearth and retrieve its forgotten, primordial experience of being as the "unthought" in Western metaphysics. In Derrida's "deconstruction" of texts, which was originally influenced by Heidegger, the term took on a more critical, "disruptive" interpretation of literary texts. Heidegger "deconstructed" Western metaphysics by reinterpreting the texts of numerous Western thinkers from the sixth-century-B.C.E. Greek philosopher Parmenides to Nietzsche.

In his analysis of "being-in-the-world," Heidegger also distinguished between things "ready-to-hand" (*Zuhanden*)—objects of practical concern with a historical and/or social context—and things "present-at-hand" (*Vorhanden*)—things abstracted from their context and made objects of our theoretical, scientific knowledge. Heidegger demonstrated that Western philosophy overlooked the original human context of "ready-to-hand" things in favor of "present-at-hand" things, "objects" in abstract space and time, as exemplified by theoretical, scientific reasoning. In this "metaphysics of presence," being itself was described as a property or essence, constantly present in things as a "substance."

One can only enumerate a few other "existentials" in *Being and Time*, such as the anonymous "they" (*das Man*); temporality in which "care," with its threefold structure of projection, thrownness, and fallenness is rooted; existential "guilt" and "conscience"; anxiety (*Angst*); "death" as the ultimate disclosure of "my" finitude and mortality, the impossibility of all my possibilities. A central place in *Being and Time* and other writings is devoted to the distinction between "logical truth" and "ontological truth" as standing in the light of being. According to Heidegger, the Greeks already implicitly distinguished ontological truth as "unconcealment" (*aletheia*) emerging from the background of a deeper "concealment" (*lethe*) prior to any logical, propositional truth.

Heidegger's later philosophy, after his so-called turn (*die Kehre*), was first expressed in the *Brief über den Humanismus* (1947; *Letter on Humanism*), according to which Western "humanism," with its one-sided emphasis on "subject" and "reason," is, nevertheless, rooted in the prior but forgotten relationship of *Dasein* to being. As opposed to traditional "calculative" thinking, as critiqued in *Beiträge zur Philosophie 1936–1938* (1989; *Contributions to Philosophy*), Heidegger's later, "meditative" thinking concerned itself with many new themes, such as art, language, science, and technology. In a highly speculative apocalyptic manner, the later Heidegger considered the present technological stage of the history of being as the abandonment of humankind by being itself. Yet,

Heidegger's later thinking, which he understood as a "thank-ing" response to the call of being, is focused on an "other beginning" for humankind. Humans must "listen" and respond in a new meditative-poetic thinking, which might lead to a transformed way of life after the ages of metaphysics, a "letting-be" (*Gelassenheit*) of beings, a term taken from Johannes Eckehart (c. 1260–?1327) and German, medieval, mystical tradition. In a few German poets (Hölderlin, Trakl, George) Heidegger saw the hidden prophets of the future "destining" (sending) of being itself to humans.

In his growing skepticism even about the use of the word "being," Heidegger looked for new words that would mark the postmetaphysical era. He chose the term "disclosive appropriating Event" (*Ereignis*, from *ereignen*, "appropriate," and *er-augen*, to see and disclose), a pure subjectless happening, from which the "fourfold" regions of the world, in their interplay between heaven, earth, mortals, and the divinities, emerge into the nearness of humanity. Heidegger's other attempts to say the "unsayable" in expressing the mystery of being (which is not in human control) include the phrases: "dif-ference" (*Unterschied*) of the simultaneous withholding and unfolding of being in beings; and the "fissure" (*Zerklueftung*) of being itself. Finally, he talked about the singular "Event" that gives and approximates being (*es gibt Sein*) and time by a simultaneous self-withdrawal and "expropriation" (*Enteignung*).

Existentialism

Existentialism, as originally presented by Sartre, de Beauvoir, and Albert Camus (1913–1960), emphasized the importance of individual existence, choice, and personal responsibility. It was opposed to impersonal systems of thought and to modern mass society. Partially rooted in the Judeo-Christian tradition of faith, existentialism has also been influenced by Søren Kierkegaard (1813–1855), Fyodor Dostoyevsky (1821–1881), Nietzsche, and by Husserl and Heidegger. Kierkegaard's ethical-religious works impacted many twentieth-century religious existentialists such as Martin Buber, Paul Tillich, Karl Barth, Gabriel-Honoré Marcel, and Emmanuel Lévinas, while Nietzsche's supposed nihilism and atheism ("God is dead") deeply influenced Karl Theodor Jaspers, Heidegger, Sartre, Foucault, Jacques Derrida, Gilles Deleuze, and Luce Irigaray.

Sartre was a philosopher, playwright, social critic, and political activist who became famous with his work *L'existentialisme est un humanisme* (1946; *Existentialism Is a Humanism*) and his phrase "Existence is prior to essence." In the late 1950s, he supplemented this individualistic, existential humanism with social and critical Marxism as expressed in his book *Critique de la raison dialectique* (1976, 1985; *Critique of Dialectical Reason*). In his early work *L'être et le néant* (1943; *Being and Nothingness*), influenced by Husserl and Heidegger, Sartre described the tension between human consciousness ("being-for-itself," *pour soi*), which is "not a thing" but an activity, and the brute existence of things ("being-in-itself," *en soi*). According to Sartre, man has absolute freedom, even in the most constrained situations as exemplified by Sartre's own experiences in the French resistance movement and his imprisonment in Germany. For Sartre, the self is always an embodied, situated self. Sartre also talked about "bad faith," which he

defined as "inauthentic" flight from the anguished burden of choice and responsibility.

Sartre's lifelong companion Simone de Beauvoir, who had a great influence upon Sartre, especially upon his later socially oriented work, wrote the famous early feminist work *The Second Sex* (1949), which described the historical and existential situation of women. According to de Beauvoir, women continue to be defined within a masculine worldview, which assumes an "eternal feminine," an unchanging biological destiny, and a feminine "essence." Men assume that women are "the other," a designation limiting women's freedom and autonomy. De Beauvoir insisted that femaleness is a social construct: "One is not born but rather becomes a woman." De Beauvoir proposed the way for the first philosophical discussion of "sexual difference" within the context of the structures of powers, and forces of desire in later feminist writers.

Camus, like Sartre, de Beauvoir, and Merleau-Ponty, one of the famous representatives of the post-war existentialist movement in France, is known for his notion of the "absurd" as expressed in his poetic writings such as *The Plague* (1947). According to Camus, the absurdity of existence provokes the question of the meaning of life and the act of suicide as "the only truly serious philosophical problem" (*Le mythe de Sisyphe*, 1942; *The Myth of Sisyphus*, p. 1). The human being must engage in an ongoing "revolt" against absurdity: "I rebel—therefore we exist" (*L'homme révolté*, 1951; *The Rebel*, p. 22).

Jaspers (1883–1969), similar to the early Heidegger, saw the historically situated freedom of the individual within certain "boundary situations" such as guilt, suffering, anxiety, and death. Existence can only be realized in communication. He considered existences a gift of Being, which he called Transcendence, God, or the "Encompassing."

Hannah Arendt (1906–1975), who had studied under Husserl, Heidegger, and Jaspers, emigrated to the United States and became a renowned political philosopher despite her sometimes controversial involvement with the Jewish cause. In her works on totalitarianism, anti-Semitism, and imperialism she took a stance against National Socialism and Heidegger's involvement with it, and against Marxism. She favored political freedom, constitutional democracy, and pluralism in her adopted country, the United States. In addition to Claude Lefort, Cornelius Castoriadis (b. 1932), and Habermas, Arendt is the best known political philosopher in the continental tradition.

Hermeneutics

Hans-Georg Gadamer (1900–2002), Heidegger's student, who taught at many German and American universities after World War II, is the father of contemporary ontological hermeneutics. His great work, *Wahrheit und Methode* (1960; *Truth and Method*), points to the problem underlying all modern philosophy (epistemology) from Descartes to Husserl, namely, the relationship between the original "truth" of human understanding within the "life world" and historical "traditions" on the one hand, and the "methods" of the sciences on the other. Inspired by Heidegger and influenced by Hegel

and German Romanticism, Gadamer transformed the method of hermeneutical understanding (*Verstehen*) in the human sciences, history, law, arts, and theology into a “universal” ontological hermeneutics. He went beyond the work of Friedrich Schleiermacher (1768–1834) and Dilthey, who had introduced the “hermeneutical circle” as the relationship of the parts to the whole, and the “implicit” to the “explicit,” out of the correspondence of the knower to the known in any interpretation. Gadamer rejected natural sciences’ explanations (*Eklären*) as the *only* way of understanding reality.

Gadamer maintained that as the art of interpretation, hermeneutics is based upon the human, linguistically constituted “life world,” the living conversation and dialogue between people that is the horizon of all human experience and knowledge. Hermeneutics aims at mutual understanding between an historically situated “author” of a text and an historically situated “reader” or interpreter. Gadamer called the hermeneutical encounter between an author and a reader the “fusion of horizons.” As such, in historical events, literature, or works of art, hermeneutics is always the relationship between two horizons of understanding and interpretation within a tradition, and it has the prospective goal of “consensus.”

Criticizing Enlightenment for its ahistorical perspectives and denying that the methods of the natural sciences are the only means to “objective knowledge,” Gadamer emphasized the deeper truth in historical understanding, which passes from generation to generation through written texts, which are—contrary to Derrida’s primacy of “writing”—always rooted in the living language. As texts are interpreted and reinterpreted throughout history, they produce a “history of effect” (*Wirkungsgeschichte*), which shape and influence our present and future understanding of reality. Since there are hidden presuppositions and cultural “prejudices” in each interpretation, Gadamer sees that hermeneutics does not focus on the isolated “true meaning” of a text or on the author’s intention. Rather, universal Hermeneutics focuses on the different suppositions and presuppositions of all interpretations in both the human and natural sciences. After the failed attempt for a fruitful encounter between Gadamer’s “phallogical” hermeneutic and Derrida’s “Deconstruction” in the 1980s, which both originated in Heidegger’s work, hermeneutics and Deconstruction remain two as yet unreconciled paradigms in contemporary philosophy. The third paradigm is Habermas’s “critique of ideology,” which rejects Gadamer’s positive evaluation of tradition, consensus, authority, and “prejudice,” as the continual “distortion of communication” by masked social and political interest. Thus, the special, yet unacknowledged interest of modern bourgeois, capitalist society disrupts and disguises understanding and communication in a worldwide global consumer society.

Paul Ricoeur (b. 1913), the proponent of a phenomenological hermeneutics, is focused on narrative, symbol, metaphor, dreams, and ideologies as the means by which our experience of the world is interpreted. Opposed to postmodernism’s abolition of the “subject,” he elaborates a notion of “subject” stripped of modern subjectivism. In contrast to Gadamer, Ricoeur does not concede a dualism between “truth”

(philosophy) and “method” (science) but bridges them by his interest in the methodological “validation” of interpretation by the methods of the human sciences. He calls the critical point of hermeneutics “the hermeneutics of suspicion” as it reveals the hidden, ideological meaning of texts, events, and social practice. For Ricoeur, the great “masters of suspicion” are Marx, Nietzsche, and Freud.

Postmodernism

Modernism is characterized by Enlightenment values; that is, trust in the autonomous human “subject,” scientific reason, and universal principles of law, morality, politics, and economics. In different ways, postmodern philosophers oppose the main ideas of the Enlightenment. Instead, they focus on a “decentered” subject, human knowledge as conditioned by history, and the mistrust of the “grand narratives” of modernity (Kant, Hegel, Marx). The French philosopher and novelist Georges Bataille (1897–1962) initiated the poststructuralist notion regarding the death of the “subject” in order to overcome its isolation in experiences of “excess” (laughter, tears, eroticism, death, sacrifice, and poetry). Similar to Nietzsche’s “perspectivism,” postmodernism critiques “objective” truth and favors a theory of multiple “interpretations” of texts. Postmodernism was preceded by poststructuralism in literature, the humanities, social sciences, and even architecture in the 1960s and 1970s. Poststructuralism partially opposed the linguistic structuralism of Ferdinand de Saussure (1857–1913). Similar to much of the analytical philosophy, Husserl, and also Derrida, Saussure saw language as a self-contained system of signs rather than as an ongoing, historical process of conversation and dialogue in the Socrates sense. In contrast to “subjective” existentialism, structuralism focused on super-individual structures such as language, kinship, and ritual in order to understand human existence. Saussure influenced the anthropological structuralism of Claude Lévi-Strauss (b. 1908), the Marxist structuralism of Louis Althusser (1918–1990), the social critique of Foucault, the political and cultural critique of Roland Barthes (1915–1980), and the psychoanalytic structuralism of Lacan. Rejecting the scientific pretensions of structuralism, poststructuralism questioned the “objectivity” of knowledge and truth, of the “subject” as a unified self, the oppressive nature of modern institutions, authority, and power. Postmodernism was marked by the abandonment of dogmatic Marxism by French intellectuals, especially after the student-worker revolution of 1968, its critique of Western imperialism, racism, and antifeminism.

Lyotard (1924–1998), through his book *La condition post-moderne* (1979; *The Postmodern Condition*), represents the postmodern movement and its great influence on the literary, political, and cultural milieu beyond professional philosophy. Lyotard pointed out the demise of grand, foundational, totalizing “metanarratives”; that is, grand theories or systems of thought such as liberalism and Marxism, which are being replaced by local narrative or smaller stories of everyday life, which are expressed in limited but pluralistic “language games” (Wittgenstein). Lyotard uses the term “differend” (*differend*) for the incommensurability or heterogeneity of these different language games, literary genres, and idioms, which can never

be reduced to logical or ontological “sameness,” not even to a political “consensus” in the sense of Gadamer, Habermas, or Rorty. For Lyotard, the knowledge of irreducible differends, that is, disputes and dissensions in politics, is the most important form of resistance to capitalism and its uniformity and injustice. In *Heidegger et “les juifs”* (1988; *Heidegger and “the Jews”*), Lyotard criticized Heidegger’s silence on the Shoah (Holocaust). He pointed out the philosopher’s duty to stand for the “marginalized” and “the Forgotten.”

The Algerian-born French philosopher Jacques Derrida (b. 1930) has had almost as much impact on French continental philosophy as Foucault, but he is hardly criticized by analytic philosophers such as John Learle. Like Heidegger, Derrida attacks the traditional Western “metaphysics of presence” and its reduction of “being” to “substance” (entity). Like Wittgenstein, Derrida asserts that logical meaning is always embedded in the historical, social, and cultural matrix of language. He accuses Western metaphysical tradition of “logocentrism” and “phonocentrism,” which favor the immediacy of the “meaning” of the spoken word rather than writing, which is characterized by distance, repeatability, and uncertainty of meaning. According to Derrida, logocentrism utilizes oversimplified, “binary opposites” such as reason-emotion, soul-body, male-female, and so on, which presuppose an unquestioned hierarchy of subordination in classical, philosophical texts and in political discourse.

Derrida’s method of “deconstructing” the logocentrism demonstrates that a particular text usually does not have just one clear meaning, understood as what the author intended to convey. Rather, it may have alternative meanings (“alterity”), which do not fit into traditional notions of “binary opposites.” The “double meaning” of texts reveals hidden ambiguities and “indeterminacies” of meaning underlying the text. In principle, it is impossible to show what a text “really means.” In Derrida’s writings, an important neologism is the term *différance*, which is a pun on a French verb meaning both “difference” of meaning and endless “deferral” of a fixed and privileged meaning. Meaning is only possible within a context and within a system where words have a “trace” of other, related words, just as speaking has a “trace” of writing.

Gilles Deleuze (1925–1995) and the psychotherapist Felix Guattari (1930–1992) also opposed the metaphysics of presence (“identity”), the representation of an “object” by a “subject.” They favored a metaphysics of difference. In their controversial *L’anti-Oedipe* (1972; *Anti-Oedipus*), they synthesized their neo-Marxist rejection of capitalism with their rejection of Freudian psychoanalysis, which they criticized as a bourgeois repression of instinctual life (“desire”) in the name of the bourgeois family (Oedipus complex). Although human nature is controlled socially, it is rooted in the chaotic presence of desire as expressed in its extreme form in schizophrenia. Deleuze also published works on theater, painting, and cinema.

Jean Baudrillard (b. 1929), whose analysis of contemporary culture was influenced by Marx, by structuralism, and by the communications theorist Marshall McLuhan’s analysis of electronic media, reversed the Marxian distinction between epiphenomenal “superstructure” (culture, the “symbolic”) and

fundamental “infrastructure” (economy, material production). He pointed out that the “symbolic” is primary for the contemporary media and consumer society, in which the boundary between image and truth, as well as between the virtual and the real, has been transformed into a new symbolic “hyper-reality” in the age of electronic media.

In the tradition of Hegel, Marx, and especially Nietzsche, Michel Foucault (1926–1984) focused on the structures used to create meaning and order in human knowledge and experience. In his early studies in the “archaeology of knowledge,” Foucault showed how our present thoughts and social-institutional practices, especially in psychology, psychiatry, and medicine, are the historically contingent outcomes of past, anonymous “epistemes” (paradigms and frameworks of discourse), which can be changed and replaced by new forms of “epistemes.” On the “threshold of modernity” at the end of the eighteenth century, the modern episteme brought about the emergence of the modern “subject” and the corresponding “human sciences,” which prescribed how the individual (psychology) and society (the state) should act. Foucault attacked modern, universalizing mega-narratives of history as well as the notion of a pre-given “human nature.” He saw the self (that is, the “subject”) as always historically conditioned within particular situations and contexts. Foucault’s antihumanist and anti-Enlightenment critique of the modern notion of “reason” is based upon very detailed historical studies, for instance, his investigations of “mental illness” and “madness” in the age of Enlightenment (*Histoire de la folie à l’âge classique: folie et déraison*, 1961; *Madness and Civilization: A History of Insanity in the Age of Reason*).

In his other works, Foucault discussed the theoretical, “discursive” practices within the larger context of “nondiscursive” practices as manifestations of social control and “power.” According to Foucault, these “disciplinary power” systems and their power techniques (as exemplified by Jeremy Bentham’s prison “panopticon”) have paralleled the development of the human sciences, which have defined what is “natural” or “deviant,” especially in sexual behavior. As the human sciences developed, the modern “subject” was defined both as a “self-responsible subject” and as an “object,” controllable by disciplinary power. These definitions first appeared in modern psychology and medicine and were then applied in education, hospitals, asylums, factories, and military barracks. Like Nietzsche, Foucault called this later work a “genealogy,” which explained the origin of the modern individual as a “subject” within institutional systems of nondiscursive power relations.

In his last work about sexuality, Foucault further developed his analysis of the subject in terms of “practices of the self.” He was especially concerned with historical, aesthetic, and repressive practices regarding sexuality. According to Foucault, sexuality is not a category of an unchanging human nature, but is historically conditioned by social “power” practices.

Foucault summarized his work by maintaining that in spite of our involvement in power relations, we are free to struggle against and to resist systems of power by relating to ourselves in new alternative, creative ways, beyond society’s system of order and discipline.

Lévinas and the “Other”

Emmanuel Lévinas (1906–1995), the Lithuanian-born, French-Jewish philosopher, introduced France to the work of Husserl and Heidegger, whom he later opposed. He was imprisoned in a German labor camp between 1940–44 and later became a professor at the Sorbonne. Like Buber, Marcel, Simone Weil (1909–1943), and Jaspers, he is usually classified as a philosopher of religion. Lévinas was deeply influenced by Franz Rosenzweig (1886–1929), the German-Jewish philosopher, and his book *The Star of Redemption*, which critiqued Hegel’s philosophical totalitarianism in favor of a metaphysics of creation.

In his masterwork *Totalité et Infini* (1961; *Totality and Infinity*), Lévinas accused Western philosophy, from Parmenides to Husserl and Heidegger, of having reduced the “Other” (that is, the other person), to an “object” of consciousness and/or to a neutral, existential relationship. From the vantage point of his Jewish background, he asserted that the ontology of the “same,” of being, and of identity leads to the idolatry of power and domination, as for example in Hegel’s master-slave dialectic and in Heidegger’s “fateful destiny of being.” The “face” of the other, its absolute “alterity,” cannot be objectified or totally comprehended. The “other” includes the victims of the Holocaust, vulnerable and defenseless, claiming: “Thou shalt not kill!” The face of the “other” reveals the priority of ethics over ontology. The infinity of the “other,” which defies any objectification, leads to God, to the “Other” beyond the human “other.” Human beings do not encounter God through “proofs” for God’s existence but rather through their relationship to the human “other,” who is a “trace of God.”

Habermas and the Frankfurt School

Retrieving some of Marx’s early humanistic writings, the original Frankfurt School of the 1920s and 1930s applied critical neo-Marxism to the analysis of the eventual transformation of modern society. The Frankfurt School was also known for its critical neo-Hegelianism, which resembled the phenomenological existentialism of certain neo-Marxist Italian philosophers such as Enzo Paci, the Polish neo-Marxists Adam Schaff and Leszlek Kolakowski, and the Yugoslavian existential-phenomenological Marxists associated with the journal *Praxis*. Max Horkheimer (1895–1973), Theodor Adorno (1903–1969), Walter Benjamin (1892–1940), Erich Fromm (1900–1980), and Herbert Marcuse (1898–1979) expressed the Frankfurt School’s critical theory in various ways. Their theory was based on a synthesis between critical theory and social “practice” according to Marx’s famous statement that appears as the eleventh of his “Theses on Feuerbach”: “Philosophers have always interpreted the world, the point is to change it.”

In contrast to orthodox Soviet Marxism and to the literary critic Fredric Jameson’s economic interpretation of “late capitalism” and postmodernism, the Frankfurt School increasingly emphasized the importance of the society’s “superstructure,” including culture and ideology rather than its material “infrastructure.” Furthermore, the Frankfurt School combined Marxist theory with Freudian psychoanalysis as important for the emancipation from social domination and from the repression of the individual mind.

Some members of the Frankfurt School, especially Horkheimer and Adorno in their collaborative work *Dialektik der Aufklärung* (1947; *Dialectic of Enlightenment*), stressed the importance of the arts, fantasy, and imagination because of their potential to subvert and emancipate society from its dependence on the one-sided, instrumental rationality of the Enlightenment and on modern science and technology. Yet, because of the failure of Soviet Marxism and the integration of its nonrevolutionary working class into the capitalist system after World War II, some members of the Frankfurt School lost confidence in a future Marxist revolution. Their initial revolutionary fervor gave way to political and cultural pessimism.

Jürgen Habermas (b. 1929), the German philosopher and social theorist, developed a new version of “critical theory” and a partially optimistic view of modernity as an “unfinished project of Enlightenment.” Opposed to dogmatic Marxism, to positivist, empirical sociology, to uncritical elements in Gadamer’s “universal hermeneutics,” and to anti-Enlightenment postmodernism, Habermas attempted to harmonize the best of Kant, Hegel, Marx, and Wittgenstein with the scientific, explanatory systems of modern social science. In his early work *Erkenntnis und Interesse* (1968; *Knowledge and Human Interests*), he argued against the prevailing positivism of the social sciences, distinguishing three basic, human, cognitive interests: (1) *technical*; that is, control of nature; (2) *practical*; that is, communication with the goal of an “ideal speech situation”; and (3) *emancipatory*; that is, the removal of limits to freedom and causes of alienation, oppression, and suffering, with the goal of building an open, liberal-democratic society.

In his book *Theorie des Kommunikativen Handelns* (1981; *The Theory of Communicative Action*), Habermas developed a “critical theory of modernity,” which was founded on the difference between “instrumental” and “communicative” rationality. Habermas also critiqued modern society’s systems of rationalization, which increasingly “colonize” and destroy the “life world.” Habermas’s later “discourse ethics,” which provided the linguistic background for communicative action, elaborated an intersubjective ethics of practical reason. This ethics too was directed against the modern, one-sided philosophy of the “subject.”

Feminist Philosophy

Feminist philosophy examines gender issues and male-oriented “ideological” solutions in Western philosophy and science, while feminist epistemology, which is centered primarily in the analytic tradition, focuses on illegitimate authority and power relationships inherent in modern concepts of the knowing, scientific “subject.” In general, feminist philosophers discuss human knowledge, truth, and objectivity in the broader context of gender, class, age, and race, while feminist moral philosophers demonstrate the importance of feminine “caring” in contrast to masculine “justice.” Addressing the work of Wittgenstein and Heidegger, feminist philosophers emphasize the contextual, historical, and social aspects of language, while simultaneously critiquing male/female dichotomies, hierarchies, and “power-structures” in traditional “masculine” philosophy and science, which are assumed to be “universal” and “objective.”

In her book *The Man of Reason* (1984), Genevieve Lloyd demonstrated that a metaphysical dualism of masculine “reason” and feminine “sense perception” and “emotion” dominates Western philosophy. According to Lloyd, the misogynistic notions of Schopenhauer and of Nietzsche are extreme forms of this antifeminist bias, which has permeated cultural, political, and economic development in the West.

In the late twentieth and early twenty-first centuries, French and North American feminist philosophers have questioned traditional, masculine interpretations of gender issues. Michèle Le Doeuff (b. 1948) has even discussed the inherent tension between being a woman and being a philosopher in the West. The American philosophers Judith Butler, Jean Grimshaw, Sandra Harding, Nancy Hartsock, Helen Longino, Seyla Benhabib, and Susan Bordo have made significant contributions to feminist philosophy, while the French philosophers Luce Irigaray and Julia Kristeva have become the most notable in the field.

Luce Irigaray (b. 1932) critiqued “masculine”-oriented Freudian and Lacanian psychoanalysis and was subsequently expelled from the Paris Psychoanalytic Association and from the University of Paris, after which she became a private psychoanalyst and writer. Best known for “deconstructing” the work of Plato, Kant, Hegel, and Freud, Irigaray demonstrates woman’s unique sexual differences; that is, her body and desire (*jouissance*), which contradict masculine-oriented theories of “identity” and “sameness.” Women, who have been defined traditionally in terms of “lack,” “absence,” and “default,” have been allowed to gain “identity” only by “mimicking” male language and male behavior. Going beyond social “gender roles” in the liberal, feminist fight of legal “equality” with men, Irigaray insisted on the unique “sexual difference” of women, their unique rights, and on the regaining of their own “subjectivity.” She often uses Sophocles’s *Antigone* and Hegel’s interpretation of the play as the example of the masculine bias in Western civilization where Antigone loses her life against the command of king Creon.

The Bulgarian-born French feminist philosopher Julia Kristeva (b. 1941) showed an early interest in the problems of psychoanalysis and linguistics. Influenced by the Russian literary theorist Mikhail Bakhtin (1895–1975) and by Dostoyevsky, Kristeva distinguishes between “semiotic” language (as expressed in the unconscious maternal world of “drives,” music, and poetry) and “symbolic” language (the logical world of the “father”). She maintains that “semiotic” language often “erupts” into “symbolic” language and subverts both male and female sexual identity. In contrast to Irigaray, who looks for a specific “female voice,” Kristeva questions the very concept of identity, male or female. For Kristeva, the oppression of women is only a portion of contemporary society’s more universal social, political, and economic oppression of “marginalized groups.” Contrary to Freud and Lacan, Kristeva not only emphasizes the *social* role of the mother in the development of the human subject but also the important role of the child. Yet both are rooted in the mother’s contact with the child prior to the “law of the father.”

See also *Consciousness; Enlightenment; Existentialism; Identity; Phenomenology; Philosophies: Feminist, Twentieth-Century.*

BIBLIOGRAPHY

PRIMARY SOURCES

- Adorno, Theodor, and Max Horkheimer. *Dialectic of Enlightenment*. Translated by John Cumming. London: Verso, 1989.
- Askay, Richard, and Jensen Farguhar. *Apprehending the Inaccessible: Freudian Psychoanalysis and Existential Phenomenology*. Evanston, Ill: Northwestern University Press, 2004.
- Beauvoir, Simone de. *The Second Sex*. Translated by H. M. Parshley. New York: Vintage, 1974.
- Foucault, Michel. *Madness and Civilization: A History of Insanity in the Age of Reason*. London: Routledge, 1989.
- Gadamer, Hans-Georg. *Truth and Method*. 2nd rev. ed. Translation revised by Joel Weinsheimer and Donald G. Marshall. New York: Continuum, 1989.
- Habermas, Jürgen. *Knowledge and Human Interests*. Translated by Jeremy J. Shapiro. Cambridge, U.K.: Polity, 1987.
- . *Theory of Communicative Action*. 2 vols. Translated by Thomas McCarthy. Cambridge, U.K.: Polity, 1991.
- Heidegger, Martin. *Basic Writings*. Edited by David Farrell Krell. Rev. and expanded ed. San Francisco: HarperSanFrancisco, 1993.
- . *Being and Time*. Translated by John Macquarrie and Edward Robinson. New York: Harper and Row, 1962.
- . *Zollikon Seminars: Protocols, Conversations, Letters*. Edited by Medard Boss. Translated from the German and with notes and afterwords by Franz Mayr and Richard Askay. Evanston, Ill.: Northwestern University Press, 2001.
- Irigaray, Luce. *An Ethics of Sexual Difference*. Translated by Carolyn Burke and Gillian C. Gill. Ithaca, N.Y.: Cornell University Press, 1993.
- Lévinas, Emmanuel. *Totality and Infinity: An Essay on Exteriority*. Translated by Alphonso Lingis. The Hague: Nijhoff, 1979.
- Merleau-Ponty, Maurice. *Phenomenology of Perception*. Translated by Colin Smith. New York: Humanities Press, 1962.
- Sartre, Jean-Paul. *Being and Nothingness: A Phenomenological Essay on Ontology*. Translated by Hazel E. Barnes. New York: Washington Square Press, 1992.
- Wittgenstein, Ludwig. *Philosophical Investigations*. Translated by G. E. M. Anscombe. 2nd ed. Oxford: Blackwell, 1958.

SECONDARY SOURCES

- Critchley, Simon. *Continental Philosophy: A Very Short Introduction*. Oxford and New York: Oxford University Press, 2001.
- Critchley, Simon, and William Schroeder, eds. *A Companion to Continental Philosophy*. Malden, Mass.: Blackwell, 1998.
- Holland, Nancy J., and Patricia Huntington, eds. *Feminist Interpretations of Martin Heidegger*. University Park: Pennsylvania State University, 2001.
- Kearney, Richard, ed. *Twentieth-Century Continental Philosophy*. London and New York: Routledge, 1994.
- Kearney, Richard, and Mara Rainwater, eds. *The Continental Philosophy Reader*. London: Routledge, 1996.
- McNeill, William, and Karen Feldman, eds. *Continental Philosophy: An Anthology*. Oxford: Blackwell, 1997.
- Solomon, Robert. *Continental Philosophy Since 1750: The Rise and Fall of the Self*. Oxford and New York: Oxford University Press, 1988.
- West, David. *An Introduction to Continental Philosophy*. Cambridge, U.K.: Polity, 1996.

Franz Mayr

CONTRACEPTION. See **Family Planning.**

CORE/PERIPHERY. See **Geography; World Systems Theory.**

CORRUPTION. Consider the first sentence of Jean-Jacques Rousseau's (1712–1778) *Discours sur les arts et sciences* (Discourse on the arts and sciences, 1750): “Has the restoration of the sciences and arts contributed to the purification of mores, or their corruption?” Corruption denotes deterioration, a qualitative decline from an original (absolutely or relatively) natural or pristine state; related terms include decay, deterioration, disintegration, corrosion, and degeneration. Corruption is sometimes used in a related (but distinct) sense, to denote a state of affairs—a “state of corruption”—often in contrast to one characterized by virtue. In either form (verb or noun) corruption is an intensely historical term, describing either a process of qualitative spoliation or the end result thereof.

The discourse of corruption and virtue offers critics and philosophers a powerful rhetorical tool with which to indict societies’ perceived shortcomings vis-à-vis some past standard. When placed into narrative form, corruption accounts generally contain four elements: (1) a description of the symptoms of corruption (social, moral, political); (2) identification of an agent of corruption; (3) a timeline by which critics identify the agent’s appearance and trace its corrupting influence; and (4) a call to action to turn back corruption and restore lost virtues.

In the history of ideas and historiography, the discourse of corruption has often, though not exclusively, been associated with the tradition of civic republicanism. More recently, a significant body of research has brought the tools of social science to bear on the identification and measurement of corruption in the political sphere, and offered general theories about conditions under which corruption is fostered or retarded. This entry will point out, in an admittedly abbreviated manner, some of the main lines of research and refer the reader to key texts in the literature on corruption.

Corruption, Civic Republicanism, and Republican Historiography

Perhaps the most rhetorically powerful and historically influential language of corruption appears in the tradition of civic republicanism associated with Italian Renaissance humanists like Niccolò Machiavelli (1469–1527), Francesco Guicciardini (1483–1540), and Leonardo Bruni (c.1370–1444), which emphasizes the civic and social nature of the human good. Drawing on such classical sources as Aristotle (384–322 B.C.E.) and Cicero (106–43 B.C.E.), republicans see the realization of civic virtue as requiring the active involvement of relatively equal citizens in making decisions about their common life. Thus, anything that distracts citizens from the common good—internal factions, luxury, security, foreign influences, great disparities of wealth (even, for some thinkers, Christianity itself)—can be seen as an agent of corruption. Conversely, anything that fosters or rewards citizens’ mutual self-regard and

keeps their efforts focused on the good of all promotes civic virtue and helps stave off corruption. Drawing on both classical and Renaissance ideas, Rousseau advances the single most important modern theory of republican virtue.

Republican concerns about virtue and corruption are not limited to Europe: the tradition has also fundamentally affected the historiography of the American experience. Alongside the American obsession with Lockean individualism, a republican school emphasized the Founders’ concern for civic virtue in the citizenry. Connecting Italian humanism and the American founding was the contribution of J. G. A. Pocock’s monumental *The Machiavellian Moment: Florentine Political Thought and the Atlantic Republican Tradition* (1975). For Pocock, a discernible discourse about corruption, virtue, and the very nature of the political task ran from Renaissance Italy through England’s civil wars and across the Atlantic, where it facilitated the development of the American character and the split with England. The ideal of the active citizen, of republican politics as the effort to preserve civic virtue and keep corruption at bay, has exerted a strong pull on the political imagination down to our own time.

Political Corruption

Political scientists have developed sophisticated analyses for the study of political corruption. No single definition of political corruption can avoid controversy since, barring consensus on the proper nature and extent of legitimate politics, we necessarily lack agreement on how to define corrupted politics. Nonetheless, as one would expect, researchers emphasize political, institutional, or bureaucratic locations of corruption; the misuse of public power; or “behavior which deviates from the formal duties of a public role because of private-regarding . . . pecuniary or status gains; or violates rules against the exercise of certain types of private-regarding influence” (Nye, p. 419).

Political corruption presents itself in a host of settings. Susan Rose-Ackerman considers the legislative and bureaucratic arenas, and presents political corruption as an economic, cultural, and political phenomenon with important implications for democratic societies. More broadly, scholars have attempted to analyze political corruption in a variety of global contexts (Heidenheimer, 1970; Heywood, 1997). Nor has this research necessarily involved a turning-away from historical concerns with equality and participation: Patrick Dobel offers a general theory of corruption that draws on classical authors yet speaks to contemporary political life, suggesting practical steps toward staving off corruption in modern states.

Other Contexts

Countless reform movements within the world’s major religions have framed their critiques by denouncing the corruption of pure or pristine doctrines. Indeed, on one view, Buddhism itself grew out of a deep dissatisfaction with the corruption and increasingly complex nature of Hinduism, not entirely unlike the early Protestants who attacked the corruption of the Roman Catholic Church and called for a return to simpler ancient doctrines. Often these critiques point to the effects of wealth and luxury on the purity of religious doctrines



Night, an engraving from the graphic series *The Four Times of the Day* (1738) by William Hogarth. Numerous examples of moral corruption and the dissipation of the human spirit are depicted as night falls on a London street. © HISTORICAL PICTURE ARCHIVE/CORBIS

and practices, and moral standards more generally: echoing civic republican themes, the fourteenth-century Islamic scholar Ibn Khaldun bluntly asserted that “luxury corrupts morals” (pp. 131–132).

The biblical account of the Fall is perhaps the paradigmatic corruption metanarrative, with its account of a lost, originally virtuous, condition and the ongoing struggle for redemption. But other religious traditions draw on the images of corruption as well: according to the Buddhist *Milindapañha* “[t]he virtuous and well-conducted man . . . is like a medicine in destroying the poison of human corruption; is like a healing herb in quieting the disease of human corruption; is like water in removing the dirt and defilement of human corruption” (ch. 5, sec. 98). The virtue here described is, of course, not social republican virtue, but rather a specifically religious understanding of what is required to stave off the corruption that can grow from within.

Finally, we should note the classical tradition that utilizes the terms “generation and corruption” in reference to the body and things subject to growth and decay in the physical realm. Plato (c. 428–348 or 347 B.C.E.) describes philosophers as those who love eternal verities “not varying from generation and corruption,” and regards gymnastic, given its emphasis on the body, as “having to do with generation and corruption” (*Republic* 485b, 521e). Indeed, Aristotle (384–322 B.C.E.) announces in

the first sentence of his *On Generation and Corruption*, that his task is “to study coming-to-be and passing-away.” Later, Augustine (354–430) brought a Christian view of the immortal soul to this classical understanding, describing the “soul pressed down by the corruptible body, and weighed down by earthly thoughts, many and various” (*De Trinitate*, 8.2).

Conclusion

How might we explain the widespread appeal of discourses on corruption? The truth likely remains somewhere deep within the individual and collective dynamics by which people attempt to come to grips with change in their lives, and to construct a meaningful narrative connection between past, present, and future. The power of corruption rhetoric seems to lie in its recognition of the inherent fragility of all human endeavor—indeed, of human bodies. Talking in terms of corruption, for civic republicans, often makes sense of a host of social changes by placing them into a coherent, purposive, and meaningful frame of reference, highlighting past glories, and spurring audiences on to greater things in the future. Corruption accounts, like all political speech, are inherently partial and moralistic, but they are also extremely effective in pointing to the price paid for progress, be it technological, political, or economic. When Adam Smith (1723–1790) boasted, in his *Inquiry into the Nature and Causes of the Wealth of Nations* (1776) that the poorest English laborer lives in material comfort undreamed of by an African king, Rousseau was there to ask about the price paid for this economic “progress,” using the language of corruption to frame and reinforce his critique.

But is corruption, however variously defined, always to be lamented? A few scholars have ventured the hypothesis that corruption is necessary, though indeed not sufficient, for such tasks as the smooth operation of an economy. Business practices routinely denounced as “corrupt” may serve a variety of extremely important social and economic functions. Such a view, overtly or not, hearkens back to Bernard Mandeville’s (1670–1733) famous dictum that private vices yield public benefits.

See also *Constitutionalism; Humanism; Poverty; Republicanism; Virtue Ethics; Wealth.*

BIBLIOGRAPHY

- Dobel, J. Patrick. “Corruption of a State.” *American Political Science Review* 72 (1978): 958–973.
- Heidenheimer, A. J., ed. *Political Corruption: Readings in Comparative Analysis*. New York: Holt, Reinhart, and Winston, 1970.
- Heywood, Paul, ed. *Political Corruption*. Oxford: Blackwell, 1997.
- Khaldun, Ibn. *An Arab Philosophy of History: Selections from the Prolegomena of Ibn Khaldun of Tunis*. Translated and arranged by Charles Issawi. London: Murray, 1950.
- Nye, Joseph S. “Corruption and Political Development: A Cost-Benefit Analysis.” *American Political Science Review* 61 (1967): 417–427.
- Pocock, J. G. A. *The Machiavellian Moment: Florentine Political Thought and the Atlantic Republican Tradition*. Princeton, N.J.: Princeton University Press, 1975.

Rose-Ackerman, Susan. *Corruption: A Study in Political Economy*. New York: Academic Press, 1978.

———. *Corruption and Government: Causes, Consequences, and Reform*. Cambridge, U.K.: Cambridge University Press, 1999.

Wood, Gordon S. *The Creation of the American Republic, 1776–1789*. Chapel Hill, NC: University of North Carolina Press, 1969.

Andrew R. Murphy

CORRUPTION IN DEVELOPED AND DEVELOPING COUNTRIES.

While corruption, in one form or another, has perverted virtually all human societies throughout history, it has not had uniform impact on any one of them. Scholars who study corruption in an effort to find ways to minimize it have had to deal with the fact that it is difficult to define and measure, making empirical testing very difficult.

Defining Corruption

Modern social science defines corruption in terms of three basic models: First, corruption is related to the performance of the duties of a public office. According to J. S. Nye, corruption is

[b]ehavior which deviates from the normal duties of a public role because of private-regarding (family, close private clique), pecuniary or status gains; or violates rules against the exercise of certain types of private-regarding influence. This includes such behavior as bribery (use of reward to pervert the judgment of a person in a position of trust); nepotism (bestowal of patronage by reason of ascriptive relationship rather than merit); and misappropriation (illegal appropriation of public resources for private regarding uses). (p. 419)

Second, corruption is related to the concept of exchange derived from the theory of the market. Jacob Van Klaveren argues that the bureaucrat views his public office as an enterprise from which to extract extra-legal income. As a consequence, the civil servant's compensation package "does not depend on an ethical evaluation of his usefulness for the common good but precisely upon the market situation and his talents for finding the point of maximal gain on the public's demand curve" (p. 26). In an economy pervaded by high levels of government regulations, civil servants may devote most of their time and effort to assisting entrepreneurs in evading state laws and statutes. In exchange the civil servants are paid extra-legal income (Mbaku, 1992).

Finally, the definition of corruption is couched in terms of the public interest, as argued by Carl Friedrich:

[t]he pattern of corruption may therefore be said to exist whenever a power holder who is charged with doing certain things, that is a responsible functionary or office holder, is by monetary or other rewards, such as the expectation of a job in the future, induced to take actions which favor whoever provides the reward and thereby damage the group or organization to which the functionary belongs, more specifically the government. (p. 15)

Friedrich argues further that the opportunistic activities of corrupt bureaucrats can severely damage the public interest and should be considered important variables in the study and evaluation of corruption.

Public choice theory and corruption. Economists, dissatisfied with these explanations for corruption, have turned to public choice theory, which sees corruption as post-constitutional opportunism designed to generate benefits for individuals or groups at the expense of the rest of society. According to public choice theory, the scope and extent of corruption in a country is determined by that country's institutional arrangements and not necessarily by the character of its civil servants and politicians. Once the constitution has been designed and adopted and a government established, there is an incentive for individuals and groups to subvert the rules in an effort to generate benefits for themselves. Rules subversion, if successful, can allow individuals to secure benefits above and beyond what would have accrued to them otherwise. This kind of behavior can occur in both democratic and nondemocratic societies.

Bureaucrats, whose job it is to design and execute public policies, may attempt to use the process to maximize their private objectives at the expense of serving the general public efficiently and equitably. The desire by civil servants to maximize their private objectives and the effort by organized interest groups to subvert the rules and to extract benefits for themselves create opportunities for corruption. For example, an entrepreneur who wants to secure a lucrative import or production permit may bribe a clerk at the ministry of trade in order to (1) secure the permit and (2) make sure that the bureau protects his new monopoly position by not issuing additional permits to entrepreneurs from the area in which he operates. In exchange for providing the entrepreneur with opportunities to earn supranormal profits, the civil servants at the ministry of trade "earn" extra-legal income, and the importer who receives the permit earns an above normal rate of return on investment, but society loses.

Government regulatory activities usually impose significant transaction costs on enterprise owners and severely affect the profitability of their operations. To minimize these regulation-induced costs, some entrepreneurs may seek help from the civil service, whose job it is to enforce the laws. Usually, the business owner pays a bribe to the government regulator in order to receive preferential treatment and minimize the burden of the regulations on his or her operations. Public choice theorists argue that bureaucratic corruption is directly related to the scope and extent of government intervention in private exchange (i.e., in markets). Effective control of corruption, then, must be based on a modification of existing rules in order to change incentive structures and constrain the ability of the state to intervene in private exchange and create artificial scarcities.

The International Dimension of Corruption

Since the end of the Cold War, policymakers in many countries have recognized the global nature of corruption and are now making efforts to coordinate their control and cleanup

efforts. Thus, instead of viewing corruption as a domestic problem caused primarily by the interaction of the bureaucracy with the private sector, many lawmakers, especially those in the developing and transition economies, are now acknowledging the contributions of transnational corporations to the problem.

Many governmental and nongovernmental organizations—including the United Nations (UN), the Organization of American States (OAS), the International Chamber of Commerce, Transparency International (TI), the World Economic Forum (WEF), World Bank, Interpol, and the Organization for Economic Cooperation and Development (OECD)—have developed an interest in dealing with corruption.

Several reasons have been advanced to explain the sudden interest by these organizations. Changes in international political relations during the period from 1989 to 1991 significantly reduced people's tolerance for incompetence, malfeasance, and venality in the public sector. As part of the movement toward improved governance, citizens of many countries demanded the elimination of corrupt practices. Thus, since the late 1980s, the balance of power in many countries has been shifting in favor of more open, transparent, and participatory governance structures.

Scholars have identified three changes that have contributed to the globalization of corruption. First, greater levels of economic integration have increased chances that corruption in one region of the world will have an impact on economic and political activities in other parts of the world. For example, when the corrupt activities of the Bank of Credit and Commerce International (BCCI) forced it into insolvency in 1991, many economies around the world were affected. In fact, several countries in Africa suffered significant financial losses from the BCCI collapse.

Second, developments in communication technology have revolutionized the international financial system and enhanced the ability of traders to engage in corruption. The emergence of electronic networks for the transfer of funds has made it quite difficult for countries to deal effectively with corruption. Many anticorruption organizations have argued that the ease with which funds can be transferred to Europe or the Caribbean from different parts of the world implies that corrupt civil servants can effectively hide their extra-legal income from the public, making it virtually impossible for such funds to be recovered in the event of conviction. Fortunately, policing agencies, especially in the West, continue to innovate and come up with technology that can effectively monitor traffic in these electronic networks. Such technology could prove very helpful in the fight against global corruption.

Third, since the end of the Cold War there has been a significant increase in the number of cooperative alliances between economic units, within countries and across borders. Continued globalization exacerbates the problem of corruption; however, it also offers opportunities for its control.

Pervasive corruption is a major threat to the maintenance of a free, multilateral trading system. In order for a global competitive economy to function properly and efficiently, participants

must play by the rules. Opportunism (e.g., corruption) by some market participants can derail the international trading system since it (i.e., corruption) invariably creates an unlevel playing field. For example, corporations or countries that do not tolerate corruption will be placed at a competitive disadvantage. Those countries that encourage their companies to engage in corruption abroad and offer favorable tax treatment for bribes paid to foreign public officials place these firms at a competitive advantage over those from countries in which corruption (including paying bribes to foreign public officials) has been criminalized. In fact, many American firms, which are prohibited by U.S. law from offering bribes to foreign officials, have complained bitterly of the disadvantage that they suffer since, until recently, many of their European counterparts were allowed and often encouraged by favorable tax treatment by their national governments to engage in corrupt practices abroad.

Many policymakers around the world, especially in the developed countries, have come to realize that the long-run social, economic, human, and political costs of global corruption are enormous and that it poses a threat to the rule of law. It can also cause citizens to lose confidence in their leaders and distort market incentives and negatively affect the flow of investment and, hence, wealth creation. Perhaps more important is the fact that corruption can prevent the poor from gaining access to welfare-enhancing and even life-saving public goods and services.

Controlling Corruption

Four strategies have been employed in the past by successive governments to deal with corruption, usually with varying degrees of success. These are societal, legal, market, and political strategies.

In the societal strategy, each society defines a common standard of morality, which can then be employed to determine if a given behavior qualifies as corrupt. Civil society is encouraged to remain vigilant and watch out for individuals who engage in corruption and report them to the police. The government and civil society organizations are expected to educate the general public about corruption and its negative effects on economic growth and development. Through such an educational program, citizens can significantly improve their ability to determine if behavior is corrupt and report perpetrators to the relevant authorities for further action. The private press plays an important role in this approach to corruption cleanup—it investigates and exposes corruption, paving the way for the police to gather the evidence needed for effective prosecution by the judiciary.

In the legal approach, the judiciary, the police, and the mass media are expected to lead the fight against corruption. First, national laws define the responsibilities of civil servants and properly constrain them in the performance of their duties. Second, the law defines corruption and corrupt behavior. Third, citizens are encouraged to be vigilant and report any suspected corrupt activities to the police. Fourth, the police are expected to thoroughly investigate such activities, gather the necessary information, and present the latter to the judiciary. Fifth, the judiciary then prosecutes the accused and imposes

the appropriate punishment if found guilty. Special commissions of inquiry or special prosecutors can be constituted and used by the government to investigate incidents that point to large-scale corruption and public malfeasance. Commissions of inquiry are especially important in cases where high-ranking officials have been implicated in corruption.

Police and judiciary officers can only perform their functions properly and efficiently if they are not corrupt—that is, they are effectively constrained by the law. If, on the other hand, these institutions are pervaded by corruption, it would be prudent to first engage in reforms to improve their efficiency before engaging them in the fight against corruption.

In many developing countries, low salaries for public servants have been given as a reason why some of these workers may engage in corruption. As part of the effort to minimize corruption in the civil service, it has been suggested that pay scales in the public sector be made competitive with those in the private sector. One must note, however, that higher pay in the public sector may simply force opportunistic civil servants to demand higher bribes to compensate for the probability of losing what is now a relatively more important and lucrative position. It has also been suggested that any civil-service reforms be supplemented with counteracting agencies such as an independent judiciary or some kind of independent review board, an ombudsman, or other investigative body. One must consider the fact that such bodies can become politicized (as evidence from many developed and developing countries shows) and used by incumbent ruling coalitions to punish the opposition and continue to monopolize political spaces.

The market approach to corruption cleanup is based on the belief that there exists a discernible relationship between market structure and corruption. Government regulation of private exchange creates opportunities for regulators to extort bribes from enterprise owners. The remedy that scholars have usually recommended is decreased government regulation and more reliance on markets for the allocation of resources. Such an approach has at least two problems. First, it is based on the manipulation of outcomes within an existing or given incentive structure (i.e., existing institutional arrangements). Second, the problem here is not with the market but with the incentive structures that traders are facing. Rules define the incentive structure faced by participants in markets and, hence, determine the behavior of these traders and market outcomes. If the government's regulatory activities are reduced and resource allocation made more dependent on the market, there is not likely to be much of a change in outcomes if the incentive structure has not been altered. The most effective way to minimize opportunistic behaviors, including corruption, is to reform or modify existing rules and, by implication, change the incentives faced by traders. Changing or modifying the rules does not imply deregulation, but reconstitution and reconstruction of the state through democratic constitution-making to provide transparent, participatory, and accountable governance and economic structures.

The political strategy emphasizes decentralization of power and argues that the concentration of power in the center

enhances the ability of the ruling coalition to engage in corrupt activities. The recommendation is that the public sector be made more transparent. For example, the public budget process should be made more open and participatory and the outcome (i.e., the budget) should be published and made available to the mass media and any other interested individuals and groups. Unfortunately, such reforms can easily be reversed (and power reconcentrated in the center) by subsequent governments in response to lobbying from interest groups.

Traditional approaches to corruption control depend on the effectiveness and professionalism of the country's counteracting institutions (e.g., the police, judiciary, and the mass media). It is assumed that institutions such as the police and judiciary are well constrained by the law and that they are free of corruption. First, a significantly large number of countries around the world do not have fully functioning private media that are free to investigate and expose corruption without fear of censure by the incumbent government.

Second, the judiciary systems of many countries are not independent of the executive branch of government. Instead, the country's chief executive controls the judiciary and retains the power to appoint and dismiss judiciary officers.

Third, many public institutions, especially in the developing countries, are pervaded by high levels of corruption. Hence, a corruption cleanup program developed and implemented by any of these institutions is not likely to be successful. An effective anticorruption program, then, must begin with the selection of appropriate new rules that (1) constrain the exercise of government agency and (2) provide the necessary foundation for the design and adoption of new and more effective counteracting agencies (e.g., an independent judiciary, a well-constrained police force, a professional and neutral military, an independent central bank, a free press, etc.).

Public Choice Theory and Corruption Control

Corruption is a "rules-related" problem. Rules determine the incentives faced by participants in markets. Unless the analyst understands the laws and institutions of the economy being examined, any attempt to study corruption and other forms of opportunism will not yield policy-relevant results.

In a 1985 study, Brennan and Buchanan argue that rules (1) determine the nature of the interaction between individuals within society; (2) provide the means for the peaceful resolution of conflict; (3) provide information to market participants, enhancing the ability of each individual to anticipate the behavior of others; and (4) constrain the behavior of individuals, as well as that of collectivities within the society. To deal effectively with corruption, for example, it is necessary that the police, who investigate and collect evidence to be used in the prosecution of those accused of corruption, be adequately constrained by the law. Since the rules determine the incentive structures faced by market participants, any effort to deal with corruption and other forms of opportunism (e.g., rent seeking) must begin with a negotiated modification of existing rules so that the economy can be provided with a new set of rules that effectively constrains state custodians and makes it quite difficult for them to behave opportunistically.

Rules can be implicit (e.g., tribal custom and tradition) or explicit (e.g., a written constitution). After a country has developed and adopted a constitution, corruption can be seen as post-constitutional opportunism—that is, behavior on the part of individuals or groups designed to generate extra-legal income for themselves, usually through the subversion of rules. One can see corruption then as part of the larger problem of constitutional maintenance or how to enforce compliance to the rules. Here, opportunism is defined as behaviors designed to improve the welfare of an individual or group at the expense of other citizens and includes such behaviors as shirking, corruption, adverse selection, moral hazard, and free riding.

The key to producing a sustainable and effective anticorruption campaign is a thorough and complete examination of the country's existing rules and by implication, its market incentives. This approach to corruption control has many benefits. First, institutional reform, especially if undertaken democratically, can produce rules that (1) reflect the values of the relevant stakeholder groups and hence are most likely to be considered legitimate tools for the regulation of sociopolitical interaction, improving the chance that people would respect and obey them; and (2) effectively constrain the state and make it quite difficult for civil servants and politicians to extort bribes from the private sector.

Second, institutional reform can be used to entrench economic freedom and improve entrepreneurship and wealth creation. Finally, institutional reform can provide each economy with more viable and effective structures for the management of ethnic diversity, resulting in a reduction in communal violence. A more peaceful society should significantly improve the environment for investment and wealth creation.

See also *Civil Society; Constitutionalism; Corruption; Economics; Globalization.*

BIBLIOGRAPHY

- Brennan, Geoffrey, and James M. Buchanan. *The Reason of Rules: Constitutional Political Economy*. Cambridge, U.K.: Cambridge University Press, 1985.
- Friedrich, Carl J. "Corruption Concepts in Historical Perspective." In *Political Corruption: A Handbook*, edited by Arnold J. Heidenheimer, Michael Johnston, and Victor T. LeVine. New Brunswick, N.J.: Transaction, 1990.
- Gillespie, Kate, and Gwenn Okruhlik. "The Political Dimensions of Corruption Cleanups: A Framework for Analysis." *Comparative Politics* 24, no. 1 (1991): 77–95.
- Glynn, Patrick, Stephen J. Kobrin, and Moisés Naím. "The Globalization of Corruption." In *Corruption and the Global Economy*, edited by Kimberly A. Elliot. Washington, D.C.: Institute for International Economics, 1997.
- Mbaku, John M. "Bureaucratic Corruption as Rent-Seeking Behavior." *Konjunkturpolitiik* 38, no. 4 (1992): 247–265.
- . *Bureaucratic and Political Corruption in Africa: The Public Choice Perspective*. Malabar, Fla.: Krieger, 2000.
- Nye, J. S. "Corruption and Political Development: A Cost-Benefit Analysis." *American Political Science Review* 61, no. 2 (1967): 417–427.
- Ostrom, Elinor, Larry Schroeder, and Susan Wynne, eds. *Institutional Incentives and Sustainable Development: Infrastructure Policies in Perspective*. Boulder, Colo.: Westview, 1993.

Passas, Nikos. "I Cheat Therefore I Exist? The BCCI Scandal in Context." In *Emerging Global Business Ethics*, edited by W. Michael Hoffman, Judith B. Kamm, Robert E. Frederick, and Edward S. Petry Jr. Westport, Conn.: Quorum, 1994.

Rose-Ackerman, Susan. *Corruption: A Study in Political Economy*. New York: Academic Press, 1978.

———. *Corruption and Government: Causes, Consequences, and Reform*. Cambridge, U.K.: Cambridge University Press, 1999.

———. "The Political Economy of Corruption." In *Corruption and the Global Economy*, edited by Kimberly A. Elliot. Washington, D.C.: Institute for International Economics, 1997.

Van Klaveren, Jacob. "The Concept of Corruption." In *Political Corruption: A Handbook*, edited by Arnold J. Heidenheimer, Michael Johnston, and Victor T. LeVine. New Brunswick, N.J.: Transaction, 1990.

John Mukum Mbaku

COSMOLOGY.

This entry includes two subentries:

Asia

Cosmology and Astronomy

ASIA

Hindu cosmologies are among the oldest surviving cosmologies in the world, dating back as far as the Vedic writings of the second millennium B.C.E. The oldest sections of the Vedas are the Samhitas (hymns), which express a relatively simple cosmology consisting of either two (earth and sky, representing male and female, respectively) or—more commonly—three parts (earth, atmosphere, and sky or heaven). There seems to be some indication of an underworld, although this is located sometimes in one of the aforementioned parts of the cosmos and at other times simply "beyond" them. Moreover, in these early Vedic works it is unclear if the gods created the cosmos (and if so, which ones) or if they were created within the cosmos. For example, in one famous account *purusha* (the "cosmic man") is sacrificed by the gods and his body divided to form the various aspects of the cosmos and the caste distinctions of Vedic society (*Rig Veda*, book 10, hymn 90). Yet in another prominent cosmogony, the author marvels at how nothing—neither being nor non-being, nor even the gods themselves—existed before the creation of the cosmos, and questions how anyone could know from whence the cosmos arose (*Rig Veda*, book 10, hymn 129). One of the significant contributions to Hindu cosmology in the Vedic hymns, however, is the notion of *rita* (roughly, "cosmic order"). Although it is not the focus of any particular hymn, the concept surfaces explicitly and implicitly in a number of Vedic hymns, and indicates an eternal law, moral standard, and underlying truth that applies to the cosmos generally and to human society in particular. In the hymns, however—and, for the most part, in the subsequent *Brahmanas* and *Aranyakas*—*rita* only suggested a ritual connection of sacrifices, devotion, and observance of a basic caste system with aiding the gods in maintaining cosmic order.

The Upanishads, the concluding sections of the Vedas written in the first millennium B.C.E., provide a more systematic and philosophically sophisticated cosmology. Most significant was the emphasis on the concept of *Brahman* (the ultimate as found in the cosmos as a whole), and its association with *Atman* (the ultimate as discovered through introspection). This shifted the entire focus of the cosmology—indicative of a larger shift in Hindu thought—from maintaining cosmic order (*rita*) to the achievement of liberation (*moksha*) from the cycle of reincarnation through identification with the Ultimate (*Brahman*). Maintaining cosmic order remains important, although it is understood in the Upanishads primarily in terms of *dharma*, which refers not only to the descriptive and normative dimensions of the cosmic order itself (as did *rita*) but also to that order as it applies to the individual's lot in life. Consistent with the identification of *Brahman* with *Atman*, achieving *moksha* is in large part a matter of understanding and observing the *dharma* of the cosmos as it applies to oneself. Although the Upanishads mark an important shift in Hindu cosmology, this shift was developed—like much of the Upanishads—on the basis of the Vedic hymns. For example, where the hymns distinguished two or three parts to the cosmos, the Upanishads distinguish seven, including a number of higher parts that correspond with achieving *moksha*. Perhaps the best example of this, however, is in the Upanishadic development of the “cosmic egg” cosmology first introduced in the *Brahmana* section of the Vedas: when split in two, the egg—which, significantly, is associated with *Brahman*—formed the earth and sky from its shells, and the mountains, streams, and the like from its insides (*Chandogya Upanishad* III.xix; see also *Shatapatha Brahmana* XI, 1, 6).

While the Upanishads mark the end of the Vedas, the cosmologies introduced there continue to be developed in the subsequent texts (for example, the *Manava Dharmashastra* or *Manusmriti* [Laws of Manu], the *Vishnu Purana*, and sections of the *Mahabharata*). While these texts differ somewhat in content, they mutually inform what has come to be the prevailing cosmology in the Hindu tradition. This cosmology draws on the Vedic account of the “egg of *Brahman*” (*Brahmanda*), although it develops the account with much greater elaboration. The world created from that egg—which, again, is identified with *Brahman*—is centered on a mythical Mount Meru, an inverted mountain that not only stands at the center of the world of the living, but also links it to numerous levels of heaven above and still more numerous hells below. The cosmography of the world includes highly figurative descriptions of geometrically oriented mountain ranges separating different lands, concentric seas of unusual liquids (for example, wine or molasses), and series of ring-shaped islands.

Accompanying this cosmography is an equally detailed account of cosmic time, according to which the world (that is, the world of living beings, as opposed to the cosmos as a whole) passes through four ages (*yuga*): the first is a golden age, and each age degrades further until the world is destroyed after the first. These four *yuga*, however, constitute but one day of Brahma, and—following a night of Brahma, which is a sustained period of cosmic rest—the world is created anew and runs through the four ages once again. This process is often

interpreted with respect to the actions of the gods Brahma (the creator, not to be confused with the impersonal *Brahman*), Vishnu (the preserver), and Shiva (the destroyer), which are seen to be three aspects of the world's continual regeneration and renewal. These accounts of time proceed to distinguish periods of time ranging from mere fractions of a second to the span of Brahma's life (numbering in the billions of years).

What is most notable about the development of Hindu cosmology is the extent to which it develops in concert with its social structures. In early Vedic literature, these structures (such as the caste system) are present, but only in their basic contours, just as is the case with Hindu cosmologies. By the time of the Upanishads, however, they have evidently taken on considerably more sophistication—again, as have the cosmologies. Finally, in the post-Vedic literature, caste distinctions and social obligation have been laid out in considerable detail, mirroring the exacting scholasticism present in the accompanying cosmologies. While the precise relation between cosmologies and social structures is a matter of ongoing debate, the development of Hindu cosmologies provides strong evidence that there is at least an important link between the two.

Buddhist Cosmologies

Buddhists are both interested and uninterested in cosmology. They are uninterested, first, because all of the distinctions that are typically taken to characterize the cosmos are seen as expressions of utmost ignorance with respect to the true nature of things. For Buddhists, there are no stable, unchanging things; rather, all things are in perpetual flux, and it is only through one's ignorance and desire that one takes them to be substantive and distinct. As this account of their lack of interest in cosmology should indicate, however, Buddhists are also very interested in cosmology, because it is not only the problem but also the solution that is cosmological. Not only can a cosmology constructed through “skillful means” (*upaya*) illumine the way to overcome ignorance, but overcoming this ignorance is itself adjusting one's understanding of the cosmos.

Thus, Buddhist cosmologies can be, but need not necessarily be, read as objective accounts of the nature of the cosmos; rather, the ultimate aim of these cosmologies is always on the achievement of enlightenment (*nirvana*), and they must be understood as means to that end. For example, in the *Vissuddhimagga* (*Path of Purification*), Buddhaghosha (fifth century C.E.) describes the “world” not in detailed spatial and temporal terms but in terms of possible destinations for rebirth: gods, humans, ghosts, and animals, and hell (strangely, the last is a spatial reference, but primarily indicates a realm for tortured souls). Likewise, in the *Abhidharmakosha*, Vasubandhu (fifth century C.E.) locates a cosmology much like Buddhaghosha's within but one of three spheres (*dhatu*): the sphere of desire (*kamadhatu*); beyond this is a sphere of pure form (*rupadhatu*), and finally a sphere of no-form (*arupadhatu*). Despite their differences, these two prominent early cosmologies serve as a roadmap for the path to enlightenment, complex enough to exemplify the key points of Buddhist doctrine, yet simple enough to serve as an accessible means for traveling along that path.

Buddhist cosmology becomes inordinately more complicated, however, with proliferation of worlds and Buddha-realms. The concept of multiple worlds is already evident in Theravadan literature, where one Buddha oversees many worlds at one time; however, this concept becomes much more prominent in Mahayana texts, where most of these worlds are associated with particular Buddha-realms (*buddhakshetra*). Each *buddhakshetra* is overseen by its own fully enlightened Buddha, and is seen as pure, impure, or mixed, depending on the degree of desire and ignorance manifested there. Our own world, Saha, is the *buddhakshetra* of Shakyamuni (the historical Buddha), and is seen alternately as impure or mixed. Significantly, this association of worlds with different Buddhas is what gave rise to Pure Land Buddhism in the Chinese and Japanese contexts: the so-called “Pure Land,” Sukhavati, is a pure world overseen by the Buddha Amitayus/Amitabha (Infinite Life/Infinite Light), and all people who are born into this realm—something attained by faith rather than merit—are sure to achieve enlightenment in one lifetime.

It should be noted that, while Buddhist cosmologies are generally intended to embody the Buddhist path to enlightenment, this does not mean that they do not also draw on the cosmologies of other religious traditions—although this is always done with some modification. For example, Buddhist cosmography, like other Indian cosmographies, is traditionally centered on Mt. Meru, although the cosmography is given a distinctively Buddhist slant by placing the entire world of the living under the dominion of *Mara* (death). Likewise, the Buddhist notion of cosmic time borrows from the Hindu account of four *yugas* after which the world is destroyed and formed again; yet this account is again given a Buddhist slant by ridding the process of any creative deities and ensuring that the unenlightened souls are preserved during these recurrent destructions. This process of borrowing and adapting would continue as Buddhism spread into China, Tibet, Korea, and Japan; what would remain constant, however, is the ultimate aim of Buddhist cosmology: namely, enabling those still suffering in ignorance to ultimately achieve nirvana.

Chinese Cosmologies

Chinese cosmologies are, like Indian and Buddhist ones, manifold in their diversity. Some of the oldest originated from the Shang dynasty (c. 1554–1045/1040 B.C.E.), and appear initially to account for the general characteristics of the observed world. For example, the cosmos is often understood as consisting of a dome-shaped heaven (represented as a circle) and a square earth; China, the “Middle Kingdom,” is situated at its center, with the surrounding world represented as kingdoms situated at each of the four cardinal points and mountains at each of the corners. Allan notes that this cosmology not only resembles a turtle (as many have observed), but more importantly that it resembles the plastron (breastplate) of a turtle; this association is significant because it points to the mythic overlay that accompanied these cosmologies: the plastron was among the most prominent mediums for divination in early Chinese rituals. In this basic cosmology, two of the most prominent features of Chinese cosmologies are already starting to develop: first, the duality between heaven and earth

anticipates the later and broader duality between *yin* and *yang*; second, there is an assumed correlation between the cosmos in its entirety and the cosmos as found in any one of its parts (such as the turtle plastron). Yet Shang cosmologies remained for the most part very basic, overseen by the supreme Lord, Shang Di, and controlled by various spiritual beings.

The Zhou dynasty (roughly 1100–250 B.C.E.) inaugurated a move from tribal society to feudal society, and the cosmologies of this period reflect that change. For example, the king takes on the title of “Son of heaven,” thus situating himself cosmologically as that which links heaven and earth. This move simultaneously afforded him cosmic legitimacy, while also constraining him with the responsibility of ensuring that the order of earth appropriately modeled the order of heaven. This latter responsibility was termed the “Mandate of Heaven,” and was taken to be a universal moral law that rulers could either observe (and continue to rule) or neglect (and lose their right to rule). Both duality and correlative thinking remained evident in Zhou cosmology, although the anthropomorphic spiritual powers of the Shang were replaced by moral principle in the Zhou in a way that both validated and restrained rulers even at the highest level, as seen in the *Shijing* (*Classic of Odes*) and the *Shujing* (*Classic of Documents*).

The cosmography of the Zhou also developed that of the Shang in much greater detail. Whereas the Shang understood earth to be square in a broad sense, the Zhou came to see space generally in terms of square units. In order to provide a more detailed description of the earth, squares were divided into nine smaller squares, each of which could be further divided to the desired level of detail; typically, this took the form of a 3 by 3 grid, but there are other variants. The result of such division was that most of Chinese cosmography was understood in terms of nines: nine domains in the Zhou empire, nine branches of the Yellow River, and so on. The most famous example of this division is the well-field system of taxation, whereby eight farmers would each farm one of the peripheral plots on a 3 by 3 grid, with the center square tended by all eight and its yield being given as a tax payment to the government. It is remarkable that even the division of land and labor was taken to be best ordered as a microcosm of the larger cosmic landscape.

What is perhaps most important about Zhou cosmologies, however, is that they set the terms for all subsequent Chinese cosmology. The most prominent features are fourfold: the duality between *yin* and *yang*, the five agents (water, fire, earth, wood, and metal), and the sixty-four hexagrams. First, the duality between *yin* and *yang* is taken to be characteristic of the cosmos as a whole, embodied in the dualities between dark and light, weak and strong, cold and hot, female and male (respectively); the profound message of this duality, however, is that these apparent opposites are actually fundamentally related, balancing, propagating, and flowing out of one another, for example, the *Daodejing* (*Classic of the Way and Virtue*) and the *Yijing* (*Classic of Change*). The theory of the five agents, in turn, represents the perpetual transformation of things as a characteristic and entirely natural feature of the cosmos; Zhou cosmologists correlated these with virtues, feelings, and arrangements of time, and used them to explain changes in

The earliest written accounts of Japanese cosmology are found in the *Kojiki* (“Records of Ancient Matters,” 712 C.E.) and the *Nihongi* (“Chronicles of Japan,” 720 C.E.). These texts originate in a time in Japanese history when Buddhism was already a significant influence, and thus serve not only as mythico-historical accounts of the origins and history of the Japanese people but also as the founding documents for the Shinto religion (which had hitherto been transmitted in spoken word and ritual practice). The presence of external influences is already apparent in these documents: the *Nihongi*, for instance, compares the initial state of the cosmos to an egg that, as heavy and light parts separate, form the heavens and the earth (as seen in many other Asian cosmogonies). The most significant influences, however, appear to stem from Chinese thought: most notably, *Yin* and *Yang*, presented in the *Nihongi* as the complementary forces underlying the cosmos, arguably stand as Japanese representations of *yin* and *yang*.

Despite their apparent external influences, Japanese sources also reveal their distinctiveness, as found most clearly in the epic of Izanagi and Izanami as found in *Kojiki*. Izanagi (“male-who-invites”) and Izanami (“female-who-invites”) represent the last generation of a series of spontaneously generated primordial gods, who develop out of one another in increasing complexity and differentiation. Izanagi and Izanami descend from High Heaven (*Takamahara*) to the unformed world to create the islands of Japan. These islands, as well as a host of smaller gods (*kami*), are brought about primarily as products of the sexual union of Izanagi and Izanami. Ultimately, however, Izanami dies while giving birth to the god of fire—she is scorched to death,

producing even more gods in the process—and descends to the land of the dead (*Yomi-no-kuni*). In his rage Izanagi destroys the god of fire for his matricide, and in his grief he enters into the land of the dead to recover his wife. However, when he finds her and sees her decaying corpse, Izanami becomes enraged and pursues him with a host of demons. When he reaches the path between the land of the living and the land of the dead, Izanagi seals the path with a large stone. Following rituals of purification and grief (through which still more gods were created), Izanagi ascends to High Heaven, leaving the land of the living to the gods he has created. These gods continue to propagate and differentiate, eventually giving birth to the Imperial Family, the Japanese people, and the rest of the creatures and features of Japan.

This basic creation myth establishes the basic tripartite cosmology of the Shinto religion, consisting of High Heaven, the world of the living, and the world of the dead. It is also used to account for a wide variety of features of the cosmos, from such mundane features as the prevalence of fire (attributed to the pulverization of the god of fire for his matricide) to the victory of life over death (as embodied by the victory of Izanagi over Izanami at the path to the land of the dead). Although Japanese cosmology would become increasingly influenced by more pan-Asian religious and philosophical traditions—most notably, Buddhism—the Shinto cosmogony and cosmology laid out in the *Kojiki* and the *Nihongi* continue to influence popular belief in Japan. Indeed, insofar as these accounts serve to express the mythical origins of the Japanese people, they have become all the more influential as the Japanese have sought to develop and emphasize their own distinctive national identity.

everything from seasons to dynasties (for example, the *Shujing*, the *Xunzi*, the *Lüshi chungiu* [*Springs and Autumns of Mr. Lü*]). Finally, the sixty-four hexagrams consist of sets of six lines that are each either broken (associated with *yin*) or unbroken (associated with *yang*); whereas earlier Chinese tradition had used these for the purposes of divination, Zhou cosmologists began to attribute cosmological significance to them by associating them with all of the possible types of change within the cosmos.

Whether explained with respect to *yin* and *yang*, the five agents, or the sixty-four hexagrams (texts often drew on all three), Chinese cosmologies ultimately grounded these differentiations in a common source. This is identified in a number of different ways, but most commonly as the Supreme Ultimate (*taiji*, which generates *yin* and *yang*), or the Dao itself (which is prior even to the *taiji*). The primary point of Chinese cosmology is that, while the cosmos embodies a wide

variety of oppositions, changes, and transformations, these are ultimately the natural expressions of an underlying cosmic balance and harmony. While subsequent Chinese would alter the precise nature of the grounding and differentiation of the cosmos, both the terms laid out in the Zhou and its emphasis on cosmic balance and harmony would remain landmarks of Chinese cosmology.

If the Zhou introduced the main tenets of Chinese cosmology, it was the Han (202 B.C.E.–220 C.E.) who brought these tenets together and systematized them. For example, it was during the Han that the great commentaries on the *Yijing* and the *Chunqiu* (*Spring and Autumn Annals*) were written. Characteristic of this systematization is the heightened role of correlative thinking, which takes on a detailed, precise, and often even numerical character. Perhaps the most prominent example of Han cosmology is that of Dong Zhongshu (c. 195–c. 105 B.C.E.), as found in his *Chunqiu fanlu* (*Luxuriant Gems of the Spring and Autumn Annals*). Whereas the *Yijing* had related all things on a general level, Dong related them in exact detail: every thing or event can be seen as the direct result of other things and events, resulting in a highly complicated but also highly ordered cosmos. More importantly, this order of the cosmos as a whole is replicated at every level of existence, such that the human body, social relations, and imperial governance are all seen to be perfect microcosms of the larger cosmos. Dong's interest in the *Chunqiu fanlu* thus arises from his desire to use past records of interaction to aid present decisions in better modeling the balance and harmony of the cosmos.

Yet for all of their systematization and rigor, Han cosmologies proved too rigid for subsequent dynasties. Scientific advances compromised the perfect order asserted by Han cosmologists, persistent political upheavals rendered many of their political associations irrelevant, and the introduction of Buddhism into China shifted philosophical interest away from cosmology and toward metaphysics. In the Song dynasty (960–1279 C.E.), which witnessed a revival of interest in classical Chinese sources amid the rise of Neo-Confucianism, many of the terms and concepts informing Chinese cosmology were revived—for example, Zhou Dunyi's *Taijitu shuo* (*Explanation of the Diagram of the Supreme Ultimate*) and Shao Yong's *Huangji jingshi shu* (*Book of the Supreme Ultimate Ordering the World*). In both the Song and the Ming (1368–1644 C.E.) dynasties, these concepts were often reworked with remarkable ingenuity—the most prominent example of this is Zhu Xi's (1130–1200 C.E.) reinterpretation of the cosmos in terms of *li* (principle) and *qi* (material form)—although it must be noted that Neo-Confucian interest, following the lead of Neo-Daoism and Buddhism, was decidedly more metaphysical than cosmological. Ultimately, not even this resurgence of interest succeeded in stemming the tide of increasing cosmological skepticism in Chinese thought.

In the Qing dynasty (1644–1912), this skepticism reached its height. Seventeenth-century China experienced a marked increase of interest and renaissance in mathematics, astronomy, and geography, due in part to the introduction of Western science by means of the Jesuits. However, these new studies ran counter to the Chinese traditions of numerology, correlation

of the orders of heaven and earth, and geometric cosmogony, thus calling these traditions into serious question. Such critique was far from unprecedented (for example, Wang Chong [c. 27–c. 100 C.E.], Ouyang Xiu [1007–1072 C.E.]), but it is only in the late Ming and Qing dynasties that scientific development had enough momentum to seriously call into question such long-standing Chinese traditions (for example, Gu Yanwu [1613–1682 C.E.], Wang Fuzhi [1619–1692 C.E.]). According to John Henderson, this shift was so significant as to inaugurate something of an “anti-cosmology”—a cosmology that, in contrast to the traditional Chinese approach via correlative thinking about an ordered cosmos, took irregularity and nonuniformity to be defining characteristics of the cosmos (for example, Wang Tingxiang [1474–1544 C.E.]). Henderson goes on to argue that it was ultimately this distrust of correlative thinking in cosmology that led to a similar distrust of scientific models in China, thus effectively cutting it off from the broader scientific revolution and global cosmological conversation.

See also *Calendar; Cosmology; Cosmology and Astronomy; Time: China; Time: India*.

BIBLIOGRAPHY

- Allan, Sarah. *The Shape of the Turtle: Myth, Art, and Cosmos in Early China*. Albany: State University of New York Press, 1991.
- Aston, William George, trans. *Nihongi: Chronicles of Japan from the Earliest Times to A.D. 697*. Rutland, Vt.: Charles E. Tuttle, 1972.
- Black, Alison Harley. *Man and Nature in the Philosophical Thought of Wang Fu-chih*. Seattle: University of Washington Press, 1989.
- Chamberlain, Basil Hall. *The Kojiki: Records of Ancient Matters*. Rutland, Vt.: Charles E. Tuttle, 1982.
- Chan, Wing-tsit. *A Source Book in Chinese Philosophy*. Princeton, N.J.: Princeton University Press, 1963.
- De Bary, William Theodore, and Irene Bloom, comps. *Sources of Chinese Tradition: From Earliest Times to 1600*. 2nd ed. New York: Columbia University Press, 1999.
- Flood, Gavin D. *An Introduction to Hinduism*. New York: Cambridge University Press, 1996.
- Flood, Gavin D., ed. *The Blackwell Companion to Hinduism*. Malden, Mass.: Blackwell, 2003.
- Gombrich, R. F. “Ancient Indian Cosmology.” In *Ancient Cosmologies*, edited by Carmen Blacker and Michael Loewe, 110–142. London: Allen and Unwin, 1975.
- Henderson, John B. *The Development and Decline of Chinese Cosmology*. Neo-Confucian Studies Series. New York: Columbia University Press, 1984.
- Kinsley, David R. *Hinduism: A Cultural Perspective*. 2nd ed. Englewood Cliffs, N.J.: Prentice Hall, 1993.
- Kloetzli, Randy. *Buddhist Cosmology: From Single World System to Pure Land—Science and Theology in the Images of Motion and Light*. Delhi: Motilal Banarsidass, 1983.
- Klostermaier, Klaus K. *A Survey of Hinduism*. Albany: State University of New York Press, 1994.
- Lopez, Donald S. *The Story of Buddhism: A Concise Guide to its History and Teachings*. San Francisco: HarperSanFrancisco, 2001.

- Michaels, Axel. *Hinduism: Past and Present*. Translated by Barbara Harshav. Princeton, N.J.: Princeton University Press, 2004.
- Miller, Jeanine. *The Vision of Cosmic Order in the Vedas*. Foreword by Raimundo Panikkar. Boston: Routledge and Kegan Paul, 1985.
- Picken, Stuart D. B. *Essentials of Shinto: An Analytical Guide to Principle Teachings*. Westport, Conn.: Greenwood Press, 1994.
- Radhakrishnan, Sarvepalli, and Charles Alexander Moore. *A Source Book in Indian Philosophy*. Princeton, N.J.: Princeton University Press, 1957.
- Rosemont, Henry. *Explorations in Early Chinese Cosmology: Papers Presented at the Workshop on Classical Chinese Thought Held at Harvard University, August 1976*. Chico, Calif.: Scholars Press, 1984.
- Sharma, Arvind. *Classical Hindu Thought: An Introduction*. Oxford and New York: Oxford University Press, 2000.
- Soifer, Deborah A. *The Myths of Narasimha and Vāmana: Two Avatars in Cosmological Perspective*. Albany: State University of New York Press, 1991.
- Walpole, Rāhula. *What the Buddha Taught*. Rev. ed. New York: Grove Press, 1974.
- Wang, Aihe. *Cosmology and Political Culture in Early China*. Cambridge, U.K., and New York: Cambridge University Press, 2000.

Robert Smid

COSMOLOGY AND ASTRONOMY

Early cosmologies, or worldviews, envisioned a universe subject to the whims of gods and were anthropocentric: focused on the role and fate of human beings. As such, cosmology and religion were often intertwined.

Babylonian Cosmology

Elimination of everything other than empirical observation and mathematical computation from Babylonian astronomical texts of the Seleucid period has been hailed by some as the first appearance of modern science and cosmology. Ancient Babylonians studied how the celestial motions went, but not why. Nor did they seek causes for physical phenomena or develop comprehensive theories about the universe. Consequently, some scholars dismiss Babylonian cosmology and astronomy as merely a set of mechanical procedures with no more theoretical content than recipes in a cookbook. They look instead to the Greeks for the birth of modern science.

Greek Cosmology

For two millennia, the Aristotelian physical cosmology of rotating spheres carrying the sun, moon, planets, and stars around the central earth permeated Western thought. The natural place for earthy material was at the center of the universe, and earthy material tended to move to its natural place. Planetary spheres rotated because that was their natural motion. Aristotle's teleological explanations, with the world fulfilling a purpose formed by a superhuman mind, would not necessarily be incompatible with Christian philosophy, which also envisioned the world as inherently meaningful and purposive. Concurrent with Aristotle's physical cosmology was Plato's geometrical cosmology, in which astronomers strove "to save

the appearances": to explain apparently irregular planetary motions with combinations of circular motions at constant speeds.

In the context of modern science, saving the appearances with uniform circular motions is an arbitrary and absurd task. The task was, however, widely accepted and pursued for around two thousand years, from the Greeks in the fourth century B.C.E. through Copernicus and the European Renaissance in the sixteenth and seventeenth centuries C.E. The historical importance of a cosmology is not necessarily negated by its absurdity, especially when that label is applied in hindsight by different people in a different age with different standards and values.

Saving the appearances is plausible in the context of Plato's philosophy, which in turn can be understood as his reaction to the moral and political chaos of his age, which left him highly dissatisfied with the physical world. His concept of an ideal reality is simply illustrated. A circle drawn on paper is an imperfect representation in the visible world of experience of a perfect circle, which exists only in the world of thought. In his *Republic*, Plato wrote that the sky was part of the visible world, and the true revolutions of the planets, sun, and moon were to be discerned by reason and thought, not by sight.

Interregnum

Greek geometrical cosmology was systematized and advanced, with rigorous geometrical demonstrations and proofs, by Claudius Ptolemy (second century C.E.). He did for astronomy what Euclid had done for geometry and earned a reputation as the greatest astronomer of the ancient world. Indeed, his *Almagest*, of about 140 C.E., was so comprehensive that its predecessors ceased to be copied and failed to survive.

The match between Ptolemy's reported observations and his theory is too good to be true, and the *Almagest* has been called the greatest fraud in the history of science. It is not a modern scientific research paper, however, but a textbook, and it is in this context that Ptolemy should be judged. He made many observations; errors largely canceled each other out; and he thus obtained an accurate planetary theory. Next he would have selected a few observations in best agreement with the theory to illustrate it, and even fabricated examples to neaten up his pedagogy. The Greek astronomical tradition was far more concerned with general geometrical procedures than with specific numerical results.

Islamic scientists rescued the Aristotelian and Platonic cosmologies when Western civilization crumbled; they transmitted Greek learning back to the West when learning revived there. Initially, Aristotelian cosmology, including the eternity of the world and denial that God could make other worlds, seemingly contradicted dogmas of the Christian faith, and in the thirteenth century the bishop of Paris condemned hundreds of Aristotelian propositions. The condemnations helped free cosmology from Aristotelian dogma and also led to the nominalist, instrumentalist, or positivist thesis. Cosmology was understood as a working hypothesis, the truth of which could not be insisted upon because God could have made the world in a different manner but with the same observational

consequences. Imaginative and ingenious discussions, including possible rotation of the earth, subsequently flourished.

Hypothetical cosmologies, however, are not the stuff of revolution. Confidence that the essential structure and operation of the cosmos is knowable would be essential to the achievements of Nicolaus Copernicus (1473–1543), Galileo Galilei (known as Galileo; 1564–1642), Johannes Kepler (1571–1630), and Isaac Newton (1642–1727).

The Copernican Revolution

Ptolemy's planetary theory matched observations, but in Copernicus's opinion, it violated the standard of uniform circular motion. Also, Ptolemy's scheme did not automatically produce phenomena that followed naturally in Copernicus's heliocentric model. An unauthorized foreword to Copernicus's 1543 *De revolutionibus orbium coelestium* presented the heliocentric theory as a convenient mathematical fiction. Copernicus, however, believed that he was describing the real world.

Revolutions in science, as in politics, often exceed the limited changes envisioned by their creators. The sphere carrying the stars was now obsolete, and soon human imagination distributed the stars throughout an infinite space. Furthermore, the earth was no longer unique. Galileo's telescopic observations emphasized that the moon was uneven and rough, like the earth. Also, Jupiter had four satellites similar to the earth's satellite.

Logical consequences of the Copernican system, Galileo's telescopic discoveries, and the principle of plenitude, which interpreted any unrealized potential in nature as a restriction of the Creator's power, all encouraged belief in a plurality of worlds. Also, political and societal critics used the moon as a literary convention, its inhabitants' arrangements being either a model of perfection or a mirror of the earth's vices. Faith in an anthropocentric universe lay shattered, leaving people's relationship with God uncertain. John Donne's 1611 poem *An Anatomy of the World*, its line the "new Philosophy calls all in doubt," and later "all Relation: / Prince, Subject, Father Son, are things forgot," refers to Christian morality as much as to the relative positions of the sun and earth.

The Newtonian Revolution

Tycho Brahe's (1546–1601) observations of comets coursing through the solar system shattered the Aristotelian crystalline spheres, and his observation of a nova, a star flaring up in brightness, pierced Aristotelian belief in an unchangeable heaven. Belief in uniform circular motion died next when Kepler used Brahe's observations to show that planets travel around the sun in elliptical orbits. A new explanation of how the planets retrace the same paths forever around the sun became a central problem of cosmology. Newton showed mathematically how a force of attraction or gravitation toward the sun continually draws planets away from straight-line motion and holds them in Kepler's elliptical orbits.

The Newtonian example of general laws in natural philosophy excited searches for general laws in other realms, including economics. In this branch of philosophy, Adam Smith

(1723–1790) played Newton's role. Also inspired by Newton's achievement, Voltaire (1694–1778) and Montesquieu (1689–1755) searched for natural laws of politics. The French Revolution owed much to Newton.

Newton was convinced that his discoveries demonstrated God's wonders. Yet the revolution in thought following from his new cosmology, particularly the concept of a mechanical, clocklike universe, threatened the historic link between cosmology and religion in Western thought. Writers of the Romantic period sought to breathe divine life back into an overly mechanized and increasingly godless universe. Under the sway of the French Enlightenment's atheistic approach to nature, however, Pierre-Simon Laplace (1749–1827) happily replaced the hypothesis of God's rule with a purely physical theory. According to legend, when Napoléon Bonaparte (1769–1821) asked Laplace whether he had left any place for the Creator, Laplace replied that he had no need of such a hypothesis.

The Newtonian solar system provided Immanuel Kant (1724–1804) a model for the larger stellar system. The same cause that gave the planets their centrifugal force, keeping them in orbits around the sun, could also have given the stars the power of revolving. And whatever made all the planets orbit in roughly the same plane could have done the same to the stars. Nebulous-appearing objects in the heavens became, in Kant's mind, island universes, like colossal solar systems. Late in the eighteenth century, William Herschel's (1738–1822) large telescopes expanded the heavens from a starry sphere to a three-dimensional firmament. He observed that most stars seemed to lie between two parallel planes. This stratum, seen from earth, is the Milky Way.

Twentieth-Century Cosmology

At the beginning of the twentieth century, it was generally thought that the Earth's galaxy was some ten thousand light-years across and that the solar system was near the center of the galaxy. This vision of the universe was soon replaced with a revolutionary new conception. Harlow Shapley at the Mount Wilson Observatory showed that the galaxy is hundreds of thousands of light-years in diameter and the solar system is far from its center. The significance of humans and their particular planet had dwindled still further. Shapley noted a historical progression from belief in a small universe with humankind at its center to a larger universe with the earth farther from the center. The geometry had been transformed from geocentric to heliocentric to acentric. The psychological change was no less, Shapley insisted, from homocentric to acentric. Furthermore, the galaxy containing the Earth is but one of many "island universes," as Edwin Hubble soon proved. Next Hubble found that the universe is expanding. Georges Lemaître, a Belgian priest and astrophysicist, explained the expansion of the universe from an initial "cosmic egg." Einstein confirmed that Lemaître's theoretical investigations fit well into the general theory of relativity.

Advances in nuclear physics fed speculations about an expanding universe resulting from thermonuclear reactions in an early, hot, dense phase. Fred Hoyle at mid-century derisively

called it the “big bang,” and the term stuck. Hoyle championed instead steady-state creation, in which the universe expands but does not change in density because new matter continuously appears. Pope Pius XII announced in 1951 that big-bang cosmology affirmed the notion of a transcendental creator and was in harmony with Christian dogma. Steady-state theory, denying any beginning or end to time, was associated with atheism, though Hoyle associated it with personal freedom and anticommunism. The debate was resolved observationally with detection of a faint cosmic background radiation, a remnant of the big bang.

In 1979 an American particle physicist, Alan Guth, proposed that important cosmological features can be explained as natural and inevitable consequences of new theories of particle physics. Guth’s theory of inflation states that in the first minuscule fraction of a second of the universe’s evolution, a huge inflation occurred. After that, the inflationary universe theory merges with the standard big-bang theory.

See also *Astrology*; *Cosmology*; *Asia*.

BIBLIOGRAPHY

- Berendzen, Richard, Richard Hart, and Daniel Seeley. *Man Discovers the Galaxies*. New York: Science History Publications, 1976.
- Crowe, Michael J. *Modern Theories of the Universe: From Herschel to Hubble*. New York: Dover Publications, 1994.
- . *Theories of the World from Antiquity to the Copernican Revolution*. New York: Dover Publications, 1990.
- Duhem, Pierre. *To Save the Phenomena, an Essay on the Idea of Physical Theory from Plato to Galileo*. Translated by Edmund Doland and Chaninah Maschler, with an introductory essay by Stanley L. Jaki. Chicago: University of Chicago Press, 1969.
- Hetherington, Norriss S. “Cosmic Journey: A History of Scientific Cosmology.” Available at <http://www.wavian.com/aip/cosmology/index.htm>.
- Hetherington, Norriss S., ed. *Encyclopedia of Cosmology: Historical, Philosophical, and Scientific Foundations of Modern Cosmology*. New York: Garland, 1993.
- Hubble, Edwin. *The Realm of the Nebulae*. New Haven, Conn.: Yale University Press, 1936; repr. New York: Dover Publications, 1958.
- Johnson, Francis R. *Astronomical Thought in Renaissance England: A Study of the English Scientific Writings from 1500 to 1645*. Baltimore: Johns Hopkins University Press, 1937; repr. New York: Octagon Books, 1968.
- Koyré, Alexandre. *From the Closed World to the Infinite Universe*. Baltimore: Johns Hopkins University Press, 1957.
- Kragh, Helge. *Cosmology and Controversy: The Historical Development of Two Theories of the Universe*. Princeton, N.J.: Princeton University Press, 1996.
- Kuhn, Thomas S. *The Copernican Revolution: Planetary Astronomy in the Development of Western Thought*. Cambridge, Mass.: Harvard University Press, 1957.
- Lovejoy, Arthur O. *The Great Chain of Being: A Study of the History of an Idea. The William James Lectures Delivered at Harvard University, 1933*. Cambridge, Mass.: Harvard University Press, 1936.
- Neugebauer, Otto. *The Exact Sciences in Antiquity*. 2nd ed. New York: Dover Publications, 1969.

Nicholson, Marjorie. *A World in the Moon: A Study of the Changing Attitude toward the Moon in the Seventeenth and Eighteenth Centuries*. Northampton, Mass.: Smith College Department of Modern Languages, 1936.

Norriss Hetherington

COSMOPOLITANISM. Cosmopolitanism refers to both a lifestyle incorporating aspects from all or many parts of the world and an ideology based upon the premise that every human shares, or should share, equal status as a “citizen of the world.” The two are not exclusive of one another, but it is certainly possible to encounter either the ideal or the lifestyle without the presence of the other. Though similar to the concept of multiculturalism, cosmopolitanism should be distinguished from this term. Whereas cosmopolitanism entails the “recognition, acceptance, and eager exploration of diversity,” multiculturalism includes more concern for boundary maintenance than for empathetic border crossings (Hollinger, p. 84).

The Ideal of Cosmopolitanism

The word *cosmopolitan* can be traced to the Greek Cynic philosophers Antisthenes (c. 445–365 B.C.E.) and his student Diogenes of Sinope (d. c. 320 B.C.E.). In the fourth century B.C.E., Diogenes likely responded to inquiry about his citizenship by boldly asserting, “I am a citizen of the world.” His statement, though often used as a humanistic slogan, expressed a rather negative notion. Since he was not a citizen of any particular locale, he was not obligated to serve his particular city-state. He offered his allegiance to no single government. The Stoic philosopher Zeno of Citium (c. 335–c. 263 B.C.E.) articulated a similar sentiment, but with more constructive implications. He imagined citizenship as a series of concentric circles. The self inhabited the innermost ring of this inclusive model, followed by family, city, region, and so on. Thus Zeno understood the individual as a part of all other affiliations.

Early Christianity also offered a unique notion of cosmopolitanism: The disciple obtained a new, spiritual citizenship that transcended the bonds of local government and regional identity through following the teachings of Jesus. St. Paul (c. 66) expressed this in an open letter to devotees in Colossi, proposing that “there is no distinction between Greek and Jew, circumcised and uncircumcised, barbarian, Scythian, slave or free” (Col. 3:11). This deconstruction of status and ethnicity represented a significant development in the cosmopolitanism as a concept, even if the established Christian church has often been a source of division.

Several humanist intellectuals advocated a cosmopolitan ideology during the Enlightenment of the seventeenth and eighteenth centuries. The philosophes imagined themselves as inhabitants in a republic of letters that transcended mere national boundaries. Believing in the preeminence of reason and scientific discovery, these men forged bonds of intellectual discourse throughout the North Atlantic. The ideas of the German philosopher Immanuel Kant (1724–1804) were especially influential through the beginning of the twenty-first century.

His writing advocated perpetual peace between nation-states during a time when nations were still being defined.

Contemporary scholars have implemented the cosmopolitanism of nineteenth- and early-twentieth-century Indians alongside that of Kant. Swami Vivekananda (1863–1902) united the teachings of the Indian religious leader Sri Ramakrishna (1836–1886) with claims of scientific validity to increase awareness of the physical and spiritual practice of yoga. His contemporary, the poet Rabindranath Tagore (1861–1941), an undoubted anticolonial himself, chided the political and religious leader Mohandas Gandhi (1869–1948) for his penchant toward national self-reliance. Instead, Tagore pleaded for a transnational interdependency. The work of these men still exercises influence upon spiritual and political cosmopolitanism.

In each of these contexts, the ideal of cosmopolitanism sought to eclipse local or regional loyalties with the belief that humans share a bond free from provincial affiliations. Whether predicated on mysticism or reason, cosmopolitanism as an ideal locates the individual within a world community. However, those espousing the ideal have not always turned this admirable belief into a reality. Religious exclusion and ethnic nationalism have continued to flourish despite these recurrent appearances of a cosmopolitan ideal. However, this is not to say that cosmopolitanism has not been practiced in various times and locales.

The Practice of Cosmopolitanism

As a lifestyle, cosmopolitanism embraces, participates in, and combines the customs of several different cultures. The cosmopolitan is not tethered by local or national habits and prejudices. Rather, he or she welcomes encounters with those from different regions and aspires to fluidly navigate from one cultural context to another.

Cosmopolitanism has been achieved in disparate historical and geographical settings. The Ottoman Empire of the fifteenth and sixteenth centuries encouraged the mingling of Northern African, Iberian, and Middle Eastern peoples. In the medieval period, Islamic scholars incorporated the works of ancient Greeks into their learning. Cities such as Istanbul became centers of trade and cosmopolitanism, even housing Freemasonry lodges in the nineteenth century.

At times, people may adapt a cosmopolitan way of life out of necessity as opposed to ideological conviction. Daniel M. Swetschinski's study of Portuguese Jews in the Netherlands of the seventeenth century recounts an historical setting in which members of a displaced ethnic group incorporated the customs of others. These "reluctant cosmopolitans," as Swetschinski calls them, became part of the flourishing Danish mercantilism. Landing in ports all throughout the Atlantic and Mediterranean, they interacted with multiple cultures while maintaining a Jewish identity.

Certain social groups are almost always associated with cosmopolitanism. Intellectuals, diplomats, creative artists, the wealthy, and merchants each to a certain extent maintain a lifestyle that might be described as cosmopolitan. Certainly since the time of the Enlightenment, academia has extended beyond

local influence. Intellectual communities, in both the humanities and the sciences, collaborate and compete along disciplinary lines rather than national borders. Diplomats, by the very nature of their profession, must be charming in midst of profound cultural difference. Adaptability to unique settings and a thorough understanding of distinct worldviews qualify political emissaries. Visual, literary, and performing artists, as well as their patrons, have long displayed a fascination with exotic subjects and media. International movements within the arts often indicate the merging of traditionally distinct ideas and people-groups. Historically, though, one need not display any of the aforementioned skills to live a cosmopolitan life. A person might become a world citizen by possessing the means to travel extensively. By journeying to distant climes, speaking foreign languages, and acquiring and displaying exotic goods, the wealthy could be included among the ranks of other cosmopolitans.

However, perhaps more than any other social group, merchants have both exemplified cosmopolitan lifestyles and prompted others to do the same. With the emergence of global capitalism, traders and business people are regularly in contact with multiple cultures and ethnic groups. Transnational enterprise demands its participants be capable of interacting with diverse populations. Moreover, through the commodification of goods produced in foreign lands, merchants encourage consumers to desire nonindigenous wares.

Opposition to Cosmopolitanism

Cosmopolitanism, as both an ideal and a lifestyle, has often been critiqued. Given those who have historically been considered cosmopolitans, it is not surprising that skeptics label it elitist. Cosmopolitanism most often required either remarkable talent or extraordinary financial means, and sometimes both. The vast majority of people simply did not have the option to participate in such a life.

Nationalists and some ethnic leaders have also attacked the concept. Because cosmopolitans lack the "roots" of others, these critics believe they cannot be loyal to the political process of a given geographic region. Ethnic essentialists are similar in that they disdain cosmopolitanism because it involves the internalization of others' cultural beliefs and practices. To the essentialist, people simply are not able to fit into any ethnic group other than their own.

Ironically, global capitalism coupled with national and religious extremism has created a nonelite group of cosmopolitans. Immigrants and refugees now bring a heterogeneous picture of humanity from their respective homelands. Moreover, relatively affordable travel and dazzlingly diverse urban landscapes bring the exotic within reach of many. In the technologically saturated, polyethnic world of the twenty-first century, the ideal and the practice of cosmopolitanism seem much more similar than they have in the past.

See also *Intelligentsia; Migration; Nationalism; Society.*

BIBLIOGRAPHY

Hollinger, David A. *Postethnic America: Beyond Multiculturalism.* New York: Basic Books, 1995.

- Nussbaum, Martha Craven. *For Love of Country: Debating the Limits of Patriotism*. Edited by Joshua Cohen. Boston: Beacon Press, 1996.
- Schlereth, Thomas J. *The Cosmopolitan Ideal in Enlightenment Thought: Its Form and Function in the Ideas of Franklin, Hume, and Voltaire, 1694–1790*. Notre Dame, Ind.: University of Notre Dame Press, 1977.
- Swetschinski, Daniel. *Reluctant Cosmopolitans: The Portuguese Jews of Seventeenth-Century Amsterdam*. London: Littman Library of Jewish Civilization, 2000.
- Vertovec, Steven, and Robin Cohen, eds. *Conceiving Cosmopolitanism: Theory, Context, and Practice*. New York: Oxford University Press, 2003. Diverse collection and rich bibliography.

Kevin James Houk

COSTUME. See **Dress.**

CREATIONISM. Creationism in a general sense refers to the theory that God made the world on his own, by miraculous means, out of nothing. In a more specific sense, the one encountered in America today, creationism is the theory that the Bible, particularly the early chapters of Genesis, is a literally true guide to the history of the universe and to the history of life, including us humans, down here on earth. This encompasses a number of beliefs: a short time since the beginning of everything (“Young Earth Creationists” think that Archbishop Ussher’s sixteenth-century calculation of about 6,000 years is a good estimate); six days of creation (there is debate on the meaning of “day” in this context, with some insisting on a literal twenty-four hours, and others more flexible); miraculous creation of all life including *Homo sapiens* (with scope for debate about whether Adam and Eve came together or if Eve came afterward to keep Adam company); a worldwide flood some time after the initial creation, through which only a limited number of humans and animals survived; and other events such as the Tower of Babel and the turning of Lot’s wife into a pillar of salt. Creationists have variously been known as fundamentalists or biblical literalists, and sometimes (especially when they are pushing the scientific grounds for their beliefs) as scientific creationists. Today’s creationists are often marked by enthusiasm for so-called intelligent design.

History of Creationism

Creationists present themselves as the true bearers and present-day representatives of authentic traditional Christianity, but historically speaking this is simply not true. The Bible has a major place in the life of any Christian, but it is not the case that the Bible taken literally has always had a major place in the lives or theology of Christians. Tradition, the teachings and authority of the Church, has always had main status for Catholics, and natural religion—approaching God through reason and argument—has long had an honored place for both Catholics and Protestants. Catholics, especially dating back to Saint Augustine (354–430), and even to earlier thinkers like Origen (c. 185–254), have always recognized that at times the Bible needs to be taken metaphorically or allegorically. Augustine was

particularly sensitive to this need, because for many years as a young man he was a Manichean and hence denied the authenticity and relevance of the Old Testament for salvation. When he became a Christian he knew full well the problems of Genesis and hence was eager to help his fellow believers avoid the traps of literalism.

It was not until the Protestant Reformation that the Bible started to take on its unique central position, as the great Reformers—especially Martin Luther (1483–1546) and John Calvin (1509–1564)—stressed the need to go by Scripture alone and not by the traditions of the Catholic Church. But even they were doubtful about totally literalistic readings. For Luther, justification by faith was the keystone of his theology, and yet the Epistle of Saint James seems to put greater stress on the need for good works. He referred to it as “right strawy stuff.” Calvin likewise spoke of the need for God to accommodate his writings to the untutored public—especially the ancient Jews—and hence of the dangers of taking the Bible too literally in an uncritical sense. The radical branch of the Reformation under Huldrych Zwingli (1484–1531) always put primacy on God’s speaking directly to us through the heart, and to this day one finds modern-day representatives like the Quakers uncomfortable with too biblically centered an approach to religion.

Eighteenth- and nineteenth-century revivals. It was really not until the revivals of the eighteenth and early nineteenth century in Britain and America—revivals that led to such sects as the Methodists—that a more full-blooded literalism became a major part of the religious scene. Then, the emphasis was on Christ’s dying on the cross for our sins (the Atonement), the priesthood of all believers, and the primacy of the Bible as a guide to the converted heart, although even then there were many opposed, often quite violently. To take but one example, the most significant movement within the Church of England (Anglicanism; Episcopalianism in America) was the High Church movement known as Tractarianism, the Oxford movement of the 1830s, led most significantly by the future Catholic cardinal, John Henry Newman (1801–1890). No one was more vitriolic and sarcastic on the subject of biblical literalism than was Newman. In one of his major writings, Tract 85, he ridiculed those who would use the Bible as a guide to science or religion, and, with the vigor of a hardened humanist, he pointed out inconsistencies in the sacred book.

In America particularly, however, literalism did take hold, and especially after the Civil War (1861–1865), it took root in the evangelical sects—especially Baptists—of the South. It became part of the defining culture of the South, having as much a role in opposing ideas and influences of the North as anything rooted in deeply considered theology. This was the time of Charles Darwin (1809–1882), whose great work, *On the Origin of Species* (1859), provoked much theological opposition. But for the great Christian opponents—Samuel Wilberforce (1805–1873), bishop of Oxford in England, and Charles Hodge (1797–1878), principal of Princeton Theological Seminary in America—simple biblical literalism was far from the front of the objections. They were certainly keen on

what became pretty standard arguments against evolution in general and Darwinism in particular. Gaps in the fossil record played a major role, as did the origin of life and the nonexistence of the direct observation of natural selection changing species. But crude reference to the Bible had no place in their scheme of things. Six thousand years of earth history was as far from the thinking of Wilberforce and Hodge as it was from that of Darwin. Problems of natural theology were far more pressing, as were topics that only tangentially have their basis in Genesis, such as the existence of immortal souls.

Early twentieth century. Creationism became more than just a local phenomenon in the early part of the twentieth century, thanks to a number of factors. First, there were the first systematic attempts to work out a position that would take account of modern science as well as a literal reading of Genesis. Particularly important in this respect were the Seventh Day Adventists, especially the Canadian-born George McCready Price (1870–1963), who had theological reasons for preferring literalism, not the least being the belief that the Seventh Day—the day of rest—is literally twenty-four hours in length. (Also important for the Adventists and for other dispensationalists—that is, people who think that Armageddon is on its way—is the balancing and complementary early phenomenon of a worldwide flood.) Second, there was the realized energy of evangelicals as they succeeded in their attempts to prohibit liquor in the United States. Flushed from one victory, they looked for other fields to conquer. Third, there was the spread of public education, which exposed more children to evolutionary ideas, provoking a creationist reaction. Fourth, there were new evangelical currents afloat, especially the *Fundamentals*, tracts that gave the literalist movement its name. And fifth, there was the identification of evolution—Darwinism particularly—with the militaristic aspects of Social Darwinism, especially the Social Darwinism supposedly embraced by the Germans in World War I.

The “Scopes Monkey Trial.” This battle between evolutionists and “fundamentalists” came to a head in 1925 in Dayton, Tennessee, when a young schoolteacher, John Thomas Scopes (1900–1970), was prosecuted for teaching evolution in class, in defiance of a state law prohibiting such teaching. There was more at stake than just the facts, evolution versus the Bible. Local businesspeople welcomed the opportunity of a high-profile court case to put their community on the map and to reap financial rewards. The American Civil Liberties Union (ACLU), backing the defense, was eager for such a case to bolster its standing with America’s liberals and to highlight its existence (it was founded in 1920). Indeed, the ACLU actively sought out someone who would be willing to stand trial. Prosecuted by the three-time presidential candidate William Jennings Bryan (1860–1925) and defended by the noted agnostic lawyer Clarence Darrow (1857–1938), the “Scopes Monkey Trial” caught the attention of the world, especially thanks to the inflammatory reporting of the *Baltimore Sun* journalist H. L. Mencken (1880–1956). Matters descended to the farcical when, denied the opportunity to introduce his own science witnesses, Darrow put on the stand the prosecutor Bryan. In the end, Scopes was found guilty and fined \$100, although this was overturned on a technicality on

appeal. Despite never again being enforced, the Tennessee law remained on the books for another forty years.

Toward the Present

After the *Scopes* trial, the creationism movement declined quite dramatically and quickly. This was not due to Americans losing interest in the science-religion relationship, for now was the time of the foundation of such organizations as the American Scientific Affiliation, which tried seriously to seek a meeting ground between science and various forms of evangelical Christianity. But as is shown well by the trials of this particular organization—forever torn by the quarrels over geology and evolution—full-blooded Creationism no longer captured universal support among biblical Christians. Yet Creationism had its lasting effects, in that textbook manufacturers increasingly took evolution—Darwinism especially—out of their books, so that schoolchildren got less and less exposure to the ideas anyway. Whatever battles the evolutionists may have thought they had won in the court of popular opinion, in the trenches of the classroom they were losing the war badly.

Things started to move again in the late 1950s. A major factor was that, in the years since the *Scopes* trial, evolutionary thinking had not stood still. Indeed, the three decades from 1930 to 1960 were times of great ferment and development, for Mendelian genetics (and after this, molecular genetics) had reached such a point that it could be synthesized with Darwinian selection to make a fully integrated evolutionary theory, known variously as “neo-Darwinism” or the “synthetic theory of evolution.” Naturally enough, evolutionists were excited and vocal about their advances, and particularly contemptuous of all who did not follow them down to the last detail. At celebrations in 1959 in Chicago to celebrate the hundredth anniversary of the publication of *On the Origin of Species*, fundamentalist objectors to the new paradigm were objects of particular scorn. This set a general background of unease and determination by biblical literalists, adding to a causal mix that had already started to ferment a year or two earlier when a more specific yeast had been added. It was then that, thanks to Sputnik, the Russians so effectively demonstrated their superiority in rocketry (with its implications for the arms race of the cold war), and America realized how ineffective was the scientific training of its young. In response, the country poured money into the production of new science texts. In this way, with class adoption, the federal government could have a strong impact and yet get around the problem that education tends to be under the tight control of individual states. The new biology texts gave full scope to evolution—to Darwinism—and with this the creationism controversy again flared up.

Fortunately for the literalist, help was at hand. A biblical scholar, John C. Whitcomb Jr., and a hydraulic engineer, Henry M. Morris, together wrote what was to be the new Bible of the movement, *Genesis Flood: The Biblical Record and its Scientific Implications* (1961). Following in the tradition of earlier writers, especially those from Seventh Day Adventism, they argued that every bit of the biblical story of creation given in the early chapters of Genesis is supported fully by the best of modern science. Six days of twenty-four hours, organisms

arriving miraculously, humans last, and sometime thereafter a massive worldwide flood that wiped most organisms off the face of the earth—or rather, dumped their carcasses in the mud as the waters receded. At the same time, Whitcomb and Morris argued that the case for evolution fails dismally. The gaps in the fossil record show that there can have been no evolution; the nature of natural selection is such that it allows no genuine check and even if it did, it could not account for the complexity of life; the measures of earth time are dicey; and much, much more.

Genesis Flood enjoyed massive popularity among the faithful, and led to a thriving creation science movement, where Morris particularly and his coworkers and believers—notably Duane T. Gish, author of *Evolution: The Fossils Say No!*—pushed the literalist line. Particularly effective was their challenging of evolutionists to debate, where they would employ every rhetorical trick in the book, reducing the scientists to fury and impotence with their bold statements about the supposed nature of the universe. By the end of the 1970s, creationists were passing around draft bills, intended for state legislatures, that would allow—instruct on—the teaching of creationism in state-supported public schools. In the biology classes of such schools, that is. By this time it was realized that, thanks to Supreme Court rulings on the First Amendment to the Constitution (which prohibits the establishment of state religion), it was not possible to exclude the teaching of evolution from such schools. The trick was to get creationism—something that *prima facie* rides straight through the separation of church and state—into such schools. The idea of creation science is to do this—although the science parallels Genesis, as a matter of scientific fact, it stands alone as good science. Hence, these draft bills proposed what was called “balanced treatment.” If one was to teach the “evolution model,” then one had also to teach the “creation science model.” Sauce for the evolutionist goose is also sauce for the creationist gander. In 1981, these drafts found a taker in Arkansas, where such a bill was passed and signed into law—as it happens, by a legislature and governor that thought little of what they were doing until the consequences were drawn to their attention.

At once the American Civil Liberties Union sprang into action, bringing suit on grounds of the law’s unconstitutionality. The judge agreed, ruling firmly that creation science is not science, it is religion, and as such has no place in public classrooms. And that was an end to matters, reinforced by a similar decision (that did not go to trial but that was appealed all the way up to the Supreme Court) in Louisiana.

Phillip Johnson and Naturalism

Nevertheless, by the beginning of the 1990s, creationism had again reared its head. The spark was an antievolutionary tract, *Darwin on Trial* (1991), by a Berkeley law professor, Phillip Johnson. Although smoother in presentation, the work covered familiar ground: gaps in the record, the complexity of DNA, the origin of life, the randomness of mutation. The main difference in Johnson’s strategy was to turn the debate in the direction of philosophy. He argued that the creation-evolution debate was not just one of science versus religion or

good science versus bad science, but rather of conflicting philosophical positions—with the implication that one philosophy is much like another, or rather with the implication that one person’s philosophy is another person’s poison and that it is all a matter of personal opinion. Thus, if it is all a matter of philosophy, there is nothing in the U.S. Constitution that bars the teaching of creationism in schools.

Crucial to Johnson’s position are a number of fine distinctions. He distinguishes between what he calls “methodological naturalism” and “metaphysical naturalism,” and contrasts them with what he calls “Christian theism” or “theistic realism.” A methodological naturalist is one who assumes there is no god when he or she does science. All must be explained through unbroken law. A metaphysical naturalist is one who believes that there is no god. He or she is directly opposed to any kind of theist, who starts with the assumption that there is a god who was and is active in the creation. According to Johnson, although you might think that you can be a methodological naturalist, something which he links with evolutionism, without necessarily being a metaphysical naturalist, in real life the former always slides into the latter. Hence, the evolutionist is the methodological naturalist, is the metaphysical naturalist, is the opponent of the theistic naturalist, which for Johnson is the equivalent of denying God’s existence—that is, denying theistic realism. So ultimately, it is all less a matter of science and more a matter of attitude and philosophy. Evolution and creationism are different world pictures, and it is conceptually, socially, pedagogically, and with good luck in the future, legally wrong to treat them differently. More than this, Johnson’s argument suggests that creationism (a.k.a. theistic realism) is the only genuine form of Christianity.

Irreducible Complexity

One oft-made criticism of Johnson was that he was too negative. It was obvious that he was against evolution, but he left unsaid whether he was a young-earth creationist like Whitcomb and Morris or whether he believed in something more moderate, perhaps an old earth and some kind of guided, law-bound creation. Later in the decade, with Johnson’s encouragement, a number of younger thinkers produced an alternative to Darwinian evolution. This they called “intelligent design theory.” There are two parts to this approach, beginning with the empirical. Lehigh University biochemist Michael Behe identifies something that he calls “irreducible complexity.” This is “a single system composed of several well-matched, interacting parts that contribute to the basic function, wherein the removal of any one of the parts causes the system to effectively cease functioning.” Behe points out that there is no way that something like this could be produced by a slow, gradual evolutionary process, for all of the parts need to be in place in order to get any functioning.

But are there such systems in nature? Behe argues that there are, and he instances the micro-world of the cell and of mechanisms (or “mechanisms”) found at that level. Take bacteria, which use a flagellum, driven by a kind of rotary motor, to move around. Every part is incredibly complex, as are the various parts combined. The external filament of the flagellum (called a “flagellin”), for instance, is a single protein that makes

a kind of paddle surface contacting the liquid during swimming. Near the surface of the cell, just as necessary is a thickening agent, so that the filament can be connected to the rotor drive. This requires a connector, known as a “hook protein.” There is no motor in the filament, so that has to be somewhere else. “Experiments have demonstrated that it is located at the base of the flagellum, where electron microscopy shows several ring structures occur” (p. 70). All are much too complex to have come into being in a gradual fashion. Only a one-step process will do, and this one-step process must involve some sort of designing cause. Behe is careful not to identify this designer with the Christian God, but the implication is that it is a force from without the normal course of nature. Darwinism is ruled out and we must look for another explanation. There is only one possible answer. Irreducible complexity spells design.

The Explanatory Filter

Backing the empirical argument are the conceptual arguments of the philosopher-mathematician William Dembski, who introduced the notion of an “explanatory filter.” We have a particular phenomenon. The question is, what caused it? Is it something that might not have happened, given the laws of nature? Is it contingent? Or was it necessitated? The moon goes endlessly round the earth. We know that it does this because of Newton’s laws. End of discussion. No design here. However, now we have some rather strange new phenomenon, the causal origin of which is a puzzle. Suppose we have a mutation, where although we can quantify over large numbers we cannot predict at an individual level. There is no immediate subsumption beneath law, and therefore there is no reason to think that at this level it was necessary. Let us say, as supposedly happened in the extended royal family of Europe, there was a mutation to a gene responsible for hemophilia. Is it complex? Obviously not, for it leads to breakdown rather than otherwise. Hence it is appropriate to talk now of chance. There is no design. The hemophilia mutation was just an accident.

Suppose now that we do have complexity. A rather intricate mineral pattern in the rocks might qualify here. Suppose we have veins of precious metals set in other materials, the whole being intricate and varied—certainly not a pattern you could simply deduce from the laws of physics or chemistry or geology or whatever. Nor would one think of it as being a breakdown mess, as one might a malmutation. Is this now design? Almost certainly not, for there is no way that one might prespecify such a pattern. It is all a bit ad hoc, and not something that comes across as the result of conscious intention. And then finally there are phenomena that are complex and specified. One presumes that the microscopical biological apparatuses and processes discussed by Behe would qualify here. They are contingent, for they are irreducibly complex. They are design-like for they do what is needed for the organism in which they are to be found. That is to say they are of prespecified form. And so, having survived the explanatory filter, they are properly considered the product of real design.

Although his arguments are philosophical, Dembski and his supporters see his work as supportive of the empirical case made by Behe. Most particularly, it speaks to an obvious

theological problem that is raised by irreducible complexity. If indeed such a phenomenon exists and if one has to suppose a designer to explain its origins, then presumably this designer was also involved in the production of the reducibly simple. And this being so, why did he do such a bad job? We have some mutations, like sickle-cell anemia, that have horrendous physical effects causing massive pain, and yet are triggered by the smallest of changes at the molecular level. Surely the designer could have prevented these? Not so, according to Dembski. Malmutations are just chance, and hence no one’s fault, especially not that of the designer. Hence he gets credit for the good and is saved from blame for the bad.

Conclusion

Not surprisingly, many Christians (both Protestant and Catholic) as well as scientists object strongly both to traditional creationism and to the more recent intelligent design theory. Both Christians and scientists deny vehemently that being a methodological naturalist at once tips you into being a metaphysical naturalist. In addition, Christians assert, as they always have, that creationism in any form is a distortion of real traditional Christianity. There is absolutely no warrant for literalistic readings of Genesis, whether or not they are dressed up as science. In like fashion, scientists object that traditional creationism (the kind to be found in *Genesis Flood*) is simply wrong in every respect, and that intelligent design is little better. It simply is not true to say that there are examples of irreducible complexity that could never be explained through evolution. Even if all the parts are now necessary for proper functioning, it may well have been the case that the parts were assembled in ways that allowed for incomplete (or completely different) functioning before they reached their present interconnected forms.

Yet, whether or not creationism is good or bad religion, and whether or not creationism is good or bad science, it would be foolish to deny its ongoing appeal. In the early twenty-first century, opinion polls regularly found that 50 percent of Americans supported some form of creationism, and most of the others thought that blind law could never, unaided, have led to the production of the higher animals, especially humans. It would therefore be unwise to pretend that creationism is about to go away or will never raise its political head. It still has the potential to force us back to the 1920s and to attempt to legislate the contents of the science curricula of publicly funded schools.

See also *Evolution; Fundamentalism; Religion; Religion and Science.*

BIBLIOGRAPHY

- Behe, Michael. *Darwin’s Black Box: The Biochemical Challenge to Evolution*. New York: Free Press, 1996.
- Brooks, Deborah J. “Substantial Numbers of Americans Continue to Doubt Evolution as Explanation for Origin of Humans.” Poll Analyses, Gallup News Service, 3 May 2001.
- Dembski, William A. *The Design Inference: Eliminating Chance through Small Probabilities*. Cambridge, U.K.: Cambridge University Press, 1998.
- , ed. *Mere Creation: Science, Faith, and Intelligent Design*. Downers Grove, Ill.: InterVarsity Press, 1998.

- Gilbert, James. *Redeeming Culture in an Age of Science*. Chicago: University of Chicago Press, 1997.
- Gish, Duane T. *Evolution: The Fossils Say No!* San Diego: Creation-Life, 1973.
- Johnson, Phillip E. *Darwin on Trial*. Washington, D.C.: Regnery Gateway, 1991.
- . *Reason in the Balance: The Case against Naturalism in Science, Law, and Education*. Downers Grove, Ill.: InterVarsity Press, 1995.
- Larson, Edward J. *Summer for the Gods: The Scopes Trial and America's Continuing Debate over Science and Religion*. New York: BasicBooks, 1997.
- McMullin, Ernan, ed. *Evolution and Creation*. Notre Dame, Ind.: University of Notre Dame Press, 1985.
- Miller, Kenneth. *Finding Darwin's God*. New York: Cliff Street Books, 1999.
- Numbers, Ronald L. *The Creationists: The Evolution of Scientific Creationism*. New York: Knopf, 1992.
- . *Darwinism Comes to America*. Cambridge, Mass.: Harvard University Press, 1998.
- Ruse, Michael, ed. *But Is It Science? The Philosophical Question in the Creation/Evolution Controversy*. Buffalo, N.Y.: Prometheus, 1988.
- . *Can a Darwinian Be a Christian? The Relationship between Science and Religion*. Cambridge, U.K.: Cambridge University Press, 2001.
- Turner, Frank M. *John Henry Newman: The Challenge to Evangelical Religion*. New Haven, Conn.: Yale University Press, 2002.
- Webb, George E. *The Evolution Controversy in America*. Lexington: University Press of Kentucky, 1994.
- Whitcomb, John C., Jr., and Henry M. Morris. *The Genesis Flood: The Biblical Record and Its Scientific Implications*. Philadelphia, Pa.: Presbyterian and Reformed, 1961.

Michael Ruse

CREATIVITY IN THE ARTS AND SCIENCES. Because creativity is a complex concept, it has multiple definitions. Of the various conceptions, however, three are currently most common. These are the product, person, and process definitions. According to the first, creativity is manifested in an identifiable outcome, such as a poem, painting, invention, or discovery. Moreover, this product must fulfill two essential conditions. First, it must be original or novel, at least with respect to an individual's discipline or culture. Simply repeating what has already been done does not count as bona fide creativity. Second, the product must be useful in some manner. For instance, a scientific discovery will have to satisfy certain theoretical or experimental standards, whereas an artistic creation will have to meet specific aesthetic criteria. This second condition is required to separate creative products from original but psychotic hallucinations and delusions.

The remaining two definitions are closely related to the product definition but shift perspective on the phenomenon. According to the person definition, creativity is whatever attributes individuals must possess to conceive creative products. These attributes may include both cognitive traits, such as intelligence, and personality traits, such as motivation. For the

process definition, in contrast, creativity is the process or set of processes by which a person conceives creative products. This definition obliges the investigator to focus on various problem-solving operations, such as insight, intuition, incubation, and even trial and error.

The choice of definition clearly determines how a researcher or scholar studies creativity. Where some assess the attributes of creative products, others examine the characteristics of creative persons, and still others scrutinize the features of the creative process. Nevertheless, despite the diversity of analytical perspectives, it is assumed that all three approaches are looking at the same underlying phenomenon.

Creativity can be manifested in a great variety of situations, from the play activities of young children to industrial research and development teams. However, discussion here will be confined to creativity in the arts and sciences. The discussion begins with historical conceptions of creativity and ends with an overview of contemporary research on the phenomenon.

Historical Conceptions

As a concept, creativity is most strongly associated with European civilization. This is not because other civilizations have not displayed creativity. On the contrary, there is no doubt that other world civilizations—such as the Chinese, Indian, and Islamic—have produced creative geniuses of the highest order. The difference stems largely from how creativity is conceived in various cultures. The basis for the difference is to be found in the very definition of the phenomenon. Although an idea is not creative unless it is both original and useful, the exact proportions of originality and usefulness are not fixed.

At the same time, world civilizations vary greatly in the relative importance they place on individualism versus collectivism. Therefore, more individualistic cultures assign more weight to originality because that feature provides a means to demonstrate personal uniqueness. In contrast, more collectivist cultures tend to stress usefulness. To be “useful” in that case means that an original idea must be compatible with societal values and cultural traditions. If not, then those ideas cannot work insofar as they would prove divisive rather than consensual.

This cultural contrast can be illustrated by looking at philosophical creativity. On the originality-individualistic side is René Descartes (1596–1650), who launches his inquiry by doubting everything he has ever learned and experienced, eventually arriving at a highly egocentric, even autistic first principle—I think, therefore I am (*cogito, ergo sum*)—on which he could base his entire philosophy. On the usefulness-collectivist side is Shankara (c. 700–c. 750), the Indian thinker who communicated his highly influential Vedanta philosophy by writing commentaries on the principal Upanishads and other ancient scriptures. Although great philosophers in other intellectual traditions frequently use the same *modus operandi*, this tactic is extremely rare in European civilization. Even in the Middle Ages, when Greco-Roman individualism had to yield some ground to the more collectivist values of Christianity, intellectual innovations were seldom embedded in commentaries on traditional texts. For example, Thomas Aquinas's (1225–1274)



Sixteenth-century painting by Qiu Ying depicting Li Bo receiving visitors. Although the concept of genius being linked to madness or unconventional behavior was more prevalent in European societies, one exception was the Chinese poet Li Bo, a reputed drunkard and carefree wanderer. THE ART ARCHIVE / PRIVATE COLLECTION PARIS / DAGLI ORTI

Summa Theologica (1266–1273) synthesized classical philosophy and Christian theology not through commentaries on Aristotle and Augustine but rather by means of a stand-alone treatise. Admittedly, like all generalizations about whole civilizations, many exceptions exist. For instance, the place of poetic creativity in China is not unlike that in Europe.

In any case, although historical conceptions of creativity are quite diverse, three views have been especially prominent: divinity, madness, and craft.

Divinity. In antiquity, creativity was a divine attribute, a capacity narrated in the creation myths that are almost universal in human cultures. Examples include the Creator of the Judeo-Christian-Islamic tradition, Odin of Norse mythology, Ormazd of Zoroastrianism, and Brahma of the Hindu trinity. Even when creativity was attributed to individual human beings, the ultimate source often remained spiritual. This connection is illustrated in the ancient Greek belief in the Muses. According to the myth, Zeus, the reigning god in the pan-

theon, fathered nine daughters with Mnemosyne, the goddess of memory. Each of these nine daughters presided over a different domain of human creativity. In particular, these muses were responsible for epic poetry, lyric poetry, sacred poetry and hymns, tragedy, comedy, music, dance, astronomy, and history. Each muse was thought to provide a guiding spirit or source of inspiration for the mortal creator. This usage underlies several common expressions, such as to say that one has lost one's muse when one has run out of creative ideas. Given this view, human creativity remained subordinate to divine creativity.

The religious or spiritual roots of creativity are also evident in the concept of genius, an idea that would later become intimately identified with creativity. According to Roman mythology, each individual was born with a guardian spirit who watched out for the person's distinctive fate and individuality. With time, the term was taken to indicate the person's special talents or aptitudes. Although in the beginning everybody could be said to "have a genius," at least in the sense of pos-

CORE CONTROVERSIES CONCERNING CREATIVITY

Despite the abundance of scientific research on the subject of creativity, several central issues continue to escape successful resolution. Of these, the following three are probably most critical:

1. Nature versus Nurture—Is creative genius born or made? Or, to phrase the question in less dichotomous terms, what are the relative contributions of genetic endowment and environmental influences, such as family background, education, and training? One special manifestation of this question regards how gender, race, and ethnicity determine individual creativity.
2. Madness versus Mental Health—How much truth is there to the traditional concept of the “mad genius”? Although both psychiatrists and psychologists continue to find provocative connections between creativity and psychopathology, it is also clear that the two phenomena are far from equivalent. Furthermore, humanistic psychologists argue

that creativity can actually be considered a sign of supreme mental health.

3. Individual versus Society—To what extent is creativity embodied in the individual and to what extent is creativity a representation of larger sociocultural phenomena? This is often expressed as the debate between genius and zeitgeist theories of creativity. Because psychologists, psychoanalysts, and psychiatrists favor the individual as the unit of analysis, they tend to support some form of the genius theory. In contrast, anthropologists, sociologists, and Marxist philosophers, who prefer cultures and societies as analytical units, are more prone to advocate some version of the zeitgeist theory.

Probably any resolution will be inclusive rather than exclusive. That is, creativity will eventually emerge as a function of nature and nurture, madness and mental health, the individual and society.

sessing a unique potential, the term eventually began to be confined to those whose gifts set them well apart from the average, such as the creative genius. Outstanding creativity then became the gift of the gods or spirits, not a human act. Even during the Italian Renaissance rudiments of this ascription persisted. For instance, when Giorgio Vasari (1511–1574) wrote his biography of the “divine Michelangelo,” he explicitly asserted that “the great Ruler of Heaven” sent the artist to earth to serve as an exemplar of artistic genius.

Madness. As European civilization became increasingly secularized, especially after the Enlightenment, creativity’s spiritual connotations gave way to more naturalistic conceptions. One prominent viewpoint was that creativity, and especially creative genius, was closely linked to madness. This linkage became especially popular during Europe’s Romantic period, attaining a peak in the first half of the nineteenth century. It was also during this period that creative genius began to become associated with alcoholism, drug addiction, and other pathological conditions. In the Preface to “Kubla Khan,” for example, Samuel Taylor Coleridge (1772–1834) claimed to have conceived this poetic masterpiece in an opium stupor.

Eventually the mad-genius conception of creativity received scientific endorsement from psychologists, psychiatrists, and psychoanalysts. For instance, Cesare Lombroso (1836–1909) attributed exceptional creativity to a genetically based “degenerative psychosis.” The only conspicuous disagreements concerned

the specific nature of the mental disorder. Unlike Lombroso, Sigmund Freud (1856–1939) saw creativity as a variety of neurotic behavior, whereas William James (1842–1910) viewed creativity as a form of “borderline” personality. Related to this issue was a debate about the extent to which creative genius bears any relation to criminality. Some psychiatrists argued that genius, madness, and criminality were all consequences of the same underlying genetic disorder.

The mad-genius view of creativity is less common in non-European civilizations, but it still appears. An example is the Chinese poet Li Bo (701–762). Popularly known as a “banished Immortal,” he was notorious for his undisciplined wanderings and incessant drunkenness. Legend even had him drowning after trying to capture the reflection of the moon while spending an evening intoxicated in a boat.

Craft. In most cultures and civilizations throughout the world, creativity was often inseparable from craft traditions. Rather than artists, there were artisans. The knowledge and skills necessary to make culturally valued objects were passed down from generation to generation through parent-child or master-apprentice relationships. Even in European civilization, the linkage between creativity and crafts persisted in many domains for many centuries. It is telling that not all forms of creativity in ancient Greece had their muses. Evidently, creativity in certain areas required no divine intervention but merely the acquisition of the necessary expertise. Even much later, painters, sculptors, and architects

would hold the status of artisans rather than artists. This position held for painters until the time of Giotto (1276–1337). And musical creativity in Europe did not completely emancipate itself from the craft image until the time of Ludwig van Beethoven (1770–1827).

Although creativity came to be separated from craft, many still considered the phenomenon as the outcome of the acquisition of some special expertise. Creativity remained a skill that anyone could acquire if they first mastered the requisite knowledge and skills. The painter Joshua Reynolds (1723–1792) expressed this view in his *Discourses on Art*, which were based on his lectures at the Royal Academy of Art. Unsympathetic to notions that artistic creativity required any special talent or genius, he argued that creativity in the arts demanded only that the student be willing to study and practice. Those who have done so sufficiently, according to Reynolds, would be indistinguishable from the so-called natural genius.

Conceptions of scientific creativity included a variation on this position. Science was defined by a special method—the logic of inference or investigation—by which scientists arrive at their discoveries and inventions. This position was first explicitly stated in Francis Bacon’s (1561–1626) *Novum Organum*, which presented his inductive method. A little later Descartes advocated his own method based on deductive reasoning. Eventually, creativity in science became the chief concern of a whole new discipline, the philosophy of science. Notwithstanding the disparate opinions of various philosophers of science, most agreed that scientific creativity consisted of a well-defined method. Like any craft, this method, once mastered, enabled the individual to become a creative scientist. Indeed, some thinkers, such as José Ortega y Gasset (1883–1955), insisted that scientific creativity required no outstanding abilities.

Contemporary Research

In the early part of the twentieth century, distinguished researchers from many different disciplines investigated artistic and scientific creativity. For example, the topic attracted the attention of the anthropologist Alfred Kroeber and the sociologist Pitirim A. Sorokin. However, as the century progressed, the research was increasingly confined to just three fields: psychiatry, psychoanalysis, and psychology. The psychiatrists were primarily interested in the association between creativity and psychopathology, whereas the psychoanalysts were mostly dedicated to psychobiographical studies of eminent creators. Only the psychologists approached the phenomenon from a tremendous diversity of theoretical and methodological perspectives. Perhaps as a result of this breadth, by the end of the twentieth century psychologists came to dominate the study of creativity. Notwithstanding the diversity of approaches, the bulk of the psychological research falls into the following four categories:

1. Cognitive psychology—Cognitive psychologists are interested in the mental processes involved in the creative process. For instance, Howard Gruber has studied Charles Darwin’s notebooks to detect the cognitive processes that he used in arriving at the theory of evolution, and Kevin Dunbar has studied the mental operations in sci-

entific laboratories by analyzing recordings of research meetings. Using more experimental techniques, Albert Rothenberg has examined special forms of thinking in artistic creativity, while Tom Ward and his colleagues have studied the cognitive processes involved in invention.

2. Differential psychology—Psychologists from this subdiscipline seek to identify how people vary on various intellectual and personality traits. For example, Robert J. Sternberg has examined the impact of cognitive styles and John Baer has investigated the role of divergent thinking. Gregory Feist has synthesized the accumulated research to indicate how scientific and artistic creators differ on a large number of personality traits.
3. Developmental psychology—Developmental psychologists are interested in two major phases of creative development. The first phase concerns the acquisition of creative potential. Examples include Mark Runco’s work on the growth of creativity in children and Mihaly Csikszentmihályi’s studies of talent development in teenagers and young adults. The second phase concerns the manifestation of that creative potential in adulthood. An instance is Ravenna Helson’s longitudinal investigation designed to determine why some talented women succeed in realizing their potential and others do not.
4. Social psychology—Social psychologists are dedicated to understanding how creativity is influenced by social context, including interpersonal relationships, group dynamics, and sociocultural systems. For example, Teresa Amabile has studied how certain social expectations can either enhance or inhibit creativity, while Paul Paulus has investigated group problem-solving behaviors (“group-think”). At a more aggregate level of analysis, Colin Martindale has examined the impact of aesthetic traditions on artistic creativity and Dean Keith Simonton has scrutinized ways in which the social, political, and cultural environment shapes creativity in both the arts and sciences.

Even though more researchers than ever before are studying creativity, inquiries still have a long way to go before the phenomenon is completely understood. In particular, some core controversies have yet to be resolved. The field is also in dire need of a theoretical system that will successfully integrate the diverse empirical findings. Although several explanatory accounts have been proposed—including computational, economic, and Darwinian models—no theory has earned sufficient assent to dominate the field.

See also Analytical Philosophy; Arts; Cartesianism; Cultural Studies; Enlightenment; Europe, Idea of; Imagination; Individualism; Romanticism in Literature and Politics.

BIBLIOGRAPHY

- Amabile, Teresa M. *Creativity in Context*. Boulder, Colo.: Westview, 1996.
- Boden, Margaret. *The Creative Mind: Myths and Mechanisms*. New York: BasicBooks, 1991.
- Boden, Margaret A., ed. *Dimensions of Creativity*. Cambridge, Mass.: MIT Press, 1994.
- Csikszentmihályi, Mihaly. *Creativity: Flow and the Psychology of Discovery and Invention*. New York: HarperCollins, 1997.
- Gardner, Howard. *Creating Minds: An Anatomy of Creativity Seen through the Lives of Freud, Einstein, Picasso, Stravinsky, Eliot, Graham, and Gandhi*. New York: BasicBooks, 1993.
- Martindale, Colin. *The Clockwork Muse: The Predictability of Artistic Styles*. New York: BasicBooks, 1990.
- Murray, Penelope, ed. *Genius: The History of an Idea*. Oxford: Blackwell, 1989.
- Runco, Mark A., and Robert S. Albert, eds. *Theories of Creativity*. Newbury Park, Calif.: Sage, 1990.
- Runco, Mark A., and Steven R. Pritzker, eds. *Encyclopedia of Creativity*. 2 vols. San Diego: Academic Press, 1999.
- Simonton, Dean Keith. *Origins of Genius: Darwinian Perspectives on Creativity*. New York: Oxford University Press, 1999.
- Smith, Steven M., Thomas B. Ward, and Ronald A. Finke, eds. *The Creative Cognition Approach*. Cambridge, Mass.: MIT Press, 1995.
- Sternberg, Robert J., ed. *Handbook of Creativity*. Cambridge, U.K.: Cambridge University Press, 1999.

Dean Keith Simonton

CREOLIZATION, CARIBBEAN. The concept of creolization lies at the very center of discussions of transculturalism, transnationalism, multiculturalism, diversity, and hybridization. This essay begins by examining the term's roots in the ethnic and cultural complexities of the Caribbean experience. It then goes on to look at the transformation of this experience into a theoretical framework for pluralism that consciously sought to avoid the binary pitfalls of its antecedents. It concludes with a brief look at the work of several key authors and surveys recent critiques of the Caribbean creolization movement.

Despite its currency in literary, cultural, and critical circles, the term *creolization* cannot be fully understood without taking into account its historical background and geographical context. In these terms, creolization must be seen not simply as a synonym for hybridity but as a phenomenon that is indispensable to understanding the New World experience. Although the history of the term dates back several decades earlier, its critical status in the early 2000s is largely the result of a number of publications emanating from the French Caribbean in the 1980s.

Caribbean Context

The origins of creolization for the Caribbean region arguably lie in the contested and interrelated processes of colonization, slavery, and migration that both brought the New World into being and gave it impetus and direction. Once the indigenous New World populations were decimated, the growth and development of plantation economies that arose in the

Caribbean in the seventeenth century produced pathbreaking patterns of economic and cultural exchange between Europe, the New World of the Americas—including Central America, the Guianas, Mexico, and Brazil—and the African continent. Catalyzed by the slave trade, which forcibly removed untold numbers of peoples of diverse racial, cultural, and geographical origin from their African homelands and transplanted them onto vast island plantations, these already variegated groups subsequently came into contact with other transplanted peoples from Europe, South Asia, China, and the Middle East. As a result, the Caribbean region quickly became a key nodal point in what would become the creolization of these composite populations.

It was the product of these intersecting influences—the inauguration of a creole society in the Caribbean Sea—that became the subject of the text *Eloge de la créolité/In Praise of Creoleness* (1989). Written by Raphaël Confiant and Patrick Chamoiseau, two Martinican novelists, in conjunction with Jean Bernabé, a Guadeloupean linguist, this manifesto can be seen in one sense as an attempt to come to terms with the paradox of French overseas departmentalization. The fact of these former colonies' incorporation into the French nation in 1946, and the conferral of French citizenship on their citizens, had done nothing to negate the ongoing material differences in history, geography, culture, and ethnicity that continued to separate these territories from the metropole, creating a double trajectory that made their citizens feel both French and West Indian. The “double consciousness” imposed by the duality of their legal and cultural status encouraged these thinkers to come to terms with the dilemma of belonging posed by departmentalization. Their solution was to seek out the origins of this pluralism, and to celebrate it.

Importantly, however, they were certainly not the first to do so. Some twenty years earlier, the Barbadian historian and poet Edward Brathwaite sought to establish patterns of creole interaction as a sort of sociological foundation for Caribbean societies. In his *The Development of Creole Society in Jamaica, 1770–1820* (1971), Brathwaite proposed that the principles of cultural distinction and unitary origin through which societies were typically analyzed and categorized be abandoned in the Caribbean case, recognizing instead the intrinsic ethnic and cultural pluralism of the islands. The cultural intersection, ethnic admixture, and linguistic cross-fertilization that lay at the core of the Caribbean experience would be made to contest the historical discontinuity and geographical and political fragmentation through which the region traditionally had been framed.

From Experience to Theory

On the surface, creolization would appear to be of a piece with *criollo* and *mestizaje* in Spanish, and with *métissage* in French. However, although each of these categories responds to the implicit pluralisms of the colonial encounter, each also reflects specific differences within the colonial experience that are not easily rendered in general terms. What the authors of the *Eloge* sought to convey above all was the abandonment of negative binaries in favor of the creative openness that lies behind any conception of the creole. “Neither Europeans, nor Africans,

PATRICK CHAMOISEAU

Patrick Chamoiseau was born in 1953 in Fort-de-France, Martinique. The son of working-class parents, Chamoiseau studied sociology and law in Paris before moving back to Martinique, where he became a social worker. His third novel, *Texaco*, won France's top literary award, the Prix Goncourt, in 1992, making him world-famous. The novel was eventually translated into more than twenty languages. Chamoiseau continues to live in Martinique, where he writes novels as well as short stories, screenplays, autobiography, childhood memoirs, and texts for pictorial histories.

Despite the publication of other novels such as *Solibo le magnifique* and *Biblique des derniers gestes*, *Texaco* remains by far Chamoiseau's best-known work. The novel traces 150 years of postemancipation Martinican history through the eyes and voice of Marie-Sophie Laborieux, the aging daughter of a freed slave. It is Laborieux's encounter with an urban planner, and her attempt to convince him to abandon his plan to raze, in the name of progress, the shantytown of the title that provides the framework for this episodic story of struggle and resistance. This structure, and its trademark of creole existing alongside and transforming the French language, allows the key nuances of ethnic and cultural exchange and linguistic wordplay to assume pride of place in a portrait of Martinique's creolized society.

nor Asians, we proclaim ourselves Creoles" (Bernabé et al., p. 75). Indeed, their aim more specifically was to develop modalities for creative expression in the arts that would reflect and embody the multiplicity and complexity of the creole mosaic. "Our history is a braid of histories . . . We are at once Europe, Africa, and enriched by Asian contributions, we are also Levantine, Indians, as well as pre-Columbian Americans in some respects. Creoleness is 'the world diffracted but recomposed' . . . a Totality" (p. 88; emphasis original).

Thus the creole language serves as a fundamental metaphor for the key goals and tenets of French Caribbean creolization. As Chamoiseau and Confiant point out in their critical work *Lettres créoles*, this language was the product of the experience of colonization and slavery. Born and nurtured on the plantation, it was brought into being both by the interaction of slaves deliberately separated by ethnic group to forestall the possibility of communication that might lead to resistance and revolt, through the influence of Maroons (runaway slaves) and by the interaction of these groups with the colonial culture. The creole language thus symbolizes cultural continuity, resistance to oppression, and the richness of ethnic admixture; as such, it serves to valorize the region's oral tradition even as it reinforces the qualities of pluralism and transformation that sum up the heterogeneity of the French Caribbean experience in particular.

Antecedents

The arc of this experience explicitly acknowledges the antecedent influence of two other key Martinican writers and thinkers, Aimé

Césaire and Edouard Glissant, and the literary movements with which their names are respectively linked: negritude and *antillanité*, or Caribbeanness. The *créolistes*, as the authors of the *Eloge* are called, address the importance of negritude to their thought formation: "To a totally racist world . . . Aimé Césaire restored mother Africa . . . Césaire's Negritude gave Creole society its African dimension" (Bernabé et al., p. 79). Indeed, they make specific reference to the irreplaceable role played here by Césaire himself. "It was Césaire's Negritude that opened to us the path for the actuality of . . . Caribbeanness . . . We are forever Césaire's sons" (p. 80).

At the same time, however, it must be recognized that the *créolistes* simultaneously acknowledge the limitations of the African model of cultural origin for the complex realities of the Caribbean basin. The basic paradox intrinsic to such an approach lay in the fact that adopting the negritude paradigm would simply amount to exchanging one unitary model of culture for another. Neither the European nor the African paradigm could contain the myriad ethnic influences and creative cultural exchange that had given rise to the Caribbean. To adequately account for the region's plural character, another model was necessary. For this, they would turn to the work of Edouard Glissant.

An accomplished novelist and poet as well as an important cultural theorist, Edouard Glissant had produced more than half a dozen creative works by the time he published his groundbreaking *Caribbean Discourse* in 1981. In this work, he

EDOUARD GLISSANT

Edouard Glissant was born in 1928 in the commune of Sainte-Marie in Martinique. A poet, novelist, dramatist, and essayist, Glissant studied philosophy at the Sorbonne and ethnology at the Musée de l'homme. In the 1950s he co-founded the *Front Antillo-Guyanais pour l'indépendance*, and went on to found the Institut martiniquais d'études in 1970. In 1982, he went to work as editor of the UNESCO *Courier*, was named Distinguished University Professor at Louisiana State University in 1988, and left there for a position at the City University of New York's Graduate Center in the mid-1990s. He began publishing in the mid-1950s, and his novels, plays, essays, and volumes of poetry have won many outstanding prizes. Perhaps the premier contemporary French West Indian cultural theorist, his influential concepts of *antillanité* (Caribbeanness) and *poétique de la relation* (cross-cultural poetics) promulgated in *Le Discours antillais* (Caribbean Discourse) seek to creatively anchor the Caribbean experience of fragmentation and disjuncture in a framework that gives voice to its central tenets of diversity and hybridity. The interpenetration of languages and cultures that lies at the core of this process of creolization posits contact and chaos, cultural relativity, and exchange and transformation as key tools in a polyvalent system of thought that redefines traditional notions of identity.

also sought to take his vision of Caribbean reality beyond the epistemological boundaries of negritude. Realizing that a response that simply negated the tenets of a colonial discourse did nothing to expunge its essential properties, Glissant sought to specify the terms and conditions of a creole culture that would be inclusive of the wider English, Spanish, and Dutch Caribbean as well as the French overseas departments of Guadeloupe and Martinique, one that would give rein to the region's constant creative flux and its insistent patterns of transformation and exchange. The core of this Caribbean vision, the one on which the *créolistes* would draw, he termed *antillanité*, or Caribbeanness.

Glissant locates the key axes of this concept between uprooting and transformation. Within these patterns of intersection and exchange, he demarcates the terms of Caribbean survival. "I feel that what makes this difference between a people that survives elsewhere . . . and a population that is transformed elsewhere *into another people* . . . and that thus enters the constantly shifting and variable process of creolization . . . is that the latter has not . . . collectively continued the methods of existence and survival, both material and spiritual, which it practiced before being uprooted" (Glissant, p. 15; emphasis original). This generative framework stresses principles of mixture and combination rather than confrontation and rupture; the infinite openness and fluidity of its practice expresses the diversity of the Caribbean collective identity in a way that allowed the architects of *créolité* scope to articulate structurally similar concerns. The productive multiplicity of the Caribbean, one that draws on its peoples and cultures to

continually transform and reinvent themselves, is thus a core principle of both *antillanité* and *créolité*.

Critiques

While the Caribbean focus of these twin discourses was seen as a much-needed corrective to metropolitan visions of the Caribbean as a region mired in fragmentation and loss, an alternative view took a much more critical line, accusing the *créolistes* of having appropriated the issue of creolization and of imbuing it with restrictive, essentialist characteristics that valorized exclusivity over process. From this viewpoint, despite the specific historic context and catalyst of migration, colonialism, slavery, and indentured labor, the concept of creolization was applicable to many cultures and civilizations beyond the Caribbean basin.

By contrast, the creolization of Glissant's *antillanité* sought to subvert universalist notions of pure and impure, positing the world as subject to ceaseless cultural transformation, a joining of braiding and becoming: "Creolization as an idea is not primarily the glorification of the composite nature of a people: indeed, no people has been spared the crosscultural process. . . . To assert peoples are creolized, that creolization has value, is to deconstruct in this way the category of 'creolized' that is considered as halfway between two 'pure' extremes" (Glissant, p. 140).

In their turn, Bernabé, Chamoiseau, and Confiant managed to expand and buttress their own positions in a key interview published some years after their manifesto. Here, they stress the

pluralities of creoleness: “our position is that there are several *créolités*” (Taylor, p. 142); valorize the role of pluralism: “*créolité* is all about understanding mosaic, multiple identities” (p. 153); and suggest that creolization is a process that encompasses more than a simple synthesis, more than *métissage*: “There’s *métissage* in creolization, but creolization is chaos—shock, mixture, combination, alchemy” (p. 136). In these terms, creolization establishes its specific difference from hybridity, reflecting its beginnings in colonialism and slavery as well as the ceaseless redefinition and rebirth that are its primary constituent elements.

See also *Africa, Idea of; Black Consciousness; Diasporas; African Diaspora; Identity: Personal and Social Identity; Language and Linguistics; Mestizaje; Negritude; Postcolonial Theory and Literature; Slavery.*

BIBLIOGRAPHY

- Balutansky, Kathleen M. and Marie-Agnès Sourieau, eds. *Caribbean Creolization: Reflections on the Cultural Dynamics of Language, Literature, and Identity*. Gainesville: University of Florida Press, 1998.
- Benítez-Rojo, Antonio. *The Repeating Island: The Caribbean and the Postmodern Perspective*. Translated by James E. Maraniss. Durham, N.C.: Duke University Press, 1992.
- Bernabé, Jean, Patrick Chamoiseau, and Raphaël Confiant. “Créolité Bites.” *Transition* 7, no. 2 (1998): 124–161. Interview.
- . *Eloge de la créolite*. Paris: Gallimard, 1989.
- Bongie, Chris. *Islands and Exiles: The Creole Identities of Postcolonial Literature*. Stanford, Calif.: Stanford University Press, 1998.
- Brathwaite, Kamau. *The Development of Creole Society in Jamaica, 1770–1820*. Oxford: Clarendon, 1971.
- Britton, Celia. *Edouard Glissant and Postcolonial Theory*. Charlottesville: University Press of Virginia, 1999.
- Burton, Richard D. E. *Afro-Creole: Power, Opposition, and Play in the Caribbean*. Ithaca, N.Y.: Cornell University Press, 1997.
- Chamoiseau, Patrick. *Ecrire en pays dominé*. Paris: Gallimard, 1997.
- Chamoiseau, Patrick, and Raphaël Confiant. *Lettres créoles: tracées antillaises et continentales de la littérature: Haiti, Guadeloupe, Martinique, Guyana, 1635–1975*. Paris: Gallimard, 1999.
- Dash, J. Michael. *Edouard Glissant*. New York: Cambridge University Press, 1995.
- Glissant, Edouard. *Caribbean Discourse: Selected Essays*. Translated by J. Michael Dash. Charlottesville: University Press of Virginia, 1989.
- . *Poetics of Relation*. Translated by Betsy Wing. Ann Arbor: University of Michigan Press, 1997.
- Lionnet, Françoise. “Créolité in the Indian Ocean: Two Models of Cultural Diversity.” *Yale French Studies* 82 (1993): 101–112.
- Murdoch, H. Adlai. *Creole Identity in the French Caribbean Novel*. Gainesville: University of Florida Press, 2001.

H. Adlai Murdoch

CRISIS. The term *crisis* comes from the Greek noun *kri-sis* (choice, decision, judgment), deriving from the Greek verb *krinein* (to decide). The word makes an ancient debut in Greek historical writing via the legal, medical, and rhetorical terminology as the turning point in a decision, illness, or argument.

Its definitive reappearance with reference to historical events, periods, or processes dates from the late eighteenth century, its classic formulation from the second half of the nineteenth century, and its proliferation as a catchall term for a crucial or decisive stage or state of affairs from the last half of the twentieth century. The history of the notion of crisis veers between failed attempts at precise definition and its inflation and devaluation as a tool of analysis.

Focus and flexibility inhere in the concept of crisis and account for much of its appeal. Crises, to be regarded as such, must occur in the course of specific events, but they can be characterized in organic, mechanistic, or revolutionary terms as critical episodes in a life cycle, indices of structural dysfunction, or corollaries of revolution. In the ideological reckoning with the great upheavals of modern history since the revolutions of the late eighteenth century, historical crises have often been cast as liberating by the Left and as proof of human fallibility by the Right. The language of crisis can be charged with drama, plotted as narrative, objectified as analysis, and pinned to empirical data.

Modern Concepts of Crisis

Karl Marx and Jacob Burckhardt brought out alternative emphases in their benchmark reflections on crisis. Marx (*Das Kapital*) developed a theory of economic crisis centered on the economics of overproduction, specifically on the chronic disequilibrium between production and consumption under capitalism; each crisis, he believed, would be more severe than the last until a “general crisis” occurred wherein the working class would rise against their exploiters. Burckhardt took politics and culture as a starting point for his pronouncements on crisis in one of his lectures on world history, first delivered in the 1860s. Historical crises typically begin with a “negative, accusing aspect,” then peak in utopian visions before giving way to reactions and restorations; the permanent results are “astonishingly meagre in comparison with the great efforts and passions which rise to the surface during the crisis.” The typology, based on the French Revolution and the European revolutions of 1848, is clear enough, but it dissolves in a rush of historical examples underwritten by the patrician conservative’s anxieties over modernization and not a little *Schadenfreude* in praise of crisis (Burckhardt, pp. 289–290).

More specialized—if less demanding—usage was widespread by the later nineteenth century and is still current, for example in political or diplomatic crisis, financial or commercial crisis, or *crise de conscience*. However, until as late as 1960, the fields of economics and economic history produced the only relatively systematic theories of crisis. Marx’s views were developed, debated, and projected back in time for a crisis of European feudalism variously dated between the fourteenth and the seventeenth centuries. Non-Marxist versions concentrated on cyclical fluctuations in price data or on the “checks” of famine, disease, and war to surplus population in Malthusian demographic cycles of preindustrial society. The thesis of a general crisis of the seventeenth century (as the transition from feudalism to capitalism) was advanced in 1954 by the British Marxist historian Eric Hobsbawm (Aston, pp. 5–58) and became a debating point in a long-running controversy

over the timing and extra-economic dimensions of what was alleged to be the formative crisis of the modern world.

By the 1960s, crisis had become a broad and expanding catchword—an alternative to the more potent idea of revolution—for practically any challenge-and-response situation or scenario. The tumultuous events of midcentury, from World War II, the collapse of colonial empires, and the Cold War to the traumas of the 1960s, were cast as symptomatic of the crisis not only of Western civilization but of established orders everywhere.

Field-specific crisis literature depended on the discourse or discipline but shared a preoccupation with breakdown or breakthrough in an established system of behavior or belief. A neoorthodox Protestant theology of crisis, a psychology of identity crisis following Erik Erikson (1902–1994), and an epistemology of crisis in “paradigm shifts” during scientific revolutions as analyzed by Thomas Kuhn (1922–1996), had their own extensive literatures. The crises of the Italian Renaissance, the Protestant Reformation, and the seventeenth-century English aristocracy were major topics for historians of early modern Europe, and a U.S. textbook series on major crises in history, including the crisis of August 1914 and the Great Depression of 1929, appeared in 1962. The Cuban missile crisis of that year became the exemplary real-world case of international diplomatic crisis at a time when crisis management, based on game theory, had become a political science specialty recognized by U.S. government research contracts.

Contemporary Definition and Usage

Two comprehensive entries on crisis in the *International Encyclopedia of the Social Sciences* (1968) and the first *Dictionary of the History of Ideas* (1968) cited, respectively, “unrestricted usage” and continuing “uncertainty.” Any number of studies had accumulated on crises of moments, decades, even eras; on political, social, economic, mental, and moral crises; on minor, major, and mid-level crises. The most exacting definitions were abstract and redundant, as in the decision-planners’ twelve “generic dimensions” of crisis (*International Encyclopedia of the Social Sciences*, v. 2, s.v. “crisis”). While suggestive connections were being made across fields, they came at the expense of clarity and coherence and sometimes recycled arguments that had already been discounted by experts in their own disciplines. Both articles placed hope in more precise future work.

In fact, the widespread interest in and development of crisis studies had already peaked by the early 1970s. Toward the end of the twentieth century, the language of crisis was worn out by overuse even as it was being eclipsed by the triumphalism of post-Cold War ideologies that prophesied, however credulously, the end of history and the containment of the upheavals and confrontations that had fueled it. The big crisis debates among historians mostly receded before the emphasis on long-term structural trends, the dismantling of so-called grand narratives, the deconstruction of the rhetoric of history, and the unfazed appreciation that conflict and confrontation were not the exception but the rule in history. The most concerted theoretical attention to crisis came from political scientists who continued to model schematic strategies for “crisis management,” especially in international affairs.

They salvaged analytical precision only by abstract model building and academic distinctions such as a sequence of phases of international crises from onset and escalation to de-escalation and impact.

The most conspicuous use of crisis terminology in the early twenty-first century is activist and political. Social movements, nongovernmental organizations, and government institutions, including the United Nations, have appropriated the term on occasion as a watchword to promote intervention in “crises” of genocide, women’s rights, HIV-AIDS, environmental degradation, or economic globalization. A “crisis of liberal values” has become a target of both radical supporters of multi-cultural politics and self-styled traditionalists who feel called upon to defend their ideals of family, patriotism, and religion. These developments, together with the leveling effects of everyday usage, have furthered the depletion of the term as an all-purpose slogan or a banal cliché.

See also *Continental Philosophy; Cycles; Feudalism, European; Game Theory; Marxism.*

BIBLIOGRAPHY

- Aston, Trevor, ed. *Crisis in Europe, 1560–1660*. London: Routledge, 1965.
- Brecher, Michael. *Crisis in World Politics: Theory and Reality*. New York and London: Pergamon, 1993.
- Burckhardt, Jacob. *Force and Freedom: Reflections on World History*. Translated by James Hastings Nichols. Boston: Beacon Press, 1964.
- Eisenstein, Zillah R. *Feminism and Sexual Equality: Crisis in Liberal America*. New York: Monthly Review Press, 1984.
- Erikson, Erik H. *Identity, Youth, and Crisis*. New York: Norton, 1968.
- Fowler, Richard A., and H. Wayne House. *Civilization in Crisis: A Christian Response to Homosexuality, Feminism, Euthanasia, and Abortion*. Grand Rapids, Mich.: Baker Book House, 1988.
- Koselleck, Reinhart. “Krise.” In *Geschichtliche Grundbegriffe: Historisches Lexikon zur Politisch-Sozialen Sprache in Deutschland*, Vol. 3, edited by Otto Brunner and Werner Conze, 617–650. Stuttgart: Klett-Cotta, 1978.
- Kuhn, Thomas S. *The Structure of Scientific Revolutions*. 3rd ed. Chicago: University of Chicago Press, 1996.
- Masur, Gerhart. “Crisis in History.” In *Dictionary of the History of Ideas*, Vol. 1, edited by Philip P. Wiener, 589–595. New York: Scribner, 1973.
- Médecins Sans Frontières, eds. *World in Crisis: The Politics of Survival at the End of the Twentieth Century*. New York: Routledge, 1997.
- Parker, Geoffrey. *Europe in Crisis, 1598–1648*. London: Fontana, 1979.
- Starn, Randolph. “Historians and Crisis.” *Past & Present*, no. 52 (August 1971): 3–22.

Randolph Starn

CRITICAL RACE THEORY. One of a family of related progressive movements in the law—others include critical legal studies, Latino critical legal studies (“Lat/Crit”), and feminist legal theory—critical race theory sprang up in the late

1970s in response to a widespread perception that the powerful civil rights coalition of the 1960s and early 1970s had stalled. Conservative administrations and an American public that seemed increasingly weary of hearing about race required new strategies and theories to deal with subtle, institutional, or color-blind forms of racism and a judiciary that no longer seemed eager to champion civil rights.

Derrick Bell, an African-American professor of law at Harvard Law School (later at New York University) and Alan Freeman, a white scholar teaching at SUNY-Buffalo Law School, laid the foundations of the movement that came to be called critical race theory and that would go on to transform our understanding of the relationship among race, racism, and official power. For his part, Bell contributed groundbreaking analyses of conflict of interest in civil rights litigation and of the role of white elite self-interest in explaining the twists and turns of blacks' racial fortunes. In an impressive article in *Yale Law Journal*, Bell pointed out that lawyers for elite civil rights organizations like the NAACP (National Association for the Advancement of Colored People), where he himself worked before entering law teaching, often were eager to pursue one agenda—law reform and innovation—while the client community wanted something else—say, better schools. The NAACP Legal Defense Fund, for example, relentlessly and courageously pursued school desegregation, while black parents often wanted something different—better funding for black schools.

If the first essay produced consternation and soul-searching among his colleagues in the civil rights movement, a second piece, on the role of interest convergence in determining the course of racial reform and retrenchment, raised eyebrows even higher. In “*Brown v. Board of Education* and the Interest Convergence Dilemma,” Bell posited that the breathtaking advances of the early civil rights years came about not so much because of moral breakthroughs by the American public or liberal judges. Rather, they were needed in order to burnish America's tarnished image in the eyes of the rest of the world and also to avert the possibility of racial unrest at home. At the time, the United States had just concluded a world war of mammoth proportions and was in the early stages of a Cold War against the forces of godless, soulless communism. In this campaign for the loyalties of the uncommitted Third World (much of which was black, brown, or Asian), it ill served this nation for the world to see front page stories and photographs of lynchings, the Emmett Till murder, and southern sheriffs turning vicious police dogs loose on peaceful civil rights leaders such as Martin Luther King Jr.

At the same time, wartime service in the U.S. military had exposed black and brown servicemen and -women to environments comparatively free of racism, in which diligent service brought rewards, promotions, and even battlefield commissions. These black and brown soldiers, having fought and exposed their lives in defense of American democracy and freedom, were unlikely to return to the former regime of menial jobs and servile relations with white society. Unrest loomed.

This convergence of black and white self-interest—rather than altruism or advancing morality—brought about *Brown v.*

Board of Education (1954), the 1964 Civil Rights Act, and other reforms of that era. And when black advances no longer served the interests of elite whites, they were quietly withdrawn or limited by narrow judicial interpretation, administrative foot-dragging, or delay. Although his skeptical hypothesis was met at first with cries of outrage, Bell subsequently applied his interest-convergence hypothesis to explain the full sweep of black civil rights history, showing how the material interests of elite whites explain practically every major advance or retreat. And Mary Dudziak, a white professor teaching at the University of Southern California Law Center, verified Bell's hypothesis by examining a host of documents, memos, and archival material related to *Brown v. Board of Education*.

Around the same time Bell was writing, Alan Freeman was carrying out an extraordinary reinterpretation of the role of the U.S. Supreme Court in guiding the course of civil rights progress. Freeman showed how our usual interpretation of the role of the liberal Warren court was both right and wrong. The Court did indeed champion civil rights causes. But in doing so, it also served as a powerful legitimating tool by confining change to manageable dimensions and denying relief for any but the most clear-cut violation.

An Organization Forms

Others (including Richard Delgado, one of the authors of this essay) soon joined Bell and Freeman, and in the summer of 1989 about thirty law scholars of color from around the United States met at a convent outside Madison, Wisconsin, to forge a new movement in the law. Settling on a name (critical race theory) and a general program, the group resolved to coordinate their scholarship and hold future meetings aimed at developing a new, radical approach to race, racism, and American law. Since then, the group has held a series of public conferences and periodic smaller workshops aimed at the development of particular themes. The group's scholarship grew rapidly to include a few dozen books and hundreds of law-review articles and essays. Many law schools around the country include critical race theorists among their ranks; perhaps two-thirds of all law schools offer one or more courses on it or a related subject.

The movement's ideas also spread to other fields. Educators use its approaches and theories to help understand hierarchy in schools, tracking, school discipline, and battles over the Western canon. Political scientists are intrigued by its studies of the role of courts in law reform; sociologists, by its analyses of racial power and authority; American Studies scholars and rhetoricians, by its use of storytelling, counterstorytelling, and revisionist history. What are some of the movement's dominant ideas? Critical race theory is a very loose collection of scholars, not all of whom would agree on this or any other platform or set of defining tenets. But most “race-crits” would acknowledge some of the following as the movement's defining themes:

Interest convergence and material determinism. Just as the movement began with Derrick Bell's impressive analysis of the role of white institutional self-interest and its relation to racial reform, critical race theorists have continued to explore

this dimension of American society. Scholars such as Lani Guinier examine how voting behavior and laws affect the quality of the representation that the minority community receives in national and state legislatures. Guinier and others study the idea of merit, standardized testing, and occupational qualifications in order to see how seemingly neutral measuring instruments and criteria incorporate bias. Writers such as Spencer Overton examine the role of property, wealth, and ownership in inhibiting black advances. A host of scholars examines affirmative action and job-hiring patterns in higher education.

Racism as ordinary and normal. Most Americans believe that their society is fair and just, and the legal system frames antidiscrimination law and doctrine with this presupposition in mind. Most critical race theorists believe the opposite is true, however; racism for them is ordinary, normal, and deeply embedded in everyday life and institutions. From songs, rhymes, and nursery stories such as Snow White, to movie roles and stereotypes, job and school criteria, and old-boy informal networks, favoritism for white, European ways exerts a subtle, ever-present force. If racism and race-themed ideas and preferences are everywhere, this makes them invisible and difficult to confront. They seem ordinary and natural; the person seeking to challenge them strikes others as impossible, nitpicky, or lacking in a sense of proportion. Litigants suing for discrimination confront the same obstacle. Unless what the defendant did was outrageous, intentional, and outside the pale, courts are unlikely to award relief.

Critique of color blindness. Currently, one of society's—and the legal system's—dominant approaches to race is color blindness. This perspective insists that race does not matter. The law should not take account of race either for the purpose of helping or handicapping any group. By the same token, advocates of color blindness assert that in ordinary life one should behave the same way—simply refusing to take note of the race of people with whom one comes into contact.

Some critical race theorists have mounted a powerful and sustained attack on the idea of color blindness, pointing out, for example, that to disregard another person's race, one first has to notice it, and that many color-blind institutions—such as an alumni preference at private colleges—strengthen white privilege and disadvantage blacks and other minorities.

The social construction of race. Most race-crits hold that race is not real and objective but that ideas of race nevertheless exert great social power. Supported by scientific findings that individuals of different races share a huge majority of their genes (perhaps as much as 99.9 percent) and the scientific community's agreement that the few genes that do account for minor differences such as hair texture and skin color cannot possibly influence distinctively human traits such as intelligence, personality, or propensity for moral or immoral behavior, critical race theorists examine how we nevertheless come to believe in the reality of race. If race is a social construction—something we choose to believe in the face of scientific evidence to the contrary—what are the mechanisms of that social construction and what keeps them in place? Social

constructionists examine how scripts, narratives, stories, and habits enable society to continue to believe that something important distinguishes blacks and whites, for example, and hold to those beliefs even in the face of evidence that people everywhere are pretty much alike (some good, some bad). They also examine the role of law in maintaining racial lines and classifications through such measures as immigration categories, rules forbidding intermarriage, and state statutes defining blackness, such as the “one-drop rule,” according to which any individual with a detectable trace of black blood is black.

Differential racialization. A recently developed theme within critical race theory discourse is differential racialization. This theory holds that the various racial groups in the United States—blacks, Latinos, Asian-Americans, and Native Americans, for example—have been racialized in different ways in response to different needs of the majority group. Moreover, the laws and legal structures society devises for each group—such as English-only laws for Latinos, alien land laws for Asians, and Jim Crow laws for blacks—operate differently in the case of the various groups. The groups feature different histories and struggles. They had to contend with different sets of discriminatory laws and practices. With Indians, for example, society wanted their land; with blacks, labor; with Latinos, first land, then labor; and so on. Social stereotypes of the various groups changed accordingly over time to facilitate society's obtaining what it wanted from the group in question. For example, during slavery, when southern whites had matters well in hand, the dominant narratives, songs, and stories about blacks were reassuring: Blacks were happy with their lives and pleased to serve whites. Later, when blacks received their freedom and were perceived as a threat, social images of them changed. Writers, cartoonists, and filmmakers depicted blacks as frightening, larger-than-life figures with (in the case of men, at least) designs on white women. These figures, of course, justified cruel repression. They would not have served well during the slave period because they would have suggested that blacks were unhappy with their lot.

The black/white binary of race. Related to the above is the notion that American concepts—and laws—related to race incorporate a black/white binary paradigm, in which two, and only two, races define the study, and system, of race. Those two races are, of course, the white and the black. Other groups, such as Latinos, Asian-Americans, Indians, and Filipinos enter into the equation only insofar as their treatment and experiences can be analogized to those of African-Americans. Sometimes the analogy holds. If antidiscrimination law would afford redress for an African-American worker whose supervisor calls him a “lazy n——” and assigns him to the least desirable tasks, it would also provide relief for an Asian worker called a “damn chink” and sent off to do unpleasant work.

But suppose the basis for discrimination is that a Latino or Asian worker speaks with an accent, or because the employer fears, wrongly, that such a worker may be an undocumented alien. Neither accent nor national-origin discrimination affects most blacks; therefore, remedial law coined with them in mind may afford no redress for these other kinds of discrimination. By the same token, Asians may be discriminated against

because of a radically different set of stereotypes—the superachiever or humorless drone who steals jobs from more well-balanced American workers, while Latinos may suffer because of the opposite stereotype—the happy-go-lucky lover of song, dance, and women. Again, none of these stereotypes affects blacks generally, with the result that courts and other decision makers are apt to be unschooled in the need to be on guard against them.

Intersectionality and antiessentialism. A further critical theme that, like differential racialization and the black/white binary, has to do with categories and power is intersectionality and antiessentialism. Opposite sides of the same coin, these two themes draw attention to the evils of overgeneralization. Both have to do with identity. Intersectionality names a phenomenon in which individuals are often found to exhibit identities that are complex. A Latino may also be black, or gay. An African-American may be female and a single parent. An Asian-American may have a parent who is Filipino or a grandparent who is Latino, and so on.

Complex identities may turn out to have legal consequences. For example, imagine an African-American woman worker who suffers discrimination on the job site because of her black womanhood. Her supervisor may dislike black women, believing them lazy or haughty. The supervisor may harbor no such dislike for black men or white women, and may treat them fairly. His discrimination runs only to black women.

Suppose that our hypothetical worker sues for workplace discrimination. How would she frame her case? She could invoke one existing body of case and statutory law that redresses discrimination on the grounds of sex. She is, after all, a woman, and her boss does discriminate against her because she is a woman—a black woman. Alternatively, she could file suit on the grounds of racial discrimination. Her supervisor treats her badly, in part, because she is an African-American. Regardless of the avenue she chooses, however, her suit will confront serious obstacles. Her boss can maintain, truthfully, that he does not discriminate against all women. In particular, he treats white women well, promoting them when they deserve it and otherwise treating them fairly.

He can also prove that he does not discriminate against African-Americans across the board. In particular, he likes black men and treats them well at work. The black woman's claim, then, could fail because her discrimination is intersectional—aimed at her because of her status as a black woman, someone with an intersectional identity. All individuals with complex identities run the risk that a system of power and authority that hinges on prefabricated categories, none of which perfectly fit the individual's situation, fails to do them justice.

Antiessentialism points to the mirror image problem. An organization, such as a woman's group, whose dominant membership is, let us say, white, may give short shrift to the needs and priorities of nonwhite members because it thinks in terms of an "essential" woman, who is, of course, white. The organization then devises strategies to advance the objectives of this member, whose aims and needs are considered to be representative of the group. The needs of nonstandard members—say,

white lesbians, or black single mothers—are deemed of secondary importance. The group will deal with them as soon as the needs of women, as women, are dealt with. And this paradigmatic woman is apt to turn out to be white and middle class.

Legal storytelling and narrative analysis. Out of the concern that conventional legal discourse—and perhaps discourse of any kind—will fail to do justice to the needs, experiences, and histories of minorities, critical race theorists have been experimenting with new modes of presenting their ideas. These new vehicles include legal storytelling and narrative analysis. Legal storytelling received a large boost when Derrick Bell, at the height of his career, received a prestigious invitation to write the foreword to *Harvard Law Review's* 1985 Supreme Court issue, devoted to the analysis of recent opinions. Disdaining the usual heavily footnoted, ponderous prose in which most of the forewords are written, Bell instead published a series of conversations—"The Civil Rights Chronicles"—with an imaginary superheroine lawyer named Geneva Crenshaw. His alter ego is young and brash; his own voice is tempered and moderate. The two discuss the current racial scene and developments in the law. Bell tries to defend the system and its steady, incremental progress. Geneva destroys every illusion with devastating wit and analysis.

Others followed Bell's lead, using fable, myth, and close observation to unmask items of the liberal faith, such as that blacks are making constant progress, color blindness is capable of redressing most racial ills, and most social institutions are prepared to grant minorities full access so long as they meet the institution's standards. Storytelling aims at increasing empathy and allowing the reader a glimpse into what life is like for the author of color. Counterstorytelling aims to debunk the many myths and generalizations that white people believe and that enable them to be comfortable in a system in which they enjoy a disproportionate share of the benefits and privileges. Both types of writing aim at a broad, multiracial audience. Storytellers such as Patricia Williams, Robert Williams, and Richard Delgado have won wide audiences and national acclaim for their work.

Attorneys and legal scholars have also applied the lessons of legal storytelling and narrative analysis to judicial proceedings and the dynamics of the courtroom. A trial is, in some respects, a battle of narratives. And the relationship between an attorney and a client may be seen as an effort to impose a narrative, or understanding, on their mutual journey. Writers such as Lucie White and Anthony Alfieri show how attention to the narrative side of lawyering allows lawyers to understand their function and provide a better brand of justice.

Hate speech. Along with the above-mentioned emphasis on language, discourse, and narrative comes a focus on an especially problematic form of expression—hate speech. Some of the earliest critical race theory work, which continues today, examines the law's treatment of racial epithets, slurs, and name-calling. Speech is a highly protected value in our legal system, yet vicious put-downs based on a person's unchangeable characteristics endanger another set of values, including health, psychological well-being, and equality. Critical theorists such

as Mari Matsuda, Charles Lawrence, and Richard Delgado analyze this conflict between free expression and equal dignity in an effort to provide greater protection for the latter value. Some have participated in the drafting of campus hate-speech codes aimed at assuring an atmosphere conducive to equal participation. They also address issues such as the Confederate flag, teams that sport demeaning Indian logos, and public monuments that memorialize slavery and a segregated past.

Spin-Off Movements

Critical race theory has spawned a number of successor movements that, while continuing to maintain relations with the original movement, pursue courses and directions of their own. Concerned about an unduly Afrocentric emphasis in critical race theory and inattention to groups falling outside the black/white binary of race, Latino scholars in the mid-1990s began caucusing separately during critical race theory meetings, then broke off to form their own multiracial organization, the conference on Latino/Critical studies. The group focuses on a number of issues—such as immigration law and policy, language and accent discrimination, and discrimination based on conquest or territorial status—to which the parent organization gives short shrift.

In similar fashion, a national organization of radical Asian-American scholars meets separately to develop a body of knowledge related specifically to the needs and problems of that population, including many of the above-named issues and, in addition, such issues as Orientalism and the notion of Asians as a model minority. For their part, gay and lesbians of color have been developing a sophisticated set of ideas and a body of scholarship devoted to sexual minorities. Critical race feminism examines issues pertaining to women within the various communities of color, including sweatshop labor, sexual abuse in minority communities, and global human rights, including resistance to genital mutilation and other practices directed against women.

A final spin-off movement is critical white studies, in which scholars apply the techniques and approaches of critical race theory—including social constructionism, historical revisionism, and close attention to myth and narrative—to whites. Scholars such as Ian Haney-López examine Supreme Court cases dealing with the legal definition of whiteness and the requirement—which endured until recently—that an applicant seeking to naturalize (acquire American citizenship) establish that he or she is white. Others examine the abovementioned “one-drop” rule and laws governing interracial marriage and adoption in an effort to learn how white preference figures in. Still others examine seemingly race-neutral laws, such as the income tax code, in search for provisions that favor whites and tacitly enact a system of white privilege, while a final group examines white-collar crime and leniency afforded sympathetic white defendants who have erred over ones who are less sympathetic, nonwhite, but who committed the same offense.

Criticism

As the reader might imagine, audacious movements championing sweeping insights into American society and employ-

ing nontraditional forms of scholarship have come in for their share of criticism. At first, criticism was relatively muted. Book reviewers and tenure committees welcomed the new scholarship and gave it a warm reception. However, critics have taken the movement to task for making undocumented assertions and substituting personal experience and anecdote for provable fact. Other critics have focused on the movement’s critique of merit and other Eurocentric mainstays. With merit, for example, Daniel Farber and Suzanna Sherry ask, what will replace it as a basis for distributing jobs, places in a law school class, and other scarce social goods? And, what are we to make of the current distribution of wealth and influence? If it was improperly gained, as the critics suggest, through a series of rigged competitions, what of minority groups such as Asians and Jews who have done well under the current regime? Perhaps the critique of merit is implicitly anti-Semitic.

Critics from the left level a different type of criticism. Interest convergence, a Supreme Court that subtly discourages racial reform even in the act of advancing it, and other bleak scenarios are too depressing to serve as rallying cries for liberal reformers. Moreover, they are poor tools for students and young attorneys, who require more action-oriented, inspiring fare. Derrick Bell and his colleagues reply that happy myths about progress and faith in the law that, in the end, turn out to be untrue discourage the activist even more and lead to disillusion and dropout. The solution for the reformer is to learn to derive meaning from the act of struggle itself—whether or not it brings immediate victory.

Other mainstream critics take the movement to task for departing from a conception of law as a system of exact, predictable, formal rules and teaching, instead, that it is full of indeterminacy and veiled, clashing interests. Some of these critics charge that critical race theory’s focus on narrative and subjectivity, instead of objectivity and uniform rules, is dangerous. Jeffrey Rosen, legal affairs editor for the *New Republic*, for example, rebuked several critical race authors for providing the basis for the O. J. Simpson acquittal. When Simpson’s lawyer, Johnny Cochrane, successfully appealed to the jury to imagine a different story from the one the state prosecutor advanced—a story in which the Simpson prosecution was infected at every stage with racial prejudice—Cochrane was simply using applied critical race theory. This strategy—“playing the race card,” in Rosen’s view—amounted to a dangerous departure from what should have been the main objective of a trial: finding the truth.

Methodology

As the above description suggests, critical race theorists address a broad span of issues having to do with race, and from a variety of perspectives. Most pay close attention to context and historical situation, valuing the individual over the universal in social and legal analysis. They also credit multiplicity, for example of narratives and identities, over broad generalization. They emphasize how legal rules and regimes look from the perspective of the disempowered and outsider groups—in Matsuda’s memorable phrase, “looking to the bottom.” And a significant faction places primary importance on material factors—labor demand, immigration needs, conquest,

DERRICK BELL

Raised in Pittsburgh, Pennsylvania, the son of working-class parents, Derrick Bell graduated from Duquesne University and the University of Pittsburgh law school, where he was the first African-American to gain membership to its prestigious law review. After graduating from law school, he worked for a number of law reform agencies, including the NAACP, then entered teaching at Harvard Law School in 1969, the first of his race to teach in a tenure-track capacity there. At the end of 1980, he left Harvard to assume the position of dean at University of Oregon Law School, the first black to lead a major, white-dominated law school in the United States. After leaving Oregon in protest over the faculty's refusal to hire a well-qualified Asian-American female professor, he returned to Harvard Law School, where he mentored students and young scholars across the country, helped found the critical race theory movement, and constantly pressed for liberalization of racial policies at his school. His persistent, heroic, sometimes quixotic struggles are recounted in two books and countless newspaper stories. An inspiration to two generations of lawyers and scholars, Bell taught as a permanent visiting professor at New York University law school in the early 2000s.

RELATED LEGAL MOVEMENTS

One of a group of progressive movements in the law, critical race theory bears close relations with a forerunner movement—critical legal studies—that flourished in the 1960s and 1970s and was still alive in the early 2000s. Building on the insights of the early-twentieth-century legal realists, critical legal studies scholars attacked the ideas of legal determinacy—that every legal problem has exactly one correct solution—and autonomy, the notion that law exists in a realm by itself. Instead, the critical legal studies scholars urged, law bears a close relation to economics, politics, social science, and even art and aesthetics. Critical race theorists build on all these ideas, as well as on the Continental school of philosophy from which many critical legal studies scholars draw inspiration.

Critical race theory also builds on some of the key ideas of radical feminism, including hierarchy, patriarchy, and the notion that everyday terms, categories, and roles advance implicit agendas and encode power relations in a way that benefits those in charge. The movement also learned from revisionist historians, such as Charles Beard and Patricia Limerick, who examined history from hitherto unexplored perspectives, such as those of women, workers, and members of outsider groups. Finally, critical race theory scholars such as Derrick Bell and Richard Delgado draw from neo-Marxist theory in exploring how race relations in the United States reflect economic struggles, shifting labor needs, and the clash of interest groups.

international tensions—in understanding the ebb and flow of U.S. racial politics. Critical of both liberal incrementalism and conservative color-blind philosophies, critical race theorists carve out new ground that places central importance on power, economics, narrative, and social construction in coming to grips with America's social problems.

The next wave of critical race theorists will likely consider the relationship between race and class, the role of minorities in a two-party political system, and the implications of globalization for domestic minorities. The United States' population of color is rapidly growing and was expected to exceed 50 percent sometime in the mid-twenty-first century. Latinos

were expected to surpass blacks as the nation's largest group of color. The implications for race relations and civil rights of all these developments are sure to be on critical race theory's agenda well into the future.

The movement is sure to remain controversial—but, of course, many social movements were in their early years. Yet in some respects, it has become the new orthodoxy. Some judges now apply its insights in understanding the racial dynamics of particular cases. Mainstream presses publish its authors; undergraduates study its teachings on hate speech, narrative, and race coding. Two critical race theorists were nominated for high positions within the Clinton administration, but proved too controversial to be confirmed. As the United States struggles to come to terms with a multiracial world and a domestic population that is increasingly black, brown, and Asian, the insights of these progressive, divergent thinkers are apt to become more and more relevant.

See also *Identity, Multiple; Identity: Personal and Social Identity; Race and Racism.*

BIBLIOGRAPHY

- Bell, Derrick A. *And We Are Not Saved: The Elusive Quest for Racial Justice*. New York: Basic Books, 1987. Expansion of the "Civil Rights Chronicles."
- . "Brown v. Board of Education and the Interest Convergence Dilemma." *Harvard Law Review* 93 (1980): 518ff. Classic statement of materialist interpretation of race.
- . "Serving Two Masters: Integration Ideals and Client Interests in School Desegregation Litigation." *Yale Law Journal* 85 (1976): 470ff. Convincing demonstration of tensions inherent in civil rights advocacy.
- Calmore, John O. "Critical Race Theory, Archie Shepp, and Fire Music: Securing an Authentic Intellectual Life in a Multicultural World." *Southern California Law Review* 65 (1992): 2129ff. Classic work on the minority condition.
- Crenshaw, Kimberlé, et al., eds. *Critical Race Theory: The Key Writings That Formed the Movement*. New York: New Press, 1995.
- . "Race, Reform, and Retrenchment: Transformation and Legitimation in Antidiscrimination Law." *Harvard Law Review* 101 (1988): 1331ff. Early statement of antiliberal critique.
- Delgado, Richard. *The Rodrigo Chronicles: Conversations about America and Race*. New York: New York University Press, 1995. Renowned example of legal storytelling.
- Delgado, Richard, and Jean Stefancic, eds. *Critical Race Theory: The Cutting Edge*. 2nd ed. Philadelphia: Temple University Press, 2000. Widely used reader on critical race theory.
- , eds. *Critical White Studies: Looking behind the Mirror*. Philadelphia: Temple University Press, 1997. Broad collection of writings about whiteness.
- , eds. *The Latino/a Condition: A Critical Reader*. New York: New York University Press, 1998. Collection of Lat/Crit writings.
- Dudziak, Mary L. *Cold War Civil Rights: Race and the Image of American Democracy*. Princeton, N.J.: Princeton University Press, 2000. Extended treatment of forces leading to *Brown v. Board of Education*.
- Farber, Daniel, and Suzanna Sherry. *Beyond All Reason: The Radical Assault on Truth in American Law*. New York: Oxford

University Press, 1997. Searching criticism of the critical race theory movement.

- Freeman, Alan D. "Legitimizing Racial Discrimination through Antidiscrimination Law: A Critical Review of Supreme Court Doctrine." *Minnesota Law Review* 62 (1978): 1049ff. Illuminating examination of role of Supreme Court in achieving social justice.
- Guinier, Lani. *The Tyranny of the Majority: Fundamental Fairness in Representative Democracy*. New York: Free Press, 1994. Innovative study of voting mechanisms.
- Haney-López, Ian F. *White by Law: The Legal Construction of Race*. New York: New York University Press, 1996. Groundbreaking study of role of law in drawing boundaries of the white race.
- Harris, Angela P. "Race and Essentialism in Feminist Legal Theory." *Stanford Law Review* 42 (1990): 581ff. Powerful treatment of white bias in mainstream feminism.
- Lawrence, Charles R., III. "The Id, the Ego, and Equal Protection: Reckoning with Unconscious Racism." *Stanford Law Review* 39 (1987): 317ff. Demonstrates the prevalence of unconscious racism and proposes ways the law may take account of it.
- Matsuda, Mari J. "Public Response to Racist Speech: Considering the Victim's Story." *Michigan Law Review* 87 (1989): 2320ff. Classic exposition of critical methodology.
- Perea, Juan F. "Demography and Distrust: An Essay on American Languages, Cultural Pluralism, and Official English." *Minnesota Law Review* 77 (1992): 269ff. Famed treatment of language rights.
- Ross, Thomas. "Innocence and Affirmative Action." *Vanderbilt Law Review* 43 (1990): 297ff. Study of the role of the power of white innocence.
- "Symposium: Critical Race Theory." *California Law Review* 82 (1994): 741ff. First and defining symposium on critical race theory.
- Williams, Patricia J. *The Alchemy of Race and Rights*. Cambridge, Mass.: Harvard University Press, 1991. Illustrious example of legal storytelling.
- Wing, Adrien K., ed. *Critical Race Feminism: A Reader*. New York: New York University Press, 2003. Classic collection of critical race feminist writings.

Richard Delgado
Jean Stefancic

CRITICAL THEORY. In the humanities, the term *critical theory* has had many meanings in different historical contexts. From the end of World War II through the 1960s, the term signified the use of critical and theoretical approaches within major disciplines of the humanities such as art history, literary studies, and more broadly, cultural studies. From the 1970s, the term entered into the rapidly evolving area of film and media studies. Critical theory took on at the same time a more specialized sense describing the work of the Frankfurt School that itself spread steadily through many disciplines of the humanities and social sciences in the English-speaking world from the 1970s on.

While critical theories were entering the humanities throughout the world, a proliferation of new theoretical

approaches from France, often associated with structuralism and then poststructuralism and postmodern theory, generated new discourses that were also assimilated to the cover concept of critical theory. Moreover, different groups such as women, gays and lesbians, and people of color also developed specific critical theories within a wide range of disciplines from the 1970s into the early twenty-first century. The situation was further complicated when many of the theoretical discourses (such as deconstruction) were associated with philosophy, which in turn gave rise in the humanities to a tendency to speak of Theory with a capital *T* when describing the proliferation of critical theories and methods and to privilege them as a necessary instrument of criticism.

To sort out this complex trajectory, it is useful to first broadly sketch the role of critical theory in the various fields of the humanities, then present the Frankfurt School version of critical theory, and finally engage the mutations of critical theory from the theory proliferation of the 1960s and 1970s, the rise of the “posts,” the interconnection of critical theory with groups associated with new social movements, its connection with philosophy, and the emergence of Theory as a privileged discourse. While this narrative is partly historical, it is mainly analytical, for in the contemporary context, different people use the term *critical theory* in diverse and contested ways following the various models and stages of the discourse. Thus there is not one single or dominant understanding of critical theory in the university of the early twenty-first century.

Critical Theory in the Disciplines

As Jürgen Habermas has documented, during the Enlightenment of the eighteenth century various modes of political, literary, and cultural criticism emerged from the salons, public houses, and other sites of the bourgeois public sphere, leading to the production of journals and books that discussed the latest cultural fashions and political trends. Major eighteenth- and nineteenth-century writers such as Jonathan Swift, Alexander Pope, Charles-Pierre Baudelaire, and Edgar Allan Poe practiced forms of criticism, as did nineteenth-century novelists such as Jane Austen, Charlotte Brontë, Charles Dickens, and George Eliot.

Critical discourse in a broad range of cultural criticism developed from philosophical and critical responses to genres of art and evaluative responses to specific art works. From Aristotle's *Poetics* through Matthew Arnold and F. R. Leavis in the literary arts, critical aesthetic theories attempted to define the key features of genres and to distinguish what constituted artistic excellence and experience.

Critical approaches in literature, art, music, dance, and the arts began emerging as a specific discipline in the nineteenth century throughout the Western world. In the first decades of the twentieth century, critics such as György Lukács, Ernst Bloch, and Walter Benjamin began applying Marxist theory to a broad range of the arts. Freudians such as Ernest Jones began using psychoanalytic theory to study culture, while Herbert Read deployed Jungian theory. By the 1950s, a variety of schools of critical theory started using major theoretical discourses of the period to discuss, analyze, interpret, and critique

the arts. There was a reaction against this theory turn, however, both from those who wanted a more scientific approach to the aesthetic work, such as I. A. Richards, and from those who wanted a more empathetic immersion in cultural artifacts, such as some members of North American New Criticism, who advocated close readings of literary texts without what they saw as the blinders of theory.

Some critical theories and methods such as Marxism, feminism, psychoanalysis, and semiotics were taken up in the 1960s in the new disciplines of film and media theory, which also developed their own autonomous discourses and methods. Critical approaches to mass communication and culture, however, were first developed by the Frankfurt School, which generated its own concept of critical theory.

The Frankfurt School and Critical Theory

“Critical theory” stood as a code for the quasi-Marxist theory of society developed by a group of interdisciplinary social theorists collectively known as the Frankfurt School. The term *Frankfurt School* refers to the work of members of the Institut für Sozialforschung (Institute for Social Research) that was established in Frankfurt, Germany, in 1923 as the first Marxist-oriented research center affiliated with a major German university. Max Horkheimer became director of the institute in 1930, gathering around himself many talented theorists, including Erich Fromm, Franz Neumann, Herbert Marcuse, and Theodor W. Adorno. Under Horkheimer, the institute sought to develop an interdisciplinary social theory that could serve as an instrument of social transformation. The work of this era was a synthesis of philosophy and social theory, combining sociology, psychology, cultural studies, and political economy, among other disciplines.

In a series of studies carried out in the 1930s, the Institute for Social Research developed theories of monopoly capitalism, the new industrial state, the role of technology and giant corporations in monopoly capitalism, the key roles of mass culture and communication in reproducing contemporary societies, and the decline of democracy and of the individual. Critical theory drew alike on Hegelian dialectics, Marxian theory, Friedrich Nietzsche, Sigmund Freud, Max Weber, and other trends of contemporary thought. It articulated theories that were to occupy the center of social theory for the next several decades. Rarely, if ever, has such a talented group of interdisciplinary intellectuals come together under the auspices of one institute. They managed to keep alive radical social theory during a difficult historical era and provided aspects of a neo-Marxian theory of the changed social reality and new historical situation in the transition from competitive capitalism to monopoly capitalism.

During World War II, the institute split up because of pressures from the war. Leo Lowenthal, Marcuse, Neumann, and others worked for the U.S. government as their contribution to the fight against fascism. Adorno and Horkheimer, meanwhile, moved to California, where they worked on their collective book, *Dialectic of Enlightenment*, which discussed how reason and enlightenment in the contemporary era turned into their opposites, transforming what promised to be instruments

of truth and liberation into tools of domination. In their scenario, science and technology had created horrific tools of destruction and death, culture was commodified into products of a mass-produced culture industry, and democracy terminated into fascism, in which masses chose despotic and demagogic rulers. Moreover, in their extremely pessimistic vision, individuals were oppressing their own bodies and renouncing their own desires as they assimilated and created their own repressive beliefs and allowed themselves to be instruments of labor and war.

After World War II, Adorno, Horkheimer, and Friedrich Pollock returned to Frankfurt to reestablish the institute in Germany, while Lowenthal, Marcuse, and others remained in the United States. In Germany, Adorno, Horkheimer, and their associates published a series of books and became a dominant intellectual current. At this time, the term *Frankfurt School* became widespread as a characterization of this group's version of interdisciplinary social research and of the particular critical theory developed by them. They engaged in frequent methodological and substantive debates with other social theories, most notably "the positivism dispute" in which they criticized more empirical and quantitative approaches to theory and defended their own more speculative and critical brand of theory.

The Frankfurt School eventually became best known for their critical theories of "the totally administered society," or "one-dimensional society," which analyzed the increasing power of capitalism over all aspects of social life and the development of new forms of social control. During the 1950s, however, there were divergences between the work of the reestablished institute and the developing theories of Fromm, Lowenthal, Marcuse, and others who did not return to Germany, which were often at odds with both the current and earlier work of Adorno and Horkheimer. Thus it is misleading to consider the work of various critical theorists during the postwar period as members of a monolithic Frankfurt School. Whereas there was both a shared sense of purpose and collective work on interdisciplinary critical theory from 1930 to the early 1940s, thereafter critical theorists frequently diverged, and during the 1950s and 1960s *Frankfurt School* as a term can really be applied only to the work of the institute in Germany under Horkheimer and Adorno.

From Structuralism to Poststructuralism and Beyond

The development of structuralism and poststructuralism in France in the 1950s and 1960s and rapid global transmission of books and ideas contributed to the development of an interdisciplinary mode of theory that became prevalent in the humanities. Structuralism is often associated with the French anthropologist Claude Lévi-Strauss, whose studies of myth, culture, and language discerned a binary structure in myth, for example, between nature and culture or the raw and the cooked. For Lévi-Strauss, culture was articulated into systems that could be described with the precision and force of a science.

Structuralism spread through the human sciences in the 1960s and 1970s, moving from Lévi-Strauss's anthropology

and study of myth, to structuralist theories of language (often combined with semiotics), to structuralist Marxism that produced structuralist accounts of the capitalist economy (Louis Althusser) and state (Nicos Poulantzas).

The human sciences were conceptualized by structuralists as self-contained systems with their own grammar, rules, and structuring binary oppositions. Texts were seen as structured networks of signs determined not by what they referred to so much as through their differential relation to other signs. Structuralist critical theory thus focused on detecting the system of binary oppositions through which textual systems were structured, and it delineated oppositions between synchronic and diachronic arrangements, or *langue/parole*, with the former referring to the synchronic social system of language and the latter referring to specific speech at a particular time.

Whereas structuralism had ambitions of attaining the status of a super science, which could arbitrate among competing truth claims and provide a foundational discipline, poststructuralism challenged any single discipline's claim to primary status and promoted more interdisciplinary modes of theory. Poststructuralism turned to history, politics, and an active and creative human subject, away from the more ahistorical, scientific, and objectivist modes of thought in structuralism.

The poststructuralist moment was a particularly fertile one as important theorists such as Roland Barthes, Jean-François Lyotard, and Michel Foucault wrote new poststructuralist works and younger theorists such as Jacques Derrida, Jean Baudrillard, Paul Virilio, and others entered into productive periods. The poststructuralist turn was evident in the famous 1966 conference on "Critical Languages and the Sciences of Man" at Johns Hopkins University, which featured an important intervention by Derrida, "Structure, Sign, and Play in the Discourse of the Human Sciences." Rejecting structuralist theories of language, Derrida stressed the instability and excess of meaning in language, as well as the ways in which heterogeneity and difference were generated. Derrida also questioned the binary opposition between nature and culture upon which Lévi-Strauss had erected his system, thus undermining a certain glorification of the human sciences in the humanities and opening the discipline for a greater appreciation of philosophy, literature, and less-scientific modes of discourse.

Derrida became one of the most prolific writers of his generation and generated great interest in philosophy throughout the humanities, but he also crossed boundaries between disciplines and contributed to both a proliferation of critical theories and more interdisciplinary humanities. Derrida's deconstruction took apart philosophical and closed scientific systems, showing that their foundational beliefs affirmed one side or another of the binary oppositions, for example, nature, with Jean-Jacques Rousseau; or culture, with cultural anthropologists who described the constructed nature of society and culture (a theme that would move into poststructuralism and many of the humanities).

Poststructuralism stressed the openness and heterogeneity of the text, how it is embedded in history and desire, its political and ideological dimensions, and its excess of meaning.

This led critical theory to more multilevel interpretive methods and more radical political readings and critiques. Foucault described how texts and discourses are embedded in power; Edward W. Said articulated the “Orientalism” of Western-centric ideology and the construction of non-Western cultures in both colonial and postcolonial discourses; and feminists described how patriarchy and the concepts of totalitarianism and subordination are inscribed in texts.

Following the poststructuralist moment of the late 1960s and 1970s, there was a proliferation of new theoretical moments of critical theory that connected with new social movements, producing a proliferation of “posts” and theory wars from the 1970s into the early twenty-first century. Baudrillard, a French theorist, took up poststructuralism and deconstruction in idiosyncratic ways. His early work analyzed the “system of objects” and “political economy of the sign” in the media and consumer society, showing how the system of commodities and consumer values were organized in a hierarchal system. Yet by the mid-1970s, Baudrillard entered a deconstructive and poststructuralist phase, taking apart in sequence the claims of Marxism and political economy, Freud and psychoanalysis, Foucault, and other forms of theory. For Baudrillard, the consumer and media society was generating novel forms of sign and signification, technology, and cultural spaces, which produced a break with modernity itself. While modern societies, he argued, were organized around production and political economy, postmodern societies were organized around technology and generated new forms of culture, experience, and subjectivities.

In *Le différend*, Lyotard valorized those voices that had been suppressed or muted in social and academic spheres. He advocated “the end of grand narratives” in the humanities and politics, and the production of small, “minor narratives” and microanalysis. This theme was also taken up by Gilles Deleuze and Félix Guattari who proliferated a dazzling range of critical theories to engage salient cultural, social, economic, and political phenomena of the day.

French poststructuralist critical theory is extremely hard to categorize as it combines social theory, cultural and political commentary, philosophy, literary stylistics, and many social and human sciences in its work, crossing boundaries between academic disciplines and fields. This interdisciplinary focus links French critical theory to Frankfurt School critical theory and to certain types of feminism and other cultural theories that practice “border crossing” (that is, they cross the borders between disciplines and the traditional division of topics and academic labor).

The proliferation of theories also produced a tendency to use the term *Theory* (with a capital *T*) to describe the wealth of conflicting critical theories. In this sense, Theory replaces philosophy as the most abstract and general mode of theoretical discourse. Theory has emerged as an autonomous enterprise in many academic disciplines, giving rise to a tendency to do work in Theory, which engages various critical theories, problems, and concepts, or explores the nature and function of theory itself in the academic disciplines.

Critical theory turned to a “politics of representation” during the 1960s and 1970s. This enterprise involved analysis of the ways in which images, discourses, and narratives of a wide range of cultural forms—from philosophy and the sciences to the advertising and entertainment of the media culture—were embedded in texts and reproduced social domination and subordination. British cultural studies, for instance, showed how problematic representations of gender, race, class, sexuality, and other identity markers were found throughout cultural forms. Cultural studies developed different critical theories and methods to analyze the production of texts, their multiple meanings, and their complex uses and effects.

Critical theories were also developed within feminism, critical race theory, gay and lesbian theory, and other groupings associated with new political movements, making critical theory part of political struggle inside and outside the university. Feminists, for instance, demonstrated how gender bias infected disciplines from philosophy to literary study and was embedded in texts ranging from the classics of the canon to the mundane artifacts of popular culture. In similar ways, critical race theorists demonstrated how racist images and discourses permeated cultural artifacts, while gay and lesbian theorists demonstrated how their sexual orientation was negatively represented and marginalized.

These critical theories also stressed giving voice to groups and individuals marginalized in the dominant forms of Western and then global culture. Critical theory began going global in the post-1960s disseminations of critical discourses. Postcolonial theory in various parts of the world developed particular critical theories as a response to colonial oppression and to the hopes of national liberation. Frantz Fanon in Algeria, Wole Soyinka in Nigeria, Gabriel García Márquez in Latin America, Arundhati Roy in India, and others all gave voice to specific experiences and articulated critical theories that expanded the global and multicultural reach of critical theory.

The past decades have thus witnessed a proliferation of critical theory to the extent that the very concept is a contested area. In the early twenty-first century, conflicting models of critical theory are used by different individuals and groups in various fields of inquiry in different parts of the world. There is also a tendency to combine critical theories in one’s work, following a recommendation by Foucault in the 1970s that many have taken up. Others who took up the anti-theory discourse of Richard Rorty and various critics of Theory have called for rigorous empirical and contextual engagement with topics and subject matter. *Critical theory* is thus a multidimensional term that continues to take on differing connotations and uses and is embedded in many different disciplines and debates.

See also **Literary Criticism; Literary History; Literature; Postcolonial Literature; Structuralism and Poststructuralism.**

BIBLIOGRAPHY

Althusser, Louis, and Étienne Balibar. *Reading “Capital.”* Translated by Ben Brewster. London: Verso, 1997.

- Baudrillard, Jean. *The System of Objects*. Translated by James Benedict. London: Verso, 1996.
- Bhavnani, Kum-Kum, ed. *Feminism and "Race."* Oxford: Oxford University Press, 2001.
- Corber, Robert J., and Stephen Valocchi, eds. *Queer Studies: An Interdisciplinary Reader*. Malden, Mass.: Blackwell, 2003.
- Deleuze, Gilles, and Félix Guattari. *A Thousand Plateaus: Capitalism and Schizophrenia*. Translated by Brian Massumi. Minneapolis: University of Minnesota Press, 1987.
- Derrida, Jacques. *Writing and Difference*. Translated by Alan Bass. Chicago: University of Chicago Press, 1978.
- Foucault, Michel. *Power/Knowledge: Selected Interviews and Other Writings, 1972–1977*. Edited and translated by Colin Gordon. New York: Pantheon, 1980.
- Habermas, Jürgen. *The Structural Transformation of the Public Sphere*. Translated by Thomas Burger with the assistance of Frederick Lawrence. Cambridge, Mass.: MIT Press, 1989.
- Horkheimer, Max. *Critical Theory*. Translated by Matthew J. O'Connell et al. New York: Herder and Herder, 1972.
- Horkheimer, Max, and Theodor W. Adorno. *Dialectic of Enlightenment*. Translated by John Cumming. New York: Herder and Herder, 1972.
- Lévi-Strauss, Claude. *The Raw and the Cooked*. Translated by John and Doreen Weightman. New York: Harper and Row, 1969.
- Lewis, Reina, and Sara Mills, eds. *Feminist Postcolonial Theory: A Reader*. Edinburgh: Edinburgh University Press, 2003.
- Lyotard, Jean-François. *The Differend: Phrases in Dispute*. Translated by Georges Van Den Abbeele. Minneapolis: University of Minnesota Press, 1988.
- Rorty, Richard. *Contingency, Irony, and Solidarity*. Cambridge, U.K.: Cambridge University Press, 1989.
- Said, Edward W. *Orientalism*. New York: Pantheon, 1978.
- Tong, Rosemarie Putnam. *Feminist Thought: A More Comprehensive Introduction*. 2nd ed. Boulder, Colo.: Westview, 1998.

Douglas Kellner

CULTURAL CAPITAL. The concept of cultural capital originated in the work of Pierre Bourdieu (1979, pp. 10, 12), who defined it as high cultural knowledge that ultimately redounds to the owner's financial and social advantage. An example would be knowing how to "dress for success." This cultural knowledge can pay off. Although they naturally seek competent personnel, employers also prefer executives who dress, talk, and comport themselves in accordance with their elite status. As a result, a job-seeker's sartorial knowledge commands a salary beyond what his or her productivity alone would have commanded. In effect, the well-dressed candidate gets a salary bonus. Most people do not know how to dress for success, do not even know the importance of doing so, and do not, in fact, do so. For this reason, the acquisition of high cultural knowledge and style, including stylish dress, table manners, golf, knowledge of wine, the right neighborhood, and arty chit-chat, represents a capital resource of the owner, vested in the owner, but it is not human capital. Usually human capital and cultural capital go together because people who have one usually have the other as well, but the two capitals are in principle distinct. Anyone may have human capital without cultural capital, or cultural capital without human

capital. In principle, adults might acquire cultural capital by hiring a tutor (Eliza Doolittle benefited from one in *My Fair Lady*). However, cultural capital is prohibitively inconvenient and expensive to acquire that way. In reality, people normally acquire cultural capital informally when they grow to maturity in advantaged socioeconomic households.

Forms of Capital

Capital: A store of value that facilitates action.

Financial capital: Money available for investment.

Physical capital: Real estate, equipment, and infrastructure of production.

Human capital: Education or training that increases productivity on the job.

Cultural capital: High cultural knowledge convertible into social and economic advantage.

Social capital: Relationships of trust embedded in social networks.

Examples of Cultural Capital

Bourdieu defines cultural capital narrowly as fluency in a society's elite culture. Fluency in low- or middle-status culture does not represent cultural capital because these cultural fluencies do not transmute into elite status; they transmute into middle or low status. Bourdieu was interested in how elites reproduced themselves from one generation to the next. High-status culture emphasizes classical art, music, dance, and literature, but it also includes furniture, architecture, cuisine, vacation resorts, and clothing. Knowledge of these arts represents capital because and to the extent that this knowledge can be turned to the owner's financial and social advantage at multiple points in the owner's life span. For example, when Josephine Smith wears the right suit, handbag, and shoes to a job interview on Wall Street, she makes a favorable impression and lands the job. Josephine's mother and peers taught her how to dress, a culturally monitored skill that paid off when Josephine landed a lucrative job. When Josephine subsequently marries a millionaire and obtains a share of his fortune, her cultural capital has produced additional financial capital.

Upper-class people acquire cultural capital in the family and in formal schooling. When the school curriculum reinforces the home curriculum, as it routinely does for children of the affluent, students obtain additional access to their own culture in school. Conversely, when the school curriculum contradicts or subverts the home culture, as it does for poor, immigrant, or ethnic minority children, students have to master a foreign culture at school while mastering their own at home. Even if they accomplish this difficult task, poor, immigrant, and minority children still do not learn everything they need to know in order to access the upper class later in life. Schools do not teach all the cultural knowledge needed for that access. For example, they do not teach dress, table manners, and demeanor. The parallel curriculum of the up-

per-status home teaches children much class-linked knowledge that schools ignore. Since poor or minority children cannot acquire many forms of class-linked cultural knowledge at school or at home, this cultural knowledge is virtually impossible for them to acquire at all.

The parallel curriculum gives children of the affluent a superior endowment in cultural capital. However acquired, at home or in school or both, cultural capital is converted to social and economic advantage in several ways of which the principal is prestige diplomas. Although formal education culminates in diplomas, degrees, and certificates, cultural capital is quite different from human capital, which also emerges from formal education. The difference between human capital and cultural capital resides in how the capital benefits its owner. Human capital increases its owner's productivity, a competence employers reward with high wages. In contrast, cultural capital conveys social recognition and acceptability on the strength of which people get desirable jobs, marriages, and business contacts. Therefore, the same diploma has value as human capital and as cultural capital; and the difference depends on whether we emphasize the real vocational competencies that diploma represents or the prestige recognition it commands. When a person's education has bestowed both enhanced productivity and prestige recognition, that person has two forms of capital (human and cultural), both of which transmute into money and social networks.

Occupational Culture and Competence

Although Bourdieu analyzed the high culture of the bourgeoisie, calling this cultural capital, he neglected the occupational culture of the bourgeoisie. This disjuncture led George Farkas to complain that cultural capital ignored competence. Sociologists understand culture as a tool kit, not a veneer. Crafted for a special purpose, Bourdieu's narrow concept of cultural capital stresses aesthetic judgment as if entrepreneurs and chief executive officers (CEOs) had only to attend art openings and poetry readings. In actuality, entrepreneurs and CEOs discharge real responsibility, which requires real vocational competence. Granted, some well-connected people obtain lucrative jobs on snob appeal alone, but an economy cannot run on snob appeal. What Brigitte Berger has called "the culture of entrepreneurship" is an occupational culture, not an aesthetic culture. The occupational culture of the business class is the skills, knowledge, attitudes and values needed to run a market economy. Like its aesthetic culture, the occupational culture of the business class is transmitted from one generation to the next at home as well as in schools. Bourgeois occupational culture means cultural traits (values, skills, attitudes, knowledge) characteristic of business owners and executives around the world. A business class equips its youth with class-appropriate cultural capital, both aesthetic and vocational.

Immigrant Experience

Oddly, immigration studies have provided a favorable context for the application of cultural capital theory as well as for its criticism and improvement. This advantage arises from often-remarked disparities in socioeconomic mobility of immigrant groups. Some groups move up the social ladder more quickly

than others (consider Jews, Koreans, and Cubans). Often this disparity arises because immigrants bring quite different financial resources with them. Some are wealthy on arrival, others impoverished. These cases are easy to explain. The most perplexing cases have been those in which equally impoverished immigrant groups obtain unequal socioeconomic results after one or two generations. Such cases compel attention to intergroup disparities in cultural capital. For instance, in 1900, Jewish, Polish, and Italian immigrants arrived in the United States. All were equally and wretchedly poor, but two decades later, the Jews were well ahead of the others in business ownership. Similarly, in the 1920s, southern-born black Americans and Caribbean-born black immigrants arrived in New York City. Both groups were impoverished, but the Caribbean blacks soon owned more businesses than did the American-born blacks. Again, in the 1960s, Cubans and Haitians arrived in Miami as impoverished immigrants, but a generation later, Cubans had built a flourishing and lucrative enclave economy whereas Haitians still worked in the informal sector.

In all these cases, socioeconomically mobile immigrant groups had more access than less mobile counterparts to vocationally relevant cultural capital. In two cases, this capital belonged to ethnic rather than class cultures, but it served nonetheless as a functional equivalent to the vocational culture of the business class. Among the Jews and the Caribbean blacks, entrepreneurship had been honed and built into the ethnic culture by centuries of harsh necessity. Although poor on arrival, they knew how to run businesses. Expropriated by the communists, Cuban business owners left their money and property in their island homeland, but they took with them their cultural capital. Thanks to this cultural knowledge, they recouped their money and property within two generations through entrepreneurship. Knowing how to run a business is an obvious advantage for socioeconomic mobility. Cultural capital's vocational component conveys exactly this know-how. Like the aesthetic knowledge that Bourdieu emphasized, this vocational capital is transmitted intergenerationally in households. Normally, we do not expect poor people to understand entrepreneurship, but infrequently they do, and, when they do, they obtain socioeconomic advantages from the knowledge.

See also *Class; Education; Human Capital*.

BIBLIOGRAPHY

- Berger, Brigitte. "The Culture of Modern Entrepreneurship." Chap. 1 in *The Culture of Entrepreneurship*, edited by Brigitte Berger. San Francisco: ICS Press, 1991.
- Böröcz, József, and Caleb Southworth. "Decomposing the Intellectuals' Class Power: Conversion of Cultural Capital to Income, Hungary, 1986." *Social Forces* 74 (1996): 797–821.
- Bourdieu, Pierre. *La distinction: critique sociale du jugement*. Paris: Editions de Minuit, 1979.
- . "Les trois états du capital culturel." *Actes de la Recherche en Sciences Sociales* 30 (1979): 3–5.
- DiMaggio, Paul. "Social Structure, Institutions, and Cultural Good." In *Social Theory for a Changing Society*, edited by Pierre Bourdieu and James S. Coleman. Boulder, Colo.: Westview Press, 1991.

- Farkas, George. *Human Capital or Cultural Capital? Ethnicity and Poverty Groups in an Urban School District*. New York: Aldine de Gruyter, 1996.
- Huuskonen, Visa. "The Process of Becoming an Entrepreneur: A Theoretical Framework of Factors Influencing Entrepreneurs' Start-Up Decisions (Preliminary Results)." In *Entrepreneurship and Business Development*, edited by Heinz Klandt. Aldershot, U.K.: Avebury, 1993.
- Lamont, Michele, and Annette Lareau. "Cultural Capital: Allusions, Gaps, and Glissandos in Recent Theoretical Developments." *Sociological Theory* 6 (1988): 153–168.
- Lee, Jennifer. *Civility in the City: Blacks, Jews, and Koreans in Urban America*. Cambridge, Mass.: Harvard University Press, 2002.
- Light, Ivan H. *Ethnic Enterprise in America: Business and Welfare among Chinese, Japanese, and Blacks*. Los Angeles: University of California, 1972.
- Light, Ivan, and Steven J. Gold. *Ethnic Economies*. San Diego: Academic Press, 2000.
- Sowell, Thomas. *Migrations and Cultures: A World View*. New York: Basic, 1996.
- Szelényi, Iván. *Socialist Entrepreneurs: Embourgeoisement in Rural Hungary*. Madison: University of Wisconsin, 1988.

Ivan Light

CULTURAL HISTORY. As a discipline, cultural history is a bit over two centuries old, but it has an extensive prehistory going back to Renaissance scholarship, especially in areas of the history of literature and the history of philosophy. In the Renaissance, *cultus* or *cultura* was commonly associated with the cultivation of literature, philosophy, eloquence, law, arts, and sciences, whose fruits were the human virtues necessary for civil society. In the seventeenth century the form "culture" (*cultura*) was employed by Francis Bacon, Thomas Hobbes, Samuel Pufendorf, Gottfried Wilhelm von Leibniz, Johannes F. Buddeus, Christian Thomasius, and others, who spoke of the cultivation of the soul, mind, intellect, or reason (*cultura animi, mentis, intellectus, rationis*); and Leibniz, for one, rendered it into the vernacular as "Cultur," or "Kultur."

The terminology was shifted from an individual to a social level as a way of indicating levels of civilization and judging "which peoples may be judged to be barbaric and which cultivated," in the words of Pufendorf in 1663. "True culture" (*vera cultura*), according to Buddeus, was an indication of morality, sociability, and emergence from an animal state; and the first question centered on the "origin of human culture and civility" and their emergence from a "primeval condition." In 1774 Jean-Bernard Mérian wrote of primitive savages as "a people of hunters, navigators, without culture, without laws, without arts." Thus "culture," together with its companion, "barbarism," represents the judgments passed by Europeans on their own and other societies, past and present.

"Cultural history" (*Kulturgeschichte*) arose as a term and a concept in the later eighteenth century, as "culture" replaced earlier equivalents, including "spirit" (*mens, esprit, Geist*, etc.), which was extended from individual psychology to collective

mentality (e.g., *Volksgeist* or *Zeitgeist*), and literature, referring to all the written remains of human cultural achievement. The "history of the human spirit" (*historia intellectus humani; histoire de l'esprit humain; Geschichte des menschlichen Geistes*) was a phrase often used by eighteenth-century historians of particular disciplines. "Literary history" (*historia literaria*), was a major genre, treating (as the seventeenth-century polyhistor Gerhard Joannes Vossius wrote) "the lives and writings of learned men and the invention and progress of the arts." As Nicholas Wickenden has put it, "What Vossius called 'literary history' was really what would now be called cultural history."

Culture and Language

In 1781, the year when Immanuel Kant's *Critique of Pure Reason* marked a revolution in philosophy, Johann Adelung, in his *Versuch einer Geschichte der Cultur des menschlichen Geschlechts*, identified "the first beginnings of culture" with the origins of language, adding that thereafter, through the development of agriculture and private property, "language follows culture," and furthermore, "Since the language of every nation has the closest relationship with its culture, its history can never be understood without continual reference to the conditions and progress of culture." For Adelung "culture is the transition from a more instinctive and animal-like condition to the more complex relations of social life" so that "When culture ceases, so does true history." Deliberately or not, Adelung set a terminological and conceptual fashion that has figured prominently in modern historiography and the human sciences for two centuries.

The best-known convert to the new terminology was Johann Gottfried von Herder, whose *Another Philosophy of History* (1784) told the story of the development of the "human spirit" from its appearance in the state of nature to the emergence of the *Volksgeist*; but a decade later, in his *Ideas for the Philosophy of History of Mankind*, he referred to the process or "chain of culture" in the sense of the cultivation of intellectual and linguistic attributes. To Kant's "critique of pure reason" he opposed a "metacritique," arguing that the object of criticism must be not pure but human reason, not transcendent and ahistorical spirit but concrete, temporal manifestations, beginning with language, without which "reason" could not express itself. For Herder, cultural history aspired not only to criticize but even to replace philosophy as the foundational discipline of human understanding. And other scholars followed Herder in associating cultural history with critical philosophy, including Christoph Meiners, Karl Franz von Irwing, K. H. L. Pöhlitz, Dietrich Hermann Hegewisch, and Johann Gottfried Eichhorn.

"Cultural history" had an extraordinary *fortuna* in the generations after Adelung and Herder. The quantity of published works was striking, and their topics were global and local, ancient and modern, general and special (including cultural histories of literature, medicine, commerce, etc.), and they were often designed for a general rather than merely a learned readership. The heyday of cultural history in this tradition was reached in the Victorian period with the voluminous publications of Wilhelm Wachsmuth, Gustav Klemm, Georg Friedrich Kolb, Gustav Freitag, Wilhelm Riehl, Friedrich

Anton Heller von Hellwald, Otto Henne am Rhyn, Karl Grün, J. J. Honegger, and Julius Lippert. Klemm, who was the founder of an extraordinary ethnographic museum in Dresden, an early model for the Smithsonian Institution, asked such questions as “What were the oldest tools of the human race? and How did early man eat, drink, shelter and cloth himself?” His *Allgemeine Cultur–Geschichte der Menschheit* (1843), while paying homage to the old Herderian tradition, presented its subject from an entirely “new standpoint,” according to which human thought and action were seen not primarily in a Biblical framework but in a prehistorical, evolutionary continuum that denied supernatural privilege to humanity and emphasized what, long before Fernand Braudel, was called “material culture” (*materielle Kultur*).

Material and Spiritual Culture

In the nineteenth century as today, the most important interdisciplinary connection of cultural history was the new field of anthropology. In the famous formula of Edward Tylor, father of modern anthropology, in his *Primitive Culture* (1881): “Culture or Civilization taken in its wide ethnographic sense is that complex whole which includes knowledge, belief, art, morals, law, custom, and any other capabilities and habits acquired by man as a member of society.” Tylor referred in particular to Klemm’s conception of “Culture–History,” which he preferred to the more conventional terminology of “civilization.” And the influence was mutual, reflecting back on German scholarship: “What is Culture?” asked the cultural historian J. J. Honegger in 1882 and, by way of answer, gave a paraphrase of the very definition given by Tylor in 1865.

Victorian scholars were poised, or torn, between two conceptions of culture. One was the material culture rooted in primitive life and the other the spiritual culture reflected in such human creations as art, literature, philosophy, and religion. “Culture and anarchy” was the famous formula of Matthew Arnold, who sought, in an idealized and progressivist culture, “the study of perfection” and perhaps “a great help out of our present difficulties.” Opposed to the focus of scholars such as Klemm were the cultivated students of spiritual culture (*geistige Kultur*), of whom Jacob Burckhardt was the most notable representative. While the first took the low road, the latter took the high road to the study of culture, although Burckhardt did not ignore popular culture, as shown by in the pages of his *Civilization of the Renaissance in Italy* (*Kulturgeschichte* was his term) devoted to costume, etiquette, domestic life, festivals, and other topics rediscovered recently by the “new cultural history.” Like Klemm, Burckhardt was a collector, drawn especially to art and literature, and he defined culture “as the sum total of those mental developments which take place spontaneously and lay no claim to universal of compulsive authority.” Suspicious of modern power politics, he was also critical of the material progress of his age, which he regarded as a principal threat to his cultivated world. “We may all perish,” he wrote, “but at least I want to discover the interest for which I am to perish, namely, the culture of old Europe” (*Letters*, p. 197).

By the end of the century, cultural history had achieved high public visibility and a significant academic base, with a

large bibliography, several journals, and historiography of its own; and it became a subject of contention among historians. The battle of methods (*Methodenstreit*) began in 1888 when Dietrich Schäfer gave a lecture denouncing the trivialities of cultural history and reasserting the primacy of politics. This manifesto was answered the next year by Eberhard Gothein, who defended cultural history against the charges of materialism and urged the value of other cultural forms—religion, art, law, and economics—in the effort to understand historical change. This was the view also taken by Karl Lamprecht, who for a generation occupied the storm center of the historical *Methodenstreit* heralded by this exchange and who became the leading figure in the theory and practice of cultural history before World War I.

In 1886 Lamprecht turned to his lifework, *Deutsche Geschichte*, which was a survey of the whole cultural history of Germany; he established at the University of Leipzig a “historical seminar” and then a more ambitious Institute for Cultural and Universal History. In his late years Lamprecht’s public life was torn by controversy about the status, role, and value of cultural history in scholarship and teaching. Lamprecht’s “new history,” as it was pejoratively called, was based on advances in linguistics, archeology, art history, economics, and especially recent psychology (i.e., *Völkerpsychologie*, social psychology). Although few of his professional colleagues, aside from students, accepted his eccentric and aggressively argued views, and he died in some disrepute, the popularity of his work testified to the appeal of his arguments.

Lamprecht’s “new history” had counterparts elsewhere in the West, especially France and the United States, which also emphasized the central role of culture. Henri Berr was already working out the agenda expressed in his concept of “synthetic history,” which underlay the efforts of his younger colleagues leading to the formation of the *Annales* school of history. It was in the wake of such discussions that James Harvey Robinson of Columbia University, in 1912, proclaimed his own version of the “new history,” which was likewise opposed to conventional political history. These views were echoed by other scholars, including Johann Huizinga, who delivered his manifesto on “the task of cultural history” in 1926. After World War I a kind of cultural history was continued in Germany in a debased form in the racist *Volksgeschichte*, which reinforced the ideology and imperialist policies of the Third Reich.

In the French and Anglophone world the semantic rival of “culture” was “civilization” (replacing “civility”), which was also a neologism of the eighteenth century, associated with Voltaire and what Carl Becker called the “new history” of the Enlightenment and which was also contrasted with “barbarism” and intended to designate the highest stage of human development. The classic history of the rise of “civilization” in the West was that of François Guizot, for whom “civilization is a fact like any other,” and indeed “the fact par excellence,” which in his famous lectures, given before the Revolution of 1830 drew him into politics, he traced from classical antiquity down to the French monarchy, which was the highest expression of this fact. Guizot set the line of argument for several

generations of cultural history in France. In England Henry Thomas Buckle's *History of Civilization in England* was hardly less influential, although its doctrinaire scientism and materialism eventually rendered it unfashionable and indeed obsolete.

Twentieth-Century Developments

The writing of cultural history expanded further in the twentieth century as textbooks and popular works presented the results of generations of research and interpretation. Notable examples were the one hundred volumes of Henri Berr's series *Evolution of Humanity* (begun in 1920); Egon Friedell's *A Cultural History of the Modern Age* (1931), which, dedicated to Bernard Shaw and glorying in its journalistic style, carried the story from the Renaissance to psychoanalysis and the "collapse of reality"; Preserved Smith's *History of Modern Culture* (1934), which, in the spirit of Robinson's new history, surveyed early modern sciences, humanities, social control, and "spirit of the times"; and *European Civilization: Its Origin and Development*, edited by Edward Eyre (7 vols., 1934–1939), which included also global frontiers beyond the West. In such works the whole world, private and public, real and imagined, natural and social, becomes a field of anthropological inquiry, interpretation, and speculation.

From the beginning the defining feature of cultural history, shared with anthropology, has been an inclination to holism—the effort to grasp "the history of everything," in Berr's famous phrase, or as Harry Elmer Barnes wrote of the new history, "the recording of everything which has happened in the past"—but of course "in the light of twentieth-century knowledge and methods." Yet cultural history was turned to analysis as well as synthesis, and so in 1940 in the United States, for example, there appeared a volume, *The Cultural Approach to History* ("edited for the American Historical Association"), which explored a wide range of techniques of cultural analysis, means of analyzing social groups, nationality, institutions, and ideas as sources of cultural history.

In this generation little has changed save the rhetorical claims in the "new cultural history," so-called since the publication of the volume by the same name by Lynn Hunt in 1989, supplemented also by the "new historicism," which has made its own contributions to cultural history, and by the study of mentalities and cultural practices carried on from the *Annales* school by Roger Chartier. In general, recent cultural history has come to embrace a wide and miscellaneous range of topics, such as crime, madness, childhood, old age, gesture, humor, smells, space, and other items (appearing on the world wide web) from addiction to unbelief. In terms of theory this self-proclaimed "new cultural history" has arisen out of the wreckage of scientific and Marxist history, which sought the concealed mechanisms of social change beneath the surface of collective behavior. This is true in the sense not only that many new cultural historians such as Natalie Davis and Lynn Hunt have emerged from the materialist assumptions of socioeconomic historical practice and/or Marxist theory, but also that cultural history has always contained a powerful critique of such methods.

In general, cultural history rejects economic and political reductionism, gives up the noble dream of objectivity, recognizes the role of imagination in historical reconstruction, and, no longer aspiring to rigorous explanation, turns instead to what has been called "interpretive social science." As represented by Clifford Geertz and Charles Taylor, interpretive social science places understanding (*Verstehen*) above explanation and so hermeneutics above causal analysis as the principal access to a knowledge of the human condition, past and present. Explanation requires some sort of reduction of experience, or evidence, to crucial factors at the expense of excluding other experience, or evidence, which not only lends color or, as Geertz says, thickness to description but also qualifies simplistic and naturalistic notions of causation.

The new cultural history may entail a sort of relativism distasteful to historians of the older schools, but the positive aspect is a more critical awareness of the meaning of the historian's craft. Not only the objects of history but the works of historians are themselves subject to the conditions of their cultural environment, and so (in contemporary parlance) "culturally constructed." Yet the premise of the new cultural history that, as Hunt writes, "the representations of the social world themselves are the constituents of social reality," is an insight not unfamiliar to earlier cultural historians; for as Huizinga reminded us, "The historical discipline is a cultural process." And like culture it is still changing and renewing itself, though not always with much appreciation for its own history.

See also *Cultural Studies; Historiography; Ideas, History of.*

BIBLIOGRAPHY

PRIMARY SOURCES

- Breysig, Kurt. *Kulturgeschichte des Neuzeit*. Berlin: G. Bondi, 1900.
- Burckhardt, Jacob. *Die Cultur der Renaissance in Italien*. Basel: Schweighauser, 1860.
- Dean, Amos. *The History of Civilization*. 7 vols. Albany, N.Y.: J. Munsell, 1868–1869.
- Eichhorn, J. G. *Allgemeine Geschichte der Cultur und Litteratur des neueren Europas*. 2 vols. Göttingen, 1796.
- Guizot, François Pierre Guillaume. *History of Civilization in Europe: From the Fall of the Roman Empire to the French Revolution*. 3 vols. 1846.
- Henne am Rhyn, Otto. *Kulturgeschichte der neueren Zeit*. Leipzig: O. Wigand, 1870–1872.
- Honegger, Johann Jakob. *Allgemeine Kulturgeschichte*. 1882.
- Klemm, Gustav Friedrich. *Allgemeine Cultur-geschichte der Menschheit*. 1843.
- Kolb, Georg Friedrich. *Culturgeschichte der Menschheit*. 2 vols. Leipzig: A. Felix, 1872–1873.
- Lamprecht, Karl. *Die kulturhistorische Methode*. Berlin: H. Heyfelder, 1900.
- . *What is History? Five Lectures on the Modern Science of History*. Translated by E. A. Andrews. New York and London: Macmillan, 1905.
- Lippert, Julius. *The Evolution of Culture*. Translated by George Peter Murdoch. New York: Macmillan, 1931.

Steinhausen, George. *Geschichte der Deutschen Kultur*. Leipzig and Vienna: Bibliographisches Institute, 1904.

Weber, Alfred. *Kulturgeschichte als Kulturosoziologie*. Munich: R. Piper, 1951.

SECONDARY SOURCES

Burke, Peter. *Varieties of Cultural History*. Ithaca, N.Y.: Cornell University Press, 1997.

Chartier, Roger. *Cultural History: Between Practices and Representations*. Translated by Lydia G. Cochrane. Ithaca, N.Y.: Cornell University Press, 1988.

Febvre, Lucien. *A New Kind of History: From the Writings of Febvre*. Edited by Peter Burke. Translated by K. Folca. London: Routledge and Kegan Paul, 1973.

Haas, Stefan. *Historische Kulturforschung in Deutschland 1880-1930*. Cologne: Böhlau, 1994.

Hunt, Lynn, ed. *The New Cultural History: Essays*. Berkeley: University of California Press, 1989.

Kelley, D. R. "The Old Cultural History." *History and the Human Sciences* (1996): 101–126.

Weintraub, Karl J. *Visions of Culture: Voltaire, Guizot, Burckhardt, Lamprecht, Huizinga, Ortega y Gasset*. Chicago: University of Chicago Press, 1966.

Wickenden, Nicholas. *G. H. Vossius and the Humanist Conception of History*. Assen: Van Gorcum, 1993.

Donald R. Kelley

CULTURAL REVIVALS. The term *cultural revival* refers to the formation of group identity around a common culture, where a claim is forwarded that the aspects of culture with which the group identifies have been recovered after losses due to colonization, forced or voluntary relocation, oppression, or modernization. Cultural revival is predominantly associated with minority populations and frequently underwrites demands for rights, restitutions, and political or legal recognition as an ethnic group. Much scholarship on the subject has taken examples of cultural revival at face value, undertaking to document the strategies such groups employ and analyze the cultural practices and materials they recover. Work by historians, anthropologists, and sociologists in the 1980s and 1990s, however, theorized the phenomenon as a hallmark of social formations under capitalist modernity.

According to these scholars, cultural revival is a tactic pursued—consciously or unconsciously—by minority communities to consolidate political identity and gain recognition through an appeal to foundationalist cultural logic—that is, the belief that “authentic” traditions are unchanging and ancient, unique to and defining of a given community, and properly transmitted only to members of that group through heredity and ancestry.

Critical Approaches

Scholarship on cultural revivals has been shaped by theoretical developments in three major areas: ethnicity, nationalism, and modernity. Since the work in the 1960s of Nathan Glazer and Daniel Patrick Moynihan, theories of ethnicity have regarded ethnic groups as “interest groups”: ethnic identity is

proposed, maintained, or solidified when political or economic gains accrue to the group through doing so, rather than because primordial ties, distinctive customs, and cultural heritage cannot be relinquished. While early scholars were interested in the persistence of ethnic identification among migrants in an assimilationist United States, subsequent Marxist anthropologists have focused on cultural revivals and ethnic nationalisms. They link them to competition between subnational communities over access to material resources and suggest that the uneven nature of capitalist expansion creates spaces in which marginalized groups bid for access to the benefits of development with culture operating as their symbolic legitimation and means of solidifying group loyalty.

Moving beyond this “instrumentalist” position, but also remaining skeptical of the “primordialist” claims of revivalists themselves, the insights of historians of nationalism have shed light on the crucial role of cultural practices, understandings, and performances in the formation and functioning of cultural revivals, and the affective experience of those involved in them. Like cultural revival, cultural nationalism is predicated on a supposed shared language, tradition, and culture, and an appeal to foundational history, which, no matter how artificially constructed (through the suppression of minority dialects, for example), is experienced as profoundly real and binding. The work of Benedict Anderson illuminated the cultural means through which the abstraction of nation produced for its members a sense of deep loyalty and belonging—an “imagined community”—otherwise absent in a secular, atomized, competitive, and individualist modernity. An influential collection by Eric Hobsbawm and Terence Ranger similarly troubles the primordialist claims of cultural revivalism while pointing to its cultural and historical significance and the power of its appeal. The essayists in *The Invention of Tradition* argued that significant bodies of what we regard as “tradition” are, in fact, of comparatively modern origin, “responses to novel situations which take the form of reference to old situations, or which establish their own past by quasi-obligatory repetition” (p. 2). The editors proposed that the rapid changes and violent discontinuities of modernity (including the dislocations of diaspora, colonization, and forcible “modernization” that frequently occasion later attempts at cultural revival) called for the formalizations of tradition that “established and symbolized social cohesion or the membership of groups, real or artificial communities” through ritual performance (p. 9).

Postmodernist interpretations of cultural revival are premised on the axiom that “culture” is a text, which, like all texts, is an assemblage of signifiers from the sign systems of cultural discourse at large. While specific signifiers become attached to specific groups by social convention (a doughnut is associated with the United States, the attribution of heightened aesthetic sensibility attaches to the French), these relations are essentially arbitrary (doughnuts, for example, originated in Germany, and heightened aesthetic sensibility is a rhetorical proposition rather than an empirical claim). Arguments that specific signifiers authentically, naturally, or historically belong to a given group—the central claim of cultural revival—operate as “truth claims,” attempts to secure and authorize a particular version of reality against possible competing versions. The irony of this

analysis for cultural revivalists is that the cultural elements reclaimed by reviving groups can, more frequently than not, be proved to be integral aspects of the sign system of the dominant culture against which the revivalists stake their claim. The idea that an indigenous people lives in harmony with nature, for example, is a recurrent theme of cultural revivals and can be argued to have much more to do with postindustrial Western romantic structures of belief than with the historical lifeways of specific indigenous populations. (See Hanson for a concise, and later controversial, application of postmodernist analysis to Maori cultural revival). Theorists such as Dean MacCannell have gone further in suggesting that contemporary cultural revivals are not only semiotic constructions (like other cultural and ethnic identities), but that they are a uniquely postmodern phenomenon that he calls “reconstructed ethnicity,” in which authenticity itself has taken on a commodity value. This fetishization of authenticity, he argues, stunts cultural agency and evacuates the particularity of local cultural expression, as groups come to project and identify with a generalized and interchangeable image of “traditional” values.

While some thinkers in the postmodernist or poststructuralist camp believe the essentialist logic of cultural revivalism—the idea that members of the group are distinguished by their unique possession of an inherent, authentic, and unchanging essence expressed through culture—to be an inherently unsound basis for a resistant politics, and devote their critical energies to discrediting such claims, others (among them, Gayatri Spivak) understand it to be a strategic necessity that can authorize beleaguered minorities (with “scrupulously conscientious” aims) to speak as political subjects within a dominant system.

Fourth World Revivals

Perhaps the most dramatic and effective cultural revivals have been those of “Fourth World” populations, defined as indigenous peoples who hold the status of political and/or numerical minorities within the nation-states that encompass their ancestral territories. These groups include North American Indians, New Zealand Maori, Australian Aboriginal, Norwegian Sami, and many others. In these contexts, cultural revival appears as a logical response to histories of state-supported genocide, assimilation, and the disruption or prohibition of cultural practices. Where such state strategies attempted, usually deliberately, to erode ethnic allegiances that opposed state hegemony, cultural revival seeks to reconstruct these communities and networks as the first step in resistance to domination. It thus indirectly addresses the conditions of socioeconomic deprivation, prejudice, and lack of opportunity that have for these groups been the corollaries of colonization, by validating cultural identities devalued by dominant or colonial culture, and providing the basis for collective pride, unity, and action. The long-term sustainability of such initiatives, however, is frequently determined by existing institutional and governance structures, both within and outside the community in question.

An example of a successful Fourth World cultural revival is the case of New Zealand Maori. After the devastating losses of a century and a half of colonization, cultural assimilation, and urbanization, a “Maori renaissance,” beginning in the

1970s, was centered around the fight for rights to land illegally taken during colonization and was inspired by independence movements in still-colonized territories and civil rights struggles in the United States. Early goals of this revival were the promotion of Maori language learning (spoken by less than one percentage point of the population in the 1970s) and the rehabilitation of knowledge of *Maoritanga* (Maori culture, custom, and identity), particularly among the youth of the community. In both of these matters, the Maori revival has been extremely effective, fostering Maori language use throughout the population and training a whole generation of Maori political leaders whose primary commitments are to their ethnic community and who understand themselves as acting in consonance with Maori priorities and customary protocol. Aided by the resilience and strength of tribal networks that survived the ravages of colonization, the united front presented by early protests forced a reconsideration of land-rights policy by the state, and subsequent restitution processes have led to the recognition of Maori cultural considerations as an integral element in national governance. While claims to authenticity were strategically important in legitimating the revival during its early stages, primordial arguments have given way with the securing of state recognition to a broad understanding that Maori culture is a living, inventive, and syncretic set of practices that provides a flexible basis for collective identity and action in changing conditions.

In contrast to these Fourth World examples, the rhetoric of cultural revival is rarely observed in postcolonial states where previously colonized ethnic groups have gained the power of self-governance, giving further credence to the theory that cultural revival is a tactic pursued predominantly by the politically marginal. In postcolonial states, culture-based claims are more likely to be suppressed in favor of the liberal individualist humanism that legitimates Western-style government, or alternatively, to be branded as divisive and backward.

Ethnic Nationalisms and Race-centered Solidarities

Similar processes of politically motivated cultural revival can be seen at work even in cases where cultural continuity has been violently severed, and collective heritage has been erased by historical traumas such as occupation or slavery. An example of this kind of revival is the race-based solidarity forged by black nationalists in the United States. Recognizing the failure of strategies of racial accommodation and integration in the face of continued structural oppression, black nationalism offered not only a framework for analysis—the black nation was colonized by white America—but a strategy for resistance: collective, anticolonial struggle. Advocates such as Harold Cruse argued in the language of cultural nationalism, claiming that championing an autonomous cultural heritage would not only create unity in a vastly diverse population, but it would also foreground and counter the colonial exploitation and derogation of black culture by whites within the United States, with all its destructive psychological effects, and suggest radical alternatives to liberal accommodationism of civil rights. Movements such as the Harlem Renaissance, Negritude, and pan-Africanism were cultural revivals in that they recognized, celebrated, and discovered cultural continuities

with a shared African heritage, fostered invented traditions (such as Kwanzaa), and authorized their ideological claims through reference to this resurgent culture.

Theoretical Trajectories and Contemporary Contexts

While it may seem at first glance that cultural revivals work to undermine the political hegemony of the nation-state, and oppose themselves to dominant cultural and economic interests, these relationships are complex and frequently ambivalent. A new generation of research on cultural revivals parses their role in the sociopolitical formations, economies, and belief systems of nations.

Antimodernism, revival, and the tourism and heritage industry. Scholars have noted the constitutive place that appeals to lost heritage have in the rhetoric of modernity. If to be “modern” is to be severed from one’s ethnic past and the holistic sense of community it represents, critiques of industrial modernity tend to be expressed through the idealization of heritage and the cultural integrity of “primitives” or “exotics.” This yearning for a lost wholeness and authenticity results in support for salvage and preservation efforts that in turn present the “lost” or “recovered” cultural materials for the consumption of the dominant, modern culture, frequently as tourist or heritage attractions. The ironic structure of belief underpinning this process has been called “imperialist nostalgia”—where imperialist or capitalist expansion causes the ongoing damage and erasure of traditional lifeways, and is “nostalgically” lamented by its agents even as they continue to perpetuate it, or “ethnological antimodernism,” expressing one’s commitment to the superiority and normativity of modernity through a romantic, consumerist overvaluation of “premodern” peoples and their cultures.

In material practice, this can lead to an uncomfortable symbiosis as the group in the process of cultural revival becomes a symbolic resource and economic asset for the very state that is responsible for their oppression as an ethnic minority. The power to articulate cultural identity, meanwhile, remains clearly in the hands of the state, the market, or the dominant ethnic interest: cultural identities are validated insofar as they conform to hegemonic agendas, and particular forms of cultural expression (a ritual, distinctive costume, or festival, for example) are selected for preservation and display while others are neglected or actively repressed. At best, cultural revival under these conditions can offer some minimal form of recognition, representation, or leverage that can be capitalized on by a minority group.

Theorists such as Barbara Kirschenblatt-Gimblett have elaborated these observations, suggesting that the action of naming and presenting a set of cultural practices as heritage constitutes in itself an ironic form of cultural revival. The culture that becomes “heritage” is both given a second life (endowed with cultural and economic value by its prospective consumers) and declared dead in the same gesture, as it enters the domain of cultures deemed to belong to “history.” An instance of this is the preservation of closed Welsh coalmines by local governments with the aim of reconstituting them as tourist attractions that feature the lifeways and work of the

colliers of a past age. This development strategy obviously has mixed implications for those for whom this way of life is a living concern and whose political energies are devoted to encouraging reinvestment in coal production by the British government.

Liberal multiculturalism. Some scholars have examined the paradoxical codependence of cultural revivals and the states against which they articulate themselves through the lens of political discourse and juridical practice. Anthropologists such as Elizabeth Povinelli, drawing on work in radical political theory, have noted that liberal multiculturalism demands the demonstration of cultural difference to validate its prevailing ethic as a “rational, non-violent form of association based on competing knowledges and moral values” (p. 6). Yet the national recognition of difference is always conditional, disqualifying differences that prevailing morality finds repugnant, however irrationally, or that are incompatible with Western constructions of “tradition” (preferring, for example, continuity over revival, spiritual over economic or material orientation). This logic is particularly conspicuous in cases where revival is accompanied by legal procedures for restitution. As in the Aboriginal land hearings that Povinelli discusses, court proceedings function as public revival rituals, occasions for the collective demonstration of national repentance and the celebration of majority tolerance, which center paradoxically around the state’s legislation of what constitutes “traditional custom,” and its demand that aboriginals not only identify with but perform this version of culture as a prerequisite of their recognition as political subjects.

Globalization and revival. The phenomenon of cultural revival is entering a new phase with the changes in social and political formation that accompany globalization, giving rise to cultural revivals that operate above the level of the nation-state, linking members of an ethnic group residing in geographically distant locations, and appealing for recognition not just to national governments but to transnational publics. Scholars of contemporary cultural revival are beginning to focus on the new strategies and discourses that emerge as revivals are shaped by their challenge to transnational rather than national relations of ethnicity and race, and operate predominantly through the dissemination of images and discourse in communications media, rather than through the immediacy of cultural performance and territorial sentiment. What new forms of affinity and belonging do global revivals draw on? What new ideas about culture do they produce, and which old ones do they perpetuate? These may well be the questions asked of cultural revival in the future.

See also *Ethnicity and Race; Ethnohistory, U.S.; Modernity; Nationalism; Practices; Tradition.*

BIBLIOGRAPHY

- Anderson, Benedict. *Imagined Communities: Reflections on the Origin and Spread of Nationalism*. London: Verso, 1983.
- Hanson, Allan. “The Making of the Maori: Culture Invention and Its Logic.” *American Anthropologist* 91, no. 4 (1989): 890–902.

- Hobsbawm, Eric, and Terence Ranger, eds. *The Invention of Tradition*. Cambridge, U.K.: Cambridge University Press, 1983.
- Kirschenblatt-Gimblett, Barbara. *Destination Culture: Tourism, Museums, and Heritage*. Berkeley: University of California Press, 1998.
- MacCannell, Dean. *Empty Meeting Grounds: The Tourist Papers*. London and New York: Routledge, 1992.
- Omi, Michael, and Howard Winant. *Racial Formation in the United States: From the 1960s to the 1980s*. New York and London: Routledge and Kegan Paul, 1986.
- Povinelli, Elizabeth A. *The Cunning of Recognition: Indigenous Alterities and the Making of Australian Multiculturalism*. Durham, N.C.: Duke University Press, 2002.
- Spivak, Gayatri Chakravorty. *The Post-Colonial Critic: Interviews, Strategies, Dialogues*. Edited by Sarah Harasym. New York: Routledge, 1990.
- Wilmsen, Edwin. "Introduction: Premises of Power in Ethnic Politics." In *The Politics of Difference: Ethnic Premises in a World of Power*, edited by Edwin N. Wilmsen and Patrick McAllister. Chicago: University of Chicago Press, 1996.
- Wood, Robert. "Touristic Ethnicity: A Brief Itinerary." *Ethnic and Racial Studies* 21, no. 2 (1998): 218–241.

Margaret Werry

CULTURAL STUDIES. Cultural studies is one of the more controversial intellectual formations of the 1990s and the first decade of the third millennium. It has experienced a period of rapid growth in the academy, appearing at many universities in a variety of forms and locations (although rarely as degree-granting departments). At the same time, it has been broadly attacked both from inside the university and outside academia.

Definitions

There are at least five distinct uses of cultural studies, making it difficult to know exactly what people are attacking or defending. It has been used to describe, alone or in various combinations:

1. Any progressive cultural criticism and theory (replacing "critical theory," which served as the umbrella term of the 1980s);
2. The study of popular culture, especially in conjunction with the political problematic of identity and difference;
3. So-called "postmodern" theories that advocate a cultural or discursive constructionism (and, thus, supposedly embrace relativism);
4. Research on the politics of textuality applied broadly to include social life, especially based in poststructuralist theories of ideology, discourse, and subjectivity;
5. A particular intellectual formation that is directly or indirectly linked to the project of British cultural studies, as embodied in the work of Ray-

mond Williams, Stuart Hall, and the Centre for Contemporary Cultural Studies (CCCS).

This entry discusses only the last of these referents even though it is especially difficult to define this intellectual formation. Even the simple claim of British origin is, in the end, probably unacceptable. Still, it provides a reasonable starting point for this discussion. The English origins of cultural studies can be linked to at least four elements of the post–World War II context. First, one of the major issues organizing political debate was framed as the challenge of Americanization, which was perceived in largely cultural terms, both in the growing presence of U.S. popular culture and in the apparent disappearance of many aspects of traditional, working-class culture.

Second, the New Left emerged as a small but influential discussion group, and included many immigrants from the "colonies." It was sympathetic to (but not aligned with) the growing Campaign for Nuclear Disarmament. The New Left had a specific and ambivalent relation to Marxism, engaging Marxist theory and politics even as it criticized it for its failure (and inability?) to account for and respond to the challenges posed by the importance of ideology, colonialism and imperialism, race, and the failures of existing socialism. This work was enabled by the translation and publication of the early writings of Marx and a wide range of European Marxist thinkers.

Third, the British university system was, to put it mildly, elitist and classist, in terms of its student population and in its isolation, aestheticization, and limitation of culture to the field of the arts. Many of the influential early figures in cultural studies were working-class or immigrant students attending university on scholarship, who were driven to look for other accounts of culture that both expanded its referent and took it more seriously.

Finally, many of these figures were deeply influenced by their experience as teachers in various institutions of adult education outside the university. If nothing else, this experience played a role in convincing them, first, of the importance of culture (and intellectual work on culture) to both political struggle and people's everyday lives, and second, of the fact that the important questions do not usually respect the disciplinary boundaries of academic competence and expertise.

Culture and Context

In this context, a number of writers—especially Raymond Williams and Richard Hoggart—began to explore the political and theoretical significance of the concept of culture in relationship to the broader contexts of social life. Trained as literary critics, they argued that cultural texts provided insights into social reality unavailable through the traditional social sciences and enabled one to understand what it felt like to be alive at a particular time and place—to grasp what Williams called "the structure of feeling." They sought to describe culture's concrete effects on people's lives. Hoggart's *The Uses of Literacy* (1957), for example, entered into the debate over Americanization, using close textual analyses to ask whether the new forms of popular culture were unsettling the established relations between working-class cultural practices and

the patterns of everyday life of the working classes. Williams—in *Culture and Society* (1958) and *The Long Revolution* (1965), and in other works throughout his career—sought the theoretical and methodological tools that would allow for description of the concrete relations among cultural practices, social relations, and organizations of power.

In 1964 Richard Hoggart set up the CCCS to continue these efforts when he was hired as professor of English literature at the University of Birmingham. This was done with the permission of both his department and the university, but with only their minimal support. He funded the Centre himself from monies he received for testifying in defense of D. H. Lawrence at an obscenity trial, and he hired Stuart Hall, who had already published *The Popular Arts* (1964) with Paddy Whannel. Hall became director in 1969 when Hoggart left to become assistant director of UNESCO. When Hall took a position as professor of sociology at the Open University in 1980, he was replaced by Richard Johnson. In the following years, the Centre was transformed and combined in a number of administrative incarnations until 2002, when the University of Birmingham dismantled the Department of Sociology and Cultural Studies.

The Centre undertook, both individually and collectively, a wide range of sometimes evolving and sometimes discontinuous researches, both theoretical and empirical, into culture and society, and was characterized internally by a wide range of positions and practices. Externally, it came to represent a more limited body of work as it engaged over the years in a number of highly visible public debates with other groups interested in the politics of culture. The Centre is most widely known for having offered a number of models of cultural studies from the mid-1970s to the mid-1980s, including models of: ideological analysis; studies of working-class cultures and subcultures, and of media audiences (all of which, taken together, constituted a particular understanding of culture as a site of resistance); feminist cultural research; hegemonic struggles in state politics; and the place of race in social and cultural processes. The Centre was primarily associated, quite commonly, with the work of the Italian Marxist Antonio Gramsci.

The work of the Centre was not known widely outside of England, and only marginally known in the United States—primarily in departments of education and communication—until the mid-1980s. In the summer of 1983, a series of events organized around the theme “Marxism and the Interpretation of Culture” at the University of Illinois brought Hall and other key figures from the Centre to the United States. In the mid-1980s, the *Australian Journal of Cultural Studies* was founded, and when it followed its editor John Fiske (a student of Raymond Williams who had emigrated to Australia) to the United States, it became the first international journal explicitly devoted to the field.

In 1992 the University of Illinois hosted a second major conference, “Cultural Studies Now and in the Future.” During and after this conference, the validity of assuming British cultural studies to be the origin of cultural studies on a larger scale was increasingly challenged. It became clear that the

British tradition was less an origin than a term around which a set of similar projects from all over the world could gather and work. People from Latin America, Asia and the Pacific Rim, Europe, and Africa offered their own indigenous traditions of cultural studies, many of which had developed without any knowledge of the British work, and often had no agreed-upon common label. During the 1990s cultural studies became visible—as something both claimed and contested—in many of the major disciplines of the humanities and social sciences (especially literary studies and anthropology) in the United States and in other parts of the world. In 2002 the first international Association for Cultural Studies was launched.

The founding insight of the British tradition was that what had been traditionally approached as an external relationship between two objects of study—the relation of culture and society—was somehow inscribed in the very complexity of culture itself: culture as a set of privileged activities (inevitably raising questions of value); culture as the uniquely human, mediating activities of symbolic life (for example, textuality, sense-making, signification, and representation); and culture as a whole way of life (linking culture to the totality of social life, including conduct, relations, and institutions). Cultural studies is about the relationship of anthropological, hermeneutic, and aesthetic discourses and practices of culture. It treats culture, then, as more than either a text or a commodity. It looks at culture as the site of the production of (and struggle over) power.

Formations of Cultural Studies

Cultural studies is concerned with describing (and intervening in) the ways cultural forms and practices are produced within, inserted into, and operate in and affect the everyday life of human beings and social formations, so as to reproduce, struggle against, and perhaps transform the existing structures of power. That is, if people make history—but within conditions not of their own devising—cultural studies explores the ways this process is enacted with and through cultural practices, and studies the place of such practices within specific historical formations. Cultural studies explores the historical possibilities of transforming people’s lives by trying to understand the relationships of power within which individual realities are constructed. That is, it seeks to understand not only the organizations of power but also the possibilities of survival, struggle, resistance, and change. It takes contestation for granted, not as a reality in every instance, but as an assumption necessary for the existence of critical work, political opposition, and even historical change. Cultural studies is not simply about texts or ideologies, but about the relationships that are historically forged among cultural practices and the contexts in which they operate.

Any further attempt to define cultural studies poses rather unique problems. It cannot be equated with any particular political agenda or with any particular theoretical position. Thus, on the one hand, while British cultural studies is often thought to have investigated class politics, it includes many examples of both feminist cultural studies and cultural studies invested in the politics of race, ethnicity, or post-coloniality. Unlike post-1960s academic formations associated with a particular political agenda (and a pre-constituted

constituency outside the academy), cultural studies has no such guaranteed agenda or constituency. On the other hand, cultural studies is not a school of thought that can be linked irrevocably with a particular theory. Again, the British school is assumed to be grounded in Marxism (and especially in the work of Gramsci), but this is only because the diversity of that tradition has been reduced to a single, small set of representatives and examples. In fact, in England as well as elsewhere, cultural studies has drawn upon, and embodied, an enormously wide range of theoretical positions, from humanism to poststructuralism, from Marx to Foucault, from pragmatism to psychoanalysis.

Raymond Williams's distinction between the common project of cultural studies, and its many different formations, recognizes that practicing cultural studies involves redefining it in response to its changing context (its geographical, historical, political and institutional conditions).

The Project of Cultural Studies

The most basic—and most radical—assumption of cultural studies is that the basic unit of investigation is always relationships, and that anything can only truly be understood relationally; thus, studying culture means studying the relationships between configurations of cultural texts and practices on the one hand, and everything that is not in the first instance cultural—including economics, social relations and differences, national issues, social institutions, and so forth—on the other. It involves mapping connections, to see how those connections are being made and where they can be remade. As a result, cultural studies always involves the study of contexts—sets of relations located and circumscribed in time and space, and defined by questions. And cultural studies is always interdisciplinary because understanding culture requires looking at culture's relationship to everything that is not culture.

Moreover, cultural studies is committed to a radical contextualism; it is a rigorous attempt to contextualize intellectual (and political) work. This contextualism shapes the project of cultural studies profoundly, and involves a commitment to complexity, contingency, and constructionism.

Contexts are not random and chaotic collections of bits and pieces on which people attempt to impose order or meaning; they are already ordered or configured when the scholar embraces them in their complexity rather than reducing them to a simplicity defined ahead of time by a theoretical or political agenda. Cultural studies refuses to reduce the complex to the simple, the specific to the exemplary, and the singular to the typical. It refuses to see this complexity as an inconvenience to be acknowledged only after the analysis. It employs a conjunctive logic—where one thing is true, another may also be true—and thereby refuses the illusion of a total, all-encompassing answer. It avoids confusing projects with accomplishments (as if intentions guaranteed effects); and it refuses to put off until later the resistances, the interruptions, and the fractures and contradictions of the context.

Cultural studies believes in contingency; it denies that the shape and structure of any context is inevitable. But cultural

studies does not simply reject essentialism, for anti-essentialism is, in its own way, another version of a logic of necessity: in this case, the necessity that there are never any real relations. Cultural studies is committed to what we might call an anti-anti-essentialism, to the view that there are relationships in history and reality, but they are not necessary. They did not have to be that way, but given that they are that way, they have real effects. Above all, there are no guarantees in history (or in reality) that things will form in some particular way, or work out in some particular way. Reality and history are, so to speak, up for grabs, never guaranteed. Cultural studies operates in the space between, on the one hand, absolute containment, closure, complete and final understanding, total domination, and, on the other hand, absolute freedom and possibility, and openness.

Finally, cultural studies assumes that relationships are produced or constructed, and not simply always the result of chance. The relations that make up a context are real through the various activities of different agents and agencies, including (but not limited to) people and institutions. Insofar as we are talking about the human world—and even when we are describing the physical world, we are within the human world as well—cultural practices and forms matter because they constitute a key dimension of the ongoing transformation or construction of reality. However, the effects of cultural practices are always limited by the existence of a material or nondiscursive reality. Cultural studies, then, does not make everything into culture, nor does it deny the existence of material reality. It does not assume that culture, by itself, constructs reality. To say that culture is constitutive—that it produces the world, along with other kinds of practices—does not mean that real material practices are not being enacted, or that real material conditions do not both enable and constrain the ways in which reality functions and can be interpreted. Cultural studies is, in the first instance, concerned with cultural practices. To put it simply, the culture we live in, the cultural practices we use, and the cultural forms we place upon and insert into reality, have consequences for the way reality is organized and lived.

The commitment to a radical contextualism affects every dimension of cultural studies, including its theory and politics, its questions and answers, and its analytic vocabulary—which includes concepts of culture (text, technology, media), power, and social identity (race, gender, sex, class, ethnicity, and generation). Cultural studies derives its questions, not from a theoretical tradition or a disciplinary paradigm but from a recognition that the context is always already structured, not only by relations of force and power, but also by voices of political anger, despair, and hope. Cultural studies attempts to engage the existing articulations of hope and disappointment in everyday life and to bring the messy and painful reality of power—as it operates both outside and inside the academy—into the practice of scholarship.

Cultural Studies, Theory, and Power

While cultural studies is committed to the absolute necessity of theoretical work, it sees theory as a resource to be used to respond strategically to a particular project, to specific ques-

tions and specific contexts. The measure of a theory's truth is its ability to enable a better understanding of a particular context and to open up new—or at least imagined—possibilities for changing that context. In this sense, cultural studies desecralizes theory in order to take it up as a contingent strategic resource. Thus, cultural studies cannot be identified with any single theoretical paradigm or tradition; it continues to wrestle with various modern and postmodern philosophies, including Marxism, phenomenology, hermeneutics, pragmatism, poststructuralism, and postmodernism.

Cultural studies does not begin with a general theory of culture but rather views cultural practices as the intersection of many possible effects. It does not start by defining culture or its effects, or by assembling, in advance, a set of relevant dimensions within which to describe particular practices. Instead, cultural practices are places where different things can and do happen. Nor can one assume, in advance, how to describe the relation of specific cultural formations to particular organizations of power. Consequently, the common assumption that cultural studies is, necessarily, a theory of ideology and representation, or of identity and subjectivity, or of the circulation of communication (production-text-consumption), or of hegemony, is mistaken. Cultural studies often addresses such issues, but that is the result of analytic work on the context rather than an assumption that overwhelms the context.

Like a number of other often overlapping bodies of intellectual and academic work that have emerged since World War II (feminism, critical race theory, postcolonial theory, and queer theory, among others), cultural studies is politically driven; it is committed to understanding power—or more accurately, the relationships of culture, power, and context—and to producing knowledge that might help people understand what is going on in the world (or in particular contexts) and the possibilities that exist for changing it.

The project of cultural studies, then, is a way of politicizing theory and theorizing politics. Cultural studies is always interested in how power infiltrates, contaminates, limits, and empowers the possibilities that people possess to live their lives in dignified and secure ways. For if one wants to change the relations of power—if one wants to move people, even a little bit—one must begin from where people are, from where and how they actually live their lives. Cultural studies attempts to strategically deploy theory (and empirical research) to gain the knowledge necessary to redescribe the context in ways that will enable the articulation of new or better political strategies. Cultural studies also approaches power and politics as complex, contingent, and contextual phenomena and refuses to reduce power to a single dimension or axis, or to assume in advance what the relevant sites, goals, and forms of power and struggle might be. Consequently, it advocates a flexible, somewhat pragmatic or strategic, and often modest approach to political programs and possibilities.

Two of the most important political assumptions of cultural studies are also among its most controversial. Cultural studies refuses to assume that people are dupes, constantly manipulated by the producers of culture and ignorant of their

own subordination. On the other hand, it does not assume that people are always in control, always resisting, or operating with an informed understanding of the context. That does not mean that cultural studies doesn't recognize that people are often duped by contemporary culture, that they are lied to, and that at times—and for a variety of reasons—either don't know it or refuse to admit it. But it does mean that cultural studies is opposed to the vanguardism of so much of contemporary political and intellectual discourse.

Cultural studies is committed to contestation, sometimes as a fact of reality, but always as a possibility that must be sought out. Contestation can also serve as a description of cultural studies' own strategic practice, which sees the world as a field of struggle and a balance of forces. Intellectual work is required to understand the balance and find ways of challenging and changing it. Of course, cultural studies recognizes that the relations among survival, change, struggle, resistance, and opposition are not predictable in advance, and that there are many forms and sites that each can take and has taken; these range from everyday life and social relations to economic and political institutions. Cultural studies, then, is an effort to produce knowledge about the context that will help to strengthen, existing struggles and constituencies, helping to relocate and redirect them, or to organize new struggles and constituencies. It seeks knowledge that will make the contingency of the present visible and open up possibilities that will help to make the world a better, more humane, place.

While it attempts to put knowledge in the service of politics, cultural studies also attempts to make politics listen to the authority of knowledge. It believes that its political commitment (and its desire for intervention) demands that it maintain a justifiable claim to authority in the face of the threat of a relativism often linked to contextualist and constructivist projects. Cultural studies, like many of its political allies in the academy, rejects foundationalism. It does believe that knowledge is dependent on its context, and hence, that all knowledge is limited and partial. There is no knowledge that is not always marked by the possibilities and the limits of the position and perspective from which it is constructed and offered.

Yet cultural studies also rejects relativism, for like foundationalism, relativism assumes that knowledge and culture exist on a different plane from the context they purport to represent. But if the knower is a constituent part of the very context he or she is trying to know, the description plays an active part in the construction of the very context it describes. The question of better or worse knowledge is, then, no longer a matter of comparing two things (the description and the reality) as if there were some place outside the reality that we could stand in order to compare them. The question is rather a matter of the possible effects of the knowledge on the context—what possibilities for change does it enable? The better the knowledge, the more (new) possibilities it will offer for transforming the present. That is what cultural studies means when it talks about knowledge without truth, and about useful knowledge. Cultural studies does demand a kind of self-reflection on its own limitations, but this is not, as in some

other projects, a requirement that one define one's identity as if it were determining, but rather that one offer a rigorous analysis of institutional conditions and a reflection of one's own contextual existence.

The question of what cultural studies will (or should) look like is only answerable within the particular context that calls cultural studies into existence. Cultural studies is not alone in privileging the questions of power or in its commitment to relationality and constructionism; it is not alone in its embrace of contingency and contextuality or in recognizing the importance of culture. But the practice that is defined by the intersection of all these commitments—*that* is the project of cultural studies. Cultural studies is an intellectually grounded practice for intervening into the “becoming” of contexts and power. It attempts, temporarily and locally, to place theory in-between in order to enable people to act more strategically in ways that may change their context for the better.

Diversity in Cultural Studies

The diversity of cultural studies is as important as its unity; yet there is no obvious single best way to organize or describe that diversity. One could display the range of objects and discourses that cultural studies has explored—including art, popular culture, media culture, news, political discourses, economics, development practices, everyday practices, organizations, cultural institutions, and subcultures. One could display the different theoretical paradigms (including pragmatism, phenomenology, poststructuralism, Marxism, and so forth) or theoretical influences (Harold Innis, Michel de Certeau, Gramsci, and Michel Foucault, among others). One could display the different political agendas—feminist, Marxist, anti-racist, anti-homophobic, anti-postcolonial, anti-ageist—or the more positive political agendas of socialism, radical democracy, and global justice, that have driven the work. One could consider the different ways the major concepts of culture, power, articulation, and context have been used. One could describe the implications of disciplinary diversity—literary studies, anthropology, sociology, communication, history, education, and geography, among others—and methodological diversity—forms of textual analysis, ethnography, interviewing, archival research, statistical analysis, and so forth. Finally, one could speculate about the significance of geographical diversity, which has become increasingly visible and important. A more useful way might be to describe some exemplary instances of cultural studies.

A first model, found in the work of Raymond Williams, reads texts as ideologies in context. That is, it uses texts to try to locate and define the common structure (e.g., homology, structure of feeling) that unites the disparate elements of social formation into a unified social totality. But this common structure of unity is available only by thinking of ideology contextually—that is, by looking at the relations among texts, and between texts and other discursive and nondiscursive practices.

A second model, found in the work of communication scholar James Carey, looks at particular cultural practices as

rituals that reenact the unity—shared meanings, structures, and identities—of a community.

A third model locates cultural texts and practices within a dialectic of domination and resistance and was closely associated with the CCCS in the 1970s, especially in the early work of David Morley, Dick Hebdige, and Angela McRobbie. The politics of culture are determined by the relations among a number of relatively autonomous moments—primarily of production and consumption—but later work added distribution, exchange, and regulation. It provided an alternative model of media communication (encoding-decoding) with an emphasis on the audience as an active interpreter of messages and of subcultures in which subcultural styles were seen to be expressions of, and symbolic responses to, lived contradictions—defined by class and generation—of the social experiences of the members of the subculture.

A fourth model explores cultural and social identities as complex sets of relations. It involves the production of differences (or structures of otherness such as race and gender) within a population, the effort to naturalize such identities as biological, the distribution of people into those categories, and the assignment of particular meanings to each identity. These differences provide the basis, along with the inequalities of power and resources, that are defined within a particular society. But they are not natural, inevitable, or fixed; instead, identities are the site of constant work and struggle over the practices by which people come to be represented and to represent themselves. This work studies the dialectical production of identity and difference, often in a kind of Hegelian dialectic of recognition. This is a logic in which the formation (identity) of one term (the self) can only be constructed through, or on top of, the assimilation and exclusion of the other. There are various tropes for this process circulating throughout the cultural studies literature (and beyond), including difference, border-crossing, hybridity, third space, and most recently, diaspora (although the last often attempts to escape the Hegelian negativity of difference). Obviously, such work in cultural studies overlaps here with many other bodies of related work, but its influence—through the work of people like Stuart Hall, Paul Gilroy, Angela McRobbie, Gayatri Spivak, and Judith Butler—has been profound.

A fifth model is concerned with the relationship between culture and the state. Influenced in part by Gramsci, such work was best illustrated by the important work of Stuart Hall and John Clarke on hegemony as an alternative to notions of civil politics as ideological consensus. Hegemony, as a struggle for the gain and consolidation of state power, involves the attempt by a particular coalition of social factions to win popular consent to its leadership. Hegemony is not a battle to the death between two camps, but a constant attempt to negotiate with various factions to put together temporary agreements for the leadership of the ruling bloc at different sites. It therefore works on (and through) the popular languages and logics of the society, and reconfigures the national common sense in order to reconstitute “a balance in the field of forces.”

A sixth model of “governmentality” emphasizes the variety of ways in which culture is used by state and other institutions to produce particular kinds of subjects and to regulate their conduct. This work focuses on the material effects of bureaucratic cultural apparatuses; it looks at how institutional discourses produce a particular structure of the subject itself as an historical effect of power. For example, Tony Bennett looks at cultural institutions such as museums in terms of the way they discipline people, organizing their behavior and teaching them, as it were, to behave properly in public as citizens. Similarly, Bennett has also argued that the pedagogy of cultural criticism functioned to render students always inadequate and incomplete, not only in terms of the classroom but as human beings in need of constant self-improvement. In his view, it is only the teacher who can recognize the politically problematic claims of any text, while the students are always guaranteed to fail. Another example involves the work of Nikolas Rose and his colleagues, who attempt to analyze the contemporary forms of neoliberal state power by looking at the micropractices of institutions and everyday life.

Finally, the seventh model looks at culture as formations or organizations of both cultural and noncultural practices, often related to, or even identified with, particular institutions. Such cultural apparatuses function in complicated ways to produce and organize social reality itself. That is to say, they are “technologies of power” that are connected on the one hand to the lived realities of everyday life (itself understood to be an organization of power) and, on the other hand to the larger structures of political and economic power. Cultural or discursive practices are integral pieces of the institutional formations of power that organize the very lived reality and structures of power in space and time. Examples of such work can be seen in the anthropological critiques of development offered by Akhil Gupta and Arturo Escobar, and in Meaghan Morris’s studies of the place of history as a cultural formation in Australian social life.

See also *Critical Theory; Hermeneutics; Marxism; Phenomenology; Structuralism and Poststructuralism; Text/Textuality.*

BIBLIOGRAPHY

- Bennett, Tony. *The Birth of the Museum: History, Theory, Politics*. London: Routledge, 1995.
- . *Outside Literature*. London: Routledge, 1990.
- Butler, Judith. *Gender Trouble: Feminism and the Subversion of Identity*. New York: Routledge, 1990.
- Carey, James W. *Communication as Culture: Essays on Media and Society*. Boston: Unwin Hyman, 1989.
- Clarke, John. *New Times and Old Enemies: Essays on Cultural Studies and America*. London: Routledge, 1992.
- Gilroy, Paul. *Against Race: Imagining Political Culture beyond the Color Line*. Cambridge, Mass.: Harvard University Press, 2000.
- Grossberg, Lawrence. *Bringing It All Back Home: Essays on Cultural Studies*. Durham, N.C.: Duke University Press, 1997.
- Grossberg, Lawrence, Cary Nelson, and Paula Treichler, eds. *Cultural Studies*. New York: Routledge, 1992.
- Hall, Stuart. *The Hard Road to Renewal: Thatcherism and the Crisis of the Left*. London: Verso, 1988.
- Hall, Stuart, and Paddy Whannel. *The Popular Arts*. Boston: Beacon, 1964.
- Hebdige, Dick. *Subculture: The Meaning of Style*. London: Methuen, 1979.
- Hoggart, Richard. *The Uses of Literacy: Aspects of Working-class Life*. London: Chatto and Windus, 1957.
- McRobbie, Angela. *Feminism and Youth Culture*. London: Macmillan, 1991.
- Morley, David. *Television, Audiences and Cultural Studies*. London: Routledge, 1992.
- Morley, David, and Kuan-Hsing Chen, eds. *Stuart Hall: Critical Dialogues in Cultural Studies*. London: Routledge, 1996.
- Morris, Meaghan. *Too Soon Too Late: History in Popular Culture*. Bloomington: Indiana University Press, 1998.
- Nelson, Cary, and Lawrence Grossberg. *Marxism and the Interpretation of Culture*. Urbana: University of Illinois Press, 1988.
- Rose, Nikolas. *Powers of Freedom: Reframing Political Thought*. Cambridge, U.K.: Cambridge University Press, 1999.
- Spivak, Gayatri. *In Other Worlds: Essays in Cultural Politics*. New York: Methuen, 1987.
- Williams, Raymond. *The Country and the City*. New York: Oxford University Press, 1973.
- . *Culture and Society, 1780–1950*. New York: Harper & Row, 1958.
- . *The Long Revolution*. Middlesex: Penguin, 1965.
- . *Television: Technology and Cultural Form*. London: Fontana, 1974.

Lawrence Grossberg

CYCLES. The idea that history is composed of cycles is ancient. Many peoples (including the Egyptians, Chinese, Babylonians, Hindus, Maya, and Greeks) observed recurrences in astronomical phenomena. These early observations were often related to calendar systems and were the foundation for later written schemes of cosmic and historical cycles in various parts of the world.

The Ancient World

One of the oldest written systems of historical cycles originated in India among the Hindus. Hindu cosmology operates within vast cycles of time, or world ages: the universe exists for the life span of the creator god Brahma (quadrillions of solar years), disappears at his death, and is reborn when a new Brahma arises. A brahmic day and night (*kalpa*) consists of one thousand *maha yugas* (great ages). A *maha yuga* is comprised of four cyclic *yugas* (ages) of 4,000, 3,000, 2,000, and 1,000 divine years (one divine year being nearly 130,000 solar years) with intervals of latency between the ages. The advancement through the *yugas* is characterized by spiritual and moral decline. The present time is considered a dark age and falls near the beginning of the fourth *yuga*, which began at Krishna’s death in 3002 B.C.E.

Greek philosophers postulated the existence of cosmic cycles. Some of them (such as Empedocles, c. 495–c. 435 B.C.E.) proposed that the events within a given cosmic cycle were iden-

tical (or very similar) to the events in earlier cycles. The Stoics held a clear conception of historical cycles. Largely based on the physics of the pre-Socratic philosopher Heraclitus (c. 535–475 B.C.E.), the Stoics theorized that the sun would periodically heat the world and cause a great conflagration (*ekpyrosis*). Unlike Heraclitus, the Stoics identified this purgative fire with God, who would subsequently recreate the world from the condensation of the elements (air, water, earth, and fire). The process of creation and destruction would then begin again.

Plato (427?–347 B.C.E.) understood cosmic and human history to be cyclical. He included statements about the cyclic nature of the world and accounts of natural disasters from which human civilization had reemerged in his *Statesman*, *Timaeus*, *Critias*, and *Laws*. Aristotle (384–322 B.C.E.) also presented history as cyclical. He mentioned the possibility of periodic cataclysms in the *Politics* and the *Meteorologica*. He stated in the *Politics* and *De caelo* (On the Heavens) that human knowledge had repeatedly been lost and rediscovered. In addition, Aristotle advanced the notion of the degeneration of governmental forms. He proposed that governments devolve in a specific order: monarchies fall into oligarchies, followed by tyrannies, and then democracies. This idea was adopted and further developed by the Greek historian Polybius (c. 203–c. 120 B.C.E.). In the *History*, he postulated a theory of constitutional cycles (*anacyclosis*). According to Polybius, six forms of government devolve in succession: monarchical governments, tyrannies, aristocracies, oligarchies, democracies, and finally rule by the mob. The cycle would then repeat.

The Early Modern Period

Polybius's ideas were revived in the Renaissance and especially influenced Niccolò Machiavelli (1469–1527), who argued for the superiority of mixed governments in his *Discourses* (1512–1517). However, notions of cyclical history were evident before the revival of Polybius. For example, a system of cyclic historical development is apparent in the *Chronicle of Florence* by Giovanni Villani (c. 1275–1348). A later example is Giorgio Vasari's (1511–1574) theory of cycles in the history of art in his *Lives of the Artists* (1550 and 1568). Vasari viewed the history of art as a long series of advances and declines. However, he believed that art had reached a peak of perfection in his own age in the works of Michelangelo; having been perfected, art could not rise further but would either be maintained or decline.

In the eighteenth century, Giambattista Vico (1668–1744) divided history into three ages in his *New Science* (1725): the age of gods, the age of heroes, and the age of humans. He saw history as the occurrence (*corsi*) and recurrence (*ricorsi*) of these ages. According to Vico, every nation follows a similar pattern of development. During the first age, nations invoke imagination in order to comprehend the world as the creation of the gods. The age of gods then gives way to the second age, wherein humans use imagination to establish moral values and institutions following heroic models. The age of heroes declines into the third age, a time when social order is created through reason. Vico's vision of history was the infinite repetition of these three ages.

The Twentieth Century

In the twentieth century, Oswald Spengler (1880–1936) and Arnold Toynbee (1889–1975) presented important theories of historical cycles. In *The Decline of the West* (1918–1922), Spengler proposed that individual societies have a life cycle similar to living organisms: they experience periods of growth, maturity, and decline. According to him, these cycles repeat themselves as new societies develop. Toynbee was influenced by his reading of Spengler's work. In *A Study of History* (1934–1961), he argued that civilizations emerge when faced with physical or social challenges. He believed that the history of a civilization was largely the record of its response to a unique challenge. On a larger scale, he saw that history moved through periods governed by universal states followed by shorter periods of religious rule. In Toynbee's view, societies decline when they fail to surmount a challenge and thereafter lose social cohesiveness. However, he acknowledged the possibility that a civilization could repeatedly meet its challenges.

Another prominent twentieth-century historian who proposed a theory of historical cycles was Fernand Braudel (1902–1985). Associated with the Annales school of historians, Braudel developed a system that encompassed short-term (individual), medium-term (social), and long-term (geographical) time periods. While acknowledging the significance of short-term events, he emphasized their integration with larger historical cycles. He incorporated an interdisciplinary approach that examined the complex interactions between history, economics, geography, politics, and culture. His major works include *The Mediterranean and the Mediterranean World in the Age of Philip II* (1949) and *Civilization and Capitalism: 15th–18th Century* (1967–1979).

See also *Historiography; History, Idea of; Life Cycle; Periodization*.

BIBLIOGRAPHY

- Braudel, Fernand. *Civilization and Capitalism, 15th–18th Century*. Translated by Siân Reynolds. 3 vols. New York: Harper, 1982–1984.
- Polybius. *The Histories of Polybius*. Translated from the text of Friedrich Hultsch by Evelyn S. Shuckburgh. 2 vols. London and New York: Macmillan, 1889.
- Spengler, Oswald. *The Decline of the West*. Authorized translation with notes by Charles Francis Atkinson. London: Allen and Unwin, 1980.
- Toynbee, Arnold. *A Study of History*. 12 vols. London and New York: Oxford University Press, 1934–1961.
- Vico, Giambattista. *The New Science of Giambattista Vico*. Translated by Thomas Goddard Bergin and Max Harold Fisch. Ithaca, N.Y.: Cornell University Press, 1984.

Frederick Liers

CYNICISM. The word *cynic* generally conveys negative ideas in modern languages. It describes someone who is unduly critical and suspicious, apathetic about certain issues and rebellious in response to others, selfish, and indifferent toward

traditions and accepted beliefs, and unconcerned with the public welfare. The cynic is often viewed as a person who has severed all ties with his social context. To be cynical in the midst of political issues and events is equivalent to being aloof from such things—the cynic does not participate because he has lost his faith in others.

Cynicism, however, has an ancient meaning, the roots of which are traceable to the classical Greeks, specifically to Socrates and his associates in the late fifth century B.C.E. A review of the history of Cynicism reveals that its meaning is significantly different from what modern cynicism has come to mean, and it is not unreasonable to agree with what Bertrand Russell said—namely, that modern cynics have hardly anything in common with the classical Cynics. As a result of a curious perversion of language, the meaning of modern cynicism appears to have been transformed into the opposite of what it once meant, despite undeniable external similarities between the old and the new cynics.

The word *cynic* is etymologically related to the Greek word *kynikos*, which literally means “like a dog.” When Aristotle, for instance, refers to Diogenes of Sinope (d. c. 320 B.C.E.), he calls him “the Dog” because that is how Diogenes was known. Likewise, when Lucian speaks of the crowds of Cynics found in every Roman town in the second century C.E., he calls them “the Army of the Dog.” The association between the Cynics and dogs seems to have originated not among the Cynics themselves, but among outsiders who discerned in them behavioral traits reminiscent of dog behavior. Beginning with Diogenes, however, the Cynics accepted the uncomplimentary appellation with enthusiasm and were happy to call themselves “the dog philosophers.”

The question as to who the first dog philosopher was has been often raised. Some argue that it was Antisthenes (c. 445–365 B.C.E.), an associate of Socrates, and others opt for Diogenes, a disciple of Antisthenes, and see Diogenes as the “founder” of Cynicism. It must be borne in mind, however, that Cynicism was not a school of philosophy comparable to Plato’s Academy or Zeno’s Stoa. Accordingly, it had neither a founder nor an identifiable place of origin nor a set of principles or beliefs. For this reason, the classical Cynics constitute an assortment of different types of individuals (men and women) who exhibited diverse styles of life and held a variety of beliefs. What allows us to distinguish them from other philosophers is a certain attitude toward their cultural and political world, as well as a distinctive way of expressing their rejection of that world.

The history of Cynicism begins in the early fourth century B.C.E. and ends in the fifth century C.E. We can define Cynicism as a practical philosophy that exhibits a permeating and inflexible commitment to saying no to the values, norms, beliefs, practices, traditions, and all other forms of living which, in the light of what the Cynics called clarity of mind, appear to be senseless or misguided. The Cynics persisted in the conviction that most people live as if immersed in a cloud of smoke (*typhos*) that prevents them from seeing clearly and does not allow them to use that which distinguishes humans

from animals—namely, the capacity to reason. In abandoning this capacity, people forsake their true nature. Diogenes often said that the human world is an enormous madhouse in which every sort of madness is found everywhere: cruelty, greed, deception, mendacity, brutality, uncontrolled hedonism, and the rest of the all-too-common diseases that afflict humanity and have become endemic in the form of things such as religion, patriotism, tradition, and other manifestations of irrationality. It was against such a condition that the Cynics declared war.

Cynicism can be understood, accordingly, as a philosophy of revolt. Although certain principles can be identified in it, the scarcity of primary sources makes this task difficult. Cynic writings are mostly nonexistent, and we suspect that even if they were available they would not be helpful because the Cynics expressed their convictions not so much through writings, but through actions and speech. It is, for example, difficult to understand precisely the sense in which the Cynics understood the concept of reason except by literally looking at what they did. A good idea of Cynicism can be gathered by reviewing the countless anecdotes found in secondary Greek, Latin, and Arabic sources, in which we encounter the Cynics in action and in many of which there is probably some element of historical truth. From such sources we can compile a list of Cynic virtues—that is, modes of behavior through which the Cynics sought to combat the world: they opposed avarice and greed with poverty, servility and submissiveness with independence and self-sufficiency, patriotism and factionalism with cosmopolitanism, addiction to pleasure with abstinence and asceticism, deceptiveness and fraud with truth-telling, social distinctions and prejudices with egalitarianism, faith in religion and superstition with skepticism and agnosticism, chatter and gossip with silence, prudishness with impudence, and irrationalism and brutality with an undeviating attachment to reason.

Although Cynicism eventually came to an end, it is undeniable that its influence has persisted until our time. After all, the Cynics exemplified a human tendency found among a small number of people of every culture and time to stand in opposition to what is unnatural and irrational. Stoicism, for instance, owed its inception and development to the ideas of the Cynics. Indeed, as long as the world remains the madhouse recognized by Diogenes, there are bound to be cynics—both in the modern sense of this word and in its ancient sense. In the former, cynicism takes the form of rebelliousness born out of selfishness and irrationality, and in the latter, it assumes a stance of defiance rooted in a desire to return humanity to its true nature, which entails a return to reason.

See also *Dialogue and Dialectics: Socratic; Stoicism*.

BIBLIOGRAPHY

- Bracht, Branham R., and Marie-Odile Goulet-Gazé. *The Cynic Movement in Antiquity and Its Legacy*. Berkeley: University of California Press, 1966.
- Navia, Luis E. *Antisthenes of Athens: Setting the World Aright*. Westport, Conn.: Greenwood Press, 2001.

- . *Classical Cynicism: A Critical Study*. Westport, Conn.: Greenwood Press, 1996.
- . *Diogenes of Sinope: The Man in the Tub*. Westport, Conn.: Greenwood Press, 1998.
- . *The Philosophy of Cynicism: An Annotated Bibliography*. Westport, Conn.: Greenwood Press, 1995.

Sloterdijk, Peter. *Critique of Cynical Reason*. Translated by Michael Eldred. Minneapolis: University of Minnesota Press, 1987.

L. E. Navia



D

DADA. Presided over by the poet and essayist Tristan Tzara (1896–1963), who served as its principal spokesman, dada was the first truly international avant-garde movement. Although the term *dada* was invented in Zurich, the movement's origins were by no means limited to Switzerland. The dada spirit existed previously in several other countries, where it expressed itself in outrageous avant-garde activity. Dada's chief concern was the achievement of total liberty: social, moral, and intellectual. Its members questioned, through their art, poetry, and performance, the basic postulates of rationalism and humanism as few had done before.

The period 1912–1914 witnessed the emergence of two of the movement's influential figures in Paris: Francis Picabia (1879–1953) and Marcel Duchamp (1887–1968). After World War I erupted, the two men moved to New York, where they proved to be important catalysts. The first dada journal had already appeared in print a few months earlier. Entitled *291*, it was edited by a group centered around Alfred Stieglitz (1864–1946) and his review *Camera Work*. Another contingent met at Walter Conrad Arensberg's apartment at 33 West 67th Street. The two groups welcomed the French artists, who were soon joined by friends and family, and emulated their latest experiments.

Emerging independently in 1916, the Zurich dadaists published an eclectic journal entitled *Cabaret Voltaire*. Named after the artistic cabaret founded by Hugo Ball, which was notorious for its outrageous productions, the journal was replaced by *Dada* in 1917. Ball himself was soon eclipsed by the flamboyant Tzara, who became the movement's chief theorist and publicist. Consisting of Romanian expatriates and former German Expressionists, the Zurich group included several accomplished poets and artists but specialized in theatrical performances. A third dada faction was situated in Barcelona during the war. Revolving about the Dalmau Gallery, it included several French expatriates in addition to Catalan artists and writers such as Joan Miró and Josep Maria Junoy. The Barcelona movement gained momentum in 1917 with the arrival of Francis Picabia, who founded the iconoclastic journal *391*.

After the War

Following the end of World War I, the dada movement underwent a significant transformation. While the original three groups continued to exist, the balance of power shifted from countries situated at the war's edge to Germany and France. Beginning in 1919, the German branch was composed of three separate factions. Dominated by Richard Huelsenbeck and



Marcel Duchamp (1887–1968). The French-born Duchamp moved to the United States in the early twentieth century and helped introduce the concept of dada to his new country. Duchamp dabbled in many different art forms, among them sculpture, painting, and even short film. © CORBIS-BETTMANN

Raoul Hausmann, Berlin dada was preoccupied with a series of political issues. In addition to satirizing politics in their art, its members sought to create a new social order. Centered around Jean Arp (also known as Hans Arp) and Max Ernst on the one hand and Kurt Schwitters on the other, Cologne dada and Hanover dada were more concerned with aesthetic issues. Despite the three groups' relatively brief lives, they were a potent force for social and artistic change. In Paris, the dada movement coalesced around four future surrealists: André Breton, Louis Aragon, Paul Eluard, and Philippe Soupault. Other participants included Francis Picabia, Marcel Duchamp, and Tristan Tzara, who arrived in 1920. In spite of dada's impressive vitality, the international movement ceased to exist a few years later. Some members, such as Picabia and Schwitters, continued to incarnate the dada spirit in their work, but most became surrealists or developed new interests.



Montage satirizing contemporary images of men and women, 1919, by Hannah Hoch. After World War I, the dada movement in Germany was partly centered on politics and political satire. Photocollages of newspaper and magazine clippings by artists such as Hannah Hoch and Raoul Hausmann denigrated German government and society. © JORG P. ANDERS, BERLIN/BILDARCHIV PREUSSISCHER KULTURBESITZ/ART RESOURCE

motto Tzara's declaration "Thought is made in your mouth," they strove to liberate language in particular.

Like their artist colleagues, the dada poets wished to stimulate thought and to achieve new states of consciousness by exploring their medium. While the dadaists valued scandal above all else, they also prized spontaneity. Both tenets derived from the fanatical devotion to freedom that characterized the dada adventure. Just as the dadaists were interested in the activity of the mind, so their preoccupation with spontaneity and the gratuitous reflected their fascination with prelogical experience and thought. In attempting to grasp our being in its primitive coherence (or incoherence), they strove to discover absolute psychological reality. In particular, the dadaists believed that the playful dimension of art offered a path to liberation. Although their poetry was necessarily verbal, it communicated on a primal level by means of images, emotions, and rhythms. Combining discursive and nondiscursive strategies, the dadaists discovered that words could be used to convey information situated outside the linguistic arena.

Critical Reevaluation

At first glance, many dada works seem impervious to critical analysis. For one thing, they contain an irrational streak that was intensified by the war and by the accompanying decay of social values. For another, their aesthetic strategies exploit the calculated misuse of convention. Employing the techniques of subversion, distortion, and disruption, dada compositions are fervently antilogical. Rejecting bourgeois values in life and in art, the dadaists considered logic to be a correlative of traditional authority. Like the latter, it was reviled for confining and debasing mankind. Because the dadaists deliberately cultivated scandalous behavior, their readers and viewers tended to react to them with hostility. Like the hapless members of the audience, contemporary critics assumed that the dada movement was a hoax. Dada was a purely destructive phenomenon, they declared, whose sole virtue was to have prepared the way for surrealism.

By contrast, the 1960s witnessed an enthusiastic neo-dadaist revival that permeated art, literature, music, and the theater. Inspired by the *Cabaret Voltaire* and similar ventures, performance artists invented a new postmodern genre: the happening. The latest in a long series of dada derivatives, including the Theater of the Absurd and abstract expressionism, the neo-dada movement shows no signs of abating. While current audiences have grown used to pop, op, and kinetic art, they continue to be scandalized by sound poets like Henri Chopin, visual poets like Fabio Doctorovich, junkyard sculptors like Robert Rauschenberg, aleatory composers like John Cage, and experimental choreographers like Alwin Nikolais. With the rediscovery of dada in a sympathetic light, the movement's positive aspects have become more apparent. The end of the twentieth century and the beginning of the twenty-first have witnessed a steadily increasing interest in dada and a series of benchmark studies by scholars such as Mary Ann Caws, J. H. Matthews, Michel Sanouillet, and Henri Béhar. Although the movement is as resistant to logical analysis as ever, it has acquired a certain respectability that threatens, ironically, to undermine its basic premises.

See also Arts; Avant-Garde; Language, Linguistics, and Literacy; Poetry and Poetics; Theater and Performance.

Despite its geographical distribution and diversity, the dada movement was amazingly cohesive. Although there was no central committee to regulate what transpired, there was widespread agreement about dada's methods and goals. Interestingly, André Breton's efforts to organize such a committee in 1922 spelled the death of Paris dada. Paradoxically, as Tristan Tzara explained to the Spanish critic Guillermo de Torre, dada's surprising unity stemmed from its lack of direction. Despite the absence of rules and regulations, the dadaists were united in their opposition to any form of authority. Dada was not an artistic credo, in any case, but a common set of values. Its adherents shared an adventurous lifestyle and a rebellious *joie de vivre*.

Reconstructing Reality

Outraged at the carnage of World War I, which they attributed to the stupidity of bourgeois politicians, the dadaists strove to wipe the slate clean so that they could begin all over. Reducing aesthetic expression to its fundamental elements—sound and typography in poetry; sound, gesture, and action in theater; color and line in art—they experimented with new, uncorrupted genres. Besides reconstructing reality to more accurately reflect modern experience, they adopted an anti-art stance that revolutionized artistic expression. Adopting as their

BIBLIOGRAPHY

- Caws, Mary Ann. *The Poetry of Dada and Surrealism: Aragon, Breton, Tzara, Éluard and Desnos*. Princeton: Princeton University Press, 1970.
- Dachy, Marc. *The Dada Movement, 1915–1923*. New York: Rizzoli, 1990.
- Foster, Stephen, and Rudolf Kuenzli, eds. *Dada Spectrum: The Dialectics of Revolt*. Iowa City: University of Iowa, 1978. Incisive and wide-ranging study.
- Gale, Matthew. *Dada and Surrealism*. London: Phaidon, 1997. Primarily devoted to art.
- Matthews, J. H. *Theatre in Dada and Surrealism*. Syracuse: Syracuse University Press, 1974.
- Motherwell, Robert, ed. *The Dada Painters and Poets: An Anthology*. 2nd ed. Cambridge, Mass.: Belknap, 1989. A valuable collection of essays, manifestos, and illustrations.
- Richter, Hans. *Dada: Art and Anti-Art*. London: Thames and Hudson, 1965. A classic study by a former participant.

Willard Bohn

DANCE. Dance is broadly conceived as physical movement organized into patterns in time and space. Writings on dance grounded in the European intellectual tradition have tended to distinguish dance from other systems of organized movement (such as sport, military drills, synchronized labor, festival processions, and sometimes ritual) by identifying a dimension of conscious craft or artistry. The discipline of anthropology has shown that this distinction is not universal by investigating how organized human movement functions in different cultures, as well as how it relates to music, theater, pantomime, storytelling, and other kinds of performative behavior.

Dance in Intellectual Traditions

The idea of dance varies within intellectual traditions. Two ancient treatises serve as examples. Where ideas are treated as a function of language, and knowledge is derived from analysis of phenomena, the body is often written out of epistemological projects. Aristotle's *Poetics* (fourth century B.C.E.), for example, analyzes the plot structure, poetry, and ethical issues presented by fifth-century Athenian tragedies. The *Poetics* mentions only briefly the physical movement of the tragic chorus as a contributor to the effect (emotional or intellectual) of a theatrical experience or as a component in knowledge. In contrast, where cognitive processes, observation, and abstract thinking include bodily experience, physical movement is thought to generate and represent abstract concepts. The body and corporeal experience have a more prominent place in the formation of ideas. The Indian treatise *Natyasastra* (c. second century B.C.E. to second century C.E.), describes in meticulous detail how correct performance of hand gestures, eye movements, posture, steps, coordination with music, and posture will affect an audience's comprehension of the narrative and its meaning.

The *Poetics* and *Natyasastra* both assume dance to be inseparable from the performance of music, theater, poetry, and dress (including masks and makeup). Both treatises also assume that performance takes place in a ritual context, where form and content are already dictated by established conventions.

Even so, the relationship between movement, emotion, and cognition is conceptualized differently in each treatise, which suggests the need for continued attention to the intellectual formulations that define the interpretation of human movement.

Until relatively recently, dance has been on the margins of the modern Western intellectual tradition. Dance appears as an object of study in two particular domains of modern Western thought: aesthetic criticism and anthropology. Aesthetic criticism, emerging in eighteenth-century dictionary projects and then taking root in nineteenth-century philosophy parallel with the development of the romantic ballet, considers dance to be an artistic practice. As performance, dance is distinguished from folk, social, or ceremonial dancing (though it may represent them) and requires formal training. The idea of dance as a formalized performance tradition is usually associated with industrial economies, urban societies, and a culture's economically secure or educated classes. Appreciation of technical mastery and performance conventions is considered evidence of cultural sophistication or artistic sensibility; meaning is communicated primarily in the visual realm of symbolic representation, mimesis, and technique. Dance criticism is an intellectual project involving analysis of choreography, performers' skill, aesthetic conventions, historical developments in dance styles, innovations in genre, and the success of performances.

Aesthetic Criticism and Analysis of Culture

In dance practice, at the beginning of the twentieth century Sergey Diaghilev's (1872–1929) experimental productions with the Ballets Russes famously challenged the aesthetic sensibilities of classical ballet by introducing parallel feet, ambiguous story lines, a lowered center of gravity, and representation of "primitive" cultures. The creation of new forms of art dance, such as expressionistic modern dance in Europe after World War I and Butoh in Japan after World War II, deliberately defied ballet's conventions of beauty but stayed within the domain of artistic performance. Aesthetic criticism accounted for and dealt with the creation of new dance genres. The purpose of aesthetic criticism remains a greater understanding of established and new dance styles, choreography (recorded in notation systems such as Labanotation), individual performances, and criteria on which stage performances can be evaluated.

The emergence of anthropology as a scientific discipline in the mid-nineteenth century, parallel with aesthetic criticism's elevation of dance as an art form and tensions in experimentation with the form, expanded a Western idea of dance to non-Western cultures and societies, often treating dance practices as folk traditions. Franz Boas (1858–1942), A. R. Radcliffe-Brown (1881–1955), and E. E. Evans-Pritchard (1902–1973) included social dancing, ceremonies, and rituals in their field studies. Curt Sachs's *World History of the Dance* (English translation, 1937) offered an evolutionary and universalizing theory of world dance forms and was followed by Franziska Boas's collection, *The Function of Dance in Human Society* (1944). Though guided by the scientific commitment to objectivity and evaluation of empirical data, early anthropological studies interpreted dances from non-Western cultures as less aesthetically developed than those on the European stages and presented the

dance traditions of North Africa, the Middle East, India, Asia, and the Americas as more primitive forms of dance. The images provided by early anthropologists were reproduced as artifacts of exotic cultures in World's Fair exhibits and romanticized in exoticized, popular stage performances such as those of Ruth St. Denis (1879–1968) and Ted Shawn (1891–1972).

Since the 1960s and 1970s, this early anthropological work on dance has been significantly revised. The idea of dance, expanded to the broader notion of movement practices, allows for greater attention to the categories that define movement systems within individual cultures, nations, or societies, as well as for comparative studies. For anthropology and its related disciplines (folklore, ethnomusicology, ethnology, and ethnography), aspects of culture are revealed in dance practices. These disciplines also look at dancing itself as a culturally constructed activity that offers information about human behavior and, by extension, culture. These interrelated disciplines, along with methods drawn from sociology, kinesthetics, and linguistics, operate with a heightened sensitivity to the imposition of Western values and desires on non-Western, indigenous, or nonindustrial cultures.

Awareness of Western ethnocentric tendencies in dance research generated different categories of analysis and new questions. Researchers began to work toward a deeper understanding of the language, customs, social structures, and modes of thinking governing localized “dance events” before attempting to interpret them. Adrienne L. Kaeppler's work on Tongan dance in the late 1970s did much to advance the study of structured human movement in a specific cultural context. In the late 1980s Paul Stoller advocated the importance of a sensual dimension in ethnographic work. Major contributors to the assessment and development of anthropological approaches to human movement in the 1960s, 1970s, 1980s, and into the 1990s include Gertrude Prokosch Kurath, Anya Peterson Royce, Helen Thomas, and Judith Lynne Hanna.

The treatment of dance as a social practice and a form of expressive culture goes beyond descriptions of local customs, ceremonies, and movement idioms. Through proscribed methods of observation, data collection, documentation, interviewing, participant observation, and interpretation of data, these methods analyze how human movement relates to culture. Many studies analyze the function and meanings of dances or dancing in situated contexts. Others track changes in the performance and interpretation of dance styles such as the tango, rumba, samba, flamenco, and hula as they are transmitted across cultures, including in the inquiry of the mechanisms of transmission. Still other studies are concerned with visual and kinesthetic communication, or how dance communicates as a kind of language. Behaviors surrounding a dance performance, such as audience participation and dancers' preparation, may be as important as the performance itself. Religious beliefs, political restrictions, integration of dance with other performance forms, and vocabularies used by practitioners to describe movement are all significant to interpreting data gathered in fieldwork.

Theory and Praxis

In the 1990s and into the twenty-first century, the critical concerns of feminism, postmodernism, poststructuralism, new historiography, cultural studies, semiotics, race and ethnic studies, and queer theory have brought to light a wide range of issues that remain crucial in studies of dance and human movement systems, namely, how dance constructs or challenges gender and sexuality, how dance practices negotiate power relations, the effects of colonialism and cultural imperialism on dance practices, exoticization of cultural “others,” institutionalization of dance practices, how dance is used to demonstrate cultural or ethnic difference, cultural ownership and authenticity of dance idioms, dance as a display of national identity, dance in marketing and tourism, the effects of stylistic hybridity on individual or group identities, performers' agency, multiple meanings in complex symbol systems, how dance practices link to social class, dance as a means of building ideological consensus, and dance as a medium of resistance and social change.

The work of scholars such as Jane Cowan, Cynthia J. Novack, Ann Daly, Sally Ann Ness, Jane C. Desmond, and Susan Leigh Foster has opened interdisciplinary territory in the effort to address these and other issues in the study of human movement in culture and as a means of cultural production. Their theoretical work has broken down the notion that Western art forms are a model of aesthetic progress. Studies of female dancers in Egypt and Morocco in the 1990s, for example, have used methods from sociology to examine performance in social conditions that define both dance and dancer. More recent attention to these concerns through ethnographic methods has shown how social control was exercised in the costuming, movements, songs, and visual spectacle in women's dances at rallies for political candidates in Malawi.

Methods of inquiry rooted in anthropology take aesthetic conventions as culturally determined rather than as marks of progress or as by-products of modernity. Aesthetics can thus serve as an entry point, whether the project is to understand culture through human movement, or human movement through culture. Applying anthropological methods to the aesthetics of classical ballet reveals, for example, that control of the body and individuality against uniformity are Western values. Cross-cultural comparisons of ballet's reception as scandalous in non-Western cultures, in contrast, show how ballet performs a desire to expose and transcend the body in contrast to local movement practices that value a body's individuality and are grounded in everyday activities. Joann Kealiinohomoku's (1983) work on ballet as ethnic dance has been followed by studies of ballet's adaptation in non-Western cultures and of how ballet choreography structures desire in its narratives.

Information made available through anthropological approaches has also led to popular appropriations of local dance forms within new cultural or social contexts. National dance troupes, such as Ballet Folklórico de México, present indigenous social dances as commercial art with aesthetic aims, often with an educational mission. Ceremonial, ritual, and

communal dances may be taken out of context, adapted for the stage, and performed as a recuperation or preservation of “traditional” cultures. Scholars have interrogated the affected aesthetics, claims to national identity, and cross-cultural misinterpretations at work in such performances. While dance forms identified with specific cultures are staged for international audiences, the same dance forms might be reinterpreted and invested with new meaning within the home culture. Kathak and Bharata Natyam as popular dance practices in India, for example, have been analyzed as resistance to the colonial legacy and as recuperation of the precolonial past. Such analyses show how adaptations of traditional dances within a culture can be used to define national, cultural, or class identity.

Reciprocity between theory and practice is evident in other areas as well. By the mid-twentieth century, ethnic fusion forms such as Afro-Cuban-jazz combined Western dance styles with those of other cultures, sometimes raising issues of cultural authenticity and appropriation. Dance forms identified with ethnicity within a dominant culture, for example African-American dance, have been analyzed as distinct and unique and, conversely, as in the process of adapting or challenging movement idioms from the dominant culture. Contemporary Western “belly dance” has been shown to remain deeply bound to nineteenth-century European Orientalist fantasies.

Dance as Experience

Though their methods, goals, and objects of inquiry differ, both aesthetic criticism and anthropology deal at some level with the fundamental question: What is being communicated, to whom, and how? This disciplinary imperative takes the human body as an agent of communication in an interpretive community or as an embodied subject acted upon by social forces. The psychological experience of dancing is generally irrelevant to aesthetic criticism’s analysis of dance as a visible medium and tangential to research grounded in kinesthetics or linguistics (though audience response can be analyzed). Beyond Romanticism and notions of the sublime in art in the Western philosophical tradition, phenomenology has offered the most appropriate frame for the ephemeral qualities of human movement, as Maxine Sheets-Johnstone demonstrated in 1966. First-person descriptions of movement as a conduit for spiritual or metaphysical experience are, however, not easily adapted to Western modes of thinking and analysis, even in studies of mainstream liturgical dance.

Paranormal experiences, dissociational states, expressions of deep inner feelings, mystical experiences, and intense emotion generated by participating in a dance are usually associated with non-Western, nonindustrial, or indigenous cultures. Movement practices that produce such experiences are identified by terms such as shamanic dancing, trance dancing, exorcism, healing dance, voodoo, spirit possession, and ritual dance. In the Western stage dance tradition, such states may be represented in artistic performance, as with the expressionist choreography of Mary Wigman (1886–1973). Numerous dance forms in Western popular culture, for example Gabrielle Roth’s “Ecstatic Dance,” the appropriation of African dances as “healing dance,” and so-called “spiritual belly dance” do

emphasize altered states of consciousness and/or physical healing. Such practices—especially those that identify with practices of nonindustrial or non-Western cultures in their costuming, symbols, stories, and idioms—offer rich sources for cultural analyses. Though some work has been done to integrate experiences of altered states of consciousness into scholarly discourse, this area requires attention.

As suggested by the example of how the ancient Greek *Poetics* and Sanskrit *Natyasastra* frame dance, understandings of human movement are not uniform across cultures. In the early twenty-first century, collaboration among researchers from different intellectual traditions reveals differences in research methods, modes of interpretation, analytical vocabularies, descriptive categories, and goals in dance research. International conferences such as the Congress on Research in Dance (CORD) and the World Dance Association (WDA) insure that ongoing research will reflect a diversity of intellectual as well as movement systems.

See also *Anthropology; Cultural Studies; Ethnography; Theater and Performance*.

BIBLIOGRAPHY

- Buckland, Theresa J., ed. *Dance in the Field: Theory, Methods, and Issues in Dance Ethnography*. New York: St. Martin’s Press, 1999.
- Cowan, Jane K. *Dance and the Body Politic in Northern Greece*. Princeton, N.J.: Princeton University Press, 1990.
- Daly, Ann. *Critical Gestures: Writings on Dance and Culture*. Middletown, Conn.: Wesleyan University Press, 2002.
- Desmond, Jane C, ed. *Meaning in Motion: New Cultural Studies of Dance*. Durham, N.C.: Duke University Press 1997.
- Dils, Ann, and Ann Cooper Albright, eds. *Moving History/ Dancing Cultures: A Dance History Reader*. Middletown, Conn.: Wesleyan University Press, 2001.
- Foster, Susan Leigh, ed. *Choreographing History*. Bloomington: Indiana University Press, 1995.
- Fraleigh, Sondra Horton, and Penelope Hanstein, eds. *Researching Dance: Evolving Methods of Inquiry*. Pittsburgh: University of Pittsburgh Press, 1999.
- Hanna, Judith Lynne. *Dance, Sex and Gender: Signs of Identity, Dominance, Defiance, and Desire*. Chicago: University of Chicago Press, 1988.
- Kaeppler, Adrienne L. “Dance in Anthropological Perspective.” *Annual Review of Anthropology* 7 (1978): 31–49.
- Kealiinohomoku, Joann. “An Anthropologist Looks at Ballet as a Form of Ethnic Dance.” In *What Is Dance? Readings in Theory and Criticism*, edited by Roger Copeland and Marshall Cohen, 533–549. Oxford: Oxford University Press, 1983.
- Kurath, Gertrude Prokosch. “Panorama of Dance Ethnology.” *Current Anthropology* 1 (1960): 233–254.
- Ness, Sally Ann. *Body, Movement and Culture: Kinesthetic and Visual Symbolism in a Philippine Community*. Philadelphia: University of Pennsylvania Press, 1992.
- Novack, Cynthia Jean. *Sharing the Dance: Contact Improvisation and American Culture*. Madison: University of Wisconsin Press, 1990.
- Royce, Anya Peterson. *The Anthropology of Dance*. Bloomington: Indiana University Press, 1977.
- Sheets-Johnstone, Maxine. *The Phenomenology of Dance*. Madison: University of Wisconsin Press, 1966.

Spencer, Paul, ed. *Society and the Dance: The Social Anthropology of Process and Performance*. Cambridge, U.K.: Cambridge University Press, 1985.

Thomas, Helen. *Dance, Modernity, and Culture: Explorations in the Sociology of Dance*. New York: Routledge, 1995.

DonnaLee Dox

DAOISM. Defining the features of Daoism (or Taoism) as one of the predominant trends in the history of Chinese thought involves accounting for its religious traits. As often happens outside the Western hemisphere—Buddhism may be the best-known example, but the same is true of Islam—the boundary between thought and religion in China is tenuous, unstable, and sometimes simply impossible to identify. Daoism, Buddhism, Confucianism, and other legacies have defined themselves as “teachings” (*jiao*) or “lineages” (*jia*, a word that primarily means “house” or “family”). The terms for “philosophy” and “religion” (*zhexue* and *zongjiao*) have become part of the standard Chinese vocabulary through late-nineteenth- and early-twentieth-century translations of Western books.

In the most general way, Daoism may be defined as a traditional form of thought and religion, based on some central notions, cults, and practices but never subject to systematization as a whole, and syncretic but at the same time self-contained—in the sense that it integrates many elements from other traditions, but frequently emphasizes its distinction from them. These basic features underlie different formulations of doctrinal notions and a large variety of practices, ranging from self-cultivation to communal rituals.

Daoism and Chinese Thought and Religion

Historically, the Daoist tradition has consisted of several schools, or rather lineages, usually based on one or more primary texts and associated with one or more divine or semi-divine beings. As a whole, these lineages and corpora have represented the higher but “unofficial” form of native religion in China. This definition points to the complexity of questions that surround the status of Daoism and its relation to Chinese religion; it is also relevant to its relation to Chinese thought, for the status of Daoism as a religion was often defined with reference to ideas and notions formulated in its early doctrinal texts.

In relation to the different forms of common religion in China, the stated purpose of Daoism is “transforming” (*hua*) people, in the sense of educating them to venerate pure deities that impersonate the Dao, instead of joining other cults—those defined as “vulgar” (*su*) or “illicit” (*yin*), which often included sacrifice and involved the assistance of spirit-mediums. The continuous incorporation of new deities and ritual forms, resulting from the interaction of Daoism with local communities and cults, upgraded these deities by admitting them into the “correct” (*zheng*) hierarchy of gods and of amending them by integrating them into the proper way of communicating with the divine world. As has often been noted, the spirit-medium, and not the Confucian officer or the Buddhist monk, was the first competitor of the Daoist priest within local communities.

The relation between Daoism and Buddhism has been fertile, with reciprocal borrowings of doctrinal formulations, theological elements, technical terminology, and forms of practice. Even though Buddhist polemical authors have often accused Daoists of appropriating Buddhist notions and topoi and even of plagiarizing their scriptures, these disputes have usually occurred in the surroundings of the imperial court. In that milieu, providing evidence of doctrinal preeminence in order to obtain official patronage was more important than highlighting any shared ground. Daoism provided Chinese Buddhism with some of that ground in the early stages of its development and, in turn, drew from it in later times. For the average faithful, anyway, subtle doctrinal distinctions surely were not the main concern, and Daoist or Buddhist deities could equally be addressed as suitable and practicable.

Daoism’s relation to Confucianism—the dominating influence behind the system of social norms, upheld by the central government, maintained by the local officers, supported by the literati, and transmitted through education—has been complex. Classical Confucianism focuses on the social aspects of human life. Daoism is by no means uninterested in these issues, but its views are based on different doctrinal grounds. Despite this, and with exceptions with respect to Neo-Confucianism, the contrast between Daoism and Confucianism has not primarily involved their philosophical views (the respective claims in this respect were known and quietly acknowledged by both), but their religious aspects. As Anna Seidel has noted (1997, pp. 39–41), although Daoism is the higher form of Chinese native religion, it has always occupied a position subordinate to the imperial—that is, official—cults. For the Confucian officers, the Daoist priests represented spiritual powers over which they had no control. Replacing the state ceremonies to Heaven and Earth, or to paragons of Confucian virtue, with rituals performed by Daoist priests and addressed to the divine personifications of the Dao, would be equivalent to granting Daoism an official role in the administration of the empire. For this reason, the Confucian officer and literatus did not hesitate to acknowledge Daoism only in its philosophical, mystical, or literary aspects, and even to regard it as equal to common religion.

The Roots of Daoism

The main early Daoist text is the *Daode jing* (Scripture of the way and its virtue), a short work consisting of aphorisms attributed to Laozi (the Old Master, or Old Child). Although some scholars have suggested that other sources might be slightly earlier, virtually all movements and lineages within Daoism consider this as the founding scripture of the entire tradition, even though they may venerate their own texts and their own founders. Another early work, the *Zhuangzi* (Book of Master Zhuang), has provided Daoism with doctrines, notions, and technical vocabulary throughout its history.

The present general consensus among scholars is that the *Daode jing* was not written by a single author, and that Laozi is the appellation of the symbolic Daoist sage whose doctrines are reflected there. The text appears to have existed in a form close to the present one between 350 and 300 B.C.E., but many of its statements likely derive from oral traditions whose dates are

impossible to determine. The *Zhuangzi*, which is deemed to be one of the masterpieces of Chinese literature, is different from the *Daode jing* from the point of view of its formal features and consists mainly of stories, anecdotes, and reflections. Zhuangzi himself probably authored the seven so-called Inner Chapters in the late fourth century B.C.E., with the other portions dating from one or two centuries later. Despite differences in emphasis, the two texts present the same view of the Dao and its relation to the world, outlined below on the basis of the *Daode jing* (references in parentheses are to the number of sections in this text).

The Dao. The word *dao* has two main meanings, “way” and “method.” These two meanings refer, respectively, to the way in which something is or the way it functions, and to the way of doing something (including the extended meaning of “practice” in a religious sense). The early Daoist texts are the first ones to use this word to mean the Absolute (Robinet, p. 26). For the *Daode jing*, the Dao has no name and is beyond any description or definition; the word *dao* itself is used only because one “is forced” to refer to it (25). The Dao is unknowable, has no form, and therefore does not undergo change (41), is “constant” (1), and is “invisible, inaudible, and imperceptible” (14). The two principles of Non-being (*wu*) and Being (*you*) are contained within it. Yet the Dao, in spite of its being “indistinct and vague” (*huanghu*), contains an “essence” (*jing*) that is the seed of the world of multiplicity (21). Under this second aspect—which can be distinguished from the previous one only within the domain of relativity—the Dao is the “origin” of the world and its “mother” (1).

The faculty that the Dao has to give life to the particular objects is its *de*, or “virtue,” and is described as “a mystery within a mystery” (1). The *Daode jing* outlines this process, which happens spontaneously and has no cause or purpose, in a famous statement: “The Dao generates the One, the One generates the Two, the Two generate the Three, the Three generate the ten thousand things” (42). According to this formulation, which like all similar outlines found in Daoist texts is meaningful only from a relative point of view, the Dao first generates the One (*yi*), the principle of the unity of existence in which the individual entities defined by forms and names are included, but have not yet emerged. The One differentiates itself into the two polar and complementary principles, Yin and Yang. The Three is the product of the joining of Yin and Yang; it represents the One reestablished at the level of each individual entity. The “ten thousand things” (*wanwu*) are the sum of entities generated by the joining of Yin and Yang. The sentence of the *Daode jing* quoted above therefore formulates both a metaphysics, by arranging the single items in a hierarchical sequence designed to show their ultimate origin in the Dao, and a cosmogony, which does not take place once and for all *in illo tempore* but is continuously reiterated within each of the cosmic cycles that the Dao brings into existence.

Both the Dao and the manifested world model themselves on *ziran* (25), a term that literally means “to be so of its own.” In reference to the Dao, the principle of *ziran* means that the Dao only regulates itself upon itself; in reference to the world generated by the Dao, *ziran* means that there is no ultimate reason for things being as they are: the Dao generates the “ten

thousand things,” but while for the relative the Absolute is its “mother,” for the Absolute the relative does not even exist. Aside from generating the world, therefore, the Dao does nothing else: it does not act in it, it is not affected by the transformation, decay, and disappearance of the forms it generates, and it neither rejoices in nor is hurt by what is, in a relative sense, good or bad.

The saintly person. Just as the Dao does nothing, so is “non-doing” or “non-action” (*wuwei*) the way to attain to it. Non-action is the practice of *ziran* in the human world: one fully responds to circumstances and events, doing no more and no less than what is required, without taking the initiative unless there is an immediate need to do so, and without being moved by personal desire, interest, or advantage (3, 19, 34, 37, 57). In particular, there is no need of striving to perform what is “good,” and even less so of attempting to impose it on others, for “when everyone knows the good as good, evil is already there” (2).

The person who has “returned to the Dao” (28, 40, 52) is called in the *Daode jing* the *shengren*, a term that in a Daoist context may be translated as “saint” to distinguish him from the Confucian “sage.” As the highest realized human being who has achieved liberation in life, the Daoist saint has transcended the limitations of individuality and form; he continues to remain in the world of multiplicity until he has completely fulfilled his function in it, but from an absolute point of view, which is the one in which he constantly dwells, his self-identity is already null, for he is identified with absolute principle. Death for him, therefore, is not even a change of state, for he has attained the state in which no change can occur. In the human world, he “practices the teaching without words” and “makes it possible for the ten thousand things to function, but does not start them” (2). He does not take an active leading role in society but benefits his fellow human beings by his mere presence. This is so even when the saint is the ruler, a figure to whom the *Daode jing* devotes much attention. In that position, the saint governs according to the principle of non-action, and that is how he ensures the well-being of his country and his subjects. In the ideal description given by the *Daode jing*, no one even needs to know who the ruler is. “Therefore the saint in his government empties their heart [i.e., their mind], fills their belly, weakens their will, and strengthens their bones. He always wants people to be without knowledge and without desires.” He does so because “not exalting the worthy prevents people from competing, not valuing goods hard to obtain prevents people from becoming thieves, and not seeing desirable things prevents the people’s heart from becoming confused” (3).

Revelations and Textual Corpora

To a significant extent, the history of Daoism may be seen as a continuous restatement of the principles enunciated in the early founding texts. To an equally significant extent, its development has been marked by the adaptation to varying historical circumstances, the response to the needs and demands of different social groups, and the incorporation of notions, beliefs, cults, and practices derived from other trends of thought and religion. These multiple factors gave rise to the

idea, apparently unknown to the early Daoist thinkers, that the Dao may appear under the guise of gods or other divine beings, and may through them take an active role in the world, in particular by granting revelations to some adepts.

The first Daoist revelation. The process that led, in the second half of the second century C.E., to the formation of the first major Daoist religious movement can only be understood in the light of the politico-religious ideals of ancient China, synthesized in the notion of Great Peace (*taiping*) and shared by different traditions including Confucianism. At the center of that process was the deification of Laozi, now represented not only as the sage who expounds the metaphysical doctrines of the *Daode jing*, but also as a messiah who embodies the Dao and reappears at different times either as a sage counselor of political rulers, or as the inspirer of religious leaders (Seidel, 1969). Scholars have pointed out the association among the spread of beliefs concerning Lord Lao (Laojun, i.e., Laozi in his divine aspect), the cults offered to him outside and even within the imperial court in the second century, and the political decline of the Han dynasty (202 B.C.E.–220 C.E.). Based on the notion that the emperor symbolized and guaranteed the balance between Heaven and Earth, the weakening of political power at the end of the Han, and the concurrent natural disasters and social unrest were deemed to reflect a rupture between the supernatural and the human world. Hence the millenarian beliefs and the messianic wait for a Savior—a new incarnation of Lord Lao who would restore Great Peace and confer the Celestial Mandate (*tianming*) to a new ruler.

In one of his transformations, Lord Lao appeared (in 142 C.E., according to the traditional date) to a healer, Zhang Daoling, in the southwestern region of Sichuan. Lord Lao established a covenant (*meng*) with Zhang Daoling, revealing to him the teaching of Orthodox Unity (*zhengyi*) and bestowing upon him the title of Celestial Master (*tianshi*). This revelation, which has been dubbed “the New Testament of the Dao” to distinguish it from the teaching of the *Daode jing*, is at the origin of the Way of the Celestial Masters (*Tianshi dao*), a priestly lineage that continues to exist in the present day (the current Celestial Master resides in Taiwan). The early Celestial Masters established a theocratically based enclave in Sichuan that maintained its political semi-independence for several decades, until the end of the Han period. Its purpose was not to terminate and replace the imperial power; rather, the intent of Zhang Daoling and his successors was to realize the kingdom of the Great Peace on earth until a new sovereign would receive the mandate to rule from Heaven.

The administrative structure of the early Way of the Celestial Masters was based on that of the Han empire; both in turn reproduced on earth the bureaucratic ordering of Heaven. Since that time, Daoist texts have often represented Heaven as an administration divided into ministries and offices, with a hierarchical classification of primary deities (often called “emperor,” *di*) and a host of ancillary gods. The same bureaucratic features are displayed in Daoist ritual, which is based in part on the forms established by the early Way of the Celestial Masters: requests of audiences in the courtly halls of celestial palaces,

arrangement of the deities on seats arrayed according to their rank, and written petitions delivered to the gods.

The Three Caverns. The diaspora of the Celestial Masters’ communities after the end of the Han resulted in the expansion of the new religion to other parts of China. Its spread in Jiangnan, the region south of the lower Yangzi River, was one of the prerequisites for the formation of two other major corpora of Daoist doctrines, texts, and practices in the second half of the fourth century. The representatives of the religious legacies of Jiangnan responded to the newly imported cults by reformulating and codifying some aspects of their own traditions in ways that admitted elements of the practices of the Celestial Masters, but were mainly based on the local traditions, which included meditation, alchemy, self-cultivation practices, and various methods for communicating with the gods and expelling demons. The first corpus, known as Shangqing (Highest Clarity), derived from revelations that occurred from 364 to 370 C.E. and was centered on meditation practices; the second, known as Lingbao (Numinous Treasure), derived from revelations that occurred between circa 395 and 405 C.E. and was based on communal ritual. These two codifications clearly define, for the first time, the two main poles of the Daoist religious experience, namely inner, individual practices on the one hand, and collective practices for the community of the faithful on the other.

The relations among these traditions were formally codified in the early fifth century in the system of the Three Caverns (*sandong*). Its main purpose was to hierarchically arrange the different legacies of Jiangnan, assigning the higher rank to Shangqing, the intermediate one to Lingbao, and the lower one to other earlier and contemporary traditions. Around 500 C.E., the corpora associated with the *Daode jing*, the *Taiping jing* (Scripture of Great Peace), alchemy, and the Way of the Celestial Masters were assigned to the so-called Four Supplements (*sifujin*). The Three Caverns also provided the formal schema for other important aspects of Daoist doctrine and practice, including the ordination stages of the Daoist priest (*daoshi*) and the arrangement of scriptural and other writings in the collections of Daoist texts (*Daozang*) that began to take shape from the early fifth century.

This model continued to perform this function even after the contours of Daoist religion were reshaped by various new revelations and codifications during the Song period (960–1279) and later, and by the creation in the early thirteenth century of Quanzhen (Complete Reality, or Complete Perfection), a monastic order that is, along with the Way of the Celestial Masters, the main branch of present-day Daoism.

Cosmos and Gods

The cosmos generated by the Dao and the heavens inhabited by deities that personify the Dao are intermediaries between the Absolute and the human world. These two domains overlap to a significant extent, for certain deities and certain features of the cosmos correspond to each other. Both of them play an essential role in the various ways that Daoism provides for “returning to the Dao” (*fandao*), which are addressed either to the single individual or to the community as a whole.

Correlative cosmology. The features and workings of the cosmic domain are explicated in Daoism largely by means of the language and images of the standard Chinese cosmological system. This system, often referred to as “correlative cosmology” by scholars, is based on several patterns of emblems (*xiang*) such as Yin and Yang, the five agents (*wuxing*), and the eight trigrams and sixty-four hexagrams of the *Book of Changes* (*Yijing*). These emblems function as categories to which the single entities or phenomena can be assigned. The five agents, for instance, emblemize the modes or states in which the one Original Pneuma (*yuanyi*) appears in the cosmos, represented by Wood, Fire, Soil, Metal, and Water. Directions of space, segments of time cycles, numbers, colors, planets, viscera of the human body, musical notes, and so forth can be assigned to one of these emblematic categories in order to define not only the relations that occur among the elements of a series, but also those that occur among the different domains. Wood, for instance, is associated with the east, spring, the numbers 3 and 8, the color green (or blue), Jupiter, the liver, and the note *jiao*. The purpose of correlative cosmology, therefore, is not so much to explain what causes an entity to exist or a phenomenon to occur as it is to define its relation to other entities and phenomena. An important corollary to this view is that an event or action happening or performed in one domain may affect the corresponding components in another domain according to the principle of “stimulus and response” (*ganying*), by which things of the same “category” (*lei*) influence each other.

Correlative cosmology, which took shape as a comprehensive system between the third and the second centuries B.C.E., is not tied to any specific intellectual or religious legacy and is the result of an effort to create a comprehensive analytic and synthetic system with contributions both by thinkers and by specialists of various traditional sciences, including diviners, astronomers, and physicians. Daoism is one of several traditions that have drawn upon correlative cosmology to formulate its views and to frame its techniques or practices. In Daoism, correlative cosmology serves not only to explicate the functioning of the cosmos, but also to illustrate the notion that single entities and phenomena ultimately originate from the Dao and that the different forms in the world of multiplicity are governed by the One, the principle of the unity of the cosmos. At the same time, the emblems of correlative cosmology serve to regulate the process of “returning to the Dao” through the support of a microcosmic framework—the ritual area, the alchemical laboratory, or the human being itself. The ritual area, for instance, is arranged so as to correspond to the cosmos and its temporal and spatial configurations (Lagerwey, 1987, pp. 3–48). In alchemy, the stages of the compounding of the elixir reproduces in a reverse sequence the cosmological configurations that intervene between the absolute Dao and the domain of relativity.

Communicating with the gods. The supreme Daoist deities are the Three Clarities (*sanzqing*), each of whom rules over one of the many heavens distinguished in Daoist cosmography. They are associated with different precosmic eras and are at the origin of the textual corpora associated with the Three Caverns. Above them some traditions place the Celestial Worthy

of Original Commencement (*Yuanshi tianzun*), who dwells in the supreme Great Canopy Heaven (*Daluo tian*). The unity of the cosmos is represented in a deified form by the Great One (or Great Unity, *Taiyi*); he resides at the symbolic center of the cosmos in the Northern Dipper (*beidou*), whose apparent rotation distributes Original Pneuma to the regions of space and sustains the cycles of time. Several other gods, such as the “emperors” of the five directions (north, south, east, west, and center), also represent cosmological principles. In addition, a multitude of deities, most of whom are the expression of local cults, contribute to form a pantheon with indefinite boundaries that takes different forms according to place and time.

The highest gods, or their representatives, reveal texts, teachings, and practices. The scriptures belonging to the Shangqing and Lingbao corpora are deemed to have taken shape from graphs coagulated from Original Pneuma, or from sounds generated by its vibration, in the early stages of the formation of the cosmos. Those graphs constitute the prototypes of the revealed scriptures, which at first are transmitted from one god to another, undergoing various stages of materialization until they are delivered to humans by a divine being. Just as the gods grant revelations mostly in the form of scriptures, and consistently with the bureaucratic metaphor mentioned above, the typically Daoist form of communicating with the gods is by writing. In Daoist ritual, the priest delivers a “memorial” (or “statement,” *shu*) to the deities to announce that a ceremony will be performed in their honor, declare its purpose, specify its program, and list the names of those who sponsor it. The so-called talismans (*fu*, a word that corresponds almost exactly to Greek *symbolon*) are traced on paper or other supports, including air, in graphs intelligible to the gods. Like the revealed scriptures—some of which, in fact, are deemed to have evolved from them—the talismans have a counterpart in Heaven, and thus serve to identify and authenticate their possessor. Talismans confer power to summon certain deities and to control demons, but they also protect space and heal illnesses; they are worn on one’s body, affixed at the four directions, placed along the path that leads to one’s dwelling, or made into ashes and drunk with water. Another important ritual object that has a written form is the “register” (*lu*), a formal document of investiture that the Daoist priest receives at various stages of his ordination and that defines his rank, the rites that he may perform, and the deities and spirits over which he has control.

The Human Being

Despite significant variations among the different traditions, the basic view of the human being and its potentialities in Daoism reflects its doctrinal principles. Many texts devoted to this subject state that full comprehension of their teachings grants the status of Real Man, or Perfected (*zhenren*). The related practices do not consist in a process of “increase” or “becoming perfect” but vice versa in reducing what obstructs one’s potential for realization, according to the principle of the *Daode jing* that “practising the Dao is called reducing; reduce and then again reduce and thereby attain to non-doing” (sec. 48). Some authors of texts of inner alchemy were aware of the ambiguity involved in the very notion of “doing” a practice in order to attain the state of “non-doing” and emphasized that

the practice operates within the domain that the adept is called to transcend; its final purpose is to reveal the limitations of that domain.

The heart (*xin*) is the symbolic center of the human being. It is the residence of spirit (*shen*) and corresponds to the Northern Dipper in heaven. Just as Oneness takes multiple forms in the cosmos, so the center of the human being reappears in multiple locations. The most important are the three Cinnabar Fields (*dantian*, immaterial loci in the regions of the brain, the heart, and the abdomen) and the five viscera (*wuzang*, namely liver, heart, spleen, lungs, and kidneys). The three Cinnabar Fields and the five viscera represent, respectively, the vertical and horizontal dimensions of the cosmos within the human being.

According to some traditions within Daoism, these and many other loci of the body are also residences of an inner pantheon of major and minor gods. The most important among them correspond to those that dwell in Heaven and perform multiple related roles: they personify the formless Dao or impersonal notions such as Yin and Yang, allow the human being to communicate with the gods of the outer pantheon, and administer the body and its functions. Several texts describe meditation practices in which the visualization of inner deities is combined with channeling essences and pneumas to the residences of the inner gods in order to provide them with nourishment. From the Tang period, these practices were largely replaced by other methods of contemplation and introspection influenced by Buddhism, but the inner gods have continued to perform an important function in ritual when they are summoned forth by the priest in order to submit the memorial to the gods in Heaven.

Alchemy, in its “inner” form (*neidan*), framed its practices in part by drawing from meditation methods and from techniques for “nourishing life” (*yangsheng*). The latter term refers to a large variety of methods that share a physiological foundation, including *daoyin* (a form of gymnastics that is one of the precursors of modern *taiji quan*), breathing, and sexual practices. Using the same word that other sources apply to the cults of common religion, several alchemical texts qualify those techniques as “secular” or “vulgar” (*su*); as other traditions within Daoism do with deities and rites, alchemy incorporates elements of those techniques but grafts them onto its own doctrinal background.

In alchemy and several other traditions, the purpose of the practice is to acquire transcendence or “immortality.” In religious imagery, in both its mystical and popular aspects, “immortality” is a state attained by superior beings, often entirely legendary, through their practices. For others, “immortality” consists in undergoing transformation, in the literal sense of “going beyond the form” and returning to the unconditioned state.

See also **Buddhism; Chinese Thought; Confucianism; Humanism; Chinese Conception of; Legalism, Ancient China; Religion: East and Southeast Asia.**

BIBLIOGRAPHY

Barrett, T. H. *Taoism under the T'ang: Religion and Empire during the Golden Age of Chinese History*. London: Wellsweep, 1996.

- Bokenkamp, Stephen R. *Early Daoist Scriptures*. Berkeley: University of California Press, 1997.
- Boltz, Judith M. *A Survey of Taoist Literature: Tenth to Seventeenth Centuries*. Berkeley: Institute of East Asian Studies, University of California, 1987.
- Despeux, Catherine. *Taoïsme et corps humain: Le Xiuzhen tu*. Paris: Guy Trédaniel Editeur, 1994.
- Kohn, Livia, ed. *Daoism Handbook*. Leiden, Netherlands, and Boston: Brill, 2000.
- Lagerwey, John. “Écriture et corps divin en Chine.” In *Corps des dieux*, edited by Charles Malamoud and Jean-Pierre Vernant. Paris: Gallimard, 1986.
- . *Taoist Ritual in Chinese Society and History*. New York: Macmillan, 1987.
- Lau, D. C., trans. *Tao Te Ching*. Hong Kong: Hong Kong University Press, 1982.
- Little, Stephen, with Shawn Eichman. *Taoism and the Arts of China*. Chicago: The Art Institute of Chicago, 2000.
- Pregadio, Fabrizio, ed. *The Encyclopedia of Taoism*. London: Routledge, 2004.
- Robinet, Isabelle. *Taoism: Growth of a Religion*. Translated by Phyllis Brooks. Stanford, Calif.: Stanford University Press, 1997.
- Schipper, Kristofer. *The Taoist Body*. Translated by Karen C. Duval. Berkeley: University of California Press, 1993.
- Schipper, Kristofer, and Franciscus Verellen, eds. *The Taoist Canon: A Historical Companion to the Daozang*. 3 vols. Chicago: University of Chicago Press, 2004.
- Seidel, Anna. “Chronicle of Taoist Studies in the West 1950–1990.” *Cahiers d'Extrême-Asie* 5 (1989–1990): 223–347.
- . *La divinisation de Lao tseu dans le Taoïsme des Han*. Paris: École Française d'Extrême-Orient, 1969.
- . “Taoism: The Unofficial High Religion of China.” *Taoist Resources* 7, no. 2 (1997): 39–72.
- Stein, Rolf A. “Religious Taoism and Popular Religion from the Second to Seventh Centuries.” In *Facets of Taoism: Essays in Chinese Religion*, edited by Holmes Welch and Anna Seidel. New Haven, Conn., and London: Yale University Press, 1979.
- Watson, Burton, trans. *The Complete Works of Chuang tzu*. New York: Columbia University Press, 1968.

Fabrizio Pregadio

DARWINISM See Evolution

DEATH. The idea of death—the irreversible end to life—has preoccupied, fascinated, and struck fear into human beings through the millennia. In the early twenty-first century, artists continue to sing about death, write about death, and depict it in paintings and photographs. Religious leaders are still talking about how to live a meaningful life in the face of death’s inevitability. Governments go to war in the name of peace and the defense of the living, causing death on a massive scale. Ethicists and activists argue over the right to die, the right to live, the right to kill. Medical personnel strive to prevent it, are often present at the bedside of the dying, and pronounce when death has occurred. Biologists and physiologists puzzle over when it occurs and how it can be measured. Counselors, therapists, relatives, and dear friends help those



The Sorrow of Andromache (1781) by Jacques-Louis David. Oil on canvas. The concepts of death, grief, and mourning have been represented by innumerable artists throughout the centuries. During the Enlightenment, themes in art were frequently linked to human mortality. ERICH LESSING/ART RESOURCE, NY

who are dying make peace with their death, and help those left behind to live on. Young children wonder what has happened to their loved ones, and families struggle with their grief.

Defining Death

Death is clearly a part of life—every day. And yet, the word defies simple definition, because there are so many aspects to death and so many perspectives. A 1913 edition of *Webster's Dictionary* defined death as “the cessation of all vital phenomena without capability of resuscitation, either in animals or plants.” The current *Concise Oxford Dictionary* defines death both as “dying” (a process) and as “being dead” (a state). As intoned in the Old Testament of the Bible, “All flesh is as grass” (Isaiah 40:6–8). The body dies but in the religious and philosophical traditions of many observers, the soul or spirit lives on.

The Roman Catholic Church, for example, advances the thought that death is the “complete and final separation of the soul from the body.” The church, however, concedes that diagnosing death is a subject for medicine, not the church. In the Zen Buddhist and Shintō religious traditions, mind and body are integrated, and followers have difficulty accepting the brain-death criteria that are now common in Western medical and legal circles. For some Orthodox Jews, Native Americans, Muslims, and fundamentalist Christians, as long as the heart is beating—even artificially—a person is still alive.

Advances in life-supporting technologies in the 1960s spawned the growth of medical ethics as a distinct field, and a new definition for physiological death was needed. For centuries death was indicated by the absence of a pulse or signs of breathing, but new technologies, including the respirator and heart–lung machine, made it possible for physicians to artificially maintain heart and lung function, blurring clear signs of an individual's death. In the United States many states have adopted legislation recognizing brain death—the loss of brain function, which controls breathing and heartbeat—as the certification of death. Canada, Australia, and most of the nations of Europe and Central and South America have broader definitions for death: either loss of all independent lung and heart function, or the permanent, irreversible loss of all brain function.

From a physiological standpoint, somatic death—the death of the organism as a whole—usually precedes the death of individual organs, cells, and parts of cells. The precise time of somatic death is sometimes difficult to determine because transient states, such as coma, fainting, and trance, can closely resemble the signs of death. Several changes in the body that occur after somatic death are used to determine the time of death and circumstances surrounding it. The cooling of the body, called *algor mortis*, is mainly influenced by the air temperature of the surrounding environment of the body. The stiffening of the skeletal muscles, called *rigor mortis*, begins from five to ten hours after death and ends in three or four days. The reddish-blue discoloration that occurs on the underside of the body, called *livor mortis*, is the result of blood settling in the body cavity. Shortly after death, blood clotting begins, along with autolysis, which is the death of the cells. The

decomposition of the body that follows, called putrefaction, is the result of the action of enzymes and bacteria.

Bereavement, Grief, and Mourning

The word *bereavement* comes from a root word meaning “shorn off” or “torn up.” It suggests that one has been deprived or robbed, dispossessed, left in a sad and lonely state. Bereavement is the state of being in which a person has suffered the death of a relative or friend.

Grief refers to the total range of emotions humans feel in response to a loss. The word suggests negative responses, including heartbreak, anguish, distress, guilt, shame, and thoughts of suicide. Grief also encompasses feelings of relief, anger, disgust, and self-pity.

Mourning is the expression of grief over someone's death. It is the process by which people incorporate the experience of loss into their ongoing lives. In mourning, a person searches for answers: How do I carry on in life? How do I survive this? Approaches to mourning are culturally prescribed: Each world culture has certain cultural “rules” for mourning in an appropriate manner. Mourning today is less formal than it was in the past, and so-called modern cultures are less formal in their rituals for mourning than traditional cultures.

Why Must People Die?

A number of answers to this question have been proposed by philosophically oriented biologists such as Sherwin B. Nuland and Basiro Davey and colleagues. The results of tissue cultures indicate that cells are “preprogrammed” by their genetic code to cease the dividing processes after a certain number of divisions have occurred, and then die. A further argument proposes that death is adaptive at the population level, ensuring that individuals do not compete with their offspring for scarce resources and instead channel precious energy into reproduction. Research accounts of the biochemical changes that occur in cells as they age support both these theories and a more straightforward “wear and tear” argument, indicating that death on a biological level can be understood as a combination of a number of factors.

These biological explanations for the occurrence of death focus on the process of aging. The death of younger people, especially one's own child, opens up broader philosophical questions that may be even more difficult to answer: “Why did my baby die, God?” is one of the ways human beings ask this type of question. If God truly is in his heaven and all is right with the world, why do babies die? Human beings have struggled with this type of question through the millennia, and there do not appear to be any definitive, widely accepted answers. Individuals seem to come to grips with such questions in an extraordinarily varied range of ways.

Historical Perspectives

In 1900 the average life expectancy at birth in the United States was 47 years, and this figure increased to a record high of 77.2 years a century later. The gap between female and male life expectancy peaked in 1979 when women outlived men an average of 7.8 years. By 2001 the gap was down to 5.4 years.

That year, women lived an average of 79.8 years and men an average of 74.4 years. White males averaged 75.0 years and black males 68.6 years; white females averaged 80.2 years and black females 75.5 years (Arias and Smith).

In 1900 more than half of the deaths involved young people, age fourteen and younger. By 2001, only 1.6 percent of the total reported deaths occur among young people. Heart disease and cancer are the leading causes of death in the early twenty-first century, together accounting for more than half of all deaths in the United States each year. In order, the top fifteen leading causes of death, comprising fully 83.4 percent of all U.S. deaths in 2001, were: heart disease, cancer, stroke, chronic lower respiratory diseases, accidents (unintentional injuries), diabetes, influenza and pneumonia, Alzheimer's disease, kidney disease, septicemia (infection from microorganisms), intentional self-harm (suicide), chronic liver disease and cirrhosis, assault (homicide), hypertension, and pneumonitis (inflammation of the lungs) due to solids and liquids.

In the past century the experience of death has changed from a time when the typical death was rapid and sudden, often caused by acute infectious diseases such as tuberculosis, typhoid fever, syphilis, diphtheria, streptococcal septicemia, and pneumonia, to a time when the typical death is a slow, progressive process. In 1900 microbial diseases, often striking rapidly, accounted for about 40 percent of all deaths; in the early 2000s accounted for only about 3 percent. In sum, in the past century U.S. society has evolved from one in which many children and young people died to a society in which death has become increasingly associated with older-aged people. The U.S. infant mortality rate reached a record low level in 2001: 6.8 deaths per 1,000 live births.

Observers of this phenomenon have proposed a theory of epidemiologic transition, a three-stage model that describes the decline in mortality levels and the accompanying changes in the causes of death that have been experienced in Western populations. The first stage, called the Age of Pestilence and Famine, is characterized by high death rates that vacillate in response to epidemics, famines, and war. Epidemics and famines often go hand in hand, because malnourished people are susceptible to infectious diseases. The second stage, the Age of Receding Pandemics, describes a time in which death rates decline as a result of the improved nutrition, sanitation, and medical advances that go along with socioeconomic development. The third stage, labeled the Age of Degenerative and (Hu)man-Made Diseases, describes the period in which death rates are low (life expectancy at birth exceeds seventy years) and the main causes of death are diseases related to the process of aging. The biggest challenge to this theory comes from the emergence of new diseases (such as AIDS/HIV, Legionnaires' disease, and Lyme disease) and reemergence of old infectious diseases (such as smallpox and malaria) in the latter part of the twentieth century. HIV/AIDS, for example, took the lives of between 1.9 million and 3.6 million people worldwide in 1999.

According to the Population Reference Bureau, life expectancy at birth for the world's population at the turn of the twenty-first century was 67 years—69 years for females, 65 years

for males. In more developed countries life expectancy averaged 76 years—79 years for females, 72 years for males. In less-developed countries, life expectancy averaged 65 years—66 years for females, and 63 years for males.

Death throughout Art History

Death, an emotionally wrenching idea, has been both a subject for artists and an incentive for artistic production throughout history. Perhaps as much as, perhaps more than, any other subject, artists have dealt with death, dying, the threat of death, escape from death, thoughts of death, and preparation for death through the centuries.

The importance of death as a concept in ancient Egyptian culture is clearly seen in the creation of the pyramids and other burial artifacts. Ancient art in Greece focused on materialistic representations of life in an ideal state, including the physical perfection of its mythological heroes. This can be interpreted as art affirming life as the Greeks experienced it or desired life to be, and the cultural rejection of the finality of death. Looking at art in the Christian tradition with its focus on the death of its central figure, some art historians have described Christianity as a highly developed death cult; the idea of death, mediated through works of Christian art over the centuries, is ultimately affirming of life. Many artists in the period of the Enlightenment of the eighteenth century were commissioned to work in service to the lay aristocracy and eventually the merchant class. The social hierarchy in this time was reinforced through highly developed techniques in portrait painting. Portraiture, seen as self-constructed identity through painting, constitutes a large segment of traditional Western art. Thus, art during the Enlightenment was closely linked to the idea of personal mortality. Major themes in modern art include the importance of self-expression in the face of the forces of mass conformity and antihumanist ideas. The universal theme of mortality is seen in many modern works, and death remains firmly established as a central theme in contemporary art, though the themes surrounding the concept of death are not as likely to reflect religious, romantic, or metaphysical concerns as they were in earlier historical periods.

No one can predict future directions in artists' responses to death, but it is most likely that humankind will continue to look to these visionaries to both document and inform our thinking. Mourners in Greece during the early fifth century were depicted striking their heads, tearing out their hair, beating their breasts, and scratching their cheeks until they bled. Today, many find solace from the largest ongoing community arts project in the world, the AIDS Memorial Quilt. In both instances, artists helped society commemorate the lives of deceased loved ones, and they supported the living in their efforts to find meaning and the strength to endure their tragic feelings of loss.

The Psychology of Dying

The American psychiatrist Elisabeth Kübler-Ross developed a five-stage model of the psychology of dying and grief. In her book titled *On Death and Dying* (1969), she proposed that in response to the awareness of their impending death, individuals move through stages of denial, anger, bargaining, depression,

and acceptance. Other authorities note that these stages do not occur in any predictable order, and feelings of hope, anguish, and terror may also be included in the range of emotions experienced.

Bereaved families and friends also go through stages from denial to acceptance. Grief can begin before a loved one has died, and this anticipatory grief helps lessen later distress. During the next stage of grief, after the death of the loved one, mourners are likely to cry, have trouble sleeping, and lose their appetite. Some feel alarmed, angry, or wounded by being left behind. After formal services for the deceased are over and conventional forms of social support end, depression and loneliness often occur.

Feelings of guilt are quite common, and in some cases individuals think seriously about taking their own life for somehow failing the loved one. This is especially true in response to the loss of a child. Though people often talk about healthy and unhealthy grief, it is very difficult to measure emotional pain in any precise way or advise how long one's grief should last. Many clinicians believe that those who abandon their grief prematurely are living in denial and make healing more difficult; but, on the other hand, it is also possible to become mired in despair. The death of a loved one, thus, threatens to take all the life out of the person who feels left behind.

Research on attitudes toward death and anxiety about death has been conducted mostly by social scientists around the world. There are more than one thousand published studies in this area, and four broad themes emerge from the findings:

1. Most people think about death to some extent and report some fear of death, but only a small percentage exhibit a strong preoccupation with death or fear of death.
2. Women consistently report more fear of death than men, but the difference in levels of fear is typically minor to moderate from study to study.
3. Fear of death does not increase with age among most people.
4. When considering their own death, people are more concerned about potential pain, helplessness, dependency, and the well-being of loved ones than with their own demise.

Death Education

The death-related experiences of most Americans and people in other Western and industrialized societies in the early twenty-first century are markedly different from how people experienced death a century ago. At present, death is much more likely to take place in a medical facility under the control of well-trained strangers. In the past, death more commonly was an intimate family event and usually took place at home with family members caring for the dying person. Loved ones were most likely present when the individual passed, and young children witnessed the events surrounding the death. The loved one's body was washed by the family and prepared

for burial. A local carpenter or perhaps even family members themselves constructed a coffin, and the body lay in state for viewing by family and friends in the parlor of the home. Children kept vigil with adults and sometimes slept in the room with the body. The body was later carried to the gravesite, which might be on the family's land or at a nearby cemetery. The local minister would be present to read Bible verses and say goodbye, and the coffin would be lowered and the grave covered, perhaps by relatives.

In the early 2000s, death has been sanitized and separated from everyday lives. It is likely to happen in a high-tech, multilayered bureaucratic hospital. The body is soon whisked away from view. It is carefully prepared for viewing and subsequent burial by professionals with an artistic flair, and placed in an elaborate and expensive casket. The body is then carried via a dazzling motor coach to the cemetery for interment in a carefully draped burial plot giving little hint that the loved one will actually end up in the earth.

The choreography of the modern death and burial process has become so elaborate that many people react in frustration and dismay and seek more simple, emotionally connected experiences of death. At the same time, the field of death education has grown as colleges and universities create courses on death and dying. These courses include both formal instruction dealing with dying, death, and grief, plus considerable time invested in talking about the participants' personal experiences with death. These developments can all be interpreted as parts of a movement toward bringing death back into people's lives, as a painful and puzzling event to be explored, experienced, and embraced rather than denied and avoided.

See also ***Death and Afterlife, Islamic Understanding of; Heaven and Hell; Heaven and Hell (Asian Focus); Immortality and the Afterlife; Suicide.***

BIBLIOGRAPHY

- Arias, Elizabeth, and Betty L. Smith. "Deaths: Preliminary Data for 2001." *National Vital Statistics Reports* 51, no. 5 (2003): 1.
- Arias, Elizabeth, et al. "Deaths: Final Data for 2001." *National Vital Statistics Reports* 52, no. 3 (2003): 21.
- Carroll, Noël. *Philosophy of Art*. London: Routledge, 1999.
- Davey, Basiro, Tim Halliday, and Mark Hirst, eds. *Human Biology and Health: An Evolutionary Approach*. 3rd ed. Buckingham, U.K.: Open University Press, 2001.
- DeFrain, John, Linda Ernst, and Jan Nealer. "The Family Counselor and Loss." In *Loss during Pregnancy or in the Newborn Period: Principles of Care with Clinical Cases and Analyses*, edited by James R. Woods Jr. and Jenifer L. Esposito Woods, 499–520. Pitman, N.J.: Jannetti Publications, 1997.
- DeSpelder, Lynne Ann, and Albert Lee Strickland. *The Last Dance: Encountering Death and Dying*. 7th ed. Boston: McGraw-Hill, 2005.
- Kastenbaum, Robert. *The Psychology of Death*. 3rd ed. New York: Springer, 2000.
- Kastenbaum, Robert, ed. *Macmillan Encyclopedia of Death and Dying*. New York: Macmillan Reference, 2003. See especially the entries on "Art History," "Causes of Death," and "Psychology."

- Kübler-Ross, Elisabeth. *On Death and Dying*. London: Macmillan, 1969.
- Nuland, Sherwin B. *How We Die*. London: Chatto and Windus, 1994.
- Olshansky, Stuart Jay, and A. B. Ault. "The Fourth Stage of Epidemiologic Transition: The Age of Delayed Degenerative Diseases." *Milbank Memorial Fund Quarterly* 64 (1986): 355–391.
- Omran, Abdel R. "The Theory of Epidemiological Transition." *Milbank Memorial Fund Quarterly* 49 (1971): 509–538.
- Population Reference Bureau. "Life Expectancy at Birth by World Region, 2001." In *2003 World Population Data Sheet*. Washington, D.C.: Population Reference Bureau, 2003.
- Seale, Clive. *Constructing Death: The Sociology of Dying and Bereavement*. Cambridge, U.K.: Cambridge University Press, 1998.
- Wollheim, Richard. *Painting as an Art*. Princeton, N.J.: Princeton University Press, 1987.
- Wyatt, R. "Art History." In *Encyclopedia of Death and Dying*, edited by Glennys Howarth and Oliver Leaman, 34–36. London: Routledge, 2001.

John DeFrain
Alysa DeFrain
Joanne Cacciatore-Garard

DEATH AND AFTERLIFE, ISLAMIC UNDERSTANDING OF. Islamic views of death and the afterlife encompass two broad streams: the individual and the collective or cosmological. The existence of an afterlife for individuals and final judgment of all creation are both central tenets of the faith. The Koran provides the foundation for Muslim views of death, with eschatological imagery leaping out from nearly every page. The Koran is supplemented by hadith, reports of the words and deeds of the prophet Muhammad (c. 570–632), as well as by numerous commentaries and treatises. While the specific beliefs and practices surrounding death and the afterlife display significant sectarian and cultural variety, the following account will focus on the most widely shared views.

Overview

Death is built into God's plan for his creation. God alone determines and knows the time and manner of each person's death and of Judgment Day. Tradition holds that an angel implants in the womb of each expectant mother a speck of soil from the place where that child is eventually fated to die. While God retains authority over death, he delegates oversight of individual deaths to an angel named Izra'il. Orthodox Sunni theology recognizes God's total omniscience and omnipotence. Thus God appoints not only each person's day of death but also the individual actions for which one is judged. This view is balanced by a recognition of God's infinite justice, a sense that humans choose and deserve their ultimate fate. The apparent paradox is addressed in the complex theological formula of "acquisition" (*iktisab*), which holds that while God authors human acts, people "acquire" them as products of free will. This doctrine is buttressed with an appeal to divine mystery, a belief that God's ways are beyond human comprehension.

In the end, most Muslims display a firm commitment to both predestination and free will, holding themselves accountable for their deeds while acquiescing to God's power. If intellectually untidy, such a view is emotionally rich and satisfying for many.

Rather than "fear," Muslim sources prefer to counsel the "remembrance" of death, the awareness that it may come at any time, and the need to be always prepared. Al-Muhasibi (c. 781–857) advises that

You need only know that death has no hour known to the servant that he might fear that particular time but be secure at other times. . . . If it does not come down at any particular period of life, one cannot be secure from it in childhood or maturity, in youth or in old age. Since it has no particular cause, one cannot be secure from it in health or in illness, in city or in desert, on land or on sea. . . . When he is watchful for death, he hastens to be prepared for it and races to complete good works before the angel of death can reach his spirit. (Sells, pp. 181–182)

Death of the Body

A tree is said to stand beneath God's heavenly throne, each leaf bearing the name of an individual, and forty days before death that person's leaf falls from the tree as a signal to the angel of death. As death nears, one should prepare by repenting from sin and reading generally from the Koran, especially sura 36, "Ya sin," and others considered notable for their reflections on death. One should face toward Mecca, as in prayer, and repeat the *Shahada* (profession of faith): "There is no god but God, and Muhammad is the Messenger of God." This serves as preparation for the questioning of the soul in the grave, and it is auspicious to die with these words on one's lips. For the incapacitated, family or other fellow Muslims should whisper pious invocations in the dying person's ears. The dying are considered particularly susceptible to Satan's temptations, and their faith must be reinforced with pious reminders.

Burial should proceed without delay. No embalming or cremation is allowed; aside from being cleaned, the body is left minimally altered. Muslims do not present the dead for viewing, as has become customary in the West. The washing of the corpse is ritualized, echoing purification for worship; it begins with the face, head, hands, and feet, as in ritual ablution, then extends to the rest of the body, proceeding from the right side to the left and accompanied by the appropriate prayers. (The body of a martyr is considered pure and is not washed.) The private parts are to be covered from sight, with the washing proceeding under the covering. The washing is preferably done by a family member of the same sex or a spouse or parent. Soap and scent may be used, and the washing is repeated three times. The body may be perfumed, and orifices covered with scented cloth. A simple white, seamless cloth shroud (preferably in three sections for men and five for women) is wrapped around the corpse, and at this point it may be laid out at home or in a mosque for the special *salat al-janaza* (prayer for a funeral). Though the Prophet urged restraint in mourning, wailing for the dead is common, and professional mourners

After being created by God, the Angel of Death cried out: "I am death who separates all loved ones! I am death who separates man and woman, husband and wife! I am death who separates daughters from mothers! I am death who separates sons from fathers . . . [and] brother from his brother! I am death who subdues the power of the sons of Adam. I am death who inhabits the graves. . . . Not a creature will remain who does not taste me."

SOURCE: Quoted in Jane Idleman Smith and Yvonne Yazbeck Haddad. *The Islamic Understanding of Death and Resurrection*, p. 35.

When the sun shall be darkened, when the stars shall be thrown down, when the mountains shall be set moving, when the pregnant camels shall be neglected [something no Bedouin would allow], when the savage beasts shall be mustered, when the seas shall be set boiling, . . . when heaven shall be stripped off, when Hell shall be set blazing, when Paradise shall be brought nigh, then shall a soul know what it has produced.

SOURCE: Koran 81:1–14, Arberry's translation.

may even be hired. Mourning traditionally consists of three days of ascetic behavior (longer for widows), and may include special observances of grief and remembrance on the fortieth day after the funeral, as well as periodic visits to the grave. The spirits of the dead are said to remain close to the grave between death and Judgment Day, and to gain comfort when they are visited by the living, who themselves benefit from the reminder of death.

After prayers, the body is borne to the burial site, accompanied by a procession of loved ones and other Muslims. A coffin is not required, and if one is used, it should not be ostentatious. A traditional grave is several feet deep with a niche to one side for the body. The body is placed in the grave on its right side, with its head facing Mecca, the niche is sealed with bricks, and the grave is filled with earth. Often the surface of the grave is built up with earth or bricks slightly above ground level. Conservative Muslims hold that graves should be minimally adorned, though many employ a marker bearing the deceased's name and some religious text. Some go much further, the Taj Mahal being an extreme example of the elaborate tombs of the wealthy and powerful. Exceptionally pious individuals or "saints" may be buried in special shrines, typically with a domed roof and a space for gathering near the grave. Such saints are popularly credited with miraculous powers and the ability to mediate between believers and God, powers that only increase upon death and draw pilgrims to saints' tombs seeking aid and blessings. Such practices are historically widespread, yet they have inspired equally widespread criticism. Orthodox Sunni theology recognizes only the prophet Muhammad as a potential

intercessor between individuals and God, and conservative Muslims decry the impression of idolatry left by the veneration of saints. Still, such practices persist in many areas as a supplement or alternative to orthodox ritual observances.

Individual Resurrection, Judgment, and Afterlife

After death each individual faces initial testing and preliminary judgment (except the martyr, one who dies "in the path of God," who goes straight to heaven [see Koran 2:154]). The Koran says relatively little regarding this time in the grave, called the *barzakh* (interval), but other genres give much, if not always consistent, detail. Most accounts treat the time in the grave as a foretaste of one's final fate on Judgment Day, and perhaps as a time of purgation of sins so that the deceased is purified and made fit for heaven. Though the exact order of events varies among the sources, the typical account begins with angels visiting the dead and drawing the soul out of the body. Abu al-Layth al-Samarqandi (d. 983) describes the worthy soul coming forth "as easily as a drop from a waterskin," whereas for the soul of an unbeliever, "the angel drags it forth like the dragging of an iron spit through moist wool, tearing the veins and sinews" (Peters, pp. 403–404). The soul is borne up to the gates of heaven; the faithful soul is carried in perfumed shrouds and admitted into heaven to be greeted by the blessed inhabitants of the seven heavens, perhaps even by God himself, while the unbeliever, carried in rough and reeking rags, is turned away at the gate. Each soul is then returned to the body, whereupon angels interrogate it, asking who is its Lord, *din* ("religion"), and prophet. The faithful answer correctly, while unbelievers

falter and misspeak. Next the dead may be visited by the person's deeds personified in the appropriately pleasant or foul form, while the grave is either cooled by a fragrant comforting breeze or blasted with tormenting smoke and fire. Some hold that these conditions endure until resurrection, others that the dead slip into a form of sleep so that the ages pass in an instant.

Resurrection and Judgment Day

At a time known only to God, all creation will be undone and all people, living and dead, will face final judgment. The Koran vividly describes the apocalyptic physical and social chaos of the end time. As these frightening events unfold, al-Dajjal, the Antichrist, will emerge, promising riches, working miracles, and gathering followers. However, as one hadith relates, "he will have with him what will appear like paradise and fire. But that which he will call paradise will be the Fire" (al-Nawawi, p. 308). This is a time of testing, and those of good faith will see through the deceits of al-Dajjal. Al-Nawawi (1233–1278) relates that at this time God

will raise the Messiah, [Jesus] the son of Mary, . . . his hands resting on the wings of two angels. . . . He will pursue the Anti-Christ and will encounter him at the gate of Lud [said to be in Palestine, but compare Gen. 10:13] and will slaughter him. The Messiah will then come to people whom God has shielded from the Anti-Christ. He will wipe away the dust from their faces and will inform them about their grades in Paradise. (al-Nawawi, p. 305)

In some accounts Jesus is preceded or accompanied by the Mahdi ("guided one"), a messianic figure who will revive Islam from decline during the end times.

These events will culminate in the sounding of a great horn (Koran 39:68, 69:13), signaling the final extinction (*fana'*) of all creation as God alone remains, completing the full reversal of original creation. God then restores the earth, resurrects all human bodies, reunites them with their souls, and presides over their final judgment. Two interwoven sets of images characterize this "reckoning" (*hisab*): a written record of each person's deeds—handed to the wicked in their left hand, to the righteous in their right hand—and the balance (*mizan*) in which an individual's deeds are weighed, the good against the bad. The Koran attests to both means of accounting, though the exact relation of the two is not clear. Many accounts then proceed to yet another test, in the form of a bridge (*sirat*) over the fires of hell (see Koran 36:66 and 37:23–24); for the faithful this is wide, while for the wicked it narrows to a knife-edge from which they tumble into perdition. While God's judgment is final, he is depicted as profoundly merciful, permitting Muhammad to intercede on behalf of some sinners, and rescuing from the fires even those with the merest trace of goodness. Some even hold that God will ultimately redeem all the inhabitants of hell, thus treating punishment as purgation rather than eternal fate.

Heaven and Hell

Heaven, sometimes said to have seven levels, is generally described as a lush garden where the faithful reap the rewards

of obedience and morality. Its inhabitants revel in "gardens underneath which rivers flow" (Koran 4:57, 22:23, etc.), peaceful serenity, cool shade and breezes, rivers of water, milk, and honey, luscious foods and drink (including nonintoxicating wine), luxurious furnishings and clothing, and so forth. While some interpret these images as metaphorical, envisioning a purely spiritual bliss in the presence of God, most tend toward literalistic and corporeal interpretations, while recognizing that the true reality of heaven is beyond earthly comprehension.

Although the afterlife is generally the same for both men and women, one aspect of heaven appears to have distinctly gendered overtones. The *hur*, virginal "companions, with beautiful, big and lustrous eyes" (Koran 56:22), are mentioned four times in the Koran (44:54, 52:20, 55:72, and 56:22), though without much detail; post-Koranic sources extrapolate on these accounts. The *hur* are understood to be rewards for males in heaven, and differ from earthly women in their delicate beauty, purity, and lack of illness, menstruation, and pregnancy. Ordinary Muslim women may also go to heaven, where each is said to have just one husband, usually her earthly husband. Thus the *hur* appear to join earthly wives as additional heavenly companions for men. However, some commentators see the *hur* as companions and servants of female believers as well: "Just as the gardens, rivers, milk, honey, fruits, and numerous other things of Paradise are both for men and women, even so are the *hur*" (Smith and Haddad, p. 167).

Hell, often called simply "the fire" (*al-nur*), is depicted in the Koran as a place of unending torment, filled with flame, acrid smoke, boiling waters, and the wails of its unfortunate inhabitants. The damned can gain no comfort: "he is given to drink of oozing pus, the which he gulps, and can scarce swallow, and death comes upon him from every side, yet he cannot die; and still beyond him is a harsh chastisement" (Koran 14:16–17, Arberry's translation). Further, "as often as their skins are wholly burned, we shall give them in exchange other skins, that they may taste the chastisement" (Koran 4:56). As noted, however, some Muslims ascribe to God such profound mercy that he ultimately rescues even the most undeserving sinner from these torments.

The vivid imagery of heaven and hell in Muslim sources adds weight to the call to "remember" death. As a late-twentieth-century Muslim author observed,

This clear reality of the future Life is always before the mind and consciousness of the devout Muslim. It is this awareness which keeps the present life, in the midst of the most intense happiness and the deepest pain alike, in perspective: the perspective of a passing, temporary abode in which one has been placed as a test in order to qualify and prepare himself for his future Home. . . . Therefore the Muslim, knowing that God alone controls life and death, and that death may come to him at any time, tries to send on ahead for his future existence such deeds as will merit the pleasure of his Lord, so that he can look forward to it with hope for His mercy and grace. (Haneef, p. 37)

See also *Death; Free Will, Determinism, and Predestination; Heaven and Hell; Islam; Paradise on Earth; Philosophies: Islamic.*

BIBLIOGRAPHY

- Arberry, Arthur J. *The Koran Interpreted*. 2 vols. New York: Macmillan, 1955.
- Averroës. *The Distinguished Jurist's Primer: A Translation of Bidayat al-Mujtahid*. Translated by Imran Ahsan Khan Nyazee. 2 vols. Reading, U.K.: Garnet, 1994. A good English-language source for death-related ritual law.
- Denny, Frederick Mathewson. *An Introduction to Islam*. 2nd ed. New York: Macmillan, 1993. Useful treatment of death rituals.
- Haneef, Suzanne. *What Everyone Should Know about Islam and Muslims*. 2nd ed. Chicago: Library of Islam, 1996.
- Ibn al-Naqib, Ahmad al-Misri. *Reliance of the Traveler: A Classic Manual of Islamic Sacred Law: "Umat al salik."* Edited and translated by Nuh Ha Mim Keller. Rev. ed. Beltsville, Md.: Ammana, 1999. Another good English-language source for death-related ritual law.
- al-Nawawi. *Gardens of the Righteous: Riyadh as-Salihin of Imam Nawawi*. Translated by Muhammad Zafrulla Khan. London: Curson, 1975.
- Peters, F. E. *A Reader on Classical Islam*. Princeton, N.J.: Princeton University Press, 1994.
- Sells, Michael A., trans. and ed. *Early Islamic Mysticism*. New York: Paulist Press, 1996.
- Smith, Jane Idleman, and Yvonne Yazbeck Haddad. *The Islamic Understanding of Death and Resurrection*. Albany: State University of New York Press, 1981. The definitive scholarly study of the topic.

Paul R. Powers

DECADENCE. See *Cycles.*

DECONSTRUCTION. See *Structuralism and Post-structuralism: Overview.*

DEISM. *Deism* holds more meanings than one word should be asked to bear. Generally, to the point of almost being meaningless, it refers to the notion that reason plays an important role in determining religious knowledge. By this definition the pre-Socratic philosophers, Plato, Aristotle, Epicurus, the Stoics, Cicero, Lucretius, Buddha, Moses, Jesus, and Muhammad all qualify to varying degrees as Deists. With more historical precision the term embraces the religious philosophy of the Enlightenment. But there is a wide range of meanings here too. To religious traditionalists, Deists were effectively atheists. To atheists and materialists, Deism represented a half-realized understanding of the universe. For those who would not have balked had the word been applied to them—hardly anyone in the eighteenth century self-identifies as a “Deist”—it signified belief in a God who could be known by naturally given reason rather than solely by revelation.

But even among this last group the word contained many antinomies. Some Deists upheld the authority of the church; others aggressively criticized customary religious thought and practice. Some used reason to develop more rigorous methods of biblical criticism; others argued that rather than texts, reason in nature offers the proper route to religious truth. Almost all Deists denied God's providence; but a few retained the vestiges of providentialism by virtue of their reasoned belief that God maintained an active, judging presence in the universe. Deism held positive meaning both for moderate Enlightenment figures and those who belong more properly in what the historian Margaret Jacob twenty years ago called the “Radical Enlightenment”; it held negative meanings for traditionalists as well as nonbelievers. The object of this entry will therefore be to explain this word's various meanings more fully by looking closely at how and in whose hands those meanings changed over time.

Early History

The word *déiste* carried a negative valence in its first appearance in the Lausanne reformer Pierre Viret's (1511–1571) *Instruction chrestienne* (1564). Viret recognized a difference between Deism and atheism, if only in seeing the latter as the superlative of the former, but by *déiste* he was likely referring to a group of Lyonnaise anti-Trinitarians rather than those who would later be identified by their rejection of Christian revelation. The word's emergence in the mid-sixteenth century was, whatever its precise referent, not accidental. Much like early modern skepticism, Deistic ideas were fueled by four major changes associated with the late fifteenth and sixteenth centuries: the ongoing recovery of works from antiquity; European encounters with non-European cultures; the confessional conflicts, both conceptual and material, that followed the Protestant and Catholic Reformations; and the spread of experimental science. All had the effect of destabilizing certainties and encouraging some men and women to recover fundamental truths from doubt. And all contributed to the context in which cultural conservatives hurled “Deist” as a term of abuse in their various attempts to confute heterodox ideas and restore unsettled epistemological foundations.

The effects of these four destabilizing changes shaped the earliest expression of arguments that prefigure Enlightenment Deism, which were published in *De veritate* (1624) by the English ambassador to France, Edward, Lord Herbert of Cherbury (1583–1648). Herbert argued that “common notions” would ultimately lead men and women of any religious upbringing to worship God piously, avoid sin, and intuit divine justice. Reason given to us by nature, in other words, could rescue belief from skepticism. The argument seemed flimsy to René Descartes (1596–1650) and Pierre Gassendi (1592–1655), much as in a later form it would strike Hume as entirely empty. But the notion that we all have the capacity to understand religious truth regardless of culture and tradition became a compelling central assumption of later Deists.

British Deism

The high point of Deism began in Britain in the wake of the civil wars of the mid-seventeenth century. The conflicts of the 1640s and the republican experiment of the 1650s opened up

a social and cultural space in which the nature of government, God, gender, and virtually every other worthwhile topic under the sun were called into question. Countless tracts printed after church and state censorship collapsed in the early 1640s assailed religious authority and gave primacy over religion to reason. When this period of kingless rule ended in 1660 with the return of Charles II (1630–1685), the religious experimentalism and enthusiasm of the 1640s and 1650s came to be associated by many with social and political instability. But Deistic ideas were nevertheless out of the bag. The splintering that would later be evident within the ranks of Deistic thinkers reflects this ambivalence about the midcentury crisis and its larger meaning. On the one hand, moderate Deists, who borrowed conservatively from the various radicalisms of the 1640s and 1650s, sought to maintain a balance between reason and religion in order to make religion less intense, more sociable, and more conducive to social and political stability. On the other hand, radical Deists with more undiluted intellectual links to the midcentury's most extreme ideas—atheism and materialism—were less bothered by the religious consequences of the rigorous application of reason to revelation.

The paragons of moderate Deistic arguments were the Enlightenment's two discursive founders: Isaac Newton (1642–1727), born the year civil war broke out, and John Locke (1632–1704), the intellectual product of the nexus of puritan selfhood, parliamentary government, and experimental science. Newton ascribed supreme importance to his investigations into natural phenomena because they brought him closer to the God who set the universe in motion; how active God was in his creation would continue to be a divisive issue for Newtonians. Locke captured in the title of his *The Reasonableness of Christianity, as Delivered in the Scriptures* (1695) his basic idea that rational interpretations of our perceptions can lead to the fundamental truths expressed in the Bible. Those same changes we noted with respect to skepticism were also at work here. Both men embraced experimental science and had a stake in securing the stability of the nation after the revolutions of 1688 to 1691, which, like the conflict four decades earlier, also stemmed from religious divisions. And if the influence of ancient ideas was showing early signs of waning, Locke was intensely interested in cultural variation, which led him to seek basic truths about the human mind that held in varied cultural conditions.

Almost as soon as Newton and Locke defined their moderate brand of Deism, radicals began to apply reason to religion more strenuously. A “Deist controversy” in printed tracts and sermonic literature erupted with the publication of *Christianity Not Mysterious* (1696) by the Irish-born Protestant convert and likely son of a Catholic priest, John Toland (1670–1722). His work appeared not accidentally a year after censorship became a nonissue after the lapsing of the Licensing Act of 1695. Toland drew from radical thinkers such as Spinoza, Gerrard Winstanley, Epicurus, and Giordano Bruno (none of whom should be classified as a Deist), but he was also the logically extreme product of Newton and Locke. Newton and Locke had argued that by reason we come to a closer understanding of the fundamental truths of Christianity; Toland deduced that if a religion's reasonableness could not be established, one had license to explore better—more reasonable—religious or even nonreligious options.

More than anyone, Toland gave Deism a deconstructive edge. He questioned the authenticity of the New Testament and argued that the Jews were originally Egyptians, while also controverting Britain's legally institutionalized anti-Semitism. Toland himself became, by his own neologism, a “pantheist,” but his ideas were picked up by others who shared his Whig politics, animosity for priestcraft, and gifts for persuasive writing. Another son of a cleric, Matthew Tindal, undercut biblical authority when he wrote that “it's an odd jumble to prove the truth of a book by the truth of the doctrines it contains, and at the same time conclude those doctrines to be true because contained in that book” (p. 49). William Wollaston used Lockean logic to solve the conundrum of whether or not God can create a mountain he cannot destroy—“God cannot be unjust or unreasonable in any one instance”—while another Lockean, Anthony Collins (1676–1729), reasoned that Christianity was a mere sect, a self-fulfilling Old Testament prophecy that the passage of time gave global prominence (Wollaston, p. 205). Even the pious skeptic Thomas Woolston claimed in the spirit of radical Deism that the supposed miracles of Jesus were, if actually anything other than pure fiction, the products of wizardry rather than divinity.

These authors and utterances did not go unchecked or unchallenged. The moderate Deists who more closely followed Newton's and Locke's intentions, particularly the late-Stuart “latitudinarians” Richard Bentley (1662–1742), Benjamin Hoadly (1676–1761), John Tillotson (1630–1694), and Samuel Clarke (1675–1729), upheld religious belief through a combination of rationality (directed against religious enthusiasm more than the Bible), faith, and reliance on textual authority. High- and low-church traditionalists alike more critically saw Deism as one of many heterodox ideas that threatened the fundamental meaning of the church, if not religion itself, while from a very different point of view the die-hard skeptic David Hume (1711–1776) viewed it as a “license of fancy and hypothesis” in a realm of philosophical thinking he thought should be devoid of religious belief (1779, 94).

Around the time the minister John Leland (1691–1766) published his four-volume *Principal Deistical Writers that Have Appeared in England in the Last and Present Century* (1754–1756), an antagonistic work that nevertheless largely determined the canon of Deists, the controversy had cooled—but not before Deism “cross-examined religion naturalistically, socially and psychologically” (Porter, p. 122). “If Mankind had never Sinn'd, Reason would always have been obeyed, there would have been no Struggle for Dominion, and Brutal Power would not have prevail'd,” wrote the protofeminist Mary Astell (1666–1731), longing for the world's return to a more reasonable state (Astell, p. 97). Edmund Burke may have rhetorically asked, Who reads Toland, Tindal, Collins, and so on? But William Wollaston's *Religion of Nature Delineated* (1724) sold 10,000 copies while radicalizing the already Deistic religious outlook of the printer who set the type for its third edition, Benjamin Franklin. Equally important, Deism became, via Newton, Locke, and their followers, the de facto religion of science, which encouraged the rationalization of religion among scientific practitioners in the British Isles, North America, and Europe's learned academies.

Deism in Europe

British Deists widely and intensively read European authors such as Spinoza, Balthasar Bekker, Descartes, Gassendi, Pierre Bayle, Faustus Socinius, and Bruno. European Deists of the next generation in turn bought clandestine French translations of British Deistic works that circulated among European texts in the underground book trade. Many of those trade networks originated in the liberal and tolerant Dutch Republic, a refuge for freethinkers that, along with Britain, forged the early Enlightenment. Journals like *De Haegse Mercurius* (1697–1698) defended Toland's Deism in the late seventeenth century; French-language presses, safe from the French censors, spread Newtonian science and theology to readers all over Europe; and later in the century Masonic lodges and other voluntary organizations disseminated Deistic thinking throughout civil society. The epitome of Dutch (radical) Deism was the *Traité des trois imposteurs* (1719; The Treatise of the Three Impostors), authored, in the international language of the time, most likely by the lawyer Jan Vroese. On the basis of textual criticism, inquiry into first causes inspired by scientific thinking, and attention to cultural variety across the globe, the *Traité* made the case that Moses, Jesus, and Muhammad were ordinary men who exploited common ignorance in order to legitimate their prophecies: "Christianity like all other Religions is no more than a crudely woven imposture, whose success & progress would astonish even its inventors if they came back to the world" (quoted in Jacob, 2001, p. 109).

Less iconoclastically, Voltaire (François-Marie Arouet, 1694–1778), the agent and nonpareil of the Anglomania that swept Europe in the 1730s and 1740s, virtually propagandized moderate British Deism as he strove to find the laws governing nature as well as God, the unity behind cultural variety, the right balance between enthusiasm and unbelief, and the compelling evidence that a God existed who could terrify the high and mighty. Deism via Voltaire in turn spread as far as Poland by way of the poetry of the satirist Bishop Ignacy Krasicki and the libertine Stanislaw Trembecki. Denis Diderot (1713–1784) and Jean Le Rond d'Alembert (1717–1783) assimilated British Deism in their *Encyclopédie* (1751–1772) and made an impression—about more than just Deism—on Russia's Catherine II. Even Rousseau's idiosyncratic and deeply influential deification of nature is unthinkable without Lockean Deism, notwithstanding Rousseau's cynicism about what society does to nature in the long term.

More radical French Deism also had influences more diverse than Newton and Locke. Henri de Boulainvilliers (1658–1722) came slowly to a Deistic position mainly by way of Baruch Spinoza (1632–1677). The Marquis d'Argens (1703–1771) drew from Spinoza, as did the Huguenot champion of religious toleration, Pierre Bayle (1647–1706). The shadowy, anti-Voltairean Themisuel de Saint-Hyacinthe (1684–1746) read Spinoza but lived in religious exile in the Dutch Republic amid Anglophiles such as Albert-Henri de Sallengre, a Dutch citizen of Huguenot origins with English connections through whom Saint-Hyacinthe would have come to know both British Deism and science. It is inaccurate to label the idiosyncratic Spinoza a "Deist" according to contemporary conceptions of the word. The same holds true for the atheist-atomists

Epicurus and his Roman mouthpiece Lucretius. But Spinozist and Epicurean writings nevertheless simmered along with British Deism in a stew of heterodox ideas that European freethinkers consumed with various appetites that were themselves determined by a complex mix of personality, cultural dispositions, and social and political conditions.

Deistic ideas also pervaded the German Enlightenment. The Prussian "philosopher-king" Frederick II may have ultimately been a disappointment to Voltaire, but he nonetheless facilitated the spread of heterodox religious thinking by making the Berlin Academy of Sciences an entrepôt for French, British, and Dutch thought as well as the homegrown Deistic ideas of Gottfried Wilhelm Leibniz (1646–1716) and Christian Wolff (1679–1754). What Kant would later call onto-, cosmo-, and physicotheology were all indebted to the writings of Deists, even if later "neologians"—rational theologians who upheld the possibility of truth in revelation—deliberately distanced themselves from radical Deism. But that should not obscure the fact that later eighteenth-century theologians such as Johann Salomo Semler (1725–1791) were as unrelenting in their textual criticism of the Bible as Woolston and others had been decades earlier.

In the more radical tradition, Hermann Samuel Reimarus's posthumously published *Apologie oder Schutzschrift für die vernünftigen Verehrer Gottes* (1774–1777; Apology or Defense of the Rational Worshipers of God) dispelled revelation as unreliable, miracles and mystery as fictional, and the New Testament as fraudulent. But like the British Deists by whom he was influenced, he also made as strong a case against atheism. Gotthold Lessing (1729–1781), who among other things published Reimarus's *Apologie*, took the small step from Deism to religious toleration in his dramatic poem *Nathan der Weise* (1779; Nathan the Wise), which gave equal treatment to Judaism, Christianity, and Islam. But the case was made more forcefully by the inspiration for Lessing's Nathan, the German-Jewish freethinker Moses Mendelssohn (1729–1786), who, instead of arguing for the dissolution of the distinctions among the Mosaic religions, made the case that all were equal but still meaningful and should be accommodated by an enlightened state. Meanwhile, the primacy of reason over revelation was underscored by Immanuel Kant (1724–1804). Kant started out maintaining the neologian position on revelation, but in later life he argued that the Bible should be judged rather than judge, that churches had value only insofar as their ends accorded with a rationally derived course for human progress, and that claims to have experienced divine revelation could never be admitted by reasonable people.

The Legacy of Deism

What also makes Deism the unofficial religious philosophy of the Enlightenment is its expiration at the close of the eighteenth century as the French Revolution turned from the apparent culmination of Deism to reaction against heterodoxy. In fact the word and concept were already showing signs of waning among British and European elites by the time the century had reached its fourth quarter. Hume wrote unsparingly in his posthumous *Dialogues Concerning Natural Religion* (1779) that belief cannot in any way be rationally defended. Even that stark judgment of the French materialists that mat-

ter in motion in a godless universe was a sufficient foundational principle for both science and morality became less repulsive to many philosophers and scientists.

We know less about Deism as a popularly held belief. Bookstore inventories and detailed wills reveal that Deistic ideas could penetrate all levels of European and North American society. There were no Deists churches—although Deism was briefly institutionalized in revolutionary France—and therefore we have no attendance sheets on which we can count rank-and-file adherents; but many of the ideas associated with Deism also made their way into popular forms of religious thought and practice. Eighteenth-century British dissenters' academies—schools for non-Anglicans—encouraged the spread of heterodox ideas alongside critical thinking and prominently featured Newton and Locke in their curricula. John Jebb's church in late-eighteenth-century London was Deist in all but name. Some religious denominations, such as Presbyterianism, became Unitarian under the pressures of, among other things, the biblical criticism pioneered by Deists. But Deism in Britain, North America, and Germany was also targeted as early as the mid-1700s on the popular level alongside other forms of intellectualized religion by much more numerous Methodists, traditionalist Anglicans, and Pietists, who stressed God's active role in our earthly lives.

In America a prominent handful of elites in the later 1700s identified themselves as Deists. Benjamin Franklin proudly and publicly recollected reading the Boyle lectures as a youth, in which “the arguments of the Deists which were quoted to be refuted, appeared to me much stronger than the refutation” (p. 63). Thomas Jefferson put Deism into practice when he took a cue from Tindal and wrote the separation of church and state into the Virginia Statute for Religious Liberty (1786), which sounded an echo the next year in the First Amendment to the United States Constitution. If the final lines of the Declaration of Independence invoke an un-Deistic “firm reliance on the protection of divine Providence,” “the laws of nature and of nature's God” in that document's more memorable opening paragraph get to the core—in a telling sequence—of a definition of Deism. But the late embrace of these ideas in America did not forestall their antagonistic reception. The British-born American patriot Thomas Paine was the target of deep animosity when in *The Age of Reason* (1794–1795) he trivialized the personal experience of divine revelation. As early nineteenth-century America witnessed a return to traditional Christianity, even onetime Deists like George Tucker of Virginia, in contrast to Jefferson, came to view religion as a form of social control that the state should subsidize.

Since Deism has no defining textual or customary point of reference, its legacy is as difficult to follow with precision as its meaning. Its most direct descendent in the nineteenth and early twentieth centuries may be the scholarly study of religion, but here the parentage is mixed. F. Max Mueller (1823–1900) and E. B. Tylor (1832–1917), for example, both owe their scientization of religious studies to the rationalism of the atheistic Hume and Spinoza as much as to Newton and Locke. Its legacy is more widely dispersed in modern variants of all three Mosaic religions—Reformed Judaism, Unitarianism, and the Baha'i faith, for example—as well as in hybrid forms of

intellectualized religiosity that borrow more consciously from Buddha and Confucius than from Tindal and Toland. One recent study has even connected Deism to the rise of Philippine nationalism by way of José Protasio Rizal's Enlightenment education at the University of Madrid in the 1880s and later attacks on the Catholic Church.

Deism's greatest legacy may be the principle of religious toleration written into the constitutions of the world's democracies. A survey of the early-twenty-first-century political landscape might suggest a disjunction between constitutional theory and practice. But that makes these ideas and their legacy more interesting than they have been since before the beginning of the nineteenth century, as religious conflict and toleration have become as culturally significant as they were during the destructive confessional struggles that defined early modern Europe.

See also *Agnosticism; Atheism; Enlightenment; Religion*.

BIBLIOGRAPHY

PRIMARY SOURCES

- Astell, Mary. *Reflections upon Marriage: . . . To Which Is Added a Preface in Answer to Some Objections*. London: Wilkin, 1706. Originally published in 1700, with an appendix added to this later edition.
- Bentley, Richard. *Remarks upon a Late Discourse of Free Thinking*. Cambridge, U.K.: Printed for C. Crownfield, 1725.
- Blount, Charles. *The Oracles of Reason . . . In Several Letters to Mr. Hobbs and Other Persons of Eminent Quality and Learning*. London, 1693.
- Chubb, Thomas. *A Discourse concerning Reason with Regard to Religion and Divine Reason*. London, 1731.
- Clarke, Samuel. *A Demonstration of the Being and Attributes of God*. London: James Knapton, 1705.
- Collins, Anthony. *A Discourse of Free Thinking*. London, 1713.
- . *A Discourse of the Grounds and Reasons of the Christian Religion*. London, 1724.
- Diderot, Denis, and d'Alembert, Jean Le Rond. *The Encyclopedia: Selections*. Edited and translated by Stephen J. Gendzier. New York: Harper and Row, 1967.
- Franklin, Benjamin. *The Autobiography and Other Writings*. Edited and with an introduction by Kenneth Silverman. Harmondsworth, U.K., and New York: Penguin Books, 1986.
- Hume, David. *Dialogues concerning Natural Religion*. London, 1779.
- Leland, John. *A View of the Principal Deistical Writers that Have Appeared in England in the Last and Present Century*. London: B. Dod, 1754–1756.
- Lessing, Gotthold Ephraim. *Nathan the Wise*. Translated by Edward Kemp. London: Nick Hern, 2003.
- Locke, John. *The Reasonableness of Christianity, as Delivered in the Scriptures*. London, 1695.
- Paine, Thomas. *The Complete Writings of Thomas Paine*. Collected and edited by Philip S. Foner, 2 vols. New York: Citadel Press, 1945.
- Reimarus, Hermann Samuel. *Reimarus, Fragments*. Edited by Charles H. Talbert, translated by Ralph S. Fraser. Chico, Calif.: Scholars Press, 1985.
- Samuel, Moses. *Moses Mendelssohn: The First English Biography and Translations*. Introduction by James Schmidt. Bristol, U.K.: Thoemmes Press, 2002.

- Spinoza, Benedictus de. *The Collected Works of Spinoza*. Edited and translated by Edwin M. Curley. Princeton, N.J.: Princeton University Press, 1985.
- Tindal, Matthew. *Christianity as Old as the Creation; or The Gospel a Republication of the Religion of Nature*. London, 1732.
- Toland, John. *Christianity Not Mysterious; or, A Treatise Showing, That There Is Nothing in the Gospel Contrary to Reason, Nor Above It, and That No Christian Doctrine Can Be Properly Call'd a Mystery*. London, 1696.
- . *Letters to Serena*. London: Bernard Lintot, 1704.
- . *Reasons for Naturalising the Jews in Great Britain and Ireland*. London, 1714.
- Voltaire, F. M. *Letters concerning the English Nation*. Translated by John Lockman. Dublin: George Faulkner, 1733.
- Wollaston, William. *The Religion of Nature Delineated*. London, 1724.
- Woolston, Thomas. *Six Discourses on the Miracles of our Savior and Defences of His Discourses*. New York: Garland, 1979.

SECONDARY SOURCES

- Bedford, R. D. *The Defence of Truth: Herbert of Cherbury and the Seventeenth Century*. Manchester, U.K.: Manchester University Press, 1979. Comprehensive work on the “first English Deist.”
- Betts, C. J. *Early Deism in France: From the So-called “Déistes” of Lyon (1564) to Voltaire’s “Lettres philosophiques” (1734)*. Boston: Martinus Nijhoff, 1984. The most detailed English study of French Deism; deals well with the complexities of the word’s definition.
- Bonoan, Raul. “The Enlightenment, Deism, and Rizal.” *Philippine Studies* 40 (1992): 53–67.
- Byrne, Peter. *Natural Religion and the Nature of Religion: The Legacy of Deism*. London and New York: Routledge, 1989. Maintains that Deistic ideas about natural religion laid the groundwork for modern religious studies.
- Champion, J. A. I. *The Pillars of Priestcraft Shaken: The Church of England and Its Enemies, 1660–1730*. Cambridge, U.K.: Cambridge University Press, 1992. Deals mainly with anti-clericalism but shows, among other things, that even the most radical Deists had a religious impulse, which was filtered through notions of civil society.
- Clark, William. “The Death of Metaphysics in Enlightened Prussia.” In *The Sciences in Enlightened Europe*. Edited by William Clark, Jan Golinski, and Simon Schaffer. Chicago: University of Chicago Press, 1999.
- Dzwigala, Wanda. “Voltaire and the Polish Enlightenment: Religious Responses.” *Slavonic and East European Review* 81 (2003): 70–87.
- Hazard, Paul. *The European Mind, 1680–1715*. Translated by J. Lewis May. London: Hollis and Carter, 1953. A still-essential study of European intellectual history, with a chapter dedicated to Deism.
- Israel, Jonathan. *Radical Enlightenment: Philosophy and the Making of Modernity, 1650–1750*. Oxford: Oxford University Press, 2001. Should be called “Spinoza’s Enlightenment.” But in following Spinoza’s influence of major and minor European freethinkers, this work is important.
- Jacob, Margaret C. *The Enlightenment: A Brief History with Documents*. Boston: Bedford Books, 2001. Excellent collection of documents on Enlightenment religion, prefaced by a clear and concise introduction.
- . *The Newtonians and the English Revolution, 1689–1720*. New York: Gordon and Breach, 1990. Puts forward an important and compelling argument about Newton’s as well as

Locke’s concerns with social and political instability and therefore deals at length with rational religion.

- . *The Radical Enlightenment: Pantheists, Freemasons, and Republicans*. London and Boston: Allen and Unwin, 1981. The original and still essential work that situates Deism among the ideas of the “radical Enlightenment”; excellent coverage of Toland and Freemasonry.
- Lund, Roger D., ed. *The Margins of Orthodoxy: Heterodox Writing and Cultural Response, 1660–1750*. Cambridge, U.K.: Cambridge University Press, 1995. Important collection of essays related to Deism.
- Marshall, John. *John Locke: Resistance, Religion and Responsibility*. Cambridge, U.K.: Cambridge University Press, 1994. The most engaging and rigorously contextualized recent work on Locke’s politics and religion.
- May, Henry Farnham. *The Enlightenment in America*. New York: Oxford University Press, 1976. Still the standard work on this subject and good for further exploration of Deism in America.
- Page, Anthony. *John Jeeb and the Enlightenment Origins of British Radicalism*. Westport, Conn.: Praeger, 2003. Interesting study of the Cambridge cleric and London reformer.
- Popkin, Richard H. *The History of Scepticism from Erasmus to Spinoza*. Berkeley: University of California Press, 1979. Continues to be the standard work on Scepticism; frames well the causes of the skeptical crisis and contains a useful section on Herbert.
- Porter, Roy. *The Creation of the Modern World: The Untold Story of the British Enlightenment*. New York and London: W. W. Norton, 2000. Will be the unrivaled synthetic study of the British Enlightenment for years to come; brilliantly written with an excellent chapter on rational religion.
- Roche, Daniel. *France in the Enlightenment*. Translated by Arthur Goldhammer. Cambridge, Mass.: Harvard University Press, 1998. Provides essential background for understanding Deism in France.
- Sullivan, Robert. *John Toland and the Deist Controversy: A Study in Adaptations*. Cambridge, Mass.: Harvard University Press, 1982. Good on the slipperiness of the definition of “Deism.”
- Sullivan, Roger J. *Immanuel Kant’s Moral Theory*. Cambridge, U.K.: Cambridge University Press, 1989. A lucid interpretive guide through Kant’s theories of religion.

Matthew Kadane

DEMOCRACY. Democracy, a direct translation of the Greek *dēmokratia*, means rule (*kratos*) by the people (*dēmos*). Both as a political idea, and as a political institution, democracy originated in the thought and practice of the ancient Greeks. They understood democracy literally: the people, deliberating and acting together in an assembly, was both sovereign and legislator. The people was not only the source of legitimate authority, but also the wielder of political power. In modern times the role of the people is limited to the legitimation of political authority, and power is wielded by elected representative assemblies.

Greek Origins

In the history of Western political thought the Greeks were the first to think and reflect about their political and social organization. The polis, with its multiple forms and varied

institutions, was the center of Greek life and culture. This plurality of political associations engendered intense philosophical speculation and lively intellectual debate regarding the relative merits of different types of government. In the process the Greeks elaborated a language and a vocabulary adequate to the analysis of the political world they had constructed.

Herodotus (484–420 B.C.E.), in his constitutional debate, weighed the value of the three governmental forms of a polis: monarchy, oligarchy, and democracy. Democracy promotes equality before the law, yet it brings to power the many who are ignorant, incompetent, unstable, and violent. Oligarchy is equally unstable and violent, and both forms eventually lead to tyranny. Only a law-abiding monarchy can inhibit the few and the many from succumbing to tyranny.

The “Old Oligarch,” a short pamphlet from the fifth century B.C.E., presents a similar picture of the many and their democracy: feckless, unreliable, and irrational. Only the best and cleverest, that is, the few, are capable of rule. At the same time the argument adds a novel element to the analysis of democracy: class conflict and factional strife. The problem is whether the demos is capable of understanding and recognizing their own particular good, a question that permeates classical political thought.

In his *History of the Peloponnesian War*, Thucydides (d. c. 401 B.C.E.) describes the moderate democracy under Pericles (c. 495–429 B.C.E.), and praises his prudence and wisdom in leading the people. The distinction he makes between Pericles and Cleon (d. 422 B.C.E.) underlines his dislike of the many and his preference for a democracy guided by the wise and the best. He attributes the fall of Athens to the rise of demagogic leaders who flattered the masses and catered to their appetites and desires. Athens was defeated by Sparta because the war generated among Athenians factionalism, greed, violence, and lust for power and for acquisition. He introduces a theme later amplified by Plato and Aristotle: external expansion and imperialism are directly related to the rise of democracy in Athens. Democracy whets the many’s appetite for power, which only expansion can satisfy and secure. For Thucydides the desire for power and the appetite for expansion are inherent to the nature of the people such that their rule is always accompanied by violent disturbances, expropriation, and instability. The rise of the many to power liberates the passions and the appetites to such an extent that the democracy is inexorably led to imperial conquest, overextension, and finally violent collapse.

Plato (c. 428–348 or 347 B.C.E.), in such works as *Gorgias*, *The Statesman*, and *The Republic*, translated Thucydides’ historical narrative of the Athenian decline and fall into a thoroughgoing critique of contemporary practices and institutions within the polis. He found all politics wanting, because those who possess knowledge are powerless, and those who have power are ignorant and thus do not know how to rule. The problem was to discover ways in which power and knowledge, politics and philosophy may be so wedded as to ensure a just and stable sociopolitical order. Statesmanship requires within the individual the rule of reason over appetite, and within the polis the rule of those who know over those who do not know.

As such, it means the exercise of self-discipline and self-restraint by both the rulers and the ruled.

To Plato, all states are divided into the few who are rich and the many who are poor, and therefore class struggle and class strife are endemic to all states. Both democrats and oligarchs pursue their particular self-interest, and thus both are motivated not by rational thought but by appetite, desire, and lust for power. Each faction when in power pursues its interest to the exclusion of the other’s, such that the polis is subjected to unstable and violent cycles of revolution and counterrevolution. The conflict between the two factions leads to the destruction of both and to the rise of tyranny. Thus no just society is possible unless the passions and appetites are subordinated to rational control, and unless the conflicts they engender are resolved and harmonized by wise and just leadership.

Aristotle (384–322 B.C.E.), following Plato, presents in his *Politics* a six-fold classification of constitutions or governments: the rule of one is monarchy or tyranny, the rule of the few is oligarchy or aristocracy, and the rule of many is either law-abiding or lawless democracy. Three are just and legitimate, three are unjust and illegitimate. The first of each set is lawful and rule is for the good of all, the second is lawless and rule is in the rulers’ particular interest. Each in its pure form is inherently unstable because its foundation is narrow and exclusive. Democracy rests on mere number and thus excludes ability and property. Similarly, because oligarchy is based on property and birth, it excludes the propertyless many. Thus each type tends toward faction, strife, and instability. The problem is to construct a type that would combine stability, legitimacy, and competent rule. This type is the polity, a constitutional government that includes the best elements of democracy, oligarchy, and monarchy. It combines number, ability, and property, and so guarantees that the class base of polity avoids the opposing poles of overly rich and overly poor. The welding of the best elements of democracy and oligarchy enables the polity to escape the cycle of violence and instability endemic to many Greek cities.

The polis, whether oligarchic or democratic, was class based, and most writers, especially Aristotle, recognized the close relationship between property, power, and stability. They also recognized, and never questioned, the centrality of slavery to the polis. Even in democratic Athens the slavery and subjection that prevailed within the private sphere of the household made possible the liberty and equality of the male citizens as they came together in public to deliberate in the assembly.

After the Polis

Greek political theory is a reaction to the decline of the polis, which was superseded first by the territorial Hellenistic monarchies and later by the Roman republic. Polybius (c. 200–c. 118 B.C.E.), who wrote his history to show how Rome came to dominate the Mediterranean, ascribes its success to its republican institutions. He superimposes Greek categories onto Roman political experience, and using the six-fold classification of governments, sees Rome as having a mixed constitution.

The consuls represent the monarchical element, the senate the aristocratic, and the popular assemblies the democratic. Wealth, ability, birth, and number were each given a role in the constitution. When the people became too violent and tumultuous, or the senate too arrogant and selfish, the republic nevertheless survived. The mixed constitution established a self-regulating system in which each element checked and balanced the other.

Cicero (106–43 B.C.E.) repeated the now-standard Greek classification of governments (monarchy, aristocracy, democracy) as well as the traditional critiques of each. Although he preferred monarchy, he understood that practical prudence required a mixed form that combined the best of all three. The state is a *res publica*, or “public affair,” and is therefore also a *res populi*, or “people’s affair.” It exists to provide justice, security, and peace. Although legitimacy and power emanate from the people, competent administration and stable authority require the wisdom and ability of the senate.

The fall of the republic and the rise of monarchy signaled the death of republican and democratic politics. The growth of quietistic philosophies such as Stoicism, the advent of Christianity, and the barbarian invasions together combined to destroy the classical world and to create a feudal and medieval civilization in which democracy and republic had no meaning.

Democratic and republican thought and practice regained their vitality and importance with the rise of the Italian communes and the concomitant rebirth of classical thought. Such an interest, when added to the historical experience of the Italian—especially Florentine and Venetian—city-states culminated in Niccolò Machiavelli’s (1469–1527) rediscovery of the people (and of the “opinion of the many”) as the foundation and ground for a new type of politics, both republican and democratic.

The passing of medieval society was a long process of religious, social, political, and economic transformation. It culminated in profound social, cultural, and political change: the disintegration of traditional ties, the Protestant Reformation and the resulting fragmentation of European Christianity, the spread of commerce and trade, the proliferation and dissemination of knowledge and wealth, literacy and printing.

The English Civil War (1642–1649), the Dutch rebellion (1621–1648) against Spain and the Holy Roman Empire, and the Glorious Revolution (1688–1689) heralded the rise and growing importance of these new developments. The execution and deposition of kings exploded traditional beliefs in the passive acceptance of governmental authority, and revealed its basis in human will and action. Major political theorists such as Thomas Hobbes (1588–1679); Hugo Grotius (Huigh de Groot; 1583–1645); Samuel von Pufendorf (1632–1694); Charles-Louis de Secondat, baron de Montesquieu (1689–1755); and John Locke (1632–1704) reflected these far-reaching changes by reevaluating and retranslating traditional ideas of natural law, human nature, and government. Dutch republicans such as Benedict de Spinoza (1632–1677) and the de la Court brothers, Jan (Johan; 1622–1670) and Pieter (c. 1618–1685), distilled ancient Roman writers, Florentine

and Venetian republicans, and the work of Thomas Hobbes, and envisioned a democratic politics whereby the state is the expression of the people’s will. Hobbes, with his absolute individualism and radical skepticism, expressed the breakdown of traditional forms of community and legitimate government and their reconstitution by human reason and will. Locke tried to wed natural law with emerging individualism and used them to domesticate and limit the power of the newly centralized state. His theory of government as a trust located authority with the representative of the people, who always retained their right to withhold consent to the government. Montesquieu, reacting to the growing absolutism of the French monarchy, translated the classical theory of mixed government into his concept of separation of powers. His theory of despotism and the balanced constitution was a major source for liberal constitutionalism and for the theory of limited government. Natural right, political obligation, social contract, and natural law were ideas used to explain and to justify radical and revolutionary change. Yet, at the time, their range and application was circumscribed, and the notion of the people to which they referred was interpreted narrowly.

Age of Enlightenment and Revolution

The Enlightenment, by underlining the human capacity for rational and critical thought, for scientific and intellectual inquiry, and generally for the future growth and “perfectibility” of humanity, slowly subverted the cultural, religious, and traditional foundations of state and society. Thinkers such as Voltaire (1694–1778) and Denis Diderot (1713–1784) in France, and David Hume (1711–1776) and Jeremy Bentham (1748–1832) in Britain, inquired into the natural and historical sources of political and social power. They produced a body of work that linked political and civil liberty and freedom of thought and speech with cultural, moral-intellectual, and scientific progress. Jean-Jacques Rousseau’s (1712–1778) critique of the Enlightenment paradoxically affirmed the movement’s belief in the centrality of human will and liberty. For Rousseau, liberty and equality define the human, such that the people assembling together as sovereign generate the general will that looks to the public, as opposed to the private, good. The general will as the embodiment of popular sovereignty was a radical critique of the inequality and the competition within civil society.

The spirit of opposition to established forms of authority (whether secular or religious), the distrust of any government not derived from rational consent, culminated in the American Revolution and its penchant for constitution building. American revolutionaries proclaimed the sovereignty of the people while simultaneously constructing a political structure that would limit and channel the power of popular majorities. They preached a new secular order while buttressing it with arguments that reached back to the English Civil War and the Glorious Revolution. The political literature of the Revolution adumbrated and summarized the arguments for and against democracy since Plato. From Thomas Paine (1737–1809), who explicitly defended democracy, to John Adams (1735–1826), who feared direct popular rule, Americans during the two decades of revolution and constitutional experimentation

attempted to find a balance between the few and the many, the rich and the poor. The compromise presented by the federalists asserted the legitimating and authorizing role of the people while establishing a self-regulating system of checks and balances at both the state and national levels. Legitimate power would issue from popular majorities, but institutional mechanisms such as separation of powers, federalism, bicameral legislatures, and indirect election would channel, control, and check the power of the people.

The American Revolution began the slow process that changed the meaning of democracy as it was understood from the Greeks to Rousseau (direct rule of the people meeting together in their assembly). As James Madison (1751–1836) noted, direct democracy, which is feasible (according to Rousseau and Claude-Adrien Helvétius) only in small states, is prone to violence and class strife; what is needed is a republic where representation refines and filters the opinion of the people. Representation both controls popular passions and makes popular government possible over a large territory and a numerous population.

The French Revolution, in terms more radical and clear than the American, proclaimed the rights of man and the citizen. It contrasted these with the privileges and aristocratic inequalities of the old order. In Jacobin ideology, the people were increasingly identified with the nation. Jacobin terror and the supremacy of Maximilien de Robespierre (1758–1794) reinforced the traditional historical unease and distaste with popular rule. Republican and democratic ideas—popular sovereignty, government as guarantor and custodian of natural rights, the idea of citizenship, and the right to liberty and equality under law—spread throughout Europe. Lively and sometimes bitter polemics emerged, some like Edmund Burke (1729–1797) attacking the Revolution, others like Tom Paine and Mary Wollstonecraft (1759–1797) defending it. The novelty was that for the first time democracy and popular government were defended by elements of the educated and wealthy classes.

Threat and Promise of Mass Democracy

Both the American and French Revolutions signaled the emergence of the popular masses as a force in history. Henceforth the people became a factor in the power equation. Whether for ill or good, whether democratic or antidemocratic, rulers must address the people to attain or to maintain power. This profound realignment of the relation between ruler and ruled produced three responses during the nineteenth century: liberal, conservative, and revolutionary.

The liberal response is embodied in the thought of John Stuart Mill (1806–1873) and Alexis de Tocqueville (1805–1859). Tocqueville believed that the European future could be foreseen in the American present. And Mill's thought was heavily influenced by Tocquevillian concerns with the safeguarding of ability, virtue, and liberty. Tocqueville analyzed the social and cultural conditions of American democracy and found in them the germs of a future tyranny. Democracy is founded on a belief in individual rights, equality, and self-government, yet the public opinion it spawns is more tyrannical than any monarch. The passion for equality generates a

uniform mass of self-centered individuals whose opinions will dominate those of the minority. This passion is antithetical to ability and strives to level all forms of excellence and skill. Mill elaborates on Tocqueville's antithesis between equality and liberty and tries to find a solution that incorporates both the people's desire for equality and the need for competence and ability. Though democracy means the rule of the many, government and administration presuppose the rule of the few over the many. Mill sees representative government based on an educated and responsible electorate as best able to link the egalitarian aspirations of the many with the competence and ability of the few.

Political participation (voting and office holding) in the West was at first circumscribed within a narrow social, ethnic-racial and economic base: property holders and white males. During the nineteenth century and the first half of the twentieth century, various political and social groups arose calling for the extension of full civil and legal rights to all. Elite competition for power combined with popular social movements gradually to expand the electorate. In the United States, the property qualification was eliminated with the rise of Andrew Jackson, in Britain with the various reform bills of the middle- to late-nineteenth century. The expansion of male suffrage in continental Europe was a complex and contradictory process. In France it was hostage to successive revolutions and changes in governmental systems, in imperial Germany it was achieved under the auspices of Bismarck as a means of bolstering the power of the ruling elites, and in Italy it facilitated elite manipulation of the parliamentary elections. Suffrage expansion in pre-World War II Italy and Germany ultimately led to the breakdown of liberal democratic institutions, while in Britain and the United States it promoted the integration of the lower classes into the pre-existing liberal structures.

In the United States, the Civil War (1861–1865) abolished slavery, and the fourteenth and fifteenth amendments to the Constitution gave the emancipated slaves full political rights. Yet through such devices as the poll tax, the white-only primary, literacy requirements, as well as the use of legal and extra-legal force, African Americans were effectively denied these rights until the advent of the Civil Rights movement and the passage of the 1965 Voting Rights Act.

The struggle over the vote was intimately linked with the struggle for the emancipation of women. Women's suffrage movements, whose prominent figures included Elizabeth Cady Stanton (1815–1902), Susan B. Anthony (1820–1906), and Emmeline Pankhurst (1858–1928), were particularly powerful in the United States and Britain. Women were granted the vote in 1920 and in 1928 respectively, though not until 1945 in Italy and France. Even today, in many countries women are excluded from public and political life. Ethnic-racial and gender equality and the integration of excluded groups into the prevailing system are considered crucial to the contemporary understanding of democracy. The right to vote is fundamental to democracy. Yet the struggle for universal suffrage underlines the importance of establishing a widely accepted culture of civil liberties and civil rights, without which the suffrage would become meaningless.

Industrialization and urbanization, as well as painful social and economic dislocations, intensified mass mobilization and mass participation in politics, which in turn created new demands partly addressed by the liberalization of social welfare measures and by the expansion of the franchise. The expansion of the electorate in turn made the system more democratic and thus more responsive to mass politics. Revolutionaries such as Karl Marx (1818–1883) and his followers argued that the equality and liberty guaranteed by liberals and democrats were merely political and formal. They did not address the material basis of rule, which is social and economic. The rights of the citizen are spurious given the underlying inequality of bourgeois capitalism, where the few wealthy dominate the many poor. What Marxism and socialism desired was a democracy both social and economic, where the unequal relations of power established by private property are eliminated. Such a concern underlay most critiques of liberal democracy, whether social democratic, syndicalist, or communist. They differed, however, in both their methods and their goals. The socialists accepted the rules of the game and worked within the system, while the latter two worked for a revolutionary overthrow. Lenin (Vladimir Ilich Ulyanov; 1870–1924) and the Bolsheviks represented a shift in the location of revolution, from the center of the bourgeois world to its periphery.

The conservative reaction to democratic politics ranged from the reactionary ideas of Joseph-Marie de Maistre (1753–1821) and Louis de Bonald (1754–1840) to the elitism of Vilfredo Pareto (1848–1923), Gaetano Mosca (1858–1941), and Roberto Michels (1876–1936). While the former wanted to return to prerevolutionary and aristocratic Europe, the latter accepted modernity and the political consequences of the American and French Revolutions. Pareto and Mosca argued that in all societies the rulers are always the few, that wealth and ability will always prevail over numbers. Michels formulated an iron law of oligarchy, which asserted that in modern society where bureaucracies and organizations are constantly proliferating only minorities can rule. Democracy—with its representative systems, electoral mechanisms, referenda, initiatives, and recall—is an illusion, a mere political formula devised to veil oligarchic power. What these writers attempted to show was the empirical and sociological impossibility of democracy. Whatever the claims of democratic ideals, government and administration must inevitably rely on organized minorities to function well and effectively.

Recent Concepts

In the first half of the twentieth century democratic theory was devoted to addressing the claims of elitists such as Mosca and Michels. First Joseph Schumpeter (1883–1950) and later Robert Dahl (b. 1915) tried to devise a theory that would account for the empirical reality of democracy (the necessity for elites) and simultaneously retain its ideals. Schumpeter saw democracy as an institutional arrangement of elite competition for the electorate's favor guaranteed by legal and procedural mechanisms. Twenty years later Dahl saw democracy as a polyarchy of social groups whose competition was also guaranteed by procedural arrangements, while Samuel Lipset and Barrington Moore Jr. distinguished between the empirical and

normative criteria of democracy. They too discerned a contradiction between the claims of majority rule and the empirical reality of mass electoral politics. The attack on the classical democratic theory produced a fundamental reinterpretation of democracy itself. Democracy no longer means rule by the people, or rule by the many. The majority legitimate power and consent to it, but organized elites rule. Whether the many rule is not as important as whether the system provides free and open elections guaranteed by civil liberties and civil rights.

Democracy as a political form and as an ideal arose from the conflict in society between the few and the many, between the wealthy and the poor. The cycle of violence and instability produced by this conflict led to attempts to establish political structures that would address the egalitarian and just demands of the many while simultaneously maintaining the rule of law. It is from the struggle to resolve the opposing interests and values of these two antagonists that the social and political ideals associated with modern democracy emerged and developed.

Today democratic theory centers on critiques of liberal democracy and on devising alternatives to it. Critics such as Hannah Arendt (1906–1975), Jürgen Habermas (b. 1929), and John Rawls (1921–2002) identified an elitist, inegalitarian, and antiparticipatory core in liberal theories of democracy. They questioned the validity and desirability of liberal democracy's major principles: interest aggregation, economic utility, rational choice and game theory, methodological individualism. Most important, they objected to the reduction of political activity to economic categories and lamented the use of the market as the model for democratic politics. While retaining the procedural and constitutional guarantees so important to liberal theory, its critics aspire to a democracy where the people may come together as citizens and participate in public deliberations and discussions.

The criticism of liberal and elite democratic theory has produced two major schools of thought: civic republicanism and deliberative democracy. Both share a classical Aristotelian belief in the possibility of achieving a common good by means of an egalitarian politics of participation. They believe that political activity is crucial to developing a well-rounded and educated citizen. Civic values, civic engagement, and open discussion help create a public space in which the business common to all citizens may be conducted. Civic republicanism and deliberative democracy, by emphasizing such ideas as the common good, virtue, common action, and political education, delve into the ways that a public-political space may emerge and grow. They also recall the ideals of political virtue and political participation first enunciated by classical thinkers, and later reclaimed by Machiavelli and Rousseau.

See also **Constitutionalism; Equality; Liberty; Public Sphere; Republicanism.**

BIBLIOGRAPHY

Ball, Terrence, and Richard Bellamy, eds. *The Cambridge History of Twentieth-Century Political Thought*. New York: Cambridge University Press, 2003.

- Bohman, James, and William Rehg, eds. *Deliberative Democracy: Essays on Reason and Politics*. Cambridge, Mass.: MIT Press, 1997.
- Burns, James Henderson, ed. *The Cambridge History of Political Thought, 1450–1700*. Cambridge, U.K.: Cambridge University Press, 1991.
- Cnuddle, Charles F. and Deane E. Neubauer, eds. *Empirical Democratic Theory*. Chicago: Markham, 1969.
- Dahl, Robert A. *Democracy and Its Critics*. New Haven, Conn.: Yale University Press, 1989.
- Dunn, John, ed. *Democracy: The Unfinished Journey, 508 B.C. to A.D. 1993*. Oxford: Oxford University Press, 1992.
- Finley, Moses I. *Democracy Ancient and Modern*. New Brunswick, N.J.: Rutgers University Press, 1973.
- Fontana, Biancamaria, ed. *The Invention of the Modern Republic*. Cambridge, U.K.: Cambridge University Press, 1994.
- Hazard, Paul. *European Thought in the Eighteenth Century*. Translated by J. Lewis May. New Haven, Conn.: Yale University Press, 1954. Translation of *Pensée européenne au XVIIIème siècle*.
- Held, David. *Models of Democracy*. 2nd ed. Stanford, Calif.: Stanford University Press, 1996.
- Lijphart, Arend. *Democracies*. New Haven, Conn.: Yale University Press, 1984.
- Palmer, Robert R. *The Age of the Democratic Revolution*. 2 vols. Princeton, N.J.: Princeton University Press, 1959–1964.
- Pateman, Carole. *Participation and Democratic Theory*. Cambridge, U.K.: Cambridge University Press, 1970.
- Rahe, Paul A. *Republics Ancient and Modern*. 3 vols. Chapel Hill: University of North Carolina Press, 1994.
- Rowe, Christopher, and Malcolm Schofield, eds. *The Cambridge History of Greek and Roman Political Thought*. Cambridge, U.K.: Cambridge University Press, 2000.
- Sartori, Giovanni. *The Theory of Democracy Revisited*. Chatham, N.J.: Chatham House, 1987.
- Skinner, Quentin. *Foundations of Modern Political Thought*. 2 vols. Cambridge, U.K.: Cambridge University Press, 1978.

Benedetto Fontana

DEMOCRACY, AFRICA. In the mid-1980s, democratic theory and politics in Africa entered a new phase as struggles for democratization spread across the continent and scholars began to vigorously debate the processes, prospects, and problems of Africa's democratic projects. This process was captured in an important collection edited by Peter Anyang Nyong'o, *Popular Struggles for Democracy in Africa* (1987), and in debates conducted in the influential newsletter of the Council for the Development of Social Science Research in Africa, *Codesria Bulletin* (1989). In 1990, all but five of Africa's fifty-four countries were dictatorships, either civilian or military. By 2000, the majority of these countries had introduced political reforms and had become either democratic or were in the process of becoming so. In the meantime, the literature on African democracy exploded. Initially, analyses centered on the forces behind the democratic transitions and their modalities; later they focused on the challenges of democratic consolidation. There were also vigorous debates on the meaning and content of democracy in which instrumental, institutional, cul-

tural, and historical approaches vied for definitional, analytical, and ideological preeminence.

Before the mid-1980s, African political systems were dominated by authoritarian regimes and African political thought was preoccupied with developmentalism: how to overcome the challenges of development through socialist- or capitalist-oriented strategies. In the 1960s, many leading political scientists even applauded the one-party state as a vehicle for nation-building and economic development; it supposedly minimized societal conflicts and conformed to African cultural traditions and a preference for consensus politics. Several prominent African political leaders and thinkers—Julius Nyerere of Tanzania (1922–1999), Leopold Senghor of Senegal (1906–2001), Sekou Touré of Guinea (1922–1984), and Kwame Nkrumah of Ghana (1909–1972)—argued passionately that African socialism not only represented a creative and viable fusion between the “communal” values and practices of precolonial African societies and Western socialist ideas, but that it embodied and ensured democracy. In the self-proclaimed Marxist–Leninist regimes, such as those of Ethiopia, Mozambique, and Angola, “democratic centralism” of the ruling party was upheld as the basis of “communist democracy” and contrasted to Western “bourgeois democracy” (Zezeza, 1997, part VI; Idahosa).

Modalities of Africa's Democratic Transition

The African transitions to democracy from the late 1980s were quite varied and characterized by progress, blockages, and reversals. In many countries, the transitions occurred quite rapidly following the onset of internal protests and external pressures on the incumbent autocratic regimes. At first, the protests and pressures were not taken seriously by many of these regimes, which responded with both repression and reform, depending on the relative strengths of the prodemocracy forces and the regimes themselves. The latter always sought to manipulate differences within the opposition; indeed, by the mid-1990s many African leaders had learned to play the new democratic game of multiparty electoral politics to their advantage.

The actual mechanisms and modalities of transition from dictatorship to democracy took three broad paths. First, there were countries in which opposition parties were legalized and multiparty elections authorized through amendments to the existing constitutions by the incumbent regime. This pattern was followed mainly in one-party states in which the opposition forces were too weak or fragmented to force national regime capitulation and the regimes still enjoyed considerable repressive resources and hegemonic capacities, for example, Zambia, Malawi, Kenya, and Tanzania. Zambia was the first country in southern Africa to undergo democratization when President Kenneth Kaunda's (b. 1924) United National Independence Party, which had ruled the country since independence in 1964, lost the elections in 1991. Three years later, President Banda's (1898–1997) Malawi Congress Party lost the elections in Malawi. In Tanzania, however, the ruling party won several multiparty elections, while in Kenya the ruling party prevailed over a fractured opposition in two elections in the 1990s, finally losing in 2002.

Second, there were countries where the transition to democracy was effected through national conferences in which members of the political class and the elites of civil society came together to forge a new political and constitutional order. These conferences were largely confined to Francophone countries and South Africa. They succeeded in countries where they were held early, before incumbent regimes had learned how to manipulate them, and where the opposition was strong and united and the regime weakened and factionalized, as was the case in Benin, Congo, and Niger. Benin held the first national conference in 1989, which succeeded in toppling the regime of Mathew Kérékou. The opposite was true in countries such as Gabon, Togo, Côte d'Ivoire, and the Congo Democratic Republic (then called Zaïre), where incumbent regimes managed to retain power for a while. In South Africa, the Convention for a Democratic South Africa, held between 1991 and 1993, was prompted by the strategic stalemate between the nationalist forces and the apartheid white minority regime and paved the way for the transition to democratic rule in 1994.

Finally, there was the path of managed transition pursued by military regimes, which tried to oversee and tightly control the process and pace of political reform. For example, in Ghana, the military ruler, Jerry Rawlings (b. 1947), turned himself into a civilian and won the multiparty elections of 1992 and 1996, but his party lost the elections of 2000, while in Nigeria the military refused to accept the results of the multiparty elections of 1992 and proceeded to entrench a repressive regime that ended only after the death of the military dictator Sani Abacha (1943–1999), when multiparty democracy was reinstalled. In Uganda, the government of Yoweri Museveni (b. 1941) clung to power while claiming to pursue “no party politics,” a rehashed doctrine of the one-party state. In Algeria, the military-backed government annulled the elections in 1992 when the Islamic Salvation Front won the first round and looked poised to win the final round. Instead of democracy, the country became involved in a vicious civil war that lasted many years.

Explanations of Africa's Democratization

By the turn of the new century, then, much had changed on Africa's political map. Democratic regimes, at least in terms of electoral politics and constitutional changes of government, had become quite common. Indeed, many countries were into their second or third round of multiparty elections, but several countries were still in the grip of authoritarian rule and autocratic tendencies persisted in many of the new democracies. Also, some elected governments were overthrown and several intrastate and interstate wars raged across the continent, all of which raised serious questions about the content and direction of the continent's democracies. Clearly, the trajectories of this wave of democracy in Africa have been quite complex and uneven.

Debate on Africa's democratization processes and prospects has centered on four interrelated issues: the relative roles of (1) internal and external factors; (2) historical and contemporary dynamics; (3) structural and contingent factors; and (4) economic and political dimensions. Those who stress the primacy

of internal factors behind the democratic transitions tend to underscore the strength of domestic political protests and prodemocracy movements engendered or energized by the failures of development, the economic crises of the 1980s and 1990s, and the disintegration of the postcolonial state's legitimacy and capacity. They also highlight the demonstration effects of regional transitions, such as Benin in Francophone West Africa, Zambia in southern Africa, the Palestinian Intifadah for North Africa, and South Africa, across the continent. Those who emphasize external forces point to the decisive impact of the end of the Cold War, the demonstration effects of the collapse of communism in Eastern Europe, and the imposition of structural adjustment programs and political conditionalities by Western bilateral and multilateral financial institutions. But some have questioned the West's commitment to the promotion of democracy in Africa, arguing that it is more rhetorical than real and is motivated by donor interests rather than recipient needs.

Proponents of the two approaches tend to place Africa's transitions to democracy in different historical contexts, either in terms of global waves of democracy or in African histories of struggles for freedom. Advocates of the first approach tend to see Africa's democratization as part of what Samuel Huntington calls the third wave of democracy, which apparently began in the 1970s in southern and eastern Europe. While each democracy wave is propelled by a different constellation of factors, it is said to be a process driven by the victorious democratic hegemonic powers. Others argue that, while Africa's democratization was influenced by developments elsewhere in the world, it was primarily rooted in the continent's long history of struggle against slavery, colonialism, and postcolonial misrule. Mohamed Salih talks of Africa's own “‘waves of democratization’ (colonial, early independence, postindependence, and the 1990s)” (p. 19). At the very least, the 1980s and 1990s—the era of democratization—represented a period of struggles for the “second independence”; the “first independence” was fought for in the 1950s and 1960s—the era of decolonization. Thus, African democratic struggles are linked to, structurally and symbolically, the rich reservoirs of earlier struggles against exploitation and oppression.

Observers also do not agree on the extent to which democratization is a product of structural factors as opposed to individual actions and events. Proponents of the latter approach stress the role of specific leaders, closely following the ebb and flow of events and tailoring their interpretations accordingly. Their focus tends to be on contingent factors, the unpredictability of developments, and human agency. Structuralist analyses, on the other hand, dwell on the structural conditions that have forestalled and facilitated and might sustain or frustrate democratization. These include colonial legacies, levels of economic development and education, size of the middle classes, the nature and vibrancy of civil society, and impediments imposed by the global system. Predictions of the prospects for the democratic project in different countries and across the continent—whether positive or negative—are often based on how these “democratic preconditions” are evaluated. To many commentators, from Western cynics and beleaguered African leaders to pessimistic intellectuals, the prospects of

democracy in Africa are undermined by the enduring realities or legacies of underdevelopment.

Finally, there is considerable debate as to whether Africa's democratization is attributable to economic or political factors. The first approach examines the role played by postcolonial development failures and, particularly, the economic crises during the "lost decade" of the 1980s, which were exacerbated by structural adjustment programs imposed by the World Bank and International Monetary Fund and generated widespread opposition from various social groups, especially the pauperized middle and working classes, who spearheaded the democratic reform movements. The second approach concentrates on the political crisis of the postcolonial state, particularly its inability to forge nationhood and manage the centrifugal forces of postcolonial society, specifically ethnicity. As Dickson Eyoh has argued, scholarly disenchantment with the performance of the postcolonial state was not only expressed in the accretion of demeaning epithets to describe the African state, it spawned the rapid growth of "civil society" as the master concept around which the dynamics of politics were increasingly debated and the possibilities of African renewal invested.

A comprehensive understanding of democratization in Africa would have to transcend these dichotomous analyses. Clearly, the struggles for democracy in the 1980s and 1990s represented the latest moment of accelerated change in a long history of struggles for freedom, an exceptionally complex moment often driven by unpredictable events and new social movements and visions, anchored in the specific histories, social structures, and conditions of each country, in which national, regional, and international forces converged unevenly and inconsistently, and economic and political crises reinforced each other, altering the terrain of state-civil society relationships, the structures of governance, and the claims of citizenship.

Visions of African Democracy

Fundamental to the question of democracy in Africa have been different conceptions and visions of what democracy means and entails. The views range from minimalist conceptions of liberal democracy, emphasizing competitive electoral processes and respect for civil and political rights, to maximalist notions of social democracy embracing material development, equality and upliftment, and respect for the so-called three generations of rights, civil and political, social and economic, and development or solidarity rights. Five prescriptive models can be identified in the writings of African political thinkers and leaders: nativist, liberal, popular democratic, theocratic, and transnational.

Nativist model. To the proponents of the nativist model, democracy in Africa can be consolidated only if it is articulated with the "consensus" or "consultative" model of democracy found in "traditional" institutions. Maxwell Owusu believes mobilizing the language, rituals, and working assumptions of traditional chieftaincy that are easily understood by local communities is essential to what he calls the "domestication of democracy." This vision is shared on the ideological right by George Ayittey, who urges a return to indigenous practices and

values in political and economic management if Africa is to recover from its debilitating crises of poor governance and development, and on the ideological left by Claude Ake, who believes it is imperative to ground democratic movements and practice in the "communal ethos" that defines many Africans' perception of self-interest, their freedom, and their location in the social whole.

Liberal model. To the pragmatic defenders of the liberal model, such as Jibrin Ibrahim and Peter Anyang' Nyong'o (1995), democracy rests solidly on a multiparty system and periodic electoral contests to promote the trinity of good governance: efficiency, accountability, and transparency. Their critics have charged that this model offers a mechanism of elite competition, recruitment, circulation, and control but presents limited benefits to the often atomized and powerless citizenry. A modified version incorporates the development imperative, the need for Africa's emerging democracies to "bring development back in." Thandika Mkandawire argues that a developmentalism will emerge out of the early-twenty-first-century context, democratic because of the continuing popular struggles against authoritarianism, and capitalist because capitalism constitutes the political program of the key actors in the struggles for democracy and of the dominant forces at the global level, following the collapse of "actually existing" Soviet socialism. Adebayo Olukoshi contends that the struggles for democracy ultimately entail struggles for material existence, although they are not purely economic, and that the possibilities of democratic consolidation are firmly tied to democracy's ability to deliver development.

Popular democratic model. Many of the critics of liberal democracy advocate the popular democratic model in which both the political and economic domains are based on democratic principles. For Samir Amin, a democracy restricted to the political sphere, as in Western democratic regimes, while economic organization is held captive to nondemocratic principles of privatization, is an incomplete one. Besides the incorporation of economic rights, the defenders of popular democracy emphasize the rights of subnational communities as a necessary part of the process of reconciling the colonial bifurcation of power between a racially exclusive urban civil society for immigrant settler citizens and a decentralized rural despotism for the "native" subjects. According to Mahmood Mamdani, African states are confronted with the challenges of democratizing the state, particularly customary power, removing state control of citizenship rights, deracializing civil society, and restructuring the unequal external relations of dependency. Feminist scholars such as Amina Mama and Ifi Amadiume have called attention to the gendered dimensions of state formation and power and the fact that democratization without women's empowerment and gender equality is clearly inadequate.

Theocratic model. All these debates and visions are secular in orientation. There are also theocratic visions and discourses about political transformation and democracy in Africa. The debate has been particularly contentious in Muslim communities undergoing revivalism due to contemporary religious, political, and cultural imperatives and pressures facing them.

Ali Mazrui has argued that different forces in different countries have fostered Islamic revivalism. For example, in Somalia and Sudan

it grew out of desolation; in the case of Libya and Iran revivalism grew out of the hazards of newly acquired oil wealth. . . . Muslims were rediscovering their faith either in dependence or in renewed self-confidence. (p. 516)

On the one hand, there are militant clerics and intellectuals, such as Hassan El-Tourabi (b. 1932) in the Sudan, who propose sweeping political changes to enshrine Islamic law (shari'a), ostensibly to strengthen the Islamic community and eradicate the corrupt Western influences of modern society. On the other hand, there are reformist scholars, such as Abdullahi An-Na'im, also from the Sudan, who offer a radical reinterpretation of the Koran in an effort to develop a modern version of Islamic law that conforms to international standards of human rights. Feminist scholars, such as Ayesha Imam, have also sought to reinterpret women's rights under Muslim laws to advance women's empowerment.

Transnational model. Finally, in response to the perceived pressures of globalization, which seem poised to erode the already diminished powers of the postcolonial state, a transnational model of democratization has emerged as embodied in new visions of regional and continental integration. Some scholars argue that none of the models above, all focused, more or less, on the nation-state, hold the key to lasting change for Africa. The economic and diplomatic justifications of regional integration for Africa's global competitiveness are as old as independence; the cultural and racial rationales go back to colonization and the origins of Pan-Africanism. What was new by the 1990s were the arguments centering on the democratic possibilities of regional integration: that it might curtail the authoritarian reflexes of the postcolonial state, thwart coups or raise the costs for the perpetrators, and facilitate the decentralization and dispersal of power, thereby dissolving incendiary clashes in conflict-prone countries.

The African Union, launched in 2002 as the successor to the Organization of African Unity, embodied the new hopes of African integration, development, and democratization. It envisioned the creation of an African parliament, a court of justice, a peace and security council, and an economic, social, and cultural council, some of whose members would come from civil society organizations, including some from the diaspora. Various economic instruments were also created, most importantly, the New Economic Partnership for African Development and a peer review mechanism for African states to evaluate each other's adherence to the principles of democratic governance and human rights.

Challenges of Democratic Consolidation

Most African scholars recognize that consolidating democracy on the continent will remain a difficult and daunting task. Available evidence indicates that, in the first fifteen years, many of the new democratic regimes were still fragile and some of

the euphoria of the early 1990s had evaporated. Some scholars and observers, such as Michael Bratton and Nicholas de Walle, even argue that democratization in Africa has been more illusory than fundamental, marking a transition from patrimonialism to neopatrimonialism. This is debatable, however. By the beginning of the twenty-first century, the authoritarianism and statism of the early postindependence years was in retreat, and, where it persisted, was vigorously contested in a context in which democratic aspirations were firmly implanted in popular consciousness and the pluralization of associational life was an integral part of the political landscape. It was indeed a mark of the changed times that, whereas previously development had been regarded as a prerequisite of democracy, now democracy was seen as indispensable for development.

The challenges facing Africa's democratic experiments are many and complex. Julius Ihnovbere and John Mbaku provide a useful summary. They include entrenching constitutionalism and the reconstruction of the postcolonial state, preventing military intervention in politics, instituting structures for the effective management of ethnic diversity, promoting sustainable development and well-enforced property rights regimes, nurturing effective leadership, combating the HIV/AIDS pandemic, empowering women, managing globalization, protecting the youth, and safeguarding human rights and the rule of law.

See also **Apartheid; Capitalism: Africa; Civil Society: Responses in Africa and the Middle East; Colonialism: Africa; Corruption in Developed and Developing Countries; Development; Globalization: Africa; Modernization Theory; Multiculturalism, Africa; Nationalism: Africa; Neocolonialism; Pan-Africanism; Socialisms, African; Westernization: Africa.**

BIBLIOGRAPHY

- Abrahamsen, Rita. *Disciplining Democracy: Development Discourse and Good Governance in Africa*. London: Zed, 2000.
- Ake, Claude. *The Feasibility of Democracy in Africa*. Dakar, Senegal: Codesria, 2000.
- Amadiume, Ifi. *Daughters of the Goddess, Daughters of Imperialism: African Women Struggle for Culture, Power, and Democracy*. London: Zed, 2000.
- Amin, Samir. "The Issue of Democracy in the Third World." In *Academic Freedom in Africa*, edited by Mahmood Mamdani and Mamadou Diouf. Dakar, Senegal: Codesria, 1994.
- An-Na'im, Abdullahi Ahmed. *Indigenous African Institutions*. New York: Ardsley-on-Hudson, 1991.
- . *Toward an Islamic Reformation: Civil Liberties, Human Rights, and International Law*. New York: Syracuse University Press, 1990.
- Ayittey, George B. N. *Africa in Chaos*. New York: St. Martin's Press, 1998.
- Bielefeldt, Heiner. "'Western' versus 'Islamic' Human Rights Conceptions? A Critique of Cultural Essentialism in the Discussion on Human Rights." *Political Theory* 28, no. 1 (2000): 90–121.
- Bratton, Michael, and Nicolas van de Walle. *Democratic Experiments in Africa: Regime Transitions in Comparative Perspective*. Cambridge, U.K.: Cambridge University Press, 1997.

- Chabal, Patrick. "A Few Considerations on Democracy in Africa." *International Affairs* 74, no. 2 (1998): 289–303.
- Cowen, Michael, and Liisa Laakso, eds. *Multi-Party Elections in Africa*. Oxford: James Currey, 2002.
- Eyoh, Dickson. "From Economic Crisis to Political Liberalization: Pitfalls of the New Political Sociology for Africa." *African Studies Review* 39, no. 3 (1999): 43–80.
- Ibrahim, Jibrin. "Democratic Transition in Africa: The Challenge of a New Agenda—Concluding Remarks." In *Democratization Processes in Africa*, edited by Eshetu Chole and Jibrin Ibrahim. Dakar, Senegal: Codesria, 1995.
- Iadahosa, P. L. E. *The Populist Dimension to African Political Thought: Critical Essays in Reconstruction and Retrieval*. Trenton, N.J.: Africa World, 2004.
- Ihonvbere, Julius O., and John M. Mbaku, eds. *Political Liberalization and Democratization in Africa: Lessons from Country Experiences*. Westport, Conn.: Praeger, 2003.
- Imam, Ayesha. "The Muslim Religious Right (Fundamentalists) and Sexuality: Women Living under Muslim Laws." *Dossier* 17 (1997): 7–25.
- . "The Place of Women under Sharia." *CRP/FNS Lagos* (2000): 16–31.
- Joseph, Richard. "Democratization in Africa after 1989: Comparative and Theoretical Perspectives." *Comparative Politics* 29, no. 3 (1997): 363–382.
- Makinda, Samuel M. "Democracy and Multi-Party Politics in Africa." *Journal of Modern African Studies* 34, no. 4 (1996): 555–573.
- Mama, Amina. "Challenging Subjects: Gender, Power, and Identity in African Contexts." *Research and Action Report* 23, no. 2 (2002): 6–15.
- . "Feminism or Femocracy? State Feminism and Democratization in Nigeria." In *Expanding Democratic Space in Nigeria*, edited by Jibrin Ibrahim, 63–80. Dakar, Senegal: Codesria, 1997.
- Mamdani, Mahmood. "Africa: Democratic Theory and Democratic Struggles." *Dissent* 39 (1992): 312–318.
- . *Citizen and Subject: Contemporary Africa and the Legacy of Late Colonialism*. Princeton, N.J.: Princeton University Press, 1996.
- Mazrui, Ali A. "African Islam and Competitive Religion: Between Revivalism and Expansion." *Third World Quarterly* 10, no. 2 (1988): 499–518.
- Mbaku, John M., and Julius O. Ihonvbere, eds. *The Transition to Democratic Governance in Africa: The Continuing Struggle*. Westport, Conn.: Praeger, 2003.
- Mengisteab, Kidane, and Cyril Daddie, eds. *State-Building and Democratization in Africa: Faith, Hope, and Realities*. Westport, Conn.: Praeger, 1999.
- Mkandawire, P. Thandika. *Thinking about Developmental States in Africa*. Geneva: United Nations Conference on Trade and Development, United Nations, 1998.
- Nyong'o, Peter Anyang'. "Discourses on Democracy in Africa." In *Democratization Processes in Africa: Problems and Prospects*, edited by Eshetu Chole and Jibrin Ibrahim. Dakar, Senegal: Codesria, 1995.
- . *Popular Struggles for Democracy in Africa*. London: Zed, 1987.
- Olsen, Girm Rye. "Europe and the Promotion of Democracy in Post Cold War Africa: How Serious Is Europe and for What Reason?" *African Affairs* 97, no. 388 (1998): 343–367.
- Olukoshi, Adebayo O. "Africa: Democratizing under Conditions of Economic Stagnation." Paper presented at Codesria Eighth General Assembly, Dakar, Senegal, June 26–July 2, 1995.
- . "Democratization, Globalization, and Effective Policy-making in Africa." In *The Politics of Trade and Industrial Policy in Africa: Forced Consensus?*, edited by Charles C. Soludo, Osita Ogbu, and Ha-Joon Chang. Trenton, N.J.: Africa World; Ottawa, Canada: International Development Research Centre, 2004.
- Owusu, Maxwell. "Democracy and Africa: A View from the Village." *Journal of Modern African Studies* 30 (1992): 369–396.
- . "Domesticating Democracy: Culture, Civil Society, and Constitutionalism in Africa." *Comparative Studies in Society and History* 39, no. 1 (1997): 120–152.
- Salih, Mohamed. *African Democracies and African Politics*. London and Sterling, Va.: Pluto, 2001.
- Sandbrook, Richard. "Economic Liberalization versus Political Democratization: A Social-Democratic Resolution." *Canadian Journal of African Studies* 31, no. 3 (1997): 482–516.
- Zezeza, Paul Tiyambe. *Manufacturing African Studies and Crises*. Dakar, Senegal: Codesria, 1997.
- . "The Struggle for Human Rights in Africa." In *Human Rights, the Rule of Law and Development in Africa*, edited by Paul T. Zezeza and Philip J. McConaughay, 1–18. Philadelphia: University of Pennsylvania Press, 2004.

Paul Tiyambe Zezeza

DEMOGRAPHY. Demography is the study of human population and its changes due to deaths, births, marriages and divorces, and migration. The term *demos* denotes people in Greek—the term *demography* literally means the systematic study of people. In the early twenty-first century the discipline encompasses a broad array of subject matters, covering, among others, economic, social, public health, and political issues. This entry will provide a brief overview of the uses of demographic data and key trends.

Contemporary demographers focus on two broad areas. The first is the size, composition, and characteristics of populations. The second focus is on processes that influence population change. Demographers need data to conduct analyses: censuses, surveys, and civil and vital registrations are sources of population-related information. Censuses collect data or information at the household level and are conducted at regular intervals. Surveys based on scientific sampling principles are conducted as needed for a variety of purposes, but participation by individuals is voluntary. The registration of births, deaths, marriages, and divorces, along with mandatory reporting requirements for communicable diseases or for residence changes, serve as excellent sources of data on fertility, mortality, nuptiality, and migration. An additional source of population data includes estimations, which are increasingly sophisticated calculations based on information not directly related to the sources listed here.

In addition to the size and spatial aspects of settlement, demographers examine and analyze factors related to the composition of populations, namely age groupings and race/ethnic and gender distributions. Characteristics of populations, such

as education and economic status, are also studied. Generally these factors are examined from a single point in time or cross-sectional perspective as well as in reference to dynamic changing processes (longitudinal).

Data on the size, composition, and characteristics of populations are used for a variety of public and private purposes. Drawing political boundaries for elections, determining commercial investment decisions, and assessing the prevalence of health problems are three examples of uses of demographic data. For example, the number of congressional districts in the United States has remained constant at 435 for nearly a century, despite a tripling of the nation's population. The allocation of congressional districts is based on a state's share of the national population.

Another example of the use of demographic analyses occurs when states, counties, and cities make decisions about infrastructure investments, such as the location of new fire stations, schools, and public libraries. Furthermore, private firms use population information such as education level and incomes to target households for marketing purposes or to estimate the need for commercial services. Demographic data are also used to calculate rates of prevalence of disease in order to assess the magnitude and the need for intervention. The incidence of communicable disease—for example, tuberculosis—is standardized (e.g., per 10,000 population), facilitating comparisons across administrative boundaries and helping to focus attention on health disparities between areas and population subgroups.

Demography addresses the processes that change populations. Three related factors affect population change:

- Fertility, which measures the average number of children born to a woman (or populations) during child-bearing ages;
- Mortality, which is the process by which deaths occur in populations; and
- Migration, which is the movement of individuals or groups that involves a permanent or semipermanent change of residence across administrative and political boundaries, that is, across county, state, and national boundaries.

The twentieth century was characterized by what has been termed a *demographic transition*, in which mortality rates dropped dramatically due to advances in sanitation, access to health care, rapid socioeconomic changes, including a change in the status of women and altered attitudes toward contraception. The reduction in mortality was followed by declines in fertility rates. The fertility decline was evident in Europe, North America, and Oceania throughout the latter part of the twentieth century, with fertility rates at or below the replacement level of 2.1 children per women. By the year 2000, most Asian and Latin American countries had entered a transition toward lower fertility, and by the start of the twenty-first century, some low-fertility countries had adopted policies to reverse the declines. Many of the countries that had not shown

fertility declines were located in sub-Saharan Africa. In addition to high infant mortality rates, mortality among the working-age population in Africa was also high as a result of the Acquired Immune Deficiency Syndrome (AIDS) epidemic, which was having a profound and detrimental impact.

By the early twenty-first century, the population aged sixty-five and above in low-fertility countries was increasing at a much faster rate than those of lower age ranges because of increased life expectancy combined with low birth rates. Since older populations typically need more health care along with support during retirement, increases in elderly populations put a strain on health care, social security, and pension systems. The aging population had a significant impact on health care systems and workforce recruitment and training and initiated a debate on how to support an aging population through publicly funded social security schemes. These debates occurred at a time when the size of the younger working population was shrinking.

In low-fertility countries, immigration mediated the impact of fertility declines. In North America and Oceania, large-scale immigration began in the nineteenth century, and net migration became a significant and increasing component of the population increase by the early twenty-first century. Other Western countries have had a history of emigration, that is, an outflow of people rather than immigration. But from the 1960s onward, an influx of African and Asian immigrants to Europe, both legal and illegal, gave rise to social and political pressures.

While fertility levels are declining in Asia, Latin America, and the Middle East, population size will continue to grow for the foreseeable future because large proportions of the population are in the younger reproductive ages. Emigration plays only a small role in reducing population growth in these regions. The challenge for many of these countries is to provide education, workforce training, and employment to their predominantly young populations, and failure to meet these needs may lead to political instability and sometimes acts of violence. Most spheres of human activity—political, social, and economic—now involve consideration of the size, composition, and characteristics of the population. This is unlikely to change as nations confront the issues discussed here.

See also *Family Planning; Migration; Population*.

BIBLIOGRAPHY

- Nam, Charles B. *Understanding Population Change*. Itasca, IL: F. E. Peacock, 1994.
- Namboodiri, Krishnan. *A Primer of Population Dynamics*. New York: Plenum, 1996.
- Saunders, John. *Basic Demographic Measures: A Practical Guide for Users*. Lanham, Md.: University Press of America, 1988.
- United Nations. *World Population Prospects: The 2000 Revision*. Vol. 3, *Analytical Report*. New York: United Nations, 2002.

Ramdas Menon

DEMONOLOGY. Some years ago, Richard Cavendish, an eminent demonologist and student of the so-called black

arts, observed that “[b]elief in the existence of evil supernatural beings” is so widespread that it “seems to be instinctive” (p. 8). Whether, as Cavendish suggests, these beliefs are in fact instinctive is still very much an open question. However, human beings do indeed appear to have a deep-seated penchant for explaining misfortune by attributing it to evil and malicious spirits and deities—that is, to demons. Such beliefs can be documented in virtually every known human society for which adequate information exists. This essay explores some of the more salient manifestations, modern as well as ancient, of this well-nigh universal component of several belief systems.

In the great majority of cases, demonic figures occur in conjunction with their opposites, that is, beneficent deities to whom worshipers turn for succor when misfortune strikes or when in need of assurance that crops will grow, illness will be avoided, and prosperity will continue. One of the earliest documented examples of such a pair can be found in ancient Egypt in Osiris and his demonic brother Seth.

Osiris and Seth

Dating from Old Kingdom times (2700–2200 B.C.E.), this pair of opposites was defined in the Pyramid Texts and other ancient Egyptian mythological texts as brothers. While Osiris—

together with his sister/wife Isis—was the incarnation of fertility and, eventually, life everlasting, Seth was evil personified. He was also a reflection of the arid desert that presses in on either side of Osiris’s domain: the fertile Nile Valley. Seth was jealous of his brother and, through trickery, caused his death. However, with the help of Isis and their son Horus, who was iconographically represented as a falcon-headed man, Osiris was resurrected and ascended to heaven to become the judge of the dead. Meanwhile, Horus and Seth struggled mightily. It was one of the first examples of a supernatural conflict between good and evil, between a demon and his diametric opposite (Horus later became identified with the pharaoh, who was worshiped as a god incarnate). The falcon-headed god finally prevailed, and Seth was killed and dismembered. But the latter remained a quintessential demon, the template, as it were, for a great many later Western demonic figures.

Ahura Mazda and Angra Mainyu

Another extremely important ancient demon can be found in the Iranian figure Angra Mainyu, or “Evil Spirit,” later known as Ahriman, who was paired in early Iranian mythology, especially as shaped by the prophet Zarathustra (or Zoroaster, as he was known to the ancient Greeks), with the beneficent deity Ahura Mazda, the “Wise Lord,” called Ormazd in Middle Persian. Although they were not held to be siblings, Angra Mainyu and Ahura Mazda were believed to be engaged in an ongoing cosmic struggle, both for world hegemony and for each individual soul. Angra Mainyu/Ahriman was a true “Prince of Darkness,” the diametric opposite—and eternal opponent—of the light-filled Ahura Mazda/Ormazd. The most extreme variant of this good-evil dichotomy was promulgated during the third-century C.E. by the Iranian religious reformer Mani (ca. 216–276 or 277 C.E.), founder of the Manichean sect, which, for a time, was a serious rival to nascent Christianity. According to the Manicheans, who emphasized free will, one could choose to follow the evil Ahriman, who might ultimately defeat Ormazd in their final, apocalyptic confrontation.

Satanism

The origins of Satan and related figures are complex. The word *satan* itself simply means “adversary” in Hebrew; in his earlier manifestations as Lucifer, the “Light-Bearer,” who rebelled against God and was cast out of heaven (cf. Isaiah 14: 12–15), he is not unlike the Greek figure Prometheus, albeit negatively valued. However, as the Zoroastrian theology of evil incarnate came to permeate post-exile Judaism, the Rebel evolved into a full-fledged evil adversary, in effect a malevolent twin of Yahweh who presided over the corrupt world of the senses.

Several centuries later, this evolution was greatly facilitated by the emergence of Gnosticism (from Greek *gnosis*, “knowledge”), a heretical movement that emerged in Alexandria and elsewhere in the early years of the common era. Gnosticism held that the mortal realm was created by a fool called the Demiurge, a corrupt if not totally malevolent pseudo-deity the Gnostics identified with the God of the Old Testament. This rejection of God linked Manichaeism to Gnosticism, but for the Gnostics the “real” world, that is, the world of the senses,

was evil, and their goal in life was to escape it and return to the Pleroma, or “Fullness,” a light-filled spiritual realm that was the antithesis of corrupt mortality. These ideas, although roundly condemned by the early church fathers, from Athanasius to Augustine, lingered on and reappeared in the twelfth century in southern France in the Cathay heresy, which was brutally suppressed during the infamous Albigensian Crusade (1208). It was out of this heretical crucible, which also came to include the “pagan” witchcraft beliefs that incited such intense persecutions between the mid-thirteenth century and the end of the seventeenth century, that Satanism as we know it today emerged. Indeed, the idea that a divine adversary who governs the sensate world is the “true” god still persists in cults such as the late Anton Szandor LaVey’s (1930–1997) Church of Satan, founded in San Francisco in 1966, and the Temple of Set, founded in 1975 by Michael Aquino (b. 1946). The idea that people are susceptible to possession by demons persists in the Roman Catholic ritual of exorcism, so graphically depicted in the film *The Exorcist* (1973).

Non-Western Demonology

Such beliefs are, of course, by no means limited to the West. Islam conceives of the demon Iblis as Allah’s prime adversary, aided by a host of malevolent spirits called jinn (the English word “genie” derives from this Arabic word), who are capable of all manner of mischief. Moreover, a great many non-Western cultures also share a belief in demonic figures. In Japan, demonic figures that have the ability to possess human beings and cause them great harm are called *oni*. There are a great many varieties of *oni*, not all of whom are really evil; however, most of them are at least mischievous. Among the more dangerous *oni* are animal spirits, including fox spirits, who are believed to be especially malevolent and are held responsible for a wide variety of personal misfortunes. Moreover, they are extremely difficult to exorcise. Similar folk beliefs can be found throughout East Asia, Southeast Asia, the Indian subcontinent, Africa, the Caribbean, and Oceania, as well as the Americas.

Hindu mythology is replete with demonic figures, the most famous of whom is the evil *raksha*, or demon, Ravanna, king of Sri Lanka, and abductor of Sita, the devoted wife of the demigod Rama. Indeed, the plot of the ancient Indian epic known as the *Ramayana*, which spread throughout much of Southeast Asia during the early centuries of the common era, turns on Rama’s conflict with Ravanna and Sita’s eventual rescue—once again, an account of an epic struggle between good and evil, although Ravanna and Rama are not conceived as siblings.

In the high Andean plateau, or *altiplano*, of Bolivia, as June Nash reports, the local miners believe that the mountains are haunted by a demon called Huari, whom they refer to as Tio, or “Uncle,” and who must be propitiated to avoid cave-ins and other calamities. This reflects another important dimension of demonology: the propitiation of evil forces and beings so as to preclude disaster and misfortune.

A further example of this ambiguous attitude toward evil figures can be found in Afro-Caribbean religions such as Santería and Voodoo, where the *orishas*, or deities, are considered both evil and beneficent, depending on the context.

Both good and evil manifestations of the gods are found in the pantheon and are regularly the recipients of sacrifices. Although for the most part absent in fully evolved Judeo-Christian demonology, this ambiguous attitude toward evil and the propitiation of what we might consider demons is an integral element of folk religious beliefs in a great many parts of the non-Western world—as well as in classical antiquity, where, for example, the ancient Greek god Pan was both benevolent and capable of creating havoc, whence the English word *panic*.

She-Devils and Female Demons

Although the majority of demons in most cultures tend to be male, female demons, she-devils, and the like are also common. One of the oldest examples of such a figure can be found in the Sumero-Babylonian demon Tiamat, wife of the primordial being Apsu. The supreme Babylonian god Marduk engaged in an epic struggle with Tiamat and, after finally defeating her, created the world from her corpse. Ancient Greek mythology abounds with evil female creatures, from the Gorgons, the most famous of whom was snake-locked Medusa, whose glance could turn a mortal into stone, to the monster Python, whom Apollo killed at the site of Delphi, to the equally bloodthirsty female Sphinx, whose riddle Oedipus managed to solve, causing her to drop dead.

In Shinto mythology, Izanami-no-Mikoto, the wife of the primeval male figure Izanagi-no-Mikoto, changed into a raging demon after she died giving birth to the Fire-god, Kagutsuchi, and descended into Yomi, the land of the dead. When Izanagi visited Yomi in order to bring her back to life, she led a band of female demons, the so-called Hags of Yomi, against him and almost succeeded in killing him. More recently, medieval European folklore knew the succubus, a demon or evil spirit who seduced unwitting mortal men and produced demonic offspring.

Space Aliens as Demons

In recent years, since accounts of UFOs and space aliens have become widespread in Europe and especially the United States, some fundamentalist Christians have asserted that these presumed extraterrestrial visitors are in fact manifestations of Satan and his demonic horde. Indeed, according to this contemporary “school” of demonology, those persons who claim to have been abducted by aliens and forced to have sex with them are believed to be victims of the same demonic possession that was reported in premodern times, which also frequently had a strong sexual component. In sum, demonology continues to persist in this otherwise secular age, just as it has since the dawn of human culture.

See also Evil; Syncretism; Witchcraft.

BIBLIOGRAPHY

- Cavendish, Richard. *The Black Arts*. New York: Berkeley Publishing Group, 1967.
- Duchesne-Guillemin, J. *The Western Response to Zoroaster*. Westport, Conn.: Greenwood Press, 1959.
- Fairman, H. W., ed. and trans. *The Triumph of Horus: An Ancient Egyptian Sacred Drama*. Berkeley: University of California Press, 1974.

- Gettings, Fred. *Dictionary of Demons: A Guide to Demons and Demonologists in Occult Lore*. North Pomfret, Vt.: Trafalgar Square Publishers, 1988.
- Littleton, C. Scott. "Japanese Religions." In *Religion and Culture: An Anthropological Focus*, edited by Raymond Scupin. Upper Saddle River, N.J.: Prentice Hall, 2000.
- Marrs, Jim. *Alien Agenda: Investigating the Extraterrestrial Presence among Us*. New York: Harper Paperbacks, 1997. See pp. 548–555.
- Murphy, Joseph M. *Santeria: An African Religion in America*. Boston: Beacon Press, 1988.
- Nash, June. "Devils, Witches, and Sudden Death." In *Magic, Witchcraft, and Religion: An Anthropological Study of the Supernatural*, edited by Arthur C. Lehmann and James E. Myers. 3rd ed. Mountain View, Calif.: Mayfield, 1993.
- O'Flaherty, Wendy Doniger. *The Origins of Evil in Hindu Mythology*. Berkeley: University of California Press, 1976.
- The Ramayana of Valmiki*. Translated by Hari Prasad Shastri. London: Shanti Sadan, 1962.
- Russell, Jeffrey Burton. *The Devil: Perceptions of Evil from Antiquity to Primitivist Christianity*. Ithaca, N.Y.: Cornell University Press, 1977.
- . *Witchcraft in the Middle Ages*. Ithaca, N.Y.: Cornell University Press, 1972.
- Wilson, Colin. *The Occult: A History*. New York: Vintage, 1973.

C. Scott Littleton

DEPENDENCY. During the 1960s and 1970s, Latin American dependency theorists produced an important challenge to modernization and growth theories of development. Associated with a number of key intellectuals from Latin America—Andre Gunder Frank, Fernando Henrique Cardoso, and Peter Evans in Latin America, Samir Amin and Walter Rodney in Africa—the *dependentistas* turned modernization theory upside down by arguing that contact with Western capitalism created (rather than solved) underdevelopment in the Third World. They challenged the Eurocentric notion that development was a "catch-up game" in which a "backward" Third World, mired in "tradition" (and thus outside modern history), could only become developed (like the West) with the help of Western capitalism.

While significant variations within this perspective would emerge, certain central tenets can be identified. Most notably, the *dependentistas* rejected the dual approach to development, arguing for a more global approach that examined unequal terms of trade and the role of Western capital in the perpetuation of these inequalities. At the same time, dependency theorists were unable to break completely from the Eurocentric discourse they were challenging. While critiquing the nation-state focus of modernization theory, their policy prescriptions tended to assert the centrality of the nation-state, with particular attention to state structures, technology, and national economic planning, thereby appropriating many of the key elements in mainstream development's toolkit. This limitation has inspired critiques of dependency writings from many different perspectives.

The Intellectual Roots of Dependency Thinking

The dependency challenge grew out of historical and economic analyses grounded in Latin America's colonial and postcolonial experiences. The historical work of Latin American scholars such as Eric Williams highlighted the links between the colonial plantations and Western economic development, particularly the use of plantation profits to bankroll European industrial development. The plantations were not precapitalist remnants of indigenous economies, they argued, but the result of capitalist penetration. This historical work undermined modernization theory's dual conception of Third World economies, arguing instead for a more integrated approach, one that paid attention to global inequalities and their link to uneven development. This argument greatly influenced the thinking of key dependency theorists, most notably Andre Gunder Frank.

The dependency approach was also influenced by a group of Latin American economists working for the Economic Commission for Latin America (ECLA), a United Nations agency established in Santiago, Chile, in 1948. Led by Raul Prebisch, these economists sought to understand why, after years of applying modernization and growth "solutions" to Latin American economies, so little progress had been made. They began to see the world as divided into an industrial core and an agrarian periphery. Rather than accepting modernization theory's premise that "backward" economies would gradually move through stages to mass consumption and industrial development, with help from northern capital and development experts (Rostow), the ECLA economists insisted that the core-periphery gap was produced (and reproduced) through patterns of unequal world trade. The very system that was supposed to develop the Third World was leading to its underdevelopment.

Prebisch and the ECLA economists thus challenged neo-classical theories of international trade, called for attention to distribution, and warned that the gap between the core/metropole and the periphery would continue unless there were explicit interventions to challenge structures of international capitalism. Yet, they still believed Latin America's development depended on industrialization and that the domestic capitalist class was the natural leader for that development. Hence, they argued for policies that would nurture this class, encourage import substitution industrialization, and put up protective tariffs until local manufacturers were ready to compete in the global economy.

Radical Dependency Theorists

Andre Gunder Frank and other radical dependency theorists drew on some of these ideas as well as the work of the neo-Marxist Paul Baran. Frank's influential English-language publications adopted the global perspective of the *latifundia* ("large landed estates," "plantations") historians (Williams), as well as Prebisch's focus on unequal terms of trade and his core/periphery model of the world economy. However, Frank rejected the ECLA economists' optimistic assessment of Third World elites. Influenced by Baran, Frank and other radical *dependentistas* argued that collusion between Third World elites and monopoly capital in the industrialized countries was one

of the leading factors causing underdevelopment in the periphery. They also rejected the dual economy assumptions of modernization theory, arguing that capitalism had penetrated all corners of the globe since its emergence in the sixteenth century. The Third World periphery was not a “backward” region that would catch up with the industrialized world; its underdevelopment was necessary for metropole’s prosperity. As Frank argued, the core and periphery were not separate entities, but, rather, the logical consequence of an integrated global capitalist system. According to Frank:

A mounting body of evidence suggests . . . that the expansion of the capitalist system over the past centuries effectively and entirely penetrated even the apparently most isolated sectors of the underdeveloped world. Therefore, the economic, political, social, and cultural institutions and relations we now observe there are the products of the historical development of the capitalist system no less than are the seemingly more modern or capitalist features of the national metropolises of these underdeveloped countries. (p. 18)

Frank and his *dependentista* colleagues challenged the assumption that decolonization had truly liberated the newly independent nations in the Third World. They argued that, in fact, exploitation had intensified, both between nations and within Third World countries, and concluded that Third World elites and their Western capitalist allies could bring nothing but underdevelopment and despair to the periphery. They called for revolutionary action to remove local political elites from power and to establish governments based on socialist ideals and structures. Only then would Third World nations be able to break their bonds of dependency, challenge global capitalist patterns of inequality, and develop as autonomous, self-reliant nations.

Radical dependency theory influenced thinkers outside Latin America as well, particularly in Africa, where it found a welcome audience among intellectuals and many policy-makers. The Guyanese historian Walter Rodney wrote a widely acclaimed analysis blaming Africa’s historical underdevelopment on the systemic inequalities resulting from capitalism, colonialism, and imperialism, and Samir Amin, an Egyptian political economist, concluded that Europe had underdeveloped large parts of Africa during the colonial period. This had led to the creation of dependent peripheral economies characterized by weak capitalist sectors focused on a small elite luxury market, with little attention to manufacturing for mass consumption or to promoting links between agriculture and industry. Deeply suspicious of Eurocentric explanations of the world and believing Western capitalist structures inevitably and inherently caused underdevelopment in the periphery, Samir Amin has been an ardent advocate of delinking from the West. Whether this is to be a regional or national project is unclear, but the imperative of delinking is never questioned.

In a similar vein, although skeptical of delinking, Immanuel Wallerstein has drawn on Frank and other radical *dependentistas* for his own project, analyzing commercial relations since the sixteenth century. His World Systems Theory (WST)

expands and complements Frank’s ideas, providing a broad global analysis of the way successive emerging cores, their peripheries, and semiperipheries have experienced capitalism over the last few centuries. While seeing capitalism as a zero-sum game, in which winners bring inevitable losers, by advancing the notion of a semiperiphery (rather than a binary world of metropole/periphery) and emphasizing its skepticism toward the benefits of delinking in a global world, World Systems Theory acknowledges the dynamics and dialectics within capitalist development. While many critics find this approach too sweeping, WST continues to have passionate advocates (as well as opponents) around the world.

Reformist Dependency Theory

During the 1970s, the emergence of vibrant economies in some parts of the Third World, especially in countries like South Korea and Taiwan, challenged the radical *dependentistas’* argument for the inevitability of underdevelopment within the capitalist system. Reformist dependency thinking emerged to deal with these contradictions. In particular, the Brazilian social scientist Fernando Cardoso and his colleague, the sociologist Enzo Faletto, while sympathetic to much of radical dependency thinking, rejected the assertion that peripheral underdevelopment was completely determined by the logic of capital accumulation, and argued that Latin America economies were better understood by looking at “forms of local societies, reactions against imperialism, the political dynamics of local societies, and attempts at alternatives” (pp. xv–xvi). Dependency, for them, depended more on local dynamics and the maneuvers of politicians, particularly their willingness to be co-opted by foreign capital, than on the inevitable workings of the world capitalist system. Indeed, they rejected the notion of a world economy, positing instead a world of multiple capitalist systems, with each nation having its own specific social formation and style of capitalism.

Cardoso and Faletto also rejected the radical *dependentistas’* blanket hostility to the national bourgeoisie. Their focus on internal factors highlighted the importance of discovering which groups and classes were willing and able to push for national development. This could include the national bourgeoisie as well as labor, peasants, ethnic groups, and civil society. No class or group was inevitably seen as inclined to help or hinder national development. Cardoso (1972) posited three ways that nations in the Global South could attain development: (1) gaining political autonomy and using that power to industrialize; (2) developing an export-oriented economy capable of accumulating enough capital to industrialize; and (3) being assisted by multinational capital investments that would foster technology transfer and eventual industrialization (a dependent form of development, however). While accepting the tendency toward dependent development rather than the achievement of economic and political autonomy in the Global South, the reformist dependency theorists stake out a very different position than their radical colleagues. For Cardoso and other reformists, genuine autonomous development can occur in the South if the correct alignment of internal forces, both structural and cultural/ideological, can be set in place.

Critiques of Dependency

Both radical and reformist dependency thinking soon encountered strong opposition. While openly hostile to the radical *dependentistas*, mainstream development policy-makers and practitioners increasingly recognized the validity of some of their arguments about the failures of modernization “solutions” to Third World underdevelopment. Organizations such as the World Bank, the International Monetary Fund, and some large government aid agencies responded to this challenge by emphasizing the need to pay more attention to basic human needs and poverty. Reassured by the reformist arguments, some mainstream agencies sought to collaborate with more “reasonable” scholars, such as Cardoso and others who were opposed to delinking and believed in the possibility of working for change within the status quo.

Interestingly, the reformists’ focus on the national bourgeoisie and class relations resonated with some of the Marxist critics of the radical *dependentistas*. For example, Ernesto Laclau condemned Frank for focusing on the market rather than class relations, despite his call for a class-based socialist revolution. Bill Warren, in a trenchant, well-researched challenge, questioned the assumption that Third World nations are inevitably caught in a cycle of underdevelopment. Citing various Third World success stories, he argued for a more specific, historical, and class-based analysis of global capitalist relations. Moreover, rather than automatically condemn the national bourgeoisie, he suggested that they could, under the right circumstances, play a crucial role in Third World development. In Africa, some *dependentistas*, such as Colin Leys, retracted their earlier positions and resurrected the national bourgeoisie as a potential instrument for escape from underdevelopment (see also Kitching).

Some feminists concerned with development issues have applauded dependency theorists for criticizing modernization theory and for grounding their analysis in Southern experiences and problems. However, dependency thinking has paid little attention to gender in general, preferring the broad sweep of global forces. Gender and development analysts have been particularly disturbed by dependency theorists’ failure to pay attention to cultural dimensions of domination. This is particularly problematic for those concerned with gender equality issues because cultural attitudes and practices clearly play a crucial role both in reinforcing and strengthening patriarchal power structures. The focus on structures rather than agency and culture are, thus, serious problems for feminists interested in utilizing the insights of dependency theory, whether radical or reformist.

Scholars and practitioners concerned with gender, alternative approaches to development, and postcolonial writings argue that in crucial ways dependency thinking has not freed itself from many of the categories of modernization theory. Development is still conceived largely in terms of economic growth, industrialization, and liberal democracy, as an evolutionary process to be led by the correct elites, whether socialist leaders or committed national bourgeoisies. The ecological implications of this growth-oriented model have been ignored, along with the voices and concerns of marginalized peoples.

Agency and difference disappear in a world dominated by powerful global forces. The possibility that hegemony is never complete, that the marginal may influence development practice and thinking, is never considered. Moreover, both the discourse and assumptions of dependency theorists focus on national economic plans, with well-developed national targets. Thus, at the level of discourse and practice, dependency perspectives are based on top-down models of development familiar to the most ardent advocates of modernization.

While there are lessons to be discovered in the writings of dependency theorists, most notably those that pay attention to specific historical forces and their relation to global structures and patterns, the shortcomings of dependency theorists, particularly their inability to move beyond the confines of modernization theory, remain serious impediments for many who are concerned with development questions in an increasingly global/local world. At the same time, the early twenty-first-century conjuncture inevitably raises questions about global forces and the potential of dependency theory’s global perspective for understanding the present. Creative, but critical, analysis, drawing on dependency thinking as well as other strands of development thought, may well be possible. Certainly the global focus of the *dependentistas* has much to say to us as we grapple with financial flows and communication systems of an intensity and speed never envisioned in the past. Perhaps useful syntheses will emerge, and, with them, the possibility of reevaluating and using much of the rich scholarship of the dependency perspective.

See also *Capitalism; Class; Colonialism; Corruption in Developed and Developing Countries; Development; Globalization; Human Capital; Marxism; Modernization Theory; Neocolonialism; Scarcity and Abundance, Latin America; State, The: The Postcolonial State; Third World; World Systems Theory, Latin America.*

BIBLIOGRAPHY

- Amin, Samir. *Accumulation on a World Scale: A Critique of the Theory of Underdevelopment*. 2 vols. New York: Monthly Review Press, 1974.
- . *Delinking: Towards a Polycentric World*. London: Zed, 1980.
- . *Unequal Development: An Essay on the Social Formation of Peripheral Capitalism*. New York: Monthly Review Press, 1977.
- Baran, Paul A. *The Political Economy of Growth*. New York: Monthly Review Press, 1957.
- Bergeron, Suzanne. *Fragments of Development: Nation, Gender, and the Space of Modernity*. Ann Arbor: University of Michigan Press, 2004.
- Cardoso, Fernando H. “Dependency and Development in Latin America.” *New Left Review* 74 (1972): 83–95.
- Cardoso, Fernando H., and Enzo Faletto. *Dependency and Development in Latin America*. Berkeley: University of California Press, 1979.
- Chilcote, Ronald H. *Theories of Development and Underdevelopment*. Boulder, Colo.: Westview, 1984.
- Evans, Peter. *Dependent Development: The Alliance of Multinationals, the State, and Local Capital in Brazil*. Princeton, N.J.: Princeton University Press, 1979.

- Frank, Andre G. *Capitalism and Underdevelopment in Latin America: Historical Studies of Chile and Brazil*. New York: Monthly Review Press, 1967.
- . “The Development of Underdevelopment.” *Monthly Review* 18 (1966): 17–31.
- . *Latin America: Underdevelopment or Revolution*. New York: Monthly Review Press, 1969.
- . *Lumpen-Bourgeoisie: Lumpen-Development, Dependency, Class, and Politics in Latin America*. New York: Monthly Review Press, 1970.
- Kitching, G. N. *Development and Underdevelopment in Historical Perspective: Populism, Nationalism, and Industrialization*. London: Methuen, 1982.
- Laclau, E. “Feudalism and Capitalism in Latin America.” *New Left Review* (May–June 1971): 19–38.
- Leys, Colin. “Kenya: What Does ‘Dependency’ Explain?” *Review of African Political Economy* 17 (1980): 108–113.
- Marchand, Marianne, and Jane Parpart, eds. *Feminism/Postmodernism/Development*. London: Routledge, 1995.
- Pieterse, Jan N. *Development Theory: Deconstructions/Reconstructions*. London: Sage, 2001.
- Rodney, Walter. *How Europe Underdeveloped Africa*. London: Bogle-L’Ouverture, 1972.
- Rostow, W. W. *The Stages of Economic Growth: A Non-Communist Manifesto*. Cambridge, U.K.: Cambridge University Press, 1960.
- Tucker, Vincent. “The Myth of Development: A Critique of a Eurocentric Discourse.” In *Critical Development Theory*, edited by R. Munck and D. O’Hearn, 1–26. London: Zed, 1999.
- Wallerstein, Immanuel M. *The Capitalist World Economy: Essays*. New York: Cambridge University Press, 1979.
- . *The Modern World System*. Vol. 1: *Capitalist Agriculture and the Origins of the European World-Economy in the Sixteenth Century*. New York: Academic, 1974.
- . *The Modern World System*. Vol. 2: *Mercantilism and Consolidation of the European World-Economy, 1600–1750*. New York: Academic, 1980.
- Warren, Bill. *Imperialism, Pioneer of Capitalism*. London: New Left Books, 1980.
- Williams, Eric E. *Capitalism and Slavery*. Chapel Hill: University of North Carolina Press, 1944.

Jane L. Parpart

DETERMINISM. The most general idea is that all events without exception are just effects. This idea has been associated with science since the seventeenth century, but it was put in some doubt by an interpretation of quantum theory in physics at the beginning of the twentieth century.

Events are things that happen. Roughly speaking, they are such occurrences as a chair having such a property as a particular location for a time. So determinism is not the idea that everything is an effect. There is a reasonable doubt, by the way, about the items that quantum theory is often interpreted as saying are not effects. Are these items actually events? Are they like numbers instead, say three? If so, then the interpretation of quantum theory is actually irrelevant to determinism.

As for effects, they are not just probable. They are events that had to happen or could not have been otherwise. They were settled in advance. They were, as philosophers sometimes

say, necessitated. There have been different thoughts about what all this comes to.

One thought is that an effect is something that would still have happened just as it did, given certain things that preceded it, whatever else had also preceded it. That match would still have lit, since it was struck the moment before and there was oxygen present and so on, whatever else had also been true.

There is a less-general idea of determinism, of greater interest to most people and to philosophers. It is an idea of human determinism, the main subject of this article. It is that human choices and decisions and the like, and also actions that flow from them, are just effects. Deciding to move one’s little finger now is just an effect—as is moving it. So with buying something, getting divorced, or killing somebody. The word *just* in either idea of determinism is only a reminder that whatever else is true of them, the events had to happen, could not have been otherwise, and so on.

The reader may want to say at this point, reasonably enough, that there is a third idea of determinism. It is that people’s choices, and so their actions, are not free. Certainly that idea exists. But it is probably better to begin with the second one, about human activities being effects. This is so for the reason that for centuries philosophers and others have disagreed about what follows logically from the second idea, about choices and actions being effects—if that is the case.

Many philosophers have of course said that if determinism in this sense is true, then people are not free. The two things seem to them obviously incompatible. Also, people are not morally responsible for their choices and actions. However, about as many philosophers have said that if this determinism is true, many of one’s choices and actions are still perfectly free.

The present article will focus on the second idea of determinism. What is really important of course is not to confuse it with the third sense, the no-freedom sense, or with the first sense, or any other sense.

One large question is whether people really are subject to this determinism. Is this determinism true? A prior question, just as important, is whether this determinism is really clear. For a start, is it clear what choices and decisions and other episodes or facts of consciousness come to? One could call this the question of clarity as against the question of truth. A third question of course is the one this discussion has been noticing. What follows about one’s freedom and responsibility if determinism is true?

One way of getting rid of the clarity question is by declaring that the mind is no more than the brain. Conscious events like deciding something are just events of the brain, neural events, nothing more. Deciding something is an event that has only electrochemical properties.

Certainly that makes determinism pretty clear. This old materialism from the seventeenth century can be dressed up, and it certainly is. But no matter how it is dressed up, it is impossible for anyone who gets it straight to believe it. Peo-

ple know, or think they know, that there is a big difference between consciousness or being conscious and any other thing or event—say a neuron or nerve cell composed of protein and so on or a little chemical substance passing between this neuron and the next neuron.

Maybe the reader will say at this point that while consciousness is mysterious, people do have a grip on it. One may say people have a better grip on it than on anything else. One may say, a little obscurely, that it is what people actually live in. People know what it is to decide something. This subjectivity as it is called, as against the objectivity of the world, is what people know immediately and best, whatever the difficulty of analyzing it.

Let us take this line about the subject matter of human determinism, which is very common philosophically and pretty respectable. It leads to the question of whether this determinism is true.

Is Determinism True?

For about a century, this question has been tied up with what is now called neuroscience—the science of the brain and the central nervous system. If nobody or hardly anybody really believes conscious deciding and so on is just neural activity and nothing else, almost everybody who looks into the question thinks there is a close connection between brains and minds, between neural activity and conscious or mental activity.

Neuroscience has been much concerned to relate particular kinds of conscious events to particular kinds of neural events. It assigns kinds of conscious events to certain locales of the brain, if not in the simple way of early neurophysiologists. But the main point is that neuroscience has taken the brain to be subject to causation. It has taken neural events to be effects. That is, it has assumed that the most general idea of determinism, the one with which this discussion started, is true of all the events in the brain. It still does, despite thoughts brought to bear on it by a few enthusiasts for the interpretation of quantum theory also mentioned at the start.

The argument that comes out of this, in short, is that if the brain is just effects, and the mind is closely connected with the brain, intimately bound up with it, then the mind has to be just effects too. If all neural events have to happen as they do, without any other possibility, then the same is true of the conscious events that go with them—different events but events that cannot possibly be separated from the brain events. If the brain is a machine, then what is bound up with it must also be a sequence of cause and effect.

The argument going the other way is about all of reality, not just brains, and it is owed to taking physics as somehow the fundamental science. In particular it is owed to the interpretation of quantum theory mentioned already. Reality is divided into two levels, the very small particles and the like of what can be called the microworld, and then the larger things in the macroworld, say from ordinary neural events that go with decisions and the like up to explosions and tides. The main proposition is that in the microworld there are events—they really are events—that are not effects.

Therefore they are chance or random events. That is not to say that one is unable to find the explanations of why they finally happen—as distinct from finding out that they are probable or what makes them probable. To say an event is a real chance or random event is to say there is no explanation in reality of why it finally happens. God, if he tried to explain this, could not, since there is no explanation to be found. There is no such thing in the world.

The present author does not go along with this argument. One reason is that although quantum theory is very useful indeed, the interpretation of it has never been proved in the ordinary sense of the word.

A second reason has to do with the two worlds and in particular with the two worlds in so far as they have brains in them. Conscious events like decisions, as one knows, are bound up with macroworld events in the brain, the ordinary events studied in neuroscience. And to add something left implicit so far, these larger events are of course related to or somehow consist in small microworld events in the brain.

The next thing to be said is that the ordinary events investigated by neuroscientists are like all the rest of the events in the macroworld: they certainly do not seem to be and certainly are not taken to be chance or random events. Whether a transmitter substance is released by a neuron, for example, is taken to be a matter of cause and effect. It is definitely not taken as something absolutely without an explanation. This is a reason, as one has heard, for thinking that the related conscious event is also a matter of cause and effect, but that is not the present concern.

How does the ordinary neural event relate to the microevents down below, microevents that at least enter into the ordinary event? If the microevents are chance or random events, as people ask, does this translate upward into the ordinary events? Does it make the ordinary events indeterministic? For anyone who wants to deny determinism with respect to the ordinary events, there seems to be a certain dilemma here.

Either there is a kind of tight relation between the microevents and the ordinary events or there is not. Either there is translation upward or there is not. Well then, since the ordinary events are plainly a matter of cause and effect, there are two possibilities, both of them bad news for the antideterminist. (1) Since ordinary events are effects and there is translation up from below, then the microevents must also be effects—despite exactly what is said of them. (2) Or given that the ordinary events are effects, it could be that the microevents are not effects but there is no translation upward. But then the fact about microevents not being effects does not matter. It is irrelevant.

But this article has to leave that and come to the main question considered by philosophers. It is not the truth of determinism but the question of what follows if it is true. What are the consequences of determinism—consequences for people's lives, for their freedom and responsibility?

Compatibilists and Incompatibilists

As indicated earlier, the history of philosophy up to the present moment has in it compatibilists, philosophers who say de-

terminism is compatible with freedom and hence that determinism does not matter much. But the history also has in it incompatibilists, those who say determinism is incompatible with freedom and hence determinism matters a lot. Both of these regiments of philosophers can make a case.

Who do you yourself think is not free?

One good answer, or a start on a good answer, is a man in handcuffs. Another is a man in jail. There is also the woman facing a man with a gun or a knife who has to do what he says. There is also a whole people or nation who cannot run their own affairs because a foreign army has invaded and is in control. Then there is somebody who is not subject to actual physical constraints—handcuffs or prison bars or to threats or coercion by other people—but is the victim of an inner psychological compulsion. It is very natural to include as unfree at least some drug addicts and also a woman who has to wash her hands about forty times a day. Probably you will also say someone is unfree who is argued into some conclusion or into doing something that goes against his or her whole personality.

The central thought is that freedom is an absence of coercion or constraints. Or to put it positively, freedom is an ability to decide and do what one wants. Freedom is being able to decide and act in accordance with one's own desires, not something conflicting with them. Maybe this idea of freedom as voluntariness, as one can call it, can be enlarged in various ways. Thinking of the drug addict, can one allow that he or she wants the heroin, but he or she is unfree in that he or she does not want to be the victim of that desire for heroin?

This voluntariness, if one thinks about it, is perfectly consistent with determinism. This kind of freedom can certainly exist—lots of it—even if determinism is absolutely true. What this amounts to is that this kind of freedom is not an absence of cause and effect but rather is a matter of a certain kind of effects. One is free in this sense, so to speak, when one's decisions and actions are owed to one, come from causes that are one's own desires or certain of one's desires, not from causes that are against one's desires.

One can also see that this kind of freedom goes with a kind of moral responsibility for what one does. If the cause of the disaster is in me, so to speak, then I am responsible for the disaster. Furthermore, if you want to reduce future disasters, I am the one to disapprove of or blame or put in jail.

So that is compatibilism, the idea that determinism is no threat at all to freedom. But it is certainly not the only way of thinking about these things. Ask that question again.

Who do you think is not free?

The best general answer, probably, is that it is somebody who does not have to do what he or she does. But does not that obviously mean that he or she is left room for choice, that he or she has different possibilities in front of him or her, that he or she can do otherwise than he or she does? And to come to the crucial bit, the crunch, does that not mean that he or she is not caused or necessitated to do what he or she does?

If that is not completely obvious, think of somebody who is really subject to determinism when he or she is unfaithful to his or her partner—say when he or she decides to dial a telephone number. If determinism is true, the dialing had to happen because of certain causes, and those causes had to happen because of still earlier ones, and so on back—say to before the person was born. The dialing could only be up to the person in question if those causes before he or she was born were up to him or her, which is impossible.

So, very differently, if somebody is free and responsible in dialing a telephone number, that must be something that is just inconsistent with determinism. It must be that the dialing is not just an effect or rather that it is owed to something that is not just an effect. It must be owed to an act of will. It must come from what philosophers call origination—very roughly, causing something without being caused to do it and thus being responsible for it in a special way.

Recent Thinking

The main philosophical dispute about determinism has been presented. It began at least as early as the seventeenth century, when the great Thomas Hobbes propounded the compatibilist case and was roundly attacked by Bishop John Bramhall. In the twentieth century the Cambridge philosopher G. E. Moore said that if one says “he could have decided otherwise,” one roughly means “he would have decided otherwise if he had seen the other reasons,” which is perfectly consistent with determinism. The Oxford philosopher J. L. Austin said in reply, as a cautious incompatibilist, that *if* is a tricky word and to say X if Y is not always to say that Y is a cause or a different cause or anything like that. Think of “there's a beer in the fridge if you want one.”

One will find new arguments, or anyway new versions of old arguments, in good new textbooks on determinism and freedom. Most philosophers and others who write about the subject are either compatibilists or incompatibilists. It may seem a person has to be one or the other. Either determinism is compatible with freedom or it is not. Many compatibilists are of a scientific outlook, many incompatibilists more traditional and maybe inclined to religious belief or an elevated kind of humanism.

Still, one does not actually have to join either of those regiments. A few philosophers think the idea of freedom as origination is so vague or confused that determinism can be true without there being any consequence that a serious person has to worry about. This can be distinguished, maybe, from compatibilism.

Go back to that question that was asked twice, “Who do you think is not free?” The reader may have liked both answers, the compatibilist one and the incompatibilist one. In fact if one spent some time thinking, one might have come up with both answers oneself. After all, they are not surprising or novel answers, are they? People in jail are not free, and people who do not really have two choices are not free.

Now think of what compatibilism and incompatibilism have in common. They have in common the proposition that peo-

ple have one idea of freedom or maybe one important idea. Compatibilists say it is voluntariness, and incompatibilists say it is origination. But surely it is just a mistake that people—the reader and the present author and the rest of the human race, or anyway those in Western culture—have only the one idea.

The truth of the matter is that people have both and that both are important. So compatibilism and incompatibilism are both mistaken. One does not have to be either a compatibilist or an incompatibilist if it just is not true that a person has only one idea of freedom.

That gets rid of one problem but certainly not all the problems about determinism and freedom. It does not get rid of what seems the real problem. It is a kind of practical problem. If one thinks determinism is true, how is he or she to deal with the fact that he or she also wants one of his or her ideas of freedom to be true—and it can not be if determinism is true?

There is something else too, not the same. A person can believe, and not just want, that his or her life has been up to him or her in some important sense even if that person is convinced of determinism, even if he or she believes his or her life was all just effects. One can still blame himself or herself for things in something like the way that involves what he or she does not accept, freedom as origination.

Could it be that what people need to do is really go back to the beginning and think about the nature of a conscious life, think about consciousness itself? Subjectivity? Was your life up to you, and do you have to have certain feelings about it, because it involves a kind of unique world in a way dependent on you?

See also *Causation; Consciousness; Free Will, Determinism, and Predestination; Subjectivism.*

BIBLIOGRAPHY

- Berofsky, Bernard, ed. *Free Will and Determinism*. New York: Harper and Row, 1966. A strong selection of papers representing mainly twentieth-century thinking.
- Dennett, Daniel. *Freedom Evolves*. New York and London: Penguin, 2003. A robust and individual defense of compatibilism by a well-known philosopher.
- Double, Richard. *The Non-Reality of Free Will*. Oxford and New York: Oxford University Press, 1991. A radical dissolution of the whole problem.
- Honderich, Ted. *How Free Are You? The Determinism Problem*. 2nd ed. New York and Oxford: Oxford University Press, 2002. A fuller expression of the views in the entry above. Like all the books above, it contains a full bibliography on determinism and freedom.
- Honderich, Ted, ed. *Essays on Freedom of Action*. London and New York: Routledge and Kegan Paul, 1973. Papers by good analytic philosophers on compatibilism and incompatibilism.
- Hook, Sidney, ed. *Determinism and Freedom in the Age of Modern Science: A Philosophical Symposium*. New York: New York University Press, 1958. Another good selection of twentieth-century papers with more attention to the question of the truth of determinism.
- Kane, Robert. *The Significance of Free Will*. Oxford and New York: Oxford University Press, 1996. A realistic discussion of both incompatibilism and freedom of origination.

Kane, Robert, ed. *The Oxford Handbook of Free Will*. New York and Oxford: Oxford University Press, 2001. A large, excellent, and up-to-date survey of the problem through the writings of contemporary philosophers.

Magill, Kevin. *Freedom and Experience: Self-Determination without Illusions*. New York: St. Martin's Press, 1997. Excellent and novel arguments for compatibilism.

Mele, Alfred R. *Autonomous Agents: From Self-Control to Autonomy*. New York: Oxford University Press, 1995. Neither compatibilist or incompatibilist.

Morgenbesser, Sidney, and James Walsh, eds. *Free Will*. Englewood Cliffs, N.J.: Prentice-Hall, 1962. Historical introduction to the problem. Twelve selections from across the centuries.

Pereboom, Derk. *Living without Free Will*. Cambridge, U.K., and New York: Cambridge University Press, 2001. Strong non-standard rejection of origination.

Strawson, Galen. *Freedom and Belief*. Oxford: Clarendon, 1986. The argument that the idea of origination is so confused that there is no opposition to determinism.

Van Inwagen, Peter. *An Essay on Free Will*. Oxford: Clarendon, 1983. A much discussed defense of incompatibilism, including the argument about past causes not being up to us.

Ted Honderich

DEVELOPMENT. *Development* in biology refers to the process of growth and differentiation that is characteristic of living organisms. It describes the continuous changes during the life cycle of individual organisms from the early stage of a single cell until death. *Development* also refers to what is today known as the process of evolution, the transformation of species through time. Other meanings of *development* are connected to economic and psychological processes. The German term *Entwicklung* has the same connotations, especially with respect to the two temporal processes of ontogeny (individual development) and phylogeny (evolutionary development), and its meaning also extends into artistic and literary domains (*Entwicklungsroman*).

Due to the gradual nature of developmental processes and the wide-ranging diversity of organisms (animals, plants, microbes) and modes of reproduction (sexual, asexual), it is not possible to clearly define a unique starting point of development that applies universally to all organisms. Nevertheless, development is a fundamental property of all organisms and one that sets them apart from other physical and chemical systems. In the language of molecular biology, development is the process that translates the sum of the genetic characteristics of an organism (its genotype) into the morphological, physiological, and behavioral features of an individual (its phenotype). Since the 1970s the prevailing interpretation of this process had become increasingly preformistic—the idea that the genotype largely determines the phenotype. With the twenty-first century, however, this view has gradually been replaced by a more interactive, or epigenetic, interpretation of development that sees the individual phenotype as the product of a dynamic interaction between the genotype and the various environments of an organism (cellular, organismal, physical, cultural). These recent positions in developmental bi-

ology also reflect the long-standing dichotomy of interpretations of development—preformistic and epigenetic—that characterized the scientific and philosophical discussion of the last 2,500 years.

Aristotle on Development

The (human) life cycle and several aspects of development, such as the fertilization of plants, the grafting of fruit trees, and the principle of generation, were already known in antiquity. As with so many other areas of knowledge, it was Aristotle who summarized existing knowledge and by adding his own observations created the first inclusive theory of development. Aristotle expressed his conception of development in *De generatione animalium* (The generation of animals) and in his whole corpus of zoological writings, and development played an integral part in his overall science and philosophy. Aristotle's view of the world was intrinsically dynamic, based on matter and change. Matter is always structured. Form is the realized potential of matter, its entelechy, which is already present within it. In organisms, according to Aristotle, the potential form (entelechy) is gradually realized in the course of development. This dynamic process of development, as well as the resulting organism, requires all four causes of the Aristotelian physics: the material, formal, efficient, and final causes. In embryological development, the female fluid, the menstrual blood, contributes the material cause on which the semen acts, providing the initial stimulus for the dynamic sequence of development. In the course of development the combination of male and female fluids allows the formal and efficient causes to shape the emerging potential of the organism, its telos. This entelechy of the organism, however, has been present from the very beginning as the potential of this particular form of matter (the combination of male and female fluids). In later periods the Aristotelian entelechy has often been identified with the notion of a "soul," but for Aristotle entelechy is not something separate that directs development from the outside, but rather is always already present within the emerging organism as its potential to be realized gradually.

Ideas of Development in the Seventeenth and Eighteenth Centuries: Preformism and Epigenesis

Aristotle's conception of development was shaped by what he could observe—fluids and semen at conception and the gradual emergence of form in the course of development. It is therefore only logical that the next major changes in the philosophical and scientific analysis of development are connected with emerging possibilities of observation during the seventeenth century. One instrument, in particular, played a central role in discussions about development—the microscope. The microscope allowed for the first time analysis of the constitution of those observable fluids at the beginning of development. Looking at semen with his single-lens microscope, Anton van Leeuwenhoek could see structures in the head of the spermatozoa. But what did those structures represent? In the wake of the scientific revolution, a mechanical approach dominated the sciences and medicine. William Harvey had found a mechanical solution to the circulation of blood, and generations of anatomists had analyzed the form and function of the human body in similar terms. In this

context of mechanical ideas, Leeuwenhoek's observations took on a specific meaning. For some of his contemporaries, the structures inside the sperm thus represented a smaller, already performed version of the adult organism, called an "homunculus" by some. Development then was simply a mechanical unfolding and subsequent growth of structures already present at the very beginning in either the sperm or the egg. Others, such as Harvey, continued to advocate the epigenetic position of Aristotle. These epigenesists also claimed that their views only described what they could observe.

Clearly, observations were ambiguous and often fit theory-driven expectations. Preformists were committed to a mechanical and materialistic explanation. They did not want to rely on any form of entelechy or vital force in order to account for development and were also opposed to ideas and reports of spontaneous generation. Epigenesists, on the other hand, were committed to the action of a vital force in nature. They also emphasized the role of observation and pointed out that several facts, such as the existence of hybrids or "monsters," could not easily be explained within the preformist framework. The influence of metaphysical commitments in shaping the interpretation of observations can best be seen in the mid-eighteenth-century debate between Caspar Friedrich Wolf and Charles Bonnet. Both looked at chick embryos at the same stage (twenty-eight hours after fertilization). Both described in detail what they saw—no clearly defined beating heart, for instance. And both arrived at radically different conclusions. For Wolf it was obvious that the heart would only form later due to the agency of a vital force (*vis essentialis*); Bonnet, on the other hand, concluded that even though he could not see it, the heart must nevertheless already be there.

Metamorphosis and Recapitulation

The eighteenth-century debates about preformism and epigenesis brought development into the spotlight of biological investigations. Ordering the known diversity of life, increasing by the day as a result of European voyages of exploration, was another major concern. For many, especially the Romantic scientists at the turn of the nineteenth century, these two areas of natural history were connected. Did the diversity of nature not arise in the course of development from similar structures? Are the creative principles in nature not the same as in the arts? Pondering these questions on a trip to Italy, the poet-philosopher-scientist Johann Wolfgang von Goethe discovered the principle of metamorphosis and established the foundations of morphology. Specifically, Goethe realized that all the diverse structures of flowering plants are transformations of one basic morphological form, the leaf. Understanding these principles of transformation, or metamorphosis, then allows the scientist or the artist to recreate all existing organic forms, as well as those that could exist but have not yet been realized. This morphological building plan (*Bauplan*) is intrinsically dynamic and developmental; it is a principle that unfolds itself in nature small and large, in the individual and the cosmos. Morphogenesis focused, for Goethe and others, on the emergence of form within a context of change.

Ideas about transformation were soon applied to species as well as individuals. In 1809 Jean-Baptiste de Lamarck published

his theory of evolution, which gave development the additional meaning of the transmutation of species. For Lamarck the transmutation of species was driven by an intrinsic drive toward perfection. In this “escalator theory” of evolution, primitive forms, created spontaneously, pass through increasingly complex stages in the course of subsequent generations. The essence of nature is thus transformation, both in the course of individual development and in the generation of the diversity of life. Lamarck’s theory was readily attacked, especially by his colleague George Cuvier, the founder of comparative anatomy. Cuvier had established the most sophisticated classification system of animals of his time, based on the recognition of four distinct types of animals and a strict hierarchy of systematic categories within each of these embranchements. Within this system species were considered immutable, and their relationships were defined by the degree of similarity between them.

Development was one way of explaining this similarity among species. All organisms begin their life as fertilized eggs—Karl Ernst von Baer would discover the mammalian egg in 1827—and the early stages of development also resemble each other more closely than later stages. Summarizing these observations, Johann Friedrich Meckel proposed in 1811 that the embryological stages of advanced organisms represent the adult stages of more primitive organisms. This was the first formulation of the principle of recapitulation, in which development became the causal explanation for the similarity as well as the differences between species. The evolutionary implications were obvious. Defending the clear separation of different systematic groups, Karl Ernst von Baer summarized his opposition to the principle of recapitulation in his developmental laws. He stated that no adult organism is like any embryo of another organism, that each developmental trajectory is unique, but that in each developmental sequence the more general features of the organismal structure appear earlier in development, which explains the close similarities between the early embryos of different species.

Von Baer’s authority carried the day, but only briefly. In his theory of evolution as descent with modification, Charles Darwin also relied on embryological evidence, especially when he needed a mechanism that would explain the origin of new variations. Another consequence of the Darwinian theory was that the historical connections between species, their genealogy, immediately suggested an explanation for the similarity between them. The more closely two species are related to each other, the more similar they will be. Homologies, those structures that were considered the same in different organisms, could now be explained as being derived from a common ancestor. The only practical problem was that the genealogical relations between species were not obvious and needed to be inferred based on the similarity between them.

Studying the development of different species offered a way to escape this circularity of reasoning. Ernst Haeckel postulated that ontogeny recapitulates phylogeny, that the developmental sequence of an individual parallels the historical sequence of evolution. For Haeckel development was simultaneously a record of history and an explanation of diversity, as new structures would occur as terminal additions in the developmental process. Development also provided a way to establish ho-

mologies; those structures that were derived from the same embryological precursors (anlagen) could be considered to be homologies and used for the reconstruction of phylogenies. Haeckel’s ideas, largely discredited today, were extremely influential in the second half of the nineteenth century and led to many proposals about the shape of the “tree of life.”

***Entwicklungsmechanik* and Developmental Genetics**

The Haeckel program in evolutionary morphology, with its descriptive outlook and its tendency to speculate about phylogenetic relationships, left many younger scientists dissatisfied. They sought a mechanistic understanding of development, more in tune with the emphasis on experimentation and causal interpretation that characterized sciences like physiology or chemistry. Championed by Wilhelm Roux, this new approach to the study of development dominated late-nineteenth-century biology in Germany and the United States. In detailed and technically demanding experiments, biologists tested the influence of physical and chemical conditions such as gravitation, pressure, temperature, and varying chemical concentrations in the environment on development of select model organisms (mostly amphibians and marine invertebrates) whose free-living embryos were easy to manipulate. This new experimental program in embryology also benefited from the newly founded marine research stations. Many of these experiments were only possible in well-equipped laboratories in close proximity to the diverse biological material of the sea.

The canonical experimental styles in *Entwicklungsmechanik* were the destruction of certain parts of the embryo and the transplantation of specific tissues between and within embryos. Both kinds of experiments disrupted normal development and allowed researchers to discover the effects of certain parts of the embryo. Puncturing one of the two cells in a two-cell-stage frog embryo, Roux found in 1888 that only half an embryo developed. In his mosaic theory of development he then argued that during differentiation the determining factors, which are all present in the fertilized egg, are gradually distributed among the daughter cells. In a similar vein, August Weismann argued in 1892 for the separation of the germ line, which he saw as retaining the full developmental potential and being passed on through the generations, and the soma, those elements of an organism that undergo differentiation. Weismann, too, thought that an unequal distribution of hereditary material accounts for the differentiation of cells during development.

When Hans Driesch repeated Roux’s experiment, shaking sea urchin embryos apart during the two- and four-cell stages, he observed the formation of complete, albeit smaller, pluteus larvae. Driesch began to think that development could not be interpreted in strictly mechanical terms. The embryos’ demonstrated ability to regulate their own developmental sequence led him to argue that organisms are harmonious equipotential systems and not just complex physico-chemical machines. Organisms as individuals are instead characterized by an irreducible telos, their entelechy, that shows itself in their regulatory abilities. Driesch subsequently embraced a form of neovitalism.

The vast majority of biologists, however, did not accept Driesch’s philosophizing but remained committed to experi-

mental study of development, mapping cell lineages and investigating fates of transplanted tissues. It was in this context that Hans Spemann and Hilde Mangold found in 1924 that a small region near the dorsal lip transplanted into the ventral side (belly) of a newt embryo could organize a second set of body axes, thus resulting in a “Siamese-twin-like” embryo. They called this specific region of the embryo the organizer, as it was capable of organizing the basic form of the full organism. In addition, researchers demonstrated that interactions between certain tissues such as mesoderm and ectoderm led to the differentiation of phenotypic structures such as the lens of a vertebrate eye, in a phenomenon called induction. The search began for the specific chemical properties of what was assumed to be the material organizer.

It was also clear that ultimately these developmentally active substances would have to be the products of heredity, since the inherited nuclear chromosomes and the genes they presumably carried, together with the material inside the egg, are what is passed on to the next generation. Research programs in developmental and physiological genetics investigated these questions and, after long and painstaking research, could identify specific causal chains, from a gene product to a phenotypic effect. Mutants, such as eye-color mutants of moths and flies, were the preferred experimental systems for this line of research. In 1940 a group headed by the biochemist Adolf Butenandt and the biologist Alfred Kühn were the first to identify and chemically characterize the substance that induced the red-eye phenotype in the moth *Epestia kühniella*.

After World War II, developmental biology gradually transformed itself into developmental genetics, especially after the techniques of molecular biology allowed researchers to study genes in their cellular context. One of the first genetic systems studied molecularly was the so-called lac-operon system, which regulates the expression of a lactose-digesting enzyme inside a bacterial cell. This focus on regulation continued as more and more regulatory networks of genes were found. In the context of molecular biology, development—the growth and differentiation of an organism—had been redefined as a problem of the regulation of gene expression. Aristotle’s epigenesis had given way to the mechanistic preformationism of the seventeenth and eighteenth centuries and had come around again to a more sophisticated blend of preformism through heredity and epigenesis through development.

Evolutionary Developmental Biology

During the last decades of the twentieth century, evolutionary developmental biology emerged to reintegrate the two temporal processes within biology, development and evolution. Evolutionary developmental biology (Evo-Devo) is based on the recognition that all genetic changes must be expressed during development in order to produce a phenotype and thus amount to observable evolutionary changes. Development is thus the mechanism that produces the raw material of phenotypic evolution. Phenotypic evolution, in contrast, appears to be highly constrained. Of all the possible forms (the total morphospace), only a small number are actually realized. Furthermore, the diversity of life is organized in a nested hierarchy, whereby millions of species can be subsumed within a few dozen

phyla, each characterized by a basic body plan (*Bauplan*). In other words, the many mutational changes of genotypes are translated into a much smaller number of phenotypic variants.

In addition, discoveries since the 1980s have lent further support to the idea that the number of developmental modules (transcription factors, such as Homeobox genes and regulatory networks) is relatively small. Furthermore, these developmental modules have been conserved through millions of years during evolution, in that flatworms, insects, and mammals share a number of regulatory genes. Thus, a limited “genetic toolkit of development” produces the astonishing diversity of life. These findings have serious consequences for the age-old discussions of preformism versus epigenesis. The fact that a small number of genetic elements is responsible for the enormous diversity of life indicates that development is essentially a problem of regulation and the interaction of genetic and environmental factors. In other words, the effects of genes in development are largely context dependent. Whether a specific transcription factor turns on a gene that triggers a cascade leading to the formation of an eye or whether it establishes the gradient for differentiation of the arm, for example, depends on the specific cellular and organismal context. In addition, environmental factors, which can affect developmental plasticity, are increasingly recognized as important. The current conception of development is thus largely epigenetic, within the context of inherited material genes.

Human and Social Dimensions of Development

Interpretations of individual development have also had powerful social impacts, especially as we have learned more about human embryology and reproductive biology. For those who hold the strongest versions of the view that each individual organism begins from unformed material, the emphasis on epigenetic emergence of form suggests that investing in “nurture” will pay off. It is worth investing in parenting that requires time and energy because this can shape the developmental process. In contrast, those who accept the view that the organism has some clear defining point at which it begins as an individual, and that its form or individuality is in some important sense already set, see much less value in investing in trying to shape what develops. Development in these cases is largely a matter of playing out the intrinsic causes. The dominant version of this interpretation maintains, of course, that heredity sets the individual’s differentiation and that development is really just a matter of growth.

Though no respectable scientist today would hold either of these extreme interpretations, there are strong preferences depending on whether the researcher is a genetic determinist or a proponent of developmental regulation. Historically, we can find some supporters for almost any interpretation along the range of possibilities. The public’s very deeply held views about individual as well as species development make it all the more important that we have a clear understanding of the historical, philosophical, and biological contexts for developmental ideas and that we understand the social implications.

See also **Biology; Evolution; Life; Life Cycle; Science, History of; Scientific Revolution.**

BIBLIOGRAPHY

- Bowler, Peter J. *The Eclipse of Darwinism: Anti-Darwinian Evolution Theories in the Decades around 1900*. Baltimore: Johns Hopkins University Press, 1989.
- Carroll, Sean B., Jennifer K. Grenier, and Scott D. Weatherbee. *From DNA to Diversity: Molecular Genetics and the Evolution of Animal Design*. Oxford, U.K.: Blackwell Science, 2001.
- Correia, Clara Pinto. *The Ovary of Eve: Egg and Sperm and Pre-formation*. Chicago: University of Chicago Press, 1997.
- Gilbert, Scott F., ed. *A Conceptual History of Modern Embryology*. Baltimore: Johns Hopkins University Press, 1994.
- Hamburger, Viktor. *The Heritage of Experimental Embryology: Hans Spemann and the Organizer*. New York: Oxford University Press, 1993.
- Holder, T. J., J. A. Witkowski, and C. C. Wylie, eds. *A History of Embryology*. Cambridge, U.K.: Cambridge University Press, 1986.
- Jahn, Ilse. *Geschichte der Biologie*. Heidelberg and Berlin: Gustav Fischer Verlag, 2000.
- Krauß, Erika. *Ernst Haeckel*. Leipzig, Germany: Teubner, 1984.
- Maienschein, Jane. "Competing Epistemologies and Developmental Biology." In *Biology and Epistemology*, edited by Richard Creath and Jane Maienschein, 122–137. Cambridge, U.K.: Cambridge University Press, 2000.
- . *Whose View of Life?* Cambridge, Mass.: Harvard University Press, 2003.
- Richards, Robert J. *The Meaning of Evolution: The Morphological Construction and Ideological Reconstruction of Darwin's Theory*. Chicago: University of Chicago Press, 1992.
- Roe, Shirley A. *Matter, Life, and Generation: Eighteenth-Century Embryology and the Haller-Wolff Debate*. New York: Cambridge University Press, 1981.

Manfred D. Laubichler
Jane Maienschein

DIALOGUE AND DIALECTICS.

This entry includes two subentries:

Socratic
Talmudic

SOCRATIC

Socrates (c. 470–399 B.C.E.) developed a method of inquiry and instruction that involved question and answer, or the “Socratic method.” Although Socrates professed to be ignorant of the answers to his questions, his questioning and testing of the answers given were designed to expose the weakness of the opinions held by his interlocutors and to refine those opinions. While Socrates left no writings of his own, the Socratic method is demonstrated in the writings of several of his pupils, especially his most famous pupil, Plato (c. 428–348 or 347 B.C.E.). The Socratic dialogues of Plato present Socrates in conversation with known contemporaries. These early dialogues involve question and answer, but most of these arrive at no definite conclusion or firm agreement.

The Greek noun *dialogos* derives from the verb *dialogesthai*, meaning “to enter into a conversation.” The term *dialectic*, or the art of argumentation (*dialectike techne*), is derived from

If, after this conversation, you try to become pregnant with other conceptions, and if, Theaetetus, you succeed, you will become great with better conceptions. And, if you are empty, you will prove less irksome to your companions and a gentler person, since in your new wisdom you will not think that you know what you do not know. These are the limits of my art.

SOURCE: Socrates in *Theaetetus* 210B–C.

this verb as well, but in the case of Socratic dialectic the relevant Greek term is *elegkhos* (*elenchus*). Elenchus means a testing, and, since those tested by Socratic questioning are often shown inadequate in their responses, it comes to mean refutation.

The Literature of Socratic Conversations

In Greek literature, dialogue, or argument, is as old as Homer and the exchange between Achilles and Agamemnon in *Iliad* 1; it is a salient feature of both Attic comedy and tragedy. Philosophical dialogue began with the conversations Aristotle (384–322 B.C.E.) knew as the *Sokratikoi logoi*, a form of imitation (*mimesis*) that captured the conversations of Socrates. Although some of the dialogues of Plato and Xenophon (c. 431–c. 352 B.C.E.) claim to record a conversation of the historical Socrates and an interlocutor (or interlocutors), all the Socratic dialogues are literary fictions based on a reality we shall never recover.

The literary presentation of philosophical conversation had antecedents in the prose comedies of the Sicilian, Epicharmus (c. 530–c. 440 B.C.E.). Our first example of a Socratic conversation comes from Aristophanes’s *Clouds* (423 B.C.E.), in which a fictional Socrates tests the intelligence and character of an older pupil. It is clear from their exchange that Socratic questioning was designed to test not only the intelligence but also the character of an interlocutor.

The “invention” of the dialogue form. In antiquity there was a dispute over who was the “inventor” of the dialogue form as a vehicle for philosophy. Our knowledge of the rival claims to this honor goes back to Aristotle, who in his dialogue *On Poets* mentions Zeno of Elea (c. 495–c. 430 B.C.E.) as the founder of what he calls dialectic and an unknown Alexamenós as the “inventor” of the mimetic dialogue. According to Diogenes Laertius, a 3rd century B.C.E. Greek writer and source of information about the Greek philosophers, an Athenian cobbler called Simon was the first to represent the conversations of Socrates in “dialectic” form. Like Xenophon, Simon was regarded as a stenographer of conversations he merely overheard.

We know something too of the Socratic dialogues of Antisthenes (c. 445–c. 365 B.C.E.) and Aeschines Socraticus (4th cent. B.C.E.). Antisthenes certainly wrote before Plato. We have several citations from Aeschines' *Alcibiades*, which gives an example of the kind of characterization we find so brilliantly displayed in the Socratic dialogues of Plato. Xenophon's dialogues probably came after Plato's, during the long period of Xenophon's exile from Athens (a city he left in 401). These include his *Apology*, *Symposium*, *Oeconomicus*, the conversations of Books 2 through 4 of the *Memorabilia* (Memoirs of Socrates's conversations), and a brief passage from his *Cyropaedia* where we meet an Armenian Socrates (3.31.10–14; 38). Both Antisthenes and Xenophon wrote quasi-philosophical dialogues in which Socrates was not a speaker; Antisthenes's *Cyrus* and Xenophon's *Hiero* are examples.

Thus, by the time he began to write his dialogues, Plato was one of many Socratics and writers of Socratic dialogues, but it was he who transformed the dialogue into a powerful instrument of philosophical inquiry. In his works, there is a distinction between the "Socratic" dialogues, in which Socrates figures as the principal speaker, and the late dialogues, in which he is either present but mainly silent (*Sophist*, *Statesman*, and the *Timaeus/Critias*) or from which he is absent (the *Laws*). Symptomatic of his disappearance in the Platonic dialogues are the long unbroken speeches of a dominant character that take up most of the *Timaeus/Critias* and the *Laws*, where we encounter Timaeus, Critias, and a stranger from Athens.

Alternatives to dialogue. To appreciate the radical character of the Platonic dialogue, it is necessary to consider the alternatives to philosophical discourse available to Plato as he began to write his first Socratic dialogues, beginning perhaps with the *Apology of Socrates*, written just after the execution of his "older friend" in 399 B.C.E. In the context of the democratic culture of fifth-century Athens, alternatives included the long display speeches the sophists delivered before large audiences. Plato's *Protagoras* is a good example of this form of exposition given by a skilled speaker who brooks no interruption or interrogation. Another alternative was the philosophical treatise or poem. Anaxagoras (c. 500–c. 428 B.C.E.), a contemporary of Socrates, reveals no evidence of dialogue in his *On Nature*. The rhetoric of early philosophical poetry tends to unbroken hierophantic pronouncements by a philosopher poet who claims divine authority for what he says, as in the case of Parmenides (b. c. 515 B.C.E.) and Empedocles (c. 490–430 B.C.E.), who actually claims that he is a god. Heraclitus (c. 540–c. 480 B.C.E.) claims his *logos* (discourse) is an expression of the higher *Logos* (principle of intelligibility).

As for "dialectic," the short anonymous treatise entitled *Dissoi Logoi* (Arguments for and against) is contemporary with the young Plato; but here, as in Protagoras's (c. 485–410 B.C.E.) more famous *Antilogiai*, dialectic or the art of argument serves as a primer for developing the ability to argue pro and con on any question. Some of the arguments of the *Dissoi Logoi* are important to the Platonic dialogues: for example, the question of whether virtue (*aretē*) can be taught is addressed in Plato's *Meno*. This handbook is an example of the training in logic given

in the Academy and recorded in the eight books of Aristotle's *Topics and Sophistical Refutations*. All these works exercise the young in debate. They treat rules and types of argument (known as *topoi*), but these arguments are disembodied and lack the characterization that is so important a feature of the Platonic dialogues.

The Socratic Dialogues of Plato

Because of their success, the originality of Plato's Socratic dialogues is easily forgotten. More than any other Socratic, Plato invested most of his Socratic dialogues in a historical context that grounds the questions they pursue in a historical reality. Likewise, his dramatic genius in characterization of Socrates and his interlocutors is sometimes overlooked. The opening of the *Charmides* gives a good example of Plato's early style. Socrates has just returned from Boeotia and the Athenian retreat of 425. He engages in a long conversation on the nature of prudent self-restraint (*sophrosyne*) with two young men whose courage was yet to be tried, Charmides and Critias, both of whom were to be tested as they emerged as two of the "Thirty Tyrants" in 404. Here historical context, characterization, and Plato's philosophical art of dramatic irony are all in evidence. Unlike the dialogues of the other Socratics, Plato's are polyphonic in that they often involve a large cast of characters.

It has long been thought that Plato's *Apology* represents what Socrates actually said in court, but it is more likely the posthumous vindication of Socrates' life. There is now a growing commitment among interpreters of Plato to understand the "literary" qualities of the Platonic dialogues in terms of Plato's philosophical intentions. And there is now less of a tendency to see Socrates (or the Eleatic Stranger of the *Sophist* and *Statesman* or the Athenian Stranger of the *Laws*) as a "spokesman" for Plato or, in the case of the earlier "Socratic" dialogues, to take Plato at Socrates' word.

The case of the *Republic* is an example of the interpretative dangers of mistaking Socrates, who has a great deal to say about the ideal state and the ideal "state" of the individual soul, for Plato, who remains silent and anonymous in all his dialogues. The assent of Plato's brothers, Glaukon and Adeimantus, to the long series of propositions Socrates advances, are easily reversed (as the opening of book 5 of the *Republic* makes clear). Here and earlier, assent to the odd proposal that the women and children of the guardian class of Socrates' state should be held in common (*Republic* 4.423B) is called into question and the dialogue is opened suddenly to the prospect of women guardians and a philosopher king (the questions of books 5–7). Like Socratic questioning, the dialogues of Plato are all open ended.

The Socratic method. The "Socratic method" is often held up as a model for education by educators, but perhaps with insufficient awareness of how complex it is. In Plato's Socratic dialogues, there is no evidence of an interlocutor being moved by Socrates to abandon a vitiated point of view in search for a view that is philosophically superior. In the case of the early series of dialogues that question four Greek virtues, there is no way out of perplexity. The Socratic *elenchus* or cross exami-

nation usually ends up by showing that a general claim made by an interlocutor has exceptions or conceals hidden assumptions that the interlocutor cannot accept. For this reason the examination of self-restraint in the *Charmides*, virtue in the *Meno*, courage in the *Laches*, and the unity of the virtues in the *Protagoras*, is termed “aporetic.” That is, they provide no way (poros) to a solution; yet they provide the stimulus of frustration. These early dialogues test Plato’s “audience of second intent” more than they test Socrates’ interlocutors. In the dialogues that lead to the *Republic*, in the *Theaetetus* (On knowledge), *Sophist*, and *Statesmen*, and, indeed, in all his dialogues, Plato seems to be offering a philosophical challenge and training to his readers to come to their own solutions to the problems he raises.

Socrates’ maieutic art. Plato clearly felt that it was impossible in one-on-one conversation or in a conversation with a great variety of possible readers to inculcate philosophical understanding. The most vigorous of Socrates’ opponents (Thrasymachos in the *Republic*, Kallikles in the *Gorgias*, and Zeno in the *Parmenides*) refuse to agree with Socrates after a long give-and-take. The genius of the “Socratic method” is that it involves frustration, not inculcation. It prompts in the interlocutor a dissatisfaction with his settled convictions.

At the end of the *Theaetetus* Socrates represents himself as the son of a midwife who is himself a midwife to the mental offspring of his interlocutors. He can either help deliver a superior conception or induce a kind of modesty in the recognition of one’s barrenness. This is his maieutic art (Gk. *maieutikos*, of midwifery). Socrates recognizes the claims to a knowledge of inspired men of the past and present. They possess a knowledge they can transmit; Socrates can only deliver knowledge already present in the individual. Thus, in the *Republic* he compares his method to a protreptic turning a companion to the light rather than cramming vision into his eyes. Such are Plato’s descriptions of the “Socratic method.”

See also **Philosophy, History of; Philosophy, Moral: Ancient; Philosophy of Mind: Ancient and Medieval; Platonism.**

BIBLIOGRAPHY

- Bakhtin, Mikhail M. *The Dialogic Imagination: Four Essays*. Edited by Michael Holquist. Translated by Caryl Emerson. Austin: University of Texas Press, 1981.
- Blondell, Ruby. *The Play of Character in Plato’s Dialogues*. New York: Cambridge University Press, 2002.
- Clay, Diskin. “The Origins of the Platonic Dialogue.” In *The Socratic Movement*, edited by Paul A. Vander Waerdt. Ithaca and New York: Cornell University Press, 1994.
- Friedländer, Paul. *Plato: An Introduction*. Translated by Hans Meyerhoff. New York: Pantheon, 1958. Translation of *Platon: Seinswahrheit und Lebenswirklichkeit*.
- Giannantoni, Gabriele, ed. *Socratis et Socraticorum Reliquiae*. 4 vols. Naples: Bibliopolis, 1990.
- Griswold, Charles H., Jr. Introduction to *Platonic Writings/Platonic Readings*. University Park: Pennsylvania State University Press, 2002. Originally published 1988.
- Kahn, Charles H. *Plato and the Socratic Dialogue: The Philosophical Use of a Literary Form*. Cambridge, U.K.: Cambridge University Press, 1996.

Nightingale, Andrea. *Genres in Dialogue: Plato and the Construct of Philosophy*. Cambridge, U.K.: Cambridge University Press, 1995.

Vlastos, Gregory. *Socratic Studies*, edited by Myles Burnyeat. Cambridge: Cambridge University Press, 1994. See “The Socratic Elenchus: Method Is All.”

Diskin Clay

TALMUDIC

The Talmuds are compendia of commentaries, legal opinions, and sayings by and about rabbis of the first six centuries C.E. There are two: the Palestinian (or Jerusalem) Talmud (c. 400) and the Babylonian Talmud, or Bavli (c. 600). Both are arranged as commentaries, tractate by tractate, of the Mishnah—the compendium of the law of Judaism—itsself a collection of legal sayings of rabbis and sages from up to the third century B.C.E.

Dialectical argument is a tool of systematic analysis. In the Talmudic framework, everything is in the moving, or dialectical, argument, the give-and-take of unsparing rationality, which, through their own capacity to reason, later generations are expected to reconstitute. Following the argument as set forth in the Talmud affords access to the issues, the argument, and the prevailing rationality. The Bavli sets forth not so much a record of what was said as a set of notes that permit the engaged reader to reconstruct thought and recapitulate reason and criticism.

A dialectical argument sets forth give-and-take in which parties to the argument counter one another’s arguments in a progression of exchanges, often in what seems like an infinite progress to an indeterminate conclusion. A dialectical argument does not merely address the problem and a single solution; it takes up the problem and the various ways by which a solution may be reached. It involves not merely questions and answers or exchanges of opinion, a set-piece of two positions, with an analysis of each, such as formal dialogue exposes with elegance. Moving in an unfolding analytical argument, it explains why this and not that, then why not that but rather the other thing; and onward from the other thing to the thing beyond that—a linear argument in constant forward motion. A dialectical argument is not static and merely expository, but dynamic and always contentious. It is not an endless argument, an argument for the sake of arguing, but a way to cover a variety of cases in testing a principle common to them all.

The Role of Dialectics in the Bavli

The Bavli translates Pentateuchal narratives and laws into a systematic account of Israel’s entire social order. In its topical presentations of thirty-seven of the Mishnah’s sixty-three topical tractates, the Bavli portrays not so much how people are supposed to live—this the Mishnah does—as how they ought to think, the right way of analyzing circumstance and tradition alike. The Bavli shows a way of thinking and talking and rationally arguing about reform. When we follow not only what the sages of the Bavli say, but also how they express themselves, their modes of critical thought and—above all—their examples of uncompromising, rigorous ar-

AN EXAMPLE OF A DIALECTICAL ARGUMENT

The Mishnah is a law code organized by topics, and *Baba Mesia*—the Middle Gate—concerns civil law, in the present case, torts and damages and contradictory claims.

Mishnah *Baba Mesia* 1:1

- A. Two lay hold of a cloak—
- B. this one says, “I found it!”—
- C. and that one says, “I found it!”—
- D. this one says, “It’s all mine!”—
- E. and that one says, “It’s all mine!”—
- F. this one takes an oath that he possesses no less a share of it than half,
- G. and that one takes an oath that he possesses no less a share of it than half,
- H. and they divide it up.

Bavli *Baba Mesia* 5B–6A

- [5b] IV.1. A. This one takes an oath that he possesses no less a share of it than half, [and that one takes an oath that he possesses no less a share of it than half, and they divide it up]
- B. Is it concerning the portion that he claims he possesses that he takes the oath, or concerning the portion that he does not claim to possess? [Samuel Daiches, *Baba Mesia* (London, 1948), ad loc.: “The implication is that the terms of the oath are ambiguous. By swearing that his share in it is not ‘less than half,’ the claimant might mean that it is not even a third or a fourth (which is ‘less

than half’), and the negative way of putting it would justify such an interpretation. He could therefore take this oath even if he knew that he had no share in the garment at all, while he would be swearing falsely if he really had a share in the garment that is less than half, however small that share might be.]”

- C. Said R. Huna, “It is that he says, ‘By an oath! I possess in it a portion, and I possess in it a portion that is no more than half a share of it.’” [The claimant swears that his share is at least half (Daiches, *Baba Mesia*, ad loc.).]
- D. Then let him say, “By an oath! The whole of it is mine!”
- E. But are we going to give him the whole of it? [Obviously not, there is another claimant, also taking an oath.]
- F. Then let him say, “By an oath! Half of it is mine!”
- G. That would damage his own claim [which was that he owned the whole of the cloak, not only half of it].
- H. But here too is it not the fact that, in the oath that he is taking, he impairs his own claim? [After all, he here makes explicit the fact that he owns at least half of it. What happened to the other half?]
- I. [Not at all.] For he has said, “The whole of it is mine!” [And, he further proceeds,] “And as to your contrary view, By an oath, I do have a share in it, and that share is no less than half!”

SOURCE: Jacob Neusner, *Tractate Baba Mesia*.

gument, we encounter a massive, concrete instance of the power of intellect to purify and refine. For the sages of the Bavli, alongside the great masters of Greek philosophy and their Christian and Muslim continuators, exercise the power of rational and systematic inquiry, tenacious criticism, the exchange not only of opinion but also of reason for opinion, argument, and evidence. They provide a model of how intellectuals take up the tasks of social criticism and pursue the disciplines of the mind in the service of the social order. This explains the widespread interest in the Bavli as shown by repeated translations of, and introductions to, that protean document. Not an antiquarian interest in a long-ago society, nor an ethnic concern with heritage and tradition, but

a vivid and contemporary search for plausible examples of the rational world order, animate the unprecedented interest of the world of culture in the character (and also the contents) of the Bavli.

The Bavli embodies applied reason and practical logic in quest of the holy society. That model of criticism and reason in the encounter with social reform is unique. The kind of writing that the Bavli represents has serviceable analogues but no known counterpart in the literature of world history and philosophy, theology, religion, and law. That is because the Bavli sets forth not only decisions and other wise and valuable information, but the choices that face reasonable persons

and the bases for deciding matters in one way rather than in some other. And the Bavli records the argument, the constant, contentious, uncompromising argument, that endows with vitality the otherwise merely informative corpus of useful insight. “Let logic pierce the mountain”—that is what sages say.

Talmudic Dialectics and Philosophical Dialectics

In that aspect, the Bavli recalls the great philosophical dialogues of ancient and medieval times. Those familiar with the dialogues of Socrates as set forth by Plato—those wonderful exchanges concerning abstractions such as truth and beauty, goodness and justice—will find familiar the notion of dialectical argument, with its unfolding, ongoing give-and-take. But Talmudic dialectics differ in two ways. First, they deal with concrete cases and laws, not abstract concepts. Second, the meandering and open-ended character of Talmudic dialectics contrasts with the formal elegance, the perfection of exposition, that characterizes Plato’s writings. While the Talmud’s presentation of contrary positions and exposition of the strengths and weaknesses of each will hardly surprise philosophers, the inclusion of the model of extensive exposition of debate is sometimes puzzling.

The Bavli’s texts of dialectical arguments are in effect notes, which we are expected to know how to use in the reconstruction of the issues under discussion, the arguments under exposition. That means we must make ourselves active partners in the thought-processes that they document. Not only is the argument open-ended, so too the bounds of participation know no limits. Indeed, the Bavli declines to tell us everything we need to know. It exhibits the remarkable confidence of its compilers that generations over time will join in the argument they precipitate, grasp the principles they embody in concrete cases, and find compelling the issues they deem urgent. It is that remarkable faith in the human intellect of age succeeding age that lifts the document above time and circumstance and renders it immortal. In transcending circumstance of time, place, and condition, the Bavli attains a place in the philosophical, not merely historical, curriculum of culture. That is why the Bavli makes every generation of its heirs and continuators into a partner in the ongoing reconstruction of reasoned thought, each generation adding its commentary to the ever welcoming text.

See also *Dialogue and Dialectics: Socratic; Judaism; Philosophy; Sacred Texts.*

BIBLIOGRAPHY

- Neusner, Jacob. *The Divisions of Damages and Holy Things and Tractate Niddah*. Vol. 2 of *Talmudic Dialectics: Types and Forms*. Atlanta: Scholars Press for South Florida Studies in the History of Judaism, 1995.
- . *Introduction. Tractate Berakhot and the Divisions of Appointed Times and Women*. Vol. 1 of *Talmudic Dialectics: Types and Forms*. Atlanta: Scholars Press for South Florida Studies in the History of Judaism, 1995.
- . *Tractate Baba Mesia*. Vol. 21 of *The Talmud of Babylonia: An Academic Commentary*. Atlanta: Scholars Press for USF Academic Commentary Series, 1990.

Jacob Neusner

DIASPORAS.

This entry includes two subentries:

African Diaspora

Jewish Diaspora

AFRICAN DIASPORA

The African diaspora, together with the Jewish diaspora—the etymological and epistemological source of the term *diaspora*—enjoys pride of place in the increasingly crowded pantheon of diaspora studies. Studies of African diasporas can be divided into two broad categories. First, there are those that discuss the patterns of dispersal of African peoples around the world and the kinds of diasporic identities these populations developed in their new locations. Distinctions are increasingly drawn between the “historic” and “contemporary” or “new” African diasporas, referring respectively to diasporas formed before and during the twentieth century. Second, some studies are concerned with analyzing the various linkages that the diasporas have maintained with Africa. Here emphasis is on the demographic, cultural, economic, political, ideological, and iconographic flows.

The term *African diaspora* gained currency from the 1950s and 1960s in the English-speaking world, especially the United States. As pointed out by George Shepperson, none of the major intellectual forerunners of African diaspora studies, from Edward Blyden (1832–1912), the influential nineteenth-century Caribbean-born Liberian thinker, to W. E. B. Du Bois (1868–1963), the renowned African-American scholar-activist, used the term *African diaspora*. The Negritude writers from Francophone Africa and the Caribbean also did not use it. Instead, the term used to define and mobilize African populations globally was *Pan-Africanism*. One of the challenges in African diaspora studies, then, has been to overcome an American and English language-centered model of identity for African diasporas globally.

Defining Diasporas

There are several conceptual difficulties in defining the African diaspora—indeed, in defining the term *diaspora*. Contemporary theorizations of the term *diaspora* tend to be preoccupied with problematizing the relationship between diaspora and nation and the dualities or multiplicities of diasporic identity or subjectivity; they are inclined to be condemnatory or celebratory of transnational mobility and hybridity. In many cases, the term *diaspora* is used in a fuzzy, ahistorical, and uncritical manner in which all manner of movements and migrations between countries and even within countries are included and no adequate attention is paid to the historical conditions and experiences that produce diasporic communities and consciousness—how dispersed populations become self-conscious diaspora communities.

Various analytical schemas have been suggested for diaspora studies in general and African diaspora studies in particular. Based on what he regards as the nine common features of a diaspora, Robin Cohen distinguishes between the “victim diasporas” (Africans and Armenians), “labor diasporas” (Indi-

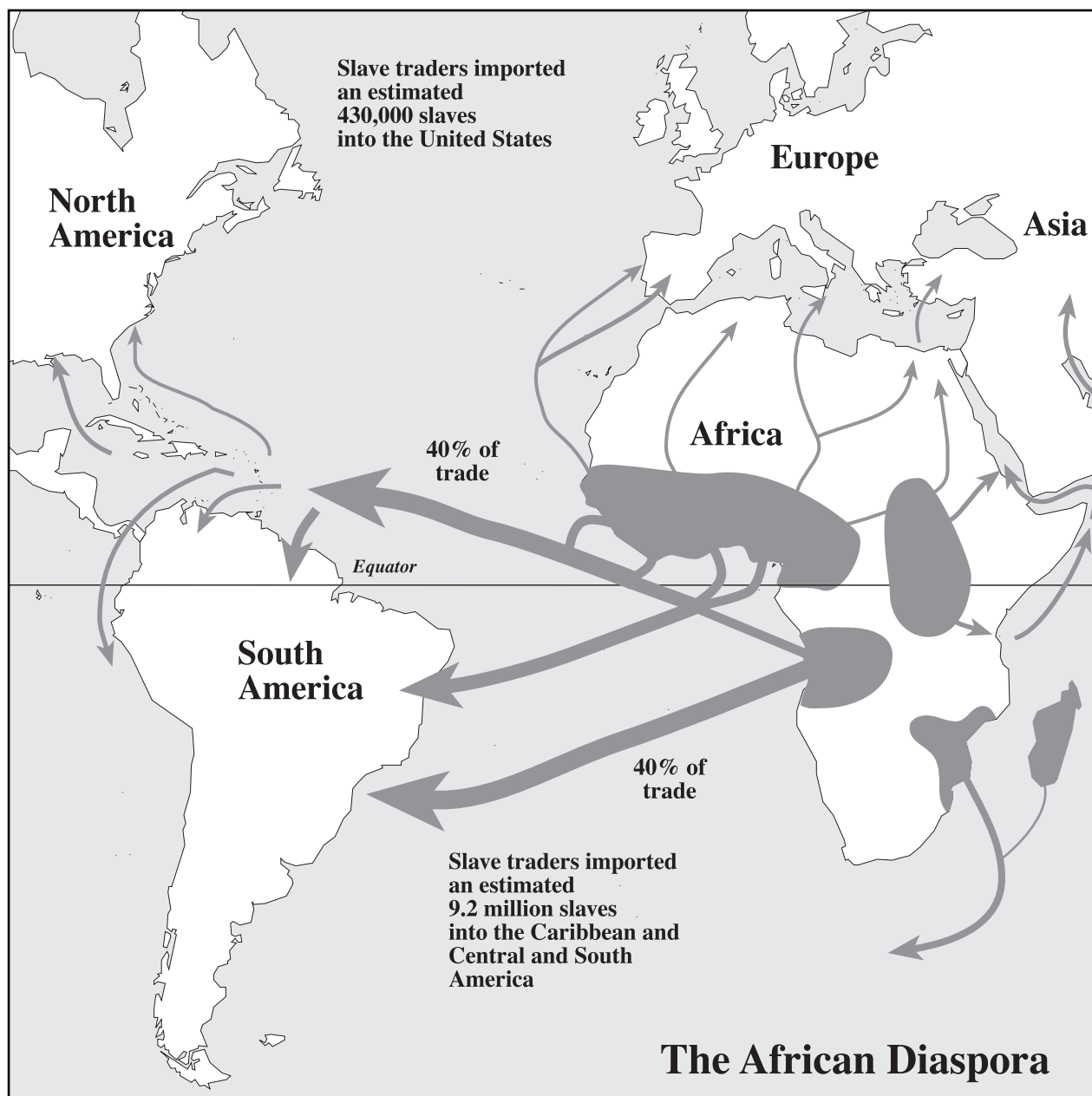

ans), “imperial diasporas” (British), “trade diasporas” (Chinese and Lebanese), and “cultural diasporas” (the Caribbean). Kim Butler, a historian of the African diaspora in Brazil, suggests another schema for diasporan study divided into five dimensions: first, reasons for and conditions of the dispersal; second, relationship with homeland; third, relationship with host lands; fourth, interrelationships within diasporan groups; and finally, comparative study of different diasporas.

Diaspora refers simultaneously to a process, a condition, a space, and a discourse: the continuous processes by which a diaspora is made, unmade, and remade; the changing conditions in which it lives and expresses itself; the places where it is molded and imagined; and the contentious ways in which

it is studied and discussed. In short, diaspora is a state of being and a process of becoming, a condition and consciousness located in the shifting interstices of “here” and “there,” a voyage of negotiation between multiple spatial and social identities. Created out of movement—dispersal from a homeland—the diaspora is sometimes affirmed through another movement—engagement with the homeland. Movement, it could be argued, then, in its literal and metaphorical senses is at the heart the diasporic condition, beginning with the dispersal itself and culminating with reunification. The spaces in between are marked by multiple forms of engagement between the diaspora and the homeland—of movement, of travel between a “here” and a “there” both in terms of time and space.

African Dispersals

It is quite common in academic and popular discourses to homogenize and racialize the African diaspora and see it in terms of the Atlantic experience of forced migration and in terms of “black” identity. The first ignores African dispersals and diasporas in Asia and Europe, some of which predated the formation of the Atlantic diasporas and which emerged out of both forced and free migrations. The second is largely a legacy of Eurocentric constructions of the continent whereby sub-Saharan Africa, from which North Africa is excised, is seen as “Africa proper,” in the words of Georg Wilhelm Friedrich Hegel (1770–1831). Early-twenty-first-century research has tried to go beyond these limitations.

There are numerous dispersals associated with African peoples over time. Colin Palmer has identified at least six: three in prehistoric and ancient times (beginning with the great exodus that began about 100,000 years ago from the continent to other continents) and three in modern times, including those associated with the Indian Ocean trade to Asia, the Atlantic slave trade to the Americas, and the contemporary movement of Africans and peoples of African descent to various parts of the globe. While such a broad historical conception of diaspora might be a useful reminder of common origins and humanity, it stretches the notion of diaspora too far beyond analytical recognition to be terribly useful. So most scholars tend to focus on the “modern” historical streams of the global African diasporas. Studies of African diasporas focus disproportionately on the Atlantic world, but literature is growing on the Indian Ocean and Mediterranean diasporas.

The historic African diasporas can be divided into four categories in terms of their places of dispersal: the intra-Africa, Indian Ocean, Mediterranean, and Atlantic diasporas. The challenges of studying intra-Africa diasporas meaningfully are quite daunting, given the extraordinary movements of people across the continent over time. Clearly it will not do to see every migration across the continent as a prelude to the formation of some diaspora. More fruitful is to focus on communities that have constituted themselves or are constituted by their host societies as diasporas within historical memory. And here may be distinguished five types based on the primary reason of dispersal: the trading diasporas (the Hausa and Doula in western Africa); the slave diasporas (West Africans in North Africa and East Africans on the Indian Ocean islands); the conquest diasporas (the Nguni in southern Africa); the refugee diasporas (e.g., from the Yoruba wars of the early nineteenth century); and the pastoral diasporas (the Fulani and Somali in the Sahelian zones of western and eastern Africa).

These intra-Africa diasporas have been studied in their own right, often without using the term *diaspora* except for the trading diasporas and the slave diasporas. But it should not be forgotten that the other diasporas, insofar as they existed, filtered into the historic diasporas or served as historical switching stations for the emergence of the new African diasporas in the twentieth century. At the same time, the formation of colonial borders and new national identities reinforced their diasporic identities and sometimes pushed them into the circuits of international migration.

African Diasporas in Asia and Europe

Recent studies clearly demonstrate that the African diaspora has very old roots in Asia, to which Africans traveled as traders, sailors, soldiers, bureaucrats, clerics, bodyguards, concubines, servants, and slaves. Hence unlike the historic Atlantic diasporas, the Indian Ocean diasporas were composed of both forced and free migrants. In India, for example, according to Richard Pankhurst, there were numerous African diasporan rulers and dynasties established between the thirteenth and eighteenth centuries by the Habshi (corruption of *Habash*, the Arabic name for Abyssinia), Sidi (corruption of the Arabic *Saiyid*, or “master”), and Kaffir (from the Arabic *Kafir*, or “unbeliever”), as the Africans were known, throughout India from the north and west (Delhi, Gujarat, the Gulf of Khambhat, Malabar, Alapur, and Jaunpur) to the northeast (Bengal), the south (Deccan), and the west coast. Besides the Indian subcontinent, significant African communities also existed in the Persian Gulf from present-day Iran and Iraq to Oman and Saudi Arabia.

Exploration of the African diasporas in the Mediterranean worlds of western Asia and southern Europe has been fraught with considerable difficulties, not least the fact that until modern times this was the most intensive zone of cultural traffic and communication, in which communities straddled multiple spaces in complex networks of affiliation. The case of the Arabs from the Arabian peninsula, who swept through northern Africa following the rise of Islam in the seventh century, is a case in point. They traversed northern Africa and western Asia, the so-called Middle East, although with the rise of the modern nation-state and national identities, notwithstanding the enduring dreams of the Arab nation, it is possible to talk of, say, the Egyptian diaspora in the Gulf.

Before the Atlantic slave trade, the most significant African presence in southern Europe was the Moors from northwestern Africa, who occupied and ruled much of Spain between the early eighth century and the late fifteenth century. As is well known, the Moors made enormous contributions to Spanish culture and society and to the modernization of Europe more generally during those seven centuries, but they are rarely discussed in diasporic terms—as an *African diaspora*. Discussions of African diasporas in the Mediterranean world, which are still relatively scanty, tend to focus on “blacks,” that is, Negroid peoples, in ancient Rome or in the Mediterranean lands of Islam, where African diasporas were absorbed into the host communities thanks to the integrative principles and capacities of Islam.

Beyond the Mediterranean littoral in Europe, there are ancient African communities from Russia to Britain. The origins of the scattered African communities on the Black Sea coast of the Caucasus mountains are in dispute. Some argue that they were brought there between the sixteenth and nineteenth centuries as slaves for the Turkish and Abkhazian rulers, while others trace their origins many centuries earlier as remnants of an Egyptian army that invaded the region in antiquity. Allison Blakely believes the two explanations may not necessarily be contradictory, in that there were probably different waves of Africans. Modern Russia did not develop a significant practice

of African slavery, but some Africans did come as slaves; others came as servants for the wealthy nobility or as immigrants, usually seamen, including some who came from the Americas. One of these Africans was Abram Hannibal from Ethiopia, who arrived as a boy around 1700 and was raised as a favorite of Peter the Great, became a general and an engineer, and was the great-grandfather of Alexander Pushkin (1799–1837), the great Russian poet.

The history of Africans in Britain can be traced back two thousand years, but the African presence became more evident following the rise of the Atlantic slave trade. Many of the Africans worked as domestic servants, tradesmen, soldiers, and sailors. A growing stream of Africans coming for education—a tradition that began in the eighteenth century and accelerated in the nineteenth and twentieth centuries—later joined them. In the nineteenth century they included some of West Africa's most illustrious intellectuals and nationalists. Out of these waves emerged a “black” British culture with its own associational life, expressive cultural practices, literature, and political idioms, all forged in the crucible of unrelenting racial violence and oppression.

The Atlantic Diasporas

The Atlantic diasporas are the most recent of the global diasporas and are far better known and researched than the others. The diaspora in the United States often stands at the pedestal, the one against which to judge the identities of the other diasporas. The fact that Brazil has the largest African diaspora in the Americas, indeed in the world, is often forgotten, and so is the fact that in the Caribbean the African diaspora is the majority, rather than a minority population as in the United States. Debates about African diasporan identities have tended to be framed in terms of African cultural retentions or erasure on the one hand and diasporan adaptations and inventions on the other. Paul Gilroy's influential text, *The Black Atlantic*, is essentially a celebration of the supposedly new and distinctive Anglophone diaspora culture in which Africa is an irrelevant reality.

In effect, the two were not mutually exclusive, insofar as diasporic communities and consciousness were forged out of complex and sometimes contradictory encounters and negotiations between what Sheila Walker, in *African Roots/American Cultures* (2001), calls the three puzzles and Stuart Hall calls the presences in the Americas—the African, European, and Native American puzzles or presences. It is also important to note that there were continuous movements of people from Africa and the diaspora and back that kept connections alive.

On the whole, studies of African diasporas in the Americas continue to be heavily focused on national histories. In situations where the African puzzle or presence is marginalized, as is often the case in the United States, excavating the dynamic import of the African cultural, religious, artistic, social, economic, and political imprint on mainstream American society has produced some exciting scholarship. In societies that have tried to “whiten” themselves, such as Argentina, the object has been to demonstrate the African demographic presence. Similar attempts have been made to demystify Africa's “absence” in the histories of other countries in America's Southern cone:

Bolivia, Paraguay, Uruguay, and Venezuela, and in the histories of the United States' immediate neighbors, Mexico and Canada, and to chronicle the contributions of African diasporas beyond picturesque folklore.

For Brazil, great store has been placed on explaining the remarkable survival and transformation of the Africans and their cultures as well as exposing the brutal realities behind the mystifications of race mixture and cultural syncretism. With their large African populations, the Caribbean islands reflect Brazil in terms of the evident demographic and cultural visibility of the African presence. Also as in Brazil, this presence, ubiquitous though it may be, has not always been valorized—at least not until the black consciousness movement of the 1970s. Perched in the Atlantic in the middle of the Middle Passage, as it were, the African diaspora in the Caribbean in fact embodies all the complex connections, crisscrossings, and cultural compositions of the African diasporas of the Atlantic. Not surprisingly, Caribbean activists and intellectuals played a crucial role in all the transatlantic Pan-African ideologies and movements, from Garveyism to Negritude to socialism.

The New African Diasporas

In the twentieth century there were several new dispersals from Africa, a continent divided into colonial territories and later into independent nation-states. Unlike their predecessors, whose communities of identity, either as imagined by themselves or as imposed by others, were either ethnic or racial (not to mention sometimes religious), the new African diasporas had to contend with the added imperative of the modern nation-state, which often frames the political and cultural itineraries of their travel and transnational networks. The “new” or “contemporary” African diasporas, as they are sometimes called, can be divided into three main waves: the diasporas of colonization, of decolonization, and of structural adjustment that emerged out of, respectively, the disruptions of colonial conquest, the struggles for independence, and structural adjustment programs imposed on African countries by the international financial institutions from the late 1970s and early 1980s.

As with the historic diasporas, the challenge has been to map out the development of these diasporas and their identities and relations with the host societies. Needless to say, and also in common with the historic diasporas, the contemporary diasporas are differentiated and their internal and external relations are mediated by the inscriptions of gender, generation, class, political ideology, and sometimes religion. Where they differ from the historic diaspora, complicating analysis, is that they have to negotiate relations with the historic diasporas themselves and also not just with “Africa” but with their particular countries of origin and the countries of transmigration. The revolution in telecommunications and travel, which has compressed the spatial and temporal distances between home and abroad, offers the contemporary diasporas, unlike the historic diasporas from the earlier dispersals, unprecedented opportunities to be transnational and transcultural, to be people of multiple worlds and focalities. They are able to retain ties to Africa in ways that were not possible for earlier generations of the African diasporas. The diasporas of the late twentieth century were even more globalized

than those earlier in the century in terms of the multiplicity of their destinations and networks.

Particularly rapid in the closing decades of the twentieth century was African migration to Europe, which was characterized by increasing diversification in the number of countries both sending and receiving the immigrants. The African diaspora from the continent and the diaspora itself grew in Britain and France, the old colonial superpowers. Quite remarkable was the emergence as immigration countries of southern European countries such as Italy, Portugal, and Spain, which were themselves emigration countries. This development was as much a product of the improving economic fortunes in these countries and their integration into the prosperity and political sphere of western Europe as it was of mounting immigration pressures on their borders to the east and the south. New African immigrant communities also formed in central and eastern Europe, especially following the end of the Cold War.

Equally rapid was the growth of African migration to North America, especially the United States. By 2000 there were 700,000 African-born residents in the United States, up from 363,819 in 1990. This new African diaspora constituted only 2.5 percent of the total U.S. foreign-born population, up from 1.9 percent in 1990. The African migrants in the United States tended to be exceedingly well educated, in fact they enjoyed the highest levels of education of any group in the United States, foreign-born or native-born. According to the 2000 U.S. Census, among the African-born residents aged twenty-five and above, 49.3 percent had a bachelor's degree or more, as compared to 25.6 percent for the native-born population and 25.8 percent for the foreign-born population as a whole (U.S. Census Bureau, 2001).

Diaspora Linkages

The continuous formation of African diasporas through migration is one way in which the diaspora and Africa have maintained linkages. There have also been numerous movements among the diasporas themselves, for example, of Caribbean communities to Central, South, and North America and Europe, so that the entire Atlantic world, including the United States, is constituted by Earl Lewis's "overlapping diasporas."

One critical measure of the diaspora condition as a self-conscious identity lies in remembering, imagining, and engaging the original homeland, whose own identity is in part constituted by and in turn helps constitute the diaspora. This dialectic in the inscriptions and representations of the homeland in the diaspora and of the diaspora in the homeland is the thread that weaves the histories of the diaspora and the homeland together. Two critical questions can be raised. First, how do the different African diasporas remember, imagine, and engage Africa, and which Africa—in temporal and spatial terms? Second, how does Africa, or rather the different Africas—in their temporal and spatial framings—remember, imagine, and engage their diasporas? Given the complex ebbs and flows of history for Africa itself and for the various regional host lands of the African diasporas, it stands to reason that the engagements between Africa and its diasporas have been built with and shaped by continuities, changes, and ruptures.

The fluidity of these engagements is best captured by the notion of flow: that flows of several kinds and levels of intensity characterize the linkages between the homeland and the diaspora. The diaspora-homeland flows are often simultaneously covert and overt, abstract and concrete, symbolic and real, and their effects may be sometimes disjunctive or conjunctive. The diaspora or the homeland can also serve as a signifier for the other, subject to strategic manipulation. The flows include people, cultural practices, productive resources, organizations and movements, ideologies and ideas, and images and representations. In short, six major flows can be isolated: demographic flows, cultural flows, economic flows, political flows, ideological flows, and iconographic flows.

Clearly, engagements between Africa and its diasporas have been produced by many flows that have been carried on by a variety of agents; but not all flows and agents are equal, nor have they been treated equally. Much scholarly attention has gone toward the political and ideological flows across the Atlantic, as manifested, for example, in the role that the transatlantic Pan-Africanist movement played in engendering territorial nationalisms across Africa and how continental nationalism and the civil rights movement in the United States reinforced each other. Only recently has the discussion of cultural flows begun to transcend the question of African cultural retentions and survivals in the Americas to examine not only the traffic of cultural practices from the Atlantic diasporas to various parts of Africa but also the complex patterns and processes of current cultural exchanges through the media of contemporary globalization, from television and cinema to video and the Internet.

The historiography of these other forms of engagement is still relatively underdeveloped. Indeed, as with the history of the dispersals analyzed above, far less is known about the engagements between Africa and its diasporas in Asia and Europe than is the case with the Atlantic diasporas. The challenge in African diaspora studies, then, is twofold: to map out more accurately the dispersals of African peoples globally, and to map out the various engagements between Africa and its diasporas for each of the major world regions.

See also Black Atlantic; Black Consciousness; Creolization; Caribbean; Pan-Africanism; Religion: African Diaspora; Slavery.

BIBLIOGRAPHY

- Blakely, Allison. *Russia and the Negro: Blacks in Russian History and Thought*. Washington, D.C.: Howard University Press, 1986.
- Butler, Kim D. "Brazilian Abolition in Afro-Atlantic Context." *African Studies Review* 43, no. 1 (2000): 125–139.
- Cohen, Robin. *Global Diasporas: An Introduction*. Seattle: University of Washington Press, 1997.
- Fryer, Peter. *Staying Power: The History of Black People in Britain*. London: Pluto, 1984.
- Gilroy, Paul. *The Black Atlantic*. Cambridge, Mass.: Cambridge University Press.
- Hall, Stuart. "Cultural Identity and Diaspora." In *Theorizing Diaspora: A Reader*, edited by Jana Evans Braziel and Anita Mannur, 233–246. Malden, Mass.: Blackwell, 2003.

- Harris, Joseph E., ed. *Global Dimensions of the African Diaspora*, 2nd ed. Washington, D.C.: Howard University Press, 1993.
- Hine, Darlene Clark, and Jacqueline McLeod, eds. *Crossing Boundaries: Comparative History of Black People in Diaspora*. Bloomington and Indianapolis: Indiana University Press, 1999.
- Hunwick, John, and Eve Trout Powell, eds. *The African Diaspora in the Mediterranean Lands of Islam*. Princeton, N.J.: Markus Wiener, 2002.
- Koser, Khalid, ed. *New African Diasporas*. London and New York: Routledge, 2003.
- Lewis, Earl. "To Turn as on a Pivot: Writing African Americans into a History of Overlapping Diasporas." *American Historical Review* 100, no. 3 (1995): 765–787.
- Okpewho, Isidore, Carole Boyce Davies, and Ali A. Mazrui, eds. *African Diaspora: African Origins and New World Identities*. Bloomington: Indiana University Press, 1999.
- Palmer, Colin. "The African Diaspora." *Black Scholar* 30, nos. 3/4 (2000): 56–59.
- Pankhurst, Richard. "The Ethiopian Diaspora in India: The Role of Habshis and Sidis from Medieval Times to the End of the Eighteenth Century." In *The African Diaspora in the Indian Ocean*, edited by Shihan de Silva Jayasuriya and Richard Pankhurst, 189–221. Trenton, N.J.: Africa World Press, 2001.
- Shepperson, George. "African Diaspora: Concept and Context." In *Global Dimensions of the African Diaspora*, 2nd ed., edited by Joseph E. Harris, 41–49. Washington, D.C.: Howard University Press, 1993.
- Thompson, Lloyd A. *Romans and Blacks*. Norman: University of Oklahoma Press, 1989.
- U.S. Census Bureau. *Profile of the Foreign Born Population in the United States*. Washington, D.C.: U.S. Census Bureau, 2001.
- Walker, Sheila S. "Introduction: Are You Hip to the Jive? (Re) Writing/Righting the Pan-American Discourse." In *African Roots/American Cultures: Africa in the Creation of the Americas*, edited by Sheila S. Walker, 1–44. New York: Rowan and Littlefield, 2001.

Paul Tiyambe Zeleza

JEWISH DIASPORA

The Greek term *diaspora*, meaning "dispersion," has been used since ancient times as a means of describing the Jewish experience as well as the fact of Jewish settlement outside of the Jewish homeland to the present day. Originally, the term *diaspora* was used with respect to only three groups whose populations were dispersed in classical times: the Greeks, the Jews, and the Armenians. More recently, the term *diaspora* has been applied to a variety of other groups throughout the world who have endured dispersion from their original homelands. To the extent recent usage has changed the term's original connotation, its continued use to characterize the Jewish historical experience in its entirety can be misleading.

Classical scholars distinguish the forced exile of the Jews following the destruction of the First and Second Temples at Jerusalem (586 B.C.E. and 70 C.E., respectively) from the voluntary emigration out of the Jewish state that first occurred on a large scale under Persian rule after 538 B.C.E. and lasted through the escalating Roman occupation and administration

of Judea after 6 C.E. Only voluntary emigration, by their analysis, truly falls under the heading of "diaspora." Forcible expulsion is more appropriately characterized by the Hebrew terms *galut* or *golah*, both referring to the state of living in exile. Part of the confusion between "diaspora" and "exile" arose after the destruction of the Second Temple in 70 C.E., when the two kinds of dispersion became inextricably intertwined and the terminology merged. The terms were not again seen to be separate and distinct until the creation of the modern State of Israel in 1948, when the creation of a central Jewish polity ended the enforced exile of Jews while many Jews elected to remain in diaspora—that is, living in areas outside the new Jewish state. After 1948, Israeli scholars began to apply the Hebrew term *tefutsot*, which does not carry the connotation of forcible expatriation, to refer to the Jewish diaspora.

The Jewish diaspora is said by classical scholars to have begun during the First Temple period, with the establishment of a community of Jewish mercenaries within the military outpost of Elephantine (Southern Egypt) and with the removal of Jewish captives from the conquered Hebrew kingdom of Israel by the Assyrians in 722 B.C.E. However, the notion of diaspora as "exile" is theologically tied to the destruction of the First Temple and the sacking of Jerusalem by the Babylonians under Nebuchadnezzar in 586 B.C.E. As part of their conquest of the Hebrew kingdom of Judah, the Babylonians exiled the Jewish elite to Babylon, where they were said to have remained for three generations. Although the Assyrian captives had also been exiled by force, it was only during the Babylonian captivity that Jews developed the institutional structures that would later allow Judaism to survive without a homeland in the nineteenth centuries following the destruction of the Second Temple and the complete suppression of a Jewish polity in Judea. In Babylon, exiled Jewish scholars completed the compilation of the written Torah, to which they added some prophetic writings and chronicles. The innovation of the synagogue for small group devotions changed the practice of public worship significantly by putting scholars at the forefront in place of the High Priest of the Temple at Jerusalem. It was during the Babylonian exile that scholarly debates over the meaning of scripture began to evolve into the study networks of rabbinic Judaism that would sustain Jewish life and traditions without access to the Temple, the central focus of all Jewish religious life where the holy Ark of the Covenant was housed.

The Babylonian exile ended in 538 B.C.E. when the Persian king Cyrus conquered Babylon and issued an edict that permitted the Jewish captives to return to their homeland. Although the exiles then had the freedom to return to Judah and re-establish the Temple under Persian rule, most chose to remain in Babylon where they had adapted to life in exile. This represented the beginning of a pronounced shift within Jewish culture with respect to the relationship between individual Jews and the Jewish state. The structures developed by the exiles in Babylon to maintain their commitment to Judaism while absent from the Jewish polity meant that it was now possible, for the first time, to sustain Jewish life without having to live in the Jewish homeland. Following the example of the former Babylonian captives, a growing number of Jews began to embrace the capacity created by the new and portable

forms of Jewish ritual life to reside in places where there were better opportunities. In the years after the completion of the Second Temple in 515 B.C.E., a growing proportion of the Jewish population lived outside the Jewish polity, some through forcible exile, and some voluntarily in pursuit of economic ventures outside the Jewish state. By the first century B.C.E., the Greek geographer Strabo noted that the Jewish diaspora had penetrated nearly every part of the known world.

Hellenism and the Jewish Diaspora

Voluntary dispersion from the Jewish homeland in the kingdom of Judah, and later Judea, was sparked by the development of a plastic Hellenistic culture, of which Judea itself would become a part, which formed following the conquests of Alexander the Great in 333 B.C.E. As Hellenistic political rule expanded throughout the Mediterranean world, the colonies, institutions, and commerce it created attracted Jews in search of trade to venture out into far-flung areas of Greek settlement, where they came into closer contact with Hellenistic ideology. It was during this period that Jews began to disperse throughout the Mediterranean basin in substantial numbers. As the philosopher Philo Judaeus noted in the first century C.E., the area of Jewish settlement within the Hellenistic world spread from Libya to Ethiopia. Important and influential diaspora communities formed at Alexandria (Egypt), Cyrene (Libya), Antioch (Syria), Pergamon (Turkey/Asia Minor) and other large Hellenistic port cities. In these places, Jews were exposed to Hellenistic teachings in philosophy and science. Some important Jewish individuals, such as Philo Judaeus of Alexandria, flourished in this bicultural environment, but the impact of Hellenistic thought on rabbinic Judaism was slight overall. This was because of a revival of Jewish nationalism and violent resistance to Greek influence within Judea, under the leadership of Judah Maccabee, as well as the emergence of Babylon, which remained outside the sphere of Hellenistic culture, as the main center for Jewish theological development and scholasticism.

The migration of Jews out of Judea continued under the Romans, but under different conditions and therefore with different motivations. The economic and social environment of the Hellenistic empire had drawn Jews out of Judea of their own volition without substantially disrupting Jewish theocratic traditions. Roman rule, however, aimed at conquest and subjugation of the Jewish state apparatus. This created a fundamental tension between Judea's inhabitants and Roman administrators that frequently erupted into violence. Jewish migration into the Roman Empire therefore, while still voluntary, was driven in large part by the desire to escape violence and oppression in Judea. Growing conflict led to two revolts by the people of Judea and the employment of ever more brutal tactics by the Romans. Roman military occupation of Judea in 63 C.E. and ongoing violence (including the destruction of the Second Temple in 70 C.E.) through the crushing of the Bar Kochba Revolt, made Judea less desirable as a place for Jews to live and encouraged further dispersion of Judea's Jews throughout the Roman world. Judea's role as the center for Jewish life declined rapidly after 138 C.E. By the

seventh century C.E., the vast majority of Jews resided in communities outside of biblical Judah and Israel, and by 1600 only one percent of the Jewish people could be found in the traditional Jewish homelands of the Hebrew scriptures.

Interpretations of the Jewish Diaspora

Rome's imperial aims involved the destruction of Jewish political independence. Once that had been achieved and Judea no longer represented a threat to Rome's territorial advances, Jews were as readily absorbed into the empire as other conquered peoples. In 212 C.E., an edict extended Roman citizenship to all free inhabitants, including Jews. Judaism was officially recognized, and Jews were free to pursue an autonomous communal life without interference from the Roman state. Although they were banned from Jerusalem, they could move and settle freely throughout the rest of the empire. This situation began to change with the spread of Christianity, as the church fathers found it imperative that they distinguish the new faith from its predecessor. In 313, the emperor Constantine issued an edict granting freedom of worship to all religious sects. For the first time, the Christian religion was no longer suppressed and it quickly came to predominate within the empire. This had negative consequences for Jews, as the Christian Church began to call for the official separation of Jews from Christians.

Initially, the Jewish diaspora throughout the Mediterranean had helped to advance the diffusion of Judaism into regions where it had previously been unknown. By the fall of the Roman Empire in the fifth century C.E., Jewish communities were well-established in sites throughout the Roman world, from Asia Minor to Spain. Rome itself had at least thirteen synagogues. A wider Jewish presence led to better knowledge of Judaism, and upon occasion to conversion of local populations. About 700 C.E., for example, Bulan, leader of the nomadic Khazar people of Central Asia, decided to convert his nation to Judaism, creating an autonomous Jewish state that lasted for some five hundred years. However, after 500, Judaism faced growing threats from the spread of Christianity and (after 632) Islam, both of which found the continuing evolution of Jewish thought threatening to their respective theological postures as successors to Judaism.

Jewish leaders of medieval Europe such as Rabbi Moses ben Nachman (otherwise Nachmanides) saw the Roman conquest of Israel as the beginning of a permanent Jewish diaspora within the Christian world. This understanding of the Jewish diaspora was grounded in personal experience with the Holy Roman Church and its dictates. By 1215, the Roman Catholic Church's Fourth Lateran Council advocated the wearing of special insignia by Jews living in Christian lands, to identify them for an uneducated Christian populace as people to be avoided and as a "badge of shame" to highlight the inferiority of their religious beliefs. Moreover, Jews living in diaspora in Europe faced successive waves of expulsion, forced conversion, and segregation into ghettos as Christians attempted different tactics to control and constrain the development of a Jewish communal presence in their midst. From the Jewish perspective, the sense of diaspora as exile was also acutely heightened (particularly during the Crusades) by the inability of Jews to

return to the Holy Land to rebuild the Temple and gather in Jewish exiles—that is, to reestablish a Jewish state as an independent political and theological entity. Exile became the dominant understanding of the diaspora in subsequent generations of both Jews and Christians. Jewish and Christian thinkers put a different spin on the notion of “exile” however. For Jews, the exile, although painful, was part of God’s plan for the Jews as a test of their faith and commitment to the Torah. Christians saw the diaspora as God’s just punishment of the Jews for their role in the death of Christ. While Islamic rulers treated Jews less harshly than did their Christian counterparts. Muslims similarly distinguished themselves from Jews and Judaism and there were scattered instances of persecution, including forced conversions, in Muslim lands.

By the late eighteenth century many Jews had come to believe that their exile from the Jewish state was permanent. For some, accepting that the diaspora was inescapable meant developing the means for resolving persistent questions about the place of Jews in the various societies within which they resided. Influenced by the developing Enlightenment, Jewish intellectuals in Europe believed that the contemporary mission of the Jewish people was to adapt to their surroundings and find ways to participate in the nation state on equal terms with other citizens. The most important of these advocates was Moses Mendelssohn in Berlin. Following Mendelssohn’s call for civil integration of the Jews, later generations of Reformers suggested a series of modifications to Jewish ritual practice that were intended to harmonize Judaism with modern life and make it possible for Jews to present their community as well disposed for social and political participation. The Reformers had great success and influence in Germany and the United States during the nineteenth and twentieth centuries. In other places, the idea of Jewish integration and acculturation was not as readily embraced. The outbreak of violence after the death of Tsar Alexander II in 1881 pushed the Jews of Russia and Poland in the opposite direction, toward Jewish nationalism, and awakened interest in reestablishing a Jewish state at the site of the original Jewish homeland. After the anti-Semitic debacle of the Dreyfus Affair in France, a broad range of European and American Jewish intellectuals were forced to the conclusion that the kind of complete civil integration imagined by the Reformers would never be possible. Accordingly, the first Zionist Congress was held at Basel, Switzerland, in 1897, to organize the push for the Jewish return to Palestine. Zionism, in effect, called for an end to the demeaning conditions in which diaspora Jews were generally forced to live through the creation of a new, modern Jewish state in Palestine.

Diaspora in the Twenty-First Century

In the early 2000s, the diaspora is commonly understood to comprise all Jews living outside modern Israel, regardless of their nation of birth. The establishment of the state of Israel following the United Nations partition plan created the opportunity to end the Jewish diaspora. The new nation attempted an ingathering of Jewish exiles from around the world, in part by establishing the Law of Return (1950), which permitted any Jew to immigrate to Israel, and the Citizenship Law (1952), which

permitted Jews to claim Israeli citizenship upon touching Israeli soil. In the first year of its independence, Israel took in and absorbed 203,000 Jews from forty-two different countries, comprising not only the survivors of European Jewry (largely Ashkenazim), but also large numbers of “Oriental” Jews from Arab lands who had become the victims of escalating violence and persecution as international pressure mounted to sanction the creation of a Jewish state in the British mandate. Some Jewish refugees arrived via special convoys organized by the Jewish Agency to move large numbers of Jewish refugees living in exigent circumstances, including Jews from Yemen (Operation Magic Carpet, 1949), Iraq (Operation Ezra and Operation Nehemiah, 1950), and later from Ethiopia (Operations Solomon, 1974, and Moses, 1984–1985). Due to extensive immigration from Europe and Arab lands where anti-Semitism surged, the Jewish population of Israel increased from 657,000 in 1948 to 1,810,000 by 1958.

There remain, in the early twenty-first century, multiple interpretations of the diaspora and its significance to Jewish history and to the modern state of Israel. Many Jews, for a variety of complex reasons, continue to reside outside the Jewish state, not only in the affluent nations of Europe and North America, but in countries around the world.

See also Exile; Ghetto; Identity, Multiple: Jewish Multiple Identity; Judaism.

BIBLIOGRAPHY

- Baer, Yitzhak F. *Galut*. Translated by Robert Warshow. Reprint. Lanham, Md.: University Press of America, 1988.
- Barnavi, Eli, ed.. *A Historical Atlas of the Jewish People: From the Time of the Patriarchs to the Present*. New York: Knopf, 1992.
- Baron, Salo Wittmayer. *The Jewish Community: Its History and Structure to the American Revolution*. 3 vols. Westport, Conn.: Greenwood Press, 1972. Originally published in 1942.
- Comay, Joan, with Beth Hatefutsoth. *The Diaspora Story: The Epic of the Jewish People among the Nations*. New York: Random House, 1980.
- Eisenstadt, Shmuel Noah. *Jewish Civilization: The Jewish Historical Experience in a Comparative Perspective*. Albany: SUNY Press, 1992.
- Gilbert, Martin. *The Atlas of Jewish History*. 3rd ed. New York: Dorset Press, 1984.
- Rawidowicz, Simon. *Israel: The Ever-Dying People and Other Essays*. Edited by C. I. Ravid. Rutherford, N.J.: Fairleigh Dickinson University Press, 1986.
- Rubinstein, Hilary L., et al. *The Jews in the Modern World: A History since 1750*. New York: Oxford University Press, 2002.

Holly Snyder

DICTATORSHIP IN LATIN AMERICA. It is a somewhat common refrain in Latin America that countries need the *mano dura* (strong hand) of a military dictatorship in order to get things done. Surveys in the early twenty-first century reveal a growing disenchantment with civilian governments, with a surprisingly large minority of Latin Americans stating a preference for a dictatorial form of government over democracy. Such sentiments date back to the founding

of the Latin American republics in the early nineteenth century. After the removal of the Iberian crowns, conservatives argued that the new states were like children who needed parental guidance. These conservatives favored a centralist form of government in which a small group of elites would hold power and rule paternalistically on behalf of the rest of the country. Positivism, with its emphasis on order and progress, often provided a philosophical basis for such regimes in Latin America.

Military rule has been a feature of Latin America dating back to the colonial period. Rather than interpreting this as a cultural phenomenon, many observers have pointed to a failure of civilian institutions to address persistent problems of poverty and corruption. Some twentieth-century military dictatorships follow the pattern of nineteenth-century caudillo leaders who often ruled more through a use of personal charisma than brute military force. In fact, the only remaining nonelected executive in Latin America at the end of the twentieth century was Fidel Castro in Cuba, and his personalist style was more in line with the leadership of classic caudillos than what many would understand as the defining characteristics of a military dictatorship. However, while caudillos could be civilians and presented a variety of ideological stripes, “dictatorship” in Latin America normally refers to right-wing rulers who maintain themselves in power through overwhelming military force. For example, the Somoza and Pinochet dictatorships in Nicaragua and Chile maintained power more through repressive means than through personalist, caudillo styles of government. Particularly in South America in the 1960s and 1970s, bureaucratic-authoritarian regimes like those in Chile and Argentina attempted to use the power of state institutions to enact a fundamental reordering of society.

In Nicaragua, a series of three Somozas established a family dynasty that ruled the country from 1936 to 1979. The United States placed the first Somoza, Anastasio Somoza García, at the head of a national guard in order to continue a fight against the nationalist hero Augusto César Sandino after the United States withdrew its military forces from the country. Somoza, as well as his two successors, his sons Luis Somoza Debayle and Anastasio Somoza Debayle, spoke English fluently and remained submissive to United States foreign policy objectives. As Franklin Roosevelt allegedly said of the elder Somoza, “He may be a son-of-a-bitch, but he is our son-of-a-bitch” (Schmitz, p. 4). Over time, the Somoza family dynasty became increasingly brutal as it extended complete control over the country. A growing disparity in land distribution and gaps between the rich and the poor led to increasing discontent. Mounting repression and corruption finally led to alienation of the middle class and evaporation of business support for the regime. On 19 July 1979 Sandinista guerrillas overthrew the dictatorship and implemented a leftist revolutionary government.

In Chile, General Augusto Pinochet overthrew the democratically elected government of Salvador Allende in a bloody 11 September 1973 coup. Allende was the first Marxist elected to the chief executive office in Latin America in freely contested elections. His goals of agrarian reform, nationalization of industry, and a shift in production from luxury to consumer goods alienated the United States, which helped engineer

Pinochet’s coup. In power, Pinochet proved to be vicious, destroying the existing political system, engaging in extensive human rights abuses, and privatizing industry while taking services away from the lower classes. Although supported by the United States, Pinochet’s military dictatorship dealt a staggering blow to democracy, freedom, and reform. Until handing partial power back to civilian leaders in 1990, Pinochet provided a classic example of a military dictatorship.

The Revolutionary Government of the Armed Forces, which came to power in Peru in 1968 under the leadership of General Juan Velasco Alvarado, provides an interesting counterpoint to these conservative military dictatorships. At first, Velasco’s rise to power appeared to be just another military coup, but he soon announced plans for deep changes in government, including the nationalization of industries, worker participation in the ownership and management of these industries, and a sweeping agrarian reform law designed to end unjust social and economic structures. In implementing these reforms, Velasco challenged the incompetence and corruption of civilian politicians who were unable to implement badly needed reforms. He announced a “third way” of national development between capitalism and socialism. As a result of his reforms, food production increased, and peasants’ wages and quality of life improved. Much as nineteenth-century caudillos sometimes brought positive changes to their countries, supporters viewed Velasco’s military government as what Peru needed to improve and advance the country.

While progressive military governments in Peru and, to a lesser extent, Ecuador and Panama ruled in favor of the lower classes, implementing agrarian, labor, and other reforms, their ultimate aim was to undercut leftist organizing strategies. Providing agrarian reforms, even though they were partial, limited, and served to support the existing class structures, drew strength away from peasant and guerrilla demands. Ultimately, however, these reforms failed to address fundamental structural problems in society. These failures reveal how difficult it was to escape from dependent development without radical structural changes in class, property relations, and income distribution. At the same time, this history reveals that military governments are not always as reactionary as one might think. Furthermore, various branches of the military also tend to have different ideological orientations. Specifically, the army is sometimes seen as progressive because of its development work in rural communities, whereas the navy is usually affiliated with the elite and the police are often accused of committing the bulk of human rights abuses. This reveals the need for a more careful and complex interpretation of the role of the military, to break away from simplistic and unidimensional perspectives on the history of dictatorships in Latin America.

See also *Authoritarianism: Latin America*.

BIBLIOGRAPHY

Hamill, Hugh M., ed. *Caudillos: Dictators in Spanish America*. Norman: University of Oklahoma Press, 1992.
 Kornbluh, Peter. *The Pinochet File: A Declassified Dossier on Atrocity and Accountability*. New York: New Press, 2003.

- McClintock, Cynthia, and Abraham F. Lowenthal, eds. *The Peruvian Experiment Reconsidered*. Princeton, N.J.: Princeton University Press, 1983.
- Schmitz, David F. *Thank God They're on Our Side: The United States and Right-Wing Dictatorships, 1921–1965*. Chapel Hill: University of North Carolina Press, 1999.
- Zimmermann, Matilde. *Sandinista: Carlos Fonseca and the Nicaraguan Revolution*. Durham, N.C.: Duke University Press, 2000.

Marc Becker

DIFFERENCE. See **Diversity; Identity.**

DIFFUSION, CULTURAL. The concept of diffusion was born to controversy. The initial debate over this issue took place during the late nineteenth and early twentieth centuries.

Contention

On one side were British thinkers such as G. Elliot Smith (with William J. Perry), who strove to trace all myths, rituals, and social institutions (except for those of hunters and gatherers) back to a single, seminal civilization—in Smith's case, that was Egypt (hence its characterization as pan-Egyptian and heliolithic). Pitted against the diffusionists were the evolutionists, such as E. B. Tylor (1832–1917) in England and the American Lewis Henry Morgan (1818–1881), who held that significant inventions are independently created in many societies because of the common mental and psychological characteristics of our species. Influenced by the biological evolutionism of Charles Darwin (1809–1882) and evolutionary paradigms of the French philosopher Henri Bergson (1859–1941), they ascribed to an essentially unilinear theory of the development of culture and may be referred to as independent inventionists and isolationists. A more moderate form of diffusionism, which absorbed certain aspects of evolutionary thought, was maintained by German-Austrian anthropologists such as Fritz Gräbner (1877–1934) and Father Wilhelm Schmidt (1868–1954), who claimed that culture originated in several areas of the world that they called *Kulturkreise* (“culture circles”). They were referred to as the culture-historical (*kulturgeschichtliche*) school.

Bronislaw Malinowski (1884–1942) and A. R. Radcliffe-Brown (1881–1955) vigorously contested the more extreme forms of diffusionism and evolutionism through what is known as functionalism. The functionalists held that biological models should not be applied to sociological inquiries and stressed that cultural traits, even when it is possible to prove that they have been imported, are frequently radically reinterpreted in the societies to which they are introduced.

In the 1920s, with Franz Boas (1858–1942) at the helm, American anthropology clung to an essentially atheoretical position that rejected the polarizing assumptions of both diffusionists and evolutionists and considered functionalism to be overly schematic and insufficiently historical. While accepting the fact that cultural traits were manifestly transmissible, they emphasized the distinctiveness of cultures and the contingent,

selective nature of borrowing. Among Boas's students was Alfred L. Kroeber (1876–1960), who put forward the modified notion of stimulus diffusion, according to which the general idea or principle of a cultural trait is thought to be adopted from one culture by another culture, but not its specific signification and purpose. Such concerns led to the examination of the mechanisms of adoption and adaptation.

Elaboration

After more than half a century of dissension over the opposition between cultural diffusionism and independent invention, many scholars began to search for means to circumvent the counterproductive impasse. A landmark event in diffusionist thinking took place at the 1948 International Congress of Americanists in New York when a Mesoamericanist archaeologist, Gordon F. Ekholm, and an art historian of South and Southeast Asia, Robert Heine-Geldern, presented an exhibition of Old World and New World artifacts that revealed startling similarities. In a subsequent series of publications, they suggested possible Hindu-Buddhist influences on the Maya and the Toltec. The methodology of new diffusionists such as Ekholm and Heine-Geldern differed markedly from that of their predecessors in that it downplayed unicentric theory and emphasized the accumulation of overwhelming amounts of juxtaposed, concrete evidence. Their work was carried on with the utmost attention to detail by researchers such as Paul Tolstoy, who pointed out striking cultural parallels between the manufacture of bark cloth in Southeast Asia and in Mesoamerica. On the theoretical plane, Tolstoy drew an important distinction between diffusion as explanation (arguable) and diffusion as event (demonstrable). Empirically grounded studies were also continued in the investigations of Stuart Piggott, who plotted the path of wheeled vehicles across large swaths of Eurasia, displaying a good example of a finely worked case study of technological diffusion.

By the beginning of the twenty-first century and the age of globalization, the discussion had been entirely recast (whether conceived of as a quantitative or qualitative difference in how cultural ideas have moved around since the dawn of humanity). A leading figure of this approach to macro- and micro-analysis of cultural contagion is Arjun Appadurai. One of Appadurai's most frequently cited texts is the essay entitled “Global Ethnoscapes: Notes and Queries for a Transnational Anthropology” (now Chapter 3 in his *Modernity at Large*), where he talks about the role of “imagination” in the transnational flow of culture that is associated with globalization. In the pathbreaking book entitled *The Social Life of Things*, edited by Appadurai, ethnohistorians look at the problem of how the objects of material culture change as they migrate, lending subtlety to the treatment of an unspoken diffusionism. It should, however, be pointed out that none of the anthropologists who are fascinated with such global phenomena claim any influence from the older schools of diffusionist thought and would undoubtedly disown it.

Resolution

While diffusionism remains unfashionable (indeed, virtually unmentionable) within anthropology, studies of diffusion in

other fields are commonplace and fruitful. Investigations of the diffusion of innovations are regularly undertaken by researchers in agricultural economics, communication, education, sociology (especially early sociology and rural sociology), food processing and preservation, geography (particularly economic geography), general economics, industrial engineering, manufacturing, marketing and management, packaging, public health and medical sociology, psychology, public administration and political science, statistics, and other areas.

Prominent among scholars who undertake this relatively uncontested kind of pragmatic diffusionism, often employing sophisticated mathematical models, are Torsten Hägerstrand, Lawrence A. Brown, and Peter J. Hugill. These researchers have made fundamental contributions to the understanding of the diffusion of innovations in global communications, the analysis of world trade patterns, and the relationship between geopolitics (including its manifestations in war and espionage) and the transfer of technology. It is odd that the mere mention of diffusion among anthropologists is still capable of evoking paroxysms of indignation, whereas in most other disciplines it is considered a perfectly normal topic for discussion. One can only conclude that issues pertaining to diffusion in anthropology carry potent politico-ideological overtones and are borne on sensitive ethnological undercurrents that are wholly lacking in more utilitarian, less value-laden research fields.

The discipline of history has finally managed to extricate itself from the more acrimonious aspects of the debate over diffusionism. This is above all true of scholars aligned with William McNeill, who has for more than four decades identified intercivilizational contact as the main motor of human history. World history is now a vibrant subfield with its own lively journal (*Journal of World History*, edited by Jerry H. Bentley) in which researchers routinely write about world systems, interaction spheres, interregional contact and exchange, and other highly productive topics in noncircumlocutory terms. It is intriguing to observe that world historians increasingly resort to reticular imagery to show that the transmission of goods and ideas is multidirectional and totally interwoven. A parallel, but not always congruent, line of intellectual history is that of world systems theory, which flourished in the 1970s and 1980s, particularly as advocated by the economic historian Immanuel Wallerstein. A major concern of world systems theorists was the movement of precious metals among polities, some of which were separated by enormous distances. The Marxian aspects of this theory, together with the postmodern reaction against it, undoubtedly is one source of contemporary anthropology's lingering unease with diffusionism.

See also *Communication of Ideas; Ideas, History of; Oral Traditions*.

BIBLIOGRAPHY

- Appadurai, Arjun. *Modernity at Large: Cultural Dimensions of Globalization*. Minneapolis: University of Minnesota Press, 1996.
- . ed. *The Social Life of Things: Commodities in Cultural Perspective*. Cambridge, U.K.: Cambridge University Press, 1986.

Cavalli-Sforza, Luigi Luca, and Marcus W. Feldman. *Cultural Transmission and Evolution: A Quantitative Approach*. Princeton, N.J.: Princeton University Press, 1981.

Christian, David. *Maps of Time: An Introduction to Big History*. Berkeley: University of California Press, 2004.

McNeill, J. R., and William H. McNeill. *The Human Web: A Bird's-Eye View of World History*. New York: W. W. Norton, 2003.

Rogers, Everett M. *Diffusion of Innovations*. 5th ed. New York: Free Press, 2003. The second edition, by Rogers with F. Floyd Shoemaker, was published as *Communication of Innovations: A Cross-Cultural Approach*, New York: Free Press, 1971.

Victor H. Mair

DISCIPLINE. See *Asceticism*.

DISCRIMINATION. Discrimination should be understood as action and therefore distinguished from prejudice, which is a matter of thought, attitude, or belief. Racial discrimination then would consist of social action that produces unjust allocation of valued resources, based on racial categorizations of individuals or groups (Banton; Kairys, 1996). This is the standard definition and still serves in many cases: where race is concerned, it provides basic standards for distributive justice, and it permits one to disaggregate prejudice and discrimination (Merton). What the standard definition does not provide, however, is a link between unjust action and social structure, and this presents serious difficulties both for social thought and for social justice.

Patterns and understandings of racial discrimination have undergone significant change during the years since World War II. Such long-established practices of racial favoritism as the South African apartheid system and the system of state-enforced racial segregation in the U.S. South (that is, "Jim Crow") have been overturned in a complex sociopolitical process that combined sustained social movement activity with state-based racial reform. As a result, the formal (de jure) rules and agencies of racial preference have been largely if not entirely jettisoned, and explicit practices of discrimination on the part of resource holders and gatekeepers, such as employers, landlords, service providers, and schools to name but a few, have been stigmatized, though these practices often persist in more concealed and publicly deniable fashions.

It is undoubtedly a significant issue that an individual, group, or agency unfairly withholds resources (say, mortgages, university admissions, or trade union membership cards), denying access on an equal basis to persons of a negatively valued racial identity or, conversely, granting privileged access to persons of a favored racial group. But action of this type is identifiable and sanctionable, precisely because it is action: that is, transitive and predicated in the material present. Of course, such action often is not identified and very often is not sanctioned; it remains widely accepted or at least tolerated. But it is at least recognizable and comprehensible as the work of particular subjects, whether individual or collective.

Past racial discrimination, though, is much more difficult to address directly. Because discriminatory action is accretive and cumulative over time, especially over long durations, its effects can be felt without the presence of any active agent. Prolonged, transgenerational access to socially valued resources, such as elite university degrees, high-status jobs and professions, political power, and culturally afforded honor of various kinds (not to mention wealth), is facilitated by belonging to the “right” racial group (Harris; Feagin). Conversely, impeded opportunities, low status, culturally attributed dishonor (e.g., stereotypes of laziness, ugliness, or low intelligence), and frequently impoverishment are all outcomes of prolonged, transgenerational denial of access to resources and opportunities (Oliver and Shapiro; Brown et al.).

Thus racial discrimination is more than social action; in its repeated and reiterated forms it develops into a social structure. It becomes habitual and is taken for granted in all sorts of invisible ways: in the design of neighborhoods, the making of foreign policy or tax policy, or the writing of television news; in the way one is addressed by a policeman, treated by a doctor, or expected to speak the language.

This invisible structural discrimination evades attempts to regulate it, for example, through the law. After the 1960s civil rights reforms of state racial policy in the United States, for example, and after the 1994 dismantling of the apartheid regime in South Africa as well, the social structure of discrimination still exhibited a great deal of resilience (Winant; Zegeye). Some of this persistence may be attributable to the weakness of reform policy and the reluctance of courts to intervene strongly in sanctioning discriminatory practices (Kairys, 1993; Ezorsky), but a great deal of discrimination escapes public attention (sometimes even from those it damages) because it has little or no active agent, is hardly or not at all the work of intention, and is regarded as normal practice. This “transparent” discrimination in effect has no living perpetrators; it is the legacy of such past practices as slavery and colonial rule.

The presence of structural racial discrimination also has the effect of legitimating much intentional discrimination, which can be rendered agentless simply by the refusal to intervene on behalf of principles of fairness or equality as resources of social value are allocated. In large-scale terms (such as determining housing or wage policies), in medium-scale terms (such as carrying out university admissions), and in small-scale terms (such as hailing a cab, or “driving while black”), present-tense, active racial discrimination is supported and camouflaged by structural discrimination.

Thus state regulation alone is insufficient to effectively eliminate discrimination. Of course, discrimination can be maintained by state regulation: notably in the United States but elsewhere as well, courts have demonstrated how effectively they can sustain discrimination at socially acceptable levels. For example, U.S. courts have established legal standards that turn on the demonstration of explicit intent to discriminate as the prerequisite for enforcement of civil rights laws. In response to this, explicit profession of an intention to discriminate has become quite rare, and active discriminators have

learned to dissemble and mask their practices under such code words as “colorblindness” and “merit” (Brown et al.).

Far more intensive measures have been proposed to eliminate or at least seriously reduce structural discrimination. These measures would be based on a policy of redistribution of resources according to a compensatory formula, sometimes viewed as reparations for past discrimination, and would also contemplate large-scale social therapy and healing projects, such as have occurred after the fall of dictatorships and after the military defeat of repressive regimes. Examples of such intensive projects include the Reconstruction period after the U.S. Civil War (Du Bois), the promulgation of a new South African constitution after the end of apartheid in 1994, and the “denazification” and supervised democratization processes that followed the defeat of the Axis powers in 1945.

While juridical processes, such as trials of human rights abusers and state-sponsored commissions like the South African Truth and Reconciliation Commission (TRC) or the Argentine National Commission on the Disappeared (CONADEP), might be expected to play a role in these transformations (Weschler), important work also would have to be undertaken at the level of civil society, of everyday life. Such activity would require an advanced commitment to democracy. Some of the TRC’s innovations, such as provision of guarantees of nonretribution to those who acknowledged their own abusive practices, may serve as an initial model. While developing the large-scale dedication needed for such intensive antidiscrimination measures would be very difficult, preliminary work done by movement activists and scholars on the implementation of reparations suggests future directions (Bittker; Brooks; Dawson and Popoff).

See also Apartheid; Prejudice; Race and Racism; Segregation.

BIBLIOGRAPHY

- Banton, Michael P. *Discrimination*. Philadelphia: Open University Press, 1994.
- Bittker, Boris I. *The Case for Black Reparations*. New York: Random House, 1973.
- Brooks, Roy L., ed. *When Sorry Isn't Enough: The Controversy over Apologies and Reparations for Human Injustice*. New York: New York University Press, 1999.
- Brown, Michael K., et al. *Whitewashing Race: The Myth of a Color-Blind Society*. Berkeley: University of California Press, 2003.
- Dawson, Michael C., and Ravana Popoff. “Reparations: Justice and Greed in Black and White.” *Du Bois Review: Social Science Research on Race* 1, no. 1 (spring 2004): 47–91.
- Du Bois, W. E. B. *Black Reconstruction: An Essay toward a History of the Part Which Black Folk Played in the Attempt to Reconstruct Democracy in America, 1860–1880*. New York: Harcourt, Brace, 1935. Reprint, New York: Atheneum, 1977.
- Ezorsky, Gertrude. *Racism and Justice: The Case for Affirmative Action*. Ithaca: Cornell University Press, 1991.
- Feagin, Joe R. *Racist America: Roots, Current Realities, and Future Reparations*. New York: Routledge, 2000.
- Harris, Cheryl. “Whiteness as Property.” *Harvard Law Review* 106, no. 8 (1993): 1709–1791.
- Kairys, David. “Unexplainable on Grounds Other Than Race.” *American University Law Review* 45 (February 1996): 729–749.

- . *With Liberty and Justice for Some: A Critique of the Conservative Supreme Court*. New York: New Press, 1993.
- Massey, Douglas S., and Nancy A. Denton. *American Apartheid: Segregation and the Making of the Underclass*. Cambridge, Mass.: Harvard University Press, 1993.
- Merton, Robert K. "Discrimination and the American Creed." In *Discrimination and National Welfare*, edited by Robert W. MacIver. New York: Harper, 1949.
- Oliver, Melvin L., and Thomas M. Shapiro. *Black Wealth/White Wealth: A New Perspective on Racial Inequality*. New York: Routledge, 1995.
- Weschler, Lawrence. *A Miracle, a Universe: Settling Accounts with Torturers*. New York: Pantheon Books, 1990.
- Winant, Howard. *The World Is a Ghetto: Race and Democracy since World War II*. New York: Basic, 2001.
- Zegeye, Abebe, ed. *Social Identities in the New South Africa*. Colorado Springs: International Academic Publishers, 2001.

Howard Winant

DIVERSITY. *Diversity*, as a word or concept, can apply to rocks, plants, animals, people, systems of law, and much else. In the United States, since the 1970s, its immediate reference, if the word is presented with nothing more to specify it, is to the diversity of races, ethnic groups, and language groups that make the United States possibly the most diverse country in the world. But its import extends far beyond its use as a neutral descriptor of this variety: It rather refers to an ideology in which this diversity is prized, considered a benefit to the society, and is to be responded to positively in public policy and by major nongovernmental interests.

Of course the differences among people can be described in many ways aside from race or ethnicity: One can refer to their opinions, their character, their height and weight, the degree of their health, and so on. But "diversity," as it is has come to be used in public and scholarly discourse since the 1970s, refers specifically to those differences, primarily in race and ethnicity, that have been the basis of exclusion or segregation or differential treatment in public action and private social interaction. Its use and import is intimately linked to the great divide of race that has shaped so much of American history, society, and culture. This specific current meaning of *diversity* grows out of the great effort in the 1950s and 1960s to overcome the inferior position, in law and social treatment, of American blacks. The civil rights revolution of the 1950s and 1960s, marked by major constitutional legal decisions, major legislation, insurgent social movements, violence, and changing ideologies and political demands, shaped the emergence of diversity as a central concept used to justify policies to favor excluded groups, primarily American blacks.

Very rapidly groups whose disabilities could be, with more or less justice, considered equivalent to those that blacks had suffered were included among those who contributed to the diversity of American society, a diversity that was now to be seen not as a problem but a benefit and a virtue, a pillar of American society. Most directly parallel to blacks in making up the roster of groups that were part of this diversity were the nonwhite races—American Indians ("Native Americans,"

in one increasingly popular formulation) and Asians (Chinese, Japanese, and many other groups, all of which are considered separate "races" in the U.S. census). A fourth group, "Hispanic Americans," as the census came to call them in 1980 (after trying "Spanish surnamed" in earlier censuses as a means of identifying a group considered "different" but clearly not a "race"), became part of the roster of the diverse, because they too suffered from disabilities—discrimination on the basis of physical differences from whites that approximate differences of race, and difference in language. These four groups emerged in the 1960s as those among the diversity of American groups that deserved some redress because of the discrimination they suffered. Asian Americans then consisted almost entirely of Chinese and Japanese, while Hispanics consisted almost entirely of Puerto Ricans and Mexicans. But very rapidly, as a result of major immigration reforms in 1965, the Asians expanded to include Indians, Koreans, Vietnamese, and many other Asian groups; and the Hispanics expanded to include Cubans, Nicaraguans, Salvadorans, Dominicans, and many other peoples from Central and Latin America and the Caribbean who left their native lands because of civil war and economic hardship.

In the wake of the civil rights legislation of the 1960s, and the institution of federal requirements for affirmative action by employers and federal contractors, employers and educational institutions were required to provide counts of their employees and students according to these ethnoracial groups and by gender. Women were part of the roster of the recognized diverse that deserved some public acknowledgment from the beginning. The disabled were soon included, under legislation parallel to civil rights legislation prohibiting discrimination against them. Those different because of sexual orientation—gays and lesbians—are also considered part of American diversity, but they receive as yet no public recognition parallel to that of the four ethnoracial groups and women. But in the world of higher education in particular, their distinctiveness and contribution to a valued diversity is broadly recognized, in ways parallel to those that recognize and respond to ethnoracial and gender diversity: through recognized student groups, courses of study devoted to the group, and the like.

Before Diversity

One kind of diversity, ethnic diversity among white Americans, is not much recognized in the current discourse on diversity, or in policies that recognize or respond to diversity. Yet before diversity became a prevailing concept to recognize and appreciate significant differences among Americans, other concepts—such as the "melting pot" and "cultural pluralism"—emerged to respond to and recognize ethnic differences among white Europeans (though they were then not all necessarily considered "white"). These concepts emerged because the large new immigrant groups of the late nineteenth and early twentieth centuries—Jews, Italians, Poles, Slavic groups, Greeks, and others from eastern and southern Europe and the Near East—were seen as different from and inferior to previous immigrants from Great Britain and northern and western Europe, and were subject to various degrees of discrimination.

The concept of the melting pot was given wide circulation by the popular play of that name, written by the English Jewish writer Israel Zangwill in 1908. But there are earlier parallels to the melting pot in the works of the nineteenth-century American writers Ralph Waldo Emerson, Herman Melville, and Walt Whitman. The melting pot concept disputes the assumption of inferiority of the newer immigrants that was so widespread among scholars and political leaders in the early twentieth century. It implies the equality of all European groups and their equal qualifications and right to form part of and merge into the common American people. While it has on the whole a positive and benign import, the melting pot gives no acknowledgment to the idea that these groups to be merged into Anglo-America might resist assimilation, might want to cling to differences in culture and language and religion. Associated with the prevailing melting pot ideology of the early twentieth century were programs of “Americanization,” the teaching of English and American history and political practice. These became particularly intense and intrusive during World War I, when it was widely feared that immigrant and ethnic groups would respond to this crisis by taking the part of their native countries, rather than as assimilated Americans.

The melting pot was then countered by a new ideology of “cultural pluralism,” formulated in World War I by the philosopher Horace Kallen, who argued that America could be a symphony of diverse cultural strands that resisted forceful assimilation and Americanization. The condition of American blacks played no role in the philosophy of cultural pluralism—it referred only to European immigrants. But cultural pluralism was a rather isolated concept, advocated by few and overwhelmed by the rush to assimilation. It emerged under other names and forms in World War II—for example, “intercultural education”—because in that war the buried identifications with European homeland were seen as aiding the American war effort rather than countering American loyalty; German dictator Adolf Hitler had oppressed so many people who could be energized to oppose him. The appreciation of difference that emerged in World War II and the postwar world now began to include blacks. Hitler’s racism was the enemy. Could American racism be unaffected? As American racism became for the first time since Reconstruction part of the national American political agenda, the stage was set for the civil rights revolution, civil rights legislation, and the canonization of diversity.

From Affirmative Action to Diversity

Affirmative action—federal policies and court decisions requiring employers and federal contractors and local and state governments to try to employ persons from the four ethno-racial groups and women in numbers proportionate to their presence in the labor force—was instituted in the late 1960s. It has been controversial ever since. Alongside of affirmative action in employment, colleges and universities instituted programs to increase the number of black and Hispanic students, though blacks comprised the main group of interest. These programs were not (for the most part) legally required but were instituted voluntarily, or in response to black student protest. Taking account of race required reducing the weight

of academic achievement in admissions decisions. Both in the case of affirmative action in employment and in admissions to colleges and universities, greater diversity as such was initially neither the objective nor the justification: Getting higher numbers of black students than could be admitted on the basis of academic grades was the objective, and making up for past discrimination was the justification. But in a key U.S. Supreme Court case from 1978, *Regents of University of California v. Bakke* (438 U.S. 265), diversity as a value in education became the sole legitimate legal basis for special consideration in admissions on the basis of race. Institutions—primarily in the South—that had once discriminated against blacks were already required by federal intervention and court order to institute quotas and preference for blacks. Most institutions in the North and West, however, had no such history.

The University of California, Davis, medical school, which was sued for impermissible discrimination against whites on the basis of race in the *Bakke* case, could not claim that its quota for underrepresented minorities was making up for past discrimination; as a young medical school, it had never discriminated. Nevertheless it had a quota for underrepresented minorities. Four justices asserted that race could not be taken into account, four asserted it could because of societal discrimination against blacks, and one justice, Lewis Powell, joined the latter four with his own justification for preference for underrepresented minorities: Student diversity would improve the educational environment by introducing the views of underrepresented groups into the educational process. This was the argument made in an amicus brief filed in the case by Columbia, Harvard, and Stanford Universities, and the University of Pennsylvania. The brief described Harvard’s admissions process as giving a plus for race to help create this diverse environment.

Various weaknesses in this argument for consideration of race have been pointed out, such as that there is no necessary connection between race and ethnicity and the views students bring to the classroom, but student diversity has since become the sole legal basis for preference. Educational institutions—undergraduate, graduate, and professional—began to lean heavily on diversity as their justification for a preference to which they are uniformly committed, for a range of reasons that would not pass constitutional muster. Important and large-scale research has been conducted to demonstrate the benefits of racial and ethnic diversity in higher education.

In 2003 the Supreme Court was forced to return to the issue of racial and ethnic preference in higher education because federal circuit courts were divided on the issue. In *Grutter v. Bollinger* (539 U.S. 306), which challenged race preference in admissions to the University of Michigan Law School, the centrality of diversity as *the* justification for affirmative action was enshrined in a new decision. The Court was very much in the same divided posture as in 1978: for four justices, to take race into account was unconstitutional; in opposition, four liberal justices defended this policy on wide grounds; and a single justice, Sandra Day O’Connor, joined the four liberal justices for the single reason, spelled out at length, that diversity aided the educational process:

The Law School's educational judgment that such diversity is essential to its educational mission is one to which we defer. The Law School's assessment that diversity, will, in fact, yield educational benefits is substantiated by respondents and their *amici*. . . . These benefits are not theoretical but real, as major American businesses have made clear that the skills necessary in today's increasingly global marketplace can only be developed through exposure to widely diverse people, cultures, ideas, and viewpoints. [Here Justice O'Connor refers to briefs by 3M Company, General Motors Corporation, and other corporations.]. . . . What is more, high-ranking retired officers and civilian leaders of the United States military assert that, "[b]ased on [their] decades of experience," a "highly qualified, racially diverse officer corps . . . is essential to the military's ability to fulfill its principle [*sic*] mission to provide national security." (*Grutter v. Bollinger*, pp. 330–331)

When the military-industrial complex, as well as the leaders of major U.S. universities, embrace diversity as a valued objective, it is clear that a great deal happened in the twenty-five years between Justice Powell's somewhat surprising choice of this single justification of affirmative action and Justice O'Connor's wide-ranging argument in its favor. America had changed. Affirmative action might still be opposed by a majority of Americans (state referenda in California and Washington had rejected it). Diversity, however, had been embraced by all.

The Diverse Society

This change cannot be ascribed only to these Supreme Court decisions, important as they are for the behavior of colleges, universities, and professional schools; it also reflects a large cultural change, and an evaluation of diversity's pragmatic benefits by key interests in American society. In the 1980s, under the administration of President Ronald Reagan, high officials hoped to limit government's affirmative action requirements by modifying the executive order that had instituted it. They discovered to their surprise, however, that big business no longer wanted to change what they had once seen as a burden. To have employees from a wide range of groups was now seen as a benefit in dealing with increasingly diverse customers and suppliers. Appreciation of diversity was widely taught in the business world, and business was perhaps more energetic in training its employees in the proper consideration of diversity than higher education itself. Affirmative action had been launched when minorities consisted overwhelmingly of blacks alone. With the opening of immigration in 1965, and the beginning of a large and unceasing flood of immigrants from Latin America, Asia, the Caribbean, and increasingly Africa, the groups considered "minority" swelled, diversity expanded, and responding to it became ever more important to businesses, the military, and politicians.

Education, however, remains in the forefront of the response to and embrace of diversity. In the 1960s, multicultural education—the inclusion in curricula of material on the four minority groups, and furthermore, the reflection of their grievances and interests everywhere in the curriculum—

became a key demand of minority groups, leading to fierce controversies. Very rapidly these demands were widely recognized as legitimate. (*Multiculturalism* was the term under which these battles were fought, but it raised the same issues as *diversity*: The only difference was that *multiculturalism* had a more muscular and aggressive tone, whereas *diversity* seemed a more accommodating concept.) The content of major parts of elementary and secondary education was transformed, particularly history, English, and social studies; sometimes even mathematics and science were affected. Textbooks were transformed under new state requirements to recognize diversity. Diversity also called for increasing efforts to recruit minorities as teachers and administrators, and many minority educational leaders became superintendents of major school systems.

The impact on higher education was as great but somewhat more restricted. The demands of diversity were reflected in new programs of black studies; Hispanic, Asian, and Native American studies; women's studies; and gay and lesbian studies. Furthermore, on many campuses special living quarters and social centers were created for minority groups, and there was a heightened emphasis on the recruitment of faculty from each group. The philosophy of diversity became the common linking outlook of university presidents—all embraced it, and there were no dissidents.

The military was possibly the most successful institution in responding to and reflecting the new appreciation of diversity. The military academies—like all institutions of higher education—instituted programs to recruit larger numbers of minority officers, and it was particularly essential that they succeed because so many of those enrolled in the voluntary military forces were from minority groups. In America's wars in the 1990s against Iraq, black and Hispanic officers held the highest positions.

Governing a Diverse Society

The United States is of course not the only diverse society. Other immigrant and liberal democratic societies—such as Canada, Australia, and New Zealand—have been as active or more active in the recognition of diversity. The liberal democracies of western Europe have become more diverse under the impact of immigration, first fostered because of labor shortages, then continuing because their liberal traditions accept such reasons for immigration as the unification of families and the seeking of refuge from persecution. In this way, the ideology of diversity has spread throughout the liberal democratic world.

In each country one may see variations in the response to diversity. Thus, Canada became a leader in promoting multiculturalism in its efforts to accommodate the demands and interests of francophone Quebec. This has made it particularly sensitive to claims of other groups, and it offered opportunities to maintain cultural distinctiveness to immigrant groups that cannot lay claim to a specific territory. It would go too far afield to describe all the various responses to diversity, but in general the kind of forceful assimilation that was common in the past—as in the case of "Russification" in the Russian empire—is everywhere in the liberal democratic world in retreat. Turkey, for example, which had long suppressed the

language and autonomy claims of its large Kurdish minority, has had to acknowledge these claims as it aims to enter the European Union.

But liberal democratic political theory, which is oriented to the individual and the individual's rights, does not sit easily with the range of issues raised by diversity. What are the rights of the group, or the rights of an individual as part of a group? The classic work of twentieth-century liberalism, John Rawls's *A Theory of Justice* (1971), takes no account of this issue—the individual confronts the state or society with no intermediate formation, and this is true of classic liberal political theory generally. If a group is concentrated in a territory, one can accommodate its interests through some degree of autonomy, but when, as in the United States and in other immigrant societies, a group is spread through the population, the recognition of diversity raises difficult questions, as was particularly evident in the battles over multiculturalism in the 1980s and 1990s in the United States. Similar conflicts are ever more evident in western Europe. What becomes of the historic national identity when a range of diverse groups is given recognition, appreciation, and places at the tables of education, culture, and government? These issues will be part of the agenda of the liberal democratic world for many years to come.

See also **Americanization, U.S.; Assimilation; Ethnicity and Race; Nation.**

BIBLIOGRAPHY

- Bowen, William G., and Derek Bok. *The Shape of the River: Long-Term Consequences of Considering Race in College and University Admissions*. Princeton, N.J.: Princeton University Press, 1998.
- Glazer, Nathan. *We Are All Multiculturalists Now*. Cambridge, Mass.: Harvard University Press, 1997.
- Kallen, Horace M. *Culture and Democracy in the United States*. New York: Boni and Liveright, 1924. Reprint, with a new introduction by Stephen J. Whitfield, New Brunswick, N.J.: Transaction, 1998.
- Kymlicka, Will, ed. *The Rights of Minority Cultures*. Oxford: Oxford University Press, 1995.
- Lynch, Frederic R. *The Diversity Machine: The Drive to Change the "White Male Workplace."* New York: Free Press, 1997.
- Schuck, Peter H. *Diversity in America: Keeping Government at a Safe Distance*. Cambridge, Mass.: Harvard University Press, Belknap Press, 2003.
- Wood, Peter. *Diversity: The Invention of a Concept*. San Francisco: Encounter Books, 2003.

Nathan Glazer

DRAMA. See **Theater and Performance; Tragedy and Comedy.**

DREAM. It is midnight in the desert, and the full moon has just passed its apex. On the sandy ground, staff in hand, guitar and jug by his side, a dark-skinned man is nuzzled by a tawny-maned lion. Is the man dreaming? Are we? Or is this

the dream of the artist, Henri Rousseau (1844–1910)? If, as some traditions have it, the Universe was dreamed into existence by its Creator, then it makes perfect sense that all of art—the microcosm created by human beings in emulation of the Creator's macrocosm—is a dream of sorts. And art is a dream, in a way—a projection of the deepest subconscious and unconscious desires upon canvas and stone, the etching plate and the loom. But when artists depict dreams and dreaming, whether explicitly, with the dreamer in the picture, or implicitly, with the picture illustrating the dream, ambiguities flourish, and polyvalency abounds.

There are many loci classici of the dream in art, in many times, places, and cultures. Some are explicit, yet ambiguous, like Rousseau's *Sleeping Gypsy* of 1897. Some are explicit and distinctly unambiguous, such as Francisco Goya's (1746–1826) *Capricho 43: El Sueno de la Razon Produce Monstruos* (1797–1798, "The Sleep/Dream of Reason Begets Monsters") or Henry Fuseli's (1741–1825) *The Nightmare* (1781) where dreams are made manifest in oil on canvas. Even those depictions in which the intention to depict a dream is overt are fraught with a multiplicity of interpretive possibilities—Maurice Sendak's (b. 1928) nightmare creatures in *Where the Wild Things Are* (1963) are both the products of the dreams of Max, the young protagonist, and of Sendak's own family history, wherein those things that go bump in the night are stand-ins for his loud, invasive, cheek-pinching aunts and uncles.

Antiquity

Just as Max creates a world in his dream, Krishna acts out the role of Vishnu in his sleep, and the universe is created out of the navel of the dreaming god. The individual adept, like the artist, assumes the role of conscious creator. Dreams have been represented in art for thousands of years. The Talmud describes sleep as "one-sixtieth part of death," one part in sixty being the threshold of perception for Jewish legal purposes—a taste, in other words, of what death is like. Likewise did the ancient Egyptians consider sleep a sort of preliminary glimpse of death, and in dreams, certain aspects of what one would call the soul encountered the upper and lower realms. The lessons thus learned were transmitted by the forces of the other world to the priests of the cult of the dead, who could then advise the dead about the pitfalls and pratfalls of the journey before them. The Ba, the spiritual entity that was believed to leave the body both in dreams and in death, is represented as a jabiru bird in art, whether in reliefs or in papyri. It is depicted hovering over the inert body as it is in the famous *Scroll of Ani* of the *Theban Book of the Dead* (c. 1250 B.C.E.).

The Egyptians also evoked the topos of the dream in art in the representation of Bes, god of crossroads and transitions, on the headrests they used as pillows. And the great Sphinx of Giza is among the earliest artworks attributable to a dream, that of Pharaoh Tutmosis IV, who either constructed or—some sources say—uncovered or rediscovered the colossus around 2620 B.C.E. on the basis of a night vision.

Some of the loveliest depictions of sleep and dreams come out of the Hellenistic-Roman world. In Greek mythology, Nyx (Night) gives birth to Hypnos (Sleep) and Thanatos (Death).

The god of dreams is Morpheus, whose symbols are a smoking horn and a staff, symbols respectively of false and true dreams. Morpheus is not often represented in art, but Hypnos is, quite often and quite beautifully. He receives a melancholically sensitive treatment in a Roman copy of a lost Bronze statue of the fourth century B.C.E., which simply depicts a winged, sleeping, boyish head. And on the famous and controversial Euphronius (flourished c. 520–470 B.C.E.) krater (Greece, 520–510 B.C.E.), a winged Hypnos is paired with his twin brother Thanatos, gently bearing Sarpedon to his eternal sleep.

The Bible in the Middle Ages

In the biblical tradition, sleep is rarely personified, but dreams bear great significance as prophetic moments, or as the means of connection between the divine and the earthly realms. Thus, occasions arise in art not to depict images that are “dream-like,” or that one may imagine represent the artists’ dreams, but that, rather, explicitly represent dreams as described in the text of the bible. Most often, these depictions include the dreamer, with the dream itself in a realm slightly above and beyond. In both Jewish and Christian art from late antiquity through the Renaissance, the biblical dreams of the Patriarchs Jacob and Joseph, the Egyptian Pharaoh, and of King Nebuchadnezzar are favorite subjects for depiction. The New Testament and, particularly, its apocrypha introduce the subjects of the dreams of Joseph the husband of Mary, those of Three Magi, and that of Pilate’s wife. The dreams are depicted sometimes simply, sometimes with elaboration, but the fact that the viewer recognizes that these are crucial prophetic turning points in the story make them ever powerful.

While many of the illustrations, illuminations, and carvings depicting these subjects are anonymous, biblical and apocryphal dreams were treated by artists known to history, such as Simone dei Crocifissi (1330–1399), whose “Dream of the Virgin” heralded an interest in this topos in Italian painting of the fourteenth century, and Piero Della Francesca’s (1415–1492) quiet and lyrical depiction of *Constantine’s Dream* as part of the fresco cycle of the *Legend of the True Cross* in the Church of San Francesco in Arezzo, Italy (c. 1457–1458). Night scenes are notoriously difficult to depict, yet the artists, through the simple devices of positioning and composition, manage to convey a supernal and pervasive sense of quietness, calm, and sacred anticipation.

Saints and Holy People, East and West

Depictions of prophetic dreams or dreams that advance the narrative of a sacred tale or myth are not limited to the biblical realm—saints and holy people of all religious traditions are depicted in art. Vittore Carpaccio’s (c. 1455–c. 1525) lyrical *Dream of St. Ursula* (Italy, early sixteenth century) is devoted mostly to a depiction of the saint asleep in bed, with a rather self-effacing angel as the only evidence that we are witnessing a dream. Again, a modesty, a sense of calm permeates the composition. In Asian art, one can view depictions of the dream of Maya, the Buddha’s future mother, in which, wakeful, she sees the white elephant that symbolizes her son’s birth. The Indian *Bhagavata Purana* of the nineteenth century describes a spontaneous out-of-body experience, a dream flight by a

woman named Usha, from which she returned with verifiable information. Her flight is depicted in illuminated manuscripts with a jewel-like clarity that parallels the clarity of her vision. And in Muslim iconography, Muhammad’s nighttime conversations with the angel Gabriel show the prophet awake but in his bed, engaged in a rather static conversation (Iran, fifteenth century). By way of contrast, the beautiful iconography of the famous *Night Journey* tends to show Muhammad in action—on his mount al-Buraq, speeding through the clouds and accompanied by angels and celestial beings.

While we like to think of dreams as spontaneous, it has long been known that they can be incubated or induced, and from antiquity through the modern period, sacred sites were used as loci of incubation. In the East and in the West, temples and churches dedicated to various deities and saints were places whose architecture and geographical disposition were believed to be conducive to dream incubation, and where believers retreated, prepared themselves, and received their visionary experiences. The total environment of these places—as enhanced by art, among other factors—was key in terms of the potential success of the visionary process.

And when dreams do come, they could advocate reconsideration of even those aspects of the culture most taken for granted—the appearance of the gods. Like the dream that gave birth to the sphinx, dreams can often be the cause of the creation of new iconography or the alteration of existing iconographic conventions, as they represent the direct intervention of the higher powers through the realm of vision. Although part of a strictly aniconic culture when it came to the depiction of the deity, the visions of the prophets Isaiah and Ezekiel, though both glimpses of the God of Israel, presented radically different “images” of that imageless deity that influenced the way those in the West envision God. Likewise, Kan Hiu, a Chinese Buddhist monk who was also a painter and a poet in the late ninth and early tenth century, was able to radically change conventional portrayals of the Buddhist saints through the inspiration of dreams. The way in which he envisioned these people was sometimes at odds with historical tradition as transmitted by the mainstream, but his vision was so compelling that the tradition changed to accommodate it. And in the same way, the visions of St. Bridget of Sweden (c. 1303–1373) completely altered the view of the Nativity for Christianity. The snowy landscape, the broken manger, the many details of the story as it is commonly depicted are responses to her dream.

Finally, inspiration and even instruction in art is attributed to dreams. William Blake (1757–1827) claimed he was instructed in painting by a spirit who appeared in his dreams in the form of a man, and whom he depicted in a lost sketch (copied, fortunately, by a friend around 1819).

Native and Tribal Societies

The dream as a time out of time, depicted from the perspective of a soul out of body, is an important topos in native and tribal cultures. The native peoples of what is now Australia imagined the Dreamtime—an era in which humans and nature came to be as they are now. They created *churinga*, magical depictions, tracings, or maps of Dreamtime events seen

from the point of view of the spiritual essence of the individual, that part of the self that exists outside of time. These are similar to maps made by shamans in a number of cultures—both in the northern and southern hemispheres and over the historical *longue durée*—depicting their dream journeys.

In native and tribal society, the active dream—the one that the dreamer calls down upon him or herself and in which he or she is a conscious participant—is an important factor in religious and spiritual life, and art and adornment help create the atmosphere in which such dreams may be invoked. An Arapaho dress, made in Oklahoma around 1890, situates the dreamer at the conjunction of various symbols that make it clear that she is on the threshold between light and darkness, between the spirit and the material worlds.

Iroquois people danced in cornhusk masks in order to help recall forgotten dreams, since these were believed to be windows on the soul. The masks, with their hungry, haunted, and longing looks, were meant to symbolize the psychological state of the dreamers seeking to remember their dream-desires and enact them in order to fulfill the hunger of their souls.

Dreams as Symbolic and Spiritual

Sleep and dreams in art can also take on symbolic and what one would term psychological valences, what would have been called at the times and places of the creation of the art stages or stations in the spiritual journey. The story of the *Seven Sleepers of Ephesus* was current in the sixth century and remained popular in both East and West throughout the Middle Ages. Paintings of this theme based in the Sufi tradition depict the seven sleepers as seven stages of human personality and its awakening into full development. Likewise, in some Arab and Muslim traditions, five sleeping, dreaming, and waking figures may represent the five organs of spiritual perception into the care of which one is delivered after regaining consciousness in sleep. The dream as a nexus for the quest for love and knowledge is vividly illustrated in the *Hypnerotomachia Poliphili* (1499), an erudite, enigmatic, and beautifully illustrated example of the book arts of the Renaissance that depicts the dream of the protagonist Poliphilo in his quest for his beloved Polia (Greek for “many things”). And the waking of the self from the dream is drawn in parallel with the alchemical process of the refinement of metals in the woodcuts of Giovanni Battista Nazari’s (1533–1599) *Della Transmutazione Metallica, sogni tre* (Brescia, 1599).

Dreams and the Visionary: Fifteenth to Eighteenth Centuries

The late medieval and early modern periods saw the triumph of the visionary in art. While not illustrations of dreams or dreamers per se, the work of this period, including the phantasms of Hieronymous Bosch (c. 1450–1516), Pieter Bruegel the Elder (c. 1525–1569), and others, first in large-scale commissions and later in more popular prints, brought the realm of the dream-like and highly imaginative to a growing audience, taking the visionary beyond the confines of the physical building of the church, and into the street. Popular series, some anonymous, some attributable to artists like Jean Duvet

(1485–1561), include prints illustrating visions of heaven and hell and of the apocalypse.

The rise of popular interest in the natural world—particularly in alchemy—gave rise to a host of fantastic images in alchemical works of the seventeenth century illustrated by Theodor de Bry (1528–1598) and others. Baroque art transformed the quotidian into the phantasmagoric, and as such, can also be viewed as dreamlike in its elaboration and imaginative ornamentation. But however dreamlike the imagery, less emphasis is ultimately placed in this period on dreams and the dreamer—on imaginative phenomena occurring outside the range of perceivable reality and nature—and more attention is devoted to the overriding interest in the ingenious exposition of the natural in fanciful ways.

Psychoanalysis, the Dream, and Art in the Nineteenth and Twentieth Centuries

The nineteenth century heralded a revolution in the understanding of the dream, with Sigmund Freud (1836–1939) and Carl Jung (1875–1961) engaging very different interpretations of what both agreed was a phenomenon highly significant for the understanding of the farthest reaches of the human subconscious. Freud argued that dreams revealed the most occluded aspects of the individual unconscious, particularly the realm of sublimated sexual desire, the universal constant of the human condition. Jung saw the dream as tapping into the universal consciousness of humankind, and containing symbols that permeate all human cultures, ultimately uniting humans in what he argued was a more elevated universal and common bond than Freud’s lowest common denominator. Art since the nineteenth century has blended these two currents, with most manifestations depicting the dream experience from the perspective of the individual (one sees the dream but not the dreamer), displaying a pervasive sexuality (whether implicit or explicit), and drawing upon the rich symbolic treasury of the entire history of world art. Consciousness of the importance of the dream experience for and in art has resulted in the creation of dream realms that are awe-inspiring, fascinating, and quite often frightening. Salvador Dali (1904–1989) and René Magritte (1898–1967) both play with the idea of the elasticity of time and perspective in the dream, while Giorgio De Chirico’s (1888–1978) dreamscapes have to do with the bending of space. Paul Delvaux’s (1897–1994) dreamlike scenes are simultaneously sexual and menacing, whereas Marc Chagall’s (1887–1985) work is playful, blending the quotidian and the bizarre in a lush, colorful, and romantic synthesis that is instantly recognizable as “dreamlike.” Max Ernst’s (1891–1976) overlapping and repeated images—recognizable, yet juxtaposed incongruously, Paul Klee’s (1879–1940) often extremely playful and “light” images that yet conceal a highly intellectual subtext, Rousseau’s lush forests and spare deserts of the imagination, and the elemental power of Constantin Brancusi’s (1876–1957) visions of flight (a common element in dreams) are but a few manifestations of the dream in twentieth century art.

The dream is a particularly widespread theme in film and photography. From Edwin Porter’s (1869–1941) early short films, notably *An Artist’s Dream* (1900) and *Dream of a Rarebit*

Fiend (1906), to the dream sequence in Alfred Hitchcock's (1899–1980) *Vertigo* (1958), Akira Kurosawa's (1910–1998) *Dreams* (1990), and the vivid dream landscapes of Ingmar Bergman's (b. 1918) *Wild Strawberries* (1957) and Federico Fellini's (1920–1993) *8 1/2* (1963), the very nature of film has proved fertile ground for the exposition of dreams through the varying lenses of each director. The deceptive realism of film provides an excellent foil for the recounting of dreams through the eyes of the dreamer.

Contemporary Art

Contemporary art is so much enamored of the idea of the dream that one would be hard-pressed to name an artist in the postwar era who did not engage the subject on some level. The work or stages in the work of some artists revolves around dreams. African and African-American artists such as Olu Amoda (b. 1959), in his *Window of Dreams* (1991), and Jacob Lawrence (1917–2000), with his *Dreams #2* (1965), have engaged the dream as a metaphor in particularly poignant and affecting ways.

Though photography is a static medium, it is like film in that it is self-conscious about giving the appearance of replicating reality while never actually and completely doing so. Jerry Uelsman's (b. 1934) untitled images with dream themes owe their sensibility to the painted dreamscapes of the nineteenth century, while works like Ralph Gibson's (b. 1939) *Sonambulist Series* (1968), with its creepy hand reaching out of a doorway, draw on the fearful depths of human consciousness, known to the ancients, filtered through Freud and Jung, and always lurking under the surface.

Yet the dark and menacing vision, as eternal and pervasive as it is, is matched by an equally pervasive transcendent mythic consciousness. Contemporary photographers Suzanne Scherer (b. 1964) and Pavel Ouporov (b. 1966), in their preoccupation with the dream, draw on such mythic archetypes as a dream maze replete with minotaur, and an Icarus-like flying dreamer, a topos they share with contemporary artists, notably Jonathan Borofsky (b. 1942) in his series titled *I dreamed I could fly*. . . . These works articulate and draw upon common dream themes in all times and places, from Muhammad's flight to Usha's, to the launching of the very universe from Krishna's dream.

See also *Consciousness; Mind; Psychoanalysis; Surrealism*.

BIBLIOGRAPHY

- Bergson, Henri. *Dreams*. Translated with an introduction by Edwin E. Slosson. London: Unwin, 1914.
- Campbell, Joseph, ed. *Myths, Dreams, and Religion*. New York: Dutton, 1970.
- Coxhead, David, and Susan Hiller. *Dreams: Visions of the Night*. London: Thames and Hudson, 1976.
- Devereux, George, ed. *Psychoanalysis and the Occult*. New York: International Universities Press, 1973.
- Freud, Sigmund. *On Dreams*. Vols. 4 and 5. Translated from the German under the general editorship of James Strachey. London: Hogarth Press, 1953. The standard edition of the complete psychological works of Sigmund Freud.
- Gamwell, Lynn, ed. *Dreams 1900–2000: Science, Art, and the Unconscious Mind*. Ithaca, N.Y.: Cornell University Press, 2000.

Jung, Carl Gustav. *Dreams*. Translated by R. F. C. Hull. Princeton, N.J.: Princeton University Press, 1974.

Marc Michael Epstein

DRESS. Since the 1980s new generations of academics, collectors, curators, and enthusiasts have discovered the value of the study of dress as an analytical research tool through which to examine aspects of social and economic history, material culture, cultural and gender studies, art history, anthropology, and sociology. As a consequence, the study of the history of dress has been transformed from its marginalized place of professional connoisseurship and amateur enthusiasms to become a firmly established academic and museum-based subject.

In the world of ethnography, a reconsideration of the cultural significance of clothing coupled with a rejection of old imperial approaches to ethnographical artifacts has revolutionized the field. In the early twenty-first century ethnographical museums have reconfigured their collections and displays, creating “living culture” exhibitions. These, as Michael Ross and Reg Crowshoe insist, must “see the world through another’s eyes” and must ensure that “respect [is] given to another world view” (p. 240). Many ethnographical museums are also faced with serious questioning about their right to hold on to artifacts that are specifically sacred to their communities of origin, who now demand their return.

The study of dress, especially European-American fashionable dress, has long had to deal with accusations, usually from male academics, that the entire subject is a frivolous, female, trivial interest. However, the use of material culture and history of consumption debates have finally overwhelmed these prejudices. Material culture approaches stem from the premise that all goods carry a weight of cultural meanings that can be specifically “read” through object-based and consumption analysis. Anne Smart Martin states that “material objects matter because they are complex, symbolic bundles of social, cultural and individual meanings fused onto something we can touch, see and own” (p. 142).

Even when the clothes themselves have gone, their shadows survive through archives such as diaries and family accounts. Amanda Vickery studied the dress of Mrs. Elizabeth Shackleton, a well-off textile merchant’s widow from the north of England, through a set of surviving personal papers dating from 1762 to 1781. Vickery concludes that Mrs. Shackleton used her clothing to identify her exact place in her gentry/merchant-class community. She did this by simplifying aristocratic style, consuming fashion with care and consideration, and altering her favorite clothes. Vickery shows that some clothes became so important to Shackleton in terms of family memory that they acquired talismanic characteristics. Vickery declares finally that her study of Mrs. Shackleton indicates significantly that women were highly responsible managers of “daily household consumption” (1993, p. 274) and far from frivolous spenders.

In 1998, Christopher Breward usefully outlined dress research developed from cultural and media studies. He noted

a new interest in dress within social anthropology and semiotics, for example, citing approaches by Ferdinand de Saussure and Roland Barthes as offering “cultural signifying systems, allowing the scholar to examine the social specificity of representations and their meaning across different cultural practices” (p. 306). Such dress-related representations include issues of behavior, the construction of appearance, the political question of identities (race, gender, and sexuality), subcultures, and semiotic interpretations of dress in films, literature, and magazines.

Caroline Evans discusses punk dress (with its patched-together use of schoolgirl uniform, bondage dress, and aggressive hair styling) as epitomizing a set of signs whose meaning is changed “through being jumbled up, re-ordered and re-contextualised next to other signs” (1997, p. 107). Fred Davis, in *Fashion, Culture, and Identity* (1992), also examined clothing as a nonverbal means of communicating social identity, “as this is framed by cultural values bearing on gender, sexuality, social status, age, etc.” (p. 191). In refuting the trickle-down style-diffusion theory, he concludes that there are two fashion systems at play at the turn of the millennium, the globalized world of mass, commodified, international fashion and the “veritable cacophony of local, sometimes exceedingly transient, dress tendencies and styles each attached, however loosely, to its own particularity, be it a subculture, an age grade, a political persuasion an ethnic identity” (p. 206).

Feminist approaches. Vickery, Jane Gaines, and Elizabeth Wilson have argued that feminist consumption analysis of the 1970s all too easily accepted a male view that women’s interest in dress was frivolous and that women had indeed allowed themselves to become “the gilding of the patriarchal cage,” on display for male pleasure (Vickery, 1998, p. 274). Wilson comments how strange it is that “when so much else has changed there still exists such a strong hostility to fashion amongst so many radicals” (p. 28). She proposes that feminists should accept “fashion as a legitimate and highly aesthetic pleasure,” (p. 33), a view shared by Caroline Evans and Minna Thornton, who wrote in 1989 that fashion “is a field in which women have found pleasure in the elaboration of meaning—meaning which is there to be taken and used” (p. xv).

Analysis of male dress. A new development in the 1990s, building on Farid Chenoune’s innovative *History of Men’s Fashions* (1993), has been the emergence of new critical examinations of menswear. This differs from the subcultural focus of Dick Hebdige in that it looks at a far wider social range of male clothing. Christopher Breward, Frank Mort, and John Tosh focus on the late nineteenth and twentieth centuries rather than on earlier periods. Their studies investigate not only the style, retailing, and consumption of men’s clothing, but also the cultural processes surrounding the construction of masculinity and they provide, for the first time, an analysis of gay culture and its impact on mainstream dressing.

Thus, the whole field of dress history and dress studies has undergone a dynamic transformation since the 1980s, though it is useful to remember Patricia Cunningham’s warning of 1988 that dress historians should not “follow other approaches

blindly, but rather let our own questions and materials lead us to new approaches” (p. 79).

Constructions of Beauty: Sexuality and Issues of Gendered Dress

Classical Greek art, including dress, has formed the basis of constructions of ideals of male and female bodily and facial beauty in the Western world, as witnessed by the continuing rereferencing of images such as the charioteer of Delphi, a bronze, life-size, votive statue from the Apollo Sanctuary, Delphi, dating from 475 B.C.E., at the end of the early classical period. In her study *Fabrics of Vision: Dress and Drapery in Painting* (2002) Anne Hollander notes that the cutting and shaping of cloth was unknown in ancient Greece. Rather “the beauty of clothing dwelt in the distinction of its woven fabric and the elegance or aptness with which it was draped around the individual body” (pp. 13–14). Typically, the charioteer of Delphi wears a long, simple, Ionic tunic held in place with cords over the shoulders that tie at the front waist. This system frees the arms and allows drapery to fall over the waist and then straight down to the ankles. Hollander notes that “the life likeness in carved Greek clothes and bodies has often produced perfection—a stylization of natural appearances so subtle as to seem absent” (pp. 13–14).

This classical draped perfection has been continually reworked within European-American dress design, nearly always in white fabric, and usually with a high waist. It was most famously appropriated as the symbol of freedom and equality during the French Revolution. Originating in the 1770s anti-establishment, neoclassical paintings of Jacques-Louis David, the style was adopted for use by women in French revolutionary festivals in the period from 1790 to 1795 and became, in modified fashion form, the fashionable attire of European and American women from 1800 until about 1825, when the high waist was abandoned. The next revivals came out of the English arts and crafts and aesthetic movements in the period from 1878 to 1910, favored by progressive, antifashion dressers. This reflected the very same search for natural feminine perfection at a time when the shape of fashionable women was distorted and restricted by corsets and bustles. The search was repeated again by Mariano Fortuny, who famously created his own “Delphos” dresses in finely pleated, plain-colored silk, modeled exactly on the tunic of the charioteer of Delphi. Fortuny produced these from his Venetian palazzo from 1910 until his death in 1949. They were worn by a group of progressive women, in defiance of the fashion of their time. Paris couturiers too, however, have famously reworked classical Greek drapery into the height of seasonal fashion, including Madeleine Vionnet, from about 1918 into the 1930s; Alix, also known as Madame Grés, through the 1930s and 1950s; and since the 1980s, John Galliano.

Maori culture. The ethnographer Dorota Starzecka confirms that among the Maori of New Zealand, ideals of beauty, fashion, and glamour, and concern over creating a strong “visual impact” were traditionally embedded in the cultural practices of both men and women. “Even the most mundane dress or humble ornament was aesthetically pleasing or tasteful; the most successful fashion statement implied



Maori warrior in traditional dress, c. 1840–1940. In Maori culture, great emphasis is placed on appearance, and garments for all purposes—ceremonial or everyday—are chosen to make the most pleasing visual impact. © SEAN SEXTON COLLECTION/CORBIS

harmony of function, texture and design as well as glamour” (p. 45).

Starzecka, quoting Margaret Mead, notes that a Maori man “anxious to follow the fashion to its highest level would need to dress his hair into a top knot with greenstone pendants and white feathers hanging from his ears; have the rei puta [pendants carved from the teeth of sperm whales] suspended from his neck, have a dogskin cloak around his body” as well as “elaborate indelible tattoo designs over his face and forehead, and over his buttocks and thighs.” (p. 39).

Starzecka describes the *moko*, or tattoo, as a fashion, albeit with mythic origins, a sacred practice, which came to New Zealand “as part of the cultural template from Eastern Polynesia. . . . With this elaborate and tastefully designed array of jewelry and other ornaments, including the permanently inscribed indigo-black patterning of the *moko*, the Maori were acutely conscious of personal appearance” (pp. 39–40).

China. In Europe and America trousers were gendered as masculine until women very gradually, through progressive dress movements, encroached on this ownership little by little from the mid-nineteenth century. In China, however, trousers were

worn by both sexes, especially among the rural peasantry. Made in blue cotton dyed with indigo and worn with simple matching jackets, this style can be seen in eighteenth- and nineteenth-century travelers’ drawings of the Chinese peasantry.

When Chairman Mao sought to represent sartorially a uniformed image of his evolution from the late 1940s, he selected the same indigo-dyed trousers and jackets for civilian use and the entire population had to wear versions of this work uniform (*zhifu*). Women’s patriotic trousered suits (*aiguo ni*), however, had “different styles of shirt and jacket to choose from, primarily distinguished by the detailing of the collar” and the shortness of the jackets (Roberts, p. 23). However, Claire Roberts notes that these differences were so slight that they “may have appeared the same to Western eyes” (p. 22). Despite the shift in political ideology and lifting of harsh dress regulations after Mao’s death in 1976, similar styles continued into the new millennium; in the early twenty-first century many ordinary women in China still wear plain trousers and jackets, though Chinese-made jeans often replace Communist-style trousers.

Clothing as a Powerful Container of National and Community Identity

Studies in clothing, as shown in Eileen Hooper-Greenhill’s discussion of the return of a Ghost Dance shirt from Glasgow to



Two young Chinese women wearing silk tunics and pants, c. 1900, southern China. While in the cultures of many countries trousers are regarded as a distinctly masculine form of attire, in China they have been part of women’s wardrobe for centuries. © MICHAEL MASLAN HISTORIC PHOTOGRAPHS/CORBIS



Lakota Sioux Ghost Dance shirt, c. 1890. In some cultures, certain garments possess great sacred or spiritual importance, such as the Ghost Dance shirt, which the Sioux believed would protect the wearer from harm. MUSEUM OF THE SOUTH DAKOTA STATE HISTORICAL SOCIETY, PIERRE, SOUTH DAKOTA

the Lakota Sioux, confirm that dress can carry a profound talismanic weight of sacred meaning, related to the specific religious practices of their community of origin. In the late twentieth and early twenty-first centuries, museums that contained such examples, either looted by conquering and occupying forces or collected by missionaries, anthropologists, or traders, found themselves at the center of demands for their return.

The clash here lies between old imperialist museum approaches and the determination of communities to be respected as living cultures on their own terms. Many such communities see their sacred artifacts as defiled through storage and display in museums. In 1993 the Wounded Knee Survivors Association started a campaign for the repatriation of a Ghost Dance shirt to the Cultural Heritage Center in Pierre, South Dakota. George Crager had collected this shirt after the massacre at Wounded Knee in 1890, when nearly three hundred Lakota Sioux were killed by the Seventh U.S. Cavalry. Crager sold the shirt to Kelvingrove Museum in Glasgow, Scotland, in 1892. By then he was the Lakota interpreter



A designer of Kente cloth holds the textile stamp used to make the design in the fabric hanging behind him. Bonwire, Ghana, c. 2000. Although it originated as the traditional national dress of Ghana, Kente cloth has become popular in the United States as well, where it serves as a symbol of African-American identity and of pride in the wearer's African heritage. © PENNY TWEEDIE/CORBIS

on Cody's Wild West Show, which visited the city that year. In an awful irony, among the cast were Short Bull and Kicking Bear, both survivors of the massacre.

In the 1880s, Ghost Dance shirts were the center of Sioux ceremonies and were seen as so deeply imbued with protective qualities that they offered protection to wearers against the white man's bullets. As Eileen Hooper-Greenhill explains in her study *Museums and the Interpretation of Visual Culture*, the Glasgow shirt, displayed since the 1950s, had been exposed in a large case with little explanation alongside mixed "Indian" items. Museum curators in Glasgow refused to return the shirt, suggesting that it was a fake. The Wounded Knee Survivors Association petitioned the city, arguing that, as a sacred symbol of their cultural heritage, the shirt's return home would bring healing and dignity to a community plagued with despair, alcoholism, suicide, and loss of identity. The City Council voted in favor of the shirt's return, and it was taken back to Pierre in 1999. Hooper-Greenhill comments that even if doubts over provenance remain, the sacred cultural weight of the shirt to the Lakota Sioux in the 1990s "merited serious consideration" (p. 156).

Kente cloth. Dress exhibitions and debates also question the role of dress within concepts of national identity. National dress, as Lou Taylor confirms, "bears the weight of representation of an entire nation . . . stemming from an urban, knowing, intellectualised awareness of the concept of nationhood" (p. 213). The UCLA Fowler Museum of Cultural History exhibition and book, *Wrapped in Pride: Ghanaian Kente Cloth and African American Identity* (1998), edited by the museum's director, Doran H. Ross, tracks the meanings placed on kente cloth from its "traditional" design, manufacture, and ritualized use in Ghana, including its use as national identity dress,

to its consumption in the United States, where it has become a symbol of African-American identity. Ross explains that “the strength of kente [is] in the ideas that bind it to African American life and tie it to the Motherland” (p. 194). Research shows kente-inspired design has been used to mark out specific African-American identity through use in women’s fashions, by children to mark Dr. Martin Luther King Jr.’s birthday, for kente ornaments for the African-American Kwanza holiday, and to trim academic and church robes. Ross confirms that all of this anchors this cloth specifically within African-American culture, “enabling” increasing numbers of African-Americans to relate to and buy into their African heritage.

European peasant dress. Dress in rural communities historically carries highly specific visual forms of ethnic identity because it is deeply embedded in local sociocultural tradition and practice. The design of dress is specific to each community, and clothes are worn with pride, uniting the village into one cohesive social and spiritual identity.

Peasant dress was worn in the more isolated rural communities of Europe until World War II. In Hungary, for exam-

ple, over 50 percent of the population lived in the countryside until 1940. In Poland the number was 80 percent. European peasant communities led a parallel existence alongside urban cities (Hofer and Fél, p. 56). Their land was usually owned by wealthy urban families, and their art was informed by urban style, though always on their own terms.

As well as identifying a community, the use of artifacts and festive clothing in seasonal, religious, and life-cycle ceremonies was so central to community belief systems that Tamás Hofer and Edit Fél state that they “represent intentions, emotions and they solemnize human relationships and sanctify them” (Csillery, Fél, and Hofer, p. 3). Every step of a villager’s life cycle (birth, courtship, marriage, and death) was celebrated by the entire community, following long-established rules that involved specific use of clothing, which represented their social and spiritual strength and unity.

Among the Matyó people of Mezőkövesd, for example, if “a woman died young, her best clothes—followed her into the grave,” while “a man’s shroud was made from the loose sleeves of the shirt he had worn as a bridegroom” (Csillery, Fél, and Hofer, p. 23). Even though Mezőkövesd was poor, interest in



Hungarian peasants in native dress, Mezőkövesd, c. 1950. In many rural societies, clothing reflects the historical traditions and ethnic identity of the members. These garments may be worn primarily for special occasions or on an everyday basis. © HULTON-DEUTSCH COLLECTION/CORBIS



Madame de Pompadour (1763–1764) by François-Hubert Drouais. Oil on canvas. During the eighteenth century, France was the fashion center of the world. Louis XV's mistress, Madame de Pompadour, introduced many new style innovations to the court. © NATIONAL GALLERY COLLECTION; BY KIND PERMISSION OF THE TRUSTEES OF THE NATIONAL GALLERY, LONDON/CORBIS

clothing was so strong that it was a “leading inspiration of peasant taste and style for surrounded area from the 1870s” (p. 50) because both men’s and women’s clothes were a riot of proudly flaunted decoration and color. Such clothes were central expressions of ethnic identity and reflected a community’s “struggle, sacrifice and joy” (p. 60).

Issues of European-American Fashion Development and Consumption

Paris became the provider of modern, elegant, and costly fashions for royal and aristocratic wear across Europe beginning in the late seventeenth century. Louis XIV established his personal image as *le Roi Soleil* (Sun King) by creating at his palace of Versailles a luxury world entirely devoted to his glorification. Key to this was the appearance of his court and especially the clothing of his courtiers. All encouragement was given to the development of a new silk-weaving industry in the city of Lyon to provide luxury fashion fabrics for the court. Thus, from the early eighteenth century Lyon became the center for the design and manufacture of the most desired fashion silks, which were worn at every European royal court. Paris itself be-



Young girl wearing mourning dress consisting of corseted dress with pleated skirt and ruffled neckline and cuffs, c. 1875. British mourning dresses helped usher in a ready-to-wear fashion market to the middle class. Prior to this most clothing was individually ordered and tailored to meet the specific needs of the purchaser, rather than mass-marketed to retail stores. © HULTON-DEUTSCH COLLECTION/CORBIS

came the center for the retailing of dress and fashion accessories. This successful Paris/Lyon commercial twinning led to the development of the Paris haute couture industry by the late nineteenth century. Through this, Paris held its place as the creator and arbiter of European-American fashion right through to the 1960s, a period of over 350 years. Paris remains the most famous center for the display of fashion, though its designers come from all over the world and are rivaled by those in New London, Milan, Tokyo, and London.

In the eighteenth century, court dressmakers and their urban and aristocratic clients were the originators of new styles. Aileen Ribeiro emphasizes the centrality of the creative fashion role of the *marchands des modes* in Paris, who “supplied and arranged” all the fancy trimmings on women’s dress (p. 68). In 1745, Madame de Pompadour became mistress to Louis XV and, as Ribeiro shows in her study *Dress in Eighteenth-Century Europe*, “her fashion sense was dominant for the next decade; she summed up the elegance of the Rococo” (p. 136). Interestingly, Colin Jones (2002) confirms that Paris, rather than Versailles, set the fashions; Madame de Pompadour “shopped

on the Rue St. Honoré and spurred the court to follow the city fashions, rather than rely on the city aping the court” (p. 153).

Britain. In Britain, nineteenth-century mourning dress can be seen as an example of the social control of women through etiquette, but also as an example of the development of a middle-class fashion market, through ready-to-wear manufacture, department store retailing, and advertising. Social pressures to enact every last detail of the three stages of mourning dress were so intense that between 1850 and 1900, no woman who sought any kind of public respectability and community approbation for her family dared defy the rules. Thus sales in dull black silk mourning crape, white widows’ caps, black woolen bombazine, and ready-made widows’ weeds flourished until the ghastly death toll of World War I eroded the pressures and etiquette regulations.

Globalization of Fashion

Since the 1980s and the growth of the global economy, there has been massive growth in what Joanne Eicher has termed “world fashion” (p. 300). At the start of the twenty-first century, the preferred garments of young people of both sexes from around the world tend to be jeans, sweatshirts, T-shirts, and sneakers. These clothes are also international icons of American culture. The global young wear the same clothing, a phenomenon made possible by the exploitative mechanisms of the globalization of clothing manufacture, distribution, and retailing and by new technologies, global commodity advertising of branded leisure clothing, and the cultural and political domination of the United States. The reasons for wearing such clothing vary, but these clothes signify youth, modernity, and an eagerness to belong to the newly globalized capitalist world.

Dress as the Image of the Cutting Edge

In the period from 1964 to 1970, styles of dress worn by young women in Britain were the most famous visible representation of the “teenage revolution” and of the cutting edge of cultural modernity. Miniskirts exposed thighs to public view for the first time in European-American fashion history. These changes were rooted in the major social and cultural upheavals of the late 1950s, generated, as Tony Bennett explains, by “a watershed around which a series of significant “before” and “after” contrasts can be drawn” (p. 7). Young, radical filmmakers, painters, writers, photographers, and designers then successfully challenged the British establishment’s hold on cultural power. Many who came from working-class backgrounds were helped into university and art-school education by postwar state grants to cover fees and living costs.

The London couture trade ignored these developments, maintaining their prewar function of creating elegant clothing for the annual high society calendar. The fashionable age in 1955 was around thirty-five but could easily be fifty-five if a woman kept a slim figure. By 1965 the fashionable age was sixteen, a near twenty-year drop in ten years.

Countercultural groups and their dress. This fashion shift was created by the young on their own terms. Angela Carter, a radical feminist writer and anti-Vietnam War ac-

tivist, felt that “one was living on the edge of the unimaginable; there was a constant sense of fear and excitement” (p. 211). Young countercultural dressers from the late 1950s wore clothing appropriated from workers’ clothing and army-surplus store outlets. “Ban the Bomb” campaigners and art students (the women often with long loose hair and the men with beards) wore fishermen’s pullovers, road-menders’ jackets, and ex-Naval duffel coats, in an effort to defy existing barriers of gender, class, and occupation. At about the same time, the subcultural, androgynous Mods focused their attention on modern jazz and on acquiring motor scooters, drugs, and neat expensive suits and short smart hair cuts. It was a tidy “look,” originally male, but one that belied an “alternative” fascination with drugs and hard partying after the end of the working day.

It was a fusion of these styles and interests that by 1964–1965 evolved into the hard-edged bright “look” of London fashion and propelled the bold, colorful geometrics of Pop and Op art. By the late 1960s however a far more exotic, ethnic, and historical revival of styles, largely drawn from the hippie culture of the West Coast of the United States became commonplace in both alternative and mainstream fashion circles.

In Britain, state art colleges were the central catalyst for the blossoming of radical fashion, producing key designers such as



Twiggy models a dress in London, 1966. During the 1960s, British fashion began to showcase youthful, eye-catching designs that featured short skirts and bold colors. Also popular was the hippie look, imported from the United States. © BETTMANN/CORBIS

Mary Quant, Ossie Clarke, and Barbara Hulanicki of Biba. As the most directional British style creator of the mid-1960s, Mary Quant's work cannot be underestimated. Always more interested in creating a whole "look," her innovative, simple clothes (with colored stockings and flat shoes appropriated from art-college, countercultural dress) were retailed at mid-market price levels. These designers threw out centuries of British upper-class clothing etiquette and nearly destroyed the London couture industry in the process.

The contrast with Paris could not be greater. There, the couture houses themselves produced a new generation of dynamic designers, such as Paco Rabanne, whose metal/plastic disc minidresses were not only more radical than London designs but also, crucially, helped keep Paris couture alive because of their direct appeal to the young.

Yoruba fashion, Nigeria. Through the 1990s the academic study of fashionable dress began to reject its Eurocentric focus and a long-held view, as Joanne Eicher comments, that "dress outside the boundaries of western civilization has experienced little change and is therefore traditional" (p. 4). Acknowledgement has finally been made that the term *fashion* applies as equally to dress designed, manufactured, and consumed, for example, in Lagos, Dakar, Rajasthan, and Chiang Mai as in Paris, London, and Milan.

One of the most useful texts is *Cloth, Dress, and Art Patronage in Africa* (1999), by Judith Perani and Norma H. Wolff. This details the design, manufacture, and consumption of contemporary Yoruba strip-weave *aso-oke* cloth, which forms the basis of fashionable women's Yoruba dress in Nigeria. Made up into wrapper, blouse, and head tie, a competitive fashion in the late twentieth century was "shine-shine" lace cloth woven from specially imported Japanese, synthetic, gold, filament yarn.

Perani and Wolff explain that "shine-shine" cloth, made on narrow, traditional Yoruba strip-weave looms by male weavers, "has been adopted by wealthy urbanites as a visible symbol of prosperity, status and pride in ethnic heritage." They show that the weavers "have their fingers on the pulse of fashion through on-going interaction with their elite consumer-patrons" (pp. 171–172). Because of the flexibility of these craft processes, the weavers can alter the design of these fabrics rapidly, in keeping with fashion shifts. As Perani and Wolff make clear, none of this bears any relationship whatsoever to elite levels of European-American "designer" dress, except through the same constant search for design modernity and newness.

Designer fashion in the twenty-first century. The world of couture has always responded to the zeitgeist of its times, as much in the twenty-first century as in Madame de Pompadour's day. In the twenty-first century's fascination with brand labels as symbols of modernity and "cool," the top designer fashion trade now serves as the glamorous front for the billion-dollar global marketing of designer-branded products of every kind. This mass retailing of branded fashion accessories, cosmetics, and perfume is built on near-mystical, magical designer images of beauty and celebrity, seen in glossy advertisements, on catwalks at the Academy Awards, and in



Japanese youth wearing American T-shirt, Tokyo, 1991.

The global mass-marketing of fashion has frequently resulted in a demand for popular designer brands that is not limited to any certain culture, race, or gender. © CATHERINE KARNOW/CORBIS

much-reported fashion shows. With only a few thousand clients personally buying couture, designers are given free reign to create. All involved—particularly the two major fashion conglomerates, of Moët Hennessy Louis Vuitton (also known as the LVMH group, which owns the salons of Givenchy, Christian Dior, Louis Vuitton, Marc Jacobs International, Kenzo, Christian Lacroix) and Pierre Bergé, owner of Yves St. Laurent, and of Gucci (which in the early 2000s owned majority holdings in the companies of Alexander McQueen and Stella McCartney)—recognize the central need for brand images to be "individual," seductive, and at the cutting edge of modernity. John Galliano's London sense of extreme, romantic, youthful modernity has, for example, been successfully appropriated in Paris, transforming the international image and bank balance of the house of Dior.

Weaving in and around this world are the conceptual designers, such as Martin Margiela, Rei Kawakubo of Comme des Garçons, and Hussein Chalayan. Defined as designers who are more interested in the ideas behind their designs than in commercial viability, all of these produce both commercial and conceptual collections. Some, such as Alexander McQueen, fuse both approaches successfully into one. Caroline Evans in



Alexander McQueen's "What a Merry-Go-Round" fashion show. By the twenty-first century, much of the emphasis of fashion began to center on spectacle and image, as seen in McQueen's 2001–2002 collection. AP/WIDE WORLD PHOTOS

her seminal study *Fashion at the Edge* (2003), argues that from the 1990s avant-garde fashion design has reflected “the dark and deathly side” of consumer capitalism (p. 37). She notes the deliberate creation of “spoiled work that reflects a spoiled world” (p. 307), spoiled by deconstruction, remaking, cutting, slashing, damaging, even despoiling with mould and bacteria as in Margeila’s exhibition work in the Netherlands in 1997. She describes these clothes as “apocalyptic visions” typified by notions of trauma, deathliness and haunting (p. 4). Evans sees these clothes as contemporary representations of cutting edge modernity, through their sartorial articulation of the political, cultural, social, and technological instabilities of the turn of the twenty-first century.

Evans shows how the work of Alexander McQueen illustrates many of these themes. She highlights his “What a Merry-Go-Round,” autumn-winter 2001–2002 collection, based on a circus theme, with models made up as white clowns “to produce a mournful and alienated image—rather than celebrating circus performance” (p. 102). Evans notes that this show stressed “the frightening and strange elements of the circus—and thus the darker side of modernity” (p. 102).

Conclusion

The wide range of past and present approaches to the study of clothing and fashion outlined here were well established by the early 2000s, as confirmed by their use within museum exhibitions and a full range of dress publications dealing with

historical, ethnographical, and fashion analysis. As Ann Smart Martin clearly states, all of this reflects, finally, “the shifts in intellectual feelings about the core relationships between humans, goods and society” (p. 143).

See also Body, The; Cultural Revivals; Cultural Studies; Masks; Textiles and Fiber Arts as Catalysts for Ideas.

BIBLIOGRAPHY

- Bennett, Tony, et al. *Politics, Ideology, and Popular Culture*. Milton Keynes, U.K.: Open University Press, 1982.
- Breward, Christopher. “Cultures, Identities: Fashioning a Cultural Approach to Dress.” *Fashion Theory* 2, no. 4 (December 1998): 301–313.
- Carter, Angela. “Truly It Felt Like Year One.” In *Very Heaven: Looking Back at the Sixties*, edited by Sara Maitland, 209–216. London: Virago, 1988.
- Csillery, Klára, Edit Fél, and Tamás Hofer. *Hungarian Peasant Art*. Budapest: Corvina, 1969.
- Cunningham, Patricia. “Beyond Artifact and Object Chronology.” *Dress* 14 (1988): 76–79.
- Davis, Fred. *Fashion, Culture, and Identity*. Chicago: University of Chicago Press, 1992.
- Eicher, Joanne B. *Dress and Ethnicity*. Oxford: Berg, 1995.
- Evans, Caroline. *Fashion at the Edge: Spectacle, Modernity, and Deathliness*. New Haven, Conn.: Yale University Press, 2003.
- . “Street Style: Subcultures and Subversion.” *Costume* 31 (1997): 105–110.

- Evans, Caroline, and Minna Thornton. *Women and Fashion: A New Look*. London: Quartet, 1989.
- Hitchcock, Tim, and Michèle Cohen. *English Masculinities, 1660–1800*. New York: Addison Wesley, 1999.
- Hofer, Tamás, and Edit Fél. *Hungarian Folk Art*. Translated by Mária Kresz and Bertha Gaster. New York: Oxford University Press, 1979.
- Hollander, Anne. *Fabrics of Vision: Dress and Drapery in Painting*. London: National Gallery, 2002.
- Hooper-Greenhill, Eileen. *Museums and the Interpretation of Visual Culture*. London: Routledge, 2000.
- Jones, Colin. *Madame de Pompadour: Images of a Mistress*. London: National Gallery, 2002.
- Martin, Ann Smart. "Makers, Buyers, and Users: Consumerism as a Material Culture Framework." *Winterthur Portfolio* 28, nos. 2/4 (summer/autumn 1993): 141–157.
- Mort, Frank. *Cultures and Consumption: Masculinities and Social Space in Late Twentieth-Century Britain*. London: Routledge, 1996.
- Perani, Judith, and Norma H. Wolff. *Cloth, Dress, and Art Patronage in Africa*. New York: Berg, 1999.
- Ribeiro, Aileen. *Dress in Eighteenth-Century Europe, 1715–1789*. New Haven, Conn.: Yale University Press, 2002.
- Roberts, Claire. *Evolution and Revolution: Chinese Dress, 1700s–1990s*. Sydney, Australia: Powerhouse, 1997.
- Ross, Doran H., ed. *Wrapped in Pride: Ghanaian Kente Cloth and African American Identity*. Los Angeles: UCLA Fowler Museum of Cultural History, 1998.
- Ross, Michael, and Reg Crowshoe. "Shadows and Sacred Geography: First Nations History-Making from an Alberta Perspective." In *Making Histories in Museums*, edited by G. Kavanagh, 240–256. Leicester, U.K.: Leicester University Press, 1996.
- Starzecka, Dorota. *Maori: Art and Culture*. Auckland, New Zealand: British Museum, 1996.
- Taylor, Lou. *The Study of Dress History*. London: Manchester University Press, 2002.
- Vickery, Amanda. "Women and the World of Goods: A Lancashire Consumer and Her Possessions, 1751–1781." In *Consumption and the World of Goods*, edited by John Brewer and Roy Porter, 274–301. London: Routledge, 1993.
- . *The Gentleman's Daughter: Women's Lives in Georgian England*. New Haven, Conn.: Yale University Press, 1998.
- Wilson, Elizabeth. "All the Rage." In *Fabrication: Costume and the Female Body*, edited by Jane Gaines and Charlotte Herzog. London: Routledge, 1990.

Lou Taylor

DUALISM. Dualism is a doctrine positing two equally powerful and antagonistic metaphysical principles, which are constitutive of the world and must explain our experience of the world. They are often conceived as dichotomies, such as good and evil, light and darkness, attraction and repulsion, or love and strife.

In religion, perhaps the most important early doctrine was Zoroastrianism (Persia, today's Iran, sixth century B.C.E.). Zoroaster (c. 628–c. 551 B.C.E.) himself is thought to have only authored the *Gathas*, the earliest part of the Avesta, the sacred texts of Zoroastrianism. In Zoroastrianism, the world

is the outcome of the struggle between Ormuzd, the author of good, and Ahriman, the principle of darkness and evil. For Zoroaster, the divinities of the Persian pantheon were servants of Ahriman. Man is a creation of Ormuzd, who created him to be free in his actions, and so open to the influences of evil. Man will be rewarded or punished in the afterlife for his choices. Ultimately, a final battle will be won by Ormuzd against evil.

Manes (Mani; 216–276 or 277 C.E.) developed a form of Gnosticism, subsequently called Manichaeism, which sought to fuse elements from Christianity with the dualism of Zoroastrianism. Manichaeism spread east as far as northern India and western China and west as far as France and Spain. In Manes's system, the Father of Light and his aeons, the good, are opposed by the King of Darkness, who tried to invade the former's kingdom. From this strife both the world and humans were born. Humans have seeds of light in their soul, and Jesus was sent to bring the knowledge necessary to free the light from darkness. Ultimately, darkness will be conquered. Although Manichaeism sought to include Christianity, or because it did, it was actively fought by the Christian establishment, especially St. Augustine of Hippo (354–430), who was a Manichaean in his youth. Later Christian dualistic heresies, thought to be derived from Manichaeism, include the Paulicians (Armenia, Albania, seventh–eighth century), the Bogomils (Bulgaria, tenth century) and the Cathars (Albigensians; southern France, twelfth and thirteenth centuries).

The Sankhya school is the most consistent example of Indian dualism. Founded by the legendary Kapila around the seventh century B.C.E., its earliest known text is *Isvarakrsna's Samkhya-karikas* (Stanzas of Samkhya, presumably written in the third century C.E.). The Samkhya school proffered a dualism of matter (*prakriti*) and soul or self (*purushas*). The two are originally separate; however, *purusha*, from being pure unqualified consciousness comes close to, and identifies itself with, aspects of matter as its object. Individualized, ego-based *ahankara* divides itself into the five senses, thus immersing *purusha* in the world of matter. Right knowledge consists of the ability of soul to rise above the ego and individuation and regain its distinction from matter. Samkhya ideas are mentioned in the earlier *Mahabharata* (one of the most famous Sanskrit texts, composed in a number of years; it reached its present version by 400 C.E.).

Earlier forms of dualism can be traced in ancient Egyptian religion, with the contest between Seth, disorder and sterility, and Osiris, fertility and life, that manifests itself in a cycle of murder and resurrection. Forms of dualism can be found in mythologies around the world, such as Native American myths (Chippewa, Navajo, Blackfeet), or Australian tribes. In such mythologies, ambivalent figures (such as the Native American coyote myths, the Bamapana of the Australian Murng tribe, and the Melanesian spider-god Marawa) can be present such as a demiurge or "trickster," who can either cooperate or rival the main deity and is often conceived as independent of him.

Metaphysical dualism is a philosophical system positing two basic nonreducible substances, typically matter (or body) and

spirit (or soul). Among the early Greeks, (the pre-Socratics) Anaximander (610–c. 647 B.C.E.) and, later, Heraclitus (c. 540–c. 480 B.C.E.), Empedocles (c. 490–c. 430 B.C.E.), and Anaxagoras (c. 500–c. 428 B.C.E.) all held doctrines of opposed natural substances, where the interplay of opposites is part of the developed world. Pythagoreanism, believed to have been founded by Pythagoras of Samos (c. 580–c. 500 B.C.E.), focused on opposing dyads such as one/two, male/female, and so forth. Plato's (c. 428–348 or 347 B.C.E.) metaphysics divides the world into two realms: the unchanging intelligible world of "forms" and the perceptual world of change. Human sense experience is of material things that are imperfect copies or likenesses that "participate" in the unchangeable and perfect forms (Ideas). Plato's *Republic* and *Timeus* give mythical accounts of the relationship between things and forms.

There is no true dualism in the Judeo-Christian tradition, though a subordinate metaphysical distinction is posed between God and created substances, and, derivatively, between soul and matter. God is uncreated, all-powerful, all-good, and infinite. Everything else is created and utterly dependent. Among created substances, soul or mind is not reducible to matter. Satan or the devil, while not as powerful as God, seems to have a power that God cannot control. Herein lie theological worries such as the problem of evil. This framework characterizes the Christian philosophy, especially high medieval Scholastic tradition such as St. Thomas Aquinas (c. 1224–1274), who attempted to reconcile Christianity with Aristotelian and neo-Platonic theories. With a very few exceptions (such as the thirteenth-century philosopher David of Dinant), dualism of created substances remained unchallenged until the revival of atomism, and the successes of the new science and mechanical philosophy in the seventeenth century (Galileo Galilei, Robert Boyle).

Most often, *dualism* is used to refer to Cartesian mind/body dualism. René Descartes (1596–1650), in his *Meditations on First Philosophy* (1641) and *Discourse on Method* (1637) developed a method, based on clear and distinct ideas, that he thought proved that thinking things were distinct from extended, inert material things. The exemplar of a clear and distinct idea was his "I think, therefore I am." Descartes struggled with the problem of how matter and mind, being different substances, could causally interact. Reactions to Cartesian dualism, in the eighteenth and nineteenth centuries, stressed the incoherence of causal connections between two different kinds of substance, and took the forms of idealism (George Berkeley, 1685–1753) or materialism (Julien Offroy de La Mettrie, 1709–1751) wherein dualism was eschewed in favor of a world composed only of ideas (spirit) or matter.

During the late nineteenth century an epistemological form of dualism arose, from Descartes's influence, that distinguished knowledge of the human sciences from the natural sciences. Wilhelm Dilthey (1833–1911) argued for a noncausal human science that would use a method of *verstehen* or interpretation of particular events as distinct from the causal inquiry of the natural sciences, and Edmund Husserl (1859–1938) began the school of phenomenology, wherein human science was based on introspections of one's own consciousness, made while bracketing the physical world.

Challenges to Dualism

In postmodern times (after 1968), Jacques Derrida (b. 1930) developed deconstruction. Derrida believes that Western thought was centered on binary hierarchical oppositions (dualisms). Examples were male and female, mind and body, nature and culture, object and subject, and so forth. Critical analysis should expose the dualistic assumptions that are taken as "given," and show the polarity itself to be a "construct," rather than something existing independently. To Derrida and his postmodern followers must be added the challenge from feminist epistemology and philosophy of science. Interestingly the male/female polarity had been "deconstructed" well before Derrida, in Simone de Beauvoir's (1908–1986) *The Second Sex*, where she wrote, "Thus humanity is male and man defines woman not in herself but as relative to him; she is not regarded as an autonomous being . . . She is defined and differentiated with reference to man and not he with reference to her; she is the incidental, the inessential as opposed to the essential. He is the Subject, he is the Absolute—she is the Other."

See also *Heresy and Apostasy; Manichaeism; Monism; Other, The, European Views of.*

BIBLIOGRAPHY

- Block, Ned, Güven Güzeldere, and Owen Flanagan, eds. *The Nature of Consciousness: Philosophical Debates*. Cambridge, Mass.: MIT Press, 1997.
- de Beauvoir, Simone. *The Second Sex*. Translated and edited by H. M. Parshley. New York: Knopf, 1953.
- Guttenplan, Samuel, ed. *A Companion to the Philosophy of Mind*. Oxford: Blackwell, 1994.
- Hamilton, Janet, and Bernard Hamilton, trans. and ann. *Christian Dualist Heresies in the Byzantine World, c. 650 – c. 1450: Selected Sources*. Assistance with the translation of Old Slavonic texts by Yuri Stoyanov. Manchester, U.K.: Manchester University Press, 1998.
- Lycan, William G., ed. *Mind and Cognition: An Anthology*. Malden, Mass.: Blackwell, 1999.

Peter Machamer
Francesca di Poppa

DYSTOPIA. Dystopia is utopia's polarized mirror image. While utilizing many of the same concepts as utopia—for example, social stability created by authoritarian regimentation—dystopia reads these ideas pessimistically. Dystopia angrily challenges utopia's fundamental assumption of human perfectibility, arguing that humanity's inherent flaws negate the possibility of constructing perfect societies, except for those that are perfectly hellish. Dystopias are solely fictional, presenting grim, oppressive societies—with the moralistic goal of preventing the horrors they illustrate.

A single literary work serves as the origin for both utopia and dystopia, the latter by critical examination of the social structures it presents as desirable and good. Thomas More's *Utopia* (1516) depicts a fictitious country named for Utopus, its first conqueror. Having reshaped a savage land into an ideal

society through planning and reason, King Utopus's benevolent reign fulfills Plato's ideal of the philosopher-king expressed in *The Republic* (c. 400 B.C.E.). Derived from the Greek *ou* ("not" or "no") and *topos* (place), a utopia is "no place," a land that does not exist. In addition to its social structure, utopia's pronunciation irresistibly suggests "eutopia" (*eu topos*), a "good place" free from civil conflict and social inequality—so a utopia is a good place that does not exist, but which is shown to be possible through social engineering.

By contrast, a dystopia (*dis topos*) is a "bad place," deliberately written to frighten the reader; the fact that it, too, is fictitious offers scant comfort, because it is equally possible. More's fictive land has eliminated most class distinctions, but with a concomitant loss of individual freedom and artistic creativity. John Stuart Mill used the term "dystopia" as early as 1868 (*Hansard Commons*, 12 March) but critics struggled for much of the twentieth century with such unwieldy terminology as "anti-utopia," "utopian satire," "reverse utopias, negative utopias, inverted utopias, regressive utopias, cacoutopias . . . non-utopias, satiric utopias, and . . . nasty utopias" (Lewis, p. 27), to say nothing of "George Knox's 'sour utopias in the apocalyptic mode' and George Woodcock's 'negative quasi-Utopias'" (Aldridge, p. 5). Given this confusing proliferation of generic labels, J. Max Patrick may be forgiven for believing that he created the term *dystopia* in 1952 as the appropriate categorization for Joseph Hall's 1605 *Mundus Alter et Idem* (Negley and Patrick, p. 298). Patrick unquestionably picked the winner, and *dystopia* has eclipsed these other labels as the term of choice for a burgeoning literary genre. As dystopian fiction has become more widespread and popular since the end of World War II, critics have grown comfortable in classifying dystopias based on their own generic qualities, rather than explicitly by contrasting them against utopias. The term *dystopia* has also grown more familiar and is commonly used to refer to any dark or unpleasant future. Finally, by the end of the twentieth century, critics seemed to have abandoned the effort to segregate dystopia from science fiction, the larger literary genre to which dystopia belongs.

Goals of Dystopian Fiction

Dystopia walks a fine line between evoking the sensations of fear and inducing a sense of futility. A dystopia must arouse fear, but fails if it completely overwhelms the reader, leaving no room whatsoever for hope of amelioration. Finding crumbs of hope within powerful dystopias can be difficult, but they are present: for example, both the Afterword of Margaret Atwood's *The Handmaid's Tale* (1985) and the Appendix on Newspeak in George Orwell's *Nineteen Eighty-four* (1949) are written in the past tense, obliquely informing the reader that the totalitarian regimes of Gilead and Oceania were not invincible and ultimately fell. Depictions of grim futures mask dystopia's basic optimism. Dystopia is a fundamentally didactic genre, of which the old saw "the best is the enemy of the good" is truly spoken. By proving that a completely perfect society is not possible—showing the awful results of what happens if the goal is social perfection rather than incremental social improvement—dystopia shocks the reader into accepting humanity's flaws as ineradicable and thereby working toward a better society rather than an ideal one.



Film still from *1984* (1956), directed by Michael Anderson. George Orwell's 1949 novel—later transferred to film—tells the story of a totalitarian regime that controls its population through constant governmental surveillance. Adhering to the rules of the dystopia, however, the appendix to Orwell's work suggests that the oligarchy was not sustained. COLUMBIA/THE KOBAL COLLECTION

Nineteenth-century Dystopias

The utopia reached its greatest popularity in the nineteenth century. As the proud confidence of the nineteenth century crumbled when faced with the horrors of the twentieth, the utopian impulse has faltered, and dystopia has grown to be the more vital and relevant of the two genres. Dystopia began to evolve as a separate literary genre late in the nineteenth century as writers published anti-utopian "answers" and "replies" attacking utopian works. Edward Bellamy's highly popular socialistic utopia *Looking Backward* (1888) incited such direct refutations as Richard Michaelis's *Looking Further Forward* (1890) and Conrad Wilbrandt's *Mr. East's Experiences in Mr. Bellamy's World* (1891). Other writers attacked Bellamy's utopian ideals without targeting *Looking Backward* directly, and in so doing produced much more absorbing fiction. Ignatius Donnelly's *Caesar's Column* (1890) and Jack London's *The Iron Heel* (1907) reverse the utopian dream of ideal society by creating repressive totalitarian oligarchies determined to hold power at any cost. H. G. Wells wrote on both sides of the divide. Like Bellamy, Wells attracted direct "replies" with such utopian fictions as *When the Sleeper Wakes* (1899) (revised and reprinted in 1910 as *The Sleeper Awakes*) and *A Modern Utopia* (1905), but unlike Bellamy, Wells also wrote anti-utopian fiction, including *The First Men in the Moon*



Film still from *Things to Come* (1936), directed by William Cameron Menzies. Based on H. G. Wells's novel *The Shape of Things to Come, the Ultimate Revolution* (1933), this film adaptation was one of the first to depict a dystopian society. THE KOBAL COLLECTION

(1901), *The War in the Air* (1908) and *The Shape of Things to Come, the Ultimate Revolution* (1933). Wells's influence on dystopian fiction has been more substantial than Bellamy's. Writers wishing to deconstruct Wells's assumptions of human social perfectibility aided by technological innovation (such as E. M. Forster, Yevgeny Zamyatin, Aldous Huxley, and Orwell) found it impossible to fully do so in mere parodies or refutations, so instead they wrote standalone fictions that depict the horrid, repressive societies that they believed would arise if Wells's ideas were carried to their ultimate conclusions.

Twentieth-Century Dystopias

The twentieth century itself lent strength and scope to the development of dystopian fiction, as horrific events and movements rendered the utopian ideal increasingly absurd and made it possible for dystopias to posit terrible fictive societies. The most powerful dystopias from this period firmly cemented the genre as independent from utopia and remain relevant to the present day: Yevgeny Zamyatin's *We* (1920), Aldous Huxley's *Brave New World* (1932) and George Orwell's *Nineteen Eighty-four* (1949). All three of these novels present totalitarian oligarchies (*Brave New World*, *Nineteen Eighty-four*) or dictatorships (*We*). Other dystopias appearing at this time include Wells's *The Shape of Things to Come*, one of the first dystopias

to be filmed, as *Things to Come* (1936). Writing as Murray Constantine, Katharine Burdekin published *Swastika Night*, which was based on the premise of the Nazis taking over the world, in 1937. Cyril Connolly's dystopian short story "Year Nine" appeared in 1938 and seems to prefigure some of the same approaches Orwell explored at greater length in *Nineteen Eighty-four* (although Connolly's story, unlike Orwell's novel, is mordantly funny).

At midcentury, dystopia crossed the Atlantic—or rather, reemerged in the United States nearly fifty years after Jack London's *The Iron Heel* (1907). Kurt Vonnegut's *Player Piano* (1952), Ray Bradbury's *Fahrenheit 451* (1953), David Karp's *One* (1953), and Walter Miller's *A Canticle for Leibowitz* (1959) all took the dystopia in different directions, primarily away from the focus on repressive totalitarian societies that dominates the earlier British dystopias. Bradbury's and Vonnegut's dystopias focus on the impact of the repressive culture on the individual protagonists (Montag the Fireman in *Fahrenheit 451*, Paul Proteus in *Player Piano*) rather than on the horrific sweep of the entire society; both also foreground human dependence on machines as contributing factors in the creation of repressive societies. Britain did not abandon the dystopia. While Erika Gottlieb opens her recent study with

the assertion that “[d]ystopian fiction is a post-Christian genre” (p. 3), Anthony Burgess recasts an explicitly Christian conflict in *A Clockwork Orange* (1962, filmed by Stanley Kubrick in 1971): in Alex’s struggle against state-imposed behavioral conditioning, Burgess recasts the opposing views of mankind argued in the fifth century between St. Augustine of Hippo (who held that humanity is permanently stained by original sin) and the heretical British monk Pelagius (who denied original sin and argued that humans can create perfect societies). Writ large, the utopist’s perspective is Pelagian, while the dystopist’s is Augustinian (Kumar, p. 100). Burgess went on to publish a second dystopia, which grew out of an appreciation of Orwell’s *Nineteen Eighty-four* published in that year—the first half of *1985* comments on Orwell’s fiction, while the second shows a dystopian society in which trade unions have become the rulers of England (now TUCland, after the Trade Union Council that holds all real power).

Recent Directions

Although usually set in the future, typically the near future, dystopian fictions invariably reflect the concerns and fears of the writer’s contemporaneous culture. As a given fear fades over time, dystopias founded upon it lose their ability to disturb (e.g., Burdekin’s *Swastika Night*: the possibility of a world dominated and controlled by the Nazis, powerfully affective in 1937, has lost its force since the end of World War II). The reverse is also true, in cases where reality has caught up with ideas that were once utterly fantastic. Arguably, Huxley’s *Brave New World* is a more powerful dystopia now than when published in 1932, given that genetic engineering, use of designer drugs, and relentless vapid entertainment media have evolved from fictions to facts. The shifting foci of dystopias display the changing philosophical preoccupations of the late twentieth century, revealing through grim fictions what their creators feared and wished to prevent.

Three interrelated trends have dominated dystopian fiction since the 1970s, although prefigurations of all three emerged before that time. The first is a concern over technological advances progressing beyond human ability to manage them effectively, if at all. As with the eponymous Machine in E. M. Forster’s “The Machine Stops” (1909) and the computer EPICAC in Kurt Vonnegut’s *Player Piano* (1952), several dystopias have shown societies turned horrific as people cede responsibilities to machines, or in which repressive regimes seize and hold power through deployment of advanced technologies. Harry Harrison’s *Make Room! Make Room!* (1966, filmed in 1973 as *Soylent Green*) shows an overpopulated Earth dependent on government-sanctioned cannibalism, while Philip Dick’s 1968 *Do Androids Dream of Electric Sheep?* (filmed as *Blade Runner* by Ridley Scott in 1982) questions whether an individual’s humanity inheres in biology or in behavior. In Andrew Niccol’s *Gattaca* (1997), deliberate genetic manipulation (including discrimination based on DNA) produces a population in which undesirable characteristics cannot emerge. The *Terminator* trilogy (*The Terminator*, 1984; *Terminator 2: Judgment Day*, 1991; *Terminator 3: Rise of the Machines*, 2003) shows a terrifying world in which a self-aware computer works to eliminate the human race. The *Matrix* tril-

ogy (*The Matrix*, 1999; *The Matrix Reloaded*, 2003; *The Matrix Revolutions*, 2003) envisions a postapocalyptic society in which humans have been spared solely to provide energy for the dominant machines—and are kept ignorant through a collective hallucination, the Matrix.

The postapocalyptic dystopia allows the writer to sweep away the complexities of civilization and concentrate instead on small groups of survivors—often showing them struggling to re-create the very circumstances that originally brought on apocalypse. Because these fictions tend to take place far in the future, they sometimes fail to be understood as dystopias. Miller’s *A Canticle for Leibowitz* (1959) broke this ground early. Other examples of postapocalyptic dystopias include Harlan Ellison’s *A Boy and His Dog* (published 1969, filmed by L. Q. Jones in 1975), Russell Hoban’s *Riddley Walker* (1980), Terry Gilliam’s *Twelve Monkeys* (1995) and Danny Boyle’s *28 Days Later* (2002). Though the first of George Miller’s *Mad Max* movies was little more than a series of chase scenes, the second and third installments (*Mad Max II: The Road Warrior*, 1981; *Mad Max Beyond Thunderdome*, 1985) are clearly dystopian: chaos reigns, the strong dominate the weak, and scarce commodities like gasoline are prized far more than human life. Alan Moore’s and David Lloyd’s collaboration on *V for Vendetta* (1998) presents an Orwellian postapocalyptic England in graphic novel format.

The most intriguing development since the 1970s has been the proliferation of dystopian fictions exploring gender issues. Early examples include Thomas Berger’s *Regiment of Women* (1973) and Ursula Le Guin’s *The Dispossessed: An Ambiguous Utopia* (1974). Suzy McKee Charnas’s four-volume *Holdfast Chronicles* began with the publication of *Walk to the End of the World* in 1974, continued with *Motherlines* in 1978 and *The Furies* (1994), and concluded in *The Conqueror’s Child* (1999). Set long after a global environmental catastrophe that has destroyed civilization, Charnas’s fiction presents an oppressive patriarchal village (the Holdfast), a nomadic culture of women who can reproduce without men (the Riding Women) and a group of ex-slave women who have escaped the Holdfast (the Free Fems). All of these groups are presented as morally defective: in the changing relationships between them, Charnas suggests that oppression and using power for its own sake are intrinsic human flaws, irrespective of gender. Octavia Butler’s *Parable of the Sower* (1993) largely agrees, but acknowledges that women, children, and ethnic minorities suffer most during social upheaval. Butler’s dystopia revolves around Lauren Olamina, a young black woman who suffers from hyperempathy. As American civilization decays, Lauren leads a small group of refugees to safety while instructing them in her self-created religion, “Earthseed.” But the sequel, *Parable of the Talents* (1998), shows the Acorn community destroyed and its people killed or enslaved by fundamentalist Christians. Lauren is forced to choose between rescuing her followers (including her daughter) and saving Earthseed from destruction.

Margaret Atwood’s *The Handmaid’s Tale* (a film version appeared in 1990) is much more narrowly focused on a patriarchal dystopia in which fertile women are reduced to breeder-slaves. Offred, Atwood’s first-person narrator, only

dimly understands how the ultra-fundamentalist Republic of Gilead has come to be, but she gives a firsthand look into the horribly repressive techniques necessary to keep the oligarchs (Commanders) in power. The first two of Suzette Haden Elgin's *Native Tongue* novels (*Native Tongue*, 1985; *Native Tongue II: The Judas Rose*, 1987) create a patriarchal but not overtly religious dystopia, one in which a few hundred Linguists are responsible for all communication between humanity and dozens of alien races; while all of humanity hates the Linguists, it is the Linguist women who are even more thoroughly oppressed. Elgin foregrounds the feminist concern with language as a tool of patriarchal repression, and she shows her Linguist women building a "women's language," Láadan, intended to be the tool of their liberation.

See also **Genre; Technology; Utopia.**

BIBLIOGRAPHY

PRIMARY SOURCES

- Atwood, Margaret. *The Handmaid's Tale*. Boston: Houghton Mifflin, 1986.
- Burgess, Anthony. *A Clockwork Orange*. 1st American ed. New York: W.W. Norton, 1963.
- Huxley, Aldous. *Brave New World*. New York: Harper and Row, 1947.
- Orwell, George. *Nineteen Eighty-four*. London: Secker and Warburg, 1949.

Zamyatin, Yevgeny. *We*. Translated by Gregory Zilboorg. Boston: Gregg Press, 1975.

SECONDARY SOURCES

- Aldridge, Alexandra. *The Scientific World View in Dystopia*. Ann Arbor: UMI Research Press, 1984.
- Booker, M. Keith. *Dystopian Literature: A Theory and Research Guide*. Westport, Connecticut: Greenwood Press, 1994.
- . *The Dystopian Impulse in Modern Literature: Fiction as Social Criticism*. Westport, Connecticut: Greenwood Press, 1994.
- Gottlieb, Erika. *Dystopian Fiction East and West: Universe of Terror and Trial*. Montreal and Ithaca, N.Y.: McGill-Queen's University Press, 2001.
- Kumar, Krishan. *Utopia and Anti-Utopia in Modern Times*. Oxford, UK: Basil Blackwell, 1987.
- Lewis, Arthur O., Jr. "The Anti-Utopian Novel: Preliminary Notes and Checklist." *Extrapolation: A Science-Fiction Newsletter* 2, no. 2 (May 1961): 27–32.
- Negley, Glenn, and J. Max Patrick, eds. *The Quest for Utopia: An Anthology of Imaginary Societies*. New York: Henry Schuman, 1952.
- Sargent, Lyman Tower. *British and American Utopian Literature, 1516–1985: An Annotated, Chronological Bibliography*. Garland Reference Library of the Humanities, vol. 831. New York: Garland, 1988.

David W. Sisk



E

ECLECTICISM. Ancient eclecticism, according to the second century C.E. doxographer Diogenes Laertius, began with Potamon of Alexandria, who broke with traditions of discipleship and doctrinal loyalty by making a selection from the tenets of all the existing sects, including Platonists, Aristotelians, Stoics, Epicureans, and Cynics. The Roman adaptation of eclectic attitudes was given legitimacy by the famous, often repeated motto of Horace (65–8 B.C.E.), “I am not bound over to swear as any master dictates.” Eclecticism included women philosophers, especially (whatever her religion) the beautiful, intellectually peerless, and ill-fated Hypatia (c. 370–415), whose death, according to Denis Diderot (1713–1784), marked also the end of ancient eclecticism. The Christian fathers also inclined to this view in their search for pagan anticipations of their wisdom, so that for example St. Clement of Alexandria (c. 150–between 211 and 215) celebrated the value of Greek and even “barbarian” philosophy according to this method, which he also called “eclectic” (*eklektikon*). This approach, which was inadvertently comparative and necessarily historical, was a prototype of the more self-conscious ideas of eclecticism, German and then French, which emerged in modern times, especially in the search for a “new philosophy.” Thus Petrus Ramus (Pierre de La Ramée; 1515–1572) claimed membership in the *secta veritatis*, “the sect not of Aristotle, of Plato, or of any man, but only of truth” (*Aristotelicae Animadversiones*, 1543; Aristotelian criticisms).

Modern Era

If the locus classicus of eclecticism was Diogenes Laertius’ *Lives of the Eminent Philosophers*, the *locus modernus* was the *Introduction to Stoic Philosophy* (1604) of Justus Lipsius (1547–1606), who argued that the method of critical choosing or “election” was superior to the dogmas of particular schools and represented the true road to truth. From the second quarter of the seventeenth century the term and concept of *eclectic philosophy* gained currency, as did the associated idea of the *liberty of philosophizing* (*libertas philosophandi*)—that is, the freedom to choose between philosophical schools, or indeed a philosophy beyond the schools. Gerardus Johannes Vossius (Gerrit Jansz Vos; 1577–1649) served philosophical apprenticeships in various schools—Aristotelians, Platonists, Stoics, and Epicureans—and concluded, “Clearly, I have become an eclectic.” Later he defended eclecticism (*secta electiva . . . sive electrix*) as a permanent condition of philosophizing and urged, “How would it be in the future if we should be not Ionic philosophers, or Italians, Eleatics, Platonists, or Peripatetics, not Stoics, Epicureans, Skeptics, or any other such sects, but

all of these?” (*De philosophia et philosophorum sectis*, 1658; Philosophy and the schools of philosophy).

The recognized founder of the eclectic school (*eclectica philosophia*; *Wahl-Philosophie* [Selective philosophy]) in Germany was Christian Thomasius (1655–1728), for whom, as for Vossius, philosophy was a collective enterprise not reducible to the teaching of one author or separable from learned tradition and succession of teachers. “I call eclectic philosophy,” Thomasius wrote in his *Introductio ad philosophiam aulicam* (*Einleitung zur Hof-Philosophie* [Introduction to court philosophy]) in 1688, “not what depends on the teaching of an individual or on the acceptance of the words of a master, but whatever can be known from the teaching and writing of any person on the basis not of authority but of convincing arguments.” For Thomasius the key to understanding was the alliance between history and philosophy. “History and philosophy are the two eyes of wisdom,” he argued. “If one is missing, then one has only half vision” (*einäugig*).

Other adherents to eclecticism included J. C. Sturm, J. F. Buddeus, C. A. Heumann, Nicolas Gundling, J. G. Heineccius, Ephraim Gerhard, Arnold Wesenfeld, J. J. Brucker, and their students in many dissertations written in the late seventeenth and early eighteenth centuries in theology, mathematics, and medicine as well as philosophy. Eclecticism was a method of separating truth from opinion and falsehood, science from superstition, and so a process of intellectual enlightenment and human progress. As Heineccius concludes in his *Elementa philosophiae rationalis et moralis* (1756; Elements of rational and moral philosophy), “one should not seek truth by oneself, nor accept or reject everything written by ancients and moderns, and so no other method of philosophizing is more reasonable than the Eclectic Method.”

Eclecticism was thus given new life in early modern times, appearing at the confluence of several intellectual movements: the revival of ancient and patristic learning, evangelical religious reform, the “liberty of philosophizing,” and the adoption of critical history as the basis for understanding.

The most lasting consequence of eclectic philosophy was the emergence of a new discipline, the history of philosophy, beginning with Georg Horn and Thomas Stanley (*History of Philosophy*, 1655) and culminating in the first journal dedicated to the history of philosophy, the *Acta Philosophorum* by C. A. Heumann and the survey of J. J. Brucker (*Historia critica philosophiae*, 1742–1744; Critical history of philosophy), which set the canon for the modern history of philosophy and which was the basis for Diderot’s entry in the French *Encyclopédie*.

Nineteenth Century

It was in the nineteenth century, however, that eclecticism achieved its greatest notoriety, especially under the leadership of Victor Cousin (1792–1867), who proposed “to select in all systems what appears to be true and good, and consequently everlasting,—this, in a single word, is ECLECTICISM.” And Cousin added, “If this philosophy is to be Eclectic, it must also be sustained by the history of philosophy.” In post-Revolutionary France philosophy was in great disarray, and Cousin looked back to the great schools of the earlier generation—French, Scottish, and German, represented respectively by Étienne Bonnot de Condillac (1715–1780), Thomas Reid (1710–1796), and Immanuel Kant (1724–1804). “It would be an interesting and instructive study,” he proposed, “to examine the weaknesses of these schools by engaging one with another and by selecting their various merits in the context of a great eclecticism which would contain and surpass all three” (*Lectures on the True, the Good, and the Beautiful*, 1858).

Over the next three decades this doctrine was publicized and extended by Cousin’s many scholarly publications, by his lectures, by his many international contacts and disciples, by translations of his works, and by his public career as minister of education and as virtually the “official philosopher” of the July Monarchy. Historian though he was, he attached little importance to German precedents in the belief that “eclecticism is a French doctrine and peculiar to us” (*Premiers essais de philosophie*, 1862, p. 280).

Among philosophers, in fact, eclecticism lost much of its credit in the nineteenth century, and indeed Cousin’s major significance was as a scholar and a founder of the “history of ideas,” which had been pioneered by Brucker, whom he honored as “the father of the history of philosophy,” and Giambattista Vico (1668–1744), whose work he was instrumental in introducing to nineteenth-century readers. In the long term, indeed, the principal contribution of Cousin and his school, as of the earlier German eclectics, was not the establishment of a viable philosophical doctrine but the exploration of the modern field of intellectual history.

See also Aristotelianism; Epicureanism; Ideas, History of; Platonism; Stoicism.

BIBLIOGRAPHY

Hochstrasser, T. J. *Natural Law Theories in the Early Enlightenment*. Cambridge, U.K.: Cambridge University Press, 2000.
 Kelley, Donald R. *The Descent of Ideas: The History of Intellectual History*. London: Ashgate, 2002.
 ———. “Eclecticism and the History of Ideas.” *Journal of the History of Ideas* 62 (2001): 577–592.
 Kelley, Donald R., ed. *History and the Disciplines: The Reclassification of Knowledge in Early Modern Europe*. Rochester, N.Y.: University of Rochester Press, 1997. See especially Martin Mulso, “Gundling and Buddeus: Competing Models of the History of Philosophy,” 103–126, and Ulrich Johannes Schneider, “Eclecticism and the History of Philosophy,” 83–102.

Donald R. Kelley

ECOLOGY. Ecology is commonly seen as a lineal descendant of traditional natural history extending back to such classical figures as Aristotle, Theophrastus, and Pliny. Notable persons in this tradition include the Swedish botanist, Carl von Linné (Carolus Linnaeus; 1707–1778), who coined the phrase “economy of nature” in 1749. Gilbert White (1720–1793), a British cleric, made astute ecological observations of his parish in *The Natural History and Antiquities of Selborne* (1789). Charles Darwin’s (1809–1882) work on evolution, published in 1859, was acknowledged as the stimulus for coinage, in 1866, of the term *ecology*. Henry David Thoreau (1817–1862), poet and naturalist, in 1860 anticipated a key phenomenon of ecology, and its name, in an article, “The Succession of Forest Trees.” In 1864 George Perkins Marsh (1801–1882), an American diplomat, anticipated the environmental crisis that was widely recognized a century later, in his book *Man and Nature in America*, which described the deleterious impact of humans on the earth.

The ubiquity of such observations was explicit in the observations of the historian Clarence Glacken (1967), who said that ecological theory originated in the design argument of nature and that every thinker from the fifth century B.C.E. to the end of the eighteenth century had something to say about one or more of the ideas about environments. Even this extended attribution omits consideration of the detailed, and commonly insightful, traditional natural history knowledge of nonliterate aboriginal cultures the world around. The premier British ecologist Charles Elton dubbed ecology as scientific natural history in 1927. Increasing recognition of the extended history of ecological insights, anticipating a formal science of ecology, called up the apt term *protoecologist* (protoecology) in 1983.

Origins

The undisputed source of the term *ecology* is the eminent German zoologist, Ernst Haeckel (1834–1919), who coined it in 1866. It is well to revert to Haeckel’s expanded definition in 1869 as translated by Allee and others:

By ecology we mean the body of knowledge concerning the economy of nature—the investigation of the total relations of the animal both to its inorganic and to its organic environment; including above all, its friendly and inimical relations with those animals and plants with which it comes directly or indirectly into contact—in a word ecology is the study of all those complex interrelations referred to by Darwin as the conditions of the struggle for existence. (Allee, 1949)

Haeckel’s definition illustrates the continuing tendency to distinguish animal and plant ecology. His emphasis on Darwinian evolution was echoed by numerous early ecologists, and later historians, and persists as evolutionary ecology.

The term *ecology* appeared sparingly in the scientific literature until the 1890s. In 1893 the president of the British Association for the Advancement of Science described ecology as a branch of biology coequal with morphology and physiology and by far the most attractive. Also in 1893, the Madison

Botanical Congress, a large meeting of professional botanists, formally adopted the term *ecology*. A chair of ecological botany was established at Uppsala University in Sweden in 1897, and in 1904 Oscar Drude, a German plant geographer, described the sudden recognition of ecology in a talk at a Congress of Arts and Sciences at the Universal Exposition in St. Louis. Charles E. Bessey, a prominent American botanist, commented in 1902 that ecology had become a fad—a slight exaggeration, as the “fad” was largely confined in America to a few Midwestern universities and state agencies. The first named textbook of ecology was published in Danish by a Danish botanist, Johannes Eugenius Bülow Warming, in 1895; and the first doctorate in ecology in the United States was granted to Henry Chandler Cowles in 1898 by the University of Chicago for his work on the dunes of Lake Michigan.

Institutionalization

In Great Britain, plant ecology was initiated by botanical surveys done by members of hundreds of local natural history societies. Arthur S. Tansley, a pioneer British plant ecologist, suggested formation of the British Vegetation Committee, which brought the scientific leadership of the natural history societies together to study British vegetation.

Continental ecology was stimulated by the experience of European biologists in tropical colonies. Several of these, notably Drude, Andreas Franz Wilhelm Schimper, and Warming produced significant works of plant ecology that influenced British and American ecology.

Ecology in America was much influenced by early state-run natural history agencies, notably in the Midwest. Stephen A. Forbes was director of the Illinois State Laboratory of Natural History for many years, influencing numerous ecologists employed there as well as producing many of the most insightful ecological articles published before 1900. Edward A. Birge was director of the natural history division of the Wisconsin Geological and Natural History Survey and a pioneer in ecological studies of lakes. Bessey organized the Botanical Survey of Nebraska, which produced the major theorist of American plant ecology, Frederic E. Clements (1874–1945). American ecologists were influenced by federal surveys of the trans-Mississippi West. Ronald Tobey traced the development of plant ecology in the Midwestern grasslands, influenced by the developments of prairie agriculture and the Clements school of ecology.

Formal ecological societies were established in Britain in 1913 and in the United States in 1915. Academic ecology developed notably in Midwestern universities. In its century as a recognizable science, ecology acquired new and expanded significance. This is evident in the proliferation of journals of ecology. English language journals numbered four in 1940, increasing to twelve by 1980. The Institute for Scientific Information (ISI) included 102 journals under ecology in 2000, fifty of which had a clear reference to ecology in the title. The journal *Ecology* went from quarterly to monthly and the number of pages per year increased from approximately 750 in 1940 to about 2,250 in 2000. This proliferation of journals is a mixed blessing, making keeping up with the literature well

nigh impossible at a time that ecologists are becoming involved in increasingly diverse enterprises.

Paradigms

Thomas Kuhn’s concept of paradigm, introduced in *The Structure of Scientific Revolutions* (1962), changed the common view of how science progresses. A paradigm is a set of overarching principles and methods shared by a scientific community within which its adherents conduct “normal science.” Science advances by changing its paradigms in revolutions.

The earliest putative ecological paradigm, the Clementsian organismic paradigm was a descendant of the traditional design or balance-of-nature concept, presuming a stable or equilibrium state as a norm. It is associated with Nebraska botanist Frederic E. Clements, who developed a concept of community or “association” as an organism or superorganism (1916). Clements envisioned the community as developing to converge on a “climax” or a stable endpoint determined by climate. This paradigm dominated early-twentieth-century ecology in America and was evident in major animal ecology references and general textbooks.

Some scholars describe a “revolution,” or paradigm change, in ecology in the 1950s, with the revival and widespread acceptance of the “individualistic concept” of H. A. Gleason (1939). The shift from Clementsian ideas of equilibrium, homogeneity, and determinism to Gleasonian ideas of nonequilibrium, heterogeneity, and stochasticity greatly increased the difficulty of ecology and has dominated its recent development.

Another paradigm in ecology, population regulation, has a long natural-history tradition and was introduced into ecology in the 1920s, described by some as the “Golden Age” of theoretical mathematical ecology. Raymond Pearl resurrected the earlier “logistic curve” $dN = rN(K - N)$ and introduced it as a “law” of population growth. The equation includes r as the rate of population growth, K as the limiting maximum population, N as the number of individuals, and d signifying change. Subsequently the physicist Alfred J. Lotka, who joined Pearl’s laboratory, and Vito Volterra, a mathematician, expanded the logistic to two species cases, especially competition. Mathematical population ecology persisted in the face of extended criticism and subsequent concerns about the basic equation. It remains to the present in much-elaborated forms with the assurance that populations at some scale are regulated but the mechanisms remain elusive.

Ecosystem

Early ecology recognized living (biotic) and nonliving (abiotic) aspects of nature but conventionally treated them separately. Environment acted on organisms, and organisms reacted on environment, according to Clements’s familiar usage. The term *ecosystem* was coined by the British ecologist Arthur S. Tansley in 1935 to treat organisms and environment as a unit system. Tansley defined ecosystem as the whole system (in the sense of physics) including not only the organism complex, but also the whole complex of physical factors forming what we call the environment of the biome—the habitat factors in the widest sense.

Tansley’s concept was particularly useful in aquatic ecology. It was used by Raymond Lindeman (1942) in a

pioneer study of a lake ecosystem. Lindeman adapted the familiar food-chain, or trophic-structure concept of ecology and emphasized the energy and nutrient relations in a pyramid of production diminishing at higher levels and relating it to a succession of lakes. A major stimulus to ecosystem ecology was the influential textbook by Eugene Odum, *Fundamentals of Ecology* (1953).

The ecosystem concept was widely hailed as a new ecology in the 1970s, particularly when designated as “systems” ecology, which changed the emphasis in ecology from organisms to “ecoenergetics,” the flux of energy in the ecosystem, along with the flow of chemicals through the ecosystem. Systems ecology flourished as ecology was turned into “big biology” by its first venture into heavily funded research in an International Biological Program (IBP) principally directed to formulating mathematical models of large-scale ecosystems. Another approach to ecosystems was the Hubbard Brook Program, begun in 1963, an intensive program of studies of a forested watershed, which examined nutrient flow and biomass accumulation. The program used computer simulations to model the complexity of natural ecosystems.

Opinions as to the merits of systems ecology in its philosophical and mathematical format vary, but the ecosystem persists as a major aspect of ecology and is frequently cited in the conservation, environmental, and even economic and political arenas. It is widely considered as producing ecosystem services, the valuable consequences of the multitudinous activities performed by biological systems to the great advantage of humans and often in spite of them. In 1988 “ecosystem” was designated “most important ecological concept” in a survey of members of the British Ecological Society, and it remains significant today.

Transecology

Ecology as a science developed largely in academia and in state, federal, and private conservation agencies until it came to the consciousness of the general public in the context of the environmental crisis of the 1970s in the guise of environmentalism. This is clearly evidenced in Mohan Wali’s “Ecology Today: Beyond the Bounds of Science.” Wali collected terms using “eco,” “ecological,” and “ecology” by professional ecologists and by nonecologists, and found that nonecologists use the term *ecology* as ideology, metaphor, allegory, myth, or gospel. Furthermore, while terms coined by professional ecologists numbered 276, those coined by nonecologists numbered over a thousand. Wali categorized the latter as General Ecologies (e.g., metaphysical ecology), Eco-business (e.g., ecopornography), Eco-Health (e.g., gyn-eco-logical), Eco-types (e.g., eco-freak), Ecosport (e.g., ecogolf), Ecophilosophy (e.g., deep ecology), and Eco-religion (e.g., ecological sin). The problem for the unwary reader is that environmentalism is exceedingly diverse and for most of the users of these terms ecological science does not exist.

Another concern is the growth since around 1980 of environmental history, which takes a more encompassing view of environmental and ecological science and sometimes confounds it with ecologism, a loose construction of philosophy

and ecology. Environmental history includes many works attending to the human environment with due cognizance of ecology and history. Other works, claiming to be histories of ecology, completely ignore the science and attribute diverse human and political foibles to ecology. One such cites no ecological science journals, but asserts that ecologists call for complete social and economic change. It links ecological ideas to Marxism, anarchism, Boy Scouts, anti-Semitism, fascism, and the German disease—Nazism.

The gross extension of the term ecology by nonscientists prompted the director of the public affairs office of the Ecological Society of America (ESA) to draft a letter to disclaim equating ecology and environmentalism, which, the letter said, diminished the credibility of ecology, and to urge members of the ESA to send it to offending publications such as the *Wall Street Journal*.

Complexity

Ecology has long been recognized as complex. One discouraged ecologist suggested, “ecology is not only more complex than we think, it is more complex than we can think.” Ecology has assembled an extended body of information about the earth’s ecosystems, but consensus on a general theoretical foundation remains elusive and some question its likelihood.

A notable effort to provide a theory of ecology was G. E. Hutchinson’s formalization of the niche concept. A species niche is its response to all variables, biological and physical. Hutchinson influenced Robert MacArthur (1969), who pursued a theory of ecology predicated on competition that was widely accepted but subsequently questioned, as other factors such as predation and disturbance were shown to influence species relations.

An early consensus on “dynamic” ecology, focusing on the ubiquitous process of succession or change in ecosystems, regarded succession as “primary” if beginning on a previously unoccupied area, or “secondary” if following disturbance. This remains a factor in complex ecology. Disturbance by biotic or abiotic factors at varied intervals, intensities, or different area sizes is common and some disturbances (e.g., fire) are integrated into the development of an ecosystem, adding to its complexity.

One of the difficulties of assessing regularities in ecology is that ecological entities exist, and functions occur, at different scales of size, time, and rate, and the perspective of history is essential. Consideration of scale is widely evident in recent ecology, increasing its inherent complexity. The traditional ecological entities, population and community, are now expanded to metapopulations, populations of a species connected by migrations among them, and landscape ecology, an extended area including diverse communities. Taxonomic populations are also considered as guilds, species with similar functions apart from their systematic relations. At an extreme the biosphere, the whole-earth system, may be considered, and has been transformed into the GAIA hypothesis, treating the earth as an integrated superorganism transcending conventional ecology.

Another approach to ecological complexity is offered in hierarchy, an effort to deal with the scale problem in ecology.

Ecological systems are considered as hierarchies in which processes at higher levels are predictable in some degree based on processes at lower levels. Some properties of the whole are said to be emergent and must be considered at the appropriate hierarchical level.

Evolutionary Ecology and Conservation Biology

Ecology was initially linked with Darwinian evolution. These ideas persist in evolutionary ecology, which explores the distribution and abundance of organisms and the control of their numbers, as in the interest in invasive species. Conservation biology is a following, overlapping discipline which focuses on the preservation of species incorporating genetic diversity. No feature of the earth is more striking than its enormous number of species. In ecological parlance number of species is called richness, number of species weighted by their proportionate abundance (number of individuals) is called diversity, and an amalgamation of all biological qualities is called biodiversity. In much ecological and common usage, however, biodiversity is simple number of species. Biodiversity has long charmed naturalists but in recent decades it has been considered a key ecological concept or paradigm and entered into environmental and political discourse as concerns grow about declining biodiversity. The emerging concern about loss of biodiversity has created urgency about its putative relation to stability and functioning of ecosystems.

Increasing recognition of the complexity of ecological systems called forth new mathematical considerations of fractals, chaos, and complexity. It led to the formation of a National Center for Ecological Analysis and Synthesis (NCEAS) on the West Coast of the United States. The NCEAS funds studies of large areas using meta-analysis of existing data and has had substantial impact on recent ecology.

Human Ecology

Early ecology had links with sociology. Patrick Geddes, British botanist-turned-sociologist, provided a classification of science in 1880 that included ecology in sociology. Much early plant ecology was called phytosociology, and a pioneer animal ecologist, Warder Clyde Allee, published *Animal Aggregations: A Study in General Sociology* in 1931. Early sociology at the University of Chicago was influenced by the ideas of the plant ecologist, Frederic E. Clements. An early animal ecologist, C. E. Adams, boldly anticipated convergence of animal and human ecology.

Both the British and American ecological societies were reluctant to engage in advocacy, and a president of the British Ecological Society said the society cannot have a corporate opinion on practical affairs lest its credibility over scientific aspects be damaged. Although many ecologists, notably Paul Sears in the United States and Arthur S. Tansley in Britain, were active proponents of environmental concerns and conservation, there was a common reluctance among ecologists and their societies to become involved in political affairs and public policy. Widespread recognition of the environmental crisis in the 1970s and the popularity of Earth Day emboldened many ecologists, their societies, and their journals to substantially change their

position in respect to advocacy. In spite of reservations, ecologists and their organizations are increasingly becoming involved in matters of public policy if not politics.

One indication of increasing involvement of ecologists in public affairs is the Millennium Ecosystem Assessment, in which ecologists join with other scientists and social scientists from sixty-six countries to address the relations between ecosystems and human well-being on a global scale. These assessments (1) address the current and future capacity of ecosystems to provide services to humans, (2) determine human responses to changes in ecosystems, and (3) consider how assessments can be conducted at scales from villages, to river basins, countries, regions, and globally. It is clear that ecological science is becoming increasingly involved in the realm of public policy. Some ecologists have noted the failure of our educational system to train students to participate in science-policy discussions. Ecologists and economists, in order to change the status quo, are attempting to provide innovative courses.

An extremely difficult problem for contemporary ecologists is to respond to the suggestions that ecology extends beyond the bounds of science. This grandiose view of ecology is a contradiction of Ralph Waldo Emerson's assertion in "Nature" of an essence unchanged by human beings: "But his operations taken together are so insignificant, a little chipping, baking, patching, and washing, that in an impression so grand as that of the world on the human mind, they do not vary the result." Ecology confirms the fear that humans vary the result decisively.

See also **Biology; Environmental Ethics; Environmental History; Evolution; Natural History; Nature; Wildlife.**

BIBLIOGRAPHY

- Allee, Warder C., et al. *Principles of Animal Ecology*. Philadelphia: Saunders, 1949.
- Bocking, Stephen. *Ecologists and Environmental Politics: A History of Contemporary Ecology*. New Haven, Conn.: Yale University Press, 1997.
- Cherrett, J. M. "Key Concepts: The Results of a Survey of Our Member's Opinions." *Journal of Ecology* 76 (1989): 1–16.
- Glacken, C. J. *Traces on the Rhodian Shore*. Berkeley: University of California Press, 1967.
- Golley, Frank B. *A History of the Ecosystem Concept in Ecology: More Than the Sum of the Parts*. New Haven, Conn.: Yale University Press, 1993.
- Graham, Michael H., and Paul K. Dayton. "On the Evolution of Ecological Ideas: Paradigms and Scientific Progress." *Ecology* 83 (2002): 1481–1489.
- Graham, Michael H., Paul K. Dayton, and Mark A. Hixon, eds. "Special Feature: Paradigms in Ecology: Past, Present, and Future." *Ecology* 83 (2002): 1479–1559.
- Kingsland, S. E. *Modeling Nature: Episodes in the History of Population Ecology*. Chicago: University of Chicago Press, 1985.
- Lawton, J. H. "Are There General Laws in Ecology?" *Oikos* 84 (1999): 177–192.
- Lindeman, R. L. "The Trophic-dynamic Aspect of Ecology." *Ecology* 23 (1942): 399–418.
- MacArthur, R. H. "Species Packing and Competitive Equilibrium for Many Species." *Theoretical Population Biology* 1 (1969): 1–11.

- McIntosh, R. P. *The Background of Ecology: Concept and Theory*. Cambridge, U.K.: Cambridge University Press, 1985.
- Mitman, Gregg. *The State of Nature: Ecology, Community, and American Social Thought*. Chicago: University of Chicago Press, 1992.
- Shrader-Frechette, K. S., and E. D. McCoy. *Method in Ecology and the Logic of Case Studies*. Cambridge, U.K.: Cambridge University Press, 1993.
- Wali, Mohan. "Ecology Today: Beyond the Bounds of Science." *Nature and Resources* 35 (1999): 38–50.

Robert P. McIntosh

ECONOMICS. The term *economics*, from the Greek *oikonomika*, means a science or art of managing the household. In modern usage, it refers to the efficient allocation of scarce resources in the production, distribution, and consumption of goods and services to satisfy various desires. As a branch of knowledge, economics or economic science is the study of how to efficiently use limited resources—natural resources (land), capital, labor, entrepreneurship, and information—to achieve maximum satisfaction of human material wants. Like other social sciences, economics studies human behavior but focuses on maximizing satisfaction or benefit as efficiently as possible or at minimum cost in the production, distribution, and consumption of goods and services. Hence, economics deals with decision making, theory, and management of the economy or economic systems. The decision makers or economic units of the economic system are households, businesses, and government.

Microeconomics is the branch of economics that deals with individual or specific economic units such as an individual industry, firm, or household and their interactions. In 1817, David Ricardo (1772–1823) wrote on the forces that determine the functional distribution of income and the theories of value and price, and it was from these theories that microeconomic theory originated. Microeconomics in the early twenty-first century includes the theory of consumer behavior, theory of production, and the theory of markets. It deals with such topics as prices of a specific product, the number of workers employed in a specific firm, the revenue or income of a particular firm or household, and the expenditures of a specific firm, government entity, or family. Microeconomic analysis focuses mostly on optimization and equilibrium analysis.

Macroeconomics deals with the aggregate economy and the behavior of its major units—households, businesses, government, and the foreign sector. Developed in the 1930s, macroeconomics was practically invented by the English economist John Maynard Keynes (1883–1946) in his attempt to develop an answer to the Great Depression. Keynes argued that the Great Depression was a problem of insufficient aggregate demand and that if the private economy could not generate sufficient demand, it was the government's responsibility to do so. Macroeconomics focuses on such issues as growth, recessions, inflation, unemployment, and government policy and deals with such topics as total output or gross domestic product (GDP), total employment, total income, aggregate expenditure, and general level of prices.

Historical Development

Although economics originally referred to the management of the affairs of the household (*oikonomia* in Greek), its meaning evolved into political economy—"the financial branch of the art or business of government" (Milgate et al., eds., vol. 2, p. 58)—then into how to make a country wealthy, and finally into a social science that studies the production, distribution, and consumption of commodities.

The economic problem or the objective of the economic arrangement, be it in a primitive hunting and gathering society or in the most sophisticated modern industrial society, is that of provision—how to use scarce resources to produce goods and services and how to appropriately distribute the product. This problem has remained basically unchanged in human history. Over time, what has differed or changed are the modes of economic organization that correspond to the cultural arrangements in human societies. But the existence of the economic problem is different from an analysis of the economic problem. Organized economic systems existed in ancient Egypt, the great African empires of Western Sudan, the Aztec and Incan civilizations of the Americas, and the Assyrian and Babylonian theocracies. But according to Joseph Schumpeter, there is no trace of analytic effort until Greece. Even the beginning of the analytic effort did not become systematic until the eighteenth century. Hence, as a field of study, economics is relatively young, and only emerged as a full-fledged separate discipline following the publication of Adam Smith's *The Wealth of Nations* in 1776.

In Western civilization wealth was the primary and original concern of economics, and in economics the questions about wealth concerned the means of acquiring, maintaining, and increasing it. Wealth was seen by Aristotle not as an end, but as a means of achieving ethical and political ends. Whereas the treatment of wealth in the noneconomic fields of religion, history, politics, and the like focused mostly on its distribution and its effect on affluence, poverty, and the state, the approach of the economists was to focus on the means to wealth.

In addition to the attempts to understand the sources of wealth, pioneer economists sought to understand human nature and the sources of value. Human nature has been viewed both in the traditional conservative view as natural and preordained and in the critical liberal view as socially determined. The traditional conservative view from the Middle Ages through slavery in the Americas and the industrial revolution sees ideas, drives, and practices as natural, inherent, God-given, or innate. Hence, the classical and neoclassical economists believed that capitalism was natural and eternal and consumer preferences were given, since individuals were born with them in the same manner that the conservative religious leaders believed that serfdom was natural and the American conservative southerners believed that slavery was ordained by God. Critical economists or the liberal view originating from Karl Marx (1818–1883), Thorstein Veblen (1857–1929), and John Maynard Keynes focused more on the evolution and transformation of economic systems and their impact on people's ideas and preferences. This premise was based on the belief that ideas and preferences are shaped by the society in which people live (Hunt and Sherman).

With all its accomplishments, economics is plagued with a crisis of identity and dissension and disagreements on how it should be taught, how it should be practiced, and how it should be used. Furthermore, the field of economics has been slow in reintegrating itself into the social sciences to become, once again, more problem-driven and more eclectic. Indeed the shift to abstraction and quantification that was started by David Ricardo continued until relatively recently and is at the source of the dispute about the usefulness of economics in modern society. Many economists complain about an undue attention paid to esoteric models, and the tendency by some economists, mostly of the orthodox school, to provide a uniquely economic answer to such social questions as the causes of growth and why some countries are underdeveloped.

Undeniably, as the twentieth century drew to a close, there was a greater recognition of the importance of noneconomic factors in explaining major economic questions and problems. For instance, mainstream economics has come to acknowledge the importance of history, political conditions, sociocultural factors, the environment, geography, and international variables in explaining such economic problems as lack of growth, underdevelopment, inequality, and poverty. This recognition notwithstanding, the field of economics has still not seriously focused on the critical and endemic problems that plague the world. For instance, despite being the least developed continent in the world representing arguably the most daunting economic challenge in modern history, Africa has been all but ignored by economics. This is amazing in light of the fact that the field's supposedly central preoccupation is the problems of income, growth, distribution, and human welfare.

Notable contributions to the field of economics include Richard Cantillon's *Essay on the Nature of Commerce* (1755), Adam Smith's *Wealth of Nations* (1776), Karl Marx's *Das Capital* (1867), Thorstein Veblen's *The Theory of the Leisure Class* (1899), and John Maynard Keynes's *General Theory of Employment, Interest, and Money* (1936). Before the publication of the *Wealth of Nations*, there were other schools of thought whose main preoccupation was wealth creation and the organization of the economy, most prominently, mercantilism and physiocracy.

Mercantilism or bullionism. Mercantilism or bullionism is a loose economic school of thought whose basic belief is that a nation's wealth originated from gold and silver bullion and other forms of treasure. The mercantilist ideas were spread in an uncoordinated three-hundred-year effort, mostly through the English pamphlet writers of the seventeenth and eighteenth centuries, a period marked by significant shortages of gold and silver bullion in Europe. Mercantilism believed in trade regulation, industrial promotion, imposition of protective duties on imports of manufactures, encouragement of exports, population growth, and low wages. This belief in regulating wealth was grounded in the conviction that favorable balance of trade leads to national prosperity.

Mercantilists assumed that the total wealth of the world was fixed and reasoned that trade would lead to a zero-sum game. Consequently, they surmised that any increase in the wealth and economic power of one nation was necessarily at the

expense of other nations. Hence, they emphasized balance of trade as a means of increasing the wealth and power of a nation.

Physiocracy. The term *Physiocracy* (the order or rule of nature) developed for less than two decades as a reaction against the doctrines and restrictive policies of mercantilism. Founded on a doctrine of noninterference, the physiocratic ideas were first enunciated by the Frenchman François Quesnay (1694–1774). Quesnay argued that only agriculture can produce net output (*produit net*). According to Physiocracy, the farmers and landowners were considered to be the productive classes whereas the merchants and industrialists were not. The Physiocrats believed in natural laws, the free enterprise system, and the free operation of the natural order of things. Quesnay also developed the famous *Tableau Economique* (economic table) in an attempt to establish a general equilibrium through a basic input-output model. The main ideas of Physiocracy that were promoted by the intellectual disciples of Quesnay—a group of French social reformers—came directly or indirectly from his *Tableau Economique*. Another important contributor to Physiocracy is Anne-Robert-Jacques Turgot (1727–1781), whose *Reflections on the Formation and the Distribution of Wealth* (1769–1770) was one of the most important general treatises on political economy written before Smith's *Wealth of Nations*.

Major Theories

The study of economics is driven by theories of economic behavior and economic performance, which have developed along the lines of the classical ideas, the Marxist idea, or a combination of both. In the process, various models were developed, each trying to explain such economic phenomena as wealth creation, value, prices, and growth from a separate intellectual and cultural setting, each considering certain variables and relationships more important than others. Within the aforementioned historical framework, economics has followed a trajectory that is characterized by a multiplicity of doctrines and schools of thought, usually identifiable with a thinker or thinkers whose ideas and theories form the foundation of the doctrine.

Classical economics. Classical economic doctrine descended from Adam Smith and developed in the nineteenth century. It asserts that the power of the market system, if left alone, will ensure full employment of economic resources. Classical economists believed that although occasional deviations from full employment result from economic and political events, automatic adjustments in market prices, wages, and interest rates will restore the economy to full employment. The philosophical foundation of classical economics was provided by John Locke's (1632–1704) conception of the natural order, while the economic foundation was based on Adam Smith's theory of self-interest and Jean-Baptiste Say's (1767–1832) law of the equality of market demand and supply.

Classical economic theory is founded on two maxims. First, it presupposes that each individual maximizes his or her preference function under some constraints, where preferences and constraints are considered as given. Second, it presupposes the existence of interdependencies—expressed in the markets—between the actions of all individuals. Under the assumption

of perfect and pure competition, these two features will determine resource allocation and income distribution. That is, they will regulate demand and supply, allocation of production, and the optimization of social organization.

Led by Adam Smith and David Ricardo with the support of Jean-Baptiste Say and Thomas Robert Malthus (1766–1834), the classical economists believed in Smith's invisible hand, self-interest, and a self-regulating economic system, as well as in the development of monetary institutions, capital accumulation based on surplus production, and free trade. They also believed in division of labor, the law of diminishing returns, and the ability of the economy to self-adjust in a *laissez-faire* system devoid of government intervention. The circular flow of the classical model indicates that wages may deviate, but will eventually return to their natural rate of subsistence.

Marxist economics. Because of the social cost of capitalism as proposed by classical economics and the industrial revolution, socialist thought emerged within the classical liberal thought. To address the problems of classical capitalist economics, especially what he perceived as the neglect of history, Karl Marx (1818–1883), a German economic, social, and political philosopher, in his famous book titled *Das Kapital* or *Capital* (1867–1894) advanced his doctrine of dialectical materialism. Marx's dialectics was a dynamic system in which societies would evolve from primitive society to feudalism to capitalism to socialism and to communism. The basis of Marx's dialectical materialism was the application of history derived from Georg Wilhelm Friedrich Hegel (1770–1831), which maintained that history proceeds linearly by the triad of forces or dialectics called thesis, antithesis, and synthesis. This transition, in Marx's view, will result from changes in the ruling and the oppressed classes and their relationship with each other. He then envisaged conflict between forces of production, organization of production, relations of production, and societal thinking and ideology.

Marx predicts capitalist cycles that will ultimately lead to the collapse of capitalism. According to him, these cycles will be characterized by a reserve army of the unemployed, falling rate of profits, business crises, increasing concentration of industry into a few hands, and mounting misery and alienation of the proletariat. Whereas Adam Smith and David Ricardo had argued that the rational and calculating capitalists in following their self-interest promote social good, Marx argued that in rationally and purposefully pursuing their economic advantage, the capitalists will sow the seeds of their own destruction.

The economic thinking or school of economic thought that originated from Marx became known as Marxism. As the chief theorist of modern socialism and communism, Marx advocated fundamental revolution in society because of what he saw as the inherent exploitation of labor and economic injustice in the capitalist system. Marxist ideas were adopted as the political and economic systems in the former Soviet Union, China, Cuba, North Korea, and other parts of the world.

The neo-Marxist doctrines apply both the Marxist historical dimension and dialectics in their explanation of economic

relationships, behavior, and outcome. For instance, the dependency theory articulates the need for the developing regions in Africa, Latin America, and Asia to rid themselves of their endemic dependence on more advanced countries. The dependency school believes that international links between developing (periphery) and industrialized (center) countries constitute a barrier to development through trade and investment.

Neoclassical economics. The period that followed Ricardo, especially from 1870 to 1900, was full of criticism of classical economic theory and the capitalist system by humanists and socialists. The period was also characterized by the questioning of the classical assumption that *laissez-faire* was an ideal government policy and the eventual demise of classical economic theory and the transition to neoclassical economics. This transition was neither spontaneous nor automatic, but it was critical for the professionalization of economics.

Neoclassical economics is attributed with integrating the original classical cost of production theory with utility in a bid to explain commodity and factor prices and the allocation of resources using marginal analysis. Although David Ricardo provided the methodological rudiments of neoclassical economics through his move away from contextual analysis to more abstract deductive analysis, Alfred Marshall (1842–1924) was regarded as the father of neoclassicism and was credited with introducing such concepts as supply and demand, price-elasticity of demand, marginal utility, and costs of production.

Neoclassical or marginalist economic theories emphasized use value and demand and supply as determinants of exchange value. Likewise neoclassicals, William Stanley Jevons (1835–1882) in England; Karl Menger (1840–1925) in Austria; and Léon Walras (1834–1910) in Switzerland, independently developed and highlighted the role of marginal utility (and individual utility maximization), as opposed to cost of production, as the key to the problem of exchange valuation. Neoclassical models assume that everyone has free access to information they require for decision making. This assumption made it possible to reduce decision making to a mechanical application of mathematical rules for optimization. Hence, in the neoclassical view, people's initial ability to maximize the value of output will, in turn, affect productivity and determine allocation of resources and income distribution. Neoclassical economics is grounded in the rejection of Marxist economics and on the belief that the market system will ensure a fair and just allocation of resources and income distribution.

Since its emergence, neoclassical economics has become the dominant economic doctrine in the study and teaching of economics in the West, especially in the United States. A host of economic theories have emerged from neoclassical economics: neoclassical growth theory, neoclassical trade theory, neoclassical theory of production, and so on. In the neoclassical growth theory, the determinants of output growth are technology, labor, and capital. The neoclassical growth theory stresses the importance of savings and capital accumulation together with exogenously determined technical progress as the sources of economic growth. If savings are larger, then capital per worker will grow, leading to rising income per capita and vice versa.

The neoclassical thinking can be expressed as the Solow-Swan model of the production function type $Y=F(N,K)$ which is expanded to

$$\Delta Y/Y = \Delta A/A + \Delta N/N + \Delta K/K$$

where Y represents total output, N and K represent the inputs of labor and capital, and A represents the productivity of capital and labor, and $\Delta Y/Y$, $\Delta A/A$, $\Delta N/N$, and $\Delta K/K$ represent changes in these variables, respectively.

The Solow-Swan model asserts that because of the diminishing marginal product of inputs, sustained growth is possible only through technological change. The notion of diminishing marginal product is rooted in the belief that as more inputs are used to produce additional output under a fixed technology and fixed resource base, additional output per unit of input will decline (diminishing marginal product). This belief in the stationary state and diminishing marginal product led neoclassical economics to believe in the possibility of worldwide convergence of growth.

Known also as the neoliberal theory, neoclassical economics asserts that free movement of goods (free trade), services, and capital unimpeded by government regulation will lead to rapid economic growth. This, in the neoclassical view, will increase global output and international efficiency because the gains from division of labor according to comparative advantage and specialization will improve overall welfare. Even modern trade models (such as the Hecksche-Ohlin) are based on the neoclassical trade theory, which assumes perfect competition and concludes that trade generally improves welfare by improving the allocation of factors of production across sectors of the economy.

Rational expectation. Rational expectation is the economic doctrine that emerged in the 1970s that asserts that people collect relevant information about the economy and behave rationally—that is, they weigh costs and benefits of actions and decisions. Rational expectation economics believes that because people act in response to their expectations, public policy will be offset by their action. Also known as the “new classical economics,” the rational expectation doctrine believes that markets are highly competitive and prices adjust to changes in aggregate demand. The extent to which people are actually well informed is questionable and prices tend to be sticky or inflexible in a downward direction because once they go up, prices rarely come down. In the rational expectation doctrine, expansionary policies will increase inflation without increasing employment because economic actors—households and businesses—acting in a rational manner will anticipate inflation and act in a manner that will cause prices and wages to rise.

Monetarism. Like rational expectations theory, monetarism represents a modern form of classical theory that believes in laissez-faire and in the flexibility of wages and prices. Like the classical theorists before them, they believe that government should stay out of economic stabilization since, in their view, markets are competitive with a high degree of macroeconomic stability. Such policies as expansionary monetary policy will, in their view, only lead to price instability. The U.S. economist Milton Friedman, who received the Nobel Prize in 1976,

is widely regarded as the leader of the Chicago school of monetary economics.

Institutionalism. Institutional economics focuses mainly on how institutions evolve and change and how these changes affect economic systems, economic performance, or outcomes. Both Frederick Hayek and Ronald Coase, major contributors to the Institutionalist School in the tradition of Karl Marx and Joseph Schumpeter, look at how institutions emerge. Hayek examines the temporal evolution and transformation of economic institutions and concludes that institutions result from human action. Hence, he suggests the existence of a spontaneous order in which workable institutions survive while nonworkable ones disappear. Coase believes that institutions are created according to rational economic logic when transaction costs are too high. Other notable contributors to institutionalism include Thorstein Veblen, Clarence Ayers, Gunnar Myrdal, John R. Commons, Wesley Clair Mitchell, and John Kenneth Galbraith.

The New Institutionalism, represented mostly by Douglas North, Gordon Tullock, and Mancur Olson, uses the classical notions of rationality and self-interest to explain the evolution and economic impact of institutions. It considers such issues as property rights, rent-seeking, and distributional coalitions and argues that institutional transformation can be explained in terms of changes in property rights, transaction costs, and information asymmetries.

Themes

As an academic discipline, economics encompasses a wide variety of themes that represent its historical and contemporary intellectual development. Some of the discipline’s major themes include economic methodology, development economics, Endogenous Growth theory, feminist economics, environmental economics, monetarist economics, and econometrics.

Economic methodology. Economic methodology refers to the method of economic investigation. It mirrors and derives from economic theory and has come to be known as the formulation and testing of hypotheses of cause-and-effect relationship. Like the field itself, which is very much in dispute, economic methodology has evolved and transformed in time from a more formal scientific approach in which methodology was emphasized to a period of lesser emphasis on scientific methodology. Before the formalization of economic theory, economists employed discourse to state and test theories and hypotheses. This heuristic approach did not permit hypothesis to be tested in a manner acceptable as scientific.

In time, economics adopted the use of the scientific method to either formulate economic laws, theories, or principles or to ascertain their validity. The process involves observing facts, making assumptions and hypothesizing about facts, testing hypotheses (to compare outcomes with predictions), accepting or rejecting hypotheses, systematically arranging and interpreting facts to draw generalizations and establish laws, theories, or principles, and often formulating policies, addressing economic problems, or achieving specific economic goals.

At the two levels of microeconomics and macroeconomics, economic methodology can either be inductive or deductive,

quantitative or qualitative, positive or normative. Economists express economic theory in terms of equations and relationships between economic variables in algebraic form and make inferences using mathematical operations. Over time, the economics discipline has witnessed an intensified mathematization of economic methodology and an increased role of abstraction and esoteric modeling that has, in effect, made it inaccessible to the untrained.

In this regard, econometrics, especially linear regression analysis, mathematical economics, game theory, and the like have played a great role. There has also been a move away from the scientific methodology involving data collection, hypothesis, analysis, and theory to an emphasis on modeling.

The 1960s and 1970s saw enormous advances in formal statistical testing and logical positivism and Popperian falsification, mostly in an attempt to establish one correct method of economics. Karl Raimund Popper (1902–1994) is one of the most influential philosophers of the twentieth century who produced influential works and political philosophy, particularly *The Logic of Scientific Discovery* (1959). Falsification is “a methodological standpoint that regards theories and hypotheses as scientific if and only if their prediction are at least in principle falsifiable, that is, if they forbid certain acts/states/events from occurring” (Blaug, 1992, p. xiii).

Development economics. Development economics or the economics of development is the application of economic analysis to the understanding of the economies of developing countries in Africa, Asia, and Latin America. It is the subdiscipline of economics that deals with the study of the processes that create or prevent economic development or that result in the improvement of incomes, human welfare, and structural transformation from a predominantly agricultural to a more advanced industrial economy. The subfield of development economics was born in the 1940s and 1950s but only became firmly entrenched following the awarding of the Nobel Prize to W. Arthur Lewis and Theodore W. Schultz in 1979. Lewis provided the impetus for and was a prime mover in creating the subdiscipline of development economics.

As a subfield concerned with “how standards of living in the population are determined and how they change over time” (Stern), and how policy can or should be used to influence these processes, development economics cannot be considered independently of the historical, political, environmental, and sociocultural dimensions of the human experience. Hence development economics is a study of the multidimensional process involving acceleration of economic growth, the reduction of inequality, the eradication of poverty, as well as major changes in economic and social structures, popular attitudes, and national institutions.

Development economics covers a variety of issues, ranging from peasant agriculture to international finance, and touches on virtually every branch in economics: micro and macro, labor, industrial organization, public finance, resource economics, money and banking, economic growth, international trade, etc., as well as branches in history, sociology, and political science. It deals with the economic, social, political, and institutional framework in which economic development takes place.

The study of economic development has been driven by theories of economic development, which have developed along the lines of the classical ideas, the Marxist idea, or a combination of both. Some approaches have focused on the internal causes of development or underdevelopment, while others have focused on external causes. Economic growth—increase in output and income—has been used as a substitute for development and, in some cases, has been treated as synonymous with development. Economic growth and economic development have been mostly studied by means of cross-country econometric analysis.

Development economics has an assortment of theories and models to inform its teaching and research—neoclassical, Marxist, demand-driven, balanced growth, unbalanced growth, stages of growth, structuralist, dependency, neoclassical, and endogenous—each trying to explain development from a separate intellectual and cultural setting, each considering certain variables and relationships more important than others. Kaushik Basu identifies three major surges in economic growth theory in this century: the Harrod Domar model and the responses it orchestrated, the neoclassical response to Harrod Domar led by Solow (1956), and the works of Lucas (1986) and Romer (1988) that gave rise to the theory of endogenous growth.

Endogenous growth theory. Proponents of the endogenous growth theory focus on technological progress and innovation and believe that technological change is endogenous, not exogenous, as neoclassical economics claims. Originally developed by Frankel, and then Lucas and Romer, endogenous growth theory argues that in addition to the accumulation of capital, technical progress is not exogenous but is planned and produced through research and development efforts. It recognizes the role of private sector and free market enterprise as the engine of growth, but suggests an active role of public policy in promoting economic development. In sum, in endogenous growth economics, several factors come together to determine the level of output in a country: government policy, economic behavior, and technology, which are determined by the expenditure on research and development, the rate of accumulation of factors of production—land, labor, capital, entrepreneurship, and savings. One could summarize the entire focus as being to explain the existence of increasing returns to scale and divergent long-term growth patterns among countries.

Feminist economics. Feminist economics is the branch of economics that advances a theory of economic equality of the sexes and deals with gender equality or the elimination of gender subordination. Feminist economics originated from the organized feminist activities and movement whose influence became more visible in the 1970s and 1990s on behalf of women’s rights and interest. It continues to exert an increasing influence on the field of economics by questioning the existing paradigms, approaches, and assumptions.

Through journals and feminist publications, feminist economists criticize what they refer to as the social construction of economics as a discipline, in particular neoclassical orthodoxy. They highlight what they consider to be the androcentric (male-centered) nature of conventional economic thinking,

question its wisdom, and reveal biases in conventional microeconomic models. Feminist economists question the nature and functioning of the markets and the classical market society, especially with regard to economic rationality and maximizing behavior. They also highlight the absence of power relations and unequal exchanges, gender, and race in mainstream economic analysis. They question the focus on choices in mainstream analysis and advocate focusing, instead, on provisioning, which, in their view, would account for such social issues as poverty and income inequality. Feminist economics also indicts the lack of emphasis on women's economic role and the noninclusion of domestic and other unpaid work in national income accounts and statistics.

Environmental economics. Environmental economics is the branch of economics that deals with the application of economic tools and principles to the understanding and analysis of environmental issues and to solving environmental problems. Environmental economics draws from both microeconomics and macroeconomics, focusing on individual decisions that have environmental consequences and changes in institutions and policies to achieve desirable environmental goals.

A major preoccupation of environmental economics is the question of externalities or spillovers, especially negative externalities or spillover costs of human action. The cost of and responses to pollution, emissions, and other negative externalities as well as population, natural resources, energy, water, agriculture, forests, and wildlife are issues considered in environmental economics. Likewise, environmental economics deals with economic dimensions of problems of both regional and global pollutants, including acid rain, ozone depletion, and global warming.

Environmental economics involves the valuation of the environment and natural resources as well as the assessment of environmental damage, management, and regulation of environmental risk, and the markets for the environment. Environmental economics takes account of sustainable development and the impact on the environment of trade, transport, deforestation, water pollution, and climatic change. It also involves analysis of the costs and benefits of the environment.

Mathematics and economics. Mathematical economics involves the use of formal and abstract analysis to develop hypotheses and analyze economic relationships. It refers to the application of mathematical techniques to the formulation of hypotheses and building economic models. The introduction of mathematics into economics by the Frenchman Antoine Augustin Cournot (1801–1877) in 1838 marked the beginning of a steady course that led to the emergence of mathematical economics. The antecedents of Léon Walras in 1874–1877 and Vilfredo Pareto in 1896–1897 were also essential in advancing mathematical economics. Henceforth, geometrical figures became conventional in economic literature and so did differential calculus and linear algebra. Game theory—the application of mathematics to the analysis of competitive situations and actions—has become a popular aspect of mathematical economics following the publication of *The Theory of Games and Economic Behavior* in 1944 by John von Neumann and Oskar Morgenstern.

Econometrics. Econometrics is the application of mathematical and statistical techniques to the testing of hypotheses and quantifying of economic theories and the solution of economic problems. Econometrics combines mathematical economics as it is applied to model-building and the hypothesis-formulation and statistical analysis involving data collection, analysis, and hypothesis-testing. The emergence of econometrics has provided economists with a tool for analyzing macroeconomic models for forecasting, simulation, and economic policy.

As the most widely used tool for empirical analysis and for constructing theories, econometrics provides a method that allows the expression of economic theory using statistical data or using statistical data to estimate economic theory. Estimation methods range from Ordinary Least Squares to panel data and time series analysis.

New methodological approaches have been developed to address some of the weaknesses of the traditional methodology. For instance, there is more emphasis on rigorous diagnostic testing, including coefficient, residual, and stability tests as well as Unit Root and Johansen tests for cointegration and Granger Causality test. Cointegration analysis of time series to determine whether a group of nonstationary series are cointegrated is an important development in empirical modeling. Improvements in multiple regression analysis often involving tests of correlation and causality as well as linear and nonlinear regression methods have proved to be important for the development of econometrics.

Global Organization and Orientation

Between the two world wars, two important phenomena affected the organization and orientation of economics in the world. The first was the Bolshevik Revolution of 1917 and the exceptionally rapid industrialization of the Soviet Union. The second was the Great Depression of the 1930s. The former led to the development of the Marxist-Stalinist economic system and state-directed development, collectivization, and the establishment of a command economy. The Great Depression led to a declining faith in the classical (*laissez-faire*) self-regulating free market capitalism, and the emergence of government interventionism, following the publication, by John Maynard Keynes in 1936, of *The General Theory of Money, Interest, and Employment*.

The new field of development economics was born in the 1940s and 1950s with W. Arthur Lewis providing the impetus for and being a prime mover in creating the subdiscipline. The new Keynesian macroeconomics and development economics advocated widespread government intervention in the economic process. Likewise, the powerful and far-reaching movements of the developing countries in Africa, Asia, and Latin America in the 1940s gave rise to the rejection of free-market capitalism in those regions. In the 1940s and 1950s, economists advocated for a dominant role of the state and comprehensive national development planning was recommended as a way to eliminate the “vicious circle of poverty” and underdevelopment. The advocacy for dirigisme was founded on the notion of market segmentation and failures as well as on information asymmetries and resource constraints. Disappointing results after World

War II forced a serious questioning and tempering of this development dirigisme.

As a social science, economics is subject to ideological manipulation. Aside from the orthodox (mainstream) and heterodox spheres, in the neoclassical intellectual tradition, there has been a split since the late nineteenth century as can be seen in the case of its liberal and conservative wings. Led by Paul Samuelson, liberal thinking is associated with advocacy for government intervention to correct market imperfections and market failures while conservatism or neoclassicism led by Milton Friedman is associated with a more pronounced advocacy for laissez-faire.

Impact of Influential Economic Ideas

Throughout the history of nations, economic ideas, notably those of Adam Smith, Karl Marx, and John Maynard Keynes, have had a profound influence on politics and society. Economics has influenced the emergence of political systems, political ideology, and the societal organization of production and distribution. The political and economic systems of democratic capitalism and socialism owe their existence to the ideas of Adam Smith and his followers and Karl Marx, respectively. Recognizing this fact, Keynes, in a famous passage from chapter 24 of *General Theory of Employment, Interest, and Money*, states: "The ideas of economists and political philosophers, both when they are right and when they are wrong, are more powerful than is commonly understood. Indeed the world is ruled by little else. Practical men, who believe themselves to be quite exempt from any intellectual influences, are usually the slaves of some defunct economist."

Adam Smith's invisible hand of competitive markets, self-interest, and division of labor gave rise to the American style of individualistic market capitalism. Smith's notion of the natural tendency of an economic system to establish equilibrium through the pursuit of self-interest and competitive markets became the foundation of liberal economics in the nineteenth century. Likewise, Marx's analysis of capitalism, his prediction of its ultimate demise, and the triumph of socialism and communism became the foundation for the socialist economic systems of the former Soviet Union and other Eastern European, African, and Asian countries. His idea of the inevitability of the historical evolution of societies from primitive society to feudalism to capitalism to socialism, and ultimately to communism due to the internal conflicts resulting from the exploitation of workers, led to socialist ideas of centralization, planning, and public ownership of resources.

The commitment by governments to macroeconomic policies that ensure full employment and economic growth; the establishment of social security systems; and even deposit insurance guarantees in the banking system are all by-products of influential economic ideas of Keynes. Keynes argued that the answer to the existence of the Great Depression was insufficient aggregate demand and recommended increase in public demand by the government as a means of increasing total demand and output. Since then, discretionary macroeconomic stabilization has become a policy goal of many countries.

Much of the distinction between political conservatism and liberalism is based on economics and in this regard, the

differentiation lies on the belief of the role of government versus the market and what type of government intervention, if any, will bring about the most optimum outcomes. In the United States, for instance, liberal politicians tend to favor government spending over lower taxes, while conservative politicians tend to favor tax reductions over government spending as fiscal policy measures against economic recessions.

See also *Capitalism; Communism; Conservatism; Liberalism; Marxism; Socialism.*

BIBLIOGRAPHY

- Aghion, Philippe, and Peter Howitt. *Endogenous Growth Theory*. Cambridge Mass.: MIT Press, 1998.
- Baran, Paul A. *The Political Economy of Growth*. New York: Modern Reader Paperbacks, 1975.
- Basu, Kaushik. *Analytical Development Economics: The Less Developed Economy Revisited*. Cambridge, Mass.: MIT Press, 1997.
- Benería, Lourdes. *Gender, Development, and Globalization: Economics as if All People Mattered*. New York and London: Routledge, 2003.
- Blaug, Mark. *Economic Theory in Retrospect*. 5th ed. Cambridge, U.K., and New York: Cambridge University Press, 1997.
- . *The Methodology of Economics, or, How Economists Explain*. 2nd ed. Cambridge, U.K., and New York: Cambridge University Press, 1992.
- Brewers, Anthony. *Marxist Theories of Imperialism: A Critical Survey*. London and Boston: Routledge and Kegan Paul, 1980.
- Frank, Andre Gunder. *Latin America: Underdevelopment or Revolution*. New York: Monthly Review Press, 1969.
- Frankel, M. "The Production Function in Allocation and Growth: A Synthesis." *American Economic Review* 52 (1962): 995–1022.
- Hunt, E. K. *History of Economic Thought: A Critical Perspective*. 2nd ed. New York: HarperCollins, 1992.
- Hunt, E. K., and Howard J. Sherman. *Economics: An Introduction to Traditional and Radical Views*. 6th ed. New York: Harper and Row, 1990.
- Lucas, Robert E. "On the Mechanics of Economic Development." *Journal of Monetary Economics* 22, no. 1 (January 1988): 3–42.
- McGrew, Anthony G., and Paul G. Lewis. *Global Politics: Globalization and the Nation-State*. Cambridge, Mass.: Blackwell, 1992.
- Milgate, Murray, John Eatwell, and Peter Newman, eds. *The New Palgrave: A Dictionary of Economics*. 4 vols. New York: Palgrave 1998. Reprint, 2002.
- Nelson, Judy A. *Feminism, Objectivity and Economics*. London and New York: Routledge, 1996.
- Nnadozie, Emmanuel, ed. *African Economic Development*. San Diego, Calif.: Academic Press, 2003.
- Romer, Paul M. "Endogenous Technological Change." *Journal of Political Economy* 98, no. 5 (1990): 71–102.
- Schumpeter, Joseph A. *History of Economic Analysis*. Edited by Elizabeth B. Schumpeter. New York: Oxford University Press, 1954.
- Sen, Amartya. "The Concept of Development." In *Handbook of Development Economics*, edited by Hollis Chenery and T. N. Srinivasan. 3 vols. Amsterdam: Elsevier Science, 1988–1995.
- Solow, Robert M. "A Contribution to the Theory of Economic Growth." *Quarterly Journal of Economics* 70 (February 1956): 65–94.

Stern, Nicholas. "The Economics of Development: A Survey." *The Economic Journal* 99 (1989): 597–685.

Swan, T. W. "Economic Growth and Capital Accumulation." *Economic Record* 32 (1956): 334–361.

Tietenberg, Tom. *Environmental Economics and Policy*. New York: HarperCollins, 1994.

Emmanuel Nnadozie

ECOSYSTEM. See **Ecology.**

ECUMENISM. *Ecumenism* derives from the Greek adjective *oikoumenikos* (ecumenical) and the noun *oikoumenē*, the latter term employed since the time of Herodotus (5th century B.C.E.) to mean "the inhabited earth" or "the whole world." *Oikoumenē* then came to refer specifically to the realm of the Greco-Roman empire and its culture as distinguished from so-called barbarian lands and cultures. During the fourth century C.E., *oikoumenē* took on the combined political-religious meanings of "the one Christian empire" or "the unified Christian world."

Christianity

The word *ecumenism* itself became prevalent after the 1910 World Missionary Conference in Edinburgh, Scotland. Delegates from missionary organizations met to address the incongruity—and scandal, no less—of historically divided and competing Christian denominations preaching a message of peace and harmony among non-Christian peoples. The World Council of Churches, the primary organizational outgrowth of the Edinburgh Conference that currently comprises more than 330 communions in over 120 countries, applies "ecumenical" to all that relates to the whole task of the whole unifying church to bring the message of Christ to the whole world.

This inhabited earth that was the point of departure for what it is to be ecumenically minded is becoming ever more interconnected and "smaller" as a result of dramatic technological advances in communications and mobilization. Whatever threatens or is of advantage to some carries embedded repercussions for all. The past half-century also witnesses to a slowly evolving consensus on what constitutes authentic human life. (The United Nations' 1948 Universal Declaration of Human Rights was a significant moment at the beginning of this process.) With the emergence of these phenomena collectively known as "globalization," there is a growing awareness in all religions that to be religious is to be interreligious; also, that each religion bears the responsibility to contribute to human security, justice, peace, planetary well being, and the development of a global ethic. Attenuation of the role that religions play as an intensifying factor in regional social conflicts and the increasing incidence of interreligious marriages further accent the need for improved interreligious relations.

Globalization "opens out" the concept of ecumenism beyond its original identity as an intra-Christian concern for unity to include the sense of mutual understanding and

reconciliation among all the world's religions. The World Council of Churches stipulated dialogue as the most appropriate method to foster improved interreligious relationships at its 1967 consultation in Kandy, Sri Lanka. Stephen J. Duffy elucidates the dimensions of interreligious dialogue:

1. Dialogue of life and hospitality, in which people living in open neighborliness share joys and sorrows, problems and concerns.
2. Dialogue of concerned service that promotes collaboration for the integral development of all persons and a more humane world.
3. Dialogue of religious experience, in which persons firmly grounded in their own traditions share their spiritual riches, prayer life, contemplation, and ways of searching for the absolute.
4. Dialogue of doctrinal exchange, in which specialists seek deeper understanding of the doctrines and practices of other heritages as well as their own to establish a communion of horizons arrived at through critical evaluations, correctives, and above all, through the openness of all to change in a shared quest for truth and identity.

These dialogues are intended to assist in breaking down prejudices and misconceptions accumulated over centuries. They enrich, enlarge, challenge, and correct the way some religions have understood and approached religious life in other traditions.

The World Council of Churches' interreligious subunit lists the following as being among its foci: multireligious reflection on secularization; the role of religion in public life and the challenges of religious plurality; Christian-Jewish-Muslim dialogue on the issue of Jerusalem; Hindu-Christian dialogue on issues such as proselytization, religious extremism, and caste; and Christian-Muslim forums on human rights.

The Roman Catholic Church, though not a member of the World Council of Churches, committed to the ecumenical enterprise unreservedly two years before the Second Vatican Council (1962–1965) was called into session. In 1960 Pope John XXIII established the Secretariat for Promoting Christian Unity, renamed the Pontifical Council for Promoting Christian Unity by Pope John Paul II in 1988. Pope Paul VI established the Secretariat for Non-Christians in 1964, renamed the Pontifical Council for Interreligious Dialogue by Pope John Paul II in 1988.

The following catalog illustrates the fact that impetus for improved interreligious relations is not derived from solely Christian initiatives and responses.

Buddhism. His Holiness the Fourteenth Dalai Lama, Tenzin Gyatso, 1989 Nobel Peace Prize winner, freely offers direction on Buddhism's spiritual path to enlightenment that entails the three higher trainings of wisdom, meditation, and moral living. The majority of the path's foundational precepts are monastic in nature; thus it is that believers that identify

with religions possessing monastic traditions find a ready dialogue partner in Buddhism with regard to this particular religious aspect. Establishments that serve the dialogues of life, religious experience, and academic exchange that involve Buddhist participation include the following: The Ecumenical Institute for Study and Dialogue in Sri Lanka; Inter-Religio, a network of institutions in eight East Asian countries; the Nanzan Institute for Religion and Culture in Japan; the bulletin published by Monastic Interreligious Dialogue. The “dialogue of concerned service” is an emerging new frontier as witnessed by the success of a 1996 conference, “Socially Engaged Buddhism and Christianity,” sponsored by the Society for Buddhist-Christian Studies. This fifth international conference of the society included such noted Asian Buddhist leaders as the Dalai Lama, Maha Ghosananda from Cambodia, Sulak Sivaraksa from Thailand, and A. T. Ariyaratne from Sri Lanka, as well as leaders from the Japanese Rissho Kosei-kai and Soka Gakkai movements, and the Korean Chogye Buddhist Order.

Issues between the two main types of Buddhism, Theravada Buddhism of South and Southeast Asia and Mahayana Buddhism of Tibet and East Asia, reflect a universal human tendency to advocate either a literalist-conservative regard for tradition (Theravada Buddhism) or a more open-ended, experimental and expansive handling of tradition (Mahayana Buddhism).

Hinduism. Philosopher-statesman Sarvepalli Radhakrishnan (1888–1975) was a particularly powerful advocate for a “dialogue of religions” while at Oxford in the early 1930s. Presently, Seshagiri Rao, general editor of the forthcoming *Encyclopedia on Hinduism*, is an active promoter of interreligious dialogue. Foundations that embody religious intercourse between Hinduism and Christianity include The North American Board for East-West Dialogue and the European Dialogue Interreligieux Monastique (same as the Monastic Interreligious Dialogue, mentioned above), both founded in 1978, and the Society for Hindu-Christian Studies, founded in 1994.

Hindus and Muslims have lived together in the subcontinent of India, Pakistan, and Bangladesh for over a millennium. The story of their coexistence is one of frequent and violent bloodletting. Here the main ecumenical challenge is to convince that dialogue is even possible. Hinduism initially encountered Islam as the religion of conquerors, and this fact continues to condition the reflexive reaction that some individual Hindus have toward Muslims in general. Yet the “dialogue of life” continues by the very fact of their juxtaposed and intermingled lives. Courageous visionaries who espouse possibilities for the full range of dialogical types issue the call to fellow Hindus, Muslims, and Sikhs alike to acknowledge and celebrate their commonalities (for example, their love of intellectual pursuits, the arts, and literature) while forging a common effort to raise the quality of life in that part of the world.

The three principle Hindu branches of Vaishnavism, Saivism, and Shaktism have at times each splintered into sectarianism at their outermost reaches; at those points, Hindus who embody their religion’s renowned characteristics of toleration, inclusiveness, and ease amidst conditions of plurality are challenged to come to the fore.

In Dialogue we affirm hope. In the midst of the many divisions, conflicts and violence there is hope that it is possible to create a human community that lives in justice and peace. Dialogue is not an end in itself. It is a means of building bridges of respect and understanding. It is a joyful affirmation of life for all.

SOURCE: Article 20, the World Council of Churches’ 2002 document, “Ecumenical Considerations for Dialogue and Relations with People of Other Religions.”

Islam. “Historically, Muslims have had little or no interest in interreligious dialogue even with other believers in God, including the ‘Ahl-al kitab’ (‘People of the Book’—Jews and Christians) . . . [Muslims] have, in general, taken the truth of Islam to be self-evident and have not expressed any great interest in having an open-ended philosophical and theological dialogue with people of other faiths,” writes Riffat Hassan. Hassan then registers the point that the universal quality of the Islamic truth as affirmed in the Koran should condition reception of non-Muslims for the purpose of constructive dialogue (in Swidler, 415–416). Indeed, representatives of the Muslim World Congress, the World Muslim League, and the World Islamic Call Society have met regularly with representatives of the Vatican and the World Council of Churches. The Royal Institute for Inter-Faith Studies, established in 1994 in Amman, Jordan, provides a venue for interdisciplinary study and rational discussion of religion and religious issues, with particular reference to Christianity in Arab and Islamic societies.

Trust building with Jews is a crucial issue. In the early 1990’s Dr. Gutbi Ahmed, the former North American director of the Muslim World League, called for cooperation between Muslim and Jewish communities for the good of society. Joint efforts leading to trust building that can affect the world at large are rightly promoted, not as a luxury, but as an immediate necessity.

As with other religions, Islam itself exhibits diversity in interpretations and expressions, and is an incubator for both dynamic growth and internal conflict. The distinctions between Sunni and Shiite Muslims are subtle but very real. They have hurled the charge “Worse than the infidels” against one another. When and where they can peacefully coexist is primarily a matter of political rather than religious exigency; this reality places in relief the value of emphasizing their common religiosity whenever the traditional alarm-cry “Islam in Danger!” is sounded. Behind the bold headlines, a quieter revolution in discourse and activism is transpiring as Muslims, like Christians and Jews, struggle with the challenges of secularism and materialism.

Judaism. Spokespersons from Judaism in ecumenical forums attest to a sense of speaking in Galuth, that is, in exile. A primary task of these representatives is to stress that Judaism is a living, complexifying religion not to be simply equated with the religion of the Hebrew Scriptures. Judaism must be defined by Jews themselves rather than by others who speak from a majority position and who have little or no sense of exile. For this reason Jewish ecumenical initiatives are numerous, and a high degree of presence is maintained in multilateral dialogues worldwide.

Relations with Christians vastly improve wherever there is real and perceivable growth in awareness of the horrors of the Shoah (Holocaust) of the World War II period, and in detection and condemnation of anti-Semitic attitudes among church members. Bilateral Bible studies also contribute to enhanced relations. This writer's personal experience with meeting Jewish initiative was in assisting Catholic-based Villanova University to join Jewish-based Gratz College in establishing the "I Am Joseph, Your Brother" partnership program in Jewish studies for Christian educators (1996–1999). Another fine, and continuing, example of academic cooperation is the Center for Christian-Jewish Learning at Boston College.

Of course, there are diverse ways of being Jewish: Reformed, Orthodox, Conservative, Reconstructed, secular, Yiddish ethnic, and Zionist among them. The image of Jacob wrestling with the stranger (Genesis 32: 23–32) has been employed to portray the dynamic of Jewish internal and external relations. The stranger blesses and changes Jacob's name to Israel, meaning "he who has wrestled with God and human beings and prevails." Adherence to Judaism continues in internal dialogues on the meaning of being a Jew and in interfaith dialogue on improved human relations. (*World Religions Today*, p. 178.)

Conclusion

The ecumenical movement does not proceed without opposition. One source of rejection stems from the fact that the contemporary globalization process is not celebrated by all. Religious fundamentalists tend to be suspicious of dialogue and cooperation across boundaries; their preference is to live within closed sets of codes and beliefs. In some eastern religions contact with the "other" continues to be regarded as an occasion of defilement. For many, ecumenism represents a temptation to religious syncretism. For such as these, truth is not served but sacrificed in dialogue, and obedience to the mission imperative dictates that conversion should be the only goal of conversation. There can also be detected among "grassroots" members of highly institutionalized religions the conviction that ecumenism is the work of elite, self-justifying cadres of ecclesiastical bureaucrats. Yet, despite determined pockets of resistance, the ecumenical spirit has created numerous college and university interfaith centers and continues to energize an ever increasing number of religious adherents and imbue them with a worldwide sense of accountability for that which lies beyond the realm of privatized concern.

See also *Deism; Religion; Toleration*.

BIBLIOGRAPHY

- Bretton-Granatoor, Gary M., and Andrea L. Weiss, eds. *Shalom! Salaam: A Resource for Jewish-Muslim Dialogue*. New York: Union of American Hebrew Congregations, 1993.
- Duffy, Stephen J. "Mission and Dialogue in a Pluralistic Global City." *Ecumenical Trends* 25 (April 1996): 10–12.
- Esposito, John L., Darrell J. Fasching, and Todd Lewis. *World Religions Today*. New York: Oxford University Press, 2002. Distinguished among the myriad of survey-type works for its ecumenical perspective.
- Gros, Jeffrey, Harding Meyer, and William G. Rusch, eds. *Growth in Agreement II: Reports and Agreed Statements of Ecumenical Conversations on a World Level, 1982–1998*. Geneva and Grand Rapids: WCC and Eerdmans, 2000.
- Hassan, Riffat. "The Basis for a Hindu-Muslim Dialogue and Steps in that Direction from a Muslim Perspective." In *Muslims in Dialogue: The Evolution of a Dialogue*, edited by Leonard Swidler, Lewiston, N.Y.: Mellen, 1992.
- Kinnamon, Michael, and Brian E. Cope, eds. *The Ecumenical Movement: An Anthology of Key Texts and Voices*. Geneva: WCC, 1997.
- Lossky, Nicholas, et al, eds. *A Dictionary of the Ecumenical Movement*. 2nd ed. Geneva: WCC, 2002. Seven hundred entries by 370 leaders in the ecumenical movement—a cornerstone for any ecumenical library.
- Rusch, William G. "The State and Future of the Ecumenical Movement." *Pro Ecclesia* 9, no. 1 (2000): 8–18.

Joseph A. Loya

EDUCATION.

This entry includes eight subentries:

- Asia, Traditional and Modern*
- China*
- Europe*
- Global Education*
- India*
- Islamic Education*
- Japan*
- North America*

ASIA, TRADITIONAL AND MODERN

The history of education in Asia reflected and extended the influence and teachings of three major philosophical, religious traditions: Hinduism (including Buddhism), Islam, and Confucianism (including Neo-Confucianism). Over time, these traditions interacted with one another, although the interaction was not entirely mutual, nor did it blunt the cultural distinctions of the various regions of South Asia, Southeast Asia, and East Asia. Indeed, while Buddhism exerted its widespread influence across East Asia from the third century B.C.E. on, it never replaced the primacy of Confucianism. Similarly, although Islam infiltrated India from the eighth century C.E. on, the foundation of Hindu cultural traditions remained unshaken.

A middle region, Southeast Asia, was influenced by Buddhism and Confucianism, resulting in a unique blended

educational experience. From the eighteenth century on, as Western culture came into the region, Asia's educational practices in general underwent a sea change that resulted in a previously unknown level of uniformity. Regional diversity, however, remains visible, reflecting the differences in political settings, cultural values, and economic development, making a comprehensive overview of education in Asia impossible. For this reason, the following discussion will deal primarily with educational practices in South and East Asia with a focus on exploring the ideological dynamics embedded within those regions and the impact of historical change from without.

South Asia

South Asia is known particularly for its cultural and linguistic heterogeneity, a feature influenced by both its topography and its history. Although the Deccan Plateau divided the subcontinent into north and south, two invasions, first by the Aryans (c. 1500 B.C.E.), then by the Turkish-speaking Muslims (from the eighth century C.E. on), deepened this division, causing social and political tensions among various ethnic groups for centuries. These invasions also, albeit temporarily, fostered a degree of political unity that makes it possible to identify some characteristics of educational practices in traditional India.

In North India, for example, where the Aryans dominated, cultural and linguistic unity was evident. Classical Hindu culture, as reflected in Vedic learning and other literary works in Sanskrit, flourished during the Gupta period (300–c. 500 C.E.) Given the religious nature of Vedic learning, the form higher learning took in Hindu culture, it was only taught exclusively among the Brahmins, the Hindu priest class. This situation remained unchanged for centuries, even under Muslim rule. The two classes just below the Brahmins, the Kshatriyas (which means “protector of gentle people”; they were the rulers and warriors) and Vaisyas (traders, businesspeople, and farmers), were allowed to enter a different type of school where they learned basic skills in writing, arithmetic, and reading, using texts written in the vernacular. Although some members of these castes pursued knowledge beyond the elementary level, they were usually allowed to excel only in areas outside of Vedic learning, such as medicine. The bottom class, the Sudras, and women were prohibited from receiving any formal schooling, although exceptions always existed.

Strict social hierarchy and diverse cultural traditions prevented India from developing a centralized educational system prior to the arrival of the British. Educational initiatives for establishing a school and selecting its teacher thus often came from a specific class or community. Most schools hired only one teacher, but though most teachers came from the Brahmin class, their qualifications varied greatly. Wealthy aristocratic communities supported their schools and the teachers' salaries with land endowments, whereas less wealthy communities paid their teachers with student fees. Whatever the case, teachers, or gurus, usually received considerable respect from their students and the community, partially because the teacher-student relationship replicated the social hierarchy of Hindu society and partially because of the way knowledge was imparted in the schools. Perhaps because the Vedas were transmitted orally for many generations before they were written

down, oral learning figured centrally in the methods of teaching. In fact the term *Veda* is called *Sruti* in Sanskrit, which means “heard from the guru,” and Vedic teachers demanded that their pupils repeat aloud what they heard for better retention. The emphasis on oral instruction also served a religious and social purpose. Since written texts were not easily accessible to students, it allowed the Brahmins to mystify and monopolize Brahmanic education and maintain and safeguard their social privilege.

The subjects of teaching varied in different historical periods, even among schools in the Brahmanic tradition. Because of the Buddhist challenge, for example, the study of *nyaya*, or logic, flourished. Buddhism exerted its influence in Indian education in other areas as well. Its egalitarianism, for instance, opened the door for members of the non-Brahmin classes to become teachers. The Buddhist emphasis on writing was also reflected in the school curricula at various levels. Likewise, the Indian educational system absorbed influences from Islam. Muslim education, which centered on recitation and memorization of the Koran, suited the Hindu emphasis on oral instruction. Like the Hindus, the Muslims also valued person-to-person transmission of knowledge, which reinforced the traditional guru-disciple relationship in Hindu culture.

East Asia

In contrast to the diverse development of education in South Asia, the history of education in East Asia related primarily to the development of Confucianism, but variations and vicissitudes were also present. Indeed, while Confucius (c. 551–479 B.C.E.) was commonly regarded as the first teacher in ancient China, he had many competitors both during and after his time. As in India, oral instruction was the main means of education in China, as shown in the *Analects*, which record the conversations between Confucius and his disciples. However, Confucius was also credited with compiling the *Six Classics*. During the Han period (206 B.C.E.–220 C.E.), when Confucianism was established as the official ideology in China, these *Classics* and their commentaries became the principal texts in the school system, which included a state university. These texts became the means by which the dynastic ruler hoped to centralize the educational system. Indeed, while each village funded its schools and hired its teachers, there was discernible unity in the educational system of imperial China. By using these texts and their derivatives, teachers imparted both knowledge and moral values to their students in an effort to prepare at least some of them for government positions. This interest intensified during the Sui (581–618 C.E.) and Tang periods (618–907 C.E.), following the establishment of the civil service examination system, for the system legally permitted any successful students, regardless of their social origin, to enter officialdom.

The cultural atmosphere in the Tang period was distinctly cosmopolitan in that the dynasty patronized, though not always concomitantly, Confucianism, Buddhism, and Daoism (an indigenous reaction to the challenge of Buddhism) while at the same time absorbing many Buddhist elements into its practices. The Buddhist influence was also present in Confucianism. Inspired by the Buddhist emphasis on lineage in knowledge transmission, Tang scholars, in their attempt to combat the intrusion

of Buddhism and Daoism and restore the Confucian orthodoxy, also identified key figures in Confucian genealogy. This restorationist project was continued and expanded in the Song period (960–1279 C.E.), marked by the rise of Neo-Confucianism. The Neo-Confucians, such as Zhu Xi (1130–1200), set out to reform education not only by supplying a new set of texts, namely the *Four Books*, but also by establishing a new type of school, the academy. Zhu's compilation of the *Four Books* extended the restorationist project of reshaping the Confucian genealogy, whereby Mengzi (c. 371–289 B.C.E.; romanized as Mencius) was canonized, as were some excerpts from the original Confucian canons, which Zhu identified as the essence of Confucian teaching. The proliferation of the academies from this period onward also provided a new venue for students, supplementing the one-teacher village schools and state-run colleges and universities.

This change had little effect on women's education, however. As in India, Chinese women usually received only a rudimentary education at home that prepared them to be good wives and mothers. Outstanding women scholars and poets, however, appeared in every historical period, for example, Ban Zhao (c. 41–120 C.E.) often argued for the necessity of women's education.

During the Ming (1368–1644) and Qing (1644–1911) periods, Neo-Confucianism consolidated its position as the ideological orthodoxy, thanks to the entrenchment of civil service examinations. As Neo-Confucianism exerted its influence beyond China and became the orthodox ideology of Korea and Japan, it also faced many challengers and critics. By the eighteenth century, a new intellectual trend arose simultaneously across East Asia that, while sharing the restorationist sentiment of the Neo-Confucians, attempted to transcend the Neo-Confucian discursive system and revive the teachings of classical Confucianism. This trend emphasized practical knowledge and scholarship; the latter was characterized by the endeavor to ascertain the authenticity of Confucian texts and the veracity of their contents by the methods of history and philology. All of this had a noticeable impact on the goals and methods of Confucian education.

South Asia

Toward the end of the eighteenth century, as education in East Asia underwent important changes associated with the ebb and flow of Neo-Confucianism, a more drastic transformation was introduced by the British in South Asia. Having undermined the native educational system via both economic and cultural means, the British introduced modern schools, initially for the purpose of training interpreters and future government officials. In so doing, it weakened the tie between students and their communities, changing the traditional goal of education in South Asia. By teaching English in those schools, the British created an additional barrier between the educated elite and the common people.

Slowly, by the mid-nineteenth century, the British had established, for the first time in history, a centralized educational system in South Asia. It consisted of three tiers of schools—elementary, secondary, and college levels—that purported to transcend the religious and ethnic division of the populace.

This system was, by and large, continued after countries in the region had gained independence from the mid-twentieth century on. In fact it is the educational norm throughout Asia in the early twenty-first century.

Modernization

In East Asia, Japan was the first country to embark on modern educational reform. In the wake of the Meiji Restoration of 1868, the government sent out a group of distinguished officials to tour many countries in Europe and America, hoping to gain firsthand knowledge about social, political, and educational systems in the modern West. The educational measures introduced by the Meiji government included creation of the ministry of education, compulsory elementary education (extended also to women), and establishment of a national university—Tokyo University—started in a renovated state school formerly devoted to Confucian learning.

By comparison, as the first country that confronted the Western powers in East Asia, China lagged behind Japan in initiating educational reform. In its struggle against the Western challenge, the reigning Qing dynasty established a few translation schools and sent out a few groups of students abroad, but throughout most of the nineteenth century China apparently lacked the desire to adopt more comprehensive educational reforms. It was not until 1895, after its shattering defeat by Japan in the Sino-Japanese War (1894–1895), that the dynasty, as well as Chinese educators, began to realize the importance of modern education. In the aftermath of the war, China witnessed a short-lived political reform, which resulted, among other things, in the founding of a modern university in 1898—the Metropolitan University—now Beijing University. As a large number of its students went abroad, most to Japan because of its proximity, to receive a modern education, the country also embarked on a rapid course of educational reform. In 1905 the thousand-year-old civil service examination was abolished, paving the way for the establishment of a modern educational system. Accompanying this change was an unprecedented opportunity for Chinese women to receive formal schooling.

All in all, the structure of modern education took root in most of Asia from the late nineteenth century on. Over time, it evolved into a uniform system across the continent and bore a striking resemblance to that of the modern West. Meanwhile, it demonstrates in its ideals and practices the diverse influences of the religious and cultural traditions and political ideologies of the region.

See also Confucianism; Daoism; Education: China; Education: India; Education: Islamic Education; Education: Japan; Hinduism; Islam: Southeast Asia; Religion: East and Southeast Asia; Westernization: Southeast Asia.

BIBLIOGRAPHY

- Crook, Nigel, ed. *The Transmission of Knowledge in South Asia: Essays on Education, Religion, History, and Politics*. Delhi and New York: Oxford University Press, 1996.
- De Bary, W. Theodore, and John W. Chaffee, eds. *Neo-Confucian Education: The Formative Stage*. Berkeley: University of California Press, 1989.

- Dore, Ronald P. *Education in Tokugawa Japan*. Berkeley: University of California Press, 1965.
- Elman, Benjamin A., and Alexander Woodside, eds. *Education and Society in Late Imperial China, 1600–1900*. Berkeley: University of California Press, 1994.
- Hayhoe, Ruth, and Marianne Bastid, eds. *China's Education and the Industrialized World: Studies in Cultural Transfer*. Armonk, N.Y.: M. E. Sharpe, 1987.
- Ko, Dorothy. *Teachers of the Inner Chambers: Women and Culture in Seventeenth-Century China*. Stanford, Calif.: Stanford University Press, 1994.
- Lee, Thomas H. C. *Education in Traditional China: A History*. Leiden, Netherlands: Brill, 2000.

Q. Edward Wang

CHINA

Since antiquity Chinese placed an inordinately high value on education. During the classical era (600–250 B.C.E.), the Chinese advanced the notion that merit and ability measured by training should take precedence over race or birth in state appointments. Since the early empire (200 B.C.E.–200 C.E.), clans and families mobilized financial and cultural resources to provide boys (and sometimes girls) with the tools of classical literacy. However, a society based on merit remained only an ideal. Through the middle empire (600–900 C.E.) education remained the privilege of landed aristocrats and prosperous merchants.

The imperial state increased its expenditures on education during the Tang (618–906) and Song (960–1280) dynasties, when it created the first examination system for selecting officials. In addition, the rise of Buddhism in medieval China created charitable institutions for the common people, which included temple schools and monasteries, where many commoners—male and female—were educated. Building on such precedents, late imperial (1400–1900) statesmen and local leaders, except for the occasional Daoist eccentric, agreed that education, particularly a classical, moral education, was one of the foundations of public order and civilized life.

Educational Ideals in Late Traditional China

Teachers in late imperial times aimed at training a highly literate elite and socializing the far less literate, or even illiterate, common people by means of exhortations and rituals. This concept never hardened into a tidy formula, given the dissatisfactions with the educational status quo that have characterized Chinese history. Wang Yangming (1472–1529) and his followers, for example, opened schools for commoners on a wider scale than ever before. The line between elites and commoners could also be blurred by political turmoil. When emperors feared that heterodox popular religions were spreading, they often conflated learning with indoctrination from above. Many literati accused Wang Yangming and his followers of heterodoxy and deceiving the people.

Separate from official studies, schools of learning among literati included poetry societies, private academies, or lineages of teachings associated with local classical, medical, or statecraft traditions. Medical and statecraft traditions were tied to

the teachings of a master, who bequeathed his teachings to his immediate disciples. In the absence of public schools in Ming China (1368–1644), education in lineage schools, charity and temple schools, or at home transmitted the classical or technical training needed by young men to pass local civil or military examinations or practice their local trades.

In Ming times, the “Learning of the Way” (Neo-Confucianism) tradition became an empirewide orthodoxy. Its followers created an imperial curriculum that was strengthened by the civil examinations. Although moralistic predispositions were favored in civil examinations, alternative and dissenting learning proliferated. Natural studies, particularly medical learning, was also a legitimate focus of private study when literati sought alternatives to official careers. The wider scope of civil policy questions dating from the early fifteenth century often reflected the dynasty’s interest in astrology, calendrical precision, mathematical harmonics, and natural anomalies.

Learning was guided by examples of past worthies and sages and encouraged by good companions and teachers. In traditional schools, the prestige of learning led to more regimentation than many literati might have wished, but this was tempered by numerous local traditions of learning outside the state. Members of literary schools held that because literature and governing were not separate, writers should avoid religious vocabulary, colloquial phrases, or popular novels. Knowledge of numbers using the abacus in tax-related economic transactions, debates about “hot” and “cold” medical therapies to deal with epidemics, and the astronomical expertise for reform of the calendar were also widespread.

Education, Society, and Examinations

After 1000, Chinese appealed to meritocratic ideals in which social prestige and political appointment depended on written examinations to establish public credentials. Elite status was corroborated by examination, which in turn produced new literati social groups that endured from 1400 to the twentieth century. Classical learning became the empirewide examination curriculum, which reached into counties and villages for the first time.

After the Ming fell, civil examinations were reinstated by the succeeding Manchu Qing dynasty (1644–1911). As before, examinations were regularly held in 140 prefectures and about 1,300 counties. Medieval examinations had been held only in the capital, while from 1000 to 1350, regular examinations only occurred in the provincial and imperial capitals. Qing emperors granted the examination system a central educational position in Chinese government and society until 1905, when the civil examinations were abolished.

Education restructured the complex relations between social status, political power, and cultural prestige. A classical education based on nontechnical moral and political theory was as suitable for selection of elites in China as humanism and a classical education were for elites in early modern Europe. The examination life, like death and taxes, became a fixture of elite education and popular culture.

Examinations represented the focal point through which imperial interests, family strategies, and individual hopes and

aspirations were directed. In the absence of alternative careers of comparable social status and political prestige, the goal of becoming an official took priority. Once set in place, the civil service recruitment system achieved for education a degree of empirewide standardization and local importance unprecedented in the premodern world. Moreover, the education ethos carried over into the domains of medicine, law, fiscal policy, and military affairs.

Several centuries before Europe, the imperial Chinese state committed itself financially to supporting an empirewide school network. Despite their initial success, dynastic schools were eventually absorbed into the examination system and remained schools in name only. Because the classical curriculum was routinized, dynastic schools became way stations, or “testing centers,” for students to prepare for civil examinations.

Training in both vernacular and classical literacy was left to families. Dynastic schools in China never entertained goals of mass education that the Maoists would later call for. Rulers recognized elite education based on the classics as an essential task of government to recruit talent. Chinese elites perceived a classical education as the correct measure of their moral and social worth. Both believed that ancient wisdom, properly generalized and inculcated, tempered men as leaders and prepared them for wielding political power.

Rulers and elites equated social and political order with moral and political indoctrination through education. High-minded officials also appealed for the autonomy of education as an antidote to the warping of classical goals by the cutthroat examination process. Private academies frequently became centers for dissenting views. Such academies also served as important educational venues for literati who preferred teaching and lecturing to pass on their classical learning. Compared to some five hundred Song and four hundred Yuan dynasty private academies, the Ming overall had in place from one to two thousand academies by its end. The Qing had upwards of four thousand empirewide.

Political Uses of Education

Imperial support of education was contingent on the examinations to supply talented and loyal men for the bureaucracy to employ. Political legitimacy was an assumed by-product of preparation for the civil and military service. In a convoluted ideological canvas of loyalties encompassing state and society, even emperors became educated in the orthodox rationale for their imperial legitimacy—by special tutors selected from the civil examinations.

Imperial support of literati-inspired cultural symbols, which were defined in terms of classical learning, painting, literature, and calligraphy, enabled the dynasty in concert with its elites to maintain the institutional conditions necessary for its own survival. The examination hierarchy stabilized existing social hierarchies by redirecting wealth and power derived from commerce or military success into education to prepare for civil and military service. A by-product was the creation of a large number of classically literate elites who produced essays, poetry, stories, novels, medical treatises, and scholarly works.

Social Consequences of Education

Education was premised on social distinctions between literati, peasants, artisans, and merchants in descending order of rank. Under the Ming, sons of merchants for the first time were legally permitted to take the civil examinations. However, occupational prohibitions, which extended from so-called mean peoples to all Daoist and Buddhist clergy, kept many others out of the civil service competition, not to mention an unstated gender bias against all women.

Because the dynastic school system was limited to candidates already literate in classical Chinese, initial stages in training and preparing a son for the civil service became the responsibility of families seeking to attain or maintain elite status. Careerism usually won out over idealism among talented young men who occasionally were forced to choose between their social obligations to their parents and relatives and their personal aspirations. Failures could, however, because of their classical literacy, choose teaching and medicine as alternate careers.

Unlike contemporary Europe and Japan, where absolute social barriers between nobility and commoners prevented the translation of commercial wealth into elite status, landed affluence and commercial wealth during the Ming dynasty were intertwined with high educational status. Because of the literary requirements, artisans, peasants, and clerks were poorly equipped to take advantage of the openness of the civil service. Clear boundaries were also erected to demarcate male education from female upbringing, which remained intact until the seventeenth century, when education of women in elite families became more common.

Nevertheless, when compared with the fatalistic ideologies common among Buddhist or Hindu peasants in South and Southeast Asia, for example, the Chinese ideology of teaching and learning did promote beliefs in the usefulness of education and created a climate of rising expectations for those who dreamed of glory but sometimes rebelled when their hopes were repeatedly dashed.

Culture and Education

Classical literacy—the ability to write elegant essays and poetry—was the crowning achievement for educated men and increasingly for elite women in the seventeenth century. This learning process began with rote memorization during childhood, continued with youthful reading, and concluded with mature writing. Literati believed that the memory was strongest at an early age, while mature understanding was a gradual achievement that derived from mastering the literary language and its moral and historical content.

Educated men, and some women, became members of a “writing elite” whose essays would mark them as classically trained. The educated man was able to write his way to fame, fortune, and power, and even if unsuccessful in his quest for an official career, he could still publish essays, poetry, novels, medical handbooks, and other works. The limitation, control, and selection of the “writing elite,” not the enlargement of the “reading public,” was the dynasty’s goal in selecting officials.

Local lineages translated their social and economic strength into educational success, which in turn correlated with their

control of local cultural resources. Lineages required classically literate and highly placed leaders who moved easily in elite circles and could mediate on behalf of the kin group with officials. Economic surpluses produced by wealthy lineages, particularly in prosperous areas, enabled members of rich segments to receive a better classical education, which via success on state examinations allowed access to political and economic prestige outside the lineage.

Dominant lineages and merchant families maintained their local status through their schools, medical traditions, and academies. Elite education stressed classical erudition, historical knowledge, medical expertise, literary style, and poetry. The well-publicized rituals for properly writing classical Chinese included cultural paraphernalia long associated with literati culture: the writing brush, ink stick, inkstone, stone monuments, fine silk, and special paper.

Although muted in practice, elites achieved a degree of cultural and linguistic uniformity through a classical education. The classical curriculum represented a cultural repertoire of linguistic signs and conceptual categories that ensured elite political power and social status. Education in dynastic schools and private academies was a fundamental factor in determining cultural consensus and conditioning the forms of reasoning and rhetoric that prevailed in elite written texts of the period.

Reform and Revolution

During the twentieth century, classical literati values, dynastic imperial power, and elite gentry status unraveled. Manchu rulers gave up civil examinations as one of their major weapons of cultural control that had for centuries successfully induced literati acceptance of the imperial system. Traditionalists who reformed classical learning after 1898 paid a form of “symbolic compensation” to classical thought by declaring its moral superiority as a reward for its historical failure. The modern Chinese intellectual irrevocably replaced the late imperial literatus in the early republic.

Increasingly, traditional education was dissolved within a westernizing reformist project. Shu Xincheng (1893–1960), an early republican educator and historian, recalled the pressure of the times to change: “The changeover to a new system of education at the end of the Ch’ing appeared on the surface to be a voluntary move by educational circles, but in reality what happened was that foreign relations and domestic pressures were everywhere running up against dead ends. Unless reforms were undertaken, China would have no basis for survival. Education simply happened to be caught up in a situation in which there was no choice” (Borthwick, p. 38).

The floodgates broke wide open after the 1904–1905 Russo-Japanese War, which was largely fought on Chinese soil. Given the frantic climate of the time, the classical educational system was a convenient scapegoat. Court and provincial officials submitted a common memorial calling for the immediate abolition of the civil examinations at all levels. The civil examinations in particular were perceived as an obstacle to new schools because a classical degree still outweighed new school degrees and prevented realizing the ideal of universal education.

A separate Education Board was established in December 1905 to administer the new schools and oversee the many semiofficial educational associations that emerged at the local and regional levels. The board reflected the increasing influence of Han Chinese officials and served the interests of the modernists in undoing the schooling mechanisms under which classical literacy and essay writing had been achieved.

Still missing, however, was the need to address the role of classical versus vernacular language in school instruction and in written examinations. Full-scale educational reform still required champions of a “literary revolution,” who became vocal during the May Fourth period after 1919. Not until the republican Ministry of Education began to move on the vernacular language of education could popular education move from ideal to practical reality.

Many unofficial organizations and groups entered the fray of school reform, which eroded the Manchu court’s control over education policy. Through the portal of local education, local official and unofficial elites took over the educational domains of the central bureaucracy. As the imperial court grew weaker, regional and local tiers of power began to create the educational institutions that would accelerate the demise of the dynasty and form the educational pillars of the republic after 1911.

The Education Board established in 1905 was renamed as a “ministry” in the republican period and remained on the side of new schools. The educational institutions of the Republic of China after 1911 were the direct legacy of the late imperial reforms. Sun Yat-sen (1866–1925) created the examination bureau as part of the republic’s 1920s “five-power constitution,” which echoed traditional institutions. The twentieth-century examination life, which was associated with university and public school entrance examinations in China and later in Taiwan, is the cultural heir of the imperial examination regime.

Despite important continuities, the affinity between longstanding expectations of traditional Chinese families and the dynasty’s objective political institutions was ripped apart. Increasingly reformed on Western and Japanese models, new schools in China precipitated a generalized down-classing of traditional education and the classical curriculum. Many conservative families failed to convert their inherited educational and literary cultural resources into new academic degrees for their children. A revolutionary transformation in student dispositions accompanied the radical change in the conditions of recruitment of public officials after 1905.

Reform of education and examinations in China after 1900 was tied to newly defined goals of Western-style change that superseded conservative imperial goals for reproducing dynastic power, granting gentry prestige, and affirming classical orthodoxy. The ideal of national unity replaced dynastic solidarity. The sprawling, multiethnic Manchu empire became a struggling Han Chinese republican state that was later refashioned as a multiethnic communist nation.

See also Chinese Thought; Confucianism; Examination Systems, China.

BIBLIOGRAPHY

- Bastid, Marianne. *Educational Reform in Early Twentieth-Century China*. Translated by Paul J. Bailey. Ann Arbor: University of Michigan China Center, 1988.
- Borthwick, Sally. *Education and Social Change in China: The Beginnings of the Modern Era*. Stanford, Calif.: Hoover Institution Press, 1983.
- De Bary, William Theodore, and John W. Chaffee, eds. *Neo-Confucian Education: The Formative Stage*. Berkeley: University of California Press, 1989.
- Elman, Benjamin A., and Alexander Woodside, eds. *Education and Society in Late Imperial China, 1600–1900*. Berkeley: University of California Press, 1994.
- Keenan, Barry. *Imperial China's Last Classical Academies: Social Change in the Lower Yangzi, 1864–1911*. Berkeley: University of California Press, 1994.
- Ko, Dorothy. *Teachers of the Inner Chambers: Women and Culture in Seventeenth-Century China*. Stanford, Calif.: Stanford University Press, 1994.
- Lee, Thomas H. C. *Education in Traditional China: A History*. Leiden, Netherlands: Brill, 1999.
- Meskill, John. *Academies in Ming China: A Historical Essay*. Tucson: University of Arizona Press, 1982.
- Rawski, Evelyn Sakakida. *Education and Popular Literacy in Ch'ing China*. Ann Arbor: University of Michigan Press, 1979.
- Walton, Linda. *Academies and Society in Southern Sung China*. Honolulu: University of Hawai'i Press, 1999.

Benjamin A. Elman

EUROPE

European pre-university education began its long odyssey with Homer. The social and literary values expressed in his poetry informed Greek education, which became the basis of Roman education. The Renaissance revived ancient literary texts and educational programs, which were modified and adapted in subsequent centuries. European humanities education still embraces in part ancient Greco-Roman educational ideals and goals.

Greek Education

The great poems the *Iliad* and the *Odyssey* believed by the ancient Greeks to have been composed by Homer during the eighth century B.C.E. contained the fundamental idea of Greek education, that the ideal warrior must also be eloquent. He won battles of words as well as arms. Homer made the point by inserting many formal speeches into his poems. And Greek children later memorized long sections of the *Iliad* and the *Odyssey*.

In the seventh and sixth centuries B.C.E. an educational program for aristocratic males of gymnastics, music, and letters developed. Then the Sophists, the first professional educators, appeared in the second half of the fifth century B.C.E. to teach well-born Athenian youths between the ages of thirteen and seventeen. Learning how to be an effective orator became the most important goal of education for Athenian males destined to rule. Simultaneously, a series of directives and principles that could be taught and learned replaced observation and imitation as the means to the goal. Then Isocrates (436–338 B.C.E.) added the view that the study of Greek literature and history

would inculcate the right moral and civic virtues in upper-class Greek males.

Greek education reached full development in the fourth century B.C.E. The Greeks passed this form of education to the rest of the known world during the Hellenistic period, which began with the conquests of Alexander the Great (r. 336–323) and lasted through the fourth century C.E. A Greek boy attended a primary school from about age seven to fourteen and learned to read, write, do a little arithmetic, and participate in music and gymnastics. In the secondary school the student read the classics of Greek literature, especially the poet Homer and the tragic dramatist Euripides (c. 484–406 B.C.E.). He also read in whole or part other authors in the Greek literary tradition, such as the epic poets Hesiod (fl. c. 700 B.C.E.) and Apollonius of Rhodes (3rd century B.C.E.), the lyric poet Callimachus (c. 305–240 B.C.E.), the tragedians Aeschylus (525–456 B.C.E.) and Sophocles (c. 496–406 B.C.E.), and the comedians Menander (342–292 B.C.E.) and Aristophanes (c. 450–c. 388 B.C.E.). He also read the histories of Herodotus (c. 484–c. 420 B.C.E.), Xenophon (428–354 B.C.E.), and Thucydides (c. 460–c. 400 B.C.E.). But which texts received most attention is difficult to determine. The most important part of the secondary school curriculum was rhetoric, learning how to write and speak well. The program consisted of practice, followed by writing various kinds of works, and then constructing formal speeches according to rules. The goal was to produce the educated upper-class Greek male who could express himself well and persuade others.

The Greeks also had higher schools for those who wished to learn more in specialized branches of knowledge. Plato's Academy, founded about 380 B.C.E. and lasting until 529 C.E. albeit undergoing many changes, had no fixed curriculum. It probably emphasized extended philosophical discussions on a variety of topics, including rhetoric. The Lyceum or Peripatetic School founded in 335 by Aristotle (384–322 B.C.E.) began with the purpose of collecting and studying scientific research and had a strong philosophical and scientific orientation. Theophrastus (c. 370–c. 288 B.C.E.) led the Lyceum after Aristotle's death, and it endured until the third century C.E. Alexandria in Egypt became famous for its museum and library (founded c. 280 B.C.E., destroyed in or about 651 C.E.) and as a center for higher scientific learning. None of the above schools offered organized formal education. Rather, they were centers of learned men who attracted followers.

Roman Education

Education in the early centuries of the Roman Republic consisted primarily of fathers passing on family traditions and skills to their sons. After reaching adulthood at the age of sixteen, the young man came under the guidance of an older man who groomed him in public speaking and other useful skills for a career as a member of a republic. He also served in the army because he would in time be expected to command troops. By the middle of the second century B.C.E., when Rome ruled a far-flung empire, formal education had developed. Greek educational ideas and practices influenced Rome, as they did the rest of the Mediterranean world. The education of upper-class Romans was Greek schooling that later became Latin. The

conquest of Greece aided this process by producing Greek slaves, some much better educated than their Roman masters. A Greek slave tutored the child in simple reading until he went to elementary school at six or seven to be taught reading, writing, and arithmetic. At twelve or thirteen the boy went to a secondary school, where he studied mostly Greek literature until the middle of the first century B.C.E. Upper-class Romans were bilingual at this time. Then, after the lifetime of Marcus Tullius Cicero (106–43 B.C.E.), who had popularized Greek pedagogical and philosophical ideas in his many works, Roman schools became Latin. Students read the great Roman poets Virgil (70–19 B.C.E.) and Horace (65–8 B.C.E.), the historians Livy (59 B.C.E.–17 C.E.) and Sallust (86–35 or 34 B.C.E.), the comic dramatist Terence (186 or 185–?159 B.C.E.) and, of course, Cicero, whose treatises systematized Greek rhetorical instruction. While Greek remained part of the curriculum, bilingualism declined.

The highest level of Roman education began at about the age of sixteen and focused on rhetoric. As in Greek education, the goal was to learn to speak and write effectively as needed in public life and the law courts. If anything, the emphasis on oratory in Roman schools was stronger than in Greek schools because other parts of the Greek curriculum, such as music and athletics, were eliminated, and the Romans had little interest in science and philosophy. Roman schools used rhetoric manuals that systematized Greek rhetorical instruction.

Greco-Roman education prepared upper-class males for leadership roles. Educators hoped to give their students the proper civic and moral values based on the traditions and literature of the Greek city or Roman state. They tried to educate the person rather than impart knowledge. Above all, Greco-Roman education taught rhetoric, a practical skill for future leaders of self-governing societies in which the spoken word meant a great deal. The emphasis on rhetoric continued even after Rome had become a dictatorship ruled by the will and whims of emperors. Despite the great mathematical, medical, philosophical, and scientific accomplishments of ancient Greece, Greco-Roman education did not stress these.

Education of Women in Greece and Rome

Little is known about the education of girls and women in Greece and Rome. It is likely that educational opportunity for girls was limited in Greece, but a little more available in Rome. During the Roman republican period ending in 27 B.C.E., it is likely that upper-class mothers who were able to do so taught their sons and daughters reading and writing in Latin and Greek. During the Empire at least a few girls studied alongside boys in primary and secondary schools outside the home. The poet Martial (c. 40–c. 104 C.E.) mentioned boys and girls studying together in what must have been secondary-level schools. For most girls formal education probably ended with marriage in the early to mid-teens. Nevertheless, the fact that many Roman wives and mothers played roles in Roman imperial politics suggests that they were reasonably well educated, and that more schooling was available for upper-class girls than can be documented. The rest of the population, male and female, below the elite in both Greece and Rome probably received no education or learned only rudimentary skills.

Medieval Education

The Roman educational system disintegrated as the empire declined in the fifth and sixth centuries. Church institutions of the early Middle Ages (c. 400–c. 1000) were forced to establish schools to train future churchmen. Bishops established schools attached to their cathedrals to train priests for their dioceses. Religious orders organized schools in their monasteries to educate young members of the order. An unknown number of parish priests taught boys from the parish or town. In each case the primary purpose was to train future clergymen, although church schools often enrolled boys who would not become clergymen. The curriculum was limited to learning medieval Latin, which differed from classical Latin, the Bible and other religious works, a little bit of arithmetic, and skills such as chanting needed to perform church rituals.

After 1100, many more Latin grammar schools appeared. Supported by towns as in Italy or endowments in England, they educated both future clergymen and lay boys. These schools developed a more sophisticated Latin curriculum that included reading manufactured verse texts of pious sentiments, grammar manuals and glossaries, and a little bit of ancient poetry, especially passages from Virgil's *Aeneid*. At the secondary level they taught *ars dictaminis*, the theory and practice of writing prose letters by following the principles found in medieval manuals. The latter offered rules for prose composition derived from Cicero's *De inventione* and the pseudo-Ciceronian *Rhetorica ad Herennium*, both written in the first century B.C.E. Upper-level students, especially those beginning university study, might also study introductory logic or dialectic, a key part of Scholastic method.

A new kind of school teaching vernacular literature and commercial mathematics and bookkeeping skills appeared in Italy in the second half of the thirteenth century. These schools taught little or no Latin, but did teach popular vernacular texts, often stories illustrating the benefits of Christian virtues and the terrible consequences of vices. The commercial mathematics (called *abbaco*) and bookkeeping skills were quite complex. The vernacular schools educated boys who would become merchants or otherwise enter the commercial world. Other parts of Europe, especially Germany, had vernacular schools in the sixteenth century, which probably means that they began in the Middle Ages, but little is known about them. Outside Italy vernacular schools did not teach the sophisticated commercial mathematics and bookkeeping skills of Italian vernacular schools until much later. These modest vernacular schools marked a new departure in European education because they educated boys for secular nonprofessional and nonuniversity careers. They marked the beginning of a separation between Latin humanistic education for the elite, university-bound student and a practically oriented education for the rest who would enter the world of work. This division lasted through World War II (1939–1945) and is still found in Europe in some measure.

From the Renaissance to the Enlightenment

The Renaissance created an educational revolution by adopting a classical curriculum for its Latin schools. This happened in Italy in the fifteenth century and in the rest of Europe in

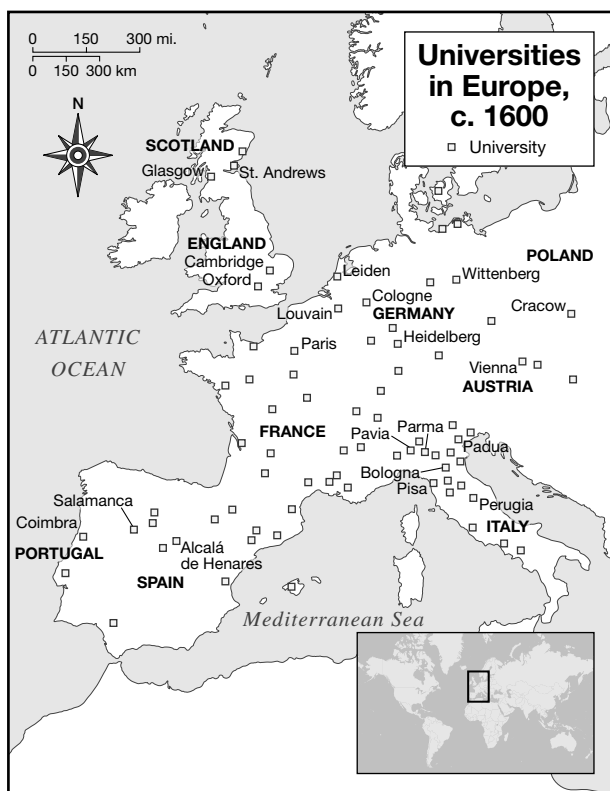

the sixteenth century. Renaissance Latin schoolmasters discarded the medieval curriculum, with a handful of exceptions at the primary school level, in favor of the works of Virgil, Cicero, Terence, Julius Caesar (c. 100–44 B.C.E.), and other ancient authors. Most were Latin; Greek authors were introduced as teachers of Greek became available. These ancient authors taught grammar, rhetoric, poetry, history, and moral philosophy, which together comprised the *studia humanitatis* (humanistic studies) based on the standard ancient authors in Latin and, to some extent, in Greek. The classical humanistic curriculum remained the core of Latin education for the elite of Europe well into the twentieth century.

The Latin that Renaissance students learned was very different from the clear and functional but seldom elegant medieval Latin. Renaissance students learned to write Latin in the ornate and complex style of Cicero, as found in his *Epistolae ad familiares* (Letters to friends) and his speeches, which had been unavailable in the Middle Ages. Humanist pedagogues sought guidance on ancient education from the *Institutio oratoria* (Institutes of oratory) of the Roman teacher of rhetoric Quintilian (c. 35–100 C.E.). Italy adopted the classical Latin curriculum in the fifteenth century, and the rest of Europe followed in the sixteenth.

The Renaissance humanistic curriculum promised more than learning to read and write like the ancients. Italian and northern European humanists argued in a series of pedagogical treatises that reading the classics would teach boys, and a few girls, wisdom as well as eloquence. The classics would inspire readers to live honorably and well. If well instructed, they

would do what was morally right and would be loyal to family, city, and country. The goal was *humanitas*, the knowledge of how to live as cultivated, educated members of society.

However, the Renaissance humanists papered over a basic contradiction. Western European Christianity viewed salvation after death as the ultimate goal of life. But ancient pagan authors as Cicero, Terence, and Virgil did not teach readers to love enemy and neighbor and to seek union with God. The texts of ancient Greek and Rome emphasized education for this life. They endorsed worldly ambition so long as it was achieved by legitimate means, and they featured acts judged sinful by European Christians. Nevertheless, Renaissance educators convinced themselves that the classics and Christian doctrine taught an identical morality of honesty, self-sacrifice for the common good, perseverance, and family and civic responsibility. The restoration of the pagan classics inserted a secularism into European schooling that never disappeared, however much Catholic teaching orders and Protestant schoolmasters emphasized religious doctrine and practice.

From the Renaissance onward, the classical secondary school was the center of European elite education. Educational leaders and probably the majority of society believed that learning ancient languages and literatures offered examples of the highest human culture in the original language, developed mental discipline, and imparted good moral and civic values.

From the Protestant Reformation to the Nineteenth Century

Despite their many differences, both Protestants and Catholics taught the new Renaissance humanistic curriculum in their Latin schools at the pre-university level. Each simply added religious instruction to the classical curriculum. Indeed, from about 1550 until the beginning of the French Revolution in 1789, the most important pre-university schools in Europe were schools with strong connections to religious institutions. In Catholic Europe the Jesuits and other religious orders founded in the sixteenth century and devoted to teaching dominated Latin education, the schooling that prepared boys for university study, the professions, and leadership roles. Latin schools organized by and under the direction of princes, cities, and religious leaders did the same in Protestant lands.

Educational opportunity for girls expanded slowly in these centuries. Some new religious orders of women in Catholic Europe offered schooling for girls. A large number of female religious convents educated Catholic girls as long-term boarders. Parents sent a girl to a convent for several years for an education that included singing, sewing, and good manners. She emerged educated, virtuous, and ready to marry. Some girls decided to remain as nuns, sometimes to further their educations. Indeed, professed nuns living in convents had a higher literacy rate and were consistently better educated than laywomen. Church organizations also sponsored charity schools for poor girls in which they learned the catechism, vernacular reading and writing, and sewing. The situation was similar in Protestant Europe. Although Martin Luther (1483–1546) strongly endorsed schooling for both boys and girls, the Protestant Reformation did not result in greater educational

opportunity for girls and probably not for boys. Churches in Protestant lands did provide some free education in Sunday Schools and charity schools, and parents emphasized home Bible instruction. Girls in wealthy families often had tutors in both Catholic and Protestant Europe.

Enlightenment philosophes began to attack church schools and, to a limited extent, the humanistic Latin curriculum, in the eighteenth century. They offered an alternative vision. They wanted the state, not churches, to organize schools, appoint teachers, and regulate studies. Children should study the national vernacular language as well as Latin and national history. The state should ensure that children were taught good morals based on fundamental ethical truths, because good morals were essential for the well-being of society. But schools should not teach religious doctrine. Enlightenment school reformers put greater emphasis on practical skills, and they sometimes argued for increased schooling for girls. Finally, they wanted to provide more free elementary education for the population as a whole but stopped short of endorsing universal education. However, very little changed, because rulers gave only half-hearted support for educational change.

Nineteenth- and Twentieth-Century Education

In the nineteenth and the first half of the twentieth centuries, national governments introduced much change into the schools. Governments across western Europe decreed that all children, boys and girls, must go to school to a certain age, which was gradually raised. The schooling was not extensive; the elementary curriculum consisted of reading, writing, arithmetic, and, outside France, religion. Governments provided more, but never enough, schools and teachers. Nevertheless, the children of the working classes, the peasantry, and girls as a whole made impressive gains across western Europe in the nineteenth century. For example, a French law of 1882 required schooling for all boys and girls between the ages of six and thirteen. As a result, literacy rates in France for the whole population, men and women, rose from 60 percent in 1870 to 95 percent in 1900. Eastern Europe and Russia lagged behind but still made progress. State governments took control of schools from the churches but continued to teach Catholic or Protestant religious doctrine except in France. They added vernacular literature and national history in the secondary school without eliminating Latin. However, the secondary school classical curriculum remained the privilege of the children of the upper and professional classes and the only path to the university.

Late-nineteenth- and twentieth-century state schools pursued cultural, national, social, and ideological goals as well. Every national school system taught one version of the national language, that of its most accomplished authors, even though most children spoke regional dialects. They taught patriotic national history. For example, Italian schools, after the unification of the peninsula under one government in 1870, made a national hero of Giuseppe Garibaldi (1807–1882), the irregular military leader of the struggle for unification. Students across Europe wrote essays on patriotic topics. Governments believed that the primary purpose of universal elementary schooling was to raise honest, hardworking, useful

citizens, devoted to family and country, but who would not rise above their station in life. The use of schools to teach political and social values reached its most extreme form in the schools of the Communist Soviet Union (1917–1991), Fascist Italy (1922–1943), and Nazi Germany (1933–1945). The ideology of the state, militarism, devotion to country, and loyalty to the regime were the order of the day in their schools.

The most important innovations of the nineteenth and twentieth centuries were several kinds of nonclassical secondary schools. At the highest level they combined limited ancient language instruction with considerable scientific and technical education. The graduates seldom went on to the university, but could attend advanced technical schools. Some countries developed nonselective secondary schools that offered vocational and practical training for workers who would basically follow instructions. These practically oriented schools were modern variations of the vernacular literature and commercial arithmetic schools of the late Middle Ages and Renaissance although there does not seem to be a direct link.

The educational system that most emphasized technical education was that of the Soviet Union. After the 1917 Russian Revolution, the Communist government of the 1920s discarded the previous curriculum of humanistic studies and religious education in favor of life education that attempted to teach children about farming and trades by having them care for plants and animals and by operating tools. By the 1930s the Soviet school system concentrated on turning out the engineers, technicians, and workers needed by a country moving from a rural economy to one of heavy industrialization directed by the central government. Although Soviet education never succeeded in creating a classless educational system—sons and daughters of Communist officials, members of the government, and professional classes enjoyed more educational benefits than others—it greatly increased and improved education for the sons and daughters of the working class and peasantry. It also expanded educational opportunity in science, medicine, and engineering for women.

Despite the innovations, western European education remained divided into two streams through the first two-thirds of the twentieth century and remained to some extent into the early twenty-first century. The classical secondary school continued to educate the upper classes of Europe, even though classical Latin no longer had practical use beyond a limited number of scholars. But pedagogues and national leaders, with a few exceptions, believed that learning ancient languages and literatures best enabled boys and some girls to realize their potential. They believed that the classical curriculum benefited the student regardless of his or her future career because it developed the individual. The concept was called *Bildung* (cultivation) in German, *culture générale* in French, and *liberal education* in English. It was a modern version of the goals of Greco-Roman and Renaissance education.

Of course, the classical curriculum of the nineteenth and twentieth centuries had practical rewards as well. Only the graduates of the classical secondary school went on to universities and won high civil service positions. They could enter the professions of law, medicine, and theology and lead the

nation. The classical secondary schools continued to select and serve a privileged elite.

A series of democratic reforms swept across European state education between the 1960s and the 1990s. They were designed to give all students some kind of secondary school graduation certificate and to increase the number of university or university-level students. They also tried to dilute the social exclusivity of the classical secondary schools and to break their monopoly on elite education. The reforms aimed at making it possible for more sons and daughters of the working classes to enter university and become leaders of the nation. It remains to be seen what the long-term effects will be.

See also *Humanism; Rhetoric; University*.

BIBLIOGRAPHY

PRIMARY SOURCES

- Humanist Educational Treatises*. Edited and translated by Craig W. Kallendorf. Cambridge, Mass., and London: Harvard University Press, 2002.
- Quintilian. *The Institutio oratoria of Quintilian*. With an English translation by H. E. Butler. 4 vols. 1920. Cambridge, Mass.: Harvard University Press, and London: Heinemann, 1958–1960.

SECONDARY SOURCES

- Blackburn, Gilmer W. *Education in the Third Reich: A Study of Race and History in Nazi Textbooks*. Albany: State University of New York Press, 1985.
- Bonner, Stanley F. *Education in Ancient Rome: From the Elder Cato to the Younger Pliny*. Berkeley and Los Angeles: University of California Press, 1977.
- Brizzi, Gian Paolo. *La formazione della classe dirigente nel Settecento: I seminaria nobilium nell'Italia centro-settentrionale*. Bologna: Il Mulino, 1976.
- Farrell, Alan P. *The Jesuit Code of Liberal Education: Development and Scope of the Ratio Studiorum*. Milwaukee, Wis.: Bruce, 1938.
- Grendler, Paul F. *Schooling in Renaissance Italy: Literacy and Learning, 1300–1600*. Baltimore and London: Johns Hopkins University Press, 1989.
- Grew, Raymond, and Patrick J. Harrigan. *School, State, and Society: The Growth of Elementary Schooling in Nineteenth-Century France: A Quantitative Analysis*. Ann Arbor: University of Michigan Press, 1991.
- Holmes, Larry E. *The Kremlin and the Schoolhouse: Reforming Education in Soviet Russia, 1917–1931*. Bloomington: Indiana University Press, 1991.
- Kennedy, George A. *A New History of Classical Rhetoric*. Princeton, N.J.: Princeton University Press, 1994.
- Marrou, Henri-Irénée. *A History of Education in Antiquity*. Translated from the French. 3rd ed. by George Lamb. New York: Sheed and Ward, 1956.
- Martin, Christopher. *A Short History of English Schools, 1750–1965*. Hove, U. K.: Wayland, 1979.
- Melton, James Van Horn. *Absolutism and the Eighteenth-century Origins of Compulsory Schooling in Prussia and Austria*. Cambridge, U.K., and New York: Cambridge University Press, 1988.
- Riché, Pierre. *Education and Culture in the Barbarian West, Sixth through Eighth Century*. Translated by John J. Contreni. Columbia: University of South Carolina Press, 1976.

- Strauss, Gerald. *Luther's House of Learning: Indoctrination of the Young in the German Reformation*. Baltimore and London: Johns Hopkins University Press, 1978.
- Williams, George L. *Fascist Thought and Totalitarianism in Italy's Secondary Schools: Theory and Practice, 1922–1943*. New York: P. Lang, 1994.

Paul F. Grendler

GLOBAL EDUCATION

Global education, or global studies, is an interdisciplinary approach to learning concepts and skills necessary to function in a world that is increasingly interconnected and multicultural. The curricula based on this approach are grounded in traditional academic disciplines but are taught in the context of project- and problem-based inquiries. The learner examines issues from the vantage point of the individual, the local community, the nation, and the world community. As social conditioning, an essential component of schooling, global studies takes an international stance that respects local allegiances and cultural diversity while adhering to the principles of the United Nations Declaration of Human Rights.

There is, however, no standard definition among proponents of global education. Kenneth A. Tye and Barbara Benham Tye of the Center for Human Interdependence (CHI) in Orange County, California, an educational training program that emphasizes global awareness, constructed the following working definition:

Global education involves learning about those problems and issues that cut across national boundaries, and about the interconnectedness of systems—ecological, cultural, economic, political and technological. Global education involves perspective taking—seeing things through the eyes and minds of others—and it means the realization that while individuals and groups may view life differently, they also have common needs and wants.

Global education is distinct from the concept of *globalization*, that is, the forces of market capitalism, which tend to focus discussion on global economic systems and information technologies. From a pedagogical standpoint, economic prosperity and technological progress are part of a broader emphasis on planetary interconnectedness, interdependency, and sustainability. Key concepts in global education include human rights, environmental responsibility, cultural studies, and sustainable economies. Global education views national politics and transnational economic policies with an eye toward international accountability. It stresses the role of global ethics in shaping humane, environmentally sound attitudes toward the world as a single ecosystem, and it teaches that a globally conscious citizenry can effectively overcome such problems as climate change, ocean pollution, and resource depletion with ingenuity, leadership, and cooperation.

One of the aims of global education is a shared international global ethic that would be used to govern socioeconomic decision-making. This ethic would be based on a system of universal values found in United Nations documents on

human rights, agreements of the Council of Europe Committee of Ministers, proposals of Amnesty International and other NGOs (nongovernmental organizations) for the realization of human rights, and the Earth Chapter project.

The value and utility of global education derives from the sense that international events require all societies and their citizens to become knowledgeable about the world beyond their national borders. Usually, this imperative is cast in economic terms. Business and political leaders warn that, as the world's economies and financial systems are incredibly interconnected, our material well-being depends on professionals and workers with sophisticated knowledge of the global economy. In their view, family and local community can no longer define our values. Rather, community-based values must be integrated into the large-scale social institutions that govern our lives.

Training Professional Educators

Much education planning in the late twentieth and early twenty-first centuries focused on preparing students for the increasingly interdependent world and the diverse societies they would graduate into. Professional educators, parents, and policymakers understood that educators need to have a sound awareness of other nations, their social milieus, cultures, customs, political and economic processes, and educational systems. Accordingly, teacher-education programs in colleges and universities around the world responded by introducing courses of study and program components to help meet this need.

Such courses and program components fall under the generic heading of Global Education but may have different labels such as Global Comparative Education or Comparative Education. Postsecondary education reacted to the globalization phenomenon in a way that sought to use the technological, economic, social, and political developments of the late twentieth century to develop a shared vision of global responsibility and economic sustainability.

Courses in global education tend to fall into two general categories: survey courses and courses dealing with specific issues. Survey courses have three basic components. First, they introduce students to the field of global/comparative studies in education. Second, they undertake examinations of selected countries as case studies. Third, these case studies provide the data and substantive content for comparing national systems of schooling; discerning common themes and trends; appreciating differences; understanding problems and controversies; and drawing conclusions, insights, and lessons.

The second category of courses focuses on specific issues in contemporary schooling, examined in an international context. The wide scope of issues addressed includes equality of educational opportunity; educational achievement; evaluation and examinations; the treatment of minority groups; women in education; formal, nonformal, and informal education; delivery modes; teacher training, certification, and supply; citizenship education; politics, ideology, and schooling; language and literacy; schooling and the economy; education, modernization, and development; education reform; accountability; effective schooling; and school administration and governance.

Schooling. Global education addresses schooling in all its aspects. Pedagogical strategies, curricular content, evaluation, classroom management, and organization and administration are conducted in fundamentally different ways around the world. Research into how children learn, what constitutes “best practices” in pedagogy, and how schools serve social and class interests is being conducted in many societies and in many different national and cultural contexts. All around the world, educators, departments of education, education research institutes, professors of education, and others are working conscientiously to produce pedagogy, curricula, and diagnostic tools to better serve students, parents, society, and the teaching profession.

Schooling will inevitably reflect the cultural biases on which it is established, but as a general rule, global education aims to:

- Find a cross-cultural foundation for knowledge and human values;
- Refine understandings of globally applicable ethical attitudes;
- Consider how international organizations might affect national political and economic decisions;
- Foster a global civic culture with a capacity for altruism and empathy, one that encourages social action and community service.

The Development of Global Perspective in U.S. Education

The progressive education movement of the twentieth century included several components, one of which was the emphasis placed on the democratic educational approach, accepting the interests and needs of an increasingly diverse student body in an increasingly interdependent world. In the 1920s this was reflected in the rebirth of comparative studies. In the 1940s, progressive education was reclassified as intergroup education. In the 1950s it focused on area studies, race relations, and ethnic studies. In the 1960s, it added peace and conflict studies, human rights education, international studies, intercultural studies, and open classrooms.

In the 1970s, the women's liberation and African-American liberation movements blossomed in both positive and negative terms. In the field of education this was reflected in the introduction of multicultural and environmental education. The 1980s saw the introduction of global education and world studies. From the 1980s to the early 2000s global education as well as multicultural education remained constant in the historical context.

Thus, global perspective in education is not a new idea. Yet, while efforts in this direction can be traced in earlier history, World War II is something of a watershed in its development. After the war, a widespread movement began around the world to foster education for “world understanding” with the purpose of preventing a third world war. Children's books in war-torn Europe, Japan, and the USSR featured peace and

antiwar themes and empathetic stories about children of other lands.

In the United States the Cold War chilled and slowed the movement for a time, especially in the 1950s, when McCarthyites saw “communism” behind every effort to increase international cooperation. But even in this climate, some educational leaders foresaw that the United States could not remain isolated forever from the rest of the world and that “international education” was in the national self-interest. The Soviet launching of Sputnik in 1957 was a spur not only to improved science education but also to increased pressure in the United States for international education. A year later Congress passed the 1958 National Defense Education Act (NDEA). Under Title VI it mandated the teaching of foreign studies, languages, and cultural understanding. However, practice did not match the preaching; allocations were minimal. Years of effort followed, as groups of educators and others in the United States pressed for congressional support for substantive international and global education programs. For a time, under the Carter administration and the leadership of Ernest Boyer as commissioner of education, major breakthroughs seemed imminent. Boyer condemned education that failed to acquaint students with the interdependence of all humans and the fragility of life in an unstable world. In this period, fourteen states adopted global education guidelines or programs. And although the notion of global education came under fire during the Reagan administration, support was growing among some U.S. business and educational leaders.

But even among those who did accept the need for global education, there was no widespread agreement on its definition, purposes, or objectives. Phrases such as *education for world understanding*, *intercultural*, *international*, *global*, or *foreign affairs education*; *global perspectives in education*, or *transnational* or *planetary* perspectives; or *education for spaceship earth*—these were used interchangeably, even by professionals, blurring important distinctions. This ambiguity may be symptomatic of the new and tenuous nature of thought in the field and of the different emphases of different persons and institutions at a given time.

The various terms also reflect a certain historical development. References to “global,” “interdependent,” “transnational,” and “planetary” education emanated in part from a new perspective of the planet—as seen from outer space—in which national political boundaries were seen as artificial human creations, the real subject being the life and functioning integrity of the planet as a whole.

Perhaps most important, the different terms are symptomatic of changing—and sometimes conflicting—worldviews or paradigms. For example, phrases such as *foreign-affairs* or *international* education suggest a state-centric vision in which the major actors are seen as governments. In contrast, terms such as *global*, *planetary*, *transnational*, or *interdependent* education suggest a frame of reference in which a variety of actors—economic, environmental, cultural, and popular as well as governmental—are considered for their impact on the world as a whole. National interest here is seen as inseparable from world interest.

Three Views of Global Education in American Educational Discourse

In a period of competing worldviews, the more interesting and significant question concerns not what terms are being used but, rather, the underlying vision and purpose of education and how it will affect our children and the people and the world of tomorrow. Three distinct views of the purpose of global education emerged in the United States during the late twentieth century.

Win the superpower contest. This view emerged from a bipolar vision of the world that assumed that the most important fact of life as the United States approached the twenty-first century was the ideological conflict between the superpowers and their competition for world hegemony. One of its more prominent spokespersons was the U.S. secretary of education, William J. Bennett. In his December 5, 1986, speech to the Ethics and Public Policy Center Conference, Bennett spoke of the United States’s global responsibilities as a global power and, as a result, the need to learn as much about the world as possible. In Bennett’s view, the defensive position of the United States and its allies to the USSR was the central fact of the political world. More recently, after criticizing other approaches to global education, Bennett suggests that global education properly understood should include geography, foreign languages, some foreign literature, and a good deal of European history. But most important, Bennett suggests that American students should learn about American literature, history, and especially democracy; about totalitarian and theocratic regimes; about the social, political, and economic differences between despotic and dictatorial nations and democratic nations; and, finally, about the key historical events of the late twentieth and early twenty-first century that created the current relations between the United States and the Muslim world.

A limitation of this approach is that it is not particularly global. It provides little understanding of other nations or cultures or of the deeper life processes of the planet. In its most benign form it is an incomplete education—inadequate preparation for life in an increasingly interdependent world. Taken to extremes, it could lead to fascism.

Win the global economic contest. A second view of the need for global education in the United States emanates from international economic competition. In this view the most important fact about the world in the late twentieth century was not superpower competition but the emergence of one world economy—global capitalism—and shifting centers of economic power within it. In the United States this shift had the potential power of a Sputnik II in reshaping the purposes and direction of education, except that the major competitor striking fear in the hearts of national leaders in the early 2000s was not the USSR but Asia and the European Union.

In addition to Japan and Korea, Hong Kong, Singapore, Taiwan, and the European Union were rapidly gaining economic ground. Together they represent a shift of economic power away from the West toward Asia. This carried not only economic importance but also potential significance with respect to political, cultural, military, and other forms of power in the future.

In the 1950s the United States enjoyed a trade surplus; by the 1980s, it was experiencing chronic trade and payment deficits. The 1990s were healthy economic years for the United States; the country managed to eliminate the trade and payment deficits. But as the United States entered the twenty-first century, economic uncertainty coupled with the events of September 11, 2001, managed to reverse the American economic forward momentum to a crawl. Thus, in contrast to the “peace” focus of international education efforts after World War II, and the military security goals that characterized the post-Sputnik emergency passage of the National Defense Education Act in 1958, some U.S. leaders saw the fundamental purpose of international education as helping to maintain U.S. economic strength.

With this in mind, when Congress decided in 1980 to make the Title VI NDEA international education programs part of the “mainstream” Higher Education Act, the strong national security rationale for these programs was augmented to include not only military but also economic security. A special business and international education provision was added to establish “export education programs,” among other things. Congress stated that

1. The future economic welfare of the United States will depend substantially on increasing international skills in the business community and creating an awareness among the American public of the internationalization of our economy.
2. Concerted efforts are necessary to engage business schools, language and area study programs, public and private sector organizations, and United States business in a mutually productive relationship which benefits the Nation’s future economic interests.

The relationship between education and economic security was underscored by the National Commission on Excellence in Education in its 1983 report *A Nation at Risk*, which stated that because “our once unchallenged preeminence in commerce, industry, science and technological innovation [was] being challenged by competition throughout the world,” a revolution in U.S. education was called for.

The Southern Governors’ Conference also addressed the problem of “international illiteracy” in the United States and its negative effect on U.S. ability to compete in the international marketplace. The conference’s Advisory Council, made up of leaders from business, education, and government, issued in November 1986 a no-nonsense report that came right to the economic point:

Americans have not responded to a basic fact: the best jobs, largest markets, and greatest profits belong to those who understand the country with which they are doing business. . . .

We operate in a global economy. There are no more guaranteed markets for our goods. We must compete—and to compete we must be able to communicate. . . .

We cannot trade goods or ideas unless we understand our customers and they understand us.

The Council’s recommendations for redressing the problem included increased emphasis in the schools on geography, international studies, and foreign languages, “sister-school” programs abroad, and teacher and student exchanges. They also recommended special educational programs and assistance to businesses, including programs on languages, foreign business practices, and cultural training.

Persons, peoples, and planet. A third view of global education sees as its purpose not winning a struggle for military or economic power but rather an understanding of humanity’s responsibility to individuals, to peoples, and to the planet itself.

This view seeks a deep understanding and appreciation of humanity’s shared evolutionary past—the story of the earth, of its creative life forces, of human becoming, and of the common human subsistence in that one earth—as well as of their more local and distinct social, cultural, economic, and political roots. It seeks to help children worldwide to understand the increasingly interdependent nature of the human world and to learn how to take a creative and responsible part in its life. It also wants them to understand the consequences of their choices—not only to themselves but also to those around them and those yet to come. Thus, the values needed to guide responsible decision-making must include not only the maximization of profit but also peace, freedom, human rights, social justice, and ecological balance. To create and maintain the conditions necessary to realize these values they must learn how to think critically, resolve conflicts, and solve problems creatively.

See also ***Education: North America; Globalization.***

BIBLIOGRAPHY

- Banks, James A. *Educating Citizens in a Multicultural Society*. New York: Teachers College Press, 1997.
- . *Teaching Strategies for Ethnic Studies*. 7th ed. Boston: Allyn and Bacon, 2002.
- Diaz, Carlos, Byron G. Massialas, and John A. Xanthopoulos. *Global Perspectives for Educators*. Boston: Allyn and Bacon, 1999.
- Lynch, James. *Multicultural Education in a Global Society*. London and New York: Falmer, 1989.
- Marciano, John. *Civic Illiteracy and Education: Battle for the Hearts and Minds of American Youth*. New York: Lang, 1997.
- O’Riordan, Tim, ed. *Globalism, Localism, and Identity: Fresh Perspectives on the Transition to Sustainability*. Sterling, Va.: Earthscan, 2001.
- Parker, Walter C., ed. *Educating the Democratic Mind*. Albany: State University of New York Press, 1996.
- Southern Governors’ Conference. Advisory Council Report. Atlanta, Ga.: The Association, 1986.
- Spring, Joel H. *American Education*. 11th ed. Boston: McGraw-Hill, 2004.
- Tye, Barbara Benham, and Kenneth A. Tye. *Global Education: A Study of School Change*. Albany: State University of New York Press, 1992.

United States, National Commission on Excellence in Education. *A Nation at Risk: The Imperative for Educational Reform*. Washington, D.C.: The Commission, 1983.

John A. Xanthopoulos

INDIA

The ideas produced, preserved, and transmitted through education in India have been as multifaceted as the many social groups who have lived in the South Asian subcontinent. Gender has been an important determinant for educational opportunities over time and across regions. When and where education was closely associated with making a living, parents assumed that women needed only domestic skills, and they were unlikely to educate their daughters. Still, there were always exceptions. For example, Pandita Ramabai (1858–1922) was given a Sanskrit education by her father, received a higher education in English as an adult, and was a strong voice for social reform to serve women's needs during the colonial period.

The territories of contemporary India, Pakistan, and Bangladesh are the geographical scope of this survey before 1947; the later focus is on contemporary India.

Ancient, Medieval, and Early Modern India

In the early Vedic period (beginning c. 1200 B.C.E.), an elite controlled the teaching of the four Vedas, the hymns and ritual practices of Aryan people who had migrated into north India in the previous century. Daughters as well as sons of higher-status families probably memorized these hymns and learned their meanings and associated ritual practices. *Rishis*, sages or seers who mostly belonged to the Brahman *varna* or caste, produced, transmitted, and controlled access to this knowledge. The Sanskrit of the Vedas was the language of classical learning, and proto-Hinduism was religious orthodoxy in the Vedic period. Respected teachers (*gurus*) taught apprentices pronunciation of the Vedas and all that it implied, as well as phonology, metrics, elementary grammar, and etymology, in return for the students' mundane services. This education was extra-institutional and closed to people of low status before the end of the Vedic period. In the modern era, nineteenth- and twentieth-century Hindu teachers of indigenous curricula frequently looked back to an idealized Vedic model for pedagogical inspiration.

In the sixth and fifth century B.C.E., historical founders Nigantha Nataputta (or Mahavira, the "Great Hero" of Jainism), and Siddhartha Gautama (the Buddha, the "Enlightened One") created heterodox belief systems that monks elaborated, preserved, and taught to initiates. Buddhist monks congregated in monasteries (*viharas*), and provided itinerant teaching for laypeople. Elder monks taught the disciplines of the *Sangha* (the monastic order) as well as discourses on doctrine, spiritual exercises, and advanced philosophical ideas. Female converts created nunneries with similar practices. The Nalanda Mahavihara in Bihar and other great monasteries were centers of learning that included secular arts and sciences as well as theology. Mahaviharas flourished in northeastern India with royal support until they were destroyed at the beginning of the

thirteenth century. In southern India, education was likewise linked to the ideas of Buddhist, Jaina, and Hindu teachings. Itinerant teachers carried ideas and the Sanskrit language to the south, where a Tamil prose and poetry tradition flourished from around 100 C.E. onwards.

Arab and Central Asian peoples brought Muslim educational models to the subcontinent in both the medieval and early modern periods. Within decades of the Prophet Muhammad's death in 632 C.E., Arab mariners began to trade, reside, and intermarry with local women in south India. Turkic peoples and other Central Asians raided northern India around 1000 C.E. and thereafter established several foreign-conquest empires. Muslim rulers promoted urban education by endowing libraries and literary societies. They also founded primary schools (*maktabs*) in which students learned reading, writing, and basic Islamic prayers, and secondary schools (*madrāsas*) to teach advanced language skills, Koranic exegesis, prophetic traditions, Islamic law (*shari'ā*), and related subjects. Often attached to mosques, Islamic schools were open to the poor but were gender segregated, often only for boys. Muslim girls of affluent families studied at home, if they received any education beyond learning to recite the Koran. From the beginning of the Mughal empire in India in 1526 until the end of Mughal political presence in 1848, Persian was the court language, and elite boys could attend Persian schools to learn literature, history, ethics, law, administration, and court protocol. Subjects such as medicine, mathematics, and logic also formed an important part of the curriculum in centers for Islamic learning. More intimate settings for the spread of ideas were the retreats (*khanqah*) of famous Sufis (Muslims who professed mystic doctrines). These new educational models did not necessarily displace older ones, although state patronage patterns shifted. Sanskrit academies continued to teach young male Brahmins literature and law; apprenticeship and commercial schools taught boys the skills needed for business. Education for girls was the exception rather than the rule.

Colonial India

The ideas and pedagogical methods of education during the colonial period, from 1757 to 1947, were contested terrain. The commercial British East India Company ruled parts of India from 1764 to 1858. A few eighteenth-century company officials became scholars of Sanskrit, Persian, and Tamil and promoted "Oriental" learning, which was classical, demotic learning in indigenous languages. However, they were outnumbered by "Anglicists," those who denigrated "Oriental" learning and advocated the introduction of institutions for Western learning based upon the British curriculum with English as the medium of instruction. By the early nineteenth century, when English was made the official language of government business, British policy promoted a cheap, trickle-down model for colonial education. When the British crown abolished company rule in 1858, government universities existed at Bombay (contemporary Mumbai), Calcutta (Kolkata), and Madras (Chennai); about two thousand students studied at thirteen government colleges in all of British India, and another 30,000 students were in government secondary schools. Direct rule did not change the decision to deemphasize

primary education to provide occupational training for young Indian men who took jobs both in the lower tiers of the government and in urban, Western-style legal and medical services.

Nongovernment schools established by Western Christian missions and Indian social and religious reform organizations provided the only opportunities for elementary education in the nineteenth century. American and English missionaries founded men's colleges, and by the twentieth century, Lucknow, Lahore, and Madras all had Christian women's colleges as well. Foreign teachers staffed these institutions, offering a Western curriculum in English with financial support for the children of Christian converts. Reformist societies also started schools, partly to provide Western education without the threat of Christian conversion. The curricula in private girls' schools ranged from the Urdu, Persian, writing, arithmetic, needlework, and Islamic studies of the Punjabi Anjuman-i-Himayat-i-Islam primary schools in northwestern India to the Western-style liberal arts curriculum of Bethune College, founded by liberal Brahmo Samajists (Hindu reformers) in Calcutta. Even voluntary societies' members who wanted to provide educational alternatives for their children disagreed about the advantages and disadvantages of the colonial educational model for both content and the language of instruction.

When British officials who represented direct rule by the crown introduced modest self-government in the 1860s, they shifted financial responsibility for education to a growing Indian middle class. Educating urban sons for professions dominated local educational spending, to the detriment of rural and women's education. Families of respectable middling status usually chose to send their daughters to gender-segregated educational institutions once there were schools taught in vernacular languages with general curricula. While older historians narrated the "insidious, total and transparent" domination of the educational system by the colonial state, more recent scholarship delineates the "'creative' resistance" to state agency and suggests that there was a "combat" between "consciously opposed sides" (Kumar). As the nationalist movement gained supporters in the twentieth century, Indian leaders developed several nationalist educational paradigms to challenge the colonial model. Mahatma Gandhi wanted the state to teach basic literacy in vernacular languages to the majority of the population. Rabindranath Tagore, India's first recipient of the Nobel prize for literature, believed that the English language provided Indians access to the sharing of knowledge across international borders and that education should include the teaching of India's cultural traditions. The fight for freedom from colonialism preempted decisions about educational ideologies until after 1947.

Independent India

Prime Minister Jawaharlal Nehru (1889–1964) and other politicians made education a fundamental right in the 1950 Constitution. The central government supported affirmative action for formerly disadvantaged social groups by reserving seats in educational institutions for candidates from the scheduled castes and tribes. However, state governments chose different educational emphases from the 1950s onward, which led to differing results. In the southern state of Kerala, for

example, the Communist government emphasized public education, and by the 1990s, the overall literacy figure for both women and men was an impressive 90 percent. In general, however, the states' efforts resulted in modest improvements, with the 1990s estimates of national female literacy at 27 percent, still only half of the overall male literacy rate.

One of the most contentious colonial educational issues, the teaching of Western science and technology, continues to be problematic. Before 1947, Indian students were denied participation in the production of scientific knowledge, particularly because there was no "organic relationship between science-technology education and indigenous society" parallel to the European context allowed to develop within the colonial milieu. Teachers who promoted learning science through vernacular languages, working against the colonial tilt toward literary education in English, made little headway. In the late twentieth century, colonial shadows still colored educational ideology, and the long-term pattern of underfunding elementary education had not changed. The constitutional pledge to provide free and compulsory education for all of India's children remains a distant goal for the twenty-first century, even as Indians who are technically educated and speak English have become one of India's prime attractions for global capital. The challenge of joining indigenism and universalism in India's education system remains.

See also *Education: Asia, Traditional and Modern; Education: China; Education: Islamic Education.*

BIBLIOGRAPHY

- Bhattacharya, Sabyasachi, ed. *The Contested Terrain: Perspectives on Education in India*. New Delhi: Orient Longmans, 1998.
- Ghosh, Suresh Chandra. *The History of Education in Ancient India, c. 3000 B.C. to A.D. 1192*. New Delhi: Munshiram Manoharlal, 2001.
- Hasan, Mushirul, ed. *Knowledge, Power and Politics: Educational Institutions in India*. New Delhi: Lotus, 1998.
- Kumar, Nita. *Lessons from Schools: The History of Education in Banaras*. New Delhi and Thousand Oaks, Calif.: Sage, 1999.
- Vaidyanathan, A., and P. R. Gopinathan Nair, eds. *Elementary Education in Rural India: A Grassroots View*. Thousand Oaks, Calif.: Sage, 2001.

Michelle Maskiell

ISLAMIC EDUCATION

A lifelong pursuit of learning is a characteristic ideal of Islamic piety. It underlies the concept of "Islamic" education. While the primary focus of this concept is the nurturing of religious belief in the individual, its scope broadened to incorporate various secular disciplines, literary and scientific, as it aimed at developing within the community fully integrated personalities, grounded in the virtues of Islam. This approach relates to the theory and practice of both primary and higher education. It is evident not only in the Koran and the literature of Prophetic Tradition (hadith), but also in countless proverbs, aphorisms, and wisdom sayings; and in poetry and prose texts of the Middle Eastern literatures including, in particular, the

numerous medieval Arabic works devoted to pedagogical and didactic issues.

Pre-Islamic Arabia

Arabian society on the eve of Islam was largely but not exclusively nomadic. It was, however, tribal and its cultural life was conditioned by tribal conflicts. Lyric poetry represented the summit of its artistic and intellectual attainment. This poetry was a highly developed art, conveyed orally. This tradition of oral transmission was to continue in the Islamic period. The use of writing and written material—also due to the material conditions at that time—played a minor role, even though the “art of writing” was already known among the Arabs and used, for example, by tradesmen and in the large settlements.

The Koran

At the beginning of the seventh century C.E., Muhammad, a native of the city of Mecca, was called to communicate the Word of God: the Koran (meaning “[Scripture] Reading,” or “Reciting”). Shortly after his death, the individual parts of the Koranic revelation were collected from both oral and written sources, arranged in one text, and published by an authorized committee of learned Muslims. Thus the Koran became Islam’s first and only holy book.

Sura (chapter) 96, traditionally considered as the very first revelation to the prophet Muhammad, starts with the divine command to “Read” (or: “Recite”/“Proclaim” words of the holy scripture). It stresses that God “taught Man that which he knew not” and that God did so “by [the use of] the pen”—suggesting that God taught humankind “the holy scriptures,” or “writing.” These verses seem to highlight that Islam, from its very beginning, expressly prioritizes the imparting and acquisition of (religious) knowledge, learning and education; and that God is humankind’s undisputed supreme teacher.

Like the previous prophets, Muhammad was called to proclaim the Word of God as contained in the heavenly archetype of the holy book. However, he was also ordered first to listen to the revelation. Only then was he to recite and read the divine text himself, to learn of its meanings by way of explanation, and eventually to convey and teach God’s message to others: in Sura 75:15–18, for example, one notes the powerful way in which the Koran addresses the oral components of receiving, listening, learning, and setting forth the Word. This, as it appears, “divinely inaugurated” method of instruction had a significant impact on the transmission of knowledge and on education in Islam in general.

Further notions on teaching and learning are to be found at Sura 2:282–283, which deals with the establishing of legal matters and explicitly refers to the need for people who are able to write, to the importance of written documents, and to the practice of writing and dictating; detailed instructions are even given on how to proceed. Sura 3:79 then reminds the “masters [in the Scripture]” and “followers of the Lord” (rab-baniyyun) of their twofold obligation: to teach and to continue studying. Other pedagogical elements in the Koran extend to issues such as: the developmental stages, habits, and socialization of the human being; ethical norms and values related to education; and human psychology.

The Prophetic Tradition

The high esteem that knowledge and education are granted in Islam is also evident in such maxims of prophetic traditions as: “To acquire knowledge is an obligation on every Muslim, male or female”; “Seek knowledge from the day of your birth until the day of your death”; and “Seek knowledge, even if it is in China.”

The Prophetic Tradition (hadith), that is, the authoritative religious literature in Islam, owes much of its vital educational potential to the “model character” of the events and messages emerging from reports and short narratives believed to preserve everything the prophet Muhammad said, did, or condoned.

Oral Instruction and Books

Between the seventh and the ninth century C.E., as Islam was spreading among diverse peoples, education came to be recognized by the Muslim community as a proper channel through which the universal and cohesive social order, in the way the Koran commanded it, could be established. This resulted in a rapidly increasing need for accessible and effective formal education at both the primary and higher levels.

Students traveled far and wide in “the quest for knowledge” (Ar., *talab al-‘ilm*) and to study under the supervision of a well-known scholar. “Sessions” (sing., *majlis*) and “circles” (sing., *halqa*) were held by Muslim scholars for the purpose of teaching. These scholarly sessions took place at public places such as mosques but also, privately, at the homes of scholars. Oral instruction was the primary technique for imparting (religious) knowledge (*‘ilm*), soon to be used in all branches of Islamic scholarship.

This strong emphasis on the oral component of learning did not exclude the fact that Muslim scholars in early Islam also based their teaching on written material such as collections of data and lecture scripts (often organized in notebooks), and notes used as memory aids. In the course of time, these thematically organized collections of data gradually gained more definite shape and came to be fixed (in writing, or memory, or both). Some old collections became known as the literary or scholarly “work” of the scholar who had prepared them initially and had then “published” them in his lectures; others were revised, edited, and formally published first by a scholar’s student(s). Scholars preparing such written collections and lecture scripts, however, were not deprived of authorial creativity altogether: for they expressed their individual opinions and convictions through thematic selection and arrangement of the material they included in their works. Beginning in the ninth century, there was a steady increase in the number of scholars who were writing books, editing them definitively, and publishing them themselves.

Educators and Institutions of Primary and Higher Education

During the first four centuries of Islam, the storyteller (*qas*), the poet (*sha‘ir*), and the transmitter of poetry and narrator (*rawi*)—main representatives of the oral tradition in Arabia before Islam—continued to fulfill their educational function. Now they did so, however, along with the educators of the



Illustration on vellum from *The Maqamat* by al-Hariri (1054–1122) depicting a literary meeting (1240). While oral tradition was considered by many to be the guiding force during the first four centuries of Islamic education, in the fifth century more organized centers of learning came into creation. Ms C-23 F.16B/ INSTITUTE OF ORIENTAL STUDIES, ST. PETERSBURG, RUSSIA/ THE BRIDGEMAN ART LIBRARY, WWW.BRIDGEMAN.CO.UK

new Islamic society such as the reciter (i.e., teacher) of the Koran (*qar'i*); the elementary schoolteacher (*mu'allim*); the instructor/educator (of upper class children; *mu'addib*); the scholar ('*alim*; pl., '*ulama*'), the expert in religious law (*faqih*; pl., *fuqaha*'), and the master or professor (*shaykh*) in one or more branches of scholarship.

In the early period of the Umayyad dynasty (ruled 661–750), the elementary school (*kuttab*, *maktab*) for pupils starting at the age of six to seven is already found to be firmly established. The education of young princes had reached a high standard of excellence and the educator was a figure of some standing at the royal court.

Under Abbasid rule (750–1258), learning and studying in the humanities and natural sciences advanced remarkably, in addition to intensive studies in the religious disciplines. This was the time when the civilization of Islam became what is called a "learning society," with the written word as the basis for knowledge. In Baghdad, the "House of Wisdom"—a famous translation academy—was officially sponsored by the caliph al-Ma'mun (ruled 813–833) to prepare professional Arabic translations of philosophical and scientific works,

particularly those in Greek. The translation movement was carried for the most part by Christian Syriac scholars. It advanced significantly the Islamic scholars' creative adaptation not only of the Hellenistic heritage, but also of the Byzantine, Iranian, and Indian. In Cairo, the Shiite Fatimids (ruled 909–1171) founded academies, at which not only Shiite theological tenants but much of the intellectual heritage of the Greeks and Persians was studied. The famous Al-Azhar in Cairo was founded in 970, eventually becoming the principal religious university of the Islamic world. High schools conducted on Sunnite principles followed under the Ayyubids (twelfth to thirteenth century). Major centers of learning also developed in cities such as Damascus, Aleppo, Basra, Kufa, Qom, Mashhad, Isfahan, and Farghana in the East; Qayrawan, Tunis (with its famous mosque-university, the Zaytuna), and Fès (with its Qarawiyyin mosque) in the West; and Córdoba, Sevilla, Toledo, Granada (and its Alhambra) in al-Andalus (Islamic Spain).

The natural sciences were practiced and taught in laboratories, observatories, and hospitals, such as at the famous medical schools in Gondeshapur (Iran), Alexandria (Egypt), and Harran (Iraq). Great achievements in mathematics, astronomy, chemistry/alchemy, medicine, pharmacology, optics, physics, engineering, architecture, irrigation, and agriculture attest to the industriousness of medieval Muslim scholarship in observation, experimentation, and theoretical consideration. Indigenous thinking is also evident in the narrative and descriptive disciplines such as history and geography, in the codification of the law, and in the development of comprehensive systems in philology and grammar. Classical Islamic philosophy demonstrates originality and brilliance in abstract thinking. Sufi (mystical) orders had a very significant share in the transmission of knowledge ('*ilm*) as it was generally considered a prerequisite for gnosis (*ma'rifa*); and influential scholarly families played a decisive role in recruiting, funding, and controlling the intellectual elite of medieval Muslim society.

To meet the growing need for skilled personnel, colleges specialized in legal and religious instruction were established: the local "mosque" (*masjid*) college dating back to the eighth century; the law school/college (*madrassa*) from about the tenth century on; and the "shrine" (*mashhad*) college. The most important type of college, the *madrassa*, flourished in the eleventh to the fourteenth centuries, with the famous Nizamiyya in Baghdad, founded in 1057 by the vizier Nizam al-Mulk (d. 1092), being the most notable example. The *madrassa* college became a characteristic feature of Islam's culture and civilization. It was often financed by a pious endowment (*waqf*), supporting both faculty and students; built close to a large mosque, combining living and teaching accommodations; and led by an imam-professor. The curriculum was largely confined to: religious law (*shari'a*) and Islamic jurisprudence (*fiqh*); the Koran and Koranic exegesis; theology; the Prophetic Tradition; along with Arabic language and literature, and logic (the latter two disciplines were considered as "instrumental," one for the accuracy of expression, the other for the correctness of thinking). With the rise of an extensive network of these institutions of Sunni higher learning in the Eastern Islamic world, the religious scholars ('*ulama*')—by then thoroughly professionalized under state patronage—and their

restricted *madrassa* curriculum came to have a far-reaching impact on the overall cohesiveness and unity of Islamic thought. To be sure, this also led to conservatism and, among certain scholars, to an opposition to secular learning.

The Concept of *Adab*

The humanist concerns of classical Islamic education are epitomized by the Arabic term *adab*. Initially, the concept of *adab* related to the “rules of conduct” and the “customs” as inherited from one’s ancestors, revered as models. From about the eighth century on, it stood for the “ethical and practical rules of proper conduct” deemed praiseworthy in the medieval Muslim world. Additional connotations of *adab* include: the knowledge necessary for a certain profession; good breeding (proper upbringing of children, their morals, and their good behavior); courtesy; etiquette, and refined manners; aristocratic learning; and urbanity. *Adab* also designates the main form of classical Arabic belles-lettres, which explicitly aims at both the education and the entertainment of the reader. (The “Mirror of Princes” literature in Arabic and Persian, providing political and ethical advice to rulers, is a fine example in this regard.)

Pedagogy and Didactics

Educational thought as such found its literary expression in Arabic texts devoted to teaching and learning; that is, in works focusing on rules of conduct for teachers and students. Based on issues raised in the Koran and the literature of the Prophetic Tradition, these works explain and analyze—in an erudite and often literary manner—teaching methods, the ways in which learning takes or should take place, the aims of education, as well as the ways in which such goals may be achieved. These include: the ways in which teachers and students act and behave, their (moral) characteristics, their relationship with one another in the process of education, didactics (including the organization and contents of learning, and the curriculum), and the means and methods of imparting and absorbing knowledge.

Concerning these medieval educational texts, the following can be noted: (a) Elements of Arabian and Persian culture and, most importantly, the Hellenistic heritage, were creatively adapted to the Islamic educational theory, especially in the works of Islamic philosophers who deal with the various stages of development of the human character and personality, child education, and higher learning. (b) Islamic education in the Middle Ages correlated—partly in beneficial mutual exchanges—with medieval Jewish and Christian views and practices of learning. (c) From the eighth to the eighteenth century, there was a continuous tradition of Arabic-Islamic scholarship dealing with pedagogical and didactic issues, regardless of the individual scholars’ theological and juridical stances, ethnic origins, or geographical affiliations. Muslim scholars writing on education included jurists, theologians, philosophers, litterateurs, hadith scholars, and scientists, many of them teachers themselves.

One of the very earliest handbooks for Muslim teachers at elementary schools was written by Ibn Sahnun (d. 870), a Maliki jurist from Qayrawan (Tunisia). The curriculum he indicates is representative to some degree of the medieval Islamic elementary school; it includes obligatory topics to be taught such as: (a) the

precise articulation of the Koran, along with knowledge of reading, orthography, and grammar; (b) the duties of worship; and (c) good manners, since these are obligations toward God; and recommended topics such as: (a) the basics of Arabic language and linguistics; (b) calligraphy, writing letters; (c) poetry—if the verses are decent—, proverbs of the ancient Arabs, historical reports and legends of their battles, and sermons; and (d) arithmetic. The author also makes it clear that physical punishment was part of rectifying a child’s behavior in Islam in the Middle Ages, leaving, however, no doubt that it should not cross the line, and that the child should not be seriously harmed: on the contrary, basing himself on prophetic traditions, Ibn Sahnun emphasizes that modesty, patience, and a passion for working with children are indispensable qualifications for teachers.

Al-Jahiz (d. 869), a man of letters and theologian of Basra (Iraq), highlights the significance of the teachers’ work by stressing that writing has had a fundamental impact on human civilization, and that writing and recording—along with calculation—are “the pillars” on which the present and the future of civilization and “the welfare of this world” rest. He notes that independent thinkers and researchers dislike memorization, and that relying on it would make “the mind disregard distinction” and, in fact, neglect thought. Al-Jahiz points to the fact that there are teachers for everything one needs to know: writing, arithmetic, law, the pillars of religion, the Koran, grammar, prosody, and poetry. Further subjects that are to be taught include: polo, hunting, horsemanship, playing musical instruments, chess and other games. Interestingly enough, he emphasizes that the schoolteachers are superior to all other categories of teachers—an appreciation put into perspective by the low social status of schoolteachers in medieval Muslim society.

In this context, it should be noted that the Islamic philosophers—although concerned with logic, natural science, and metaphysics—did not neglect the need for educating the young. Ibn Sina (Avicenna; d. 1037), a physician and philosopher born near Bukhara in what is now Uzbekistan, for example, recommends that the instruction of young children should start when they are perceptive enough, both physically and mentally.

Ibn Sina’s main critic, the celebrated theologian and mystic Abu Hamid Ghazali (d. 1111), is noted for accepting Greek logic as a neutral instrument of learning and for recommending it for theologians. It is, however, in his mystical writings that are encountered two things of significance to education: the first is his incorporation of basically Aristotelian ethical values into an Islamic mode, representing them as Sufi values; the second is his insistence that the path to mystical gnosis must begin with traditional Islamic belief. Al-Ghazali is considered as one of the intellectual masterminds behind Islam’s classical educational philosophy and ethics. His understanding of education as “guidance” rather than “rectification” of the young is a major pedagogical principle that recurs in most classical writings on Islamic education.

Abu Bakr ibn al-‘Arabi (d. 1148), a judge from Seville (Spain), stresses the physical aspects of education, maintaining that students harden their bodies by physical exercise and a “Spartan” lifestyle. Burhan al-Din al-Zarnuji (first half of the

thirteenth century), a Hanafi scholar from Iran, provides detailed pious advice on the study of theology, including the first steps in studying; the amounts of material to be mastered; and the need for repetition of what was learned. He emphasizes—as many scholars of his and later times do—the integrity and purity of the transmission of the knowledge that has already been definitely established.

Nasir al-Din al-Tusi (d. 1274), a Shiite philosopher-vizier and scientist from Iran, suggests that education is a process involving the student, the teacher, and the father of the student. He maintains that the process of obtaining knowledge is in itself a pleasure and that it can lead to everlasting happiness. He says that knowledge is rewarded twice: by God in the after-life, and by humans in this life who remember and honor scholars even after their death. Al-Tusi also provides practical advice regarding the procedure for selecting the appropriate branches of knowledge to study, and the most suitable teacher and companions to study with, rules on punctuality and scheduling time for study, and other matters such as food and a healthy lifestyle that help retain or increase a good memory.

Ibn Jama'a (d. 1333), a Shafi'i chief judge in Egypt and in Syria, and al-'Almawi (d. 1573), a Shafi'i scholar and preacher in the Great Umayyad Mosque in Damascus, strongly promote the idea of books being indispensable tools for learning. Much advice is provided on the ethics and the techniques of written text transmission. Al-'Almawi suggests, for example, that it is "more important to spend your time studying books rather than copying them," and to pay due respect to the text of the manuscript, for caution is needed so as not to alter hastily what might be the correct wording.

These and other late medieval works appear to sum up much of the educational thought of the preceding generations. However, as Franz Rosenthal put it, "it would seem that a steady refinement and completion of the relevant material took place until it took its final form" (p. 8) in these valuable documents of medieval Muslim scholarship.

Education of Women

Most medieval texts deal exclusively with the education of boys and male students, despite well-known traditions such as the one stating that whoever "teaches his daughter good manners, educates her in the best possible way, and spends on her from the blessings God bestowed on him, will be spared from Hell." There is also clear evidence (especially in historical and biographical sources) suggesting that girls and women were at no time completely excluded from elementary or higher learning, nor were girls always confined to moral education provided within their families. This view is supported furthermore by data on women who were well-respected in medieval Muslim society for their share in the study of the Koran and the transmission and dissemination of prophetic traditions; for their fine poetry; for their talents as copyists, musicians, and singers; or as mystics and spiritual guides.

Reform Movements and the Print Revolution

The nineteenth and twentieth centuries were marked by reform movements and secularizing nationalists. With the presence of

European colonial powers in the Middle East and Southeast Asia, an era of intensive contact and a flow of ideas between the Muslim world and the West began, with far-reaching impact on the Islamic societies. Educational reforms were implemented to raise the standard and widen the scope of learning: in Egypt by Pasha Muhammad 'Ali (d. 1849), and in Turkey by Sultan 'Abdulmajid I (d. 1861). In India, Sir Sayyid Ahmad Khan (d. 1898), an educational reformer and founder of Islamic modernism in India, established in 1878 an Islamic Anglo-Oriental College in Aligarh (modeled after the universities in Oxford and Cambridge), which was raised to the rank of a university in 1920; in 1886 he instituted the Muhammadan Educational Conference, with annual meetings in various cities.

In the Arab world, the intellectual reform movement of the Nahda ("Awakening") aimed at reconciling traditional and modern (Western) areas of knowledge in a spirit of openness to the world, yet without destroying the values of Islam and Muslim identity. In Egypt, Muhammad 'Abduh (d. 1905), a Muslim theologian and founder of the Egyptian modernist school, called for an educational reform and the reformulation of Islamic doctrine in the light of modern thought; and Qasim Amin (d. 1908) campaigned for the liberation of women. Similar attempts were made in Tunisia by Muhammad Bayram (d. 1889); in Iraq by the Alusi family; and in Algeria by Ibn Badis (d. 1940), an intellectual educational reformer and founder of an orthodox reform movement for the renewal of Arab-Islamic culture. In Turkey, major steps to secularize education were taken as a result of the establishment of the Turkish nation state in 1923, when the Kemalist concept of secular nationhood in an Islamic country was implemented.

One must not neglect to mention the educational activities of Christian missionaries, especially in Lebanon and Syria, and at institutions such as the Syrian Protestant College opened in 1866 (later the American University of Beirut) and the introduction of printing to the Muslim world: in Calcutta (with Arabic, Persian, and Urdu printing) from the 1780s onward; in Teheran, Tabriz (Persian), and Istanbul (Turkish) in the eighteenth century; and in Beirut and Cairo (Arabic) in the nineteenth century. The latter made possible the production of a number of important educational journals.

Secular Education and the Revival of Traditional Islamic Learning

On account of the struggle between secular and Islamic ideologies throughout much of the twentieth century, global socioeconomic, political, cultural, and environmental challenges, and a new politicization of Islam in large parts of the Muslim World since the 1970s, (populist) discourses over the meaning of "modernity" have had a serious impact on the concept of Islamic education. These complex developments seem to have provided the ground for a revival of "traditional" Islamic (that is, religious) education in new guises in recent years.

In addition to well-known and reputable secular universities in the Muslim world, based on internationally accepted educational principles, institutionalized Islamic learning today is associated above all with the traditionally highly respected

centers of religious scholarship in Cairo, Mecca, Medina, Najaf, Qom, and Hyderabad. New international Islamic universities were established, for instance, in Islamabad, Pakistan (1980), and in Kuala Lumpur, Malaysia (1983), both also admitting women.

More specialized religious learning and the training of imams is taking place in seminaries and colleges—the *madaris*; singular., *madrasa*—with each branch of the Islamic faith having its own chain of such institutions. This notion would exclude certain institutions (in Southeast Asia) apparently misusing the name of the madrasa for purposes other than religious. In essence different from those latter, the academically oriented *madrasa* of our days understands itself as an heir to the medieval college, and to the industrious spirit and the tradition of fourteen hundred years of Islamic learning.

See also **Islam: Shii; Islam: Sunni; Law, Islamic; Philosophies: Islamic; Sacred Texts: Koran.**

BIBLIOGRAPHY

- al-Azmeh, Aziz. *Arabic Thought and Islamic Societies*. London and Dover, N.H.: Croom Helm, 1986.
- Berkey, Jonathan. *The Transmission of Knowledge in Medieval Cairo: A Social History of Islamic Education*. Princeton, N.J.: Princeton University Press, 1992.
- Bothwot, C. E., H. A. R. Gibb, J. H. Kramers, E. Levi-Proeuvencal, and J. Schacht, eds. *Encyclopaedia of Islam*. New Edition. Leiden: Brill, 1954–. See especially “Matba’a [Printing]” (by G. Oman), Vol. 6 (1991): 794–803; and “Nahda [Awakening]” (by N. Tomiche), Vol. 7 (1993): 900–903.
- Chamberlain, Michael. *Knowledge and Social Practice in Medieval Damascus, 1190–1350*. Cambridge, U.K., and New York: Cambridge University Press, 1994.
- Günther, Sebastian. “Muhammad, the Illiterate Prophet. An Islamic Creed in the Qur’an and in Qur’anic Exegesis.” *Journal of Qur’anic Studies* 4, no.1 (2002): 1–26.
- Gutas, Dimtri. “Classical Arabic Wisdom Literature: Nature and Scope.” *Journal of the American Oriental Society* 101 (1981): 49–86.
- Hanebutt-Benz, Eva, Dagmar Glass, and Geoffrey Roper. *Middle Eastern Languages and the Print Revolution: A Cross-cultural Encounter* [. . .], Westhofen: WVA-Verlag Skulima, 2002.
- Lapidus, Ira M. “Knowledge, Virtue, and Action: The Classical Muslim Conception of Adab and the Nature of Religious Fulfillment in Islam.” In *Moral Conduct and Authority: The Place of Adab in South Asian Islam*, edited by Barbara D. Metcalf, 39–61. Berkeley: University of California Press, 1984.
- Makdisi, George. *The Rise of Colleges: Institutions of Learning in Islam and the West*. Edinburgh: Edinburgh University Press: 1981.
- Marín, Manuela, and Randi Deguilhem, eds. *Writing the Feminine: Women in Arab Sources*. London: Tauris, 2002.
- Marmura, M. E. “Ghazali’s Attitude to the Secular Sciences and Logic.” In *Essays on Islamic Philosophy and Science*, edited by George F. Hourani, 100–111. Albany: State University of New York Press, 1975.
- McAuliffe, J. D., ed. *Encyclopaedia of the Qur’an*. Leiden: Brill, 2001. See “Knowledge and Learning” (by P. E. Walker), Vol. 3 (2003): 1–5; and “Teaching” (by S. Günther), Vol. 4. (Forthcoming).
- Pedersen, Johannes. *The Arabic Book*. Translated by Geoffrey French. Princeton, N.J.: Princeton University Press, 1984.

- Rosenthal, Franz. *The Technique and Approach of Muslim Scholarship*. Rome: Pontificium Institutum Biblicum, 1947. See esp. pp. 8, 13, 22.
- Savage-Smith, Emilie. “Islamic Science and Medicine.” In *Information Sources in the History of Science and Medicine*, edited by Pietro Corsi and Paul Weindling. London and Boston: Butterworth Scientific, 1983.
- Schoeler, Gregor. *Écrire et transmettre dans les débuts de l’Islam*. Paris: Presses universitaires de France, 2002.
- Shalaby, Ahmad. *History of Muslim Education*. Beirut: Dar al-Kashshaf, 1954.
- Somel, Selçuk Akşin. *The Modernization of Public Education in the Ottoman Empire, 1839–1908: Islamization, Autocracy, and Discipline*. Leiden and Boston: Brill, 2001.
- Young, M. J. L., J. D. Latham, and R. B. Serjeant, eds. *Religion, Learning, and Science in the ‘Abbasid Period.* Cambridge, U.K., and New York: Cambridge University Press, 1990.

Sebastian Günther

JAPAN

The classical autocratic state required an educated bureaucracy. During the Taika Reforms (645 C.E.), Chinese political systems (from the Sui [581–618] and Tang [618–907] dynasties) were imported to establish a legal-political system called the *ritsuryo* system that would last some five centuries. The *ritsuryo* government established the *daigakuryo*, a school that trained administrative bureaucrats in the capital. It also established schools in the outlying regions. The Taiho Code of 701 C.E. consolidated the curriculum. Confucian teaching was primary, with four courses established in mathematics, law, Chinese literature, and Chinese history. The schools nurtured mid- to lower-level aristocratic bureaucrats. Despite its small scale, difficulties in finding appropriate teachers and materials led to institutional stagnation. By the ninth century, as the *handen* (ancient land allotment) system shifted to the *shoen* (manorial) system, the lords of estates established their own schools. Buddhist studies also existed during this time. In 771, the first public library that held the *kanseki* (Chinese classics) was established. In 828, Buddhist priest Kukai opened a private academy for commoners, but their educational needs were not high and this endeavor did not last beyond his lifetime.

The *shoen* system declined due to the failure of the court nobility in the capitol to retain strong ties with outlying estates, and led to *bushi* (warrior) rule. Primarily, the warrior and the monk supported medieval education (1192–1603). In 1177, the *daigakuryo* burned and was not rebuilt. Because the Kamakura regime (1192–1333) was established upon a warrior code, despite the relative lack of education among *bushi*, upper-class *bushi* could not completely forsake education and cultural refinement. They invited into their own families scholar-families that had kept ancient knowledge alive over generations in order to study the Confucian classics and poetry. Despite political weakness, the culture of the nobility (*kuge*) remained prestigious, and in the Muromachi period (c. 1392–1573), the *bushi* assimilated *kuge* culture. During the medieval period, many aristocrats studied the arts, and many books were gathered and published, but most upper-class *bushi* created private libraries. The most representative of this was the Kanezawa library, established

in the mid-thirteenth century in the Hojo family Buddhist temple. It not only trained Buddhist priests, it also educated commoners. The only school founded in the mid-Muromachi Period, a time of revived political instability, was the Ashikaga School (established c. 1432–1439). This school did not teach the Buddhist scriptures, and focused solely on Chinese studies. Later, medicine, military science, and astronomy (divination) were also taught, which sought to meet the needs of military elite during the *sengoku* (warring states) period.

Buddhism arrived in Japan in the early sixth century via Paekche (one of the three kingdoms that comprised modern-day Korea prior to 660 C.E.), and gained the patronage of the state in the seventh century. Systematic education of priests took place in the larger temples. Since classical times, it had become common to study the Confucian classics as a foundation for understanding Buddhist scriptures. During the medieval period, as the aristocracy weakened, temple relationships with *bushi* and commoners deepened: children studied in temples for reasons other than training for the priesthood; heirs also attended to increase their literacy and cultivate knowledge; *bushi* studied martial arts to win battles. This education also emphasized the family. Family precepts were established in order to teach the norms of self-sacrifice and family honor. These precepts focused upon the ruler-subject relationship of Confucianism, piety from Buddhism, the disciplines of daily life, and the importance of education. The *bushi* also found solace in the midst of volatile times in a new Buddhism that differed from ancient Buddhism, resulting in many educational relationships with both famous and less famous priests.

The Tokugawa ended the warring states period and established a relatively peaceful rule by a *shogun* (military leader) that lasted over two and a half centuries (1603–1868), increasingly secluded from the outside world due to the policy of *sakoku* (closed country). In this context, the *bushi* class increasingly acted as an early modern version of a centralized bureaucracy. The official state ideology was Confucian, though the shogunate also received legitimacy through the emperor whose significance was established by Shinto teachings. Confucian thought was taught at the *shoheiko* (central government school), and Confucian scholars such as Hayashi Razan (1583–1657), who deeply influenced the first Tokugawa leaders, helped to keep it dominant through much of the period. Each domain eventually created their own schools for the education of samurai children. The curriculum generally included the Confucian Four Books and Five Classics, with a focus on nurturing the moral values that supported the order. However, in the late Tokugawa Period, challenges to orthodox Confucianism arose: Buddhism, while not in favor, continued to be taught and practiced; Dutch studies (*rangaku*) and Western studies (*yogaku*), despite the insulating effects of the seclusion policy, became increasingly popular; and the growing power of merchants contradicted Confucian teachings, which placed them at the bottom of the social hierarchy. Even within the Confucian tradition, a branch emphasizing empirical investigation challenged prior emphases on Confucian texts. In this context, *kokugaku* (native learning) asserted the importance of indigenous Japanese texts and traditions and led to the revival of Shinto teachings and the restoration of the imperial line to political prominence.

The resignation of the Tokugawa shogun and the 1868 Meiji Restoration of imperial rule significantly impacted education. The Meiji Emperor's Charter Oath of Five Articles stated that "knowledge shall be sought throughout the world," and this led to the importation of ideas from abroad, especially Western. After a period of relative liberal influence in the 1870s, in which American and British thought had great influence, the following decade brought a conservative response that made orthodox a more conservative, statist philosophy strongly influenced by German conservative and French statist thought. The 1889 Meiji Constitution reflected these conservative European, as well as Shinto and Confucian ideas. Shinto thought established the authority of the emperor, and its teachings were taught in classrooms nationwide. While state-sanctioned orthodoxy could not control all heterodox ideas, conservative, statist influences clearly remained dominant: *shushin* (ethics courses) emphasized the ontological priority of the emperor; the state, and society over the individual; and the virtues of duty, loyalty, filial piety, and self-sacrifice for the good of the nation.

Under the U.S. occupation, along with the implementation of a liberal constitution, educational reforms taught liberal democratic values and prohibited conservative and militaristic content. The 1947 Fundamental Law of Education and School Education Law emphasized how education should nurture individual development. After the occupation, the government sought to correct what some considered to be its excesses. Moral education was reinstated, though not with the militaristic overtones critics feared. Education was also shaped to meet the needs of postwar economic recovery. In 1960, the Economic Planning Agency advocated more emphasis on science and technical education so that individuals would contribute to the nation's economic and technological needs. Beginning in the late 1970s, however, various groups, both domestic and foreign, voiced criticisms of postwar education. The Organization for Economic Cooperation and Development, for example, criticized the system as overly emphasizing conformism, standardization, while insufficiently emphasizing individuality and creativity. However, in the context of Japan's economic successes in the 1980s, Western scholarship considered Japanese schools as possible models for others to follow, though this was more subdued by the end of the twentieth century.

See also Communication of Ideas: Asia and Its Influence; Education: Asia, Traditional and Modern; Education: China.

BIBLIOGRAPHY

- Adolphson, Mikael S. *The Gates of Power: Monks, Courtiers, and Warriors in Premodern Japan*. Honolulu: University of Hawai'i, 2000.
- Beauchamp, Edward R., ed. *Dimensions of Contemporary Japan: A Collection of Essays*. New York: Garland, 1998.
- Beauchamp, Edward R., and Richard Rubinger. *Education in Japan: A Source Book*. New York: Garland, 1989. Excellent bibliographical survey.
- Borgen, Robert. *Sugawara no Michizane and the Early Heian Court*. Cambridge, Mass.: Council on East Asian Studies, Harvard University, 1986. See for a discussion of the *daigakuryo*.

- Hood, Christopher P. *Japanese Education Reform: Nakasone's Legacy*. London and New York: Routledge, 2001.
- Kassel, Marleen. *Tokugawa Confucian Education: The Kangien Academy of Hirose Tanso (1782–1856)*. Albany: SUNY Press, 1996.
- Lincicome, Mark E. *Principle, Praxis, and the Politics of Educational Reform in Meiji Japan*. Honolulu: University of Hawai'i Press, 1995.
- Najita, Tetsuo. *Visions of Virtue in Tokugawa Japan: The Kaitokudō Merchant Academy of Osaka*. Chicago: University of Chicago Press, 1987.
- Najita, Tetsuo, and Irwin Scheiner, eds. *Japanese Thought in the Tokugawa Period, 1600–1868: Methods and Metaphors*. Chicago: University of Chicago Press, 1978.

*Hideki Takemura
Genzo Yamamoto*

NORTH AMERICA

What distinguishes the development of education in North America has been its cautious, halting, but nevertheless relentless movement toward universality and inclusivity, an impulse that owes much to the progressive ideals of the eighteenth-century Enlightenment and to the consequent development of liberal democracy on the continent. In the early twenty-first-century Canada and in the United States, citizens expect to be able to pursue an education, often at state expense, limited only by their abilities, interests, and preferences. But, however powerful, the sentiment in favor of universal access to education has never meant that education, or its benefits, has been shared equally. It remains the case that racial discrimination, gender bias, and economic necessity force many to forego advanced schooling and to endure lower wages, episodic unemployment, and a generally lower standard of living.

How do we explain this seeming contradiction? Both the impulse to universality and the unequal distribution of education are artifacts of two centuries of developments in educational policy and practice that owe much to the seventeenth-century origins of schooling in North America.

The Beginnings

Three interacting forces shaped education in the North American colonies: religious fervor, early Enlightenment thought, and contact with native peoples and with the wilderness itself. The early settlers of North America, as distinguished from the mercantile explorers who worked the traps in Hudson Bay and planted the tobacco fields of Virginia, or the explorers and missionaries who controlled the Spanish and French territories, immigrated to the North American continent to establish Christian religious communities with strong sectarian identities. The settlers arrived in the New World with a sense of righteousness and a powerful sense of possibility. They aimed at nothing short of creating a new kind of society on the tabula rasa of the New World. But when they arrived, the settlers discovered that the indigenous peoples of the continent had created complex communities with deep histories and an easy relationship to the wilderness they inhabited. Within just a few years, the leaders of settlements across New England began to doubt the internal coherence of their communities,

castigating the younger generation for their wavering faith. The chief cause, they surmised, was the lack of civilizing structures they had left behind in the established cities of Europe. They worried, too, that the wilderness and native culture were temptations to be resisted, and in their sermons they began to demonize the tribes who were their neighbors. To remedy this perceived declension and entropy, settlements turned to education as a means of reinforcing common values and ideals. In 1640, the General Court of the Massachusetts Bay Colony enacted the first law on the continent requiring universal education among its youth as a way of defeating “that ould deluder, Satan,” and of securing the tenuous hold the colony had over the hearts and minds of its citizens.

Formal education, then, has its origins in North America as a tool for the dissemination of common norms and values perceived as necessary by the leaders of the religious colonies of the seventeenth century. Education was, in other words, a defensive force aimed at the conservation of a particular set of ideas, values, and behaviors. Throughout the seventeenth century, communities across North America supported education as a means of internal cohesion. Schools, such as they were, were often temporary or informal affairs, connected to local churches, established at home by women who could teach their charges to read and write as well as cook and sew, or by masters who taught their apprentices to read by candlelight after the day's work was done. Even at Harvard and William and Mary, the first of the colonial colleges, admission, courses, and requirements were informal affairs. Critically, during this period of local informality, gender roles, racial discrimination, and even the socioeconomic stratification of opportunity, while ubiquitous, were neither as rigid nor as obvious as they were to become. Their very ubiquity made them a part of the social fabric, unobserved and unscrutinized. At the same time, the lack of rigid structures enabled individuals, especially young women, to enjoy relatively unfettered access to primary education. Indeed, throughout the colonial period rates of literacy for women in North America exceeded those for men.

The Revolution

The American Revolution deepened the North American affection for using education as a tool of social control. The creation of a liberal republican nation-state on the continent provided a new locus for policy-making and a new imperative for generating political solidarity. In the new United States, one of the few things that George Washington, Thomas Jefferson, James Madison, and John Adams could agree upon was the necessity of creating a system of universal education that reinforced the principles of the new nation. Education should be spread widely, they argued, and children should be taught to reject monarchy and to embrace republican democracy. They could be made, wrote the early reformer Benjamin Rush, into “republican machines.” It was this impulse to social control, less than the logic of liberal democracy, that spurred the growth of schooling in the new nation.

In Canada, governors and ministers shaken by events to the south sought to consolidate their own political culture by mandating the establishment of schools that reinforced allegiance to the British Crown and to the Church of England. Reformers

sought to rationalize and nationalize educational practice, especially in the French-dominated colony of Lower Canada. Government ministers made periodic attempts to graft educational policies generated around the “Irish Question” onto affairs there.

As much as it was shaped by the insecurity of the emerging nation-state and its need to create a compelling internal narrative, the unique character of the universal rights language of the late Enlightenment amplified the universalist educational ideology of the early republican period in the United States. By those ideas, individuals’ stations could and should be separated from their inherent status as men, men imbued with qualities, rights, and opportunities that could and should not be abrogated by policy or practice. Among those rights was the right to participate in the establishment of laws and the conduct of government. It became particularly important, in this framework of broad participation, for citizens to possess at least a rudimentary education by which they could assess the strengths of various arguments and positions.

Embedded in the rights language of the late Enlightenment, however, is an even more fundamental proposition supporting individual freedom and fundamental equality, concepts that expanded over the course of the next two centuries to include women, native peoples, freed African slaves, and immigrants. As these groups came to be regarded as inheritors of the same inalienable rights that had traditionally been the province of white men, the need to provide an education that would enable them to exercise those rights within a prescribed set of social norms became critical. From this expansion of language regarding rights and freedoms, combined with the ever-present impulse to use education as a tool of social cohesion, comes the particular North American emphasis on inclusive and universal schooling.

For example, even in the early years of the Republic, educators and political leaders discussed following the internal logic of the Revolution to formalize the education of girls and women as a national priority. Mothers, the argument went, were a child’s first teacher, and to educate women well was an important bulwark to the safety of the nation. Importantly, it was this connection between rights of democratic participation and the need to create a national narrative that reinforces order which led to the expansion of educational opportunity across wide swaths of the population in North America over the next two and a half centuries.

The Nineteenth Century

The nineteenth century was a time of expansion and change on the North American continent. Expansion of the white population westward brought more and more native peoples into contact with settlers and their brand of civilization. Displacement, disease, and successive wars of conquest decimated the native peoples from Florida to Saskatchewan and brought those who survived into a strongly paternalistic relationship with the governments in the United States and Canada. Across North America, state-run schools for indigenous peoples or state-supported missionary schools sought to teach their charges their appropriate role in the polity and the economy. Typically these schools taught habits of deportment and hygiene, the English language,

loose Protestant catechism, the rudiments of politics, and, most importantly, a set of vocational skills appropriate to a subservient class. This model, one of providing education to support political stability and training for appropriate roles in the economy, bolstered the universalist impulse among elites, who saw it as a way of promoting stability. Among emerging groups, the picture is less clear. Some saw the provision of any education as an advance. Others saw the internal limits to this kind of learning.

Throughout the nineteenth century, state-sponsored education replaced the more informal arrangements of the seventeenth and eighteenth centuries, built upon the twin pillars of political necessity and economic stability. By mid-century in Canada and the United States, education came to be seen as the most powerful tool in creating stable, well-ordered societies in the face of increasing mobility and immigration. Yet this rise of the public school and its hegemonic construction of a political and social narrative aimed primarily at immigrants and non-elites did not go uncontested. Across North America, religious groups, particularly Catholics, protested the growing incursion of state-written (British Canada) or state-influenced (United States) curriculum that either explicitly or implicitly supported Protestantism. Ethnic groups in the mid-western regions of the United States and Canada created strong regional schools where subjects were often taught in German or Polish. And finally, elites, who supported public schools for the general stability they generated, supported independent schools and sent their children there in preparation for matriculation at colleges and universities.

Higher Education

Indeed, until the middle of the nineteenth century, higher education was off-limits to most women and to all but the most affluent of men. Female seminaries existed, and the end of the nineteenth century saw the development of specialized teacher training colleges for women. But the opportunities that existed for collegiate training remained the province of wealthy white men. That changed in the United States in 1862 with the passage of the Morrill Act establishing a series of land-grant colleges. These institutions were originally intended to advance technical training in agriculture but rapidly expanded into multipurpose institutions where individuals from diverse backgrounds could secure higher education.

Unlike primary and secondary schools, colleges and universities, even state-supported institutions, remained relatively free from the conserving political dynamic that is at the heart of educational expansion in North America. As a result, colleges and universities were freer to open their doors to new peoples and new views. Historically black institutions and the land-grant colleges became the training ground for leaders of hitherto underrepresented groups. These leaders and allies from majority groups began, by the middle of the twentieth century, to explore critically the internal structuring of universal education in North America.

The Future

Most obvious to these critics was the existence of a multitiered system of schooling, in which minority and immigrant groups

were channeled by the education they received into low-paying jobs and subservient positions in society while whites, including, to a lesser extent, white women, were provided an education that created opportunity for mobility and access to political power. In the United States, from the 1954 *Brown v. Board of Education* decision declaring separate schools for black children unconstitutional, to state-by-state decisions to equalize school finance and school resources, to the 2002 national No Child Left Behind act, policy-makers have worked to create a system that is not just universal, but that provides equal opportunities to all. Such a system of education would go well beyond the original social control arguments in favor of publicly supported schooling. Instead, such a system would preserve liberal democracy in the United States and Canada by bringing to life the noblest aspirations of the liberal democratic ideals upon which the nation-states of North America ultimately rest.

See also *Americanization, U.S.; Assimilation; Democracy; Segregation; University.*

BIBLIOGRAPHY

- Anderson, James D. *The Education of Blacks in the South, 1860–1935*. Chapel Hill: University of North Carolina Press, 1988.
- Cremin, Lawrence A. *American Education: The Colonial Experience 1607–1783*. New York: Harper and Row, 1970.
- Horowitz, Helen Lefkowitz. *Campus Life*. New York: Knopf, 1987.
- Kaestle, Carl F. *Pillars of the Republic: Common Schools and American Society, 1780–1860*. New York: Hill and Wang, 1983.
- Tyack, David. *Seeking Common Ground: Public Schools in a Diverse Society*. Cambridge, Mass.: Harvard University Press, 2003.
- Tyack, David, and Hansot, Elizabeth. *Learning Together: A History of Coeducation in American Public Schools*. New York: Russell Sage Foundation, 1992.
- Veysey, Laurence R. *The Emergence of the American University*. Chicago: University of Chicago Press, 1965.
- Walters, Raymond. *The New Negro on Campus: Black College Rebellions of the 1920's*. Princeton, N.J.: Princeton University Press, 1975.

Theodore R. Mitchell

EMIGRATION. See *Migration.*

EMOTIONS. Ideas about emotions and their function in human and animal life have been a major theme in philosophy—and more recently in psychology and the social sciences—since the time of the ancient Greeks. The history of ideas about emotion is an essential part of the history of ideas about human nature and about human continuity—and discontinuity—with other animals. Whether emotions are essentially part of our “animal nature” or products of culture and cultivation, for example, is an issue that determines a great deal about our attitudes toward and evaluations of them. The history of ideas about emotion plays a particularly controversial

role in the history of ideas about gender and culture. Whether women are “more emotional” (and thus less rational) than men, whether Greeks are more emotional and less rational than “Barbarians” or Englishmen are more emotional and less rational than their colonized subjects have been central themes in the often ugly histories of sexism and racism. Thus it is noteworthy that recent feminist studies have deeply probed the *political* role of the emotions and gender politics. And the history of ideas about emotion provides several important threads in the history of ethics, whether in the guise of “passion as a threat to reason” or in the more benign role of sympathy and the moral sentiments. Whether emotions contribute to or undermine rationality has been a central issue in ethics (at least since Socrates).

Definitions

What is an emotion? And are emotions rational? Those two questions have dominated the philosophical history of the subject, and, of course, the answer to one suggests a set of plausible answers to the other. If emotions are such as to contribute to our well-being and the good life, and if emotions motivate moral behavior, then it makes good sense to say that emotions are rational or at least contribute to rationality. On the other hand, if emotions are merely an unintelligent residue of our “animal nature,” they are more likely to be distractions or obstacles to civilized living and thereby irrational. Nevertheless, the picture is more complicated than this would suggest. One train of thought since ancient times suggests that the emotions are indeed an aspect of our animal life, unsuitable to civilized life. But since Charles Darwin (1809–1882), the emotions have been argued to be continuous in the evolution from animal to man and, so considered, probably functional and adaptive at least at some point in their history. In either case, this biological view of emotions has been supported in the past few centuries—since René Descartes in the seventeenth century—by increasingly sophisticated physiological and neurological models of emotion.

The history of ideas about emotion is thus divided into two sometimes complex and interweaving tracks in which emotions tend to be “dumb” and “sophisticated,” respectively. The first kind of theory takes an emotion to be a feeling or physiological process. In medieval medicine, the emotions were the result of organic “humors” in the body. In early modern philosophy, they were the product of “animal spirits” in the blood, which caused simple sensations of pleasure and discomfort. William James (1842–1910), at the end of the nineteenth century, insisted that emotions are sensations caused by physiological disruptions. In the twenty-first century, many psychologists and philosophers hypothesize that emotions, or at least the “basic” emotions, are “affect programs,” essentially hard-wired and evolutionarily derived complexes of neurological, hormonal, and muscular responses, with accompanying feelings, of course. But such feelings are of minimal significance, mere “icing on the cake” according to one prominent researcher (Joseph Le Doux). An emotion is for the most part an unconscious or at least not necessarily conscious physiological process, which may or may not still serve an evolutionary function but does not involve sufficient “cognition” to be rational in any meaningful sense.

By contrast, Aristotle (384–322 B.C.E.) insisted that emotions, while fully natural, are also an essential part of rational, civilized life and themselves social and cultural, consisting of ideas, learned and cultivated and even “intelligent.” In the twentieth century, many psychologists and philosophers defended various “cognitive” and “appraisal” theories of emotion, in which an emotion is constituted, at least in part, by ideas, beliefs, or judgments and by an active engagement with the world. Aristotle insisted, accordingly, that quite the contrary of a dumb reaction, an emotion such as anger was a learned and cultivated response to what was recognized as an offense or a “slight,” and as such it required not only the recognition of the nature of the offense but a measured and appropriate response. As such, emotions represented sophisticated, sometimes uniquely human, behavior. A cat might be aggressive or defensive, but only a human being with a moral upbringing can be morally indignant. A dog might demonstrate dependency and affection, but only a human being can fall in love. Thus some contemporary theorists who defend an “affect program” conception of emotions distinguish between “basic” and “higher cognitive” emotions, perhaps insisting that only the former are “really” emotions but acknowledging that many of the most important emotions—guilt, shame, pride, and jealousy, for instance—require cultivation and culture.

Many theorists would argue that whether or not anything like an affect program is involved in emotions (and no one would argue against the idea that emotions are somehow the product of our brains), that is not what an emotion really is. An emotion is a kind of experience of the world, and, as such, it necessarily involves *intentionality*, an orientation toward objects in the world (for example, situations, other people, or oneself). Thus anger is not just feeling flushed and tense; it is a feeling *about* something, involving, for instance, a judgment that someone has insulted or wronged you. And love is not just a feeling but an attitude (or a huge complex of attitudes) *about* someone. Emotions are “cognitive” in that they seem to involve and presuppose beliefs about the world; for example, fear is premised on the judgment that one is in danger, and shame is based on the recognition that one has done something shameful. They are also evaluative (and involve “appraisals”) in that they involve the recognition that some things are important. Grief, for instance, is an emotion that recognizes a serious (perhaps devastating) loss. Emotions are therefore not “dumb” but, one might say, potentially as smart and sophisticated as the person who has them and the culture that embeds and teaches them. Anger may sometimes be nothing more than blind rage, but it can also be an exquisite response to injustice. Love may be as naïve and foolish as a teenage “crush,” or it may be profoundly insightful and involve deep mutual intimate knowledge. Feelings and physiology play their roles, of course, but the emotion is much more than that.

How Rational Are Emotions?

Plato (c. 428–348 or 347 B.C.E.) famously divided the soul into three parts: reason, spirit, and appetite. He also used a dramatic metaphor to explain the harmonious interrelation between them, reason as the charioteer driving two spirited horses. But Plato also recognized that what we call *emotions* seem to encompass not only spirit and appetite but reason as well. When, in his

Rhetoric, Aristotle defines anger as “a distressed desire for conspicuous vengeance in return for a conspicuous and unjustifiable contempt of one’s person or friends,” he makes it quite clear that emotion and reason are not to be divided but combined. Aristotle, who was so precocious in so many disciplines, seems to have anticipated many contemporary theories. His analysis of anger includes a distinctive cognitive component, a specified social context, a behavioral tendency, and physical arousal. Whereas Aristotle took emotion to be essential to the good life, the Stoics analyzed emotions as conceptual errors, conducive only to misery. In modern terms, the Stoics Lucius Annaeus Seneca (4 B.C.E.–65 C.E.) and Chryssipus (c. 280–c. 206 B.C.E.) developed a full-blooded cognitive theory of the emotions two millennia ago. Emotions, in a word, are judgments, judgments about the world and one’s place in it. The disagreement between Aristotle and the Stoics was whether these judgments were rational and thus conducive to happiness, or not.

Even before the ancients in the Mediterranean, fascination with the emotions occupied the best minds in early India and China. In India, the emotions (*rasas*) were considered central to the arts, artistic expression, and, most important, aesthetic appreciation. Thus the cataloging and analysis of the emotions, their causes, and their effects on the mind and body formed the heart of Indian aesthetics. In Buddhism, the control of one’s emotions, the elimination of the agitating emotions (*klesas*), and the cultivation of compassion were all viewed as essential to enlightenment and to putting an end to the suffering that was so characteristic of life. In China, both Confucians and Daoists recognized that the cultivation and management of one’s emotions (*qing*) was essential to living well. The Confucians emphasized the importance of cultivating social emotions such as respect and reverence. The Daoists focused their attention on the more “natural” and spontaneous emotions. The concept of rationality as such did not play the central role it did in the Western tradition, but nevertheless, insofar as that concept embodied a general sense of wisdom and well-being, the cultivation of the right emotions played an essential role in their various philosophies. Meanwhile, in the Middle East, the ancient Hebrews endowed their God with a whole range of (super)human emotions, from wrath and jealousy to love. In the New Testament, the emphasis shifted to love and faith, which the medieval scholars argued to be the epitome of rationality. The great importance of such emotions guaranteed that the subject would remain of great interest to the theologians of the Christian tradition.

Friedrich Nietzsche (1844–1900), like Sigmund Freud (1856–1939), who admired him, described instead the darker, more instinctual and less rational motives of the human mind. This was not to say that all passions are wise; some, he declares, “drag us down with their stupidity,” and others, notably the “slave morality” emotion of resentment, are devious and clever but nevertheless disastrous for both the subject and society. Nietzsche, like the ancient Greeks, insisted on the cultivation of the right emotions—those having to do with strength and self-sufficiency, but he insisted even more on the self-destructiveness of emotions such as resentment and envy. There is wisdom in emotion, he says in *The Will to Power*, “as if every passion didn’t contain its own quantum of reason.” So, too, in *The Emotions: Outline of a Theory*, the French

existentialist Jean-Paul Sartre (1905–1980) gave a “phenomenological” analysis of emotions as “magical transformations of the world”—willful strategies for coping with a difficult world. Again, emotions were conceived as inherently purposeful, with an added twist: We choose our emotions, according to Sartre, and so we are responsible for them.

Thus, emotions have been conceived, in many cultures since ancient times, as conducive to wisdom and well-being, and in this sense at least some of the emotions can be said to be rational. And emotions, if conceived of as “cognitive” and involving beliefs and appraisals, are rational in a further sense. They involve concepts and judgments. But our emotions are rational or irrational *within* a culture depending on whether they are appropriate or inappropriate to the circumstances, more or less accurate in their perception and understanding and more or less warranted in their evaluation of the situation. Thus it is mistaken to say either that emotions (in general) are rational or irrational. It depends on the emotion and the circumstances as well as on the culture. But what is most important in this conception of emotions as much more than mere “gut reactions” and thus as rational or irrational is that what we think about our emotions, the ideas we have about them, in part determine what they are. It is not as if thought and reflection are irrelevant to the emotions, which have their own animal life. Our emotions are to some extent products of our thoughts and reflections, and, of course, our thoughts and reflections are often the product of our emotions. Thus the ideas we have about emotions become part and parcel of our emotional lives.

See also *Friendship; Intentionality; Love, Western Notions of; Moral Sense; Philosophy, Moral.*

BIBLIOGRAPHY

- Damasio, Antonio. *Descartes' Error: Emotion, Reason, and the Human Brain*. New York: Putnam, 1994.
- . *The Feeling of What Happens: Body and Emotion in the Making of Consciousness*. New York: Harcourt Brace, 1999.
- De Sousa, Ronald. *The Rationality of Emotion*. Cambridge, Mass.: MIT, 1987.
- Lyons, William. *Emotion*. Cambridge, U.K., and New York: Cambridge University Press, 1980.
- Sartre, Jean-Paul. *The Emotions: Outline of a Theory*. Translated by Bernard Frechtman. New York: Philosophical Library, 1948.
- Solomon, Robert C., ed. *Thinking about Feeling: Contemporary Philosophers on Emotions*. New York: Oxford University Press, 2004.
- , ed. *What Is an Emotion?: Classic and Contemporary Readings*. New York: Oxford University Press, 2003.

Robert C. Solomon

EMPIRE AND IMPERIALISM.

This entry includes six subentries:

Overview
Americas
Asia

Europe
Middle East
United States

OVERVIEW

The multiple meanings of *empire* have a long history. To the ancient Greeks, the concept, expressed by the term *monarchy*, referred to the Persian Empire, the vast power that fought the Greeks in a series of campaigns in the early fifth century B.C.E. To the Greeks, the empire was a gigantic war machine, one in which military officers employed whips to force their soldiers to fight, unlike the Greeks, who fought voluntarily as freemen. Empire thus signified conquest and slavery, as opposed to the city-state, which signified freedom.

Roman Imperium

The ancient Roman conception of empire differed from the Greek. The term came from the Roman concept of *imperium*, meaning jurisdiction or lawful authority. A Roman official who ruled a subject population or who commanded troops possessed *imperium*, an authority symbolized by the fasces, which was borne as a sign of authority before the consuls who ruled Rome. The fasces, a band of rods bound around the handle of an ax, symbolized the power to flog or to execute those under Roman jurisdiction. The associated term *imperator* identified an especially successful general, someone who had won a significant battle in the service of Rome. What neither *imperium* nor *imperator* meant was rule over a specific territory and the office of the one who ruled over a specific place in the modern sense of empire and emperor.

The terms *imperium* and *imperator* did become permanently associated with rulership over a designated region with the reign of Augustus Caesar (27 B.C.E.–14 C.E.). Although in theory Rome remained a republic, the end of the civil wars following the murder of Julius Caesar in 44 B.C.E. saw the formation of a hereditary monarchy under Augustus, who bore the title of *imperator*. The vast collection of lesser units that comprised the territory over which Augustus exercised *imperium* became the Roman Empire, at least in the eyes of subsequent generations. To later observers, the Roman Empire was the rule of a single man over a large space occupied by a wide variety of peoples and maintained by an army.

Christian Conceptions

Empire had a mystical or spiritual meaning in the ancient world as well. In the ancient Near East, the course of human history was often symbolized in terms of empires. One of the most famous examples of this is in the biblical Book of Daniel, where there is an image of man composed of gold, silver, bronze, iron, and clay. Each element represents one of the stages of human history, a history of decline from the best to the worst. The mystical conception of a cycle of empires comprehending the history of mankind continued to reverberate in Christian circles for the next two millennia. Succeeding generations of Christians attempted to interpret their contemporary world in terms of the Fifth Monarchy, the final great empire the appearance of which signaled the end of the world as we know it.

During the Middle Ages and later, the Greek, the Roman, and the biblical conceptions of empire circulated along with new ones that emerged. The most significant new conception of empire emerged in the year 800 when Pope Leo III crowned Charlemagne, king of the Franks, as emperor, transferring the Roman imperial office from Constantinople, where it had resided since the Emperor Constantine established that city in 330, to the king of the Franks. While the pope never explained what he intended by this action, it seems clear that his goal was to link the most powerful European ruler to the church and to assert the superiority of the spiritual power over the temporal. In doing this, Pope Leo was initiating the process whereby the empire was brought within the ecclesiastical conception of a right political order with the emperor serving as the agent of the pope in the administration of Christian society.

The Carolingian empire gradually dissolved over the next century, breaking up into several small kingdoms, the most important being France and Germany. The imperial title gradually came to signify less and less. Beginning in 911, however, the title began to acquire increased importance as it became associated with the kings of Germany. The most important of these emperors, the Ottonians (936–1002), bore not only the title king of Germany but king of Italy and king of Arles or Burgundy as well, suggesting that an emperor was the ruler of several kingdoms and the defender of Christian society against its enemies.

The last of the Ottonians, Otto III (r. 983–1002), announced a revival of the imperial vision on his official seal, which read *renovatio imperii Romanorum* (renewal or revival of the empire of the Romans), suggesting the creation of some vast empire under German leadership. In conjunction with this, he began the practice of identifying the empire as the Holy, or Christian, Roman Empire. This medieval German empire, a combination of a Christian conception of empire and a German one, reached its peak in the reigns of the great Hohenstaufen emperors Frederick I Barbarossa (r. 1152–1190), and Frederick II (r. 1212–1250).

Holy Roman Empire and Church versus State

The great medieval conflict between church and state from the eleventh to the thirteenth centuries focused, for the most part, on the relationship between emperors and popes. Each party possessed a vision of Christian society in which it played the leading role. In the decretal *Venerabilem* (1202), Pope Innocent III (r. 1198–1216) spelled out in detail the papal conception of the function and role of the emperor within Christian society. He distinguished between the office of king of Germany, an office whose occupant was elected by seven electors, three archbishops, and four lay magnates representing the body of German higher clergy and nobles, and the imperial office, which was in the gift of the pope. The electors could elect anyone they wished to the royal office, but if they wanted their candidate to be raised to the imperial office, they had to ensure that he would be acceptable to the pope. In effect, the pope held a veto over the royal selection process. In Innocent III's view, pope and emperor were the coordinate but not coequal heads of Christian society. The emperor was the senior secular ruler with some vague right of precedence over all other Christian rulers, while the pope was at the peak

of Christian society. In symbolic terms, the emperor was the strong right arm of the church, applying force when spiritual admonitions were not sufficient.

In 1356 the nature and status of the Holy Roman Empire received its final medieval shape when Emperor Charles IV (r. 1347–1378) issued the Golden Bull. This document generally restated earlier positions on the relationship between the papacy and the empire but with an important caveat. Under the terms of the bull, the pope had the authority to crown the emperor, but his relationship to the emperor ends at this point. The emperor is no longer seen as the agent of the pope, the strong right arm of the church to be flexed at the command of the pope. The emperor answers not to the pope but to God for his actions. By the end of the fifteenth century, the claims of imperial jurisdiction had so shrunk and its identification with German royal interests become so strong that the empire became known as the Holy Roman Empire of the German Nation.

The notion of a Christian empire the jurisdiction of which coincided with that of the church itself did not die, however. In the *De monarchia*, the Italian poet Dante (1265–1321) outlined a Christian world order in which the emperor was the ruler of Christian society and, presumably, as missionaries converted the rest of mankind, would eventually be the ruler of the entire world. The theologian and philosopher Nicholas of Cusa (1401–1464) developed a similar theory of imperial jurisdiction in the fifteenth century. There was, however, a paradox in these fourteenth- and fifteenth-century discussions of universal imperial power. In reality, the actual power of the emperor, based as it was on the wealth and power of the king of Germany, was declining to its lowest limits as emperors such as Maximilian I (r. 1493–1519) struggled to maintain themselves in the face of the loss of most of the sources of royal revenue. On the other hand, although no one could have prophesied it, the Holy Roman Empire was about to be resurrected for one last tumultuous era in the sun as Maximilian was succeeded by his grandson, Charles V (r. 1519–1556), whose accumulated dynastic possessions were to include most of the Americas and much of the rest of the world as a result of the division of the New World by Pope Alexander VI (r. 1492–1503).

Evolution of Europe

While the medieval use of the terms *empire* and *imperial* is usually seen as restricted to the Holy Roman Empire, in fact this was not the case. Several other medieval rulers referred to themselves as emperor and their possessions as an empire, or were said to have possessed imperium over a variety of peoples. The *Ecclesiastical History of England*, by the scholar and theologian Bede (672 or 673–735), referred to Anglo-Saxon rulers who possessed imperium over those who dwelled beyond the bounds of the king's own kingdom. Some Anglo-Saxon kings also seem to have used the imperial title in the tenth century. The title also was employed by some Spanish monarchs. At least one Visigothic ruler, Reccared (r. 586–601), was labeled an emperor. Subsequently, the king of León in the tenth century and a king of Castile in the eleventh century claimed imperial status as a consequence of their conquests. The use of the imperial title by rulers other than the kings of Germany gradually faded, however.

The fact that the terms *emperor* and *empire* were not employed by most European rulers does not mean, however, that European rulers were not in some sense imperialists. The various kingdoms that developed in medieval Europe were in fact composed of numerous smaller jurisdictions that had come under the authority of a single dynasty as a result of conquest, marriage, inheritance, and so on. Spain, for example, was composed of the former kingdoms of Castile, Aragon, and León. Likewise, Anglo-Saxon England at one time consisted of seven kingdoms that eventually came under the control of King Alfred (r. 871–899) and his family. One might even describe medieval Europe as consisting of a collection of miniature empires.

In the long run, the medieval concept of empire has been judged in a variety of ways. German scholars have often asserted that the efforts of medieval German rulers to control Italy, one of the kingdoms of the empire and the seat of the ancient Roman Empire, distracted them from their true task, the development of a German national kingdom, and therefore lay the basis for the modern German state. Others have seen the claims of the medieval emperors as a kind of fantasy that could never be fulfilled. For others, the great battles between the popes and the emperors was a disaster for the development of Europe. From the perspective of the twenty-first century, however, the notion of a Europe united under pope and emperor suggests a forerunner of the European Union.

See also Anticolonialism; Christianity; Colonialism; International Order; Monarchy; Peace.

BIBLIOGRAPHY

- Abulafia, David. *Frederick II: A Medieval Emperor*. Oxford and New York: Oxford University Press, 1992.
- Carlyle, R. W., and A. J. Carlyle. *A History of Mediaeval Political Theory in the West*. 6 vols. Edinburgh and London: W. Blackwood, 1903–1936.
- Fanning, Steven. “Bede, Imperium, and the Bretwaldas.” *Speculum* 66 (1991): 1–26.
- Folz, Robert. *The Concept of Empire in Western Europe from the Fifth to the Fourteenth Century*. Translated by Sheila Ann Ogilve. London: Edward Arnold; New York: Harper and Row, 1969.
- Heer, Friedrich. *The Holy Roman Empire*. Translated by Janet Sondheimer. New York: Praeger, 1968.
- Koebner, Richard. *Empire*. Cambridge, U.K.: Cambridge University Press, 1961.
- Muldoon, James. *Empire and Order: The Concept of Empire, 800–1800*. New York: St. Martin’s, 1999.
- Pagden, Anthony. *Peoples and Empires: A Short History of European Migration, Exploration, and Conquest, from Greece to the Present*. New York: Modern Library, 2001.
- Sullivan, Richard E., ed. *The Coronation of Charlemagne: What Did It Signify?* Boston: D. C. Heath, 1959.

James Muldoon

AMERICAS

An empire presupposes an unequal relationship between an elite of an ethnicity, or polity and the peoples of a dependent and subservient ethnicity or polity, the periphery, on issues

such as service or tribute and dominant language and culture, as shown by unequal material or service exchanges and the spread of art styles, architectural forms, and politico-religious practices.

The Americas have a long history of empires, although archaeologists argue fiercely about when the incipient civilizations that can be identified in Mesoamerica and the Andean regions thousands of years before the arrival of Europeans became imperial powers. What is uncontested, however, is that when Columbus, and later Cortés and Pizarro, arrived in the New World, it had long been a region in which empires rose and fell. The ancient Maya are thought by many to represent the pinnacle of Native American civilization, but their political structure was largely one of independent city-states that struggled against one another in a long succession of internecine wars.

In contrast, the Inca and Aztec empires, both of which were flourishing at the time of Spanish contact, were highly successful, rapidly expanding, centralized systems adept at collecting taxes and tribute, with mobile armies, mathematicians and bureaucrats well versed in the intricacies of keeping accounts, and a state cult that harnessed ancient religious traditions in the service of empire. Amazingly, both of these empires were new phenomena, only a few hundred years old when the Spanish arrived, although both rested upon long political and cultural traditions that made their rapid growth possible.

In North America, Hernán Cortés made contact with and, after two years of struggles, conquered the capital of the Nahuatl-speaking Mexica city-state, Tenochtitlán, the center of a tributary empire that stretched from what is now northern Mexico to the Isthmus of Tehuantepec and from the Gulf of Mexico to the Pacific Ocean. In western South America, Francisco Pizarro led several expeditions further and further south until he made contact with the expanding Inca armies and captured the Inca emperor, called the Cuzco, one afternoon in November of 1532.

Both the Aztec and Inca empires originated when a relatively small ethnicity began to expand. In Central Mexico, the Mexica allied with two other city-states to form the Triple Alliance, which they would come to dominate. This alliance began to conquer other city-states. Subject peoples gave tribute in the form of foodstuffs, clothes, and other items that subsidized the elaboration of the dominant cult and the Mexica elite. Such imperial success over time made the cult of Huitzilopochtli, the god and patron of war, the dominant one in their pantheon. The Mexica, content with such tribute, did not impose their gods on subject peoples and did not force them to speak their language or follow their cultural lead. So the Mexica empire remained a loose confederation of city-states under the control of an elite that ruled from the island capital of Tenochtitlán in the middle of Lake Texcoco.

Like the Mexica, the Inca were a relatively small people and polity in the southern Andes. Their expansion dates from a challenge by another group, the Chancas, for the claim to be called the People of the Sun. The Inca won the military struggle that followed and, once triumphant, began to subjugate

independent groups forcefully and persuaded others in their path to ally with them. They promised aid in times of need and, implicitly, peace. At the time of Spanish contact, the Inca dominated peoples who lived in what are the twenty-first century countries of Colombia, Chile, Peru, Bolivia, and Argentina. All subject peoples contributed labor service to their Inca rulers. Inca delegates organized this labor to build roads and bridges that united the far-flung ethnic groups of the empire, to terrace mountainsides to win additional agricultural lands for the farmers, and to build ceremonial centers for ritual purposes. Scattered storehouses filled with food, clothes and blankets, and weapons also announced the capability of the Inca state to supply local needs in times of crisis or to subjugate peoples again in case of disobedience or revolt.

But in contrast to the Mexica, the Incas forced their subjects to adopt their language, Quechua, and worship their gods, most importantly the sun god. In so doing, subject peoples were venerating the Inca emperor, who claimed to be the son of the sun god. The Incas also rewarded cooperating local leaders with gifts of women, intending to form a mega-lineage. In these ways, the Incas planned to meld the various groups they subjugated into a homogeneous whole—of one birth under one law. Perhaps for this reason the Inca emperor was called the Cuzco, which can be translated as “navel,” literally the center, an earthly representative of a bloodline that extended back to their miraculous descent from the sun.

In the sixteenth century, the devastating plagues and disease that had already ravaged the New World native populations and the seemingly easy Spanish victory over the Inca emperor in 1532 largely discredited the native theocratic regime, as local folk interpreted the illnesses and defeat as signs of the coming of a more powerful Spanish god who had been victorious over their own. But if the initial victories over the highly centralized Inca and Aztec empires were relatively easy, the conquest of the entire continent was not. The Maya region, with its dozens of larger and smaller polities, was the scene of decades of bloody, inconclusive struggle, while the Amazon region, with its dense tropical forest and hundreds of scattered, independent tribes, was still largely unconquered when the Spanish empire itself came to an end. And even in the Inca and Aztec heartlands, insurrections large and small continued throughout the colonial period, some of which, such as the Tupac Amaru rebellion of 1780 and 1781 in Peru, came close to toppling the new imperial power.

Ironically, many historians trace the final defeat of the Native American societies to the new American republics established in the nineteenth century, which, fueled by a sense of invincible racial superiority, dismantled the protections that the Spanish Empire had granted to its Indian subjects.

See also *Anticolonialism: Latin America; Colonialism: Latin America*.

BIBLIOGRAPHY

- Brundage, Burr Cartwright. *Empire of the Inca*. Norman: University of Oklahoma Press, 1963.
- Keen, Benjamin. *A History of Latin America*. 4th ed. 2 vols. Boston: Houghton Mifflin, 1991.

Ramirez, Susan E. *The World Upside Down: Cross-Cultural Contact and Conflict in Sixteenth-Century Peru*. Stanford, Calif.: Stanford University Press, 1996.

Susan Elizabeth Ramirez

ASIA

Asia has its own long history of large and enduring empires that have rivaled those in the West. The Chinese ideal of a universal empire to be ruled by one “son of heaven” was first actualized by the first Qin emperor in 221 B.C.E., and even though the succeeding centuries saw significant periods of disintegration and divided dynasties, that ideal, though somewhat modified during the last century to encompass only territories inhabited by all Chinese people, has never wavered. Under that system, the emperor ruled the “middle kingdom” directly through a bureaucratic structure of appointed officials and set up a “tributary system” to treat all bordering regions not formally incorporated as well as neighboring countries. Then, by ranking their rulers hierarchically below him in fictive kinship terms, the emperor recognized a Chinese world order with himself as paterfamilias. He expected and welcomed these rulers to send tribute-bearing missions to his capital, and in return, he presented them with gifts of equal or greater value. In practice, these exchanges became a part of delicate diplomatic calibrations reflecting the true relationships between China and its neighbors at any one time, and a channel for international trade. Overall, until the early nineteenth century, such an imperial system worked fairly well in East Asia most of the time because of China’s relative geographical isolation and dominant economy and culture in the region. Indeed, from the early seventeenth to the mid-eighteenth century, a succession of powerful Manchu rulers not only conquered the declining Ming Chinese empire, but also went on to more than double China’s traditional boundaries by incorporating large regions of northeastern and central Asia that historically belonged to the Manchu, Mongol, Tibetan, Uighur, and other peoples into the new and vigorous Qing Chinese empire.

While this was going on, the rest of the Asian landmass to the Urals and the Caucasus was dominated by four other powerful and expanding empires: Mughal India in the south, Safavid Iran in the southwest, Ottoman Turkey and the Middle East in the west, and Romanov Russia in the central region and the north. The last was led by Russian-speaking Slavs from northeastern Europe, but the other three shared a common origin with the Manchus—as nomadic or seminomadic peoples from the steppes of Asia. Their ascendancy followed a pattern of ebb and flow in the continual struggle between farmers and herdsmen. Rising at somewhat different times but all occurring in the sixteenth or seventeenth century, they made use of superior military organization and swift mobility to defeat the wealthier settled societies with their slower reacting standing armies. As for their having to rely on their relatively small numbers to control a large variety of peoples and languages, that was accomplished by their use of tribal solidarity, shared religion, or similar way of life to absorb other tribal groups while preserving their own ethnic identity. Once successfully established in this manner, they would exploit the

accumulated resources of their conquered farmland to enhance their strategic strike capabilities, and to further expand their territories. However, inasmuch as these empires settled down and ruled by the same sociopolitical institutions and farm-based economy that they inherited from those they had vanquished, over time they, too, became subject to the same disintegrating dynamics of that traditional order.

In both India and China, social unrest set in as the result of economic and demographic pressures as well as weakening leadership at the top that led to the growth of official malfeasance and general misrule: India by the early eighteenth century, China toward the end of that same century. Similar internal problems emerged to weaken the others. But in each case, instead of a return to the old pattern of ebb and flow of traditional empires, new external forces came in to disrupt that cycle and to bring forth fundamental changes to all these Asian empires.

Imperialism and Market

The new agent of change was Western imperialism. In its traditional form, imperialism as the exercise of principally political hegemony or territorial acquisition by one state power or empire over another was widely practiced in both the East and the West. What distinguishes its new strain, which first operated in Southeast Asia (or the East Indies) under the Dutch from the seventeenth century, then in India under the English and the French during the eighteenth century, and finally in China under several western European powers by the nineteenth century, was the different rationale and the innovative institutions that guided this instrument of power. The institutions grew out of what many European historians have called the “general crisis of the seventeenth century,” during which major directional shifts took place in European political, religious, and ideological developments, and resulted in new forms of nation building and political legitimacy, and of a new multistate international order in Europe. In their effort to acquire new resources from, and new markets in, the Americas, the East Indies and India, several European powers took turns to form new transoceanic empires with the primary goal of maximizing their economic gains.

Thus, in around 1600, when both the Dutch and the English initiated a new type of organization in the form of privately capitalized trading companies to launch trade in Asia, these commercial ventures quickly transformed themselves into imperialistic agents of state power. Licensed by their respective states, the Dutch East India Company (*Vereenigde Oostindische Compagnie* or VOC) and the English East India Company (EIC) made use of their ships’ superior navigational technology and greater firepower to dominate specific shipping lanes and trading ports and to demand exclusive trading rights from local chieftains. From these footholds along the coast and with Batavia in Java as its main port, the Dutch VOC expanded into the interior, first to set up plantations, and then to secure markets. In India, the English EIC took advantage of a declining Mughal Empire by the early eighteenth century to establish similar footholds and trading privileges in the Calcutta and Madras regions. It soon found itself fighting a war with the regional leader of Bengali authorities in Calcutta, the latter having received support from a rival

trading company, the French *Compagnie des Indes*. Two successive battle victories against the Bengali in Plassey and the French in Pondicherry followed in 1757 and 1760. Like the Dutch VOC in the East Indies, the English EIC had formed its imperial arm, and kept on expanding on the Indian subcontinent until the entire country was incorporated into a formal part of the British Empire a century later, in 1857. By then, the EIC had already ceased to exist.

Impact on China

Meanwhile, the trading activities of the English EIC had extended to China. But unlike the Mughal Empire of the eighteenth century, Qing China remained strong and united. Under the reigns of the Kangxi (r. 1662–1722) and the Qianlong (r. 1735–1796) emperors, the Chinese economy and territorial expansion as well as cultural refinements reached their apogee, although several symptoms of decline began to emerge by Qianlong’s later years. Under a new set of regulations promulgated by the Chinese government in 1760 that came to be known as the “Canton System,” all of the rules of engagements, including trade with all the Europeans, as well as the Americans who came after their War of Independence, were conducted on Chinese terms. And the Chinese authorities were unsparingly harsh in restricting all foreign trade to the port of Canton (since renamed Guangzhou), in limiting access of these foreign traders to a small number of specially licensed Chinese merchants who alone could trade with them, and who, when needed, would carry their petitions to the attention of Chinese officials. Some of the petitions involved European complaints about seemingly unjust punishments meted out to their sailors who had committed infractions under a Chinese legal system that was so different from their own. But various efforts by the English EIC and the government to negotiate for a more equitable relationship, culminating in the dispatch of Lord George Macartney as King George III’s emissary to China in 1792–1793, did not affect any change. Lord Macartney arrived at Qianlong’s court on the occasion of the emperor’s eightieth birthday; he was treated as the head of a tribute-bearing mission, and Qianlong’s reply praised the English king for his solicitations but firmly rejected all his requests for less restrictive trade or more direct communication.

The Chinese had made their response out of ignorance of how their world and the Western world were becoming more and more interconnected through rapid political, economic, and technological changes. Since the Canton system was put in place in China in the mid-eighteenth century, the English had begun an industrial revolution that allowed them to greatly increase their capability to produce more manufactured goods at far lesser costs. This in turn led them to try secure more raw materials and more markets to sell their finished products, and to the extent they were successful in these efforts, the nation reaped the benefit of greater wealth and stronger military power. Moreover, England’s advances in military technology only made the Chinese unimproved military more and more obsolete. It was just a matter of time before the English felt that they had sufficient military logistical support to engage China in a war off China’s own doorstep.

That came in 1839. The English, having chafed at unbalanced trade for many decades during which the Chinese had

much to sell but would buy very little in return, had been importing larger and larger quantities of illegal opium until the trade imbalance switched against the Chinese side. After a court decision to strictly enforce the ban and an order then went out forcing all foreign merchants in Canton to surrender all opium still in their possession, the English official representative soon escalated the confrontation into a military conflict. The Opium War (or Anglo-Chinese War) ensued, and with their inevitable defeat the Chinese had no choice but to sign the Treaty of Nanjing with the English in 1842. This became the first of several treaties between China and the Western powers over the course of the next hundred years, for there would be other conflicts, more defeats, and further concessions. The series set up a new “treaty port” structure, providing territorial concessions and administrative autonomy for foreign settlements in specific treaty port cities like Shanghai. Other areas would be ceded (Hong Kong) or leased (Hong Kong’s extension, the New Territories), while all Western imports could land on any treaty port—by the 1890s, there would be almost one hundred of them along the coast and on interior riverbanks—and at nominally low customs duties the rates of which the Chinese government could not raise. All Western residents in China, including Christian missionaries, were also granted extraterritoriality so that they would not be subject to Chinese laws. By thus giving away these and other rights, China from the mid-nineteenth century on no longer exercised full sovereign powers. But unlike India or the East Indies, it did not become a colony. Indeed, by the late nineteenth century, increasing rivalry among the major Western powers meant that it was in their interest to maintain the survival of the weakened Manchu regime in Beijing so that each one could turn China into a part of its own informal empire in East Asia.

Varieties of Imperialism in the Twentieth Century

The onset of a new century, the twentieth century, seems to have ushered in new sets of meanings and purposes for empire and imperialism in general. If markets had been their principal purpose from the seventeenth to the nineteenth century, national security and the balance of power among nations, between alliances, or in a region of the world appeared to be taking over as one area of primary concern. Certainly the so-called scramble for Africa that divided that continent up among Germany, France, and Britain at the end of the nineteenth century was one such evidence. In East Asia, along China’s seacoast, a similar “scramble” for new territorial possessions by the major powers took place soon after the surprise naval victory of Japan over China in 1895. The Japanese justification was to restore the strategic balance of the various powers in China. And in 1899, when the United States signed the peace treaty with Spain and acquired the Philippines, there was indeed some consideration to use the Philippines to ensure America’s access to the China market. But the overriding concern was a geopolitical one that sought to allow the United States, as an emergent Pacific power, to play a role in the rebalancing among the powers for the East Asian region. As a nation founded on republican principles, the United States took on colonies with a great deal of ambivalence even as the appeal to national security gave it cover. And it would often criticize European imperialism for its greed and oppression,

but when it came to its turn in China and elsewhere, America would participate equally.

Probably the country that used national security to the extreme to justify the use of imperialism was Japan. Unlike those nineteenth-century Chinese political and intellectual leaders who refused to accept that the West had overtaken them technologically and economically and so never made fundamental reforms to confront the Western challenge, Japan quickly, during the 1870s and 1880s, transformed itself from a secluded, traditional society into a modernizing one by borrowing systematically from the West. Then when it fought a war against China in 1894–1895 and won, it did so to replace China’s dominance over Korea with its own. From a geopolitical perspective, Japan was concerned that Korea might be turned into “a dagger” pointing at Japan’s own backside by imperialistic neighbors like Russia. By 1910, it annexed Korea into its own empire. Japan continued to use the same rationale of strategic needs when it expanded into Manchuria and North China. Even when there were self-evident economic interests, as in the case of the mineral-rich Manchuria, those interests would be explained away in strategic terms—as needed resources for a country already so small and so deficient in strategic materials. Then when a rising tide of nationalism occurred in China, Korea, India, and elsewhere in Asia by the beginning years of the twentieth century, Japan tried to soften these new forces against its imperialism by preaching the ideal of a Japan-led pan-Asian movement to confront Western imperialism. When that failed to generate much support, it briefly accepted a policy of restraint during the 1920s before economic failures at home allowed its military leaders to resume its military expansion in the 1930s. This time the slogan was a Japan-led “Greater East Asian Co-prosperity Sphere.” But like its promise of liberation and self-independence to the nationalist leaders in the colonial Dutch East Indies, Malaya, the Philippines, and elsewhere, the Japanese army not only failed to live up to these pledges, it also left behind a trail of great brutality toward fellow Asians. Sixty years after its fall, hostility and distrust toward Japan still persists in all the countries that once formed a part of the empire. This short Japanese experiment shows the pitfalls and costs of empires. Its costs ran higher than whatever returns it brought back. And it did not provide the national security that was its *raison d’être*; instead, when Japan surrendered to the Allied forces in 1945 and stopped this experiment, the country was in total ruins.

During the twentieth century, the common person’s rising awareness of political and economic exploitations of all forms—of race, gender, class, or power relationships—affected both the form and substance of empires and imperialism, as did the many mass movements involving revolutionary struggles between democracy and totalitarianism. All empires that exercise direct control over vast areas and various people from one metropolis and by a single person or a small group of individuals lost their moral high ground and were forced to break up or modify their form. This is certainly true of the British, Russian, Dutch and many other empires. Cultural studies, such as Edward W. Said’s *Orientalism*, (1978) also warned of the danger of intellectual and cultural imperialism in one’s own understanding or assessment of empires from other cultures. Yet all this has not eliminated

the existence of imperialist tendencies and views. Indeed, with increasingly rapid advances in technology at the turn of the twenty-first century, especially those involving communication of all forms, the world has been turned into a veritable global village. And since the village is made up of many very unequal parts, the shorter distances and the greater stratifications allow for some countries to exercise imperialism even more easily.

In the late twentieth and early twenty-first centuries, this has given rise to such new terms and concepts as *soft power* and *hard power*. Older terms, such as *informal empire*, have also taken on new meaning. In this respect, the United States with its unchallenged military might and a national economy considerably larger than any other nation's becomes a primary example. No longer does a powerful nation like the United States need a formal empire like the British Empire of a century ago. Instead, America has unrivaled "hard power" in its military bases and command posts in various parts of the world, including one in East Asia, as well as various forms of "soft power" in economic and cultural dominance that cast tremendous influence over many sovereign nations, from creating alliances to making them a part of its informal empire. In economics, American soft power domination is not just manifested in big transnational corporations or international finance, but also in corporate culture and in setting the standard for the operational systems in computer technology, and in many other areas of research and development for modern industry. In the cultural areas, they range from popular music, videos, and films to youth fashions, icons, and fast food. To differing degrees, these various forms of contemporary American imperialism have become a part of daily existence in all the nations of East Asia—from Japan and South Korea, which are staunch allies of the United States and accept American military leadership and welcome its influences in the economic and cultural spheres, to China, which is weary of American political and cultural influences but readily accepts its economic support and counsel.

Imperialism Reconsidered

We still lack a historical perspective from which to make a judgment on these contemporary forms of American imperialism. On the other hand, there is some general understanding on the nature of empire and imperialism as they were practiced in the recent past. In the sixteenth and seventeenth centuries, the European transoceanic empires that voyaged to Asia, first the Portuguese and the Dutch and then the British, appear to have contributed to the expansion of international trade and the flow of capital, while the Asian ones remained land-bound. From the late eighteenth century on, control over the market took over as the dominant goal, and the empires of modern Europe, led by the British, rode roughshod over all the Asian powers in demanding territory, capital, and material resources, and in unfair trade practices so that Western imperialism became a tool for political subjugation and economic exploitation, designed to maximize the surplus value produced by those under its control. Colonial rule, as in India and parts of urban China, also led to cultural dependency.

However, not all imperialistic imports were bad. Western science and technology, education, modern industry, and

political and social organization and theories promoted reforms and modernization in Asia. They also brought in investment and modern management. Indeed, among many Western liberal economists from Adam Smith onward, there is a different—though not contradictory—assessment that European imperialists' demands for preferential treatment distorted the free market forces so that in the long run, their use of imperialism represented a coercive integration of the world economy that would not benefit their own economy, while their investments in Asia as well as their expenses in defending their Asian empires became added burdens that in the end produced negative returns.

See also Anticolonialism: Southeast Asia; Colonialism: Southeast Asia; Occidentalism; Orientalism; Westernization: Southeast Asia.

BIBLIOGRAPHY

- Beasley, W. G. *Japanese Imperialism, 1894–1945*. Oxford and New York: Clarendon, 1987.
- Chaudhuri, K. N. *The Trading World of Asia and the English East India Company, 1600–1760*. Cambridge, U.K., and New York: Cambridge University Press, 1978.
- Cohen, Warren I. *East Asia at the Center: Four Thousand Years of Engagement with the World*. New York: Columbia University Press, 2000.
- Embree, Ainslie T., and Carol Gluck, eds. *Asia in Western and World History: A Guide for Teaching*. Armonk, N.Y.: M. E. Sharpe, 1997.
- Fairbank, John K., ed. *The Chinese World Order: Traditional China's Foreign Relations*. Cambridge, Mass.: Harvard University Press, 1968.
- Frank, Andre Gunder. *ReOrient: Global Economy in the Asian Age*. Berkeley: University of California Press, 1998.
- Goldstone, Jack A. *Revolution and Rebellion in the Early Modern World*. Berkeley: University of California Press, 1991.
- Hobsbaum, Eric J. *Industry and Empire: An Economic History of Britain Since 1750*. Reprint, London: Penguin, 1975.
- Marks, Robert B. *The Origins of the Modern World: A Global and Ecological Narrative*. Lanham, Md.: Rowman and Littlefield, 2002.
- Pomeranz, Kenneth. *The Great Divergence: China, Europe and the Making of the Modern World Economy*. Princeton, N.J.: Princeton University Press, 2000.
- Wong, R. Bin. *China Transformed: Historical Change and the Limits of European Experience*. Ithaca, N.Y.: Cornell University Press, 1997.

Wellington K. K. Chang

EUROPE

Few subjects have generated as much controversy as that of European imperialism in the nineteenth and twentieth centuries. Because of the term's pejorative connotations, even attempting to define it causes difficulties. What, precisely, constitutes an empire? Is any relationship between two societies involving an imbalance of power in some way "imperial"? For many years, imperialism was narrowly defined as applying only to actual conquest and administration of one state by another. More recently, it has been accepted that

imperialism can be perceived in broader terms, and that a variety of methods of exerting influence by one state over another, stopping short of conquest, can amount to imperialism; this “informal” imperialism, it is argued, is as imperial as the more “formal” conquest more usually described. Even accepting this distinction, there is considerable debate over the meaning of the term. Marxist scholars would see imperialism as a relationship involving economic exploitation, with economic benefits flowing from subject to ruler; some conceive of this in the broadest terms, with imperialism represented by an unequal economic relationship that involves a degree of continuing dependency going well beyond formal colonial rule. Critics of these economic models, however, would see imperialism in political terms and restrict its application to the assertion of political or strategic goals by one society over another.

For the purposes of this entry, imperialism is defined to involve the subordination of one society by another to the benefit of the latter, in a relationship that involves some degree of control over a period of time.

In historical terms, imperialism is herein taken to refer to the subjugation of the states and societies of Africa, Asia, and the Pacific by the European powers during the nineteenth and twentieth centuries. Such expansion, of course, did not begin in this period and can be traced back to the Iberian voyages of discovery of the fifteenth century. Yet clearly this phenomenon took on new impetus in the nineteenth century, when much of Africa, Asia, and the Pacific came under European rule in what is sometimes called the “New Imperialism.” What characterized this period was how extensive this process became, not only in incorporating most of the world under European rule but also in involving most of the major European powers. By 1900, the British ruled 400 million subjects and a quarter of the globe, while French possessions encompassed 6 million square miles and 52 million subjects. Germany, united only in 1871, by 1900 had acquired an empire of 1 million square miles and 15 million people, while Italy and Belgium also obtained significant overseas territories in the years before 1914. By that year most of the globe—with China and the Middle East the main exceptions—had experienced formal European rule; this was to expand to include the Middle East after 1919 and was to continue in most parts of the world until after 1945. This was a remarkable transformation in the relationship between Europe and the wider world.

Causes

The explanation for the change in this relationship during the nineteenth century remains complex. Initial explanations for the development of nineteenth-century imperialism located the causes as lying within Europe and focused in particular on economic factors. Such a view, derived ultimately from J.A. Hobson’s seminal *Imperialism: A Study*, and which was taken up by Lenin and Marxist writers, saw imperialism as driven by the exploitation of the economic resources of the wider world, with financiers pressing governments to annex colonies in order to protect their overseas investments. However, because of the limited returns from imperial conquest in this period and because colonial expansion did not, in practice, follow

overseas investments, this view has been criticized. Alternative explanations have emphasized the importance of chauvinist ideas in the origins of European expansion, stressing how deep-rooted militaristic values in nineteenth century European society, alongside racist and nationalist theories, and reinforced in turn by ideas of social Darwinism and of Europe’s “civilizing mission” overseas, led to the assumption that colonies were essential for national prestige.

However, historians are skeptical of interpretations that locate imperialism’s origins solely within Europe. Such views, it is argued, erroneously see Africans and Asians as passive ciphers in a process that ought to be seen as involving a shifting relationship of power between Europe and the wider world. The historians writing in the 1950s and 1960s as the societies of Africa and Asia threw off European rule acquired an awareness of the role played by developments in what was termed “the periphery”—that is, areas on the frontiers of existing European territories overseas. The most influential of such historians were Ronald Robinson and Jack Gallagher. Their work stressed how Britain’s expansion was driven by strategic imperatives in the defense of the route to the Indian empire, and the threats to it that developed within Africa and Asia in the 1870s and 1880s. Robinson and Gallagher emphasized the variety of methods—including gunboat diplomacy and “influence” as much as formal annexation—Britain used to defend these interests, these varying according to the relationship Britain was able to negotiate with those Africans and Asians living on “the periphery.”

Certainly any explanation of European expansion has to include developments outside Europe as well as factors within it, and has to be located in the existing, and already growing, overseas interests of the European powers—primarily Britain and France—in the mid-nineteenth century. Important in this was the corrosive impact of an industrializing West on societies in Africa and Asia, and the problems this impact—economic, social, cultural, and technological—generated within these societies and in relations with Europeans. What transformed this process into the large-scale conquest of Africa and Asia was Germany’s intervention overseas in 1883–1885. For the German chancellor Otto von Bismarck (1815–1898), colonial expansion was relatively cheap and was popular within Germany, but most significantly, it brought with it major diplomatic gains for Germany’s position in Europe. By threatening the existing possessions of Britain and France, German colonial expansion showed the importance of German diplomatic friendship. The ensuing furor not only diverted the danger of diplomatic isolation for Germany but also ensured that Britain and France had to expand in order to defend their overseas interests.

Impact of Imperialism on Europe

The overall economic profit and loss from empire is complex. While European economies no doubt benefited from cheaper access to raw materials and markets, that has to be weighed against the increased taxation to pay for defense. In the British case, to take one example, the positive economic impact of empire on the British economy in the period 1870 to 1914 has been calculated as marginal at best, while historians have suggested that reliance on imperial markets diverted Britain

from the more difficult but more productive road of modernizing her economy.

Perhaps the most significant impact of empire on Europe was cultural. By the 1920s and 1930s there could have been few Europeans, in the cities of Europe at least, whose lives would not have been influenced in some way by empire. This was of course a process that went back several centuries, but in the nineteenth century this influence took on more profound forms. One can see this most obviously in language, as in the way Hindi words such as *bungalow*, *pajamas*, and *thug*, to name but a few, entered English, or in the way cheap tropical foodstuffs enriched the European diet. Empire also had an important impact in art and design, with the various colonial exhibitions set up by European governments, such as in London (1924) and Paris (1931), prompting new interest in colonial and African and Asian motifs. Pablo Picasso (1881–1973) and Henri Matisse (1869–1954), famously, were deeply influenced by their encounter with collections of African art in the 1900s, while colonial topics became the subject of interest to novelists, poets, filmmakers, and artists such as Rudyard Kipling (1865–1936), Joseph Conrad (1857–1924), Alphonse Daudet (1840–1897), and Julien Viaud (1850–1923).

Much of this interest in empires and colonial peoples lay within traditional structures of European fascination with an exotic “orient.” Indeed, the most significant impact empire had was the impetus it gave to racial stereotyping in European society in these years. This process was reinforced by the influence of pseudoscientific racism in the late nineteenth century that propagated the idea that races had immutable identities and were ordered in a hierarchy of civilization; central to the whole imperial project was the notion of racial distinction between supposedly superior Europeans and supposedly inferior Africans, Asians, and Pacific islanders. Equally important, it should be noted, was the role of imperial expansion in reinforcing existing European constructions of femininity and masculinity.

Relationship between Metropole and Colonies

For all the European powers, policies toward overseas areas of influence, or so-called informal empire, were dictated by local circumstances. As far as formal colonies were concerned, however, the European powers evolved policies that were justified by imperial theories. For the French Empire, the universalist ideals of the French revolution meant that some colonies, such as Algeria, were regarded as an integral part of France. The administration of such colonies was centralized on Paris, with metropolitan laws applied directly to the colonial territory; deputies from the colonies sat in the legislature in Paris from the 1870s onwards. Indigenous chiefs or agents who were utilized within the French administrative system were seen as employees of the French state. Underlying this was the idea of “assimilation,” that subjects of the empire would in time become citizens of France. This centralization was reflected in economics too, with the introduction of tariffs around French colonies during the 1880s and 1890s. Belgian colonialism was equally centralized, while German autocratic centralization meant that the German Emperor was the sole legislative authority for the colonies.

British imperial ideas in theory differed. British policies, rooted in earlier approaches toward the so-called colonies of settlement, stressed the ultimate aim of colonial self-government. Underlying this was the idea of *trusteeship* with regard to colonial subjects, with the aim of British rule being to enable subjects ultimately to stand on their own feet. In a process beginning in the mid-nineteenth century, these colonies of settlement, including Australia and Canada, were granted self-government from Britain, culminating in the 1931 Statute of Westminster. Such ideas of trusteeship also influenced the rest of the British Empire in the shape of what came to be termed “indirect rule.” This is reflected in the ideas of Frederick Lugard (1858–1945), a hugely influential governor of Nigeria in the early twentieth century, and involved acceptance of, and administration through, the existing political structures of indigenous society, with local chiefs given considerable latitude as agents of imperial rule.

Whatever the theoretical distinctions between these colonial policies, over time there came to be little difference between them. A pragmatic adjustment to the realities of indigenous society became the norm as the European colonial powers attempted to make their empires pay their way. One way of doing this was through encouraging settlement from the imperial mother country, or metropole, as it is more usually termed by scholars. For the French, Algeria was their main settlement colony; by 1954 nearly one million French people lived in Algeria. For British emigrants, their main destinations in the British Empire were the colonies of Australia, Canada, New Zealand, and South Africa, though significant numbers, encouraged by the Empire Settlement Act (1922), settled in Kenya and Southern Rhodesia.

Changing Attitudes to Empire

There were many in Europe who responded to the newly acquired possessions with enthusiasm and propagandized about their potential benefits. The German *Kolonialverein*, a society set up in 1882 to campaign in support of Germany’s colonial expansion, was one such example, while the French Union *Coloniale Française*, an association of business leaders with colonial interests established in 1893, was another. Many politicians enthusiastically supported imperial causes, Joseph Chamberlain (1836–1914) and Leo Amery (1873–1955) in Britain and Jules Ferry (1832–1893) and Albert Sarraut (1872–1962) in France being the most prominent. Supporters justified empire on the grounds of economic self-interest and the alleged moral good—the “civilizing mission”—that Europe brought to the conquered populations of Africa and Asia.

Yet popular enthusiasm for empire, at least before 1914, was limited. For the working classes in particular, conscious of increased taxation and the human cost of wars, support for empire was episodic. Chamberlain’s campaign for tariff reform as part of a broader policy of imperial federation in 1903–1906 came to little. “Little Englander” ideas that emphasized the cost of colonies to the taxpayer, so prevalent within mid-nineteenth-century Britain, remained strong. Such ideas reinforced a moral critique of empire that questioned Europe’s assumed right to rule other peoples, given the horrific human, environmental, and economic cost of conquest to Africans and

Asians. The South African War (1899–1902) between the British Empire and two Boer republics was an important moment in this critique, as the stories of the deaths of white civilians in British camps stimulated a burgeoning movement of imperial critics in Britain, a process reinforced thereafter by revelations of appalling atrocities in the Belgian Congo. Such atrocities were all too common.

This anti-imperial trend was reinforced by the changing international climate of opinion generated by World War I, and particularly new ideas of self-determination. Following the war, in which colonial personnel and resources had played a significant role, and with the emergence of the League of Nations in 1919 and its concept of colonial “mandates” (the term applied to the former possessions of defeated Germany and Ottoman Turkey), colonial rule had increasingly to justify itself with ideas of trusteeship. This view, best summed up in Lugard’s *Dual Mandate* (1922), was that imperial rule combined self-interest and moral good. This was reflected in Britain’s Colonial Development Act of 1929 and, later, in the French *Fonds d’investissement et de développement économique et social*, established in 1946, whereby funds were made available for investment in the colonies’ economic and social welfare.

Perhaps more significantly, these ideas coincided with critics from within the colonies who, from the late nineteenth century, took up European ideas of national self-determination and applied them to the colonial situation to demand reforms. The most significant of these was the Indian National Congress, established in 1885. In time these critics moved from an accommodationist position to a rejectionist one, demanding independence from their colonial rulers. With the growing importance of trusteeship arguments after 1919, such critics found an increasingly appreciative global audience by the interwar years.

Decline of Empire

One striking aspect of the European empires was how quickly they disappeared. In 1947 the British withdrew from India, and after 1956, from their African colonies; in 1962, the French left Algeria. With the Portuguese withdrawal from their African colonies in 1975, the colonial empires were virtually over. The reasons for this withdrawal are manifold. The increasing criticism from nationalists was undoubtedly significant; the pressure exerted by the Indian National Congress, skillfully shaped by Mohandas Gandhi (1869–1948) in a series of major civil disobedience campaigns between the 1920s and 1940s, for example, succeeded in forcing major concessions from the British. After 1945, nationalist unrest throughout the colonial empires showed colonial rulers just how costly maintaining colonial rule would be.

Yet colonial powers had successfully resisted nationalist pressure before, and by itself nationalism was not enough to end European imperial rule. Of major significance was the weakening of European powers consequent to the two world wars. Not only did these wars drain European economies, they also fatally undermined the very bases of colonial rule, empire’s myth of impregnability, and its claim to protect colonial peoples. The defeat of several of the colonial powers by Germany in World War II and the loss of European colonies

in Southeast Asia to the Japanese were clearly critical to this process. Even where colonial rule had survived, as in Africa, the promises made to nationalists in return for help for the war effort had changed things fundamentally.

Perhaps the key consequence of the world wars, however, was the emergence of new world powers, namely the United States and the Soviet Union. These two, in the shape of the Cold War, divided global politics between them. Colonial rulers, to avoid driving nationalists into Soviet hands, made major concessions to nationalist critics after 1945. Equally important in prompting such reforms was the need to maintain support from the Americans, a need that was clearly shown in the experience of Britain and France in the Suez Crisis of 1956. Moreover, U.S. global dominance after 1945, with its stress on open markets and free trade, showed that the age of European empires, at least in a formal sense, was dead. In its place came institutions like the Commonwealth and the French Union.

Legacy of Imperialism

Although the age of formal imperialism was relatively short, the impact of Europe on the wider world in the nineteenth and twentieth centuries, and vice versa, was immense. European society and culture was deeply influenced by its colonies. This process of interaction between metropole and the wider world continued after independence, and the development of immigration from former colonies into the former metropolises has contributed immensely to the development of multicultural societies in Europe through the turn of the twenty-first century.

Equally, the impact of Europe on the wider world has been significant. On a cultural level, this can be seen in the way European languages such as English and French are spoken, European education systems are widely copied, and European sports like cricket or football (soccer) are widely played across much of Asia, Africa, and the Pacific. Europe also has profoundly shaped the economic sphere, where the legacy of imperialism can be seen in the economic structures, communication networks, and ties to metropolitan economies that typify the former colonies. Imperialism in this sense was the precursor of the globalization that characterizes the contemporary world. This legacy is by no means entirely benign. The consequence of this process of structuring of the economies of former colonies has been dependency: on exports, on a monoculture economy, and on the fluctuations of the world market; ultimately this has been a dependency on the economies of the metropolises. This has proved difficult to remove.

Similarly, the political legacy of empire has proved by no means entirely positive. The attempt by colonial rulers on their departure to establish Westminster-style or Paris-style democracies has been seen by some as inappropriate to African or Asian societies. Only in relatively few cases, such as India, have these Western-style political systems flourished; more usually they have broken down into serious instability with repeated military coups the consequence. This instability had deep roots in the colonial period. A political system based, ultimately, on force left behind it the lesson that force had a place in politics. Equally, the artificiality of colonial boundaries, drawn to suit European interests but bearing little relation to ethnic

reality on the ground, combined with the colonial privileging of one ethnic group over another, reinforced these political difficulties and made civil war a problem for several former colonial states. Empire shaped the modern world, and for many former colonial peoples, its legacy is still being played out.

See also *Anticolonialism; Colonialism; Empire and Imperialism: Overview.*

BIBLIOGRAPHY

PRIMARY SOURCES

- Hobson, John A. *Imperialism: A Study*. London: James Nisbet, 1902.
- Lenin, Vladimir I. *Imperialism: The Highest Stage of Capitalism (1916)*. Moscow: Foreign Languages Publishing House, 1947.
- Lugard, Frederick J. D. *The Dual Mandate in British Tropical Africa*. Edinburgh and London: Blackwood and Sons, 1922.

SECONDARY SOURCES

- Aldrich, Robert. *Greater France: A History of French Overseas Expansion*. London: Macmillan, 1996.
- Clarence-Smith, W. Gervase. *The Third Portuguese Empire 1825–1975: A Study in Economic Imperialism*. Manchester, U.K.: Manchester University Press, 1985.
- Gallagher, John, and Ronald Robinson. “The Imperialism of Free Trade.” *Economic History Review* 6 (1953): 1–15.
- Holland, Robert F. *European Decolonization, 1918–1981: An Introductory Survey*. London: Macmillan, 1985.
- Koebner, Richard, and Helmut D. Schmidt. *Imperialism: The Story and Significance of a Political Word, 1840–1960*. Cambridge, U.K.: Cambridge University Press, 1964.
- Langer, William L. *European Alliances and Alignments, 1871–1890*. 2nd ed. New York: Knopf, 1956.
- Louis, W. Roger, ed. *The Oxford History of the British Empire*. 5 vols. Oxford: Oxford University Press, 1999.
- Robinson, Ronald, and John Gallagher, with Alice Denny. *Africa and the Victorians: The Official Mind of Imperialism*. London: Macmillan, 1961.
- Rodney, Walter. *How Europe Underdeveloped Africa*. London: Bogle L’Ouverture, 1972.
- Said, Edward W. *Culture and Imperialism*. London: Chatto and Windus, 1993.
- Smith, Woodruff D. *The German Colonial Empire*. Chapel Hill: University of North Carolina Press, 1978.

Martin Lynn

MIDDLE EAST

In the modern era, the Middle East, broadly defined to include North Africa, was the seat of a major empire, that of the Ottoman Turks. Ottoman rule at its height dominated Eastern Europe through Hungary and extended across the Middle East and North Africa to include Algeria, with Iran and Morocco excluded from Turkish authority.

Global Imperialism, Europe, and the Ottomans to 1914

From the eighteenth century onward, the Ottomans were directly threatened by the imperial aspirations of two land-based

empires, Russia and Austria (Austria-Hungary after 1867). In addition, the Ottoman Middle East became unwittingly embroiled in the rivalries of two seaborne empires, Great Britain and France, illustrating the global scope of imperial competition.

The treaty ending the French and Indian War in North America in 1763 saw France cede not only Canada to Britain but also French claims to India. The swiftest route to India for Britain lay through Ottoman territory, first overland via Syria and Mesopotamia, then by the Suez Canal once it opened in 1869. The British empire centered in India defined British strategic interests in the Middle East as preserving the security of the Egyptian Suez Canal route and dominance in the Persian Gulf to block other powers access to India. By 1914 and the outbreak of World War I, Britain had occupied Egypt (1882), extended its interests to include southern Mesopotamia and the oil fields of southwest Iran, and had backed Kuwaiti secession from Ottoman-controlled Mesopotamia.

France, the first to occupy Ottoman land in the Middle East, invaded Algeria in 1830 and colonized it. France later occupied Tunisia in 1881 and took Morocco in 1912, while Italy invaded Libya in 1911. By 1914, the Ottomans controlled no territory in North Africa, nor in eastern Europe, where their remaining possessions were lost in the Balkan Wars of 1912–1913. Ottoman rule remained in Anatolia and in the central Arab lands of Syria, Lebanon, Palestine, Mesopotamia (Iraq after World War I), and portions of the Arabian peninsula.

The Causes, Ideology, and Theories of Imperialism

European imperial expansion in the Middle East to 1914 was a small part of a global takeover of non-Western lands from the mid-nineteenth century onward that saw nearly all of the African continent and independent territories in Asia either occupied or forced to bow to European demands, as in the case of China.

Scholars attribute this imperial expansion to several impulses; the primary factors were the desire to control markets or natural resources and European continental rivalries extended to denial of lands to a rival. Behind the specific reasons lay the basic driving force of European technological superiority established by the scientific and industrial revolutions, creating a reservoir of power and skills lacking in non-European regions. This facilitated conquest and fueled attitudes of racial superiority referred to as Social Darwinism. A transference of Darwin’s theory of natural evolution to societal development, this theory justified white domination of non-whites because they had evolved to a superior level of civilization.

More recent approaches to the study of imperialism have expanded the range of scholarly inquiry. Cain and Hopkins’s theory of “gentlemanly capitalism,” where individuals close to power influenced decisions based on their own investments in areas such as Egypt, has attracted attention, but other studies point to the greater complexity of imperial associations, challenging previous assumptions. Occupation did not automatically mean economic dominance, as shown by France’s control of the Imperial Ottoman Bank and the fact that its economic interests in Egypt were greater than those of Britain, the

occupying power, demonstrated in the work of Jacques Thobie and Samir Saul.

Intertwined with such economic penetration of non-Western areas was the nature of the indigenous response, whether nationalist or, for minorities, often collaboration with overseas capital. Further complicating matters is the question of the impact of outside investment on local economies, possibly leading to Lebanese migration to the Western hemisphere, as Akram Khater has shown, at the same time that Europeans might be migrating to northern African countries for economic opportunities lacking in their own lands, processes seen in the scholarship of Mulia Clancy-Smith, Robert Tignor, and Roger Owen.

Finally, much recent scholarship has approached imperialism, Middle Eastern or otherwise, from the vantage point of ordinary people, European or the colonized. This approach automatically makes available many more sources than those found in official government archives, and especially calls attention to the role of women as either part of the imperial venture or the objects of it in the imperial imagination and representation of non-Western women.

World War I and the Mandate Period

World War I saw the Ottomans ally with Germany and Austria-Hungary, primarily against Russia, its traditional rival, which formed an Entente with Britain and France.

By war's end, Russia, following the 1917 Bolshevik revolution, had renounced imperial ambitions, but Britain and France hoped to gain further spoils, against each other if necessary. All possessions held by the losers were to be taken by the victors, but outright imperial acquisition was barred by American disapproval. Consequently, the mandate system was devised. Under League of Nations supervision, mandate rule meant that all imperial spoils of World War I could be taken by the victors only on the promise that they would prepare the inhabitants for independence at some undetermined future date. There were three classes of mandates—A, B, and C—the last being those areas least prepared for future self-governance. The Arab lands to be handed over to Britain or France, those under Ottoman sway in 1914, were Class A mandates, deemed closest to self-rule following tutelage by their European overlords. Britain received mandates for Iraq and Palestine, the French for Syria and Lebanon.

Scholars have attributed differing imperial ideologies to Great Britain and France. They consider the former to have governed with more regard for local authority and practices, remaining aloof from local culture, whereas France undertook a *mission civilisatrice*, or civilizing mission, that signified more direct involvement in local culture and governance. Intended to promote admiration for France that would secure the French occupation, this process has been referred to by Deguilhem as “intellectual colonization.”

British Mandates: Iraq and Palestine

The British mandate for Iraq was affected by its attempt to renege on their wartime promise of 1916 (Sykes-Picot Agreement) to acknowledge French paramountcy in Syria. They did

so by installing in Damascus Emir Faisal ibn Husayn of the Hejaz. When the British ploy failed and the French ousted Faisal, Britain gave him the kingship of Iraq in 1921 as compensation and agreed to lessen the scope of its mandatory powers. In return, Faisal agreed to host a British military presence in Iraq; the Hashemite dynasty he created lasted to 1958.

The Palestine mandate contradicted the official intent of that arrangement. In the Balfour Declaration of 1917, Britain had promised the Jewish national movement, Zionism, that it would sponsor the growth of a Jewish national home in Palestine; it was understood that Palestine would become a Jewish state. This was done for several reasons: immediate wartime propaganda; sympathy for past Jewish suffering in Europe; and for strategic reasons of empire, to justify a British presence in Palestine to block any potential French threat from Syria/Lebanon to Egypt and the Suez Canal.

The Balfour Declaration was written into the British mandate for Palestine. Thus, the people Britain would prepare for self-government were not the Palestinian Arabs, but the future Jewish majority once enough immigrants had arrived; Jews were at most 12 percent of the population in 1920. The legacies of this decision are the Palestinian-Israeli and Arab-Israeli conflicts.

French Mandates: Lebanon and Syria

French officials divided Syria into districts to encourage factionalism, hoping unsuccessfully to weaken Syrian national awareness and resistance to their rule.

At the same time, France arbitrarily enlarged the area it called “Lebanon” by adding to it land considered part of “Syria,” in order to establish a more stable base of operations in alliance with the Maronite Catholic community that had campaigned for French rule and protection. This new area, present-day Lebanon, incorporated many more Muslims and non-Maronite Christians, ultimately endangering Maronite minority rule and fostering civil strife in the 1950s and 1970s. Although the mandates did not officially end until 1946, both Syria and Lebanon had their independence recognized in 1945 by the newly formed United Nations.

Pre-1914 Imperial Possessions

France granted independence to Tunisia and Morocco in 1956–1957 after little nationalist strife, primarily in the hope of retaining Algeria, which it had incorporated into the French governmental system, making it part of France. Algerians achieved independence in 1962 after a brutal seven-year war for independence costing an estimated one million lives, mostly Algerian.

Egypt, under British occupation, gradually acquired more self-governance, but it took nationalist resistance, as in North Africa, and a revolution in 1952 to create the circumstances leading to full British withdrawal in 1956. As for Libya, Italy's defeat in World War II led to the creation of the Idrisid dynasty that reigned until ousted by Muammar Qaddafi in 1969.

Conclusion

The most lasting legacy of Anglo-French imperialism in the Middle East and North Africa following World War I was

the creation of states where none had existed previously, the boundaries drawn to suit Anglo-French interests. Out of the former Arab provinces of the Ottoman empire emerged Iraq, never unified previously, a Syria truncated by France's taking its land for the expanded Lebanon, Palestine (intended to become Israel), and, as a result of wartime alliances and tribal rivalries, the creation of Saudi Arabia and the sheikhdoms of the Persian Gulf. In addition, Turkey became a state by repelling a British-encouraged Greek invasion and establishing its independence in the Anatolian heartland of the former Ottoman Empire.

These new states, other than Turkey, Iran, and the newly formed Saudi Arabia, remained under foreign occupation or, in Iraq's case, tied to the former occupier, until the decolonization area following World War II. Their sociopolitical trajectories were quite different, starkly contrasted in Turkey's secularization process undertaken by Mustafa Kemal (Ataturk) and the creation of the fundamentalist Wahabbite Islamic kingdom of Saudi Arabia.

As a result, the nature of national identity and the basis of allegiance to these new states has varied and occasionally been challenged, leaving open the question of Islam as the ongoing basis of loyalty for most Muslims. Turkey itself has seen since World War II the renewed strength of Islam in the public sphere, in part a byproduct of its democratization process. Iran, whose Pahlavi dynasty sought to follow Ataturk's example, experienced an Islamic revolution in 1979 seen by many Iranians as repudiation of American imperial influence on the late shah. Syria and Iraq underwent strenuous secularization driven by Baathist socialist regimes, but the American overthrow of Saddam Hussein in Iraq in the name of democracy may lead to a new regime strongly influenced by Shii Islam and strengthened ties to Iran, which the U.S. has designated as part of the "Axis of Evil."

These experiences illustrate the ongoing complexity of the process of state formation and creation of national and religious loyalties, processes set in motion before World War I but only fully attempted afterward. They demonstrate that the impact of European imperialism on the broader Middle East has persisted and has yet to be resolved, with new dynamics put in place by the United States' intervention in Iraq whose consequences will be far-reaching and possibly contrary to the goals articulated by Washington before the invasion.

See also *Anticolonialism: Middle East; Colonialism; Nationalism: Middle East; State, The: The Postcolonial State; Westernization: Middle East.*

BIBLIOGRAPHY

- Aldrich, Robert. *Greater France: A History of French Overseas Expansion*. London: Macmillan, 1996. Overview of French imperial ideology.
- Andrew, Christopher, and A. S. Kanya-Forstner. *The Climax of French Imperial Expansion, 1914–1924*. Stanford, Calif.: Stanford University Press, 1981. Study of French domestic policy debates over imperial goals during World War I.
- Cain, P. J., and Anthony Hopkins. *British Imperialism: Crisis and Deconstruction*. New York: Longman, 1993.

- . *British Imperialism: Innovation and Expansion, 1688–1914*. New York: Longman, 1993.
- Chaudri, Nupur, and Margaret Strobel, eds. *Western Women and Imperialism: Complicity and Resistance*. Bloomington: Indiana University Press, 1992.
- Clancy-Smith, Julia. "European Empires, Settler Colonialism, and Sources of Knowledge about Women in Islamic Cultures." In *Encyclopedia of Women and Islamic Cultures*. 6 vols. Leiden: E. J. Brill, 2004. Critical discussion of questions of gender in imperial context.
- Cloarec, Vincent. *La France et la question de Syrie, 1914–1918*. Paris: CNRS, 1998. The best study of French imperial policy and Anglo-French rivalries for the period.
- Deguilhém, Randi. "Turning Syrians into Frenchmen: The Cultural Politics of a French Non-Governmental Organization in Mandate Syria—The French Secular Mission Schools." *Islam and Christian-Muslim Relations* 13, no. 4 (2002): 449–460. Good case study of the variations found in applying the *mission civilisatrice*.
- Kent, Marian, ed. *The Great Powers and the End of the Ottoman Empire*. 2nd ed. London and Portland, Ore.: Frank Cass, 1996. Survey of the views of all combatants during the war.
- Khoury, Philip S., and Joseph Kostiner, eds. *Tribes and State Formation in the Middle East*. Berkeley: University of California Press, 1990. While ranging well beyond World War I, the essays engage conceptual variables such as the state and chiefdom.
- Lieven, Dominic. *Empire: The Russian Empire and Its Rivals*. New Haven, Conn., and London: Yale University Press, 2000. Comparisons of the Russian, British, Hapsburg, and Ottoman Empires with extensive bibliography.
- Monroe, Elizabeth. *Britain's Moment in the Middle East, 1914–1971*. 2nd ed. London: Chatto and Windus, 1981. Updated edition of the classic account (first published 1963) of British imperial policy in the region.
- Owen, Roger. *The Middle East in the World Economy*. New York: Methuen, 1987.
- . *State, Power and Politics in the Making of the Modern Middle East*. London and New York: Routledge, 1992. Overview of the subject that engages theoretical perspectives.
- Owen, Roger, and Robert Sutcliffe, eds. *Studies in Theory of Imperialism*. London: Longman, 1972.
- Saul, Samir. *La France et l'Égypte de 1882 à 1914: Intérêts économiques et implications politiques*. Paris: Comité pour l'Histoire Economique et Financière de la France, 1977.
- Thobie, Jacques. *Ali et les 40 voleurs: Impérialismes au Moyen-Orient de 1914 à nos jours*. Paris: Messidor, 1985. Thobie is the leading scholar of French imperialism in the late Ottoman period and after World War I.
- . *Intérêts et impérialisme français dans l'Empire ottoman: 1895–1914*. Paris: Impr. nationale, 1977.
- Tignor, Robert L. *Capitalism and Nationalism at the End of Empire: State and Business in Decolonizing Egypt, Nigeria, and Kenya, 1945–1963*. Princeton, N.J.: Princeton University Press, 1998.

Charles D. Smith

UNITED STATES

The question of whether the United States is an imperial power that, like other previous imperial powers, has been acquiring an empire of its own has been hotly contested in U.S. political

history. On the one hand, the United States likes to think of itself as different from other powers in the past who have acquired empires, because its motives are supposedly superior (democracy, human rights, a liberal or neoliberal economic order, free trade) and because it has only rarely acquired permanent “colonies.” On the other hand, the United States does throw its weight around; has regularly intervened, including militarily, in the internal affairs of other, usually smaller, countries; and has acquired over the decades a large number of satellite states, quasi-colonies, proxy states, and countries that are dependent on the United States. These issues became particularly controversial as, since the end of the Cold War, the United States emerged as the only superpower (“hyperpower,” the French say) and because of its new doctrines of preemption and intervention in such countries as Afghanistan and Iraq.

The United States does not like to think of itself as an imperial nation. Americans tend to believe that the United States is an exceptional nation, immune from the great power motivations and machinations of other imperial states. It does not acquire “colonies” or practice imperial policies. Rather, Americans see their motives as selfless and humanitarian: peacekeeping, spreading democracy, people-saving or nation-building (as in Somalia or Haiti) interventions. Critics scoff at this, saying the United States intervenes frequently in the affairs of other states, overthrows governments it does not like, protects the corrupt, nondemocratic oil states (Kuwait, Saudi Arabia) on which the U.S. economy is dependent, and has sent military forces into dozens of countries to protect U.S. interests. In addition, the critics say, the supposedly altruistic goals for which the United States works, such as neoliberalism, globalization, and even democratization (which encourages stability), all seem to redound mainly to U.S. advantage.

The mythology of U.S. exceptionalism began in the nineteenth century when the United States was a new, young, and still weak power. The country believed it was a “beacon on a hill,” an exception to other nations, and in the Monroe Doctrine proclaimed its difference from the Machiavellian states of Europe. But even as a weak power the United States acquired territory, not always with the best of motives, from Spain, France, and Mexico and had imperialistic designs on Cuba, parts of Central America, and the Caribbean. With the country’s growth as a major power after the Civil War, and then in the Spanish-American War of 1898, the United States acquired Hawaii, Cuba, the Philippines, Puerto Rico, and a string of bases throughout the Pacific and the Caribbean. If the United States was “imperialistic,” it was initially so in Latin America and the Western Hemisphere.

During the long Cold War (1947–1989), the United States did not acquire colonies, but it repeatedly intervened in the affairs of other nations, often exercised proconsular or quasi-governing roles in their internal politics, and established subservient governments in many nations. Was this imperialism or not? The United States argues that it was not because it did not acquire *permanent* colonies, because when it intervened, it usually withdrew shortly thereafter, and because its goals were not domination but stability and anti-communism—presumably good for the countries affected—and

eventually democracy and human rights. Relatively few critics of U.S. policy raised the “imperialism” charge. It was mainly Marxists who charged the Americans with colonialism and imperialism, and their critique was largely dismissed, especially as the Soviet Union collapsed.

In the early twenty-first century, as the sole remaining superpower with overwhelming military, economic, political, and cultural influence, the United States again stands accused of imperialism and “neocolonialism.” The American public does not like to hear these accusations, but elsewhere in the world they are widespread. They are particularly prevalent in the Middle East where the United States has sought to remake Islamic society in the image of American democracy, as well as in Europe, Latin America, and some parts of Asia. The focus of the critique is not just U.S. military power, which is overwhelmingly dominant, but also U.S. cultural influence (rock music, movies, styles of dress and behavior), U.S. political power, which forces countries to change political institutions and practices they would often rather not change, and U.S. economic influences, which force countries to adopt neoliberal policies that often hurt their economies but work to the economic advantage of the United States itself. In all these areas the United States presumes like an old uncle to know best for the rest of the world. Globalization also seems to benefit mainly the United States. Is this colonialism or imperialism? Most voices in the United States avoid the issue, but abroad many people see the United States as practicing hegemonic policies or neocolonialism—albeit in new garb.

See also *Anticolonialism; Colonialism.*

BIBLIOGRAPHY

- Bacevich, Andrew J. *American Empire: The Realities and Consequences of U.S. Diplomacy.* Cambridge, Mass.: Harvard University Press, 2002.
- Chomsky, Noam. *Hegemony or Survival: America’s Quest for Global Dominance.* New York: Metropolitan Books, 2003.
- Johnson, Chalmers. *The Sorrows of Empire: Militarism, Secrecy, and the End of the Republic.* New York: Metropolitan Books, 2004.
- Mandelbaum, Michael. *The Ideas That Conquered The World: Peace, Democracy, and Free Markets in the Twenty-first Century.* New York: Public Affairs, 2002.

Howard J. Wiarda

EMPIRICISM. Empiricism is a family of theories of knowledge (epistemology) claiming that all knowledge about the extant universe is based on experience, primarily on perception via the five senses. Some empiricists add introspection, a moral sense, or a special sensitivity to religious or aesthetic experience. Strong empiricists claim that all knowledge whatever derives from experience. They must show how empiricism can handle apparently a priori knowledge, including logic, mathematics, and ordinary truths such as “Bachelors are unmarried males.” Empiricism also provides an account of mind, language, and learning. The traditional contrast of empiricism is with rationalism and nativism, the view that we do possess a priori knowledge, either furnished by reason alone or innate. Empiricists tend to

perceptualize the mind and its operations, while rationalists tend to intellectualize it. With its down-to-earth emphasis on concrete experience and clarity, empiricism has flourished in Anglophone countries, whereas the more speculative rationalist and Kantian ideas have flourished on the Continent. This is one aspect of the divide between Continental philosophy and Anglo-American, “analytic,” and “linguistic” philosophies.

In the twenty-first century nearly everyone is an empiricist in the everyday sense of taking experience seriously as a basis for knowledge claims about the natural world and human behavior, but most philosophers reject traditional, doctrinaire empiricism—the view that human sense experience provides a special connection of the knowing mind to the world and thus provides a foundation on which knowledge can build, step by step.

A Thumbnail History

In ancient times Aristotle was an empiricist relative to Plato’s other-worldly rationalism. Modern empiricism began around 1600 with Francis Bacon (1561–1626), who promoted a new, experimental philosophy combining experience and reason, and with Galileo Galilei (1564–1642), who united experimental observation with a Platonic mathematical framework. Thomas Hobbes (1588–1679) further enriched early empiricist thinking, but the “big three” British empiricists were John Locke (1632–1704), George Berkeley (1685–1753), and David Hume (1711–1776). Locke first systematically expounded modern empiricism (see below). He was followed in the eighteenth century by Berkeley, notorious for his subjective idealism, the radical empiricist view that there are no material objects, that everything can be analyzed into minds and their ideas. Hume then took the further step of denying that there is even a substantial mind or ego. We introspect only a bundle of passing impressions. The mind is governed by natural laws of association, analogous to Isaac Newton’s (1642–1727) law of gravitation, without needing an executive overseer. Hume also denied that inductive inference can be justified by logical argument, but he defended a wider conception of rationality (or at least sensible action) based on our natural impulses to believe and act. As he wrote in *A Treatise of Human Nature* (1739–1740) and its popularization, *An Enquiry Concerning Human Understanding* (1748), passion or custom, not reason, is “the great guide of human life.”

The leading nineteenth-century empiricist was John Stuart Mill (1806–1873), who developed a full-fledged phenomenalism. Mill held that simple induction by enumeration (ravens 1, 2, 3, . . . n are black; therefore all ravens are black) is sufficient to support both science and mathematics: even the principles of logic and mathematics are very general empirical laws. Twentieth-century empiricists such as Bertrand Russell (1872–1970), George Edward Moore (1873–1958), and Alfred Jules Ayer (1910–1989) denied this, as did the logical empiricists of the Vienna Circle, who contended that the laws of logic and mathematics are both a priori and analytically true, that is, true by virtue of logical form and our linguistic conventions, hence completely empty of empirical content. By contrast, many twentieth-century thinkers, following Willard Van Orman Quine (1908–2000), have returned to a more naturalistic pragmatism.

The most damaging criticisms of British empiricism were leveled first by Immanuel Kant (1724–1804) and by the German and British idealists who followed him, then by Ludwig Wittgenstein (1899–1969), Gilbert Ryle (1900–1976), Quine, Wilfrid Sellars (1912–1989), Thomas Kuhn (1922–1996), and other twentieth-century figures, who attacked the entire Cartesian-Lockean conception of mind, experience, and language. Shocked by Hume’s apparent skepticism about causality and Newtonian science, Kant synthesized rationalism and empiricism, while critically transcending both. The human mind itself furnishes the conceptual and rational apparatus necessary to organize our experience, as he argued in his *Critique of Pure Reason* (1781). “Concepts without percepts are empty; percepts without concepts are blind.” Kant retained a vestige of the rationalist idea that we possess a special sort of intuition that enables us to make substantive, “synthetic” claims about the world that are nonetheless known a priori. He held that Euclidean geometry and the basic principles of Newtonian mechanics are such “synthetic a priori” truths. Post-Kantian empiricists deny this.

Foundational Empiricism

The traditional empiricists and rationalists were foundationists in epistemology. Foundationism postulates a base set of propositions that play a distinctive epistemic role plus a superstructure (comprising the bulk of our knowledge) appropriately related to the base. The empiricists and rationalists added the constraints that the basic statements must be certain and self-justifying (self-evident to reason for the rationalists and evident to the senses for the empiricists) and that the relation of base to superstructure be one of logical inference: deductive and perhaps inductive logic must suffice to generate the superstructure from the base. The justification is one-way or “linear” in the sense that the various layers of superstructure depend only on lower layers and, hence, ultimately on the base for their justification. Euclidean geometry provides the intellectual model. In this case the inferences are strictly deductive.

Given such a Euclidean geometry-inspired model, one wants the largest possible superstructure from the narrowest and most certain possible base. Two main problems stand in the way: the base problem (whether the base itself can be adequately justified) and the superstructure problem (whether the inferential resources are sufficient to support the desired superstructure on the base). From the beginning, empiricists have addressed the second problem by restricting the superstructure to claims within reach of observation and experiment and by developing the resources of logic, probability theory, and statistical inference. The British empiricists did not fully recognize the seriousness of the first problem.

Within this foundationist framework, Locke established the overall structure of a specifically empiricist theory in *An Essay Concerning Human Understanding* (1690), one of the founding works of the Enlightenment:

1. All simple ideas come from experience. There are no innate ideas. Contrary to nativists such as

René Descartes (1596–1650), the mind is a *tabula rasa*—that is, a blank slate—at birth.

2. Ideas of solidity, movement, number, and so forth, resemble features of the real world (primary qualities), whereas sensations of color, sound, taste, and so forth, do not resemble the physical powers (secondary qualities) in objects that produce these sensations in the mind. They are mind-dependent.
3. Complex ideas are compounds of simple, atomic ideas, and, so, are image-like.
4. Thus knowledge, which is the intellectual recognition of the agreement or disagreement of ideas, cannot go beyond the limits of experience. (Locke's is an "idea empiricism," but knowledge requires an operation of mind in addition to the presence of ideas.)
5. Neither can meaningful language transcend experience, since the meaning of a word is an idea in the mind. Having the appropriate idea in mind is what distinguishes a person's from a parrot's uttering, "I want a cracker."
6. We each learn our native language by attaching public noises or marks (words) to ideas. We can then communicate our ideas to others by making the appropriate noises or marks.
7. Thought is a connected sequence of ideas.
8. The immediate objects of perception and thought are ideas in the mind, which in turn represent external things and situations (doctrine of representative perception, two-object theory of cognition).
9. All existing things are concrete and particular.

Empiricists immediately encountered the superstructure problem. Locke recognized that most meaningful words are general and many are abstract (rather than proper names of concrete objects, e.g., *canine* versus *Lassie*), so how do we get the corresponding ideas (meanings) from experience, which furnishes only particular ideas? From an image of a particular triangle, said Locke, we can *abstract* from its being equilateral, isosceles, or scalene, and thus construct a general idea of a triangle that is "all of these and none of these at once." Berkeley and Hume improved on this unsatisfactory solution, but to this day empiricist abstraction accounts face serious difficulties. Hume added to the superstructure problem by denying the adequacy of reason alone to produce, from particular experiences, either (a) moral judgments, about what one ought to do, or (b) inductive conclusions, such as "All ravens are black" and Newton's laws. The former is his point that one cannot deduce "ought" from "is" or value judgments from objective facts, and the latter is the aforementioned problem of induction. Meanwhile, Berkeley had challenged Locke's empirical base by rejecting his distinction between primary and secondary qualities.

The Appearance-Reality Distinction

The two problems resurrect the old difficulty of bridging the gap between appearance and reality. Seventeenth-century advocates of the new science joined Plato in sharply distinguishing the world of everyday experience from underlying reality. Empiricists, with their limited resources, have tended to stick close to the experiential surface of the world by either narrowing the gap between appearance and reality, denying the existence of an underlying reality altogether, adopting the skeptical position that we simply cannot know it, or rejecting all talk of a reality beyond experience as "metaphysical" and hence meaningless. In short, they have wavered over commitment to the reality of unobservable entities and processes.

Locke denied that we can know the real essences of things. Our classifications are not natural but artificial—conventions made for human convenience. Hume and the later positivists, with their verifiability theory of meaning, ruled out metaphysics as meaningless. Ernst Mach (1838–1916), the Viennese physicist and positivist, denied the existence of atoms and developed a phenomenalistic account of the world. Berkeley had denied the existence of matter with his principle, "To be is to be perceived or to perceive" (*Principles of Human Knowledge*, 1710). Only minds and ideas exist. Does the cat then go out of existence when it disappears beyond the sofa? No, because God (the biggest mind) still perceives it, replied Berkeley. Mill later used a logico-linguistic device to remove the need for God and thus obtain a full-fledged phenomenalism. In *An Examination of Sir William Hamilton's Philosophy* (1865), he attempted to reduce physical objects to "permanent possibilities of sensation," expressible by (impossibly) long series of statements about what a person *would* experience or *would have* experienced in such-and-such a situation. Russell, using the new symbolic logic to the same end, attempted to reduce mind itself to a logical construction out of experiences. He took the same line for the postulated theoretical entities of physics: "Wherever possible, logical constructions out of known objects are to be substituted for inferred entities" ("The Relation of Sense Data to Physics," in *Mysticism and Logic*, 1917). This was a halfway house between realism and instrumentalism or fictionalism. If electrons are logical constructions out of actual and possible laboratory operations and the resulting observations, then they are not real entities of underlying reality; but neither are they complete fictions. Rather, electron talk is a convenient, economical *façon de parler*.

The Twentieth Century and Beyond

Twentieth-century thinkers abandoned or at least transformed British empiricism for its failure to solve the base and superstructure problems. These developments include: (1) The linguistic turn. Linguistic philosophers speak about terms in a language rather than, vaguely, about ideas in the mind. They also employ the full power of symbolic logic or the subtle devices of ordinary language to address the twin problems of relating subjective experience to basic statements and basic statements to superstructure. (2) The holistic turn. This is a further shift from the atomism of individual ideas or terms to

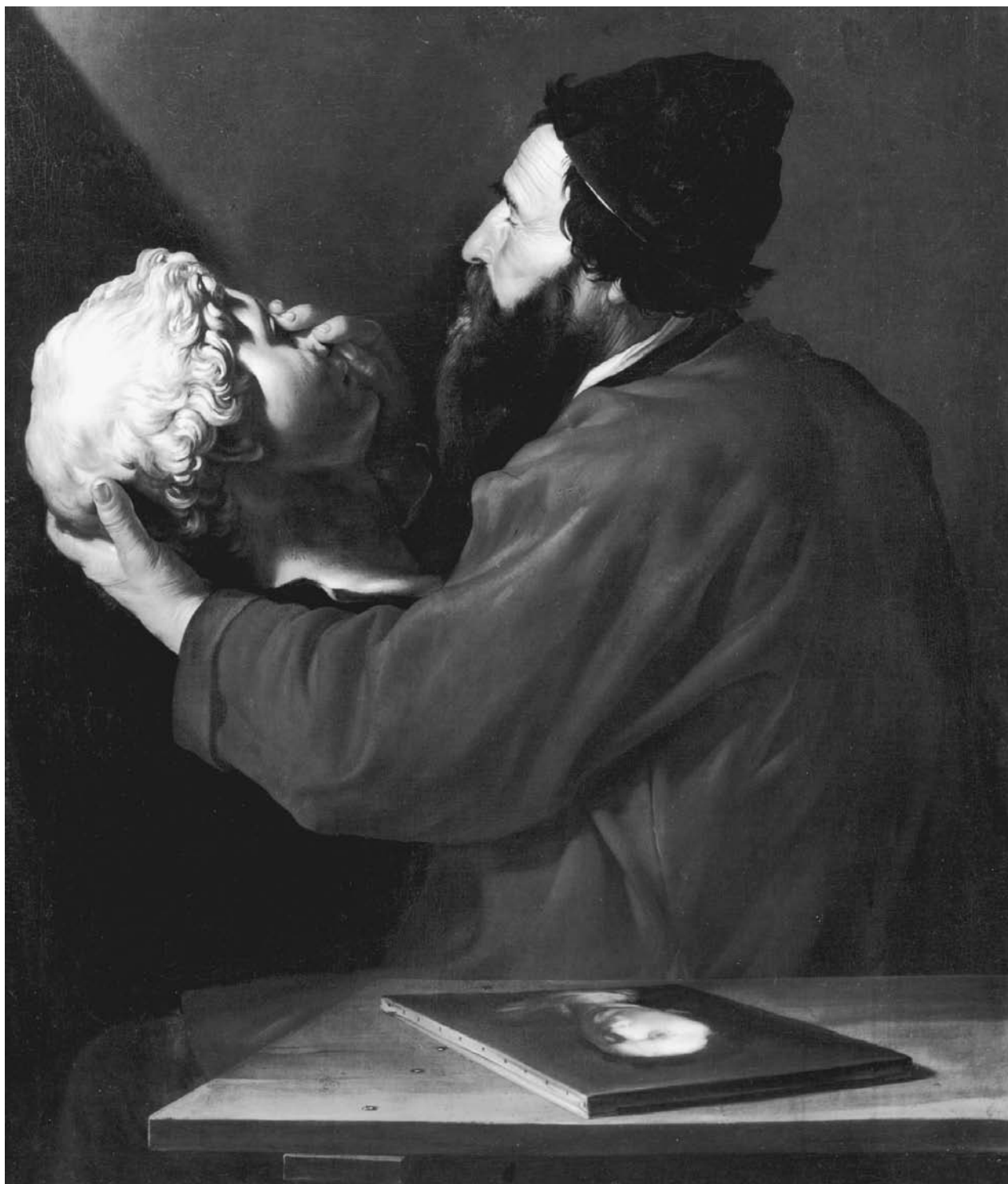

The Sense of Touch (1615–1616) by Jusepe de Ribera. Oil on canvas. Although its roots can be traced to ancient times, modern empiricism began in the early seventeenth century. Empiricists believe that knowledge comes from experience, such as that which can be gained through the senses. THE NORTON SIMON MUSEUM

whole statements, representing completed thoughts, and even to entire languages and conceptual frameworks. In “Two Dogmas of Empiricism” (1951), Quine argued that neither individual terms nor even full statements (not even basic observation statements) can be directly correlated with experience. Moreover, the data of experience logically underdetermine our theoretical claims. (3) Rejection of the analytic-synthetic distinction, also by Quine. We cannot factor theories into purely empirical and purely analytic components, only the first of which is vulnerable. “No statement is immune to revision,” come what may, not even the statements of mathematics—for example, it is now known that Euclidean geometry is not the only conceivable geometry and that it is not even true. Quine’s work called into question not only the concept of analytic statement but also that of analysis as a philosophical method, for no one has provided an adequate analysis of analysis! (4) Rejection of the scheme versus content distinction by Donald Davidson, who proclaimed this the third and last dogma of empiricism. (5) Rejection of the correspondence theory of truth and of (6) the linear-foundational model of justification. These doctrines give way either to a weaker, nonlinear and fallibilist foundationism or to a coherence theory of justification based on the idea of a mutually supporting network of claims and practices. For some, pragmatic problem-solving supplants truth as a goal of research. (7) Anti-Kantian Kantianism. Despite the rejection of Kantian intuition and synthetic a priori claims, logical empiricists Hans Reichenbach (1891–1953) and Rudolf Carnap (1891–1970) and historian Kuhn in different ways defended the need for larger structures, at least temporarily immune to serious revision, in order to make sense of the history of science as well as individual cognition. These structures are not mere hypotheses up for testing, alongside the others, for they are *constitutive* of experience and of normal scientific practice, in a quasi-Kantian way. To reject them would be to throw out the baby with the bath water. (8) Rejection by Karl Popper (1902–1994) and the positivists of the traditional identification of empiricism with inductivism, the view that we must gather and classify facts prior to theorizing. They developed a sophisticated, hypothetico-deductive model of scientific research, which was in turn subjected to severe criticism.

(9) Rejection of the imagist tradition that treats cognitive states or contents as little pictures before consciousness, and of (10) “the myth of the given,” by Sellars and others, the idea that subjective experience provides a special, direct, infallible, nonnatural connection of knowing mind to known world. These difficulties highlight the problem of the empirical base. Insofar as our experiential claims are certain they are not about physical reality (because we have had to retreat into the certainty of our subjective sense data of the moment), and insofar as they are about reality, they are not certain (because they are now subject to override by other observers or even by widely accepted theories). The price of relevance is fallibility. Thus accepting a basic statement is a social decision. All conceptual thinking, including perception, is mediated by language (a further phase of the linguistic turn). There is no prelinguistic cognitive (conceptual) awareness. There is no thought, no fully human perception or scientific observation, prior to language. Roughly, “language games” (Wittgenstein’s term) take over the

role played by Kant’s categories. All inquiry is thus fallible and mediated by language and by participation in an appropriate community of inquirers. The isolated Cartesian inquirer is a myth. The result is (11) the failure of phenomenalism and sense datum theories of perception and, more generally, (12) rejection of the whole Cartesian-Lockean conception of cognition and language. This conception is based on a Cartesian dualism of mind and body and, specifically, upon the privacy, immediacy, and alleged epistemological privilege of one’s current mental contents. Philosophical and psychological behaviorism provided strong arguments against the Cartesian conception even for those thinkers, such as Sellars, who went beyond behaviorism.

(13) The failure of attempts to define knowledge precisely as justified true belief, which inspired (14) externalism versus internalism in epistemology. Internalism is the Cartesian-Lockean view that a person’s knowledge claims must be justified in terms of the beliefs to which that person has access. The most popular form of externalism is reliabilism. According to process reliabilists, knowledge or justification consists of true beliefs formed by a reliable process whether or not the believer has sufficient Cartesian access to that process to justify it internally. Virtue epistemology, analogous to virtue ethics, is a variant of this idea: reliable beliefs are those formed by an intellectually virtuous process. (15) Recognition of the importance of tacit versus explicit knowledge (knowledge-how vs. knowledge-that) and of embodied knowledge, for example, skilled practices that we cannot fully articulate. (16) The feminist introduction of gender variables into epistemology. (17) Competing attempts to naturalize and socialize epistemology. Increasingly, empiricist philosophers work in the cognitive sciences, although few share Quine’s view that epistemology will simply become a branch of psychology. Meanwhile, sociologists of knowledge regard their sociological approach as more fundamental than psychological studies of cognition. (18) The postmodern critique of empiricism. Postmodernists, including Richard Rorty and radical feminists and sociologists, regard empiricism, epistemology in general, and, indeed, the entire Enlightenment project to replace a tradition-bound life with modern life based on empirical science as a “modern” enterprise whose time is past. It is a mistake, they say, to abstract from sociohistorical contexts with their specific power and gender relations to seek the “one true account” of the world, as if there were a determinate world out there waiting for us to provide a correct description in its own language. Rather, say the critics, the world and our modes of inquiry are all socially constructed, as is empiricism itself. It is now time to deconstruct it. These controversial oppositions have generated “the science wars.”

Although philosophical thinkers have abandoned both traditional rationalism and empiricism and although Quine, Davidson, and others have rejected the “dogmas” of empiricism and hence empiricism itself as a technical philosophical doctrine, there is a wider sense in which empiricism wins. For everyone is an empiricist in regarding observation and experience as crucial to justifying claims about the world, while almost no one believes that such claims can be defended purely a priori or on the basis of some kind of nonempirical intuition.

However, this is no longer an empiricist *epistemology* in the old sense, for gone is the idea that epistemology commands special resources that can provide external or transcendental justification for any enterprise. The sciences, for example, can only justify their claims internally, by applying further scientific tests and by their own fruits.

See also *Knowledge; Positivism; Rationalism; Realism.*

BIBLIOGRAPHY

- Alston, William P. *Epistemic Justification: Essays in the Theory of Knowledge*. Ithaca, N.Y.: Cornell University Press, 1989.
- Barnes, Barry, David Bloor, and John Henry. *Scientific Knowledge: A Sociological Analysis*. Chicago: University of Chicago Press, 1996.
- BonJour, Laurence. *The Structure of Empirical Knowledge*. Cambridge, Mass.: Harvard University Press, 1985.
- Dancy, Jonathan, and Ernest Sosa, eds. *A Companion to Epistemology*. Oxford: Blackwell, 1992.
- Goldman, Alvin I. *Epistemology and Cognition*. Cambridge, Mass.: Harvard University Press, 1986.
- Kornblith, Hilary, ed. *Naturalizing Epistemology*. 2nd ed. Cambridge, Mass.: MIT Press, 1994.
- Longino, Helen E. *The Fate of Knowledge*. Princeton, N.J.: Princeton University Press, 2002.
- Quine, Willard Van Orman. "Two Dogmas of Empiricism." Reprinted in his *From a Logical Point of View: Logico-Philosophical Essays*. Cambridge, Mass.: Harvard University Press, 1953.
- Rorty, Richard. *Philosophy and the Mirror of Nature*. Princeton, N.J.: Princeton University Press, 1979.
- Schmitt, Frederick F., ed. *Socializing Epistemology: The Social Dimensions of Knowledge*. Lanham, Md.: Rowman and Littlefield, 1994.
- Van Fraassen, Bas C. *The Empirical Stance*. New Haven, Conn.: Yale University Press, 2002.
- Woolhouse, R. S. *The Empiricists*. Oxford: Oxford University Press, 1988.

Thomas Nickles

ENCYCLOPEDIISM. Encyclopedism is not restricted to the history of encyclopedias as we now know them. Certainly, since the eighteenth century, this identification has been the dominant one; however, the term *encyclopedism* is best seen as a heuristic device that can legitimately be applied to other intellectual projects. Three main forms of encyclopedism can be discerned: first, the classical Greek and Roman notion of a circle of learning that an educated person should pursue; second, various schemes aimed at comprehensive collection and classification of an intellectual field or an aspect of the world; and third, the aim of condensing and summarizing knowledge from a wide range of subjects in a set of volumes, variously called compendium, dictionary, or encyclopedia.

The Circle of Learning

We owe the word *encyclopaedia* to Quintilian's (first century C.E.) Latinized version of the Greek term denoting a circle of learning. Works such as Marcus Terentius Varro's *Disciplines*

(c. 50 B.C.E., now lost) defined this circle as the "seven liberal arts," which later formed the trivium and quadrivium of the medieval university curriculum. Varro also included medicine and architecture. However, the circle of learning, comprising selected subjects, must be distinguished from the circle of all knowledge. A similar outlook is found in authors of the Middle Ages who placed the classical learning within a Christian framework, seeking to document the knowledge required by man for salvation. Important examples of such works are Flavius Magnus Cassiodorus's *Institutiones* (c. 560 C.E.), Isidore of Seville's *Etymologiae* (636), and Hugh of St. Victor's *Didascalicon* (c. 1130). Including both sacred and secular learning, these works expanded the original Greek concept; indeed, in Isidore there are hints of encyclopedism as near-comprehensive coverage of knowledge, including topics outside the liberal arts.

The most famous of the medieval works was the *Speculum maius* (The greater mirror), compiled between 1245 and 1260 from a range of authorities by the Dominican friar Vincent of Beauvais; it was reprinted as late as 1624. It comprised three books, or mirrors—of nature, of history, and of doctrine. The last book, the *Speculum doctrinale* (Mirror of doctrine), covered the liberal and mechanical arts, mathematics, and natural philosophy. Gregor Reisch's *Margarita philosophica* (The philosophic pearl), first published in Freiburg in 1496, is one of the most successful examples of an encyclopedic compendium. Reisch summarized arts and sciences in the university curriculum of his day and implied a sequence of disciplines, sometimes by matching subjects to particular stages of life. This work went through ten editions between 1503 and 1599. At the other end of the Renaissance period Johann Heinrich Alsted's (1588–1638) *Encyclopaedia* (4 vols, 1630), considered the last and best of the neo-Scholastic encyclopedias, treated thirty disciplines in separate treatises arranged in accordance with a philosophical schema; in addition, an index to each treatise allowed access to a specific discipline. Yet even such a large work was conceived as a summary of subjects that in principle outlined an educational path. Alsted described his work as presenting a "methodological understanding of everything than man must learn in this life" (book 1).

Who could truly encompass this circle of knowledge? Indeed there were already doubts, especially given Francis Bacon's (1561–1626) stress on new knowledge, steadily accumulating over time. Nevertheless, the idea of "encyclopaedia" revived by Renaissance humanists was still selective, conceived as a circle of learning, not a summary of all knowledge in a single work. A version of this ideal supported the notion of general learning in the arts curriculum of the early modern European universities. In the English case, for example, this included rhetoric, logic, mathematics, and moral and natural philosophy. This curriculum was predicated on the interdependence of various branches of knowledge, a conviction elaborated by the Cambridge mathematician and divine, Isaac Barrow (1630–1677), who advised that "one Part of Learning doth confer Light to another, . . . that he will be a lame Scholar, who hath not an insight into many kinds of knowledge, that he can hardly be a good Scholar, who is not a general one" (Barrow, vol. 1, p. 184). In his *Glossographia* of 1656 Thomas Blount (1618–1679) reflected this position by defining the

“encyclopædy” as “that learning which comprehends all Liberal Sciences; an Art that comprehends all others, the perfection of all knowledge.”

Encyclopedic Collections

Pliny the Elder’s *Naturalis historia* (77 C.E.) is often cited as an early encyclopedic work. His thirty-seven books and 2,493 chapters collated information from over four hundred authors, offering (in his estimate) some twenty thousand facts about the natural history of animals, objects, and techniques. However, Pliny was not concerned with the unity of knowledge or the relations between disciplines. Instead, he managed to give “encyclopedia” a wider denotation by announcing in his opening epistle that the Greeks meant by this a complete body of arts and sciences. Pliny thereby forged a link between natural history and the notion of encyclopedism imagined as comprehensiveness. During the Renaissance the *Natural History* came to be seen as a museum catalog, a shopping list for assembling a cabinet of curiosities. Moreover, the activity of collecting was informed by the ideal of encyclopedic learning. By possessing rare or otherwise valuable objects, an individual collector displayed his knowledge of them, their classical literary associations, and their place in a larger schema, such as the Great Chain of Being. The polymath Athanasius Kircher (1601–1680) established a museum in the Jesuit College in Rome and regarded it as his “enciclopedia concreta” (actual or tangible encyclopedia). Gabriel Naudé, in his *Advis pour dresser une bibliothèque* (1627; Instruction concerning establishing a library), declared that a library should represent the encyclopedic circle of learning. The architecture of the buildings (museums and libraries) that held such treasures was often seen as a physical expression of the encyclopedia, now increasingly regarded as a model or microcosm of divine creation.

Eventually, however, large collections began to tell against the notion of the individual collector as knowing his possessions as one might be said to know the seven liberal arts. Sir Hans Sloane’s (1660–1753) private collection (the founding collection of the British Museum) comprised some forty thousand books, three thousand manuscripts, and two hundred thousand objects, such as coins and medals, natural history, anthropological specimens, and other curious items. Such collections were often called “encyclopedic,” but this now indicated that they were so extensive as to be beyond the capacities of a single mind, or memory. By at least the early 1700s critics were saying that once a collection reached a certain size, its value must be found in the various uses different people might make of it. Encyclopedism, in this guise, severed its link with the notion of the “encyclopedia” as a path of individual learning.

It is also possible to consider encyclopedism as supporting the notion of virtual collections. Conrad Gesner’s (1516–1565) *Bibliotheca universalis* (1545; Universal library) was a bibliography of all known books—eighteen hundred authors and ten thousand titles—rather than a catalog of any existing library. During the eighteenth century, attempts to classify books, objects, or aspects of nature—even if not held in any collection—were regarded as encyclopedic because they allowed a large number of things to be comprehended by a single person,

independent of being actually seen or touched. This is how the taxonomies of the plant and animal worlds, such as those of Carolus Linnaeus (1707–1778), were understood and promoted.

In German universities from the eighteenth century, particular disciplines were given “encyclopedic” arrangements, so that encyclopedias of philology, law, and medicine were offered as introductory and summary courses within particular departments. As Henri Abrams wrote in his *Encyclopédie juridique* (1855; Juridical encyclopedia), “An encyclopedia may be regarded in general as a synthetic plan embracing a science in all its parts.”

Alphabetical Encyclopedias

By the early 1700s, a new expression of encyclopedism was the publication of encyclopedias in the form of alphabetical dictionaries of terms and subjects. These were regarded as summaries of accumulated information in various fields of knowledge, produced in a form accessible to a wide readership. Such works acknowledged the medieval and Renaissance legacy of encyclopedism, but the scope of these new works extended beyond the subjects of the university and also explicitly confronted the problem of keeping pace with the incessant progress of knowledge in all fields.

Distinctions must be made within the set of alphabetical dictionaries that emerged toward the end of the seventeenth century. By 1700 there were specialist lexicons for anatomy, chemistry, and other subjects; the predecessors of the modern language dictionary; the historical (and biographical) dictionary; and the dictionary of arts and sciences. The last two kinds are most relevant here because for a time the distinction between them had a bearing on the contemporary definition of an encyclopedia. Louis Moréri’s *Grand Dictionnaire Historique* (Great historical dictionary), first published in Lyon in 1674 and then issued in an expanded second edition in 1681, is usually regarded as the first work (other than bibliographies) to summarize a range of subjects in strictly alphabetical order. Pierre Bayle’s *Dictionnaire historique et critique* (2 vols., 1697; enlarged 2nd ed., 1702; Critical and historical dictionary,) began as an attempt to remedy Moréri’s errors. Although large works for their time, neither pretended to the title of “encyclopaedia” because they were conceived as historical dictionaries covering major aspects of sacred and secular history by means of biographical entries on key figures.

The new genre of the dictionary of arts and sciences was the more direct predecessor of the modern encyclopedia. Three significant examples are Antoine Furetière’s (1619–1688) *Dictionnaire universel*, published in three volumes at the Hague in 1690, two years after his death; John Harris’s *Lexicon technicum* (2 vols., 1704, 1710); and Ephraim Chambers’s (1680–1740) *Cyclopaedia* (2 vols., 1728). These works consisted of entries on terms (mainly from the arts and sciences) in alphabetical order, but they professed to be more than definitions of words by also being descriptions of things. The category of “arts and sciences” was flexible enough to embrace apparently disparate subjects such as law, music, and architecture, as well as the disciplines of the physico-mathematical disciplines and the new experimental sciences. The *Lexicon technicum* was strong on the latter but far less comprehensive than

Chambers's *Cyclopaedia*, which justified its use of that title by covering systematic disciplines belonging to the category "*scientia*"—such as grammar, theology, logic, music, astronomy, mechanics, optics, and other parts of natural philosophy, as well as of subjects capable of being brought into scientific order, such as anatomy, medicine, natural history, and the practical and mechanical arts and trades. It did not include biography or history. Thus early-eighteenth-century encyclopedism tolerated a division of labor—between historical/biographical dictionaries and those dealing with the arts and sciences (and assuming the title of encyclopedia). The *Grosses vollständiges Universal-Lexicon aller Wissenschaften und Künste* . . . (Great, complete universal lexicon of all sciences and arts . . .), begun in 1732 by the Leipzig publisher Johann Zedler, is an example of an historical dictionary that included entries on scientific topics in addition to those on history, theology, philosophy, and biography; it reached sixty-four folio volumes by 1750. By at least the early 1800s, encyclopedic coverage meant a comprehensive survey of all knowledge of the kind attempted by the *Encyclopaedia Britannica*, especially in its ninth edition (25 vols, 1875–1889).

Chambers compiled his *Cyclopaedia* single-handedly, drawing from various sources and presenting the information under key terms. With the famous *Encyclopédie* (1751–1780), edited by Denis Diderot (1713–1784) and Jean Le Rond d'Alembert (1717–1783), encyclopedism became collaborative. While acknowledging their debt to Chambers, the French editors declared that a complete survey of knowledge required the efforts of many hands and so recruited contributions from leading members of the Republic of Letters. When completed, the *Encyclopédie* consisted of seventeen folio volumes of text and eleven volumes of plates, incorporating an extensive documentation of the arts, crafts, and trades, and illustrated by some twenty-five hundred engravings. Whereas Chambers's sought to condense "the vast bulk of universal knowledge into a lesser compass" (Chambers, 1738, vol. 1, xxiv), the French editors welcomed long essays covering the history and current views on a particular subject. This set the pattern for subsequent encyclopedias. The *Encyclopaedia Britannica* (3 vols., 1771) departed from Chambers's format of relatively short entries on terms, instead presenting major disciplines as "systems" in separate treatises of at least twenty-five pages each. From its third edition (10 vols., 1788–1797) experts were invited to write these treatises. Similarly, the *Encyclopédie methodique* (166 vols., 1782–1832), the successor to the *Encyclopédie*, was organized by disciplines, so that, for example, there were at least nine volumes on natural history. Each subject was under the control of a leading expert with a license (almost without a word limit) to describe and codify a field. Previously a concept that assumed the value of general learning, encyclopedism now depended on specialists.

This shift had implications for the rationale of Enlightenment encyclopedias. Both Chambers and Diderot claimed that the integrity of particular sciences and the relations between them could still be perceived, in spite of alphabetical arrangement. This is why they provided maps or charts of knowledge in their prefaces, albeit recognizing that such classification was to some degree arbitrary. Given the expansion of knowledge, especially in the natural sciences, they admitted that there was no longer a

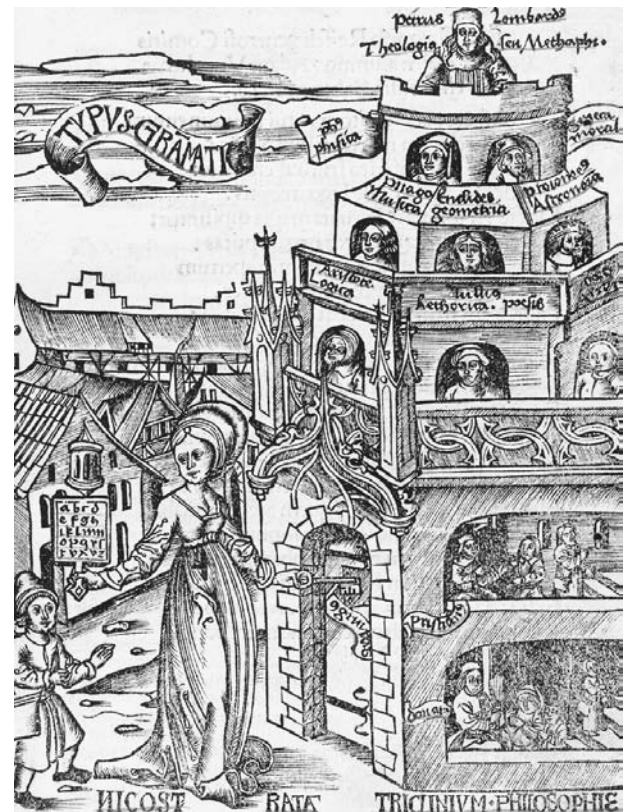

Woodcut from Gregor Reisch's *Margarita philosophica* (1496). Reisch's popular compendium, published during the early Renaissance period, sought to summarize and compartmentalize the disciplines of art and science. ANNENBERG RARE BOOK & MANUSCRIPT LIBRARY, UNIVERSITY OF PENNSYLVANIA

single circle of learning (such as the seven liberal arts) but insisted that their works were informed by an awareness of the links between subjects and that cross references allowed the reader to follow these in a methodical fashion. By the late 1700s, however, most encyclopedias had abdicated responsibility for any systematic classification of the subjects they covered. The *Britannica* never included a map of knowledge. One exception was the *Encyclopaedia metropolitana* (26 vols, 1827–1845), organized on a plan devised by the English poet Samuel Taylor Coleridge. This was a return to the systematic, or at least thematic, format of earlier encyclopedic works. Rejecting alphabetical arrangement, Coleridge recommended an order of subjects that reflected the hierarchy of the disciplines in the classification he supplied, beginning with the abstract, formal subjects of logic, grammar, and geometry (all in the first two volumes), then the mixed-mathematical disciplines such as astronomy, optics, and music; then the various parts of natural history, and so on. This sequence of subjects was intended to prescribe a proper order of study. But this format had limited appeal, and the work was a commercial failure. Encyclopedism had finally lost touch with the original sense of the Greek concept of a circle of learning that an individual could, and should, pursue.

Nevertheless, understood as comprehensive coverage of either a single subject or the totality of knowledge, encyclopedism

- Collison, Robert. *Encyclopaedias: Their History through the Ages*. New York: Hafner, 1964.
- Chartier, Roger. *The Order of Books: Readers, Authors, and Libraries in Europe between the Fourteenth and Eighteenth Centuries*. Translated by Lydia G. Cochrane. Cambridge, U.K.: Polity Press, 1994.
- Darnton, Robert. "Philosophers Trim the Tree of Knowledge." In his *The Great Cat Massacre and Other Episodes in French Cultural History*. London: Penguin, 1985.
- Findlen, Paula. *Possessing Nature: Museums, Collecting, and Scientific Culture in Early Modern Italy*. Berkeley: University of California Press, 1994.
- Kafker, Frank A., ed. *Notable Encyclopedias of the Seventeenth and Eighteenth Centuries: Nine Predecessors of the Encyclopédie*. Studies on Voltaire and the Eighteenth Century, vol. 194. Oxford: Voltaire Foundation, 1981.
- Kafker, Frank A., ed. *Notable Encyclopedias of the Late Eighteenth Century: Eleven Successors of the Encyclopédie*. Studies on Voltaire and the Eighteenth Century, vol. 315. Oxford: Voltaire Foundation, 1994.
- Yeo, Richard. *Encyclopaedic Visions: Scientific Dictionaries and Enlightenment Culture*. Cambridge, U.K., and New York: Cambridge University Press, 2001.

Richard Yeo

ENLIGHTENMENT. In the years since the publication of the first *Dictionary of the History of Ideas*, the Enlightenment has become an increasingly fragmented and decreasingly coherent historical rubric. In fact that fragmentation began in the *Dictionary of the History of Ideas* itself, in an article titled "Counter-Enlightenment," written by Isaiah Berlin and categorized out of alphabetical order, appearing as an appendix to the main entry on "Enlightenment," written by H. O. Pappé.

Pappé defined the Enlightenment as a historical period extending from the late seventeenth century (the Glorious Revolution, the era of John Locke [1632–1704] or Pierre Bayle [1647–1706]) to the late eighteenth or early nineteenth century (American Revolution, French Revolution, or the defeat of Napoleon and the Romantic reaction against the Enlightenment). The Enlightenment was also a mood emphasizing individualism, toleration, and cosmopolitanism. The Enlightenment was a social philosophy with common basic conceptions about humanity and society and a common methodological approach involving the search for laws that govern nature and society and commonly held values directed toward social reform. By this definition the Enlightenment was monolithic, but it was not all-encompassing. It was an avant-garde "movement" involving a relatively small number of thinkers. The movement began in England and reached its climax in mid-eighteenth-century Paris and Scotland, while the "Italian and German Enlightenment, though distinguished by outstanding contributors, was derivative."

Counter-Enlightenment

Berlin's counterargument focused specifically on those "derivative" countries, offering Giambattista Vico (1668–1744), Johann Georg Hamann (1730–1788), Johann Gottfried von

Herder (1744–1803), and Immanuel Kant (1724–1804) as the bearers of a genuine, indigenous, and innovative agenda alternative to the mainstream Enlightenment of France and Britain. Vico rejected the existence of a timeless, universal natural law that could be explained by mathematics or logic. Mathematics was certain only because it was a human invention; it did not correspond to an objective structure of reality. Mathematics was a method only, not a body of truth, and while it could explain *what* happened in the world, it could not explain *why* or to what end. Human beings had no access to the final causes or purposes of nature. What they could know were human truths, human behavior, and human motives. These human truths were particular, not universal—that is, each nation developed its own standards of beauty, truth, and goodness. Because different nations asked different questions of the universe, they came up with different answers.

Hamann represented the distinctly antirational strain of Berlin's Counter-Enlightenment. For Hamann too truth was particular, never general. As a human invention, reason was a tool for the arrangement and classification of data to which nothing in reality corresponded. The true language was divine: Nature, plants, animals, and society were the symbols by which God communicated with his creatures. To understand was to be communicated with, either by people or by God. True knowledge was direct perception—experience—not logical proof. Only love, the most intimate form of direct experience, could demonstrate anything. Through the medium of Herder, Berlin placed a hermeneutic of empathy at the center of his Counter-Enlightenment. To understand something was to understand its individuality and unique development. Only by entering into the experience of another, through the imagination and rigorous scholarship, could one understand the organic structure of society. Berlin emphasized what he (not Herder) called the "incommensurability of cultures" that "should flourish side by side like so many flowers in the great human garden."

Kant's autonomy of the will represented the fourth aspect of Berlin's antirational Counter-Enlightenment. Figures of the Counter-Enlightenment recognized that the model of the universe espoused by Cartesianism, rationalism, and natural law was inherently deterministic (in that all motion was caused by previous action and conformed to specific natural laws) and fatalistic (no action could violate those natural laws). Applied to society, such a view divested human actors of their moral responsibility. If all action was regulated by nature, then an individual could blame the system of the universe for any evil perpetrated by himself. In response, Kant held that only as independent actors—not acted upon by previous or external forces—could human beings be considered moral agents.

All of this amounted to a tacit apology for hermeneutics: the emphasis on language as the defining characteristic of a nation; cultural particularism and the uniqueness of each; the attempt to understand by entering the experience of another in an act of empathy. Even if the methods and assumptions of the Counter-Enlightenment differed from the mainstream rationalists, the goals and values described by Berlin nevertheless sound distinctly similar to those described by Pappé: cosmopolitanism,

pluralism, tolerance, and social reform. Indeed to those who championed the Enlightenment from the end of World War II to the 1970s, eighteenth-century social thought was a convenient platform from which to display their own liberal sensibilities.

Fractured Enlightenment

In 1973, then, we see the Enlightenment divided in two parts: a western European rationalist Enlightenment and a negatively defined central European antirationalist Counter-Enlightenment. In fact defining the Enlightenment, even in 1973, was not as easy as creating a binary opposition. Beginning in the 1960s Franco Venturi also divided Continental Europe into two distinct political traditions, with multiethnic empires in central and eastern Europe and “great states” in western Europe. He emphasized concurrent developments in republican Mediterranean Europe (Italy, Iberia, France) and monarchical eastern Europe, but he excluded England from the equation, saying that “in England the rhythm was different.” Venturi defined the Enlightenment by the presence or absence of philosophes, self-appointed secular intellectuals who critiqued society and presented themselves as its guides toward modernity and reform. Although they were present in Scotland in the mid-eighteenth century, intellectuals of the stature of Voltaire, Jean Le Rond d’Alembert, Denis Diderot, and so on did not emerge in England until the 1780s and 1790s with Thomas Paine, Richard Price, William Godwin, and Jeremy Bentham. Venturi acknowledged a problem in his definition given the Englishness of Edward Gibbon (1737–1794), whom he considered “a giant of the Enlightenment”: either Gibbon was no philosophe or he was a lonely figure in England in the 1760s and 1770s.

In fact the French philosophes were great admirers of the English in the 1760s, wrote Roy Porter in *The Enlightenment in National Context* (1981): “Certainly England produced no *Critique of Pure Reason*. But why should systematic theorizing be the touchstone of Enlightenment?” Voltaire noted that the English were “the only people upon the earth who have been able to prescribe limits to the power of Kings by resisting them.” That resistance was galvanized in institutions of sociability—gentlemen’s clubs, Masonic lodges, colleges, coffee houses—where private individuals might gather in public discourse to discuss and debate matters of law, politics, religion, and culture. Gibbon might have been a lonely giant among enlightened Lilliputians, but E. P. Thompson pointed to scores of minor “intellectual enclaves” throughout the United Kingdom where individuals exercised their rational and critical faculties.

The very title of Porter and Teich’s volume, *The Enlightenment in National Context*, indicates the direction of Enlightenment historiography in the late 1970s and 1980s. That volume still took the Enlightenment to be monolithic (“a cultural movement,” p. xi) and headed in a specific direction, although the constituent parts of that movement expressed enlightened values in terms of their indigenous and traditional concerns. Thirteen separate national expressions of the Enlightenment were identified by the contributors, and the editors acknowledged that even that number was not adequate.

Should the Swiss Enlightenment have been considered a unit, or were there distinct traditions in the French and German cantons? Contemporaries of the eighteenth century expressly believed the latter. Germany was divided into two Enlightenments, Catholic and Protestant, but among the Protestant at least three distinct movements can be identified based on divisions within German Lutheranism: an Orthodox Lutheran Enlightenment centered at Leipzig and Dresden in Saxony; a Pietist Enlightenment centered at Berlin and Halle, where a university was founded in 1690 specifically as a platform for an intellectual movement that saw itself as separate from the Orthodox; and a post-Pietist Enlightenment centered at Göttingen, which defined itself in opposition to both Saxony and the Brandenburg of Frederick the Great. Were the Württemberg Protestants allied with the Hanoverians? Can the Danish and Swedish Lutherans be taken as a unit, and how should their relationships with the Germans be defined? The possibilities for a rigorous classification of cultural movements in the eighteenth century boggle the mind.

The attempt to rescue the Gulliverian Gibbon continues into the twenty-first century. In the first installment of a study of Gibbon that is well on its way toward rivaling the length of Gibbon’s own *Decline and Fall of the Roman Empire*, J. G. A. Pocock invented an Enlightenment in which Gibbon did participate. Pocock started by pluralizing Enlightenments, declaring it “a premise of this book that we can no longer write satisfactorily of ‘The Enlightenment’ as a unified and universal intellectual movement” (*The Enlightenments of Edward Gibbon*, 1999, p. 12; notice the plural in the title). Pocock accepted Venturi’s thesis that there was no Enlightenment in England, and he showed that Gibbon did not participate in a separate French Enlightenment either. Instead he placed Gibbon in an “Arminian Enlightenment,” referring to the heretical movement within Calvinism and defining an area that extended from Lake Geneva down the Rhine to the Netherlands and across the Channel to Oxford. Pocock presented the Arminian Enlightenment as a unit that unified intellectuals from a variety of backgrounds, and by his participation in the movement, Gibbon could move easily across national, linguistic, and regional boundaries and still find intellectual continuity.

For Pocock this solution had the advantage of retaining “the philosophes and their enterprises, Venturi’s *settecento riformatore* and perhaps even ‘the Enlightenment Project,’ as cosmopolitan and Europe-wide phenomena, while denying them the privilege of defining ‘Enlightenment,’ or ‘Europe,’ by formulae from which either Gibbon or England must be excluded” (p. 295). On the other hand, one wonders whether a series of regional Enlightenments that do not even conform to national or linguistic boundaries, each presented as more or less autonomous from the others, dooms the Enlightenment to an increasingly fractured existence and perhaps renders the rubric altogether useless.

The New Cultural History

One result of Enlightenment historiography in the past thirty years, then, has been to carve the movement into different geographic, confessional, and linguistic groupings. And even within these groupings, further fragmentation has taken place.

In the original “Enlightenment” article in the *Dictionary of the History of Ideas*, Pappé explicitly declared the Enlightenment to be an elite movement. In a parenthetical digression he acknowledged that:

Side-by-side with these productions, the period witnessed the growth of a new cheap entertainment literature as well as a greater diffusion of writings in the old tradition, which aimed at the new enlarged reading public. Although popular reading habits and crowd behavior have come to fascinate some modern historians, such publications are ignored here, as they hardly contributed to the march of ideas, that is to the *incivilimento* due to man’s creative liberty.

Indeed it is precisely the study of reading habits and crowd behavior that have fueled the redefinition of the Enlightenment in the past thirty years. In the mid-1970s Peter Burke pointed out the rediscovery of “the People,” by which he meant a renewed interest in folklore, festivals, and the early Germanic and Celtic oral tradition that swept across Europe beginning in about the 1760s, spurring the Romantic movement. Working initially in the *Kulturgeschichte* mode of Jacob Grimm, Jacob Burckhardt, Aby Warburg, and Johan Huizinga but augmenting that totalizing method with anthropological and literary techniques, scholars such as Natalie Davis, Carlo Ginzburg, and Keith Thomas began to study the social function of myth, ritual, and behavior in early modern Europe itself.

Robert Darnton examined not just the ideas of the Enlightenment but the “business” of it as well in a publishing history of the *Encyclopédie* in the last quarter of the eighteenth century. In *The Literary Underground of the Old Regime* he looked beyond the successes of Voltaire, d’Alembert, Étienne Bonnot de Condillac, and Jean-Jacques Rousseau to the failure of a host of would-be philosophes who lacked the patronage, money, and access to presses enjoyed by the Encyclopedists and members of learned academies. This too in effect split the Enlightenment into two parts, high and low—or those who got published by presses on Fleet Street and the Strand versus hacks living on Grub Street who were lucky if they got published at all. Darnton showed how the world of those lesser authors functioned—their pirating of copyrighted texts, sale of pornographic and censored books and serials, and the fortune of their original satires and social critiques that never acquired the reputation of Voltaire’s.

Darnton called his method the “social history of ideas” (as Peter Gay had done years before). While it lacked a grand narrative of social and intellectual development, the microhistorical approach of scholars such as Darnton was important because if the Enlightenment and French Revolution were the products of new ideas (or of old ideas newly interpreted), then the logistical process of how those ideas were conveyed to the public sphere was just as important as the content of the ideas in themselves. Which texts were circulated? What were the motives of the authors, publishers, and booksellers? Which texts were intended to be circulated but never reached the market due to silly logistical failures? To what extent were authors,



The Triumph of Virtue and Nobility Over Ignorance (c. 1740–1750) by Giovanni Battista Tiepolo. Oil on canvas. The Age of Enlightenment began in England in the late seventeenth century and reached its pinnacle in the mid-eighteenth century. The period was characterized by a desire for reason, toleration, and social reform. NORTON SIMON COLLECTION, PASADENA, CALIFORNIA/THE BRIDGEMAN ART LIBRARY, WWW.BRIDGEMAN.CO.UK

publishers, and booksellers motivated by their economic and social circumstances? That is, how business was conducted influenced what kinds of ideas were circulated in the public sphere.

Rather than taking “popular culture” to be monolithic, Roger Chartier emphasized the different uses of print by different segments of society. These segments frequently overlapped, and a single member might perform several roles depending on the context in which he or she acted. Chartier worked to abolish some of the presumptive categories such as high and low Enlightenment, philosophe and Grub Street hack, even printed text and oral tradition. Whereas the historiography of popular culture of the 1960s and 1970s used techniques of historical anthropology appropriate to understanding forms of expression and communication in preliterate societies, Chartier’s cultural history focused on the production, circulation, and function of printed texts. Early modern society was thoroughly dependent on writing, even those who could not read or who grasped a text only when it was read aloud to them. In reconstructing social practice, Chartier found that advice manuals, mandates, and slogans were *appropriated* by the audience (or, better, plural “audiences,” because he emphasized that different overlapping groups read, understood, and acted upon a given text in their own ways). A text might be creatively interpreted, its message adjusted or diverted to purposes not intended by the author or even resisted. Chartier was interested chiefly in action: the act of reading; followed by behavior inspired by the text. He was less interested in the creation of ideas than the reception of ideas once those ideas left the author’s desk, or how ideas walked, as it were, around in society.

The most glaring example of how ideas walked around in eighteenth-century society was the French Revolution. Were

ideas responsible for the collapse of the Old Regime? Was there a necessary and causal connection between the Enlightenment and the French Revolution? Were ideas really that effective in producing constitutional change and touching off events like the Terror? Assuming that Daniel Mornet was at least partially correct in *Les origines intellectuel de la Révolution Française* (1933) that ideas bore at least some responsibility for the Revolution, Chartier wanted to know: How, exactly? “Is it certain that the Enlightenment must be characterized exclusively or principally as a corpus of self-contained, transparent ideas or as a set of clear and distinct propositions?” Chartier asked. “Should not the century’s novelty be read elsewhere—in the multiple *practices* guided by an interest in utility and service that aimed at the management of spaces and populations and whose mechanisms (intellectual or institutional) imposed a profound reorganization of the systems of perception and of the order of the social world?”

In the 1990s, then, the connection between ideas and practice moved to center stage in eighteenth-century historiography. The inquiry into practices of “sociability” was assisted by the translation into English of Jürgen Habermas’s *Structural Transformation of the Public Sphere* (1989, originally 1956). Dena Goodman, Daniel Gordon, and others explored institutions and practices of sociability in prerevolutionary France and the movement of ideas from the closed intellectual circles of salons to the active realm of political reform. Margaret Jacob explored the Enlightenment’s direct relationship to “lived political experience,” particularly through the window of Freemasonry, emphasizing international trends such as the republicanism described by Franco Venturi. And Daniel Gordon has edited a volume on “Postmodernism and the Enlightenment.”

Given the many directions of Enlightenment research, it is no wonder James Schmidt reopened the question of the 1780s: “What is Enlightenment?” Yet even that question was limited to Protestant Germany, taken for granted (or, rather, not formulated at all) in the rest of Europe. If the 1780s had answers, the 1990s had only questions, and it is unlikely that any time soon there will be an answer as definitive as the one offered in the first *Dictionary of the History of Ideas*.

See also Deism; Historiography; Renaissance; Revolution; Romanticism in Literature and Politics.

BIBLIOGRAPHY

- Burke, Peter. *Popular Culture in Early Modern Europe*. New York: Harper and Row, 1978.
- Chartier, Roger. *The Cultural Origins of the French Revolution*. Translated by Lydia G. Cochrane. Durham, N.C.: Duke University Press, 1991.
- . *The Cultural Uses of Print in Early Modern France*. Translated by Lydia G. Cochrane. Princeton, N.J.: Princeton University Press, 1987.
- Darnton, Robert. *The Business of Enlightenment: A Publishing History of the Encyclopédie, 1775–1800*. Cambridge, Mass.: Belknap Press, 1979.

- . *The Literary Underground of the Old Regime*. Cambridge, Mass.: Harvard University Press, 1982.
- Goodman, Dena. *The Republic of Letters: A Cultural History of the French Enlightenment*. Ithaca, N.Y.: Cornell University Press, 1994.
- Gordon, Daniel. *Citizens without Sovereignty: Equality and Sociability in French Thought, 1670–1789*. Princeton, N.J.: Princeton University Press, 1994.
- Habermas, Jürgen. *Structural Transformation of the Public Sphere: An Inquiry into a Category of Bourgeois Society*. Translated by Thomas Burger with the assistance of Frederick Lawrence. Cambridge, Mass.: MIT Press, 1989.
- Jacob, Margaret C. *Living the Enlightenment: Freemasonry and Politics in Eighteenth-Century Europe*. New York: Oxford University Press, 1991.
- Pocock, J. G. A. *Barbarism and Religion*. Vols. 1–3. Cambridge, U.K., 1999–2003.
- Porter, Roy, and Mikulás Teich. *The Enlightenment in National Context*. Cambridge, U.K.: Cambridge University Press, 1981.
- Schmidt, James, ed. *What Is Enlightenment? Eighteenth-Century Answers and Twentieth-Century Questions*. Berkeley: University of California Press, 1996.
- Venturi, Franco. *Settecento Riformatore*. 4 vols. Turin: Einaudi, 1969–1984. Vols. 3 and 4 have been translated into English by R. Burr Litchfield as *The End of the Old Regime in Europe (1768–1776)* and *The End of the Old Regime in Europe (1776–1789)*. Princeton, N.J.: Princeton University Press, 1989, 1991.
- . *Utopia and Reform in the Enlightenment*. Cambridge, U.K.: Cambridge University Press, 1971.

Michael C. Carhart

ENTELECHY. *See Development.*

ENVIRONMENT. The term *environment* became specialized beginning in about the 1960s to designate the context of human and animal groups, with a special emphasis on the natural world and its physical and vegetal components. Within this framework, the word took on an even more limited meaning and in the early twenty-first century refers primarily to the interaction between human and animal activity on the one hand and to humans and the natural world on the other, principally the impact of the former on the latter. In this context, “environment” is often linked with notions of habitat deterioration and species endangerment, and with appropriate responses to these threats, such as species recording and protection and natural-resource and habitat conservation. In a broader sense, however, *environment* refers to all elements (physical, biological, psychological, social, and cultural) that constitute the context in which life (vegetal, animal, and human) has evolved and continues to evolve. Four major components of this complex notion are taken into consideration here for their particular historical relevance and importance in Western culture: the notion of animism; materialist conceptualizations of environment (including diseases, medicines, and astrology); theological understandings; and contemporary approaches to the environment and environmental issues.

Early Environment and Animism

In addition to sustaining life, the environment has been a major factor in the shaping of life (vegetal, animal, and human) from its origins. For example, some plants produce chemical substances called alkaloids, known for their therapeutic properties; in some cases alkaloids have a toxic effect, interpreted as an adaptive response of the plant to a stress from the environment, specifically predation. Through their negative action on animal physiology (producing intestinal disturbance or even death), such substances aim at provoking an adaptive reaction in predators (avoidance of grazing), defending the plant species against animal aggressions and reducing the risk of or avoiding extinction.

Human beings are so deeply shaped by environment that not only their behavior but their individual physical characteristics have been interpreted as adaptive responses to environmental parameters. A science of the impact of external factors (including but not limited to the social environment) on individual physical features developed as early as the fourth century B.C.E. in ancient Greece; physiognomy dealt with the description and interpretation of individual physical characteristics. In its original form, it consisted in comparing human and animal characteristics, and in interpreting the former with respect to a resemblance to the latter. Although this science did not explicitly appear before the fourth century B.C.E., it certainly predates that time: already in Homer's *Iliad*, which related historical happenings dating back to the twelfth century B.C.E. and was probably written during the eighth century B.C.E., warriors are frequently compared to animals. In one of its most evolved forms, such theory aimed, principally with the Italian physician Cesare Lombroso (1836–1909), at predicting the behavior (especially deviant) of individuals on the basis of the observation, measurement, and type of their physical characteristics, as they were considered to be almost totally determined by environmental factors, particularly but not exclusively of a social and economic nature.

Although the earliest history of the conceptualization of environment cannot be reconstituted, anthropology throws some light on the subject by means of a comparison with contemporary Aboriginal societies. Australian Aborigines, for instance, believe that the environment was created by ancestor beings who are still living in the physico-geographical peculiarities they created (mountains, rivers, deserts, and so on). As a consequence, the environment cannot be modified, for it is charged with totemic value. Similarly, humans belong to and are shaped by their environment (not vice versa). This is so ingrained in Aboriginal thought that individuals consider that they cannot be separated from their territory.

Another approach is provided by analytic ethnobotany and ethnopharmacology—that is, the analysis of the constitution of botanical and pharmacological knowledge in the so-called traditional culture (in fact, non-Western ones). Discovery on the part of human beings of the properties of environmental constituents (for example, the nutritive and therapeutic value of plants) is interpreted as having occurred in two different and opposite ways in the general context of a learning theory by trial and error: (1) by biological transmission from animal to human (namely genetic vertical transmission in the tree of life);

or (2) by cultural acquisition through at least two possible procedures (neither of which is exclusive): human imitation of animal behavior (for example, that of bees gathering pollen), and human assessment of heads of poppy as remarkable influenced human cultivation of poppies for medicinal use.

Aboriginal thinking was not absent in the Western tradition. In the cultures of the Near East (Mesopotamia), human diseases were understood to be caused by spirits living in specific areas. Ponds, for instance, were supposedly inhabited by bad spirits generating illness, perhaps what a later age would determine to be malaria. Animistic conceptions of the environment lasted until the classical period, as the treatise *On Sacred Disease*, attributed by tradition to Hippocrates (c. 460–after 377 B.C.E.), shows: the author, probably a physician of the second half of the fifth century B.C.E., argued that epilepsy resulted not from spirit possession but from an internal physical malady.

Materialist Conceptualization and Pharmaceuticals

Within Western culture, materialist conceptions of the environment do not seem to take shape until the sixth century B.C.E. by the philosophers of the school of Miletus (in Asia Minor). From Thales (625?–547 B.C.E.) to Anaximander (610–c. 547 B.C.E.) to Anaximenes (fl. c. 545 B.C.E.), these thinkers proposed to reduce the multiplicity of the world to its primary substance or *archê* (principle): water (in the case of Thales), air (Anaximenes), and an undetermined, eternal substance (*apeiron*) containing all contraries (Anaximander). It was Aristotle (384–322 B.C.E.) who fully transformed the environment into an object of study by introducing the concept of matter (*ulê*), which made it possible to conceptualize physical processes (from generation to transformation and movement). Significantly, the period from the sixth to the fourth centuries B.C.E. saw the first systematic inventories of all components of the world: physical geography with Anaximander and Hecataeus (sixth–fifth century B.C.E.) also from Miletus; human geography with Herodotus (c. 484–c. 420 B.C.E.); astronomy with Thales and Eudoxus of Cnidus (c. 400–c. 350 B.C.E.); zoology with Aristotle and his *Historia animalium* (Research on animals); botany and geology with Theophrastus (c. 372–c. 287 B.C.E.) in the *Historia plantarum* (Research on plants) and *De lapidibus* (On stones), respectively.

A fundamental question was the interaction between environment and humans, particularly health issues. The Hippocratic treatise *Airs, Waters, Places*, probably by the same author as *On Sacred Disease* (second half of the fifth century B.C.E.), is a study of the implications of environment on human health. The wealth of data provided in the work suggests that the idea was not new at the time, and indeed probably had a long history. The discussion centers on diseases and medicines (especially those made from plants). Diseases were attributed to two different, but possibly complementary, causes: internal disturbances (imbalance of the bodily components) and external effects of the environment. The latter was especially implicated in cases of contagious disease—epidemics, in the current meaning of the word—provoked by some corruption of the air, specifically material particles (the *miasmata*). As for medicines,

their action was explained according to two systems, which perhaps developed chronologically: first, a physical immaterial property (heat or cold, for instance) was understood to be transmitted from the medicinal matter to the body. This system implicitly underpins the most important treatise on medicines of antiquity, *De materia medica* by the Greek Dioscorides (first century C.E.). Whatever its nature, such a property was conceived as a material element transmitted from the medicinal plant—for example, to the body—in a way that recalls an archaic conceptualization wherein an immaterial element is transmitted from environment to humans. The nature of the property to be introduced into the body was determined by the nature of the disease, and was intended to compensate for a deficiency according to the principle of allotherapy (*contraria contrariis*). In this way, the environment allowed a return to the natural state of the body.

In a more abstract and probably successive phase, the action of medicines (including plants) was conceived as an exchange of atoms (considered as small indivisible particles, not the atoms of contemporary science). Such a system, which was rooted in atomistic thinking and its medical application, so-called methodism (first century B.C.E.), was best represented by the Greek physician Galen (129–after 216 C.E.). Although more elaborated (since it could account for a wider range of properties), such explanation relied at the end on the same idea as the previous—that is, an exchange between environment and human physiology—with the idea of reestablishing the natural equilibrium of the body. Dioscorides's system, which was most probably not devised by him but utilized anterior knowledge, included a classification of environmental materials ranked so as to form a hierarchy from positively connoted elements to their opposite, with a gradual loss of qualities according to the principle of entropy. Such a classification reflected the history of the world as narrated in the account of the four ages of humankind. According to ancient tales, humankind passed through four ages (from gold to silver, bronze, and eventually iron), each of which corresponded to a degradation of humans' environment and living conditions. Iron era, the present one, is characterized by work, sufferance, and death. Evolution was seen as regressive, not dynamic as in nineteenth-century Darwinian theory, where evolution proceeds by adaptation to changing circumstances and, consecutively, by selection.

Environment and Theology

Astrology presented a special case of the relationship between the environment and health. According to the archaic theory of the symbiosis of environment and humans, planets were among the elements that exerted an influence on individuals, particularly one's health and the course of one's life. Such a system, already attested in Babylonia at the end of the sixth century B.C.E., was transformed in the Greek world from the fourth century B.C.E. onward, with the development of scientific (observational and explanatory) astronomy: as the passage of planets across the sky was predictable, so was their action on the human body. At the end of the fourth century B.C.E., astronomic astrology encountered Eastern and Egyptian religions (where celestial bodies were personalized and venerated as divinities), particularly with the expedition of Alexander the

Great (356–323 B.C.E.) to Persia and India, the conquest and occupation of Egypt, and the creation of Alexandria (332 B.C.E.). Astrology had a new meaning: from its abstract mathematical form, it was personalized and transformed into a religion-like practice, in which the action of divinities—that is, of elements of the world—could be solicited and guided to a determined target, provided that ritual forms were duly followed.

Such para-religious practices, which were not incompatible with the official forms of religion of the Hellenistic and Roman world, collided with Christianity. Following the Jewish tradition, indeed, the new religion conceived the world as God's creation. A new literary genre appeared as early as the fourth century C.E., the *Hexaemeron* (The account of the six days [of creation]), which narrated the whole process of Creation, from the universe to humankind, including the paradisiacal environment. Similarly, a new anthropology developed, first represented by Nemesius of Emesa (fourth/fifth centuries C.E.). Creation included a hierarchy at the top of which was human beings, who had been created in God's image. In this context, there was no place for evolution: Creation was perfect, all the more because the negative forces of the world had been defeated. Humans were entrusted with the mission of governing and preserving the world, because humans were a reflection of God's wisdom. This theological concept had an impact on such scientific questions as the causes of disease and the origin of the therapeutic properties of plants and other natural substances. Neither resulted from natural causes: diseases were inflicted by God as punishment of sins, and plants were curative owing to the grace of God. The materialistic system was abandoned in favor of that proposed by Galen, which was much more compatible with the Christian understanding of the environment, due to its immaterial nature. As a result of this new vision of the world, human beings' relationship with the environment was no longer direct, but mediated through God. Such a triangular understanding, which lasted until the seventeenth century at least, did not prevent, however, humans from studying and knowing the world: such an undertaking reflected human beings' nature as God's creation. The study and contemplation of the environment, and the exploitation of its resources, became occasions for individuals to discover and adhere to the plan of God.

Contemporary Approaches

From the Renaissance onward, the idea of the environment underwent several successive and rapid transformations. The natural world became a sphere of aesthetic feeling and theist religiosity; it could restore well-being and reflect as well as be imbued with human emotion. It became an object of positivist study and exploitation for human economic activity during the industrial revolution and afterward. In the twentieth century, understanding of the environment was shaped by a broad range of factors such as extensive farming and overexploitation of natural resources; the systematic screening of floras in search of new molecules with previously unknown therapeutic activity; global transportation favoring the transfer of plants and animals into nonnative habitats, where they become invasive, threatening native biota; and the escalation in the size of in-

dustrial plants and commercial vectors. The latter concern is related to such major environmental catastrophes as the oil spill of the supertanker *Torrey Canyon* off the coast of England in 1967, and of a spill by the *Amoco Cadiz* almost ten years later (1978) affecting the beaches of France and England; the emission of a vapor cloud containing toxic dioxin after a chemical facility explosion in Seveso, Italy, in 1976; the partial meltdown of an atomic reactor at Three Mile Island in the United States in 1979; and the explosion of a similar reactor at Chernobyl, in Ukraine, in 1986.

The absence of preventive regulations and of policies to compensate for damages to persons and the environment after such disasters, in addition to advances in genetic engineering enabling modifications in nature, and globalization, creating a feeling of ubiquity and a common model of thought, contributed during the last decades of the twentieth century to initiatives addressing uncontrolled technological development and the dangers posed to the environment. The modern ideology of continuous and cumulative advances in technological civilization and hence of social well-being came into question, with lingering concerns that history does not necessarily lead to a better future. This was accompanied by the notion that social and technological progress had led to humans being cut off from their environment. Perhaps in reaction to this feeling, an avid search for connection began, for a recovery of a direct and personal contact with nature, a reengagement with traditional environmental values. Such a return took several different forms and affected many if not all areas of contemporary societies in developed countries, from scientific research in traditional (natural) medicines, for instance, to repatriation programs, to protection of the intellectual property of local, namely traditional, communities on the uses of natural substances, to large-scale international agreements such as the Convention on Biological Diversity (1992). "Ecotourism," environmental management, and sustainable development were all concepts aimed at leaving to future generations a healthy and viable world.

See also *Animism; Bioethics; Evolution; Materialism in Eighteenth-Century European Thought; Nature; Religion; Science: Overview; Technology.*

BIBLIOGRAPHY

- Black, Jeremy, and Anthony Green. *Gods, Demons, and Symbols of Ancient Mesopotamia: An Illustrated Dictionary*. Austin: University of Texas Press, 1992.
- Chadwick, Derek J., and Joan Marsh, eds. *Ethnobotany and the Search for New Drugs*. Chichester, U.K.: Wiley, 1994. An overview of current research methods and approaches.
- Convention on Biological Diversity. Available at <http://www.biodiv.org/convention/articles.asp>.
- Dubos, René. "Environment." In *Dictionary of the History of Ideas: Studies of Selected Pivotal Ideas*. Edited by Philip P. Wiener. Vol. 2. New York: Scribners, 1973.
- Fritz, Robert S., and Ellen L. Simms, eds. *Plant Resistance to Herbivores and Pathogens: Ecology, Evolution, and Genetics*. Chicago and London: University of Chicago Press, 1992.
- Johns, Timothy. *The Origins of Human Diet and Medicine: Chemical Ecology*. Tucson: University of Arizona Press, 1996. On

the adaptive responses of plants to stresses from the environment, including the process of domestication.

- Larchet, Jean-Claude. *Théologie de la maladie*. Paris: Editions du Cerf, 1991.
- Robic, Marie-Claire et al., eds. *Du milieu à l'environnement: Pratiques et représentations du rapport homme/nature depuis la Renaissance*. Paris: Economica, 1992.
- Rumsey, Alan, and James Weiner, eds. *Emplaced Myth: Space, Narrative, and Knowledge in Aboriginal Australia and Papua New Guinea*. Honolulu: University of Hawaii Press, 2001.
- Schultes, Richard Evans, and Siri von Reis, eds. *Ethnobotany: Evolution of a Discipline*. Portland, Ore.: Dioscorides, 1995. A selection of readings.
- Touwaide, Alain. "Therapeutic Strategies: Drugs." In *Western Medical Thought from Antiquity to the Middle Ages*, edited by Mirko D. Grmek. Cambridge, Mass., and London: Harvard University Press, 1998.
- Whorton, James C. *Nature Cures: The History of Alternative Medicine in America*. Oxford and New York: Oxford University Press, 2002.

Alain Touwaide

ENVIRONMENTAL ETHICS. Environmental ethics emerged as a subdiscipline of philosophical ethics in the early 1970s, following the first Earth Day in 1970 and a sharply increased awareness of environmental problems at that time. Courses began appearing in university curricula, and books, articles, and journals proliferated to meet the growing interest. To judge by student demand and university courses and programs, environmental ethics is today a mature and robust subject. To judge by intellectual content, however, it is still in the early stages of development.

Antecedents

The intellectual sources of environmental ethics go back at least to God's first injunction in Genesis 1:28: "Be fruitful, and multiply, and replenish the earth, and subdue it: and have dominion over the fish of the sea, and over the fowl of the air, and over every living thing that moveth upon the earth." Literary discussions of the value of nature in the West, having been stimulated by global exploration and the European discovery of the Americas, go back at least to the sixteenth century. Wilderness began to appear as an allegorical theme in European and American painting in the eighteenth century. The awesome forces of nature remind us that the human condition demands the virtues of faith, hard work, and steadfastness as we negotiate the path of our lives on earth. These writings and images of course helped shape the themes of contemporary environmental ethics, and today's writers also pay homage to Ralph Waldo Emerson (1803–1882), Henry David Thoreau (1817–1862), and the views of early-twentieth-century writers like Gifford Pinchot (1865–1946) and John Muir (1838–1914).

Of these early sources for environmental ethics, none is more significant than Aldo Leopold (1887–1948), an ecologist and wildlife manager who in his essays argued the need to

reconsider our attitude toward nature. Writing in *A Sand County Almanac* (1949), his frequently cited classic of American nature writing, Leopold bemoaned the fact that, as it appeared to him, “there is as yet no ethic dealing with man’s relation to land and to the animals and plants which grow upon it,” and called for an evolutionary shift in what he viewed as the traditional perspective in ethics. “All ethics so far evolved rest upon a single premise: that the individual is a member of a community of interdependent parts. His instincts prompt him to compete for his place in that community, but his ethics prompt him also to cooperate” (pp. 203–204). Arguments for cooperation in ethics, however, had been limited in scope to other humans. Leopold urged his readers to think about cooperation in a more expansive sense, which would include the environment. This land ethic, as he called it, “simply enlarges the boundaries of the community to include soils, waters, plants, and animals, or collectively: the land.” Without much defense or argument, Leopold went on to formulate some basic principles of a land ethic, but his influence on later writers comes mainly from his vision that enlarging the scope of ethical concern is a mark of intellectual progress.

The Debate over Anthropocentrism

Following Leopold’s suggestion, the central issue in the first quarter century of environmental ethics has been a debate about anthropocentrism and the idea of intrinsic ethical value. Traditional ethical theories are characterized as anthropocentric because they regard only humans or human experience (or reason) as having intrinsic ethical worth. Everything else is valuable only as a means to promoting or enhancing human interests. For Aristotle, this much is obvious. “Clearly, then, we must suppose . . . that plants are for the sake of animals, and that other animals are for the sake of human beings. . . . If then nature makes nothing incomplete or pointless, it must have made all of them for the sake of human beings” (*Politics*, 1256b15–22) John Locke, writing in the seventeenth century, reflected the consensus view when he spoke of the distinction between man and nature. Mankind is “the workmanship of one omnipotent, and infinitely wise maker,” and thus the law of nature teaches us that man “has not the liberty to destroy himself,” and that “no one ought to harm another in his life, health, liberty, or possessions” (*Second Treatise of Government*, chap. 2, par. 6). But reason also tells us that, “land that is left wholly to nature, that hath no improvement of pasturage, tillage, or planting, is called, as indeed it is, *waste*; and we shall find the benefit of it amount to little more than nothing” (chap. 5, par. 42). For land to have value, it must be made to serve human needs and ends.

The classical utilitarians were the first to move explicitly beyond anthropocentrism. They argued that sentience was the locus of intrinsic value, and thus the ultimate ethical end was an existence “exempt as far as possible from pain, and as rich as possible in enjoyments.” Morality consists of “rules and precepts,” as John Stuart Mill (1806–1873) put it in his *Utilitarianism* (1861). Its aim is to secure such an existence “to all mankind; and not to them only, but, so far as the nature of things admits, to the whole sentient creation” (chap. 2). Although utilitarianism may provide a basis for rejecting an-

thropocentrism, it will not get us to anything resembling a land ethic. Even if sentience is a sufficient basis for gaining intrinsic worth or value, it gives us no reason for regarding endangered species, forests, wilderness, or ecosystems as worth preserving in their own right. Thus, philosophers who follow Leopold have rejected utilitarianism along with anthropocentric conceptions of ethics.

The problem with extending the scope of morality beyond sentience is to explain the basis for attributing intrinsic value to entities that have no inner lives and are not subjects of experience. Two ways of attempting this extension figure most prominently in the literature. The first is to identify intrinsic value with having an interest, which is interpreted in turn as having an end or a natural good. If it makes sense to say of any thing that it has an end, then we can make sense of talking about what is good or bad for that thing. And just as sentient beings have an interest in not suffering, all living things, sentient and nonsentient alike, have an interest in realizing their natural ends. It is in this sense good for any such thing to thrive (Goodpaster).

One objection to extending the scope of intrinsic ethical value in this way is that the idea of having an end or a natural good applies to more than living organisms. This might appear to be a good thing for the purposes of developing environmental ethics in the direction of a land ethic, because it would allow us to include entities like species and ecosystems within the community of intrinsically valuable beings. An ecosystem is not a living organism, but it has a good (however difficult it may be to determine it), which it is in its interest to realize. The problem is that this analysis does not allow us to discriminate among living things to exclude deadly viruses or invasive species from having intrinsic moral worth, nor does it allow us to discriminate among other nonliving entities with ends, such as gangs, terrorist cells, or corrupt political regimes. Each of these has ends and an interest in thriving, but surely they do not all have intrinsic moral worth.

A second objection to this proposal is that it equivocates on the morally relevant concept of an interest. Utilitarians extend the idea of intrinsic moral worth to sentient creatures because nonhuman animals not only have an interest in avoiding suffering, they can act in ways that show that they take an interest in seeking enjoyment and avoiding pain. If human suffering is morally relevant not merely because we are capable of suffering but because as conscious agents we care about or take an interest in avoiding suffering, then nonhuman suffering should be morally relevant for the same reason. But when we talk about the interests of nonsentient entities (and perhaps the interests of many species of lower animals, such as sponges or clams), we do so in a different sense. They may *have* interests, but they cannot *take* an interest in anything. It begs the question to suppose that having an interest in any sense that does not presuppose subjectivity or consciousness has any moral relevance of its own.

A second way to reject anthropocentrism and extend the scope of intrinsic ethical value beyond sentience is associated with deep ecology, a political movement that emerged in the

1980s in response to disillusionment with large, well-funded environmental groups that some critics saw as having been co-opted by prevailing political powers. The “shallow ecology” of these large environmental organizations, in the eyes of their critics, was associated exclusively with the fight against pollution and resource depletion, which were seen as elitist and anthropocentric goals of affluent classes living in developed countries. Deep ecology defends the idea of ecocentric identification, a form of self-realization, which calls on us humans to see ourselves not at the top of creation but as merely one part of the “web of life,” on an equal footing with every other part. The deep ecology manifesto claims that nonhuman life has value in itself that is “independent of the usefulness of the nonhuman world for human purposes” (Devall and Sessions, p. 70). If a living, free-flowing river is a good thing to have on this planet, then it is good independently of human existence and interests, and it would equally be a good thing on a planet that never hosted conscious life.

Leaving political agendas aside, many people who have sympathy for Leopold’s land ethic find deep ecology an unsatisfying way to develop the idea. It is one thing to believe that traditional conceptions of ethics have perhaps wrongly viewed nature as having no value except as resources for human satisfaction. It is quite a different matter to think that the only alternative to such a conception of ethics is ecocentric identification in the sense demanded by deep ecology.

Value as a Feature of Actions and Attitudes

Early in the twentieth century, G. E. Moore (1873–1958) argued that goodness was a nonnatural property that good things possessed, and although his arguments for this view have had a profound influence on the course of ethical theory, the view itself is not widely accepted (chaps. 1–3). There seems no satisfactory way to resolve disagreements over what things have this property or how to act and make tradeoffs when necessary. Should we preserve the redwood trees, or clear them to make room for the weeds that will thrive in their place? It will not do to identify ethical value with the products of evolution or natural processes, for humans are natural creatures and our creations are in some sense as much a part of nature as fossils and spider webs. What makes the forest more valuable in its own right than the strip malls along the highway? The idea that value is a nonnatural intrinsic property of things is mysterious, and many philosophers simply reject Moore’s intuitions about what has it and what does not. Nor could the existence of such value in itself tell us much about what to do or how to act and choose. These same issues arise for deep ecology and for any attempt to move beyond anthropocentrism in locating intrinsic ethical value.

If we think about value as something we express in our actions and attitudes, rather than as an intrinsic property of objects, then the difference between anthropocentrism and its opposite seems smaller and less significant. For even those who insist that value originates in reasons and attitudes are quick to acknowledge that we value different parts of the world in different ways and for a multitude of reasons. This includes valuing things other than humans, human experiences, and reason as ends. We can realize Leopold’s vision of

a land ethic without rejecting anthropocentrism, by concentrating instead on the reasons we have for attitudes toward nature that see it as worth preserving in its own right. Thinking of nature as a resource for our use in promoting human enjoyment is of course one attitude we may have, and thinking about the effects of environmental change on human health is another. But we also find it reasonable to adopt attitudes of appreciation, reverence, awe, love, and fear toward different parts of the world around us, and the appropriateness of these attitudes moreover seems to be connected intimately to other aspects of morality, such as the virtues of humility and gratitude (Hill).

Ethics and Environmental Policies

The appropriateness and implications of these attitudes give rise to other substantive issues in environmental ethics because they imply that it is reasonable to value different parts of nature in ways that go beyond the distinction between valuing something instrumentally and valuing it as an end. Thus, one topic in environmental ethics concerns the appropriateness of using decision-making techniques developed by economists for determining environmental policies. These techniques are enormously flexible, and they include regarding aspects of the environment as having existence value as well as use value. But these techniques in the end measure values in terms of a willingness to pay for different levels and kinds of protection. They assume that environmental values are commensurable, but it remains an open question in environmental ethics whether this is true. Distinguishing between use value, existence value, and the addition of other values that can be measured by these techniques may also fail to address the appropriate ways to express reverence or respect, and these are the kinds of attitudes that some people believe a reasonable land ethic demands.

A related topic in environmental ethics concerns the way we interpret the value of ecosystems. An endangered ecosystem, or an endangered species within an ecosystem, may be valued differently according to whether we think of an ecosystem only as providing useful services or also as worth preserving in its own right. Debates on this issue go to the meaning of environmental protection and to the reasonableness of some statutes like the Endangered Species Act.

At least three other kinds of substantive issues have emerged recently as major topics in environmental ethics. One has to do with the nature of environmental risk of the kind one finds in issues surrounding possible climate change and global warming. What are rational decision procedures in areas involving great uncertainties but also possibilities of very large consequences and irreversible changes? Should we be aiming to maximize expected values, or should we be trying instead to develop and apply more precautionary principles? A second issue has to do with depleting nonrenewable environmental resources. What are our obligations as stewards of the environment to future generations, and what do we regard as appropriate substitutions for the resources we deplete, so that we can protect the environment in a sustainable way? A third issue concerns environmental justice. Do we need special principles of distributive justice to ensure that economically

disadvantaged or politically vulnerable populations do not bear unfair environmental burdens?

These issues are often addressed by writers who express little concern with the philosophically more basic questions about the nature of environmental values, but as discussion of these substantive issues proceeds, it usually leads back to basic questions in ethical theory. For these reasons, environmental ethics is not only a popular and apparently permanent part of university curricula, it is also a subject that increasingly draws the attention of philosophers who are concerned with the more basic and theoretical parts of their subject.

See also *Ecology; Nature; Wildlife*.

BIBLIOGRAPHY

- Crocker, David A., and Toby Linden, eds. *Ethics of Consumption: The Good Life, Justice, and Global Stewardship*. Lanham, Md.: Rowman and Littlefield, 1998.
- Devall, Bill, and George Sessions. *Deep Ecology*. Salt Lake City: G. M. Smith, 1985.
- Feinberg, Joel. "The Rights of Animals and Unborn Generations." In *Philosophy and Environmental Crisis*, edited by William T. Blackstone, 43–68. Athens: University of Georgia Press, 1974.
- Goodpaster, Kenneth. "On Being Morally Considerable." *Journal of Philosophy*, 75, no. 6 (1978): 308–325.
- Hill, Thomas E., Jr., "Ideals of Human Excellence and Preserving Natural Environments." *Environmental Ethics* 5 (1983): 211–224.
- Leopold, Aldo. *A Sand County Almanac, and Sketches Here and There*. New York: Oxford University Press, 1949. Reprint, 1987.
- Naess, Arne. "The Shallow and the Deep, Long-Range Ecology Movement. A Summary." *Inquiry* 16 (1973): 95–100.
- Nash, Roderick. *Wilderness and the American Mind*. 3rd ed. New Haven, Conn.: Yale University Press, 1982.
- Plumwood, Val. *Feminism and the Mastery of Nature*. London and New York: Routledge, 1993.
- Rolston, Holmes, III. "Values in and Duties to the Natural World." In *Ecology, Economics, Ethics: The Broken Circle*, edited by F. Herbert Bormann and Stephen R. Kellert, 73–96. New Haven, Conn.: Yale University Press, 1991.
- Singer, Peter. "The Environment" In his *Practical Ethics*, 264–288. 2nd ed. Cambridge, U.K., and New York: Cambridge University Press, 1993.
- Sober, Elliott. "Philosophical Problems for Environmentalism." In *The Preservation of Species: The Value of Biological Diversity*, edited by Bryan Norton, 173–194. Princeton, N.J.: Princeton University Press, 1986.

Douglas Maclean

ENVIRONMENTAL HISTORY. Environmental history is the study of the changing affairs of humans within the natural world. This definition, in contrast to other useful phrasings, such as the study of "interactions between humans and nature" (Merchant, 2002, p. xv), embodies a fundamental, not merely semantic, point of emphasis. First, and obviously, humans are part of nature, biological organisms subject to the laws of physics and biology. More importantly, hu-

mankind must be situated within natural processes because, not only do they affect human societies and economies, but human actions increasingly influence natural processes. In the past one hundred years and more, human transformation and degradation of the environment has grown to such proportions that humanity fondly imagines it is liberated from physical limitations and controls nature. It does not. What people need, instead, is an accurate view of their place in nature. Environmental history is a powerful tool for gaining knowledge that can secure humanity's future.

Certain key characteristics of the relatively new field of environmental history, especially its parameters and achievements, can be apprehended in a number of ways: by describing its emergence since the 1970s as a coherent subfield of historical inquiry; identifying the range of interests pursued by environmental historians; assessing the crucial importance of interdisciplinary methods in its practice; considering how environment intersects with gender as an analytical category; and discussing the interplay of different genres and narrative strategies, and the progressive expansion of scale in individual studies.

Development of the Field

Environmental history seemingly burst into view in the scholarly world in the 1970s. Intellectual and political trends, such as the controversy over Rachel Carson's *Silent Spring* (1962) and the first Earth Day (1970), motivated many historians to explore historical aspects of environmental problems. But there were important precursors to the developments of the 1970s, even though this research derived from other specialties and was not explicitly conceived as environmental history. Samuel P. Hays's *Conservation and the Gospel of Efficiency* (1959) was a landmark work on environmental politics, and Roderick Nash's *Wilderness and the American Mind* (1967) carefully documented evolving perceptions of nature as embodied in wilderness in the United States. Walter Prescott Webb and James Malin produced even earlier work on the Great Plains, which are now acknowledged as pioneering environmental histories, though their primary impact only came later. Influential work by Marc Bloch, Fernand Braudel, and other French historians of the Annales school (founded 1929) inspired others to look anew at agricultural landscapes and the broader role of geography in human affairs.

From the 1940s, the Berkeley school of historical demographers (including historians Woodrow Borah and Lesley Simpson, physiologist Sherburne Cook, and geographer Carl Sauer) initiated the study of Indian population decline in colonial Mexico and the related topics of economic stagnation, land exploitation, and soil erosion. But among the most important contributors to this "prehistory" of environmental historiography were historically minded researchers who were not professional historians, such as geographers Sauer and Clarence Glacken and scientists such as Carson and Aldo Leopold, as well as unclassifiable intellectuals such as Lewis Mumford. By the mid-1970s, with the founding of the American Society for Environmental History and its journal, *Environmental Review* (now *Environmental History*), a distinct field of inquiry had emerged, making it almost impossible to discuss the environ-

ment without referring often to the substantial contributions of history.

What Is Environmental History?

A coherent definition helps one understand environmental history. The field emerges still more clearly when considering its range and subject matter, including the prominent issues raised in public discourse on the environment—land degradation, air and water pollution and waste disposal, wildlife conservation and wilderness preservation—but its importance goes beyond simply adding time-depth to current political debates. Environmental history encompasses a holistic view of history through the human–nature nexus, and, while not all history is environmental, the field has quite broad parameters. A recent list of topics in U.S. environmental history applies well, with modifications, to global concerns:

modes of living and patterns of natural resource use of indigenous peoples in the Eastern and Western hemispheres;

ideas, plants, animals, diseases, people, and production systems transplanted or encountered by European colonizers and entrepreneurs;

interactions between genders and racial and ethnic groups vying for control of resources;

practices, regulations, and laws used to manage the land;

effects of industrialization and urbanization in creating environmental problems;

ideas about nature and humans' place in it; and

struggles to direct or moderate the impacts of economic development (Merchant, 2002, p. xiv).

Environmental historians also address issues specific to particular places and times, and in this endeavor they are strongly influenced both by historic and current events. The African droughts and famines of 1968 to 1974 and 1984 to 1985 drew attention to the history of famine and food supply, and highlighted the importance of fluctuations in global climate related to El Niño episodes (the periodic warming of ocean currents in the South Pacific), which helped account for still earlier droughts. The post-Columbian collapse of Native American populations brought on by European-introduced diseases inspired fierce debates and research on this unprecedented catastrophe, and on the history of disease in general. Asia's densely populated agrarian landscapes and ancient cities shaped historians' interest in agricultural ecology, irrigation systems, and patterns of urban production and consumption. Few of these issues are exclusive to one area: they point to the necessity of addressing variations in the historical experience of different regions and indicate the broad scope of environmental history.

Richard White's overview of environmental history shows how the field has expanded. While early studies often focused on ideas about nature or political struggles over conservation, partly because of abundant data in the written sources tradi-

tionally available to historians, White speculated on future developments in environmental history. After twenty years, one major trend is clear: the proliferation of studies that document and analyze the actual processes of ecological change occurring around the world. Environmental historians have not abandoned their interest in politics and philosophy; they increasingly link them in suggestive ways to interpret observable transformations. Carolyn Merchant formulates a promising synthesis with her theory of ecological revolutions, which are

major transformations in human relations with nonhuman nature. They arise from changes, tensions, and contradictions that develop between a society's mode of production and ecology, and between its modes of production and reproduction. These dynamics, in turn, support the acceptance of new forms of consciousness, ideas, images, and worldviews. (1989, pp. 2–3)

Her New England study identified colonial and capitalist ecological revolutions, and posited a coming global ecological revolution, offering hope for a sustainable world. Searching everywhere for the same sequence of revolutions would be problematic; in much of Africa and Asia, for instance, capitalism arrived before formal colonialism. But the general concept of ecological revolutions is a valuable one, and has been applied elsewhere (see Jacobs, p. 75).

Interdisciplinary Methods

As the preceding discussion indicates, environmental history draws on an array of disciplines for data, research methods, analytical frameworks, and theoretical insight. Like other historians, environmental historians still rely on written evidence for primary source material. But their subject matter, emphasizing the role of nonhuman nature in human history, requires them to look beyond written records, which contribute so much to history, because for many times and places the physical environment is sparsely documented. Those conventional sources that do exist may not readily yield answers to the questions asked of them, compelling researchers to turn to other disciplines for interpretive assistance. Anthropology, ecology, economics, epidemiology, geography, philosophy, political science, religion, sociology, the history of technology, and women's studies all make vital contributions to understanding the history of humans within nature. Environmental history developed out of necessity as a kind of "interdisciplinary discipline," and it remains so at the start of the twenty-first century, albeit with most practitioners identifying themselves as historians.

Some environmental historians initially drew on ecology, in particular, to enhance their work, attracted by its holistic conception of the earth as a web of organic relationships. In practice it has proven difficult to apply concepts derived from the sciences to human history directly, with all its messy indeterminacy, contingency, and unpredictability. Geography probably did more to shape the field by documenting changing patterns of settlement, land use, and alterations in landscape itself. Field scientists, geographers, and anthropologists inspired the strong commitment to field research that distinguishes environmental history from other kinds of history. As

R. H. Tawney famously observed, “What historians need is not more documents but stronger boots” (quoted in Hancock, p. 95). His point was more about engaging with the wider world, but some historians responded literally by pulling on boots and exploring the great outdoors.

Anthropology’s fieldwork methods, particularly participant observation, increasingly influenced environmental historians, who took up extended residence in the communities and environments they studied and learned how people actually utilized and interacted with nonhuman nature. Such fieldwork, including data from oral interviews with informants, opened new avenues of inquiry, especially in regions like Africa, the Americas, and other places where literacy either developed relatively recently or reflected the experiences of dominant political and economic actors (Jacobs; Moore and Vaughan). The most fruitful approaches combine written sources with the results of community-based fieldwork.

Environment and Gender

One sign that environmental history is still an evolving field is an awareness of gaps in coverage of its subject matter. As William Cronon notes, environmental historians need to do more “to probe below the level of the group to explore the implications of social division. . . . In the face of social history’s classic categories of gender, race, class, and ethnicity, environmental history stands much more silent than it should” (cited in Jacobs, p. 17). It is not enough to document the role of irrigated rice production in South Asian economies, Americans’ changing perceptions of nature, or the benefits to Argentina of commercial wheat and beef production. One must always ask who dug or maintained irrigation works and who appropriated the harvest; who wrote and read books on wilderness; and which Argentines owned or worked the fields and factories.

Analyzing class and race or ethnic relations in these and other settings clearly strengthens environmental history, as recent studies show. Perhaps the most crucial analytical category for environmental history is gender, and not only because this “minority” actually comprises a majority of humankind. Past discussions of gender and environment mythologized men as hunters or exploiters of nature and females as mothers, nurturers, and protectors of nature, with the latter an especially problematic class- and race-based notion. Merchant provides much data on women’s work in New England agriculture and industry, but this issue emerges still more clearly when examining the lives of women beyond modern Europe and America. For the vast majority of non-Western women, living with nature involves hard, unrelenting work: fetching water and wood for fuel, growing and preparing food, craft and commodity production to generate income, in addition to the demands of childcare. Enjoying nature’s beauty is an unaffordable luxury in such circumstances. One recent study does much to bridge the gap in understanding by revealing the history of women in U.S. national parks, with a strong oral history component linking their activities as tourists and conservation advocates to professional careers as National Park Service employees. As Kaufman shows, accurately reconstructing past lives requires using sophisticated and multilayered levels of analysis.

Genre, Scale, and Narrative

In what form does environmental history scholarship reach its audience? The choice of unit of study influences research and writing. This is often geographical, such as a national park, river valley, dam, region, or individual city, but can be an idea like environmentalism or an occupation such as hunting; detailed case studies presented in research monographs and articles comprise the most common publications. Despite occasional misgivings among practitioners, the case study is the essential building block for knowledge in environmental history. The need for in-depth research, using archives, field exploration, oral history, and expertise in related disciplines helps keep projects within manageable size. Singling out any particular book discriminates against numerous other fine case studies, but Nancy Jacobs’s *Environment, Power, and Injustice* (2003), on the Kuruman region in South Africa, realizes much of environmental history’s potential in exploring the connections between nature, race, class, gender, state power, and economic development.

Some of the most exciting environmental histories synthesize primary data and case studies to expose crucial connections between regions or events previously examined in isolation. Alfred Crosby’s excellent *The Columbian Exchange* (1972) shows how exchanges of people, plants, animals, and germs between Eastern and Western hemispheres shaped their history. His *Ecological Imperialism* (1986) extended that analysis with the concepts of “demographic takeover” of Neo-Europes (including North America, Australia, New Zealand, Argentina, and Uruguay), though his earlier emphasis on mutual exchanges between colonizers and colonized is missing. Richard Grove’s many publications on the history of environmentalism break new ground by showing the development of environmental thinking in Europe’s island colonies such as Mauritius, St. Helena, and the Caribbean, and also India and South Africa. His work extends the search for environmentalism’s roots beyond U.S. intellectual history, though the issue of whose influence was first and greatest is best viewed in terms of multilinear intellectual evolution. Such works conceived on a global scale seem well suited to making connections between human activity and nonhuman nature over time.

Environmental histories often have a characteristic structure, a declension narrative, or story of decline and degradation. The facts of ecological change and nature’s devastation by humans provide ample evidence of destruction, but historians increasingly recognize the need for more conscious choice in telling such stories. Describing the replacement of indigenous species by exotic invaders, for instance, as a process of decline, let alone in terms of good or bad, reveals an implicit value system. Do people destroy nature or improve on it? Cronon’s analysis of soil erosion in 1930s America shows how the same events can be variously interpreted, depending on how one perceives change. Part of the burden originates in assumptions that major historical processes, such as the spread of capitalism or colonialism, are inherently wrong, yet even Karl Marx viewed capitalism as a progressive force, creating as much as it destroyed. In Cronon’s words, “At its best, historical storytelling keeps us morally engaged with the world by showing us how to care about it and its origins in ways we had not done before” (p. 1375; also see McCann). The challenge

is to avoid unknowingly smuggling one's moral values into a narrative under the guise of objectivity.

Present and Future Prospects

An accurate conclusion requires a dose of realism. In spite of its numerous contributions and the respect accorded to individual practitioners, environmental history has not taken over the historical profession. Some other historians continue to view it as marginal, even trendy, though an endeavor that flourishes for decades surely constitutes more than a "trend." The finite influence of intellectuals in public discourse, notably in the United States, amplifies this marginalization, as does any public perception that environmental regulation entails job losses or lower standards of living. Unlike disciplines such as economics or public health, history is more suited to reflection, not solving practical problems, so a presentist quest for utility or "relevance" remains a lesser priority.

Despite these caveats, environmental history helps to educate an informed citizenry. Contemporary environmental challenges are not going away, and will likely worsen in the twenty-first century: a global capitalist economy that neglects environmental and social costs of maximizing profits; a growing and aging human population that everywhere aspires to higher material standards of living; sharper conflicts over access to increasingly depleted critical resources such as water, land, food, and sources of energy. These and other potential crises must be confronted if humans are to sustain life on the planet. One is left hoping, as Merchant suggests, that a global ecological revolution in thought and behavior is on the horizon, and environmental history has a part to play in this transformation.

See also *Development; Ecology; Environment; Environmental Ethics; Nature; Science; Wildlife.*

BIBLIOGRAPHY

- Arnold, David, and Ramachandra Guha, eds. *Nature, Culture, Imperialism: Essays on the Environmental History of South Asia*. Delhi, India: Oxford University Press, 1995.
- Cronon, William. "A Place for Stories: Nature, History, and Narrative." *Journal of American History* 78 (1992): 1347–1376.
- Crosby, Alfred W. *The Columbian Exchange: Biological and Cultural Consequences of 1492*. Westport, Conn.: Greenwood, 1972.
- . *Ecological Imperialism: The Biological Expansion of Europe, 900–1900 A.D.* Cambridge, U.K., and New York: Cambridge University Press, 1986.
- Grove, Richard H. *Green Imperialism: Colonial Expansion, Tropical Island Edens, and the Origins of Environmentalism, 1600–1860*. Cambridge, U.K., and New York: Cambridge University Press, 1995.
- Hancock, W. K. *Country and Calling*. London: Faber and Faber, 1954.
- Jacobs, Nancy J. *Environment, Power, and Injustice: A South African History*. Cambridge, U.K., and New York: Cambridge University Press, 2003.
- Kaufman, Polly Welts. *National Parks and the Woman's Voice: A History*. Albuquerque: University of New Mexico Press, 1996.
- McCann, James C. *Green Land, Brown Land, Black Land: An Environmental History of Africa, 1800–1990*. Portsmouth, N.H.: Heinemann, 1999.

Merchant, Carolyn. *The Columbia Guide to American Environmental History*. New York: Columbia University Press, 2002.

———. *Ecological Revolutions: Nature, Gender and Science in New England*. Chapel Hill and London: University of North Carolina Press, 1989.

Moore, Henrietta L., and Megan Vaughan. *Cutting Down Trees: Gender, Nutrition, and Agricultural Change in the Northern Province of Zambia, 1890–1990*. Portsmouth, N.H.: Heinemann, 1994.

White, Richard. "American Environmental History: The Development of a New Historical Field." *Pacific Historical Review* 54 (1985): 297–335.

Thomas Pyke Johnson

EPICUREANISM. Epicureanism gets its name from Epicurus (341–270 B.C.E.), who founded his philosophical school (The Garden) in 306 B.C.E. at Athens. Epicureanism emerged at roughly the same time as Stoicism, which was founded by Zeno of Citium (c. 335–c. 263 B.C.E.) and developed by Chrysippus of Soli (c. 280–206 B.C.E.). Epicureanism was introduced into Rome in the early second century B.C.E. where it caught the attention of Cicero (106–43 B.C.E.) and also the poet Lucretius (c. 96–c. 55 B.C.E.), who wrote *De rerum natura* in an effort to explain Epicureanism. Horace (65–8 B.C.E.) and Virgil (70–19 B.C.E.) were also notably associated with Epicureanism.

Epicureanism, as an acceptable metaphysical viewpoint, was suppressed once Christianity began to experience some success by the second century C.E. Christians were critical of the apparently selfish nature of Epicurean teachings on pleasure. Epicureanism essentially disappeared for about one thousand years until it was revived by Lorenzo Valla (1405–1457), who criticized Scholasticism in *Disputazioni dialettiche* and supported Epicureanism in *De Voluptate*. Pierre Gassendi (1592–1655), the critic of Scholasticism and of Descartes, often gets the credit for rediscovering Epicureanism, however, with his *De vita et Moribus Epicuri*. The influence of Gassendi's work on John Locke (1632–1704) has been credited with providing the impetus for Locke's social contract theory and, by extension, for the American Revolution. Indeed, Thomas Jefferson (1743–1826) himself claimed, in a letter to William Short (dated 31 October 1819), to be an Epicurean. Finally, Epicureanism must be distinguished from utilitarianism, which arose during the nineteenth century. Utilitarianism retains the Epicurean view that humans naturally seek pleasure and avoid pain, but while Epicureans laud pleasure seeking and pain avoidance for their effects on the psychological state of the actor, utilitarians use it to express the consequentialist view that a good action maximizes pleasure and minimizes pain.

Epicurus on Pleasure

While Epicureanism is not strictly an ethical theory, it has been most influential in the field of ethics. Epicurus emphasized empiricism, and his theories were foundationalist in the sense that he believed all sense perceptions were true (Inwood and Gerson, A53.63). In keeping with this, he denied that a theory of meaning was possible. Rather, we come to a "basic grasp"

(prolepsis) of what people say based on our memories of “what has often appeared in the external world” (Inwood and Gerson, A7.33). As such, the Epicurean notion of *areté* (human excellence) involves pleasure, and we do have some sensible experience with pleasure. It should be very easy to attain human excellence in this sense, but Epicurus believed that many people were not excellent. To address this problem, Epicurus developed a psychological theory, which argued that most people suffer from neurotic beliefs that inhibit the pursuit of the pleasant life. He identified the neurotic beliefs as a fear of death and a misunderstanding of the gods. He claimed that neither death nor the gods concerned humans and thus they should not fear them. We must overcome these fears in order to live a pleasant life.

Epicurus conceived of pleasure in two ways. “Kinetic” pleasure is that pleasure felt while performing an activity, such as eating or drinking. “Katastematic” pleasure is that pleasure felt while being in a state. This is the pleasure of not being disturbed, of being free from pain. Both types of pleasure occur in the body and the soul. The absence of pain (katastematic pleasure) in the soul (*ataraxia*), though, is the highest good for Epicurus.

Epicurus has often been misunderstood as a “sensualist.” Cicero, an avowed Stoic, seemed to think that kinetic pleasure was also an end for Epicurus (*De Finibus* II.31–32). But this does not seem to be correct. While kinetic pleasures are desirable for Epicurus, they are not always to be pursued. In fact, it seems that they should be pursued only when they contribute to *ataraxia* (untroubledness). In some cases it might even be necessary to endure pain in order to preserve or contribute to *ataraxia*.

Epicurus on Human Excellence

According to Stephen Rosenbaum, most scholars now recognize that Epicureanism did not advocate a life of sensual delights. Rather, the Epicurean pursues “sober reasoning” to achieve the “pleasures” of *aponia* (absence of pain in the body) and *ataraxia* (p. 21). Nonetheless, this does not entail the elimination of desires. When one is in the state of *ataraxia*, one does not avoid opportunities to enjoy kinetic pleasures, but at the same time one is not bothered by the absence of these opportunities. If one has developed a taste for caviar, for example, one enjoys it when it is available and is not disturbed by its absence.

Epicurus has also been criticized for his notion of excellence. Excellence and pleasure are inseparable for Epicurus. But we do everything for the sake of pleasure (*ataraxia* in particular) not excellence. *Ataraxia*, then, is the highest human good. Cicero argues that occasions might arise where pleasure-seeking conflicts with acting virtuously (i.e., for the right reason) (*De Finibus* II.68–73, 111ff.). He claims that it is not possible to do something for the right reason and at the same time to get pleasure from the act in the way Epicurus claims. Rather, because the Epicurean always seeks what is pleasurable, what is right can always be redefined. In other words, excellence is never stable in the Epicurean scheme because whatever leads to pleasure in a specific instance is always right. So in one instance one may benefit (in terms of pleasure) from acting unjustly while in some other instance one may benefit

from acting justly. On Cicero’s account, then, both actions would be right actions for the Epicurean because both lead to pleasure. But this understanding rests on a faulty assumption. It assumes that the Epicurean feels no remorse. Thus, he need not act justly if acting unjustly leads to pleasure. However, for the Epicurean the “greatest fruit of justice is freedom from disturbance,” or *ataraxia* (Inwood and Gerson, A120). As such, it seems that, for the Epicureans, the fruits of injustice would be disturbance and not *ataraxia*. Pleasure, then, can align with justice, and thus with excellent activity.

Epicureans and Stoics Compared

While both the Epicureans and the Stoics emphasize *ataraxia*, the Epicurean view of the highest human good, or *eudaimonia* (happiness), differs from the Stoic view. Epicurus believed that excellence is natural in the sense that we naturally seek pleasure and avoid pain. This contrasts with the Stoic view of nature and thus of excellence. The process leading to *eudaimonia*, then, is fundamentally different for the Stoics.

Stoic ethics differ from Epicurean ethics in at least three ways. First, their views of nature differ. For the Stoics, self-preservation is the first natural instinct while pleasure plays this role for the Epicureans. This difference affects their views of human excellence (*areté*). Epicurus saw pleasure and excellence as inseparable while for the Stoics, self-preservation leads to valuing reason for itself, which leads to the accordance of a special value to excellence.

The second difference between Stoics and Epicureans involves their views of the emotions. For the Epicureans, it was not necessary to eliminate pathos. As Gisela Striker notes, the Epicurean realizes that only a few desires are needed for a pleasant life and they can be easily satisfied (p. 100). In the Epicurean state of *ataraxia* one does not avoid desires, but one is not bothered by the inability to satisfy one’s desires either. As such, the Epicurean is “unperturbed” (p. 100.). The Stoic, on the other hand, is “unperturbable” because he or she has completely eliminated pathos (p. 100).

Finally, the Epicureans and Stoics differ on the role of excellence. For the Stoics, excellence alone is sufficient for *eudaimonia*, and it results directly from reason. The Epicureans attach pleasure to excellence, but this does not lead to *eudaimonia*. Rather, the rational person recognizes that the highest form of pleasure (*areté*) is *ataraxia*. And actions performed from the state of *ataraxia* are the actions of the *eudaimon* (happy) individual. This individual is tranquil, and she or he has good reasons for feeling tranquil.

Other Aspects of Epicureanism

The Epicureans were noted for their emphasis on physics. They were materialists and, in particular, followers of Democritean atomism. Sextus reports that “Epicurus said that all sensibles are true and that every presentation comes from something existing and is of the same sort as that which stimulates sense-perception” (Inwood and Gerson, A53.63). This belief drove his empiricism, which depended upon the existence of void (or space) and bodies. The bodies, in turn, were compounds

of atoms, which were not “subject to dissolution in any way or fashion. Consequently, the principles of bodies must be atomic natures” (Inwood and Gerson, A2.40–41).

Epicureanism is not known for its politics. Epicurus showed very little interest in politics and, as a result, had very little to say about it. In fact, Plutarch reports that Epicurus urged his “adherents to avoid public life and express disgust for those who participate in it . . . providing there is no fear of beatings and punishments” (Inwood and Gerson, A35). Epicurus does, however, appear to have hewed to the idea of a harm principle. The thirty-first of his “principal doctrines,” as reported by Diogenes Laertius, claims that the “justice of nature is a pledge of reciprocal usefulness, [i.e.] neither to harm one another nor be harmed” (Inwood and Gerson, A5.XXXI). This view lends itself well to a liberal social contract theory, though no such theory seems to have ever been proposed by Epicurus or his immediate followers.

See also Emotions; Foundationalism; Happiness and Pleasure in European Thought; Social Contract; Stoicism; Utilitarianism.

BIBLIOGRAPHY

- Cicero, Marcus Tullius. *De Finibus Bonorum et Malorum*. Translated by H. Rackham. Cambridge, Mass.: Harvard University Press, 1983.
- Inwood, Brad. *Ethics and Human Action in Early Stoicism*. New York: Oxford University Press, 1985.
- Inwood, Brad, and L. P. Gerson, trans. *Hellenistic Philosophy: Introductory Readings*. Indianapolis: Hackett, 1988.
- Irwin, Terence. “Virtue, Praise and Success: Stoic Responses to Aristotle.” *The Monist* 73 (1990): 59–79.
- Jones, Howard. *The Epicurean Tradition*. London and New York: Routledge, 1989.
- Mitsis, Phillip. *Epicurus’ Ethical Theory: The Pleasures of Invulnerability*. Ithaca, N.Y.: Cornell University Press, 1988.
- Osler, Margaret J., ed. *Atoms, Pneuma, and Tranquillity: Epicurean and Stoic Themes in European Thought*. Cambridge, U.K., and New York: Cambridge University Press, 1991.
- Osler, Margaret J., and Letizia A. Panizza. “Introduction.” In *Atoms, Pneuma, and Tranquillity: Epicurean and Stoic Themes in European Thought*. Edited by Margaret J. Osler. Ithaca, N.Y.: Cornell University Press, 1991.
- Reesor, Margaret E. *The Nature of Man in Early Stoic Philosophy*. London: Duckworth, 1989.
- Rosenbaum, Stephen E. “Epicurus on Pleasure and the Complete Life.” *The Monist* 73 (1990): 21–41.
- Striker, Gisela. “Ataraxia: Happiness as Tranquillity.” *The Monist* 73 (1990): 97–110.

Tim Duvall

EPIGENESIS. *See Development.*

EPISTEMOLOGY.

This entry includes three subentries:

Ancient

Early Modern

Modern

ANCIENT

Many ancient cultures had sophisticated methods for organizing knowledge. However, systematic, self-conscious reflection on the nature of knowledge itself appears to have originated in Greek philosophy.

Pre-Socratic Philosophy

Greek philosophy began, around 600 B.C.E., with a series of attempts to specify the fundamental constituents of the universe. Questions soon began to be raised about the prospects for success in this enterprise. The poet-philosopher Xenophanes (c. 560–c. 478 B.C.E.) denied that knowledge—as opposed to belief or opinion—was possible, at least about the gods and the nature of the universe. However, since Xenophanes himself had much to say about gods, he must have considered some opinions more reliable than others; and other evidence seems to support this. Similarly, Democritus (c. 460–c. 370 B.C.E.) expressed very serious doubts about our ability to know the real nature of things. But he too was the proponent of an ambitious cosmological theory—the original atomic theory—so he must have found room for some types of reasonable beliefs. He does speak of reason as superior to the senses, and able to go further than the senses alone. Yet he recognizes the need to rely on the senses as a starting point for inquiry, and this sets limits to how far anyone can repudiate the evidence they provide. How exactly he resolved this tension is debatable.

A sharp distinction between the senses and reason had earlier been drawn by Parmenides (born c. 515 B.C.E.), again to the detriment of the senses. But Parmenides also criticized those who relied on their senses as out of touch with true being, to which only pure reason can give access; the division between cognitive faculties is thus paralleled by a division

XENOPHANES

And as for what is clear, no man has seen it,
nor will there be anyone

Who knows about the gods and what I say
about all things;

For even if one should happen to say what
has absolutely come to pass

Nonetheless one does not oneself know; but
opinion has been constructed in all cases.

SOURCE: Xenophanes, fragment DK B34 (translation author’s).

ARISTOTLE

We think we know a thing without qualification . . . whenever we think we know the explanation because of which the thing is so, know that it is the explanation of that thing, and know that it does not admit of being otherwise.

SOURCE: Aristotle, *Posterior Analytics*, 71b9–12. In *Aristotle: Selections*, trans. Terence Irwin and Gail Fine.

between levels of reality—the ordinary world around us being stigmatized as less than fully real. This division is a prototype for Plato’s distinction between purely intelligible Forms and the world perceived by the senses.

Socrates and Plato

Socrates (c. 470–399 B.C.E.), as portrayed in numerous dialogues of Plato (c. 428–348/347 B.C.E.), is famous for professing his ignorance. He does not say, as often claimed, that he knows he knows nothing, but that he knows he knows nothing truly valuable. How, then, does Socrates conceive the truly valuable knowledge that he lacks? A plausible answer is that it is knowledge of the nature of the human virtues—knowledge that, if one possessed it comprehensively, would amount to a quite general grasp of how to live our lives. In some of the same dialogues, Socrates also proposes a principle that has been called the Priority of Definition: unless one can provide a definition of a thing—unless one can specify what it is—one is in no position to say anything authoritative about that thing. It is difficult to see how inquiry can proceed if this principle is fully adopted, a problem that Plato has Socrates face in the *Meno*. Socrates’ answer is the Pythagorean-influenced doctrine that “learning is recollection.” We all have lived many past lives, and have knowledge buried within us; the trick is to reactivate this knowledge or bring it to the surface. The same dialogue also includes an account of the difference between knowledge and opinion; knowledge involves an ability to explain why things are as they are. Knowledge (or *epistēmē*, one of the words regularly translated “knowledge”) thus seems to be a kind of systematic understanding of some subject-matter, as opposed to the mere awareness of isolated facts designated by the term “opinion.”

The idea that learning is recollection recurs in other works of Plato, but in conjunction with the notion of separate, purely intelligible Forms. How exactly Plato conceives of Forms, and the motivations he has for postulating them, are controversial. But it is clear that each Form is thought of as encapsulating the being, or the essence, of the quality of which it is the Form; the Form of Beauty, for example, is the true nature of beauty,

which particular beautiful objects in the world around us exemplify only in a limited or partial way. It is emphasized in the *Republic* that genuine knowledge is restricted to those who have a grasp of the Forms; anyone whose experience is limited to the everyday sensory world is only capable of opinion. To grasp Forms requires lengthy training, focused on minimizing one’s reliance on the senses; a central tool in this process is pure mathematics.

The one dialogue of Plato devoted specifically to the question “What is knowledge?” is the *Theaetetus*; but this, though probably a mature work, surprisingly contains no mention of Forms whatever. The three definitions of knowledge considered are “Knowledge is perception,” “Knowledge is true judgment,” and “Knowledge is true judgment plus an account.” While all three definitions are rejected, the third seems to come closest to success; and this interestingly resembles the picture of knowledge as appropriately justified true belief, favored by many contemporary epistemologists.

Aristotle

Aristotle (384–322 B.C.E.) has comparatively little to say directly about knowledge. But it is clear that he too conceives of knowledge as involving systematic understanding. The findings of a properly developed science, he thinks, can ideally be laid out in connected sequences of explanations. The starting points are the natures or essences of the objects being studied—say, the essence of a cow; these natures or essences explain why the objects have certain features, which in turn explain why they have certain other features, and so on. Aristotle’s remarks on how we come to know the starting points are somewhat baffling. What is clear is that sense perception is a crucial ingredient in the process of coming to know, but that sense perception by itself does not constitute knowledge. This is because sense perception shows us only particular objects; genuine knowledge is by definition about universal characteristics of things. One thus needs to be able to grasp the universal characteristics present in a body of related sensory information. Aristotle shows no lack of confidence in the ability of human beings to do this reliably. But this is no surprise; it is clear that he conceives of the world as ordered in such a way as to be understandable, and of human beings as having the capacities necessary to achieve that understanding—most notably, rationality. However, he stresses, particularly in his ethical works, that one cannot expect complete precision in all subjects; the study of ethics, no matter how expertly conducted, is bound to yield conclusions less exact and more subject to exceptions than the study of mathematics.

Hellenistic Theories

Neither Plato nor Aristotle was particularly concerned with how knowledge is possible, or with warding off doubts on that score. In the Hellenistic period (roughly, the last three centuries B.C.E.) this topic became much more prominent; this was also the period of the organized skeptical movements. The Stoics shared Aristotle’s conception of *epistēmē* as involving a systematic understanding of a body of truths. But they were also much concerned with the notion of an “apprehensive appearance,” which is an impression, sensory or otherwise, that somehow guarantees its own correctness. It is not entirely clear

how this was supposed to work. Some evidence suggests that the Stoics considered such impressions to have an inherent clarity or distinctness that left no room for error; but the guarantee of truth may instead have been regarded as due to their having been appropriately caused by their objects. The leading members of the Academy (the school founded by Plato) in this period relentlessly attacked the idea of “apprehensive appearances”; they also argued that nothing of the sort was necessary for living a reasonable human life.

The Epicureans, in the same period, also seem to have been concerned with minimizing error. They strikingly claimed that “all perceptions are true,” and that error occurs only in our interpretations of them. However, this seems to be bound up with the atomist theory of sense perception, in which objects give off constant streams of atoms that enter our eyes (or other sense organs). “All perceptions are true” in the sense that there is no possibility of error concerning the configuration of atoms that strikes the sense organ. But that configuration need not accurately represent the shape of the original object; the film of atoms given off by a square tower, for example, may be eroded in transit, so that it is round when it reaches one’s eye. There is therefore no guarantee that we perceive the world as it really is. Nonetheless, this theory does have the resources to explain how we manage to be mostly correct about the world around us, while also explaining why we sometimes make mistakes.

The Academics were not the only skeptical movement in Greek philosophy. There was also the Pyrrhonist movement (claiming inspiration from Pyrrho (c. 365–c. 275 B.C.E.), which began in the first century B.C.E. but is best known through the writings of Sextus Empiricus (probably 2nd century C.E.). According to Sextus, the skeptic suspends judgment on all questions about the nature of things, because of the “equal strength” of the opposing arguments and impressions available on any given topic. Sextus also claims that this posture results in *ataraxia*, “freedom from disturbance”; the stakes, for a skeptic, are simply much lower than for everyone else.

See also *Empiricism; Rationalism; Skepticism*.

BIBLIOGRAPHY

PRIMARY SOURCES

- Aristotle. *Aristotle: Selections*. Translated, with introduction, notes, and glossary, by Terence Irwin and Gail Fine. Indianapolis: Hackett, 1995.
- . *Posterior Analytics*. 2nd ed. Translated with a commentary by Jonathan Barnes. Oxford: Clarendon Press, 1993.
- Inwood, Brad, and L. P. Gerson, eds. *Hellenistic Philosophy: Introductory Readings*. 2nd ed. Indianapolis: Hackett, 1997.
- McKirahan, Richard D., Jr. *Philosophy before Socrates: An Introduction with Texts and Commentary*. Indianapolis: Hackett, 1994.
- Plato. *Complete Works*. Edited, with introduction and notes, by John M. Cooper. Indianapolis: Hackett, 1997.

SECONDARY SOURCES

- Burnyeat, Myles, and Michael Frede. *The Original Sceptics: A Controversy*. Indianapolis: Hackett, 1997.

- Everson, Stephen, ed. *Epistemology*. Cambridge, U.K., and New York: Cambridge University Press, 1990.
- White, Nicholas. *Plato on Knowledge and Reality*. Indianapolis: Hackett, 1976.

Richard Bett

EARLY MODERN

Modern philosophy is generally thought to be distinguished by an “epistemological turn.” Prior philosophical tradition accorded special status to metaphysics, or “first philosophy” (the general philosophical investigation into the nature of reality). The modern tradition, by contrast, holds that it is necessary to determine the nature and bounds of human knowledge before any sure advance into metaphysics can be achieved.

Modern epistemologies are traditionally sorted out as “rationalist” or “empiricist.” According to the rationalist position, the intellect is the foundation of all human knowledge, including knowledge of the material world; the classic expression of rationalism in the modern era is found in the philosophy of René Descartes (1596–1650), who took a cue from Plato and held that the senses are detrimental to true knowledge. But according to the empiricist position, sense experience is the foundation of knowledge. Much of the development of empiricism in the early modern era involved the purification of its principles through the removal of vestigial traces of Cartesian rationalism; this purification reached its pinnacle in the philosophy of David Hume (1711–1776). The “critical philosophy” of Immanuel Kant (1724–1804) is generally regarded as the culmination of the modern tradition, since it arose out of an assessment of the shortcomings of both empiricism and rationalism, and a synthesis of their insights.

Defining the Modern Tradition: Cartesian Beginnings

It is convenient to point to Descartes’s *Meditationes de prima philosophiae* (1641; *Meditations on first philosophy*) as the inauguration of modern philosophy, since it advertises its project as making a radical break with the Aristotelian-scholastic tradition. “Some years ago,” its narrator begins, “I was struck by the large number of falsehoods that I had accepted as true in my childhood, and by the highly doubtful nature of the whole edifice that I had subsequently based upon them” (*Philosophical Writings*, vol. 2, p. 12). The meditator’s first task is the “general demolition” of all of his “opinions”; this is necessary, he claims, in order to establish the foundations of scientific knowledge.

Since a central tenet of the rejected Aristotelian-scholastic tradition is the empiricist thesis that “nothing is in the intellect that was not first in the senses,” the work of mediation is conceived as a radical withdrawal from the senses. Through it, the mind is supposed to find itself “in its own freedom” and to “distinguish without difficulty what belongs to itself, i.e., to an intellectual nature, from what belongs to the body” (p. 9). Mind and physical body, according to Descartes, are the two kinds of reality or “substance.” The essence of mind is thinking; it is fundamentally active and self-determining. The essence of body is to be extended, or to take up space; it

is fundamentally passive, and the state of one body is determined solely through its relation to other bodies. The *Meditationes* are supposed to demonstrate that humans have better knowledge of the mind than of any material body: the first certainty established after the “general demolition” of the meditator’s former opinions is the certainty of his own existence as a “thinking thing.”

According to Descartes, whatever can be known through the intellect alone—including the nature of the intellect itself—is known “clearly and distinctly.” The famous experiment with a piece of wax in the Second Meditation is supposed to show that humans know the nature of body by means of the intellect as well. On the basis of sense experience, one can appreciate the color, texture, smell, and size of the piece of wax; but these determinations are known only in an “imperfect and confused” manner, since they all undergo alteration as the wax is brought nearer the fire. One can have “clear and distinct” knowledge only of the material substance that underlies these changes—that is, “merely something extended, flexible and changeable” (p. 20).

Although Descartes’s conception of mind and its essential distinctness from body is not itself a universally shared theory of modern philosophy, it nevertheless sets out a problem with which the entire ensuing tradition must deal. To understand how that unfolds, it will be helpful to consider three central concerns of early modern philosophy in general: its “mechanistic” conception of nature, the theory of sense perception that is tied to that conception of nature, and skepticism.

Nature as Mechanism

The root of the modern conception of nature lies in Descartes’s idea that there are but two kinds of substance: spiritual substance (mind) and material substance (body). Since the essence of body is extension, and extension can be determined quantitatively, mathematics is the language of nature. The modern conception of nature departs from the Aristotelian-scholastic conception, which placed heavy emphasis on teleological explanation. According to this view, distinct principles determine the character or essence of different kinds of things in nature (or “natural kinds”); each kind of thing is driven, as it were, to express its “nature” according to its principle. In contrast, the modern mechanistic view deemphasizes the importance of determining natural kinds, focusing instead on universal laws of the motion of matter.

The natural philosopher Robert Boyle (1627–1691) and others charged that the Aristotelian framework was unable to yield satisfying explanations of natural phenomena. As Boyle developed his account, he advanced a hypothesis about minute particles of matter called “corpuscles”: according to the “corpuscular philosophy,” particular phenomena—including the appearance of qualities like color—can, in theory, be explained in terms of the arrangement and motion of these atoms. The theory of corpuscles was merely a hypothesis advanced on the recommendation of its explanatory power: “corpuscles” were theoretical entities, which had not been perceived even with the aid of instruments.

Theory of Sense Perception

The early modern theory of sense perception combined aspects of the mechanistic conception of nature with the Cartesian dualism of mind and body. Sense representations are “ideas,” things proper to the immaterial mind; they are caused by qualities that are attributed to material bodies. It was thought to be possible, at least in principle, to give a mechanistic account of how a particular arrangement of the corpuscular microstructure brings about—through the motion of bodies—a certain “impression” on our sensory organs. But without overcoming the problematic of Cartesian dualism, no satisfying explanation of how some such physical impact (an “impression”) could yield something mental (an “idea”). John Locke (1632–1704), an empiricist philosopher who ambivalently accepted aspects of Cartesian dualism, claimed in his *Essay concerning Human Understanding* (1690) that one must “take notice” of impressions in order to enjoy ideas of sense or have any sense perception at all (book 2, chapter 5). This capacity of the mind to “take notice” of impressions thus figures as an unexplained explainer in Locke’s philosophy.

Descartes and Locke both thought that unnoticed judgments play an important role in sense perception. This again has to do with the Cartesian conception of the mind: the mind is transparent to itself, having infallible awareness of its own contents, or “ideas.” People err only when they make judgments about the world on the basis of these ideas. To account for this, Descartes distinguishes between the understanding, which is simply an active capacity to be conscious of the mind’s ideas, and the will, which affirms or denies that certain relations of ideas represent states of affairs in the world. For Descartes, judgment involves an act of the will. Although Locke denies Descartes’s view about the role that the will plays in judgment, he agrees that unnoticed and habitual judgments play an important role in perception. When looking at a sphere of a uniform color, Locke claims, “the *Idea* thereby imprinted on our Mind, is of a flat Circle variously shadow’d”; but a habitual judgment “alters the Appearances into their Causes” so that what is perceived is “a convex Figure, and an uniform Colour” (p. 145).

Skepticism and the Cartesian Framework

The Cartesian meditative project invites a skeptical worry about the existence of the external world, for when the mind withdraws from the senses, it cuts itself off from the material world altogether. Indeed, in order for the narrator of the *Meditationes* to achieve his goal of razing the edifice of all of his former opinions, he must deliberately cultivate a radical form of skepticism, accepting the possibility that his ideas do not represent any independent material reality but may instead be the work of a “malicious demon.” By the end of the *Meditationes*, the existence of the external world is supposed to have been established through a proof of the existence of God, which is in turn supposed to yield results about the reliability of the meditator’s cognitive faculties (on the testimony of which the meditator supposes that there is a world independent of his mind).

Philosophers after Descartes continued to struggle with the fact that the Cartesian framework compels one to conclude

that perception does not put us in direct contact with the outside world. One has contact with the world only through a “veil of ideas,” and it seems one can only infer the presence of an external, independent, material world.

George Berkeley (1685–1753) tried to defend common sense against this skeptical worry by advancing an idealist account of perception in *Three Dialogues between Hylas and Philonous* (1713). His account is “idealist” because it argues that there is no mind-independent reality. At bottom Berkeley disputes the coherence of the Cartesian conception of material substance. Building on the premise that one cannot represent any physical object without having “ideas” of its qualities, he argues that objects are identified by the constant conjunction of certain ideas: “Take away the sensations of softness, moisture, redness, tartness, and you take away the cherry. Since it is not a being distinct from sensations; a *cherry*, I say, is nothing but a congeries of sensible impressions” (p. 130). The cause of these ideas cannot be material substance, Berkeley argues, but only the mind of God. Berkeley’s curious defense of common sense comes down to a denial that there is any reality independent of “mind” at all.

The Scottish philosopher Thomas Reid (1710–1796) saw more clearly than any of his predecessors that skepticism about the “veil of ideas” is the unavoidable result of any adherence to the dominant modern theory of perception. He argues so at length in *An Inquiry into the Human Mind, on the Principles of Common Sense* (1764) and *Essays on the Intellectual Powers of Man* (1785) and offers a new account of perception that is not based on the modern “way of ideas.” Although Reid was largely neglected by historians of philosophy for most of the twentieth century, his account of perception has received greater attention since the mid-1990s as a source of philosophical insight in its own right.

Humean Skepticism

Hume’s epistemology is quite unencumbered by skeptical worries about the existence of the physical world. However, Hume’s philosophical preoccupations are shaped by a new kind of skepticism, which is most clearly expressed in the *Enquiry concerning Human Understanding* (1748).

For Hume, the problem of epistemology is justificatory: it must be established how people take themselves to have knowledge of the causal order of nature. For “nature,” Hume remarks, “has kept us at a great distance from all of her secrets, and has afforded us only the knowledge of a few superficial qualities of objects; while she conceals from us those powers and principles, on which the influence of these objects entirely depends” (*Enquiry*, §4, p. 21).

The problem Hume identifies can be traced back to Locke, who noted that people do not have knowledge of the corpuscular microstructure of things (see *Essay*, book 4, chapter 3). They have knowledge only of the “nominal essence” of things; in other words, humans identify natural kinds on the basis of observable qualities that are constantly conjoined in experience, but since they cannot give an account of the corpuscular microstructure that allows them to observe these qualities, they

do not have knowledge of the “real essence” of things. Hume generates a skeptical worry out of this: given that one has no cognitive access to the “secret nature” of things, then for all one knows this “secret nature” could change without any alteration in the observable properties of things. Hume recognizes that ordinary human cognitive practices carry on without people becoming encumbered by this skeptical worry. Yet “as a philosopher,” he wonders: On what basis do we infer that the regular course of our experience should be a guide to determining a necessary connection of events observed in nature?

Hume responds to his “skeptical doubts” with a “skeptical solution” (*Enquiry*, §§4–5). People are able to make causal determinations only in a “subjective” fashion. In the course of experience, human minds are shaped by repetitions in circumstances. The result is the formation of tacit expectations, or anticipatory dispositions, which Hume calls “customs.” These anticipatory dispositions are formed mechanically through associations of the imagination. The necessary connection thought in the concept of cause is merely something that “we *feel* in the mind, this customary transition of the imagination from one object to its usual attendant” (*Enquiry*, §7, p. 50). This “sentiment,” Hume argues, is the source of the concept of causality. Thus Hume ends up with the following view. It cannot be said that one thing (A) brings about an effect in another thing (B); it may be said that representations of A are customarily conjoined with representations of B. Thus the necessity thought in the concept of cause is merely subjective: when faced with an event of type A, a subject cannot help but to anticipate an event of type B.

Kant’s Critical Philosophy

Philosophy in Germany in the late seventeenth and early eighteenth centuries was largely dominated by the legacy of the rationalist philosopher G. W. Leibniz (1646–1716), but by the middle of the eighteenth century German philosophers were increasingly well read in the empiricist philosophy of Locke and Hume. Kant’s mature philosophy, advanced in his *Kritik der reinen Vernunft* (1781, rev. 1787; Critique of pure reason) and presented in a “popular” form in his *Prolegomena* (1783), is generally thought to be a critical synthesis of these two traditions.

Hume’s skeptical worries focused Kant’s attention on the nature of scientific knowledge. For Kant, the very idea of such knowledge rests on a presupposition that humans can have cognitive access to laws (as opposed to mere regularities) of nature. Given the viability of scientific knowledge, Kant supposes, one must be in the possession of certain concepts on the basis of which one can combine representations independently of experience. One such concept is “cause and effect.” But Hume’s attempt to account for the concept of causality within a skeptical, empiricist framework required that he hold that genuine laws of nature are cognitively inaccessible. Hume’s skeptical worries, Kant famously remarked, “first interrupted my dogmatic slumber” (*Schriften*, vol. 4, p. 260); but Hume’s skeptical solution was not a happy one for Kant, who never doubted human capacity for genuine scientific knowledge.

In the *Critique*, Kant is particularly interested in the questionable status of metaphysics as a science. The first words of

the book attest to the “peculiar fate” of human reason—namely, that it is compelled to ask questions that are beyond its capacity to answer. Kant principally has in mind the classic questions of metaphysics: for example, whether the soul is simple or composite or whether the world is finite or infinite. Reconceiving of what the proper task of metaphysics should be, Kant takes a cue from the flourishing science of Newtonian physics. But while the goal of physics is to explain some particular array of phenomena, the goal of metaphysics is to give an account of nature as such. For Kant, metaphysics begins with an exhaustive account of human cognitive capacity as the source of the fundamental principles that determine what it is to figure in the domain of nature at all. The main argument of the *Critique* is a demonstration of the relevant principles, which Kant takes to be the basis of the laws of nature.

See also *Epistemology: Ancient; Epistemology: Modern; Idealism; Kantianism; Skepticism.*

BIBLIOGRAPHY

- Berkeley, George. *Three Dialogues between Hylas and Philonous*. Edited by Jonathan Dancy. Oxford and New York: Oxford University Press, 1998.
- Boyle, Robert. *Selected Philosophical Papers of Robert Boyle*. Edited by M. A. Stewart. Manchester, U.K.: Manchester University Press, 1979.
- Descartes, René. *Oeuvres de Descartes*. Edited by Charles Adam and Paul Tannery. New ed. 11 vols. Paris: CNRS/Vrin, 1974–1986. The standard edition of Descartes’s works, in the original Latin and French.
- . *The Philosophical Writings of Descartes*. Translated by John Cottingham, Robert Stoothoff, and Dugald Murdoch. 3 vols. Cambridge, U.K.: Cambridge University Press, 1984–1991. The standard edition of Descartes’s works in English translation.
- Hume, David. *An Enquiry concerning Human Understanding*. Edited by Eric Steinberg. Indianapolis and Cambridge, U.K.: Hackett 1977.
- . *Treatise of Human Nature*. Edited by L. A. Selby-Bigge and P. H. Nidditch. 2nd ed. Oxford: Clarendon 1978. Although the *Enquiry concerning Human Understanding* is largely a restatement of book 1 of the *Treatise*, it is generally thought to contain the more emphatic expression of Hume’s skeptical position.
- Kant, Immanuel. *Critique of Pure Reason*. Translated by Paul Guyer and Allen W. Wood. Cambridge, U.K.: Cambridge University Press, 1997.
- . *Gesammelte Schriften*. Edited by the Königlich Preussischen Akademie der Wissenschaften, later the Deutschen Akademie der Wissenschaften zu Berlin. 29 vols. Berlin: Walter de Gruyter, 1900–. The standard edition of Kant’s works, in the original German and Latin.
- . *Prolegomena to Any Future Metaphysics That Will Be Able to Come Forward as Science*. New ed. Translated by Paul Carus and revised by James W. Ellington. Indianapolis and Cambridge, U.K.: Hackett, 1977.
- Locke, John. *An Essay concerning Human Understanding*. Edited by Peter H. Nidditch. Oxford: Clarendon, 1975.
- Reid, Thomas. *Essays on the Intellectual Powers of Man*. Edited by Derek R. Brookes. Edinburgh: Edinburgh University Press, 2002.

———. *An Inquiry into the Human Mind on the Principles of Common Sense*. Edited by Derek R. Brookes. Edinburgh: Edinburgh University Press, 1997.

Melissa McBay Merritt

MODERN

The understanding of knowledge at work, implicitly or explicitly, in much of ancient and modern epistemology is that of knowledge as *justified true belief*. According to this traditional account (TAK), a subject, S, knows that *p* if and only if the following three conditions are met: (i) *p* is true; (ii) S believes that *p*; (iii) S is justified in, or has adequate evidence for, believing that *p*. While (i) and (ii) are almost entirely uncontroversial, (iii) lies at the heart of intense controversy. It is generally agreed that (i) and (ii) are not sufficient; knowledge cannot be analyzed as true belief. Suppose S took a medication that causes paranoid delusions. As a result, S believes he is being followed. Suppose further that S’s belief happens to be true. There is broad agreement that accidentally true beliefs like that do not count as knowledge. However, what knowledge requires in addition to truth and belief is highly controversial. According to TAK, it is justification.

The Gettier Problem

If TAK were correct, conditions (i)–(iii) would be sufficient for knowledge. Using a couple of clever examples, Edmund Gettier showed that they are not. Ever since, it has become common practice to refer to cases that demonstrate the insufficiency of (i)–(iii) as “Gettier cases.” Here is a simple example. Suppose S believes that there is a sheep in the field. But what S takes to be a sheep is merely a rock that, bizarrely, looks exactly like a sheep. Since S has no reason to assume that he is misled in that way, he is justified in believing that there is a sheep in the field. Thus far, S’s belief is justified and false. But suppose further that, behind a bush that blocks S’s view, there really happens to be a sheep in the field. Given this further assumption, S’s belief turns out to be a justified true belief that clearly fails to be an instance of knowledge. What condition must be added to (i), (ii), and (iii) to rule out Gettier cases? Even today, about three decades after the publication of Gettier’s 1963 article, this puzzle, commonly referred to as the “Gettier problem,” remains unresolved.

According to philosophers who favor traditional epistemology, the existence of the Gettier problem does not establish that TAK is without merit. It merely shows that TAK is an approximation that needs further refinement. From this point of view, if S is to know that *p*, S must indeed have justification, or a good reason, for believing that *p*. But if the justification requirement is understood as a demand for the possession of good reasons, then the following problem—known as the regress problem—arises. Suppose S’s reason for believing *p* is *q*. Now, if *q* is to justify S’s belief that *p*, S must have justification for accepting that *q*. Given that justification requires the possession of a good reason, it follows that S must have a further reason, *r*, for *q*, and that S must have a still further reason, *s*, for *r*, and so forth. Regarding the structure of this regress, there are the following possibilities: (i) it contin-

ues ad infinitum; (ii) it terminates in basic belief: a belief that is justified without receiving its justification from any other beliefs; (iii) it circles back to its origin, the belief that p . These possibilities allow for the following positions, characterized in rough outline: Skeptics endorse (i) and conclude that justification is impossible. Infinitists agree with skeptics that the regress cannot be stopped, but hold that a chain of reasons can justify even if it is infinite. Foundationalists advocate (ii), and coherentists favor (iii). Neither infinitism nor skepticism enjoys broad appeal. Foundationalism and coherentism, therefore, may be considered the main contenders.

Foundationalists claim the following: (i) in addition to mediately justified beliefs—beliefs that receive their justification from other beliefs—there are immediately justified, or basic, beliefs: beliefs that are somehow justified without depending for support on any other beliefs; (ii) ultimately, all mediately justified beliefs have their justification conferred upon them by immediately justified beliefs. Accordingly, foundationalists face two main challenges. They must give a plausible and detailed account of how it is possible for a belief to be justified without receiving its justification from any other beliefs, and they need to explain precisely how basic beliefs provide justification for mediately justified beliefs. According to classical foundationalism, basic beliefs are infallible and entail the mediately justified beliefs that are inferred from them. According to more recent, modest versions of foundationalism, basic beliefs need not enjoy any epistemic privilege as strong as infallibility, and can support nonbasic beliefs without entailing them.

Coherentists claim that there are no basic beliefs. All justified beliefs receive their justification from other beliefs. The chief idea coherentists invoke is that justification is holistic. For a given belief, B , to be justified, the subject must have justification for an entire set of other beliefs that, together with B , form a coherent whole. Coherentist theories are typically defended by highlighting the difficulties involved in the idea of immediate justification. For example, Sellars points out that, when it comes to explaining how basic beliefs are justified, foundationalists face the dilemma of having to conceive of a basic belief's justification as being either propositional or nonpropositional. In the former case, the regress problem returns, for if what justifies an allegedly basic belief that p is a proposition q , the question immediately arises of what reason there is for believing that q is true. In the latter case, the problem is how we are to conceive of nonpropositional justification. Presumably, such justification arises from what is "given" in perceptual experience: some kind of nonpropositional content. But, according to Sellars, if what is experientially given is nonpropositional, it simply is not the kind of thing that has the capacity to justify anything. Coherentism, then, derives its main defense from the apparent impossibility of immediate justification. Unfortunately, the alternative coherentists offer is no less problematic. Versions of coherentism that are developed in detail either suffer from circularity or regress problems, or else threaten to collapse back into foundationalism. The regress problem may, therefore, be viewed as one of the persistent and seemingly unsolvable puzzles of epistemology.

A straightforward, though certainly not uncontroversial, response to the regress problem becomes available when the traditional conception is rejected on behalf of a radical epistemological reorientation, according to which justification is a matter of, not possessing evidence or good reasons, but instead originating in causes of the right kind. Obviously, if justification does not require reasons, placing a justification condition on knowledge will not generate a regress of reasons. The key idea of the reoriented approach is that beliefs are caused by cognitive processes that are either reliable or unreliable. Perception, memory, and introspection are reliable processes. Biased thinking, wishful thinking, and making hunches are unreliable processes. According to reliabilism, this distinction is crucial for developing a successful theory of justification. The basic idea is roughly that a belief is justified (or, according to other versions, an instance of knowledge) if and only if it is caused by a reliable cognitive process—that is, a process that would produce mostly true beliefs in a wide range of different circumstances. Related theories assert, roughly, that S 's belief that p qualifies as knowledge if S would not believe that p if p were false, or that S 's true belief that p , on the basis of a reason r , qualifies as knowledge if S would not have r if r were false.

Advocates of TAK reject such theories on the following grounds. First, for a belief to be justified, it need not have its origin in a reliable cognitive process. Consider the victim of an evil demon. Such a subject has a belief system and evidence analogous to that of a normal person. But unlike the beliefs of a normal person, those of an evil demon victim are massively false. Reliabilism implies, implausibly, that the victim's beliefs are unjustified. Second, origination in reliable cognitive processes is not sufficient for making a belief justified, or, if true, an instance of knowledge. Advocates of TAK would argue that, for S to be justified in believing that p , or to know that p , it is necessary for S to have a good reason for p . (For a *locus classicus* of that kind of criticism, see BonJour, chapter 3.)

Theories that favor the traditional conception of knowledge are typically labeled "internalist." In contrast, causal theories that make de facto reliability the key notion of epistemic assessment are referred to as "externalist." Traditional theories, which identify justification with the possession of a good reason, are claimed to be internalist on the following ground: whether a subject, S , has a good reason for believing that p is something that S can determine merely by reflecting on the matter. Advocates of reliabilism and related theories are considered externalists because they deny that what determines a belief's justificational status must be something that is recognizable upon reflection.

In recent years, an approach closely related to causal theories and reliabilism—virtue epistemology—has received much attention (Sosa; Zagzebski). Virtue epistemologists advocate that justification and knowledge must be understood as arising from the employment of virtuous—that is, reliably working—cognitive faculties. Plantinga developed in detail a widely discussed theory of this kind. Its basic claim is that warrant—the property that a true belief into knowledge—must be identified with the proper functioning of faculties that are well designed, either by God or natural selection.

A central concern of contemporary epistemology, connecting back to such seminal figures as René Descartes, David Hume, Thomas Reid, George Edward Moore, and Bertrand Russell, is skepticism. The modern version of Descartes's evil demon is the mad scientist who controls the thoughts and beliefs of a brain in a vat (BIV). A BIV's evidence is, *ex hypothesi*, the same as yours or mine. For example, you have experiences of your hands—you see and feel them—on the basis of which you claim to know that you have hands. A BIV has hand-like experiences just as you do, but of course is mistaken in her belief that she has hands. On what grounds, then, can you claim to know that you have hands? The skeptical problem arises because the skeptical hypothesis in question—I am BIV—is incompatible with many of the ordinary propositions you take yourself to know. For example, if you are a BIV, then your current beliefs about your location, and the objects in your immediate environment, are all false. A skeptic, then, could argue as follows: You don't know that (say) you have hands unless you know that the BIV hypothesis is false. But you don't know that that hypothesis is false. Consequently, you don't know that you have hands.

In response to such skepticism, the following responses have been advocated: (i) evidentialism: I actually have evidence for believing that I am not a BIV; (ii) the relevant alternatives theory: the skeptical hypothesis fails to undermine ordinary knowledge claims since it is not a relevant alternative; (iii) inference to the best explanation: the skeptical hypothesis fails to defeat ordinary knowledge claims because it explains our beliefs and experiences less well than the hypothesis that the world is pretty much what we take it to be. A relatively new and influential response to skepticism is (iv) contextualism, according to which knowledge attributions are true or false depending on the attributor's standards of knowledge. When skeptical hypotheses are entertained, the standards of knowledge rise and become extremely stringent. As a result, a subject in such a context would be incorrect in saying she knows that she is not BIV, or that she has hands. However, in contexts in which skeptical hypotheses are ignored, the standards of knowledge remain low. It will then be correct to say that one has knowledge of one's hands. According to contextualists, what recommends this approach is that it preserves the truth of our ordinary knowledge claims and, at the same time, gives skepticism its due. For the gist of the contextualist solution is that our typical knowledge attributions, such as "I know I have hands," are in ordinary situations correct, and incorrect only in those contexts in which we concern ourselves with skeptical hypotheses. (For a collection of important essays on the problem of skepticism, see De Rose and Warfield. For a collection of essays debating a wide range of contemporary epistemological issues of the kind mentioned above, see Sosa and Steup.)

See also *Epistemology: Ancient; Foundationalism; Hermeneutics; Skepticism*.

BIBLIOGRAPHY

BonJour, Laurence. *The Structure of Empirical Knowledge*. Cambridge, Mass.: Harvard University Press, 1985.

- Chisholm, Roderick M. *The Theory of Knowledge*. 3rd ed. Englewood Cliffs, N.J.: Prentice Hall, 1989.
- De Rose, Keith, and Ted A. Warfield, eds. *Skepticism. A Contemporary Reader*. New York: Oxford University Press, 1999.
- Dretske, Fred I. *Knowledge and the Flow of Information*. Cambridge, Mass.: MIT Press, 1981.
- Gettier, Edmund. "Is Knowledge Justified True Belief?" *Analysis* 23 (1963): 121–123.
- Goldman, Alvin I. *Epistemology and Cognition*. Cambridge, Mass.: Harvard University Press, 1986.
- Lehrer, Keith. *Theory of Knowledge*. Boulder, Colo.: Westview, 1990.
- Nozick, Robert. *Philosophical Explanations*. Cambridge, Mass.: Harvard University Press, 1981.
- Plantinga, Alvin. *Warrant and Proper Function*. New York: Oxford University Press, 1993.
- Sellars, Wilfrid. "Empiricism and the Philosophy of Mind." In his *Science, Perception and Reality*. London: Routledge and Kegan Paul, 1963.
- Sosa, Ernest. *Knowledge in Perspective: Selected Essays in Epistemology*. Cambridge, U.K.: Cambridge University Press, 1991.
- Sosa, Ernest, and Matthias Steup. *Contemporary Debates in Epistemology*. Oxford and Cambridge, Mass.: Blackwell, 2004.
- Zagzebski, Linda Trinkhaus. *Virtues of the Mind: An Inquiry Into the Nature of Virtue and the Ethical Foundations of Knowledge*. Cambridge, U.K., and New York: Cambridge University Press, 1996.

Matthias Steup

EQUALITY.

This entry includes three subentries:

Overview
Gender Equality
Racial Equality

OVERVIEW

Though simple as a mathematical concept, equality is complex and contested as a political goal and philosophical concept. Many political struggles, both historical and ongoing, have engaged in the contests over the nature of equality. This contestation revolves around the basic question, What kinds of equality matter? The answer to this in part depends on whether the topic is approached from a predominantly political, economic, ethical/philosophical, or social perspective. Discussing the history of ideas on the concept of equality poses two further challenges. First, equality is so intimately related to the concept of justice that it is impossible to fully untangle the two. Second, there are so many voices and movements to consider on the subject that any concise discussion requires difficult choices on who to include and who to neglect. This overview thus will (1) touch on many (but not all) the important thinkers and developments in the history of ideas in the Western tradition, and (2) introduce some of the major debates and conflicts in that tradition over the concept of equality.

Ancient Views of Equality

For the purposes of understanding the concept of equality within the Western tradition, one has to look back to the two most influential strands of thought that inform the modern West: the Hebrew (and later Judeo-Christian) tradition and the Greek. While the Hebrews did not undertake an analysis of the concept of equality, the worldview and subsequent laws were steeped with a sense of equality unusual in the Western tradition at or before their time. The distance between a supremely powerful single God and humanity was most likely fundamental to this worldview, in which God's creations seemed relatively equal in comparison. Unlike other well-known law codes of the age (e.g., the code of Hammurabi), Jewish law applied to all Hebrews equally, regardless of their sex or class (see especially Exodus 19–35 and Deuteronomy 12–26). At the founding of the second temple in Jerusalem, Jewish law became a kind of first social contract—quite literally in the public reading of the Torah and the people signing that they will live by these laws—establishing a direct relationship between all the Hebrew people and their God (see Ezra-Nehemiah). There was not one secret teaching for the elites and another for the people; rather, all the teachings were available to all the people, and the covenant required the understanding and consent of all.

The first systematic analyses of equality as a concept comes from the Greeks of the classical age, which is perhaps not surprising given their intense interest in mathematics. One of the most thorough of these early systematic explorations of equality was undertaken by Aristotle (384–322 B.C.E.) in several of his works. In his investigation into the virtue of justice in the *Nicomachean Ethics*, Aristotle uses the Greek word for “equal” (*isos*) but gives it a meaning that is more akin to “fairness.” Equality is a state to be striven for, intermediate between giving someone more or less than he or she is due, relative to a specific activity or social realm. In disputes over contracts, for instance, a judge must determine the differences in harms inflicted by the breaking of a contract and restore the position of equality by subtracting the profit the offender has reaped from the infraction (*Ethics*, 1132a1–19).

It is in Aristotle's discussion of political justice that he examines equality in a way that more closely resembles the usual meaning of the term today. Political justice is a matter for citizens, whom he defines as “those who share in common a life aiming at self-sufficiency, who are free and either proportionally or numerically equal” (*Ethics*, 1134a27–29). Justice, in the political sense, can occur only among those who are free and fundamentally equal in their capacity as citizens, most importantly, in their equality in ruling and being ruled (*Ethics*, 1134b14–16). In the *Politics*, Aristotle further refines the concept of political equality in his discussions of justice in a political association. He tells us that the virtue of justice is agreed by all to be a proportionality based on desert or merit, but he adds that “some consider themselves to be equal generally if they are equal in some respect, while others claim to merit all things unequally if they are unequal in some respect” (*Politics*, 1301b35–39). As neither view is wholly right or wrong, and since reason alone cannot resolve the fundamental conflict, a good regime will attempt to see the legitimacy and limitations

of both and attempt to arrange politics and political institutions so that the factions that normally form around these competing views enter into constructive negotiation rather than risk intense civil conflict or rule by superior power alone (*Politics*, 1301b39–1302a15, 1318a27–b1).

While Aristotle believes in some natural inequalities among humans that today we reject—between men and women, between “natural slaves” and free men—he does lay a foundation for a political critique of economic inequalities. The best regime will be one without extremes of wealth or poverty, not because these inequalities are inherently unjustifiable but because they undermine good politics. The wealthy, because they are unequal (i.e., superior) in wealth to their fellow citizens, believe they should be superior in political power as well—a false and dangerous belief. As a solution to the potential of class rule by either the wealthy or the poor, Aristotle encourages regimes to nurture the growth of the middle classes, whom he sees as better able to grasp the merits and limitations of the two extremes and thereby be a moderating political force (*Politics*, 1295a33–1296a21; for a brief general introduction to the topic, see Terchek and Moore).

Athenian political practice is just as important as Athenian philosophy to understanding the Greek contribution to ideas of equality. Through the centuries of reforms that would lead to the rise of full-fledged democratic government, three stand out. The first, *isonomia*, means literally equality of law, embodying both the concept that all citizens be treated equally with regard to the laws and that they participate equally in their making. The second reform, *isēgoria*, or equality of speech, allows all citizens, regardless of class, to rise in the assembly and attempt to convince their fellow citizens on the best policies and laws. The final reform allows all citizens to participate equally in the agenda-setting aspect of politics rather than just expressing preference on the agenda given to them. While political equality in contemporary democracies has been restricted for most citizens to the voicing of preference rather than the ability to effectively participate in setting or influencing the political agenda, the Athenian reforms highlight that this is only one aspect of true political equality (see Ober, 1989, 1996).

Like the Athenians, Rome came to base its laws on the notion that they should apply to all citizens equally. And as with the Athenians, it was the result of a struggle between the many and the few. During the republic, the plebian class, angered that the laws were applied differently to them and to the elites of the patrician class, pushed for reforms that resulted in the adoption of the Twelve Tables. Stating basic laws in a clear way helped to eliminate their ad hoc alteration in legal proceedings, where they could be made to say one thing for the elite and another for the many.

Equality in the Church and the Protestant Reformation

During the Middle Ages, there were two important developments that affect the modern conception of equality. First, a natural law tradition developed around the notion that all humans, as God's creations, are owed certain rights and protections and that these natural laws cannot be altered by political

associations or rulers. Thus we see in thinkers like St. Thomas Aquinas (c. 1224–1274) a rigorous defense of the principle that all people are due a certain minimal set of legal protections based solely on the fact of their humanity.

The second role the church played is more subtle, serving as a force for the gradual and irresistible movement toward a society organized around the fundamental fact of equality. The church took in members of the lower classes, gave them an education, allowed them to rise through the church hierarchy, and, given the important role church officials played in European state affairs, made it possible for individuals of humble origins to join the royal state's inner circle of advisers. It thus provided a clear counterexample to the notion that one is born to one's station, contributing to the decline of the view that society should be based on fundamental inequality in accordance with one's birth (Tocqueville, pp. 9–10).

As the Protestant Reformation approached, Christian humanists set out to understand the precise meaning of the founding texts (the Bible and doctrines of the early church fathers). This, combined with the advent of the printing press and the widespread publication of the Bible and other writings in the common tongues of the people, created an atmosphere in which intense scrutiny of and debate over the meaning of Christian doctrine was considered appropriate, and individuals came to see themselves as capable of judging doctrine for themselves based on their knowledge and skills. This culminated in Martin Luther's (1483–1546) statement, in a debate with Johann Eck, that the Bible, not the pope or church councils, is the sole guide for human conscience. It is a short leap from these views to the modern liberal notion that individuals, with no need of an intermediary or authority to tell them what to think, can best determine their own beliefs and interests. In the Reformation era, individuals became radically equal in their capacities to judge matters for themselves.

Liberalism, Civic Republicanism, and the Age of Revolution

Modern conceptions of equality are deeply rooted in both the liberal and civic republican traditions of thought as well as in the age of revolution. Here we will look at each of these as well as at the socialist challenge to liberalism in particular. As we will see, in addition to natural, legal, and political forms of equality, economic equality (or inequality) also concerns many modern thinkers.

At its core, liberalism grew out of the social contract theories espoused by Thomas Hobbes (1588–1679) and John Locke (1632–1704). For Hobbes (a proto-liberal), the individual is naturally equal because in a hypothetical state of nature he or she is equally at the mercy of other people, as even the weakest can kill the strongest through guile or collected effort. Escaping this environment of all against all is the reason for and basis of our entering into a social contract whereby we agree to give over most of our natural rights to a sovereign who will protect us, thereby allowing us to pursue our own interests. The focus in Hobbes is on abstract and radically equal individuals, and in his solution he does not worry much about

the individual carrying his or her equal natural rights into the civil society that results from the social contract.

As the first true liberal, Locke emphasizes natural equal rights, roughly equal reason, and the need for a social contract to protect equal rights to pursue one's interests and realize the benefits of one's labor and property. However, Locke deemphasizes the salience of economic inequalities for politics. As we shall see, unlike the civic republicans, Locke does not emphasize that property is a means to an end and therefore should not be pursued without limit. In the commons-based economy of Locke's state of nature, and in the absence of money, it would be unjust to hoard forms of property that would "spoil," but in a private-property-based, money economy there is no natural limit to accumulation and therefore no natural limit to inequalities of property. In fact Locke argues that since money only has value through the "tacit and voluntary consent" of human beings, "men have agreed to a disproportionate and unequal possession of the earth" (*Second Treatise*, p. 29). Material inequalities are not only inevitable, humans have chosen them. Moreover Locke emphasizes that privatization of the commons—and the inequalities that entails—will allow a more productive use of resources. While Locke repeatedly reminds readers that God "hath given the world to men in common," he offers no admonition—on the basis of natural law, reason, or religious teaching—that we limit our accumulation of wealth, and he does not offer warnings about the effects of inequalities of property on politics (*Second Treatise*, p. 18).

For Adam Smith (1723–1790), the key economic inequality of his time that needed to be eliminated was mercantilist monarchy's awarding economic opportunities not to all alike but to a few well-connected subjects. Out of Smith's critique of mercantilism comes the notion of equality of economic opportunity. Given equal economic opportunities, individuals will pursue their own interests on the basis of their abilities, and the fact that inequality of outcome will result is not a problem for Smith as long as political equality is protected. Smith is fundamentally worried, however, about an economic system in which the players have unequal market power. His ideal market comprises many small producers and consumers, none of whom have the power to significantly influence prices and thereby infringe on the liberty of others by extracting benefits beyond what they would as equally powerless players. Furthermore, while Smith does not worry overly much about economic inequality per se, he is troubled both by the dangers of pursuing wealth too avidly and by the deprivations of having too little, especially when they force one into dependence on a work environment that dulls one's reasoning faculties.

A slightly different strand within the liberal tradition follows Immanuel Kant (1724–1804). Kant's important contribution to the notion of equality has to do with his contention that from a moral or ethical point of view there is an obligation (categorical imperative) to treat individuals as ends in themselves and not merely as means for some other end. This rises from the human capacity to reason and therefore the will to be self-determining (see *Practical Philosophy*, pp. 77–82). This notion will deeply influence modern ethical thought, es-

pecially thinking about human rights as it informs the Universal Declaration of Human Rights adopted by the General Assembly of the United Nations in 1948.

Civic Republicanism

The civic republican tradition—including thinkers such as Aristotle, Niccolò Machiavelli (1469–1527), Jean-Jacques Rousseau (1712–1778), and Thomas Jefferson (1743–1826)—differs from that of the early liberals by emphasizing economic inequality as a threat to liberty and democratic government. For Rousseau, liberal social contract theory undermines itself in that it does not resolve the fundamental conflict over the unequal private property that lies at the very heart of the social contract. For thinkers such as Locke, individuals form a social contract in order to escape the conflicts that develop over property so that they may enjoy their property and the fruits of their labor. Rousseau, however, contends that by leaving property unequally distributed, Locke failed to resolve the conflict that stands in the way of civil peace and individual liberty. For Rousseau, the logical missing step necessary to solve Locke's error is for all individuals to give up their private property as a condition of entering the social contract. This property is then distributed equally as a private holding of all citizens under the contract. This arrangement allows all individuals equal capacity to tend to their interests and needs and to participate in their collective self-governance. Rousseau's ideas will inform the French Revolution and its Declaration of the Rights of Man and of the Citizen, which calls for liberty, equality, and fraternity and attempts to eliminate the privileges of the old aristocratic order.

For Jefferson and for other early U.S. thinkers such as J. Hector St. John de Crèvecoeur (1735–1813), one of the great characteristics of the United States was its egalitarian distribution of property compared to Europe's. Americans, according to Crèvecoeur, work for themselves, not lords. He boasts that in America, even the “meanest of our log-houses is a dry and comfortable habitation. Lawyer and merchant are the fairest titles our towns afford” (*Letters*, p. 46). We see here an American expression of the civic republican aspiration of working for oneself, with no master or overseer. This aspiration is also egalitarian in its societal outcomes: the poorest live in dry and comfortable homes, and the richest are merely lawyers or merchants.

Clearly the reality in the colonies and the United States was never this egalitarian. However, Crèvecoeur's vision is an exemplar of mainstream American views on equality in that it does not require anything other than equality of opportunity. The redistribution from the rich and aristocracy necessary to achieve some kind of equality in Europe is rendered invisible through the myth of a frontier of largely empty land that can be settled by Americans of European descent. The equality of opportunity that is the basis of the American consensus has never been the sole cause for the realization of the ideal of a citizen free from overt dependence (Bercovitch; Appleby).

Jefferson was similarly egalitarian in his attitudes toward work and property (and perhaps similar in his tendency to neglect the realities of inequality in early America). In 1785 he wrote to James Madison that

I am conscious that an equal division of property is impracticable. But the consequences of this enormous inequality producing so much misery to the bulk of mankind, legislators cannot invent too many devices for subdividing property. . . . Whenever there is in any country, uncultivated lands and unemployed poor, it is clear that the laws of property have been so far extended as to violate natural right.

He goes on to argue that where persons are excluded by the privatization or enclosure of land, governments must “take care that other employment be furnished to those excluded from the appropriation” (*Jefferson*, p. 396).

For Jefferson, as for other thinkers in the civic republican tradition, a relatively egalitarian distribution of property and the ensurance of all households' livelihoods are not merely ends in themselves but are important means to good democratic citizenship.

Here [in America] every one may have land to labor for himself. . . . Every one, by his property, or by his satisfactory situation, is interested in the support of law and order. And such men may safely and advantageously reserve to themselves a wholesome control over their public affairs, and a degree of freedom, which, in the hands of the *canaille* of the cities of Europe, would be instantly perverted and to the demolition and destruction of everything public and private. (*Jefferson*, p. 538)

Ordinary Americans have something to lose; they have something at stake in the political economic regime. (On stakes in civic republican thought, see Terchek, 1997.) They will not threaten property relations since they are neither impoverished nor exploited. Therefore, from the perspective of elites, ordinary Americans can be trusted as democratic citizens. Extremes of economic inequality—in which some citizens have much more than they need and others have no livelihood with which to sustain themselves and their families—are not just violations of natural law; they threaten democracy by undermining the respect for law and moderation that allows democracy to function well.

We need also notice the important role equality plays in the founding of the United States. Jefferson inserts at the heart of the preamble of the Declaration of Independence the phrase “We hold these truths to be self-evident, that all men are created equal, that they are endowed by their Creator with certain unalienable Rights, that among these are Life, Liberty and the pursuit of Happiness.” However, while espousing a basic equality at the very core of the American political experiment, the 1787 Constitution also institutionalized a great deal of inequality. First is the compromise that protects the practice of slavery and determines that slaves count as three-fifths of a person for the purpose of determining representation, even though they cannot participate in selecting those representatives. The Constitution excluded those who do not own property from full citizenship until the reforms of the Jacksonian era, and women were excluded from full citizen status until the beginning of the twentieth century. Furthermore, even

once the United States adopted universal adult suffrage, it maintained one of the most unequal instances of representation in any of the stable, advanced democracies: the U.S. Senate. The Senate is based on the principle of equality for states, not for citizens. Thus a citizen of the least populous state has about sixty times as much voting power as a citizen of the most populous state in determining Senate representation.

Socialism

Although the socialist tradition is much more diverse than this choice suggests, we will focus on the ideas of Karl Marx (1818–1883) as exemplary of the socialist critique of liberal capitalism. The political economic philosophy of Marx approaches economic inequalities with a concern for freedom, rejecting the liberal assumption that economic inequalities do not affect political equalities and breaking with both the republican and liberal traditions by focusing on the inequalities of neither individuals nor citizens but entire classes. For Marx, the most fundamentally problematic inequality is that between those who own the means of economic production and those who do not. That some are rich and others poor is of concern, but this is only symptomatic of the former, deeper inequality. Moreover, from a Marxist perspective, inequalities that seem not to be economic in nature—inequalities between the sexes, for instance—are outgrowths of the fundamental economic inequality that forms the basis of a capitalist political economic system.

In a capitalist political economy it is not just the economy that is driven and controlled by the capitalist class. All the institutions of society, or superstructure of society, rest on an economic base and serve to legitimate but also disguise that base. The ideologies of liberal democracy only serve to legitimate what is in fact a system of freedom and democracy only for some. The political equality emphasized by liberals is but a veil for the economic inequality that is so fundamental to a capitalist society and so detrimental to human freedom.

For Marx, the central normative problem with capitalism is not simply the poverty or powerlessness of the proletariat or the inequality between the classes in and of itself. The central problem is that no one is truly free in a capitalist regime. According to Marx the fundamental nature of our species is to produce—ideas and art as well as the material objects necessary for survival. By appropriating the workers' product, capitalism denies them, or alienates them from, their fundamental nature. In this alienation workers are unfree, because they are unable to become their fully human selves. Even members of the bourgeoisie are unfree, because in using others to produce for them they are also alienated from their nature as producers. Freedom, then, would be the end of alienation and the realization of humanity's species being as producers. A classless society, in which all own the means of production and all are producers in the deepest sense, is the only means of achieving the end of alienation and therefore freedom (*Economic and Philosophic Manuscripts of 1844*). As for other thinkers, equality is not an end in itself for Marx. Instead, equality in ownership and control of the means of production is a necessary prerequisite for freedom.

There are several important developments in contemporary thought about what equality means and which equalities matter. In contemporary capitalist democracies, political theorists and philosophers still debate whether or not the economic inequalities generated by a capitalist economy are consistent with political equality. Defenders of the theories and practices of capitalism, such as F. A. Hayek and Milton Friedman, argue that if a political economic system provides all persons with an equal opportunity to succeed, then inequality of outcome or result is acceptable. That some are rich and others poor fairly reflects individuals' differing aptitudes, work ethics, and even luck. Free markets, according to such thinkers, justly distribute the economic products of a society among its members because they reward economic contributions on the basis of existing demand for those contributions. Efforts to equalize the living standards of rich and poor would rely on coercive governmental power that would sacrifice individual freedom and rights to a kind of equality that may not even be politically important. For such thinkers, then, economic inequality is not a problem as long as political equality—equal rights and capacities to participate in political processes—exists.

Capitalism and Its Critics

Critics of free-market capitalism attack these claims on philosophical, historical, and practical bases. Many question whether indeed the market is a just distributor of the economic products and economic burdens of a society—and therefore whether economic inequalities are just in and of themselves. More generally, non-Marxist critics such as Michael Walzer want a society in which no social good “serves or can serve as a means of domination” (*Spheres of Justice*, p. xiv; see also Lindblom, 1977, 1982). Other thinkers approach concerns over economic inequalities from a more ethical perspective that incorporates the Kantian and social contract approaches to liberalism. Most notable among these is John Rawls, who contends that to correct the inequalities that arise in society we should begin with a thought game in which we imagine ourselves behind a “veil of ignorance,” not knowing what circumstances we will be born into, what attributes and handicaps we will be born with, or what fortune will bring us in life. If we did not know what our situation was, how would we arrange society and what programs to remedy inequality would we propose? He contends that as rational beings we would favor an initial position in the social contract that is basically equal and maintains some meaningful degree of fairness. According to Rawls's difference principle, inequalities are justified only to the extent that they are designed to bring (and actually bring) the greatest possible benefit to the least advantaged among us.

Generally, political thinkers today also debate whether equality of opportunity—assuming it truly exists in advanced capitalist regimes—is indeed enough to ensure political equality, which all in liberal democratic regimes agree is necessary for a polity to be just. Many observers of U.S. politics today, including some who support a free-market capitalist economy, worry that the wall separating political from economic inequalities is regularly breached. One of the most obvious ways in which the wall is breached is through the financing of po-

litical campaigns by private, independent economic actors. Such contributions amount to a powerful form of political influence with which it is difficult for ordinary citizens to compete and which undermines the political equality on which democracy rests.

A less obvious way in which the wall between economic inequalities and political equality is breached is described by Charles Lindblom. For Lindblom, even when corporations do not gain unequal political influence through campaign contributions, they enjoy a “privileged position” in policy-making because of their very real ability to shape economic outcomes. For example, polluting industries have special leverage in lobbying Congress not to enact stricter air-quality standards because they can convincingly claim that the effects of such standards would cause them to lay off workers.

The concentration of economic power in the hands of a few, then, may translate quite directly into a concentration of political power in the hands of the same few. Even if economic inequalities are tolerable in and of themselves, most agree that political equality is sacrosanct and that the translation of economic inequality into political inequality is a serious problem when or if it occurs. These problems with economic inequality exist alongside any threats to good democratic citizenship discussed by civic republican thinkers, such as the tendency of rule by one class in its own interest, which worried Aristotle, and the threat to democratic stability posed by a class with nothing to lose, as Jefferson discussed.

Another, more recent set of questions has been raised by those concerned with global inequalities—especially those inequalities between the economically advanced countries and the less wealthy nations of the world—who point out that limiting discussions of equality and remedies to address perceived inequalities within the nation-state are not appropriate to a highly economically interconnected world. The international political economic environment has inherited inequalities of the colonial era, to which are added the unequal outcomes of international goods and capital markets and the privileging of economically advanced countries by the major international political economic institutions, principally the International Monetary Fund (IMF), World Bank, and World Trade Organization (WTO). Yet most of the mechanisms by which we address socioeconomic inequalities within a nation-state are inappropriate or impractical for use in addressing global inequalities.

Related to these concerns are challenges raised by the rise of international governance institutions—the above-mentioned political economic institutions, the United Nations, regional international organizations, bodies set up to address specific issues, and so on. If the notion of equal representation is fundamental to liberal democratic politics, how ought it be applied to international governance bodies? Generally today such bodies give representation either to each nation-state equally (as with the United Nations) or in some proportion to financial contribution (as with the IMF). The former approach is a holdover from the early days of the modern nation-state, when the state was identified with a monarch who was being

represented in the international realm. However, liberal democracy is based on representation being roughly proportional to population of districts or regions—but this could privilege the elites of populous but nondemocratic states. Basing representation on IMF contributions, many argue, simply reinforces the global economic and political advantages already possessed by the advanced capitalist regimes.

Movements for Equality—Equal to Whom?

Since the mid-1800s, equality has been the rallying cry in the United States for abolitionists, suffragists, the civil rights movement, the feminist movement, gay and lesbian movements, and even some sectors of the environmental movement. One striking aspect of many such movements is their persistence in appropriating the language of the Declaration of Independence that “all men are created equal” or, more broadly, in returning to what Martin Luther King Jr. called the “great wells of democracy . . . dug deep by the Founding Fathers” (“Letter from the Birmingham Jail,” pp. 33–34). Frederick Douglass’s abolitionism, the Declaration of Sentiments of the early U.S. women’s movement, King’s rhetoric, and some voices in the gay and lesbian movement have generally called not for changing the fundamental institutions or political values of the United States but for fully and equally including particular groups in American political life. Equality for these movements has to a large extent meant equal rights, including equal voting rights for women, equal civil rights for African-Americans, and equal marriage rights for same-sex partners (although the latter is debated within gay and lesbian communities).

Members of such movements have debated whether this emphasis on inclusion—in place of a broad critique of the system that has excluded certain groups—is a strength or a weakness. More moderate activists have argued that American ideals and institutions are fundamentally sound and that the problem lies in the unequal inclusion in practice of certain groups into political life. Radical voices in all these movements have suggested that it is not enough to assert a right to the privileges enjoyed by heterosexual white men. The political theorist Wendy Brown has built on this critique. She argues that to the extent that feminists as well as racial and ethnic minority movements operate within the framework of the liberal individualist tradition, they privilege their particular identity as the basis for equality claims. Such thinking “overburdens” their particular identity with the harms they perceive. It also overburdens with blame members of the group defined as dominant in the unequal relationship between identity groups (for women, men; for African Americans, whites; for gays and lesbians, heterosexuals). A larger analysis of the political economic system and inequalities that come from their other social relationships (particularly class) tends to be absent. This, in Brown’s words, “wounds” equality claims by failing to notice the power of the capitalist political economic system to unequally distribute harms and goods. This overburdening also can produce a backlash by placing too much blame for one group’s perceived harms on members of the dominant identity groups. In a sense the dominant group is “wounded” beyond the harm they may have caused when a critique of the political economic system is missing. Such thinking also fails

to notice that many harms are also suffered by members of the dominant group who are in inferior social relationships themselves along some axes of domination—especially class.

Questions such as what kinds of equality are important, as well as equality to whom and for whom, are still contested, even within movements for equality. Multiple identities—ethnic, racial, class, sexual, religious, and so on—create multiple sites for inequalities to emerge, and movements often choose to focus on one site of inequality, sometimes at the expense of another. Moreover, with the globalization of economic production and consumption and the emergence of institutions such as the European Union, questions about the equal treatment and equal rights of migrant and minority groups remain unresolved (see Kymlicka).

Concerns about Equality

Many political thinkers have worried that applications of an ideal of equality may undermine freedom. For Alexis de Tocqueville (1805–1859), equality can easily come to dominate people's political aspirations. As he puts it, citizens (Americans in particular) “want equality in freedom, and if they cannot have that, they still want equality in slavery” (p. 506). Worse, people may tolerate not being free as long as everyone is equally unfree. Equality also isolates individuals, according to Tocqueville. It ends any sense of mutual responsibility that may have previously existed; there is no longer any sense of duty either to one's “superiors” or one's “inferiors” because there are no real superiors or inferiors. Hannah Arendt echoes Tocqueville in her distinction between liberation and freedom. Liberation of the poor from crushing material necessity and dependence on others is a prerequisite to freedom, but it is not freedom because it does not entail participation in self-governance. However, there is a tendency for revolutionary movements to settle for liberation—for relative material equality—rather than seeking complete freedom. Finally, the liberal John Stuart Mill (1806–1873) is concerned that with the undermining of “differences of position” in society, and with “the ascendancy of public opinion in the State,” groups and individuals are increasingly the same and find less and less room for dissent and nonconformity (p. 70). All these thinkers share a general sense that while some forms of equality are key prerequisites of a good politics, equality must not be mistaken for the ultimate political ideal, which for these thinkers is freedom.

Conclusion

For political thinkers concerned with what constitutes good democratic politics, concentrations of power are sources of concern wherever they are found. This is especially the case when these concentrations of power threaten the basic democratic notion that citizens should have a meaningful capacity to govern themselves and participate on a roughly equal basis with other citizens in their collective self-governance. In thinking about what constitutes a good democratic politics we need to recognize the inherent contestability of the very concept of equality and that equality is one value among many (albeit a very important value to democracy). Democracy, by its very nature, requires that no conception of the nature of equality can be taken off the table of political discourse and debate.

Furthermore, no single conception should always prevail in democratic deliberations or it risks the commitment of citizens who do not share the dominant conception of the democratic project. It is in fact the rich contestation over equality and its relation to other political values that helps ensure that new forms of domination cannot creep unnoticed into democratic polities.

See also **Democracy; Liberalism; Marxism.**

BIBLIOGRAPHY

- Appleby, Joyce. *Capitalism and a New Social Order: The Republican Vision of the 1790s*. New York: New York University Press, 1984.
- . *Liberalism and Republicanism in the Historical Imagination*. Cambridge, Mass.: Harvard University Press, 1992.
- Aquinas, Thomas. *Summa Theologiae*. 3 vols. Translated by the Fathers of the English Dominican Province. New York: Benzinger Bros., 1948.
- Arendt, Hannah. *On Revolution*. New York: Viking, 1963.
- Aristotle. *Nicomachean Ethics*. Indianapolis, Ind.: Hackett, 1999.
- . *Politics*. Chicago: University of Chicago Press, 1984.
- Bercovitch, Sacvan. “The Rites of Assent: Rhetoric, Ritual, and the Ideology of American Consensus.” In *The American Self: Myth, Ideology, and Popular Culture*, edited by Sam B. Girgus, 5–42. Albuquerque: University of New Mexico Press, 1981.
- Brown, Wendy. *States of Injury: Power and Freedom in Late Modernity*. Princeton, N.J.: Princeton University Press, 1995.
- hooks, bell. *Feminist Theory: From Margin to Center*. Boston: South End Press, 1984.
- Jefferson, Thomas. *The Portable Thomas Jefferson*. Edited by Merrill D. Peterson. New York: Viking, 1977.
- Kant, Immanuel. “Groundwork of the Metaphysics of Morals.” In his *Practical Philosophy*, translated and edited by Mary J. Gregor, 37–60. Cambridge, U.K.: Cambridge University Press, 1996.
- Kymlicka, Will. *Multicultural Citizenship: A Liberal Theory of Minority Rights*. New York: Oxford University Press, 1995.
- Lindblom, Charles. “The Market as Prison.” *Journal of Politics* 44 (1982).
- . *Politics and Markets*. New York: Basic Books, 1977.
- Locke, John. *Second Treatise on Government*. Edited by C. B. Macpherson. Indianapolis: Hackett, 1980.
- Marx, Karl, and Friedrich Engels. *The Marx-Engels Reader*. 2nd ed. Edited by Robert C. Tucker. New York: Norton, 1978.
- Mill, John Stuart. *On Liberty*. Edited by Elizabeth Rapaport. Indianapolis: Hackett, 1978.
- . *The Subjection of Women*. Mineola, N.Y.: Dover, 1997.
- Ober, Josiah. *The Athenian Revolution*. Princeton, N.J.: Princeton University Press, 1996.
- . *Mass and Elite in Democratic Athens*. Princeton, N.J.: Princeton University Press, 1989.
- Rae, Douglas, et al. *Equalities*. Cambridge, Mass.: Harvard University Press, 1981.
- Rawls, John. *A Theory of Justice*. Rev. ed. Cambridge, Mass.: Harvard University Press, 1999.
- Rousseau, Jean-Jacques. “A Discourse on the Origin of Inequality.” In his *The Social Contract and Discourses*, translated by G. D. H. Cole. New ed. London: Dent, 1993.
- Schneir, Miriam, ed. *Feminism: The Essential Historical Writings*. New York: Vintage, 1994.

- St. John de Crèvecoeur, J. Hector. *Letters from an American Farmer*. Garden City, N.Y.: Doubleday, n.d.
- Terchek, Ronald J. *Republican Paradoxes and Liberal Anxieties*. Lanham, Md.: Rowman and Littlefield, 1997.
- Terchek, Ronald J., and David K. Moore. "Recovering the Political Aristotle: A Critical Response to Smith." *American Political Science Review* 94, no. 4 (December 2000): 905–911.
- Tocqueville, Alexis de. *Democracy in America*. Translated by George Lawrence. New York: Harper and Row, 1969.
- Walzer, Michael. *Spheres of Justice: A Defense of Pluralism and Equality*. New York: Basic Books, 1983.

Alexandra Kogl
David K. Moore

GENDER EQUALITY

The coupling of equality and gender may indicate a paradox, if not an oxymoron. If equality were to exist, would gender? Does the persistent salience of the idea of gender with regard to equality provide evidence of fundamental flaws or contradictions in theories and practices of equality? Can the pursuit of equality reproduce rather than undermine gender dominance? While these questions are central to contemporary discourses on equality and gender, consensus on answers or even means to address them is absent.

Equality is a relational term. It entails establishing a relation between two or more things. Logically, differences between the objects of comparison must exist, for otherwise the question of their equivalence would not occur. However, establishing equality requires specifying a characteristic potentially shared by each thing. Furthermore, it demands identifying a class of objects among which the characteristic might be found. For example, if one declares, "all men are born equal," then one must specify the criterion that warrants this statement. In so doing, the boundary marking equality's terrain is simultaneously established. In this case, equality is significant, or meaningful, only in relations among men, not men and other beings; within this formulation the question "Are men and animals equal?" is unintelligible. Establishing equality thus requires identifying the common criterion and commensurable objects. Having done so, it is then possible to evaluate the relation of each relevant thing to the common measure—if each partakes of the common quality to the same degree, then equality exists.

Thus establishing equality does not require that the objects within its specified class be in all respects identical. However, while discourses of equality do not deny that differences exist, they do claim that in regard to some practices or claims, existing differences are irrelevant. In these practices or claims, what matters is partaking of the common quality. Those who share the quality equally ought to count identically or have equal access to the practice or claim. For example, if one claims that natural rights are innate to each human, then each human's rights are entitled to the same treatment and regard as every other human's. So equality requires a commitment to disregard some characteristics when distributing certain goods or treatment in favor of a presumption of equivalence.

Equality, Liberalism, and Feminism

The idea that public life ought to be organized on the basis of this presumption of a formal equivalence and its ensuing entitlements emerged relatively recently. It is a distinguishing characteristic of modern liberalism, modes of thought and practices that emerged in seventeenth- and eighteenth-century Western Europe. Thomas Hobbes (1588–1679), John Locke (1632–1704), and Jean-Jacques Rousseau (1712–1778) are among the most important early liberal theorists. Their writings reflect and refine the new bourgeoisie's claims of equality arising in the political struggles in early modern Europe against older feudal hierarchal orders. These new movements rejected the ideas of a natural basis for authority or the relevance of certain ascribed characteristics, such as one's family of origin, to the legitimacy of claims to rule or to the distribution of public power.

In the apparent rejection of the significance of at least some ascribed characteristics to the distribution of power, discourses of equality would appear to have the potential to dissolve the basis of many asymmetrical relationships. Indeed, one can argue that modern feminisms emerged simultaneously with and within theories and practices of liberal equality. However, while perhaps siblings, feminisms and their related liberal discourses are not identical. From the first, feminisms exposed the contradictions and limits of liberal equality. Feminist movements fought (and in some countries, continue to fight) sustained and difficult battles to attain suffrage and equal rights to education, reproductive freedom, employment, and protection under the law. Such rights are called formal equality. As more countries extend formal equality to previously excluded groups and declare their commitment to gender neutrality, however, the contradictions and limits of formal equality become more evident. Consequently the meanings of and relationships between equality and gender are increasingly complex and contested.

Equality and Sexual Difference

Tensions between equality and gender exist partially as the result of each term's traditional construction. While equality is understood as equivalence and entails stipulating a common quality or uniform measure, gender has been constituted through difference, specifically "sexual difference." Until recent feminist discourses, *gender* and *sexual difference* have been interchangeable and identical terms. As traditionally conceived, gender is constituted in and through "naturally occurring" sexual (anatomical) differences. Male and female are dichotomous natural kinds; gender categories simply reflect a biologically determined order. All humans are one and only one of gender's constituent binary pair: man/woman. Conventionally, gender is not only a binary, but an asymmetrical, hierarchical one. The male is the norm and superior, the female deviant and lacking.

Given this ranking, when theorists began to evaluate the significance of equality discourses to women's situations, certain questions inevitably arose. These included whether sexual difference was a kind of difference relevant to theories and practices of equality and, if so, if women's difference was misconceived. In other words, despite women's difference, were

they in the relevant sense equal to men? The relevant sense would be that they sufficiently partake of the common quality the possession of which warrants claims to equality. Thus eighteenth-century writers such as Mary Wollstonecraft (1759–1797) argue that reason is the common quality that renders humans equal. Women are as capable of reasoning as men; hence, they deserve equal enjoyment of all public rights. Later John Stuart Mill (1806–1873) argues that given the existing subordination of women, it is impossible to know what their true nature might be. Therefore, one ought to assume that they are as able and desiring as men to exercise the innate capacities of self-development and reason that define humanness.

Gender Asymmetries and the Limits of Formal Equality

Coupled with strenuous political activity, such claims of women's sameness—in regard to being “like men” in their possession of the essential quality grounding equality—eventually produced formal legal equality for women in most states. In most countries in the early twenty-first century, according to law, women can vote, own property, enter professions, receive an education, hold public office, and so forth. However, despite this formal equality, few would argue that gender asymmetries have disappeared. Women worldwide are far more likely than men who are otherwise similarly situated in race, ethnic, and class positions to be poor or illiterate; to perform the most dangerous, low-paying work; to suffer sexual violence; and to be absent from positions of public, economic, and cultural power.

The persistence of such gender asymmetries generates vigorous feminist debate. Some argue discourses of equality replicate rather than undermine male dominance. The male side of the gender binary remains the norm, hence female difference is devalued. Equality simply means the integration of women within “male-ordered” states. Insofar as individual women seek to emulate male-dominant values, they may attain equal access to political, cultural, and economic institutions. Such individual access will do nothing to transform the devaluation of the feminine or undermine patriarchal ways of life. True equality would require a reevaluation of female difference and its incorporation, not erasure, within revised norms and social practices. Alternatively, some argue that the persistence of gender asymmetry is a symptom of pervasive, systemic domination. Equality is insufficient or inappropriate to overturn such social relations. Instead, theorists recommend a variety of alternate approaches, for example, ones rooted in theories and practices of justice, radical democracy, or sex or class revolution.

Beyond Gender Neutrality

Other feminists deconstruct the apparently gender-neutral qualities said to ground human equality and question the putative neutrality of the liberal state. They examine abstract notions of reason and the individual posited by philosophers such as Immanuel Kant (1724–1804) or John Rawls (1921–2002) to warrant formal equality. Abstract reason and individualism require a split between the particular, phenomenal, material, embodied person and the universal, noumenal, unsituated mind. The identification of body with error and mind with

capacity to grasp truth maps too neatly with the gendered split of female (body)/male (mind). In particular, some argue, it replicates the devaluation or denial of the unique, generative power of women—only they can give birth to children. Excluding female difference from the public world enables the actual constitution of its modal citizens, male heads of households, to remain obscured. Incorporating sexually differentiated embodiment within reason would undermine its universalistic appearance and hence its capacity to ground equality. If females were no longer the only markers of embodied difference, the gender specificity of all citizens could no longer be denied. Once this were to occur, the patriarchally ordered nature of existing public worlds would be evident. Unless transformed, a patriarchal state cannot institute true gender equality.

Some deconstructive approaches raise the further question of whether there are any universalizable (gender-neutral) qualities that could ground equality, and if so what they might be. Equality would have to be radically rethought without recourse to the presumption that such qualities exist. Such questions intersect with the concerns of gender activists in “postcolonial” states. Here, as in the West, states may use gender as the basis for differential social control and distribution of resources, but such practices may also be justified in the name of a “tradition” that resists contemporary forms of cultural and political-economic Western imperialism. For example, in contemporary Iran and Saudi Arabia, state-sanctioned constraints on women's mobility, public activities, and employment are justified as protecting women's modesty. This modesty is said to be required by the Koran, and in turn Islam is represented as a barrier to postcolonialist Western domination. Given the effects of globalization and transnational politics on the postcolonial states, whether discourses of equality are intrinsically “Western” and colonizing remains an important concern for feminists of these countries.

Inequality or Domination?

Rather than a reflection of biologically given sexual difference, feminists argue, gender is socially constructed or an effect of power. Male/female is constituted so as to sustain male dominance. So are all other aspects of human existence—work, culture, family, politics, knowledge, sexuality, and subjectivity. Writers point, for example, to the structure of work in capitalist economies. Working hours and responsibilities are often inflexible and do not easily fit with caretaking or other household responsibilities. Hence, work replicates and reproduces a gendered public/private split and the sexual division of labor. The modal worker is a heterosexual, married male. His wife takes care of children and all other domestic responsibilities. Due to their reproductive capacities and existing gender expectations, women are disadvantaged within these structures. Formal equality cannot resolve or even recognize such systematic disadvantage, for it only comes into play when women are already equally situated relative to men. Equality stipulates equal pay for equal work, but it does not transform the workplace to take equally into account the multiple demands of wage labor and caretaking. Thus structural disadvantage persists.

Indeed some writers argue that it is in precisely those areas where sexual difference most disadvantages women that formal equality is most ineffective or even counterproductive. Three areas of particular concern are reproduction, the sexual division of labor, and sexual violence. Women are not similarly situated to men in any of these areas. Currently only women can be pregnant; moreover, public policies regarding matters such as abortion or forced sterilization, maternity leave, and exclusion from certain jobs on “health” grounds will necessarily impact women differently than men. Similarly, women are far more likely to suffer sexual violence and harassment than are men. The power of cultural norms and pressures of socialization and unconscious subjective desires and identity formation sustain gendered norms of caretaking so that most responsibility for domestic labor, child care, tending to the elderly, and so forth, continues to fall on women. Differential effects of public policies (or the lack of them)—concerning social welfare provision, divorce law, and health care—on women and men result from this sexual division of labor. Insistence that women are “like men” or that there is a gender-neutral norm in such areas is likely to sustain women’s current disadvantages.

Politics of Inequality and Difference

Writers differ, however, on policies to remedy such problems. Some emphasize the need to reorganize the sexual division of labor within the family so as to render males and females equally situated there. Others envision a radical reorganization of all spheres so that caretaking is treated as a public matter and civic responsibility, not simply a private duty. Some extend this argument to support a more extensive breakdown of the gendered split between nurturance and public action and a reevaluation of stereotypically female values. They argue that the “female virtues” of care and attention to particulars ought to inform practices of citizenship and all other aspects of political-economic life.

Attention to disadvantages arising from women’s difference has generated many social movements. Some activist groups have pushed for reproductive rights for women (both for legal abortion and for women’s ability to shape “population” policy and eliminate forced sterilization). Other groups have successfully generated pressure to recognize sexual harassment as a form of sexual discrimination, actionable under law. Reproductive-rights activists in some countries have succeeded in ensuring that women now have increased access to legal and safe abortions and more control over decisions affecting their own bodies. Still other groups focus on the social provision of resources in areas typically seen as women’s responsibility; such resources range from child care to clean water, care of the old and sick, and “microloans” to fund small-scale economic enterprises so that women can support themselves and their children.

Gender, Sexuality, and Sexual Difference

While respecting the practical achievements resulting from attention to gender/equality, whether in the form of formal equality or sexual difference/disadvantage, some writers and activists claim neither approach goes far enough in identifying and combating the fatal flaws intrinsic to current construc-

tions of gender and equality. Of central importance are the constructions of gender itself. Some writers argue that gender, sexual difference, and sexuality must be delinked and reconceived. Others stress the internal complexity of gender and its simultaneous constitution through social relations such as race, sexuality, class, and geographic location. Attention to these concerns raises further questions about the relevant measure by which equality ought to be gauged and also in whose name “equality” is claimed.

Judith Butler and others argue that sex difference should not be understood as a “natural” kind. Rather, gender relations produce sexual difference by organizing the body in particular ways and attributing social significance and meaning to certain of its features. There is no necessary relation between anatomy and gender; rather, each subject is engendered through mandatory social practices. These social practices, rather than biology, demand that individuals locate themselves and others on one or the other side of the binary male/female. Absent gender domination, there might be many genders, or none at all, and embodiment would not be read as and through “sexual difference.” Similarly, there is no necessary relationship between anatomy and sexuality. Sexuality is about desire and pleasure, and practices expressing and gratifying these affects are highly variable. Hetero- and homosexuality are equally social constructs, ones that reinforce and naturalize gender and sexual difference. Appropriate objects of desire are specified and gender identities are stabilized by linking desire and “sexual difference”; I am a man because I desire a woman; I desire a woman because my penis makes it “natural” to do so.

In this view the goal is not equality between men and women, but an end to compulsory gender and heterosexuality. This would both produce and necessitate radically different notions and practices of subjectivity, family, and kinship. Rather than distribute labor more evenly among men and women within heterosexual families, the emphasis should be on multiplying the possibilities of affective ties and seeking their legal-social recognition and support. These ideas both undergird and reflect a move toward “queer” politics, in which the goal is to resist gender and to undermine male/female as mandatory subject positions. In pursuit of such goals, queer politics advocates policies including recognition of legal rights of homosexual partners and alternate kinship relations, nontraditional adoption, treating homophobic or violent acts toward those who resist traditional gendering as legally actionable wrongs, and extending the right of privacy beyond heterosexual practices.

Race, Gender, Class, and Geographic Location

Another area of sharp contention is whether gender can be understood best as the subordination of women by men. What then defines women is their shared inequality. While some writers such as Catharine A. MacKinnon and Susan Moller Okin claim that gender subordination is universal (all women are oppressed by male domination), others argue for a more differentiated view. First, the question remains, what is the valid standard or norm serving as the unit of measurement? Is it the social, political, economic, and cultural positions of the most privileged men in the world? In relation to this group, many men, due to their race, ethnicity, geographic location,

sexuality, or other social relations, are extremely disadvantaged. Are women to be situated in relation to men who share their other social locations? In this case, a poor woman might in many dimensions be equal to her male peer, yet highly disadvantaged in relation to other women.

Second, the binary approach to gender cannot do justice to the multiple ways it is enacted. Binary conceptions occlude the particular, complex qualities of women's and men's locations. The doing of gender is shaped by many factors. Gender is always inflected by other social relations, just as those relations are inflected by gender. Global patterns of the distribution of resources have an enormous impact on women's (and men's) lives, and not all these patterns are solely a function of male dominance. Relative to some marked female, others constituted differently enjoy many privileges. The privilege of some women, due to constituting constellations of race, sexuality, class, or location, and so forth, often rests on the continuing disadvantage of others. For example, the sustained economic deterioration of some areas leads to the immigration of poor women into more prosperous countries. The low-wage labor of these women enables other women to purchase domestic services and compete more effectively for access to higher-paid professions. Conversely, the shared oppressions of many women and men along race, location, ethnic, class, or other lines produces forms of solidarity and common interest among some women and men. In the United States, for example, the intersections of race and gender have produced complex patterns of deep loyalty among many women and men of color as well as oppression of these women both by men of color and by white men and women. Similarly, the horrific forms of colonialist and racist domination of men by other men and some women's complicity in it cannot be ignored. Thus struggles for meaningful transformations of women's condition and gender relations must take local and diverse forms. Unable any longer to speak in the name of a singular subject or to generate a consensus on a universalizable equivalent, discourses of equality may be poorly suited to address such complexities.

See also *Feminism; Gender; Human Rights; Women's Rights; Identity, Multiple*.

BIBLIOGRAPHY

- Butler, Judith. *Gender Trouble: Feminism and the Subversion of Identity*. New York: Routledge, 1990.
- Butler, Judith, and Joan W. Scott, eds. *Feminists Theorize the Political*. New York: Routledge, 1992.
- Collins, Patricia Hill. *Black Feminist Thought: Knowledge, Consciousness, and the Politics of Empowerment*. New York: Routledge, 2000.
- Davis, Angela Y. *Women, Race, and Class*. New York: Vintage, 1983.
- Flax, Jane. "Beyond Equality and Difference." In *Beyond Equality and Difference: Citizenship, Feminist Politics, and Female Subjectivity*, edited by Gisela Bock and Susan James. New York: Routledge, 1992.
- . "On Encountering Incommensurability: Martha Nussbaum's Aristotelian Practice." In *Controversies in Feminism*, edited by James P. Sterba. Lanham, Md.: Rowman and Littlefield, 2001.

- MacKinnon, Catharine A. *Feminism Unmodified: Discourses on Life and Law*. Cambridge, Mass.: Harvard University Press, 1987.
- Mill, John Stuart. "The Subjection of Women." In *John Stuart Mill: Three Essays*. New York: Oxford University Press, 1975.
- Mohanty, Chandra Talpade, Ann Russo, and Lourdes Torres. *Third World Women and the Politics of Feminism*. Bloomington: Indiana University Press, 1991.
- Nussbaum, Martha. "In Defense of Universal Values." In *Controversies in Feminism*, edited by James P. Sterba. Lanham, Md.: Rowman and Littlefield, 2001.
- Okin, Susan Moller. *Justice, Gender, and the Family*. New York: Basic Books, 1989.
- Scott, Joan W. "Deconstruction Equality-Versus-Difference: Or, the Uses of Poststructuralist Theory for Feminism." In *Conflicts in Feminism*, edited by Marianne Hirsch and Evelyn Fox Keller. New York: Routledge, 1990.
- Wollstonecraft, Mary. *A Vindication of the Rights of Woman*. Edited by Charles W. Hagelman, Jr. New York: Norton, 1967.

Jane Flax

RACIAL EQUALITY

Racial equality is the belief that individuals, regardless of their racial characteristics, are morally, politically, and legally equal and should be treated as such. Furthermore, it is the belief that different racial groups, as groups, are equal, with none being inherently superior or inferior in intelligence, virtue, or beauty. In the United States the term is commonly linked to the belief in equal treatment under the law as well as equal opportunity as a principle to ensure individuals, regardless of their race, an equal opportunity in education, employment, and politics.

In reality, the ideal of racial equality, however defined, has not always been practiced, nor has it been fully achieved anywhere in the world. This is because the belief in racial equality has historically had to counter both deeply rooted beliefs in racial inequality as well as the concrete political, legal, and customary practices of racial discrimination and oppression. Hence racial equality is expressed in antiracist philosophy and in antiracist political mobilization.

Racism as Ideology

The idea of racial equality has disputed long-standing beliefs in racial inequality that can be traced back several hundred years. Centuries ago, the colonization or enslavement of a people was often justified on grounds of cultural superiority (as in the case of British colonial control over India) and even on religious grounds (for example, slavery was rationalized as biblically ordained by Noah's curse of Ham or as a process of bringing Christianity to heathens). In the 1700s, however, racial inequality was increasingly given a scientific justification.

Contemporary categories of race ("white," "black," etc.) were given a scientific status by Carolus Linnaeus and Johann Friedrich Blumenbach. Typical of the era, each explained race with reference to climate and geography. In 1758, Linnaeus classified humans as "Americanus" (currently Native American), whom he described as red, upright, choleric, and ruled by habit; "Europaeus" (currently European), whom he de-

scribed as white, sanguine, muscular, and ruled by custom; “Asiaticus” (currently Asian), whom he described as pale yellow, melancholy, stiff, and ruled by belief; and “Africanus” (currently African), whom he described as black, phlegmatic, relaxed, and ruled by caprice. Later, in 1795, Blumenbach asserted the moral equality of races but still categorized and ranked them according to his conception of beauty: Caucasians were his ideal, with Malays and Ethiopians representing one line of “degeneration” and Americans and Mongolians representing a second line. These typologies had the inevitable result of not only reifying race as a scientific category, but also solidifying the alleged link between race, beauty, intelligence, and the capability of exercising self-government.

In the nineteenth and early twentieth centuries, racial inequality was justified by several different scientific approaches. First, polygenism attempted to explain that each race is genetically distinct, with Europeans seen as superior to blacks, Asians, and Native Americans. Indeed, in his *Essay on the Inequality of Human Races*, Joseph Arthur de Gobineau asserted that whites were superior to other races and advised great nations to preserve their racial purity, since racial mixture, he claimed, led to cultural degeneration and political decline. Then craniometry was used in an attempt to explain intelligence according to brain size. Similarly, criminal anthropology attempted to explain criminality with reference to facial features such as the slope of one’s forehead. Also, World War I-era intelligence quotient tests were originally used to link intelligence to heredity, ranking whites above European immigrants and African-Americans. By reducing race to biology, these approaches, as Ashley Montagu observed:

alleged that something called “race” is the prime determinant of all the important traits of body and soul, of character and personality, of human beings and nations. And it is further alleged that this something called “race” is a fixed and unchangeable part of the germ plasm, which, transmitted from generation to generation, unfolds in each people as a typical expression of personality and culture. (p. 14)

Because biological determinism alleges that race is fixed, unchangeable, and hierarchical, these approaches lend favor to discriminatory, reactionary, or do-nothing policy approaches (Gould, pp. 51–61).

These approaches, however, were flawed both because they were tainted by the prejudices of the researchers and because they lacked scientific rigor. For example, Montagu’s reanalysis of early intelligence quotient tests found that the average score for blacks from the North was higher than the average score for whites from the South. If these results reveal anything, it is *not* that intelligence is innately connected to race but that the quality of and funding levels for public education are strongly correlated with results (Gould, pp. 249–250). This lends support not to heredity and biology as inherently connected to intelligence but to an approach that stresses the social and educational environment in which a person grows up. Since racial inequality in practice provides some groups with access to good educational opportunities and denies them to

others, it is no surprise if test scores differ across these groups. If racial inequality is affected by unequal social factors, this environmental approach suggests that improving those social factors will promote racial equality.

In the twentieth century, scholars such as Franz Boas and Montagu have argued that attempts to reduce race to biology should be rejected because they prop up ideologies and practices of inequality. Going one step further, Montagu suggested, “[b]ased as it is on unexamined facts and unjustifiable generalizations, it were better that the term ‘race,’ being so weighed down with false meaning, be dropped altogether from the vocabulary” (p. 62). Many scientists continue to point out that race does not exist in any scientific sense. For example, human beings are genetically 99.988 percent identical, with more genetic variation existing within racial categories than between them. Despite this, social scientists have not dropped “race” from their vocabulary. Instead, while they agree that race is indeed a useless scientific category, it is nevertheless real because race has very real social consequences that affect an individual’s or group’s opportunities, rights, and resources, or lack thereof, in a particular society.

In this sense, race is socially and legally constructed, and its meaning varies across time and place. F. James Davis, for example, illustrates how different legal definitions of “black” were codified during slavery and segregation to maintain the racial hierarchy on which each was based. Furthermore, Howard Winant illustrates how race is defined differently according to historical, cultural, economic, and legal contexts when one compares the United States, South Africa, Brazil, and other countries. Scholarship such as this rejects the biological or scientific notion of race as a myth but accepts the notion that race is socially, politically, and economically “real” because of the ways in which people are privileged or disadvantaged by its meanings and practices.

The Politics of Racial Inequality

This discussion will now look at how racial inequality manifests itself in a variety of constitutional, legal, policy, and cultural practices.

In the United States, the Constitution accommodated the interests of the slaveholding states in three areas: first, the famous “3/5ths clause” that counted five enslaved blacks as three free persons for purposes of taxation and representation; second, the new Congress was prohibited from even considering abolishing the importation of slaves until 1809; and third, the Constitution (Article IV, section 2) required states to assist in returning any person escaped from bondage back to the state from which they had escaped. Indeed, citing the intent of the framers of the Constitution, the Supreme Court ruled in the *Dred Scott* decision of 1857 that enslaved Africans and their descendants in the United States were never intended to be citizens. The Court ruled that black people “had no rights that the white man was bound to respect.”

Racial equality was constitutionally established through three amendments during the Reconstruction Era. The Thirteenth Amendment barred slavery or involuntary servitude, the



Wedgwood medallion bearing the inscription “Am I not a man and a brother?” (1787). Jasper ware. The knowledge that all humans are almost completely identical on the genetic level has led many social scientists to consider the use of the term *race* as more of a social concept than a biological term. WILBERFORCE HOUSE, HULL CITY MUSEUMS AND ART GALLERIES, UK / THE BRIDGEMAN ART LIBRARY, WWW.BRIDGEMAN.CO.UK

Fourteenth Amendment established standards of due process and equal treatment under the law for all citizens, and the Fifteenth Amendment guaranteed that the right to vote could not be denied due to race, color, or previous condition of servitude. However, by the end of the nineteenth century blacks were effectively disenfranchised as a result of violence, intimidation, and a range of tricks adopted by states (e.g., the Grandfather Clause, white primaries, poll taxes, and literacy tests) to avoid compliance with the Fifteenth Amendment. Furthermore, the Supreme Court issued decisions that limited the effectiveness of the civil rights acts passed by Congress during Reconstruction. Finally, in the *Plessy v. Ferguson* decision of 1896, the Supreme Court ruled that “separate but equal” accommodations in public transportation were not a violation of the Fourteenth Amendment’s equal protection clause. This phrase, “separate but equal,” was then applied to all spheres of life and epitomized the era of “Jim Crow” segregation. Facilities were separate but they were anything but equal. For example, white schools in some states received ten times the financial support compared to black schools (Fairclough).

In Germany, the biological determinism of nineteenth-century writers such as Gobineau was influential in the emergence of nationalism, fascism, and Nazism. For instance, Jewish people were seen as a biologically inferior race that represented a cultural and political threat to the superiority and purity of the Aryan race idolized by Adolf Hitler. As a result,

they were subjected to economic and political ghettoization, used as forced labor, and targeted for genocide. Also, in South Africa, a gradual process of racial separateness, or apartheid, began with the Native Land Act of 1913 that divided land to promote white ownership and domination as well as limited face-to-face interaction between blacks and whites. With the victory of the Nationalist Party in 1948, apartheid was fully institutionalized as a complete set of policies whereby the white minority completely segregated and dominated the black majority (Frederickson, 1981, pp. 239–249).

Countries have also used immigration policy as a discriminatory device, often basing immigration law on notions that certain racial groups were inferior and represented cultural or economic threats. In the mid-1800s in the United States, Chinese laborers were relied on to help build the transcontinental railroad. However, a nativist movement emerged, with white working-class men viewing Chinese laborers as an economic threat. As a result, the U.S. Congress passed the Chinese Exclusion Act in 1882, which prohibited Chinese immigration as well as the naturalization of Chinese laborers already in the United States. By 1917, U.S. immigration law prohibited immigration of labor from all of Asia except for Japan, as well as placing a tax on Mexican employees. Also in the early twentieth century, Australia adopted immigration laws designed to limit the number of Indian, Pacific Islander, and Asian immigrants. Such laws were adopted on the biological-determinist argument that these immigrants were racially inferior and a cultural threat to the superior “white Australia” (Miles, pp. 90–98).

Institutionalized racial inequality is also intertwined with economic inequality. In the United States, enslaved blacks provided a labor source for the Southern agrarian economy. Even after slavery was abolished, Southern blacks were still treated as a source of tenant farmers and laborers. In the twentieth century, blacks have typically faced twice the unemployment rate of whites and have struggled against discrimination in hiring, promotion, and pay. In 1942, due to labor shortages caused by World War II, the U.S. government established the Bracero program, under which Mexico sent to the United States workers who were given some legal status but exploited as cheap labor. Also during World War II, Japanese-Americans, but not Italian- or German-Americans, were subject to relocation and internment because of President Roosevelt’s Executive Order 9066 in 1942, resulting in a gross violation of civil rights as well as a loss of property and businesses.

The Struggle for Racial Equality

To combat and dismantle racial inequality, a variety of groups and tactics emerged throughout the twentieth century in the United States and other countries. The predominant strategy has been nonviolent disobedience, the political mobilization of resources, and moral suasion to mobilize public opinion. However, some groups have advocated armed self-defense or violence as a strategy for revolutionary change.

By the dawn of the twentieth century, several strategies emerged to oppose Jim Crow and challenge the United States to live up to its professed ideals. Some reformers, such as Booker T. Washington, urged blacks to not push for civil and

political rights but instead to work hard, acquire a trade, and eventually hope for white acceptance. Others, such as W. E. B. Du Bois, argued that black people had every right to mobilize for equal civil and political rights that were now constitutionally guaranteed and that to do anything less was to accept a permanent second-class status. Du Bois and other reformers formed what turned into the preeminent civil rights organization of the twentieth century, the National Association for the Advancement of Colored People (NAACP), in 1909. The NAACP marched, protested, and, under the guidance of Charles Hamilton Houston, created a legal defense fund to pursue a strategy of social change through litigation.

This strategy came to fruition with the landmark *Brown v. Board of Education*, *Topeka* decision of 1954, in which the Supreme Court overturned the *Plessy* standard of “separate but equal” and declared that separate educational facilities are inherently unconstitutional. In the 1960s and 1970s, the litigation strategy and the NAACP Legal Defense Fund itself were used as models for other groups: the Mexican American Legal Defense and Education Fund (MALDEF), formed in 1968; the Puerto Rican Legal Defense and Education Fund (PRLDF), formed in 1972; and the Native American Rights Fund (NARF), formed in 1970.

The economics of racial inequality were also opposed and changed with a range of tactics. In the United States there have been several campaigns organized under the “don’t shop where you can’t work” strategy. Furthermore, in the 1950s and 1960s, economic boycotts were used to withdraw financial support from businesses and public transportation systems that engaged in segregation. Many of these were successful, the most famous one being the Montgomery bus boycott of 1955, which made Rosa Parks a civil rights icon and helped Martin Luther King, Jr., become a national civil rights leader. In 1962, Cesar Chavez helped form the National Farmworkers Association (NFWA) to defend the rights of Mexican-American and Asian-American agricultural workers. The NFWA helped negotiate contracts with corporate growers and was supported by consumer boycotts of targeted products, such as grapes. Also, in the 1980s, a global antiapartheid movement used economic and cultural boycotts, as well as pressuring companies and governments to divest from South Africa, to force the National Party to negotiate the dismantling of apartheid.

Nonviolent marches, sit-ins, and freedom rides were tactics used both to pressure private companies to end segregation but also to pressure the federal government to enforce civil rights laws in Southern states. The Southern Christian Leadership Conference (SCLC) was formed in 1957 with King as its leader. The SCLC drew on the organizational support of black churches and ministers to organize marches and protests across the South as well as the March on Washington for Jobs and Freedom in 1963, at which King gave his famous “I have a dream” speech. Other groups and tactics also emerged. The Student Nonviolent Coordinating Committee (SNCC) was led by college-aged black youth and eventually included white college-aged members. SNCC was active in sit-ins to integrate segregated lunch counters in Greenville, North Carolina. Together with members of the interracial Congress

of Racial Equality (CORE), SNCC members were active in “freedom rides” to desegregate bus terminals in the South, and members of both organizations were active in voter-registration efforts in Mississippi in 1963 and 1964 (Dittmer).

Such efforts finally pressured Congress and the president to act. The Civil Rights Act of 1964 guaranteed equal access and equal treatment under the law, banned segregated public accommodations, and prohibited discrimination in hiring on the basis of race, gender, or national origin. A year later, the Voting Rights Act of 1965 banned all discriminatory voter-registration laws and gave the Justice Department power to ensure that voting and election laws were not discriminatory. Indeed, with this act the promise of the Fifteenth Amendment was finally fulfilled. Also in 1965, immigration policies were reformed finally to dismantle any legacies of racial preference and discrimination. In 1968, the final major civil rights act of the era banned discrimination in the sale or rental of property and housing.

With these victories in the courts and in Congress, many Americans thought the nation’s principles of equality were finally matched by its practices. In one way, this is true. For example, black voter-registration rates in Mississippi went from about 6 percent of eligible voters in 1965 to about 63 percent in 1971 and 1972 (Lawson). On the other hand, while legislation and litigation helped establish the principles of equality under the law, voting rights, and equal access to public accommodations, there still exists a legacy of economic inequity and social injustice.

Occasionally, groups pursued a strategy of armed self-defense or violence as a means to combat entrenched racial inequality. Contrary to the nonviolent philosophy of the civil rights movement in the 1950s and 1960s, individuals such as Robert F. Williams in North Carolina and groups such as the Deacons for Defense and Justice in Louisiana advocated civil and political rights but also reserved the right to self-defense when facing violent opposition (Tyson). In South Africa, the African National Congress (ANC) was formed to resist apartheid and originally set out on a course of nonviolent disobedience. However, some within the ANC eventually adopted a strategy of limited armed resistance that used selective acts of force for purposes of economic sabotage (Fredrickson, 1995). For this, Nelson Mandela was imprisoned until 1990, when he was released as part of South Africa’s dismantling of apartheid.

The Continuing Struggle

Historically speaking, it is only recently that the belief in racial equality has refuted biological arguments that support racial hierarchies. In the early twenty-first century it has been commonplace for scholars to refer to race not as a biological concept but as a social construction. It is also only recently that the belief in racial equality has helped mobilize social change through a variety of tactics that resulted in the dismantling of legalized segregation in the United States and apartheid in South Africa. Despite these gains, however, racial equality remains elusive. As King and others had already observed in the late 1960s, changes in the attitudes of whites as well as legal and legislative changes to promote equal treatment, voting

rights, and equal opportunity are all necessary steps in the effort to establish racial equality. The next set of steps includes a strong enforcement of civil rights as well as a major restructuring of economic resources, economic opportunities, educational opportunities, and political influence (King).

In the United States, several issues since the early 1970s serve as reminders that racial equality remains elusive. Fifty years after the *Brown* decision, there are increasing levels of segregation in the public schools of large, Northern cities, indicating that residential segregation also exists. College attendance rates for Latinos and blacks continue to lag behind those of whites and Asian-Americans. Indeed, gaps in educational achievement measured by standardized test scores have spurred the reemergence of biological explanations of race and intelligence (Gould). Incidents of police brutality and the harassment of black motorists (referred to as “racial profiling” or “driving while black”) are signs that civil rights enforcement is still needed. And despite an emerging black middle class, there is controversy surrounding “affirmative action,” a range of policies to ensure equal educational and employment opportunity.

On affirmative action and other issues, large differences of opinion between white and black Americans are emerging—so large that some scholars have labeled them “chasms” (Smith and Seltzer). Ironically, some invoke Dr. King’s notion that individuals should be judged by the content of their character, not the color of their skin, to oppose policies intended to promote racial equality. Some find the goal of “color blindness” laudable; others believe diversity should be respected through pursuance of a “multiracial” set of policies that are conscious of race and targeted at ameliorating racial inequalities as a better path toward racial equality in the United States.

In global terms, several issues continue to demand attention and controversy. The legacies of past injustices, such as the Holocaust, slavery, segregation, and apartheid, have led to debates surrounding apologies, compensation, and reparations. South Africa has established a Truth and Reconciliation Commission to document the injustices of apartheid as well as to promote national reconciliation as it builds a multiracial democracy. The U.S. Congress passed the Civil Liberties Act of 1988, which issued an apology and offered a small monetary compensation to Japanese Americans interned during World War II. However, calls for an apology or compensation to black Americans for the legacies of slavery and segregation remain controversial (Brooks).

Additionally, the rights of economic and political refugees and migrants continue to be a focal point of the struggle for racial equality in Europe and the United States. Indeed, migrants and refugees constitute a cheap and exploitable source of labor but also spark xenophobic and nationalist reaction. Right-wing movements and leaders have emerged in France, Germany, Austria, and the United States to oppose the immigration of people they see as culturally, linguistically, or racially inferior. These and other concerns were the focus of the United Nations Conference against Racism, Racial Discrimination, Xenophobia, and Related Intolerance, held in Durban, South Africa, in August and September of 2001.

However, due to concerns that the conference would take strong stands against Israeli treatment of Palestinians as well as potentially open the door to reparations for slavery, the United States did not participate.

It is clear from these and other issues that the goal of racial equality remains in a constant and ongoing struggle against racism, both its current manifestations and its legacies, within the United States and around the world.

See also *Apartheid; Justice; Prejudice; Race and Racism*.

BIBLIOGRAPHY

- Brooks, Roy L., ed. *When Sorry Isn't Enough: The Controversy over Apologies and Reparations for Human Injustice*. New York: New York University Press, 1999.
- Davis, F. James. *Who Is Black? One Nation's Definition*. University Park: Pennsylvania State University Press, 1991.
- Dittmer, John. *Local People: The Struggle for Civil Rights in Mississippi*. Urbana: University of Illinois, 1994.
- Fairclough, Adam. *Better Day Coming: Blacks and Equality, 1890–2000*. New York: Viking, 2001.
- Fredrickson, George M. *Black Liberation: A Comparative History of Black Ideologies in the United States and South Africa*. New York: Oxford University Press, 1995.
- . *White Supremacy: A Comparative Study in American and South African History*. New York: Oxford University Press, 1981.
- Goldhagen, Daniel Jonah. *Hitler's Willing Executioners: Ordinary Germans and the Holocaust*. New York: Knopf, 1996.
- Gould, Stephen Jay. *The Mismeasure of Man*. Rev. ed. New York: W.W. Norton, 1996.
- King, Martin Luther, Jr. *Where Do We Go from Here: Chaos or Community?* Boston: Beacon Press, 1968.
- Lawson, Steven. F. *Running for Freedom: Civil Rights and Black Politics in America Since 1941*. New York: McGraw-Hill, 1991.
- Miles, Robert. *Racism*. London: Routledge, 1989.
- Montagu, Ashley. *Man's Most Dangerous Myth: The Fallacy of Race*. 5th ed. New York: Oxford University Press, 1974.
- Smith, Robert C., and Richard Seltzer. *Contemporary Controversies and the American Racial Divide*. Lanham, Md.: Rowman and Littlefield, 2000.
- Tyson, Timothy B. *Radio Free Dixie: Robert F. Williams and the Roots of Black Power*. Chapel Hill: University of North Carolina Press, 1999.
- Winant, Howard. *The World Is a Ghetto: Race and Democracy since World War II*. New York: Basic Books, 2001.

Gregory W. Streich

ESCHATOLOGY. The concept of eschatology was created by the Lutheran theologian Abraham Calov (1612–1686) and became popular through the works of the Prussian Reformed theologian F. D. E. Schleiermacher (1768–1834). It is derived from a sentence in *Jesus Sirach*: “In whatever you do, remember your last days [Greek: *ta eschata*], and you will never sin” (Sir. 7:36). Calov’s concept is nothing but a new name for the traditional genre of Christian dogmatic treatises about “the last things” (Latin: *De novissimis* or *De extremis*). Generally, it

can be said that eschatology deals with death and the things that, according to Christian doctrine, happen after death: the resurrection, the last judgment, and the eternal life in the Beyond. Relatively recently scholars in religious studies have begun to apply the concept of eschatology to the teachings about death and immortality in virtually all religions. But a continuous tradition of eschatological doctrine exists only in Christian theology.

Jewish Roots

Christian eschatology emerges from Jewish apocalypticism. The early Jewish apocalypses, such as those in the biblical book of Daniel, were written in the Hellenist period, when the Ptolemaic, the Seleucid, and later the Roman empires ruled Palestine. A growing number of Jews no longer believed in the coming of a messiah who would renew the glorious kingdom of David. Having seen one empire follow another, they believed the Jewish people had successively lost the ability to establish an independent kingdom. The gap between their consciousness of being God's elected people and political reality led to a deep crisis of the Jewish self-understanding (best described in the apocryphal Fourth Book of Ezra). The crisis was solved by the discovery of the Beyond. Modern historians of religion emphasize that Persian, Egyptian, Greek, and other historical influences played a role in this intellectual process, but the apocalyptic authors themselves describe the paradigm shift as a revelation (*apokalypsis*), gained in visionary experiences. They often give detailed accounts about the journeys they made into the Beyond.

The basic ideas of Jewish apocalypticism live on in Christian eschatology, in orthodox doctrine as well as in the preaching of sects and heretical groups. Mankind and the world are in a pathological state, for they are corrupted by original sin—a hereditary disease that cannot be cured. Therefore God will destroy this world and create a new one. But he will save the just believers and transfer them into the perfect order of the Beyond. Since the apocalyptics had lost all faith in national messianism, the decisive question is no longer whether a believer belongs to the elected people of Israel. The Jews might have a certain prerogative, but no guarantee of salvation. God is no longer the God of Israel but the ruler of the universe; the structure of world history is predetermined by his unchangeable plan. All the empires and political orders, the tyrants and the warlords are tools in the hand of God used to test the believers. The just ones must not partake in the political and military struggles of the corrupted world but must stay strong in their faith and wait for the annihilation of all evil and the beginning of God's kingdom.

All features of Christian eschatology that differ from Jewish apocalypticism are related to the experience of Christ. Although there is a variety of sometimes contradictory meanings of the word "Christ" already to be found in the New Testament, they all agree on one point: the presence of Christ among sinful mankind moderates the sharp distinction between this world and the Beyond. Christ answers the Pharisees, a Jewish group of apocalyptic intellectuals, who were waiting for dawn of the new eon: "The kingdom of God is not coming with

signs to be observed; nor will they say, 'Lo, here it is!' or 'There!' for behold, the kingdom of God is in the midst of you" (Luke 17:20–21).

According to Christian experience, the presence of the Savior introduces an anticipation of the Beyond; it signifies a breakthrough of the future into the present. The *eschata*, the resurrection of the dead, the last judgment, and the creation of the new world, are therefore the completion of a process already started by Christ in this world.

Pauline and Augustinian Contributions

The most influential interpretation of the experience of Christ was given by the Apostle Paul. He preached that Christ's incarnation, passion, and crucifixion redeem from sin anyone who becomes a member of the church (*ekklesia*), the mystical body of Christ. Paul's concept of the church points to two specific features of Christian eschatology. First, collectivity: The *eschaton* is not a personal event. Salvation from death is available only for the members of Christ's mystical body. On judgment day, the dead members of the church will be resurrected and unite with the living to form a single community of salvation (1 Thess. 4:13–17). Throughout Christian history, Hellenist-influenced theologians challenged Paul's collective eschatology by emphasizing the individual ascent of the immortal soul. They could justify their view with some quotations from the Gospels. Paul, however, clearly rejects the idea of the soul's solitary ascent and insists on the resurrection of the spiritually transformed body. Second, processuality: in this world the church already collects all the citizens who will establish the heavenly citizenship (*politeuma*) of the Beyond (Phil. 3:20). Therefore the creation of a new world is not a single event at the end of history but can be observed now in the church (2 Cor. 5:17). The establishment and growth of the church already belongs to the *eschata*. Christian existence is an eschatological existence between "already now" and "not yet." The Holy Spirit transforms the "inward man" of the members of the church, but a purely spiritual existence will be achieved only in the Beyond, after the "outward man," the carnal and mortal body, has died (2 Cor. 4:16, 5:6; Phil. 3:21).

The Gospels and the letters of Paul show that the early Christians awaited the final events in the imminent future. Yet the church became a historical reality and, after the Roman emperors turned to Christianity, a powerful institution in this world. This new experience led to two different variations of Christian eschatology. First, theologians such as Eusebius of Caesarea (c. 263–c. 339) worked out an imperial eschatology. The basic dogma was that God chose the Roman Empire to spread Christianity all over the world. Church and empire seemed to melt together under the rulership of the Constantinian dynasty. According to Eusebius, the Roman emperors succeeded Christ to fulfill the divine plan on earth; and at the end of history, Christ would return and succeed the emperors. The *eschaton*, the kingdom of God, appears as the perfection of the Roman Empire. Second, other Christians returned to apocalypticism and insisted that only the just ones who did not collaborate with the worldly powers would be saved. The chiliasts, who also appeared in later epochs of Christian history, believed

that Christ would return in the near future and, after the destruction of all worldly empires, would establish a kingdom lasting a thousand (Greek: *chilia*) years. The Revelation of John, which was incorporated into the canon of the New Testament, seemed to confirm their view (cf. Rev. 20:4).

In the early fifth century, when the decline of the Western empire became obvious, empirical reality seemed to speak in favor of the apocalypics. But the church father Augustine (354–430) rejected the imperial theology as well as apocalypticism by reformulating the Pauline eschatology as a theology of history. In his view, all of the elected—those who had received the grace of God—form the true body of Christ, the City of God (*civitas Dei*). And all wicked ones form the body of the devil, the earthly city (*civitas terrena*). Sacred history is nothing but the struggle between these two cities. Augustine calls the two cities mystical communities, since they are not identical with any empirical society. Even the Catholic Church is not identical with the City of God, but a *corpus permixtum*, a mixed body, composed of just and wicked human beings. The elect are only pilgrims in this world and its political orders. Only after the final judgment, after the separation of the just and the wicked, will the mystical societies become visible. The citizens of the City of God will be seen going to heaven and the others, to hell.

The Joachimite Turn

Augustinian eschatology governed the self-understanding of the Catholic Church until it was heavily shaken by the theology of an Italian abbot, Joachim of Fiore (c. 1135?–1202) and the numberless movements that referred to him. Joachim was convinced that God had revealed to him a new understanding of the Bible. He predicted the beginning of a third age (*tertius status*) of the Holy Spirit that would follow the first age of the Father, as described in the Old Testament, and the second age, which ran from the incarnation of Christ to Joachim's present. The abbot taught that the Trinity reveals itself in three progressive stages. The revelation of the Father had formed the patriarchal society of Israel; the revelation of the Son had formed the church of the clerics. And soon the revelation of the Holy Ghost would create the new spiritual church (*ecclesia spiritalis*), a church dominated by monks. In Joachim's view, the third age appears as an anticipated realization of the perfect order of the Beyond.

Several scholars of the twentieth century, such as Karl Löwith (1897–1973), Eric Voegelin (1901–1985), Norman Cohn (1915–), and Jacob Taubes (1923–1987), claimed that Joachim of Fiore started a process in which Christian eschatology was “immanentized” (Voegelin) or “secularized” (Löwith). The four authors recognized the transformation of Christian eschatology into ideologies of inner-worldly progress as the decisive formative power of modernity. The third stadium of Auguste Comte's positivism was to be seen as a modern transformation of Joachim's third age, as well as the Third Reich of the National Socialists and the Marxist realm of freedom.

See also *Christianity; Judaism; Millenarianism; Mysticism.*

BIBLIOGRAPHY

PRIMARY SOURCES

- Augustine. *The City of God against the Pagans*. Ed. and trans. R. W. Dyson. Cambridge Texts in the History of Political Thought. Cambridge, U.K., and New York: Cambridge University Press, 1998.
- Charlesworth, James H., ed. *The Old Testament Pseudepigrapha. Vol 1. Apocalyptic Literature and Testaments*. New York: Doubleday, 1983.
- McGinn, Bernard, trans. *Apocalyptic Spirituality: Treatises and Letters of Lactantius, Adso of Montier-en-Der, Joachim of Fiore, the Franciscan Spirituals, Savonarola*. Classics of Western Spirituality. New York: Paulist Press, 1979.

SECONDARY SOURCES

- Bultmann, Rudolf Karl. *History and Eschatology*. Edinburgh: University Press, 1957.
- Cohn, Norman. *Cosmos, Chaos, and the World to Come: The Ancient Roots of Apocalyptic Faith*. New Haven, Conn.: Yale University Press, 1993.
- . *The Pursuit of the Millennium: Revolutionary Millenarians and Mystical Anarchists of the Middle Ages*. Rev. and expanded ed. New York: Oxford University Press, 1970.
- Löwith, Karl. *Meaning in History: The Theological Implications of the Philosophy of History*. Chicago: University of Chicago Press, 1949.
- Reventlow, Henning Graf, ed. *Eschatology in the Bible and in Jewish and Christian Tradition*. Sheffield, U.K.: Sheffield Academic Press, 1997.
- Taubes, Jacob. *Abendländische Eschatologie*. Munich, Germany: Matthes and Seitz, 1991.
- Voegelin, Eric. *Modernity without Restraint*, edited by Manfred Henningsen. Columbia: University of Missouri Press, 2000.

Matthias Riedl

ESSENTIALISM. Essentialists believe true essences exist. In the *Metaphysics*, Aristotle (384–322 B.C.E.) specifies the classic definition: an essence of a thing is that which it is said to be per se. It is that which is most irreducible, unchanging, and therefore constitutive of a thing. A thing's essence is that property without which the thing would cease to exist as itself. Each individual thing is one and the same as its essence, necessarily and not accidentally. Objects derive their coherence and intelligibility from the unchangeability and homogeneity of their underlying essences. Essence belongs primarily and simply to substance. The substance of things is their primary cause of being. Essences are anterior to and causative of ideas or practices. All things that have the same substance or essence are identical. Only a species or genus can have an essence. An essence is true of the thing in general, it does not derive from the manifold particulars of a thing. To define an essence is to give an account of a primary real—one that does not imply the assertion of something about something else. A distinctive set of ontological postulates thus appears intrinsic to essentialism. A realm of being outside time and culture or historical change exists. This realm is the real, the stable, the structured and eternal underlying the flux and chaos of the infinite variety of transitory appearances. The real world is made

up of homogeneous, clear, and distinct essences. Innate or given essences sort objects naturally into species or kinds (natural kinds). The resulting categories are eternal, unchanging, stable, and universal.

Essences and Knowledge

Philosophers differ on whether humans can apprehend such constituting essences. While Plato (c. 428–348 or 347 B.C.E.) and Aristotle argue they can, others such as Immanuel Kant (1724–1804) deny the possibility of directly grasping the noumenal world (how things are in themselves). Thus, a belief in the intelligibility of essences requires supplementary assumptions concerning the nature of mind and language. The mind itself must have an essence, some essential faculty empowering it to directly and accurately register the essences of things. For Plato and Aristotle, this faculty is reason. The intelligibility of essences also requires positing language as a neutral, transparent medium. Language is a reporting device; it can neither enter into the constitution of the recorded essence nor distort it, for then our knowledge of essences could never attain eidetic accuracy.

Essentialism is a response to problems of recognition and meaning. Amid all the variety of empirical experience and the multiple forms that objects assume, how do we recognize many differently appearing things as instances of the same phenomenon? Where do the categories in and through which we organize empirical experience come from? As the Scottish philosopher David Hume (1711–1776) and others argue, we do not have direct empirical experience of abstract, general categories. Unmediated empirical experience is a transitory flux of fleeting sense impressions and sensations. Chairs, for example, come in many colors, sizes, and shapes. Yet, we recognize many variations as instances of one species. How is this possible? Plato argues that such recognition is contingent on the prior existence of a form or an essence, chairness, or the idea of a chair. Such an idea is pure form, and all empirical chairs are simply approximations of this idea. While approximations are changeable and all empirical objects will eventually decay or disappear, the idea or pure form of a chair is eternal.

Essences and Ethics

For both Plato and Aristotle, essence is intertwined with another notion, *telos*. *Telos* connotes purpose, end, and good. Its essence is what a thing is meant to be. Matter is merely full potential, unactualized. Only by realizing its essence, can the thing fully exist. However, Plato and Aristotle differ on how fully an essence can be realized in the empirical world. For Plato, a pure essence can be at best imperfectly realized as long as it is mixed with any empirical matter. Aristotle does not think all such mixtures are intrinsically flawed. Nonetheless, for both, this necessity has ethical as well as existential connotations. Understanding humans' essence simultaneously and necessarily stipulates what we are and what (or how) it is good for us to be. Humans must actualize and conform to this true essence. Only then can we live a fully human life. However for the good, the real, and the true to coincide, supplementary metaphysical assumptions are necessary. For example, both Plato and Aristotle postulate that an eternal and univer-

sal natural law governs the real world. Natural law endows each thing, person, and human association or practice with its particular *telos*. It guarantees that the purpose, end, and good of each thing are identical. In realizing its purpose, the thing also attains its natural completion and its good. Natural law is knowable, but not created, by human reason. Intrinsic to reason is the obligation and capacity to discover this law and adjust our souls and social arrangements accordingly.

Empiricist Objections to Essentialism

Many philosophers object to essentialism. Empiricists like the English philosopher John Locke (1632–1704) reject its a priori postulation of innate ideas or universal truths. They claim that the only preexisting real is the human capacity for sense experience and reflection upon it. Unlike Aristotle, Locke claims that all knowledge originates in sense experience, and the simple ideas derived from our sensations and unmediated thoughts represent the limits of the knowable. Real essences can only be discovered by close empirical observation; all else is idle and potentially dangerous speculation. Every truth claim, including essentialist ones, must be subject to any individual's empirical investigation and verification. Otherwise, objective evaluation of whether such claims actually reflect nothing but the weight of tradition or the power of authority masquerading as truth is impossible.

Modern philosophers, including Karl Popper, extend Locke's rejection of unverifiable claims regarding essences. Rationality demands a skepticism regarding the self-evident existence of anything. For a claim to have truth value, it must be possible to specify conditions under which it can be falsified. These conditions must be translatable into empirical tests that at least conditionally rule out the falsity of the statement. What intersubjectively verifiable tests could we possibly devise for claims like "humans have a soul," much less that it is our essence?

Kripke: Essentialism Recast

Some philosophers such as Saul Kripke attempt to rescue essentialism by situating its claims within semantics. Kripke asserts that "rigid designators" exist. A rigid designator is an expression that designates the same object in all the possible worlds in which it designates at all. It is determined by an essential property of its referent. Modern semantics can devise meaningful tests for propositions about essences. Properties must be physical and their correlated mental states incorrigibly knowable. For example, Kripke claims the term *pain* is a rigid designator. Pain is necessarily a physical state. It is identical to this physical state. If any phenomenon is picked out in exactly the same way we pick out pain, it must be correlated with that physical state, and hence the phenomenon must be pain.

However, this and other forms of essentialism are vulnerable to objections posed by pragmatists and social constructionists. Pragmatists argue that coherence, meaning, and intelligibility arise out of our immersion in a common way of life, from practical agreement, or a shared understanding for some purpose or activity. Meaning arises from use; use is enabled through sharing a common set of practices. Over time, practices generate a tacit, usually background network of

meanings that appear to always have been there, existing independently outside the practices that create and sustain them. These ordered patterns reflect neither metaphysical reality nor ontological necessity, but rather the effects of social expectations, chance, shared language games, convention, or force.

Pragmatist and Social Constructionist Objections to Essentialism

Twentieth-century philosophers have supplemented such criticism by critiquing essentialist philosophies of language. For example, Richard Rorty advocates permanently abandoning essence. Essentialism necessarily requires a value-free vocabulary that can report facts and render sets of factual statements commensurable. However, language is not a neutral medium through which truth or fact is reported; it is also neither an arbitrary nor a necessary system of signs connecting words and things. Language cannot be understood as composed of words or sentences in any nominalist way. Words are saturated with social meanings. They incorporate accounts of experience and ways of recognizing it as a case of x as opposed to y . Even what feels like empirical experience is already linguistically organized. Language is best apprehended in terms of language games, complex sets of practices that constitute ways of life. Furthermore, these games are not grounded in anything outside or beyond themselves. Relationships of reference, for example, are not objectively necessary but simply further parts of the world of the present day.

Social constructionists typically emphasize the constituting effect of human practices. However, some, for example Michel Foucault (1926–1984), extend the domain of relevant practices and propose novel approaches to questions of meaning and truth. Unlike many pragmatists and constructionists, Foucault pays close attention to relations of power and how these both enable and constrain modes of subjectivity, meaning, knowledge and truth. Foucault relocates problems of identity, truth, knowledge, reality, and meaning outside their traditional domains of ontology, epistemology, and metaphysics into discourse analysis. Discourses are complex, dynamic systems of practices, knowledge, and multiple kinds of power. Such discourses generate disciplinary norms that simultaneously produce and constrain subjects and question formation; they enable participants to recognize and evaluate truth claims. Foucault suggests displacing “what/who is it?” as central questions about any of these topics with a different one—“how is it?” How is it requires a genealogy that unpacks multiple kinds of practices. Among the practices some subjects are expected to enact are the discovery or enunciation of the essences of things, including themselves. Genealogies of historically specific discourses indicate that questions about essences could arise and remain salient or even intelligible only within certain ways of life.

Feminist Disputes

Essentialism is a contested topic within feminist discourses. Feminist theorists critique traditional, essentialist accounts of woman. One could argue that contemporary Western feminism began with the publication of Simone de Beauvoir’s (1908–1986) *The Second Sex* (1949). De Beauvoir asserts that

woman is made, not born, and proceeds to delineate recurrent attempts within Western culture to reduce woman to her putative, biological essence. Since at least Aristotle, philosophers have claimed that woman has an essence and that this essence is a material one. Woman is matter; she is defined by her unique physical property (reproduction). The identity of each individual, actually existing woman is ultimately and necessarily determined by this essence.

Feminist discourse extends this critique into an investigation of the interdependence of gender arrangements, gender-based asymmetries, heterosexism, and the “essential” or natural, factual meanings of body, matter, nature, and sex. Judith Butler’s work is especially influential. Butler argues that “sex” is an effect of gender and heterosexism. How we understand bodies and matter and what is assigned to categories of “natural” and “social” fact, indeed these very categories, must be deconstructed into the social and linguistic practices and power relations that generate them. An adequate response to essentialist constructs of woman requires a strategy different from disconnecting the social (gender) and the biological (sex) and claiming that the biological does not determine the social. To claim that woman is made is still to assume that “woman” exists. Furthermore, it leaves sex undisturbed as a natural kind, inaccessible to genealogical investigation.

Subaltern Objections to Essentialism

Feminists also question “feminist” essentialism. Angela Harris defines essentialism as the belief that a monolithic race or gender experience exists that can be described independently of other social relations. To be antiessentialist means to understand that the lives of women of color and all people generate and enact multiple forms of subjectivity. It is erroneous to posit heterosexuality as the norm or that black male experience is the exemplar for black women and all minorities. The authors of the influential collection *Home Girls* (1983) and Elizabeth Spelman label essentialist any claim that an essential woman exists beneath differences among women. Any assertion of a universal property or position shared by all women is suspect. Such claims obscure the many important differences among women. Belief in a common identity requires conflating one group of women with the whole and erasing differences, especially those of race, class, and sexuality. Differences among women can be safely ignored or relegated to footnotes. However, this approach simply obfuscates the effects of whiteness and other dominant social relations on and as particular modes of womanhood. It obscures the ways race is constituted in contemporary practices such that only people of color are marked by race and white remains the unmarked, unraced. Within such practices, any woman leached of all color is actually white. Removing race only results in removing black women. Black women then become white women only more so. White women can then represent all women. Paradoxically, this then redounds more so to warrant assertions of the common oppression of all women, including white ones. All women, from the most impoverished “third world woman” to the wealthiest white one, are equally instances of women’s universal condition.

Paul Gilroy and others within cultural and subaltern studies also critique essentialism. In their view, it enables, expresses, and reproduces global systems of domination. Colonialist discourses postulate essential human traits that non-Western others lack or could only imperfectly possess. The homogeneity of such essences existed only through contrast with heterogeneous others. Projecting all impurity, materiality, and instability on these others enabled certain subjects to imagine themselves as instances of the pure and eternal—reason, the soul, the fully human, etc. Such ideas then underwrote Western claims of the right to rule and civilize (to the extent possible) these inferior others.

Feminist Essentialism

These antiessentialist arguments are controversial. Some insist that social movements require a deep notion of shared position and condition. Writers such as Diana Fuss and Gayatri Spivak argue that essentialism itself has no essence; the problem is how it is used. Oppressed groups can deploy essentialism strategically. Essentialist concepts enable the oppressed to organize resistant forms of identity and sustain a powerful sense of solidarity.

Other theorists such as Luce Irigaray, Catharine MacKinnon, and Martha Nussbaum also deploy a feminist essentialism. Irigaray argues that the problem is not that woman has been conceived in essentialist terms but rather the content of those terms. Woman's essence has been defined by men, as not-man or lesser man. Women have never articulated their own difference, among themselves and for themselves. For Irigaray, this essence can never be one; it does not conform to the unitary logic of homo-centric discourse. Irigaray employs the metaphor of the labia; two lips, always two, not divisible into one; neither one nor two. Two lips provide the basis for a speaking (as) woman, to articulate a feminine imaginary. MacKinnon insists that gender difference is a socially constructed concept invented to sustain male dominance. Under patriarchy, all women share a common essence—sexuality. Sexuality is a social process that creates and directs desire. Woman is produced through this process as an object whose only purpose is to gratify men. While Nussbaum situates herself within the language of rights and human capacities, she too insists that male dominance is universal and universally experienced by all women. Their liberation requires stipulating universal norms. Justice cannot exist without a binding consensus on a universalist account of human functioning and its regulative force. Those most deprived of support for the essential human capacities (often women outside the West) are most in need of such norms.

Despite ingenious attempts to rescue it, modern essentialism has yet to provide satisfactory responses to skeptical inquiries regarding how we know if we have grasped a true essence. While problems of meaning, representation, intelligibility, and identity remain, essentialists have yet to persuade skeptics to abandon their doubts.

See also Feminism; Form, Metaphysical, in Ancient and Medieval Thought; Humanity; Metaphysics; Natural Law.

BIBLIOGRAPHY

- Butler, Judith. *Bodies That Matter: On the Discursive Limits of 'Sex.'* New York: Routledge, 1993.
- De Beauvoir, Simone. *The Second Sex.* Translated by H. M. Parshley. New York: Bantam, 1961.
- Foucault, Michel. *Ethics: Subjectivity and Truth.* Edited by Paul Rabinow. Translated by Robert Hurley and others. New York: New Press, 1997.
- Fuss, Diana. *Essentially Speaking: Feminism, Nature, and Difference.* New York: Routledge, 1989.
- Gilroy, Paul. *Against Race: Imagining Political Culture beyond the Color Line.* Cambridge, Mass.: Harvard University Press, 2000.
- Harris, Angela. "Race and Essentialism in Feminist Legal Theory." In *Critical Race Feminism: A Reader*, edited by Adrienne Katherine Wing. New York: New York University Press, 1997.
- Irigaray, Luce. *This Sex Which Is Not One.* Translated by Catherine Porter with Carolyn Burke. Ithaca, N.Y.: Cornell University Press, 1985.
- Kripke, Saul. "Identity and Necessity." In *Philosophy As It Is*, edited by Ted Honderich and Myles Burnyeat. New York: Penguin, 1979.
- MacKinnon, Catharine A. *Feminism Unmodified: Discourses on Life and Law.* Cambridge, Mass.: Harvard University Press, 1987.
- Nussbaum, Martha. *Sex and Social Justice.* New York: Oxford University Press, 1999.
- Popper, Karl R. *Conjectures and Refutations: The Growth of Scientific Knowledge.* New York: Basic Books, 1962.
- Rorty, Richard. *Philosophy and the Mirror of Nature.* Princeton, N.J.; Princeton University Press, 1979.
- Smith, Barbara, ed. *Home Girls: A Black Feminist Anthology.* New York: Kitchen Table: Women of Color Press, 1983.
- Spelman, Elizabeth V. *Inessential Woman: Problems of Exclusion in Feminist Thought.* Boston: Beacon Press, 1988.
- Spivak, Gayatri Chakravorty. *A Critique of Postcolonial Reason: Toward a History of the Vanishing Present.* Cambridge, Mass.: Harvard University Press, 1999.

Jane Flax

ETHICS. *See Bioethics; Environmental Ethics; Philosophy, Moral; Virtue Ethics.*

ETHNICITY AND RACE.

This entry includes three subentries:

Africa
Anthropology
Islamic Views

AFRICA

There is an abiding paradox in the concept of race. It is a biological fiction but a social reality. Biologically it is now established beyond doubt that there are no distinct races among human beings and that the genetic variation within particular groups of people is much higher than between groups. The view

that people possess inherent personality characteristics attached to particular irreducible phenotypes has been systematically discredited, yet the outward appearance of people still plays a profound social role in the manner in which different people relate to each other. These readily perceived phenotypical differences are often the bases upon which people construct social differences between themselves. Skin color is the most obvious of these differences. The apartheid (translates as “separateness”) regime in South Africa represented the clearest possible expression of the political use of skin color to discriminate against blacks, by disenfranchising them, excluding them from the central institutions of the state, and by ensuring that they would be available as cheap labor in the mines, on the farms, and in the factories.

The instrumental use of race as a convenient means to attain political and economic goals was forcefully articulated by Oliver Cox when he insisted that race should be defined socially, not biologically, since it connotes social relations of exploitation between people and not biological differences. There is an ongoing debate about the origin of the concept of race and its adjuncts, racism and racialism. While some argue that these are concepts that are as old as humanity itself, others argue that they arose as a direct result of the modern era and are intimately connected to colonial conquest and the slave trade. Anthony Appiah has drawn an interesting distinction between racialism and racism. *Racism* refers to negative varieties of discrimination on the basis of an ideology that orders society into a hierarchy of supremacy and domination, where some people may see others as inherently inferior on the basis of an undefined racial essence. It has both an institutionalized form (for example, apartheid) and an interpersonal presence. Racism thus consists of the view that this unspecified racial essence translates into certain inherent, usually objectionable properties (such as laziness, filth, lack of punctuality, and so on) that justify treating people differently, usually unequally. On the other hand, *racialism* refers to the recognition of physical difference between people as being socially and psychologically significant in the sense that they share certain traits and characteristics, but without attaching any inherently inferior or superior characteristics to different people. Many argue that this position is debatable, suggesting that perceiving such differences almost invariably implies the acceptance of inequality between people.

Race in Africa

Frantz Fanon offered a trenchant critique of colonialism as a form of racism at both the institutional and interpersonal levels. Being a psychiatrist, he was particularly interested in the manner in which colonial racism created problems of self-identification for blacks since it conveyed the brutal message that might was right and might was almost invariably white. By simple deduction, therefore, white was almost always right. Fanon argued very forcefully that the colonizers had successfully imposed their image of the colonized on Africans and that it was incumbent on Africans to rid themselves of this image of inferiority, often through violence. Colonial subjugation had a devastating effect on black subjects that the postcolonial regimes have not overcome, because in many ways the new black elites have simply mimicked their past rulers in the most grotesque fashion.

The Senegalese poet and president Léopold Sédar Senghor, in developing the concept of *negritude*, provided an eloquent negation of French culture and the colonial policies of assimilation and acculturation that produced black Frenchmen and -women as “photographic negatives of the colonizers.” While their knowledge of French culture, their French accents, and their appreciation of the finer qualities of French wine may have been impeccable, a racial line prevented blacks from becoming fully fledged Frenchmen and -women. Thus, Senghor and a host of others reacted in various ways to this racial exclusion that Paul Gilroy captured so eloquently for England in his captivating title *There Ain't No Black in the Union Jack*.

Amilcar Cabral, for example, articulated a theory of liberation based on the retained collective cultural identity of blacks as distinct from that of the Portuguese colonialists, in his clarion call to “return to the source.” His theory was rooted in the material conditions of Guinea that he regarded as a reservoir of local experiences ripe for anticolonial mobilization. Under these conditions liberation was necessarily an act of asserting and affirming African culture.

The Francophone and Lusophone (Portuguese-speaking) African experiences were very different from the Anglophone, where, for example, racial exclusion led Steve Biko to a departure from the white liberal student organization as part of the Black Consciousness movement. The move was couched in political as well as psychological terms. Having seen blacks oppressed to such an extent that they started to actively despise themselves, Biko preached a counterideology of psychological liberation as a precondition for true emancipation, using slogans such as “Black man you are on your own” and “Black is beautiful.” The apartheid regime defined *black* in the narrow sense to mean only those Africans who spoke indigenous languages, excluding the so-called coloreds and Indians. The black consciousness movement responded with a generic definition of blackness to encompass all those who suffered a common political disability, having been disenfranchised. *Black* was thus defined politically to mean all those who would readily support the struggle against apartheid, while those who worked the machinery of their own oppression were termed sellouts, just as similar people were called Negroes in the United States.

Given the extreme, official, and institutionalized form of racism of apartheid, it was appropriate that the third United Nations World Conference against Racism, Racial Discrimination, Xenophobia and Related Intolerance (Durban, 2001) should be held in South Africa. One of the debates of relevance to the definition of racism concerned whether Zionism should be included as a form of racism in terms of the manner in which the Israeli state treated the Palestinians. Both the Israeli and United States governments withdrew from the conference on account of this and other issues, while Yasser Arafat was adamant in describing the Israeli occupation of Palestinian land as “a racial discrimination policy in their ugliest forms and image” and “a new and advanced type of apartheid.”

The Concept of Ethnicity

While *race* thus refers to the social construction of difference on the basis of perceived physical or morphological differences,

ethnicity is supposed to refer to cultural differences between people. The two obviously intersect in many ways since racists readily use the concept of ethnicity to mask their racism. The apartheid regime, for example, changed its official nomenclature from *race* and *tribe* to *ethnic group* and then to *nation* in an effort to legitimize its policy of territorial segregation. The term closest to *ethnicity* and in fact still in use after being systematically discredited for many years is *tribalism*.

In broad terms there are two main approaches to the study of ethnicity. On the one hand, the primordialist approach sees ethnicity and ethnic diversity as relatively permanent features that are deeply rooted in the essential and particularistic experiences of groups of people. People are thus divided on an enduring basis and in an unchanging manner. In this view ethnic groups are seen as distinctive units usually based on the idea of a common descent, where the commonality of culture is inherited and thus given from the past and people are born into particular ethnic groups. On the other hand, the social constructionist approach sees ethnicity as a modern instrumentalist symbol in advancing the material interests of groups whose composition may change in response to competitive opportunities. In this sense ethnicities are created or “invented” by elites as they seek to manipulate ideas about ethnicity in order to secure their own interests. The primordialist/constructionist divide has had a profound impact on the debate about the significance of ethnicity in Africa. The main terms of this debate concern whether ethnic groups connote real categories of people or whether cultural differences are manipulated by pernicious political leaders for their own reasons of personal aggrandizement and petty ambitions of power. The position of the primordialists on ethnicity comes close to the concept of race as a historical given, and the distinctions between these are quite blurred. However, the constructionists reject these essentialisms and instead allow room for choice and individual agency in the formation of ethnicities.

Ethnicity Debates in Africa

The tensions in these approaches have polarized studies on ethnicity in Africa. Okwudiba Nnoli, for example, takes up the primordialist position, accepting that ethnic groups do exist, are real with clearly defined interests, and play a pervasive role in African politics. Arguing along the same lines that ethnic conflict needs to be taken seriously, Ibbo Mandaza ends with an entirely different conclusion, suggesting that the persistent danger of ethnic conflict imposes a necessary reconciliation of the elites of the various groups (he includes tribes) in the nation-building project of postcolonial Africa. In response to this widespread position among African leaders and scholars, Mohamed Salih advances the opinion that recognizing rather than denying ethnicity may be the key to the democratization project in Africa. Taking the ethnic basis of political mobilization at face value, Salih argues that this reality rests awkwardly next to the public denial of ethnicity manifested in the banning (across Africa, except in Ethiopia) of political parties that are explicitly ethnically based with an unambiguous ethnic constituency. On the basis of an impressive array of empirical evidence, Salih makes the point that most African political parties are ethnically based in any case, and it is time to simply rec-

ognize this reality to allow for it to play a positive legitimizing force in contemporary African politics. While it is clear that ethnicity is endemic in Africa, Salih does not elaborate on how to overcome the inevitable problems of exclusion and inclusion in a political process that is ethnically based. Put bluntly, if ethnically based political parties win an election, then they would have to deliver to an ethnic constituency that would obviously define the winners and losers in ethnic terms. It is extremely difficult to imagine how this could translate into a legitimate polity.

Archie Mafeje scolds Nnoli and others for not providing an analysis of ethnicity and for treating ethnic groups as things in themselves, following the empiricism rife in American political science. Instead he dispels the idea that there are discrete, naturally occurring entities of belonging that may be called ethnic groups in Africa. He draws a distinction between social groups and social categories, where the former are characterized by inevitable patterns of social interaction such as lineages or associations, and the latter does not imply such regular interaction at all but is rather defined by common identity, such as members of the same religion. Mafeje’s argument is that ethnicity is related to the national competition for scarce resources in response to the centralization of power rather than to local particularistic conflicts. In this sense, ethnicity has a recent derivation since it refers to an ideological ploy used by political elites to yield the benefits of power and wealth. In this view, ethnicity does not represent some preexisting African cultural essence but a convenient means of political mobilization for elites.

In a paper delivered at the Networking with a View to Promoting Peace conference in 1999, Dan Nabudere attempts to reconcile these two perspectives by drawing a distinction between positive and negative aspects to ethnicity, where the former refers to the notion of self-identification, self-expression, and enjoyment in membership of a stable entity in a “posttraditional” manner capable of coping with the demands of modernity. The negative aspect of ethnicity accommodates Mafeje’s concern with elite manipulation of ethnic sentiment for narrow political ends of positions in the state.

In the postcolonial period, there was a flurry of scholarly activity as the new elites tried to redefine their pasts in ways that placed the ambivalent significance of the colonial period in its proper perspective. The question of race and ethnicity was crucial, especially in the southern African settler societies. History was being rewritten just as history was being made. New myths were invented in an effort to construct united national cultures since separate ethnicities were regarded as threatening to the nation-building project.

According to Mahmood Mamdani, one of the key challenges of the process of independence from colonial rule was to break down the barriers between ethnically defined rural subjects and racially defined urban citizens. However, Mamdani argues that decolonization did not have “an agenda for democratising customary power.” Michael Chege provides a very critical review of Mamdani’s thesis, arguing that it is simplistic in its dualism and does not appreciate the nuances

of rural African society. Chege is particularly scathing about Mamdani's use of *tribe*, *tribespeople*, *tribalism*, and *customary law* "as concrete categories of political behaviour."

South African historiography, especially during the 1970s and 1980s, was dominated by endless debates on the relation between race and class in attempts at explaining the nature of the apartheid regime. For some there was a contingent relation between the two; for others the relation was an instrumental one, with race being used as a convenient tool for the class exploitation of blacks; for still others race had an independent existence. The race/class debate in South Africa provides a useful historiographical glimpse of an important era in the evolution of social science thought.

Ethnic Experiments in Africa

Ethiopia and South Africa represent two opposite poles in dealing with ethnicity. The two countries are on entirely separate constitutional journeys. South Africa has emerged from the ethnic balkanization of apartheid and moved toward the constitutional establishment of a unitary state with the idea of a single nation. Ethiopia, on the other hand, has emerged from an imposed imperial unity via a centralist, militarized distortion of socialism to a dispensation of ethnic federalism. Ethiopia is the only country in Africa that explicitly recognizes ethnicity in its constitution, enshrined in the construction of ethnically based regional states and the official acknowledgment that there are many nations. In the case of Ethiopia, the nature of feudal autocracy determined the invariably ethnic-based form of opposition. For example, virtually all the liberation movements involved in the overthrow of the military regime had secession from Ethiopia as an integral part of their programs. This aim was obviously influenced by the slogan of the rights of nations to self-determination. Imperial oppression was structured along the lines of imposing a policy of Amharization (officially promoting the language and culture of the Amhara) in an effort to construct a unitary national culture in Ethiopia. It is not surprising, therefore, that opposition was founded on the affirmation of separate peoples, nations, and nationalities and that virtually all multiethnic or nonethnic political parties have failed dismally in Ethiopia. It is instructive that the form of rule is termed ethnic federalism, but the groups that occupy these positions are referred to as peoples, nations, or nationalities.

If South Africa and Ethiopia represent two poles on a continuum, then Nigeria exists somewhere between these two in the manner in which it has chosen to deal with ethnicity. The Nigerian constitution does not explicitly recognize ethnicity, but it recognizes the federal character of the country, or the regional (read ethnic) differences between people. Here sharing of the national cake is very explicitly seen in ethnic terms, even if ethnically based parties are banned. The federal character principle adopted in the First Republic was supposed to be reflective of the wide diversity of the Nigerian population, but it has not prevented Northern domination of the federal government. It was in response to this tendency toward Northern control that a system of rotating presidencies was proposed by parties in the running for the presidential elections.

People obviously have different cultural practices. These mark the distinctive ways in which identity and consciousness are formed in different communities. Whether these ethnic identities should be politicized is an ongoing debate in African social thought. All African societies are diverse, and how to accommodate and even celebrate that diversity without the endless civil strife and ethnically inspired violence remains an abiding challenge.

See also Africa, Idea of; Anticolonialism: Africa; Apartheid; Black Consciousness; Colonialism: Africa; Humanity: African Thought; Multiculturalism, Africa; Nationalism: Africa; Pan-Africanism; Race and Racism.

BIBLIOGRAPHY

- Chege, Michael. Book review of Mahmood Mamdani's *Citizen and Subject. African Studies Quarterly: The Online Journal for African Studies* 1 (1997). Available at <http://web.africa.ufl.edu/asq>.
- Cox, Oliver. *Cast, Class, and Race*. Garden City, N.Y.: Doubleday, 1948.
- Fanon, Frantz. *Toward the African Revolution*. Translated by Haakon Chevalier. New York: Grove Books, 1967.
- Hymans, Jacques Louis. *Léopold Sédar Senghor: An Intellectual History*. Edinburgh: Edinburgh University Press, 1971.
- Mafeje, Archie. "Multi-party Democracy and Ethnic Divisions in African Societies: Are They Compatible?" In *Breaking Barriers, Creating New Hopes: Democracy, Civil Society, and Good Governance in Africa*, edited by Abdalla Bujra and Said Adejumobi. Trenton, N.J.: Africa World Press, 2002.
- Mamdani, Mahmood. *Citizen and Subject: Contemporary Africa and the Legacy of Late Colonialism*. Princeton, N.J.: Princeton University Press, 1996.
- Mandaza, Ibbo. *Southern Africa in the Year 2000: An Overview and Research Agenda*. Harare, Zimbabwe: SAPES, 1993.
- Nnoli, Okwudiba, ed. *Ethnic Conflicts in Africa*. Dakar: CODESRIA Book Series, 1998.
- Salih, M. A. Mohamed. *African Democracies and African Politics*. London: Pluto Press, 2001.

Fred Hendricks

ANTHROPOLOGY

Ethnicity, as defined in the public domain, is "the cultural characteristics that connect a particular group or groups of people to each other" (<http://en.wikipedia.org/wiki/Ethnicity>). Twenty-first-century anthropologists, however, are likely to complicate simple notions of ethnicity, or they might refuse to accept a general definition of the concept without first demanding accounts of the particular formation of an ethnic identity in a unique place and time. Citizens of the United States, for example, are enculturated to associate ethnicity with a mapping of cultural or national origin to language, religious practices, styles of adornment, types of non (or un-) American foods, and oftentimes, physical looks. Anthropologists, however, are much more interested in ethnicity as a historically and politically situated set of identity practices, rather than as a state of natural or expected correspondence between physicality, behaviors, and attitudes. Such a nuanced view of ethnicity has not always been the norm in anthropology or in

**FRANZ BOAS, ETHNICITY, AND CONTEMPORARY PHYSICAL ANTHROPOLOGY:
CONTINUING TENSIONS**

Franz Boas (1858–1942), widely considered to be the father of American anthropology, spent much of his career arguing vigorously against racism and theories of the fixed physiological nature of ethnicity. Though fondly remembered by most anthropologists as a rigorous ethnographer and mentor to such famous names as Margaret Mead and Zora Neale Hurston, he remains a contradictory and complicated figure for two disparate groups: Native Americans and physical anthropologists. First, for some Native American people, his participation—along with many of his museum curator and academic contemporaries—in the looting and desecration of Native graves for the collection of “specimens” for comparative anatomical research has forever tarnished his reputation. Likewise, some of the research methods of the time, considered controversial both when they were practiced and into the twenty-first century, included a simple anthropometry, or the measurement and comparison of certain continuous human characteristics. Native Americans and other nonwhite people are often and rightly suspicious of such techniques, since anthropologists used them to substantiate racist hierarchies.

Boas, however, employing the same anthropometric methodology, stringently critiqued the assumed fixity of human cranial dimensions, arguing that even slight changes in developmental and environmental conditions could make the simple measurements meaningless for human classification. For example, a ratio of the length to the width of the skull—the cranial index—was considered by early anthropologists to be a reliable measurement for distinguishing people of different ethnicities from each other, such as Hungarians, Poles, and European Jews. Boas disagreed.

Concerned about the rise of anti-immigrant prejudice in the United States, Boas, a German Jewish immigrant himself, secured funding from Congress in 1908 to undertake a massive cranial measurement study of immigrants in New York City, ostensibly to substantiate his views on

human cranial plasticity and to prove the uselessness of the cranial index (see Boas). His conclusions, that the children of immigrants are different physically from their “ethnic” parents and therefore successfully integrating into American society, were embraced by sociocultural anthropologists (but not politicians, to Boas’s dismay) as undeniable proof of the intergenerational flexibility of bodies. Cranial morphology was proven to neither be a direct function of ethnicity, culture, or language group. Anthropologists, then, could no longer pin ethnicity reliably and regularly to physical type, at least in the anthropological literature. Boas also argued, given his analysis, that anthropologists could not use cranial size and shape to link past skeletal populations with living human groups.

Boas’s historical place among the physical anthropologists in the twenty-first century, though, especially given the methodological similarities between them, is growing even more complicated. Physical anthropologists, while no longer participating in the construction of racial taxonomies, often use detailed anthropometric techniques to track morphological changes and microevolution in human populations through time. Many physical anthropologists claim that new and detailed cranial metric techniques can distinguish different past groups from each other by culture or ethnicity, directly contradicting Boas’s earlier findings. Some of these comparisons, ironically, are used to assign cultural labels to Native American skeletal remains for repatriation and reburial under the Native American Graves Protection and Repatriation Act (NAGPRA, P.L. 101–601).

In the early 2000s Boas’s landmark study of cranial plasticity was the subject of a debate between two teams of physical anthropologists. Both teams reevaluated some of Boas’s data using updated statistical methods. Sparks and Jantz conclude: “[O]ur analysis reveals high heritability . . . and variation among the ethnic groups, which
(continued on the next page)

FRANZ BOAS, ETHNICITY, AND CONTEMPORARY PHYSICAL ANTHROPOLOGY: CONTINUING TENSIONS

(continued from previous page)

persists in the American environment" (p. 14637). Gravlee and his colleagues, however, contradicted the first team, affirming Boas's conclusions that statistically significant differences exist between U.S.-born children and their foreign-born parents.

However this debate is resolved, most anthropologists still have Franz Boas to thank for

his early critiques of the former assumption that race or ethnicity should correspond with language and culture. Furthermore, *sociocultural* anthropologists have little interest in quantifying morphological difference between people. Physical or biological anthropologists, however, are still struggling to define the meaning of some of the differences they find, especially when comparisons between different past skeletal populations have policy implications in the present.

social science. A central story of ethnicity in anthropology is its labored disentanglement from now discredited biological and evolutionary notions of "race," ideas that continue to contribute to the general public's conceptualization of the "ethnic" as a physically distinct type of person.

In the mid-nineteenth century the terms *ethnic* and *racial* first came into common use, employed by pre- and post-Darwinian scientists, and later anthropologists, to construct human racial and cultural taxonomies. As the social corollary of race, "ethnic" (*ethnicity* as a unique term does not emerge in the United States until the 1950s) initially served to reinscribe physical notions of racial, and in some cases national, identity onto groups of people often naively assumed to have a shared cultural, historical, or even evolutionary past.

Throughout the nineteenth and into the twentieth century, race, was the dominant concept for the scientific, social, and political classification of human groups in the Western world. Though scientific and popular ideas of what makes a race, who embodies race, and what being of a certain race means have changed drastically through time, the eighteenth-century Enlightenment ushered in a very specific scientific classification of human beings, particularly the ordering of non-European and colonized peoples. Before the scientific community accepted the theory of evolution by natural selection in the nineteenth century, human races were thought to be the product of divine creation. Following the Adam and Eve story closely, monogenists believed in a single creation from which all people and consequently all races arose. Polygenists, though, believed that there was a separate creation for each major race. Furthermore, proponents of both of these pre-evolutionary models used continental labels for creating physical races as bounded groups. Anthropologists assumed that all Europeans, Asians, Africans, and Native Americans were naturally distinct from each other—even on the level of the species—through differentiation over time (monogeny) or through natural, created difference (polygeny). Cultural-historical notions of identity as essentially unchanging and the delineation of fixed anatomical categories also served to determine a certain people's "racial type."

The adoption of an evolutionary framework for understanding human difference, however, did little to transform early anthropologists' fixed ideas of race and racial connections to ethnic identity. Instead, scientists quantified human variation through morphology, mostly using erroneous comparisons of skull size and shape. These practices became the basis for the development of methodology in physical (or biological) anthropology in the United States and Europe. Based on misinterpreted and even falsified anthropometric data, physical anthropologists wrongly assigned labels of either "less evolved" or "degenerated" to nonwhite peoples. Evolutionary ideas initially applied to global racial taxonomies were also used to classify people on other physical, behavioral, or cultural scales. Anthropologists also considered white women, European and European-American people of lower socioeconomic classes, convicted criminals, disabled people, and people who practiced homosexual or other seemingly scandalous sexual practices (such as adulterers and prostitutes) lower on natural scales of evolution and development. Similarly, nonwhite people were wrongly thought to be more naturally susceptible to various behavioral and cultural vices, damaging stereotypes that persist among racists and cultural isolationists in the United States in the early twenty-first century.

Likewise, until ethnicity's emergence in the 1960s and 1970s as a term describing more fluid social processes of identity formation, social scientists used *ethnic* to describe a natural or fixed category of person. In the United States, especially during the intense debate over Eastern European and Mediterranean immigration in the early portion of the twentieth century, an "ethnic" was a person of a marked, lower, category, opposed to a bourgeois white identity. Ethnics, in this context, became lower-class whites, Jews, and nonwhite, colonized, or indigenous peoples.

Ideas of ethnicity have, therefore, consistently been relational; that is, one's ethnic identity, either physical or cultural, is defined through both assumed similarities within a group and assumed differences between groups. Franz Boas's 1912 study of cranial plasticity in American immigrants, however,

ARCHAEOLOGIES OF ETHNICITY

Traditional archaeologists, whose field developed in the same racialized and colonial context as the rest of anthropology, were typically concerned with tracking the material remains of contemporary groups into the past. This cultural historical approach and the search for ethnicity in the archaeological record often led archaeologists to uncritically project modern and national identities into the past. Prominent examples include French claims to Roman and Gallic identities, Nazi projections of past “Aryan” peoples onto much of Northern and Western Europe, and general European continental claims to the material heritage of ancient Greece and classical Egypt (see Jones).

New approaches to identity in archaeology, though, are leading to more accurate and complex reconstructions of past peoples. Moreover, archaeologies of gender, sexuality, and ethnicity are encouraging researchers to include different and historically marginalized voices, such as African resistance to slavery in Kenya and African-American cultural expressions in the colonial archaeology of the United States. Researchers in these areas generally resist drawing simplistic conclusions between desires to trace “ethnic origins” in the past for mobilization and political use in the present.

was the first and arguably most influential anthropometric contestation of the fixed physical nature of ethnicity and racial identity. Among some anthropologists, though, fear of the negative or racially degrading influence of a large ethnic presence in America was used to argue against Boas’s conclusions, and for increasingly strict immigration policies and the establishment of eugenics programs across the nation.

Moreover, after the devastating results of such “Aryan” hysteria in Europe during World War II, greater anthropological use of the term *ethnic group* coincided with a general repudiation of biological determinism and racism within the social sciences as a whole, as well as with a particularly anthropological recognition of the emergence of anticolonial nationalism outside the First World. Specifically, anthropologists replaced *tribe* or *tribalism* with *ethnic group*, especially when describing African migrants to colonial urban centers. Still, all these early uses of the term *ethnic* in anthropology imply a bounded set of cultural traits, historical commonalities, or mental similarities between people of the same ethnic group, even if they later became delinked from physical or racial characteristics.

Cultural Fundamentalism and Instrumental Ethnicities

Disengaging race and ethnicity from biology, though, does not automatically imply equality under the law or in all aspects of political, economic, and social life. As theorists rejected race biology in the mid-twentieth century, a new “cultural fundamentalism” emerged in many places in the world. Anthropologist Marisol de la Cadena eloquently describes this shift: “The academic repudiation of biological notions of race

was significant for anthropology, as it meant the emergence of the concept of ‘ethnic groups’ to explain human differences . . . it implied the reification of culture, which thus potentially prolonged the naturalization of sociohistorical differences earlier contained in the European notion of biological race” (p. 28). In the twentieth century, ethnicities were just as stable and unchanging whether they were formed out of biology or culture.

As well, the initial glosses of ethnic described above were also etic in nature. That is, most ideas of ethnicity in anthropology before the late twentieth century served as theoretical or methodological techniques of classification from outside the group being classified. Anthropologists and other social scientists were not alone, though, in reifying or naturalizing ethnic groups and ethnicity. From approximately the end of World War II to the 1970s, “ethnics,” nonwhite and other marginalized or oppressed people across the world fought for and won greater sovereignty, more influential voices on regional or national political stages, and generally more civil and political rights to self-representation.

This new agency, though patently different in different areas of the world, empowered previously colonized or oppressed people to create and affirm ethnic identities for use in varied political spheres. These uses, though, often included the drawing of fixed boundaries around ethnicities or cultures and the exclusion of individuals who were not perceived to be ethnic enough. For example, most federally recognized Native American nations or tribes use blood quantum, or the proportion of “Indian blood” within a person calculated by the percent within their parents or grandparents, to determine who makes the official membership rolls. Widespread implementation of blood quantum rules have

effectively excluded Indian people of African descent from official membership in communities they and their families have lived in for centuries (see Brooks).

Ethnicity and Difference

In early-twenty-first-century sociocultural anthropology, ethnicity is envisioned as a complicated, fluid, politically charged, perhaps even ephemeral quality or qualities of individual or group identity that map differently to various social categories depending on people's particular histories. The formation or maintenance of an ethnicity, then, is not a necessary by-product of predictable biological, cultural, or social forces. Anthropological thinking on ethnicity is also informed by newer theories of race as a political category, differently expressed and marked within particular political and cultural struggles.

Anthropologists are also adapting frameworks from fields theorists in cultural studies, who focus on difference not to the exclusion of others, but toward the multiplication of meanings and the highlighting of marginal identities. As Stuart Hall cautions: "We are all . . . ethnically located and our ethnic identities are crucial to our subjective sense of who we are. But this is also a recognition that this is not an ethnicity which is doomed to survive . . . only by marginalizing, dispossessing, displacing, and forgetting other ethnicities" (p. 447).

Further, acceptance of the social construction of race in the humanities and social sciences, and lately by progressives in the U.S. public at large, has spurred anthropologists to more widely publicize disciplinary views on race and ethnicity as both educational and policy recommendations. In particular the American Anthropological Association's "Statement on Race" deconstructs the dangers of relying on fixed notions of identity in social and cultural research and interactions, saying that "racial myths bear no relationship to the reality of human capabilities or behavior." Likewise, myths of ahistorical, unchanging ethnicities are also falling by the wayside in anthropological thought.

See also *Anthropology; Other, The, European Views of Race and Racism*.

BIBLIOGRAPHY

- American Anthropological Association. *Statement on Race*. 1998. Available at <http://www.aaanet.org/stmts/racepp.htm>
- Banks, Marcus. *Ethnicity: Anthropological Constructions*. New York: Routledge, 1996.
- Boas, Franz. "Changes in Bodily Form of Descendants of Immigrants." *American Anthropologist* 14 (1912): 530–563.
- Brooks, James F, ed. *Confounding the Color Line: The Indian-Black Experience in North America*. Lincoln: University of Nebraska Press, 2002.
- Cadena, Marisol de la. *Indigenous Mestizos: The Politics of Race and Culture in Cuzco, Peru, 1919–1991*. Durham, N.C.: Duke University Press, 2000.
- Gould, Stephen Jay. *The Mismeasure of Man*. New York: W.W. Norton, 1981.
- Grant, Madison. *The Passing of the Great Race; or the Racial Basis of European History*. New ed., rev. and amplified, with a new

preface, by Henry Fairfield Osborn. New York: C. Scribner's Sons, 1918.

- Gravlee, Clarence C., H. Russell Bernard, and William R. Leonard. "Heredity, Environment, and Cranial Form: A Reanalysis of Boas's Immigrant Data." *American Anthropologist* 105 (2003): 125–138.
- Hall, Stuart. "The New Ethnicities." In *Ethnicity*, edited by John Hutchinson and Anthony D. Smith. New York: Oxford University Press, 1996.
- Jones, Siân. *The Archaeology of Ethnicity*. London: Routledge, 1997.
- Morley, David, and Kuan-Hsing Chen, eds. *Stuart Hall: Critical Dialogues in Cultural Studies*. New York: Routledge, 1996.
- Omi, Michael, and Howard Winant. *Racial Formation in the United States: From the 1960s to the 1980s*. New York: Routledge, 1986.
- Pierpont, Claudia R. "The Measure of America: How a Rebel Anthropologist Waged War on Racism." *New Yorker* 8 March 2004.
- Sparks, Corey, and Richard Jantz. "A Reassessment of Human Cranial Plasticity: Boas Revisited." *Proceedings of the National Academy of Sciences* 99 (2002): 14636–14639.
- Stocking, George W. *Race, Culture and Evolution: Essays in the History of Anthropology*. London: Collier-Macmillan, 1968.
- Williams, Raymond. *Keywords: A Vocabulary of Culture and Society*. Rev. ed. New York: Oxford University Press, 1985.

Ann M. Kakaliouras

ISLAMIC VIEWS

The Koran makes only passing reference to racial or ethnic categories. One verse refers to "the variety of your tongues and hues" as one of the many signs of God's divine power (30:22). Another proclaims the primacy of piety over racial or tribal distinction: "O mankind, we have created you male and female, and appointed you races and tribes, so that you may know one another. Surely the noblest among you in the sight of God is the most godfearing of you" (49:13). Revealed to a largely homogeneous Arab ethnic community, explicit ethnic or racial stratification and prejudice are absent from the Koran. The most fundamental category of differentiation and identification in Islam's sacred scripture is that of religion, of the new community of Muslims as "the best community [*umma*] ever brought forth to men" (3:106), and hence as the central focus of loyalty and affiliation for a believer.

As the Muslim community expanded beyond the confines of the Arabian peninsula and over time incorporated numerous ethnic and racial groups, both an awareness of ethnic distinctions and a sense of racial hierarchies developed. The sunna, the voluminous body of normative sayings and practices (hadith) collected by pious Muslims in the early Islamic centuries and attributed (sometimes erroneously) to the Prophet Muhammad, contain sayings both asserting Arab ethnic supremacy within Islam ("If the Arabs are humbled, Islam is humbled") and challenging Arab precedence within the *umma* ("The people with the greatest share in Islam are the Persians"). Other hadith of the early centuries alternatively give voice to a sentiment of the superiority of white over black ("beware of the *Zanji* [black], for he is a distorted creature"), and declare the irrelevance of color in the eyes of God ("in Par-

adise the whiteness of the Ethiopian will be seen over a stretch of a thousand years"). Still others insist on the universality of Islam, as in the Prophet's saying "I was sent to the red and the black," a hadith interpreted to mean that the message of Islam was intended to encompass all humanity.

The heterogeneity of the sunna notwithstanding, in religious writings the dominant normative view echoed the Koran's insistence that religiosity took precedence over ethnic or racial background. As the thirteenth-century commentator Abd Allah Baydawi (d. 1292 or 1293) stated the prevailing theological position, "we have created every one of you by means of a father and mother. All are equal in this and there is no reason therefore for boasting of one's lineage. . . . [L]et him who desires honour seek it in piety" (Levy, p. 55). The most important practical implication of this assertion of the primacy of religious affiliation lay in the central discipline of Islamic law, which made no legal distinctions based on ethnicity or race. This was particularly relevant in regard to slavery, where the law made no presumption of slavery being linked to race and forbade the enslavement of free Muslims regardless of ethnic origin. Slavery was never indelibly associated with color in the Muslim world, as came to be the case in the Western world.

If Islamic theology and law were color-blind, Muslims were not. There is a considerable body of what can be termed ethnographic literature written by Muslims, in which Muslim geographers and others describe the physical characteristics and the moral qualities of different ethnic and racial populations. Reflecting the increasing diversity of Muslim society as time progressed, ethnic and racial hierarchies were a contested issue in this literature. Where one author would assert the supremacy of Arab over Persian or black over white, another would defend the virtues of the group in question. A common ethnographic schema was one privileging neither black nor white, but the "brown" people of the Middle East. For the tenth-century author Abu Bakr Ahmad ibn Ibrahim al-Hamadhani ibn al-Faqih (writing in 902/903), the "pale brown color" of the people of Iraq was "the most apt and proper color." Unlike the Slavs of the north, with their "blond, buff, blanché and leprous coloring," or the *Zanj* and Ethiopians of the south, "black, murky, malodorous, stinking, and crinkly-haired," "the Iraqis are neither half-baked dough nor burned crust, but between the two" (Lewis, 1974, vol. 2, p. 209). For many medieval Muslims, brown was beautiful.

Within the *umma* itself, ethnic stereotyping, ranking, and snobbery sometimes undercut the theoretical equality of all believers. The fact that Islam had originally been revealed to the Arabs and the preeminence of Arabs in the early centuries of Muslim history initially fostered a sense of Arab superiority to other ethnic groups that expressed itself in literature, in an initial reluctance to accept non-Arab converts as the equals of Arab Muslims, and in a lingering prejudice against Arab marriage with non-Arabs justified on the basis of the saying "marry like with like."

Arab ethnocentrism in time produced a backlash. A social and literary movement of importance in the ninth and tenth centuries was the *Shu'ubiyya*, a school of Iranian Muslim writ-

ers who challenged the presumption of Arab superiority over other Muslims by extolling the more refined and civilized social customs practiced by Iranians, emphasizing the rich historical heritage of pre-Islamic Iran, and asserting the richness and beauty of the Persian language in comparison to Arabic. A similar if more muted sense of ethnic distinctiveness has been identified in medieval Egypt, where Egyptian Muslim authors praised the legendary fertility of Egypt, the country's historical role as a source of science and wisdom, and later Egypt's prominence in serving as a bulwark of Islam against the Crusader and Mongol onslaughts.

The biblical story of the curse of Ham made its way into Muslim legend, and formed part of the basis for the negative stereotypes of black Africans as physically unattractive and morally deficient that comprise a sinister undercurrent in medieval Muslim literature. The images attached to particular ethnic groups could also evolve as social and political conditions shifted. Thus the Turkic peoples, originally outside the Muslim world and known primarily as military slaves, were initially stereotyped as uncouth barbarians. As Turkic groups converted to Sunni Islam, entered the Muslim world en masse, and eventually became politically dominant, the prevailing image shifted first to the Turks as opponents of Shii heresy, later as champions of Islam against the pagan Mongols, and eventually as ruthless alien overlords tyrannizing other Muslims.

The increasing salience of ethnic identity and the corresponding growth of nationalist movements based on language across much of the Muslim world in the nineteenth and twentieth centuries was by and large a new phenomenon only tangentially connected to preexisting attitudes regarding ethnicity and race. It was specific social and political conjunctures of the modern era, as well as the impact of nationalist concepts from the West, that produced Arab, Turkish, Iranian, and other modern nationalisms among Muslim peoples. Arab pride in their historical role as the founders of Islam; Turkish awareness of their political prominence as the ruling elite of a later period; Iranian glorification of the achievements of ancient Iran: these echoes of previously expressed attitudes regarding ethnic groups reinforced and served as ammunition for modern ethnic nationalism, but were not the fundamental cause of the same.

Similarly, modern ethnic nationalism has been only incidentally influenced by the racist theory that developed in and disseminated outwards from Europe in the nineteenth and early twentieth centuries. Most modern nationalisms among Muslim peoples antedate Muslim awareness of modern racist theory and were produced by other causes. The one Middle Eastern area where racist thought had a temporary impact was Iran (that is, Aryan), where the world prominence of the fellow-Aryans of Germany in the early twentieth century influenced both Iranian constructs of self and more briefly the foreign policy of the Iranian state. Modern Arab animosity toward Jews ("Arab anti-Semitism" in its literal sense is an oxymoron, since Arabic is a Semitic language) originated in the political circumstances of the national conflict over Israel/Palestine rather than in racist theory. It has found convenient fodder in the occasional negative references to Jews found in the Koran as well as in a growing familiarity with European anti-Semitic tracts such as the

Protocols of the Elders of Zion, but at base is rooted in and driven by national conflict.

In the later decades of the twentieth century and beyond, the ethnic nationalisms so prominent earlier in the century began to be superseded by a religiously-based sense of identity and by activism defined in terms of religion rather than of ethnicity. Islamism—the reassertion of the primacy of the religious bond over that of language, “race,” or territory, and the emergence of transnational movements of Muslims working to cleanse the entire *umma* of foreign influence—was an old/new phenomenon of increasing prominence at the start of the twenty-first century. Its ultimate trajectory, as well as that of the ethnic nationalisms that it denounces as alien to Islam, is yet to be determined.

See also *Anti-Semitism: Islamic Anti-Semitism; Nationalism: Middle East*.

BIBLIOGRAPHY

- Goldziher, Ignaz. *Muslim Studies*. Edited by S. M. Stern, translated by C. R. Barber and S. M. Stern. London: Allen and Unwin, 1967. An English translation of the classic study of tribal and ethnic sentiment in medieval Islam.
- Haarmann, Ulrich W. “Ideology and History, Identity and Alterity: The Arab Image of the Turk from the ‘Abbasids to Modern Egypt.” *International Journal of Middle East Studies* 20, no. 2 (May 1988): 175–196.
- . “Regional Sentiment in Medieval Islamic Egypt.” *Bulletin of the School of Oriental and African Studies* 43, no. 1 (1980): 55–66.
- Levy, Reuben. *The Social Structure of Islam*. Cambridge, U.K.: Cambridge University Press, 1962. Contains a chapter on “The Grades of Society in Islam.”
- Lewis, Bernard. *Islam: From the Prophet Muhammad to the Conquest of Constantinople*. 2 vol. New York: Harper and Row, 1974.
- . *Race and Slavery in the Middle East*. New York: Oxford University Press, 1990. A survey of the issues of race and slavery, mostly in the premodern period.

James Jankowski

ETHNOCENTRISM. Ethnocentrism is a notion not widely used in the early twenty-first century. Coined by William Graham Sumner in the early twentieth century, the term owes what conceptual life it has to the likes of anthropology and intercultural communication. Dominant strains of these disciplines, especially anthropology, have examined the lives and cultural expressions of ethnically defined or identified groups and the misinterpretations resulting from Western perspectives.

Nevertheless, a survey of contemporary critical works on ethnicity and race, including those in critical anthropology, reveal an almost complete lack of engagement with the concept. In Anglo-American studies, the term *ethnocentrism* carries a largely descriptive and fleeting connotation, its meaning more or less taken for granted. It has been overshadowed perhaps by more readily invoked characterizations or charges of racism, racialization, and ethnoracial determination. This is perhaps less the case in mainstream European social analysis, where

race remains a largely taboo category and ethnic configurations and characterizations are far more readily and uncritically invoked. It is unsurprising, then, that the thickest critical engagement to be found with the notion of ethnocentrism is in French works from the late 1980s (Taguieff; Todorov).

Definition

Ethnocentrism can be understood as the disposition to read the rest of the world, those of different cultural traditions, from inside the conceptual scheme of one’s own ethnocultural group. The ethnocentric attitude assumes that one’s own ethnic *Weltanschauung* (worldview) is the only one from which other customs, practices, and habits can be understood and judged. Ethnocentrism thus is conceived critically as involving overgeneralizations about cultures and their inhabitants, others’ or one’s own, on the basis of limited or skewed, if any, evidence. So the notion of ethnocentrism is conceived as a profound failure to understand other conceptual schemes, and, by extension, practices, habits, expressions, and articulations of others on their own terms. Standing inside our own conceptual schemes, we are blinded even to the possibilities of other ways of thinking, seeing, understanding, and interpreting the world, of being and belonging—in short, other ways of worldmaking.

It would seem to follow, as many definitions in fact insist, that ethnocentrism is a claim about the superiority of one’s own culture or ethnic standing. While this is perhaps a strong presumption in many ethnocentric claims, we should be careful not to make it definitionally so. One can imagine claims of inherent and inescapably culture-bound judgments about ethnically ascribed others, about inherent differences, without assumption or assertion of cultural superiority. If there is any coherence to the concept, “differentialist ethnocentrism” must factor into any working definition of the term as well.

As an analytic concept, ethnocentrism took hold only in the late 1960s and 1970s, and the word did not appear in authoritative dictionaries until the mid-1970s. The reasons are not unrelated to the conceptual history of the term *racism*. While invocation of the notion of “race” in regard to human beings (and by extension, discussion of racism) became a taboo subject in Europe in the wake of the Holocaust, concerns around racism, socially and analytically, emerged forcefully in the United States. The anthropological concern with culture turned increasingly to the language of ethnicity, reinforced by the emergent hold of area studies and liberal distribution of development aid as an arm of geostrategic politics in the face of colonial liberation and the Cold War. The romance with ethnicity seemed more respectful than the legacy of race, its faux universalism enabling an easy evasiveness. At the same time, the concept of ethnocentrism—largely descriptive and individualist in analytic disposition—could offer a liberal contrast to the more critically pressing concept of “institutional racism,” with its sociostructural connotations, emergent in the late 1960s (Carmichael and Hamilton). Indeed, proponents of ethnocentrism today will often claim both racism and colonialism as subspecies of ethnocentrism. But this would seem to undercut the sociohistorical specificities of both racisms and colonialisms.



Billboard erected on California's Highway 99 during the Depression. Practitioners of ethnocentrism assume that their own ethnic worldview is the only one from which other customs, practices, and habits can be understood and judged. HULTON ARCHIVE/GETTY IMAGES

Universalizing Ethnocentrism

There is a widespread insistence among those who readily invoke the notion that ethnocentrism is a universal condition. All cultures, the argument goes, express ethnocentric attitudes toward others. This might be called the “universality of ethnocentrism” claim. It is the supposition that everyone necessarily stands inside one—and perhaps only one—culture. It would follow that we must (cannot but? always?) express inherently partial judgments about others from inside the inescapable frame, whether or not we thereby assume our own cultural commitments to be preferable or better.

This claim suggests that there is a spectrum of ethnocentrisms. They supposedly range from the less to the more pernicious, from judgments about others inescapably expressed from, and expressive of, a cultural stance not theirs to a dismissal of cultural differentiation as inferior, as lesser. Analysts or commentators usually define ethnocentrism in the latter sense, that is, as belief in or claim to the superiority of one's own culture, as this article suggests earlier. For example, mainstream Japanese society is deemed ethnocentric for its sense of discriminatory superiority over “Burakumin,” or social outcasts, those deemed barely human and good only for menial employment (Weiner). Defined as such, ethnocentrism is seen as deeply linked, or leading to, the scapegoating of those deemed

inferior or difficult, demanding, or incapable. Consider the enmity between Hutu and Tutsi in Rwanda during the 1990s. Those deemed “incapable” are often identified as the cause of things gone wrong in society, of dangers threatening, of social conditions gone sour, of frustrations with socioeconomic concerns turning to ethno-tensions and fast exploding into violence. “They” are the cause of “our” difficulties. If “we” have “failed” it must be “their” fault. But it also reveals that the socially produced responses to such ethnocentrism vary widely from avoidance or dismissal to outright rejection or, worse still, to outright attack, purging, or ultimately to genocide.

The universality claim thus expressed, however, undercuts critical judgments against ethnocentric commitment. If we are all party to such narrowness, if we are inescapably of and judge from (inside) our culture, then it cannot be that bad. After all, those so judged have their own culture not only from which to render their inescapably ethnocentric judgments but also as a form of defense. Ethnocentrism as a claim to universal inevitability conceptually reduces to a case of culture war.

The universalizability claim is considered by self-satisfied critics as revealing the poverty of extreme forms of relativism. Value universalists cannot be so smug, however. The “universality of ethnocentrism” claim on the more extreme relativistic side has its characteristic correlate among bigoted universalists

too. Call this by contrast the “ethnocentrism of universality” claim. Tzvetan Todorov revealingly defines ethnocentrism to capture just this characterization. Ethnocentrism, he writes, takes the values of one’s own society without warrant as universal, as applying to all anytime, everywhere.

Consider Keith Windschuttle’s characteristic assumptions in attacking what he questionably deems the “ethnocentrism of [the anthropologist] Clifford Geertz,” who Windschuttle reads as the quintessential relativist.

From its origins in classical thought and Christianity, Western culture has always had a strong tendency towards universalism. This principle has long been expressed in the idea of the unity of human kind and the belief that all human beings had a common origin and were equal before God. During the European Enlightenment, these Christian concepts were secularized to produce the notions of a common human nature and universal human rights. . . . In other words, the universalizing principle has been one of the great strengths of Western culture and has been central to the self-assurance and development of Western civilization.

Here the universalizing project of “Western Enlightenment,” precisely in the name of criticizing relativistic ethnocentrism, is the project to universalize its values. This is to insist that, because these are universal values, they ought to be universally recognized. Blaise Pascal writes that “We have to admit that there is something astonishing about Christian religion . . . though I was born in it, I soon found it astonishing” (p. 23). So astonishing, it turns out, that its values—the only religion whose values are rationally produced, Pascal says—should hold for all, absolutely, everywhere, always. The assertion of the universality of one’s society’s or religion’s values fails to acknowledge that even such general values as liberty and equality are open to interpretation and inflection. Liberty and equality may be general values aspired to very widely. But value universalists all too often generalize the specific interpretation or meanings of those commitments from within their own sociocultural boundaries, insisting that they should apply universally, thereby denying interpretations to these terms diverging from dominant, usually Western conceptions (though proselytizing Islamic universalists, for example, might be guilty of this too).

These presumptively universal values and interpretations, which proponents such as Windschuttle seek to generalize and have rule the world, turn out invariably to be those of a relatively small group of people. They are a distinct minority actually in the global scheme of things, with a particular history of domination and subjugation. Critics of ethnocentrism often contrast ethnocentric disposition to that of tolerance, which is promoted as the proper response to ethnic distinction and differentiation. It is curious consequently to note accordingly how critics of value universalism are dismissed by proponents such as Windschuttle as incorrigible relativists, or even worse as relativistic multiculturalists. These are charges that themselves reveal the ethnocentric reification of such universalistic claims, not to mention the

distinct horizons of application and scope when it comes to tolerance, which after all is always expressed from a position of power (Goldberg). But as Todorov points out, regarding what he calls the “ethnocentric spirit” exhibited by Pascal, having absolutized local values or interpretations ethnocentrists then judge their own values and practices as universally ordained. The “ethnocentrism of universality” becomes at once the rationalization of local values imposed universalistically.

The “ethnocentrism of universalism” and the “universalism of ethnocentrism” thus converge in the end. The ethnocentrism of universalism ends up flattening out all distinction. If I universalize the values of “my” culture (given that I can identify a coherent universalizable set) to apply to all cultural and social arrangements, I effectively deny or belie what makes those cultures unique. And if I insist, seemingly by contrast, that all societies, universally, are ethnocentric, and so their members do and perhaps can only exercise value judgments from within their cultural horizons, then effectively I must be claiming that the universalism of ethnocentrism amounts to no more than the ethnocentrism of universalism: my judgment from within a culture is, from my point of view, all there can be, and so must perversely be the grounds of universal judgment. The ethnocentric disposition at least implicitly denies historical relations connecting the ethnically dominated to the ethnically dominant. Whether taken substantively as a standpoint from which judgments are expressed about others or as an analytic framework for understanding historical circumstances, ethnocentrism implodes on the common claim to social homogeneity.

Conclusion

The social dynamics of ethnocentric charge and countercharge are confined almost exclusively to the cultural wars over values and their scope. Social power and the relative positionings of those charging and charged remain largely unaddressed. And yet power is at the heart of the ethnocentric concern, in both its universalistic versions, to maintain and refine social homogeneity. The most extreme form of ethnically predicated and produced homogenization is reflected in the phenomenon of “ethnocratic states.” These are states in which a single ethnically defined or self-ascribed group seeks, and seeks to maintain, power on just those terms (Yiftachel, 2002, 2004). In the self-defining extreme, ethnocratic states are keen to remove all those identified within as “minorities” who refuse or (more likely) are refused to join or affirm the dominant conception of social value and belonging, the common “nation-state.” The ethnocratic state takes itself to be born out of a single, common history, cultural legacy, language, religious tradition, and racial kinship. Consider, for example, the radical Romanian nationalist Radu Sorescu who first defined the “ethnocratic state” as an aspiring commitment, in his case for Romania in the 1930s (Dreapta). The ethnocratic state thus conceived fashions a peculiar sort of state personality, mixing the perceived need to defend society against or “clean” it of threatening heterogeneities with the related concern to claim power by asserting it over those deemed inferior or immature, distinct or detrimental.

Ethnocentrism as a concept fails in its self-assured lack of relational analysis. It refuses, by extension, any engagement

with relations of social power and differentiated social positionings that has been the mark, by contrast, of race critical theory (Essed and Goldberg).

See also *Colonialism; Critical Race Theory; Ethnicity and Race; Race and Racism*.

BIBLIOGRAPHY

- Barger, Ken. "Ethnocentrism: What Is It? Why Are People Ethnocentric? What Is the Problem? What Can We Do about It?" 2003. Available at <http://www.iupui.edu/~anthkb/ethnocen.htm>
- Carmichael, Stokely, and Charles Hamilton. *Black Power: The Politics of Liberation in America*. New York: Random House, 1967.
- Dreapta, Noua. "The Romanian Ethnocratic State." In *Fascism*, edited by Roger Griffin, 207–209. Oxford and New York: Oxford University Press, 1995.
- Essed, Philomena, and David Theo Goldberg, eds. *Race Critical Theories: Text and Context*. Oxford: Blackwell, 2001.
- Goldberg, David Theo. *The Death of Race*. Oxford: Blackwell, 2005.
- . *The Racial State*. Oxford: Blackwell, 2002.
- Mamdani, Mahmood. *When Victims become Killers: Colonialism, Nativism, and the Genocide in Rwanda*. Princeton, N.J.: Princeton University Press, 2001.
- Pascal, Blaise. *Pascal's Pensees*. Translated by Martin Turnell. London: Harvill, 1962.
- Taguieff, Pierre-Andre. *The Force of Prejudice: Racism and its Doubles*. Translated and edited by Hassan Melehy. Minneapolis: University of Minnesota Press, 2001.
- Todorov, Tzvetan. *On Human Diversity: Nationalism, Racism, and Exoticism in French Thought*. Translated by Catherine Porter. Cambridge, Mass.: Harvard University Press, 1993.
- Weinter, Michael, ed. *Japan's Minorities: The Illusion of Homogeneity*. London and New York: Routledge, 1997.
- Windschuttle, Keith. "The Ethnocentrism of Clifford Geertz." October 2002. Available at <http://www.newcriterion.com/archive/21/oct02/geertz.htm>
- Yiftachel, Oren. "'Ethnocracy': Land, Settlement, and the Politics of Judaizing Israel/Palestine." 2002. Available at <http://www.palisad.org/papers/yiftachel1.htm>
- . "Ethnocratic States and Spaces." 2004. Available at http://www.usip.org/fellows/reports/2004/0121_yiftachel.html

David Theo Goldberg

ETHNOGRAPHY. Ethnography, often paraphrased as "participant observation," is a mode of deriving knowledge about particular, local worlds through direct engagement with their peoples and ways of life. As a mode of inquiry, it is primarily associated with the discipline of anthropology, the comparative study of human societies and cultures that took definitive shape as a scholarly field in the early years of the twentieth century. But the implications of the approach are more complex than suggested by this definition; for while ethnography is empirical in spirit, in practice it flouts many of the assumptions underlying positivist investigation, and has long enjoyed something of a maverick status within the social sciences.

Tracing its mythic origins to the celebrated research of Bronislaw Malinowski in the Trobriand Islands in Melanesia in the teens of the last century, anthropological ethnographers have classically worked in non-European contexts, relying less on written records or formal techniques than on qualitative perceptions gleaned from interpersonal encounters in the field. In this enterprise, writes Claude Lévi-Strauss, "[t]he observer apprehends himself as his own instrument of observation" (p. 35). Such frank reliance on the role of subjective experience in empirical investigation sits somewhat uneasily with the value-free ideals of mainstream social science methodology. In fact, while it is in many ways a product of the Enlightenment impetus to bring the universe under the Western gaze, ethnographic observation, and the cultural relativism with which it has long been associated, has always been controversial. While hailed by many as a uniquely sensitive means of unsettling European hegemonies and revealing the cogency of other orders of meaning and value, it has also been accused of biases, ranging from insurmountable ethnocentrism to a fetishism of difference. Ironically, as critique of the method has mounted *within* anthropology in recent years, ethnography has been ever more enthusiastically embraced in several fields *outside* itself, among them cultural and legal studies, musicology, education, sociology, and political science. True, it is often hard to gauge, once the method is separated from the anthropological perspective that spawned it, just what it implies (besides "talking to people"). But even in watered-down form, its current popularity is surprising: How are we to explain its appeal in these postcolonial, global times, when many scholars have come to question the capacity of small-scale qualitative methods to grasp the ever more intensive translocal forces spanning the planet?

The Paradox

In fact, such ironies are not new. Ethnography was founded on a paradox that has rendered it both unusually useful and vulnerable to critique. This conundrum is also integral to modern anthropology, which is simultaneously universalizing in its key assumptions (about the intrinsic nature of humans as social, signifying beings, for example) and relativizing (about the fact that societies and cultures vary fundamentally with context). As a critic once quipped, anthropologists believe that "people everywhere are the same, except where they are different." Put in more generous terms, the discipline seeks to subvert modern universalist assumptions by making Westerners aware of other viable forms of reasoning and rectitude, kinship and sexuality, religion and representation, politics and politesse. But this procedure also raises thorny epistemological problems. To what degree can one assume that cultural categories are translatable across lines of difference? Is it not the case that the platonic referents of the whole enterprise—not to mention the politics of its practice—remain indisputably Eurocentric? What violence do we do to African assumptions that people can harm each other by powerful, superhuman means when we refer to these etiologies as "witchcraft"? How does such a term, which Europeans associate with dark ages past, color our rendering of African existential realities in the present? How does one establish the qualities and currency of such a "belief" in the first place?

These questions of method rest on a host of interpretive presumptions: What constitutes a field for analytical purposes? How systematic is culture, and how much is it the stuff of conscious reflection? How much does one impose order on action through one's very observation and description? Such things clearly are also matters of theoretical assumption, and here again ethnography can never simply be distinguished from the presuppositions and interests of those who practice it. What is more, scholarly values have varied across time and place: the accounts of the early ethnographers Edward Evans-Pritchard (1902–1973) and Margaret Mead (1901–1978) were hailed in their time as relativist correctives to unquestioned Western orthodoxies. But in a later, postcolonial climate, their texts have quite often been criticized for offering timeless, essentialist, exoticized depictions of “others” (Said, and Clifford and Marcus).

Intrinsic Features

In what ways are these vulnerabilities inherent in the way ethnography has been harnessed to the project of anthropology? As a method, ethnography seems quaintly anachronistic. It puts its primary trust in evidence generated by the human senses, being vested in the direct empirical gaze—the naked eye, as it were. This way of seeing characterized the early-nineteenth-century biological sciences (Foucault), which served as a model for early anthropology, described by one of its founders as the “natural science of society” (Radcliffe-Brown). Yet despite occasional scientific pretensions, anthropology has remained at base a resolutely humanistic art (Evans-Pritchard, 1950) vested in insights generated by a “long conversation” between ethnographer and subject(s) (Bloch). Mastering this somewhat underspecified art is still a crucial component of recruitment to the anthropological profession. And certain canons of practice did become standard, at least as ideals: fluency in the primary field language, for example; minimal reliance on formal interviews and artificial situations; sufficient time in situ to distinguish patterns of repetition from random events; and sensitivity to the ethical implications of one's presence and one's representations of local life. The qualitative nature of such observation, coupled with the anthropological concern with demonstrating the salience and complexity of meaning and value in human action, makes writing a crucial aspect of the ethnographic enterprise: the observer must communicate his or her insights in language that conveys the expressive richness and texture of local experience, yet retains the authority of objective reportage. In the late twentieth century, a heightened sensitivity in the human sciences to the independent life—and political mediation—of texts brought the conventions of ethnographic prose under new scrutiny. More than one observer has noted that ethnography preserves features from an era of travel writing and adventure and that it is still dependent in large part on the legitimacy of first-hand experience and interpretation (Pratt).

Yet it could be argued that what some see as the greatest weaknesses of ethnography are also its major strengths. Most significantly, its practitioners refuse to put their trust in techniques that grant scientific (and above all, quantifying) methods an exaggerated sense of objectivity. They distrust instruments that rely on a priori questions and units of analysis, for instance,

preferring to derive their categories of inquiry from a direct engagement with the phenomena at issue; and they are critical of investigative means that reify human action by divorcing it from its social context or claim to eliminate subjective bias. The very concept of participant observation—an oxymoron to some—implies that knowledge is inseparable from its knower. Thus, while ethnographers do seek to objectify social facts in the world, and also to make viable generalizations about them, their assertions remain clearly identified as the fruit of interaction between reporters and their subjects. But in this, ethnography is merely a marked instance of the inescapable interplay of fact and value that renders all human observation partial, imperfect, and a product of its time and place.

The Native's Point of View?

If ethnographers are unusually aware of the dangers of vulgar empiricism, why have they themselves frequently been accused of essentializing others? To what extent has such critique actually been aimed at the wider anthropological project? How much does it reflect a growing discomfort, in a postcolonial world, with experts—still largely of Western origin—who claim a privileged ability to interpret other cultures, or to represent those threatened by a dominant world order? The claim that anthropology was directly complicit with colonial rule, and that it remains irredeemably orientalist in perspective, is clearly overdrawn: much early ethnography was liberal, even critical in intent, and the discipline has long been subversive of establishments of most kinds, at home and abroad. At the same time, the discipline's enduring investment in cultural difference and local particularity—and in the independent existence of the powerless peoples within the world order—has laid it open to the charge that it fails realistically to come to terms with the oppressive, large-scale forces ravaging these local contexts (Graeber, and Comaroff and Comaroff, 2003). The taint of European paternalism lingers—although this does not necessarily attach itself to ethnography per se, which some see as having the potential to empower its former subjects. Thus Archie Mafeje, a respected African scholar, has declared that ethnography, to be true to itself, needs to be liberated entirely from anthropology so that it can become a source of “social texts authored [solely] by the people themselves” (Mafeje).

There is also a history of efforts to deploy participant observation beyond the orbit of anthropology in Western contexts. From the classic “Chicago School” of urban sociology in the 1920s, to those of the late-twentieth-century Birmingham Centre for Contemporary Cultural Studies, investigators have seized on what Graeme Turner has called “the democratic impulse” of ethnography—its promise to give expression to human worlds that exist beyond established cultural discourses, elite institutions, and highbrow media (Turner, p. 178). The approach has yielded resonant accounts of European and American phenomena like youth cultures and urban underclasses (Park, Whyte, Willis, Duneier) and the everyday life of formal institutions and the professions (Goffman, Becker). The impetus to understand forms of ordinary activity that lie in the shadow of grand institutions is closely related to the methods of social history, the kind that aim to recuperate the texts and traces from other times to uncover “hidden” chronicles,

written “from below” (Samuel, Davis). It has often been noted that, to the degree that they treat the past as “another country,” historians work very much like participant observers, practicing what amounts to an “ethnography of the archives” (Comaroff and Comaroff, 1992; Hobsbawm; Cohn). But nonanthropological ethnographers have not entirely escaped the accusation of paternalism, or of exoticizing “local” worlds. Speaking of British cultural studies, an approach that shares anthropology’s concern with culture (but more as a function of class differences within societies than totalizing differences between them) Turner suggests that “the democratic impulse and the inevitable effect of ethnographic practice . . . contradict each other” (p. 178). Here one might do well to recall that there are non-Western critics who believe that the method might serve as a means of empowerment. It might also be argued that the tendency to fetishize “marginal” cultures is not altogether absent from the paradigm of cultural studies itself.

Ethnography and Globalization

While rooted in phenomena that pass directly before the observer’s eye, ethnographic description also involves selection and interpretation. Its practitioners usually aim to produce generalizations about the nature of relations and significations, about reproduction, rupture, or change in specific kinds of contexts. Classically, participant observation has been deployed within tightly bounded analytic fields, within which a certain coherence was presumed to exist (whether it resided in kin ties, productive forces, norms, signs, networks, subcultures, or nations). While holism of this sort has often lent itself to bold theory-making, ethnography-generated insights tend to be of human scale and humanist by implication. Ethnographers have tended to mount strong arguments against formalist models of economy and society that divorce phenomena like markets or international relations from actual social contexts, or that reduce human motivation to formulae like “rational choice.”

The small-scale compass of ethnography, and the relatively bounded fields within which it has been effective, have raised new questions at a time of heightened global awareness, when most social phenomena seem so obviously to extend beyond local situations. At a moment when many domestic groups count transnational migrants among their close kin, and consume goods and images from across the planet, it becomes less and less possible to divorce intimate contexts from larger social forces, such as worldwide movements of capital.

The challenge of practicing ethnography “in the modern world system” (Marcus) should not be underestimated. It has produced creative efforts intended to extend the range of existing methods to accommodate the intensified circulation of persons and things in the world, and to comprehend these expanded flows. In part, this has involved combining ethnographic observation with other ways of generating social knowledge—those of political economy and literary theory, for example. But the most significant response has been to insist that now, more than ever, as people everywhere seem captured by material processes of planetary scale, it is necessary to demonstrate that no world-transforming force exists without the engagement of tangible human agents and interests. As the

ideologies of the powerful seek to make their policies seem like technical necessities, operating beyond the realm of politics and value, the perspectives of ethnography insist on the opposite: that all activities, large and small, can be shown to have social and cultural determinations and, hence, are susceptible to debate, contestation, and intervention. Therein lies appeal of participant observation in an unpromising age.

See also Anthropology; Borders, Borderlands, and Frontiers, Global; Cultural Studies; Ethnocentrism; Ethnohistory, U.S.; Globalization; Identity, Personal and Social Identity; Interdisciplinarity.

BIBLIOGRAPHY

- Asad, Talal. “Two European Images of Non-European Rule.” In *Anthropology and the Colonial Encounter*, edited by Talal Asad, 103–118. London: Ithaca, 1973.
- Becker, Howard, et al. *Boys in White: Student Culture in Medical School*. Chicago: University of Chicago Press, 1961.
- Bloch, Maurice. “The Past and the Present in the Present.” *Man* 12 (1977): 278–292.
- Clifford, James, and George E. Marcus, eds. *Writing Culture: The Poetics and Politics of Ethnography*. Berkeley: University of California Press, 1986.
- Cohn, Bernard. *An Anthropologist Among the Historians and Other Essays*. Delhi: Oxford University Press, 1987.
- Comaroff, Jean, and John Comaroff. “Ethnography on an Awkward Scale: Postcolonial Anthropology and the Violence of Abstraction.” *Ethnography* 4, no. 2: 291–324.
- Comaroff, John, and Jean Comaroff. *Ethnography and the Historical Imagination*. Boulder, Colo.: Westview, 1992.
- Davis, Natalie Zemon. *Women on the Margins: Three Seventeenth-Century Lives*. Cambridge, Mass.: Harvard University Press, 1995.
- Duneier, Mitchell. *Slim’s Table: Race, Respectability, and Masculinity in America*. Chicago: University of Chicago Press, 1992.
- Evans-Pritchard, Edward E. “Social Anthropology: Past and Present.” *Man* no. 198 (1950): 118–124.
- . *Witchcraft, Oracles and Magic among the Azande*. Oxford: Clarendon, 1937.
- Foucault, Michel. *The Birth of the Clinic: An Archaeology of Medical Perception*. Translated by A. Sheridan Smith. London: Tavistock, 1973.
- Goffman, Erving. *Asylums: Essays on the Social Situation of Mental Patients and Other Inmates*. Garden City, N.Y.: Doubleday, 1961.
- Graeber, David. “The Anthropology of Globalization (with Notes on Neomedievalism, and the End of the Chinese Model of the Nation-State).” *American Anthropologist* 104, no. 4 (2002): 1222–1227.
- Hobsbawm, Eric J. “Escaped Slaves of the Forest.” *The New York Review of Books* 37, no. 19 (6 December 1990): 46–48. A review of *Alabi’s World*.
- Lévi-Strauss, Claude. *Structural Anthropology*, vol. 2. Translated by Monique Layton. New York: Basic, 1976.
- Mafeje, Archie. “Anthropology and Independent Africans: Suicide or End of an Era?” *African Sociological Review* 2, no. 1 (1998): 1–43.
- Marcus, George E. “Contemporary Problems of Ethnography in the Modern World System.” In *Writing Culture: The Poetics and Politics of Ethnography*, edited by James Clifford

- and George Marcus. Berkeley: University of California Press, 1986.
- Mead, Margaret. *Coming of Age in Samoa: A Psychological Study of Primitive Youth for Western Civilisation*. New York: New American Library, 1949.
- Park, Robert E., Ernest W. Burgess, and Roderick D. McKenzie. *The City*. Chicago: University of Chicago Press, 1925.
- Pratt, Mary Louise. "Fieldwork in Common Places." In *Writing Culture: The Poetics and Politics of Ethnography*, edited by James Clifford and George Marcus. Berkeley: University of California Press, 1986.
- Radcliffe-Brown, Alfred R. *A Natural Science of Society*. Glencoe, Ill.: Free Press, 1957.
- Said, Edward. "Representing the Colonized: Anthropology's Interlocutors." *Critical Inquiry* 15 (winter 1989): 205–225.
- Samuel, Raphael. "Heroes Below the Hooves of History." *The Independent* no. 902 (31 August 1989): 23.
- Turner, Graeme. *British Cultural Studies: An Introduction*. Media and Popular Culture series, 7. Boston: Unwin Hyman, 1990.
- Whyte, William F. *Street Corner Society: The Social Structure of an Italian Slum*. Chicago: University of Chicago Press, 1993.
- Willis, Paul E. *Learning to Labour: How Working Class Kids Get Working Class Jobs*. Farnborough, U.K.: Saxon, 1977.

Jean Comaroff

ETHNOHISTORY, U.S. Ethnohistory, first used in Vienna in the 1930s by ethnologist Fritz Roack and the Viennese Study Group for African Cultural History, and a subfield of anthropology, is the use of ethnological and historical methods and materials to gain knowledge of the nature and causes of change in a culture defined by ethnological concepts and categories. This definition, as the ethnohistorian Robert C. Euler explained in 1972, is the basic premise upon which American ethnohistorians can base their studies, formulate their methodologies, and construct their hypotheses. The concept and practice of ethnohistory is largely confined to the United States. Usually dealing with small groups that do not have written histories, ethnohistory offers a way of utilizing the rich record of historical experience in the search for processes. It is defined by ethnological concepts and categories gained through field observations and combines cross-disciplinary methods of historical document research and ethnographic studies such as linguistics, archaeology, and ecology to provide as complete a picture as possible of a whole culture.

Ideally, according to most American ethnohistorians, the discipline of anthropology should provide a natural meeting ground for ethnology and history. The supposed harmonious connection between the ethnological and historical fields has allowed for a more complete historical understanding of the materials and their uses and of the various approaches to the practice of ethnohistory, and offers suggestions and direction for the growth of the ethnohistorical field. Yet, as the ethnohistorian Bruce C. Trigger noted in 1982, significant social and ideological implications are inherent in the distinction between ethnohistory and history. Not the least of these dis-

tinctions appears in the argument put forward by the anthropologist Shepard Krech III, who suggested in 1991 that if one restricts the application of ethnohistory to particular groups or extends it to certain ethnic groups (minorities?) but not others (majorities?), then one may be charged with applying a special name to the history of the culturally distant Other.

Introduced in the United States during the 1950s, ethnohistory was virtually synonymous with the study of North American Indian societies. Ethnologists studied North American Indians, particularly their kinship and religion, because their societies were accessible, diverse, and perhaps most significant, safe subjects for scrutiny because the cultural artifacts were confined to specific areas and for the most part were not contaminated by previous study. But before the early 1950s ethnologists concerned themselves with the study of ethnic entities without a historical focus. This means that the identities, locations, contacts, and movements of various Indian tribes were studied—but not the history of how these variables come to be. As such, the understanding of ethnohistory, federal legislation, and ethnologists' focus on ethnic entities, combined with their lack of historical training, presented a number of problems in relation to the study and development of ethnohistory in the post-1970 period.

The first problem was that ethnohistory, as it came to be understood in the early 1950s, too long delayed in achieving a realistic position in American historical anthropological research because, in the first half of twentieth-century America, anthropology was dominated by the followers of Franz Boas (1858–1942). The anthropologist Robert Carmack indicated in 1972 that the Boasian school represented the field of "specific history" or the writing of histories of specific societies in terms of their past events or culture traits as manifested in time, space, and concrete act. Within this context, the main task of the Boasians was to infer historical reconstructions of aboriginal American Indian cultures with data obtained primarily from oral tradition. This type of research discounted the necessity for a "history in the round," in which a more narrative history—or ethnohistory—of the American Indians would be written in order to counterbalance the Boasian accounts.

Thus, as the ethnohistorian Karl Schwerin noted in 1976, "ethnohistoric research," and its influence on the post-1970s period, goes back at least to the time of Lewis H. Morgan who in 1877 drew on a variety of historical records in writing *Ancient Society: or, Researches in the Line of Human Progress from Savagery through Barbarism to Civilization*. Chief among the early-twentieth-century ethnohistories are John Swanton's 1931 *Source Material for the Social and Ceremonial Life of the Choctaw Indians*, Alfred Goldsworthy Bailey's 1937 study *The Conflict of European and Eastern Algonkian Cultures, 1504–1700: A Study in Canadian Civilization*, William Duncan Strong's 1940 *From History to Prehistory in the Northern Great Plains*, Thomas Dale Stewart's 1939 *Anthropometric Observations on the Eskimos and Indians of Labrador*, and Bronislaw Malinowski's 1945 *The Dynamics of Culture Change: An Inquiry into Race Relations in Africa*. Philip Dark and John Crosskey's 1958 *Mixtec Ethnohistory: A Method of Analysis of*

the Codical Art, which also needs to be included, provided one of the earlier studies of ethnohistoric methodology. The totality of these studies suggests that they influenced American anthropologists to attempt to weld data from ethnography, history, and archaeology (ethnohistory) in the reconstruction of culture history. Yet, not every anthropologist agreed with this assessment.

Robert Carmack, offering a position on ethnohistoric theory and methodology, suggested in 1972 that it would be unwise to label the theoretical use of history by such a wide variety of anthropologists as ethnohistory because any exclusive definition of ethnohistory depends primarily on methodological considerations. Carmack argued this point because anthropologists' inclusion of a historical dimension is basically recognition of the dynamic nature of social living and the need to build change into their explanatory models. Yet, Carmack's focus on anthropology in general was a type of disciplinary chauvinism, insisting that ethnohistorical theory is drawn from anthropology simply because anthropologists have been more explicit in stating their assumptions than have historians. Up till 1972, this was not the only theory to alter the direction of ethnohistory.

Federal legislation, the Indian Claims Commission Act of 1946, greatly influenced the course of ethnohistory. In the course of doing research, ethnologists examined realistically the reliability and validity of historical documentary sources, oral tradition, and ethnographic studies in the attempt to verify the extent of past control over territories claimed by particular Indian groups.

Although oral tradition and ethnographic studies are also valuable, documentary sources were used by ethnologists partly as a way of moving the field of ethnohistory from the once-promising use of "upstreaming" (working back from the present functioning society through the minds of individual informants to release cultural memories of which the informants themselves were but dimly aware) and partly because, as Eleanor Leacock and Nancy Lurie suggested in 1971, ethnographic reconstruction rather than "specific history" had become the overriding interest in the field. Still, there are anthropological theories that argue for the combination of the documentary sources with the oral tradition as a major part of ethnohistory. This is because the most common genre in ethnohistoric work is without question the historical narrative, which chronicles (part of) the past of a tribe or nation.

This anthropological involvement in the Indian Claims Commission Act led to the founding in the same year of the American Indian Ethnohistoric Conference. Two years earlier, the journal *Ethnohistory* had been founded under the chairpersonship of Erminie Wheeler Voegelin, of the Ohio Valley Historical Indian Conference. From the beginning, as Henry Dobyns noted in *Ethnohistory* in 1972, "many of the publications" in this journal were directly relevant to the serious problem of fair dealing with Native Americans by the central government.

Some twenty years later (1966), following an open invitation to students in the fields of Oceanic, Asian, African, and Latin American ethnohistory to join and contribute research

papers to *Ethnohistory*, the American Indian Conference changed its name to the American Society for Ethnohistory. The anthropologist Francis Jennings suggested in 1980 that the name change reflected "in microcosm the movement of interest [in ethnohistory] among collaborating historians and anthropologists in the United States, starting from a subject matter base in American Indians and broadening their sights to encompass tribal and peasant societies everywhere" (p. 90). This call for participation and contribution in the field of ethnohistory led to studies appearing in *Ethnohistory* on Peru, Bolivia, Chile, Argentina, and other countries not typically associated with this field of study.

Consequently, in relation to the ethnologist's focus on ethnic entities, or what could be labeled the study of folk culture (which could be a literal meaning of the word *ethnohistory*), ethnohistoric research began to include much of North American and Latin American history. Reasons for including Latin American history vary, but research based on documents that ethnologists used to study the North American Indian before the early 1950s has a long and honorable history in Latin America. Indeed, it can be argued that one of the fertile fields for future ethnohistoric research is to be found in Latin America. Two pre-1970s essays—Richard Adams's 1962 essay *Ethnohistoric Research Methods: Some Latin American Features* and William Sturtevant's 1966 essay *Anthropology, History, and Ethnohistory*—made clear that as the 1970s approached there were strong suggestions that the progression of the ethnohistoric field depended on scholars and students of ethnohistory (with an increasing connection to the physical sciences) studying Indian societies outside the United States.

Indeed, there is a link between ethnohistory and physical science and biology (natural history). In a most basic form, the ethnologist, who deals with affairs of the mind through observation, classification, and interpretation, viewed himself as a natural scientist and as much a humanist as the historian. And since the humanist focus is the ethnologist's stock in trade and its analysis and description in time and space is the business of ethnology, ethnohistory has the virtue of neither reducing anthropology to history nor excluding a scientific viewpoint.

Directly related to this point was the organization of one of the first U.S. symposia on the concept of ethnohistory. Held in 1961, the symposium's theme, outside of historical aspects of folklore and the relationship of archaeology to ethnohistory, was providing a definition for ethnohistory. From the standpoint of the ethnohistorians and others who attended, ethnohistory came to be defined as original research in the documentary history of the culture of primitive peoples.

One year later (1962), Fenton argued that he was struck by the fact that the field collecting and laboratory work of the natural scientists and the arrangement of collections had influenced anthropological research in natural history, particularly in archaeology and material culture. Thus, one of the legacies of the natural sciences is that ethnologists and natural historians share a sense of problem and a sense of design. This sense of connection provides a lead-in to several points and suggestions to improve the state, outlook, and direction of ethnohistory in the twenty-first century.

Perhaps the most realistic argument to be made is that a stronger position for ethnohistory in the curricula of academic departments of both history and anthropology, with a focus on seminar classes, would improve the ethnohistorical approach to research. Fellowships and professorships would allow scholars and students to work at centers of materials and to examine the languages and cultures of the New World in light of their contribution to Western thought as reflected in the literatures of linguistics, anthropology, and social theory.

There should also be a continuation of a cultural historic approach to folk history, including studies of North American Indian tales and pre-Hispanic Mesoamerican folk history. In relation to demography and the close attention it has recently received in ethnohistory, there is still a need to focus on the causes of population growth and the factors that influence the stabilization of populations. And, although once considered a rare field for ethnohistoric study, a comprehensive ecological examination of human impact upon the land can lead to the change over time of the connections between humans and their culture. And finally, ethnohistoric study can have a profound impact on the study of ideology that could lead to electrifying growth within this field.

Whereas it has been noted that most of the interest in ethnohistory results from native people creating a new awareness of themselves among European-Americans, the growing interest and research in ethnohistory finds support in a number of journals outside of *Ethnohistory*. These include the *Journal of African History*, the *Journal of Pacific History*, the *Journal of Comparative Society and History*, and the *Proceedings of the American Philosophical Society*. These journals provide a broad view of important ethnohistoric work on African cultures, cultures of the Pacific islands, and Judeo-Christian cultural development in the West.

See also *Anthropology; Cultural Studies; Ethnography*.

BIBLIOGRAPHY

- Adams, Richard N. "Ethnohistoric Research Methods: Some Latin American Features." *Ethnohistory* 9, no. 2 (1962): 179–205.
- Axtell, James. "Ethnohistory: An Historian's Viewpoint." *Ethnohistory* 26, no. 1 (1979): 1–13.
- Berkhofer, Robert F. Jr. "Faith and Factionalism among the Senecas: Theory and Ethnohistory." *Ethnohistory* 12, no. 2 (1965): 99–112.
- Carmack, Robert M. "Ethnohistory: A Review of Its Development, Definitions, Methods, and Aims." *Annual Review of Anthropology* 1 (1972): 227–246.
- Dobyns, Henry F. "Ethnohistory and Contemporary United States Social Problems." *Ethnohistory* 19, no. 1 (1972): 1–12.
- Euler, Robert C. "Ethnohistory in the United States." *Ethnohistory* 19, no. 3 (1972): 201–207.
- Fenton, William N. "Ethnohistory and Its Problems." *Ethnohistory* 9, no. 1 (1962): 1–23.
- Fixico, Donald L., ed. *Rethinking American Indian History*. Albuquerque: University of New Mexico Press, 1997.
- Jennings, Francis. "A Growing Partnership: Historians, Anthropologists, and American Indian History." *The History Teacher* 14, no. 1 (1980): 87–104.

Krech, Shepard III. "The State of Ethnohistory." *Annual Review of Anthropology* 20 (1991): 345–375.

Leacock, Eleanor Burke, and Nancy Oestreich Lurie, eds. *North American Indians in Historical Perspective*. New York: Random House, 1971.

Schwerin, Karl H. "The Future of Ethnohistory." *Ethnohistory* 23, no. 4 (1976): 323–341.

Sturtevant, William C. "Anthropology, History, and Ethnohistory." *Ethnohistory* 13, no. 1–2 (1966): 1–51.

Trigger, Bruce G. "Ethnohistory: Problems and Prospects." *Ethnohistory* 29, no. 2 (1982): 1–19.

Glen Anthony Harris

ETIQUETTE. The practice of etiquette has been central to all cultures and civilizations because it functions to establish boundaries of proper comportment in the realm of social relations and hierarchies. The Bible contained imperatives to regulate indecorous behavior, with the Book of Ecclesiastes advising one to "Eat as it becometh a man . . . and devour not, lest thou be hated," while in the Talmud, the importance of controlling the self's more primal urges is asserted in enjoinments against licking fingers, belching, drinking wine in one gulp, or giving off "an offensive odor." Even more important was the manner in which etiquette prescribed deference toward teachers, elders, social superiors, and those at the center of power; according to an Egyptian conduct book dating from 2000 B.C.E., not only is it "worthy" when a "son hearkens to his father," but so should one practice flattery towards a superior, for example, by "laugh[ing] when he laughs."

A Civilizing Process

Though the Middle Ages in Europe witnessed the harnessing of knights to a code of chivalry and the flourishing of a romance troubadour culture demanding particular rules of conduct, it was the Renaissance that brought social codes and conventions to new heights of importance. Courts now served elites and sycophants as thriving centers of power, requiring the ability to fashion one's identity and climb the social ladder in a frequently precarious, if not treacherous, milieu. With the development of the printing press, courtesy books such as Giovanni della Casa's *Il Galateo* (1560) flourished to meet a growing demand, but it was Baldassare Castiglione's *Book of the Courtier* (1528) that most brilliantly epitomized the rules by which the perfect courtier—urbane, witty, sporty, educated, and discrete—should live. In a world dependent upon networks of patronage and the dispensing of favors, right manners at the table or on the playing field were an essential aspect of self-projection along the trajectory of personal and professional advancement.

Manners preoccupied early modern intellectuals as well, most notably Desiderius Erasmus (1466?–1536), whose *De civilitate morum puerilium* (1530; On civility in boys) was one of the most influential and best-selling treatises of the sixteenth century. Underneath Erasmus' injunctions that boys not eat with their mouths open or cast sidelong glances at others were

deeper issues concerning self-regulation and emerging notions of shame that centered upon the body. It was the sociologist and social historian Norbert Elias who most seminally examined this shift from the Middle Ages in individual self-restraint and bodily control and labeled it a “civilizing process”; according to Elias, the emergence in the early modern period of the state, with its monopoly over physical force and its growing social interdependencies, resulted in a transformation of human relationships and with it “corresponding changes in men’s manners [and] in their personality structure, the provisional result of which is our form of ‘civilized’ conduct and sentiment.” The theory, while not without its critics—who declared it Eurocentric, misrepresentative of history, or overly teleological—nevertheless witnessed from the 1970s onward a resurgence of interest among anthropologists and historians, who found in it a guiding framework in understanding the history of the body, power relations, social and gender relations, the history of private life, and the larger connection between historical currents and social and psychological processes.

Elias paid particular attention to the relationship between manners and the rise of the absolutist state, and certainly Louis XIV’s seventeenth-century court at Versailles constituted another defining moment in the history of etiquette and the French notion of *civilité*. According to the court observer Saint-Simon, the king cast a watchful eye over his realm of co-opted noblemen, projecting his royal aura through material ostentation, expecting flattery even from his preachers, and spending equal time on cookery as on politics. Knowing “how to make the most of a word, a smile, even . . . a glance,” Louis, by addressing another with some trifling remark, could cause “all eyes [to turn] on the person so honored,” just as he could with equal frivolity “ruin . . . many men in all ranks of life.” The emphasis on protocol and display and on competing for the king’s favor also served to reinforce a larger centralization of power, since, as Saint-Simon puts it, the king “compelled his courtiers to live beyond their income, and gradually reduced them to depend on his bounty for means of subsistence.”

As notable figures at court, women could also play a significant role in determining the tone of conduct that would prevail; the highly educated and needlepointing (though occasionally crude) Elizabeth I (1533–1603), for example, oversaw such well-bred, neochivalric luminaries as Sir Philip Sidney and Sir Walter Raleigh. Women, however, were more frequently the intended audience for courtesy book writers, who sought to instill values of proper wifeliness, including compliance, modesty, and, according to one seventeenth-century English guidebook, protectiveness (or “extreme . . . tender[ness]”) toward the husband’s reputation. Civility in this respect represented the confluence of manners with morals as well as the assertion of social control and structures of domination—all of which would continue through the proliferating etiquette and domestic-life books of the nineteenth century.

Manners in Modern Times

The eighteenth century continued to advance a program of proper court behavior, with the influential Lord Chesterfield (1694–1773) coining the term *etiquette* in letters to his son

that spoke of the “art of pleasing” at court and the necessity of cultivating “that easy good breeding, that engaging manner, and those graces, which seduce and prepossess people in your favour at first sight.” It was this kind of naked and cynical self-aggrandizement that caused the backlash by Dr. Samuel Johnson (1709–1784), who claimed that the letters instilled in readers “the morals of a strumpet with the manners of a dancing master.” Rather than simply reflecting the privileged if arbitrary codes of the aristocratic class, however, manners were also seen in the eighteenth century as reinforcing stability in society, with Edmund Burke (1729–1797) stating famously that “Manners are more important than laws. Upon them . . . the laws depend,” and John Locke (1632–1704) similarly connecting good conduct with the stability and health of a democratic polity.

The art of social decorum nevertheless suffered further reputational damage with the Romantic movement and its more rough-hewn ideals of authenticity. Not only was society itself perceived by Jean-Jacques Rousseau and (1712–1778) others as a realm of corrupt artifice opposed to more truthful nature, but they considered that the manners on which that society depends expedite the process of self-alienation. At the same time, the nineteenth century gave rise in England and America to a surging middle class and a new ethic of the sentimental and domestic that allowed ideals of behavior to take on new forms and vibrancy. Where before etiquette had been associated with the aristocratic class, it now became diffused among a broader, albeit still privileged, middle class. To know the rules—that coffee was not to be served at the dinner table, that introductions were to be handled in a particular way, that one took one’s place in a quadrille at the front rather than the back of the ballroom—marked one’s place in the world as being on the inside of social privilege; to be otherwise was to be “vulgar” or “common” and coldly cast out.

In the New World, Americans’ manners, such as hastily eating (or “devouring”) their food, particularly galled the English, with Charles Dickens (1812–1870) describing Washington, D.C., as the “headquarters of tobacco-tinctured saliva” shooting forth from the mouths of “not always good marksmen.” Nevertheless, Americans, and particularly women, proliferated as authors of etiquette manuals, which counseled on housework, child-raising, personal grooming, and marriage as well as entering polite society. In this regard America undertook its own “civilizing process,” trafficking in lifestyle aspirations under the stern but gentle injunctions of an Emily Post, a Miss Manners, or, in its postmodern incarnation, a Martha Stewart.

See also *Class; Everyday Life; Tradition*.

BIBLIOGRAPHY

- Arditi, Jorge. *A Genealogy of Manners: Transformations of Social Relations in France and England from the Fourteenth to the Eighteenth Century*. Chicago: Chicago University Press, 1998.
- Aresty, Esther. *The Best Behavior: The Course of Good Manners—from Antiquity to the Present—As Seen through Courtesy and Etiquette Books*. New York: Simon and Schuster, 1970.
- Ariès, Philippe, and Georges Duby, eds. *A History of Private Life*. 5 vols. Cambridge, Mass.: Belknap Press, 1987–1991.

Bryson, Anna. *From Courtesy to Civility: Changing Codes of Conduct in Early Modern England*. Oxford: Clarendon, 1998.
 Elias, Norbert. *The Civilizing Process*. Translated by Edmund Jephcott. Oxford and Cambridge, Mass.: Blackwell, 1994.

Sarah Covington

EUGENICS. The term *eugenics*, derived from the Greek *eugenēs*, was first coined by the English mathematician and geographer Francis Galton (1822–1911) in his *Inquiries into Human Faculty and Its Development* (1883) to refer to one born “good in stock, hereditarily endowed with noble qualities.” As an intellectual and social movement in the early twentieth century, eugenics came to mean, in the words of one of its strongest American supporters, Charles B. Davenport (1866–1944), “the improvement of the human race by better breeding.” For both Galton and Davenport, better breeding involved using the known scientific principles of heredity. Eugenics was the human counterpart of scientific animal and plant husbandry. It seemed ironic to eugenicists that human beings paid such careful attention to the pedigrees of their farm and domestic stock while ignoring the pedigrees of their children. The ideology of eugenics was characterized by a strong belief in the power of heredity in determining physical, physiological, and mental traits; an inherent ethnocentrism and racism that included belief in the inferiority of some races and superiority of others (a view extended to ethnic groups and social classes as well); and a belief in the power of science, rationally employed, to solve social problems, including ones so seemingly intractable as pauperism, crime, violence, urban decay, prostitution, alcoholism, and various forms of mental disease, including manic depression and “feeble-mindedness” (retardation).

Eugenics movements did not begin to arise in Europe or the United States until the first decade of the twentieth century, and they did not become generally effective in promoting social and political programs nationally or internationally until after 1910. The earliest eugenics movements were founded in Germany in 1904, in Britain in 1907, and in the United States in 1908–1910. Other eugenics movements appeared subsequently around the world: in Western Europe (France, Norway, Sweden, Denmark), Russia, Latin America (Cuba, Brazil, Mexico), Canada, and Asia (Japan). However, it was in the United States, Britain, and Germany that eugenics as an intellectual and social movement made its greatest strides and, from eugenicists’ point of view, achieved its greatest ideological and political effects.

Because eugenics developed in a variety of national contexts with a wide range of ideological and political programs, its content and style varied from one country to another and over time, from the early 1900s until just before the onset of World War II. For example, British eugenicists were particularly concerned with the high fecundity and inherited mental degeneracy of the urban working class, particularly those labeled as “paupers.” By contrast, American eugenicists were more concerned with the number of feeble-minded who filled the prisons and insane asylums and, after World War I, with

the supposed genetic deficiencies of immigrants. In Germany mentally ill, psychotic, psychopathic, and psychiatric patients along with the congenitally deaf, blind, and feeble-minded were of greatest concern. German eugenicists were also particularly interested in increasing the number of “fitter” elements in society (positive eugenics)—where prior to the National Socialist takeover in 1933, “fitness” was understood more in terms of class than of race. Certain core principles and beliefs did link various eugenics movements together, however, and the three major international eugenics congresses, held in 1912, 1921, and 1932, emphasized the similarities among the various movements while also revealing the differences.

The core principles of eugenics as they came to be understood by the mid-1930s were summarized in a report, *Eugenical Sterilization: A Reorientation of the Problem*, published in 1936 by the Committee for the Investigation of Eugenical Sterilization of the American Neurological Association. The report articulates four major principles: first, that a number of social and behavioral problems, such as “insanity, feeble-mindedness, epilepsy, pauperism, alcoholism and certain forms of criminality are on the increase”; second, that people bearing these various defective traits “propagate at a greater rate than the normal population”; third, that such defects in mental function and behavior are “fundamentally and mainly hereditary”; and fourth, that the environment in which a person was raised was of much less importance than the germ plasm inherited from his or her parents as the cause of “adverse social status,” criminality, or general “social maladjustment.” Significantly improving the cognitive ability of the feeble-minded or making the criminal into a model citizen was deemed virtually impossible. Biology was destiny.

The Historical Development of Eugenics, 1904–1950

In most countries eugenics movements combined theory with various forms of social and political programs, from education committees to lobbying political leaders. Before 1925 most eugenicists were well-respected members of the scientific community, and the eugenic ideas they espoused were not considered eccentric or bizarre. The acknowledged leader of American eugenics, Charles Davenport, received his Ph.D. from Harvard, taught at the University of Chicago, and then established his own research laboratory to promote the study of heredity and its relationship to selection and evolution. In Britain, Davenport’s equivalent was Karl Pearson (1857–1936), director of the Eugenics Record Office and Galton Professor of Eugenics at University College, London. In Germany, Eugen Fischer (1874–1967), the academic leader of *Rassenhygiene* (racial hygiene), was the director of the newly founded Kaiser-Wilhelm Institute for Anthropology, Human Genetics, and Eugenics (KWIA) in Berlin-Dahlem. Along with other colleagues, these investigators contributed solid work on aspects of human inheritance as well as more tenuous studies on inheritance of feeble-mindedness, mental capacity, and social traits.

In addition to such conspicuous national leaders, many well-known, rank-and-file biologists, especially in the period 1910–1925, enthusiastically endorsed the aims of eugenics. The attraction for these biologists was that the new science of ge-

netics appeared to offer a solution to recurrent social problems that had eluded social workers and charitable organizations. Eugenics was seen as the efficient, rational, and scientific way to solve these problems by eliminating the cause rather than treating the symptoms. These supporters all contributed in some way to spreading the eugenics message to a broader public.

Financial support for eugenics research and propaganda came from the economic, political, and social elite and clearly served several special interests. First was economic efficiency: it was expensive to let defective people be born and then spend taxpayers' money to keep them in institutions for much of their lives. Second, the eugenic argument that social problems originated in "bad genes" deflected criticism of social policies and conditions and placed the blame for social problems on individuals.

Research Methods

Eugenicists were faced with the problem of defining and measuring the traits whose patterns of inheritance they wanted to determine. Definition posed a considerable problem when the traits were complex behaviors that were often defined in different ways in different cultures or different historical periods. What counted as an alcoholic or a criminal? How was "feeble-mindedness" defined? Recognizing that such conditions are culturally defined, Davenport, for example, lumped all such individuals into the category of "social defectives" or "socially inadequate persons." For most of the behavioral and mental traits in which eugenicists were interested, no objective and quantitative definitions or measurements existed. For the most part, they had to rely on highly qualitative, subjective methods of defining traits and categorizing individual behavior.

One trait that could be expressed quantitatively was intelligence, tests for which were developed, particularly in the United States. In 1912 Davenport arranged for Henry H. Goddard (1856–1962) to administer versions of the French Binet-Simon test to immigrants arriving at Ellis Island. Although the Binet-Simon test was intended to measure only an individual's mental functioning at a given point in time, Goddard and a host of American psychometricians considered that it also measured innate, genetically determined intelligence. Goddard coined the term "feeble-mindedness" to refer to those who scored below seventy on his tests. He claimed, "Feeble-mindedness is hereditary and transmitted as surely as any other character. We cannot successfully cope with these conditions until we recognize feeble-mindedness and its hereditary nature, recognize it early, and take care of it" (p. 117).

Psychometricians and eugenicists maintained their belief that their tests measured innate capacity rather than merely accumulated knowledge despite the abundance of culturally specific material and terminology in the tests. Even when results from the U.S. Army tests during World War I showed that the longer recruits from immigrant families had lived in the United States, the better they did on the tests, Carl C. Brigham (1890–1943), a Princeton psychologist who analyzed the data, argued that the trends showed a decline in the quality of immigrants over time, not their degree of familiarity with the cultural content of the tests.

The family pedigree chart was one of the main means for displaying and analyzing data on the heredity of a behavioral trait. The data were often anecdotal and subjective and many times were obtained from second- and thirdhand sources. Typical examples are the family studies carried out through the auspices of the Eugenics Record Office at Cold Spring Harbor. Starting with an individual, usually incarcerated in a mental or penal institution, field-workers would interview not only that individual but as many members of the family as possible. Where possible, medical records would be obtained. The data were then organized into pedigree charts to suggest how heredity influenced many behavioral, personality, and mental traits. For example, in a study published in 1919, Davenport claimed that thalassophilia, or "love of the sea," was due to a sex-linked Mendelian recessive appearing in the families of prominent U.S. naval officers. That the condition must be sex-linked was clear to Davenport, since in pedigree after pedigree only males showed the trait. Similar simplistic arguments were extended to explain the differences between racial, ethnic, and national groups, such as the claim that blacks showed genetic tendencies toward "shiftlessness" and the Irish toward "alcoholism."

Eugenics in the Public Arena

Eugenics ideology was spread not only through scientific but also through popular channels, including the press, exhibits, the eugenicists' own popular journals such as *Eugenical News*, various movies, "fitter family" contests at state fairs, and even a eugenical sermon contest. The number of articles on eugenics in popular magazines rose precipitously between 1910 and 1914 and again in the 1920s, especially when the immigration restriction issue was being debated in Congress between 1921 and 1924. Most high school biology textbooks included some discussion of eugenics. By the early to mid-1920s many segments of the American, British, and wider European public were at least aware of a claim, made in the name of modern science, that many social, especially mental, traits were genetically determined, that many segments of society were genetically unfit for anything but the most menial work, and that in these respects blacks, Native Americans, and many non-Nordic or non-Anglo-Saxon groups were genetically inferior.

From the start most eugenicists were anxious to play a role in the public arena. A good deal of eugenicists' efforts focused on lobbying for compulsory sterilization laws for the "genetically unfit" and, especially in the United States, for eugenically informed immigration restriction.

The United States pioneered in the passage of eugenical sterilization laws. The majority of such laws were passed by state legislatures during the interwar period. Eugenical sterilization was aimed specifically at those individuals in mental or penal institutions who, from family pedigree analysis, were considered likely to give birth to socially defective children. Eugenical sterilization reached astounding proportions worldwide in the first half of the century. In the United States over sixty thousand eugenical sterilizations were performed between 1907 and 1963. A similar number was estimated for Sweden, while the Germans ultimately sterilized over 400,000.

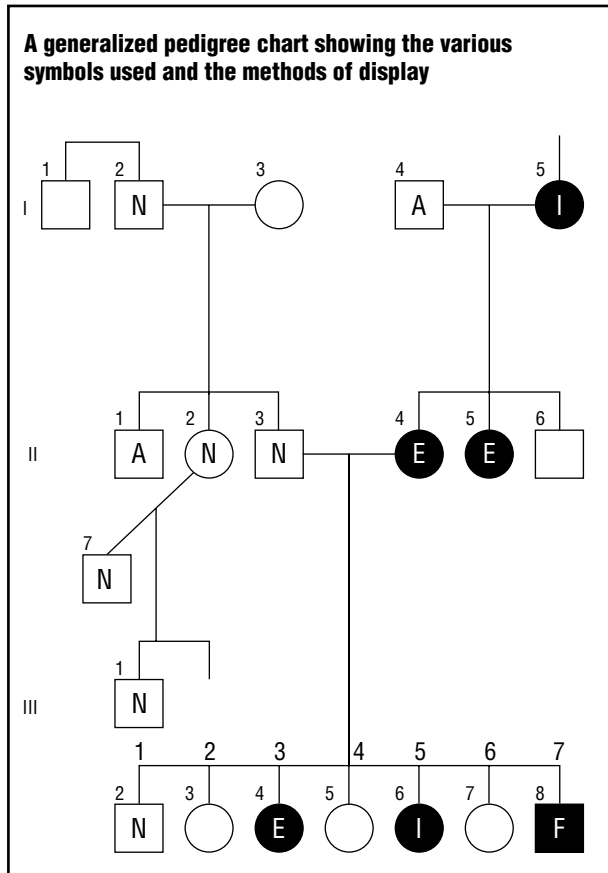

In the United States eugenicists were instrumental in the passage of the 1924 Immigration Restriction Act. Immigration from Europe, especially from eastern and southern Europe, had increased significantly since the 1880s, replacing the traditional immigrant groups from northern Europe and the British Isles. IQ test scores and data on institutionalization of various immigrant groups for feeble-mindedness, insanity, criminality, blindness, and so on were used to support the claim that recent immigrants were less genetically fit than the older, northern European stock. Eugenics provided an air of scientific objectivity for what various nativist groups wanted to accomplish for reasons of economics or prejudice.

Because racial policy and eugenics formed one of the cornerstones of National Socialism, eugenics research and policy found considerable support in Germany after 1933. When Fischer retired as director of the KWIA in 1942, he was succeeded by his protégé Otmar von Verschuer, one of the pioneers in the use of identical twins in genetic and eugenic research. Verschuer eventually took the institute's research into extermination and slave-labor camps, where his assistant and former doctoral student, Josef Mengele, made pairs of twins available, especially for research on pathological conditions. For example, twins (with non-twins as controls) were infected with disease agents to study the effects of the same and different hereditary constitutions on the course of disease. After they died or were killed, twins' body organs were sent back to

the KWIA for analysis. Such procedures, when brought to light at the Nuremberg trials, not only shocked the world but indicated the extent to which eugenic work could so easily transgress the bounds of acceptable scientific practice.

Criticisms of Eugenics

Almost from the beginning, many of the basic premises of eugenics received critical scrutiny by biologists, medical doctors, social workers, and laypersons from all walks of life. Criticisms emerged in most countries by the mid-1920s, though the reasons differed widely.

In Catholic countries criticism of eugenics was made official by the papal encyclical *Casti connubi* of 1930. Prior to the encyclical, however, in countries like France eugenic claims were tempered by the prevailing theory of inheritance of acquired characters, sometimes referred to as "neo-Lamarckism" after the French zoologist Jean-Baptiste de Lamarck (1744–1829), who had emphasized the influence of the environment as a cause of adaptations acquired by organisms during their lifetime and passed on to their offspring. If such adaptations could be inherited, then the environment had a much larger role to play in changing human behavior than eugenicists thought. Consequently in France prior to 1930 and in the countries whose scientific culture it influenced (particularly in Latin America), eugenics was always coupled with programs for public health reforms and attention to improving environmental conditions.

Russia had a small but flourishing eugenics movement before the Bolshevik Revolution of 1917. With the advent of the Communist regime, some biologists hoped that the application of scientific principles to reproductive policies, as to agriculture, would receive official support. But many Soviet biologists, recognizing that complex human behaviors and social values cannot be ascribed to genes in any clear way, found the claims of Western eugenicists naive and class-based. Moreover the "hard" hereditarian line promoted by most Western eugenicists was at odds with the Communist views of the malleability of human nature and thus appeared to provide no role for the environment in shaping human destiny. The Central Committee of the Communist Party outlawed work on eugenics in 1930, making the Soviet Union the only country where eugenics was officially denounced by governmental legislation.

In Western countries like the United States and Britain, criticisms began to arise over the sloppiness of many eugenicists' research methods. Among the first and most important critics in the United States was Thomas Hunt Morgan (1866–1945), a geneticist at Columbia University and prior to 1915 a moderate supporter of eugenics. Morgan felt that the movement had become more propagandistic than scientific and criticized eugenic claims in print, starting with his book *Evolution and Genetics* (1925). He chastised eugenicists for lumping many mental and behavioral conditions together under a rubric like "feeble-mindedness" and treating it as if it had a single underlying cause in a single gene. He argued that because environmental influences on mental and nervous development are so strong and since it is impossible to raise humans

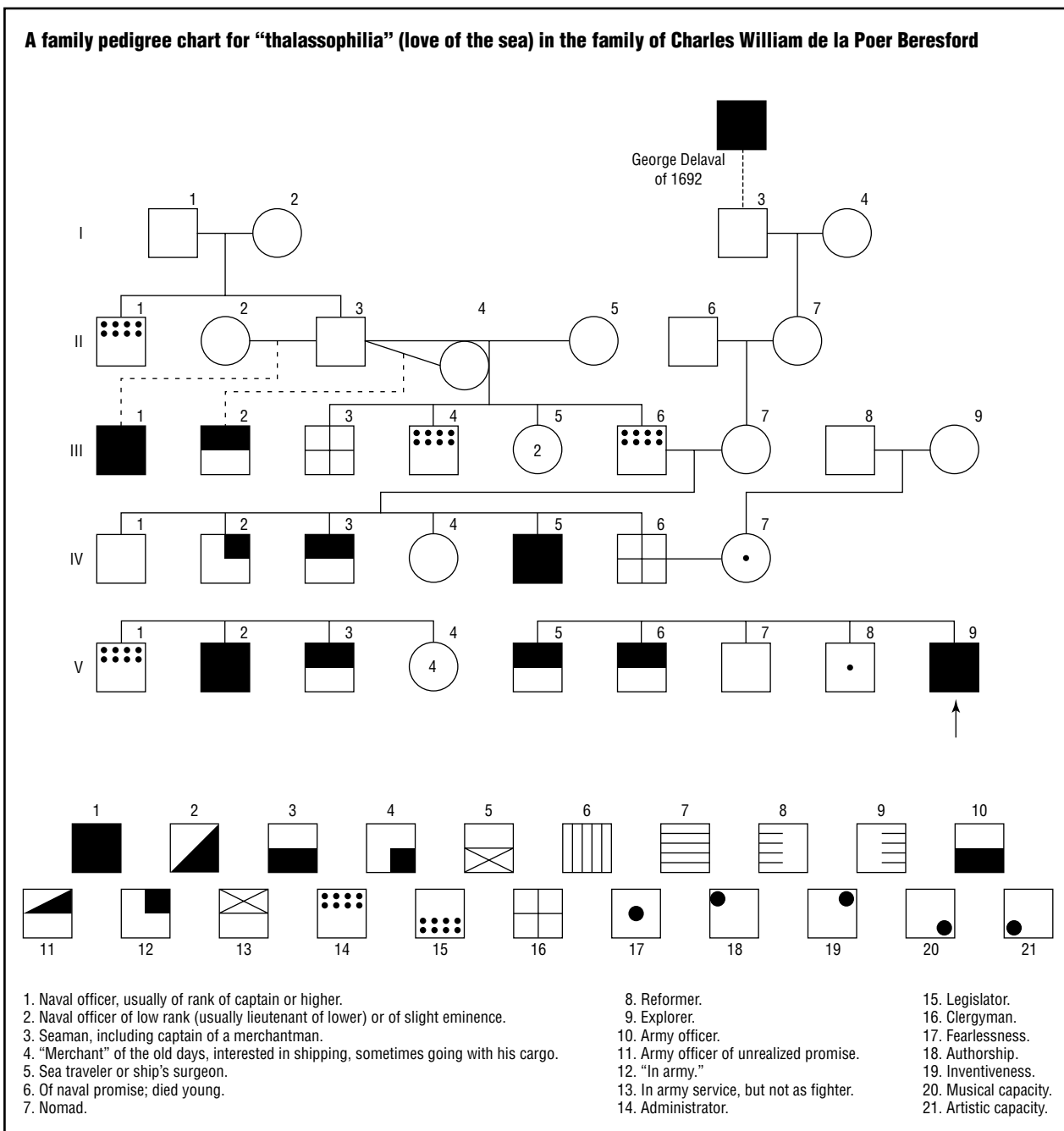

under controlled conditions like fruit flies, no rigorous claims could be made about a genetic basis for such traits.

Echoing similar concerns, the English mathematician and geneticist and sometime eugenicist Lancelot Hogben (1895–1975) made one of the clearest statements at the time about the oversimplified concept of genetics that informed much of the eugenics movement: “No statement about a genetic difference has any scientific meaning unless it includes or implies a specification of the environment in which it manifests itself in a particular manner” (Ward, p. 305). Furthermore, as Reginal C. Punnett (1875–1967) noted, even if a trait were

found to be controlled by a single Mendelian gene, unless it was a dominant, it would take hundreds of generations of rigorous selection to eliminate it from the population.

A more public attack on eugenics came from Raymond Pearl (1879–1940) at Johns Hopkins University, himself a onetime eugenics supporter. Pearl and his Hopkins colleague Herbert Spencer Jennings (1868–1947) both agreed with the basic principles and aims of eugenics but felt that propagandists like Harry Laughlin and others made claims that went far beyond any reasonable biological evidence. Jennings wrote a series of rebuttals of Laughlin’s claims and a small book

(*Prometheus, or Biology and the Advancement of Man*; 1925) condemning the vulgarization and racism of some eugenic writers. H. J. Muller (1890–1967), a student of Morgan, delivered a searing attack on “old style” eugenics at the Third International Eugenics Congress in New York City in 1932. Muller, who harbored strong eugenical beliefs as well as socialist leanings, argued that until the economic and social environment could be equalized, it would be impossible to know how much of any individual’s “social inadequacy” was due to heredity and how much to environment.

Except for Germany and the countries it influenced or occupied, by the mid-1930s eugenics began to decline in general popularity and political effectiveness. Scholars have suggested several possible reasons for this change of fortune. Clearly both the depression of 1929–1933 and reports of Nazi eugenics activity played some part in a general disaffection with eugenical principles. In the depression people without jobs became “paupers” and “social inadequates” overnight with no change in their genetic makeup, while in Germany the sterilization and infamous Nuremberg Laws (1935) showed the extent to which eugenical legislation under a powerful central government could erode personal liberties. An additional factor may have been the recognition that eugenicists were increasingly out of touch with the most recent findings of laboratory genetics. Davenport’s and Laughlin’s simple unit-character concept did not square with recent experimental data suggesting that most traits were produced by the interaction of many genes and that evidence for a clear-cut genetic basis of complex human social behaviors was almost nonexistent.

Eugenics in the Twenty-First Century

The history of the eugenics movement raises many issues relevant to the expanding work in genomics at the beginning of the twenty-first century, especially the Human Genome Project (HGP). Since the advent of new technologies associated with test-tube babies, sequencing the human genome, cloning new organisms from adult cells, stem cell research, genetic testing, and the prospects of gene therapy, the term *eugenics* has once again come into popular culture. Since it is possible, through in utero testing, to determine if a fetus is male or female or has Down syndrome or a mutation for Huntington’s disease, cystic fibrosis, thalassemia, or Tay-Sachs disease, should these tests be required for all pregnant women? And if so, who should have access to the results? Can medical insurance companies refuse to cover families or their children if the mother does not undergo genetic testing of the fetus? Some medical ethicists argue that the outcome—controlling births in order to reduce the number of “defective” people in society—is identical to that issuing from the old eugenics movement. According to this view, it makes little difference whether state legislation or social and economic pressures force people to make reproductive decisions they might not otherwise make. Other ethicists, however, argue that state coercion, as in the old eugenics movement, is qualitatively different from various forms of social pressure, since the latter still gives the individual some range of choice. In addition it can be argued that modern genetic decisions are made on a case-by-case ba-

sis and do not involve application of policies to whole groups defined racially, ethnically, or nationally.

Clearly it is in the interests of insurance companies to reduce as much as possible the medical costs incurred by their clients. And some would argue that it is also in the interest of individual families to avoid bringing a seriously disabled child into the world. But ethicists raise the question of what is “disabled” and who should be the judge. These issues have become more pressing the more costly medical care has become and the more ancillary social services are cut back. Ironically, as a result of sequencing the human genome, a project that carried with it funds for ethical considerations, geneticists now know that there is no one-to-one correspondence between genotype and phenotype and that the reading out of the genetic code is far more plastic than previously believed. Individuals with the same mutation in the cystic fibrosis gene, for example, can have quite different phenotypes (some are seriously affected and others are not or the effects manifest themselves in different organs and at different stages in development). Thus in utero genetic testing may reveal a mutant gene but will provide little information on how the child will turn out phenotypically.

While these various ethical issues are problematical, with well-defined clinical conditions, they are infinitely more so when mental, behavioral, and personality traits are the center of discussion. From the last quarter of the twentieth century many claims have been made for identifying genes that affect human behavior or personality (alcoholism, manic depression, criminality, homosexuality, shyness, aggression). No gene or group of genes has ever been isolated or shown clearly to affect any of these conditions, yet the belief that the conditions are to a significant degree genetically determined has become widespread throughout the media and in the public. Reproductive decisions based on circumstantial or nonexistent data add another level of ethical considerations in the growing debate about reproductive technologies. Recognizing the consequences of policies put forward under the guise of the old eugenics movement can help avoid some of the more obvious errors of the past.

See also Biology; Class; Development; Evolution; Family Planning; Genetics; Health and Disease; Hygiene; Lysenkoism; Medicine: Europe and the United States; Race and Racism; Social Darwinism.

BIBLIOGRAPHY

- Adams, Mark B., ed. *The Wellborn Science: Eugenics in Germany, France, Brazil, and Russia*. New York: Oxford University Press, 1990.
- Allen, Garland E. “The Eugenics Record Office at Cold Spring Harbor, 1910–1940: An Essay in Institutional History.” *Osiris*, 2nd ser., 2 (1986): 225–264.
- . “Mendel and Modern Genetics: The Legacy for Today.” *Endeavour* 27, no. 2 (2003): 63–68.
- American Neurological Association, Committee for the Investigation of Eugenic Sterilization. *Eugenical Sterilization: A Re-orientation of the Problem*. New York: Macmillan, 1936.

- Barkan, Elazar. *The Retreat of Scientific Racism: Changing Concepts of Race in Britain and the United States between the World Wars*. Cambridge, U.K.: Cambridge University Press, 1992.
- Broberg, Gunnar, and Nils Roll-Hansen, eds. *Eugenics and the Welfare State: Sterilization Policy in Denmark, Sweden, Norway, and Finland*. East Lansing: Michigan State University Press, 1996.
- Carlson, Elof Axel. *The Unfit: A History of a Bad Idea*. Cold Spring Harbor, N.Y.: Cold Spring Harbor Laboratory Press, 2001.
- Chase, Allan. *The Legacy of Malthus*. New York: Knopf, 1977.
- Davenport, Charles B. *Naval Officers, Their Heredity and Development*. Washington, D.C.: Carnegie Institution of Washington, 1919.
- Davenport, Charles B., et al. *The Study of Human Heredity*. Eugenics Record Office Bulletin no. 2. Cold Spring Harbor, N.Y.: Eugenics Record Office, 1911.
- Galton, Francis. *Inquiries into Human Faculty and Its Development*. New York: Macmillan, 1883.
- Goddard, Henry Herbert. *The Kallikak Family: A Study in the Heredity of Feeble-Mindedness*. New York: Macmillan, 1913.
- Kevles, Daniel J. *In the Name of Eugenics*. New York: Knopf, 1985.
- Kühl, Stephan. *The Nazi Connection: Eugenics, American Racism, and German National Socialism*. New York: Oxford University Press, 1993.
- Lombardo, Paul A. "Three Generations of Imbeciles: New Light on *Buck v. Bell*." *New York University Law Review* 60 (1985): 30–62.
- Mazumdar, Pauline M. H. *Eugenics, Human Genetics, and Human Failings: The Eugenics Society, Its Sources, and Its Critics in Britain*. London: Routledge, 1992.
- Müller-Hill, Benno. *Murderous Science: Elimination by Scientific Selection of Jews, Gypsies, and Others, Germany 1933–1945*. Oxford: Oxford University Press, 1988.
- Paul, Diane B. *Controlling Heredity*. Montclair, N.J.: Humanities Press, 1995.
- Proctor, Robert. *Racial Hygiene: Medicine under the Nazis*. Cambridge, Mass.: Harvard University Press, 1988.
- Selden, Steven. *Inheriting Shame: The Story of Eugenics and Racism in America*. New York: Teachers College Press, 1999.
- Tucker, William H. *The Funding of Scientific Racism: Wickliffe Draper and the Pioneer Fund*. Urbana: University of Illinois Press, 2002.
- Ward, Harold. "The Dilemma of Eugenics." *New Republic*, 24 (April 1925): 305.

Garland E. Allen

EUROCENTRISM. *Eurocentrism* refers to a discursive tendency to interpret the histories and cultures of non-European societies from a European (or Western) perspective. Common features of Eurocentric thought include:

- Ignoring or undervaluing non-European societies as inferior to Western;
- Ignoring or undervaluing what Asians or Africans do within their own society or seeing the histories of non-European societies simply in European terms,

or as part of "the expansion of Europe" and its civilizing influence.

Eurocentrism is very old indeed. Already in the fifth century B.C.E. the Greek historian Herodotus mentions "barbaric" Asian hordes who, despite splendid architecture, lack European individuality.

Although Eurocentrism has been common through the ages, it has not been constant, nor has it affected the way Europeans have viewed all non-European societies equally. Moreover, Europeans have not always been in full agreement with each other over the merits or failings of particular non-European societies. In some writers and periods we find a tendency to romanticize Asia and Africa. In general, Eurocentrism has been more pronounced during periods of greatest European assertiveness or self-confidence, the most outstanding example being the age of imperialism and colonialism in the nineteenth and early twentieth centuries.

There are certain beliefs, valid or otherwise, that have led Eurocentric thinkers toward ignoring, undervaluing, or condemning non-European societies. There is a wide range of these, some applying more broadly in chronological terms than others. They include the following:

- Non-European societies tend to be despotic and servile, as against the West's freedom and individualism.
- Non-European societies are Islamic, or pagan, or believe in strange religions, which are inferior to Christianity, or lack its truth.
- Non-European societies are cruel and lack concern for human life. They practice barbaric customs toward women, such as female genital mutilation (north Africa), widow-burning (*sati*, India) or foot-binding (China).
- Non-European societies are inflexible and unchanging. Some European thinkers have attributed this lack of change to topography or climate, for instance extreme dependence on a major river, such as the Nile or the Yellow River, or extreme heat or dryness.
- Non-European societies are poor, backward, and underdeveloped, as opposed to the industrialized, progressive, and rich West.
- Non-European societies lack rational modes of thinking and scientific approaches.

Examples

There are innumerable European or Western observers who can be categorized as Eurocentric or otherwise. Between extreme Eurocentrism and its antithesis is a whole spectrum of attitudes toward non-European cultures and peoples, some thinkers being quite Eurocentric in general, but still showing remarkable sympathy toward non-Europeans in some respects, and vice versa. To some extent, the history of Western Asian

England, it is true, in causing a social revolution in Hindostan, was actuated only by the vilest interests, and was stupid in her manner of enforcing them. But that is not the question. The question is, can mankind fulfil its destiny without a fundamental revolution in the social state of Asia? If not, whatever may have been the crimes of England she was the unconscious tool of history in bringing about that revolution.

SOURCE: Karl Marx, "The British Rule in India," p. 493.

and African studies shows a spectrum from extreme Eurocentrism to opposition to Eurocentrism, though in most periods the mean tends toward the Eurocentric end. A few examples of major Western thinkers or ideas on Asian and/or African peoples and cultures are selected as illustrations.

Aristotle (384–322 B.C.E.) regarded Africa and Asia as monolithic and influenced by their hot climates, contrasting with temperate or cold Europe. He saw their governments as despotic and peoples as servile and lacking in spirit. On the other hand, he regarded Asians as intelligent and was impressed with Egypt because leisure among the priestly caste had allowed them to found the mathematical arts.

Medieval Europe's main impression of North Africa and Asia was distrust, then fear of, and hostility to, Islam. And in 1242, the Mongols came very close to Vienna and could have captured it but for news reaching them of their khan's death. Yet the thirteenth century also produced Marco Polo, who traveled through much of Asia and left a detailed account of life in China, which is remarkably positive and even romanticized.

The missionaries of the Catholic Society of Jesus (Jesuits) worked in many parts of Asia and Africa. In that they preached a religion that was strongest in their own (European) countries, they were Eurocentric. However, their policy was to try to understand the people they were converting and to adapt to local conditions, practices, and rites as far as they could. Moreover, they were pioneers in scholarship about several Asian countries, especially China. Jesuit missionaries sent back to Europe a flood of information from various parts of Asia, including, from 1703 to 1776, the "Lettres édifiantes et curieuses" (Edifying and curious letters), about one-third of which dealt with China.

Enlightenment. The Enlightenment philosophers also discussed Asia and Africa. Although most of their ideas were Eurocentric, some were remarkably inclusive thinkers. Non-European civilizations became part of major philosophical debates in Europe about government, economy, and religion.

Among his three kinds of government, republic, monarchy, and despotism, Charles-Louis de Secondat, baron de Montesquieu (1689–1755) puts Asian societies unequivocally in the last. Being of the view that climate and topography influence government system, Montesquieu saw despotism in Asia, especially in China and India, as the result of vastness and heat. Although he does see some merits in Asia, such as lenient laws in India, the general picture he presents of Asia is grim and Eurocentric. To be fair, his *Lettres persanes* (1721; Persian letters) is in a style new to his time and explicitly non-Eurocentric in showing Persian visitors to Europe criticizing what they found.

Montesquieu's most vigorous opponent was François Quesnay (1694–1774), the leader of the philosophical school called the Physiocrats. His primary interest was in the economy, and specifically agriculture, and the model he chose was China. His main work, *Le despotisme de la Chine* (1767; Despotism in China), shows that he regarded that country as an example of despotism. However, it was an enlightened despotism, with the emperor governing according to natural laws both he and all his subjects must obey.

The most famous of the Enlightenment thinkers was Voltaire (1694–1778). His great *Essai sur les mœurs et l'esprit des nations et sur les principaux faits de l'histoire depuis Charlemagne jusqu'à Louis XIII* (1756; Essay on the customs and spirit of the nations and the principal facts of history from Charlemagne to Louis XIII) is a world or "universal" history, and the first ever written to treat the growth of civilization as a whole. It has two chapters on China, two on India, one on Persia, and two on the Arabs. In that sense it is the very antithesis of Eurocentrism, even though it does give much more space to European than to other cultures.

Voltaire's picture of China and India was very positive, especially China, which drew his praise for its secular government. However, he regarded both civilizations as having made their greatest contributions many centuries before, at a time when Europe was still at the stage of barbarism, and having since become static.

Marx. Karl Marx (1818–1883) belongs in the tradition of Eurocentric thinkers. He developed the idea of "oriental despotism" into his theory of the "Asiatic mode of production," the most important plank of which was an absence of private property in land—the commune, state, or monarch being the owner of all land. Marx's main exemplars for his theory were India and China, but also included Egypt and the countries of the Sahara, as well as Arabia and Persia. Ironically he exempted Japan from the "Asiatic mode of production," being thus one of a number of Western thinkers for whom Japan was in many respects more like a Western than an Asian society.

The basis of "Asiatic mode" societies was villages and communities, which Marx regarded as backward, miserable, and lacking in historical spirit. He believed the government of such societies was despotic, because communal agriculture necessitates large-scale hydraulic works and irrigation, itself requiring large-scale bureaucracy. Marx was thus in a long line of environmental determinists.

Because of Marx's environmental determinism, he castigated "Asiatic mode" societies as unchanging. It required outside force to impose change and, while that may have been painful, it was necessary. In an article entitled "The British Rule in India," published in the *New-York Daily Tribune* on 25 June 1853, he condemns British activity in India, but still believes that British colonialism there was historically progressive.

The chief follower of Marx's environmental determinism in the twentieth century was Karl A. Wittfogel (1896–1988), whose main work concerned China. Wittfogel was initially an activist in the German Communist Party but migrated to the United States and became naturalized in 1939, turning strongly against communism. He continued his work on Asia there, especially in *Oriental Despotism* (1957), where he argues strongly that the need for large-scale waterworks spawns despotic bureaucracies that impact on the whole nature of societies.

Weber. Max Weber (1864–1920) is most famous for attributing the growth of the capitalist spirit to the Puritan Protestant work ethic, especially John Calvin's (1509–1564) belief in predestination. Yet he also deserves a mention here for his attempts to develop a comparative methodology of sociology through his studies of the religious cultures of Asia, notably India and China.

In order to determine *why* Asian societies had failed to develop the "spirit of capitalism," Weber examined in great detail the impact on society and "personality" of great religions such as Confucianism, Buddhism, Hinduism, and, though to a slighter extent, Islam. His conclusion: that none of the Asian religions engaged with the world in such a way as to seek salvation through exertion in a calling and through profitable work in the way that ascetic Protestantism did. Confucianism he characterized as the ethic of officials, which adapted to the world, while Buddhism divorced itself from the world and Islam sought to rule it. Weber believed that the religions of Asia all accepted the world just as it was, the implication of this being that there was no incentive to transform it. He also saw the family systems in societies such as China and India as major inhibitors of modernization.

Weber's views, including those on Asia, remain controversial. In the late twentieth century many argued that Confucianism, including the Confucian emphasis on family, was responsible not for economic backwardness, but for capitalist progress. Despite his attempts to compare cultures dispassionately, Weber's basic conclusions point to commendation for the accomplishments of peoples following ascetic Protestantism, and criticism for other cultures, including Asian and African.

Twentieth-Century Critics of Eurocentrism

Frantz Fanon (1925–1961) was born in Martinique but trained mostly in France, serving in the French army during World War II. A strongly anticolonial theorist, he became involved in the Algerian war against the French and was the most articulate spokesperson for its cause. He did not live to see peace restored, dying of leukemia in Washington, D.C. in 1961. His most famous work is *Les damnés de la terre* (1961;

So, my brothers, how is it that we do not understand that we have better things to do than to follow that same Europe?

That same Europe where they were never done talking of Man, and where they never stopped proclaiming that they were only anxious for the welfare of Man: today we know with what sufferings humanity has paid for every one of their triumphs of the mind.

Come, then, comrades, the European game has finally ended; we must find something different. We today can do everything, so long as we do not imitate Europe, so long as we are not obsessed by the desire to catch up with Europe.

SOURCE: Frantz Fanon, *The Wretched of the Earth*, pp. 251–252.

The wretched of the earth), which is a passionate indictment of colonialism, especially that in Africa.

A major point of criticism of Eurocentrism in Fanon's work is his attacks on those Africans who internalize European culture at the expense of their own. He calls on Africans to promote their own culture as the symbol of their national consciousness. And that involves rejecting Europe and its sense of superiority, in other words Eurocentrism.

Edward Said (1935–2003) was a Palestinian Arab, who was born in Jerusalem but was trained in Cairo and the United States. He spent most of his professional career working at Columbia University in New York. Famous as a public intellectual and thinker generally, Said became a passionate critic of Eurocentrism.

Said's best known work is *Orientalism* (1978), a strong attack on Western scholarship on Islamic West Asia and North Africa, which he regarded as deeply ethnocentric or "Orientalist." By its nature, the theory of "Orientalism" applies to all non-Western societies, even though its focus is West Asia. He claims that in colonizing West Asia and North Africa, European states also "colonized" knowledge about these regions, meaning that there is a power factor of superior/inferior in Western scholarship concerning them, which is deeply "hegemonic." The result is that Western scholarship is generally simply an abstraction or invention shot through with various kinds of racism or imperialism. Certainly, it is incapable of examining Asian or African cultures and societies in their own terms. It is in line with a Western political agenda and suits Western interests generally.

Despite what many critics have claimed as an extreme view, Said does acknowledge the possibility that Western scholarship can be “decolonialized.” His belief was that allegiance to a discipline, not to area studies, can lead to scholarship “that is not as corrupt, or at least as blind to human reality” as the Orientalist type (p. 326). Naturally, it is essential that all links between scholar and state be very specifically ruptured.

Said’s work has attracted both support and criticism. Among the supporters is Ronald Inden, who has written works with similar thrust concerning India, especially *Imagining India* (1990). It has also sparked an opposite theory of “Occidentalism,” which lies outside the scope of this entry.

The twentieth century saw numerous other critics of Eurocentrism closely involved in antiracist and anticolonial movements. A particularly distinguished American example was W. E. B. Du Bois (1868–1963), a leader of the American civil rights movement as well as an advocate of black rights worldwide. A distinguished academic as well as a political activist, he wrote many books attacking Eurocentric and racist thinking, as well as defending black integrity, identities, and traditions. Du Bois was also notable in his understanding of the relationship between racism and sexism and in his high evaluation of the contributions of black women. He was born and lived most of his life in the United States, but emigrated to Africa in 1961, dying in Ghana.

Eurocentrism, Anticolonialism, Modernity, Postcolonialism

The tendency to examine the histories of Asia and Africa through the prism of “European expansion” was very common, even prevalent, in Western scholarship on these two continents in the nineteenth and twentieth centuries. The rise of nationalism, anticolonialism, and independence movements brought greater realization of the importance Asians and Africans had played in their own country, and hence a trend away from Eurocentrism. Scholars from Africa and Asia went to live in the West in increasing numbers for training. They brought understandings from their own countries as well as taking back ideas from the West. At the same time, the rise in influence of many former colonies brought about a shift in attitude in the West itself toward Asia’s and Africa’s histories and cultures.

One illustrative example is the literary movement *negritude* of the 1930s to the 1950s. Led by Léopold Sédar Senghor, who was elected first president of the previously French-colonized West African Republic of Senegal in 1960, this movement arose in Paris, where several major literary figures from French African colonies lived. It attacked the humiliation and contempt European colonialism had inflicted on Africa and black people. Above all, it opposed colonialism and Eurocentrism by seeking to reassert the value and dignity of African traditions.

Modernity. Modernity and the question of when the modern age began are important in Eurocentrism. Until World War II, most scholars studying Asian and African peoples were content to attach modernity to European colonialism or

imperialism. But this attitude came under attack in the postwar West, and even more with the Vietnam War of 1965–1973, because it ignores or underplays processes that might have been taking place in the country of concern.

Taking China as an example of a major civilization that never actually became a colony despite major attacks from imperialist powers ranging from Britain to Japan, we find that prewar Western historians of the “modern” period tended to see the beginnings of modernity in the middle of the nineteenth century, which was when the Western impact began in earnest. For example, the great American sinologist John King Fairbank (1907–1991) developed a theory of “change within tradition” before the Western impact, but “transformation” brought about by the West in the nineteenth century. Since the 1970s, more and more historians see internal dynamics within the long range of Chinese history, in which the Western impact of the nineteenth century was an important factor, but certainly not one so fundamental as to define the boundaries of “modern” China. They challenge the notion of a stagnant China awaiting deliverance from a dynamic West as Eurocentric, and either see no point in assigning the boundary of a “modern” China or choose times other than the mid-nineteenth century.

Postmodern and postcolonial studies. Since the 1980s Eurocentrism has been more closely associated in the humanities and social sciences with ideologies such as sexism and racism. “Subaltern studies,” which attack all forms of scholarship and ideology that give space to any kind of dominationism or inequality have become increasingly influential in the humanities and social sciences.

One highly significant example is the rise of gender and feminist scholarship that associates Eurocentrism, imperialism, and racism with sexism. These theories argue against the possibility of fully understanding imperialism without reference to gendered power. Colonialism was male in its interests and violent in its methods. Europe was essentially male, the colonies female.

An interesting case study of the way anti-Eurocentrism has merged with antiracism in the field of ancient history is the argument that Ancient Greek civilization derived from Asia and Africa, especially Egypt. Ancient Greece is generally regarded as one of the most important sources, or even “the cradle,” of European civilization. But Martin Bernal (1987) suggests that it was nineteenth-century racism that exalted the Ancient Greeks as racially pure Aryans, even though the roots of their civilization were Semitic, Phoenician, and Egyptian.

Together with the existence of a thinker like Edward Said, these examples of alternative paradigms suggest that Eurocentrism is on the decline in the postcolonial era. But it is very far from dead.

See also Anticolonialism; Colonialism; Cultural Revivals; Internal Colonialism; Negritude; Occidentalism; Orientalism; Other, The, European Views of.

BIBLIOGRAPHY

- Amin, Samir. *Eurocentrism*. Translated by Russell Moore. New York: Monthly Review, 1989. Major attack on Eurocentrism.
- Bernal, Martin. *The Fabrication of Ancient Greece, 1785–1985*. Vol. 1 of *Black Athena: The Afroasiatic Roots of Classical Civilization*. London: Free Association Books, 1987. Argues that Ancient Greek civilization had its roots in Africa and Asia.
- Blaut, James M. *The Colonizer's Model of the World: Geographical Diffusionism and Eurocentric History*. New York: Guilford, 1993.
- Fanon, Frantz. *The Wretched of the Earth*. Preface by Jean-Paul Sartre. Translated by Constance Farrington. Harmondsworth, U.K.: Penguin, 1967. Classic text condemning colonialism, including its influence on the mind.
- Goody, Jack. *The East in the West*. Cambridge, U.K.: Cambridge University Press, 1996. Major anti-Eurocentrist theory of world history.
- Inden, Ronald B. *Imagining India*. Oxford: Blackwell, 1990.
- Lach, Donald F. *Asia in the Making of Europe*, 3 vols. Chicago: University of Chicago Press, 1965–1993. In three volumes and nine books covers South Asian, East Asian, and Southeast Asian impact on Europe over three centuries.
- Mackerras, Colin. *Western Images of China*. Oxford: Oxford University Press, 1989. Covers all periods.
- Marx, Karl. "The British Rule in India." In *Karl Marx and Frederick Engels: Selected Works, in Three Volumes*. Vol. 1. Moscow: Progress Publishers, 1969. Classic text summing up Marx's views on environmental determinism and colonialism.
- McClintock, Anne. *Imperial Leather: Race, Gender, and Sexuality in the Colonial Contest*. New York and London: Routledge, 1995. Using mainly African examples, argues interconnections among imperialism, sexism, racism, and class.
- Said, Edward W. *Orientalism*. New York: Pantheon, 1978. Major twentieth-century theory attacking Eurocentrism.
- Wittfogel, Karl A. *Oriental Despotism, A Comparative Study of Total Power*. New Haven, Conn.: Yale University Press, 1957. Summation of Wittfogel's ideas on the "hydraulic society."

Colin Mackerras

EUROPE, IDEA OF. In classical times *Europe* was above all a geographical and mythological notion, the word referring to one of the three known continents—Asia and Africa (or Libya) being the other two. In the famous story of "the rape of Europa," the daughter of Phoenix, king of Phoenicians, was kidnapped and abducted by the Greek god Zeus, who in the guise of a white bull brought her to the island of Crete. In the Middle Ages, Europe was identified with Western Christianity or the commonwealth of Christians. This commonwealth, however, was considered to include only the western part of the Continent, thereby excluding the Eastern Church. The term *Europe* was commonly replaced by *Christianity*, although as early as the ninth century Charlemagne, the king of the Franks, was honored as "the king, father of Europe" (*rex, pater Europae*).

In the early modern period Europe was increasingly compared with the other continents and considered the most civilized part of the world. After the "discovery" of America, world maps usually depicted Europe as an empress surrounded with various symbols of power. The idea of Europe had been secularized by the Enlightenment, and the term was used



The Rape of Europa by Maerten de Vos (1531–1603). According to myth, the Greek god Zeus changed into a beautiful white bull to lure the princess Europa onto his back. He then swam with her to Crete, where he seduced her. Europa's name was given to the continent as recompense for her ill treatment. © ARCHIVO ICONOGRAFICO, S.A./CORBIS

without its former religious connotations. This was the first time in history when the urban elites thought of themselves as Europeans and proclaimed in Parisian salons that, in the words of the conservative Englishman Edmund Burke, "no European can think himself as a foreigner in any part of the continent."

The American Revolution and the new U.S. Constitution were models for many Europeans wanting to establish "the United States of Europe." In the nineteenth century, however, when waves of nationalism swept across Europe, the idea of a federal European state was not powerful enough to seize the people of the Continent. Having shed his illusions in World War I, an inhabitant of the lost Austro-Hungarian Empire, Count Richard Coudenhove-Kalergi, sought in the 1920s to raise a Pan-European movement based on the Continental superpowers, excluding Britain as "an Atlantic empire." In Coudenhove-Kalergi's view, Europe had to unite because the East (that is, Russia) wanted to conquer it, and the West (the United States) aimed to buy it. It was only the two world wars of the twentieth century, though, that finally forced the nations of Europe to pursue more peaceful cooperation.

European Identity

The feeling of togetherness and solidarity among European nations and peoples has tended to increase in periods of perceived external threat. As early as the classical period, the Greeks regarded the inhabitants of Asia Minor as *barbars* or "mumblers," people who could not speak clearly and were therefore considered irrational. Later the term *barbarians* also referred to non-Christian people. At various times Persians, Muslims, Mongols, Turks, and Russians have all been treated as barbarians and enemies of Europe; the dichotomy between "Us" and "the Other" has been very persistent in European history. There is little wonder that the question has sometimes been

raised whether European identity and solidarity among European people in fact depends on a picture of an enemy.

At the beginning of the twenty-first century the European Union (EU) has eagerly pursued more peaceful definitions of a common European identity. The discussion of the idea of Europe and European identity started at the very time that European integration was finally beginning to move forward. In the 1940s Federico Chabod, an Italian historian, wrote the first book on the idea of Europe, rooting it in classical Greece but also emphasizing the Enlightenment as the cornerstone of a common European identity. Since the middle of the twentieth century, European identity has usually been seen as built on three pillars dating from the classical period: Greek reason and rational thinking, Roman law and order, and Christian faith and religion. Other factors have since been added to the list, among them the scientific revolution and the idea of progress typical in the Enlightenment period.

Some critical voices, however, have increasingly considered these kinds of factors too abstract to animate the Europeans. Thus Anthony D. Smith, a British professor of political science, has repeatedly asked whether the attempts to build such an identity are actually efforts to impose western European values and ideas on the eastern and northern peripheries of the Continent. It is a moot point whether Europe really has a common history and memories to be shared; such sharing is crucial if one is to engage emotionally with an identity.

European Regions

It is obvious that the different regions of Europe have different histories and therefore also different memories. The idea of a German-ruled central Europe (*Mittleuropa*) had been elaborated already by the beginning of the twentieth century. After the collapse of the Third Reich, eastern central Europe came under Soviet hegemony and was referred to as Eastern Europe. In the 1970s and 1980s the idea of a culturally constructed *Mittleuropa* was revived by dissidents, such as the Czechs Milan Kundera and Vaclav Havel, who were living under Soviet-dominated socialist rule. After the reunification of Germany and the collapse of the Soviet Union, however, the idea of a “third way” between consumer capitalism and socialist planned economy lost much of its former meaning.

Besides the division between East and West, there are also other demarcation lines in Europe. When the European Economic Community (EEC), the predecessor of the European Union, was founded in 1957, the six founding states (Belgium, France, Italy, Luxembourg, the Netherlands, and West Germany) were mostly Christian countries of central Europe. Later many southern and northern states with different historical traditions, religions, and political and social systems joined what became the European Union (EU). The Nordic countries, for example, have emphasized “the northern dimension” in the politics of the EU, while one of the organization’s fundamental and ongoing issues has been the question of Britain’s role in the “common European family.”

In accordance with its famous slogan “Unity in Diversity,” the European Union has sought to accommodate various value systems. Moreover, since the enlargement it will undertake further enlargement, when the Mediterranean islands of Malta and Cyprus as well as a number of former Eastern European (socialist) countries will join the EU. The question of European identity and the legitimization of the union will probably become even more crucial for the EU in the near future. However, the idea of Europe has in fact always been contested and in a state of transition.

Political Integration and European Citizenship

Since the 1990s there has been growing discussion of whether European integration should be above all political and cultural and not just an economic matter. In 1992 the Maastricht Treaty established a formal European citizenship, but this has had few practical consequences in the politics of the union. Some European thinkers, including the British-based Gerard Delanty and the German Jürgen Habermas, have emphasized the need to build a common political forum, a European demos, where all the inhabitants of the Continent could take part in decision-making processes. In the present situation many minority groups, such as immigrants, have only a few political rights in the EU. In addition to the issues of ethnicity and religion, many European women have felt that European society has developed in accordance with patriarchal cultural roots and thus marginalized women’s roles in society.

Habermas and Delanty have sought a new political identity for all the inhabitants of the Continent. Instead of a mythic common European history and common traditions that can never be shared by all inhabitants of the Continent, this identity could be a genuine force in building up a truly democratic European Union. It remains to be seen whether the bureaucrats in the salons of Brussels will take up this challenge. By giving European citizenship real political value, the EU could perhaps create a union—in the Enlightenment vision—where “no European could think himself a foreigner” any more.

See also Africa, Idea of; America; Barbarism and Civilization; Colonialism; Cultural History; Education; Europe; Empire and Imperialism; Europe; Eurocentrism; Migration; Migration in World History; Nationalism; Other, The, European Views of.

BIBLIOGRAPHY

- Delanty, Gerard. *Inventing Europe: Idea, Identity, Reality*. New York: St. Martin’s, 1995.
- Guerrina, Roberta. *Europe: History, Ideas, and Ideologies*. London: Arnold, 2002.
- Habermas, Jürgen. *The Inclusion of the Other: Studies in Political Theory*. Cambridge, Mass.: MIT Press, 1998.
- Mikkeli, Heikki. *Europe as an Idea and an Identity*. New York: St. Martin’s, 1998.
- Pagden, Anthony, ed. *The Idea of Europe: From Antiquity to the European Union*. Washington, D.C.: Woodrow Wilson Center Press; New York: Cambridge University Press, 2002.
- Shore, Cris. *Building Europe: The Cultural Politics of European Integration*. London and New York: Routledge, 2000.

Smith, Anthony D. *Nations and Nationalism in a Global Era*. Cambridge, U.K.: Polity Press, 1995.

Heikki Mikkeli

EVERYDAY LIFE. When everyday life was first considered a proper subject for reflection it is obviously impossible to say, but an increasing interest in the subject can be traced over the last few centuries, at least in the West. Mystics have long regarded everyday things and everyday routines as a way to become closer to God. From the fifteenth century onward, painters in the Netherlands in particular paid more attention to everyday objects and to the everyday lives of ordinary people, creating new genres such as the still-life and the genre painting. Whether painters or their patrons were becoming more interested in daily life for its own sake, or whether their aim was to look beneath the everyday surface for moral or mystical meanings, remains controversial. For example, Louis Le Nain's painting of peasants having a meal (*Le repas des paysans*, 1642), now in the Louvre, has been variously interpreted as an example of realism and as an attempt to sanctify the everyday in the manner recommended by the religious writer Jean-Jacques Olier a few years later in his *La journée chrétienne* (1657).

Everyday Antiquities

The antiquarians of the Renaissance were another group who were taking an interest in everyday life in the fifteenth century as part of their attempt to revive the culture of ancient Rome. Writing about "antiquities" exempted them from respecting the principle of the "dignity of history," a principle that ruled out references to ordinary people or things. Antiquarians wrote about practices such as burying the dead, reclining at table, gladiatorial shows, and religious and secular festivals, as well as about everyday objects such as clothes, rings, shoes, beards, lamps, and vehicles.

Out of the work of the antiquarians there developed in the eighteenth century what was known in English as the "history of society" and in French as *histoire de la vie privée*. One French scholar, Jean-Baptiste Couture, studying ancient Rome in this way, drew attention to "what an individual living an ordinary life did in the course of a day" (*ce qu'un particulier menant une vie commune, faisoit dans le cours d'une journée*) in an article in the *Memoires de l'Academie des Inscriptions*. In the nineteenth century, the new disciplines of folklore, archaeology, anthropology, and sociology all focused on everyday life, for somewhat different reasons, while some historians continued to study the subject, from Jacob Burckhardt in his famous essay on the Renaissance to the Dane T. H. Troels-Lund in his great work *Dagligt Liv i Norden* (Daily life in the north), published in fourteen volumes from 1879 onward.

The Everyday in Academic Discourse

It was only in the first half of the twentieth century, however, that the everyday became academically respectable across a whole range of disciplines. Freud was well aware of the value of studying everyday events such as lapses of memory or slips of the tongue as evidence of an individual's psychological



The Peasant's Meal (1642) by Louis Le Nain. Oil on canvas. Works of art depicting everyday habits are often open to interpretation, as some critics see in them a deeper moral or mysterious subtext, while other simply see an attempt at realism. LOUVRE, PARIS, FRANCE. LAUROS/GIRAUDON/THE BRIDGEMAN ART LIBRARY, WWW.BRIDGEMAN.CO.UK

states. Franz Boas, one of the founders of the discipline of anthropology in the United States, argued in *Race, Language and Culture* that "To the ethnologist, the most trifling details of social life are important."

In sociology Max Weber launched the idea of *Veralltäglic-hung*, a term normally translated as "routinization," though "quotidianization" might be nearer the mark. Norbert Elias followed the lead of Max Weber in his historical sociology, famously describing the details of changes in table manners, for instance, as a means to arrive at a grand interpretation of what he called "the civilizing process." Forty years later, Elias would offer one of the most incisive critiques of the ambiguities of the concept "everyday," noting the confusion between everyday life and ordinary people and between working days and festivals. Aimed at a more general public was the successful series on the history of everyday life launched by the French publisher Hachette in 1938 (*Histoire de la vie quotidienne*). The volume on the everyday life of ancient Rome by Jérôme Carcopino became a classic and the series eventually included nearly 250 volumes.

The phenomenologist Edmund Husserl has been described as giving the everyday world, the *Lebenswelt*, "philosophical dignity," and a similar comment might be made about the British philosophers who saw their task as unravelling the implications of ordinary language. As a means of underlining the traditional division between art and life, artists such as Marcel Duchamp became interested in ordinary objects (*objets trouvés*), while composers like John Gage introduced ordinary sounds into their music.

The Discovery of the Everyday

From the 1950s onward, the everyday or the "ordinary" was discovered in the sense of becoming a focus of interest as a

way of inserting human experience into an increasingly abstract social theory and social history. Alfred Schutz, in studies of “the world of everyday life,” bridged the gap between the philosophy of Husserl and the practice of sociologists, like the Hungarian Agnes Heller, who combined ideas from Marx, Weber, and Husserl in her work. Phrases such as “everyday culture,” “everyday knowledge,” and “everyday thought” became commonplace.

In France, the sociologist Henri Lefebvre offered a critique of recent changes in everyday life from a Marxist point of view. The philosopher Michel Foucault drew attention to the importance of power relations at an everyday level. The polymath Michel de Certeau’s study of French society in the late 1970s, which emphasized the freedom of ordinary people to construct or “invent” their daily life as workers, consumers, or viewers, helped bring the concept of the everyday into common currency (a historian of mysticism as well as a sociologist, Certeau may have been inspired by treatises like that of Olier mentioned above).

In Russia, the semiologist Yuri Lotman studied what he called the “poetics of everyday behavior,” for example the influence of literature on life or the theatricalization of the behavior of Russian nobles in the late eighteenth century. In the English-speaking world, Erving Goffman’s vision of everyday life as a series of dramas has attracted much attention, while feminist sociologists such as Dorothy Smith have used the everyday as a point of entry into the social world of women.

The idea of “practices” has become central to the study of the everyday, especially the “rules” or conventions underlying everyday life, what Lotman called “poetics” and the anthropologist-sociologist Pierre Bourdieu the “theory of practice.” Thus the history of science is being rewritten as the history of practices such as experiment. A linked concept is that of “tactics,” in other words attempts to obtain what one wants within the framework of the rules or by finding ways round them. Thus the American anthropologist James Scott has drawn attention to the importance of what he called the “everyday resistance” of agricultural laborers, viewed as a middle way between obedience and open revolt.

The History of the Everyday

The history of everyday life, once the preserve of amateurs, was taken up by academic historians after World War II. In the 1960s, Fernand Braudel produced an ambitious comparative study of material life in the early modern world, viewed as the sphere of routine, as opposed to economic life, the sphere of change. In Germany a little later, there was a movement of social historians such as Hans Medick and Alf Lüdtke under the banner of “the history of the everyday” (*Alltagsgeschichte*), defining themselves against the scholars interested in the more abstract history of social structures. To join the two approaches, linking the micro level with the macro level, remains an unrealized ambition of historians and social scientists to this day.

See also *Anthropology*; *Historiography*; *Practices*.

BIBLIOGRAPHY

- Boas, Franz. *Race, Language and Culture*. New York: Macmillan, 1940.
- Braudel, Fernand. *The Structures of Everyday Life*. London: Collins, 1981. Translation of *Les structures du quotidien*. A pioneering study of material culture in early modern Europe, first published in 1967.
- Certeau, Michel de. *The Practice of Everyday Life*. Translated by Stephen Rendall. Berkeley and Los Angeles: University of California Press, 1984. Translation of *L'invention du quotidien*. A classic that put the sociological study of everyday life on the intellectual map.
- Elias, Norbert. “The Concept of Everyday Life.” In *The Norbert Elias Reader: A Biographical Selection*, edited by Jan Goussblom and Stephen Mennell, 166–174. Oxford, U.K., and Malden, Mass.: Blackwell Publishers, 1998. An incisive reminder of the ambiguities of the concept. Translation of “Zum Begriff des Alltags.”
- Freud, Sigmund. *Psychopathology of Everyday Life*. New York: Macmillan, 1914. Translation of *Zur Psychopathologie des Alltagslebens*, 1904.
- Goffman, Erving. *The Presentation of Self in Everyday Life*. Garden City, N.Y.: Doubleday, 1959. An influential study, viewing the everyday in terms of drama.
- Heller, Agnes. *Everyday Life*. Translated by G. L. Campbell. London and Boston: Routledge and Kegan Paul, 1984. A philosophy of everyday life drawing on Marx, Husserl, and Weber, originally published in Hungarian in 1970.
- Lefebvre, Henri. *Critique of Everyday Life*. London and New York: Verso, 1991. Translation of *Critique de la vie quotidienne*. A pioneering sociological study, insufficiently appreciated when it was first published in 1947.
- Lotman, Juri. “The Poetics of Everyday Behaviour in Russian Eighteenth-Century Culture.” In *The Semiotics of Russian Culture*. Edited by Ann Shukman. Ann Arbor: University of Michigan Press, 1984.
- Lüdtke, Alf. “The Historiography of Everyday Life.” In *Culture, Ideology and Politics*, edited by Raphael Samuel and Gareth Stedman Jones, 38–54. London: Routledge, 1982.
- Schutz, Alfred. “On Multiple Realities.” In his *Collected Papers*. Vol. 1. Edited by Maurice Natanson. 3 vols. The Hague: M. Nijhoff, 1962–1966. Originally published in 1945.
- Scott, James C. *Weapons of the Weak. Everyday Forms of Peasant Resistance*. New Haven, Conn.: Yale University Press, 1985.

Peter Burke

EVIL. The descriptive-normative term *evil* is a significant anomaly in our relativistic and noncognitivist age. Otherwise careful thinkers deploy it as if its extension were obvious and indisputable. And yet it is used in widely differing ways even in our own time. A narrow meaning confines it to the deliberate infliction of harm. This corresponds to only part of the so-called problem of evil, and it is different again from what is feared by those who pray, “deliver us from evil.”

Aspects of the problems of wickedness, of suffering, of finitude, and indeed of meaning come together in reflection on evil. But it is not obvious that these problems form a larger whole. Paul Ricoeur (1985) suggests that it is distinctive to

western thought to see “sin, suffering and death” as aspects of a single enigma.

Evil’s enigmatic character seems to demand narrative treatment. How did evil come into the world? Why and how are human beings sucked into it? And no less important: what can be done to escape it? Given the variety and extent of evils, we should perhaps not be surprised to find every tradition replete with stories and theories. As Wendy Doniger O’Flaherty has suggested, a welter of often incompatible stories may be the most psychologically satisfying response to an insoluble problem.

Yet evil is not just an intellectual challenge. Some of the worst forms of suffering human beings endure are caused by human agents. Our capacity for inflicting such suffering challenges our very understanding of human agency. Can a will capable of evil ever be fully trusted—or even understood?

The challenge goes deeper yet. Because vulnerability to evil and a capacity to inflict it are parts of human nature, evil is not something we can hope to consider in a disinterested way. The very desire to generate a disinterested account of it has often been seen as itself a manifestation of evil, whether as hubris, *curiositas*, or disregard for the humanity of one’s fellows. Religious ritual is turned to because we are out of our depth, our capacities for understanding and reform so weak it is a danger to take comfort in them.

It is sometimes thought a specifically modern condition to be suspicious of philosophical theodicies, but the truth seems closer to the opposite. What is specifically modern, rather, may be supposing that we can peer into the abyss without being overwhelmed by it.

The following discussion will first survey understandings of evil as a problem so broad that it defies conventional intellectual or ethical response. An account of the changing fortunes of philosophical accounts of “the problem of evil” will show the distinctiveness of modern discussions. Reference to other traditions will be made, but the discussion will focus on Western materials.

Evil

Modern understandings of religion make accounting for evil one of the fundamental tasks of religion. It is widely believed, for instance, that Buddhism is primarily a response to a universal “problem of evil.” But *dukkha*, “suffering, unsatisfactoriness” is not evil. Different traditions define different things as evils (as they do goods), and prescribe different kinds of responses. Thinking about evil is usually accompanied by ritual.

Myth. Ricoeur has argued that an “enigmatic element” makes evil the realm of human experience most profoundly ruled by myth.

Cosmogony. Myth narrates the creation or emergence of the world, often out of chaos. Suffering and death are often presented as the consequences of poor choices made by the first humans. But the miserable lot of humanity is also sometimes seen as the result of the carelessness, malice, or envy of the

gods. Not all gods are good. The orderly world we know may be the result of the destruction and dismemberment of a primordial evil power. In many traditions the world remains evil, a place of exile or punishment.

The creation or imposition of meaning and order is precarious. Jon Levenson has shown that the fear that chaos will return permeates the Hebrew Bible. The force of evil, associated with the seas and often represented as a sea monster (Leviathan), continually threatens order and is continually reconquered by God. That God will prevail is never in question. He may need reminding, however.

Dualism. The world may be the site of a struggle between good and evil forces. True dualism, such as that of the Manichaeans, is rare; even in Zoroastrianism, the eventual victory of good and light over evil and darkness is assured. But dualism haunts monotheism, as the near-omnipresence of the devil in Christian tradition shows. While defeated by Christ, Satan is still the prince of this world. His power and indeed his very existence are a serious problem for monotheism. What kind of God permits the devil such power—or is God too weak to control him?

Beyond good and evil. One response is to assert that evil happens when God turns his back on creation or is silent. The hidden God is beyond our understanding. But perhaps evil is no less an expression of the divine nature than is good. “I form the light, and create darkness,” says the God of Second Isaiah, “I make peace, and create evil” (45:7). It has even been suggested, as the Jewish mystical *Book of Bahir* puts it, that “God has an attribute called ‘evil.’”

Metaphysical accounts. Metaphysical views of the nature of evils arose in response to tensions within and among mythical views.

Fate. Many traditions speak of a fate or order to which even the gods are subject. This fate can be just, as in Buddhism’s karmic “law of cause and effect.” It can also be meaningless. “Vanity of vanities,” says Qoheleth, “all is vanity and vexation of spirit” (Eccles. 1:2).

Among the most widespread of these views is the view that time itself leads to decay and returns creation to chaos. Rituals like the human sacrifices of the Aztecs sought to erase time. In most ancient traditions, time moves in greater and smaller cycles. Even if all rituals are correctly performed, the world will one day succumb to chaos, but from its ashes a new world will emerge. Only in noncyclical traditions are the depredations of evil seen as final.

The philosophical correlate of cosmological dualism is the view that evil is an inescapable part of creation: the stuff of which the world is made is inert or even resistant to order. In his *Timaeus* Plato argues that the demiurge brought the best possible order to unruly matter. Aligned with other dualities inherited from Pythagoras, the dualism of reason and matter was soon connected with mind/body dualism. While opposed to each other, Gnosticism and Neoplatonism both offered dualisms of matter and spirit.



Saturn Devouring One of His Sons (1820–1823) by Francisco José de Goya y Lucientes. Mural transferred to canvas. Due to its amorphous nature, evil is said by some to be the concept of human experience most profoundly influenced by mythology. © Archivo Iconografico, S.A./Corbis

Privation. In response to dualisms, evil was reconceptualized. It is not a substance or a force at all, but just an absence, a privation. God created *ex nihilo*, nothing constraining him. “Whatever is, is good, and evil . . . is not a substance, because if it were a substance it would be good” (St. Augustine, *Confessions* 7.12). This was the official view of medieval theologians, but it is difficult to maintain in practice. Reproducing a similar move in Plotinus, Augustine conflated it with a dualism of body and soul to arrive at the view that it is because we are made of nothing that we are prone to error and sin.

Contrast. A different kind of view claims that it is impossible or undesirable to create a world without evil, either because there cannot be evil without good, or because good cannot be recognized without evil with which to contrast it. These often conflated views are sometimes described as examples of “aesthetic theodicy.” The place of evils in a good cre-

ation is justified by reference to the value of beauty or variety. A mosaic is not only more beautiful with dark as well as light pieces but impossible without them.

Human evil. As the pawn or the prize of the forces that made and govern the world, the human being has always been seen as a source of evil.

Ignorance. Humanity may be seen as essentially limited because its understanding is finite. Justifications of evil almost always appeal to a bigger picture the questioner does not or can not see. Incomplete understanding of things not only leads to error but is also a reason human beings should not expect to be able accurately to judge God’s work. Finite reason may be seen as essentially incompetent to understand reality or divinity at all. “My thoughts are not your thoughts, neither are your ways my ways, saith the LORD. For as the heavens are higher than the earth, so are my ways higher than your ways, and my thoughts than your thoughts” (Isa. 55:8–9).

Negative theology starts from this premise, as do those views that insist on the centrality of paradox to a proper human understanding of God. God may operate by different standards than ours. He may indeed make the rules. The moral and even the logical laws that rightly bind us come from God but in neither case do they give us access to his nature. Human evil can thus arise from resentment at creaturely dependence—but also from misplaced efforts of *imitatio Dei*.

Freedom. Free will is the centerpiece of reflection on human evil. This view goes beyond the evil that humans do out of ignorance to assert that free will is the ability to choose between good and evil. Evil can be deliberately willed, not just under the view that it is good. It undermines freedom to invoke a tempter here. (It also makes the creator of the irresistible temptation the true author of evil!) A free act has no cause beyond itself. As St. Anselm of Canterbury put it when asked why Satan willed evil: “Only because he wills . . . this will has no other cause by which it is forced or attracted, but it was its own efficient cause, so to speak, as well as its own effect” (*De casu diaboli* 27).

But an understanding of freedom as “liberty of indifference” does not yet explain why human agents might choose evil, and indeed has a hard time doing so. Augustine insisted that trying to understand an evil will “is like trying to see darkness or to hear silence” (*City of God* 12.7). Immanuel Kant thought evil “radical”—it is not grafted onto a human will predisposed to the good but is a tendency at its very “root.” Friedrich Wilhelm Joseph von Schelling took the next step and insisted that freedom is abyssal in good no less than in evil acts, opening the way for postmodern explorations.

Not all human beings were thought to be similarly able to use their free will for good. It was Eve who succumbed to the serpent’s wiles and submitted to Adam’s authority in punishment. Throughout history groups denied (and so demonstrated) their own capacity for evil by projecting this onto outsiders.

Original sin. Not all explanations of evil as the consequence of poor or perverted human choices think human will is free.



Woodcut of a witch, a demon, and a warlock, c. 1400. Throughout the centuries, humans have sought to understand evil by ascribing it to certain supernatural beings or even to other humans who they perceived to be “different” from the accepted norm of society. HULTON GETTY/LIAISON AGENCY

On some accounts, the wills of fallen humanity are no longer free to do good at all; only humanity’s original parents had complete freedom. The idea that we are responsible for the sins of our ancestors and for evil acts of our own that we could not avoid seems incoherent and masochistic. It does, however, give human agency a cosmic significance. It was a human act that brought death into the world.

Original sin can be understood in less dramatic ways as a humility that expects human failure and so is not thrown into despair by it. It may also provide a framework for conceptualizing the ways in which our societies and characters are shaped by the ignorance and injustice our ancestors left us.

The Problem of Evil

The experiences of wickedness, suffering, and death are presumably universal, but they do not come to pose intellectual prob-

lems—let alone a single problem—until there are philosophical expectations with which they clash. For most of Western history, the problem of evil has been dismissed as beyond our ken. Philosophical engagement with it is the historical exception.

Antiquity. Discussions of various kinds of evil appear in some of the oldest texts from antiquity.

Job. The biblical Book of Job is often seen as an early response to the problem of evil, but it is both less and more than this. The Book of Job recounts the vindication of the innocence of a human sufferer by the very God who permitted the infliction of the suffering and—despite Job’s pleas and accusations—never explains why. Appearing in a whirlwind, God rails at Job for the effrontery of his demand to understand what was going on. “Where wast thou when I laid the foundations of the earth?” (38:4) But it is Job’s friends, who interpreted Job’s suffering as punishment,

MORAL AND NATURAL EVIL

A distinction is commonly made between evils that are caused by free human acts (moral evil) and those that are part of nature (natural or physical evil). Moral evils alone seem our responsibility, and so natural evil has largely fallen away in secular discussion. (It lives on in a different form as the problem of suffering.) And yet in experience the two seem entangled.

Moral evil causes suffering in its victims, and suffering seems to be the only way to atone for it. But evil seems deeper than the distinction between agent and victim. Paul Ricoeur (1985) describes a “strange experience of passivity at the very heart of evil-doing.” And the extremest forms of suffering, as Simone Weil argued, can feel deserved.

Caution about these categories is in order. Historically, they are the remains of the closed

system of *culpa* (fault) and *poena* (penalty), which from Saint Augustine of Hippo on claimed to justify all evils at once. All natural suffering, including death and even the carnivorousness of animals, was understood to be just punishment for the crimes of men (or angels), crimes defined not in terms of the harm they do to other creatures but of disobedience or rebellion. Ignoring victims, this system elides the central problematic of modern discussions, innocent suffering.

Conceptually, most discussions of moral evil subscribe to a philosophically embattled understanding of human freedom, which is threatened also by developments in the sciences. By restricting discussion to intentional individual acts, these theories also obscure (and quite literally naturalize) social or cultural evils.

whom God condemns: “ye have not spoken of me the thing that is right, as my servant Job hath” (42:7).

Is the Book of Job itself an answer to the problem of evil? Job’s example shows that the faithful can live without knowing the reason for their suffering, but his story’s power comes from its insistence that the problem of the suffering of the just is at once inescapable and insoluble.

Hellenistic debates. In its philosophical form, the problem of evil seems to be one we inherit from Hellenistic philosophy. Stoics asserted the existence and intelligibility of providence. Epicureans argued that the way to achieve happiness was to accept that there is in fact no providence, to avoid such pains as can be avoided and stop thinking of the rest (like death) as evil. Skeptics argued that it was best to avoid strong views for or against providence, and poked holes in the arguments of both sides.

What made this the first real debate on the problem of evil was the overall agreement of the parties concerned on means—philosophical analysis of human experience—and ends—*eudaimonia*, happiness in this life. Both of these would be called in question by Christianity, leading to an eclipsing of this problem until the revival of the Hellenistic philosophies in the changed world of early modernity.

Religious views. Religious traditions are important sources for thinking about evils.

Jewish views. Jewish tradition does not offer systematic accounts of evil before the medieval period. Apparent injustices

are either consequences of past or foreign sins or tests that will be redressed in the world to come, but the point is that God, who has bound himself to Israel despite its flaws, is perfect and perfectly in charge. “The Lord has made all things for Himself: yea, even the wicked for the day of evil” (Prov. 16:4).

While there may or may not be evil powers, there is an evil inclination in human nature itself, which the human individual is free to resist. This evil inclination, too, is part of a creation that the God of Genesis deemed “very good,” however, so it is not to be rejected as alien but assimilated. In a widely quoted early rabbinic view, “had it not been for the Evil Inclination, no man would build a house or marry a woman or procreate children.” Even when kabbalistic authors argued that evil came from the godhead or was a consequence of the flawed design of the Creation, the emphasis was always on the power of free human good deeds to repair the world.

Christian views. An understanding of a God mercifully active in history shaped the way Christians, too, approached (or avoided) the problem of evil. Christian views were various, but John Hick has argued that Augustine was the father of all the most important elements. Alongside aesthetic views and the claim that God brings a greater good out of every evil, the central claims were the privative nature of evil and the Fall. The last were not explanations for woes of the world so much as reasons for the questioner not to get stuck in the question, however. The answer lies not in philosophy but in conversion and repentance.

This is not to say that philosophical reflection has no part to play. No less a figure than Thomas Aquinas mentioned the problem of evil as the first objection to the existence of God.

EPICURUS' OLD QUESTIONS

The monotheistic problem of evil is often summarized as a trilemma cited in David Hume's *Dialogues Concerning Natural Religion* (book 10): "Epicurus' old questions are yet unanswered. Is he [God] willing to prevent evil, but not able? then is he impotent. Is he able, but not willing? then is he malevolent. Is he both able and willing? whence then is evil?"

While it seems to force the question, "God or evil?" the trilemma can be approached in other ways. Ancient skeptics and dualists found it congenial to their ends. Theological reflection has taken the "aporetic" path of accepting all of the three claims as valid. So understood, the trilemma challenges us to deepen our understanding of the nature of the divine attributes and of evil.

Aquinas discussed evil in many places and even devoted a separate work to it, but his final view was that it was the special kind of nonproblem that *privatio* implies, pointing toward the good, and so toward God. The point was that philosophical reflection conducted without the acknowledgement of the differences between ourselves and God leads nowhere.

The problem of evil remained a challenge to natural theology. Theodicy became harder to avoid as physico-theology came to seem more and more important. Reformation theologians insisted the issue be faced head-on, albeit for a different reason. Martin Luther thought it necessary for philosophy to experience shipwreck over evil. And John Calvin insisted that while it was importunate to claim to be able to understand the fallen world, a view of God without providence was tantamount to atheism.

Theodicy and modernity. The problem of evil as a philosophical challenge to the intelligibility of the world, with or without God, became a central concern of Western thinkers with the rise of the modern age.

The invention of theodicy. The goodness and intelligibility of creation became a battlefield in the fight for religion as the world became increasingly disenchanted, as religious authority fractured, and as confidence in the capacity of human beings to make objective moral judgments grew. The problem of evil was presented as proof for the incompatibility of reason and faith by the skeptic Pierre Bayle in the 1690s. Gottfried Wilhelm Leibniz responded with the claim that this is "the best of all possible worlds," a view he traced back to Plato. His argument is entirely a priori, however, and designed precisely to prevent anyone's drawing conclusions like those of Pangloss in Voltaire's *Candide* (1759). Sounding more Stoic than he knew, Leibniz argued that if we knew all that God does, we would see why this was the world he chose.

The challenge of new Skeptics and Epicureans made this position seem weak, and a half century of nervous teleologizing ensued. Arguing that human beings can and should see

the optimality of everything in the world, from bedbugs to avarice, these arguments were quickly conflated with arguments like Bernard Mandeville's linkage of "private vice" with "public virtue," and seemed to many to undermine not only religion but morality too. If the world, with all its horrors, cannot be improved upon, and for reasons we cannot hope (and perhaps do not need) to understand, why do anything at all?

Theodicy overturned. Immanuel Kant presented theodicy as the enemy of piety and ethics. In a manner Luther would have appreciated, he argued that the experienced "failure of all philosophical efforts in theodicy" ensures the continued importance of moral struggle and makes religious faith both permissible and necessary. Kant commended the figure of Job for basing his religion on his morality and not his morality on his religion: both do better when the pretension to theodicy is abandoned. Georg Wilhelm Friedrich Hegel and Arthur Schopenhauer in their very different ways found this view premature, insisting that one needed either to find the meaning of suffering in history or to accept that there is and never will be one.

Friedrich Nietzsche dealt the decisive blows to theodicy. In the *Genealogy of Morals* (1887) he argues that "evil" is not merely a human category, but a bad one, developed by creatures of resentment chagrined by the excellence of other human beings. Arguing that the others must be evil because they themselves were good, "slaves" and their priests succeeded in upsetting an earlier and more noble set of values. The noble "free spirit" does not ask whether the world is good or meaningful (this question defines nihilism) but affirms it in all its joys and pains. Value is not found in the world but generated by the overflowing vitality of creative spirits. Nietzsche's historical relativization of value categories and his call for a transvaluation of contemporary values spelled the end of theodicy, at least in continental European thought.

Contemporary developments. But the philosophical problem of evil has not gone away, in part because the twentieth century

brought with it new and unprecedented horrors. Some religious thinkers have responded to the “logical problem of evil” (Is the existence of evil compatible with divine omnipotence and goodness?) by proposing views of a divinity in some way limited in power; the growing, suffering God of process thought is an example. Hick’s “Irenaean” view of theodicy argues that God is doing as well as anyone could at the time-consuming task of getting human beings freely to love him.

Analytic philosophers of religion have largely moved beyond the logical to the “evidential problem of evil” supposedly inaugurated by Hume in his *Dialogues*. The question is no longer whether evil in the abstract is compatible with theism—that may even be true—but whether the quantity and variety of evils we find do not constitute an argument for the irrationality of theism. While still far from concrete, discussion now hangs on the existence of “horrendous” or “irredeemable” forms of evil.

But there are also strong religious movements rejecting the very enterprise of theodicy, in Christian thinkers like Karl Barth (building on the Lutheran Søren Kierkegaard) and Jewish thinkers like Emmanuel Levinas (building on the Neokantian Hermann Cohen). Especially in response to the Holocaust, thinkers have argued for the obsolescence of all traditional views and have urged reconceptualizations of God and his relation to human history and suffering.

Conclusion

After decades of neglect, the language of evil has been reintroduced to public life in the rhetoric used by political leaders in the early twenty-first century. Some political theorists, too, have argued that a revival of the language of evil is required to maintain a sufficient outrage at genocide, nuclear weapons, terrorism, and threats to the ecological stability of the planet.

Shared indignation at the worst things people do seems to be all that remains of a shared normative view of the world. But does this justify reviving the language of evil? Feminist scholars are not the only ones to caution against so quintessentially dualistic a concept. Evil allows no compromise. But the history of human societies shows that it is almost always the other who is demonized. Perhaps what Carl Gustav Jung called a “morality of evil”—an integration through honest recognition of the capacity for evil in human nature—is safer.

The modern problematic of theodicy, with its confidence in reason and shared conceptions of the good, may not survive our postmodern age. As long as we try to make moral sense of the world and of human life, however, “evil” will remain a challenge and a temptation.

See also *Christianity; Free Will, Determinism, and Predestination; Natural Theology; Religion; Theodicy*.

BIBLIOGRAPHY

- Adams, Marilyn McCord. *Horrendous Evils and the Goodness of God*. Ithaca, N.Y.: Cornell University Press, 1999.
- Bernstein, Richard J. *Radical Evil: A Philosophical Interrogation*. Cambridge, U.K.: Polity Press, 2002.

- Copjec, Joan, ed. *Radical Evil*. London: Verso, 1996.
- Hick, John. *Evil and the God of Love*. 2nd ed., with a new preface. Basingstoke: Macmillan, 1985.
- Howard-Snyder, Daniel, ed. *The Evidential Argument from Evil*. Bloomington: Indiana University Press, 1996.
- Larrimore, Mark. *The Problem of Evil: A Reader*. Oxford: Blackwell, 2001.
- Leaman, Oliver. *Evil and Suffering in Jewish Philosophy*. Cambridge, U.K.: Cambridge University Press, 1995.
- Levenson, Jon. *Creation and the Persistence of Evil: The Jewish Drama of Divine Omnipotence*. Princeton, N.J.: Princeton University Press, 1994.
- Marquard, Odo. “Unburdenings: Theodicy Motives in Modern Philosophy.” In *In Defense of the Accidental: Philosophical Studies*. Translated by Robert M. Wallace, pp. 8–28. New York and Oxford: Oxford University Press, 1991.
- Noddings, Nel. *Women and Evil*. Berkeley: University of California Press, 1989.
- O’Flaherty, Wendy Doniger. *The Origins of Evil in Hindu Mythology*. Berkeley: University of California Press, 1976.
- Ormsby, Eric L. *Theodicy in Islamic Thought: The Dispute over al-Ghazālī’s “Best of All Possible Worlds.”* Princeton: Princeton University Press, 1984.
- Ricoeur, Paul. “Evil: A Challenge to Philosophy and Theology.” *Journal of the American Academy of Religion* 53, no. 3 (1985): 635–648.
- . *The Symbolism of Evil*. Translated by Emerson Buchanan. New York: Harper and Row, 1967.
- Russell, Jeffrey Burton. *The Prince of Darkness: Radical Evil and the Power of Good in History*. Ithaca, N.Y.: Cornell University Press, 1988.
- Schreiner, Susan. *Where Shall Wisdom Be Found: Calvin’s Exegesis of Job from Medieval and Modern Perspectives*. Chicago: University of Chicago Press, 1994.
- Schwarz, Hans. *Evil: A Historical and Theological Perspective*. Translated by Mark W. Worthing. Lima, Ohio: Academic Renewal Press, 2001.
- Surin, Kenneth. *Theology and the Problem of Evil*. Oxford: Blackwell, 1986.
- Weil, Simone. “The Love of God and Affliction.” In *Waiting for God*, pp. 117–136. Translated by Emma Craufurd. New York: Harper and Row, 1951.
- Whitney, Barry L. *Theodicy: An Annotated Bibliography on the Problem of Evil, 1960–1990*. New York: Garland, 1993.
- Williams, Rowan. “Insubstantial Evil.” In *Augustine and His Critics: Essays in Honour of Gerald Bonner*. Edited by Robert Dodaro and George Lawless, pp. 105–123. London and New York: Routledge, 2000.

Mark Larrimore

EVOLUTION. Although it can encompass cosmic and cultural change, *evolution* is a term usually associated with the modern scientific theory of species change and is most closely associated with the work of Charles Darwin (1809–1882) and, to a lesser extent, Alfred Russel Wallace (1823–1913). Darwin himself did not refer to his specific theory as “evolution” but instead used the phrase “descent with modification.” Only the very last word of his famous work laying out the argument for his theory, *On the Origin of Species*, which appeared

in 1859, was “evolved.” The term gained widespread currency especially in the English language and came to be virtually synonymous with Darwin and Darwinism because of its use by contemporaries like the social theorist Herbert Spencer (1820–1903) and by the numerous commentators, advocates, and translators, such as Thomas Henry Huxley (1825–1895) and Ernst Haeckel (1834–1919), who were carrying meanings into the theory of species change from areas of biology concerned with developmental processes like embryology.

Before then, the term *evolution* had been used in a number of contexts. Stemming from the Latin verb *evolvere*, the term generally refers to an unrolling or unfolding. The substantive form *evolutio* refers to the unrolling of a scroll. Implied in these meanings is the fact that something is there to unfold, develop, or unroll. Its scientific use was first noted in mathematics in the sixteenth century, but it was soon applied to the development or unfolding of ideas or principles. In the seventeenth century the term began to take on a biological cast when it was first used by an anonymous English reviewer to characterize the embryological theories set forth by Jan Swammerdam (1637–1680). A preformationist, Swammerdam postulated a theory of insect development that relied on preexisting or preformed parts that expanded and grew in the embryonic larva. The semen of the male was required in this process, but only as a stimulus to realize the development of the adult form already encased in the semen of the female. The term *evolution* was thus coined initially to describe a developmental or embryological process of unfolding resulting in the reproduction of an adult form. Its application to the process of species change took place gradually in fits and starts over the next 150 years or so by a broad range of thinkers who increasingly carried over meanings of developmental or embryological unfolding in reproduction to theories of species change within historical, temporal, or geographical frame of references.

The extent to which the German *Naturphilosophen* (“nature philosophers”) or German Romantic thinkers like Friedrich Wilhelm Joseph von Schelling (1775–1854) may have held evolutionary theories and the extent to which such views of *dynamische Evolution* (“dynamic evolution”) shaped or even resembled subsequent evolutionary theories leading eventually to Darwinian evolution is the subject of lively discussion and controversy among historians of evolution of the eighteenth and early nineteenth centuries. The received view of the history of evolutionary thought does not usually locate the origins of Darwinian evolution in the German philosophical context, or in movements like Romanticism, but has instead located its intellectual origins in the context of Enlightenment views that included belief in progress, in theological movements like natural theology, and in the shifting views and practices of traditional natural history that led to reforms in taxonomic practices and in emerging related “sciences” like geology. Its social origins are generally linked to late-eighteenth-century economic theories that articulated laissez-faire policies, to the rise of industrial capitalist societies and states, and to the increasing linkage between natural history (and indeed science as whole) to colonialism and to imperialist ambitions, especially in Great Britain. In the received view, the history of

evolution long predates Darwinian developments, though Darwin and his theory are given exceptional emphasis.

Evolution as a Theory of Species Change

The belief in a changing or dynamic universe can be first seen in ancient Greek philosophy. Heraclitus (c. 540–c. 480 B.C.E.), also known as the “flux philosopher,” believed that change was a fundamental property of the universe. His successor, Empedocles (c. 490–430 B.C.E.), first articulated a crude but dynamic theory that postulated that the origin of life had taken place in a manner that suggested evolution. With the philosophical worldview established by Aristotle (384–322 B.C.E.), the belief in a changing universe fell into disfavor. Aristotle and his numerous medieval and Renaissance translators, commentators, and supporters instead believed in a static universe which held that living organisms were created initially by a designer (the Demiurge of Plato’s *Timaeus* or the biblical Creator) and then remained essentially unchanged. These ideal types or species were arranged hierarchically in what came to be known as the *scala naturae*, or the ladder of creation. Like the rungs of a ladder, each species was arranged hierarchically, with lower forms of life on the bottom and higher forms of life on the top. During the Renaissance, the ladder of creation gave way to the popular metaphor of the “great chain of being,” which referred to a progression of living forms linked in an orderly chainlike arrangement. Extinction, the sudden disappearance of a species, in such a scheme was unthinkable since it meant that the chain would lose a vital link. Belief in the fixity of species and in the species characterized by an ideal type therefore dominated thinking about living entities and was most clearly demonstrated in the modern classification scheme that originated with Carolus Linnaeus (1707–1778).

Belief in species change, or more precisely what was termed “transmutationism,” slowly began to emerge during the Enlightenment. One reason for this was the recognition that the earth was of greater antiquity than previously thought and that fossils, long held to be curiosities of nature that adorned the shelves of Renaissance collectors were in fact the remnants of once living organisms. The organic origin of fossils had been suggested earlier by Nicholas Steno (1638–1686) and others who were concerned with them.

Another reason was that the Enlightenment also saw the emergence of the belief in a progressive world, both scientific and social, at the same time that it was slowly realized that the earth itself had a long and tumultuous history of its own. The closing of the eighteenth century saw the beginnings of attempts to understand the history of the earth in terms of natural causes and processes. These geological theories suggested that fossils were of organic origin and that uniform or constant processes rather than catastrophic or one-time events had shaped the Earth’s history. In the eighteenth century two rival schools of thought existed: the first, known as the catastrophists, upheld the belief in the uniqueness of geological events, while the second upheld the belief that geological processes were not unique or catastrophic but instead were part of a uniform and largely gradual process of natural change.

The latter school was associated with a “uniformitarian” theory of geological change and its advocates known as uniformitarians.

The French naturalist Georges-Louis Leclerc, comte de Buffon (1707–1788), was one of the first to embrace a uniformitarian philosophy, to question the fixity of species, and to suggest a transmutationist theory for species change. Although he was a respected naturalist, writing a forty-four-volume treatise on the natural history of the world known as *L'histoire naturelle* (Natural history), his theoretical explanations for the origin of life and of species change were not accepted during his time; he provided no cogent mechanism for such changes. Buffon's transmutationist ideas were also not accepted because they were undermined by the philosophical teachings of his successor, Georges Cuvier (1769–1832), an anti-uniformitarian who thought successive “revolutions” or catastrophes had shaped the pattern of diversity of life on earth. Cuvier was a pioneer of comparative anatomy and is generally regarded as the father of modern vertebrate paleontology. He upheld the fixity of species despite fossil evidence of species change. Ironically, although he opposed transmutationism strongly, Cuvier was the first to recognize the phenomenon of extinction, or the view that species had disappeared from the biological record. His system of classification placed living organisms into four distinct groupings or what he termed *embranchements*: the Vertebrata, Articulata (arthropods and segmented worms), Mollusca, and Radiata (echinoderms and cnidarians). The four “branches” were distinct from one another and could not share any evolutionary transformation. If any similarities existed, this was due to shared functional circumstances and not to any common ancestry. Cuvier's influence in zoology in particular and in French science generally was enormous and played a role in discrediting efforts to formulate transmutationist theories.

The first to suggest a viable theory of transmutation was the Frenchman Jean-Baptiste de Lamarck (1744–1829), a contemporary of Cuvier's who faced notable opposition from him. First an expert on botany, Lamarck was given the lowly task of organizing the invertebrate collections at the Musée National d'Histoire Naturelle (National Museum of Natural History). In the process of working with the little-known group (Lamarck coined the term *invertebrate*), he began to note progressive trends in the group. He became particularly interested in adaptation, or the manner and process by which organisms are able to adapt physiologically and morphologically to their environment, and he was especially interested in how well-adapted organs originated. His most celebrated example was the modification of the neck of the giraffe, which became elongated in response to stretching during feeding on the leaves of trees on the African plains. This and other examples were explored in works such as *Philosophie zoologique* (Zoological philosophy), published in 1809. According to Lamarck, the use, or in many cases the disuse, of such vital organs could lead to the origin of novel but well-adapted traits; the cumulative effect of these adaptations could eventually lead to new species. Lamarck never provided a cogent mechanism by which this physical transformation took place, however, though he did draw on contemporary theories from animal physiology to suggest that the body heat generated by physical exercise could lead to such structural transformation. Sometimes called “the

inheritance of acquired characters,” Lamarckian transmutationism, also later called Lamarckian evolution or “Lamarckism,” was subsequently shown to be erroneous because changes acquired as a result of use and disuse were shown to be not heritable. The German experimental biologist Auguste Weismann (1834–1914) is generally credited with disproving Lamarckian inheritance through a number of experiments that included cutting off the tails of hundreds of mice, and through his famous theory that first made the distinction between germplasm (cells that passed on hereditary information) and somatic or bodily cells. The “Weismann Barrier,” which eventually became one of the central dogmas of modern biology, postulated that hereditary information moves only from the genes to the somatic cells and not vice versa.

Lamarck's ideas were, however, very popular throughout much of the nineteenth century, especially among naturalists interested in adaptation, and continued to gain support in some communities well into the twentieth century, sometimes being associated with “neo-Lamarckian” theories of species change. Darwin himself relied heavily on the inheritance of acquired characters to explain many adaptations that he later outlined in laying out his own transmutationist theory as it finally appeared in 1859.

Transmutationism itself became increasingly acceptable in the early decades of the nineteenth century. It captured the interest of Darwin's own grandfather, Erasmus Darwin (1731–1802), who suggested that life had originated from “one living filament” in his two-volume work *Zoonomia* (1794–1796). Other transmutationists included the French anatomist Étienne Geoffroy Sainte Hilaire (1805–1861), who studied teratology, or the science of birth defects. He suggested that through such “monstrous births” new species might arise in a sudden or rapid process, a theory later challenged by modern genetics.

In the nineteenth century a series of scholars began to uphold not just transmutationist doctrines but theories suggestive of what eventually would become known as Darwinian natural selection. In 1813 William Wells delivered a paper to the Royal Society with the title “An Account of a Female in the White Race of Mankind.” Wells suggested that new human races originated when groups moved into new territories where they encountered new conditions of life. In the process of adaptation to these new conditions, newer improved races of humans would emerge. In 1831 Patrick Matthew came even closer to formulating a view of natural selection in the appendix to an obscure treatise, *On Naval Timber and Arboriculture*. In this account Matthew invoked the extinction of species by catastrophic events, after which the survivors would diversify into new, better-adapted species that would remain stable for long periods of time. In 1835 yet another scholar, Edward Blyth (1810–1873), in a paper titled “An Attempt to Classify the Varieties of Animals,” suggested a competitive process echoing natural selection whereby the elimination of the unfit groups would take place.

In 1844 the work of one transmutationist in particular drew the attention of wide Victorian audiences. Writing anonymously at first, Robert Chambers (1802–1871) outlined a transmutationist theory under the title *Vestiges of the Natural*

History of Creation. The book became an instant sensation for its many readers, who were greatly entertained by the provocative—and indeed some thought scandalous—account of the origins of the solar system and of the origins of humanity, which postulated evolution from the apes. Though it was widely read and discussed, it received devastating criticism from scientists; this was so much the case that Charles Darwin, witnessing the controversy precipitated by *Vestiges*, is thought to have been dissuaded from publishing his own transmutationist views for nearly fifteen years.

Charles Darwin and Descent with Modification by Means of Natural Selection

Charles Darwin was the leading transmutationist of the nineteenth century. The grandson of Erasmus Darwin, and the son of a fairly successful country physician, Robert Waring Darwin, Charles was born into an educated and affluent English family that fostered his interest in natural history. His mother, Susanna Wedgwood, was the daughter of the famed industrialist and potter Josiah Wedgwood (1730–1795) and heir to a family fortune. Charles was the youngest of two sons and had three sisters, who doted on him after the premature death of his mother when Charles was only eight. His scholastic achievements were less than stellar, though he early on developed a passion for natural history. He first made an attempt to study medicine at Edinburgh University but gave up after witnessing an operation on a young child without the aid of anesthesia. Although his formal medical studies disappointed him, Darwin did enjoy interactions with local experts in natural history. In particular he fell under the influence of an ardent transmutationist, Robert E. Grant (1793–1874), a keen student of marine invertebrates who encouraged Darwin's interest in natural history and also encouraged him to consider the leading transmutationist theories of the day. Under Grant's tutelage at Edinburgh, Darwin was exposed seriously to the scientific theories of Lamarck and to the insights of his own grandfather Erasmus, which he entertained but did not enthusiastically accept, at least at that time. He also made some of his first scientific observations using a microscope on the mode of fertilization of the marine polyp *Flustra*.

His second attempt at formal education shortly thereafter in theology at Cambridge University exposed him to the popular views of natural theology, with its focus on adaptation and design, especially the work of William Paley (1735–1805) and his *Natural Theology* (1802). Darwin's only formal scientific training had been in geology under the tutelage of Adam Sedgwick (1785–1873) when John Stevens Henslow (1796–1861), the professor of botany and his mentor, recommended him to the Admiralty for a geographic expedition to chart the coast of South America. Under the command of Captain Robert FitzRoy (1805–1865), the HMS *Beagle* set sail in 1831, with Darwin on board serving as gentleman-companion to the captain and increasingly playing the role of ship's naturalist. The five-year voyage, which charted the coastline of South America and then continued to the Galapagos Islands, Tahiti, New Zealand, and Australia, exposed Darwin to the variation and distribution of living organisms in both continental and island environments. Darwin collected extensive specimens of flora and fauna and

made notable observations of the geological history of the locales he visited. Frequently referring to Charles Lyell's (1797–1875) recently published *Principles of Geology* (1830–1833), which was part of the personal library that he had taken with him, Darwin sought to understand the geographic distribution of plants and animals in terms of a uniformitarian geology. He was especially struck by the manner in which related forms appeared to replace each other as one traveled up and down the coast of eastern South America, by the resemblance of extinct fossil forms to extant life, by the similarity between island species in the Galapagos to nearby continental areas like western South America, and by the differences displayed between those island species on the Galapagos. All of these patterns suggested that some natural and gradual process that involved migration and adaptation to local environments had taken effect, rather than some act of unique or special creation.

Darwin increasingly sought a general explanation for his observations of the natural world during the five-year voyage, and after returning to England he devoted himself to this end by revising his journals, reexamining his specimens, consulting with noted experts, and reading extensively in the scientific literature available to him. Between 1837 and 1838—generally regarded as the crucial years in the formulation of his famous theory—Darwin read the *Essay on the Principle of Population* by Thomas Robert Malthus (1766–1834). More than any other work, the essay provided Darwin with the intellectual backdrop for his theory by suggesting that competition for natural resources was a fact of life and that populations remained stable as a result of processes that included checks and balances. In this competitive world where there was a struggle for existence, those organisms with the most favorable characteristics would be favored to survive and reproduce themselves. Given enough time, those with favorable traits and characters would diverge from the ancestral forms to give rise to new species. The new elements to transmutationism that Darwin introduced thus included the struggle for existence, but also the fact that heritable variation that was favorable and that conferred an advantage would be likely preserved in the process of reproduction.

Darwin recorded the development of his ideas at this time in a series of notebooks that reveal his attempts to understand the branching process for the origin of species, which had “descended” from some common ancestor. Although he had the major features of his theory at this time, Darwin did not make his work public until much later. There is much speculation in the scholarly literature about the delay in publishing his theory, but there is general agreement that Darwin spent the next interval of his life collecting evidence in support of what he knew would be a contentious theory. He wrote to experts collecting information that might be useful in support of his theory, he engaged in detailed taxonomic work on some little-known species of barnacles to familiarize himself with general problems in the taxonomy of a particular group, and most importantly he closely followed the practices of domestic breeders, especially by frequenting exhibitions and shows on popular or fancy breeds of pigeons. In 1842 he wrote a historical sketch outlining his theory and extended it into a longer historical essay in 1844, neither of which was made public, while all the while compiling the data he was amassing from

experts all over the world and from his own research and reading. He was finally forced into joint publication of an abbreviated version of his theory in 1858 shortly after the English naturalist Alfred Russel Wallace independently formulated his own parallel theory. Up to that point, Darwin had been laboring for some twenty years to complete a comprehensive work he planned to title “Natural Selection.”

Under pressure to complete a manuscript, Darwin took less than a year to outline his theory of species change, which he ultimately called “descent with modification” by means of natural selection. The full title of his famous book was *On the Origin of Species by Means of Natural Selection; or, The Preservation of Favoured Races in the Struggle for Life*. It appeared in bookstores on 24 November 1859 and sold out on the first day. It went through six editions as Darwin modified his theory in response to his many critics. Historians generally cite the first edition of this book for their scholarly attempts to understand Darwin’s theory, since subsequent editions included such prolonged attempts to accommodate his critics that the text and scientific explication is considered unclear, if not actually inaccurate.

In addition to natural selection, Darwin included some four or five other ways that species change could take place, including the inheritance of acquired characters. Though he did not address human evolution in this book (only one sentence alludes to human evolution), Darwin’s readers quickly made the connection between humans and primates thanks in part to the efforts of earlier transmutationists like Robert Chambers. Darwin turned to human evolution only later, in 1871, when he wrote the two-volume *Descent of Man and Selection in Relation to Sex*. In this book Darwin corrected earlier misconceptions of his work and made it clear that humans had not evolved from apes or monkeys but that both had shared a common ancestor. The book also included pronounced reflections on Darwin’s views of human societies and the evolution of civilizations, some of which supports the present-day idea that Darwin himself was indeed a “Social Darwinist.” The second part of this book, sexual selection, was an explication of Darwin’s theory of sexual selection that was first articulated in 1859. Sexual selection was the process by which Darwin thought fanciful characters like male plumage had evolved, largely through the process of female mate choice. It was one point that led to a disagreement with Wallace, who did not support sexual selection because he thought it acted against natural selection.

Darwin’s theory did face notable criticism in his day. One problem had to do with the absence of any viable theory of heredity in it. This led to the criticism—most closely ascribed to Fleeming Jenkin (1833–1885) in a famous review of 1867—that new or novel characters would be diluted or “swamped” out with subsequent generations. Darwin was aware of this criticism, and in his 1868 book *The Variation of Animals and Plants under Domestication*, he attempted to formulate his “provisional hypothesis of pangenesis,” a theory postulating that organs of the body generate hereditary information in the form of gemmules which become combined in the gonads during reproduction. The hypothesis remained largely just an unproven hypothesis. This problem was eventually addressed,

during the “rediscovery of Mendel” in 1900, by the discovery that heredity is particulate in nature.

Another problem was the age of the Earth, which, according to estimates made by William Thomson, later Lord Kelvin (1824–1907), was about one hundred million years old. This was an insufficient amount of time to account for the slow, gradual process that Darwin envisioned. The problem was solved after the late-nineteenth-century discovery of radioactivity, which, when accounted for in estimates of the age of the earth, increased it to nearly five billion years, an estimate of time long enough to account for evolution. Yet another problem came from objections to the randomness of the process and the apparent lack of rigor in Darwin’s methodology. Leading this charge against Darwin’s theory, the astronomer J. F. W. Herschel (1792–1871) described Darwinian natural selection as the “law of higgledy-piggledy.” Perhaps most problematic of all was the fact that Darwin had no direct proof for a process that took place over such a long stretch of time and that had not been easily detected in the fossil record (most of his evidence was indirect, based on evidence from biogeography, from analogies to artificial selection, or from “imaginary illustrations”). Darwin knew this, and he predicted that it would take some fifty years for evidence to support this theory. The first direct proof of evolution by means of natural selection in natural populations was finally provided beginning in the 1920s with the example of industrial melanism in the peppered moth, *Biston betularia*. Though the peppered moth example was later challenged by some who thought that the shift to the melanic form did not constitute a true speciation event, it remains a famous example of evolution in action since it demonstrates the rapid shift in allele frequencies following strong selection pressure. Since the case of industrial melanism became known, numerous studies in the wild or under laboratory conditions have provided definitive evidence in support of Darwinian natural selection. Some of the best examples are the morphological responses in beak shape and size to drought conditions on some of the Darwin finches in the Galapagos, and the evolution of antibiotic resistance in pathogenic strains of microorganisms that cause diseases like tuberculosis.

More difficult to resolve were the theological and philosophical questions that followed from the mechanistic theory of natural selection. Even though Darwin had only one line in his 1859 book on human evolution, the theory implied that humans were subject to the same mechanistic process as plants and animals. Natural selection challenged the argument for God’s existence from design and led to a nonpurposive view of the world. To some, this echoed the fears raised earlier by the poet Alfred, Lord Tennyson (1809–1892), that such a competitive and nonpurposive view of nature implied that it was “red in tooth and claw.” Darwin’s own views of “nature,” as embodied in works such as *On the Origin of Species*, appeared to be much more subtle. Nature, to Darwin, appeared to be benignly passive or indifferent to the drama playing itself out in the struggle for existence. Darwin’s religious views became increasingly secular; there was no “death-bed conversion” to religious belief.

Despite considerable controversy over the mechanism, the fact of evolution was rapidly accepted by scientists and by pop-

**IN DARWIN'S SHADOW: ALFRED RUSSEL WALLACE AND
THE "DARWIN-WALLACE THEORY OF EVOLUTION."**

Though Darwin's name is virtually synonymous with the theory of evolution, the name of his codiscoverer Alfred Russel Wallace (1823–1913) is very often forgotten or relegated to the role of minor player. Yet Wallace himself was a gifted naturalist who distinguished himself for his scientific insights, especially in understanding island biogeography, and for his literary talents, especially excelling in the genre of the travel narrative.

Unlike Darwin, Wallace was born to a family of modest means in Usk, Monmouthshire, England. Lacking an extensive formal education, Wallace was an autodidact, frequenting lending libraries and attending public lectures on science. His first formal job at the age of fourteen was assisting his older brother at surveying counties in England, which gave him technical skills at observation and measurement, and he was later appointed as drawing master at the Collegiate School in Lancaster, where he fell in with Henry Walter Bates (1825–1892), a fellow teacher who shared a passion for the natural world.

In 1848 the two friends decided to embark on joint careers as commercial collectors of precious natural history specimens by traveling to the Amazon. They eventually took separate routes, collecting in increasingly unexplored regions, with Wallace traveling extensively up the Rio Negro, a tributary of the Amazon River. In 1852 Wallace returned to England, but nearly all of his magnificent collection was lost when his ship caught fire and sank. Wallace recovered from his setback rapidly, writing his account of the expedition in 1853, mostly from memory, as *A Narrative of Travels on the Amazon and Rio Negro*.

One year later he was once again in search of commercial specimens, this time setting off to the Malay Archipelago, where he traveled for nearly eight years. During this time he made one of the most notable observations in the history of island biogeography now associated with "Wallace's

Line," an imaginary line that separated the two islands of Bali and Lombok; entirely different flora and fauna existed on either side of this geographic line. This disjuncture was only understood in the later twentieth century as the product of continental drift (the two areas are on separate plates).

Wallace's acute observations also led to his formulation, independently of Darwin, of a general theory of evolution that included a process closely resembling natural selection. In 1858, while suffering from malarial fever, Wallace connected the ideas of Malthus with his observations of the distribution of plants and animals and quickly drafted his celebrated paper "On the Tendency of Varieties to Depart Indefinitely from the Original Type." He proceeded to send the completed paper to Darwin, with whom he had had some previous correspondence. Darwin received the letter and immediately recognized the parallel views that Wallace had independently formulated. To avoid an unseemly priority dispute, Darwin turned over Wallace's paper along with his own historical sketch, essay, and correspondence with Asa Gray documenting the independence of the two efforts to Charles Lyell and Joseph Hooker and relied on them to negotiate the awkward situation. Both these men communicated these documents and a joint paper written by Darwin and Wallace to the Linnaean Society on 1 July 1858. Later that year the joint paper titled "On the Tendency of Species to form Varieties; and on the Perpetuation of Varieties and Species by Natural Means of Selection," by Charles Darwin and Alfred Wallace, was published in the *Journal of the Proceedings of the Linnaean Society*. Strangely enough, the paper failed to garner much negative attention or controversy. A year later, Darwin completed the famous "abstract" of his theory, published as *On the Origin of Species*, and from that point on Wallace's original contribution played at best only a supporting role.

(continued on the next page)

**IN DARWIN'S SHADOW: ALFRED RUSSEL WALLACE AND
THE "DARWIN-WALLACE THEORY OF EVOLUTION."**

(continued from previous page)

Wallace himself was generally pleased to play this lesser part. He was a lifelong friend and supporter of Darwin, serving finally as pallbearer at Darwin's funeral with Huxley and Hooker. Darwin in turn supported Wallace through some especially difficult times, helping him secure a government pension. Wallace never properly attained financial security, and he also continued to uphold some radical ideas for his day that included land nationalization and an extreme opposition to vaccination campaigns in addition to more popular causes such as women's suffrage, labor reform, and universal education. Most disturbing to many establishment Victorian scientists generally, and Darwin in particular, was Wallace's growing

support of spiritualist movements: Wallace's own support of the materialistic and mechanistic natural selection made an exception of the evolution of the human mind; he believed the "human spirit" could continue to progress even after the process of death.

His scientific work continued, earning him a permanent place in the history of science. Especially noteworthy were his contributions to island biogeography, which included the publication of *The Geographical Distribution of Animals* in 1876 and *Island Life* in 1880. In the late twentieth century Wallace's initial insights on the ecological dynamics of smaller island populations provided the intellectual backdrop to sciences such as conservation biology and to biodiversity studies.

ular audiences. Some of the greatest advocates and promoters of Darwin and his theory in fact disagreed with some rather major aspects of the theory. In the United States, the leading advocate of Darwin's theory was the botanist Asa Gray (1810–1888) at Harvard University. Though Gray found Darwin's theory useful to biogeography, he found the mechanistic implications of natural selection distasteful. It was Gray who brought Darwinian evolution to the attention of many American scientists and who defended Darwin against critical assaults by figures like his Harvard colleague in zoology Louis Agassiz (1807–1873). In Germany, Darwin and evolution found especially fertile ground in one of his greatest advocates, Ernst Haeckel. Beginning in 1866 with his *Generelle Morphologie der Organismen* (General morphology of organisms), Haeckel promoted Darwin and his evolutionary theory because of its materialistic flavor yet either misunderstood or disagreed with Darwinian natural selection. Rather than upholding an intricately branching and nonprogressivist view of evolution as Darwin had described in *Origin*, Haeckel retained a linear, progressive model only with some lateral branching. Haeckel continued to draw on embryological or developmental models for the evolutionary process and believed that evolution was guided by historical evolutionary forms that could still be seen in the process of individual development. In the process of development, the ontogeny (or developmental pattern of the organism) recapitulated the phylogeny (or the evolutionary history of the organism). Though German embryologists like Karl Ernst von Baer (1792–1876) argued against such a crude linear progressivist model of evolutionary development in favor of more complex branching models, the view that "ontogeny recapitulated phylogeny," also known as "the biogenetic law," continued to have mass appeal especially in Germany.

Haeckel was a prolific and popular writer whose numerous attempts to reconstruct "phylogenetic trees" with the main trunk running upward to the human "race" as the pinnacle of development shaped popular understanding of evolution in the late nineteenth century. Haeckel's influence also had the unfortunate effect of linking Darwinian evolution with what he thought were materialist progressivist leanings toward the struggle for national development. His *Generelle Morphologie* and subsequent writings, which gained currency in the late nineteenth century, eventually provided pseudo-scientific justifications for nationalism and racism.

Darwin's most famous, indeed notorious, advocate was his close friend, the anatomist Thomas Henry Huxley. It was Huxley, along with the Kew Gardens botanist Joseph Dalton Hooker (1817–1879) and Charles Lyell, who formed the "inner circle" of friends and supporters who promoted and defended Darwin's name and his theory. Though Huxley earned himself the title of "Darwin's Bulldog" while supporting Darwin's theory—which stressed slow, gradual evolution—he preferred instead the view that evolution could take place more suddenly and rapidly. Like others of his time, Huxley closely linked views of evolutionary progress with social progress; he used the principles of evolution to support his reformist views of English society.

By the turn of the twentieth century, a staggering number of evolutionary theories—that added to, amended, or outright disagreed with Darwin's selection theory—were being actively entertained. These included a revitalization of the inheritance of acquired characters into movements associated with neo-Lamarckism; directed evolution, aristogenesis, and orthogen-

esis, all of which upheld the view that evolution was guided by an internal driving force; and “creative evolution,” a quasi-mystical evolutionary theory endorsed by the French philosopher Henri Bergson (1859–1941), who postulated that living organisms were guided by an *élan vital*, or special living force.

One of the most popular alternatives to Darwinian selection theory was the “mutation theory” of the Dutch botanist Hugo de Vries (1848–1935). One of the “rediscoverers of Mendel,” de Vries upheld a particulate theory of heredity that stressed the importance of what he termed “mutation pressure” in generating evolutionary novelty. Much of his theory was based on observations he made on the evening primrose plant, *Oenothera lamarckiana*, which appeared to throw off new varieties or species suddenly. De Vries erroneously interpreted these new forms as being entirely new species that had been generated by strong mutation pressure (these new forms of the primrose were subsequently shown to be regularly occurring varieties that resulted from its genetic structure). Natural selection was not ruled out, but it came into play only in selecting the most advantageous of these forms; it therefore played an eliminative role in evolution, while mutation pressure played the more active or creative role. Because it drew on the newer science of genetics, which appeared to be more rigorous because it was experimental, mutation theory was widely adopted by younger scientists at the turn of the century, who did not favor the natural-history-oriented approach associated with Darwin or his naturalist followers. The interval of time between approximately the rediscovery of Mendel and the late 1920s thus saw a period of dissonance between younger geneticists and older naturalists, all of whom sought a viable evolutionary theory that could be a rigorous experimental science that could also explain patterns of adaptation in natural populations. Others, who were strict followers of Darwinian selectionism and stressed the fact that Darwin endorsed a slow, gradual process that operated at the level of small, individual differences, turned to the newer science of statistics to create a new school known as “biometry.” Francis Galton (1822–1911), Darwin’s famous first cousin, was an exponent of the biometrical school, which tried to understand evolution in statistical terms. He was also the individual who coined the term *eugenics* in this attempt to formulate a viable theory of heredity and evolution that could then provide social reformers with the tools to “improve society” through selective breeding.

The turn of the century as a whole saw a series of proposed evolutionary theories that some have claimed were in fact “non-Darwinian” evolutionary theories. This was so much the case that Julian Huxley (1887–1975) the famous grandson of Thomas Henry Huxley, designated this interval of time “the eclipse of Darwin,” a period of confusion and disagreement over the mechanism and mode of evolution. Only after the mechanism of heredity was understood and only after the science of genetics was integrated with natural history was the debate over the mechanism of natural selection extinguished. This did not take place until the interval of time between 1920 and 1950 and was part of the event called the “evolutionary synthesis.” The synthesis brought together Darwinian selection theory with Mendelian genetics in a populational view of evolution to account for the origin of biological diversity. It first drew primarily

on the work of three mathematical population geneticists, R. A. Fisher (1890–1962) and J. B. S. Haldane (1892–1964) in England and Sewall Wright (1889–1988) in the United States, all of whom offered models demonstrating the efficacy of natural selection under a range of different parameters. The theoretical work of these modelers was tested in field conditions with natural populations of organisms in the mid-1930s. This then led to the writing of a series of synthetic accounts that integrated Darwinian selection theory with Mendelian genetics.

The new science called evolutionary genetics was most closely associated with Theodosius Dobzhansky (1900–1975) and his synthetic book *Genetics and the Origin of Species* (1937). In addition to genetics, the “evolutionary synthesis” drew on systematics, botany, paleontology, cytology, and morphology to create what is now called the “synthetic theory of evolution” or the “neo-Darwinian theory of evolution.” In addition to drawing on the work of Dobzhansky, it drew on the work of twentieth-century biologists like Ernst Mayr (b. 1904), George Ledyard Stebbins (1906–2000), George Gaylord Simpson (1902–1984), and Julian Huxley. It endorses the view that natural selection is the dominant mechanism that drives evolutionary change. Within such a modern, populational frame of reference, evolution itself became redefined as “any relative change in gene frequencies.” This definition has been debated extensively, especially by naturalists-systematists who prefer a more inclusive consideration of the process of speciation.

Accompanying the emergence of the “modern synthesis” (Julian Huxley’s exact phrase for the new science of evolution), the first international Society for the Study of Evolution (SSE) was formed in 1946 and sponsored the journal *Evolution*, the first international journal for the dissemination of scientific knowledge of evolution. With the “evolutionary synthesis,” the varied sciences that informed evolution thus became reorganized into the new science of evolutionary biology. Because it drew on so many scientific disciplines, encompassing the breadth of the biological sciences and many of the social sciences, like psychology and anthropology, evolutionary biology began increasingly to play a central, integrative role in the biological sciences, especially beginning in the late 1950s and early 1960s. In 1975 Dobzhansky stated the important fact that “nothing in biology makes sense except in the light of evolution.” In stating this, he was stressing the fact that evolution by means of natural selection serves as the central, unifying principle of the modern science of biology.

Though there have been varied attempts to amend or alter the synthetic theory as it was formulated during the “evolutionary synthesis” in the latter half of the twentieth century, the theory remains fundamentally intact. Among the varied points of agreement are included the primacy of natural selection, the continuation between microevolutionary and macroevolutionary processes, and the fact that evolution takes place at the level of small individual differences—all pretty much formulated in the 1930s–1950s. New techniques and methods from molecular biology have led to a virtual revolution in understanding evolution at the molecular level, while more traditional evolutionary biologists continue to mine the fossil record and to explore developmental biology, areas such

as behavior and functional morphology as well as biochemistry to give a more detailed account of the evolutionary history of life on earth.

See also **Biology; Creationism; Development; Eugenics; Genetics; Lysenkoism; Natural History; Natural Theology; Nature; Naturphilosophie; Progress, Idea of; Social Darwinism.**

BIBLIOGRAPHY

- Appleman, Philip. *Darwin*. New York: Norton, 1970.
- Bowler, Peter J. "The Changing Meaning of 'Evolution.'" *Journal of the History of Ideas* 36 (1975): 95–114.
- . *The Eclipse of Darwinism: Anti-Darwinian Evolution Theories in the Decades around 1900*. Baltimore: Johns Hopkins University Press, 1983.
- . *Evolution: The History of an Idea*. 3rd ed. Berkeley: University of California Press, 2003.
- . *The Non-Darwinian Revolution. Reinterpreting a Historical Myth*. Baltimore: Johns Hopkins University Press, 1988.
- Browne, Janet. *Charles Darwin: A Biography*. 2 vols. New York: Knopf, 1995–2002.
- Burkhardt, Richard W., Jr. *The Spirit of System: Lamarck and Evolutionary Biology*. Cambridge, Mass: Harvard University Press, 1977.
- Darwin, Charles. *On the Origin of the Species by Means of Natural Selection: or, The Preservation of Favoured Races in the Struggle for Life*. London: J. Murray, 1859.
- Desmond, Adrian J. *The Politics of Evolution: Morphology, Medicine, and Reform in Radical London*. Chicago: University of Chicago Press, 1989.
- Desmond, Adrian J., and James R. Moore. *Darwin*. London: Michael Joseph, 1991.
- Dobzhansky, Theodosius Grigorievich. *Genetics and the Origin of Species*. New York: Columbia University Press, 1937.
- Fichman, Martin. *An Elusive Victorian: The Evolution of Alfred Russel Wallace*. Chicago: University of Chicago Press, 2004.
- Gould, Stephen Jay. *The Structure of Evolutionary Theory*. Cambridge, Mass: Belknap Press, 2002.
- Greene, John C. *The Death of Adam: Evolution and Its Impact on Western Thought*. Rev. ed. Ames: Iowa State University Press, 1996.
- Huxley, Julian. *Evolution: The Modern Synthesis*. London: Allen and Unwin, 1963.
- Kohn, David, ed. *The Darwinian Heritage*. Princeton, N.J.: Princeton University Press, 1985.
- Mayr, Ernst. *The Growth of Biological Thought: Diversity, Evolution, and Inheritance*. Cambridge, Mass: Belknap Press, 1982.
- . *What Evolution Is*. New York: Basic Books, 2001.
- Mayr, Ernst, and William B. Provine, eds. *The Evolutionary Synthesis: Perspectives on the Unification of Biology*. Cambridge, Mass: Harvard University Press, 1980; rev. ed., 2000.
- Raby, Peter. *Alfred Russel Wallace: A Life*. Princeton, N.J.: Princeton University Press, 2001.
- Richards, Robert J. "Evolution." In *Keywords in Evolutionary Biology*, edited by Evelyn Fox Keller and Elizabeth Lloyd, 95–105. Cambridge, Mass: Harvard University Press, 1992.
- . *The Meaning of Evolution: The Morphological Construction and Ideological Reconstruction of Darwin's Theory*. Chicago: University of Chicago Press, 1992.

- . *The Romantic Conception of Life: Science and Philosophy in the Age of Goethe*. Chicago: University of Chicago Press, 2002.
- Ruse, Michael. *The Darwinian Revolution: Science Red in Tooth and Claw*. 2nd ed. Chicago: University of Chicago Press, 1979.
- . *Monad to Man. The Concept of Progress in Evolutionary Biology*. Cambridge, Mass.: Harvard University Press, 1996.
- Secord, James A. *Victorian Sensation: The Extraordinary Publication, Reception, and Secret Authorship of Vestiges of the Natural History of Creation*. Chicago: University of Chicago Press, 2000.
- Shermer, Michael. *In Darwin's Shadow: The Life and Science of Alfred Russel Wallace. A Biographical Study on the Psychology of History*. Oxford and New York: Oxford University Press, 2002.
- Smocovitis, Vassiliki Betty. *Unifying Biology: The Evolutionary Synthesis and Evolutionary Biology*. Princeton, N.J.: Princeton University Press, 1996.
- Wallace, Alfred Russel. *Island Life*. Amherst, N.Y.: Prometheus Books, 1998. Originally published in 1881.
- Young, Robert M. *Darwin's Metaphor: Nature's Place in Victorian Culture*. Cambridge, U.K., and New York: Cambridge University Press, 1985.

Vassiliki Betty Smocovitis

EXAMINATION SYSTEMS, CHINA. Civil examinations in late imperial China (1400–1900) intersected with politics, society, economy, and Chinese intellectual life. Both local elites and the imperial court influenced the dynastic government to reexamine and adjust the classical curriculum and to entertain new ways to improve the system for selecting officials. As a result, civil examinations represented a test of educational merit that served to tie the dynasty and literati culture together bureaucratically.

Civil examinations were not an obstacle to modern state building. Classical examinations were an effective cultural, social, political, and educational construction that met the needs of the dynastic bureaucracy while simultaneously supporting late imperial social structure. Gentry and merchant status groups were defined in part by examination degree credentials. Although civil examinations themselves were not an avenue for widespread social mobility, nevertheless a social by-product was the limited circulation of elites in the government from gentry, military, and merchant backgrounds.

In addition, the large pool of examination failures created a source of literary talent that flowed easily into ancillary roles as novelists, playwrights, pettifoggers, ritual specialists, and lineage agents. The unforeseen consequences when the civil examinations were summarily eliminated by modern reformers in 1905 reveals that late imperial civil examinations represented a partnership between the dynasty in power and its gentry-merchant elites. Imperial interests and literati values were equally served. They fell together in the twentieth-century Chinese revolution.

Late imperial examinations broke with medieval (650–1250) poetic and literary traditions and successfully made "Learning of the Way" (Neo-Confucianism) the state orthodoxy. The intersections between elite social life, popular

culture, religion, and the mantic arts reveal the full cultural scope and magnitude of the examination in 1,300 counties, 140 prefectures, and 17 provinces. These testing sites elicited the voluntary participation of millions of men—women were excluded—and attracted the attention of elites and commoners.

Its demise brought with it consequences that the last rulers of imperial China and reformist gentry underestimated. The Manchu Qing dynasty was complicit in its own dismantling after the forces of delegitimation and decanonization were unleashed by reformist Chinese gentry, who prevailed in late-nineteenth-century education circles and convinced the imperial court to eliminate the entire examination institution in 1904.

Reform of education and the elimination of examinations in China after 1905 was tied to newly defined national goals of Western-style change that superseded conservative imperial goals of maintaining dynastic power, granting gentry prestige, and affirming classical orthodoxy. Since the Song-Yuan-Ming transition (1250–1450), the struggle between insiders and outsiders to unite the empire had resulted in over four hundred years of so-called barbarian rule over the Han Chinese. With the Republican Revolution of 1911, that historical narrative ended.

Power, Politics, and Examinations

Classical philosophy and imperial politics became partners during the Mongol Yuan dynasty, when Song dynasty (960–1279) classical interpretations were made the orthodox guidelines for the imperial examination system. Ming (1368–1644) and Qing (1644–1911) appropriations of that orthodoxy affected how literati learning would be interpreted and used in later dynasties as a political ideology.

The late imperial civil system elaborated the Song-Yuan civil examination model under the impact of commercialization and demographic growth, which allowed the process to expand to all 1,300 counties. In addition, the upsurge in candidates meant that officialdom became the prerogative of a very slim minority. As the door to a fixed number of official appointments, civil examinations also conferred social and cultural status on families seeking to become or maintain their status as local elites.

Competitive tensions also explain the policelike rigor of the civil service examinations that Han Chinese insiders and Manchu warrior outsiders both supported. Political forces and cultural fears forced Han Chinese and their non-Han rulers to agree publicly how imperial and bureaucratic authority was conveyed through the accredited cultural institutions of the civil examinations. Political legitimation transmitted through education succeeded because enhanced social status and legal privileges were an important by-product of the examination competition.

Quotas based on the ratio between successful and failed candidates further demonstrated that the state saw access to the civil service as a means to regulate the power of elites. Government control of selection quotas was most keenly felt at the

initial, licensing stages of the examination competition. By 1400, for example, there were about 30,000 classical literate licentiates out of an approximate population of 65 million, a ratio of almost one licentiate per 2,200 persons. In 1600 there were perhaps 500,000 licentiates in a total population of some 150 million, or a ratio of one licentiate per 300 persons.

Because of economic advantages in South China (especially the Yangzi Delta but also Fujian and Guangdong), candidates from the south performed the best on the civil examinations. To keep the south's domination of the examinations within acceptable bounds, Ming education officials settled in 1425 on an official ratio of 60 to 40 for allocations of the highest degrees to candidates from the south versus the north, which was slightly modified to 55 to 10 to 35 a year later by adding a central region.

The examination hall became a contested site, where the political interests of the dynasty, the social interests of its elites, and the cultural ideals of classical learning were compromised. Examination halls were supervised by literati officials, who were in charge of the military and police apparatus to control the thousands of men brought together to be tested at a single place. Forms of resistance to imperial prerogative emerged among examiners, and widespread dissatisfaction and corruption among the candidates at times triumphed over the high-minded goals of some of the examiners.

Literacy and Social Dimensions

The monopolization of cultural resources by literati and merchant elites depended on their linguistic mastery of nonvernacular classical texts. Imperial examinations thus created a written linguistic barrier between those who were allowed into the empire's examinations compounds and classical illiterates who were kept out. Because there were no public schools, the partnership between the court and the bureaucracy was monopolized by gentry-merchant literati who organized into lineages and clans to provide superior classical educations.

Language and classical literacy played a central role in culturally defining high and low social status in late imperial Chinese society. The selection process permitted some circulation of elites in and out of the total pool, but the educational curriculum and its formidable linguistic requirements eliminated the lower classes from the selection process. In addition, an unstated gender ideology forbade all women from entry into the examination compounds.

Literati regularly turned to religion in their efforts to understand and rationalize their emotional responses to the competitive examinations. Examination dreams and popular lore spawned a remarkable literature about the temples candidates visited, the dreams that they or members of their family had, and the magical events in their early lives that were premonitions of later success. Popular notions of fate influenced the examination marketplace and were encoded as cultural glosses with unconscious ties to a common culture and religion.

Anxiety produced by examinations was a historical phenomenon, experienced personally and deeply by boys and men.

Fathers and mothers, sisters and extended relatives, shared in the experience and offered comfort, solace, and encouragement, but the direct, personal experience of examination success or failure belonged to the millions of male examination candidates who competed with each other against difficult odds.

The civil service competition created a dynastic curriculum that consolidated gentry, military, and merchant families into a culturally defined status group of degree holders that shared a common classical language, memorization of a shared canon of classics, and a literary style of writing known as the “eight-legged essay.” Internalization of elite literary culture was in part defined by the civil examination curriculum, but that curriculum also showed the impact of literati opinion on imperial interests.

In addition to helping define literary culture, the examination curriculum also influenced the literatus’s public and private definition of his moral character and social conscience. A view of government, society, and the individual’s role as a servant of the dynasty was continually reinforced in the memorization process leading up to the examinations themselves. For the literatus, it was important that the dynasty conformed to classical ideals and upheld the classical orthodoxy that literati themselves had formulated.

The bureaucracy made a financial commitment to staffing and operating the empirewide examination regime. Ironically, the chief consequence was that examiners could not take the time to read each individual essay carefully. Final rankings, even for the eight-legged essay, were haphazard. We should guard against overinterpreting the classical standards of weary examiners as a consistent or coherent attempt to impose orthodoxy.

An interpretive community, canonical standards, and institutional control of formal knowledge were key features of the civil examination system. The continuities and changes in linguistic structures and syllogistic chains of moral argument in the examination system reveal an explicit logic for the formulation of questions and answers and an implicit logic for building semantic and thematic categories of learning. These enabled examiners and students to mark and divide their cognitive world according to the moral attitudes, social dispositions, and political compulsions of their day.

Fields of Learning

Literati fields of learning, such as natural studies and history, were also represented in late imperial examinations. Such inclusion showed the influence of the court, which for political reasons widened or limited the scope of policy questions on examinations, and of the assigned examiners, whose classical knowledge echoed the intellectual trends of their time. In the eighteenth century new guidelines were also applied to the civil examination curriculum. As a result, the Song rejection of medieval belles lettres in civil examinations was revoked.

In the late eighteenth century the examination curriculum started to conform with philological currents popular among literati. The scope and content of the policy questions increasingly reflected the academic inroads of newer classical

scholarship among examiners. Beginning in the 1740s, high officials debated new initiatives that challenged the classical curriculum in place. They restored earlier aspects of the civil examinations that had been eliminated in the Yuan and Ming dynasties, such as classical poetry.

In the mid-eighteenth century, because of the increasing numbers of candidates, Qing officials emphasized “ancient learning” to make the examinations more difficult by requiring all the Five Classics. In addition, the formalistic requirements of poetry gave examiners an additional tool, along with the eight-legged essay grid, to grade papers more efficiently. Later rulers failed to recognize that an important aspect of the civil examinations was the periodic questioning of the system from within that gave it credibility from without.

Delegitimation and Decanonization

After 1860 radical reforms were initiated to meet the challenges of the Taiping Rebellion (1850–1864) and Western imperialism. The Taipings instituted their own Christian-based civil examinations. In the last years of the Qing dynasty, the civil examinations lost their cultural luster and became the object of ridicule by literati officials as an unnatural educational regime that should be discarded. During the transition to the Republic of China, new political, institutional, and cultural forms emerged that challenged the creedal system of the late empire.

The emperor, his bureaucracy, and literati cultural forms quickly became symbols of backwardness. Traditional forms of knowledge were uncritically labeled as superstition, while modern science was championed by new intellectuals as the path to knowledge, enlightenment, and national power. Most representative of the changes was the dismantling of the civil examination regime that had lasted from 1370 to 1905.

By dismantling imperial institutions such as the civil examination system so rapidly, Chinese reformers and early republican revolutionaries underestimated the public reach of historical institutions that had taken two dynasties and five hundred years to build. When they delegitimated the institutions all within the space of two decades starting in 1890, Han Chinese literati helped bring down both the Manchu dynasty and the imperial system of governance. Its fall concluded a millennium of elite belief in literati values and five hundred years of an empirewide imperial orthodoxy.

See also Chinese Thought; Confucianism; Education: Asia, Traditional and Modern; Education: China.

BIBLIOGRAPHY

- Chaffee, John W. *The Thorny Gates of Learning in Sung China*. New ed. Albany: State University of New York Press, 1995.
- Des Rotours, Robert. *Le traité des examens, traduit de la Nouvelle histoire des T'ang*. Paris: Leroux, 1932.
- Elman, Benjamin. *A Cultural History of Civil Examinations in Late Imperial China*. Berkeley: University of California Press, 2000.
- Herbert, P. A. *Examine the Honest, Appraise the Able: Contemporary Assessments of Civil Service Selection in Early T'ang China*. Canberra: Australian National University, 1988.

- Ho, Ping-ti. *The Ladder of Success in Imperial China*. New York: Wiley, 1962.
- Kracke, E. A. *Civil Service in Early Sung China*. Cambridge, Mass.: Harvard University Press, 1968.
- Lo, Winston W. *An Introduction to the Civil Service of Sung China*. Honolulu: University of Hawaii Press, 1987.
- Miyazaki, Ichisada. *China's Examination Hell*. Translated by Conrad Schirokauer. New Haven, Conn.: Yale University Press, 1981.
- Twitchett, Denis. *The Birth of the Chinese Meritocracy: Bureaucrats and Examinations in T'ang China*. London: China Society, 1976.
- Wittfogel, Karl. "Public Office in the Liao Dynasty and the Chinese Examination System." *Harvard Journal of Asiatic Studies* 10 (1947): 13–40.
- Zi, Etienne. *Pratique des examens litteraires en Chine*. Shanghai: Mission Catholique, 1894. Reprint, Nendeln, Liechtenstein: Kraus, 1975.

Benjamin A. Elman

EXISTENTIALISM. Existentialism is a philosophical movement that became associated with the philosophy of Jean-Paul Sartre (who rejected the name as too confining) and whose roots extend to the works of Søren Kierkegaard and Martin Heidegger. Sartre, like most of his existentialist colleagues, was too much the individualist to accept the idea of being part of a movement, no matter how exclusive. Both Heidegger and the writer Albert Camus rejected the label, offended by being so linked to Sartre. But the name stuck, and Sartre, at least, accepted it with reservations. And so existentialism came to name one of the most powerful intellectual and literary movements of the last century and a half.

Sartre's philosophy is generally taken as the paradigm of existentialist philosophy, and other figures are usually considered existentialists insofar as they resonate with certain Sartrean themes—extreme individualism, an emphasis on freedom and responsibility, and the insistence that we and not the world give meaning to our lives. Thus some key figures who might be considered existentialist, Camus and Friedrich Nietzsche, for example, are sometimes excluded because they are not sufficiently Sartrean. Existentialism can be defined as a philosophy that puts special emphasis on personal existence, on the problems and peculiarities that face individual human beings. It tends to distrust abstractions and overgeneralized formulations of "human nature," on the grounds that each of us, in some important sense, makes his or her own nature. Søren Kierkegaard emphasized the "existence" of the individual and the importance of individual choice. The first conception of a movement should be credited to Karl Jaspers (1883–1969), a German philosopher-psychiatrist who noted the similarities between Kierkegaard and Nietzsche and identified them as early practitioners of what he called "existence-philosophy" (*Existenzphilosophie*).

Kierkegaard and Nietzsche differed radically, most famously in their approach to religion (Christianity in particular).

Kierkegaard was devout while Nietzsche was a blasphemous atheist. But so, too, twentieth-century existentialism would include both religious and atheistic philosophers. The religious existentialists include, among others, Karl Barth (1886–1968), Martin Buber (1878–1965), Gabriel Marcel (1887–1973), Jacques Maritain (1882–1973), and Paul Tillich (1886–1965). Among those labeled atheistic existentialists, Jean-Paul Sartre, Simone de Beauvoir (1908–1986), Albert Camus, and Maurice Merleau-Ponty (1908–1961) are prominent. But existentialism also includes a number of more ambiguous figures, notably Martin Heidegger, who was certainly no orthodox Christian thinker but nevertheless bemoaned modernity's abandonment of religion and insisted that "only a new god can save us." So, too, existentialism usually embraces such tormented literary figures as Fyodor Dostoyevsky (1821–1881), André Gide (1869–1951), and Franz Kafka (1883–1924), writers like Norman Mailer (b. 1923), and sympathetic international figures like Miguel de Unamuno (1864–1936) and Keiji Nishitani (1900–1990).

Twentieth-century existentialism was greatly influenced by phenomenology, originated by Edmund Husserl (1859–1938) and pursued into the existential realm by his student Heidegger. The "ontological" problem for Heidegger, "the problem of being," was to find out who one is and what to do with oneself or, as Nietzsche had asked earlier, how one is to become what one is. Phenomenology, for Heidegger, becomes a method for "disclosing [one's] being." Following both Husserl and Heidegger, Sartre used the phenomenological method to defend his central thesis that humans are essentially free, and Merleau-Ponty further refined both that method and the resulting notion of freedom to incorporate a more bodily conception of human existence, pointing to the complexities of freedom in a politically conflicted and ambiguous world.

Oddly enough, the existentialists, perhaps the most moralistic or in any case moralizing philosophers of modern times, often seem to avoid ethics. Kierkegaard noted that ethics was one choice among several. Nietzsche insisted that Western morality is slave morality, and he wrote with delight (in *Die fröhliche Wissenschaft*, 1882, 1887; English trans. *The Gay Science*) about dancing on morality's grave. Heidegger emphatically insisted that he was not offering any ethics, and he continued to speak with disdain about those who confusedly worry about values. Even Sartre, moralist par excellence, followed Heidegger in insisting that his existentialism was not an ethical philosophy, although he did promise that the "phenomenological ontology" of his great tome *L'être et le néant* (1943; English trans. *Being and Nothingness*, 1956) would be followed up by an ethics, which never came.

The existentialists were rejecting a certain "bourgeois" conception of morality, the kind of ethics that worries about keeping one's promises, paying one's debts, and avoiding scandal. Instead, they were after an ethic of a larger kind, an ethics of "authenticity" or what we would call personal integrity. They called for responsibility, even heroism, in the face of the bourgeois modern world. They rejected traditional philosophical and scientific rationality and typically resorted to literature, prophecy, pamphleteering, and ponderous obfuscation, any

means necessary to wake up the world from its boring bourgeois and at the same time brutal and irresponsible behavior.

Jaspers's special word, *existence*, which he took from Kierkegaard to summarize the centrality of self-doubt and painful freedom that defined the human condition, focused a new kind of attention on the individual. Thus existentialism tends to be a solitary philosophy. Kierkegaard, in particular, wrote at length about "subjective truth" and saving "The Individual" from the crowd, the "public," the Hegelian collective "Spirit." Nietzsche encouraged a muscular individualism in which the "higher man" should reject "the herd" and follow his own noble instincts. Heidegger calls mass-man (*Das Man*) "inauthentic" and urges us to discover our own unique "authentic" self. Camus exploded onto the literary and philosophical scene with his novel *The Stranger*, whose protagonist had only the most tenuous connections with other people, lost as he was in his own sensuous experience. Sartre focused on individual consciousness as "being-for-itself" and treated "being-for-others" as a continuous threat. In his play *Huis clos* (1944; English trans. *No Exit*, 1947), he even tells us "Hell is other people."

One might generalize that existentialism represents a certain attitude particularly appropriate for modern (and post-modern) mass society. The existentialists share a concern for the individual and personal responsibility (whether or not they embrace "free will"). They tend to resist the submersion of the individual in larger public groups or forces. Thus Kierkegaard and Nietzsche both attacked "the herd," and Heidegger distinguished "authentic existence" from mere social existence. Sartre, in particular, emphasizes the importance of free individual choice, regardless of the power of other people to influence and coerce our desires, beliefs, and decisions. Here he follows Kierkegaard, especially, for whom passionate, personal choice and commitment are essential for true "existence."

Søren Kierkegaard (1813–1855)

Kierkegaard was born and raised in Copenhagen, where he spent virtually his entire life. He was a pious Lutheran who once defined his task in philosophy as "a Socratic task," to define (or redefine) what it is to be a Christian. At the time, the rationalist influence of Immanuel Kant (1724–1804) and Georg Wilhelm Friedrich Hegel (1770–1831) dominated the Lutheran church, but Kierkegaard insisted that faith was by its very nature irrational, a passion and not a provable belief. Against Hegelian Holism, Kierkegaard insisted on the primacy of the individual and the profound "Otherness" of God. And against the worldly Lutherans, Kierkegaard preached a stark, passionate, solitudinous, and unworldly religion that, in temperament, at least, would go back to the monastery. To properly and passionately choose to be a Christian—as opposed to merely being born into the church and mindlessly reciting its dogmas—was to enjoy true existence. To be or become a Christian, according to Kierkegaard, it is necessary to passionately commit oneself, to make a "leap of faith" in the face of the "objective uncertainty" of religious claims. One cannot know or prove that there is a God; one must passionately choose to believe.

Kierkegaard formulated the seemingly self-contradictory notion of "subjective truth" in opposition to the idea that all life choices have a rational or "objective" resolution. In choosing the religious life, for example, Kierkegaard insists that there are no ultimately rational reasons for doing so, only subjective motives, a sense of personal necessity and a desire for passionate commitment. Similarly, choosing to be ethical, which is to say, choosing to act according to the principles of practical reason, is itself a choice, which is not rational. The notion of subjective truth does not mean, as it may seem to mean, a truth that is true "for me." It means resolution in the face of the objectively unknown. More important than what is believed is how it is believed. Against the calm deliberations of so much of the history of philosophy, in opposition to the celebration of reason and rationality, Kierkegaard celebrates angst and the passions, the "leap" into the unknown, and the irrationality of life.

Friedrich Nietzsche (1844–1900)

Nietzsche was a German philosopher whose writing was flamboyant and deliberately provocative, repudiating the whole Judeo-Christian tradition and liberal ethics. Nietzsche saw a conflict between the West's heroic Greek heritage and its Judeo-Christian history. He was struck, for example, by the difference between the two traditions' approaches to human suffering. While the Judeo-Christian tradition sought the explanation of misfortune in sin, the ancient Greeks took profound suffering to be an indication of the fundamentally tragic nature of human life. His first book, *Die Geburt der Tragödie* (1872; English trans. *The Birth of Tragedy*, 1909), analyzed the art of Athenian tragedy as the product of the Greeks' deep and nonevasive thinking about the meaning of life in the face of extreme vulnerability.

Nietzsche applauded the ancient Greeks for their ethical outlook, which stressed the development of excellence and nobility in contrast with what he saw as the Judeo-Christian obsession with sin and guilt. In short, he defended an ancient ethics of virtue and excellence in opposition to the modern morality of equality and "the good will" that he found, for example, in Kant's formalization of Judeo-Christian moral philosophy.

In contrast with the morality of the Homeric Greeks, a morality of heroism and mastery, Christian morality made the mediocre person of no great enthusiasm or accomplishments the moral exemplar. A good person, on this view, is someone who does no harm, breaks no rules or laws, and "means well." Nietzsche complains that the Christian moral worldview has urged people to treat the afterlife as more important than this one. Instead of urging self-improvement in earthly terms, the Christian moral vision emphasizes abstaining from "selfish" action. The person who does essentially nothing with his or her life but has avoided "sin" might merit heaven, in the Christian view, while a creative person will probably be deemed "immoral" because he or she refuses to follow "the herd." Thus the prohibitions of Judeo-Christian and Kantian ethics are in fact "leveling" devices that the weak and mediocre resentfully use to put more talented and stronger spirits at a

disadvantage. Accordingly, Nietzsche suggests that we go “beyond good and evil,” beyond our tendencies to pass moralistic judgment and toward a more creative and naturalistic perspective.

Nietzsche denied the very idea of the “otherworldly” and the idea of an all-powerful benign deity. As an antidote to the Christian worldview, which treats human life as a mere path to the afterlife, Nietzsche advocates a revival of the ancient view of “eternal recurrence,” the view that time repeats itself cyclically. If one were to take this image of eternal recurrence seriously and imagine that one’s life must be lived over and over again, suddenly there is enormous weight on what otherwise might seem like the mere “lightness” of being. But it is life, this existence, that alone counts for anything.

Martin Heidegger (1889–1971)

Heidegger was a theology student before he became a phenomenologist, and his concerns were existentialist concerns, questions about how to live and how to live “authentically,” that is, with integrity, in a politically and technologically seductive and dangerous world. His philosophy falls into two parts. His early work as a phenomenologist, culminating in his great tome, *Sein und Zeit* (1927; English trans. *Being and Time*, 1962), suggests that he deserves to be counted among the existentialists. Like Kierkegaard, he investigates the meaning of authentic existence, the significance of our mortality, our place in the world and among other people as an individual. Heidegger’s later work takes a different turn as he comes to see how his early work is still mired in the suppositions of traditional metaphysics. His philosophy seeks a new openness, a new receptivity toward the world, one that turns out to be very much in line with the program of many radical or “deep” ecologists and, as Heidegger himself later discovered, with several non-Western cultures, which had never been distracted by humanistic arrogance of his own philosophical tradition.

Heidegger’s “existentialist” philosophy begins with a profound anti-Cartesianism, an uncompromising holism that rejects any dualism regarding mind and body, the distinction between subject and object, and the very language of “consciousness,” “experience,” and “mind.” Thus he begins with an analysis of *Dasein* (literally, “being-there”). But the question emerges, because we are the “ontological” (self-questioning) creatures we are, just who this *Dasein* is. Thus Heidegger’s philosophy becomes a search for authenticity or “own-ness” (*Eigentlichkeit*), or personal integrity. This search for authenticity will carry us into the now familiar but ever-renewed questions about the nature of the self, and the meaning of life, as well as Heidegger’s somewhat morbid central conception of “Being-unto-Death.” It will also lead to Heidegger’s celebration of tradition and “heritage,” the importance of resolutely committing oneself to one’s given culture.

In contrast to the Cartesian view of the primacy and importance of knowledge, Heidegger suggests that what attaches or “tunes” us to the world is not knowledge but moods. It is in our moods, not the detached observational standpoint of knowledge, that we are “tuned in” to our world. Mood is the starting point for understanding the nature of the self and who

we are, and much of Heidegger’s analysis of *Dasein* is in terms of its moods, angst and boredom, for example.

What *Dasein* cannot be is what Descartes called “a thinking thing.” But, then, who is *Dasein*, what is the self? It is, at first, merely the roles that other people cast for me, as their son, their daughter, their student, their sullen playmate, their clever friend. That self, the *Das Man* self, is a social construction. There is nothing authentic, nothing that is my own, about it. The authentic self, by contrast, is discovered in profound moments of unique self-recognition, notably, when one faces one’s own death. It is not enough to acknowledge that “we are all going to die.” That, according to Heidegger, is merely an objective truth and inauthentic. It is one’s own death that matters here, and one’s “own-ness” thus becomes “Being-unto-Death,” facing up in full to one’s own mortality.

Jean-Paul Sartre (1905–1980)

Sartre developed his existentialist philosophy during the difficult years of World War II and the Nazi occupation of Paris, where he lived and spent virtually his entire life. At the center of his philosophy was an all-embracing notion of freedom and an uncompromising sense of personal responsibility. In the oppressive conditions of the Nazi occupation and during the embattled years following the war, Sartre insisted that everyone is responsible for what he or she does and for what he or she becomes or “makes of oneself,” no matter what the conditions, even in war and in the face of death. Sartre later insisted that he never ceased to believe that “in the end one is always responsible for what is made of one” (*New Left Review*, 1971) an only slight revision of his earlier, brasher slogan, “man makes himself.” To be sure, as a student of Hegel and Marx—and as one afflicted by physical frailty and the tragedies of the war—Sartre had to be well aware of the many constraints and obstacles to human freedom. But as a Cartesian, he never deviated from Descartes’s classical portrait of human consciousness as free and sharply distinct from the physical universe it inhabited. One is never free of one’s “situation,” Sartre tells us, but one is always free to “negate” that situation and to try to change it.

In his early work, Sartre follows Edmund Husserl’s phenomenology, but he distinguishes between consciousness and the self. The self, Sartre suggests, is out there “in the world, like the self of another” (*Transcendence of the Ego*). It is an ongoing project in the world, and Sartre’s existentialism is very much bound to the question of how we create that self and how we try to evade that responsibility. This preliminary defense of freedom and the separation of self and consciousness provide the framework for Sartre’s great philosophical treatise, *Being and Nothingness*.

Sartre defines his existentialist ontology of freedom in terms of the opposition of “being-in-itself” and “being-for-itself,” which in us as individuals is manifested in the tension between the fact that we always find ourselves in a particular situation defined by a body of facts that we may not have chosen—our “facticity”—and our ability to transcend that facticity, imagine, and choose—our transcendence. We may find ourselves confronting certain facts—poor health, a war, advancing age,

or being Jewish in an anti-Semitic society—but it is always up to us what to make of these and how to respond to them. We may occupy a distinctive social role as a policeman or a waiter, but we are always something more; we always transcend such positions. When we try to pretend that we are identical to our roles or the captive of our situations, however, we are in “bad faith.” It is bad faith to see ourselves as something fixed and settled, defined by a job or by “human nature.” It is also bad faith to ignore the always restrictive facts and circumstances within which all choices must be made. We are always trying to define ourselves, but we are always an “open question,” a self not yet made. Thus, Sartre tells us, we have a frustrated desire to “be God,” to be both in-itself and for-itself, defined and free.

Sartre also defines a third ontological category, which he calls “being-for-others.” Our knowledge of others is not inferred, for example, by some argument by analogy, from the behavior of others. Our experience of other people is first of all the experience of being looked at, not spectatorship or curiosity. Someone “catches us in the act,” and we define ourselves in their terms, identifying ourselves with the way we appear “for others.” We “pin down” one another in the judgments we make, and these judgments become an inescapable ingredient in our sense of ourselves.

In his *Critique of Dialectical Reason* (1958–1959), Sartre turned increasingly to politics and to a defense of Marxism in accordance with existentialist principles. He rejected the materialist determinism of Marxism, but he contended that political solidarity was the condition most conducive to authenticity. Not surprisingly, Sartre found the possibility of such solidarity in revolutionary engagement.

Simone de Beauvoir (1908–1986)

Simone de Beauvoir deserves special mention as a philosophical novelist who shared with Sartre this emphasis on freedom and responsibility for what one is and “what one makes of what is made of one.” In her *Pour une morale de l'ambiguïté* (1947; English trans. *Ethics of Ambiguity*, 1948) she spelled out the ethical implications of Sartre's philosophy. Beauvoir advanced the important thesis (shared with Merleau-Ponty) that the “ambiguity” of situations always undermines the wishful thinking that demands “right” and “wrong” answers. Beauvoir was always fascinated by her society's resistance to sensitive topics and consequently became one of the most controversial authors of the age. Beauvoir was appalled that her society, and virtually all societies, gave very little attention to the problems and inequities afflicting women. Later in life, she attacked the unsympathetic insensitivity to the inevitability of aging.

Beauvoir's most lasting contribution to philosophy and social thought was her revolutionary discussion of what it meant to be a woman. In *Le deuxième sexe* (1949; English trans. *The Second Sex*, 1953) Beauvoir initiates a discussion on the significance of gender. Hers is a powerful existentialist perspective in which gender becomes a matter of choice and imposition (being-for-others) and not a matter of mere biological facticity.

Albert Camus (1913–1960)

Camus borrowed from Heidegger the sense of being “abandoned” in the world, and he shared with Sartre the sense that the world does not give meaning to individuals. But whereas Sartre joined Heidegger in insisting that one must make meaning for oneself, Camus concluded that the world is “absurd,” a term that has (wrongly) come to represent the whole of existentialist thinking. Indeed, one of the persistent errors in the popular understanding of existentialism is to confuse its emphasis on the “meaninglessness” of the universe with an advocacy of despair or “existential angst.” Camus insists that the absurd is not license for despair.

At the outset of World War II, Camus published a novel entitled *L'étranger* (1942; first trans. in English as *The Outsider*, 1955; best known by the title *The Stranger*) and an essay called *Le Mythe de Sisyphe* (1942; English trans. *The Myth of Sisyphus*, 1955). With those two books, he became a spokesman for the new modern morality, the ability to face life in the face of “the Absurd,” a metaphysical sense of confrontation between ourselves and an “indifferent universe.” *The Myth of Sisyphus* is ostensibly a re-telling of the story of Sisyphus, who was condemned to spend all of eternity pushing a rock up a mountain, where it would then roll back down of its own weight. This is the fate of all of us, Camus suggested. We expend all of our energy pushing our weight against futility and frustration. Camus presents the question of whether life is worth living, or, put differently, whether we ought to commit suicide. Camus's Sisyphus throws himself into his meaningless project, and thereby makes it meaningful. “One must consider Sisyphus happy,” concludes Camus, and so, too, by acknowledging and throwing ourselves into the absurdity of our own lives, might we be.

The protagonist of *The Stranger*, by way of contrast, accepts the absurdity of life without much thinking about it. Is our acceptance of the absurd therefore tinged with bitterness and resentment? Camus seems torn between acceptance and defiance. Similar themes motivate *La Peste* (1947; English trans. *The Plague*, 1948) and *L'Homme révolté* (1951; English trans. *The Rebel*, 1954). In Camus's final novel, *La Chute* (1956; English trans. *The Fall*, 1957), a perverse character named Jean-Baptiste Clamence exemplifies the culmination of all of the bitterness and despair for the most part rejected by his previous characters and in his earlier essays. Clamence, like Meursault in *The Stranger*, refuses to judge people, but Clamence makes the refusal to judge a matter of philosophical principle, “for who among us is innocent?” Indeed, how can one be innocent in a world that is absurd?

Existentialism today has weathered thirty years of post-modernism and a shift of the center of philosophy from Europe to America. Enthusiasm for Kierkegaard, Nietzsche, Heidegger, and Sartre is as great as ever, and the philosophy of choice and responsibility remains the cornerstone of a great deal of American philosophy, even among those who would not recognize their debt to the existentialists.

See also Marxism; Phenomenology; Rationalism; Religion; Romanticism in Literature and Politics.

BIBLIOGRAPHY

- de Beauvoir, Simone. *The Second Sex*. Translated and edited by H. M. Parshley. New York: Knopf, 1953.
- Camus, Albert. *The Fall, and Exile and the Kingdom*. Translated by Justin O'Brien. New York: Random House, 1957.
- . *The Myth of Sisyphus and Other Essays*. Translated by Justin O'Brien. New York: Random House, 1955.
- . *The Plague*. Translated by Stuart Gilbert. New York: Knopf/Random House, 1948.
- . *The Stranger*. Translated by Matthew Ward. New York: Knopf, 1993.
- Heidegger, Martin. *Being and Time*. Translated by John Macquarrie and Edward Robinson. New York: Harper, 1962.
- Kierkegaard, Søren. *Concluding Unscientific Postscript to Philosophical Fragments*. Edited and translated by Howard V. Hong and Edna H. Hong. Princeton, N.J.: Princeton University Press, 1992.
- . *Either/Or*. Edited and translated by Howard V. Hong and Edna H. Hong. Princeton, N.J.: Princeton University Press, 1987.
- Nietzsche, Friedrich. *The Birth of Tragedy*. Translated by Douglas Smith. Oxford, England, and New York: Oxford University Press, 2000.
- . *The Gay Science: With a Prelude in Rhymes and an Appendix of Songs*. Translated by Walter Kaufmann. New York: Random House, 1974.
- . *Twilight of the Idols, or, How to Philosophize with a Hammer*. Translated by Duncan Large. Oxford, England, and New York: Oxford University Press, 1998.
- Sartre, Jean-Paul. *Being and Nothingness: an Essay on Phenomenological Ontology*. Translated by Hazel E. Barnes. New York: Philosophical Library, 1956.
- . *No Exit, and Three Other Plays*. Translated by S. Gilbert and L. Abel. New York: Vintage Books, 1956.
- Solomon, Robert C. *From Hegel to Existentialism*. New York: Oxford University Press, 1987.

Robert C. Solomon

EXPERIMENT. This entry traces the life of experiment from its emergence in the early seventeenth century to its transformation to a collective activity after World War II. The topics discussed include the rise of experimental philosophy and its institutional expression in the new scientific societies of the seventeenth century; the spread and character of experimentation in the eighteenth century; the quest for precision and the rise of laboratories in the nineteenth century; and the emergence of a new form a collective experimental life after World War II.

The Emergence of Experiment

The birth of experiment has been the subject of considerable debate among historians of early modern science. The received view is that experimentation emerged in the seventeenth century as part of an era of radical discontinuity in the methods and practices of investigating nature. Among the natural philosophers who developed and practiced experimentation, some of the most eminent were Francis Bacon (1561–1626), Galileo Galilei (1564–1642), Robert Boyle (1627–1691), and Isaac Newton (1642–1727). There have been challenges to this

view, most notably by A. C. Crombie, who suggested in the early 1950s that the experimental method originated in the late medieval period. In the thirteenth and fourteenth centuries medieval scholars reflected in a systematic fashion on experiment as a method for the acquisition of natural knowledge. Furthermore, experiments had been performed, mostly in the context of mathematical sciences such as optics, well before the seventeenth century. Other historians have pointed out that experimentation had a prehistory in craft traditions and in occult practices, such as alchemy and natural magic. The practical skills of craftsmen and artisans and the experimental practices of alchemists contributed significantly to the emergence of experimental science in the seventeenth century.

It remains the case, however, that *systematic* and *extensive* attempts to understand and manipulate nature by means of experiment did not take place before the seventeenth century. Before the scientific revolution, the dominant means of acquiring information about the natural world was unaided observation. That was in line with Aristotelian natural philosophy, which attributed a prominent epistemological role to quotidian (common, everyday) experience. In the seventeenth century that role was gradually taken over by experiment—the active “interrogation” of nature—which was carried out by intervening in nature’s workings and by manipulating its forces. In the process, unaided observation gave way to observation by means of instruments (such as the barometer, thermometer, air pump, and microscope), which enabled natural philosophers to measure and explore nature under controlled and, sometimes, artificial conditions. Those instruments considerably extended the range of phenomena that was accessible to the senses.

Two Experimental Traditions: Classical and Baconian

To understand the rise of experiment, it would be helpful to recall a significant distinction, drawn by Thomas S. Kuhn, between two different traditions in the development of the sciences. The first tradition, the classical sciences (mathematics, astronomy, harmonics, optics, and statics), had been well developed since antiquity. Those sciences were radically transformed in the sixteenth and seventeenth centuries. In that transformation, however, experimentation played a minor role. The second tradition, the Baconian sciences that emerged in the seventeenth century, investigated electric, magnetic, chemical, and heat phenomena. Experimentation was instrumental in the emergence and development of this tradition.

Furthermore, the mode of experimentation was different in the two traditions. In the classical tradition experiments were guided by theory, involved idealization, and were, often, not clearly distinguished from thought experiments. Their outcomes were presented in the form of universal, lawlike generalizations. In the Baconian tradition, on the other hand, experiments had an exploratory character and were carried out with an eye to the local, contingent conditions that gave rise to the observed phenomena. Detailed circumstantial information about those phenomena was included in the written reports of the experiments, whose aim was to establish particular “matters of fact.” Those phenomena were created or measured by some of the

new instruments that were invented in the seventeenth century (such as thermometers, air pumps, and electrostatic generators).

These two traditions started to merge only toward the end of the eighteenth century in France, where Pierre-Simon Laplace (1749–1827) and his followers attempted to develop mathematical theories of the phenomena investigated by the Baconian tradition.

Galileo Galilei

The extent to which Galileo did experiments has been a controversial issue. The dominant view well into the twentieth century was that Galileo was among the first “scientists” who experimented extensively and developed his theories on the basis of his experiments. In the 1930s Alexandre Koyré disputed that view and argued strenuously that Galileo’s engagement with experiment was minimal. Galileo, according to Koyré, was a Platonist philosopher, who, for the most part, did not perform real experiments and reached his theoretical conclusions relying on a priori (deductive) reasoning and thought experiments. A significant reason for Koyré’s claim was the excessive accuracy of many of the experimental results that Galileo reported in his published work.

Subsequent scholars have disputed some of Koyré’s claims. Starting in the early 1960s, Thomas B. Settle and Stillman Drake, among others, drawing on a wider range of Galileo’s manuscripts than was available to Koyré, managed to replicate several of Galileo’s experiments on motion and obtained results that were close to the ones that he reported. In the wake of these studies, a consensus has developed among Galileo scholars that he was an ingenious experimenter, who designed and carried out a variety of experiments. Furthermore, experimentation and measurement were essential to Galileo’s widely known discoveries, the law of free fall and the parabolic trajectories of projectiles. Galileo’s image as the preeminent experimental philosopher has been reinstated.

One of the problems faced by experimental philosophers was how to legitimize experimentation as a means of acquiring knowledge of nature. Common experience could function as an unproblematic foundation for natural philosophy because of its familiarity and accessibility to everyone. The novel phenomena discovered by means of experiment, on the other hand, were neither familiar nor accessible to all. Two issues had to be tackled: first, the veracity of experimental results had to be attested. Second, particular results obtained under local, contingent circumstances had to acquire the status of general truths about nature.

An instance of how Galileo attempted to address these issues is provided by his investigations of free fall, which were carried out in the early years of the seventeenth century and published many years later in his *Two New Sciences* (1638). In that work he did not provide any circumstantial information about the particular experiments he had performed with rolling balls on incline planes. Furthermore, he did not report the specific results he had obtained. Rather he gave a generic description of the experimental setup and pointed out that the

results conformed repeatedly (“a full hundred times”) to what he had anticipated.

Experimental philosophers in the Baconian tradition also faced the problem of legitimizing experiment, but they confronted it differently. This tradition is the topic of the next two sections.

The Baconian Program and Its Institutional Expression

Francis Bacon was one of the most eloquent advocates of the new experimental method. In *The New Organon* (1620), a logical treatise that was meant to supersede Aristotle’s *Organon*, he stressed the importance of inductive reasoning for the investigation of nature. Bacon argued, however, that the starting point of inductive reasoning should not be the information obtained by the unaided senses, because it is limited or even deceptive. Rather, the senses should be assisted by “instances and experiments fit and apposite” (p. 53). The knowledge thus acquired about natural phenomena would then be codified in natural or experimental “histories.” Furthermore, the point of natural knowledge was to give humans the power to intervene in natural processes for their own benefit. The understanding of nature and its manipulation were inextricably tied: “Nature to be commanded must be obeyed” (p. 39).

Another important aspect of Bacon’s program was his emphasis on the social nature of the knowledge-seeking enterprise. In his utopian *New Atlantis* (1627) he suggested that investigation of the natural world should be a collaborative pursuit, carried out in special institutions. Bacon’s vision inspired the founding of the Royal Society of London (1660) and the Académie Royale des Sciences in Paris (1666). Christiaan Huygens (1629–1695), a prominent member of the Paris Academy, contended that “the principal occupation of the Assembly and the most useful must be, in my opinion, to work in natural history somewhat in the manner suggested by” Bacon (Dear, p. 116). The primary aim of the Royal Society was also Baconian, namely the advancement of experimental knowledge. As one of its statutes reads, “The business of the Society in their Ordinary Meetings shall be to order, take account, consider, and discourse of philosophical experiments and observations” (Hall, p. 1).

Yet, the experiments that were carried out and discussed under the auspices of the Royal Society had a different aim than that envisaged by Bacon. Bacon viewed experiment as a means for discovering general truths about nature. Experimental outcomes were not just particular events, but instances of universal generalizations. The kind of experimentation practiced in the Royal Society, on the other hand, aimed at establishing particular facts. The presentations of experiments that were published in *The Philosophical Transactions of the Royal Society* were written in a specific manner, containing detailed and circumstantial information about the experiments in question. The point of this rhetorical strategy was to create the illusion of “virtual witnessing” and thereby persuade the intended audience of the veracity of the results obtained. This fascination with particular “matters of fact” is evident in the work of Robert Boyle.

The Boyle–Hobbes Dispute

Boyle was among the more eminent followers of the Baconian program. Many of the issues and difficulties faced by that program can be seen in his controversy with the philosopher Thomas Hobbes (1588–1679) over the character of knowledge in natural philosophy. For Boyle knowledge of nature should be descriptive and based on consensus. The aim of experimental inquiry had to be the establishment of matters of fact and not the discovery of their underlying causes. Hobbes, on the other hand, argued that knowledge should be demonstrative, causal, and necessary. Thus, the experimental production of artificial effects could not lead to true knowledge, because the inference from effect to cause is always hypothetical.

In the course of their controversy Hobbes and Boyle debated the implications of the latter's experiments with the air pump. By means of that instrument, Boyle had managed to create a vacuum. In defending his results, he claimed that his experiments were publicly performed and could be replicated at will. Hobbes disputed those claims and emphasized the artificiality of Boyle's results. Hobbes's critique was an instance of a more general skepticism toward scientific instruments, some of which created phenomena that did not exist in nature. For that reason, their legitimacy was contested. At issue was whether they revealed natural processes or produced artifacts and, thereby, distorted nature.

According to Steven Shapin and Simon Schaffer, the significance of the Boyle–Hobbes debate extended far beyond natural philosophy. Shapin and Schaffer made a fascinating case that the eventual establishment of the experimental “form of life” implicated wider social and religious issues. In particular, they argued that Boyle's experimental program was in tune with the need for order and consensus in Restoration England. The general validity of this thesis, however, is questionable. By the end of the seventeenth century the “experimental philosophy” had spread throughout continental Europe, where the social and religious conditions differed significantly from those in England.

The rise of experimental philosophy gradually undermined the identification of science with demonstratively certain knowledge. Experimental results came to be seen as only “morally” certain—that is, certain for all practical purposes. Explanatory hypotheses, on the other hand, came to be regarded as merely probable. The quest for certainty, though, was never entirely abandoned, as is testified to by Isaac Newton's work.

Newton as an Experimental Philosopher

Newton famously claimed that hypotheses are not admissible in natural philosophy. The proper method of inference was deduction from the phenomena:

whatever is not deduced from the phenomena is to be called an hypothesis; and hypotheses, whether metaphysical or physical, whether of occult qualities or mechanical, have no place in experimental philosophy. In this philosophy, particular propositions are inferred from the phenomena, and afterwards rendered general by induction. (p. 547)

As several historians and philosophers of science have pointed out, however, there was a gap between Newton's methodological pronouncements and his actual scientific work. Newton himself frequently made use of hypotheses. His various deductions from the phenomena relied on various theoretical assumptions, and thus the “deduced” propositions were not, strictly speaking, deduced from the phenomena.

Newton was a prominent member of the Royal Society, and its president from 1703 until his death. His main experimental contributions concerned the mathematical science of optics. In his experimental work Newton attempted to come up with “crucial experiments” that would enable him to choose among competing hypotheses of the phenomena under investigation. Robert Hooke (1635–1703), in his *Micrographia* (1665), coined the term *experimentum crucis*.

During the 1660s Newton carried out a series of experiments on light, using a familiar instrument, the prism. Based on those experiments, he concluded that light was a composite entity, consisting of distinct rays, whose refractive properties depended on their color. Newton reported the experiments he had carried out in a paper that was published in the *Philosophical Transactions of the Royal Society* in 1672, where he adopted the customary presentation style of the Royal Society. That paper got him involved in a prolonged controversy with Hooke, who was then the curator of experiments in the Royal Society, a controversy that lasted until 1678. Hooke did not dispute the results of Newton's experiments, which he managed to reproduce. Rather he challenged Newton's inferences from those results and, in particular, Newton's conclusions on the composition of light.

After that controversy Newton remained silent on optics until Hooke's death. He then published his experimental and theoretical investigations on light in *Opticks* (1704), a book that was written in the vernacular without the use of mathematics. In that book Newton developed a corpuscular theory of light, which encountered opposition in continental Europe. Newton took advantage of his presidency of the Royal Society and his ever-growing power to face that opposition. He directed the work of the official experimentalists of the Royal Society, Francis Hauksbee (c. 1666–1713) and John Desaguliers (1683–1744), who effectively promoted the Newtonian worldview through their experimental researches, public lecturing, and textbook writing.

The Spread of Experimental Philosophy in the Eighteenth Century

The fortunes of experimentation in the eighteenth century were closely linked with the spread of Newtonianism. *Opticks* functioned as a model of a developing experimental tradition. Prominent representatives of that tradition were the Dutch Newtonians Willem Jacob 's Gravesande (1688–1742) and Petrus van Musschenbroek (1692–1761), who wrote very influential books, whose main function was educational.

In the first half of the eighteenth century there was still no clear distinction between professional and amateur experimental philosophers. It was customary for experimentalists to

obtain part of their income by performing striking electrical or optical experiments in public. This aspect of experimentation enlarged the audience for natural philosophy. However, it annoyed some university professors, who observed with dismay that the popularity of experiments was based on their potential for entertainment.

Experimentation for most of the eighteenth century was predominantly empirical and qualitative, without systematic guidance by mathematically formulated theories. Various phenomena (electrical, thermal, and chemical) were explored experimentally, on the assumption that they were manifestations of hidden imponderable entities (electric fluids, caloric, and phlogiston, respectively). The invention of new instruments (for example, the Leyden jar), and the improvement of existing ones (such as the thermometer), played a seminal role in investigating these phenomena. Earlier in the century the acquisition of instruments was the responsibility of well-off professors of experimental physics, who collected and stored them in “physical cabinets.” In the second half of the century the task of establishing and maintaining collections of instruments was gradually taken over by universities and scientific academies.

Toward the end of the century, and especially in France, there was a shift toward the quantification of experimental physics. New quantifiable concepts were introduced, such as charge and heat capacity, which facilitated this shift and led to the construction of mathematical theories of static electricity and heat. Furthermore, precise measurements were systematically carried out and meticulously reported in numerical tables. Precision measurement gradually became a central preoccupation of experimental physics.

The Nineteenth Century

Experiment continued to be a significant driving force in the development of the physical sciences in the first half of the nineteenth century. The experimental discovery of novel phenomena (for example, electromagnetism) and the precise measurement of physical parameters (such as the mechanical equivalent of heat) were instrumental in the development of electromagnetic theory and thermodynamics. The articulation of these theories in the second half of the nineteenth century guided, in turn, the further experimental exploration of thermal and electromagnetic phenomena. In the process the mathematical and the experimental traditions of physical science merged.

By the end of the nineteenth century, precision in measurement had become almost an obsession among physicists, who believed that it held the key to the further development and eventual closure of their discipline. In the words of James Clerk Maxwell (1831–1879),

This characteristic of modern experiments—that they consist principally of measurements,—is so prominent, that the opinion seems to have got abroad, that in a few years all the great physical constants will have been approximately estimated, and that the only occupation which will then be left to men of science will be to carry on these measurements to another place of decimals. (Badash, p. 50)

Several experimental developments (such as X rays, radioactivity, the photoelectric effect, and blackbody radiation) at the end of the nineteenth century put off the end of physics. Under the weight of these and other experimentally probed phenomena, the edifice of classical physics would crumble.

The nineteenth century was also an important period for the establishment of a new physical and institutional space devoted to experimentation, the academic laboratory. With some exceptions, laboratories had previously been private places, usually located in the houses of wealthy experimentalists. In the 1870s and 1880s the founding of new university laboratories (including the Cavendish Laboratory at Cambridge, the Clarendon Laboratory at Oxford, the Jefferson Laboratory at Harvard) and new institutes (for example, the Physikalisch-Technische Reichsanstalt near Berlin) devoted to experimental research marked a new era for experimentation, which became an essential element of both research and teaching in the physical sciences.

Coda: Experimentation in the Twentieth Century

In the twentieth century perhaps the most significant break with respect to the character of experimentation came via World War II. The Manhattan Project for the development of the atomic bomb marked the beginning of experimentation on an enormous industrial scale. After the war a new form of experimental life, so-called big science, developed. Laboratories in certain areas of physics came to resemble huge factories, where hundreds, or even thousands, of scientists collaborated to design and carry out extremely expensive and time-consuming experimental projects. In these fields, tabletop experiments by a few experimentalists became a thing of the past.

See also *Empiricism; Science; Science, History of*.

BIBLIOGRAPHY

- Bacon, Francis. *The New Organon and Related Writings*. Edited by Fulton H. Anderson. New York: Macmillan, 1985.
- Badash, Lawrence. “The Completeness of Nineteenth-Century Science.” *Isis* 63 (1972): 48–58.
- Buchwald, Jed Z., and Sungook Hong. “Physics.” In *From Natural Philosophy to the Sciences: Writing the History of Nineteenth-Century Science*, edited by David Cahan, 163–195. Chicago: University of Chicago Press, 2003.
- Cohen, H. Floris. *The Scientific Revolution: A Historiographical Inquiry*. Chicago: University of Chicago Press, 1994.
- Crombie, A. C. *Robert Grosseteste and the Origins of Experimental Science, 1100–1700*. Oxford: Clarendon, 1953.
- Dear, Peter. *Revolutionizing the Sciences: European Knowledge and Its Ambitions, 1500–1700*. Princeton, N.J.: Princeton University Press, 2001.
- Galison, Peter. *How Experiments End*. Chicago: University of Chicago Press, 1987.
- . *Image and Logic: A Material Culture of Microphysics*. Chicago: University of Chicago Press, 1997.
- Gooding, David, Trevor Pinch, and Simon Schaffer, eds. *The Uses of Experiment: Studies in the Natural Sciences*. Cambridge, U.K.: Cambridge University Press, 1989.

- Hall, Marie Boas. *Promoting Experimental Learning: Experiment and the Royal Society, 1660–1727*. Cambridge, U.K.: Cambridge University Press, 1991.
- Heilbron, J. L. *Electricity in the Seventeenth and Eighteenth Centuries: A Study of Early Modern Physics*. Mineola, N.Y.: Dover, 1999.
- James, Frank A. J. L., ed. *The Development of the Laboratory: Essays on the Place of Experiment in Industrial Civilisation*. New York: American Institute of Physics, 1989.
- Kuhn, Thomas S. *The Essential Tension: Selected Studies in Scientific Tradition and Change*. Chicago: University of Chicago Press, 1977.
- Newton, Isaac. *Sir Isaac Newton's Mathematical Principles of Natural Philosophy and His System of the World*. Translated by Andrew Motte in 1729. Reprint, with translations revised by Florian Cajori, Berkeley: University of California Press, 1934.
- Peltonen, Markku, ed. *The Cambridge Companion to Bacon*. Cambridge, U.K.: Cambridge University Press, 1996.
- Price, Derek J. de Solla. *Little Science, Big Science*. New York: Columbia University Press, 1963.
- Sargent, Rose-Mary. *The Diffident Naturalist: Robert Boyle and the Philosophy of Experiment*. Chicago: University of Chicago Press, 1995.
- Shapin, Steven, and Simon Schaffer. *Leviathan and the Air-Pump: Hobbes, Boyle, and the Experimental Life*. Princeton, N.J.: Princeton University Press, 1985.
- Wise, Norton M., ed. *The Values of Precision*. Princeton, N.J.: Princeton University Press, 1995.

Theodore Arabatzis

EXPRESSIONISM. Of all the “isms” in the early twentieth century, Expressionism is one of the most elusive and difficult to define. Whereas, on the one hand, Expressionism has been said to reveal its “universal character,” abandoning all theories that imply a narrow, exclusive nationalistic attitude, on the other, it has been considered a “specific and familiar constant in German art for hundreds of years” (Vogt, p. 16). Scholarship has attempted to address the problematic range of the term and the contradictory emphases in its historiography. Although Expressionism did not constitute a cohesive movement or homogenous style, attention has been directed to the origins of the word and its meanings in critical discourse as well as to the contingent issues of art, society, and politics framing Expressionist avant-garde culture. Spurred on by an increasing overlap of the humanities with social, cultural, and gender studies, recent investigations reject notions of a transcendent *Zeitgeist* in focusing on Expressionism’s interface with the public sphere.

Expressionism in Germany flourished initially in the visual arts, encompassing the formation of Künstlergruppe Brücke (Artists’ Group Bridge) in Dresden in 1905 and the Blaue Reiter in Munich in 1911. The notion of the *Doppelbegabung*, or double talent, characterized many artists’ experimentation in the different art forms, whether lyric poetry, prose, or drama. The notable precedent for this was the music-dramas of Richard Wagner and the attendant concept of the *Gesamtkunstwerk*, which excited artists’ and writers’ interests in the union of the arts into a theatrical whole. Performed at the Wiener

Kunstschau in 1909, Oskar Kokoschka’s (1886–1980) *Mörder, Hoffnung der Frauen* (Murderer, hope of women) is considered one of the first Expressionist plays to involve a high degree of abstraction in the text, *mise en scène*, sound effects, and costume. Comparatively speaking, Reinhard Sorge’s (1892–1916) play *Der Bettler* (The beggar), written in 1910, is more discursive, though no less abstracted in relaying the metaphysical stages (*Stationen*) achieved by the chief protagonist, “the Poet” himself (Furness, in Behr and Fanning, p. 163). Hence, by 1914, the concept of Expressionism permeated German metropolitan culture at many levels, gaining momentum during World War I and in the wake of the November Revolution in 1918. However, any attempt to define Expressionism chronologically is as problematic as doing so in terms of style, since its influence was still felt in film after the holding of the first *Neue Sachlichkeit* (New Objectivity) exhibition in Mannheim in 1925.

It is telling that the kernel concept of the “expressive”—the primacy of the creative process at the expense of verisimilitude—became significant in Germany at the height of the Second Empire, corresponding to the reign of the Hohenzollern king of Prussia, Wilhelm II. The period between 1890 and 1914 was characterized by colonial expansion abroad, an unprecedented degree of urbanization and technical transformation at home, and promotion of a hide-bound national public art. Generally speaking, Expressionism grew out of late-nineteenth-century dissatisfaction with academic training and the mass spectacle of state-funded salons, the Munich (1892) and Berlin secessions (1898) withdrawing from such official or professional affiliation. In their exhibitions, the secessions fostered a sense of pluralism and internationalism, maintaining links with the art market and Paris-based Impressionism and Postimpressionism.

Within this shifting ambience between tradition and the modern, the term *Expressionisten* (Expressionists) was initially applied to a selection of French Fauvist and not German artists in the foreword to the catalog of a Berlin Secession exhibition, held in April 1911. Given the largely Impressionist leanings of the Secession, the collective term was a convenient way of signifying the “newest directions” in French art. Here the art of self-expression, or *Ausdruckskunst* as it was articulated in German, involved a degree of expressive intensification and distortion that differed from the mimetic impulse of naturalism and the Impressionist mode of capturing the fleeting nuances of the external world. This aesthetic revolt found theoretical justification in the writing of the art historian Wilhelm Worringer (1881–1965), whose published doctoral thesis *Abstraktion und Einfühlung* (1908, Abstraction and empathy) proposed that stylization, typical of Egyptian, Gothic, or Primitive art, was not the result of lack of skill (*Können*) but was propelled by an insecure psychic relationship with the external world. An impelling “will to form,” or *Kunstwollen*, underscored art historical methodology at the time (Jennings, in Donahue, p. 89).

Evidently, the label *Expressionism* was not invented by the artists themselves but abounded in the promotional literature and reviews of current exhibitions. The proliferation of

specialist journals and technological invention in publishing at the turn of the twentieth century was integral to the avant-garde's dissemination of their ideas in Expressionist literary and artistic journals, such as *Der Sturm* (Riot) and *Die Aktion*. Although the milieu encompassed a diverse political and disciplinary spectrum, commentators were united by the historical concept of *Neuzeit*, or modernity, "embodying a particular experiential pattern, in which it was the future that was the bearer of growing expectations" (Koselleck, p. 243). In their manifesto, members of the Brücke declared their independence from older established forces and called on all youth to look toward the future in searching for authentic expression. Similarly, in Wassily Kandinsky's (1866–1944) theoretical treatise *Über das Geistige in der Kunst* (1912, On the spiritual in art), he invoked the principle of "inner necessity" in postulating the evolution of art toward a utopian, transcendent form of creative expression.

Yet Expressionism was marked by a profound ambivalence toward modernity, and subject matter frequently operated between the antimonies of metropolitan alienation and the rural idyll. Both literary and artistic groups who frequented the Café des Westens in Berlin drew on the Nietzschean concept of "pathos" to convey their embrace of the dynamism of contemporary life. In emulation of the Neopathetisches Cabaret that attracted well-known poets, the painter Ludwig Meidner (1884–1966) adopted the title *Die Pathetiker* for his major group exhibition that was held in November 1912 at the Sturm Gallery. The city landscape was invested with elements of primal and cosmic destruction, comparable to the *Bild*, the word picture, which marks the Expressionist poetry of Georg Heym's (1887–1912) *Umbra vitae* (1912) or Jacob van Hoddis's (1887–1942) *Weltende* (1911, End of the world). Clearly, their utopian assumptions were compromised by a modernizing world, which was perceived as fallen and chaotic.

Kulturkritik (cultural criticism) aimed to heal this tired civilization through the reference to untainted, preindustrialized and autochthonous communal traditions. Viewed through the lens of modern French painting, the Brücke artists—Ernst Ludwig Kirchner, Karl Schmidt-Rottluff, Erich Heckel, Max Pechstein—located authenticity in old German woodcuts, African and Oceanic tribal art, which informed their carved sculpture, graphic techniques, studio interiors, and figural landscapes. In the *Blaue Reiter Almanac* (1912), the editors, Kandinsky and Franz Marc (1880–1916), interspersed essays on art, music, poetry, and theater with photographs of Russian and Bavarian folk art, African and Oceanic masks, and child art, seeking to legitimize the technical radicalism of modern painting through resonances with so-called primitive examples. As has been argued, primitivism was a permutation of agrarian romanticism. By the end of the nineteenth century the image of the European peasantry and nature had exhausted itself. "Nostalgia had now to cast its net wider and beyond rural Europe" (Lübbren, pp. 57–58).

On the eve of war, in his book *Der Expressionismus*, the art critic and newspaper feuilletonist Paul Fechter (1880–1958) invested Expressionism with the connotations of the anti-intellectual, the emotional, and the spiritual—

the "metaphysical necessity of the German people" (Fechter, p. 29). Here he drew heavily on Worringer's professorial thesis *Formprobleme der Gotik* (1911, Form in gothic), which constructed a genealogy for German artistic identity based on the anticlassical features of the Gothic past. By this time, the engendering of Impressionism as feminine, as celebrating sensory, passive experience, was well established in critical debates, and Fechter strove to inculcate a more masculine *Ausdrucksgefühl* (expressive feeling) in contemporary German art. However, the Teutonic nationalization of Expressionism was inconsistent.

Internationalism was advanced through the agencies of dealership and dispersal. The musician, writer, and dealer Herwarth Walden (1878–1941), whose Sturm Gallery was established in Berlin in 1912, displayed the works of Expressionists as well as those of Futurists and Cubists. Before and after the outbreak of war, he sent traveling exhibitions to Scandinavia, Holland, Finland, and Tokyo. As a founding member of Zurich dada, the German Poet Hugo Ball (1886–1927) provided a link between Expressionism and Dada. Ball's preoccupation with mysticism and anarchism led him to Switzerland during the war, and in a key lecture he delivered on Kandinsky (1917), he proclaimed the value of abstraction in painting, poetry, and drama to cultural regeneration.

Even in 1916, in his book *Expressionismus*, the art critic, novelist, and playwright Hermann Bahr (1863–1934) remained warmly disposed toward Picasso and French art since Manet. Bahr was writing at a time when Germany had suffered staggering reversals on the battlefield and disillusionment had set in with mechanized warfare of a kind that no one had imagined. Fiercely antitechnological and antibourgeois, he characterized the era as a "battle of the soul with the machine," articulating the desire for a prelapsarian state of innocence (p. 110). In 1917 literary Expressionism came of age with Kasimir Edschmid's (1890–1966) manifesto *Über den Expressionismus in der Literatur und die neue Dichtung*, strengthening the emphasis on *Schauen*, or "visionary experiences," rather than on *Sehen* ("observation of visual details") (Weisstein, p. 207). Given its emphasis on spiritual values, the literary critic Wolfgang Paulsen would have labeled this genuine Expressionism so as to distinguish it from Activist Expressionism, deriving from the lineage of Karl Marx. However, not all socialism ran counter to the notion of "spiritual revolution" and, according to Rhys Williams, Georg Kaiser's (1878–1945) play *Von morgens bis mitternachts* (1916, From morn to midnight) can be read as a "dramatization of [Gustav] Landauer's indictment of capitalism" and the search for the *verbindender Geist* (unifying spirit) that he advocated (Behr and Fanning, pp. 201–207).

With the Revolution of November 1918 and the collapse of the Second Reich, such intellectuals saw the opportunity for the initiation of a new society, and the link between Expressionism and revolutionary theory became more emphatic. A second generation of Expressionists emerged that, although widespread in regional centers throughout Germany, was more cohesively defined by its members' antiwar sentiments. As the son of a working-class family, the artist Conrad Felixmüller (1897–1977)

spearheaded the formation of the Dresden Secession Group in 1919 and was committed to an agenda of proletarian culture.

In Berlin, the organization Novembergruppe was founded. It called on all Expressionists, Futurists, and Cubists to unite under the banner of cultural reform and reconstruction. Although initially attracting dadaists to its ranks, the equation between Expressionism and radicalism became more difficult to sustain within the stabilization of order brought about by the Weimar government. Due to democratization and to pressure exerted by various artists' councils, Expressionism made inroads into the public sphere and was avidly collected by major museums throughout Germany. Moreover, well-known Expressionists such as Kandinsky and Paul Klee (1879–1940) were approached to teach at the Bauhaus in Weimar, founded in 1919 by the architect Walter Gropius (1883–1969). This school was based on socialist and utopian principles that placed artists at the center of a new kind of design that served modern society. Though Kandinsky sustained his belief in the expressive and mystical values of art, he abandoned the expressive abstraction of the Munich years and explored geometric formal elements in a more systematic manner.

However, the death knell of Expressionism, according to many commentators, lay in its commercialization and consequent loss of authenticity. It was considered debased in losing its soul to mass culture. In the early twenty-first century, scholars tend to regard the ability of Expressionism to adapt to the demands of technological advancement as a measure of its success. The silent film *The Cabinet of Dr. Caligari*, directed by Robert Wiene (1881–1938), was released in Berlin in 1920 and achieved resounding international acclaim. Fritz Lang's (1890–1976) *Metropolis* (1927) and Josef von Sternberg's (1894–1969) *The Blue Angel* (1930) appeared after Expressionism's demise and Georg Wilhelm Pabst's (1885–1967) *Pandora's Box* in 1928.

During the 1930s, the polarization in German politics and society led views on the left and the right to target Expressionism. From a position of exile in Moscow, the Marxist theoretician Georg Lukács (1885–1971) launched an attack in his essay "Größe und verfall des Expressionismus" (1934; Expressionism: its significance and decline, Washton-Long, pp. 313–317). Favoring a form of typified realism that was deduced from nineteenth-century literary sources, Lukács considered Expressionism the product of capitalist imperialism. According to this model, its subjectivity and irrationalism would inevitably lead to fascism. Debates ensued in the émigré literary journal *Das Wort*, the Marxist philosopher Ernst Bloch (1885–1977) vigorously defending the role of autonomous experimentation in the visual arts in his essay "Diskussion über Expressionismus" (1938; Discussing Expressionism, Washton-Long, pp. 323–327). In post-1945 historiography, critics tended to lose sight of Bloch's salvaging of the utopian and communal aspirations of Expressionism.

Interestingly, even after the Nazis assumed power in 1933, there was rivalry between the antimodernist Alfred Rosenberg (1893–1946) and the Minister of Public Enlightenment and Propaganda Joseph Goebbels (1897–1945), who considered Expressionism and the works of Emil Nolde (1867–1956) to

be uniquely German. Indeed, Goebbels's novel *Michael* adopted the declamatory style and format of the Expressionist *stationendrama* in tracing the journey of the eponymous hero from soldier to Nazi superman (1929). In 1934, Rosenberg's appointment as spiritual overseer of the National Socialist Party sealed the fate of the avant-garde. Official confiscation of works from public collections accompanied the dismissal of Expressionists, left-wing intellectuals, and Jews from prominent positions in the arts.

In 1937, moreover, the infamous exhibition "Entartete Kunst" (Degenerate art) was inaugurated in Munich, signaling the Third Reich's devastating efforts to expunge Expressionism's claim to cultural status. Expressionism underwent transformation in exile as refugee artists, writers, and filmmakers reexamined their cultural identity in light of the demands of their adoptive countries. Others were not as fortunate. Kirchner resided in Switzerland since 1917, and his frail psychological state was exacerbated by the pillaging of 639 of his works from museums and by the inclusion of thirty-two in the "Entartete Kunst" exhibition. He committed suicide in 1938. The poet Van Hoddiss, who was of Jewish origin and suffered mental disorders for many years, was transported to the Sobibor concentration camp in 1942, the exact date of his murder being unrecorded.

See also *Avant-Garde; Dada*.

BIBLIOGRAPHY

PRIMARY SOURCES

- Bahr, Hermann. *Expressionism*. Munich: Delphin, 1916. Translated by R. T. Gribble. London: Frank Henderson, 1925.
- Edschmid, Kasimir. *Über den Expressionismus in der Literatur und die neue Dichtung*. Berlin: Reiß, 1919.
- Fechter, Paul. *Der Expressionismus*. Munich: Piper, 1914.
- Goebbels, Joseph. *Michael: Ein Deutsches Schicksal in Tagebuchblättern*. Munich: Franz Eber, 1929.
- Kandinsky, Wassily, and Franz Marc, eds. *Blaue Reiter Almanac*. Munich: Piper, 1912.
- . *Complete Writings on Art*. Edited by Kenneth Lindsay and Peter Vergo. London: Faber, 1982.
- . *Über das Geistige in der Kunst*. Munich: Piper, 1912.
- Miesel, Victor, ed. *Voices of German Expressionism*. Englewood Cliffs, N.J.: Prentice-Hall, 1970.
- Paulsen, Wolfgang. *Aktivismus und Expressionismus: Eine typologische Untersuchung*. Berne and Leipzig: Gotthelf, 1935.
- Raabe, Paul, ed. *The Era of German Expressionism*. London: Calder and Boyer, 1974.
- Washton-Long, Rose-Carol, ed. *German Expressionism: Documents from the End of the Wilhelmine Empire to the Rise of National Socialism*. Berkeley: University of California Press, 1995.
- Worringer, Wilhelm. *Abstraktion und Einfühlung*. Munich: Piper, 1908. Translated by Michael Bullock. New York: International Universities Press, 1953.
- . *Formprobleme der Gotik*. Munich: Piper, 1911. Translated by Herbert Read. London: Putnam's, 1927.

SECONDARY SOURCES

- Barron, Stephanie, ed. *Degenerate Art: The Fate of the Avant-garde in Nazi Germany*. Los Angeles: Los Angeles County Museum of Art, 1991.

- . *German Expressionism, 1915–1925: The Second Generation*. Los Angeles: Los Angeles County Museum of Art, 1988.
- Barron, Stephanie, and Wolf-Dieter Dube, eds. *German Expressionism: Art and Society*. Milan: Bompiani, 1997.
- Behr, Shulamith. *Expressionism*. New York: Cambridge University Press, 1999.
- . *Women Expressionists*. New York: Rizzoli, 1988.
- Behr, Shulamith, David Fanning, and Douglas Jarman, eds. *Expressionism Reassessed*. Manchester, U.K.: Manchester University Press, 1993.
- Bridgwater, Patrick. *Poet of Expressionist Berlin: The Life and Work of Georg Heym*. London: Libris, 1991.
- Bushart, Magdalena. “Changing Times, Changing Styles: Wilhelm Worringer and the Art of His Epoch.” In *Invisible Cathedrals: The Expressionist Art History of Wilhelm Worringer*, edited by Neil H. Donahue, 69–85. University Park: Pennsylvania State University Press, 1995.
- Furness, Raymond. “The Religious Element in Expressionist Theatre.” In *Expressionism Reassessed*, edited by Shulamith Behr and David Fanning, 163–173.
- Gordon, Donald E. “On the Origin of the Word ‘Expressionism.’” *Journal of the Warburg and Courtauld Institute* 29 (1966): 368–385.
- Jennings, Michael. “Against Expressionism: Materialism and Social Theory in Worringer’s *Abstraction and Empathy*.” In *Invisible Cathedrals: The Expressionist Art History of Wilhelm Worringer*, edited by Neil H. Donahue, 87–104. University Park: Pennsylvania State University Press, 1995.
- Koselleck, Reinhart. *Futures Past: On the Semantics of Historical Time*. Translated by Keith Tribe. Cambridge, Mass.: MIT Press, 1985.
- Lloyd, Jill. *German Expressionism: Primitivism and Modernity*. New Haven, Conn.: Yale University Press, 1991.
- Lübbren, Nina. *Rural Artists’ Colonies in Europe, 1870–1910*. Manchester, U.K.: Manchester University Press, 2001.
- Manheim, Ron. “Expressionismus—Zur Entstehung eines kunsthistorischen Stil—und Periodenbegriffes.” *Zeitschrift für Kunstgeschichte* 49, no. 1 (1986): 73–91.
- Perkins, Geoffrey. *Contemporary Theory of Expressionism*. Frankfurt am Main: Peter Lang, 1974.
- Rumold, Rainer, and O. K. Werckmeister, eds. *The Ideological Crisis of Expressionism: The Literary and Artistic War Colony in Belgium, 1914–1918*. Columbia, S.C.: Camden House, 1990.
- Vogt, Paul. “Introduction.” *Expressionism: A German Intuition, 1905–1920*. New York: Solomon R. Guggenheim Museum, 1980.
- Weinstein, Joan. *The End of Expressionism (Art and the November Revolution in Germany, 1918–19)*. Chicago: University of Chicago Press, 1990.
- Weinstein, Ulrich. “Expressionism in Literature.” In *Dictionary of the History of Ideas*, edited by Philip P. Wiener. Vol. 2. New York: Charles Scribner’s Sons, 1973.
- Werenskiold, Marit. *The Concept of Expressionism: Origin and Metamorphoses*. Oslo: Universitetsforlaget, 1984.
- Williams, Rhys. “Culture and Anarchy in Expressionist Drama.” In *Expressionism Reassessed*, edited by Shulamith Behr, David Fanning, and Douglas Jarman, 201–212. New York: Manchester University Press.

Shulamith Behr

EXTINCTION. See **Environment; Evolution; Nature.**

EXTIRPATION. The term *extirpation* is most commonly associated with the Catholic Church’s project to eradicate traditional religious practices in the Americas after the Spanish conquest. The Andean highlands, Mesoamerica, and other areas of high indigenous cultural development have rich religious traditions that predate the Spanish conquest by millennia. Ending these practices became an early and determined goal of European missionary efforts in the Americas and in a sense was an extension of the wars of conquest. In 1571, Philip II decided to exclude Indians from the Spanish Inquisition because of their poor understanding of the Catholic faith. Although never as institutionalized as the Holy Office of the Inquisition, which sought to wipe out heretical thought from the Iberian population in both Europe and the New World, campaigns for the “extirpation of idolatries” emerged out of the same context of religious intolerance and visited similar consequences of pain and suffering on the target populations. In a sense, as some scholars have observed, these extirpation campaigns were a bastard child of the Inquisition. “The systematic visitations, interrogations, torture, punishments, and exiles,” Mills notes, “represent perhaps the most sustained religious persecution of indigenous peoples in the history of colonial Latin America” (p. 170). Organized legal campaigns that recorded native beliefs and traditions with the goal of exterminating “diabolical deceptions” took place primarily in the viceroyalty of Peru, but similar attitudes influenced Spanish actions toward native religions throughout the Americas. These attempts were never completely successful, and indigenous and African religious practices continue to thrive in the Americas in the early twenty-first century.

Francisco de Avila was one of the earliest and most noted leaders in attempts to suppress indigenous religions. Avila oversaw the drafting of a document known as the *Huarochiri Manuscript* to use as a tool in his prosecution of religious practices that he considered to be diabolical. Avila pursued his extirpation of native idolatries with an usual religious zeal, probably as a revenge against local villagers who had accused him of economic exploitation and violations of moral standards of behavior. In 1609 Avila began to grandstand his cause, engaging in show trials designed to procure public confessions of idolatry while undermining his enemies. His success led to even more aggressive and repressive campaigns to destroy Andean religions, similar to what would happen later in North America with the Salem witch trials in the 1600s and the McCarthy hearings in the 1950s. Ideological deviance alone cannot explain the fury with which such campaigns are carried out. The extirpations advanced the reputation and career of Avila along with the colleagues who joined him, as well as economically benefitting the campaigners because Spanish law rewarded them with the confiscated wealth from these pagan deities. While the veracity of charges in the extirpation campaigns is questionable, they clearly built on existing ideological constructions and played off local social conflicts.

Written in the Andean Quechua language, the *Huarochiri Manuscript* records traditional practices with the goal of ex-

terminating them while at the same time, ironically, preserving a historical memory of these beliefs. Trial records provide rich ethnographic data that document indigenous cultures. In the Andes, traditional religious practices revolved around a reverence for deities known as *huacas*. Rooted in the practice of ancestor worship, *huacas* were often local physical markers such as a tree, stone, or cave from which inhabitants believed their ancestors emerged. In general, *huacas* were material objects or sometimes even humans that were assigned supernatural attributes. Particularly objectionable to the Spanish was the tradition of preserving the bodies of dead family members and parading these mummies during religious ceremonies. Worshipping these objects provided a mechanism for mediating societal controls.

Avila's extirpation campaigns illustrate the similarities and differences between Spanish crusades against native religions and the function of the Inquisition. Both used judicial tools and a repressive apparatus to root out native religious deviance. Trials typically culminated in an auto-da-fé, with the destruction of offending objects and the punishment of the convicted. Unlike the Inquisition, however, extirpation campaigns never became institutionalized. Attempts to root out idolatries came and went according to the interests of local church leaders, and a lack of support from central authorities would lead to the collapse of an extirpation campaign. Furthermore, charges of idolatry often became a cover for local conflicts. While the Inquisition provided checks against the testimony of personal enemies that might undermine the legitimacy of a conviction, extirpation trials thrived on local conflicts in order to extract compromising information.

Extirpation campaigns did not end with Avila's persecutions but, rather, continued sporadically throughout the colonial period, occasionally reaching points of extreme repression in attempts to reform the lives and practices of indigenous peoples. These campaigns, which are sometimes referred to as an "Inquisition for Indians" (Mills, p. 171), have been divided into three periods: 1609 to 1621, 1625 to 1626, and 1646 to 1670. The irregular appearance of these campaigns leads Griffiths to conclude that they were aberrations, not a commonplace phenomenon in colonial Latin America. In the final period, which Griffiths considers to be the zenith of the campaigns, Archbishop Pedro de Villagómez sent prosecutors to extract origin stories from native provincial elites outside Lima. These campaigns often targeted the most vulnerable subjects and were not above using torture and blackmail to extract confessions. Native priests in particular were targeted. Victims were whipped, exiled, or even executed, and ancestor-cult mummies and other religious artifacts were burned.

Villagómez declared his efforts successful, and the extirpation campaigns slowed and became less vicious. In their final stages, the Catholic Church considered *huaca* worship to be simple acts of superstition that could be more easily tolerated than idolatry. The Spanish and native worlds appeared to be finally coming to an accommodation with each other. Mills challenges standard interpretations that contend that this development represents a victory of extirpation campaigns and a passive acceptance on the part of indigenous peoples of the

European religion. It represented more of a change in terminology than attitude. Traditional practices persisted, and as a result, occasional prosecutions continued to the mid-1700s. By the end of the colonial period, extirpation campaigns had finally sputtered out without the ideological drive and passion of earlier efforts.

In New Spain, these campaigns became even more localized and less rooted in institutional structures. Without active leadership, the viceroyalty never experienced the waves of religious repression that swept through Peru. Rather than large-scale extirpation campaigns, anti-idolatry programs became "an ongoing struggle, engaged in on a day-to-day basis by individual missionaries, with the support of the military garrison" (Warner, p. 171). Idolatry became a very vague and shifting concept that served different purposes at various times. "No systematic test for idolatry ever existed," Tavárez notes and because of this, "an act of idolatry could only be committed by native subjects who were *willing* to confess to someone" (pp. 135, 136). Intent became a key part of the extirpation campaigns. As Chuchiak observes, "the term idolatry can be understood as expressing the shared realities of a religiously bifurcated region of the colonial world" (p. 167). Practitioners tended to hide their activities by camouflaging them as Catholic rituals. As a result, indigenous conversion to European religious practices was superficial at best. Often the two religions coexisted in a syncretic mixture.

The story of the Virgin of Guadalupe in Mexico is the most noted example of a syncretic religion, and reflects the failure and even co-optation of attempts at religious extirpation. In this event, the Virgin Mary allegedly appeared to Juan Diego in 1531 at the Tepeyac Hill just north of the recently conquered Aztec capital of Tenochtitlan. The local bishop finally believed the Indian shepherd when the virgin's image was miraculously imprinted on his cloak. Scholars have noted how anachronisms, inconsistencies, internal difficulties, and the European structure of the story cast doubt on its veracity. Not only does the Indian have a Spanish name, but "Guadalupe," a dark-skinned virgin from Spain, is an Arabic word that would be difficult for a Nahuatl-speaker to pronounce. The cult appears to be a Spanish fabrication to redirect Indian "idolatry" from a "pagan" to a Christian focus. In fact, during the Spanish conquest it had become a common practice to construct Spanish temples on top of Indian pilgrimage sites. Although the intent of these efforts was the extirpation of idolatrous practices, the result was somewhat different, as the Virgin of Guadalupe became a symbol of cultural pride in Mexico. She has also been seen as a defender of the Indians and was successfully used as a symbol of liberation during campaigns for Mexican independence, during the Mexican Revolution, and among Hispanic civil rights struggles in the United States.

As the Virgin of Guadalupe indicates, there is some question as to the lasting impact and legacy of extirpation campaigns. "Andean beliefs and practices survived because they changed and were adapted to colonial realities," Mills argues, "and because people assimilated Christian terms, ideas, rituals, and explanations into an expanding religious framework" (p. 4). In attempting to eradicate "demonic" religious practices, the Spanish

EXTIRPATION

forced adaptations that allowed indigenous religious to survive and also led to modifications of the Spanish religion. Even the structure and approach of the Inquisition had to be adapted to the native world in the form of the extirpation campaigns. What theologically should have been a stark opposition instead became a space for negotiated adaptations. Catholicism continued to be the dominant religion in Latin America, but it assumed a flavor strongly influenced by native and even African religious practices. The failure of the extirpation campaigns highlights the partial, contradictory, and incomplete nature of the Spanish conquest of the Americas.

See also **Colonialism; Genocide; Syncretism.**

BIBLIOGRAPHY

- Chuchiak, John F., IV. "Toward a Regional Definition of Idolatry: Reexamining Idolatry Trials in the 'Relaciones de Méritos' and Their Role in Defining the Concept of 'Idolatria' in Colonial Yucatán, 1570–1780." *Journal of Early Modern History* 6, no. 2 (May 2002): 140–167.
- Griffiths, Nicholas. *The Cross and the Serpent: Religious Repression and Resurgence in Colonial Peru*. Norman: University of Oklahoma Press, 1996.
- Mills, Kenneth. *Idolatry and Its Enemies: Colonial Andean Religion and Extirpation, 1640–1750*. Princeton, N.J.: Princeton University Press, 1997.
- Poole, Stafford. *Our Lady of Guadalupe: The Origins and Sources of a Mexican National Symbol, 1531–1797*. Tucson: University of Arizona Press, 1995.
- Salomon, Frank, and George L. Urioste, eds. *The Huarochiri Manuscript: A Testament of Ancient and Colonial Andean Religion*. Austin: University of Texas Press, 1991.
- Tavárez, David E. "Idolatry as an Ontological Question: Native Consciousness and Juridical Proof in Colonial Mexico." *Journal of Early Modern History* 6, no. 2 (May 2002): 114–139.
- Warner, Rick. "'Ambivalent Conversions' in Nayarit: Shifting Views of Idolatry." *Journal of Early Modern History* 6, no. 2 (May 2002): 168–184.

Marc Becker



F

FALLACY, LOGICAL. A logical fallacy is a mistake in reasoning. The premises of good arguments support the conclusion, so that in the case of deductive arguments, if the premises are true, the conclusion must also be true. In the case of inductive arguments, true premises make the conclusion more likely. Deductively valid argument forms can be defined as those in which true premises never lead to a false conclusion, no matter what content is presented in that form. In logic, arguments and argument forms are studied and a system of rules is created to systematically distinguish between valid and invalid arguments. Invalid argument types that appear frequently and that seem to be especially deceptive have been categorized and given names. The study of logic and the naming of logical fallacies began with Aristotle (384–322 B.C.E.), and standard Latin names of fallacies have been inherited from the Middle Ages, so “logical fallacy” is not a concept that has changed much with time. However, the teaching of logical fallacies has been revived with the popularity of courses entitled “critical thinking” rather than “logic” in order to highlight their emphasis on natural language and informal fallacies, rather than on formal logical systems.

Formal Fallacies

It is standard practice to distinguish formal and informal fallacies. Formal fallacies break one or more of the rules of a system of logic and can be seen when an argument is presented in either schematic form or in a natural language. Informal fallacies, by contrast, can often only be seen when the argument is presented in natural language, since they depend often on ambiguity or some other misuse of language. Other common fallacies that do not clearly break a rule of logic are also classified as informal, even when they do not depend on misuse of language.

In traditional Aristotelian logic, a set of rules can be established for the formation of valid arguments. Because breaking any one of the rules results in an invalid argument, there is a logical fallacy corresponding to each rule. Examples of such fallacies include excluded middle, illicit major, illicit minor, etc. One important formal logical fallacy is affirming the consequent, which can be given schematically as an argument of the form “If *P*, then *Q*. *Q*. Therefore, *P*.” The logic of conditional statements has been thought to be essential to the testing of scientific theories, since predictions are written in conditional form. A fact such as “Water freezes at 32° F” can be written as the conditional “If (pure) water is below 32° F, then it will freeze.” However, as Karl Popper (1902–1994) emphasized, one cannot claim to prove anything if one obtains a

positive result, and indeed would be committing the formal logical fallacy of affirming the consequent if this reasoning is used to support one’s claim. Suppose someone had claimed that they have a magic box that freezes water, and that water always freezes when it is put into the box. One should not be impressed if this prediction comes true, not even if this experiment is repeated multiple times. What is needed is a way of isolating the different factors that may be relevant to the change of state that water undergoes—is it being in the box, or being in the dark, or being in the cold that is the crucial factor? This problem of scientific reasoning is highlighted by the fallacy of affirming the consequent. A conditional statement can properly be rejected if a negative result is obtained, but nothing can be concluded deductively from a positive result.

Informal Fallacies

The multitude of names given to informal fallacies can be more confusing than helpful, but nevertheless, the names of logical fallacies are important terms of art in any kind of argumentative writing or speech. Informal logical fallacies can be classified in different ways, but it is common to put them into groups such as fallacies of relevance, weak induction, ambiguity, and presumption.

Fallacies of relevance. Slippery slope, red herring, and straw person are fallacies that change the issue under discussion to something that is easier to attack. An ad hominem argument attacks the person, rather than the issue. The fact that someone is untrustworthy, for example, does not guarantee that the conclusion of their argument is wrong or that their argument is invalid. The question of whether or not such information is relevant can, however, be rather subtle, because a person’s trustworthiness would legitimately lead to questioning what they say. “Tu quoque” means “you too” and is a fallacious argument used in a debating situation to try to undermine the criticism of an opponent, but without actually presenting evidence in one’s own defense. Appeal to the popularity of an idea (*ad populum*), to force, and to pity are further examples of arguments that present irrelevant evidence and draw attention away from the issue being debated.

Fallacies of weak induction. Premises may present relevant information without justifying the claim made in the conclusion. A hasty generalization, for example, makes use of either too few cases or unrepresentative cases to make a broad claim. An appeal to ignorance attempts to justify a positive claim by rejecting the evidence on the other side as insufficient. To say, for example, that there is no intelligent life except on Earth,

because there is no evidence of such life, is too strong a claim. However, the burden of proof is generally on those who make a positive claim, so it would be legitimate to say that there is no reason to believe in extraterrestrial intelligence. Appeal to authority is also a fallacy of weak induction. Although people constantly rely on information given to them by others, the opinions of experts alone are insufficient to justify a controversial opinion. Experts must have some reasons by which they were convinced of their beliefs and these should be communicated to others.

Fallacies of ambiguity. The fallacy of equivocation describes an argument in which a word is used in two different senses. Such an argument can be thought of as formally invalid, but since only subtle changes of meaning are misleading, this fallacy is considered to be informal. Amphiboly is the name given to an argument that relies on ambiguity, but involving the grammar of the sentence rather than the meaning of an individual word. Composition and division are a pair of fallacies, in which an illicit inference is made from the properties of individuals in a class to the class itself, or from the class to the individuals. No one would be taken in by an argument that the concept “mammal” must be hairy because all mammals are hairy, but arguments that have seemed very compelling to many people may be of the same form. For example, some versions of the argument from design argue that the order and purpose found in every object in the universe implies that the universe as a whole has a purpose and a designer.

Fallacies of presumption. Using the conclusion of the argument as a premise or otherwise assuming what is being claimed in the conclusion is called “begging the question.” Circular reasoning appears to be formally valid, since the conclusion really does follow from the premises (*P*, therefore *P*). However, if it is assumed that *P* is controversial and therefore requires some kind of justification, it is clear that a circular argument will not advance the discussion. “That begs the question” is a phrase that is changing its meaning, at least in colloquial usage, to simply mean “that raises the question.” This dubious usage loses any connection to the idea of logical fallacy, since the phrase is no longer being used to evaluate an argument. Begging the question is usually classified as an informal fallacy because it relies on tricking the reader into not noticing that the subject of controversy is being assumed.

See also *Logic; Rhetoric*.

BIBLIOGRAPHY

- Aristotle. *Aristotle on Fallacies; or, the Sophistici Elenchi*. Translated by Edward Poste. New York: Garland, 1987.
- Copi, Irving M. *Introduction to Logic*. New York: Macmillan, 1994.
- Fearnside, W. Ward. *Fallacy: The Counterfeit of Argument*. Englewood Cliffs, N.J.: Prentice-Hall, 1959.
- Hurley, Patrick J. *A Concise Introduction to Logic*. Belmont, Calif.: Wadsworth, 1997.

David J. Stump

FALSIFIABILITY. Karl Popper (1902–1994) made falsifiability the key to his philosophy of science. It became the most commonly invoked “criterion of demarcation” of science from nonscience.

According to the simple, hypothetico-deductive (H-D) model of scientific inquiry, a law claim, theory, or hypothesis *H* is falsifiable when a potentially checkable prediction *O* can be logically deduced from it, that is, when $H \rightarrow O$. If *O* is observed to be true, then *H* passes this predictive test (although it may fail other tests). If *O* tests false, then *H* must also be false, since no true statement can logically imply a falsehood. For example, Isaac Newton’s (1642–1727) theory of gravitation predicts a slow rotation of the orbit of the planet Mercury different from what astronomers observe. Thus Newton’s theory is not only falsifiable (empirically vulnerable) but also actually falsified (shown to be false). Albert Einstein’s (1879–1955) general theory of relativity is subject to the same test, so it, too, is falsifiable; but it passes the test. “All life in the universe employs the same genetic coding found on Earth” is falsifiable in principle but not in current practice, since to date (2004) we have identified no examples of extraterrestrial life. By contrast, “The universe is recreated at each instant by a divine being” yields no predictive tests at all, so it is not falsifiable even in principle.

Note that *falsifiable* does not mean “falsified” or “false” any more than *breakable* means “broken.” On the simple model, even if, *per impossibile*, an empirical law could be known to be absolutely true in our universe, it would still be falsifiable in the sense that it would be empirically testable and would test false were the world relevantly different. A falsifiable claim rules out some potentially observable situations; and the more it excludes, the greater is its empirical content, that is, the more it claims about the structure of our universe.

Popper’s Emphasis on Falsifiability

Falsifiable contrasts with *verifiable*. A claim is empirically verifiable if possible observation statements logically imply the truth of the claim. If actual observation statements do imply the claim, then it is verified. “This raven is black” verifies “There are black ravens.” During the 1930s the logical empiricists of the Vienna Circle proposed verifiability both as a criterion of demarcation of science from nonscience and a criterion of meaning. Their idea was that a statement is meaningful if and only if verifiable in principle, and its meaning is given by its method of verification. For the logical empiricists, only empirically verifiable claims make genuine assertions about the world and are, in this broad sense, scientific. All other claims (metaphysical, religious, ethical, etc.) are cognitively meaningless. In his *Logik der Forschung* (1934; *Logic of Scientific Discovery*), Popper replied by rejecting the logical empiricists’ concern with language and meaning and by noting that verifiability as a criterion of demarcation excludes scientific law claims and thus the core of science itself. For since a law claim is universal in scope (in simplest form, “All *As* everywhere and everywhen are *Bs*”), it cannot possibly be verified: there are always actual or potential instances beyond those so far observed. Yet a universal claim can be falsified by a single negative instance. The first observed black swan refuted

the claim “All swans are white.” (Law claims of statistical-probabilistic forms are more problematic.) Based on this logical asymmetry of verification and falsification, Popper proposed falsifiability as a criterion of demarcation of science from nonscience, although not as a criterion of meaning. According to Popper, nonscience includes pseudoscience (e.g., Freudian psychology and Marxism) and metaphysics, the one fraudulent, the other sometimes providing a valuable heuristic for science. Many deep scientific problems have their roots in metaphysics, but to be scientific, a claim must take an empirical risk. Moreover, falsifiability, as the ongoing risk of falsification in *our* world, is a permanent status for Popper. No amount of successful testing can establish a hypothesis as absolutely true or even probable: it forever remains conjectural. That all scientific theories remain falsifiable entails fallibilism, the view that our best epistemic efforts remain open to future revision. There can be no certain foundations to knowledge.

Popper’s falsifiability doctrine lies at the heart of his empiricist epistemology and scientific methodology of “conjectures and refutations.” The latter, he claims, shows how it is possible to learn from experience without induction from the facts. Previously, empiricism had been equated with inductivism. Popper attacked as question-begging the view that we must arrive at our ideas by induction, that is, by first gathering masses of facts and then gradually detecting regular patterns in them—letting nature speak for herself. Rather, said Popper, we first propose a conjecture to solve a problem, then test the conjecture by trying to falsify it. It is the conjecture that tells us which observations are even relevant. Contrary to the inductivists, it does not matter where our ideas come from, only how we test them. There is no logic of discovery, only a logic of testing.

Since law claims can be falsified but not verified, Popper concluded that the way to truth is indirect, by elimination of falsehood. Hence, error, in the sense of faulty hypotheses, is not a bad thing. On the contrary, it is necessary to scientific progress. “We learn from our mistakes.” This is Popper’s more extreme form of the nineteenth-century idea that science is a fallible but self-correcting enterprise. Since bold hypotheses that yield novel predictions are risky and hence easier to test, Popper urged boldness. He explicitly forbade, as a form of intellectual dishonesty, ad hoc tinkering to save a hypothesis from falsification. Popper spoke of degrees of falsifiability and attempted, with limited success, to measure both simplicity and the empirical content of a claim (how much it says about the world) in terms of its degree of falsifiability.

Complications of the Simple Model

Many scientists, administrators, and the legal community take falsifiability seriously as a criterion of demarcation of science from nonscience. But other scientists and science-studies experts consider falsifiability a heuristic rule of thumb at best, not a rigid requirement. Among the difficulties facing Popper’s conception are these: In most scientific research, a hypothesis is tested against a competitor (often the “null hypothesis”) rather than in isolation. The test typically discloses the comparative fit of the two hypotheses to the data rather than the outright falsity of one of them. The history of science discloses

many cases in which a claim is not immediately falsifiable by known methods, yet the claim remained important to scientific investigation and later became testable. In the nineteenth century, August Comte (1798–1857) notoriously announced that we could never know which chemical elements were present in the Sun, yet only a few years later new spectrographic techniques revealed this information, including the existence of a hitherto unknown element, dubbed helium. In 1931 Wolfgang Pauli (1900–1958) postulated the existence of the neutrino, a chargeless and presumably massless particle that scarcely interacted with ordinary matter and was hence undetectable by any known means. Yet this turned out to be one of the more fruitful ideas of twentieth-century physics, and various kinds of neutrino are now detectable. By the end of the twentieth century, science-studies disciplines were characterizing science in terms of its practices rather than simply in terms of the logical status of its claims.

Furthermore, Popper himself admitted that absolute logical falsification, and hence absolute falsifiability, are impossible in scientific practice, since the allegedly refuting observations can never be known with certainty. Since observations themselves are not statements and can have no logical relations to statements, Popper held that observation statements (roughly, data) are accepted by convention. Moreover, they are theory-laden; there is no such thing as pure observation. Although Popper never employed falsifiability as a criterion of meaningfulness, attempting to formulate the falsifiability requirement with logical precision runs afoul of the same sorts of difficulties faced by the logical empiricists with their verifiability theory of meaning.

A specific difficulty, raised already by Pierre Duhem (1861–1916) and extended by Willard Van Orman Quine (1908–2000), is that, in isolation, universal claims yield no specific predictions. By itself, the hypothesis H , “All A s are B s,” implies no testable prediction, not only because of its logical form but also because A and B will be typically abstract, theoretical terms. To generate predictions from hypothesis H , we must conjoin H with one or more auxiliary premises, A_1, \dots, A_n . So the simple H - D model of the testing situation must be replaced by a more complex logical model: $(H \ \& \ A_1 \ \& \ \dots \ \& \ A_n) \rightarrow O$, where “&” means the logical “and.” If prediction O is false, logic now tells us that at least one of the conjoined premises was mistaken, but not which one(s). Logic permits us to blame the failure on an auxiliary assumption rather than on H . In his influential article “Two Dogmas of Empiricism,” Quine parlayed the Duhem problem into a controversial argument for holism: “our statements about the external world face the tribunal of sense experience not individually but only as a corporate body.” We do not test scientific claims individually against nature but instead adjust our entire “web of belief” to fit our experience. Critics reply that deductive logic does not exhaust the distinctions licensed by scientific practice. Quineans forget that experiments are *designed* to test specific components of a theory or model, that an experiment designed to test H will rarely test the auxiliary assumptions as well (Sober). Furthermore, the relation of observation to theory is typically more complex than even the Duhem model, which remains deductive rather than probabilistic. Typically, several levels of data processing and theoretical modeling occur between theory and observation.

Thomas Kuhn (1922–1996), a leading opponent of H-D models of science, famously argued that Popper’s falsificationist methodology fails to fit the history of physical science. In *The Structure of Scientific Revolutions* (1962), Kuhn advanced an alternative conception of physical science, according to which normal scientific work is highly constrained by “paradigms,” the central tenets of which are immune from serious criticism and competition and hence unfalsifiable in practice. Only when a paradigm breaks down do we find the kind of critical and revolutionary ferment that Popper advocated for all scientific work. Moreover, much of normal science consists of tinkering of just the sort that the Popperians considered ad hoc. Subsequently, Popper’s former student Imre Lakatos distinguished several kinds of falsificationist methodology, from simple to sophisticated. Attempting a compromise between Popper and Kuhn, he analyzed science in terms of competing research programs involving entire series of not-always-successful theories rather than individual theories in isolation. Predictive failure does not directly and immediately falsify a research program.

Finally, Larry Laudan deplores the ritual invocation of Popper’s “toothless” falsifiability criterion in legal proceedings (such as the 1981–1982 creationism trial, *McLean v. Arkansas*) to distinguish good science from pseudoscience. Traditionally, the term *science* demarcated a body of established truths or scientifically warranted assertions, whereas falsifiability requires only empirical testability. For example, so-called Creation Science is false and hence falsifiable. By Popper’s standard it is scientific—and so is the statement that the Earth is flat! A useful concept for certain purposes, falsifiability, by itself, fails as the hallmark of good science sought by the legal and political community.

See also *Empiricism; Paradigm; Positivism; Science; Science, History of.*

BIBLIOGRAPHY

- Cartwright, Nancy. *The Dappled World: A Study of the Boundaries of Science*. Cambridge, U.K.: Cambridge University Press, 1999.
- Lakatos, Imre, and Alan Musgrave, eds. *Criticism and the Growth of Knowledge*. Cambridge, U.K.: Cambridge University Press, 1970.
- Laudan, Larry. *Beyond Positivism and Relativism: Theory, Method, and Evidence*. Boulder, Colo.: Westview, 1996.
- Popper, Karl. *Conjectures and Refutations: The Growth of Scientific Knowledge*. New York: Basic Books, 1962.
- . *The Logic of Scientific Discovery*. New York: Basic Books, 1959. Popper’s expanded translation of his *Logik der Forschung*, 1934.
- Quine, Willard Van Orman. “Two Dogmas of Empiricism.” Reprinted in his *From a Logical Point of View: Logico-Philosophical Essays*. Cambridge, Mass.: Harvard University Press, 1953, pp. 20–46.
- Sober, Elliott. “Testability.” *Proceedings and Addresses of the American Philosophical Association* 73 (1999): 47–76.
- Worrall, John. “Falsification, Rationality, and the Duhem Problem.” In *Philosophical Problems of the Internal and External Worlds*, edited by John Earman et al., 329–370. Pittsburgh: University of Pittsburgh Press, 1993.

Thomas Nickles

FAMILY.

This entry includes two subentries:

Modernist Anthropological Theory
Family in Anthropology since 1980

MODERNIST ANTHROPOLOGICAL THEORY

Although anthropology has devoted a great deal of attention to families, anthropologists do not generally speak of studying the *family*, a word whose meaning varies so much throughout history and around the world that it may be said to have no objective or transcultural meaning whatsoever. Many of the families that anthropologists and historians study bear little resemblance to the nuclear family portrayed in American mass culture. There are the enormous, rigidly hierarchicalized patrilineal families of pre-revolutionary China, which bound together ranked sets of wives, sons, and servants under the control of a senior male; the gender-segregated villages of twentieth-century Amazonian South America, where men might well consider “home” to be the central men’s house where they live for years at a time, rather than the smaller residences occupied by their wives, children, and dogs; the “bands” of foraging societies like the Ju/’hoansi (ZHUN-twasi) of southern Africa, with their flexible membership and fluid boundaries; or the “houses” of some gay prostitutes in the urban United States, where senior transvestites rename themselves “Mother” and take in younger boys off the streets, offering them a new kind of family to replace the biological kin who disowned them. Furthermore, this confounding word, *family*, is made even more slippery by the great burden of quite specific emotional, symbolic, and pragmatic meanings with which people invest it: it is the opposite of a value-neutral descriptive term.

In their efforts to bring some analytical rigor to the study of this confusing but important concept, anthropologists have come to speak not of “the family” but of “kinship,” a larger, more inclusive category that can refer to any and all of the ways in which we find or forge relationships between ourselves and others, although it is usually confined to those relationships that are at least metaphorically connected to coresidence and/or reproduction. The study of kinship was long a mainstay of anthropology, and dominated the field during the heyday of modernist anthropology; indeed, so central is it to the discipline’s identity that the decline of interest in kinship studies during the latter decades of the twentieth century was seen by many as an indication that anthropology itself was about to disappear. By the same token, the emergence of a revitalized but vastly changed form of kinship studies at century’s end seemed to indicate that anthropology, too, would continue to reinvent itself to fit the changing circumstances of the twenty-first century.

The history of kinship studies is a contentious one, filled with lively debates and sudden changes in direction that make distinguishing three clearly distinguishable phases relatively easy, although some underlying intellectual trends do not conform to these neat temporal divisions. Broadly speaking, there was an early phase dominated by evolutionary theories; an early-

to mid-twentieth-century period of modernist anthropology—the true heyday of kinship studies; and a final, heterogeneous period of change and reformulation, spurred first by feminist and later by gay and lesbian anthropology, as well as by intellectual movements that refocused attention away from underlying structures and toward the practices of everyday life, and the interplay of biology, technology, and society. The focus here is primarily on the first two of these phases, but the emphasis is on those aspects of early kinship studies that are most relevant to contemporary anthropological thought about the family.

The Family in Early Social Evolutionary Theory

The origins of the academic discipline of anthropology—and of the study of kinship—can be found in the writings of nineteenth-century European and European-American intellectuals, men who constructed grand comparative schemes designed to clarify the relationship between their own societies and those of the colonized peoples of Africa, Asia, and the Americas, a relationship that most of these scholars understood as intrinsically hierarchical, with Western Europe representing the pinnacle of human cultural achievement and racial superiority. A countervailing strain of romantic primitivism within this same intellectual tradition found in simpler societies a purity later contaminated by modernity, but even these more favorable interpretations of what were imagined to be our “primitive” forebears did not challenge the notion that all human societies, and all of human history, could be placed within a single evolutionary framework. These writers too often melded an entirely hypothetical history of early human life—and of the family—with anecdotal evidence from contemporary societies deemed to be primitive, or not yet fully “evolved,” creating a matrix in which geographical distance from Western metropolitan life was equated with temporal distance from modernity.

Twentieth-century social scientists would reject such speculative histories, and later anticolonialist writers would excoriate the scientific racism that undergirded their construction. Nevertheless, the quest for a single human history, and for an overarching theory that explained the coexistence at a single moment in time of societies that differed enormously in their scale and organization, inspired much of the foundational thinking of twentieth-century social science, including that of Karl Marx (1818–1883), Sigmund Freud (1856–1939), Émile Durkheim (1858–1917), and Max Weber (1864–1920). And while most of the social sciences and humanities have rejected these evolutionary schemas, they retain a fascination outside of academia, where notions of primitive matriarchies and shamanic tribal religions continue to have romantic appeal. Within academia, too, hypothetical early histories of the family continue to find a place among evolutionary psychologists, who find evidence of long-vanished primitive sexual and reproductive customs in the foibles of contemporary urban-dwellers.

In the nineteenth century, along with the evolution of religious thought from animism to polytheism to monotheism, the purported evolution of the family was a central theme for intellectuals interested in social history, who typically proposed a tripartite development of family life from an earliest phase, that of the promiscuous horde, through matriarchy to patriarchy. Perhaps best exemplified in the Swiss scholar J. J. Bachofen’s

(1815–1887) *Das Mutterrecht* (1861; *Mother Right*), this narrative imagines humans beginning their social existence with a sexual life barely distinct from bestiality, in which an undifferentiated group mated indiscriminately, producing children without distinct social identities. Women, finding this form of life abhorrent, then initiated a social revolution, in which they introduced religious worship and the family, the latter centered on the bond between a mother and her children. This was, however, an incomplete revolution, with human potential still to be finally realized by a second transformation, led by men, in which matriarchy was converted to patriarchy, primitive earth religions to monotheism, and the role of motherhood and of the family confined to an interior, domestic life, while the larger social sphere became the world of politics and, ultimately, of the state, understood to be the domain of men.

Bachofen’s writings were very influential at the time, but the writer whose work would endure into the twentieth century was the American lawyer Lewis Henry Morgan (1818–1881); the sharply bifurcated history of Morgan’s influence on later scholars exemplifies a fundamental conflict in kinship studies between historical materialism and structural functionalism. Morgan’s master narrative of social evolution, *Ancient Society* (1877), with its detailed framework of evolutionary stages extending from “savagery” through “barbarism” to “civilization,” was clearly his most significant contribution to nineteenth-century intellectual life. Two significant attributes of this work are its materialist orientation, in which basic technological and economic developments such as fishing or farming were seen as causal factors that determined the shape of social life, and an underlying moral interpretation of human history that was far more ambivalent about progress and civilization than most of his social-evolutionary peers.

This combination of a materialist slant and a critical stance toward contemporary capitalist society made Morgan’s work an inspiration to two German intellectuals, Karl Marx and Friedrich Engels (1820–1895). After Marx’s death, Engels found among his papers detailed notes on *Ancient Society*, and used them to write his own tome on world history, *The Origin of the Family, Private Property and the State* (1884). This book, although it follows the same sort of evolutionary scheme as many others, and despite its clear debt to Morgan, differs radically from its sources in its insistence that the evolution of the family can best be seen as the development of an institution dedicated to the oppression of women. Its other enduring contribution is its clear articulation of an idea also found in Bachofen and Morgan: that far from being a universal, unchanging institution that predates the development of complex social structures such as capitalism or the state, the family is a structure that takes radically different forms within different political economies or modes of production. Recapitulating the stages of evolution described by Morgan, Engels emphasizes the fundamental differences between “barbaric” social forms such as the ancient Roman family—a structure of domination rooted in a slave-holding economy, in which the paterfamilias exerted absolute control over slaves, wives, and children—and “civilized” nineteenth-century forms of marriage as found among the bourgeoisie, for whom the management of assets mattered intensely, and among the proletariat, whose lack of inheritable

property freed women and men to marry for love. In each case, the fundamental economic organization of the class or society in question determined not only the shape of the family itself, but individual access to such fundamental human rights as control over sexual access or the right to have children.

Although Engels's evolutionary scheme would remain central to the development of anthropology within the Soviet Union and would, in turn, influence Third World scholars within the Soviet sphere, intellectual history in Western Europe and the United States soon took a new turn that sidelined Engels's insights, and evolutionary social theory in general, for several decades. Within the newly emergent paradigm of what would later be called modernist anthropology, Morgan would still have an important role to play as a founding figure in the study of kinship, but only through a sharply limited and partial reading of his work designed to excise all that Marx had found most stimulating about it.

The Modernist Study of Kinship

Twentieth-century anthropology was founded on a total rejection of what had come before. Instead of pseudohistory and pseudoscience, this new social science would be based on a rigorous empiricism that would examine social groups as they are, in the present, with an emphasis on the functionality of existing social structures and institutions. Taking as a basic premise that all living humans share the same intellectual and moral capacities, scholars such as Franz Boas (1858–1942) in America, or E. E. Evans-Pritchard (1902–1973) in England, regarded all human cultural laws as based on rational principles, regardless of the race of a society's members, the alien nature of their customs, or the simplicity of their material culture. The evolutionary thinking of the past was declared anathema, but an exception was made for Lewis Henry Morgan because in his work was to be found the germ of the new scientific study of kinship. Morgan, an American, differed from his European contemporaries in one important respect: as a young man in upstate New York, he had done actual empirical research among the Seneca, one of the Iroquois nations, with the assistance of an astute Iroquois intellectual named Ely Parker (1828–1895). If Morgan's *Ancient Society* was now to be consigned to the dustbin, his publications on Iroquois kinship terminology—the first to accurately record the kinship nomenclature found within a unilineal descent system—became the subject of exhaustive study. This new approach to reading Morgan, with its emphasis on the elucidation of principles of descent through a close analysis of the language of kinship terms and relations, exemplified the modernist theory of culture, which envisioned the latter as a complex system of rules and rites. Although field-workers would collect a great deal of evidence about everyday work practices in the ensuing decades, this evidence would be valued primarily for what it could reveal about underlying structures and principles, which were taken to be the real focus and goal of ethnographic research. And for all its liberal championing of human equality and of non-European cultures, a fundamental conservatism would drive this new anthropology. Engels's emphasis on the family as an institution that could support multiple inequities, from the oppression of women to the sexual abuse of slaves, would completely van-

ish, replaced by a Durkheimian emphasis on social cohesiveness and the stability of institutions. The study of everyday practice, of social inequality, and of the deployment of power would have to wait for a different era.

These new structural-functionalist anthropologists, as they came to be called, were still deeply interested in comparative ethnology, but now, instead of an evolutionary paradigm, unprejudiced comparisons would be made based on the discovery of similar structural patterns between different societies. In the small-scale, non-Western, and premodern societies that were the focus of much anthropological work, economic, political, and religious life was organized among kin, so that these underlying structural principles were especially to be found through study of the rules of kinship.

Reading the work of the structural-functionalists in the early twenty-first century, a curious dichotomy emerges. On the one hand, this intellectual paradigm freed scholars to study non-Western societies with as few presuppositions as possible, and stimulated an enormous amount of excellent research on native peoples throughout the world. Once-obscure places and peoples—the Andaman Islands, the Trobriands, the Nuer, the Azande—were made famous in anthropological circles. The rules of non-Western kinship became ever clearer, as did the fact that, while other peoples did not share Western assumptions about family and society, every society had social rules that provided systems of etiquette, standards of morality, and a way to ensure continuity over time. Anthropologists elucidated three key structural elements that constituted any given kinship system: descent, residence, and marriage. Descent systems included unilineal structures, such as patriliney and matriliney, and bilateral systems like those in most of the United States. Residence might be uxorilocal (meaning that the new family lives in the wife's family's home), virilocal (the family lives in the husband's family's home), or neolocal (the couple moves to their own home). Marriage might be monogamous or polygamous. Some of the findings challenged Western ideas more than others. E. E. Evans-Pritchard, in his study of the North African Nuer, found that a vast network of segmentary lineages could take the place of the state, allowing thousands of people to live together without an overarching centralized political authority. Bronislaw Malinowski (1884–1942), like Morgan before him, studied a matrilineal people, for whom the role of the father was far different, and much less important, than in European society. Instead, it was the mother's brother, the adult male who came from the mother's lineage, who represented authority, discipline, and an ideal of adulthood for young males, a fact that led Malinowski to challenge Freud's ideas about the Oedipus complex. Pointing out that young men within matrilineal societies channel their hostility toward their mother's brothers, rather than their own fathers, he posited that competition over the right to claim political authority, rather than sexual tension, underlies the resentment that growing boys feel toward adult men within their family circle. This use of the cross-cultural record to challenge assumptions about human universals would become the hallmark of twentieth-century anthropology, as seen in the later arguments of Margaret Mead (1901–1978) about adolescence.

But if structural-functionalists were engaged in documenting the diversity of forms of family to be found in global societies, at the same time they oddly insisted on the supposed universality of a certain basic family form, hidden within the apparent diversity of polygyny and polyandry, lineage and clan, band and tribe. Whether these (mostly) male scholars were motivated to insist on the universality of women's status as wife and mother by a desire to oppose feminist movements within their own society would later become the subject of some debate, as would, more recently, the question of whether they also suppressed or downplayed evidence of homosexuality in other societies. What is clear is that the claim of a biologically determined basic family structure was critically important for the modernist anthropologists as a refutation of the evolutionists' claim that the human family had not always been the same, and it is difficult, given the intellectual climate of the Cold War, not to see a certain political utility in this hostility toward a body of theory so closely associated with Marxist intellectual history.

A. R. Radcliffe-Brown (1881–1955), a founding father of functionalist kinship studies, saw an unchanging natural “substratum” beneath the whole edifice of social structure, which he called the “elementary family.” In 1969 Meyer Fortes began an important lecture in honor of Morgan with an oblique reminder that the “momentous importance” of the scientific study of kinship lies in its special insight into the basis of human social life. The implication was made explicit in 1973 when John Barnes in turn introduced a tribute to Meyer Fortes by flatly stating that kinship is the aspect of human culture with the closest links to the natural world. All of these statements spring from an underlying assumption that the structures of kinship and culture are built on a natural foundation: the biological link of physiological reproduction that connects mother and child. As Malinowski stated, in the domain of kinship, above all others, physiology creates purely cultural institutions.

Malinowski placed greater emphasis on the biological underpinnings of culture than his peers, for whom the elementary or natural family, because of its ahistorical, essential nature, was unimportant. What really mattered, because it was the locus of cultural creativity, was what Meyer Fortes called the “jural dimension” (1969): the social edifice constructed on this natural base. Underlying this distinction is a theory of procreation—and of gender—succinctly summarized in John Barnes's (1973) equation “genetrix:genitor::nature:culture.” Roger Keesing elaborates:

Humans everywhere observe the same processes of sex and reproduction. A female has sexual intercourse. . . . Once she is pregnant, it is ultimately obvious that she is, and that the infant is connected to her by the most physical of bonds—by the umbilical cord, by childbirth, by the milk of her breasts. But the connection of the one or several men who had intercourse with the mother . . . to the process of pregnancy and childbirth is far from obvious . . . [creating] a gulf between ‘social’ and ‘physical’ kinship, or between pater [the legitimate social father] and genitor [the presumed physical begetter of the child]. (1975, pp. 11–12)

The diversity of kinship forms that anthropology celebrated, then, with the implication that humans are free to invent their own societies as they will, is here invested with a strict gender segregation: while creativity and historicity are granted to males, females remain rooted in a biological reality that precludes them from becoming fully cultural actors or agents of history. Men may invent many forms of social fatherhood, as Malinowski had documented, but women must always be simply mothers. That the actual data gathered by these anthropologists contained ample evidence to contradict this assertion, such as the multiple cases in which people insisted on calling other women “mother” within their kinship network, such as their mother's sisters or father's or brother's wives, and the prevalence of socially constructed forms of motherhood completely divorced from biological reproduction, such as the “Mother Superior” of a convent, did not seem to matter.

With the rise of feminist anthropology in the 1970s, these assumptions would come under rigorous scrutiny and produce vigorous debates. A precursor to these events was the turn that kinship studies took toward a still greater emphasis on the symbolic realm, and even further away from Malinowski's emphasis on the family's role in fulfilling basic physiological needs. The two figures most prominently associated with this move are the great French philosopher–anthropologist Claude Lévi-Strauss (b. 1908), and the American cultural anthropologist David Schneider (1918–1995). While their work did not directly address questions of gender—and Lévi-Strauss, in particular, was seen by many later anthropologists to be antifeminist—it is in their writings that feminist scholars would find the inspiration for a new form of kinship studies in which the agency of women, both as mothers and on their own terms, would be front and center.

Lévi-Strauss's *Les structures élémentaires de la parenté* (1967; *The Elementary Structures of Kinship*, 1969), the great masterpiece of modernist kinship studies, rests on the insights of previous scholars from Durkheim to Radcliffe-Brown. Durkheim had early recognized the significance of the incest taboo as a foundational law that created the social fabric by forcing people out of their natal families and into alliances with other groups. Radcliffe-Brown had emphasized the social-structural and juridical aspects of marriage, such as the exchanges of gifts between kinspeople in Africa, which served to sever women from their natal kin and bind them to their husband's family, and he had insisted that kinship “results from the recognition of a social relationship between parents and children, which is not the same thing as the physical relation, and may or may not coincide with it” (1967, p. 4), and that the primary purpose of the institution of marriage was as a “social arrangement by which a child is given a legitimate position in the society” (p. 5). In other words, it organized descent more than it facilitated union. Lévi-Strauss took these themes and built from them a single Hegelian (Georg Wilhelm Friedrich Hegel [1770–1831]) principle of social organization in which the opposition between descent and alliance is continually forced, through the operation of the incest taboo, to create new, synthetic social units. Consanguinity (social relationships based in the parent–child link) and affinity (social relationships based

in marriage, such as between husband and wife, or son-in-law and father-in-law) thus joins the set of great, foundational oppositions out of which each human society then constructs its own unique cultural pattern, along with life and death, youth and age, masculinity and femininity. Like Radcliffe-Brown, he saw marriage, not from the point of view of the actual spouses, but as a system of exchange between descent groups compelled by the incest taboo to give away some of their kin to other groups in order to gain spouses and, thereby, children. This emphasis on exchange—of persons, and of the flow of gifts that surrounds this central transfer—is a direct outgrowth of the Durkheimian tradition, and especially of Marcel Mauss's (1872–1950) *The Gift*. And, like Radcliffe-Brown, Lévi-Strauss envisioned this exchange not in gender-neutral terms, but specifically as an exchange of women by men.

Where Lévi-Strauss departs from previous authors is in his more direct engagement with the question of what is natural and what is cultural, and his insistence that this contrast is itself part of culture: the very idea of nature, he argued, is itself “an artificial creation of culture” (1969, p. xxix). Similarly, he states in the book's conclusions that, while kinship reshapes “biological relationships and natural sentiments,” it is ultimately a completely social product; it is, in fact, “the social state itself” (1969, p. 490). The text is contradictory on this point: he is sometimes even more explicit than previous modernist anthropologists in defining consanguinity and descent as produced by, and symbolic of, physical reproduction and, thus, as something that appears to be part of the natural sphere, in contrast to the purely social structure of alliances between kin groups created through the exchange of women. Unlike his predecessors, however, he insists that the incest taboo does not derive from natural law, but is a purely cultural invention, and is, in fact, the prototypical form of all cultural rules. Similarly, his understanding of the position of women within the system is more nuanced than that of his predecessors: while he assumes the existence of an apparently universal patriarchal ideology, implicit in symbol and language, that posits women as objects rather than subjects, he nevertheless famously asserted that, whatever meaning may be given to “women in general” within a particular symbolic system, each woman is always, in actual fact, “a person . . . a generator of signs . . . never purely what is spoken about,” but also one who speaks (1969, p. xx).

In the twenty-first century, it is difficult to remember how deeply and widely influential Lévi-Strauss was in Europe and the United States, both inside anthropology and beyond. His work on kinship spurred a wide range of new research, and his compelling, but ambiguous, arguments about nature, culture, and gender stimulated tremendous debate within the emerging field of feminist anthropology. The path-breaking text, *Woman, Culture, and Society* (1974, Rosaldo and Lamphere), contained two influential articles that, in very different ways, engaged his arguments. One was Sherry Ortner's “Is Female to Male as Nature is to Culture?,” in which she used Simone de Beauvoir's reading of Lévi-Strauss to assert that women's reproductive lives condemned them to be seen forever as closer to nature than men. In response, Carol P. MacCormack and Marilyn Strathern produced an edited volume of their own, *Nature, Gender, and Culture* (1980), in which each

author used Lévi-Straussian analysis to demonstrate the quite distinct workings of the nature:culture and female:male oppositions within various cultural settings. Their goal was both to disprove Ortner and to reclaim structural analysis for feminist ends. Strathern would go on to produce a dazzling series of influential analyses of kinship and gender in which traditional modernist anthropology and feminist theory are brought to bear on one another, culminating in a series of publications about postmodern Britain in which she uses the example of new reproductive technologies and their rearrangement of conventional categories of kinship to argue that the nature:culture dichotomy has finally disappeared, and with it the modernist era in which Lévi-Strauss was so dominant a figure.

David Schneider, while couching his argument in less lofty philosophical terms than Lévi-Strauss, would eventually take an even stronger position against biologicistic interpretations of kinship. More so than other authors, he would provide inspiration to an entire generation of feminist anthropologists, many of them his students, to reinvent kinship studies yet again. Schneider attacked the biological assumptions that underlay conventional kinship studies directly, arguing forcefully that they derived from the folk beliefs of European-American kinship itself, rather than from any scientific basis, and that the rules of kinship, like those of culture itself, should be seen as a purely symbolic system in which any aspect of the natural world or physiological processes could become centrally meaningful. The great importance that kinship theorists had placed on the biological links between a birth mother and her child, and their insistence that these were of a different order than other kinds of relationships, had more to do with the culturally specific beliefs from the anthropologists' own culture, such as “blood being thicker than water,” than with the structures of meaning they found within other societies.

One trajectory in kinship studies in the modernist period, then, was away from biologicistic and toward increasingly symbolic analyses of the underlying rules that govern descent and alliance. In these discussions, the dichotomy between nature and culture, and debates about gender, became ever more salient. Feminists saw—and were quick to condemn—clear continuities between the assumptions about the opposition between the “elementary” family and the larger social world, and Bachofen's earlier notion that progress was achieved when women were confined to the domestic sphere, safely under men's control. Discussion of the opposition between public and private spheres, and whether this existed within all societies, thus also became part of the debate over the nature of the family, and the role of women within it. This particular argument, like early feminist social science in general, was also influenced by another important trend in American academia during the latter part of the twentieth century: the reemergence of Marx and Engels.

Marxism reentered American anthropology from a number of directions outside of kinship studies: the growing politicization of American society in the wake of the Vietnam war, and a renewed interest in evolutionary theory, now linked to the newly emerging field of ecological anthropology and to

intellectual developments within archaeology. Once the door was open, younger, mostly women anthropologists began reading Engels, and found there the focus on inequality and the oppression of women that they found missing in twentieth-century anthropology. Eleanor Leacock, Karen Sacks, and Richard Lee are among the many American scholars who reintroduced Engels's assumption that the form of the family, even at its most fundamental level, differs radically from society to society. An especially lively debate arose over whether, or to what degree, women had greater equality within the small-scale, egalitarian societies of foragers where "family" and "society" were coterminous, rather than separated into public and private domains. Another productive area of research was whether, as Engels had posited, the rise of the state coincided with a loss in female autonomy and power. A third, more theoretical question dealt with the relationship between production and reproduction.

One of the most stimulating sets of ideas was introduced by Gayle Rubin in her essay on "The Traffic in Women," which also appeared in *Woman, Culture, and Society*, and which brought together Lévi-Strauss and Marx in a single, breathtaking argument. Bringing Marxian questions about inequality and feminist interests in gender and sexuality to bear on conventional kinship studies, she extended the notion of the incest taboo into the very creation of gender itself, which she named "the taboo against sameness." As Lévi-Strauss had done with the incest taboo and with the idea of nature itself, Rubin assumed that the difference between women and men was itself a product of culture, rather than nature, despite its apparent naturalness. This argument presaged the later development of gay and lesbian anthropology and of queer theory, fields in which Rubin would continue to play an important role.

As the end of the twentieth century approached, modernist anthropology began to lose its appeal, and with it the study of kinship as conventionally defined. Marx and Lévi-Strauss, key intellectual figures in the 1970s and 1980s, began to fade from view, replaced in the 1990s by Pierre-Félix Bourdieu (1930–2002), Michel Foucault (1926–1984), and Judith Butler (b. 1956), as structuralism was replaced by a poststructuralist and postmodernist emphasis on the practices of everyday life, and analyses of inequality by a diffuse notion of power. With the publication of his private diaries, with their controversial racial language, Malinowski would become the object of scornful critique by writers who wished to "decolonize" anthropology, just as the modernist anthropologists had rejected nineteenth-century evolutionism. In general, many of the classics of British and American structural-functionalism would cease to be much read by younger anthropologists. Conventional kinship studies, with their emphasis on rules, structures, and terminology, their avoidance of questions about power relations within the family, and their insistence on an "elementary" set of essential, biologically determined relations at the heart of every kinship system, would become a thing of the past. But new questions—about the reshaping of kinship by new reproductive technologies; about the relationship between biological and social reproduction; and above all, about gender and sexuality—would bring younger anthropologists back to the study of the family, and would also find them bringing to

bear some of the same techniques and theoretical insights utilized by the modernist and even the evolutionary anthropologists of the past.

See also Anthropology; Equality; Gender Equality; Gender; Gender Studies; Anthropology; Kinship; Marriage and Fertility; European Views; Matriarchy; Motherhood and Maternity; Property; Sexuality; Society; Work.

BIBLIOGRAPHY

- Carsten, Janet. *Cultures of Relatedness*. New York: Cambridge University Press, 2000.
- Goody, Jack. *The Development of the Family and Marriage in Europe*. Cambridge, U.K.: Cambridge University Press, 1983.
- Fortes, Meyer. *The Web of Kinship among the Tallensi*. London: Oxford University Press, 1949.
- , ed. *Marriage in Tribal Societies*. Cambridge, U.K.: Cambridge University Press, 1962.
- Fortes, Meyer, and E. E. Evans-Pritchard, eds. *African Political Systems*. London: Oxford University Press, 1940.
- Keesing, Roger M. *Kin Groups and Social Structure*. New York: Holt, Rinehart and Winston, 1975.
- Lévi-Strauss, Claude. *The Elementary Structures of Kinship*. Translated from the French by James Harle Bell, John Richard von Sturmer, and Rodney Needham, editor. Boston: Beacon Press, 1969.
- MacCormack, Carol, and Marilyn Strathern, eds. *Nature, Culture, and Gender*. Cambridge, U.K.: Cambridge University Press, 1980.
- Morgan, Lewis Henry. *Systems of Consanguinity and Affinity of the Human Family*. Washington, D.C.: Smithsonian Institution, 1870.
- Parkin, Robert, and Linda Stone. *Kinship and Family: An Anthropological Reader*. Malden, Mass.: Blackwell, 2004.
- Rosaldo, Michelle, and Louise Lamphere, eds. *Woman, Culture, and Society*. Stanford, CA: Stanford University Press, 1974.
- Schneider, David. *American Kinship: A Cultural Account*. Englewood Cliffs, N.J.: Prentice-Hall, 1968.
- . *A Critique of the Study of Kinship*. Ann Arbor: University of Michigan Press, 1984.
- Weston, Kath. *Families We Choose: Lesbians, Gays, Kinship*. New York: Columbia University Press, 1991.

Mary J. Weismantel

FAMILY IN ANTHROPOLOGY SINCE 1980

Until the last decades of the twentieth century, anthropological definitions of the family were heavily influenced by largely unexamined Western cultural assumptions about biology and its relationship to kinship. Indeed, disentangling the history of family studies from kinship studies in anthropology is very difficult because, among researchers, kinship early on became the basis for understanding family. In an effort to make cross-cultural comparisons meaningful, anthropologists concerned themselves with attempting to find a universal definition of the "family"—one that could be used across time and place. Family was distinguished from household, with "family" most often defined as a group composed of individuals who share some genetic connection—expressed most obviously in the nurturing of children—and having jural rights to property,

especially land. In practice, the first part of this definition resulted in a tendency for researchers to place women at the emotional and reproductive centers of the family, while the second part served to place men, through whom inheritance usually occurred, in the jural and productive center. "Household" referred to individuals sharing residential space, domestic resources, and usually productive tasks but who may not share a genetic connection. It was argued that households were distinct from families but sociologically important because households reflect the structural linkages between kinship reckoning and social groups. However, it is in the family (not the household) where the necessary reproductive activities of childbearing and child rearing take place, and it was "the family" that was frequently imbued with certain affective or emotional orientations. At its extreme, the core unit of a family was defined by Ward Goodenough as primarily composed of a mother and her children but as potentially including others who are vaguely defined as "functionally significant" (Yanagisako, p. 164).

The late 1970s marked a turning point in anthropology for studies of the family. Invigorated by new ideas from both within and outside the academy, this was a time when old, embedded assumptions about the universality of the family and its sociological purposes were debated and ultimately discarded. Especially in American anthropology, the new approaches to the study of the family were influenced by two intersecting currents. First, some scholars were concerned with contributing to the debates about the possible social changes to the family brought about by the American feminist movement. At the time there was much public discussion about the potential dangers of the inevitable decline of the "American family," which opponents of the feminist movement claimed would necessarily accompany changes in women's social roles. Using cross-cultural evidence, feminist anthropologists such as Jane Collier, Michelle Rosaldo, and Sylvia Yanagisako sought to expose the unsupported assumptions that guided popular and academic discourses concerning the "ideal" composition and configuration of the family. The second intellectual influence was a discipline-wide shift in the orientation of social theory writ large. Anthropologists were moving away from the almost century-long pursuit of identifying "types" and defining human universals—necessarily etic categories—toward more nuanced analyses of cultural meanings and their relationships to particular social forms and processes.

New Directions for Family Studies

By far the most important anthropological work concerning the family to emerge in the 1970s was Yanagisako's comprehensive article "Family and Household: The Analysis of Domestic Groups" (1979). This review of almost a century of anthropological work exposed the problematic assumptions that guided studies on the family, and it set an agenda for further study. It is important to understand Yanagisako's critiques in detail as they were central in establishing theoretical approaches to the family for the next twenty years. Yanagisako grouped previous studies into two types: those concerned with identifying similarities in cross-cultural family types and household formation; and those that took a more developmental perspective focused on the evolution of particular family types over time. She found both types of studies lacking.

Yanagisako critiqued family studies that sought to identify cross-cultural universals on several fronts. First, she argued against static definitions of the family. In particular she posited that definitions that focused on the genealogical composition of a family, and especially those that reduced it to the mother-child "core," did not reflect reality but rather the Western intellectual tendency to draw unsupported parallels between the biological/natural world and the sociological. While the mother-child dyad is clearly essential for biological reproduction, cross-cultural evidence indicates that it is not the only possibility for social reproduction. Similar biological constraints do not necessarily create similar ideological or moral orientations. Not only did it become apparent that mothers do not have the same role in child rearing across cultures, but it was also clear that the nurturing of children is not done exclusively by mothers. Hence the mother-child core of the family is revealed to be only an idealized Western construct, not an ethnographic truth. Indeed, the concern for debunking the tenacious idea about the universal nature of mothering continued to be explored throughout the 1980s by scholars working in multiple disciplines. Anthropological critiques were influenced by feminist scholars outside of anthropology including Sara Ruddick and Nancy Chodorow, who refuted assumptions about the "natural" and immutable qualities of maternal love and attachment and, by extension, the universal significance of a mother's role in the family.

Second, Yanagisako argued that many family studies placed too much emphasis on categorizing families into immutable types such as nuclear, joint extended, and so on. These types were determined by examining the intersection of genealogical connections and residence patterns. In addition to limiting the possibilities for family configuration to etically generated categories, this practice serves to obscure meaningful differences that may be inherent within typologies. Families that look the same structurally (joint extended, for example) may in fact behave very differently in practice, and those differences may be extremely important. Unfortunately, differences become obscured under the weight of homogenizing stereotypes about how families of any given configuration should ideally function.

The effort to categorize families into types also contributed to the second group of studies that Yanagisako critiqued, the ones oriented toward understanding the development of particular types. In particular she argued that identifying a limited range of family forms serves to reinforce (increasingly) questionable ideas about cultural evolution. The logic of the evolutionary argument is as follows. If family "types" could be shown to have consistent associations with particular subsistence strategies—the nuclear family with industrialization, the joint extended with agriculture, and so on—then family formation could be seen as an adaptation to subsistence. Hence the direction of change in family forms could even be predicted over time.

However, as Yanagisako pointed out, the problems with these studies are numerous. First, the family as a social institution, and individuals as members of them, become divested of all agency and dynamism in this model. Possibilities for both inter- and intrafamilial differences disappear. Second, the

relationships between families and larger social structures and forms becomes mechanistic and unidirectional—as subsistence forms change, families will necessarily change in particular and predictable ways. Nuclear families “naturally” evolve to meet the needs of industrial capitalism, and so forth (for a critique of this idea, see Moore). Obviously this type of thinking leaves the door open for the labeling of some family “types” as abnormal when they do not mirror the established, adaptive norm. For example, as Carol Stack describes, the black, matrifocal family in America was often portrayed as deviant because it differed from the nuclear family norm. Stack, however, never fully moves away from an adaptive framework as she argues in *All Our Kin* (1974) that the matrifocal family is an adaptation to American poverty.

Finally, the focus on families as self-contained units operating in particular ecological settings denies the connections and relationships that all families have with larger social institutions and formations, including the state. Indeed, both the reification of the mother-child core bond and the focus on households as self-contained economic units serves to reinforce the mistaken notion that the domestic or private realms (in other words, families and households) exist outside of and independent from the public sphere.

In an attempt to set out an agenda for new studies of the family, Yanagisako urged researchers to move away from trying to delineate forms (and universal definitions) toward an analysis that is sensitive to the myriad activities and diverse meanings created within and by families. Mirroring David Schneider’s groundbreaking work on kinship, she argued that families are “symbolic” systems laden with multiple and complex meanings. These meanings are important not only for understanding the domestic domain but because they can lead to greater understanding of broader cultural themes. Yanagisako also borrowed from gender studies, especially the work of Rosaldo, and urged a rethinking of the public (male)/private (female) split so often seen in family studies. Researchers should explore not only how women may operate in the public domain but how their domestic activities and roles impact the political. Finally, Yanagisako urged researchers to put the analysis of the family in a broader, more comprehensive framework. In particular, studies ought to include a consideration of the impacts that inequality (both societal and intrafamilial) have on family configuration and meaning and how relations of production and inequality affect domestic groups. Rather than necessarily viewing families as statically functional or adaptive institutions, intrafamilial dynamics should be explored, including tensions over the distribution of power and resources. The family should be viewed as a historically situated and dialectically responsive “ideological” unit composed of individual actors, not as a concrete thing that can be tacitly defined and described.

Putting Theory into Practice: Family Studies of the 1980s and Early 1990s

As noted above, prior to the 1980s, discussions of the family in anthropology were almost exclusively linked to larger studies of kinship, a topic that held a central position in anthropological analyses from the inception of the discipline. Kinship

studies, which suffered under similar, if not harsher, critiques as the ones for family studies, fell somewhat out of favor in the 1980s. However, that does not mean that work on the family had been abandoned. In fact, it could be argued that it was reinvigorated by its repositioning. Discussion of the family now appeared to take a more central role in social analysis in part because of its very close linkages to the important emerging theme of gender. Ethnographies were increasingly considered incomplete without a significant and meaningful discussion of women’s roles, and this often meant a lengthy discussion of the family.

The following section highlights just a few of the major themes addressed in anthropology of gender in the 1980s and early 1990s, with a special emphasis on their contributions to larger theoretical concerns in relation to anthropology of the family. These themes include history and colonialism, relations of production, and intrafamilial dynamics. Each topic reflects the concerns that Yanagisako outlined above as well as those reflected in the discipline-wide shift away from formalist thinking. No clear distinctions are made here between the 1980s and the early 1990s, since work on the family during this time reflects an evolution of ideas rather than a real paradigm shift.

History, colonialism, gender, and the family. Much of anthropological writing as a whole was woefully bereft of historical contextualization. Almost from the beginning, anthropologists adopted the technique of writing in the ethnographic “present,” which served to create an image of the culture under study as timeless and relatively unaffected by historical influences. That radically changed in the 1980s as anthropologists rediscovered history as an important analytic tool. This turn toward the historical included interest in private as well as public life, and the domestic world was laid open to historical reconstruction. Colonialism in particular became a pivotal theme to address, and feminist scholars, among others, concerned themselves with attempting to show how gender roles and family relations were historically, not naturally, created.

While the exact circumstances obviously vary considerably, under colonialism important economic relations changed; these impacted the ways in which families engaged in productive activities and ultimately the form and configurations of families. Under European colonial rule, land relations were altered, thereby impacting who could and could not own land. In some cases families lost all of their lands, reconfiguring family production patterns and shifting possibilities for inheritance, while in other cases women lost the ability to own land and the productive benefits that entailed. Moreover, land was often alienated from those who long worked it, changing household production from auto-production to dependence on patron-client relations or wage labor. In many parts of the world, for the first time, men, women, and children were sent from their households to work for others. Over time, households in some regions became increasingly linked to global, not domestic, economies, altering the meaning of productive work and often putting control over it, usually via wage labor, into the hands of men. In sum, researchers noted that as inheritance, division of labor, and production patterns changed, the family was transformed in unique and locally specific ways.

Along with economic changes, colonialism also brought with it important ideological shifts. European ideologies of gender and especially Christian morality toward sexuality significantly altered gender and family relations. Using Hawaii as an example, Patricia Grimshaw writes that women's lives were considerably different prior to colonialism and the work of Christian missionaries. Descent was traced through the male and female lines, adolescent female sexuality was not restrained, marriages were easily terminated, and infants were often adopted and/or reared by extended kin networks. The overall picture is one of relative freedom for at least some Hawaiian women to make choices about sexuality and marriage. Christian missionaries actively worked to expunge these ideas, and in doing so they shifted Hawaiian families toward greater control over female sexuality and ultimately toward patriarchy. Elsewhere, Christianity has been associated with the dissolution of extended family networks because it stresses individual, not group, responsibility.

Relations of production and the family. Another area of considerable research in anthropology on the family concerns understanding the relationship between economic change, women's roles, and changes in the composition and functioning of the family. Among the themes most frequently explored by anthropologists are the impacts of incipient capitalism and the effects that the increasing penetration of the world economy has had on family roles and domestic orientations. How, for example, does unequal access to wage labor produce changes in men's and women's influence and roles within the family? How might participation in capitalism influence family configuration and intrafamilial dynamics? The evidence is plentiful, if not straightforward.

In Latin America, for example, anthropologists such as Hans Buechler and Judith-Maria Buechler have found that women who are engaged in petty commodity production or in market vending often find that their ability to support themselves and their children financially can free them from oppressive, patriarchal relationships with their husbands. Through work, entrepreneurial women have created networks beyond the family, allowing them the financial and sometimes the social freedom to reconstruct their family lives. However, access to income generation does not always translate to a drastic change in women's roles within the household. According to Florence Babb, Peruvian market women, much like their North American counterparts, often work a double day—first in the market and then at home—resulting in little real change in family relations.

What is clear from the cross-cultural evidence is that capitalism does not necessarily provide the conditions for equality within households and in fact may reinforce patriarchy. In places where wages are low and the state options for child care are very limited, women often find their abilities to access wage labor severely constrained by practical, if not ideological, considerations. Women often take the lowest-paid jobs, which offer flexibility, or they find they are unable to work except perhaps at the very margins of the informal sector. Rather than empowering women, wage labor often makes them more dependent on male wage-earners than they may have been in an agricultural setting where men and women share the productive tasks. Similarly,

families often become more patriarchal as the sole male breadwinner takes on the responsibility of "head of household." The point of interest on a theoretical level is the recognition that the effects of any particular structural or economic change, in this case the penetration of capitalism, are never uniform, and they vary not only regionally but also locally and intersect with a range of other important cultural variables.

Family dynamics. Interest in inequality extended beyond the analysis of how social inequalities inscribe themselves on families and led some scholars to explore more deeply the ways in which inequality is manifest in intrafamilial dynamics. This was fairly new terrain for anthropologists because most studies left unquestioned the assumption that families were for the most part unified and coherent institutions. It had long been presumed that families function in a manner that implies a degree of cooperation between members and that decision making within a family involves a consideration of shared, mutual goals. Families, it was thought, were corporate groups in which hierarchy was generally unquestioned and decision making relatively smoothly enacted for the good of the family, not the individual. Yet an examination of the day-to-day lives and decision-making practices of families gives evidence that families are often far less harmonious than these functionalist theories would imply. Families, like states, are domains in which hierarchy and domination are negotiated continually, often mirroring other structural inequalities but sometimes not. The nature and content of familial conflicts, how they change over time, and the ways in which families resolve them (if at all) are important areas of scholarly concern because they reveal domains of important cultural and social tension.

One area where the conflictual role of intrafamilial dynamics has been most obviously documented is in the shifting nature of families engaged in the various forms of labor migration. One of the effects of the unequal penetration of capitalism globally has been that families must send away one or more of their members to seek wage labor. Sometimes this migration results in a rural-to-urban move of one individual or the whole family and sometimes in the international migration of one or more family members. In all of these cases families often face radical changes. Conflicts and tensions are myriad. They can appear between husbands and wives as they negotiate between urban and rural gender roles and expectations. Generational tensions can mount as young adults find themselves responsible for navigating a world their parents cannot understand. Siblings can find their worlds colliding in unexpected ways as they vie for scarce educational resources. And immigrant fathers may find their child-rearing preferences in conflict with host-country norms.

Anthropological work on the intersection of family and the global economy also contributed to our understandings of families as constructed units and not necessarily biologically based ones. For example, focusing on the Caribbean, Christine Ho discusses the emergence of what she terms "international families." International families are organized primarily around women and include kin, fictive kin, and friends who participate in mutual aid and exchange networks that span multiple cities and even continents. Ho argues that international families are

responding to particular global economic inequalities, but she points out that this response is creative and dynamic and not preordained by circumstances.

The 1990s and Beyond: Reimagining Family

While gender provided the thematic focus for studies of the family in the 1980s, in the 1990s families became a focus of study in their own right. Abundant cross-cultural literature emerged in this field, but some of the most important theoretical contributions came from studies of Western families, particularly same-sex families. At the very least, the 1990s can be characterized as a period in which there existed a growing recognition of family pluralism both inside and outside the academy. The *postmodern* family, a term first used by Edward Shorter in 1975, has come to signal the many diverse, fluid, contested, and negotiated family arrangements most obviously noted in the West.

In 1990 Judith Stacey published *Brave New Families*, which made visible the improvisational and creative nature of contemporary postindustrial family life due to changes in economic realities, gender roles, and kinship conceptualizations. *Brave New Families* was read widely outside the academy and proved to be a touchstone for “family values” proponents who locate many contemporary social ills in the breakdown of the male-headed nuclear family. The resulting “family values” debate has provided fertile ground for the development of post-structuralist critiques of one of the most sacrosanct categories of Western thought, “the family.” What many have called for are theories that seek to reveal the continuities as well as the shifting symbolism and creativity that people enact in the realm of kinship (Rapp). Moreover, anthropologists have turned their attention toward scrutinizing relations of power. Their interest in the “family” stems from a larger ambition to analyze family as an institution that is affected by multiple structural variables assembled in the name of both public and private well-being. These variables include legal regulation, moral ideologies, economic change, and political discourses.

Same-sex families. At one time, same-sex families of certain configurations were inconceivable in America. However, beginning in the 1980s circumstances slowly changed and have altered the complexion of family life for gays and lesbians. Due to numerous socioeconomic changes over the last decades of the twentieth century, including the financial independence of women in lesbian families, the availability of donor sperm and the decoupling of sexuality and reproduction, and the increased acceptance of lesbians and gay men by adoption agencies and courts, planned gay and lesbian parenting is a phenomenon that has grown tremendously. However, this social transformation does not come without serious opposition. For example, in the late 1980s and early 1990s “family values” rhetoric was redirected to spotlight same-sex families, particularly child-rearing by gays and lesbians (see, for example, Polikoff). The argument typically falls along the line that same-sex and transgender families threaten “the traditional American family.”

Attempts in popular culture to frame same-sex families as an “exotic” other (at best) or as the “end of the American family as we know it” (at worst) were countered in the academy

and elsewhere by the assertion that same-sex families are neither marginal nor exceptional but represent and illustrate a larger process of contesting dominant and sometimes oppressive concepts of the “ideal” family. While gay and lesbian parenting has sparked the ire of social critics, it has provided fertile ground for scholars in anthropology and other disciplines to reconceptualize theory.

Gay and lesbian theory. In the 1990s gay and lesbian research moved away from issues of sexual identity to issues of the meanings of intimate relationships including romantic relationships, lesbian mothers and gay fathers, and the psychological development and social adjustment of children of lesbian and gay parents. Unfortunately, much of this work took a psychological orientation. In a review of 2,598 articles, David Demo and Katherine Allen found that while there was an important base for beginning to conceptualize how sexual orientation affects family experiences, sexist and heterosexist assumptions also underlay most of the research on same-sex families. Studies often took a “deficit model” stance in which same-sex families were compared to heterosexual nuclear families and found lacking. These studies tended to focus on individuals and outcomes rather than on gay family life as it is embedded in the broader social context.

Gay and lesbian family theory within anthropology has taken a different orientation. Gay and lesbian family theorists, most of whom are urban anthropologists in North America and Great Britain, suggest a multiplicity of theories to understand ever-increasing diversity across and within same-sex families. While little literature exists, much of gay and lesbian family theory focuses on two themes. The first attempts to locate family within a discourse on the deconstruction of the modern heterosexual nuclear family and “family values” rhetoric. The second calls for a deconstruction of the family as a concept and a radical rethinking of how social categories become embedded. For example, the term *queer* was reclaimed by gay and lesbian activists to illustrate their resistance to hegemonic ideal constructs. Queer theory, positioned at the radical end of gay and lesbian activism, provides an important critique of family rhetoric in general. The argument proposed by queer theorists is that discussions of the family, even within the gay and lesbian movement, are predicated on certain hegemonic ideas concerning the distribution of power, division of labor, and so on. The queer movement urges a rethinking of the whole concept of family as necessarily linked to structures of power that marginalize, exclude, and oppress.

Studies that attempt to deconstruct rigid formulations of family argue that most family theories were developed with the assumption of a heterosexual orientation for all family members. The presence of same-sex families challenges that assumption. Gay and lesbian families provide a context in which to expand discussions of the relationships among gender, sexuality, and kinship. Moreover, discussions of gay and lesbian kinship reinvigorated some of the ideas set out in 1968 by David Schneider. In particular, he argued that American kinship is a symbolic system resting on two axes of contrasting but mutually dependent notions of blood and love. While blood was often discussed in the literature on families, love rarely was.

In *Families We Choose* (1991), Kath Weston argues that gay and lesbian families are a domain in which relationships are most obviously based on love rather than biological connections. According to Weston, these families are negotiating a new model of kinship ideology that repositions biology as potentially irrelevant. Weston demonstrates that gay families represent one element in a broader discourse on family whose meanings are continuously negotiated in everyday situations. Moreover, families are positioned vis-à-vis relations of power in society at large. By demonstrating the resourcefulness of many gay families as they seek to solidify and define what family means to them at a particular place and time, she acknowledges that power is not unidirectional. Her work is not merely theoretical or a cultural/historical analysis but ethnographic and therefore evocative of real experiences and real people as they attempt to negotiate “familiness” in the presence of institutions that both constrain and enable that process.

Valerie Lehr argues that queer studies offer a more radical discourse on family, one that provides an alternative to liberal, rights-based political frameworks. A rights-based approach to marriage and family does not challenge established institutions and power as much as it advocates for some gays and lesbians gaining additional power within the established social system. Rights-based approaches reinforce hegemonic symbols of family and paint the gay and lesbian “community” as a monolithic whole while denying legitimization of alternative ways to framing family. Following Lehr, Ruthann Robson argues that gay and lesbian theorists have left unproblematic the concept of family as they have shifted their focus to advocating recognition for “our” family. By not contextualizing and problematizing “functional familialism,” the not-so-implicit message becomes that gay and lesbian relationships will be accorded the status of family only to the extent that they replicate the traditional husband-wife couple, a tradition based on property relations.

Theoretical discussions of family in the 1990s point to the family as an ideological construct firmly embedded in historical and material conditions of everyday life. The emergence of same-sex families as a cultural category has brought into focus the contrasting yet interdependent notions of kinship based on blood and love as well as a need for problematizing the category of “family” writ large. Moreover, as more diverse “imagined” families are created and dissolved, the legal system and social system must rethink the boundaries and meanings of “family” to accommodate the ever-shifting realities. Some relevant and urgent questions future anthropological research might address are: How do the existing structures enable or constrain how gays and lesbians imagine and construct family? Which gays and lesbians are most likely to be agents of change? How do the actions of certain people impact the production or reproduction of certain structures? At what point do these family experiences, policy positions, and incremental shifts in popular thought reach the “tipping point,” the point at which difference bubbles up to a critical mass and creates change in social structure? To pose and then investigate these questions offers an opportunity to reinvigorate kinship studies by coupling them to theoretically important and timely research on gender studies, colonialism, class relations, identity, and the construction of the “other.”

Conclusion

Anthropological studies of the family reflect many of the larger tensions and trends that have typified the discipline in the latter half of the twentieth century. Central anthropological arguments including those about the role of biology in social reproduction, the evolution of culture, the organization of social and cultural data, and the pervasiveness of Western ideologies have played a major role in the development of the anthropological literature on the family. Moreover, because the “family” is a social concept with very real ideological and political orientations, academic work on the family has been alternately stymied and invigorated by popular cultural assumptions, debates, and trends. In particular, since the 1970s, first feminism and then gay and lesbian studies have made important contributions in moving anthropology toward an understanding of family that is analytically sophisticated in its ability to think about heterogeneity at the same time that it reflects the on-the-ground realities of real families.

See also Childhood and Child Rearing; Family: Modernist Anthropological Theory; Feminism; Friendship; Gay Studies; Gender Studies: Anthropology; Kinship; Motherhood and Maternity.

BIBLIOGRAPHY

- Babb, Florence E. *Between Field and Cooking Pot: The Political Economy of Marketwomen in Peru*. Austin: University of Texas Press, 1989.
- Buechler, Hans, and Judith-Maria Buechler. *The World of Sofia Velasquez: The Autobiography of a Bolivian Market Vendor*. New York: Columbia University Press, 1996.
- Collier, Jane, Michelle Z. Rosaldo, and Sylvia Yanagisako. “Is There a Family? New Anthropological Views.” In *Rethinking the Family: Some Feminist Questions*, edited by Barrie Thorne and Marilyn Yalom, 25–39. New York: Longman, 1982.
- Creed, Gerald W. “Family Values and Domestic Economies.” *Annual Review of Anthropology* 29 (October 2000): 329–355.
- Demo, David H., and Katherine R. Allen. “The Families of Lesbians and Gay Men: A New Frontier in Family Research.” *Journal of Marriage and Family* 57 (February 1995): 111–127.
- Grimshaw, Patricia. “New England Missionary Wives, Hawaiian Women, and ‘The Cult of True Womanhood.’” In *Family and Gender in the Pacific: Domestic Contradictions and the Colonial Impact*, edited by Margaret Jolly and Martha Macintyre, 19–44. Cambridge, U.K., and New York: Cambridge University Press, 1989.
- Ho, Christine. “The Internationalization of Kinship and the Feminization of Caribbean Migration: The Case of Afro-Trinidadian Immigrants in Los Angeles.” *Human Organization* 52 (1993): 32–40.
- Lehr, Valerie. *Queer Family Values: Debunking the Myth of the Nuclear Family*. Philadelphia: Temple University Press, 1999.
- Moore, Henrietta L. *Feminism and Anthropology*. Cambridge, U.K.: Polity Press/Blackwell, 1988.
- Polikoff, Nancy D. “Raising Children: Lesbian and Gay Parents Face the Public and the Courts.” In *Creating Change*, edited by John D’Emilio, William B. Turner, and Urvashi Vaid, 305–335. New York: St. Martin’s Press, 2000.
- Rapp, Rayna. “Toward a Nuclear Freeze: The Gender Politics of Euro-American Kinship Analysis.” In *Gender and Kinship: Essays Toward a Unified Analysis*, edited by Jane Fishburne

- Collier and Sylvia Junko Yanagisako, 49–70. Stanford, Calif.: Stanford University Press, 1987.
- Robson, Ruthann. “Resisting the Family: Repositioning Lesbians in Legal Theory.” *Signs: Journal of Women in Culture and Society* 19 (summer 1994): 975–996.
- Schneider, David. *American Kinship: A Cultural Account*. Englewood Cliffs: N.J.: Prentice Hall, 1968.
- Shorter, Edward. *The Making of the Modern Family*. New York: Basic Books, 1975.
- Stacey, Judith. *Brave New Families: Stories of Domestic Upheaval in Late Twentieth Century America*. New York: Basic Books, 1990.
- Stack, Carol B. *All Our Kin: Strategies for Survival in a Black Community*. New York: Harper and Row, 1974.
- Thorne, Barrie. “Feminist Rethinking of the Family: An Overview.” In *Rethinking the Family: Some Feminist Questions*, edited by Barrie Thorne and Marilyn Yalom, 1–24. New York: Longman, 1982.
- Weston, Kath. *Families We Choose: Lesbians, Gays, Kinship*. New York: Columbia University Press, 1991.
- Yanagisako, Sylvia Junko. “Family and Household: The Analysis of Domestic Groups.” *Annual Review of Anthropology* 8 (1979): 161–205.

Cynthia E. Foor
Ann Miles

FAMILY PLANNING. Family planning refers to the use of modern contraception and other methods of birth control to regulate the number, timing, and spacing of human births. It allows parents, particularly mothers, to plan their lives without being overly subject to sexual and social imperatives. However, family planning is not seen by all as a humane or necessary intervention. It is an arena of contestation within broader social and political conflicts involving religious and cultural injunctions, patriarchal subordination of women, social-class formation, and global political and economic relations.

Attempts to control human reproduction is not entirely a modern phenomenon. Throughout history, human beings have engaged in both pro- and antinatalist practices directed at enhancing social welfare. In many foraging and agricultural societies a variety of methods such as prolonged breast-feeding were used to space births and maintain an equilibrium between resources and population size. But in hierarchical societies, population regulation practices did not bring equivalent or beneficial results to everyone. Anthropologists Marvin Harris and Eric Ross have shown that “As power differentials increase, the upper and lower strata may, in fact, develop different or even antagonistic systems of population regulation” (p. 19).

Being uniquely endowed with the capacity for reproduction, women of course have borne the costs of pregnancy, birth, and lactation, as well as abortion and other stressful methods of reproductive regulation. Social-class dominance over reproduction often takes place through the control of lower-class women by upper-class men. The particular forms these controls take vary across historical periods and cultures. In feudal agricultural and “plantation economies” experiencing labor shortages and short life expectancies, for example, there has

been great pressure on women to bear as many children as possible.

In the modern era of industrial capitalist development, conservative fundamentalist groups have tended to oppose abortion and reproductive choice for women on grounds of religion and tradition. They believe that abortion and contraception are inimical to the biological role of women as mothers and to the maintenance of male-dominant familial and community arrangements. In both the industrialized north and the poor countries of the south, religious fundamentalists oppose abortion and the expansion of reproductive choices for women, and sometimes they do so violently, as in the attacks in the United States against clinics and doctors providing legal abortions. The rapid spread of evangelical Christianity and militant Islam around the world further aggravate the situation.

Partly as a result of religious fundamentalist opposition, in the early twenty-first century abortion remains illegal in many countries. It is estimated that worldwide approximately 200,000 women die annually due to complications from illegal abortions. The actual figures may be higher, since only about half the countries in the world report maternal mortality statistics. Indeed, the unchallenged position of the Vatican against artificial conception and the U.S. government policy against funding for international abortions has led some to believe that illegal abortions and maternal mortality could further increase. Not only does the Bush administration refuse money for abortions, but it also prohibits medical professionals in international organizations such as International Planned Parenthood from talking about abortion if they receive U.S. government support. In the context of both the conservative religious backlash and the problems attributed to global population expansion, family planning seems an enlightened and progressive endeavor. Yet, the movement to provide modern contraception has been fraught with gender, race, and class inequalities and health and ethical problems from the outset. Efforts to reform and democratize international family planning must necessarily grapple with these concerns.

Origin and Evolution of Family Planning

The idea of modern population control is attributed to Thomas Malthus (1766–1834), who in 1798 articulated his doctrine attributing virtually all major social and environmental problems to population expansion associated with the industrial revolution. However, as a clergyman turned economist, Malthus was opposed to artificial methods of fertility control. He advocated abstinence and letting nature take its toll and allowing the poor to die.

In contrast, birth control emerged as a radical social movement led by socialists and feminists in the early twentieth century in the United States. The anarchist Emma Goldman (1869–1940) promoted birth control not only as a woman’s right and worker’s right, but also as a means to sexual freedom outside of conventional marriage. But soon birth control became increasingly medicalized and associated with science and corporate control as well as with the control of reproduction within marriage and conventional family life. As the radicals



Poster advocating small families, Singapore, 1972. Due to a demographic imbalance, by the mid-twentieth century countries in the southern hemisphere had a much denser population than those in the north, leading to a focus of family planning efforts in those areas. © UPI/CORBIS-BETTMANN

lost their leadership of the birth control movement to professional experts, mostly male doctors, by the 1920s birth control, which refers to voluntary and individual choice in control of reproduction, became aligned with population control, that is, a political movement by dominant groups to control the reproduction of socially subordinate groups.

During the influx of new immigrants in the 1920s and 1930s and during the depression, when the ranks of the unemployed were swelling, eugenicist (hereditary improvement) ideology and programs for immigration control and social engineering gained much ground in the United States. Even the birth-control pioneer Margaret Sanger (1879–1966) and suffragists such as Julia Ward Howe (1819–1910) and Ida Husted Harper (1851–1931) surrendered to ruling-class interests and eugenics, calling for birth control among the poor, blacks, and immigrants as a means of counteracting the declining birth rates of native-born whites. Influenced by eugenicist thinking, twenty-six states in the United States passed compulsory sterilization laws, and thousands of persons—mostly poor and black—deemed “unfit”

were prevented from reproducing. By the 1940s, eugenicist and birth-control interests in the United States were so thoroughly intertwined that they became virtually indistinguishable. In the post–World War II era, compulsory sterilization became widespread in the so-called Third World where the birth rates have been higher than in the industrialized countries (in 1995, fertility per woman was 1.9 in the more developed regions and 3.6 in the less developed regions).

In the late twentieth century, the fear of demographic imbalance again seemed to be producing differential family-planning policies for the global north and the south. This was evident in corporate-scientific development of stronger contraceptives largely for poor women of color in the south and new reproductive technologies for fertility enhancement largely for white upper-class women in the north. Some insurance companies in the United States continue to refuse to cover conception in the early twenty-first century. Countries concerned with population “implosion” in the north such as Sweden, France, and Japan are pursuing pronatalist policies encouraging women to have more children while at the same time pursuing antinatalist policies encouraging women in the south to have fewer children.

Family Planning in the Global South

Given the massive increase in population in the south hemisphere countries since World War II, much of global family-planning efforts have been directed toward those poor countries of the so-called Third World. The followers of Malthus, the neo-Malthusians, have extended his thinking, blaming global poverty, political insecurity, and environmental degradation on the “population explosion” and calling for population control as the primary solution to these problems. Their efforts have helped turn family planning into a vast establishment of governmental and nongovernmental organizations with financial, technological, and ideological power emanating from the capitals in the north toward the remote corners of the south. Within countries in the south, the hierarchical family-planning model spreads from professional elites in the cities to the poorest men and women in the villages. In India alone, there are an estimated 250,000 family-planning workers. Every year vast amounts of money are spent to promote “contraceptive acceptance” among the poor populations in the world. Contraceptive use in the “developing world” has increased from less than 10 percent of couples of reproductive age in the 1960s to more than 50 percent (42 percent excluding China) in the 1990s. The rapidly falling birth rates in the Third World are generally attributed to the “family-planning revolution” represented by expanding use of modern contraceptives.

The International Conference on Population and Development (ICPD), held in Cairo in 1994, is generally considered to have ushered in a new approach to population and development, upholding reproductive health and rights of women over meeting numerical goals for reducing fertility and population growth. Departing from earlier positions and upholding voluntary choice in family size, the ICPD Programme of Action states that demographic goals in the form of targets and quotas for the recruitment of clients should not be imposed on family-planning providers and expresses disapproval

of the use of incentives and disincentives. It acknowledges the setting of demographic goals as a legitimate subject of state development strategies to be “defined in terms of unmet needs for [family-planning] information and services” (United Nations, 1994). But, as human rights activists concerned with continued abuses in family-planning programs point out, there is still a long way to go in establishing policies and ethical standards to ensure that the new health and women’s rights objectives are achieved.

Notwithstanding massive spending and extensive family-planning promotion over three decades, many poor people in the Third World remain reluctant to use modern contraception in the early twenty-first century. Attitudes and the need for children among the poor are often quite different from that of family-planning enthusiasts, who are mostly middle-class professionals. Even when poor people use modern contraceptives, their continuation rates are often low due to lack of access to health care, side-effects of contraceptives, and other reasons. Given these realities and the urgency to reduce fertility, international family planning continues to rely on the use of economic incentives and disincentives as well as highly effective, provider-controlled, female methods.

Although male sterilization (vasectomy) is a much simpler operation than female sterilization (tubectomy), female sterilization is the most favored method of family planners and the most widely used method of fertility control in the world. Tubectomy is more common than vasectomy because the men in many areas refuse to have vasectomies, leaving the women little choice if they don’t want more children. Female sterilization constituted about 33 percent and male sterilization 12 percent of all contraceptive use in the developing countries at the end of the 1980s. In terms of the numbers, sterilization is an increasing success, and for many women and men in the north and the south, sterilization represents a choice to be free of biological reproduction. But closer examination of conditions under which most women consent to be sterilized shows that sterilization abuse continues to be a pervasive problem for poor women.

Poverty and adverse social conditions—including lack of information and access to other methods of birth control, threats of discontinued social benefits, and economic constraints—set the conditions for abuses in family-planning programs. Targets and economic incentives/disincentives have defined the operation of many Third World family-planning programs from their inception. They have also been associated with programs directed at poor communities of color in the United States. In the early 2000s a nonprofit organization known as C.R.A.C.K. (Children Requiring A Caring Kommunity) promised a cash incentive of \$200 to drug-addicted women upon verification that they had been sterilized or were using a long-term birth control method such as Norplant, Depo-Provera, or an IUD (American Public Health Association).

While targets and incentives in other realms of social policy are not necessarily wrong, the pressure to meet targets and the offer of economic incentives in family-planning programs have resulted in a highly techno-bureaucratic and monetarist approach obsessed with numbers of acceptors and financial

rewards. Within such a quantitative approach, the complex psychological, sociocultural dimensions of sexuality and reproduction are easily overlooked. Not only do poor people lack much relevant information, but also, in many cases, the desperation of poverty drives them to accept contraception or sterilization in return for payments in cash or kind. In such situations, choice simply does not exist. Direct force has reportedly been used in population-control efforts in some countries, including China, India, Bangladesh, and Indonesia. But coercion does not pertain simply to the outright use of force. More subtle forms of coercion arise when individual reproductive decisions are tied to sources of survival, like the availability of food, shelter, employment, education, health care, and so on.

The “Second Contraceptive Revolution”

Claiming that the earlier contraceptive revolution was a major success, the international family-planning establishment declared the launching of a “second contraceptive revolution” and a “contraceptive 21 agenda” for the twenty-first century. This, like the earlier phase, upheld the biomedical model of mass female fertility management. In 2004 about ninety-four new contraceptive products were being pursued, of which many were variants of existing methods. Among these were four IUDs, seven hormonal implants, five hormonal injectables, five hormonal pills, six vaccines, and six methods for female sterilization.

The second contraceptive revolution also envisaged a greater role for private industry. Given the “latent demand” for new contraceptives, liberalization of trade, privatization of state-run enterprises, and other factors, contraceptive marketing in the Third World promised to be even more profitable for pharmaceutical companies than they had been in the past. The privatization of health sectors, increasing corporate mergers (such as the merger of Pharmacia Sweden and Upjohn of the United States), and the extension of intensive contraceptive promotional and marketing strategies further augmented the power and profits of transnational pharmaceutical companies in the south.

The United States Food and Drug Administration (USFDA) in the early 2000s was completely exempting more and more drugs and medical devices from review before marketing, a move that could have detrimental repercussions across the world. The ICPD and its “new” reproductive-rights agenda, however, did not address the need for strict guidelines to monitor contraceptive trials and the marketing practices of corporations. Calls for population stabilization in the context of GATT (General Agreement on Trade and Tariffs) and other “free trade” agreements, could result in further easing of protocols for contraceptive trials. Feminist activists fear increased corporate dumping of dangerous and experimental contraceptives on the bodies of poor women. Their concerns are based on the history of experimentation of contraceptives such as Depo-Provera and Norplant on poor women in the north and the south without informed consent, the use in the Third World of the Dalkon Shield IUD and other contraceptive devices banned in the United States, and other unethical and dangerous practices. The FDA has, however, been stalling on making emergency contraception available over the counter,

maintaining that it needs further testing. Planned Parenthood, NOW, and NARAL, among other feminist organizations, have long urged the approval of the drug.

Health and Human Rights of Women

Modern family-planning programs have provided many poor women with contraceptives and the ability to limit family size; but they have rarely given women genuine choice, control over their bodies, or a sense of self empowerment. The focus of family planning has been on population stabilization and the meeting of targets rather than on the means or the processes to achieve its ends. Although many family planners in the early 2000s call for women's reproductive rights, population-control programs seem to be moving in authoritarian directions.

Article 16 of the Teheran Proclamation issued by the United Nations Conference on Human Rights in 1968 states that "Parents have a basic human right to determine freely and responsibly the number and spacing of their children" (United Nations, 1974). This Article represented a major victory for the population-control movement. Perhaps the term "responsibly" was the real victory because it can be interpreted in a more-or-less coercive way. Indeed, the overwhelming importance given by international donors and local governments to fertility control has led to a relative neglect of other aspects of family planning and reproductive and human rights such as the right of the poor to health and well-being, including the right to bear and sustain children. Indeed, the neglect of the survival issues by the family planners has allowed right-wing fundamentalists to appear as the only ones concerned with family and community.

The emphasis on family planning has undermined public health care and Maternal and Child Health (MCH) in many countries. In 2004, many of the new hormonal and immunological contraceptives did not protect against HIV/AIDS. In many poor communities in Africa ridden with AIDS, modern contraception was widely available while pharmaceutical drugs for AIDS were not. Target pressure and incentives continued to drive interests of health-care personnel toward population control over provision of health care. Population agencies spoke in public of integrating family planning within a broader health-care framework. But in private some have argued that family-planning programs should not be "held hostage" to strict health requirements and that maximum access to contraceptives should override safety and ethical concerns. Even when the population-control organizations have taken efforts to address public-health issues and women's social and economic rights, the population-control objective has continued to be dominant. The Safe Motherhood Initiative is an example.

The Safe Motherhood Initiative was launched by the World Bank, United Nations Development Program, United Nations Children's Fund (UNICEF), United Nations Fund for Population Activities (UNFPA) and the World Health Organization (WHO) to reduce maternal mortality. In many cases, this initiative has aimed simply to reduce childbearing; the assumption being that fewer births will cause fewer maternal deaths. A 1992 World Bank evaluation of its population-sector work admitted that its foray into broader health initiatives had been motivated by the "political sensitivity" of population control

and the need to dissipate Third World perception that "population control is really the Bank's strategic objective." The report further notes that many countries that would not accept donor support for population control would nevertheless "accept support for family health and welfare programs with family planning components" and that the likelihood of family planning getting "lost in an MCH program" was less because MCH was better accepted as a "legitimate intervention for both health and demographic reasons" (World Bank, 1992).

As Indian health researcher Malini Karkal has pointed out, the tendency to attribute maternal mortality simply to pregnancy and childbirth by the Safe Motherhood Initiative and other such programs has led to a relative neglect of causes of reproductive mortality that supercede maternal mortality. Deaths due to unsafe sterilization, hazardous contraceptives, deaths associated with sexually transmitted diseases, cancer of the reproductive organs, and unsafe treatment of infertility also account for a large proportion of reproductive mortality. Where births have been "averted" due to family-planning programs, the reproductive choices or conditions of women or of the general population, for that matter, have not increased as a result. In India, although birth rates have declined, infant mortality at about 72 per 1,000 births and maternal mortality at about 460 per 100,000 live births in 1995 continued to be relatively high. As women's-rights advocates argue, improvement of the status of women is not the consequence of family-planning programs as believed by the population planners. Rather it is a more complex outcome resulting from rise of age in marriage, education, employment, better living conditions, and general awareness, as well as family planning. Indeed, everywhere, voluntary acceptance of contraception seems to be correlated with women's access to education.

Phenomenon of "Missing Women"

In the 1980s and 1990s in several Asian countries, the proportion of girls born and living appeared to be steadily decreasing. In India, the ratio of women to men was 929 females to 1,000 males, whereas in 1901 it was 972. In China after the one-child family policy was implemented in 1979, the sex ratio became more skewed. There were 94.1 women per 100 males in the 1982 census; in the 1990 census, there were only 93.8 females per 100 males. Demographic data shows that in the early 2000s in China, India, Pakistan, Bangladesh, Nepal, West Asia, and Egypt, 100 million or more women were unaccounted for by official statistics. Further skewing of sex ratios particularly in the world's two most populous countries, India and China, are likely to create serious demographic and gender issues in the future.

One factor contributing to the problem of "missing women" is sex-selective abortions. New technologies such as amniocentesis, ultrasound, and chorionic biopsy, developed for purposes of prenatal testing for birth defects, are increasingly used for the purpose of sex determination. Sex-selection procedures are increasingly advertised in the United States as scientific advances intended to improve choice in family planning and they are likely to become routine procedures. In the patriarchal societies of China and India, where the preference for male children and the pressures to reduce family size are

both very strong, abortions of female fetuses seem to be widespread. Although the use of technologies for sex selection is illegal in China, they are readily available even in rural areas. With a small bribe, parents can easily find out the sex of the embryo and abort it if it is female, thus ensuring that the only child allowed by the State's one-child-family law be a male.

In India too, sex-selective abortion is a thriving business. According to some estimates, between 1978 and 1983 alone, 78,000 female fetuses were aborted after sex-determination tests. Researchers have found that some poor districts in Uttar Pradesh, Maharashtra, and Gujarat, which do not have basic services such as potable water and electricity, have clinics doing a flourishing business in prenatal diagnostic techniques for sex selection. Even poor farmers and landless laborers were willing to pay 25 percent compound interest on loans borrowed to pay for those tests. Given extreme social pressures to produce sons, many women, not only poor uneducated women, but also educated urban women are resorting to abortion of female fetuses. Some middle-class Indian women justify these actions on grounds of choice, and some medical doctors and intellectuals have also argued that it would prevent the suffering of women and that in the long run the shortage of women would lead to their improved status in society. Nurses seeking to meet their family-planning targets actively encourage "scanning" for sex determination and abortion of female fetuses. Some doctors also promote sex-selective abortion as an effective method of population control that would allow the Indian government to achieve its population-control targets.

Female infanticide and underreporting of girls are other factors contributing to the "missing women" phenomenon. The Chinese government has either denied or condemned the practice of female infanticide, but reliable data are not available. Female infanticide does have a long tradition in patriarchal societies such as China and India. But as the demographer Terrence Hull has noted, the "behavioral and emotional setting of infanticide in contemporary China" tends to be substantially different from the traditional pattern (Hull p. 73). The resurgence of infanticide since the early 1980s, is at least partly related to the pressures of the Chinese family-planning program, and the infants killed at birth have been overwhelmingly female. Most of the abandoned infants who end up in state-run orphanages are girls. Many of these girls, as well as boys, are subjected to starvation, torture, and sexual assault. Women's rights activist Viji Srinivasan, who has studied female infanticide among poor communities in Tamil Nadu, India, has also identified the "internalization of the small family norm" due to family-planning promotion as a source of female infanticide (pp. 53–56). Her study raises questions about the ethics of aggressive population control in highly patriarchal societies and underscores the need for economic empowerment and elevation of women's status.

Family Planning and Authoritarianism

Family-planning advocates and organizations claim that the modern "contraceptive revolution" has been achieved without coercion, through "purely voluntary means" with only "minor disadvantages" to people in the Third World (UNFPA). But a closer examination of the methods of contraception and

strategies of family planning reveals widespread human-rights violations and safety and ethical problems. In this regard, it is well to remember the arguments commonly put forward by influential neo-Malthusian demographers, according to whom political will and strong measures need to be used in the fight against population growth, and democratic norms may have to be sacrificed for the sake of the greater good.

Some analysts argue that neo-Malthusian family planning is a quantitative, technical, and bureaucratic approach driven by urgency and aggression to reduce the numbers of the human population in a race against the mechanical clock. Controlled by money and political influence, it has erected a vast global family-planning enterprise far removed from the broader economic needs and cultural interests of the masses whose numbers it seeks to control. Such a hierarchical and at times violent approach can reinforce existing psychosocial structures of domination and subordination; men over women (patriarchy); capital over labor (capitalism); north over south (imperialism); white over people of color (white supremacy/racism); and so on.

Dualistic thinking, the separation of self and other and of subject and object, lies at the root of neo-Malthusianism. As such, it is unable to comprehend the inherent connectedness between the self and the other. Fear of the unknown and desire for permanence and control, in this case, the control of the global masses and their reproduction, underlies this dichotomous thinking. As a fragmented, top-down, and homogeneous approach, Malthusianism leaves no room for more balanced, qualitatively oriented participatory and diverse approaches, for example, indigenous peoples' and women's approaches to reproduction. Aggression and conquest rather than compassion and caring drive the population-control establishment and the larger model of technological-capitalist development that it represents.

Indeed, understanding and empathy require patience; but, according to its advocates, population control is urgent; it cannot lose time. Thus, terminal and high-tech methods are seen as being quicker, easier, and more efficient to administer than women-controlled methods of fertility control. However, myopic vision arising out of self-interest and fear leads to dangerous policies of gender, race, and class oppression. If unchallenged and unchecked, neo-Malthusian family planning could become an even greater tool of authoritarianism and social engineering in the future than it has been in the past. A shift from population control to birth control, from external domination to greater individual control over reproduction, can only be achieved through fundamental transformation of the global political-economic order and the dominant ideologies of both religious fundamentalism and neo-Malthusianism.

Reproduction is a highly political issue and it is unlikely that in the long term either the problem of population stabilization or the global social crisis will be resolved by political repression or high technology. Questions pertaining to democracy and authoritarianism are embedded in the structures of the society. Widespread protests against forced sterilizations in India under the Emergency imposed by Indira Gandhi were a major factor in her defeat in the subsequent elections. Field

researchers who have observed grassroots reactions to coercive population-control policies in India have warned that mounting dissatisfaction could again lead to conflict and violence as it did under the Emergency.

In China too, despite state authoritarianism, there have been outbursts and protests against family-planning policies, and the government has had to soften its policies on a number of occasions. Reporters who have traveled in the Chinese countryside have observed that the government's population policy has caused "a mixture of anger, support, frustration, enthusiasm, deviousness and pain" and that the "desire to procreate" stirs more emotion than any desire for political democracy (cited in Bandarage, 1997, p. 102).

Toward Democratic Reproductive Rights

A democratic and sustainable approach to human reproduction must incorporate social, ethical, and ecological criteria avoiding the dogmatism and extremism of both pronatalist right-wing religious fundamentalism and antinatalist neo-Malthusian family planning. Appropriate technology and democratic social relations must define the realm of human biological reproduction as they must the realm of economic production. Numerical targets and economic incentives must be abolished from family-planning programs in the south and they must not be extended to the north. Quality health-care services and a range of safe contraceptives that help protect people against STDS and HIV/AIDS are required. Development of safe male contraceptives is essential for greater male-female partnership in birth control and family planning. Abortion should not be used as a contraceptive method, but safe and legal abortions should be available to women who need them. Given that abortion is a painful decision for women, there must be social support and compassion for women to make their own decisions. Where needed, safe methods of infertility treatment should also be made available to poor women, not merely fertility control.

Reproductive rights cannot be realized where the basic material needs of people are not met. Education, employment, and access to other economic resources are essential if people are to make their family-planning decisions freely. Thus, the very definitions of reproduction and family planning need to be enlarged to include the material needs of individuals, families, and communities. Continued avoidance of basic health and economic survival issues will only enable religious fundamentalist groups to present themselves as the guardians of family and community. This is beginning to happen in the area of HIV/AIDS prevention, which has been relatively neglected by family planners. The powerful evangelical Christian movement in the United States is beginning to take a leadership role in international HIV/AIDS prevention with the backing of the current U.S. government. While efforts to eradicate the deadly disease need to be welcomed, it is important to recognize that the fundamentalist Christians may use the opportunity to propagate their own moral values with regard to sexuality and gender norms and to advocate abstinence over protected sex.

In many regions, poverty eradication is also falling into the hands of internationally funded religious fundamentalist groups.

Evangelical Christian groups in particular are stepping in to fill the social and economic vacuum created by privatization of state sectors and cutbacks in state social welfare accompanying economic globalization. But unlike the family planners who provide economic incentives to the poor for acceptance of sterilization or contraception, the religious proselytizers require religious conversion to their faith and the acceptance of their moral injunctions. These developments are adding further confusion and complexity to societies already torn asunder by other political-economic and cultural contradictions.

If poverty eradication is to be genuine, it must go beyond economic incentives given in exchange for contraceptive acceptance or religious conversion. In the long-term, poverty eradication calls for setting limits on corporate profit-making and on the widening gaps between the north and the south and between the rich and the poor within countries. In order to have democratic family planning, overconsumption of resources by rich families needs to be reduced and underconsumption by poor families needs to be augmented. The optimum balance between human well-being and environmental sustainability can be achieved through rational use of natural resources, sustainable economic production, and more equitable consumption.

The concepts of family and community need to be further extended, recognizing that childbirth and human reproduction are increasingly taking place outside male-headed nuclear families. It is necessary to find a more democratic approach toward reproductive rights and human liberation that transcends the extremes of both patriarchal right-wing fundamentalism and top-down authoritarian family planning. To do so, a balance needs to be struck between the traditional role of the self-sacrificing mother and the modern role of the individualist career woman. To find a middle path, women need support from men, their families, communities, work places, and the larger world. To confront the extraordinary challenges facing humanity, it is essential to create more loving and sustainable families. Family planning needs to move beyond the narrow focus of fertility control to treating humanity, if not all planetary life, as one extended family.

See also *Equality: Gender Equality; Eugenics; Feminism; Human Rights; Third World.*

BIBLIOGRAPHY

- American Public Health Association. "Opposition to Coercion in Family Planning Decision Making." 01/01/2001. Available at <http://www.apha.org/legislative/policy/policysearch/>.
- Bandarage, Asoka. "Ethnic and Religious Tension in the World: A Political-Economic Perspective." In *Global Political Economy and the Wealth of Nations*, edited by Philip O'Hara. London: Routledge, 2004.
- . "Women of Color and the Global Population Question." In *Black Woman, Globalization, and Economic Justice*, edited by Filomina Steady. Rochester, Vt.: Schenkman, 2001.
- . *Women, Population, and Global Crisis: A Political-Economic Analysis*. London: Zed Books, 1997.
- Boston Women's Health Book Collective. *Our Bodies, Ourselves for the New Century: A Book by and for Women*. New York: Simon and Schuster, 1998.

- Burkhalter, Holly. "The Politics of AIDS: Engaging Conservative Activists." *Foreign Affairs* 83, no.1 (Jan./Feb.2004): 8–14.
- Davis, Angela Y. *Women, Race, and Class*. New York: Vintage, 1981.
- Davis, Kingsley. "Wives and Work: The Sex Role Revolution and Its Consequences." *Population and Development Review* 10, no. 3 (September 1984): 397–417.
- Gordon, Linda. *Woman's Body, Woman's Right: A Social History of Birth Control in America*. New York: Grossman, 1976.
- Harris, Marvin, and Eric B. Ross. *Death, Sex, and Fertility: Population Regulation in Preindustrial and Developing Societies*. New York: Columbia University Press, 1987.
- Hartmann, Betsy. *Reproductive Rights and Wrongs: The Global Politics of Population Control*. Boston: South End, 1995.
- Hull, Terrence. "Recent Trends in Sex Ratios at Birth in China." *Population and Development Review* 16, no.1 (March 1990): 63–83.
- Karkal, Malini. "Why the Cairo Document Is Flawed." *Third World Resurgence* 50 (1994): 19.
- King, Maurice. "Health Is a Sustainable State." *The Lancet* 336 (15 September 1990): 664–667.
- Mamdani, Mahmood. *The Myth of Population Control: Family, Caste, and Class in an Indian Village*. New York: Monthly Review, 1972.
- Srinivasan, Viji. "Death to the Female: Foeticide and Infanticide in India." *Third World Resurgence* 29, no. 30 (Jan.–Feb. 1993): 53–56.
- United Nations. "Proclamation of Teheran." In *United Nations Action in the Field of Human Rights*. New York: United Nations, 1974.
- . *Report of the International Conference on Population and Development (ICPD)*, Cairo, 5–13 September 1994.
- United Nations Fund for Population Activities (UNFPA). *State of the World Population*. New York: UNFPA, 1991.
- Warwick, Donald. *Bitter Pills: Population Policies and Their Implementation in Eight Developing Countries*. Cambridge, U.K.: Cambridge University Press, 1982.
- World Bank. "Population and the World Bank: Implications from Eight Case Studies." Washington, D.C.: Operations Evaluation Department, 1992.

Asoka Bandarage

FASCISM. For the purposes of this article, fascism will be treated as a politicized and revolutionary form of ultranationalism bent on mobilizing all remaining "healthy" social and political energies to resist the perceived onslaught of decadence so as to achieve the goal of a regenerated national community. It is a project that involves the rebirth (palingenesis) of both the political system and the social and moral culture that underpins it.

In discussing fascism's place within the history of ideas two basic issues must be addressed: first its genesis as a new "generic" political force that emerged at a particular point in the evolution of Western society, and second the various ideological components that it subsumes in the individual permutations it forms, in particular in national and political contexts. It will then be possible to offer some observations about fascism's evolution since 1945, one that has led some of its contemporary variants to be arguably of more interest to the history of ideas than to conventional political analysis.

The Origins of Generic Fascism

The ideological core of fascism postulated here contains one timeless component that cannot be said to have a historical source as such, while the other component originates in a relatively specific time and place within the history of ideas. The vision of rebirth, of palingenesis, of a new cycle of regeneration and renewal growing out of what appeared to be an irreversible linear process of decay, dissolution, or death, appears to be an archetype of human mythopoeia, manifesting itself, for example, as much in the Christian faith in the Resurrection of Christ and of all true believers as in the Hindu cosmology, which computes in mathematical detail the universe's infinite cycle of creation and destruction.

Ultrationalism, on the other hand, could only appear in countries where populist notions of sovereignty as the inherent property of a national community had already firmly established themselves. Fascism was able to emerge as a modern political ideology only after nationalism had arisen as a major ideological force in an increasingly secular Europeanized world where the foundations of traditional social systems (tribal, feudal, or absolutist) had been extensively eroded. In the wake of the French Revolution, several variants were formulated by intensely patriotic ideologues who imagined the nation as a supraindividual community subject to organic processes such as decay and growth and destined to rise to greatness. Though such a concept of the nation had already been formulated in the early nineteenth century by Germans such as Johann Gottlieb Fichte (1762–1814) and Ernst Arndt (1769–1860), it was the widespread obsession in fin-de-siècle Europe with the degeneracy of liberal civilization and its urgent need for moral regeneration that first made possible the conjuncture of palingenetic myth with ultrationalism that together formed the ideal climate within which fascism was incubated.

A major contributing factor in the evolution of organic conceptions of the nation was the rise of cultural, biological, and political racism, Aryan theory, and anti-Semitism in eighteenth- and nineteenth-century Europe. These had no single source, but drew both on the widespread and highly diverse preconceptions about race first articulated by such figures as Johann Gottfried von Herder (1744–1803), Joseph-Arthur de Gobineau (1816–1882), Robert Knox (1798–1862), Richard Wagner (1813–1883), Cesare Lombroso (1836–1909), Ernst Haeckel (1834–1919), Herbert Spencer (1820–1903), Vacher de Lapouge (1854–1936), Houston Chamberlain, (1855–1927), and Friedrich Nietzsche (1844–1900), as well as on currents of humanistic, scientific, and scientific thought such as national histories, philology, physical and cultural anthropology, criminology, sociology, genetics, demography, eugenics, Social Darwinism, and vitalism. Once blended in with ultrationalism and palingenetic myth, racism could provide a pseudoscientific (scientific) rationale to the myth that a nation in decline can only fulfill its transcendent historical mission once purged of forces allegedly compromising the "purity of the race" (for example, materialism, individualism, cosmopolitanism, immorality, miscegenation, "alien" ideological elements, or some combination of these).

It was in the first decade of the twentieth century that artists and cultural commentators such as the numerous writers of



Mussolini addresses crowd from eagle-shaped podium, Turin, Italy, 1939. Fascism was born in Italy in the early twentieth century, during the regime of dictator Benito Mussolini (1883–1945). Mussolini attempted to create a corporative state, in which the working population was divided into groups representing different economic sectors. HULTON ARCHIVE/GETTY IMAGES

völkisch literature in Germany, Charles Maurras (1868–1952) and Maurice Barrès (1862–1923) in France, Giovanni Papini (1881–1956) and Gabriele D’Annunzio (1863–1938) in Italy, and Nicolae Iorga (1871–1940) in Romania provided poetic or theoretical expression to the importance of reawakening the national soul from the debilitating slumber induced by liberal modernity. Some attempts to turn these ideas into political movements were made before World War I, notably by Maurras’ Action Française (1897–), the Pan-German League (1886–1914) under Heinrich Class (1868–1953), the Christian Social Party (1893–1938) founded by the Austrian anti-Semite Karl Lueger (1844–1910), and the Italian Nationalist Association (1910–1923). But it was the shattering impact of the “Great War” itself that transformed marginalized and essentially cultural movements for national rebirth into political formations with a serious revolutionary strategy based on a blend of populist rally for change, a democratic party, and an extra-parliamentary paramilitary movement. It was the war that simultaneously nationalized the masses subjectively while creating localized pockets of objective political, social, and economic upheaval in many European countries, not least the collapse of the Hohenzollern, Habsburg, and Romanov dynasties and the

Russian Revolution itself, that were indispensable for new forms of revolutionary nationalism to thrive. The first of these new “militia parties” to seize power was Fascism, which conquered the Italian state in two stages, 1922–1925 (when Mussolini was head of state) and 1925–1929 (when he established a dictatorship), and it is from this movement and regime that the generic term takes its name. Since the 1920s, *fascist* has been applied by historians, political commentators, and activists to a number of dictatorial regimes that emerged in interwar Europe and in the wider Europeanized world, notably in Latin America. However, significant differences of opinion persist between experts about which regimes are embraced by the term, the inclusion of the Third Reich being especially contentious.

An Overview of the “Fascist Epoch”

The period 1918–1945 has become widely known as “the fascist epoch.” Certainly by the autumn of 1941, after the recent triumph of Francisco Franco (1892–1975) in the Spanish Civil War (1936–1939) and the apparently inexorable success of Adolf Hitler’s (1889–1945) Blitzkrieg in France, Scandinavia, and Poland, and with victory in Soviet Russia seemingly imminent, there were good grounds for this, however problematic the phrase may have become for later historians. By this time Benito Mussolini’s (1883–1945) Partito Nazionale Fascista (PNF) and Hitler’s Nationalsozialistische Deutsche Arbeiterpartei (NSDAP, whose core ideology correspond closely to the generic definition given above) had created the templates of organization and style for revolutionary nationalists to emulate all over the Europeanized world. Even democracies as stable as Switzerland, Denmark, and Iceland, or new nations still confident in their future such as the United States and Australia, hosted minute fascist parties attempting in vain to emulate the performance of mass revolutionary movements. More significant (though safely contained) fascist movements developed where the structural conditions of crisis were sufficiently strong, notably in Finland, France, Hungary, Romania, Brazil, Chile, and South Africa, and some abortive fascist movements achieved prominence under Nazi occupation, notably Vidkun Quisling’s Nasjonal Samling in Norway, Léon Degrelle’s Rex in Belgium, and (in 1944) Ferenc Szálasi’s “Hungarist” Arrow Cross movement. Thus José Streele, a leading spokesman of the collaborationist Belgian Rex movement, had not succumbed to delusions of grandeur when he asserted in 1942 that, whether it was called “fascism,” “national socialism,” or “the new order,” “a new force” able to “synthesize the needs of the age” was “everywhere at work giving birth to the revolution of the twentieth century” (quoted in Griffin, 1995, p. 206).

In the final analysis the fascist assault on modern history was abortive. Only two fascisms managed to conquer state power and attempt to turn their revolutionary vision into reality, and eventually both met with crushing military defeat having failed to realize their revolutionary objectives. All other fascisms were successfully marginalized by liberal democracies or fended off by conservative authoritarian states by being either crushed or absorbed. It was nevertheless a tribute to the degree to which fascism had come to be associated with the future of civilization by the 1930s that a number of authoritarian states modeled themselves on the style of fascism.

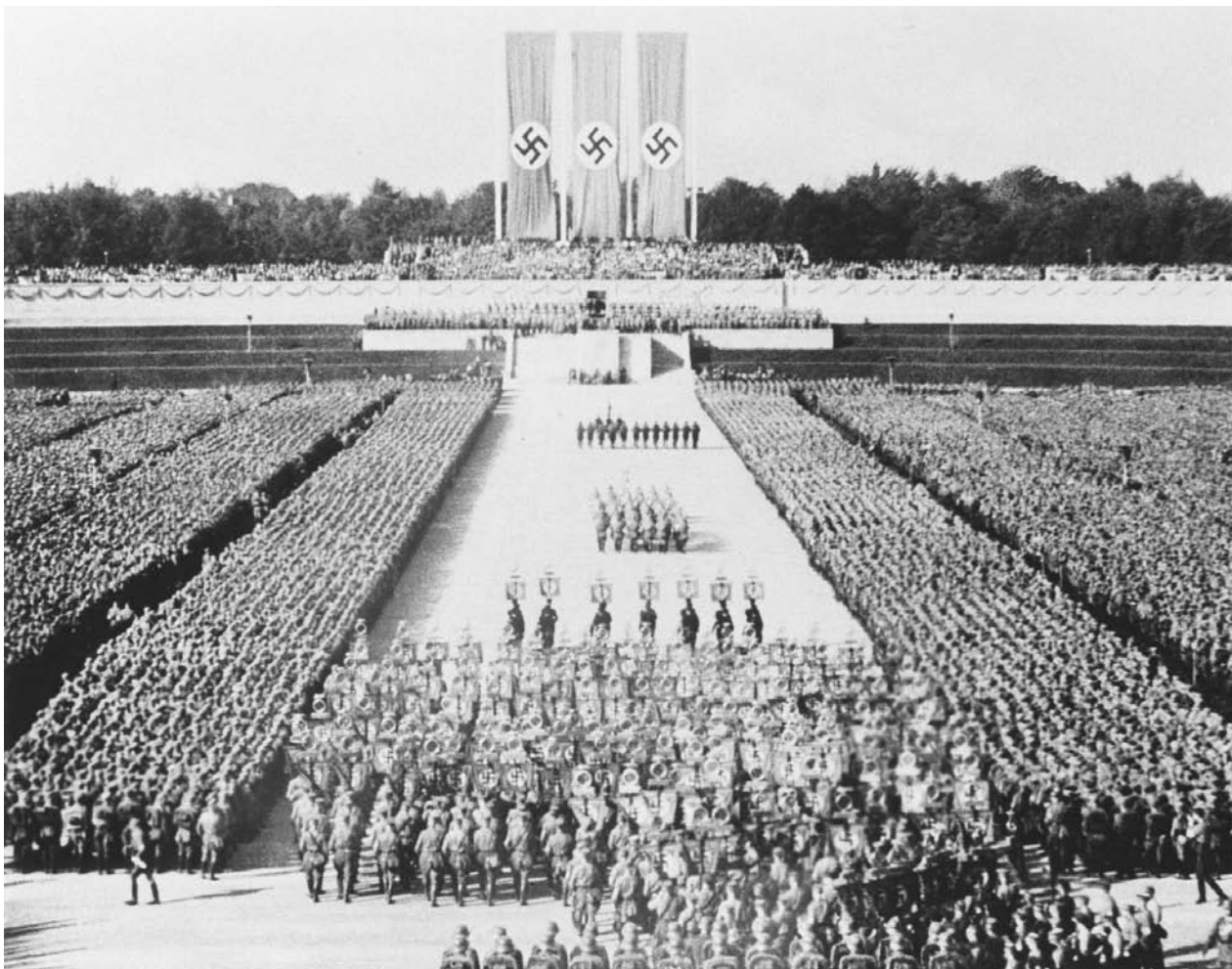

Still from the 1934 German propaganda film *Triumph of the Will*, directed by Leni Riefenstahl. Nazism, or National Socialism, was similar to Italian Fascism, with some distinctions. Nazism was based on the concepts of military authority and racial superiority, and its followers advocated a purging of those who did not adhere to certain criteria. THE KOBAL COLLECTION

A number of other authoritarian states chose to simulate the “real thing” by such ploys as organizing “from above” nationwide single parties, youth movements, and other mass organizations, proliferating nationalistic symbols, declaring the inauguration of new eras in the life of the nation or the creation of “new states,” staging theatrical political events, and engineering phony leader cults. This pattern was most prominent in Franquist Spain (1938–1975), Antonio de Oliveira Salazar’s Estado Novo in Portugal (1926–1974), Philippe Pétain’s Vichy France (1940–1944), Ion Antonescu’s National Legionary State in Romania (1940–1941), Ioannis Metaxas’s dictatorship in Greece (1936–1940), Karlis Ulmanis’ authoritarian Latvia (1934–1940), and Miklós Horthy de Nagybánya’s authoritarian state in Hungary (1919–1944). It was equally a sign of the times that the ultimate victor was liberalism (or liberal capitalism), apparently the weakest of them all.

Spain and Portugal progressively defascistized themselves once the tide of war started to turn against the Axis powers.

Once para-fascism is taken into account and with the benefit of hindsight, it is clear that interwar Europe was dominated not by fascism at all, but by a titanic struggle between liberalism, conservatism, communism, and fascism, in which fascism, which at one point looked like carrying all before it, eventually came off worst.

Non-European Fascisms

Traditionally, comparative fascist studies have focused almost exclusively on fascism as a European phenomenon. However, it should be noted that, while the emphasis on the totalitarian bid of fascism to create a new type of society distinguishes it from conservative regimes, whether traditionalist or military, there were in the “fascist epoch” a small number of non-European countries that hosted attempts to emulate the achievements of revolutionary nationalism in Italy and Germany. The most important examples are the Ossewabrandwag and the Greyshirts in South Africa, the National Socialist Movement (MNS) in Chile, and the Brazilian Integralist Action (AIB)

movement that arose under Getúlio Vargas's dictatorship in Brazil (1937–1945). All of them suffered the fate of most of their European counterparts by being marginalized or crushed.

Breaking with the European pattern, two military dictatorships seem to have made a genuine bid to fascistize the nation from above rather than using fascism as a means of generating mass conformism and passivity: Chiang Kai-shek's (1887–1975) nationalist regime in China, eventually overwhelmed by Japanese imperialism, and the military dictatorship of the Grupo de Oficiales Unidos (GOU) in Argentina (1943–1946). GOU created a legacy that Juan Péron would build on after the war during his rule (1946–1955), which was in ideological and organizational terms an eclectic blend of political elements of which fascism was only a muted part.

It should also be noted that the most highly developed, dynamic, and destructive para-fascist nation of all arguably emerged not in Europe but when imperial Japan entered its most totalitarian and expansionist phase between 1937 and 1945. Despite its alliance with Italian Fascism and German Nazism, it carried out its aggressive scheme of territorial expansion under a divine emperor and with its feudal social system intact rather than under a charismatic “new man” in a “reborn” nation. Nor did the defeat of Italy in 1943 and then of Germany in 1945 cause it to relent in the radicalness of its prosecution of the war, a fact that underlines the need to recognize that fascism by no means has a monopoly of right-wing totalitarian violence.

The Diversity of Individual Fascisms

We now turn to the second aspect of fascism that impinges on the history of ideas, its ideological constituents. A central premise behind the definition applied in this article is that fascism is to be treated on a par with the other major political “isms” of the modern age, such as liberalism and socialism, as an ideology in its own right with its own agenda for creating the ideal society. A corollary of this is that it can be conceived for analytic purposes as a cluster of core (“ineliminable”) ideological components, which we have identified here with just two components: the conception of the people as an organic organism, and a palingenetic concept of history that envisages national decay giving way imminently or eventually to a process of regeneration and renewal. This core can become associated in particular times and places with many varied and even conflicting secondary (“adjacent” or “peripheral”) concepts, with the result that fascism is externalized itself in a wide range of specific manifestations shaped by particular conjunctures of historical forces.

Another implication of this approach is that it is futile to search for the sources of generic fascism in the work of a particular thinker, such as Georges Sorel's thesis of the primacy of myth, Ernst Haeckel's organicism, Vilfredo Pareto's theory of the circulation of elites, Friedrich Nietzsche's calls for a new breed of superman, or Oswald Spengler's scheme of the decline and “Caesarist” renewal of the West, however much they may have influenced individual ideologues or movements. For the same reason it is fallacious to see all forms of fascism

drawing on the same currents of thought or driven by the same process, such as Social Darwinism, eugenics, corporatism, Marxist revisionism, modernization, or antimodernity, let alone to attribute it to generic forces such as “irrationalism,” “capitalism,” or “moral decline,” which have minimal heuristic value as explanatory concepts.

In fact, one of fascism's outstanding traits is its eclecticism, the propensity of its numerous individual variants to accommodate or synthesize ideological components from a wide range of sources taken from any part of the left-right spectrum. Italian Fascism, for example, merged elements of right-wing politics (nationalism, imperialism, authoritarianism) with left-wing syndicalist claims of creating social justice and abolishing class conflict, and the cult of the Roman past with elements of the Futurist cult of hypermodernity. It also attracted a number of former Marxists in Italy and Germany, hosted left-wing and right-wing variants of corporatist theory, and accommodated currents of philosophical idealism and technocratic modernism; clerical Fascism and neopaganism; cultural racism (which treated patriotic Italian Jews as full members of the reborn Italy, although a more “biological” current eventually led to the adoption of anti-Semitic race laws); and the full spectrum of aesthetics from neoclassicism to futurism, from anti-cosmopolitan ruralism to international modernism. Even Nazism was far from homogeneous ideologically, embracing ruralist and technocratic visions of the new order, varying degrees of paganism and accommodation with Christianity, several varieties of racism, an anticapitalist (“Strasserite”) current, and even a strand of promodernist aesthetics. Fascism's animus against communism and the degenerative impact of liberalism on the organic national community nevertheless makes it sensible to locate fascism within the tradition of right-wing politics rather than simply “beyond” left and right (as it sometimes claims to be).

Fascism can also manifest itself in a variety of organizational forms. It does not necessarily take the form of a properly constituted movement, let alone a full-fledged party-political movement, and has only twice formed a regime. This is why attempts to elaborate or extend the fascist minimum identified here (for example, by adding such elements as paramilitarism, the leader principle, corporatism, or territorial expansionism) severely restrict its heuristic value.

Race. Once we move from the synoptic panorama of the whole fascist epoch to consider individual fascisms in close-up, the heterogeneity of their fascist ideology emphasized here soon becomes apparent. The sense of national identity promoted by Italian Fascism, for example, was originally little more than an antiliberal version of heightened patriotism, which attempted to present the current generation as heirs of the same genius that had created the Roman Empire, the Roman Catholic Church, and the artistic and scientific Renaissance. Partly because of the powerful presence of organized Christianity in social life, “modern” biological or eugenic concepts of racial purity were relegated to a subordinate position, even if they were implicit in the demographic campaign and in the laws against miscegenation introduced in the wake of the colonization of Ethiopia. Certainly an Italian equivalent of the Nazi

“euthanasia” campaign to cleanse the national community of its “hereditarily ill” was unthinkable, and though a current of anti-Semitism existed in Fascism independently of Nazism, when anti-Semitic race and citizenship laws were eventually introduced in 1938 declaring the Italians to be of Aryan stock they were widely experienced as both un-Italian and un-Fascist.

Long before coming to power, Nazism was notorious for disseminating a vision of the national community based on a concept of race that included cultural, Social Darwinian, and eugenic components. As a result, decadence was considered at least partly the product of racial decay, which in turn meant that the nation had to be purged of both ideological and physical enemies before it could be reborn. It followed from the same racial concept of the nation that its boundaries “naturally” extended to cover the whole geopolitical area in which ethnic Germans constituted a majority, and ensured that the Third Reich’s plans for territorial conquest were based on a hierarchical conception of racial superiority and inferiority familiar from European imperialism overseas, but never applied before to peoples in mainland Europe.

If the abortive fascist movements are taken into account, yet more permutations of the nationalist myth come into view. The Romanian Iron Guard was viscerally anti-Semitic, elaborated its own myth of Romanian racial purity, and planned to set up an anthropological institute to build up a database on the variegated racial makeup of those living on Romanian soil. Yet its outstanding feature was its stress on the importance of Romanian Orthodox Christianity as an indicator of national and cultural identity. Other fascisms that, in contrast to the overtly neopagan Fascism and Nazism, incorporated local versions of Christianity into their concept of national belonging were the Spanish Falange, the Finnish *Isänmaallinen Kansanliike* (Patriotic People’s Movement), and the *Afrikaner Ossewabrandwag*.

A different permutation of fascist racial myth again is exhibited by the ABI (the Brazilian Integralist Action), whose membership grew to 200,000 before it was outlawed by Getúlio Vargas’s parafascist military regime. This highly original permutation of fascism attributed the national genius and potential for rebirth not to any one of the many ethnic groups that make up modern Brazil, but to its unique blend of peoples and cultures, a concept that precluded the pursuit of racial purity through eugenic or exterminatory policies. This avenue was also barred by the powerful presence of Catholicism in Brazil’s social and political culture, though it is significant that the ABI developed an elaborate form of “political religion” for its meetings and rallies. It is also consistent with the ABI’s essentially pagan conception of renewal that its leader, Plinio Salgado, published his philosophy of history according to which his movement was leading Brazilians into the “fourth era of humanity.”

Economics. Although Marxists have always seen fascism as driven by a crisis of the capitalist economic system and the rise of socialism, and some non-Marxist experts identify interwar fascism with corporatism, the truth is predictably more complex. The relationship between fascism and finance capital, big business, or the bourgeoisie is far from straightforward, and

there were currents within Nazism and Fascism that were anticapitalist to the extent that they took seriously the idea of a “national socialism.” Contemporary fascism contains currents that are, at least on paper, extremely hostile to (Jewish, U.S., globalizing, corporate) capitalism, notably the New Right, Third Positionism, and National Bolshevism, and some prominent “Strasserite” Third Positionists, striving to develop a stance beyond both capitalism and communism, currently use *fascist* as a pejorative term for national revolutionaries not prepared to reject capitalism.

As for corporatism, only Italian Fascism attempted to install a corporatist state, which failed in practice to fulfill the ideals of any of the rival theories of corporatism that jostled for position under Mussolini. These included a “left-wing” syndicalist current, an authoritarian nationalist strand, and a version promoted by Catholics encouraged to do so by the Catholic Church, which saw in corporatism a way of mitigating the evils of unbridled materialism and individualism. However, such was the appeal of a “third way” between *laissez-faire* capitalism and the Soviet planned economy that the British Union of Fascists adopted the theory of the corporatist state, and a number of interwar fascisms (e.g., in Spain, Portugal, Hungary, Brazil, and Chile) advocated a fusion of nationalism with the power of organized labor, whether it was termed “national syndicalism” or “national socialism.” It should also be pointed out that the parafascist states (both Catholic countries) of Salazar and Franco retained corporatist elements in their economic systems well into the postwar period, and during the 1940s these achieved some degree of success, though at the cost of organized labor, which was forced to forfeit much of its political and economic power.

On the other hand, Nazi Germany rejected the idea of the corporatist state except in the sphere of cultural production. Nevertheless, in tune with the spirit of the age, which favored the strong state and the planned economy, the Third Reich ruthlessly applied the principle of the primacy of politics over economics that legitimized unlimited state intervention in the running of the economy. It should be added that the British strand of one of the most consistently anticapitalist forms of postwar fascism, namely Third Positionism, attempted in the 1990s to resuscitate one of the interwar “alternative” economic theories, namely distributionism, but with no prospect of practical application to date, and that many contemporary fascisms are influenced by radical Green critiques of the unsustainability of the global economy.

Culture. Fascism’s relationship with modern culture is even more resistant to generalizations than its economics. One of the more unusual features of Brazil’s AIB was that its ideology grew out of currents of Latin American cultural theory developed by an intelligentsia influenced by European modernism and the “revolt against positivism.” In this it had parallels with Italian Fascism, which hosted a number of currents of modernism, notably futurism, whose artists believed that the innovative dynamic or conceptual dimension of their style expressed the energy that was creating the New Italy. At the same time it was possible for the experimental, anarchic, taboo-breaking thrust of modernism to be seen as embodiments of the very

decadence that it was fascism's mission to banish from modern life. As a result, fascism also attracted support from those who looked to a revitalized neoclassicism, vernacular, or ruralist art to create the iconic statements of healthy values that were to be an integral part of the reborn nation. Under Mussolini both interpretations of modernism coexisted and a rich variety of aesthetics resulted. Rather than promote an official Fascist style, the regime was content to be associated with creativity under all its aspects, a principle known as "hegemonic pluralism."

In stark contrast to Brazil and Italy, in 1935 Nazi Germany launched a campaign to purge Germany of modernism, henceforth officially declared the expression of cultural and biological degeneracy. Yet even here a campaign had been fought to have expressionism classified as Aryan, and a number of artists with highly modernist temperaments, notably Gottfried Benn and Ernst Jünger, were initially attracted to the regime. The diverse subject matter of some Nazi painting, which included motorway bridges, sporting events, factories, bombing raids, and battle scenes, also underlines the need to avoid simplistic generalizations about the antimodernity of fascism or the longing to return to the idylls of peasant existence allegedly at the heart of Nazi art. It is also significant that the Nazis paid even more attention to encouraging a "healthy" national cinema industry than the Italian Fascists, hardly the sign of a compulsive antimodernity. While some films under both regimes were overtly propagandistic, the majority were made without direct state interference and dealt with the emotional and social comedies and dramas of modern Italian and German existence against the backcloth of the new order. By endorsing the values, normalcy, and modernity of fascist society they bear witness to the way the power of the film to create an aesthetic illusion of wholeness was seamlessly adapted to the new societies, thereby contributing to the routinization of the fascist revolution in the experience of "ordinary" Italians and Germans.

Architecture. The architecture of the two regimes reflected their different relationships to modernism. Despite a marked tendency toward monumentalism and the increasing use of neoclassicism for many civic buildings by the late 1930s, Fascist architects worked in a number of styles, some of them deeply indebted to the international modernism of the day. Its protagonists saw the bold use of steel and glass as reflecting the future-oriented, hypermodern dynamic of the New Italy, its urge to throw off the dead weight of tradition. This was unthinkable in Nazi Germany, where the Bauhaus was considered the symbol of "cultural Bolshevism," and the prescribed style for civic buildings was a Spartan neoclassicism whose symmetry, lack of ornament, and gargantuan proportions supposedly evoked the "purity" and heroic "will to construct" of the Aryan.

However, the Third Reich's retention of elements of modernism for such projects as bridges, factories, high-density holiday accommodation, and power stations, as well as the fact that Ludwig Mies van der Rohe tendered an unashamedly modernist design for the Dresden Bank before leaving Nazi Germany for the United States, invites a more complex reaction to its state architecture than simply dismissing it as philistine reaction. Rather, its neoclassicism is to be seen as the expression of the aesthetic correlation to the eugenics and

"racial hygiene" applied in social and demographic policy. The austere, lifeless pseudoclassical buildings and sculptures whose aesthetics it determined betoken not a nostalgia for a bygone age, but the belief in the ongoing rebirth of the German people from the quagmire of Weimar decadence. They embody in permanent plastic form the presence of "eternal values."

The anthropological revolution. When considering individual spheres of art it is important to bear in mind that art for fascists was no longer to be a separate sphere of human endeavor remote from the mainstream of political and social life in the same category as leisure or sport and prey to the forces of commercialization. For the cultural theorists of Fascism, Nazism, the British Union of Fascists, the Falange, the Iron Guard, or the AIB, whatever their stance on modernism, realism, or the celebration of rural life, art was meant to express the uncorrupted soul of the people, and made manifest the health or decadence of the entire culture. They assumed that just as the chaos and commercialism of modern art reflected the current decadence of the West, so the regenerated nation would spontaneously produce an artistic renaissance. This would come about once artists were no longer concerned with "self-expression," innovation, or experimentation; their reunion with their people and nation naturally ensured that each sculpture, film, novel, musical composition, or building expressed the values of the new age.

Art was only one of the spheres of social activity that were supposed to contribute to this ethos of palingenesis. Schools, universities, youth and leisure organizations, mass rallies, newsreels, newspapers, sporting events, national holidays, local festivals, the organization of work, business, and industry, in fact any context in which the public sphere impinged on the private became sites for the further integration of the individual into the national community. In this sense the deepest level of the fascist revolution was not political or military, but cultural. As long as fascism remained a genuinely charismatic force in Italy and Germany it was not a revolution simply imposed on society, but was fed by the spontaneous enthusiasm of many thousands of creative individuals who wanted to contribute to the transformation. This interpretation is fully consistent with recent theories of totalitarianism that place an emphasis on its bid to bring about an anthropological revolution, and on seeing the political religion that it institutes not as an exercise in collective brainwashing but as a means to transform society's political and moral culture.

This attempted anthropological revolution had particular implications for women. True to the spirit of an age that had recently experienced World War I, the interwar fascist image of the new man embraced elements of the archetypal warrior and knight, and the celebration of militarism, war, and the new order was pervaded by values that would now be recognized as male chauvinist. The corollary of this was that fascism was hostile to feminism as a force that destroyed the "natural" roles dictated by biology, and both Fascist Italy and Nazi Germany introduced legislation to remove women from the workplace, criminalize abortion, encourage big families, and glorify motherhood and domestic functions as the true vocation of women. The demographic campaign in both countries was backed up

by antenatal, maternity, and childcare services that anticipated some of the best practice of the modern welfare state.

However, it is erroneous to dismiss such measures as proof of fascism's reactionary bid to turn the clock back to traditional family values. The creation of mass organizations for women of all ages and social categories, including auxiliary units for those drawn to life in the armed services, were symptomatic of an attempt to free the female population from the constraints of domesticity and motivate it into playing an active, if subordinate, role within the new national community on a par with the Soviet mobilization of women. A physically and morally healthy motherhood was celebrated as a key element in the triumph over decadence and the regeneration of the nation. A "new woman" would arise to assist the "new man" in his heroic revolutionary task. It might also be pointed out that the stereotype of women destined to breed new members of the national community is no more degrading than the stereotype that declared the destiny of men lay in their readiness to kill and be sacrificed for the sake of the new order.

A far more terrible fate than that which befell female members of the Nazi national community awaited the millions of those, male and female, adult and children, who were excluded from it on grounds of hereditary illness, asocial behavior, or membership of an inferior race, and thus were subjected to sterilization, enslavement, torture, experimentation, or extermination. It was in the fanatical persecution and mass elimination of "life unworthy of life" and "subhumans" by the Third Reich under the cover of World War II that fascism's archaic palingenetic logic of "cathartic destruction" reveals its most chilling potential for impacting on modern history.

The Survival Strategies of Postwar Fascism

The ideological definition of fascism adopted in this article leads to an interpretation of its development that sees the defeat of the Axis powers not as putting an end to fascism, but forcing it to adopt new strategies to survive in a political environment no longer characterized by the upheaval and crises that were the precondition for Fascism and Nazism to take the form of mass movements producing spectacular displays of charismatic politics. The Allied victory over fascism inaugurated the sustained recovery of liberal capitalism, which eventually outlived the state socialist experiment in creating a new order conducted by the Soviet Union and its satellites. The massive loss of life caused by World War II and the horrors committed by the Third Reich and imperial Japan in the alliance with Fascism utterly discredited the rhetoric of militarism, ultranationalism, imperialism, and new orders for all but a small, highly marginalized minority of fanatics. The mass constituency of potential trans-class support for revolutionary brands of nationalism simply evaporated (although it reemerged quickly in the chaotic conditions of post-Soviet Russia).

In such conditions any attempts to emulate the PNF or NSDAP were doomed to have even more pathetic results than those achieved by the many abortive movements in the "fascist epoch." Even the most successful postwar fascist party, Italy's Movimento Sociale Italiano (MSI), had to dissociate itself from any paramilitary activity and strictly abide by the democratic



French presidential candidate Jean-Marie Le Pen with slogan reading "France found again," 2002. Right-wing political parties such as Le Pen's National Front (best known for its anti-immigration platform) have often tried to place what they see as the decline of society in a larger geocultural context. AP/WIDE WORLD PHOTOS

"rules of the game." This strategy put it in the position to emerge from the political ghetto reconstituted as the Alleanza Nazionale in 1994, though only after it had renounced any attachment to its revolutionary and totalitarian past.

Meanwhile, faced by the almost complete disappearance of its natural interwar habitat, "real" fascism demonstrated a remarkable capacity for adaptation. While at the level of the general public, xenophobia and anxieties over the erosion of national identity in some countries found an outlet in a new type of party, the right-wing populist party embodied in Jean-Marie Le Pen's National Front and Jörg Haider's Austrian Freedom Party, intransigent national revolutionaries could follow several tactics to keep the revolutionary vision alive. One was to concentrate on forming small cadres of fanatics dedicated to "the cause," some of whom in the 1970s and 1980s carried out a series of terroristic outrages in pursuit of what was known as the "Strategy of Tension" designed to bring down the Italian state.

A second tactic was for fascists to abandon narrow nationalism and place their concern with the decadence of society in a wider geocultural context, whether that of the white or Aryan race, or of Europe, conceived as a federation of cultural homogeneous nations or *ethnies*. A third was to withdraw from the political sphere altogether and concentrate on civic space, the realm of ideas and culture, thus turning fascism into a largely "metapolitical" force, made up not of full-fledged movements, but of numerous atomized formations known collectively as the "groupuscular right." An outstanding example of this is the pan-European vision of rebirth advocated (in conflicting terms) by the European New Right and by Third Positionism. The latter still has not abandoned political activism and the use of violence in theory (or rather in rhetoric), even if the transition to a new era has by implication been indefinitely postponed, leaving a few stoic spiritual warriors to resist the forces of cultural suicide true to the principle of

“leaderless resistance.” The logical consequence of this process of extreme atomization is the type of “lone wolf” terrorist act committed by Timothy McVeigh (in Oklahoma) or David Copeland (the London nail bomber), both of whom internalized and acted on the fascist critique of the state without belonging to any formal organization.

The Struggle for “Cultural Hegemony”

The most sophisticated incarnation of fascism in the “postfascist” epoch is the New Right. This is an umbrella term for a movement with a local base in a number of European countries but important international linkages, and consists of both groupuscules and some high-profile cultural think tanks such as GRECE in France and networks of associations such as Thule-Netz in Germany. In Russia a particularly influential form of the New Right is known as “Euroasianism.” In it the fascist attack on the degeneracy of liberalism as an increasingly globalized cultural and economic system combined with the call for an entirely new order has been thoroughly “metapoliticized,” while the ultranationalist nostalgia for roots and organic ethnic communities has undergone extensive “Europeanization.”

Many scholars, and certainly New Right intellectuals themselves, would strenuously disagree that an ideology that operates purely in the realm of ideas and has abandoned belligerent nationalism and racism can be classified as a form of fascism at all. However, the French New Right, which under the aegis of the extraordinarily prolific Alain de Benoist (b. 1943) pioneered the international movement, demonstrably grew out of a fascist milieu that by the mid-1960s despaired of seizing power through conventional political or violent means. Moreover, the war against decadence and longings for rebirth, which were the hallmarks of interwar fascism, can still be shown to form the ideological core of the sophisticated discourse of cultural criticism it has evolved since then, even if the palingenesis of the organic cultures and communities of Europe is no longer imminent.

By dedicating itself exclusively to the struggle to win “cultural hegemony” (a tactic known as “right-wing Gramscism”), the New Right has been able to exert influence on right-wing populism and neofascist activism at one stage removed. This it does by providing elaborate ideological critiques of the prevailing “system,” as well as disseminating a subtle form of “differentialist” racism that preaches not racial superiority but the value of all cultures and the need to preserve them from the corrosive effects of multiculturalism, mass immigration, egalitarianism, and the “leveling” of society by cultural globalization.

The Conservative Revolution

In adapting itself so thoroughly to the prolonged “interregnum” before the next “rebirth,” New Right fascism has systematically shed every external aspect of its interwar manifestations. There is no hint of charismatic leader, paramilitarism, expansionist imperialism, or theatrical politics. Yet fascism’s ideological nucleus remains intact: the longing for a new order based on the restoration of organic communities, the defeat of liberalism, the transcendence of communism, materialism, chaos, and

decadence, remains intact. It is no coincidence if the New Right draws extensively on the same ideologues of the Conservative Revolution, notably Friedrich Nietzsche, Ernst Jünger (1895–1998), Carl Schmitt (1888–1985), and Martin Heidegger (1889–1976), that helped prepare the way for the Nazis’ war on Enlightenment values, even if one of the pioneers of the New Right, Armin Mohler (1920–2003), was careful to dissociate them from Nazism by calling them “the Trotskyites of the German Revolution” (Hitler being its Stalin).

Some thinkers of the New Right have also been influenced by the “Traditionalist” philosophy of history elaborated by the Italian “philosopher” Julius Evola (1898–1974), which posits a Hindu-like cycle of rebirth and decadence shaping human history. In his canonical diagnoses of the postwar world (which also influenced both “black” terrorism of the Strategy of Tension and contemporary Third Positionism) Fascism and Nazism are indicted with failing to inaugurate the process of rebirth, with the result that those with a sense of higher values are now condemned to stay faithful to the cause of a higher metapolitical order with no immediate prospect of inaugurating the new age. Another fruitful source of inspiration of the New Right crusade against the “decadent” Judeo-Christian, materialist, U.S.-dominated West are carefully edited liberal and far left critiques of the “totalitarianism” and metaphysical vacuousness of contemporary capitalist society. In the New Right, fascism has in a sense returned to its fin-de-siècle roots as a current of radical cultural criticism lacking any concrete political vehicle or clear strategy for gaining power other than that of taking over what one of their main spokesmen, Pierre Krebs, calls “the laboratories of thinking” (quoted in Griffin, 1995, p. 349).

The Future of Fascism

Fascists of any denomination are not alone in believing that deep structural problems threaten the sustainability of the present “hegemonic system” in the West, notably escalating ecological and resources crises, and the demographic explosion in the “two-thirds world” (often called the “third world,” even though in terms of population it is far bigger than the first world). Nor can it be denied that mass immigration and globalization pose threats to established national and cultural identities. There will thus be no shortage of empirical data to convince those with a fascist mind-set that we live in an age of decadence and that “our” only hope lies, sooner or later, in a total palingenesis capable of pioneering a new type of modernity while preserving ethnic roots, cultural identity, and belonging. Given the unusual capacity of fascism for eclecticism and adaptation, it seems likely that, at least in its metapoliticized, internationalized, and groupuscularized permutations, it will continue to thrive as a permanent, though marginalized and ineffectual, part of the political and social subculture of civic society throughout an increasingly Europeanized (or Americanized) world. It will thus continue to generate a steady flow of fresh ideological specimens to occupy political scientists and historians of ideas for the foreseeable future.

See also Authoritarianism; Communism; Eugenics; Nationalism; Propaganda; Race and Racism; Social Darwinism.

BIBLIOGRAPHY

- Bauman, Zygmunt. *Modernity and the Holocaust*. Ithaca, N.Y.: Cornell University Press, 1989.
- Davies, Peter, and Derek Lynch. *Fascism and the Far Right*. London: Routledge, 2002.
- Drake, Richard. *The Revolutionary Mystique and Terrorism in Contemporary Italy*. Bloomington: Indiana University Press, 1989.
- Gentile, Emilio. *The Sacralization of Politics in Fascist Italy*. Cambridge, Mass.: Harvard University Press, 1996.
- Griffin, Roger. "Interregnum or Endgame? The Radical Right in the 'Post-fascist' Era." In *Reassessing Political Ideologies: The Durability of Dissent*, edited by Michael Freeden. New York: Routledge, 2001.
- Griffin, Roger, ed. *Fascism*. Oxford: Oxford University Press, 1995.
- Kallis, Aristotle A., ed. *The Fascism Reader*. London: Routledge, 2002.
- Larsen, Stein, ed. *Fascism outside Europe: The European Impulse against Domestic Conditions in the Diffusion of Global Fascism..* New York: Columbia University Press; Boulder, Colo.: Social Sciences Monographs, 2001.
- Mosse, George L. *Fascist Revolution: Toward a General Theory of Fascism*. New York: Fertig, 1999.
- Paxton, Robert O. *The Anatomy of Fascism*. New York: Knopf, 2004.
- Payne, Stanley G. *A History of Fascism, 1914–1945*. Madison: University of Wisconsin Press, 1995.
- Sternhell, Zeev. "Fascist Ideology." In *Fascism: A Reader's Guide: Analyses, Interpretations, Bibliography*, edited by Walter Laqueur. Berkeley: University of California Press, 1976.
- Taylor, Brandon, and Wilfried van der Will, eds. *The Nazification of Art: Art, Design, Music, Architecture, and Film in the Third Reich*. Winchester, U.K.: Winchester Press, 1990.

Roger Griffin

FATALISM. Fatalism is the thesis that whatever happens must happen. This is not to be confused with the completely innocuous idea that whatever happens, happens. Nor is fatalism to be conflated with the proposition that, necessarily, whatever happens happens, where this assertion simply expresses the tautologous nature of the prior innocuous idea. Fatalism is a substantive thesis that claims that the occurrence of every event or state of affairs is necessary.

Elucidation of this thesis requires the articulation of the fatalist's necessity; we must know what the "must" amounts to when the fatalist tells us that whatever happens must occur. Since *fatalism* is to some measure a term of art, there are not tight a priori restrictions about how the necessity used by the fatalist is to be understood. There is, however, one criterion for any acceptable definition. Fatalism has occupied thinkers for more than two millennia primarily because its truth appears to have the consequence that we lack the power (capability, capacity) to perform any actions other than those that we actually do perform. If we perform an act, which is a type of event, and this event is necessitated, then no other act could have occurred. And, if no other act could have occurred, then we have no power to bring about any act other than the one that we, in fact,

produced. If fatalism is true, there are no alternative courses of action open to us and so the conception of ourselves as meaningful, free-willed agents who have the power to affect the constitution of the future is thoroughly compromised. Any account of fatalistic necessity worth the name needs to respect the *prima facie* tension between fatalism and autonomous behavior.

Virtually all philosophers construe fatalistic necessity as logical or conceptual. Steven Cahn is representative when he states that fatalism

is the thesis that the laws of logic *alone* [his italics] suffice to prove that no man has free will, suffice to prove that the only actions which a man can perform are the actions which he does, in fact, perform, and suffice to prove that a man can bring about only those events which do, in fact, occur and can prevent only those events which do not, in fact, occur. (p. 8)

Although logical construals of fatalistic necessity meet the minimal requirement of maintaining the *prima facie* antagonism between fatalism and the actions of autonomous persons, they unfairly caricature the nature of some arguments that all parties deem as fatalistic. If all fatalistic arguments are conceived as containing only statements of logical laws (i.e., tautologies) as premises, it is difficult to see both how any substantive thesis could evolve and how any disagreement about the truth of fatalism could be more than merely a verbal squabble. In fact, the sophisticated fatalistic arguments of Aristotle (384–322 B.C.E.), Diodorus Cronus (d. c. 284 B.C.E.), and others demonstrate that there are implicit substantive, albeit controversial, assumptions concerning the nature of truth and time. Before examining these arguments, it is important that we distinguish between fatalism and determinism, two theses that are frequently conflated.

Fatalism and Determinism

Regardless of the exact articulation of fatalistic necessity that one accepts, virtually all agree that it should be distinguished from the necessity of determinism. This distinction is especially important since determinism can be legitimately characterized in precisely the same way as fatalism: whatever happens must happen. The necessity of determinism is causal or natural necessity; all events or states of affairs are causally determined by antecedent states of affairs and the laws of nature. Alternatively, determinism claims that it is logically necessary that given an antecedent state of the world and the laws of nature, a particular subsequent state of the world will occur. On the traditional conception of fatalism as a logical thesis, there is no reference to natural laws or causality. Presumably, logical fatalism can be true in the absence of any causality in the world.

Aristotle's Sea Battle

Aristotle's discussion in *De interpretatione*, book 9, gives rise to the following:

1. There will be a sea battle on 1 January 3000 or there will not be a sea battle on 1 January 3000.

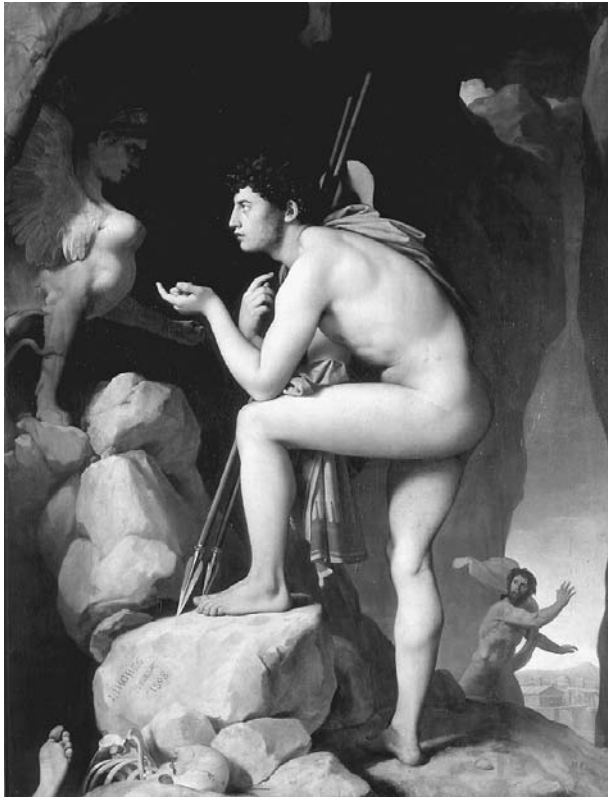

***Oedipus and the Sphinx (1808) by Jean-Auguste-Dominique Ingres.* Oil on canvas.** According to mythology, oracles foretold that Oedipus would kill his father, the king of Thebes. Although both father and son took measures to ensure this did not come to pass, fate could not be avoided and Oedipus did indeed take his father's life. © LOUVRE, PARIS, FRANCE/ THE BRIDGEMAN ART LIBRARY

2. If there will be a sea battle on 1 January 3000 then it was always true (it was always a fact that) there will be a sea battle on 1 January 3000; if there will not be a sea battle on 1 January 3000 then it was always true (it was always a fact that) that there will not be a sea battle on 1 January 3000.
3. If it was always true that there will be a sea battle on 1 January 3000, then there was never a time at which anyone could prevent the sea battle; if it was always true that there will not be a sea battle on 1 January 3000, then there was never a time at which anyone could bring about the sea battle.
4. Thus either no one, at any time, could prevent the sea battle or no one, at any time, could bring about the sea battle.
5. Thus, either the occurrence of the sea battle is necessary or the nonoccurrence of the sea battle is necessary.
6. The sea battle is merely an arbitrarily selected event.

7. Therefore, all events are necessitated.

8. Therefore, fatalism is true.

The necessity that this argument attaches to events is necessity of the past. That is, we are to think of our powerlessness to affect the constitution of the future as we conceive of our inability to affect the constitution of the past. Just as the past is now closed to us, so too is our future. Aristotle's radical solution was to deny that future contingent statements had truth values, and so, "there will be a sea battle" and "there will not be a sea battle" were both neither true nor false. Contemporary times have produced other reactions to the argument. Some have questioned the meaningfulness of tensing truth, of the significance of speaking of truths holding at certain times. Others have suggested that we are not powerless to affect the truth-value of some claims about the past because some of these claims represent "soft facts" and are, in part, claims about the future. The question then becomes whether a statement to the effect that it was always true that a sea battle will occur on 1 January 3000 represents a soft fact. It should be clear that a robust discussion of Aristotle's argument requires investigating foundational claims about the nature of truth and time.

Theological Fatalism

Traditional Judeo-Christian theology considers God to have omniscient infallible foreknowledge and ubiquitous providence. If God knows all that will happen in a manner that cannot be mistaken, it is difficult to understand how any event can occur differently than it actually does. And, if no event can occur differently, it appears that there are no alternative courses of action that are open to us. We seem to be impotent concerning the constitution of the future. Additionally if everything that occurs is under the control of God's will, then it appears as if every event is divinely determined and so, once again, it appears as though we do not have the power to act otherwise than we actually do.

There have been three major types of response. The Boethian solution is to conceive of God as an atemporal being, one whose beliefs and will do not occur in time. The second approach is Ockhamism, which suggests that facts about God's past beliefs (and will) are soft facts and so should not be endowed with a type of necessity of the past that precludes autonomous action. The Molinist, or "middle knowledge" solution, attempts to find space for autonomy by suggesting that God knows the contingent future by knowing "counterfactuals of freedom," statements that describe what actions persons would freely perform in every possible situation. Using this knowledge, God then creates (wills) the future.

See also **Autonomy; Determinism; Free Will, Determinism, and Predestination; Responsibility.**

BIBLIOGRAPHY

- Bernstein, Mark H. *Fatalism*. Lincoln: University of Nebraska Press, 1992.
- . "Fatalism." In *The Oxford Handbook of Free Will*. Edited by Robert Kane, pp. 65–84. New York: Oxford University Press, 2002.

- Cahn, Steven M. *Fate, Logic, and Time*. New Haven, Conn.: Yale University Press, 1967.
- White, Michael. *Agency and Integrality: Philosophical Themes in the Ancient Discussions of Determinism and Responsibility*. Dordrecht, Holland: Reidel, 1985.
- Zagzebski, Linda. *The Dilemma of Freedom and Foreknowledge*. Oxford: Oxford University Press, 1991.

Mark H. Bernstein

FEMINISM.

This entry includes five subentries:

- Overview*
- Africa and African Diaspora*
- Chicana Feminisms*
- Islamic Feminism*
- Third World U.S. Movement*

OVERVIEW

Feminism may broadly be defined as a movement seeking the reorganization of the world upon the basis of sex equality, rejecting all forms of differentiation among or discrimination against individuals upon grounds of sex. It urges a worldview that rejects male-created ideologies. At another level, it is also a mode of analysis and politics, committed to freeing all women of gender-based oppressions. Literally, then, anyone who supports such an ideology can be a feminist, regardless of gender.

Since the 1980s, following women's campaigns and struggles as well as theoretical and empirical research highlighting gender discrimination pervasive in law, policy, and opportunities to work, organizations and governments around the world have begun to incorporate gender considerations into policies and programs. International agencies such as the United Nations support many women's projects globally, including World Conferences on Women (Mexico, 1975; Copenhagen, 1980; Nairobi, 1985; Beijing, 1995), bringing together thousands of women to facilitate exchange and global networks.

Any discussion of feminism must analyze not only its genesis, practices, and forms of resistance (organized women's movements) but also its writing and theorizing, which has been an important form of self-expression and indeed a conscious exercise in building a body of feminist knowledge. Since the 1980s Western feminist thought has generated newer, more nuanced understandings of such concepts as "sex," "gender," and "woman." In this entry, the term *feminism* is used inclusively to discuss facets of the women's movement as well as feminist theorizing.

Feminism (both as ideology and struggle) can hardly be discussed as a seamless narrative, for in the twenty-first century it is practiced within different social and political configurations, and women's movements flourish in diverse locations. However, it is evident that despite broad commonalities, feminist struggles are influenced by local, cultural, national, and indeed global factors that shape local politics and economies.

An overview of salient developments reveals fascinating interrogations of Western feminism by non-Western women as well as deep divisions among Western feminists based on race, class, and sexual orientation. In fact, in the early 2000s many believe that the term is valid only in its plural form, *feminisms*, to reflect its many transnational manifestations across race, class, and religion.

This entry begins with a broad chronological overview, introducing important strands within Anglo-American feminism, which occupied a "mainstream" position in scholarship until the mid-1980s, when challenges from African-American women forced major reconceptualizations. The variety of issues around which women organized created issue-based trajectories, or "schools" (cultural feminism, ecofeminism, lesbian feminism). Next, the article describes how feminist scholars drew inspiration from Marxism, psychoanalysis, and post-modernism to analyze the female subject in academia, law, and society, generating a rich variety of feminist theory. Following this is a discussion of how challenges by "Third World" feminists and documentation of feminism(s) from diverse global locations enriched feminism as a whole, offering new models for organizing across nations and cultures. Examples drawn from contexts as varied as Iran, India, Russia, China, and Latin America highlight the variety of feminist struggles and theorizing. Finally, the entry touches upon some key issues that remain the focus of feminist engagement: abortion, sexuality, legalization of prostitution, and the pressures of globalization on millions of women in developing economies.

Anglo-American Feminism

Developments in Anglo-American feminism are often characterized in terms of waves, with the "first wave" in the United States beginning with initiatives as early as the organization of the National Woman Suffrage Association in 1869 by Susan B. Anthony and other such efforts in the early decades of the twentieth century when women's liberation was seen in terms of "human" liberation. These struggles led to the passage of the Nineteenth Amendment in the U.S. Constitution, enfranchising American women in 1920.

Following this there was a comparative lull in feminist activity. Betty Friedan's *The Feminine Mystique* (1963) is widely cited as a seminal text that precipitated public dialogue in America about feminism by pointing to an inchoate sense of "something wrong lodged in the minds of countless American housewives." Kate Millet's classic text *Sexual Politics* (1970) located women's oppression in patriarchies that operated through women's most intimate sexual relationships. Anglo-American feminists of this period were also drawn to developments in French feminism, which in turn drew inspiration from early seminal texts such as Simone de Beauvoir's *The Second Sex* (1953).

The "second wave" was marked by an explosion of complicated theories borrowing from philosophy, psychoanalysis, and politics that aimed (1) to challenge patriarchal values and constructs that oppressed women and to critique such portrayals in contemporary literature and popular culture, and (2) to represent the figure of the woman as an autonomous subject,

focusing on the gendered body of woman to better understand such issues as reproductive rights, sexual harassment, and violence. Consciousness-raising was seen as a key tool for furthering feminism, and oft-repeated slogans of this phase were “sisterhood is powerful” and “the personal is political.”

The active entry of black women served to expose polarities within U.S. “mainstream” feminist politics. Black feminist politics, rooted in the black liberation and civil rights movements (1960s–1970s), had convinced many African-American women of the need for a politics that was both antiracist and antisexist. The Combahee River Collective (a Boston-based black feminist group founded in 1974) aimed at “struggling against racial, sexual, heterosexual, and class oppression.” From these contestations emerged new practices of theorizing, most prominently articulated by bell hooks. Sisterhood, hooks asserted, required a commitment on the part of white women to examine their own complicity in white privilege, because black women’s oppression was located at the intersections of race, class, and gender. Reacting to a narrowly defined feminism, the African-American writer Alice Walker coined the term *womanist* to describe a woman “committed to survival and wholeness of an entire people, male and female.” Thus, responding to the reality of women’s multiple identifications, feminism broadened out along issue-based trajectories.

Trajectories within Feminism

Interrogations within feminism have spawned various strands in feminist thought that have acquired labels. Although categorizations hardly do justice to the variety of complex positions, some broad explanations are possible.

Liberal feminism. Liberal feminists see the oppression of women in terms of inequality between the sexes and are concerned with equal access to opportunities for women. However, they believe that private and public domains are governed by different rules, attitudes, and behavior. Thus, in matters of family for instance, love, caring, and sensitivity come first. The National Organization for Women (NOW, 1966), an early organization of the second wave in the United States, exemplified such feminist practice.

Radical feminism. Radical feminists, on the other hand, link women’s oppression to patriarchy and see its manifestations in personal relationships and sexuality. Early articulations of this position led to the celebration of women’s lives and the writing of women’s history. Radical feminists have founded women’s newsletters, bookstores, and presses. Many radical feminists celebrate lesbianism, although all radical feminists are not lesbians.

Lesbian feminism. Lesbian feminists in the United States in the 1970s began by theorizing about how society’s treatment of lesbianism reflects not only its attitudes toward homosexuality but also its attitudes toward sexuality, femininity, male power, and gender politics in general. They argued that lesbianism in turn teaches about gender politics and forces a rethinking of constructions of sexuality and female desire. Thus social lesbianism emerged as an ideology and practice that sought to transform dominant ideas of sexual roles. Disrupting hegemonic sexual roles and division of labor, lesbianism seriously calls into

question traditional attitudes toward women’s roles as being primarily reproductive.

Ecofeminism. Ecofeminism links the patriarchal domination of woman with the exploitation of nature—both as forms of oppressing the “other.” Their analyses involve dualisms where attributes are thought of in terms of oppositions (culture/nature, mind/body, man/woman). They campaign against racism and economic exploitation as well as the exploitation of nature. Many ecofeminists are also environment activists.

Feminist Theory and Women’s Studies

From the social action of the women’s movement in the United States there emerged research consciously done within a feminist context, analyzing gender issues embedded in the most familiar facets of life—family, relationships, work, education, religion, media. Thus began women’s studies, in which women became “subjects” rather than “objects” of study. Women’s studies centers and departments drawing scholars from disparate academic disciplines became institutionalized in the U.S. academy in the 1970s. The National Women’s Studies Association (1977) and the Feminist Press (1970) were committed to the production of feminist texts in order to create a body of knowledge that could be used to teach women’s studies as an academic discipline.

As feminist scholars researched and questioned women’s invisibility in history and psychology, “scientific” constructions of women in medical discourses, and popular images in literature, art, and religion, there emerged feminist theory, which sought to uncover the gender bias in the production of academic knowledge. Researchers challenged the tools of analysis used in sociology, history, psychology, and economics to argue that conceptualizations excluded women and that the disciplinary models used silenced women’s voices. They argued that a “method of feminist inquiry” in an academic discipline did not necessarily involve alternative methods but rather a focus on alternative origins of problematics, explanatory hypotheses, and evidence and a new prescription for the appropriate relationship between the inquirer and her or his subject of inquiry. Feminist theorizing, in its project of writing women into theory and law, thus became a strategy of resistance. Feminist scholars drew from a range of ideologies to challenge existing disciplinary paradigms.

Feminism and Other Ideologies

In analyzing the roots of women’s oppression, feminist theorists were attracted to two of the central ideologies of the twentieth century—Marxism and psychoanalysis. Marxist analyses provided a framework for understanding women’s economic oppression and issues of class within feminism. Psychoanalysis, with its preoccupation with sexual differences, offered a means for analyzing personality structures and object relations in the hope that individuals (i.e., women) would be freed from their unconscious conflicts. Sigmund Freud (1856–1939) became an important influence—although, while some scholars found in his theorizing important tools for their own, others attacked him for being a misogynist.

Given that by the 1980s many feminists believed that women’s experience of patriarchy and male domination differed

by race, class, and culture, feminist theorizing needed other theoretical tools. Those who realized the limitations of constructing theories based on generalizations about the experience of Western white middle-class women found a natural ally in postmodernism. Postmodernist critiques offered a resistance to modernist conceptions of reason and claims of scientific “neutrality.” There emerged clear overlaps between the postmodernist stance and feminist positions, which had long criticized Enlightenment ideals that legitimized an autonomous self as being reflective of masculinist agendas. Constructivism and deconstruction, which challenged the positivist tradition in science and essentialist theories of a single “truth” or “reality,” appealed to feminist theorists. These approaches opened up possibilities for understanding how power operates through constructions of knowledge (i.e., about women) that are perpetuated through the medium of language by those who have the power over language/knowledge (i.e., men). Feminist psychologists used constructivism to argue that theories of women’s sexuality were in fact organized within particular assumptive frameworks that strengthened patriarchal controls over women’s bodies and desires. Thus constructivism, with its focus on representations of gender (rather than sex difference) provided for feminist thought a germinal insight: that woman, beyond the sexual differences, is a *social* category.

Gradually a whole range of disparate concepts were inserted in feminist thought that drew not only from Freud but also Jacques Lacan (1901–1981) and Michel Foucault (1926–1984). In theorizing about difference, feminist theorists were influenced by the writings of the French philosopher Jacques Derrida (b. 1930). Foucauldian conceptualizations of power and hegemony proved useful for understanding institutionalized patriarchal power structures that subordinated women. The “postmodern turn” thus became a pressing issue for feminist scholars, although there are many diverse positions within this framework.

Anglo-American feminist theory from the 1960s into the 1980s reflected the viewpoints of white middle-class North American and western European feminist scholars who did not interrogate their own methodological legacies and failed to recognize the embeddedness of their own assumptions within a specific historical context. An example of this approach was represented by Robin Morgan’s book *Sisterhood Is Global* (1984), which asserted that women in their experience of oppression “shared a common world view.” These assumptions of sameness were fiercely contested for their ethnocentric bias in the 1980s.

Theoretical Challenges: Race and “Third World” Feminism

The United Nations international conferences in Mexico (1975) and Copenhagen (1980) revealed tensions between First World and Third World women. Clearly divisions along lines of nationality, race, class, caste, religion, and sexual orientation needed to be inserted into women’s experiences of oppression. By the Nairobi Conference (1985) the myth of “global sisterhood” had been abandoned and feminism became as heterogeneous as the women who supported it across the globe.

The 1980s witnessed a lashing out against white middle-class feminists’ universalizing and homogenizing discourses

that erased the voices of women who differed in race, class, ethnicity, or sexual orientation. Although the contestations had already been initiated by black women, an even stronger challenge came from women of color (of other ethnicities: Latina, Chicana) and Third World women from postcolonial societies in Asia and Africa. Chandra Talpade Mohanty theorized in a 1986 article about the location of Third World women “Under Western Eyes.” The writings of Trinh T. Minh-ha and Gloria Anzaldúa powerfully critiqued white women’s hegemony in conceptualizations of feminism and feminist struggles. Sophisticated theorizing by Gayatri Spivak, Minh-ha, and Mohanty established that women in formerly colonized societies had cast aside old lines of dependency on the “center.”

These influential and groundbreaking texts on issues of race, ethnicity, region, sexuality, and class forced remappings of feminism within and beyond the United States. Henceforth, histories of women were more consciously inclusive, emphasizing multiculturalism and incorporating the experiences of African-American, Latin-American, Asian-American, and Native-American women. Thus feminism was strengthened by voices from the “margins.” “Identity” and “location” became important concepts, pushing the boundaries of earlier conceptualizations to acknowledge that all oppressions are interrelated and that identity politics cannot be separated from other aspects of liberation.

Global Feminisms: Nationalism and Religion

After the mid-1980s, documentation of women’s resistance movements in non-Western societies further deepened understandings of women’s liberation globally. Historical reconstructions of women’s movements in the nineteenth and twentieth centuries in Asia (India, Sri Lanka, China, Indonesia, Vietnam, and Japan) and elsewhere (Egypt, Turkey, and Iran) established that women had played significant roles in the national liberation and revolutionary movements of their countries. Feminist struggles had progressed along varied, sometimes interrelated trajectories, all of which contributed to the growth of feminist consciousness. This challenged the view that feminism was a “foreign” ideology being imposed upon Third World countries and asserted that, like socialism, feminism had no ethnic identity.

In the 1990s further documentations of feminist struggles in the postcolonial nations of Asia, Africa, and Latin America challenged the omissions in the existing literature. They also interrogated two other predominant Eurocentric tendencies: (1) to link women’s movements with modernization and development, and (2) to assume that feminism grows out of a linear process of social change. Regional data revealed that poor women in India, Brazil, Chile, and Peru had been at the forefront of many local struggles involving issues of work, wages, and environment and that, since women’s movements in India and the Philippines were stronger than in the more industrialized Japan and Russia, it could hardly be assumed that “development” and “modernity” were prerequisites for women’s movements to flourish.

Thus, similarities and divergences within feminism(s) have become more starkly visible. In Africa and West Asia there

appear regional similarities because feminist struggles have been intertwined with movements of national liberation and state consolidation. In Latin America, on the other hand, women's movements have been closely connected to democratization movements against authoritarian states. Women's movements in Asia, Eastern and Western Europe, and Russia are characterized by much more diversity.

Such documentation of global feminism(s) has further refined the understandings of women's movements in relation to state control and how that shapes or restricts feminist engagement, as in the cases of Russia, China, South Africa, and Palestine. For instance, although erstwhile Russia and other communist states in eastern Europe curtailed the growth of independent women's movements, they passed labor laws, legalized abortion, and created employment for women and supportive public institutions to reduce some of women's domestic work. China is one of the countries where state-affiliated women's organizations form the backbone of the women's movement. Rural women support the All-China Women's Federation (ACWF) more than they support women's groups.

Regimes of colonial domination provide important illustrations of how women's movements have had to think of race and gender simultaneously and how colonial domination facilitated women's entry into nationalist struggles and therefore into public spaces. In many postcolonial societies (India, for example), women did not have to struggle for suffrage; they gained the right to vote alongside the men when their countries were declared sovereign. Contemporary India has an active women's movement encompassing a range of issues—work, environment, ecology, civil rights, health. Abortion is legal and accessible. However, feminists are alarmed at the use of reproductive technologies (sex-determination tests) to selectively abort female fetuses despite legislation in 1994 banning such testing. Campaigns are underway to lobby for a Women's Reservation Bill, giving women 30 percent reservation in Parliament (Menon, 1999).

In the South African context, given the history of apartheid, feminism has been in intimate dialogue with the political movement. Unlike in the United States, where scholars have had to develop a feminist knowledge in the absence of a mass feminist movement, South African women have been theorizing within the context of an ongoing liberation politics—addressing apartheid as well as struggling for agency within the anti-apartheid movement. In Islamic societies struggles for women's rights have involved campaigns against conservative gender-discriminatory interpretations of Islam, particularly in relation to the use of the veil, women's right to education, and for more favorable provisions in marriage and divorce laws. Women's movements in Iran and Turkey have histories of activism, and Egyptian women have made considerable progress in creating spaces for women in civil society as professionals, activists, and politicians. Even in Afghanistan and Palestine, where women have long suffered under militarization, women's groups have continued to run girls' schools and support groups to aid medical and other relief projects for victims of war and insurgency.

However, there have been destructive implications for women when ethnic and religious nationalisms have become

xenophobic. In the name of preserving a cultural national identity women have been put behind the veil by fundamentalist regimes such as the Taliban in Afghanistan. In Kashmir (India), as militancy grew in the 1980s, Muslim women felt pressured to cover their faces, although veiling was not a widespread practice in the region. Women's movements have often been challenged by caste and religious affiliations that compel women to defend oppressive cultural practices as part of asserting loyalty to religious (rather than gender) identities. Veiling in Islamic societies and female circumcision in parts of Africa are classic examples, yet it is important to appreciate regional women's viewpoints. Feminists also have been concerned about the appropriation of feminist discourse by right-wing political forces—as by the Hindu Right in India (1990s) and by neoconservative elements in U.S. politics.

However, critiques of women's status within conservative Christianity, Judaism, Islam, Hinduism, or Buddhism ultimately lead many scholars of religion to argue that while orthodox religious practices may be relentlessly misogynist, more in-depth examination can help revitalize deeper, more ancient egalitarianism in most religions. Thus feminists in the 1990s examined religious theologies pointing to both the contradictions and the spaces for subversions within religions. Such understandings can provide tools to subvert existing gender hegemonies within orthodox religions.

Some Key Issues

Theoretical dilemmas and practical issues continue to challenge the women's movement across the globe. Issues such as pornography and women's portrayal in the media have been important issues for urban women, while for millions of rural Third World women, resisting development-related policies has been critical if they are to survive the march of globalization and avoid displacement as multinational corporations appropriate their lands. Gender-discriminatory laws governing marriage and divorce in many regions and religions have generated feminist struggles for social change. Trafficking in women and children and legalization of prostitution and abortion are key issues for feminism in many countries. Feminist practices and legal strategies continue to grapple with lawmakers, state authorities, and sometimes with the conservative strands among the women's movement itself. Below is a brief discussion of some issues facing feminism(s) in the early twenty-first century, with special emphasis on the ongoing attempt within the movement to build transnational collaborations and feminist communities of solidarity that stretch beyond divisions of culture, nation, region, and privilege.

Abortion and new reproductive technologies. Abortion (the conscious decision to terminate pregnancy) has long been a contentious issue. Religion and tradition are invoked by conservative “pro-life” groups, especially within the Roman Catholic Church and some Protestant organizations. However, feminist activists the world over stress that abortion should be viewed as an issue of autonomy, constitutionality, and economic status rather than simply of ethics. There are interesting ironies: while pro-life groups in America and Europe attack abortion clinics, millions of women in ostensibly more traditional societies (China and India) have easy access to abortion.

State population control policies in these countries support a pro-choice situation.

Another critical area with regard to women's reproductive roles is the explosion of technology enabling the manipulation of genetics and reproduction, procedures collectively known as new reproductive technologies (NRTs), used for in-vitro fertilization (IVF) and surrogate motherhood. Inherent in such technologies are social consequences closely affecting women. Feminists criticize the invasive role of NRTs and the manipulation of women's bodies through powerful hormones and surgical procedures that can traumatize the system. Feminists also point out the contradiction that in America pro-life campaigners have routinely threatened abortion clinics, whereas most IVF clinics still manipulate (and often "waste") embryos for surrogate motherhood. Feminists who campaign against the use of invasive technologies argue for women's bodies to be as free from intervention as men's and not to be "plundered medically."

Globalization, feminism, and transnational collaborations. Economic reforms undertaken by many nations in recent times have had complex implications for women and have shaped feminist agendas. With growing capitalism in China, for instance, many benefits and protections for women have been dismantled. In Russia, privatized enterprises rarely provide women the protection and maternity benefits that a strong, less democratic state did. In developing countries in Latin America and Asia, globalization and World Bank policies have rendered many women and unskilled laborers jobless. Feminists have critiqued this neoliberal globalization and U.S. policy, arguing that feminism(s) of the West must resist the cultural and economic domination of their home country over the lives of Afghans, Iraqis, Palestinians, and Israelis. Many feminists in the United States have been engaged in the effort to pluralize feminism. Zilla Einstein (2004) argues for a "polyversal feminism—multiple and connected" to express women's shared humanity. Chandra Mohanty (2003), reiterating the need to "decolonize feminism," conceptualizes transnational solidarities among women that recognize and accept difference. Such transnational "feminist communities anchored in justice and equality" aim for a feminism "without borders."

Antifeminism: The Backlash

Feminist movements the world over continue to face resistance, whether from the Catholic Church, Islamic leaders, or right-wing Hindu fundamentalists who promote restrictions on women beyond familial roles. Pro-life religious groups in Europe have been pitted against feminists lobbying for a woman's right to abortion. Resistance to feminism is manifest not only in religious fundamentalism but also in a backlash broadly termed as "antifeminism," which accuses feminism of promoting "anti-family" ideologies that threaten the well-being of children and communities. Antifeminist campaigns in the United States use Internet technology to "warn" readers about the hidden, "destructive subversions" in feminism.

Besides this issue-based resistance, it is necessary to point out that in many non-Western societies (such as Chile, India, Bangladesh, Turkey, and Iran) it is not uncommon to encounter suspicion even among women toward "feminists," who

are perceived to be "man-haters" who promote "anti-family" agendas. In fact, many women who believe in broadly feminist ideals and engage in activities that promote women's rights refuse to be called "feminists." A plausible explanation for the discomfort many women feel at being called feminists may be that in its inspiration, origins, and relevance, the "ideology" of feminism is still widely perceived to be Western and bourgeois, however erroneously.

In the United States, debates continue even within feminism with regard to the goals of feminism and its successes. Conservatives within feminism argue that feminists have exaggerated the problems of workplace discrimination and violence against women and disapprove of trends in the women's movements, which they believe have hurt women by forcing them out of traditional roles. Feminists, however, argue that the women's movement is alive and well and that much ground still needs to be traversed toward achieving gender equality. They assert that in the new millennium feminism offers a politics of solidarity that, while acknowledging difference, can build feminist communities to resist many contemporary crises in the context of globalizing economies and rising fundamentalism.

See also Antifeminism; Equality: Gender Equality; Family Planning; Feminism: Africa and African Diaspora; Feminism: Chicana Feminisms; Feminism: Islamic Feminism; Feminism: Third World U.S. Movement; Gender; Human Rights: Women's Rights; Motherhood and Maternity; Philosophies: Feminist, Twentieth-Century; Sexual Harassment; Womanism; Women and Femininity in U.S. Popular Culture; Women's History; Women's Studies.

BIBLIOGRAPHY

- Basu, Amrita, ed. *The Challenge of Local Feminisms: Women's Movements in Global Perspective*. Boulder, Colo.: Westview Press, 1995.
- Beauvoir, Simon de. *The Second Sex*. Translated by H. M. Parshley. New York: Knopf, 1993. Originally published in 1953.
- Daymond, Margaret J., ed. *South African Feminisms: Writing, Theory, and Criticism, 1990–1994*. New York: Garland, 1996.
- Disch, Estelle. *Reconstructing Gender: A Multicultural Anthology*. 3rd ed. Boston: McGraw-Hill, 2003.
- Einstein, Zilla. *Against Empire: Feminisms, Racism and the West*. London and New York: Zed Books, 2004.
- Firestone, Shulamith. *The Dialectic of Sex: The Case for Feminist Revolution*. New York: Morrow, 1970.
- Harding, Sandra. *The Science Question in Feminism*. Ithaca, N.Y.: Cornell University Press, 1986.
- , ed. *Feminism and Methodology: Social Science Issues*. Bloomington: Indiana University Press, 1987.
- hooks, bell. *Talking Back: Thinking Feminist, Thinking Black*. Boston: South End Press, 1989.
- Jaywardena, Kumari. *Feminism and Nationalism in the Third World*. London and Totowa, N.J.: Zed Books, 1986.
- Menon, Nivedita, ed. *Gender and Politics in India*. New Delhi and New York: Oxford University Press, 1999.
- Mohanty, Chandra. *Feminism without Borders: Decolonizing Theory, Practicing Solidarity*. Durham, N.C., and London: Duke University Press, 2003.

- Mohanty, Chandra, and G. Anzaldúa, eds. *This Bridge Called My Back: Writings by Radical Women of Color*. 3rd ed. Berkeley, Calif.: Third Woman Press, 2001.
- Mohanty, Chandra, Ann Russo, and Lourdes Toores, eds. *Third World Women and the Politics of Feminism*. Bloomington: Indiana University Press, 1991.
- Narayan, Uma. *Dislocating Cultures: Identities, Traditions and Third-World Feminism*. New York: Routledge, 1997.
- Shaw, Susan M., and Janet Lee. *Women's Voices, Feminist Visions: Classic and Contemporary Readings*. 2nd ed. Boston: McGraw-Hill, 2004.

Maina Chawla Singh

AFRICA AND AFRICAN DIASPORA

Feminism is broadly defined as the struggle for the liberation of women, and encompasses epistemologies, methodologies, theories, and modes of activism that seek to bring an end to the oppression and subordination of women by men. An individual person espousing feminism is referred to as a *feminist*, while collective mobilizations of women against the oppression of women are referred to as *feminist movements* wherever they occur. Feminist movements are defined by their relatively radical gender politics and located as a subgroup within the broader category of *women's movements*. Analysts of African women's movements have documented the mobilization of women by both military and civilian dictatorships (Abdullah; Mama) and by conservative and religious forces within civil society (Lazreg; Badran; Hale; Karam), thus contributing to the theorization of women's movements by broadening it to include mobilizations of women that may not be liberatory in the sense of bringing an end to the oppression of women.

Even so, the term *feminism* covers a diverse array of politics centered around the pursuit of more equitable gender relations; this is true of feminism in Africa. However, proper documentation and analysis of the various manifestations of feminism, and the manner in which these have changed over time in different African contexts, is hampered by the lack of access to resources and the limited opportunities for debate, networking, and scholarship grounded in continental contexts. As a result the debate around African feminism and feminism in Africa remains highly contested and difficult to define. Even in the era of nationalism, many African thinkers have rejected the word outright, considering it as "un-African" and derogating "feminists" as sexually unattractive and humorless man-haters, troublemakers, Westernized, and sexually disreputable women who pose a threat to traditional culture and society. Others have displayed varying degrees of acceptance and tolerance, generally around the emancipation and enfranchisement of women, and supporting the inclusion of women in hitherto male-dominated institutions and development. African women have devoted much effort to the redefinition of feminism evident in the plethora of publications generated under the broad rubric of gender and women's studies carried out in African contexts since the 1980s. Feminist thinkers have done much to excavate the histories of women's movements in African societies, some even going so far as to argue that Western feminism has derived much of its inspiration from Africa. Since the 1970s, Western anthropological studies of African

women have often been invoked (and at times appropriated) to provide evidence that the gender divisions of patriarchal Western societies were neither universal nor immutable, but culturally and socially constructed and therefore changeable.

Continental Feminism

African feminism draws much of its inspiration from historical, anthropological, and political evidence of African women's leadership, of women's mobilizations, and of dynamic and disparate gender relations. The diversity of contemporary African articulations of feminism can be found in a number of periodicals that have carried lengthy discussions on feminism and gender theory. Notable examples include the South African *Agenda*, "a feminist media project in Africa committed to giving women a forum, a voice and the skills to articulate their needs and interests towards transforming unequal gender relations," and the continental gender studies journal *Feminist Africa*, which "seeks to provide a platform for cutting edge, informative and provocative gender work attuned to African agendas . . . a forum for the publication and dissemination of high-quality feminist scholarship in African contexts."

These publications address the contemporary development of feminist thought in African contexts, locating it within the challenging economic, political, and cultural conditions that have given rise to a plethora of feminist struggles, ideas, and scholarship.

The conditions giving rise to feminism in Africa include the history of colonial rule and imperialism, women's involvement in nationalist struggles, and other social movements. Contemporary manifestations of feminist consciousness owe much to the particular and persistent harshness of the conditions under which most African women still live, conditions that in the early twenty-first century are widely being attributed to contemporary economic and political regimes, and the fascination with cultural restoration that many societies display when it comes to gender relations. While there are many feminist thinkers who valorize and defend aspects of African cultures, the majority are critical of the many patriarchal and abusive practices that Africans often justify in defense of "culture." Meanwhile, African cultures continue to be assailed by a complex combination of forces far more powerful than African feminist movements.

History

Feminist thinkers often draw inspiration from the history of women's leadership roles in African societies, citing examples of women who ruled kingdoms and led wars of conquest since the earliest epochs of human civilization. Most often cited are the seventh-century Berber queen known as the Kahina of the Maghreb, the ninth-century Magajiyas of Daura, the legendary sixteenth-century Queen Amina of Zazzau, the nineteenth-century Nzinga of Angola, and Nehanda of Zimbabwe. These examples illustrate that African women leaders exercised their authority—often in the distinctly feminine styles of their times—in a manner that spanned spiritual, political, and military realms, and that has served to inspire feminist ideas all over the world.

The cultural complexity and dynamism of a region in which so many cultures coexisted and interacted with one another

throughout the ages has given rise to quite disparate, at times idiosyncratic, gender relations and philosophies. There is little commonality between the complex and contradictory gender cultures expressed in Yoruba, Somali, Hausa, or Egyptian oral poetry, yet all of them are African, and all are rooted in conditions and contexts that are African in the sense of having been generated and inspired on the continent.

Women's movements on the African continent reflect the gendered cultural, social, and political organization of the numerous African societies in which they are located. There is enough evidence to suggest that African history is replete with diverse examples of mobilization against women's oppression, even though these have often been omitted by historians (Zeleza). Many of these at times phenomenal movements defy a simple definition of feminism. The available evidence suggests that women's movements in Africa reflect the traditions of organization that have characterized spiritual and material life in Africa as far back as recorded history goes. Few would seriously challenge the idea that gender differentiation has been a key feature of social, cultural, and political life all over the continent as far back as records can be found. Accordingly, African women have long been organized around lineage and kinship groupings, and around women's religious, cultural, and political duties and their productive and reproductive roles. The record also shows that these existing organizations were sporadically activated to defend women's interests.

Kenyan women were organized in *mumikanda* (work parties) and in various social and welfare groups—*ngwatio* among the Kikuyu-speaking communities, and *mwethya* among the Kamba-speaking communities. In Nigeria, Igbo women were organized as in various patrilineage wives and daughters associations, and governed through women's councils. Such networks of women collectively imposed sanctions on husbands who erred (the practice of "sitting on a man"), and proved capable of instigating widespread civil disturbances when they found their interests being compromised. The early-twentieth-century example of the Nwabiola Dancing Women's Movement in colonial Igboland (Eastern Nigeria) illustrates the manner in which apparently conservative organizational forms could become militantly activist when women saw their interests being threatened (Mba). All across West Africa business has long been conducted through market women's associations and trading networks that were periodically activated in defense of women's economic interests, and at times their political interests.

As colonialism gained ground, some of the earlier women's associations and groups were redirected by missionary groups and colonial governments, often through volunteers with a degree of Western education. These modern "women's clubs" were often designed to "civilize" and "uplift" African women, usually by instilling western European ideologies of domesticity and offering training in related skills (Tranberg Hansen). Domestication notwithstanding, it is clear that African women exercised enough agency to deploy whatever skills they acquired in innovative ways that empowered them and laid the ground for future involvement in national public life. Examples of women's groups coming together as larger bodies include the Mother's Union and the Catholic Women's Clubs

of Uganda, the Federation of Nigerian Women's Societies, the National Council of Women of Kenya, and the Association of Women's Clubs in Zimbabwe. When nationalist movements gained momentum, seemingly conventional women's groups and associations—charitable and welfare groups, mother's groups, and market women's associations—often directed their energies in support of nationalist goals. The Convention People's Party led by Kwame Nkrumah was among those nationalist movements that benefited substantially from the support of women—in this case the market women of Ghana.

Many of the women who later became leading educators, activists, and politicians were initially involved in the women's clubs of the colonial era, among them Margaret Ekpo of Nigeria, Agatha Constance Cummings-John of Sierra Leone, Mable Dove-Danquah of Ghana, and Gertrude Kabwasingo of Uganda. The more radical among these women—most of whom were elite and educated women—mobilized across the class lines too, as Funmilayo Ransome-Kuti did with such success. Ransome-Kuti was a key player in the Abeokuta Women's Union, which mobilized to oust an oppressive *alake* (chief) in 1948. In the ensuing decades she became a leading national political figure identified with nationalist, socialist, and feminist causes (Johnson-Odim and Mba). Ransome-Kuti's life is illustrative of African women's vibrant and militant history of resistance to colonial rule and imperialism and highlights the key roles that women activists played in nationalist movements all over the region, long before the second wave of feminism emerged in the Western world. Well-documented examples of more overtly political women's movements include those of Egypt, Nigeria, Ghana, Kenya, Uganda, Algeria, Mozambique, and the anti-apartheid movement of South Africa.

Some were chapters for women in the existing nationalist structures (for example, SWAPO Women's League, ZANU Women's League) or women's battalions in the nationalist militia (for example, the Algerian women in the FLN, the Frelimo Women's Brigade convened by Josina Machel, the short-lived women's detachment in the National Resistance Movement [NRM], or the women fighters said to make up 30 percent of the Eritrean People's Liberation Front). Other political women's organizations derived from party organs but broke away out of frustration, at times to pursue feminist agendas more overtly, as was the case with the Egyptian Feminist Union that broke away from the Egyptian Wafdist Party under the leadership of Huda Sharaawi. In an unspecified number of cases, women established new kinds of organizations with varying degrees of autonomy.

Postcolonial Feminism

The relationships between women's organizations and patriarchal states has continued to present ongoing challenges for feminist thinkers. The attainment of national independence during the 1960s saw the earlier traditions of organizing continue alongside the establishment of new and more modern manifestations of feminism, both within and outside government. At critical moments in the history of feminism in Africa, these different levels of mobilization have coalesced broader movements to pursue shared goals or platforms (see below).

Overall, post-independence feminism in Africa has been characterized by an emphasis on the state, as women have directed their demands for legal and policy reforms at their governments. While this has resulted in substantial legal and policy reforms in a great many countries, to the extent that formal exclusions have largely been removed from the statute books, feminist policy analysts have found cause to be critical of a lack of serious or concerted efforts to implement and sustain these reforms.

The state has often responded to feminist demands by creating a designated bureaucratic structure, in keeping with the United Nations call on member states to set up a government machinery for women and to include gender considerations in policies and projects.

Feminist analysts have found cause to remain critical of such government initiatives, especially where governments themselves have not been legitimate or democratic. In the context of the Nigerian military dictatorship, the high-profile gender activism on behalf of the regime has been characterized as “state feminism” (Mama, 1995), or “state pseudo-feminism” (Abdullah). More broadly, the deployment of women as functionaries in untransformed state bureaucracies has been characterized as “femocratic.” While this has meant a significant increase in the number of women within government in South Africa, in less-than-democratic African contexts state-driven initiatives on women have often involved the wives of the ruling elite in a manner that lacks public legitimacy, a phenomenon referred to as “first-ladyism” (Mama, 1995). First ladies who are well known for their role in mobilizing women to support and legitimize despotic regimes include Mama Ngina of Kenya, Maryam Babangida and Mariam Abacha of Nigeria, and Nana Konadu-Rawlings of Ghana.

The national machinery has taken various institutional forms, ranging from small desks within mainstream organs to whole ministries or commissions with intersectoral mandates. However, there is evidence to suggest that while state structures may have sought to co-opt women into the task of nation-statehood, they have not been as effective in pursuing feminist agendas and interests even when these have been clearly and, at times assertively, articulated.

The most elaborate of these is in South Africa, where there is a complex set of structures comprising an Office on the Status of Women within the president’s office, a Commission for Gender Equality, a Parliamentary Standing Committee on the Quality of Life, and Status of Women and gender desks in all major national and provincial structures. The efficacy of these has been constrained by both resource and capacity limitations. These appear to have led to a persistent gap between gender policy commitments and their realization in practice, leaving most women marginalized and subordinated. Many of the gains that might have accrued to women as a result of policy commitments to more equitable service delivery and fairer representation in the public sphere have been undermined by global shifts away from public provision of services and cutbacks in public sector employment.

Feminist Activism

Despite its diversity, feminist activism in Africa in the early twenty-first century can probably be defined by its relative autonomy from the state, and the expansion and spread of numerous kinds of organizations within and across borders. While much African feminist activism continues to focus on lobbying and making demands on the state, the limited gains in recent decades have seen many activists preferring to work from outside, rather than within the state. This explains the proliferation of organizations and networks that do not derive any support from government. The growth of feminist thinking within African universities reflects the increase in the overall numbers of women attaining higher levels of education and becoming less likely to passively accept the subordinate positions that African societies continue to arrogate to women. While there has been an increase in the number of women pursuing political careers, only a minority pursue explicitly feminist agendas, and there is a growing consensus over the need for strong autonomous women’s movements to push feminist agendas in and beyond the sphere of government.

The Zimbabwean women’s movement is a good example of this shift. While the new state established a women’s bureau and opened up some space for legal and policy reforms, it was only a few years before key activists left government to establish independent organizations, among them the Women’s Action Group and the Zimbabwe Women’s Resource Centre and Network. The Women’s Action Group was formed to resist the widespread victimization of women during Operation Clean-up in the early 1980s. The Zimbabwe Women’s Resource Centre’s key role in supporting the formation of a coalition of women’s organizations to intervene in the constitutional drafting process and the Land Lobby in the 1990s is illustrative of this capacity for autonomous activism. The increasingly oppressive nature of the regime of President Robert Mugabe has also had negative effects on the women’s movement and has created a new degree of reticence that did not characterize the same movement five years earlier.

In South Africa the Women’s National Coalition (WNC) marked a high point in South African feminism. Formed during the negotiations that culminated in the coming to power of the African National Congress (ANC), the WNC carried out nationwide consultations and produced the National Women’s Charter and ensured women a high level of participation in the emerging polity. However, the institutionalization of gender within the state apparatus has become identified as a source of concern, as independent activism has largely subsided since then, allowing for a slowing down of change, despite the proliferation of “gender desks” within government.

The uptake of gender matters within the state has seldom led to radical changes, although it has seen incremental increases in the number of women in government in many countries. Analysts frequently point to the importance of more autonomous mobilizations that can continue to lobby and advocate for change.

Despite the limits encountered within state-focused activism, the 1990s were also years of growth and diversification

for feminist activism across the region, as evidenced in the number of independent organizations and networks espousing feminist causes. The best known national and subregional organizations include the Tanzania Gender Networking Programme (TGNP), the Zimbabwe Women's Resource Centre and Network, Baobab and Gender and Development Action in Nigeria, the Nairobi-based FEMNET, and the Women and Law in Southern Africa network based in Harare. Various branches of international women's organizations like the Federation of International Democratic Advocates (FIDA), the Soroptimists, and the numerous church-related and Islamic women's organizations also deserve to be mentioned.

There is also a trend toward greater specialization in organizations, as more have taken on a sectoral focus, or have been established to pursue work in a defined field. Specific organizations have addressed matters that cover the full range: domestic violence, legal rights, education, health and sexuality, reproductive rights, HIV/AIDS, militarization, peacebuilding, housing and land, cultural and religious practices, female genital mutilation. These are just some of the areas being addressed by women's movements in different parts of Africa.

More recently African feminists are deploying information and communication technologies in highly innovative and radical ways, as evidenced by the activism of a number of electronically-based networks, notably ISIS-WICCE, GAIN, GENNET, and the Feminist Studies Network.

However, autonomous movements of the 1980s have often been replaced or displaced by nongovernmental organizations (NGOs) primarily charged with the delivery of specific funded projects. NGOs differ from women's movements in being usually small in scale, urban-based, often sectorally specialized, and reliant on external funding. The NGO reliance on donor funding, while ensuring space for gender activism to continue in increasingly resource-starved environments, is increasingly viewed as compromising the capacity for autonomous feminist activism. Critics variously describe this as the "projectization" or "NGO-ization" of feminist movements, drawing attention to the manner in which even limited funding can have divisive and fragmenting effects, and lead to the reintroduction of conventional hierarchical structures and the neutralization of feminist agendas. It is this complicated scenario that leads African feminist Sisonke Msimang to write

I am part of a new generation of young African feminists whose entrance into "the movement" has been marked by feminist engagement in ways that are distinctly new. Many of us are feminists by profession and our "experience" and analysis comes from having worked on projects that employ the terminology of Gender and Development. We enter the arena of activism not necessarily through struggles specifically geared towards women's liberation, but through a complicated route that often involves the technical jargon of Gender and development and human rights. (p. 54)

With the democratization of politics in many African countries, women have continued to mobilize, demanding greater

participation in political life, a concern reflected in the Beijing platform of 1995. In doing so they have also challenged the patriarchal biases of the political establishment, its militaristic culture, and the fact that large sums of money are necessary to the pursuit of political careers. Feminist politicians who have held seats in parliament have often found themselves profoundly challenged on key issues such as militarism, HIV/AIDS, land, and financial corruption, and in situations that have left them unsupported by the political mainstream. More commonly, they are simply not taken seriously by their male counterparts, as Sylvia Tamale's insightful study of women in the Ugandan parliament indicates.

Feminist Intellectuals

Well-known feminist thinkers who have played prominent roles in political and intellectual debates throughout the 1970s and 1980s include Nawal El Sadaawi (Egypt), Zeneberke Tadesse (Ethiopia), Fatima Mernissi (Morocco), Fatou Sow (Senegal), Bolanle Awe (Nigeria), Patricia MacFadden (Swaziland), Ifi Amadiume (Nigeria), Ruth Meena (Tanzania), and Fatma Allo (Zanzibar). In terms of organizations, the establishment in 1977 of the Association of African Women for Research and Development (AAWORD) marked the growing assertiveness of African feminists. The founding workshop set out to establish a continent-wide network of scholars dedicated to undertaking research from an African and gender perspective. The declared mission of AAWORD includes two clearly feminist commitments: to analyze and transform gender relations and social conditions in Africa; and to build a powerful African women's movement linking human rights to the theory and practice of development.

During the 1980s AAWORD was joined by several other research and documentation centers, notably the Women's Research and Documentation Centre (WORDOC) at the University of Ibadan, set up by a group of Nigerian academics that included the historian Bolanle Awe, and the Women's Research and Documentation Project (WRDP) at the University of Dar Es Salaam initiated by Tanzanian academics.

The 1990s saw a continuing proliferation of documentation centers and gender and women's studies units on African campuses, as well as several new initiatives to bring these together through research and networking activities. In pursuing an initiative designed to network and strengthen the work of scholars in gender and women's studies working in African institutions, the African Gender Institute (itself formed in 1996) was able to identify as many as thirty such sites in Africa's 316 universities, with several others still being established (Boswell, 2002). The scholarly output in the field of gender studies, much of which bears the influence of feminist thinking, has also increased rapidly, as several recent reviews indicate (Mama, 1995; Lewis).

The expansion of the field appears to be continuing in the early twenty-first century, despite the apparently unfavorable context offered by Africa's beleaguered universities, most of which remain extremely resistant to the idea of feminism and offer very limited institutional support to gender and women's studies, teaching, and research (Feminist Africa). A core concern reflected

in both AAWORD and the African Gender Institute is the commitment to bring critical reflection and political activism together for the benefit of women. Intellectual activism is intrinsic to feminism worldwide, but in African contexts it has raised unique challenges because of the particular salience afforded to “gender planning” and “gender mainstreaming” in the international development discourses that have such profound effects on the region.

Feminism in the African Diaspora

Diasporan feminism is rooted in the historical experience of enslavement and racism, so it challenges the oppression of women within the relations of racism that still curtail the prospects of black people located in Western contexts.

African diasporan thinkers in the United States have therefore developed feminist thinking that maintains the centrality of racism in black women’s experience. In the United States these include Angela Davis’s book *Woman, Race and Class* (1982) and bell hooks’s *Ain’t I a Woman: Black Women and the Politics of Feminism* (1982). Literary works that illustrate changing African-American feminist perspectives include the well-known work of writers such as Toni Morrison, Audre Lourde, June Jordan, Maya Angelou, and Alice Walker, all of whom have had an influence far beyond the United States.

In the European diaspora, the debate on black feminism opened up in the early 1980s with the publication of Hazel Carby’s article. Caribbean and black European feminist thinkers have since produced a body of feminist thought that incorporates antiracist and anti-imperialist perspectives, while displaying a sensitivity to class oppression (Amos and Parmar; Grewal et al.). Julia Sudbury’s *Other Kinds of Dreams: Black Women’s Organisations and the Politics of Transformation* (1998) presents an overview of the British black feminism that emerged out of the black struggles against racism and state harassment carried out within the predominantly working-class Caribbean, African, and Asian communities during the 1980s.

The history of feminism in the Caribbean diaspora is also rooted in antislavery and antiracist movements, with its contemporary manifestations typifying postcolonial struggles around identity and difference, while pursuing feminist agendas of antiviolenace activism, and responses to sexual exploitation and global economic development, to name only some of the various fronts (Reddock; Mohammed; Antrobus; Barriteau). The Caribbean Association for Feminist Research and Activism (CAFRA) and the Centre for Gender and Development Studies at the University of the West Indies have played key roles in articulating and internationalizing Caribbean feminism.

African and African diaspora women concerned with emphasizing the distinctiveness of African legacies and not always wishing to be identified with feminists in the Western world have improvised a number of alternative terms. *Womanism* is a term attributed to the African-American writer Alice Walker and adopted by some South African and Nigerian writers, while others prefer the term *motherism*. Catherine Achonulu advocates *motherism*, while Omolara Ogundipe-Leslie advocates *stiwanism*, to denote commitment to the social transformation

involving women of Africa (*stiwani*). The more pragmatic term *gender activism* has been increasingly deployed by women activists working in development organizations, where policy demands require expertise in gender, but the term *feminism* is considered too political.

While it may be hard to discern a unified and coherent feminist movement in many African countries given the complexity of gender politics and the disparate influences of the state, local, and international development agencies and diverse women’s movements, it is clear that African women have been able to come together as a powerful force at key historical moments in various countries during the recent historical period. Feminist thought continues to evolve on the African continent and to maintain links with women located in various Western countries, not least because conditions on the continent ensure that continental feminists often find themselves in the diaspora.

See also **Feminism: Overview; Feminism: Islamic Feminism; Gender; Modernity: Africa; Womanism.**

BIBLIOGRAPHY

- Antrobus, Peggy. *The Rise and Fall of Feminist Politics in the Caribbean Women’s Movement 1975–1995: The Lucille Mathurin Mair Lecture March 2000*. Kingston, Jamaica: Centre for Gender Development Studies, University of West Indies, 2000.
- Badran, Margot. *Feminists, Islam and Nation: Gender and the Making of Modern Egypt*. Princeton, N.J.: Princeton University Press, 1995.
- Barriteau, V. Eudine. “Confronting Power and Politics: A Feminist Theorising of Gender in Commonwealth Caribbean Societies.” *Meridians: Feminism, Race, Transnationalism* 3, no. 2 (2003): 57–92.
- Boswell, B. “Gender and Women’s Studies in Africa in the Year 2002: A Directory of Institutional Sites.” 2003. Available at www.gwsafrica.org/directory.
- Collins, Patricia Hill. *Black Feminist Thought: Knowledge, Consciousness and the Politics of Empowerment*. Boston: Unwin Hyman, 1990.
- Davis, Angela Y. *Woman, Race, and Class*. New York: Vintage, 1982.
- Feminist Africa. “Intellectual Politics.” *Feminist Africa* (2002). Available at <http://www.feministafrica.org>. First issue of an electronic journal.
- Hale, Sondra. *Gender Politics in Sudan: Islamism, Socialism, and the State*. Boulder, Colo.: Westview, 1997.
- hooks, bell. *Ain’t I a Woman: Black Women and the Politics of Feminism*. Boston: South End Press, 1982.
- Jayawardena, Kumari. *Feminism and Nationalism in the Third World*. London: Zed Books, 1986.
- Johnson-Odim, Cheryl, and Nina Emma Mba. *For Women and Nation: Funmilayo Ransome-Kuti of Nigeria*. Urbana: University of Illinois Press, 1997.
- Kabira, Wanjiku Mukabi, and Elizabeth Akinyi Nzioki. *Celebrating Women’s Resistance: A Case Study of the Women’s Groups Movement in Kenya*. Nairobi: African Women’s Perspective, 1993.
- Karam, Azza M. *Women, Islamisms, and the State: Contemporary Feminisms in Egypt*. London: Macmillan Press; New York: St. Martin’s Press, 1998.
- Khasiani, S. A., and E. I. Njiro, E. *The Women’s Movement in Kenya*. Nairobi: African’s Women’s Perspective, 1993.

- Lewis, Desiree, ed. *African Women's Studies: 1980–2001: A Bibliography*. Cape Town: African Gender Institute, 2003.
- Mama, Amina. "Feminism or Femocracy? State Feminism and Democratization in Nigeria." *Africa Development* 20, no. 1 (1995): 37–58.
- Mba, Nina Emma. *Nigerian Women Mobilized: Women's Political Activity in Southern Nigeria, 1900–1965*. Berkeley: Institute of International Studies, University of California, 1982.
- Mismang, Sisonke. "Editorial: African Feminisms Two." *Agenda* 54 (2002).
- Mohammed, P. "Rethinking Caribbean Difference." *Feminist Review* 59 (1998): 6–39.
- Reddock, Rhoda. "The Early Women's Movement in Trinidad and Tobago 1900–1937." In *Subversive Women: Historical Experiences of Gender and Resistance*, edited by Saskia Wieringa. London and Atlantic Highland, N.J.: Zed Books, 1995.
- Sharaawi, Huda. *Harem Years: The Memoirs of an Egyptian Feminist*. Translated and introduced by Margot Badran. New York: Feminist Press, 1987.
- Sudbury, Julia. *Other Kinds of Dreams: Black Women's Organizations and the Politics of Transformation*. London and New York: Routledge, 1998.
- Tamale, Sylvia. 1999. *When Hens Begin To Crow: Gender and Parliamentary Politics in Uganda*. Boulder, Colo.: Westview, 1999.
- Tranberg Hansen, Karen. *African Encounters with Domesticity*. New Brunswick, N.J.: Rutgers University Press, 1992.
- Tsikata, D. "Gender Equality and the State in Ghana: Some Issues of Policy and Practice." In *Engendering African Social Sciences*, edited by Ayesha M. Imam, Amina Mama, and Fatou Sow. Dakar, Senegal: Council for Development of Social Science Research in Africa (CODESRIA), 1999.
- Women's Studies and Studies of Women in Africa during the 1990's*. CODESRIA Working Paper Series No. 5. Dakar, Senegal: Council for Development of Social Science Research in Africa (CODESRIA), 1996.
- Zelega, P. T. "Gender Biases in African Historiography." In *Engendering African Social Science*, edited by Ayesha M. Imam, Amina Mama, and Fatou Sow. Dakar, Senegal: Council for Development of Social Science Research in Africa (CODESRIA), 1999.

Amina Mama

CHICANA FEMINISMS

There are many definitions of feminism, and many scholars now assert that the word should be used in its plural form to encompass women's various social locations. As such, Chicana feminisms address the specific historical, economic, and social experiences of women of Mexican descent in the United States. The field of Chicana feminisms developed within the context of feminist movements in the United States, including the feminist writings of African-American, Asian-American, Native American, and white scholars. Although Chicana feminist analyses focus specifically on the condition of Chicanas, writers claim allegiance to U.S.-based as well as internationally based politically progressive movements (Saldívar-Hull).

There are four distinctive features that distinguish Chicana feminisms from other forms of feminism: history, culture, intersectionality, and political coalitions.

The Importance of History

The end of the Mexican-American War in 1848 codified in the Treaty of Guadalupe Hidalgo the colonized status of Mexico's former citizens in what became part of the U.S. southwestern states of Arizona, California, Colorado, New Mexico, and Texas. Mexicans residing in this region lost their citizen rights and saw their language and culture displaced overnight. It was this act of colonization that Chicanos in general and Chicana feminists in particular use as central in claiming a particular social and economic position in the United States that makes them different from other immigrant groups. The initial act of colonization influences even recent Mexican immigrants as they join Chicano communities in the United States that are treated differently from mainstream white communities.

During the Chicano civil rights movement of the 1960s, many Chicano writers sought to expose the suppressed history of Mexicans in the United States. Chicana feminist writers focused on highlighting the political resistance and "underground" feminisms of many important women leaders since 1848. Women of Mexican descent in the United States have a long history of resistance and political mobilization, as demonstrated by strong women leaders such as Emma Tenayuca, who was a labor leader in Texas, and *las soldaderas* (women soldiers) who fought in the Mexican Revolution of 1910. Dolores Huerta (b. 1930) followed this tradition of political leadership as she fought side-by-side with César Chávez (1927–1993) to unionize California farmworkers and continued into the twenty-first century carrying out Chávez's important political work after his untimely death in 1993.

The Importance of Culture

Chicana feminist writers agree with other feminists that patriarchy exists in most societies. However, patriarchy is manifested in culturally specific ways, and as such, Chicanas' culture and history are central to their analysis of gender in their communities. Chicana feminists have identified several cultural elements that are central in defining Chicana definitions of proper womanhood. One is the veneration of La Virgen de Guadalupe (the Virgin of Guadalupe, the national saint of Mexico); another is the figure of La Malinche, an indigenous woman who facilitated the conquest of Mexico by Hernán Cortés (1485–1547) by serving as translator and go-between in the negotiations that ultimately defeated the Aztec leader Montezuma in 1519. Both women are iconic figures of what is desirable and undesirable for Mexican women in Mexico as well as Chicanas in the United States.

The desirable aspects of Mexicana/Chicana womanhood based on La Virgen de Guadalupe are piety, dedication, humbleness, selflessness, dedication to family, and virginity. The undesirable traits, as embodied in La Malinche, are treachery, lying, deceitfulness, and sexual promiscuity. Although other cultures usually describe this distinction between women as a "virgin-whore" dichotomy, in Mexican or Chicano culture the dichotomy is tied specifically to these two figures rather than a general distinction with no cultural or historical referent. These culturally appropriate and inappropriate ways of expressing Chicana womanhood do not apply to non-Chicana

DOLORES HUERTA

Dolores C. Huerta, cofounder and first vice-president emeritus of the United Farm Workers of America—AFL-CIO (UFW)—played a major role in the American civil rights movement.

Dolores Huerta was born on April 10, 1930, in a small town in northern New Mexico. Her father, Juan Fernandez, was a miner, fieldworker, union activist, and state assemblyman. Dolores was raised by her mother, Alicia Chávez, after her parents divorced when she was three years old. Dolores along with her two brothers and two sisters grew up in the San Joaquin Valley in the farmworkers community of Stockton, California. Her mother was a businesswoman who owned a restaurant and a seventy-room hotel that often put up farmworkers and their families for free.

Dolores Huerta attributes her accomplishments and lifelong activism to her mother's influence and caring. Dolores was one of the first Chicanas to graduate from her high school and one of the first to receive a teaching degree from the University of the Pacific's Delta Community College. As a teacher, however, she soon realized that she could make more of a difference in her students' lives if she helped improve the lives of farmworkers—so their children did not have to attend school hungry.

Dolores began community organizing in 1955 as a founding member of the Stockton chapter of the Community Service Organization (a grassroots organization fighting social injustice). While working for the CSO, she helped create the Agricultural

Workers Association (in 1960), and as a lobbyist in Sacramento in the early 1960s she was instrumental in the passage of legislation allowing voters the right to vote in Spanish and allowing individuals to take the driver's license examination in their native language. She later lobbied in Washington, D.C., for an end to the so-called *bracero* program that encouraged the use of "captive labor" from Mexico. In 1962 she joined Cesar Chávez in Delano, California, and they created the National Farm Workers Association, precursor to the United Farm Workers union.

In 1966 Huerta negotiated a farmworkers' contract with the Schenley Wine Company, marking the first time in the history of the United States that agricultural workers negotiated a labor contract with a major corporation. Her struggles on behalf of farmworkers continued into the next decades. In her seventies, she was still fighting to preserve and extend the rights of agricultural workers in the United States, working long hours and traveling to cities across North America promoting *La Causa*—the farmworkers' cause—and women's rights.

Huerta received a number of honorary doctorate degrees, was a board member for the Fund for the Feminist Majority (advocating for the political and equal rights for women), and president of the Dolores Huerta Foundation, with the mission of establishing Communities of Conscience focusing on community organizing and leadership training in low-income, underrepresented communities.

women and therefore merit a different feminist analysis from those developed by other cultural groups.

The Importance of Intersectionality

Many writers of Chicana feminisms had been active participants in the 1960s Chicano civil rights movement and in the white feminist movement. Their experience in multiple political struggles alerted them to the exclusion of gender and sexuality in ethnic mobilizations and the exclusion of social class, race, and ethnicity in feminist mobilizations. From the experience of always feeling only partially understood, Chicana feminists developed, in conjunction with other feminists of color, the

concept of intersectionality. Chicana feminisms ascribe to the notion that women belong to more than one oppressed group and that through understanding the intersection of how these different social categories—sexuality, class, race, ethnicity, gender—intersect in contextually specific situations, Chicanas' multiple oppressions can be understood. For example, a poor, lesbian, immigrant, Mexican farmworker will experience patriarchy and gender subordination differently from a middle-class, heterosexual, third-generation U.S.-Chicana professor. Intersectionality immediately recognizes that not all women are the same and that social locations identified through group memberships can elucidate women's multiple sources of oppression.

A corollary to intersectionality is that the experience of multiple sources of oppression facilitates Chicanas' experiencing social reality as multilayered. That is, knowledge of more than one language and one culture allows the potential for realizing the arbitrary nature of social categories. Chicana feminist writers have identified the ability to perceive and translate different social realities as *mestiza* consciousness (Moraga and Anzaldúa), *concientización* (Castillo), and shifting consciousness (Sandoval), and have capitalized on this intellectual dexterity to capture fully the internal diversity of Chicanas in the United States and to avoid essentializing the "Chicana experience." Furthermore, the ability to communicate multiple realities has also facilitated Chicana feminist writers speaking to different constituencies through their intellectual production and addressing different sources of oppression depending on whom they are addressing (Arredondo et al.).

The Importance of Political Coalitions

Chicana feminisms do not situate the sources of women's oppression only in gender or exclusively in class, race, ethnicity, or sexuality. Their commitment to examine women's disadvantages through the lens of intersectionality allows them actively to seek political coalitions with other oppressed groups, including men of color. Chicana feminisms refuse to "rank the oppressions" (Moraga and Anzaldúa) and are committed to being self-reflexive about how everybody, regardless of their apparent powerlessness, can contribute to oppression within restricted contexts (Pérez). At the same time, Chicana feminisms see class struggles as fundamental to worldwide liberation (Saldívar-Hull).

The Future of Chicana Feminisms

Chicana feminisms are a vibrant field of study in several disciplines: American studies, anthropology, art, ethnic studies, film studies, literature, psychology, sociology, and women's studies. At the start of the twenty-first century, with Chicana feminisms as a field almost three decades old, a third generation of writers were expanding and elaborating the basic features of Chicana feminisms. Furthermore, young, educated Chicanas were embracing the political goals set out by the first generation of Chicana feminist writers and using their various professions to implement many of the ideas written about almost thirty years earlier. All of these developments, coupled with the flexibility and self-reflexivity inherent in the paradigms proposed by Chicana feminisms, make it a promising and expanding field of study as well as a potential framework for political action.

See also *Chicano Movement; Feminism: Third World U.S. Movement; Women's History*.

BIBLIOGRAPHY

Arredondo, Gabriela F., Aída Hurtado, Norma Klahn, Olga Nájera-Ramírez, and Patricia Zavella, eds. *Chicana Feminisms: A Critical Reader*. Durham, N.C.: Duke University Press, 2003. This is the most recent and comprehensive overview of the influence of Chicana feminisms on multiple disciplines.

Castillo, Ana. *Massacre of the Dreamers: Essays on Xicanisma*. Albuquerque: University of New Mexico Press, 1994. An important analysis of the historical and social influences on Chicana feminist thought.

Hurtado, Aída. *Voicing Chicana Feminisms: Young Women Speak Out on Sexuality and Identity*. New York: New York University Press, 2003. The only empirical study of young, educated Chicanas and their views on feminisms.

Moraga, Cherríe, and Gloria Anzaldúa, eds. *This Bridge Called My Back: Writings by Radical Women of Color*. Foreword by Toni Cade Bambara. Watertown, Mass.: Persephone Press, 1981. A classic in the field of Chicana feminisms.

Pérez, Emma. *The Decolonial Imaginary: Writing Chicanas into History*. Bloomington: Indiana University Press, 1999. One of the most important books in Chicana feminist thought and theorizing of their historical presence in U.S. society.

Saldívar-Hull, Sonia. *Feminism on the Border: Chicana Gender Politics and Literature*. Berkeley: University of California Press, 2000. An important exploration from a Chicana feminist perspective of creative writings by Chicanas and their connection to the U.S.-Mexican border.

Sandoval, Chela. *Methodology of the Oppressed*. Foreword by Angela Y. Davis. Minneapolis: University of Minnesota Press, 2000. The most comprehensive analysis of the connections between Chicana feminist thought and classic philosophical writings in cultural studies.

Aída Hurtado
Jessica M. Roa

ISLAMIC FEMINISM

The term *Islamic feminism* was first used in the 1990s. It is not certain who coined the term. Nor is it evident that those who first used it were aware of the explosive impact that the juxtaposition of these two words was to have. Rather than imagining and promoting a revolution in the heart of Islam, these women in Saudi Arabia, South Africa, and some Asian Muslim communities were merely describing what they and others like them were doing. They were challenging the misogyny that they saw to be essential to the projection of a newly politicized Islam.

Defining "Islamic Feminism"

To understand Islamic feminism, both words have to be examined separately and then together. The epithet "Islamic" situates a person somewhere on the continuum between a cultural identity that is Muslim and coexists easily with secularism and occasional expressions of religious observance on the one hand, and Islamist, which describes a way of life committed to fighting for the establishment of an Islamic state. "Feminist" refers to a consciousness that women are unjustly treated simply because they are women. This consciousness may, but need not, be galvanized into action to do something to change this unjust system (see introduction in Badran and Cooke).

"Islamic feminist" describes the speech, action, writing, or a way of life committed to gender justice and also an engagement with Islamic epistemology as an expansion of a faith position rather than a rejection of it. At the same time that they address themselves to this discourse and derive from it

rhetorical strategies to construct a resistant identity, these women are struggling with and on behalf of all Muslim women and their right to enjoy with men full participation in a just community. Justice and citizenship, however defined, would not be borrowed, modern accretions but rather ideals integral to the spirit underlying the founding Islamic community. More recently, Islamic feminism has been described as broadening the scope of Western feminism because of its emphasis on community and belonging.

By the late 1990s, when the term *Islamic feminism* had become current, it came under scrutiny (e.g., Moghissi). What did it mean to want to be a member of a religious community considered to be patriarchal in its norms and values and, at the very same time, to demand respect for oneself as a woman with inalienable rights? Was it false consciousness to believe that such a position might be empowering?

Some Muslims and non-Muslims were writing dogmatically about Islamic feminism, calling it an oxymoron without meaning. They protested that organized religions, and particularly Islam, are unremittably patriarchal, misogynist even. It is misguided to hope for a woman-friendly interpretation of foundational texts and laws that would allow for a transformation in attitude toward women's roles in society outside the domestic space. Some might go further to claim that proponents of Islamic feminism were merely ignorant. Either they had not read the Koran and sunna (the life of the prophet Muhammad, codified in the Traditions), or if they had, they did not understand what they had read because, despite the wide diversity of the Muslim world, "the cultural articulation of patriarchy (through structures, social mores, laws and political power) is increasingly justified by reference to Islam and Islamic doctrine" (Shaheed, p. 79).

Others, mostly Muslim women, conceded that there were women who were calling for women's empowerment within the context of a well-understood Islam, but that they were not feminists. They might look like feminists, act like feminists, but feminism would not be the right term to use. When asked for alternatives, they might come up with suggestions like "womanist" or "remaking women" (see Abu-Lughod), or they would deny the need for a single term to describe their actions and demands. Many of these women are particularly critical of non-Muslims when they describe a person, a behavior, or a language as Islamic feminist.

Clearly, there are some sensitivities involved in the word *feminism* when used to refer to the language and behavior of Muslim women. What is the problem with the term? Do Jewish, Christian, or Buddhist feminists face the same conundrum? Probably not because for them the term *feminist* is not as imbricated in recent experiences of European, colonial domination as it is for Muslims living under the yoke of the Christian civilizing mission of European colonialism. During the nineteenth century, British and French colonizers in North Africa and West and South Asia claimed to be especially concerned about the welfare of women in the societies they had invaded and occupied. Deploring barbaric practices like female genital mutilation, *sati* (Hindu women's self-immolation on their husbands' funerary pyres), veiling, and women's seclusion,

white European men made it their business to save Arab Muslim women from their men. Some scholars, such as Leila Ahmed, have pointed to these men's hypocrisy—feminists abroad, they were tyrants at home. Furthermore, they have revealed their cunning, for by pretending to protect indigenous women, they were separating them from their men. Thus, they were better able to control them and, by extension, rule their men. Feminism became deeply enmeshed in colonialism.

The Modern Era

Muslim women activists at the turn of the twentieth century were careful to distinguish their behavior, language, and appearance from those of their Western sisters. Always speaking within an observant Muslim context, they demanded education, employment opportunities, control over their lives (for example, marriage choice) and over their bodies (to veil or not to veil). They insisted that their demands were not what European women wanted. Above all, they honored their religion, their husbands, and their fathers, and all they wanted was to bring up intelligent sons. They argued that the call for unveiling indicated a desire to gain access to institutions that would make them better wives, mothers, and Muslims; it would not destroy the moral fiber of their society by encouraging promiscuity, widescale divorce, and the kind of immoral European society contemporary religious authorities were denouncing.

Many of these early activists on behalf of women's rights, such as Nazira Zayn al-Din, a Lebanese writer of the early twentieth century, prefaced their demands with claims about their qualifications to do so. They were pious Muslims, daughters of pious Muslim men (a surprising number were daughters of Islamic clerics). By the 1930s women throughout the Muslim world were gaining rights unimaginable only thirty years earlier. It became acceptable to call oneself a feminist, although the term *Islamic feminist* was never used, as though the Islamic part was assumed.

Then in 1979 a radically conservative Shiite Islamic revolution was waged and won in Iran. Bazaar, university, and women came together to expel the shah with his Western friends and worldview. The women put on veils to mark their Iranian identity, a kind of nationalist uniform. When the ayatollahs came to power, they decreed the wearing of the veil to be part of the new establishment look. Women who wanted to work in government or even only appear in public had to don the chador. Islam came to represent the restitution of authentic norms and values in a society corrupted by its overidentification with the West (a term was coined, *gharebzadegi*, "west-toxicification").

From Iran the movement to re-Islamize Muslim societies spread and encountered the Sunni thrust of Saudi Arabia. The language and symbols of a newly invigorated Islam came to dominate public space. Women were central to this transformative process. Women in public had to look and act in such a way that they confirmed the Islamicness of that space. Religious authorities issued pronouncements on what women should and should not do. The rules and regulations increased and tightened. Interpretations of foundational texts based on

flimsy evidence or on proven misogynist interpretations from the early centuries of Islam, like those of Ibn Taymiyya and Ibn Jawzi, came to assume a new importance in the public practice of the religion.

Interpreting the Role of Women in Islam

By the mid-1980s women were realizing that they were going to have to assume responsibility for interpreting foundational texts if they were to hold on to rights for which their mothers had fought and that they were seeing erode under their very eyes. If they did not stop the advance of an Islamic movement that systematically targeted women's established rights and liberties, then no one would. In fact, they were wrong, because men soon joined these women. Farid Esack in South Africa raised the banner for what he called "gender jihad," and in Iran, in the heart of what was thought to be the beacon of conservative Islam, some male clerics were opposing their colleagues' antiwomen legislations.

Political and religious context, and also the Muslimness of the dominant culture, determined whether the new veiling was radical or conservative. Some women in Muslim countries like Saudi Arabia adopted the veil and strict Islamic dress codes and then called for women's rights even as they condemned Western practices and norms. They were thus able to do what before had been forbidden, namely to gather publicly in large numbers and listen to "charismatic, wealthy women, knowledgeable in religion and shari'a" (Yamani, p. 279). Other Muslim women in non-Muslim societies, such as France, put on the distinctive headscarf in order to draw attention to their religious-cultural identity. Muslim women in secular Muslim Turkey suffered the same opprobrium as their Muslim sisters in France.

The Islamization of knowledge accompanied the new veiling movement. From Indonesia to Morocco to the United States, women and men turned to the Koran, sunna, and Islamic law to collect evidence about the emancipatory nature of the religion and its founder Muhammad. The women around Muhammad were invoked as models for contemporary women: strong, intelligent, integral to the emergence of the new faith in seventh-century Arabia. His wives Khadijah and Aisha, the warrior Nusayba who saved his life in battle, his daughter Fatima, and his granddaughter Zaynab proved that from the beginning Islam was a religion unusually open to women and supportive of their rights.

Sociologists, historians, literary scholars, engineers, and physicians started to retrain themselves to become proficient in religious sciences. They studied hermeneutics and applied their new knowledge to the law and its foundations. Some, such as Amina Wadud-Muhsin, focused on the Koran and in a manner characterized by some as "textual fundamentalism," deconstructed sections word by word to produce positive meaning out of the most apparently negative passages. Others chose the Traditions, the sayings and actions of the prophet Muhammad reported by his Companions and down the generations through chains of reliable authorities. Fatima Mernissi showed how shaky was the witness of two of the most authoritative Companions, especially in what they reported the Prophet to have said about women leaders.

Teams of women collaborated on transnational projects to examine aspects of Islamic law that had negative repercussions for women. In 1982, Sisters in Islam based in Malaysia was among the first organizations to coordinate efforts on behalf of women who wanted to be good Muslims and strong, public women. Founded in 1986 by the Algerian Marie-Aimee Helie-Lucas, Women Living under Muslim Laws (WLUML) launched their Women and Law Project in 1994. Their goal was to establish a transnational feminist network that would ensure the wide dissemination of reliable information about women's rights under Islamic rule. The Iranian Mahnaz Afkhami established in 1998 the Women's Learning Partnership that produced manuals to educate women about their Islamic rights to inheritance, education, choice in marriage, choice in appearance, and protection from violence ranging from rape in marriage to honor killing. All are mobilizing on behalf of the implementation in their countries of the UN Convention on the Elimination of All Forms of Discrimination Against Women (CEDAW).

By the late 1990s this feminist labor was happening everywhere, even in the Islamic Republic of Iran. Women were studying in Tehran and Qum in women's colleges of Islamic jurisprudence and law. In Saudi Arabia women preachers were educating women in schools, colleges, and public meeting places about women's religiously guaranteed rights. They were teaching audiences how to interpret key texts for themselves in order that they not remain ignorant puppets in the hands of manipulative men. Mosques became important rallying places for women's learning circles. Feminism as a term associated with the West and its imperial projects in the lands of Islam once again became suspect. Those most opposed to its use produced a rhetoric uncannily mimetic of that of their foremothers.

However, this worldwide movement of activists struggling for the rights of women within a well-understood Islam attracted those who had not previously projected themselves as particularly religious. In Iran, journalists writing for the feminist journal *Zanan* celebrated the marriage between Islam and feminism. Far from apologizing for their use of the word *feminism*, they underscored the importance of its connections with European-American feminisms and their sociopolitical underpinnings and rigorous methodological and theoretical framing. They were proud to be both Muslim and feminists and they announced that they were Islamic feminists. This is the context in which the first Muslim woman won the Nobel Peace Prize in 2003. Shirin Ebadi, an Iranian lawyer who defended women's and children's rights throughout the toughest times of the Islamic regime, emphasized that her work had been conducted within an Islamic framework.

Ebadi is not alone in Iran or elsewhere. More and more women and men, Muslims and non-Muslims, are recognizing the dangers of a political Islam that targets Muslim women and Western institutions and then justifies this violence in religious language. They are fighting back with the goal of restoring meaning and efficacy to the word *justice* by emphasizing law. They do not see religion alone as the cause for violence and injustice, but they do believe that religion rightly understood and applied may be the key to a better future.

See also *Anticolonialism; Colonialism; Fundamentalism; Gender: Gender in the Middle East; Human Rights.*

BIBLIOGRAPHY

- Abu-Lughod, Lila, ed. *Remaking Women: Feminism and Modernity in the Middle East*. Princeton, N.J.: Princeton University Press, 1998.
- Afkhami, Mahnaz, ed. *Faith and Freedom: Women's Human Rights in the Muslim World*. Syracuse, N.Y.: Syracuse University Press, 1995.
- Ahmed, Leila. *Women and Gender in Islam: Historical Roots of a Modern Debate*. New Haven, Conn.: Yale University Press, 1992.
- Badran, Margot, and Miriam Cooke, eds. *Opening the Gates: A Century of Arab Feminist Writing*. Bloomington: Indiana University Press, 1990.
- Göle, Nilüfer. *The Forbidden Modern: Civilization and Veiling*. Ann Arbor: University of Michigan Press, 1996.
- Mernissi, Fatima. *The Veil and the Male Elite: A Feminist Interpretation of Women's Rights in Islam*. Translated by Mary Jo Lakeland. Reading, Mass.: Addison-Wesley, 1991.
- Mir-Hosseini, Ziba. *Islam and Gender: The Religious Debate in Contemporary Iran*. Princeton, N.J.: Princeton University Press, 1999.
- Moghadam, Valentine. "Islamist Movements and Women's Response in the Middle East." *Gender and History* 3, no. 3 (1991): 268–283.
- Moghissi, Haideh. *Feminism and Islamic Fundamentalism: The Limits of Postmodern Analysis*. London: Zed Books, 1999.
- Shaheed, Farida. "Networking for Change: The Role of Women's Groups in Initiating Dialogue on Women's Issues." In *Faith and Freedom: Women's Human Rights in the Muslim World*, edited by Mahnaz Afkhami. Syracuse, N.Y.: Syracuse University Press, 1995.
- Wadud-Muhsin, Amina. *Qur'an and Women*. Kuala Lumpur: Fajar Bakti, 1992.
- Yamani, Mai, ed. *Feminism and Islam: Legal and Literary Perspectives*. New York: New York University Press, 1996.
- Zayn al-Din, Nazira. *Al-sufur wa al-hijab* (1928). Damascus: Dar al-Mada, 1998.

Miriam Cooke

THIRD WORLD U.S. MOVEMENT

Historically, women's participation in revolutionary struggles or mass sociopolitical movements has been linked with the development of a feminist consciousness. Studies of women involved in revolutionary movements, such as the Chinese, Cuban, Mexican, and Nicaraguan revolutions, document the origins of feminist movements within the context of male-dominated nationalist struggles. Women may develop a feminist consciousness as a result of their experiences with sexism in revolutionary struggles or mass social protest movements. Such feminist consciousness represents a response to patriarchal dynamics in their respective struggles within the context of resistance to oppressive societal conditions.

Similarly, case studies of the white feminist movement in the United States during the 1960s reveal the tensions, constraints, and struggles experienced by women both in the New Left movement and in the civil rights movement. Male domination

within each of these sociopolitical protest movements contributed directly to the rise of a feminist movement among white women during this time period.

African-American feminists have also traced the origins of their feminist movement to their experiences with sexism within the Black Nationalist movement. Although cultural, political, and economic constraints limited the development of a feminist consciousness and movement among Asian-American women during the early 1960s, the cross-pressures resulting from the demands of a nationalist and feminist struggle led Asian-American women in time to organize feminist organizations. Native American women also voiced their feminist agenda as they clashed with sexism demonstrated by their male counterparts in the American Indian Movement. Similarly Latina women, particularly Mexican-American women who were activists during the Chicano social protest movement El Movimiento of the 1960s and 1970s, traced the emergence of their feminist "awakening" to the internal struggles within their respective cultural nationalist movements.

Defining feminism and feminist movements represents a critical question within feminist discourse. A persistent lack of consensus reflects divergent racial/ethnic, class, sexual orientation, and other critical variables that shape the lives of women. African-American, Asian-American, Latina, and Native American women all shared the task of defining their own group's feminist ideology and political strategies. Several common themes and issues emerged over the pivotal years of the 1960s and 1970s. Women of color struggled to gain equal treatment as political activists and gain access to leadership positions within the various organizations of which they were members. Through their writings and speeches, women of color called for an end to male domination, stressing the importance of understanding the multidimensionality of oppression. They identified the multiple sources of their oppression, primarily race/ethnicity, class, and gender.

For women of color, feminism represented a movement to end sexist oppression within their own communities, political organizations, and American society in general. They understood that their feminist movement needed to go beyond women's rights to include the men of their groups, with whom they shared the experience of racial/ethnic subordination and, perhaps even more important, a commitment to build resistant movements against such oppression. Political movements among women of color in the United States represented both a cultural-nationalist and a feminist orientation.

The history of these separate political movements documents the intensity of these "feminist wars." Their male counterparts, exhibiting varying degrees of a sexist brand of cultural nationalism, challenged feminist women of color to validate their feminist political stands. For example, many Mexican-American women activists experienced dramatic ostracism. Cultural nationalists, both men and women, developed a political discourse that equated feminism with antinationalism, seeing feminism as a "white" ideology and therefore a divisive one. Feminists were labeled as "sellouts" and infiltrators whose aim was to sabotage the Chicano cultural-nationalist protest movement.

Similarly, African-American feminist women were cast as interlopers whose feminist critiques of African-American male dominance represented a dangerous departure for the civil rights and Black Power movements. Cultural nationalists argued that a feminist ideology and separatist feminist movement incited internal strife that would jeopardize the advancement of the general movement for equality and self-determination. Cultural nationalists further argued that the “woman problem” could not take center stage in the nationalist agenda; as in the Cuban revolution, the feminist agenda would be taken up once the movements succeeded in their contestation of discrimination based on race and ethnicity. Racism superseded feminism, and anyone, specifically women, who pushed for consideration of feminist concerns was labeled a traitor to the cause.

For example, Mexican-American feminist women experienced virulent attacks for adopting a so-called foreign ideology that had been introduced from the larger American society in an attempt to attack the Mexican-American community’s struggle for equality and self-determination. Feminism became identified as an ideology devised to undermine the flourishing cultural renaissance emerging within Latino communities throughout the Southwest. Mexican-American feminists, like their Puerto Rican counterparts, represented a threat to their male colleagues, who argued that the attacks on male domination and sexism served only to demoralize men. Men of color developed a counterdiscourse to the emergence of a feminist one among women of color. Men of color viewed male domination or “machismo” as less an exaggerated or pernicious form of sexism and more a rational response to what they called a racist and internal colonial hegemonic control of men of color. Attacks on their manhood by all feminists—but most seriously by feminist women of color—served to reinforce the subordinate position of African-American, Asian-American, Latino, and Native American communities and others that had existed under siege by the dominant white society. Thus women of color who embraced a feminist ideology were seen as having “bought into” a dominant ideology used to suppress movements for self-determination.

Feminist women of color developed various strategies to answer these antifeminist attacks. African-American women, for example, addressed this issue by pointing to African-American history to illustrate that feminist movements had a long-standing history within their communities. They pointed to the participation of their foremothers in the antislavery movement and the role of women such as Sojourner Truth in raising women’s issues within the antislavery discourse.

Similarly, Native American women relied on their specific tribal histories and traditions to underscore the vital role that their female ancestors played in resistance struggles against the tribal land encroachments and genocidal practices their communities were forced to endure. Asian-American feminists also used history to establish a link between their racial struggles and feminist struggles. Mexican-American women linked their feminist agenda to that of the Mexican women who participated in the Mexican Revolution. Puerto Rican

women also fought against claims that feminism was a “foreign” ideology by stressing the critical role that women had played in nationalist struggles that had long been an issue in the territorial relations between Puerto Rico and the United States.

Interestingly, feminist women of color also reacted to their respective cultural-nationalist attacks by distancing themselves from the white feminist movement. Although women of color criticized white feminists for both subtle and overt acts of racism, they often exaggerated their separation from white feminism as a survival strategy that would lessen the impact of antifeminist attacks. Perhaps the most significant and successful technique was the argument that feminism among women of color actually strengthened the cultural-nationalist struggle by stressing the importance of women and men joining ranks in a united front to battle racism and sexism. In sum, feminist women of color struggled against the cultural-nationalist attacks but were not always successful. Nevertheless, their concerted efforts to put feminism on the agenda became a long-lasting legacy for future generations of women of color battling against multiple sources of oppression.

Not all the feminist organizations started by women of color survived, but a few continued into the twenty-first century to serve as advocacy groups for all women of color. Issues of reproductive rights, community health care delivery, immigration, poverty, and welfare policies continued to represent targets for feminist action. The decline of the cultural-nationalist period lessened but did not obliterate attacks against feminist women of color. Feminism continues to produce tensions and unresolved conflicts within communities of color in the United States; however, African-American, Asian-American, Latina, and Native American women persist in their efforts to achieve equality and social justice for themselves as women and for their communities in general.

See also **Feminism: Africa and African Diaspora; Feminism: Chicana Feminisms; Philosophies: Feminist, Twentieth-Century.**

BIBLIOGRAPHY

- Allen, Paula Gunn. *The Sacred Hoop: Recovering the Feminine in American Indian Traditions*. Boston: Beacon Press, 1986.
- Chow, Esther Nagan-Ling. “The Development of Feminist Consciousness among Asian American Women.” *Gender and Society* 1 (1987): 284–299.
- Davis, Angela Y. *Women, Race and Class*. New York: Vintage Books, 1983.
- Garcia, Alma M. “The Development of Chicana Feminist Discourse: 1970–1980.” *Gender and Society* 3 (1989): 217–238.

Alma M. Garcia

FETISHISM.

This entry includes two subentries:

- Overview*
Fetishism in Literature and Cultural Studies

OVERVIEW

Since the seventeenth century, thought about fetishism has been concerned with four overriding questions, all of them emerging in conflicts over representation that arose at the borders between cultural and historical worlds. These four questions concern the relationship between images and their referents in religious discourse; the attribution of causality and the nature of reason; the means for assessing and representing economic value; and desire and the relationship between consciousness and the material world. Although the term *fetishism* had its origins in comparative religious studies, it has become mainly associated with Marxian economic analysis on the one hand and psychoanalysis on the other.

Historical and Linguistic Origins

Most historical accounts trace the word *fetish* to the Portuguese term *feitiço* and its creolization as *fetisso*. Although a transliteration of the Portuguese term dominated discussion of the religious and economic practices of non-European peoples with whom merchants traded and against whom colonial powers waged wars of domination in the modern era, most of the Romance languages and English (by virtue of its residual Anglo-Norman elements) contain numerous related terms that predate this contact. These words share a Latin root meaning fabrication (*facticium*), and they are thus anchored in a historical tradition of suspicious theorizing about the human production of artifacts and artificiality. The root of *fetish* is to be found in words indicating enchantment or sorcery (*Faé, faerie*, and *faee* in Anglo-Norman; *fechiceria* in Portuguese and *hechicero* in Spanish). It is also contained in words meaning form or vessel, including that which contains spirit (*faetel* in Anglo-Norman, *feitio* in Portuguese). The same root is found in the Anglo-Norman and Middle English terms for plating or gilt, especially with gold (*faet* in this sense appears in the Anglo-Saxon saga, *Beowulf*). And, related to this, it is the root of those terms meaning to artificially enrich, as when an animal is fattened (*faeted*) in preparation for sacrifice.

If some dimension of fabrication was recognized in diverse economic and religious contexts and eras, fetish-worship was nonetheless a particularly modern accusation. As Marcel Mauss (1872–1950) observed of all magic, accusations of fetish-worship tend to be directed at religious or cultural others. Thus Christians, Jews, and Muslims, as well as Protestants and Catholics, traded accusations of fetish-worship and sorcery in the culturally contested space of the Iberian Peninsula, just as Portugal was about to embark on its imperial project along the Guinea Coast. It was there, in Africa, argues William Pietz (1985), that the multiplicity of meanings evoked by the term *feitiço* became the basis of a universalizing term, one that was not indigenous to any particular language but which seemed to travel fluidly among all. It circulated not only in the travelogues of Portuguese merchants, but also in the Dutch- and German-language reports of colonial chaplains and adventurers, wherein it was variously written as *fytyz*, *füttise*, and *fytyzi*. Apparently, the word had also entered African (especially Akan-Ashanti) vocabularies by the 1660s. Wilhelm Johann Müller's *Description of the Fetu Country, 1662–1669* (1673) not only provided na-

tive translations for what he identified as fetishes and fetish-worship, but also references the local use of the Portuguese terms *fitiso* and *fitisero* as well as a Dutch form of the word. Müller himself theorized that residents of Fetu used the term *fitisiken* to refer to their “idol-worship,” because they generally rendered foreign words in a diminutive form, following the Dutch pattern. His own definition of *fitiso* included a belief in the sacred quality of natural objects, a deity demanding sacrifice, a hereditary spirit associated with the family or lineage imagined as protector, the enforcer of law, and the instrument of an oath.

Comparative Religion, Philosophy, and Fetishism

A full and comparatively oriented theory of fetishism, modeled on the concepts of animism, pantheism, and monotheism appeared a century later, when Charles de Brosses published *Du culte des dieux fétiches* (1760; On the worship of divine fetishes). On the basis of historical linguistics, de Brosses gave fetishism a meaning distinct from idolatry, with which fetish-worship had previously been conflated. He described its definitive attribute as the worship of an object per se, not as a representation of another power and hence as a confusion of a divinity with its sign, but as a material incarnation and even as a real source of power. In so describing fetishism as a carnal faith, de Brosses emphasized the arbitrariness of fetish objects, which could include plants, animals, and grander natural phenomena like oceans, mountains, and rivers, when these are treated “as Gods.”

De Brosses's book not only invented a term, it initiated a critical practice whereby the identification of a seemingly “primitive” habit (in this case, random substitution) becomes the starting point for an identification of comparable qualities in the heart of so-called modern societies and institutions. He compared the putative fetish-worship of snakes in Africa to the serpent of Judah in the Book of Daniel (even contrasting fetishism with the vulgar idolatry of monotheists), while also giving to fetishism the full status of a religion (it thus constituted something like an elementary form of religious life, which Émile Durkheim [1858–1917] identified as *totemism*).

When Denis Diderot (1713–1784) included the term *fétiche* in his *Encyclopédie*, he tellingly assigned the word a modern origin but defined it only as the “name that the people of Guinea in Africa give to their divinities.” By contrast, de Brosses discerned fetishism everywhere, from the Americas to Egypt, from Africa to Asia (comparative religion continues to operate on this basis). This was because fetishism was beginning to bear a more general meaning, and to connote a lack of reason whose chief symptom was a confusion of aesthetic, religious, and economic functions. Europeans conflated what they perceived to be a lack of standard measures for assessing value with what they presumed to be a capricious forging of equivalences between otherwise incommensurate things, whence emerged the possibility for the inflation and overvaluation of otherwise trivial things. This was, furthermore, associated in their minds with counterfeiting, either through the dissembling of value (as through gold-plating) or through its debasement (as through the use of alloyed gold, the latter actually being referred to as *fétiche gold*) (Pietz, 1988, pp. 110–111).

Various European philosophers found in the idea of fetishism the ideal image of Reason's other. For Immanuel Kant (1724–1804), fetishism indicated lack of judgment, an aesthetic incapacity. For Georg Wilhelm Friedrich Hegel (1770–1831), it constituted a very early if not yet fully developed form of religion within a history that he described as progressing from the perception of oneself as master of nature (associated with an unmediated magic aimed at power over single things) to the intuition of *self-consciousness* as the object of worship. Hegel observed in fetishism (and animal worship) the beginnings of a dialectical relationship, insofar as fetishism placed before the human being some kind of independent power. But he also emphasized the characteristics of contingency and arbitrariness of the fetish, and noted an aggressive relationship to the fetish, which could be destroyed and substituted with another fetish if it failed to function. Not incidentally, when writing notes on the 1871 study *The Origin of Civilisation and the Primitive Condition of Man*, by John Lubbock (1834–1913), Karl Marx (1818–1883) later reiterated this belief that fetishism is destructive of that which it venerates, when he contrasted it to idolatry as a kind of submission to objects.

The concern with substitution and (and hence, displacement) was awkwardly related to what had been an overriding interest in the affective excess posited at the heart of fetishism—and Marx's Hegelian reading of the relationship as an aggressive one was never really developed. Thus the simultaneous overattachment to an object and the capacity to destroy it was read as doubly symptomatic of irrationality and excess. Ironically, it was precisely because of this excess that Auguste Comte (1798–1857) accorded fetishism a curative function in the hyper-rationalized world of his logical positivist utopia. He deemed that the rationalization of the social world could enable freedom if its principles were fully understood—hence his effort to describe that world in terms of “social statics”—but this rationalization had itself been excessive in the long but necessary development of Reason's civilization. Comte therefore advocated as corrective a “religion of Humanity.” This religion would cathect people to self-sustaining values, such as an appreciation of the material and social environment, and would cultivate what he termed “universal love.” It would do so through the supplementary establishment of a “Great Fetish,” to which, he hoped, everyone would be spontaneously drawn. Later, Max Müller (1823–1900), whose own definitions led him to remark that neither has any religion been without fetishism, nor has fetishism ever constituted a religion unto itself, excluded Comte's Great Fetish from the very category of fetishism, on the grounds that it constituted a monotheistic deity.

Commodity Fetish

Comte was perhaps the only philosopher to advocate fetishism, but he was not the only one to identify its affective force. Nor was he alone in discovering an immanent and mimetic power in fetishism. Something of the latter is present in Marx's reading of the fetish character of the commodity, but in Marx's writing the fetish no longer grounds a strategic religion but is, rather, the conceptual basis of a strategy for reading both religion and the secular religion of capital. Significantly, Marx uses the term *fetishism* (*Fetischismus*) almost exclusively in his

analyses of religion, referring to the commodity in terms of an analogous fetish-character (*Fetischcharakter*). This is an important distinction, and Marx's choice of words reflects his argument that economy had arisen in the place that religion had occupied in earlier periods, where it functioned as the institution from which law seemed naturally to emanate. Accordingly, Étienne Balibar (while overlooking the terminological distinction) argues that Marx's idea of commodity fetishism explains why, on the one hand “the capitalist mode of production . . . is the mode of production in which the economy is most easily recognized as the ‘motor’ of history,” and, on the other, it is the mode in which “the essence of this ‘economy’ is unrecognized in principle” (Althusser and Balibar, p. 216). Balibar and Louis Althusser invoke the works of Marxist anthropologists to argue that in nonindustrial societies the nature of social relations is thought to be determined by extra-economic factors and institutions, which seem “natural or divine,” such as the church or the monarchy. By contrast, capitalism “is the mode of production in which *fetishism* affects the economic region *par excellence*” (Althusser and Balibar, p. 179). Many anthropologists have indeed argued that in societies where there is no market economy, fetishism operates by endowing products with the qualities of the social milieu, and Michael Taussig has described the conflicts that may emerge between one regime of fetishism and another in precisely this manner. Marx, however, distinguishes between fetishism proper and an economy in which commodities possess the characteristics of the fetish.

Marx's first sustained published references to fetishism appear in his 1842 response to Karl Heinrich Hermes's newspaper article defending the Prussian state on religious grounds. In his own article, Hermes had followed Hegel in referring to fetishism as the “crudest form of religion.” Marx ridiculed this argument, and Hermes's description of religion as that which raises man “above sensuous appetites.” Instead, he said, fetishism is “the *religion of sensuous appetites*” (*die Religion der sinnlichen Begierde*), adding that “the fantasy of the appetites tricks the fetish worshipper into believing that an ‘inanimate object’ will give up its natural character to gratify his desires. The crude appetite of the fetish worshipper therefore *smashes* the fetish when the latter ceases to be its most devoted servant” (Marx, 1993, p. 22).

In the same year, Marx read several works on comparative religion, including a German translation (by Pistorius) of de Brosses's book. His investigations on the topic continued until the end of his life, and the posthumously published *Ethnological Notebooks* include several sustained passages on the topic. Nonetheless, it is the analysis of the fetish-character of commodities that has made Marx the most important single theorist of “fetishism.” In *Capital*, Marx's reading of the commodity's fetish-character discloses a double substitution. First, the commodity form substitutes the objective characteristics of the products of labor for social characteristics of human labor; people are dehumanized at the same time as things appear to take on animate power and social relations are transferred from people to things. Second, the commodity form is the means by which an abstract equivalence can be posited between otherwise sensuously different objects. In this

case, material difference is momentarily effaced in the fantastical image of secular transubstantiation (money appears to be capable of assuming any form) and this makes it possible for one object to substitute for another.

Marx's analysis clearly states that the fetish character of commodities arises from the social nature of production, and, at the same time, that commodities become the exclusive means by which the social character of private labor can appear. Hence, commodities seem to make possible a socialization that, in actuality, already exists by virtue of the division of labor. Thus, what reveals the social is also what hides it. Hence the fetish in Marx's analysis is what requires reading, but it is also what makes reading difficult, for it structures consciousness at a primary level. In this sense, Marxian analysis understands fetishism to be something more than excessive valorization, or overinvestment, although these attributes are not alien to it. Rather, the "the fetish-character [*Fetischcharakter*] which attaches itself to the products of labor as soon as they are produced as commodities . . . is therefore *inseparable from the production of commodities*" (1976, p. 165, my emphasis, translation modified). As Theodor Adorno (1903–1969) later summarized the point (in a dialogue with Walter Benjamin [1892–1940]), "the fetish character of the commodity is not a fact of consciousness, but dialectic in the eminent sense that it produces consciousness" (Buck-Morss, p. 121).

It is, however, when discussing the money form that Marx discerns the relationship between a misrepresentation and an overvaluation. For when money can function as the seemingly magical means by which difference can be transcended (anything can be converted into money and vice versa), and through which anything can be rendered as private property, money becomes the object of a wild desire. This desire initially fixates on money's earliest metallic forms, namely gold and silver, which leads to an aesthetic valorization of precious metals. However, in its truly abstract form (paper money, credit), the commodity makes possible an "unrestricted" desire, which Marx, in the *Grundrisse*, had specified as "greed." This greed is always greed for money—for that which can become, by purchasing, anything. Ironically, however, it is through hoarding, in which the "hoarder sacrifices the lusts of his flesh to the fetish of gold" that reserves are created and money flows regulated (Marx, 1976, p. 231). Hence, it is in the libidinous desire of the hoarder of money that capital has its origins. Fetishistic desire therefore enters Marx's analysis not as the origin but as the transformative element, the alchemical principle in capitalism's history. In a further development of this argument, Slavoj Žižek has suggested that a new stage in commodity fetishism should be recognized, namely that in which the fetish, that ostensibly sensuous object through which abstraction is made real, has been dematerialized. He identifies electronic money as the source of this dematerialization, which, he nonetheless argues, strengthens the commodity form's claims to universalizability.

Whether or not electronification does away with the sensuousness of the money fetish, much recent work shares a sense that, in the postindustrial era, commodity desire is itself productive of value and is a major stimulus for money's circula-

tion. These analyses are often indebted to the insights of Walter Benjamin, who first argued that display value was coming to displace both exchange value and use value in the marketplace of desire. Benjamin associated the emergence of a purely representational value in the era of shopping arcades with new ideological potency, as people became enthralled with what they could never possess, and were overrun by desire. Moreover, he identified this emergence with a new valuation of newness (and a corollary commodification of history), manifest most visibly in the fashion world. "Fashion prescribes the ritual according to which the commodity fetish wishes to be worshiped," he wrote (p. 153). Because fashion is also the institution in which sexual difference is deployed and cultivated, the analysis of commodity fetishism in fashion has been a staple of much feminist cultural criticism. However, this has been possible only because psychoanalysis has allowed us to see that the concept of fetishism is itself part of the organization of sexual difference, an organization that takes place in language but that is felt as an irreducibly material fact.

Psychoanalytic Interventions

Not incidentally, Sigmund Freud's (1856–1939) concept of the fetish also takes as its starting point the phenomenon of substitution. In his most direct address to the topic, the 1927 essay, "Fetishism," he argues that a fetish is a special form of penis substitute. For the boy who apprehends his mother's (and other women's) "lack" of a penis as the representation of his own possible castration, the woman's genitalia generate a "fright" (p. 154), which, Freud surmised, is universal. The woman's genitalia are henceforth an object of horror and fear for the boy, although the "normal" adult man learns to transform it into an object of desire. For some individuals, such adjustment is impossible, the trauma is too great; in the effort to overcome it, the male psyche finds a substitute, which then constitutes a "permanent memorial" to the boy's initial experience of horror. The language of memorialization is significant, and the structure of substitution as the normal (and normative) mechanism for overcoming loss recurs throughout Freud's writing. In the essay on fetishism, this substitute is the fetish: both a "token of triumph over the threat of castration *and* a safeguard against it" (p. 154, my emphasis).

At the end of the 1927 essay, Freud remarks the doubleness as well as the seeming contradictoriness of the fetish as substitute, which both "disavow[s] and . . . affirm[s]" the castration of women (p. 156). Indeed, Freud describes fetishism as a special kind of split within the subject, one that allows the male to sustain two "incompatible assertions" (p. 157). Much feminist criticism has attempted to repudiate Freud's claim that the boy naturally perceives his mother as the lacking body and as the representation of his own possible injury. Feminists have also criticized the presumption that the woman's genitalia are always already legible to the masculine subject only as lack, the negative mirroring of masculine presence. And they have suggested, in a vein ironically opened up by Jacques Lacan (1901–1981), that normative masculinity works analogously, as the substitution of the phallic symbol for the penis—not in a way that posits lack in the boy but in a manner that allows the male subject to have and to use his penis, as though by right.

Lacan had insisted that the maternal figure is phallic for the boy (she has power over him). This is possible, he says, precisely *because* she has no penis. For male subjects, the movement between having a penis, which is present, to the realm of having power can only occur in and through language, from which the Real (and hence any actual penis) is always exiled. Hence, fetishism (which is also a mode of accessing power) is a function of language, but it occurs when language is simultaneously literalized and its fully symbolic dimensions are denied. More important, it occurs as the sexual expression of a displacement made possible by this rendering of language as image (Lacan and Granoff, p. 272). Lacan makes this argument by remarking that the story on which Freud based his initial analysis, that of the young man who has an extreme and arousing affection for shiny noses, emerges from the boy's movement between languages, namely German and English. Thus, "glance on the nose" in English is linked to "*Glanz auf der Nase*" (the shine on the nose; p. 267). Here, language and, more specifically mistranslation, is the context for a substitution or "displacement," one that moves from meaning to image. Lacan and Granoff describe this displacement as one in which a person attempts to "give reality to an image" (p. 269). The resulting interstitial condition, which they believe emerges when the anxiety born of loss is linked to the guilt that is called forth by law, is one characterized by an incapacity to fully enter social relationships—those relationships mediated by the presence of another, and more particularly, a sexual other (pp. 272–273). Thus stranded, and consequently mute, "frozen in the permanent memorial" which is the fetish, the fetishist is able to find satisfaction in substitutional images. For the psychoanalytic theorist, fetishism is less an image than a kind of tableau vivant in which, as Lacan and Granoff wrote, one can find evidence for the existence of those very categories that explain fetishism as a pathology of vacillation or permanent liminality: the "symbolic, the imaginary and the real" (p. 275).

Feminist Criticism and Poststructuralist Readings

As a symptom, fetishism reveals not only the substitution through language (and its misrecognition) of one object for another, and of an object for a subject, but also the emergence of a new theory of language, one that presumes the arbitrary and unmotivated nature of the sign. However, as feminist scholars have observed, the phallus may be a signifier (or standard bearer), and even a signifier pretending to universality, but it functions by virtue of a conflation between the signifier and a material reality, to which it cannot cease referring. Jean Baudrillard links the Marxian and the Freudian analyses in order to make this point. To the extent that the money form is absolutely abstracted, its form dematerialized, it becomes a sign, operating within a code whose general principles are those of binary opposition. But this fact determines a sexual politics. Marxism fails, he suggests, because it refuses to recognize the "imposition of the law of value in the sexual domain," by which he means "the imposition of the phallus, the masculine, as the general sexual equivalent" (p. 136).

Other psychoanalytic theorists have attempted to expand the category of fetishism as part of an effort to separate the phallic from the anatomical penis. Thus, Alan Bass rereads Freud's later

work and emphasizes his belief that the splitting of the ego, which fetishism incarnated and dramatized, was a general principle of all psychopathology and not just the sexual perversion of fetishism. Bass then suggests that fetishism be understood, in general, as the problem of providing "substitutes for a disturbing reality" (p. 48) and he observes that it does so in a manner that gives to consciousness a consoling concreteness while keeping unconscious what has been registered but is, nonetheless, disavowed or "defended against" (p. 51). On this ground, he goes much further than Freud to suggest that any concrete object that functions as a transitional phenomenon, as a concrete substitute for a "magical, relieving object" can provide the basis of "fetishistic formations" (pp. 207–208). The mother's breast, as much as the maternal phallus, can thus be fetishized.

This expansion of the category of fetishism may not achieve the full radicality of what Baudrillard imagined, but it addresses many feminist concerns about the tendency of the discourse on fetishism to reinscribe patriarchal narratives of phallic domination and especially those that naturalize the phallus in male anatomy. There is, of course, no single feminist analysis of fetishism. Feminist critiques have, variously, argued that sexual perversions, including fetishism, are symptoms of a conflicted effort to conform to gender stereotypes; they have noted the logical impossibility of female fetishism but also used it as a means of understanding women's and especially lesbian desire; and they have even called for a politics of fetishistic undecidability as a means of repudiating the primacy of phallic order. Such criticism has perhaps been most successful when applied to the reading of those institutional and cultural forms wherein the law of desire and the law of value, as Baudrillard would have it, are operative and mutually sustaining, namely in cinema and mass culture. Feminist film criticism, in particular, has taken up the question of cinematic spectacle, in which the woman's body is made to function as both the object of desire and of a powerful aggressivity. Laura Mulvey summarizes this long, sometimes Marxian, sometimes Freudian, analytic trajectory by identifying the "homology of structure" that allows the intensified image of the woman to cover over both the mechanics of cinematic production, and, in a double displacement, "disguises the collapse of industrial production itself" (p. 13). She asserts that the slide of signifiers characteristic of fetishism not only allows the material relations of production (and causality) to be concealed, but also it permits the tendency to conceal these relations to be itself hidden. In this process, she argues, historical analysis is lost.

Readings of fetishism are frequently, as Mulvey suggests, efforts to restore a recognition of historical materiality by attending to the ways that a seeming investment in material objects and sensuous pleasures displaces (often only partially) a true recognition of real material causes. It can, however, also entail the opposite move, namely the reading of such material investments as substitutions for the recognition of a more primary absence. Thus, Michael Taussig describes state fetishism as the conjuring of a social force that exceeds the sum powers of the individuals who constitute the social body, thereby installing a power to which people submit, and which they adore, but which exists only by virtue of such submission and adoration. Here, an object not only substitutes for a subject, it

also subjects people. If there is continuity between the notion of fetishism as used by the old comparativists of religion, from de Brosses forward; the Marxian analysts of economy; the psychoanalytic descriptions of sexual perversion; and feminist critiques, then it is the sense that fetishism demands reading. This reading must entail a translation, and a recognition that, whether primitive or modern (or, as Pietz says, the product of intercultural contact in the process of modernizing colonialism), fetishism is a discourse of substitution through which the economic, erotic, and political provenance are made to converge. It is, perhaps, what the anthropologists, referring to archaic institutions of exchange, would call a “total social fact.” As a modern artifact, however, it perhaps substitutes for the recognition that total social facts are no longer possible.

See also *Anthropology; Fetishism: Fetishism in Literature and Cultural Studies; Gender Studies: Anthropology; Psychoanalysis.*

BIBLIOGRAPHY

- Althusser, Louis, and Étienne Balibar. *Reading “Capital.”* Translated by Ben Brewster. London: Verso, 1997. First French edition 1968.
- Bass, Alan. *Difference and Disavowal: The Trauma of Eros.* Stanford, Calif.: Stanford University Press, 2000.
- Baudrillard, Jean. *Mirror of Production.* Translated by Mark Poster. St. Louis, Mo.: Telos, 1975.
- Benjamin, Walter. “Paris, Capital of the Nineteenth Century.” 1955. Reprinted in *Reflections: Essays, Aphorisms, Autobiographical Writings*, translated by Edmond Jephcott, edited with an introduction by Peter Demetz, 146–162. New York: Schocken, 1986.
- Buck-Morss, Susan. *The Dialectics of Seeing: Walter Benjamin and the Arcades Project.* Cambridge, Mass.: MIT Press, 1989.
- Comte, Auguste. “Système de logique positive, ou traité de philosophie mathématique.” In *Œuvres D’Auguste Comte*. Vol. 12. Paris, 1856.
- de Brosses, Charles. *Du culte des dieux fétiches.* Paris: Fayard, 1760.
- Freud, Sigmund. “Fetishism.” In *Standard Edition of the Complete Psychological Works of Sigmund Freud* [SE], edited by James Strachey, vol. 21, 149–157. London: Hogarth, 1961. Essay originally appeared in 1927.
- Grosz, Elizabeth, “Lesbian Fetishism?” In *Fetishism As Cultural Discourse*, edited by Emily Apter and William Pietz, 101–115. Ithaca, N.Y.: Cornell University Press, 1993.
- Lacan, Jacques, and Wladimir Granoff. “Fetishism: The Symbolic, the Imaginary, and the Real.” In *Perversions, Psychodynamics, and Therapy*, edited by Sándor Lorand, 265–276. New York: Random House, 1956.
- Marx, Karl. *Capital: A Critique of Political Economy*. Vol. 1. Introduced by Ernest Mandel, translated by Ben Fowkes. London: Penguin, 1976. First German edition 1867.
- . “The Leading Article of No. 179 *Kölnische Zeitung*.” In Karl Marx and Friedrich Engels, *On Religion*, edited by Reinhold Niebuhr, 16–40. Atlanta, Ga.: Scholars, 1993. First English edition 1964.
- Müller, Max. “Is Fetishism a Primitive Form of Religion?” 1878. Reprinted in *The Essential Max Müller: On Language, Mythology, and Religion*, edited by Jon R. Stone. New York: Palgrave Macmillan, 2002.
- Müller, Wilhelm Johann. *Die Afrikanische auf der guineischen Gold Cust gelegene Landschaft Fetu*. 1673. Translated and reprinted as “Müller’s Description of the Fetu Country, 1662–9.” In *German Sources for West African History, 1599–1669*, edited by Adam Jones, 134–259. Wiesbaden: Franz Steiner Verlag, 1983.
- Mulvey, Laura. *Fetishism and Curiosity*. London: British Film Institute, 1996.
- Pietz, William. “The Problem of the Fetish, I.” *Res* 9 (spring 1985): 5–17.
- . “The Problem of the Fetish, II.” *Res* 13 (spring 1987): 23–45.
- . “The Problem of the Fetish IIIa: Bosman’s Guinea and the Enlightenment Theory of Fetishism.” *Res* 16 (autumn 1988): 105–123.
- Taussig, Michael T. *The Devil and Commodity Fetishism in South America*. Chapel Hill: University of North Carolina Press, 1980.
- . “Maleficium: State Fetishism.” In *Fetishism As Cultural Discourse*, edited by Emily Apter and William Pietz, pp. 217–247. Ithaca, N.Y.: Cornell University Press, 1993.
- Žižek, Slavoj. *The Plague of Fantasies*. London: Verso, 1997.

Rosalind C. Morris

FETISHISM IN LITERATURE AND CULTURAL STUDIES

Fetishism is a term widely disseminated in literary and cultural studies. It carries a variety of generic meanings. Most of these derive to some degree from Marxist and psychoanalytic discourses, where the term *fetishism* has technical significance.

Commodity Fetishism

Karl Marx (1818–1883) explains his concept of fetishism in *Capital I*, where he argues that when it comes to the exchange of commodities in capitalism, a social relation between people assumes the form of a relation between things. Material objects circulated as commodities, in other words, seem to embody inherently certain characteristics that, in fact, derive from social relations. He argues that commodity fetishism originates in the social character of labor: how labor becomes value when added to what is produced by that labor. Thus work is objectified in the commodity, becoming a property of the commodity itself: its value. Marx explains the analogy with anthropological uses of the term *fetishism* in the following manner: “In order, therefore, to find an analogy, we must take flight into the misty realm of religion. There, the products of the human brain appear as autonomous figures endowed with a life of their own, which enter into relations both with each other and with the human race” (p. 165). Thus Marx associates fetishism—which he takes from a German translation of Charles de Brosses’s eighteenth-century work on the cult of fetish-gods—with a religious practice that consists in anthropomorphizing objects, animating or personifying them. This is not, however, a matter of belief; it is not a matter of willfully dispelling the “mist” to which he refers. Rather, for value—the product of labor—to be understood as social and not as an objective property of products themselves, the mode of production would have to change.

History of the Fetish

According to William Pietz, who provides a historical study of the concept of the fetish that situates its use in Marx and Sigmund Freud (1856–1939), both the term and the idea of the fetish achieve new meaning and define a new problem in the cross-cultural spaces of the West African coast in the sixteenth and seventeenth centuries. He argues that the fetish comes into being at the moment of the cultural encounter between emergent capitalist modes of production and multiple noncapitalist ideologies and societies (1985, 1987); the pidgin word *Fetisso*, from the Portuguese *fetiço* (meaning, in the Middle Ages, “magical practice” or “witchcraft”), came to describe a material object that could embody a set of disparate values: religious, commercial, aesthetic, and sexual. Thus the fetish as a term comes to designate precisely the problem of value—on the contradictory cusp between materiality and abstraction—as relative and differential in circuits of exchange.

Fetishism in Psychoanalysis

As the modern European sexual perversion best known perhaps from the writings of Freud, fetishism makes its appearance in continental fin-de-siècle literary texts and in medical and psychiatric discourses of the 1880s and 1890s known as *sexology*. Freud’s most extended treatment of the topic is in a relatively late essay entitled “Fetishism” (1927). Here Freud describes fetishism as a response to the refusal to acknowledge, on the part of the male child, the absence of a penis on the mother’s body. This refusal occurs because to recognize its absence suggests the possibility of castration for the little boy, the possibility, in other words, that he too might lose his penis. He therefore substitutes a presence for the absence that he finds; the substitute object is often metonymically related to the area of the body where the traumatic realization would have otherwise taken place. Freud mentions that it is often the last thing seen before this moment.

Jean Laplanche and Jean-Bertrand Pontalis note that in this essay Freud seems to hesitate between two structures to describe fetishism: on the one hand, he discusses it in connection with repression; on the other—and this is the fetishistic dynamic that proves most productive as a concept in other fields—fetishism is the result of a splitting, the simultaneous denial and recognition of the absence of the woman’s penis. This is the meaning of disavowal, an oscillation between two logically incompatible beliefs, captured nicely in the words of psychoanalyst Octave Mannoni’s (1899–1989) patient, “I know very well, but nevertheless. . . .”

Fetishism in Feminism

According to Freud, and for obvious reasons, fetishism is a perversion restricted to men alone; however, feminist psychoanalytic and cultural theorists have also theorized the concept’s broader applicability. Naomi Schor coins the term for feminism in her studies of textual instances of fetishism in the writing of Georges Sand. For Emily Apter, the combined commodity and sexual fetishism of Marx and Freud can be seen to be pastiche, parodied, and more generally deployed as a feminine phenomenon, where objects are substituted for absences and endowed with perverse, specific, “valueless” value, as illustrated in the collection of

memorabilia in, for example, the artist Mary Kelly’s installation *Post-Partum Document* (1976). Elizabeth Grosz, Teresa de Lauretis, and Judith Butler have argued the applicability of notions of fetishism and the fetish for descriptions of lesbian “perverse” desire. Grosz proposes that, for women, it is not the mother’s but the daughter’s castration that may be disavowed (that is to say, their own). According to Grosz, in Freudian theory there are three possibilities for female fetishism. Femininity itself can be seen to be a fetish, the substitution of material signs on the woman’s own body for the “missing” phallus, thereby remaking the entire body into the phallus through narcissistic self-investment. The hysteric, by contrast, invests a part of her own body with displaced sexuality. Finally, Freud’s “masculinity complex” in women most closely illustrates the disavowal proper to fetishism through the substitution of an object outside of the woman (another woman’s body), rather than her own or part of her own. Butler’s “lesbian phallus” illustrates the potential detachability of the phallus as an idealized signifier of desire in Freudian and Lacanian theory; thus it can be transferred to and reappropriated by other kinds of bodies and subjects. De Lauretis definitively frees fetishism from its moorings in phallogocentric theories (the positing of the fetish as penis or phallus substitute, the explanation of fetishism as related to horror at the sight of female genitals) by arguing that the fetish—as Sarah Kofman noted—is not the substitution for a “real” lack but is, as it were, the fetish of a fetish, the material sign of a desiring fantasy that marks both an “object” and its absence. Thus what is fetishized in lesbian desire, de Lauretis argues, is the female body itself or something that is metonymically related to it. These revisions allow feminist theorists to theorize forms of feminine desire—and especially lesbian desire—that do not correspond to heteronormative and phallogocentric theories of sexuality.

Film theorists such as Metz have used the scopic specificity of the fetish—the fact that it arises in the context of a visual moment of recognition and misrecognition—to describe the workings of cinema as a medium, while feminist film theorists such as Laura Mulvey focus particularly on the fetishization of the woman’s body in film (especially classic Hollywood cinema) as a way to critique the pleasures produced by narrative film for the masculine viewing subject.

Fetishism and Ideology

Combining Marx and Freudian notions of fetishism via Jacques Lacan, Slavoj Žižek has argued that ideological fantasies function according to the logic of disavowal. His studies focus on capitalism and thus on metropolitan political economies, the United States in particular. His insight is to point out that the misrecognition involved in commodity fetishism is not on the level of knowledge—that people do not know that economic exchanges are the reification of social relations—but that it is on the level of practice itself. Thus, paraphrasing Mannoni’s patient’s declaration, Žižek argues that individuals know very well that relations between people are behind relations between things but that they act nevertheless as though commodities embody value and thus produce social reality as fetishistic “illusion.” Social reality, Žižek argues, is thus structured by an unconscious illusion that he calls ideological fantasy. This revision of Marx’s commodity

fetishism, combined with psychoanalytic notions of disavowal, allows Žižek to explain some of the new forms ideology takes—including cynical reason, or the perception that society is “postideological”—in postmodernity.

Fetishism and Postcolonial Studies

Following on the work of the Martinican psychoanalyst and revolutionary theorist Frantz Fanon (1925–1961), whose work sought to understand the fantasies that produce racist colonial stereotypes, postcolonial and critical race theorists use the ambivalent oscillation of fetishistic disavowal to describe how racial difference works fetishistically in colonial encounters. For Homi Bhabha, the colonial stereotype is not a static entity but a scenario that has to be continually (and anxiously) restaged as a defense and that moves between the contradictory poles of recognition and refusal of racial, cultural, and historical difference. Thus the notion of fetishism allows colonial relations to be understood as always under construction, ever ambivalent, and thus potentially open to rearticulation, resignification, and change. Anne McClintock combines the anthropological, Marxist, and psychoanalytic histories of the concept to argue that fetishism is a way to think through the displacement of social contradictions onto “impassioned objects” (p. 184) and thus that it can be usefully dislodged from Freud’s Eurocentric family romance to describe the meeting points of public imperial projects and private domesticities, desire and commodity fetishism, and psychoanalysis and social history. In bringing together in a dynamically ambivalent configuration the racial and the sexual, the social and the individual, the economic and the psychic—all elements that are part of the rich historical genealogy of the concept—fetishism has proven an extraordinarily productive notion for understanding the investment of desire in objects.

See also *Body, The; Cultural Studies; Psychoanalysis*.

BIBLIOGRAPHY

- Apter, Emily. *Feminizing the Fetish: Psychoanalysis and Narrative Obsession in Turn-of-the-Century France*. Ithaca, N.Y.: Cornell University Press, 1991.
- Apter, Emily, and William Pietz, eds. *Fetishism as Cultural Discourse*. Ithaca, N.Y.: Cornell University Press, 1993.
- Bhabha, Homi. *The Location of Culture*. New York: Routledge, 1994.
- Butler, Judith. *Bodies that Matter: On the Discursive Limits of “Sex.”* New York: Routledge, 1993.
- De Lauretis, Teresa. *The Practice of Love: Lesbian Sexuality and Perverse Desire*. Bloomington: Indiana University Press, 1994.
- Freud, Sigmund. “Fetishism.” 1927. In *Sexuality and the Psychology of Love*, edited by Philip Rieff. New York: Collier, 1963.
- Grosz, Elizabeth. “Lesbian Fetishism?” *Differences* 3, no. 2 (1991): 39–54.
- Laplanche, J., and J.-B. Pontalis. *The Language of Psycho-Analysis*. Translated by Donald Nicholson-Smith. New York: Norton, 1973.
- Mannoni, Octave. “Je sais bien, mais quand même . . .” In *Clefs pour l’imaginaire; ou L’autre scène*, 9–33. Paris: Seuil, 1969.
- Marx, Karl. *Capital*. Vol. 1. Translated by Ben Fowkes. New York: Vintage, 1977.
- McClintock, Anne. *Imperial Leather: Race, Gender, and Sexuality in the Colonial Conquest*. New York: Routledge, 1995.
- Metz, Christian. *Le significant imaginaire: psychanalyse et cinéma*. Paris: Union générale d’éditions, 1977.
- Mulvey, Laura. *Visual and Other Pleasures*. Basingstoke, U.K.: Macmillan, 1988.
- Nye, Robert A. “The Medical Origins of Sexual Fetishism.” In *Fetishism as Cultural Discourse*, edited by Emily Apter and William Pietz. Ithaca, N.Y.: Cornell University Press, 1993.
- Pietz, William. “The Problem of the Fetish, I.” *RES: Journal of Anthropology and Aesthetics* 9 (1985): 5–17.
- . “The Problem of the Fetish, II: The Origin of the Fetish.” *RES: Journal of Anthropology and Aesthetics* 13 (1987): 23–45.
- Schor, Naomi. “Fetishism.” In *Feminism and Psychoanalysis: A Critical Dictionary*, edited by Elizabeth Wright. Cambridge, Mass.: Blackwell, 1992.
- Žižek, Slavoj. *The Sublime Object of Ideology*. New York: Verso, 1989.

Carla Freccero

FEUDALISM, EUROPEAN. In everyday speech, *feudal* can mean “aristocratic” (in contrast to democratic), “sumptuous,” “reactionary,” “hierarchical” (as opposed to egalitarian), “primitive,” “medieval,” or simply “despotic” or “oppressive” when speaking about political, social, or economic regimes. Since the nineteenth century it has been used this way, most often as a term of opprobrium, in English, German, and the Romance languages. *Feudalism* in the sense of either a period or a regime dominated by lords or domination by people who possess financial or social power and prestige is a relatively late arrival. It first appeared in French in 1823, Italian in 1827, English in 1839, and in German only in the second half of the nineteenth century. What it refers to, however, had already appeared as *la féodalité* in the Comte de Boulainvilliers’s *Histoire des anciens Parlements de France* (1737; published in English as *An Historical Account of the Antient Parliaments of France or States-General of the Kingdom*, 1739). The expression, derived from seventeenth-century legal treatises, was translated as “feodal [*sic*] government” in the English version and popularized as both “feudal government” and “the feudal system” in Adam Smith’s *Wealth of Nations* (1776).

As a term of art used by historians, the adjective *feudal* and the noun *feudalism* may mean many things, most of them variants on one or more of three basic conceptions. First, they meant the legal rules, rights, and obligations that governed the holding of fiefs (*feuda* in medieval Latin), especially in the Middle Ages. This was the only meaning of *feudal* in any language before the eighteenth century. In the eighteenth and nineteenth centuries this definition was extended to encompass the nature of government at the time when fiefs were a prominent form of landholding, in particular one in which those who held fiefs exercised powers of jurisdiction and constraint either by their own customary right or by grant or usurpation from the king or emperor. In this definition such grants and usurpations are often referred to as “the privatization of public powers.” Second, they meant a social economy in which landed

lords dominated a subject peasantry from whom they demanded rents, labor services, and various other dues and over whom they exercised justice. This was essentially the meaning given to the term by Adam Smith and later adopted by Karl Marx. Third, they meant a form of sociopolitical organization dominated by a military class or Estate, members of which were connected to each other by ties of lordship and honorable subordination (“vassalage”) and in turn dominated a subject peasantry. Lordship gave protection and defense; vassalage required service, especially service in arms. This personal relationship inseparably involved a tenurial relationship as well, the vassal holding land of his lord. Feudal domination therefore took shape within an economy where the primary source of wealth was land and its products. It was supported by a complex of religious ideas promoted by a hierarchical church that was integrated into the structure of lordship.

These three conceptions are clearly related. Modern historians may insist that one or another or some combination is the “true” or “correct” definition or may discuss one while recognizing that alternative definitions exist. German historians in the later nineteenth century invented separate terms for these different concepts: *Lehnwesen* for the first; *Feudalismus* for the second and third. British and American historians may refer to the first as *feudalism* and the second as *manorialism*, while the third may be called *feudal society*.

At the beginning of the twentieth century the English legal historian F. W. Maitland argued that “feudalism is an unfortunate word” that had been given an “impossible task” (Pollock and Maitland, vol. 1, pp. 66–67). And since the 1960s a number of historians, particularly in the United States and in England, have argued that the confusion caused by these different meanings is reason enough to ban the term from professional use. A more complex objection to the use of the term in any of its meanings has come from the difficulty historians have in reconciling the historical assumptions that lie behind all conceptions of feudalism with what they find in their detailed research into medieval social, political, and economic relationships. There has also been a shift in the academic discipline providing the tools to study medieval society. Almost all nineteenth-century and early-twentieth-century students of the subject came to it from training in the law—Roman law on the Continent and the common law in England; their accounts were shaped by legal categories. In the second half of the twentieth century, especially in the United States, anthropology increasingly influenced the conceptual framework of medievalists and therefore the way in which they read the sources. In this light, they found many legal-institutional concepts wanting, among them the concept *feudalism*.

History of the Concept

All the definitions of feudalism were born in the ideological conflicts of the Enlightenment and the French Revolution and the revolutionary politics that swept out of France across Europe in the nineteenth century. They have been shaped by the ideologies of economic liberalism, political egalitarianism, democracy, and socialism, particularly the Marxist variety. They have also been shaped by nineteenth-century philoso-

phies of history that were created in the same ideological environment. Since the eighteenth century the invidious meanings of *feudal* in popular polemical usage and the attempts by historians to give the term a technical, professional meaning have never been far apart.

The eighteenth century. On 11 August 1789, the French revolutionary National Assembly abolished the “feudal regime” (*régime féodal*). A jurist who was asked to explain to an assembly committee what exactly the act had abolished replied that it included not only rights belonging to or derived from fiefs properly speaking but all lordly rights, including rights to peasants’ labor (*corvées*), crop sharing (*champart*), rents, monopolies (*banalités*), and all rights of justice “for rights of justice follow the fief and there is no fief without rights of justice.”

In abolishing these lordly rights, especially those of justice, the assembly took the final logical step in a program that royal jurists had been promoting since the late sixteenth century—to establish that all rights of justice and command belonged to the state (*res publica*), were embodied in the king, and were exercised by royal commission or grant. If that were so, then all claims on the wealth or work of others, if they were not freely contracted, were likewise public powers held of the king. Once “the people,” represented in the assembly, came to embody the state, they could reclaim what had once been alienated.

During the eighteenth century the two components of the “feudal regime,” lordly rights over dependent tenants and lordly rights to positions of authority, had been defended by appeals to history. This is hardly surprising, for landlords pressed for funds were increasingly hiring specialists, called “feudists,” to examine their ancient muniments and discover dues and rights long forgotten. Two diametrically opposed versions of the historical record emerged. One, represented notably by L’abbé Dubos in his *Histoire critique de l’établissement de la monarchie française dans les Gaules* (1734; Critical history of the establishment of the French monarchy in Gaul), argued that the original Frankish kings were appointed by the Roman emperors and themselves appointed the nobility to its positions and commissioned nobles to exercise their powers. Against Dubos, Boulainvilliers and, especially, Montesquieu, in his *L’esprit des lois* (1748; The spirit of laws), argued, on the contrary, that the Frankish kings and nobility with their followers had come as conquerors. The nobility, whose eminence was recognized by both grants of fiefs and participation in the assemblies that these authors believed were the precursors of the Estates, had from the beginning exercised justice over their subordinates. As they constructed their historical narratives, Boulainvilliers and Montesquieu stopped at many of the way stations that would continue to be the standard monuments of the history of feudalism in twentieth-century textbooks: the Germanic war bands described by Tacitus, the early Frankish *antrustiones* (royal followers), Carolingian oaths of fidelity, the capitulary of Quierzy, which made noble offices hereditary, and many others.

By 1789 the debate over the historical origin of noble rights had also been transformed by a dramatic change in the concept of liberty. For Boulainvilliers and Montesquieu, *liberty* meant the rights that distinguished one person or group from

others, the meaning it had had since the Middle Ages. *Liberty* for them was what the modern world calls “privilege.” It was in this sense that Charles Forman declared his translation of Boulainvilliers into English to be “for the instruction of . . . British lovers of liberty.” For the revolutionaries of 1789, in contrast, *féodalité* was the antithesis of *liberté*, which could be realized only by equality before the law. The only distinctions the law could legitimately recognize were differences in property, excluding all those rights of exaction and justice that aristocrats had claimed as their property. Property was the realm of “private” activity; justice, taxation, and all powers of command were “public.”

When combined with the earlier historical narratives, this revolutionary redefinition of liberty bequeathed two fundamental themes to all nineteenth- and twentieth-century historical accounts of “feudalism.” First, feudalism involved the devolution of “public” power into “private” hands, a process that happened when the ruler granted such powers to his or her followers, or when the followers usurped them, or when the state, embodied in royal power, broke up. The historical problem became to discover exactly when and how this devolution occurred and how the “feudal state” was held together. Second, in the feudal regime all rents and obligations that were not freely contracted, whether in money, in kind, or in labor services, were the product of the political, social, and military domination of the strong over the weak, of lords over peasants. Again the historical problem was to discover how and when this developed.

The nineteenth and twentieth centuries. It was in nineteenth-century Germany that these two themes diverged, each eventually becoming the domain of an academic discipline as well as a polemical model. After the Napoleonic wars, aristocratic privileges and princely governments were partially restored in the lands of the old Holy Roman Empire. At the same time, national unity was more than ever the fervent desire of many intellectuals. Legal and constitutional historians in the developing universities sought to reconcile the two—the status quo and the desire for unity—by making “feudal government,” *Lehnwesen*, the fundamental character of the old Germanic state. By defining *Lehnwesen* in a narrow technical sense as the law of fiefs (and inventing a new name for it) and at the same time universalizing it into a constitutional form, they sought to cleanse the idea of feudalism of its embarrassing polemical connotations inherited from the French Revolution. The narratives they developed were essentially variations on Montesquieu’s, although they also debated whether the original German nations were unitary states of ruler and subjects (Waitz, vol. 6, pp. 357–367), or already “feudalized,” as earlier historians had claimed, and if they were unitary, how and why the system of fiefs developed with its fragmentation of state power. They resolved the old debate between the “Romanist” origin of noble powers and the “Germanic” by making the “institutional” side of feudalism Roman and the “personal,” Germanic.

Whatever the differences among historians, all were convinced that the “feudal state” was an organized hierarchy of fiefs and powers, from the king down to the most minor lord. The “feudal pyramid” was born. Thus they gave the German princes historical legitimacy while still asserting the existence of a “-

German constitution.” William Stubbs adopted this German definition in his three-volume *Constitutional History of England* (1874–1878), asserting that William the Conqueror brought feudalism “full blown” from France. It has remained the “technical” meaning of feudalism in British historiography ever since.

Meanwhile, philosophers of history and political polemicists, most notably Karl Marx, sought to place feudalism among the stages in the historical development of human society. For Marx, the critical questions to ask in defining each stage were: Who owns the means of production? And what are the class relations to those means of production? In the stage of feudalism, landlords are the owners, and they use political and military force to extract surpluses from their peasant subjects. This conception of feudalism was the required view in the Soviet world. Since World War II it has also had a large following among western European historians. Non-Marxist or semi-Marxist “stage narratives” of the origins of feudalism have also proliferated, combining the story of the subjection of the peasantry to political and military force with various aspects of the other “technical” feudal narrative (Poly and Bournazel; Bisson).

Problems with all conceptions of feudalism have come from the discovery that before the thirteenth century fiefs had an insignificant place in aristocratic landholding; that, other than in England, peasants owed few if any labor services and in some places owned some of their land and held the rest by rental contracts; that the conception of serfdom varied widely from place to place and changed radically over time; that the relations among landholding, lordship, and fidelity likewise varied widely in space and time. Historians have questioned whether and in what ways one can speak of law and legal institutions in Europe before the revival of Roman law in the twelfth century. They have also questioned whether one can speak in any meaningful way of an early medieval state. This and much else has led some historians to argue that the concept no longer has a place in historical discourse.

See also *Bushido; Economics; History, Economic; Honor; Marxism; Monarchy.*

BIBLIOGRAPHY

- Bisson, Thomas N. “The ‘Feudal Revolution.’” *Past and Present* 142 (February 1994): 6–42.
- Bloch, Marc Léopold Benjamin. *Feudal Society*. Translated by L. A. Manyon. Chicago: University of Chicago Press, 1961.
- Brunner, Otto. “Feudalismus,’ ein Beitrag zur Begriffsgeschichte.” Akademie der Wissenschaften und der Literatur in Mainz, *Abhandlungen der geistes- und sozialwissenschaftlichen Klasse* no. 10. Mainz, 1958. Translated as “Feudalism: The History of a Concept.” In *Lordship and Community in Medieval Europe: Selected Readings*, edited by Fredric L. Cheyette, 32–61. New York: Holt, Rinehart, and Winston, 1968.
- Cheyette, Fredric L. “Some Reflections on Violence, Reconciliation, and the Feudal Revolution.” In *Conflict in Medieval Europe: Changing Perspectives on Society and Culture*, edited by Warren C. Brown and Piotr Górecki. Aldershot, U.K., and Burlington Vt.: Ashgate, 2003.
- Coulborn, Rushton, comp. *Feudalism in History*. Princeton, N.J.: Princeton University Press, 1956.

- Mazauric, Claude. "Note sur l'emploi de 'régime féodal' et de 'féodalité' pendant la Révolution Française." In *Sur la Révolution Française: Contributions à l'histoire de la révolution bourgeoise*, by Claude Mazauric, 119–134. Paris: Éditions sociales, 1988.
- Montesquieu, Charles de Secondat, baron de. *L'esprit des lois*. Books 28–31. Paris: Bibliothèque de la Pleiade, 1958.
- Pollock, Frederick, and Frederic William Maitland. *The History of English Law before the Time of Edward I*. 2nd ed. Boston: Little, Brown, 1905.
- Poly, Jean-Pierre, and Éric Bournazel. *La mutation féodale, Xe–XIIIe siècles*. Paris: Presses Universitaires de France, 1980.
- Reynolds, Susan. *Fiefs and Vassals: The Medieval Evidence Reinterpreted*. Oxford and New York: Oxford University Press, 1994.
- Stubbs, William. *Constitutional History of England*. 3 vols. Oxford: Clarendon, 1874–1878.
- Waitz, Georg. *Deutsche Staats-Wörterbuch*. Vol. 6. Edited by Johann Caspar Bluntschli and Karl Brater. Stuttgart, Germany: Expedition des Staats-Wörterbuchs, 1861.
- Wunder, Heide. "Einleitung." In *Feudalismus: Zehn Aufsätze*, compiled by Heide Wunder, 10–76. Munich: Nymphenburger Verlagshandlung, 1974.

Fredric L. Cheyette

FICTION. See *Genre*.

FIELD THEORIES. In physics, the field concept describes the distribution and propagation of effects such as magnetism and gravity through space. Field theories have helped implement the program of unifying the "forces" of nature.

Forces Propagating in Space

The discovery of a connection between electricity and magnetism is usually attributed to Hans Christian Ørsted (1777–1851), who in the winter of 1819 found that a wire carrying a current deflects a magnet. Subsequent experiments determined the dependence of the effect on the relative distance and orientation between the wire and the magnet. Ørsted had pursued his investigations because of his commitment to *Naturphilosophie* and his belief that "the same forces manifest themselves in magnetism as in electricity" and that the fundamental forces of nature were polar. Ørsted's discovery motivated numerous further investigations, by Francois Arago (1786–1853), Jean-Baptiste Biot (1774–1862), Felix Savart (1791–1841), among others, and particularly by André-Marie Ampère (1775–1836) who formulated the force law describing the interaction between two current-carrying wires. Ampère's guiding assumption was that all electrodynamic phenomena could be understood in terms of the interactions among electric charges and the currents they produce when in motion; a magnet being composed of an aggregate of electric currents.

Michael Faraday (1791–1867), prompted by analysis of Ørsted's and Ampère's investigations and of their theoretical assumptions, carried out a series of perceptive experiments. In 1821 Faraday corroborated that the force on a magnet near a

current-carrying wire did not act along the line between the centers of two bodies. Following Sir Isaac Newton's (1642–1727) law of action and reaction, Faraday expected that for every effect of electricity on magnetism there should correspond an effect of magnetism on electricity. Displeased with theories of instantaneous action-at-a-distance, he sought the causes of electric and magnetic effects not only within conductors and magnets, but in the medium around them. He assumed that such effects would take time to propagate through space as "lines of force" that could interact with matter. He came to believe in the reality of these lines of force. In 1831 he found that only a *changing* current in a wire will induce a current in a nearby second wire. He came to believe that the phenomenon of the induction of a current in a wire near another that carried a time-varying current was due to its "cutting" lines of force. He also discovered that as light passes through glass near a magnet, the polarization of light rotates. Having found such connections among electricity, magnetism, and light, Faraday continued to investigate the properties of the field around ponderable bodies. His conceptualization of lines of force and of fields continued to evolve from the early 1830s through the late 1840s. Constant in this evolution was the belief that the forces between two or more electrically charged bodies were mediated by some influence—the field—that was created by each body separately, propagated in space and acted upon the other charged bodies. It is difficult to summarize Faraday's notions because contemporary language uses some of the same words as he used but with different meanings. And since Faraday did not use mathematics to describe his theoretical models, we cannot rely on that technical language to clarify his works, as in the case of later researchers. What is clear is that Faraday's notion of a *field* was entwined with his visualization of it in terms of lines of force.

In the 1840s, William Thomson (1824–1907) began to mathematically analyze Faraday's findings in terms of the deformations of a hypothetical material substance, an "ether." Drawing analogies to hydrodynamics and heat conduction, he applied the Laplace/Poisson equation to electrostatics. He showed how to represent work as spread throughout space, and described the ponderomotive force as the tendency of the field to distribute work. He represented magnetic lines of force by vortices and sought a vortex theory of ether and matter.

James Clerk Maxwell (1831–1879) developed extensively this line of research. Following Faraday, Maxwell showed that the lines of electric current and the magnetic lines were linked in a "mutual embrace." He formulated a theory with differential equations that conveyed the reciprocal embrace of constant field lines, and in 1863, for fields varying in time. The latter resulted in transverse waves in the medium, which Maxwell identified as propagating light waves. Like Thomson, Maxwell sought a mechanical account of the ether. He devised a model consisting of cellular vortices and idle wheels that transmit the motion amongst cells and represent electricity.

In Maxwell's theory, the field, which stored and conveyed energy, was fundamental and its displacements constituted charges and currents. Maxwell's theory showed a close causal connection between the separately existing electric and magnetic fields. Heinrich Rudolph Hertz (1857–1894) experimentally

demonstrated the existence of invisible electromagnetic waves. Meanwhile, theorists such as Hendrik Antoon Lorentz (1853–1928) interpreted the source terms in Maxwell's equations as densities of charged particles, called electrons. Lorentz developed a theory in which ether and electrons were fundamental entities. He showed that even inside ponderable bodies, electric and magnetic effects are not merely states of matter, but of the fields within.

Fields and Subatomic Particles

In 1905, Albert Einstein (1879–1955) disposed of the concept of the mechanical ether. Electromagnetic fields propagated in vacuo with the speed of light in all inertial frames. His special theory of relativity showed that the electric and magnetic fields could be represented by one (tensor) field, such that the effects that appear in a reference system as arising from a magnetic field appear in another system moving relative to the first as a combined electric field and magnetic field, and vice versa. The theory also engendered the conception of space and time as a four-dimensional continuum. To account for gravity as a field effect, Einstein formulated the general theory of relativity in 1915. Using tensor calculus and the non-Euclidean geometry of Bernhard Riemann (1826–1866), Einstein described gravitational fields as distortions of the space-time continuum. Meanwhile, following Maxwell, some physicists attempted to construe material particles as structures of fields, places where a field is concentrated. Einstein was among them, yet in 1905 he had proposed that light is composed of particles, “photons.”

In the 1920s, Werner Heisenberg (1901–1976), Erwin Schrödinger (1887–1961), Max Born (1882–1970), and others formulated quantum mechanics. Its instrumental successes suggested the possibility of describing all phenomena in terms of “elementary particles,” namely electrons, protons, and photons. The components of atoms were treated as objects with constant characteristics and whose lifetimes could be considered infinite. Protons and electrons were specified by their mass, spin, and by their electromagnetic properties such as charge and magnetic moment. Particles of any one kind were assumed to be indistinguishable, obeying characteristic statistics.

Quantum mechanics originally described nonrelativistic systems with a *finite number of degrees of freedom*. Attempts to extend the formalism to include interactions of charged particles with the electromagnetic field brought difficulties connected with the quantum representation of fields—that is, systems with an infinite number of degrees of freedom. In 1927, Paul Adrien Maurice Dirac (1902–1984) gave an account of the interaction, describing the electromagnetic field as an assembly of photons. For Dirac, particles were the fundamental substance. In contradistinction, Pascual Jordan (1902–1980) argued that fields were fundamental. Jordan described the electromagnetic field by operators that obeyed Maxwell's equations and satisfied certain commutation relations. Equivalently, he could exhibit the free electromagnetic field as a superposition of harmonic oscillators, whose dynamical variables satisfied quantum commutation rules. These commutation rules implied that in any small volume of space there would be fluctuations of the electric and magnetic fields

even for the vacuum state, that is even for the state in which there were no photons present, and that the root mean square value of such fluctuations diverged as the volume element probed became infinitesimally small. Jordan advocated a unitary view of nature in which both matter and radiation were described by wave fields, with particles appearing as excitations of the fields.

The creation and annihilation of particles—first encountered in the description of the emission and absorption of photons by charged particles—was a novel feature of quantum field theory (QFT). Dirac's “hole theory,” the relativistic quantum theory of electrons and positrons, allowed the possibility of the creation and annihilation of matter. Dirac had recognized that the (one-particle) equation he had devised in 1928 to describe *relativistic* spin 1/2 particles, besides possessing solutions of positive energy, also admitted negative energy states. Unable to avoid transitions to negative energy states, Dirac eventually postulated in 1931 that the vacuum be the state in which all the negative energy states were filled. The vacuum state corresponded to the lowest energy state of the theory, and the theory now dealt with an infinite number of particles. Dirac noted that a “hole,” an unoccupied negative energy state in the filled sea, would correspond to “a new kind of particle, unknown to experimental physics, having the same mass and opposite charge to an electron” (p. 62). Physicists then found evidence that positrons exist.

Beta-decay was important in the field theoretic developments of the 1930s. The process wherein a radioactive nucleus emits an electron (β -ray) had been studied extensively. In 1933, Enrico Fermi (1901–1954) indicated that the simplest model of a theory of β -decay assumes that electrons do *not* exist in nuclei before β -emission occurs, but acquire existence when emitted; in like manner as photons emitted from an atom during an electronic transition.

The discovery by James Chadwick (1891–1974) in 1932 of the neutron, a neutral particle of roughly the same mass as the proton, suggested that atomic nuclei are composed of protons and neutrons. The neutron facilitated the application of quantum mechanics to elucidate the structure of the nucleus. Heisenberg was the first to formulate a model of nuclear structure based on the interactions between the nucleons composing the nucleus. *Nucleon* was the generic name for the proton and the neutron, which aside from their differing electric charges were assumed to be identical in their nuclear interactions. Nuclear forces had to be of very short range, but strong. In 1935, Hideki Yukawa (1907–1981) proposed a field theoretic model of nuclear forces. The exchange of a meson mediated the force between neutrons and protons. In quantum electrodynamics (QED), the electromagnetic force between charged particles was conceptualized as the exchange of “virtual” photons. The massless photons implied that the range of electromagnetic forces is infinite. In Yukawa's theory, the exchanged quanta are massive. The association of interactions with exchanges of quanta is a feature of all quantum field theories.

QED, Fermi's theory of β -decay, and Yukawa's theory of nuclear forces established the model upon which subsequent de-

velopments were based. It postulated impermanent particles to account for interactions, and assumed that relativistic QFT was the proper framework for representing processes at ever-smaller distances. Yet relativistic QFTs are beset by divergence difficulties manifested in perturbative calculations beyond the lowest order. Higher orders yield infinite results. These difficulties stemmed from a description in terms of local fields, a field defined at a sharp point in space-time, and the assumption that the interaction between fields is local (that is, occurs at localized points in space-time). Local interaction terms implied that photons will couple with (virtual) electron-positron pairs of arbitrarily high momenta, and electrons and positrons will couple with (virtual) photons of arbitrary high momenta, all giving rise to divergences. Proposals to overcome these problems failed. Heisenberg proposed a fundamental unit of length, to delineate the domain where the concept of fields and local interactions would apply. His *S*-matrix theory, developed in the early 1940s, viewed all experiments as scattering experiments. The system is prepared in a definite state, it evolves, and its final configuration is observed afterwards. The *S*-matrix is the operator that relates initial and final states. It facilitates computation of scattering cross-sections and other observable quantities. The success of nonrelativistic quantum mechanics in the 1920s had been predicated on the demand that only observable quantities enter in the formulation of the theory. Heisenberg reiterated that demand that only experimentally ascertainable quantities enter quantum field theoretical accounts. Since local field operators were not measurable, fundamental theories should find new modes of representation, such as the *S*-matrix.

During the 1930s, deviations from the predictions of the Dirac equation for the level structure of the hydrogen atom were observed experimentally. These deviations were measured accurately in molecular beam experiments by Willis Eugene Lamb, Jr. (b. 1913), Isidor Isaac Rabi (1898–1988), and their coworkers, and were reported in 1947. Hans Albrecht Bethe (b. 1906) thereafter showed that this deviation from the Dirac equation, the Lamb shift, was quantum electrodynamical in origin, and that it could be computed using an approach proposed by Hendrik Kramers (1894–1952) using the technique that subsequently was called “mass renormalization.” Kramers’s insight consisted in recognizing that the interaction between a charged particle and the electromagnetic field alters its inertial mass. The experimentally observed mass is to be identified with the sum of the charged particle’s mechanical mass (the one that originally appears as a parameter in the Lagrangian or Hamiltonian formulation of the theory) and the inertial mass that arises from its interaction with the electromagnetic field.

Julian Schwinger (1918–1994) and Richard P. Feynman (1918–1988) showed that all the divergences in the low orders of perturbation theory could be eliminated by re-expressing the mass and charge parameters that appear in the original Lagrangian, or in equations of motions in which QED is formulated, in terms of the actually observed values of the mass and the charge of an electron—that is, by effecting “a mass and a charge renormalization.” Feynman devised a technique for visualizing in diagrams the perturbative content of a QFT, such that for a given physical process the contribution of each

diagram could be expressed readily. These diagrams furnished what Feynman called the “machinery” of the particular processes: the mechanism that explains why certain processes take place in particular systems, by the exchange of quanta. The renormalized QED accounted for the Lamb shift, the anomalous magnetic moment of the electron and the muon, the radiative corrections to the scattering of photons by electrons, pair production, and bremsstrahlung.

In 1948, Freeman Dyson (b. 1923) showed that such renormalizations sufficed to absorb all the divergences of the scattering matrix in QED to all orders of perturbation theory. Furthermore Dyson demonstrated that only for certain kinds of quantum field theories is it possible to absorb *all* the infinities by a redefinition of a *finite* number of parameters. He called such theories renormalizable. These results suggested that local QFT was the framework best suited for unifying quantum theory and special relativity. Yet experiments with cosmic rays during the 1940s and 1950s detected new “strange” particles. It became clear that meson theories were woefully inadequate to account for all properties of the new hadrons being discovered. The fast pace of new experimental findings in particle accelerators quelled hopes for a prompt and systematic transition from QED to formulating a dynamics for the strong interaction.

For some theorists, the failure of QFT and the superabundance of experimental results seemed liberating. It led to generic explorations where only general principles such as causality, cluster decomposition (the requirement that widely separated experiments have independent results), conservation of probability (unitarity), and relativistic invariance were invoked without specific assumptions about interactions. The American physicist Geoffrey Chew rejected QFT and attempted to formulate a theory using only observables embodied in the *S*-matrix. Physical consequences were to be extracted without recourse to dynamical field equations, by making use of general properties of the *S*-matrix and its dependence on the initial and final energies and momenta involved.

By shunning dynamical assumptions and instead using symmetry principles (group theoretical methods) and kinematical principles, physicists were able to clarify the phenomenology of hadrons. Symmetry became a central concept of modern particle physics. A symmetry is realized in a “normal” way when the vacuum state of the theory is invariant under the symmetry that leaves the description of the dynamics invariant. In the early 1960s, it was noted that in systems with infinite degrees of freedom, symmetries could be realized differently. It was possible to have the Lagrangian invariant under some symmetry, yet not have this symmetry reflected in the vacuum. Such symmetries are known as spontaneously broken symmetries (SBS). If the SBS is global, there will be massless spin zero bosons in the theory. If the broken symmetry is local, such bosons disappear, but the bosons associated with broken symmetries acquire mass. This is the Higgs mechanism.

The Standard Model and Beyond

In 1967 and 1968, the American nuclear physicist Steven Weinberg and the Pakistani nuclear physicist Abdus Salam independently proposed a gauge theory of the weak interactions

that unified the electromagnetic and the weak interactions using the Higgs mechanism. Their model incorporated suggestions advanced by the American theoretical physicist Sheldon Glashow in 1961 on how to formulate a gauge theory in which the weak forces were mediated by gauge bosons. Glashow's theory had been set aside because physicists doubted the consistency of gauge theories with *massive* gauge bosons, and such theories were not renormalizable. SBS offered the possibility of giving masses to the gauge bosons. The renormalizability of such theories was proved by the Dutch physicist Gerardus 't Hooft in 1972 under the guidance of Martinus Veltman. The Glashow-Weinberg-Salam theory (GWS) rose to prominence. Experiments in 1973 corroborated the existence of weak neutral currents embodied in this "electroweak" theory. The detection of the W^\pm and of the Z_0 in 1983 gave further confirmation. Gauge theory, the mathematical framework for generating dynamics-incorporating symmetries, now plays a central role in the extension of QFT. Symmetry, gauge theories, and spontaneous symmetry breaking are the three pegs upon which modern particle physics rests.

Particles such as protons and neutrons are now understood as composed of "quarks." Quantum chromodynamics (QCD) describes the strong interactions between six quarks. Evidence for the sixth was confirmed in 1995. Quarks carry electrical charge and also a strong "color" charge, in any of three color states. QCD does not involve leptons because they have no strong interactions. It is a gauge theory involving eight massless gluons and the tricolor gauge bosons. The GWS of the weak interactions is a gauge theory involving two colors. Each quark thus carries an additional weak color (or weak charge). Four gauge bosons mediate the weak interactions between quarks. Since the 1980s, successful accounts of high energy phenomena using QCD have proliferated.

This elegant "standard model" does not accord with the known characteristics of weak interactions nor with the phenomenological properties of quarks. Local gauge invariance requires that the gauge bosons be massless, and therefore that the forces they generate be of long range. But actually, the weak force is of minute range and the masses of the W and Z bosons are large. Nor does the model accommodate quark masses. A Higgs SBS mechanism is commonly invoked to overcome such difficulties. Establishing its reality is an outstanding problem.

The work of the American physicist Kenneth Wilson and Weinberg gave support to a more restrictive view: All extant field theoretic representations of phenomena are only partial descriptions, valid in the energy domain specified by the masses of the particles that are included, and delimited by the masses of the particles that are excluded. QFTs can be viewed as low energy approximations to a more fundamental theory that is not necessarily a field theory. Such reconceptualizations have led to a hierarchical structuring of the submicroscopic realm with the dynamics in each domain described by an effective field theory. Some see it as rectifying the reductionist ideology that gripped physics. Others pursue the possibility of a more global and symmetric unification than provided by

the standard model. String theory is the only extant candidate for a consistent quantum theory to incorporate general relativity and yield a finite theory. The finiteness of the theory is the result of the fact that its fundamental entities are not point-like, but string-like, and space-time is not limited to four dimensions. Particles are then conceived as the quantum states corresponding to excitations of the basic stringlike entities.

Some theorists herald the possibility of a "final theory" that will consistently fuse quantum mechanics and general relativity and unify the four known interactions. This hope was given some credence in 1984 when superstring theory emerged as a candidate to unify all the particles and forces, including gravitation. A newer version in 1994 imagined that there is a single "big theory" with many different phases, consisting of the previously known string theories, among other things. Yet very many questions remain, including how to make contact with the experimental data explained by the standard model. Nor is it clear that such a theory—if formulated—would constitute a final theory and that no lower level might exist.

See also **Physics; Relativity; Quantum.**

BIBLIOGRAPHY

- Buchwald, Jed Z. *From Maxwell to Microphysics: Aspects of Electromagnetic Theory in the Last Quarter of the Nineteenth Century*. Chicago: University of Chicago Press, 1985.
- Cao, T. Yu. *Conceptual Developments of Twentieth Century Field Theories*. Cambridge, U.K.: Cambridge University Press, 1997.
- Davies, Paul, ed. *The New Physics*. Cambridge, U.K.: Cambridge University Press, 1989.
- Dirac, P. A. M. "Quantised Singularities in the Electromagnetic Field." *Proceedings of the Royal Society of London Series A* 133 (1931): 60–72.
- Fitch, V. and Rosner, J. "Elementary Particle Physics in the Second Half of the Twentieth Century." In *Twentieth Century Physics*, edited by Laurie M. Brown, Abraham Pais, and Sir Brian Pippard. Philadelphia: American Institute of Physics, 1995.
- Hoddeson, Lillian, et al., eds. *The Rise of the Standard Model: Particle Physics in the 1960s and 1970s*. Cambridge, U.K.: Cambridge University Press, 1997.
- Marshak, Robert E. *Conceptual Foundations of Modern Particle Physics*. Singapore: World Scientific, 1993.
- Pais, Abraham. *Inward Bound: Of Matter and Forces in the Physical World*. Oxford: Oxford University Press, 1986.
- Pickering, Andrew. *Constructing Quarks: A Sociological History of Particle Physics*. Chicago: University of Chicago Press, 1984.
- Purinton, Robert D. *Physics in the Nineteenth Century*. New Brunswick, N.J.: Rutgers University Press, 1997.
- Schweber, Silvan S. *QED and the Men Who Made It: Dyson, Feynman, Schwinger, and Tomonaga*. Princeton, N.J.: Princeton University Press, 1994.
- Weinberg, Steven. *The Quantum Theory of Fields*. 3 vols. Cambridge, U.K.: Cambridge University Press, 1995–2000.
- Whittaker, E. T. *A History of the Theories of Aether and Electricity*. London: Longmans, Green, 1910. Reprint, Los Angeles: Tomash, 1989.

Alberto A. Martínez
Silvan S. Schweber

FILM. See *Cinema*.

FORM, METAPHYSICAL, IN ANCIENT AND MEDIEVAL THOUGHT.

The metaphysical notion of *form* (*eidos*, *morphe*, Gr.; *idea*, *forma*, *species*, Lat.), as it emerged in the works of Plato, must be carefully distinguished from the everyday notion from which it derived, namely, the shape or outer appearance of a thing as it presents itself to the eyes. The outer appearance of a mannequin, for instance, may be deceptively similar to that of a human being, yet, the *form* in the philosophical sense would be radically different for the two. The *form* of the thing in the philosophical sense is what determines the kind of thing it is, and so the kinds of properties it can or cannot have, and the kinds of things it can or cannot do or suffer. The mannequin, being a lifeless artifact, obviously cannot perform the characteristic operations any human being naturally can (unless prevented by some circumstance), such as walking, talking, begetting or giving birth to human offspring, and so forth. Therefore, a human being and a mannequin must have different forms. But does it follow that two individual human beings must have the *same* form? Two individual human beings are equally humans, and as such they equally have the same *sort* of characteristic operations and abilities. However, no two human beings have *numerically* the same operations and abilities. This author's activity of writing this article is not anybody else's activity, although another human being could perform exactly the same *sort* of activity. Still, the author's activity and the other person's activity are *two*, hence *numerically* distinct, activities, even if they are of the same *sort*. In the same way, the form on account of which the author has the ability to perform this activity is not numerically the same as the form on account of which another person would be able to perform the same sort of activity. So, there must be some numerically *distinct individualized* forms, namely, forms that individually determine one's essential abilities.

Forms as Universal Exemplars in Plato

Still, these individualized forms, which Plato (c. 428–348 or 347 B.C.E.) briefly recognizes in his *Phaedo* (102d–103c), are not what he would call Forms or Ideas in his Theory of Forms. Plato's Forms are rather the universal exemplars after which individualized forms are modeled. Consider, for example, any geometrical shape, say, a sphere. Any spherical thing, such as a pearl, is spherical on account of its own spherical shape (its individualized shape), but all pearls (and all billiard balls, bowling balls, etc.) are spherical because they all have the same *sort* of shape, as if each were just a copy or imitation of a common, universal model, the Form of Sphere, or Sphericity itself. To be sure, different spherical things may realize their common Form differently, say, with different diameters, and with different sorts of imperfections, but insofar as they all realize the same Form, they all constitute the same sort of objects. Indeed, imitating or participating in the same Form is precisely what Plato would take to be the reason why distinct particulars of the same kind belong to the same kind.

But how does one know about these Forms? In his *Phaedo* (73c.–75c.), Plato presents an interesting argument to show that the ability to recognize things as more or less perfect realizations of their exemplars entails people's souls' prenatal acquaintance with these exemplars. The gist of the argument can be restated as follows. Whenever one sees things that are more or less equal, the ability to recognize them as such and to judge them as being more or less perfectly equal presupposes the acquaintance with absolute, perfect Equality, the Form that all imperfectly equal things are trying to imitate with their imperfect equality. For how else would one know that an equal pair of sticks is not perfectly equal? But perfect equality can certainly never be met in one's sensory experiences. So, this acquaintance with Equality itself cannot be obtained from sensory experience. However, experiences begin with birth. Therefore, people must have their acquaintance with Equality from a prenatal form of existence, from before their souls entered their bodies at birth.

This little piece of reasoning contains all major elements of Plato's philosophical theory in a nutshell. Metaphysically, Forms are the independently existing perfect, universal standards for the perfection of any thing of any given kind. In epistemology, Forms are the source of the possibility of true universal knowledge: by recollecting one's knowledge of their universal exemplar, one has universal knowledge of all particulars that share in the same Form. Finally, in moral and political theory, the realm of Forms is that domain of pure perfection where immortal human souls belong by nature; therefore, one's task in this life is to prepare the soul for its safe return by living one's life according to the standards of perfection set by the Forms.

That the "naïve" Theory of Forms (as presented here) is inconsistent was recognized already by Plato in his *Parmenides*, where can be found the first formulation of the famous Third Man argument (132a–b), proving the inconsistency of the theory.

Consider the Form of Humanity. According to the theory, each human belongs to this species by participating in one and the same Form. But the Form itself is perfectly human, so it also belongs to the species of humans. Therefore, it should also pertain to this species by participating in the Form of Humanity. However, it cannot participate in itself, for what participates is inferior to what it participates in, and nothing can be inferior to itself. So, there has to be another Form of Humanity, which itself would also have to be human, that is, there would have to be a *Third Man*, besides the particular humans, and the first Form of Humanity. Indeed, the same reasoning could be repeated, yielding an infinite series of Forms for the species of humans. However, the theory also claims that for a species of particulars there is only a single Form in which they all participate, which is inconsistent with the infinity of Forms also implied by the claims of the theory. Therefore, the theory cannot be true as stated.

Individualized Forms in Aristotle

Moved by this and a number of other arguments, Aristotle (384–322 B.C.E.) famously rejected Plato's Forms. Hence the adage attributed to Aristotle, usually quoted in Latin: *amicus Plato sed magis amica veritas*—I love Plato, but I love the truth

even more. Aristotle did not abandon, however, what has been called above the individualized forms of things. For Aristotle, it is these forms that individually determine each thing's nature, sorting them into their natural kinds, reflected in the Aristotelian system of categories.

Individualized forms are either substantial or accidental. Substantial forms are what account for the individual existence of substances, the independently existing individuals that are not properties of other individuals, such as this man. Accidental forms (or briefly, accidents) are the individualized properties of substances, such as the height or color of this man. Individual substances and accidents are classified in the system of categories into their universal kinds, their species and genera.

But how can individuals have universal knowledge concerning all individuals of the same species and genera if they cannot have the direct acquaintance with their universal exemplars presumed by Plato? Aristotle's answer is his *theory of abstraction*. In his view, the human intellect is not a merely passive recipient of "ready-made" universal information obtainable from the universal exemplars of particulars, but it is capable of actively extracting this universal information from the experience of several particulars by separating what is common to all and disregarding what is peculiar to each. The human soul, the individualized substantial form of a human body, uniquely has this ability among other living bodies, through the so-called active intellect (*nous poietikos*, Gr.; *intellectus agens*, Lat.). This unique ability of the human soul ranks it the highest in perfection among all material forms, linking it to the realm of immaterial forms or separate substances. In fact, some commentators of Aristotle, such as Averroës (Ibn Rushd; 1126–1198), interpreted Aristotle as claiming that the active intellect itself is such a separate substance. Other, more perfect separate substances are the movers of celestial spheres that by the light of the celestial bodies they hold provide the influx of energy required for the activity of the natural agents on earth (mixing the four elements, and sustaining the generation and corruption of living things). However, Aristotle argues that it is impossible to go in the series of ever more perfect movers moved by even more perfect ones to infinity. So, ultimately all are moved by a first unmoved mover, the Prime Mover, which is therefore the source of the activity of everything else.

Forms as Divine Ideas in St. Augustine

The next important step in the development of the notion form was provided by St. Augustine of Hippo's (354–430) Neoplatonic Christian conception. For Augustine, Forms are universal exemplars, just as they are for Plato, but they are not Plato's mind-independent models of various species, for they are the archetypes of creation in the Divine Mind. The Divine Ideas are the models for creatures in the eternal thought of God. Therefore, Augustine argues, a moment of understanding some eternal truth is but a glimpse into divine thought granted to humans by God in an act of illumination. Augustine's conception powerfully combined Christian teaching with elements of Platonic philosophy, but it raised a number of new questions. Especially, in epistemology, it raised the issue of why a natural capacity of the human mind, namely, the understand-

ing of "secular" eternal truths, say, in logic or mathematics, should be regarded as directly dependent on divine grace.

The Syncretic Theory of Forms of St. Thomas Aquinas

This question, and many others, received a balanced "naturalistic" answer in the Aristotelian Christian synthesis of St. Thomas Aquinas (c. 1224–1274), reconciling Christian religious doctrine and important elements of the Neoplatonic tradition with Aristotelian philosophy. For Aquinas, divine grace does not work against nature (even if it could), but through nature: *gratia non tollit naturam, sed perficit*—grace does not destroy nature, but perfects it (2SN, d. 9, q. 1, obj. 8; ST1, q. 1, a. 8, resp. 2.). Therefore, the divine light of Augustinian illumination for Aquinas becomes the same as the Aristotelian active intellect, which (pace Averroës) is not a separate substance, but a natural, although immaterial, power of the human soul. The soul itself is the Aristotelian substantial form of the human body, which, however, on account of its immaterial power, is naturally capable of surviving the death of a human person, to be supernaturally resurrected in the same body by God. The human soul thus straddles the ontological divide between material and immaterial, having access to both. The natural world of material substances, each having its natural powers on account of its characteristic substantial form, but all in need of a constant influx of energy for its natural operation, is kept in motion by the movement of heavenly spheres, in accordance with the laws of Aristotelian physics. These in turn are moved by their immaterial movers, Aristotle's subsistent forms or separate substances, which Aquinas further identifies with biblical angels. But even these immaterial forms are not pure actuality or energy (*actualitas*, Lat.; *energeia*, Gr.). Therefore, they owe their activity as well as their actual being to the Aristotelian Prime Mover, the first cause of all causes, which for Aquinas is also the creator of the universe, both material and immaterial, namely, the Judeo-Christian God, the subsistent form that is pure energy or actuality, that is, nothing but pure being: He Who Is (ST1, q. 13, a. 11; *Exodus* 3:14).

See also *Aristotelianism; Platonism*.

BIBLIOGRAPHY

PRIMARY SOURCES

- Aquinas, Thomas. *Scriptum super libros Sententiarum*. In *S. Thomae Aquinatis Opera Omnia*; ut sunt in *Indice Thomistico*: additis 61 scriptis ex aliis medii aevi auctoribus. Stuttgart-Bad Cannstatt: Frommann-Holzboog, 1980.
- . *Summa Theologica*. A complete English translation, translated by the Fathers of the English Dominican Province. Westminster, Md.: Christian Classics, 1981.
- A Summary of Philosophy*. Translated and edited, with introduction and glossary, by Richard J. Regan, S.J. Indianapolis: Hackett, 2003. A modern translation of selected philosophical texts from Aquinas's theological masterpiece.
- Aristotle. *The Complete Works of Aristotle: The Revised Oxford Translation*. 2 vols. Edited by Jonathan Barnes. Princeton, N.J.: Princeton University Press, 1984.
- Augustine. *The Essential Augustine*. Edited by Vernon J. Bourke. Indianapolis: Hackett, 1974. See especially "Divine Ideas as

Prototypes,” pp. 61–62; selection from Augustine’s *Eighty-three Different Questions*, q. 46, 1–2.

Plato. *Five Dialogues*. Translated by G. M. A. Grube. Revised by John M. Cooper. Indianapolis,: Hackett, 2002.

———. *Plato’s Parmenides*. Translated with introduction and commentary by Samuel Scolnicov. Berkeley: University of California Press, 2003.

SECONDARY SOURCES

Davies, Brian. “Thomas Aquinas.” In *Blackwell’s Companion to Mediaeval Philosophy*, edited by Jorge Gracia and Timothy Noone, 643–659. Oxford: Blackwell, 2002.

Fine, Gail. *On Ideas: Aristotle’s Criticism of Plato’s Theory of Forms*. Oxford: Clarendon, 1993.

Klima, Gyula. “Natures: The Problem of Universals.” In *The Cambridge Companion to Medieval Philosophy*, edited by Arthur Stephen McGrade, 196–207. Cambridge, U.K.: Cambridge University Press, 2003.

Vlastos, Gregory, ed. *Plato: A Collection of Critical Essays*. Notre Dame, Ind.: University of Notre Dame Press, 1978.

Gyula Klima

FORMALISM. Formalism in literary studies was not merely about formal elements of literature, though it stressed the importance of studying form. In fact, it proclaimed the unity of form and content by emphasizing that in a literary work the former cannot properly be understood when separated from the latter and vice versa. At the same time, formalism stressed the need to view literature as an autonomous verbal art, one that is oriented toward itself. Thus, formalism addressed the language of literature and established the basis for the origins and development of structuralism in literary studies.

Origins

As a movement in literary studies and a school of literary theory and analysis, formalism emerged in Russia and Poland during the 1910s. In Russia its official beginning was marked by an establishment of two organizations: the Moscow Linguistic Circle, founded in 1915 by such linguists of Moscow University as Roman Jakobson, Grigory Vinokur, and Petr Bogatyrev; and the Society for the Study of Poetic Language (or OPOYAZ, an acronym for the group’s name in Russian), founded in 1916 in Petrograd (later Leningrad and then St. Petersburg—the city’s original name) by literary scholars such as Osip Brik, Boris Eikhenbaum, and Viktor Shklovsky, as well as the linguist Lev Yakubinsky. A few years later the latter group was joined by the literary theorists Boris Tomashevsky and Yury Tynianov, along with some other scholars from the Petrograd State Institute of Art History.

In Poland the beginning of formalist ideas dates back to as early as the period 1911 to 1914, when Kazimierz Wóycicki, the founder of Polish formalism, wrote his first works on literary scholarship. Yet despite its early indigenous beginnings, formalism in Poland had to wait until the mid-1930s to take concrete shape as the Polish Formalist School, which had two centers: Warsaw and Wilno (present-day Vilnius, Lithuania).

Highly indebted to Russian formalism, which by 1930 had already been suppressed by Stalinist pressures, the school was formed by Manfred Kridl, who integrated the movement by drawing together his own students from the University of Wilno, notably Maria Renata Mayenowa, Maria Rzeuska, and Czesław Zgorzelski, and some other students from the University of Warsaw, including Kazmierz Budzyk, Dawid Hopensztand, and Franciszek Siedlecki.

Autonomy and “Science” of Literature

Formalism emerged as a reaction against the methods of literary scholarship of the late nineteenth and early twentieth centuries. It countered the study of literature that took an exclusive approach in which the content and ideas of literary works were embraced as faithful reflections of social and political reality. Thus formalism rejected the study of literature’s background, its external conditions, its social and national tasks, and the psychology and biography of the author; instead, it proposed a focus on the literary work itself and a study of its constituent, that is, formal, components. This led to an insistence on the autonomy of both imaginative literature and of literary scholarship. Under formalism, works of literature were to be approached as artistic phenomena independent of any social, historical, ideological, or psychological circumstances. This isolation of literature from its external conditions entailed efforts to systematize and define literary scholarship. Indeed, the formalists’ true concern was to reform literary study and make it a more scientific discipline. They attempted a “science” of literature by defining what the real subject of literary study is and by establishing its own methods of inquiry.

Literariness and Device

According to formalism, the background of literature and other extraliterary phenomena do not belong to literary scholarship. The proper subject matter of the discipline is not even literature itself but a phenomenon that Jakobson, in his work *Noveishaya russkaya poeziya* (1921; Recent Russian poetry), called *literaturnost’* (literariness). He declared that it is literariness that makes a given work a literary work. In other words, literariness is a feature that distinguishes literature from other human creations and is made of certain artistic techniques, or devices (*priemy*), employed in literary works. These devices became the primary object of the formalists’ analyses and, as concrete structural components of the works of literature, were essential in determining the status of literary study as a science.

One of the most important devices with which the formalists dealt was the device of “defamiliarization” (*ostraneniye*). As described by Shklovsky in “Iskusstvo kak priem” (1917; Art as device), defamiliarization, a typical device of all literature and art, serves to present a familiar phenomenon in an uncommon fashion for the purpose of a renewed and prolonged (the device of retardation) aesthetic perception. This kind of perception is an aim of art.

The notion of device was very seminal, as it helped the formalists do away with the traditional division of literature into form and content. They claimed that form and content are inseparable and that they constitute one unity. In place of form

and content the formalists proposed to use the notions of device and material, respectively. Material stands for the raw and unorganized stuff of literature, not only themes, ideas, emotions, events, and the “outside world,” but also language; device transforms material into an artistically shaped literary work of art.

Poetic Language

In their studies of the distinguishing features of literature the formalist scholars, many of whom were linguists and followers of the Polish linguist Jan Baudouin de Courtenay (1845–1929), turned to the problems of language in literature. The idea of literariness is easily embraced in terms of what differentiates literature from nonliterature. What distinguishes these is language and its particular use. The formalists juxtaposed the language of imaginative literature, especially poetry, with the language of everyday conversations to present the specific function assigned to language phenomena in literature. Colloquial language, they indicated, serves purely communicative purposes, whereas in poetry this communicative function of language is reduced to a minimum. Thus, Jakobson defined poetry as a “language in its aesthetic function” (*Noveishava russkaya poeziya*, p. 11). He also said, and Tomashevsky repeated in *Teoriya literatury: Poetika* (1925; *Literary theory: Poetics*), that the language of poetry is oriented toward itself and draws attention to its own properties.

To demonstrate their thesis about the aesthetic function of poetic language, the formalists turned in their early works to the study of sound and its role in poetry. The Russian scholars investigated the sound-oriented avant-garde futurist poetry, while the Polish formalists, especially Siedlecki in *Studia z metryki polskiej* (1937; *Studies in Polish metrics*), demonstrated that the same can be said about sound and its aesthetic use with reference to a more traditional, non-avant-garde kind of poetry. In their more mature studies the formalists investigated poetic language not only through limiting it to the sound structure but also through including its other components: syntax, vocabulary, and semantics. Wóycicki’s *Forma dźwiękowa prozy polskiej i wiersza polskiego* (1912; *Sound form of Polish prose and verse*) and Tynianov’s *Problema stikhotvornogo yazyka* (1924; *The problem of verse language*) serve as the best examples of formalist studies concentrated on a close correlation of sound and meaning in poetry.

What Is Literature?

In their efforts to indicate the distinguishing features of literature, the formalists did not stop at studying the use of language in poetry; they continued their inquiry with regard to prose. One of the most fundamental points of departure for the formalists was the question about the essence of literature. Indeed, they wanted to know what literature is and what makes literary works. The study of concrete prose works seemed like a valid approach in this essentialist search. It produced masterful textual analyses of narrative fiction, innovative studies in the morphology of the literary work, and new definitions of a work of literature, as well as groundbreaking inquiries into the problems of style. In such studies as “Kak sdelana *Shinel’* Gogolya” (1919; *How Gogol’s The Overcoat is made*) by Eikhenbaum and “*Tristram Shendi*”

Sterna i teoriya romana (1921; *Sterne’s Tristram Shandy and the theory of the novel*) and “Kak sdelan *Don Kikhot*” (1921; *How Don Quixote is made*) by Shklovsky, the formalists showed the structure, mechanisms, and laws of narrative fiction. In studying the structural components of the concrete prose works, they addressed the problems of plot composition, organizing principles of narration, and dynamism of the internal structure of the literary work. By looking into these problems the formalists were able to define the literary work in such innovative and diverse terms as a sum total of devices (Shklovsky), a uniform structure, a whole closed in itself, an organic and stylistic unity of structural components (Wóycicki), an artfully made object (Kridl), an aesthetic system (Tynianov, Wóycicki), and a dynamic structure (Tynianov, Wóycicki).

Literary Evolution

Even though the formalists, both in their theory and practice, insisted on an autonomous and intrinsic approach to literature, over time they acknowledged the importance of studying literary history and literature’s connections with other spheres and “systems” of life. (In the case of the Russian formalists, this change resulted from Stalinist pressures.) Thus in its later phase, formalism introduced the notions of literary evolution and renewal and the dynamism of literary forms. These notions stood for the formalist understanding of the history of literature. It was concerned with literary change, modifications of the literary tradition, the laws of literary processes, and the development of art forms in relation to other aspects of culture. Literary change and evolution was explained in original terms of gradual shifts and reshufflings among the functions of devices, genres, works, styles, traditions, and “systems.” Thus, the formalists skillfully reexamined the notion of literary history, which traditionally had been viewed as an unbound mosaic of writers and works. They showed the mechanics of continuity in the development of literature.

Suppression and Influence of Formalism

The connections of literature with other spheres and “systems,” such as social conventions and other extraliterary factors, were most directly addressed in the 1928 essay “Problemy izucheniya literatury i yazyka” (Problems of the study of literature and language) by Tynianov and Jakobson. This essay, however, was only a theoretical acknowledgment by the formalists of the links between literature and social forces. These links were also presented as autonomous and separate systems governed by their own laws. Such a presentation of the problem did not spare the formalists from the attacks by Russian Marxists, who saw literature as an integral, not a separate, part of social forces. By 1930 the formalists in Russia had been silenced. Operating in a totally different environment, the Polish Formalist School, as well as the Prague Linguistic Circle in Czechoslovakia, continued the work of the Russian scholars, taking it even further, toward structuralism. The outbreak of World War II, however, finally suppressed the activity of the Polish formalists and Czech structuralists.

After the war formalism exerted a powerful influence on many trends and schools of literary criticism both in the Slavic countries and beyond. Most indebted were structuralism, con-

sidered a natural continuation of formalist theorizing, and semiotics. The Anglo-Saxon New Criticism was not influenced by formalism, but the obvious points of convergence between the two schools, comparable to the affinities among formalism, structuralism, and semiotics, clearly point to the universality, vitality, and significance of formalist ideas.

See also *Literary Criticism*; *Literary History*; *Literature*; *New Criticism*.

BIBLIOGRAPHY

PRIMARY SOURCES

- Eikhenbaum, Boris. "How Gogol's *Overcoat* Is Made." In *Gogol from the Twentieth Century: Eleven Essays*, edited and translated by Robert A. Maguire, 269–291. Princeton, N.J.: Princeton University Press, 1974. Translation of "Kak sdelana *Shinel'* Gogolya."
- . "The Theory of the 'Formal Method.'" In *Readings in Russian Poetics: Formalist and Structuralist Views*, edited by Ladislav Matejka and Krystyna Pomorska, 3–37. Cambridge, Mass.: MIT Press, 1971. Translation of "Teoriya 'formal'nogo metoda."
- Jakobson, Roman. *Noveishaya russkaya poeziya. Nabrosok pervyi. Velemir Khlebnikov*. Prague: "Politika," 1921.
- Shklovsky, Viktor. "Art as Technique." In *Russian Formalist Criticism: Four Essays*, edited and translated by Lee T. Lemon and Marion J. Reis, 3–24. Lincoln: University of Nebraska Press, 1965. Translation of "Iskusstvo kak priem."
- . "The Making of *Don Quixote*." In his *Theory of Prose*, translated by Benjamin Sher, 72–100. Elmwood Park, Ill.: Dalkey Archive Press, 1990. Translation of "Kak sdelan *Don Kikhot*."
- . "Sterne's *Tristram Shandy*: Stylistic Commentary." In *Russian Formalist Criticism: Four Essays*, edited and translated by Lee T. Lemon and Marion J. Reis, 25–57. Lincoln: University of Nebraska Press, 1965. Translation of "*Tristram Shendi*" *Sterna i teoriya romana*.
- Siedlecki, Franciszek. *Studia z metryki polskiej*. Wilno: Dom Książki Polskiej, 1937.
- Tomashevsky, Boris. *Teoriya literatury: Poetika*. Moscow and Leningrad: Gos. Izdatel'stvo, 1925.
- Tynianov, Yury. "On Literary Evolution." In *Readings in Russian Poetics: Formalist and Structuralist Views*, edited by Ladislav Matejka and Krystyna Pomorska, 68–78. Cambridge, Mass.: MIT Press, 1971. Translation of "O literaturnoi evolutsii."
- . *The Problem of Verse Language*. Edited and translated by Michael Sosa and Brent Harvey. Ann Arbor, Mich.: Ardis, 1981. Translation of *Problema stikhotvornogo yazyka*.
- Tynianov, Yury, and Roman Jakobson. "Problems in the Study of Literature and Language." In *Readings in Russian Poetics: Formalist and Structuralist Views*, edited by Ladislav Matejka and Krystyna Pomorska, 79–81. Cambridge, Mass.: MIT Press, 1971. Translation of "Problemy izucheniya literatury i yazyka."
- Wóycicki, Kazimierz. *Forma dźwiękowa prozy polskiej i wiersza polskiego*. Warsaw: Wyd. Tow. Naukowego Warszawskiego, 1912.

SECONDARY SOURCES

- Erllich, Victor. *Russian Formalism: History, Doctrine*. 3rd ed. New Haven, Conn.: Yale University Press, 1965.
- Hansen-Löve, Aage A. *Der russische Formalismus: Methodologische*

Rekonstruktion seiner Entwicklung aus dem Prinzip der Verfremdung. Vienna: Verlag der österreichischen Akademie der Wissenschaften, 1978.

- Jackson, Robert Louis, and Stephen Rudy, eds. *Russian Formalism: A Retrospective Glance; A Festschrift in Honor of Victor Erllich*. New Haven, Conn.: Yale Center for International and Area Studies, 1985.
- Karcz, Andrzej. *The Polish Formalist School and Russian Formalism*. Rochester, N.Y.: University of Rochester Press, 2002.
- Pomorska, Krystyna. *Russian Formalist Theory and Its Poetic Ambiance*. The Hague: Mouton, 1968.
- Steiner, Peter. *Russian Formalism: A Meta-poetics*. Ithaca, N.Y.: Cornell University Press, 1984.
- Striedter, Jurij. *Literary Structure, Evolution, and Value: Russian Formalism and Czech Structuralism Reconsidered*. Cambridge, Mass.: Harvard University Press, 1989.
- Thompson, Ewa M. *Russian Formalism and Anglo-American New Criticism: A Comparative Study*. The Hague: Mouton, 1971.

Andrzej Karcz

FOUNDATIONALISM. Knowledge is more than true belief. True beliefs that come from just lucky guesswork do not qualify as knowledge. Knowledge requires that the satisfaction of its belief condition be appropriately related to the satisfaction of its truth condition. In other words, knowledge requires a justification condition. A knower must have an adequate indication that a known proposition is true. A traditional view, suggested by Plato (c. 428–348 or 347 B.C.E.) and Immanuel Kant (1724–1804), proposes that this adequate indication consists of evidence indicating that a proposition is true. This view requires that true beliefs qualifying as knowledge be based on justifying evidence, or reasons.

When reasons are beliefs, we have inferential justification: one belief is justified on the basis of another belief. How is the latter, supporting belief itself justified? Is another supporting belief always needed? According to foundationalism, another supporting belief is not always needed.

Two-Tier Structure of Justification

Foundationalism acknowledges a two-tier structure in justification: Some justification is noninferential (that is, foundational), and all other justification is inferential (that is, nonfoundational) in that it derives ultimately from foundational justification. This view was proposed by Aristotle (384–322 B.C.E.), in *Posterior Analytics*, as a view about knowledge. It emerges too in René Descartes's *Meditationes de prima philosophia* (1641; *Meditations on first philosophy*), where it joins with the assumption that foundations of knowledge must be certain. Foundationalism is represented in varying forms in the writings of John Locke (1632–1704), Kant, Bertrand Russell (1872–1970), Clarence Irving Lewis (1883–1964), and Roderick M. Chisholm (1916–1999), among others. Foundationalism about evidence and justification explains a belief's (or a proposition's) having justification for a person; it does not explain one's showing that a belief has justification or is true.

Versions of foundationalism vary in explaining noninferential (foundational) justification, and in explaining how justification transmits from foundational beliefs to nonfoundational beliefs. Some philosophers have assumed that foundational beliefs must be certain (that is, indubitable or infallible). This leads to radical foundationalism, which requires that foundational beliefs be certain and that such beliefs guarantee the certainty or the truth of supported nonfoundational beliefs. Radical foundationalism faces two problems. First, very few (if any) empirical beliefs are certain. Second, beliefs that might be candidates for certainty (for instance, the belief that I am thinking) are not informative enough to guarantee the certainty or the truth of specific inferential beliefs about the external world (for example, beliefs of the sciences).

Modest foundationalism states that foundational beliefs need not possess or yield certainty and need not guarantee the truth of justified nonfoundational beliefs. A noninferentially justified, foundational belief has justification that does not derive from other beliefs, even if the causal basis of foundational beliefs includes other beliefs. Modest foundationalists have offered three influential approaches to noninferential (foundational) justification: (1) self-justification, (2) justification by nonbelief, nonpropositional experiences, and (3) justification by a reliable nonbelief origin of a belief.

Recent proponents of self-justification include Chisholm and C. J. Ducasse (1881–1969). They held that a foundational belief can justify itself, apart from evidential support from something else. Proponents of foundational justification by nonbelief experiences dissent. They hold, following Lewis, that foundational perceptual beliefs can be justified by nonbelief sensory or perceptual experiences (for example, my nonbelief experience involving seeming to see snow falling here) that either make true, are best explained by, or otherwise support those foundational beliefs (for example, the belief that snow is falling here). Advocates of foundational justification by reliable origins hold that noninferential justification depends on nonbelief belief-forming processes (such as perception, memory, and introspection) that are truth conducive, that is, they tend to produce true rather than false beliefs. Such reliabilism invokes as a justifier the reliability of a belief's nonbelief origin, whereas the previous view invokes the particular sensory experiences underlying a foundational belief. Proponents of modest foundationalism typically agree that noninferential justification for a belief can be defeated upon the acquisition of new justified beliefs, at least in most cases.

An Objection

Wilfrid Sellars and Laurence Bonjour have argued against noninferential justification, on the ground that one is justified in holding a belief only if one has good reason to think that the belief is true. This ground, they suggest, implies that the justification of an alleged foundational belief will depend on an argument of this type:

1. My foundational belief that *P* has feature *F*.
2. Beliefs having feature *F* are likely to be true.
3. Hence, my foundational belief that *P* is likely to be true.

If the justification of alleged foundational beliefs depends on such an argument, these beliefs will not actually be foundational. Their justification will depend on the justification of other beliefs, namely, the beliefs represented by premises (1) and (2).

The justification of one's belief that *P*, however, does not require justified belief that premises (1) and (2) are true. Given such a requirement, I will be justified in believing that *P* only if I am justified in believing that my belief that *P* has feature *F*. Given these requirements, I will be justified in believing that (1) my belief that *P* has *F* only if I am justified in believing an additional proposition: that (4) my belief that (1) has *F*. In that case, we have no plausible way to preclude that similar requirements apply to the latter proposition—namely, (4)—and to each of the ensuing infinity of required justified beliefs. We do not have, however, the required infinity of increasingly complex beliefs. The conclusion is that if the justification for a belief must be accessible to a person holding the belief, that accessibility should not itself be regarded as requiring further justified belief. Some critics of foundationalism have missed this conclusion.

Current debates over internalism and externalism regarding justification concern what sort of access, if any, one must have to the justification for one's justified beliefs. Internalism incorporates an accessibility requirement of some sort on what provides justification, whereas externalism does not. Debates about internalism and externalism are prominent in contemporary epistemology and show no sign of easy resolution.

Outstanding Challenges

Proponents of foundationalism must specify the exact conditions for noninferential justification. They must also specify the exact conditions for the transmission of justification from foundational beliefs to inferentially justified (nonfoundational) beliefs. Modest foundationalism, as noted above, allows for nondeductive, merely probabilistic connections that transfer justification from foundational to nonfoundational belief. Proponents of modest foundationalism have not, however, reached consensus on the exact nature of such connections. Some proponents of modest foundationalism hold that “inference to a best explanation” underlies the transmission of justification from foundational to nonfoundational beliefs in many cases. The belief, for example, that snow is falling here can, in certain circumstances, provide a best explanation of various foundational beliefs about one's perceptual experiences (including one's seeming to see snow falling here). This, however, is a controversial matter among contemporary proponents of foundationalism.

Versions of foundationalism that restrict noninferential justification to subjective beliefs about what one seems to see, hear, feel, smell, and taste confront a special problem. These versions must explain how such subjective beliefs can yield justification for beliefs about conceiving independent physical objects (for instance, beliefs about household objects). Such subjective beliefs do not logically entail beliefs about physical objects. Given that extensive hallucination is always possible, it is possible that one's subjective beliefs are true while the pertinent beliefs about physical objects are false. This consideration

challenges any version of foundationalism that includes the view that statements about physical objects can be translated, without loss of meaning, into logically equivalent statements merely about subjective states characterized by subjective beliefs. Perhaps a proponent of foundationalism will identify some nondeductive relations that explain how subjective beliefs can confer justification on beliefs about physical objects. Currently, however, no set of such relations has attracted consensus acceptance from supporters of foundationalism. Some versions of foundationalism allow for the noninferential justification of beliefs about physical objects, thereby avoiding the problem at hand.

In sum, then, foundationalism offers an influential response to questions about the nature of inferential justification. It is, however, a work in progress given its controversial features.

See also Knowledge; Logic.

BIBLIOGRAPHY

- Alston, William P. *Epistemic Justification*. Ithaca, N.Y.: Cornell University Press, 1989.
- Audi, Robert. *The Structure of Justification*. Cambridge, U.K.: Cambridge University Press, 1993.
- BonJour, Laurence. *The Structure of Empirical Knowledge*. Cambridge, Mass.: Harvard University Press, 1985.
- Chisholm, Roderick M. *The Foundations of Knowing*. Minneapolis: University of Minnesota Press, 1982.
- Lewis, Clarence Irving. *An Analysis of Knowledge and Valuation*. La Salle, Ill.: Open Court, 1946.
- Moser, Paul K. *Knowledge and Evidence*. Cambridge, U.K.: Cambridge University Press, 1989.
- Moser, Paul K., and Arnold vander Nat, eds. *Human Knowledge: Classical and Contemporary Approaches*. 3rd ed. New York: Oxford University Press, 2003.

Paul K. Moser

FREEDOM. *See Liberty.*

FREE WILL, DETERMINISM, AND PREDESTINATION. The concept of “free will” developed slowly. Discussions of the “will” arose only when ancient philosophical descriptions of intentional action came into contact with religious concerns about human and divine freedom. The predominant contemporary understanding of freedom as a completely undetermined choice between any two alternatives was introduced at the end of the Middle Ages. It is not clear how to reconcile free will with modern and contemporary science.

Ancient Greek Philosophy

The Greek understanding of freedom has its roots in legal codes that distinguish between intentional and nonintentional action. Socrates’ (469–399 B.C.E.) understanding of human action reflects the Greek emphasis on the importance of knowledge for intentional action. Moreover, he appears to think that every agent acts for what is good, and that this good

is good both in itself and for the agent. According to Socrates, virtue is knowledge and vice is ignorance. No one acts against what he knows to be good. Plato (427?–347 B.C.E.) adopts this Socratic view, although in his later works he emphasizes that the passions have an influence on what the agent knows. The good person not only has reason, but his reason is directed toward the good.

Aristotle (384–322 B.C.E.) thinks that the Socratic account cannot explain incontinence, which is the condition in which someone does what he knows to be bad. He departs from this account by distinguishing between theoretical knowledge, which is about what cannot be changed, and practical knowledge, which is about what can be changed. The practically wise individual (*phronimos*) has that knowledge that is relevant to the action and acts upon it. Every voluntary action requires that the agent know what he is doing. An agent does not deliberate about the end, which is human happiness. Every human desires happiness. The agent deliberates only about the means that are within his power. The incontinent agent suffers from a temporary ignorance of what is good for him but always acts for the sake of something that appears to be good. For example, an incontinent person might know that chocolate cake is unhealthy, and yet his attention is drawn not to its badness but to its tastiness. He eats it not because it is unhealthy but because it is tasty.

Although Aristotle is not overly concerned with determinism, he does stress that human action requires contingency. Practical knowledge is about those events that can be changed by human action. His discussion of how future contingents are known reflects this connection and becomes important in later discussions. For Aristotle, the statement that there will be a sea battle tomorrow is neither true nor false because the event is contingent and consequently not determined by and knowable from previous events. In contrast, the Stoics believed in a strict determinism in which everything is ordered to the best. Humans cannot change the outcome of events. Nevertheless, the Stoics allowed for freedom and responsibility in that they thought that humans should understand this order and adapt themselves to it.

Jews, Christians, and Muslims

Unlike ancient philosophers, Jews and Christians believe that the whole world is contingent at least in the sense that God could have decided either to create it differently or not to create it. Everything that exists is the result of God’s free choice. Moreover, the Jewish Scriptures emphasize the importance of a covenant between humans and God whereby humans freely follow its conditions. For Christians, the Epistles of Paul explain the struggle between the flesh and the spirit within a Christian. This influence of Jewish and Christian Scriptures, combined with his own moral experience, enabled Augustine of Hippo (354–430 C.E.) to develop the first explicit doctrine of the will.

Although the word *voluntas* existed previously, Augustine was the first to use it similarly to the way in which the word “will” is now used. He underwent an intellectual conversion to Christianity without at first changing his behavior. Consequently, he

was compelled to reconsider the problem of incontinence. According to Augustine, the explanation of why someone is unable to do what he knows to be good is that his will is disordered. He does not use the term “free will” but “free choice” (*liberum arbitrium*). Nevertheless, he thinks that on account of their will, humans can choose to do what is right or wrong.

Although Augustine developed his understanding of the will in a primarily moral context, Greek Christians developed a parallel notion in their defense of the orthodox Christian belief that Jesus Christ has both a divine and a human will (*thelesis*). John Damascene (c. 675–c. 749) summarized the Greek teaching and emphasized that reason has its own appetite. Some later Christians base their understanding of the will as a rational appetite on his thought. Just as the senses desire what is pleasant to them, so does reason desire what it apprehends as good.

The Jewish and Christian Scriptures contributed greatly to the recognition of what we now call the will. Nevertheless, they also raised the problem of how to reconcile human wills with God’s will. Although Jews and Muslims share a common belief in providence and human freedom, for the most part they have developed different approaches to explaining their compatibility. The most influential medieval Jewish position developed in response to the Muslim attempt to combine the Koran’s emphasis on human freedom with the emphasis in the hadith (the body of traditions relating to Muhammad and his companions) on providence. The earliest Muslim position, namely the Mu’tazilite, distinguished between God’s causality and that of human acts, for which humans are praised or blamed. God is not responsible for sin. In contrast, the Ash’arite position is that humans appropriate an act that comes from God. Although humans are responsible for their actions, they do not act independently of God. The Sunnis adopted this account, although there is no clear explanation of what this appropriation is. The greatest medieval Jewish thinker, Moses Maimonides (1135–1204), reacted strongly against the Ash’arite position. His reaction is at least partially based on the Jewish Scripture’s insistence that God’s covenant with the Jews requires a free response. In general, Muslims emphasize God’s providence, whereas Jews emphasize human freedom.

Christians share the same difficulties as Muslims and Jews, but they also hold the doctrine of predestination, according to which God’s providential decision to save some humans is prior to their response. Augustine developed this teaching in opposition to the Pelagian position that humans can obey God’s commands and merit heaven without the special form of help from God that is called grace. He argued that human freedom is severely damaged by original sin and that humans are unable to perform meritorious actions on their own. Moreover, Augustine and his followers responded to a position that was later described as Semipelagian, according to which humans have the first choice in accepting or rejecting grace. The Western Church condemned Pelagianism and Semipelagianism.

Augustine’s description of predestination presented many difficulties for later Christians. God moves the will, and yet the will

moves freely. The agent cannot be primarily responsible for good actions, yet he is solely responsible for his bad ones. Final perseverance in grace precedes merit, although reprobates are punished only on account of their sin. Although the tension between these beliefs is most strongly felt during the early Protestant Reformation, even in the Middle Ages many thinkers emphasized some aspects of Augustine’s thought at the expense of others. For example, in the early Middle Ages the Predestinarians argued that reprobation is parallel to predestination. Just as God freely wills to save some before considering their merits, so he wills to eternally punish others apart from their offenses. Predestinarianism was strongly condemned by the Western Church. Consequently, later Catholic theologians were careful to avoid Pelagianism on the one hand and predestinarianism on the other.

Scholastic Christian Thought

Thomas Aquinas (1225–1274) attempted to harmonize Augustine’s account of predestination and human freedom with Aristotle’s understanding of human action. Following John Damascene, Aquinas describes the will as a rational appetite. Although humans cannot choose whether to desire the ultimate end, namely happiness, they can choose between different proximate goods. He distinguishes the liberty of exercise from the liberty of specification. The liberty of specification is that freedom that has its root in reason’s ability to consider alternative courses of action. The liberty of exercise rests in the will’s ability to act or not to act. Scholars disagree over how significantly Aquinas’s account of free choice differs from Aristotle’s account of intentional action.

Like Aristotle, Aquinas thought that deliberation must be about contingent events that are not knowable as future. Unlike Aristotle, Aquinas clearly held that God is omniscient and omnipotent. How does God know future contingents? Following the early Christian writer Boethius (c. 475–525), Aquinas held that God knows future contingents not as future but as they are present to him eternally. Even God could not know them as future. How does God’s providence extend to contingent events such as free human acts? God causes necessary events to happen in a necessary way and contingent events to happen in a contingent way. God is the complete universal cause of a free act, even though the agent is its complete proximate cause. Following Augustine, in his later writings Aquinas clearly states that predestination is antecedent to any foreseen merits and that original sin has made it impossible to live a fully virtuous life without grace. There is no reason on the part of the individual why God chooses to save him and allow another to sin and be damned.

Stephen Tempier, bishop of Paris, and many theologians were concerned that the reception of Aristotle’s works was leading to an intellectual determinism that compromised human freedom. In particular, Franciscan theologians regarded the will as the ultimate root of human free choice, although many Dominicans followed their brother Thomas’s emphasis on the intellect. Although the Franciscan John Duns Scotus (c. 1266–1308) broadly agreed with Aquinas’s account of predestination and God’s eternal knowledge, he had a weaker understanding of original sin and emphasized the will over the intellect. Like Aquinas, Scotus thought that the will has an inclination to the

good, but he distinguishes between the inclination toward the just and the inclination toward the advantageous. Freedom results from the ability to choose between the two.

The Franciscan William of Ockham (c. 1285–c. 1349) comes much closer to the modern understanding of “free will,” according to which an agent has a liberty of indifference whereby he can make any choice whatsoever. Moreover, Ockham adopts an alternative understanding of predestination according to which at least some are predestined on account of their foreseen merits. He thinks that God has knowledge of future contingents from the perspective of the past, and that both God and the agent are immediate partial causes of a free action. Consequently, God cannot internally move the will of even the great saints but must either put them in suitable circumstances or withhold his causal action when they would sin. Ockham’s views on predestination were influential throughout the later medieval period, and they led to a medieval Augustinian reaction. But the greatest reaction was to occur during the Protestant Reformation.

Reformation and Counter-Reformation

Martin Luther’s (1483–1546) theological education exposed him to a largely Ockhamist understanding of human freedom and predestination. He reacted strongly against this approach by denying that the human will is significantly free apart from grace and apparently by holding that predestination and reprobation are parallel. Although medieval theologians had described this position as predestinarianism, modern and contemporary scholars often call it double predestination. Subsequent Lutherans modified his position. Similarly, John Calvin (1509–1564) explicitly rejected the medieval understanding of free choice and may have adhered to double predestination. However, later Reformed theologians such as Pietro Martire Vermigli (1500–1562; also known as Peter Martyr) defended the medieval distinction between predestination and reprobation. There is not one official Reformed position on predestination. For example, Reformed theologians split over whether God’s eternal decree that some will be reprobate is prior or posterior to his permission of Adam’s sin. In general, later Protestant Orthodoxy permitted views on Predestination that were less severe than those of the early Protestant Reformers.

There was a variety of early Catholic responses to the Protestant Reformers, since Catholic theologians were variously Augustinian, Thomist, Scotist, and Ockhamist. Even humanists such as Erasmus (1466?–1536) were worried about the apparent denial of human freedom. The new Jesuit order reacted strongly by emphasizing a free human cooperation with grace. The Jesuit Luis de Molina (1535–1600) taught that God decides what someone will do only by foreseeing what he would do in a set of circumstances and then creating the agent and those circumstances. In general, Jesuits held an Ockhamist understanding of God’s causation whereby both God and the agent contribute to the agent’s action. Dominicans such as Dominic Banez (1528–1604) and John of St. Thomas (1589–1644) were the most important critics of the Jesuit positions. John held that the Protestants and Jesuits both err in thinking that a predetermination by God’s grace is incompatible with

human freedom. Moreover, he thought that God wills to deprive the reprobate of grace and glory, and that this decision is prior to the permission of Adam’s sin. The Dominicans claimed with some plausibility that they followed the teachings of both Augustine and Thomas Aquinas. Pope Paul V declared that the Jesuits were not to be called Semipelagians and the Dominicans were not to be called Calvinists, and they were both allowed to teach their respective positions until further notice.

Contemporary theologians and philosophers of religion still read with sympathy the works of Thomas Aquinas, William of Ockham, and Luis de Molina. Nevertheless, the Augustinian and Thomist accounts of predestination have few contemporary followers. Many now adhere to “open” theories according to which God has no complete foreknowledge of and control over human actions. Earlier Christians would have rejected such views for denying God’s omnipotence and omniscience.

Modern Science and Human Freedom

In the seventeenth century modern science seemed to provide a mechanistic understanding of the world that threatened human freedom. René Descartes (1596–1650), the father of modern philosophy, held a dualistic theory whereby physical events are determined although human actions have a liberty of indifference because the soul is not material. In general, modern and contemporary philosophers have been determinists, compatibilists, or libertarians. Determinists hold that everything is physically determined and that there is no human freedom. Libertarians such as Descartes hold that human actions are free and that the free agent must have a liberty for choosing alternative possibilities that are not determined. Compatibilists such as David Hume (1711–1776) hold that human freedom is entirely compatible with physical determinism. Most compatibilists think that the indeterminacy of libertarians would only make the free actions arbitrary. Immanuel Kant (1724–1804) appeared to be a hard determinist with respect to the world of appearances and a libertarian with respect to the real world.

Contemporary philosophers still fall roughly into one of these three categories. Although a combination of chaos theory and quantum mechanics has now thrown into doubt determinist scientific theories, many philosophers think that the new science has no significant impact on debates over human freedom.

The history of ideas shows that there is no one concept of “free will.” Instead, concepts of human freedom develop in response to perceived threats such as ignorance, God’s omnipotence, intellectual determinism, and physical determinism.

See also Christianity; Islam; Liberty; Reformation; Scholasticism.

BIBLIOGRAPHY

Adams, Marilyn McCord. *William Ockham*. 2 vols. Publications in Medieval Studies 26. Notre Dame, Ind.: University of Notre Dame Press, 1987. Compares Ockham with Thomas Aquinas and Scotus.

- Bourke, Vernon. *Will in Western Thought: An Historico-Critical Survey*. New York: Sheed and Ward, 1964.
- Burrell, David B. *Freedom and Creation in Three Traditions*. Notre Dame, Ind.: University of Notre Dame Press, 1993. Includes a discussion of Jewish and Muslim thought.
- Dihle, Albrecht. *The Theory of Will in Classical Antiquity*. Sather Classical Lectures 48. Berkeley: University of California Press, 1982.
- Flint, Thomas P. *Divine Providence: The Molinist Account*. Ithaca, N.Y.: Cornell University Press, 1998.
- Gallagher, David M. "Free Choice and Free Judgment in Thomas Aquinas." *Archiv für Geschichte der Philosophie* 76 (1994): 247–277.
- Garrigou-Lagrange, Reginald. *Predestination*. Translated by Dom Bede Rose. St. Louis, Mo.: Herder, 1939.
- Kane, Robert, ed. *The Oxford Handbook of Free Will*. Oxford: Oxford University Press, 2001.
- McGrath, Alister E. *Iustitia Dei: A History of the Christian Doctrine of Justification*. 2nd ed. Cambridge, U.K.: Cambridge University Press, 1998.
- Muller, Richard A. *Christ and the Decree: Christology and Predestination in Reformed Theology from Calvin to Perkins*. Studies in Historical Theology 2. Durham, N.C.: Labyrinth Press, 1986.
- Rimbach, Harald. *Gnade und Erkenntnis in Calvins Prädestinationslehre: Calvin im Vergleich mit Pighius, Beza und Melancthon*. Neue Beiträge zur Historischen und Systematischen Theologie 19. Frankfurt am Main: Peter Lang, 1996.
- Rist, John M. *Augustine: Ancient Thought Baptized*. Cambridge, U.K.: Cambridge University Press, 1994.

Thomas M. Osborne Jr.

FRIENDSHIP. The visibility of “friendship” in historical writings has fluctuated over time. For the ancient Greeks and Romans, friendship was the dominant paradigm. In medieval Europe, Christian teachings subordinated human friendship to spiritual friendship. In the modern period, with its focus on impartiality, friendship was relegated to the private sphere. Toward the end of the twentieth century there was a revival of writings on friendship, with a resumption of discussions about the role of friendship in society, and debates about the politics and the ethics of friendship. Friendship, which involves close personal relations, affection, caring for and commitment to another, is intertwined with other emotions such as love, passion, patronage, spiritual love, sexual love, romance, and kinship. Different aspects and interpretations of friendship have been emphasized in different eras.

Male-Male Friendship

Anthropological evidence gives many examples of the role of friendship in different societies and cultures. For example, the Arapesh of northwestern New Guinea, the Hopi of Arizona, and the Tikopia in the Solomons created ritual or ceremonial bonds of non-kin friendship, mainly between males. Yet the traditions that focused most explicitly on friendship were the societies of classical Greece and Rome, and it is the treatises of Plato, Aristotle, and Cicero that form the linchpin around which the subsequent philosophical debate has turned or to



Ancient Iranian relief showing two dignitaries exchanging a gesture of friendship, staircase of the Tripylon, Achaemenid period (559–330 B.C.E.) Many ancient societies placed great emphasis on male-male friendships, and some even included rituals and ceremonies to bind friends even closer together. PERSEPOLIS, IRAN. © THE ART ARCHIVE / DAGLI ORTI

which it will return. Most of the classical philosophical writing on friendship presupposes a sociological context of male-male friendship. Greek writers, such as Plato and Xenophon reporting on Socrates’ teaching, discuss *eros* and *philia* almost interchangeably to describe the very close relationship between men or between men and boys. Aristotle limits his concept of perfect altruistic friendship to men of virtue. The extension of friendship into a civic bond between fellow citizens is, for Aristotle, the ideal basis for politics. Cicero’s accounts of friendship or *amicitia* in ancient Rome are also linked to politics and describe not only personal male heterosexual friendship, but also the concept of patronage, which sustained business and political relationships.

The ancient canon of friendship, which stresses the interests of the “other self,” reciprocal consideration, and the role of friendship in contributing to a virtuous and good life, was superseded, in the medieval period, by the concept of spiritual friendship. With the rise of Christianity and hieratic religions, based on a divinity and priesthood, the relationship between man and godhead assumed prominence. The guiding emotions in religions with a supreme and omnipotent god, and especially in Christianity, were *agape*, or the love of God, and *caritas*, or charity toward others. Concepts of love and friendship were redefined by monks and theologians, as human relationships were triangulated to include God as an essential mediating force between human friendships. St. Augustine (354–430), Aethelred of Rievaulx (c. 1110–1167), and Thomas

Aquinas (1225–1274), reworking the treatises of Plato, Aristotle, and Cicero, write of spiritual friends—the need to love God in order to make possible friendships between men.

Other religious traditions also synthesize classical ideas of friendship. The Muslim theologian al-Ghazali (1058–1111) builds on the Aristotelian ideal of friendship, overlaying it with notions of the spiritual bond of Sufi brotherhood. Moses ben Maimon (Maimonides; 1135–1204) the Jewish sage, reflects both Socratic and Aristotelian ideas in advocating the importance of finding a friend.

In the modern period, few philosophers have considered friendship worthy of attention, with some notable exceptions. Francis Bacon (1561–1626) and Ralph Waldo Emerson (1803–1882) write in praise of friendship. For Michel de Montaigne (1533–1592), his friendship with the writer Étienne de La Boétie (1530–1563) represented a pure and unique experience of the finest thing in life, but was unobtainable by most men and all women. Friedrich Nietzsche (1844–1900) challenges the complaisance he sees in the thinking about friendship. He describes a friend as the “third” between I and me, with the true friend being one’s best enemy. Like Aristotle and Montaigne, he considers that only “higher” forms of humans are capable of friendships. Jacques Derrida continues Nietzsche’s interrogation, using the mantra “O my friend, there is no friend” to illustrate the contradictions and anomalies in the history and politics of friendship, including the omission of women in this history of friendship. The distinction between love and friendship becomes, for Derrida, submerged into ideas of “aimance” or “lovence.”

Female-Male Friendship

Most philosophy, poetry, and literature discusses male-female relationships in terms of eros, romance, passion, sex, and marriage, rather than friendship. Friendship between males and females was acknowledged by some of the ancients, but almost exclusively as husband and wife. In Homer’s *Odyssey*, Penelope had a role in extending *xenia* or guest friendship to various visitors to the family home in the absence of her husband, Odysseus. Her loyalty to Odysseus meant that this relationship got no closer. Lucius Annaeus Seneca (c. 4 B.C.E.–65 C.E.) and Plutarch (c. 46–after 119 C.E.) both write about the importance of friendship between husband and wife. The only philosopher of antiquity to consider women and men as equally capable of engaging in friendship was Epicurus (341–270 B.C.E.), whose Garden of Friends was open to all—men, women, and slaves.

Courtly love of the Middle Ages and the idealized relationships of the Romantic era emphasized not equal affectionate friendships, but unattainable, idealized, and exclusive male-female intimacy. It was the movement for women’s equality that transformed relationships for women, both with men and with other women. The personal and political were combined in, for example, the friendships of one of the first feminists, Mary Wollstonecraft (1759–1797), during the French revolution with dissenters such as Richard Price (1723–1791) and Joseph Priestly (1733–1803), or in the bohemian literary and art circles of the

TERMINOLOGY

Philia:	friendship
Eros:	passionate/sexual love
Agape:	unselfish love
Amicitia:	friendship/patronage
Caritas:	charity
Lovence:	friendship/romance
Aimance:	friendship/romance
Gyn/affection:	female friendship
Xenia:	guest friendship

early twentieth century, as with the New Zealand writer Katherine Mansfield and the Scottish painter J. D. Ferguson. Women’s participation in the civil rights and the antiwar movements in the 1960s brought men and women together as friends fighting political battles. However, the concurrent sexual revolution, which endeavored to free women from the restraints of Victorian attitudes, focused on uninhibited carnal relationships rather than nonsexual friendships. The literature of heterosexual relationships became dominated by the field of psychology and includes warnings to women to avoid “love addiction” or advice about sexual enjoyment.

Female-Female Friendship

For women, whose traditional role has been in the home, social mobility meant that friendship assumed more importance as kinship ties were stretched or broken. Stories, such as the Old Testament account of Ruth and Naomi, two women related by marriage, illustrate the strength of female kinship. When friendship between women is discussed, it includes both lesbian and nonlesbian relationships. The love poems of the best-known woman writer of antiquity, Sappho (fl. c. 610–c. 580 B.C.E.), could be describing both heterosexual and lesbian relationships, but her community of women on the island of Lesbos has become the symbol of modern lesbianism.

Medieval monastic writings often portray women as a danger to men, the object of inferior emotions such as carnal desire. Suspicion was also cast upon groups of women living together in convents, especially as the nuns adopted Aethelred’s notion of spiritual friendship, a companionship of souls, which sanctioned particular intimate friendships. The writings of women mystics and saints, such as Teresa of Ávila (1515–1582) Catherine of Siena (1347–1380), and Juana Inés de la Cruz, (1651–1695), expressed passionate love of the souls of their sisters.

For evidence of women’s friendships, we have to rely not on the treatises written about male friendships, but on personal cor-

respondence, diaries, novels, and poetry. Nineteenth-century romantic friendships between women were expressed in affectionate letters to each other. The suffragettes of the late nineteenth century and early twentieth century interspersed their political communication with expressions of personal friendship.

Women's friendships with women, as well as with men, became civic bonds important for politics in the twentieth century. The second wave of feminism in the 1960s, with its slogan of "the personal is political," produced a women's network of consciousness-raising groups. Women relied on the friendship of other women for support. Janice Raymond's term "Gyn/affection" aims to describe female friendships involving not only fondness and affection, but also the sense of empowerment that female friendships can create.

Conclusion

Contemporary writings on friendship all point to a lacuna in modern literature. But toward the end of the twentieth century this gap was being addressed by various challenges, both to the impartiality of liberalism and to the objectivity of modernism by movements such as communitarianism, feminism, and post-modernism, which created a rich and ongoing scholarly debate and which resurrected some of the ideals of classical philosophy in an attempt to recognize the valuable role that can be played by friendship in the twenty-first century.

See also *Emotions; Feminism; Love, Western Notions of*.

BIBLIOGRAPHY

- Badhwar, Neera Kapur, ed. *Friendship: A Philosophical Reader*. Ithaca, N.Y.: Cornell University Press, 1993.
- Bell, Sandra, and Simon Coleman. *The Anthropology of Friendship*. Oxford: Berg, 1999.
- Blosser, Philip, and Marshall Carl Bradley, eds. *Friendship: Philosophic Reflections on a Perennial Concern*. Lanham, New York, and Oxford: University Press of America, 1997.
- Derrida, Jacques. *Politics of Friendship*. Translated by George Collins. London and New York: Verso, 1997.
- Hunt, Mary E. *Fierce Tenderness: A Feminist Theology of Friendship*. New York: Crossroad, 1991.
- Hutter, Horst. *Politics as Friendship: The Origins of Classical Notions of Politics in the Theory and Practice of Friendship*. Waterloo, Ont.: Wilfrid Laurier University Press, 1978.
- King, Preston, and Heather Devere, eds. *The Challenge to Friendship in Modernity*. London: Frank Cass, 2000.
- Leaman, Oliver, ed. *Friendship East and West: Philosophical Perspectives*. Richmond: Curzon, 1996.
- Pakaluk, Michael. *Other Selves: Philosophers on Friendship*. Indianapolis: Hackett, 1991.
- Raymond, Janice. *A Passion for Friends: Toward a Philosophy of Female Affection*. Boston: Beacon, 1986.
- Rouner, Leroy S., ed. *The Changing Face of Friendship*. Notre Dame, Ind.: University of Notre Dame Press, 1994.

Heather Devere

FRONTIERS. See **Borders, Borderlands, and Frontiers, Global.**

FUNDAMENTALISM. A term used loosely to describe a reaction of (neo)traditional religion against the pressures of modernity, *fundamentalism* became a widespread topic of interest in the media and the academy during the last quarter of the twentieth century. According to many observers, fundamentalism is a worldwide phenomenon, arising in various societies with differing cultural backgrounds and experiences of modernity. The original understanding of fundamentalism, however, took shape in an American Protestant context—a context that initially informed popular and scholarly notions of fundamentalism and sometimes led to simplistic comparative interpretations. For this reason, among others, critics have questioned the viability of fundamentalism as a universal religious category, especially when applied to non-Western societies; and comparative studies of fundamentalism have been marked by self-conscious attempts to prove the existence of the phenomenon that they are presumably examining.

Origins

As a movement, fundamentalism emerged in response to the rise of liberal views within American Protestant denominations in the late nineteenth and early twentieth centuries. Liberal thinking had been influenced by evolutionary theory and German "higher criticism," a type of biblical criticism that sought to interpret the text in light of new philological and archaeological evidence, free from dogmatic and confessional assumptions. Liberals eschewed traditional theology, with its attendant belief in miracles and the supernatural, fostering instead a rational, human-centered vision of Christianity. Most offensive to fundamentalists, liberals turned accepted doctrines of faith, such as the creation story, virgin birth, atonement, and resurrection, into figurative myths, replete with meaning but devoid of historical reality. For liberals, the findings of science and the secularism of the day were fully compatible with Christianity rightly understood. Indeed, liberal theology fostered an image of Christ as immanent within the culture and thus an active force for the kind of progressive social change that modernity itself seemed to promise.

For fundamentalists, the accommodating trend of the liberals threatened to undermine both Christian faith and the moral society it had nurtured in the United States. The most coherent reply to the liberal challenge came in *The Fundamentals*, a multivolume set of essays that began publication in 1910 and lent the movement its name. While the essays did little to stem the liberal tide, they did serve to clarify the ideological rift within Protestantism. Sedate and scholarly, *The Fundamentals* appealed to an intellectual audience. The broader public, however, took notice of the doctrinal debate when the populist presidential candidate William Jennings Bryan (1860–1925) toured the country warning of the grave danger posed by liberals. The debate reached a national audience—and something of a fevered pitch—in the Scopes trial of 1925, which saw John Thomas Scopes (1900–1970), a Tennessee public school teacher, charged with breaching state law prohibiting the teaching of evolution.

Bryan, one of the prosecutors, presented the case as a referendum on the eternal truths of the Bible and their revered place in public life. The main defense attorney, Clarence Darrow, made academic freedom and separation of church and

GUSH EMUNIM IN ISRAEL

Gush Emunim or Bloc of the Faithful emerged as a faction within Israel's National Religious Party (NRP) in 1974, following the shock of the Yom Kippur War and the subsequent land concessions to Egypt in the Sinai. Gush members eventually split from the NRP, focusing their efforts on settlements and territorial expansion; but the movement's effective, sometimes militant activism for a greater Zionist state made it an important force in the nation's political debate over borders and peace. Through insightful manipulation of political divisions and popular Zionist sentiments within Israel, Gush managed to claim and build settlements upon strategic plots of land in what some regarded as the occupied territories but Gush maintained was part of Eretz Yisrael, holy ground deeded to the people of Israel in perpetuity by God in the Bible. The "ideotheology" (Sprinzak) that informed the movement traced back to the theological Zionism of Rabbi Abraham Isaac Kook (1864–1935) and the radicalization of this theology by his son, Rabbi Zvi Yehuda Kook (1891–1982). In the context of Israel's debate over its territorial future and relations with its Arab neighbors, "Kookism" (Aran) gave rise to a religious nationalist fundamentalism in which theology triumphed over policies of the secular state and compromise over territory was tantamount to a breach of God's covenant.

state the issues at stake. Clearly in violation of the law, Scopes was convicted, though the verdict was later overturned on a technicality. Bryan and the fundamentalist cause, however, emerged from the trial the real losers. Under harsh questioning from Darrow, Bryan proved incapable of offering a rational defense of biblical literalism; and news reports, especially those written by the Baltimore critic H. L. Mencken (1880–1956), portrayed fundamentalists as anti-intellectual and backward—an image from which they never fully recovered.

Political and Cultural Developments

Early detractors of fundamentalism suspected political motives behind the movement, but with few exceptions, fundamentalists avoided participation in the political arena. In fact, following the Scopes trial, fundamentalists maintained a low-key presence in the United States. By the late 1970s, however, fundamentalists had split into two distinct wings: separatists who viewed politics as a distraction from the main task of all true Christians, the salvation of individual souls; and activists who regarded social and political engagement as the best means of spreading the message of Christ. The latter returned to the public scene in force, and they began to assert their political voice in both local and national elections. Joining the fundamentalist political effort was a different, though related, group of Christian conservatives, the Evangelicals, whose numbers had grown dramatically throughout the first half of the twentieth century. This combined force came to be called the Religious Right or the New Christian Right and, as the political vector suggests, was closely linked with the concerns and candidates of the Republican Party. At work behind this conservative coalition was a cultural realignment that had been brewing for

decades. Interestingly enough, this realignment was signaled by the presidency of Jimmy Carter (1924–), a Democrat and professed born-again Southern Baptist.

The cultural agenda of Christian conservatives was shaped and broadcast by organizations such as the Moral Majority, Christian Roundtable, and, later, the Christian Coalition, whose goal was to oppose and turn back the tide of political liberalism. The United States, so these fundamentalist organizations claimed, had been founded as a Christian nation and had achieved its preeminent place in world history because of its commitment to Bible-based morality; but liberal thinking and policies had led the nation astray, and signs of decline were apparent: increasing drug use and sexual promiscuity, abortion on demand, the high rate of out-of-wedlock births and divorce, tolerance of homosexuality, absence of religion in the public schools, and court-supported attacks on public displays of faith. For fundamentalists, America's continued God-ordained prosperity depended on a return to traditional religious values and, by theological extension, a commitment to conservative political ideals, such as unwavering patriotism and anticommunism, a strong national defense, support for Israel, fiscal conservatism, and small government.

This blend of moral theology, religious nationalism, and conservative public policy had broad appeal among the electorate and helped solidify support for Ronald Reagan (1911–2004) in the 1980 presidential election. Throughout Reagan's two terms in office, fundamentalists enjoyed a measure of public attention and success that would have been hard to imagine in the aftermath of the Scopes trial. Fundamentalists basked in the glow of their newfound strength and sought to retake the cultural

BHARATIYA JANATA PARTY IN INDIA

The Bharatiya Janata Party (BJP), or Indian People's Party, was founded in 1980 after Hindu nationalists, working through the Janata Party, fared poorly in general elections against the secular Congress Party, which had ruled India since independence in 1947. The BJP drew its members from the infamous Rashtriya Swayamsevak Sangh, founded in 1925, a radical Hindu nationalist organization, one of whose former members had assassinated Mohandas K. Gandhi (1869–1948). The BJP worked to rally support for a vision of modern India that was grounded in the idea of *Hindutva* or Hindu-ness, an idea first propounded by Vinayak Damodar Savarkar (1883–1966). *Hindutva* portrayed India's diverse ethnic and religious factions as historical offshoots of Hinduism; and since all Indians were at base Hindus, Hindus alone

were best able to express the political identity and desires of the nation. Here again, the fundamentalism at work takes the form of hyperreligious nationalism that offers citizens a cultural identity at odds with the more secular model of civic pluralism. The volatile potential of this cultural and political chauvinism manifested itself in the dispute over the Babri Masjid, which saw BJP-instigated mobs attack, in 1991, and later destroy, in 1992, a mosque at Ayodhya that Hindu nationalists claimed had been built over a temple dedicated to the god Rama. Despite the immediate political setback suffered by the BJP, the party went on to great political success, leading some to question the commonly held view that the BJP was incapable of ruling a truly democratic nation (Juergensmeyer, 1995; Hansen).

ground that they felt they had lost to liberals in the shaping of law, education, the arts, the family, and politics. Liberals, by contrast, believed that fundamentalists had, in contravention of the separation of church and state, hijacked the political process and were attempting to impose their narrow religious agenda on the country, thereby undermining the United States' civil contract of democratic pluralism. The contestation between conservatives, both political and religious, and liberals to define national identity grew so acrimonious during the 1980s that it became known as the "culture wars." It was during these wars that fundamentalism began to emerge as a comparative tool among academics, and the 1979 Islamic revolution in Iran provided the major impetus for such comparisons.

Islamic Revolution in Iran

The image of bearded clerics ruling a heretofore avowedly secular and Western-friendly Islamic country sent shock waves through the West and the Muslim world. Of particular concern among political commentators and scholars was the power of religion to contribute to the kind of revolutionary political transformation that students of history had come to associate only with modern forces like nationalism and Marxism. A revolution in the name of religion suggested to many a reassertion of premodern thinking and hence a step backward in Iran's development. Much the same view surrounded the rise to prominence of Protestant fundamentalism in the United States, which occurred against the backdrop of the 1979 Islamic revolution in Iran. Indeed, for many Western liberals, the two events had obvious dangerous parallels: a religious takeover of politics, retrograde attitudes and policies toward women, religious intolerance, and suppression of dissent. These very themes received

popular treatment in Margaret Atwood's 1986 novel *The Handmaid's Tale*, which portrays the United States as a theocratic fundamentalist nation along the lines of postrevolution Iran.

To explain the revolutionary turn in Iran, scholars of the region drew on traditional social-movement theory, especially the work of Max Weber (1864–1920), whose interpretive connection to fundamentalism remained at the time unarticulated. In fact, it was in the course of analyzing the Islamic revolution in Iran, and less dramatic but equally worrying events elsewhere in the Middle East (e.g., Egypt, Algeria, and Syria), that such connections began to emerge. Scholars largely agreed (1) that the cause of the Islamic revolution lay in a crisis of cultural authenticity brought about by the Shah's failed attempts at political and social modernization; (2) that the response to this crisis was the molding of traditional Shii ideas and symbols into an ideological force for change; and (3) that the ideological formulation of Islam exhibited in the Islamic revolution was part of a larger pattern of political religion common throughout the Middle East and the larger Muslim world. Not all scholars viewed fundamentalism as a useful tool for explaining this trend, and among those who did, there were various definitions of fundamentalism proffered. Two important interrelated questions, however, informed the general debate about this trend that some called "fundamentalism." First, is it a uniquely modern phenomenon? Or is it part of a cyclic pattern of social response that can be found throughout Islamic or world history? Second, is it a progressive movement, one that will allow developing Muslim countries to move forward along the modernization path? Or is it in fact a regressive revolutionary force, one that will impede hopeful advances that had already begun to reshape Muslim societies?

MUSLIM BROTHERHOOD OF EGYPT

Founded in Egypt in 1928, some fifty years prior to the Islamic revolution in Iran, the Muslim Brotherhood is considered the premier Sunni Islamist organization in the Muslim world. The writings of its founder, Hassan al-Banna (1905–1949), and its main ideologue, Sayyid Qutb (1906–1966), have become standard reading for Muslim activists. Both figures were martyrs to the Islamist cause, killed by an authoritarian state that eliminated sources of authority that it could not easily control. The preaching and activism of the Brotherhood set the stage for a new kind of Muslim reformer, one who engaged society and confronted the state on a broad spectrum of issues. Indeed, through its array of clinics, schools, businesses, and mosques, the Brotherhood tried to create a mini-society that modeled the power of the Islamic alternative to Western-style modernization. This alternative included the rejection of the nation-state as a legitimate form of Muslim political organization, though some scholars believe that the Brotherhood's ultimate goal was to replace secular nationalism with religious nationalism. In either case, the Brotherhood's proposed "Islamic order"—the notion of a society and polity integrated according to Islamic cultural values and ideas—served, and continues to serve, as a challenge to the Western-leaning policies of the Egyptian government.

Scholars divided over the modern-versus-perennial question, but, like the academic debate about the nation, a consensus pointed to a modern point of origin for fundamentalism. Scholars also disagreed about fundamentalism's potential to contribute positively to the challenges of developing nations, but, once again, the tendency was to emphasize the backward-looking and thus retarding nature of the movement. Those who advocated a fundamentalist paradigm for understanding the Islamic revolution recognized that the distinction between developing and developed nations prevented direct comparisons between Iran and America. Instead, they proposed a general set of characteristics that defined fundamentalism across social and cultural boundaries, the two most common of which were a totalizing worldview—subsuming every aspect of life under religion—and scripturalism—a devotion to the inerrancy and immutability of sacred Scripture. Fundamentalists, then, rooted in the sole authority of sacred Scripture, approached the world in uncomplicated and uncompromising terms, ordering their lives and their communities (however limited or expansive based on their power) according to a strict set of God-ordained guidelines that separated the saved from the damned.

Problems with the Fundamentalist Paradigm

Fundamentalism proved a popular and important idea because it held out the promise of accounting for perceived patterns of thinking and behavior in diverse societies with differing religious and political cultures. Critics of the fundamentalist paradigm, however, saw in the patterns an inherent Western bias that created problems for meaningful comparison. For example, Protestant fundamentalists in the

United States defined themselves over and against liberal trends by highlighting their scripturalist views. In the Muslim world, by contrast, the vast majority of Muslims expressed literalist attitudes toward the Koran. In fact, some scholars claimed that Muslim societies were dominated by scripturalist fundamentalism, and that their successful modernization depended on the development of a more liberal interpretive strand in Islam. Hence a supposed comparative characteristic that serves to identify and analyze a *faction* of the religious population in one context, the United States, loses this capacity in another, the Muslim world.

A similar problem arose with the pattern of a totalizing worldview. Unlike their more civic-minded and secularized fellow citizens, American Protestant fundamentalists may indeed see the private and public spheres as indivisible and necessarily religiously ordered. To speak of the same phenomenon in Muslim societies, however, is to miss the overarching role that religion has come to play in the political process. Certain groups in Muslim societies may be totalizing in their worldview, but the search for cultural authenticity has also led to a basic pattern of politicized religion among all factions. Fundamentalism, then, even if it were deemed to exist in the form of Islamism, is just a small portion of the public Islam that dominates the lives of modern Muslims. And with Islamic ideas and symbols being deployed by so many Muslim citizens with differing political agendas, how can one reasonably highlight a single faction as blending religion and politics in a distinctively different manner? For this reason, some scholars of the Muslim world avoid the term "fundamentalism," preferring instead terms like "Islamic resurgence" (Dessouki) or "Muslim

politics" (Eickelman and Piscatori) to capture the multipurpose political ends to which the Islamic tradition has been put.

The above-mentioned descriptors of fundamentalism clearly contained proscriptive judgments about its rational viability. When applied to American Protestantism, totalism and scripturalism often implied that fundamentalists were out of step with modern, mainstream thinking about both Christianity and the place of religion in American public life, thus isolating the group as an aberrant form of religiosity. By contrast, when applied to entire Muslim societies, as they often were, these same descriptors leveled a more far-reaching social critique. Here fundamentalism served as a warning sign of a failure in the process of modernization, for totalism and scripturalism were thought to interfere with the kind of progressive politics and progressive religion that developing societies needed to achieve. Here too the notion of progress is clearly borrowed from a Western model, where political modernization and secularization are viewed as one, and where religions have presumably made peace with this arrangement. Not all interpretations of fundamentalism suffer from the same cultural bias, but the term has been shadowed by the uses to which it has been put.

State of the Field

Two interrelated issues have come to dominate fundamentalism as a field of study. The first relates to the shifting meaning of the phenomenon depending on whether the focus of analysis is a specific case, a regional culture, or a cross-cultural comparison. Narrowly defined examples bring out important nuances that are often glossed over when attempting to aggregate common patterns regionally or internationally. And scholars who are prepared to see a particular case in terms of fundamentalism, rightly defined, are sometimes less convinced once this case has been situated in a schema of fundamentalist types. By the 1990s, fundamentalism had become something of a cottage industry within the academy, and the result was a burgeoning number of supposed cases around the world. Typing these cases, however, has remained an elusive task, with scholars tending to select those examples that best fit their analytic agenda. In the end, the proliferation of fundamentalisms created a situation where the parameters of the field became more indistinct and fundamentalism itself more difficult to comprehend.

The other issue, and a more hopeful sign, is the growing realization that the comparative study of fundamentalism has become entangled in a global transformation of politics and culture at the end of the twentieth century. With the collapse of the Soviet Union and the declining ability of the West to impose its policies and values around the world, indigenous ethnic and religious identities—often regarded as fundamentalist—have reasserted themselves, especially in those regions that were once the object of Cold War competitive interest. For the Western academy, then, tracking the rise of fundamentalisms worldwide has been a lesson in the limits of the West. Thus what began as a study of the antimodern, antiseccular "other" evolved into a study of the Western self (Marty and Appleby).

See also *Christianity; Islam; Judaism; Orthodoxy; Orthopraxy; Secularization and Secularism.*

BIBLIOGRAPHY

- Appleby, R. Scott, ed. *Spokesmen for the Despised: Fundamentalist Leaders of the Middle East*. Chicago: University of Chicago Press, 1997.
- Aran, Gideon. "The Father, the Son, and the Holy Land: The Spiritual Authorities of Jewish-Zionist Fundamentalism in Israel." In *Spokesmen for the Despised: Fundamentalist Leaders of the Middle East*, edited by R. Scott Appleby. Chicago: University of Chicago Press, 1997.
- Bruce, Steve. *The Rise and Fall of the New Christian Right: Conservative Protestant Politics in America, 1978–1988*. Oxford: Clarendon Press, 1988.
- Dekmejian, R. Hrair. *Islam in Revolution: Fundamentalism in the Arab World*. Syracuse, N.Y.: Syracuse University Press, 1985.
- Dessouki, Ali E. Hillaal, ed. *Islamic Resurgence in the Arab World*. New York: Praeger, 1982.
- Eickelman, Dale F., and James Piscatori. *Muslim Politics*. Princeton, N.J.: Princeton University Press, 1996.
- Hansen, Thomas Blom. *The Saffron Wave: Democracy and Hindu Nationalism in Modern India*. Princeton, N.J.: Princeton University Press, 1999.
- Hunter, James Davison. *Culture Wars: The Struggle to Define America*. New York: Basic Books, 1991.
- Huntington, Samuel P. *The Clash of Civilizations and the Remaking of World Order*. New York: Simon and Schuster, 1996.
- Juergensmeyer, Mark. "Antifundamentalism." In *Fundamentalisms Comprehended*. Vol. 5. Edited by Martin E. Marty and R. Scott Appleby. Chicago: University of Chicago Press, 1995.
- . *The New Cold War? Religious Nationalism Confronts the Secular State*. Berkeley: University of California Press, 1993.
- Lawrence, Bruce B. *Defenders of God: The Fundamentalist Revolt against the Modern Age*. San Francisco: Harper and Row, 1989.
- Marsden, George M. *Fundamentalism and American Culture: The Shaping of Twentieth Century Evangelicalism, 1870–1925*. New York: Oxford University Press, 1980.
- Marty, Martin E., and R. Scott Appleby. "The Fundamentalism Project: A User's Guide." In *Fundamentalisms Observed*, vol. 1, edited by Martin E. Marty and R. Scott Appleby. Chicago: University of Chicago Press, 1991.
- Munson, Henry. *Islam and Revolution in the Middle East*. New Haven, Conn.: Yale University Press, 1988.
- Nielsen, Niels C., Jr. *Fundamentalism, Mythos, and World Religions*. Albany: State University of New York Press, 1993.
- Riesebrodt, Martin. *Pious Passion: The Emergence of Modern Fundamentalism in the United States and Iran*. Translated by Don Reneau. Berkeley: University of California Press, 1993.
- Sandeen, Ernest R. *The Roots of Fundamentalism: British and American Millenarianism 1800–1930*. Chicago: University of Chicago Press, 1970.
- Sprinzak, Ehud. *The Ascendance of Israel's Radical Right*. New York: Oxford University Press, 1991.
- Watt, William Montgomery. *Islamic Fundamentalism and Modernity*. London and New York: Routledge, 1988.

Jeffrey T. Kenney

FUTUROLOGY. Futurology is the study of the future to obtain knowledge of it on the basis of present trends. Beginning in the 1960s, it is a relatively new field of study. The word *futurology* was first used in 1943 by Ossip Flechteim, a political scientist, to describe a new scientific field of human

knowledge based on a critical, systematic, and normative analysis of questions related to future. However, *future studies* (or *futures studies*), *futures research*, *futuristics*, *prognostics*, and *future* are also used for the term *futurology*.

Interest in the future of humanity, society, and the world in general is an age-old phenomenon. In a two-volume extensive scholarly work, Fred Polak (1961) has outlined “the close relationship between the history of images of the future and the general course of history itself” and shown that “positive images of the future, in and through their own history, have foreshadowed the outlines of the oncoming course of general events.” In his study the images of future are largely those presented by the utopia. An important lesson, most relevant to futurology, drawn from his study is that the utopia “can be used by intelligent and humanitarian men as a tool for reworking society” and further that the future of society rests in human hands. This idea that man has within him the power to create a desirable future conducive to the general well-being of man and nature has guided this new field of futurology. Dramatic events, such as the successful completion of the Manhattan Project during World War II and later development in space research leading to the successful landing of a human being on the Moon, opened people’s eyes to the new power of science and technology—that it can be harnessed not only to help humans determine a future desired goal, but also to achieve it in a stipulated time. Realization of this fact—that a desirable future objective can be planned and achieved—was decisive in creating this new field of futurology. It was also soon realized that human society was facing critical problems such as overpopulation, food shortages, growing economic disparities, resource depletion, worldwide energy crises, environmental pollution, threat of terrorism, and other perils, which—if unchecked—might lead to a disastrous future. It was imperative that corrective measures for such impending global dangers be taken. These afforded immediate objective for the new field of studies. In a sense, the perception of the future as a supreme resource is the driving force of futurology.

One recurrent theme appearing in the writings of the futurists characterizing the present age is what Peter Drucker refers to as the “age of discontinuity.” The cleavage with the past in many important respects is brought about by the unprecedented growth in the scientific and technological knowledge, leading the world to the brink of a great transformation. The fallout of this transformation is many sided and varied, encompassing everything of human activity. What is unprecedented about this transformation is the accelerated rate of change in development, exemplified, for example, by the fact that the computer speed is doubled every eighteen months (Moore’s law). Such changes have consequent impact on the nature of work, habitat, transportation, communication, and all spheres of human activity. The stress of having to cope with all the changes within a short time produces the “future shock” discussed by Alvin Toffler (1970). It is the “dizzying disorientation brought on by the premature arrival of the future,” “a time phenomenon, a product of the greatly accelerated rate of change in society” (Toffler). The writings of Alvin Toffler, Arthur C. Clarke, and Buckminster Fuller have caught the

imagination of the general public and generated interest in the future of human civilization.

Objectives and Characteristics

Future is to be created, as it does not yet exist. Also the events are interrelated, as changes in some components will affect the future. This indicates that there are many “futures,” but the one that will finally emerge is already determined by the events of the past. Thus the emergent future comes out of all possible futures—where anything might happen. These are further limited to probable futures, which are most likely to happen and already shaped by the immediate past. Futurists would like to work for the most preferable or a desired future. Thus planning for the future presupposes importance of three factors: the interlinking of events, a vision of the future and ideas for different events that would ultimately lead to the desirable future, and time. Time is related to the importance of short-term, medium-term, and long-term planning for realization of the future. A convenient time frame for studying the future are: near-range: up to a period of one year; short-range: up to a period of five years; medium-range: from five years to twenty years; long-range: from twenty years to fifty years; and far: beyond fifty years.

Some characteristics of this new field of study as noted by Olaf Helmer (1978) are that its function is primarily predictive and not explanatory; it constructs tentative models for which no hard data about the future is available; often the intuitive judgment of the experts is the main guidance; and, most important, it is highly multidisciplinary.

However, views and perspectives about future studies differ. One view tends to project it as a way of providing “decision-makers with operationally meaningful assistance in the form of information and analysis” to facilitate better decision-making and looks upon future studies work as an “objective exploration of what future has to offer” (Helmer, p. 764). However, against this trend for confining future studies merely to forecasting in utopian areas, there are those who want future studies to lead forecasting “to planning, decision, and creative action” and require that futures research be responsive to global challenge ahead. This demands an increasingly holistic and global, more explicitly normative, and increased participation. The fundamental assumption in future studies is that interventions can change the future; this also implies assumption of responsibility for the process of changing the future. Together with its multidimensional and interdisciplinary character, creation of awareness about the desirable future, making people conscious of the effect of their action on the future, and acting as a pressure group mark the uniqueness of this field.

One common method of prediction is to extend current trends, but such interlinked and interacting systems, as futurology deals with are generally of the common adaptive type. These exhibit a range of nonadditive effects that simply cannot be summed to give the overall effect. However, even in such cases, computer-based modeling comes to help. One such mathematical modeling resulted in the widely circulated and criticized “Limits of Growth” concept published in early

1970. Methods developed since 1970 include the Delphic method, trend-impact analysis, cross-impact analysis, structural analysis, technology-sequence analysis, decision and statistical modeling, relevance trees and morphological analysis, science and technology road-mapping, scenarios and interactive scenarios, and the state of the future index method (see, for example, Glen and Gordon, 2003). In spite of such skeptics' declarations as "Futurism is dead" and that the futurist window to the world of tomorrow is just a "mirror reflecting the prejudices and preconceptions of one's own time" (Jones), futurology is going strong, with professional futurists helping their clients "draw the maps of the future and identify the obstacles (and opportunities) along the way" (Wagner). Much development in the field of ecology and sustainable development results in international cooperation in decreasing global warming and ozone hole depletion, and can be attributed to this field. Things are happening at all levels, projects like restorative development are future-inspired action plans. Rapid developments in the new field of science and technology such as NBIC (nanotechnology, biotechnology, information technology, and cognitive science) have led to a plethora of futuristic writings in these fields (see Eric Drexler [1987]; Ray Kurzweil [2000]; Rodney Brooks [2002]; John Brockman [2002]; Douglas Mulhall [2002]).

To state a truism, future begins where history ends, and it is befitting to conclude this entry with a quotation from Francis Fukuyama's much acclaimed "End of History and the Last Man":

The unfolding of modern natural science has had a uniform effect on all societies that have experienced it, for two reasons. . . . technology confers decisive military advantages on those countries that possess it, and given the continuing possibility of war in the international system of states, no states that value its independence can ignore the need for defensive modernisation. Second, modern natural science establishes a uniform horizon of economic production possibilities. Technology makes possible the limitless accumulation of wealth, and thus the satisfaction of an ever expanding set of human desires. This process guarantees an increasing homogenization of all human societies, regardless of their

historical origins or cultural inheritances. All countries undergoing economic modernisation must increasingly resemble one another; they must unify nationally on the basis of the centralized state, urbanize, replace traditional forms of social organizations like tribe, sect, and family with rational ones based on function and efficiency, and provide for universal education of their citizens" (pp. xiv–xv).

See also *Cycles; History, Idea of; Science Fiction; Technology.*

BIBLIOGRAPHY

- Brockman, John, ed. *The Next Fifty Years*. New York: Vintage, 2002.
- Brooks, Rodney. *Flesh and Machines: How Robots Will Change Us*. New York: Pantheon Books, 2002.
- Cornish, Edward. *The Study of the Future*. Bethesda, Md.: World Future Society, 1977.
- Drexler, Eric. *Engines of Creation*. New York: Anchor Books, 1987.
- Fukuyama, Francis. *End of History and the Last Man*. New York: Free Press, 1992.
- Glenn, Jerome C., and Theodore T. Gordon. *Futures Research Methodology*. Washington, D.C.: Millennium Project/American College for the United Nations University, 2003.
- Helmer, Olaf. "The Research Task before Us." In *Handbook of Future Research*, edited by Jib Fowles. London: Greenwood Press, 1978.
- Jones, John. "The Amateur Prophets." Available at <http://www.ensc.sfu.ca/people/faculty/jones/ENSC100/future/node4.html>
- Kurzweil, Ray. *The Age of Spiritual Machines: When Computers Exceed Human Intelligence*. New York: Penguin Putnam, 2000.
- Mulhall, Douglas. *Our Molecular Future*. Amherst, N.Y.: Prometheus, 2002.
- Polak, Fred, L. *The Image of the Future*. New York: Oceana Publications, 1961.
- Toffler, Alvin. *Future Shock*. New York: Random House, 1970.
- Wagner, Cindy. "Futurism Is NOT Dead" (editorial for *The Futurist*). Available at <http://www.wfs.org/futurism.htm>

Paramanonda Mahanta

new dictionary of the history of ideas

EDITORIAL BOARD

Editor in Chief

Maryanne Cline Horowitz, *Occidental College*
University of California, Los Angeles

Associate Editors

Jonathan Berkey, *Davidson College*
Zvi Ben-Dor Benite, *New York University*
Benjamin A. Elman, *Princeton University*
George Esenwein, *University of Florida, Gainesville*
Cary J. Nederman, *Texas A&M University*
Vassiliki Betty Smocovitis, *University of Florida, Gainesville*
Neferti Tadiar, *University of California, Santa Cruz*
Mary J. Weismantel, *Northwestern University*
Paul Tiyambe Zeleza, *Pennsylvania State University*

Advisors

Diane Apostolos-Cappadona, *Georgetown University*
Edwina Barvosa-Carter, *University of California, Santa Barbara*
Nupur Chaudhuri, *Texas Southern University*
Kostas Gavroglu, *University of Athens, Greece*
Donald R. Kelley, *Rutgers University*
Zine Magubane, *University of Illinois, Urbana-Champaign*
J. B. Schneewind, *Johns Hopkins University*
Blair Sullivan, *University of California, Los Angeles*
Reed Ueda, *Tufts University*

Librarian Advisory Board

Mary W. George, *Princeton University*
Suzy Szasz Palmer, *University of Louisville*

Editorial Assistant

Lisa Griffin

new dictionary of the history of ideas

maryanne cline horowitz, editor in chief

volume 3

Game Theory to Lysenkoism



CHARLES SCRIBNER'S SONS

An imprint of Thomson Gale, a part of The Thomson Corporation

THOMSON
—★—™
GALE



New Dictionary of the History of Ideas
Maryanne Cline Horowitz, Editor in Chief

©2005 Thomson Gale, a part of the Thomson Corporation.

Thomson and Star Logo are trademarks and Gale is a registered trademark used herein under license.

For more information, contact
Thomson Gale
27500 Drake Rd.
Farmington Hills, MI 48331-3535
Or you can visit our Internet site at
<http://www.gale.com>

ALL RIGHTS RESERVED

No part of this work covered by the copyright hereon may be reproduced or used in any form or by any means—graphic, electronic, or mechanical, including photocopying, recording, taping, Web distribution, or information storage retrieval systems—without the written permission of the publisher.

For permission to use material from this product, submit your request via Web at <http://www.gale-edit.com/permissions>, or you may download our Permissions Request form and submit your request by fax or mail to:

Permissions Department
Thomson Gale
27500 Drake Road
Farmington Hills, MI 48331-3535
Permissions Hotline:
248-699-8006 or 800-877-4253, ext. 8006
Fax: 248-699-8074 or 800-762-4058

Since this page cannot legibly accommodate all copyright notices, the acknowledgments constitute an extension of the copyright notice.

While every effort has been made to ensure the reliability of the information presented in this publication, Thomson Gale does not guarantee the accuracy of the data contained herein. Thomson Gale accepts no payment for listing; and inclusion in the publication of any organization, agency, institution, publication, service, or individual does not imply endorsement of the editors or publisher. Errors brought to the attention of the publisher and verified to the satisfaction of the publisher will be corrected in future editions.

LIBRARY OF CONGRESS CATALOGING-IN-PUBLICATION DATA

New dictionary of the history of ideas / edited by Maryanne Cline Horowitz.

p. cm.

Includes bibliographical references and index.

ISBN 0-684-31377-4 (set hardcover : alk. paper) — ISBN 0-684-31378-2 (v. 1) — ISBN 0-684-31379-0 (v. 2) — ISBN 0-684-31380-4 (v. 3) — ISBN 0-684-31381-2 (v. 4) — ISBN 0-684-31382-0 (v. 5) — ISBN 0-684-31383-9 (v. 6) — ISBN 0-684-31452-5 (e-book)

1. Civilization—History—Dictionaries. 2. Intellectual life—History—Dictionaries.

I. Horowitz, Maryanne Cline, 1945–

CB9.N49 2005
903—dc22

2004014731

This title is also available as an e-book.

ISBN 0-684-31452-5

Contact your Thomson Gale sales representative for ordering information.

Printed in the United States of America

10 9 8 7 6 5 4 3 2 1

CONTENTS

Volume 1

List of Articles

Preface

Historiography

Reader's Guide

NEW DICTIONARY OF THE HISTORY OF IDEAS

Abolitionism–Common Sense

Volume 2

Reader's Guide

Communication of Ideas–Futurology

Volume 3

Reader's Guide

Game Theory–Lysenkoism

Volume 4

Reader's Guide

Machiavellism–Phrenology

Volume 5

Reader's Guide

Physics–Syncretism

Volume 6

Reader's Guide

Taste–Zionism

List of Contributors

Index

EDITORIAL AND PRODUCTION STAFF

Project Editors

Mark LaFlaur, Scot Peacock, Jennifer Wisinski

Editorial Support

Kelly Baiseley, Andrew Claps, Alja Collar, Mark Drouillard,
Kenneth Mondschein, Sarah Turner, Ken Wachsberger,
Rachel Widawsky, Christopher Verdesi

Art Editor

Scot Peacock

Chief Manuscript Editor

Georgia S. Maas

Manuscript Editors

Jonathan G. Aretakis, John Barclay, Sylvia Cannizzaro,
Melissa A. Dobson, Ted Gilley, Gretchen Gordon,
Ellen Hawley, Archibald Hobson, Elizabeth B. Inserra,
Jean Fortune Kaplan, Christine Kelley, John Krol,
Julia Penelope, Richard Rothschild, David E. Salamie,
Linda Sanders, Alan Thwaites, Jane Marie Todd

Proofreaders

Beth Phaner, Carol Holmes, Melodie Monahan,
Laura Specht Patchkofsky, Hilary White

Cartographer

XNR Productions, Madison, Wisconsin

Caption Writer

Shannon Kelly

Indexer

Cynthia Crippen, AEIOU, Inc.

Design

Jennifer Wahj

Imaging

Dean Dauphinais, Lezlie Light, Mary Grimes

Permissions

Margaret Abendroth, Peggie Ashlevitz, Lori Hines

Composer

GGIS Information Services, York, Pennsylvania

Manager, Composition

Mary Beth Trimper

Assistant Manager, Composition

Evi Seoud

Manufacturing

Wendy Blurton

Senior Development Editor

Nathalie Duval

Editorial Director

John Fitzpatrick

Publisher

Frank Menchaca

READER'S GUIDE

This Reader's Guide was compiled by the editors to provide a systematic outline of the contents of the New Dictionary of the History of Ideas, thereby offering teachers, scholars, and the general reader a way to organize their reading according to their preferences. The Reader's Guide is divided into four sections: Communication of Ideas, Geographical Areas, Chronological Periods, and Liberal Arts Disciplines and Professions, as indicated in the outline below.

COMMUNICATION OF IDEAS

Introduction to History of Communication of Ideas

Communication Media

GEOGRAPHICAL AREAS

Global Entries

Africa

Asia

Europe

Middle East

North America

Latin and South America

CHRONOLOGICAL PERIODS

Ancient

Dynastic (400 C.E.–1400 C.E.)

Early Modern (1400–1800 C.E.)

Modern (1800–1945)

Contemporary

LIBERAL ARTS DISCIPLINES AND PROFESSIONS

Fine Arts

Humanities

Social Sciences

Sciences

Professions

Multidisciplinary Practices

Especially Interdisciplinary Entries

COMMUNICATION OF IDEAS

This category is the newest aspect of the *New Dictionary of the History of Ideas*; cultural studies, communications studies, and cultural history are moving the disciplines in this direction.

Introduction to History of Communication of Ideas

The following entries focus on the media humans have used to communicate with one another.

Absolute Music
Aesthetics: Asia
Architecture: Overview
Architecture: Asia
Arts: Overview
Astronomy, Pre-Columbian and Latin American
Bilingualism and Multilingualism
Borders, Borderlands, and Frontiers, Global
Calendar
Cinema
City, The: The City as a Cultural Center
City, The: The City as Political Center
Communication of Ideas: Africa and Its Influence
Communication of Ideas: Asia and Its Influence
Communication of Ideas: Europe and Its Influence
Communication of Ideas: Middle East and Abroad
Communication of Ideas: Orality and Advent of Writing
Communication of Ideas: Southeast Asia
Communication of Ideas: The Americas and Their Influence
Consumerism
Cultural Revivals
Cultural Studies
Dance
Diffusion, Cultural
Dress
Dualism
Education: Asia, Traditional and Modern
Education: Global Education
Emotions
Experiment
Garden
Gesture
Humor
Iconography
Images, Icons, and Idols
Japanese Philosophy, Japanese Thought
Language and Linguistics
Language, Linguistics, and Literacy
Learning and Memory, Contemporary Views
Mathematics
Media, History of
Metaphor
Migration: United States
Modernity: Africa
Museums
Music, Anthropology of

READER'S GUIDE

Musical Performance and Audiences
Oral Traditions: Overview
Oral Traditions: Telling, Sharing
Political Protest, U.S.
Practices
Protest, Political
Reading
Realism: Africa
Reflexivity
Relativism
Representation: Mental Representation
Resistance
Resistance and Accommodation
Rhetoric: Overview
Rhetoric: Ancient and Medieval
Ritual: Public Ritual
Ritual: Religion
Sacred Places
Text/Textuality
Textiles and Fiber Arts as Catalysts for Ideas
Theater and Performance
Third Cinema
Totems
Tradition
Translation
Virtual Reality
Visual Culture
Visual Order to Organizing Collections

Communication Media

This is a listing of the types of historical evidence the author used in writing the entry. While entries in the original Dictionary of the History of Ideas were to a great extent the history of texts, the entries in the New Dictionary of the History of Ideas are generally the cultural history of ideas, making use of the records of oral communication, visual communication, and communication through practices, as well as the history of texts, in order to show the impact of the idea on a wide variety of people.

ORAL

The selective list below contains the entries that give the most coverage to historical examples of the oral transmission and transformation of ideas.

Civil Disobedience
Civil Society: Europe and the United States
Communication of Ideas: Orality and Advent of Writing
Cosmopolitanism
Cultural Capital
Determinism
Dialogue and Dialectics: Socratic
Dialogue and Dialectics: Talmudic
Dream
Emotions
Empire and Imperialism: Europe
Equality: Overview
Etiquette
Fascism
Harmony
Magic
Masks
Media, History of
Millenarianism: Latin America and Native North America

Music, Anthropology of
Musical Performance and Audiences
Musicology
Nomadism
Oral Traditions: Overview
Oral Traditions: Telling, Sharing
Populism: United States
Psychoanalysis
Public Sphere
Republicanism: Republic
Rhetoric: Overview
Ritual: Public Ritual
Ritual: Religion
Slavery
Theater and Performance
Tragedy and Comedy
Trope
Wisdom, Human
COMMUNICATION THROUGH HIGH TECHNOLOGY MEDIA (radio, television, film, computer, etc.)
Absolute Music
Africa, Idea of
Alienation
Americanization, U.S.
Anticolonialism: Africa
Anti-Semitism: Islamic Anti-Semitism
Architecture: Overview
Avant-Garde: Overview
Bilingualism and Multilingualism
Bioethics
Calculation and Computation
Capitalism: Overview
Capitalism: Africa
Censorship
Chicano Movement
Cinema
City, The: The City as a Cultural Center
City, The: The City as Political Center
Colonialism: Southeast Asia
Communication of Ideas: Africa and Its Influence
Communication of Ideas: Asia and Its Influence
Communication of Ideas: Europe and Its Influence
Communication of Ideas: Middle East and Abroad
Communication of Ideas: Orality and Advent of Writing
Communication of Ideas: Southeast Asia
Communism: Latin America
Composition, Musical
Computer Science
Consciousness: Overview
Consumerism
Cosmopolitanism
Creativity in the Arts and Sciences
Critical Theory
Cultural Studies
Death
Demography
Development
Dream
Dress
Dystopia
Empire and Imperialism: United States
Environmental History
Expressionism
Fascism
Fetishism: Fetishism in Literature and Cultural Studies

Field Theories
 Futurology
 Game Theory
 Gay Studies
 Gender: Gender in the Middle East
 Gender in Art
 Genetics: Contemporary
 Genetics: History of
 Genocide
 Genre
 Geography
 Globalization: General
 Harmony
 Hinduism
 History, Economic
 Human Capital
 Iconography
 Intelligentsia
 Jihad
 Jouissance
 Judaism: Modern Judaism
 Language and Linguistics
 Law
 Learning and Memory, Contemporary Views
 Life
 Life Cycle: Elders/Old Age
 Literary Criticism
 Literature: Overview
 Literature: African Literature
 Loyalties, Dual
 Lysenkoism
 Maps and the Ideas They Express
 Masks
 Mathematics
 Media, History of
 Medicine: Europe and the United States
 Medicine: Islamic Medicine
 Meme
 Memory
 Modernism: Overview
 Modernism: Latin America
 Modernity: East Asia
 Motherhood and Maternity
 Motif: Motif in Music
 Music, Anthropology of
 Musical Performance and Audiences
 Musicology
 Nuclear Age
 Occidentalism
 Pan-Arabism
 Parties, Political
 Physics
 Political Protest, U.S.
 Political Science
 Postmodernism
 Power
 Presentism
 Privacy
 Probability
 Progress, Idea of
 Propaganda
 Property
 Protest, Political
 Public Sphere
 Quantum

Reading
 Reform: Europe and the United States
 Reform: Islamic Reform
 Relativity
 Representation: Mental Representation
 Resistance
 Rhetoric: Overview
 Science Fiction
 Sexuality: Overview
 Social History, U.S.
 Society
 State, The: Overview
 Symbolism
 Taste
 Technology
 Third Cinema
 Third World
 Totalitarianism
 Victorianism
 Virtual Reality
 Visual Culture
 War and Peace in the Arts
 Westernization: Africa
 Westernization: Middle East
 Women and Femininity in U.S. Popular Culture
 Work
 World Systems Theory, Latin America

VISUAL

Each of the following entries in the *NDHI* either evocatively describes ideas, includes a visual image of an idea, or provides historical examples of societies visually transmitting and transforming ideas.

Abolitionism
 Aesthetics: Africa
 Aesthetics: Asia
 Aesthetics: Europe and the Americas
 Alienation
 Altruism
 Ambiguity
 Americanization, U.S.
 Ancestor Worship
 Animism
 Anti-Semitism: Overview
 Apartheid
 Architecture: Overview
 Architecture: Africa
 Architecture: Asia
 Arts: Overview
 Arts: Africa
 Asceticism: Hindu and Buddhist Asceticism
 Asceticism: Western Asceticism
 Asian-American Ideas (Cultural Migration)
 Assimilation
 Astrology: Overview
 Astronomy, Pre-Columbian and Latin American
 Authoritarianism: Latin America
 Autobiography
 Avant-Garde: Militancy
 Aztlán
 Barbarism and Civilization
 Beauty and Ugliness
 Behaviorism

READER'S GUIDE

Bioethics
 Black Atlantic
 Black Consciousness
 Body, The
 Bushido
 Calculation and Computation
 Calendar
 Cannibalism
 Capitalism: Overview
 Capitalism: Africa
 Causation
 Censorship
 Change
 Chemistry
 Childhood and Child Rearing
 Cinema
 City, The: Latin America
 City, The: The City as a Cultural Center
 City, The: The City as Political Center
 City, The: The Islamic and Byzantine City
 Civil Disobedience
 Classicism
 Classification of Arts and Sciences, Early Modern
 Colonialism: Southeast Asia
 Common Sense
 Communication of Ideas: The Americas and Their Influence
 Communication of Ideas: Asia and Its Influence
 Communication of Ideas: Europe and Its Influence
 Communication of Ideas: Orality and Advent of Writing
 Communication of Ideas: Southeast Asia
 Composition, Musical
 Computer Science
 Consciousness: Overview
 Consumerism
 Continental Philosophy
 Cosmology: Asia
 Cosmopolitanism
 Creativity in the Arts and Sciences
 Critical Race Theory
 Critical Theory
 Cultural Capital
 Cultural History
 Cultural Revivals
 Cultural Studies
 Cycles
 Cynicism
 Dada
 Dance
 Death
 Death and Afterlife, Islamic Understanding of
 Demography
 Demonology
 Determinism
 Development
 Diasporas: African Diaspora
 Diasporas: Jewish Diaspora
 Dictatorship in Latin America
 Discrimination
 Diversity
 Dream
 Dress
 Dystopia
 Ecology
 Education: Europe
 Education: Islamic Education
 Emotions
 Empire and Imperialism: Europe
 Empire and Imperialism: United States
 Empiricism
 Encyclopedism
 Enlightenment
 Environment
 Environmental History
 Epistemology: Ancient
 Epistemology: Early Modern
 Equality: Overview
 Equality: Racial Equality
 Essentialism
 Ethnicity and Race: Anthropology
 Ethnicity and Race: Islamic Views
 Ethnocentrism
 Etiquette
 Eugenics
 Europe, Idea of
 Everyday Life
 Evil
 Expressionism
 Extirpation
 Family Planning
 Fascism
 Fatalism
 Feminism: Overview
 Feminism: Chicana Feminisms
 Feminism: Third World U.S. Movement
 Fetishism: Overview
 Fetishism: Fetishism in Literature and Cultural Studies
 Feudalism, European
 Field Theories
 Form, Metaphysical, in Ancient and Medieval Thought
 Foundationalism
 Friendship
 Futurology
 Game Theory
 Garden
 Gender: Overview
 Gender: Gender in the Middle East
 Gender in Art
 Genetics: Contemporary
 Genetics: History of
 Genius
 Genocide
 Geography
 Geometry
 Gesture
 Ghetto
 Globalization: Asia
 Globalization: General
 Greek Science
 Harmony
 Hate
 Health and Disease
 Heaven and Hell
 Heaven and Hell (Asian Focus)
 Hedonism in European Thought
 Heresy and Apostasy
 Hinduism
 History, Economic
 History, Idea of

- Honor
 Honor, Middle Eastern Notions of
 Humanism: Chinese Conception of
 Humanity: African Thought
 Humanity: European Thought
 Humanity in the Arts
 Humor
 Hygiene
 Iconography
 Idealism
 Ideas, History of
 Identity: Identity of Persons
 Identity, Multiple: Overview
 Identity, Multiple: Jewish Multiple Identity
 Images, Icons, and Idols
 Imagination
 Impressionism
 Intentionality
 Interdisciplinarity
 Islam: Shii
 Islamic Science
 Jainism
 Jihad
 Jouissance
 Knowledge
 Landscape in the Arts
 Language, Linguistics, and Literacy
 Law, Islamic
 Leadership
 Learning and Memory, Contemporary Views
 Liberty
 Life Cycle: Overview
 Life Cycle: Elders/Old Age
 Literary History
 Love, Western Notions of
 Machismo
 Magic
 Maps and the Ideas They Express
 Masks
 Mathematics
 Matriarchy
 Mechanical Philosophy
 Media, History of
 Medicine: Europe and the United States
 Medicine: Islamic Medicine
 Memory
 Men and Masculinity
 Mestizaje
 Metaphor
 Microcosm and Macrocosm
 Migration: United States
 Millenarianism: Islamic
 Millenarianism: Latin America and Native North
 America
 Minority
 Miracles
 Modernism: Overview
 Modernism: Latin America
 Modernity: Overview
 Modernity: Africa
 Monarchy: Overview
 Monasticism
 Motherhood and Maternity
 Motif: Motif in Music
 Museums
 Musical Performance and Audiences
 Musicology
 Mysticism: Chinese Mysticism
 Mysticism: Christian Mysticism
 Myth
 Nation
 Nationalism: Overview
 Natural History
 Naturalism
 Naturalism in Art and Literature
 Naturphilosophie
 Negritude
 Newtonianism
 Nomadism
 Nuclear Age
 Nude, The
 Occidentalism
 Organicism
 Orthodoxy
 Pacifism
 Pan-Asianism
 Paradigm
 Paradise on Earth
 Periodization of the Arts
 Person, Idea of the
 Perspective
 Philosophies: American
 Philosophies: Feminist, Twentieth-Century
 Philosophy: Relations to Other Intellectual Realms
 Phrenology
 Physics
 Political Protest, U.S.
 Population
 Postmodernism
 Practices
 Pre-Columbian Civilization
 Prejudice
 Privacy
 Property
 Protest, Political
 Psychoanalysis
 Public Sphere
 Pythagoreanism
 Queer Theory
 Race and Racism: United States
 Reading
 Realism
 Relativism
 Religion: Indigenous Peoples' View, South America
 Religion and Science
 Religion and the State: Latin America
 Renaissance
 Representation: Mental Representation
 Representation: Political Representation
 Republicanism: Republic
 Resistance
 Resistance and Accommodation
 Responsibility
 Ritual: Public Ritual
 Ritual: Religion
 Romanticism in Literature and Politics
 Sacred and Profane
 Sacred Places
 Science, History of
 Science Fiction

READER'S GUIDE

Scientific Revolution
Sexuality: Overview
Sexuality: Sexual Orientation
Shinto
Slavery
Social History, U.S.
Sophists, The
Sport
Subjectivism
Superstition
Surrealism
Symbolism
Syncretism
Taste
Terror
Text/Textuality
Theater and Performance
Theodicy
Third Cinema
Third World Literature
Toleration
Totalitarianism
Totems
Trade
Tragedy and Comedy
Treaty
Untouchability: Menstrual Taboos
Utilitarianism
Utopia
Victorianism
Virtual Reality
Visual Culture
Visual Order to Organizing Collections
Volunteerism, U.S.
War
War and Peace in the Arts
Westernization: Southeast Asia
Witchcraft
Witchcraft, African Studies of
Women and Femininity in U.S. Popular Culture
Women's History: Africa
World Systems Theory, Latin America
Yin and Yang

PRACTICES

Most of the entries in the *NDHI* discuss how specific societies habituated people to specific ideas. This selective list includes the entries on schools of thought and practice, religions, and political movements, as well as the entries on distinctive practices.

Abolitionism
Afropessimism
Agnosticism
Alchemy: China
Alchemy: Europe and the Middle East
Anarchism
Ancestor Worship
Animism
Anticolonialism: Africa
Anticolonialism: Latin America
Anticolonialism: Middle East
Anticolonialism: Southeast Asia
Anticommunism: Latin America
Antifeminism

Anti-Semitism: Overview
Anti-Semitism: Islamic Anti-Semitism
Apartheid
Aristotelianism
Asceticism: Hindu and Buddhist Asceticism
Asceticism: Western Asceticism
Astrology: Overview
Astrology: China
Atheism
Avant-Garde: Militancy
Behaviorism
Black Consciousness
Buddhism
Bureaucracy
Bushido
Cannibalism
Capitalism: Overview
Capitalism: Africa
Cartesianism
Character
Chicano Movement
Chinese Thought
Christianity: Overview
Christianity: Asia
Cinema
Citizenship: Naturalization
Civil Disobedience
Classicism
Classification of Arts and Sciences, Early Modern
Colonialism: Africa
Colonialism: Latin America
Colonialism: Southeast Asia
Communication of Ideas: Orality and Advent of Writing
Communism: Europe
Communism: Latin America
Communitarianism in African Thought
Computer Science
Confucianism
Conservatism
Constitutionalism
Cosmopolitanism
Creationism
Critical Theory
Cultural Capital
Cultural Studies
Cynicism
Dance
Daoism
Deism
Dialogue and Dialectics: Socratic
Dialogue and Dialectics: Talmudic
Discrimination
Diversity
Eclecticism
Ecumenism
Empire and Imperialism: Overview
Empire and Imperialism: Americas
Empire and Imperialism: Asia
Empire and Imperialism: Europe
Empire and Imperialism: Middle East
Empire and Imperialism: United States
Empiricism
Epicureanism
Equality: Overview
Etiquette

- Eugenics
 Everyday Life
 Existentialism
 Extirpation
 Fascism
 Fatalism
 Feminism: Overview
 Feminism: Africa and African Diaspora
 Feminism: Chicana Feminisms
 Feminism: Islamic Feminism
 Feminism: Third World U.S. Movement
 Fetishism: Overview
 Feudalism, European
 Game Theory
 Genocide
 Ghetto
 Gift, The
 Gnosticism
 Health and Disease
 Hegelianism
 Hinduism
 Humanism: Renaissance
 Humanism: Secular Humanism in the United States
 Human Rights: Overview
 Human Rights: Women's Rights
 Interpretation
 Islam: Africa
 Islam: Shii
 Islam: Southeast Asia
 Islam: Sunni
 Jainism
 Japanese Philosophy, Japanese Thought
 Jihad
 Judaism: Judaism to 1800
 Judaism: Modern Judaism
 Kantianism
 Law
 Leadership
 Legalism, Ancient China
 Liberalism
 Liberation Theology
 Machiavellism
 Magic
 Manichaeism
 Maoism
 Marxism: Overview
 Marxism: Asia
 Marxism: Latin America
 Masks
 Mechanical Philosophy
 Medicine: China
 Medicine: Europe and the United States
 Medicine: India
 Medicine: Islamic Medicine
 Migration: Migration in World History
 Monarchy: Overview
 Monasticism
 Multiculturalism, Africa
 Museums
 Music, Anthropology of
 Musical Performance and Audiences
 Musicology
 Myth
 Nationalism: Overview
 Nationalism: Africa
 Nationalism: Cultural Nationalism
 Nationalism: Middle East
 Neoplatonism
 Nihilism
 Nomadism
 Nonviolence
 Orthodoxy
 Orthopraxy: Asia
 Orthopraxy: Western Orthopraxy
 Pacifism
 Pan-Africanism
 Pan-Arabism
 Pan-Asianism
 Pan-Islamism
 Pan-Turkism
 Paradigm
 Phrenology
 Physics
 Platonism
 Political Protest, U.S.
 Polytheism
 Population
 Populism: Latin America
 Positivism
 Practices
 Pragmatism
 Pseudoscience
 Psychoanalysis
 Psychology and Psychiatry
 Public Sphere
 Punishment
 Race and Racism: Asia
 Race and Racism: Europe
 Race and Racism: United States
 Radicals/Radicalism
 Rational Choice
 Reading
 Realism: Africa
 Reflexivity
 Reform: Europe and the United States
 Relativism
 Religion: Overview
 Religion: Africa
 Religion: African Diaspora
 Religion: East and Southeast Asia
 Religion: Indigenous Peoples' View, South America
 Religion: Latin America
 Religion: Middle East
 Republicanism: Latin America
 Republicanism: Republic
 Resistance
 Resistance and Accommodation
 Responsibility
 Revolution
 Ritual: Public Ritual
 Ritual: Religion
 Romanticism in Literature and Politics
 Sacred and Profane
 Scholasticism
 Science: Overview
 Scientific Revolution
 Secularization and Secularism
 Segregation
 Skepticism
 Slavery

READER'S GUIDE

Socialism
Socialisms, African
Sophists, The
Sport
Stoicism
Subjectivism
Suicide
Superstition
Symbolism
Syncretism
Temperance
Terror
Theater and Performance
Time: Traditional and Utilitarian
Totalitarianism
Totems
Trade
Tradition
Tragedy and Comedy
Tribalism, Middle East
Untouchability: Overview
Untouchability: Menstrual Taboos
Untouchability: Taboos
Utilitarianism
Visual Order to Organizing Collections
Volunteerism, U.S.
Westernization: Africa
Westernization: Middle East
Westernization: Southeast Asia
Witchcraft
Witchcraft, African Studies of
Work
Yoga
Zionism

TEXTUAL

Every entry in the *New Dictionary of the History of Ideas* used texts. The following is a list of entries that focused mainly on the history of a succession of texts. Each academic discipline has a succession of major authors with whom later practitioners of the discipline build upon and respond to creatively. The historian of a discipline—such as the history of political philosophy, literary history, or the history of science—considers the responses of thinkers and practitioners of a discipline to the major earlier texts in the discipline. In tracing the origin, development, and transformation of an idea, the historian of ideas considers thinkers' responses to texts from a variety of disciplines.

Agnosticism
Alchemy: Europe and the Middle East
Algebras
Altruism
America
Analytical Philosophy
Aristotelianism
Asceticism: Hindu and Buddhist Asceticism
Autobiography
Autonomy
Biography
Bureaucracy
Capitalism: Overview
Cartesianism
Casuistry

Causality
Censorship
Change
Chinese Thought
Civil Disobedience
Class
Communitarianism in African Thought
Conservatism
Continental Philosophy
Cosmology: Cosmology and Astronomy
Creolization, Caribbean
Crisis
Cycles
Death and Afterlife, Islamic Understanding of
Deism
Dialogue and Dialectics: Socratic
Dialogue and Dialectics: Talmudic
Eclecticism
Encyclopedism
Epistemology: Ancient
Epistemology: Early Modern
Equality: Gender Equality
Eschatology
Essentialism
Existentialism
Experiment
Falsifiability
Fatalism
Fetishism: Fetishism in Literature and Cultural Studies
Form, Metaphysical, in Ancient and Medieval Thought
Free Will, Determinism, and Predestination
General Will
Generation
Genius
Genre
Geometry
Gift, The
Globalization: Asia
Gnosticism
Good
Greek Science
Happiness and Pleasure in European Thought
Heaven and Hell
Hegelianism
Hermeneutics
Hierarchy and Order
Hinduism
Historical and Dialectical Materialism
Historicism
Historiography
History, Idea of
Humanism: Africa
Humanism: Chinese Conception of
Humanism: Renaissance
Humanity: Asian Thought
Human Rights: Overview
Idealism
Ideas, History of
Identity, Multiple: Overview
Identity: Identity of Persons
Imagination
Immortality and the Afterlife
Individualism
Intelligentsia
Jouissance

Judaism: Judaism to 1800
 Justice: Overview
 Justice: Justice in American Thought
 Justice: Justice in East Asian Thought
 Kantianism
 Knowledge
 Language, Philosophy of: Ancient and Medieval
 Language, Philosophy of: Modern
 Legalism, Ancient China
 Liberalism
 Liberty
 Literature: African Literature
 Materialism in Eighteenth-Century European Thought
 Mechanical Philosophy
 Medicine: China
 Metaphor
 Metaphysics: Ancient and Medieval
 Metaphysics: Renaissance to the Present
 Microcosm and Macrocosm
 Mind
 Modernity: East Asia
 Mohism
 Moral Sense
 Motif: Motif in Literature
 Mysticism: Chinese Mysticism
 Mysticism: Christian Mysticism
 Mysticism: Kabbalah
 Natural Law
 Natural Theology
 Naturalism
 Naturphilosophie
 Negritude
 Neocolonialism
 New Criticism
 Nihilism
 Organicism
 Orientalism: Overview
 Orthopraxy: Western Orthopraxy
 Paradigm
 Phenomenology
 Philosophies: African
 Philosophies: Islamic
 Philosophy: Historical Overview and Recent Developments
 Philosophy, History of
 Philosophy, Moral: Ancient
 Philosophy, Moral: Medieval and Renaissance
 Philosophy, Moral: Modern
 Philosophy and Religion in Western Thought
 Philosophy of Mind: Ancient and Medieval
 Philosophy of Religion
 Pietism
 Platonism
 Poetry and Poetics
 Political, The
 Postcolonial Theory and Literature
 Practices
 Pragmatism
 Prehistory, Rise of
 Progress, Idea of
 Psychoanalysis
 Queer Theory
 Race and Racism: Overview
 Rationalism
 Reading

Realism: Africa
 Reflexivity
 Relativity
 Religion: Overview
 Representation: Political Representation
 Republicanism: Republic
 Romanticism in Literature and Politics
 Sacred Texts: Asia
 Science: East Asia
 Science, History of
 Science Fiction
 Social Capital
 Social Contract
 State of Nature
 Stoicism
 Structuralism and Poststructuralism: Overview
 Structuralism and Poststructuralism: Anthropology
 Taste
 Text/Textuality
 Toleration
 Treaty
 Truth
 Universalism
 Utopia
 Virtue Ethics
 Wealth
 World Systems Theory, Latin America

GEOGRAPHICAL AREAS

Global Entries

EXEMPLARY GLOBAL ENTRIES

Anthropology
 Atheism
 Bilingualism and Multilingualism
 Black Atlantic
 Christianity: Overview
 Communication of Ideas: Orality and the Advent of Writing
 Constitutionalism
 Critical Theory
 Dance
 Environmental History
 Eurocentrism
 Feminism: Overview
 Fundamentalism
 Garden
 Historiography
 History, Economic
 Humanity in the Arts
 Identity, Multiple: Jewish Multiple Identity
 International Order
 Islam: Shii
 Islam: Sunni
 Life Cycle: Elders/Old Age
 Magic
 Maps and the Ideas They Express
 Marxism: Overview
 Mathematics
 Migration: Africa
 Migration: Migration in World History
 Migration: United States
 Monasticism
 Music, Anthropology of

READER'S GUIDE

- Musical Performance and Audiences
Nuclear Age
Pan-Africanism
Peasants and Peasantry
Person, Idea of the
Polytheism
Postcolonial Theory and Literature
Property
Protest, Political
Religion and the State: Africa
Resistance and Accommodation
Ritual: Religion
Sacred Places
Secularization and Secularism
Slavery
Sovereignty
Superstition
Syncretism
Temperance
Third Cinema
Third World Literature
Tradition
Treaty
Witchcraft
Women's Studies
- ENTRIES ON AT LEAST THREE GEOGRAPHIC
AREAS OR A GLOBAL TOPIC
- Abolitionism
Aesthetics: Africa
Africa, Idea of
Alchemy: China
Alienation
Animism
Anthropology
Anticolonialism: Africa
Anticolonialism: Latin America
Anticolonialism: Southeast Asia
Antifeminism
Architecture: Overview
Arts: Overview
Arts: Africa
Asceticism: Hindu and Buddhist Asceticism
Astrology: Overview
Atheism
Authoritarianism: Overview
Authority
Autobiography
Barbarism and Civilization
Bilingualism and Multilingualism
Bioethics
Biography
Black Atlantic
Body, The
Borders, Borderlands, and Frontiers, Global
Buddhism
Calculation and Computation
Calendar
Cannibalism
Capitalism: Overview
Capitalism: Africa
Censorship
Childhood and Child Rearing
Cinema
Citizenship: Overview
City, The: The City as a Cultural Center
Civil Disobedience
Civil Society: Europe and the United States
Colonialism: Africa
Colonialism: Southeast Asia
Communication of Ideas: Africa and Its Influence
Communication of Ideas: Middle East and Abroad
Communication of Ideas: Orality and the Advent of
Writing
Computer Science
Consciousness: Overview
Corruption in Developed and Developing Countries
Cosmology: Asia
Cosmopolitanism
Creativity in the Arts and Sciences
Creolization, Caribbean
Critical Theory
Cultural Capital
Cultural Studies
Dance
Death
Deism
Democracy
Demography
Demonology
Dependency
Diasporas: African Diaspora
Diasporas: Jewish Diaspora
Discrimination
Diversity
Dream
Dress
Dualism
Ecology
Economics
Ecumenism
Education: Global Education
Education: Islamic Education
Empire and Imperialism: Overview
Empire and Imperialism: Asia
Empire and Imperialism: Europe
Empire and Imperialism: Middle East
Empire and Imperialism: United States
Environment
Equality: Overview
Equality: Gender Equality
Equality: Racial Equality
Ethnicity and Race: Anthropology
Ethnocentrism
Ethnography
Evil
Family: Family in Anthropology since 1980
Family Planning
Fascism
Feminism: Africa and African Diaspora
Feminism: Islamic Feminism
Feminism: Third World U.S. Movement
Fetishism: Overview
Friendship
Futurology
Gay Studies
Gender: Overview
Gender: Gender in the Middle East
Gender in Art
Gender Studies: Anthropology
Generation

- Genius
 Genocide
 Geography
 Ghetto
 Globalization: General
 Hate
 Heaven and Hell
 Honor
 Human Capital
 Humanism: Chinese Conception of
 Humanity: African Thought
 Human Rights: Overview
 Human Rights: Women's Rights
 Iconography
 Identity, Multiple: Overview
 Images, Icons, and Idols
 Immortality and the Afterlife
 Intelligentsia
 Islam: Africa
 Islamic Science
 Jihad
 Judaism: Modern Judaism
 Justice: Overview
 Kinship
 Landscape in the Arts
 Language, Linguistics, and Literacy
 Law
 Liberation Theology
 Liberty
 Life Cycle: Overview
 Life Cycle: Adolescence
 Literature: Overview
 Machiavellism
 Masks
 Matriarchy
 Media, History of
 Medicine: China
 Meditation: Eastern Meditation
 Men and Masculinity
 Millenarianism: Overview
 Millenarianism: Latin America and Native North America
 Minority
 Miracles
 Modernism: Overview
 Modernism: Latin America
 Modernity: Overview
 Modernity: Africa
 Modernization Theory
 Monarchy: Overview
 Motif: Motif in Music
 Museums
 Musicology
 Mysticism: Chinese Mysticism
 Myth
 Nation
 Nationalism: Overview
 Nationalism: Africa
 Native Policy
 Negritude
 Neocolonialism
 Nihilism
 Nomadism
 Nonviolence
 Occidentalism
 Oral Traditions: Overview
 Organicism
 Orientalism: Overview
 Orientalism: African and Black Orientalism
 Orthodoxy
 Orthopraxy: Asia
 Other, The, European Views of
 Pacifism
 Paradise on Earth
 Peace
 Periodization
 Periodization of the Arts
 Perspective
 Philosophies: African
 Philosophy: Historical Overview and Recent Developments
 Philosophy: Relations to Other Intellectual Realms
 Philosophy, Moral: Africa
 Political Science
 Population
 Postcolonial Studies
 Practices
 Prehistory, Rise of
 Prejudice
 Presentism
 Privatization
 Pseudoscience
 Race and Racism: Overview
 Reading
 Reflexivity
 Religion: Overview
 Religion: East and Southeast Asia
 Religion: Latin America
 Religion and the State: United States
 Representation: Political Representation
 Republicanism: Republic
 Rhetoric: Overview
 Ritual: Public Ritual
 Sacred and Profane
 Scarcity and Abundance, Latin America
 Science: Overview
 Segregation
 Sexuality: Overview
 Social Capital
 Society
 Sport
 State, The: Overview
 Structuralism and Poststructuralism: Anthropology
 Symbolism
 Third World
 Time: China
 Toleration
 Totalitarianism
 Totems
 Trade
 Translation
 Travel: Travel from Europe and the Middle East
 University: Overview
 University: Postcolonial
 Untouchability: Overview
 Untouchability: Menstrual Taboos
 Untouchability: Taboos
 Victorianism
 Visual Order to Organizing Collections
 War

READER'S GUIDE

War and Peace in the Arts
Westernization: Africa
Westernization: Southeast Asia
Wisdom, Human
Work
World Systems Theory, Latin America

Africa

ENTRIES FOCUSING ON AFRICA

Aesthetics: Africa
Anticolonialism: Africa
Architecture: Africa
Arts: Africa
Authenticity: Africa
Black Atlantic
Capitalism: Africa
Colonialism: Africa
Communication of Ideas: Africa and Its Influence
Communitarianism in African Thought
Democracy, Africa
Diasporas: African Diaspora
Ethnicity and Race: Africa
Feminism: Africa and African Diaspora
Globalization: Africa
Humanism: Africa
Humanity: African Thought
Islam: Africa
Literature: African Literature
Migration: Africa
Modernity: Africa
Multiculturalism, Africa
Mysticism: Mysticism in African Thought
Nationalism: Africa
Pan-Africanism
Personhood in African Thought
Philosophies: African
Philosophy, Moral: Africa
Realism: Africa
Religion: Africa
Religion: African Diaspora
Religion and the State: Africa
Sociability in African Thought
Socialisms, African
Sufism
Westernization: Africa
Women's History: Africa
Witchcraft, African Studies of

ENTRIES THAT CONSIDER AFRICA

Abolitionism
Africa, Idea of
African-American Ideas
Afrocentricity
Afropessimism
Ancestor Worship
Anthropology
Apartheid
Arts: Overview
Bilingualism and Multilingualism
Black Consciousness
Buddhism
Christianity: Overview
Civil Disobedience
Civil Society: Responses in Africa and the Middle East
Communication of Ideas: Orality and Advent of Writing

Creolization, Caribbean
Critical Theory
Dance
Demography
Dependency
Diasporas: Jewish Diaspora
Discrimination
Dress
Ecology
Empire and Imperialism: Europe
Empire and Imperialism: Middle East
Environmental History
Equality: Racial Equality
Ethnography
Eurocentrism
Family: Modernist Anthropological Theory
Fascism
Feminism: Overview
Feminism: Islamic Feminism
Fetishism: Overview
Genocide
Globalization: General
Historiography
History, Economic
Humanity in the Arts
Identity, Multiple: Jewish Multiple Identity
International Order
Islam: Shii
Islam: Sunni
Jainism
Kinship
Law
Liberation Theology
Life Cycle: Elders/Old Age
Machiavellism
Magic
Maps and the Ideas They Express
Masks
Mathematics
Men and Masculinity
Migration: Migration in World History
Migration: United States
Minority
Modernism: Overview
Motherhood and Maternity
Museums
Music, Anthropology of
Negritude
Neocolonialism
Nomadism
Oral Traditions: Overview
Orientalism: African and Black Orientalism
Pacifism
Peasants and Peasantry
Person, Idea of the
Philosophies: Islamic
Polytheism
Postcolonial Studies
Postcolonial Theory and Literature
Property
Protest, Political
Race and Racism: Overview
Religion: Latin America
Religion and the State: United States
Resistance and Accommodation

Ritual: Religion
 Sacred and Profane
 Sage Philosophy
 Segregation
 Slavery
 State, The: The Postcolonial State
 Syncretism
 Temperance
 Third Cinema
 Third World
 Third World Literature
 Time: Traditional and Utilitarian
 Toleration
 Totems
 Treaty
 Tribalism, Middle East
 University: Postcolonial
 Untouchability: Menstrual Taboos
 Victorianism
 War
 Wisdom, Human
 Witchcraft
 Womanism
 Women's Studies
 Work
 World Systems Theory, Latin America

Asia

ENTRIES FOCUSING ON ASIA

Aesthetics: Asia
 Alchemy: China
 Anticolonialism: Southeast Asia
 Architecture: Asia
 Authoritarianism: East Asia
 Buddhism
 Causation in East Asian and Southeast Asian Philosophy
 Chinese Thought
 Chinese Warlordism
 Christianity: Asia
 Colonialism: Southeast Asia
 Communication of Ideas: Asia and Its Influence
 Communication of Ideas: Southeast Asia and Its Influence
 Confucianism
 Consciousness: Chinese Thought
 Consciousness: Indian Thought
 Cosmology: Asia
 Daoism
 Education: Asia, Traditional and Modern
 Education: China
 Education: India
 Education: Japan
 Empire and Imperialism: Asia
 Examination Systems, China
 Globalization: Asia
 Heaven and Hell (Asian Focus)
 Hinduism
 Humanism: Chinese Conception of
 Humanity: Asian Thought
 Islam: Southeast Asia
 Jainism
 Japanese Philosophy, Japanese Thought
 Justice: Justice in East Asian Thought
 Landscape in the Arts

Legalism, Ancient China
 Literature: Overview
 Maoism
 Marxism: Asia
 Medicine: China
 Medicine: India
 Meditation: Eastern Meditation
 Modernity: East Asia
 Mysticism: Chinese Mysticism
 Mysticism: Islamic Mysticism in Asia
 Orthopraxy: Asia
 Pan-Asianism
 Pan-Turkism
 Philosophy: Historical Overview and Recent Developments
 Race and Racism: Asia
 Religion: East and Southeast Asia
 Sacred Texts: Asia
 Science: East Asia
 Time: China
 Time: India
 Westernization: Southeast Asia
 Women's History: Asia

ENTRIES THAT CONSIDER ASIA

Algebras
 Ancestor Worship
 Anthropology
 Anticolonialism: Africa
 Architecture: Overview
 Arts: Overview
 Asceticism: Hindu and Buddhist Asceticism
 Asian-American Ideas (Cultural Migration)
 Astrology: China
 Astronomy, Pre-Columbian and Latin American
 Atheism
 Autobiography
 Barbarism and Civilization
 Beauty and Ugliness
 Bilingualism and Multilingualism
 Biography
 Body, The
 Borders, Borderlands, and Frontiers, Global
 Bushido
 Calculation and Computation
 Cannibalism
 Censorship
 Childhood and Child Rearing
 Christianity: Overview
 Cinema
 Civil Disobedience
 Civil Society: Responses in Africa and the Middle East
 Communication of Ideas: Middle East and Abroad
 Communication of Ideas: Orality and the Advent of Writing
 Constitutionalism
 Cosmopolitanism
 Creativity in the Arts and Sciences
 Critical Theory
 Cultural Revivals
 Cycles
 Dance
 Deism
 Demography
 Demonology
 Dependency

READER'S GUIDE

Diasporas: African Diaspora
Diffusion, Cultural
Dream
Dress
Dualism
Ecumenism
Education: Global Education
Education: Islamic Education
Empire and Imperialism: Europe
Empire and Imperialism: Middle East
Empire and Imperialism: United States
Environment
Environmental History
Ethnography
Eurocentrism
Evil
Family: Family in Anthropology since 1980
Family Planning
Fascism
Feminism: Overview
Field Theories
Friendship
Fundamentalism
Garden
Gay Studies
Gender Studies: Anthropology
Generation
Genetics: Contemporary
Genocide
Globalization: General
Health and Disease
Heaven and Hell
Historiography
History, Economic
Human Capital
Humanity in the Arts
Hygiene
Iconography
Identity, Multiple: Asian-Americans
Identity, Multiple: Jewish Multiple Identity
Images, Icons, and Idols
Imagination
Immortality and the Afterlife
Individualism
Intelligentsia
International Order
Islam: Shia
Islam: Sunni
Islamic Science
Kinship
Language, Linguistics, and Literacy
Liberty
Life Cycle: Overview
Life Cycle: Adolescence
Life Cycle: Elders/Old Age
Machiavellism
Magic
Maps and the Ideas They Express
Marxism: Overview
Masks
Mathematics
Matriarchy
Migration: Migration in World History
Migration: United States
Miracles
Modernism: Latin America
Modernity: Africa
Modernization Theory
Mohism
Monarchy: Overview
Monasticism
Monism
Motherhood and Maternity
Motif: Motif in Music
Museums
Musical Performance and Audiences
Musicology
Nation
Neoliberalism
Nomadism
Nonviolence
Nuclear Age
Nude, The
Occidentalism
Organicism
Orientalism: Overview
Orthodoxy
Pacifism
Paradise on Earth
Peace
Peasants and Peasantry
Periodization
Person, Idea of the
Perspective
Philosophy: Relations to Other Intellectual Realms
Political Science
Population
Postcolonial Studies
Postcolonial Theory and Literature
Practices
Prehistory, Rise of
Privacy
Property
Protest, Political
Race and Racism: United States
Reading
Religion: Overview
Religion and the State: United States
Resistance and Accommodation
Revolution
Rhetoric: Overview
Ritual: Public Ritual
Ritual: Religion
Sacred and Profane
Sacred Places
Secularization and Secularism
Sexual Harassment
Sexuality: Sexual Orientation
Shinto
Slavery
Society
Sovereignty
Sport
Suicide
Superstition
Syncretism
Taste
Temperance
Terror
Textiles and Fiber Arts as Catalysts for Ideas

Third Cinema
 Third World
 Third World Literature
 Toleration
 Totems
 Trade
 Translation
 Treaty
 University: Postcolonial
 Untouchability: Overview
 Untouchability: Menstrual Taboos
 Untouchability: Taboos
 Victorianism
 Virtue Ethics
 Visual Order to Organizing Collections
 War and Peace in the Arts
 Wisdom, Human
 Witchcraft
 Women's Studies
 Work
 World Systems Theory, Latin America
 Yin and Yang
 Yoga
 Zen

Europe

ENTRIES FOCUSING ON EUROPE

Architecture: Overview
 Capitalism: Overview
 Christianity: Overview
 Classification of Arts and Sciences, Early Modern
 Colonialism: Africa
 Colonialism: Latin America
 Colonialism: Southeast Asia
 Communication of Ideas: Europe and Its Influence
 Communism: Europe
 Consumerism
 Dada
 Democracy
 Dialogue and Dialectics: Socratic
 Dialogue and Dialectics: Talmudic
 Education: Europe
 Empire and Imperialism: Overview
 Empire and Imperialism: Europe
 Encyclopedism
 Enlightenment
 Epistemology: Ancient
 Epistemology: Early Modern
 Epistemology: Modern
 Eurocentrism
 Europe, Idea of
 Existentialism
 Expressionism
 Fascism
 Feudalism, European
 Greek Science
 Happiness and Pleasure in European Thought
 Hedonism in European Thought
 Historical and Dialectical Materialism
 Humanism: Europe and the Middle East
 Humanism: Renaissance
 Humanity: European Thought
 Judaism: Judaism to 1800
 Judaism: Modern Judaism
 Landscape in the Arts

Literature: Overview
 Love, Western Notions of
 Marxism: Overview
 Materialism in Eighteenth-Century European Thought
 Mechanical Philosophy
 Medicine: Europe and the United States
 Metaphysics: Ancient and Medieval
 Metaphysics: Renaissance to the Present
 Monarchy: Overview
 National History
 Orthopraxy: Western Orthopraxy
 Other, The, European Views of
 Pan-Turkism
 Philosophy: Historical Overview and Recent Developments
 Philosophy, Moral: Ancient
 Philosophy, Moral: Medieval and Renaissance
 Philosophy, Moral: Modern
 Philosophy and Religion in Western Thought
 Philosophy of Mind: Ancient and Medieval
 Pythagoreanism
 Race and Racism: Europe
 Regions and Regionalism, Eastern Europe
 Religion and the State: Europe
 Scientific Revolution
 Victorianism

ENTRIES THAT CONSIDER EUROPE

Abolitionism
 Absolute Music
 Aesthetics: Europe and the Americas
 Africa, Idea of
 Afrocentricity
 Agnosticism
 Alchemy: Europe and the Middle East
 Algebras
 Alienation
 Altruism
 Ambiguity
 America
 Americanization, U.S.
 Analytical Philosophy
 Anarchism
 Animism
 Anthropology
 Anticolonialism: Africa
 Anticolonialism: Latin America
 Anticolonialism: Middle East
 Anticolonialism: Southeast Asia
 Antifeminism
 Anti-Semitism: Overview
 Anti-Semitism: Islamic Anti-Semitism
 Apartheid
 Architecture: Africa
 Aristotelianism
 Arts: Overview
 Arts: Africa
 Asceticism: Western Asceticism
 Assimilation
 Astrology: Overview
 Atheism
 Authoritarianism: Overview
 Authority
 Autobiography
 Autonomy
 Avant-Garde: Overview

READER'S GUIDE

Avant-Garde: Militancy
 Barbarism and Civilization
 Beauty and Ugliness
 Behaviorism
 Bilingualism and Multilingualism
 Biography
 Biology
 Black Atlantic
 Body, The
 Borders, Borderlands, and Frontiers, Global
 Buddhism
 Bureaucracy
 Calculation and Computation
 Calendar
 Cannibalism
 Cartesianism
 Casuistry
 Causality
 Causation
 Censorship
 Change
 Character
 Chemistry
 Childhood and Child Rearing
 Christianity: Asia
 Cinema
 Citizenship: Overview
 Citizenship: Naturalization
 City, The: The City as a Cultural Center
 City, The: The Islamic and Byzantine City
 Civil Disobedience
 Civil Society: Europe and the United States
 Civil Society: Responses in Africa and the Middle East
 Class
 Classicism
 Common Sense
 Communication of Ideas: Africa and Its Influence
 Communication of Ideas: Middle East and Abroad
 Communication of Ideas: Orality and the Advent of Writing
 Communication of Ideas: Southeast Asia
 Composition, Musical
 Computer Science
 Consciousness: Overview
 Conservatism
 Consilience
 Constitutionalism
 Continental Philosophy
 Corruption
 Cosmology: Cosmology and Astronomy
 Cosmopolitanism
 Creationism
 Creativity in the Arts and Sciences
 Creolization, Caribbean
 Crisis
 Critical Theory
 Cultural Capital
 Cultural History
 Cultural Revivals
 Cultural Studies
 Cycles
 Cynicism
 Dance
 Deism
 Demography
 Demonology
 Dependency
 Determinism
 Development
 Diasporas: African Diaspora
 Diasporas: Jewish Diaspora
 Diversity
 Dream
 Dress
 Dystopia
 Eclecticism
 Ecology
 Economics
 Ecumenism
 Education: Global Education
 Education: India
 Education: Islamic Education
 Emotions
 Empire and Imperialism: Asia
 Empire and Imperialism: Middle East
 Empire and Imperialism: United States
 Empiricism
 Environment
 Environmental Ethics
 Environmental History
 Epicureanism
 Equality: Overview
 Equality: Gender Equality
 Equality: Racial Equality
 Essentialism
 Ethnicity and Race: Africa
 Ethnicity and Race: Anthropology
 Ethnocentrism
 Etiquette
 Eugenics
 Everyday Life
 Evil
 Evolution
 Experiment
 Extirpation
 Fallacy, Logical
 Falsifiability
 Family: Modernist Anthropological Theory
 Family: Family in Anthropology since 1980
 Family Planning
 Fatalism
 Feminism: Overview
 Feminism: Africa and African Diaspora
 Feminism: Islamic Feminism
 Fetishism: Overview
 Fetishism: Fetishism in Literature and Cultural Studies
 Field Theories
 Form, Metaphysical, in Ancient and Medieval Thought
 Formalism
 Foundationalism
 Free Will, Determinism, and Predestination
 Friendship
 Fundamentalism
 Garden
 Gay Studies
 Gender: Gender in the Middle East
 Gender in Art
 Gender Studies: Anthropology
 General Will
 Generation

- Genetics: Contemporary
- Genetics: History of
- Genius
- Genocide
- Geography
- Geometry
- Gesture
- Ghetto
- Gift, The
- Globalization: Africa
- Globalization: Asia
- Globalization: General
- Good
- Harmony
- Hate
- Health and Disease
- Heaven and Hell
- Hegelianism
- Hegemony
- Heresy and Apostasy
- Hermeneutics
- Hierarchy and Order
- Hinduism
- Historicism
- Historiography
- History, Economic
- History, Idea of
- Honor
- Human Capital
- Humanity in the Arts
- Human Rights: Overview
- Humor
- Hygiene
- Iconography
- Idealism
- Ideas, History of
- Identity: Identity of Persons
- Identity, Multiple: Overview
- Identity, Multiple: Jewish Multiple Identity
- Images, Icons, and Idols
- Immortality and the Afterlife
- Impressionism
- Individualism
- Intelligentsia
- Intentionality
- Interdisciplinarity
- International Order
- Interpretation
- Islam: Africa
- Islam: Shii
- Islam: Sunni
- Islamic Science
- Jainism
- Jouissance
- Justice: Overview
- Kantianism
- Kinship
- Knowledge
- Language and Linguistics
- Language, Linguistics, and Literacy
- Language, Philosophy of: Ancient and Medieval
- Language, Philosophy of: Modern
- Law
- Leadership
- Learning and Memory, Contemporary Views
- Liberalism
- Liberation Theology
- Liberty
- Life
- Life Cycle: Overview
- Life Cycle: Elders/Old Age
- Linguistic Turn
- Literary Criticism
- Literary History
- Logic
- Logic and Philosophy of Mathematics, Modern
- Loyalties, Dual
- Lysenkoism
- Machiavellism
- Magic
- Manichaeism
- Maoism
- Maps and the Ideas They Express
- Masks
- Mathematics
- Matriarchy
- Media, History of
- Medicine: Islamic Medicine
- Meme
- Memory
- Men and Masculinity
- Metaphor
- Microcosm and Macrocosm
- Migration: Africa
- Migration: Migration in World History
- Migration: United States
- Millenarianism: Overview
- Millenarianism: Islamic
- Millenarianism: Latin America and Native North America
- Mind
- Miracles
- Modernism: Overview
- Modernism: Latin America
- Modernity: Overview
- Modernity: Africa
- Modernity: East Asia
- Modernization
- Modernization Theory
- Monasticism
- Monism
- Moral Sense
- Motherhood and Maternity
- Motif: Motif in Literature
- Motif: Motif in Music
- Museums
- Music, Anthropology of
- Musical Performance and Audiences
- Musicology
- Mysticism: Christian Mysticism
- Mysticism: Kabbalah
- Mysticism: Mysticism in African Thought
- Myth
- Narrative
- Nation
- Nationalism: Overview
- Nationalism: Africa
- Nationalism: Cultural Nationalism
- Nationalism: Middle East
- Native Policy

READER'S GUIDE

Natural History
Natural Theology
Naturalism
Naturalism in Art and Literature
Nature
Naturphilosophie
Negritude
Neocolonialism
Neoliberalism
Neoplatonism
New Criticism
Newtonianism
Nihilism
Nonviolence
Nuclear Age
Nude, The
Objectivity
Obligation
Occidentalism
Organicism
Orientalism: Overview
Orthodoxy
Pacifism
Pan-Africanism
Pan-Asianism
Pan-Islamism
Paradigm
Paradise on Earth
Parties, Political
Patriotism
Peace
Peasants and Peasantry
Periodization
Periodization of the Arts
Person, Idea of the
Perspective
Phenomenology
Philosophies: African
Philosophies: Feminist, Twentieth-Century
Philosophies: Islamic
Philosophy: Relations to Other Intellectual Realms
Philosophy, History of
Philosophy, Moral: Africa
Philosophy of Mind: Overview
Phrenology
Physics
Platonism
Pluralism
Poetry and Poetics
Political, The
Political Science
Polytheism
Population
Positivism
Postcolonial Studies
Postcolonial Theory and Literature
Postmodernism
Poverty
Power
Practices
Pragmatism
Pre-Columbian Civilization
Prehistory, Rise of
Prejudice
Presentism
Privacy
Probability
Progress, Idea of
Propaganda
Property
Prophecy
Protest, Political
Pseudoscience
Psychology and Psychiatry
Public Sphere
Punishment
Puritanism
Quantum
Queer Theory
Radicals/Radicalism
Rational Choice
Rationalism
Reading
Realism
Realism: Africa
Reason, Practical and Theoretical
Reform: Europe and the United States
Reform: Islamic Reform
Reformation
Relativism
Relativity
Religion: Overview
Religion: East and Southeast Asia
Religion: Latin America
Religion: Middle East
Religion and Science
Religion and the State: Latin America
Religion and the State: United States
Renaissance
Representation: Mental Representation
Representation: Political Representation
Republicanism: Latin America
Republicanism: Republic
Resistance
Resistance and Accommodation
Responsibility
Revolution
Rhetoric: Overview
Rhetoric: Ancient and Medieval
Ritual: Public Ritual
Ritual: Religion
Romanticism in Literature and Politics
Sacred and Profane
Sacred Places
Sage Philosophy
Scarcity and Abundance, Latin America
Scholasticism
Science: Overview
Science, History of
Science Fiction
Secularization and Secularism
Sexuality: Overview
Skepticism
Slavery
Social Capital
Social Contract
Social Darwinism
Socialism
Socialisms, African
Society

Sophists, The
 Sovereignty
 Sport
 State, The: Overview
 Stoicism
 Structuralism and Poststructuralism: Overview
 Structuralism and Poststructuralism: Anthropology
 Subjectivism
 Suicide
 Superstition
 Surrealism
 Symbolism
 Taste
 Technology
 Temperance
 Terror
 Terrorism, Middle East
 Textiles and Fiber Arts as Catalysts for Ideas
 Theodicy
 Third Cinema
 Time: Traditional and Utilitarian
 Toleration
 Totalitarianism
 Trade
 Tragedy and Comedy
 Translation
 Travel: Travel from Europe and the Middle East
 Treaty
 Trope
 Truth
 Universalism
 University: Overview
 University: Postcolonial
 Untouchability: Overview
 Untouchability: Menstrual Taboos
 Untouchability: Taboos
 Utilitarianism
 Utopia
 Virtue Ethics
 Visual Order to Organizing Collections
 Volksgeist
 Volunteerism, U.S.
 War
 War and Peace in the Arts
 Wealth
 Westernization: Africa
 Westernization: Middle East
 Westernization: Southeast Asia
 Wildlife
 Wisdom, Human
 Witchcraft
 Witchcraft, African Studies of
 Women's History: Africa
 Women's Studies
 Work
 World Systems Theory, Latin America
 Zionism

Middle East

ENTRIES FOCUSING ON THE MIDDLE EAST

Alchemy: Europe and the Middle East
 Anticolonialism: Middle East
 Civil Society: Responses in Africa and the Middle East
 Communication of Ideas: Middle East and Abroad
 Death and Afterlife, Islamic Understanding of

Dialogue and Dialectics: Talmudic
 Education: Islamic Education
 Empire and Imperialism: Middle East
 Feminism: Islamic Feminism
 Gender: Gender in the Middle East
 Honor, Middle Eastern Notions of
 Humanism: Europe and the Middle East
 Intercession in Middle Eastern Society
 Islam: Shii
 Islam: Sunni
 Islamic Science
 Judaism: Judaism to 1800
 Judaism: Modern Judaism
 Law, Islamic
 Literature: Overview
 Medicine: Islamic Medicine
 Monarchy: Islamic Monarchy
 Nationalism: Middle East
 Pan-Arabism
 Pan-Islamism
 Pan-Turkism
 Philosophies: Islamic
 Religion: Middle East
 Religion and the State: Middle East
 Sufism
 Terrorism, Middle East
 Tribalism, Middle East
 Westernization: Middle East
 Zionism

ENTRIES THAT CONSIDER THE MIDDLE EAST

Africa, Idea of
 Algebras
 Anthropology
 Antifeminism
 Anti-Semitism: Overview
 Anti-Semitism: Islamic Anti-Semitism
 Architecture: Overview
 Architecture: Africa
 Aristotelianism
 Arts: Africa
 Astrology: Overview
 Astrology: China
 Atheism
 Authoritarianism: Overview
 Authority
 Barbarism and Civilization
 Bilingualism and Multilingualism
 Biography
 Calendar
 Childhood and Child Rearing
 Christianity: Overview
 City, The: The Islamic and Byzantine City
 Class
 Communication of Ideas: Africa and Its Influence
 Communication of Ideas: Europe and Its Influence
 Communication of Ideas: Orality and the Advent of Writing
 Computer Science
 Constitutionalism
 Cosmopolitanism
 Creativity in the Arts and Sciences
 Critical Theory
 Dance
 Deism
 Demography

READER'S GUIDE

Demonology
Dependency
Diasporas: African Diaspora
Diasporas: Jewish Diaspora
Dream
Dualism
Ecumenism
Empire and Imperialism: Europe
Environment
Ethnicity and Race: Islamic Views
Eurocentrism
Evil
Family Planning
Feminism: Overview
Feminism: Africa and African Diaspora
Free Will, Determinism, and Predestination
Friendship
Fundamentalism
Garden
Gay Studies
Gender in Art
Ghetto
Gift, The
Gnosticism
Hate
Health and Disease
Heaven and Hell
Heresy and Apostasy
Historiography
Humanity in the Arts
Iconography
Identity, Multiple: Jewish Multiple Identity
Images, Icons, and Idols
Imagination
Immortality and the Afterlife
Intelligentsia
International Order
Islam: Africa
Jihad
Language, Linguistics, and Literacy
Language, Philosophy of: Ancient and Medieval
Liberty
Life Cycle: Elders/Old Age
Literature: African Literature
Logic
Manichaeism
Maps and the Ideas They Express
Mathematics
Matriarchy
Microcosm and Macrocosm
Migration: Africa
Migration: Migration in World History
Millenarianism: Overview
Millenarianism: Islamic
Minority
Miracles
Monarchy: Overview
Motherhood and Maternity
Museums
Musicology
Mysticism: Islamic Mysticism
Mysticism: Islamic Mysticism in Asia
Mysticism: Kabbalah
Mysticism: Mysticism in African Thought
Nation
Nationalism: Cultural Nationalism
Nihilism
Nomadism
Nonviolence
Nuclear Age
Organicism
Orientalism: Overview
Orientalism: African and Black Orientalism
Orthodoxy
Orthopraxy: Western Orthopraxy
Pan-Africanism
Paradise on Earth
Peace
Perspective
Philosophies: African
Philosophy, Moral: Medieval and Renaissance
Philosophy of Mind: Ancient and Medieval
Political Science
Polytheism
Postcolonial Studies
Postcolonial Theory and Literature
Property
Prophecy
Protest, Political
Pythagoreanism
Reform: Islamic Reform
Religion: East and Southeast Asia
Religion and Science
Religion and the State: Africa
Religion and the State: Europe
Religion and the State: United States
Resistance and Accommodation
Rhetoric: Overview
Sacred Places
Sacred Texts: Koran
Science, History of
Scientific Revolution
Secularization and Secularism
Sexual Harassment
Sexuality: Islamic Views
Slavery
Sovereignty
Suicide
Superstition
Syncretism
Temperance
Textiles and Fiber Arts as Catalysts for Ideas
Theodicy
Third Cinema
Third World Literature
Toleration
Totalitarianism
Totems
Travel: Travel from Europe and the Middle East
Treaty
University: Overview
Untouchability: Menstrual Taboos
Untouchability: Taboos
Visual Order to Organizing Collections
Westernization: Africa
Westernization: Southeast Asia
Wisdom, Human
Women's History: Africa
Women's Studies
World Systems Theory, Latin America

North America

ENTRIES FOCUSING ON NORTH AMERICA

African-American Ideas
 America
 Asian-American Ideas (Cultural Migration)
 Black Atlantic
 Chicano Movement
 Christianity: Overview
 Civil Society: Europe and the United States
 Communication of Ideas: The Americas and Their Influence
 Consumerism
 Democracy
 Education: North America
 Empire and Imperialism: Americas
 Empire and Imperialism: United States
 Ethnohistory, U.S.
 Feminism: Chicana Feminisms
 Feminism: Third World U.S. Movement
 Humanism: Secular Humanism in the United States
 Identity, Multiple: Asian-Americans
 Judaism: Modern Judaism
 Justice: Justice in American Thought
 Landscape in the Arts
 Medicine: Europe and the United States
 Migration: United States
 Millenarianism: Latin America and Native North America
 Native Policy
 Philosophies: American
 Political Protest, U.S.
 Populism: United States
 Race and Racism: United States
 Reform: Europe and the United States
 Religion and the State: United States
 Volunteerism, U.S.

ENTRIES THAT CONSIDER NORTH AMERICA

Abolitionism
 Aesthetics: Europe and the Americas
 Africa, Idea of
 Afrocentricity
 Altruism
 Americanization, U.S.
 Analytical Philosophy
 Anthropology
 Anticolonialism: Latin America
 Anticolonialism: Southeast Asia
 Antifeminism
 Asceticism: Western Asceticism
 Assimilation
 Astronomy, Pre-Columbian and Latin American
 Atheism
 Authoritarianism: Latin America
 Authority
 Autobiography
 Aztlán
 Beauty and Ugliness
 Behaviorism
 Bilingualism and Multilingualism
 Bioethics
 Biology
 Body, The
 Borders, Borderlands, and Frontiers, Global
 Buddhism
 Calculation and Computation

Cannibalism
 Causation
 Censorship
 Childhood and Child Rearing
 Cinema
 Citizenship: Overview
 Citizenship: Cultural Citizenship
 Citizenship: Naturalization
 City, The: The City as a Cultural Center
 Civil Disobedience
 Colonialism: Latin America
 Communication of Ideas: Africa and Its Influence
 Communism: Latin America
 Computer Science
 Conservatism
 Consilience
 Constitutionalism
 Continental Philosophy
 Cosmopolitanism
 Creationism
 Critical Race Theory
 Critical Theory
 Cultural Capital
 Cultural Revivals
 Cultural Studies
 Dance
 Death
 Deism
 Demography
 Diasporas: African Diaspora
 Diasporas: Jewish Diaspora
 Discrimination
 Diversity
 Dream
 Dress
 Dualism
 Dystopia
 Ecology
 Economics
 Ecumenism
 Education: Global Education
 Emotions
 Empire and Imperialism: Asia
 Empiricism
 Enlightenment
 Environment
 Environmental Ethics
 Environmental History
 Equality: Overview
 Equality: Gender Equality
 Equality: Racial Equality
 Essentialism
 Ethnicity and Race: Anthropology
 Ethnocentrism
 Ethnography
 Eugenics
 Eurocentrism
 Everyday Life
 Evil
 Evolution
 Family: Modernist Anthropological Theory
 Family: Family in Anthropology since 1980
 Family Planning
 Feminism: Overview
 Feminism: Africa and African Diaspora

READER'S GUIDE

Feminism: Islamic Feminism
Fetishism: Overview
Fetishism: Fetishism in Literature and Cultural Studies
Field Theories
Foundationalism
Friendship
Fundamentalism
Game Theory
Garden
Gay Studies
Gender: Overview
Gender: Gender in the Middle East
Gender in Art
Gender Studies: Anthropology
Generation
Genetics: Contemporary
Genetics: History of
Genius
Genocide
Ghetto
Globalization: Asia
Globalization: General
Hate
Hegelianism
Historiography
History, Economic
Human Capital
Humanity: European Thought
Humanity in the Arts
Human Rights: Overview
Ideas, History of
Identity: Identity of Persons
Identity: Personal and Social Identity
Identity, Multiple: Overview
Identity, Multiple: Jewish Multiple Identity
Impressionism
Intentionality
Interdisciplinarity
Internal Colonialism
International Order
Interpretation
Islam: Shii
Jainism
Justice: Overview
Kantianism
Language and Linguistics
Language, Philosophy of: Modern
Law
Leadership
Learning and Memory, Contemporary Views
Liberation Theology
Life
Life Cycle: Adolescence
Life Cycle: Elders/Old Age
Linguistic Turn
Literary Criticism
Literary History
Loyalties, Dual
Machismo
Magic
Maps and the Ideas They Express
Marxism: Overview
Marxism: Latin America
Masks
Mathematics
Matriarchy
Media, History of
Meme
Men and Masculinity
Mestizaje
Migration: Africa
Migration: Migration in World History
Millenarianism: Overview
Mind
Minority
Modernism: Latin America
Modernity: Overview
Monasticism
Motif: Motif in Music
Museums
Music, Anthropology of
Musical Performance and Audiences
Myth
Narrative
Nation
Nationalism: Overview
Nationalism: Africa
Natural History
Natural Theology
Naturalism
Neocolonialism
Neoliberalism
New Criticism
Nihilism
Nuclear Age
Objectivity
Obligation
Occidentalism
Orientalism: African and Black Orientalism
Orthodoxy
Other, The, European Views of
Pacifism
Pan-Africanism
Paradigm
Parties, Political
Periodization
Person, Idea of the
Philosophies: Feminist, Twentieth-Century
Philosophy: Relations to Other Intellectual Realms
Philosophy of Mind: Overview
Pluralism
Political Science
Population
Positivism
Postcolonial Studies
Postcolonial Theory and Literature
Postmodernism
Practices
Pragmatism
Prehistory, Rise of
Prejudice
Presentism
Privacy
Probability
Progress, Idea of
Property
Protest, Political
Pseudoscience
Psychology and Psychiatry
Quantum

Queer Theory
 Race and Racism: Overview
 Rational Choice
 Reading
 Reflexivity
 Relativism
 Relativity
 Religion: Latin America
 Religion and Science
 Renaissance
 Representation: Mental Representation
 Representation: Political Representation
 Resistance
 Resistance and Accommodation
 Responsibility
 Rhetoric: Overview
 Ritual: Religion
 Scarcity and Abundance, Latin America
 Science, History of
 Science Fiction
 Secularization and Secularism
 Segregation
 Sexual Harassment
 Sexuality: Overview
 Sexuality: Sexual Orientation
 Slavery
 Social History, U.S.
 Sovereignty
 Sport
 State, The: Overview
 Subjectivism
 Suicide
 Superstition
 Syncretism
 Taste
 Technology
 Temperance
 Terrorism, Middle East
 Time: Traditional and Utilitarian
 Totems
 Trade
 Treaty
 Trope
 Truth
 University: Postcolonial
 Utilitarianism
 Victorianism
 Visual Culture
 Visual Order to Organizing Collections
 War
 War and Peace in the Arts
 Westernization: Southeast Asia
 Wildlife
 Witchcraft
 Womanism
 Women and Femininity in U.S. Popular Culture
 Women's Studies
 World Systems Theory, Latin America

Latin and South America

ENTRIES FOCUSING ON LATIN AND SOUTH AMERICA

Anticolonialism: Latin America
 Astronomy, Pre-Columbian and Latin American
 Authoritarianism: Latin America

Black Atlantic
 Colonialism: Latin America
 Communication of Ideas: The Americas and Their Influence
 Communism: Latin America
 Creolization, Caribbean
 Empire and Imperialism: Americas
 Marxism: Latin America
 Millenarianism: Latin America and Native North America
 Modernism: Latin America
 Native Policy
 Populism: Latin America
 Pre-Columbian Civilization
 Religion: Indigenous Peoples' View, South America
 Religion: Latin America
 Religion and the State: Latin America
 Republicanism: Latin America
 Scarcity and Abundance, Latin America
 World Systems Theory, Latin America

ENTRIES THAT CONSIDER LATIN AND SOUTH AMERICA

Abolitionism
 Aesthetics: Africa
 Africa, Idea of
 America
 Ancestor Worship
 Animism
 Anthropology
 Arts: Overview
 Atheism
 Authenticity: Africa
 Authoritarianism: Overview
 Autobiography
 Aztlán
 Bilingualism and Multilingualism
 Borders, Borderlands, and Frontiers, Global
 Calculation and Computation
 Cannibalism
 Chicano Movement
 Christianity: Overview
 Cinema
 Citizenship: Overview
 Citizenship: Cultural Citizenship
 Citizenship: Naturalization
 Critical Theory
 Cultural Capital
 Dance
 Demography
 Demonology
 Dependency
 Diasporas: African Diaspora
 Diffusion, Cultural
 Discrimination
 Diversity
 Empire and Imperialism: United States
 Environmental History
 Ethnohistory, U.S.
 Evil
 Extirpation
 Family Planning
 Fascism
 Feminism: Overview
 Feminism: Africa and African Diaspora
 Feminism: Chicana Feminisms

READER'S GUIDE

Fetishism: Overview
Friendship
Gender in Art
Genetics: Contemporary
Historiography
History, Economic
Honor
Humanity in the Arts
Identity, Multiple: Overview
Identity, Multiple: Jewish Multiple Identity
Indigenismo
Internal Colonialism
International Order
Liberation Theology
Life Cycle: Overview
Life Cycle: Elders/Old Age
Machiavellism
Machismo
Magic
Maps and the Ideas They Express
Masks
Mathematics
Matriarchy
Media, History of
Men and Masculinity
Mestizaje
Migration: Africa
Migration: Migration in World History
Migration: United States
Minority
Modernism: Overview
Modernization Theory
Motherhood and Maternity
Motif: Motif in Music
Museums
Music, Anthropology of
Nationalism: Africa
Negritude
Orthopraxy: Western Orthopraxy
Pan-Africanism
Peasants and Peasantry
Periodization of the Arts
Perspective
Phrenology
Political Protest, U.S.
Polytheism
Population
Postcolonial Studies
Postcolonial Theory and Literature
Practices
Prehistory, Rise of
Property
Protest, Political
Race and Racism: Overview
Religion: African Diaspora
Resistance and Accommodation
Revolution
Rhetoric: Overview
Ritual: Public Ritual
Ritual: Religion
Secularization and Secularism
Segregation
Slavery
Sport
State, The: Overview

Structuralism and Poststructuralism: Anthropology
Surrealism
Syncretism
Temperance
Third Cinema
Third World
Third World Literature
Trade
Treaty
University: Overview
University: Postcolonial
Visual Order to Organizing Collections
Witchcraft
Women's Studies
Work

CHRONOLOGICAL PERIODS

This section is divided according to five periods in world history: Ancient, Dynastic, Early Modern, Modern, and Contemporary. Use this section together with the section on Geographical Areas.

Ancient (before 400 C.E.)

ENTRIES FOCUSED ON THE PERIOD

Buddhism
Consciousness: Chinese Thought
Consciousness: Indian Thought
Democracy
Dialogue and Dialectics: Socratic
Epicureanism
Gnosticism
Greek Science
Hinduism
Justice: Justice in East Asian Thought
Language, Linguistics, and Literacy
Microcosm and Macrocosm
Orthopraxy: Asia
Orthopraxy: Western Orthopraxy
Poetry and Poetics
Sacred Places
Sacred Texts: Asia
Sophists, The
Textiles and Fiber Arts as Catalysts for Ideas
Time: China
Time: India
Yin and Yang

ENTRIES WITH EXAMPLES FROM BEFORE 400 C.E.

Generally the examples in this category are from the ancient Middle East, Europe, or Asia.

Aesthetics: Asia
Aesthetics: Europe and the Americas
Africa, Idea of
Alchemy: China
Alchemy: Europe and the Middle East
Algebras
Ambiguity
Anarchism
Anthropology
Anti-Semitism: Overview
Architecture: Overview

- Architecture: Africa
 Architecture: Asia
 Aristotelianism
 Arts: Overview
 Asceticism: Western Asceticism
 Astrology: Overview
 Astrology: China
 Atheism
 Authority
 Autobiography
 Barbarism and Civilization
 Beauty and Ugliness
 Biography
 Biology
 Body, The
 Borders, Borderlands, and Frontiers, Global
 Bureaucracy
 Calendar
 Casuistry
 Causality
 Causation
 Causation in East Asian and Southeast Asian Philosophy
 Censorship
 Change
 Character
 Childhood and Child Rearing
 Chinese Thought
 Christianity: Overview
 Christianity: Asia
 City, The: The City as a Cultural Center
 City, The: The City as Political Center
 City, The: The Islamic and Byzantine City
 Civil Society: Europe and the United States
 Class
 Classicism
 Classification of Arts and Sciences, Early Modern
 Communication of Ideas: Asia and Its Influence
 Communication of Ideas: Europe and Its Influence
 Communication of Ideas: Middle East and Abroad
 Communication of Ideas: Orality and Advent of Writing
 Communication of Ideas: Southeast Asia
 Communication of Ideas: The Americas and Their Influence
 Composition, Musical
 Confucianism
 Constitutionalism
 Corruption
 Cosmology: Asia
 Cosmology: Cosmology and Astronomy
 Cosmopolitanism
 Creationism
 Creativity in the Arts and Sciences
 Creolization, Caribbean
 Cycles
 Cynicism
 Dance
 Daoism
 Death
 Demonology
 Development
 Diasporas: Jewish Diaspora
 Dream
 Dress
 Dualism
 Eclecticism
 Ecumenism
 Education: Asia, Traditional and Modern
 Education: China
 Education: Europe
 Education: India
 Emotions
 Empire and Imperialism: Overview
 Empire and Imperialism: Asia
 Environment
 Epistemology: Ancient
 Equality: Overview
 Eschatology
 Essentialism
 Etiquette
 Eurocentrism
 Europe, Idea of
 Evil
 Evolution
 Experiment
 Fallacy, Logical
 Fatalism
 Form, Metaphysical, in Ancient and Medieval Thought
 Foundationalism
 Free Will, Determinism, and Predestination
 Friendship
 Fundamentalism
 Garden
 Gay Studies
 Gender in Art
 Generation
 Genre
 Geography
 Geometry
 Gesture
 Gift, The
 Good
 Happiness and Pleasure in European Thought
 Harmony
 Health and Disease
 Heaven and Hell
 Heaven and Hell (Asian Focus)
 Hedonism in European Thought
 Hegemony
 Heresy and Apostasy
 Hierarchy and Order
 Historiography
 History, Idea of
 Humanism: Chinese Conception of
 Humanism: Europe and the Middle East
 Humanity: African Thought
 Humanity: Asian Thought
 Humanity: European Thought
 Humanity in the Arts
 Human Rights: Overview
 Humor
 Hygiene
 Ideas, History of
 Identity, Multiple: Jewish Multiple Identity
 Images, Icons, and Idols
 Imagination
 Immortality and the Afterlife
 Individualism
 International Order
 Interpretation

READER'S GUIDE

Jainism
Judaism: Judaism to 1800
Justice: Overview
Knowledge
Landscape in the Arts
Language, Philosophy of: Ancient and Medieval
Leadership
Legalism, Ancient China
Liberty
Life
Literary History
Literature: Overview
Literature: African Literature
Logic
Love, Western Notions of
Loyalties, Dual
Machiavellism
Manichaeism
Maps and the Ideas They Express
Marriage and Fertility, European Views
Mathematics
Matriarchy
Mechanical Philosophy
Media, History of
Medicine: China
Medicine: Europe and the United States
Medicine: India
Medicine: Islamic Medicine
Meditation: Eastern Meditation
Memory
Men and Masculinity
Metaphor
Metaphysics: Ancient and Medieval
Migration: Migration in World History
Millenarianism: Overview
Miracles
Mohism
Monarchy: Overview
Monasticism
Monism
Motherhood and Maternity
Museums
Music, Anthropology of
Musical Performance and Audiences
Mysticism: Chinese Mysticism
Mysticism: Christian Mysticism
Narrative
Nation
Natural Law
Nature
Neoplatonism
Nomadism
Nonviolence
Nude, The
Organicism
Orthodoxy
Other, The, European Views of
Pacifism
Paradigm
Paradise on Earth
Patriotism
Peace
Periodization
Periodization of the Arts
Perspective
Philanthropy
Philosophies: African
Philosophies: Islamic
Philosophy: Historical Overview and Recent Developments
Philosophy: Relations to Other Intellectual Realms
Philosophy, Moral: Ancient
Philosophy, Moral: Medieval and Renaissance
Philosophy and Religion in Western Thought
Philosophy of Mind: Ancient and Medieval
Physics
Platonism
Pluralism
Political, The
Political Science
Poverty
Prehistory, Rise of
Presentism
Prophecy
Punishment
Pythagoreanism
Rationalism
Reading
Reason, Practical and Theoretical
Reform: Europe and the United States
Reformation
Religion: Overview
Religion: Africa
Religion: East and Southeast Asia
Religion and the State: Europe
Renaissance
Representation: Political Representation
Republicanism: Republic
Resistance
Responsibility
Revolution
Rhetoric: Overview
Rhetoric: Ancient and Medieval
Ritual: Public Ritual
Science: East Asia
Scientific Revolution
Shinto
Skepticism
Slavery
Society
Sovereignty
Sport
State of Nature
Stoicism
Suicide
Superstition
Syncretism
Taste
Text/Textuality
Toleration
Totalitarianism
Tragedy and Comedy
Translation
Travel: Travel from Europe and the Middle East
Treaty
Trope
Truth
University: Overview
Untouchability: Overview
Untouchability: Menstrual Taboos

Virtual Reality
 Virtue Ethics
 Visual Order to Organizing Collections
 War and Peace in the Arts
 Wealth
 Wildlife
 Witchcraft
 Work
 Yoga
 Zen

Dynastic (400 C.E.–1400 C.E.)

ENTRIES FOCUSED ON THE PERIOD

Astronomy, Pre-Columbian and Latin American
 Buddhism
 Death and Afterlife, Islamic Understanding of
 Dialogue and Dialectics: Talmudic
 Feudalism, European
 Heresy and Apostasy
 Motif: Motif in Literature
 Orthopraxy: Western Orthopraxy
 Sacred Places
 Sacred Texts: Asia
 Sacred Texts: Koran
 Scholasticism
 Textiles and Fiber Arts as Catalysts for Ideas

ENTRIES WITH EXAMPLES FROM THE PERIOD
 400 C.E.–1400 C.E.

Aesthetics: Asia
 Africa, Idea of
 Alchemy: China
 Alchemy: Europe and the Middle East
 Algebras
 America
 Anti-Semitism: Overview
 Anti-Semitism: Islamic Anti-Semitism
 Architecture: Overview
 Architecture: Africa
 Architecture: Asia
 Aristotelianism
 Arts: Overview
 Asceticism: Western Asceticism
 Astrology: Overview
 Astrology: China
 Authority
 Autobiography
 Aztlán
 Barbarism and Civilization
 Beauty and Ugliness
 Biography
 Biology
 Body, The
 Borders, Borderlands, and Frontiers, Global
 Bureaucracy
 Bushido
 Calculation and Computation
 Calendar
 Casuistry
 Causality
 Causation in East Asian and Southeast Asian Philosophy
 Change
 Childhood and Child Rearing
 Chinese Thought
 Christianity: Overview
 Christianity: Asia

City, The: The City as a Cultural Center
 City, The: The Islamic and Byzantine City
 Civil Disobedience
 Civil Society: Europe and the United States
 Class
 Classicism
 Classification of Arts and Sciences, Early Modern
 Communication of Ideas: Africa and Its Influence
 Communication of Ideas: Asia and Its Influence
 Communication of Ideas: Europe and Its Influence
 Communication of Ideas: Middle East and Abroad
 Communication of Ideas: Orality and Advent of Writing
 Communication of Ideas: Southeast Asia
 Communication of Ideas: The Americas and Their
 Influence
 Composition, Musical
 Confucianism
 Consciousness: Indian Thought
 Consilience
 Constitutionalism
 Corruption
 Cosmology: Asia
 Cosmopolitanism
 Creationism
 Creativity in the Arts and Sciences
 Daoism
 Death
 Democracy
 Demonology
 Diasporas: Jewish Diaspora
 Dream
 Dualism
 Eclecticism
 Ecumenism
 Education: Asia, Traditional and Modern
 Education: China
 Education: Europe
 Education: India
 Education: Islamic Education
 Education: Japan
 Empire and Imperialism: Overview
 Empire and Imperialism: Asia
 Encyclopedism
 Equality: Overview
 Eschatology
 Ethnicity and Race: Islamic Views
 Etiquette
 Eurocentrism
 Europe, Idea of
 Evil
 Examination Systems, China
 Experiment
 Fallacy, Logical
 Feminism: Islamic Feminism
 Form, Metaphysical, in Ancient and Medieval Thought
 Free Will, Determinism, and Predestination
 Friendship
 Garden
 Gay Studies
 Gender: Gender in the Middle East
 Gender in Art
 Gesture
 Gift, The
 Globalization: Asia
 Good

READER'S GUIDE

- Happiness and Pleasure in European Thought
 Harmony
 Health and Disease
 Heaven and Hell
 Hegemony
 Hierarchy and Order
 Hinduism
 Historiography
 History, Idea of
 Honor, Middle Eastern Notions of
 Humanism: Africa
 Humanism: Chinese Conception of
 Humanism: Europe and the Middle East
 Humanity: Asian Thought
 Humanity: European Thought
 Humanity in the Arts
 Human Rights: Overview
 Hygiene
 Iconography
 Identity, Multiple: Jewish Multiple Identity
 Images, Icons, and Idols
 Imagination
 Immortality and the Afterlife
 Individualism
 Intentionality
 International Order
 Interpretation
 Islam: Africa
 Islam: Shii
 Islam: Sunni
 Islamic Science
 Jainism
 Japanese Philosophy, Japanese Thought
 Jihad
 Judaism: Judaism to 1800
 Knowledge
 Landscape in the Arts
 Language, Philosophy of: Ancient and Medieval
 Law, Islamic
 Liberty
 Literary History
 Literature: Overview
 Logic
 Love, Western Notions of
 Loyalties, Dual
 Manichaeism
 Maps and the Ideas They Express
 Marriage and Fertility, European Views
 Mathematics
 Medicine: China
 Medicine: Europe and the United States
 Medicine: Islamic Medicine
 Metaphor
 Metaphysics: Ancient and Medieval
 Microcosm and Macrocosm
 Migration: Africa
 Migration: Migration in World History
 Millenarianism: Overview
 Millenarianism: Islamic
 Millenarianism: Latin America and Native North America
 Miracles
 Monarchy: Islamic Monarchy
 Monarchy: Overview
 Monasticism
 Monism
 Motif: Motif in Music
 Musical Performance and Audiences
 Mysticism: Chinese Mysticism
 Mysticism: Christian Mysticism
 Mysticism: Islamic Mysticism
 Mysticism: Islamic Mysticism in Asia
 Mysticism: Kabbalah
 Nation
 Natural Law
 Natural Theology
 Neoplatonism
 Nomadism
 Nude, The
 Objectivity
 Organicism
 Orthodoxy
 Other, The, European Views of
 Paradigm
 Paradise on Earth
 Patriotism
 Peace
 Peasants and Peasantry
 Periodization
 Periodization of the Arts
 Perspective
 Philanthropy
 Philosophies: African
 Philosophies: Islamic
 Philosophy: Historical Overview and Recent Developments
 Philosophy, Moral: Medieval and Renaissance
 Philosophy and Religion in Western Thought
 Philosophy of Mind: Ancient and Medieval
 Physics
 Platonism
 Poverty
 Pre-Columbian Civilization
 Prophecy
 Protest, Political
 Race and Racism: Asia
 Reform: Islamic Reform
 Religion: Africa
 Religion: East and Southeast Asia
 Religion: Middle East
 Religion and the State: Europe
 Religion and the State: Middle East
 Religion and the State: United States Renaissance
 Representation: Political Representation
 Republicanism: Republic
 Responsibility
 Revolution
 Rhetoric: Overview
 Rhetoric: Ancient and Medieval
 Ritual: Public Ritual
 Scientific Revolution
 Sexuality: Islamic Views
 Shinto
 Skepticism
 Sophists, The
 Sovereignty
 Stoicism
 Sufism
 Suicide
 Superstition

Syncretism
 Taste
 Terror
 Time: Traditional and Utilitarian
 Toleration
 Totalitarianism
 Tragedy and Comedy
 Translation
 Travel: Travel from Europe and the Middle East
 Tribalism, Middle East
 University: Overview
 Untouchability: Menstrual Taboos
 Virtual Reality
 Virtue Ethics
 Visual Order to Organizing Collections
 War
 War and Peace in the Arts
 Wealth
 Women's History: Asia
 Work
 Yoga
 Zen

Early Modern (1400–1800 C.E.)

ENTRIES FOCUSED ON THE PERIOD

Astronomy, Pre-Columbian and Latin American
 Cartesianism
 Casuistry
 Empiricism
 Humanism: Renaissance
 Idealism
 Identity: Identity of Persons
 Kantianism
 Materialism in Eighteenth-Century European Thought
 Mechanical Philosophy
 Moral Sense
 Naturphilosophie
 Newtonianism
 Phrenology
 Protest, Political
 Reformation
 Renaissance
 Scientific Revolution
 Theodicy
 Time: Traditional and Utilitarian
 Westernization: Middle East

ENTRIES WITH EXAMPLES FROM THE PERIOD

1400–1800 C.E.
 Abolitionism
 Aesthetics: Africa
 Aesthetics: Asia
 Aesthetics: Europe and the Americas
 Africa, Idea of
 African-American Ideas
 Agnosticism
 Alchemy: Europe and the Middle East
 Algebras
 Ambiguity
 America
 Ancestor Worship
 Anticolonialism: Latin America
 Antifeminism
 Anti-Semitism: Overview
 Apartheid
 Architecture: Overview

Architecture: Asia
 Aristotelianism
 Arts: Overview
 Arts: Africa
 Asceticism: Western Asceticism
 Astrology: Overview
 Atheism
 Authoritarianism: Latin America
 Authority
 Autobiography
 Autonomy
 Aztlán
 Barbarism and Civilization
 Beauty and Ugliness
 Biography
 Biology
 Body, The
 Borders, Borderlands, and Frontiers, Global
 Buddhism
 Bureaucracy
 Bushido
 Calculation and Computation
 Calendar
 Cannibalism
 Capitalism: Overview
 Capitalism: Africa
 Causality
 Causation
 Causation in East Asian and Southeast Asian Philosophy
 Censorship
 Change
 Character
 Chemistry
 Childhood and Child Rearing
 Chinese Thought
 Christianity: Asia
 Christianity: Overview
 City, The: The City as a Cultural Center
 City, The: Latin America
 Civil Disobedience
 Civil Society: Europe and the United States
 Civil Society: Responses in Africa and the Middle East
 Class
 Classicism
 Classification of Arts and Sciences, Early Modern
 Colonialism: Africa
 Colonialism: Latin America
 Colonialism: Southeast Asia
 Common Sense
 Communication of Ideas: Africa and Its Influence
 Communication of Ideas: The Americas and Their Influence
 Communication of Ideas: Asia and Its Influence
 Communication of Ideas: Europe and Its Influence
 Communication of Ideas: Middle East and Abroad
 Communication of Ideas: Orality and Advent of Writing
 Communication of Ideas: Southeast Asia
 Communism: Europe
 Composition, Musical
 Computer Science
 Confucianism
 Consciousness: Overview
 Conservatism
 Constitutionalism

READER'S GUIDE

Consumerism
 Context
 Continental Philosophy
 Corruption
 Cosmology: Asia
 Cosmology: Cosmology and Astronomy
 Cosmopolitanism
 Creationism
 Creativity in the Arts and Sciences
 Creolization, Caribbean
 Crisis
 Critical Theory
 Cultural History
 Cycles
 Death and Afterlife, Islamic Understanding of
 Deism
 Democracy
 Dependency
 Determinism
 Development
 Diasporas: African Diaspora
 Diasporas: Jewish Diaspora
 Dictatorship in Latin America
 Dream
 Dress
 Dualism
 Dystopia
 Eclecticism
 Ecology
 Economics
 Education: Asia, Traditional and Modern
 Education: China
 Education: Europe
 Education: India
 Education: Islamic Education
 Education: Japan
 Education: North America
 Empire and Imperialism: Americas
 Empire and Imperialism: Asia
 Empire and Imperialism: Middle East
 Encyclopedism
 Enlightenment
 Epistemology: Early Modern
 Equality: Overview
 Equality: Gender Equality
 Equality: Racial Equality
 Eschatology
 Essentialism
 Etiquette
 Eurocentrism
 Europe, Idea of
 Everyday Life
 Evil
 Evolution
 Examination Systems, China
 Experiment
 Extirpation
 Fascism
 Fetishism: Overview
 Field Theories
 Foundationalism
 Free Will, Determinism, and Predestination
 Friendship
 Garden
 Gay Studies
 Gender in Art
 General Will
 Genius
 Genre
 Geography
 Geometry
 Gesture
 Ghetto
 Gift, The
 Globalization: Africa
 Globalization: Asia
 Globalization: General
 Gnosticism
 Good
 Harmony
 Health and Disease
 Hedonism in European Thought
 Hierarchy and Order
 Historiography
 History, Idea of
 Honor
 Honor, Middle Eastern Notions of
 Human Capital
 Humanism: Africa
 Humanism: Chinese Conception of
 Humanism: Europe and the Middle East
 Humanism: Secular Humanism in the United States
 Humanity: African Thought
 Humanity: Asian Thought
 Humanity: European Thought
 Humanity in the Arts
 Human Rights: Overview
 Humor
 Hygiene
 Iconography
 Identity, Multiple: Overview
 Identity, Multiple: Jewish Multiple Identity
 Imagination
 Immortality and the Afterlife
 Indigenismo
 Individualism
 International Order
 Interpretation
 Islam: Africa
 Islam: Shii
 Islam: Southeast Asia
 Islam: Sunni
 Islamic Science
 Japanese Philosophy, Japanese Thought
 Judaism: Judaism to 1800
 Judaism: Modern Judaism
 Justice: Overview
 Justice: Justice in American Thought
 Knowledge
 Landscape in the Arts
 Language, Linguistics, and Literacy
 Leadership
 Liberalism
 Liberty
 Life
 Life Cycle: Overview
 Literary History
 Literature: Overview
 Logic
 Love, Western Notions of

- Loyalties, Dual
 Machiavellism
 Magic
 Maps and the Ideas They Express
 Marriage and Fertility, European Views
 Mathematics
 Medicine: Europe and the United States
 Medicine: Islamic Medicine
 Men and Masculinity
 Mestizaje
 Metaphor
 Metaphysics: Renaissance to the Present
 Microcosm and Macrocosm
 Migration: Africa
 Migration: Migration in World History
 Migration: United States
 Millenarianism: Overview
 Millenarianism: Islamic
 Millenarianism: Latin America and Native North America
 Mind
 Modernity: Africa
 Monarchy: Overview
 Monarchy: Islamic Monarchy
 Monasticism
 Monism
 Motif: Motif in Literature
 Motif: Motif in Music
 Museums
 Mysticism: Christian Mysticism
 Mysticism: Kabbalah
 Nation
 National History
 Native Policy
 Natural History
 Natural Law
 Natural Theology
 Nature
 Neoplatonism
 Nomadism
 Nude, The
 Objectivity
 Obligation
 Oral Traditions: Overview
 Organicism
 Orientalism: Overview
 Orthodoxy
 Orthopraxy: Western Orthopraxy
 Other, The, European Views of
 Paradigm
 Paradise on Earth
 Patriotism
 Peace
 Periodization
 Periodization of the Arts
 Perspective
 Philanthropy
 Philosophies: American
 Philosophies: Feminist, Twentieth-Century
 Philosophy: Historical Overview and Recent Developments
 Philosophy: Relations to Other Intellectual Realms
 Philosophy, History of
 Philosophy, Moral: Africa
 Philosophy, Moral: Medieval and Renaissance
 Philosophy, Moral: Modern
 Philosophy and Religion in Western Thought
 Philosophy of Mind: Overview
 Philosophy of Religion
 Physics
 Pietism
 Platonism
 Pluralism
 Poetry and Poetics
 Political Protest, U.S.
 Political Science
 Polytheism
 Poverty
 Power
 Pre-Columbian Civilization
 Prehistory, Rise of
 Presentism
 Probability
 Progress, Idea of
 Propaganda
 Property
 Prophecy
 Punishment
 Puritanism
 Pythagoreanism
 Race and Racism: Asia
 Race and Racism: Europe
 Radicals/Radicalism
 Rationalism
 Reason, Practical and Theoretical
 Reform: Europe and the United States
 Reform: Islamic Reform
 Relativity
 Religion: Africa
 Religion: African Diaspora
 Religion: East and Southeast Asia
 Religion: Indigenous Peoples' View, South America
 Religion: Latin America
 Religion and Science
 Religion and the State: Europe
 Religion and the State: Latin America
 Religion and the State: Middle East
 Religion and the State: United States
 Representation: Political Representation
 Republicanism: Latin America
 Republicanism: Republic
 Resistance
 Resistance and Accommodation
 Responsibility
 Revolution
 Rhetoric: Overview
 Ritual: Public Ritual
 Ritual: Religion
 Romanticism in Literature and Politics
 Scarcity and Abundance, Latin America
 Scholasticism
 Science: Overview
 Science, History of
 Secularization and Secularism
 Sexuality: Overview
 Sexuality: Islamic Views
 Shinto
 Skepticism
 Slavery
 Social Contract

READER'S GUIDE

Society
Sovereignty
Sport
State of Nature
Stoicism
Sufism
Suicide
Superstition
Syncretism
Taste
Temperance
Terror
Text/Textuality
Toleration
Totalitarianism
Tradition
Tragedy and Comedy
Translation
Travel: Travel from Europe and the Middle East
Treaty
Tribalism, Middle East
Trope
Truth
Universalism
University: Overview
Untouchability: Taboos
Utopia
Virtue Ethics
Visual Order to Organizing Collections
Volkgeist
Volunteerism, U.S.
War and Peace in the Arts
Wealth
Westernization: Middle East
Westernization: Southeast Asia
Witchcraft
Women's History: Africa
Work
World Systems Theory, Latin America

Modern (1800–1945)

ENTRIES FOCUSED ON THE PERIOD

Alienation
Altruism
Americanization, U.S.
Analytical Philosophy
Avant-Garde: Overview
Avant-Garde: Militancy
Black Atlantic
Bureaucracy
Chicano Movement
City, The: Latin America
Civil Disobedience
Consumerism
Continental Philosophy
Democracy
Empire and Imperialism: Europe
Eugenics
Evolution
Existentialism
Expressionism
Fascism
Field Theories
Fundamentalism
Futurology

Globalization: Africa
Globalization: Asia
Globalization: General
Hegelianism
Hegemony
Historicism
Humanism: Secular Humanism in the United States
Impressionism
Internal Colonialism
Kantianism
Life
Linguistic Turn
Literary History
Logic and Philosophy of Mathematics, Modern
Maoism
Marxism: Overview
Marxism: Asia
Marxism: Latin America
Media, History of
Modernism: Overview
Modernism: Latin America
Modernity: Overview
Modernity: Africa
Modernity: East Asia
Modernization
Modernization Theory
National History
Nationalism: Overview
Nationalism: Africa
Nationalism: Cultural Nationalism
Nationalism: Middle East
Naturalism
Naturalism in Art and Literature
Naturphilosophie
Neocolonialism
Neoliberalism
Orientalism: African and Black Orientalism
Pan-Africanism
Pan-Arabism
Pan-Asianism
Pan-Islamism
Pan-Turkism
Parties, Political
Phenomenology
Philosophies: Feminist, Twentieth-Century
Phrenology
Populism: Latin America
Populism: United States
Positivism
Pragmatism
Protest, Political
Psychoanalysis
Psychology and Psychiatry
Quantum
Realism
Realism: Africa
Relativism
Relativity
Science Fiction
Secularization and Secularism
Segregation
Sexuality: Sexual Orientation
Sociability in African Thought
Social Darwinism
Socialism

- Socialisms, African
- Structuralism and Poststructuralism: Overview
- Structuralism and Poststructuralism: Anthropology
- Subjectivism
- Surrealism
- Technology
- Third World
- Time: Traditional and Utilitarian
- Totalitarianism
- Utilitarianism
- Victorianism
- Westernization: Africa
- Westernization: Middle East
- Westernization: Southeast Asia
- Work
- Zionism
- ENTRIES WITH EXAMPLES FROM THE PERIOD
1800–1945
- Abolitionism
- Absolute Music
- Aesthetics: Africa
- Aesthetics: Asia
- Aesthetics: Europe and the Americas
- Africa, Idea of
- African-American Ideas
- Agnosticism
- Alchemy: China
- Alchemy: Europe and the Middle East
- Algebras
- Ambiguity
- America
- Anarchism
- Ancestor Worship
- Animism
- Anthropology
- Anticolonialism: Africa
- Anticolonialism: Latin America
- Anticolonialism: Middle East
- Anticolonialism: Southeast Asia
- Antifeminism
- Anti-Semitism: Overview
- Anti-Semitism: Islamic Anti-Semitism
- Apartheid
- Architecture: Overview
- Aristotelianism
- Arts: Overview
- Arts: Africa
- Asceticism: Western Asceticism
- Asian-American Ideas (Cultural Migration)
- Assimilation
- Atheism
- Authenticity: Africa
- Authoritarianism: Overview
- Authoritarianism: East Asia
- Authoritarianism: Latin America
- Authority
- Autobiography
- Barbarism and Civilization
- Beauty and Ugliness
- Behaviorism
- Bilingualism and Multilingualism
- Bioethics
- Biography
- Biology
- Body, The
- Borders, Borderlands, and Frontiers, Global
- Buddhism
- Bushido
- Calculation and Computation
- Capitalism: Overview
- Capitalism: Africa
- Cartesianism
- Casuistry
- Causality
- Censorship
- Change
- Character
- Chemistry
- Childhood and Child Rearing
- Chinese Warlordism
- Christianity: Overview
- Christianity: Asia
- Cinema
- Citizenship: Overview
- Citizenship: Naturalization
- City, The: The City as a Cultural Center
- City, The: The Islamic and Byzantine City
- Civil Society: Europe and the United States
- Civil Society: Responses in Africa and the Middle East
- Class
- Classicism
- Colonialism: Africa
- Colonialism: Latin America
- Colonialism: Southeast Asia
- Common Sense
- Communication of Ideas: Africa and Its Influence
- Communication of Ideas: The Americas and Their Influence
- Communication of Ideas: Asia and Its Influence
- Communication of Ideas: Europe and Its Influence
- Communication of Ideas: Middle East and Abroad
- Communication of Ideas: Orality and Advent of Writing
- Communication of Ideas: Southeast Asia
- Communism: Europe
- Communism: Latin America
- Composition, Musical
- Computer Science
- Confucianism
- Consciousness: Overview
- Conservatism
- Constitutionalism
- Context
- Corruption
- Corruption in Developed and Developing Countries
- Cosmology: Asia
- Cosmology: Cosmology and Astronomy
- Cosmopolitanism
- Creationism
- Creativity in the Arts and Sciences
- Creolization, Caribbean
- Crisis
- Critical Theory
- Cultural Capital
- Cultural History
- Cultural Revivals
- Cycles
- Dada
- Dance
- Death
- Death and Afterlife, Islamic Understanding of

READER'S GUIDE

Deism
Democracy: Africa
Dependency
Determinism
Development
Diasporas: African Diaspora
Diasporas: Jewish Diaspora
Dictatorship in Latin America
Diffusion, Cultural
Discrimination
Diversity
Dream
Dress
Dystopia
Ecology
Economics
Education: Asia, Traditional and Modern
Education: China
Education: Europe
Education: Global Education
Education: India
Education: Islamic Education
Education: Japan
Education: North America
Emotions
Empire and Imperialism: Asia
Empire and Imperialism: Middle East
Empire and Imperialism: United States
Empiricism
Environmental Ethics
Environmental History
Epistemology: Modern
Equality: Overview
Equality: Gender Equality
Equality: Racial Equality
Eschatology
Essentialism
Ethnicity and Race: Africa
Ethnicity and Race: Anthropology
Ethnicity and Race: Islamic Views
Ethnography
Etiquette
Eurocentrism
Europe, Idea of
Everyday Life
Evil
Examination Systems, China
Experiment
Falsifiability
Family: Modernist Anthropological Theory
Family Planning
Feminism: Overview
Feminism: Africa and African Diaspora
Feminism: Chicana Feminisms
Feminism: Third World U.S. Movement
Fetishism: Overview
Fetishism: Fetishism in Literature and Cultural Studies
Formalism
Foundationalism
Friendship
Game Theory
Gay Studies
Gender: Gender in the Middle East
Gender in Art
Gender Studies: Anthropology
General Will
Generation
Genetics: Contemporary
Genetics: History of
Genius
Genocide
Genre
Geography
Geometry
Gesture
Ghetto
Gift, The
Gnosticism
Good
Happiness and Pleasure in European Thought
Harmony
Health and Disease
Hermeneutics
Historical and Dialectical Materialism
Historiography
History, Economic
History, Idea of
Honor, Middle Eastern Notions of
Human Capital
Humanism: Africa
Humanism: Chinese Conception of
Humanism: Europe and the Middle East
Humanity: African Thought
Humanity: Asian Thought
Humanity: European Thought
Humanity in the Arts
Human Rights: Overview
Humor
Hygiene
Iconography
Idealism
Ideas, History of
Identity: Identity of Persons
Identity, Multiple: Overview
Identity, Multiple: Asian-Americans
Identity, Multiple: Jewish Multiple Identity
Imagination
Immortality and the Afterlife
Indigenismo
Individualism
Intelligentsia
Intentionality
Intercession in Middle Eastern Society
International Order
Interpretation
Islam: Africa
Islam: Shii
Islam: Southeast Asia
Islamic Science
Japanese Philosophy, Japanese Thought
Jihad
Jouissance
Judaism: Modern Judaism
Justice: Overview
Justice: Justice in American Thought
Justice: Justice in East Asian Thought
Kinship
Knowledge
Landscape in the Arts
Language and Linguistics

- Language, Linguistics, and Literacy
 Language, Philosophy of: Modern
 Law
 Law, Islamic
 Leadership
 Learning and Memory, Contemporary Views
 Liberalism
 Liberty
 Life Cycle: Adolescence
 Life Cycle: Elders/Old Age
 Literary Criticism
 Literature: Overview
 Literature: African Literature
 Love, Western Notions of
 Loyalties, Dual
 Lysenkoism
 Magic
 Maps and the Ideas They Express
 Marriage and Fertility, European Views
 Masks
 Mathematics
 Matriarchy
 Medicine: Europe and the United States
 Medicine: India
 Medicine: Islamic Medicine
 Memory
 Men and Masculinity
 Mestizaje
 Metaphor
 Metaphysics: Renaissance to the Present
 Microcosm and Macrocosm
 Migration: Africa
 Migration: Migration in World History
 Migration: United States
 Millenarianism: Overview
 Millenarianism: Latin America and Native North America
 Mind
 Minority
 Monarchy: Overview
 Monarchy: Islamic Monarchy
 Monasticism
 Monism
 Motherhood and Maternity
 Motif: Motif in Literature
 Motif: Motif in Music
 Multiculturalism, Africa
 Museums
 Music, Anthropology of
 Musical Performance and Audiences
 Musicology
 Mysticism: Kabbalah
 Mysticism: Mysticism in African Thought
 Myth
 Narrative
 Nation
 Native Policy
 Natural History
 Natural Theology
 Nature
 Negritude
 New Criticism
 Nihilism
 Nonviolence
 Nude, The
 Objectivity
 Obligation
 Occidentalism
 Oral Traditions: Overview
 Organicism
 Orientalism: Overview
 Orthodoxy
 Orthopraxy: Western Orthopraxy
 Other, The, European Views of
 Pacifism
 Paradigm
 Patriotism
 Peace
 Peasants and Peasantry
 Periodization
 Periodization of the Arts
 Person, Idea of the
 Philanthropy
 Philosophies: African
 Philosophies: American
 Philosophy: Historical Overview and Recent Developments
 Philosophy: Relations to Other Intellectual Realms
 Philosophy, History of
 Philosophy, Moral: Africa
 Philosophy, Moral: Modern
 Philosophy and Religion in Western Thought
 Philosophy of Mind: Overview
 Philosophy of Religion
 Physics
 Platonism
 Pluralism
 Poetry and Poetics
 Political Protest, U.S.
 Political Science
 Political, The
 Polytheism
 Population
 Postcolonial Studies
 Poverty
 Power
 Practices
 Prehistory, Rise of
 Prejudice
 Presentism
 Privacy
 Probability
 Progress, Idea of
 Propaganda
 Property
 Pseudoscience
 Punishment
 Puritanism
 Queer Theory
 Race and Racism: Overview
 Race and Racism: Asia
 Race and Racism: Europe
 Race and Racism: United States
 Radicals/Radicalism
 Rational Choice
 Rationalism
 Reading
 Reason, Practical and Theoretical
 Reflexivity
 Reform: Europe and the United States

READER'S GUIDE

Reform: Islamic Reform
Regions and Regionalism, Eastern Europe
Religion: Overview
Religion: Africa
Religion: African Diaspora
Religion: East and Southeast Asia
Religion: Indigenous Peoples' View, South America
Religion: Latin America
Religion: Middle East Religion and the State: Africa
Religion and Science
Religion and the State: Europe
Religion and the State: Latin America
Religion and the State: Middle East
Religion and the State: United States
Renaissance
Republicanism: Latin America
Republicanism: Republic
Resistance
Resistance and Accommodation
Responsibility
Revolution
Rhetoric: Overview
Ritual: Public Ritual
Ritual: Religion
Romanticism in Literature and Politics
Sacred and Profane
Sacred Places
Sage Philosophy
Scarcity and Abundance, Latin America
Science: Overview
Science, History of
Sexuality: Overview
Sexuality: Islamic Views
Shinto
Skepticism
Slavery
Social Capital
Social History, U.S.
Society
Sophists, The
Sovereignty
Sport
State of Nature
State, The: Overview
Sufism
Suicide
Superstition
Symbolism
Syncretism
Temperance
Terror
Text/Textuality
Toleration
Totems
Trade
Tradition
Translation
Travel: Travel from Europe and the Middle East
Treaty
Trope
Truth
Universalism
University: Overview
Untouchability: Overview
Untouchability: Menstrual Taboos

Untouchability: Taboos
Utopia
Virtual Reality
Visual Culture
Visual Order to Organizing Collections
Volksggeist
Volunteerism, U.S.
War
War and Peace in the Arts
Wealth
Wildlife
Wisdom, Human
Witchcraft
Witchcraft, African Studies of
Women's History: Africa
Women's History: Asia
World Systems Theory, Latin America

Contemporary

ENTRIES FOCUSED ON THE PERIOD

African-American Ideas
Americanization, U.S.
Anticolonialism: Africa
Anticolonialism: Latin America
Anticolonialism: Middle East
Anticolonialism: Southeast Asia
Anti-Semitism: Islamic Anti-Semitism
Apartheid
Bioethics
Black Atlantic
Black Consciousness
Buddhism
Bureaucracy
Capitalism: Africa
Chicano Movement
Citizenship: Naturalization
Civil Disobedience
Communitarianism in African Thought
Consumerism
Continental Philosophy
Creationism
Critical Race Theory
Critical Theory
Cultural Studies
Democracy
Dress
Dystopia
Empire and Imperialism: Europe
Empiricism
Eugenics
Field Theories
Fundamentalism
Futurology
Gay Studies
Gender: Overview
Genetics: Contemporary
Globalization: Africa
Globalization: Asia
Globalization: General
Historicism
Humanity: African Thought
Human Rights: Overview
Human Rights: Women's Rights
Internal Colonialism
International Order

Jihad
 Liberation Theology
 Liberty
 Life
 Linguistic Turn
 Literary History
 Logic and Philosophy of Mathematics, Modern
 Maoism
 Marxism: Overview
 Marxism: Asia
 Marxism: Latin America
 Media, History of
 Modernization
 Modernization Theory
 Nationalism: Overview
 Nationalism: Africa
 Nationalism: Cultural Nationalism
 Nationalism: Middle East
 Neocolonialism
 Neoliberalism
 Nuclear Age
 Orientalism: African and Black Orientalism
 Pan-Africanism
 Pan-Arabism
 Pan-Asianism
 Pan-Islamism
 Pan-Turkism
 Paradigm
 Parties, Political
 Personhood in African Thought
 Phenomenology
 Philosophies: Feminist, Twentieth-Century
 Poetry and Poetics
 Populism: Latin America
 Populism: United States
 Positivism
 Postcolonial Studies
 Postcolonial Theory and Literature
 Postmodernism
 Pragmatism
 Presentism
 Privatization
 Protest, Political
 Psychoanalysis
 Psychology and Psychiatry
 Quantum
 Queer Theory
 Realism: Africa
 Relativism
 Relativity
 Science Fiction
 Segregation
 Sexual Harassment
 Sexuality: Sexual Orientation
 Sociability in African Thought
 Social Darwinism
 Socialisms, African
 Structuralism and Poststructuralism: Overview
 Structuralism and Poststructuralism: Anthropology
 Subjectivism
 Technology
 Terrorism, Middle East
 Text/Textuality
 Theater and Performance
 Third Cinema

Third World
 Totalitarianism
 Virtual Reality
 Virtue Ethics
 War
 Westernization: Africa
 Westernization: Southeast Asia
 Witchcraft
 Womanism
 Women and Femininity in U.S. Popular Culture
 Women's Studies
 Zionism

ENTRIES WITH EXAMPLES FROM THE PERIOD
 SINCE 1945 (especially since the 1970s)

Absolute Music
 Aesthetics: Africa
 Aesthetics: Asia
 Aesthetics: Europe and the Americas
 Africa, Idea of
 Afrocentricity
 Afropessimism
 Agnosticism
 Algebras
 Alienation
 Altruism
 Ambiguity
 America
 Analytical Philosophy
 Anarchism
 Animism
 Anthropology
 Antifeminism
 Anti-Semitism: Overview
 Architecture: Overview
 Architecture: Africa
 Arts: Overview
 Arts: Africa
 Asceticism: Western Asceticism
 Asian-American Ideas (Cultural Migration)
 Assimilation
 Atheism
 Authenticity: Africa
 Authoritarianism: Overview
 Authoritarianism: East Asia
 Authoritarianism: Latin America
 Authority
 Autobiography
 Autonomy
 Avant-Garde: Overview
 Aztlán
 Barbarism and Civilization
 Beauty and Ugliness
 Behaviorism
 Bilingualism and Multilingualism
 Biography
 Biology
 Body, The
 Bushido
 Calculation and Computation
 Cannibalism
 Capitalism: Overview
 Cartesianism
 Casuistry
 Causality
 Causation

READER'S GUIDE

Censorship
 Change
 Character
 Childhood and Child Rearing
 Christianity: Overview
 Christianity: Asia
 Cinema
 Citizenship: Overview
 Citizenship: Cultural Citizenship
 City, The: The City as a Cultural Center
 City, The: The City as Political Center
 City, The: The Islamic and Byzantine City
 Civil Society: Europe and the United States
 Civil Society: Responses in Africa and the Middle East
 Classicism
 Colonialism: Africa
 Colonialism: Southeast Asia
 Communication of Ideas: Africa and Its Influence
 Communication of Ideas: Asia and Its Influence
 Communication of Ideas: Southeast Asia
 Communism: Europe
 Communism: Latin America
 Composition, Musical
 Computer Science
 Confucianism
 Consciousness: Overview
 Conservatism
 Consilience
 Context
 Corruption
 Corruption in Developed and Developing Countries
 Cosmopolitanism
 Creolization, Caribbean
 Crisis
 Cultural Capital
 Cultural History
 Cultural Revivals
 Cycles
 Dada
 Dance
 Death
 Death and Afterlife, Islamic Understanding of
 Deism
 Democracy: Africa
 Demography
 Demonology
 Dependency
 Determinism
 Development
 Diasporas: African Diaspora
 Diasporas: Jewish Diaspora
 Dictatorship in Latin America
 Diffusion, Cultural
 Discrimination
 Diversity
 Dream
 Dualism
 Ecology
 Economics
 Ecumenism
 Education: Europe
 Education: Global Education
 Education: Islamic Education
 Education: North America
 Emotions
 Empire and Imperialism: Middle East
 Empire and Imperialism: United States
 Enlightenment
 Environment
 Environmental Ethics
 Environmental History
 Epistemology: Modern
 Equality: Overview
 Equality: Gender Equality
 Equality: Racial Equality
 Essentialism
 Ethnicity and Race: Africa
 Ethnicity and Race: Anthropology
 Ethnicity and Race: Islamic Views
 Ethnocentrism
 Ethnography
 Ethnohistory, U.S.
 Etiquette
 Eurocentrism
 Europe, Idea of
 Evil
 Existentialism
 Experiment
 Falsifiability
 Family: Modernist Anthropological Theory
 Family: Family in Anthropology since 1980
 Family Planning
 Fascism
 Fatalism
 Feminism: Overview
 Feminism: Africa and African Diaspora
 Feminism: Chicana Feminisms
 Feminism: Islamic Feminism
 Feminism: Third World U.S. Movement
 Fetishism: Overview
 Fetishism: Fetishism in Literature and Cultural Studies
 Formalism
 Foundationalism
 Free Will, Determinism, and Predestination
 Friendship
 Game Theory
 Gender: Gender in the Middle East
 Gender in Art
 Gender Studies: Anthropology
 Generation
 Genetics: History of
 Genius
 Genocide
 Geography
 Ghetto
 Gift, The
 Gnosticism
 Good
 Happiness and Pleasure in European Thought
 Harmony
 Hate
 Health and Disease
 Hegelianism
 Hermeneutics
 Hierarchy and Order
 Hinduism
 Historical and Dialectical Materialism
 Historiography
 History, Economic
 History, Idea of

- Honor, Middle Eastern Notions of
 Human Capital
 Humanism: Africa
 Humanism: Europe and the Middle East
 Humanism: Secular Humanism in the United States
 Humanity: European Thought
 Humanity in the Arts
 Humor
 Ideas, History of
 Identity: Identity of Persons
 Identity: Personal and Social Identity
 Identity, Multiple: Overview
 Identity, Multiple: Asian-Americans
 Identity, Multiple: Jewish Multiple Identity
 Imagination
 Immortality and the Afterlife
 Impressionism
 Intelligentsia
 Intentionality
 Intercession in Middle Eastern Society
 Interdisciplinarity
 Islam: Shii
 Islam: Southeast Asia
 Jainism
 Japanese Philosophy, Japanese Thought
 Jouissance
 Judaism: Modern Judaism
 Justice: Overview
 Justice: Justice in American Thought
 Kantianism
 Kinship
 Knowledge
 Landscape in the Arts
 Language and Linguistics
 Language, Philosophy of: Modern
 Law
 Law, Islamic
 Leadership
 Learning and Memory, Contemporary Views
 Liberalism
 Life Cycle: Adolescence
 Life Cycle: Elders/Old Age
 Literary Criticism
 Literature: African Literature
 Lysenkoism
 Machiavellism
 Machismo
 Magic
 Maps and the Ideas They Express
 Marriage and Fertility, European Views
 Masks
 Mathematics
 Matriarchy
 Medicine: China
 Medicine: Europe and the United States
 Medicine: Islamic Medicine
 Meditation: Eastern Meditation
 Meme
 Memory
 Men and Masculinity
 Mestizaje
 Metaphor
 Metaphysics: Renaissance to the Present
 Migration: Africa
 Migration: Migration in World History
 Migration: United States
 Millenarianism: Overview
 Millenarianism: Islamic
 Millenarianism: Latin America and Native North America
 Mind
 Minority
 Modernism: Latin America
 Modernity: Overview
 Modernity: Africa
 Modernity: East Asia
 Monarchy: Overview
 Monasticism
 Monism
 Moral Sense
 Motherhood and Maternity
 Motif: Motif in Literature
 Motif: Motif in Music
 Multiculturalism, Africa
 Museums
 Music, Anthropology of
 Musical Performance and Audiences
 Musicology
 Mysticism: Mysticism in African Thought
 Narrative
 Nation
 Native Policy
 Natural Law
 Natural Theology
 Nature
 Negritude
 New Criticism
 Nihilism
 Nomadism
 Nonviolence
 Objectivity
 Obligation
 Occidentalism
 Oral Traditions: Overview
 Organicism
 Orientalism: Overview
 Orthodoxy
 Pacifism
 Patriotism
 Peace
 Peasants and Peasantry
 Periodization of the Arts
 Person, Idea of the
 Perspective
 Philanthropy
 Philosophies: American
 Philosophy, History of
 Philosophy, Moral: Africa
 Philosophy, Moral: Modern
 Philosophy and Religion in Western Thought
 Philosophy of Mind: Overview
 Philosophy of Religion
 Pluralism
 Political Protest, U.S.
 Political Science
 Population
 Poverty
 Power
 Practices
 Prejudice

READER'S GUIDE

Privacy
Probability
Progress, Idea of
Propaganda
Property
Pseudoscience
Public Sphere
Punishment
Race and Racism: Overview
Race and Racism: Asia
Race and Racism: Europe
Race and Racism: United States
Radicals/Radicalism
Rational Choice
Reading
Reason, Practical and Theoretical
Reflexivity
Reform: Europe and the United States
Reform: Islamic Reform
Regions and Regionalism, Eastern Europe
Religion: Africa
Religion: African Diaspora
Religion: Indigenous Peoples' View, South America
Religion: Latin America
Religion: Middle East
Religion and Science
Religion and the State: Africa
Religion and the State: Latin America
Religion and the State: Middle East
Religion and the State: United States
Renaissance
Representation: Mental Representation
Representation: Political Representation
Resistance
Resistance and Accommodation
Responsibility
Ritual: Public Ritual
Ritual: Religion
Sacred Places
Sacred Texts: Koran
Sage Philosophy
Science: Overview
Science: East Asia
Science, History of
Scientific Revolution
Secularization and Secularism
Sexuality: Overview
Sexuality: Islamic Views
Shinto
Skepticism
Slavery
Social Capital
Social Contract
Social History, U.S.
Society
Sophists, The
Sovereignty
Sport
State, The: Overview
State, The: The Postcolonial State
State of Nature
Superstition
Surrealism
Symbolism
Syncretism

Taste
Terror
Third World Literature
Toleration
Totems
Trade
Tradition
Translation
Treaty
Tribalism, Middle East
Trope
Truth
Universalism
University: Overview
University: Postcolonial
Untouchability: Overview
Untouchability: Menstrual Taboos
Untouchability: Taboos
Utilitarianism
Utopia
Visual Culture
Visual Order to Organizing Collections
War and Peace in the Arts
Wealth
Wildlife
Wisdom, Human
Witchcraft, African Studies of
Women's History: Africa
Women's History: Asia
Work
World Systems Theory, Latin America

LIBERAL ARTS DISCIPLINES AND PROFESSIONS

This section is in accord with the university divisions of the Liberal Arts into Fine Arts, Humanities, Social Sciences, and Sciences and the graduate programs of the professions of Law, Medicine, and Engineering. The sample of Interdisciplinary Programs are listed under their most common university grouping. For example, Fine Arts includes Performance Arts; Social Sciences includes Women's Studies and Gender Studies, as well as Ethnic Studies; Sciences includes Ecology and Geology, as well as Computer Sciences; Humanities includes programs of Communication, Language, and Linguistics. Meanwhile, the growth of interdisciplinary programs reflects the increasing overlap between studies listed under the labels of Fine Arts, Humanities, Social Sciences, and Sciences. A discipline or interdisciplinary program only appears once, but an entry may appear under the several disciplines and interdisciplinary programs that influenced the scholarship of the article. Titles that appear in bold indicate entries that are especially suited as an introduction to the discipline.

Under the category Multidisciplinary Practices, there are entries on the many methods, techniques, theories, and approaches that have spread across the disciplines. The Multidisciplinary Practices help explain the contemporary trend of interdisciplinarity for which the history of ideas has long been known. At the end of this Reader's Guide is a listing of a number of entries that overlap three of the four divisions and a listing of entries that overlap all four divisions.

Fine Arts

VISUAL STUDIES

Absolute Music
 Aesthetics: Africa
 Aesthetics: Asia
 Aesthetics: Europe and the Americas
 Ambiguity
 Anthropology
 Architecture: Overview
 Architecture: Africa
 Architecture: Asia
 Arts: Overview
 Arts: Africa
 Asceticism: Hindu and Buddhist Asceticism
 Asceticism: Western Asceticism
 Avant-Garde: Overview
 Avant-Garde: Militancy
 Aztlán
 Beauty and Ugliness
 Body, The
 Buddhism
 Change
 Chinese Thought
 Cinema
 City, The: Latin America
 City, The: The City as a Cultural Center
 City, The: The Islamic and Byzantine City
 Classicism
 Classification of Arts and Sciences, Early Modern
 Communication of Ideas: Asia and Its Influence
 Composition, Musical
 Consumerism
 Context
 Cosmopolitanism
 Creativity in the Arts and Sciences
 Cultural History
 Dada
 Death
 Dream
 Dress
 Dystopia
 Environmental Ethics
 Environmental History
 Everyday Life
 Expressionism
 Extirpation
 Fascism
 Fetishism: Overview
 Garden
 Gay Studies
 Gender in Art
 Genre
 Geography
 Geometry
 Gesture
 Ghetto
 Globalization: Asia
 Heaven and Hell (Asian Focus)
 Hinduism
 History, Idea of
 Humanity: European Thought
 Humanity in the Arts
 Humor
 Iconography
 Ideas, History of

Images, Icons, and Idols
 Imagination
 Impressionism
 Islamic Science
 Kantianism
 Knowledge
 Landscape in the Arts
 Life Cycle: Overview
 Literary History
 Literature: Overview
 Maps and the Ideas They Express
 Masks
 Matriarchy
Media, History of
 Medicine: Europe and the United States
 Mestizaje
 Modernism: Overview
 Modernism: Latin America
 Modernity: Africa
 Modernity: East Asia
 Monarchy: Overview
 Motherhood and Maternity
 Museums
 Musical Performance and Audiences
 Musicology
 Mysticism: Chinese Mysticism
 Mysticism: Christian Mysticism
 Naturalism in Art and Literature
 Negritude
 Nude, The
 Occidentalism
 Organicism
 Pan-Africanism
 Paradise on Earth
Periodization of the Arts
 Perspective
 Philosophy: Historical Overview and Recent Developments
 Political Protest, U.S.
 Postmodernism
 Pre-Columbian Civilization
 Protest, Political
 Psychoanalysis
 Pythagoreanism
 Realism
 Realism: Africa
 Religion: Africa
 Renaissance
 Representation: Mental Representation
 Ritual: Public Ritual
 Sacred Places
 Sacred Texts: Asia
 Science: East Asia
 Science, History of
 Science Fiction
 Social History, U.S.
 Sport
 Surrealism
 Symbolism
 Syncretism
 Taste
 Text/Textuality
 Textiles and Fiber Arts as Catalysts for Ideas
 Third Cinema
 Victorianism

READER'S GUIDE

Virtual Reality
 Visual Culture
 Visual Order to Organizing Collections
 War and Peace in the Arts
 Westernization: Southeast Asia
 Women and Femininity in U.S. Popular Culture
 Yin and Yang

MUSIC
 Absolute Music
 Aesthetics: Africa
 Aesthetics: Asia
 Authenticity: Africa
 Avant-Garde: Overview
 Cinema
 Classicism
 Classification of Arts and Sciences, Early Modern
 Communication of Ideas: Africa and Its Influence
 Composition, Musical
 Context
 Cosmopolitanism
 Dada
 Dance
 Empire and Imperialism: United States
 Formalism
 Generation
 Genre
 Harmony
 Hinduism
 Humanism: Africa
 Humanism: Chinese Conception of
 Humor
 Iconography
 Identity, Multiple: Jewish Multiple Identity
 Judaism: Judaism to 1800
 Knowledge
 Learning and Memory, Contemporary Views
 Love, Western Notions of
 Modernism: Overview
 Motif: Motif in Music
Music, Anthropology of
Musical Performance and Audiences
Musicology
 Mysticism: Chinese Mysticism
 Orientalism: Overview
 Pan-Asianism
 Pietism
 Political Protest, U.S.
 Postmodernism
 Protest, Political
 Pythagoreanism
 Realism: Africa
 Religion: Africa
 Religion: African Diaspora
 Resistance
 Resistance and Accommodation
 Society
 Sophists, The
 Symbolism
 Taste
 Text/Textuality
 Third Cinema
 Virtual Reality
 Visual Order to Organizing Collections
 Westernization: Africa

PERFORMANCE ARTS (includes drama, dance, oratory, ritual, and ceremony)
 Absolute Music
 Aesthetics: Africa
 Aesthetics: Asia
 Alienation
 Americanization, U.S.
 Ancestor Worship
 Anthropology
 Arts: Overview
 Asceticism: Hindu and Buddhist Asceticism
 Asceticism: Western Asceticism
 Astronomy, Pre-Columbian and Latin American
 Authenticity: Africa
 Autobiography
 Avant-Garde: Overview
 Body, The
 Cannibalism
 Censorship
 Cinema
 Civil Disobedience
 Civil Society: Europe and the United States
 Communication of Ideas: Africa and Its Influence
 Communication of Ideas: Asia and Its Influence
 Communication of Ideas: Orality and Advent of Writing
 Communication of Ideas: Southeast Asia
 Composition, Musical
 Confucianism
 Context
 Cosmopolitanism
 Creolization, Caribbean
 Cultural Capital
 Cynicism
 Dada
Dance
 Determinism
 Dialogue and Dialectics: Socratic
 Dialogue and Dialectics: Talmudic
 Dictatorship in Latin America
 Dream
 Dress
 Emotions
 Empire and Imperialism: Europe
 Environment
 Equality: Overview
 Ethnicity and Race: Anthropology
 Etiquette
 Everyday Life
 Expressionism
 Extirpation
 Fascism
 Feminism: Chicana Feminisms
 Fetishism: Overview
 Fetishism: Fetishism in Literature and Cultural Studies
 Game Theory
 Gay Studies
 Gender: Overview
 Gender in Art
 Generation
 Genre
 Gesture
 Harmony
 Hinduism
 History, Economic

- History, Idea of
 Honor
 Humanism: Africa
 Humanism: Chinese Conception of
 Humanity: African Thought
 Humor
 Ideas, History of
 Identity, Multiple: Jewish Multiple Identity
 Images, Icons, and Idols
 Intelligentsia
 Islam: Shii
 Islam: Sunni
 Jouissance
 Judaism: Judaism to 1800
 Knowledge
 Language and Linguistics
 Language, Philosophy of: Modern
 Law, Islamic
 Leadership
 Learning and Memory, Contemporary Views
 Life Cycle: Overview
 Literary Criticism
 Literary History
 Literature: African Literature
 Love, Western Notions of
 Magic
 Manichaeism
 Masks
 Media, History of
 Medicine: China
 Medicine: Islamic Medicine
 Meditation: Eastern Meditation
 Men and Masculinity
 Metaphor
 Millenarianism: Islamic
 Millenarianism: Latin America and Native North America
 Modernism: Overview
 Modernity: Overview
 Modernity: Africa
 Motif: Motif in Music
 Music, Anthropology of
 Musical Performance and Audiences
 Musicology
 Mysticism: Chinese Mysticism
 Mysticism: Islamic Mysticism in Asia
 Mysticism: Kabbalah
 Myth
 Narrative
 Nation
 Nationalism: Middle East
 New Criticism
 Nomadism
 Nuclear Age
 Oral Traditions: Overview
 Orientalism: Overview
 Orthodoxy
 Orthopraxy: Asia
 Pan-Turkism
 Periodization of the Arts
 Person, Idea of the
 Philosophies: African
 Philosophies: American
 Philosophies: Feminist, Twentieth-Century
 Philosophies: Islamic
 Philosophy: Historical Overview and Recent Developments
 Philosophy, Moral: Ancient
 Philosophy of Mind: Ancient and Medieval
 Pietism
 Poetry and Poetics
 Political Protest, U.S.
 Populism: United States
 Postmodernism
 Practices
 Pre-Columbian Civilization
 Propaganda
 Protest, Political
 Psychoanalysis
 Punishment
 Queer Theory
 Reading
 Realism: Africa
 Reflexivity
 Reform: Europe and the United States
 Relativism
 Religion: Africa
 Religion: African Diaspora
 Religion: East and Southeast Asia
 Religion: Indigenous Peoples' View, South America
 Religion: Latin America
 Religion: Middle East
 Religion and the State: United States
 Republicanism: Republic
 Resistance
 Resistance and Accommodation
 Responsibility
Rhetoric: Overview
Rhetoric: Ancient and Medieval
 Ritual: Public Ritual
 Ritual: Religion
 Romanticism in Literature and Politics
 Sacred Places
 Sacred Texts: Asia
 Sexuality: Overview
 Shinto
 Slavery
 Society
 Sophists, The
 Sport
 Stoicism
 Subjectivism
 Superstition
 Surrealism
 Symbolism
 Syncretism
 Taste
 Temperance
 Text/Textuality
Theater and Performance
 Third Cinema
 Third World Literature
 Time: China
 Time: India
 Toleration
 Totalitarianism
 Totems
 Tragedy and Comedy
 Translation
 Trope

READER'S GUIDE

Untouchability: Menstrual Taboos
Utilitarianism
Victorianism
Virtual Reality
Volunteerism, U.S.
Westernization: Middle East
Westernization: Southeast Asia
Wisdom, Human
Witchcraft
Witchcraft, African Studies of
Yin and Yang
Yoga

Humanities

COMMUNICATION, LANGUAGE, AND LINGUISTICS

Aesthetics: Africa
Aesthetics: Asia
Africa, Idea of
Afrocentricity
Agnosticism
Algebras
Americanization, U.S.
Analytical Philosophy
Anthropology
Anticolonialism: Africa
Asceticism: Hindu and Buddhist Asceticism
Asceticism: Western Asceticism
Astronomy, Pre-Columbian and Latin American
Authenticity: Africa
Avant-Garde: Overview
Avant-Garde: Militancy
Aztlán
Barbarism and Civilization
Beauty and Ugliness
Behaviorism
Bilingualism and Multilingualism
Body, The
Borders, Borderlands, and Frontiers, Global
Buddhism
Calculation and Computation
Calendar
Cannibalism
Casuistry
Censorship
Chinese Thought
Cinema
Civil Disobedience
Classification of Arts and Sciences, Early Modern
Colonialism: Southeast Asia
Communication of Ideas: Africa and Its Influence
Communication of Ideas: The Americas and Their Influence
Communication of Ideas: Asia and Its Influence
Communication of Ideas: Europe and Its Influence
Communication of Ideas: Middle East and Abroad
Communication of Ideas: Orality and Advent of Writing
Communication of Ideas: Southeast Asia
Computer Science
Consumerism
Context
Continental Philosophy
Cosmopolitanism
Creolization, Caribbean
Critical Theory
Cultural Capital

Cultural History
Cultural Revivals
Cultural Studies
Cynicism
Dance
Democracy
Determinism
Dialogue and Dialectics: Socratic
Diasporas: Jewish Diaspora
Dictatorship in Latin America
Diffusion, Cultural
Discrimination
Diversity
Dream
Dress
Ecumenism
Education: Asia, Traditional and Modern
Empire and Imperialism: Asia
Empire and Imperialism: Europe
Empire and Imperialism: United States
Empiricism
Encyclopedism
Epistemology: Ancient
Epistemology: Early Modern
Epistemology: Modern
Ethnicity and Race: Africa
Ethnicity and Race: Anthropology
Ethnicity and Race: Islamic Views
Etiquette
Eurocentrism
Everyday Life
Examination Systems, China
Extirpation
Fallacy, Logical
Feminism: Overview
Feminism: Chicana Feminisms
Fetishism: Overview
Fetishism: Fetishism in Literature and Cultural Studies
Feudalism, European
Formalism
Gender: Gender in the Middle East
Gender in Art
Geometry
Gesture
Globalization: Asia
Globalization: General
Greek Science
Harmony
Hegemony
Hermeneutics
Hinduism
History, Economic
History, Idea of
Humanism: Africa
Humanism: Chinese Conception of
Humanism: Europe and the Middle East
Humanism: Renaissance
Humanity: African Thought
Human Rights: Overview
Idealism
Ideas, History of
Identity: Identity of Persons
Identity, Multiple: Overview
Identity, Multiple: Jewish Multiple Identity
Indigenismo

- Intelligentsia
 Interdisciplinarity
 Interpretation
 Islam: Africa
 Islam: Southeast Asia
 Islam: Sunni
 Islamic Science
 Japanese Philosophy, Japanese Thought
 Jihad
 Jouissance
 Judaism: Judaism to 1800
 Kantianism
 Kinship
 Knowledge
Language and Linguistics
Language, Linguistics, and Literacy
 Language, Philosophy of: Ancient and Medieval
 Language, Philosophy of: Modern
 Law
 Liberty
 Life Cycle: Overview
 Linguistic Turn
 Literary Criticism
 Literary History
 Literature: Overview
 Literature: African Literature
 Machismo
 Magic
 Maps and the Ideas They Express
 Masks
 Materialism in Eighteenth-Century European Thought
 Mathematics
 Matriarchy
 Media, History of
 Medicine: Europe and the United States
 Medicine: India
 Meme
 Mestizaje
 Metaphor
 Metaphysics: Renaissance to the Present
 Migration: Africa
 Migration: United States
 Millenarianism: Latin America and Native North America
 Mind
 Minority
Modernism: Overview
 Modernity: Overview
 Modernity: Africa
 Monarchy: Overview
 Motherhood and Maternity
 Motif: Motif in Literature
 Motif: Motif in Music
 Multiculturalism, Africa
 Music, Anthropology of
 Musical Performance and Audiences
 Musicology
 Mysticism: Chinese Mysticism
 Mysticism: Christian Mysticism
 Mysticism: Islamic Mysticism in Asia
 Mysticism: Kabbalah
 Mysticism: Mysticism in African Thought
 Narrative
 Nation
 Nationalism: Overview
 Nationalism: Middle East
 Native Policy
 Natural History
 New Criticism
 Nomadism
 Objectivity
 Occidentalism
Oral Traditions: Overview
 Organicism
 Orientalism: Overview
 Orthodoxy
 Pacifism
 Pan-Africanism
 Pan-Arabism
 Pan-Asianism
 Pan-Turkism
 Paradigm
 Patriotism
 Periodization of the Arts
 Person, Idea of the
 Personhood in African Thought
 Philosophies: African
 Philosophies: American
 Philosophies: Feminist, Twentieth-Century
 Philosophies: Islamic
 Philosophy: Historical Overview and Recent Developments
 Philosophy of Mind: Overview
 Philosophy of Mind: Ancient and Medieval
 Philosophy of Religion
 Poetry and Poetics
 Political Protest, U.S.
 Positivism
 Practices
 Pre-Columbian Civilization
 Prejudice
 Presentism
 Privacy
 Probability
 Progress, Idea of
 Propaganda
 Protest, Political
 Pseudoscience
 Psychology and Psychiatry
 Public Sphere
 Punishment
 Pythagoreanism
 Quantum
 Queer Theory
 Race and Racism: Asia
 Race and Racism: Europe
 Race and Racism: United States
 Reading
 Realism
 Realism: Africa
 Reflexivity
 Relativism
 Relativity
 Religion: Africa
 Religion: African Diaspora
 Religion: East and Southeast Asia
 Religion: Indigenous Peoples' View, South America
 Religion: Latin America
 Religion: Middle East
 Religion and the State: Latin America

READER'S GUIDE

Religion and the State: Middle East
Representation: Mental Representation
Republicanism: Republic
Resistance
Resistance and Accommodation
Responsibility
Rhetoric: Overview
Ritual: Public Ritual
Ritual: Religion
Romanticism in Literature and Politics
Sacred and Profane
Sacred Places
Sacred Texts: Asia
Sacred Texts: Koran
Sage Philosophy
Science: East Asia
Science, History of
Sexual Harassment
Sexuality: Overview
Sexuality: Sexual Orientation
Shinto
Slavery
Social History, U.S.
Society
Sophists, The
Sport
State, The: Overview
Stoicism
Structuralism and Poststructuralism: Overview
Structuralism and Poststructuralism: Anthropology
Subjectivism
Superstition
Surrealism
Symbolism
Syncretism
Technology
Temperance
Text/Textuality
Textiles and Fiber Arts as Catalysts for Ideas
Theater and Performance
Third Cinema
Third World Literature
Time: India
Time: Traditional and Utilitarian
Toleration
Totalitarianism
Totems
Trade
Tragedy and Comedy
Translation
Travel: Travel from Europe and the Middle East
Treaty
Trope
Truth
Untouchability: Taboos
Utilitarianism
Victorianism
Virtual Reality
Visual Culture
Visual Order to Organizing Collections
Westernization: Middle East
Westernization: Southeast Asia
Wisdom, Human
Witchcraft
Witchcraft, African Studies of

Womanism
Women and Femininity in U.S. Popular Culture
Yin and Yang

LITERATURE

Absolute Music
Aesthetics: Africa
Aesthetics: Asia
Aesthetics: Europe and the Americas
Africa, Idea of
African-American Ideas
Alienation
America
Anticolonialism: Africa
Anti-Semitism: Overview
Architecture: Asia
Asceticism: Hindu and Buddhist Asceticism
Authenticity: Africa
Autobiography
Avant-Garde: Overview
Aztlán
Biography
Buddhism
Bushido
Casuistry
Chinese Thought
Cinema
Classicism
Classification of Arts and Sciences, Early Modern
Colonialism: Africa
Communication of Ideas: Africa and Its Influence
Communication of Ideas: Asia and Its Influence
Communication of Ideas: Europe and Its Influence
Communication of Ideas: Middle East and Abroad
Communication of Ideas: Orality and Advent of Writing
Communication of Ideas: Southeast Asia
Consciousness: Overview
Continental Philosophy
Corruption
Cosmopolitanism
Creativity in the Arts and Sciences
Critical Race Theory
Critical Theory
Cultural Studies
Dada
Dialogue and Dialectics: Socratic
Dream
Dystopia
Education: Islamic Education
Empire and Imperialism: Europe
Enlightenment
Etiquette
Europe, Idea of
Evil
Examination Systems, China
Existentialism
Expressionism
Extirpation
Fascism
Feminism: Overview
Feminism: Chicana Feminisms
Feminism: Third World U.S. Movement
Fetishism: Fetishism in Literature and Cultural Studies
Formalism
Friendship
Futurology

- Game Theory
 Gay Studies
 Gender: Overview
 Gender: Gender in the Middle East
 Generation
 Genius
Genre
 Globalization: Asia
 Gnosticism
 Heaven and Hell
 Heaven and Hell (Asian Focus)
 Hedonism in European Thought
 Hermeneutics
 Hinduism
 Historiography
 History, Economic
 History, Idea of
 Honor, Middle Eastern Notions of
 Humanism: Africa
 Humanism: Chinese Conception of
 Humanism: Renaissance
 Humanity: African Thought
 Humor
 Ideas, History of
 Identity, Multiple: Jewish Multiple Identity
 Imagination
 Indigenismo
 Individualism
 Intelligentsia
 Interdisciplinarity
 Interpretation
 Islam: Africa
 Islam: Shii
 Islam: Sunni
 Islamic Science
 Japanese Philosophy, Japanese Thought
 Jouissance
 Judaism: Judaism to 1800
 Judaism: Modern Judaism
 Language and Linguistics
 Language, Philosophy of: Ancient and Medieval
 Language, Philosophy of: Modern
 Law, Islamic
 Leadership
 Life Cycle: Overview
 Linguistic Turn
 Literary Criticism
Literary History
 Literature: Overview
 Literature: African Literature
 Love, Western Notions of
 Magic
 Manichaeism
 Marxism: Overview
 Marxism: Latin America
 Masks
 Matriarchy
 Medicine: China
 Medicine: Islamic Medicine
 Memory
 Men and Masculinity
 Mestizaje
 Metaphor
 Metaphysics: Renaissance to the Present
 Microcosm and Macrocosm
 Millenarianism: Overview
 Millenarianism: Islamic
 Millenarianism: Latin America and Native North America
 Modernism: Overview
 Modernism: Latin America
 Modernity: Overview
 Modernity: East Asia
 Mohism
 Monarchy: Overview
 Motherhood and Maternity
 Motif: Motif in Literature
 Motif: Motif in Music
 Musicology
 Mysticism: Chinese Mysticism
 Mysticism: Christian Mysticism
 Myth
 Narrative
 Nation
 Nationalism: Africa
 Naturalism
 Naturalism in Art and Literature
 Nature
 Negritude
New Criticism
 Occidentalism
 Oral Traditions: Overview
 Organicism
 Orientalism: Overview
 Orientalism: African and Black Orientalism
 Pan-Africanism
 Pan-Asianism
 Person, Idea of the
 Phenomenology
 Philosophies: African
 Philosophies: American
 Philosophies: Feminist, Twentieth-Century
 Philosophies: Islamic
 Philosophy: Historical Overview and Recent Developments
 Philosophy, Moral: Ancient
 Philosophy, Moral: Medieval and Renaissance
 Pietism
 Platonism
Poetry and Poetics
 Political Protest, U.S.
 Postcolonial Studies
 Postcolonial Theory and Literature
 Postmodernism
 Practices
 Privacy
 Property
 Prophecy
 Protest, Political
 Psychoanalysis
 Queer Theory
 Race and Racism: Europe
 Reading
 Realism: Africa
 Religion: Africa
 Religion: African Diaspora
 Religion: East and Southeast Asia
 Religion: Indigenous Peoples' View, South America
 Religion: Latin America
 Religion: Middle East

READER'S GUIDE

- Religion and the State: United States
Renaissance
Republicanism: Republic
Resistance and Accommodation
Rhetoric: Overview
Rhetoric: Ancient and Medieval
Ritual: Public Ritual
Romanticism in Literature and Politics
Sacred Texts: Asia
Sacred Texts: Koran
Sage Philosophy
Scholasticism
Science Fiction
Science: Overview
Sexuality: Overview
Slavery
Social History, U.S.
Society
Sophists, The
State of Nature
Stoicism
Structuralism and Poststructuralism: Overview
Surrealism
Symbolism
Syncretism
Text/Textuality
Theater and Performance
Third World Literature
Toleration
Totalitarianism
Tragedy and Comedy
Translation
Travel: Travel from Europe and the Middle East
Trope
Utopia
Victorianism
Virtue Ethics
Visual Order to Organizing Collections
War and Peace in the Arts
Wisdom, Human
- RELIGION
- Abolitionism
Aesthetics: Africa
Aesthetics: Asia
Africa, Idea of
Agnosticism
Alchemy: China
Alchemy: Europe and the Middle East
Alienation
Altruism
Americanization, U.S.
Ancestor Worship
Animism
Antifeminism
Anti-Semitism: Overview
Anti-Semitism: Islamic Anti-Semitism
Architecture: Overview
Architecture: Asia
Aristotelianism
Arts: Overview
Arts: Africa
Asceticism: Hindu and Buddhist Asceticism
Asceticism: Western Asceticism
Assimilation
Astrology: Overview
- Astrology: China
Astronomy, Pre-Columbian and Latin American
Atheism
Authority
Autonomy
Bioethics
Body, The
Buddhism
Calendar
Cannibalism
Capitalism: Overview
Cartesianism
Casuistry
Causality
Causation in East Asian and Southeast Asian Philosophy
Censorship
Change
Chinese Thought
Christianity: Overview
Christianity: Asia
City, The: Latin America
City, The: The Islamic and Byzantine City
Civil Disobedience
Civil Society: Europe and the United States
Classification of Arts and Sciences, Early Modern
Colonialism: Southeast Asia
Communication of Ideas: Africa and Its Influence
Communication of Ideas: Asia and Its Influence
Communication of Ideas: Middle East and Abroad
Communication of Ideas: Orality and Advent of Writing
Communication of Ideas: Southeast Asia
Composition, Musical
Confucianism
Consciousness: Indian Thought
Conservatism
Continental Philosophy
Corruption
Cosmology: Asia
Cosmology: Cosmology and Astronomy
Cosmopolitanism
Creationism
Cultural History
Dance
Daoism
Death
Death and Afterlife, Islamic Understanding of
Deism
Demonology
Dialogue and Dialectics: Talmudic
Diasporas: Jewish Diaspora
Dictatorship in Latin America
Diversity
Dream
Dress
Dualism
Ecology
Ecumenism
Education: Asia, Traditional and Modern
Education: Europe
Education: Islamic Education
Education: Japan
Empire and Imperialism: Overview
Empire and Imperialism: Americas
Empire and Imperialism: Europe
Enlightenment

- Environment
 Environmental Ethics
 Environmental History
 Epicureanism
 Epistemology: Early Modern
 Epistemology: Modern
 Equality: Overview
 Eschatology
 Ethnicity and Race: Islamic Views
 Etiquette
 Europe, Idea of
 Everyday Life
 Evil
 Evolution
 Existentialism
 Expressionism
 Extirpation
 Family: Family in Anthropology since 1980
 Fascism
 Fatalism
 Feminism: Overview
 Feminism: Africa and African Diaspora
 Feminism: Chicana Feminisms
 Feminism: Islamic Feminism
 Fetishism: Overview
 Form, Metaphysical, in Ancient and Medieval Thought
 Free Will, Determinism, and Predestination
 Friendship
 Fundamentalism
 Gay Studies
 Gender: Gender in the Middle East
 Gender in Art
 General Will
 Genetics: Contemporary
 Genocide
 Ghetto
 Gift, The
 Globalization: Asia
 Gnosticism
 Good
 Harmony
 Health and Disease
 Heaven and Hell
 Heaven and Hell (Asian Focus)
 Hedonism in European Thought
 Heresy and Apostasy
 Hermeneutics
 Hierarchy and Order
 Hinduism
 Historicism
 Historiography
 History, Idea of
 Honor
 Honor, Middle Eastern Notions of
 Humanism: Africa
 Humanism: Chinese Conception of
 Humanism: Renaissance
 Humanism: Secular Humanism in the United States
 Humanity: African Thought
 Humanity: Asian Thought
 Humanity: European Thought
 Humanity in the Arts
 Human Rights: Overview
 Iconography
 Ideas, History of
 Identity: Identity of Persons
 Identity, Multiple: Jewish Multiple Identity
 Images, Icons, and Idols
 Imagination
 Immortality and the Afterlife
 Individualism
 Intelligentsia
 Intentionality
 Intercession in Middle Eastern Society
 Interdisciplinarity
 Islam: Africa
 Islam: Shii
 Islam: Southeast Asia
 Islam: Sunni
 Islamic Science
 Jainism
 Japanese Philosophy, Japanese Thought
 Jihad
 Jouissance
 Judaism: Judaism to 1800
 Judaism: Modern Judaism
 Kantianism
 Kinship
 Knowledge
 Language and Linguistics
 Language, Philosophy of: Ancient and Medieval
 Law, Islamic
 Liberation Theology
 Life
 Literary History
 Love, Western Notions of
 Magic
 Manichaeism
 Marriage and Fertility, European Views
 Marxism: Overview
 Marxism: Latin America
 Masks
 Materialism in Eighteenth-Century European Thought
 Matriarchy
 Medicine: Europe and the United States
 Medicine: Islamic Medicine
 Meditation: Eastern Meditation
 Men and Masculinity
 Metaphor
 Millenarianism: Overview
 Millenarianism: Islamic
 Millenarianism: Latin America and Native North America
 Minority
 Miracles
 Modernity: Overview
 Mohism
 Monarchy: Overview
 Monarchy: Islamic Monarchy
 Monasticism
 Monism
 Motherhood and Maternity
 Motif: Motif in Music
 Multiculturalism, Africa
 Museums
 Music, Anthropology of
 Musical Performance and Audiences
 Mysticism: Chinese Mysticism
 Mysticism: Christian Mysticism
 Mysticism: Islamic Mysticism

READER'S GUIDE

Mysticism: Islamic Mysticism in Asia
 Mysticism: Kabbalah
 Mysticism: Mysticism in African Thought
 Myth
 Nation
 Nationalism: Cultural Nationalism
 Nationalism: Middle East
 Naturalism
 Natural Law
 Natural Theology
 Newtonianism
 Nomadism
 Nonviolence
 Nude, The
 Obligation
 Organicism
 Orientalism: Overview
 Orientalism: African and Black Orientalism
 Orthodoxy
 Orthopraxy: Asia
 Orthopraxy: Western Orthopraxy
 Other, The, European Views of
 Pacifism
 Paradise on Earth
 Parties, Political
 Peace
 Periodization of the Arts
 Person, Idea of the
 Personhood in African Thought
 Perspective
 Philanthropy
 Philosophies: African
 Philosophies: American
 Philosophies: Feminist, Twentieth-Century
 Philosophies: Islamic
 Philosophy: Historical Overview and Recent Developments
 Philosophy: Relations to Other Intellectual Realms
 Philosophy, Moral: Africa
 Philosophy, Moral: Medieval and Renaissance
 Philosophy, Moral: Modern
 Philosophy and Religion in Western Thought
 Philosophy of Mind: Ancient and Medieval
 Philosophy of Religion
 Physics
 Pietism
 Platonism
 Political Protest, U.S.
 Polytheism
 Population
 Poverty
 Practices
 Pre-Columbian Civilization
 Privacy
 Propaganda
 Prophecy
 Protest, Political
 Pseudoscience
 Psychoanalysis
 Punishment
 Puritanism
 Pythagoreanism
 Race and Racism: Europe
 Rationalism
 Reading
 Reflexivity
 Reform: Islamic Reform
 Reformation
 Relativism
 Religion: Overview
 Religion: Africa
 Religion: African Diaspora
 Religion: East and Southeast Asia
 Religion: Latin America
 Religion: Middle East
 Religion and Science
 Religion and the State: Africa
 Religion and the State: Europe
 Religion and the State: Latin America
 Religion and the State: Middle East
 Religion and the State: United States
 Renaissance
 Representation: Political Representation
 Republicanism: Latin America
 Resistance and Accommodation
 Responsibility
 Rhetoric: Ancient and Medieval
 Ritual: Religion
 Romanticism in Literature and Politics
 Sacred and Profane
 Sacred Places
 Sacred Texts: Asia
 Sacred Texts: Koran
 Scholasticism
 Secularization and Secularism
 Sexuality: Islamic Views
 Shinto
 Skepticism
 Slavery
 Sophists, The
 Subjectivism
 Sufism
 Suicide
 Superstition
 Symbolism
 Syncretism
 Temperance
 Theodicy
 Time: China
 Time: India
 Time: Traditional and Utilitarian
 Toleration
 Totalitarianism
 Totems
 University: Overview
 Untouchability: Overview
 Untouchability: Menstrual Taboos
 Untouchability: Taboos
 Utilitarianism
 Victorianism
 Visual Order to Organizing Collections
 Volunteerism, U.S.
 War
 War and Peace in the Arts
 Westernization: Africa
 Westernization: Middle East
 Westernization: Southeast Asia
 Witchcraft
 Witchcraft, African Studies of
 Yin and Yang

- Yoga
 Zen
 Zionism
 PHILOSOPHY
 Absolute Music
 Aesthetics: Asia
 Aesthetics: Europe and the Americas
 Africa, Idea of
 African-American Ideas
 Afrocentricity
 Agnosticism
 Alchemy: China
 Algebras
 Alienation
 Altruism
 Ambiguity
 Analytical Philosophy
 Anticolonialism: Africa
 Antifeminism
 Architecture: Overview
 Architecture: Asia
 Aristotelianism
 Asceticism: Hindu and Buddhist Asceticism
 Asceticism: Western Asceticism
 Astronomy, Pre-Columbian and Latin American
 Atheism
 Authenticity: Africa
 Autonomy
 Avant-Garde: Militancy
 Bioethics
 Black Consciousness
 Body, The
 Buddhism
 Cartesianism
 Casuistry
 Causality
 Causation
 Causation in East Asian and Southeast Asian Philosophy
 Censorship
 Change
 Character
 Chemistry
 Chinese Thought
 Christianity: Overview
 Civil Disobedience
 Civil Society: Europe and the United States
 Civil Society: Responses in Africa and the Middle East
 Class
 Classification of Arts and Sciences, Early Modern
 Common Sense
 Communitarianism in African Thought
 Confucianism
 Consciousness: Overview
 Consciousness: Chinese Thought
 Consciousness: Indian Thought
 Conservatism
 Consilience
 Context
 Continental Philosophy
 Corruption
 Corruption in Developed and Developing Countries
 Cosmology: Asia
 Cosmopolitanism
 Creationism
 Critical Race Theory
 Critical Theory
 Cultural History
 Cycles
 Cynicism
 Dance
 Daoism
 Death
 Deism
 Democracy
 Democracy: Africa
 Determinism
 Dialogue and Dialectics: Socratic
 Dream
 Dress
 Dualism
 Dystopia
 Eclecticism
 Education: China
 Education: Global Education
 Education: Japan
 Emotions
 Empiricism
 Enlightenment
 Environment
 Environmental Ethics
 Environmental History
 Epicureanism
 Epistemology: Ancient
 Epistemology: Early Modern
 Epistemology: Modern
 Equality: Overview
 Equality: Gender Equality
 Equality: Racial Equality
 Essentialism
 Ethnocentrism
 Eugenics
 Everyday Life
 Evil
 Existentialism
 Expressionism
 Fallacy, Logical
 Falsifiability
 Family Planning
 Fascism
 Fatalism
 Feminism: Overview
 Feminism: Africa and African Diaspora
 Feminism: Chicana Feminisms
 Feminism: Islamic Feminism
 Field Theories
 Form, Metaphysical, in Ancient and Medieval Thought
 Foundationalism
 Free Will, Determinism, and Predestination
 Friendship
 Gender: Gender in the Middle East
 Gender in Art
 General Will
 Genetics: Contemporary
 Genetics: History of
 Geometry
 Gift, The
 Globalization: Asia
 Gnosticism
 Good
 Greek Science

READER'S GUIDE

- Happiness and Pleasure in European Thought
 Harmony
 Health and Disease
 Heaven and Hell (Asian Focus)
 Hedonism in European Thought
 Hegelianism
 Hegemony
 Hermeneutics
 Hierarchy and Order
 Hinduism
 Historical and Dialectical Materialism
 Historicism
 Historiography
 History, Idea of
 Humanism: Africa
 Humanism: Chinese Conception of
 Humanism: Europe and the Middle East
 Humanism: Secular Humanism in the United States
 Humanity: African Thought
 Humanity: Asian Thought
 Humanity: European Thought
 Human Rights: Overview
 Human Rights: Women's Rights
 Idealism
 Ideas, History of
 Identity: Identity of Persons
 Identity, Multiple: Overview
 Identity, Multiple: Jewish Multiple Identity
 Immortality and the Afterlife
 Impressionism
 Individualism
 Intelligentsia
 Intentionality
 Interdisciplinarity
 International Order
 Islam: Africa
 Islam: Sunni
 Islamic Science
 Jainism
 Japanese Philosophy, Japanese Thought
 Jouissance
 Judaism: Modern Judaism
 Justice: Overview
 Justice: Justice in American Thought
 Justice: Justice in East Asian Thought
 Kantianism
 Knowledge
 Language and Linguistics
 Language, Philosophy of: Ancient and Medieval
 Language, Philosophy of: Modern
 Law
 Liberalism
 Liberty
 Life
 Linguistic Turn
 Literary Criticism
 Literary History
 Logic
 Logic and Philosophy of Mathematics, Modern
 Magic
 Manichaeism
 Maoism
 Marxism: Overview
 Marxism: Latin America
 Materialism in Eighteenth-Century European Thought
 Mathematics
 Mechanical Philosophy
 Medicine: China
 Medicine: Europe and the United States
 Meditation: Eastern Meditation
 Memory
 Metaphor
 Metaphysics: Ancient and Medieval
 Metaphysics: Renaissance to the Present
 Microcosm and Macrocosm
 Mind
 Modernism: Latin America
 Modernity: Overview
 Mohism
 Monism
 Moral Sense
 Music, Anthropology of
 Musicology
 Mysticism: Chinese Mysticism
 Myth
 Narrative
 Natural History
 Natural Law
 Natural Theology
 Naturalism
 Nature
 Naturphilosophie
 Neoplatonism
 Newtonianism
 Nihilism
 Nonviolence
 Nuclear Age
 Objectivity
 Obligation
 Occidentalism
 Organicism
 Orientalism: Overview
 Orthopraxy: Asia
 Other, The, European Views of
 Pacifism
 Pan-Africanism
 Paradigm
 Parties, Political
 Peace
 Person, Idea of the
 Personhood in African Thought
 Phenomenology
 Philanthropy
 Philosophies: African
 Philosophies: American
 Philosophies: Feminist, Twentieth-Century
 Philosophies: Islamic
 Philosophy: Historical Overview and Recent Developments
Philosophy: Relations to Other Intellectual Realms
 Philosophy, History of
 Philosophy, Moral: Africa
 Philosophy, Moral: Ancient
 Philosophy, Moral: Medieval and Renaissance
 Philosophy, Moral: Modern
 Philosophy and Religion in Western Thought
 Philosophy of Mind: Overview
 Philosophy of Mind: Ancient and Medieval
 Philosophy of Religion
 Physics

- Pietism
 Platonism
 Pluralism
 Poetry and Poetics
 Political Protest, U.S.
 Political Science
 Population
 Populism: United States
 Positivism
 Postcolonial Studies
 Postmodernism
 Poverty
 Practices
 Pragmatism
 Presentism
 Privacy
 Probability
 Progress, Idea of
 Protest, Political
 Pseudoscience
 Punishment
 Pythagoreanism
 Quantum
 Queer Theory
 Race and Racism: Overview
 Radicals/Radicalism
 Rational Choice
 Rationalism
 Reading
 Realism: Africa
 Reason, Practical and Theoretical
 Reflexivity
 Reform: Europe and the United States
 Relativism
 Relativity
 Religion: Overview
 Religion: East and Southeast Asia
 Religion: Middle East
 Religion and Science
 Religion and the State: United States
 Renaissance
 Representation: Political Representation
 Resistance
 Responsibility
 Rhetoric: Overview
 Romanticism in Literature and Politics
 Sacred Texts: Asia
 Sage Philosophy
 Scholasticism
 Science: Overview
 Science: East Asia
 Science, History of
 Scientific Revolution
 Secularization and Secularism
 Sexual Harassment
 Sexuality: Overview
 Skepticism
 Sociability in African Thought
 Social Darwinism
 Socialisms, African
 Society
 Sophists, The
 State of Nature
 Stoicism
 Structuralism and Poststructuralism: Overview
- Subjectivism
 Suicide
 Surrealism
 Symbolism
 Taste
 Text/Textuality
 Theodicy
 Time: China
 Time: India
 Toleration
 Totalitarianism
 Translation
 Truth
 Universalism
 Utilitarianism
 Victorianism
 Virtue Ethics
 Visual Culture
 Visual Order to Organizing Collections
 Volksgeist
 Volunteerism, U.S.
 War
 Wildlife
 Wisdom, Human
 Witchcraft
 Witchcraft, African Studies of
 Womanism
 Yin and Yang
 Yoga
 Zen
- EDUCATION**
 Abolitionism
 Aesthetics: Africa
 Aesthetics: Asia
 Afrocentricity
 Altruism
 Americanization, U.S.
 Anthropology
 Anticolonialism: Africa
 Anticolonialism: Southeast Asia
 Antifeminism
 Anti-Semitism: Overview
 Apartheid
 Architecture: Overview
 Aristotelianism
 Asceticism: Hindu and Buddhist Asceticism
 Authenticity: Africa
 Authoritarianism: Latin America
 Behaviorism
 Bilingualism and Multilingualism
 Biology
 Black Consciousness
 Body, The
 Buddhism
 Bushido
 Calculation and Computation
 Capitalism: Overview
 Capitalism: Africa
 Character
 Childhood and Child Rearing
 Chinese Thought
 Christianity: Asia
 Citizenship: Naturalization
 City, The: The City as a Cultural Center
 Civil Society: Europe and the United States

READER'S GUIDE

Classification of Arts and Sciences, Early Modern
 Communication of Ideas: Africa and Its Influence
 Communication of Ideas: Asia and Its Influence
 Communication of Ideas: Europe and Its Influence
 Communication of Ideas: Southeast Asia
 Composition, Musical
 Confucianism
 Consciousness: Chinese Thought
 Consciousness: Indian Thought
 Cosmopolitanism
 Creationism
 Creolization, Caribbean
 Cultural Capital
 Cultural Revivals
 Cultural Studies
 Dance
 Daoism
 Death and Afterlife, Islamic Understanding of
 Democracy: Africa
 Dialogue and Dialectics: Socratic
 Dialogue and Dialectics: Talmudic
 Diasporas: Jewish Diaspora
 Diffusion, Cultural
 Discrimination
 Diversity
 Dress
 Eclecticism
Education: Asia, Traditional and Modern
Education: China
Education: Europe
Education: Global Education
Education: India
Education: Islamic Education
Education: Japan
Education: North America
 Emotion
 Empire and Imperialism: Asia
 Empire and Imperialism: Europe
 Empire and Imperialism: United States
 Enlightenment
 Environmental Ethics
 Environmental History
 Epicureanism
 Epistemology: Ancient
 Epistemology: Early Modern
 Epistemology: Modern
 Equality: Overview
 Ethnicity and Race: Anthropology
 Etiquette
 Examination Systems, China
 Experiment
 Extirpation
 Family Planning
 Fascism
 Feminism: Overview
 Feminism: Africa and African Diaspora
 Feminism: Chicana Feminisms
 Feminism: Islamic Feminism
 Gender: Gender in the Middle East
 Generation
 Globalization: Asia
 Good
 Greek Science
 Harmony
 Health and Disease
 Hermeneutics
 Hinduism
 Historical and Dialectical Materialism
 Historiography
 History, Economic
 Human Capital
 Humanism: Chinese Conception of
 Humanism: Europe and the Middle East
 Humanism: Renaissance
 Humanity: Asian Thought
 Hygiene
 Ideas, History of
 Identity, Multiple: Jewish Multiple Identity
 Individualism
 Interdisciplinarity
 Interpretation
 Islam: Africa
 Islam: Southeast Asia
 Islam: Sunni
 Islamic Science
 Japanese Philosophy, Japanese Thought
 Jihad
 Jouissance
 Judaism: Judaism to 1800
 Judaism: Modern Judaism
 Justice: Justice in East Asian Thought
 Kantianism
 Kinship
 Knowledge
 Language and Linguistics
 Language, Linguistics, and Literacy
 Learning and Memory, Contemporary Views
 Life Cycle: Overview
 Life Cycle: Adolescence
 Life Cycle: Elders/Old Age
 Literary Criticism
 Loyalties, Dual
 Maoism
 Maps and the Ideas They Express
 Marxism: Overview
 Masks
 Matriarchy
 Medicine: Europe and the United States
 Men and Masculinity
 Mestizaje
 Metaphor
 Minority
 Modernity: Overview
 Modernity: Africa
 Modernity: East Asia
 Modernization Theory
 Mohism
 Motherhood and Maternity
 Multiculturalism, Africa
 Museums
 Music, Anthropology of
 Musical Performance and Audiences
 Musicology
 Mysticism: Chinese Mysticism
 Mysticism: Islamic Mysticism in Asia
 Mysticism: Kabbalah
 Nation
 Nationalism: Africa
 Natural History
 Negritude

- Neoplatonism
- Newtonianism
- Nuclear Age
- Nude, The
- Objectivity
- Occidentalism
- Oral Traditions: Overview
- Organicism
- Orientalism: Overview
- Orthodoxy
- Pan-Arabism
- Pan-Asianism
- Paradigm
- Periodization of the Arts
- Philosophies: American
- Philosophies: Feminist, Twentieth-Century
- Philosophies: Islamic
- Philosophy: Historical Overview and Recent Developments
- Philosophy, History of
- Philosophy, Moral: Ancient
- Philosophy, Moral: Medieval and Renaissance
- Philosophy, Moral: Modern
- Philosophy of Mind: Ancient and Medieval
- Physics
- Platonism
- Political Protest, U.S.
- Population
- Populism: United States
- Practices
- Pragmatism
- Prejudice
- Privacy
- Propaganda
- Protest, Political
- Pseudoscience
- Psychoanalysis
- Punishment
- Queer Theory
- Reading
- Realism: Africa
- Reason, Practical and Theoretical
- Reflexivity
- Reform: Islamic Reform
- Reformation
- Relativism
- Religion: East and Southeast Asia
- Religion: Middle East
- Religion and the State: Europe
- Religion and the State: Latin America
- Religion and the State: Middle East
- Religion and the State: United States
- Renaissance
- Representation: Political Representation
- Republicanism: Republic
- Resistance
- Rhetoric: Overview
- Rhetoric: Ancient and Medieval
- Ritual: Public Ritual
- Sacred Places
- Sacred Texts: Asia
- Sage Philosophy
- Scholasticism
- Science: East Asia
- Segregation
- Sexuality: Overview
- Skepticism
- Slavery
- Sociability in African Thought
- Social Capital
- Social History, U.S.
- Sophists, The
- Sport
- State, The: Overview
- Stoicism
- Subjectivism
- Sufism
- Superstition
- Temperance
- Theater and Performance
- Third Cinema
- Third World Literature
- Time: China
- Totalitarianism
- Tragedy and Comedy
- University: Overview
- University: Postcolonial
- Untouchability: Menstrual Taboos
- Untouchability: Taboos
- Utilitarianism
- Utopia
- Victorianism
- Visual Order to Organizing Collections
- Volunteerism, U.S.
- War and Peace in the Arts
- Westernization: Africa
- Westernization: Middle East
- Westernization: Southeast Asia
- Wisdom, Human
- Women's History: Africa
- Women's Studies
- Yoga
- Zen

Social Sciences

WOMEN'S STUDIES AND GENDER STUDIES

- Abolitionism
- Aesthetics: Asia
- African-American Ideas
- Anarchism
- Anthropology
- Antifeminism
- Asceticism: Western Asceticism
- Autobiography
- Beauty and Ugliness
- Biography
- Black Atlantic
- Body, The
- Capitalism: Africa
- Censorship
- Chicano Movement
- Childhood and Child Rearing
- Christianity: Overview
- Cinema
- Class
- Colonialism: Africa
- Colonialism: Southeast Asia
- Communication of Ideas: Southeast Asia
- Composition, Musical
- Confucianism

READER'S GUIDE

Consumerism
Continental Philosophy
Creativity in the Arts and Sciences
Critical Race Theory
Critical Theory
Cultural Studies
Dance
Death
Death and Afterlife, Islamic Understanding of
Democracy: Africa
Demography
Diversity
Dress
Dystopia
Economics
Education: Asia, Traditional and Modern
Education: China
Education: Europe
Education: Islamic Education
Education: North America
Emotions
Environmental History
Equality: Overview
Equality: Gender Equality
Essentialism
Etiquette
Eugenics
Eurocentrism
Everyday Life
Existentialism
Family: Modernist Anthropological Theory
Family: Family in Anthropology since 1980
Family Planning
Fascism
Feminism: Overview
Feminism: Africa and African Diaspora
Feminism: Chicana Feminisms
Feminism: Third World U.S. Movement
Fetishism: Overview
Fetishism: Fetishism in Literature and Cultural Studies
Friendship
Gay Studies
Gender: Overview
Gender: Gender in the Middle East
Gender in Art
Gender Studies: Anthropology
Genius
Genre
Hate
Historiography
History, Economic
Honor
Honor, Middle Eastern Notions of
Human Capital
Humanism: Renaissance
Humanity: Asian Thought
Humanity: European Thought
Human Rights: Women's Rights
Humor
Iconography
Identity: Identity of Persons
Identity, Multiple: Overview
Impressionism
Intelligentsia
Interdisciplinarity
Internal Colonialism
Interpretation
Islam: Shii
Jouissance
Justice: Overview
Kinship
Knowledge
Law
Law, Islamic
Legalism, Ancient China
Liberalism
Liberation Theology
Life Cycle: Adolescence
Literary History
Literature: African Literature
Love, Western Notions of
Machismo
Marriage and Fertility, European Views
Masks
Matriarchy
Medicine: Europe and the United States
Men and Masculinity
Mestizaje
Minority
Modernism: Overview
Motherhood and Maternity
Music, Anthropology of
Musicology
Mysticism: Christian Mysticism
Narrative
Nude, The
Orientalism: African and Black Orientalism
Orthodoxy
Pan-Africanism
Periodization of the Arts
Philosophies: African
Philosophies: American
Philosophies: Feminist, Twentieth-Century
Philosophy: Historical Overview and Recent Developments
Poetry and Poetics
Political Protest, U.S.
Population
Postcolonial Studies
Postcolonial Theory and Literature
Postmodernism
Pre-Columbian Civilization
Privacy
Progress, Idea of
Propaganda
Prophecy
Protest, Political
Psychoanalysis
Public Sphere
Queer Theory
Radicals/Radicalism
Reading
Reflexivity
Relativism
Religion: Africa
Religion: African Diaspora
Renaissance
Republicanism: Latin America
Resistance and Accommodation
Rhetoric: Ancient and Medieval

- Ritual: Public Ritual
 Ritual: Religion
 Romanticism in Literature and Politics
 Science: Overview
 Science, History of
 Science Fiction
 Scientific Revolution
 Secularization and Secularism
 Sexual Harassment
Sexuality: Overview
Sexuality: Islamic Views
Sexuality: Sexual Orientation
 Shinto
 Slavery
 Social Contract
 Social History, U.S.
 Sport
 State, The: The Postcolonial State
 Structuralism and Poststructuralism: Overview
 Subjectivism
 Symbolism
 Universalism
 University: Overview
 Untouchability: Menstrual Taboos
 Utopia
 Victorianism
 Virtue Ethics
 Visual Culture
 Visual Order to Organizing Collections
 Volunteerism, U.S.
 War
 Witchcraft
 Witchcraft, African Studies of
 Womanism
 Women and Femininity in U.S. Popular Culture
 Women's History: Africa
 Women's History: Asia
Women's Studies
 Work
- ETHNIC STUDIES**
 Abolitionism
 Absolute Music
 Africa, Idea of
 African-American Ideas
 Afrocentricity
 America
 Americanization, U.S.
 Ancestor Worship
 Anthropology
 Anticolonialism: Africa
 Anticolonialism: Southeast Asia
 Anti-Semitism: Overview
 Anti-Semitism: Islamic Anti-Semitism
 Apartheid
 Architecture: Africa
 Arts: Overview
 Assimilation
 Astronomy, Pre-Columbian and Latin American
 Authenticity: Africa
 Autobiography
 Aztlán
 Barbarism and Civilization
 Bilingualism and Multilingualism
 Black Atlantic
 Black Consciousness
- Body, The
 Borders, Borderlands, and Frontiers, Global
 Cannibalism
 Capitalism: Overview
 Capitalism: Africa
 Chicano Movement
 Cinema
 Citizenship: Cultural Citizenship
 City, The: Latin America
 City, The: The City as a Cultural Center
 City, The: The City as Political Center
 Civil Disobedience
 Class
 Colonialism: Africa
 Colonialism: Latin America
 Colonialism: Southeast Asia
 Communication of Ideas: Southeast Asia
 Communitarianism in African Thought
 Composition, Musical
 Consumerism
 Context
 Cosmopolitanism
 Creolization, Caribbean
 Critical Race Theory
 Critical Theory
 Cultural Capital
 Cultural Revivals
 Cultural Studies
 Dance
 Death
 Demography
 Diasporas: African Diaspora
 Diasporas: Jewish Diaspora
 Diffusion, Cultural
 Discrimination
 Diversity
 Dress
 Education: North America
 Empire and Imperialism: Europe
 Empire and Imperialism: Middle East
 Environmental History
 Equality: Overview
 Equality: Racial Equality
 Essentialism
Ethnicity and Race: Africa
Ethnicity and Race: Anthropology
Ethnicity and Race: Islamic Views
 Ethnocentrism
Ethnography
 Ethnohistory, U.S.
 Eugenics
 Eurocentrism
 Extirpation
 Family Planning
 Fascism
 Feminism: Overview
 Feminism: Africa and African Diaspora
 Feminism: Chicana Feminisms
 Feminism: Third World U.S. Movement
 Fetishism: Overview
 Fetishism: Fetishism in Literature and Cultural Studies
 Gender Studies: Anthropology
 Generation
 Genetics: Contemporary
 Genocide

READER'S GUIDE

Gesture
 Ghetto
 Gift, The
 Hate
 Hinduism
 History, Economic
 Honor
 Humanity: European Thought
 Humor
 Hygiene
 Iconography
 Identity, Multiple: Overview
 Identity, Multiple: Asian-Americans
 Identity, Multiple: Jewish Multiple Identity
 Indigenismo
 Intelligentsia
 Interdisciplinarity
 Internal Colonialism
 Islam: Africa
 Jouissance
 Judaism: Modern Judaism
 Kinship
 Law
 Liberation Theology
 Life Cycle: Adolescence
 Literary History
 Literature: African Literature
 Loyalties, Dual
 Machismo
 Marxism: Latin America
 Mathematics
 Matriarchy
 Men and Masculinity
 Mestizaje
 Migration: Africa
 Migration: Migration in World History
 Migration: United States
 Minority
 Modernism: Overview
 Modernity: Africa
 Motherhood and Maternity
 Multiculturalism, Africa
 Music, Anthropology of
 Musical Performance and Audiences
 Mysticism: Kabbalah
 Nation
 Nationalism: Overview
 Nationalism: Africa
 Nationalism: Cultural Nationalism
 Nationalism: Middle East
 Native Policy
 Naturalism
 Negritude
 Nomadism
 Nuclear Age
 Occidentalism
 Orientalism: Overview
 Orientalism: African and Black Orientalism
 Orthodoxy
 Other, The, European Views of
 Pan-Africanism
 Pan-Asianism
 Pan-Islamism
 Pan-Turkism
 Patriotism
 Periodization of the Arts
 Person, Idea of the
 Philosophies: African
 Philosophies: American
 Political Protest, U.S.
 Population
 Populism: United States
 Postcolonial Studies
 Postcolonial Theory and Literature
 Postmodernism
 Practices
 Pre-Columbian Civilization
 Prehistory, Rise of
 Prejudice
 Privacy
 Protest, Political
 Psychoanalysis
 Queer Theory
 Race and Racism: Overview
 Race and Racism: Asia
 Race and Racism: Europe
 Race and Racism: United States
 Reading
 Realism: Africa
 Reflexivity
 Regions and Regionalism, Eastern Europe
 Relativism
 Religion: African Diaspora
 Religion: Indigenous Peoples' View, South America
 Religion: Latin America
 Religion: Middle East
 Republicanism: Latin America
 Resistance and Accommodation
 Ritual: Religion
 Sage Philosophy
 Scarcity and Abundance, Latin America
 Secularization and Secularism
 Segregation
 Sexuality: Overview
 Shinto
 Slavery
 Socialisms, African
 Sport
 State, The: The Postcolonial State
 Superstition
 Symbolism
 Syncretism
 Terror
 Third Cinema
 Third World
 Third World Literature
 Time: Traditional and Utilitarian
 Totalitarianism
 Totems
 Trade
 Translation
 Treaty
 Untouchability: Menstrual Taboos
 Untouchability: Taboos
 Utopia
 Victorianism
 Visual Culture
 Volksgeist
 Volunteerism, U.S.
 War

- Westernization: Africa
 Westernization: Southeast Asia
 Wisdom, Human
 Witchcraft, African Studies of
 Womanism
 Women and Femininity in U.S. Popular Culture
 Women's History: Africa
 Women's Studies
 Work
 World Systems Theory, Latin America
 Zionism
- HISTORY**
- Aesthetics: Europe and the Americas
 Afrocentricity
 Afropessimism
 Altruism
 Americanization, U.S.
 Anthropology
 Anticolonialism: Latin America
 Anticolonialism: Southeast Asia
 Anti-Semitism: Overview
 Architecture: Overview
 Architecture: Africa
 Asceticism: Hindu and Buddhist Asceticism
 Authoritarianism: Latin America
 Autobiography
 Autonomy
 Aztlán
 Barbarism and Civilization
 Biography
 Buddhism
 Capitalism: Overview
 Change
 Childhood and Child Rearing
 Chinese Thought
 City, The: The City as a Cultural Center
 Classification of Arts and Sciences, Early Modern
 Colonialism: Africa
 Colonialism: Latin America
 Colonialism: Southeast Asia
 Consciousness: Overview
 Conservatism
 Context
 Continental Philosophy
 Cosmology: Asia
 Creolization, Caribbean
 Crisis
 Cultural History
 Cultural Revivals
 Cultural Studies
 Cycles
 Dance
 Determinism
 Diasporas: African Diaspora
 Diasporas: Jewish Diaspora
 Dictatorship in Latin America
 Diffusion, Cultural
 Dress
 Ecology
 Economics
 Education: Europe
 Empire and Imperialism: Overview
 Empire and Imperialism: United States
 Enlightenment
 Environmental History
- Ethnography
 Ethnohistory, U.S.
 Eurocentrism
 Everyday Life
 Evil
 Extirpation
 Fascism
 Fatalism
 Feminism: Overview
 Feminism: Third World U.S. Movement
 Feudalism, European
 Futurology
 Gender in Art
 Generation
 Genius
 Genre
 Geography
 Globalization: Asia
 Hegelianism
 Hermeneutics
 Historical and Dialectical Materialism
 Historicism
Historiography
 History, Economic
History, Idea of
 Honor
 Iconography
 Ideas, History of
 Identity, Multiple: Jewish Multiple Identity
 Intelligentsia
 Intentionality
 Interdisciplinarity
 Internal Colonialism
 International Order
 Interpretation
 Islamic Science
 Japanese Philosophy, Japanese Thought
 Jihad
 Judaism: Judaism to 1800
 Knowledge
 Language and Linguistics
 Leadership
 Learning and Memory, Contemporary Views
 Life Cycle: Elders/Old Age
 Linguistic Turn
 Literary Criticism
 Literary History
 Literature: African Literature
 Love, Western Notions of
 Machiavellism
 Maoism
 Marxism: Overview
 Marxism: Asia
 Marxism: Latin America
 Matriarchy
 Media, History of
 Memory
 Mestizaje
 Metaphor
 Migration: Africa
 Migration: Migration in World History
 Millenarianism: Overview
 Millenarianism: Islamic
 Millenarianism: Latin America and Native North America

READER'S GUIDE

Modernism: Latin America
Modernity: Overview
Modernity: Africa
Modernity: East Asia
Modernization
Modernization Theory
Motif: Motif in Literature
Music, Anthropology of
Musicology
Narrative
Nation
Nationalism: Overview
Nationalism: Africa
Native Policy
Negritude
Nomadism
Nuclear Age
Occidentalism
Oral Traditions: Overview
Pan-Asianism
Paradigm
Patriotism
Peasants and Peasantry
Periodization
Periodization of the Arts
Philosophies: Feminist, Twentieth-Century
Philosophy: Historical Overview and Recent Developments
Philosophy, History of
Philosophy of Religion
Poetry and Poetics
Political Protest, U.S.
Polytheism
Postcolonial Theory and Literature
Postmodernism
Power
Practices
Pragmatism
Pre-Columbian Civilization
Presentism
Privacy
Progress, Idea of
Protest, Political
Public Sphere
Queer Theory
Race and Racism: Asia
Reading
Realism: Africa
Reflexivity
Reform: Europe and the United States
Reformation
Regions and Regionalism, Eastern Europe
Relativism
Religion: East and Southeast Asia
Religion: Indigenous Peoples' View, South America
Religion: Middle East
Religion and the State: United States
Renaissance
Republicanism: Latin America
Republicanism: Republic
Resistance
Responsibility
Revolution
Ritual: Public Ritual
Sacred Texts: Asia
Scarcity and Abundance, Latin America
Science: Overview
Science, History of
Scientific Revolution
Sexuality: Overview
Skepticism
Slavery
Social Capital
Social Darwinism
Social History, U.S.
Society
Sophists, The
Sport
State of Nature
Structuralism and Poststructuralism: Overview
Subjectivism
Surrealism
Syncretism
Technology
Theater and Performance
Theodicy
Third World
Time: China
Time: India
Time: Traditional and Utilitarian
Toleration
Totalitarianism
Trade
Treaty
Trope
Utopia
Victorianism
Visual Order to Organizing Collections
Volkgeist
War
War and Peace in the Arts
Westernization: Middle East
Westernization: Southeast Asia
Witchcraft
Witchcraft, African Studies of
Women's History: Africa
Women's History: Asia
World Systems Theory, Latin America

ANTHROPOLOGY AND SOCIOLOGY

Aesthetics: Asia
Aesthetics: Europe and the Americas
Africa, Idea of
Alienation
Altruism
Americanization, U.S.
Ancestor Worship
Anthropology
Anti-Semitism: Overview
Architecture: Overview
Architecture: Africa
Asceticism: Hindu and Buddhist Asceticism
Asceticism: Western Asceticism
Astronomy, Pre-Columbian and Latin American
Aztlán
Barbarism and Civilization
Beauty and Ugliness
Bilingualism and Multilingualism
Body, The
Borders, Borderlands, and Frontiers, Global
Buddhism

- Calendar
 Cannibalism
 Capitalism: Overview
 Character
 Childhood and Child Rearing
 Chinese Thought
 Cinema
 Citizenship: Cultural Citizenship
 City, The: The City as a Cultural Center
 Civil Society: Europe and the United States
 Colonialism: Latin America
 Colonialism: Southeast Asia
 Communication of Ideas: Orality and Advent of Writing
 Communication of Ideas: Southeast Asia
 Communitarianism in African Thought
 Composition, Musical
 Context
 Continental Philosophy
 Cosmopolitanism
 Creativity in the Arts and Sciences
 Creolization, Caribbean
 Cultural Capital
 Cultural History
 Cultural Revivals
 Cultural Studies
 Dance
 Death
 Death and Afterlife, Islamic Understanding of
 Demography
 Demonology
 Development
 Diasporas: African Diaspora
 Diasporas: Jewish Diaspora
 Diffusion, Cultural
 Discrimination
 Diversity
 Dream
 Dress
 Ecology
 Environment
 Environmental Ethics
 Environmental History
 Ethnicity and Race: Africa
 Ethnicity and Race: Anthropology
 Ethnocentrism
Ethnography
 Ethnohistory, U.S.
 Etiquette
 Eugenics
 Eurocentrism
 Europe, Idea of
 Everyday Life
 Extirpation
 Family: Modernist Anthropological Theory
 Family: Family in Anthropology since 1980
 Family Planning
 Fascism
 Feminism: Overview
 Feminism: Third World U.S. Movement
 Fetishism: Overview
 Gender Studies: Anthropology
 Generation
 Genetics: Contemporary
 Genetics: History of
 Gesture
 Ghetto
 Gift, The
 Globalization: Asia
 Hinduism
 Historiography
 History, Economic
 History, Idea of
 Honor
 Honor, Middle Eastern Notions of
 Humanism: Chinese Conception of
 Humanity: African Thought
 Humanity: European Thought
 Humor
 Ideas, History of
 Identity: Personal and Social Identity
 Identity, Multiple: Asian-Americans
 Identity, Multiple: Jewish Multiple Identity
 Intelligentsia
 Intentionality
 Interdisciplinarity
 Interpretation
 Jouissance
 Judaism: Modern Judaism
 Kinship
 Knowledge
 Language and Linguistics
Life Cycle: Overview
Life Cycle: Adolescence
Life Cycle: Elders/Old Age
 Linguistic Turn
 Literary Criticism
 Machiavellism
 Magic
 Manichaeism
 Marriage and Fertility, European Views
 Marxism: Overview
 Masks
 Matriarchy
 Meditation: Eastern Meditation
 Memory
 Men and Masculinity
 Mestizaje
 Metaphor
 Migration: Migration in World History
 Migration: United States
 Minority
 Motherhood and Maternity
 Motif: Motif in Music
 Music, Anthropology of
 Musical Performance and Audiences
 Musicology
 Mysticism: Chinese Mysticism
 Myth
 Nation
 Native Policy
 Natural History
 Occidentalism
 Oral Traditions: Overview
 Organicism
 Orientalism: African and Black Orientalism
 Orthodoxy
 Orthopraxy: Asia
 Other, The, European Views of
 Peasants and Peasantry
 Person, Idea of the

READER'S GUIDE

- Philosophies: Feminist, Twentieth-Century
 Philosophy, Moral: Africa
 Phrenology
 Pluralism
 Polytheism
 Postcolonial Theory and Literature
 Postmodernism
 Power
 Practices
 Pre-Columbian Civilization
 Prehistory, Rise of
 Prejudice
 Presentism
 Privacy
 Psychoanalysis
 Public Sphere
 Queer Theory
 Race and Racism: Asia
 Reading
 Reflexivity
 Reform: Europe and the United States
 Relativism
 Religion: Overview
 Religion: Africa
 Religion: African Diaspora
 Religion: Latin America
 Religion: Middle East
 Representation: Mental Representation
 Resistance
 Resistance and Accommodation
 Ritual: Public Ritual
 Ritual: Religion
 Sacred and Profane
 Scarcity and Abundance, Latin America
 Sexuality: Overview
 Sexuality: Sexual Orientation
 Social Capital
 Social Darwinism
 Social History, U.S.
 Society
 Sport
 State of Nature
 Structuralism and Poststructuralism: Overview
 Structuralism and Poststructuralism: Anthropology
 Subjectivism
 Superstition
 Surrealism
 Symbolism
 Syncretism
 Textiles and Fiber Arts as Catalysts for Ideas
 Theater and Performance
 Time: Traditional and Utilitarian
 Toleration
 Totalitarianism
 Totems
 Trade
 Tradition
 Tragedy and Comedy
 Tribalism, Middle East
 Trope
 Untouchability: Menstrual Taboos
 Untouchability: Taboos
 Utilitarianism
 Victorianism
 Virtue Ethics
 War and Peace in the Arts
 Westernization: Southeast Asia
 Wisdom, Human
 Witchcraft
 Witchcraft, African Studies of
 Women's History: Africa
 Work
 World Systems Theory, Latin America
 Yin and Yang
POLITICAL SCIENCE (emphasizing political philosophy)
 Abolitionism
 Absolute Music
 Africa, Idea of
 African-American Ideas
 Afrocentricity
 Afropessimism
 Alienation
 Altruism
 America
 Americanization, U.S.
 Anarchism
 Anthropology
 Anticolonialism: Africa
 Anticolonialism: Latin America
 Anticolonialism: Middle East
 Anticolonialism: Southeast Asia
 Anti-Semitism: Overview
 Anti-Semitism: Islamic Anti-Semitism
 Apartheid
 Architecture: Overview
 Architecture: Africa
 Architecture: Asia
 Asceticism: Western Asceticism
 Asian-American Ideas (Cultural Migration)
 Assimilation
 Astronomy, Pre-Columbian and Latin American
 Authoritarianism: Overview
 Authoritarianism: East Asia
 Authoritarianism: Latin America
 Authority
 Autobiography
 Avant-Garde: Militancy
 Aztlán
 Barbarism and Civilization
 Bilingualism and Multilingualism
 Bioethics
 Black Atlantic
 Black Consciousness
 Borders, Borderlands, and Frontiers, Global
 Bureaucracy
 Bushido
 Calculation and Computation
 Cannibalism
 Capitalism: Overview
 Capitalism: Africa
 Casuistry
 Censorship
 Chicano Movement
 Childhood and Child Rearing
 Chinese Warlordism
 Christianity: Overview
 Christianity: Asia
 Citizenship: Overview
 Citizenship: Cultural Citizenship
 Citizenship: Naturalization

- City, The: Latin America
 City, The: The City as a Cultural Center
 City, The: The City as Political Center
 Civil Disobedience
 Civil Society: Europe and the United States
 Civil Society: Responses in Africa and the Middle East
 Class
 Colonialism: Africa
 Colonialism: Latin America
 Colonialism: Southeast Asia
 Common Sense
 Communication of Ideas: Europe and Its Influence
 Communication of Ideas: Middle East and Abroad
 Communication of Ideas: Southeast Asia
 Communication of Ideas: The Americas and Their Influence
 Communism: Latin America
 Communism: Europe
 Communitarianism in African Thought
 Composition, Musical
 Computer Science
 Confucianism
 Consciousness: Overview
 Consciousness: Chinese Thought
 Conservatism
 Constitutionalism
 Continental Philosophy
 Corruption
 Corruption in Developed and Developing Countries
 Cosmopolitanism
 Creolization, Caribbean
 Critical Race Theory
 Cultural Studies
 Cycles
 Cynicism
 Dada
 Dance
 Daoism
Democracy
 Democracy, Africa
 Demography
 Dependency
 Determinism
 Dialogue and Dialectics: Socratic
 Diasporas: African Diaspora
 Diasporas: Jewish Diaspora
 Dictatorship in Latin America
 Discrimination
 Diversity
 Dress
 Dystopia
 Ecology
 Economics
 Education: China
 Education: Global Education
 Education: India
 Education: Japan
 Education: North America
 Empire and Imperialism: Overview
 Empire and Imperialism: Americas
 Empire and Imperialism: Asia
 Empire and Imperialism: Europe
 Empire and Imperialism: Middle East
 Empire and Imperialism: United States
 Environmental Ethics
 Environmental History
 Equality: Overview
 Equality: Gender Equality
 Equality: Racial Equality
 Ethnicity and Race: Africa
 Ethnicity and Race: Anthropology
 Ethnicity and Race: Islamic Views
 Etiquette
 Eugenics
 Eurocentrism
 Europe, Idea of
 Evil
 Examination Systems, China
 Existentialism
 Expressionism
 Extirpation
 Fallacy, Logical
 Family Planning
 Fascism
 Feminism: Overview
 Feminism: Africa and African Diaspora
 Feminism: Chicana Feminisms
 Feminism: Islamic Feminism
 Feminism: Third World U.S. Movement
 Fetishism: Overview
 Feudalism, European
 Friendship
 Fundamentalism
 Futurology
 Game Theory
 Garden
 Gay Studies
 Gender: Gender in the Middle East
 Gender in Art
 General Will
 Generation
 Genetics: Contemporary
 Genocide
 Ghetto
 Globalization: Africa
 Globalization: Asia
 Globalization: General
 Good
 Happiness and Pleasure in European Thought
 Heaven and Hell
 Heaven and Hell (Asian Focus)
 Hegelianism
 Hegemony
 Hinduism
 Historical and Dialectical Materialism
 Historiography
 History, Economic
 History, Idea of
 Honor
 Honor, Middle Eastern Notions of
 Human Capital
 Humanism: Chinese Conception of
 Humanism: Europe and the Middle East
 Humanism: Renaissance
 Humanism: Secular Humanism in the United States
 Humanity: African Thought
 Human Rights: Overview
 Human Rights: Women's Rights
 Hygiene
 Ideas, History of

READER'S GUIDE

- Identity, Multiple: Overview
 Identity, Multiple: Asian-Americans
 Identity, Multiple: Jewish Multiple Identity
 Individualism
 Intelligentsia
 Intentionality
 Intercession in Middle Eastern Society
 Interdisciplinarity
 Internal Colonialism
 International Order
 Islam: Africa
 Islam: Shii
 Islam: Southeast Asia
 Islam: Sunni
 Islamic Science
 Japanese Philosophy, Japanese Thought
 Jihad
 Jouissance
 Justice: Overview
 Justice: Justice in American Thought
 Justice: Justice in East Asian Thought
 Kantianism
 Kinship
 Knowledge
 Language and Linguistics
 Law
 Law, Islamic
 Leadership
 Legalism, Ancient China
 Liberalism
 Liberation Theology
 Liberty
 Life Cycle: Elders/Old Age
 Literary Criticism
 Literary History
 Literature: Overview
 Literature: African Literature
 Lysenkoism
 Machiavellism
 Machismo
 Maoism
 Maps and the Ideas They Express
 Marriage and Fertility, European Views
 Marxism: Overview
 Marxism: Asia
 Marxism: Latin America
 Masks
 Mathematics
 Matriarchy
 Medicine: Europe and the United States
 Meme
 Men and Masculinity
 Mestizaje
 Migration: Migration in World History
 Migration: United States
 Millenarianism: Islamic
 Millenarianism: Latin America and Native North America
 Minority
 Modernism: Overview
 Modernism: Latin America
 Modernity: Overview
 Modernity: Africa
 Modernity: East Asia
 Modernization
 Modernization Theory
 Mohism
Monarchy: Overview
 Monarchy: Islamic Monarchy
 Motherhood and Maternity
 Motif: Motif in Literature
 Multiculturalism, Africa
 Music, Anthropology of
 Musical Performance and Audiences
 Musicology
 Mysticism: Chinese Mysticism
 Myth
 Narrative
 Nation
 Nationalism: Overview
 Nationalism: Africa
 Nationalism: Cultural Nationalism
 Nationalism: Middle East
 Native Policy
 Natural Law
 Naturalism
 Negritude
 Neocolonialism
 Neoliberalism
 New Criticism
 Newtonianism
 Nihilism
 Nomadism
 Nonviolence
 Nuclear Age
 Objectivity
 Obligation
 Occidentalism
 Organicism
 Orientalism: Overview
 Orientalism: African and Black Orientalism
 Orthodoxy
 Orthopraxy: Asia
 Pacifism
 Pan-Africanism
 Pan-Arabism
 Pan-Asianism
 Pan-Islamism
 Pan-Turkism
 Paradigm
 Parties, Political
 Patriotism
 Peace
 Periodization of the Arts
 Person, Idea of the
 Personhood in African Thought
 Philanthropy
 Philosophies: American
 Philosophies: Feminist, Twentieth-Century
 Philosophies: Islamic
 Philosophy: Historical Overview and Recent Developments
 Philosophy, History of
 Philosophy, Moral: Africa
 Philosophy, Moral: Ancient
 Philosophy, Moral: Modern
 Philosophy of Religion
 Phrenology
 Pluralism
 Political Protest, U.S.

- Political Science**
 Political, The
 Population
 Populism: Latin America
 Populism: United States
 Postcolonial Studies
 Poverty
 Power
 Practices
 Pre-Columbian Civilization
 Prejudice
 Presentism
 Privacy
 Privatization
 Probability
 Progress, Idea of
 Propaganda
 Property
 Protest, Political
 Pseudoscience
 Psychoanalysis
 Public Sphere
 Punishment
 Puritanism
 Pythagoreanism
 Quantum
 Queer Theory
 Race and Racism: Overview
 Race and Racism: Asia
 Race and Racism: United States
 Radicals/Radicalism
 Rational Choice
 Reading
 Realism
 Realism: Africa
 Reason, Practical and Theoretical
 Reflexivity
 Reform: Europe and the United States
 Reform: Islamic Reform
 Regions and Regionalism, Eastern Europe
 Relativism
 Religion: Africa
 Religion: African Diaspora
 Religion: East and Southeast Asia
 Religion: Latin America
 Religion: Middle East
 Religion and the State: Africa
 Religion and the State: Europe
 Religion and the State: Latin America
 Religion and the State: Middle East
 Religion and the State: United States
 Renaissance
 Representation: Political Representation
 Republicanism: Latin America
 Republicanism: Republic
 Resistance
 Resistance and Accommodation
 Responsibility
 Revolution
 Rhetoric: Ancient and Medieval
 Ritual: Public Ritual
 Romanticism in Literature and Politics
 Sacred and Profane
 Scarcity and Abundance, Latin America
 Science, History of
 Science Fiction
 Secularization and Secularism
 Segregation
 Sexual Harassment
 Sexuality: Overview
 Sexuality: Islamic Views
 Sexuality: Sexual Orientation
 Shinto
 Skepticism
 Slavery
 Sociability in African Thought
 Social Capital
 Social Contract
 Social History, U.S.
 Socialism
 Socialisms, African
 Society
 Sophists, The
 Sovereignty
 Sport
 State, The: Overview
 State, The: The Postcolonial State
 State of Nature
 Stoicism
 Subjectivism
 Sufism
 Suicide
 Superstition
 Surrealism
 Symbolism
 Syncretism
 Technology
 Temperance
 Terror
 Terrorism, Middle East
 Third Cinema
 Third World
 Third World Literature
 Time: China
 Time: Traditional and Utilitarian
 Toleration
 Totalitarianism
 Trade
 Translation
 Treaty
 Tribalism, Middle East
 University: Postcolonial
 Untouchability: Menstrual Taboos
 Untouchability: Taboos
 Utilitarianism
 Utopia
 Victorianism
 Virtue Ethics
 Visual Order to Organizing Collections
 Volksgeist
 Volunteerism, U.S.
 War
 War and Peace in the Arts
 Wealth
 Westernization: Africa
 Westernization: Middle East
 Westernization: Southeast Asia
 Wildlife
 Witchcraft
 Witchcraft, African Studies of

READER'S GUIDE

- Women's History: Africa
 Work
 World Systems Theory, Latin America
 Zionism
ECONOMICS
 Abolitionism
 Africa, Idea of
 African-American Ideas
 Afropessimism
 Alienation
 Altruism
 Anarchism
 Anthropology
 Anticolonialism: Africa
 Anticolonialism: Latin America
 Anticolonialism: Middle East
 Anticolonialism: Southeast Asia
 Anti-Semitism: Islamic Anti-Semitism
 Apartheid
 Architecture: Africa
 Arts: Africa
 Asceticism: Western Asceticism
 Asian-American Ideas (Cultural Migration)
 Assimilation
 Astronomy, Pre-Columbian and Latin American
 Authoritarianism: East Asia
 Authoritarianism: Latin America
 Avant-Garde: Militancy
 Bioethics
 Black Atlantic
 Black Consciousness
 Bureaucracy
 Bushido
 Calculation and Computation
 Capitalism: Overview
 Capitalism: Africa
 Chicano Movement
 Cinema
 City, The: The City as a Cultural Center
 City, The: The City as Political Center
 City, The: The Islamic and Byzantine City
 Civil Society: Europe and the United States
 Civil Society: Responses in Africa and the Middle East
 Class
 Colonialism: Africa
 Colonialism: Southeast Asia
 Communication of Ideas: Africa and Its Influence
 Communication of Ideas: Middle East and Abroad
 Communication of Ideas: Southeast Asia
 Communism: Europe
 Communism: Latin America
 Composition, Musical
 Confucianism
 Consumerism
 Corruption in Developed and Developing Countries
 Critical Race Theory
 Cultural Capital
 Cultural History
 Cultural Studies
 Democracy: Africa
Demography
 Dependency
 Diasporas: African Diaspora
 Diasporas: Jewish Diaspora
 Dictatorship in Latin America
 Diffusion, Cultural
 Discrimination
 Diversity
 Dress
 Dystopia
Economics
 Education: China
 Education: Global Education
 Empire and Imperialism: Americas
 Empire and Imperialism: Asia
 Empire and Imperialism: Europe
 Empire and Imperialism: Middle East
 Empire and Imperialism: United States
 Environmental Ethics
 Environmental History
 Equality: Overview
 Equality: Gender Equality
 Equality: Racial Equality
 Eugenics
 Eurocentrism
 Europe, Idea of
 Everyday Life
 Examination Systems, China
 Family: Modernist Anthropological Theory
 Family Planning
 Fascism
 Feminism: Overview
 Feminism: Africa and African Diaspora
 Feminism: Chicana Feminisms
 Feminism: Islamic Feminism
 Feminism: Third World U.S. Movement
 Fetishism: Overview
 Fetishism: Fetishism in Literature and Cultural Studies
 Feudalism, European
 Futurology
 Game Theory
 Generation
 Genetics: Contemporary
 Ghetto
 Gift, The
Globalization: Africa
Globalization: Asia
Globalization: General
 Good
 Hegelianism
 Hegemony
 Hinduism
 Historical and Dialectical Materialism
 Historicism
 Historiography
 History, Economic
 History, Idea of
 Human Capital
 Human Rights: Women's Rights
 Ideas, History of
 Identity, Multiple: Asian-Americans
 Indigenismo
 Individualism
 Intelligentsia
 Intentionality
 Internal Colonialism
 Interpretation
 Islam: Africa
 Islam: Sunni
 Islamic Science

- Jainism
- Japanese Philosophy, Japanese Thought
- Jihad
- Justice: Overview
- Justice: Justice in American Thought
- Law, Islamic
- Leadership
- Liberalism
- Liberation Theology
- Life Cycle: Elders/Old Age
- Literary Criticism
- Maoism
- Maps and the Ideas They Express
- Marriage and Fertility, European Views
- Marxism: Overview
- Marxism: Asia
- Marxism: Latin America
- Mathematics
- Migration: Africa
- Migration: Migration in World History
- Migration: United States
- Minority
- Modernity: Africa
- Modernity: East Asia
- Modernization
- Modernization Theory
- Motherhood and Maternity
- Nationalism: Africa
- Native Policy
- Naturalism
- Neocolonialism
- Neoliberalism
- Nomadism
- Nuclear Age
- Occidentalism
- Orthopraxy: Asia
- Pan-Africanism
- Pan-Asianism
- Parties, Political
- Peasants and Peasantry
- Philanthropy
- Philosophies: American
- Philosophy, History of
- Political Protest, U.S.
- Political Science
- Population
- Populism: Latin America
- Populism: United States
- Postcolonial Studies
- Poverty
- Practices
- Pre-Columbian Civilization
- Presentism
- Privacy
- Privatization
- Probability
- Progress, Idea of
- Property
- Protest, Political
- Pseudoscience
- Public Sphere
- Punishment
- Puritanism
- Race and Racism: United States
- Radicals/Radicalism
- Reason, Practical and Theoretical
- Reform: Europe and the United States
- Religion and the State: Africa
- Religion and the State: Latin America
- Renaissance
- Representation: Political Representation
- Republicanism: Republic
- Resistance
- Resistance and Accommodation
- Responsibility
- Ritual: Public Ritual
- Ritual: Religion
- Scarcity and Abundance, Latin America
- Secularization and Secularism
- Segregation
- Sexual Harassment
- Sexuality: Islamic Views
- Slavery
- Social Capital
- Social Darwinism
- Social History, U.S.
- Socialism
- Sport
- State, The: Overview
- State, The: The Postcolonial State
- Technology
- Terrorism, Middle East
- Third Cinema
- Third World
- Third World Literature
- Time: China
- Time: Traditional and Utilitarian
- Totalitarianism
- Trade
- Translation
- Travel: Travel from Europe and the Middle East
- Treaty
- Untouchability: Taboos
- Utilitarianism
- Victorianism
- Visual Culture
- Volunteerism, U.S.
- War and Peace in the Arts
- Wealth
- Westernization: Africa
- Westernization: Middle East
- Westernization: Southeast Asia
- Women and Femininity in U.S. Popular Culture
- Women's History: Africa
- Work
- World Systems Theory, Latin America
- Zen
- Zionism
- GEOGRAPHY
- Africa, Idea of
- America
- Anthropology
- Architecture: Overview
- Barbarism and Civilization
- Borders, Borderlands, and Frontiers, Global
- Capitalism: Overview
- Chinese Warlordism
- Cultural Studies
- Diffusion, Cultural
- Economics

READER'S GUIDE

Environment
Environmental History
Ethnicity and Race: Anthropology
Ethnicity and Race: Islamic Views
Eurocentrism
Feudalism, European
Geography
Ghetto
Globalization: Asia
Globalization: General
History, Economic
History, Idea of
Identity, Multiple: Jewish Multiple Identity
Islamic Science
Maps and the Ideas They Express
Mathematics
Migration: Africa
Migration: Migration in World History
Migration: United States
Minority
Nation
Nationalism: Africa
Natural History
Nomadism
Occidentalism
Orientalism: Overview
Pan-Africanism
Pan-Asianism
Perspective
Population
Privacy
Race and Racism: Asia
Race and Racism: United States
Regions and Regionalism, Eastern Europe
Religion: Indigenous Peoples' View, South America
Sacred Places
Scarcity and Abundance, Latin America
Third Cinema
Third World
Travel: Travel from Europe and the Middle East
Victorianism
Westernization: Southeast Asia
World Systems Theory, Latin America

Sciences

HISTORY OF SCIENCE, EARLY (entries focused on early ideas about nature and the human relationship with nature)
Alchemy: China
Alchemy: Europe and the Middle East
Anthropology
Aristotelianism
Asceticism: Hindu and Buddhist Asceticism
Astrology: Overview
Astrology: China
Astronomy, Pre-Columbian and Latin American
Change
Confucianism
Consciousness: Chinese Thought
Cosmology: Asia
Daoism
Ethnicity and Race: Africa
Ethnicity and Race: Anthropology
Ethnicity and Race: Islamic Views
Greek Science

Harmony
Hierarchy and Order
Hinduism
Humanism: Chinese Conception of
Humanity: African Thought
Ideas, History of
Lysenkoism
Magic
Manichaeism
Medicine: China
Medicine: India
Metaphysics: Ancient and Medieval
Mysticism: Chinese Mysticism
Myth
Natural Theology
Naturphilosophie
Organicism
Paradigm
Person, Idea of the
Philosophies: Islamic
Philosophy: Historical Overview and Recent Developments
Philosophy of Religion
Phrenology
Pseudoscience
Race and Racism: Europe
Race and Racism: United States
Religion: Indigenous Peoples' View, South America
Religion and Science
Ritual: Religion
Sacred Places
Science: East Asia
Segregation
Sexuality: Sexual Orientation
Slavery
Superstition
Syncretism
Time: China
Time: India
Untouchability: Menstrual Taboos
Witchcraft
Yin and Yang
HISTORY OF SCIENCE, MODERN AND CONTEMPORARY (entries focused on the origins of modern or contemporary ideas in the physical, chemical, biological, mathematical, or earth sciences)
Agnosticism
Algebras
Behaviorism
Body, The
Calendar
Cartesianism
Causation
Causation in East Asian and Southeast Asian Philosophy
Chemistry
Communication of Ideas: Middle East and Abroad
Computer Science
Context
Continental Philosophy
Cosmology: Cosmology and Astronomy
Creationism
Creativity in the Arts and Sciences
Cultural History
Demonology
Determinism

- Development
 Ecology
 Education: Islamic Education
 Empiricism
 Enlightenment
 Environment
 Environmental History
 Epistemology: Early Modern
 Equality: Racial Equality
 Everyday Life
 Experiment
 Falsifiability
 Free Will, Determinism, and Predestination
 Health and Disease
 History, Economic
 Idealism
 Islamic Science
 Kantianism
 Knowledge
 Life
 Linguistic Turn
 Mathematics
 Mechanical Philosophy
 Medicine: Europe and the United States
 Medicine: Islamic Medicine
 Metaphor
 Museums
 Nature
 Newtonianism
 Nuclear Age
 Objectivity
 Philosophies: African
 Philosophies: Feminist, Twentieth-Century
 Philosophy, History of
 Philosophy of Mind: Overview
 Philosophy of Mind: Ancient and Medieval
 Physics
 Platonism
 Poetry and Poetics
 Positivism
 Prehistory, Rise of
 Probability
 Progress, Idea of
 Pythagoreanism
 Quantum
 Race and Racism: Asia
 Rationalism
 Reason, Practical and Theoretical
 Reflexivity
 Reform: Europe and the United States
 Relativity
 Renaissance
 Scholasticism
 Science: Overview
Science, History of
Scientific Revolution
 Sexuality: Overview
 Social Darwinism
 Social History, U.S.
 Technology
 Victorianism
 Visual Order to Organizing Collections
PSYCHOLOGY
 Absolute Music
 Aesthetics: Asia
 Aesthetics: Europe and the Americas
 Alchemy: Europe and the Middle East
 Alienation
 Altruism
 Ambiguity
 Ancestor Worship
 Animism
 Anthropology
 Anti-Semitism: Overview
 Asceticism: Hindu and Buddhist Asceticism
 Asceticism: Western Asceticism
 Authoritarianism: East Asia
 Beauty and Ugliness
 Behaviorism
 Bioethics
 Biography
 Biology
 Body, The
 Buddhism
 Cartesianism
 Character
 Cinema
 Communitarianism in African Thought
 Composition, Musical
 Computer Science
 Consciousness: Overview
 Consciousness: Chinese Thought
 Consciousness: Indian Thought
 Consumerism
 Context
 Continental Philosophy
 Creativity in the Arts and Sciences
 Cultural Studies
 Dada
 Dance
 Daoism
 Death
 Demonology
 Determinism
 Diffusion, Cultural
 Discrimination
 Dream
 Emotions
 Empiricism
 Epistemology: Early Modern
 Epistemology: Modern
 Ethnicity and Race: Africa
 Eugenics
 Everyday Life
 Existentialism
 Feminism: Overview
 Fetishism: Overview
 Fetishism: Fetishism in Literature and Cultural Studies
 Form, Metaphysical, in Ancient and Medieval Thought
 Foundationalism
 Friendship
 Gay Studies
 Gender: Overview
 Gender: Gender in the Middle East
 Gender in Art
 Gender Studies: Anthropology
 Gesture
 Harmony
 Hate
 Health and Disease

READER'S GUIDE

Heaven and Hell
Hinduism
Humanism: Secular Humanism in the United States
Humanity: African Thought
Humanity: European Thought
Identity: Identity of Persons
Identity: Personal and Social Identity
Identity, Multiple: Overview
Identity, Multiple: Asian-Americans
Images, Icons, and Idols
Imagination
Immortality and the Afterlife
Impressionism
Indigenismo
Intentionality
Jainism
Jouissance
Kinship
Knowledge
Language and Linguistics
Learning and Memory, Contemporary Views
Life
Life Cycle: Elders/Old Age
Literary Criticism
Love, Western Notions of
Machismo
Magic
Manichaeism
Masks
Medicine: China
Medicine: Europe and the United States
Meditation: Eastern Meditation
Memory
Men and Masculinity
Metaphor
Metaphysics: Renaissance to the Present
Mind
Modernism: Overview
Modernity: Overview
Modernity: Africa
Modernity: East Asia
Monarchy: Overview
Monism
Motherhood and Maternity
Musical Performance and Audiences
Mysticism: Chinese Mysticism
Mysticism: Islamic Mysticism in Asia
Myth
Narrative
National History
Nationalism: Overview
Naturphilosophie
Negritude
Objectivity
Person, Idea of the
Personhood in African Thought
Philosophies: Islamic
Philosophy, Moral: Modern
Philosophy of Mind: Overview
Philosophy of Mind: Ancient and Medieval
Philosophy of Religion
Phrenology
Political Science
Prejudice
Presentism
Privacy
Probability
Progress, Idea of
Protest, Political
Psychoanalysis
Psychology and Psychiatry
Punishment
Queer Theory
Realism: Africa
Reflexivity
Religion: Africa
Religion: African Diaspora
Religion: Indigenous Peoples' View, South America
Religion: Latin America
Religion and Science
Representation: Mental Representation
Resistance and Accommodation
Responsibility
Ritual: Public Ritual
Sexuality: Overview
Sexuality: Sexual Orientation
Slavery
State of Nature
Structuralism and Poststructuralism: Overview
Subjectivism
Superstition
Surrealism
Symbolism
Syncretism
Temperance
Text/Textuality
Third Cinema
Toleration
Totalitarianism
Tragedy and Comedy
Untouchability: Menstrual Taboos
Untouchability: Taboos
Utilitarianism
War and Peace in the Arts
Witchcraft
Witchcraft, African Studies of
Womanism
Women and Femininity in U.S. Popular Culture

BIOLOGICAL SCIENCES
Agnosticism
Altruism
Ancestor Worship
Anthropology
Antifeminism
Asceticism: Hindu and Buddhist Asceticism
Asceticism: Western Asceticism
Beauty and Ugliness
Behaviorism
Bioethics
Biology
Body, The
Buddhism
Cannibalism
Cartesianism
Casuistry
Classification of Arts and Sciences, Early Modern
Composition, Musical
Computer Science
Consciousness: Overview
Consilience

- Creationism
 Critical Race Theory
 Death
 Demography
 Determinism
 Development
 Dystopia
 Ecology
 Emotions
 Environmental Ethics
 Environmental History
 Epistemology: Early Modern
 Equality: Racial Equality
 Ethnohistory, U.S.
 Eugenics
Evolution
 Family: Modernist Anthropological Theory
 Family: Family in Anthropology since 1980
 Family Planning
 Feminism: Overview
 Game Theory
 Garden
 Gender: Overview
 Gender: Gender in the Middle East
 Gender in Art
 Gender Studies: Anthropology
Genetics: Contemporary
Genetics: History of
 Genocide
 Gesture
 Greek Science
 Health and Disease
 Heaven and Hell
 History, Idea of
 Humanism: Secular Humanism in the United States
 Humanity: African Thought
 Hygiene
 Identity: Identity of Persons
 Immortality and the Afterlife
 Intentionality
 Islamic Science
 Jainism
 Jouissance
 Kinship
 Learning and Memory, Contemporary Views
 Life
 Life Cycle: Adolescence
 Life Cycle: Elders/Old Age
 Lysenkoism
 Machiavellism
 Marriage and Fertility, European Views
 Masks
 Materialism in Eighteenth-Century European Thought
 Mechanical Philosophy
 Medicine: China
 Medicine: Europe and the United States
 Medicine: Islamic Medicine
 Meme
 Memory
 Men and Masculinity
 Mestizaje
 Monarchy: Overview
 Motherhood and Maternity
 Musical Performance and Audiences
 Natural History
 Naturalism
 Natural Theology
 Nature
 Naturphilosophie
 Negritude
 Organicism
 Other, The, European Views of
 Periodization of the Arts
 Person, Idea of the
 Perspective
 Philosophies: Islamic
 Philosophy of Mind: Ancient and Medieval
 Phrenology
 Population
 Prehistory, Rise of
 Probability
 Progress, Idea of
 Psychoanalysis
 Psychology and Psychiatry
 Punishment
 Queer Theory
 Religion: Indigenous Peoples' View, South America
 Representation: Mental Representation
 Science: East Asia
 Science, History of
 Sexuality: Overview
 Sexuality: Sexual Orientation
 Sociability in African Thought
 Social Darwinism
 Sport
 State of Nature
 Subjectivism
 Superstition
 Temperance
 Terror
 Text/Textuality
 Totems
 Untouchability: Menstrual Taboos
 Utilitarianism
 Victorianism
 Visual Order to Organizing Collections
 War and Peace in the Arts
 Wildlife
 Women and Femininity in U.S. Popular Culture
- PHYSICAL SCIENCES**
 Agnosticism
 Alchemy: China
 Astrology: China
 Astronomy, Pre-Columbian and Latin American
 Calculation and Computation
 Calendar
 Causality
 Causation
 Causation in East Asian and Southeast Asian Philosophy
 Change
 Chemistry
 Classification of Arts and Sciences, Early Modern
 Computer Science
 Consciousness: Overview
 Consilience
 Cosmology: Asia
 Cosmology: Cosmology and Astronomy
 Creationism
 Cycles

READER'S GUIDE

Ecology
 Empiricism
 Environmental Ethics
 Environmental History
 Epistemology: Early Modern
 Ethnohistory, U.S.
 Experiment
 Falsifiability
 Field Theories
 Form, Metaphysical, in Ancient and Medieval Thought
 Geography
 Geometry
 Greek Science
 Harmony
 Hinduism
 History, Economic
 Islam: Sunni
 Islamic Science
 Japanese Philosophy, Japanese Thought
 Knowledge
 Language, Philosophy of: Modern
 Life
 Literary History
 Logic and Philosophy of Mathematics, Modern
 Maps and the Ideas They Express
 Materialism in Eighteenth-Century European Thought
 Mathematics
 Mechanical Philosophy
 Metaphysics: Renaissance to the Present
 Microcosm and Macrocosm
 Monism
 Myth
 Natural Theology
 Naturalism
 Nature
 Naturphilosophie
 Newtonianism
 Nuclear Age
 Paradigm
 Periodization of the Arts
 Philosophies: Islamic
 Philosophy: Historical Overview and Recent Developments
 Philosophy, History of
Physics
 Positivism
 Power
 Pragmatism
 Probability
 Progress, Idea of
 Psychoanalysis
 Pythagoreanism
 Quantum
 Rationalism
 Realism: Africa
 Reason, Practical and Theoretical
 Relativity
 Religion: East and Southeast Asia
 Religion: Indigenous Peoples' View, South America
 Religion and Science
 Science: Overview
 Science: East Asia
 Science, History of
 Scientific Revolution
 Sophists, The

Stoicism
 Subjectivism
 Superstition
 Time: China
 Time: India
 Victorianism
ECOLOGY AND GEOLOGY
 Aesthetics: Asia
 Anthropology
 Architecture: Overview
 Architecture: Asia
 Astronomy, Pre-Columbian and Latin American
 Authoritarianism: Overview
 Bioethics
 Biology
 Borders, Borderlands, and Frontiers, Global
 Calendar
 Capitalism: Overview
 City, The: Latin America
 City, The: The City as a Cultural Center
 City, The: The Islamic and Byzantine City
 Creationism
 Death
 Dystopia
Ecology
 Education: Global Education
Environment
 Environmental Ethics
 Environmental History
 Evolution
 Feminism: Overview
 Garden
 Genetics: Contemporary
 Genetics: History of
 Genocide
 Geography
 History, Economic
 History, Idea of
 Hygiene
 Impressionism
 Landscape in the Arts
 Life
 Life Cycle: Elders/Old Age
 Lysenkoism
 Machiavellism
 Maps and the Ideas They Express
 Matriarchy
 Medicine: Islamic Medicine
 Memory
 Migration: Migration in World History
Natural History
 Nuclear Age
 Organicism
 Periodization of the Arts
 Political Protest, U.S.
 Prehistory, Rise of
 Presentism
 Protest, Political
 Religion: Latin America
 Ritual: Religion
 Scarcity and Abundance, Latin America
 Science, History of
 Social Darwinism
 Totems
 Untouchability: Menstrual Taboos

- Utopia
- Visual Order to Organizing Collections
- Wildlife
- Witchcraft
- Witchcraft, African Studies of
- World Systems Theory, Latin America
- CHEMISTRY**
- Alchemy: China
- Alchemy: Europe and the Middle East
- Biology
- Chemistry**
- Classification of Arts and Sciences, Early Modern
- Computer Science
- Consciousness: Overview
- Development
- Experiment
- Genetics: Contemporary
- Genetics: History of
- Health and Disease
- Islamic Science
- Life
- Materialism in Eighteenth-Century European Thought
- Mechanical Philosophy
- Medicine: Europe and the United States
- Mysticism: Chinese Mysticism
- Paradigm
- Philosophies: Islamic
- Physics
- Quantum
- Science: East Asia
- Science, History of
- MATHEMATICS**
- Absolute Music
- Aesthetics: Europe and the Americas
- Algebras**
- Analytical Philosophy
- Astronomy, Pre-Columbian and Latin American
- Beauty and Ugliness
- Calculation and Computation
- Causation
- Causation in East Asian and Southeast Asian Philosophy
- Chemistry
- Classification of Arts and Sciences, Early Modern
- Computer Science
- Cosmology: Cosmology and Astronomy
- Death
- Demography
- Economics
- Empiricism
- Environmental History
- Equality: Overview
- Experiment
- Fallacy, Logical
- Falsifiability
- Foundationalism
- Futurology
- Game Theory
- Generation
- Genetics: Contemporary
- Genetics: History of
- Genocide
- Geometry**
- Harmony
- History, Economic
- Humanism: Chinese Conception of
- Islamic Science
- Knowledge
- Language, Philosophy of: Ancient and Medieval
- Language, Philosophy of: Modern
- Language and Linguistics
- Logic and Philosophy of Mathematics, Modern
- Mathematics**
- Newtonianism
- Perspective
- Philosophies: Islamic
- Philosophy: Historical Overview and Recent Developments
- Physics
- Political Science
- Positivism
- Prejudice
- Probability
- Pythagoreanism
- Quantum
- Rationalism
- Reading
- Reason, Practical and Theoretical
- Relativism
- Relativity
- Representation: Mental Representation
- Scientific Revolution
- Social History, U.S.
- Sophists, The
- Truth
- COMPUTER SCIENCE**
- Calculation and Computation**
- Computer Science**
- Consciousness: Overview
- Futurology
- Game Theory
- Genetics: Contemporary
- Genetics: History of
- Geography
- History, Economic
- Interdisciplinarity
- Language and Linguistics
- Learning and Memory, Contemporary Views
- Maps and the Ideas They Express
- Mathematics
- Privacy
- Probability
- Social History, U.S.
- Virtual Reality
- Professions**
- MEDICINE**
- Alchemy: China
- Alchemy: Europe and the Middle East
- Americanization, U.S.
- Ancestor Worship
- Anthropology
- Asceticism: Hindu and Buddhist Asceticism
- Asceticism: Western Asceticism
- Astrology: China
- Bioethics
- Biology
- Body, The
- Casuistry
- Chemistry
- Childhood and Child Rearing

READER'S GUIDE

Computer Science
Creativity in the Arts and Sciences
Death
Demography
Determinism
Diversity
Environment
Environmental History
Eugenics
Feminism: Overview
Feminism: Third World U.S. Movement
Gay Studies
Gender: Overview
Gender Studies: Anthropology
Genetics: Contemporary
Genetics: History of
Greek Science
Health and Disease
Hinduism
Humanity: African Thought
Humor
Hygiene
Iconography
Islam: Sunni
Islamic Science
Life
Life Cycle: Elders/Old Age
Literary Criticism
Magic
Mathematics
Medicine: China
Medicine: Europe and the United States
Medicine: India
Medicine: Islamic Medicine
Meditation: Eastern Meditation
Miracles
Motherhood and Maternity
Music, Anthropology of
Mysticism: Chinese Mysticism
Narrative
Naturphilosophie
Philosophies: Feminist, Twentieth-Century
Philosophies: Islamic
Phrenology
Population
Privacy
Psychoanalysis
Psychology and Psychiatry
Pythagoreanism
Queer Theory
Religion: Africa
Religion: African Diaspora
Religion: East and Southeast Asia
Religion: Indigenous Peoples' View, South America
Ritual: Religion
Science: East Asia
Science, History of
Sexuality: Overview
Skepticism
Superstition
University: Overview
Untouchability: Menstrual Taboos
Utilitarianism
Victorianism
Visual Culture

Visual Order to Organizing Collections
Volunteerism, U.S.
Westernization: Africa
Witchcraft
Women and Femininity in U.S. Popular Culture
Yin and Yang

LAW

Abolitionism
African-American Ideas
Altruism
Anticolonialism: Africa
Anticolonialism: Latin America
Anticolonialism: Southeast Asia
Antifeminism
Anti-Semitism: Islamic Anti-Semitism
Apartheid
Asian-American Ideas (Cultural Migration)
Assimilation
Authoritarianism: Overview
Authoritarianism: East Asia
Barbarism and Civilization
Bioethics
Black Consciousness
Cannibalism
Capitalism: Overview
Capitalism: Africa
Casuistry
Censorship
Citizenship: Overview
Citizenship: Cultural Citizenship
Citizenship: Naturalization
City, The: The Islamic and Byzantine City
Civil Disobedience
Civil Society: Europe and the United States
Colonialism: Southeast Asia
Consciousness: Chinese Thought
Constitutionalism
Context
Corruption in Developed and Developing Countries
Creationism
Critical Race Theory
Cultural History
Cultural Revivals
Deism
Democracy
Democracy: Africa
Dialogue and Dialectics: Socratic
Dialogue and Dialectics: Talmudic
Dictatorship in Latin America
Discrimination
Diversity
Education: Islamic Education
Empire and Imperialism: Overview
Empire and Imperialism: Europe
Empire and Imperialism: United States
Environmental History
Equality: Overview
Equality: Racial Equality
Ethnicity and Race: Anthropology
Ethnicity and Race: Islamic Views
Europe, Idea of
Extirpation
Fallacy, Logical
Falsifiability
Family Planning

- Fascism
 Feminism: Overview
 Feminism: Africa and African Diaspora
 Feminism: Islamic Feminism
 Feudalism, European
 Gender: Gender in the Middle East
 General Will
 Genetics: Contemporary
 Genetics: History of
 Genocide
 Ghetto
 Globalization: Africa
 Good
 Hate
 Heresy and Apostasy
 Hinduism
 Honor, Middle Eastern Notions of
 Human Rights: Overview
 Humanism: Secular Humanism in the United States
 Iconography
 Identity, Multiple: Jewish Multiple Identity
 Indigenismo
 Individualism
 Intentionality
 Interdisciplinarity
 International Order
 Islam: Africa
 Islam: Shii
 Islam: Southeast Asia
 Islam: Sunni
 Jihad
 Judaism: Judaism to 1800
 Justice: Overview
 Justice: Justice in American Thought
 Justice: Justice in East Asian Thought
 Kinship
 Language and Linguistics
Law
Law, Islamic
 Learning and Memory, Contemporary Views
 Legalism, Ancient China
 Liberalism
 Liberty
 Life Cycle: Elders/Old Age
 Literary Criticism
 Loyalties, Dual
 Marriage and Fertility, European Views
 Masks
 Matriarchy
 Migration: United States
 Minority
 Modernity: Overview
 Monarchy: Overview
 Monarchy: Islamic Monarchy
 Motherhood and Maternity
 Mysticism: Islamic Mysticism
 Narrative
 Nation
 Nationalism: Cultural Nationalism
 Nationalism: Middle East
 Native Policy
 Natural Law
 Nonviolence
 Nuclear Age
 Obligation
 Person, Idea of the
 Philanthropy
 Philosophies: American
 Philosophies: Feminist, Twentieth-Century
 Philosophies: Islamic
 Philosophy: Historical Overview and Recent Developments
 Philosophy, Moral: Ancient
 Political Protest, U.S.
 Population
 Postcolonial Studies
 Power
 Privacy
 Progress, Idea of
 Property
 Protest, Political
 Punishment
 Queer Theory
 Race and Racism: United States
 Reason, Practical and Theoretical
 Reform: Europe and the United States
 Regions and Regionalism, Eastern Europe
 Relativism
 Religion: African Diaspora
 Religion: Middle East
 Religion and the State: Africa
 Religion and the State: Europe
 Religion and the State: Middle East
 Religion and the State: United States
 Representation: Political Representation
 Republicanism: Republic
 Resistance
 Responsibility
 Rhetoric: Ancient and Medieval
 Ritual: Public Ritual
 Sacred Texts: Koran
 Segregation
 Sexual Harassment
 Sexuality: Overview
 Sexuality: Islamic Views
 Sexuality: Sexual Orientation
 Skepticism
 Slavery
 Sociability in African Thought
 Social Contract
 Socialisms, African
 Society
 State, The: Overview
 State, The: The Postcolonial State
 State of Nature
 Stoicism
 Subjectivism
 Sufism
 Suicide
 Temperance
 Toleration
 Totalitarianism
 Treaty
 University: Overview
 Untouchability: Taboos
 Utilitarianism
 Victorianism
 Virtue Ethics
 Visual Order to Organizing Collections
 Volunteerism, U.S.
 War and Peace in the Arts

READER'S GUIDE

Westernization: Africa
Westernization: Middle East
Westernization: Southeast Asia
Wildlife
Witchcraft
ENGINEERING
Alchemy: China
Alchemy: Europe and the Middle East
Architecture: Overview
Architecture: Africa
Architecture: Asia
Beauty and Ugliness
Biology
Calculation and Computation
Capitalism: Overview
Capitalism: Africa
Cinema
City, The: Latin America
City, The: The City as a Cultural Center
City, The: The City as Political Center
City, The: The Islamic and Byzantine City
Communication of Ideas: Southeast Asia
Computer Science
Diffusion, Cultural
Dystopia
Ecology
Empire and Imperialism: Europe
Environmental History
Epistemology: Early Modern
Experiment
Futurology
Gender Studies: Anthropology
Genetics: Contemporary
Genetics: History of
Genocide
Geometry
Globalization: General
Greek Science
Harmony
Historical and Dialectical Materialism
History, Economic
Humanism: Secular Humanism in the United States
Interdisciplinarity
Japanese Philosophy, Japanese Thought
Knowledge
Literary Criticism
Maps and the Ideas They Express
Mathematics
Mechanical Philosophy
Meme
Modernity: Overview
Modernity: Africa
Modernity: East Asia
Modernization
Modernization Theory
Motherhood and Maternity
Music, Anthropology of
Musical Performance and Audiences
Mysticism: Chinese Mysticism
Newtonianism
Nomadism
Nuclear Age
Occidentalism
Perspective
Power

Presentism
Privacy
Progress, Idea of
Protest, Political
Reform: Europe and the United States
Relativity
Science, History of
Science Fiction
Technology
Textiles and Fiber Arts as Catalysts for Ideas
Totalitarianism
Victorianism
Virtual Reality
Visual Culture
War and Peace in the Arts
Westernization: Middle East
Westernization: Southeast Asia
World Systems Theory, Latin America

Multidisciplinary Practices

The *New Dictionary of the History of Ideas* has many entries that discuss the methods by which scholars and researchers pursue knowledge. The entries below discuss approaches, methods, and practices that have influenced many disciplines.

ENTRIES ON MULTIDISCIPLINARY PRACTICES THAT ORIGINATED IN ANCIENT TIMES

Aesthetics: Asia
Africa, Idea of
Algebras
Anthropology
Architecture: Overview
Architecture: Asia
Aristotelianism
Astrology: Overview
Biology
Body, The
Buddhism
Casuistry
Causality
Censorship
Classicism
Classification of Arts and Sciences, Early Modern
Composition, Musical
Cosmology: Asia
Creationism
Creativity in the Arts and Sciences
Daoism
Development
Dialogue and Dialectics: Socratic
Dualism
Eclecticism
Education: China
Education: Europe
Epistemology: Ancient
Equality: Overview
Essentialism
Eurocentrism
Experiment
Fallacy, Logical
Fetishism: Fetishism in Literature and Cultural Studies
Form, Metaphysical, in Ancient and Medieval Thought
Fundamentalism
Gender in Art
Genre

- Geometry
 Greek Science
 Harmony
 Health and Disease
 Hierarchy and Order
 Hinduism
 History, Idea of
 Humanism: Europe and the Middle East
 Humor
 Ideas, History of
 Imagination
 Interpretation
 Knowledge
 Language, Philosophy of: Ancient and Medieval
 Life
 Literary History
 Literature: African Literature
 Logic
 Maps and the Ideas They Express
 Mathematics
 Medicine: China
 Medicine: Europe and the United States
 Medicine: India
 Memory
 Metaphor
 Metaphysics: Ancient and Medieval
 Monism
 Museums
 Music, Anthropology of
 Musical Performance and Audiences
 Mysticism: Chinese Mysticism
 Narrative
 Nature
 Orthodoxy
 Orthopraxy: Asia
 Orthopraxy: Western Orthopraxy
 Paradigm
 Periodization
 Perspective
 Philosophies: African
 Philosophies: Islamic
 Philosophy: Historical Overview and Recent Developments
 Philosophy and Religion in Western Thought
 Physics
 Platonism
 Presentism
 Progress, Idea of
 Pythagoreanism
 Rationalism
 Reading
 Reason, Practical and Theoretical
 Religion: Overview
 Responsibility
 Rhetoric: Overview
 Rhetoric: Ancient and Medieval
 Sacred Places
 Sacred Texts: Asia
 Science: East Asia
 Scientific Revolution
 Skepticism
 Sophists, The
 Syncretism
 Taste
 Text/Textuality
 Toleration
 Translation
 Trope
 Truth
 Virtual Reality
 Wisdom, Human
 Yin and Yang
- ENTRIES ON MULTIDISCIPLINARY PRACTICES OF
 MORE RECENT ORIGIN
 Absolute Music
 Aesthetics: Africa
 African-American Ideas
 Afrocentricity
 Analytical Philosophy
 Astronomy, Pre-Columbian and Latin American
 Avant-Garde: Militancy
 Behaviorism
 Bilingualism and Multilingualism
 Bioethics
 Black Atlantic
 Calculation and Computation
 Class
 Conservatism
 Consilience
 Continental Philosophy
 Critical Race Theory
 Critical Theory
 Cultural Studies
 Dada
 Dialogue and Dialectics: Talmudic
 Dream
 Dystopia
 Economics
 Education: Global Education
 Education: Islamic Education
 Empiricism
 Encyclopedism
 Environmental Ethics
 Environmental History
 Epistemology: Early Modern
 Epistemology: Modern
 Ethnicity and Race: Anthropology
 Ethnocentrism
 Ethnography
 Ethnohistory, U.S.
 Examination Systems, China
 Expressionism
 Family: Modernist Anthropological Theory
 Feminism: Overview
 Fetishism: Overview
 Field Theories
 Formalism
 Futurology
 Game Theory
 Gender: Gender in the Middle East
 Generation
 Genetics: Contemporary
 Genetics: History of
 Geography
 Hegelianism
 Hermeneutics
 Historicism
 Humanism: Africa
 Humanism: Renaissance
 Iconography

Idealism
 Identity: Identity of Persons
 Intentionality
 Interdisciplinarity
 Japanese Philosophy, Japanese Thought
 Language, Philosophy of: Modern
 Language and Linguistics
 Law, Islamic
 Learning and Memory, Contemporary Views
 Linguistic Turn
 Literary Criticism
 Logic and Philosophy of Mathematics, Modern
 Masks
 Metaphysics: Renaissance to the Present
 Mind
 Modernism: Overview
 Modernism: Latin America
 Modernization
 Modernization Theory
 Motif: Motif in Literature
 Motif: Motif in Music
 Mysticism: Kabbalah
 Myth
 Naturalism
 Naturalism in Art and Literature
 Naturphilosophie
 Newtonianism
 Objectivity
 Oral Traditions: Overview
 Orientalism: Overview
 Philosophies: Feminist, Twentieth-Century
 Philosophy, Moral: Africa
 Philosophy of Religion
 Phrenology
 Poetry and Poetics
 Polytheism
 Positivism
 Postcolonial Studies
 Postmodernism
 Power
 Practices
 Pragmatism
 Prejudice
 Probability
 Pseudoscience
 Psychoanalysis
 Queer Theory
 Realism
 Realism: Africa
 Reflexivity
 Regions and Regionalism, Eastern Europe
 Relativism
 Relativity
 Religion: Indigenous Peoples' View, South America
 Religion and Science
 Representation: Mental Representation
 Romanticism in Literature and Politics
 Sacred Texts: Koran
 Sage Philosophy
 Scholasticism
 Science: Overview
 Science, History of
 Science Fiction
 Secularization and Secularism
 Social Capital

Social History, U.S.
 State, The: Overview
 Structuralism and Poststructuralism: Overview
 Structuralism and Poststructuralism: Anthropology
 Subjectivism
 Symbolism
 Third Cinema
 Totems
 Tradition
 Universalism
 Utilitarianism
 Visual Culture
 Volksgeist
 Women's Studies

Especially Interdisciplinary Entries

The most interdisciplinary entries synthesized knowledge by using the methods and focusing on the topics of practitioners of several disciplines. Very few entries listed below are in only one division. Common pairs for the history of ideas are social sciences and humanities, social sciences and sciences, and humanities and sciences. In the early twenty-first century there is generally a recognition of the common overlap of the social sciences with the humanities; social scientists may take ethical and literary factors into consideration and humanists may incorporate societal contexts into their work. The presence of psychology in the sciences, as well as the quantitative nature of some social sciences work, creates an overlap of social sciences with sciences. Another interesting overlap is between humanities and sciences—topics that in antiquity were treated as philosophy or religion are now investigated by those following scientific methods.

SOCIAL SCIENCES, SCIENCES, AND FINE ARTS

Architecture: Africa
 Geography
 Phrenology
 Virtual Reality

SCIENCES, FINE ARTS, AND HUMANITIES

Enlightenment
 Epistemology: Early Modern
 Feminism: Third World U.S. Movement
 Field Theories
 Geometry
 Globalization: Asia
 Text/Textuality

FINE ARTS, HUMANITIES, AND SOCIAL SCIENCES

Aesthetics: Africa
 Alienation
 Americanization, U.S.
 Anticolonialism: Africa
 Arts: Overview
 Arts: Africa
 Authenticity: Africa
 Autobiography
 Avant-Garde: Overview
 Aztlán
 Censorship
 Chinese Thought
 City, The: The Islamic and Byzantine City
 Civil Disobedience
 Civil Society: Europe and the United States
 Colonialism: Southeast Asia
 Communication of Ideas: Africa and Its Influence
 Communication of Ideas: The Americas and Their Influence

Communication of Ideas: Asia and Its Influence
 Communication of Ideas: Orality and Advent of Writing
 Cultural Capital
 Cultural History
 Cynicism
 Dialogue and Dialectics: Socratic
 Dialogue and Dialectics: Talmudic
 Diasporas: Jewish Diaspora
 Dictatorship in Latin America
 Etiquette
 Everyday Life
 Expressionism
 Extirpation
 Fascism
 Feminism: Chicana Feminisms
 Gay Studies
 Gender Studies: Anthropology
 Genre
 Ghetto
 Honor
 Humanity in the Arts
 Humor
 Identity, Multiple: Jewish Multiple Identity
 Images, Icons, and Idols
 Islam: Shii
 Landscape in the Arts
 Leadership
 Life Cycle: Overview
 Linguistic Turn
 Literature: African Literature
 Maoism
 Millenarianism: Islamic
 Millenarianism: Latin America and Native North America
 Minority
 Modernism: Latin America
 Musicology
 Mysticism: Christian Mysticism
 Mysticism: Islamic Mysticism in Asia
 Mysticism: Kabbalah
 Mysticism: Mysticism in African Thought
 Nation
 New Criticism
 Nude, The
 Oral Traditions: Overview
 Orientalism: Overview
 Orthodoxy
 Orthopraxy: Asia
 Pan-Africanism
 Pan-Asianism
 Pan-Turkism
 Philosophies: African
 Philosophies: American
 Philosophy, Moral: Ancient
 Populism: United States
 Postmodernism
 Practices
 Pre-Columbian Civilization
 Realism
 Religion: Africa
 Religion: Middle East
 Religion and the State: United States
 Renaissance
 Resistance

Romanticism in Literature and Politics
 Sage Philosophy
 Shinto
 Society
 Taste
 Theater and Performance
 Theodicy
 Third World Literature
 Wisdom, Human
HUMANITIES, SOCIAL SCIENCES, AND SCIENCES
 Afropessimism
 Alchemy: China
 Alchemy: Europe and the Middle East
 Altruism
 Antifeminism
 Asceticism: Hindu and Buddhist Asceticism
 Asceticism: Western Asceticism
 Astrology: China
 Astrology: Overview
 Borders, Borderlands, and Frontiers, Global
 Calculation and Computation
 Calendar
 Capitalism: Overview
 Capitalism: Africa
 Cartesianism
 Casuistry
 Causality
 Causation
 Causation in East Asian and Southeast Asian Philosophy
 Character
 Chicano Movement
 Childhood and Child Rearing
 Confucianism
 Consciousness: Chinese Thought
 Consciousness: Indian Thought
 Consilience
 Cosmology: Asia
 Cycles
 Daoism
 Demography
 Demonology
 Discrimination
 Dress
 Dualism
 Education: Islamic Education
 Empiricism
 Equality: Racial Equality
 Ethnicity and Race: Africa
 Ethnohistory, U.S.
 Fallacy, Logical
 Foundationalism
 Futurology
 Genetics: Contemporary
 Genetics: History of
 Genocide
 Health and Disease
 Hermeneutics
 Historical and Dialectical Materialism
 Hygiene
 Intelligentsia
 Internal Colonialism
 Islam: Africa
 Jainism
 Japanese Philosophy, Japanese Thought
 Kinship

READER'S GUIDE

- Law, Islamic
 - Machiavellism
 - Machismo
 - Medicine: China
 - Medicine: India
 - Meme
 - Memory
 - Mestizaje
 - Modernization Theory
 - Motif: Motif in Music
 - Museums
 - Music, Anthropology of
 - Nationalism: Africa
 - Natural History
 - Naturalism
 - Negritude
 - Objectivity
 - Philosophy, History of
 - Philosophy, Moral: Modern
 - Philosophy of Religion
 - Population
 - Positivism
 - Pragmatism
 - Prejudice
 - Presentism
 - Privacy
 - Probability
 - Quantum
 - Race and Racism: Overview
 - Race and Racism: Asia
 - Race and Racism: Europe
 - Reason, Practical and Theoretical
 - Religion: Overview
 - Religion and Science
 - Science: Overview
 - Scientific Revolution
 - Segregation
 - Sexuality: Islamic Views
 - Sexuality: Sexual Orientation
 - Skepticism
 - State of Nature
 - Structuralism and Poststructuralism: Overview
 - Time: China
 - Time: India
 - Truth
 - Universalism
 - University: Overview
 - Wildlife
 - World Systems Theory, Latin America
- FINE ARTS, HUMANITIES, SOCIAL SCIENCES, AND SCIENCES
- Absolute Music
 - Aesthetics: Asia
 - Aesthetics: Europe and the Americas
 - Ancestor Worship
 - Anthropology
 - Architecture: Overview
 - Architecture: Asia
 - Astronomy, Pre-Columbian and Latin American
 - Beauty and Ugliness
 - Bilingualism and Multilingualism
 - Bioethics
 - Body, The
 - Cannibalism
 - Change
 - Chemistry
 - Cinema
 - City, The: The City as a Cultural Center
 - City, The: The City as Political Center
 - Classification of Arts and Sciences, Early Modern
 - Communication of Ideas: Southeast Asia
 - Composition, Musical
 - Computer Science
 - Consciousness: Overview
 - Consumerism
 - Context
 - Continental Philosophy
 - Cosmopolitanism
 - Creationism
 - Critical Theory
 - Cultural Studies
 - Dance
 - Death
 - Determinism
 - Dream
 - Dystopia
 - Ecology
 - Emotions
 - Empire and Imperialism: Europe
 - Environment
 - Environmental Ethics
 - Environmental History
 - Equality: Overview
 - Equality: Gender Equality
 - Ethnicity and Race: Islamic Views
 - Eugenics
 - Examination Systems, China
 - Feminism: Overview
 - Fetishism: Overview
 - Fetishism: Fetishism in Literature and Cultural Studies
 - Friendship
 - Game Theory
 - Gender: Gender in the Middle East
 - Gender in Art
 - Generation
 - Greek Science
 - Harmony
 - Heaven and Hell
 - Hinduism
 - History, Economic
 - History, Idea of
 - Humanity: African Thought
 - Ideas, History of
 - Identity, Multiple: Overview
 - Intentionality
 - Interdisciplinarity
 - Islam: Sunni
 - Islamic Science
 - Kantianism
 - Knowledge
 - Language and Linguistics
 - Learning and Memory, Contemporary Views
 - Life
 - Literary Criticism
 - Literary History
 - Love, Western Notions of
 - Magic
 - Manichaeism
 - Maps and the Ideas They Express
 - Masks

- Mathematics
 Matriarchy
 Medicine: Europe and the United States
 Medicine: Islamic Medicine
 Meditation: Eastern Meditation
 Men and Masculinity
 Metaphor
 Modernism: Overview
 Monarchy: Overview
 Modernity: Africa
 Modernity: East Asia
 Motherhood and Maternity
 Musical Performance and Audiences
 Mysticism: Chinese Mysticism
 Myth
 Narrative
 Newtonianism
 Nomadism
 Nuclear Age
 Occidentalism
 Organicism
 Paradigm
 Periodization of the Arts
 Person, Idea of the
 Philosophies: Feminist, Twentieth-Century
 Philosophies: Islamic
 Philosophy: Historical Overview and Recent Developments
 Poetry and Poetics
 Political Protest, U.S.
 Progress, Idea of
 Property
 Protest, Political
 Pseudoscience
 Psychoanalysis
 Punishment
 Pythagoreanism
 Queer Theory
 Reading
 Realism: Africa
 Reflexivity
 Reform: Europe and the United States
 Relativism
 Religion: East and Southeast Asia
 Religion: Indigenous Peoples' View, South America
 Religion: Latin America
 Representation: Mental Representation
 Resistance and Accommodation
 Responsibility
 Ritual: Public Ritual
 Ritual: Religion
 Sacred Places
 Science: East Asia
 Science, History of
 Science Fiction
 Sexuality: Overview
 Social History, U.S.
 Sophists, The
 Sport
 Stoicism
 Subjectivism
 Superstition
 Surrealism
 Symbolism
 Syncretism
 Temperance
 Third Cinema
 Toleration
 Totalitarianism
 Totems
 Tragedy and Comedy
 Untouchability: Menstrual Taboos
 Untouchability: Taboos
 Utilitarianism
 Utopia
 Victorianism
 Visual Culture
 Visual Order to Organizing Collections
 Volunteerism, U.S.
 War and Peace in the Arts
 Westernization: Middle East
 Westernization: Southeast Asia
 Witchcraft
 Witchcraft, African Studies of
 Yin and Yang



G

GAME THEORY. Game theory, the formal analysis of conflict and cooperation, has pervaded every area of economics and the study of business strategy in the past quarter-century and exerts increasing influence in evolutionary biology, international relations, and political science, where the rational-choice approach to politics has been highly controversial. In a strategic game, each player chooses a strategy (a rule specifying what action to take for each possible information set) to maximize his or her expected payoff, taking into account that each of the other players is also making a rational strategic choice. In contrast to economic theories of competitive equilibrium, the focus of game theory is on strategic interaction and on what information is available to a player to predict the actions that the other players will take.

The Origins of Game Theory

Writings by several nineteenth-century economists, such as A. A. Cournot and Joseph Bertrand on duopoly and F. Y. Edgeworth on bilateral monopoly, and later work in the 1930s by F. Zeuthen on bargaining and H. von Stackelberg on oligopoly, were later reinterpreted in game-theoretic terms, sometimes in problematic ways (Leonard, 1994; Dimand and Dimand). Game theory emerged as a distinct subdiscipline of applied mathematics, economics, and social science with the publication in 1944 of *Theory of Games and Economic Behavior*, a work of more than six hundred pages written in Princeton by two Continental European emigrés, John von Neumann, a Hungarian mathematician and physicist who was a pioneer in fields from quantum mechanics to computers, and Oskar Morgenstern, a former director of the Austrian Institute for Economic Research. They built upon analyses of two-person, zero-sum games published in the 1920s.

In a series of notes from 1921 to 1927 (three of which were translated into English in *Econometrica* in 1953), the French mathematician and probability theorist Emile Borel developed the concept of a mixed strategy (assigning a probability to each feasible strategy rather than a pure strategy selecting with certainty a single action that the opponent could then predict) and showed that for some particular games with small numbers of possible pure strategies, rational choices by the two players would lead to a minimax solution. Each player would choose the mixed strategy that would minimize the maximum payoff that the other player could be sure of achieving. The young John von Neumann provided the first proof that this minimax solution held for all two-person, constant-sum games (strictly competitive games) in 1928, although the proof of the minimax theorem used by von Neumann and Morgenstern in 1944 was based on the first elementary (that is, nontopological) proof

of the existence of a minimax solution, proved by Borel's student Jean Ville in 1938 (Weintraub; Leonard, 1995; Dimand and Dimand). For games with variable sums and more players, where coalitions among players are possible, von Neumann and Morgenstern proposed a more general solution concept, the stable set, but could not prove its existence. In the 1960s, William Lucas proved by counterexample that existence of the stable set solution could not be proved because it was not true in general.

Although von Neumann's and Morgenstern's work was the subject of long and extensive review articles in economics journals, some of which predicted widespread and rapid application, game theory was developed in the 1950s primarily by A. W. Tucker and his students in Princeton's mathematics department (see Shubik's recollections in Weintraub) and at the RAND Corporation, a nonprofit corporation based in Santa Monica, California, whose only client was the U.S. Air Force (Nasar). Expecting that the theory of strategic games would be as relevant to military and naval strategy as contemporary developments in operations research were, the U.S. Office of Naval Research supported much of the basic research, and Morgenstern was named as an editor of the *Naval Research Logistics Quarterly*.

Much has been written about the influence of game theory and related forms of rational-choice theory such as systems analysis on nuclear strategy (although General Curtis LeMay complained that RAND stood for Research And No Development) and of how the Cold War context and military funding helped shape game theory and economics (Heims; Poundstone; Mirowski), mirrored by the shaping of similar mathematical techniques into "planometrics" on the other side of the Cold War (Campbell). Researchers in peace studies, publishing largely in the *Journal of Conflict Resolution* in the late 1950s and the 1960s, drew on Prisoner's Dilemma games to analyze the Cold War (see Schelling), while from 1965 to 1968 (while ratification of the Nuclear Non-Proliferation Treaty was pending) the U.S. Arms Control and Disarmament Agency sponsored important research on bargaining games with incomplete information and their application to arms races and disarmament (later declassified and published as Mayberry with Harsanyi, Scarf, and Selten; and Aumann and Maschler with Stearns).

Nash Equilibrium, the Nash Bargaining Solution, and the Shapley Value

John Nash, the outstanding figure among the Princeton and RAND game theorists (Nasar; Giocoli), developed, in articles

from his dissertation, both the Nash equilibrium for noncooperative games, where the players cannot make binding agreements enforced by an outside agency, and the Nash bargaining solution for cooperative games where such binding agreements are possible (Nash). Nash equilibrium, by far the most widely influential solution concept in game theory, applied to games with any number of players and with payoffs whose sum carried with the combination of strategies chosen by the players, while von Neumann's minimax solution was limited to two-person, constant-sum games. A Nash equilibrium is a strategy combination in which each player's chosen strategy is a best response to the strategies of the other players, so that no player can get a higher expected payoff by changing strategy as long as the strategies of the other players stay the same. No player has an incentive to be the first to deviate from a Nash equilibrium.

Nash proved the existence of equilibrium but not uniqueness: a game will have at least one strategy combination that is a Nash equilibrium, but it may have many or even an infinity of Nash equilibria (especially if the choice of action involves picking a value for a continuous variable). Cournot's 1838 analysis of duopoly has been interpreted in retrospect as a special case of Nash equilibrium, just as Harsanyi perceived the congruity of Zeuthen's 1930 discussion of bargaining and the Nash bargaining solution. Refinements of Nash equilibrium, which serve to rule out some of the possible equilibria, include the concept of a subgame perfect equilibrium (see Harsanyi and Selten), which is a Nash equilibrium both for an entire extended game (a game in which actions must be chosen at several decision nodes in a game tree) and for any game starting from any decision node in the game tree, including points that would never be reached in equilibrium, so that any threats to take certain actions if another player were to deviate from the equilibrium path would be credible (rational in terms of self-interest once that point in the game had been reached). A further refinement rules out some subgame perfect Nash equilibria by allowing for the possibility of a "trembling hand," that is, a small probability that an opposing player, although rational, may make mistakes (Harsanyi and Selten). Thomas Schelling has suggested that if there is some clue that would lead players to regard one Nash equilibrium as more likely than others, that equilibrium will be a focal point.

Nash equilibrium, with its refinements, remains at the heart of noncooperative game theory. Applied to the study of market structure by Martin Shubik (1959), this approach has come to dominate the field of industrial organization, as indicated by Jean Tirole (1988) in a book widely accepted as the standard economics textbook on industrial organization and as a model for subsequent texts. More recently, noncooperative game theory has found economic applications ranging from strategic trade policy in international trade to the credibility of anti-inflationary monetary policy and the design of auctions for broadcast frequencies. From economics, noncooperative game theory based on refinements of Nash equilibrium has spread to business school courses on business strategy (see Ghemawat, applying game theory in six Harvard Business School cases for MBA students). Some economists view business strategy as an application of game theory, with ideas flowing in one direction, rather than as a distinct field (Shapiro).

However, scholars of strategic management remain sharply divided over whether game theory provides useful insights or just a rationalization for any conceivable observed behavior (see the papers by Barney, Saloner, Camerer, and Postrel in Rumelt, Schendel, and Teece, especially Postrel's paper, which verifies Rumelt's Flaming Trousers Conjecture by constructing a game-theoretic model with a subgame perfect Bayesian Nash equilibrium in which bank presidents publicly set their pants on fire, a form of costly signaling that is profitable only for a bank that can get repeat business, that is, a high-quality bank).

Nash proposed the Nash bargaining solution for two-person cooperative games, that the players maximize the product of their gains over what each would receive at the threat point (the Nash equilibrium of the noncooperative game that they would play if they failed to reach agreement on how to divide the gains), and showed it to be the only solution possessing all of a particular set of intuitively appealing properties (efficiency, symmetry, independence of unit changes, independence of irrelevant alternatives). Feminist economists such as Marjorie McElroy and Notburga Ott have begun to apply bargaining models whose outcome depends critically on the threat point (the outcome of the noncooperative game that would be played if bargaining does not lead to agreement), as well as Prisoner's Dilemma games, to bargaining within the household (see Seiz for a survey).

Another influential solution concept for cooperative games, the Shapley value for n -person games (Shapley), allots to each player the average of that player's marginal contribution to the payoff each possible coalition would receive and, for a class of games with large numbers of players, coincides with the core of a market (the set of undominated imputations or allocations), yet another solution concept discovered by graduate students at Princeton in the early 1950s (in this case, Shapley and D. B. Gillies) and then rediscovered by Shubik in Edgeworth's 1881 analysis. There is a large literature in accounting applying the Shapley value to cost allocation (Roth and Verrecchia).

Applications of Game Theory

Lloyd Shapley and Shubik (1954), two Princeton contemporaries of Nash, began the application of game theory to political science, drawing on Shapley's 1953 publication to devise an index for voting power in a committee system. William Riker and his students at the University of Rochester took the lead in recasting political science in terms of strategic interaction of rational, self-interested players (see Riker and Ordeshook; Shubik, 1984; Riker in Weintraub), and there is now a specialized market for game-theory textbooks for political science students (Morrow). Donald Green and Ian Shapiro (1994) criticize recent applications to politics of game theory and related forms of rational-choice theory as viewing political behavior as too exclusively rational and self-interested to the exclusion of ideologies, values, and social norms (see Friedman for the ensuing controversy).

Recasting Marxism in terms of rational choice and analyzing class struggle as a strategic game is especially controversial (Carver and Thomas). Conflict and cooperation (whether in the

form of coalitions or contracts) are at the heart of law, as of politics. Douglas Baird, Robert Gertner, and Randal Picker (1994), among others, treat such legal topics as tort, procedure, and contracts as examples of strategic interaction, as the growing subdiscipline of law and economics increasingly reasons in terms of game theory. As a counterpart at a more “macro” level to game-theoretic analysis of political and legal conflict and cooperation, Andrew Schotter (1981) and Shubik (1984) propose a “mathematical institutional economics” to explain the evolution of social institutions such as contract law, money, trust, and customs, norms, and conventions (“the rules of the game”) as the outcome of strategic interaction by rational agents. This approach shows promise, but has been received skeptically by economists such as Ronald Coase who rely on less mathematical neoclassical techniques to develop a “New Institutional Economics,” and with even less enthusiasm by economists outside the neoclassical mainstream, such as Philip Mirowski. Going beyond the explanation of merely mundane institutions, Steven Brams (1983) uses game theory to explore questions of theology.

Prisoner’s Dilemma

Game theorists and social scientists have been fascinated by Prisoner’s Dilemma, a two-by-two game (two players, each with two possible pure strategies) with a particular payoff matrix (Rapoport and Chammah; Poundstone). The game’s nickname and the accompanying story were provided by A. W. Tucker. Suppose that two prisoners, accused of jointly committing a serious crime, are interrogated separately. The prosecutor has sufficient evidence to convict them of a lesser crime without any confession, but can get a conviction on the more serious charge only with a confession. If neither prisoner confesses, they will each be sentenced to two years for the lesser charge. If both confess, each will receive a sentence of five years. However, if only one prisoner confesses, that prisoner will be sentenced to only one year, while the other prisoner will get ten years. In the absence of any external authority to enforce an agreement to deny the charges, each player has a dominant strategy of confessing (given that the other player has denied the charges, one year is a lighter sentence than two years; given that the other player has confessed, five years is a lighter sentence than ten years). The unique Nash equilibrium is for both players to confess (defect from any agreement to cooperate) and receive sentences of five years, even though both would be better off if both denied the charges (cooperated).

This game has been used as an explanation of how individually rational behavior can lead to undesirable outcomes ranging from arms races to overuse of natural resources (“the tragedy of the commons,” a generalization to more than two players). If the game is repeated a known finite number of times, however large, the predicted result is the same: both players will confess (defect) on the last play, since there would be no opportunity of future punishment for defection or reward for cooperation; therefore both will also confess (defect) on the next-to-last play, since the last play is determined, and so on, with mutual defection on each round as the only subgame perfect Nash equilibrium. However, the “folk theorem” states that for *infinitely* repeated games, even with discounting of future benefits or a constant probability of the game

ending on any particular round (provided that the discount rate and the probability of the game ending on the next round are sufficiently small and that the dimensionality of payoffs allows for the possibility of retaliation), *any* sequence of actions can be rationalized as a subgame perfect Nash equilibrium. (The folk theorem owes its name to its untraceable origin.)

However, players do not generally behave in accordance with Nash’s prediction. Frequent cooperation in one-shot or finitely repeated Prisoner’s Dilemma has been observed ever since it was first played. The first Prisoner’s Dilemma experiment, conducted at RAND by Merrill Flood and Melvin Drescher in January 1950, involved one hundred repetitions with two sophisticated players, the economist Armen Alchian from the University of California, Los Angeles, and the game theorist John Williams, head of RAND’s mathematics department. Alchian and Williams succeeded in cooperating on sixty plays, and mutual defection, the Nash equilibrium, occurred only fourteen times (Poundstone, pp. 107–116). Robert Axelrod (1984) conducted a computer tournament for iterated Prisoner’s Dilemma, finding that Rapoport’s simple “tit for tat” strategy (cooperate on the first round, then do whatever the other player did on the previous round) yielded the highest payoff.

One way to explain the observed extent of cooperation in experimental games and in life is to recognize that humans are only boundedly rational, relying on rules of thumb and conventions, and making choices about what to know because information is costly to acquire and process. Assumptions about rationality in game theory, such as common knowledge, can be very strong: “An event is common knowledge among a group of agents if each one knows it, if each one knows the others know it, if each one knows that each one knows that the others know it, and so on . . . the limit of a potentially infinite chain of reasoning about knowledge” (Geanakoplos, p. 54). Ariel Rubinstein (1998) sketches techniques for explicitly incorporating computability constraints and the process of choice in models of procedural rationality. Alternatively, evolutionary game theory, surveyed by Larry Samuelson (2002), emphasizes adaptation and evolution to explain behavior, rather than fully conscious rational choice, returning to human behavior the extension of game theory to evolutionarily stable strategies for animal behavior (Maynard Smith; Dugatkin and Reeve).

Conclusion

The award of the Royal Bank of Sweden Prize in Economic Science in Memory of Alfred Nobel to John Nash, John Harsanyi, and Reinhard Selten in 1994 recognized the impact of game theory (and a film biography of Nash, based on Nasar’s 1998 book, subsequently won Academy Awards for best picture and best actor), while the multivolume *Handbook of Game Theory*, edited by Robert Aumann and Sergiu Hart (1992–2002), presents a comprehensive overview. Reflecting on what has been achieved, David Kreps concludes that

Non-cooperative game theory . . . has brought a fairly flexible language to many issues, together with a collection of notions of “similarity” that has allowed economists to move insights from one context to another

and to probe the reach of these insights. But too often it, and in particular equilibrium analysis, gets taken too seriously at levels where its current behavioural assumptions are inappropriate. We (economic theorists and economists more broadly) need to keep a better sense of proportion about when and how to use it. And we (economic and game theorists) would do well to see what can be done about developing formally that senses of proportion. (pp. 184)

Strategic interaction has proved to be a powerful idea, and, although its application, especially beyond economics, remains controversial, it has proven fruitful in suggesting new perspectives and new ways of formalizing older insights.

See also **Economics; Mathematics; Probability; Rational Choice.**

BIBLIOGRAPHY

- Aumann, Robert J., and Sergiu Hart, eds. *Handbook of Game Theory with Economic Applications*. 3 vols. Amsterdam: North-Holland, 1992–2002.
- Aumann, Robert J., and Michael B. Maschler, with the collaboration of Richard E. Stearns. *Repeated Games with Incomplete Information*. Cambridge, Mass.: MIT Press, 1995.
- Axelrod, Robert. *The Evolution of Cooperation*. New York: Basic Books, 1984.
- Baird, Douglas, Robert H. Gertner, and Randal C. Picker. *Game Theory and the Law*. Cambridge, Mass.: Harvard University Press, 1994.
- Brams, Steven J. *Superior Beings: If They Exist, How Would We Know? Game-Theoretic Implications of Omniscience, Omnipotence, Immortality, and Incomprehensibility*. New York: Springer-Verlag, 1983.
- Campbell, Robert W. "Marx, Kantorovich, and Novozhilov: Stoimost' versus Reality." *Slavic Review* 20 (1961): 402–418.
- Carver, Terrell, and Paul Thomas, eds. *Rational Choice Marxism*. Houndmills, U.K.: Macmillan, 1995.
- Dimand, Mary Ann, and Robert W. Dimand. *The History of Game Theory*, Vol. 1: *From the Beginnings to 1945*. London and New York: Routledge, 1996.
- Dugatkin, Lee Alan, and Hudson Kern Reeve, eds. *Game Theory and Animal Behavior*. New York: Oxford University Press, 1998.
- Friedman, Jeffrey, ed. "Rational Choice Theory." *Critical Review* 9 (1995).
- Geanakoplos, John. "Common Knowledge." *Journal of Economic Perspectives* 6 (1992): 53–82.
- Ghemawat, Pankaj. *Games Businesses Play: Cases and Models*. Cambridge, Mass.: MIT Press, 1997.
- Giocoli, Nicola. *Modeling Rational Agents: From Interwar Economics to Early Modern Game Theory*. Cheltenham, U.K., and Northampton, Mass.: Edward Elgar, 2003.
- Green, Donald P., and Ian Shapiro. *Pathologies of Rational Choice Theory: A Critique of Applications in Political Science*. New Haven, Conn.: Yale University Press, 1994.
- Harsanyi, John C., and Reinhard Selten. *A General Theory of Equilibrium Selection in Games*. Cambridge, Mass.: MIT Press, 1988.
- Heims, Steve J. *John Von Neumann and Norbert Wiener: From Mathematics to the Technologies of Life and Death*. Cambridge, Mass.: MIT Press, 1980.
- Kreps, David M. *Game Theory and Economic Modelling*. Oxford: Clarendon Press, 1990.
- Leonard, Robert J. "From Parlor Games to Social Science: Von Neumann, Morgenstern, and the Creation of Game Theory, 1928–1944." *Journal of Economic Literature* 33 (1995): 730–761.
- . "Reading Cournot, Reading Nash: The Creation and Stabilisation of the Nash Equilibrium." *Economic Journal* 104 (1994): 492–511.
- Mayberry, John P., with John C. Harsanyi, Herbert E. Scarf, and Reinhard Selten. *Game-Theoretic Models of Cooperation and Conflict*. Boulder, Colo.: Westview 1992.
- Maynard Smith, John. *Evolution and the Theory of Games*. Cambridge, U.K.: Cambridge University Press, 1982.
- Mirowski, Philip. *Machine Dreams: Economics Becomes a Cyborg Science*. Cambridge, U.K.: Cambridge University Press, 2002.
- Morrow, James D. *Game Theory for Political Scientists*. Princeton, N.J.: Princeton University Press, 1994.
- Nasar, Sylvia. *A Beautiful Mind: A Biography of John Forbes Nash, Jr., Winner of the Nobel Prize in Economics, 1994*. New York: Simon and Schuster, 1998.
- Nash, John F., Jr. *Essays on Game Theory*. Cheltenham, U.K., and Brookfield, Vt.: Edward Elgar, 1996.
- Poundstone, William. *Prisoner's Dilemma: John von Neumann, Game Theory, and the Puzzle of the Bomb*. New York: Doubleday, 1992.
- Rapoport, Anatol, and Albert M. Chammah. *Prisoner's Dilemma: A Study in Conflict and Cooperation*. Ann Arbor: University of Michigan Press, 1965.
- Riker, William H., and Peter C. Ordeshook. *An Introduction to Positive Political Theory*. Englewood Cliffs, N.J.: Prentice Hall, 1973.
- Roth, A. E., and R. E. Verrecchia. "The Shapley Value as Applied to Cost Allocation: a Reinterpretation." *Journal of Accounting Research* 17 (1979): 295–303.
- Rubinstein, Ariel. *Modeling Bounded Rationality*. Cambridge, Mass.: MIT Press, 1998.
- Rumelt, Richard P., Dan E. Schendel, and David J. Teece, eds. *Fundamental Issues in Strategy: A Research Agenda*. Boston: Harvard Business School Press, 1994.
- Samuelson, Larry. "Evolution and Game Theory." *Journal of Economic Perspectives* 16 (2002): 47–66.
- Schelling, Thomas. *The Strategy of Conflict*. Cambridge, Mass.: Harvard University Press, 1960.
- Schotter, Andrew. *The Economic Theory of Social Institutions*. Cambridge, U.K.: Cambridge University Press, 1981.
- Seiz, Janet A. "Game Theory and Bargaining Models." In *The Elgar Companion to Feminist Economics*, edited by Janice Peterson and Margaret Lewis. Cheltenham, U.K., and Northampton, Mass.: Edward Elgar, 1999.
- Shapiro, Carl. "The Theory of Business Strategy." *RAND Journal of Economics* 20 (1989): 125–137.
- Shapley, Lloyd S. "A Value for n-Person Games." In Harold Kuhn and Albert W. Tucker, eds., *Contributions to the Theory of Games*, Vol. 2, *Annals of Mathematics Studies*, no. 28. Princeton, N.J.: Princeton University Press, 1953.
- Shapley, Lloyd S., and Martin Shubik, "A Method for Evaluating the Distribution of Power in a Committee System." *American Political Science Review* 48 (1954): 787–792.
- Shubik, Martin. *A Game-Theoretic Approach to Political Economy*. Vol. 2 of *Game Theory in the Social Sciences*. Cambridge, Mass.: MIT Press, 1984.

- . *Strategy and Market Structure: Competition, Oligopoly, and the Theory of Games*. New York: Wiley, 1959.
- Tirole, Jean. *The Theory of Industrial Organization*. Cambridge, Mass.: MIT Press, 1988.
- Von Neumann, John, and Oskar Morgenstern. *Theory of Games and Economic Behavior*. Princeton, N.J.: Princeton University Press, 1944; 3rd ed. 1953.
- Weintraub, E. Roy, ed. *Toward a History of Game Theory*. Durham, N.C.: Duke University Press, 1992. Annual supplement to *History of Political Economy*.

Robert W. Dimand

GARDEN. The term *garden*, which is of Germanic origin, means “yard” or “enclosure” and denotes ways of organizing earth, water, plants and, sometimes, people, animals, and art (sculpture, architecture, theater, music, and poetry), the formal qualities of which are determined as much by pleasure, artistry, or aesthetics as by convenience or necessity. This definition excludes arrangements of sacred space based on religious customs and sports, exclusions that are consistent with most societies.

Not all cultures have gardens. For many reasons, anthropologists and garden historians consider most small cultivated plots to be forms of agriculture, as opposed to gardens. Gardens presuppose agriculture but in addition embrace a cultural and psychological distance from agriculture expressed in aesthetics.

Gardens in the History of Ideas

Gardens have the capability to give physical form to ideas either by being modeled on familiar ideas or by creating a new design that generates or evokes new ideas, or through a combination of the two. Gardens make abstract ideas concrete—visible, tangible, and kinesthetic. In so doing, gardens can communicate complex abstract ideas convincingly.

Death

Gardens express ideas of victory over death in three ways. First, since their living components could die at any time (as a result of neglect or the whim of the owner or overwhelming natural forces), their mere existence represents a triumph over ill-will, chaos, and death; gardens signal that the world can be made right, especially through the use of human knowledge, skill, and spirit. Second, because gardens’ biological materials inevitably grow, die, decay, and are then reconstituted to form life once again, they provide a powerful symbol of the cyclical aspect of life, negating death’s apparent finality with a metaphorical triumph over death, fear, and hopelessness. This biological cycle implicit in the garden suggests a transmutation of death and an antidote to despair. Finally, depending on the culture, the form gardens are given reflects either (a) their triumph over the chaos found in nature, a chaos that is perceived as a constant threat to humanity—and in monotheistic cultures, a symbol of humanity’s distance from God, or (b) the tremendous power of nature, of which humanity is a necessary part. In this manner, the garden’s form reflects the innate hope

that humans express by either taming or cooperating with nature. This hope, this expression, allows beholders to feel part of larger forces, bigger than their own short lives and limited powers. These three symbolic triumphs over death and fear are so compelling that exceptions, such as the “monster” sculptures in one part of the Boboli Garden at the Pitti Palace, are rare. Usually they are ironic: the agony of Christ in the garden of Gethsemane; the tortures of damnation in Hieronymous Bosch’s painting *The Garden of Earthly Delights*.

Time and Temporality

Related to death are the various ideas of time and temporality—the internal experiences of time. Gardens in seasonal climates reveal the cyclical experience of the seasons, and all gardens underscore the cycles of day and night. Through these cycles one becomes more aware of the passing of time, of recurrence and passing away forever. Gardens often utilize sundials, or poems, to highlight the awareness of a particular idea of time.

Poems and allusions of all kinds, as well as relics and historical artifacts, can also be used to make people aware of the past (or some idea of it) and of their collective or personal histories.

Order and Plenty

The people of ancient Egypt understood that by controlling the Nile River and the agriculture dependent upon it, they might impose order on the primordial chaos that was always a potential threat. Egyptian garden paintings, the world’s earliest, show geometry and symmetry as the formal indications of this valuable foundation of such order. These early images show rectangular pools filled with fish, ducks, and lotus surrounded by regularly spaced fruit trees—emblematic of an ideal of the good life as it exists around the world.

The idea of the garden as a place where order is imposed upon an inherently chaotic, disorderly, painful, and dangerous natural world is central to ancient Egyptian, Persian, Islamic, European, and European-American concepts of the garden. The noted landscape gardener Lancelot “Capability” Brown (1715–1783), famous for designs of gardens that looked like natural landscape, considered his efforts as improvements on the natural state (as well as on the rigid and geometric designs of previous gardenists); even nineteenth-century Romantic-era gardens, which thrived on the appearance of disorder, were carefully planned.

Related to the idea of an order that provides for humanity—and to the idea of the garden as a triumph over death—is the idea of the garden as a site of never-ending bounty, never failing with the seasons. This idea is more common in India and the monotheistic Middle East, Europe, and America. Homer described the garden of Alcinoos, king of the Phaeaceans, in *The Odyssey* (book vii): “and verdant olives flourish round the year. / The balmy spirit of the western gale / eternal breathes on fruits untaught to fail.” Chinese and especially Japanese gardens differ in being more likely to celebrate the different beauties of the several seasons.

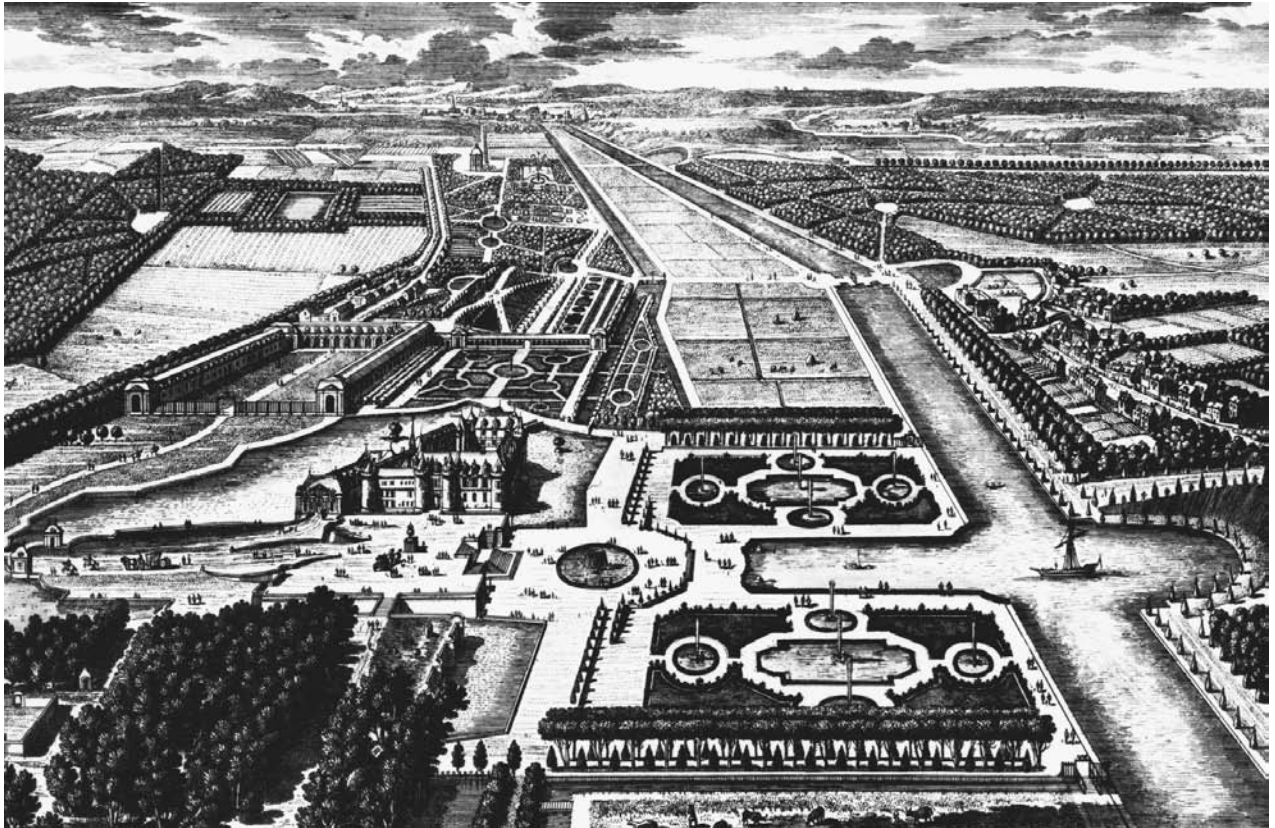

France. *Vue Generale de Chantilly du cote de l'Entrée* by Adam Perelle, 1650. A European villa garden. DUMBARTON OAKS, RESEARCH LIBRARY AND COLLECTION, WASHINGTON, D.C.

European villa gardens, of both the informal “pastoral” and the more formal French types, reflected and instantiated the notion of the garden as a place of plenty by extolling the ideal of a close relationship to agriculture. Often this closeness was literal: gardens were situated within the larger farm, and might include (geometric) herb gardens, grape arbors, or symmetrically planted fruit groves; adjacent fields were actively cultivated.

The Lost Home

Nebuchadnezzar (r. 605–562 B.C.E.), the Chaldean king of Babylon, introduced another persistent idea of the garden, that of the garden as a lost home. Nebuchadnezzar built the Hanging Gardens, one of the Seven Wonders of the ancient world, to comfort one of his wives, who missed “the meadows of her mountains, the green and hilly landscape of her youth” (Thacker, p. 16). A similar motivation prompted the creation of the Tuileries Gardens in Paris. The Qing emperor Kang Xi (1662–1723) built the Pi-shu shan-chuang at Rehe (Jehol) in China to emulate the Manchurian homelands. In the modern era, retirees in the deserts of the American Southwest, self-exiled from temperate climates, recreate the comforting lawns, maples, and flowers reminiscent of their previous homes. Homer used Odysseus’s memories of his childhood in his garden with his father, who gave him fruit trees and taught him the names of the plants, to underscore the hero’s longing for home.

The Hanging Gardens of Babylon were described by Diodorus Siculus:

Since the approach to the garden sloped like a hillside and the several parts of the structure rose from one another tier on tier . . . [it] resembled a theater . . . the uppermost gallery, which was fifty cubits high, bore the highest surface of the park . . . the roofs of the galleries were covered with beams of stone . . . sufficient for the roots of the largest trees; and the ground, when levelled off, was thickly planted with trees of every kind that . . . could give pleasure to the beholder . . . The galleries contained many royal lodgings; and there was one gallery which contained openings leading from the topmost surface and machines for supplying the garden with water. (Thacker, p. 17)

Admired by the ancient Greeks and Romans, they demonstrate several characteristics of gardens persisting to the early twenty-first century: the use of engineering and technology—often, paradoxically, to achieve a natural effect—and the attempt to make the garden a place of pleasure and sensuous delight; the integration of agriculture in the garden; and the integration of theater, poetry, and painting.

In terms of world history (not just garden design), the most far-reaching, if poignant, image of the garden as lost home is



Italy: Ancient Rome. Courtyard garden in Pompeii, with paintings of birds and flowers on the interior walls of the colonnade. MARA MILLER

found in the story of the Garden of Eden in the *Book of Genesis*.

Garden as Paradise and Enclosure.

In 401 B.C.E., the Greek historian Xenophon, in his *Oeconomicus*, Book IV, introduced the idea of the pleasure garden (Persian, *paradeisos*, “enclosure”) to Greece, based on gardens he had seen while fighting in Persia, and recommended its imitation. Xenophon’s description of the Persian gardens was again popularized in 1692 by the Englishman William Temple in his influential *Essay upon the Gardens of Epicurus: Or, of Gardening, in the Year 1685* (1692):

a paradise among them [the Persians] seems to have been a large Space of Ground, adorned and beautified with all Sorts of Trees, both of Fruits and of Forest, either found there before it was inclosed [*sic*], or planted after; either cultivated like Gardens, for Shades and for Walks, with Fountains or Streams, and all Sorts of Plants usual in the Climate, and pleasant to the Eye, the Smell, or the Taste; or else employed, like our Parks, for Inclosure [*sic*] and Harbour of all Sorts of Wild Beasts, as well as for the Pleasure of Riding and Walking: And so they were of more or less Extent, and of differing Entertainment, according to the several Humours of the

Princes that ordered and inclosed [*sic*] them. . . . (quoted in Hunt and Willis, pp. 96–97)

Enclosure is central to many types of gardens, including ancient Roman courtyards, which were surrounded by the house, Chinese and Korean courtyard gardens, and Japanese dry rock gardens (*karesansui*). Unlike the medieval European cloister gardens derived from them, Roman gardens often included mural paintings of gods and landscapes.

The Persian model of the garden as a paradise on earth later evolved into the Islamic *chahar-bagh*, an enclosed quadrangular garden with central perpendicular paths or canals dividing it into four equal sections. Later made famous in carpets and brought to India by the Mughals, *chahar-baghs*, the most famous example of which is the Taj Mahal, reached Europe as the medieval *hortus conclusus*, or enclosed garden, as a result of the Crusades (1050–1150) and through Islamic gardens in Spain, Italy, and Sicily. Many twentieth-century rose gardens continue this form. Like its Islamic prototypes, the medieval garden was practical and symbolic, evoking the earthly and spiritual pleasures of the biblical Paradise and the Garden of Eden. Secular poetry such as the medieval French *Le Roman de la Rose*, purportedly composed during a dream in a rose garden, extended the *hortus conclusus* to include romantic love and Platonic ideals of fulfilment. Paintings and tapestries, too, especially the unicorn tapestries at Cluny



Medieval France. Bonnefont Cloister and Herb Garden, modeled after medieval gardens, The Cloisters, New York City. © GAIL MOONEY/CORBIS

and the Cloisters of the Metropolitan Museum of Art, showing unicorns and the “Lady in the Garden,” take on various symbolic and allegorical readings.

The Garden of Eden, of course, is also a “lost home.” Eden is described in *Genesis* as a kind of *chahar-bagh*, enclosed, divided into quarters by rivers meeting at right angles in the center, containing the Tree of the Knowledge of Good and Evil. Construed by Jews, Christians, and Muslims as an actual place from the human past, it was distinguished from Paradise, which was an ideal realm to be experienced by the righteous or the beloved of God in the future, and for Christians after their death or after the Second Coming. Eden as a prototype for European gardens was vastly expanded by the literary version John Milton presented in his epic *Paradise Lost* (1667) as a natural landscape (Hunt, p. 79).

The earliest East Asian depictions of the four Buddhist paradises show Buddhas and Bodhisattvas in palaces surrounded by fragrant trees and flowers, dancers, and musicians. As cave paintings at Dunhuang (China) show, the religious significance of lotus suggested using the visual image of the lotus floating in a pond; azure rectangles of water with pink blossoms began to appear, growing larger, eventually with buds showing souls reborn in paradise as babies. This inspired actual gardens, including the famous Buddhist garden at Anapchi, in Kyongju, Korea (674 C.E.).

The pond at Anapchi shows a second visual allusion to paradise, the Daoist Isles of the Immortals. Depicted here as actual islands, they are sometimes represented by rocks on an “ocean” of dry gravel. Originating with the Chinese emperor Wudi (141–87 B.C.E.), such depictions were originally intended to attract the Immortals themselves, in the hope they would share their secrets.

A number of Fujiwara-period (989–1185) Japanese gardens, starting with the Byodo-in’s Phoenix Hall (a villa in Uji outside Kyoto), simulated the Mahayana Paradise described in a sutra that attested to women’s ability to reach enlightenment (yienpruksawan). These gardens were designed to make paradise tangible and imaginable. Since the daughters of the Fujiwara clan were consistently married off to emperors, their eventual enlightenment was important both to their families and to the nation. The ability to visualize paradise was believed to facilitate enlightenment (legendary Queen Vaidehi’s instruction by Buddha in meditation through visualization, including visualization of Paradise, was painted at Dunhuang). The construction of gardens as an aid to such visualization meant that the empresses would actually attain Paradise more easily.

Garden as Rustic Retreat

The Romans invented the idea of the villa—a home and farm in the countryside—which they believed provided a manner



Korea. Anapchi Garden in Kyongju, Unified Silla Period, 674 C.E. MARA MILLER

of living superior to that of city life. The villa achieves this goal both physically and spiritually or culturally by affording self-expression, self-cultivation, and self-definition. The garden became the setting and the occasion of this ideal, where by emulating cultured and educated men one became more cultured and educated oneself. (Although the model is largely patriarchal, a few women have done the same: the Duchess Eleonora di Toledo [wife of Cosimo I] in the Boboli Garden, the Countess of Bedford at Moor-Park [Hertfordshire], and Mildred Bliss at Dumbarton Oaks, designed by Beatrix Farrand).

The Roman pastoral ideal symbolized by the villa and its garden ideal was revived in Renaissance Italy and eighteenth-century England, whence it spread to America. It was based on models found in Vergil's *Aeneid* and *Georgics*, in the letters of Pliny the Younger, and in the architect Andrea Palladio's (1508–1580) books and buildings reinterpreting classical architecture. Pliny's celebratory descriptions of life in the country influenced literati in their creation of an image of a life worth living—and in their designs of gardens within which to live. The Greek and Roman forms of government presupposed politically active citizens, and the resuscitation of these models as an ideal form elicited from Europeans, Britons, and Americans active participation not only in governing but in reimagining the ways the world might be governed and how social intercourse could be encouraged; creating gardens as

representations of these emerging worldviews was part of the process of re-imagining.

The idea of the villa garden as a realm of personal cultivation in which one emulates historical role models is strikingly similar to one set of East Asian ideas of gardens, wherein gardens serve as places for contemplation, scholarship, artistic engagement, and social interaction with other literati. From the time of Wang Wei (699–c.760), East Asian paintings represent gardens of the literati as places of retreat from the corrupt world of everyday affairs, places that made possible the personal cultivation or “self-transformation” according to Buddhist, Confucian, and Daoist models. Paintings of the scholar Tao Yuanming (365–457), famous for his integrity, show a rustic fence and a few chrysanthemums depicting the garden whose tending was the pretext of his retirement.

Fruit-bearing trees and other forms of agriculture were important parts of Chinese villas and literati gardens of “retirement” (Clunas), a feature that also recalls Paradise and the notion of plenty.

In both Europe and East Asia, villa gardens as ideal realms eliciting personal cultivation coexist with the ideal of the rustic retreat, be it a shell-lined grotto or a humble thatched hut. Both remained vital for centuries, inspiring garden construction and permitting endless reformulation of intellectual literati ideas and ideals.



Korea. The courtyard and garden of the Confucian Academy T'oson Sowon (established 1574) were derived from Chinese influences. MARA MILLER

Garden as Art

Gardens were often regarded as art, both in theory and as a result of intimate and intricate relations among gardens and other arts. Most famous is Horace Walpole's (1717–1797) theory of the interrelations of the “three arts,” poetry, painting, and the garden, in his *History of the Modern Taste in Gardening* (1771–1780).

The inclusion of carved or handwritten poetic quotations is found frequently in Asian and European gardens of nearly all styles, and visual allusions to well-known poems, legends, or stories provide the basis for garden vignettes, such as the flat angular “eight-plank” bridges alluding to the tales of Ise in Japanese gardens, as well as themes for garden “rooms” or motifs. Highly influential gardens have been designed—or described—by poets, most famously Murasaki Shikibu (d. c. 1014–1020), John Milton, Alexander Pope (1688–1744), Ishikawa Jozan (1583–1672), and Yuan Mei (eighteenth century).

Italian, French, German, and British formal gardens were used for theatrical entertainments and masques, sometimes in pavilions designed for the purpose (later gardens included shallow amphitheatres), while masques, operas, and other forms

of early modern theater often had scenes set in a garden. Architecturally, gardens encompass—or are encompassed by—a house, palace, or temple. But formal gardens, English “natural” landscape gardens, European-American romantic gardens, and large Chinese gardens also incorporated small pavilions or “follies”; Japanese gardens often feature small rustic tea houses, or halls (later donated to temples). All have bridges both decorative and useful.

Garden as Microcosm of Nature

East Asian thinking in many cases centered on the nature of the cosmos, the relation of yin and yang, the place of human beings in nature, and so on. These ideas were at once conceptual/intellectual, artistic, spiritual, and experiential/imaginative, designed to provide the scholar with an opportunity for contemplation of nature like that provided within the landscape itself. Miniature gardens assembled on trays (bonsai) presented the macrocosm in microcosm for the viewer to use to immerse himself in nature or contemplate the Dao.

Sixteenth-century European explorers returned home with exotic plants that were featured in the new scientific botanical gardens. The first botanic gardens were quartered geometric arrangements simulating the “four quarters of the world” with plants in the area allotted to their continent of origin. Twentieth-century botanic gardens specialized in the creation of miniature systems representing whole environments, either cultural (Japanese gardens) or biological, recreating specific biomes (tropical, desert) and capable of sustaining the plants (and sometimes animals) native to them. (The Denver and Brooklyn Botanic Gardens have both types.) In the twenty-first century zoos (formally known as “zoological gardens”) have started re-creating the topography and native vegetation of the animals in their collections, thus becoming more like gardens.

Garden as Microcosm of the State

In Han China (202 B.C.E.–220 C.E.) gardens such as Tu Yuan (Rabbit Park) were used to “extend the grandeur of the princely dwelling, to be a site for ceremonies and magic, and to continue the time-honored mold of a game park” (Morris, p. 13). The contemporary Chinese imperial garden described by Pere Attiret (1757) was designed to represent the country for the emperor, whose status forbade traveling freely.

From the sixteenth century, French gardens were used politically in myriad ways: “to impress foreigners with the power of the court, to stir the loyalty of Frenchmen and, after the political and religious crisis deepened in the second half of the sixteenth century, to subtly express the political policy of the state. The court festival, especially as it was masterminded by Catherine de Médicis, often provided an opportunity to bring together opposed factions, turning their ‘real conflicts into a chivalrous pastime’” (Adams, p. 33). Versailles has been shown to be an elaborate four-dimensional demonstration of the power of Louis XIV; decision-making that went into the planning of its park was explicitly political (Berger). The British designed and interpreted gardens that were symbolic of the state and of political power. Such a connection was first drawn in Britain by Shakespeare in the gardener's speech in *Richard II* (act 3, scene 4).



Mughal India. *Jahangir and Prince Khurram Feasted by Nur Jahan*, c. 1617. Opaque watercolor and gold on paper. FREER GALLERY OF ART, SMITHSONIAN INSTITUTION, WASHINGTON, D.C.: GIFT OF CHARLES LANG FREER, F1907.258



England. View of the Elysian Fields, Stowe, which were first established in 1731. MARA MILLER

The propensity to use gardens to express political arguments and commitments, and to understand garden design in political terms, permitted the garden historian Walpole to associate French formal gardens with monarchy and tyranny, and “natural” growth and irregularity with the newly emerging opposition government (Chase; Miller, “Gardens as Political Discourse”).

Landscape

The idea of the garden as a landscape is, in the early 2000s, most familiar as the natural landscape garden, or *jardin anglos-chinois*, an artistic bequest of the eighteenth-century British.

The garden as natural landscape rejecting artificiality and the symmetric knots of formal gardens is an extrapolation of Eden from *Paradise Lost* (1667). According to Horace Walpole, Milton is responsible for popularizing in garden design the idea that “only after the Fall did man have to invoke art to shore a damaged nature” (Hunt and Willis, p. 79).

During the eighteenth century this account inspired new garden design in England. Since formal gardens exemplified monarchies, the specifics of Milton’s description of Eden as a natural landscape rather than as a geometric formal garden (favored by kings) are a function of his intense interest in Puritan antimonarchical politics, adding to their persuasive force.

In 1692 William Temple introduced the Chinese term *sharawadgi*, of which the origin is undertermined (although he thought Chinese), to refer to beauty that imitated nature rather than relying on geometric pruning and symmetrical designs. Temple defined *sharawadgi* as that sort of order “where Beauty shall be great, and strike the Eye, but without any Order or Disposition of Parts, that shall be commonly or easily observ’d” (Hunt and Willis, p. 98). For half a century Chinese “irregular” gardening principles, known also from Matteo Ripa’s illustrations of Chinese gardens, were associated with anti-monarchical (even Whig) politics, until Walpole reversed that association by comparing the Chinese gardens described by the French missionary to China Pere Attiret to French formal monarchical gardens.

In addition, visual appropriation of adjacent landscape was integral to gardens in Renaissance Italy, eighteenth-century Britain, and Muromachi, Momoyama, and Edo, Japan, where the term *shakkei*, or “borrowed scenery,” was coined to describe it (Nitschke). In Japan, gardens have been imitating nature for nearly one thousand years, and the rules for such gardens were transmitted both orally and in writing (Slawson).

Garden as Picture

One variant of the garden as a landscape is the garden based on landscape painting (*Ut pictura hortus*). Christopher Hussey’s landmark study *The Picturesque* demonstrated the



Japan. Landscape with figures by Unkoku Tjogan, Momoyama period (1573–1615). One of a pair of six-panel screens, ink on paper. AVERY BRUNDAGE COLLECTION, THE ASIAN ART MUSEUM OF SAN FRANCISCO



Japan. Daitoku-ji Temple in Kyoto. Dry rock garden of the landscape type inspired by Song Dynasty Chinese landscape painting. MARA MILLER

power of the garden, once it was modeled on painting, to make the “picturesque” a category that could be applied to all landscape—the principle upon which highway scenic overlooks are based. According to Walpole, the early English landscape gardens by William Kent were also designed based upon pictorial compositions. The idea of modeling a garden on a landscape painting has a lively history in East Asia as well, where it can be seen in the dry rock gardens of Daitoku-ji Temple in Kyoto, based on Song Chinese landscape paintings.

Artists have created many highly influential gardens, among them Wang Wei (690–c. 760), William Kent (1685–1748), and Claude Monet (1840–1926). Gardens such as those by Manet and Gertrude Jekyll (1843–1932) utilized an artist’s sense of color. In all cultures with gardens, gardens present themselves as pictures, providing subject matter for painters; in East Asia they are particularly important philosophically.

Contemporary Gardens

Contemporary gardens continue to express many of these ancient ideas. In the early twenty-first century, as throughout history, when gardeners adopt and adapt the designs and practices and materials of new technologies or foreign garden traditions, they also adopt—and perhaps change—the underlying ideas. When they use the large rocks of Japanese landscape gardens in a front yard in Colorado or a University grounds in Montreal, they usher in a different way of understanding nature, the relationship of the building to its environment, the meaning of being at home. When they cultivate domestic and public lands with native grasses or wildflowers, they visualize specific ideas of the meaning of that place and its place in the natural environment. When they plant the tops of their buildings with a “green roof,” they present a new perception of the role of the building in its environment and of humanity’s responsibility for that environment.

See also Landscape in the Arts; Nature; Paradise on Earth; Wildlife.

BIBLIOGRAPHY

- Adams, William Howard. *The French Garden, 1500–1800*. New York: Braziller, 1979.
- Berger, Robert W. *In the Garden of the Sun King: Studies on the Park of Versailles Under Louis XIV*. Washington, D.C.: Dumbarton Oaks Research Library and Collection, 1985.
- Chambers, Douglas. *The Planters of the English Landscape Garden: Botany, Trees, and the Georgics*. New Haven, Conn., and London: Yale University Press, 1993.
- Chase, Isabella Wakelin Urban. *Horace Walpole: Gardenist. An Edition of Walpole’s “The History of the Modern Taste in Gardening,” with an Estimate of Walpole’s Contribution to Landscape Architecture*. Princeton, N.J.: Princeton University Press, 1943.
- Clunas, Craig. *Fruitful Sites: Garden Culture in Ming Dynasty China*. Durham, N.C.: Duke University Press, 1996.

- du Prey, Pierre de la Ruffinière. *The Villas of Pliny from Antiquity to Posterity*. Chicago and London: University of Chicago Press, 1994.
- Everett, Nigel. *The Tory View of Landscape*. New Haven, Conn.: Yale University Press, 1994.
- Goody, Jack. *The Culture of Flowers*. Cambridge, U.K., and New York: Cambridge University Press, 1993.
- Harvey, John. *Medieval Gardens*. London: B. T. Batsford, 1981.
- Hunt, John Dixon, and Peter Willis, eds.. *The Genius of the Place: The English Landscape Garden 1620–1820*. London: Elek, 1975. Reprint, Cambridge, Mass.: MIT Press, 1988.
- Hussey, Christopher. *The Picturesque*. London and New York: G. P. Putnam, 1927.
- Itoh, Teiji. *Space and Illusion in the Japanese Garden*. Translated and adapted by Ralph Friedrich and Masajiro Shimamura. New York: Weatherhill, 1973.
- Jashemski, Wilhelmina Mary Feemster. *The Gardens of Pompeii: Herculaneum and the Villas Destroyed by Vesuvius*. New Rochelle, N.Y.: Caratzas, 1979.
- Lehrman, Jonas. *Earthly Paradise: Garden and Courtyard in Islam*. Berkeley and Los Angeles: University of California Press, 1980.
- Marx, Leo. *The Machine in the Garden: Technology and the Pastoral Ideal in America*. Oxford: Oxford University Press, 1964.
- Miller, Mara. *The Garden as an Art*. Albany: State University of New York Press, 1993.
- . “The Garden as Significant Form.” *Journal of Speculative Philosophy* 2, no. 4 (1988): 267–287.
- . “Gardens as Political Discourse in the Age of Walpole.” In vol. 5 of *Politics, Politeness, and Patriotism: Proceedings of the Folger Institute for the History of British Political Thought*, edited by Gordon Schochet, 263–280. Folger Shakespeare Library, 1993.
- . “Knot Gardens and the Genesis of the Scientific Attitude.” *Comparative Civilizations Review* 18 (spring 1988): 58–90.
- . “The Lady in the Garden: Subjects and Objects in an Ideal World.” In *Crossing the Bridge: Comparative Essays on Medieval European and Heian Japanese Women*, edited by Cynthia Ho and Barbara Stevenson. New York: Palgrave, 2000.
- . “The Politics of Garden Design: Perspective on the Walpole-Chambers Debate.” In vol. 6 of *Empire and Revolutions: Proceedings of the Folger Institute for the History of British Political Thought*, edited by Gordon Schochet, 227–234. Washington, D.C.: Folger Shakespeare Library, 1993.
- Morris, Edwin T. *The Gardens of China: History, Art, and Meanings*. New York: Scribners, 1983.
- Nitschke, Gunter. *Japanese Gardens: Right Angle and Natural Form*. Cologne, Germany: Benedikt Taschen, 1993.
- Pevsner, Nikolaus. *The Picturesque Garden and Its Influence Outside the British Isles*. Washington, D.C.: Dumbarton Oaks, Trustees for Harvard University, 1974.
- Prest, John. *The Garden of Eden: The Botanic Garden and the Recreation of Paradise*. New Haven, Conn., and London: Yale University Press, 1981.
- Quaintance, Richard E. “Walpole’s Whig Interpretation of Landscaping History.” *Studies in Eighteenth-Century Culture* 9 (1979): 285–300.
- Sirén, Osvald. *China and Gardens of Europe of the Eighteenth Century*. New York: Ronald Press, 1951.
- . *Gardens of China*. New York: Ronald Press, 1949.
- Slawson, David A. *Secret Teachings in the Art of Japanese Gardens: Design Principles, Aesthetic Values*. Tokyo: Kodansha, 1987.

- Stein, Rolf A. *The World in Miniature: Container Gardens and Dwellings in Far Eastern Religious Thought*. Translated by Phyllis Brooks. Stanford, Calif.: Stanford University Press, 1990.
- Thacker, Christopher. *The History of Gardens*. Berkeley and Los Angeles: University of California Press, 1979.
- Yiengpruksawan, Mimi. “The Phoenix Hall at Uji and the Symmetries of Replication.” *The Art Bulletin* 77 (1995): 647–672.

Mara Miller

GAY STUDIES. Gay studies in the early twenty-first century is a lively interdisciplinary field encompassing studies of literature, anthropology, sociology, psychology, the visual arts, indeed all fields in which nonheteronormative sexuality—and its institutionalized suppression—has become a point of politico-philosophical argument. It has two origins: a more recent starting point in twentieth-century liberal Western discourse, prompted by gay liberation and political and social movements on the one hand, and intellectual trends in literary theory and philosophy on the other, and the much older fact of same-sex love, a facet of human history that permeates and predates recorded civilization. Gay studies is today closely linked to notions of the democratic struggle for civil equality, because the sexual practices that are its focus have been the target of authoritarian forces as diverse as Judeo-Christianity, Puritanism, Neo-Confucianism, psychiatry, Nazism, Maoism, and McCarthyism, all of which have variously punished non-normative sexual practices to promote conformist, repressive political structures. In other times and places, however, while sexuality was always subject to societal pressures to conform, patterns of repression and acceptance varied considerably.

Premodern Traditions of Same-Sex Love in the West

Though classical Greek homosexuality became a romantic, wistful reference point for Victorian, Edwardian, and modern Anglo-American homoerotic literature, its relative cultural norms must not be conflated with bourgeois romance or twentieth-century sexual democracy. The early Stoics, for example, rationally argued for gender and sexual equality and removed conventional morality from the discussion of sex, and Zeno of Citium (c. 335–263 B.C.E.), father of the Stoics, “never resorted to a women, but always to boy-favorites,” according to his biographer Antigonus of Carystus, quoted by Louis Crompton. A more typical example of ancient Greek attitudes toward sexuality can be found in Plato’s Academy, founded circa 387 B.C.E. Here, convention dictated a bisexual model of intergenerational mentorship and pederasty, whereby men fulfilled social obligations for marital, procreative sex while erotically tutoring beardless, flowering adolescent boys. For two adult male citizens to form permanent relationships was infrequent and slightly transgressive; yet the taxonomy of love found in Plato’s *Symposium*, the greatest text on Greek eros, finds mundane heterosexuality pedestrian in contrast to an idealized vision of male love. Nevertheless, in his ultimate work, the *Laws*, an elderly Plato ascetically renounces erotic life. The only documentation for Greek female homosexuality is found in the fragmentary verses of the poet Sappho (fl. c. 610–c. 580 B.C.E.), whose literary influence has nonetheless been significant.

Homosexuality was common during the Roman Empire, but in this period militarism and imperialism turned Platonic mentorship into hedonistic relations between imperialistic Roman masters and conquered, penetrated slaves—a possible source of contemporary formulaic oppositions of masculine-aggressive and feminine-passive sexual and gender roles. Juvenal satirized a widespread homosexuality perceived as base and undignified, but Roman literature elsewhere bustles with lively homoeroticism, most obviously in Petronius's *Satyricon*, Ovid's *Metamorphoses*, and the verse of Catullus and Virgil. With the rise of Judeo-Christian morality, antihomosexual prohibitions such as the infamous passages in Leviticus 20:13 crept into Western thought, prompting the emperor Justinian, in 533 C.E., to make homosexuality a capital offense in his *Corpus juris civilis* (Body of civil law), thus foreshadowing the Christian animus toward homosexuality throughout Anglo-Saxon, medieval, and Renaissance times.

Until recently, the image in the West of homosexual life in the succeeding centuries was grim. In the Middle Ages, sodomites were burned along with witches (the origin of the epithet “faggot”); in the Renaissance Christopher Marlowe (1564–1593) was charged with espousing blasphemous (that is, homosexual) sentiments; and in 1644 the Puritans infamously banned all English theater, fearing licentiousness stemming from both the cross-dressed boys who played women's roles and the unladylike introduction of female actors in 1629. The Renaissance Neoplatonists abstracted Socratic male love into a purely intellectual bond, and in 1767 the first English rendition of Plato's *Symposium* was deliberately mistranslated to remove all elements of homosexuality.

More recent scholarship, however, has challenged this picture of unrelenting homophobia. Biblical revisionists now speculate that the Levitical prohibitions were more narrowly targeted than they appear, intended only to quash blasphemies and paganisms the Bible associated with sodomites (1 Kings 14:24), or to curb male prostitution and public bawdry. In the 1990s, scholars from the Conservative Judaic tradition interpreted homosexuality as no more sinful than not keeping kosher, breaking the Sabbath, or violating any of the other 613 Talmudic commandments. More controversially, John Boswell's landmark studies *Christianity, Social Tolerance, and Homosexuality* (1980) and *Same-Sex Unions in Premodern Europe* (1994) offer highly contested evidence that until the Middle Ages the Catholic and Eastern Orthodox Churches actually condoned homosexuality and sanctioned pseudomarital homosexual partnerships.

Similarly, a wealth of new studies of Renaissance and early modern Europe offer a far more complicated picture of gender and sexuality. Nevertheless, the insights from early gay and lesbian studies of the 1970s remain significant. These studies rejected the Augustinian split between mind and body, identified sexual orientation in terms of undeniable desire and not repressible behavior, and reclaimed male and female homosexuality as two sets of desire distinct from both heterosexual power structures and each other. Though by current standards insufficiently nuanced, this liberal platform offered a critique of Western Christian thinking that nevertheless provided an

important outline of the interrelationship between homophobia and misogyny that remains a significant cultural inheritance. Within this paradigm, the female body was perceived mainly as a procreative vessel, and female pleasure was considered nearly irrelevant prior to the discoveries and theories of Sigmund Freud (1859–1939). Homosexuality, meanwhile, was reductively understood as a corruptive male sodomy that produces the passive, womanly, and thus powerless identities into which patriarchal men fear falling. Male homosexuals, exercising the power of Christian free will, could redeem themselves by mastering (or, in Freudian terms, sublimating) their desires, as Augustine suggests; disempowered women, however, officially had no desires to willfully redeem, though they were, paradoxically, still open to charges of sinful lust.

Non-Western Traditions

Anthropologists have documented a wide range of attitudes toward sexuality in tribal and small-scale societies, which tend to be more egalitarian and to tolerate a far wider range of sexual behaviors, perhaps because where there are no significant forms of inherited wealth, sex can be more easily separated from procreation. Nevertheless, many small-scale societies developed elaborate forms of sexual identities and rituals, including “third sex” figures such as the Polynesian mahu and Native American “two-spirit person” (formerly referred to as “the berdache”), and the male–male semen ingestion rituals of Melanesia. None of these phenomena, still less others such as the cross-dressed performances common in shamanic ritual or the Indian phenomenon of the *hijra* (a broad category encompassing eunuchs and gender-ambiguous persons), are easily interpreted within Western notions of homosexuality and heterosexuality, but all of them attest to the rich variability of human sexual desire and gender performance.

In state-level societies characterized by hierarchies of class, wealth, and power, in contrast, patriarchy was the rule. Nevertheless, some forms of same-sex love were tolerated and even encouraged, often in hierarchical forms that allowed elite males to explore their desires through rarefied aesthetics of same-sex eroticism. In imperial China, for example, one finds homosexuality among the emperors of the Han dynasty (206 B.C.E.–220 C.E.), and the cross-dressing gender performance of Beijing and Cantonese opera, ranked among the most esteemed of all Chinese arts. Though Neo-Confucianists worried homosexuality would threaten family stability, an epicurean aesthetic of male love was routine among dynastic aristocrats, as the Ming dynasty (1368–1644 C.E.) anthology *Duan xiu pan* (Records of the cut sleeve) attests. In Japan, an intergenerational tradition of sexual mentoring—not too different from Plato's—was customary and honorable between older samurai (*nenja*) and adolescent initiates (*wakashu*), and during the Tokugawa period (1603–1867) bisexual “connoisseurs of boys” (*shōjin-zuki*) vied for the affections of young Kabuki actors, who typically doubled as male prostitutes, mainly for the merchant classes. Japan's bisexual ethos is present even in its greatest literary classic, *Tale of Genji* (early eleventh century), whose rakish hero sleeps with boys as well as women, while Ihara Saikaku, famous for *The Great Mirror of Male Love* (1687) and *The Life of a Sensuous Man* (1682),

is arguably the world's first author of commercially produced homosexual and bisexual erotica.

The Medicalized, Industrialized Nation-State

The French Revolution's republican ideologies prompted much of Europe to reexamine its anachronistic, antigay worldview: The Napoleonic Code in 1810, Bavaria in 1813, and Spain in 1822 all legalized consensual homosexuality. With the rise of nineteenth-century industrialism, however, homosexuality was no longer only a sinful offense to God, but a social offense to an emerging bourgeois state attempting to manufacture conformist, nationalistic, and procreative-cum-capitalistic values. Thus was the stage set for modernity's first gay-rights struggle. Under an umbrella of progressive medical science and the burgeoning discipline of psychology, early German gay-rights activists sought to debunk the 1851 Prussian penal code's antigay Paragraph 143, asserting that same-sex attraction was not a sin borne of Christian free will but an innate, genetic trait beyond one's control. In 1864 Karl Heinrich Ulrichs began publishing his multipart, pseudoscientific *Forschungen über das Rätsel der mannmännlichen Liebe* (Researches into the riddle of "man-manly" love), which theorized homosexuality as a natural mental "hermaphroditism" causing discontinuities between gender and sexual object choice. Continuing Ulrichs's notion of genetic abnormality, in 1869 Karl Westphal, a German physician, described a condition of "contrary" sexuality, of masculine women and effeminate men, a view later echoed by the German neuropsychiatrist Richard von Krafft-Ebing's *Psychopathia Sexualis* (1886; Sexual psychopathology). Though Westphal opposed punishment of homosexuality, he believed contrary sexuality could be remedied—unlike Ulrichs, who passionately pled for open tolerance. In English, Westphal's "contrary" sexuality became mistranslated as "inversion," a term popularized by Havelock Ellis's *Sexual Inversion* (1896), whose humanistic case studies argued that "inverts" should live as productive citizens, not be punished for received, arbitrary genetics. Perhaps more progressive was Karl Maria Benkert (creator of the word *homosexual*), who in 1869 published tracts that sought to undermine the Prussian penal code and rebuked Ulrichs's special pleadings, and instead advanced sexual egalitarianism based on French Revolutionary principles.

The most celebrated early gay scholar was the German-Jewish sexologist Magnus Hirschfeld (coiner of the term *transvestite*), who first argued for sexual broadmindedness in *Sappho und Sokrates* (1896) and *Jahrbuch für sexuelle Zwischenstufen* (1899–1923; Yearbook for intermediate sexual types) the world's first homosexually themed journal, which suggested that homosexuals constituted a "third," intermediate sex. In 1919 Hirschfeld founded his Institute for Sexual Science—eventually torched by the Nazis in 1933—and cowrote the screenplay for the world's first gay film, *Anders als die Andern* (Different from the others), which again pleads for homosexual tolerance on medical-genetic grounds. Hirschfeld, certainly, was marginal within the psychological community, and Freud's idea of an arrested latent stage, as coupled with an unresolved Oedipal complex, became the accepted model of homosexual identity until the contemporary gay-rights movement. Unlike Westphal and Krafft-Ebing, Freud viewed homosexuality not as an inborn de-

fect but as a commonplace neurosis no worse than any other, and in 1930 he signed a public statement calling for the repeal of Paragraph 175 (an 1871 revision of Paragraph 143), which the Nazis would soon use to persecute homosexuals.

Undoubtedly, the pathologization of homosexuality affected all spheres of contemporary art and culture: Homosexual or bisexual authors such as Nikolay Vasilyevich Gogol (1809–1852) and Leo Tolstoy (1828–1910) endured psychological torment because of their efforts to suppress their illicit desires, Marcel Proust (1871–1922) and Thomas Mann (1875–1955) framed their homosexualities as upper-class neurosis and decadence, and those who dared de-closet themselves risked the imprisonment Oscar Wilde (1854–1900) suffered, even if, occasionally, the romantic, private verse of an Arthur Rimbaud (1854–1891) or A. E. Housman (1859–1936) covertly legitimized a tender gay sensibility. When Radclyffe Hall's *The Well of Loneliness*—currently regarded as the first lesbian novel—first appeared in 1928, audiences were shocked that its tale of "sexual inversion" was presented in heroic, albeit tragic, terms. Immediately banned in Britain, it became the focus of notorious obscenity trials, and then a touchstone for early lesbian rights movements. Meanwhile, the nations of a rapidly modernizing Asia suppressed (or, in the case of Maoist China, erased) their millennia-old homosexual histories and blindly adopted Western medical prejudice. Japanese homosexuality would reappear (albeit with Western notions of shame attached) only in 1948 with Yukio Mishima's *Kamen no kokuhaku* (Confessions of a mask), and in the early twenty-first century consensual homosexuality remains illegal in communist China, whose memory-impaired leaders insist it is a decadent, Western illness.

Nevertheless, the antibourgeois anarchism that fueled the 1905 and 1917 Russian revolutions also birthed a tentative, fleeting acceptance of modern homosexuality, and the 1922 Bolshevik criminal code officially legalized consensual sodomy. Though a paranoid Joseph Stalin, the Soviet premier, would fully recriminalize homosexuality in 1933, the antibourgeois radicalism first witnessed in Russia still ignites much of modern and postmodern (homo)sexual discourse.

Militancy and Visibility: The Assertion of Gay Identity

The contemporary gay-rights movement is usually traced to the riots that began on June 28, 1969, when patrons at Manhattan's Stonewall Inn refused to submit to the lewdness arrests gay men regularly endured at the time. There were, however, liberal precedents in Henry Gerber's short-lived Society for Human Rights (1924), the first gay-rights organization in the United States, and Communist Party leader Harry Hay's homophilic Mattachine Society (1950) and its sister lesbian organization, Daughters of Bilitis (1955). Meanwhile, under the nose of McCarthyism a contentious, frequently prosecuted homosexual subculture newly awakened through avant-garde filmmaker Kenneth Anger's *Fireworks* (1947), Allen Ginsberg's *Howl* (1956), William S. Burrough's *Naked Lunch* (1959), Christopher Isherwood's *A Single Man* (1964), and the gay-positive "physique" artistry of Bob Mizer, Bruce Bellas, and Tom of Finland. But it was Stonewall's unprecedented militant visibility politics that delivered gays and lesbians from the closet and into the mainstream.

The years following 1969 witnessed the Gay Liberation Front; *The Boys in the Band* (1970), Hollywood's first gay film; John Murphy's *Homosexual Liberation: A Personal View* (1971); *The Journal of Homosexuality* (1974); and (heterosexual) psychologist George Weinberg's *Society and the Healthy Homosexual* (1972), whose neologism *homophobia* identified public prejudice, not the homosexual, as neurotic. In 1973 the American Psychiatric Association—mainly to appease post-Stonewall politics—declassified homosexuality as a pathology in its *Diagnostic and Statistical Manual of Mental Disorders* (DSM), though the DSM-IV persists in recognizing a “gender identity disorder,” implying that homosexual men and women are healthy only insofar as they respectively behave according to masculine-aggressive and feminine-passive gender stereotypes. In the 1970s and 1980s, psychiatry's patriarchal conservatism became a favorite target of lesbian feminists, most notably Monique Wittig, whose revolutionary declaration that lesbians were “not women” rejected Freud's mystifying construction of female sexuality and removed lesbians from the stifling female roles patriarchy had mandated.

In 1970 University of Nebraska professor Louis Crompton created academia's first gay studies class; in 1972 the first gay studies program in the United States was initiated at California State University, Sacramento. While initially gay studies sought to deconstruct the fallacious nineteenth-century medicalization of homosexuality (thus, the substitution of the nonstigmatic *gay*), and resist what Adrienne Rich would later call patriarchy's “compulsory heterosexuality,” by the mid-1970s gay academics began turning to literature, resuscitating the tacitly recognized but largely unexamined homosexualities of authors whose canonical status could legitimize a tentative field susceptible to ridicule. The sexual orientations of Lord Byron, André Gide, Walt Whitman, and W. H. Auden were no longer incidental, but central to a critical literary approach to text, voice, subjectivity, and especially intentionality. Conservatives balked when gay scholars read Herman Melville's *Billy Budd* or Shakespearean sonnets as coded gay texts, but reader-response critics also argued that an author's sexuality was irrelevant, because all textual meaning is not received frozen from history but is an active, contemporary creation of a (sexually) empowered subjectivity. Nevertheless, a secondary gay canon emerged around definitively gay authors such as E. M. Forster, W. Somerset Maugham, Edward Carpenter, Jean Genet, and Gertrude Stein, and gay studies began intersecting with film studies to address the leftist gay cinemas of Pier Paolo Pasolini, Rosa von Praunheim, Rainer Werner Fassbinder, and Derek Jarman. But only in the late 1970s and early 1980s, under the guidance of lesbian feminism and multiculturalism, would once-Eurocentric gay academia fully embrace the likes of Audre Lorde, James Baldwin, Djuna Barnes, and Langston Hughes.

From Gay Identity to Queer Theory

By the 1980s, gay studies came to a critical turning point. Its achievements were clear: A body of theory had emerged that legitimized nonreproductive sexualities, locating sexual desire in politically marginalized yet physically expressive bodies, and exploring how those bodies operated, or were operated upon, within repressive political climates. But if placing gay and les-

bian bodies in opposition to marital and economic norms offered the pleasures of subversion and righteous indignation, it also doomed them to permanent pariah status. Moreover, there was a growing awareness that gay studies, like the earlier disciplines it critiques, risked producing its own essentialized core gender identities, based upon a naturalized gay identity that still perceived anatomy and biology as inescapable. Missing from these formulations were the often polymorphous forms of gender identity and polyamorous quality of desire. The AIDS crisis, which took its toll throughout the 1980s to Reaganite-Thatcherite indifference, also fueled calls for a new, more radical politics. Queer theory responded by abandoning the neo-Marxism and social activism of gay rights, and built upon Michel Foucault's *The History of Sexuality* (1978–1984) and literary poststructuralism to argue that both sexuality and gender are social constructions produced within specific historical contexts. Queer social constructionism decouples sexuality from gender, abandoning any notion of sexual orientation as biologically determined. Male and female are no longer biological polarities but malleable constructs, and thus gender and sexuality (straight or gay) no longer automatically follow from one another. Sexual desire is not perceived as fixed and inherent in the body, but as a culturally created response that may or may not be related to a fixed social identity. Incorporating all categories of gay, lesbian, bisexual, transgender, transsexual, and even voluntary heterosexual desire, “queer,” by having no definitive “Other” to mobilize against, represents everything and nothing, and posits a suprademocratic category through which identities—of class and race as well—can radically hybridize and transform.

The same intellectual ferment that began to define *gay* as retrogressive and *queer* as politically progressive inspired a new academic vocabulary. The word *homophobia*, for example, came under new scrutiny in the mid-1980s. Though it astutely characterized sexual bigotry as a passively received mass neurosis and not a moral choice, Weinberg's term was now seen as etymologically illogical, literally meaning a fear of sameness but figuratively suggesting a fear of otherness. Homophobia was replaced with *heterosexism*, emphasizing not a special “phobia” but a chauvinism as banally evil as sexism or racism. *Heteronormative*, popularized by queer theorist Michael Warner in the early 1990s, moves beyond heterosexism's critique of mere prejudice to challenge the ways patriarchy—especially the patriarchy implicit in late global capitalism—normalizes essential gender identity and punishes all nonheterosexual conduct. Perhaps most influential is Eve Kosofsky Sedgwick's neologism *homosocial*, introduced in *Between Men: English Literature and Male Homosocial Desire* (1985), which argues that heterosexual social institutions, particularly marriage, have historically used women to triangulate and transmit male bonds that, while not actually homosexual, transitively accrue ambiguous homoerotic meanings. After much overuse, however, the parameters of homosociality have become (perhaps deliberately) vague, and there is a tendency to overoptimistically describe all same-sex, homosocial institutions—schools, prisons, monasteries, and so on—as fertile breeding grounds for imagined or potential homosexualities, regardless of those environments' coercive or insular qualities.

More recently, theorists such as Gayatri Chakravorty Spivak have linked queer and postcolonial arguments to investigate how, even in the postmodern world of hybrids and multiple subjectivities, Asian and African nation-states continue to regulate sexual identity and suppress female agency in accordance with colonialist mentalities that they, in a postcolonial era, have failed to progress beyond, and often unwittingly internalize. Most radical has been Judith Butler, whose notion of “performativity,” first introduced in *Gender Trouble* (1990) and later refined in *Bodies That Matter* (1993), maintains that gender is not simply a construct into which humans are historically delivered, but is a mask, a controllable, conscious act of mimicry, parody, and self-parody, as best represented in drag performance. After Butler, however, queer theory’s drive to reimagine sexuality without boundaries or definitions seemed to reach an impasse. One emergent critique sees the elegant philosophical games and abstruse language of authors such as Butler and Spivak as elitist, and questioned whether such texts can be effective political tools for inspiring large-scale cultural change. Some authors even question the concept of Butlerian performativity, dismissing it as stylistic gamesmanship. While queer theorists might argue that questions of rhetoric and performance are key to sociopolitical norms and thus to their transformation, the critique of queer theory as elitist and jargon-filled has nonetheless been widely perceived as justified. Some gay scholars have, in response, recast queer theory in more populist terms, as does Warner in *The Trouble with Normal* (2000), in which he suggests that by seeking marriage rights, gays and lesbians misguidedly try to legitimize their sexualities through an oppressively monogamous, proprietary, shame-based institution that forbids constructions of freer sexuality.

As national debates about gay marriage and civil rights continue, the gay identity politics queer postmodernism hoped to replace are making a resurgence. Recent years have seen a slightly less radical interpretation of queerness, which, lest it unintentionally reproduce an intolerant, authoritarian voice *within* queer communities, should also potentially include identity-based gay activism and oppositional lesbian feminism.

Indeed, as increased gay/queer visibility in film, television, and other popular media has only inflamed the fears of social conservatives, a diversified strategy of neopragmatic gay activism and utopian queer theory may be necessary to neutralize prejudices ingrained throughout the centuries.

See also *Cultural Studies; Gender; Protest, Political; Sexuality*.

BIBLIOGRAPHY

- Boswell, John. *Christianity, Social Tolerance, and Homosexuality: Gay People in Western Europe from the Beginning of the Christian Era to the Fourteenth Century*. Chicago: University of Chicago Press, 1980.
- Butler, Judith. *Bodies That Matter: On the Discursive Limits of “Sex.”* New York: Routledge, 1993.
- Crompton, Louis. *Homosexuality and Civilization*. Cambridge, Mass.: Harvard University Press, 2003.
- Foucault, Michel. *The History of Sexuality*, Vol. 1: *An Introduction*. Translated by Robert Hurley. New York: Pantheon, 1978.

- Hirschfeld, Magnus. *The Homosexuality of Men and Women*. Translated by Michael A. Lombardi-Nash. Amherst, N.Y.: Prometheus Books, 2000.
- Murphy, John. *Homosexual Liberation: A Personal View*. New York: Praeger, 1971.
- Rich, Adrienne. “Compulsory Heterosexuality and Lesbian Existence.” *Signs: Journal of Women in Culture and Society* 5, no. 4 (1980): 631–660. Reprint, in her *Blood, Bread, and Poetry: Selected Prose, 1979–1985*, 23–75. New York: Norton, 1986.
- Saikaku, Ihara. *The Great Mirror of Male Love*. Translated by Paul Gordon Schalow. Stanford, Calif.: Stanford University Press, 1990.
- Sedgwick, Eve Kosofsky. *Epistemology of the Closet*. Berkeley and Los Angeles: University of California Press, 1990.
- Ulrichs, Karl Heinrich. *The Riddle of “Man-Manly” Love: The Pioneering Work on Homosexuality*. 2 vols. Translated by Michael A. Lombardi-Nash. Buffalo, N.Y.: Prometheus Books, 1994. Collected works of Ulrichs.
- Warner, Michael, ed. *Fear of a Queer Planet: Queer Politics and Social Theory*. Minneapolis: University of Minnesota Press, 1993.
- Weinberg, George. *Society and the Healthy Homosexual*. New York: St. Martin’s Press, 1972.

Andrew Grossman

GENDER.

This entry includes two subentries:

- Overview*
- Gender in the Middle East*

OVERVIEW

Gender is an old term in linguistic discourse used to designate whether nouns are masculine, feminine, or neuter. It was not normally used in the language of social or natural sciences or in sexology until 1955, when John Money adopted the term to serve as an umbrella concept to distinguish femininity, or womanliness, and masculinity, or manliness, from biological sex (male or female). Though the term was quickly adopted in studies of transvestism and transsexualism, it did not receive widespread circulation until 1972 in a book coauthored by Money and Anke Ehrhardt. Its popularity became firmly established in the 1980s as the feminist movement increasingly adopted the term *gender studies* as a replacement for *women’s studies*. In a sense by using a new term to describe a variety of phenomena, Money opened up a whole new field of research since it implied that genitalia were not the only factor involved in being a man or a woman.

Money himself went on to develop a number of terms such as *gender identity* and *gender role* to categorize different aspects of one’s identity. He also argued that the term *sex* should be used with a qualifier as in *genetic sex*, *hormonal sex*, or *external genitalia sex*. Gender was more inclusive since it entailed somatic and behavioral criteria on how one conducts oneself personally and socially, and how one is regarded legally. Sex belonged more to reproductive biology than to social sciences, romance, or nur-

ture, whereas gender covered them all. The term was seized upon by an increasingly powerful feminist movement that was concerned with overcoming the biology-is-destiny argument that had been so long used to keep women in a subordinate status.

Gays and lesbians also found the term helpful in challenging traditional ideas. Since both the feminist and the gay and lesbian movements had well-organized constituencies, the research into gender had increasing political implications.

Popular adoption of the term, for example, was a major factor in the undermining of traditional Western ideas about dimorphic essentialism, that is, males and females are different and should display erotic sex and gender characteristics congruent with their sex because of their biological makeup or, in religious terms, their God-given nature had made it so. In simplistic terms, the first stage of a growing controversy was over whether nature or nurture was more important in forming individual development. Some of the early feminists argued that women's subordination to men had resulted from the dominance of the male, and if girls and boys were simply raised differently they would react differently. Boys, they argued, should be given dolls and girls trucks; girls should be encouraged to be more aggressive; and the role of males and females in society would change. There is undoubtedly an element of truth in such a belief, but it is much too simplistic. Still many of the differences were social and cultural, as demonstrated by the fact that once barriers were removed through equal opportunity legislation, women rapidly moved into fields formerly dominated by men and began to approach financial parity in salary and perquisites. Women athletes have also become increasingly important. As research progressed, important gender differences between the sexes were noted, but at the same time the issue also became much more complicated.

Some Research on Gender Differences

Ann Constantinople, for example, questioned the assumption that masculinity was the opposite of femininity and suggested that the identification of masculine traits might be independent from rather than opposite to the identification of feminine traits. As new scales for masculinity and femininity were developed by researchers, they found wide variation in gender traits among individuals of the same biological sex, but interestingly they also found an almost compulsive pressure to conform put on those who varied too far from the norm. This was particularly noted to be the case in feminine boys. The wide spectrum of behaviors led to a greater emphasis on biological answers.

One theory developed by Bonnie Bullough (in a work coauthored with Vern Bullough) for the formation of gender identities and sexual preference held that there were at least three steps:

1. A genetic predisposition for a gender or cross-gender or cross-sexual identity, including high or low levels of activity and aggression.
2. Prenatal hormonal stimulation supported or countered the genetic predisposition, perhaps indelibly marking the neural pathways so the pattern that produced variant gender behavior con-

tinued after birth.

3. The socialization pattern shaped the specific manifestation of the predisposition.

It was not only social and natural scientists who entered the debate about the differences in gender behavior but scholars from the humanities and arts as well. One of the best known was Marjorie Garber, who attempted to escape the bipolar notions of male and female by advocating a third category, a way of describing alternative possibilities. Bipolar approaches, she held, create a "category crisis," a failure of definitional distinction, resulting in a border that becomes permeable and permits border crossing.

Research on homosexual men, for example, has found that a significant number were identified as feminine boys during their youth. Richard Green's longitudinal study of extremely effeminate boys, most of whom wished they had been born girls, found that 75 percent of his sample identified themselves as homosexual as adults although almost all of them had become less feminine in their behavior during their teens. The fact that not all of them came to identify as homosexual as adults emphasized the complexity of development although it was possible that some of them might at a later stage still identify as homosexual. Masculine-identified girls, or tomboys, have a lower proportion identifying as lesbians as adults perhaps because the pressure on them to conform was also less. Unfortunately, much less research has been done on tomboys than on feminine boys.

Challenge to Bipolar Assumptions

Several strains of research seemed to be important in challenging traditional bipolar assumptions: genetic or biological research, the study of hermaphrodites, investigation of transsexuality, homosexuality, and bisexuality. The major subjects of Money's early studies were hermaphrodites. He was surprised to find that many who later were identified by chromosome analysis to have been raised in the wrong sex, preferred to remain in the sex in which they had been raised. This led him to posit that there was a critical stage in development where one's personal gender identity was set. While he was originally ambiguous on when this might happen, he eventually held that the age of two was critical. But such an assumption was difficult to prove.

Money felt he had found an ideal case in identical twin brothers, one of whom, while being circumcised at age seven months by an electric cautery gun, had his penis burned off. The parents, after considerable anguish, had the child's testicles removed and with Money as consultant and adviser, began raising the child as a girl at about twenty months. Initial follow-up articles pointed to a successful transition, and the case was widely used to emphasize the importance of social conditioning on sex identity. After the case disappeared from the literature, it turned out the "girl" had rebelled at her change in her teens, and after being finally told her story decided to become a boy. Such a change had been predicted by a critic of Money, Milton Diamond, and it was only through his long efforts to find the boy, who was then an adult male, that the

GENDER STUDIES

The term *gender*, proposed by John Money in the 1950s, was immediately seized upon by scholars in a variety of disciplines, perhaps because it avoided the use of the term *sex*, a term many thought not suitable for public discourse, but the finite definition that Money and other scholars early used was quickly abandoned. Questions seeking to determine an individual's sex, even on government forms, no longer asked for sex but for gender. Feminists particularly favored the use of the term and many programs that had started out as *women's studies* were renamed gender studies. By 2004, almost every American university had a program on gender studies and so did many high schools. Gay and lesbian studies became gay, lesbian and gender studies, or more often just gender studies. Gender studies are ubiquitous and not confined to the social and behavioral sciences, but appear in courses in literature and the humanities, and even in biology.

Gender studies deal with transvestism, transsexualism, bisexuality, as well as intersex, the original source of Money's classification. Vern Bullough, in his study of the history of sex research, predicted that gender would be the dominant theme of research upon sexuality in the first part of the twenty-first century and it certainly seems to be the case.

The advantage of using the term *gender studies* instead of *sexuality studies* is that gender in

itself implies for a more variable interpretation of what being a woman or a man involves. Whether a person is an XX or an XY, there is much more to being a man or woman than chromosomes. Though males impregnate and females become impregnated, there is much more to gender than that. Some women are more masculine than a significant minority of men and some men are much more feminine than many women. Gender study data showing and explaining these differences and similarities have been growing as more and more disciplines enter the field. One of the interesting sequella of this is the increasing number of individuals who are calling themselves transgendered. Gender studies, in effect, have resulted in basic challenges on what a man or woman should be or could be.

In spite of the vast increase of publications on gender, there is still much that is not known. For example, the experiences of "Bruce" as told in John Colapinto's book *As Nature Made Him* and other similar stories have brought greater attention to biological components of variation as opposed to simply focusing on the effects of social settings or nurturing experiences on gender. The more we learn the more complicated the whole question of gender becomes. This seems to imply that gender studies will continue to increase since it offers such a rich field for research and perhaps even more radical changes in public behavior.

full story came out, much to the discredit of Money's theory. But the issue even here is complicated by the fact that another boy who also had a similar background, continued as an adult to live as a woman, although as a somewhat masculine-looking and -acting one. The two cases together emphasize that there might be strong biological factors involved.

Some adults very much want to belong to the opposite sex than that associated with their genitalia. This issue came to national attention through the Christine Jorgensen case in the 1950s. Jorgensen achieved worldwide notoriety by having her penis and testicles amputated, and through the administration of hormones successfully made a transition into a woman. What gender confusion could make a man want to be a woman? Whatever it was, surgery and hormones could make it possible, and Jorgensen's path to the opposite sex has since been taken by tens

of thousands of others, although there are somewhat fewer females who have undergone surgery to become males than of males to become females. There are also large numbers of transvestites who cross-dress and identify as women either for short periods or longer periods without benefit of sex-change surgery. Millions of people in the United States today identify as transgender, transsexual, homosexual, lesbian, or bisexual, and others like them exist all over the world and probably always have throughout human history. They represent one end of the continuum on gender development while the majority of the world lies elsewhere with many individual variations.

Some researchers like Diamond have argued that, in addition to chromosomes, prenatal hormones exert influence on neural pathways and the neural endocrine axis (the link between the hypothalamus, the pituitary gland, and other

endocrine glands). These neural pathways control future hormonal production and consequently influence sexual behavior and gender identification. He holds that there are separate neural pathways for sexual identity as a male or female, for sexual object choice, for sexual patterns of maleness or femaleness, and for the sexual response patterns.

Variations in Gender Behavior between and among the Sexes

Researchers (and perhaps common sense) have shown that the behavior pattern most associated with males is that of aggressiveness, and this has undoubtedly influenced gender characteristics in women, including the relative servitude that has marked their history as the subordinated sex. Aggressiveness, however, has varied levels in males, with some being much more aggressive than others. The same differential exists in females but at a lower scale. If this has any meaning politically, then the way to lessen its impact is by equal opportunity laws and regulations, a path that feminists and others have adopted in the United States and elsewhere.

When all the findings about gender are summarized, it seems that there is a wide variation in gender behavior between and among the sexes. Those societies that in the past had adopted strict dimorphic gender patterns will have more difficulty in changing to sexual equality than those that allow somewhat more ambiguity. In the United States and in much of the world, cross-gender behavior in the past was stigmatized and punished. Since the nineteenth century, when the medical model came into prominence as a means of diagnosing nonconforming sex and gender behavior, significant departures from a dimorphic model of masculinity and femininity were labeled as an illness. Similarly, sexual orientations other than exclusive heterosexuality were considered an illness until the American Psychiatric Association voted in 1973 to drop ordinary homosexuality from the upcoming edition of its *Diagnostic and Statistical Manual of Mental Disorders*.

New Directions

In terms of research into sex and gender, the 1990s saw a shift in emphasis from societal factors, cultural molding, and nurture to physiological factors. Much of this research concentrated on the brain and on intrauterine developments. Boy babies as a group, for example, are more likely to spend more time looking at mechanical objects than do baby girls, who look longer at a human face. But there is also a tremendous amount of overlap and wide variation among individuals, and how society deals with this overlap is more a political and economic question than one science or social science can determine.

See also *Feminism: Overview*; *Sexuality: Overview*.

BIBLIOGRAPHY

American Psychiatric Association. *Diagnostic and Statistical Manual of Mental Disorders*. 3rd ed. Washington, D.C.: American Psychiatric Association, 1980.

Baron-Cohen, Simon. *The Essential Difference: The Truth about the Male and Female Brain*. New York: Perseus, 2003.

Bullough, Vern L. *Science in the Bedroom: A History of Sex Research*. New York: Basic Books, 1994.

Bullough, Vern L., and Bonnie Bullough. *Cross Dressing, Sex, and Gender*. Philadelphia: University of Pennsylvania Press, 1995.

Colapinto, John. *As Nature Made Him: The Boy Who Was Raised as a Girl*. New York: HarperCollins, 2000.

Constantinople, Ann. "Masculinity-Femininity: An Exception to a Famous Dictum." *Psychological Bulletin* 80 (1973): 389–407.

Diamond, Milton. "A Critical Evaluation of the Ontogeny of Human Sexual Behavior." *Quarterly Review of Biology* 40 (1965): 147–175.

———. "Human Sexual Development: Biological Foundations for Social Development." *Human Sexuality in Four Perspectives*, edited by Frank A. Beach. Baltimore: Johns Hopkins University Press, 1977.

Garber, Marjorie. *Vested Interests: Cross-Dressing and Cultural Anxiety*. New York: Routledge, 1992.

Green, Richard. *The "Sissy Boy Syndrome" and the Development of Homosexuality*. New Haven: Yale University Press, 1987.

Jones, Steven. *Y: The Descent of Men*. Boston: Houghton Mifflin, 2004.

Money, John. "Hermaphroditism, Gender, and Precocity in Hyper-Andrenocorticism: Psychologic Findings." *Bulletin of Johns Hopkins Hospital* 96 (1955): 253–254.

Money, John, and Anke A. Ehrhardt. *Man & Woman, Boy & Girl*. Baltimore: Johns Hopkins University Press, 1972.

Thorne, Barrie. *Girls and Boys in School: Together or Separate*. Reprint, New Brunswick, N.J.: Rutgers University Press, 1993.

Vern L. Bullough

GENDER IN THE MIDDLE EAST

The term *gender* has no exact correlate in Middle Eastern sources, but instead is identified by scholars as a major analytical tool in the definition of differences between men and women. Many researchers in every discipline argue that gender has always been embedded in all societies, past and present. Scholars who study gender seek to question dominant, normative definitions of every society's assigned male and female roles. The gendered implications of religious and legal definitions, scripted as timeless injunctions, may be interrogated to reveal previously ignored multiple symbolic meanings. Thus, the interactive cultural categories of male and female, masculine and feminine, analyzed through the lens of gender, may be read as human interpretations and constructions rather than divine and eternal definitions. The study of the Middle East contextualizes the accepted readings assigned to both genders in all disciplines and documents them not as a process of consistent conformity, but rather as an outcome of internal contests over power and constructed meaning. The results of this research aims to historicize accepted truths and undermine those who seek to define them as forever divided into simple oppositional, binomial categories of male and female, right and wrong, sacred and profane.

Origins

Feminist and women's studies in the 1960s and 1970s paved the foundation for the emergence of gender analysis in the

1980s. Women's studies and gender studies arose to combat the absence of documentation about women in all Western disciplines. Yet the focus on gender emphasizes the inextricable interaction between both sexes, while women's studies' singular focus does not. Documenting the experience of women led to the realization that it was necessary to deepen the exploration of the multiple meanings of male and female on symbolic and practical levels. Female scholars dominate this methodology, but men now contribute to the field. Gender studies draws theoretical inspiration from Western interdisciplinary sources but continues to refine such precedents, proving at once the importance of universal conceptual frameworks and the centrality of Middle Eastern context in their refinement. Proponents of gender studies support both academic intent and often an activist agenda for social change. Therefore, many intellectuals and religious leaders in Middle Eastern societies reject gender as an intrusive European and American construct.

Evidence of Islamic feminism in the Middle East does exist as the historical foundation for gender studies, but few scholars there connect this movement to the precedent of earlier challenges to male authority. In 1923, Huda Sha'rawi (d. 1947) founded the Egyptian Women's Union and called for equal rights for both women and men. She also publicly removed her veil as a denial of traditional strictures that she perceived as part of a corrupt, oppressive social hierarchy. Support for her reformist platform received public approbation from select secularist men and many upper-class Christian and Muslim women. Sha'rawi's example did not incite a mass movement in support of either feminism or, by extension, new definitions of male and female identity in the Middle East. Stiff opposition to such movements remains the norm.

In the late 1970s, Elizabeth Warnock Fernea and Basima Bezirgan edited a groundbreaking collection of documents designed to more accurately represent the complex history and multiple roles of Muslim women. These translated selections filled the need for English-speaking audiences to understand the women in this area in their own terms. The precedent-setting lives of early female historical figures were set alongside contemporary women's stories, poems, and recollections of resistance to colonial occupation. These selections drew in part upon previous works in the 1930s and 1940s by scholars such as Margaret Smith, who illuminated the importance of the early ascetic mystic, Rabi'a of Basra (c. 714–801 C.E.).

In the 1980s, women scholars in the Middle East took up the challenge raised by female coreligionists in the early twentieth century to oppose the assumed right of male authorities to define and control every aspect of their lives. They explicitly identified with Western feminist agendas and, as a result, their publications were condemned in their native lands. Fatima Mernissi's classic work, *The Veil and the Male Elite* (1987), argued that accepted male readings of the medieval Islamic past were deeply flawed and sexist when applied to the present. Although this work predated the emergence of gender studies, it, together with similar works, helped spur its birth. Ironically, Mernissi found the most receptive audience for her work outside the Middle East where feminists identified shared concerns. Support for her critique

of male dominance from scholars abroad fueled accusations in the Middle East that Mernissi had been co-opted by the enemies of Islam.

Since the 1990s, the struggle to apply gender inquiry to Middle Eastern societies has also been forcefully challenged by Muslim women in the United States. Many questioned the right of non-Muslims to speak on behalf of Middle Eastern men and women. In the wake of these protests, Western scholars of the Middle East display greater self-awareness as well as greater sensitivity to cultural differences. Muslim women seeking to better understand their place in Islamic society now increasingly invigorate public discussions of the gendered definitions of both sexes. In this process, Muslim women challenge long-standing precedents about cultural hierarchies and praxis. They claim the right to an active intellectual presence, which disrupts the assumption that Middle Eastern women are either silent or passive in their own societies.

Anthropology, Literature, and History

Anthropological studies of gender contributed pioneering fieldwork that recorded definitions of masculine and feminine honor, sexuality, and self-representation through poetic expression in rural areas from Morocco to Iran. The documentation of unequal, gendered hierarchies of power demonstrated that women negotiated these structures in distinctly inventive ways. Erika Friedl's revealing observations of women in a rural Iranian village allowed the voices of these women to be heard without seeming intrusion. The gendered implications of their rich, lived experience in marriage, childbirth, and complex daily life emphasized their resilience. The support they lent one another often negated the poverty and isolation of their lives. Friedl's self-awareness of her role as observer, participant, and confidant questioned the boundaries between Middle Eastern women and their representation by outsiders.

Scholars of Middle Eastern literature differentiated between premodern works written by men about women and the emergence of women's writing about men, society, and themselves in the nineteenth and twentieth centuries. Medieval male writers devoted extensive amounts of energy to their definition of the feminine as the exact opposite of the masculine. These assertions received no recorded response by women in this period. In contrast, the emergence of women's writing in all genres of poetry, history, and social commentary emerged in full bloom in the nineteenth and twentieth centuries throughout the Middle East. These sources sought redefinition of women in tandem with new female definitions of men. Literary critics and historians, the latter informed by postmodern theoretical models and interests in the formation of modernity, examined magazines founded, edited, and written by women for upper- and middle-class women. Marilyn Booth's study of gender definitions replete in biographical collections authored by women captured the emergence of a new hierarchy of female exemplars, ranging from the Prophet's daughter, Fatima, to Joan of Arc. Booth's study deftly reconfigured gender at the intersection of Egyptian reaction to the British occupation and the emergence of nationalism.

Numerous studies now document gender in all periods of Middle Eastern history. Male articulations of the role of the Prophet's most controversial wife, Aisha bint Abi Bakr (614–678 C.E.), were dissected to yield new insights into the medieval construction of gender in politics, sexuality, and the sectarian division between Sunni and Shii Muslims. The importance of education, as taught to women by men and one another in the medieval period, also proved critical to a reexamination of literacy and intellectual achievement. Scholars of gender contradicted through archival research the traditional theory that Ottoman imperial decline was precipitated by meddlesome, royal women in the harem. In spheres of daily life presumed to have been exclusively masculine, the contributions of women's labor to the marketplace, silk production, and agriculture redefined the agency of nonelite women.

Gender Politics: The Veil and the Koran

The issue of the veil, or modest Muslim attire for women, has, since the early twentieth century, been a vexed issue. This symbol also provoked debates about the gendered roles of women in a male-dominated society. Issues of power and female agency masked long-standing assumptions about the distinctions between men and women, which this clothing revealed. Human rationales for the veil were presumed to be supported by either divine Koranic injunction or oppressive male interpretation. Men and women in the Middle East often agreed upon the necessity for either doffing or donning the veil. The contentious, seemingly endless battle over the meaning of the veil has also been influenced by negative, misinformed reaction articulated in Western societies. Leila Ahmed's inquiry into the position of gender at the roots of these changes emphasized multiple discourses and agendas focused on the veil as articulated by secularists, nationalists, and Islamists.

Early feminist movements in the twentieth century based their platforms of equality in reinterpretations of the Koran. Opponents also focused on this source and the precedent of the prophet Muhammad's words about women. The struggle for exclusive interpretations of the truth served the purposes of those who defined both the subordination and liberation of women, respectively. Contests over power in society were scripted by adherents in each camp in terms of gender hierarchy. Historical transformations in the interpretation of the Koran in the Middle East were deftly documented by Barbara Freyer Stowasser. Many contemporary Muslim women in the Middle East and the United States now reject previous exclusive male commentaries and submit their own interpretations as equally valid. This position is demonstrated in the work of Amina Wadud, who powerfully argued, from within her faith, for the right of all Muslim women to engage the Koran directly and overwrite centuries of patriarchal domination. New readings by Muslim women implicitly recognize questions of gender in their desire to find revealed sources of more positive self-definition and religious participation. These directions have not met with a warm reception in the Middle East, where they remain a minority position.

Gender and the Law

The study of Islamic law has always possessed a revered status in the Middle East. The law retained an exclusively masculine mystique because its educational and juristic institutions traditionally denied women access. Male legal interpretations of gender difference confined women to separate spheres because they were defined as intellectually deficient and dangerous to all men. Studies of gender as a factor in actual courtroom cases refuted the notion of female passivity when faced with male lawyers and judges. Judith Tucker's investigation of the preserved transcripts of women plaintiffs contradicted the assumption of a complete absence of female agency. She established the complicated relationship between gender and Islamic law in Ottoman Syria and Palestine. Women advanced their interests through their knowledge about the differences between Sunni law schools in family and inheritance law.

Women remain the objects of Islamic male legal decisions, which no longer offer recourse for question or dissent in much of the Middle East. Khaled Abou El Fadl documented the emergence of authoritarian control over women in this area. He asserted that those men who claim to speak for God in their decrees abuse the moral and religious bases of Islamic law. His book, *Speaking in God's Name: Islamic Law, Authority, and Women* (2001), focused, in part, on the example of the Saudi Arabian-based institute for legal opinions. These rulings continue to be spread not just in the Middle East, but worldwide through well-funded publications and Web sites. The highest level of Shii clerics in Iran also staunchly defend their singular capacity to interpret Islamic law for all adherents of the faith. They consistently embrace the ideal of a gender hierarchy in which women remain eternally subordinate. Gender differences based on male superiority are also articulated as divinely inspired.

The Mainstream and the Margins

New centers founded by women in the Middle East incorporate gender in their research publications. In Egypt, scholars of the Women and Memory Forum publish a range of works dedicated to women and the recovery of their place in Islamic society. Every spectrum of ideological affiliation, from feminist to Islamist and positions in between, enriches the scholarship of this collective enterprise. Contributors to annual publications engage heated contemporary and historical problems from varied disciplinary perspectives. Familiarity with the concept of gender, whether applied or rejected, unites disparate ideological and scholarly affiliations.

In the early twenty-first century academic sites on the Internet link and inform scholars of gender and the Middle East around the world. H-Gender-MidEast, a source of announcements for specialists and nonspecialists, features information about conferences, research opportunities, and sources of both general and specialized information. Reviews of books in Western and Middle Eastern languages reach large, enthusiastic audiences. The web site, a collaborative effort based at the American University of Cairo and supported by the Humanities Network at Michigan State University, attempts to eradicate obvious geographical and cultural divisions. These

collaborative initiatives equalize and embrace audiences from Western and Middle Eastern societies. H-Gender-MidEast promotes a forum for exchange and debate, which has helped refute the notion that the study of gender is an exclusively Western enterprise.

Senior female scholars now have the editorial power to incorporate gender within major, authoritative reference works on the Middle East. They select their authorities from the expertise of researchers found throughout the world. The definitive English-language *Encyclopaedia of the Qur'an* (2001), edited by Jane Dammen McAuliffe, includes a separate entry on gender's linguistic, legal, and thematic implications for the sacred text and its interpretation. Many other entries featured in this work are informed by gender, challenging the assumptions of older reference collections. The *Encyclopedia of Women and Islamic Cultures* (2003) locates both women's studies and gender studies at their point of Western inception, but underscores the importance of this methodology. This encyclopedia carefully maps the history of scholarly debate over conflicting responses to gender in an effort to avoid the appearance of Western bias and thus avoid the contentious identity politics of the 1990s. The goal of both these magisterial collections emphasizes inclusive rather than exclusive authorship and readership.

Female scholars of the Middle East founded the field of gender studies. They continue to predominate in this area of research. Their work has been acknowledged by male colleagues, who cite their pioneering studies but often appropriate the fruits of their research without mention of gender as a methodological category. This is true of scholars in the Middle East as well, who raise questions present in gender studies without acknowledging the discipline. Popular, accessible works of Middle Eastern studies now include obligatory chapters on women, but they frequently fail to differentiate between the materials they offer and the gendered interpretations that have led to their documentation. Students and the general public thus remain unaware that their understanding of male and female roles in Islamic societies is the product of a form of inquiry that often troubles and provokes male authorities in both Middle Eastern and Western societies. The reason for this marginalization of gender reveals that even scholarship mirrors contests over power and representation. Gender remains a charged category of analysis in process and practice everywhere.

See also *Feminism: Islamic Feminism; Islam; Women's Studies*.

BIBLIOGRAPHY

- Abou El Fadl, Khaled. *Speaking in God's Name: Women, Authority, and Law*. Oxford: Oneworld Press, 2001.
- Ahmed, Leila. *Women and Gender in Islam: Historical Roots of a Modern Debate*. New Haven, Conn.: Yale University Press, 1992.
- Badran, Margot. "Gender." In *Encyclopaedia of the Qur'an*, edited by Jane Dammen McAuliffe. Vol. 2, 288–292. Leiden, Netherlands: Brill, 2001.

- . "Women Studies/Gender Studies." In *Encyclopedia of Women and Islamic Cultures*, edited by Suad Joseph. Vol. 1. Leiden, Netherlands: Brill, 2003.
- Booth, Marilyn. *May Her Likes Be Multiplied: Biography and Gender Politics in Egypt*. Berkeley: University of California Press, 2001.
- Fernea, Elizabeth Warnock, and Basima Qattan Bezirgan, eds. *Middle Eastern Muslim Women Speak*. Austin: University of Texas Press, 1977.
- Friedl, Erika. *Women of Deh Koh: Lives in an Iranian Village*. Washington, D.C.: Smithsonian Institution Press, 1989.
- Mernissi, Fatima. *The Veil and the Male Elite: A Feminist Interpretation of Women's Rights in Islam*. Translated by Mary Jo Lakeland. Cambridge, Mass.: Perseus Books, 1987.
- Smith, Margaret. *Muslim Women Mystics: The Life and Work of Rābi'a and Other Women Mystics in Islam*. Reprint, New York: Oxford University Press, 2001.
- Spellberg, D. A. *Politics, Gender, and the Islamic Past: The Legacy of 'A'isha bint Abi Bakr*. New York: Columbia University Press, 1994.
- Stowasser, Barbara Freyer. *Women in the Qur'an, Traditions, and Interpretation*. New York: Oxford University Press, 1994.
- Tucker, Judith. *In the House of the Law: Gender and Islamic Law in Ottoman Syria and Palestine*. Berkeley: University of California Press, 1998.
- Wadud, Amina. *The Qur'an and Woman: Rereading the Sacred Text from a Women's Perspective*. Reprint, New York: Oxford University Press, 1999.

D. A. Spellberg

GENDER IN ART. *Gender*, other than a biological or physical determination of the sexes, is a cultural and social classification of masculinity and femininity. Gender presentations in art are the outcome of the cultural process of defining sexual and social identity. Pictorial art and literature, as means of expression through transformation and stylization, are the predominant media reflecting this cultural process.

While the term *gender* refers to both sexes, the concept of gender issues has been primarily driven by a movement of women's emancipation and the twentieth-century emergence of feminism, as women have sought to obtain the rights, privileges, and unique forms of expression that men have enjoyed historically in patriarchal societies where class, race, and sexuality were defined by the dominant gender. The emergence of feminist art and art history since the 1960s has not only resulted in a re-appreciation of the representation of the woman as a subject, creator, and receptor of pictorial art but also has inspired a broader examination of gender-related issues in art through the establishment of gay studies and men's studies, where questions of homosexuality, heterosexuality, masculinity, femininity, and indeed sex itself all pertain to the concept of *gender*. The understanding of gender in art is thus intrinsically linked to the method and perspective of contemporary gender research.

From Antique through Classical Art

Intellectual perceptions of masculinity and femininity have



Terracotta relief of “The Queen of the Night,” southern Iraq, c. 1800–1750 B.C.E. In many male-dominated cultures, such as that of ancient Mesopotamia, strong female figures were often associated with seductiveness and the destructive sexual sway they held over men. BRITISH MUSEUM (NO. ANE 2003-7-18, 1), © JAMES DARLING/REUTERS/CORBIS

been transformed into visual arts since antiquity. Female fertility and motherhood, as well as gender relationships, are prevalent themes in ancient depictions. One of the earliest pictorial examples of gender presentation is the faceless Paleolithic statuette *Venus of Willendorf* (c. 28,000–25,000 B.C.E.). This is a depiction of a female figure in a symbolic and conceptual context, representing feminine fertility. In a sculpture from Pakistan the figure of Hariti, the ancient Buddhist Indian goddess of childbirth and women healers, is presented surrounded by children. The exposed breast of Venus and Hariti’s emphasized breast emerge as pictorial symbols of fertility and motherhood.

Gender representations in male-dominated cultures are often determined by notions of power and weakness, superiority and inferiority, benevolence and malevolence. This is exemplified in the figure of the Mesopotamian deity *Queen of the Night*, in an old Babylonian relief from around 1800 B.C.E. She might be as well the deity Ishtar, the Mesopotamian goddess of sexual love and war, or Ishtar’s sister and rival, the goddess Ereshkigal, who ruled over the underworld. Other scholars believe the female figure represents the demoness Lilitu, known in Jewish tradition as Lilith. The nude female figure embodies a monolithic notion associated with women for ages and in diverse cultures, that of female sexual power and its asserted destructiveness.



***Nativity and Adoration of the Shepherds* (gospel book; 1262) by T’oros Roslin. Tempera on parchment.** During the Middle Ages depictions of the Virgin Mary symbolized contemporary notions of the feminine ideal—a mother devoted to the spiritual concepts of chastity, humility, piety, repentance, and salvation. THE WALTERS ART MUSEUM, BALTIMORE

Gender relations address both the intimate interactions and the social roles of men and women. An Egyptian relief of Tel el Amarna from around 1335 B.C.E. depicts the Egyptian royal couple Smenkhkare and his wife, Meritaten. His wife is depicted giving him flowers and expressing her affection yet at the same time illustrating her submissive marital position. While both figures have similar proportion and pictorial emphasis, the emperor’s status is clearly designated.

In classical art, gender qualities associated with women are beauty, domesticity, and passivity and for males the contrary principles such as power, dominance, and social status. Antique art presentations of male nudity, such as in Greek sculpture, underline the physical perfection of the male body, representing superiority and civic authority. Yet domestic and everyday scenes depicting roles of men and women had less importance than symbolic representations of gender. In the antique world gender attributes served to emphasize and elevate the human and superhuman characteristics of gods, goddesses, and mythological figures. This becomes especially prominent in classical art. In ancient Greek depictions of Centauromachy (the mythological battle of the Centaurs with the Lapiths), notions of masculinity are transformed into battling figures that are half-man, half-animal. Goddesses such as Pallas Athena, Aphrodite, and Nike combine both male and female attributes to signify their dominance. Ro-



Sixteenth-century portrait *Simonetta Vespucci* by Piero di Cosimo (1462–1521). Italian Renaissance portraiture typically served to idealize the subject rather than serve as a realistic representation. The snake around the subject's neck symbolizes the dangers of temptation and lust. © BETTMANN/CORBIS

man reliefs, sculptures, and coins, depicting emperors and empresses, often relate the figures to gods and goddesses, or they personify gender-specific virtues. Female figures in Roman art frequently represent virtues such as justice or piety or symbolize wisdom and victory.

Middle Ages

During the Middle Ages, presentations of gender were sublimated mostly in depictions of biblical figures. Notably a single figure, that of the Virgin Mary, represented most of the attributes associated with the feminine in an idealized figure. Mary's role as Christ's mother in depictions such as T'oros Roslin's *Christ's Nativity and the Adoration of the Shepherds*, represents at the same time her physical burden as a spiritual concept of chastity, humility, piety, repentance, and salvation. The vast number of depictions of the Virgin Mary as well as her special spiritual importance has redefined other established female stereotypes in art since the Middle Ages. Furthermore, moralistic tendencies in the representations of gender relations can be found from the late Middle Ages onwards, as in the so-called *Weibermacht* (woman's power) depictions showing maltreatment of men at the hands of women. These depictions by male artists represent the polarity of viewing the female sex: idealization or misogyny.



***Flora* (c. 1515–1520) by Tiziano Vecelli (Titian).** Oil on canvas. Titian's painting of the goddess of spring, flowers, and fertility celebrated sexuality and asserted the beauty of the subject during a period when there was much criticism of works that celebrated female eroticism. © FRANCIS G. MAYER/CORBIS

The Renaissance and the Baroque

Since the Renaissance, writers, intellectuals, and artists have been increasingly engaged with gender issues, particularly in discussing the social role of the feminine. The French phrase *querelle des femmes* (debate about women) referred to humanist discussions about womanhood and the female place in the contemporary culture of their day. Until then, following the Aristotelian approach, women were perceived as imperfect, created inferior to men. In his *De claris mulieribus* (Concerning famous women), Giovanni Boccaccio (1313–1375), the Italian Renaissance poet and writer, introduced women as powerful role models. Nevertheless, the virtues that Boccaccio saw women capable of achieving were established "male qualities" of the time.

One of the first to give voice to the autonomous virtues of women was the French poetess and historiographer Christine de Pisan (c. 1363–c. 1430). In her *Livre de la cité des dames* (c. 1404; Book of the city of the ladies) Pisan developed a comprehensive categorization of women's positions and functions as found in the society of her time. Others, like the Dutch writer Erasmus Desiderius of Rotterdam (1466?–1536), the Spanish humanist and philosopher Juan Luis Vives (1492–1540), and the German writer and philosopher Heinrich Cornelius Agrippa von Nettesheim (1486–1535), had laid the foundation for humanism's more progressed vision of women's role in society and culture.

Renaissance portraits of women intend to convey beauty—almost archetypical—and social role. The male was defined by attributes of profession and social status. Female portraiture in Italian Renaissance art was not meant to be a direct representation of the individual. An example in premodern Italian portraiture is the bust of a nude woman by Piero di Cosimo (1462–1521). The moralistic implication is represented by a snake around the woman's neck to remind of the dangers of temptation and lust, traditionally known as the vice of *luxuria*.

Eroticism—the sublimation and stylization of sexual desire—depends on culture and social milieu. In art this relation is reflected in the sublimation of sexuality. Traditionally the key elements associating gender themes to visual issues have been female sexuality and nudity. Nudity and sexuality are the predominant aspects of gender themes in Renaissance and Baroque visual art. Sandro Botticelli's (1445–1510) painting *The Birth of Venus* from around the year 1485 has refined symbolism with the nude goddess of love being placed within the spiritual context of Renaissance philosophy. Erotic female presentations are central in the paintings by Titian (Tiziano Vecellio; 1488 or 1490–1576), as in his erotically charged painting of Flora, the goddess of spring, flowers, and fertility. The era also saw the emergence of female patronage in arts.

During the Renaissance and the Baroque Italian, female artists such as Lavinia Fontana (1552–1614) and Sofonisba Anguissola (1527–1625), offering a distinctive view of female artistic perspective at the time, promoted a more assertive image of the woman. This is most apparent when the woman becomes a violent figure as in Artemisia Gentileschi's painting *Judith Slaying Holofernes*. Gentileschi's heroines, struggling with the other sex and evoking strong empathy in the viewer, have become a focal point in gender studies of art history.

The Flemish Baroque artists Peter Paul Rubens (1577–1640) and Anthony van Dyck (1599–1641) depicted women with symbolic and allegorical references, emphasizing the sitters' high social status, as was popular in traditional Italian Renaissance portraiture during the fourteenth and fifteenth centuries (for example, van Dyck's *Venetia Stanley, Lady Digby, as Prudence*, 1633). Seventeenth-century Dutch portraits of women, however, express a new trend toward gender identity: men and women figures are not presented anymore as an ideal or a symbol but mostly in their realistic surroundings in a neutral manner (for example, Johannes Cornelisz Verspronck's *The Regentesses of the St. Elizabeth Hospital*, 1641). Rembrandt van Rijn's (1606–1669) depictions of his intimate partners Saskia van Uylenburgh and Hendrickje Stoffels suggest an authenticity that transcended traditional social gender conventions (see his *Saskia as Flora*, 1641). In popular seventeenth-century Dutch history paintings and genre scenes, sexuality is concealed in moralistic criticism. But in his presentation of the original sin (1638), Rembrandt transforms an archetypical presentation into a psychologically sensitive depiction of Adam and Eve as two insecure sinners.

Eighteenth and Nineteenth Centuries

During the eighteenth and nineteenth centuries there was a gradual shift from an emphasis on gender to an emphasis on class. This change in visual art during the period of Louis XIV

The growing appreciation of the necessity to redefine female social roles coexisted with such phenomena as male dominance, misogyny, and the witch hunt. In Renaissance and Baroque visual arts, mostly made by men, female figures appear less often than depictions of men, irrespective of whether they are the central figures or not. In addition to their outnumbering presentations, males are mostly depicted in dominant and central positions.

Since the Middle Ages demonology had been chiefly associated with femininity. The identification of women as more prone to witchcraft than men was based on traditional misogynist beliefs of what was perceived as basic female nature. Trials of witchcraft promoted discussions of gender issues and influenced the visual arts. In Renaissance graphic art, especially in northern Europe, female sorcery was a popular theme, as can be seen in engravings and woodcuts by Albrecht Dürer (1471–1528) and Hans Baldung Grien (1484–1545). In these works naked or partly nude, unsightly sorceresses are depicted in a variety of allegedly supernatural acts.

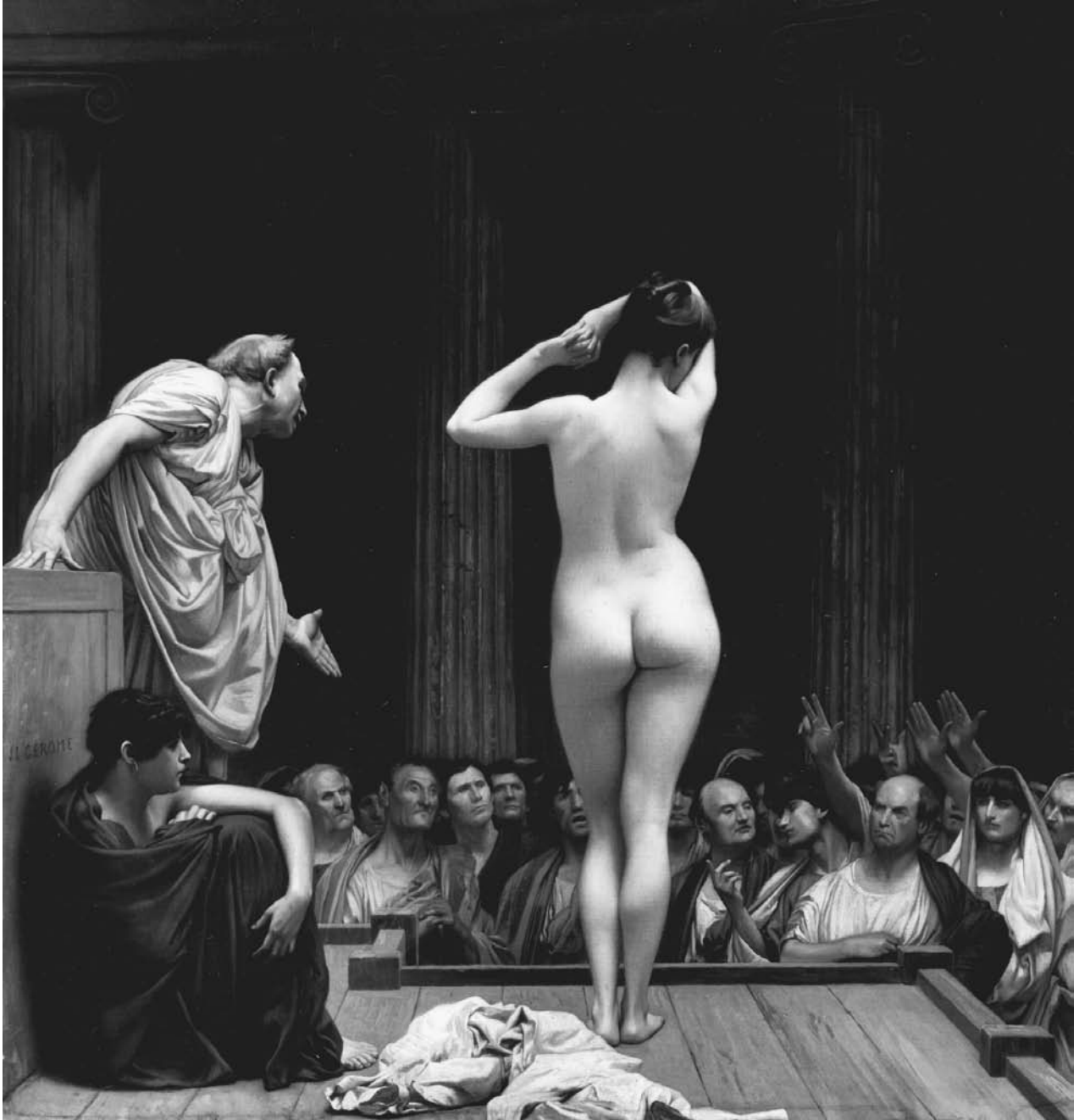

***A Roman Slave Market* (1867) by Jean-Léon Gérôme. Oil on canvas.** Issues of male dominance, feminine submissiveness, and societal repression of women were frequently addressed in the works of nineteenth-century artists. THE WALTERS ART MUSEUM, BALTIMORE

(1638–1715) coincided with the emergence of a middle class in France. Increasing public appreciation was afforded women artists such as Rosalba Carriera (1675–1757), who was elected as a member of the male-dominated Académie Royale in 1720. Other significant female artists were Élisabeth Vigée-Lebrun (1755–1842), who was commissioned to portray Queen Marie Antoinette and later on became a member of the French academy, as well as Angelica Kauffmann (1741–1807), one of the founding members of the British Royal Academy.

Sexism and patriarchy were prevalent in the nineteenth century. In his painting *The Slave Market* the French artist Jean-Léon Gérôme (1824–1904) presents masculine dominance and male voyeurism in relation to female abuse. In Victorian English art, traditional binary gender distinctions prevailed (for example G.E. Hicks's *The Sinews of Old England*, 1757). Moralistic concepts of pure and modest womanhood, glorification of domestic life, and Christian ethics influenced gender visual imagery. In her painting *War* from

1883, Anna Lea Merritt highlights the Victorian ideal of female seclusion and spatial division of genders.

Such established gender types as the mother, the female as a lover or courtesan, and the femme fatale were often represented in Art Nouveau works by male artists such as the British illustrator Aubrey Beardsley (1872–1898) and the Austrian painter Gustav Klimt (1862–1918). Erotic gender identities and representation of traditional male roles, as in Klimt's painting *The Kiss*, show a gradual transition. Reciprocal roles and interchangeable gender identities manifest themselves in the art of Art Nouveau.

Twentieth Century

The appearance of new fashion designs for women in the beginning of the twentieth century with its acknowledged elements designating traditional masculine features signaled a change in gender identity and the emergence of a cross-gender figure. This pertains to both new presentations on gender roles in society and culture. In the work of the Mexican artist Frida Kahlo (1907–1954), her masculine appearance in *Self-Portrait with Cropped Hair* testifies to a growing effort to legitimize broader gender boundaries while being a statement of an assertive femininity. The work of the German female artist Käthe Kollwitz (1867–1945) explores the humanity of both male and female sexes and testifies to a growing social gender equality, combining both to create a powerful political statement.

Gender perceptions in the 1960s and 1970s were defined by the emergence of the feminist movement. Art of both genders became instruments of political and social change. In visual arts the pop art movement took issue with popular gender ideologies and icons such as beauty and eroticism by overamplifying them, as in multiple lithographed duplications of Marilyn Monroe's image by Andy Warhol. The American feminist artist Judy Chicago (b. 1939), in a 1979 installation titled *The Dinner Party*, questioned women's achievements and their social roles.

In visual art since the 1970s, physical appearance and gender distinctions blur. The photographers Cindy Sherman (b. 1954) and Nan Goldin (b. 1953) challenged and transformed stereotyped gender roles while exploring female identity, love, violence, and transgender identities. The feminist American artist Barbara Kruger (b. 1945) portrayed the female body as a battleground for gender dominance. The conceptual female artist Laurie Anderson (b. 1947) combined multimedia performance with music, poetry, and visual arts. Known for her unusual mix of music, art, and the spoken word, she ironically challenged gender stereotypes and male social dominance.

Another social development, the emergence of an open and confident gay and lesbian community, has redefined gender portrayals. Robert Mapplethorpe combined over-masculinized bodies and images of homosexuality with the stylized aestheticism of glamour photography. Lesbian visual art as it has emerged since the 1960s is multifaceted yet does not represent a cohesive stylistic movement. The artists reflect the experience of being a lesbian in patriarchal society. Lesbian artists such as Harmony Hammond (b. 1944) have been defining a homosexual iconography and terminology, individual and

sometimes reflecting stereotypes. This "queer" art has explored and broken down the conventions of traditional gender and sexual roles, as in John Kirby's *Self-Portrait* (1987), in which the artist presents himself in feminine underwear without concealing his masculine body.

Gender and Art History

Feminist art history is closely related with the feminist movement. One of the earliest themes of feminist art historians was that of the male gaze and its consequence on visual art. The early feminist art historians documented works of women's art and the perception of the woman in male art and defined the history and methodologies of feminist art. In 1972 the scholarly study *Woman as Sex Object: Studies in Erotic Art, 1730–1970* was published by Thomas B. Hess and Linda Nochlin, the American art historian, introducing a feminist perspective to the field of art history and criticism. In the beginning of the 1980s, in *Old Mistresses: Women, Art and Ideology*, the British scholars Rozsika Parker and Griselda Pollock surveyed the place of women within the history of art. Subsequent feminist scholars such as Norma Broude and Mary D. Garrard have stated that feminist art history should not be confined to analysis of women artists alone and should not exclusively be the domain of female researchers. In the early 2000s, the focuses of gender studies in art history are gender identity, gender indistinctness, and cross-gender definitions as well as self-consciousness and perspectives on women looking at the other sex.

See also Aesthetics: Europe and the Americas; Gay Studies; Gender Studies: Anthropology; Humanity in the Arts; Men and Masculinity; Nude, The; Queer Theory; Sexuality: Overview; Women and Femininity in U.S. Popular Culture; Women's Studies.

BIBLIOGRAPHY

- Aldrich, Robert, and Garry Wotherspoon, eds. *Who's Who in Gay and Lesbian History*. London and New York: Routledge, 2002.
- Broude, Norma, and Mary D. Garrard. *Feminism and Art History: Questioning the Litany*. New York: Harper and Row, 1982.
- , eds. *The Expanding Discourse: Feminism and Art History*. New York: Icon HarperCollins, 1992.
- Butters, Ronald R., John M. Clum, and Michael Moon, eds. *Displacing Homophobia: Gay Male Perspectives in Literature and Culture*. Durham, N.C.: Duke University Press, 1989.
- Chadwick, Whitney. *Women, Art, and Society*. London: Thames and Hudson, 1990.
- Dotson, Edisol W. *Behold the Man: The Hype and Selling of Male Beauty in Media and Culture*. New York: Haworth Press, 1999.
- Edwards, Tim. *Erotics and Politics: Gay Male Sexuality, Masculinity, and Feminism*. London and New York: Routledge, 1994.
- Garrard, Mary D. *Artemisia Gentileschi: The Image of the Female Hero in Italian Baroque Art*. Princeton, N.J.: Princeton University Press, 1989.
- Hammond, Harmony. *Lesbian Art in America: A Contemporary History*. New York: Rizzoli, 2000.
- Hess, Thomas B., and Linda Nochlin. *Woman as Sex Object: Studies in Erotic Art, 1730–1970*. New York: Newsweek, 1972.
- Jacobs, Fredrika H. *Defining the Renaissance Virtuosa: Women Artists and the Language of Art History and Criticism*. Cambridge, U.K., and New York: Cambridge University Press, 1997.

- Macleán, Ian. *The Renaissance Notion of Woman: A Study in the Fortunes of Scholasticism and Medical Science in European Intellectual Life*. Cambridge, U.K.: Cambridge University Press, 1980.
- Minton, Henry L. *Gay and Lesbian Studies*. New York: Haworth Press, 1992.
- Parker, Rozsika, and Griselda Pollock. *Old Mistresses: Women, Art, and Ideology*. London: Routledge and Kegan Paul, 1981.
- Perry, Gill, ed. *Gender and Art*. New Haven, Conn., and London: Yale University Press, 1999.
- Russell, H. Diane, and Bernadine Barnes. *EvalAve: Woman in Renaissance and Baroque Prints*. Washington, D.C.: National Gallery of Art/Feminist Press at the City University of New York, 1990.
- Tinagli, Paolo. *Women in Italian Renaissance Art: Gender, Representation, and Identity*. Manchester, U.K.: Manchester University Press, 1997.

Anat Gilboa

GENDER STUDIES: ANTHROPOLOGY. Gender studies in anthropology has a relatively short history, dating to the latter half of the twentieth century, but its prehistory can be discerned in the discipline's early concern with kinship and social reproduction. At the turn of the twentieth century, anthropologists focused their attentions mainly on small-scale societies in which kinship appeared to provide the organizing structure for production. What kinship studies revealed is that production and reproduction (both social and material) are mutually implicated processes, and that the relationship between these processes is sustained by principles of difference.

The evidence suggests that among the most powerful symbolic vehicles for both structuring and legitimating such differentiation around the world has been the representation of persons in gendered terms. Accordingly it has been the long and arduous project of gender studies to examine and explicate the ways in which gender difference is produced and subsequently naturalized, rendered in terms of iconic ideals, and incorporated in the bodily unconscious of human subjects. This not only has entailed considerations of the mechanisms for materializing sexual and gendered difference in ritual and other cultural practices, it has also required analyses of the political and economic structures of production within which they operate, the historical transformations to which they have been subject, and the relationships between gender and other discourses of difference at all levels, from household to state. More recently it has entailed recognition of the violences and excesses generated in and by systems of gendered difference, the possibilities for resistance that they facilitate, and the myriad forms in which desire, disavowal, attraction and revulsion, procreative energies and amity can appear across time and space.

Kinship and/or Gender?

In 1987 Jane Fishburne Collier and Sylvia Junko Yanagisako described their goal as putting gender "at the theoretical core of anthropology" by "calling into question the boundary between [the] two fields" of gender and kinship (p. 1). That kinship studies should have appeared as an autonomous field, distinct and

perhaps even resistant to the analysis of gender, was attributed largely to the particular conception of society espoused by the structural functionalists, led by A. R. Radcliffe-Brown. Like many feminist anthropologists, Collier and Yanagisako questioned the degree to which discussions of women's lives were relegated to considerations of the domestic sphere and to reproductive function. They repudiated assumptions (explicit or implicit) that the maternal-child relation is invariant across time and space, and they cast suspicion on the tendency to see historical change as a factor relevant only to political and economic systems in the public domain, while familial life was presumed to be constant and unchanging. Finally, they discerned in structural-functionalist writings an erroneous presumption that all societies have institutional functions that are comparable, even when the forms of their institutions differ.

Many of the questions articulated by Collier and Yanagisako generated productive new approaches to ethnography. In a companion essay in the same volume, they went on to pose another question which resurrected and refined one of Margaret Mead's (1901–1978) earlier challenges—namely, "What social and cultural processes cause men and women to *appear* different from each other?" (p. 15). In *Male and Female* (1949), Mead had observed that anatomical differences provide only the first point of identification for boys and girls, and noted that, from that moment on, children would compare themselves to others and in this fashion acquire a socially mediated sense of sexual selfhood based on traits and characteristics privileged or denigrated by their elders. Her own conception of sexual difference was indebted to Sigmund Freud's (1856–1939) analysis of sexuality in *Three Essays on the Theory of Sexuality* (1905) and retained his binary conception of sexual difference as based on biological antinomy. However, Mead disagreed with Freud's students and with his own postulation of a universally phallic stage in female development.

Against the backdrop of the Cold War and a burgeoning arms race, Mead's contribution to the ongoing tradition of gender studies is rooted in the denaturalizing comparativism that she embraced as the ground of critical anthropology: "If we recognize that we need every human gift and cannot afford to neglect any gift because of artificial barriers of sex or race or class or national origin, then one of the things we must know is where the assumed differences between the sexes are mere elaborations of unimportant differences that can be dealt with easily in this invention-conscious world" (p. 15). To this end Mead emphasized the extraordinary diversity of conceptions of ideal maleness and femaleness across cultures, and on this basis hypothesized the possibility that children might even disavow some of their "biological inheritance" in order to achieve a social ideal of masculinity or femininity (pp. 136–138). She thereby introduced a conception of maleness and femaleness as a social construction irreducible to the physiological basis in which it grounds itself. Nonetheless, the question of gender remained secondary to that of kinship, where it constituted an assumption rather than object of inquiry for several more decades.

Kinship theory in anthropology can be traced to Lewis Henry Morgan's treatise, *Systems of Consanguinity and Affinity of the Human Family* (1870), a work that would consider-

ably influence Friedrich Engels, as well as both structuralist and Marxist anthropologists. Morgan argued that the family as an institution emerged only after a period of promiscuity and then incestuous cohabitation, and that it depended on the creation of a law of exogamy. Nearly a century later, Claude Lévi-Strauss (b. 1908) revived and revised Morgan's argument when he claimed that the incest taboo constituted the archetypal form of all law, and that it marked the threshold between nature and culture. Although he asserted that sexuality was the origin of sociality, insofar as sexual desire is an instinct that requires another person, it was the incest taboo that transformed consanguinity into alliance by rendering women as "the supreme gift" in his analysis.

Rituals of Becoming: The Making of Sexual Difference

One of the primary assumptions of contemporary gender theory is the social construction of gender, but although this core idea is closely linked to the recognition that kinship and even parentage is not a biological matter but a social one and that descent is a mode of recognizing children rather than transmitting genetic material, the connection between the theorization of gender and kinship was not immediately obvious to anthropologists of the early twentieth century. Even Bronislaw Malinowski, who claimed that sex must be understood as but one moment in a vast system comprising love, eroticism, mythology, courtship, kinship, family life, economic and religious practices, and tribal structure, devoted little time to a consideration of how boys and girls come to assume the qualities that make them socially recognizable as such. For him, sexual and social maturation were inimitably linked, but his attention was narrowly focused on the transformation of willful desire between two persons—expressed most purely and freely by adolescents—into a relation capable of self-negation in parenting. Malinowski's most profound insight may have come in his argument that kinship is not so much a matter of sexual intercourse as it is a sublation of dyadic relations into triadic ones, of interpersonal intimacies into intergenerational dependencies. Yet, because his concern lay with the functional appropriation of individual facts for social ends and because his concept of function was so immediate, Malinowski never seems to have considered the difficulty of achieving what Margaret Mead would later term ideal maleness or femaleness.

For the majority of early writers on kinship, gender was the axiomatically binary ground on which kinship and marital exchange could be erected. In Western theoretical traditions, this axiomatic quality of binary gender differences naturalizes itself in biological metaphors to such an extent that gender difference collapses into sexual difference and appears as anatomically and/or genetically determined. Two main sources of critique inform the development of the social constructivist analysis of gender per se. The first is the vast literature on ritual and corporeal practice, from the archive of which anthropologists have assembled their cases for the relativity of somaticization and sexualization. The second is to be found in the reconsideration of earlier theoretical arguments about such practice, especially as developed in the 1970s and 1980s under

the influence and in the context of new social movements, especially feminism. This discussion begins with the consequences and potentialities of ritual theory for gender analysis.

In 1909 Arnold van Gennep undertook to formalize a theory of the rites associated with transitional stages of life and offered a tripartite model consisting of separation, liminality, and re-aggregation to explain their operations. Later elaborated by Victor Turner (1969) in a manner that highlighted the ambiguity and potential subversiveness of the interstitial phase, the notion of the ritual production of social status entailed a recognition that the bodily identity of a person is an inadequate determinant of her or his social identity. Indeed, Van Gennep made the brilliant observation that initiation rites work by overcoming the enormous chasm between biological puberty and what he termed "social puberty." Even more radically, he suggested that these rites do not so much mark puberty as they produce sexuality, removing people from an asexual state and birthing them as either male or female sexual subjects, who can then enter into legitimate sexual and especially reproductive relations with other adults. Van Gennep's radicalism has been mainly forgotten, but feminist anthropology has reclaimed his constructivist insight following a rapprochement with linguistic theory and dialectical materialism, the invention of "gender" as a category, and the emergence of a political project that has made the pursuit of resistance and other forms of counter-hegemonic practice the goal of much comparativist work.

Feminist Interventions: The Legacy of the Seventies

The first intervention of feminist anthropologists into the field of kinship studies and, thence, into anthropology more generally, consisted in the creation of a discursive object that would permit the simultaneous critique of existing theories and the reassessment of its empirical claims. That category was "gender," understood as "the constitutive element of social relationships based on perceived differences between the sexes" and as "a primary way of signifying relationships of power" (Scott, p. 42). Indeed "power and difference" became the crucial axes of gender analysis from the 1980s onward.

Feminists began by accusing early social theorists, but perhaps especially Claude Lévi-Strauss, of mistaking an ideological justification for the oppression of women with an ontology of the social. Because women are treated as commodities does not imply that their functioning as commodities is logically intrinsic to social life everywhere. Because women are frequently relegated to private or domestic domains does not mean that the social world is logically bifurcated along the axis of public and private or that these domains would have to be gendered when they were. And because sexual difference is the primary structure for differentiation of labor and structuring power in small-scale societies that lack a public sphere does not mean that, logically, gender must be a salient structural principle only in domestic spheres when these are encompassed by larger public ones. From these logical arguments emerged a series of questions regarding the universality and extremity of male dominance, the organization of domestic and public or political life, the relationship between political complexity and the status of women, the range of property systems through

which women do or do not gain access to economic resources, and the more subterranean forms of power, value, renown, and influence that women exercise even in those contexts where formal authority is vested in male subjects. In essence, these questions and the energetic research that they spurred were driven by the pursuit of a counterexample. Evidence of equality or a different organizational imperative in one society would undermine claims for the universal virtue, necessity, or naturalness of particular inequalities everywhere else. Or so a generation of feminist scholars hoped. Their project was empiricist and comparativist, collaborative and emphatically political. Its result can be seen in the series of volumes they generated, including those edited by Michelle Rosaldo and Louise Lamphere (1974), Rayna Reiter (1975), Carol MacCormack and Marilyn Strathern (1980), Mona Etienne and Eleanor Leacock (1980), and Sherry Ortner and Harriett Whitehead (1981).

The contributors to these volumes arrived at various and oftentimes contradictory conclusions. Some of the writers included in Rosaldo and Lamphere's collection, notably Rosaldo, Nancy Chodorow, and Ortner, concluded that male dominance *is* universal, with Rosaldo attributing it to the division of labor and the distribution of authority across a violently enforced private/public divide, Chodorow locating women's exclusion from the public in their maternal function and the socialization of girls, and Ortner revising Lévi-Strauss's argument to claim that women are universally perceived as relatively close to nature and therefore thought to be in need of more vigorous regulatory oversight. Other writers, however, especially those influenced by Marxist thought and Friedrich Engels's *The Origin of the Family, Private Property, and the State*, differed. Karen Sacks and, later, Eleanor Leacock (1981) argued that not all societies are dominated by men and that egalitarianism prevails in those where private property, and the particular construction of women as private property, has not yet developed. In this case male dominance is a function of history and a relatively recent emergence. Still others, such as Peggy Sanday, asserted that male dominance is vitiated over time as technology and the transformation of production attenuates the advantages conferred by physical strength.

Such arguments stood or failed according to the persuasiveness with which the ethnographic evidence was adduced, and many of the writers later recanted or were persuaded by competing positions. One of the most lucid and sustained theoretical critiques to emerge from Rosaldo and Lamphere's 1974 volume was penned by Gayle Rubin under the title "The Traffic in Women: Notes Toward a 'Political Economy' of Sex." Rubin's essay commenced with a new category, that of the "sex/gender system." It was intended to overcome the prevalent dichotomy between sexual and economic systems and to prevent sexual relations from being reduced to reproductive function. As a formally empty category, the idea of a sex/gender system demanded ethnographic specification of the same sort that would distinguish between socialist or capitalist production. Rubin took Lévi-Strauss to task precisely for his lack of such differentiation, especially on the question of the traffic in women. Failing to differentiate between historically actual cases of women who are "given in marriage, taken in battle, exchanged for favors, sent as tribute, traded, bought

and sold" rendered the notion vacuous for Rubin, and she observed that men are also trafficked—for different purposes (p. 175). Michael Peletz would corroborate this assertion in 1996 with descriptions of the traffic in men by women in nineteenth-century Malay communities. It is, however, in her deconstruction of the concept of gender, as assumed in Lévi-Strauss's *The Elementary Structures of Kinship*, that Rubin made her most incisive intervention. Observing that the incest taboo as described by Lévi-Strauss is not merely a prohibition on incest but also on homosexuality and on sameness, one that orchestrates desire in terms of sexual difference, Rubin offered as counterexamples those instances in which same-sex relations are considered necessary for the production of adult gender (as in some parts of New Guinea) and those in which same-sex marriage is permitted (as among the Azande or the Dahomey), or where institutionalized transvestism is practiced (such as Native North America or India). Given these facts, she asserted, the taboo is not universal but merely the representation of a particular, if commonplace, ideology—for which, she admits, both Freud and Lévi-Strauss offer refined descriptions and unapologetic but illegitimate justifications.

Materialism and Dialectical Analysis

Rubin began her essay by asserting that "there is no theory which accounts for the oppression of women . . . with anything like the explanatory power of the Marxist theory of class oppression" (p. 160). She concluded by calling for a new version of Engels's *The Origin of the Family*. Efforts to integrate gender analysis with class analysis and with more generally materialist concerns have taken a number of forms since Rubin's article was published. In general these have concerned the relationship between unremunerated housework and the reproduction of labor, the impact of colonialism and capitalist penetration on gender relations in local cultures, the new international division of labor, and the feminization of geopolitical regions.

Historically concerned with small-scale societies and undergirded by the assumption that the most elementary form of any social phenomenon reveals an essence that carries across other manifestations, Marxist anthropologists imagined the division of labor between men and women to be identical to the division between productive and reproductive functions. However, during the 1980s and beyond, questions of production and reproduction and of the status of women were increasingly reframed in terms of the colonial encompassment of indigenous economies and the new international distribution of labor. This led to studies of new logics of power, such as those by which class has displaced status as a rubric of social stratification in some places. It also generated analyses of new competitive relations between men and women as economic power became unified in a single (generalized) commodity form where previously it had been divided among regimes of value. In these contexts gender became the contested mechanism for regulating access to economic resources. A vast literature also developed in response to the emergence of transnational labor networks and the establishment of new manufacturing zones in the digitizing global economy of multinational finance. By attending to the gendered organization of value, and not merely the symbolic

value (or lack thereof) accorded women (Weiner), it has become possible to speak of a “feminization of the global economy.”

Materialist analyses of these latter processes, which take place in a transnational realm that exists both above and below the level of the nation-state, have perhaps inevitably privileged economic questions, but they have often stopped short of economic determinism. Dialectical analysis has been summoned here as a means of recognizing the degree to which indigenous forms of familial and social organization remain resilient or resistant in the face of encompassment by multinational capital, global finance, and other transnational forces. But a dialectical approach to the transformation of gender (or the sex/gender system) must actually redouble itself. For it not only entails the recognition that local life-worlds are transformed without being destroyed in the modern moment (hence it must examine the dialectics between the local, the global, and the emergence of transnationally comparable values like locality), it also requires a reading practice that seeks to comprehend, from two distinct locations or perspectives, the facts of these historical processes. Reading for resistance became a primary objective of much work in the field of gender studies during the last two decades of the twentieth century. Promising in many regards, it has nonetheless been weakened by a tendency to conflate the fact of social and structural specificity with an intentionalized and often strategic, or at least tactical, opposition to the forces of both foreignness and new inequity.

Resistance was the term by which gender studies sought to rescue itself from the absolutist pessimism of structuralist universalism as well as economic and cultural determinism. Under the influence of Clifford Geertz, American anthropological analysis of culture had tended to represent culture as a system of shared signs or symbols. Conceived as a theoretical refutation of the economic determinism that cruder forms of Marxism espoused, culturalism nonetheless reproduced its problematic negation of agency while also eviscerating any recognition of structural contradiction. Resistance conceived within the culturalist tradition thus came to be imagined as a possibility originating in the critical reading and interpretation of those signs and symbols that comprised cultural totalities. Ironically, the language of resistance permitted two distinct theoretical traditions to converge, those of the Italian Marxist Antonio Gramsci (1891–1937) and the French libertine philosopher Michel Foucault (1926–1984). It was a thematically and methodologically driven reading of Foucault’s later writings on sexuality that informed the genealogical turn in gender studies and in anthropology more generally.

Foucault and the Genealogy of Sexuality

Although Foucault’s early writings attempted to excavate the sedimented structures of thought in a particular moment (and the discontinuous relations between moments), it was his development of a retrospective historiographical mode that made his writings on sexuality appear exemplary for historicist anthropologies concerned with the emergence of particular sex/gender systems. The first volume of *The History of Sexuality*, in particular, was quickly hailed for its demonstration of what the genealogical method could offer gender studies—although

many theorists mistook a mere reversal of chronology for Foucault’s more radical demand that ontological thought be surrendered in favor of a negative concept of becoming.

Two main contributions were recognized. Firstly, Foucault argued that prohibition does not work to contain or repress that which it outlaws but rather cultivates its sanctioned objects in a new mode. The sexual repression of the Victorians, for example, did not so much eliminate an interest in sex as it permitted the extension of erotic pleasures into the domain of language, such that talking about sex—even in the form of denunciation—could be seen as one more incitement of sex, while making speech itself a scene of excitement. The second contribution lay in its analysis of the relationship between sexuality and political power in Western cultures.

At the end of *History of Sexuality*, Foucault described the emergence of a new political technology, one marked by power’s investment in life, in the control and management of human beings as productive entities whose health and well-being it assiduously cultivated. Discourses on sexuality, and on so-called healthy sexuality, were coterminous for him with the displacement of centralized power by diffuse forms of discipline and control that saturated all dimensions of the life-world. Foucault described this new technology as one that entailed a “power over life” rather than a “right of death” and designated it as “biopower.” From Europe’s eighteenth century onward, biopower worked through the surveillance of sexual practice and by placing same-sex intimacies under increasingly violent prohibitions, as the demand for total productivity and intentionalized reproductivity intensified in the modern industrial era. In other contexts, he admitted, the organization of power over life might take other forms, and might structure subjectivity in terms other than those of sexuality, but his primary focus was the more familiar history of European modernity.

In Europe and elsewhere, Foucault’s claim that homosexuality was a modern invention, the product of discourses upon normalcy and sexual health, scandalized many scholars and was initially misunderstood by many to imply the relatively recent appearance of same-sex intimacy. Foucault made no such claim; he was instead identifying a moment in which practice and identity were merged by virtue of new representational logics. This merging produced not same-sex intimacies but the figure, and henceforth, the felt experience, of the homosexual.

Although his exemplary case study came from the archives and entailed the story of an ambivalently sexed figure, Herculine Barbin, who was forced to assume a male identity by French medical and police authorities, feminists quickly observed that Foucault’s analysis failed to distinguish between sexuality as it came to be configured for women and men. In other words, they argued that sexuality without consideration of gender could only reproduce the relative claim that the figure of maleness has on universality in Western philosophical discourse. Feminist writers were quick to observe, for example, that the prerogative of transvestism is often limited to members of one gender and suggested that the distribution of this prerogative might itself be indicative of power in the organization of local sex/gender systems. At the same time,

however, many anthropologists, influenced by the burgeoning phenomenon of gay and lesbian studies, also saw in the tale of Barbin an exemplary ur-figure of modernity's sexualizing violence. A vast array of cross-cultural studies were devoted to excavating eras in other places where sex and gender was (or continues to be) organized according to less rigorously binary structures. And older reports of female husbands, institutionalized transvestism and androgyny, and legitimate same-sex intimacy were revisited with avidity.

The best of such work is assiduously historical, grounding itself in the meticulous scrutiny and translation of evidence from diverse archives and unofficial sources. However, much of the more ethnological comparativism has ignored Foucault's suggestion that biopower might be differently structured elsewhere and has sought analogues to European historical developments instead. As a result, it has borne a not inconsiderable resemblance to the oftentimes prurient studies of earlier sexology, especially when anthologized in collections devoted to the category of "third sex," "third gender," or comparative homosexualities. Historians, by contrast, have generated a series of supplementary histories that augment, clarify, or refute the suggestions made in Foucault's more programmatic moments, often bringing the same kind of analytic lens to the history of heterosexuality as he brought to homosexuality. And some anthropologists have attempted to understand the implications of Foucault's project for an analysis of institutional and discursive histories in the colonial context, paying particular attention to the organization of populations, institution of new educational systems, juridical rationalization, and forms of both public morality and sentiment that colonial regimes implemented.

Feminist critique of the masculinist bias in early Foucaultian analyses of sexuality has been followed by a bifurcation in the field and a proliferation of studies devoted to the analysis of masculinity and its relationship to systems of power, both within households and at the level of the state. These studies, whether overtly Foucaultian or not, consider the corporeal tactics and the ideological representations and values (such as machismo, honor, and valor) by which masculinity is cultivated in men, emphasizing the disjuncture between merely anatomical sex and social gender even when the two are conflated in local discourse (a 1998 study by Judith Halberstam extends this analysis in a consideration of what she terms "female masculinities"). The Foucaultian turn might thus be read as the process by which the feminist political slogan "the personal is the political" gets inverted, such that the political is understood as that which generates embodied persons. In any case, it generated a renewed theory of the importance of ritual in the constitution of sexual and gendered difference.

Repeating Ritual: The Idea of Performativity

Feminism and gay studies, Foucault and the study of ritual, came together in the work of Judith Butler. In an eclectic theoretical blending of Foucault's discourse analysis, J. L. Austin's *How to Do Things with Words* (1962) linguistic pragmatics, and Hegelian dialectics tempered by Louis Althusser's notion

of interpolation, Butler demonstrated that the principle of iteration (etymologically linked to rite and ritual) can be seen in the myriad gestures of daily life. Although her early work implied a degree of voluntarism not present in Austin's theory, Butler's later writings recognize that these gestures or "repeated acts" take place "within a highly rigid regulatory frame," and they produce, for Butler, gendered bodies not only as representations but as materialized and sensuously experienced entities. They do so in two senses. Repetition generates habitual forms that are recognized within the social world; and they subject persons to ideals but in a manner that leaves them relentlessly deficient. Transforming Althusser's notion of ideological hailing as that gesture by which power names and thereby summons a person in the terms that power confers, Butler suggests that all individuals are both hailed and made to bear the unconscious knowledge that they cannot, by definition, achieve the image that power gives to them as ideal. Compulsively enacting the forms that would demonstrate conformity to gender ideals, most train their bodies to become sexually legible. For some, however, a consciousness of the gap between ideal gender and materially actual difference can become the basis for resistance to the sex/gender system.

Butler's work reached anthropology in the wake of Pierre Bourdieu's "practice theory" (1977; see also Morris, 1995; Ortner, 1984) and was often read as the politically radical version of the French sociologist's reinvigorated structuralism. Bourdieu had analyzed what he termed the "doxa" of everyday life and suggested that architectural forms shape and constrain bodily gesture, inculcating dispositions that then cause people to act in ways that exteriorize the social structure. His description of this process in Kabyle villages suggested a necessary complementarity between men's and women's acts as the instruments for realizing a whole world otherwise divided between public and private domains. Bourdieu's notion of practice gave new life to Marcel Mauss's original assertion in 1968 that no bodily act, not even sex, is natural, and that the ideational or symbolic order of a given culture is something that exists in the body. This corporeal unconscious is never fully amenable to objectification in language and is actually dissipated in the moment that it becomes articulate. Unlike Bourdieu's vision of practice, which seemed incapable of explaining change, however, Butler provided a theory of how unconscious bodily sensitivities could become the basis of conscious opposition to the predominating sex/gender system.

Whether in response to Bourdieu or to Butler, the result was a proliferation of works broadly construed as anthropologies of the body. Many of these attempted to examine corporeal practices that appeared to be conspicuously implicated in the unequal distribution of power and the material constraint of women's sexual and sensual capacities. Many were also driven by the ambition to discover the different ways in which women interpreted these practices, so as to discover in them unexpected freedoms or self-experiences that differed from, and perhaps contradicted, the ideological representations of dominant discourse. Here the anthropology of the body met a globalizing feminist consciousness and a new politics of representation.

Power, Representation, and Resistance: Lending Ears and Voices

Finding resistance in the interpretation of genital cutting—as, for example, freedom from desire, or in the experiences of factory workers possessed by spirits—as liberation from the monotonies of the assembly line may seem odd. Are these painful and debilitating experiences the ground of resistance? Or the symptoms of a system that makes women the handmaids of their own oppression? Can resistance be unconscious? And if so, is resistance a sign of agency?

In direct counterpoint to these readings of the subjectivity-less women in whose bodies the social world demonstrated its own violence and limitations there emerged in the 1980s another body of literature whose aims were to give expression to the conscious agencies of dominated women and other minorities, especially in the Global South.

Giving voice, or facilitating the self-expression of others—often through narrative forms that included biography and autobiography, fiction, poetry, and tokens of other expressive culture—became the commonplace gestures of well-intentioned anthropologists. These self-consciously feminist writers introduced a salutary counterbalance to those older texts in which the words of women, never mind their thoughts and experiences, were obliterated in generalizing and ostensibly genderless statements about “the way things are.” The felicitous result: the textured life-worlds of soap-opera-watching housewives in Egypt, of ambitious but marginalized poor women healers and middle-class merchants on the Indonesian periphery, of devout Pentecostals in South Africa and proudly political mothers in Argentina, all entered the canon of ethnography, irrevocably transforming it in a humanist direction.

Works in this oeuvre share a certain descriptive quality. They also share an ambition to translate, both literally and figuratively, the experiences of others. Ironically, perhaps, the instruments of that translation have been the concepts of gender—including men and women—and experience. For this new anthropology has made its claim on the basis of a presumptive capacity for readers to recognize, as the experience of women (or men), the representations provided by anthropologists.

In light of all the anthropological evidence that being female or male differs between cultural contexts, and after all the theoretical labor aimed at debunking the universalist presuppositions of structural functionalism and then structuralism, there remains in feminist anthropology an indissoluble commitment to the transcultural and transhistorical viability of woman as a category of infinite translatability. The same can be said of gender, which appears to be an empty category but which nonetheless works through the presumption that the social difference organized through reference to sexual difference is distinct from all other kinds of difference.

This presumption has been called into question by a number of minority writers from the Global South. They have insisted that there is no material referent for the abstract category of “woman,” and that, to the contrary, those named as women are subjects whose lives are determined by complex webs of politico-economic and therefore discursive forces, whether

these be ones of race, class, location, or other principles. The implications of these claims for comparative gender studies have been enormous and deeply sobering, insofar as they suggest that there are not comparable communities of women whose experiences can be described and then compared. If some anthropologists ceded this point by advocating the self-representation of indigenous women (or by reading indigenous expressive forms as inherently self-representational), they did so in the face of an even more radical critique. The most acute proponent of that critique, Gayatri Chakravorty Spivak, argues that “subaltern women” cannot simply be ascribed or asked to inhabit the same kind of subjectivity that defines the position of white males in the European metropole. They cannot make themselves heard, except through a self-translation that rends them from their original location of invisibility and transforms them, through an ironically “enabling violence,” into the kinds of beings whose speech is heard and recognized but only to the degree that it resembles that of its listeners.

Spivak’s intervention made translation a question not only of technique but one determining the very possibility of gender studies. To be sure, translation had always been a question for comparative gender studies in anthropology, but it was defined much more narrowly. Originally it was recognized mainly in the comparative lexicons that anthropologists produced to demonstrate the relativity of kin terms (in places where men and women use different pronouns and kin terms). Since then it has been addressed through a variety of idioms, with silence and indirection often standing for women’s incapacity to achieve or command a language of universal legibility. Conversely, silence and indirection have been read as indices of intentional resistance to dominant modes of communication (Gal). In a particularly innovative study of domestic intimacy in Sumatra, James T. Siegel demonstrated in 1969 how mistranslation, of the kind that lets women comprehend their treatment of men as patronizing indulgence (and hence indicative of their power) while also permitting men to read the same gestures as ones of deference (and hence testimony to their relative importance), actually facilitates gendered inequity and an odd kind of stability in Athenese households. Siegel’s writings offer an alternative theory of translation, one in which incommensurabilities in language and interpretation do not so much prohibit communication as they facilitate incompletely comprehended social relations, ones infused by power, which is dissimulated in the gaps between interlocutors. This does not make mistranslation a scene of resistance, any more than the translation of a subaltern woman’s experiences into the representation of subalternity (for Western women readers) makes her an equal collaborator in global feminism. In very different ways, then, Siegel’s and Spivak’s insistence that power dissimulates itself in language and in claims to translational adequacy reveals the need for reflection upon the situation of speaking and reading. This problem is not mitigated by a recognition that globalization has brought about an increasing traffic in the terms and discourses emanating from the Anglo-American and European West.

Lexicalization and the transportation of idioms and concepts from one location to another—especially those concerning gender and sexuality, women’s rights and human rights—do

not guarantee that their meanings will be constant or comparable. Reflecting on the instability of the category “woman” across continents, languages, and power divides, and recognizing that anatomy does not obviate translational problems, contemporary writers have also reflected on the history and intensification of instabilities in the so-called biological being of women in the context of technological modernity.

Redux: Sex, Kinship, and Agency in the Machine Age

Three main strands of thought have dominated the anthropological study of gender and technological modernity. The first of these, already discussed, concerns the organization of labor and the destructive or liberating effects of the commodity form and capitalism (industrial and financial) on the status of women, the organization of families, and the international division of labor. The second concerns the category of modernity itself and what it means for local life-worlds transformed by imperialism, colonialism, and multinational capital. Finally, analyses of gender and modernity have led to an interrogation of the consequences of new technological developments on reproductive possibilities, forms of kinship, the relationship between the pharmaceutical state and individual rights, bodily identity, and the transnational economy of suffering and its amelioration. It is the latter strand of thought—that which directly addresses the material conditions of mechanically dominated societies—that in the mid-1980s returned gender studies to its origins in kinship and the study of primitive society.

Donna Haraway’s 1985 essay “A Manifesto for Cyborgs” threw down the gauntlet in this domain with its assertion that the corporeal and therefore sexualized body is not the discrete and encapsulated entity on which the fantasies of autonomous selfhood (and their attendant discourses of possessive individualism) are erected. Rather, they are discursively organized and technologically extended—opened and re-formed, as it were—by everything from drugs to plastic surgery, shoes to artificial joints. This recognition of the human body as a pliant material entity, the boundaries of which cannot be known in advance, resonated with anthropological accounts of ritual reform, such as those that marked gendered maturity or sexual transition through forms of scarification, genital cutting, and tattooing, among other practices.

These insights have been especially fruitful in the feminist study of Western scientific discourse, medical practice in the United States, and of medical representations more generally. Scholars have drawn attention to the violences and objectification that medicalization can entail. They have also revealed how the female form has been made to both figure and legitimate an invasive medical science whose invasiveness exceeds any possible utility.

Other writers have examined the ways in which economic logics enter and determine the conceptualization of bodies. Illustrative here is Emily Martin’s (1994) argument that the contemporary concepts of bodily immunity and social epidemiology on which much AIDS research and prevention strategies have been based tends to valorize flexibility in a manner that mirrors contemporaneous economic logics. Bodies, in this sense,

reproduce what the economy produces, but at the level of representation. By contrast, Linda Singer (1993) argues that while an intimacy is to be discerned between economy and sexuality in the age of epidemic (mainly but not exclusively the age of AIDS), it lies in the logic of the panic. Such panic, when linked to sexuality, would permit the increased regulation of persons and populations, and it would do so in the very moment that sexuality would be valorized and, indeed, valued in the terms provided by late capitalism. Singer’s early insistence that AIDS be conceived as a biopolitical economy and not merely as a disease was paradigmatic for other scholars who, in very different ways, attempted to map the geopolitics of life, illness, death, and healing, in examinations of the pharmaceutical state and the transnational traffic in gendered bodies, prostheses, and drugs.

In the 1990s there also emerged a less dystopic approach to the question of gender and technological modernity, one that manifests a distinctly American conception of private, rights-bearing subjects whose sense of personal agency and entitlement permits them to instrumentalize, if not fully control, the discourses and technologies afforded by contemporary science, especially medical science. Rayna Rapp’s 1999 account of amniocentesis, and many of the essays in Faye Ginsburg and Rapp’s 1995 collection on reproductive technologies, certainly evince the tendency of women’s reproductive functions to be appropriated through new technologies, and they reveal the degree to which a vast medico-technological and pharmaceutical apparatus is brought to bear on women in the interest of securing their reproductive functions (often reducing women to such functions). At the same time, however, their accounts of women who are forced into difficult choices by knowledge about fetal health or viability is supplemented by the sense that these “choices” can also become the ground of new agencies.

A concern with choice is also evident in gay, lesbian, and queer studies, where the problem of kinship continues to provide an orienting point for theoretical explorations of identity formation and social status. In many cases, such as Kath Weston’s 1991 study of gay and lesbian families, entitled *Families We Choose*, sexual alterity becomes the iconic representation of absolute agency and self-determining choice. Although some thinkers have repudiated this model and proposed a genetic basis for homosexuality, anthropological evidence contradicts such efforts, and suggests that the category of homosexuality is not fully translatable across cultures. Same-sex intimacy is variously accommodated in a range of sex/gender systems without ever cohering into a single identity structure. Here again translation emerges as a crucial issue for comparative sexuality studies.

Gay, lesbian, and queer transnational alliances that, like those of earlier humanist feminisms, have arisen in the interest of producing, recognizing, and securing rights for individuals engaged in same-sex intimacy around the world. Violent repudiations of “homosexuality” and the designation of it as a Western perversion have been associated with new assertions of cultural sovereignty throughout the world, although, as in parts of Western Europe and the Americas, such disavowals symptomatize modernity as much as they resist a globalization of sexual cultures. Just as Western labors to solicit gender solidarity were forced to confront the competing demands for

sovereignty made by individuals and collectivities (in the name of sexual and individual rights or gender asymmetry and cultural rights), so gay, lesbian, and queer activism faces a comparably agonistic confrontation between the notions of collaboration across difference and solidarity based in identification. The terrain of this conflict is often the idea of family.

Conclusions

It is important to recognize that kinship (and the family), as reconstructed by feminist gender studies since the 1970s, is not merely the particular locus of social production and reproduction. It is the symbol of sociality: an iconic form that stands for *something else*, just as the body can *stand for anything else*, as Margaret Mead recognized so many years ago. Similarly, it has been the project of gender studies to demonstrate how gender stands for and structures something else—namely, power and, therefore, difference.

In retrospect, then, it is necessary to understand gender studies not only as a discipline premised upon this fundamental axiom—that gender represents, and performatively constitutes, relations of power—but as a field whose own interests have been structured by other questions. Particularly in the United States but in the West more generally, gender studies has partaken of a general problematic, namely the opposition between choice and determination—a problematic central to the constitution of liberal democratic politics and their self-representation. Anthropologists, following Margaret Mead, referred to this opposition in terms of the “nature/nurture” binary, with “nature” being variously understood as comprised of anatomy, genetics, or mental structures. “Nurture” was the term applied to socially variable factors and has been widely equated with “environment.” In culturalist discourse, this has lent an aura of voluntarism to social practice, which, because it is not natural, has appeared to be something to which individuals choose to accede. Notwithstanding structuralist efforts to demonstrate that the arbitrariness of social forms is precisely overcome by habit, convention, and history, a tendency to valorize individual choice has been omnipresent in gender studies and especially feminist anthropology. In this regard, studies of resistance can be seen as continuous with culturalism, albeit only insofar as they make social disadvantage or abjection a source of alienation from what history gives individuals as the natural form of society. The question of choice was, of course, differently conceived by Marxists, for whom history and the organization of production, rather than biology, constituted the primary sources of social determination.

Elizabeth Povinelli asserted in 2002 that sexuality is the discourse through which choice becomes the means of claiming Western subjecthood—compared to, for example, cultural descent, which makes a lack of choice, or submission to cultural law, the means of asserting subjecthood in many non-Western cultures, at least as they are represented to and for the West. This observation can be extended to include gender, sex, and sexuality. However, if conceptions of queer kinship privilege choice, many other analyses of gender and sexuality, and especially those grounding themselves in biologism, do not. The question is not whether sexuality is (always already) a discourse

of choice, but how and when gender or sexuality become the concept metaphors through which the questions of individual choice and social or natural determination get posed. A reflexive analysis of the conditions of possibility within which these questions emerge is, as Foucault rightly argued, prerequisite for any progress in the study of sociality.

See also Family; Gay Studies; Kinship; Queer Theory; Sexuality; Structuralism and Poststructuralism: Anthropology; Women and Femininity in U.S. Popular Culture; Women's Studies.

BIBLIOGRAPHY

- Abu-Lughod, Lila. “The Romance of Resistance: Tracing Transformations of Power through Bedouin Women.” In *Beyond the Second Sex: New Directions in the Anthropology of Gender*, edited by Peggy Reeves Sanday and Ruth Gallagher Goodenough, 311–338. Philadelphia: University of Pennsylvania Press, 1990.
- . *Veiled Sentiments: Honor and Poetry in a Bedouin Society*. Cairo: American University of Cairo Press, 1986.
- Barbin, Herculine. *Being the Recently Discovered Memoirs of a Nineteenth-Century French Hermaphrodite*. Introduction by Michel Foucault; translated by Richard McDougall. New York: Pantheon, 1980.
- Bourdieu, Pierre. 1972. *Outline of a Theory of Practice*. Translated by Richard Nice. Cambridge and New York: Cambridge University Press, 1977.
- Butler, Judith. *Bodies That Matter: On the Discursive Limits of “Sex.”* New York: Routledge, 1993.
- . *Gender Trouble: Feminism and the Subversion of Identity*. New York: Routledge, 1990.
- Chodorow, Nancy. “Family Structure and Feminine Personality.” In *Woman, Culture, and Society*, edited by Michelle Zimbalist Rosaldo and Louise Lamphere, 43–66. Stanford, Calif.: Stanford University Press.
- Collier, Jane Fishburne, and Sylvia Junko Yanagisako. “Introduction.” In *Gender and Kinship: Essays toward a Unified Analysis*, edited by Jane Fishburne Collier and Sylvia Junko Yanagisako, 1–13. Stanford, Calif.: Stanford University Press, 1987.
- Di Leonardo, Micaela. *Gender at the Crossroads of Knowledge: Feminist Anthropology in the Postmodern Era*. Berkeley: University of California Press, 1991.
- Engels, Friedrich. *The Origin of the Family, Private Property, and the State*. New York: International Publishers, 1942.
- Etienne, Mona, and Eleanor Leacock, eds. *Women and Colonization: Anthropological Perspectives*. New York: Praeger, 1980.
- Foucault, Michel. *History of Sexuality*. 3 vols. Translated by Robert Hurley. New York: Vintage, 1986.
- Freud, Sigmund. 1905. *Three Essays on the Theory of Sexuality*. Translated by James Strachey. New York: Basic Books, 1975.
- Gal, Sue. “Between Speech and Silence: The Problematics of Research on Language and Gender.” In *Gender at the Crossroads of Knowledge: Feminist Anthropology in the Postmodern Era*, edited by Micaela di Leonardo, 174–203. Berkeley: University of California Press, 1991.
- Gennep, Arnold van. 1909. *The Rites of Passage*. Translated by Monika B. Vizedom and Gabrielle L. Caffee. Chicago: University of Chicago Press, 1960.
- Ginsburg, Faye, and Rayna Rapp, eds. *Conceiving the New World Order: The Global Politics of Reproduction*. Berkeley: University of California Press, 1995.

- Ginsburg, Faye, and Anna Lowenhaupt Tsing, eds. *Uncertain Terms: Negotiating Gender in American Culture*. Boston: Beacon, 1990.
- Halberstam, Judith. *Female Masculinity*. Durham, N.C.: Duke University Press, 1998.
- Haraway, Donna. "A Manifesto for Cyborgs: Science, Technology, and Socialist Feminism in the 1980s." *Socialist Review* 80, no. 2 (1985): 65–108.
- Herd, Gilbert. *Third Sex, Third Gender: Beyond Sexual Dimorphism in Culture and History*. New York: Zone, 1994.
- Jordanova, Ludmilla. *Nature Displayed: Gender, Science, and Medicine, 1760–1820*. London and New York: Longman, 1999.
- Katz, Jonathan Ned. *The Invention of Heterosexuality*. New York: Dutton, 1995.
- Leacock, Eleanor Burke. *Myths of Male Dominance: Collected Essays on Women Cross-Culturally*. New York: Monthly Review Press, 1981.
- Lévi-Strauss, Claude. *Elementary Structures of Kinship*. Rev. ed. Translated by James Harle Bell, John Richard von Sturmer, and Rodney Needham, editor. Boston: Beacon Press, 1969.
- MacCormack, Carol P., and Marilyn Strathern, eds. *Nature, Culture, and Gender*. Cambridge and New York: Cambridge University Press, 1980.
- Malinowski, Bronislaw. *Sex and Repression in Savage Society*. London: International Library of Psychology, Philosophy, and Scientific Method, 1927.
- . *The Sexual Life of Savages*. 3rd ed. Preface by Havelock Ellis, introduction by Annette Weiner. Boston: Beacon, 1987.
- Martin, Emily. *Flexible Bodies: Tracking Immunity in American Culture from the Days of Polio to the Age of AIDS*. Boston: Beacon, 1994.
- Mauss, Marcel. 1968. "Techniques of the Body." In *Incorporations*, edited by Jonathan Crary and Sanford Kwinter, 454–477. New York: Zone, 1992.
- Mead, Margaret. *Male and Female: A Study of the Sexes in a Changing World*. New York: Morrow, 1949.
- Mohanty, Chandra Talpade, Ann Russo, and Lourdes Torres. *Third World Women and the Politics of Feminism*. Bloomington: Indiana University Press, 1991.
- Morgan, Lewis H. *Systems of Consanguinity and Affinity of the Human Family*. Smithsonian Contributions to Knowledge 17, no. 218. Washington, D.C.: Smithsonian Institution, 1870.
- Morris, Rosalind C. "All Made Up: Performance Theory and the New Anthropology of Sex and Gender." *Annual Review of Anthropology* 24 (1995): 567–592.
- Nash, June. "Aztec Women: The Transition from Status to Class in Empire and Colony." In *Women and Colonization*, edited by Mona Etienne and Eleanor Leacock, 134–148. New York: Praeger, 1980.
- Ong, Aihwa. *Spirits of Resistance and Capitalist Discipline*. Albany: State University of New York Press, 1987.
- Ortner, Sherry B. *Making Gender: The Politics and Erotics of Culture*. Boston: Beacon, 1996.
- . "Theory in Anthropology since the Sixties." *Comparative Studies in Society and History* 26, no. 1 (1984): 126–166.
- Ortner, Sherry B., and Harriet Whitehead, eds. *Sexual Meanings: The Cultural Construction of Gender and Sexuality*. Cambridge and New York: Cambridge University Press, 1981.
- Peletz, Michael G. *Reason and Passion: Representations of Gender in a Malay Society*. Berkeley: University of California Press, 1996.
- Povinelli, Elizabeth A. "Notes on Gridlock: Intimacy, Genealogy, Sexuality." *Public Culture* 14, no. 1 (2002): 215–238.
- Radcliffe-Brown, A. R. "Introduction." In *African Systems of Kinship and Marriage*, edited by A. R. Radcliffe-Brown and Daryll Forde. 1950. Reprint, Oxford: International African Institute and Oxford University Press, 1967.
- Rapp, Rayna. *Testing Women, Testing the Fetus: The Social Impact of Amniocentesis in America*. New York: Routledge, 1999.
- Reiter, Rayna R., ed. *Toward an Anthropology of Women*. New York: Monthly Review Press, 1975.
- Rubin, Gayle. "The Traffic in Women: Notes toward a 'Political Economy' of Sex." In *Woman, Culture, and Society*, edited by Michelle Zimbalist Rosaldo and Louise Lamphere, 157–210. Stanford, Calif.: Stanford University Press, 1974.
- Rosaldo, Michelle Zimbalist, and Louise Lamphere, eds. *Woman, Culture, and Society*. Stanford, Calif.: Stanford University Press, 1974.
- Sacks, Karen. "Engels Revisited: Women, the Organization of Production, and Private Property." In *Toward an Anthropology of Women*, edited by Rayna R. Reiter, 211–234. New York: Monthly Review Press, 1975.
- Sanday, Peggy. "Female Status in the Public Domain." In *Woman, Culture, and Society*, edited by Michelle Zimbalist Rosaldo and Louise Lamphere, 189–206. Stanford, Calif.: Stanford University Press, 1974.
- Schneider, David M. *American Kinship: A Cultural Account*. Englewood Cliffs, N.J.: Prentice-Hall, 1968.
- Scott, Joan. "Gender: A Useful Category of Historical Analysis." In her *Gender and the Politics of History*, 28–50. Rev. ed. New York: Columbia University Press, 1999.
- Siegel, James T. *The Rope of God*. Berkeley: University of California Press, 1969.
- Singer, Linda. *Erotic Welfare: Sexual Theory and Politics in the Age of Epidemic*, edited with an introduction by Judith Butler and Maureen MacGrogan. New York: Routledge, 1993.
- Stoler, Ann Laura. *Carnal Knowledge and Imperial Power: Race and the Intimate in Colonial Rule*. Berkeley: University of California Press, 2002.
- . *Race and the Education of Desire: Foucault's History of Sexuality and the Colonial Order of Things*. Durham, N.C.: Duke University Press, 1995.
- Strathern, Marilyn. *Reproducing the Future: Anthropology, Kinship, and the New Reproductive Technologies*. Manchester, U.K.: Manchester University Press, 1992.
- Spivak, Gayatri Chakravorty. "Can the Subaltern Speak?" In *Marxism and the Interpretation of Culture*, edited by Cary Nelson and Lawrence Grossberg, 271–313. Urbana: University of Illinois, 1988.
- Turner, Victor. *The Ritual Process: Structure and Anti-Structure*. Chicago: Aldine, 1969.
- Weiner, Annette B. 1976. *Women of Value, Men of Renown: New Perspectives in Trobriand Exchange*. Austin: University of Texas Press, 1983.
- Weston, Kath. *Families We Choose: Lesbians, Gays, Kinship*. New York: Columbia University Press, 1991.
- Yanagisako, Sylvia Junko, and Jane Fishburne Collier. "Toward a Unified Analysis of Gender and Kinship." In their *Gender and Kinship: Essays toward a Unified Analysis*, 14–50. Stanford, Calif.: Stanford University Press, 1987.

Rosalind C. Morris

JEAN-JACQUES ROUSSEAU

Jean-Jacques Rousseau (1712–1778), was born a “Citizen of Geneva,” a title he used on many of his important works to suggest the challenge his thought posed to the regimes of his day. He ran away from his native city at sixteen, and led an unsettled life for the next dozen years, teaching himself a variety of subjects. He arrived in Paris in the early 1740s, hoping to make a name for himself as a composer and the inventor of a new system of musical notation. While his musical enterprises mostly failed, he became intimate with the circle of intellectuals who were soon involved in the *Encyclopédie*. He was commissioned to write the articles on music for the great compendium of enlightenment, but gained international celebrity with the publication of the *Discourse on the Sciences and Arts* (1751), in which he argued that the advancement of the sciences and arts had corrupted morals. He followed up

the success of this first work with a series of increasingly provocative works published over the next decade: a well-received opera, *Le Devin du Village* (1752), a philosophical treatment of the historical development of human nature; the *Discourse on Inequality* (1755); a best-selling novel, *Julie* (1761); a pedagogical work, *Emile* (1762); and his political treatise, the *Social Contract* (1762). When the *Social Contract* and *Emile* were banned and burned both in Paris and his native Geneva, Rousseau fled Paris and lived essentially in exile for the rest of his life. During this time, apart from defenses of his works, he published his *Dictionary of Music* (1768), the first such lexicon, and wrote several autobiographical works published only posthumously, including the *Confessions*, usually considered the first modern autobiography, *Dialogues*, and *Reveries of the Solitary Walker*.

GENERAL WILL. *General will (volonté générale)* is inextricably associated with the philosophy of Jean-Jacques Rousseau (1712–1778). While Rousseau appropriated the general will from the theological debates of the late seventeenth and early eighteenth centuries, he made the concept his own with the political formulation he gave it in his *Du contrat social* (1762; *On the social contract*). Interpretations of the general will since Rousseau have largely been colored by views of the French Revolution (1789–1799) and of the role both thinker and concept played in the ideological justification of the Revolution and assessments of its inheritance.

The General Will before Rousseau

The term *general will* originated in the debates over divine grace and providence nearly a century before Rousseau. The French philosopher Nicolas de Malebranche (1638–1715) first used the term in these debates to explain the divine governance of the realms of nature and grace through general laws as opposed to the notion that God operates through a continuous series of “particular wills.” While the general will had little direct political bearing in these theological debates, the concept in its original usage did refer to the proper source and form of law.

The French political philosopher Montesquieu (1689–1755) was the first to give the general will a specifically political usage, doing so in one of the most important passages of his *De l'esprit des lois* (1748; *On the spirit of the laws*). In his discussion of the separation of powers, Montesquieu states that the “general will of the state” is located in the legislature but

argues that the execution of the law must be placed in separate executive and judicial bodies. Uniting the legislative and executive functions in a single body would lead to tyranny since that body “can plunder the state through its general wills” in making law and then, in executing it, “destroy each citizen through its particular wills” (Montesquieu, I.6).

If Montesquieu put the general will on the political map, the most important influence on Rousseau’s own development of the concept was the encyclopedist Denis Diderot (1713–1784). In the article “Droit naturel” (Natural right) for the *Encyclopédie* (1755), Diderot described the general will of all humanity as the source and rule for justice and morality. The right to decide the nature of the just and unjust must come from all humankind “because the good of all is the only passion it has. Particular wills are suspect . . . but the general will is always good” (p. 27). Using their reason and consulting the principles of right of all civilized nations, individuals should address the general will of humankind to consult their duties. Rousseau first responded to his then-friend’s argument in his own article for the *Encyclopédie*, “Économie politique” (Political economy, 1755), conceived as a companion piece to Diderot’s article. Rousseau rejected the conception of the general will as the will of all humanity, instead finding it in the legislative will of a free people in the state. “The first and most important maxim of legitimate or popular government—that is, one that has the good of the people as its object—is therefore . . . to follow the general will in all matters” (“Économie politique,” pp. 247–248). He would develop these ideas in *Du contrat social*.

Rousseau's General Will

Rousseau's *Du contrat social* was epoch-making in its argument that law legitimately comes only from the sovereign people legislating for itself: from the general will. Rousseau followed in the social contract tradition of Thomas Hobbes (1588–1679), John Locke (1632–1704), and others, but sought to find a form of political association in which naturally free individuals can join with others and yet remain as free as before. His solution was direct democratic self-legislation in which each citizen, as a member of the sovereign, makes laws that apply equally to all. “Each of us puts his person and all his power in common under the supreme direction of the general will; and in a body we receive each member as an indivisible part of the whole” (*Contrat social*, I.6). Rousseau pressed a radically voluntarist principle into service as the binding force of the political community. Although he recognized a “universal justice emanating from reason alone,” he argued that this justice is ineffective for want of a natural sanction (*Contrat social*, II.6). Rousseau's general will was confined to the limits of the state.

“The general will is always right,” claimed Rousseau. His statement has often been taken to imply a kind of mystical popular will in whose name the force of the state can be exercised. The general will is not something that transcends the state, but is the will of the citizens qua citizens in their capacity as members of the sovereign. Immediately after claiming that the general will is always right, Rousseau pointed to what he saw as the central problem of the state: “But it does not follow that the people's deliberations will always have the same rectitude” (*Contrat social*, II.3). The people may err in their deliberations for several reasons, but the rectitude of the general will is distorted most importantly by the natural tendency of individuals to consult the particular will they have qua individuals. “Indeed, each individual can, as a man, have a private will contrary to or differing from the general will he has as a citizen. His private interest can speak to him quite differently from the common interest.” Such a person, Rousseau infamously concluded, “will be forced to be free.” While this paradoxical statement has been interpreted as an authoritarian element in Rousseau's thought, less noticed is the continuation of the passage: “For this is the condition that, by giving each citizen to the fatherland, guarantees him against all personal dependence” (*Contrat social*, I.7). The mutual obligations of the political association ensure that the citizens are dependent only on the law of their own making, and not on the will of another individual (see Melzer). The law must come from everyone and apply equally to all. The general will is always directed toward the common justice and utility by virtue of its very generality: “the general will, to be truly such, should be general in its object as well as in its essence; that it should come from all to apply to all” (*Contrat social*, II.4). Proper civic education and favorably egalitarian conditions are necessary for the deliberations of the citizens to have the rectitude they require to make the general will triumph over particular interests. Self-legislation as part of the sovereign makes possible a new kind of freedom, a civil and moral freedom that transcends the natural freedom we have as individuals. Rousseau's general will inspired his followers with what they saw as a promise of revolutionary moral and political transformation.

The General Will after Rousseau

A quarter century after the publication of Rousseau's political treatise, the French Revolution began, and the fortunes of the general will and the philosopher who gave the concept currency have been forever tied to the epochal event. Revolutionaries such as Maximilien de Robespierre (1758–1794) and the Abbé Sièyes (1748–1836) pressed the general will into service to legitimate their rule in the name of the nation. On the philosophic front, Immanuel Kant (1724–1804), Johann Fichte (1762–1814), and Georg Wilhelm Friedrich Hegel (1770–1831) appropriated and analyzed the concept itself as well as its seeming political instantiation. Kant's categorical imperative, although explicitly universal in scope, exhibits the direct influence of Rousseau's general will as self-legislation in the form of a generalizable law. Hegel associated the general will with the Terror and criticized what he saw as its one-sided subjectivity and arbitrary or absolute freedom. Later thinkers attempted to adapt the general will in less radical form. Grappling directly with the revolutionary inheritance, Benjamin Constant (1767–1830) criticized Rousseau's affinity for the liberty of the ancients, but still began his own *Principes de politique* (1815; Principles of politics) by stating: “Our present constitution formally recognizes the principle of the sovereignty of the people, that is, the supremacy of the general will over every particular will” (p. 310). The tension between the individual and the community that Rousseau tried to reconcile in his own way through the general will continues to dominate contemporary debates in political theory and practice.

See also *Authority; Enlightenment; Liberalism; Social Contract; State of Nature; Terror.*

BIBLIOGRAPHY

PRIMARY SOURCES

- Constant, Benjamin. *Principes de politique*. In *Écrits politiques*. Paris: Gallimard, 1997.
- Diderot, Denis. “Droit Naturel.” In *Oeuvres complètes*, vol. 7. Paris: Hermann, 1976. Originally published in vol. 5 of the *Encyclopédie*.
- Montesquieu, Charles-Louis de Secondat, Baron de. *De l'esprit des lois*. In *Oeuvres complètes*, vol. 1. Paris: Gallimard, 1949–1951.
- Rousseau, Jean-Jacques. *The Collected Writings of Rousseau*. Edited by Roger D. Masters and Christopher Kelly. Hanover, N.H.: University Press of New England, 1990–. 10 vols. to date. The standard edition of Rousseau's works in English translation.
- . *Oeuvres complètes*. Paris: Gallimard, 1959–1995. 5 vols. The standard critical edition of Rousseau's works. *Du contrat social* and *Économie politique* are included in vol. 3.

SECONDARY SOURCES

- Keohane, Nannerl O. *Philosophy and the State in France: The Renaissance to the Enlightenment*. Princeton, N.J.: Princeton University Press, 1980.
- Melzer, Arthur M. *The Natural Goodness of Man: On the System of Rousseau's Thought*. Chicago: University of Chicago Press, 1990.
- Riley, Patrick. *The General Will before Rousseau: The Transformation of the Divine into the Civic*. Princeton, N.J.: Princeton University Press, 1986.

John T. Scott

GENERATION. In its most widely accepted modern sense, a *generation* is comprised of a group of people born around the same time and sharing certain formative experiences. The concept of generations has been used by social scientists, historians, and anthropologists to explain social change over time and to identify differences within social groups. The term has also been applied loosely to describe literary groups and genres, such as the metaphorical designation of “lost generation” applied by Gertrude Stein (1874–1946) to certain post–World War I writers and artists or the “lost generation” of British writers who literally disappeared in the trenches of the Western Front, or the Beat Generation of 1950s America. In the second half of the twentieth century, it was also deployed by advertisers and other producers of mass media–based popular culture (for example, Generation X) and entered into common usage as a way to identify and distinguish oneself or a particular group.

Early references to the significance of generations may be found in Western and non-Western classical texts and in both the Old and New Testaments of the Bible. Such references were mainly genealogical in nature yet also considered generations as a concept to chart change over time. Both Plato (c. 428–348 or 347 B.C.E.) and Aristotle (384–322 B.C.E.) recognized the significance of generational conflict as a motor of political change, with the former advocating that citizens older than ten years of age be expelled from the republic in order to facilitate the construction of the model society. Homer, in the *Iliad*, wrote that “as the leaves of the trees are born and perish, thus pass the ages of man.” Herodotus (484–between 430 and 420 B.C.E.) used a scale of “a hundred years for each three generations” in recounting the succession of Egyptian kings and high priests, thus providing one of the earliest references to the common characterization of one generation spanning thirty years. The fourteenth-century Arab scholar Ibn Khaldun (1332–1406) also reflected extensively on the nature of familial, tribal, and dynastic ties and succession.

But it was not until the nineteenth century that European scholars attempted systematically to define the term and apply it to the study of human society. The first such important attempt was made by Auguste Comte (1798–1857). In *Cours de philosophie positive* (1830–1842; *The course of positive philosophy*), Comte proposed that social change is determined by generational change and in particular conflict between successive generations. As the members of a given generation age, their “instinct of social conservation” becomes stronger, which inevitably and necessarily brings them into conflict with the “normal attribute of youth”—innovation. Following Comte closely was John Stuart Mill (1806–1873), who argued that generational change and the process of a new “set” of people taking “possession of society” marked off one historical “age” from another. Around this time the German literary scholar Wilhelm Dilthey (1833–1911) suggested that the leading lights of German Romanticism, who were born at around the same time and shaped decisively in their young years by their social and intellectual milieu, represented a distinct and influential generation.

Most influential, however, was Karl Mannheim (1893–1947), who argued that two approaches to the study of generations had heretofore been dominant, neither of them satis-

factory. The “positivist” approach of Comte emphasized social change measured exclusively in fifteen-to-thirty-year life spans, which in Mannheim’s view reduced history to “a chronological table.” Conversely, the “Romantic-historical” school, represented by figures such as Dilthey, Wilhelm Pinder, and Martin Heidegger (1889–1976), emphasized the qualitative experience of the individual but downplayed or ignored the importance of social context (though Dilthey was not oblivious to this). Mannheim did not deny that the biological

life-death cycle produces “generations” but added that those born around the same time “share a common location in the historical dimension of the social process” and are thus formed by social experience, especially at a relatively young age. Change takes place as members of younger generations come into contact with members of older generations. Crucial for Mannheim was the rapidity in which the social context was changing, as not every generation comes to define itself as distinct. Hence periods of accelerated social change tended to produce more cohesive and distinctive generations. Yet Mannheim also noted that each generation can contain “a number of differentiated, antagonistic generation-units.” He also called attention to the intersection of generation and class, though he did not attempt a theoretical reconciliation.

Another effort to theorize about generation was made by Jose Ortega y Gasset (1883–1955), who proposed that what constitutes a “generation” is not a select or large group of individuals but a “particular type of sensibility, an organic capacity for certain deeply rooted directions of thought” that places each generation on a “vital trajectory”; within the life span of each individual lies the basis for generational conflict and hence historical change. For Ortega, the years between one and fifteen are not marked by any political participation, whereas the following fifteen years are spent learning but also in passivity. From thirty to forty-five, the individual enters into conflict with the preceding generation—that is, those between forty-five and sixty and the possessors of power. In the final stage—sixty to seventy-five—the individual is a “survivor” who remains “outside of life” and a mere “witness.” Gasset’s ill-defined notions of “sensibility” and “vital trajectory” never attracted sustained critical attention from future scholars.

In 1949, one of Ortega’s students, Julian Marias, summarized the various theories of generations, suggested new avenues of inquiry, and pointed out some of the shortcomings of the various conceptualizations. Marias argued that “generations” do not in fact exist but are purely social constructions, that the series of fifteen-year benchmarks proposed by Ortega and others is similarly arbitrary, that scholars had ignored women and were generally unclear on who gets included in a particular generation, and that theorizing on generations had not accounted for the rebel individual or “elite minorities” within generational groups. Marias himself did not advance a theory of generations of lasting influence, but his critique of previous characterizations pointed the way to more sophisticated interpretations.

In the postwar era, political scientists and sociologists, mainly in the United States and Germany, have produced the

most extensive empirically based studies of generations. Political scientists have attempted to identify “political generations” as birth cohorts who share formative experiences and then go on to mobilize themselves for some kind of political action. The upheavals of the 1960s sparked considerable interest in the systematic study of generations in the United States, in large part because of the large role young people played in the civil rights, free speech, antiwar, and other protest and countercultural movements. While some scholars and much popular literature identified a “generational revolt” at the heart of the student protest movements, much evidence suggested that the rebellions, at least in the United States, were a response to the process of being socialized in a system that proclaimed liberal democratic values but did not live up to them in practice. Thus much of the student revolt was a confrontation with hypocrisy rather than parental values. The revolt produced a search for political and cultural models that could reconcile the perceived gulf in rhetoric and reality. Many young people became enamored of Third World revolutionaries, pioneered women’s and gay liberation politics, focused on the environment, or experimented with countercultural lifestyles revolving around communal living, music, and experimentation with drugs.

Political scientists have also examined generational differences and political party loyalty in the United States. An influential study published in 1960, *The American Voter*, argued that younger American citizens were not as loyal to political parties as were their older compatriots. Further research confirmed that the high degree of party loyalty that had previously characterized American politics declined, at least among white voters, from 1952 to 1984. Some scholars argued for a “life-cycle thesis” while others pointed to the presence of distinct political generations in the postwar United States, thus suggesting that particular historical events account for the decline in partisanship.

Post-1980 scholarship on political generations has considered developments in the non-Western world. Ruth Cherrington’s research on young intellectuals (the “reform generation”) in 1980s China employed Mannheim’s theoretical conceptualization to demonstrate that well-educated young people became disillusioned with the lack of political and economic change following the Cultural Revolution, the death of Mao Zedong and Chou Enlai, and certain educational and economic reforms that promised young people better lives and the possibilities of changing Chinese society. In the mid-1980s, this “reform generation” seems to have developed a distinct generational consciousness fueled by rising expectations, a sense of superiority vis-à-vis older generations, and a greater awareness of technological change and the world outside China. Largely though not exclusively as a result of this generational shift, a student movement and a prodemocracy movement emerged, culminating in the events of June 1989.

Historians have also studied generations with illuminating results, with the upheavals of the American and French revolutions, the failed revolutions of 1848, the American Civil War and reconstruction, the unifications of Germany and Italy, the defeat of Spain by the United States in 1898, and above all World War I and its aftermath providing particularly fertile

fields of study. Robert Wohl examined how members of the “generation of 1914”—a select cohort of educated young British, French, Italian, Spanish, and German men who fought in the Great War or at least were altered irrevocably by its traumas—thought of themselves as representing a new generation freed from the stultifying past of bourgeois complacency and charged with the rejuvenation of their societies. Wohl sees this rejection of the past and desire to revitalize the society of the present as fueling many members of this self-proclaimed generation’s enthusiasm for fascism. In modern Arab and Israeli political culture and thought there are several key historical concepts related to generations and associated with decisive defeats or victories: *Jil al-Nakba* (Generation of the Catastrophe), namely the generation that experienced the defeat of 1948; and *Jil al-Naqsa* (Generation of the Setback), the generation that experienced the defeat of 1967. In Israeli culture the term “dor tashach” (the generation of 1948) refers to the men and women who fought for and created the modern Jewish state.

The German historian Michael Wildt examined the generation of young men who formed the leadership cohort of the Nazi Reich Main Security Service of the SS (the Schutzstaffel) and became responsible for directing the early stages of the systematic assault on Europe’s Jewish populations. Of the 221 individuals studied by Wildt, three quarters were born in and after 1900 and thus were too young to have fought in World War I yet old enough to have been shaped by the traumas of the postwar years and the accelerating radicalization of German political culture. Wildt noted that the Reich Main Security Office drew more than three quarters of its members from this *Kriegsjugendgeneration*. Well educated and in the prime of their lives when Hitler came to power in 1933, they were ideal matches for an institutional culture of the regime’s ideological police, a culture that promoted both unwavering ideological fervor (further radicalized by war) and obedience along with modern rational bureaucratic organizational skills.

The generations theme has also been important for historians of modern immigration. Particularly influential was Marcus Lee Hansen’s thesis that the second generation of the children of immigrants tends to strive for complete assimilation and shows little interest in parents’ home cultures while the third generation becomes remarkably interested in “returning” to grandparents’ cultural roots. Hansen’s thesis was a broad generalization based largely on personal experience rather than empirical research, yet it influenced successive scholars of the immigrant experience, such as Nathan Glazer, Oscar Handlin, and many others. By the 1980s, however, scholars had demonstrated via local studies of ethnic and religious groups the weakness of Hansen’s thesis. More recently, scholars of immigration have begun to consider “generations” as social constructions used, for instance, by immigrant-descended writers exploring the tensions between assimilation and identity. The concept of “generations,” therefore, is not a satisfactory explanatory tool but merits study as a cultural construction.

Anthropologists have focused on generations principally in terms of genealogy, the structures of kinship, and aging. Yet they have also relied on the modern social-scientific concept-

alization of a generation as a cohort of people who identify with each other based on common experiences. Cultural anthropology, however, has turned away from generalizations based on culture and has considered the importance of difference, local context, and structures of power and how these things influence conceptions of age, kinship, and gender. Cultural anthropologists have also recently addressed the kinship ties in gay and lesbian families. Some scholars have argued that gay and lesbian families are distinct from dominant conceptions of the “American family” in that they do not place a high value on biological ties in defining kinship. Others have argued that “motherhood” is central to womanhood in American culture, thus overriding any distinct “lesbian” identities.

That the conceptualization of a birth cohort shaped by social forces has become the standard approach to defining and analyzing a generation or generations is illustrated by recent popular and scholarly work on the “hip-hop generation.” Journalists and scholars have sought to move beyond the pop culture industry to explore the relationship between hip-hop, black youth culture, and the persistence of political and economic inequality in the United States. Bakari Kitwana has employed Mannheim’s basic framework in analyzing the cohort of black Americans born between 1965 and 1984 and has argued that hip-hop largely defines this cohort, the first to come of age in postsegregation America. Hip-hop culture has evolved beyond its original four core elements—graffiti, break dancing, DJing, and rap music—to encompass language, dress, attitude, and political and social activism that both draw and distinguish it from the experiences and values of the preceding generation.

Kitwana suggests that six factors have shaped this generation’s worldview. One is rap music, which has given black youth culture unprecedented international visibility while providing the “medium” by which a common culture could be constructed. A second is the accelerated development of global capitalism in the 1980s and 1990s, which has led to increased income disparities that have hit black Americans disproportionately hard. Third is the persistence of segregation and inequality in wages and salaries, housing, electoral politics, and other segments of society. A fourth factor is widespread mistrust of and cynicism about the criminal justice system. A fifth involves the ways in which young blacks are portrayed in the mainstream media, particularly in reporting on crime. Finally, there is the reality of relatively high unemployment rates and rates of incarceration, gang activity, gun homicide, suicide, and AIDS. Kitwana suggests that the implications of these factors remain little studied or understood by scholars, journalists, or policy-makers. Further, he argues that an enormous divide exists between the hip-hop generation and the preceding generation, which was influenced decisively by the black Church and the civil rights and Black Power movements.

While “generation” as conceptualized by Mannheim continues to draw some interest from scholars and has become pervasive and scholarly popular points of reference, the main problem with the study of generations has been that the collective identity of any birth cohort is crosscut and shaped by

multiple factors, thus greatly complicating empirical research and generalization. Sustained interest in some of these factors—above all class, race, ethnicity, gender, and the body—among social scientists, historians, literary scholars, and cultural anthropologists has not encouraged substantial new theoretical or empirical work on generations. Further, in the last decades of the twentieth century the influence of postmodern cultural theory, which challenged the validity of sweeping explanatory models or “metanarratives” that claim to explain social change—such as “generations”—contributed to the decline in scholarly work on the subject.

See also Cycles; History, Idea of; Life Cycle.

BIBLIOGRAPHY

- Abramson, Paul R. “Generations and Political Change in the United States.” *Research in Political Sociology* 4 (1989): 235–280.
- Ajami, Fouad. *The Dream Palace of the Arabs: A Generation’s Odyssey*. New York: Pantheon, 1998.
- Campbell, Agnes. *The American Voter*. New York: Wiley, 1960.
- Cherrington, Ruth. “Generational Issues in China: A Case Study of the 1980s Generation of Young Intellectuals.” *British Journal of Sociology* 48 (1997): 302–320.
- Comte, Auguste. *The Positive Philosophy*. With a new introduction by Abraham S. Blumberg. New York: AMS Press, 1974.
- Dilthey, Wilhelm. *Über das Studium der Geschichte der Wissenschaft*. Leipzig: Teubner, 1924.
- Eisenstadt, Shmuel. *From Generation to Generation: Age Groups and Social Structure*. Glencoe, Ill.: Free Press, 1956.
- Elon, Amos. *The Israelis: Founders and Sons*. New York: Penguin, 1983.
- Hansen, Marcus Lee. *The Immigrant in American History*. Edited with a foreword by Arthur M. Schlesinger. Cambridge, Mass.: Harvard University Press, 1940.
- Hayden, Corinne P. “Gender, Genetics, and Generation: Reformulating Biology in Lesbian Kinship.” *Cultural Anthropology* 10 (1995): 41–63.
- Kitwana, Bakari. *The Hip Hop Generation: Young Blacks and the Crisis in African American Culture*. New York: Basic Civitas Books, 2002.
- Kivisto, Peter, and Blanck, Dag, eds. *American Immigrants and Their Generations: Studies and Commentaries on the Hansen Thesis after Fifty Years*. Urbana: University of Illinois Press, 1990.
- Mannheim, Karl. “The Problem of Generations.” In his *Essays on the Sociology of Knowledge*, edited by Paul Kecskemeti. New York: Oxford University Press, 1952.
- Marias, Julian. *Generations: A Historical Method*. Translated by Harold C. Raley. Mobile: University of Alabama Press, 1970.
- Mill, John Stuart. *A System of Logic, Ratiocinative and Inductive: Being a Connected View of the Principles of Evidence and the Methods of Scientific Investigation*. Edited by J. M. Robson. Toronto: University of Toronto Press, 1978.
- Ortega y Gasset, Jose. *The Modern Theme*. Translated by James Cleugh. New York: Norton, 1933.
- Wildt, Michael. *Generation des Unbedingten: Das Führungskorps des Reichssicherheitshauptamtes*. Hamburg, Germany: Hamburger Edition, 2002.
- Wohl, Robert. *The Generation of 1914*. Cambridge, Mass.: Harvard University Press, 1979.

Steven P. Remy

GENETICS.

The entry includes two subentries:

*History of
Contemporary*

HISTORY OF

Genetics as a discipline is young, but the concept that forms its subject—inheritance—stretches back in time. The word has been formed from the adjective *genetic*, found in the sciences of the nineteenth and twentieth centuries—for example, biogenetic law, genetic affinity, genetic psychology—and meaning, according to the *Oxford English Dictionary*, “pertaining to, or having references to, origin.” Not until 1906 was the noun *genetics* publicly proposed to cover those labors that, in the words of its author, William Bateson, “are devoted to the elucidation of the phenomena of heredity and variation: in other words to the physiology of descent, with implied bearing on the theoretical problems of the evolutionist and the systematist, and application to the practical problems of breeders, whether of animals or plants.”

We begin, therefore, by commenting briefly on the long history of notions of heredity and variation, reflecting the while on the significance of cultural and economic factors that both drew attention to them and shaped them. Next we turn to the father figure of genetics, Gregor Mendel (1822–1884), and his introduction of the Mendelian experiment. With the rediscovery of his work in 1900 we explore the contribution of the early “Mendelians,” the melding of Mendelian heredity with the theory of the chromosome, a synthesis that revealed a geography of heredity in the cell but did not answer the question, “What is the identity of the genetic material?” Only with the introduction of the Watson-Crick structure for DNA in 1953 was a window opened through which to glimpse the terrain that was to become “molecular genetics.”

Heredity and variation are today considered as two sides of the same coin. Thus variation among sibs results from the varied commingling and expression of the hereditary determinants from two parents. Spontaneous changes in the hereditary material (mutations) give rise to variations, and these are inherited. In other words there is heredity, variation, and the heredity of variation, and they belong together. Prior to the latter half of the nineteenth century this conceptual framework did not exist. There still lingered relics of the ancient view of heredity as the result of the reproduction of the type, whereas any deviance from the type was ascribed to the effects of the mother’s imagination, changed conditions of life, and so on. Moreover both heredity and variation were situated within the broad topic of “generation.” This included the regeneration of lost and damaged organs, the development of the embryo from the fertilized egg, and all forms of reproduction, both sexual and asexual. But as attention directed to human heredity increased during the nineteenth century the subject of the transmission of hereditary characters began to acquire a separate conceptual status.

In the eighteenth century two rival conceptions of the phenomenon of inheritance were in play: the doctrine of preformation claimed that like generates like because the offspring are in some way already present in the germ and have only to unfold or “evolve” to yield offspring like the parents. A literal view of this doctrine was held by some who claimed that hidden miniatures of future generations must have existed from the time of creation, all nested one within another, like a set of Russian dolls, hence the term preexistence for this version of the doctrine. Procreation became, as it were, the act of revealing what had been created long before. Opposed to this was the doctrine of epigenesis, according to which the parts of the offspring are formed successively, and in the process the embryo undergoes a series of transformations. Support for this view came from descriptions of the development of the fertilized egg. Experimental support came also from the hybridization experiments of Joseph Kölreuter, who in 1766 described how he had succeeded in transforming one species of plant into another. How, he asked, was this possible if the offspring is already preformed? He also found that no matter which parent supplied the “male seed” (pollen) and which the female “seed” (ovules), the resulting hybrids were the same. How could these results be accounted for on the basis of any theory of preformation—whether, as the animalculists claimed, the preformed miniatures reside in the spermatozoa, or as the ovists urged, in the egg? A further difficulty arose for preformationists when nineteenth-century microscopists developed a cell theory according to which the fundamental unit of life is the cell, not some preformed rudiments of the organism.

These two resources—hybridization and the cell theory—were to form the basis for Gregor Mendel’s research. Prior to his work, however, the study of hybridization had been carried out under different assumptions and in a much more limited manner. The number of hybrid offspring grown in an experiment was limited, and the prevalence of the effect of hybridization in diluting character differences supported the view that heredity is a blending process, like the mixing of ink and water. The conception of the organism too was generally holistic: that is, the type of the species acts as a whole, its “essential” characteristics—flower color, habit, leaf shape, and so on—being but expressions of the type. With this point of view, effective analysis of hereditary transmission is impossible.

Gregor Johann Mendel

Raised on a farm in rural Heinzendorf in German-speaking Silesia, the young Johann, as he was christened, had an early education in the practical aspects of horticulture and agriculture before he left home to attend a gymnasium and at eighteen years of age entered the University of Olmütz. The stress of inadequate finances there led him to apply in 1843 to the Augustinian monastery in Brünn, the industrial and economic capital of Moravia. It was there that, supported by the wise and understanding abbot Cyril Napp, he was encouraged to institute experiments analyzing the phenomenon of hybridization. The subject was of concern to the monastery, with its extensive agricultural holdings in Moravia, a region known for its sheep and wine. Also thanks to the abbot, Mendel had spent two years at Vienna University, studying principally

physics, botany, and zoology. There he had learned about the cell theory, according to which the organism is composed neither of a continuous fabric like lacework nor of a multitude of globules but of individual vesicles or *cells*, all formed by division of preexisting cells that can be traced back to the foundation cell or fertilized egg, this having arisen by fertilization of the egg cell by one pollen cell.

The experiments that led to his well-known theory began with the testing of thirty-four varieties of the edible pea (*Pisum*) followed by eight years of hybridization (1856–1863). Taking seven traits, he followed the hereditary transmission of each. The scale of the research was unprecedented, the size of his progeny populations being such that clear statistical regularities emerged. It was not just that he noted the separate behavior of the seven traits he studied, nor that there was a marked difference between the population sizes of those carrying the two contrasted characters, but that they approximated to the ratio 3:1. Thus for the trait seed color, Mendel harvested 6,022 green seeds and 2,001 yellow from his hybrid progeny, offering the most striking example among his seven traits of a 3:1 ratio. Further research revealed that two-thirds of the larger class did not breed true and the other third did. Thus the ratio 3:1 was really constituted of three classes in the ratio 1:2:1.

As a physicist trained in combinatorial mathematics this ratio reminded him of the binomial equation $(A + a)^2 = 1A^2 + 2Aa + 1a^2$. Using A and a to represent the potential carried in the pollen cell and in the egg cell, and knowing that A obscures (is dominant over) a , this expansion appears as $3A + 1a$. Well-grounded in cytology, he suggested that the differing elements brought together in the hybrid remain together until the germ cells are formed. Then they separate and pass into separate germ cells. There result, he declared, “as many sorts of egg and pollen cells as there are combinations possible of formative elements.” These claims—known as “germinal segregation” and the “independent assortment” of characters—he supported from his crossing of plants differing in two and in three traits. These two principles were later to be called Mendel’s two laws.

Mendel’s work did not meet with an enthusiastic response because it was opposed to several securely held beliefs. All the traits he included in the data concerned nonblending characters, but the consensus was that blending is the rule and that the agreed representation of heredity is in terms of fractions: one-half being from the two parents, one-quarter from the four grandparents, and so on, implying that no contribution is entirely lost but that there is a repeated dilution of differences in reproduction. Mendel’s theory denied this, for in his theory, after segregation, the elements in question would either be present or absent in a given pollen cell or egg cell, and it would be a question of chance as to which elements finished up in the foundation cell of the offspring.

His paper was directed to two specific questions: First, whether hybridization can lead to the multiplication of species; and second, what part hybridization plays in the production of variation. On the first of these he was clear that *Pisum* does not yield constant hybrids—that is, hybrids that breed true, reproducing the hybrid form like a pure species. Therefore he insti-

tuted experiments with other species to test the general validity of his results. As to the second question, he explained how the variation following hybridization can be understood as the result of the recombination of independently transmitted characters brought together in the hybrid. Therefore he opposed those who, like Darwin, attributed such variation ultimately to the act of bringing together species that have been exposed to different conditions of life. Those who claimed, like Darwin, that cultivated plants are more variable than wild ones due to their changed conditions of life, he also strongly opposed.

Rediscovery

In 1900 three European botanists, Hugo de Vries, Carl Correns, and Erik Tschermak, published the results of their experiments carried out in the 1890s that supported Mendel’s experimental results and his conclusions. Although the first two had in fact seen Mendel’s paper earlier, its significance had not struck them. Only later, when they had their own results, did they encounter his paper again and realize its importance. In England the Cambridge zoologist William Bateson teamed up with the Reverend William Wilks, secretary of the Royal Horticultural Society, and Maxwell Masters, chairman of the society’s scientific committee, to spread the word about Mendel. Through this prestigious and influential society Bateson introduced Mendel’s work to the English-speaking world, and the Reverend Wilks asked Charles Druery, a hybridist and fellow of the society, to translate Mendel’s paper into English for its publication in the society’s journal.

It was at the Royal Horticultural Society’s Third International Conference on Hybridisation and Cross-breeding that Bateson introduced the term “genetics” to the audience gathered in London in 1906. When the conference proceedings appeared Wilks had renamed it *Report of the Third International Conference 1906 on Genetics: Hybridization*.

British biologists were for the most part unreceptive to Mendel’s work. Karl Pearson, upholder of Galton’s biometric tradition, was opposed. Darwinians like Alfred Russel Wallace were appalled, and the Oxford professor Edward B. Poulton reported the consensus he had found among eminent zoologists that Mendelian writings were “injurious to Biological Science, and a hindrance in the attempt to solve the problem of evolution.” According to Pearson, the Mendelian theory was not conformable with the statistical data he was amassing on the relation between successive generations (the regression coefficients). It took the insight and persistence of the young Ronald Aylmer Fisher (1890–1962) to remove this roadblock to the integration of Mendelism and biometry. His solution of the problem finally appeared in 1918.

The biometricians’ theory was ancestorial, meaning that the hereditary constitution of offspring was considered to be a collection of representations from the ancestors, the proportions of which are based on some form of the old fractional theory. This was formulated under the title “The Ancestral Law of Inheritance.” Confining their attention to what is visible, the biometricians were not concerned with so-called hidden elements. As a positivist, Karl Pearson was particularly concerned not to invent or invoke unobservable entities like Mendelian

factors. Mendelians, by contrast, were opening up the space between the hereditary determinant (Mendelian factor) and the observable character or characters for which it is responsible. Mendel's language of the transmission of characters was giving place to the Mendelians' growing reference to the transmission of factors.

Powerful opposition to the biometricians came not only from Bateson in England but from Wilhelm Johannsen in Denmark. He complained that the biometric approach was based on the assumption that the "personal qualities" of an individual "are the true heritable elements or traits." But this, he declared, "is the most naïve and oldest conception of heredity" and can be traced back to Hippocrates. It was, he claimed, borrowed from the legal language of inheritance and heirs to property. As such it includes not only long-standing possessions but what has been acquired by the testator in his or her lifetime. But in biology the evidence was against acquired characters being heritable, and the modern view of heredity was that the "sexual substances" in the egg and sperm determine the personal qualities of the individual, not the reverse. To banish these confusions Johannsen proposed a new language for heredity in the form of the "gene," "genotype," and "phenotype." "The gene," he explained, "is nothing but a very applicable little word, easily combined with others, and hence it may be useful as an expression for the 'unit-factors,' 'elements,' or 'allelomorphs' in the gametes, demonstrated by modern Mendelian researchers. A 'genotype' is the sum total of all the 'genes' in a germ cell or fertilized egg. Avoiding speculation as to the nature of the gene, he felt that "the terms 'gene' and 'genotype' will prejudice nothing" (Johannsen, p. 133). But just as it took a long time for the term *genetics* to become generally established, so was the case for Johannsen's terms.

The Chromosome Theory of Heredity

Meanwhile, in America a bridge between zoology and Mendelism was being constructed at Columbia University, New York City. There, Edward Beecher Wilson was promoting the search for parallels between Mendelian heredity and the theory of the chromosome. Subsequently the embryologist Thomas Hunt Morgan, studying the determination of sex and the hereditary transmission of mutations in the fruit fly (*Drosophila*), discovered what he called "sex-limited" inheritance, and in 1911 he associated it with a specific chromosome. This led in 1915 to his groundbreaking text *The Mechanism of Mendelian Heredity*, which he coauthored with the three young men working under him: Alfred Henry Sturtevant, Hermann Joseph Muller, and Calvin Bridges. Here the authors distanced themselves from any suggestion that the factorial hypothesis ("gene" hypothesis) can account for the embryological development of the hereditary characters. A whole mysterious world, they explained, lies between the factor and the character. So they challenged the claim that "until we know something of the reactions that transform the egg into the adult" our hereditary theories "must remain superficial." The Mendelian theory, they argued, does not explain development, nor does it pretend to. Yet "it stands as a scientific explanation of heredity, because it fulfills all the requirements of any causal explanation" (Morgan, p. 280).

Here the authors were seeking to separate genetics from embryology. At the same time, they were developing its relation with the cytologists' study of the chromosomes. This association had at first seemed improbable since many organisms were known to have very few chromosomes—*Pisum* has seven pairs, the fruit fly four, and the horse thread worm (*Parascaris*) only two. Assuming the Mendelian factors for the numerous hereditary factors are able to recombine in all possible combinations, as Mendel claimed, surely they could not be tied together on just a few chromosomes. Fortunately in 1909 F. A. Janssens in Belgium had observed "cross-over" patterns between chromosomes that he called "chiasmata," a discovery that gave Morgan the idea that chromosomes might exchange parts, thus permitting recombination. This insight was followed by Sturtevant's suggestion that the frequency of such recombinations between factors could be used as a measure of the distance separating them along the chromosome, and the mapping of genes became a reality. Already the simple picture of Mendelian heredity had been complicated by the discovery of interaction between factors, association of factors (linkage), and the determination of a character by many factors (polygenic inheritance). The latter brought blending heredity under the explanatory arm of Mendelian heredity. The degree of blending was determined by the number of genes involved. Ancestral inheritance was absorbed into Mendelian heredity. What had once been likened to fluids mixing was now attributed to a finite and fixed number of Mendelian factors.

Culture of Heredity

Alongside the developing experimental tradition of the biologists, the nineteenth century saw increasing attention given to family histories (genealogy) and to population studies (biometry). Both owed their popularity to the growing concerns about human heredity. Was increasing urbanization affecting the quality of human heredity as evidenced by the increasing numbers of the insane, the tubercular, the alcoholic? Supporting this concern was the medical concept of a diathesis—that is, the predisposing to certain diseases, especially those chronic conditions like gout, epilepsy, asthma, tuberculosis, and cancer, that are often manifested later in life. Diatheses were judged to be features of a person's hereditary constitution. Although the tuberculous diathesis was not banished by Robert Koch's isolation of the tubercle bacillus in 1882, it did become transformed into the genetic susceptibility to the pathogen.

Genealogy became of special interest for several reasons. Many an aspiring family in Napoleonic Europe, wishing to claim the status of *majorat* (Napoleon I's substitute for aristocracy), needed to provide their family genealogies as evidence of the fraction of "blue blood" in their ancestry. In Jamaica the fractional theory was used to draw the line between those descended from mulattos who could and could not be considered white. Hence the classification: mulatto, half black; terceron, one-quarter; quateron, one-eighth; quinteron, one-sixteenth. In England, Francis Galton, concerned about what he saw as a growing mediocrity in urban populations, used genealogy to argue for the inheritance of what he called "genius"—exceptional ability that is inborn. Such he found in families like the Bachs, Bernoullis, and Darwins and thought to find especially among

judges. In the early years of the twentieth century, with the advent of Mendelism, the hunt for pedigrees that exemplified Mendelian heredity was all the rage. Hereditary night blindness offered the most extensive pedigree, but many were the studies of the familial incidence of feeble-mindedness, inebriation, epilepsy, pauperism, and criminality. Concerns about degeneration of the European races, and the felt need to apply science to the problem, provided a political climate in which Galton decided in 1904 he could launch his bid for the science he had earlier (1883) called “eugenics” and defined as “the science of improving the stock . . . which, especially in the case of man, takes cognizance of all the influences that tend in however remote a degree to give to the more suitable races or strains of blood, a better chance of prevailing speedily over the less suitable than they otherwise would have” (*Human Faculty*, p. 17).

The stark hereditarian leaning of Galton did not go unchallenged. His first book, *Hereditary Genius* (1869), received mixed reviews, the accuracy of his biographical data coming under fire. In Switzerland, Alphonse de Candolle argued persuasively for the effects of the educational, cultural, and political climate, rather than heredity, to account for the remarkably high representation of Swiss scientists among foreign members of the Royal Society and the Académie des Sciences. In this way de Candolle countered the emphasis Galton had placed on heredity in his work *English Men of Science* (1874). As for the enthusiasts for eugenics, both those in the biometric tradition of Galton and the experimental tradition of Mendel were for the most part supportive. One Mendelian who adopted a more cautious position was William Bateson. Though an elitist, he judged the scientific basis of many of the eugenicists’ claims inadequate and kept his group of coworkers at a distance from the eugenically inspired Mendel Society that had formed in England during the early years of Mendelism. As an hereditarian, of course, Bateson was concerned that those carrying harmful genes should be discouraged from bearing offspring. He was thus a supporter of negative eugenics. But as to positive eugenics—the encouraging of selected individuals to mate and have offspring—he was not clear what particular traits should be looked for.

Fine Structure of the Gene

Morgan’s introduction of the fruit fly to genetics revolutionized it because the fly’s rapid life cycle and minute size enabled the scale of experimentation to be markedly increased. Contrast the whole year required between generations of peas and corn with the two weeks needed for the fruit fly. This meant that in a short time over a hundred characters had been studied and many mutants found. *Drosophila* became as a result the most prominent “model organism” of genetics. Bridges oversaw and maintained the growing stock of the mutant types and made them freely available internationally. The lab at Columbia, known as the “Fly Room,” was an example of team effort, led by a genial, exuberant boss. Morgan had to undergo quite a conversion by his team, but the outcome was a giant step forward in genetics, crowned with the award of the Nobel Prize in 1933.

H. J. Muller was less close to Morgan than the others and did not long remain in the group. Their views on genetics dif-

fered. Whereas Morgan was happy to leave to one side the question of the material basis of the gene, Muller wanted to know the answer. His pioneer work on the production of mutations by X rays not only won him the Nobel Prize but offered him the hope of establishing the size of the gene. This approach was used by the brilliant Russian geneticist N. V. Timoféeff-Ressovsky, in Germany, to yield an estimate of the “sensitive volume” of the gene as that space needed by one thousand atoms, or about the size of an average protein. Unfortunately, as later work revealed, the methodology and interpretation of this experiment proved faulty.

Drosophila was by no means the only model organism for genetics. In addition to commercial cereal crops, poultry, mice, and yeast, the bread mold *Neurospora* figures prominently in the development of the field. Using this organism, George Beadle and Edward Tatum concluded that there is a 1:1 relation between a gene and a given enzyme, thus suggesting that the primary product of a gene is an enzyme. But for the fine structure analysis of the gene the model system that was to bring the analysis down to the molecular level was the viral infected colon bacillus (*Escherichia coli*). Here the bacterial virus (bacteriophage, or phage) has just one chromosome, and in mixed infections this chromosome can recombine with one from another, thus permitting recombination and making fine structure mapping possible. By 1957 Seymour Benzer had used this system to make an estimate of the likelihood of crossing-over between two mutants one DNA base apart in the bacteriophage T4 to be 1 in 10,000. His own analysis had then reached 1 in 20,000.

Molecular Genetics

The period covering the first half of the twentieth century is often referred to as “classical genetics.” Morgan had set the tone, treating the gene as an abstraction and the Mendelian analysis of experimental data as an algorithm. But as early as 1922 Muller had drawn the analogy between bacterial viruses and genes and glimpsed the possibility of grinding “genes in a mortar” and cooking them “in a beaker.” There existed too a continuing concern during this period to identify gene products chemically, working with flower pigments in plants and eye pigments in insects. Nonetheless, the chemical constitution of the gene remained vague, and geneticists were content to assume it was a protein of a special kind: one that can both catalyze its own reproduction (autocatalysis) and provide an enzyme that catalyzes a quite different reaction in the general metabolism of the cell (heterocatalysis.)

The protein nature of the gene was called into question in 1944 when three Rockefeller scientists, Oswald Avery, Colin MacLeod, and Maclyn McCarty, published their identification of the so-called transforming principle as deoxyribonucleic acid (DNA). This principle, obtained from dead bacterial cells of one strain, was shown to transfer a characteristic from that strain to another strain. This extract contained only the minutest traces of protein; the rest was DNA. Geneticists knew about this work, but the majority assumed that the DNA was acting as a mutagen, altering the genetic constitution of the recipient cell, not transferring a gene. Evidence from other quarters was needed to shift the status quo. It came from the cytochemists and the phage biologists. The former discovered

the correlation between the quantity of DNA in the nucleus and the number of chromosomes. Germ cells had half the content of body cells. Cells containing multiple sets of chromosomes (polyploids) had correspondingly raised DNA content. The same was not true of protein.

Phage biologists did not achieve as clean a transfer of DNA in their work as had Avery in his, but they were able to separate the functions of the protein and the nucleic acid of the phage particle, assigning the protein to the task of attaching to the host and causing it to burst (lyse), whereas the nucleic acid finds its way into the host and is used to constitute the progeny phage particles. By 1952 Alfred Hershey and Martha Chase at Cold Spring Harbor Laboratory could show that 85 percent of the parental DNA is present in the progeny particles. This result had an impact because of the visual evidence previously provided by the electron microscope of the sperm-like particles and their “ghosts” empty, their DNA contents removed.

Making the case for DNA acting as the repository of the genetic specificities of the organism called for establishing the kind of structure DNA possesses that would permit it to function thus. Known to be a long-chain molecule, its backbone composed of sugar rings attached to one another by phosphate arms, it has only four kinds of side-groups attached to the sugars—the bases adenine, guanine, thymine, and cytosine. This contrasts unfavorably with the proteins, for they have twenty different amino acids that can be arranged in countless different sequences.

The proposal of the double-helical model of DNA by James Watson and Francis Crick in 1953 overcame this difficulty because their structure, a cylindrical one with the four kinds of bases packed inside the two helically entwined sugar-phosphate backbones, permits any kind of sequence of the bases. Moreover, these bases are paired by weak bonds across from one base to its opposite number, adenine with thymine, guanine with cytosine. Watson and Crick therefore visualized the duplication of the gene as the result of separating the two chains of the parent double helix and attaching free bases to those now unpaired in accordance with the above complementary relations.

The work of Rosalind Franklin and Maurice Wilkins in London had not only aided Watson and Crick in devising their proposed structure, but when published alongside it offered crucial support. Yet it was not until 1958 that evidence from quite different approaches was published confirming predictions made from the model. Only then did interest in the structure become widespread. In genetics the work of Sydney Brenner, Francis Crick, Leslie Barnett, and R. J. Watts-Tobin, using mutagenesis in bacteriophage to establish the general nature of the genetic code, was published in 1961. It marked a success in applying the genetic approach to questions at the molecular level, for they showed that the genetic message is composed of triplets of bases, read from a fixed starting point, in only one direction, and without commas between the triplets. Meanwhile biochemists had been establishing the identity of the amino acids coded by given triplet sequences of bases.

It was the physicist George Gamow who had first suggested a DNA code for the amino acids in proteins. He had hoped

the right code could be established by mathematical reasoning but had to accept that nature does not use the most mathematically elegant solution. The amino acid sequences being discovered in proteins showed no limitations on the permutations of nearest neighbors of the kinds required by these mathematical codes. Hence the need to turn to the biochemists and the geneticists to solve the problem. They attacked it with vigor, and by 1966 the full details of the code were established. But the major transformation of genetics came with the introduction in the 1970s of the techniques of recombinant DNA technology that made directed manipulation of the genetic material possible.

The Molecular Gene

It has been remarked that molecularizing the gene, far from establishing it as a discrete entity, had the opposite effect, fragmenting and destroying it. True, ever since the 1930s there had been discussion of what was euphemistically called “position effect”—the idea that a gene defined by its function can suffer two distinct mutations and that even if one normal example of the two mutated sites is present in the cell, the gene will only function when both lie on the same chromosome. The neat coincidence between the gene defined by function, by location, and by mutation was broken in these cases. But unraveling the mystery of protein synthesis, in which the function of the genes is to specify which amino acids are to be incorporated into the protein and in what order, revealed further complexity. It turned out that the genetic message (messenger RNA) from many genes is cut into parts, some fragments being rejected (known as introns) and the remainder (exons) incorporated into the chain that is transcribed into a sequence of amino acids. Different parts of the same message may thus be incorporated into different gene products. To those working in the field, these complexities are par for the course. The word *gene* has not died and been buried, but the context in which it is used tells the informed listener in what sense to understand the term. The simple conception of the Mendelian factor or gene of classical genetics has surely suffered a major series of revisions. The simple picture of genes like beads on a string, though essential to get a hand-hold on the problem, has not survived. But the early claim of Richard Goldschmidt that any discreteness of the gene be dropped, and that the chromosome be considered one continuous developmental unit, has never been accepted. There are codons in the DNA for starting and terminating the genetic message. Genes are interspersed with non-coding regions in the DNA. But the relation between the DNA and the proteins around it is a subtle and dynamic one.

Since Johannsen introduced the term “gene” first in 1909 it has served as a flexible concept, suffering many revisions and acquiring many meanings. In the process the extreme hereditarian view of DNA as dictating the life of the cell has been undermined by the discovery of a hierarchy of interactions between DNA and proteins. Genetics has in truth found its place at the core of biology, and in doing so it has revealed a machinery of the cell more intricate and subtle than could ever have been imagined.

See also **Biology; Eugenics; Evolution; Genetics: Contemporary; Health and Disease; Hygiene; Life; Medicine: Europe and the United States.**

BIBLIOGRAPHY

PRIMARY SOURCES

- Bateson, William. "After Dinner Speech." In *Report of the Third International Conference 1906 on Genetics: Hybridisation (Cross-Breeding of Genera or Species, the Cross-Breeding of Varieties, and General Plant Breeding)*, edited by the Reverend W. Wilks, 91. London: Royal Horticultural Society, 1907.
- Corcos, Alain F., and Floyd V. Monaghan. *Gregor Mendel's Experiments on Plant Hybrids: A Guided Study*. New Brunswick, N.J.: Rutgers University Press, 1993.
- Crick, Francis. *What Mad Pursuit: A Personal View of Scientific Discovery*. New York: Basic Books, 1988. See especially chapter 8, "The Genetic Code."
- Crick, Francis H. C., Leslie Barnett, Sydney Brenner, and R. J. Watts-Tobin. "General Nature of the Genetic Code for Proteins." *Nature* 192 (1962): 1227–1232.
- De Candolle, Alphonse. *Histoire des sciences et des savants depuis deux siècles, d'après l'opinion des principales académies ou sociétés scientifiques*. Edited by Bruno Latour. Paris: Fayard, 1987.
- Galton, Francis. *Inquiries into Human Faculty and Its Development*. London: Macmillan, 1883. (Quotation taken from the slightly altered reprint, London: Dent; and New York: Dutton, 1908.)
- Johannsen, Wilhelm. "The Genotype Conception of Heredity." *American Naturalist* 45 (1911): 329–363.
- Stern, Curt, and Eva R. Sherwood. *The Origin of Genetics: A Mendel Source Book*. San Francisco: Freeman, 1966.
- Watson, James D. *The Double Helix: A Personal Account of the Discovery of the Structure of DNA*. Edited by Gunther S. Stent. New York: Norton Critical Editions, 1980.
- Wilkins, Maurice. *The Third Man of the Double Helix*. Oxford and New York: Oxford University Press, 2003.

SECONDARY SOURCES

- Adams, Mark B., ed. *The Wellborn Science: Eugenics in Germany, France, Brazil, and Russia*. New York: Oxford University Press, 1990. See especially Adams's essay "Towards a Comparative History of Eugenics," 217–231.
- Allen, Garland, E. *Thomas Hunt Morgan: The Man and His Science*. Princeton, N.J.: Princeton University Press, 1978.
- Baxter, A., and John Farley. "Mendel and Meiosis." *Journal of the History of Biology* 12 (1979): 137–173.
- Beurton, Peter J., Raphael Falk, and Hans-Jörg Rheinberger, eds. *The Concept of the Gene in Development and Evolution: Historical and Epistemological Perspectives*. Cambridge, U.K., and New York: Cambridge University Press, 2000. See especially the essay on Seymour Benzer by Frederick L. Holmes.
- Brock, Thomas D. *The Emergence of Bacterial Genetics*. Cold Spring Harbor, N.Y.: Cold Spring Harbor Laboratory, 1990.
- Chadarevian, Soraya de. "Sequences, Conformations, Information: Biochemists and Molecular Biologists in the 1950s." *Journal of the History of Biology* 29 (1996): 361–386.
- Gillham, Nicholas. *A Life of Sir Francis Galton: From African Exploration to the Birth of Eugenics*. New York: Oxford University Press, 2001.

- Henig, Robin Marantz. *The Monk in the Garden: The Lost and Found Genius of Gregor Mendel, the Father of Genetics*. Boston: Houghton Mifflin, 2000.
- Kevles, Daniel J. *In the Name of Eugenics: Genetics and the Uses of Human Genetics*. Cambridge, Mass., and London: Harvard University Press, 1995.
- Kohler, Robert. *The Lords of the Fly: Drosophila Genetics and the Experimental Life*. Chicago: University of Chicago Press, 1994.
- Magnello, M. Eileen. "The Non-Correlation of Biometrics and Eugenics: Rival Forms of Laboratory Work in Karl Pearson's Career at University College London." *History of Science* 37 (1999): 79–106, 123–150.
- Meijer, Onno G. "De Vries No Mendelian." *Annals of Science* 42 (1985): 89–232.
- Morange, Michel. *A History of Molecular Biology*. Translated by Matthew Cobb. Cambridge, Mass., and London: Harvard University Press, 1998.
- Olby, Robert. "Constitutional and Hereditary Disorders." In *Companion Encyclopedia of the History of Medicine*, edited by W. F. Bynum and Roy Porter, 412–437. London and New York: Routledge, 1993.
- . "The Dimensions of Controversy: The Biometric-Mendelian Debate." *British Society for the History of Science* 22 (1989): 299–320.
- . "Horticulture: The Font for the Baptism of Genetics." *Nature Reviews Genetics* 1 (2000): 65–70.
- . "The Monk in the Garden, by Robin M. Henig." *Perspectives in Biology and Medicine* 46 (2003): 142–145.
- . *The Path to the Double Helix*. London: Macmillan, 1974.
- Orel, Vitezslav. *Gregor Mendel: The First Geneticist*. Translated by Stephen Finn. Oxford and New York: Oxford University Press, 1996.
- Paul, Diane B. *Controlling Human Heredity: 1865 to the Present*. Atlantic Highlands, N.J.: Humanities Press, 1995.
- Peters, James A. *Classic Papers in Genetics*. Englewood Cliffs, N.J.: Prentice Hall, 1959.
- Pick, Daniel. *Faces of Degeneration. A European Disorder, c. 1848–c. 1918*. Cambridge, U.K., and New York: Cambridge University Press, 1989.
- Pinto-Correia, Clara. *The Ovary of Eve: Egg and Sperm and Pre-formation*. Chicago and London: University of Chicago Press, 1997.
- Roe, Shirley A. *Matter, Life, and Generation: Eighteenth Century Embryology and the Haller-Wolff Debate*. Cambridge, U.K., and New York: 1981.
- Roll, Hansen. "The Crucial Experiment of Wilhelm Johannsen." *Biology and Philosophy* 4 (1989): 303–329.
- Russell, Nicholas. *Like Engend'ring Like: Heredity and Animal Breeding in Early Modern England*. Cambridge, U.K., and New York: Cambridge University Press, 1986.
- Wood, Roger J., and Vitezslav Orel. *Genetic Prehistory in Selective Breeding: A Prelude to Mendel*. Baltimore: Johns Hopkins University Press, 2003.

Robert Olby

CONTEMPORARY

One of the most startling and disturbing revelations from the Nuremberg Trials following World War II was the extent of the atrocities committed by the Nazi government in the name

of genetics. Massive sterilizations and euthanasia programs for those deemed genetically unfit (“lives not worth living” in Nazi phraseology) had raised ethical issues about the use and abuse of science and the complicity of scientists at a level equaled only by that of development of the atomic bomb. By the end of the war, participation of physicists in the development of such a massively destructive force had already brought moral and ethical issues to the fore in a painful way. In a similar way, biologists—geneticists in particular—who had participated in the worldwide eugenics movement between 1910 and 1940 faced the enormous ethical and moral consequences of their pursuits. The legacy for those in the genetics community continues to be felt in the twenty-first century. Since the end of World War II it has become impossible to maintain the conventional myth of science as an ivory tower pursuit “following truth wherever it may lead.” In Germany, many geneticists sought out ways to work for the Nazi cause, whether in research on eugenics or other biological problems such as germ warfare. In other countries, especially the United States, where eugenicists had struggled for over fifteen years to enact state compulsory sterilization laws for the “genetically unfit,” there was widespread excitement (and a little envy) at the ease and rapidity with which German eugenicists and race hygienists passed a national eugenic sterilization law in 1933, only months after taking power.

This entry focuses on the ethical and moral issues raised by genetic technology during the whole of the twentieth century. The issues divide chronologically between the first and second halves of the century, associated with different genetic theories and technologies in each time period. Between 1900 and 1950, the science of genetics emerged as a professional field with enormous practical (agricultural, medical) and sociopolitical (race improvement) implications. This was the era in which heredity assumed center stage among the life sciences, beginning in 1900 with the rediscovery of Mendel’s paper on hybridization in peas, originally published in 1866. As Mendel’s generalizations were shown to apply to an ever-widening group of organisms, including humans, hopes ran high that at long last biologists would be able to solve the persistent problems of animal and plant breeding as well as understand the basis of many human physical and mental diseases. The new science was viewed with great esteem, as it also represented one of the first areas of biology to incorporate many of the characteristics of the physical sciences: experimentation, quantification, prediction, and mathematical analysis. Almost immediately, especially after 1910, the new Mendelian genetics was applied by a group of social reformers known as eugenicists to the solution of many seemingly intractable societal problems, from tuberculosis to “feeble-mindedness,” manic-depressive alcoholism, criminality, pauperism, and sexual perversion.

In the second half of the twentieth century a new genetic technology, molecular genetics, deriving from elucidation of the molecular structure of DNA and the mechanisms of replication and protein synthesis, led to a revival of many of the same sorts of agricultural, medical, and social hopes that had inspired classical geneticists fifty years earlier. In both periods new and exciting work in the laboratory led to a view of genetics as a “magic bullet” that would solve a host of agricultural, medical, and so-

cial ills. The argument that in the early twenty-first century we are not in danger of falling into the errors of the past because “we now know so much more” has a certain validity, since we do in fact know a great deal more about genetic mechanisms and the genetic basis of many diseases than in the 1920s or 1930s. But it is also true that the *use* to which our knowledge—or our still partial knowledge—is put continues to confront the same social, ethical, and legal issues that were raised in the early twentieth century. Thus, an understanding of both the historical and philosophical underpinnings of genetics since that time will provide the basis for evaluating issues in the twenty-first century: What are valid claims for the genetic basis of various traits (Huntington’s disease versus intelligence or criminality)? How should genetic information be used in the public and private spheres? What sorts of genetic information should be stored as parts of a person’s medical record? Who should have access to that record and under what conditions? Should humans be cloned to supposedly replace lost loved ones? Should embryos be cloned solely for providing replacement organs? Should stem cells be cultivated for medical and genetic therapies? Many of the twenty-first century’s issues involve technologies that could not have been imagined in the early twentieth century. Yet the experience of those who have enthusiastically embraced the genetic technology of the day (past or present) without consideration of the full social, moral, and ethical issues involved can serve as a somber reminder that science must always be understood and used in its social context as a guide for exploring current genetics.

Eugenics and the Ethical Issues of Selective Breeding (1900–1945)

The term *eugenics*, derived from the Greek *eugenes*, was first coined by the English mathematician and geographer Francis Galton (1822–1911) in his book *Inquiries into Human Faculty and Its Development* (1883) to refer to one born “good in stock, hereditarily endowed with noble qualities.” As an intellectual and social movement in the early twentieth century, eugenics came to mean, in the words of one of its strongest American supporters, Charles B. Davenport (1866–1944), “the improvement of the human race by better breeding.” For both Galton and Davenport, better breeding implied improving the hereditary quality of the human species by using the known scientific principles of heredity and selective mating. Eugenics movements were prominent in many countries of Western Europe, Canada, Latin America, and Asia, though they were strongest and most long-lived in the United States, Britain, Scandinavia, and Germany (where eugenic principles became one of the cornerstones of the Nazi state). Although some eugenics movements (France, Brazil) were based on non-Mendelian concepts of heredity (most notably neo-Lamarckism, or the inheritance of acquired characteristics), the majority operated within the new Mendelian paradigm: genes were seen as discrete hereditary units, each controlling a specific adult trait (such as eye color, height, or skin color, the so-called unit-character hypothesis). Although laboratory geneticists recognized by 1920 that genes often interacted with one another (epistasis), or that most genes affected a number of traits (pleiotropy), among eugenicists the unit-character concept held sway, especially in the United States, well into the 1930s.

Unlike genetic research on laboratory organisms (mice, fruit flies, corn) eugenic research involved studying inheritance in an organism that could not be bred under controlled conditions and that had so few offspring that statistically significant results were hard to come by. As a result, eugenicists were forced to use the correlation and family pedigree methods of investigation. Correlation studies were based on choosing particular traits, such as height, that could be correlated between groups of known genetic relatedness, for example parents and offspring. Strong correlations (0.7 or higher out of a total 1.0) suggested a significant relationship, which eugenicists interpreted as demonstrating a strong genetic component. The problem with this method was that while it applied to groups, it did not provide any way of assessing the genetic influence in any individual case. Thus it was of little value in the long run for eugenical purposes, where the aim was to identify individuals who should be encouraged to breed (what was called positive eugenics) or discouraged or prevented from breeding (what was called negative eugenics). The alternative methodology, family pedigree studies, involved tracing a given trait (or traits) through numerous generations of a family line. The advantage of this method was that it provided data for a specific family, and if the family were large enough, some general predictions might be made for future reproductive decisions (especially for relatively clear-cut traits such as hemophilia or Huntington's disease). The disadvantage of the pedigree method is that reliable information on the traits was often difficult to come by, and families were often not large enough to provide statistically significant numbers. Where social and personality traits were concerned, both methods suffered from problems of defining clearly and objectively the conditions, especially complex ones such as "criminality," "alcoholism," or "feeble-mindedness." In addition, neither method had any way to separate out the effects of environment (families share lifestyles, including diets, exercise, use of alcohol, and so on, as well as genes), and without knowing the details of both the genetic and environmental components, assessing the relative influence of each on the adult trait becomes exceedingly difficult. Such problems did not bother many eugenicists, however, who often made bold claims about the genetic basis of feeble-mindedness (measured as scoring below 70 on the standard IQ tests of the day), alcoholism, criminality, even thalassophilia ("love of the sea").

Eugenicists did not restrict their efforts solely to research. Many were actively interested or engaged in various educational and political activities. Many wrote popular articles or gave public lectures, and there were eugenics societies in most major industrialized countries. There were several major international eugenics organizations, and three international congresses (in 1912 in London, 1921 and 1932 in New York). On the political front, eugenicists lobbied successfully in Britain for the Mental Deficiency Act (1913) and in the United States for immigration restriction based on eugenic claims and for passage of compulsory eugenic sterilization laws in over thirty states. Eugenic sterilization became a major international eugenics crusade, including in Canada, Germany, and the Scandinavian countries. It is ironic that Germany was one of the last countries to adopt eugenical sterilization—only after the Nazis came to power in 1933. By that time the United States was leading the world in the total number of eugen-

cally based compulsory sterilizations (somewhere around thirty thousand). Germany ultimately sterilized over ten times that number before sterilization evolved into euthanasia. In all cases, however, one of the main (though not the only) argument for sterilization was to prevent the individual from passing on his or her defective genes to the next generation. (Other frequently cited reasons included the claim that, especially in the case of those with mental defects, even if the child were normal the parent would not be fit to raise him or her). In most countries, but especially in the United States and Germany, the rationale for sterilization (as opposed to segregation) was economic and social efficiency. It was argued that states (and countries) were spending millions of dollars a year to house defectives who "should never have been born." The rational and efficient procedure would be to sterilize the adult defective and, where possible, return him or her to society, or at least, if they remained incarcerated, to be sure reproduction was impossible. In Germany genetically defective or other nonproductive people were referred to as "useless eaters."

The ethical as well as legal dimensions of compulsory sterilization raised many questions both at the time and in subsequent years. The eugenical sterilization laws in countries other than Germany were aimed exclusively at institutionalized persons, including the mentally ill, paupers, criminals, and the mentally defective (in other words, those who were called "feeble-minded" at the time). This group often represented the poorest and most vulnerable elements of society, those least able to defend themselves. All countries' sterilization laws specified some sort of due process by which the sterilization decision was made, allowed for a family member or someone else to appear on behalf of the patient, and had some provisions for appeal. In most cases that have been studied historically, however, it appears that the proceedings of such courts or due process committees were often perfunctory. Particularly vulnerable for sterilization were children brought up for sterilization in reformatories, as they entered puberty. In some cases sterilization was a condition for being released; in others as a condition for remaining in the institution (a particularly powerful threat for families unable or unwilling to deal with a retarded or recalcitrant child at home).

The ethical problems encountered with sterilization involve both biological and moral claims. On the biological side, the evidence that many of the traits for which people were sterilized (feeble-mindedness, pauperism, criminality, sexual promiscuity, aggression) had a genetic basis was circumstantial at best, nonexistent at worst. Since the methods for determining human heredity could not effectively separate out genetic from environmental effects, the claims that individuals who came from families with various defects would automatically "pass on" these traits was biologically unsound. The moral questions that arose revolved around whether sterilization was a "cruel and unusual punishment," whether tampering with reproductive capacity involved the state superseding its proscribed powers, whether the state should decide who is "defective" or not, and whether having a child was a "right" (more or less the traditional view) or a "privilege" (the eugenical view). Religious groups, especially the Catholic Church, were among the strongest critics of eugenics, especially on the sterilization issue.

In 1930 a papal encyclical, “*Casti connubii*,” specifically targeted eugenical sterilization as violating Catholic doctrine. After Nuremberg, the issue became even more clear with regard to the state’s right to determine who should and who should not be parents. The line has remained a fuzzy one, however, since it is generally accepted that the state has the right to regulate matters of public health: on the grounds that reproducing defective offspring constituted a public health hazard, it was argued that eugenical sterilization fell under a public health aegis. In setting out the majority opinion in the well-known 1927 Supreme Court case of *Buck v. Bell*, which tested the constitutionality of Virginia’s eugenical sterilization law, Chief Justice Oliver Wendell Holmes argued that compulsory sterilization of genetically defective individuals could be justified by the same public health principle that required compulsory vaccination. Eugenics stood for the right of the community to safeguard itself against certain wasteful expenditures over the automatic right of the individual to bring children into the world.

DNA, Genomics, and the New Ethical Dilemmas

In many respects the genetic technology that has grown up around the elucidation of the molecular structure of DNA since 1953 has raised even more ethical and moral questions than its predecessor in the classical Mendelian era. The rapid and exciting development of molecular genetics in the period from 1953 to 1970 provided the basis for understanding aspects of genetics at the molecular level that had only been imagined by prewar geneticists. Understanding how DNA replicates itself and how genes control cell function by coding for proteins that serve both structural and catalytic (enzymatic) roles, the nature and universality of the genetic code itself, and the way in which genes are controlled (turned on and off during development) all suggested that soon human beings would be able to engineer organisms in almost any conceivable direction. Indeed, the term *genetic engineering* was coined during the 1960s and early 1970s to express the new hope and excitement held forth by the understanding of molecular mechanisms of heredity.

As with the rapid advances in Mendelian and chromosome genetics in the 1920s and 1930s, so with the advancement of molecular genetics; new genetic discoveries were being announced almost weekly. Although many theories of molecular genetics came and went, they were all subject to being tested and accepted or rejected. For example, initial claims about how transcription (forming messenger RNA from a DNA strand) and translation (using the messenger to synthesize a specific protein), based on work with prokaryotic (bacterial) systems, proved to have many differences from the same process in eukaryotic cells (as in all cells of higher organisms). Bacterial and viral chromosomes turned out to be organized quite differently from the chromosomes of the fruit fly or the human. The statement that “what is true for *E. coli* [a common bacterium used for molecular genetic research] is true for the elephant,” as molecular biologist Jacques Monod put it, turned out to be not quite that simple. But yet there did appear to be an evolutionary unity among all forms of life on earth that was even more apparent at the molecular level than at the level of gross phenotype.

The application of the new genetics to practical concerns, both in agriculture and medicine, raised a number of social, political, and ethical issues, some of which overlapped with concerns from the classical era and some of which were quite new to the molecular era. At the agricultural level, one of the first great controversies to emerge concerned the technology for transferring genes from one organism to another. The common method for doing this was to use a bacterial or viral plasmid (a small chromosome-like element of DNA) as a “vector.” An isolated segment of DNA from one type of organism could be inserted into the plasmid, which, because of its size, could be incorporated into another cell type and eventually integrated into the host cell’s genome. This meant that the foreign, or transplant, DNA would subsequently be replicated every time the DNA of the host cell replicated. Characteristics such as insect, mold, and frost resistance could thus be genetically engineered by transferring DNA (genes) from a species that had one of these traits of great commercial value. The controversies arising from the appearance of this technology reached significant proportions in the early 1980s in Cambridge, Massachusetts, where much of the experimental work was being carried out by Harvard and Massachusetts Institute of Technology biologists. Fear that viral plasmids could “get loose” into the community through the massive use of the new technology sparked a series of public meetings and calls for a moratorium on all genetic engineering until safeguards could be assured. A meeting of many of the leading biotechnological researchers at Asilomar, California, in 1975 brought to the fore a discussion of the potential hazards from inserting genes from one kind of organism into the genome of another. Although hailed as one of the boldest exercises in social responsibility by scientists since World War II, interestingly enough, the most dangerous use of the new biotechnology—that is, to create biological weapons—was discussed. Later guidelines incorporated into all grants funded by the National Institutes of Health were based on some of the early decisions among molecular biologists themselves.

Especially in the agricultural realm, the issue of “genetically modified organisms” (GMOs) became a matter of global concern in the 1980s and 1990s. Although the use of viral and bacterial plasmids turned out not to pose as serious a threat as originally thought, critics of biotechnology argued that GMOs could have altered metabolic characteristics in a way that could adversely affect the physiology of the consumer and of the environment at large. One such case became a cause célèbre in 1999 when it was found that corn genetically modified to contain a bacterial gene, Bt, that made the corn insect resistant, was killing off monarch butterflies in various localities in Britain where the corn was being planted. Indeed, as megacorporations such as Monsanto and others turned aggressively to exploiting the GMO market, many countries, especially those in the European Union and Africa, began to place restrictions on, or even ban, the sale or importation of GMOs within their borders. The issue was less the effect on a specific species such as the monarch butterfly than the fact that destruction of the monarch symbolized a major problem with GMOs: as a result of competitive pressure from rival companies they were often rushed onto the market without thorough

testing. Long-standing distrust of corporate agribusiness, where quick profits have been seen as taking precedence over human health and the quality of the environment, has fueled much of the negative response to GMOs worldwide.

Equally as important has been the issue of using human subjects in genetic research. The problem of “informed consent,” never something biologists routinely worried about prior to World War II (though some were scrupulous about informing their subjects about the nature of the research in which they were involved) became a central aspect of the ethics of all human subject research protocols from the 1970s onward. All universities and hospitals engaged in any sort of human genetics (or other) research now have internal review boards (IRBs) responsible for overseeing projects in which human subjects are involved. With regard to genetic information about individuals, the issue of consent is meant not only to insure that individual subjects understand the nature of the research of which they are a part, and to insure their safety, but also to place tight restrictions on who has access to the resulting information. A particular concern regarding genetic information about people in clinical studies is whether individual subjects could be identified from examining published or unpublished reports, notebooks, or other documents. Preserving anonymity has become a hallmark of all modern genetic research involving human subjects.

The question of accessibility of genetic information has had ramifications in another aspect of medicine as well as that of designing research protocols. As testing for genes known to be related to specific human genetic diseases, such as sickle-cell anemia, Huntington’s disease, or cystic fibrosis (CF) has been made available to clinicians, two questions have loomed large, especially in the United States: the accuracy of the tests (that is, incidence of false positives) and the question of who should have access to the information. Fears that genetic information might lead to job or health care discrimination have surfaced throughout the United States as genetic screening programs have become more technically feasible and thus more frequently employed. Perhaps the more general concern is the potential for insurance companies to obtain, or even require, genetic testing of adults as the basis for medical coverage, or harkening back to what seems like an almost eugenic-like view of testing fetuses, with the threat of loss of coverage if a fetus with a known genetic defect is born. Medical insurance companies in the past have tried to classify genetic diseases as “prior conditions” that are thus exempt from coverage. Most of these attempts have not been carried through, but the threat is there and raises a host of legal as well as social and psychological concerns. As of 2004 a small number (seven) of states in the United States have passed legislation specifically prohibiting insurers from denying coverage to individuals based on genetic data.

Human Behavior Genetics

In the latter half of the twentieth century a field known as behavior genetics came to prominence, focusing largely on animal models (fruit flies, mice, honeybees, spiders). Specific behaviors, such as *Drosophila* mating dances, were observed to involve several different genetic components, a mutation in any one of which could alter the course and outcome of the mat-

ing response. Inevitably attempts were made to apply similar claims to complex human behavior—indeed, to many of the same behaviors that had been the subject of investigation by eugenicists a half century earlier. Starting the late 1960s an upsurge in claims about the genetic basis of traits such as IQ, alcoholism, schizophrenia, manic depression, criminality, violence, shyness, homosexuality, and more newly named traits such as attention deficit hyperactivity disorder (ADHD), obsessive-compulsive disorder (OCD) and “risk taking” became widespread in both clinical and popular literature. Many of these newer studies were carried out by psychologists and psychiatrists employing the more traditional methods of family, twin, or adoption studies, correlated with genetic markers, that is, marker regions of chromosomes or DNA. Many of these studies attracted controversy that threw doubts on much of the methodology on which the current human behavior genetics is based. Among the controversial studies were those published in 1969 by the Berkeley psychologist Arthur Jensen claiming that IQ is 80 percent heritable, based on data collected over a half century by the British psychologist Cyril Burt (later claimed to be spurious or even falsified); a study published in the late 1980s by the Minnesota psychologist Thomas Bouchard of identical twins raised apart, which claimed that traits such as liking John Wayne movies, having wives with the same names, or driving identical cars are genetic in origin (no similar results have been confirmed by other researchers); and a 1994 study by Dean Hamer that claimed to have found a genetic marker associated with homosexuality in thirty-three out of forty pairs of gay brothers but that could not be replicated by a separate lab study using a different study population.

The same methodological problems that confronted eugenicists has confronted many of these current theories: difficulty in defining behaviors in a clear manner; treating complex behaviors as if they were a single entity; the difficulty of separating out familial and cultural inheritance from biological inheritance; the problematic use of statistics, especially “heritability”; and difficulty in replicating the results of one study using a different population. As in the eugenic period, critics of hereditarian studies have argued that despite the uncertainty of the conclusions, the widespread dissemination of the results as positive outcomes serves the social function of distracting attention from social and economic reforms that might go a long way toward altering the prevalence of certain “problem” behaviors. As Thomas Hunt Morgan (1866–1945), the first Nobel laureate in genetics (1933) stated in 1925: “In the past we could have bred for greater resistance to cholera or disease; but it was quicker and more satisfactory to clean up the environment.” Many fear that modern claims for a genetic basis of many social problems will serve as a smokescreen for “cleaning up the environment” by blaming societal problems on the “defective biology” of individuals.

Cloning and Stem Cell Research

With increased research in molecular genetics per se two related technologies have come to the fore as centers of ethical concern: cloning and research on embryonic stem cells. Cloning is the process of creating a new organism that is a carbon copy of an already existing organism. In one sense cloning

is not a new technology, since bacterial and all other asexually reproducing organisms reproduce in clones (a bacterial colony is a clone, as are tissue cultures that have been used for decades in biological research). What is new in the controversy about cloning in the twenty-first century is the prospect of producing a higher organism such as a mammal or human being from a single cell of an already existing adult organism. In 1997 Dolly the sheep became the most sensational and well-known example of a cloned organism. Dolly was produced by removing the nucleus from the egg cell of one female sheep and causing that enucleated cell to fuse with an adult cell from (with its nucleus intact) a different donor sheep. The new “hybrid” egg cell contained a full set of chromosomes from the donor and thus would develop into a genetic replica of the donor. While transplanting nuclei from one variety of animal to another had been accomplished with amphibians in the early 1950s, nothing of the sort had been accomplished with mammals until the mid-1990s. The advantage of cloning for agriculture is clear: the genetic composition of the offspring is completely predictable (which is not true in conventional breeding methods). The major biological question raised by Dolly was whether cloned organisms are as healthy and long-lived as ones produced by natural fertilization of an egg by a sperm. As it turned out, Dolly showed signs of early aging, a result perhaps of the fact that the donor cell came from a six-year-old ewe, who was already halfway through the sheep’s natural life span. The chromosomes of mammals gradually shorten at the ends (telomeres) with aging, a process that is not completely understood but which appears to have important implications for cloning from already aging adult cells.

The leap from Dolly to cloning humans and other mammals (businesses sprang up offering to clone family pets, for example) was quick in coming. Among the ethical problems raised here was the expectation that by having an organism with the same genetic composition it was going to be a replica in every way of the adult from which the donor cell was taken. With humans or pets this meant to many people having a new individual with the same personality and behavioral traits as the donor. Such expectations were based on a simplistic understanding of genetics, especially with regard to complex characteristics such as behavior and personality. One of the important lessons of modern genetic research has been that genes do not unfold automatically into an adult trait. Genes interact with other genes and with the environment to produce a number of variant outcomes, so that a genetic clone would no more behave like its progenitor than any two organisms of the same species.

Cloning humans, of course, raises all sorts of other ethical issues, particularly those surrounding what has come to be known as fetal selection. What does it mean if parents want to control so completely all the physical and physiological, not to say psychological, characteristics of their children? Bioethicists raise the question of how far engineering human traits should be allowed to go. Would it be permissible to clone an embryo from a person who needs a kidney or liver transplant just to get an immunologically compatible organ? Is an embryo produced by cloning really a human being, since it has

not been formed by union of egg and sperm? If the answer is yes, then should cloning and bringing the embryo to full term be allowed? Should we be able to clone a terminally ill child in order to provide a replacement? These are not simple questions, but as the technology becomes more certain and available (as it no doubt will) the social and ethical questions must be faced critically and squarely.

Stem cell research poses many of the same problems raised by cloning, but it has a more realistic and immediate medical application as well as some distinct ethical issues of its own. Stem cells are undifferentiated embryo-like cells that are found in various tissues of the adult body. Among the earliest recognized and prolific stem cells are those in bone marrow, but biologists have now found stem cells even in brain tissue that has previously been regarded as incapable of regeneration. What has attracted so much attention about stem cells is that for the most part they have retained the ability to differentiate into a variety of other specialized cells. This is particularly true of embryonic stem cells, which are the most totipotent (capable of differentiation into virtually all other body cell types) of all stem cells. Research into how to culture and deliver stem cells to specific tissues in individuals suffering from particular diseases (for example providing brain stem cells to a person with Alzheimer’s or to someone who has suffered brain damage from a stroke) thus offers considerable potential for treating conditions that are now considered incurable. Creating embryos by cloning and growing them just long enough to harvest embryonic stem cells would provide the most ready source of totipotent cells. But many ethicists and religious leaders claim that such embryos *are* truly human beings and that to grow them only for stem cells, like growing them only for organs and tissues, would amount to murder. Issues like this surfaced after biologists began using existing embryonic stem cell lines for research (derived from frozen embryos left over from fertility clinics) with the result that U.S. President George W. Bush banned the production of any more embryos specifically for the purpose of culturing stem cells (an existing 1993 law had prevented the use of any tax dollars for research on human embryos). The questions of how a human life is defined, at what point in the biological life cycle does it become “human,” and, regardless of how we define it, how to form humane social and legal policies regarding early human embryos as research objects are all issues about which there is a great deal of current disagreement. Biomedical researchers and many others think that early embryos (less than twelve weeks) should be available for research purposes, while many political conservatives and religious spokespeople oppose the use of *any* human embryo that has the capability of developing normally into a fetus. Many countries of Europe, especially England, have been more liberal with their policies regarding embryonic stem cell research, with the consequence that some U.S. researchers have either moved or have contemplated moving their laboratories abroad.

Conclusion

New genetic technologies, whether those associated the classical genetics of the first half of the twentieth century or the molecular genetics and genomics of the second half, have al-

ways raised a wide variety of ethical issues within the larger society. Whether genetic knowledge is being used politically to place blame for social problems on “defective biology” or genetic engineering technologies are being used to produce “designer babies,” geneticists have continually found themselves in the midst of highly controversial issues, ones that are often far more difficult and complex than those associated with other biomedical technologies. This may be in part a result of the long-standing, though mistaken, view that “genetics is destiny” and that knowing the genotype (genetic makeup) of an organism can lead to accurate predictions about its ultimate phenotype (that is, what actual traits will appear and in what form). But it is also in part due to Western society’s optimistic faith that science and technology can provide answers to larger economic and social issues. This is an unrealistic view of what role scientific and technological information can play in human life. There is no question that knowing the science involved in any given area of biomedicine (especially human genetics) is critical for making social and political decisions. But it is never enough. Even if scientists could predict with complete accuracy the exact clinical effects that would characterize a fetus with Down’s syndrome or Huntington’s disease, the decision about how to respond to that knowledge would involve social, political, economic, and philosophical considerations that lie outside of the science itself. As much as anything else, consideration of the ethical and moral aspects of genetic technology should be a reminder that science itself is not, nor has it ever been, a magic bullet for the solution of social problems. Nowhere has that been demonstrated more clearly than in the history of genetics in the twentieth century.

See also Behaviorism; Bioethics; Biology; Determinism; Eugenics; Genetics: History of; Health and Disease; Medicine: Europe and the United States; Nature.

BIBLIOGRAPHY

- Allen, Garland E. “The Ideology of Elimination: American and German Eugenics, 1900–1945.” In *Medicine and Medical Ethics in Nazi Germany: Origins, Practices, Legacies*, edited by Francis R. Nicosia and Jonathan Huener, 13–39. New York: Berghahn Books, 2002.
- Goodman, Alan H., Deborah Heath and M. Susan Lindee. *Genetic Nature/Culture: Anthropology and Science beyond the Two-Culture Divide*. Berkeley: University of California Press, 2003.
- Kevles, Daniel J. *In the Name of Eugenics*. New York: Knopf, 1985.
- Maienschein, Jane. *Whose View of Life? Embryos, Cloning and Stem Cells*. Cambridge, Mass.: Harvard University Press, 2003.
- Paul, Diane B. *Controlling Human Heredity, 1865 to the Present*. Atlantic Highlands, N.J.: Humanities Press, 1995.
- Weir, Robert F., Susan C. Lawrence, and Evan Fales, eds. *Genes and Human Self-Knowledge: Historical and Philosophical Reflections on Modern Genetics*. Iowa City: University of Iowa Press, 1994.

Garland E. Allen

GENIUS. The notion of genius as it is known in the early twenty-first century emerged most fully during the eighteenth-

century Enlightenment period. Although the idea of genius was around before the time of Immanuel Kant (1724–1804), Kant most clearly defined it in the late eighteenth century in his third critique, *The Critique of Judgment*. In fact, Kant’s discussion still influences contemporary notions of genius. Kant opposed genius to a notion of *taste*. Genius, Kant says, is “the exemplary originality of the natural endowments of an individual in the free employment of his cognitive faculties” (p. 181). Genius is a natural human ability; it is not measurable or traceable, and the vagaries of language cannot adequately articulate it. Genius cannot define itself. Genius must, nonetheless, inspire imitation, so that the concept of the product of that genius may be derivatively articulated. Genius must inspire concept, but it cannot conceptualize.

To the function of taste is accorded the responsibility of conceptualizing the products of genius. Kant wrote that “taste, like judgment in general, is the discipline (or corrective) of genius. It severely clips its wings, and makes it orderly or polished; but at the same time it gives it guidance directing and controlling its flight, so that it may preserve its character of finality” (p. 183). Taste is a matter of judgment, a critical faculty that works in relation to genius. In contrast, genius is a matter of imagination. In Kant’s model, taste and genius work together dialectically: taste shapes and guides genius, whereas genius creates fine art precisely by working free “from all guidance of rules” (p. 180). In Friedrich Nietzsche’s (1844–1900) view, the genius is in fact a criminal, because he or she works outside conventional standards.

Kant’s notion of genius is still quite viable in the academic institutions of the twenty-first century. Most English departments, for instance, continue to categorize their curricula according to “literature”—or the critical study of literature—and “creative writing.” The underlying assumption of this organization is that creation of art is one thing, the critical assessment of art entirely another.

Genius, above all, was for the eighteenth century and even much of the nineteenth century *ahistorical*: although still considered human, the genius artist was not thought by eighteenth-century thinkers to be confined to social, political, or historical circumstances. The genius artist was judged to be so to the degree that she or he realized *universal* values or truths. An entirely Romantic notion, genius emerged contemporaneously with the idea of *the self*, the free and creatively self-sustaining individual of classical liberalism. The genius artist, like the self in classical liberalism, was thought to be a spontaneous creator, in a nearly divine sense. Seventeenth-century philosopher René Descartes (1596–1650) proved the veracity of his existence merely by asserting, “I think, therefore I am.” It is this lionization of the human ability to reason from which the notion of genius gained its energy. If the human self is powerful enough to reason, then the human self is powerful enough to create *ex nihilo*.

Genius in the Twentieth Century

Although much eighteenth-century thought about genius continues to be retained in academic institutions as well as in popular culture, late-twentieth-century critics returned to reconsider the category of genius in the light of contemporary

critical trends. Literary criticism was dominated in the latter half of the twentieth century by poststructuralism, a critical school the major by-product of which is the critique of *discourse*. The meaning of any linguistic utterance always exceeds the utterance itself; there is always more meaning in any text than may be apprehended by simply understanding the words. This excess meaning, the poststructuralists say, is socially, historically, and politically determined and produced. With this critical apparatus, critics have reconsidered the category of genius of the eighteenth and nineteenth centuries as a *discursive* formation. That is, current critics see the notion of genius as an idea that was shaped, indeed constructed, by the social, political, and historical circumstances of the Enlightenment.

In addition to the poststructuralist idea that meaning is produced, the twentieth-century philosopher and critic Jacques Derrida (b. 1930), in his theory that is now called *deconstruction*, has pointed out that all of Western thinking is predicated on a system of binary oppositions, such as good and evil, man and woman, white and black. More important, Derrida argues that one component of these Western oppositions is always prioritized over the other. Good is always better than evil, white is always better than black, and man is always better than woman. Likewise, reason has always, for nearly the entire span of recorded Western history, been prioritized over feeling. Both Aristotle and Plato valued reason above emotion; these Aristotelian and Platonic ideas were revived by Renaissance thinkers in the fourteenth and fifteenth centuries. By the eighteenth century the priority of reason was fully entrenched. Western culture has not yet let it go. Derrida's principal contribution was to point out that all the prioritized components in Western oppositions tend to enjoy similar advantage. Reason, prioritized over emotion, is thus a predominantly male characteristic. Genius, with its divine ability to create, was on a par with the divine ability to reason; likewise, genius was associated with masculinity and with men's superior ability to reason. While Kant opposed genius to taste, this opposition did not obtain in the discursive formation of genius. Rather, genius, in its association with human power (of reason and creation), became notably opposed to sentiment.

But even before the poststructuralism of the latter part of the twentieth century, feminists were already beginning to ascertain the historical vicissitudes of genius. Virginia Woolf, in her remarkable 1929 book *A Room of One's Own*, conducts a lively thought experiment, imagining that Shakespeare had a sister named Judith and wondering what life would have been like for her. After considering all the social constraints placed on an Englishwoman of the sixteenth century, Woolf concludes that "a highly gifted girl who had tried to use her gift for poetry would have been so thwarted and hindered by other people, so tortured and pulled asunder by her own contrary instincts, that she must have lost her health and sanity to a certainty" (p. 49). Woolf points to the unevenness of history's representation of genius; she identifies the sociohistorical circumstances that determined which writers would be published and read, and what those writers would write about. And although Woolf wrote before Derrida, Derrida's critique of Western culture applies.

Woolf, however, does not identify genius itself as a discursive formation, because she still believes in it, and argues for the genius of women writers; but she does indicate the way in which women were not allowed to realize their genius until around the nineteenth century. While Woolf rightly identifies the exclusion of women writers from "high culture," she does not consider "genius" itself to be a discursively formed masculine category. For Woolf, poetry is the "high culture" into which women ought to be admitted. Although Woolf recognizes the gendering of genre, she fails to recognize the gender of genius. A deconstructive reading, by contrast, identifies genius as a prioritized oppositional category; moreover, the category of "high culture" is prioritized in its opposition to "popular culture."

In the late twentieth- and early twenty-first centuries critics have considered genius precisely through the critical lens of gender. Literary reviewers most often relegated women writers of the nineteenth century to the category of sentimentalism. In Derrida's register, genius was opposed to sentiment, with the concomitant prioritization of genius. In nineteenth-century evaluations of artists, genius and sentiment worked as a gender-determined opposition. Woolf is aware of this opposition in *A Room of One's Own*. She evaluates the novel as the likely genre for women writers such as Jane Austen and Emily Brontë because of the novel's propensity for feeling and sentiment. Yet Woolf wishes for women to realize their genius in *poetry*—she seems not to notice the genderedness of genius, as do late-twentieth-century critics. Historically, genius was, gender studies critics maintain, a territory mapped out for masculine writers. The categories of domesticity and sentiment emerged as a standard for evaluating women's writing that excluded women from the "high culture" of genius.

Queer theorists have taken this work in the gender of genius and explored the ways in which nineteenth-century constructions of genius actually crossed gender lines. The critic Gustavus Stadler has found that many male authors were consumptives and victims of affect, indulgences that the literary community was generally content to allow its genius writers. These afflictions were typically associated with the feminine gender; the degree to which male "geniuses" were afflicted with these tendencies suggests the way in which "genius" routinely crossed the gender divide in the nineteenth century. Stadler points out that, "It is on this queer turf [of genius], in which famous literary men become madwomen and dying girls enable women to become public authors, that the discourse of genius holds the most promise for disrupting and diversifying the assumptions about gender and sexuality that undergird our understanding of nineteenth-century American literature" (p. 662).

Critics have also noted the ways in which conventions and styles of writing were overtly gendered by nineteenth-century literary movers and shakers. For instance, Andrew Elfenbein has noted that women writers were considered poor writers if they engaged in "literary cross-dressing" (p. 931)—if, that is, they wrote in genres that were the reserved province of male writers, or wrote in a style usually thought of as masculine. In short,

women were supposed to write about private life, domesticity, and matters exclusively feminine in concern. Some writers, however, did cross-dress, Elfenbein tells us, such as Mary Wollstonecraft, who thought that genius was a combination of masculine characteristics, such as logical thinking and intense concentration, with feminine qualities, such as emotionality and loss of control. Here in Wollstonecraft can be seen an attempt to deconstruct the traditional oppositions associated with nineteenth-century notions of genius.

See also *Creativity in the Arts and Sciences; Enlightenment; Person, Idea of the.*

BIBLIOGRAPHY

PRIMARY SOURCES

- Kant, Immanuel. *The Critique of Judgment*. Translated by James Creed Meredith. Oxford: Clarendon, 1952. The best translation in English.
- Woolf, Virginia. *A Room of One's Own*. Foreword by Mary Gordon. San Diego, Calif.: Harcourt Brace Jovanovich, 1929.

SECONDARY SOURCES

- Battersby, Christine. *Gender and Genius: Towards a Feminist Aesthetics*. Bloomington: Indiana University Press, 1989. Writers often refer to this text for a discussion of gender and genius.
- Bromwich, David. *A Choice of Inheritance: Self and Community from Edmund Burke to Robert Frost*. Cambridge, Mass.: Harvard University Press, 1989. See especially "Reflections on the Word *Genius*," 20–42.
- Elfenbein, Andrew. "Lesbianism and Romantic Genius: The Poetry of Anne Bannerman." *English Literary History* 63, no. 4 (1996): 929–957.
- Murray, Penelope, ed. *Genius: The History of an Idea*. Oxford: Basil Blackwell, 1989. This volume is a comprehensive study of the history of genius from antiquity to postmodernism. It also examines the role of genius across several disciplines, from literature to psychiatry.
- Stadler, Gustavus. "Louisa May Alcott's Queer Geniuses." *American Literature* 71, no. 4 (1999): 657–677.

Valerie Holliday

GENOCIDE. Mass slaughter of human beings by other human beings has been a recurrent phenomenon over the centuries, but until recently neither governments nor international legal specialists had sought to devise formal rules and institutions that could help prevent, or if necessary punish, the perpetrators of large-scale atrocities. Massacres that took place during and immediately after World War I, when Turks killed hundreds of thousands of Armenians, and the systematic annihilation of millions of Jews and hundreds of thousands of Gypsies (Roma) by Nazi Germany during World War II, gave rise to the concept of *genocide*, which is defined by *Merriam-Webster's Collegiate Dictionary* as "the deliberate and systematic destruction of a racial, political, or cultural group." Scholars have differed in their analyses of the concept, but the most widely accepted understanding of genocide pertains to the deliberate slaughter of vast numbers of human beings.

Origins and Evolution of the Concept

The term *genocide* was coined in the mid-1940s by Raphael Lemkin (1900–1959), a lawyer of Polish Jewish origin who escaped from Poland after the Nazis occupied it in September 1939. Lemkin fled to Lithuania and then to Sweden before eventually reaching the United States in April 1941. In November 1944 he published a lengthy book, *Axis Rule in Occupied Europe*, which exhaustively documented the legal basis of the Nazis' policies of mass extermination, deportations, and slave labor. The book is best remembered nowadays for Lemkin's use of the new word *genocide*. He settled on that term after much deliberation and defined it as "a coordinated plan of different actions aiming at the destruction of essential foundations of the life of national groups, with the aim of annihilating the groups themselves." Because the word became indelibly associated with the Nazi Holocaust, it promptly gained wide currency as the standard by which to judge human destructiveness. Lemkin himself, however, never believed that the term should refer only to carnage and atrocities of the magnitude perpetrated by the Nazis against Jews. He wanted it to encompass all attempts to destroy cultural or ethnic identities, regardless of whether the perpetrators were seeking to exterminate every member of the targeted group.

From the time Lemkin's book appeared, the term genocide has stirred controversy both in the public arena and among scholars. Lawyers, scholars, and political leaders have differed over the scope and nature of the crimes involved. Some, like Lemkin, have sought as broad a definition as possible, not limiting it to large-scale killing. Others, including many prominent historians and political scientists, have advocated a more restrictive definition, focusing on clear-cut cases of mass slaughter and attempts at systematic extermination. Still others have questioned whether genocide necessarily requires the targeting of a specific cultural, ethnic, racial, or linguistic group. Scholars who express reservations about this last point have argued that if genocide depends on the targeting of a particular cultural or ethnic group, slaughters such as those perpetrated by the Khmer Rouge in Cambodia in 1977–1978—with a death toll as high as 1.5 million—would not be covered. By the same token, many of the atrocities committed in the Soviet Union under Joseph Stalin or in China under Mao Zedong would not be classed as genocide if the target had to be a specific ethnic or cultural group. Although Stalin did carry out mass deportations of nationalities in the 1930s and 1940s, most of his other violent abuses, affecting tens of millions of people, were not directed against ethnic groups per se. The same is true of most of the slaughters and systematic atrocities perpetrated in China under Mao. By excluding many of the worst abuses and crimes of the twentieth century, the requirement of a targeted cultural or ethnic group has arguably been the most controversial aspect of the concept of genocide.

To help fill these crucial gaps, Barbara Harff and Ted R. Gurr have argued that the concept of *politicide* should supplement genocide. *Politicide*, as Harff and Gurr define it, refers to the killing of groups of people who are targeted not because of shared ethnic or communal traits, but because of "their hierarchical position or political opposition to the regime and

dominant groups” (p. 360). Similarly, Rudolph Rummel has suggested that the term *democide* could cover all intentional killing of unarmed civilians by governments. According to Rummel, democide includes the slaughter of cultural and ethnic groups, the massacring of politically marginal groups, and all other government-sponsored killing of unarmed civilians. The concept has come under criticism for being too amorphous, but Rummel has sought to refine it in a number of books. Although neither “politicide” nor “democide” has been widely adopted by other scholars, the coinage of these terms highlights the continuing dissatisfaction with the term *genocide*.

One other issue that has sparked occasional disagreement is whether genocide must be deliberate from the start. This question has been most often raised in analyses of devastating famines such as the one that occurred in southern regions of the Soviet Union in 1932–1933 or in Ireland in the 1840s. The Soviet famine, which killed as many as four million Ukrainians, a million Russians, and a million Kazakhs, resulted from policies adopted by Stalin to crush the Soviet peasantry and to force the collectivization of agriculture. Some scholars, such as Nicolas Werth and Andrea Gnazio, have argued that even if Stalin did not set out to kill so many people, the famines were the inevitable result of his policies. They also have pointed out that when Stalin learned that vast numbers of people were dying of starvation, he took steps to keep peasants from escaping the affected regions, thereby consigning them to certain death.

The Soviet famine has come up particularly often in discussions of genocide because of what some writers, such as Robert Conquest, perceive as the deliberate targeting of Ukrainians (though it should be noted that, proportionally, more Kazakhs than Ukrainians died in the famine). Other specialists such as Jean-Louis Margolin have argued that even when famines do not affect concentrated ethnic or cultural groups, the deaths may still amount to genocide. Among the examples cited by those who subscribe to this view are the terrible famines in China in the late 1950s that resulted from Mao’s Great Leap Forward policies. Although Mao undoubtedly did not foresee that the Great Leap Forward would cause tens of millions of people to die of starvation, he failed to take any remedial action even when he became aware of the scale of the suffering. Hence, scholars such as Margolin have argued that the death toll during the Great Leap Forward should be added to the millions of other victims whom Mao deliberately set out to kill.

The Genocide Convention

Revelations at the end of World War II about the scale of the Nazi Holocaust spurred an effort within the newly created United Nations (UN) to set up an international legal convention that would prohibit genocide and require signatory governments to take all necessary steps to prevent or halt it. Although political leaders were initially slow in moving on the issue, Lemkin did his best to keep the issue on the UN’s agenda. He repeatedly called on the world’s governments to establish a legal framework that would apply to all acts of genocide, not just to those committed during interstate wars. In December 1946 the UN General Assembly unanimously

adopted a resolution denouncing genocide as “the denial of the right of existence of entire human groups” and describing it as “contrary to moral law and to the spirit and aims of the United Nations.” The resolution also set up a committee to draft an international treaty that would formally outlaw genocide. The result, after protracted and often arduous negotiations, was the Convention on the Prevention and Punishment of the Crime of Genocide, which was approved by the UN General Assembly on a 55-to-0 vote in December 1948. The Genocide Convention was slated to enter into force after twenty of the fifty-five UN member-states that voted in favor of it submitted their formal instruments of ratification. Although some signatories of the convention, notably the United States, took many years before they ratified it, ratification by the twentieth country was completed in October 1950, allowing the convention to take effect in January 1951.

The Genocide Convention defines genocide as “acts committed with intent to destroy, in whole or in part, a national, ethnical, racial or religious group.” In giving examples of the type of “acts” encompassed by this phrasing, the convention makes clear that genocide can occur even if no one has carried out (or intends to carry out) “mass killings.” The definition in the convention is largely in keeping with Lemkin’s own preference for the broadest possible scope. It also is in keeping with Lemkin’s belief that genocide is targeted against an ethnic, religious, or racial group, and that the motives of the perpetrators are irrelevant. Although the convention stipulates that genocide is deliberate and purposeful (reflected in the phrase “intent to destroy”) and includes “conspiracy to commit genocide” and “incitement to commit genocide” as well as the destruction itself, it does not require the signatories to determine why the perpetrators are seeking to wipe out the targeted group. Under the convention, genocide can occur irrespective of motive, in peacetime or in war.

The long delay in U.S. ratification of the Genocide Convention stemmed in part from domestic political maneuvering, but it also reflected continued disagreements among lawyers and politicians about the concept of genocide. Some U.S. senators were concerned, especially during the Korean War and the Vietnam War, that U.S. officials might come under frivolous accusations of genocide. Others worried that if the United States formally adhered to the convention, the government would be obligated to send military forces to distant countries to enforce it. Not until February 1986—nearly four decades after the convention was signed—did the U.S. Senate vote 83 to 11 in favor of ratification, albeit with a list of “reservations” in the resolution of ratification. It took another two years before Congress passed legislation that actually implemented the convention by making genocide a crime under U.S. law. Moreover, even after the ratification was approved (with reservations), U.S. officials and legislators continued to debate such matters as the scope of the convention and the means of enforcement. One of the ironies of the convention, as demonstrated during the mass killing in Rwanda in 1994, is that U.S. and other Western leaders have been reluctant to enforce it. As a result, they have refrained from using the term *genocide* to describe even flagrant instances of systematic killing and large-scale atrocities.

Some observers, notably Samantha Power in her prize-winning book on U.S. policy toward genocide in the twentieth century, have argued that U.S. leaders would be more inclined to enforce the convention if they knew they would be held accountable for failing to uphold it. Short of some action by Congress, however, there are few if any ways to ensure that presidents will faithfully implement the convention. Thus far, Congress has not tried to hold the president or other senior foreign policy officials accountable for preventing or punishing genocide. On the contrary, many in Congress have shared the executive branch's reluctance to send troops to enforce the Genocide Convention. (Although the convention was not invoked by the administration of U.S. president Bill Clinton when it decided to bomb Serbia in 1999 to curb human rights abuses in Kosovo, some specialists argued that the convention was in fact relevant. Yet, congressional support for even that limited use of force was meager.) Power maintains that the calculus of U.S. officials on this matter will not be altered unless they are held "publicly or professionally accountable for inaction" (p. 510).

Persistent Controversies and Ambiguities

The concept of genocide has remained a source of disagreement not only in the political arena, but also among legal scholars, historians, and political scientists. Although most scholars accept the view that genocide is targeted against a particular group, many have sought to expand the criteria for identifying particular groups. Rather than limiting the potential victims to ethnic and cultural groups, scholars such as Helen Fein and Leo Kuper have argued that genocide can also be directed against political or socioeconomic groups. This broadening of the concept is in line with Harff's and Gurr's concept of *politicide*, but it departs from the criteria laid out in the Genocide Convention. Some specialists, however, find even the broader conception of targeted groups to be still insufficient. In particular, Rummel has argued that the requirement for victims to be members of a group is a fatal drawback for those who want to take account of the full range of government-sponsored killing of unarmed civilians. Most scholars readily agree that genocide, if conceived of as directed against groups, leaves out many instances of slaughter and atrocities, but they still find the concept a useful one for describing a particular form of extreme abuse.

Even as scholars have generally expanded the range of potential victims of genocide, they have tended to move in the opposite direction when discussing the nature and scale of acts that fit under the rubric of genocide. In recent years, relatively few historians and political scientists have used the expansive definition of acts of genocide laid out in the Genocide Convention (in accord with Lemkin's preferences). The trend in the 1990s and early twenty-first century has generally been toward a more restrictive definition—a definition that limits acts of genocide to intentional killing of particular groups. Steven T. Katz, for example, has argued that "the concept of genocide applies only when there is an actualized intent, however successfully carried out, to physically destroy an entire group (as such a group is defined by the perpetrators)" (p. viii), and Mark Kramer has defined genocide as "deliberate mass slaughter aimed at complete extermination." (p. 2). Although some

scholars continue to espouse a much broader definition of acts of genocide (a definition that would include such things as mass slavery, restrictions on cultural practices, discriminatory education policies, and limits on travel), the narrower conceptions have tended to win favor in the scholarly community.

Outside the scholarly community, however, genocide has remained an expansive concept. Many advocacy groups and nongovernmental organizations (NGOs), such as Human Rights Watch, Amnesty International, and Genocide Watch, have sought to broaden, not restrict, the definition of acts prohibited by the Genocide Convention. They also have tried to strengthen the means of enforcing the convention. These groups vigorously supported efforts in the 1990s to establish international criminal tribunals to investigate and prosecute mass atrocities committed in the former Yugoslavia and in Rwanda. They also strongly backed the ultimately successful campaign to set up an International Criminal Court (ICC), which was created under a statute signed in Rome in July 1998. Although the United States and China declined to take part in the ICC, enough other governments ratified the Rome Statute to enable the ICC to begin functioning in mid-2002.

The human rights NGOs have been less successful, however, in their attempts to persuade Western governments to enforce the Genocide Convention more rigorously. No governments adhering to the convention were willing to brand as genocide the mass atrocities committed in the late 1980s and early 1990s by the Iraqi leader, Saddam Hussein, against Kurds, marsh Arabs, and Iraqi Shiites. Nor were any Western governments willing to regard the mass killing in Bosnia-Herzegovina in the first half of the 1990s as genocide. Even during the slaughter of some 800,000 people (predominantly Tutsis) by Hutus in Rwanda in 1994, Western governments carefully refrained from using the term *genocide* to describe what was going on. Officials worried that the mere use of the term would obligate them to send troops to put an end to the killing.

The unwillingness of governments to invoke the Genocide Convention in response to the massacres in Rwanda in 1994 or to the systematic atrocities perpetrated by government-backed Arab militias in the Darfur region of western Sudan in 2004 underscored the limits of both the convention and the ICC. In the absence of a concerted effort by parties to the convention to enforce it, debates about the precise scope and nature of acts of genocide are largely irrelevant. The special international tribunals for the former Yugoslavia and Rwanda and the ICC have no means of enforcing their own rulings; instead, like all international organizations, they depend entirely on individual states for enforcement. The Genocide Convention, as Lemkin recognized from the outset, is little more than a paper document unless the signatories are willing to take concrete steps to prevent mass killing and to punish the perpetrators. In a few instances, states have sent military forces to put an end to egregious human rights abuses, as Vietnam did in Cambodia in 1978 and Tanzania did in Uganda in 1979. In both of these cases, the interventions were only partly motivated by humanitarian concerns, but there is no doubt that the actions, whatever their motive, did put an end to systematic atrocities. Nonetheless, these incidents were rare exceptions.

The most powerful countries, including the United States and other permanent members of the UN Security Council, have been averse to intervening abroad solely to uphold the Genocide Convention.

Despite the problems in enforcing the Genocide Convention, the document has had a notable influence on international politics. In large part through Lemkin's efforts and the widespread revulsion at the atrocities perpetrated by Nazi Germany, the convention not only attached a permanent stigma to the crime of genocide, but also helped ensure that governments could not simply brush it aside as an "internal affair" of a sovereign state. The convention made clear that unless a government lived up to certain minimum standards of conduct vis-à-vis its own citizens, that government could potentially be removed and punished by other states. No longer would sovereignty be an insuperable barrier against international action. Moving from this principle to concrete enforcement has not yet been practical, but the establishment of the principle itself has been a crucial step on the road toward more effective international responses to genocide.

See also *Human Rights; International Order; Race and Racism; State, The; War*.

BIBLIOGRAPHY

- Chalk, Frank, and Kurt Jonassohn. *The History and Sociology of Genocide: Analyses and Case Studies*. New Haven, Conn.: Yale University Press, 1990.
- Fein, Helen. *Genocide: A Sociological Perspective*. London and Newbury Park, Calif.: Sage Publications, 1993.
- Gellately, Robert, and Ben Kiernan, eds. *The Specter of Genocide: Mass Murder in Historical Perspective*. New York: Cambridge University Press, 2003.
- Harff, Barbara, and Ted R. Gurr. "Toward Empirical Theory of Genocides and Politicides: Identification and Measurement of Cases since 1945." *International Studies Quarterly*, 37, no. 3 (September 1988): 359–371.
- Katz, Steven T. *The Holocaust in Historical Context*. Vol. 1: *The Holocaust and Mass Death Before the Modern Age*. New York: Oxford University Press, 1994.
- Kramer, Mark. "Introduction." In *Redrawing Nations: Ethnic Cleansing in East-Central Europe, 1944–1948*, edited by Philipp Ther and Ana Siljak, 1–42. Lanham, Md.: Rowan and Littlefield, 2001.
- Kuper, Leo. *Genocide: Its Political Use in the Twentieth Century*. New Haven, Conn.: Yale University Press, 1982.
- Lemkin, Raphael. *Axis Rule in Occupied Europe: Laws of Occupation, Analysis of Government, Proposals for Redress*. Washington, D.C.: Carnegie Endowment for International Peace, 1944.
- Power, Samantha. "A Problem from Hell": *America and the Age of Genocide*. New York: Basic Books, 2002.
- Rummel, R. J. *Death by Government*. New Brunswick, N.J.: Transaction Books, 1994.

Mark Kramer

GENRE. Genre is the division and grouping of texts on the basis of formal, thematic, or stylistic criteria. Texts may be

produced, it can be argued, in compliance with or against the strictures of an established and identifiable genre, though it is equally feasible to impose a genre identity upon a work in retrospect, thus attributing to it further possibilities of meaning or, conversely, limiting its potential signification. Paradoxically, genre is conceptually located both within and outside of an individual text; it is a tool that may be employed with equal facility by author, reader, and critic. It is, equally paradoxically, both an instrument of restriction and a mode of liberation.

As a system of division, genre lacks universally accepted boundaries. It is, perhaps, most obviously vested in the formal distinctions between narrative (or prose), drama, and poetry (or verse), though there are some critics who would distinguish these three broad, recurrent identities as "modes," reserving the distinction of genre for what are essentially a work's technically distinguishable or thematically organized components—the sonnet within lyric or poetry, the novel and the gothic within prose fiction, tragedy within drama, and so on. Confusingly, other critics have been known to use the term *mode* to indicate a recognized textual tendency within one of the three broad genres. These already unstable boundaries may be further confused through an adaptation of the terminology of the German critic Karl Viëtor (1892–1951), under which genre distinctions, such as the romance and the pastoral, that occur across cultures may be labeled (somewhat misleadingly) as "universals."

On the one hand—and to adopt, for the purposes of argument, what is admittedly an extreme position—the regulated and regularized conventions of genre represent a restriction on what *may* be produced and what *ought* to be consumed. The conventions of genre, in this respect, hold the potential of functioning as instruments of a restrictive conservatism of generation and reception which may both discourage innovation at the level of the individual text and exclude noncompliant examples from the canon. To write within a culturally accepted or approved genre is thus both to aspire to inclusion within a community of letters and to align the text (and, possibly, its creator) with implications and identities that are often as much social as they are literary. The same might be said for other cultural practices in which genre is the primary mode of division—art, music, and cinema providing obvious parallels. These issues of production, interpretation, imposition, and definition apply as much in these visual and aural media as they do in oral and written textuality. For the sake of clarity and accessibility, the contentions of this essay are illustrated primarily with the oral and written text.

Conversely, however, the conventions and requirements of genre may function more as developmental departure-points than as blockades restricting innovation. They may enhance or supplement rather than concretize the existing borders of a genre, evolving and expanding in order to comprehend the novelty of texts that take issue with their own heritage. Although such innovation within genre may easily be taken as evidence of the artistic and cultural vitality of the context out of which any particular genre arises, it may equally proclaim the final limit of toleration, the point at which a genre may be seen to divide internally into subgenres or even, at the extreme, to fragment

into new extragenic divisions, often distinctly named in order to proclaim the finality and totality of separation. Drama may embrace within its bounds both tragedy and comedy, and may exhibit sufficient flexibility for all concerned to comprehend such a hybrid as tragicomedy. However, purists concerned with the study of the gothic novel, a literary genre whose origins lie in the eighteenth century, may find it considerably less easy to accept the existence of a subgenre proclaiming itself “gothic science fiction,” even though the antecedent of such a concept might arguably include that quintessential “first-wave” gothic novel, Mary Shelley’s *Frankenstein* (1818), published at the close of the period commonly designated as the “first wave” of gothic writing. In short, the degree to which the title of genre is awarded to a broader or narrower field of artistic production, and the extent to which that distinction is accepted, reflects the debate between the interested parties in authorship, reception, and culture more generally.

Genres, in common with the texts that sustain and promulgate them, thus exist in relationship to other bodies and other institutions, textual as well as organizational. Equally, genres exist and are modified and negotiated in debates among literary critics, as well as in the critical function and content of the artistic work itself. The relationships between genres may be complementary or oppositional, and may vary between the two across a period of cultural history. Fixity is not an invariable feature of internal genre identity and, equally, the complementary or combative relationships that pertain between genres are themselves fluid. The literary critic Jonathan Culler suggests that “the function of genre conventions is essentially to establish a contract between writer and reader” (p. 147). From Culler’s observation that this contract serves in part to “make certain relevant expectations operative,” it is logical to suggest that such a contract always retains the potential for renegotiation, given the constant revision of genre standards and components. Culler, however, appears to disregard the presence in such contractual renegotiations of a third party, namely the publishing and marketing industries. Indeed, it is this commercial activity, which, by way of evocative series titles and cover blurbs, has both popularized the notion of genre in the public imagination and, in the case of some popular genres, most notably the historical novel and gothic traditions, has reduced the dynamics of production to little more than stylistic repetition. This has been a risk associated with genre from its origins in classical writing.

Classical Origins

The distinction that underpins the three broad divisions of genre have their origins in the rigid formalities and hierarchies of classical thought. Book 3 of Plato’s *Republic* (c. 380 B.C.E.) is preoccupied with the effective censoring of writing deemed inappropriate to the dignity of the projected Republic and its guardians. Though this activity finds its parallel in Aristotle’s later consideration of “decorum,” or the proper relationship of style to subject matter, Plato’s dialogue is most influential in its systematization of genre, albeit in a vision premised upon the perception of narrative voice through direct speech, rather than a more protracted encounter with technique in itself, as the primary item of definition. Plato’s division, contained for the most

part within what are traditionally numbered paragraphs 392–396 of Book 3, contends that “any poem or story deals with things past, present or future” by way of “either simple narrative, or representation, or a mixture of both” (p. 131). The division here is based upon the relative positions of the poet allegedly speaking as himself (“narrative”) and the imitative function whereby the speech or manner of another person is imitated in an act of “representation.” Using Homer’s *Iliad* as an example, the dialogue further develops the presence of a hybrid form in which passages of narration alternate with those of representation, the poet speaking first “in his own person” and then “in the person of Chryses” (p. 131). Notably, the later genre distinction between “poetry [and] drama” is ignored in this early classification, the “styles” of narration being the only distinction permitted to those engaged in the act of creation.

The most influential classical formulation of discrete and persistent genre criteria based upon a perceived difference in media as much as on the condition of narrative voice and subject matter is in Aristotle’s undated treatise *On the Art of Poetry* (also known as *The Poetics*), though it is apparent that the work may have had limited currency from antiquity until its rediscovery during the Renaissance. The treatise is committed to a hierarchical differentiation of poetry, Aristotle’s introductory history of poetic writing acknowledging an early division of art into “two channels”: a “serious-minded” tradition preoccupied with “noble actions and the doings of noble persons” (p. 35) and a more invective, trivial form that charted the dealings of the “meaner sort of people” (p. 36). Three different methods of distinguishing the essential nature of a work are outlined in the *Poetics*, these being the medium (effectively the verse or rhythmic form) through which a work may imitate reality; the “object of imitation” (how a character is represented or exaggerated—in Aristotle’s contention, specifically in moral terms); and finally (and in continuation of the Platonic model), the “manner of imitation” or difference between representation and narration (pp. 32–34).

The hierarchical model exercises itself within the *Poetics* through the distinction between the qualities of tragedy, comedy, and epic. Comedy, it is suggested, is a “low” form, in that it is a projection of the ridiculous or of that which is painful to perceive, though this is undertaken in such a manner as not to cause pain to the audience. One would add to this the assumption that such a form would be unlikely to provoke deep thought or self-reflection, though developments in the satirical tradition of Roman literature might well achieve this. In Aristotle’s understanding, Greek epic and tragedy, in contrast to comedy, do provoke introspection, both laying claim to be “a reflection, in dignified verse, of serious actions” (p. 38)—though Aristotle eventually concludes the tragic to be the more effective and thus the most prestigious of the two.

Epic differs from tragedy also through formal conventions. According to Aristotle, epic, alone, conventionally “keeps to a single metre and is in narrative form” (p. 38). The two are dissimilar, again, in the scope of their respective temporal coverage, the epic being restricted by “no limits in its time of action” where tragedy was traditionally associated with “a complete action” played out during a period of around twenty-four hours

(pp. 45, 38). There is considerably more at stake in this genre distinction than the convention of “fear and pity” (p. 48), which has been at times simplistically used as the defining icon of tragedy. Different meters distinguish the various forms considered by Aristotle, the iambic, for example being derived from an association with the “iamb” or lampoon, where heroic hexameter “is the right metre for epic” (p. 67). Stage tragedy employed choral song in lyric meters, with spoken exchanges delivered in tetrameters or iambic trimeters. The notion of “decorum” or appropriateness is rigid in this vision of genre: the “dignified verse” of epic or tragedy being reserved only for those forms, the diction of the latter being modified still further through “the use of expanded, abbreviated and altered forms of words” to “raise the diction above the commonplace” (pp. 63, 65). Contorted language in comedy would, by contrast, prototypically lead to confusion rather than to the thought-provoking—and ultimately fatal—riddle posed by the Sphinx, or indeed those posed by Teiresias to Oedipus in Sophocles’ *Oedipus the King*. Inappropriate usage, in this respect, would challenge audience expectation, were not the classical institutions of literature so rigid in their discouragement of such experimentation.

Aristotle’s preoccupation with tragedy in the *Poetics* has left a corresponding deficiency in the criticism of the lyric, comedy, and, to a considerably lesser extent, epic—criticism of the latter being inevitably colored by the explicit partial congruence with tragedy as well as through Aristotle’s discrete pronouncements upon epic stylistics. In consequence, subsequent critics have addressed this imbalance not merely by considering those genre areas specifically but also by developing further the Platonic and Aristotelian canons of genre beyond their apparent boundaries of lyric, comedy, and epic. This expansion and clarification is in many ways retrospective, based as it is in part upon an observation of recurrent textual preoccupations rather than any universally accepted criteria for generation. In contrast to the specific denominations of Platonic and Aristotelian criticism, such developments are frequently termed “classical divisions” or “the classical genres,” gaining a certain value—as alleged origins, as touchstones for subsequent work—in consequence.

Access to the specifics of these “classical” genres—and to the vagueness that often surrounds them—might be most conveniently made through what has effectively become a genre in modern criticism itself, the critical handbook marketed at undergraduate readers. Writing in 2002, John Peck and Martin Coyle inform the student reader that “the main generic division today is into poetry, drama and the novel, but in earlier times the major genres were recognised as epic, tragedy, lyric, comedy and satire” (p. 1). Ross Murfin and Supryia M. Ray, writing in 1997, concur, though they offer “pastoral” as an equal to the five “classical” genres. What is apparent, again, is the lack of consensus among critics.

Notable also, however, is the particular valorization of satire as a discrete genre, rather than in its more traditional status in Greek criticism as an element in comedy. Claimed as a uniquely Roman tradition by Quintilian, satire was in Aristotelian terms little more than a base ancestor of comedy or a mere component of that lesser genre. Although its inclu-

sion in a modern tabulation of genres may reflect the acknowledgment of the parallel status of Roman art alongside Greek, it may arguably also be associated with the enhanced status enjoyed by satirical writing in the modern world. The pastoral or “bucolic” genre similarly enjoyed a classical reputation as a component of epic, lyric, or tragedy, though its potential as a discrete genre was established by the Greek poet Theocritus (third century B.C.E.), its conventions being further developed and popularized by the Roman poet Virgil (70–19 B.C.E.). Again, though classical antecedents are undoubtedly important in the establishment of pastoral as a discrete genre, it must be acknowledged that its status in the contemporary critical field is enhanced by the influence of pastoral stylistics upon individual writers from William Shakespeare to Thomas Hardy, and its contribution to literary and critical movements from the Romanticism of the eighteenth and nineteenth centuries to late-twentieth-century ecocriticism. Genre, as it were, may be valued as much for the texts it has inspired indirectly as for its direct generational capacity as a literary matrix.

Renaissance, Neoclassical, and Romantic Conceptions

The Age of Reason, as has so often been asserted, was an age characterized for many by a commitment to individual and social order, supported by the adoption of taxonomies and systems conducive to the maintenance of that order. It should come as no surprise, therefore, to perceive the continued presence of genre, particularly as a limiting agent in literary culture, for a significant part of this period, albeit with limited acceptance in some quarters toward the close of the eighteenth century.

The persistence of genre in the Age of Reason is a logical continuation of the revival of classical thought, and indeed, of renewed reverence for the classical texts of Greek and Roman antiquity, during the Renaissance period of the fifteenth and sixteenth centuries. The Renaissance brought a revival of interest in the writings of Aristotle in particular, and already-established notions of decorum—the relationship of form to subject matter or occasion—were in many respects confirmed for the purposes of the present by the antecedent of classical thought. The association, for example, of the sonnet as a form particularly suitable for amorous verse was effectively concretized in the courtly writings of the Renaissance period, the essay also coming to parallel (and subsequently to eclipse, albeit later, in the eighteenth century) the Socratic dialogue as the appropriate medium for philosophical and literary speculation. The broader genres of classical thought thus began to fragment into distinct stylistic identities that held the potential of eventual development into genres (or at least subgenres) in their own right. The pastoral also reappeared in the form of eclogues (short poems, not necessarily in dialogue form) in the Latin and vernacular tongues, in many cases under the influence of the Italian poet Petrarch (1304–1374) and his imitators, following a period of neglect during the Middle Ages.

This is not to say that the Renaissance was simply an age of revival, devoid of genre development and speculation. Developing from a medieval and early Renaissance tradition of chivalric, and at times fantastic, storytelling, the romance became an established literary form from the fifteenth century,

and in England at least was considered predominantly a prose genre. In this context, the romance is a genre of adventure or experience, describing events and actions often fanciful or exaggerated, though which may be frequently utilized as a vehicle for personal or social exploration. The Renaissance genre of romance—and, by implication, its medieval antecedents in the depiction of Arthurian and classical heroes—itself enters into introspection in the early seventeenth century with the publication of Miguel de Cervantes' *Don Quixote* (1605–1615), which mocks not merely the style of romance but its aspirations toward an idealized and meaningful life. Significantly, the romance, with its pretensions of the fantastic and its recollections of a recent, spectacular past, became unfashionable as neoclassical thought gained aesthetic ascendancy, returning to an enhanced position only with the rise of gothicism and Romanticism in the second half of the eighteenth century.

The Renaissance is the period also, perhaps unsurprisingly, of the rise as a distinct tendency within prose fiction of the picaresque, or novel of roguery. Growing from literary origins in sixteenth-century Spain, the picaresque evolved into a prose genre closely aligned to the romance by the early eighteenth century. The generic distinction, it must be noted, was applied in retrospect from the nineteenth century, though such tales of illicit love and scandal had been often distinguished in England from the mid-seventeenth century through the term *novel*. Despite this precedent, extended (and often episodic) picaresque works were frequently prefaced on their title pages by grandiose distinctions, such as “history” or “expedition”—applied to Henry Fielding's *Tom Jones* (1749) and Tobias Smollett's *Humphry Clinker* (1771), respectively—these niceties adding a pretension of factuality to tantalize, or trap, the potential reader. As in the classical period, any discrete genre exists in relation to other literary forms, and the relative status of one might be accreted to another through the appropriation of a signifier such as a recurrent device in titling or structure. Order, as it were, implies hierarchy and stratification as much as control and regularity: such falsehoods as those on the title pages of *Tom Jones* and *Humphry Clinker* effectively resist the alleged control exercised by the neoclassical preoccupations of the Age of Reason.

It would be overly simplistic to structure the rise of Romanticism from the last quarter of the eighteenth century as being little more than a reaction to the spiritual, political, and literary strictures allegedly imposed by the Age of Reason. Indeed, the movement proposed little more than an alternative aesthetic rather than an end to conventionalism and formulaic production through genre. In its engagement with outmoded or discarded forms of spirituality and its addressing of demotic identities, Romanticism maintained a restrictive convention of decorum, albeit one at odds with neoclassicism's reverence of Greek and Roman stylistics. Demotic and elaborately archaized forms of poetry were particularly celebrated in the presentation of uncanny events and scenes of pathos, the latter at times developing many of the sentimental attributes previously associated with the pastoral. The ballad, in particular, became a major and distinctive vehicle by which poetry might be directed away from the lofty forms and heroic subject matter of classicism and

neoclassicism toward an often emotional evocation of the language and social environment of common people. Again, the association of form with subject matter or voice is an agent in the fragmentation of larger genre identities.

Romantic writers were often influenced to a greater or lesser degree by the gothic, which flourished in its first wave from the mid-eighteenth century to the early nineteenth. In terms of genre, however, the importance of the gothic lies not in its predominantly supernatural subject matter or commitment to depictions of the grotesque and excessive, but to its aesthetics and conventions being applied across prose, poetry, and drama. The rise of the gothic arguably marks the distinctive transition from a conception of genre based primarily upon formal differentiation to one where conventions of subject matter predominate. Decorum may no longer impose singularity: the poetic ballad may be as suitable a medium for gothic description as the prose novel. The same ballad, again, might hold the potential of being viewed as a product not merely of gothic stylistics but, recalling the parallel influence of Romanticism, as a representation of demotic or folk culture, also. Though such possibilities had been hinted at by earlier literary developments—the novel of sensibility had retained some affinity with sentimental poetry, for example—the gothic was arguably the most influential force in this blurring of generic boundaries essentially inimical to the rigid hierarchies of Enlightenment thought.

In addition to this, the shift in perception that placed subject-matter convention over form encouraged a new interest in satire, itself a form of literary production that blurs genre boundaries through its intertextual dynamic between allusion and satiric comedy. In gothic, the novelistic mockeries of Thomas Love Peacock (1785–1866) and Jane Austen (1775–1817) inform a long tradition of acute observation and wry comment, which underpins the twentieth-century cinematic satires of *Young Frankenstein* (1974) and *The Rocky Horror Picture Show* (1975). Modern gothic, it might be added, is cinematic as well as theatrical, poetic, and novelistic in its compass.

Twentieth-Century Perceptions

Although the gothic, with Romanticism, effectively crossed and revised the boundaries between the three major genre fields of prose, poetry, and drama, this lead was not readily taken up with any effectiveness by another major transgenre movement until the rise of modernism. Instead, critical attention across the nineteenth century became preoccupied with the increasing specialization within the three major genres, a process alternatively of subdivision or fragmentation that might lead, depending on perspective, to subgenres or genres in their own right. Such changes are not necessarily evolutionary—the grotesque social awareness of Charles Dickens (1812–1870), for example, does not lead seamlessly to the politicized naturalism of Émile Zola (1840–1902). Critics in both the nineteenth and twentieth centuries have, however, attempted at times to appropriate a model of evolution (and in the case of Max Nordau, of decadence) to the act of criticism, associating changes in taste and genre with the perceived development or regression of the social and cultural standards that form the text's content. To do this is again to engage with the exclusive powers of genre: the decadent fiction of

the nineteenth-century *fin de siècle*, for example, may have been critically rejected upon formal grounds, though the institutions of the dominant culture are more likely to have taken issue with its subject matter. The sense of decorum here does not stop conventionally at associating one set of formal criteria as being appropriate to the depiction of a specific issue or subject. In the context of the nineteenth-century *fin de siècle*, the debate on decorum of preoccupied with whether *any* form should be associated with the matter depicted by the authors deemed decadent. “Decadence” thus becomes effectively another genre engaged in defining works, often in conventional form, that fall outside the canons of taste.

It is clear, though, that genre was enhanced (whether as internal division or fragmentation outward is irrelevant here) by the rise of a mass publishing and distribution industry in the nineteenth century, and through public consciousness of a world made considerably more complex through social change, empire, and technology. It is this context that maintains the novel as a convenient physical form for distribution and consumption, but that prefaces that demarcation with conditions generated out of the context of the day. Thus, the term *novel* progressively functions only as the mantissa of a variable concept conditioned by its prefix. In the United Kingdom, the century was to see the rise and fall of “condition of England” novels in the 1840s, the “new woman” novel of gender assertiveness in the 1890s, and the “problem novel” of sexual manners in the early 1900s. Such specialisms may lay claim to distinctiveness of subject matter, some enjoying a discrete and highly conventionalized decorum of form in addition. Audiences, again, often became equally specialized and well-versed in the conventions of the genre, their demand for works both stimulating production and potentially blocking its development beyond existing boundaries. Notably, many of the minor genres of the century were short lived, their currency being determined as much by fashion and the topicality of current affairs as by literary taste.

There remains, however, a perceptible difference between the stylistically and overtly literary production and the merely prosaic act of communication, and this distinction came to preoccupy the systematic scrutiny of fiction undertaken by Russian formalist critics during the first three decades of the twentieth century. Abandoning the social contexts of art in favor of a return to structural and formal issues, the movement produced a number of significant concepts pertinent to the issues of genre and genre formation. Among these was Roman Jakobson’s conceptualization of a literary type by way of “the dominant,” “the focusing element of a work of art,” which “rules, determines and transforms the remaining components” (p. 82). The dominant, as Jakobson subsequently clarifies, may be external to the work, a component of the stylistic canon of the poetic school or age. The parallels to earlier notions of genre are obvious here, though it is worth adding a note of caution to Jakobson’s assertion by way of a reference to Jurij Tynjanov’s observation that the foregrounding of “dominant” elements necessarily implies the deformation of components elsewhere in the text. It may equally imply the overlooking of components in the drive to define a genre by its most prominent—or most fashionable—feature.

This deformation, though, is not immutable. Evolution, or a change of emphasis in the definition of a genre by the hierarchy of its components, may determine how a body of texts is defined across a historical period. Citing the example of the novel, Tynjanov notes that where once it was distinguished by its commitment to a narrative of “love intrigue,” the genre has subsequently become defined by “its size and the nature of its plot development” (p. 73). Tynjanov’s definition appears here to treat of the broadest category of novel, rejecting the generic fragmentations so popular in the nineteenth century, though elsewhere Jakobson acknowledges the importance of “transitional genres”—exemplified by “letters, diaries, notebooks, travelogues”—which are “extraliterary and extrapoetical” or supplementary to the canonical genres of literature (p. 86). Again, these might well be defined as genres within their own right under an alternative critical viewpoint. Emphasis, and interpretation, remains in the eye of the perceiver.

Jakobson’s contention—which appears orthodox across Russian formalist thought—that genre is as much a hierarchy and system of values as verse does have important implications for generic change. Changes in the hierarchy of poetic devices within a genre affect how that genre may be defined. Generic evolution is not so much a question of the disappearance of certain elements but of a shift in the relationship of dominant to muted, a change of emphasis rather than a change of content. Russian formalism demands that an approach to genre be based upon a consciousness of its status as a system, and of the relationship of the text to elements within that system as well as those that might be deemed “extraliterary”—for the moment, at least.

This systematic approach also informs the influential work of both Northrop Frye and Tzvetan Todorov, two major theoreticians of genre brought into effective dialogue through the publication of Todorov’s *The Fantastic: A Structural Approach to a Literary Genre* (1970). As Todorov observes, Frye formulates in his *Anatomy of Criticism* (1957) a theoretical rather than historical model of genre. It is apparent that in part this model draws upon Aristotelian concepts not merely of division, but also of presentation. Decorum is, thus, again a limiting factor. The primary demarcations envisaged by Frye are, conventionally, drama (poetry or prose to be performed), lyric (poetry to be sung), epic (poetry to be recited) and prose that may simply be read. The first three are, essentially, performative, and the texts they produce remain within their respective genre definitions even when presented in the form of the printed page. These three genres are further associated with what Frye terms the *epos*, a convention of addressing an audience based upon oral presentation. Frye refines his fourth genre area, that of prose, by moving quickly to a consideration of “fiction,” “the genre of the printed page” or, alternately, “the genre that addresses a reader through a book” (p. 248) rather than in expectation of oral performance.

This demarcation, though, may be compromised by the conventions of writing itself, so that prose fiction may assume a connection with the *epos*, or oral address, according to Frye, simply by making “some attempt to preserve the convention of recitation and a listening audience” (p. 248). Further con-

fusion may also occur through Frye's generalization that fiction is continuous and the *epos* conventionally episodic. As he admits, under both of these criteria the works of Charles Dickens are wholly fiction when published in volume form, though they will—because Victorian serials were conventionally read aloud to family gatherings—have been touched by the *epos* in their earlier incarnation in periodical form. Further, when Dickens began to undertake public reading tours, during which his works were first arranged and then declaimed by the author to an audience, “the genre changed wholly to *epos*” (Frye, p. 249). Though at first sight conventionally rigid, Frye's demarcations become somewhat permeable as the relationship between text and reader (or audience) becomes acknowledged as mutable rather than fixed.

One might also point out here briefly Frye's consideration of “archetypes” or recurrent acts of communication and their implications for genre. Although, Frye observes, “certain common images,” such as “the sea or the forest,” may connect “one poem with another” (p. 99), creating a perceptible unity between them, the works of an author might equally be recalled to the coherence of an oeuvre through that writer's “preoccupation with two or three archetypes” (p. 268). Taken to an extreme, there appears to be little conceptual difference between an oeuvre and genre by this definition, particularly where questions of *epos* and audience are themselves apparently questionable. Both are adequate modes of division, but little more—and the adequacy of genre as an effective container of certain liminal forms (which Frye himself demonstrates as being far more diverse than the transitional genres associated with Jakobson) appears far from convincing in the detail of his model. Frye's model is far from conclusive, and indeed far from comprehensive given its often conflicting complexity. He should, though, be credited with a consideration that might profitably inform all attempts to improve, define, or use genre. As Frye asserts, genre distinctions are not practical but rather “among the ways in which literary works are *ideally* presented, whatever the actualities are” (p. 247).

The first chapter of *The Fantastic* is for much of its length a response to *Anatomy of Criticism*, its focus being directed in particular to the perceived incoherence and lack of specificity in of Frye's tabulation of genre. Although the subsequent nine chapters of *The Fantastic* demonstrate Todorov's thought through the exposition of a single genre and its internal structures and tensions, much of that thought encloses the polemical content of the first chapter. Like Frye and the earlier formalists, Todorov asserts the individual text to be the product of convention, a reworking of what has already been achieved in literature rather than an emotive or unique form of self-expression. The individual text is thus not valued in its own right but rather becomes the basic resource in a deductive process from which a hypothesis or generalization regarding “a principle operative in a number of texts” (Todorov, p. 3) may be projected. Such distinctions are not adequate for the formulation of universal laws, though they are appropriate for smaller (and implicitly more coherent) theoretical units—generic identities such as the fantastic, through which Todorov explicates his theory.

Central to Todorov's model of genre is the statement that “every work modifies the sum of possible works” (p. 6). This is not a new idea: it has a precedent in the Russian formalist definition of the literary by way of defamiliarization and innovation. Todorov, however, does not dismiss the noninnovative work as being merely prosaic or unliterary, thus compromising its position within genre. Rather, he considers such productions as being effectively within genre, albeit as (dependent upon audience context) “so-called ‘popular’ or ‘mass’ literature in the one case; in the other that of the academic exercise or unoriginal experiment” (p. 6). The innovative text, though, permits a statement to be made in criticism about the context of genre through its own evocation of fiction, just as genre itself facilitates commentary upon the text. Again, this is not original: Jakobson suggests in “The Dominant” how a reader may be aware of “two orders,” namely “the traditional canon and the artistic novelty as a deviation from that canon” (p. 87). *Canon*, in this context, functions as an effective synonym for *genre*. A problem arises, however, with regard to the comparative prestige that is associated, in Russian formalism and elsewhere, with the iconoclastic text. Canon, like genre, is traditionally the standard to be emulated and maintained, lest the individual text be dismissed or suppressed. Modern criticism, however, has inverted that hierarchy, the generic or canonical context being relegated to the status of a starting point, the prestige going to each successive departure from a seemingly devalued standard that yet paradoxically holds its value as a reference point to be exceeded. If a text does not challenge an accepted norm it is, on the one hand either “popular” or “unoriginal,” though on the other it is conservatively “generic.” It is, in effect, unstable, locked into a conceptual position where more than one perception may formulate its definition, its acceptance or rejection.

The Future of Genre

Todorov's contention that “any description of a text . . . is a description of genre” (p. 7) may thus set the tone for the future of genre considerations. The awareness that characterizes the reading process as much as it does the writing activity in postmodernity has irrevocably changed the relationship between text and audience, in the same way as it has disrupted that which has previously pertained between text and genre. Jonathan Culler, quoting the critic Gérard Genette, asserts that literature, “like any other activity of the mind[,] is based on conventions of which, with some exceptions, it is not aware” (p. 116). Even at the time of its publication in 1975 this was an extraordinary—and, indeed, outmoded—statement. Genre awareness—in this case, of the discrete form of the novel in the nineteenth and twentieth centuries, and of literary theory as a context for the writing of postmodern fiction—surely informs not merely the writing of, but also critical acclamation for, John Fowles's seminal *The French Lieutenant's Woman* in 1969. Similar assumptions might be made about equally self-consciously “literary” or “theoretical” works such as Muriel Spark's *The Driver's Seat* (1970) and Robert Coover's *The Public Burning* (1977). The reader versed in such things is no longer positioned as a passive spectator, his or her only prerogative being to respond in a predictable manner to customary genre signals or to concur in the rejection of texts that breach decorum. Though some readers may

maintain such standards, the postmodern reader is allegedly well informed, and capable of rejecting the orthodox rather than the heterodox in textuality. The author, too, is aware, and the text is the emblem of that awareness by its own evocation of questions of theory, reception, and, inevitably, genre. Metafiction—self-conscious, self-referential, and reciprocally intimate to the generalizations that organize textuality at all levels—is the logical outcome of the cultural preoccupation with genre.

In the late twentieth century, fiction in the form of metafiction became a commentary not merely upon other texts (through intertextuality), nor indeed solely upon the internal workings of the fictional artifact itself (through the laying bare of device). To expand upon Todorov's contention above, a statement made within or demonstrated by the workings of an individual text is, equally, a statement about genre and, consequently, the limitations and the liberties associated with genre. The reader's recognition not merely of the genre context but also of the development of that context is crucial to such experiments, which are, perversely, both anti-genre and yet genre-dependent for their effect. Genre, in its function as reference point within the very texts that seek to signal their departure from its structures is, at the start of the twenty-first century, possibly as much as a conceptual ideal as Frye suggested it was in the late 1950s.

See also *Literary Criticism; Narrative; Postmodernism*.

BIBLIOGRAPHY

- Anonymous. "Satire." In *The Oxford Companion to Classical Literature*, edited by M. C. Howatson, 507. Oxford: Oxford University Press, 1997.
- Anonymous. "Tragedy." In *The Oxford Companion to Classical Literature*, edited by M. C. Howatson, 575–578. Oxford: Oxford University Press, 1997.
- Aristotle. *On the Art of Poetry*. In *Classical Literary Criticism*, translated by T. S. Dorsch, 31–75. Harmondsworth, U.K.: Penguin, 1979.
- Culler, Jonathan. *Structuralist Poetics: Structuralism, Linguistics, and the Study of Literature*. Ithaca, N.Y.: Cornell University Press, 1975.
- Currie, Mark, ed. *Metafiction*. London and New York: Longman, 1995.
- Dubrow, Heather. *Genre*. London and New York: Methuen, 1982.
- Frye, Northrop. *Anatomy of Criticism: Four Essays*. Princeton, N.J.: Princeton University Press, 1957.
- Howatson, M. C., ed. *The Oxford Companion to Classical Literature*. Oxford: Oxford University Press, 1997.
- Jakobson, Roman. "The Dominant." 1935. In *Readings in Russian Poetics: Formalist and Structuralist Views*, edited by Ladislav Matejka and Krystyna Pomorska, 82–87. Ann Arbor: Michigan Slavic Publications, 1978.
- Keating, Peter. *The Haunted Study: A Social History of the English Novel, 1875–1914*. London: Secker and Warburg, 1989.
- Murfin, Ross, and Supryia M. Ray. *The Bedford Glossary of Critical and Literary Terms*. Boston: Bedford Books, 1997.
- Peck, John, and Martin Coyle. *Literary Terms and Criticism*. 3rd ed. Basingstoke, U.K.: Palgrave, 2002.
- Perry, Anne. *The Twisted Root*. New York: Ballantine, 1999.
- Plato. *The Republic*. Translated by H. D. P. Lee. Harmondsworth, U.K.: Penguin, 1968.
- Punter, David. *The Gothic Tradition*. Vol. 1 of *The Literature of Terror: A History of Gothic Fictions from 1765 to the Present Day*. 2nd ed. London and New York: Longman, 1996.
- Seed, David. "Gothic Science Fiction." In *The Handbook to Gothic Literature*, edited by Marie Mulvey-Roberts, 272. Basingstoke, U.K.: Macmillan, 1998.
- Shklovsky, Victor. "Art as Technique." 1917. In *Russian Formalist Criticism: Four Essays*, translated by Lee T. Lemon and Marion J. Reis, 3–24. Lincoln: University of Nebraska Press, 1965.
- Sophocles. *Oedipus the King*. In *The Theban Plays*, translated by E. V. Rieu, 23–68. Harmondsworth, U.K.: Penguin, 1967.
- Todorov, Tzvetan. *The Fantastic: A Structural Approach to a Literary Genre*, translated by Richard Howard. Ithaca, N.Y.: Cornell University Press, 1975.
- Tynjanov, Jurij. "On Literary Evolution." 1927. In *Readings in Russian Poetics: Formalist and Structuralist Views*, edited by Ladislav Matejka and Krystyna Pomorska, 66–78. Ann Arbor: Michigan Slavic Publications, 1978.

William Hughes

GEOGRAPHY. Only relatively recently accepted as a subject of study by universities, geography has been characterized as a Cinderella among the disciplines. It was not one of the traditional liberal arts, and it appeared in its modern form in the curriculum of universities in the nineteenth and twentieth centuries; it still remains a small component, and is sometimes not present at all, in institutions of higher learning. Part of the reason for this is that society, and even geographers themselves, are not sure of the nature of geography. Geographers are only rarely members of national academies of science, or of the humanities, falling between the stools with the social or so-called soft sciences.

The Nature of Geography

In his seminal studies on the methodology of the subject, Richard Hartshorne (1899–1992) proposed the following definition: "Geography is concerned to provide an accurate, orderly, and rational description of the variable character of the earth's surface" (Hartshorne, p. 21). Understandably this characterization has not been universally accepted, and others have suggested terms such as "areal differentiation," and "spatial interaction" as better expressing the core of geography. It has been seen as more akin to history than to the systematic sciences (physics, chemistry, biology, geology, meteorology, etc.) in that it has no body of material peculiar to itself, but rather adopts a point of view. But subjects studied by some geographers, such as map projections, are highly "scientific."

In France the alliance between geography and history—"geohistory"—extends from Jean Bodin to Montesquieu to Jules Michelet to the *Annales* school, especially Lucien Febvre, *A Geographical Introduction to History*, and Fernand Braudel and their followers. In Germany geography was an auxiliary science in the encyclopedia of history, or *Historik*, as taught in the universities from the eighteenth century; and there are parallels in other national traditions.

If geography is Cinderella, its Prince Charming is cartography and, by extension, remote sensing of the environment. Maps and related images of the Earth have a wide appeal to collectors and others and are used professionally in several disciplines. But preeminently, they are the tools of geographers so that their study is often confused with the reality of the Earth itself, as expressed in the old tag “Geography is about maps.”

Maps may help in an understanding of the “reality” of geography, but are not “reality” themselves, consisting, as they do, of conventional symbols. Humankind, since prehistoric times, has been concerned with the local environment, as evidenced in maps made before the written record. The subject came into focus in the later classical period as exemplified by the *Geography* of Strabo (63 B.C.E.–c. 24 C.E.), a verbal description of the then-known world, and the similarly titled *Geographia* of Ptolemy (second century C.E.), containing instructions for map-making, of essentially the same area of Eurasia and North Africa described earlier by Strabo. The Greeks from the time of Plato (427–348 or 247 B.C.E.) appear to have accepted the idea of the Earth as a perfect sphere, which, apparently, was not a part of early Babylonian, Egyptian, or Chinese cosmography. Although Buddhism spread from India to China and Japan (after 400 B.C.E.), and following the establishment of Buddhism there, priests returned to India to seek their religious roots and wrote about their travels, this geographical lore did not enter the mainstream of thought in translation until comparatively recent times. The same is largely true of Islam following the death of Muhammad (570–632 C.E.), in spite of close contact between this religion and Christianity in the Mediterranean and elsewhere over many centuries. Thus the travels of “Sinbad the Sailor” and more scientific geographies were available only in translation as relatively late additions to European literature and in this sense are considered to be “nonhistorical” in the West. Even the accounts of Marco Polo (1254–1324) of his travels from Venice to Cathay (China) and return were at first disbelieved.

This article need not go into detail concerning the remarkably accurate measurement of the circumference of the Earth by Eratosthenes (third century B.C.E.), or its rejection by others (including Ptolemy), until the later Renaissance and the scientific revolution in Europe, of the fifteenth to seventeenth centuries. At that time Ptolemy’s *Geographia* was “re-discovered” and translated from Greek into Latin and formed the basis of much of the study of geography in this era. It was in turn criticized, improved upon, and superseded during the period of European ascendancy in science and global discovery when half the coasts of the world were “discovered” and charted. The dichotomy represented by the conceptions of the Greeks—Strabo on the one hand and Ptolemy on the other—continued into the Enlightenment period through the writings of, for example, Bernhard Varen (Varenius, 1622–1650) in regional geography, or chorography, and in the ideas of Edmond Halley (1656–1742), who, in addition to his work in astronomy, laid the foundations of physical, thematic mapping, with representations of winds, tides, and Earth magnetism with isogones (lines of equal magnetic variation) delineated on published charts. More than a century later, the polymath

Alexander von Humboldt (1769–1859), well trained in the natural and physical sciences, attempted to give unity to geography, while still considering the Earth in relation to the cosmos (*Kosmos* is the title of his greatest work). It was Humboldt’s contemporary Carl Ritter (1779–1859) who, similarly, emphasized the unity of the field, but with a person-centered (even teleological) approach to human/land relationships, following Immanuel Kant (1724–1804) and others. But the division between physical and human geography continued and increased in the nineteenth and in the first half of the twentieth century in France, Britain, the United States, and areas influenced by these countries. That this is still the case is evidenced by recent multiauthored volumes titled, respectively, *Horizons in Physical Geography* (1987) and *Human Geography: An Essential Anthology* (1996). Accordingly, it is necessary to recognize recent trends in these major, separate divisions of geography; this article will later cite attempts at reconciliation between these two disparate streams, and others.

Geographical Determinism

A concept that retarded the acceptance of geography as a serious academic endeavor until quite recently was geographical determinism. Although stemming from earlier work by the German geographer and ethnographer Friedrich Ratzel (1844–1904), with adherents in other European countries, the high priestess of this cult in the United States was Ellen C. Semple (1863–1932); another American espouser of “determinism” was Ellsworth Huntington (1876–1947). In its extreme expression the theory asserts that the work of humans is controlled or “determined” by geographical conditions: climate, landforms, and the like. This idea was opposed by the scientifically trained English scholar Eva G. R. Taylor (1879–1966) and others in Britain, France, and elsewhere. The debate continued throughout the twentieth century, but has few adherents in the early 2000s. An alternative to determinism was proposed, namely possibilism, which suggests that humans have a number of possibilities from which to select. Possibilism apparently owed its origin to the French geographer Paul Vidal de la Blache (1845–1918), who, with his followers, never accepted the concept of determinism. At this time most of the world, including North America, was influenced by European ideas so that traditional, indigenous geographies became subsumed under colonial and other European ideology. Thus India, under British rule, became one of the best studied and surveyed areas in the world. China, Japan, and Korea resisted this cultural hegemony, but eventually accepted it.

Military and Public Geography

If geography has had a mixed reception in research universities, its ideas and practitioners have been embraced by both the military and the public sectors. Thus Napoléon Bonaparte (1769–1821) not only developed strategy based on knowledge of geography but also sponsored a translation of Strabo’s *Geography*. Following the Napoleonic Wars there was a great interest in geographical exploration worldwide, especially the interiors of the continents (little known at the time), and geographical societies were founded in major cities. Furthermore, instruction in geography has been part

of the training in service academies ever since. There is, understandably, an increased interest in geographical intelligence during times of war in all of the military services—navy, army, and air forces—which engage in so-called defense studies and mapping. Thus during World War II the British Royal Navy, Naval Intelligence Division, commissioned a series of handbooks on the geography of various areas that were later declassified and made available to general libraries. This was also true of maps made by the U.S. Army Map Service and of charts, the work of various hydrographic services together with coastal studies in the form of navigational pilot books. The role of air forces is well-known in not only providing the means for aerial reconnaissance but also in sponsoring aeronautical chart series at “geographical” scales. Thus map coverage of the Earth on the scale of 1:1,000,000, begun through the efforts of Albrecht Penck (1858–1945) as the International Map of the World (IMW), was completed at this scale by the maps of the U.S. Aeronautical Chart and Information Service during World War II. Ironically the United States had not officially cooperated with the IMW, but the private American Geographical Society of New York mapped all of Latin America at this scale. Furthermore, as a result of wartime experience, many returning veterans in several countries during this period made careers in applied or theoretical geography, some founding or working in geography departments, which were established in many colleges and universities in the 1940s and 1950s. These personnel are now mostly retired, or deceased, and later wars did not produce a similar great expansion in academic geography. In fact some of the then newly created departments, especially in the United States, were merged with other instructional units, renamed, or terminated. This is attributable to a number of causes, not least the abandonment of the geography department at Harvard University during the presidency of the scientist James Conant (1893–1978). The Harvard precedent was followed by other, even public, institutions that formerly had strong departments of geography. These universities often have splendid map collections, which find little use among students and faculty not geographically “literate.”

Just as geography is essential to the military establishment, so it is valued in the public, civilian sector. Thus, that most fundamental of human geographical distributions, population itself, is of the greatest interest to census bureaus of various countries and internationally, with the United Nations having a vital concern with demography. Similarly, topographic and land use data of various scales is essential to the effective administration of urban and rural areas in the form of maps and reports. Thomas Jefferson (1743–1826), who also sponsored geographical exploration and wrote an important geographical treatise, well understood this, and he initiated the United States Public Land Survey, passed into law as the Land Ordinance of 1785 and first applied in Ohio. Subsequently rectilinear surveys expanded over three-quarters of the United States, which became the public domain, thereby transforming the American landscape and producing a torrent of cadastral maps, plat books, and county atlases in the nineteenth century, and beyond. Also, between World War I and World

War II, the detailed Land Utilisation Survey of Britain was conducted under the direction of L. Dudley Stamp (1889–1966), and it has had a profound effect on the economic life of that area (despite its title, Scotland was not covered). The idea was to make a record of existing land uses and to plan for the future. By 1940 the survey was essentially complete and proved of enormous value to Britain as it expanded its agricultural production during World War II. The concept was adopted by other, especially densely settled, countries and gave rise to the formation of the Commission of the International Geographical Union (IGU) on land use.

The remarkable expansion and improvement of highways of all kinds during this period led to the production of road data, published by government highway departments, automobile clubs, or oil and tire companies in many countries, becoming perhaps the most commonly available geographical source material worldwide. To a lesser or greater degree all government departments from foreign offices to small municipalities require geographical data, and more personnel are needed to process this information than are trained in existing educational institutions. However, the great success of geography in these applied fields has not been matched by similar success in theoretical realms in recent years, which will be the subject of most of the remainder of this essay.

Geographical Theories

Both Kant in Königsberg and Isaac Newton (1642–1727) at Cambridge University in England taught what might be called geography today, but they are not remembered for that activity. Newton also postulated that the Earth is an oblate (polar flattened) spheroid before it was proved by geophysical methods. This and other findings were to be of practical use in the development of detailed topographic maps in the nineteenth and twentieth centuries and especially during the space age in the second half of the twentieth century and the first years of the twenty-first century. Among the greatest contributions to science have been understanding of the shape, size, and motions of the planet Earth and of its place in the Universe. Although other societies and cultures such as the Chinese and Indian probably recognized the “curved” surface of the Earth, a full realization of the figure, mass, and movements of this planet is essentially a triumph of Western thought. This has become almost universally accepted so that Eurocentrism, as well as Sino-, Indo-, and other “centrism” are dead, or dying.

This article has stressed the duality of the subject between physical and human, and theoretical and applied aspects, and needs now to detail a further division, that between systematic and regional geography. Some scholars will take a physical entity, such as vegetation or soils, or a cultural feature, such as urbanization or transportation, and discuss it with little or no reference to other topics. Contrasting with this is regional geography, in which the worker attempts to characterize an assemblage of features such as landforms, rivers, roads, soils, human population, and settlements to demonstrate how they are related, or “interact.” Of course, the choice of what factors are most significant in a given area is of critical importance. Some assert that it is easier to analyze than to synthesize, and that regional geography is “the highest form of the geographer’s craft.”

The Limits in Geography

What are the limits of the focus in the study of geography? It is usually assumed that geography is concerned with the surface or “shell” of the Earth, but workers do not specify how deep or high this sphere of interest to geographers extends. With some prescience Hartshorne wrote before 1966, “Man has for the first time projected his world of action beyond the [Earth’s] atmosphere . . . and may soon be expected to extend that range to the moon” (Hartshorne, p. 24). This prediction was shortly realized when the United States, through its Apollo 11 mission of July 1969, landed two astronauts on the Earth’s natural satellite, and images were taken of the Earth from the Moon. Further, rocks from the lunar surface were collected for the study of which the term *geology* was employed. Subsequently, many artificial satellites, both with humans aboard and unmanned, have been launched so that we now have a much greater understanding of the “blue planet” Earth, from above. Considering that the first aerial photographs of parts of the Earth were taken from a balloon in 1858, and that the science of photogrammetry—making maps from overlapping vertical air photographs—was developed in the first half of the twentieth century, progress has been remarkable. This was largely accomplished in European and North American countries, which assisted other areas that benefited from this technology.

Another realm of the Earth that has been seriously investigated is the ocean depths, made possible by modern technology—sonar or echo sounding. The oceans, the greater part of the surface of the Earth, have, of course, long interested maritime nations but until recently this interest had been confined to the surface, coastal limits, and other shallow areas—or to speculation. The most remarkable example of the latter is the postulation by the German meteorologist and physicist Alfred Wegener (1880–1930), who proposed that at an earlier period the continent(s) consisted of a single or, at most, two major land masses that had subsequently drifted apart. At the time of his death, not enough evidence was forthcoming to prove Wegener’s theory of “continental displacement,” or “continental drift” as it was later termed. Sonic sounding now permits continuous traces, or profiles, to be made across the ocean floor by ships in progress, which, in aggregate, provide a true three-dimensional image, making possible the charting of the ocean basins. This process has revealed an assemblage of “forms” as varied as those on land areas above sea level, including profound depths greater than the highest mountains on Earth. Most important, it has given validity to Wegener’s theory, through identification of mid-ocean ridges, from which apparently the continents spread for the most part laterally. Other forms of evidence support this fundamental, and now widely accepted but hitherto controversial, theory.

The two examples given above illustrate how the Earth’s surface or limits have been vastly enlarged in the past half century, and they also suggest that geographers who are concerned with the Earth as the “home” of humankind must come to terms with this increased realm. Geography, however, remains a very divided subject searching for a core. As indicated above, a few women geographers in the past have made signal contributions to the subject. However, as in many other studies, often women geographers became editors, school teachers, and

librarians, in spite of the tradition of the intrepid Victorian lady traveler. Until quite recently women were often “excused” from field work in geography departments, considered a necessary part of the curriculum for males. Now that they constitute about one-half of the enrollment in colleges and universities, and owing to changing mores, women are now making an impact on the subject at the research level. This is expected to continue and expand, since previously, half of the human in human (and physical) geography had been excluded. The closeness of the female to Mother Nature, it is speculated, gives women an advantage in geography that is now being realized, understood, and, to a greater extent than previously, appreciated.

Just as women and their special points of view have not been an important part of geography in the past, so, it is argued, have the interests and aspirations of the proletariat not been included. An attempt to address this lacuna has been through what has been called in its extreme form (and comparable to feminist geography) Marxist or, more acceptably, socialist geography. Notable proponents of feminist geography are Cindi Katz and Janice Monk; and of Marxist and Socialist geography, Massimo Quaino and David Harvey. Marxist and socialist practitioners assert, with considerable justification, that geography has been a white male, Eurocentric (even imperialistic) study, with the protection of the “establishment” in mind. This conservative view is being challenged by new graduates of “red-brick” universities, particularly, recalling their working-class roots. This concern also extends to various, often ethnic, minorities who were not previously part of the geographical equation. How far this development will redress past inequities and affect the future direction of the discipline may depend on further recruitment of university students from the underclasses and those concerned with their welfare.

The wide range of topics investigated by geographers will not be elaborated here, but it is suggested by the indexes of textbooks in physical and human geography where they are later treated in varying degrees of detail. Methods mentioned earlier, including field work, interpretation of aerial photographs, and individual images from space are of course still available, but other methods have been added recently: continuous surveillance and imaging of the Earth, since 1972, through the Earth Resources Technology Satellite (ERTS) and its successor, Landsat; and new computer programs, especially ARC/INFO, introduced in 1982.

Geographical Models

Before treating computer graphics and geographical information systems (GIS), which purists consider only tools, mention should be made of the criticism of academic geography as being mere description, with a lack of theories. Traditionalists would argue that all places on the Earth are different, that therefore description of these variations represents reality, and that geographers need only address themselves to the “real” world. These practitioners often reject models, two of the most successful of which in geography have been Central Place Theory in human geography, and the Köppen system of world climates in physical geography, which are examined, as examples, below.

Central Place Theory arose from studies of the distribution of settlements in the eighteenth century in Germany where it was postulated that places of varying size and function on a “uniform plain” would be arranged in hexagonal hierarchies. This has proved to be essentially the case, for example, on the delta of the Nile in Egypt, and elsewhere, as demonstrated by cartography and remote sensing. An elaboration of this is in the location of functional areas within cities, as exemplified by the case of Chicago. However, critics have observed that both concentric and sector patterns are evident in Chicago and that what obtains in a relatively modern city in the American Midwest does not necessarily apply to European and especially Asian cities. Chicago, with its location on the shores of one of the Great Lakes, is unique because of its special geographical setting and other factors.

More successful has been the Köppen system of climatic classification, which also had its origins in Europe, through the work of Wladimir Köppen (1846–1940) in the nineteenth and twentieth centuries. When long-term information was available from weather stations worldwide, it was observed that patterns were repeated in separate, but expected locations around the globe. Thus, to take one example, between approximately 30° and 40° latitude on the west coasts of all the continents, a Mediterranean climate was recognized. This climatic type is characterized by having high-sun (summer) drought and almost all of its precipitation in the low-sun (winter) months, the opposite of what would be expected. Thus in addition to the type example in Europe and the Middle East, it was found that California in the northern hemisphere, and Central Chile, Southwest Africa, and Southwest Australia in the southern, have “Mediterranean” climates. On the basis of climatic similarities, scholars have attempted to refine the Köppen system so that six major, and a total of sixteen, subtypes are now recognized globally. Being based to some extent on “native” vegetation, and not altogether on climate, critics consider the Köppen system to be a technical grouping rather than a true classification. Nevertheless, the Köppen system has proved to be a powerful teaching device that has not been superseded by other classifications. Although largely similar, each of the geographically separated Mediterranean areas have differences owing to local factors but, in comparison with other areas, they are more alike than different. This is also true of the other subtypes of the Köppen climatic classification. Critics assert that all places on Earth have some, if only minor, differences and thus cannot be classified.

The two examples of theoretical geography given above, with their origins in the past, have been fine-tuned and have become part of the curricula of geography departments, more than most other theories in a field that has been characterized as more empirical than theoretical. Since the mid-1970s, two developments have revolutionized geography—the computer and space exploration—as much as any previous advances.

Computers and Space Exploration

Before the computer, proto-quantitative geography was developed with the aid of various calculating machines, but it was only after Herman Hollerith (1860–1929) combined punched

cards with the then-recent electromagnetic inventions that it became possible to count and classify in a much shorter time and with greater detail and precision than by any previous methods. But through the 1950s the machines required to perform these operations remained expensive, large, and clumsy. A turning point occurred in 1982 with the introduction of ARC/INFO, a geographical information software package that combines traditional automated systems with advanced spatial data-based handling capability. This is accomplished by combining a series of layers each with a different theme: relief, roads, political boundaries, settlements, and so on—the desideratum of the regional geographer. Specifically, ARC/INFO uses both vector (line) and raster (tabular) storage; transformations can be undertaken and questions asked concerning numbers, distance, addresses, and so forth. The utility of such a system to those who are concerned with geographical distributions is enormous, as is time saved by these procedures. Maps can be made using the system and simulated, three-dimensional representations produced. It can also be animated to show, for example, population change through time. The machines on which these procedures can be accomplished have been incredibly reduced in size, price, and availability.

Equally as remarkable as the widespread utility of the computer to geography have been the space programs of various countries and consortia. As in the case of the computer, space technology did not arrive fully developed without a period of gestation, partly alluded to above in the references to aerial photography. A breakthrough similar to that of the computer was made when German rocket scientists joined the incipient United States space program, and that of the Soviet Union, following World War II. Prior to this, around 1910, the Germans had used rockets fitted with cameras to image small areas of the Earth. The range of these missiles was increased in World War II when, as *Vergeltungswaffe 2* (V-2) rockets, they were used for military purposes. From 1960, the Television and Infra-Red Observation Satellite (TIROS), a series of unmanned satellites, was launched in the United States, and demonstrated the ability to gather weather data from above Earth’s cloud layers, the first important use of the new technology. Meanwhile the Soviets launched the Synchronously Programmed User Terminal and Network Interface (Sputnik) in 1957, imaged the previously unseen side of the Moon in 1959, and put a human in space in 1961. The next year marked the first manned space flight by the United States, which soon began a series of missions imaging the Earth from space—Gemini (1965–1966), and Apollo (1968–1969), with handheld cameras loaded with color and, later, color infrared (CIR) film, which had been perfected during World War II. As mentioned above, it was the Apollo 11 mission in 1969 that landed humans on the Moon. Subsequently, nonphotographic systems were also used so that the term “Remote Sensing of the Environment” was coined to replace air photo interpretation, which was included in the definition.

The next development was continuous, extensive surveillance of the planet Earth, first accomplished by the Earth Resources Technology Satellite (ERTS) in 1972. Another similar satellite was launched in 1975, and the program was renamed Land Remote Sensing Satellite (Landsat). Since that time, the

surface of the Earth (except the polar regions that the system does not cover) has been scanned by Landsat every nine days. By international agreement Landsat imagery, which is telemetered to the Earth in at least four multispectral bands, is available to users in any part of the world. The French Satellite Pour l'Observation de la Terre (SPOT) and various Russian satellite programs produce very high quality images but, unlike Landsat, do not have continuous satellite coverage of the Earth. However, other countries and consortia (such as the European Space Center) make contributions to existing programs, as in the case of Britain and Australia. At the time of writing China has successfully launched an extraterrestrial satellite, recalling the early interest of the Chinese in gunpowder and rockets, and the United States has an operating imaging system on Mars.

Summary and Conclusion

An attempt to bring the subject together, after a long hiatus, is *Geography: A Modern Synthesis* by Peter Haggett. This is suggested by the titles of a selection of chapters of his book: "The Fertile Planet"; "Environment Risks and Uncertainties"; "Ecosystems and Environmental Regions"; "Resources and Conservation"; "Spatial Diffusion"; "Toward a Regional Convergence"; and "Outer Space, Inner Space." Analysis may give partial answers, but synthesis is essential to provide cohesion to the reality that is geography. The holistic view of the Earth as seen from space should be imperative for geography as a unified discipline, concerned with ecosystems on a fragile planet.

As indicated above, in recent decades the study of geography has suffered a decline in institutions of higher learning in the United States, and it is opined that there will only be improvement by the re-establishment of the subject in high schools. The abysmal ignorance of most Americans about the world, which may be a legacy of isolationism, contrasts with the situation in other (even so-called Third World) countries where geography is taught at all levels. In those colleges and universities in the United States where the subject continues to be taught it is often necessary to recruit faculty worldwide. If wars in the Middle East and elsewhere are not enough to goad Americans into giving more attention to the subject, then perhaps increasing dependence on resources from overseas will provide the impetus to achieve this end.

See also *Demography; Maps and the Ideas They Express*.

BIBLIOGRAPHY

- Agnew, John, David N. Livingstone, and Alisdair Rogers, eds. *Human Geography: An Essential Anthology*. Oxford and Cambridge, Mass.: Blackwell, 1996. See especially: David Harvey, "On the Present Condition of Geography"; J. B. Harley, "Deconstructing the Map"; Yi Fu Tuan, "Space and Place"; Torsten Hagerstrand, "Diorama, Path and Project"; and Stan Openshaw, "A View of the GIS Crisis in Geography."
- Clark, Michael J., Kenneth J. Gregory, and Angela M. Gurnell, eds. *Horizons in Physical Geography*. Basingstoke and London: Macmillan Education, 1987. See especially: Roger G. Barry, "Perspectives on the Atmosphere"; Keith M. Clayton, "Per-

- spectives on the Geosphere"; and Richard J. Chorley, "Perspectives on the Hydrosphere."
- Cosgrove, Denis. *Apollo's Eye: A Cartographic Genealogy of the Earth in the Western Imagination*. Baltimore and London: John Hopkins University Press, 2001.
- Diamond, Jared. *Guns, Germs, and Steel: The Fates of Human Societies*. New York: Norton, 1999.
- Entrikin, J. Nicholas, and Stanley D. Brunn, eds. *Reflections on Richard Hartshorne's "The Nature of Geography."* Washington, D.C.: Association of American Geographers, 1989.
- Haggett, Peter. *Geography: A Modern Synthesis*. 2nd ed. New York: Harper and Row, 1975.
- Hartshorne, Richard. *Perspective on the Nature of Geography*. Chicago: Published by Rand McNally and Company as Monograph No. 1, 1959.
- . *The Nature of Geography: A Critical Survey of Current Thought in the Light of the Past*. Lancaster, Pa.: The Association, 1939. Reprint: Westport, Conn.: Greenwood Press, 1976.
- Harvey, David. *Spaces of the Capital: Towards a Critical Geography*. Edinburgh: Edinburgh University Press, 2001.
- Katz, Cindi, and Janis Monk, eds. *Full Circles: Geographies of Women over the Life Course*. London and New York: Routledge, 1993.
- Lewis, Martin W., and Karen E. Wilgen. *The Myth of Continents: A Critique of Metageography*. Berkeley and Los Angeles: University of California Press, 1997.
- Livingston, David N., and Charles W. J. Withers, eds. *Geography and Enlightenment*. Chicago: University of Chicago Press, 1999.
- Quaino, Massimo. *Geography and Marxism*. Translated by Alan Braley. Totowa, N.J.: Barnes and Noble, 1982.
- Romm, James S. *The Edges of the Earth in Ancient Thought: Geography, Exploration, and Fiction*. Princeton, N.J.: Princeton University Press, 1992.
- Spate, O. H. K. "Toynbee and Huntington: A Study in Determinism." *Geographical Journal* 118 (1952): 406–428.
- Thrower, Norman J. W. *Maps and Civilization: Cartography in Culture and Society*. 2nd ed. Chicago and London: University of Chicago Press, 1999.

Norman J. W. Thrower

GEOMETRY. While the origins of geometry are likely to remain a matter of pure speculation, the elaborate written cultures of ancient Egypt and Babylon provide a wealth of information about the uses of geometry. Area and volume measurements abound in work connected with taxation, the provision of cities, and large-scale building works. Sometimes the Babylonians' evidence (which survives because they wrote on durable clay tablets) spills over into purer matters, and reveals methods for finding the areas of circles, and an impressive calculation of the length of the diagonal of a unit square. The so-called Pythagorean Theorem for right-angled triangles was used to find sides and diagonals of rectangles, and approximate methods for finding square roots. Other tablets display a cut-and-paste method for dealing with questions that could be formulated as quadratic equations—the origins of the method of completing the square—that depends for its validity on a certain amount of elementary geometry.

Antiquity and the Middle Ages

Unfortunately there is little evidence of the transmission of geometrical knowledge from either Egypt or Babylonia to the emerging Greek culture. Significantly, the Greeks seem to have been interested in proof, and the nature of mathematical knowledge, in a way that these other cultures were not. Plato's dialogues display these features in a dramatic way. In the *Meno*, for example, Plato has Socrates ask a slave boy about the diagonal of a square. What Socrates elicits is a comparison between the square of the diagonal and the square on the side; not a numerical answer, and not an approximation to $\sqrt{2}$, but an argument accompanied by a proof.

The advent of proof permitted an important discovery: $\sqrt{2}$ is what we would call an irrational number: there are no integers p and q such that $\sqrt{2} = p/q$. Historians used to present this discovery as momentous. Allegedly the mathematics of earlier, Pythagorean, times was based on the idea that everything could be counted, any two lengths could be regarded as multiples of a common measure. The incommensurability of the side and diagonal of a square put an end to that belief and caused a crisis in Greek mathematics. In the late twentieth century, however, historians retreated from this position. The only evidence for it is very late, and no contemporaneous evidence suggests a crisis. Rather, as Plato's dialogues suggest, there might have been surprise and excitement. The slave boy, after all, gave an acceptable answer. The existence of incommensurable pairs of lengths greatly complicated the theory of proportion, which is attributed to Eudoxus of Cnidus (c. 400–c. 350 B.C.E.) and presented in books 5 and 6 of Euclid's (fl. c. 300 B.C.E.) *Elements*, but again there is no suggestion of a crisis.

The paradoxes of Zeno. Further evidence of the sophistication of Greek thought is found in Zeno of Elea's (c. 495–c. 430 B.C.E.) paradoxes, which survive only in the form of a somewhat hostile account by Aristotle (384–322 B.C.E.). Zeno aimed to show that the analysis of motion led inevitably to contradictions. Achilles may never catch a tortoise, because each time he runs to where the tortoise was it is still ahead, committing Zeno to an infinite chase. Indeed, by a somewhat similar argument he cannot get started. An arrow cannot move in an instant; therefore, it is at rest in every instant of its flight and therefore always at rest. Whatever Zeno's intention in proclaiming them, his paradoxes testify to a deep-seated interest in logical reasoning, and they continued to attract interest.

The notion of proof. Much of Greek mathematics would be impossible without good notions of proof. The simplest form of proof was proof by showing, in which arrangements of pebbles were used to show such results as the sum of two odd numbers is even. Zeno's paradoxes display another form of reasoning, called *reductio ad absurdum*, in which a proposition is refuted by showing that it leads logically to a self-contradiction or other evident impossibility. This method was used extensively by Archimedes in his estimation of areas and volumes, and also earlier by Euclid in his *Elements*, for example when he showed that there are infinitely many prime numbers. For, if there are not, then there are only finitely many prime numbers, p_1, p_2, \dots, p_n say, in which case the number $p_1 p_2 \dots p_n + 1$ is larger than

any of these, so it cannot be prime, and yet it is divisible by none of them, so it must be prime.

Proofs in geometry turn approximate estimates based on a finite number of cases into certain knowledge. For example, the assumptions made at the start of Euclid's *Elements*, including the parallel postulate as described below, permitted Euclid to prove that the angle sum of a triangle is exactly two right angles by exhibiting a suitable pair of parallel lines, to prove Pythagoras's theorem by moving areas around, and, ultimately, to show that there are exactly five regular solids.

Euclid's Elements and the axiomatization of geometry.

The most impressive form of proof, however, in Greek mathematics is the axiomatic method, developed at length in Euclid's *Elements*. The aim, not perfectly honored but impressively so, was to state definitions of the fundamental terms, gives rules for what may be said about them, and then to derive truths successively from this base of assumptions (the axioms). The result is that later propositions in each book of the *Elements* depend in an elaborate, tree-like way, on the earlier ones, and confidence in these results depends on the transparency of the proofs and the quality of the original axioms.

Apollonius and Archimedes. One of the intellectual high points of Greek mathematics is undoubtedly Apollonius of Perga's (c. 262–c. 190 B.C.E.) theory of conic sections. It is forbiddingly austere, but it goes a long way to creating a unified theory of all (nondegenerate) plane sections of a cone: the ellipse, parabola, and hyperbola. The names derive from the way their construction is shown to produce an area that falls short, is equal to, or exceeds another area (compare the terms for figures of speech: elliptical, or of few words; a parable is exact, hyperbole an exaggeration). The comparisons of areas yield a proportion, which is modernized as the equation of the curves, and Apollonius shows in some detail how the equation may be simplified by suitable geometric choices and how properties of the conic sections may be obtained, such as the focal properties of conics and the construction of tangents.

Archimedes (c. 287–212 B.C.E.), a near contemporary of Apollonius, has earned a reputation as the greatest of the Greek geometers not only for the brilliance of his achievements, but also perhaps because they are easier to admire. He found volumes of sections of cones and various solid figures, he was the first to show that the constant (π) that enters the formulas for

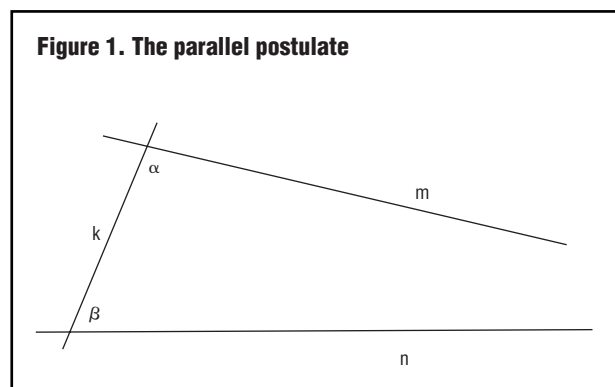

Figure 1. The parallel postulate

the circumference and the area of a circle is in fact the same, and he also made a number of practical and mechanical discoveries. He also left a unique account, known as the Method, of how he came to some of his discoveries by heuristic means, regarding areas as made up of lines that could be moved around. A tenth-century copy of this account was discovered in 1906 in a monastery in Istanbul. It was then lost again, but reappeared in 1998, when it was put on auction and sold for the surprisingly small sum of \$2.2 million.

Arabic and Islamic work on geometry. Islamic scholars did much more than simply transmit Greek ideas to the later West, as some accounts have suggested. They far surpassed all previous cultures in geometric design. They also produced the most penetrating analyses of the single most obvious weakness in all of Euclid's *Elements*: the parallel postulate. Euclid had assumed that if two lines m and n cross a third, k , and the angles α and β the lines m and n make with k are less than two right angles on one side of the line (in the figure $\alpha + \beta < 2$ right angles) then the lines will meet on that side of the line if they are produced sufficiently far (see fig. 1).

Unlike all Euclid's other assumptions, the parallel postulate makes claims about what happens arbitrarily far away and so could be false. However, very few theorems can be proved unless the parallel postulate is known, so mathematicians were in a quandary. Greek and still more Islamic commentators took the view that it would be better to drop the parallel postulate from the list of axioms, and to derive it instead from the other axioms as a theorem.

Remarkably, from Thabit ibn Qurrah (c. 836–901) to Nasir ad-Din at-Tusi (1201–1274), they all failed. To give just one example, Ibn al-Haytham (Alhazen; 965–1039) assumed that if a segment of fixed length and perpendicular to a given line moves with one endpoint on the line then the other end point draws a straight line, parallel to the given line. Certainly, the parallel postulate follows as a theorem if one may make this assumption, and the parallel postulate implies it, but this only invites the question: how can the assumption itself be proved, or is it merely an alternative assumption to the parallel postulate? Some years later, Omar Khayyám (1048?–?1131) objected to the assumption on just these grounds, arguing that it was an illegitimate use of motion in geometry to attempt to define a curve this way, still more to assume that the curve so produced was a straight line.

Modern Era

Significant Western interest in mathematics ebbed for a long time during and after the Roman Empire, before flowing at times in the Middle Ages. Only in the sixteenth century did a continual process of growth begin, aided by the rediscovery of Greek and Arabic texts and the publication of editions of Euclid's *Elements* and the works of Apollonius and Archimedes. At the same time, the discovery of the method of single-focused perspective transformed first architecture and then the practice of painting, where it produced a dramatically heightened realism. The technique proved eminently teachable, although few painters apart from Piero della Francesca (c. 1420–1492) also understood the mathematics involved.

Figure 2. Part of a surface of constant negative curvature

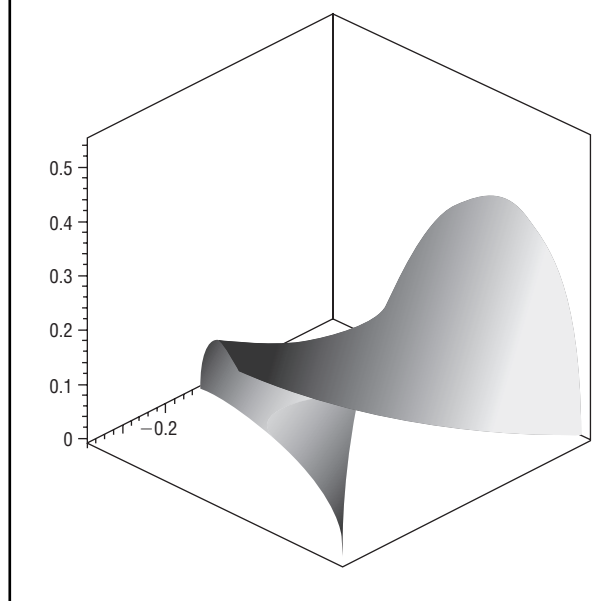

Analytic and projective geometry. Girard Desargues (1591–1661) brought together projective ideas from both architecture and painting to create the first fully unified theory of conic sections (all nondegenerate conic sections are projections of a circle). This theory naturally highlights those aspects that are projective (such as tangency questions) and it led directly or indirectly to a number of novel discoveries over the next century before it petered out. It was then rediscovered by Gaspard Monge (1746–1818) and Jean-Victor Poncelet (1788–1867) at the time of the French Revolution. In the form of simple horizontal and vertical projections it became the core technique of descriptive geometry or engineering drawing, a mainstay of French mathematical education throughout the nineteenth century, and, of course, it is still in use in the early twenty-first century.

Poncelet's breakthrough at the start of the nineteenth century was to see that, for many geometric properties a curve is equivalent to any of its "shadows" (its images under central projection). His own way of doing this was not found to be acceptable by later mathematicians, but Michel Chasles (1793–1880) in France and August Ferdinand Möbius (1790–1868) and Julius Plücker (1801–1868) in Germany all independently found more rigorous ways of making his insight work, and the resulting subject of projective geometry became the fundamental geometry of the nineteenth century. Although the details remained obscure for some time, the key point was that projective geometry discussed geometric properties of figures that do not involve the concept of distance. Any theorem in projective geometry is true in Euclidean geometry, but not vice versa, and so projective geometry is more basic than Euclidean geometry.

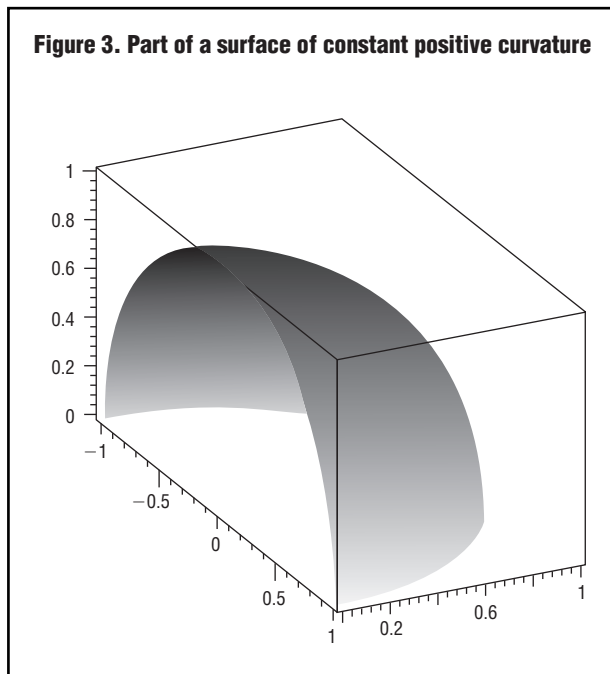

Desargues's contemporary, René Descartes (1596–1650) was much more successful with a work that was ruthlessly modern in its approach, and entirely eclipsed earlier attempts. Descartes took contemporary algebra, rewrote it in simpler notation, and proceeded to solve geometric problems by recasting them in algebraic terms and solving them by algebraic means, then reinterpreting the solution in geometric terms. Typically, the algebraic solution will be a single equation between two unknowns. Descartes interpreted this as defining a curve, and gave an elaborate discussion of how, given an equation, the corresponding curve can be drawn. He published his ideas as an appendix (entitled *La géométrie*) to a longer philosophical work in 1637.

Descartes did not explain the more elementary parts of his approach. This was done by a number of Dutch scholars who came after him, and the study of geometry by means of algebra (Cartesian, analytic, or coordinate geometry) was swiftly established. It took about a century for mathematicians to decide that the algebraic equation was an acceptable answer to a geometric problem, and to drop Descartes's search for geometric constructions, but the idea that geometric figures are naturally and fruitfully described by algebra has remained central to much of mathematics ever since.

Differential geometry. Differential geometry, on the other hand, began as the study of curves and surfaces where the calculus is allowed. It is connected to such questions as: when a map of the earth's surface (assumed to be a sphere) is made on a plane, what geometric properties can be preserved? The decisive reformulation of the early nineteenth century came when Carl Friedrich Gauss (1777–1855) investigated the curvature of surfaces in space. The curvature of a surface at a point (and generally the curvature of a surface varies from point to

point) is a measure of the best fitting sphere, plane, or saddle at that point (see figs. 2 and 3).

Gauss found that this quantity is intrinsic: it can be determined by measurements taken in the surface itself without reference to the ambient Euclidean space. This property was so unexpected Gauss called the result an exceptional theorem.

Gaussian curvature and the emergence of non-Euclidean geometries. After Gauss's death it emerged that he, alone of the mathematicians of his time, had had some sympathy with efforts to show that Euclidean geometry was not the only possible geometry of space, and indeed his astronomer friends Friedrich Wilhelm Bessel (1784–1846) and Heinrich Wilhelm Matthäus Olbers (1758–1840) had also inclined that way. This leads back to the question of the parallel postulate.

Around 1830 János Bolyai (1802–1860) in present-day Hungary and Nicolai Ivanovich Lobachevsky (1792–1856) in remote Kazan in Russia, wrote down and published detailed accounts of what a geometry would look like in which the parallel postulate was false and the angle sum of a triangle is always less than two right angles (reprinted in English translation in Bonola, 1912). Although independent, their work is remarkably similar and can be described together. They studied geometry in two and three dimensions, and found formulas for triangles in the plane analogous to the formulas of spherical trigonometry for triangles on the sphere. These new formulas showed that small regions of the new geometry differed only slightly from small regions of the Euclidean plane, thus explaining why the new geometry had not been noticed hitherto, but they also showed what many a previous defence of the parallel postulate had hinted at—that the new geometry was different from Euclidean geometry in many respects.

Such was the novelty of Bolyai's and Lobachevsky's work that few read it and the published responses to it were extreme in their hostility. Most people instinctively found it incoherent; they "knew" it was wrong but were not willing to find out where. Gauss, however, wrote to Bolyai to say that he agreed with János's presentation but implying that he knew it all already (a claim for which there is little surviving evidence). János was so enraged he never published again. In 1840 Gauss nominated Lobachevsky to the Göttingen Academy of Sciences, but did nothing else to promote the new geometry. The result was that both men died without getting the acclaim their discoveries undoubtedly merited.

Riemann's generalization for spaces of higher dimensions. The hegemony of Euclidean geometry came to an end not with the discoveries of Bolyai and Lobachevsky, but in stages, starting with Riemann's wholly novel approach to geometry that severely undercut it. Bernhard Riemann (1826–1866) was a student of mathematics at the University of Göttingen in the mid-1850s. In his postdoctoral thesis he set out the view that geometry was the study of any "space" of points upon which one could talk about lengths, and he indicated a variety of ways in which the techniques of the calculus could do such service. This is a rather natural and elementary idea, the problems come in spelling out the details in any useful way.

Riemann concentrated on intrinsic properties of the space, such as Gauss's idea of the curvature of a surface, and he noted that there would be different geometries on spaces with different intrinsic properties. That includes spaces of different dimensions, and also spaces of dimension two, say, but different curvatures. What it does not do is say that Euclidean space of some dimension is the source of geometric concepts, thus Euclidean geometry is overthrown.

Riemann's thesis was published posthumously in 1867, just in time to resolve the doubts of an Italian mathematician, Eugenio Beltrami (1835–1899), who had come to some of the same ideas. He immediately published his reworking of the geometry of Bolyai and Lobachevsky as the geometry of a surface of constant negative curvature, of which he had a description in a disc of unit (Euclidean) radius. Beltrami's map and Riemann's philosophy of geometry convinced mathematicians, but not all philosophers, of the validity of non-Euclidean geometry, as the Bolyai-Lobachevsky geometry became known.

Twentieth Century

There, curiously, Riemann's ideas remained for more than a generation. There was some interest in novel three-dimensional geometries, almost none in geometries, in Riemann's sense, of higher dimensions, except to show that mechanics could be done in such a setting, and in simplifying the formidable algebraic complexity of the subject (today handled by means of the tensor calculus). The decisive change came with the work of Albert Einstein (1879–1955).

Einstein's special theory of relativity of 1905 was a thorough reworking of the mathematics of motion, and at first Einstein was unsympathetic to the geometrical reworking given to his ideas by Hermann Minkowski (1864–1909) in 1908. But when Einstein started to think of a general theory of relativity that would find an equivalence between forces and accelerations, he found the ideas of Riemannian differential geometry invaluable. The theory he came to in 1915 formulated gravitation as a change in the metric of space-time. On this theory, matter changes the shape of space, which is how it exerts its attractive force.

Felix Klein's Erlangen program. By the 1870s, projective geometry had established itself as the fundamental geometry, with Euclidean geometry as a special case, along with some other geometries not described in this essay. The young German mathematician Felix Klein (1849–1925) then proposed to unify the subject, by treating projective geometry as the main geometry, and deriving the other geometries as special cases. Every geometry Klein was interested in, most strikingly non-Euclidean geometry, was defined on projective space or a subset of it, and the relevant geometric properties were those kept invariant by the action of a suitable subgroup of the group of all projective transformations. This view, called the Erlangen Program, after the university where Klein first published it, has remained the orthodoxy since the 1890s, when Klein republished it, but in its day the novelty was the explicit introduction of the then-novel concept of a group, and the shift of attention from properties of figures to the idea that these properties are geometric precisely because they are invariant under the appropriate group of transformations.

Italians, Hilbert, and the axiomatization of geometry.

Klein's geometries do not include many of the geometries Riemann had pointed toward. It included only those that have large groups of transformations, which, however, is most of those of interest in physics and much of mathematics for a long time, including, it was to transpire, Einstein's special theory of relativity. The first step beyond what Klein had done, and for that matter Riemann, was proposed by David Hilbert (1862–1943), starting in 1899, although a number of Italian geometers had had similar ideas in the decade before.

Hilbert was insistent that theorems in geometry should only use the properties of objects that entered into their definitions, and to this end he formulated elementary geometry carefully in terms of five families of axioms. What distinguished his work from his Italian predecessors was his insistence that there was an interesting new branch of mathematics to be explored, which studied axiom systems. It would aim at showing the independence of certain axioms from others, and establishing what sorts of axioms were needed to deduce particular results. Whereas the Italian mathematicians had mostly aimed at axiomatizing projective and perhaps Euclidean geometry once and for all, Hilbert saw the axiomatic method as both creative and of wide applicability. He even indicated ways in which it could work in mathematical physics.

By 1915, the axiomatization of geometry had begun to spread to other branches of mathematics as well, with a consequent improvement in the standards of formal proof, and Einstein's general theory of relativity had similarly improved the ideas about the applications of geometry.

See also Cosmology: Cosmology and Astronomy; Greek Science; Islamic Science; Mathematics; Physics; Relativity.

BIBLIOGRAPHY

- Berggren, J. Len. *Episodes in the Mathematics of Medieval Islam*. New York: Springer-Verlag, 1986.
- Bonola, R. *History of Non-Euclidean Geometry*. Translated by H. S. Carslaw, preface by F. Enriques. Chicago: Open Court, 1912.
- Bos, Henk. J. M. *Redefining Geometrical Exactness: Descartes' Transformation of the Early Modern Concept of Construction*. New York: Springer-Verlag, 2001.
- Field, Judith V., and Jeremy J. Gray, eds. *The Geometrical Work of Girard Desargues*. New York: Springer-Verlag, 1987.
- Fowler, David H. *The Mathematics of Plato's Academy: A New Reconstruction*. 2nd ed. Oxford: Clarendon, 1999.
- Gray, Jeremy J. *The Hilbert Challenge*. Oxford: Oxford University Press, 2000.
- . *Ideas of Space: Euclidean, Non-Euclidean, and Relativistic*. 2nd edition. Oxford: Oxford University Press, 1989.
- Hilbert, David. *Foundations of Geometry*. 10th English edition, translation of the second German edition by L. Unger. Chicago: Open Court, 1971.
- Høyrup, Jens. *Lengths, Widths, Surfaces: A Portrait of Old Babylonian Algebra and Its Kin*. New York: Springer-Verlag, 2002.
- Jaouiche, K. *La théorie des parallèles en pays d'Islam: Contributions à la préhistoire des géométries non-euclidiennes*. Paris: Vrin, 1986.

Robson, Eleanor. "Neither Sherlock Holmes nor Babylon: A Re-assessment of Plimpton 322." *Historia Mathematica* 28 (2001): 167–206.

Salmon, Wesley C., ed. *Zeno's Paradoxes*. Indianapolis: Bobbs-Merrill, 1970.

Jeremy Gray

GESTURE. The concept of gesture suffers to some extent from insufficiently defined and imprecisely drawn outlines of what we understand by this term. The *Oxford English Dictionary* defines gesture as any "significant movement of limb or body"; Merriam Webster's *Collegiate Dictionary* defines it as "any movement of the body, or part of the body, that expresses or emphasizes an idea, sentiment or attitude." However varied the definitions may be, they always contain the same element: a gesture is a combination of a body movement (or a bodily posture) and a meaning. It is generally assumed (and borne out by social practice) that this combination is understood by the outside spectator, and hence functions as a means of communication.

Taking the concept in its broadest sense, gestures can be roughly divided into two major types. One type consists of conventionalized body movements or limited actions, such as pointing with the hand and the outstretched index finger, or shaking hands. These movements have a firmly established, "timeless" meaning. They are consciously performed, and since their meaning is instantly and clearly understood, they play a significant part in everyday communication, and have a role in the arts.

The other group of gestures consists of body movements made without conscious intention, often even without a person's being aware of performing them. Nevertheless, they can clearly convey some meaning, and are thus understood as communicating some message. Blushing is interpreted as a sign of shame; going pale is understood as a sign of sudden fear. Though in fact it is sometimes hard to tell such gestures from symptoms in medicine, the study of gestures must also consider such "natural" occurrences.

Conventionalized body movements in particular play an important and often highly visible part in many domains of social life. Both their shapes and meanings have been preserved for many ages. One thinks, for example, of the religious sphere. The gestures of kneeling and folding the hands in prayer are in no need of explanation in the Western world, nor are the movements of the priest officiating at Mass, especially in the elevation of the host and in other religious rituals. In different parts of the world, with various religions and rituals, equivalent gestures, even if somewhat dissimilar in their execution, have been developed for worship and are instantly understood.

The military is another domain in which the shape of at least some body movements is given much attention. Of individual military gestures, gait and the salute instantly come to mind. Military education explicitly cultivates certain modes of body movement, seeing such performance as expressing an overall spirit.

Highly conventionalized gestures are not found only in special fields; they abound in all domains of established social life.

When a witness stands up in court and raises his hand to take an oath, or when a man lifts his hat to greet an acquaintance on the street, he is performing a highly conventional gesture that has a long history.

Some conventional gestures have become so fully crystallized in themselves, and what they convey has become so deeply engraved in our minds, that they could be detached from the figure performing them. One example of such an independent gesture, detached, as it were, from the person making it, is the movement of making the sign of the cross; another is a hand with outstretched index finger pointing in a direction.

Conventional gestures have often been defined as a universal language, and the question of whether gesture language has, or does not have, a grammar, has occupied scholars. The most developed codification of gestures is found in the sign language of the deaf. Other attempts at linguistic codification of gestures are known from history, a well-known example being that of the Cistercian monks who, abstaining from speech as part of their ascetic life, developed a sign language and even prepared a dictionary of the most frequently performed body movements that replaced spoken words.

The Study of Gestures

The interpretation of gestures, their origin, and the long history of gesticulation, has attracted the attention of students whose discussions, even if intermittent, have shed interesting



Sculpture relief depicting the goddess Tyche of Palmyra. Throughout history, from ancient civilization to contemporary times, works of art have frequently incorporated gestures to convey mood and concept.

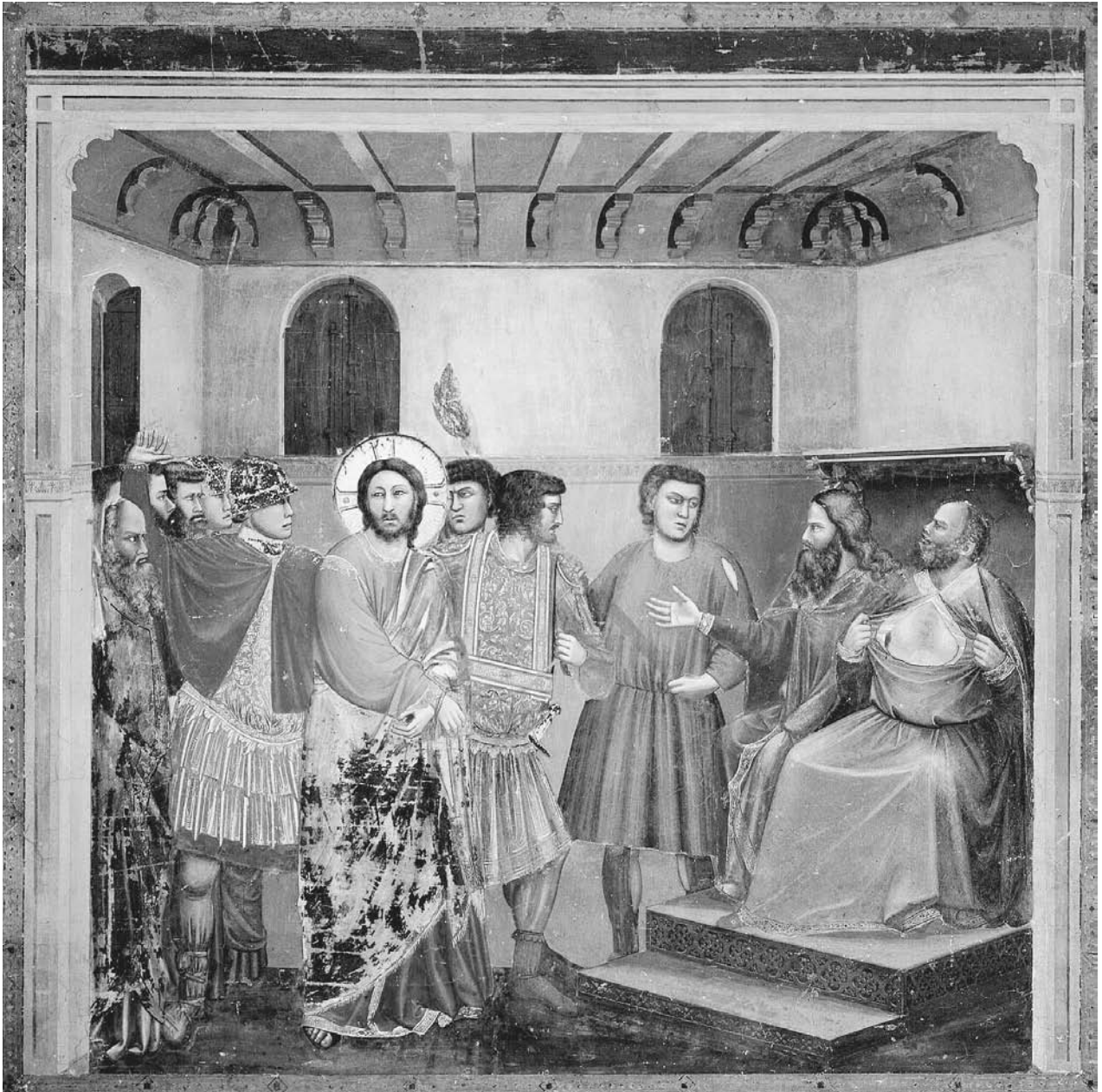

Christ before Caiaphas (1304–1306) by Giotto di Bondone. Fresco. Gestures have long been a part of religious ritual and imagery. Many gestures of this genre, though they may differ from faith to faith, are universally recognizable. THE ART ARCHIVE/SCROVEGNI CHAPEL PADUA/DAGLI ORTI (A)

light on the problems that emerge in the study of gestures. In recent decades, concern with the human body and its manifold manifestations has attracted increasing attention to gestures, both conventional and spontaneous.

Reflections on gestures, however fragmentary, are found in the literature of early history. In the Bible, prayer gestures are described as self-evident: “And when ye spread forth your hands, . . . when ye make many prayers” (Isaiah 1:15). Reflections on specific gestures are scattered throughout the literature

of classical antiquity, especially in texts on physiognomics and rhetorics, but references to gesticulation are also found in other writings. Homer abounds in allusions to gestures and expressive movements, as may be seen for instance in his reference to mourning (*The Iliad*, 18:23–27).

In Roman civilization the “eloquence of the body” (*eloquentia corporis*) commanded a great deal of attention. Two categories of professionals in particular, orators and actors, studied gesture intensively. Bodily gestures follow movements of the



Coin depicting Roman Emperor Domitian at surrender of Germany. Distinctive gestures have been a component of military organization since ancient times. Ritualized gestures are frequently seen as a method of fostering unity among soldiers.

soul. Cicero compared man's body, face, and voice to the strings of a harp: "They sound just as the soul's motion strikes them" (*De oratore* 3.216). And Quintilian says simply: "Gesticulation obeys our mind" (*Institutio oratoria* XI, chap. 3, 65). The most detailed and careful description of gestures that survives from ancient literature is found in Quintilian (XI, chap. 3). Since he saw gesticulation as part of the delivery of a speech, he included a discussion of gestures in his teaching of oratory. The Roman stage was another place for the formalization of gestures. As stock types were preferred on the stage, gestures were basic and strictly codified. Broad gestures, such as shaking the head or slapping the thigh in anger, were typical of slaves.

In antiquity, another field of knowledge pertaining to our subject was defined and flourished: physiognomics, the reading of character from the structure and movement of body and face. The literary legacy of ancient physiognomics influenced thought in modern times. The works of the Renaissance scholar Giambattista della Porta, the great French artist Charles Le Brun (around 1700), and the Swiss scholar Johann Lavater in the eighteenth century are ample testimony to this influence in the culture of Europe.

In the Middle Ages, especially in the earlier part of the period, codified gestures seem to have played a particularly important part in legal transactions. Since most people could not read or write, documents were frequently validated through the use of prescribed gestures. A richly illuminated late medieval manuscript, the *Sachsenspiegel*, gives us some inkling of the variety and role of conventional gestures in the legal and political life of the time.



Supplicating barbarian. Bronze figurine. Gesture and physicality commanded a great deal of attention in ancient Roman culture. Gestures in stage productions of the period were often broad and eloquent.

In Renaissance culture, which gave so much thought and attention to the comportment of people (especially the nobility) and to their education, the problem of gesture was approached from a new point of view. The concern was with how the educated should behave in their bodily presentation, and how the child and young person should be taught so that, as an adult, he or she would behave in a proper manner. Some of the central figures in Renaissance culture, such as Baldassare Castiglione, author of *The Courtier*, and Desiderius Erasmus, devoted much attention to proper gesticulation. Erasmus wrote a little book on the education of children (*Institutio principis Christiani* [1516; *Education of a Christian Prince*]) which in the sixteenth century alone went through eighty editions in Latin, and was certainly a factor in forming habits of movement and views of gesture.

In spite of this long history, however, it is safe to say that the critical, scientific study of gestures is a product of the nineteenth century. It was also then that the major approaches to the interpretation of gesture crystallized. Reduced to basic distinctions, two lines of thought emerge. One of them may be called universal language (or universalizing), the other particularistic (or particularizing).

The notion of gesture as a universal language is based upon the assumption that all people and societies in all ages make



Illustration of hand and facial gestures. Comprehensive study and classification of gestures did not properly begin until the nineteenth century. Early pioneers in the field were Charles Darwin and Wilhelm Wundt.

essentially the same gestures under similar conditions and as a response to similar situations. This interpretation was put forward in explicit and systematic form for the first time by Charles Darwin in his *The Expression of the Emotions in Man and Animals* (1872). In this work Darwin devoted a great deal of attention, both in particular observations and in comprehensive classification, to gestures of the body and the face. Summing up his ideas, he says that he has “endeavored to show in considerable detail that all the chief expressions exhibited by man are the same throughout the world.”

When we consider Darwin’s work within the earlier prevailing tradition of interpreting human gestures, two features stand out. First, Darwin’s observations are exclusively observations of

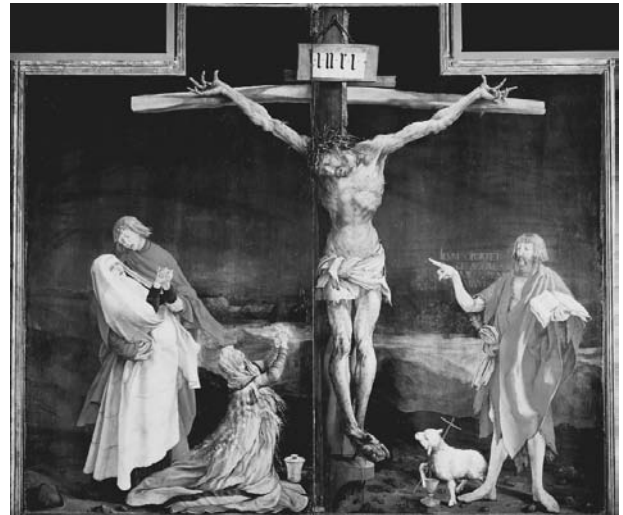

Crucifixion of Christ (1515) by Matthias Grunewald. From the Isenheim Altarpiece, oil on wood. During the Renaissance, much emphasis was placed on bodily comportment and gesticulation, a trend readily apparent in creations by artists of the period. PHOTO CREDIT: ERICH LESSING/ART RESOURCE, NY

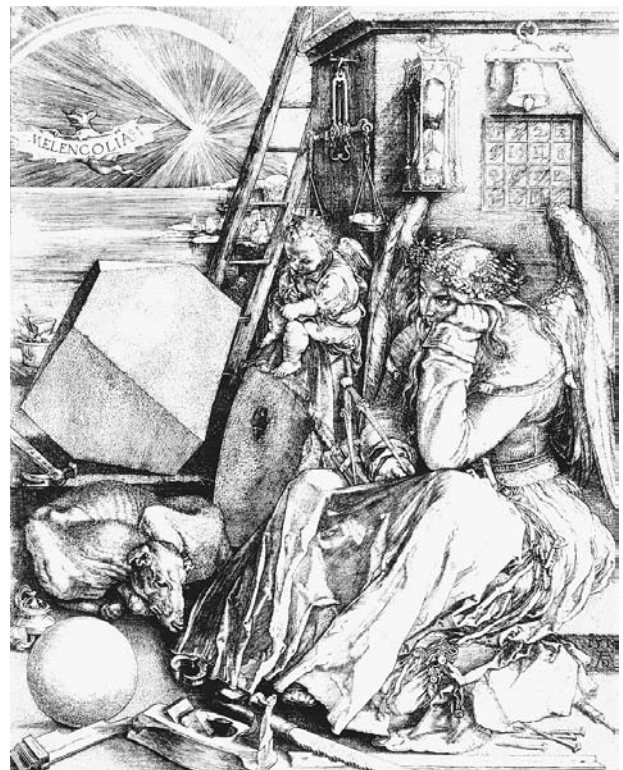

Melencolia I (1514) by Albrecht Dürer. Line engraving. A gesture does not always require movement to be understood. Often, the positioning of the body is enough to indicate mood or meaning. THE GRANGER COLLECTION, NEW YORK



Quarrel in Naples, by Andrea de Jorio. In 1832 de Jorio published a study of the gestures of his fellow Neapolitans. He sought to understand how ancient gestures were manifested in contemporary society as a means to interpret the body movements in classical plays.

nature, that is, observations of the behavior of living creatures; he excludes literary texts or pictorial representations. The cultural artifact is beyond the scope of his study. In the introduction he even explicitly states that the artistic representation of figures dominated by an emotion (suffering) follows principles differing from those of nature, and are therefore misleading as materials for the student of natural reality. Second, an idea permeating Darwin's study is that there is a continuity from the bodily behavior and gesticulation of some kinds of beasts to the gestures commonly performed by human beings. While there are some gestures that are characteristic only of man, most of the expressive movements are found, to some degree, in certain classes of animals.

One of the many examples that Darwin adduces is the facial expression of rage. The physiognomic changes undergone by a human in the grip of rage, and the typical gestures he or she performs in this condition, have occupied the human mind in all ages; already in antiquity books were being written on the subject—for example, Seneca's *De ira*. In art the features of an angry man's face have been firmly established. Darwin finds the physiognomic contortions of the angry human face also in beasts, in such expressions as snarling and prominently exhibiting the teeth. "Considering how seldom the teeth are used by men in fighting," he says, the "retraction of the lips and the uncovering of the teeth during paroxysms of rage, as if to bite" are remarkable. In this facial gesture the memory survives of our ancestors, the higher primates, that still really fight with their teeth. This theory further supports the doctrine of the universality of gesture language.

The influential German scholar Wilhelm Wundt, who in 1900 published the first volume of his *Völkerpsychologie*, which contains an extensive discussion of gesture, claimed that primordial speech was a kind of gesticulation that "mirrored the soul."

In modern kinesics, the systematic study of the relationship between nonlinguistic body motions and communication, and related fields of study (especially some branches of linguistics), communicating gestures are regarded as a kind of language, possibly even the predecessor of spoken language in general. Students have compiled dictionaries of expressive body movements. Of particular interest are collections of such movements performed by aboriginals. In the background of these scientific studies one finds the idea of gesture as a universal language.

The other, altogether different interpretation of the origin of gestures sees individual modes of behavior, as they developed in small groups living under specific conditions, as the true origin of, and the force shaping, our expressive movements. The first text of modern gesture study presented this view. *La mimica degli antichi investigata nel gestire napoletano*, written by Andrea de Jorio, a cleric from Naples with wide intellectual interests, was published in 1832. In this work, which may be considered the birth certificate of the modern discussion of gestures, the author devotes his main efforts to the observation and description of the actual gestural behavior of Neapolitans of his day. The northern nations, de Jorio believes, are restrained in gesture; southerners, especially people living in and around Naples, have rich gesticulation. His motive, however (as he explicitly states

it), was not to study the habits of contemporary Neapolitans. He wanted to contribute to a better understanding of the plays of antiquity. De Jorio believed that there was a long and continuous tradition leading directly from some of the ancient communities to people in the Naples area in the early nineteenth century. In this tradition gestures were transmitted through the ages, and if we look at people in Naples we can, therefore, grasp what ancient poets meant when in their plays they alluded to body movements. Gestures, then, do not have a universal origin, but emerge from specific conditions prevailing in individual societies. Gestures are inherited from such particular traditions and remain in use for ages.

In the middle of the twentieth century this trend of thought received a classic formulation from the French anthropologist Marcel Mauss. His most influential study of the subject, “*Les techniques du corps*,” reverberates in the study of gesture to this day. Mauss describes his approach as “descriptive ethnology” and focuses on the specific forms of gesticulation in specific societies. Based on heritage and tradition, we continue to perform gestures in the form we inherited from former generations and as they were shaped by education and experience. He focuses on social and cultural differences rather than a supposed common origin and universal validity. Mauss believed that he could identify a girl educated in a convent by her comportment and way of walking: she will walk with her hands closed into fists.

Another view of the particular interpretation of gestures is the influential concept of the body and its manifestations as formulated by the anthropologist Mary Douglas in which she perceives the body as a symbol of social relations. As social relations change, the body and its movements—the gestures we make—manifest these changes.

Gestures in the Arts

Gestures play a significant part in the arts, particularly in the performing and visual arts, as the history of these arts makes clear. In antiquity, especially in the Roman period, a particular category of theater play emerged, the pantomime. (*Pantomimus* meant both the play and the actor performing it.) The main characteristic of the pantomime was that it replaced the spoken text with a wide range of gestures, including dance. We know that whole tragedies were performed without the actor uttering even a single word, using instead a highly developed system of postures and gestures. In the sixth century C.E. Cassiodorus still characterizes the activity of the pantomime actor by describing his “speaking hands,” his fingers that are similar to tongues, and his “loud sounding silence.”

The origin of the pantomime is believed to have been the Dionysian feast in Egypt inaugurated during the rule of the Ptolemies. The multinational, and hence also multilingual, composition of society and army in the Roman Empire probably favored an art form that did not rely on a specific language and thus evaded linguistic limitations. The pantomime reached a peak of popularity in the imperial period in Rome. Pantomime actors, quite a few of whom are known to us by name, seem to have been idols of Roman society. When the emperor Augustus exiled a famous pantomime player, Pylades, from Italy, the reaction of popular audiences in the

capital was so powerful that the ruler had to cancel his edict and bring the banished actor back to Rome. The pantomime as a particular genre had a long life, and in the course of centuries many fathers of the church, among them Tertullian, Clement of Alexandria, and Minucius Felix, violently condemned such performances. In the year 305 the Church Council of Elvira decided that a pantomime actor who wanted to convert to Christianity had to give up his profession.

In the Middle Ages the pantomime did not persist as an independent genre, but the gesticulation of the actors in a medieval performance (which took place in a church or town square) was pronounced and exaggerated, often even grotesque. A good deal of the effect these plays had on their audiences was achieved by means of expressive body movement. Grotesque gesticulation plays a major part from medieval plays to performances of the *commedia dell'arte*. In modern times the performance based largely on body movements has had a long and eventful history. The recent inheritors of this tradition are the modern ballet and, more rarely, actual pantomime performances.

Since the time of the Egyptian and Mesopotamian cultures, the representation of gestures in painting and sculpture has been a central means of conveying moods, ideas, and even more conceptual messages. The great artists of all centuries, especially since the Renaissance—among them Leonardo da Vinci, Michelangelo, Gian Lorenzo Bernini, Rembrandt, and up to some works by Picasso—created classic formulations of gestural motifs that have impressed themselves profoundly on the modern cultural memory.

See also *Anthropology; Body, The; Cultural Studies; Theater and Performance*.

BIBLIOGRAPHY

- Barasch, Moshe. *Giotto and the Language of Gesture*. Cambridge, U.K.: Cambridge University Press, 1987.
- Bremmer, Jan, and Herman Roodenburg, eds. *A Cultural History of Gesture*. Ithaca, N.Y.: Cornell University Press, 1992. Includes a useful bibliography.
- Brilliant, Richard. *Gesture and Rank in Roman Art: The Use of Gestures to Denote Status in Roman Sculpture and Coinage*. New Haven, Conn.: Academy, 1963.
- Darwin, Charles. *The Expression of Emotions in Man and Animals*. London: F. Pinter, 1983. First published in 1872.
- Douglas, Mary. *Natural Symbols: Explorations in Cosmology*. New York: Pantheon, 1970.
- Jorio, Andrea de. *La mimica degli antichi investigata nel gestire napoletano*. Naples, 1832. English translation published as *Gesture in Naples and Gesture in Classical Antiquity*, edited by Adam Kendon. Bloomington: Indiana University Press, 2000.
- Kendon, Adam, ed. *Nonverbal Communication, Interaction, and Gesture*. The Hague: Mouton, 1981.
- Mauss, Marcel. “*Les techniques du corps*.” *Journal de psychologie normale et pathologique* 39 (1935): 271–293. English translation appears in Mauss, *Sociology and Psychology*, 97–123. London: Routledge, 1979.
- Schmitt, Jean-Claude. *La raison des gestes dans l'Occident médiéval*. Paris: Gallimard, 1990.
- Sittl, Karl. *Die Gebärden der Griechen und Römer*. Leipzig: Teubner, 1890.

Moshe Barasch



Jewish family in Nazi ghetto, Lublin, Poland, c. 1941. Although the term *ghetto* has evolved to serve as a name for any poor urban neighborhood, it was originally used in the sixteenth century to denote an area in which Jews were forced to live. AP/WIDE WORLD PHOTOS

GHETTO. The name of a district in sixteenth-century Venice where Jews were required to live, *ghetto* came to be the name for any segregated Jewish quarter. The name was applied (1) to compulsorily segregated Jewish residential districts in Europe between 1516 and 1870; (2) to urban areas of first settlement of Jewish immigrants and their distinctive culture after about 1880; and (3) from 1940 to 1944, to rigidly segregated districts in German-occupied European cities where the occupiers imprisoned Jews before methodically murdering them.

As a striking historical example of recurring policies of marginalization and demonization, *ghetto* was also applied to phenomena of Western history unconnected with Jews. In the nineteenth century, the term came to refer to (1) urban concentrations of distinctive businesses, classes, and ethnic groups. In the twentieth century in the United States, the term was applied to ethnic neighborhoods, particularly to (2) black neighborhoods in northern cities. Other urban areas have been called “the hippie ghetto,” “Pakistani ghettos in the (English) midlands,” and “the golden ghetto.” Before the Enlightenment, mention of the ghetto was meant to arouse re-

vulsion at the inhabitants; afterward, its mention could also be meant to evoke indignation at the infliction of shame and suffering.

Jewish Urban Quarters before the Ghetto

Diaspora Jews in late antiquity and the European Middle Ages lived together voluntarily, for security and communal convenience, in urban neighborhoods that were called *Judengasse*, in German-speaking countries; *giudecca*, *Judaica*, *juiverie*, *carrière*, or *juderia* in Romance-speaking countries; and, in Muslim countries, equivalents of Harat-al-Yahud, “the Jewish quarter.” Besides these voluntary Jewish enclaves, in which non-Jews also lived, medieval governments occasionally attracted Jews to settle in undeveloped regions by reserving special areas for them. These voluntary Jewish districts were usually walled and gated.

A different form of restricted residence that affected millions of Jews was the Russian Pale of Settlement, covering four hundred thousand square miles between the Baltic and Black seas, defined in 1791 and abolished after the 1917 revolution. Between 1772 and 1795, Russia, which had no Jews, annexed Polish territory with a large Jewish population. It restricted Jewish residence to some of the annexed territory, which Czar Nicholas I (reigned 1835–1855) gave the name “Pale of Settlement.” In the course of the nineteenth century, Jews, who were a minority in these territories, were expelled from villages and compelled to live in towns and cities, and were limited to certain occupations. These regulations, which by 1897 applied to nearly five million Jews, became onerous at a time when restrictions on other population groups were relaxed. Pauperization, legal restrictions, and hostility in the pale provoked mass Jewish emigration, which flowed to the ghettos in other countries.

Establishment of Ghettos

To control heresy, the Roman Catholic Church tried at times to separate Jews from Christians. Separation became a widespread policy from 1300 to 1600, when England, France, Spain, and Portugal expelled Jews, and many German and Italian cities enacted strict controls on those who were allowed to remain. Venice first permitted Jews to residence in 1513 and in 1516 required them to settle in the *ghetto nuovo*, the “new foundry” district, which it encouraged Christians to leave. The city later allowed Jewish settlement in other districts, the *ghetto vecchio* and the *nuovissimo ghetto*.

In 1555, as part of Counter-Reformation policy, Pope Paul IV (reigned 1555–1559) restricted Jewish residence in papal territories to segregated quarters, which by 1562 were called “ghettos.” Through the eighteenth century they were established in western and central Europe. “Ghetto” conventionally evoked a forbidding image of impoverished Jews who lived locked behind walls from dusk to dawn in crowded, narrow streets, under their own authorities. During the French revolutionary wars, Napoleon Bonaparte (1769–1821) abolished ghettos and granted citizenship to Jews; this became permanent during the nineteenth century. The last ghetto, in Rome, was abolished in 1870.

Ghetto as Metaphor for Slum

The image of the ghetto was applied to a variety of situations. The *Oxford English Dictionary* records *ghetto* as referring in 1887 to a neighborhood of book dealers. In 1903, Jack London compared the ghetto to the misery of slums inflicted on workers—only a small percentage of them Jews—by the unrestrained operation of *laissez-faire* economics:

At one time the nations of Europe confined the undesirable Jews in city ghettos. But today the dominant economic class, by less arbitrary but nonetheless rigorous methods, has confined the undesirable yet necessary workers into ghettos of remarkable meanness and vastness. East London is such a ghetto, where the rich and the powerful do not dwell, and the traveler cometh not, and where two million workers swarm, procreate, and die.

The areas of first settlement by the mass immigration of Russian and Polish Jews to the United States, between 1880 and 1924, were called ghettos. Some earlier settlers considered these immigrants—like those from Italy, Poland, Scandinavia, and Asia—threats to American morality, hygiene, economics, and race. The immigrant “ghetto slums” lasted for a generation or two, until most inhabitants moved away or became invisible by learning English and adopting the manners and clothing of the country.

Black Ghettos

Large numbers of black Americans in search of economic and social opportunities also arrived in northern cities in waves of internal migration during World War I, World War II, and the 1950s. They often first settled in immigrant neighborhoods, and the terms *ghetto* and *slum* came to refer to visible poor black neighborhoods that did not disappear through assimilation. Sociologist Kenneth Clark wrote:

America has contributed to the concept of the ghetto the restriction of persons to a special area and the limiting of their freedom of choice on the basis of skin color. The dark ghetto’s invisible walls have been erected by the white society, by those who have power, both to confine those who have no power and to perpetuate their powerlessness. . . . The objective dimensions of the American urban ghettos are overcrowded and deteriorated housing, high infant mortality, crime, and disease. The subjective dimensions are resentment, hostility, despair, apathy, self-depreciation, and its ironic companion, compensatory grandiose behavior.

Many social scientists later discarded the ghetto metaphor because it carried misleading expectations that the underclass in the inner city would also disappear automatically.

Nazi Ghettos

Between 1939 and 1944, Nazi racial ideology was put into operation in German-occupied Europe. The occupiers separated Jews from other subject peoples and imprisoned them in more

than one thousand ghettos, which the Germans did not consistently give that name. The Germans ruled through governing councils that they selected. The occupiers allowed disease to spread widely and imposed both starvation rations and the death penalty for smuggling food.

Hans Frank, chief of the Generalgouvernement of Poland, summarized the policy in August 1942 when he stated that if the Jews did not die of starvation, other measures would need to be taken. The Germans liquidated all the ghettos, and sent the survivors to extermination camps. Under these conditions, the Jews’ attempts to preserve normal communal life and to demonstrate their productivity qualify as resistance, but the desperate armed uprising by the last inhabitants of the ghetto in Warsaw, in April and May 1943, added an unprecedented association to the term *ghetto*.

See also Anti-Semitism; Ethnicity and Race; Genocide; Resistance; Segregation.

BIBLIOGRAPHY

- Clark, Kenneth B. *Dark Ghetto: Dilemmas of Social Power*. New York, Evanston, Ill., and London: Harper and Row, 1965.
- “Ghettos.” In *The Holocaust Encyclopedia*, edited by Walter Laqueur, 259–265. New Haven, Conn., and London: Yale University Press, 2001.
- Gutman, Yisrael. *The Jews of Warsaw, 1939–1943: Ghetto, Underground, Revolt*. Bloomington: Indiana University Press, 1982.
- London, Jack. *The People of the Abyss*. London and Sterling, Va.: Pluto Press, 2001. Originally published in 1903.
- Ravid, Benjamin C. I. “From Geographical Realia to Historiographical Symbol: The Odyssey of the Word Ghetto.” In *Essential Papers on Jewish Culture in Renaissance and Baroque Italy*, edited by David B. Ruderman, 373–385. New York: New York University Press, 1992.
- Slutsky, Yehuda. “Pale of Settlement.” In *Encyclopedia Judaica*, columns 24–28. Jerusalem: Encyclopedia Judaica, 1971.
- Ward, David. *Poverty, Ethnicity, and the American City, 1840–1925: Changing Conceptions of the Slum and the Ghetto*. Cambridge, U.K., and New York: Cambridge University Press, 1989.
- Wirth, Louis. *The Ghetto*. New Brunswick, N.J.: Transaction, 1998. Originally published in 1928.

Arthur M. Lesley

GIFT, THE. Reflection on gifts and their paradoxes goes back to the Bible, where humans are reminded that everything they have is a gift from God, for which they must be grateful and which should inspire them to give to others. Yet the Scriptures also condemn gifts, as those to judges, which corrupt or harm. Greek literary texts describe a wide range of gift practices, from the honorable gifts among warriors to the strategic hospitality to foreigners, but also warn of ambiguities, as in the saying “the gifts of enemies are not gifts.”

Aristotle’s (384–322 B.C.E.) *Nichomachean Ethics* embedded gifts and benefits in his discussion of the virtue of liberality, the forms of friendship, and the varieties of just distribution. Here, too, there were good gifts and bad: the liberal person

gave “to the right people the right amounts and at the right time,” the prodigal person bestowed gifts on flatterers and other wrong people, and received from bad sources as well. Aristotle saw giving-and-taking and buying-and-selling as versions of the exchange and reciprocity that held society together, but giving-and-taking was his preferred model. Humans “give a prominent place to the temple of the Graces—to promote the requital of services; for this is characteristic of grace—we should serve in return one who has shown grace to us, and should another time take the initiative in showing it” (bk. 4, ch. 1, pp. 1120a 25–26; bk. 5, ch. 5, pp. 1133a1–5). Giving-and-taking had a utilitarian element to it, but it also drew on feelings of gratitude.

Gratitude is a central theme of Seneca’s (4 B.C.E.–65 C.E.) *On Benefits*, the other great gift-text of classical times. Gratitude was a “natural” response to a gift, benefit, or kindness, and this would generate further generosity in the recipient. The ungrateful person was detestable. Seneca explored all the fine points of giving and receiving, including between persons of unequal status. Of return on the gift, there should ideally be no expectation by the donor: “to bestow a favor in hope to receive another is a contemptible and base usury” (bk. 1, chap. 6, p. 6). Even more than Aristotle, Seneca contrasted the rules for gifts with the rules for sales and loans, especially in regard to the time for rewarding a benefit: the person who “requited a kindness with too much haste hath not the mind of a grateful man, but of a debtor” (bk. 4, chap. 40, p. 178).

Biblical, classical, and patristic texts nourished the Christian writing on gifts during the medieval period, even while thinkers responded to new socioeconomic relations and political and religious institutions. Gift subjects flowed into diverse channels: writings on the church as an object of charitable donation and an instrument for dispensing charity; on the Mass as a heartfelt sacrifice to God; on the virtue of charity and the vice of avarice; on various kinds of poverty and the meaning of alms; on the importance of hospitality, both ecclesiastical and feudal. Similarly, in the fifteenth, sixteenth, and seventeenth centuries, giving-and-taking themes clustered around diverse subjects: the liberality of the nobleman and noblewoman and the ordering of their obligations; the gifts of kings and queens, and whom they should reward; charitable donations to the poor, and how they should be organized; gifts of parents to children, and how they should be decided. At the same time, gifts were quarreled about and denounced as wrongful. The gifts that were omnipresent in the quest for favor in the political life of early modern polities were condemned as “corruption,” especially when they went to judges, and the word *bribe* became part of parlance in English. Sermons warned against alms to the “undeserving poor” among the beggars and vagabonds, now identified more sharply than ever before. Meanwhile, the Protestant Reformation and Catholic Counter-Reformation of the sixteenth and seventeenth centuries offered alternate concepts of the meaning of sacrifice and of how gratitude for God’s gifts should express itself in human behavior.

Disparate though this writing was, it was still linked by the common belief in the necessity for gratitude: the world was a gift from God, for which one should be grateful and be moved

to generosity. The three Graces were often depicted in emblem books, with the message of reciprocity repeated.

The notion of a single realm of gift, as something to generalize about beyond the movement of gifts in diverse places and forms, emerged only after the idea of the economy or of the political economy. By the mid-eighteenth century, as colonial markets and European markets expanded and fields of social thought sought “scientific” systematization, tracts on trade had names such as *Tableau Oeconomique* or *Inquiry into the Principles of Political Oeconomy*. Gifts had little role in these texts, not because gifts had ceased to exist, but because the new theories left little room for them. Whatever he had said about sympathy in his early *Theory of Moral Sentiments*, Adam Smith’s (1723–1790) *Wealth of Nations* (1776) is based on persons seeking their own advantage as they sell and buy goods on the market. Harmony came from the pursuit of self-interest, not through the alliance of gift-giving generating more gifts. Jeremy Bentham (1748–1832) allowed a prudently limited benevolence in his calculus of morals, as in the pleasure of giving a friend something for nothing, but a person could enjoy the same pleasure from a gain through exchange.

Interestingly enough, when Karl Marx (1818–1883) came to criticize political economy, he too left little space for gift relations. Linen, silk, paper, watches, and other useful things become “commodities” when they are put into exchange under the capitalist mode of production. The human labor that went into preparing them and gives them their true value is hidden in capitalist exchange. Instead the things themselves are assigned value: commodities are “fetishized,” that is, the social relations of labor are transmuted into relations between things exchanged on the market. Marx made no analysis of what happened to things and the perception of things when they passed as gifts. His countermodels were patriarchal peasant production, where things stayed within the family (he did not discuss their internal distribution), and the performance of services and payments in kind under the “personal dependence” of feudal society. Charity and other gift forms were presumably among the “idyllic” relations and illusions torn up by the “naked self-interest” of capitalism. Even his image of a future society, where the means of production were held in common, stressed “free individuals” and “free development for each” rather than patterns of sharing.

Other critics of political economy, especially in late nineteenth-century Germany, found in gift-giving an alternate approach. By the time the French sociologist Marcel Mauss (1872–1950) began his great work on the gift, he could draw on historical studies such as Richard Meyer’s *Zur Geschichte des Schenkens* (1898, *On the History of Gift-Giving*) and on anthropological studies, notably Bronislaw Malinowski’s (1884–1942) description of the circular exchange among the Trobriand Islanders and Franz Boas’s (1858–1942) account of the potlatch among the Kwakiutl on America’s Northwest coast. When it appeared in 1925 Mauss called his book *Essai sur le Don (Essay on the Gift: The Form and Reason for Exchange in Archaic Societies)*. With his phrase *the gift*, Mauss committed himself to the search for a common pattern or mode of behavior, under which one could group the diverse forms of gifts, including sacrifice. Exchange and contract in “archaic societies,” he explained, are carried on in the

form of gifts: “In theory [the gifts] are voluntary, in reality given and returned obligatorily”; “apparently free and disinterested, [they are] nevertheless constrained and self-interested” (p. 3). Every gift produces a return gift in a chain of events that brings about many things: goods are exchanged and redistributed in societies that do not have separate commercial markets; peace is maintained and sometimes alliance and friendship; and status is confirmed or competed for in rival display. Mauss asked what beliefs impelled people in these societies to keep the gift moving: to give presents, to receive presents, to reciprocate presents. His answer drew upon the *hau* or “spirit of things” of the Maori people, an idea of embeddedness rather different from Marx’s fetishization of commodities. In the former, the given object carries with it something of the giver, stressing the personal bond created through gifts; in the latter, the displaced symbolism conceals the personal relation of work and oppression in capitalism.

In his historical treatment of the gift economy, Mauss was something of an evolutionist. As markets and formal contracts advanced and legal systems distinguished between persons and things, so the total gift economy contracted. Still, as an independent socialist, he saw evidence for the gift ethos in his own day and hoped it would expand.

In the years since Mauss’s book appeared, anthropologists, economists, historians, and philosophers have reflected on his argument and the gift more generally. Discussion has circled around two subjects: the relation of gifts to markets and the character of reciprocity. In his *Great Transformation* of 1944 and subsequent essays in the next twenty years, the economist Karl Polanyi (1886–1964) argued that until capitalist markets and the profit motive took hold in the eighteenth century, goods and services moved by gifts or redistribution. Personal relations and obligations took precedence, and money exchange, while present, was limited by regulation and convention. Once in place, the capitalist mode simply swept away competing forms of exchange and mentalities. But he did not see this as an inevitable historical stage, and hoped that post-colonial societies might take a different path.

If some writers continued to hold to the older evolutionary scheme, an important strand of current research and interpretation in both anthropology and history has discarded it altogether. Instead, gift forms and commercial market forms are seen as permanent and significant parts of the social landscape, albeit in shifting relations to each other. So anthropologist Maurice Godelier (b. 1934) has maintained even for Western societies, while Nicholas Thomas has described objects in Oceanic societies as “entangled” in both gift and market meanings, and Serge Latouche has shown how exchange in African communities operates “between the gift and the market.” Historical studies have described crossovers between gift practices and commercial practices in both early modern and modern periods in Europe, and have identified some growth in gift forms, especially in the political and international sphere, even while market mentalities expanded. These views have required a reexamination of what transactions can be called gifts, and, as Serge Latouche has urged, the rejection of a simple *homo donator* (Man the Giver), as narrowly conceived as a *homo oeconomicus* (Economic Man).

Studies on the cultural possibilities in gift reciprocity have addressed such challenges and have led to images more complex than Mauss’s gift/return-gift, with its psychology of “in theory, voluntary, in reality, obligatory.” The anthropologist Marshall Sahlins (b. 1930) suggested a “spectrum of reciprocities,” with “generalized reciprocity” at one end, involving free and unstinting giving with little thought of return, and “negative reciprocity” at the other, as in trying to get something for nothing. Annette Weiner (1933–1997), going back to Malinowski’s Trobriand Islands and especially to their women, broadened the time span in gift relations from a circular model to one lasting over the life cycle and across the generations.

Historical studies have drawn upon these patterns, but have also added new ways of thinking about gift exchange. At one end of the scale, medieval and early modern Christian discourse sometimes constructed human gifts to God in terms of reciprocity, other times in gratuitous terms. At the other end of the scale, concern about the bad gift, the gift that “corrupts,” has a long history, expressed already in the Bible. “Bribes” were a recognized danger of gift systems in medieval and early modern political life, and provide a helpful perspective on contemporary political “corruption.”

Writing of gift economies after World War II, Georges Bataille (1897–1962) noted both the grand excess in nature and human life, which must be expended “in gift-giving . . . without reciprocation” (pp. 37–38) and the use of gifts on the international scale to compel loyalty in the Cold War. Jacques Derrida (b. 1930) has dismissed the true gift and gratuitousness as logically impossible, but most commentators welcome the paradoxes and ambiguities in gift relations, and find them relevant to an age of globalization and its discontents.

See also Anthropology; Economics; Poverty; Utilitarianism; Wealth.

BIBLIOGRAPHY

- Algazi, Gadi, Valentin Groebner, and Bernhard Jussen, eds. *Negotiating the Gift: Pre-Modern Figurations of Exchange*. Göttingen, Germany: Vandenhoeck and Ruprecht, 2003.
- Aristotle. “Nicomachean Ethics.” In *The Basic Works of Aristotle*, edited by Richard McKeon. New York: Random House, 1941.
- Bataille, Georges. *The Accursed Share: An Essay on General Economy*. Translated by Robert Hurley. New York: Zone Books, 1988–1991. Published in French in 1947.
- Bentham, Jeremy. *An Introduction to the Principles of Morals and Legislation*. 1789. Oxford: Clarendon, 1996.
- Caillé, Alain. *Don, intérêt et désintéressement: Bourdieu, Mauss, Platon et quelques autres* (Gift, interest, and selflessness: Bourdieu, Mauss, Plato and others). Paris: La Découverte/MAUSS, 1994.
- Carrier, James G. *Gifts and Commodities: Exchange and Western Capitalism since 1700*. London and New York: Routledge, 1995.
- Clavero, Bartolomé. *La grâce du don: Anthropologie catholique de l'économie moderne* (The grace of the gift: Catholic anthropology and early modern economy). Translated from the Spanish by Jean-Frédéric Schaub. Paris: Albin Michel, 1996.
- Davis, Natalie Zemon. *The Gift in Sixteenth-Century France*. Madison: University of Wisconsin Press; Oxford: Oxford University Press, 2000.

- Derrida, Jacques. *Donner le temps* (Given time). Paris: Éditions Galilée, 1991.
- Godbout, Jacques T. *Le don, la dette et l'identité: Homo donator versus homo oeconomicus* (Gift, debt and identity: Homo donator versus homo oeconomicus). Montréal: Éditions du Boréal, 2000.
- Godelier, Maurice. *L'énigme du don* (The enigma of the gift). Paris: Fayard, 1996.
- Groebner, Valentin. *Liquid Assets, Dangerous Gifts: Presents and Politics at the End of the Middle Ages*. Translated by Pamela E. Selwyn. Philadelphia: University of Pennsylvania Press, 2002.
- Hénaff, Marcel. *Le prix de la vérité: Le don, l'argent, la philosophie* (The price of truth: gift, money, philosophy). Paris: Éditions du Seuil, 2002.
- Hirschman, Albert O. *The Passions and the Interests. Political Arguments for Capitalism before Its Triumph*. Princeton, N. J.: Princeton University Press, 1977.
- Hyde, Lewis. *The Gift: Imagination and the Erotic Life of Propriety*. New York: Vintage Books, 1983.
- Latouche, Serge. *L'autre Afrique: Entre don et marché* (The other Africa: Between gift and market). Paris: Albin Michel, 1998.
- Malinowski, Bronislaw. *Argonauts of the Western Pacific: An Account of Native Enterprise and Adventure in the Archipelagoes of Melanesian New Guinea*. 1922. London: Routledge and Kegan Paul, 1964.
- Marx, Karl. *Capital: A Critique of Political Economy*. Translated by Samuel Moore and Edward Aveling; edited by Frederick Engels. New York: Modern Library, 1906.
- Mauss, Marcel. *The Gift: The Form and Reason for Exchange in Archaic Societies*. Translated by W. D. Halls. New York and London: W. W. Norton, 1990. The best translation of Mauss's 1925 *Essai sur le Don*.
- Nagel, Thomas. *The Possibility of Altruism*. Oxford: Clarendon, 1979.
- Noonan, John T. *Bribes*. New York: Macmillan, 1984.
- Peck, Linda Levy. *Court Patronage and Corruption in Early Stuart England*. London and Boston: Unwin Hyman, 1990.
- Polanyi, Karl. *The Great Transformation. The Political and Economic Origins of Our Time*. New York: Rinehart, 1944.
- . *Primitive, Archaic and Modern Economies; Essays of Karl Polanyi*. Edited by George Dalton. Boston: Beacon Press, 1968.
- Sahlins, Marshall. *Stone Age Economics*. Chicago: Aldine, 1972.
- Seneca. *On Benefits*. Translated by Thomas Lodge. London: Aldine House, 1899.
- Smith, Adam. *An Inquiry into the Nature and Causes of the Wealth of Nations*. 1776. Edited by R. H. Campbell and A. S. Skinner. Oxford: Clarendon, 1976.
- Thomas, Nicholas. *Entangled Objects: Exchange, Material Culture, and Colonialism in the Pacific*. Cambridge, Mass.: Harvard University Press, 1991.
- Titmuss, Richard. *The Gift Relationship: From Human Blood to Social Policy*. New York: Vintage Books, 1972.
- Wacquet, Jean-Claude. *Corruption: Ethics and Power in Florence, 1600–1770*. Translated by Linda McCall. University Park: Pennsylvania State University Press, 1991.
- Weiner, Annette B. *Inalienable Possessions: The Paradox of Keeping-While-Giving*. Berkeley and Los Angeles: University of California Press, 1992.
- . *Women of Value, Men of Renown: New Perspectives in Trobriand Exchange*. Austin: University of Texas Press, 1976.

Natalie Zemon Davis

GLOBALIZATION.

The entry includes three subentries:

Africa
Asia
General

AFRICA

Globalization represents a process of rapid intensification of broad economic, political, and cultural interconnectedness among the different actors in the global system. The process is qualitatively different from the global expansion of product markets that is inherent to the capitalist socioeconomic system and emerges during certain epochs of capitalism under conditions of political and economic hegemony and a balance of power among social classes that is decisively tilted in favor of capital at the global level. A confluence of these two conditions, which are not always present in the capitalist system, sets in motion a vision of capitalism that aims to integrate national economies into a single economic space through various institutional arrangements and policy instruments crafted along the liberal ideology.

Old Globalization versus New Globalization

There is little agreement on whether globalization is new or old. Some observers contend that the unfolding global order is entirely new. Others claim that it is not fundamentally different from the order that prevailed in the nineteenth century roughly between 1840 and 1914 under the political and economic hegemony of Great Britain. In any case, globalization has emerged since the closing decades of the twentieth century after an interlude of roughly seventy-five years that were characterized by the episodes of the welfare state system and socialism, two social systems characterized by the relative ascendancy of working-class influence in global politics and the absence of a hegemonic power and a hegemonic ideology.

Old globalization incorporated countries outside of western Europe and North America largely through imperialism and often through direct colonialism. The rise of powers that were able to challenge British hegemony by the end of the nineteenth century culminated in World War I and brought old globalization to an end.

Like old globalization, new globalization is projected by a new political and economic hegemony and the ascendancy in the power of capital relative to other social classes. Views on the nature of the new hegemony vary widely. One view is that the United States sets the rules of the new global order and represents the new hegemonic power. Another view is that the new hegemony is a collective hegemony dominated by the advanced countries led by the United States, which has largely co-opted lesser powers. A third view contends that the new hegemony is composed of a decentralized transnational political elite. Despite these differences, there is a consensus that a hegemonic political, economic, and ideological order has emerged in the post–Cold War global system.

Unlike old globalization, new globalization has unfolded without direct colonialism. Instead it utilizes institutional arrangements and policy instruments as globalizing mechanisms. In the African context, as in many other developing countries, these mechanisms include retrenchment of state involvement in economic activity and institutional changes, such as privatization, and liberalization of trade and capital mobility. These policies are encapsulated in the package of reforms known as structural adjustment programs.

Globalization's Implications for Africa

Incorporation of African economies into the global capitalist system produced profound changes on African societies. New globalization has also begun to impact African societies in significant ways. The literature on Africa's incorporation, however, has not drawn a distinction between the continent's incorporation into the capitalist system and its incorporation under globalization. The lack of distinction may be due to the fact that, despite their differences, both types of incorporations have been painful to the continent. The distinction, however, has to be made, as there are significant differences.

At least four different phases of Africa's incorporation into the global capitalist system can be identified. The first phase took place prior to the era of colonization roughly between the middle of the fifteenth century and the middle of the nineteenth century. This phase itself had at least two stages, including the early commercial incorporation and the pillage of Africa during the era of slave trade, when roughly 22 million slaves were exported out of Africa between 1500 and 1890 (Ogot, p. 43). The second phase of incorporation took place during the period of direct colonial domination roughly between 1884 and 1960. The pillage that took place during the era of the slave trade was devastating for African societies, but it did not produce the broad fundamental changes in African political and economic systems, culture, and institutions that old globalization's incorporation of the continent through colonialism did. Africa's present political map, economic structures, and its place in the global division of labor were all formed during this phase to best serve the interests of European powers.

The third phase of Africa's incorporation took place during the three decades between the beginning of its decolonization in the early 1960s and the end of the Cold War in 1991. Due to many factors, decolonization did not give African countries the level of sovereignty necessary for determining their own terms of integration with the global system. Nevertheless, decolonization meant a marked loosening of the monopolistic grip on African economies by European colonial powers, resulting in some diversification of the trading partners of African countries. The Cold War rivalry between the superpowers and the welfare state ideology of compromise between social classes that prevailed during the Cold War era also allowed African states to expand public services, such as education and health care, to their populations and to initiate some level of industrialization behind protectionist policies. Despite these benefits, the Cold War context of decolonization subjected African countries to ideological cleavage and fre-

quent external intervention from both ideological camps. Civil wars in the Congo, Mozambique, Angola, and Ethiopia are the most obvious examples. Many of the post-decolonization African political elite were also co-opted in order to preserve the old economic structures, fragmenting postcolonial African political systems.

The fourth phase of Africa's incorporation corresponds with the advent of new globalization and represents significant reduction of the limited sovereignty African countries mustered at the time of decolonization and modification of the Cold War era terms of incorporation of African economies into the global system. As noted, with new globalization, retrenchment of state involvement in economic activity, along with policies of liberalization that foster openness of the economy, has become a condition for integration with the global economy for African economies as well as for those of other developing countries.

African perspectives on globalization are diverse but mostly apprehensive. Many African leaders are publicly critical of it but few have dared to oppose its implementation. African leftist scholars are highly critical of globalization. Even scholars of the liberal persuasion, who are sympathetic to globalization, are critical of the rigid conditionalities international financial institutions impose on African countries. A 2003 survey by the Pew Research Center, however, shows that 58 percent of Nigerians, 46 percent of Kenyans, 44 percent of Ugandans, and 41 percent of South Africans view globalization very positively. At the same time, the survey shows that more than 80 percent of African respondents view globalization as a serious threat to African traditions.

Proponents argue that globalization promotes economic growth and diversification and by so doing fosters political stability, gender equality, and cultural development in African societies. Economic diversification, for example, is expected to accelerate the absorption of women into the modern economy, which has a strong positive gender equity effect. Economic prosperity is also expected to promote cultural development by expanding leisure opportunities for the population. Proponents contend that openness and liberalization of trade allow local opportunity costs of resources to be reflected more accurately. Decontrolling interest rates also raises rates and thereby encourages savings and the adoption of appropriate technology. Liberalization of capital mobility is also expected to stimulate foreign investment, and it is anticipated that privatization of banks will allow banks to allocate funds to finance private investments in industry.

However, each of these policies can also produce adverse results depending on the prevailing conditions. Lifting protectionist policies can, for example, lead to loss of revenue and the destruction of potentially competitive local infant industry by cheap imports. Higher interest rates and tight credit may also hurt industry, which tends to have higher working capital needs, while privatization of banks may discourage investments in industry, which tends to have longer duration and higher risks. Deregulation of capital mobility may also destabilize monetary systems, as has occurred in several developing economies.

In contrast to the optimism of proponents, the adverse impacts of liberalization have been severe in many African countries. According to the United Nations Development Programme (UNDP, 2002), for instance, twenty-two sub-Saharan African countries had lower per capita incomes in 2000 than they did in the period between 1975 and 1985. Industries of a number of African countries have also suffered significant losses due to cheap imports. The textile industries of Nigeria, Mozambique, Malawi, and Tanzania, for example, have been devastated by cheap imports triggered by premature and indiscriminate free trade. Beyond the identified examples, the overall picture of Africa's industry since the implementation of liberalization policies beginning in the middle of the 1980s has been rather grim. Average annual growth rates of value added in industry in sub-Saharan Africa have declined from 2.2 percent for the 1975–1984 period to 1.7 percent for the 1985–1989 period and to 1.3 percent for the 1990–2000 period. Annual average gross national savings as percentage of GDP have also declined from 20.6 percent in 1975–1984 to 15.7 percent in 1985–1989 and to 12.8 percent in 1990–2000 (World Bank, 2002).

Another globalizing mechanism promoted through the structural adjustment programs is retrenchment of public expenditures to reduce budgetary deficits. This policy is intended to restrain the growth of money supply and thereby lead to stable prices and a climate conducive for investment. Obviously unrestricted budgetary deficits are unsustainable as they are likely to lead to economic instability undermining the development process. However, in the African case, where the level of human development and development of infrastructure is extremely low, retrenchment of public expenditures is likely to limit investments in human development and development of infrastructure, curtailing the long-term prospects for overall development of African countries. With a human development index of less than 0.500 for 2000, sub-Saharan Africa ranks the lowest of all geographical regions in terms of human development (UNDP, 2002). All twenty-four countries at the bottom of the index and thirty out of the thirty-four countries at the bottom of the index are in sub-Saharan Africa. The number of the destitute—people living on less than one U.S. dollar per day—has also increased from 241 million in 1990 to 329 million in 2000. Many sub-Saharan African countries have also retrenched their expenditures on public services since adopting adjustment mechanisms. Public expenditure on education has, for example, declined from 4.5 percent of GDP in 1992 to 3.3 percent in 1999 (World Commission on the Social Dimension of Globalization, 2004).

The globalization mechanisms also fail to address some of the serious external constraints African countries face, including the ever-increasing debt burden, Africa's limited access to the markets of developed countries, the paltry foreign investment flows to Africa, and the continent's persistent unfavorable terms of trade, which have declined from 0.6 for the 1974–1984 period to –3.8 for the 1985–1989 years and to –0.5 for 1990–2000 (World Bank, 2002). Sub-Saharan Africa's total external debt service payments (long-term loans and International Monetary Fund credit) have averaged \$11.643 million annually

for the years 1990–2000. Farming subsidies in rich countries have also made it difficult for African countries to compete in the markets of rich countries. Even more damaging to African countries is that subsidized agricultural exports from rich countries are driving small farmers out of business.

In the absence of the expected growth and economic diversification, retrenchment of public expenditures and state involvement in the economy is likely to lead to perpetuation and exacerbation of gross inequalities that are rampant in the continent, including gender inequalities. Transformation of the subsistence sector, which is essential for internal integration of the economy, is also likely to be adversely affected by state disengagement. Regional and ethnic inequalities in access to public services are also likely to linger without active state engagement, fueling internal conflicts. Cultural fragmentation is also more likely than cultural development to take place.

Globalization certainly is not the only culprit for these problems. Many factors, including poor governance and widespread political unrest, along with poor infrastructure, eroding educational systems and human capital, and lack of diversification of the economy have contributed to Africa's economic ills. Such domestic factors in fact prevent African countries from taking advantage of some of the limited opportunities globalization creates. However, the hegemonic ideology of globalization blocks the search for alternative development strategies that may address these factors and undermines the limited autonomy that African states were able to muster at the time of their decolonization. New globalization has thus integrated African economies in terms of ideology and policy, but in terms of participation in global production it has perpetuated their relegation to the peripheral margins of the global capitalist system as suppliers of primary commodities.

See also Africa, Idea of; Afropessimism; Anticolonialism; Africa; Capitalism: Africa; Colonialism: Africa; Development; Postcolonial Studies; Socialisms, African; Westernization: Africa.

BIBLIOGRAPHY

- Ake, Claude. "The New World Order: A View from Africa." In *Whose World Order? Uneven Globalization and the End of the Cold War*, edited by Hans-Henrik Holm and Georg Sørensen, 19–42. Boulder: Westview Press, 1995.
- Amin, Samir. *Delinking: Towards a Polycentric World*. London: Zed Books 1985.
- Bienefeld, Manfred. "The New World Order: Echoes of New Imperialism." *Third World Quarterly* 15, no. 1 (1994): 31–48.
- Duncan, Alex, and John Howell. "Assessing the Impact of Structural Adjustment." In *Structural Adjustment and the African Farmer*, edited by Alex Duncan and John Howell, 1–13. London: Overseas Development Institute/James Currey/Heinemann, 1992.
- Ogot, B. A. *General History of Africa: Africa from the Sixteenth to the Eighteenth Century*. Abridged ed. Paris: UNESCO, 1999.
- Petras, James, and Henry Veltmeyer. *Globalization Unmasked: Imperialism in the Twenty-first Century*. Halifax, N.S.: Fernwood/Zed Books, 2001.

- Pew Research Center. "Globalization with Few Discontents?" 3 June 2003.
- Sachs, Jeffrey. "International Economies: Unlocking the Mysteries of Globalization." *Foreign Policy* 110 (spring 1998): 97–111.
- United Nations Economic Commission for Africa. *African Alternative Framework to Structural Adjustment Programmes for Socio-Economic Recovery and Transformation*. Addis Ababa: The Commission, 1991.
- UNDP. *Human Development Report 2002*. New York and Oxford: Oxford University Press, 2002.
- Wood, Ellen Meiksins. "Capitalist Change and Generational Shifts." *Monthly Review* 5, no. 5 (October 1998): 1–10.
- World Bank. *African Development Indicators 2002*. Washington, D.C.: World Bank, 2002.
- . *World Development Indicators 2001*. Washington, D.C.: World Bank, 2001.
- World Commission on the Social Dimension of Globalization. *A Fair Globalization: Creating Opportunities for All*. Geneva: ILO, 24 February 2004.

Kidane Mengisteb

ASIA

Globalization is a far-ranging topic. It has as many perspectives as commentators. Western views of globalization often focus on economics and politics, while Eastern views often focus on philosophy and culture. Two Canadian scholars, Marshall McLuhan and Harold Innis, seem to bridge both East and West in their studies.

Asian Views of Globalization

In the early 1960s the Canadian communications pioneer Marshall McLuhan (1911–1980) was one of the first scholars to seriously consider globalization. His perspective was shaped by a multicultural Canadian environment. From the inception, globalization was a concept intertwining both Eastern and Western civilizations. Impressed by another Canadian, the historian Harold Innis (1894–1952), McLuhan began a study of both Asian and Western societies that spanned the entirety of his academic career. Innis had recognized that technology was changing the face of modern nation-states. The direction was clearly set. Space was over-coming time. In making a case for the wisdom of the past, Innis embarked on a discussion of ancient cultures, including Greece, Egypt, and especially China. Decades later McLuhan followed this lead. At first Innis recognized that China had a time-biased civilization. It created mammoth temples and statues that stood the test of the ages. China later invented paper, ink, and books. The motivation was spatial. While temples and statues would last for millennia, their accessibility was restricted. Scrolls and books could be transported easily but were limited by physical structure and duration. They were space-biased. For thousands of years, China managed to reinvigorate its civilization through a finely tuned combination of temporal and spatial communications alongside oral and written traditions. The oral tradition assisted Buddhism in gaining popularity during its migration from India, while the written tradition helped solidify the reverence for Confu-

cianism. Printing accommodated both: popular literature for Buddhists and classical texts for Confucians. These yin-yang polarities of writing and speaking had worldwide implications. As well the import of Chinese paper accelerated the influence of the Greeks, Persians, and Arabians throughout Europe. As such, Innis and McLuhan highlight positive functions of an archaic Chinese form of globalization.

While Chinese paper and goods encouraged the trade with the Western world, it also set the stage for a clash of civilizations and belief systems. The technological revolutions of the Western world with its infatuation for space and property ownership would eventually annihilate the East's sacredness of time and its philosophical wisdom. As Innis writes, "The oral tradition implies the spirit but writing and printing are inherently materialistic" (p. 130). Taking a cue from China, Innis maintained that a harmony of time and space was necessary for a healthy society or a healthy world. Nevertheless, the West shunned religion and the oral tradition that it represented in favor of reason and the written tradition that legitimized it. When the equilibrium of time/space and oral/written fell out of kilter, the West colonized the very civilizations that initially helped fashion its communicative modes.

The Global Village

McLuhan went one step further than Innis. While the mechanical world extended bodies in space, the electric and electronic technologies "extended our central nervous system itself in a global embrace, abolishing both space and time as far as our planet is concerned" (1964, p. 19). Hence we have the expression "the global village." But this village was not as harmonious as those ancient societies of time/space concordance. McLuhan maintains, "The global village is at once as wide as the planet and as small as the little town where everybody is maliciously engaged in poking his nose into everybody else's business" (quoted in Benedetti and DeHart, p. 40). Globalization is a two-edged sword that extends Western knowledge everywhere but threatens the wisdoms of the Eastern world. According to McLuhan, the world needs a combination of both Western and Eastern knowledge. The West operates by way of visual space as a linear, quantitative mode of perception, while the East operates by way of acoustic space as a holistic, qualitative mode of perception. Because both worlds are constantly colliding, we need a mutual understanding in order to foster peace (see McLuhan and Powers).

McLuhan encapsulates Western visual space as a "mind's eye" that connects abstract figures with definitive boundaries and is "homogenous (uniform everywhere), and static (qualitatively unchangeable)" (McLuhan and Powers, p. 45). Eastern acoustic space as a "mind's ear" encompasses both preliterate and postliterate cultures. It is nonhomogenous and discontinuous. As McLuhan relates: "Its resonant and interpenetrating processes are simultaneously related with centers everywhere and boundaries nowhere. Like music . . . acoustic space requires neither proof nor explanation but is made manifest through its cultural content" (p. 45). Hence visual and acoustic spaces are "bicultural." They are at the same time incompatible (like history and eternity) and compatible (like science and art). According to McLuhan, the East utilizes both visual and acoustic

space. As he writes, “A Westerner, for example, arranges flowers in space; the Chinese and Japanese harmonize the space between the flowers” (pp. 62–63). Manipulating the discontinuous space, the Asians fill the void with imagination. In this sense, the overly logical Western world could learn from the East.

For McLuhan, Rudyard Kipling’s famous expression “East is East, and West is West” was obsolete. It gave way to James Joyce: “The west shall shake the East awake . . . while ye have the night for morn” (quoted in McLuhan and Fiore, p. 143). Innis and McLuhan were two of the first thinkers in the West to recognize the importance of East Asia in the formation of concepts of globalization.

Definitions of Globalization: West and East

Globalization is itself an equivocal term. There are as many definitions of globalization as there are interpreters. Globalization is not as value laden as “cultural imperialism” or “orientalism.” The latter two terms are more prone to views of domination, especially by the West over the East. The following definitions are neutral. David Jary and Julia Jary define globalization in *HarperCollins Dictionary of Sociology* as: “a multifaceted process in which the world is becoming more and more interconnected and communication is becoming instantaneous” (p. 249). This includes: “(a) the transformation of the spatial arrangement and organization of social relations involving ‘action at a distance,’ a stretching of social relations and transactions (and power) . . . ; (b) the increasing extensity, intensity, velocity and impact of global social relations . . . ; (c) the creation of new networks and nodes—the ‘network society’ . . . ; (d) a dialectic between the global and the local” (p. 249). Unlike imperialism or orientalism, globalization is rather open-ended. The “have” nations do not automatically overshadow the “have not” nations. Tim O’Sullivan and colleagues define globalization as “the growth and acceleration of economic and cultural networks which operate on a worldwide scale and basis. Globalization is strongly linked with debates about ‘world culture,’ and emerged as a critical concept in the late 1980s. The term refers to the whole complex of flows and processes which have increasingly transcended national boundaries in the last twenty years” (p. 130).

In China, there is a distinction between internationalization (*guojihua*) and globalization (*quanqihua*). Internationalization refers to trading with wealthy nations, such as the United States or Germany. This is generally considered good for China’s world development. Globalization refers literally to matters of change in the entire world, such as ecological considerations and appropriate responses. McLuhan’s term “global village” (*quanqiu*) entered Chinese-English dictionaries in the early 1980s possibly because of China’s keen interest in friendly relations with Canada and Canadian thinkers. By contrast, in Japan, internationalization (*kokusaika*) is a heavily laden term that is either extremely good or bad, depending on one’s national allegiance; globalization (*gurobarizeshon* or *gurobaruka*) is a term that conjures up fears of falling behind, especially as Japan seems to recede into an economic sunset in the wake of China’s emergence as a world force. On the one hand, globalization for Japan means that the goddess Amaterasu is backing

into her cave, a time in Shinto legend when the world falls into darkness. On the other hand, globalization for China means the awakening of a sleeping dragon or a time of renewal, revitalization, and resurrection.

Globalization in Classical China

While the term *globalization* is relatively new in China, its concept is not. China has participated in globalization for thousands of years. For the most part, the history of China involves open-ended relations with the world. As a Middle Kingdom (*zhongguo*), China reached across the globe in exploration with the express purpose of exchanging ideas, technology, and goods. In the preface to a book on Eastern and Western cultures, Jeff Yang writes, “America was Asian before it was American; the ancestors of the continent’s original inhabitants were Siberians who made the long, cold journey across the Bering Strait some 11,000 years ago” (Yang et al., introduction). Yang goes on to state that “the Chinese have their own pre-Columbus discovery myth: they claim that Hui Shen, a Buddhist monk living in the fifth century C.E., sailed to Mexico, lived there for 40 years, and returned to tell the tale.” While these examples are legendary, they do point to Zheng He, a Yunnan Muslim explorer from the Ming dynasty who traveled to India and Africa on seven voyages between 1405 and 1433. With hundreds of vessels and thousands of sailors, the expeditions were not “colonizing.” Rather, they were “diplomatic.” As John Fairbank relates, “They exchanged gifts, enrolled tributaries, and brought back geographic information and scientific curiosities” (p. 138). Jacques Gernet argues that the expeditions followed well-established trade routes of the eleventh century that continued uninterrupted for several hundred years. In explaining the differences between Mongol military conquest and Ming explorations, Gernet writes that “it was no longer a question of undertaking mere conquests for the sake of economic exploitation but of securing the recognition of the power and prestige of the Ming empire in South-East Asia and the Indian Ocean” (p. 401).

The Ming voyages were curtailed in 1433 and their records destroyed in 1479. Nevertheless, China was far out front of any other nation in the age of exploration. It was a half century ahead of the Portuguese traveling to the Gold Coast of Africa or of Columbus arriving in the West Indies. Although highly speculative, Gavin Menzies even proposes that Zheng He made a voyage to North America in 1421 in gigantic junks almost five hundred feet long.

As early as the Qin Dynasty (221 B.C.E.), China utilized the Silk Roads to India as two-way streets of communications, commerce, and culture. Along the trade routes, goods such as tea and silk came from China, while hundreds of Buddhist religions came from India. The Silk Roads stretched from Chang’an, the capital of the Western Han dynasty through Dunhuang, the Tarim Basin, Kashgar, and the Pamir Mountains all the way to Antioch on the Mediterranean Sea. Other routes moved to Hanoi in Vietnam through to Indonesia, the Malay Peninsula, and the Indian Ocean, which facilitated sea commerce to the Roman Orient. In 139 B.C.E. Emperor Han Wudi sent his envoy Zhang Qian to the edges of the Hellenistic world in Bactria, from whence Zhang Qian returned with information on the distant Roman world. Bring-

ing silk and bamboo to the West, he came back with pearls, linen, and horses from central Asia. In 104, 102, and 42 B.C.E. Chinese armies defeated the Turkic nomad Xiongnu alongside captive Roman soldiers in the former Greek kingdom of Sogdiana. Describing further Roman contact, Ann Paludan writes, "In A.D. 122 jugglers from Da Qin (Rome) arrived [in China] from the south and were followed in 166 by a group of merchants claiming to be ambassadors from the Roman emperor Antun (Marcus Aurelius Antoninus)" (p. 56). Attesting to the early interaction between Eastern and Western civilizations, anyone visiting the Confucian homes in China's Anhui Province notices similarities with Roman houses, especially the open courtyard designs, entrances, and interior chambers.

Globalization in Modern China

According to Liu Kang, China in the early twenty-first century has a multifaceted view of globalization that stands in between two significant historical events: the disintegration of Soviet-led communism and a rapidly expanding transnational capitalism. For China, the challenge of globalization is to withstand the wholesale commodification of Western-style capitalism while still entering the world system as a prominent player with its own unique socialist values. In the late twentieth and early twenty-first centuries China has engaged in debates in "nationalism, postmodernism, and neo-humanism, and a 'discursive hybridity' that blends neo-conservatism and radicalism" (Liu, p. 165). The results are necessarily fragmented and unevenly displayed. Yet they seem to congeal into a new global Chinese intellectual strategy.

Part of China's response to the overwhelming compulsion toward Western modernity is to embrace its own past, much of which was suspended during a century of hot and cold wars. In this sense, China once again becomes a "cloud water" (*yun-shui*) or a shape shifter that metamorphoses to fit the times. The "cloud water" is a Buddhist term of old that referred to young, novice monks who gathered around a master like wandering clouds; alternatively it is like a vagabond Daoist priest, changing his shape like water.

In October 1994 China celebrated both the overthrow of the Qing dynasty and the 2,545th anniversary of Confucius's birth. This celebration was remarkable for its unique assembly of both scholarly and political figures. Participants included Gu Mu, a former politburo member and vice premier who was acknowledged as the engineer of Deng Xiaoping's economic modernization program. Others included Li Ruihuan, chair of the Chinese People's Political Consultative Congress; Zhou Nan, an important Beijing representative in Hong Kong; Lee Kuan Yew, former founding prime minister of Singapore; and Jiang Zemin, president of China. Li's inaugural speech praised the ancient Confucian philosopher Mencius for his advice to rulers to listen to the people. Gu Mu's talk was especially important for outlining China's philosophy in a global age, both at home and abroad. The essence of this strategy was to transform China's culture by adapting to Western style on the outside while retaining Eastern essence on the inside. Gu Mu relates, "Culture serves both as the emblem of the level of civilization of a nation or a country and the guidance for its political and economic life" (quoted in de Bary and Tu, p. xii).

In adhering to Confucian ideals of "harmony-making for prosperity" and "harmony above all," China would attempt to merge Eastern and Western views of nation, patriotism, science, and democracy.

Philosophy Returns to China

Since this mandate, China's attitude to globalization relies on the primacy of cultural exchanges with the rest of the world alongside a reemergence and reappraisal of both classical Eastern and Western philosophy. Mutual topics of exchange include the self and society, rights and rites in Confucian ritual, and Chinese law and human rights in global perspective.

The Twelfth International Conference on Chinese Philosophy met in July 2001 in Beijing, where nearly four hundred leading world scholars gathered to debate issues around globalization in terms of the practicality of ancient and contemporary theories. As a significant moment in Chinese history, it announced the return home of Chinese philosophy. China once again became the center of its own philosophy that had been marginalized during the twentieth century. The conference was hosted by the Chinese government under the supervision of Fang Keli, director of the Graduate School of the Chinese Academy of Social Sciences and president of the International Society for Chinese Philosophy (ISCP). The ISCP, founded in 1975 by Cheng Chung-Ying, is one of the best examples of China's program for globalization based on an international community of inquirers who engage in the comparison of Eastern and Western philosophy, religion, and culture. In 1993 the ISCP was the first international conference of top-ranking scholars of Chinese philosophy acknowledged and accepted by the Beijing government. Not only does Chinese philosophy play a leading role in the revitalization of traditions and the renewal of Chinese civilization, but it also adapts to and learns from Western thought. Hence it is the cornerstone of global strategies. As Cheng writes, "Chinese philosophy can contribute to a global ethics of virtue and right, a global metaphysics of the dao and God, a global epistemology of naturalization and transcendence, a global political philosophy of justice and harmony, a global aesthetics of genius and refinement, a global logic of communication and understanding, and a global science of human well-being and liberation" (p. 404).

In an attempt to rediscover core human values in this global context, the works of Jürgen Habermas (1929–), Jacques Derrida (1930–), Hans-Georg Gadamer (1900–2002), and Martin Heidegger (1889–1976) have come to the forefront in China as well as the three ancient teachings of Confucianism, Daoism, and Buddhism.

Habermas and Derrida in China

In April 2001 Habermas toured China, speaking on various topics, including globalization and communicative rationality. China is intrigued with his Weberian-inspired views on value rationality and instrumental (purposive) rationality, that is, in the relationship between the ends themselves and the means to ends in both economic and social actions. What distinguishes Habermas from Max Weber is a focus on the universality of communicative action within internationally sensitive lifeworlds. In debate with Habermas, Tong Shijun, a leading

philosopher, characterizes China's discourse on modernity as composed of several stages: (1) the early twentieth century creation of science and democracy, (2) the later twentieth century socialist model, and (3) the early-twenty-first century discussion on market economies and legal systems (p. 82). Tong utilizes an ancient Chinese polarity of *ti* (substance, body, ground) and *yong* (function, use, manifestation) to compare with Habermas: *ti* as value rationality and *yong* as instrumental rationality. The relation between an object and its movement, the nature of a thing and its expression, a moral principle and its application is the connection of *ti* and *yong*. Closely related to these pairings are *dao* (way) and *qi* (instrument). In the nineteenth century Qing bureaucrats referred to the slogan "Chinese learning as *ti* or substance and Western learning as *yong* or function" (Tong, p. 82). These pairings might neatly compare with Gu Mu's dictum for Chinese views of globalization: Eastern on the inside and Western on the outside. In dialogue with Western thinkers such as Habermas, the Chinese pairings help grapple with everyday interactive decisions of the lifeworld over and against the global compulsions of economic, political, social, and philosophical systems.

In September 2001 Derrida completed a similar tour. Chinese intellectuals discussed his "specters of Marx" theory that still holds transformational possibilities. Although Chinese Marxist scholars primarily view globalization as an economic moment in the continuing internationalization of capitalist modes of production, they are also concerned with cultural consequences. Derrida's multicultural approach to law, language, and society might help the Chinese form a New International that addresses the homogenization of global economics by way of a participatory response of cultural difference and diversity. China can be in globalization without completely being of globalization. Chinese scholars look for universal value in globalization beyond obvious hegemonic implications. Derrida agrees that there are many confusing debates around globalization because of "a certain transparency and with the appearance of liberal exchange" (Zhang Ning, p. 160), while forms of monopoly march forward. China's awareness of these trends and continued participation in the discourse on globalization can profit from European philosophers (including postmodernists) as a complement to North American thinkers.

Gadamer in China

In June 2002 the Gadamer translator Richard Palmer explained hermeneutics to China in his lecture tour. As a close associate and student of Gadamer, Palmer offered the first comprehensive outline on hermeneutics for a North American audience and did the same for China three decades later. In recovering its ancient world, China wishes to employ exegetical strategies for regenerating universal claims from both Eastern and Western classics in a search for new humanist values to suit a global age. Palmer argues that, like Confucius, Gadamer was an educator who valued the virtues of classical traditions, poetry, and art. Like Confucius, he pursued harmony through a "fusion of horizons." Drawing upon the corpus of Heidegger's work, Gadamer's "truth" and "method" were aimed at disclosing the ontological experiences of everyday life along the way to things as they are. Somewhat following Heidegger,

Gadamer's *Zeitlichkeit* (timeliness) speaks to the power of language in revealing the universal truth of a text. The essence of ancient time can be recovered in the simultaneity or contemporaneity of today. Gadamer's emphasis on phronesis (the Greek term for practical wisdom) as an ethical judgment implies a facility for selecting the virtuous. This is similar to Confucius, who emphasizes the care of doing what is right. Part of the understanding of both thinkers involves *applicatio* (application) as the proper fit of understanding and daily use. Gadamer's hermeneutics can be collected into one major concept, that of *wirkungsgeschichtliches Bewusstsein* (consciousness in which history is always working). This is similar to Heidegger's hermeneutic circle, where one must already understand in order to understand. Gadamer's emphasis on openness in *Gespräch* (conversation) and respect for interlocutors is a crucial platform for China's global dialogues, as he demonstrated in an *Auseinandersetzung* (debate) with Habermas, Derrida, and others in the late twentieth century and early twenty-first century.

Heidegger in China

While Gadamer's rhythmic style of thinking parallels Confucius in many ways, Heidegger's reclusive mountain life parallels the Daoist and Buddhist perspectives that he revered. In lectures at Beidaihe, Beijing, Shanghai, and Wuhu in Anhui Province in the summers of 2001 and 2002, Jay Goulding, accompanying Cheng Chung-Ying and Palmer, explained the interactions between Heidegger's hermeneutic phenomenology and ancient Chinese philosophy (see Goulding, forthcoming). Not only are the Chinese embracing a hermeneutics of disclosure but they are also concerned with the phenomenological shaping of appearances in a global lifeworld. The Chinese word for phenomenology is *xianxiangxue*. It means literally the study of the manifestation of appearance or that which shines forth through the present. Those appearances are philosophical, cultural, religious, economic, political, and psychological all wrapped together. As the number one Western philosopher in China in the early twenty-first century, Heidegger's shift from rational, logical prose styles of writing to poetry seems to follow the shift from Confucian logic to Daoist and Buddhist philosophy and meditation. An early translator of Daoist and Buddhist classics in North America, Chang Chung-yuan, writes, "It was after Heidegger's *Being and Time*, however, that he made a complete change from complexity to simplicity, from an analytical approach to a direct, intuitive one, from highly technical, philosophical expressions to common, simple language, from book-form presentation to plain, simple dialogue, such as in his 'Conversation of a Country Path'" (p. 246). This shift continues forward from *Dichtung* (poetry) to *Lichtung* (the clearing). The clearing is an imaginative opening for the simultaneous revelation and concealment of being. It is a place for the renewal of society and thought. For Heidegger, wood paths can lead either to a clearing or to a dead end. The Chinese word for *Lichtung* is *chengming* (the clearing); it captures both Heidegger's luminosity and the Daoist cultivation of clarity and stillness.

What China gains from the above thinkers, especially Gadamer and Heidegger, is the idea of an authentic person comporting himself or herself toward the truth. This form

of authenticity is similar to the Confucian *junzi* (a gentle and upright scholar) and the Daoist *zhenren* (a true and sincere person). In all three, there is an ability to change with the times while retaining principles, a valuable talent in a global age.

Globalization in Classical Japan

Japan holds a different view of globalization than China. Its position, however, is inextricably interwoven with China's fate. Much of the early history of Japan was peppered with samurai clan warfare. Consequently it was occupied with an inward-looking gaze, while China enjoyed an outward-looking gaze. By the Tang dynasty (618–907 C.E.), periods of disunity in China came to a close and the spread of Chinese culture throughout Asia flourished. By the sixth century Confucianism and Buddhism flooded into Japan through Korea. The effect of Chinese models of government, culture, and philosophy influenced Japan for more than a millennium throughout the Nara, Heian, Kamakura, and Ashikaga periods. In the sixteenth century Portuguese and Dutch traders appeared in Japan with muskets and Bibles. This changed the course of Japanese history in terms of warfare, religion, and relationships with the newly developing global trade networks. At the end of the Muromachi Bakufu, another period of fierce clan "provincial" warfare, a triumvirate of unifiers emerged: Oda Nobunaga (1534–1582), Toyotomi Hideyoshi (1536–1598), and Tokugawa Ieyasu (1542–1616). These three *daimyo* (great names) were open to Western influences as far as it could advance their cause. Oda, for instance, supported the Jesuits in an attempt to disrupt Buddhist alliances against him. Likewise Toyotomi encouraged Jesuit trade while sending out his own commercial ships (vermillion seal ships) to ports in the Philippines and Siam. In 1570 Omura Sumitada, a prominent *daimyo* (samurai lord) who converted to Christianity, opened Nagasaki to Portuguese trade, later yielding it to the Jesuits as a territorial possession.

After the deaths of Oda and Toyotomi, Tokugawa ended another century of conflict at the battle of Sekigahara in 1600 that marked the beginning of the Tokugawa Shogunate. Lasting until 1868, the Tokugawa peace undertook a policy of *sakoku* (closed country) or national seclusion that officially saw the banning of Christianity, the revival of Shinto, and the suspicion of foreign philosophies, including China's. However, Japan was not as secluded as it pretended. Although frowned upon by the shogunate, the newly developed town cultures of Edo, Osaka, and Kyoto continued to see an influx of Western and Asian traders. This culture was known as the *ukiyo* (the Floating World) that included tea houses, baths, brothels, and theaters. As a compendium of Eastern and Western cultural trends, the Floating World left a lasting mark on both sides of the Pacific. Popular among the townsfolk were paintings, poetry, literature, puppet plays, and *kabuki* theater that were in turn exported to Europe. Unofficially Chinese junks continued to arrive at a welcoming Nagasaki port. Marius Jansen reports on Tokugawa's false image of isolation and its true indebtedness to China:

Chinese influence rose to a peak in the Tokugawa years. The rising tide of literacy meant that more Japanese could read and write Chinese. The production of poetry in Chinese, something expected of every educated

person, was so great that it may have exceeded the amount of verse composed in Japanese. (p. 4)

Various Chinatowns populated the coast from the Kii Peninsula to Kyushu and in Yamaguchi, Matsuyama, Kawagoe, and Odawara. In 1853 U.S. admiral Matthew Perry's "black ships" arrived in Japan from the United States, followed in 1856 by Townsend Harris, the first American consul. The resulting trade treaties effectively ended Tokugawa's seclusion policy as it entered a new global age. While the Meiji Restoration (1868–1911) oscillated between cries of expelling the barbarians and returning to ancient wisdom, it witnessed a wave of scholars and youth leaving for North America. On the home front, Tokyo and Yokohama saw the introduction of railroads, telegraph, steamships, and other Western inventions that continued up until World War I.

Globalization in Modern Japan

Following World War II, Japan's inventive role in communication technologies enhanced global perspectives on Japan itself. The exportation of cultural artifacts from Tokugawa's era sees a parallel in the technological products of computers, VCRs, and videocassette tapes in the early twenty-first century. Not only these technologies but their contents are part of Japan's changing role in globalization. Koichi Iwabuchi describes Japan's ironic return to Asia after a long hiatus following defeat in World War II:

Japan and Asia tend to be discussed and perceived within Japan as two separate geographies, whose inherent contradiction is unquestioned. Japan is unequivocally located in a geography called 'Asia,' but it no less unambiguously exists outside a cultural imaginary of 'Asia' in Japanese mental maps. (p. 7)

Iwabuchi maintains that "the West" became a positive role model for Japanese culture, while "Asia" receded into a negative mystical hallucination. He writes: "In prewar Japan, Japanization was articulated in the term *kominka*, which means 'the assimilation of ethnic others (such as Ainu, Okinawans, Taiwanese, and Koreans) into a Japanese imperial citizenship under the Emperor's benevolence.' Japanization also referred to the indigenization and domestication of foreign (Western) culture. The famous slogan '*wakon yosai*' (Japanese spirit, Western technologies) exemplifies the latter usage" (Iwabuchi, p. 9). In a global context, Japanization involves the adaptation of both American and Asian products, customs, and idea systems to a Japanese cultural landscape. With the end of the Cold War and the emergence of economy and culture under a revitalized Chinese aegis, Japan once again searches for an identity within Asia.

Japanese popular culture illustrates a response to American influences. With an inundation of American cultural icons, Japan responds defensively with the global going local or the global in the local. A typical case of this is the Japanese *anime* (animated cartoons) of Miyazaki Hayao. Although overwhelmed with the Western-style action of sword and sorcery on the sur-

face, Miyazaki plummets to the depth of Chinese and ancient Japanese philosophy, religion, and folklore. *Princess Mononoke* (*Mononoke hime*) is an epic-style film of individual dueling and massive battle scenes that appeals to Western audiences. Yet it also explores relationships between Shinto, Buddhism, and Confucianism against a backdrop of *Nihonshoki* (Chronicle of Japan) and *Kojiki* (Record of ancient matters) that are Japanese equivalents of Greek and Roman myths. Similarly *Spirited Away* (*Sen to chihiro no kamikakushi*) is an American dreamscape of a child's day at an amusement park. Yet it also explores relationships between Shinto and Confucian interpretations of a Buddhist hell. Rather than be overrun by Western sensibilities alone, Japan recycles them into the themes of the ancient Asian world. Looking for the roots of Japanese philosophy and culture in the Chinese world is a trend of scholarship encouraged by the Japanese government in the last decade.

Western Thinkers in Japan

Concerning the reception of Western philosophers of global issues, Japan's reaction is somewhat more guarded than China's. Heidegger is an exception. His work is still read with excitement because of the early contact with renowned Japanese scholars such as Kuki Shuzo and Nishitani Keiji. Heidegger's compassion for mutual understanding of Eastern and Western life in a global context is foremost in these thinkers. Attesting to his popularity, Japan has attempted more translations of Heidegger's 1927 magnum opus, *Sein und Zeit* (English trans. *Being and Time*, 1962), and probably published more secondary sources than any other nation.

Habermas and Derrida have received varied responses. Since Japanese discussion of premodern and modern societies began in the nineteenth century, much of Habermas's debates with postmodern thinkers such as Jean-François Lyotard are considered outdated. Naoki Sakai sees Habermas's position on global communicative rationality as obsolete. Habermas's "Occidental rationalism" juxtaposes Western reason to Eastern myth in a naive way. While the West might need the East as a "mirror" for its own clarification, "Habermas obviously does not ask if the mirror may be extremely obscure" (p. 96). Instead, Sakai echoes Iwabuchi in arguing that "it is understandable that the discursive object called Japan has presented a heterogeneous instance that could not be easily integrated into the global configuration organized according to the pairing of the modern and the premodern" (p. 97).

In regard to Derrida, the Japanese have maintained that their society has no structure, and therefore deconstruction is not possible. Japan is so much a product of globalization's hyper-accelerated consumption that the very space of such academic talk is already swallowed up. Hence, the transcriptions of Derrida's conversations would be consumed (and forgotten) in one week. From a Japanese perspective, Japan is caught in something like a McLuhanesque series of conundrums between the negativities of mass consumption and the liberating powers of media knowledge.

See also *Communication of Ideas; Confucianism; Empire and Imperialism: Asia; Orientalism.*

BIBLIOGRAPHY

- Benedetti, Paul, and Nancy DeHart, eds. *Forward through the Rearview Mirror: Reflections on and by Marshall McLuhan*. Toronto: Prentice-Hall Canada, 1996.
- Chang Chung-yuan. "Commentary on J. Glenn Gray's 'Splendor of the Simple.'" *Philosophy East and West* 20, no. 3 (July 1970): 241–246.
- Cheng Chun-Ying. "An Onto-Hermeneutic Interpretation of Twentieth-Century Chinese Philosophy: Identity and Vision." In *Contemporary Chinese Philosophy*, edited by Cheng Chung-Ying and Nicholas Bunnin, 365–404. London and Malden, Mass.: Blackwell, 2002.
- Craig, Timothy J., and Richard King, eds. *Global Goes Local: Popular Culture in Asia*. Vancouver: University of British Columbia Press, 2002.
- De Bary, William Theodore. "Preface." In *Confucianism and Human Rights*, edited by William Theodore de Bary and Tu Weiming. New York: Columbia University Press, 1998.
- De Bary, William Theodore, and Tu Weiming, eds. *Confucianism and Human Rights*. New York: Columbia University Press, 1998.
- Dirlik, Arif, and Xudong Zhang, eds. *Postmodernism and China*. Durham, N.C.: Duke University Press, 2000.
- Fairbank, John King. *China: A New History*. Cambridge, Mass.: Belknap Press of Harvard University Press, 1992. Enlarged ed., with Merle Goldman, 1998.
- Gadamer, Hans-Georg. *Gadamer in Conversation: Reflections and Commentary*. Edited and translated by Richard E. Palmer. New Haven, Conn.: Yale University Press, 2001.
- Gernet, Jacques. *A History of Chinese Civilization*. 2nd ed. Translated by J. R. Foster and Charles Hartman. Cambridge, U.K., and New York: Cambridge University Press, 1996.
- Goulding, Jay. "Li Chenyang, the Tao Encounters the West: Explorations in Comparative Philosophy." *Dao: A Journal of Comparative Philosophy* 2, no. 1 (winter 2002): 166–171.
- . *Visceral Manifestation and the East Asian Communicative Body*. Cresskill, N.J.: Hampton Press, forthcoming.
- Heidegger, Martin. *Being and Time*. 1927. Reprint, translated by John Macquarrie and Edward Robinson. New York: Harper and Row, 1962.
- Hirth, Friedrich. *China and the Roman Orient: Researches into Their Ancient and Mediaeval Relations as Represented in Old Chinese Records*. Shanghai and Hong Kong: Kelly and Walsh, 1885. Reprint, Chicago: Ares Publishers, 1975.
- Innis, Harold A. *The Bias of Communication*. Toronto: University of Toronto Press, 1951.
- Ivy, Marilyn. "Critical Texts, Mass Artifacts: The Consumption of Knowledge in Postmodern Japan." In *Postmodernism and Japan*, edited by Masao Miyoshi and H. D. Harootunian, 21–46. Durham, N.C.: Duke University Press, 1989.
- . *Discourses of the Vanishing: Modernity, Phantasm, Japan*. Chicago: University of Chicago Press, 1995.
- Iwabuchi, Koichi. *Recentering Globalization: Popular Culture and Japanese Transnationalism*. Durham, N.C.: Duke University Press, 2002.
- Jameson, Fredric, and Masao Miyoshi, eds. *The Cultures of Globalization*. Durham, N.C.: Duke University Press, 1998.
- Jansen, Marius B. *China in the Tokugawa World*. Cambridge, Mass.: Harvard University Press, 1992.
- Jary, David, and Julia Jary. *The HarperCollins Dictionary of Sociology*. 3rd ed. Glasgow: HarperCollins, 2000.
- Li, Anshan. *A History of Chinese Overseas in Africa*. Beijing: Chinese Overseas Publishing House, 2000.

- Li, Chenyang. *The Tao Encounters the West: Explorations in Comparative Philosophy*. Albany: State University of New York Press, 1999.
- Liu, Kang. "Is There an Alternative to (Capitalist) Globalization? The Debate about Modernity in China." In his *The Cultures of Globalization*. Durham, N.C.: Duke University Press, 1998.
- McLuhan, Marshall. *Understanding Media: The Extensions of Man*. New York: Signet Books, 1964.
- McLuhan, Marshall, and Quentin Fiore. *The Medium Is the Massage: An Inventory of Effects*. New York: Bantam Books, 1967.
- McLuhan, Marshall, and Bruce R. Powers. *The Global Village: Transformations in World Life and Media in the 21st Century*. New York: Oxford University Press, 1989.
- Menzies, Gavin. *1421: The Year China Discovered America*. New York: William Morrow, 2003.
- Miyoshi, Masao, and H. D. Harootunian, eds. *Postmodernism and Japan*. Durham, N.C.: Duke University Press, 1989.
- Morley, David, and Kevin Robins. *Spaces of Identity: Global Media, Electronic Landscapes, and Cultural Boundaries*. New York: Routledge, 1995.
- O'Sullivan, Tim, et al. *Key Concepts in Communication and Cultural Studies*. 2nd ed. New York: Routledge, 1994.
- Palmer, Richard E. *Hermeneutics*. Evanston, Ill.: Northwestern University Press, 1969.
- . "Seven Key Terms in the Philosophy of Hans-Georg Gadamer." Lecture presented at Anhui Normal University, Wuhu China, 22–24 June 2002.
- Paludan, Ann. *Chronicle of the Chinese Emperors: The Reign-by-Reign Record of the Rulers of Imperial China*. London: Thames and Hudson, 1998.
- Parkes, Graham. "Translator's Preface." In *Heidegger's Hidden Sources: East Asian Influences on His Work*, by Reinhard May. Translated by Graham Parkes. New York: Routledge, 1996.
- Said, Edward W. *Culture and Imperialism*. New York: Knopf, 1993.
- Sakai, Naoki. "Modernity and Its Critique: The Problem of Universalism and Particularism." In *Postmodernism and Japan*, edited by Masao Miyoshi and H. D. Harootunian. Durham, N.C.: Duke University Press, 1989.
- Tanaka, Stefan. *Japan's Orient: Rendering Pasts into History*. Berkeley: University of California Press, 1993.
- Tong, Shijun. "Habermas and Chinese Discourse of Modernity." *Dao: A Journal of Comparative Philosophy* 1, no. 1 (winter 2001): 81–106.
- Varley, Paul. *Japanese Culture*. 4th ed. Honolulu: University of Hawai'i Press, 2000.
- Wang, Jing. *High Culture Fever: Politics, Aesthetics, and Ideology in Deng's China*. Berkeley: University of California Press, 1996.
- Wilson, Rob, and Wimal Dissanayake, eds. *Global/Local: Cultural Production and the Transnational Imaginary*. Durham, N.C.: Duke University Press, 1996.
- Xu Shi Gu, executive ed. *A New English-Chinese Dictionary*. 2nd ed. Beijing and New York: Commercial Press and John Wiley and Sons, 1984.
- Yang, Jeff, et al. *Eastern Standard Time: A Guide to Asian Influence on American Culture from Astro Boy to Zen Buddhism*. New York: Houghton Mifflin, 1997.
- Zhang Dainian. *Key Concepts in Chinese Philosophy*. Translated and edited by Edmund Ryden. New Haven, Conn., and Beijing: Yale University and Foreign Language Press, 2002.
- Zhang Ning. "Jacques Derrida's First Visit to China: A Summary of His Lectures and Seminars." *Dao: A Journal of Comparative Philosophy* 2, no. 1 (winter 2002): 141–162.

Jay Goulding

GENERAL

Globalization is a complex and controversial concept. There is little agreement in the literature on what it is, whether it is or is not taking place, whether it is new or old, and if it is good or bad. In its narrower conception, globalization signifies a process of intensification of economic, political, and cultural interconnectedness among the various actors in the global system. In the economic arena, where globalization is pursued more systematically, it represents a process of integration of national economies with the aim of making the global economy develop the capacity to work as a unit.

Conceptualizing Globalization

The process of intensification of interconnectedness, however, does not come about without certain underlying socioeconomic conditions and policy mechanisms. Globalization, thus, needs to be understood not merely in terms of greater interconnectedness or of creating a single global economic space but also in terms of the underlying context that has made it possible, as well as the institutional arrangements and policy instruments that serve as mechanisms for promoting it. A brief examination of some of the most important changes that have precipitated globalization over the last two or more decades helps shed some light on what constitutes globalization's broader conception.

One major change in the global system that facilitated globalization was the reconfiguration of the distribution of power at the global level and the emergence of the United States as the sole superpower following the collapse of the Soviet Union. This reconfiguration of the distribution of power has largely eliminated (at least for now) the contest among competing powers for global dominance and leadership. It would be unlikely for the global system to move in the direction of forming a single economic space when there are contending superpowers. From this angle, the view that globalization is essentially a U.S.-dominated global system seems to be compelling. This view also implies that globalization emerges from a single, unchallenged configuration of power and that the process would be reversible if another center of power should emerge to counteract the hegemony of the United States.

Another underlying factor that facilitated globalization is the restoration of the global hegemony of capitalism and of the market system following the collapse of the Soviet economic system. Contending economic systems and visions would be incompatible with the process of creating a single economic space. The rise to prominence of the neoliberal ideology and the absence of a serious competition between different economic visions has created a conducive environment for globalization.

With the establishment of the identified underlying conditions, various policy instruments, crafted along the lines of

neoliberal doctrine, have been developed to serve as mechanisms of globalization. New multilateral institutions have also been created and older ones have been retooled to promote and manage globalization mechanisms. The World Trade Organization (WTO), the International Monetary Fund (IMF), and the World Bank are among the key institutions. Policy mechanisms crafted along the lines of the neoliberal ideology have also been developed to foster globalization. Such mechanisms include the retrenchment of state involvement in economic activity (including its regulatory measures) and institutional changes such as privatization, restriction of trade barriers, and liberalization of capital mobility. These mechanisms have been promoted in much of the developing world through the IMF and World Bank–sponsored structural adjustment programs.

Two main reasons may help us explain why globalization entails homogenization of economic policy along neoliberal lines. The first is that it would be almost impossible to conceive of an integration of national economies into a single space dominated by a hegemonic power where states are unrestrained from exercising their own power to unilaterally design economic policies in a manner that corresponds to their specific circumstances. Another explanation is that the identified underlying changes represent a shift in the balance of power among social classes in favor of capital at the global level. This shift, in conjunction with U.S. hegemony, has created a condition for the consolidation of capital's vision of the global economic system. The vision entails liberalization of trade and the flow of capital and the deregulation of labor markets in line with the interests of big capital. Liberalization of the flow of capital across borders, together with advances in communication technology, have, in turn, reinforced the surge in the power of capital by giving it the power of mobility. By contrast, labor's ability to organize and to maintain collective bargaining has been weakened by deregulation of the labor market (and capital mobility) and by technological advances, which either replace labor or reorganize work.

In light of the identified underlying changes and the globalizing mechanisms, globalization can be defined more comprehensively as a process of intensification of interconnectedness among national economies with the vision of creating a single economic space, largely corresponding with the interests of capital, and spearheaded by a hegemonic power and promoted through various institutional arrangements and policy instruments.

Is Globalization New?

There are lingering questions as to whether or not globalization is new. Some consider it to be not only new but revolutionary. Others, such as Kenneth Waltz, dispute the claim that global interconnectedness has intensified, noting that the current global system has not even attained the level of integration that existed during the pre–World War I era. Waltz also contends that governments now intervene much more than they did in the pre–World War I era. The points raised in this argument are valid. However, they do not repudiate the fact that capitalism has now resumed a vigorous pace of global integration that was interrupted during the interwar period (1918–1939) and during much of the Cold War era, when

the Keynesian welfare state system was predominant in the Western world and the socialist system prevailed in the East. The levels of integration of the global system of production and state disengagement from economic activity may not yet have exceeded the levels of 1910, but they are rapidly intensifying and are likely to soon surpass the levels of 1910 if globalization continues at its present pace.

The welfare state system that predominated since the interwar years of the last century has also declined notably and a new vision of global order, crafted along the lines of the intellectual tradition of Friedrich Hayek and Milton Friedman, has emerged. In Hayek's view, for instance, concerns of social inequality are mere vestiges of the bygone era of primitive communalism that need to be weeded out and replaced by individual freedom and responsibility, irrespective of the problems of inequality and poverty. There has also been a surge in the perception that national economies have converged into a single space of global economy and that there is only one appropriate form of social organization. A single world economy is far from being a reality. However, there has emerged a powerful advocacy for such a perspective.

In any case, as Kevin O'Rourke and Jeffrey Williamson point out, in historical terms the liberal order that globalization represents is not new, as it was the predominant order in the nineteenth century, roughly between 1840 and 1914. However, globalization represents a significant departure from the global order that prevailed between the outbreak of World War I and the end of the Cold War.

There is also controversy over the factors that promote globalization. Some view globalization as largely driven by technology. Needless to say, technological advances have facilitated the intensification of interconnectedness. It is not likely, however, that technological changes, by themselves, would bring about globalization without a corresponding ideological homogenization or the growing disengagement of the state from economic activity that is currently underway. It is not clear, for example, that capital mobility would come about as a result of technological changes alone, although advances in communication technology, along with the deregulation of capital flows, have enhanced capital mobility.

Others contend that globalization is shaped by market forces. However, an economic system cannot be realized without a corresponding political system, and globalization is shaped by the acquiescence (if not active support) of governments, especially the U.S. hegemonic power and other advanced countries, as Thomas Friedman notes. Adherents of the market forces argument claim that globalization is forced upon governments and that these governments cannot stand in the way of globalization without incurring severe costs. Powerful capital interests are certainly in a position to punish governments that adopt fiscal and monetary policies that adversely impact their goals. The government of South Africa, for example, can be punished by capital flight if it insists on implementing its agenda of social reform outlined in its Reconstruction and Development Program. However, the masses of South Africa are likely to sustain heavier costs if the government abandons its mandate for social reforms in order

to comply with the demands of globalization. Faced with such a dilemma, governments in developing countries have generally selected the side of capital, largely because of the pressure they face from governments in advanced countries and the multilateral agents of globalization.

Capital has now succeeded in capturing the attention of most governments. It is unlikely that the global economic order projected by globalization would be possible in an environment in which labor is organized enough to counterbalance the influence of capital on governments. Powerful countries such as the United States are not helpless against globalization. They can prevent it if they choose to do so or if the balance of power among social classes within the powerful countries changes. The demise of nineteenth-century globalization, due primarily to political forces, as O'Rourke and Williamson note, also indicates that globalization does not come and go merely as a result of market forces or technological change. The view that the state has facilitated (if not authored) globalization is thus compelling. Yet there is little doubt that changes in economic forces and advances in technology, along with changes in government policies reflecting changes in the balance of power among social classes, have all contributed to making globalization possible.

Implications of Globalization

Views on the positive or negative impact of globalization are also highly polarized. Proponents credit globalization with promoting global prosperity, peace, stability, and democracy. Critics, however, attribute to globalization a long list of societal ills, including rising inequality and poverty, environmental mismanagement, and the narrowing of the scope of democracy. Some even view it as a veil for imperialist domination of the developing world. The global cultural interconnectedness that has expanded with the rise of economic interconnectedness is also often viewed as Western cultural imperialism. Some, however, reject this view. Anthony Giddens, for example, claims that global economic and cultural influences are mutual since, as the West is increasingly influenced by the rest of the world, "reverse colonialism" has become more common. Others contend that, along with economic boundaries, cultural boundaries are coming down and culture without space is emerging. Claims of cultural hybridization or cultural deterritorialization, however, grossly understate the disparity in the levels of influence reflected in the imbalance of the control of capital, technology, and media outlets between the advanced West and the developing world.

Proponents of globalization assert that there is a strong positive relationship between the "openness" attained by reducing the allocating and regulatory roles of states and success in industrial development and socioeconomic transformation in those states. Others show that the claim is at best contentious. There is also strong historical evidence that countries that have successfully industrialized did so behind protectionist policies and strong state involvement in their economies. The Dutch Golden Age of the seventeenth century, for example, was perpetuated by strong state involvement in the importation of raw materials and exportation of manufactured goods. During the eighteenth century, Britain stimulated industrialization,

especially in the area of textiles, not only by imposing tariffs on imports from India and China but also by outlawing the wearing of some imported items. In the nineteenth century, countries like France, Germany, and the United States, in an effort to develop national industries, counteracted British hegemony through nationalist economic strategies that included protective tariffs and credit facilities from state banks. In the twentieth century Japan, South Korea, and Taiwan promoted industrialization through a number of state-instituted policy measures, including land reform, targeting of investments and credits to selected industries, and the protection of young industries, and by providing extensive support for marketing and research facilities.

With regard to the relationship between globalization and democracy, opponents argue that globalization reduces democracy to mere electoral contestations with little of substance determined by popular vote. They note that the more limited the role of the state, the more the sphere of public decisions narrows, resulting in hollow democracy. For proponents such as Hayek (1978), Samuel Brittan (1977), and Hutt (1979), only market democracy constitutes genuine democracy, and state involvement in economic activity—as in the welfare state system—represents the transfer of control from the people and market democracy to politicians and coercive interest groups.

Despite the polarization of views, globalization appears to present gains and opportunities to some and losses and challenges to others both within and among countries. Generally, the more advanced economies, which have the ability to compete in open markets, face opportunities, while those less able to compete, such as sub-Saharan African countries, face challenges. Globalization's economic vision, including deregulation of labor and the retrenchment of the welfare state, has also increased inequality and relative (if not absolute) poverty. Various aspects of workers' rights have been rolled back in order to bolster the bottom line of corporations. The plight of the masses in low-income countries, such as those in sub-Saharan Africa, where governments have been unable or unwilling to provide their populations with even the most basic protection from the brunt of the structural adjustment programs, has been particularly severe.

The impact of globalization on democracy also has been both positive and negative. Globalization has contributed to the spread of democracy but it has also limited the scope of democracy by narrowing the sphere of public decisions. The argument that market democracy is more genuine (and less exclusive) is not convincing. Market democracy, in which voting rests on a base of purchasing power, is inherently oligarchic in an economic system that is characterized by inequality—as capitalism is.

Conclusion

According to the foregoing analysis, globalization is not merely an intensification of global interconnectedness brought about by market forces and technological change. Rather, it is a worldview shaped by capital and hegemonic power that aspires to establish a global system in line with the interests of capital. Capitalism, as a market-oriented system of production, has an inherent globalizing tendency. However, capitalism is not

always characterized by the level of adherence to the liberal principles that globalization represents. In E. M. Wood's penetrating analysis, globalization represents a new phase of capitalism that is more universal, more unchallenged, more pure, and more unadulterated, than ever before.

The financial crises affecting different countries have shaken the confidence of the advocates of globalization. The World Bank, for example, in stark contrast to the minimalist state dictum it advocated in the 1980s, in the early twenty-first century recognizes the importance of the role of the state in protecting and correcting markets. There also has been a growing realization that unfettered financial flows, especially from advanced countries to emerging markets, can create profound instability. Some proponents of globalization have even admitted that Keynes's skepticism about financial mobility may still be relevant today. The September 11, 2001, terrorist attacks on the United States also (temporarily, at least) raised questions about the wisdom of supporting globalization. Yet despite notable setbacks and shaken confidence, the advocacy for globalization remains strong.

See also *Capitalism; Economics; Hegemony; Human Rights; Modernization; Neoliberalism; Technology; Third World.*

BIBLIOGRAPHY

- Bienefeld, Manfred. "The New World Order: Echoes of a New Imperialism." *Third World Quarterly* 15, no. 1 (1994): 31–48.
- Brittan, Samuel. "Can Democracy Manage an Economy." In *The End of the Keynesian Era*, edited by Robert Skidelski. New York: Holmes and Meier, 1977.
- Castells, Manuel. *End of Millennium*. Malden, Mass.: Blackwell, 1998.
- Edwards, Sebastian. "Openness, Trade Liberalization, and Growth in Developing Countries." *Journal of Economic Literature* 31, no. 3 (September 1993): 1358–1393.
- Friedman, Thomas L. *The Lexus and the Olive Tree*. New York: Farrar, Straus, and Giroux, 1999.
- Giddens, Anthony. *Runaway World: How Globalization Is Reshaping Our Lives*. New York: Routledge, 2000.
- Hayek, F. A. *Law, Legislation, and Liberty: A New Statement of the Liberal Principles of Justice and Political Economy*. Vol. 1. Chicago: University of Chicago Press, 1973.
- . "The Miscarriage of the Democratic Ideal." *Encounter* 50, no. 3 (1978): 14–17.
- Hutt, W. H. *The Keynesian Episode: A Reassessment*. Indianapolis: Liberty Press, 1979.
- Krugman, Paul. "Dutch Tulips and Emerging Markets." *Foreign Affairs* (July–August 1995): 28–44.
- O'Rourke, Kevin, and Jeffrey G. Williamson. *Globalization and History: The Evolution of the Nineteenth Century Atlantic Economy*. Cambridge, Mass.: MIT Press, 2000.
- Panitch, Leo. "Rethinking the Role of the State." In *Globalization: Critical Reflections*, edited by James H. Mittelman. Boulder, Colo.: Lynne Rienner, 1996.
- Petras, James, and Henry Veltmeyer. *Globalization Unmasked: Imperialism in the Twenty-first Century*. Halifax, Nova Scotia: Fernwood, and New York: Zed Books, 2001.
- Sachs, Jeffrey, and Andrew Warner. "Economic Reform and the Process of Global Integration." *Brookings Papers on Economic Activity* 1 (1995): 1–118.
- Skidelsky, Robert, ed. *The End of the Keynesian Era*. New York: Holmes and Meier, 1977.
- Stiglitz, Joseph, and Lyn Squire. "International Development: Is It Possible?" *Foreign Policy* (spring 1998): 138–151.
- Waltz, Kenneth N. "Globalization and Governance." *PS: Political Science and Politics* 32 (December 1999): 693–700.
- Wertheim, Wim F. "The State and the Dialectics of Emancipation." *Development and Change* 23, no. 3 (July 1992): 257–281.
- Wood, Ellen Meiksins. "Capitalist Change and Generational Shifts." *Monthly Review* 50, no. 5 (October 1998): 1–10.
- World Bank. *World Development Indicators 1997*. Washington D.C.: The World Bank, 1997.

Kidane Mengisteab

GNOSTICISM. Gnosticism is a modern category used for defining a set of second- and third-century C.E. schools of thought and trends that have in common gnosis, a peculiar form of revealed knowledge that leads to salvation, having in itself both its value and its basis. In opposition to faith, gnosis takes root in the experience, generally human, of perceiving a division, a split between the self and the world, between the self and God, and between the self as a founding reality and the empirical ego. As global and absolute knowledge, gnosis aims at overcoming these dichotomies, recovering the individual's threatened integrity and restoring the lost unity of being.

Gnostic forms of knowledge leading to salvation are present in several religious traditions, theistic or not, such as Hinduism, Buddhism, Hebrew kabbalah, or Islamic esoteric traditions. However, in the Gnosticism of the second century C.E. a complex historical reality occurred, characterized by specific identity features, demonstrated by the fact that the holders of gnosis called themselves *gnostikoi*.

The plurality of available sources, from the Nag Hammadi texts to the writings of those fathers of the church, the so-called heresiologists who fought against Gnosticism as a heresy, makes difficult a reconstruction both of its origins and its history. The use of the category "Gnosticism" has been criticized because it provides an overview that hides the complexity of ancient historical reality by imposing an alleged unity to phenomena that were very different. However, this category is a legitimate interpretative historical tool, the only one that grasps the distinctive and unifying feature of schools of thought and movements otherwise different and at times controversial.

Overview

The Nag Hammadi texts are dated no earlier than the second century C.E. The heresiological texts support this dating. The integrated study of these sources leads to an unavoidable conclusion: based on earlier texts that defended the existence of a Gnostic myth—either pre-Christian or contemporary with the origins of Christianity, and probably of Jewish origin—the phenomenon of Gnosticism arose and became established during the second century C.E. in large Hellenistic cities such as Alexandria. It was linked to Scholastic forms of transmission based on esoteric background of a special knowledge, and was

deeply bound with the history of the formation of Christianity as a religion.

Besides a first, less well known stage during which, according to the heresiological texts, figures such as Saturninus, Menander, Basilides and, toward the middle of the century, Marcion and Valentinus followed one another, a second stage took place in the second half of the century, mastered by the Valentinian school of thought. Through the contribution of some Nag Hammadi texts, a tradition of sage philosophy also clearly stands out, deeply influenced by the coeval Platonic schools, and audaciously reinterpreting the Christian theological heritage using the background of doctrinal myths intended to go into the mystery of God's eternal genesis as well as the bond that unites the individual Gnostic to the world of the divine fullness, the pleroma. Beside this Christian Gnostic school of thought, Nag Hammadi texts disclose the existence of a plurality of groups and deeply diversified Gnostic trends tenuously tied to the nascent Christianity of the second half of the second century.

Some scholars supposed the existence of a real Sethian group, so named by the common mythical ancestor, the Seth in Genesis (Gen. 4:25) who became, in the Gnostic myth, the celestial founder of the Gnostics, a select group of divine origin predestined to salvation despite all the attempts at subjugation by the wicked Demiurge and its archons. It is impossible to apprehend from these mythological stories, taking place in the rarefied and impenetrable atmosphere of the pleroma of divine life, precise and convincing sociological indications. Nowadays the dominant trend is to look independently into each of the different texts once attributed to the alleged Sethians, trying to reconstitute the ideology and the course of the groups who used them, by a thorough editorial analysis.

The Gnostic communities reserved a special place for women: the possession of gnosis eliminated normal power hierarchies, favoring, in an ascetic background, a spiritual equality. This explains the privileged role played in certain texts by female figures such as Mary Magdalene. However, one must not draw sociological conclusions from the role played by figures of female saviors present in certain Gnostic texts.

Mythology and doctrine. The subject of the Gnostic revelation is the ontological Self, the true spiritual reality, consubstantial with (of the same substance as) the divine. Communicated by a revealer-savior and guaranteed by an esoteric tradition, this gnosis is often associated with instruction that has as a subject the communication of a mythical story. It aims at answering the questions related to existence arising from a radically pessimistic conception of the world as created by a god or a wicked demiurge in opposition to the good, absolutely transcendent God—unknown and unknowable except through Gnostic enlightenment. The Gnostic mythology narrates the events of that Gnostic god, describing his divine origin, expressing and explaining the causes for the oblivion that is his prison, and showing in the end the way back, which brings salvation.

The variegated world of Gnostic mythology is formed starting from this dualistic vision, opposing, in some ways, the pleroma, or world of light and fullness, to our world of

darkness, in others, the pneuma, or spiritual reality, to the psychophysical compound created by the Demiurge. The Gnostic myths share the story that, originally, the divine world experienced a perfect fullness, which, through an "accident" within the life itself of the pleroma (in its best-known version it is represented as a mistake committed by Sophia, the last of the aeons emanated by the primordial androgyne), gave way to a world of lack and emptiness, whose master is the Demiurge.

This mythology contains a theogony narrating the unknown God's "eternal birth," which makes it possible for the Gnostic in its turn to be born again reviving his new life; a cosmogony that presents the antibiblical Gnostic version of the genesis of this cosmos, the seat of evil and prison of the Gnostic; an anthropogony, according to which the Demiurge creates the psychophysical compound into which he then (Gnostic reinterpretation of Gen. 2:7) unconsciously inflates the spiritual principle inherited by his mother, the pleromatic Sophia; and, finally, an eschatology, according to which the world is destined to destruction and only the spiritual dimension will survive, returning then to pleroma.

Influence and global reach. In the Western tradition of thought, Gnosticism experienced historical revivals, from Manichaeism to the medieval Catharism. Generally these were internal dualistic forms within the Christian area, which retained the cosmic pessimism and the conception of a second wicked god creator. Beginning in the Renaissance, the Christian esoteric traditions occupied the privileged place of transmission and retention of Gnostic forms of thought. Fundamental is the work of Jakob Böhme (1575–1624), whose theosophy, phenomenologically akin to that of Gnosticism, is marked by the absence of dualism and whose work fed the subsequent fortunes of Gnosticism. Leaving out of consideration, as devoid of historic importance, the attempts of neognostic churches to revitalize ancient Gnosticism, the next important Gnostic revival was early German Romanticism, with its insistence on totality and absolute knowledge, as well as pessimistic and nihilistic hints. It provided twentieth-century culture—in forms that are sometimes difficult to investigate—themes at times tied to the pessimistic side of Gnosticism, at times to its optimistic side. These themes seem to be spread in heterogeneous sectors of our culture, from the depth psychology referring to Carl Gustav Jung (1875–1961), to Gnostic themes appearing in new forms of religiousness. However, a more precise identification and interpretation looks difficult, in the absence of a clear sociological basis of specific worship forms and, in general terms, because of the difficulty inherent in defining a modern Gnosticism.

See also Agnosticism; Christianity; Evil; Heresy and Apostasy; Knowledge; Manichaeism; Mysticism; Myth; Nihilism; Philosophy of Religion; Platonism; Sage Philosophy; Scholasticism.

BIBLIOGRAPHY

PRIMARY SOURCES

Robinson, James M., ed. *The Nag Hammadi Library in English*. San Francisco: Harper and Row, 1988.

SECONDARY SOURCES

- Faivre, Antoine. *Theosophy, Imagination, Tradition: Studies in Western Esotericism*. Albany: State University of New York Press, 2000. Fundamental collection of studies, with an excellent bibliography.
- Filoramo, Giovanni. *A History of Gnosticism*. Oxford: Blackwell, 1990.
- King, K. L. *Images of the Feminine in Gnosticism*. Philadelphia: Fortress, 1988. Exemplary study of gender.
- Scholer, David M. *Nag Hammadi Bibliography, 1948–1969*. Leiden: Brill, 1971. Vol. 2: *Nag Hammadi Bibliography, 1970–1994*. Leiden: Brill, 1997.
- Turner, John D., and Anne McGuire, eds. *The Nag Hammadi Library after Fifty Years*. Leiden, New York, and Cologne, 1997. Important critical balance.

Giovanni Filoramo

GOD. See **Religion**; see also *specific religions by name*.

GOOD. Philosophical accounts of “the good” are, broadly speaking, accounts of what it is to be an *object of value*—especially of moral value. A systematic study of these accounts is aided by such distinctions as the following.

Moral versus Nonmoral Good

There is an important difference between “moral” and other types of value (e.g., aesthetic, economic, or informational). One might say, broadly, that the nonmoral good is what we find “attractive,” what is apt to serve as enjoyment; whereas the moral good is that which pertains more narrowly to moral virtue or moral rules. Hence at the very beginning of his *Foundation of the Metaphysics of Morals* (1785), the German philosopher Immanuel Kant (1724–1804) distinguishes “the good will” (the

will that acts on the basis of the moral law) as what possesses the highest moral value. In comparison, all other things—even such good qualities as courage and intelligence—have, in Kant’s doctrine, at best a kind of relative moral goodness: they are morally good only insofar as they are guided by a good will.

Intrinsic and Merely Instrumental Good

Another important difference, first clearly enunciated by Aristotle (384–322 B.C.E.), is that between what is “intrinsically good” (good in itself) and what is “instrumentally good” (good as a means to some other end). So, for instance, from the perspective of philosophical utilitarianism (the views, most prominently, of the nineteenth-century British thinkers Jeremy Bentham and John Stuart Mill), pleasure is the sole (intrinsic) good; other things, including money, health, and even such “virtues” as philosophers have traditionally recognized (honesty, generosity, integrity) are good merely as means to that end. By contrast, for Aristotle himself, the virtues would be both means to what he regards as the supreme end (*eudaimonia*—i.e., “happiness” or “well-being”) but also *part* of that supreme good and thus, to that extent, ends in themselves.

Some have questioned, however (see Korsgaard), whether there might not be *two* differences here: good as a means versus good as an end; “intrinsic” versus “extrinsic” good. The difference between each pair is perhaps clearest in such cases as this. Someone might hold that the good of a beautiful sunset is “extrinsic,” that it is grounded in something outside itself—say, human modes of perception and aesthetic response—but still *resist* holding that this sunset is good merely as a means to something else—for example, the enjoyment of those happening to see it.

Subjective versus Objective Accounts

Another pervasive difference would involve “subjective” versus “objective” conceptions of the good. At its crudest, a subjective view would simply identify the good for a given person as

TELEOLOGICAL VERSUS CONSEQUENTIALIST VIEWS OF THE GOOD

There are actually two major, competing, nondeontological traditions of the good. One, running from Aristotle to the pragmatic naturalism of American philosophers such as John Dewey (1859–1952) and Ralph Barton Perry (1876–1957) in the first half of the twentieth century, is “teleological”—that is, it construes the good in terms of the fulfillment of such ends as are natural or proper to a creature. Thus the good is conceived as internal or immanent. By contrast, the consequentialist holds that the good is some quantity to be maximized (produced in or by our acts). Against the teleological conception, the consequentialist may object that teleology stands in need of some standard of value (like that provided by utilitarianism) to distinguish between good and bad tendencies in us. Against consequentialism, the teleologist may object that a merely external standard (such as utilitarianism offers) need not provide a compelling reason or motive of action.

STOIC AND EPICUREAN VISIONS OF “THE GOOD LIFE”

Ancient Greek philosophy—especially in the “Hellenistic” period following Aristotle (384–322 B.C.E.)—aimed to provide not merely accounts of such abstractions from life as “the good” or the “virtuous” but more concrete guidance as to how the good life was to be achieved. In this regard, two schools stand out. The Stoics taught a rigorous adherence to virtue, duty, and honor. These, they reasoned, were subject to our control and attainable through correct discipline of the will; thus attained, they would be a source of happiness regardless of one’s external circumstances. The followers of Epicurus (341–270 B.C.E.), like the Stoics, warned against such emotional attachments as could easily threaten one’s peace of mind but, unlike the Stoics, identified the goal of life (and the purpose for avoiding such attachments) as pleasure—not the extremes of sensual pleasure, but pleasures moderate in intensity and apt to endure (to be attained through self-sufficiency, simplicity of life, and friendship).

what that person “prefers” or “desires.” This appears to be the working conception of “the good” employed in economic theory. A number of views, especially in the empiricist tradition, tend toward this conception. For the “positivist” school, because value judgments are not scientifically verifiable, they can amount to no more than expressions of what one likes or desires. For an important strain in eighteenth-century British thought (the Scots Adam Smith and David Hume being perhaps its most important representatives), the good is understood in terms of one’s preferences under ideal (e.g., personally disinterested, emotionally calm) circumstances.

At the other extreme, views in the tradition of Plato (c. 428–348 or 347 B.C.E.) construe “the good” as a kind of object of abstract contemplation. This object, then, is not constituted by our preferences or desires; it exists as an objective feature of the universe—according to Plato’s analogy in the *Republic*, like the sun shedding light on all other things.

There is a related point of difference between subjective and objective views. In the former, the good is fundamentally an object of noncognitive attitudes such as desire or will. If, however, the good is conceived as an object existing independently of the human mind, it is natural to construe it as primarily an object of knowledge. Critics of the objective view—most prominently Hume—claim that it cannot account for the “action-guiding” nature of values and moral discourse generally. Mere contemplation of an object does not necessarily affect one’s desires and will; but recognition that something is good surely does have this effect. For their part, defenders of an objective view have often replied that a subjective conception cannot account for genuine moral disagreement. They point out that a subjective account of a moral disagreement (in which person A says “*x* is good” while B says that “*x* is not good”) will imply that it is merely a case of A saying “I

desire *x*” and B saying “I don’t desire *x*”—which is no real disagreement.

Aristotle, Platonism, and Christianity

We may notice how Aristotle’s conception of the good partakes of both elements of this dichotomy between objective and subject conceptions. For Aristotle, the good is identified in the first instance as what one “aims at” in any given activity—in a word, “the end” (*telos*) of that activity. Thus the end of running might be health or winning races. Ultimately, though, we arrive at the aforementioned “happiness” (*eudaimonia*) as the final good (end) for human beings. This end, however, is not a mere subjective preference. It depends, in Aristotle’s account, ultimately on our natural purpose or function as rational creatures. At the same time, however, it is not a Platonic object, existing separate and apart from humanity or human tendencies.

This difference between Aristotle’s “teleological” and Plato’s more “metaphysical” conception of the good is important in understanding the good as it figures in Western religious thought. One important strain in Christian thought draws on a Platonic conception of the good as residing in a distinct object accessible to human knowledge yet quite remote from ordinary, this-worldly experiences. A more “Aristotelian” strain of Christianity, most clearly represented in the thought of Saint Thomas Aquinas (1225–1274), accepts Aristotle’s conception of the good as happiness but construes this “final end” as including our spiritual as well as our physical, social, and intellectual ends as humans. So in this conception more than in the Platonic, secular and otherworldly goods are seen as complementary; the spiritual is seen as completing or “perfecting” nature—rather than as standing in stark Platonic opposition to it.

The Good of the Whole: Leibniz, Whitehead, and Spinoza

If the good is somehow objective, one will want to inquire as to the elements or proper analysis of this object. Even G. E. Moore (1873–1958), who argued that goodness was a simple, indefinable property (see below), held that we could say something about the nature of the good as a kind of “organic unity.” In this vein, one finds something of a consensus among those philosophers who have addressed this particular concern (including even the diverse pair of metaphysicians Gottfried Leibniz [1646–1716], the seventeenth-century German rationalist, and Alfred North Whitehead [1861–1941], the twentieth-century British mathematician): that the good must involve a kind of maximum of both complexity and organic unity. Such a conception has an important bearing both on questions of environmental or ecological value and on the traditional theological problem of evil.

Environmentalists (especially of the more radical variety) are concerned to uphold the intrinsic (or noninstrumental) value of nature, but this raises important questions of whether or how everything in nature (for example, a solitary gnat) has such value. Here the Leibniz-Whitehead vision of unity in complexity can be helpful in understanding the value, for instance, of living organisms—indeed, of nature as a whole. Theologically, such a conception may be employed to justify apparent evil as part of a desirable ordered complex unity. In Whitehead’s theodicy, all evil is the result of a lack of unity (yielding disharmony and ultimately pain) or a lack of complexity (ultimately yielding boredom).

Quite a different metaphysical vision is offered by Baruch Spinoza (1632–1677), the seventeenth-century Dutch thinker. For Spinoza, such an ordered complexity is strictly neither good nor bad; thus, since he identifies this whole with God, God is beyond such attributes. Still, according to Spinoza, in the contemplation and especially in the understanding of this whole there lies a kind of supreme good for humankind.

The Good in Metaethics

Especially during the first half of the twentieth century, for philosophers in the Anglo-American “tradition,” metaethics (an analysis of the distinctive *language* of moral discourse) tended to replace direct ethical and metaphysical argument. Thus in his *Principia Ethica* (1903), G. E. Moore argued for the indefinability of the term *good* and against attempts to construe “good” naturalistically. Moore pointed out in his famous “open question test” that one might significantly ask whether, say, pleasure is good, but not whether “good is good” (thus arguing that goodness could not be defined as or identified with such natural qualities as pleasure). The next-generation Oxford moral philosopher R. M. Hare (1919–2002) explained Moore’s results by claiming that that ascribing “goodness” to an object is not describing it at all but performing a different type of linguistic act, one of “commending.” Still, a third highly influential British metaethicist, Philippa Foot, advanced a form of naturalism with affinities to Aristotle. Foot was especially critical of an apparent consequence of Hare’s “non-descriptive” account: that one could call literally anything good as long as one was performing an act of commending it.

The Right and the Good

Modern ethical theory is defined largely by its distinction between “the good” as a morally positive goal to be achieved through our acts, and “the right” as a set of rules or moral norms *constraining* our pursuit of the good. In contemporary parlance, the “consequentialist” takes the good as primary, treating “right acts” as those productive of the most good. The contrasting view, that of deontology, takes the right as primary, as defined independently of the good, and as forbidding even acts productive of the most good when these violate such fundamental moral rules as the prohibitions against killing, theft, and lying.

A consequentialist may be a utilitarian (identifying pleasure as the sole good; pain as the sole evil), may advocate some other form of naturalism (e.g., equating the good with evolutionary fitness, as did such nineteenth-century Social Darwinists as Herbert Spencer), or (like G. E. Moore) may reject a naturalistic account of the good altogether. Deontologists, in turn, may be distinguished according to whether they take the aforementioned constraints to be absolute (as does Kant, who treats lying, for instance, as wrong even to save a life) or merely having some independent force—that is, *sometimes* able to override considerations of doing good (as does W. D. Ross [1877–1971], an early twentieth-century British moral theorist).

In philosophy since the mid-twentieth century, perhaps the most significant employment and development of these ideas is in John Rawls’s *A Theory of Justice* (1971). In Rawls’s view, the principles of justice state norms capable of overriding merely utilitarian considerations. These norms, as in the contract tradition of such early modern political philosophers as Thomas Hobbes, John Locke, and Jean-Jacques Rousseau, are conceived as being chosen by appropriately situated individuals out of their own self-interest. But clearly such individuals must have some notion of “what is good” (beyond the bare abstraction of “my good”). Accordingly, Rawls distinguishes a “thin conception” of the good required in the “original position” (the situation of choice) from a fuller conception, one resulting from the choices they make.

Virtues, Perfectionism, and the Good Life

The moral virtues might be characterized, roughly, as those qualities apt to be productive of moral good. Yet there is an important difference between consequentialist and virtue ethics. This pertains not only to the split between teleology and consequentialism just described but also to two factors distinctive of virtue ethics and going back to Aristotle. First, virtue ethics rejects the supposed distinction between the strictly “moral” in a Kantian sense and what is more broadly of personal value. The four cardinal virtues of Greek thought (courage, wisdom, temperance, justice) illustrate this, as only the last of these is “moral” in a Kantian sense. The second difference is that virtue ethics tends to focus on qualities of an *agent* as opposed to those of an act. Thus the right act is seen in terms of what the best sort of person (the virtuous agent) would do.

These features of virtue ethics, carried far enough, may lead to quite a different moral conception in which the good is understood in terms of the achievements of those relatively few truly good (or “great”) individuals. In modern philosophy,

this tendency is perhaps most clearly realized in Friedrich Nietzsche's (1844–1900) figure in *Thus Spake Zarathustra* (1883–1891) of the *Übermensch* (“overman,” or superman), whose self-mastery, creativity, and other virtues transcend the mediocrity of the common run of humankind. It is also pre-saged in Aristotle's conception of the “great-souled man”—who “thinks he deserves and actually does deserve great things” (*Nicomachean Ethics*, book 4). More broadly, a perfectionist conception of the good understands value in terms of an individual's realization of such qualities, talents, and skills as might represent “the best in him or her.” Hence, like the novelist Ayn Rand (*The Fountainhead*, 1943), the perfectionist upholds the value of individuality and stands in extreme opposition to what is termed *communitarianism* in contemporary political philosophy.

See also *Evil; Moral Sense; Virtue Ethics*.

BIBLIOGRAPHY

- Aristotle. *Nicomachean Ethics*. Translated with an introduction by David Ross, revised by J. L. Ackrill and J. O. Urmson. Oxford and New York: Oxford University Press, 1998.
- Cahn, Steven, and Peter Markie, eds. *Ethics: History, Theory, and Contemporary Issues*. 2nd ed. New York: Oxford University Press, 2001.
- Gibbard, Allan. *Wise Choices, Apt Feelings: A Theory of Normative Judgment*. Cambridge, Mass.: Harvard University Press, 1990.
- Kant, Immanuel. *Foundations of the Metaphysics of Morals*. Translated by Lewis White Beck, critical essays edited by Robert Paul Wolff. Indianapolis: Bobbs-Merrill, 1969.
- Korsgaard, Christine. “Two Distinctions in Goodness.” *Philosophical Review* 92 (1983): 169–195.
- Leopold, Aldo. *A Sand County Almanac*. Enlarged ed. New York: Oxford University Press, 1966.
- MacIntyre, Alasdair. *A Short History of Ethics*. New York: Macmillan, 1966.
- Mill, John Stuart. *Utilitarianism*. Edited by Roger Crisp. Oxford and New York: Oxford University Press, 1998.
- Naess, Arne. “Self-Realization in Mixed Communities of Humans, Bears, Sheep, and Wolves.” *Inquiry* 22 (1979): 231–242.
- Pepper, Stephen C. *The Sources of Value*. Berkeley: University of California Press, 1958.
- Ralston, Holmes, III. *Environmental Ethics: Duties to and Values in the Natural World*. Philadelphia: Temple University Press, 1988.
- Scanlon, T. M. *What We Owe to Each Other*. Cambridge, Mass.: Harvard University Press, 1998.
- Scheffler, Samuel. *The Rejection of Consequentialism: A Philosophical Investigation of the Considerations Underlying Rival Moral Conceptions*. Rev. ed. New York: Oxford University Press, 1994.
- Singer, Peter, ed. *A Companion to Ethics*. Oxford and Cambridge, Mass.: Blackwell Reference, 1991.

James A. Montmarquet

GOVERNMENT. See **Political Science**.

GREEK SCIENCE. The activities characterized as Greek science cover a wide range of practices and theories that do not correspond to modern science in a simple or meaningful way.

The boundaries between disciplines were fluid in the ancient period and the definition of subjects and methodologies were discussed vigorously. Hence, it is often futile to try to draw firm boundaries between subjects such as philosophy, medical theory, mathematics, technology, astrology, and astronomy. Rival theories were discussed and challenged to produce a wide range of competing theories and methodologies. Indeed, an important characteristic of much Greek scientific thought is that it is self reflexive and often concerned with “second order” problems such as what constitutes a good theory or a persuasive proof.

Early Cosmology

Thales, Anaximander, and Anaximenes (sixth century B.C.E.)—all from Miletus—are often identified as the earliest Greek philosophers and cosmologists. This identification is partly due to Aristotle (384–322 B.C.E.), who presented them as “fore-runners” for his own physical theories. Aristotle is also the main source for their work, so his accounts must be treated with care as they are frequently colored by his theories. More generally, because so little is known about them, the Milesians have proved a malleable material to later thinkers in search of a Greek origin for their discipline.

The Milesians dealt both with natural phenomena, such as earthquakes and lightning, and with the structure of the cosmos, for instance how the earth is supported. Their explanations refer to the physical properties of things, but often rely on reasoning rather than observation. Thales supposedly argued that the earth is supported by water, while Anaximander stated that the earth rests in the middle of the cosmos, because it has no more reason to go in one direction than another. Aristotle identified a fundamental physical entity in each of the thinkers' theories: water, the boundless, and air, respectively. It is unlikely, however, that all the Milesians used these entities as material building blocks of the cosmos in the way that Aristotle envisaged.

The theories of the Milesians are often contrasted with mythological accounts found in Hesiod and Homer. However, while the Milesians do not refer to actions of the gods in their cosmologies, their theories owe much to earlier Greek and near-Eastern myths and their explanations are speculative.

The Milesians were followed by an array of thinkers criticizing and developing their thoughts. Among these were the Atomists, who argued for an infinite cosmos consisting of atoms and the void, and governed only by material interaction.

Plato

Plato's (427–347 B.C.E.) main interest was with morals and he distanced himself from the material forms of explanation found in the Milesians and the Atomists. In the *Timaeus* he gives an account of the cosmos based on theology, in which the world is created by a divine craftsman. With this image he clearly demonstrates his commitment to design and an ordered and purposeful universe.

According to the account in the *Timaeus*, the Earth lies at the center of the cosmos and consists of atomic elements shaped like regular solids; geometry is thus built into the system at the most basic level. The cosmos has a soul and

is itself a living being. After the creation a little soul was left over and human souls consist of remnants of the world soul. Studying the geometrical regularities exhibited by the movements of the stars and planets improves the human soul, because they mirror the world soul. According to Plato, astronomy should not be studied for its usefulness or in order to understand the physical world. Rather Plato recommends in the *Republic* that astronomy is studied to direct the mind toward an unchanging reality of which the sensible world is but a faint image.

Because of Plato's lack of interest in the sensible world he has often been seen as an enemy of science. However, this view must be tempered not least because of his emphasis on the fundamental role of mathematics. Plato also founded the Academy, which drew many eminent mathematicians and philosophers, among them Plato's most famous student, Aristotle.

Aristotle

The works of Aristotle are of special interest in the history of science, not just because of his physical theories and their immense influence, but also because of his profound interest in how we should organize and understand our knowledge of nature. In *Posterior Analytics*, Aristotle offers the first technical definition of knowledge, *episteme*, as an organized body of deductive arguments. Although Aristotle did not himself adhere to his own rigorous requirements for presenting knowledge, the idea of establishing strict conditions for what counts as knowledge and for its presentation was highly influential.

Aristotle's *Physics* sets out a program for how to study nature. He argued that to know about a thing or a phenomenon one has to consider its four causes: first the *material* cause, which asks what something is made of; second the *formal* cause, which concerns its shape or organization; third the *efficient* cause, which is the agent or "origin of change" that produced the thing; and last the *final* cause, which is the "end" or purpose of something. For Aristotle nature is directed toward the best. The teleology in Aristotle's approach to nature is particularly evident in his thoroughly researched biological treatises where functional explanations play an important role.

In Aristotle's account of the cosmos, all matter on earth consists of combinations of four elements: earth, water, fire, and air. Each of the elements has a natural direction of motion: downward for the former two, and upward for the latter. Thus the Earth is situated in the center of the universe, while air and fire move outward toward the heavens. The cosmos is divided into two distinct spheres. The terrestrial sphere is characterized by change, force, and the movements of the four elements. The celestial on the other hand is unchanging, and the heavenly bodies are made of a fifth element, ether, which moves in perfect circles, thus accounting for the regular circular motions of stars and planets.

In general Aristotle's work is characterized by a lack of dogmatism and a willingness to adopt new methods to deal with the problem at hand. Later Aristotelianism produced influential systematic accounts of Aristotle's work, but these do not reflect the breadth of Aristotle's interests and approaches.

Mathematics

The early history of advanced geometry is little known, but hotly debated. The deductive-axiomatic method typical of Greek geometry appears to have developed in both mathematics and philosophy and it was probably practiced by Eudoxus in the late fourth century B.C.E. The first complete axiomatic work that has been preserved, however, is Euclid's (c. 325–270 B.C.E.) *Elements*. Euclid presents geometry as a deductively ordered sequence of propositions derived from a set of indemonstrables. It is known to contain material from earlier mathematicians and its aim was probably to systematize known material rather than to present original work.

With Archimedes (287–212 B.C.E.) the geometrical approach is developed and extended. Archimedes used the axiomatic method to explore new areas such as curvilinear figures; in *Plane Equilibria* and *On Floating Bodies* he also made the physical phenomena of statics and hydrostatics accessible to mathematical analysis. While Archimedes' work presents a series of rigorous geometrical proofs, he shows, in the *Method*, how many of the results were first found through a mechanical method.

Late antiquity was dominated by a mathematical tradition based on commentaries, which produced new classifications, systematizations, and definitions based on earlier work. Despite the dependence on earlier work, the treatises of mathematicians such as Pappus (fl. 320 C.E.) and Proclus (410–485 C.E.) cannot be described as merely derivative.

At any time, the community of advanced practitioners was probably very small. Mathematics as a whole, however, was not a minority pursuit or isolated from the world. Mathematics included disciplines such as optics, mechanics, harmonics, and astronomy, and professions such as builders, astrologers, land measurers, tax collectors, and traders used and displayed mathematical knowledge for a variety of purposes.

Mechanics and Technology

It is often claimed that technology and science were completely separate activities in the ancient world, and that technology was marginalized and played a minor role in ancient society. This view, however, collapses when considering the relationship between mechanics and technology. Practical expertise, *techne*, however, often had to fight against associations with simple manual labor.

The discipline of mechanics in the ancient periods was concerned with the construction of machines, but it is uncertain to what extent the machines described were actually built. At times they were treated as mathematical objects and at times described as real machines. The earliest preserved mechanical treatise, *Mechanical Problems*, was written by a member of the Aristotelian school and answers an array of questions with reference to the principle of the lever. Later mechanical writers from Alexandria, such as Philo of Byzantium (c. 200 B.C.E.) and Hero of Alexandria (first century B.C.E.), wrote a large number of works on mechanical topics ranging from the construction of automatic theaters and mirror devices for temples to techniques for land measurement, lifting, and catapult con-

struction. The mechanical treatises combined practical claims to efficacy with mathematical treatments demonstrating a close relationship between geometry, technology, and physics in this field.

While many of the devices described in mechanical treatises may have been pure invention, others were based on real machines. Technological invention and skill played important roles in construction work, land measurement, entertainment, and catapult construction. Catapults were becoming widespread in warfare from the fourth century B.C.E. and were central in sieges; and mechanical automata were used to induce wonder, for instance in religious processions. Images of instruments on gravestones and on wall paintings also testify that technology was part of society at a multitude of levels.

Astronomy

The use of the rising and setting of stars to mark seasons is described in literature from the sixth century and some Mesopotamian data were known in Greece certainly by the fifth century. In the fourth century Greek astronomy begins to focus on producing geometrical models of planetary movements based on uniform circular motion. The first known geometrical model of planetary motion is associated with Eudoxus (late fourth century), who also played a central role in the axiomatization of mathematics. Though his model was geometrically sophisticated, it deviated from observed facts in many respects, thus revealing an important aspect of early Greek astronomy; that it was concerned with producing geometrical models of planetary motion rather than with describing the physical cosmos.

The mathematical models were made more complex by the introductions of epicycles (a circle whose center moves on the circumference of another circle) and eccentric models (placing the earth off the center). Such techniques were used by Aristarchus of Samos (c. 280 B.C.E.), famous for proposing a heliocentric model of the world as well as the standard geocentric one, and were developed by Hipparchus of Nicea (fl. late second century) who began to use models to predict astronomical events.

Only little is known about the achievements of these writers as their work was eclipsed by Claudius Ptolemy's (c. 100–170 C.E.) great oeuvre on astronomy, the *Syntaxis* (often known under its Arabic title *Almagest*). Here, Ptolemy derives models for the planets, Sun, and Moon from first principles, using geometrical methods and observed data. In much of his work, Ptolemy mixed a geometrical approach with observation and an interest in physical mechanisms, carefully combining the rhetorical powers of mathematical precision with the status of Aristotelian physics. Ptolemy also wrote an important work on astrology, the *Tetrabiblos*, and in general astrological traditions flourished in the ancient Greek world.

Medicine

Disease and its causes occupied a prominent place in Greek culture and thinking. It played central roles, for example in Homer's epic poems, in histories and in tragedies, and there exists evidence for a plurality of competitive practices ranging

from inscriptions at temples to literary material with close ties to philosophy.

The main source on early medicine is a collection of medical treatises known as the *Hippocratic corpus*, which derives from many authors mainly from the fifth and fourth centuries. It is difficult to characterize this diverse collection of works, but the majority of the Hippocratic doctors were committed to explaining health and disease as physical phenomena. Authors recommend systematic approaches to diagnosis through close observation of symptoms and offered dietary regimes to maintain health. The treatise *On the Nature of Man* influentially described health as a balance between the humors: blood, yellow and black bile, and phlegm.

In Alexandria in the Hellenistic period anatomy and physiology changed through the work of Herophilus (c. 335–280 B.C.E.) and Erasistratos (c. 304–250 B.C.E.), who unusually for the Greek world based their work on human dissection. Later in this period different medical schools also emerged, which vigorously debated the relative merits of theory and practice in medicine; these debates are known mainly through Galen's somewhat biased accounts of them.

Galen of Pergamum (probably 130–200 C.E.) shaped subsequent medical theory up until the renaissance and a vast number of his works has been preserved. Galen drew on material from many previous authorities, but explicitly attempted to reconcile the theories of the Hippocratics (for example, on the humors) with those of Plato (such as the tripartite division of the soul). He famously stated that the best doctor is also a philosopher and recommended demonstrative knowledge in medicine. He also, however, emphasized that a doctor must be good with his hands and he describes both surgery and dissections of animals in great detail.

See also Cosmology; Geometry; Islamic Science; Physics; Science; Science, History of.

BIBLIOGRAPHY

- Aristotle. *The Complete Works of Aristotle: The Revised Oxford Translation*, edited by J. Barnes. Princeton, N.J.: Princeton University Press, 1984.
- Cuomo, Serafina. *Ancient Mathematics*. London: Routledge, 2001. Accessible account of ancient mathematics and mechanics in its historical context.
- Evans, James. *The History and Practice of Ancient Astronomy*. New York: Oxford University Press, 1998. Covers both theories and instrumentation.
- Heath, Thomas, L. *A History of Greek Mathematics*. 2 vols. Oxford: Clarendon, 1921. Comprehensive study of Greek mathematics focusing on the mathematical content.
- Kirk, G. S., J. E. Raven, and M. Schofield. *The Presocratic Philosophers: A Critical History with a Selection of Texts*. 2nd rev. ed. Cambridge, U.K.: Cambridge University Press, 1982. Main collection of fragments from the earliest Greek philosophers with commentary.
- Lloyd, Geoffrey E. R. *Aristotelian Explorations*. Cambridge, U.K.: Cambridge University Press, 1996. Discussions of a number of issues in Aristotle's thought.

- Lloyd, Geoffrey E. R., ed. *The Hippocratic Writings*. Harmondsworth, U.K.: Penguin, 1995. Translations with a general introduction.
- Marsden, E. W. *Greek and Roman Artillery*. 2 vols. Oxford: Clarendon, 1971. Detailed account of the development of Greek and Roman artillery with translations of ancient texts on artillery-construction.
- Netz, Reviel. *The Shaping of Deduction in Greek Mathematics: A Study in Cognitive History*. Cambridge, U.K.: Cambridge University Press, 1999. Important study of the development and characteristics of Greek deductive mathematics.
- Nutton, Vivian. *Ancient Medicine*. London: Routledge, 2004. Accessible account covering the whole period.
- Plato. *Complete Works*. Edited by J. M. Cooper. Indianapolis: Hackett, 1997.
- Toomer, G. J., ed. and trans. *Ptolemy's Almagest*. Rev. ed. Princeton, N.J.: Princeton University Press, 1998. Commentary and translation.
- Vlastos, Gregory. *Plato's Universe*. Oxford: Clarendon, 1975. Plato's theory of the cosmos.
- Von Staden, Heinrich. *Herophilus: The Art of Medicine in Early Alexandria*. Cambridge, U.K.: Cambridge University Press, 1989. Translations with interpretive essays and an introduction on Alexandrian medicine.

Karin Tybjerg

HAPPINESS AND PLEASURE IN EUROPEAN THOUGHT.

Most contemporary understandings of happiness are hedonic: happiness is a state of feeling most precisely defined by the subject of the feeling. Happiness in this sense is subjective and can be of brief duration. Ancient discussions of happiness, however, revolve around the Greek term *eudaimonia*, and while this word is commonly translated as "happiness," it has a different meaning and scope than hedonic understandings of happiness.

Aristotle (384–322 B.C.E.) gives the earliest complete discussion of *eudaimonia* in the *Nicomachean Ethics* where he says *eudaimonia* is the one final overall good we aim at. *Eudaimonia* is complete, self-sufficient, and most choice-worthy; it applies to the life as a whole, not to a transitory and subjective sensory state, and so functions like a "life plan." The specification of *eudaimonia* as the final end for an individual is necessarily thin in Aristotle, corresponding to a general notion of one's life going well. Aristotle—while recognizing disagreement about what constitutes living well—adds substance to *eudaimonia* by stating in *Nicomachean Ethics* 1.7 that this highest human good is an "activity of the soul in conformity with virtue," thus linking *eudaimonia* with his theory of the virtues. *Eudaimonia*, then, is ultimately located in the *bios theoretikos* ("contemplative life") and hence highly dependent on a teleological biology.

Linking *eudaimonia* with an individual's final end produced two broad categories of commentary on the eudaimonistic tradition. Some critics argue that eudaimonistic focus on the *bios theoretikos* divorces one's own happiness from broader ethical or moral considerations, and so conclude that the eudaimonistic tradition had no conception of genuine moral virtues. Most current readers of the eudaimonistic tradition, however, see no conflict between the pursuit of individual happiness and external considerations, hence eudaimonism can encompass ethical and altruistic components.



The Hellenistic Era

Hellenistic thinkers agree with Aristotle that *eudaimonia* is the final end for humans but differ in their description of what happiness consists. The broadest school of Hellenistic philosophy, the Stoics, held that happiness consisted in a disposition to restrict one's will and achieve a state of *ataraxia*, or tranquility. This means that one must reduce one's desires as nearly as possible to those that can be satisfied autonomously; these turn out to be largely internally regulated. Maintaining *ataraxia* against external vicissitudes allows impassivity in the face of changing fortune and an eudaimonistic life. *Eudaimonia* for the Stoics was similar in this sense to the beliefs of classical thinkers: it held that happiness was a way in which one lived as opposed to a subjective emotional state.

One notable exception in Hellenistic thinking on happiness is Epicurean philosophy. While the Epicureans held similar views on the place of happiness in a human life, their views on what happiness was came closest in the ancient world to hedonic conceptions of happiness. But there is an important distinction to be kept in mind in making this comparison. While Epicurus (341–270 B.C.E.) held that happiness consisted in staving off unpleasant sensations, he said one does this by keeping one's needs simple and easily satisfied. The reason for this was that Epicurus held that pleasures are largely products of the mind, and that consequently people can find greater pleasure through the mind than by pursuing things that most people mistakenly believe to be greater pleasures.

The Medieval View

Medieval discussions of happiness link discussions of happiness with proximity to or contemplation of the divine. Saint Augustine of Hippo (354–430 C.E.) follows the Greeks in emphasizing that all men desire happiness but makes a distinction between fleeting forms of happiness found in earthly existence and true happiness, which is found in the divine. Most human beings mistake hedonic forms of happiness for true happiness, which comes only from proximity to God. Thomas Aquinas (c. 1224–1274) agrees, following Aristotle's discussion of final ends, adding that happiness consists in the operation of speculative rather than practical intellect, which in turn leads one to the divine.

Modern Views on Happiness

In the modern epoch, the notion of happiness has narrowed considerably. Immanuel Kant (1724–1804) plays a principal role in this development in his *Groundwork of the Metaphysics of Morals*. There, he establishes his deontological moral theory, which has no room for happiness since moral actions are undertaken out of a sense of duty rather than from a psychological state or feeling. In this view, any "moral" system based on happiness amounts to hedonism, which cannot possibly provide the groundwork for morality. As such, the importance of happiness in ancient virtue ethics gets severely undercut.

Act Utilitarianism

In some ways, then, Kant's deontological system opens the door for defenses of happiness, and consequentialism emerged

in this role. Of course, happiness in the consequentialist accounts is treated much more vaguely than it was in the virtue ethics accounts. Utilitarianism, especially as promoted by Jeremy Bentham (1748–1832), provides a counterview to both the virtue ethicists and the deontologists. Bentham's version of utilitarianism establishes it as a hedonistic view in which the maximization of pleasure and the minimization of pain are classified as good. On the face of it, Bentham appears to be reviving the ancient Epicurean view, especially since, like the Epicureans, Bentham contends that humans naturally seek pleasure and avoid pain. But Epicurean hedonism differs from Benthamite hedonism insofar as the Epicureans grounded their view in *ataraxia*, which corresponds quite well with the ancient view of happiness or *eudaimonia*. Bentham's hedonism contains no such ground. Instead, what makes an action good is not its effect on the psychological state of the actor but rather the consequences of the action for the (narrow) happiness of the actor. An action is good if its consequences are good (i.e., if the action maximizes pleasure and minimizes pain).

Rule Utilitarianism

This "act utilitarianism" has been criticized because it only seems to consider the consequences of an act for the actor and therefore leaves aside the consequences of an action for others. As a result, John Stuart Mill (1806–1873) and John Austin (1790–1859) proposed a system of "rule utilitarianism" in which actions would be deemed moral based upon their adherence to a specific rule of conduct that has the best overall consequences. Of course some, principally David Lyons (b. 1935), have argued that rule utilitarianism amounts to the same thing as act utilitarianism since it would simply suggest that the same sorts of acts be followed as in act utilitarianism. The only apparent difference between the two systems is that they follow different methods in order to arrive at the same place.

John Rawls

In more recent years, philosophers have returned in some ways to views of happiness that are quite similar to that of the virtue ethicists. John Rawls (1921–2002), in *A Theory of Justice* (1971), provides the best example. Consciously drawing on Aristotle, Rawls claims that "a person's good is determined by what is for him the most rational long-term plan of life given reasonably favorable circumstances. A man is happy when he is more or less successfully in the way of carrying out this plan" (pp. 92–93). The favorable circumstances to which Rawls refers are found in his "primary goods," a notion that links up well with the importance of "external goods" in Aristotle's system. Primary goods, like Aristotle's external goods, are the "necessary means" to achieving "one's system of ends" (p. 93). As such, at least among certain philosophers the view of happiness has refocused on the virtue ethics' position. Still, this is a far cry from saying what Aristotle was able to say in the *Nicomachean Ethics*, namely, that the identification of *eudaimonia* (or happiness) as the final good for humans was a platitude. We have surely not gotten back to this position on happiness.

See also *Emotions; Epicureanism; Stoicism; Utilitarianism*.

BIBLIOGRAPHY

- Annas, Julia. *The Morality of Happiness*. Oxford, U.K., and New York: Oxford University Press, 1993.
- Austin, Jean. "Pleasure and Happiness." *Philosophy* 43 (1968): 51–62.
- Austin, John. *The Province of Jurisprudence Determined*. Amherst, N.Y.: Prometheus Books, 2000.
- Cooper, John M. *Reason and Human Good in Aristotle*. Cambridge, Mass.: Harvard University Press, 1975.
- Dongan, Alan. *The Theory of Morality*. Chicago: Chicago University Press, 1977.
- Irwin, Terence. *Aristotle's First Principles*. Oxford, U.K.: Clarendon Press, 1988.
- Kant, Immanuel. *Groundwork of the Metaphysics of Morals*. Translated by Mary Gregor. Cambridge, U.K., and New York: Cambridge University Press, 1998.
- Kenny, Anthony. "Happiness." *Proceedings of the Aristotelian Society* 66 (1965–1966): 87–102.
- Long, A. A. *Hellenistic Philosophy: Stoics, Epicureans, Sceptics*. 2nd ed. Berkeley: University of California Press, 1986.
- Lyons, David. *Forms and Limits of Utilitarianism*. Oxford, U.K.: Clarendon Press, 1965.
- Mill, John Stuart. *Utilitarianism*. 2nd ed. Edited by George Sher. Indianapolis: Hackett, 2002.
- Montague, R. "Happiness." *Proceedings of the Aristotelian Society* 67 (1967): 87–102.
- Nussbaum, Martha C. *The Fragility of Goodness: Luck and Ethics in Greek Tragedy and Philosophy*. Cambridge, U.K., and New York: Cambridge University Press, 1986.
- Rawls, John. *A Theory of Justice*. Cambridge, Mass.: The Belknap Press of Harvard University Press, 1971.
- Ring, M. "Aristotle and the Concept of Happiness" In *The Greeks and the Good Life: Proceedings of the Ninth Annual Philosophy Symposium, California State University, Fullerton*, edited by D. J. Depew, 69–90. Indianapolis: Hackett, 1980.
- Tuck, Richard. *Natural Rights Theories: Their Origin and Development*. Cambridge, U.K., and New York: Cambridge University Press, 1979.
- Wike, Victoria S. "The Role of Happiness in Kant's Groundwork." *The Journal of Value Inquiry* (1987): 73–78.
- Williams, Bernard. *Ethics and the Limits of Philosophy*. Cambridge, Mass.: Harvard University Press, 1985.

Tim Duwall
Jeffrey Miller

HARMONY. *Harmony* is derived from the classical Greek *harmonia* (meaning a joint between the planks of a ship or a joining of those planks). From the beginning, the term was also used in its current metaphorical sense, that of a combination of parts or related things to form a consistent whole or an agreement.

Harmony in Ancient Greek Writings on Music

In ancient Greek writings on the subject of music, harmony (also known as "harmonics") was the study of the formation of melody. This study began with the elements of melody—the individual notes—and continued with the specification of appropriate ways in which pairs of notes, a higher and a lower,

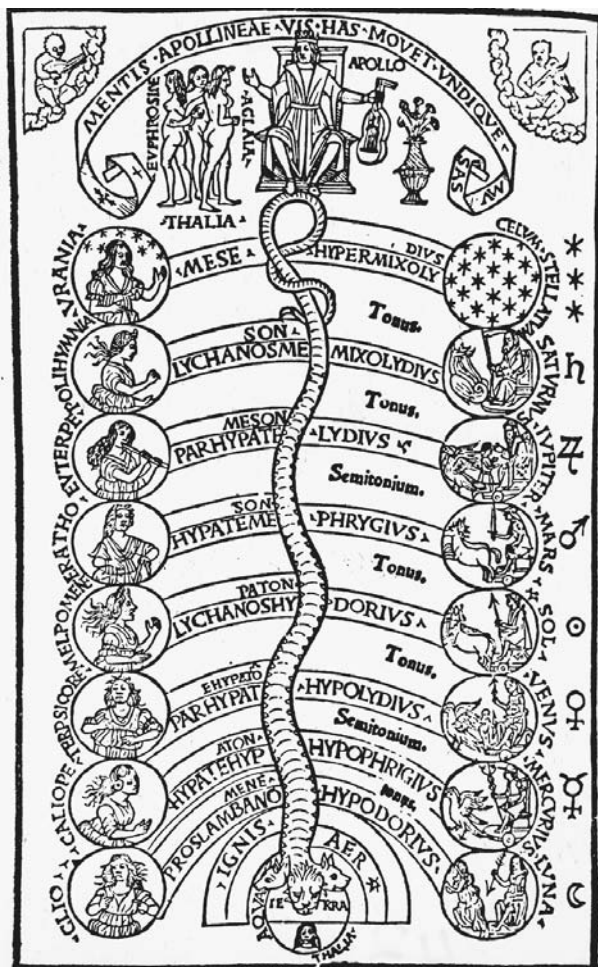

Diagram of Apollo, the planets, the Muses, and the Modes. From *Practica musicae* (1496) by Franchino Gaffurio. The philosopher Plato believed the universe was constructed and arranged based on harmonic principals that closely resembled Pythagorean numerical theory. APOLLO PRESIDING OVER THE MUSIC OF THE SPHERES, FROM 'PRACTICA MUSICAÆ' BY FRANCHINO GAFFURIO, FIRST PUBLISHED IN 1496 IN 'REVUE D'HISTOIRE DU THEATRE,' 1959 (WOODCUT) (B/W PHOTO), ITALIAN SCHOOL (15TH CENTURY)/BIBLIOTHEQUE DES ARTS DECORATIFS, PARIS, FRANCE, CREDIT: ARCHIVES CHARMET/WWW.BRIDGEMAN.CO.UK

could be combined successively into melodic intervals. (The simultaneous combination of notes was not a part of classical Greek musical practice.) These melodic intervals were in turn combined into a variety of complex scalar systems, the defining structures of complete melodies. In general terms, classical Greek harmonics falls into two traditions: the Aristoxenian and the Pythagorean.

Aristoxenian harmonics. To Aristoxenus (c. 375–300 B.C.E.), a prolific writer on a variety of philosophical and historical subjects and the son of a musician, harmonics was the study of music as we hear it. Its task was to arrive at an understanding of the musical sounds that the human ear hears as pleasing or melodic through a systematic analysis of the perceived

phenomena. The definition of “melodic” must concern itself only with the sounded elements of music—the notes, described exactly as they are heard by the ear, namely, as different pitches on a melodic continuum; furthermore, the general rules that govern melodic structure must not be derived from any abstract principles. However, Aristoxenus, to support his phenomenalist argument for the existence of certain melodic combinations of notes that have an “affinity” with one another, makes an analogy to a related property of speech: “And yet the order which relates to the melodic and unmelodic is similar to that concerned with the combination of letters in speech: from a given set of letters a syllable is not generated in just any way, but in some ways and not in others” (Barker, p. 153).

Pythagorean harmonics. By contrast, Pythagorean harmonics, the set of beliefs about music attributed to the contemporary followers of Pythagoras of Samos (c. 580–c. 500 B.C.E.) and his intellectual heirs in the fourth and third centuries B.C.E., was centered on the discovery that the fundamental melodic intervals of the octave, the fifth, and the fourth could be produced by the lengths of the two sections of a stretched string in the simple and elegant mathematical ratios of 2:1, 3:2, and 4:3, respectively. The Pythagoreans took this musical discovery as an affirmation of their belief in the mathematical nature of reality and argued that certain musical intervals are pleasing to the ear because of their underlying structure, not for any reason having to do with musical sound considered only as an audible phenomenon. Within Pythagorean harmonics, all subsequent combinations of tones into scalar systems were generated from these basic ratios, including 9:8, the mathematical ratio associated with a musical whole tone. To the Pythagoreans, these scalar constructions—the Pythagorean system of intonation—were musical embodiments of a cosmic scalar relationship among the planets governed by their distances from the earth and their revolutionary speed: the harmony of the spheres. (This idea may have had Mesopotamian roots; see Kilmer, “Mesopotamia.”)

Plato's Harmonic Cosmology

None of the writings produced by Pythagoras or his contemporaries are extant (see Burkert for a discussion of the authenticity of information about fifth- and sixth-century B.C.E. Pythagoreans), but the impact that the simplicity and exactness of the Pythagorean proportions had on the philosopher Plato (428–348 or 347 B.C.E.) is revealed most clearly in his late dialogue *Timaeus*, in which Timaeus, a man trained in Pythagorean doctrine, describes the origin and nature of the physical world. Central to this cosmological drama is the Demiurge, a kind of primary arranger, who begins with formless matter in a primitive state of chaos. He proceeds by using a fixed set of numbers to construct the soul of the world as a mixture of metaphysical oppositions (indivisible and divisible existence, indivisible and divisible sameness and difference). Successive lengths of primary material are mixed in the ratios 2:1, 3:2, 4:3, and 9:8, that is, exactly the Pythagorean harmonic ratios (*Timaeus* 35–36, pp. 64–73). Thus the world's soul is constructed as a harmony of opposites permeated by number in which the formative principles of Platonic cosmology are identical to those of Pythagorean harmonic theory. In a following section, Plato

turns to the construction of the physical universe as an “eternal image, moving according to number” (*Timaeus* 37D, pp. 76–77). The seven celestial bodies—the Moon, Mercury, Venus, the Sun, Mars, Saturn, and Jupiter—are created and placed in orbits about the earth determined by these same harmonic ratios. According to this model, the sun is located at the midpoint of a seven-note scale of revolving bodies; the whole thing is contained within an outer starry sphere that sets the limits of the universe. In his *Republic*, written some thirty years before the *Timaeus*, Plato had used striking imagery rather than mathematical relationships to describe his harmonic universe of planetary spheres: “And on the upper surface of each circle is a siren, who goes round with them, hymning a single tone or note. Together they form the concord of a single harmony [musical scale]” (“The Myth of Er,” *Republic* 617B, pp. 502–505).

Neoplatonic Speculative Harmony

At some point Plato’s sirens were replaced by Muses, possibly in the lost commentary on the *Republic* by the Neoplatonist Porphyry (c. 234–c. 305). A unique passage transmitting the “musical” version of Plato’s image is found in the first book of Martianus Capella’s fifth-century Neoplatonic treatise, *De nuptiis Philologiae et Mercurii* (On the marriage of Philology and Mercury). Martianus describes the Muses arriving at their celestial locations:

The upper planets and the sevenfold spheres produced together the clear harmonies of a certain sweet melody in a sound even more pleasant than usual, undoubtedly because they knew that the Muses were approaching. Passing through all the spheres one by one, each Muse stopped when she recognized the pitch that was familiar to her. Urania occupied the most distant sphere of the starry universe, which was carried along resonating an acute clear tone. Polymnia took the circle of Saturn; Euterpe that of Jupiter. Erato, once she had entered the sphere, sang the pitch of Mars. Melpone took the middle orbit where the sun makes the sky beautiful with his flaming light. Terpsichore was united with the gold of Venus. Calliope took possession of the sphere of Mercury, and Clio the innermost circle . . . on the moon, which resonated a deep pitch in a harsher tone. (Martianus Capella, *De nuptiis*, book 1, pp. 12–13)

Later in the treatise, Martianus describes Philology’s traveling from earth through the heavenly bodies to the outermost sphere, giving the length of each leg of her journey in terms of a specific musical interval and indicating that the entire musical distance is equal to six whole tones, or an octave. Thus he presents an explicit working-out of the Platonic cosmological parallel between the ordering of the universe and the harmonic organization of a musical scale.

Continuation of the Pythagorean-Platonic Tradition in Music

Pythagorean–Platonic musical mathematics was transmitted to scholars during the Latin Middle Ages principally through the following texts: Calcidius’s late-fourth-century Latin translation of most of the *Timaeus* (up to *Timaeus* 53c) and his

accompanying commentary on that text; Macrobius’s fifth-century commentary on Cicero’s *Somnium Scipionis* (Scipio’s dream); Martianus Capella’s *De nuptiis philologiae et Mercurii*, quoted above; book 2 of Cassiodorus’s sixth-century *Institutiones divinarum et humanum litterarum* (Institutions); book 3 of Isidore of Seville’s sixth-century *Etymologiae* (Etymologies); and finally the extremely important work of Boethius (c. 480–c. 524), *De institutione musica* (The fundamentals of music), a learned statement of the Neopythagorean and Neoplatonic traditions in music probably based on the work of the Greek writers Nicomachus of Gerasa (fl. c. 100 C.E.) and Ptolemy (2nd century C.E.). After affirming the correctness of Plato’s assertion that the soul of the universe is joined according to musical concord (Boethius, book 1, chapter 1), Boethius formulates an evocative triadic version of the tradition (Boethius, book 1, chapter 2): *musica mundana* (cosmic music), the principle of the universe controlling planetary motion, seasons, and elemental combinations; *musica humana* (human music), the integrating force between body and soul; and *musica instrumentalis* (instrumental music), the music produced by string, wind, and percussion instruments.

By about the middle of the ninth century, during the Carolingian era, writers on the subject of music began to produce treatises that contained large excerpts from the writers cited above, but that attempted to place the Pythagorean–Platonic harmonic tradition within a Christian framework and adapt it to the current need to codify and regulate the performance of liturgical chant within the mass and the holy office. For example, Aurelian of Réôme in his *Musica disciplina* (The discipline of music), written around the middle of the ninth century, justifies the classification of liturgical chant into eight different modes by referring to the seven planetary orbits plus the outer starry sphere (now referred to as the Zodiac), exactly as laid out in Plato. Referring to his Latin authorities (Boethius, Cassiodorus, Isidore), he writes that “the whole theory of the art of music consists of numbers . . . Music has to do with numbers that are abstract, mobile, and in proportion” (Aurelian, *Musica disciplina*, chapter 8, pp. 22–23).

The last truly original and complete statement of Pythagorean–Platonic speculative harmony was given in the Renaissance by the German astronomer and writer on music Johannes Kepler (1571–1630), who in his treatise *Harmonice mundi* (The harmony of the world) posits a world created by God in accordance with the archetypal harmonies represented in the principal musical consonances. The tradition, however, is clearly implicit in subsequent works, such as *Die Welt als Wille und Vorstellung* (The world as will and representation) by Arthur Schopenhauer (1788–1860), and explicit in the work of the twentieth-century Swiss aesthetician Hans Kayser (1891–1964). Kayser’s principal contribution was a harmonic theory, informed by a close reading of Kepler’s *Harmonice mundi*, according to which the measurement of the intervallic properties of sound could also serve as an exact measurement of feeling. Finally, late-twentieth-century “superstring theory,” a cosmic physical theory that, in principle, is capable of describing all physical phenomena, is clearly Pythagorean in essence and scope:

Music has long since provided the metaphors of choice for those puzzling over questions of cosmic concern.

From the ancient Pythagorean “music of the spheres” to the “harmonies of nature” that have guided inquiry through the ages we have collectively sought the song of nature in the gentle wanderings of celestial bodies and the riotous fulminations of subatomic particles. With the discovery of superstring theory, musical metaphors take on a startling reality, for the theory suggests that the microscopic landscape is suffused with tiny strings whose vibrational patterns orchestrate the evolution of the cosmos. The winds of change, according to superstring theory, gust through an aeolian universe. (Greene, p. 135)

Harmony as the Organizing Principle of Western Music

In a significant departure from its original meaning in Greek music theory as the melodic or horizontal combination of two different notes, the term *harmony*, beginning with the two-voice polyphony of the Middle Ages, came to refer to the simultaneous or vertical combination of two or more notes, as well as the horizontal or linear relationships between the complex sounds thus produced. The primary subjects of harmonic analysis are relationships between notes, properties of chords, consonance and dissonance, and tonality and key. Since the Middle Ages, the study of harmony has developed in two basic areas: speculative or theoretical harmony and practical harmony.

Speculative or theoretical harmony. The theoretical study of harmony developed directly from ancient mathematical speculations on the foundation and structure of music, in particular, Pythagorean, Platonic, and Neoplatonic theory. At least through the seventeenth century, mathematical relationships were generally considered to be the formative principles of musical phenomena. Then in the eighteenth century, Jean-Philippe Rameau (1683–1764), in a series of treatises inspired by the acoustical research of Joseph Sauveur (1653–1716), broke with the Pythagorean–Platonic tradition and attempted to discover a strict scientific basis for musical sound through a consideration of the physical principles observable in the natural harmonic series, consisting of a principle tone generated by a vibrating body (*corps sonore*) at a particular frequency and the integral multiples of that tone that are known as its harmonics or overtones. Although this “natural” theory—which can be viewed as a continuation of the Aristoxenian or phenomenalist tradition of harmonic analysis—was intuitively more appealing as a basis for the generation of musical intervals and chords than the proportional divisions of a stretched string offered by the purely mathematical tradition, Rameau’s analysis failed to provide a complete systematic explanation of all commonly used chords and chordal progressions.

In the mid-nineteenth century, Moritz Hauptmann (1792–1868), in *Die Natur der Harmonie und der Metrik* (The nature of harmony and meter), turned away from both the mathematical tradition and the type of physical explanation proposed by Rameau to argue—probably following Hegelian philosophical doctrine—that the universal principles underlying music must be identical to those of human thought: unity,

opposition, and reunion or higher unity. In recent years, in addition to theoretical investigations of the physical properties of musical sound, empirical studies of musical perception and cognition have produced information of a comparative nature about different musical styles and cultures in an effort to demonstrate the existence of universally perceived harmonic properties, such as scalar organization of tones and tonal centers (see, for example, Krumhansl, *Cognitive Foundations*).

Practical harmony. The study of practical harmony, rather than having the aim of producing speculative theories about musical phenomena, is intended to educate musical practitioners: composers, performers, educators, and amateurs. Its history largely coincides with that of harmonic tonality, the Western music of the “common practice” period, approximately 1600 through 1910. From the beginning, practical harmony, or harmonic practice, has included topics such as rules for the composition of counterpoint; techniques of improvisation; and the vertical and horizontal analysis of chordal structures and chordal progressions, the so-called Roman numeral analysis of tonal music. Throughout much of the twentieth century, following the nineteenth-century consolidation of the canon of music within the Western “classical” tradition (that is, “art music” rather than “popular music”), textbooks on harmonic practice tended to concentrate on the analysis of the musical structures at work in the compositions of Bach, Beethoven, Brahms, and other composers of this repertory (see, for example, Piston, *Harmony*). This approach, however, produces somewhat chaotic results when applied to the extremely chromatic, and therefore not strictly tonal, music of the late nineteenth century. Musicologist Jean-Jacques Nattiez, for example, cites thirty-three different functional harmonic analyses of one particular chord—the famous “*Tristan* chord,” F–B–D#–G#—which occurs in the opening measure of the prelude to Richard Wagner’s opera *Tristan und Isolde* (Nattiez, chapter 9). A significant late-twentieth-century development has been the loosening of the distinction between classical and popular music and the inclusion of largely diatonic, rather than chromatic, musical idioms—such as folk music, jazz, blues, and rock and roll—within contemporary textbooks on harmonic practice.

See also **Composition, Musical; Mathematics; Musicology; Platonism; Pythagoreanism.**

BIBLIOGRAPHY

PRIMARY SOURCES

- Aurelian of Réôme. *Musica disciplina*. Translated by Joseph Ponte. Colorado Springs: Colorado College Music Press, 1968.
- Boethius. *De institutione musica*. Translated, with introduction and notes, by Calvin M. Bower. Edited by Claude V. Palisca. New Haven: Yale University Press, 1989.
- Martianus Capella. *De nuptiis Philologiae et Mercurii*. Edited by James Willis. Leipzig: B. G. Teubner, 1983.
- Plato. *Republic, Books 6–10*. Translated by Paul Shorey. Loeb Classical Library no. 276 (*Plato*, vol. VI). Cambridge, Mass., and London: Harvard University Press, 1935. Reprint, 2000.
- Plato. *Timaeus*. Translated by R. G. Bury. In Loeb Classical Library no. 234 (*Plato*, vol. IX). Cambridge, Mass. and London: Harvard University Press, 1942. Reprint, 1989.

SECONDARY SOURCES

- Barker, Andrew, ed. *Greek Musical Writings*. Vol. 2: *Harmonic and Acoustic Theory*. Cambridge, U.K., and New York: Cambridge University Press, 1990.
- Burkert, Walter. *Love and Science in Ancient Pythagoreanism*. Translated by E. L. Minar. Cambridge, Mass.: Harvard University Press, 1972.
- Godwin, Joscelyn, ed. *Harmony of the Spheres: A Sourcebook of the Pythagorean Tradition in Music*. Rochester, Vt.: Inner Traditions International, 1993.
- Greene, Brian. *The Elegant Universe: Superstrings, Hidden Dimensions, and the Quest for the Ultimate Theory*. New York and London: W. W. Norton, 1999.
- Kilmer, Anne Draffkorn. "Mesopotamia." In *The New Grove Dictionary of Music and Musicians*, edited by Stanley Sadie and John Tyrrell, vol. 16, pp. 480–487. London: Macmillan, 2001.
- Krumhansl, Carol L. *Cognitive Foundations of Musical Pitch*. Oxford Psychology Series No. 17. New York and Oxford: Oxford University Press, 1990.
- Mathiesen, Thomas J. *Apollo's Lyre: Greek Music and Music Theory in Antiquity and the Middle Ages*. Lincoln: University of Nebraska Press, 1999.
- Nattiez, Jean-Jacques. *Music and Discourse: Toward a Semiology of Music*. Translated by Carolyn Abbate. Princeton: Princeton University Press, 1990.
- Nolan, Catherine. "Music Theory and Mathematics." In *The Cambridge History of Western Music Theory*, edited by Thomas Christensen, pp. 272–304. Cambridge, U.K., and New York: Cambridge University Press, 2002.
- Piston, Walter. *Harmony*. 5th ed. Revised and expanded by Mark De Voto. New York and London: W. W. Norton, 1987.
- Stephenson, Bruce. *The Music of the Heavens: Kepler's Harmonic Astronomy*. Princeton: Princeton University Press, 1994.

Blair Sullivan

HATE. As a concept, hate has several interrelated dimensions. It attempts to provide historical, psychological, and sociocultural depth to the forms of hostility and animosity that the term *hate* ostensibly defines, and to make the idea clear in terms of its linguistic usages. As such, it faces obstacles that often appear insuperable. Nonetheless, "hate crimes"—criminal acts and behaviors motivated by hate—have been added to the repertoire of statutory codes of criminal justice jurisdictions throughout the world. The laws help to illuminate the social and political dynamics of racial and xenophobic ethnic hostility as well as gender discrimination.

Hatreds based on identities, lifestyles, cultural values, and tastes appear to have historic continuity and keep simmering across generations. Hate crimes reflect a reservoir of biases and angry memories widely shared within groups that nurse grievances whose origins are often blurred or obscured by time but that retain, nevertheless, a need for revenge and retribution. These antagonisms can act as a flash point for violent behavior in times of economic deprivation or during the stresses that accompany profound demographic transitions in a community that experiences the impact of forced immigration.

Indeed, crimes precipitated by hate involve some of our deepest and darkest instincts. Although moral and ethical principles are basic to the understanding of the problem and instrumental in its resolution, it should not be supposed that effective coping with this particular negative human potential has been achieved.

Hate Mongering

Saying hateful things is facilitated by the standard discourse of most cultures, which usually furnishes speakers with a rich vocabulary of words and colloquial expressions that can demean, denigrate, mortify, insult, instigate, and arouse violent behavior. Even mass media outlets appear to have been polarized along political–ideological cleavages in which extremist fringes (on the right or left) disseminate pernicious ideas and caricatures, all under the guise of free speech.

International Scope of Hate Crimes

In April 2002, the United Nations Centre for International Crime Prevention issued a paper on "Preventing Hate Crimes: International Strategies and Practice." The document suggested that most countries are concerned about hate crime, but that there are important differences in the kinds of behavior that may be included under the rubric "hate crime."

European nations, including Germany and the United Kingdom, emphasize primarily crimes where a racial motive is apparent. Hateful speech also falls under hate crime definitions in these states. French law refers to hate crime in terms of racism, intolerance, and xenophobia. By contrast, in Germany, the expression "hate crime" is rarely used. Instead, "politically motivated violence," "xenophobic criminality," and "right- or left-wing extremism" are more common indicators of hate crimes. Australia refers to the idea of "racial vilification" as its criminal conceptualization of a hate crime. The legal terminology of Canada and the United States tends to be more inclusive by citing as hate crimes acts against those of a particular religious affiliation, ethnic and racial background, sexual orientation, age, gender, and, more recently, disability or physical impairment.

The United States Hate Crime Statistics Act of 1990 (HCSA) defines hate crimes as "crimes that manifest evidence of prejudice based on race, religion, sexual orientation, or ethnicity, including, where appropriate, the crimes of murder, non-negligent manslaughter, forcible rape, aggravated and simple assault, intimidation, arson, and destruction, damage, or vandalism of property." The act has also been amended to include physical disability.

In determining whether a hate crime has been committed, the qualifier "hate" must convey a distinctive sense about the underlying dynamics promoting this behavior, showing that behind the crime is an aversion for the victim or a morbid attraction to a potential victim precisely because of his or her perceived individual and social attributes. Thus, what seem to distinguish hate crimes from other crimes are the motives that drive violent, destructive behavior against others or their property. However, proving that hate is the prime motive in committing a criminal act can be very difficult, and in consequence



Man bearing the brand of the Ku Klux Klan, Boston, Massachusetts, 1924. The origins of the Ku Klux Klan—also known as the Invisible Empire—can be found during the period immediately following the American Civil War, when the group formed to oppose the Reconstruction government and espouse white supremacy. © HULTON-DEUTSCH COLLECTION/CORBIS

many such offenses go unrecorded or are not prosecuted as hate crimes for lack of a strong, convincing body of evidence.

New Perspectives

With the end of the forty-five years of the Cold War (1945–1991), the major powers that were left standing dismantled their empires, leaving in their wake a bevy of new states and nations striving to establish their sovereignty. Another legacy of the colonial period is the abiding hatred and bitter resentment of former colonies, many of which are mired in tribalism, warlordism, and an unremitting fear of “others.”

In the new world of the twenty-first century the phenomenon of hate crimes is a cultural artifact of a particular kind, however etiolated by social and psychological theories. To understand hate crimes in this context of new and swarming states, it is essential to consider how they have come into historical being, in what ways their meanings have changed over time, and why, today, they command emotional legitimacy. It appears that hate crimes are the distillation of complex racial, ethnic, and political-historical forces. These elements are further defined and formulated into legal and/or criminal categories, and concomitantly into statutory law, becoming “modular.” Hence, they are capable of being transplanted, with varying degrees of applicability, to a variety of social terrains, and to merge and be merged with a correspondingly broad class of legal and criminal codes.

A forerunner of modern hate crime legislation was the American civil rights movement of the 1950s and 1960s, which brought about profound changes in American jurisprudence concerned with hate-related violations of individual rights. The movement’s ethical and legal courage bequeathed to the world new standards of decency in behavior and attitude expressed in hate crime law.

The terrorist attacks of September 11, 2001, and subsequent terrorist actions around the globe have made it clear that, despite the significant advances societies have attained in humane treatment of their members, there still lurks a world-view as treacherous as the Nazi insanity of the twentieth century. Unbridled terrorist violence, with its conjoining fanaticisms, steps across moral thresholds accepted by most of the world. Simply put, there are groups who are skilled in the use of chemical weapons, ballistic devices, and biological weapons that can correctly be classified as weapons of mass destruction, who are prepared to kill randomly. In viewing these two notions, terrorism and hate, as folded into each other, it is quickly sensed that more than a political point is being made. Gratuitous hatred is painfully evident.

These terrorists make no effort to justify the bloodshed beyond perfunctory claims of imperialist colonialism, Zionist oppressions, and American-led interventions into non-Christian societies.

Hate crimes will probably continue to occur because, regardless of the actual inequality and exploitation that may prevail in every country, the state/nation itself, at any point in time, is ultimately conceived as a deep, horizontal comradeship. It is this fraternity that makes criminal behavior driven by hate possible.

See also **Empire and Imperialism; Human Rights; Prejudice; Terror.**

BIBLIOGRAPHY

- Jacobs, James, and Kimberly Potter. *Hate Crimes: Criminal Law and Identity Politics*. Oxford: Oxford University Press, 1998.
- Kelly, Robert, and Jess Maghan, eds. *Hate Crime: The Global Politics of Polarization*. Carbondale: Southern Illinois University Press, 1998.
- “Preventing Hate Crimes: International Strategies and Practice.” United Nations Centre for International Crime Prevention, 2002.
- Public Law 101-275, 104STAT. 140: Hate Crime Statistics Act. Washington, D.C.: U.S. Government Printing Office, 1990.
- Title VII of the Civil Rights Act of 1964 as amended by the Equal Employment Opportunity Act of 1972, Statutory Provisions, section 14:55. Washington, D.C.: U.S. Government Printing Office.

Jess Maghan

HEALTH AND DISEASE. Health and disease seem at first glance to be obvious and opposing concepts. We are either healthy or suffering from some disease. In practice, however, health and disease are neither clearly defined nor mutually exclusive. Asthmatics and diabetics have won Olympic gold medals, and amputees can live to a ripe old age. “Healthy” people in their eighties cannot do things they could easily have done half a century before; they may still be able to perform tasks they could not have as healthy infants. Conditions that would be perceived as a disease in one society might be considered perfectly normal in another.



Fresco showing doctor giving treatment to sick man with cut on leg (1443) by Domenico di Bartolo. Due to the strong influence of religion during the Middle Ages, illness was often blamed on supernatural forces or sins committed by the sick person. © THE ART ARCHIVE/SANTA MARIA DELLA SCALA HOSPITAL SIENA/DAGLI ORTI (A)

Health is a more problematic and conditional state than is disease, and it is generally less visible historically. It is less likely to be noticed by the individual or commented on by healers or philosophers. Often, health is simply the default mode, the condition to which people revert after they recover from some illness. Illness is of course not the same as disease. The former is a subjective experience, suffered by a person; the latter is more objective, in that others, especially medical practitioners, share in its conceptualization. The diagnosis, or naming, of the disease generally presupposes some notion of its cause. There may be different frameworks of putative causation operating between patients and their healers. The patient may believe he or she fell ill because of exposure to the cold or consumption of the wrong kind of food. The doctor may have other ideas. For most of human history, however, doctors and patients shared similar causative cosmologies. With the rise of modern biomedicine, the potential divergence of the explanatory frameworks increased. This separation of the conceptual worlds of doctor and patient is part of the power, and the problems, of modern medicine.

More constant are the normative dimensions of health and disease. Health, however conceived, has positive qualities, disease negative ones. Aesthetics plays a large part in contemporary judgments on these matters. Sumo wrestlers and weight lifters are perceived as healthy, even if their life expectancies

may be less than those of ninety-pound weaklings. Straight teeth are considered healthier than crooked ones. Plump women in some cultures are considered healthier than their leaner sisters; in other times and places, the reverse is the case. Sunbathing is a relatively recent phenomenon among the lighter skinned races; malignant melanoma has caused a reevaluation of the relative merits of the aesthetic and the medical.

All of these examples point to the complexity and historical contingency of perceptions of health and disease. Following Alexander Pope's dictum, "this long disease, my life," this essay will use disease as the standard and assume that notions of health are somehow implicit in the historical perception of disease.

Beginnings

In preliterate societies, disease was often assumed to be the product of one of two opposing occurrences: object intrusion or spirit loss. The intrusion of some foreign object was invoked to explain diseases marked by pain, restlessness, and other acute symptoms. Spirit loss resulted in wasting, lethargy, and other signs of debility. These grand divisions, corresponding very roughly to "noisy" (acute) diseases and "quiet" (chronic) ones, recur throughout history. In preliterate societies, the explanations were embedded within magico-religious frameworks, and the remote causes of disease might be witchcraft, malevolent spirits, or individual transgression of some cultural taboo. Healing was often a communal affair, and the principal healer generally combined the offices of priest and doctor. While the conceptual framework was religious or magical or both, the steps toward healing, or disease prevention, rationally followed the assigned causes. Notions of health generally incorporated aspects of fecundity or potency and are reflected in famous prehistoric works of art.

Literate Near Eastern communities in Egypt, Mesopotamia, and elsewhere developed medical systems that indissolubly mixed the religious and the medical, and the priest-physician was a central figure in them all. Myths of a golden age, when disease did not exist, were common, as was the tacit assumption that individual transgression could be implicated as the root cause of disease.

Three great systems of medicine with great staying power developed in the centuries before the Common Era. These arose in Greece, India, and China. Modern Western biomedicine can be traced to the work of Hippocrates and his followers. The ayurvedic system in India developed autonomously, as did Chinese medicine. The latter two systems still have many followers and have been more impervious to change than has Hippocratic medicine. There are a few, probably incidental, commonalities in the three systems. In each of them, bodily fluids (humors) and spirits (pneuma) were more important than the solid parts in determining health and disease. Longevity was a more explicit goal of health than was fertility or potency. Notions of balance were central to each system.

There are also important differences. The Chinese associated health with plumpness (Buddha is always depicted as rotund), whereas Greek sculptures of idealized athletes show the



Shaman attending to a sick child, Ladakh, India. In many early cultures, ministering to the sick was the purview of religious leaders called shamans. These healers attempted to cure the illnesses of community members through spiritual possession. © CHRIS LISLE/CORBIS

taut muscular development that Western values still identify with health and vitality. The Chinese polar principles of yin and yang have no obvious parallels in Western thought. The three Indian humors (*dosa*) of wind, bile, and phlegm cannot be equated to the four humors of Greek medicine.

The series of treatises written between the fifth and second centuries B.C.E. by Hippocrates and his followers provide the touchstone of modern Western biomedicine. So powerful is this legacy that both the dominant scientific biomedicine and the alternative Western medical cosmologies, such as homeopathy, naturopathy, osteopathy, chiropractic, and hydrotherapy, all claim descent from this “father” of Western medicine. The Hippocratics naturalized disease, making it part of ordinary human existence, rather than the result of supernatural forces. They also reinforced the notion of health as a balance of the four humors, disease occurring when one or more of the humors was in excess or deficiency.

Greek humoralism was one of the most powerful explanatory systems ever devised within medicine. It was linked to Greek natural philosophy (the four humors having their counterparts in the four elements, air, earth, fire, and water) and contained a framework that made good sense of the human life cycle, individual temperament, and the role of the environment in health and disease. One Hippocratic treatise, *Airs, Waters, Places*, is simultaneously a subtle treatise on environmental medicine and a foundation document on the formative role of place and topography on human culture.

The Hippocratics always insisted that the physician was the servant of nature. Through their important doctrine of the healing power of nature (*vis medicatrix naturae*), they interpreted the phenomena of the bedside—sweating, vomiting, diarrhea, jaundice, productive coughs—as evidence that the body was trying to rid itself of its excessive humors or to restore defective or deficient ones. Disease was for them an individual

affair, based on the person’s stage in the life cycle, normal temperament, sex, occupation, and other individualized factors. They elaborated a system of hygiene, advice to the individual on how he or she might preserve health and achieve longevity, through diet, exercise, and mode of living. Humoral medicine made no sharp distinction between mental and bodily disorder, explicating melancholy, mania, and hysteria along identical lines as fevers, cancer, or chronic wasting diseases such as phthisis.

Hippocratic humoralism was by no means the only medical system developed during the Mediterranean antiquity, but it was the most influential one, especially after Galen (c. 129–c. 199/216) identified with it and consolidated and extended its nuances. Hippocrates and Galen enjoyed positions of unrivalled prestige for more than a millennium. Galen’s monotheism and philosophical bent especially appealed to elite physicians after Christianity became the dominant religion of the West. The otherworldly dimension of Christianity during the medieval period meant that bodily health and disease could be devalued, in pursuit of the eternal felicity of the other world, but medical orthodoxy still operated within the humoral framework. Both religion and magic also offered important alternative interpretations, and both cause and cure of disease could be sought in the realms of the supernatural. Holy shrines and pilgrimages became part of the simultaneous expiation of sin and restoration of health. Several of the seven deadly sins (gluttony and sloth, for example) were also intertwined with causative explanations of disease. Indeed, sloth (also called *acedia*) was actually medicalized into a diagnostic category and seemed to be especially common among monks who found it difficult to leave their warm beds for early-morning prayers.

Early Modern Concepts

The early modern period witnessed great changes in physical science, with the decline of Aristotelianism and the mechanization of the world picture during the period dubbed the scientific revolution. Notions of health and disease reflected some of these developments, although continuities are also obvious. Manuals of health and longevity became popular, as health became a desirable goal in societies now concerned with investigating the wider world and the stars above. As always, health was generally associated with moderation, especially through the regulation of what were called the six “nonnaturals”: air, food and drink, sleep and wakefulness, retentions and excretions, motion and rest, and the affections of the mind. An Italian nobleman, Luigi Cornaro (c. 1463–1566), wrote in his old age a treatise on hygiene, based on his own experience of moderate living. It was widely translated and remained in print for several centuries. Although the explanatory framework would differ today, Cornaro’s treatise is filled with advice that would not be out of place in a contemporary lifestyle medical manual.

There was much continuity in advice manuals on health for a long time after Cornaro, but ideas about the causes and mechanisms of disease began to change. Hippocratic humoralism had much staying power, but doctors such as Paracelsus (1493–1541) and Jan Baptista van Helmont (1579–1644) elaborated new medical systems. Van Helmont linked physiological

function in both health and disease with a vital power that he identified with the *archeus*, a principle he associated with each organ. It had the effect of separating the disease from the body of the individual sufferer, as the *archeus* had some sort of independent existence. Van Helmont inclined toward chemical explanations of disease, but other doctors leaned toward mechanical models of both normal and pathological functions, following in the wake of the triumphant natural philosophers such as Galileo Galilei (1564–1642) and Isaac Newton (1642–1727). Iatrochemists and iatromechanists, as they were called, vied with each other for theoretical dominance from the late seventeenth century.

In the midst of all these theoretical concerns, one clinician remained true to Hippocratic humoralism. Thomas Sydenham (1624–1689), the “English Hippocrates,” approached clinical medicine without much concern for the newfangled chemistry or mechanical physiology. He left superb descriptions of a number of diseases, including gout, smallpox, and hysteria, insisting that medicine was an empirical affair, ultimately based on careful observation and the trial-and-error use of remedies. One such remedy, Peruvian bark (which contains quinine), so impressed him in its capacity to extirpate “agues” (malarial fevers), that he came to believe that diseases could be classified in the same way that naturalists classified plants and animals. Nosology, or disease classification, became a preoccupation among eighteenth-century physicians. It came to be based primarily on symptoms, and the number of disease categories multiplied. Sydenham’s remarks on the specificity of diseases came into their own in the late nineteenth century, when germ theorists began to identify the disease with the germ that was proposed as its causative agent.

Hippocratic humoralism gradually lost its persuasiveness during the eighteenth century, as doctors turned to the blood, nervous system, or glands as the primary foci of disease causation. At the same time, pathologists such as Giovanni Morgagni (1682–1771) began to note consistent patterns of structural changes in the bodies of patients they autopsied and to attempt to correlate these changes in the organs and tissues with the diseases they had diagnosed and the symptoms that the patient had suffered from during life. This clinico-pathological correlation became the basis of the hospital medicine that flourished in Paris after the French Revolution.

The Modern Period

In order better to follow the course of disease in the living, French clinicians routinized systematic physical examinations of their patients. Jean Corvisart (1755–1821) developed percussion, tapping on the thorax and abdomen, to demarcate enlarged organs, collections of fluid, or tumors, and René Laennec [1781–1826] invented the stethoscope in 1816. Paris itself became a world center of medical education, and foreign students exported the French way of doing things throughout the Western world. French medicine was based primarily on the diseases of the organs, such as the heart, lungs, or liver. The development of better microscopes in the 1820s encouraged doctors to push pathological analysis into the tissues (a concept popularized by the French clinician M. F. X. Bichat [1771–1802]), and by the late 1830s, cell theories had been

elaborated by German scientists such as Matthias Jakob Schleiden (1804–1881), for plants, and Theodor Schwann (1810–1882), for all living organisms. Rudolf Virchow’s (1821–1902) *Cellular Pathology* (1858) put the cell at the heart of medical reasoning.

At about the same time, the work of microbiologists such as Louis Pasteur (1822–1895) and Robert Koch (1843–1910) showed the causative importance of bacteria and other microorganisms in a host of diseases. The germ theory of disease had dramatic practical spin-offs for medicine and public health, but it also separated the “disease” (the microorganism) and the victim of disease. Without the tubercle bacillus, there could be no tuberculosis. For some doctors, the disease could now be equated with its causative organism.

The germ theory was never without problems. Many clinicians considered germs as either incidental to or the result of disease, rather than its cause. Enthusiastic researchers found germs for many diseases, such as pellagra and cancer, which subsequent investigations would disprove. Some social activists complained that obsession with germs deflected concern from other factors that also influenced health, such as housing or inequalities of wealth. Why two individuals exposed to the same germ might have completely different reactions highlighted important host-parasite interactions. The range of agents causally associated with disease has been extended from the bacteria to include worms, plasmodia, amoebas, viruses, and, more recently, prions. Always, anomalies have driven researchers back to the bedside, community, or laboratory.

Since the mid-nineteenth century, the thrust of biomedical levels of disease explanation has been toward ever more minute categories: intracellular elements, chemicals, and molecules with known compositions and structures. Molecular biology is the preeminent science of the present day, created just before, but reaching powerful maturity after, the elucidation of the structure of DNA in 1953 by James Watson and Francis Crick. The biological importance of DNA had been recognized before Watson and Crick’s work, but understanding its structure provided a model of how this long-chained molecule, found in the chromosomes of the cell’s nucleus, controlled the inherited continuity that is characteristic of living organisms.

Modern biomedical research has revealed many of the mechanisms of disease at the molecular level. The first “molecular disease,” sickle-cell anemia, was identified by Linus Pauling in 1949 as the result of a minor structural (but large functional) change in the hemoglobin molecule. Molecular medicine has progressed rapidly since the mid-twentieth century, with the Human Genome Project offering the prospect of much greater knowledge about the role of genetic factors in health and disease. Genetic information also creates a host of ethical problems, such as confidentiality, insurance premiums, employability, and advice on parenthood. Critics argue that it is eugenics in new dress; advocates insist that the knowledge itself is neutral and its use is a matter for society to sort out.

By the twenty-first century the concept of disease had been diluted, as we have all been medicalized. Acts, desires, and

choices that in previous generations would have been conceptualized within moral, religious, or legal frameworks could now be attributed to disease. Eating disorders, suicide, many forms of criminality or deviancy, stress, and many other “facts” of modern life are often included within disease categories. Homosexuality has been a normal stage of the life cycle, a sin, a crime, a disease, and a life choice in different periods within Western society. “Mental” diseases continue to carry a moral burden.

If modern medicine has been expansionist in the field of disease, it has been less successful in assimilating health into its orbit. The more we know, the more prevalent disease, or potential disease, seems to be. Orthodox medical advice about health is largely statistical in its foundations and behavioral, not medical, in its recommendations. The Hippocratic injunction to moderation is still at the heart of Western medicine. What is “normal”—that is, healthy—is often based on epidemiological surveys, actuarial information, and cultural values. Despite the enormous power of modern biomedicine, health and disease still have important cultural, aesthetic, and moral dimensions to them.

See also *Biology; Eugenics; Hygiene; Medicine; Psychology and Psychiatry; Scientific Revolution.*

BIBLIOGRAPHY

- Canguilhem, Georges. *On the Normal and the Pathological*. Dordrecht, Netherlands, and London: Reidel, 1978.
- Caplan, Arthur L., Tristram H. Engelhardt, and James J. McCartney, eds. *Concepts of Health and Disease: Interdisciplinary Perspectives*. Reading, Mass.: Addison-Wesley, 1981.
- Conrad, Lawrence I., et al. *The Western Medical Tradition: 800 B.C.–1800 A.D.* Cambridge, U.K.: Cambridge University Press, 1995.
- Cooter, Roger, and John Pickstone, eds. *Medicine in the Twentieth Century*. Amsterdam: Harwood, 2000.
- Faber, Knud H. *Nosography: The Evolution of Clinical Medicine in Modern Times*. Rev. ed. New York: Hoeber, 1930. Reprint, New York: AMS, 1978.
- Gerhardt, Uta. *Ideas about Illness: An Intellectual and Political History of Medical Sociology*. New York: New York University Press, 1989.
- Gilman, Sander L. *Health and Illness: Images of Difference*. London: Reaktion, 1995.
- King, Lester S. *Medical Thinking: A Historical Preface*. Princeton, N.J.: Princeton University Press, 1982.
- Kiple, Kenneth F., ed. *The Cambridge World History of Human Disease*. Cambridge, U.K.: Cambridge University Press, 1993.
- Kuriyama, Shigehisa. *The Expressiveness of the Body and the Divergence of Greek and Chinese Medicine*. New York: Zone Books, 1999.
- Rosenberg, Charles E., and Janet Golden, eds. *Framing Disease: Studies in Cultural History*. New Brunswick, N.J.: Rutgers University Press, 1992.
- Temkin, Owsei. *The Double Face of Janus and Other Essays in the History of Medicine*. Baltimore: Johns Hopkins University Press, 1977.

W. F. Bynum

HEAVEN AND HELL. Aspects of heaven and hell cross religious traditions. Paradise can be a city, a palace, a court, a garden, a vision of God, a mystical diagram, or an ineffable concept. Physical, indeed sexual, terms and images express the soul's union with God. In Hell, fires, dragons, serpents, stench, cacophony, torturers, and their paraphernalia abound. Christian, Islamic, Zoroastrian, and Japanese sources test souls on a sword-edged bridge to paradise over a fiery stream or feculent abyss, the voracious hell. Unbelievers fall to torment below. Many voyagers observe these worlds: Enoch, Wiraz, Muhammad, Paul, Dante, and various bodhisattvas throughout time. Overlapping with religious images are the secular hells of war, poverty, and disease and their inverted counterparts in bliss, the paradises of resorts, wealth, luxury, and sexual pleasure. Transcending these, most religions insist that heaven and hell—or their approximate counterparts—are out of all proportion to our experience of time, joy, distress, or understanding. Analysis can only approximate their positions. Furthermore, each religion produced many schools of thought, and no one position stands for all.

No postmortem fate is possible without the notion that some aspect of the person survives death. That inner core, the heart, soul, spirit, or atman, is sometimes perceived first as one's self-knowledge; sometimes in the experience of ghosts, the personalities of the dead. The term “porous death” refers to an idea of death in which the dead return to haunt the living and the living may visit the dead, for example, in dreams or visions. By contrast, “neutral death” refers to an idea in which the living banish all the dead, whether good or evil, to a distant enclosure that is neither heaven nor hell. The ancient Babylonian land of the dead (*Arallu*), the Jewish Sheol (the Grave), and the Greek Hades (particularly in Homer) are morally neutral.

In “moral death,” reward follows a good life; punishment, an evil one. Moral death has two main varieties, cyclical and linear. In some linear systems, retribution is eternal; in others, destruction awaits the wicked. In the cyclical concept, postmortem pleasure and pain vary over eons as the person awaits promotion or demotion in eventual rebirths. (Cultures that oppose spirit to flesh call this process reincarnation.) Both linear and cyclical concepts of moral death are of great antiquity and emerge first in Egypt and India, respectively.

Egypt

In ancient Egypt, texts inscribed on the inner walls of the pyramids and coffins or on papyrus scrolls like the *Book of the Dead*, which began to circulate in the sixteenth century B.C.E., make the dead testify to their own moral character. One image weighs the heart against a standard of justice. A monster devours those who flunk. Images from the *Book of Gates* (c. 1320 B.C.E.) show the fate of those who oppose the sun god, Re, as he plumbs the underworld at night and ascends at dawn each day. These enemies of rebirth and of Osiris, the god who is its symbol, are dispatched into ovens and destroyed—not punished forever. The god's friends move beyond judgment to the same occupations they had when alive: cultivating fields, reaping bounteous harvests. These contrasting fates presuppose a distinction between good and evil.



Dante and Virgil in Hell (1822) by Eugène Delacroix. Oil on canvas. Dante's version of hell is multileveled in structure, with different categories of sinners confined to a particular level. The inhabitants suffer excruciating physical torments specific to the crimes they have committed. ERICH LESSING/ART RESOURCE, NY

Zoroastrianism

The prophet Zoroaster (Zarathustra) understood the cosmos as divided in enduring conflict between good and evil, truth and the lie, darkness and light (but not body and soul or spirit and flesh). After nine thousand years, a purging cataclysm separates the opposing forces and subordinates evil to good. At this time, the eternal community of good prevails in light and annihilates the community of the lie. *The Book of the Righteous Wiraz* fixes the Cinvat Bridge between hell and heaven. Only the saved can cross it. The morally neutral inhabit the heavens of the sun, moon, and stars. Above them paradisaical gardens of perpetual radiance welcome the faithful. Beneath the bridge, condemned by their own deeds, which appear dramatically before them personified as aggressive hags, the wicked endure graphically described tortures. They beg for the nine thousand years to end. When it does, their punishment proves temporary.

Hinduism

Other consequences of moral difference emerged in India. Early on, in the *Rig Veda*, Yama, the first man to die, now a

god, rules the dead from "the highest heaven" (10:14). The soul or self (atman) carries with it the moral qualities and blemishes of all its lives. Determined by its own actions (karma), it moves through cycles (samsara) of births, deaths, and rebirths, making all life the result of one's past lives. Life in the world becomes a temporary hell (or purgatory) that creates a yearning for release (*moksha*). In the Hinduism closest to the *Upanishads*, release occurs only when one understands the unity of the self or soul and the cosmos. Then the individual soul transcends itself and becomes its true atman as it blends in glory into the unity of the cosmos and attains Brahman. Brahman is Hinduism's highest reality, but it is not synonymous with the heavens, which are below, part of changeable samsara.

Later, after Hinduism adopted a savior figure active in multiple forms, or avatars, the *Bhagavad Gita* distinguished among the dead persons, who become either like gods or like demons. "The fate of a god is release (*moksha*); the fate of a demon is bondage." For the arrogant there is a downward spiral of rebirth into successive wombs of demons. "[This] is how men of evil karma fall down into hells." The *Markandeya Purana*

characterizes seven hells administered by Yama, each with its own name: The Terrible Hell, the Great Terrible, Cutting-off, Unsupported, Sword-leaf-forest, and the Hot-pot hells. The reborn progress through lives as “worms, insects, moths, beasts of prey, mosquitoes . . . elephants, trees, untouchable women, finally up through the castes as Servant, Commoner, Warrior, Priest.” Meritorious people enjoy celestial garlands, gems, singing, dancing, nymphs, rebirth into royal and noble families, “the very best pleasures.” Yet there is a “great misery even in heaven” at the thought of a fall, since the heavens are also subject to samsara (chapters 10–12). Only *moksha* is perfect release.

Buddhism

Siddhartha Gautama, the Buddha, modified the Hindu tradition he inherited. The two religions share a belief that karma determines each life and assigns a series of experiences that can include various heavens or hells or rebirth as humans. Though even in Hinduism “atman” and “self” are not synonymous, the Buddha repudiated any association between them as a misguided psychological crutch that might multiply illicit cravings for property, offspring, or fame and so impede the emptiness required for nirvana. The goal instead is detachment from all desire. The human being is not an individual but a variable combination of five aspects of personhood: form, sensations, perceptions, volitions, and consciousness. Since emptiness alone attains nirvana, those addicted to a self are reborn. The “Wheel of Life” charts the fates of persons reborn into any of six realms as humans, gods, titans, animals, ghosts, and denizens of hell. Even the realms of light, residences of the gods, like the Hindu heavens, are painful, since they are less than nirvana, that is, they still participate in samsara. As Edward Conze paraphrases “Nanda the Fair,” attributed to Ashvaghosha: “The sojourn in Paradise is only temporary, and . . . the day must come when the deities fall to earth and wail in deep distress.”

Mahayana (or Great Vehicle) Buddhism proposed four heavenly Buddhas in their own paradises at the cardinal points of the compass surrounding the historic Buddha in the center. Mystical diagrams called mandalas chart this cosmos. Each Buddha takes an active role in saving his devotees. Helpful in this effort and mitigating the distinction between the cycle of rebirths and salvation are the bodhisattvas, saintly creatures so charitable as to refuse enlightenment for themselves until they have helped all sentient beings from the six realms. Their concern for the dead may reflect very ancient Chinese cults in which care for graves and offerings for ancestors were central to piety. Later, in *The Tibetan Book of the Dead*, Yama instructs the recently deceased as he judges them by the image of their souls in the Mirror of Karma. “Apart from one’s own hallucinations, in reality there are no such things existing outside oneself as Lord of Death, or god, or demon.” One’s inner life is all.

Ancient Greek Religion

Aspects of moral death entered Greek religion from Persia and Egypt. Legends of Pythagoras in the underworld and the Eleusinian mysteries bring this change. The distinction between swamps for outsiders and Elysium for initiates of the mysteries parallels a shift from Homer’s neutral Hades to Plato’s punitive Tartarus. In the Myth of Er, which concludes

Plato’s *Republic*, heaven preserves the righteous from further reincarnations, and Tartarus imprisons “the incurable” forever. The majority are reincarnated. In his version of moral death, therefore, Plato combined linear and cyclical time. In mythology, heroes the gods engendered with humans could, by apotheosis, attain eternal life among the Olympians. Like Hercules, they become constellations in the physical heavens.

Etruscans and Romans

Archaeological evidence from before Roman dominance preserves Etruscan tombs modeled on homes, an indigenous tradition projecting earthly existence into the afterlife. Roman popular religion preserves not the dwelling, but the familial tie. The divine *manes* (parents and ancestors) rewarded piety (respect for family, divinities, and the state) with active intercession and a “better option” among the dead. Despite its formal state cult based on the Olympian pantheon, Roman religion had no central authority, hence no orthodoxy. Virgil incorporates a Platonic system in Book VI of the *Aeneid*, but only literati knew this cyclical, moral afterlife. Worship of the emperor was a small part of this complex whole, though it gained heaven for Christian martyrs executed for spurning it.

Judaism

Moral death entered the Hebrew Bible gradually and late. Judaism’s neutral otherworld (Sheol) draws the scorn of Job, because the wicked and the just “lie down alike in the dust” (21:26). Jeremiah begins to distinguish a separate fate for those who worshipped false gods. In Ge-hinnom (Gehenna), a ravine outside Jerusalem, he says, the dead lie unburied, their bones exposed to the sun and the stars whom they wrongly worshipped (7:30–8:2, 19:7). Their evil loyalties should determine their evil fates, which should never end. Isaiah (14:15) imagines the wicked king of Babylon not merely in Sheol, but reviled in the depths of the Pit. Psalm 73 identifies moral categories: the false dispatched “far from thee” and the loyal “near God.” These images of place follow from the idea of paradise as the Garden of Eden, where God set Adam and Eve, but from which he banished them. Return to *gan eden*, which Christians would call “the Earthly Paradise,” is physical yet also beyond time: an eternally blissful state. The most recent book of the Hebrew Bible articulates moral death clearly. Daniel (12:2) proclaims resurrection and assignment either to “everlasting life” or “everlasting contempt.”

Postbiblical Judaism offered great latitude on these matters. Though all pray for “a portion in the world to come,” the Talmudic sages left open the questions of how God renders judgment, where his justice parts from his mercy, and how long sinners remain in Gehenna. The tenth-century Sa’adia Gaon argues for eternal reward and punishment. Around 1200, Moses Maimonides regarded these as childish ideas that students should outgrow. In contrast to tolerance concerning the otherworld, the Talmud and subsequent speculation insist on the resurrection of the flesh.

Christianity

The New Testament of the Christian Bible promises the faithful eternal life. The blessed inherit “the kingdom prepared for

you from the foundation of the world" (Matt. 25:34) or "the marriage supper of the Lamb" (Rev. 19:9), a kingdom of light, host to "armies . . . upon white horses, clothed in fine linen" (Rev. 19:14). It is also a court that renders judgment on the physically resurrected dead, where the elect are witnesses (Rev. 20, *passim*). Paul proclaims a collective view: a God who in the end will be "all in all" or everything to everyone (1 Cor. 15:28). "The Kingdom of God," by far the most frequent name for heaven in the Bible, Luke declares, is *entos humōn*, "within you" or "among you," depending on the translation. "Heaven," therefore, covers a physical place where the divine King holds court, a communal bond, and an internal condition. For the wicked, the Christian Scriptures threaten those who neglect the helpless with "everlasting fire, prepared for the devil and his angels" (Matt. 25:41) and "the lake of fire and brimstone, where . . . [the wicked] shall be tormented day and night for ever and ever" (Rev. 20:10). Unbelievers are "condemned already" (John 3:18).

Christians debated whether hell is eternal. Origen of Alexandria (185?–254?) opposed eternal punishment: divine action must be curative. Souls expiate their sins through repeated reincarnations. Restoration (*apokatastasis*) makes the end like the beginning, evoking Paul's phrase "all in all." Though condemned twice by Justinian, this tradition remains influential in Eastern Christianity. Rejecting Origen's cycles of reincarnation, Augustine (354–430) defended a hell that, because it afflicts the body physically, causes the spirit "fruitless repentance." Despite his opinion that hell wracks flesh, Augustine considered the reprobates' severest torment to be exile from God. Conversely, heaven is eternal life in God's presence, the communion of the elect, true peace, and endless bliss.

A late-fourth-century apocryphal vision, the Apocalypse of Saint Paul, relates Paul's visit "up to the third heaven" (2 Cor. 12:2–3). There he tours the Land of Promise. He sees the four rivers of paradise running with milk, honey, wine, and oil. He meets major figures from the Hebrew Bible: the patriarchs, Moses, Lot, Job, Noah, David, the prophets, and finally the Virgin Mary. Twelve walls surround Christ's golden city. In hell he sees rivers of fire, demons slashing victims' entrails, stonings, worm infestations, hangings, dismemberments, carcasses roasted on spits, and inmates gnawing their own bodies. In the center of this chaos is a covered well within which the punishments are seven times harsher. Seeing these, Paul sighs; Jesus hears. Christ visits this pit, chastises the inmates, then grants them amnesty every Sunday. For all its gore, this text aspires to mitigate hell.

Building on the idea of exile and its associated alienation, allegorical and psychological interpretations multiplied. Though he describes many gruesome physical torments in the *Inferno*, Dante identifies hell's essence while describing souls encased in flames: "Each one swathes himself in that which makes him burn" (26.48). The reformer Martin Luther put the afterlife in a psychological context, too, when he declared in 1517, "Hell, Purgatory, and Heaven appear to differ as despair, almost despair, and peace of mind differ." Of his own spiritual rebirth he said, "I felt that I was altogether born again and had entered paradise itself through open gates."

If faith is the way to heaven, hell begins even before death, when the faithless soul endures isolation and disorientation. As Luther put it, "Everyone carries his own hell with him wherever he is." Though earlier theology anticipates the statement, Calvin appears the first (1534) to say "Hell is not a place but a condition." In 1999, Pope John Paul II declared heaven "complete intimacy with the Father," partnership "in his heavenly glorification," the "blessed community of all who are perfectly incorporated into Christ." Hell he called "the ultimate consequence of sin itself, which turns against the person who committed it." This definition of hell emphasizes the alienating, self-reflexive character of freely chosen exclusion, whereas heaven embraces a longed-for community wholly dedicated to the divine. Invoking the scriptural letter, Evangelicals resist allegorical interpretations.

Islam

The Koran abounds in references to "the Fire," "the Burning," and "the Gardens beneath which rivers flow." Beyond the Koran, many hadith (sayings) and other, later records of oral traditions develop Islamic eschatology. The account of Muhammad's Ascension, which retraces the Prophet's progress from hell to paradise, resembles Asian and European accounts in organization and vividness. In the late eighth century, the Sufi mystic Rabi'ah of Basra claimed that neither fear of hell nor hope for heaven befit the pious soul: "O God! if I worship Thee in fear of Hell, burn me in Hell; and if I worship Thee in hope of Paradise, exclude me from Paradise; but if I worship Thee for Thine own sake, withhold not Thine everlasting beauty!"

See also *Buddhism; Christianity; Death; Death and Afterlife; Islamic Understanding of Heaven and Hell (Asian Focus); Hinduism; Immortality and the Afterlife; Judaism; Platonism.*

BIBLIOGRAPHY

- Bernstein, Alan E. *The Formation of Hell: Death and Retribution in the Ancient and Early Christian Worlds*. Ithaca, N.Y.: Cornell University Press, 1993.
- Conze, Edward, ed. *Buddhist Scriptures*. London: Penguin, 1959.
- Eliade, Mircea. *A History of Religious Ideas*. 3 vols. Translated by Willard R. Trask. Chicago: University of Chicago Press, 1978–1985.
- Gardiner, Eileen, ed. *Visions of Heaven and Hell before Dante*. New York: Italica Press, 1989.
- King, Charles. "The Living and the Dead: Ancient Roman Conceptions of the Afterlife." Ph.D. diss., University of Chicago, 1998.
- McDannell, Colleen, and Bernhard Lang. *Heaven: A History*. New Haven, Conn.: Yale University Press, 1988.
- O'Flaherty, Wendy Doniger, ed., with Daniel Gold, David Haberman, and David Shulman. *Textual Sources for the Study of Hinduism*. Chicago: University of Chicago Press, 1990.
- Russell, Jeffrey Burton. *A History of Heaven: The Singing Silence*. Princeton, N.J.: Princeton University Press, 1997.
- Smith, Jane Idleman, and Yvonne Yazbeck Haddad. *The Islamic Understanding of Death and Resurrection*. Albany: State University of New York Press, 1981.
- Wright, J. Edward. *The Early History of Heaven*. New York: Oxford University Press, 2000.

Zaleski, Carol. *Otherworld Journeys: Accounts of Near-Death Experience in Medieval and Modern Times*. New York: Oxford University Press, 1987.

Alan E. Bernstein

HEAVEN AND HELL (ASIAN FOCUS). The ideas on heaven and hell are closely associated with human imagination about the afterlife in Asian civilizations. The images of heaven and hell, however, vary greatly in different regions such as in the southern, central, and eastern parts of the Asian continent, and they have changed significantly throughout history. There is no such thing as a unique Asian mind or a collective Asian concept of heaven and hell, and therefore we should not simplify or twist the historical evidence available to us in order to create a clear statement of the Asian idea of heaven and hell for the convenience of a Western audience. Instead, we should examine the two related concepts in their original historical and regional contexts and focus on both textual and material evidence to discuss the compositions and historical changes of heaven and hell in Asian cultures.

Heaven

Mainly as an ideal place for the afterlife, heaven was described as a mysterious island in the ocean or a palace on the top of mountain or a multilayered structure in the sky. In different regions and times, people have different ideas about the location and appearance of heaven.

South Asia. Various heavens, seven in total and one above the other, are recorded in the Pali literature, some of the earliest written information on heaven preserved in South Asia. Thirty-three heavens, again one above the other, are also described in ancient Sanskrit texts. These ideas about heaven were adopted in the sixth century B.C.E. by the historical Buddha, who, in turn, developed a more systematic and elaborate vision of heaven that we see in the surviving Buddhist scriptures. From the Buddhist perspective, the most important heaven is Sukhavati or the Western Paradise, the land of bliss. The master of the Western Paradise is Buddha Amitabha and the residents of the land are all holy beings. At the opposite location is the Eastern Paradise of Buddha Bhaisajya-guru or the Healing Buddha. This horizontal placement of the Western and Eastern Paradises is supplemented by a vertical structure consisting of thirty-three heavens in the sky. Beautiful and comfortable, all Buddhist heavens are occupied by holy beings such as the Buddhas and Bodhisattvas and are ready to accept the reborn souls of the virtuous Buddhist devotees. In early Buddhist iconography, heaven is depicted as a part of the narrative representation of Siddhartha Gautama Buddha's (the historical Buddha, c. 563–483 B.C.E.) life; it is shown as a small house located on the top of a pagoda-like ladder. The Tushita Heaven of Bodhisattva Maitreya is also depicted as a frame-like house. The number of pictorial representations of heaven in ancient Indian Buddhist art, however, seems to be very small. The scarcity and simplicity of heaven images in ancient Indian art suggest that the motif of paradise in India was far less popular than in East Asian countries.

East Asia. Before the introduction of Buddhism into China around the first century C.E., heaven and paradise were considered two different concepts. Heaven is up in the sky, and from there deceased ancestors provide legitimacy to the living rulers or send mythical signs celebrating or criticizing the rulers' behavior. Paradise is a livable place located either in the Eastern Sea or on the top of the Kunlun Mountains in the west. In the early thoughts of Daoism, an indigenous religion that began in China at almost the same time as Buddhism in South Asia, the islands of immortality float in the sea in the east. The lucky ones might obtain elixirs from the immortals on the islands and live forever. The most influential local paradise before the introduction of Buddhism is the paradise of the Queen Mother of the West, located on the top of the Kunlun Mountains in the remote west of China. The islands of immortality in the Eastern Sea and the Queen Mother's paradise on the Kunlun Mountains in the west also form a horizontal orientation. During the Qin-Han period (third century B.C.E. to third century C.E.), heaven (or the sky) and paradise (place for the afterlife) are shown in totally different visual forms: the former is perceived as an astronomical entity and depicted as a star map, and the latter is understood as a place and depicted as a remote mount where the deceased could meet the Queen Mother. When Buddhist ideas of heaven-paradise entered China in the first century C.E., they provided a great stimulation to the Chinese imagination regarding the afterlife and fundamentally changed the vision of heaven throughout East Asia. Thousands of pictures of the Buddhist paradise were created in medieval China and Japan to serve as aids in visualization by religious practitioners and to satisfy the need of ordinary devotees to accumulate merits and prepare for the future entrance into paradise. The most popular visual pattern of Buddhist paradise in East Asia consists of four basic elements: the holy icons of the Buddha and Bodhisattvas, the palatial buildings in which devotees could imagine themselves living, large water ponds in which devotees could imagine themselves being reborn, and musicians and dancers who could entertain the devotees. In most cases, the visual details are created according to local and contemporary customs and somehow reflect the historical conditions of that time. The local visions of Buddhist paradise created in various regions in Asia can certainly help us understand the diversity of heaven images and provide us with critical evidence to understand the histories and cultures of Asia.

Hell

While Buddhist heaven is designed for the holy beings and prepared for the virtuous devotees who will live pure and happy lives there upon their deaths, a painful underground hell is imagined as a place to imprison the souls of those who do not behave well in their lifetime. Heaven and hell, therefore, form a system of reward and punishment according to religious and social disciplines. In addition to its primary function as a place for punishment, hell is also one of the six states of existence (e.g., gods, men, monsters, hell, hungry ghosts, and animals). The six states of existence are interchangeable through the process of rebirth, and no state is permanent. The six states of existence are also described as six paths of rebirth and visually represented as a wheel, which is divided into six radiating panels in

Buddhist art. Ten courts of justice, supervised by the ten kings of hell, are set up on the way to hell to clarify the sinners' specific evil deeds and to decide the level or type of punishment. The most evil sinner is sent to Avici, the deepest and most painful section of hell. The tortures in hell include hot and cold treatments such as being thrown into fire, dipped into boiling oil, drinking hot liquid copper, or staying in a frozen cave of ice. In some local versions, a specific means of punishment is created to target a certain crime. An old woman who badmouths a neighbor, for instance, might be punished by having her tongue cut off by an executioner in hell as we can see in stone carvings at Dazu, Sichuan province, in south-western China.

Conclusion

Heaven and hell are not only religious ideas but also philosophical, social, and political concepts in Asia. The visual forms of heaven and hell are mostly local products with identifiable regional features and could be better understood in local historical context.

See also *Buddhism; Death; Death and Afterlife, Islamic Understanding of; Heaven and Hell; Immortality and the Afterlife; Religion: East and Southeast Asia*.

BIBLIOGRAPHY

- Gómez, O. Luis, trans. *The Land of Bliss: The Paradise of the Buddha of Measureless Light*. Honolulu: University of Hawaii Press, 1996.
- Law, Bimala C. *Heaven and Hell in Buddhist Perspective*. Reprint, Varanasi, India: Bhartiya Publishing House, reprint, 1973.
- Loewe, Michael. *Ways to Paradise: The Chinese Quest for Immortality*. London and Boston: Allen and Unwin, 1979.
- Qiang, Ning. *Art, Religion, and Politics in Medieval China: The Dunhuang Cave of the Zhai Family*. Honolulu: University of Hawaii Press, 2004.
- Soothill, William Edward, and Lewis Hodous, comps. *A Dictionary of Chinese Buddhist Terms*. Reprint, Taiwan: Buddha-Light Publishing House, 1979.
- Teiser, Stephen F. *The Ghost Festival in Medieval China*. Princeton: Princeton University Press, 1988.
- . *The Scripture on the Ten Kings and the Making of Purgatory in Medieval Chinese Buddhism*. Honolulu: University of Hawaii Press, 1994.
- Wu, Hung, and Ning Qiang. "Paradise Images in Early Chinese Art." In *The Flowering of a Foreign Faith: New Studies in Chinese Buddhist Art*, edited by Janet Baker, 54–67. New Delhi: Marg Publication, 1998.

Ning Qiang

HEDONISM IN EUROPEAN THOUGHT. Hedonism is a modern word derived from the Greek *hedone*, or "pleasure." As a philosophical position, moral hedonism justifies pleasure as a good, or even the good. Its history can be traced back to Hellenistic philosophy.

Ancient ethics can be defined as a response to the question: "What is a good life?" The first reply to such a question is

"happiness" (*eudaimonia*). This starting point is common to Plato (c. 428–348 or 347 B.C.E.) and Aristotle (384–322 B.C.E.), to Epicureanism and Stoicism, but then the competition about the proper definition of "happiness" begins. What is happiness? And here, with the variety of meanings of *eudaimonia*, the discrepancy among philosophical traditions unfolds. Yet, at the point where the disagreement begins, we find a remarkable consensus about what usually comes to mind as the most obvious candidate. It is pleasure.

Now, for Plato, Aristotle, and the Stoics, *hedone* is both the first and the worst candidate. Only the Epicureans, after the Cyrenaics, accept it fully as the condition of a good life. The claim that pleasure is a value, even the criterion for moral worth, lies at the core of hedonism and its tradition.

Of all the philosophers who reject the value of pleasure, the most radical is Plato. He endorses the archaic vision of delight as oblivion, carelessness, and selfishness; worse still, except in the enjoyment of knowledge, pleasure cannot truly be, because desire is insatiable.

Whereas, for Plato, pleasure is unlimited, irrational, incompatible with virtue, especially justice, for Epicurus (341–270 B.C.E.), pleasure is rational. It is a state of well being, made possible by the avoidance of pain, both physical and psychological, and by the satisfaction of desires, which are necessary, natural, and measured. For Epicurus, you calculate the amount of pleasure gained from an action, a passion, or a habit. You weigh the consequences, you make an optimal decision, choosing between an intense excitement, for which you will have to pay later, and a renouncement that will prevent predictable anxieties. This evaluation requires a constant use of prudence (*phronesis*), the moral and intellectual ability to anticipate the consequences of your choices in the long run. Pleasure is thus compatible with virtue. It is even virtue's essential goal, since, in order to be healthy and tranquil, you need to be thoughtful, cautious, and wise in all deeds. To the same end, you also have to manage the people around you, your beloved, your friends, your fellow citizens; and in view of that, you have to act beautifully (*kalos*) and justly (*honeste*).

Justice is nothing else than what is useful (*sympheron*) to avoid reciprocal harm within a community. Natural law is the acknowledgment of what successfully serves individuals in order not to injure each other. Pleasure is not ecstatic and excessive, and therefore it is not destructive. It is, on the contrary, beneficial and peaceful, thus it is vital. It is not shortsighted and self-centered; it is clairvoyant and inevitably generous. The Epicurean shift in the ethics of pleasure, intended as a person's best interest, is innovative. It is the original source of utilitarianism and of the transformation of the passions into reasonable calculations, a critical turn in the emergence of modernity.

During antiquity, Epicurus's thought was little known in Greece, yet became influential in Italy, where its simplicity fascinated the Roman elite. Philosophically, it was constantly under attack. Its novelty—its candid acknowledgment that human beings are equipped for honest pleasure and entitled to it—appeared always suspicious. Cicero was particularly contemptuous of it, precisely because of the conflation of *honestas* and

voluptas (pleasure). The Epicureans couple the two, he claims, something which is to be deplored since the latter obscures—not to say pollutes—the full splendor of the former. The dialogue *De finibus bonorum et malorum* revolves around the disaster of such a disfiguration. Cicero argues that virtue and pleasure must be distinct and opposed to each other. When it comes to morality, the skeptical Cicero speaks a language with Stoic accents and sets the stage of a paradigmatic controversy about hedonism, which will constantly reemerge in modern philosophy.

On one side of this debate stand the Stoics, with their theory of virtue as the exercise of reason, the eradication of passions, and a complete detachment from any contingency. Following the principle of Platonic ethics, the Stoics fight against any form of instrumentality to which the good might be made subservient. To say that virtues are conducive to pleasure, and that pleasure should be their end, would be to degrade them to the level of means; this would be contradictory to the idea of *honestum*, as that which should be attained for its intrinsic, absolute value. On the other side are the Epicureans, for whom the good life results from a constant assessment of profits and losses, contingent to what can be expected, from the environment and in the foreseeable future. Virtue is connected to pleasure for an ethical and psychological reason. Evil is not simply done: it is not conducive to pleasure because evil is also felt by the one doing evil. Mistakes cause emotional disturbance. Vices are sources of endless worries, fears, and anxiety, whereas pleasure consists, above all, in a sensation of relief, from any kind of unsettling feelings. It is for the sake of tranquility and in one's best interest to avoid wickedness, envy, lust, violence, and all other flawed behaviors for the life of those who cultivate these passions is nothing but distress (*intercapedo molestiae*). By contrast, the *honestum* and the *iustum* (justice) set the mind to rest and results in ataraxy, a peaceful, as well as a virtuous, experience. It follows from a rational choice not to be anguished, but that means, of course, that the value of all the virtues depends upon their utility to that end. "Pleasure" is the name of their instrumentality.

In the fifteenth century, Lorenzo Valla and other humanists revived this debate about the possibility of a *honesta voluptas* and of a voluptuous excellence. The most important statement about the value of Epicurus's wisdom, however, is to be found in Erasmus' *Colloquium familiare*, entitled *Epicureus* (1533). This dialogue in defense of *vera voluptas* (pleasure in truth) offers a fervid celebration of the Garden, certainly inspired by Lorenzo Valla. Following a traditional line of argument that reverts to Torquatus, the Epicurean character in Cicero's *De finibus bonorum ac malorum*, a Mister Pleasure, Hedonius, takes up the defense of what can be an authentic and fine form of hedonism, against an incredulous Spudaeus (Earnest). There is no virtue without pleasure, Hedonius claims, and no true pleasure without virtue. This morality is compatible with Christian theology, because the calculation of pleasure is the perfect means to reach the end of afterlife bliss.

Even more, a virtuous existence is already exquisitely agreeable. Epicurus "puts the happiness of man in pleasure" and considers that a life is the happiest if it contains the maximum

of pleasure and the minimum possible of sadness. "What could be said, that would be more saintly [*sanctius*] than this sentence?" asks Mister Pleasure. Indeed, nobody is more Epicurean than the Christians who lead a pious life (*Christianie viventes*): here are the most Epicurean people. True pleasure has nothing to do with sensuality and luxury, but with the fruition of true goods (*vera bona*), he argues. Now such enjoyment is possible only in a healthy and pious soul, because only a virtuous existence makes humanity happy, by reconciling God, the source of the highest good (*summi boni fons*) with man. The origin of that *fruitio* (fruition) and thus of *voluptas*, is God, more precisely the absolute goodness of God, the *summum bonum* that flows, so to speak, into the various forms of goodness accessible on Earth. Erasmus' praise of the Epicurean/Christian pleasure could not offer a more consistent resonance to the morality presented by Raphael Hythlodius and the Utopians in Thomas More's *Utopia* (1515). With their insights about *voluptas*, those virtuous pagans, untouched by the Revelation, have found a kind of pre-Christian wisdom.

The defense of honest pleasure, against the recurrent misunderstandings of Epicurean ethics, continues along the same lines and with the same anti-Stoic arguments through the works of Pierre Gassendi to culminate in the "apology of Volupté," to be found in the *Encyclopédie* by Denis Diderot (1713–1784) and Jean Le Rond d'Alembert (1717–1783). After the eighteenth century, it is in the language of utilitarianism, therefore in terms of maximized advantage or best interest, that this ethic continued to flourish. In the early twenty-first century hedonism lost all philosophical dignity, to become a lifestyle, good only for literature and advertising.

See also *Altruism; Epicureanism; Happiness and Pleasure in European Thought; Utilitarianism*.

BIBLIOGRAPHY

- Gosling, J. C. B. *Pleasure and Desire: The Case for Hedonism Reviewed*. Oxford: Clarendon, 1969.
- Mitsis, Phillip. *Epicurus' Ethical Theory: The Pleasures of Invulnerability*. Ithaca, N.Y.: Cornell University Press, 1988.
- Rosenbaum, Stephen E. "Epicurus on Pleasure and the Complete Life." *The Monist* 73 (1990): 21–41.
- Rudebusch, George. *Socrates, Pleasure, and Value*. New York: Oxford University Press, 1999.
- Vaughan, Frederick. *The Tradition of Political Hedonism: From Hobbes to J. S. Mill*. New York: Fordham University Press, 1982.

Giulia Sissa

HEGELIANISM. Given the complexity of his thought, it is not surprising that Hegel's philosophy has been interpreted in a number of different and often opposed ways. As such, while many philosophical movements might be described as "Hegelian," there is no univocal sense of this term, nor any unanimity about what the proper interpretation of Hegel's idealism involves. Perhaps because of these interpretive difficulties, the appeal of Hegelianism in its various guises has waxed and waned in the two centuries following Hegel's own work.

At first glance, Hegel's philosophy presents a seemingly thoroughgoing idealism, in which the world is explained as a manifestation or determination of Absolute Spirit. The *Logic*, for example, begins with an exploration of Being and dialectically derives from it the particularity of the world. But while there is some truth to viewing Hegel's idealism in such metaphysical terms, the system he develops is far more complicated and subtle than the initial appearance might suggest. Rather, Hegel is concerned to answer a question that had been posed by Kant: How can people find certainty in their knowledge of the world? Another central feature of Hegel's position involves the claim that rationality cannot be understood apart from history: thought matures in a dialectical process that, for Hegel, reveals the development of reason's own capacities in various social and historical epochs. This emphasis on the historical nature of reason stands as a hallmark of much of what can be called "Hegelianism."

Although the bulk of Hegel's philosophical work was done in the early part of the 1800s, its influence was not forcibly felt in Germany until 1818, when he was appointed to a position in Berlin. His lectures there—on topics ranging from history to aesthetics—attracted an enormous amount of attention, especially among students interested in social and political reform. Hegel himself was not especially active politically, but even before his death in 1831, a heated debate broke out between his more conservative interpreters—the "Old Guard"—and the more socially oriented and reform-minded "Young Hegelians." At issue was whether Hegel's famous assertion that "the actual is the rational" expressed a factual claim about contemporary Prussia as the culmination of the dialectic of Spirit, or whether it stood as a call to arms to lead society to greater heights. Where the Old, or Right, Hegelians focused mostly on the religious aspects of the Absolute in the service of justifying a conservative Prussian state, the Young, or Left, Hegelians were far more inspired by what they saw as the radical implications of Hegel's political thought. For the Left Hegelians, notably Ludwig Feuerbach and Bruno Bauer, the *Philosophy of Right* provides a blueprint for the reform of European politics, with an emphasis on free markets and participatory democracy. The Left Hegelians also embraced a humanist project: Feuerbach, Bauer, and Strauss, for example, all offered historicist accounts of Christianity, and attempted to show that religion must be understood as a social rather than a divine phenomenon. The force of the Left Hegelian movement, however, was thwarted in 1841 by the appointment of the aging Friedrich Schelling to Hegel's former chair in Berlin in an attempt to quash the threat of reformist Hegelianism.

By the end of the 1850s, Hegel's influence had begun to fade, and indeed the neo-Kantian movement—guided by the motto "Back to Kant!"—arose largely in response to a perceived lassitude in Hegelianism. For these thinkers, philosophy required a recovery from what became known as "Hegelian bankruptcy," which was induced by an overemphasis on the metaphysical trappings of Hegel's system.

Marxist Hegelianism

Despite Hegel's waning influence in the middle of the nineteenth century, the Left Hegelian movement did produce one

lasting effect in Marxism. Like the other Left Hegelians, Marx's reception of Hegel was not free of substantial criticism. The most overt aspect of Hegel's influence on Marx is the so-called "dialectical method" by which theoretical and social entities are said to inherently generate their opposites. Marx and his followers make frequent use of this method, though in many cases it assumes the coarse and popular triad of "thesis-antithesis-synthesis," which was never used by Hegel himself. Marx's main criticism of Hegel is directed at the latter's idealism, which Marx aimed to replace by his own "dialectical materialism." Hegel's social and historical philosophies also exercised considerable influence over Marx. This may seem odd at first sight since Hegel was *the* bourgeois philosopher par excellence. Yet Hegel's intellectual integrity compelled him to uncover the unavoidable abuse of the poor in the ideal society and state he envisaged in his *Philosophy of Right*, and this latent social criticism was adopted and radically intensified by Marx. Marx and Hegel also share the view of humanity as product of society and history as well as the view of human history as a series of dialectical developments whose final end is the realization of freedom. Marx, however, rejects the quietist implications of Hegel's philosophy of history, according to which one cannot comprehend a period and act in it simultaneously since, according to Hegel, philosophical understanding of a period comes only once this period has already passed.

In spite of the sharp decline of Hegelianism at the second half of the nineteenth century, Marx considered himself a pupil of Hegel till his very last days. The importance of Hegel for the understanding of Marx was a matter of dispute among Marx's followers. While Lenin argued that Marx cannot be understood without the background of Hegel's *Logic*, the more common Marxist attitude seems content with mere lip service to Hegel's dialectical method. In 1923, following the discovery of Marx's early manuscripts, two important works by George Lukács and Karl Korsch attempted to reassert the importance of Hegel for Marxist philosophy, but this approach was strongly rejected by the official international communist movement (Third International), while nonorthodox Marxists of the Frankfurt School (most notably Theodor Adorno and Max Horkheimer) related to it more sympathetically. French structuralist Marxism tended to be hostile to the association of Marxism with Hegel's thought.

Hegel in France

From its very inception, existentialism has been in an intense dialogue with Hegel's heritage. Kierkegaard, for example, considered his own thought as a rebellion against the effacement of individuality in Hegel's grand system. Twentieth-century French existentialism was much more sympathetic to Hegel. The crucial event in the development of twentieth-century French reception of Hegel was a series of lectures on Hegel's *Phenomenology* given by the Russian émigré, Alexandre Kojève, at the École Pratique des Hautes Études between 1933 and 1939 (the lectures were edited and published in 1947). Among the participants in these seminars were Maurice Merleau-Ponty, Simone de Beauvoir, Jean-Paul Sartre, Georges Bataille, Alexandre Koyré, Emmanuel Levinas, Eric Weil, and Jacques Lacan. Through this extraordinary group of intellectuals Kojève's reading of Hegel became extremely influential.

For Kojève, the key text for understanding the *Phenomenology* was the famous dialectic of master and slave. Kojève's reading, which is significantly indebted to both Marx and Heidegger, centers upon the human struggle for recognition by the other and the emergence of human culture [*Bildung*] from the life and consciousness of the slave. Another influential interpretation of Hegel was suggested by Jean Hyppolite, who attempted to reconcile the humanistic spirit of the *Phenomenology* with the rigorous and individual-effacing *Logic*.

Postmodern French philosophy engaged with Hegel and his grand logical and historical narratives as part of the main stream of Western metaphysics, whose undermining was one of the main aims of deconstructionist thought. In contemporary French thought, Jean-Luc Nancy seems to present the most interesting attempt to revive the philosophical dialogue with Hegel.

Hegel and Anglo-American Philosophy

During the second half of the nineteenth century, Hegel's ideas began exercising considerable influence on several British and American philosophers, notably Edward Caird, F. H. Bradley, Bernard Bosanquet, and John McTaggart. For them, Hegel provided the vantage point from which they could criticize the empiricism and metaphysical atomism of the utilitarians. Both Russell and Moore also began in this tradition, and their break from—and response to—it in the early 1900s marks the beginning of Anglophone “analytic” philosophy.

Despite continued interest in Hegel's thought, the main stream of Anglo-American philosophy in the twentieth century tended to be hostile to Hegel because of his opaque style of writing and his alleged willingness to compromise the absoluteness of the law of noncontradiction. Popper's view of Hegel as one of the sources of modern totalitarianism and nationalism was also very influential in the Anglo-American world (though it is now known that unlike Kant, Hegel was despised by the Nazis).

In the last two decades of the twentieth century, the animosity toward Hegel among “analytic” philosophers abated. Works by Charles Taylor, H. S. Harris, Terry Pinkard, and Robert Pippin, among others, have helped to revive interest in Hegel's thought, and many of these efforts have attempted to present a “critical” rather than metaphysical interpretation of Hegel. Pippin, for example, develops an account of Hegel's idealism that stresses its indebtedness to Kant while noting the ways in which Hegel's emphasis on history and society advance Kant's critical project. Also, in recent works both John McDowell and Robert Brandom have begun the process of what McDowell calls the “domestication” of Hegel's idealism in the service of developing an alternative to naturalist accounts of cognition and intentionality.

See also *Continental Philosophy; Existentialism; Phenomenology; Philosophy*.

BIBLIOGRAPHY

Beiser, Frederick C., ed. *The Cambridge Companion to Hegel*. Cambridge, U.K.: Cambridge University Press, 1993. Includes a detailed and categorized bibliography.

Hegel, G. W. F. *Elements of the Philosophy of Right*. Edited by Allen W. Wood and translated by H. B. Nisbet. Cambridge, U.K.: Cambridge University Press, 1991.

———. *The Encyclopedia Logic, with the Zusätze: Part I of the Encyclopaedia of Philosophical Sciences with the Zusätze*. Translated by T. F. Geraets, W. A. Suchting, and H. S. Harris. Indianapolis: Hackett, 1991.

———. *Gesammelte Werke—Kritische Ausgabe*. Deutsche Forschungsgemeinschaft im Verbindung mit Rheinische-westfälischen Akademie der Wissenschaften. Hamburg, Germany: Felix Meiner Verlag, 1968–. The critical edition of Hegel's works. New volumes are published every few years.

———. *Phenomenology of Spirit*. Translated by A. V. Miller. Oxford: Clarendon 1977.

Hyppolite, Jean. *Genesis and Structure of Hegel's Phenomenology of Spirit*. Translated by Samuel Cherniak and John Heckman. Evanston, Ill.: Northwestern University Press, 1974.

Kojève, Alexandre. *Introduction to the Reading of Hegel: Lectures on the Phenomenology of Spirit*. Assembled by Raymond Queneau, edited by Allan Bloom, and translated by James H. Nichols, Jr. Ithaca, N.Y.: Cornell University Press, 1969. An abridged translation of the French text.

Nancy, Jean-Luc. *Hegel: The Restlessness of the Negative*. Translated by Jason Smith and Steven Miller. Minneapolis: University of Minnesota Press, 2002.

Pippin, Robert. *Hegel's Idealism: The Satisfactions of Self-Consciousness*. Cambridge, U.K.: Cambridge University Press, 1989.

*Yitzhak Y. Melamed
Peter Thielke*

HEGEMONY. Hegemony, from the Greek *hegemón* (guide, ruler, leader) and *hegemonia* (rule, leadership), denotes the pre-eminent influence a state, social class, group, or individual exercises over others. Today it is especially associated with the Italian Marxist and revolutionary Antonio Gramsci (1891–1937), for whom it is the core and organizing concept of his social and political ideas. More recently hegemony has gained wide currency in social and political thought, international politics, as well as in cultural and literary studies.

In ancient Greek usage, one meaning of a *hegemón* is leader of a consensual alliance of the military forces of different *poleis*. Another, and more important, sense of *hegemón* refers to a *polis* at the head of an alliance consisting of a number of *poleis* that come together freely in order to address a common military threat. Here hegemony is a system of alliances in which a state exercises power and leadership over mutually consenting states. Herodotus (484–c. 420 B.C.E.) in his *Histories* describes the war of the Greeks against the Persians in terms of such an alliance. Thucydides (460/455–c. 401 B.C.E.), in his *History of the Peloponnesian War*, often uses the term in both senses of a military and political alliance. He notes that the Delian League, originally a voluntary alliance of states under the leadership of Athens established to confront the Persian threat against the common interests of the members, gradually turned into an Athenian Empire in which allies became subjects serving only Athenian self-interest. Thucydides cites this transformation as the primary reason for the Peloponnesian War.

In effect, in ancient Greece an alliance in which a hegemonic state assumes predominant military and political leadership is characterized by four fundamental structural elements. The first is a duality in structure: the *hegemón* on one side and its allies on the other. The second factor is the lack of a common citizenship. Individuals were citizens only of their own *polis*. And the third characteristic was that membership in the alliance was fluid—that is, different *poleis* entered or left it according to the strategic and political dynamics of the international environment. A fourth element, historically but not necessarily conceptually linked to the other three, is the tendency of a hegemonic alliance to transform itself into the imperial rule of the leading state.

Aristotle (384–322 B.C.E.) and Isocrates (436–338 B.C.E.) also employ hegemony to distinguish imperial from hegemonic rule. In the *Politics*, Aristotle distinguishes two types of rule, despotic and political (or constitutional). The first describes government over unequals in the interest of the ruler, and the second is rule among equals in the interest of the ruled. He uses the term *hegemony* when talking about the leadership of equals in the interest of all, and *despotism* when discussing the domination of others in the ruler's self-interest. It is to be noted that Aristotle's use of hegemony is closely related to his classification of governments in which legitimate and illegitimate types are differentiated according to whether they are law-abiding and pursue the common good.

Isocrates, in such works as *The Panegyricus* and *On the Peace*, laments the transformation of the Delian League into the Athenian Empire, attributing Athens's fall to its despotic rule over Greeks. He establishes a distinction not unlike Aristotle's: hegemony is leadership exercised over free and consenting allies, and despotism is the exercise of domination or force. Isocrates links the exercise of hegemony with the dissemination of moral/intellectual as well as cultural and aesthetic ideas. Athens is the natural hegemonic leader because she is the school of Hellas, the teacher and guide of Hellenes and, through them, the world.

Athens as the cultural and moral center of Greece (also proclaimed by Pericles in his Funeral Oration) points to another important meaning of hegemony: namely, as the ruling or guiding principle or idea. Thus Isocrates, following the rhetorician Gorgias (c. 485–c. 380 B.C.E.), proclaimed the supremacy of reason and discourse. Thus too rhetoric and public speech were deemed central to political and social life, and opposing discourses and narratives competed for recognition and preeminence. Moreover, Greek political thought generally struggled with the relation between power and knowledge. Without knowledge, power is reduced to mindless violence and coercion, purposeless and unpredictable. And without power, knowledge is ineffectual. Greek thinkers tried to reconcile or synthesize power and knowledge in order to construct a stable and just political order. Hegemony as a ruling principle expresses this ambition to empower knowledge and to educate power.

Macedon and Rome put an end to these political and conceptual distinctions. The rise of Stoicism and Epicureanism, the triumph of Christianity, combined with the Germanic invasions, inaugurated a new civilization wherein the classical

emphasis on political and public action, with its concomitant distinctions between free rule and despotism, hegemony and empire, ceased to have meaning. The rise of the Italian city-states, the coming of the Reformation, and the rise of English and Dutch republican radicalism, as well as the social, economic, and cultural/intellectual changes that paralleled these events, once again placed at center stage political and conceptual issues dealing with liberty and domination, constitutional and despotic government, state independence and imperialism.

Hegemony, however, both as a term and a concept, did not regain currency until the nineteenth century. Since then, with important exceptions and under the rubric of hegemonism, it was generally applied to the international sphere in which a state exercises overwhelming power over others and thus comes to dominate them.

In Europe during the latter half of the nineteenth century, the rise of working-class and peasant parties and movements, combined with socialist, anarchist, and Marxist critiques of liberalism and capitalism, challenged the existing sociopolitical order and questioned the legitimacy of its moral/intellectual claims to liberty and equality. In Germany, controversies within the working-class movement and its Social Democratic Party centered around the mechanics of capitalism and appropriate strategies (reform or revolution) for its overthrow. In Russia the term *hegemony* was made current by socialists such as George V. Plekhanov (1855?–1918), Paul B. Akselrod (1850–1928), Leon Trotsky (1879–1940), and Vladimir I. Lenin (1870–1924), and it referred to the leading role of the working class in a system of alliances directed against the prevailing order. During the first decade of the twentieth century, Lenin and the Bolsheviks, in their competition with Mensheviks and socialist revolutionaries for the favor of workers and peasants, devised a revolutionary strategy in which the proletariat would assume a hegemonic role and lead the peasantry and oppressed national minorities to the overthrow of tsarism and the institution of a socialist sociopolitical order. Here hegemony is seen as an alliance of social forces in which the working class plays a preeminent role. The Bolshevik seizure of power in 1917, the dissolution of the Constituent Assembly in 1918, and the consequent imposition of party dictatorship revealed the authoritarian character of Soviet communism, which exposed the rhetoric of hegemony and democratic alliances as mere instrumental formulas masking domination and terror.

It is with Antonio Gramsci, especially in his prison writings collected in the *Prison Notebooks* (1929–1935), that hegemony acquired conceptual coherence and theoretical significance. In his thought, hegemony became more than a synonym for preeminent power or a term used ad hoc to refer to asymmetrical power relations. Like Lenin, he criticized the economic determinism of Marxist thought and emphasized the use of reason and will to change economic, social, and political structures. Unlike Lenin, he developed a more nuanced and more articulated theory of state and society. His notion of hegemony regarded state and society and their interrelationships as based on the formulation and dissemination of cultural, ideological, and moral/intellectual systems of value and belief. Thus the

state is not pure force and violence, nor is it merely the dictatorship of one class over another. Returning to Hegel's notion of history and politics as the products of humanity's reflexive activity in the world, Gramsci understood hegemony as the historical unfolding and its articulation within concrete societies of a conscious and disciplined human subjectivity.

Both Lenin and Gramsci identified the formation of a conscious historical subject as the fundamental problem of revolutionary Marxism: though the economic and structural conditions were present, the working class, the actor assigned to carry out the revolution, was culturally and politically ill prepared to organize it and construct a new order. In Russia, Lenin and the Bolshevik Party gave history a push and manufactured the revolution in the name of the workers and peasants, a strategy that failed in more advanced countries. Attempting to understand this failure, especially the victory of fascism in Italy, Gramsci focused on the differences between the West and Russia regarding the nature, structure, and purpose of state and society. Gramsci contrasts the sociopolitical order confronting Lenin's Bolsheviks in Russia and that faced by the communists in the West. The differences in social and political structures between the East and the West require different methods and strategy in order to overcome liberal capitalism. Gramsci notes that in Russia the "State was everything" and civil society "primordial" and weak, while in the West civil society was strong and resilient, such that there was a "proper relation" between state and civil society.

Gramsci radically changes both the Marxist conceptions of state and society and their interrelationship. Civil society is the sphere of liberty, where consent and persuasion are generated. Yet it is also the sphere of cultural, ideological, religious, and economic conflict, where this conflict is defined by the contest of voluntary and secondary associations such as trade unions, political parties, sects and churches, schools and universities, civic organizations, and interest groups of various kinds. Civil society in the West has developed massive and complex structures of social and political institutions that together legitimate and render stable the prevailing order. The interwoven and multiple layers of complex associations of modern democracy render revolution impossible in the West. Gramsci opposes civil society to political society and hegemony to dictatorship. The latter means the juridical, administrative, and military apparatus of government and represents force and coercion. It is also the classical liberal understanding of the state, what nineteenth-century Europeans called the "night-watchman" state. The two spheres, while analytically distinct, mutually penetrate and reinforce each other. In fact, one presupposes the other. Hence Gramsci sees what he calls the "integral state" as "civil society plus political society." Hence too, in Gramsci (as in Hobbes and Locke), one cannot have a viable civil society without a viable government.

Hegemony is intimately linked to civil society. The strength and viability of civil society (i.e., the degree of complexity and articulation of social, economic, and cultural groups) is directly related to the degree of hegemonic power. Within both state and society, hegemony is seen as the generation and organization of consent—namely, the formation of a "conception of the

world" and its dissemination throughout the people. Such a conception (an "ideology" or a system of beliefs) is always opposed to different conceptions of the world. These are constantly in conflict, in a "battle" against each other, and the hegemonic conception is one that has been transformed into the generalized habits and customs of the people. A counterconception, or a counterhegemony, is constantly generated, even if only embryonically, to challenge the prevailing one. Intellectuals generate and disseminate these values and ideas, yet the latter cannot become politically and historically significant without their proliferation throughout the people. Hence, in modern society, especially democracies, the battle over opposing values and competing *Weltanschauungen* underlines the crucial role played by the people, especially in the form of public opinion.

What Gramsci looks at is the ways in which minority elite opinion (of intellectuals and opinion makers generally) is transformed into the people's or the majority's opinion and, in turn, the ways in which the two kinds of opinion interact and mutually affect one another. These concerns are reflected in his analyses of popular culture and its relation to high culture, in his discussion of the role played in modern society by newspapers, journals, and mass media generally, and in his inquiry into the historical and social bases of myth, folklore, and religion. The focus on popular culture and its relation to elite culture reflects Gramsci's original radical project: to discover within capitalist society a subordinate group (called "subaltern" by Gramsci) potentially able to become hegemonic. The purpose, character, and direction of Gramsci's hegemony is to understand why power structures are stable and persist over time and simultaneously to uncover within this structure subaltern groups, cultures, and ideas capable of hegemonic development.

Thus the hegemonic and the subaltern are intimately related, such that each is defined by the other. A group is hegemonic to the extent that it formulates a coherent system of knowledge and an articulated conception of the world that, once disseminated throughout the population, have become the way of life and the way of thinking of the entire society. Similarly, a group is subaltern to the extent that its ways of thinking and its consciousness are "disaggregated," fragmented and "discontinuous," such that it is incapable of autonomous action. It is in the opposition between the hegemonic and the subaltern that a sociopolitical and sociocultural space opens up for the autonomous development of the latter. Hegemony was developed by Gramsci to identify within the preexisting order groups capable of opposition, both cultural and political, and capable of presenting an alternative to the structure of power and to its system of beliefs. The movement from the subaltern to the hegemonic is the movement from fragmentation to political and cultural coherence, and is what describes the formation of a group capable of self-government and thus capable of rule. In this sense, every hegemony generates a counterhegemony, in which opposing conceptions of the world, and opposing systems of knowledge, confront each other in a struggle to construct and to transform reality.

Gramsci's emphasis on culture, its generation, proliferation, and transmission, led him to inquire into the reciprocal ways that language and power influence each other. Language

formation and use construct ways of looking at the natural and social world. Language not merely expresses or reflects reality, but, more important, organizes and structures the world. There is a reciprocal relation between a hegemonic ruling group and the language it uses to define itself and to establish its supremacy. A subordinate group aspiring to preeminence must devise a language capable of understanding and capturing the reality it seeks to master. Languages, therefore, are either hegemonic or subaltern, and if the latter, potentially hegemonic.

In effect, hegemony is a complex and highly articulated concept and operates at various levels. First, in the manner of the ancient Greeks, it is a free and consensual alliance of groups that share similar interests and perhaps similar values, under the leadership of that group that manages to represent and pursue the interests and aims of the associated groups. Gramsci expresses this relationship in the polarity domination/leadership: leadership is exercised over allied groups, and domination (“even with armed force”) over antagonistic groups. Second, hegemony may refer to the formation of an equilibrium between force and consent, such that force does not prevail “too much” over consent. Third, hegemonic power is power generated by values and beliefs, by moral/intellectual ideas through which the world is organized and perceived and through which the world acquires meaning. In this case hegemonic takes the sense of ruling principle or organizing idea. It explains the strength and resilience of the existing liberal capitalist system and the ability of its ruling groups to attain and maintain the allegiance of subordinate groups. Fourth, hegemony refers to a group equal to or capable of rule and self-rule—and capable of extending its view of the world throughout society. It describes the process by which a subordinate group acquires the ideological, institutional, and political means to formulate its own hegemonic conception of the world and oppose it to that espoused by the existing ruling group.

Hegemony, originally developed by Gramsci to unpack the complex of economic, political, and cultural sources of power in order to discover within the existing system the germs for revolutionary transformation, has been appropriated, either selectively or more rigorously, by a diverse number of intellectual discourses and academic disciplines. In international politics and political science, it is used variously either to describe an imperial system of domination, a voluntary alliance under a leading state, or simply to refer to the noncoercive, nonmilitary elements of power. In anthropology, it refers to the power and structural characteristics that underlie culture in its broadest sense. In sociolinguistics, the interaction between sociopolitical power and the emergence and development of languages (natural and specialized, local and dialectal) is stressed. In literary and cultural studies, popular forms of narratives and art as well as folk traditions and beliefs are analyzed. The polarity between the hegemonic and the subaltern has become central to fields of inquiry ranging from colonial and neocolonial studies to philosophy of language, to the study of rhetoric, and to the philosophy and sociology of education.

Such a polarity uncovers the power and class relationships that underlie fields of knowledge and the cognitive and methodological constructions developed to understand and to capture the material and the sociocultural reality. Since the

hegemonic and the subaltern presuppose each other, understanding of a given reality means inquiring into the ways in which a dominant hegemony interacts with a subordinate culture, as well as the manner in which elite and mass mutually penetrate, oppose, or reinforce each other. Since the relation between hegemony and subalternity is fluid and changing, and since the subaltern is potentially hegemonic, contemporary uses of hegemony in various fields and disciplines articulate, and reflect, a political contest among competing interpretations and opposing values. Precisely because hegemony was developed as methodological concept to investigate established sociopolitical reality, it is also a political and social tool useful in the “battle” to generate differing views of the world and competing models of knowledge.

See also *Civil Society; International Order; Leadership.*

BIBLIOGRAPHY

- Adamson, Walter L. *Hegemony and Revolution: A Study of Antonio Gramsci's Political and Cultural Theory*. Berkeley: University of California Press, 1980.
- Anderson, Perry. “The Antinomies of Antonio Gramsci.” *New Left Review* 100 (1976): 7–78.
- Buttigieg, Joseph A. “Introduction.” In Antonio Gramsci, *Prison Notebooks*, vol. 1, edited by Joseph A. Buttigieg, and translated by Joseph A. Buttigieg and Antonio Callari. New York: Columbia University Press, 1993, pp. 1–64.
- . “Philology and Politics: Returning to the Text of Antonio Gramsci.” *Boundary 2*, no. 21 (1994): 98–138.
- Davidson, Alastair. *Antonio Gramsci: Towards an Intellectual Biography*. London: Merlin Press, 1977.
- Ehrenberg, Victor. *The Greek State*. New York: W. W. Norton, 1960.
- Finocchiaro, Maurice A. *Gramsci and the History of Dialectical Thought*. Cambridge, U.K.: Cambridge University Press, 1988.
- Fontana, Benedetto. “Logos and Kratos: Gramsci and the Ancients on Hegemony.” *Journal of the History of Ideas* 61 (2000): 305–326.
- Gill, Stephen, ed. *Gramsci, Historical Materialism and International Relations*. Cambridge, U.K.: Cambridge University Press, 1993.
- Gramsci, Antonio. *Further Selections from the Prison Notebooks*. Translated and edited by Derek Boothman. Minneapolis: University of Minnesota Press, 1995.
- . *Selections from Cultural Writings*. Edited by David Forgacs and Geoffrey Nowell-Smith and translated by William Boelhower. Cambridge, Mass.: Harvard University Press, 1985.
- . *Selections from the Prison Notebooks of Antonio Gramsci*. Edited and translated by Quintin Hoare and Geoffrey Nowell-Smith. New York: International Publishers, 1971.
- James, Martin, ed. *Antonio Gramsci: Critical Assessments of Political Philosophers*. 4 vols. London: Routledge, 2001.
- Sassoon, Anne Showstack. *Gramsci and Contemporary Politics: Beyond Pessimism of the Intellect*. London and New York: Routledge, 2000.
- Sinclair, T. A. *A History of Greek Political Thought*. Cleveland, Ohio: World, 1968.
- Wolf, Eric. *Envisioning Power: Ideologies of Dominance and Crisis*. Berkeley: University of California Press, 1999.

Benedetto Fontana

HELL. See *Heaven and Hell*.

HERESY AND APOSTASY. *Heresy* is derived from a Greek word literally meaning “a choice.” St. Irenaeus (c. 120 to 140–c. 200 to 203) defined heresy as deviation from the standard of sound doctrine. This definition provided a model for subsequent conceptions of heresy. Referring to the Greek word, St. Jerome (c. 347–419 or 420) wrote that each one chooses the rule that one judges to be the best. So, he continued, “anyone who understands Scripture in a way other than the Holy Spirit, which dictated how Scripture should be written, demands would be called heretic, even if he is not excluded from the Church, and derives from the work of the flesh because he chooses the worst.” The voluntary choice of a carnal meaning leads a reader of Scripture to shape a doctrine that contradicts the teaching of the church, thereby falling into heresy. Heresy, then, was a departure from the unity of the faith, while believing to subscribe to the Christian faith. The reverse side of it is the church’s assertion of doctrinal authority. Heresy, denial or doubt of any defined doctrine, is sharply distinguished from apostasy, which denotes deliberate abandonment of the Christian faith itself. Hence, in a Christian context, heretics do not include the people of other faiths like the Jews and the Muslims, although they were not immune from religious persecution along with Christian heretics. The distinction between schism and heresy, on the other hand, is not as clear, since both concepts denote the separation from unity; indeed, the schism between the Western and Eastern Churches generated the accusation by both churches of the other being heretical rather than schismatic.

Early Christianity

The earliest form of Christian heresy originates in Jewish sectarianism. The teachings of the Gnostic master Simon of Samaria, which combined Jewish teaching with some Christian doctrines, appear in the early catalogue of heretics, and Eusebius of Caesarea (c. 260–c. 339) recorded him as the prime author of every kind of heresy. Perhaps the most prominent of heresies is Arianism, which claimed that Christ was mere creation, thereby rejecting the eternity of the Son of God. The Arian view, despite official condemnation by Alexander, patriarch of Alexandria (St. Alexander; c. 250–328), continued to spread until the emperor Constantine’s (ruled 306–337) call for unity at the Council of Nicaea (325). Among other early Christian heresies were Manichaeism and Donatism. Manichaeism was a Gnostic dualistic doctrine influenced by St. Paul’s teaching, whilst Donatism was a schismatic group in the African church dissenting from the appointment of Caecilian as bishop of Carthage. Faced by the Donatist controversy, St. Augustine of Hippo (354–430), a Manichaean before his spiritual conversion, was a powerful proponent of the use of state punishment for the leaders of heresy. For Augustine, it is not only right for the public authority to use compulsive measures to punish wrongdoers, since in so doing they are acting on behalf of God. It is also an act of charity that is intended to correct and reform those who are punished.

In the twelfth century, speculative theologians like Peter Abelard and St. Bernard of Clairvaux viewed heretics as the

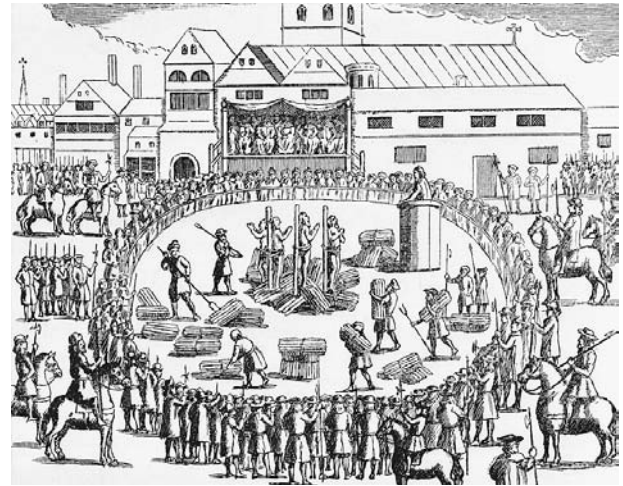

Engraving showing Protestants being burned at the stake by Roman Catholics (1546). During the rule of Pope Innocent III (1198–1216), the practice of accusing people of heresy began to be replaced with inquisitions. The typical sentence for those found guilty was excommunication. A later inquisition in Spain, however, led to the execution of thousands of suspected heretics. © BETTMANN/CORBIS

product of pride and the aspiration for fame. But heresy was not only the concern of doctrinal theology but also of canon law. Once Gratian of Bologna produced the *Decretum* (c. 1140), the juristic concept of heresy was established: the essential feature of heresy was considered pertinacity or obstinacy. Heresy was reduced to repeated refusals to submit to doctrinal correction by ecclesiastical authority. Heresy, therefore, required the church’s authority to declare it; typically, it was maintained that the authority to declare heresy rested with the pope. This juristic idea of heresy pervaded the practice of inquisition and censure, which was triggered by the rise of popular heretical movements such as Cathars and Waldensians. The Cathars are a loosely identified group of heretics who embraced dualism: a belief that there are two powers in the universe, good and omnipotent God and its opponent Devil. Catharism, which increased its influence rapidly in Western Europe in the twelfth century, did not constitute a theologically coherent unity. The Albigensians, a rigorous branch of the Cathars who were mainly based in Southern France, were condemned by successive councils including the Fourth Lateran Council (1215).

Faced by the rapid and widespread proliferation of popular heresy, Pope Innocent III (ruled 1198–1216) recognized the urgent need for the efficient prosecution of heretics; therefore, he replaced the hitherto widely practiced accusatorial procedure with inquisitorial practice, thereby curtailing the presumption of innocence. This “persecuting” culture penetrated the academic community from the late thirteenth century onward; the bishop of Paris, Stephen Tempier’s condemnation of 219 propositions (1277) restricted academic freedom and opened the way to the condemnation of the idiosyncratic teachings of thinkers like Peter John Olivi, Jean de Pouilly, and Thomas Waleys. Peter Olivi’s teaching of *usus pauper*—the rigorous

practice of poverty that rejects ownership and restricts use of the goods—attracted a number of followers constituting the Spiritual Franciscans, a significant heretical group of the “non-conformist” friars.

Heresy, however, was not a problem that could be observed among theologians and lay believers alone. Heretical ecclesiastics, including the pope, were an ecclesiological dilemma that troubled theologians and canonists alike, and the classical solution to this problem was that a heretical pope would be ipso facto deposed. However, this argument is, in practical terms, insignificant because no one is supposed to be superior to the pope in the ecclesiastical order. In his involvement with the dispute between the Avignon papacy and the Friars Minor, the Franciscan William of Ockham (c. 1285–c. 1347) propounded an extensive discourse on heresy with special reference to papal heresy. In it he redefined heresy as deliberate rejection of the truth of Christian doctrine manifested in the Bible and other doctrinal sources. Thus, Ockham reduced heresy to an interpretative category of theological enquiry into doctrinal texts, thereby rejecting the juristic idea of heresy as repeated disobedience to ecclesiastical authority. This implied that the discovery of heresy requires no ecclesiastical authority. This cognitive perspective on heresy was also evident in the polemical writings of the Italian political philosopher Marsilius of Padua (c. 1280–c. 1343), who proposed that the detection of heresy should be entrusted to the experts of Scripture rather than the holders of the ecclesiastical office.

The Oxford philosopher John Wycliffe’s (c. 1330–1384) rejection of the scriptural foundations of religious life—papal authority and the mendicant orders in particular—and his attack on the doctrine of transubstantiation inspired the popular heretical movement of Lollardy. The Lollards were the loyal heir of Wycliffe’s teaching of *sola scriptura*; the doctrinal appeal to the Bible alone was an antithesis to the contemporary practice of Roman Catholic Christianity. The influence of Wycliffe’s teaching reached beyond England; in Bohemia, Jan Hus (1372 or 1373–1415) assimilated the Wycliffite reformative ecclesiology, which resulted in his official condemnation and execution at the Council of Constance (1414–1418)

Non-Christian Heresy

Heresy is not an idea known to Christian civilization alone. The Islamic concept equivalent to heresy may be *bid’a*, meaning literally “deviation”: the counterconcept of *sunna*, meaning the tradition established by Muhammad. Unlike heresy, *bid’a* does not always have negative denotation; departure from the tradition may be tolerated as innovation, and the extreme deviation alone may be subject to condemnation. *Zandaqa*—the idea that rejects the existence or omnipotence of God, as in Zoroastrianism and Manichaeism—exemplifies Islamic heresy. The Islamic concept equivalent to apostasy is called *irtidat* or *ridda*, which is according to the Koran subject to death penalty or life imprisonment.

Heresy seems to be an idea whose application is overwhelmingly confined to monotheistic religions. While occasional attempts have been made to regularize the teachings of Confucianism, and thus to create a division between orthodoxy

and heresy, these have not succeeded for long. The revealed word of a single god implies heterodoxy in a way that the assumptions about supernatural belief in other religions do not.

See also *Christianity; Ecumenism; Islam; Manichaeism; Orthodoxy; Religion; Toleration.*

BIBLIOGRAPHY

- Jeanjean, Benoît. *Saint Jérôme et l’hérésie*. Paris: Institut d’Études Augustiniennes, 1999.
- Lambert, Malcolm. *Medieval Heresy: Popular Movements from the Gregorian Reform to the Reformation*. Oxford: Blackwell, 2002.
- Laursen, John Christian, ed. *Histories of Heresy in Early Modern Europe: For, against, and beyond Persecution and Toleration*. New York: Palgrave, 2002.
- Leff, Gordon. *Heresy in the Later Middle Ages*. 2 vols. Manchester: Manchester University Press, 1967.
- Moore, R. I. *The Formation of a Persecuting Society: Power and Deviance in Western Europe, 950–1250*. Oxford: Blackwell, 1987.
- Pelikan, Jaroslav. *The Christian Tradition: A History of the Development of Doctrine*. 5 vols. Chicago: University of Chicago Press, 1971–1989.

Takashi Shogimen

HERMENEUTICS. Traditionally understood as the art of interpretation (*ars hermeneutica*) that provided rules for the interpretation of sacred texts, hermeneutics today serves to characterize a broad current in contemporary continental philosophy that deals with the issues of interpretation and stresses the historical and linguistic nature of our world-experience. Since this characterization is also valid for contemporary thinking as a whole, the boundaries of hermeneutics are difficult to delineate with pinpoint accuracy. In contemporary thought it is mostly associated with the thinking of Hans-Georg Gadamer (1900–2002), who continues the hermeneutic tradition of thinkers such as Wilhelm Dilthey (1833–1911) and Martin Heidegger (1889–1976). All three authors unfolded a distinct philosophical understanding of hermeneutics (that is, interpretation theory) that drew on the more ancient tradition of hermeneutics. Since their thinking is a radicalization of and reaction to this older conception, it is with it that one must start.

The Art of Interpretation of Sacred Texts

Originally, hermeneutics was developed as an auxiliary discipline in the fields that deal with the interpretation of canonical texts, i.e. texts that contain authoritative meaning such as sacred or judicial texts. Hermeneutic rules were especially required when one was confronted with ambiguous passages (*ambigua*) of Scripture. Some of the most influential treatises in this regard were St. Augustine of Hippo’s *De doctrina Christiana* (427) and Philipp Melancthon’s *Rhetoric* (1519). Since most of these rules had to do with the nature of language, the major thinkers of the hermeneutic tradition up until the nineteenth century borrowed their guidelines from the then still very lively tradition of rhetoric, for example, the requirement

that ambiguous passages should be understood within their context, a rule that later gave rise to the notion of a “hermeneutical circle” according to which the parts of a text should be comprehended out of the whole in which they stand, such as the whole of a book and its intent (*scopus*), of a literary genre, and of the work and life of an author. Supplying such rules, hermeneutics enjoyed a normative or regulatory function for the interpretation of canonical texts. A specific hermeneutics was developed for the Bible (*hermeneutica sacra*), for law (*hermeneutica juris*), and for classical texts (*hermeneutica profana*).

The German theologian Friedrich Schleiermacher (1768–1834) is a foremost example of this tradition, but also an author who points to a more philosophical understanding of hermeneutics in at least two ways. First, at the beginning of his lectures on hermeneutics, published posthumously by his pupil Friedrich Lücke (1791–1855) in 1838, he complains that there are many special hermeneutics and that hermeneutics does not yet exist as a general or universal discipline, i.e. as an art (*Kunst, Kunstlehre*) of understanding itself that would establish binding rules for all forms of interpretation. Second, Schleiermacher further laments that hermeneutics has hitherto only consisted of a vague collection of dislocated guidelines. Hermeneutical rules, he urges in *Hermeneutics and Criticism*, should become “more of a method” (*mehr Methode*). A more rigorous methodology of understanding could enable the interpreter to understand the authors as well or even better than they understood themselves.

Hermeneutics as the Methodological Basis of the Human Sciences

Most familiar with the thinking and life of Schleiermacher, of whom he was the biographer, Dilthey devoted his lifework to the challenge of a foundation of the human sciences (*Geisteswissenschaften*). Whereas the exact sciences had already received, in the wake of Immanuel Kant’s *Critique of Pure Reason*, a philosophical base and a methodology guaranteeing the validity of their knowledge, the human sciences still lacked such a foundation. Under the motto of a “critique of historical reason,” Dilthey sought a logical, epistemological, and methodological foundation for the human sciences. Without such a foundation, their own scientific legitimacy could be called into question: is everything in the human sciences merely subjective, historically relative, and, as we tend to say, but with a touch of derision, a mere matter of interpretation? If these areas of our knowledge are to entertain any scientific credibility, Dilthey argued, they need to rest on a sound methodology.

In some of his later texts (most notably in his essay “The Rise of Hermeneutics,” 1900), Dilthey sought such a methodical basis for the humanities in hermeneutics, the old discipline of text interpretation that could receive renewed actuality in light of this new challenge. Hermeneutics could serve as the bedrock of all human sciences and could thus be called upon to fulfill a need that arises out of the emergence of historical conscience and threatens the validity of historical knowledge. Even if it remains largely programmatic in his later texts, the idea that hermeneutics could serve as a universal foundation of the human sciences bestowed upon hermeneutics a

philosophical relevance and visibility that it never really enjoyed before Dilthey. Up to this day, important thinkers such as Emilio Betti and E. D. Hirsch look to hermeneutics to deliver a methodical foundation for the truth claim of the humanities, the literary, and the juridical disciplines. According to them, a hermeneutics that would relinquish this task would miss the point about what hermeneutics is all about.

Life articulates itself, Dilthey says, in manifold forms of expression (*Ausdruck*) that our understanding seeks to penetrate by recreating the inner life experience (*Erlebnis*) out of which they sprang. Dilthey’s far-reaching intuition is that interpretation and understanding are not processes that occur simply in the human sciences but that they are constitutive of our quest for orientation. The notion that historical life is as such hermeneutical and interpretatory to the core was buttressed by Friedrich Nietzsche’s contemporaneous reflections on the interpretatory nature of our world-experience. “There are no facts, only interpretations,” wrote Nietzsche in Fragment 481 of *The Will to Power*. This first glimpse of the potential universality of the “hermeneutic universe” appeared to call into question Dilthey’s dream of a methodical foundation of the human sciences, but it raised a new hermeneutics task.

Heidegger’s Hermeneutics of Existence

Seizing upon this idea that life is intrinsically interpretative, the early Heidegger spoke of a “hermeneutical intuition” as early as 1919. His teacher Edmund Husserl (1859–1938) had reinstated the urgency and legitimacy of primal “intuition” in philosophy. But Heidegger revealed himself a reader of Dilthey when he stressed that every intuition is hermeneutical. Understanding is not a cognitive inquiry that the human sciences would methodically refine, it is our primary means of orientation in the world. Our factual life is involved in this world (“being there”: *Dasein*, as he would later put it) by ways of understanding. Relying here on the German expression *sich auf etwas verstehen*, which means “to know one’s way about,” “to be able,” Heidegger puts a new twist on the notion of understanding by viewing it less as an intellectual undertaking than as an ability. It is more akin to a “know-how.” Understanding is not primarily the reconstruction of the meaning of an expression (as in classical hermeneutics and Dilthey); it always entails the projecting, and self-projecting, of a possibility of my own existence. There is no understanding without projection or anticipations.

We are factually (*faktisch*) thrown into existence as finite beings, in a world that we will never fully master. This anxiety for one’s own being is for Heidegger the source of understanding. Because we are overwhelmed by existence and confronted with our mortality, we project ourselves in ways of intelligibility and reason that help us keep things in check for a while. Every mode of understanding is related to this “being there” (*Dasein*) in this overwhelming world. A momentous shift in the focus of hermeneutics has silently taken place in the work of Heidegger from texts or a certain type of science to existence itself and its quest of understanding.

This rising program was carried over in Heidegger’s main work *Being and Time* (1927), but with some slight modifications

(Grondin, 2003). While it remained obvious that human facticity is forgetful of itself and its interpretatory nature, and possibilities, the focus shifted to the question of Being as such. The primary theme of hermeneutics was less the immediate facticity of our Being in this world than the fact that the presuppositions of the understanding of Being remain hidden in a tradition that needs to be reopened (or “destroyed,” as Heidegger puts it). Such a hermeneutics still aims at a self-awakening of existence, but it does so by promising to sort out the fundamental structures of our understanding of being.

These structures are temporal in nature (hence the title *Being and Time*) and have everything to do with the inauthentic or authentic carrying through of our existence. Heidegger’s later philosophy, while relinquishing the notion of hermeneutics as such, nevertheless radicalized this idea by claiming that our understanding of Being is brought about by the event of an overbearing history of Being that commands all our interpretations. Postmodern readings of Heidegger (Michel Foucault, Gianni Vattimo, Richard Rorty, Jacques Derrida) drew relativistic conclusions out of this shift of hermeneutics toward the history of Being. Hence, the tendency in recent debates to amalgamate hermeneutics and postmodernism, a tendency that the hermeneutics of Gadamer seems both to encourage and to combat.

Gadamer’s Hermeneutics of the Event of Understanding

Hans-Georg Gadamer’s project is strongly influenced by Heidegger, but in his masterpiece *Truth and Method* (1960) his starting point is undoubtedly provided by Dilthey’s hermeneutical inquiry on the methodology of the human sciences. While taking anew the dialogue with the human sciences and the open question of their claim to truth, Gadamer calls into question Dilthey’s premise according to which the experience of truth in the humanities depends on method. In seeking a methodological foundation that alone could guarantee their scientific or objective status, Dilthey sought to keep the humanities to the model of the exact sciences and would thus have forfeited the specificity of the humanities, where the involvement of the interpreter whose understanding is constitutive of the experience of meaning: the texts that we interpret are texts that say something to us and that are always understood in some way out of our questions and “prejudices.” The implication of the interpreter in the “event” of meaning, as Gadamer likes to put it, can only be deemed detrimental from the model of objectivity heralded by the natural sciences. Instead of this outdated notion of objectivity, the human sciences would do well to understand their contribution to knowledge out of the somewhat forgotten tradition of humanism and the importance it bestowed upon the notion of *Bildung* (formation and education). The humanities do not seek to master an object that stands at a distance (as with the exact sciences), but their aim is rather to develop and form the human spirit. The truth one experiences in the encounter with major texts and history is one that transforms us, taking us up in the event of meaning itself.

Gadamer finds the most revealing model for this type of understanding in the experience of art since we are always

involved by the presentation of an art work, which Gadamer understands as the revelation of the truth or the essence of something, so that a play reveals something about the meaning of existence, just as a portrait reveals the true essence of someone. Yet it is a truth-experience in which we partake in that it can only unfold through a process of interpretation. For Gadamer hermeneutics is to be understood, first and foremost, out of the arts we call the “arts of interpretation” or the “performative arts”: just as a piece of music must be interpreted by the violinist (that is, never arbitrarily, but with a leeway that has to be filled by the virtuosity of interpretation), a drama by the actors or the ballet by the dancers, a book must be interpreted through the process of reading and a picture must be contemplated by the eye of the beholder. It is only in this presentation (*Darstellung* or *Vollzug*) of a meaning to someone, a performance which is always an interpretation, that meaning comes to be realized. One notices here that “interpretation” refers both to the interpretation of a work of art by the performers and to the “spectators” who attend the performance and must also “interpret” the piece.

The difference between the two forms of interpretation is less important for Gadamer than the fact that the experience of meaning, and the truth experience it brings out, essentially requires the productive implication of the interpreter. The same holds for the interpretation of a text or a historical event, even in the scientific context of the human sciences. The point is that interpretation is not the simple recreation of a meaning that always remains the same and can be methodically verified, nor, for that matter, the subjective, and potentially relativistic, bestowing of meaning upon an objective reality (because the reality to be understood can only be reached through a renewed attempt of understanding). In other words, to claim that interpretation is relativistic on the grounds that it implies the subjectivity of the interpreter is to miss the point of what the humanities and the experience of meaning are all about.

The objectivistic model of the exact sciences is ill-equipped to do justice to this experience of meaning. Distance, methodical verification, and independence from the observer, Gadamer concludes, are not the sole conditions of knowledge. When we understand, we do not only follow a methodical procedure but we are “taken up” as the art experience illustrates, by the meaning that “seizes” us, as it were. The instrumental sounding idea of procedure is somewhat suspect for Gadamer, for understanding is more of an event than a procedure. “Understanding and Event” is indeed one of the original titles Gadamer thought about for his major work, before settling on “Truth and Method,” which underlines the very same point that truth is not only a matter of method and can never be entirely detached from our concerns.

But these concerns come to us from a tradition and a history that are more often than not opaque to consciousness. Every understanding stands in the stream of a *Wirkungsgeschichte* or “effective history,” in which the horizons of the past and the present coalesce. Understanding thus entails a “fusion of horizons” between the past and the present, that is, between the interpreter, with all the history silently at work in his understanding, and his or her object. This fusion is not to be viewed as an autonomous

operation of subjectivity but as an event of tradition (*Überlieferungsgeschehen*) in the course of which a meaning from the past is somehow applied to the present.

This leads *Truth and Method* to suggest that the best model for the humanities was perhaps offered by disciplines that had been traditionally preoccupied with the questions of interpretation such as juridical and theological hermeneutics, insofar as the meaning that is to be understood in these fields is one that has to be applied to a given situation. In the same way a judge has to creatively apply a text of law to a particular case and a preacher has to apply a text of Scripture to the situation of his or her congregation, every act of understanding involves an effort of “application” of what is understood to the present. Gadamer does not mean by this that one first has to understand a meaning, of a text or a historical event and then apply it to a given situation by bestowing new “relevance” upon it. His idea is rather that every understanding is at its root an application of meaning, where our experience and background are brought to bear. This “application” is, by no means, a conscious procedure. It always happens in the course of understanding to the extent that interpretation brings into play the situation and “prejudices” of the interpreter that are less “his” or “hers” than the ones carved by the effective history in which we all stand.

Gadamer expands on this idea by comparing understanding to a process of translation. “I understand something” means that I can translate it into my own words, thus applying it to my situation. Any meaning I can relate to is one that is translated into a meaning I can articulate. It is not only important to underline the obvious fact that translation always implies an act of interpretation (a translator is also called in English an *interpreter*) but even more to stress that this interpretation is by no means arbitrary: it is bound by the meaning it seeks to render, but it can only do so by translating it into a language where it can speak anew. What occurs in the process of translation is thus a fusion of horizons between the foreign meaning and its interpretation-translation in a new language, horizon, and situation, where the meaning resonates.

Truth and Method draws on this insight to highlight the fundamentally linguistic nature of understanding. Understanding is always an act of developing something into words, and I only understand to the extent that I seek (and find) words to express this understanding. Understanding is not a process that could be separated from its linguistic unfolding: to think, to understand, is to seek words for that which strives to be understood. There is a crucial fusion between the process of interpretation and its linguistic formulation. It will not be the only fusion of horizons that will interest Gadamer in his hermeneutics of language. His thesis goes even further: not only is the process (*Vollzug*) of interpreting (*interpretare*) linguistically oriented, what it seeks to understand (the *interpretandum*) is also language. Language also determines the object (*Gegenstand*) of understanding itself. In the end there occurs a fusion between the “process” of understanding and its “object” in the sense that no object (*Gegenstand*) can be separated from the attempt (*Vollzug*) to understand it. Gadamer’s famous phrase to express this fusion between the object and the process of understanding itself is: “Being that can be understood is language.”

This simple, yet enigmatic dictum can be read in two quite different directions: it can mean that every experience of Being is mediated by language, and thus by a historical and cultural horizon (negatively put: “there is no experience of Being without an historical understanding or language”). This would seem to draw Gadamer into the “relativistic camp.” It is striking to note, however, that Gadamer always resisted this merely relativistic appropriation of his thought. This has been overlooked by postmodern readers of Gadamer, but in his dictum “Being that can be understood is language,” the stress can also be put on Being itself. What Gadamer hopes to say by this is that the effort of understanding is in a way ordained to the language of the things themselves. A difficult and unpalatable notion for postmodernism, to be sure, but one that is essential to Gadamer’s hermeneutics: language is not only the subjective, say, contingent translation of meaning, it is also the event by which Being itself comes to light. Our language is not only “our” language, it is also the language of Being itself, the way in which Being presents itself in our understanding. This is why, when one speaks and interprets, one cannot say everything one fancies. One is bound by something like the language of the thing. What is this language? Difficult to say since we can only approach it through *our* language, and the language of tradition, but it is nevertheless the instance that resists too unilateral or too violent readings of this Being. It is this language of Being that I seek to understand, and to the extent that understanding succeeds, a fusion of horizons has happened, a fusion between Being and understanding, an event I do not master, but in which I partake.

Gadamer and His Critics

The history of hermeneutics after Gadamer can be read as a history of the debates provoked by *Truth and Method*. Some of the first responses to Gadamer were sparked by the methodological notion of hermeneutics that prevailed in the tradition of Dilthey. After all, it had been the dominant conception of hermeneutics until Gadamer (with the sole, albeit very peculiar, exception of Heidegger’s “hermeneutics of existence” that had left behind the older hermeneutic tradition which had been concerned with text interpretation and the human sciences). Since Gadamer, in spite of his Heideggerian roots, took his starting point in Dilthey’s inquiry on the truth claim of the humanities, he was often seen and criticized from this tradition. Emilio Betti, the Italian jurist who had published a voluminous *General Theory of Interpretation* (in Italian) in 1955, which was intended as a methodical foundation of the humanities in the Dilthey tradition, vigorously criticized Gadamer’s seeming rejection of the methodological paradigm. If Gadamer’s own “method” for the humanities consisted in saying that one just has to follow one’s own prejudices, it had to be condemned as a perversion of the very idea of hermeneutics. Betti, who was followed in this regard by E. D. Hirsch in America, opposed the relativistic idea that interpretation always entails an essential element of application to the present. Surely, texts do acquire different meanings or relevance in the course of their reception, but one has to distinguish the actuality or significance (*Bedeutsamkeit*) thus garnered from the original meaning (*Bedeutung*) of the texts, that is, the meaning of the text in the mind of its author (*mens auctoris*), which remains the focus of hermeneutics.

Coming from the Frankfurt School, Jürgen Habermas hailed, for his part, this element of application in understanding, claiming that knowledge is always guided by some interests. This hermeneutical insight, he believed, could help free the social sciences, spearheaded by psychoanalysis and the critique of ideology, from an all too objectivistic understanding of knowledge and science. Hermeneutics teaches us that our understanding and practices are always motivated and linguistically articulated. It is Gadamer's too strong reliance on tradition and the importance of authority in understanding that Habermas opposed. He faulted it for being "conservative"; but Habermas's lasting point, that language can also transcend its own limits, followed an idea that he discovered in Gadamer but turned against him. When Gadamer said that our experience of the world was linguistic, he also stressed, for Habermas, that it is open to self-correction, that is, that it could, to some extent, overcome its own limitations by seeking better expressions or dissolving its own rigidity and was thus open to any meaning that could be understood. Habermas and Karl-Otto Apel drew from this self-transcendence of language the important notion of a linguistic or communicative rationality, which is laden with universalistic assumptions that can form the basis of an ethical theory.

Paul Ricoeur tried to build a bridge—a most hermeneutical task and virtue in itself—between Habermas and Gadamer, by claiming both authors had stressed different but complementary elements in the tension that is inherent to understanding: whereas Gadamer underlined the belongingness of the interpreter to his object and his tradition, Habermas took heed of the reflective distance toward it. Understanding, viewed as application, does not only have to appropriate naively its subject matter, it can stand at a critical distance from it—a distance that is already given by the fact that the *interpretandum* is an objectified text. This notion of a hermeneutics that seeks to decipher objectifications came mainly from Dilthey, but Ricoeur used it in a productive manner in his decisive confrontations with psychoanalysis (Sigmund Freud) and structuralism (Claude Lévi-Strauss). He linked them to a "hermeneutics of suspicion" that is most useful in that it can help us get rid of superstition and false understanding. But such a hermeneutics can only be conducted in the hope of a better and more critical understanding of understanding. A "hermeneutics of trust" thus remains the ultimate focus of his work: the meaning we seek to understand is one that helps us better understand our world and ourselves. We interpret because we are open to the truths that can be gained from the objectifications of meaning in the grand myths, texts, and narratives of mankind, in which the temporal and tragic aspects of our human condition are expressed. Ricoeur drew far-reaching ethical conclusions from this hermeneutics of trust that has learned from the school of suspicion.

Betti, Hirsch, Habermas (and, to a certain extent, Ricoeur) all faulted Gadamer and hermeneutics for being too "relativistic" (i.e., too reliant on tradition). Postmodernism went, to some degree, in an opposite direction: it welcomed Gadamer's alleged "relativism" but only believed it did not go far enough. Gadamer would have been somewhat inconsequential in not acknowledging fully the relativistic consequences of his hermeneutics.

To understand this shift in the hermeneutical debates, it is important to observe that authors such as Heidegger (especially the later Heidegger) and Nietzsche play a paramount role for postmodernist thinkers. One thinks, in this regard, of the Nietzsche who said that there are no facts, only interpretations, or of the Heidegger who claimed that our understanding was framed by the history of Being. The postmodernists lumped this Nietzschean-Heideggerian outlook together with Gadamer's seeming critique of scientific objectivity, his stress on the prejudices of interpretation, and his insistence on the linguistic nature of understanding. Stressing these elements, hermeneutics, they believed, jettisoned the idea of an objective truth. There is no such thing given the interpretatory and linguistic nature of our experience. This led Gianni Vattimo to "nihilistic" consequences and Richard Rorty to a renewed form of pragmatism: some interpretations are more useful or amenable than others, but none can per se be claimed to be "closer" to the Truth. In the name of tolerance and mutual understanding, one has to accept the plurality of interpretations; it is only the notion that there is only one valid one that is harmful.

Jacques Derrida can also be seen in the "postmodern" tradition, since he too depends heavily on the later Heidegger and Nietzsche, stresses the linguistic nature of our experience, and also urges a "deconstructive" attitude toward the tradition of metaphysics that governs our thinking, an attitude that Paul Ricoeur would classify in the "hermeneutics of suspicion." But his deconstruction does not directly take the direction of the pragmatist tradition of Rorty or the nihilism of Vattimo. Despite the Heideggerian origins of his notion of deconstruction and his pan-linguisticism, Derrida does not identify himself with the tradition of hermeneutics. His "deconstruction" is indeed distrustful of any form of hermeneutics: every understanding, he contends, would involve or hide a form of "appropriation" of the other and its otherness. In his discussion with Gadamer in 1981, he challenged Gadamer's rather commonplace assumption that understanding implies the goodwill to understand the other. What about this will? asked Derrida. Is it not chained to the will to dominate that is emblematic of our metaphysical and Western philosophical tradition? Hence Derrida's mistrust of the hermeneutical drive to understand the other and of the hermeneutic claim to universality. Gadamer was touched by this criticism to the extent that he claimed that understanding implied some form of application, which can indeed be read as a form of appropriation. This is perhaps the reason why, in his later writings, he more readily underlined the open nature of the hermeneutical experience. "The soul of hermeneutics," he then said, "is that the other can be right."

See also *Modernity; Postmodernism; Relativism.*

BIBLIOGRAPHY

- Bernstein, Richard J. *Beyond Objectivism and Relativism: Science, Hermeneutics, and Praxis*. Philadelphia: University of Pennsylvania Press, 1983. Sees in the hermeneutical rehabilitation of common sense a parallel to pragmatism and a corrective to the bugbear of relativism.
- Betti, Emilio. "Hermeneutics as the General Methodology of the *Geisteswissenschaften*." 1962. Reprinted in *Contemporary*

- Hermeneutics: Hermeneutics as Method, Philosophy, and Critique*, edited by Josef Bleicher. London and Boston: Routledge and Kegan Paul, 1980. Polemical defense of a methodology of interpretation against Gadamer.
- Bleicher, Josef, ed. *Contemporary Hermeneutics: Hermeneutics as Method, Philosophy and Critique*. London and Boston: Routledge and Kegan Paul, 1980. Best collection of essays by Betti, Gadamer, Habermas, Apel.
- Caputo, John D. *Radical Hermeneutics: Repetition, Deconstruction and the Hermeneutic Project*. Bloomington: Indiana University Press, 1987. Postmodern, Derridian reading and critique of hermeneutics.
- Dilthey, Wilhelm. "The Rise of Hermeneutics." In his *Hermeneutics and the Study of History*, edited by Rudolf A. Makkreel and Frithjof Rodi, 235–258. Vol. 4. Princeton, N.J.: Princeton University Press, 1996. Seminal study on the significance of hermeneutics for Dilthey.
- Dostal, Robert J., ed. *The Cambridge Companion to Gadamer*. Cambridge, U.K., and New York: Cambridge University Press, 2002. Authoritative collection of essays on Gadamer, with good biographical and bibliographical material.
- Gadamer, Hans-Georg. *Philosophical Hermeneutics*. Translated by David E. Linge. Berkeley: University of California Press, 1976. Studies that complete Gadamer's opus magnum.
- . *Truth and Method*. Translation revised by Joel Weinsheimer and Donald G. Marshall. New York: Crossroad, 1989. The bible of contemporary hermeneutics.
- Grondin, Jean. *Introduction to Philosophical Hermeneutics*. Translated by Joel Weinsheimer. New Haven: Yale University Press, 1994. History of the hermeneutic tradition from antiquity to the present from the vantage point of the inner word.
- . *Le tournant herméneutique de la phénoménologie*. Paris: PUF, 2003. A study of the different conceptions of hermeneutics espoused by Heidegger, Gadamer and Derrida.
- Habermas, Jürgen. "The Hermeneutic Claim to Universality." In *Contemporary Hermeneutics: Hermeneutics as Method, Philosophy, and Critique*, edited by Josef Bleicher. London and Boston: Routledge and Kegan Paul, 1980. A famous critique of Gadamer inspired by ideology critique and psychoanalysis.
- . "A Review of Gadamer's Truth and Method". In *Understanding and Social Inquiry*, edited and translated by Fred R. Dallmayr and Thomas A. McCarthy. Notre Dame, Ind.: University of Notre Dame Press, 1977.
- Heidegger, Martin. *Being and Time*. Translated by John Macquarrie and Edward Robinson. New York: Harper, 1962. Heidegger's main work, based on a hermeneutics of existence.
- . *Ontology: The Hermeneutics of Facticity*. 1923. Translated by John van Buren. Bloomington: Indiana University Press, 1999. Seminal text of Heidegger's early hermeneutic conception.
- Hirsch, E. D., Jr. *Validity in Interpretation*. New Haven: Yale University Press, 1967. Defends a methodical conception of hermeneutics against Gadamer.
- Michelfelder, Diane P., and Richard E. Palmer, eds. *Dialogue and Deconstruction. The Gadamer-Derrida Encounter*. Albany: State University of New York Press, 1989. Contains the basic texts of the famous encounter between Derrida and Gadamer.
- Palmer, Richard E. *Hermeneutics. Interpretation Theory in Schleiermacher, Dilthey, Heidegger, and Gadamer*. Evanston, Ill.: Northwestern University Press, 1969. Ground-breaking and clear presentation of the major figures of the hermeneutic tradition.
- Ricoeur, Paul. *Hermeneutics and the Human Sciences: Essays on Language, Action, and Interpretation*, edited and translated by John B. Thomson. Cambridge, U.K., and New York: Cambridge University Press, 1981.
- . *From Text to Action. Essays in Hermeneutics*. Translated by Kathleen Blamey and John B. Thompson. Evanston, Ill.: Northwestern University Press, 1991. Both books document the hermeneutic itinerary of a major hermeneutic thinker of our time.
- Rorty, Richard. "Being That Can Be Understood Is Language." *London Review of Books*, 16 March 2000, 23–25. A tribute to Gadamer's alleged linguistic relativism.
- . *Philosophy and the Mirror of Nature*. Princeton, N.J.: Princeton University Press, 1979. Hermeneutics presented as the outcome of philosophy, out of the tradition of American pragmatism.
- Schleiermacher, Friedrich. *Hermeneutics and Criticism and Other Writings*. Edited and translated by Andrew Bowie. New York: Cambridge University Press, 1998. Classical texts of the founder of modern-day hermeneutics.
- Vattimo, Gianni. *Beyond Interpretation: The Meaning of Hermeneutics for Philosophy*. Translated by David Webb. Cambridge, U.K., and New York: Polity Press, 1997.
- . *The End of Modernity: Nihilism and Hermeneutics in Postmodern Culture*. Translated by Jon R. Snyder. Baltimore: John Hopkins University Press, 1988. Both volumes testify to the postmodern appropriation of hermeneutics.

Jean Grondin

HIERARCHY AND ORDER. Hierarchy (Greek *hierarchia*; from *hieros*, sacred + *archein*, rule) is a kind of order, supposing existence of higher (or more sacred) and lower (less sacred) levels of reality. Order, in its turn, is a linkage of fundamentally different elements by means of general laws, so that the whole is greater than a simple arithmetical sum of its parts. Since order presupposes difference, it often takes the form of hierarchy. The place of an element in the hierarchical order is determined by the same laws of the whole, which are constitutive of the order itself.

Uncreated Cosmos

The understanding of the universe as a hierarchical order came into being in early antiquity and is reflected in mythological conceptions. Ancient Greek mythology and philosophy put forth this idea in the conception of Cosmos as being opposite to Chaos. The Cosmos (meaning "beautiful" in its most ancient definition) is sculpturally organized by the laws of beauty and as such is similar to that of a beautiful human body. So, according to Platonic thought, the order of the Cosmos is similar to the order of the human being. The Cosmos is not created by any god, which means there is both a complex dialectic of Cosmos and Chaos and the idea of hierarchical primacy of the Cosmos over all other things, including gods and human beings. The last idea is expressed in mythology by the concept of destiny, which defines the exact place of any thing in the order of the Cosmos. Neither god nor man can escape from destiny, which is why, for example, Oedipus is doomed to be blinded and Juno, the wife and sister of the supreme Roman god Jupiter, cannot affect the life of Aeneas, who was destined to be the founder of Rome.

The dialectic of Cosmos and Chaos is one of the most puzzling questions in Greek philosophy. In mythology this dialectic is described as a birth of the hierarchy of gods out of primitive Chaos. According to Hesiod's *Theogony*, "Verily at the first Chaos came to be, but next wide-bosomed Earth, the ever-sure foundations of all" (line 116). This "coming to be," however, is described in pre-Socratic philosophy as a complex process of the circulation of Chaos and Cosmos. According to the Greek philosopher Heraclitus (c. 540–c. 480 B.C.E.), fire, which is the basis of the world, flares up and dies out at times. The extinction of fire is interpreted as the birth of the world order and the worldwide conflagration is the death of the Cosmos. According to Empedocles (c. 490–430 B.C.E.), another pre-Socratic philosopher, the Cosmos is organized through the struggle of two constitutive forces, Love (*Philia*) and Strife (*Oikos*). This struggle gives birth to four stages of the world's development, the first of which is Chaos (constituted by the absolute predominance of Strife) and the last being absolute unity of everything in the form of a sphere (which is organized by predominant Love).

In the Platonic tradition, the material Cosmos is just a shadow of the order of ideas (*kosmos noētikos*). Ideas, being hierarchically primary to material things—understood by Plato as forms (*eidōn*), reasons (*logoi*), and exemplars (*paradeigmata*) of things—are themselves organized in hierarchical order. The idea of the Good (*ta kalon*), being the most general of all ideas (*eidōs tōn eidōn*), is on the very top of this hierarchy. Things are striving for their prototypes and this striving, by the same token, is responsible for the maintenance of the world's order. However, the very nature of the relations between the realm of ideas, which is situated in some beyond-celestial place (*hypra-uranios topos*), and the world of things is problematic in the context of Platonic doctrine and was described differently in variants of Platonism. For Plato, a Master (*Demiourgos*) was responsible for creating the world, and the nature of the striving of things to their ideas is described as an activity of the World's Soul. The Roman philosopher Plotinus (205–270 C.E.), the father of Neoplatonism, described the creation of the world order as the process of emanation of the One (*to hen*), and the Cosmos is meant to be a reference point for the self-conscious existence of the Soul. However, another problem arises in both Platonic traditions: the question of obvious defects in the world's order. Namely, if the ideal Cosmos is good (because the most general idea is the idea of the Good), who is responsible for the origin of evil? According to Plato, it is a result of imperfect reflection of ideas in matter. Matter is described as a pure potency of existence. As such, it is actually nothing (*mēon*), while it has potential to be something. It follows that if evil is a result of the materiality of things, it can be described as nothing as well, that is, as a defect of reflection. Influenced by the Gnostics of the second century C.E., who had explained existence of evil by the imperfection or even wickedness of God the Creator (*Demiourgos*), Plotinus described the origin of evil as a result of the error made by the Soul in valuing its expressions in physical Cosmos over the contemplation of the divine Forms.

Created Order

Christian thought shares the Neoplatonic understanding of order as two actual orders: the lower one is the order of the

material world and higher one is the structure of the ideal Cosmos. The difference, however, is that the order of material things was now considered a created one. The realm of the Forms or ideas transforms into the content of Divine Logos, the Word of God, pre-existing the world. The origin of the universal order is described as creation out of nothing (*creatio ex nihilo*). However, the understanding of this formula in Christian thought is quite different. Some philosophers consider the process of creation as the creation out of some existing nothing (so, according to Russian philosopher Sergey Nikolaevich Bulgakov (1871–1944), the levels of the order should range from nothingness to the highest hierarchy of Trinity). Others understand it as the assertion that God did not need anything for the creation of the world (Anselm of Canterbury, 1033 or 1034–1109). Finally, some thinkers believe that creation out of nothing means creation of the world out of God's nature. Thus, for John Scotus Erigena (c. 810–c. 877) uncreated and creating nature (God) descends through created and creating nature (the ideas or primordial causes) into created and not creating nature (numeric things). These three natures, forming the order of the Universe, will be united in the end of the world into the form of uncreated and not creating nature.

This shift from emanation to creation meant that: (1) neither God, nor matter created by God can be responsible for the existence of the evil. Evil is described as a result of man's free will; (2) God is understood as both immanent to the world (because God is present in it) and transcendent (because God exists in eternity and the world is created); (3) God is a guarantee for the maintenance of the world's order; and (4) that a human being is able to overcome the laws of the Cosmos and be united with God again in deification (Gk. *theosis*, Lat. *deificatio*).

One of the teachings of order, transitional from the ancient to the Christian understanding, was a doctrine of Origen of Alexandria (185?–254?), a near contemporary of Plotinus (205–270). In *De Principiis* he describes the world's order as a set of parallel worlds, which are the places for the fallen souls, created by God in eternity. Being eternal, the souls can proceed from one world to another and, thus, with the lapse of time, all of them (including the soul of Satan) will be united with God. The present world's order will come to an end, and the condition of *apokatastasis* (restoration of all things) will be established. However, in eternity, some souls will misuse their free will again, a new Fall will ensue, and a new world will be created. This conception obviously has some elements of ancient teaching on the circulation of Cosmos and Chaos.

In the fifth century, St. Augustine of Hippo (354–430) in the West and Dionysius the Areopagite (Pseudo-Dionysius) in the Christian East constructed the foundations for mature Christian doctrine of order and hierarchy. Augustine in his early treatise *De ordine* (On order) asserted that nothing could be out of the order of created things. What seems to us to be evil also exists in the framework of order. So, if there were no hangmen, robbery would fill the earth, and if there were no prostitutes, debauchery would flourish. The origin of evil lies in the free will of the human being, but God uses what is worst in the best

possible way. Once evil has been created, God included it in God's order, which is good as a whole. This means that nothing is absolutely evil and God does not leave the world unattended after its creation. Rather the process of creation can be described as a continuous holding of things into being (*creatio continua*). Ideas became the content of God's Logos (Word), by which God has created all things. These ideas are exemplars for material things and were also created by God in God's Word. Thus, the problem of the relations between ideas and material things has been solved through the conception of creation, and the problem of evil has been solved both through the notion of the Fall, which had been caused by the misuse of free will, given by God to human beings, and through the notion of continuous creation of the world. The last notion became the main basis of Gottfried Wilhelm Leibniz's (1646–1716) theodicy, interpreting the world as the best of all possible worlds. Indeed, according to Leibniz, this world is the best exactly because God uses the worst things in the best possible way.

Pseudo-Dionysius considered evil things as belonging to the realm of non-being. Indeed, according to him, everything that is connected with God, who is the Being and the Good, exists and is a good thing. That means that everything which exists is good. Evil is privation and lack of goodness in good things, and, thus, exists in the good as in its substance. In other words, evil things are evil only because they are less good than the others. This conception is quite Neoplatonic, but it does not constitute Docetism, that is, a heresy based upon the doctrine of the fundamental evilness of the matter. The connection of all things with God is described in Pseudo-Dionysius's doctrine as the presence of God in all things, described as *theophanias* (God's appearances). That means, in its turn, that the universe is united with God by virtue of the presence of God's energies (*dynamis*) in this world. This conception was implemented in Pseudo-Dionysius's well-known ideas of celestial and ecclesiastical hierarchies. In *The Celestial Hierarchy*, Pseudo-Dionysius distinguishes three groups of three angelic orders (*taksis*). The first consists of Seraphim, Cherubim, and Thrones, the second of Dominions, Virtues, and Powers, and the third of Principalities, Archangels, and Angels. Those nine angelic orders deliver information from God to human beings. The higher orders are responsible for purification (Gk. *katharsis*, Lat. *purificatio*), illumination (Gk. *phōtismos*, Lat. *illuminatio*) and deification (Gk. *theosis*, Lat. *deificatio*) of the lower ones. Purification, illumination, and deification are also the stages of human mystical experience. Ecclesiastical hierarchy (described by Pseudo-Dionysius in his *Ecclesiastical Hierarchy*) consists of two triple groups, reflecting the structure of celestial hierarchy. One group is of hierarchs, priests, and deacons and the other consists of monks, believers, and catechumens. The place of the highest order is occupied not by human beings, but by sacraments, uniting heaven and earth. This is the order of Eucharist, Baptism, and Anointing. By means of these two hierarchies, according to Dionysius, God communicates with human beings and enables them also to be purified, illuminated, and perfected.

Ideally, the order of the society in medieval thought corresponded with the order of the universe. God was considered to be the single source of power both in theocratic society and in the universe as a whole. This picture, however,

was complicated first by struggle between spiritual and temporal powers and secondly by opposition between the aspiration for one great Christian empire and the complex system of feudal rights. The theories of political order in the middle ages ranged from ideas of the bull *unam sanctam* of Pope Boniface VIII (1235–1303), asserting absolute power of the pope, to Marsilius of Padua's (c. 1275–c. 1342) functionalist doctrine of an autonomous and independent state.

Human society, existing in history, represents a developing image of the eternal divine order and follows God's providential plan. This plan was often described as a divinely ordered sequence of four world empires, engaged in a conflict that would eventually lead to the last great empire. According to St. Augustine's *De civitate dei*, this fifth kingdom is a spiritual one, constituted by love for God. An idea still present in some millenarist doctrines can be found in the thoughts of Joachim of Fiore (c. 1132–1202) who saw the whole world history as a tripartite process, the successive ages of God representing God the Father, God the Son, and God the Holy Spirit.

Platonic, Aristotelian, and Christian concepts of hierarchy and order were fused in a theory known as the Great Chain of Being, which dominated cosmology from the Middle Ages to the dawn of modernity. The idea was that the universe consists of an immense or even infinite number of links, ranging hierarchically from the lowest being (or nothingness) through every possible grade to the highest, most perfect Being (*ens perfectissimum*). The levels of perfection were described differently: according to a Renaissance vision, for instance, they were constituted by different proportions of matter and spirit in different things. That is why alchemists of the Renaissance believed that lower lead could be transformed to higher gold, if someone could learn the method for adding some spirit to the mix. The idea of the Great Chain of Being reached its culmination in the doctrines of Benedict de (Baruch) Spinoza (1632–1677) and Leibniz. For them the chain has every possible degree of perfection and, therefore, is complete. The perfection of the whole, by the same token, does suppose existence of imperfect things. This idea formed a new basis for theodicy. According to Leibniz, the differences in perfection are infinitesimal and, therefore, the universe is a continuum. Imperfect things are caused, contingent, and dependent, the most perfect God is self-caused (*causa sui*). Because nothingness is on the bottom of the chain, more perfection means more being. That is why both Spinoza and Leibniz were inclined to accept Anselm of Canterbury's ontological argument for God's existence, based on the thought that the very idea of the most perfect being had to be the idea of being in existence.

Nonwestern and New Conceptions

Conceptions of order and hierarchy are by no means occidental ones. Ancient Chinese philosophers, discussing the world's order, used the term *dao* (way, guide). They usually spoke of three main species of *dao* (and, consequently, of three orders): human (social) *dao*, *tian* (natural or heavenly) *dao*, and great *dao*. The first is a way or guide for human behavior; the second is similar to the laws of nature, which cause things to happen reliably; the third comprises everything which has

happened, is happening, or will happen in the world. It is obvious, therefore, that both human *dao* and *tian dao* are parts of the great *dao*. It is great *dao* that is responsible for the order of things in the world.

However, because the concept of *dao* is rather vague, there are different interpretations of this order, ranging from anarchist and pluralist doctrines to hierarchical and authoritarian interpretations. It is possible to say that philosophical doctrines of Daoism lean toward pluralism, skepticism, political equality, and freedom. Religious mysticism, on the other hand, often claims some direct access to a single correct *dao*, forming a basis for esoteric, hierarchical and authoritarian thought. The most prominent representatives of philosophical Daoism were Laozi (c. 604–c. 531 B.C.E.), author of *Dao De Jing*, and Zhuangzi (c. 369–c. 286 B.C.E), who created a mature form of philosophical Daoism.

In the Indian Buddhist tradition, the main cause of the order in the world is human will, attaching human being to the world and dragging the world into an endless circle of suffering, the true essence of the world's order. The main point of Buddhist ethics is to stop the suffering through quitting the will and achieving the highest possible mental state, that of *nirvana*.

Scholars of African religious traditions show that African religious philosophy, such as Yoruba belief, implies a complex hierarchy in the world, created by the supreme god Oludomare, described as the omnipotent creator of all good and bad things. The numerous gods, created by Oludomare, form a hierarchy of mediators between him and the world. The most striking feature of Yoruba belief, distinguishing this religion from Judeo-Christian tradition, is that Oludomare is perceived as responsible for both good and evil, using both good and bad in the process of ensuring justice. Moreover, the world is ordered in a way that implies immediate punishment for sinful deeds of the people.

One Eastern Christian doctrine of hierarchy and order can be found in the Russian philosophy of All-Unity, which flourished at the end of the nineteenth century. The main idea of this tradition is that the world can be reunited with God through the efforts of human beings and by uniting the things with the prototypes that exist in Divine Wisdom (Sophia). For the founder of this tradition, Vladimir Solovyev (1853–1900), Sophia is a world in its ideal, true being and is created in eternity by eternal Logos. Sergey Bulgakov, who worked in the first half of the twentieth century, considered Sophia as God's fourth hypostasis. Sophiology enabled these philosophers to understand the order of the universe as potential all-unity, already existed in Divine Sophia.

Contemporary theories of order are not so numerous. The crisis of the idea of the Great Chain of Being, caused both by the rise of natural science and by the crisis of religious consciousness, led to nonhierarchical understandings of order. The order becomes a characteristic feature of various systems. The Brussels school in natural science (Prigogine and Stengers) considers order as a spontaneous result of the process of self-organization in open systems, exchanging energy with their environment. Society and biological systems, according to

Prigogine, are such self-organizing systems and cannot be described in terms of the old mechanical paradigm of science.

Contemporary postmodern and poststructuralist authors criticize "western logocentric tradition" for its attempts to find order, hierarchy and meaning in all things. They argue for the existence of many differences, which are so chaotic in their relations to each other that they exclude any possibility of organized oppositions. As a result, the unordered chaos does not allow for the contrast of differences, and differences are no longer perceived as such. Gilles Deleuze (1925–1995), in his quest for "difference in itself," rejects the old Platonic and Hegelian tradition, which understands the difference in reference to self-identical objects, and which, in turn, makes the difference an element of hierarchical structure. Difference-in-itself, on the contrary, does not imply order at all, and various differences, remaining in "formless chaos," does not form any structure.

See also **Christianity; Cosmology; Daoism; Harmony; Neoplatonism; Platonism; Society.**

BIBLIOGRAPHY

- Armstrong, A. H., trans. *Plotinus: The Enneads*. 7 vols. Cambridge, Mass.: Harvard University Press, 1966–1988.
- Cooper, John M., ed. *Plato: Complete Works*. Indianapolis: Hackett Publishing, 1997.
- Crouzel, Henri. *Origen: The Life and Thought of the First Great Theologian*. Translated by A. S. Worrall. San Francisco: Harper and Row, 1989.
- Ferguson, Everett, ed. *Encyclopedia of Early Christianity*. New York: Garland, 1990.
- Garber, Daniel, and Roger Ariew, trans. *Discourse on Metaphysics and Other Essays*. Indianapolis: Hackett, 1991.
- Lovejoy, Arthur O. *The Great Chain of Being: A Study of the History of an Idea*. Reprint, Cambridge, Mass.: Harvard University Press, 1970.
- Luibheid, Colm, trans. *Pseudo-Dionysius: The Complete Works*. New York: Paulist Press, 1987.
- Origen of Alexandria. *On First Principles* [De Principiis]. In *The Ante-Nicene Fathers*, vol. 4. Reprint, Grand Rapids, Mich.: Eerdmans, 1979.
- Prigogine, Ilya, and Isabelle Stengers. *Order Out of Chaos: Man's New Dialogue with Nature*. London: Heinemann, 1984.
- Shirley, Samuel, trans. *Baruch Spinoza: The Ethics; Treatise on the Emendation of the Intellect; Selected Letters*. Edited by Seymour Feldman. Indianapolis: Hackett, 1992.
- Solovyev, Vladimir. *Lectures on Godmanhood*. London: Dennis Dobson, 1948.
- Taliaferro, R. C., trans. *Saint Augustine: The Immortality of the Soul and Other Works*. Washington, D.C.: Catholic University of America Press, 1950.

Maxim Khomiakov

HINDUISM. Hinduism, the religion of nearly one billion people mostly of South Asian provenance or descent, is notoriously difficult to define or even to describe with accuracy and comprehensiveness. Like all complex and ancient religious traditions, it is problematic to speak about Hinduism as if it were one monolithic religion rather than merely a label for many

different traditions. The conglomeration of religious traditions sheltered under this umbrella incorporates a bewildering array of texts, beliefs, practices, and sects—so disparate a collection that some modern scholars have questioned the legitimacy of artificially unifying them. According to these scholars, one cannot really speak about a single Hinduism but at best only a variety of Hinduisms.

Defining Hinduism

The word *Hinduism* itself derives from one of the principal rivers of South Asia, the Indus, and was probably first used by the ancient Persians to designate the people and territory of the northwestern portion of the subcontinent. As a name for a religion (at first inclusive of what is now differentiated as Hinduism, Jainism, and Buddhism), it probably owes its origin to the Muslim invaders of the early part of the second millennium C.E., and as a discrete (but still enormously variegated) Indian religion, *Hinduism* was the term the British gave in the nineteenth century to all those in India who were neither Muslim nor Christian.

Diversity—historical, cultural, linguistic, doctrinal, and sectarian—is descriptive of all world religions also designated by a unitary label, including Christianity, Judaism, Buddhism, and Islam. Hinduism may be an extreme example, but it is hardly unique in this regard. And as is true in other religions, in Hinduism conceptual unity can be identified within this diversity. Some scholars have identified a set of key concepts or beliefs they regard as distinctively Hindu, including the beliefs in karma and rebirth; the impermanent and fundamentally suffering nature of the world (*samsara*); and the possibility of liberation from suffering and rebirth and the attainment of a permanent state of bliss (*moksha*). None of these beliefs, however, belongs exclusively to Hinduism. Buddhism, Jainism, and other “non-Hindu” Indian religions also hold these doctrines. Other observers content themselves with the notion that Hinduism is distinguished by religious methods and practices that may be categorized under three broad headings or paths: the way of action or ritual (*karma margā*), the way of knowledge or wisdom (*jnana margā*), and of devotion (*bhakti margā*).

Still others argue that what is truly distinctive of Hinduism is its social structure—the caste system—and the religious ideology that underlies it, especially the notion of the superiority and spiritual purity of the Brahman castes. Indeed, some scholars use the term *Brahmanism* (or *Brahminism*) as synonymous with *Hinduism* to emphasize the notion that the essence of this religion is its belief in caste hierarchy, with the Brahmans at the top. But although it is true that caste and Brahman privilege are ancient and enduring features of Indian society, it is not clear that a religion is defined by the social structure it promotes, nor is caste confined to “Hinduism”—there are Muslim, Christian, Sikh, and Parsi castes as well as Hindu ones.

Perhaps the most promising way to envision the underlying unity of Hinduism is to concentrate on the way Hindu traditions understand and use scriptural authority to legitimate a variegated set of beliefs and practices. Hinduism can thus be understood as a unified and continuous religious tradition in terms of the particular sources and strategies used to establish,

legitimate, and maintain its religious authority. The most common way Hindus of various sorts do this is to appeal to the authority of the Veda, the most ancient and most universally acknowledged of Hinduism’s sacred texts. Hinduism, then, might be envisaged as the label for those traditions that legitimate themselves through the authority of the Veda. Traditions that deny the sacrality and authority of the Veda and posit alternative sources of such authority (those traditions called Buddhist, Muslim, Christian, Sikh, and so on) are, for this reason, not Hindu. Although the subject matter of the Vedic texts is not always, or even usually, of importance to any given Hindu sect or tradition, the legitimating authority of the Veda has been one, and perhaps the only, mark of orthodoxy in the long history of this complex group of Indic traditions.

Hinduism has had an incalculable impact on Indian society. Indeed, some modern religious nationalists in India would argue that Indian and Hindu culture and history are synonymous, although this turns a blind eye to the enormous contribution of Muslims and others who are, under virtually any definition, not Hindus. Nevertheless, in virtually all areas of Indian society and culture, including social structure, art, music, architecture, literature, and government, Hinduism has left its imprint, such that India cannot really be understood without some understanding of its majority religion.

Historical Overview

Most scholars trace the earliest origins of Hinduism to two different sources. The first of these is the Indus Valley civilization, which dates back to the third millennium B.C.E. and reaches its high point around 2000 B.C.E. The characteristics of this civilization remain somewhat elusive, since the inscriptions on the artifacts that have been recovered remain undeciphered. Nevertheless, on the basis of both large-scale and small-scale remains, scholars have postulated that certain features of later Hinduism may have their earliest foundations and expressions in the Indus Valley civilization. These features include the emphasis on ritual purity, the worship of a goddess figure connected to fertility, and the sacrality of certain animals and trees. The most famous of the depictions found on seals dug up at the various archeological sites is what has been called proto-Shiva. A horned figure, surrounded by animals and sitting in what appears to be a yogic position with an erect phallus, seems to indicate a possible connection to the later Hindu deity who is similarly conceptualized and symbolically represented.

The second root of Hinduism is the Aryans or Indo-Europeans who, it is thought, began to enter the Indic subcontinent from the northwest in several migratory waves beginning sometime in the second millennium B.C.E. The South Asian branch of the far-flung Indo-European peoples is associated with the Vedic period of Indian history. Named after the texts called the Vedas (or, collectively, the Veda), which are written in Sanskrit, this historical epoch is known to us almost entirely on the basis of those ancient texts. The Vedas depict a religion entirely oriented to the performance of and philosophical speculations concerning fire sacrifice. Sacrifices, or *yajnas*, were offered to the pantheon of deities located in

one or another of the three worlds of sky, atmosphere, and earth; some of the gods of the later Hindu pantheon were already worshipped in the Vedic era. Sacrifices to the gods were performed with oblations of cakes made of grain but also with animals (goats, rams, bulls, stallions, and, at least theoretically, human males) and with the apparently intoxicating juices from the plant known as soma.

The basic assumption of the Vedic sacrifice was that if the gods were pleased through such offerings, the cosmos would be put into order and beneficial results would be procured by the sacrificer. These results included prosperity of all sorts, worldly success and fame, long life, and a place in heaven after death. As time went on, it seems as though the sacrifice took on power of its own, apart from the will and favor of the gods. If the ritual was performed correctly by the Brahman priests, who knew all the rules of the sacrifice, results would occur automatically.

Also over time, an increasing emphasis seems to have been put not only on the simple performance of the ritual but also on mystical knowledge of the hidden meanings of or connections between the sacrifice, the cosmos, and the individual. These speculations reached their apogee in the middle centuries of the first millennium B.C.E. as is recorded in the texts known as the Upanishads. Mystical knowledge or wisdom (*jnana*) in these texts supersedes ritual action (karma) as the way to attain the highest goal, now conceived of not as a place in heaven but rather as the realization of one's true nature, expressed in the equation between one's true self (*atman*) and the underlying cosmic unity (*brahman*).

The Upanishads are also associated with a world-renunciatory movement of the middle centuries of the first millennium B.C.E. that also brought Buddhism and Jainism into being. For the renouncers, ascetics, and mystics of this period, the Vedic sacrifice was regarded as, at best, of lesser importance than practices associated with self-discipline, meditation, yoga, and renunciation of ritual and worldly pursuits. Action, or *karma*, especially when motivated by desire, was seen as problematic in that it was supposed to result in repeated, and potentially endless, rebirth. The world was seen as a place of suffering and imprisonment, and a new goal, release from this wheel of birth, death, and rebirth, was posited.

As a result both of challenges within the tradition (the world-renouncing strains that were manifest in the Upanishads) and without (the heterodox traditions of Buddhism, Jainism, and other new religions), Hinduism was reformulated. Texts dating to around 400 B.C.E. and those produced subsequently over the course of several centuries reflect characteristic and definitive shifts in the religion. Among these was a sense of orthodoxy, which can be seen both in the way the Vedas were now understood as revealed, or *shruti*, and in the religio-social importance given to caste and the hierarchically superior place of the Brahmans. Especially important was the concept of *dharma*, or religious duty, and the reinstatement of religious value to worldly life. From this time on, Hinduism has harbored within itself both an emphasis on doing one's duty in the world and the importance of renouncing the world.

By the early centuries of the first millennium C.E. can be seen the earliest manifestations of another development within the increasingly variegated mix of traditions collectively called Hinduism. This was the rise of a new form of theistic religion called the *bhakti* movement, which brought with it the rise to supreme importance of the major deities of the Hindu pantheon, especially Vishnu (in all his incarnations, including Krishna and Rama), Shiva, and the various forms of the Goddess. The first temples where such deities were worshipped date to this period, as do Sanskrit and Tamil texts that center on one or another of these principal divinities. From this time forth, in addition to the notion (dating to the Upanishads) that the divine is "without qualities" (*nirguna*), one finds within Hinduism the conceptualization of God "with qualities" (*saguna*) and the representation of the divine in the form of images.

Dating also to this period is another widespread and influential movement that would add yet another ingredient to Hinduism. This movement, itself varied in its beliefs and practices, has been called Tantrism. Originating perhaps in the peripheral areas of northwest and northeast India, Tantric ideas and practices probably date to the fifth century C.E. or before, although most of the texts in which the distinctive doctrines of this strain within Hinduism appear are several centuries later. With an emphasis on radical and unconventional methods (including, in some cases, ritual sex) for attaining liberation in the present lifetime, and with an array of deities—almost always including a goddess figure—often depicted in quite horrific forms, the Tantric movement was always esoteric and controversial. Nevertheless, by the medieval period and in subsequent centuries Tantrism influenced all forms of Hinduism. It has been noted that the pantheon of present-day Hinduism is largely made up of Tantric deities. Tantrism also left its imprint on the temples, iconography, and rituals of the more mainstream Hinduism.

The mainstream—by which is usually meant the elite, Sanskrit tradition of orthodox or Brahmanic Hinduism—was philosophically systematized beginning in the early centuries of the first millennium C.E. into six schools. Perhaps the most influential of these is Vedanta and its greatest teacher was Shankara (c. 800 C.E.). Based on a particular reading of the earliest Upanishads, the Vedanta philosophy in all its forms (and there are several) argues for some version of monism and regards the phenomenal world of experience as fundamentally illusory. The philosophical schools of Yoga and Samkhya, by way of contrast, envision a kind of dualism between matter and spirit and see the goal of the religious quest as the isolation of the pure spirit. Other and less influential of the philosophical schools emphasize analysis of Vedic ritual and ritual speech (Mimamsa), logic and methods of argumentation (Nyaya), and a theory of atomism (Vaisheshika).

The second millennium C.E. saw the further development of *bhakti*, or devotional, forms of Hinduism, especially among poet-saints, who composed often ecstatic songs and poems in the vernacular languages of India. These poet-saints sometimes included women and members of the lower castes, and in general the devotional movement became more and more the

religion of the Hindu masses. As Muslim influence and eventually rule was established in north India, syncretistic devotional figures and groups emerged. The *bhakti* of a saint like Kabir (1440–1518), for example, was heavily influenced by Islamic monotheism, iconoclasm, and other concepts.

The European impact on Hinduism came primarily in the form of British imperialism and colonialism. Modern Hinduism, especially as it is conceptualized by the educated elite of India, was shaped by the interactions and dialectical relations between outside influences and rising nationalist aspirations. Nineteenth-century reformers such as Rammohan Roy, Dayananda Sarasvati, and Vivekananda created what has sometimes been called Neo-Hinduism in an effort to modernize and respond to the challenges of Western colonialism while retaining pride in the traditions of ancient Hinduism. The reforming impulse put into motion by these leaders and others has also sometimes been labeled the back-to-the-Vedas movement because of its emphasis on returning to the ancient past's purity to validate innovations such as rights for women, opposition to image worship, and caste reform.

In the twentieth century, two different and contrasting influences have exerted influence on the shape of Hinduism. On the one hand, Mohandas Gandhi (1869–1948; the Mahatma, or Great Soul) put forward an inclusive, tolerant Hinduism that picked up one strand of the ancient past: the non-violence and self-control of the world-renouncers. On the other hand, the twentieth century also saw the rise of an often militant form of Hindu nationalism that emphasized an exclusivist Hinduism and valorized powerful Hindu kings of the past and divine ruler-warriors like the god Rama.

Sacred Texts and Sects

The Veda are earliest texts of Hinduism. Written in Sanskrit and for millennia preserved only orally, the oldest portion of the Veda—the Rig Veda, composed about 1200 B.C.E. or before—is also among the oldest known texts of the Indo-European world.

The Vedas are entirely centered on the performance of and speculations surrounding the ancient religion of the Aryans in India, the cult of fire sacrifice. Each of the four Vedas—the Rig, Yajur, Sama, and Atharva—consists of a Samhita (collection of hymns, verses, and chants), a Brahmana (in which the mythical origins, contexts, and meanings of the ritual are explained), an Aranyaka (a forest text, where the more esoteric and secret significances of the rites are detailed), and an Upanishad (comprised of mystical speculations and philosophical ruminations). The Samhitas of the four Vedas are correlated to the functions of the four main priests of the Vedic sacrifice and were composed and preserved by these priests for ritual use. Each of the four Vedas has several recensions due to the varying practices of different ritual schools; some of these recensions have survived—completely or in fragments—and many have not.

The Veda is traditionally thought to be unauthored (either by a god or humans); rather, it is believed to exist eternally in the form of sound. Ancient sages are said to have heard it (or

part of it) and then recited it to others. The Veda was, and continues to be, memorized syllable by syllable and transmitted orally by means of an intricate method of recitation. Although ancient India had a writing system by the middle of the first millennium B.C.E., it was only in relatively recent times that the oral Veda was written down.

Hinduism traditionally accorded the Vedic texts the status of revelation, or *shruti*. All the other sacred texts of Hinduism, no matter the esteem in which they are held by their adherents, are technically classified not as revelation but only as traditional or remembered (*smriti*). The *smriti* texts are admittedly authored by great teachers of the past.

The earliest of the traditional texts are collectively known as the Vedangas or limbs of the Veda. Composed mainly from about 700 B.C.E. to about 200 C.E., these works were technical treatises written in the shorthand, aphoristic form called the *sutra*. The Vedangas make up the six sciences necessary for the correct and exact performance of the Vedic rituals: *vyakarana* (the study of grammar, linguistics, and philology); *nirukta* (etymology); *chanda* (the explanation and practice of verse meters); *shiksha* (the study of faultless pronunciation); and *gyotisha* (the science of astronomy and astrology). The sixth limb of the Veda is the Kalpa Sutras, manuals in which the rules for performing the various types of Vedic sacrifice are given. The Shrauta Sutras lay out the rules for performing the most elaborate of these sacrifices, and the Grhya Sutras detail the protocol for executing the simpler rites of the domestic ceremonial performed by the householder himself. Also included are the Shulba Sutras, in which geometrical rules are laid out for the proper construction of the sacred space and altars of the Vedic ritual.

The last component of a Kalpa Sutra (and again, different versions of these texts were composed and preserved by a variety of ritual schools) is the Dharma Sutra (also known as the Dharma Shastra, or Teaching, or the Dharma Smriti). These encyclopedic texts extend the rules governing human activity, which were previously confined to the ritual sphere, to nearly every aspect of daily life, and especially concentrate on the specific obligations or duties (*dharma*) one has as a member of a particular social class or caste at various stages of life.

The *sutra* form was also favored by the authors of several other important texts. The Mimamsa Sutras, attributed to Jaimini and dated at about 200 B.C.E., is the root text of the philosophical school of Mimamsa, or enquiry into the cosmic and moral significance of the Vedic sacrifice. The Yoga Sutras of Patanjali (c. 200–300 C.E.) are the first systematic presentation of the practice and theory of yoga, or psycho-physical discipline. And the Vedanta Sutras of the great teacher Shankara (c. early ninth century C.E.), which are actually commentaries on an earlier text, form the most important enunciation of the highly influential Hindu philosophical tradition known as Advaita Vedanta, which teaches an absolute monistic doctrine of the oneness of all being.

Among the most popular and best-known of the Hindu scriptures are the two great epics *The Mahabharata* and *The Ramayana*. Both of these enormous works (*The Mahabharata*

is a collection of over 100,000 stanzas and *The Ramayana* is about one-fourth of that) were composed, in various recensions, over a period of almost a thousand years between approximately 400 B.C.E. and approximately 400 C.E. Both consist of a heterogeneous assortment of material—mythology, pseudo-historical lore, folktales, teachings concerning religious duty, the meaning of life, and salvation—but both also relate narratives that have come to be regarded as the backbone of the Indian cultural heritage.

The Mahabharata claims to be divinely inspired and all-encompassing. The text tells the story of a legendary battle for rule over India fought between two sides of the same family. After many twists and turns in the plot, the warring parties meet at the battlefield for the climactic battle. It is at this point in the story that perhaps the single most popular Hindu text and one of the world's greatest religious works is found. *The Bhagavad Gita*, or Song of the Lord, is a discussion of duty and faith conducted by one of the warriors, Arjuna, and his charioteer, Krishna—who is, the reader learns in the course of the text, God in human form.

The Ramayana, attributed to the seer Valmiki, is the story of Rama, the Prince of Ayodhya: his birth and childhood, his marriage to Sita, his unjust banishment and exile into the wilderness, Sita's abduction by the wicked Ravana, Rama's battle with and defeat of Ravana and his rescue of Sita, and Rama's triumphant return to Ayodhya as king. Whereas the characters in *The Mahabharata* tend to be flawed in various ways, Rama and Sita are widely regarded as ideals of obedience, loyalty, fidelity, strength, courage, and heroism. Both of the great Hindu epics were traditionally recited by bards at the courts of kings but were also often recited or dramatically enacted for the masses as religious performance and popular entertainment. Both have also been made into television serials and videotapes, thus metamorphosing into a somewhat different kind of sacred text.

Beginning in the early middle centuries of the Common Era, Sanskrit texts that codified the worldviews, doctrines, and practices of the various Hindu theistic sects were composed. Chief among these are the Puranas (Stories of antiquity). Centering on one or another of the principal deities of sectarian Hinduism—Vishnu, Shiva, or the Goddess—these texts are traditionally said to comprise five topics: the creation of the world, the dissolution of the world, the ages of the world, genealogies, and the history of dynasties. In actuality, however, the Puranas are as encyclopedic as the epics, replete with all sorts of myths, legends, didactic passages on religious duty and salvation, ritual instructions for temple and image worship, and tales about holy places and pilgrimage sites. Early-twenty-first-century scholarship has indicated that most, if not all, of the Puranas were composed under the auspices of one or another ruler of particular Hindu kingdoms by priests associated with the dominant sect of the region.

Other sectarian texts are known by different names. The 108 sacred texts of the Vaishnava sect known as the Pancaratras are designated Samhitas (collection of hymns, verses, and chants) or Agamas; certain sects worshipping the god Shiva have also produced texts called Agamas; and sects worshipping

one or another form of the goddess have composed Tantras—sectarian treatises that are similar in content and purpose to the Puranas but tend to be more purely theological in their orientation and to specify ritual practices to be followed in the temple and at home.

Whereas all the literature discussed above is in Sanskrit, the sacred texts of what might be called popular Hinduism were composed in one or another of the vernacular languages of South Asia. Among the most important of these are the Tamil works of the poet-saints who served as figureheads for the devotional, and often ecstatic and emotional, movements that began in South India as early as the seventh century C.E. Led by the devotees of Vishnu known as the Alvars and the worshippers of Shiva called the Nayanmars, the devotional movement became popular and spread throughout India. The poems and songs of later Hindu saints of north India—Kabir, Caitanya (1485–1533), Surdas (1485–1563), Mirabai (sixteenth century), and others—also depict the longing for God and the bliss of union with the divine in simple yet moving terms.

Principal Beliefs

While it is difficult to list doctrines that *all* Hindus and Hindu traditions would accept, there is a group of core beliefs that come close to being universally shared by all those called “Hindu.”

Karma and Rebirth. The original meaning of the word *karma* is “work,” and the earliest application of the term in Vedic texts is “ritual action or labor”—that is, correctly and precisely executed activity that will have a salutary effect on the participants of the ritual and on the universe as a whole. Rituals beginning with the *samskaras*, rites of passage performed at critical junctures in the life of a youth, had as their purpose to repair the imperfections of birth. Ritual work thus also consisted of the construction of a religiously viable self, and while Vedic fire sacrifices tended to be eclipsed by other forms of religious practice in later Hinduism, the performance of the *samskaras* has continued to the present day and is done for much the same reason. Finally, already in the Vedic period, ritual work was also the means for creating a desirable afterlife for oneself. A divine, or heavenly, self is “born out of the sacrifice”—that is, it is the product of one's ritual résumé, of the work one has done throughout one's lifetime.

The notion that one's own ritual acts (for in Vedic times these were the only acts that really mattered) had consequences—in the future as well as the present—is one of the possible sources for a doctrine that was to have huge implications for the Hindu religious worldview: the notion that all actions produced fruit, good or bad, that determined the quality of one's life. This causal and moral law of karma first appears in the early Upanishads and also features as a prominent doctrine in the new religions that arose in India at this time, Buddhism and Jainism. From this time forward, the nature of one's actions—and the attitude with which actions were performed—was believed to have determinative consequences over one's future, both in this lifetime and in future rebirths.

This concept of a “law of karma”—whereby good acts result in good results, bad in bad—extends the Vedic notion of

consequential action from the confines of the ritual to the whole of life. Just as in the Vedic period one's future life is the product of one's activity, here too one's rebirth is directly correlated to actions performed in this life. But the law of karma also presupposes a series of past lives; the deeds done in those lives determine the circumstances of one's present existence. And the theory assumes future lives, not just in heavens or hells but in this world or any of a potentially infinite number of world systems. Finally, it presupposes that one may be reborn in any of these locales as any number of entities, ranging from gods to inanimate objects; good karma obviously would entail a better rebirth, bad karma results in a worse existence.

Dharma and the Varnashrama Dharma system. Another key concept of Hinduism, and one that is closely connected to those of karma and rebirth, is dharma, a multivalent term that includes within its semantic range religion or righteousness, but also duty. Doing one's dharma means not only remaining ethical but also assuming the duties that are proper to the class or caste one is born into (due to one's past karma), and to the stage of life one is presently in. Performing one's own duty (*svadharma*), as it has been assigned to by birth and by the stage of life, has traditionally been an important Hindu ideal: "Your own duty done imperfectly is better than another man's done well. It is better to die in one's own duty; another man's duty is perilous" (*Bhagavad Gita*, 3.35).

The doctrine of *svadharma*, backed up by the concepts of karma and rebirth, underlies one of the most important and enduring institutions of Hindu India, the caste system. Inequalities in the present life are regarded as a result of differing past karma, and the inequalities of a projected future will reflect the rewards and punishments of actions done in the present: "Now people here whose behavior is pleasant can expect to enter a pleasant womb, like that of a woman of the Brahman [the priestly class], the Kshatriya [the warrior class], of the Vaishya [agriculturalist and trader] class. But people of foul behavior can expect to enter a foul womb, like that of a dog, a pig, or an outcaste woman" (Chandogya Upanishad, 5.10.7).

From the time of the Veda onward, the four basic classes of Hindu society—Brahmans, Kshatriyas, Vaishyas, and Shudras (servants)—were assigned specific roles and functions and urged not to deviate from such in-born duties. The naturalness of this arrangement—or even its divine sanction—was asserted in part by integrating the origins of the social classes within stories about the cosmos's origins. The most famous of the texts in which the social classes are depicted as part of the original creation is Rig Veda 10.90, which tells of the universe originating from a primordial sacrifice of God, here called the Cosmic Man. From that sacrifice and dismemberment, the various elements of the cosmos came into being: the worlds, the sun and moon, the seasons, the various types of supernatural beings, the animals, and so forth. The social classes originated then, brought forth from the parts of the body of the creator god: "When they divided the Cosmic Man, into how many parts did they apportion him? What do they call his mouth, his two arms and thighs and feet? His mouth became the Brahmin; his arms were made into the Kshatriya; his thighs

the Vaishya; and from his feet the Shudras were born" (Rig Veda, 10.90.11–12).

Such is the basic outline of the caste system: four principal classes, each with its own assigned occupation, hierarchically ranked (and correlated with the appropriate body part of the creator god). At the top is the class whose job concerns the religious sphere; the Brahman priest is, according to the texts (not coincidentally composed by members of this class), to be regarded as a kind of human god. The Kshatriyas are to be rulers and warriors and engage in the activities appropriate to their birth. As for the commoners, they are to pursue occupations concerned with wealth and prosperity, tending to livestock and trade. The servants' duties and occupations are straightforward: to humbly serve members of the higher classes and hope for a better rebirth. Finally, there are the occupations of those who live below this hierarchy, the so-called untouchables, who are below even the servants.

Dharma, or proper duty, is thus differentiated according to class and caste but also according to stage of life. The first stage in the ideal structure laid out in Hindu texts is that of a student. A young boy is given over to a teacher, or guru, with whom he lives and serves for a period of many years while studying the sacred Veda under the teacher's guidance. The lifestyle assigned to this stage of life is one of austerity, asceticism, and discipline. Among the other duties laid out for those in the student stage of life are chastity, study of the sacred texts, and obedience to the teacher.

The next stage of life, that of the householder, begins when the student leaves his teacher's home, marries, and takes up his proper profession. In the householder stage of life, he properly pursues not only dharma (used here in the specific sense of religious duties) but also the human ends of *artha*—private gain, understood as material prosperity, self-interest, political advantage, and in general getting ahead in the world—and *kama* or pleasure. The householder is charged with supporting not just his household but also other community members through alms and other gifts to those in other stages of life.

After having raised a family as a householder, a man may enter the third stage of life as what is called a forest-dweller. This stage is characterized by ascetic practices and gradual detachment from the world, including the renunciation of cultivated food (he should live on food that grows in the jungle) and of "all possessions":

After he has lived in the householder's stage of life in accordance with the rules in this way, a twice-born Vedic graduate should live in the forest, properly restrained and with his sensory powers conquered. . . . When a householder sees that he is wrinkled and gray, and (when he sees) the children of his children, then he should take himself to the wilderness. Renouncing all food cultivated in the village and all possessions, he should hand his wife over to his sons and go to the forest—or take her along He should eat vegetables that grow on land or in water, flowers, roots, and fruits, the products of pure trees, and the oils from fruits. . . . He should

not eat anything grown from land tilled with a plough, even if someone has thrown it out, nor roots and fruits grown in a village, even if he is in distress [from hunger]. (Manu, 6.1–3, 13, 16)

The final stage of life is that of the world-renouncer, who continues and furthers the ascetic practices of the forest-dweller. In this stage, the wandering hermit should live entirely detached from the things of this world, alone and without companionship, perfectly content and in a state of equanimity. He should beg but once a day, and not be “addicted to food,” hope for lots of alms, or be disappointed should he receive nothing:

He should always go all alone, with no companion, to achieve success; realizing that success is for the man who is alone, he neither deserts nor is deserted. The hermit should have no fire and no home, but should go to a village to get food, silent, indifferent, unwavering and deep in concentration. A skull-bowl, the roots of trees, poor clothing, no companionship, and equanimity to everything—this is the distinguishing mark of one who is freed. He should not welcome dying, nor should he welcome living, but wait for the right time as a servant waits for orders. . . . He should live here on earth seated in ecstatic contemplation of the soul, indifferent, without any carnal desires, with the soul as his only companion and happiness as his goal. . . . He should go begging once a day and not be eager to get a great quantity, for an ascetic who is addicted to food becomes attached to sensory objects, too. . . . He should not be sad when he does not get anything nor delighted when he gets something, but take only what will daily sustain his vital breath, transcending any attachment to material things. (Manu, 6.42–45; 49; 55; 57)

Samsara, liberation, and the ways to attain liberation.

Yet another central concept in Hinduism is the notion that perpetual birth, death, and rebirth occur not just at the level of human beings but of the universe as a whole. The Sanskrit name for this theory is *samsara*, a word that literally means to wander or pass through a series of states or conditions. *Samsara* describes the beginningless and endless cycle of cosmic or universal death and rebirth; all of phenomenal existence is transient, ever-changing, and cyclical. Correlative to this understanding of the world is belief in the fundamentally illusory nature of the world of appearances—a concept known in Hinduism as *maya*. It is because one is ignorant of reality’s true nature that one perceives a world of differentiation and change; and it is through our own ignorance that we suffer and produce karma.

Samsara is contrasted to an unconditioned, eternal, and transcendent state that is equated with freedom or liberation from such ignorance, transience, suffering, and rebirth. All Hindu traditions posit an alternative to karma and rebirth and the wheel of *samsara*. This state of release, freedom, or liberation from karma and rebirth is called *moksha*. To obtain this liberation, most Hindu traditions believe that one must find a way to stop the workings of karma and the ignorant desire

that motivates ordinary action. Among the various groups of world-renouncers that have arisen in the history of Hinduism, a kind of pessimism surrounds the value of worldly life. Release from the wheel of phenomenal existence among these groups often entails eliminating desire through ascetic practices and renouncing the world of ordinary activity:

On knowing him [the true self], one becomes an ascetic. Desiring him only as their home, mendicants wander forth. Verily, because they know this, the ancients desired not offspring, saying: “What shall we do with offspring, we whose is this Soul, this world?” They, verily, rising above the desire for sons and the desire for wealth and the desire for worlds, lived the life of a mendicant. For the desire for sons is the desire for wealth, and the desire for wealth is the desire for worlds; for both these are desires. (Brhadaranyaka Upanishad, 4.4.22)

Another strategy for eliminating karma and its bonds to *samsara* was the development of the discipline called yoga. Yoga was intended to calm the mind and body, obtain equanimity and tranquility, by ceasing to act (“curbing his movements,” as the text below states) and focusing the mind:

When he keeps his body straight, with the three sections erect, and draws the senses together with the mind into his heart, a wise man shall cross all the frightful rivers. . . . Compressing his breaths in here and curbing his movements, a man should exhale through one nostril when his breath is exhausted. A wise man should keep his mind vigilantly under control, just as he would that wagon yoked to unruly horses. (Svetesvatara Upanishad, 2.8–9)

Yet another method to final liberation within the traditions that comprise Hinduism is the development of wisdom, or *jnana*. The path of wisdom requires, first and foremost, that one understand properly the nature of the universe. In the monistic philosophy first encountered in the Upanishads and later forming one of the principal schools of Hindu philosophy, *jnana* means penetrating the illusory appearance of the world as differentiated, and attaining a mystical wisdom of the unitary true nature of the universe and all that is in it. Attaining such transformative wisdom is itself equated with *moksha*, or liberation—liberation from ignorance, and also liberation from karma.

True knowledge is the knowledge of the true self’s unity and identity (the *atman*) with the cosmic One, the *brahman*. Both the real self (which is not the individual ego but one’s changeless true nature) and the cosmic One are depicted as unborn, unchanging, and therefore not affected by karma: “Verily, he is the great, unborn Soul, who is this [person] consisting of knowledge among the senses. In the space within the heart lies the ruler of all, the lord of all, the king of all. He does not become greater by good action nor inferior by bad action” (Brhadaranyaka Upanishad, 4.4.22). Wisdom acts as a kind of fire that burns up the individual’s accumulated past

karma, and uproots desire, which is the very source of karma and the rebirths it provokes.

Another strand within the Hindu tradition also accepts the necessity for wisdom and self-discipline to attain the final goal but denies that action can simply be avoided or somehow arrested. The point is not to renounce society and duty but rather to attain a desireless state within the world of activity. Although upholding the doctrine of duty, or *svadharma*, *The Bhagavad Gita* also teaches that such actions should be performed without desire. Since desire is the root cause of karma, desireless action in accordance with one's dharma will have no karmic consequences. Such a person is said to be truly wise, like the world-renouncers, but unlike them does not abandon action but rather performs it in the right way.

Also in *The Bhagavad Gita* are found the earliest expressions in the Sanskrit texts of what would become an enormously influential movement in Hinduism, that of devotion to a personalized deity. The theistic strains within Hinduism emphasize a different method to liberation, that of *bhakti*, or devotion to and faith in God. In the *Gita*, desireless action is also represented as sacrificial action, with the karmic fruits of all acts being given up to God. It is, finally, devotion, or *bhakti*, to Krishna that the *Gita* teaches is the way to salvation:

Whatever you do—what you take, what you offer, what you give, what penances you perform—do as an offering to me, Arjuna! You will be freed from the bonds of action, from the fruit of fortune and misfortune; armed with the discipline of renunciation, your self liberated, you will join me. (*Bhagavad Gita*, 9.27–28)

The devotionalistic wings of Hinduism, with their array of deities, each one regarded by devotees as supreme, all assume that it is by God's grace that suffering can be overcome and salvation made possible. In some of its forms, the *bhakti* movement seems to have attracted many low caste followers and others who had been left out or diminished by caste-oriented Hinduism. The movement's emphasis on simple devotion, humility, and the power of God's grace to redeem even the sinner had obvious appeal, and the power attributed to *bhakti* to short-circuit the karmic process is often said to be enormous and unfathomable. The *bhakti* movement also reinterpreted a long-standing Hindu belief that desire was the product of ignorance and the root of karma, rebirth, and suffering. For in devotionalistic traditions, longing for God—often portrayed in erotic terms—and the pain of separation from the object of desire become the emotional means for ratcheting up one's devotion to fever pitch. At the same time, most devotionalistic cults eschewed the goal of merging with or achieving identity with the object of their devotion, for that would preclude the bliss of remaining distinct while basking in God's love.

The set of traditions collectively termed Tantrism likewise reworked desire from its conceptualization as the ultimate source of human suffering into a religious tool. Esoteric tantric groups gained notoriety for their radical and transgressive methods, often arguing that the best way to attain liberation from suffering and its causes was not to renounce but rather

to confront them and, under ritual conditions, engage in practices that for the uninitiated would result in the most disastrous karmic ends. Through various meditative and ritual techniques, the tantric practitioner could practice what others prohibited and could eradicate desire by means of desire.

For some tantric groups, methods to liberation included antisocial ascetic practices such as eschewing clothing and ordinary hygiene, meditating in cemeteries, carrying human skulls as begging bowls, practices involving human corpses, and the worship of deities in gruesome, terrifying forms. For others, it has meant engaging in ritualized sex and exchange of bodily fluids, or rituals that call for the ingestion of otherwise prohibited substances. In all cases, the purpose of such antinomian behavior seems to have been in one way or another to transcend the world of dualities (including pure/impure, good/bad) and achieve the liberation from samsara all Hindu groups posit as the highest goal.

For most Hindus, however, final liberation seems to be out of reach in this life. The vast majority, past and present, simply try to live virtuously and obtain, as a result, a pleasant life here on earth and a better rebirth in the future. From Vedic times to the present, rituals such as sacrifice and the worship service known as *puja* (performed either in the temple or at home), whereby one ritually honors the deity in the form of an image, had pleasing the gods as their goal in the hopes that the gods would protect and aid the worshipper. Festivals, pilgrimages, and lifecycle rituals are also popular among ordinary Hindus, as they are among religious practitioners the world over. Although religious virtuosi may follow the various methods laid out to attain the highest ends of Hinduism, the vast majority of Hindus content themselves with more modest goals.

See also *Buddhism; Christianity; Islam; Jainism; Judaism; Religion*.

BIBLIOGRAPHY

- Embree, Ainslie T., ed. *Sources of Indian Tradition*. Vol. 1: *From the Beginning to 1800*. 2nd ed. New York: Columbia University Press, 1988.
- Herman, A. L. *A Brief Introduction to Hinduism: Religion, Philosophy, and Ways of Liberation*. Boulder, Colo.: Westview, 1991.
- Hopkins, Thomas J. *The Hindu Religious Tradition*. Encino, Calif.: Dickenson, 1971.
- Kinsley, David R. *Hinduism: A Cultural Perspective*. 2nd ed. Englewood Cliffs, N.J.: Prentice Hall, 1993.
- Klostermaier, Klaus K. *A Survey of Hinduism*. Albany: State University of New York Press, 1989.
- The Laws of Manu*. Translated by Wendy Doniger, with Brian K. Smith. London, New York: Penguin Books, 1991.

Brian Smith

HISTORICAL AND DIALECTICAL MATERIALISM.

Historical and dialectical materialism are doctrines in the philosophy of history and in metaphysics, respectively. They were developed within the Marxist tradition and refer to ideas found in the works of Karl Marx (1818–1883). However, neither term

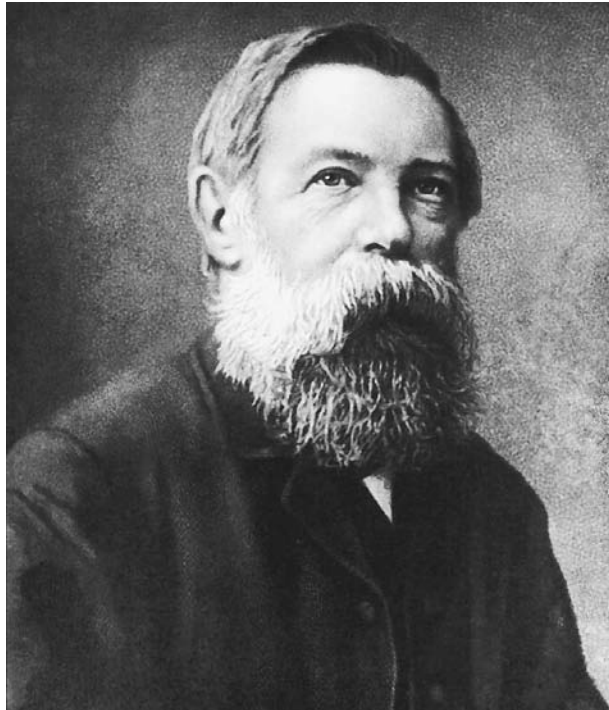

Friedrich Engels (1820–1895). Engels, a friend and collaborator of Karl Marx, believed that the concept of private property was to blame for all the problems of society. He authored several publications espousing scientific socialism, including the *Communist Manifesto* which he cowrote with Marx.

was used or endorsed by him explicitly, and the relationship between those doctrines and his writings has always been problematic. In recent years scholarship has clarified these questions considerably. While in the later twentieth century dialectical materialism all but faded away, historical materialism has had a remarkable revival in an “analytical” form.

Engels and Marxism

Marx’s friend and sometime collaborator Friedrich Engels (1820–1895) coined the term *materialist conception of history* (later shortened to historical materialism). In a review (1859) of the first published version of Marx’s critique of contemporary economic science, Engels strove to introduce Marx to the public as a powerful intellect and polymathic systematizer. In his short narrative, Engels simplified a selection of Marx’s ideas and presented them in a doctrinal form. In Engels’s account Marx was said to have a method coincident with both Hegelian philosophy and contemporary physical science. On the latter point Engels identified Marx with a mechanistic materialism of matter-in-motion, and on the former with “dialectical” thought that was said to mirror this ontological universal. Engels repeated those views much more famously in his *Anti-Dühring* (1878; excerpted as *Socialism: Utopian and Scientific*, 1880) and *Ludwig Feuerbach and the End of Classical German Philosophy* (1886).

Marxism as a comprehensive worldview, allegedly based on these twin pillars of materialism, was developed only after

Engels’s death. This doctrine was said to be applicable to human history and to unify philosophical with scientific thinking. It attracted numerous adherents in the intellectual world and drew millions into political movements. This process was abetted by even simpler versions, such as those by Georgi Plekhanov, V. I. Lenin, Nikolai Bukharin, Joseph Stalin, and Mao Zedong. Further millions learned this kind of Marxism from anti-Marxists pursuing an opposing politics. However, Marx and Engels were by no means completely known quantities because further works from both appeared posthumously during the twentieth century, and the complete works are not yet published in full. Engels’s notebooks on “dialectics” were published in 1927 as *Dialectics of Nature*, and were said to account for nature in a way consistent with the work that he had left on history (summarized as historical materialism) and on thought itself (a vastly simplified reworking of Hegelian logic). Dialectical materialism (or “dialectics” or *diamat*) was thus said by the 1930s to be the master doctrine of Marxism, summarized into three laws: transformation of quantity into quality, interpenetration of opposites, and negation of the negation. Overall it was a doctrine of “becoming” rather than “being” in a fixed and static sense, and one that emphasized development and progress through contradictions, whether in logical relations or in political struggles. Historical materialism was a specially interesting instance of this overall view, given its directly political character.

Economics, History, and Materialism

The political character of historical materialism derives from its narrative history of civilization, and the special role assigned to “relations of production” and technological change within it. Matter-in-motion does not figure in this account, except as an unacknowledged ontological presumption. Rather the materialism operative in the doctrine is transformed metaphorically into a selective focus on the human activities ordinarily termed “economic,” that is, the production, consumption, distribution, and exchange of the “material” means of life. Linking those activities with materialism played on the material qualities of economic goods, associating them in turn with what is basic and indispensable for human life. This doctrine further suggests that the economic activities associated with goods of this kind are more real and therefore have more explanatory power than anything else, particularly “mere” ideas or thoughts. Religion, utopianism, “good intentions,” morality, and moralizing were commonly cited by Marxists as “superstructural,” as opposed to the material “foundation” or “basis” in economic activities regarded as “determining.” The base/superstructure distinction is itself a metaphor derived from Marx’s own preface to his *A Contribution to the Critique of Political Economy* (1859), the occasion for Engels’s original systematizing review.

In the *Preface* Marx offers a periodization of history in successive “modes of production.” These were evidently based on composites of technology together with legal and property systems: Asiatic, ancient, feudal, and modern. Since some of these were coincident with others in the world at large, the schema does not represent a strict diachronic account of history, nor is it the case that all transitions were necessarily progressive. What is clear is that Marx regarded modern commercial and

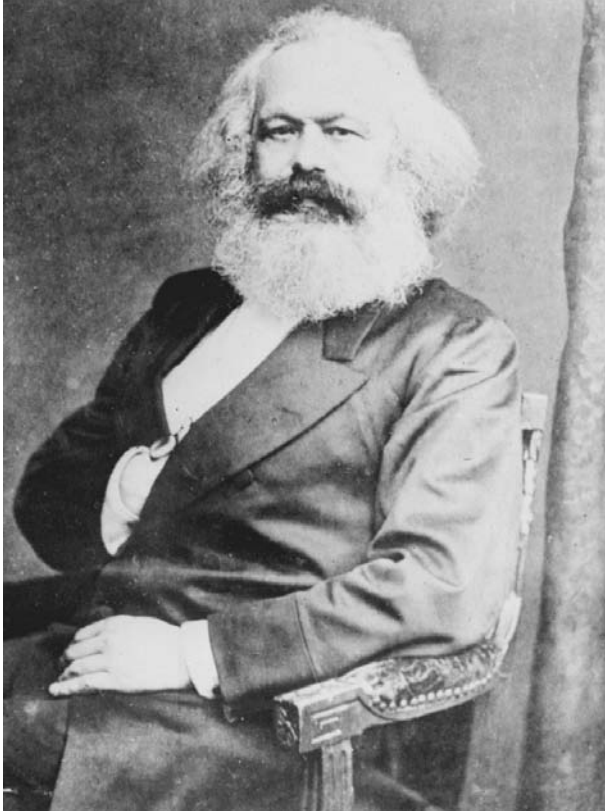

Karl Marx (1818–1883). Marx strove to organize a movement of the working class predicated on the principles of communism. He believed that society was headed for eventual economic collapse and an overthrow of the capitalist ruling class. ARCHIVE PHOTOS

capital-accumulating societies as distinctly different from previous economic and political systems because they were so much more productive of goods and services and so continuously innovative. Moreover they seemed to him to be a prelude to a comprehensive economic collapse and a political struggle between contending socioeconomic classes. From that would come a vastly different society, which he variously termed communism or socialism. Alternatively, he wrote (with Engels) in the *Communist Manifesto* (1848), the result would be a “common ruin.”

Marx’s *Preface* also contained certain passages that were commonly interpreted as causal claims relevant to the social and political changes marking a transition, for example, from feudalism to capitalism: “At a certain stage of their development the material productive forces of society come into contradiction with the already existing relations of production. . . . From forms of development of the productive forces these relations turn into their fetters. Then an epoch of social revolution commences.”

Technological innovations, and the introduction of “free” wage-labor and individualized “private” property, were the important elements through which this massive change was effected. Marx’s conception was thus an ambitious attempt to recast history in terms of economic systems and economic

changes (rather than reigns, religions, empires, etc.). It also aimed to identify the most crucial changes in modern life and politics with the economic changes around and through which revolutionary political forces gathered, ushering in constitutional, liberal democratic, and “bourgeois” forms of government. Whether these phrases fit the “dialectics” espoused by Engels, who late in life supplemented this with a notion of “determinism in the last instance,” or whether they fit instead some non-dialectical explanatory model favored by other writers, has been a recurrent issue within and about the Marxist tradition.

Analytical Marxism and the Future

In the 1970s a group of self-styled “analytical Marxists” revitalized historical materialism by redefining it as a doctrine of historical explanation, but excising all aspects of “dialectics.” The main historical theorist of the group was G. A. Cohen, who developed a reworded version of Marx’s own views. He attempted to edit them stringently to fit what could be empirically demonstrated in history as true, and to relocate his views on forces and relations of production, base, and superstructure, within a functional understanding of explanation. Ultimately Cohen concluded that his attempt to rework Marx’s conceptions and phrases in what he termed the most favorable light proved the theory a failure. In terms of contemporary historiography and philosophy, however, this had the effect of liberating Marx’s ideas about history and progress from any indissoluble connection with an overarching “dialectical” doctrine.

Contemporary Hegelians are unlikely to be much interested in Engels’s attempt to marry dialectical thought with matter-in-motion materialism, since the latter has little purchase in philosophy, history, or social science, and the former is very naive and banal, particularly compared with later idealist, phenomenological, and poststructural appropriations of Hegel. Historical materialism, however, has a brighter future, in so far as Marx’s own enigmatic and ambiguous writings on history and politics will prove a source of continuing inspiration.

See also *History, Idea of; Marxism; Socialism.*

BIBLIOGRAPHY

PRIMARY SOURCES

- Engels, Friedrich. *Anti-Dühring*. In *Karl Marx and Frederick Engels: Collected Works*. Vol. 25. London: Lawrence and Wishart, 1987.
- . *Dialectics of Nature*. In *Karl Marx and Frederick Engels: Collected Works*. Vol. 25. London: Lawrence and Wishart, 1987.
- . *Ludwig Feuerbach and the End of Classical German Philosophy*. In *Karl Marx and Frederick Engels: Collected Works*. Vol. 26. London: Lawrence and Wishart, 1990.
- . *Review of Marx: A Contribution to the Critique of Political Economy*. In *Karl Marx and Frederick Engels: Collected Works*. Vol. 16. London: Lawrence and Wishart, 1980.
- . *Socialism: Utopian and Scientific*. In *Karl Marx and Frederick Engels: Collected Works*. Vol. 24. London: Lawrence and Wishart, 1989.

Marx, Karl. *Manifesto of the Communist Party* (with Friedrich Engels). In *Marx: Later Political Writings*, edited and translated by Terrell Carver. Cambridge, U.K., and New York: Cambridge University Press, 1996. Reprint, 2002.

———. “Preface to *A Contribution to the Critique of Political Economy*.” In *Marx: Later Political Writings*, edited and translated by Terrell Carver. Cambridge, U.K.: Cambridge University Press, 1996. Reprint, 2002.

SECONDARY SOURCES

Carver, Terrell. *Marx's Social Theory*. Oxford and New York: Oxford University Press, 1982.

Cohen, G. A. *Karl Marx's Theory of History: A Defence*. Oxford: Oxford University Press, 2000.

Giddens, Anthony. *A Contemporary Critique of Historical Materialism*. 2 vols. Cambridge, U.K.: Polity, 1985.

Jordan, Z. A. *The Evolution of Dialectical Materialism: A Philosophical and Sociological Analysis*. New York: St. Martin's, 1967.

Kolakowski, Leszek. *Main Currents of Marxism: Its Rise, Growth, and Dissolution*. Translated by P. S. Falla. 3 vols. Oxford: Oxford University Press, 1978.

Ruben, David-Hillel. *Marxism and Materialism: A Study in Marxist Theory of Knowledge*. Rev. ed. Brighton, U.K.: Harvester, 1979.

Wetter, Gustav A. *Dialectical Materialism: A Historical and Systematic Survey of Philosophy in the Soviet Union*. Translated by Peter Heath. London: Routledge and Kegan Paul, 1958.

Wilde, Lawrence. *Marx and Contradiction*. Aldershot, U.K., and Brookfield, Vt.: Avebury, 1989.

Terrell Carver

HISTORICISM. Historicism (German *Historismus*, French *historisme*, Italian *storicismo*) is a term of Romantic origins associated first with the German Historical Schools and then more generally with historical method as applied to all the arts and sciences and to human life. “Historicism” appeared first in a fragment of Novalis, who contrasted it with other methods (chemical, mathematical, artistic, etc.) and associated it with “the system of confusion.” Contemporaneously Friedrich Schlegel associated *Historismus* with the modern science of philology. The word was occasionally used in philosophical polemics, and again the usage seems pejorative since it was opposed to academic philosophy and, especially, unhistorical Kantian idealism. Felix Dahn argued that “historicism is above all a methodological moment, not a speculative principle . . . ; its goal is [not philosophy but] life”; Christlieb Julius Braniss opposed it to the reductionist and deterministic philosophy of naturalism; and in 1879 Karl Werner applied the phrase “philosophical historicism” to the work of Giambattista Vico, a connection later endorsed by Benedetto Croce, Friedrich Meinecke, Erich Auerbach, and others. And in 1895 Lord Acton pointed to “that influence for which the depressing names historicism and historical-mindedness have been devised”—“all things,” for him, including law, theology, science, and philosophy itself.

By the later nineteenth century historicism had acquired a largely pejorative meaning because of its associations with relativism and the threats posed to the assumptions and values

of philosophy, theology, and economics, which represented three of the absolutes of Western culture, namely, reason, religion, and the free market. The attack began in the newly professionalized field of economics, especially in 1883 by Karl Menger's liberal assault on “the errors of historicism,” that is, the irrational methods of Gustav Schmoller and other members of the so-called younger historical school of economics. In a sense this war of methods (*Methodenstreit*) recapitulated the struggles between the historical and philosophical schools in the nineteenth century, but now with the weaponry of modern positivism and quantitative techniques. Liberal rejection of historicism, indeed of historical method in any sense, has persisted in many areas of social sciences, as well as in the humanities, as in Russian formalism, structural linguistics, and the New Criticism.

The Errors of Historicism

In theology the errors of historicism were equally offensive. In the prewar years, religious controversies raged around the various forms of “modernism,” which had been denounced in Pope Pius IX's “Syllabus of Errors” of 1864, accompanied by a whole list of other secularizing “-isms.” Positivism, psychology, and historicism all posed threats not only to traditional moral values but also to the validity of both reason and revelation. The historicizing of Christianity was the avowed aim of the historical school of religion (*religionsgeschichtliche Schule*) headed by Weber's friend Ernst Troeltsch, whose classic work, *Die Soziallehren der christlichen Kirchen und Gruppen* (1912; *The Social Teachings of the Christian Churches*), marked the intersection of the socioeconomic and theological problematics of historicism; and it, too, was carried on with heavy anxiety about questions of traditional norms and the elimination of metaphysical and metahistorical absolutes.

Philosophers had worried about the threat of history since the later eighteenth century, and their anxieties resurfaced in the early twentieth century as a “crisis of historicism.” In 1910 Edmund Husserl denounced historicism as the enemy of “philosophy as a rigorous science.” Martin Heidegger, following Friedrich Nietzsche's famous critique of “the use and abuse of history,” contrasted it with true historicity (*Geschichtlichkeit*) grounded in contemporary existence. Like Braniss, Troeltsch opposed “historicism” to “naturalism” and traced this war of methods back to the seventeenth century with special reference to Vico's attack on Cartesianism; and he celebrated historicism for removing the “dead hand” of dogma while at the same time fearing the threat it posed to philosophical and moral tradition. Following Troeltsch, Karl Heussi distinguished between “history for the sake of history” (*l'histoire pour l'histoire*), relativism, radical evolutionism, and speculative philosophy of history, and analyzed them all under the rubric “the crisis of historicism.”

Historicism represented a problem for all the human sciences and, for Karl Mannheim, a complete *Weltanschauung* beyond the level of conscious reflection or ideology, so that history itself was caught in its net. It served the modern dynamic world as “timeless reason” had served a more static world. As a counterpart to the older faith in reason, now itself historicized, historicism also needed to be the object of

critical theory. Yet it was not absolute but only bound to assumptions of spatial, temporal, and material conditions that had undercut universalist conceptions. The virtue of historicism for Mannheim was that it set dynamism at the center of its conceptualizations instead of relativizing it as in “the old static system,” and so made it “the Archimedean lever” for the modern worldview and life experience, that is, made it in effect the condition of human, historical, and indeed philosophical understanding.

Croce, following Vico and Hegel, thought that the Germans had not pushed historicism far enough. He rejected the claims of modern social science, such as those of Max Weber and Émile Durkheim, to universal status, regarding them all as open to contingency and subject to historical conditions. So were human values, and Croce had no fear that relativism was a major threat, since for him historicism was “a logical principle . . . , the very category of logic.” In Germany historicism was the reigning condition of contemporary thought and life—and according to Croce’s famous aphorism, “every true history is contemporary history.” Indeed philosophy itself was “absolute historicism,” so that historicism was not the source of the intellectual crisis of the twentieth century but rather its potential solution. Croce’s views and prejudices were carried over into the Anglophone world by R. G. Collingwood, who translated his work and followed his interpretation of historiographical tradition and who turned back to the classical view of history as a form of “inquiry” into human behavior, proceeding through the interpretation of evidence and aiming ultimately at “human self-knowledge.”

The best known interpretation was Friedrich Meinecke’s *Die Entstehung des Historismus* (1936; *Historicism: The Rise of a New Historical Outlook*), which offered a comprehensive map of European historical thought since the seventeenth century and gave systematic form to the Rankean principles of individuality and development. He granted a place for cultural history—as in Vico, Voltaire, Wallace K. Ferguson, Johann Joachim Winckelmann, and Johann Gottfried von Herder—and indeed he ended with a detailed assessment of Goethe, “Herder’s pupil,” down to the breakthrough of the fundamental ideas, though not to its “full evolution.” Yet he also includes the arch-naturalist Gottfried Wilhelm von Leibniz in his curious canon and so tends to overlook the linguistic and literary—and indeed in many ways antiphilosophical—orientation of historicism as it emerged in the age of Romanticism, neglecting the contributions of the historical schools (Reinhold Niebuhr, J. G. Eichhorn, Friedrich von Savigny, Jakob Grimm, Wilhelm Roscher, et al.) and the scholarly tradition as a whole. By reducing historicism to a philosophical doctrine, Meinecke violates the original impulse; for in general historicism is not a concept but an attitude, not a theory but a scholarly practice, not a system of explanation but a mode of interpretation; and it was part of an effort not to make history into a philosophical doctrine but rather to transform it into a foundational discipline to which philosophy itself would be subject. In this sense historicism penetrated even into Russia.

The later semantic history of historicism has become increasingly muddled because of misappropriations of the word

for philosophical or ideological but quite un- or even antihistorical purposes, beginning with Karl Popper’s *Poverty of Historicism* (1957), which identifies historicism with naive biological determinism (precisely the opposite of the view of Braniss) and a total innocence of history, experience, and even common sense. Another instance is the book of Maurice Mandelbaum, who writes in *History, Man, and Reason*, “Historicism is a belief that an adequate understanding of the nature of any phenomenon and an adequate assessment of its value are to be gained through considering it in terms of the place which it occupied and the role which it played within a process of development,” and Michael Gillespie, who thinks historians go “critically astray” in tracing the source of historicism to the attitudes associated with historical scholarship, especially that of early modern Europe. On the contrary, historicism was and is an alternative to conventional philosophy and scientific naturalism, and it flourished in the rich soil of literary and antiquarian learning and the teachings of the historical schools. In fact historicism is positioned in opposition to the scientisms that evade questions of point of view, perspective, cultural context, and the necessity of interpretation in posing questions about a past that is not only a “foreign country” but also largely inaccessible except through traces and testimonies that happen to have survived and that must be expressed in the language and conditions of the present—a present that is itself on its way soon to becoming a past.

The New Historicism

The so-called new historicism, popularized since 1980, goes back at least to 1942, when Croce wrote that “The New Historicism accepts, extends, and applies Vico’s principle that men know only what they do.” The newer New Historicism, though avoiding philosophical claims, likewise turns, as Vico had done, to cultural forms, especially literature and art, to reveal underlying interests and power structures and to penetrate to inarticulate levels and marginal groups of society. In general, this New Historicism was part of the linguistic and textualist turn taken by history and the human sciences, including philosophy, in the past generation; and so were the closely allied innovationist movements that call themselves “the new cultural history” and “a new philosophy of history.” Despite attempts to deprecate the Old Historicism on ideological as well as methodological and terminological grounds, the New Historicism shared or inherited some of the same assumptions and goals and in a long perspective forms part of the same story.

See also *Historiography; History, Idea of.*

BIBLIOGRAPHY

- Bambach, Charles R. *Heidegger, Dilthey, and the Crisis of Historicism*. Ithaca, N.Y.: Cornell University Press, 1995).
- Croce, Benedetto. *History as the Story of Liberty*. Translated by Sylvia Sprigge. New York: W. W. Norton, 1941.
- . *History, Its Theory and Practice*. Translated by Douglas Ainslie. New York, 1960.
- Heussi, Karl. *Die Krisis des Historismus*. Tübingen: Mohr, 1932.
- Iggers, Georg G. *The German Conception of History: The National Tradition of Historical Thought from Herder to the Present*. Middletown, Conn.: Wesleyan University Press, 1983.

- Mannheim, Karl. "Historicism." In *Essays on the Sociology of Knowledge*. Translated by Paul Kecskemeti. London: Routledge and Kegan Paul, 1952.
- Meinecke, Friedrich. *Historism: The Rise of a New Historical Outlook*. Translated by J. E. Anderson. London: Herder and Herder, 1972.
- Popper, Karl. *The Poverty of Historicism*. Boston: Beacon Press, 1957.
- Roberts, David. *Benedetto Croce and the Uses of Historicism*. Berkeley: University of California Press, 1987.
- Thaden, Edward C. *The Rise of Historicism in Russia*. New York: Peter Lang, 1999.
- Thomas, Brook. *The New Historicism and Other Old-Fashioned Topics*. Princeton: Princeton University Press, 1991.
- Troeltsch, Ernst. *Historismus und seine Probleme*. Tübingen, 1922.
- . *The Social Teaching of the Christian Churches*. Translated by Olive Wyon. New York: Harper, 1960.

Donald R. Kelley

HISTORY, ECONOMIC. Economic history emerged in the late nineteenth century as an academic field devoted to the study of past economic phenomena and processes. Since then it has undergone significant changes in terms of its thematic and theoretical concerns, analytical methodologies and language, and the spatial and temporal scales in which it is framed. Distinctive national and regional approaches and traditions can be identified that reflect the different and changing social systems and ideologies across the world as well as the diverse forms of training and disciplinary affiliations of the economic historians themselves.

The Emergence of Economic History

As an academic discipline, economic history first emerged in Western Europe and North America, specifically, in Britain, Germany, and the United States. Although publications that, more or less, incorporated economic history go back to the eighteenth century, the phrase "economic history" apparently first appeared in a book title in the work of a German scholar, Von Inama-Sternegg, published in 1877 and 1879, *Über die Quellen der deutschen Wirtschaftsgeschichte* and *Deutsche Wirtschaftsgeschichte*, covering the Middle Ages. The first academic appointment in economic history was made at Harvard University in 1892 and went to a British scholar, William Ashley. The work of the early economic historians focused on either general economic development or specific sectors and processes, especially agriculture, commerce, and industrialization.

But the emerging field exhibited different regional and national tendencies. Although neoclassical models dominated, Marxist perspectives had a lot more appeal to European economic historians, especially in Germany, than to those in America. German historical economists mainly saw economic development in terms of stages and they emphasized the inductive rather than the deductive method. In Britain, the political economists who turned to economic history stressed issues of distribution, especially prices and wages. For their part, American economic historians showed a strong preference for quantitative approaches. Their studies increasingly focused on

business history and business cycles, thanks in part to the relative abundance of statistics from census data and governmental and private agencies. In fact, the subsequent growth of economic history in these countries and elsewhere in the world was tied to the increasing capacity and needs of governments to produce and consume statistical data. Also critical was the expansion of, and rising disciplinary specialization in, the universities, the improvement of library collections and archives, the establishment of economic history societies and journals, and the production of large-scale surveys and other bibliographic resources.

Many of the pioneer economic historians were men, but the field also included some remarkable women, such as Eileen Power in Britain, who was at the center of the Economic History Society and the London School of Economics until her death in 1940, and Katherine Coman in the United States, who published an influential economic history text, *Industrial History of the United States*, in 1905. Unfortunately, the important contributions of these women were ignored as the discipline became more male dominated, particularly after World War II, as the concerns and constituencies of the discipline narrowed, although corrective studies have appeared in more recent years.

Economic History in Asia, Latin America, and Africa

By the 1940s economic history had become an established discipline not only in Western Europe and North America, but also in other parts of the world. In Japan, Tokuzo Fukuda, who studied in Germany and tried to apply the German theory of economic stages to Japan, published the first treatise on Japanese economic history in 1900. In the next few decades, besides economic stage theory, Japanese economic history was dominated by historical materialism. Analytical focus shifted from commercial activities to rural and local economic history, whereas externally much attention was paid to the economic history of England, seen as the classical homeland of capitalism (see, for example, Komatsu). In China, which became officially communist from 1949, the Marxist approaches became even more pervasive, although Marx's notion of the "Asiatic mode of production" was disavowed. Chinese economic historians were preoccupied with two issues: first, the question of transition from "feudalism" to "capitalism," and second, the contradictory but ultimately destructive impact of Western imperialism on China's economy.

For formerly colonized regions and countries the question of imperialism and the challenges of internalizing their economic history loomed large, affecting everything from periodization to the themes and theories selected for analysis. In India, for example, economic historiography, which began to flourish following independence in 1947, had to grapple with the validity of the division between "ancient India" and "modern India," designating the periods before and after European conquest, a periodization based largely on political events rather than on economic processes. In the early postindependence years, Indian economic historians, notwithstanding differences in the topics or periods of focus, displayed two main tendencies: first, a nationalist orientation in which the stable and productive character of early Indian economic and social institutions were emphasized and by implication at least the destructive impact of British rule was indicted, and second, a

spatial concentration on the economic history of North India at the expense of other regions.

Periodization proved even more problematic for Latin American economic history, given the region's complex histories of European and African settlement and relations with the indigenous peoples. The region's economic historians, whether those influenced by neoclassical models of international trade, Marxist categories and stages of development, or dependency perspectives on underdevelopment and unequal exchange, largely took an external view of the region's economies as indicated by the preponderance of studies on the export sector. The emphasis on export rather than on the domestic economy began to shift in the mid-1950s, but there was continued concentration on the "modern" sector to the neglect of the "traditional" one.

The development of African economic history was a post-independence phenomenon, in which scholars grappled with various sets of generalizations made about African economic history. Geographically, the "Africa" discussed was largely confined to "sub-Saharan" Africa; thematically, there was excessive focus on trade and exchange systems, especially external trade, rather than on domestic production. Historically, the precolonial period was depicted as a static "traditional" backdrop to changes introduced by colonialism. Theoretically, there was the ubiquitous use of dichotomous models, in which change was often depicted as the abrupt substitution of one ideal type by its opposite—"traditional-modern" societies, "subsistence-market" economies, or "formal-informal" sectors. Various approaches vied for analytical preeminence, including neoclassical development theory, and dependency and Marxist paradigms.

The Rise of Cliometrics or the New Economic History

At the turn of the 1960s a "new economic history," sometimes referred to as *cliometrics* or *econometric history*, emerged in the United States. The new approach involved the systematic application of economic theory and quantitative methods to economic history. It was facilitated by the existence of a large stock of quantitative data produced by various agencies, advances in computer technology that fostered the collection of large historical samples, and a new generation of economic historians keen to apply statistical and mathematical models and counterfactual arguments for more precise measurements of economic developments and relationships. The need for economic and statistical skills meant that cliometricians were increasingly recruited from economics rather than from history departments, and they tended to concentrate on topics with measurable variables and more recent historical periods on which adequate quantitative data was available. One effect was that fewer economic historians were located in history departments, whereas in economics departments their distinctiveness apparently dwindled.

Prominent among the new economic historians were Robert Fogel and Douglas North, who won the Nobel Prize for Economics in 1993. Initially, they both focused on the effects of changes in the price of transportation—Fogel on the railroads and North on shipping—and on the economic impact of slavery on the American South. In both cases and on many

other topics their results challenged and sometimes overturned conventional historiographical wisdom. For example, it was demonstrated that the economic impact of the railroads was minimal and the alleged stagnation of the antebellum South was a myth. Fogel later turned his attention to the complex connections between nutrition, health, and productivity, and North concentrated on studying the role of institutions and organizations in economic growth.

Cliometric history had its critics in the American academy. Some charged that because of its hypothetical models, which could not be verified, and "antiempiricistic" and "antipositivistic" methods, it was not history but "quasihistory" (Redlich). But unlike the situation in Europe, where Fogel lamented the new economic history was not initially practiced, it became increasingly dominant among American economic historians. However, the frontier of cliometrics did expand beyond the United States. Writing in 1978 Donald McCloskey enthused, "Cliometrics has at least begun in the histories of Canada, Mexico, Brazil, Australia, Japan, China, India, Russia, West Africa, Israel, Italy, France, Central Europe, the Low Countries, Scandinavia, Ireland, and England" (p. 25). In an extensive survey, Nicholas Crafts provided interested examples in cliometric history ranging from unemployment in interwar Britain to comparisons between Britain and the United States centered on the Habakkuk debate on technological progress, the Kuznets curve on patterns of income distribution, and demographic transitions.

Nevertheless, cliometrics moored firmly in neoclassical principles remained predominantly an American school and preoccupation. The distinguished British economic historian A. K. Cairncross implored the cliometricians to bear in mind constantly "the contrast between the sharp outlines of their concepts and the fuzziness of real life categories and between the certainties of their conceptual relationships and the uncertainties of the data" (p. 178). He concluded that in his view "there is scope for econometric methods of analysis, complete with models and counterfactuals, in some but not by any means all situations that economic historians encounter" (p. 180). From the 1990s, the call for a reunion between the old qualitative and the new quantitative economic history, between narrative and statistics, words and numbers, became louder. One prominent pioneer called for a "post-New Economic History" and urged his fellow economic historians to reintegrate themselves with other historians by changing their methods: "Historians are the synthesizers of social science. Our goal should be to help them to incorporate our insights into their developing syntheses. To do this we must make our models adaptable, more portable, and more human" (Sutch, pp. 277–278).

In an extensive review and prognosis of European economic and social history, Charles Tilly and colleagues proclaimed,

As we peer into the futures of economic and social history, our most general message is quite simple: *it is time to de-economize economic history and re-economize social history*. The de-economization of economic history should include the analysis of rights, power, coercion,

state action, and related “institutional” factors; it does not entail the abandonment of economic analysis, but its broadening from a single-minded application of free-market models. The re-economization of social history should include new treatments of the interdependence among different forms of production and reproduction, both material, biological, and social. It should challenge the surprising recent tendency either to treat the three as separate spheres or to reduce all of them to artifacts of discourse. In this limited but crucial sense, we call for the revival of materialist social and economic history [*italics in original*]. (p. 647)

Late-Twentieth-Century Developments in Economic History

Economic theory and economic history have increasingly had to deal with new intellectual currents in economics, principally feminist economics, environmental economics, and the new institutional economics. Feminist economists have sought to liberate neoclassical economics from its positivist Cartesian trap, to broaden its analytical and thematic scope from a preoccupation with the rational choices of individual economic man, and to study how humans, both men and women, in interaction with each other and the environment, provide for their own needs and survival. They have tried to infuse gender in both macroeconomics and microeconomics, to strip neoclassical economics of its universalism and timelessness, as well as its normative and prescriptive certainties, to challenge stylized facts and dichotomies, and to make women and gender relations in all economic activities visible, by grounding economic analysis in concrete societies and histories that are invariably marked by inequalities, discrimination, exploitation, and struggle inscribed by the social and spatial constructions and hierarchies of gender, class, and place.

Environmental economics evolved out of diverse intellectual and ideological roots in the 1970s and 1980s in the context of growing concerns for sustainable development. Environmental economists seek to analyze the impact of economic activity on the environment and the influence of the environment on economic activity and human welfare by reformulating familiar neoclassical concepts, and occasionally inventing new, “greener” ones. And so they talk of the need to internalize externalities, that is, to account for the environmental effects of economic activity, to incorporate environmental factors in social cost–benefit analysis. They see environmental “resources” and “services” as “commodities” with consumptive, nonconsumptive, existence and bequest values, and discuss the preservation of natural environments in terms of their value as collective or public goods, and their expected utility or option value for future generations. A series of sophisticated methods and techniques has been devised to give monetary values to the environmental “commodities” and to measure the costs of environmental damage and degradation, and the impacts of market and policy failures and of investment projects and programs.

A key premise of the new institutional economics is that institutions matter, that economic change and development are products of both the institutional environment and the

institutional arrangement. Studies inspired by the institutional perspective range from those that focus on the broad range of factors that have shaped the institutional environment, including the state, culture, and ideology, to those that concentrate on specific institutional arrangements, such as how changing regimes of property rights and transaction costs affect each other and economic performance. There is a lively debate on what constitutes an institution. Institutions are said to exist as a means to reduce transaction and information costs so that markets can operate efficiently, and markets themselves are regarded as institutions that interact with other social, political, and cultural institutions in the process of economic growth and change.

These new approaches offered opportunities for economic history to gain new analytical models and insights. They were welcomed by economic historians who believe that historical economic phenomena and processes are inseparable from cultural, political, social institutions, and the physical environments in which they occur, and the hierarchies and struggles inscribed by gender, class, and other social markers. Thus, economic history became increasingly more interdisciplinary.

Interdisciplinarity had long characterized economic history in the global South thanks to the paucity of statistical data and the pressing demands of development. According to Anthony Hopkins, a renowned economic historian of West Africa, African economic historians have always had a generous definition of economic history, one which embraces anthropology and political history as well as economics, which can be attributed to the youthfulness of the subject, the fortunate failure of any one school of thought to impose its dominance, and the diversity of evidence.

Economic historians of other regions appear to be moving in this direction. Readings on European economic history suggest growing interest in reconnecting economic, social, and political history. Before econometric history spread from the United States in the 1960s and specialization led to fragmentation of the discipline, one writer recalls, “few people then doubted that economic history included social history.” (Barker, p. 25). Now the discipline seems to be returning to some of its roots and using new sources, including oral sources, which “can fill many gaps and much enrich our understanding of ordinary folk’s social conditions and personal priorities” (Barker, p. 27).

The winds of change seem to be blowing even to the United States, as several commentators have noted. In a major intervention on the development of the American economy during the late nineteenth century, when corporate capitalism rose to prominence, James Livingston makes a compelling argument for bringing social analysis into American economic history:

At a higher level of argument it . . . follows that economic events are explicable only by reference to the social relations within which they appear—by reference, that is, to historically specific contexts of production and exchange. . . . We can see that the social and cultural context of economic change is not what the new economic historians have assumed it to be—an “exogenous

factor” that can safely be ignored in building quantitative models of economic behavior and growth. (p.71)

Similar trends are apparent in Asian economic historiography. In China, for example, social and economic historians have been developing new paradigms, divorced from Western neoclassical models and communist models, both of which were based on simplistic dualisms and shared a vision of the benefits of commercialization (Huang, pp. 335–336).

A survey of the Eleventh International Economic History Congress held in 1994 confirms these developments toward the broadening of economic history. It shows that only one session was devoted to cliometrics and that the new economic history papers altogether accounted for about 20 percent of the whole congress program and were mainly given by North American scholars. Most of the papers took into account the role played by noneconomic factors and reflected “the influence of other kinds of histories, in particular social history, and other social sciences such as sociology, management and organization studies, and political science” (Subacchi, p. 607).

See also *Capitalism; Communism; Economics; Historiography; Marxism.*

BIBLIOGRAPHY

- Barker, Theodore C. “What Is Economic History?” *History Today* February (1985): 25–27.
- Berg, Maxine. “The First Women Economic Historians.” *Economic History Review* 45, no. 2 (1992): 308–329.
- Cairncross, A. K. “In Praise of Economic History.” *Economic History Review* New Series 42, no. 2 (1987): 173–185.
- Cochran, Thomas C. “Economic History, Old and New.” *American Historical Review* 74, no. 5 (1969): 1571–1572.
- Cole, Arthur H. “Economic History in the United States: Formative Years of a Discipline.” *Journal of Economic Perspectives* 28, no. 4 (1968): 556–589.
- Coleman, D. C. “History, Economic History and the Numbers Game.” *Historical Journal* 38, no. 3 (1995): 635–646.
- Crafts, Nicholas F. R. “Cliometrics, 1971–1986: A Survey.” *Journal of Applied Econometrics* 2, no. 3 (1987): 171–192.
- Elson, Diane. “Gender Analysis and Economics in the Context of Africa.” In *Engendering African Social Sciences*, edited by Ayesha Imam, Amina Mama, and Fatou Sow, 153–189. Dakar: Codesria Book Series, 1997.
- Feuerwerker, Albert. “China’s Modern Economic History in Communist Chinese Historiography.” *China Quarterly* 22 (1965): 31–61.
- Fogel, Robert W. “The New Economic History. 1. Its Findings and Methods.” *Economic History Review* New Series, 19, no. 3 (1966): 642–656.
- Furubotn, Eirik, and Rudolf Richter, eds. *Institutions and Economic Theory: Contributions of the New Institutional Economics*. Ann Arbor: University of Michigan Press, 1998.
- Goldin, Claudia. “Cliometrics and the Nobel.” *Journal of Economic Perspectives* 9, no. 2 (1995): 191–208.
- Gras, Norman S. B. “The Rise and Development of Economic History.” *Economic History Review* 1, no. 1 (1927): 12–34.
- Hopkins, Anthony G. “African Economic History: The First Twenty-five Years.” *Journal of African History* 30 (1989): 157–163.

- Huang, Philip C. “The Paradigmatic Crisis in Chinese Studies: Paradoxes in Social and Economic History.” *Modern China* 17, no. 3 (1991): 299–341.
- Komatsu, Y. “The Study of Economic History in Japan.” *Economic History Review* New Series 14, no. 1 (1961): 115–121.
- Livingston, James. “The Social Analysis of Economic History and Theory: Conjectures of Late Nineteenth-Century American Development.” *American Historical Review* 92 (1987): 69–95.
- McCloskey, Donald N. “The Achievements of the Cliometric School.” *Journal of Economic History* 38, no. 1 (1978): 13–28.
- McGreevey, William Paul, and Robson B. Tyrer. “Recent Research on the Economic History of Latin America.” *Latin American Research Review* 3, no. 2 (1968): 89–117.
- Morris, David, and Burton Stein. “The Economic History of India: A Bibliographic Essay.” *Journal of Economic History* 21, no. 2 (1961): 179–207.
- Rawski, Thomas G., et al. *Economics and the Historian*. Berkeley: University of California Press, 1996.
- Redlich, Fritz. “‘New’ and Traditional Approaches to Economic History and Their Interdependence.” *Journal of Economic History* 25, no. 4 (1965): 480–495.
- Subacchi, Paola. “Meta-Economic History: A Survey of the Eleventh International Economic History Congress.” *Economic History Review* New Series 48, no. 3 (1995): 602–611.
- Sutch, Richard. “All Things Reconsidered: The Life-Cycle Perspective and the Third Task of Economic History.” *Journal of Economic History* 51, no. 2 (1991): 271–288.
- Tisdell, Clem. *Environmental Economics: Policies for Environmental Management and Sustainable Development*. Aldershot, U.K.: Edward Elgar, 1993.
- Zezeza, Paul Tiyambe. *A Modern Economic History of Africa*. Vol. 1: *The Nineteenth Century*. Dakar, Senegal: Codesria, 1993.

Paul Tiyambe Zezeza

HISTORY, IDEA OF. “History” began, with Herodotus (5th century B.C.E.), as a form of empirical inquiry and has had an adventurous semantic career since its early Greek coinage. It has come to refer not only to procedures of investigation but also to speculations about the past. From the very beginning there was confusion between history as what happened in the past and history as memory and description of human events and, on a further level, conjectures about their larger meaning. The definition of history ranged from the study of particulars to philosophical reflection, and the idea of history had a corresponding range of reference both in theory and in practice. For Herodotus, history was intended not only to cast light on the customs of the “barbarians” but also to explain the causes of the wars with the Persians.

For the Romans history was designed, as with Livy (59 B.C.E.–17 C.E.), not only to celebrate national traditions but also, as with Cicero (106–43 B.C.E.), to furnish moral lessons for careful readers; and in both models the political-nationalist and the moral-exemplarist modes of historical writing entered into alliance with rhetoric and its apparatus of persuasion and inspiration as manifested in “art of history” (*ars historica*). At its best, history was, in the words of Dionysius of Halicarnassus

(fl. c. 20 B.C.E.), “philosophy teaching by example.” These motives were all preserved in the conception of history of Christian authors, with the addition of an overarching providential design inherited from Judaism, which itself arose in the context of Near Eastern—and for Western authors “barbarian”—religions. Not that the idea of history in some sense was limited to the classical and Judeo-Christian traditions, but the writings of other cultures remained outside the Western sphere until the early modern period.

The key to the conceptualization of history is the effort to essentialize the past, first in a Herodotean or Thucydidean narrative, and then in more rational, conjectural, philosophical, and religious ways. The “past” became (in Arnold Toynbee’s phrase) an “intelligible field of study,” and anthropomorphism as well as religious beliefs and ethnic prejudices came into play in the interpretation of the results of historical inquiry. In the West this meant above all the biblical framework and history as the “grand design of god,” which posited human experience in time as a pilgrimage under the laws of providence. From St. Augustine of Hippo (354–430) to Gotthold Ephraim Lessing (1729–1781) history was seen as the “education of the human race,” whether on the way to a final judgment or to an earthly destiny represented as progress, destiny, or a cyclical trajectory. To be ignorant of history, in the often-cited words of Cicero, was always to remain a child. This line of thought was pursued within the framework of a “world history,” which transcended the parochial biblical story, which was extended by “conjectural” methods in the eighteenth century, which, in the work especially of Johann Gottfried von Herder (1744–1803) and Georg Wilhelm Friedrich Hegel (1770–1831), eventuated in the genre of the “philosophy of history,” which was given a more secular and “scientific” twist by Auguste Comte (1798–1857) and Karl Marx (1818–1883) and their followers, and which today is preserved in attempts at global history.

Controversies and Models

Ancient notions of history were revived in the Renaissance and not only adapted to modern conditions but also subjected to critical scrutiny, focusing on the question of whether history was an art or a “science,” a question debated by historians down to the past century, notably in the famous exchange between George Macaulay Trevelyan (1876–1962) and John Bagnell Bury (1861–1927). In the sixteenth century history was in effect promoted from the level of art to that of science, especially in the work of Jean Bodin (1530–1596) and his followers on the “method” of history, although his primary aim was to place historical knowledge in the service of the sciences of law and society. Yet history retained its relations with philosophy, especially as a fulfillment of the ancient Greek motto of self-knowledge. “Know thyself,” quoted Bodin’s disciple Pierre Droit de Gaillard in another “method” of history. “Now this knowledge depends upon history, sacred as well as profane, universal as well as particular.” Such was one of the essential elements of historical study down to the famous work on the “idea of history” by Robin George Collingwood (1889–1943). Another contemporaneous French scholar, Henri de la Popelinière, likewise carried on Bodin’s project by writing not

only a history of history but also a discussion of the “idea of perfect history” (*l’idée de l’histoire accomplie; historia perfecta*), which followed Bodin’s ideas but preserved the autonomy of the discipline of history.

Another central theme of the theory of history begins with Aristotle’s (384–322 B.C.E.) famous and debate-inspiring contrast between poetry and history, which maintains that the latter stands in relation to philosophy as the particular to the general, and indeed this distinction was maintained not only by early modern scholars but also in the contrast made in the later nineteenth century by Wilhelm Windelband (1848–1915) and Heinrich Rickert (1863–1936) between sciences that were “idiographic,” treating particulars, and those that were “nomothetic,” seeking general laws. German “historicism” as defined by Friedrich Meinecke (1862–1954) was a view that likewise set history apart from philosophy through the principle of “individuality” (as well as development). Among the manifestations of individuality and vulgar empiricism were the isolation of particular “facts” and “events,” which came under fire from more sophisticated views of historical knowledge.

In the early modern period, history, following the usage of “natural history,” was defined especially as the knowledge of particulars (*singulorum notitia, particularis cognitio*), but increasingly it was also connected with the dimension of time and chronology, which, with geography, was regarded as one of the “eyes” of history. Here the central question was the form taken by the temporal process: where did it begin, and where was it headed? Was it continuous, filled with crises or revolutionary breaks, or perhaps cyclical? How could historians move back into that “foreign country” that is the past? Was ordinary memory, supported by reason, sufficient for such explorations, or was imagination required as well? Or did history require assistance from neighboring disciplines in the human sciences? All these questions and more have given substance, shape, and direction to the idea of history in modern times.

Hermeneutical Principles

In the nineteenth century the competing paradigms for historical interpretation were the natural-science model and cultural history inclining toward art and aesthetics, the first represented especially by Leopold von Ranke (1795–1886) and Theodor Mommsen (1817–1903) and the second by Jules Michelet (1798–1874) and Jacob Burckhardt (1818–1897)—and both represented in the famous exchange between Bury and Trevelyan. In general, historians have taken two paths to disciplinary science, one based on brute empiricism and reliance on primary sources and the other, under the influence of positivism, seeking general laws, as notoriously did Henry Thomas Buckle (1821–1862) and Hippolyte Taine (1828–1893). In this mode history was represented as a physical process that followed set patterns, a view that was reinforced by the analogy of Darwinian evolution. It was in this context, too, that the ideal of objectivity—history *sub specie aeternitatis*—was defended against the idea of history as a subjective literary art, to the extent indeed that the term “literary” became a pejorative term for scientific and professional historians following the quest of Ranke for history “as it actually happened.”

Yet historians had long been aware that history had to be written from a particular “point of view” (*Sehepunkt*), and this hermeneutical insight, first expressed by Johann Martin Chladenius (1710–1759), was taught by the classical historian, and Ranke’s colleague, Johann Gustav Droysen (1808–1884), for whom history was indeed partial insight and not “objective knowledge.” For Droysen history was, as it had been for Herodotus, a matter of endless inquiry—“not,” alluding to John the Baptist, “the light and the truth’ but a search therefor, a sermon thereupon, a consecration thereto.” This was especially appropriate for art history, which was the model chosen by Jacob Burckhardt, for whom “History is actually the most unscientific of all the sciences” (1979, p. 21). Burckhardt rejected the “bogus objectivity” of Ranke for the subjectivity that arose in the Renaissance and Reformation. As he wrote about his own classic study of the civilization of the Renaissance in Italy, “To each eye, perhaps, the outlines of a given civilization present a different picture, [so that] it is unavoidable that individual judgment and feeling should tell every moment both on the writer and on the reader” (1950, p. 1). The result was a principle of relativism that applied to the study of history itself, for “each age has a new and different way of looking at the more remote periods of the past” (1998, p. 7).

Many Ideas

One of the results of this is that to understand what the “idea of history” is, it is necessary to trace what it has been, and such indeed was the practice of Benedetto Croce (1866–1952) and his disciple Collingwood, for whom historical understanding had to be not a search for general or logical causes but a concern for individual motives—a kind of contemporary reenactment of past events in the fashion of Agatha Christie’s sleuth, Hercule Poirot, and along the lines of modern hermeneutics. In any case Collingwood concludes his review of the “idea of history” (1946) by reducing it, in modern terms, to the Greek view that history was a unique form of inquiry into human behavior, proceeding through the interpretation of evidence, aiming at self-knowledge. One of the dangers of this view was the “Whig interpretation of history,” denounced by Herbert Butterfield in 1931, but there seems no avoiding this sort of parochialism in a general sense.

In the twentieth century the idea of history took a number of forms, beginning with the old scientific ideal, encouraged by interdisciplinary studies and especially the methods and aims of the social sciences. One example of this was Marxist history, in which economic conditions and class struggle furnished the motor and revolution the goal of historical change, but in fact many political, social, and economic conditions have in their own ways preserved the search for the mechanisms of cause and effect underlying the historical process. This applies also to the adjacent field of the philosophy and theology of history, which has continued in the old Hegelian form, but which has diverged as well into the modern tradition of analytical philosophy, which is traceable back at least to F. H. Bradley’s *Presuppositions of Critical History* (1874), but which became a major project in the third quarter of the twentieth century, when philosophers of history focused on published historical

accounts and the examination of propositions and explanations with little or no attention to problems of research and heuristics but with great interest in the propositional analysis of stable terms and in assigning of causes and determining the “covering laws” to be extracted from the discourse of historians. Yet this abstractive focus on the “logic” of historical inquiry in the style of F. H. Bradley, Maurice Mandelbaum, William Dray, and Morton White seems to have run its course, or at least outlived its usefulness for historians.

Current Approaches

In many ways contemporary ideas of history have been reshaped and redirected in the wake of the linguistic and cultural turns taken by historical investigation and interpretation in the past century. With the decline of Marxist ideology and the rise of an anthropological model, historians have shifted from social to cultural matters, from the search for underlying causes to the human condition over time. Cultural history rejects the reductionism of economic and political history, gives up the “noble dream” of objectivity, the privileging of particular causes, recognizes the fundamental role of imagination in historical reconstruction, and, no longer aspiring to rigorous explanation, turns instead to what Clifford Geertz and Charles Taylor have called “interpretive social science.” For cultural historians, following the lead of anthropology, nothing human was alien to their inquiries, so that their aim indeed became, in the words of Fernand Braudel, “the history of everything.” Life around the clock, around the globe, from cradle to grave, and including the secrets of private life and sexuality: these have been the horizons of what has been trumpeted as the “new cultural history”; and the postmodern rejection of “grand narratives” has reinforced this move toward microhistory, multiple points of view, and loss of historiographical focus.

Yet the contemporary idea of history has in other ways lowered its sights, especially by shifting from a natural science to a linguistic model and so from a concern with primary sources to literary criticism of secondary, published and usually classic, narratives of key texts and questions of historiography. In a sense this shift, most conspicuously exemplified in the work of Hayden White and his followers, represents a return to the ancient rhetorical tradition of historical writing (and reading). To read history out of a text or to read history as a text: in either case we are impelled to shift from history as past reality (*res gestae*) to history as a phenomenon of literature (*rerum gestae narratio*)—from context to text. According to this shift of perspective, illustrated by the “New Historicism” of recent vintage, history is not a bygone process to be explained but a field of written accounts whose meaning can only be represented through the interpretation of traces, mainly linguistic traces. History is not rational but commemorative and imaginative; and there is no Archimedean point from which to view, still less to move, humanity in its passage. We may pose questions, but we cannot link cause and effect in any rigorous way. We may tell many stories, true as well as probable, about the past; but we cannot tell *the* story, the whole truth, the metanarrative, as scientific, philosophical, and theological historians used to do and, in some quarters, are still doing. This is the critical

perspective from which the idea of history has encountered various deconstructionist, poststructuralist, and postmodernist views of the human sciences that have changed the way many historians write if not the way they think.

Such are some of the conditions of the modern idea, or ideas, of history. As Michael Oakeshott long ago and Croce longer ago argued, history is not a thing of the past; and as the authors of the old *artes historicae* also taught, writing and reading history is a thing of the present. So are the remnants and relics of the past on which historical interpretation is based and the “contexts” that historians try to reconstruct from their own standpoints. The result is to qualify some of the key elements of our received ideas of history. There can be no single account of an essentialized “past” but only multiple stories that select, arrange, and interpret surviving records, testimony, and artifacts from particular points of view; nor can there be “facts” outside of human interpretations of its remains and uncertain human memory—no objects outside a human subject. A philosopher has written that we cannot speak the truth because “words cannot mimic the way the world is.” How much less can historians speak the truth of the way the world *was*—and its languages *were*? History cannot “speak” except through human ventriloquism, and (to invoke Jean-François Lyotard’s postmodernist criticism) there can be no “metanarrative” that captures the “nature and destiny of man.” Such metanarratives we have, of course—they have founded all sorts of ideologies and utopias—but as frameworks for the story of humanity they all sooner or later come to grief. The idea of history has in many ways become globalized. Yet it remains a human—time- and culture-bound—creation, whose technologically enhanced future is as uncertain as its past has been controversial and irregular; and its history will continue to be rewritten.

See also *Cycles; Hegelianism; Historiography; Marxism; Periodization; Prehistory, Rise of.*

BIBLIOGRAPHY

- Ankersmit, Frank, and Hans Kellner, eds. *A New Philosophy of History*. Chicago: University of Chicago Press, 1995.
- Bodin, Jean. *Method for the Easy Comprehension of History*. Translated by Beatrice Reynolds. New York: Columbia University Press, 1945.
- Burckhardt, Jacob. *The Civilization of the Renaissance in Italy*. Translated by S. G. C. Middlemore. New York: Phaidon, 1950.
- . *The Greeks and Greek Civilization*. New York: St. Martin’s Press, 1998.
- . *Reflections on History*. Indianapolis: Liberty Classics, 1979.
- Burke, Peter, ed. *New Perspectives on Historical Writing*. University Park: Pennsylvania State University Press, 1992.
- Butterfield, Herbert. *The Whig Interpretation of History*. New York: AMS, 1978.
- Certeau, Michel de. *The Writing of History*. Translated by Tom Conley. New York: Columbia University Press, 1988.
- Collingwood, Robin G. *The Idea of History*. Oxford: Clarendon, 1946.
- Croce, Benedetto. *History: Its Theory and Practice*. Translated by Douglas Ainslie. New York: Russell and Russell, 1960.
- Green, Anna, and Kathleen Troup, eds. *The Houses of History*. New York: New York University Press, 1999.
- Kelley, Donald R. *Faces of History: Historical Inquiry from Herodotus to Herder*. New Haven, Conn.: Yale University Press, 1998.
- . *Fortunes of History: Historical Inquiry from Herder to Huizinga*. New Haven, Conn.: Yale University Press, 2003.
- . “The Theory of History.” In *Cambridge History of Renaissance Philosophy*, edited by Charles B. Schmitt et al., 746–762. Cambridge, U.K.: Cambridge University Press, 1988.
- Kelley, Donald R., ed. *Versions of History: From Antiquity to the Enlightenment*. New Haven, Conn.: Yale University Press, 1991.
- Koselleck, Reinhart. *Futures Past*. Translated by Keith Tribe. Cambridge, Mass.: MIT Press, 1985.
- Kramer, Lloyd, and Sarah Maza, eds. *A Companion to Western Historical Thought*. Malden, Mass.: Blackwell, 2002.
- Le Goff, Jacques, and Pierre Nora, eds. *Constructing the Past*. New York: Cambridge University Press, 1985.
- Lowenthal, David. *The Past Is a Foreign Country*. New York: Cambridge University Press, 1985.
- Mandelbaum, Maurice. *History, Man, and Reason*. Baltimore: Johns Hopkins University Press, 1971.
- Meinecke, Friedrich. *Historism*. Translated by J. E. Anderson. New York: Herder and Herder, 1972.
- Patrides, C. A. *The Grand Design of God*. London: Routledge and Kegan Paul, 1972.
- Smith, Bonnie. *The Gender of History*. Cambridge, Mass.: Harvard University Press, 1998.
- Stern, Fritz, ed. *The Varieties of History*. New York: Vintage, 1972.
- White, Hayden. *Metahistory*. Baltimore: Johns Hopkins University Press, 1973.
- White, Morton. *Foundations of Historical Knowledge*. New York: Harper and Row, 1965.

Donald R. Kelley

HONOR. Codes of honor are all-pervasive in human societies, but the modern study of honor as an academic formulation originated in the Mediterranean region, and especially in the work of anthropologists working in Spain and Greece. Julio Caro Baroja, J. G. Peristiany, and Julian Pitt-Rivers wrote some of the seminal and most influential works on the concept of honor. They placed the honor complex in the Mediterranean world and based their work primarily on rural societies. Since those early works, the use of honor as a framework to study different cultures, especially those of Latin America with their Mediterranean roots, has become almost ubiquitous. Furthermore, the initial categories of analysis used in honor studies have been considerably refined and expanded.

The early model of Mediterranean honor as a catchall framework soon became the target of criticism by later scholars dissatisfied by a model based on peasant and rural sources, whose conceptions of honor cannot be transferred and applied willy-nilly to other times and places. Modern honor studies, although retaining these frameworks as a very useful starting point, take into account regional and temporal variations in the notion of honor, especially when applied to extremely diverse societies far distant from the Mediterranean.

Early Conceptualizations of Honor

For these early scholars, honor was a brittle value—one that could not be rescued if harmed. They emphasized honor as a framework for social hierarchy and as an attribute that people were both born with (status) and attained or retained through proper behavior (virtue). More recently Frank Henderson Stewart has criticized this way of formulating honor. In his model, honor retains its dual characteristic of having both inner and outer manifestations, but more emphasis is placed on the interconnection between the two. Key to this argument is the notion that honor must be conceived as a right—the inherent right to be treated with respect. As such, the bipartite aspect of honor—as conceived by most scholars—becomes linked to inner values and outer respect.

Another way of approaching honor in a somewhat dualistic manner is to emphasize its inverse quality, that of shame. For instance, Ramón Gutiérrez's influential study of gender and sexuality in colonial New Mexico depends heavily on this model. Although honor represents the ability to hold one's head up high in public, there is a strong element of shame that feeds the system. The conduct that must be observed and respected in order to be respectable is reinforced because of sentiments of shame. Women, in particular, were expected to mediate their behavior based on their sense of shame. This could be translated into their body movements and contacts outside of the home and the ways in which they covered their bodies outside the walls of their house.

Much of this notion of honor comes from historical studies of the Mediterranean region but also from literary sources. In particular, plays of Golden Age Spain, as well as other nations, presented honor dramas in which the battle over honor was marked by seductions, betrayals, and many battles over reputation. Some scholars found these representations of honor quite persuasive and made an extrapolation from these literary sources to the societies that they were studying. More recent scholarship has been highly critical of such attitudes, citing the lack of any link between the types of behavior presented on stage and page and that found in the more mundane documents produced by individuals. These authors have pointed out that many of the groups not covered within the literary codes of honor actually viewed themselves as possessors of honor, and that, in contrast to literary representations of honor, there are many historical examples of lost honor being repairable.

Public Expressions of Honor

The literature on honor and shame is closely connected to the study of public and private realms. Honor was a quality that was expressed in public, and contested there: insults and slights enacted in the public sphere could be construed as attacks on the public persona or reputation of a person, and thus on his honor. Thus, societies where honor was perceived as an important value were marked by violent outbursts particularly between men who protected their social reputation with duels for the elite and more informal fights—usually knife fights—for plebeians. Yet, despite what the early scholars of honor would have one believe, the courts were also a valid venue for the reparation of honor. Members of the elite in particular often used

litigation to defend their honor against public insults, as did women, to a surprising degree. Colonial Latin American court records have revealed many cases in which women sought to regain lost honor by having a seducer condemned as a rapist or forced to marry his victim—and sometimes both.

Honor was codified in such written forms as genealogies, titles of nobility, or coats of arms. In the Spanish world, public office, admission to universities, and most good marriages could only be obtained with the presentation of a kind of genealogy called a *limpieza de sangre* (purity of blood lines). Such a family tree certified that the party in question did not have any ancestors who were illegitimate, heretical, non-Catholic or newly converted, convicts, or who had held base employment. Titles of nobility also provided a strong case for the possession of honor as did coats of arms, which were, in a sense, a physical manifestation of one's honor. Other externals included the type of clothes one wore, the entourage, horses and carriages, and the body's bearing. In the Latin American context, *pureza de sangre* has been much discussed as an antecedent to later racial hierarchies; the combination of lineage and birth with elements of deportment and social reputation—and codes of honor—in this earlier concept can be seen to have influenced later ideas about race, in which individual behavior and family reputation are similarly emphasized in addition to purely physical attributes.

The public nature of honor was also expressed tangibly, through such bodily attitudes as doffing hats, bowing, curtsying, and lowering the eyes. Conversely, turning one's back or refusing to remove headgear could be construed as an attack on honor. The hierarchies of honor and its distribution were also made material through processions. These often religious, but also political, events placed people in an order that reflected their levels in society and thus represented the rankings of honor both to the general population and also to this smaller group.

Honor and Gender

There were alternate types of morality based on gender. Male morality had little to do with prudent sexuality. In fact, men enhanced their honor at times by seducing women. In seventeenth-century Spain there was even a fashion in the upper circles of trying to seduce nuns. On the other hand, women protected family honor by remaining virginal until marriage or the taking of order and then remaining chaste within the bounds of their status. Straying from this model of sexual purity not only besmirched the honor of the woman in question but also that of any man considered responsible for her conduct—usually husbands, brothers, or fathers.

To be honorable, a woman had to demonstrate her chastity. Traditional studies of honor systems understood this female imperative as passive, in contrast to the active role of the patriarch as defender of female honor. More recent scholarship has found that women took a more active role, from actual physical violence to hidden pregnancies and “adoptions” of illegitimate children. Ann Twinam has shown that illegitimacy could be overcome in colonial Spanish America through a bureaucratic process, and other scholars have demonstrated how

stains on honor were often overlooked particularly for the elite. For plebeian women, such exemptions were not available. The establishment of foundling homes was a response to these women's predicaments, both to protect their reputations and to rescue their babies from infanticide.

Honor and Violence

Historians have been fascinated by the violence associated with the defense of honor, and especially with the duel. The ritualized nature of duels made this violence acceptable in elite male contexts, an acceptance that plebeians and women in general could not reproduce. In a larger sense, dueling has been analyzed as an example of the relationship between forms of social mediation and levels of violence within particular different societies, with some historians looking especially to the theories of civilization of Norbert Elias in order to understand the evolution of duels and social violence as a central part of honor culture.

Much of the scholarship on dueling has focused on the reasons for its gradual abandonment. Historians have found that while governments often tried to legislate dueling out of existence, other factors such as a generalized social disapproval, changing weaponry (from swords to pistols), and new understandings of honor were stronger factors. Even after duels had disappeared, however, the culture surrounding them privileged certain members of society.

Insults have proven a particularly useful source for historians interested in the workings of honor in past societies. Insults are linked to violence as they precede or provoke it, but they also constitute a type of verbal assault in their own right. Most often, these words only came to light when litigation ensued. Legal codes recognized insults as cause for restitution because they harmed the individual, attacking their honor and their ability to function in their own community.

Honor and Space

Systems of honor also affected the way people conceived of spaces. The places in which insults were bandied have been productively analyzed to reveal the spatial framework of honor. Anthropologist Beverly Chiñas's study of Mexican Zapotec women added a gendered dimension: women acted covertly to manipulate men's movements, either preventing men who nursed a sense of insult against one another from meeting in public spaces—or putting them on a collision course. More generally, the dichotomy of public and private shaped honor for women, whose presence inside the home was honorable and outside the home was dangerous and dishonorable; codes of conduct and particularly dress were drastically affected by this dichotomy as well. For men, in contrast, absence from the public sphere might be considered questionable.

A more complex analysis of honor and space comes from the historians Elizabeth Cohen and Thomas Cohen, who showed how the house in sixteenth-century Rome became symbolic of the human body. Seating at public events and the relative arrangement in terms of height or distance from the most honorable point in the room became a concrete manifestation of the ideas of honor made concrete in spatial terms.

Non-Elite Honor

Early twenty-first century scholarship has taken issue with the notion that slaves had no claim to honor. An earlier formulation held that the very purpose of the slave in the social scheme was to be "dishonored," and so to provide their owners, and indeed all free people, with enhanced status in contrast to the slave's abasement. In fact, however, studies have shown that the Africans who became part of slave society worked within the honor system and absorbed its values. Thus slaves often made claims on honor, and also used their honorable status—as married persons, for example—to make claims for justice.

Plebeians, too, once thought to be outside the reach of codes of honor, regularly made claims to honor and defended this status quite vigorously. Although plebeian men and women could not produce illustrious genealogies, they were very much aware of their status as derived from the legitimacy of their relationships. They also derived status from relative affluence within the ranks of plebeians. Finally, the external reputation for honorable conduct was extremely important to plebeians because it was their way of assuring credit. Small loans between market women or artisans were only possible for those whose conduct was unblemished and thus honorable.

Honor and the State

One early-twenty-first-century development in the study of honor has been a changing appreciation for its role in the development of the modern state during the nineteenth and twentieth centuries. Earlier studies either focused on traditional societies or rural communities portrayed as isolated from modernity, or premodern state societies such as the European *ancien régime*. More recently, however, historians have used a more dynamic concept of honor to study such nineteenth-century phenomena as the integration of qualities associated with honor into the definition of citizenship. Instead of the family, the state becomes the guardian of honor, and begins to intervene in and exert control over individual struggles regarding honor, as in the attempts to stop the practice of dueling, discussed above. Similarly, the nation-state became much more involved in controlling the individual morality of women, particularly in campaigns about prostitution, but also as an arbiter of virginity and morality more generally. Men too began to feel more pressure to assume the role of income-earning head of household rather than simply inheriting the mantle of patriarchy, and honor began to be more entwined with both military or state service.

Conclusion

Honor seems to be a value or social system that is so basic as to exist—under many other names—in most societies. Honor as a framework to understand past social dynamics has been diffused widely, from China to African slave societies to the more traditional Mediterranean cultures. Yet this very diffusion of honor as an analytical framework has attracted some criticism. Because of its seductive appeal, honor has perhaps been used in an ahistorical and sometimes facile manner. Thus it is important to balance the wide-ranging applicability of honor as an analytical framework and its aptness for the study of diverse historical circumstances.

See also *Citizenship; Gender; Honor, Middle Eastern Notions of; Identity; Machismo.*

BIBLIOGRAPHY

- Caro Baroja, Julio. *La ciudad y el campo*. Madrid: Alfaguara, 1966.
- Chíñas, Beverly. *The Isthmus Zapotecs: Women's Roles in Cultural Context*. New York: Holt, Rinehart, and Winston, 1973.
- Cohen, Elizabeth S., and Thomas V. Cohen. "Open and Shut: The Social Meanings of the Cinquecento Roman House." *Studies in the Decorative Arts* 9, no. 1 (fall–winter 2001): 61–84.
- Elias, Norbert. *Power and Civility*. Translated by Edmund Jephcott. New York: Pantheon Books, 1982.
- Gowing, Laura. *Domestic Dangers: Women, Words, and Sex in Early Modern London*. Oxford and New York: Clarendon, 1996.
- Gutiérrez, Ramón A. *When Jesus Came, the Corn Mothers Went Away: Marriage, Sexuality, and Power in New Mexico, 1500–1846*. Stanford, Calif.: Stanford University Press, 1991.
- Johnson, Lyman L., and Sonya Lipsett-Rivera, eds. *The Faces of Honor: Sex, Shame and Violence in Colonial Latin America*. Albuquerque: University of New Mexico Press, 1998.
- Miller, William Ian. *Humiliation and Other Essays on Honor, Social Discomfort, and Violence*. Ithaca, N.Y.: Cornell University Press, 1993.
- Peristiany, J. G., ed. *Honour and Shame: The Values of Mediterranean Society*. London: Weidenfeld and Nicolson, 1966.
- Peristiany, J. G., and Julian Pitt-Rivers, eds. *Honor and Grace in Anthropology*. Cambridge, U.K., and New York: Cambridge University Press, 1992.
- Pitt-Rivers, Julian. *The Fate of Shechem; or, The Politics of Sex. Essays in the Anthropology of the Mediterranean*. Cambridge, U.K.: Cambridge University Press, 1977.
- Reddy, William M. *The Invisible Code: Honor and Sentiment in Postrevolutionary France, 1815–1848*. Berkeley: University of California Press, 1997.
- Stewart, Frank Henderson. *Honor*. Chicago: University of Chicago Press, 1994.
- Twinam, Ann. *Public Lives, Private Secrets: Gender, Honor, Sexuality, and Illegitimacy in Colonial Spanish America*. Stanford, Calif.: Stanford University Press, 1999.
- Wyatt-Brown, Bertram. *Southern Honor: Ethics and Behavior in the Old South*. New York: Oxford University Press, 1982.

Sonya Lipsett-Rivera

HONOR: MIDDLE EASTERN NOTIONS OF. Ancient and modern Arabs, as well as other ethnic groups of Muslim and Mediterranean peoples, adopted ideas of honor that reinforce the ties of an individual to his or her tribal clan or extended family. One type of honor, *sharaf*, applies to men and is attained through maintenance of a family's reputation, hospitality, generosity, chivalry, bravery, piety, and, sometimes, nobility or political power. Another variant of honor, *irdh* in Arabic (*irz* in Turkish), pertains to women, or more specifically, to the sexual use of their bodies, their virginity, or their chaste behavior. The honor of the clan was besmirched if unmarried women did not remain virgins, and if married women were unfaithful. Men were to maintain their clan's honor by punishing their errant women if they brought shame on the group, thus maintaining the patrilineal nature of lineage

and society. Scholars have termed this concept and resultant or related behavior the honor/shame dynamic. Lila Abu Lughod, in her study of the Awlad'Ali Bedouin, shows the complexities of this dynamic, for being humble and exhibiting "shame," *hashham*, can paradoxically demonstrate pride and honor.

Historically, honor has been closely connected to the institution of marriage. Women's honor corresponded to men's lineage rights, because the ultimate violation of *irdh* took place if a woman, unmarried or married, gave birth to an illegitimate child. Yet since a man's honor required legitimate male offspring to carry on his lineage, a wife's infertility could provide a man with an argument for taking a second wife, since polygamy is sanctioned by Islam, and outlawed in the early twenty-first century only in the Muslim countries of Tunisia and Turkey. Many groups continue to believe that family honor is maintained through endogamous marriages, often of cousins. While this tendency may be subsiding in larger cosmopolitan centers, men in Bedouin society are frequently required to marry relatives whether or not they form a romantic attachment with them, and this also provides a rationale for polygamy.

Beyond marriage, many customs in the Middle East have developed to display or protect honor. Various articles of dress, which varied tremendously by geographic area, group, and subclimate, often identified membership in a particular tribe, or occupation, and thus demonstrated the honor of that group—for example, the urban notables or wealthy town dwellers of Moroccan cities. The custom of female as well as male circumcision was also related to the notion of honor. Male circumcision was and is practiced by Jews and Muslims in the region, but is not thought by most scholars to affect male sexual functions. Female circumcision, however, which involves removal, or partial removal, of the clitoris and sometimes the labia, as well as infibulation, and is found in North and Western Africa, the Nile valley, and among the Bedouin of the Sinai peninsula and the Negev, is clearly related to sexual honor. The custom predates the monotheistic religions, but is now considered by some to be "Islamic" and a marker of cultural purity and family honor since it may render girls less susceptible to sexual stimulation. Families still believe the custom to confer honor and purity on girls and that, if uncircumcised, they will be unwanted as marriage partners.

Clan or family honor was a strong factor in the pervasive system of tribal law governing revenge or monetary compensation, termed *dhiya* (blood payment), for murder or severe bodily injury. The act of revenge, or the sum paid in its place, restored "honor" to male family members who must avenge crimes involving their relatives. By making payment, or enacting revenge, a lengthier feud could be avoided. The system of compensation or revenge was incorporated into Islamic law, although modern civil penal codes since the nineteenth century have substituted state punishments or incarceration in most nations.

Mediation of conflicts by respected and honorable individuals in rural or urban settings derives in part from tribal norms, wherein the precise technique of choosing mediators

and the method of mediation is customary. Similarly, some parties may seek refuge from avengers in the homes of honorable or prestigious clan members. Honor is often connected with status, prestige, noble lineage, and reputation.

Notions of honor have affected literary conventions, and also religious and political ideas. In classic Islamic literature, women's honor was seen to be protected when references to the beloved were made with the masculine verbal forms and pronouns in Arabic. The notion of courtly love, *hubb'udbri*, manifested ideals of honor, for this love was unrequited, indeed often undeclared, and so brought no shame upon the beloved. This ideal encircled the Mediterranean and was not restricted to Muslim countries.

Notions of honor have interacted with other ideals such as respect for piety, pious learning, and reverence for the prophet Muhammad, his family or descendants, other holy men and women, religious scholars, or the dedicated leaders of the Sufi orders. Such individuals believed to uphold the honor of the community through their devotion to piety, good works, and their ability to intercede for ordinary Muslims. In the Mediterranean and Middle East, similar beliefs concerning the honor of and respect for holy sites, connected with Christian saints and martyrs, or religious figures in Judaism, cause people to associate honor with a sacred landscape.

There is a popular belief that urbanization, modernization, materialism, the sedentarization of tribal peoples, incursions of tourism, and Western influences are eroding the traditional honor of individuals and groups. Hospitality is a revered aspect of honor to many groups in the region, expressed through a code of behavior toward strangers as well as neighbors or relatives. Festivities mounted by families for weddings and other celebrations are an extension of their honor. Couples also regard failures to supply material goods stipulated by marriage agreements as breaches of the other side's honor. Thus, honor is an increasingly expensive commodity, and not merely a philosophical "good."

Problems may be experienced where tourists violate, by their presence or conduct, norms of gender segregation, or where tribal members are economically impelled to serve as guides, or otherwise work in tourist-related services. Many women who have donned the head covering or dress referred to as *hijab*, or Islamic dress, perceive themselves to be upholding their honor, just as much as their piety or religiosity, since so many of them work in mixed-gender settings, or travel to work on public transportation.

Historically, and in the modern era, honor is also claimed by the rulers and ruling classes. In some cases, the noble or honorable lineage of particular rulers, such as the Hashemites of Jordan, or the rulers of Morocco, is attributed to their historical derivations and descent from the Prophet, and for the Hashemites as the former administrators of the holy cities of Mecca and Medina.

Presidents of modern countries are accorded a large degree of pomp and circumstance, and in the Middle East this is culturally expressed in terms of their honorable status and not



Iranian women, Tehran, 1979. Many Islamic women wear garments that conceal most of their body to show their piety and to uphold their honor. The Arabic concept of *irdh*, which addresses the acceptable behavior of women, disavows women who are not virgins at marriage or who are unfaithful. © CHRISTINE SPENGLER/CORBIS

merely the fact of their political power. Similarly, the elite politicians of many Mediterranean and Middle Eastern countries have held open houses, through which they have both claimed honor and granted political favors to their supporters.

Paradoxically, while honor accrued to those with power, tribal mores tended to elevate individuals. Politically, this construction of honor has been interpreted as a form of integrity, often in the face of an overwhelmingly corrupt milieu. Even beyond the Arab regions, such honorable integrity is, in the early twenty-first century, a part of a modernist, Islamist ideal for men that Fariba Adelkhah terms *javanmard*.

Honor has proved problematic for certain marginal elements in society. The honor of professional entertainers in Muslim and Mediterranean society has often been questioned; for females, because their bodies or voices were displayed in public; and for males, because their patrons might expect to dictate their choice of performance. Thus superior entertainers would uphold "honor" by demonstrating adherence to their own aesthetics and choice of repertoire.

See also **Feminism: Islamic Feminism; Gender: Gender in the Middle East; Sexuality: Islamic Views.**

BIBLIOGRAPHY

- Abu-Lughod, Lila. *Veiled Sentiments: Honor and Poetry in a Bedouin Society*. Berkeley: University of California Press, 1986.
- Adelkhah, Fariba. *Being Modern in Iran*. Translated by Jonathan Derrick. New York: Columbia University Press, 2000.
- Altorki, Soraya. *Women in Saudi Arabia: Ideology and Behavior among the Elite*. New York: Columbia University Press, 1986.
- Ginat, Joseph. *Blood Disputes among Bedouin and Rural Arabs in Israel: Revenge, Mediation, Outcasting, and Family Honor*. Pittsburgh: University of Pittsburgh, 1987.
- al-Krenawi, Alean, and John R. Graham. "Culturally Sensitive Social Work Practice with Arab Clients in Mental Health Settings." *Health and Social Work* 25, no 1 (2000): 9–22.

- Lavie, Smadar. *The Poetics of Military Occupation: Mzeina Allegories of Bedouin Identity under Israeli and Egyptian Rule*. Berkeley: University of California Press, 1990.
- Zuhur, Sherifa. "Building a Man on Stage: Masculinity, Romance and Performance according to Farid al-Atrash." *Men and Masculinities* 5, no. 3 (January 2003): Special Issue, "Islamic Masculinities," edited by Lahoucine Ouzgane, 275–294.
- . *Criminal Law, Women and Issues of Gender, Sex and Sexuality in the Middle East, North Africa, and the Islamic World*. Istanbul: Women for Women's Human Rights, 2004.
- . *Revealing Reveiling: Islamist Gender Ideology in Contemporary Egypt*. Albany: State University of New York Press, 1992.

Sherifa Zuhur

HUMAN CAPITAL. Human capital refers to the knowledge, skills, and capabilities of individuals that generate economic output. Human capital averages about two-thirds of the total value of the capital of most economies, which includes land, machinery, and other physical assets as well as the skills and talents of people. The value of human capital is often apparent after physical destruction, as during World War II—many of the German and Japanese cities that were bombed intensely were able to recover 80 to 90 percent of their previous levels of production within months.

More than two centuries ago, Adam Smith observed in *Wealth of Nations* (1776) that an educated man must earn more than "common labor" to "replace to him the whole expense of his education." Human capital was first discussed extensively by two Nobel Prize-winning economists, Theodore Schultz (1979) and Gary Becker (1992), to explain how any personal decision to sacrifice today for a return tomorrow can be analyzed in the same way that a business considers an investment decision, such as whether to buy new machinery. A nation's stock of human capital and thus its economic growth potential could be increased, they reasoned, if governments reduced the cost and increased the benefits of schooling, the human capital embodied in individuals.

Human capital is rented in the labor market rather than "sold." Individuals exchange effort for reward, and acquire human capital in the expectation that their incomes will be higher. Human capital takes time to acquire, and the basic model of human capital acquisition compares the income stream from going to school with that of going to work immediately. The costs of going to school include the direct costs, in the form of tuition and books, as well as the indirect costs, the forgone earnings that could have been received from working. The benefits of more schooling are higher earnings in the future.

Costs and Benefits

These costs and benefits must be brought to a single point in time so that the present value of the higher average lifetime earnings with more schooling and the lower average earnings with less schooling can be compared. A rational individual chooses the education and work profile that maximizes the present value of lifetime earnings.

This investment approach to education yields several important predictions about behavior. First, most people will get some education, and most students will be young, because the early years of education have few direct costs, and there are no forgone earnings because most societies prohibit children from working; younger people also have a longer period over which they can recoup their educational investment in the form of higher earnings. The analysis gets more interesting when young people reach the age at which they can work, sixteen or eighteen in most industrial countries, and twelve to fifteen in many developing countries. Youth in industrial countries tend to stay in school because the direct costs are often low and the forgone earnings may be low (working as a teen is often at the minimum wage), while earnings with a college education can be significantly higher. The interest rate used to compare future and present earnings is also important; if this interest rate is low because of subsidized loans, more people will choose to get more education.

Second, government policies shape individual decisions about how much human capital to acquire by affecting the cost of schooling and the payoff from work. Social attitudes also play a role, encouraging young people to stay in school, or to go to college with friends in industrial countries, but in developing countries often encouraging children to help support the family as soon as possible. More forward-looking people, those most able to sacrifice now for future returns, are likely to get the most education, such as those willing to undergo rigorous and time-consuming medical education.

In the United States a combination of higher lifetime earnings, government policies, and social attitudes has increased the percentage of high school graduates who go to college. In 1960, about 45 percent of all high school graduates enrolled in college in the following twelve months, 54 percent of men and 38 percent of women. By 1980, 49 percent of high school graduates enrolled in college: men dropped to 47 percent, and women rose to 52 percent. In 1999, the most recent data available, 63 percent of high school graduates enrolled in college, 61 percent of men and 64 percent of women. Most studies find that men are more present-oriented to immediate earnings opportunities than women, explaining why more women are in college.

The average earnings of college-educated persons are higher than the earnings of high school graduates, and rose in the late twentieth century. In 1979, male college graduates earned 33 percent more than high school graduates, the so-called college earnings premium, and female college graduates earned 41 percent. By 2000, these college earnings premiums rose to 84 percent for men and 67 percent for women, in part because the real earnings of those with less education fell as a result of globalization, which reduced the wages of many high school graduates employed in manufacturing.

Education is generally a good investment: the private rate of return to a college education ranges from 12 to 40 percent in most countries, more than the return on investments in stocks and bonds. Around the world, the rate of return to primary school education was estimated to be 29 percent in the

early 1990s, 18 percent for secondary schooling, and 20 percent for higher education. In developing African countries, these rates were 39, 19, and 20 percent, respectively, while in the industrial countries that are members of the Organisation for Economic Co-Operation and Development (OECD), the rates were 22, 12, and 12 percent, respectively. The high rate of return on primary education suggests that countries should subsidize it most.

It is very hard to compute average rates of return for higher levels of education because it is likely that the most capable individuals go to college, so that colleges transmit knowledge that increase productivity and also serve as screening institutions for employers seeking the best workers; some economists argue that the screening role is more important than the productivity-increasing role. On the other hand, the private rate of return to a college education may be higher if more highly educated individuals have both higher incomes as well as more fringe benefits and better or more prestigious jobs. The social rate of return may be even higher than the private rate if highly educated individuals provide more leadership and commit fewer crimes.

Any personal investment that raises productivity in the future can add to an individual's human capital, including on-the-job training and migration. A job that offers training, for example, may have lower earnings but still be attractive because a person knows that, after completing the military, aviation, or stockbroker course, earnings will rise. On-the-job training that makes the person more useful to the employer who provided it is called job-specific training, while training that transmits general skills that make the trained individual useful to many employers is called general training. Employers are more likely to pay for specific than general training. Employers do a great deal of training; by some estimates, U.S. employers spend almost as much on training as is spent at colleges and universities.

Migration of Human Capital

If people truly are the "wealth of a nation," should developing countries worry about a "brain drain" if their doctors, nurses, and scientists migrate to richer countries? The answer depends on the 3 R's of recruitment, remittances, and returns. Recruitment deals with who migrates abroad: Are the emigrants employed managers whose exit leads to layoffs, or unemployed workers who have jobs and earnings abroad but would have been unemployed at home? Remittances are the monies sent home by migrants abroad: Are they significant, and fuel for investment and job creation, or small and not used to speed development? Returns refers to whether migrants return to their countries of origin: Do they return after education or a period of employment abroad with enhanced skills, or do they return only to visit and retire?

During the 1990s the migration of highly skilled workers from developing to more developed countries increased, reflecting more foreign students as well as aging populations able to pay for more doctors and nurses and the internet-related economic boom. International organizations are exploring ways in which the more developed countries could replenish

the human capital they take from the developing world via migration, perhaps by contributing to or backing loans to improve their educational systems. If the human capital that migrates is not replenished, global inequalities may increase.

See also *Education; Globalization; Social Capital*.

BIBLIOGRAPHY

- Becker, Gary S. *Human Capital. A Theoretical and Empirical Analysis, with Special Reference to Education*. New York: National Bureau of Economic Research, 1964.
- Blaug, Mark. "The Empirical Status of Human Capital Theory: A Slightly Jaundiced Survey." *Journal of Economic Literature* 14 (September 1976): 827–855.
- Mincer, Jacob. *Schooling, Experience, and Earnings*. New York: Columbia University Press, 1974.
- Organisation for Economic Co-Operation and Development. *Human Capital Investment: An International Comparison*. Paris: OECD, 1998.
- Psacharopoulos, George. "Returns to Investment in Education: A Global Update." *World Development* 22, no. 9 (1994): 1325–1343.
- Smith, Adam. *An Inquiry into the Nature and Causes of the Wealth of Nations*. Dublin: Whitestone, 1776.

Philip L. Martin

HUMAN RIGHTS.

This entry includes two subentries:

Overview

Women's Rights

OVERVIEW

The idea of human rights posits that human beings, regardless of extrinsic differences in circumstance (nationality, class, religion) or physical condition (race, gender, age), possess a basic and absolute dignity that must be respected by governments and other people. Sometimes these rights claims have been grounded in systems of positive law, sometimes in conceptions of human nature or divine creation. Most scholars who study moral and political ideas on a global basis agree that the concept of human rights is Western in origin, although it has spread throughout the world in recent times. The United Nations Universal Declaration of Human Rights of 1948 and other proclamations that have followed from it establish that such rights pertain across the globe regardless of cultural, religious, social, or political differences. In this sense, the very idea of human rights stands logically opposed to moral relativism of any sort. Depending on one's perspective, this hallmark of rights is either a shortcoming or an advantage.

Stoicism and Roman Jurisprudence

The assertion of the modernity of human rights theory must be qualified by the recognition that many of its characteristic elements were present in and elaborated by earlier theorists. For instance, scholars have found in Aristotle (384–322 B.C.E.) the logical rudiments of a rights theory, albeit imperfectly

articulated and applied. More directly influential were the teachings of the Hellenistic Stoic philosophers. Starting with the founder of the school, Zeno of Citium (c. 335–c. 263 B.C.E.), the Stoics held that human beings were subject to a basic law of nature, the dictates of which were accessible to all equally by application of their reason. Of course, most human beings submitted to their passions rather than to reason, meaning that the vast majority were unhappy as well as vicious. The Roman author Cicero (106–43 B.C.E.), while not the Stoic sage that he was once thought to be, extended the doctrine of natural law to cover a basic guarantee of justice for all human beings equally and without differentiation. In his *De officiis* (44 B.C.E.; On duties), Cicero articulated the principle that people have a duty to secure justice for all members of the human race, regardless of their nationality or ethnicity.

The thinking of Cicero and others influenced by the Stoics led to what might be considered the earliest coherent expression of the language of human rights. The language of *ius* (“right”) emerged quite soon after the foundation of the Roman Republic, mainly to denote a form of divine judgment. In later Roman times, *ius* constituted the basis of valid or obligatory Roman law, such that persons were fundamentally bearers of rights derived from and fixed by law. At the same time, Roman law drew a clear and enduring distinction between *ius naturale* and *ius civile*: the latter pertained to specific legal and social systems and might be variable, whereas the former comprised general rules or principles of equity with which all legal codes—regardless of time or place—were expected to comply. Thus, *ius naturale* captures one fundamental element of human rights: the universality of such rights that cannot be overridden by appeal to particular contexts or cultural conditions.

Christianity and Medieval Contributions

Roman legal concepts and terminology carried over into the Christian era in Europe, albeit with important changes and additions. Medieval canon (church) lawyers and Scholastic philosophers insisted that God endowed human beings with basic rights regarding themselves and those goods they required to preserve their divinely created lives. Some recent scholars, most notably Brian Tierney (1997), have identified in the work of twelfth- and thirteenth-century canonists a consistent distinction between “subjective” and “objective” rights. The former resemble modern “natural rights” to life, liberty, and estate, while the latter are moral duties imposed by God regarding fellow human beings. The canonistic texts generally do not support the presence of a rigid and thoroughly examined separation between “subjective” and “objective” components of *iura* (rights), and no canonist developed a complete theoretical argument on the basis of the distinction. Yet, there is certainly evidence that church lawyers sometimes sought to develop a principle of human rights compatible with human freedom, a connection also central to an encompassing human rights theory.

Many attempts have been made to identify the “first” theorist of human or natural rights in the Middle Ages. The Scholastic philosophers/theologians Jean de Paris (c. 1255–1306), William of Ockham (c. 1285–?1349), and Jean Gerson (1363–1429) have been among the candidates. Several participants in

the fourteenth-century controversy between the papacy and the members of the spiritual wing of the Franciscan order over the status of voluntary ecclesiastical poverty also moved the debate about the humanness of property ownership in the direction of a theory of rights. Yet, in each instance, some of the elements central to a fully “subjective” or individualistic doctrine of human rights associated with modern thought are absent.

It is perhaps best to examine the development of the theory of human rights as an incremental process. Various thinkers contributed important dimensions to its history without necessarily enunciating the idea in its final form or perhaps even appreciating the wider significance of their particular contributions. One such source may be found in the work of a group of theologians of a Thomist orientation working at the University of Paris in the later fifteenth and early sixteenth centuries, most prominently Konrad Summenhart (c. 1455–1502), John Mair (1469–1550), and Jacques Almain (c. 1480–1515). In a number of writings, these authors equated *ius* with *dominium* (lordship or ownership), which was understood to reside in people naturally and to license in them the power or faculty of acquiring those objects necessary for self-preservation. Their argument was as much theological as legal or philosophical: just as God enjoyed ultimate ownership of the earth and the rest of his creations by virtue of his will, so human beings, in whom God’s image resided, could claim dominion over themselves and their property.

Modern Natural Rights

Arguably, the idea of human rights culminated in the natural rights theories that characterize modern legal and political thought. The idea of natural rights may be contrasted with earlier teachings about natural law that were grounded in more robust principles of reason and natural or divine teleology. Many important thinkers of early modern Europe subscribed to a version of natural law without endorsing a doctrine of human rights. Central to the concept of natural rights is the view that each and every human being enjoys a complete and exclusive dominion over his or her mental and bodily faculties and the fruits thereof in the form of personal property. Thus, a human rights theory entails a conception of private ownership grounded in the subjective status of the individual human being. The rights arising from such human subjectivity are both inalienable and imprescriptible, in the sense that any attempt to renounce or extinguish them would constitute the cessation of one’s personhood. Thus, for example, human rights theory renders incoherent arguments for slavery based on alleged human inequalities of intellect or physique.

Consequently, an important feature of the fully developed idea of natural rights is its direct and immediate political bearing. Given that natural rights may not be curtailed or eliminated without the denial to a person of his or her very humanity, any government that attempts to suppress them has no claim to the obedience of its citizens. Natural rights always take precedence over artificial communal or public rights that might be imposed by political institutions. In this way, the doctrine of natural rights circumscribes political power and may even generate a defense of resistance to or revolt against systems of government that violate the rights of persons.

One of the epochal moments that posed a challenge to the doctrine of human rights was the European encounter with the Americas. While the Roman Church had long experience with questions arising from the legal status of “infidels,” the discovery of entire civilizations that had experience neither of European culture nor of Christian religion—in conjunction with the fact that they were rich in natural and mineral resources—created a severe intellectual crisis, especially in the Iberian world. Some thinkers were willing, on slender evidence, to equate the inhabitants of the Indies with Aristotelian “barbarians” or “slaves by nature.” But Bartolomé de Las Casas (1474–1566), a member of the Spanish conquering class in the New World who experienced a profound change of heart, produced a voluminous body of writings that argued in favor of the “rights” of indigenous peoples. Las Casas drew on canonistic and civil legal literature, as well as scholastic and humanistic political discourse, to develop a polemical case that the inhabitants of Central and South America enjoyed an unfettered right (individually and collectively) to live unmolested by Europeans and to resist with force those who would kill or enslave them. Las Casas’s clear invocation of human rights suggests that a watershed had been reached.

The Reformation and Its Aftermath

At nearly the same time that Las Casas was grappling with Spanish imperialism, the idea of human rights also received refinement and application in the context of the religious Reformation. On the Protestant side, rights theory became a major element of late-sixteenth-century Huguenot efforts to ground their justification of resistance to governments that imposed doctrinal conformity on religious dissenters. While the earliest generations of Reformers had looked toward duty to God in order to justify acts of political disobedience, a noticeable change in language and concepts occurred in the wake of the St. Bartholomew Day’s Massacre of 1572. In this vein, Théodore de Bèze (1519–1605) and Philippe de Mornay (1549–1623), as well as a large body of anonymous texts, argued for a condition of human liberty—a privilege of nature whose rightful withdrawal is impossible—that precedes the creation of political society. Therefore, any subsequent government must result from, and must be consonant with, the basic natural state of humanity. Those who would use political power to deny to human beings the exercise of their liberty—including the freedom of conscience to dissent from the established Roman Church—may properly and licitly be challenged with forms of resistance to their tyranny. The Huguenots stopped short, however, of advocating popular rebellion. Instead, they looked to “intermediary magistrates” as the appropriate instigators of resistance to tyrannical conduct. Hence, for sixteenth-century Reformers, the idea of human rights became a stimulus for a religio-political movement that directly opposed forms of religious intolerance and suppression of dissent.

The Counter-Reformation produced its own version of human rights theory that developed out of the language and concepts pioneered by the Parisian theologians Mair and Almain. This is especially evident in the work of the “Second Scholastic” thinkers associated with the School of Salamanca, such as

Francisco Vitoria (1486?–1546), Domingo de Soto (1494–1560), and Francisco Suárez (1548–1617). Vitoria had been trained in Paris and returned to Spain to spread the ideas to which he had been exposed there. Although Vitoria himself wrote nothing, leaving only lecture summaries, his students and their intellectual progeny produced some of the fullest and most enthusiastic elaborations of human rights (Las Casas, for example, was influenced by him). In particular, Vitoria and de Soto explored the complexities of rights theories, moving away from the traditional Thomistic conception of rights as objective duties required by reason. Vitoria’s work seems to have contained two differing conceptions of subjective human rights—one connected with individual *dominium*, the other defined in relation to communal law. Each position involved notable limitations and flaws, which led de Soto to attempt to resolve them into a coherent formulation of rights that incorporated both public and private dimensions. Suárez added further to the theory by identifying *ius* with self-preservation and drawing from this some, albeit limited, political implications. He held that a human right existed to resist extreme forms of tyranny, construed as those circumstances in which the survival of the community as a whole was endangered. Otherwise, the misbehavior of government was to be tolerated, lest communal destruction result from acts of disobedience and resistance.

While the School of Salamanca remained steeped in the neo-Aristotelian doctrines of the later Middle Ages, other thinkers attempted to replace this framework with a paradigm for human rights rooted purely in legal principles. Especially celebrated in this regard were Hugo Grotius (1583–1645) and John Selden (1584–1654). Grotius proposed that rights should be grounded solely on the universality of the propriety of human self-preservation, thereby placing self-interest at the center of a human system. He reasoned that human beings enjoy *dominium* over those goods that are immediately necessary in order to preserve themselves: rightful private ownership is directly licensed as a human right. Moreover, he attacked the Aristotelian doctrine of the naturalism of political society. Instead, for Grotius social order must be voluntary, and the only reason that people would join civil society would be for self-protection. As a consequence, the individual does not surrender human rights by entering into a communal arrangement and, indeed, may resist a direct attack on those rights by a magistrate. While Selden enunciated a sustained critique of Grotius, he ultimately embraced an account of human rights derived from his adversary. Selden devalued reason in sense of a moral force with the power to bind and compel the actions of individuals. Rather, he stressed that human rights are directly correlated to natural liberty, such that the only basis for individual obligation is free assent to contracts and compacts, which, once agreed to, must be maintained without exception. For Selden, in contrast to Grotius, natural liberty itself could be renounced by a valid act of human will.

The Classic Theories: Hobbes and Locke

Selden’s best-known adherent was Thomas Hobbes (1588–1679), who developed the insights of the former into a powerful individualist theory of human rights. In his major works, culminating in *Leviathan* (1651), Hobbes ascribed to all human

beings natural liberty as well as equality, on the basis of which they are licensed to undertake whatever actions might be necessary to preserve themselves from their fellow creatures. Such self-preservation constituted the indispensable core of human rights. Adopting an extreme position against the Aristotelian teaching of political naturalism, Hobbes maintained that the exercise of one's natural liberty leads directly to unceasing conflict and unremitting fear, inasmuch as nature confers on each individual the right to possess everything and imposes no limitation on one's freedom to enjoy this right. Unalloyed nature yields a state of chaos and warfare and, as a result, a "nasty, brutish, and short" life, the avoidance of which leads human beings to authorize a single sovereign ruler in order to maintain peace. The exchange of natural freedom for government-imposed order, constructed through a social compact, requires renunciation of all claims on rights that humans possess by nature (except, of course, for the right of self-preservation itself) and voluntary submission to any dictate imposed by the sovereign. In this way, Hobbes seconds Selden's defense of absolute government, yet upholds the basic right to self-preservation. Moreover, under the terms of Hobbes's absolute sovereignty, subjects are still deemed to retain the right to choose for themselves concerning any and all matters about which the ruler has not explicitly legislated.

John Locke (1632–1704) crystallized the preceding conceptions of human rights into the quintessential statement of the modern idea. He began his major work on political theory, the *Two Treatises of Government* (written c. 1680; published 1689), by postulating the divinely granted human rights of individuals, understood in terms of the absolute right to preserve one's life and to lay claim to the goods one requires for survival. Arguing against the patriarchal doctrine of Sir Robert Filmer (1588–1653), Locke insists that no natural basis—neither paternity nor descent—justifies the submission of one person to another. Rather, all people are deemed sufficiently rational, as well as free and equal, in their natural condition that they can govern themselves according to a basic cognizance of moral (natural) law, and, thus, will generally respect the rights of others. In contrast to Hobbes, Locke maintains that the condition of perfect natural liberty does not represent a state of war. In the state of nature, human beings can enjoy unimpeded rights to acquire private property, the ownership of which is asserted on the basis of the admixture of their labor (the natural talents and industry of their bodies) with the physical world. Indeed, Locke's state of nature resembles nothing so much as a fully functioning commercial society, which has introduced a system of exchange relations and money, all perfectly consonant with the recognition of the human rights of individuals.

On Locke's account, then, there is no pressing necessity for people living in the state of nature to eschew this condition for formalized communal life. Hence, should they choose to enter into bonds of civil society by means of a contract, the sole reason that they do so is to avoid the "inconveniences" and inefficiency of the pre-civil world. This does not require parties to the contract to surrender any of their human rights. Indeed, the only government worthy of authorization is that which strictly upholds and protects the rights that persons possess by

nature. According to Locke, any magistrate that systematically denies to his subjects the exercise of their natural rights to their life, liberty, and estate is tyrannical and unworthy of obedience. Locke closes the *Second Treatise* with a discussion of the dissolution of government. In his view, a regime that systematically violates human rights places itself in a state of war with the members of civil society, who severally and individually may renounce allegiance to it and may vote to establish a new government. Some have viewed Locke as justifying revolution on the basis of human rights, but his actual point seems to be less extreme: the retention of one's human rights in civil society affords one the ability to protect oneself from those (whether housebreakers or magistrates) who would try to take one's property or limit one's proper sphere of liberty. Locke's resistance theory represents a chastened, but nonetheless genuine, defense of human rights.

Reception of the Classic Theories

Locke's theory, then, stated an integrated position that drew on many of the earlier strands of human rights thought. In turn, the eighteenth century would see the extension, refinement, and, in some respects, radicalization of the fundamentals of the Lockean doctrine. Locke's language was adopted, for instance, by both theorists and polemicists who sought to halt Europe's complicity in the global slave trade. Likewise, defenders of the equal rights of women to political and social power, such as Mary Wollstonecraft (1759–1797), framed their ideas in the language of rights. Critics of natural nobility and other claims to inborn human inequality invoked the universality of rights as the basis of their assertion of the equal worth and dignity of all people, regardless of birth, class, or occupation. Among the most famous of these was Thomas Paine (1737–1809), whose treatise on *The Rights of Man* (1789) was read and admired on both sides of the Atlantic. Of course, Lockean natural rights theory received its share of criticism during the eighteenth century as well, whether from communalist democrats such as Jean-Jacques Rousseau (1712–1778) or from more individualistic proponents of political economy such as Adam Smith (1723–1790).

Yet, in general, the 1700s may well be regarded as the "century of human rights." The American Declaration of Independence (1776), written by Thomas Jefferson (1743–1826), reaffirmed the "self-evidential" character of human rights. The elaboration of the Lockean stance during the eighteenth century perhaps enjoyed its European apotheosis in the post-Revolutionary French Declaration of the Rights of Man and the Citizen (1789). The declaration, which forms perhaps the major source for all later declarations of human rights, proclaims that the aim of civil life was "the preservation of the natural and imprescriptible rights of man"—they nearly included woman, too—including political, economic, social, religious, and cultural rights as well as resistance to tyranny.

Critique and Disuse

The spread of rights language in political discourse was countered at the dawn of the nineteenth century by criticisms of the intellectual foundations of rights theory. Most famously, the major exponent of the utilitarian school, Jeremy Bentham

(1748–1832), denounced the doctrine of natural rights as “simply nonsense,” adding that the conjunction of natural *and* inalienable rights was “nonsense upon stilts.” Bentham’s objection was at once political and philosophical. Having witnessed the violent consequences of appeals to absolute rights during the French Revolution and its aftermath, Bentham was appalled by the abuse of rights talk in order to justify coercive restrictions and individual “leveling.” While sympathetic to democratic reforms, and no friend of conservative values, Bentham believed that legality constituted the only viable means of securing human liberty. Moreover, Bentham found the metaphysics (whether religious or naturalistic) that supported eighteenth-century conceptions of human rights to be hopelessly outdated and even intellectually dangerous, inasmuch as such doctrines could be as easily invoked to inhibit individual calculations of utility as to realize them.

From a very different perspective, social conservatives also strongly condemned the idea of rights. Most famously, Edmund Burke’s (1729–1797) *Reflections on the Revolution in France* (1790) pointed out the political terror implicit in the invocation of metaphysically abstract human rights as the foundation of social and political order. Such rights could readily be employed to ruthlessly suppress existing institutions (the church, class status, governmental units) that constituted the sources of human identity and solidarity, which Burke took to be the real or concrete basis of human rights. As bearers of abstract rights, but without a context in which to exercise them, Burke expected that the masses would turn to an authoritarian figure who would direct them. In the rise of Napoleon Bonaparte (1769–1821), his expectations were accurately realized.

On the political left, suspicion of human rights was also rife among socialists, communists, and anarchists. Pierre-Joseph Proudhon (1809–1865) regarded rights to be the theory, and private ownership the practice, of theft. For Karl Marx (1818–1883) and many of his followers, “rights” were necessarily “bourgeois rights,” that is, an ideological superstructure that bolstered and justified the appropriation of the surplus labor of the proletariat by the economically dominant capitalist class. In Marx’s view, the rights posited in capitalist society—economic rights to property ownership and to sell one’s labor as well as minimal political rights—are partial and cannot be historically distinguished from the interests of capital. By starting with an abstract and unhistorical concept, appeals to human rights thus necessarily covered over and legitimized the base structures of human domination.

Twentieth-Century Developments

Despite the critiques of philosophers and activists, the idea of human rights remains one of the most compelling, salient, and popular political doctrines of recent times. Impetus was given to this by the 1948 U.N. Universal Declaration of Human Rights and the many other attendant international and multinational agreements that have reinforced the notion that human beings as morally dignified persons are bearers of rights. The declaration offered a more robust version of what constitutes basic human rights than did most previous statements and theories. In addition to personal, political, legal, and economic rights, the framers of the declaration included a full set

of social rights that they regarded as essential to a minimum level of human flourishing. These included social welfare, public education, workplace protections, and an assured living standard—in sum, the way of life to which European social democracies aspire. It is an open question whether such human rights are really more a matter of social justice than fundamental moral dignity.

Stripped of theological and metaphysical connotations, rights in the post–World War II era again became intellectually respectable among certain legal and political theorists. Some thinkers interpreted rights in a positivistic fashion, namely, a “right” properly connotes a power that an individual might reasonably expect to have vindicated by the judicial system in a particular political system. Thus, it is meaningless to assert one’s “right to free speech” in an authoritarian regime or to claim a “right to same-sex marriage” in a society that has constitutionally prohibited such unions. Hence, in the positivist interpretation, the appeal to human rights cannot be deployed as the grounds for social criticism or civil disobedience.

Likewise, the analytical school of philosophy that has predominated in the English-speaking world from the middle of the twentieth century has shown an interest primarily in examining the various contexts in which rights language is asserted. Perhaps the best-known figures on this score are H. L. A. Hart (1907–1992) and A. I. Melden (1910–1991), for whom the assertion of a right is the ground of a claim, in others, an appeal to a fundamental or irreducible principle. That such grounds are not always recognized, or that they are on occasion overridden, does nothing to contradict the linguistic observation that when a person appeals to a right he or she is affirming a precept that is deemed antecedent to, rather than created or authorized by, law. Analytical theory, of course, takes this to be a point about the use of human language or logic, not about an idea that must be rooted in metaphysical truths.

One finds an analogous, if more extreme, attitude toward rights arising from postmetaphysical schools of philosophy such as poststructuralism, multiculturalism, and neopragmatism. In the view of adherents to these antifoundationalist approaches, the very attempt to impose a universal category such as “human rights” takes on authoritarian overtones. From the inherent rights perspective, Muslim women who wear traditional headdress and garb must be oppressed by their religious and patriarchal society and are in need of liberation to dress however they wish. Such a claim, for postmetaphysical theorists, reveals the inherent secular, individualistic and, ultimately, paternalistic biases of human rights doctrines.

The denial of an extraconventional grounding to rights has, however, been challenged since the late twentieth century by neonatural law theorists such as John Finnis, Germaine Grisez, and Robert George. For these thinkers, appeal to rights without some theological or metaphysical foundations is incoherent. Robert Nozick’s (1938–2002) influential *Anarchy, State, and Utopia* (1974) sought to reclaim for libertarian political thought the Lockean version of natural rights theory, albeit in a modified form that circumvented the metaphysical issues implicit in Locke. The politician Tom Campbell and others

attempt to capture rights language for the political in order to support progressive causes in the realms of workers' organization, indigenous peoples, and the environment. While some liberal feminists also invoke rights language, there remains skepticism about the gendered history of the promulgation of human rights that makes it difficult for many academic feminists to include rights in their intellectual arsenal.

In comparison with lingering ambivalence among contemporary thinkers concerning the assertion of human rights, popular social and legal discourse in the Western world is permeated with declarations of personal and group rights. In a famous attack on the current prevalence of rights talk, Mary Ann Glendon (b. 1938) points out the corrosive effects of constant appeals to rights. Citizens who constantly seek "their" own rights tend to think of their fellows as obstacles to fulfillment rather than partners or persons with whom they share important qualities. In this quasi-Hobbesian world in which everyone primarily seeks his or her own rights, all are ultimately frustrated in their ability to attain what they believe is rightfully "theirs."

See also **Abolitionism; Authority; Citizenship; Class; Communism; Conservatism; Constitutionalism; Democracy; Enlightenment; Equality; Feminism; Hierarchy and Order; Human Capital; Justice; Law; Liberalism; Liberty; Person, Idea of the; Power; Property; Protest, Political; Resistance; Responsibility; Revolution; Social Contract; Society; Sovereignty; Totalitarianism; Utilitarianism.**

BIBLIOGRAPHY

PRIMARY SOURCES

- Burke, Edmund. *Reflections on the Revolution in France*. Edited by J. G. A. Pocock. Indianapolis: Hackett, 1987.
- The Cambridge Translations of Medieval Philosophical Texts*. Vol. 2: *Ethics and Political Philosophy*, edited by Arthur S. McGrade, John Kilcullen, and Matthew Kempshall. Cambridge, U.K.: Cambridge University Press, 2001.
- Cicero, Marcus Tullius. *On Duties*. Edited by M. T. Griffin and E. M. Atkins. Cambridge, U.K.: Cambridge University Press, 1991.
- Hobbes, Thomas. *Leviathan*. Edited by Edwin Curley. Indianapolis: Hackett, 1994.
- Las Casas, Bartolomé de. *In Defense of the Indians*. Translated by Stafford Poole. DeKalb: Northern Illinois University Press, 1974.
- Locke, John. *Two Treatises of Government*. Edited by Peter Laslett. Cambridge, U.K.: Cambridge University Press, 1988.
- Paine, Thomas. *Rights of Man*. Edited by Henry Collins. Harmondsworth, U.K.: Penguin, 1969.
- Vitoria, Francesco de. *Political Writings*. Edited by Anthony Pagden and Jeremy Lawrance. Cambridge, U.K.: Cambridge University Press, 1991.

SECONDARY SOURCES

- Brett, Annabel S. *Liberty, Right, and Nature: Individual Rights in Later Scholastic Thought*. Cambridge, U.K.: Cambridge University Press, 1997.
- Finnis, John. *Natural Law and Natural Rights*. Oxford: Clarendon, 1980.

- Glendon, Mary Ann. *Rights Talk: The Impoverishment of Political Discourse*. New York: Free Press, 1991.
- Haakonssen, Knud. *Natural Law and Moral Philosophy: From Grotius to the Scottish Enlightenment*. Cambridge, U.K.: Cambridge University Press, 1996.
- Melden, A. I., ed. *Human Rights*. Belmont, Calif.: Wadsworth, 1970.
- Miller, Fred D., Jr. *Nature, Justice, and Rights in Aristotle's Politics*. Oxford: Clarendon, 1995.
- Nozick, Robert. *Anarchy, State, and Utopia*. New York: Basic Books, 1974.
- Tierney, Brian. *The Idea of Natural Rights: Studies on Natural Rights, Natural Law, and Church Law, 1150–1625*. Atlanta, Ga.: Scholars Press, 1997.
- Tuck, Richard. *Natural Rights Theories: Their Origin and Development*. Cambridge, U.K.: Cambridge University Press, 1981.
- Waldron, Jeremy, ed. *Theories of Rights*. Oxford: Oxford University Press, 1984.

Cary J. Nederman

WOMEN'S RIGHTS

The Universal Declaration of Human Rights, adopted by the General Assembly of the United Nations (U.N.) on 10 December 1948, provided the most detailed outline of the human rights and fundamental freedoms of individuals in the modern era. Furthermore, it was a milestone in that these rights and freedoms applied to every person around the world. The language of the document was, however, gender neutral, meaning that it did not specify the unique rights of women. Throughout the modern human rights era, the debate continues as to whether or not this document and others like it truly encapsulate the needs and views of non-Westerners. Efforts to address the human rights of women have likewise been plagued by such disagreements. Nonetheless, by the turn of the twenty-first century much progress had been achieved, while more work remained to be done to advance the rights of women around the world.

U.N. Decade for Women and World Conferences on Women

The Commission on the Status of Women (CSW), established in 1946 by the U.N. Economic and Social Council to promote the rights of women in political, economic, civil, social, and educational fields, successfully lobbied the U.N. General Assembly to designate 1975 the International Women's Year. The highlight of the year was the first World Conference on Women, held in Mexico City, which recommended a U.N. Decade for Women (1976–1985). The decade sought to address the needs of women in what were then known as the first, second, and third worlds with a tripartite theme of equality, peace, and development by making recommendations for action at local, national, and international levels.

Midway through the Decade for Women, in 1980, the World Conference of the U.N. Decade for Women was held in Copenhagen. A world conference was held in Nairobi in 1985 to review the achievements of the Decade for Women and to create a ten-year action plan for the advancement of women. The resulting document, *Forward-Looking Strategies*

Landmark events for the advancement of women within the United Nations system

Year	Landmark Events for the Advancement of Women within the UN
1946	Establishment of the Commission on the Status of Women and the Branch for the Advancement of Women
1948	Adoption of the Universal Declaration of Human Rights
1953	Adoption of the Convention on the Political Rights of Women
1957	Adoption of the Convention on the Nationality of Married Women
1962	Adoption of the Convention on Consent to Marriage, Minimum Age for Marriage and Registration of Marriages
1967	Approval of the Declaration on the Elimination of All Forms of Discrimination against Women
1975	International Women's Year, International Women's Day (8 March), World Conference of the International Women's Year (Mexico City)
1976–85	United Nations Decade for Women
1979	Adoption of the Convention on the Elimination of All Forms of Discrimination against Women
1980	World Conference of the United Nations Decade for Women (Copenhagen)
1985	World Conference to Review and Appraise the Achievements of the United Nations Decade for Women (Nairobi)
1995	Fourth World Conference on Women (Beijing)
2000	Beijing +5 (New York)

SOURCE: Courtesy of the author

for the *Advancement of Women to the Year 2000*, served as a benchmark to measure improvements in women's conditions. Despite having begun with divergent goals, the U.N. Decade for Women succeeded in finding common ground between activists in the North and the South hemispheres and further legitimized activities to promote women's rights within the U.N. system and beyond. Aimed at accelerating implementation of the Nairobi agreement, the Platform for Action, approved at the Fourth World Conference on Women, held in Beijing in 1995, called for strategic action in twelve critical areas of concern, including women and poverty, education and training, women's health, and violence against women. Given the focus on human rights, population, and social development at world conferences in Vienna (1993), Cairo (1994), and Copenhagen (1995), respectively, increased attention was given to the issue of equality at Beijing. Implementation of the agreements made at Nairobi and Beijing and initiatives for the future were assessed at a special session of the General Assembly, commonly referred to as Beijing +5, held in New York in 2000.

Women in the U.N. System

Women's issues are addressed by many agencies and bodies of the United Nations, several of which focus exclusively on the rights of women. Among them are the Division for the Advancement of Women (DAW) and the U.N. Development Fund for Women (UNIFEM). Other U.N. agencies have developed their own gender divisions such as the Bureau for Gender Equality of the International Labour Organization (ILO). These divisions strive to achieve the United Nations' goal of gender mainstreaming—a strategy to make gender perspectives and gender equality central to all activities of the United Nations including policy development, research, and program implementation. Despite the extensive institutionalization of gender mainstreaming throughout the United Nations, some have argued for the continued need for women-specific activities and enhanced efforts to draw more men into these processes.

Nongovernmental Organizations

Nongovernmental organizations (NGOs) having consultative status with the United Nations have regularly influenced in-

ternational policies concerning women. With the growth in numbers and diversity of NGOs since the 1970s, a new breed of women's NGOs and networks has emerged. At each of the major world conferences on women, representatives from these NGOs participated in parallel NGO forums. Their involvement in the preparatory processes of other international conferences has ensured the inclusion of women's issues on international agendas, particularly those impacting women in developing countries and those incorporating a multiplicity of feminist perspectives.

International Treaties and Women's Rights

While a few other international treaties have addressed the rights of women, the Convention on the Elimination of All Forms of Discrimination against Women (CEDAW) surpasses these other treaties in terms of its scope and in its monitoring capabilities. This "international bill of rights for women" was officially adopted by the U.N. General Assembly in December 1979 and entered into force two years later. By ratifying CEDAW, states pledge to end discrimination against women in all forms and must submit regular reports on the status of implementation of the convention to the U.N. Committee on the Elimination of Discrimination against Women. It is one of the most widely accepted international human rights treaties in existence, although a number of countries have submitted reservations to key articles of the agreement on cultural and religious grounds. For example, several Muslim countries have submitted reservations against articles deemed to run counter to Islamic law.

Major Issues in the Human Rights of Women

The scope of issues falling under the heading of the human rights of women has expanded greatly since the 1970s, with poverty and violence being two major areas that have been addressed.

Women and poverty. According to the United Nations, of the world's 1.3 billion poor people, it is estimated that 70 percent are women. To blame is a complex web of factors including external debt, structural adjustment policies, and globalization. Ester Boserup's pivotal 1970 book *Woman's Role in Economic Development* first brought to light women's role in the process

of development. Since then, the field has experienced a range of policy approaches (welfare, equity, antipoverty, efficiency, and empowerment), which reflect the changing debates on the topic and expanded participation of women from the Southern Hemisphere. Development has been a key issue in several international conferences and declarations and has been incorporated into the intersectoral work of several U.N. agencies.

In the late twentieth century, the topic evolved into discussions of gender and macroeconomics and women and poverty. Multiple actors, including governments, multilateral financial and development institutions, and national and international nongovernmental organizations and women's groups, have been urged to provide women economic opportunities, autonomy and resources, access to education and support services, and equal participation in decision-making processes. Despite several decades' worth of efforts to improve the lot of poor women, in the early years of the twenty-first century the gap between the world's rich and poor continued to expand unceasingly.

Violence against women. Women and girls are often victims of violence because of their sex. Thanks in large part to the efforts of transnational networks, the topic of violence against women finally gained U.N. attention in the mid-1980s. It has since garnered enormous notice in a wide range of areas of concern including domestic violence, sexual assault and abuse, sexual harassment and trafficking in women, as well as prenatal sex selection in favor of male babies, female infanticide, female genital mutilation, forced prostitution, dowry-related violence, battering, and marital rape. In the late twentieth and early twenty-first centuries, there has been a surge in violence against women in situations of armed conflict, in particular murder, systematic rape, sexual slavery, and forced pregnancy.

The Declaration on the Elimination of Violence against Women, adopted by the U.N. General Assembly in 1993, and the Beijing Platform for Action are the most comprehensive international policy statements to address gender-based violence. The U.N. General Assembly established at UNIFEM the Trust Fund in Support of Actions to Eliminate Violence against Women with the aim of identifying and supporting inventive projects to prevent and eliminate gender-based violence. Among other suggestions, governments and other national bodies are urged to enact and enforce legislation against the perpetrators of practices and acts of violence against women, to promote the modification of social and cultural patterns that condone violence, and to ameliorate institutional mechanisms for the reporting of violence. With increased attention to the issue, violence against women is bound to appear to get worse before it improves due to an increase in the reporting of violence and an ever expanding number of acts subsumed in the definition of violence.

Women have long strived to expand modern notions of human rights to move beyond Western, liberal conceptions based on the rights of *man* meaning males. Those from the South in particular have struggled to ensure that the human rights of women take into consideration their unique needs and concerns. With the help of national governments and national and international organizations, including human rights and women's rights networks, the U.N. system has become instrumental in identi-

fying and addressing the human rights of women as being unique from those of men. Though progress has been achieved, much work remains for the full realization of equality between the sexes.

See also Equality; Gender Equality; Feminism; Gender.

BIBLIOGRAPHY

- Agosin, Marjorie. *Women, Gender, and Human Rights: A Global Perspective*. New Brunswick, N.J.: Rutgers University Press, 2001.
- Askin, Kelly D., and Dorean M. Koenig, eds. *Women and International Human Rights Law*. Ardsley, N.Y.: Transnational, 1999.
- Benedek, Wolfgang, Esther M. Kisaakye, and Gerd Oberleitner, eds. *The Human Rights of Women: International Instruments and African Experiences*. London and New York: Zed Books, 2002.
- Chen, Martha Alter. "Engendering World Conferences: The International Women's Movement and the U.N." In *NGOs, the U.N. and Global Governance*, edited by Thomas G. Weiss and Leon Gordenker. Boulder, Colo.: Lynne Rienner, 1996.
- Cook, Rebecca J., ed. *Human Rights of Women: National and International Perspectives*. Philadelphia: University of Pennsylvania Press, 1994.
- Kerr, Joanna, ed. *Ours by Right: Women's Rights as Human Rights*. London and Atlantic Highlands, N.J.: Zed Books, 1993.
- Lockwood, Carol Elizabeth, et al., eds. *The International Human Rights of Women: Instruments of Change*. Washington, D.C.: American Bar Association, 1998.
- Peters, Julie, and Andrea Wolper, eds. *Women's Rights, Human Rights: International Feminist Perspectives*. New York: Routledge, 1995.
- Pietilä Hillikka, and Jeanne Vickers. *Making Women Matter: The Role of the United Nations*. Rev. ed. London and Atlantic Highlands, N.J.: Zed Books, 1994.
- Sen, Gita. *Development, Crises, and Alternative Visions: Third World Women's Perspectives*. New York: Monthly Review Press, 1987.
- United Nations. *The United Nations and the Advancement of Women, 1945–1996*. Rev. ed. New York: Department of Public Information, United Nations, 1996.
- Walter, Lynn, ed. *Women's Rights: A Global View*. Westport, Conn.: Greenwood Press, 2001.

Christine Min Wotipka

HUMANISM.

This entry includes five subentries:

- Africa*
- Chinese Conception of*
- Europe and the Middle East*
- Renaissance*
- Secular Humanism in the United States*

AFRICA

A common misconception of African humanism is that it is a set of values brought into, instead of emerging from, communities on the African continent. This prejudice is due primarily to

the influence of modern European humanism, which is premised upon a secular naturalism as the only model of humanism. The modern European humanist tradition, which treats Christianity as the model of all religion, is critical of Christianity because it claims that Christianity discourages human beings from focusing on the value of human action on Earth beyond concerns for redemption from original sin in an afterlife. If we define humanism as a value system that places priority on the welfare, worth, and dignity of human beings, we should also consider those traditions in which human beings do not seek redemption in an afterlife because, for them, punishment or redemption exists only on Earth. Consequently, their tendency is to place great weight on human action and human subjects. The focus on earthly actions is a key feature of many African religions and, consequently, African humanism.

Indigenous Foundations

Despite the presence of many indigenous ethnic groups in Africa, there is much similarity in the cosmologies that ground their religious practices, especially those of people south of the Sahara. A major reason for this commonality is that many of them are descended from a set of communities along the ancient lakes and plains of the Sahara-Sahelian region of northern Africa that subsequently dried up, becoming desert. The cosmologies of these groups tend to have a concomitant ontology, or conception of being, and a system of values, in which greater reality and value are afforded to things of the past. Thus, the Creator, being first, has the greatest ontological weight, and whoever is brought into being closer in time to the moment of the origin of the world is afforded greater weight. This view gives one's ancestors greater ontological weight and value than their descendants. Also, one's past actions are of greater ontological weight than one's present actions. (One's future actions are of no ontological weight since they have not yet occurred.) Indigenous African systems affirm that human beings negotiate their affairs with the understanding that they cannot change the past (although they can be informed by it, especially through ancestors), are entirely responsible for the present, and must take responsibility for their future. This form of humanism does not require the rejection of religion, but may exist alongside it. As Kwame Gyekye observed in his classic study of Akan humanism among the Asante of Ghana, for example:

In Akan religious thought the Supreme Being is not conceived as a terrible being who ought to be feared because he can cast one into eternal hellfire. (The Supreme Being is believed to punish evildoers only in this world.) Again, in spite of Akan belief in immortality, their conception of the hereafter does not include hopes of a happier, more blessed life beyond the grave. Western humanism sees religion as impeding the concentration of human energies on building the good society. In Akan thought this tension between supernaturalism and humanism does not appear; for the Akan, religion is not seen as hindering the pursuit of one's interests in this world . . . Akan humanism is the consequence not only of a belief in the existence of a Supreme Being and other supernatural entities, but, more importantly I think, of

a desire to utilize the munificence and powers of such entities for the promotion of human welfare and happiness. (pp. 144–145)

Muslim Humanism in North Africa

Ibn Rushd (1126–1198), known by his Latin name Averroës, was a North African philosopher whose work came to prominence in Cordoba, Spain. He was a pioneer in African Muslim thought, and his influence includes commentaries on Aristotle that affected European scholasticism and the struggles to transform it. Rushd argued for the secularization of political life and the dominance of reason. For this position, he was widely rejected in the Muslim world, save for a small set of followers. The debate over these ideas, however, continued in the question of the role of modernity in the Muslim world. Among the many scholars who took up this issue was the Egyptian-born Imam Muhammad Abdou (1849–1905), who argued for freeing thought from convention and who presented a political theory of citizen rights for social justice, rather than blind obedience to the religious state. Zaki Naguib Mahmoud (1905–1993) defended the dominance of reason through logical positivism in science and based his form of humanism on secular naturalism. Abdel-Rahman Badawi (1917–2002), also Egyptian born, presented his atheistic existential philosophy as a more radical humanism for the Muslim world by comparing it with Sufism. In both Sufism and his philosophy, he argued, the human subject is prioritized. The writings of the Algerian novelist and historian Assia Djebar (1936–) has brought a new dimension to the question of subjectivity and the impact of physical and historical limits. In her historical work, Djebar examines the emergence of women revolutionaries under extraordinary repressive circumstances and, in her novels, how reclamation of their voices and bodies exemplify liberation for women.

“Modern” African Humanism

Beyond the indigenous models of humanism there has arisen what may be called modern African humanism, which emerged from African responses to conquest, colonization, and the various slave trades along the African coasts. These forms usually involve engagements with Christian, liberal, and republican (domination-free) values, or with values that emerged as a result of engagement with various Muslim empires in the Middle Ages, whose impact continues to be felt today. We should bear in mind that much of eastern Africa is also populated by Semitic peoples, and that their Coptic and Abyssinian (or Ethiopian) Christianity has left a legacy that is as old as its European, Roman, and Greek counterparts.

Many modern African humanists address a problem raised in early medieval African Christian philosophy in the thought of St. Augustine of Hippo (354–430): the problem of theodicy, which involves accounting for the presence of evil in a universe ruled by an omnipotent, omniscient, and benevolent god or God. It is a problem also found in the thought of the Ethiopian Christian philosopher Zara Yacob (1599–1696). St. Augustine argued that human beings are responsible for evil because such actions are a necessary possibility of freedom. He also argued that human beings have limited knowledge of God's ultimate will or God's justice—the literal meaning of

theodicy, *theo* (god) and *dikē* (justice). The modern African faced the same problem when he or she looked at such evils as the slave trade and colonialism. Wilhelm Amo (1703–1756) and Ottobah Cugoano (b. c. 1757), both from Ghana, wrote treatises calling for the abolition of the slave trade. These authors argued that human beings are responsible for their actions, and that Europeans faced the negative moral consequences of the slave trade. Although couched in a Christian context, their work included reflections on the humanity of African peoples that have become a feature of modern African humanistic thought—namely, its concern with philosophical anthropology.

Secular Humanism in Africa

In the twentieth century, a form of secular humanism emerged in Africa primarily through the efforts of the Senegalese intellectuals Cheikh Anta Diop (1923–1986) and Léopold Sédar Senghor (1906–2001). Diop advocated a strong historicist humanism that focused on the achievements of ancient Africans as the first *Homo sapiens*, arguing that they laid the groundwork for the cultural life of the species. Although secular, the familiar theme of ancestral value is echoed in his work. Senghor is best known as a co-founder, with the Martinican poet Aimé Césaire (b. 1913) of the negritude movement, which focused on the creative potential of black consciousness. Whereas Diop represented the historicist tradition of African secular humanism, Senghor is the father of the poeticizing tradition. He defended the humanity of black Africans primarily through literature, although his thought also included reflections on music. Senghor argued that African value systems were more properly humanistic than European ones because the African models affirmed that the passionate or emotional side of a person carries the same value and legitimacy as the rational, analytic side. In Ghana, the secular humanist tradition also took hold through the thought of Kwame Nkrumah (1909–1972), who in 1946 offered what he called *consciencism*, or critical material consciousness. For Nkrumah, African humanism was a call for explicitly political responses to social problems.

The most famous formulation of secular humanism to emerge on the African continent came, however, by way of the thought of Frantz Fanon (1925–1961), a Martinican expatriate in Algeria. Fanon diagnosed a sick modern world premised upon human actions, wherein the tasks faced by contemporary Africans must be to build up their material infrastructure (based on national consciousness) and thereby transform negative cultural symbols into positive ones that could set humanity aright. The secular humanist tradition continued along historicist and poeticizing lines, and with political allegiances of the Marxist (and, occasionally, liberal) variety through such writers and political leaders as Almícar Cabral and Julius Nyerere until the emergence of leaders in the struggle against apartheid in South Africa took center stage.

The two most influential formulations of secular humanism to emerge focused on the question of consciousness. The first was Stephen Bantu Biko (1946–1977), who developed a theory of black consciousness that drew upon the political dimension of racial oppression. *Black*, for Biko, designated a form of oppression that could be faced by an East Indian, an East Asian, or a colored (in Africa, a person of mixed race, for example of

indigenous and Afrikaaner parents) as well as an indigenous African. The second was Noël C. Manganyi, advisor to the vice-chancellor and principal of the University of Pretoria. Manganyi is a psychologist whose writings during the apartheid years were of an existential phenomenological variety, with many similarities to Fanon and Jean-Paul Sartre. There have, however, also been highly political Christian humanist responses in the South African context that should be considered, the most noted representative of which is the Nobel Peace Prize laureate Bishop Desmond Tutu, whose leadership in forming South Africa's Peace and Reconciliation Commission exemplifies what might be called the Christian liberal tradition.

Recent African Humanisms

The last quarter of the twentieth century was marked by the emergence of African academic intellectuals as chief spokespersons for secular African humanism. Many of these writers present their case from the disciplinary perspectives of philosophy, political theory, and political economy (especially as critics of development studies), and many of them, save, for example, Kwame Gyekye (Ghana), Manganyi (South Africa), Mbogo P. More (South Africa), and Samir Amin (Senegal), are expatriates living in North America and Europe. They include, among others, V. Y. Mudimbe (Congo/Zaire), Ato Sekyi-Otu (Ghana), Kwasi Wiredu (Ghana), K. Anthony Appiah (United Kingdom/Ghana), Nkiru Nzegwu (Nigeria), Oyeronke Oyewumi (Nigeria), D. A. Masolo (Kenya), Tsenay Serequeberhan (Eritrea), Teodros Kiros (Ethiopia), Albert Mosley (Senegal), Souleyman Bachir Diagne (Senegal), Elias Bongmba (Cameroon), and Samuel Imbo (Kenya). To this academic group can be added East Indian and white Africans such as Mahmood Mandani (Uganda), John and Jean Comaroff, David Theo Goldberg, and Neil Lazarus (all from South Africa). This stage of African secular humanism is marked by such themes as postmodern skeptical humanism, liberal cosmopolitanism, New Left Marxism, and African feminism.

The poeticist-humanist tradition has continued through many novelists and dramatists such as Wole Soyinka (Nigeria), Chinua Achebe (Nigeria), Ngugi wa Thiong'o (Kenya), Ama Ata Aidoo (Ghana), Ayi Kwei Armah (Ghana), and white authors, the best known of whom are the South African Nobel laureates Nadine Gordimer and John Coetzee. There is also the emergence of a form of musical poeticist humanism that has been part of the rise of "world music," whose artists come from all parts of Africa and represent nearly all its traditions. They serve as critical commentators on Africa's contemporary condition. Perhaps the most famous of such artists was the Nigerian Fela Anikulapo-Kuti (1938–1997).

See also Africa, Idea of; African-American Ideas; Black Consciousness; Humanity: African Thought; Negritude; Philosophies: African.

BIBLIOGRAPHY

- Comaroff, John, and Jean Comaroff. *Of Revelation and Revolution*. 2 vols. Chicago: University of Chicago Press, 1997.
- . "On Personhood: An Anthropological Perspective from Africa." *Social Identities* 7, no. 2 (2001): 267–283.

- Eze, Emmanuel Chukwudi, ed. *African Philosophy: An Anthology*. Oxford: Blackwell, 1998.
- Gyekye, Kwame. *An Essay on African Philosophical Thought: The Akan Conceptual Scheme*. Rev. ed. Philadelphia: Temple University Press, 1995.
- Hallen, Barry. *A Short History of African Philosophy*. Bloomington: Indiana University Press, 2002.
- Henry, Paget. "African and Afro-Caribbean Existential Philosophies." In *Existence in Black: An Anthology of Black Existential Philosophy*, edited by Lewis R. Gordon, 11–36. New York: Routledge, 1997.
- . *Caliban's Reason: Introducing Afro-Caribbean Philosophy*. New York: Routledge, 2000.
- Kopytoff, Igor, ed. *The African Frontier: The Reproduction of Traditional African Societies*. Bloomington: Indiana University Press, 1987.
- Masolo, D. A. *African Philosophy in Search of Identity*. Bloomington: Indiana University Press, 1994.
- Mbiti, John. *African Religions and Philosophy*. 2nd rev. and enl. ed. Oxford: Heinemann, 1990.
- Wiredu, Kwasi, ed. *A Companion to African Philosophy*. Malden, Mass.: Blackwell, 2004.

Lewis R. Gordon

CHINESE CONCEPTION OF

The dominant Chinese conception of humanism is the Confucian theory of *ren*. The term *ren* has been translated in various ways, including as "benevolence," "goodness," "virtue," "humanity," "humanness," and "being authoritative." These different translations indicate the complexity of this Confucian theory.

In introducing *ren* as the central notion of his philosophy, Confucius (551–479 B.C.E.) takes it both as a general ethical quality and as a particular one. As a particular ethical quality, the term means "to love one's fellow men" (*Analects*, 12:22). "Benevolence" is an appropriate translation for capturing this sense of love and affection. *Ren* as benevolence is distinguished from other particular virtues, such as courage and knowledge, and can be conceived independently of them. More often, however, *ren* refers to a general dispositional state that embraces particular character traits such as knowledge, courage, filial piety, loyalty, respectfulness, tolerance, trustworthiness in word, and generosity. In this sense, *ren* is a virtue in its entirety or in its inclusiveness and has also been reasonably rendered or referred to as "virtue" or "complete virtue."

Ren as the dispositional state is based on what a human being is. Both the *Doctrine of the Mean* (chap. 20) and *Mencius* (7a: 16)—two texts that have been grouped together with the *Analects* (plus the *Great Learning*) as the four core Confucian classics—include the formula "Ren zhe ren ye," literally "to be *ren* is to be a man." This means that *ren* is the quality that makes a person a true person. It is for this reason that many translators choose "humanity" or "humanness" to render this term. Such a translation is essentially correct, and it effectively points out that the Confucian theory of *ren* is a form of humanism. Nevertheless, it is important to keep in mind that, while both "humanity" and "humaneness" can refer to the in-born characteristic of a person, the notion of *ren*, although

based on the special human characteristic, is a cultivated disposition, that is, humanity or humanness in its cultivated form. The theory of *ren*, then, is the combination of humanism and virtue ethics.

Confucius calls a person who possesses the character of *ren*, *junzi* (variously translated as "the gentleman," "the profound person," or "the exemplary person"). This term literally means "the lord's son" and refers to the aristocrats or feudal princes. Confucius shifts its meaning to "the man possessing noble human qualities." By doing so, he emphasizes that the good quality of human beings is not limited to one special class but is related to the humanity that all humans share in common. Simply put, because *ren* is what makes a person a person, *junzi*, a person of *ren*, is one who has fulfilled and manifested what is genuinely human.

Underlying Beliefs

Understanding what is genuinely human in the Confucian theory of *ren* requires knowing *ren*'s underlying metaphysical and psychological beliefs. According to ancient Chinese belief, Heaven (*tian*, literally meaning "sky") has an impersonal ordering force. Heaven is said to have its *dao* (literally, "path" or "road," usually translated as "way," meaning the characteristic mode of existence or action of a thing). Everything in the world has its own *dao*, or way, as well. Each particular thing's *dao* is related to the *dao* of Heaven in the way that the *dao* of each thing is the individualization of the *dao* of Heaven in that thing. If everything follows its imparted or natural *dao*, the *dao* prevails in the whole world and the world is a harmonious and integrated organism. Following this, the human *dao* is thought to be the *dao* of Heaven as individualized in a human life. It is the *dao* in accordance with which one should lead one's life. If one can live in accordance with the human *dao*, one also embodies the *dao* of Heaven. Such a life is meaningful and authentic. In Chinese intellectual history, it was Confucius who first raised the following question: Where is the *dao* of Heaven as individualized in a human life, that is, the way (*dao*) of being a human? From Confucius on, it became the common task for classical Chinese philosophers to find and establish the *dao*. Chinese philosophical schools in the classical period offered competing accounts of what *dao* is.

Human *dao*, the individualization of the *dao* of Heaven in human beings, is called *de* (related to the verb "to get"). A person who acquires the *dao* of Heaven is a person of *de*. The term appears in the ancient oracle bone inscriptions, referring to the psychic power that an individual possesses to influence and attract other people and even the surrounding environment. In particular, *de* means the power that rulers hold that enables them to command others without appealing to physical force. Because the exertion of such power is associated with desirable attributes such as kindness and dutifulness, *de* comes to be used to refer to these attributes or qualities as well, and hence it is usually translated into English as "virtue."

The *Analects* has this *dao/de* (way/virtue) framework at its core in its discussion of what a human being is, as in the following passage: "How can a man be said either to have anything or not to have anything who fails to hold on to virtue

[*de*] with all his might or to believe in the *dao* with all his heart[?]" (19:2). Both *dao* and *de*, however, are formal concepts. When Confucius sets out to reflect systematically upon what human *dao* or *de* is, that is, the way of being a human, he must provide a substantive specification of its content.

The theory of *ren* is a specification of what Confucius thinks human *de* or human *dao* is. (This explains why both *de* and *ren* in the *Analects* can be translated as "virtue." *De* is a formal conception of virtue, whereas *ren* is Confucius's understanding of what it is in a substantial sense). Hence, Confucius's theory of *ren*, that is, his humanism, is about the *dao*, or way, of being a human, and in his pursuit of human *dao*, he appeals to *ren* (the virtuous disposition that makes a human being a true human being).

Achieving *Ren*

How, then, does one achieve *ren*? Confucius's first reply is that to achieve *ren* is "to return to *li*" (*Analects*, 12:1). *Li* refers to the traditional ritual and cultural practices, fully developed in China's early Zhou dynasty (founded in the eleventh century B.C.E.). Its core is a humane social hierarchy modeled on family relationships. "Let the ruler a ruler, the subject a subject, the father a father, the son a son" (12:11). "To return to *li*" means to be shaped or transformed by traditional values. Moreover, to be a person of *ren* also involves an emotional aspect. According to Confucius, to be *ren* means to "love your fellow men" (12:22). The love is based on one's filial love for parents and brothers and is extended to all human beings (1:2, 1:6). Furthermore, *ren* involves an intellectual aspect: "The Master said, 'In his dealings with the world the gentleman is not invariably for or against anything. He is on the side of what is appropriate [*yi*]" (4:10). This intellectual aspect enables a Confucian agent to avoid following traditional values blindly.

The cultivation of *ren* is not an isolated process. The path toward human realization goes through family, community, tradition, state, and even the whole world. To promote human realization, the Confucian school teaches, in addition to the classics that record traditional values, six arts in its curriculum: ritual, music, archery, charioteering, calligraphy, and arithmetic. To a great extent, this corresponds to the Renaissance *studia humanitatis*.

Because Confucius's ethics has a metaphysical basis—that *ren* is the manifestation of Heaven's *dao* in a human being—it presupposes that humans must have the root of *de* or *ren* in their original nature that comes from Heaven. Confucius himself holds that humans have a natural potential for becoming good: "Is *ren* really far away? No sooner do I desire it than it is here" (*Analects*, 7:30). Nevertheless, although everyone has the root of *ren*, it is through learning and practice that one can manifest and actualize it. Thus, Confucius says that "men are close to one another by nature [*xing*]. They diverge as a result of repeated practice" (17:2).

The Beliefs of Mencius

Mencius (c. 371–c. 289 B.C.E.), the most influential Confucian after Confucius, focuses on a specification of what this natural basis of *ren* is. Mencius is known for his view that *xing*

(usually translated as "nature" or "human nature") is good. He believes that in everyone's natural endowment there is an organ called *xin* (heart/mind) that carries with it four inborn seeds (*duan*) for moral behavior: the heart of compassion (also called "the unbearable mind"), the sense of shame and disgust, the sense of compliance and respect, and the sense of right and wrong. These seeds are not infused into people from outside, but were there from the beginning (*Mencius*, 6a/6). Human beings do not have to learn or work in order to get them; in fact, they have them just as they have four limbs (2a/6). When these seeds grow and become mature, they turn into four major virtues: benevolence, dutifulness, observance of propriety, and wisdom. These are not four independent virtues, but four different aspects of the general virtue of *ren*.

When Mencius says that human nature is good, he does not mean that everything that is inborn is good. He is fully aware that human nature itself is a complex, inclusive not only of elements that are good but also of elements that are either morally neutral or have little moral value. When he says that *xing* (human nature) is good, he refers only to one part of this complex, the part that is composed of the four seeds and the flourishing of which makes a noble person (*junzi*).

Mencius singles out this part from the complex of human nature because it is the part that makes a human being a human being, and because it distinguishes human beings from other animals (*Mencius*, 2a/6). Although humans have these inborn seeds, the seeds are fragile and it takes great human effort to make them grow. A person who completely casts away these seeds is not much different from the beasts (6a/8). A person who preserves and develops these seeds becomes an excellent person (4b/19). It is the four seeds that form the characteristic feature of being a human, and to be a person of *ren* is to actualize these seeds.

Because *ren* has such a natural basis that is imparted from the *dao* of Heaven, the actualization of *ren* is not just a moral ideal, but a state in which one is unified with Heaven. This state is called *cheng* ("self-completion," also translated as "sincerity" or "creativity"), in which one completely actualizes one's humanity, one's self-understanding, and Heaven, and in which one can help other people fulfill their humanity. *Cheng* is an ever-renewing and ceaseless process of self-understanding and creativity. In this way, a person becomes a counterpart of Heaven and Earth, or a participant in their creative activity, in the sense that as Heaven and Earth help things in the world grow and flourish, persons of *ren* fulfill others as well as themselves.

To sum up, Confucian humanism pursues a desirable kind of humanity and involves features such as a belief in the goodness of human nature, confidence in the power of education and self-cultivation in actualizing human goodness, an emphasis on traditional community and family values, the requirement of altruist love and affection, and a strong belief in the organismic unity of man and nature. This Confucian human ideal was further elaborated by subsequent Confucians in different dynasties, most notably by the Neo-Confucianism of the Song-Ming period (960–1644). In coping with the challenge from Buddhism, Neo-Confucianism sought to provide a more solid and detailed cosmological basis for Confucian humanism.

Contemporary Revival of Confucianism

In the second half of the twentieth century, there was a revival of Confucianism, both in East Asia and in the United States, called “New Confucianism,” or “The Third Epoch of Confucian Humanism.” The revival of Confucianism was greatly encouraged and promoted in the 1970s and 1980s by the industrial success of the states located in the circle of Confucian culture. Led by Tu Wei-ming, Confucian scholars explored the relationship between Confucian humanism and the East Asian entrepreneurial spirit and argued that Confucianism provided an alternative view of Enlightenment rationalism and modern Western liberalism. They further maintained that Confucianism, the main concern of which is the well-being of humanity, can answer many serious challenges in the contemporary world community, and that Confucian values should be universalized.

The contemporary value of Confucian humanism can also be appreciated from its similarity to the virtue ethics of the Greek philosopher Aristotle (384–322 B.C.E.). Aristotelian virtue ethics, which has seen its own revival within contemporary ethics, is attractive for two main reasons. First, it concerns the goodness of the agent’s whole life rather than focusing on moral acts, as modern Western ethics does; second, its consideration is centered on the character and virtue that a person must have in order to live happily or to flourish, rather than contending that the task of ethics is to formulate rules and principles to govern moral acts. The Confucian humanist ethics shares these two features. Its main concern is to find the human *dao*, that is, the path a person’s life should take, and this *dao* is through the cultivation of *ren*, the virtuous disposition based on humanity. Indeed, the Confucian view that *ren* is what makes a human being a true human being is similar to Aristotle’s definition of human virtue (*areté*) as the excellent performance of human function as a rational animal, although Confucians emphasize not only rationality but also emotion and human relationality. It is in elaborating the notion of *ren* that Confucianism reflects and discusses issues such as human nature and its fulfillment, the role of social custom and traditions, moral character and cultivation, emotion, habituation and education, the mode of moral reasoning, family, friendship, the role of ethics in politics, and so on. These are precisely Aristotle’s main concerns in his exposition of virtue. To a great extent, Aristotelian ethics is taken as a model by contemporary virtue ethics precisely because these important ethical concerns have been left out or at least marginalized in dominant modern moral theories. A virtue ethics approach to Confucianism can help bring out the contemporary significance of Confucian humanism.

See also *Chinese Thought; Consciousness; Chinese Thought; Virtue Ethics*.

BIBLIOGRAPHY

- Chan, Wing-tsit. “The Evolution of the Confucian Concept *Jen*.” *Philosophy East and West* 4, no. 4 (1955): 295–319.
- Confucius. *The Analects*. Translated by D. C. Lau. Hong Kong: Chinese University Press, 1979.
- Graham, A. C. *Disputers of the Tao: Philosophical Argument in Ancient China*. La Salle, Ill.: Open Court, 1989.

Mencius. *Mencius*. Translated by D. C. Lau. Hong Kong: Chinese University Press, 1984.

Tu, Wei-ming. “The Third Epoch of Confucian Humanism.” In his *Way, Learning, and Politics: Essays on the Confucian Intellectual*, 141–159. Albany: State University of New York Press, 1993.

Jiyuan Yu

EUROPE AND THE MIDDLE EAST

The introduction of the term *humanism* is commonly attributed to the German pedagogical theorist F. J. Niethammer’s 1808 book, which promoted reading of the ancient classics among secondary students as a counterweight to scientific and technological training. The word soon enjoyed wide currency in many European languages, in part because the much earlier Italian term *umanista* was already used to describe a person committed to the production or study of the artifacts of human culture. In turn, humanism contains echoes of the much earlier Latin ideal of *humanitas*, humanity or humaneness.

The application of the term *humanism* has been widely disputed. Some scholars, most notably Paul Oskar Kristeller, insist that it should be employed strictly to denote the intellectual and literary movement associated with Renaissance Italy, and especially Florence, during the fifteenth century and spreading thereafter to the rest of Europe. Others apply a less rigorous definition that permits a broader field of use, both culturally and chronologically. Joel L. Kramer has isolated three features that are germane to a capacious conception of humanism: the common kinship and unity of humankind; an emphasis on *paideia*, or the shaping of human mental and moral capacities through literary and philosophical education; and the recognition of *philanthropia*, that is, humane love or love of humanity. An even more general account of humanism permits its application to any position that ascribes intrinsic value to the activity of human beings or to their pursuit of happiness in a human way apart from extra-human considerations. All these ideas of humanism offer useful filters and standards on the basis of which to understand its history. The more capacious constructions of humanism may be best, however, because they enable scholars to find bases of comparative analysis between world cultures across time.

The Greek “Discovery” of Human Nature

The earliest philosophers of ancient Greece directed their attention almost exclusively toward the nature of the cosmos and of metaphysical being. During the course of the fifth century B.C.E., this orientation began to change. The reasons are myriad. Certainly, Greek expeditions (mainly for commercial purposes) throughout the Mediterranean region led to encounters with cultures and social systems that were organized differently than the Hellenic city-state (*polis*), and these encounters led philosophers to reflect on the ways in which human beings lived—their *nomoi*, meaning conventions or ways of life as well as laws. The rise of medical science, especially the school on the island of Cos that is associated with Hippocrates, highlighted the problems posed by a specifically human sort of nature (*physis*), separate and distinct from the sorts of substance that pertained to *psyche* (soul or mind).

The first group of thinkers to address conceptual problems of the human condition were the Sophists (from the Greek word for *wise men*), a term applied to a loose affiliation of teachers and writers who mingled in Athens during the second half of the fifth century B.C.E.. Although divided on most issues of philosophical import, and thus not strictly speaking a school of thought, the Sophists were united in directing their interest toward humanity, and in particular toward the moral, political, and epistemic questions arising from human life. Perhaps the most famous of these thinkers was Protagoras of Abdera (c. 490–c. 420 B.C.E.), whose name is associated with the principle that “man is the measure of all things.” Although his doctrines must be pieced together from fragmentary sources, Protagoras seems to have embraced a *polis*-centered form of moral and political relativism and a subjectivist epistemology that endowed human beings with the capacity to fashion their own conditions of life and forms of fulfillment. It is perhaps not surprising that Protagoras was reputedly a counselor to the famous Athenian democratic leader Pericles.

Socrates (469–399 B.C.E.) also advanced important humanist themes. While distancing himself from the Sophists, whom he regarded as charlatans, Socrates asserted that virtue was a form of knowledge, and that knowledge was teachable if the correct method (namely the question-and-answer technique of Socratic dialectic) was employed. Even those who might be considered too benighted to know anything—such as a simple adolescent slave, for example—could be shown to possess knowledge of sophisticated abstract concepts. Hence, all human beings were for Socrates capable of knowing goodness and of acting in accordance with it, since this knowledge was imprinted on each and every human soul and could be recovered by means of self-reflection.

A further manifestation of humanistic ideals came from the Hellenistic philosophical school of Stoicism, which appeared in the fourth century B.C.E.. The Stoics upheld a cosmopolitan doctrine of universal human reason and rejected particularistic attachments to place and culture in preference to a generalized care for humanity. This doctrine became popular among Roman thinkers such as Marcus Tullius Cicero (106–43 B.C.E.), who posited a general “bond” in human society, among persons who are connected through speech and reason, and from which arose the moral and material fruits of civilized human conduct. The aspirations toward *humanitas* and *philanthropia* crystallized in the Hellenistic and early Roman periods.

Tenth-Century Islamic Humanism

In the tenth century C.E., a group of philosophically inclined men with literary training who were associated with the Abbasid dynasty participated in an Islamic renaissance centered in Baghdad. Joel L. Kraemer has claimed for this group of thinkers the mantle of humanism on the grounds that they subscribed to an intellectual agenda that privileged the wisdom of the ancient Greeks, upheld the ideal of “urbanity,” and endorsed ideas such as individualism, cosmopolitanism, and secularism, which are commonly embraced by humanists.

Although this humanist movement exercised a limited influence on later Islamic philosophy, it seems to have enjoyed

a wide following among both scholars and courtly scribes. In turn, these figures were patronized by some of the most powerful political officials of the Muslim world at the time. Hence, the Islamic humanist revival ought not to be viewed as a tangential or marginal phenomenon in medieval Arabic civilization. Indeed, it helps explain the more advanced state of learning in the East than in the Christian West throughout the Middle Ages.

Twelfth-Century Renaissance Humanism

Christianity, with its orientation toward otherworldly existence and its potential for asceticism and extreme self-renunciation, may seem to be at odds with humanism, yet scholars have repeatedly held that forms of humanism flourished during the European Middle Ages in spite of countervailing tendencies within the Christian faith. In particular, the twelfth century witnessed a renewed interest in human ideals and aspirations not dissimilar to that which had occurred in the Islamic East a couple of centuries earlier.

The humanism of what is called the twelfth-century Renaissance had several facets. One, highlighted by Charles Homer Haskins, whose 1927 book drew attention to this Renaissance, is its similarity to the literary humanism that typified the fifteenth-century Renaissance. Many texts dating to Latin antiquity began to circulate for the first time in centuries, and Latin translations of both classical Greek authors and Arabic commentaries made their first appearance in Europe. Moreover, the revival of interest in classical rhetoric, and in the art of persuasive writing (particularly in the form of letters), emphasized the importance of developing an accomplished literary style and urbane expression.

More recently, Richard Southern has emphasized a second aspect of medieval humanism, which stresses its scholastic base. According to this view, the humanist elements in twelfth-century thought derived from a recognition of human dignity and of the concomitant dignity of nature, both of which were seen as intelligible and capable of being accessed by human beings through the application of reason. The truth that authors sought was, therefore, nothing less than a comprehensive knowledge of the operation of the universe in which humanity itself constituted the noblest (if still flawed, because fallen) of God’s creations. This scholastic humanism embraced an optimistic confidence that the acquisition of truth about divine creation was not only possible but constituted a demonstration of religious devotion.

A third facet of twelfth-century humanism was the valorization of human life, which stood in contrast to the despairing, antihumanist orientation of thinkers who devalued and disparaged all forms of earthly existence. This conception of humanism was more minimalist and circumscribed than either the literary or scholastic varieties, inasmuch as it placed heavy weight on the centrality of God to human life. Yet by opposing those who denigrated the worth of all earthly human achievements, this self-consciously Christian humanism upheld the view that works of virtue and intellect could be found even among those who had not accepted (or who had lived before the time of) Christianity and endorsed the idea that although ultimate

human beatitude occurred only within the confines of religious salvation, a measure of human happiness could be found in the temporal realm through the pursuit of human (and humane) goals. This definition acknowledged the existence of a human path to happiness that all human beings sought and could know. Happiness was not given to the human race but was something that had to be earned by exertion, and human beings could be fooled or mistaken about the correct sources of happiness—for example, by confusing pleasure with true satisfaction. Hence, happy human existence embraced both active and reflective dimensions: One must do the good (virtue) as well as know the good (wisdom) in order to flourish. Thus, although non-Christians were unable to achieve ultimate salvation, their earthly lives could still have merit. Moreover, in matters of happiness pertaining to the present life, humans could learn equally from the deeds and writings of infidels and from those of believers. Christian authorities would certainly guide humans toward happiness (eternal as well as temporal), but they could usefully be supplemented by studying the acts and ideas of worthy pagans, which also contributed toward instilling in humanity the virtue and wisdom that produced the measure of earthly fulfillment of which humans were capable. This account of humanism, then, can comport with both the literary and scholastic ideas of humanism already discussed.

Christian humanism continued to resonate into the Renaissance, when many of the Italian humanists and their northern successors privileged human dignity because of humanity's creation "in the image and likeness of God."

Modern Humanism

The humanists of medieval and Renaissance Europe—and indeed of Greek antiquity and Islam—were driven by spiritual, moral, and cultural ideals and values. In the eighteenth century, another form of humanism, one that adopted a more materialistic stance concerning human perfectibility, emerged. The Enlightenment stressed that the application of human reason, unimpeded by the state or by religious authority, could alone produce human progress in the sense of improved conditions of life for the whole human race. Immanuel Kant's (1724–1804) plea in his essay "What Is Enlightenment?" for the release of the human intellect from its condition of tutelage into the full flower of its maturity captured this demand for the freeing of the human mind. The French philosophes, such as Voltaire (1694–1778) and Denis Diderot (1713–1784), may have spearheaded this position, but it echoed throughout the Western hemisphere during the late eighteenth and early nineteenth centuries—in Great Britain (David Hume, Jeremy Bentham), Germany (Immanuel Kant, G. E. Lessing, Moses Mendelssohn), and North America (Benjamin Franklin, Thomas Jefferson). Whereas the Enlightenment version of humanism was more scientific than literary in its orientation, its demand for an anthropocentric perspective on human affairs, encouragement of creative enterprise, and advocacy of social and political reform marked it as a clear successor to earlier forms of humanistic thought.

The question of what impeded the realization of the humanist project became crucial for humanism in the nineteenth century. For the philosopher Ludwig Feuerbach (1804–1872),

it was religion that stood in the way of human fulfillment. Although other humanists had questioned whether religious institutions or monotheistic beliefs were compatible with humanism, Feuerbach attacked religion *per se*. Adapting the Hegelian dialectical method to a materialist metaphysics, Feuerbach asserted that the supposedly divine object of worship was itself something human, a purely mundane creation. Until human beings realized that they had abased themselves before a fictitious deity that represented nothing more than the sum of humanity's creative and intellectual potential, they would live under conditions of extreme self-alienation and immiseration.

Although he drew on many elements of Feuerbach's analysis, Karl Marx (1808–1883) found his conclusion that the elimination of religious faith would herald the beginning of human happiness far too idealistic. In his writings dating from the early 1840s, Marx claimed that mere atheism constituted "theoretical humanism." He asserted, by contrast, that communism was "practical humanism" or a truly "radical" humanism. Marx meant by this that the sources of inhumanity were not products merely of the human mind but also of the distribution of property into private hands and of an economic system that forced the vast mass of humankind to toil under conditions of extreme alienation. Communism, which he saw as social ownership of the means of production, would yield the material conditions under which all of humanity could flourish in a free and creative manner.

Humanism in more recent times has been manifested in a number of different movements. In addition to "secular humanism" in the United States, existentialism has been trumpeted as a form of humanist philosophy, inasmuch as it holds that individual human freedom constitutes the source of all authentic human values. For the existentialist, the failure to choose by submitting to the value systems of others (whether churches, nations, or political movements) is a dehumanizing force. In Eastern Europe during the 1950s and 1960s, and in recognition of the rediscovery of Marx's early writings, many socialists reinterpreted their philosophy as a form of humanism, emphasizing the subjective consequences of economic and political oppression. This not only generated a reinvigorated critique of the alienated state of capitalist society but also became a stimulus for communist regimes to loosen their grip on their populations.

See also **Classicism; Existentialism; Humanity; Marxism; Renaissance; Secularization and Secularism.**

BIBLIOGRAPHY

- Feuerbach, Ludwig. *The Essence of Christianity*. Translated by George Eliot. New York: Harper, 1957.
- Fromm, Erich, ed. *Socialist Humanism*. New York: Doubleday, 1965.
- Haskins, Charles Homer. *The Renaissance of the Twelfth Century*. Cambridge, Mass.: Harvard University Press, 1927.
- Jaeger, Werner. *Paideia: The Ideals of Greek Culture*. 2nd ed., 3 vols. Translated by Gilbert Highet. New York: Oxford University Press, 1945.
- Kerford, G. B. *The Sophistic Movement*. Cambridge, U.K.: Cambridge University Press, 1981.

- Kraemer, Joel L. *Humanism in the Renaissance of Islam: The Cultural Revival during the Buyid Age*. 2nd ed. Leiden, Netherlands: Brill, 1992.
- Kristeller, Paul Oskar. *Renaissance Thought: The Classic, Scholastic, and Humanist Strains*. New York: Harper and Row, 1961.
- Marx, Karl. *Early Writings*. Translated by T. B. Bottomore. New York: McGraw-Hill, 1964.
- Sartre, Jean-Paul. *Existentialism and Humanism*. Translated by Philip Marier. Brooklyn, N.Y.: Haskell House, 1977.
- Southern, R. W. *Scholastic Humanism and the Unification of Europe*. 2 vols. Cambridge, Mass.: Blackwell, 1995–2001.
- Trinkaus, Charles. *In Our Image and Likeness: Humanity and Divinity in Italian Humanist Thought*. 2 vols. Chicago: University of Chicago Press, 1970.
- Versényi, Laszlo. *Socratic Humanism*. New Haven, Conn.: Yale University Press, 1963.
- Walsh, Gerald G. *Medieval Humanism*. New York: Macmillan, 1942.

Cary J. Nederman

RENAISSANCE

In the mid-twentieth century, Paul Oskar Kristeller (1905–1999) established the understanding of Renaissance humanism accepted by all scholars in the field. Humanists or *umanisti* were practitioners of the *studia humanitatis* or liberal arts: grammar, poetry, rhetoric, history, and moral philosophy. Their origins are traceable to the notaries who worked for courts and cities in medieval Italy writing letters and preparing legal documents. The practice of these notaries was, from 1100, influenced by the *ars dictaminis* or manuals of letter writing emanating from France. Italian notaries subsequently began to write manuals of their own; their innovation was to abandon medieval Latin style and to emulate the Latin style of classical Roman writers. They focused particularly on the rhetoricians (most notably Cicero from the 1380s), whose interests as public lay intellectuals most closely matched their own.

Spread of Humanism

Humanism first achieved public visibility through Francesco Petrarca (Petrarch; 1304–1374) whose achievements impressed his humanist contemporaries. His immediate disciples were Giovanni Boccaccio (1313–1375) and Coluccio Salutati (1331–1406), both Florentines. Salutati, as chancellor (chief administrative officer) of the city from 1375 until his death, did much to encourage the growth of humanism, especially employing humanists and bringing Manuel Chrysoloras (c. 1353–1415) to Florence, where he taught Greek for three years (1397–1400) and left behind a group of scholars competent to continue Greek studies on their own. From its center in Florence, humanism spread rapidly throughout Italy during the fifteenth century and established itself as the most defining intellectual movement of the Renaissance (1350–1600). Its spread always involved the establishment of schools. Three influential pedagogues were Gasparino Barzizza (1360–1430), the most outstanding scholar of Cicero in his generation, who taught in Venice, Bologna, and Padua; Vittorino da Feltrè (1378–1446), a student of Barzizza's who taught in Padua and Venice and established a school in Mantua; and Guarino da Verona (Guarino Veronese; 1374–1460), who taught in Venice,

Verona, and Florence, and established a school in Ferrara. All three had illustrious students, some of whom became rulers of city-states, others reputable scholars and teachers.

During the second half of the fifteenth century the movement also established itself in Spain, France, Germany, the Low Countries, and England, as well as in eastern Europe as far as Prague, Vienna, and Budapest. But during the second generation of its expansion outside Italy, the Reformation in Germany and then elsewhere absorbed a good deal of humanist energy. The influence of humanism on the religious disputes of the sixteenth century was great, in large part because the Bible and the church fathers came so centrally into play. But its influence extended to other areas as well: to art, politics, philosophy, medicine, law, and mathematics. Humanism began to merge into other intellectual movements after 1600, though its program of education remained central in western Europe and the United States until the twentieth century.

Development of the *Studia humanitatis*

The classical texts of Greece and Rome were the basis of humanist education, the purpose of which was to teach students to read, write, and speak well in Latin by using classical sources. The earliest of many humanist treatises on education was Pierpaolo Vergerio's (c. 1369–1444) *De ingenius moribus et liberalibus studiis* (1403; The character and studies befitting a free-born youth); he is the first to describe in print the *studia humanitatis* as the best course of study for an emerging non-clerical elite, both in private letters and in public life. Leonardo Bruni (c. 1370–1444) wrote a parallel treatise (as a letter) for girls (*De studiis et litteris*; [1524, The study of literature]). Grammar for each of them meant a thorough knowledge of Latin, enabling a student to read the historians, rhetoricians, poets, and moral philosophers (Bruni especially includes the church fathers among these) of classical Latin antiquity. Although Vergerio also includes arithmetic and geometry in his curriculum, Bruni eliminates these as well as rhetoric from the education of women, for whom these subjects have no practical use, since all are related to public vocations not open to women. Later humanists not only wrote educational treatises (Maffeo Vegio, Enea Silvio Piccolomini, Battista Guarini, Erasmus, and Juan Luis Vives among them) but also produced texts designed to help students master Latin, most notable among these Lorenzo Valla's (1407–1457) *Elegantiae linguae latinae* (1437, pub. 1471; Elegances of the Latin language) and a number of works by Desiderius Erasmus (1466?–1536), including *De ratione studii ac legendi interpretandique auctores* (1511; On the method of study and of reading and interpreting authors), *De conscribendis epistolis* (1522; On the writing of letters), *De pueris statim ac liberaliter instituendis declamatio* (1529; A declamation on the subject of liberal education for children), and the *Colloquia familiaria* (1518–1533; Colloquies).

Under the heading of grammar, the humanist emendations of texts and the development of methods of textual study and their literary and historical critique should also be included. A method for doing so was put forth by Angelo Poliziano (1454–1494) in his *Miscellaneorum centuria prima* (1480; Miscellanies), marking the real beginning of modern methods of

textual research. The most famous attack on a forged text was Lorenzo Valla's *De falso credita et ementita Constantini donatione declamatio* (1440; Falsely believed and fictitious Donation of Constantine), in which he proved on philological and historical grounds that the Donation was an eighth-century forgery.

Rhetoric. In the Middle Ages, Cicero was known as a philosopher, but his orations and his major theoretical works on oratory were entirely unknown. Petrarch made the earliest discovery of a Ciceronian oration, *Pro Archia poeta* (In defense of the poet Archias), extolling the value of poetry and literature. Gian Francesco Poggio Bracciolini (1380–1459) discovered ten additional orations of Cicero and a complete copy of Quintilian (which provides the step by step education of an orator), and Cicero's *De institutione oratoria* (On the education of the orator). In 1421 Gerardo Landriani discovered in Lodi Cicero's other major oratorical treatises: *Brutus* (his history of rhetoric), *Orator* (the ideal orator), and *De oratore* (the ingredients of a great orator). Thus Cicero the orator became known again for the first time in a thousand years.

The Greek tradition was recovered more slowly. George of Trebizond (1396–1473) made the first humanist translation of Aristotle's *Rhetoric* into Latin. But it was not until the following century that the Greek rhetorical tradition was made as fully available as is now known. Aldus Manutius published *Rhetores graeci* (1508) comprising ninety manuscripts, and including the works of Plato, Aristotle, Hermogenes, Aphthonius, Demosthenes, Isocrates, Aeschines, and other Attic orators.

Humanists also wrote treatises on rhetoric and aids to teaching it. George of Trebizond wrote the first comprehensive rhetoric of the Renaissance, *Rhetoricorum libri V* (1434), in which illustrations from both Greek and Latin traditions were included. In the next century Philipp Melancthon's (1497–1560) *Institutiones rhetoricae* (1521; Training in rhetoric) extended the humanistic rhetorical art to Protestant Germany, while Cypriano Soares's *De arte rhetorica libri tres ex Aristotele, Cicerone, et Quintiliano deprompti* (1562; Three books on the art of rhetoric drawn from Aristotle, Cicero, and Quintilian) circulated in Jesuit schools throughout the world and was continuously reprinted into the eighteenth century. Among the many practical treatises Erasmus wrote to teach rhetoric was *De duplici copia verborum ac rerum* (1512, rev. 1514, 1534; Copia of words and ideas), offering many ideas and ways to amplify ideas.

Humanists used their rhetorical models to attack scholastic philosophy and the central position given to logic in it. Valla, in his *Disputationes dialecticae* (1439), claimed that the logicians had created fictitious abstractions and categories; he did away with the abstractions and most of the categories and made logic a subdivision of invention, one of the five parts of rhetoric. Rodolphus Agricola (Roelof Huysman; 1443 or 1444–1485) studied in Italy and in later years published *De inventione dialectica* (1479, pub. 1515; On dialectical invention; 47 editions by 1562, all in northern Europe). It is not clear whether he knew Valla's earlier work, but he sought to substitute a logic based on topics for one based on terms, and the probabilities of dialectic and rhetoric for the certitude of the syllogism. Agricola's views were taken up by Johannes

Sturm (1507–1589) who propagated them in Paris (1528–1535) and Strasbourg (1538 ff.). While in Paris he taught Petrus Ramus (Pierre de La Ramée; 1515–1572), who attacked Aristotelian logic in his *Aristotelicae animadversiones* (1543; Aristotelian animadversions) and developed a topics logic following Agricola, emphasizing rules of natural reasoning. He was enormously popular between 1575 and 1600, and in Puritan New England during the seventeenth century.

History. Latin historians were known during the Middle Ages, but humanists began the scholarly study of their texts by annotating and emending manuscripts of the classical Roman historians (notably Livy, Tacitus, Suetonius, Caesar, Sallust, and Velleius Paterculus), and once printing became established in the late 1460s the Roman historians were among the most popular texts printed. The Greek historians were less known, but between 1400 and 1450 many Greek manuscripts were brought from Constantinople to Italy, and a cadre of humanists trained in Greek began to translate them. Plutarch's *Lives* were particularly popular as comparative biographies, and Polybius's discussion of the various forms of constitutions attracted much interest. Humanists began at once to translate these texts into Latin. Niccolò Perotti translated Polybius 1–5, and Valla translated Herodotus and Thucydides.

Erasmus published editions of a number of the church fathers and the first Greek edition of the New Testament (1516, expanded and republished in 1519, 1522, 1527, and 1535) placing in a parallel column his own translation of it into Latin, and adding annotations as well. In separate volumes he published paraphrases. Martin Luther (1483–1546) used Erasmus's first edition in his lectures on Romans in 1516. Cardinal Jiménez de Cisneros (1436–1517) founded the University of Alcalá de Henares in 1499 (opened 1508) to promote study of the biblical languages. His first large project was publication of the Bible in its original languages, which was accomplished between 1513 and 1517 in six volumes, though a delay until 1520 in gaining papal approval prevented publication of the New Testament; hence Erasmus's Greek Bible was the first to appear.

Humanists were prolific writers of history. They regarded it as a branch of moral philosophy ("moral philosophy taught by example"), but over time the lessons they drew became increasingly complex. Bruni's history of Florence, modeled on Livy, was one of the earliest and most famous humanist histories, extolling the liberty and virtue of Florence, triumphant over Milanese attempts to conquer the city. By the end of the century, histories of Florence by Niccolò Machiavelli (1469–1527) and Francesco Guicciardini (1483–1540), written in Italian rather than in Latin, were much more grim in evaluations of human character, behavior, and judgment—and much more fully grounded in documentary evidence. Flavio Biondo (1392–1463) wrote the first history of medieval Italy, making use of archaeological information; but a history covering much the same period by Carlo Sigonio (ca. 1522–1584) a century later used archives to make a great advance in detail and precision over what Biondo was able to achieve.

Historical writing developed in important ways also in France. Paolo Emilio (d. 1529), who returned from Italy to France with Charles VIII in 1498, abandoned the medieval

chronicle tradition. Guillaume Budé (1467–1530) wrote the first extensive humanist study of Justinian's Digest. In the next generation Jacques Cujas (1522–1590) introduced the *mos gallicus docendi*, the French or historical method of teaching Roman law based on the awareness that the law was specific to a given society, changed over time, and was not universal. The *mos italicus*, to which the French method was opposed, sought to clarify the universal principles exemplified in the law and continued to be practiced in Italy. Cujas inspired a group of historians to study the French past in the same way; Jacques Auguste de Thou (1553–1617) went further and tried to incorporate the histories of the various European states into one history, a “universal” or “perfect” history.

Poetry and poetics. Humanists wrote a great deal of Latin poetry, virtually all of which faded into obscurity with the rise of the vernaculars. Petrarch's Italian lyric poetry and the sonnet form he created, however, exercised enormous influence on Renaissance Italian, French, and English poets. In the sixteenth century Ariosto and Tasso, who created the most influential narrative poems in Italian (see below) were trained as humanists and wrote poetry in Latin as well as Italian, but self-consciously turned against Latin and, in Ariosto's case, became critical of humanist education.

Humanist texts on literary theory, on the other hand, exercised great influence. Aristotle's *Poetics* was published in a new Latin translation from Greek in 1498; the Greek text was published in 1508. After a lag of a generation humanists began to write commentaries on it, most notably Ludovico Castelvetro (*Poetica di Aristotele vulgarizzata*; 1570). But they also wrote treatises on their own poetics, most famously Julius Caesar Scaliger, *Poetices libri septem* (1561; Seven books on the art of poetry) and Francesco Patrizi, *Della poetica* (1586; On the art of poetry). Philip Sidney's *Defence of Poesie* (1583, pub. 1595) was much influenced by the Italian tradition and skillfully blended Horace and Aristotle. These works led to various literary debates, among them the importance of Aristotle's unities of time, place, and plot. Ludovico Ariosto's (1474–1533) *Orlando furioso* (1516, 1532) did not honor them, while Torquato Tasso's (1544–1595) later *Gerusalemme liberata* (1581) was regarded as having done so, setting off a debate in favor of one or the other.

Moral philosophy. Humanists were not “school” philosophers, but they recovered many texts that belonged to various schools, including most of Plato, Greek Stoicism (Epictetus), Epicureanism (Lucretius), and Skepticism (Sextus Empiricus). Platonism became a strong presence through the Platonic “Academy” in Florence under Marsilio Ficino (1433–1499), who translated Plato and Platonists (including Plotinus) into Latin, making them available in that language for the first time in more than a thousand years. The translation of Sextus Empiricus into Latin (1563) was the major source behind Michel de Montaigne's (1533–1592) pyrrhonian stance in his “Apology for Raymond Sebond” (1575).

Humanists used these and other texts to reflect on moral issues. Is happiness, the supreme good, achievable in this life? Petrarch said no and criticized Aristotle for having believed otherwise; many humanists agreed with him, as did Valla in his *De voluptate* (1434; On pleasure), in which he argued that

while Epicurus was right to argue for the superiority of pleasure over virtue, the supreme pleasure was achievable only through Christian faith in life after death. Ficino, on the other hand, believed enjoyment of God was possible in this life. Isotta Nogarola (1418–1466), one of a dozen or so women humanists in fifteenth-century Italy, wrote a dialogue, together with a Venetian humanist, Ludovico Foscarini, on the relative responsibility of Adam and Eve for the Fall; Nogarola defended Eve, Foscarini Adam.

The relative merits of men and women was another important topic. The starting point for this discussion was Boccaccio's *De claris mulieribus* (1361; Famous women), portraits of mostly classical (and excluding Christian) women, which provided many of the examples used by Christine de Pizan (1364–c. 1430) in building her city of ladies (*Le livre de la cité des dames*, 1405; The book of the city of ladies). Thus a humanist text led to a new chapter in the debate about women (the *querelle des femmes*), new because de Pisan was the first woman to respond directly to male misogynistic treatises. The most important humanist text in this debate, was Baldassare Castiglione's (1478–1529) *Il cortegiano* (1528; Book of the courtier.), written in Italian, book 3 of which summed up the *querelle* to that point and influenced later writing in the genre. Several women writers from Venice wrote important texts in Italian on the theme in the seventeenth century: Moderata Fonte (1555–1592), *Il merito delle donne* (pub. 1600; The worth of women); Lucrezia Marinella (1571–1653), *La nobiltà et eccellenza delle donne, co' difetti et mancamenti de gli huomini* (1600, 2nd ed., 1601; The nobility and excellence of women and the defects and vices of men); and Arcangela Tarabotti (1604–1652), *Tirannia paterna* (pub. 1654; Paternal tyranny). Marie le Jars de Gournay wrote an important text in French, *Égalité des hommes et des femmes* (1622; Equality of men and women) on the same subject.

The “mirror of princes” literature sought to describe the perfect prince and the education that would produce one; Erasmus's *Institutio principis Christiani* (1516; Education of a Christian prince) is a notable example. Others sought to describe the perfect courtier or gentleman; the most enduring of these has been Castiglione's *Il cortegiano*, which portrays both the perfect male (Book 1) and the perfect female (Book 3) courtier; Sir Thomas Elyot's (c. 1490?–1546) *Boke Named the Governour* (1531) is an English counterpart. Much debated were the relative merits of the contemplative and active life, with most opting for the latter. The relation between intellect and will was also much discussed, the latter being much more strongly supported by humanists skeptical of the power of reason to know and do the good. A related topic was the power of fate and fortune over human life. On none of these issues did humanists speak with a single voice; they explored all sides of questions and took various positions.

In three cases humanist moral philosophical texts achieved greatness: Erasmus's *Encomium moriae* (1511; Praise of folly; rev. 1512, 1514, 1516), François Rabelais's (c. 1494–1553) *Gargantua and Pantagruel* (1532–1556), and Montaigne's *Essais* (1580, 1588, 1595). The first, written in Latin, is an oration of praise spoken by a goddess, Folly, who praises folly as wise, an oxymoron that becomes transformed in the “Christian fool,”

whose divine wisdom is folly to all the world. Though unique as a text, its spirit is visible in Rabelais, whose book celebrates the violation of boundaries, and in nothing more than in providing serious commentary and in the next breath undoing all he had just said. The *Tiers Livre* (1546) does this throughout on the question of marriage and is a central text in the *querelle des femmes*. Montaigne's *Essays* is filled with quotations and allusions from classical authors, as if all of humanist scholarship had been poured into him, but it is all employed to explore his own consciousness and distill his experience in a new "essay" form, which he invented.

Political Implications of Renaissance Humanism

Leonardo Bruni, who later followed Salutati as chancellor of Florence (1427–1444), was the first to use an ancient Greek model (Aelius Aristides' *Panathenaicus*) to compose a panegyric (*Laudatio florentinae urbis*, 1403–1404; Panegyric to the city of Florence). This has turned out to be a very important text, since Hans Baron (1900–1988) made much use of it in developing his theory that "civic humanism" first emerged in Florence as a result of the struggle for Florentine liberty (1389–1402) against the tyrant of Milan, Gian Galeazzo Visconti. According to Baron, this struggle led to a new awareness on the part of Florentine humanists of their citizenship in a republic, which they (and most notably Bruni) began to defend. This change meant, Baron argued, that the humanists had to bring their classical studies and civic commitment into harmony. Initially rejecting Machiavelli as a civic humanist, Baron subsequently included him, arguing that his *Discourses on Livy*, which supported a republican view of government, superseded his earlier *Prince*, supporting authoritarian rule. Because of Florence's central place in Renaissance culture, Baron contended that civic humanism influenced all of Europe and lay behind the growth of western democracy into the nineteenth century. This thesis has been among the most hotly contested in Renaissance humanist studies ever since it was propounded in 1956. If any consensus has emerged out of this debate it is that civic humanism is recognizable as a humanist option, but that its appearance cannot be neatly tied to the one event to which Baron links it; the allegiances of humanists were complicated, beginning with those of Bruni, on whom no critical biography has yet been written.

A significant debate took place in Spain in 1550–1551 between a humanistically trained lawyer and cleric, shortly after the Spanish conquest in the New World, over the question of whether Christians had a right to enslave the natives in the New World; Bartolomé de Las Casas (1474–1566), a Dominican (and the first person to be ordained in the New World), challenged that right as unchristian, and Juan Ginés de Sepúlveda (1490?–1572 or 1573) defended it on the basis of Aristotle's view that some are born to be natural slaves.

Humanists contributed two classics to political literature: Machiavelli's *Prince* (1513, pub. 1532) and Thomas More's *Utopia* (1516). Machiavelli was the first to describe politics as a struggle for power, which may well be incompatible with morality and religion. More presents a vision of how politics might remain moral, which should always be its aim. Both texts have created very large literatures ever since they were first published.

See also *Philosophy, Moral; Poetry and Poetics; Reformation; Renaissance; Rhetoric*.

BIBLIOGRAPHY

PRIMARY SOURCES

- Astell, Mary. *The First English Feminist: Reflections on Marriage and Other Writings*. Edited by Bridget Hill. New York: St. Martin's Press, 1986.
- Boccaccio, Giovanni. *Famous Women*. Edited and translated by Virginia Brown. The I Tatti Renaissance Library. Cambridge, Mass.: Harvard University Press, 2001.
- Henderson, Katherine Usher, and Barbara F. McManus. *Half-Humanity: Contexts and Texts of the Controversy about Women in England, 1540–1640*. Urbana: University of Illinois Press, 1985.
- King, Margaret L., and Albert Rabil, Jr., eds. *Her Immaculate Hand: Selected Works by and about the Women Humanists of Quattrocento Italy*. 2nd ed. Asheville, N.C.: Pegasus Press, 1997. Separate volumes devoted to the writings of three of the writers included in this volume have appeared in "The Other Voice" series (below): Laura Cereta, Cassandra Fedele, and Isotta Nogarola.

"The Other Voice in Early Modern Europe," a project in the textual recovery of continental European women's writings, c. 1400–1700, edited by Margaret L. King and Albert Rabil Jr. and published by the University of Chicago Press. Sixty-eight volumes have been approved for publication, and as of the end of 2003, twenty-five had been published, translated from French, Italian, Latin, and Spanish. Published texts include those by Moderata Fonte, Marie le Jars de Gournay, Lucrezia Marinella, Isotta Nogarola, Anna Maria van Schurman, and Arcangela Tarabotti, some of whom are mentioned in the body of this essay.

SECONDARY SOURCES

- Baron, Hans. *The Crisis of the Early Italian Renaissance*. 2 vols. in one. Princeton, N.J.: Princeton University Press, 1966.
- . *In Search of Florentine Civic Humanism: Essays on the Transition from Medieval to Modern Thought*. 2 vols. Princeton, N.J.: Princeton University Press, 1988. See, in conjunction with both entries, James Hankins, "The 'Baron Thesis' after Forty Years and Some Recent Studies of Leonardo Bruni," *Journal of the History of Ideas* 56 (1995): 309–339; and AHR Forum on the Baron thesis, with commentary by Ronald Witt, John Najemy, Craig Kallendorf, and Werner Gundersheimer, *The American Historical Review* 101 (1996): 107–144. See further, Mark Jurdjevic, "Civic Humanism and the Rise of the Medici," *Renaissance Quarterly* 52 (1999): 994–1020, which argues convincingly why and how civic humanists could support the Medici regime in Florence after 1434.
- Eden, Kathy. *Hermeneutics and the Rhetorical Tradition: Chapters in the Ancient Legacy and Its Humanist Reception*. New Haven, Conn.: Yale University Press, 1997.
- Garin, Eugenio. *Italian Humanism: Italian Philosophy and Civic Life in the Renaissance*. Translated by Peter Munz. New York: Harper and Row, 1965. His thesis concerning the conjunction of these three elements (humanism, philosophy, civic life).
- Kekewich, Lucille, ed. *The Renaissance in Europe: A Cultural Enquiry*. Vol. 1: *The Impact of Humanism*. New Haven, Conn., and London: Yale University Press in association with The Open University, 2000. There are two additional volumes on other aspects of Renaissance culture art and politics), plus two

- volumes accompanying the entire series, one of ancillary secondary readings and the other of primary sources. The best of contemporary scholarship distilled for teaching.
- King, Margaret L. *Venetian Humanism in an Age of Patrician Dominance*. Princeton, N.J.: Princeton University Press, 1986.
- . *Women of the Renaissance*. Chicago: University of Chicago Press, 1991.
- Kraye, Jill, ed. *The Cambridge Companion to Renaissance Humanism*. Cambridge: Cambridge University Press, 1996.
- Kristeller, Paul O. *Renaissance Thought: The Classic, Scholastic, and Humanist Strains*. New York: Harper and Brothers, 1961.
- . *Renaissance Thought II: Papers on Humanism and the Arts*. New York: Harper and Row, 1965. These two short books are the best statements of Kristeller's thesis regarding humanism, its difference from other movements in Renaissance Italy, and its diffusion.
- Nauert, Charles G., Jr. *Humanism and the Culture of Renaissance Europe*. Cambridge, U.K.: Cambridge University Press, 1995. The best of the recent book-length treatments of humanism designed for students and general readers.
- Rabil, Albert, Jr., ed. *Renaissance Humanism: Foundations, Forms, and Legacy*. 3 vols. Philadelphia: University of Pennsylvania Press, 1988. Paperback edition with corrections 1992. The most comprehensive contemporary treatment of the subject in one source.
- Rummel, Erika. *The Humanist-Scholastic Debate in the Renaissance and Reformation*. Cambridge, Mass.: Harvard University Press, 1995.
- Trinkaus, Charles. *In Our Image and Likeness: Humanity and Divinity in Italian Humanist Thought*. 2 vols. Chicago: University of Chicago Press, 1970. Demonstrates in great detail the religious and theological interests of Italian humanists.
- Witt, Ronald G. *In the Footsteps of the Ancients: The Origins of Humanism from Lovato to Bruni*. Boston: Brill, 2000. The emergence of humanism from the 1240s until just after 1400 in Italy; the second volume in a two-volume study of the historical background of humanism. The first volume (forthcoming) will cover developments in the earlier Middle Ages up to the 1240s (outlined in Rabil, ed., above, 1.29–70). Witt's thesis refines but does not alter Kristeller's paradigm.

Albert Rabil Jr.

SECULAR HUMANISM IN THE UNITED STATES

The philosophy and ideology of secular humanism has its roots in Enlightenment thought and is based in large part on the Western tradition of liberalism and notions about the status and role of science in the modern world. At base it is a non-theistic belief system that upholds the prime importance of rationality, human autonomy, and democracy. The term *secular humanism* has come to be widely used in the United States to indicate both an explicitly worked-out humanistic worldview as well as a more ambiguous irreligious or nonreligious secularism with which it is often confused.

Influences on Humanism

The groundwork for modern humanism was laid during the Enlightenment by those philosophers who sought to purge religion of most of its superstitious elements and replace them with a deistic or atheistic rationalism. Thomas Paine's *Age of*

Reason (1794–1796), which argues for a religion based on a belief that the world was created by a rational God, was one of the most important such works in this period.

In the nineteenth century, two major influences were important. First, at an institutional level, the Unitarian Church came into existence and by century's end had developed a commitment to toleration and a disavowal of any type of creedalism. This development, combined with the Unitarians' progressive, liberal ideology, created a framework that would accept the kind of religious radicalism that humanists came to espouse in the early twentieth century. The fact that humanism came to be institutionalized in the Unitarian Church would be both fortunate and problematic.

One of the most significant intellectual transformations of the nineteenth century was the widespread acceptance of a developmental view of the past. This revolution in thought had a profound effect on modern religious history. Although many people found ways to reconcile biological evolution and traditional religion, naturalistic evolution gave ammunition to critics of Christianity who branded it as intellectually stagnant and naïve. More important, however, developmentalism also made it possible to see human history as in flux; indeed when applied to religious history, it had the effect of relativizing religion. Humanism drew on both aspects of evolutionary thinking.

Religious Humanism

Humanism as a distinct intellectual movement arose in early-twentieth-century America among self-described religious humanists. It arose first among radical theologians, especially Unitarian clergymen, who saw religious humanism as anything but an irreligious movement; although these men entirely rejected the "God language" of their colleagues, they felt it essential to retain the institution of religion. Religion was a historical construction, they believed, which developed and changed over time to accommodate new social forms, and it would have to remake itself dramatically in order to continue to exist in the modern world. Already many Protestant modernist theologians were arguing that traditional religion was outdated, based as it was on views of God as a king or lord over creation, and that religion must change and embrace a democratic ethos. The humanists went further, rejecting all discussion of God as unjustified in a scientific age. And yet, they argued, religion itself was not defunct; it fulfilled certain social and psychological urges of human beings. The challenge for moderns was to find ways to integrate current scientific knowledge and democratic social values with the institutions of religion. This is largely what early religious humanism was designed to do.

Progress and Science

Liberal theologians were not the sole architects of twentieth-century humanism. These religionists were also joined by a number of well-respected academic philosophers in the Deweyan tradition, who were either fellow pragmatists or scientific naturalists. The influential Columbia University school of philosophy as well as a number of professors in mid-Western universities actively participated in the humanist movement.

Humanists by and large rejected teleology even as many other early-twentieth-century thinkers, philosophers and religionists alike, embraced it. No deity, the humanists argued, was responsible for the direction of the cosmos, nor did nature and human history have a direction apart from human effort and human will. Mankind, they said, should not look outside of humanity for assistance to their problems; our fate was entirely in our own hands. Although some thinkers who espoused these ideas came to be called futilitarians because of the somewhat pessimistic outlook that this notion of “man alone in the cosmos” seemed to connote, most humanists were not pessimistic. Indeed, one might characterize the humanist movement as driven by a powerful optimism concerning the ability of human beings to make their own future.

One reason that humanists remained optimistic about human progress in the face of an impersonal cosmos was that they held great faith in the ability of human beings to learn and apply their knowledge in rational and ethical ways. Scientific knowledge and technological control of nature gave human beings the power to identify problems and find solutions to them. Democracy and respect for human rights gave people the ethical framework within which to apply this knowledge. As a result, humanists have not been averse to considering technologies that claim to offer solutions to major social issues even when those technologies might otherwise challenge core beliefs about human nature and freedom. In recent years, for example, humanists have advocated psychological conditioning and genetic engineering as solutions to social problems. These ideas have not been unanimously or uncritically accepted by all who consider themselves humanists, but in general, scientific faith and technological optimism lie at the root of humanist thought, in contrast to a more skeptical and restrained approach to science and technology typical among more traditional religionists.

Humanism in American Culture

In the last third of the twentieth century, American humanism went through a variety of transitions, and the movement diversified and grew, although still remaining quite small in absolute terms. It was in this period that the term *secular humanism* came into currency, popularized by conservative Christians who saw humanism as a nascent secular religion. These religious conservatives argued that the extensive secularization of America in the second half of the century was largely a result of the influence of secular humanists in control of American social and cultural institutions.

They portrayed the issue as a constitutional problem. Since the late 1940s the federal judiciary had issued a series of landmark rulings strictly enforcing church-state separation and removing traditional religious influence on public institutions. This was especially true for public schools, where morning prayer and religious instruction were banned. At the same time, secular modernity strongly influenced those same institutions, and ideas opposed to traditional religious tenets were introduced. Evolution and sex education, for example, were integrated into the school curriculum. These changes seemed to many Christian critics to be tantamount to the establishment of a competing religion, which they identified with humanism.

The existence of the American Humanist Association (AHA), which was founded by Unitarian and Ethical Culture ministers, gave fodder to the critics' charges that humanism was a religion in its own right. A 1933 document, “A Humanist Manifesto,” published by some of these early humanists and signed by such notable scholars as John Dewey, was frequently cited as evidence of the religious dogma of humanism. By tying this “religion without God” to secularization in general, the conservative Christians argued that the government was in many ways abetting the establishment of a humanist religion in flagrant violation of the First Amendment. And indeed, similar arguments underlay court challenges to the teaching of evolution in the public schools in this same period. This argument proved ineffective in Supreme Court battles in the United States, but it was effective in marshaling grassroots political support among conservative religious activists. Humanists for their part attacked the rise of Christian fundamentalism and defended their stance as truly secular; in fact, many humanists in the 1970s and 1980s explicitly rejected the “religious humanist” label as misleading.

In contrast to the first two-thirds of the twentieth century, the decades after 1970 were not a comfortable time for humanists, who found their ideas under attack not only by conservative Christians but also in other areas of popular and elite culture. Humanists declaimed against the irrationality of superstitions and paranormal beliefs such as UFOs, haunted houses, and many alternative medical practices. Furthermore, they worried about growing irrationalism in the academy as postmodern philosophy gained popularity. In all of these arenas, it appeared to humanists that rational thought and scientific authority were endangered. Because of their long-held views that democracy and fundamental human rights were inseparable from modern, rational, scientific thought, humanists also worried about growing authoritarian tendencies and the decline of political liberalism.

The philosophy of humanism at the beginning of the twenty-first century is fostered by several membership organizations in North America, many of which publish nationally circulated magazines and newsletters; there is a successful publishing house directed by a major humanist leader; and the various organizations collaborate to support an institute for training humanist leaders. The movement is small but has established a stable and influential presence in American culture.

See also Religion and the State: United States; Secularization and Secularism.

BIBLIOGRAPHY

- Dewey, John. *A Common Faith*. New Haven, Conn.: Yale University Press, 1934.
- Ehrenfeld, David W. *The Arrogance of Humanism*. New York: Oxford University Press, 1978.
- Kurtz, Paul, ed. *The Humanist Alternative: Some Definitions of Humanism*. Buffalo, N.Y.: Prometheus Books, 1973.
- LaHaye, Tim. *The Battle for the Mind*. Old Tappan, N.J.: Revell, 1980.
- Lamont, Corliss. *The Philosophy of Humanism*. 7th ed. New York: Continuum, 1990.

Meyer, Donald H. "Secular Transcendence: The American Religious Humanists." *American Quarterly* 5 (winter 1982): 524–542.

Radest, Howard B. *The Devil and Secular Humanism: The Children of the Enlightenment*. New York: Praeger, 1990.

Stephen Weldon

HUMANITY.

This entry includes three subentries:

African Thought

Asian Thought

European Thought

AFRICAN THOUGHT

While reason tells us that it is obvious to anyone, irrespective of his or her background, that humans are bipedal, featherless creatures, other characteristics we attribute to humans are not always so obvious. Also, while we all appear to assume that humans are creatures who have minds, in contrast to other creatures, it is not quite obvious what is meant by "mind" or what happens at death to the elements that constitute the essential elements we attribute to humanness. Less obvious still are the social characteristics that we consider primary to humans. Questions regarding human nature, personhood, or the self continue to form the core of metaphysical inquiries. As a result, there are not only multiple constitutive views about human nature, but also questions about whether humans, like other beings, can be said to have an ideal or perfect nature that they already have or aspire to have under certain circumstances. These nonobvious ideas about how we think of the essence of humankind define the differences and similarities in the various beliefs that make up various traditions throughout the world, whether they are cultural traditions passed down from one generation to the next, or intellectual ones shaped by a combination of inherited beliefs with systematic conceptual accounts. Yet, despite these differences, all such beliefs are compatible with the wider thesis that underlies them, namely that all natural kinds have essences.

There are variations in African beliefs as well as in contemporary African philosophical thought regarding how these essences are endowed in humans. Some believe that humans acquire much of what defines the course of their life from a deity or that deity's emissaries, thus adopting a fairly deterministic view of human nature. The Yoruba people of West Africa believe that the human person, *èníyán*, is constituted of several elements, supreme among which is *orí*, the determinant of destiny. The others are *ara*, *okán*, and *emí*. The god *Olodumare* delegates tasks to his emissaries, the lower divinities under him called *orisas*, and they oversee the various elements that are then "assembled to construct" selves, the *èníyáan*, with their individual identities. According to Segun Gbadegesin, a Yoruba-born philosopher who has explicated many of these matters, "Ara is the physico-material part of the human being [and] includes the external and internal components" (1991, p. 28).

Because *èníyán* denotes personhood beyond mere biological identity and selfhood, the Yoruba rebuke selfish people by saying that their views stop at their *ara*, meaning that they ignore what really matters, namely their higher value as *èníyán*. It would therefore appear that *ara* refers to the material or physical individuality of every person. Also physical is *okán*, the element believed to be responsible for the organic functions of the body, like pumping and circulating blood throughout the system. But it also has attributes that are not entirely physical, because, according to Gbadegesin (p. 32), the Yoruba make references to people keeping their inner thoughts in their *okán*. Again, although it is believed to be material in nature, it is also regarded as the element responsible for the emotional and mental states and functions of a person and indicates his or her conscious identity. In other words, "it is that from which thought originates" (Gbadegesin, p. 30). Emotional qualities such as bravery, love, hate, joy, sadness, and cowardice are attributed to *okán*. *Emí* is believed to be the life principle or vital spirit; it turns *èníyán* on (to life). Legend has it that the chief divinity *Orisà-nlá* molded the body and then put *emí* into it to make it fully functional—speaking, walking, eating, and even thinking—although one thinks with *okán*, the mind, but without *emí*, even *okán* would not perform its thinking function. *Emí*, however, is also a kind of private consciousness: when one puts his or her mind (*okán*) on some idea, it is *emí* that pictures the idea; it "looks" at it through *okán*. *Emí* does not require rest like the *ara*, the body. It is tirelessly always at work; thus, it is what travels and speaks to other people when *ara*, the body, is asleep. It is the dreamer. It is the conscious self. Yet, in the Yoruba modes of thought, all these human functions, including the decision-making activities of *emí*, are predestined by *orí*, the determinant of everyone's path in life. The Yoruba teach that, in life, humans are constantly striving to attain the good, because their *emí* learns about what is good and is drawn to it. If, however, the desires of *emí* are in contrast with the selection of their *orí*, their striving will be to no avail, as they will be destined to be controlled by the dictates of the superior element, the *orí*. By this token, in the Yoruba conceptual scheme *orí* is regarded as the most important aspect of life, for all endeavors of a person's life depend on this element and must be relied on to lead one through the complexities of life. People may not pay attention to the little things that occur in the course of their everyday life experiences, but significant ones, such as big fortunes or calamities, will often raise questions about fate. In this regard, ignorance of the future, that shield that the French social philosopher Jean-Jacques Rousseau (1712–1778) called "the veil of ignorance," allows us to act as if we were free agents capable, so we believe, of creating the world—in terms of influencing history—by our false sense of freedom. It is this sense of false freedom that makes us agents generally, and moral agents in particular. Evidently, it can be a difficult task trying to reconcile the roles played by all the elements in the ensemble of *èníyán*, the plurally constituted self. What is clear is that there is an attempt to understand and account for all the characteristics exhibited by being human, both functionally and by constitution.

We gather from Chinua Achebe's fiction, *Things Fall Apart*, that, like the Yoruba, the Igbo, also of West Africa, believe that human destiny is controlled by one's chosen *Chi*. For

them, however, life is made much less deterministic by human amnesia, which makes us forget the dictates of *Chi* we chose before birth, and so we strive to attain goals in life as if we were free. The amnesia accounts for human courage and diligence in setting and pursuing goals, making life worthwhile until constant and inexplicable failure drives one to seek divinatory counseling and explanation.

The above examples indicate other interesting characteristics of Africans' conceptualization of human nature. Among these is the view of human agency and responsibility, namely, that there are two levels at which we perform in the process of executing those matters that pertain to our specific kind. On the surface, we are free enough for our consciousness to deliberate and execute its duties according to the rules and principles demanded by the various circumstances of human experience, including the acquisition and application of knowledge appropriate to different domains. Yet, both collectively and individually, and unknown to us in specific terms, we are bound by some type of predestination; what we do is actually regulated by and is in line with the dictates of our inner nature as bestowed on us by the divinities. This consideration raises the question of whether humans act freely or are predestined to act the way we do. As Achebe indicates in the novel, questions of this nature arise in those instances when we realize that, despite our unflinching diligence and self-application to tasks, either all or a significant portion of our actions yield negative results. We also observe that others succeed with far less effort where we fail, despite what we reckon to be great and right effort. We are then led to infer that we have a fate that runs contrary to our desires and aspirations. It is this that leads Igbo people to infer that their *Chi* has a different and unalterable destiny for them.

African thought oscillates between these two metaphysical views about human action. The Luo of Kenya, a people who are deeply monistic in their metaphysics of things and of humans, laugh at the idea of predestination, especially when this is attributed to some distant deity beyond time and the world. In their view, most human efforts, if well executed, should yield their intended results. The failure of people's aspirations and goals is the result of either of two causes: one's own lapses, or the actions of another, ill-intentioned person who knowingly and clandestinely undermines other people's plans. Such a person is a *jajuok*, one who is morally crooked and so wishes others ill, going out of his or her way to see that those they do not like or are jealous of do not succeed in their endeavors.

A major question and the source of a major difference among African philosophers concerns whether the ideas about the various elements in human nature as just described do actually articulate multiple substances which, together in some kind of union or relation with each other, make up personhood. Contrary to the preceding pluralist claims, other African philosophers opine that such names are no more than mere conceptual distinctions of the different functions of an otherwise singular and physical constitution of the person.

This view, championed principally by the Ghanaian philosopher Kwasi Wiredu, contends that such names as *èmi*, *okán*, and so on, as used in Yoruba belief, and arguably present in

the conceptual schemes of several other African communities, are no more than indications of different functions of the same complex material body. This physicalist view proposes that, in African conceptions, for anything to be claimed to exist, it must occupy space; hence nothing can be claimed to be a separate entity that, in conjunction with others, makes up personhood unless all of them, like the body, can be shown to either actually occupy or be capable of occupying a physical space distinct from the body with which they are believed to be in union.

According to Wiredu, it would be ridiculous, among the Akan of Ghana, to think or imagine a clear-cut dualism, à la René Descartes (1596–1650), that posits mind and body as distinct from each other in such a way that one can operate independently of the other. Thus, the claim, "I think therefore I am," turns out to be logically untenable for the Akan. To be sure, mind is not physical in the same measure as the body is, so it is neither an appendage of the body nor identical with it, but it is a functional (responsive) property of the specifically human body by means of which it learns cognitively to respond to its surroundings. The body manifests it in the instance of perception of both self and the external world, although its objects and contents are ordered and given shape gradually through communication. It is brought into existence by the functions of the body while its objects and contents are given order through communication. Thus, mind is a quasi-physical thing, just as the glow in a light bulb is the physical property of the type and arrangement of energy-conducting wires.

The body, at least the human body, is a complex organ that responds to different stimuli to produce different "things." In Wiredu's view, the fault of claiming the constituents of personhood to be separate entities is not with the belief systems in which these ideas are found; rather, it is the failure to analyze the ideas received from tradition critically and sufficiently, a failure probably attributable to currents of cultural influences, such as Christianity, on both African scholars drawn into it and on foreign Africanists who read African worlds through the lenses of Western conceptual categories. Dualism originates from ancient Egyptian worldviews, from their belief that there is something divinely permanent and indestructible about human nature that, by ordinary everyday evidence, is also significantly physical.

Dualism was also clearly present in Greek thought by the fifth century B.C.E., before it became a pertinent issue in the systematic approach of the Socratic period. Later Egyptian thinkers of the Greco-Roman era helped to infuse Christian teachings with it, together with the doctrines of immortality and resurrection. These were assimilated, joining other dogmatic pillars of the Christian faith. According to Wiredu, the concepts of mind and body in African thought are not expressed as the polarized material-spiritual opposition found in Western thought. Rather, many African beliefs appear to indicate a quasi-physical conception not only of the mind, but also of the afterlife. The ancient Egyptian concepts of the afterlife clearly expected those who died to return to this life physically. According to this expectation, the dead wander away into the world of sunset *in order to* rise again one day,

and African beliefs in the continuous “social” engagement between the dead and the living is an extension of this quasi-physical conception of personhood. Its foreignness to the Western Christian theory of the afterlife continues to indicate a sort of mystery within the system because of its incongruence with the clear Cartesian dualist principle to which Christian teaching tends to cling. The African influence on the Christian aspiration was never cleanly attained, and several “mysteries” considered crucial to Christian faith resulted from the failed merger of African beliefs with non-African aspirations (Masolo, 2004).

As a constituting element of human nature, mind, too, is a function of the social nature of humans. Mind draws its origin from and depends on communication. It is the human capacity to process meanings that are the core and formal object of communication: that is, the cognitive responsiveness of the human organism to its social surroundings and through society—from which the individual learns the theoretical and practical meanings—to the rest of the surrounding world in which such meanings are tested and applied. Perhaps emphasis on the social dimension of human nature separates African thought most significantly from other traditions. At both the personal and social levels, African thought reflects considerations and maxims that view the individual as socially embedded. Not only is mind, such a significant part of individual selfhood, considered to be socially generated, but its operations, like the determination of what is true and what is good, are played out in the social realm, thus defining knowledge, both cognitive and moral, as inherently social enterprises. In *Cultural Universals and Particulars*, Wiredu describes mind in the Akan conceptual scheme as “primarily the capacity to think thoughts, feel emotions, construct arguments, imagine things, perceive objects and situations, dream dreams of both night and day and so on” (1996, p. 126).

Like the Akan, the Luo think of mind as part of the biological functioning specific to humans. Mind is powered by *chuny*, the sustainer of biological life that all living things share, including plants. The human *chuny* is no greater than, nor superior to, that of a cornstalk or of a flower; they only perform different things in each case. Thus, in humans, *chuny* is the seat of thought, meditation, and imagination, but the acts take place in the head. Even the instinctive reactions of a dog are coordinated in its head by *chuny*. At death, the *chuny* stops or, as the Luo literally put it, disconnects its flow, and so all the animal operations cease and plants wither. In every case, it is said that the *chuny* has disconnected (*chunye ochot*). Because *chuny* is the center of everything, when it is broken, such as happens at death, or when the core of an argument (*chuny wach*) is shattered by a counterposition, total disintegration occurs.

In these Akan and Luo metaphysical examples, personhood emerges in the course of an individual human being’s learning to respond to and participate in the social world of handling meanings through which the operations of mind are shaped in an ascending degree of complexity. But it is in African social theory that the communalist nature of personhood has been best articulated. Modern African politics, as

well as the more established indigenous political orders and systems of defining and managing kinship systems, emphasize every person’s responsibility for the communal good as the end that everyone seeks, even when they may differ in their separate “ways” to it. Thus, although the immediate postindependence ideology dubbed “African socialism” has waned as the guiding ideological and moral norm for political and socioeconomic orders, the communalistic spirit that it reflected continues to drive Africans’ value judgments. Sometimes such judgments are made spontaneously in response to needs of others in family circles, at other times they are consciously applied as political strategies for implementing public policy and programs. Thus, communalism continues to be present in the political and socioeconomic practices at various levels of society, despite the individualistic challenges it faces from capitalist economy and values.

If human nature is communally cultivated over time by enabling individuals to develop and to use their specifically human capacities within given sociocultural contexts, then it is reasonable to expect that the sustenance and improvement of the human condition will require no less than the provisions and circumstances that enable its attainment. Indeed, the idea of human rights agrees with and reasserts this expectation by stipulating, in effect, that every person deserves those provisions and conditions necessary for the quality of life commensurate with the moral status of humans. There appears to be, in the 1948 U.N. Declaration of Human Rights, a hidden argument that the social nature of human life makes it imperative that the attainment and sustenance of those human rights be the result of active commitment by all. Thus, not only does every person have the right to life, but he or she also has the right to a quality of life that enables him or her, both as an individual and as a member of a group, to exercise the characteristics of his or her humanity fully, namely, to be able to perform, have, or enjoy those things that human beings perform and pursue to have or to become by virtue of being members of the species.

Understandably, the specifics and measures of these will, in diverse manners, be culturally determined and allowed under the guidance of right reason. Although philosophers no longer concur that reason, in its instrumental sense, is what distinguishes humans from other entities in the world, it is at least plausible to claim that the freedom of having and expressing one’s opinion is still characteristically human. And, because such ideals are what every human being requires, they turn out to be the common goods that can be effectively realized only by reciprocal (intersubjective) recognition and respect among us. They are the foundations of the humane treatment of others as a social, if not a moral, ideal.

Ultimately, it is not difficult to see why the observance of human rights for all is important. Africans have borne witness to sufferings and other forms of humiliation associated with the denial of their human rights. Not only did colonialism strip Africans of their civil and political freedoms, it also tried to obliterate their historical identity by trying to destroy everything they had created in terms of material, intellectual, and religious traditions. As if these colonial calamities had not caused enough

suffering, African people have, since independence, been subjected to civil wars and cycles of violence perpetrated on them by their own leaders and neighbors, resulting in the denationalization of millions constrained to live in refugee camps and other forms of makeshift settlements abroad. It is easy, therefore, to see how the postcolonial African state has been mired in contradictions. Ironically, not only did such leaders and other perpetrators of African genocide violate fundamental (common or universal) human rights of their victims, they violated, in the name of ethnic and personal interests, those very rights considered in African communalist thought to be most basic to the concept of humanity. Lessons from such experiences drive home the idea that the practice of mutual recognition and respect is likely to allow everyone to become, in turn, an active and competent participant in the production and consumption of the material, as well as the cognitive, moral, sociopolitical, economic, and aesthetic values on which specifically human life is based. Human beings can, therefore, be regarded as living an acceptable level of human life only if: they are accorded moral dignity and respect; they live a life of reasonable social and political freedom under adequate and appropriate social and political protection; they have the necessary means to live a life free of degrading or dehumanizing poverty; and they live a life that allows them free and reasonable cultural expression. To unduly deny, interrupt, or interfere with any of these rights with respect to other persons, groups, or nations, is to deny them their basic human rights, viewed as those rights every human being can claim as necessary for the expression of his or her humanity.

See also *Authenticity: Africa; Colonialism: Africa; Communication of Ideas: Africa and Its Influence; Communitarianism in African Thought; Person, Idea of the; Personhood in African Thought; Philosophies: African; Religion: Africa.*

BIBLIOGRAPHY

- Achebe, Chinua. *Things Fall Apart*. Oxford: Heinemann, 1996.
- Gbadegesin, Segun. *African Philosophy: Traditional Yoruba Philosophy and Contemporary African Realities*. New York: Peter Lang, 1991.
- Gyekye, Kwame. *An Essay on African Philosophical Thought: The Akan Conceptual Scheme*. 2nd rev. ed. Philadelphia: Temple University Press, 1995.
- . *Tradition and Modernity: Philosophical Reflections on the African Experience*. New York and Oxford: Oxford University Press, 1997.
- Hallen, Barry. *The Good, the Bad, and the Beautiful: Discourse about Values in an Yoruba Culture*. Bloomington: Indiana University Press, 2000.
- Hallen, Barry, and J. O. Sodipo. *Knowledge, Belief, and Witchcraft: Analytic Experiments in African Philosophy*. 2nd ed. Stanford, Calif.: Stanford University Press, 1997.
- Karp, Ivan, and D. A. Masolo, eds. *African Philosophy as Cultural Inquiry*. Bloomington: Indiana University Press, 2000.
- Masolo, D. A. "African Philosophers in the Greco-Roman Era." In *A Companion to African Philosophy*, edited by Kwasi Wiredu. Malden, Mass.: Blackwell, 2004.
- . "The Concept of the Person in Luo Modes of Thought." In *African Philosophy: New and Traditional Perspectives*, edited by Lee M. Brown. Oxford: Oxford University Press, 2004.

Wiredu, Kwasi. *Cultural Universals and Particulars: An African Perspective*. Bloomington: Indiana University Press, 1996.

———. *Philosophy and an African Culture*. Cambridge, U.K.: Cambridge University Press, 1980.

Wiredu, Kwasi, and Kwame Gyekye, eds. *Person and Community: Ghanaian Philosophical Studies, I*. Washington D.C.: Council for Research in Values and Philosophy, 1992.

D. A. Masolo

ASIAN THOUGHT

Philosophy in East Asia generally avoids abstract metaphysical speculation and focuses on practical questions. Discussions of human nature tend to be related to concerns about social problems and how to solve them. This practical orientation can be seen in the thought of Confucius (Kong fuzi, 551–479 B.C.E.), China's most influential philosopher, who lived during a time of social strife and whose life was dedicated to reforming China and returning it to the paradigms of the past as he understood them.

Confucius's study of ancient Chinese classics led him to believe that during the reigns of the "sage kings" Yao and Shun, China had been well governed and harmony had prevailed throughout their realms. This was accomplished not through harsh punishments or excessive regulations, but by the moral force of their personalities and their attention to social rituals. They are extolled as examples of "noble men" (*junzi*), who embodied the best of human virtues and whose good qualities prompted others to strive for moral excellence themselves. Confucius believed that the presence of such people in a society is the key to social harmony and that all men have the capacity to become perfect exemplars of virtue. He was, however, a product of his time, and his writings indicate that he did not view women as having the same capacities as men. All of his students and close associates were men, and the few instances of mentions of women indicate that he mainly saw them as wives and supporters of men striving to perfect themselves.

For Confucius, education is the key to moral development. Although humans have the capacity to become "noble men," only those who study diligently and actively pursue this ideal are able to reach it. He urged his students to study the classics in order to discern for themselves the eternal paradigms that guide sages. A true sage, in his conception, is one who has learned to discipline his mind and body, whose outward comportment is always appropriate and whose thoughts are oriented toward the betterment of society. Such a person is resolute in the pursuit of virtue but not rigid, learned but not boastful, deeply moral without being moralistic, courageous but not reckless, and always strives to practice what is right in any given situation.

Human Nature: Good or Evil?

One of the enduring questions of East Asian philosophy concerns how human nature should be construed: Are humans by nature good or evil? Is morality natural to humans, or must they be taught (or coerced) to do what is right? Confucius never directly answered these questions, but the perfectibility of humanity is a dominant theme in his philosophy, and he

clearly thought that humans (or at least male humans) possess the capacity for perfection, although they must consciously strive to actualize it. Mencius (Mengzi, c. 371–c. 289 B.C.E.), the most prominent thinker in the tradition after Confucius, asserted that human nature is good, and believed that people are naturally inclined toward virtue. Unfortunately, the negative elements of society tend to corrupt most people, and only a few are able to overcome them. He compared the tendency toward goodness to Ox Mountain, a hill that was once forested. The trees were cut down in order to make a place for cows to graze, but tree shoots continue to crop up there. The cows chew them, and so the trees never reach maturity, but the potential for tree growth is always present. In the same way, humans have the capacity to pursue sagehood, but most become corrupted and fail to actualize this potential.

According to Mencius, the path to perfection begins with cultivation of the heart/mind (*xin*), an innate faculty that allows us to discriminate between right and wrong. It operates in harmony with “vital energy” (*qi*), a universal force that pervades all phenomena and that promotes both personal morality and social harmony. Those who cultivate their heart/mind through study and practice of morality increase the power of their vital energy, which becomes a “flood-like *qi*” (*haoran qi*) in sages. As a strong wind bends grass, flood-like *qi* prompts those who encounter sages to emulate their example.

After Mencius, the notion that human nature is basically good was widely accepted by Confucians, but many of their rivals held other positions. The Legalists, for example, contended that human nature is evil and that unless people are regulated by laws and punishments they will go astray. Society only functions harmoniously when the populace fears the apparatus of state control, and the Legalists counseled rulers to keep their subjects in line by publicly inflicting harsh punishments on those who transgress the laws and by maintaining a powerful and pervasive police force and a network of spies.

A rival position was propounded by Mozi (c. 470–c. 391 B.C.E.), who advocated a philosophy of “universal love” (*jianai*). He contended that China’s problems stemmed from a lack of shared benevolence, and he urged people to recognize that if everyone were to practice love of everyone else, the entire society would benefit. When people pursue their self-interest at the expense of others, everyone suffers, and so he taught that the most rational course of action for individuals is to contribute to the common good so that everyone might prosper.

Responding to Mozi, Confucians characterized his ideas as impracticable. First, Confucians believed that people naturally have deeper feelings for those who are close to them and that it is appropriate to favor them. Second, an appeal to pursue morality out of self-interest is bound to fail because those who are moral for selfish reasons will soon realize that while the whole society may benefit from universal love, an individual who takes advantage of the situation might well profit more than others. Only a universal code of morality will make people behave in a truly moral way.

In responding to the Legalists, the Confucians stated that in their version of society people become morally degenerate. They live according to society’s expectations and will only be moral as long as there is a credible threat of punishment. They will not develop a moral sense, which is only possible for people who feel shame when they transgress the moral code. Shame keeps the noble man on track even when there is no one to punish or disapprove of immoral behavior.

Another alternative view of human nature was propounded by the Daoists. Laozi (571?–480? B.C.E), the most prominent of the early Daoist thinkers, held that humans at birth are like uncarved blocks of wood (*pu*) and that as they get older, society molds and shapes them. While the Confucians believed that this process is desirable and that education is the key to attaining human perfection, Laozi contended that it brutalizes people and creates the seeds of social turmoil and negative behavior. Trees need no education to grow in accordance with the rhythms of nature, nor does water need to study the classics in order to flow toward its lowest point. Like all the things of the world, humans are born with an innate sense of right and wrong, which accords with the movement of the *dao*, an impersonal, universal force that pervades all phenomena and regulates how things grow and develop.

In the ideal Daoist society, people do not waste their time with education and moral training; rather, the Daoist ruler works to keep his subjects ignorant so that they remain happy with their simple lives. He ensures that they have enough to eat and he avoids conflicts with neighboring states so that the people are not disturbed by wars or overburdened with taxes. In the perfect society, according to Laozi, the people will be so content in their rural villages that even if they hear the cocks crowing in a neighboring town they have no interest in visiting because they have everything they need at home.

Revival of the Tradition

During most of Chinese history Confucianism was the dominant philosophy and the basis of the state cult, but significant numbers of Chinese intellectuals rejected it in favor of Daoism and later Buddhism. Following centuries of decline, the Confucian tradition was revived in the Song dynasty (960–1279), when a new movement generally referred to as Neo-Confucianism (*xing li xue*, “learning of nature and principle” in Chinese) began among Chinese literati. Many of them had been Buddhists and Daoists, and they often incorporated elements of these systems into their philosophies. During this time the new Confucians initiated educational and political reforms, wrote new histories, and edited classical texts. At the same time, new evolutionary cosmologies and systems of humanistic ethics were devised, and a vigorous defense of Confucianism was mounted.

The Neo-Confucians dismissed Daoism as impracticable and unsuited to the real needs of Chinese society, while Buddhism was characterized as un-Chinese because of its emphasis on monasticism (which they claimed leads people to ignore their filial duties). In addition, the Buddhist doctrine of “emptiness” (Sanskrit, *sunyata*; Chinese, *kong*) was used as an example of the “nihilism” of Buddhism, while Confucianism

was described as practical and world-affirming. Moreover, because Buddhist monastics are not supposed to work for a living and are required to subsist on alms, they were characterized as social parasites.

At the same time, aspects of society that had been neglected by Confucius and early Confucians were addressed by thinkers of this period. A number of books regarding the proper conduct of women were composed—mostly by men, although a few were written by women. A central concern was women's education. Early Confucians had generally held that women should be illiterate because their mental capacities are inferior to those of men and education is irrelevant to their primary duties within the domestic sphere. The Neo-Confucians accepted the inferior status of women and the notion that their main roles in the society should be as wives and mothers, but some contended that they would be more effective in raising and training their children if they had at least rudimentary knowledge of the classics and the philosophies of Confucianism.

One of the earliest writers to espouse this theme was Ban Zhao (c. 79–8 B.C.E.), whose *Admonitions for Women* (*Nujie*) is a set of instructions regarding the “way of wives” (*fudao*). She accepts the traditional hierarchy of Chinese society, in which wives are subservient to their husbands, and their primary sphere of activity is within the home and family. She advises her readers to be humble and thrifty, to serve their husbands and families to the best of their abilities, but she also holds that success in women's work requires a solid education.

Other female Confucian writers echoed these sentiments while acknowledging the secondary place of women in society. But just as Confucian officials had a duty to remonstrate with wayward or corrupt rulers even at the risk of imprisonment or death, women were allotted the role of moral compass for their husbands. In Madam Cheng's *Classic of Filial Piety for Women* (*Nu Xiaojing*), for example, women are told to be humble and obedient, but service to their husbands also requires that they correct them when they transgress Confucian morality. In Madam Cheng's vision, the virtue, humility, and filiality of their wives should serve as salutary examples for husbands, whose own conduct will be uplifted by that of their spouses. In the fifteenth century, Empress Xu (the third wife of the third Ming emperor, Yongle) expanded the potential role of women in Chinese society, arguing that all humans possess the same capacity for sagehood and that even women can aspire to the supreme goal of Confucianism. In her *Instructions for the Inner Quarters* (*Neixun*), she contends that women play a central role in the regulation of the state, which begins with well-trained children and well-regulated families. She accepts the notion that the home is the primary sphere of women's activities, but in her system it is the basis for proper functioning of the whole society, and women are not merely adjuncts to their husbands, but rather complementary partners in the task of promoting social harmony and order.

Zhu Xi and the Study of Principle

The most influential thinker of Neo-Confucianism was Zhu Xi (1130–1200), who wrote new commentaries on most of

the Confucian classics and whose school became the orthodox tradition in China and Korea. Zhu emphasized the “learning of principle” (*lixue*). The term “principle” (*li*) appears in the classics, where it refers to a standard or pattern. Zhu contended that there is a principle that underlies all existence and that this can be discerned through studying phenomena. There is one principle, but it is manifested variously in the things of the universe. The myriad phenomena are in a state of constant flux, but all changes are determined by the universal principle. The force behind change is vital energy, which is the means by which principle is manifested. Both principle and vital energy influence each other, and they are central to the proper functioning of both the natural world and human society. Sages regulate and control their vital energy and act in accordance with principle, and thus they are able to manifest human-heartedness, filiality, and righteousness.

In common with the mainstream of the Confucian tradition, Zhu believed that education is the key to both moral behavior and sagehood. His approach is referred to as “investigation of things” (*kewu*), which involves beginning with what is known and then proceeding to understand the mysterious. Because everything manifests principle, as one investigates things, one progressively comes to understand the nature and elaborations of principle, and this in turn leads to improved wisdom and morality.

Zhu's main opponent was Wang Yangming (1472–1528), who rejected the notion of the exhaustive study of things as a waste of time. He agreed with Zhu that principle is manifested in all phenomena, but held that the human faculty of the heart/mind allows people to discern it directly without an exhaustive study of things. Because humans are innately endowed with the capacity for sagehood, all that is necessary is to engage in introspection using the heart/mind, and through this they can comprehend principle directly.

The Spread of Confucianism

Although Wang's school was widely influential, Zhu's tradition became the state orthodoxy in China, and it was also imported to Korea and Japan. By the fourth century C.E., Confucianism was well-established in Korea, and during the Koryu dynasty (918–1392) a number of Confucian academies were built. Although Buddhism was the official state ideology, the government instituted a system of civil examinations that followed the Chinese Confucian model.

During the Yi dynasty (1392–1910), Confucianism replaced Buddhism as the state ideology, and Zhu Xi's school became dominant. Korean Confucians generally emphasized the study of human nature and principle (*songnihak*) and “learning of the way” (*tohak*). Following Zhu's lead, Korean Confucians focused on the concepts of principle, vital energy, and heart/mind. The most influential Korean Neo-Confucian, T'oegye (the literary name of Yi Hwang, 1501–1570), was primarily concerned with practical questions of how Confucian ideas should be manifested in human activity.

After Confucianism became the state ideology, the main emphasis of the tradition was textual study, which over time

became mostly arid and unoriginal. In the seventeenth and eighteenth centuries, a new school arose in Korea, which came to be known as the “Practical Learning” (Silhak). Its proponents criticized the scholastic Confucians for focusing on words and ignoring practical concerns. Chung Mong-ju (1337–1392), the founder of the movement, stated that “the way of Confucianism lies in the ordinary affairs of daily life. Even in sexual relations and in eating and drinking there is a meaningful principle.” The main focus of this school was on how to improve society and directly help the people, and its adherents characterized traditional Confucians as being overly concerned with empty academic study that had no practical use.

The Yi dynasty ended with the Japanese invasion and annexation of Korea in 1911. During the occupation, Confucianism declined due to lack of state support, and when the Japanese were expelled after World War II, the new government decided not to support Confucian institutions, which continued their decline. In the early twenty-first century most of the remaining Confucian academies are museums, but there is still one Confucian university, the Songgyun’gwan in Seoul, and a few traditional scholars (mostly elderly) who continue to uphold the tradition. Their numbers are dwindling, however, and there are few young Koreans who are interested in undertaking the extensive training required of traditional Confucians.

Despite its modern travails, Confucianism continues to be widely influential in East Asia, and its philosophies and moral codes are a core element of the culture of China, Korea, and Japan. In the early 2000s the Confucian educational system that once dominated the intellectual life of East Asia is a thing of the past, and the great Confucian academies are merely historical monuments, but Confucian ideas about human nature, morality, and good governance still influence the way people in the region see themselves and their societies.

See also *Confucianism; Daoism*.

BIBLIOGRAPHY

- Ames, Roger T., ed. *Self as Person in Asian Theory and Practice*. Albany: State University of New York Press, 1994.
- Csikszentmihályi, Mark, and Philip J. Ivanhoe. *Religious and Philosophical Aspects of the Laozi*. Albany: State University of New York Press, 1999.
- De Bary, Wm. Theodore, and JaHyun Kim Haboush, eds. *The Rise of Neo-Confucianism in Korea*. New York: Columbia University Press, 1985.
- Hall, David L., and Roger T. Ames. *Thinking Through Confucius*. Albany: State University of New York Press, 1987.
- Ko, Dorothy. *Teachers of the Inner Chambers: Women and Culture in Seventeenth-Century China*. Stanford, Calif.: Stanford University Press, 1994.
- Kohn, Livia. *Early Chinese Mysticism: Philosophy and Soteriology in the Daoist Tradition*. Princeton, N.J.: Princeton University Press, 1992.
- Mann, Susa, and Yu-Yin Cheng, ed. *Under Confucian Eyes: Writings on Gender in Chinese History*. Berkeley: University of California Press, 2001.
- Schwartz, Benjamin. *The World of Thought in Ancient China*. Cambridge, Mass.: Belknap Press, 1985.

Yao, Xinzhong. *An Introduction to Confucianism*. Cambridge, U.K., and New York: Cambridge University Press, 2000.

John Powers

EUROPEAN THOUGHT

Studies of European views of *man* and of the *dignity of man* have been central to the history of ideas, and books continue to be published discussing Western or European views of *man*. Meanwhile, women, lower-class men, and people of color have delved into the scholarship to determine if a thinker’s text intended *man* (*homme* in French) to be generic as in the Hebrew *adam*, Greek *anthropos*, or Latin *homo sapiens*; or whether the intention or application was narrowed by sex, rank, class, nationality, or ethnic/racial construct. Of course the androcentric *man* does emphasize the male in implying *humanity*. Feminist scholarship, with precedents in medieval and early modern women authors, has sought out instances wherein *man* androcentrically included *woman* and the *dignity of man* the *dignity of man and woman*. Likewise, with precedents in the sixteenth-century debates between Bartolomé de Las Casas (1474–1566) and Juan Ginés de Sepúlveda (1490–1572 or 1573) on the humanity of indigenous peoples of the Americas, as well as in the eighteenth- and nineteenth-century movements against the trade and enslavement of Africans, scholars have explored the documents that did expand inclusively the “natural rights of man.” *Humanity* as a term for the human species has begun to be utilized to replace *man* in discussion of texts that meant by *man* all humans. The history of the idea of *humanity* (or philosophical anthropology as Charles Trinkaus labeled it in his *“In Our Image and Likeness”: Humanity and Divinity in Italian Humanist Thought*, 1970) is then a sequel to previous scholarship on the history of the idea of generic man, *anthropos*.

Universalism versus Particularism

A guiding universalist principle might be that if an idea about *man* is valid, or if an international law is fair, then it applies to all of *humanity*. In the postcolonial era, those opposing false universalism—which intentionally misleads the oppressed—have targeted especially European ideas about *man* that were meant to apply only to elite European males and white feminists’ ideas about women that exploit or ignore women of color. Global feminist critiques, as by Chandra Talpade Mohanty, deconstructed the Eurocentric generalizations about “Third World women” and “First World women.” Historical and legal scholarship by necessity covers a spectrum from universalist to particularist, exposing in their wake examples of false universalism. Lynn Hunt’s *The French Revolution and Human Rights* (1996) applies universalism in exploration of origins of human rights in the natural rights document “The Declaration of the Rights of Man and Citizen” (1789) and applies particularism in exposing the policy debates among French Revolution deputies about citizenship rights of the poor and the propertied, the Jews, free blacks and slaves, and women.

In updating the “Universal Declaration of Human Rights” (United Nations, 1948) by the “Beijing Declaration and

Platform of Action” (United Nations Fourth World Conference on Women, 1995), women planned to realize generic human rights by considering the particularities of women’s situations: socioeconomic conditions such as regional poverty and obstacles to women’s paid employment; political situations such as men leaving women out of decision making; and bodily factors such as control over health, especially one’s own fertility. Emerging is an idea of humanity that recognizes difference.

Essentialism versus Choice

Ancient Greek philosophers from the fifth century B.C.E. onward speculated on the essence of human nature, and Aristotle’s views came to dominate in medieval universities. In his four-part theory of causation (material, efficient, teleological, and formal causes), Aristotle (384–322 B.C.E.) defined human nature by the end (the *telos*) and the form, the fully developed human being; his ideal human was the free, self-governing man who ruled over household and shared community rule in a democratic state. As he noted that a black parent and white parent could mate and produce a child of either color, he viewed all human peoples as the same species. Proposing that all human seeds strive for their full development, which he viewed as male, he thought that women were defective males, but alas the same species. Aristotle’s view contrasted with his teacher Plato (c. 428–348 or 347 B.C.E.), who in the *Republic* taught that the only difference between men and women is that one begets within the other; in order to have the best women available and trained to be philosopher-kings, Plato proposed a communal mating and child-rearing system in the guardian class. Throughout the Middle Ages the text of Plato most available was the *Timaeus*, which suggests that men who misbehave are reincarnated as women; as a result, Renaissance male commentators tended to read the *Republic* with the misogynist preconception from the *Timaeus*. When the *Republic* was discussed in the Renaissance, there was mockery of Plato’s description of women exercising in the nude as men did in Greece. Nevertheless, in a treatise defending the dignity of female humanity, “La nobilita et l’ecellenza delle done, co’ diftette mancamenti de gli huomini” (1600; The nobility and excellence of women and the defects and vices of men) Lucretia Marinella (1571–1653) handled the arguments of Aristotle and Plato with aplomb; and the twentieth-century daycare, as proposed in Vladimir Ilyich Lenin’s *State and Revolution* (1917) or as established by many employers by the early twenty-first century, applied Plato’s distinction between birth mother and the child caregiver to release parents’ talents for the good of the community.

Renaissance humanists were knowledgeable in the debates of ancient Greek philosophers on the essence of human nature and the highest good, but they viewed the essence and highest good within the biblical framework of the Creator God. Giovanni Pico della Mirandola (1463–1494) in his *Oration*, in stating God’s words to androgynous “adam” (before woman was separated), broke with a fixed essence for human nature by emphasizing freedom of will as the essence of human nature. He suggested that humans may choose to lower themselves in imitating animal behavior or raise themselves in imitation of angelic behavior. Pico poses as the highest goal to

attempt in one’s lifetime to contemplate God, a viewpoint compatible with his teacher Marsilio Ficino’s (1433–1499) proof that the striving to contemplate God in this life suggests that there must be an afterlife where the goal can be achieved (texts in *Renaissance Philosophy of Man*, 1948).

The rejection of “essences” awaited atheist Jean-Paul Sartre’s “Existentialism Is a Humanism” (1946), wherein he declares that there is no essential human nature, but that all persons must choose their own natures. He rejects the essentialist human nature of Denis Diderot, Voltaire, and Immanuel Kant, and follows Martin Heidegger in proclaiming that existence precedes essence. Like Pico, Sartre emphasizes the freedom of the will; unlike Pico, Sartre leaves it up to persons to determine the universalist image of humanity that they believe is best for molding themselves. In dialogue with Sartre, Simone de Beauvoir in the *Second Sex* (1949) elaborated on the complexities of a woman’s existence and the challenges of defining her own essence when woman is seen as “the other” by men and has internalized men’s viewpoints. Peoples of Africa and India, freeing themselves from the “otherness” of European colonial rule, extended the discourse to their own definitions of essence in establishing political independence. A diversity of feminists questioned whether there was any common essence to womanhood, and emphasized differences. Sartre’s viewpoint of each individual defining an essence as best for humanity gave way to self-definitions particularized to national, religious, and racial communal norms, as well as to self-definitions expressive of multiple identities and of personal individuality.

Potential for Good or for Evil

While the Homeric religion of the ancient Greeks suggested that the gods and goddesses played with human events, the ancient Greek philosophers after Socrates (c. 470–399 B.C.E.) analyzed the parts of the human psyche to gain control over human conduct, and debated the highest good (*eudaimonia*). The Platonic Academy under Plato sought contemplation of the Forms such as Justice, Truth, and Beauty. Criticized not only by the Aristotelian Lyceum, but also by the Epicureans who proposed pleasure as highest good, and the Stoics who proposed virtue and the highest good, the Academy in its skeptical stage during the second century B.C.E. sought tranquility from doubt. Marcus Tullius Cicero (106–43 B.C.E.) passed on the heritage of the Hellenistic debates in numerous Latin dialogues wherein he proposed to fellow Romans of the Republic his goal of *studia humanitatis*, the studies appropriate to a free citizen. The particular set of disciplines constituting the humanities education have changed over the centuries but retain Cicero’s educational goal to develop natural potentiality of humanity. Influenced by Greek Stoic imagery of notions imprinted on the mind, Cicero described the positive potential in human nature as the rudimentary beginnings of intelligence, right reason, or common notions that the mind naturally develops. Lucius Annaeus Seneca’s (4 B.C.E.–65 C.E.) *Epistles* passed down to medieval Christians the identification of common notions with seeds of virtue and knowledge. In this optimistic view of human nature, right reason is an internal access to natural law, and humans know to seek good and flee evil.

While born of a noble Florentine family of modest means, Dante around 1310 in his *Convivio* (*The Banquet*) establishes a clear-cut precedent for a tracing of nobility only to virtue:

Let not those men who are of the Uberti of Florence, nor those of the Visconti of Milan say “Because I am of such a family or race, I am Noble,” for the Divine seed falls not into a race of men, that is into a family; but it falls into individual persons, and, as will be proved below, the family does not make individual persons Noble, but the individual persons make the family Noble. (*The Banquet*, book 4, ch. 20, trans. Sayer, p. 238 in A. Smith-Palmer, *The Ideal of the Gentleman*, p. 172)

Yet Dante in *Paradiso* also expresses pride in meeting his twelfth-century noble ancestor Cacciguida. Note the use of *race* in premodern Europe for a family line or lineage, especially for the distinction between those families of highest social rank and other people. It was in the eighteenth century that race came to be an anthropological term to distinguish body types encountered in different continents. In the early twenty-first century, many scholars viewed much previous discussion of race as pseudoscience and studied instead the “racial constructs” of particular cultures.

In contrast to the Greco-Roman tradition, wherein ethics and law developed without a heavy interference from religion, Hebrew scriptures provided a divinely revealed law code, on which rabbinical discussion ensued in the Babylonian Talmud. A basic premise of Judaism is that the created world of God is good and that humanity in particular is very good: “created in the image of God, male and female” (Gen. 1:26). Psalm one compares a righteous man to “a tree . . . that bringeth forth its fruit in its season,” and the prophet Jeremiah holds man responsible for bringing forth sweet good deeds (Jer. 2:21).

St. Augustine of Hippo (354–430) reinterpreted Genesis in his development of the doctrine of original sin, a sin Augustine viewed as committed by Adam and passed down to offspring through male concupiscence in sexual intercourse. While through baptism, a Christian overcomes some original sin inherited from Adam through the grace of the new Adam, Jesus, humans are stained nevertheless and must be alert to temptations. In his *Summa Theologiae*, St. Thomas Aquinas (c. 1224–1274) utilizes the phrase “seeds of virtue and knowledge” to explicate the basis of natural law within human nature, and Thomism vied with Augustinianism. During the Italian Renaissance, a prosperous middle class rising into the nobility argued that nobility was based not on the “seed of lineage” but on the “seed of virtue.” The further optimism concerning potentialities of human free will of the Renaissance neo-Platonists Ficino and Pico della Mirandola helped bring about a reemphasis on Augustinian original sin through Martin Luther (1483–1546) and John Calvin (1509–1564) and among Catholic Jansenists.

More radical than the Protestant and Catholic Reformations were the secular authors who attempted to describe

human nature independently from the Judeo-Christian tradition. Niccolò Machiavelli (1469–1527) used ancient models to write about history and politics, and proposed autonomous principles governing the success of a new prince over the unruly human nature of his population. The Enlightenment thinkers sought to define human nature within a pregovernment ancient state of nature suggested by Cicero’s description of the origins of government in the common notions of community. Following Machiavelli’s negative view of human nature, Thomas Hobbes (1588–1679) suggested a war of each against all. In contrast, John Locke (1632–1704) transformed the natural law into natural rights within human nature, and a philosophical tradition developed that attributed ills of humankind to social arrangements. Jean-Jacques Rousseau (1712–1778) culminated this tradition in looking back to a golden age before inequality became so severe, and suggesting that human communities might make a new social contract, which would provide equality to male citizens. In the nineteenth century utilitarians worked out arrangements for the greatest good of the greatest number; utopian socialists developed schemes for community ownership of property; and Karl Marx (1818–1883) and Friedrich Engels (1820–1895) developed a historical theory for revolutionary change to result ultimately in such peaceful relations of humanity that the government would wither away. Twentieth-century behaviorist psychologists continued the nurture versus nature debate on the side of the malleability of humanity, while the testing industry attempted to measure more and more precisely the variations in abilities among students.

The beats of Igor Stravinsky’s *Rites of Spring* (1913), as well as Expressionist art, evoke the transformation of views of human

nature by authors exploring the irrational in antiquity as well as in modern clashes of world cultures. Friedrich Nietzsche (1844–1900) followed Machiavelli in criticizing the feminine weakness of Christianity and seeking to revive the masculine warrior courage of the Romans. Nietzsche provided an image of a human greater than ordinary for whom ordinary morality was too limiting. Such a person might transcend moral convention. Sigmund Freud (1856–1939) suggested that sexuality pervaded the human psyche. Humanity was driven by the sexuality and aggression of the id; the ego tried to control the id under guidance from the parentally socialized superego. These psychological explorations suggested a more sinister side of human nature, evident in the European colonial competitions in Africa and in the developments of totalitarian regimes in Europe.

Twentieth-century authors had to contend with the realization of the nightmare of two world wars fought on European soil. A revival of Augustinian notions of original sin developed within Catholic and Protestant theologians, yet the Second Vatican Council, 1962–1965, in its ecumenical discussions, did affirm “that God does not deny the possibility of salvation to all men of good will” (reaffirmed by Pope John Paul II, *The Splendor of Truth*, pp. 6–7). Most European theorists of human nature, absorbed in witnessing the atrocities of their times, concluded negatively on human nature. Yet in July 1944, Anne Frank, hoping the Nazis would not find her Jewish residence in Amsterdam, wrote “It’s really a wonder that I haven’t dropped all my ideals. . . . Yet I keep them, because in spite of everything I still believe that people are really good at heart” (p. 287).

See also *Class; Essentialism; Evil; Existentialism; Feminism; Free Will, Determinism, and Predestination; Good; Humanism; Race and Racism; Stoicism; Universalism.*

BIBLIOGRAPHY

PRIMARY SOURCES

- Frank, Anne. *The Diary of a Young Girl*. Translated by B. A. Mooyarrt-Doubleday. New York: Doubleday, 1967.
- Fromm, Eric, and Ramón Xirau, eds. *The Nature of Man: Readings*. New York: Macmillan, 1968.
- Osborne, Martha Lee, ed. *Woman in Western Thought*. New York: Random House, 1979.
- Palmer, Abram Smythe. *The Ideal of a Gentleman; or, A Mirror for Gentlefolks: A Portrayal in Literature from the Earliest Times*. London: Routledge, 1908.

SECONDARY SOURCES

- Cassirer, Ernest, et al., eds. *Renaissance Philosophy of Man*. Chicago: University of Chicago Press, 1948.
- Horowitz, Maryanne Cline. *Seeds of Virtue and Knowledge*. Princeton, N.J.: Princeton University Press, 1998.
- Horowitz, Maryanne Cline, ed. *Race, Class, and Gender in Nineteenth-Century Culture*. Rochester, N.Y.: University of Rochester Press, 1991.
- , ed. *Race, Gender, and Rank: Early Modern Ideas of Humanity*. Rochester, N.Y.: University of Rochester Press, 1992.
- John Paul II. *The Splendor of Truth*. Washington, D.C.: U.S. Catholic Conference, 1993.
- Mohantry, Chandra Talpade. “Under Western Eyes: Feminist Scholarship and Colonial Discourses.” In *Feminist Theory: A*

- Reader*, edited by Wendy Kolmar and Frances Bartkowski. London: Mayfield, 2000.
- Nussbaum, Martha. “In Defense of Universal Values.” In *Controversies in Feminism*, edited by James P. Sterba. Lanham, Md.: Rowman and Littlefield, 2001.
- Passmore, John. *The Perfectibility of Man*. 3rd ed. Indianapolis, Ind.: Liberty Fund, 2000.
- Richards, Graham. *“Race”, Racism, and Psychology: Towards a Reflexive History*. New York: Routledge, 1997.
- Sassi, Maria Michela. *The Science of Man in Ancient Greece*. Translated by Paul Tucker. Chicago: University of Chicago Press, 2001.
- Trigg, Roger. *Ideas of Human Nature: An Historical Introduction*. 2nd ed. Malden, Mass.: Blackwell, 1999.
- Tuana, Nancy. *The Less Noble Sex: Scientific, Religious, and Philosophical Conceptions of Woman’s Nature*. Bloomington: Indiana University Press, 1993.
- Winston, Andrew S., ed. *Defining Difference: Race and Racism in the History of Psychology*. Washington, D.C.: American Psychological Association, 2004.

Maryanne Cline Horowitz

HUMANITY IN THE ARTS. Four sculpted images of the male figure loom before the viewer. These four works span a period of almost 2,500 years, are fabricated from a variety of media, and range from naturalistic to realistic to abstract presentations. Perceived through the eyes of art historians they have been described as “the classic nude,” “a prime force,” “in

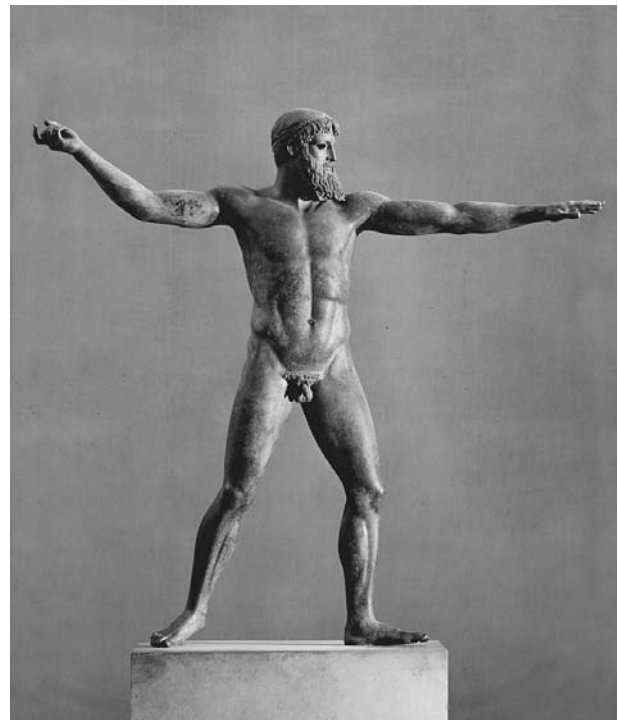

Idealized male figure. Zeus (or Poseidon) from Cape Artemisium (c. 460 B.C.E.). Bronze. © ERICH LESSING/ART RESOURCE, NY



Vitality of the male form. *Saint John the Baptist* (1879) by Auguste Rodin. Bronze. © CHRISTIE'S IMAGES/CORBIS

motion,” and “*pars pro toto*, or the part which stands for the whole.” However, when seen through the eyes of cultural historians, these same four sculptures are characterized with such diverse adjectives as “heroic,” “fragmented,” “ethereal,” or “earthly” and described as “ideal,” “cultic,” “tragic,” or “ambiguous,” as symbolic of cultural attitudes toward the body, the human person, and thereby of humanity. Yet all four provide sufficient visual information to be deemed male, figural, and most especially, human—not divine, animal, or object.

The classical principles of the human form as an expression of the idea of humanity, especially that of the athlete, as the “temple of the gods,” is reflected in the idealized male figure in *Zeus* (or *Posideon*) (c. 460 B.C.E.). He stands with his left leg bent slightly at the knee and his left foot planted firmly upon the earth as his right foot springs forward slightly, providing both a sense of motion and a gesture of transcendence. As his muscular right arm bends at the elbow to propel his energies through his right hand, this athlete apparently prepares to hurl a javelin. His left arm extends outward to direct his sight and the projected path of his weapon. Balanced according to the classical proportions between head and torso and then between head and legs and arms, his handsome body, through its posture and gestures, voices the cultural attitude of the perfection of the human form as a nexus of humanity and divinity, of immanence and transcendence.

The otherwise distinctive presentation of the male body with shortened extremities, diminutive hands, enlarged feet, elongated torso, protruding belly, and protracted phallus on the otherwise untitled Baluban sculpture *Male Figure* (probably nineteenth century), might at first glance appear as a “primitive” distortion of the human image. However, prolonged observation proffers the indigenous perspective on the human, if not simply the male, body. The widespread stance of this man is echoed in the extension of his hips and buttocks and balanced by his broad shoulders. His bare feet, which appear initially to be too large for his legs, are entrenched firmly and flatly on the earth and support his dense male body. Whether simply by weight or symbolic values, his distended belly and penis sag downward toward the earth. His undersize hands clutch the outermost perimeter of swollen belly, emphasizing simultaneously the abdominal protuberance and enhanced navel and his long genital. Gesture, posture, and bodily attributes turn the viewer’s eye not upward toward this figure’s enlarged head or dramatically incised facial features but rather downward toward the earth. The visual connectives denote the sympathetic magic with the fertility of the earth and two distinctive traits of the African ethos: its earth-centeredness and the centrality of the human body in the indistinguishable unity of art, life, and spirituality, even to the conclusion that dance is Africa’s primal and primary art.

The sinewy musculature of the life-size bronze rendering in Auguste Rodin’s *St. John the Baptist* (1879) evokes simultaneously a response of awe at the sculptor’s craftsmanship and marvel at the handsomeness of the human body. Captured at mid-stride, the bronze body of this male figure pulsates with the connections between muscle, sinew, skin, and respiration. Like the figure of Zeus, this St. John has one foot flat on the ground and the other slightly elevated to accentuate the internal and external motion of a walker. He gestures welcome with his right hand while his left hand turns the viewer’s attention to the earth as he signifies immanence as a direction toward transcendence. No matter how long or great the distance from which we look, it is the torso of St. John that captures the viewer’s attention. The careful detailing of his rib cage, including the intimate relationships between flesh and muscle, muscle and bone, capture our attention, enabling the viewer to recognize the artistic, medical, and technical advances that separate Zeus from St. John while also highlighting the commonalities between these two visual renditions of the male figure, especially as a representation of the idea of humanity.

The greater visual divide is the artistic move in the early twentieth century to abstractions leading to Constantin Brancusi’s *Torso of a Young Man* (1924). As with his three sculpted predecessors, this bronze sculpture captures the essence of being male and human despite the absence of a full representational and physical body, an individualized face, or symbolic gestures. Rather, the energies emanating from this carefully composed abstracted torso and its initial point of division into two lower limbs simultaneously references humanity and maleness. The sculptor has carefully placed his piece on an orchestrated base that affects our seeing of it as a torso, as human, as male—not simply as three interconnected brass cylinders. Nonetheless, these four variations in sculptural

styles and forms enable the viewer to see the essence of the male figure and, more generically, humanity. The focus in this visual essay is the modes and means by which sculpture relays the idea(s) of humanity across historical and cultural boundaries. The methodology is comparative but not chronological, as the concerns here are the visual transmission of an idea and the visual critique of a universal ideal. This procedure will then create a recognition of this idea not by the chronological sequence of stylistic developments in sculpture but rather through the transmission of key elements in both universal and regional conceptions of being human.

Toward a Definition of the Idea of Humanity

The primary definitions of *humanity* in the *Oxford English Dictionary* include “The quality or condition of being human, manhood; the human faculties or attributes collectively; human nature; man in the abstract.” As a plural, *humanities*, the *OED* continues, “Human attributes; traits or touches of human nature or feeling; points that concern mankind, or appeal to human sensibilities.” Further, in connection with the word *humane*, *humanity* is defined as “The character or quality of being humane; behaviour or disposition towards others such as befits a human being.” This examination of the idea of humanity through the sculpted image incorporates these

three characteristics of being human in representational, figural, or abstract forms; in the expression of sensibilities and sensitivities; and in depictions of modes of behavior and interactions with others. The duality within the phrase “humanity in the arts” is exemplified by the artistic recognition of the existence in nature of the human body, and further of the potential symbolic and evocative patterns of human forms, gestures, and postures.

In his 1954 Andrew W. Mellon Lecture in the Fine Arts, the art historian Herbert Read focused his attention on the problematic of *The Art of Sculpture* (1956). Through detailed analyses of sculptures from varied cultures and time periods, Read proposed that more than 90 percent of all sculpture is of the human body, thereby naming the close association between sculpture and humanity. More than forty years later, another art historian, Tom Flynn, pronounced that the history of the sculpture was the history of the body (1998). The close associations between sculpture and humanity are confirmed in classical myths such as the stories of Deucalion and Pyrrha and of Pygmalion. Further recognition of this affinity in Western culture is found in the Second Commandment, as biblical and art historical scholars have argued over the centuries as to the meaning of the terms *graven image* and *idol*. Clearly, early Western monotheism emphasized the negative connectives between idolatry, graven images, and sculpture even unto the almost complete absence of sculpted images in Christianity until the Middle Ages. The visual and emotive realities are obvious: the encounter with either a life-size or monumental sculpture is similar to that with another human being.

The often-missed irony is that the majority, if not all, of the world’s religions, including Christianity, incorporate within their narratives of origins a story of the creation of humanity. Western monotheistic traditions premise their univocal foundation toward human nature and, thereby, humanity, on *Genesis*, especially 1:26–27. The operative principles are that humanity is fashioned as both men and women and in the image of God, implying both a parity of the sexes and a scriptural anthropology. Each of the monotheistic traditions, however, reads these and ensuing passages with distinct theological eyes so that the original story becomes layered with scriptural, theological, and societal meanings.

For example, Judaism encodes the categories of men and women with cultural, societal, and scriptural definitions to affirm its distinctiveness within the larger cultures in which it existed. Christianity affirms *Genesis* 1:26–27 with the Incarnation of Jesus as the Christ (*John* 1:14) and the later theological theses including the fourth-century patristic texts of Augustine and Jerome. The early Christian understanding of humanity is, of course, complicated by the dogmatizing of Christology in the face of heresies, controversies, and debates. The fourth-century transformation of Christianity into the Imperial Church simultaneously transformed the social order toward that of the Byzantine court, thus resulting in fewer roles for women in liturgical ceremonies, sacramental rites, and church life. Analogous modifications occurred throughout the history of Christianity in its multiple public formations. Koranic teachings reaffirm and oftentimes enhance the *Genesis*



A symbol of fertility. *Chac Mool, the Rain Spirit* from Chichén Itzá (948–1697). Limestone. THE ART ARCHIVE/NATIONAL ANTHROPOLOGICAL MUSEUM MEXICO/DAGLI ORTI

narrative in light of the then contemporary cultural, legal, and societal situations of Islam.

Nonwestern cultures, however, do not necessarily either frame or discuss the idea of humanity within this same, or similar, structural boundaries, interpretive narratives, or visualizing processes. Nevertheless, the reality exists that there is a universal foundation that privileges the relationship between humanity and the religious as evidenced in scriptural or spiritual texts and visual evidence with regional and religious variations, that is, indigenous traditions, Buddhism, Confucianism, Daoism, Hinduism, and so on.

As an example of the cross-cultural and transhistorical scope of the discussion of the idea of humanity in sculpture, consider this revisiting of one of Herbert Read's comparisons between

a *Chac Mool, the Rain Spirit* from Chichén Itzá (948–1697) and the twentieth-century sculpture by Henry Moore of a *Reclining Woman* (1929). The parallels are not one-for-one between these two images, as if Moore had seen and had been highly influenced by the Aztec work; rather, the similarities are in the potential affinities and differences in the understandings of humanity. From that perspective, we see two figures resting on the ground: the one more geometric and angular in form, the other curved and rotund even unto her “squared” right shoulder and thigh. The *Chac Mool* rests his lower back and buttocks on the ground, raises his legs, which are bent at the knees, but has his feet flat on the ground as did the *Baluban man*. His torso is elevated almost as if leaning against a series of pillows as he twists his head to acknowledge any approaching supplicants. Typically Mesoamerican art

emphasizes a strong connection between fertility and death, thereby the natural order of the life cycle. The Chac Mool, as both a rain spirit and a male figure who connects so clearly to the earth, affirms the empathy between the rain that encourages the fertility of the earth and the male semen that signifies human fertility.

Moore's female figure reposes more naturally than her geometrically compact Aztec ancestor. She is a supine configuration of intersecting curves and lines as her body rests on the ground and her shoulders twist upward with her left arm raised to support her head, which turns to face the viewer. Continuing the Western cultural and religious fascination with the affinities between the female and the earth, this twentieth-century depiction accentuates her hips and thighs and positions her legs to underscore the genital area. The commonalities between these two images encompass the universality and ahistoricity of "natural" placements in which the human body can be positioned, the representation of gender and thereby of power, and a consideration of the original function as opposed to the sanctification such works of art receive by being installed in museums.

The form, shape, posture, gesture, and costume conferred upon the human body by sculptors in different cultures, historical periods, and religious commitments allow researchers to see and critique the embedded inscriptions of gender, class, identity, and power. Body types vary not simply from geographic region to geographic region but also from cultural categories that transmute according to prevailing economic, political, religious, and social attitudes. Sculptures such as the Baluban *Male Figure*, the Aztec *Chac Mool*, and the Greek *Zeus (Poseidon)* invite comparisons in relation to their varying centers of gravity, which define their physical postures and their internal spiritual nexuses. Analyses of their comparative expressions of mass, weight, and volume coordinate projections of natural versus ideal body types, symbolic patterns of the human body especially with regard to divinity and the sacred, and nutritional and medical factors that reveal information about class, race, and gender.

The Task of the Sculpted Body for the Idea of Humanity

The critical question voiced by the art historian Moshe Barasch—"What tasks is the human figure made to fulfill in painting and sculpture, and how has it been employed by artists and understood by the viewer in varying periods?"—affects the interpretation(s) and valuing of the idea of humanity. Expressive of a diverse spectrum of religious values and cultural attitudes, the imaging of the human body has been instrumental in fertility rites, magical ceremonies, cult objects and rituals, idolatry, natural medicine, social advancement, intellectual achievement, and sacred correspondence. One of the significant components in the artistic renderings of humanity has been in the social and cultural constructions of gender, that is, what distinguishes the categories "feminine" and "masculine" in modes of behavior, demeanor, dress, and meaning. Biology determines sex, while society, from its privileged coordination of culture, economics, politics, and religion, conditions definitions of and attitudes toward gender.

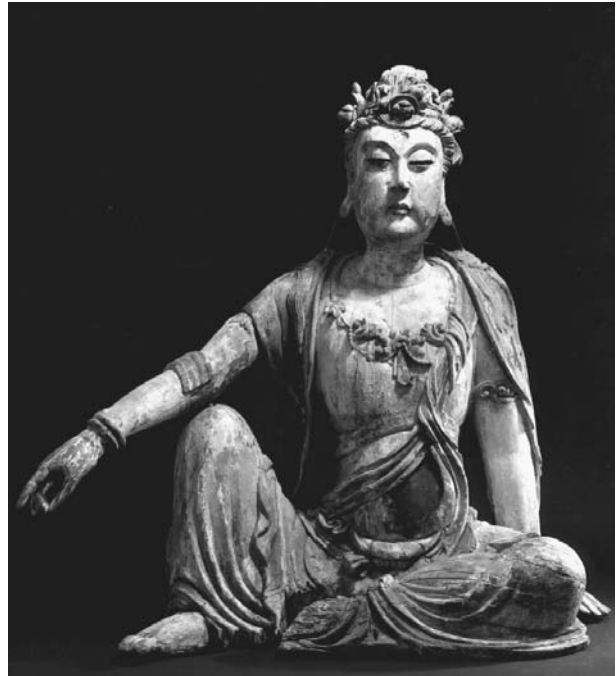

An androgynous deity. *Kuan-yin* (China, 960–1279). © FOTO WETTSTEIN & KAUF; MUSEUM REITBERG ZÜRICH

Post-1960s scholarship, which introduced and incorporated the inclusion of the marginalized—that is, those previously neglected groups such as racial and ethnic minorities, the economically impoverished, and women—has prompted reevaluations of the canons and categorizations of Western history. Commensurately, this new scholarship critiqued and questioned the traditional litany of the distinctions between "East" and "West" from cultural, philosophic, and religious perspectives. Differing cultures define particularized patterns and structures for identical realities such as gender, as evidenced in the classical Mediterranean *Aphrodite of Knidos* (350 B.C.E), the Indian *Rukmini* (tenth century), and the Chinese *Kuan-yin* (or Guanyin, 960–1279). Ostensibly these three images depict female bodies with some regional distinctions apparent, such as the small, almost adolescent breasts but thickened waist, wide hips, and heavy thighs on the Greco-Roman goddess of love as opposed to the narrowed waist and globular breasts on the Hindu deity of fertility or the wispy waist and prepubescent chest of the Buddhist purveyor of mercy and compassion. All three representations correspond to the principle of the human form as the vehicle through which the divine is expressed or manifested. All three interconnect in their gestural signs, which communicate the empathy between the feminine and fertility and the earth—from Aphrodite's right hand denoting female modesty, the site of generation, and sexual pleasure, to Rukmini's voluptuous display of her feminine attributes, to Kuan-yin's earthbound posture and right-handed gesture pointing toward the earth.

However, there is a disconnect here despite the ostensibly feminine presence of these three deities. For upon careful examination of physical characteristics there is the question of



The allusion of spirituality in a classically inspired work.
Apollo and Daphne (1622–1624) by Gian Bernini. Marble.
 © BETTMANN/CORBIS

the gender ambiguity of Kuan-yin, who appears to be more androgynous than specifically male or female. Historians of religion, especially those specializing in Eastern religions, have debated the reasons for and the historical route of the transformation of the Indian Buddhist male bodhisattva Avalokiteshvara into the androgynous Chinese Buddhist bodhisattva Kuan-yin, who becomes ultimately the Japanese Buddhist female bodhisattva Kwannon. The present issue is not an attempt to unravel this religio-historical conundrum but rather to raise the question of cultural perceptions of gender and thereby of humanity. For by whatever name this deity is identified and by whatever anthropomorphic form configured, the fundamental questions of identification relate first to the fact that this is the deity of mercy and compassion—virtues that cultural conditioning may categorize as feminine or masculine—and second to cultural disparities in attitudes toward gender, meaning that the gestures, postures, and modes of behavior one culture (say, southern Europe) names as “male” and “female” are opposite to those of the Indian subcontinent or the Far East. Both in terms of artistic creation and scholarly interpretation, it is necessary to

recognize that Western culture, and thereby Western scholarship, has traditionally been preoccupied with order and clarity. Gender distinctions and their ensuant visualizations may be more subtly rendered and understood in non-Western cultures and defy normative Western iconographic patterns, thereby proffering wider horizons for defining and evaluating universalized ideas of humanity.

The human body, whether male, female, androgynous, or hermaphrodite, is a carrier of meaning and values inscribed with subjective associations and objective perceptions, stylistic variations, and institutional identifiers. One of the most significant of those “inscribers” is religion. The enigma of religious art—the question of what makes art religious beyond the labeling of an image as religious—is a consideration in the visual comparison of the idea of humanity in Gian Bernini’s seventeenth-century sculptures of *Apollo and Daphne* (1622–1634) and *The Ecstasy of Saint Teresa* (1645–1652). Each of these works is a “group” as opposed to an individual sculpture, that is, there is more than one person represented; in the former it is a mythological couple and in the latter an angel paired with the female mystic. So the dynamics of interaction between individuals becomes central to the ways that such sculptures project internally the idea of humanity. The Baroque characteristics of theatrical drama of the moment, of an upward swirling movement, and of theatrical lighting combine with a reaffirmed sense of the spirituality of the body to fashion an aesthetic that reflects the changing Counter-Reformation attitudes toward the human and the human body in opposition to the harmony, balance, order, and anthropocentrism of the Renaissance.

Bernini’s two works challenge the viewer to consider the importance of posture, dress, and narrative in the projection of the idea of humanity through the vehicle of the human body in sculpture. Daphne appears almost completely uncovered, a nude female in the classic sense of the term as she gracefully swivels her body away from the clutches of her pursuer, the similarly minimally clad Apollo. The upward gyrations of her escape are transformed into an elegant series of curvilinear swirls of what appears to be drapery suggestively covering her pubic area and her left leg while skimming the inner edge of her right leg. Close observation, however, reveals that this drapery is the initiation of the trunk of the laurel tree that will enclose her and thereby protect her from Apollo. Her upraised arms curve into what had been her hands, which have transmogrified into laurel tree branches. Although both the running figure of Apollo and that of the metamorphosing Daphne are clearly modeled upon classical prototypes, Bernini’s bodies lack the muscular weight and tension found in the classical Greek *Zeus (Poseidon)* or the classical Greco-Roman *Aphrodite of Knidos*. Despite the time factor—more than a century of cultural, medical, political, scientific, social, and theological advances—Bernini’s figures appear softer to the eye, as if they were almost weightless and thus able to float off from the earth as opposed to the earthbound realistic renderings of the human body as muscled and monumental, characterized by the Renaissance. Further, this characterization of Apollo is that of a soft beautiful youth who hovers between masculinity and androgyny. Although the theme is secular, the ethereal quality



Reverential or voyeuristic? *The Ecstasy of Saint Teresa* (1645–1652) by Gian Bernini. Altar of Cornaro Chapel, Church of Santa Maria della Vittoria, Rome. THE ART ARCHIVE/ALBUM/JOSEPH MARTIN

of the sculpted bodies of Apollo and Daphne direct the viewer to consider the spiritual implications of this “chase.”

Bernini’s rendering of the bodily presence of the Carmelite mystic Teresa of Avila is almost bodiless as she sinks backward onto the rocky ledge (or cloud?) that is poised immediately beneath her. The lassitude of her body might suggest either a weightlessness caused by faint or trance or that graceful liteness of a ballerina as she “floats through the air.” The vitality of this sculptured figure is the dramatic energy released by the swirls of drapery that envelope her while the elasticity of her protruding left hand and foot effect the *pars pro toto* of her swooned body. The tight whirling and spinning of the angel’s robes contrast with the looser delicate layering of cloth that swallows the mystic’s limp body. As opposed to the “in unison” posture of the two standing figures in Bernini’s earlier work, the male angel stands erect as he looks down upon the supine figure of the female saint. The interrelationships thereby shift from one of physical or gender parity to one of dominance or empowerment. The visibly insubstantial nature of the saint’s body creates an aura of spiritual apprehension.

The presence and signification of the familiar form of the angel as divine messenger directs the viewer to contemplate this work as religious art. The question becomes how an individual without a culturally trained Western eye or knowledge of Christianity would see these images. Is the attitude toward the body as corruptible, redeemed, or mystical unique to Christianity, Western culture, or even to this singular sculptor? The normative reading has been that this sculpture is a visualization of the sacramentalism of the human body in a moment of agapic love as appropriate to the Tridentine teachings of Roman Catholicism. Nonetheless, criticisms of this same image identify it as a secular, almost voyeuristic, depiction of female orgasm. The lens, then, through which images are seen ordains the method and mode of interpretation, as does the receptivity of the viewer, as discussed in the relatively new category of response theory (see Freedberg). Thus revisiting Barasch’s question, it may now be paraphrased as: “What tasks is the human figure made to fulfill in painting and sculpture, and how has *the viewer understood that image?*”

Comparative Studies in World Cultures

Through a series of categories—the authority of the male figure, the human as divine revelation, maternity, and abstraction of anxiety and uncertainty—comparisons of selected images from differing historical cultures are contrasted in a bifurcated effort to identify the process of the visual transmission of ideas and to encourage thinking about the meaning, function, intentionality, and reception of the body as the idea of humanity. The curious, if not ironic, fact that the human body is a product of the natural order, however one comes to understand that body, is shaped by social reality and cultural and religious values.

The authority of the male figure. The male figure, which is identified as normative in defining power and authority, or so feminist scholars in the late twentieth century would assert, can serve as a locus for consideration of the relationship between the function of images and the idea of humanity. Referencing

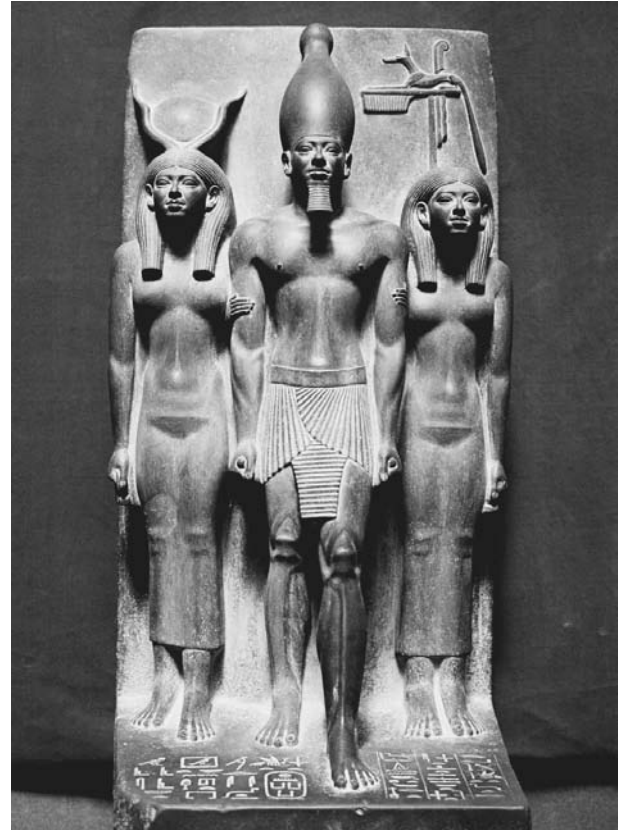

The human form interpreted as symbols of power and authority. *King Men-kau-Ra between the goddess Hathor and the Goddess of the Nome of Diospolis Parva* (Egypt, IV Dynasty, 2800 B.C.E.). Schist. © ROGER WOOD/CORBIS

the classical Greek statue of *Zeus (Poseidon)* (460 B.C.E.) as a particularly fine example of the visualization of the classical principles of harmony and order through the human figure, the handsomeness of this human form becomes quickened by muscular tensions, especially in his arms, legs, and torso, and the intimations of respiration. This sculpted rendition of male energy and movement can be read as expressive of ideal form, creation and fertility, kingship and military power, guardian and athlete, and prevalent social and cultural order. A figure of extraordinary vitality, *Zeus (Poseidon)* visually attests to the “Western” principle of entrancement with the beauty of the human figure, especially as the revelation of the imaged forms of the gods and goddesses. Muscular structure, movement (whether internal or external), and the ability to connote emotion through facial expression, gesture, or pose, are among the sculptor’s tools in transmitting the idea of humanity. This sculpture is called by the name of a god, but he is in the form of a human being.

By contrast, the classical Egyptian carved relief of *King Men-kau-Ra between the goddess Hathor and the Goddess of the Nome of Diospolis Parvis* (IV Dynasty, 2800 B.C.E.) is more formal in presentation and interrelationships among the three figures than the group interaction in either of Bernini’s works. This is a sculpture of hieratic art in which the depictions of

the human body do not visualize the canon of beauty through harmony and order; rather, this is an envisioning of social structures and of the body more as a symbol than an organic composition. The conception of bodily forms, while identifiably male and female even by twenty-first-century Western standards—physical attributes such as breasts, distinctive hairstyles, and social positioning (female behind the male, the male in the leadership slot)—are evident beyond the static geometric and linear emphases. Here the “ideal body” mirrors the social constructs of authority, power, and sovereignty as much through the weightiness of forms as through individual postures.

The straight-backed, almost stiff bearing of all three personages voices their class and role in their cultural world as they affirm, not challenge, the received situation in daily life. Both the king and the goddesses display their bodies without a sense of shame or rejection. Extraordinary delicacy and dexterity was required to carve the diaphanous garments on the two goddesses and the pleated kilt of manhood on the king. The bodily proportions of both the male and female figures are realistic, neither elongated nor disjointed. However, the smooth formation of the torsos and extremities unto the visual lack of muscle-skin-bone-respiration provides us with the reverse situation of *Zeus (Poseidon)*, for Men-kau-Ra is a human being in the form of a god.

The human as divine revelation. Perhaps the fundamental connector between Eastern and Western cultures, especially in terms of religious values and the arts, is the human figure as the signifier of the hypothetical image of divinity. The classical Greek tradition advocated the idealization of the human form as a reflection of divine beauty, a philosophic and artistic legacy operative throughout the evolution of Western culture, which affirmed the dignity of humanity. Christianity inherited this principle but was oftentimes antagonistic to it and vacillated in its attitudes toward the human as graced by the Incarnation, as matter in need of redemption, as the vehicle of innocence, and as the purveyor of sin and lust, especially in terms of women. Commensurately the Eastern attitude, despite its religious and cultural variations, affirmed an abstracted relationship between humanity and the supernatural. This is to say that the human body, either wholly or in part, signified an aspect or character of the mystical ideal so that nakedness/nudity, especially in the Indian subcontinent, connoted the sensuality of the fertility spirits, postures, and gestures, while in Chinese art, nakedness/nudity served a didactic function, especially in terms of ethical behavior. More generically, however, the distortion of a specific body part or its total abstraction signified its embodiment of spiritual ideals.

Variations in body types do not necessarily signal distinctive attitudes toward the idea of humanity but more likely than not reflect the actuality of the global assortment of climatic, meteorological, agricultural, and dietary differences not simply between East and West but also North and South, intracontinental as well as intercontinental. So for example, there is an identifiable “northern European body type” which can be distinguished from a “southern European body type.” The latter is premised upon the Greek ideal of beauty and proposes that whether male or female, the torso is distinguished by two equal

triangles with the base of one running the width of the hips with the intersecting side angles converging toward the waist to meet the tip of the other triangle, which expands as its inverted base crosses the span of the shoulders. This visual sensation of a mathematically balanced harmony is extended through a geometric progression of the size of the head to a grouping of four heads to the length of the torso and extremities, respectively. This “southern body,” which basks regularly in the sun and its warmth, also benefits from the regularity of fresh crops and is thereby comfortable in its skin, wearing lighter and perhaps revealing clothing not for sexual enticement but for physical ease and climatic comfort.

Conversely, the “northern body” displays less proportionate relationships between shoulder and waist, waist and hip, head and torso, and torso and limbs. Rather one sees in works of art and other visual documentation men and women with narrowed shoulders, elongated torsos, protruding abdomens, slender hips, and spindly extremities. Like the huddled masses, they cover themselves with layers of heavy clothing to protect their bodies from the almost perpetual cold and damp weather. Further, this “northern body” is not regularly sustained by the availability of fresh fruits and vegetables; rather the normal diet consisted of salted and preserved meats, pickled vegetables, dark breads, and beer. Similar variations in body types and sizes can be distinguished throughout world cultures, as can the ideal of beauty and the definition of the exotic. Thereby the recognition of the fundamental roles of nature and natural elements in the formation of the human body must not be ignored, and attitudes toward humanity extend beyond what we identify as normative but created influences: culture, economics, politics, religion, and society.

A further consideration to be discussed is posture and stance. How individuals perceive themselves and others and how they are viewed by others is dependent upon a variety of factors including physical position. So whether standing or seated, an individual figure projects differing attitudes toward herself and others, as well as reflecting societal status, class distinctions, and hierarchical values. Similarly the element of dress, or lack thereof in the instance of sculptured figures, also places an interpretive value on the human person and her identity. Gestures, whether digital, hand, or facial, communicate more than emotions, sensitivities, or feelings. Ideas including cultural, religious, and social values can be exchanged or taught through gesturing. All aspects of the human body, then, can safely be said to contribute to the idea of humanity in world cultures, as individual regional groups develop specific forms of body and gestural language and attitudes toward gender, body types, and dress within the more universal categorizations of sex and stages of physical maturation.

One of those universals is the body as a nexus for humanity and divinity. For example, consider the following four sculptures: the figure of Christ from *The Pentecost* (c. 1132), *Standing Buddha* (first century), *The Maitreya of the Koryuji Temple* (seventh century) and *Shiva Nataraja, Lord of the Dance* (eleventh century). These are four different renderings of the divine through the human figure in standing, seated, praying, and dancing postures; clothed, draped, and partially

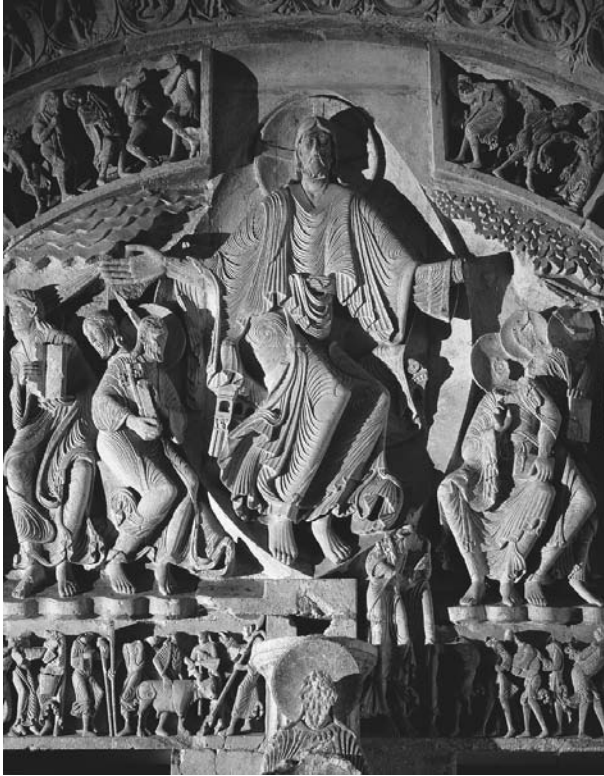

Poised between heaven and earth. *Christ of the Pentecost* (detail from *The Pentecost*, c. 1132), tympanum in the narthex of the Cathedral de la Madeleine, Vézelay. THE ART ARCHIVE/DAGLI ORTI

clothed forms; and with or without halos. Each communicates simultaneously the nobility and the simplicity of being human and male and yet also configured in some way divine.

The twelfth-century Christ of *The Pentecost* tympanum is an elegantly rendered, seated but nonetheless kinetic figure. This particular image is identified iconographically as a *Majestas* (or *Maiestas Domini*, or Lord's Majesty), in which the Resurrected Christ, denoted by his cruciform nimbus, is depicted as the ruler (and judge) of the universe, surrounded by the tetramorphs (Ezekiel 1:4–28; Revelation). His bodily form is ethereal, with elongated torso and limbs and enlarged hands and feet. This is not a depiction premised upon the Greek ideal; rather this is a mystical rendering of the “Word made flesh” who is emphatically contoured against the large mandorla that encases him as a sign of his divinity. The refined drapery is highlighted by the variations between thin and thick reticulations in the folds and pleats. At certain places the drapery highlights the naturalness of his humanity, such as the almost sheer covering over his legs, particularly the protrusion of his right knee, while in other places the heavy layers of fabric, such as that over his arms, resembles wings. Throughout, the curvature of these draped layers of fabric create dynamic, musically organized circles, arcs, and curves that express extraordinary vitality. Thereby, although seated, this male form is enlivened yet hesitates between a state of vibrant motion and calm stillness. This is a Christ caught, if you will, between heaven and earth, between humanity and divinity, between materiality and

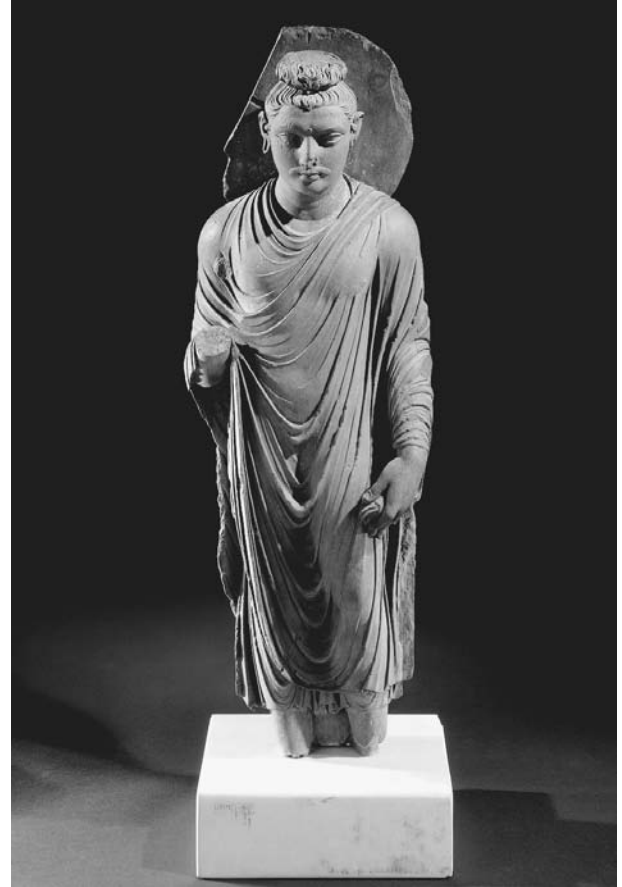

Simultaneously human and divine. *Standing Buddha* (1st century C.E.), Takht-i-Bahi, northwest Pakistan. Schist. HIP/SCALA/ART RESOURCE, NY

spirituality. This is not a Christ who would be known or understood by early Christians who affirmed his Incarnation but envisioned him only symbolically.

By contrast the first-century C.E. *Standing Buddha* radiates serenity, calm, and stillness. His skillfully delineated garment swirls leisurely around his almost pillar-like form. Such an image of the Buddha was influenced by the Greco-Roman models of both sculpted figures and costume. Like the Christ figure, this Buddha is also missing a hand—the former his left hand, the latter his right hand. Ostensibly such selective destruction is the result of an act of iconoclasm that is often religiously inspired when the “images” provoke too much of an aura of reality and threaten the status quo of a religion or political group. Whereas the Christ communicated ethereality and the perceived ability to float away from the cathedral wall and upward to the heavens, this Gandharan Buddha is solidly placed on the ground, although the viewer does not see how firmly, as his feet have either been excised purposively or removed by a natural disaster. This is an image of the eternal, divine Buddha, not the moral teacher of the earliest Buddhist tradition. He is simultaneously regal and humble, human and divine, solid yet spiritual. Despite the refinement, spirituality, and disciplined strength, this Buddha image communicates the

gravitas of humanity as refined aristocracy, particularly when contrasted with the Christ figure.

The Maitreya of the Koryuji Temple is a elegantly aligned figuration of the Japanese Buddhist principles of silence, calm, and compassion that lead toward enlightenment. Although a male form, this Maitreya is an asexual androgyne with soft and delicate hands and fingers that gesture teachings on wisdom and compassion. His slender body almost defies the weight of his enlarged head and thickened neck as it tilts forward in a meditation posture. His slight frame—small, gentle bones with minimal to no musculature—is revealed by his naked torso. His legs are covered by a loosely pleated drape as they intertwine into a yoga position with the soles of his feet turned outward to the sky and away from the earth. As with images of the human form in other historical time periods, cultures, and media, this Maitreya privileges the symbolic nature of the body over portraiture, emblem, or realism. The delicacy and fragility of this bodhisattva portends the ideals of spiritual wisdom and compassion, especially as expressed through love. Another commonality between Eastern and Western religious art in the utilization of the human body is that of the portrayal of love, especially divine love, in which men are characterized by a softening of their otherwise hard-edged masculinity. Thus John the Beloved Disciple (also known as John the Evangelist) is rendered as a soft, delicate, almost fragile but youthful male figure verging for some viewers on androgyny or femininity.

The ecstasy of the so-called Dancing Shiva professes the fundamental essence of rhythmic movement as both a primordial human act and a signifier of divine energies. The Hindu tradition characterizes Shiva, like the other deities, through a multiplicity of forms such as the Lord of the Dance who creates and destroys in one conflated activity. The child at his feet is the representative of the new: life, year, creation. However, for the new to emerge the old must be destroyed in the choreography of the life cycle. This is the image of an anthropomorphic deity who defies traditional categories of description as he balances the world on one foot. That foot, however, is symbolically naked and absolutely flat on the ground or the resting child. The contorted postures of his bent knees, elevated left leg, swaggered buttocks, wispy waist, dramatically stiff neck and head, and ceremoniously gesturing four arms and hands are coordinated to presuppose the appearance of a circle, particularly a flaming circle, as the symbol of eternity. Curiously, if the Christ from *The Pentecost* were placed next to the *Shiva Nataraja* one is brought to silence by the visual parallels and counterpoints. The extension of Shiva's outer arms is identical to that of Christ, although the hand gestures differ significantly: Shiva is holding objects such as a cymbal and a lotus in his hands, while the remaining right hand of Christ is empty as it turns palm out to the viewer; presumably he held a book, Bible, or orb in his left hand. The dramatic swag of the hips is visually parallel, although Christ's two enlarged bare feet rest flat on the edge of the mandorla while Shiva's enlarged feet are positioned differently. The right foot rests flatly and firmly on the offered child, while his right leg is elevated high above his bent left knee. Although further visual comparisons could be made here, what becomes significant is the difference: the ethereality of Christ causes a viewer to wonder if he won't just float away, while the gravitas of Shiva leaves him earthbound.

Maternity. The universal category of maternity is something "more" than the iconographic convention of Mother and Child in either religious or secular art. This image is a confirmation initially of the limitless importance and nature of fertility and secondarily of the survival of both the species and of individual human beings. Found in all forms of religious and secular art within world cultures, the presentation of women with their children is simultaneously ahistorical and historicized. If the faces, costuming, or relationships depicted are identifiable then this pairing can be interpreted as individualized, portraiture, and historical; if unidentifiable or universalized as types, depictions of the mother and child are categorized as ahistorical, symbolic, and culturally or socially relevant. For example, consider the contrasts and commonalities between a twelfth-century Byzantine-style *Virgin and Child* (late eleventh to early twelfth century), a Gothic *Virgin and Child* (fourteenth century), an Indian *Mother and Child* (eleventh century), Michelangelo's *Vatican Pietà* (1498–1500), and Stephen De Staebler's *Pietà* (1988).

The Byzantine-styled *Virgin and Child* projects a vision of clear demarcations as to the theological and social definitions of maternity. The rigid, almost stiff posture of this standing female figure is emphasized, if not highlighted, by the tightly draped and pleated fabric of her dress and mantle, which cover



Formalized depiction of maternity. *Virgin and Child* (Byzantine; 11th–12th century). Ivory. VICTORIA & ALBERT MUSEUM, LONDON/ART RESOURCE, NY

the disproportionate frame of her androgynous body. Her feminine attributes are visible only in her softened but anonymous facial features, her conveyance of a child, and in the gentle emotion expressed in their mutual hand gestures. The



Naturalized rendering of the divine mother and child. *Virgin and Child* (14th century; Cathedral de Notre-Dame, Paris). GIRAUDON/ART RESOURCE, NY

normative convention—in Byzantine and in Western medieval and Renaissance art—of depicting the Christ Child as a miniature adult heightens the hieratic posture and authority communicated by this ivory sculpture. The visual moment of naturalness is found solely in the forward positioning of her left leg as the mother shifts her imagined body weight to accommodate that of her child. The unnaturalness of these figures may be exacerbated by the then dominant Christian antagonism both to sculpture and to the artistic rendering of natural bodies.

The elegant form of the Gothic *Virgin and Child* creates the impression of quiet motion through the interconnecting linear and curvilinear relationships of the loosely pleated layers of fabric of her garments with the S-shaped curve of her body. Exhibiting a very natural swayed posture for a mother who hoists her child on either her protruding hip or twisting upper body, this depiction of the Virgin offers a visual and societal counterpoint to the Byzantine portrayal. The legal status and rights of women, albeit women of class, expanded at this time in history, as evidenced by the way in which this Gothic queen, whose elaborate crown replaces the simple mantle of her Byzantine counterpart, holds forth the symbol of her country with her right hand and the body of her son with her



Mother as creator and nurturer. *Mother and Child* (11th century). Statue from Kajuraho, Madhya Pradesh, India. Chandella dynasty. BORROMEIO/ART RESOURCE, NY

left hand. He offers his mother a round object, apparently an apple or an orb but in either case an object, a piece of property for her to hold and to own. The softened female form of this Virgin, despite her postural exaggeration and that of her child, approach a regularized vision of the human form.

As a contrast, or perhaps a confirmation, of the universality of maternity as an idea and a visual expression of the idea of humanity, consider an eleventh-century Indian sculpture of *Mother and Child*. The normative “Eastern” approach to the softened and voluptuous body of the female figure is evident even without the exaggerated turns of the neck and abdomen. The intersecting curves and arches of this woman’s body both nurture and commune with the rounded figure of her child, whom she holds before her with a firm right hand, placing the child in a position for maternal examination as her solidly balanced left hand draws the child near to her rotund breasts. This mother figure, like her Indian contemporaries, is dressed both for bodily display and for comfort. Her minimized clothing emphasizes the biologically female characteristics of full lactating breasts, an abdominal swell, and swaying hips in coordination with the soft and delicate expression of maternal love and compassion.

Although this Indian mother, like her Byzantine-styled and Gothic counterparts, is depicted standing, she communes directly with her child, from the bend of their heads to the physicality of their connections—the child’s hands on her



The maternal life force. *Pieta* (1988) by Stephen De Staebler. Bronze. PHOTO BY SCOTT MCCUE; COURTESY OF STEPHEN DE STAEBLER

breasts, legs akimbo across the mother’s abdomen, the mother silently extending her pelvic region forward to support her child—so that the emphasis here is on maternal kinetics as opposed to religious, societal, or ritual significance. Fertility and survival fuse in this visual metaphor for human creation as the sacred merges with the secular into a potent motif that transcends geographic borders, economic classes, and religious divisions to express fundamental human and moral values.

Michelangelo amplifies the mother and child relationship and the nature of maternity in his first presentation of the *Pietà*, a Christian iconographic motif signaling the singular mourning of the mother for her dead child. This is a moment of great intimacy and emotion, which Michelangelo elevates to the higher levels of spiritual significance. Here the now seated mother encompasses the limp body of her deceased son in her lap. The varying circular, linear, arched, and swirled drapery that enfolds her body and her head turns initial attention away from both the size and symbolic meaning of her form. The sculptor skillfully creates a series of internal relationships between these two figures so that our sense in seeing this *Pietà* is first of the beauty of the human figures and the placid presentation of emotion.



Emotional presentation of mother and child relationship. *Pietà* (1498–1500) by Michelangelo. Marble. © BETTMANN/CORBIS



The imperfections of humanity. *Archangel* (1987) by Stephen De Staebler. Bronze. PHOTO BY SCOTT MCCUE; COURTESY OF STEPHEN DE STAEBLER

However, careful viewing results in the recognition of the circuit of visual games Michelangelo has created within this one sculpture. There is the Neoplatonic philosophic emphasis on the beauty of form and thereby of a retrieval of the classical Greek tenet of the spiritual valuing of the body. This formal beauty, in fact, is of religio-philosophical importance for Renaissance Christianity and a distraction from the more important internal visual “game.” The mother’s body is greatly out of proportion to the relationship of an adult male body to that of an adult female body. Attentive viewing moves us beyond the theological reading that Mary’s ample body signifies *mater ecclesia* (mother church) to a recognition that the interrelationship between mother and son is actually that of mother with her youthful child. Further, she attends not to the viewer as her Byzantine and Gothic ancestresses did but rather to the sighting of the life force within her son’s body—respiration. Given the Renaissance fascination with and knowledge of human anatomy and medicine, this sighting of Christ’s diaphragm is more than a visual centering point; it is emblematic of the merged valuation of art, life, religion, and science.

Stephen De Staebler’s late-twentieth-century *Pietà* provides a counterpoint to these four sculptures of the universal of maternity. Manifesting a modern recognition of the fragmenta-

tion and fragility of the human body with the eternal dynamic of spirituality, this pairing of figures is abstracted to their fundamental essences. Removing all pretense or social conventions of costume and decoration, as well as any historicized identity by “erasing” identifiable facial features on both the mother and her child, De Staebler recognizes the universal truth of maternity as a life force defiant against disaster, war, and limitations. The child is fused to the mother through her heart as well as her body, as signaled in the positioning of his head emergent from her breast. This abstraction, however, visually reaffirms the natural postural relationships between mothers and children as evidenced in the four sculptures here examined as well as in everyday situations. This mother strides forward on elevated toes as her fragmented body appears poised to levitate above the restrictions of human finitude and guilt, of life and death, despite the scientific and medical advances of the twentieth century; and yet she remains conjoined to the earth, whose contours and surface textures parallel those of this same figuration.

Among the most powerful symbolic pairs in world art and iconography, the stylization, exaggeration, postures, or body types in renderings of the mother and child relate as much to the historical and political time periods in which they are

EXCERPTS FROM SIR HERBERT READ

We are immediately struck by the surprising fact that at least nine-tenths of all the sculpture ever carved is devoted to one subject—the human body.

Only by conceiving an *image* of the body can we situate ourselves in the external world.

SOURCE: Herbert Read, *The Art of Sculpture*, 1956, pp. 25, 29.

Man is the product of the attributes of heaven and earth, by the interaction of the dual forces of nature, the union of the animal and intelligent souls, and the finest subtle matter of the five elements.

Therefore man is the heart and mind of heaven and earth, and the visible embodiment of the five elements. He lives in the enjoyment of all flavours, the discriminating of all notes of harmony, and the enrobing of all colours.

SOURCE: “The Nature of the Universe and Man” from the Li Ki. *The World Bible*, New York, 1939, pp. 492–493.

created as to the religious or secular values they signify. Whether African, Oceanic, Mesoamerican, pre-Columbian, prehistoric, or modern, this universal expression of the idea of humanity confirms visually the enduring meaning of fertility, survival, and love through maternity.

Abstraction of anxiety and uncertainty. The final universal category for the idea of humanity through sculpture is that of the abstraction of anxiety and uncertainty as recorded in Brancusi’s *Torso of a Young Man* (early twentieth century), Alberto Giacometti’s *Figure of a Man* (1947), and Stephen De Staebler’s *Archangel* (1987). Despite the diversity of styles and artistic movements identified as twentieth-century sculpture, the common descriptor is the term *abstract*, which is derived from the Latin *ab stracto*, “to take the essence from.” These three modern, thereby abstract sculptures simplify the traditional detailing and characteristics of the human figure in calculated departures from the philosophy, spirituality, and politics of the classical ideal. Economic but elegant employment of lines and curves analyze the essence of the structure and geometry of the human form while never denigrating the native spirituality of the idea of humanity.

Beginning with Brancusi’s elemental torso, the human body is depicted as a fragment symbolic of the whole. Such a fragmenting of the body is often interpreted as a disruption, a sign of the philosophic and religious distress of the early twentieth century and a cause for anxiety. However, given the influences on Western culture and art of *le primitif*, especially the influence of Africa and Oceania in the late 1800s and early 1900s, of “the East” at midcentury, and of “the marginalized” from the late 1960s, the tendency toward abstracting expressed here, first through Brancusi and finally by De Staebler, signifies a retrieval of the fundamental native symbolic valuing communicated through the image of humanity. How humanity is configured—radical simplification, emotional expression, organic forms, geometric structures, or ideal beauty—is as dependent upon cultural attitudes, social mores, and religious values as on the realities of climate, nutrition, economics, and the prevailing conventions of art.

In contrast to Brancusi, Giacometti appears to return to figuration. However, it is not the classic ideal but rather an elongated and disproportionate figure that connotes the anguish and distress of World War II, existentialism, and the recognition of human finitude and frailty. Nonetheless the spindly distentions of this man’s arms create a curious mixture of identifying gesticulations in his right hand and transcendence through his left hand, almost as if he were the reincarnation in minimalist terms of the Christ figure at the Last Judgment. The distortions in Giacometti’s figure are, however, no less calculated than those in Michelangelo’s sculptures. The geometrically progressive nature of the relationships of head to torso and torso to extremities combine with the fundamental human characteristic of gestural communication to project the sense of a “real person.”

De Staebler’s *Archangel* may initially be perceived as disjunctive, as the angelic form merges with the human in what appears to be a visual fragment. However, just as cultural and philosophic shifts occur throughout cultural history, the viewer’s mode of “reading” images moves from that of a sequential narrative to a gradual absorption of shifting concepts of truth and fiction. Reflective of midcentury societal and religious critiques, De Staebler’s figures are a re-visioning of the idea of humanity, no longer premised on the philosophic ideals of classical Greece but rather upon the realities of human frailty, including variations in body types, illness, and the process of aging. Although Western artists have recognized that the idea of humanity, like the human form, can be deduced from the most minimized detail, it was sculptures such as De Staebler’s *Archangel* that challenged late-twentieth-century viewers to ponder the meaning of being human and to rejoice in the spirituality of humanity despite its imperfections.

Scholarship on Humanity through Sculpture

There is no central or classic study of the theme of the idea of humanity either in the arts or more specifically in sculpture.

For the student of art who wishes to trace the dramatic changes that have taken place in the rendering of man, it is the cultural image of the human body that will remain in the foreground. The student of art will always be concerned with how man sees himself, and how he documents this vision in painting and sculpture. The process of perceiving and imaging the human body is to some degree made up of social and cultural components.

SOURCE: Moshe Barasch, *Imago Hominis: Studies in the Language of Art*, 1994, p. 11.

However, there are classic studies such as Herbert Read's *The Art of Sculpture* (1956) and Tom Flynn's *The Body in Three Dimensions* (1998) that consider the chronological development of sculpture in Western culture in relation to artistic presentation of and cultural attitudes toward the body. Kenneth Clark's masterful *The Nude: A Study in Ideal Form* (1956) is a carefully argued art historical analysis of the cultural concepts of the naked and the nude with a subtext that the body is a conveyor of cultural and religious values. The art historian Moshe Barasch expands the boundaries of Read, Flynn, and Clark to include gestures, postures, and philosophic attitudes toward the body as transmitter of culture and values in his collected essays published as *Imago Hominis: Studies in the Language of Art* (1991). The now classic texts of Margaret Walters's *The Male Nude* (1978) and Bernard Rudofsky's *The Unfashionable Human Body* (1971) are specialized studies that initiated a series of critical questions related to the body and gender well in advance of scholarly interest in the marginalized. A variety of intriguing texts including Linda Nochlin's *The Body in Pieces: The Fragment as a Metaphor of Modernity* (1994), Marcia R. Pointon's *Naked Authority: The Body in Western Painting* (1990), and Margaret R. Miles's *Carnal Knowing: Female Nakedness and Religious Meaning in the Christian West* (1989) provide a feminist lens through which to analyze and critique the depiction of the human form in the visual arts. Similarly Caroline Walker Bynum's *The Resurrection of the Body in Western Christianity* (1995) and Bram Dijkstra's *Idols of Perversity: Fantasies of Feminine Evil in Fin-de-Siècle Culture* (1986) provide specialized studies of theological, cultural, and philosophic depictions of specific engendered renderings of humanity in the arts. The reality of both the interdisciplinary motif and methodology for the study of the idea of humanity through sculpture has been privileged by Western scholars within the frame of Western cultural history. The three singular exceptions, simultaneously the only culturally comparative works on a closely identified theme, are the exhibition and catalog for *In Her Image: The Great Goddess*

in *Indian Asia and the Madonna in Christian Culture* by Rebecca P. Gowen, Gerald J. Larson, and Pratapaditya Pal (1980); the exhibition and catalog for *The Human Image* edited by J. C. N. King (2000); and several special issues of *P Art and Culture Magazine*, which is published in Turkey.

See also **Buddhism; Christianity: Overview; Classicism; Dress; Gender in Art; Gender: Overview; Gesture; Hinduism; Men and Masculinity; Motherhood and Maternity.**

BIBLIOGRAPHY

- Adler, Kathleen, and Marcia Pointon, eds. *The Body Imaged: The Human Form and Visual Culture since the Renaissance*. Cambridge, U.K., and New York: Cambridge University Press, 1993.
- Arscott, Caroline, and Katie Scott, eds. *Manifestations of Venus: Art and Sexuality*. Manchester, U.K.: Manchester University Press, 2000.
- Barasch, Moshe. *Imago Hominis: Studies in the Language of Art*. Vienna: IRSA, 1991.
- Baring, Anne, and Cashford, Jules. *The Myth of the Goddess: Evolution of an Image*. London: Penguin, 1993.
- Bernal, Martin. *Black Athena: The Afro-Asiatic Roots of Classical Civilisation*. London: Vintage, 1991.
- Blundell, Sue. *Women in Ancient Greece*. London: British Museum Press, 1995.
- Bowie, Theodore, and Cornelia V. Christenson, eds. *Studies in Erotic Art*. New York: Basic Books, 1970.
- Broude, Norma, and Mary D. Garrard, eds. *The Expanding Discourse: Feminism and Art History*. New York: Icon Harper-Collins, 1992.
- . *Feminism and Art History: Questioning the Litany*. New York: Harper and Row, 1982.
- Bynum, Caroline Walker. *The Resurrection of the Body in Western Christianity, 200–1336*. New York: Columbia University Press, 1995.
- Carson, Fiona, and Claire Pajackowska, eds. *Feminist Visual Culture*. New York: Routledge, 2001.
- Clark, Kenneth. 1956. *The Nude: A Study in Ideal Form*. Princeton, N.J.: Princeton University Press, 1984.
- Dijkstra, Bram. *Idols of Perversity: Fantasies of Feminine Evil in Fin-de-Siècle Culture*. New York: Oxford University Press, 1986.
- Dutton, Kenneth R. *The Perfectible Body: The Western Ideal of Physical Perfection*. London: Cassell, 1995.
- Feher, Michel, Ramona Naddaff, and Nadia Tazi, eds. *Fragments for a History of the Human Body*. 3 vols. New York: Zone Books, 1989.
- Freedberg, David. *The Power of Images: Studies in the History and Theory of Response*. Chicago: University of Chicago Press, 1989.
- Flynn, Tom. *The Body in Three Dimensions*. New York: Harry N. Abrams, 1998. Published in the U.K. as *The Body in Sculpture*. London: Weidenfield and Nicolson, 1998.
- Gowen, Rebecca, Gerald J. Larson, and Pratapaditya Pal, eds. *In Her Image: The Great Goddess in Indian Asia and the Madonna in Christian Culture*. Santa Barbara: UCSB Art Museum, University of California, Santa Barbara, 1980. Exhibition catalog.
- Hollander, Anne. *Seeing through Clothes*. New York: Viking Press, 1978.
- Kemp, Martin, and Marina Wallace. *Spectacular Bodies: The Art and Science of the Human Body from Leonardo to Now*. Berkeley: University of California Press, 2000. Exhibition catalog.

- King, J. C. N., ed. *The Human Image*. London: British Museum Press, 2000. Exhibition catalog.
- Kristeva, Julia. *Powers of Horror: An Essay on Abjection*. Translated by Leon S. Roudiez. New York: Columbia University Press, 1982.
- Lucie-Smith, Edward. *Sexuality in Western Art*. New York: Thames and Hudson, 1991.
- Mellor, Philip A., and Chris Shilling. *Re-Forming the Body: Religion, Community, and Modernity*. London: Thousand Oaks, 1997.
- Miles, Margaret R. *Carnal Knowing: Female Nakedness and Religious Meaning in the Christian West*. Boston: Beacon, 1989.
- Mullins, Edwin. *The Painted Witch: How Western Artists Have Viewed the Sexuality of Women*. London: Secker and Warburg, 1985.
- Nochlin, Linda. *The Body in Pieces: The Fragment as a Metaphor of Modernity*. London: Thames and Hudson, 1994.
- Paglia, Camille. *Sexual Personae: Art and Decadence from Nefertiti to Emily Dickinson*. New Haven, Conn.: Yale University Press, 1990.
- Perry, Gill, ed. *Gender and Art*. New Haven, Conn.: Yale University Press, 1999.
- Pointon, Marcia R. *Naked Authority: The Body in Western Painting, 1830–1908*. Cambridge, U.K.: Cambridge University Press, 1990.
- Read, Herbert. *The Art of Sculpture*. New York: Pantheon, 1956.
- Rudofsky, Bernard. *The Unfashionable Human Body*. Garden City, N.Y.: Doubleday, 1971.
- Saunders, Gill. *The Nude: A New Perspective*. New York: Harper and Row, 1989.
- Sennett, Richard. *Flesh and Stone: The Body and the City in Western Civilisation*. London: Faber, 1994.
- Shilling, Chris. *The Body and Social Theory*. London: Thousand Oaks, 1993.
- Smith, Alison. *The Victorian Nude: Sexuality, Morality, and Art*. Manchester: Manchester University Press, 1996.
- , ed. *Exposed: The Victorian Nude*. London: Tate, 2001. Exhibition catalog.
- Steinberg, Leo. *The Sexuality of Christ in Renaissance Art and in Modern Oblivion*. 2nd rev. ed. Chicago: University of Chicago Press, 1996.
- Suleiman, Susan Rubin, ed. *The Female Body in Western Culture: Contemporary Perspectives*. Cambridge: Harvard University Press, 1986.
- Üster, Celâl, ed. “Nude in Art.” *P Art and Culture Magazine* 9 (spring 2003): 1–132. Special issue.
- Vernant, Jean-Pierre. *Mortals and Immortals: Collected Essays*, edited by Froma I. Zeitlin. Princeton, N.J.: Princeton University Press, 1991.
- Walters, Margaret. *The Nude Male*. London: Penguin, 1979.

Diane Apostolos-Cappadona

HUMOR. Humor is such an integral part of the human psyche that philosophers and other intellectuals have long been fascinated with its origins in and its effects on the human brain. Several early theorists have provided subject matter for continuing observation and debate. The Greek word *chumoi* means “juices,” and the ancient Greeks used the word, from which we get the English *humor* (as well as *humid*), to refer

to the bodily fluids of blood, phlegm, yellow bile, and black bile. The amount of these fluids and how they happened to be mixed in a person’s body was assumed to determine that person’s disposition or temperament. When authors, playwrights, and comedy performers create eccentric characters, they are going back to this old idea of some people being extremely bilious, phlegmatic, sanguine, or jaundiced.

Related to this idea of bodily fluids is a belief that humor is good for one’s health as reflected in the Book of Proverbs: “A merry heart doeth good like a medicine; but a broken spirit drieth the bones” (17:22). In 1979 Norman Cousins, a talented writer and former editor of the *Saturday Review*, popularized the wish-fulfilling idea that laughter could reduce pain and release healing chemicals into people’s bodies. While the idea caught the fancy of the general public on a worldwide scale, the twenty-first century’s thoughtful researchers are asking questions about possible confusions between causes and effects. For example, even if well-documented evidence could be collected to show that people with a sense of humor live longer, it might be that they have a sense of humor because they are healthy and things are going well. Along the same lines, it might be that hospital patients who are pleasant and find things to laugh about will get well faster than grumpy patients because their pleasant personalities attract a broader support group and make doctors and nurses more willing to spend time with them.

Release or Relief Theory

The subjects that people joke about are likely to be things that make them feel unsure or uncomfortable, as with questions about religion, politics, sex, and ethnic differences. People joke about these subjects as a way of releasing feelings of tension and also as a way of sending up trial balloons. If they say something that does not go over well, they can backtrack and hide behind the cliché, “I was only kidding.”

At a 1984 humor conference held at Arizona State University, Robert Priest, a psychologist at West Point, reported on his Moderate Intergroup Conflict Humor (MICH) theory. He agreed that for people to be inspired to create a joke they must feel some tension, but he argued that joking will relieve only moderate levels of tension. If groups or individuals are feeling strong—rather than moderate—levels of tension, they will feel frustrated rather than satisfied by jokes. He illustrated his point by showing how history is filled with jokes about the so-called battle of the sexes, but in the late 1970s and the 1980s, as the feminist movement developed and hostilities between men and women increased, sexist joking was no longer viewed as humor. Instead, it was viewed as aggression, and those who told sexist jokes were taken to court and punished for creating hostile workplaces.

A related way of explaining this idea that people need some distance from a problem before they can find humor in it is the statement that “tragedy plus time equals humor.” James Thurber has been credited with this observation, but many people, including Steve Allen and Bob Hope, have commented on the idea. After the September 11, 2001, tragedy, it was a topic of general public discussion when comedy clubs and late-night comedians took time off.

he claimed that laughter is an emotion that arises from a strained expectation suddenly reduced to nothing. William Hazlitt, in his 1819 *Lectures on the Comic Writers*, credited laughter as coming from the incongruity that results when one idea disconnects or is bumped up against another feeling. Arthur Schopenhauer agreed in 1844, when he explained in *The World as Will and Idea* that laughter is a way of acknowledging an incongruity between the conceptions that listeners or viewers hold in their minds and what happens to upset their expectations.

The incongruity theory is especially powerful in explaining humor across different genres, including accidental humor and humor in nature. Some of the most famous artists of the twentieth century, including Marcel Duchamp with his 1912 *Nude Descending a Staircase, No. 2*, surprised and amused (and sometimes offended) the public by breaking with the expectation that an artist's job was to faithfully re-create items as seen by the human eye. Playful dance companies and playful musicians startle audiences by suddenly changing their patterns, as did Franz Joseph Haydn (1732–1809) in his Symphony no. 94, also known as the *Surprise Symphony*. Haydn interspersed fortissimo chords into soft repetitive sequences to wake up slumbering audiences. Designers of theme-park hotels and of much of the community art that decorates modern American cities play with surprise and incongruity. Even comedians who tell stories in sets of three (two to establish a pattern and one to break it) are relying on surprise and incongruity.

Superiority Theory

Conflicts over the censorship of humor go back at least to the fifth century B.C.E., when Plato expressed the idea in his *Republic* that jokes and humorous incidents should be removed from stories about the gods before they are presented to young people. Plato's idea was that if children were amused by the gods, they would feel themselves superior and hence would lose respect.

Several centuries later the English philosopher Thomas Hobbes spelled out more clearly the idea that humor is an expression of superiority. In his 1651 *Leviathan*, he defined humor as “the sudden glory arising from the sudden conception of some eminency in ourselves, by comparison with the infirmity of others.” In the seventeenth century Blaise Pascal, a French scientist and philosopher, proposed, “Nothing produces laughter more than a surprising disproportion between that which one expects and that which one sees.” In 1750 the Scottish philosopher Frances Hutcheson further developed what has come to be known as the incongruity theory. In his *Reflections upon Laughter*, Hutcheson pointed out that people do not go to asylums to laugh at the “inferior” beings, nor do they laugh at animals except when they resemble human beings. Even when someone slips on a banana peel, observers laugh not because they feel superior but because of the incongruity between expectations and reality.

Incongruity Theory

In 1790 the German philosopher Immanuel Kant in *The Critique of Judgment* focused on the requirement of surprise when

Scatological humor is incongruous in that it “unmasks” people as it reminds them of their animal nature. This was one of the ideas expressed by Sigmund Freud in his 1905 *Jokes and Their Relation to the Unconscious*. Freud viewed the jokes that people told as a window to their minds. He thought that jokes were more likely to come from the id or subconscious, while people's other communications come from the superego, where they are refined by a public consciousness. Freud's work with jokes and his belief that humor is basically tendentious and hostile is not as respected as is his other work because modern critics, especially feminists, point out that the source of his jokes (his patients) were far from being a typical sample. Other critics reject the idea that jokes are formed in the subconscious in the same way that dreams are.

The one concept that the general public recognizes from Freud's work is that of the Freudian slip. These are verbal mistakes that people make, which Freud said revealed what they really wanted. In actual conversations, Freudian slips may or may not reveal inner desires. Sometimes they are simply pronunciation or spelling errors, as with the examples that Richard Lederer collected for his popular *Anguished English* (1987). On the other hand, when creative writers put Freudian slips into the mouths of their characters, their intention is to communicate something about the speaker's personality. Norman Lear was a master at this when in the popular television show *All in the Family* (1971–1979) he had Archie Bunker reveal his lack of education and his xenophobic tendencies with such phrases as “Blackberry Finn,” “pushy imported ricans,” “welfare incipients,” and “the immaculate connection.”

Wit, or Derisive Humor

The French philosopher Henri Bergson in his *Le rire* (*Laughter*, 1911) made the point that wit or derisive humor is a universal corrective for deviancy in the social order. He softened the idea of overt hostility by saying that the creators of wit undergo “a momentary anesthesia of the heart” as they poke fun at the actions of someone. According to Bergson’s point of view, wit is a tool of satire in that its purpose is to bring about change. Such thinkers and writers as Ambrose Bierce, H. L. Mencken, Ogden Nash, Dorothy Parker, Will Rogers, Carl Sandburg, George Bernard Shaw, Mark Twain, Artemus Ward, and Oscar Wilde used their wit to focus attention on the kinds of behavior they thought inappropriate or damaging to society as a whole. Most of the twenty-first century’s editorial cartoonists and late-night comedians use wit for similar purposes as they criticize changing social, sexual, religious, and political mores.

John Simon in *Paradigms Lost* describes wit as “aggressive, often destructive (though one hopes, in a good cause), and almost always directed at others.” He compares it to humor, which he describes as “basically good natured and often directed toward oneself, if only by subsumption under the heading ‘general human foolishness’” (p. 72).

Simon’s description of self-deprecating humor as being “basically good natured” is important in understanding why members of ethnic groups can tell jokes about themselves but get offended when someone from outside the group tells the same joke. When a person is inside a group and clearly identifies with that group, then the telling of a joke about the group usually falls under the category of good-natured encouragement for group members to think about changing their ways. Henry Spalding in his *Joys of Jewish Humor* (1985) says that many Jewish jokes come in the form of “honey-coated barbs” at the people and things loved most by Jews. While they verbally attack their family and friends as well as their own religion, they do it with a great sense of affection. A joke teller from outside of a group has little or no influence on group beliefs and actions and so by telling such jokes is cementing negative stereotypes rather than bringing about changes.

Christie Davies, who has collected and studied jokes across different cultures, as has the cultural anthropologist Alan Dundes, explains that there is great satisfaction in assigning a negative trait to someone outside of one’s own group. Placing negative traits far away from oneself is satisfying because it frees the joke tellers from having to think about whether these characteristics are pertinent to their personalities. The comedy writer Max Shulman, in a 1982 talk at Arizona State University, said something similar when he explained that if one of his stories makes a reader say, “I know someone like that,” the reader is amused and laughs. But if the story is so on target that the reader says, “Oh, no, that’s me!” the reader is not amused.

Other Views

While scholars still believe in theories of superiority and hostility and of surprise and incongruity, the twenty-first century’s mass media provides the world with so many different kinds of humor that few scholars try to make observations about all humor. Instead, they study humor to gain insights into their

particular areas of expertise. For example, in *They Used to Call Me Snow White . . . but I Drifted: Women’s Strategic Use of Humor* (1991), the feminist scholar Regina Barreca uses examples of women’s humor to illustrate how a group’s humor is shaped as well as evaluated according to the roles that the members play in society. Henry Louis Gates did something similar in *The Signifying Monkey: A Theory of Afro-American Literary Criticism* (1988) by showing how African-American slaves developed double entendre trickster signifiers because they were denied the use of normal and private communication.

For obvious reasons, performers, comedians, public speakers, and advertisers are interested in the features or the characteristics of humor. They want to know what makes people laugh so that they can create and re-create such situations. Rhetoricians and teachers of writing are also interested. Mary Ann Rishel, a professor in the Department of Writing at Ithaca College, teaches a class in comedy writing and has authored a book on the subject. Her idea is not to prepare students to move to Hollywood or New York to join comedy writing teams. Instead, she wants to use the pleasures of humor to help students develop the skills needed for most kinds of writing: originality of vision, a keen eye for observation, the inclusion of telling details, and most importantly, succinctness.

The historian Joseph Boskin collects joke cycles, what he calls comic zeitgeists, and uses their popularity as data for revealing Americans’ preoccupations and attitudes. He concludes his book *Rebellious Laughter* (1997) with “Tattered Dreams,” a chapter about how “the roseate years of expansion” (p. 180) that followed World War II collided with such technological failures as the meltdown at the Three Mile Island nuclear plant in Pennsylvania, the radioactive explosion at Chernobyl, the loss of the *Challenger* space shuttle, and such oil spills as that of the *Exxon Valdez*. These catastrophes “overwhelmed sensibilities from the late 1970s into the 1990s,” and the jokes were as extreme as the events (Boskin, p. 181). They offered “the specter of a totally irrational universe,” where the only defense was to engage in what has been labeled “a hellish laughter” (Boskin, p. 190).

Modern literary critics often focus on this kind of humor as they work with deconstructionism, postmodernism, and magical realism. They have long defined *satire* (which often includes elements of irony and wit) as humor designed for the specific purpose of convincing readers and viewers of the need for some kind of action or a change in attitude and beliefs. On the other hand, black humor or dark humor (also referred to as gallows humor, absurd humor, existentialism, and film noir) illustrates the futility of looking for easy and neat answers to the tragedies of life. In such humor, the lines between fantasy and reality and between tragedy and comedy keep shifting. People laugh because they do not know what else to do. The laughter is itself a testament to the strength of the human spirit in showing that people can laugh in spite of bewilderment, death, and chaos.

Linguists, especially computer programmers working with artificial intelligence and translation, study jokes because their abbreviated scripts leave listeners to fill in the mundane details that “go without saying.” Many jokes provide an even greater challenge for computers because they are designed to lead listeners

to interpret the story along mundane lines, but then comes the climax or the punch line, which makes listeners laugh in surprise as they realize they have been led “down the garden path.” The linguist Victor Raskin at Purdue University is working to program computers with the ability to bring in a myriad of cultural references while simultaneously testing possible interpretations so as to arrive at the one that is “funny.” In his book *Semantic Mechanisms of Humor* (1985) Raskin distinguishes between what he calls bona fide scripts and joke scripts. Joke scripts differ from stereotypes in that a stereotype is an idea that many people seriously believe in and act on, while joke or comic scripts are more literary than sociological or political. They are amusing ideas that serve as the nucleus for folklore. New Englanders do not really believe that French-speaking Canadians are stupid, nor do the British think that the Irish are dirty, nor does the world at large think that Italians are cowards, yet extensive joke scripts circle around these and many other groups. The fact that joke scripts develop rather haphazardly out of the history of particular countries helps to explain why people from different cultures have a hard time catching on to each other’s jokes, many of which are variations on old themes or examples of one’s expectations being suddenly violated.

The idea of looking at the creation and reception of humor to trace the intellectual (as opposed to the emotional) paths that humor takes through the brain is fairly new. Arthur Koestler in *The Act of Creation* (1964) claims that for people to think in new and creative ways, they must engage in bisociative thinking so as to bring concepts together in original ways. The “Ah!” kind occurs when people have an emotional reaction as they create or recognize artistic originality. The “Aha!” kind occurs when they bring divergent concepts together into scientific discoveries, while the “Ha Ha!” kind occurs with the comic recognition of ridiculous situations.

As indicated by these examples, the humor research of the future is likely to focus on particular kinds of humor as created and received by individuals in particular situations. And as the world grows smaller and people are forced to communicate with and adapt to people with different customs and beliefs, there will probably be increased interest in understanding both the bonding and the out-bonding as well as the release of frustration that comes when people laugh together.

See also *Dream; Mind; Philosophy; Tragedy and Comedy*.

BIBLIOGRAPHY

- Barreca, Regina. *They Used to Call Me Snow White—but I Drifted: Women’s Strategic Use of Humor*. New York: Viking, 1991.
- Bergson, Henri. *Laughter: An Essay on the Meaning of the Comic*. Translated by Cloudesley Brereton and Fred Rothwell. New York: Macmillan, 1911.
- Boskin, Joseph. *Rebellious Laughter: People’s Humor in American Culture*. Syracuse, N.Y.: Syracuse University Press, 1997.
- Cousins, Norman. *Anatomy of an Illness as Perceived by the Patient: Reflections on Healing and Regeneration*. New York: W.W. Norton, 1979.
- Davies, Christie. *Ethnic Humor around the World: A Comparative Analysis*. Bloomington: Indiana University Press, 1990.

- Freud, Sigmund. *Jokes and Their Relation to the Unconscious*. Translated and edited by James Strachey. New York: W.W. Norton, 1960.
- Gates, Henry Louis, Jr. *The Signifying Monkey: A Theory of Afro-American Literary Criticism*. New York: Oxford University Press, 1988.
- Koestler, Arthur. *The Act of Creation*. New York: Macmillan, 1964.
- Lederer, Richard. *Anguished English: An Anthology of Accidental Assaults upon Our Language*. Charleston, S.C.: Wyrick, 1987.
- Morreall, John, ed. *The Philosophy of Laughter and Humor*. Albany: State University of New York Press, 1987.
- Nilsen, Alleen Pace, and Don L. F. Nilsen. *Encyclopedia of Twentieth-Century American Humor*. Phoenix, Ariz.: Oryx Press/Greenwood, 2000.
- Raskin, Victor. *Semantic Mechanisms of Humor*. Dordrecht, Netherlands: Reidel, 1985.
- Rishel, Mary Ann. *Writing Humor: Creativity and the Comic Mind*. Detroit: Wayne State University Press, 2002.
- Simon, John. *Paradigms Lost: Reflections on Literacy and Its Decline*. New York: Potter/Crown, 1980.
- Spalding, Henry D. *Joys of Jewish Humor*. New York: Jonathan David, 1985.

Alleen Pace Nilsen

Don L. F. Nilsen

HYGIENE. *Hygiene* is defined in current English dictionaries as “the science of health.” This definition, though formally correct, hides a long history of change in the word’s use, from its holistic classical meaning of “individual regimens to preserve health” to its nineteenth-century connotations of “social medicine” (including lethal eugenics programs), to its current limited construal as “personal cleanliness” or “germ removal.” For more than 2,500 years of use in many different lands, concepts of hygiene have been integral to personal identity, shaping sense of self through boundary maintenance and spirituality.

The Ancient World, c. 500 B.C.E.–200 C.E.

In Greek mythology Hygeia was one of the daughters of Aesculapius, a renowned healer and demigod; she was considered the goddess of health. The Greek word *hygiene* *hygieinē* meant “sound, healthy, or strong,” and was possibly related to the Sanskrit *ugias*, or “strength.” In the works of Greek physicians, from Hippocrates (460–c. 377 B.C.E.) onward, hygiene was that branch of medicine dedicated to the “art of health,” distinguished by Galen (129–c. 199 C.E.) from its other arm, therapeutics, or the treatment of disease. The Greeks understood the world to be composed of four elements—earth, air, fire, and water—and, analogously, understood life to be controlled by the four principles of hot and cold, wet and dry, which corresponded to the four “humors” that composed the body: yellow and black bile, blood, and phlegm. The body was understood holistically as a dynamic state of interaction between these four principles, whose imbalance could cause disease. The goal of hygienic practice was to achieve qualitative and humoral balance within the body, and thus for each person to live out their allotted lifespan.

practices with the moral order of their culture: a hygienic person went with his fellows to the gymnasium, was abstemious with alcohol, and had only acceptable sexual relations.

The Greeks' conception of the body as an organic whole integrated into its environment, and their regimen-based methods of preserving health by achieving harmony within the body, were remarkably similar to health systems that apparently coincidentally evolved in India and China. Though their explanatory frameworks differ from the Greeks and from each other, both Indian Ayurvedic medicine and traditional Chinese medicine have longevity and prolonged states of health as their goal, and both discuss which substances, qualities, and actions are life-enhancing and which are not. Because of these similarities, the word *hygiene* is sometimes inaccurately used to refer to these traditions in English-language medical histories of these peoples.

The Middle Ages and Renaissance, 200–1700 C.E.

European medical writing all but ceased as academic study disintegrated with the Roman Empire. Academic medicine owed its revival in the ninth century C.E. to the enthusiasm of Muslim scholars, who, having established an empire from Persia to Spain, translated and extended the classical medical corpus, particularly the works of Galen. The concept of *hygiene* was revitalized, particularly as it could readily absorb the Islamic belief that the spiritual unity of the cosmos was the basis for all medical practice and the cleansing and purification rituals that surrounded prayer. New texts of regimens for health were produced by such renowned physicians as Abu Bakr Muhammad ibn Zakariya ar-Razi (Rhazes; c. 865–between 923 and 935 C.E.) and Avicenna (Ibn Sina; 980–1037 C.E.).

These Islamic physicians followed Galen's successors in considering the six "nonnaturals" (that is, factors external to the body) as the canonical categories that composed hygiene: air (or "environment"), food and drink, sleeping and waking, movement and rest, retention and evacuation (including ejaculation), and mental-emotions ("passions of the soul"). Regimens and advice books were structured around these categories. While regimens were widely respected, in practice, as in the classical period, many people blended them with the incantations, rituals, and charms of popular medicine, just as the notion of spiritual harmony integral to Islamic hygiene coexisted with religious notions of disease as a test or punishment.

European enthusiasm for hygiene returned with the upsurge in medical writing that marked the Renaissance, and handbooks were produced for a much wider audience. For example, in England between 1456 and 1604, 115 out of 392 editions of books on medicine and regimen were issued in the vernacular. However, these works contained an increasing diversity of thought that left the content of hygienic practice unfixed, further blurred the distinction between hygiene and therapeutics, and, under the influence of nascent sciences and the growing authority of mathematics, assigned and calculated degrees to humoral balance. Emphases and goals were shifting. For example, although exercise had largely dropped out of hygienic manuals in the medieval period, there was a renewed emphasis on regimens of movement in the Renaissance; and practitioners now aimed higher than the Galenic allotment of years,

Hygienic instruction was tailored to each individual's constitution, itself the result of humoral activity, and to their environmental and personal circumstances, such as age, sex, status, and relations with others. Proper hygiene included regulations concerning sexual activity, sleeping and waking, bathing, exercise (a central activity for freeborn Greeks), and above all, diet. Dietary regimens were extremely detailed as to when it was or was not appropriate to eat particular kinds of animals or grains and considered food very carefully in all its cooked and raw states, discussing strategies such as boiling, grilling, roasting, and breading that would moisten, dry, heat, and bind. Because food was considered to have such powers in altering a person's internal humoral balance, the distinction between hygiene and therapeutics was blurred, as the same foods could be prescribed to cure disease as well as maintain health. Although the Greek physicians regarded their work as purely empirical, in contrast to superstitious medical practices such as appeasing angry gods, their texts clearly equated healthy



Health propaganda poster, c. 1940s. As civilization progressed during the twentieth century into expanded industrialization, frequent overcrowding, and two world wars, health risks increased. As a result, governments instituted programs aimed at encouraging citizens to practice good hygiene for a healthier society. © K.J. HISTORICAL/CORBIS

wishing instead to preserve their youth and achieve an unlimited longevity.

Personal hygiene also became more clearly equated with the health of the soul as it was reinterpreted through Christian belief and practice. Thus classical hygienic prescriptions on diet became condemnations of the “sins” of gluttony and drunkenness. Self-help and an increasing asceticism (all-cold regimens were popular) were the twin characteristics of hygiene at this time. The works of social theorists John Locke (1632–1704) and John Wesley (1703–1791, founder of Methodism) emphasized “hardening” regimens and sobriety. These clearly moralistic ideas about hygiene fueled criticisms of “civilization” by Jean-Jacques Rousseau (1712–1778) and others, who suggested that compared with the “noble savages” of the “new” world, Europeans were being devitalized by nervous diseases brought on by overeating and drinking, failure to exercise, late rising, and tight lacing. Hygienic regimens were to aid in maintaining European identity in the face of dissolution.

Hygiene and Public Health, 1700–1945

The concept of hygiene underwent immense changes during and after the eighteenth century. As the use of dissection and

the microscope became increasingly common for the new medical sciences of anatomy, physiology, and pathology, Galenic theories were quickly discarded. Many physicians began to treat traditional hygiene as at best a branch of education rather than an area of medicine, at worst a form of folklore. However the status of hygienic study was defended by Paris professor of medicine Jean Noel Hallé (1754–1822), who argued that the subject of hygiene had two facets: the individual, in which the physician would consider such factors as age, sex, temperament, habits, profession, poverty, and travel; and the social, in which the physician would consider climate, location, occupations, customs, laws, and governments, as they affected health. This transference of many of the ideas incorporated in traditional hygiene to the level of the public and the population was reflective of a general growing interest in “state science,” literally “statistik.” This referred to the collection of numerical data about the composition, strengths, and weakness of a *population* on the grounds that the economic and political strength of a nation were directly proportional to the health of its citizens. (Indeed, the concept *population* may be said to have been produced by these new measurement techniques.) As Hallé wrote, the hygienist must become counsel and spiritual guide to the legislator, intervening in those areas where an individual had little control.

The concept of “public hygiene” increased in importance as European societies experienced the devastating epidemics of cholera, typhoid, smallpox, and plague that struck as a result of war, colonization, and industrialization. Acting on the statistical relationship between mortality rates and living conditions, the primary government response was in terms of “sanitation,” the removal of environmental pollution by garbage and nightsoil collection services, building ventilation devices in houses, and limiting industrial refuse. This environmental focus in public-health strategies reflected the popularity of the miasmatic theory of disease transmission, which conceived disease as the airy product of refuse, decay, and smell. It also shaped, and was shaped by, an increasing social preoccupation with cleanliness, possibly attributable to the transmission of the eighteenth-century French aristocracy’s mannerly culture, a new kind of hygienic regimen that was distinguished from its predecessors by its cleansing rituals, from nose-blowing to bathing. *Hygiene* was partially distinguished from *sanitation* (though the two terms were interchangeable) by its focus on the social and moral health of society, the ultimate aim of sanitation. As Benjamin Ward Richardson (1828–1896) captured in his utopian tale *Hygeia: A City of Health*, it was felt that the mere fact of living in uncrowded conditions and enjoying regular bathing would result in the moral and spiritual uplift and pursuit of self-improvement among the great unwashed who were filling the fever-decimated hospitals, prisons, shipping vessels, and factories of the day.

Thus hygiene became a central technique of social government in the nineteenth and early twentieth centuries; indeed this could well be termed the Hygienic Era in honor of the proliferation of societies and subjects devoted to hygiene, each of which connected individuals to projects in governing society. In domestic hygiene, maternal hygiene, tropical hygiene, international hygiene, industrial hygiene, sex hygiene, moral

RACIAL HYGIENE

In the hygienic era, national populations were conceptualized as biological entities, that is, as races. Encompassing much more than skin color, the notion of race reflected social characteristics (such as courage or honesty) as well as physical ones (such as longevity and intelligence) that were considered to be hereditary. Races were thought about in Darwinian terms as organisms that could evolve or degenerate, win or become extinct, according to changes in their membership and in competition with others. Accordingly, at the beginning of the twentieth century many Western physicians and social reformers were concerned that their race would “degenerate” and become devitalized by the reproduction of “unfit” specimens, that is, those with undesirable physical and social characteristics thought to be heritable, including insanity, alcoholism, Down’s syndrome, epilepsy, criminality, and poor eyesight. As new tests for fitness, such as the Binet IQ test, were developed and distributed across populations, ever increasing numbers of such “unfit” were discovered and anxieties worsened.

Racial hygienists sought to improve their racial stock by encouraging the propagation of the fit, sterilizing the unfit, and forbidding racial “dilution” by intermarriage. These policies were written into law in most Western countries in one form or another, such as in the antimiscegenation and sterilization laws passed in a majority of the United States, which by 1941 had caused 36,000 individuals to have been compulsorily sterilized. The ultimate expression of these ideas was of course found in Nazi Germany, where euthanasia of “unfit” children and of the inmates of psychiatric institutions was carried out in the 1930s, a precursor to the horrors of the mass genocide of Jews, Gypsies, and others designated unfit during World War II.

In the aftermath of war, many racial hygiene associations, where couples had been encouraged to seek medical testing and confirmation of fitness before marrying, gradually became planned parenthood organizations with different social goals in mind.

hygiene, and many other arenas of hygiene, governments sought to regulate their citizens’ movements, interactions, choices, habits, and thoughts. As public-health measures proliferated, from establishing house, city, or national-border based quarantines to building “lock hospitals” for prostitutes with venereal disease, “lines of hygiene” became literally lines of rule, and conversely, lines of rule were manifest through hygienic regulations. This was most obvious in the colonial world, where the containment, education, and/or exclusion of nonwhites (predominantly ethnic populations and immigrant laborers) were often managed medically by quarantines or isolation measures directed at their supposedly diseased bodies and unhygienic habits.

Population hygiene or health was now clearly predicated on notions of purity and pollution as Western cultures struggled to imaginatively maintain the boundaries of their bodies and identities against the incursions of various “others,” from viruses to Chinese gold-seekers. Domestic hygiene aimed at excluding dirt, and equivalently moral hygiene aimed at excluding evil. Indeed, practices and instruments of hygiene, such as the minutely detailed bodily training given to those with tuberculosis or inactive typhoid bacteria about how to prevent their illness from spreading to others, produced identities. Hygienic practice marked who was white or nonwhite,

citizen or alien, clean or contaminated, a good wife and mother or an impure one. By World War I, proper hygiene was regarded as a duty that all citizens owed their society. The widespread acceptance of the germ theory of disease in the 1890s encouraged this trend by focusing public-health measures away from the general environment and much more on personal practices, as the ordinary actions of apparently healthy people were now revealed to be the mechanisms that transmitted illness. With the sudden explosion of antibacterial soaps, powders for clothing, tissues, and face masks—beards were shaved and skirts lifted as Americans worried they harbored germs—came a renewed obsession with domestic and bodily cleanliness as the markers of healthiness and moral and civic responsibility.

In the late twentieth century, the concept of hygiene lost its prewar obsessions with purity and its heavy moral agenda. *Hygiene* in the twenty-first century refers virtually solely to personal cleanliness, and more particularly to personal habits that minimize exposure to germs. For the past century this has been its global definition also, as since the nineteenth century the practices of personal hygiene have been relentlessly proselytized in developing nations, not only by anxious colonizing Europeans, but also by indigenous cultures as they replaced traditional knowledges with Western medicine. (For example, the Japanese Private Association of Hygiene was founded in

HYGIENE

1883, a decade after the new Medical Constitution of Japan, which formally declared that Western medicine would be the only legal practice in the nation, was passed.) Many physician-historians regard the spread of such personal hygiene practices as having been, and continuing to be, directly responsible for saving millions of lives, and point to the sharp downward slide in incidence of once-devastating epidemic diseases as evidence for this contention. They are not wrong—but ideas about hygiene have produced and continue to produce identities and politics that colonize other social worlds, as well as healthy bodies.

See also **Biology; Eugenics; Health and Disease; Medicine.**

BIBLIOGRAPHY

PRIMARY SOURCES

- Galen. *A Translation of Galen's Hygiene (De sanitate tuenda)*. Translated by Robert Montraville Greene. Springfield, Ill.: Thomas, 1951.
- Richardson, Benjamin Ward. *Hygeia: A City of Health*. London: Macmillan, 1876.

SECONDARY SOURCES

- Armstrong, David. "Public Health Spaces and the Fabrication of Identity." *Sociology* 27 (1993): 393–403.
- Bashford, Alison. *Imperial Hygiene: A Critical History of Colonial-*

ism, Nationalism, and Public Health. New York: Palgrave Macmillan, 2003.

- Hamarneh, Sami Khalaf. *Health Sciences in Early Islam: Collected Papers*. San Antonio, Tex.: Zahra, 1983.
- Mikkeli, Heikki. *Hygiene in the Early Modern Medical Tradition*. Helsinki: Finnish Academy of Science and Letters, 1999.
- Proctor, Robert. *Racial Hygiene: Medicine under the Nazis*. Cambridge, Mass.: Harvard University Press, 1988.
- Tomes, Nancy. *The Gospel of Germs: Men, Women, and the Microbe in American Life*. Cambridge, Mass.: Harvard University Press, 1998.
- Vigarelo, Georges. *Concepts of Cleanliness: Changing Attitudes in France since the Middle Ages*. Cambridge, U.K.: Cambridge University Press, 1988.
- Wear, Andrew. "History of Personal Hygiene." In *The Companion Encyclopedia of the History of Medicine*, edited by William F. Bynum and Roy Porter. Vol. 2. London and New York: Routledge, 1993.
- Yamamoto Shun Ichi. "Introduction of the Western Concept and Practice of Hygiene to Japan during the Nineteenth Century." In *The History of Hygiene: Proceedings of the Twelfth International Symposium on the Comparative History of Medicine, East and West*, edited by Yosio Kawakita, Shizu Sakai, and Yasuo Otsuka. Susono-shi, Shizuoka, Japan: Ishiyabe EuroAmerica Inc., 1987.

Claire Hooker



I

ICONOGRAPHY. Iconography is the description, classification, and interpretation of the subject matter of a work of art. Derived from the Greek words *eikon*, meaning image or icon, and *graphia*, meaning description, writing, or sketch, the word *iconography* is one of the least understood, most abused, and most flexible terms in the English language. Its primary purpose is to understand and explicate the meaning behind what is represented. Simply described, it is by definition closely related to the equally complex but more abstract term *iconology*, traditionally understood as a more advanced (and secondary) phase in visual definition. Iconology has been described as “the description, classification, or analysis of meaning or symbolism in the visual arts that takes into account the tradition of pictorial motifs and their historical, cultural, and social meaning” (Baca, p. 89). Whereas these two terms were historically distinct, with the latter usually seen as the ultimate aim of all iconographic research, it is clear that modern usage has lessened their division. They have, to a certain extent, become interchangeable.

As a subject iconography is as old as the first image created by humans, but as a concept in the history of ideas its documented study first dates from the end of the sixteenth century. Although iconography is still largely the province of the art historian, in whose discipline it was first used and with which it became irretrievably linked, it is clear that this is no longer true. Within that discipline its purpose has changed significantly from its prime association with the representational; iconography is now used to support new fields of research at the crossroads of disciplinary studies. Increasingly iconography is being applied to the nonvisual and to studies using textual, aural, or verbal material, which has extended its meaning. Within the field of popular research and computerization, studies have shown that iconography is the most widely used field of inquiry apart from that of artist or maker.

Iconography can work on many levels, from the simply descriptive to the cultural and symbolic, and may be applied to the wider relational framework of content. The easiest of these is undoubtedly the descriptive, where the multivalent nature of images causes the greatest problems (Eliade, p. 15). Even though most art-historical research is underpinned in one form or another by iconography, this study will deal only with the historical development of the concept, the methodology used in its classification, and some modern trends and not with research such as that by Johannes Molanus in *De picturis et imaginibus sacris* (1570), which uses an iconographical approach but does not deal with the idea itself.



Madonna of Mercy (1445–1462) from the *Polyptych of the Madonna della Misericordia* by Piero della Francesca. Mixed technique on panel. By the early twentieth century, systemization in the field of iconography was underway. Categories such as origin and artist could be cross-referenced with broader subject headings such as Christian art or landscapes. © ALINARI ARCHIVES/CORBIS

Historical Development

Italy at the end of the sixteenth century provided the first scholarly studies in iconographical classification, all of which appeared within twenty-five years of each other. These include Andrea Alciati's *Emblematum liber* (Augsburg, 1531), Pierio Valeriano's *Hieroglyphica* (Basel, 1556), and Vincenzo Cartari's



Black Madonna and Child. Haitian. As the field of iconography has grown in importance, studies have grown broader and deeper, addressing such once-neglected issues as gender, race, and color. PHOTO CREDIT: NICOLAS SAPIEHA/ART RESOURCE, NY

Le imagini, con la spositione de i dei de gli antichi (Venice, 1556). All of these were superseded by what is now seen as the first study to deal with the theory of iconography, Cesare Ripa's

Iconologia (c. 1555–1622), a slightly ironic publication in that it was initially published without any image whatsoever (not until the third edition in 1603 were woodcuts included). Ripa's study formed the basis for much subsequent research and is one of the most comprehensive iconographic manuals for the student of personifications. It was thanks to the success of his study (and the inclusion of images in subsequent editions) that Ripa's original focus on his subject matter, as documented by the textual, was lost.

Images came to assume a greater role with the consequent and irretrievable association of what was then called iconology and art history. Ripa's initial conceptualizations of what could be represented were removed from its meaning, and iconology came to assume an association with what was there rather than what could be there. Iconology came to deal in visual fact, not theory, and began to take on humanistic associations. From the mid-seventeenth century onward, iconology was synonymous with the study of visual matter, with a slight emphasis initially on religious themes (which was later extended to the secular). It was also around this time that iconography, the now more widely used of these two terms, came into use with its specific reference to visual (usually portraits) rather than textual material. Over time it was a word that came to be applied to specific generic types of subject matter—not only portraits but medical and scientific material as well. Although the term *ichnography* (the art or process of drawings), yet a third variant, had been in use since the late fifteenth century or early sixteenth century, it became popular at the beginning of the seventeenth century for its particular reference to architectural subjects. The primary position occupied by Ripa throughout the eighteenth and nineteenth centuries was never seriously threatened despite the appearance of a series of other iconographical dictionaries, encyclopedias, and studies, such as those by Giovanni Pietro Bellori (1672), Jacob Spon (1679), Giuseppe Kurtzböck (1735), Honoré Lacombe de Prézel

CESARE RIPA (FL. 1593)

Little is known of Ripa apart from the fact that he was probably born in Perugia between 1555 and 1560 and is next recorded in the service of Cardinal Antonio Maria Salviati, for whom he acted as controller of the household in Rome. His *Iconologia* was first published in 1593 to great acclaim and included descriptions of over 1,250 personifications ranging from *Abondanza* (I, 1 Abundance) to *Zelo* (V, 417 Zealousness), each of which is described in detail as a manual for writers, artists, and illustrators of the period. The personifications are always described in terms of human forms with their attributes and poses clearly delineated. This dictionary of visual imagery is highly subjective; Ripa not only drew widely on existing representations but, when such precedents did not exist, created structures showing how they should be depicted. The modern iconographic research into nonvisual material is very much in keeping with Ripa's focus, which was intended to encompass all of the arts, visual and otherwise.

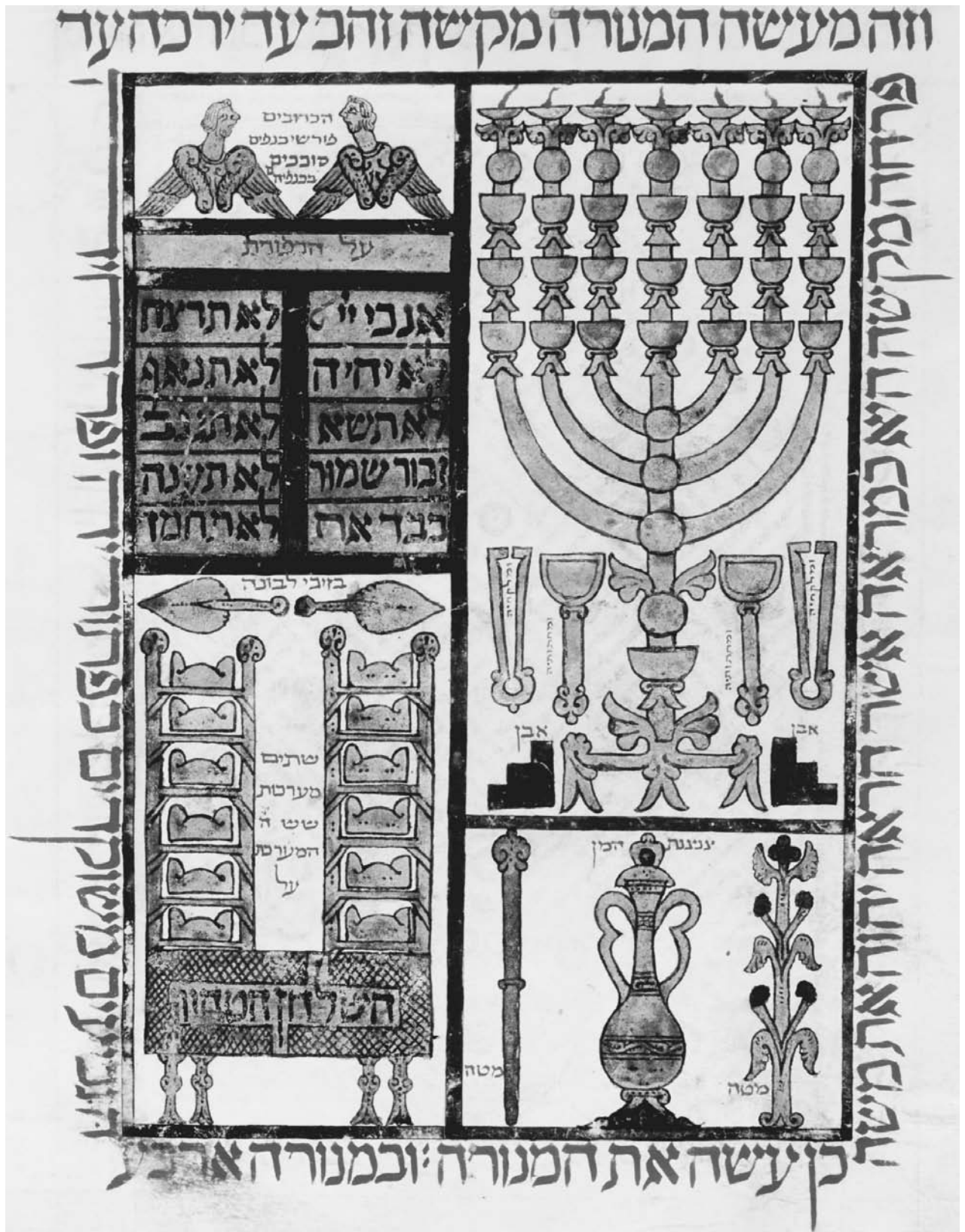

Manuscript illumination depicting Jewish ritual objects, c. 1300. By the twenty-first century, the study of iconography had expanded from primarily Western art forms and moved into other realms such as Islamic and Jewish art. © ARCHIVO ICONOGRAFICO, S.A./COR-BIS



Welcoming Descent of Amida Buddha, eighteenth century. Many iconographers of the twentieth century believed that the subtextual evaluation of a work of art could exemplify the religious persuasion of a society. © CHRISTIE'S IMAGES/CORBIS

(1756), Jean-Charles Delafosse (1768), Johann J. Winckelmann (1717–1768), Friedrich Rehberg (1794), August Stöber (1807), Adolphe-Napoléon Didron (1806–1867), Josef Strzygowski (1885), and Henry Spencer Ashbee (1895).

The nineteenth century saw the organized beginnings of large-scale iconographical studies. This was what could be called the age of theory in art history, in which iconography was to assume a pivotal and dominant role and extend its tenets into other fields. One of the most important interdisciplinary approaches was that developed out of textual studies by a group of French scholars, including Fernand Cabrol (1855–1937), Charles Cahier (1807–1882), François-René de Chateaubriand (1768–1848), Adolphe-Napoléon Didron (1806–1867), Émile

Mâle (1862–1954), Albert Marignan (fl. nineteenth century), Xavier Barbier de Montault (1830–1901), and Walter Pater (1839–1894). These studies were formative in the establishment and development of iconography as a modern interdisciplinary tool. If the works by these scholars were largely iconographical (with occasional forays into iconology), they nevertheless defined the parameters of future research.

Prior to this time, the focus of iconographical studies had been largely on style. However, a new emphasis on content, based on the concept of beauty personified in the Christian ideas embedded in medieval art, emerged with the publication of Chateaubriand's *Génie du Christianisme* in 1802. In it, he balanced neoclassicism and rationalism against the concept of genius and spirit as represented by the world of medieval art. If Chateaubriand justified the study of art in all its forms from a slightly conceptual stance, it was Didron who actually enforced a more comprehensive iconographical approach. They were the first art historical iconographers of medieval art, which at that stage was still in its infancy and which culminated in Mâle's *L'art religieux du XIIIe siècle en France: Étude sur l'iconographie du Moyen Age* (trans., *Religious Art in France, the Thirteenth Century: A Study of Medieval Iconography and Its Sources*), first published in 1898. Mâle's nationalistic stance may be seen as a subjective aside (a factor of the post-World War I period) and not one that was to influence future iconographical studies. On the other hand, he is the first art historian to be either criticized or credited with the fact that iconography became irrevocably text-driven. The association between text and image is a characteristic that has both hindered and promoted research since then and is an element whose relationship is still not clearly defined.

The twentieth century brought about a major reevaluation of the meaning of such terms and an even wider application of the practice. Resulting largely from the establishment of art history as a formal discipline in universities and the improvement of photographic reproductions, along with the greater availability of images and an increase in publications, iconography and iconology came into common usage and were applied to large-scale collections. The establishment for the first time of art historical photographic archives, such as the Witt Library (Courtauld Institute of Art), the Index of Christian Art (Princeton University), and the Frick Art Reference Library, meant that relatively large-scale visual resources were available for the study of particular themes and subjects.

The organization of the many large photo archives created at the start of the century used subject matter or iconography as a point of access. One of the best-known archives, the Index of Christian Art, founded in 1917 at Princeton University, was also one of the earliest to use a thematic approach developed by Erwin Panofsky (1892–1968). This archive was undoubtedly to provide the impetus for what is considered the most innovative and insightful approach into the psychology of iconographical perception created by Panofsky, who was not only a friend of the founder but also one of the most ardent users and supporters of the Index.

It was in the first few decades of the twentieth century that the value of iconography was analyzed for the first time in hu-

ÉMILE MÂLE (1862–1954)

Mâle was the first art historian to deal exclusively with medieval iconography, albeit largely with French medieval material. A student of literature at the École normale supérieure in Paris until 1886, his first appointment was as professor of rhetoric at the university at St.Étienne. His reputation was established once he accepted the position of chair in the Department of Medieval Archaeology at the Sorbonne, Paris, in 1908. His studies largely focused on the French origins of both Romanesque and Gothic sculpture and were conducted from a strongly nationalistic and religious perspective. His major work, *L'art religieux du XIIIe siècle en France*, was published in 1922 and was the first in a series of similarly titled studies that evaluated the entire medieval period as a progressive movement, from a stylistic and iconographical stance. Named director of the École française de Rome in 1923, Mâle was criticized both during his lifetime and afterward for his tendency to view iconography as a finite concept and for his unwillingness to see beyond his own period or area of expertise.

ERWIN PANOFSKY (1892–1968)

Born in Hanover, Panofsky received his Ph.D. in 1914 from the University of Freiburg. He is recognized as one of the most influential scholars of the twentieth century, not only for his academic studies but for his analysis of the methodologies of iconographic analysis and interpretation, which culminated in *Studies in Iconology* (1939). Before assuming part-time teaching duties at New York University in 1931, he taught at the Universities of Munich, Berlin, and Hamburg (1926–1933), where he was strongly influenced by Aby Warburg and what was then known as iconographical analysis. After the Nazis came to power, Panofsky left Germany for good and took up teaching in New York. In 1935, at the invitation of his friend Charles Rufus Morey, Panofsky transferred to the newly established Institute for Advanced Study at Princeton University, where he remained until his death in 1968. His writings are characterized by a rare erudition and range. A humanist in the broadest sense, Panofsky wrote on such diverse topics as Gothic scholasticism, Albrecht Dürer, German sculpture, and Suger and the Abbey of St. Denis as well as Mozart, the cinema, and the detective story.

manistic terms. Typical of such studies were those by Charles Rufus Morey (1877–1955), who saw iconography as a linchpin in understanding the broader context of any art-historical work. Iconography could therefore be used to determine date, style, and the broader sociocultural position of the work and was no longer limited to subject matter. This movement was ultimately to lead to a certain degree of stagnation in a number of studies prior to the 1930s in which iconography was a slave to the determination of date and origin. It was Morey who was responsible for bringing Erwin Panofsky to Princeton's

Institute for Advanced Study. It is difficult not to acknowledge the influence the index must have had on Panofsky's theories, considering that the work undertaken in the archive had been under way some twenty years before his work (*Studies in Iconology: Humanistic Themes in the Art of the Renaissance*, 1939) was published. Morey, like Panofsky, was a firm believer in the theory that iconography could be "read" like a text—a practice that continues in most cataloging systems. Though he is generally seen as the father of iconography, Panofsky's theories (see sidebar) have been sharply criticized

in the late twentieth century, but his work is pivotal in understanding the methodology of subject analysis and would influence the role that iconography was to assume to the end of the twentieth century and beyond.

If Panofsky is seen as the scholar whose work culminated in the best-known study, Aby Warburg (1866–1929), a like-minded scholar, was also instrumental in promoting iconographical research methods. Panofsky was also preceded by some notable iconographers, mostly on the other side of the Atlantic (with the exception of Meyer Schapiro [1905–1996], who, although born in Lithuania, lived in the United States), whose theories paralleled his own. Among these were Fritz Saxl (1890–1948) and Edgar Wind (1900–1971) of the Warburg Institute. All German by birth and training, they saw a need to evaluate the work from an interdisciplinary perspective in which its true meaning could be elucidated not just in relation to its immediate context but in its broader value, thus revealing “the basic attitude of a nation, a period, a class, a religious or philosophical persuasion” (Panofsky, 1939, p. 7). Panofsky’s theories are very much the product of the art-historical milieu in which he lived and worked, a world in which art history was termed *Kunstgeschichte als Geistesgeschichte* (art history as the history of ideas; see Dvořák), and of course his Kantian philosophy. The German philosopher Immanuel Kant (1724–1804) was a major influence in Panofsky’s formulation of a number of theories, such as “Copernican Revolution,” in which he argues that it is the image or representation that makes the object possible instead of the opposite. Kant’s belief that the human brain played an active role in perception and was not just a passive recipient influenced Panofsky’s structure as to how the brain perceived images and structured iconography. It was at this stage that the terms *iconography* and *iconology* were revised, with iconography redefined as the basic stage of interpretation and iconology seen as the more advanced stage of interpretation.

Iconography was to develop slowly yet consistently through the rest of the twentieth century until a period of critical self-examination in art history brought about some new developments. The whole discipline—not just iconography or Panofsky’s theories—came under criticism and revision in the 1960s and 1970s. The relevance of iconography in art-historical studies was questioned, mainly by iconographers, and relegated to a secondary position by some factions within the discipline. Iconography, like Panofsky’s theories, was seen as resistant to change and too self-contained within its own parameters. Now that this period of self-examination seems to have abated, the relevance of iconography to what is called the “new art history” has once again been accepted as one of the fundamental tenets of the discipline. The implications for its understanding have also been extended into previously under-researched fields, such as reception, color, gender, and ethnography.

Methodology

If Ripa was among the first iconographical theoreticians to realize the importance of structure and systematization in this field, others did not follow his path until the beginning of the

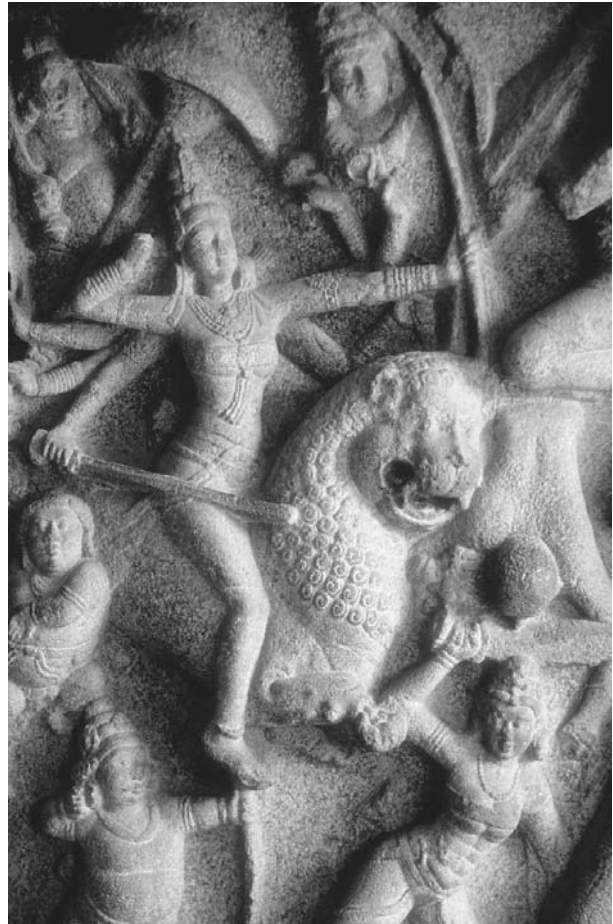

Detail of *Durga Slaying the Buffalo Demon*. Relief sculpture, Mahabalipuram, Tamil Nadu, India. Although the study of iconography is not limited to the visual arts, and indeed can be applied to textual or verbal material, it is still considered primarily the purview of the art historian. © GIAN BERTO VANNI/CORBIS

twentieth century. Informal, loosely defined, and independent structures were developed at the end of the nineteenth century with many scholarly studies in which related concepts and themes were grouped together, and significant and dominant subjects were discovered with the amassing of large bodies of visual data. It was from such studies that the twin applications of methodology to cataloging and interpretation developed. The former, albeit on a less-developed basis, was in place prior to Panofsky’s work.

The need to organize large visual collections using meaningful and practical guidelines led not only to the creation of formal principles but was directly responsible for Panofsky’s work, which could only have emerged with such a platform in place. This work was initially undertaken in the photo archives that developed at the start of the century. It must be remembered that because no guidelines existed for the handling of such material, the organizational principles in use largely emulated those of the traditional book library—a policy that has caused some difficulties. The primary cataloging

principle in visual collections was organization on a national basis (French, Italian, Spanish). This was followed by the maker's name (Fragonard, Giotto, Goya). The output was iconographically subdivided (portraits, male, landscapes, still life, abstract), depending on the complexity of the artist's output. Such subject headings could also form the primary access point to the material, as in the case of the Index of Christian Art or the Rijksbureau Voor Kunsthistorische Documentatie in The Hague.

Whereas such structures were broadly similar in their construction and could include any number of themes (usually referred to as subject headings), there were no existing principles or guidelines with which to determine terminology or structure. This was to change with Panofsky's pioneering study, which provided a framework for interpreting and understanding iconography and iconology. His three-fold division of interpretation and understanding also examined the psychology and mental processes involved in creative work:

1. The first level is a description of the factual (or expressional), termed the "pre-iconographic description," in which uninterpreted subjects are enumerated. This level does not require any in-depth knowledge of either the work or its context, apart from the ability to recognize what is represented.
2. The secondary level, iconographical analysis, involves an understanding of the subject matter. It "constitutes the world of images, stories and allegories" (Panofsky 1939, p. 14) and requires an analysis of the pre-iconographic material, which can be derived only from a familiarity with and knowledge of the themes and concepts represented. The recognition of such themes can be based on external sources (such as textual material) and may be extensive, but it is usually acquired from familiarization with the material.
3. The third or iconographical level is the most complicated of the three and involves an understanding of the intrinsic meaning or content, constituting the world of "symbolical values." This level requires "a familiarity with the essential tendencies of the human mind" and attempts to place the deeper meaning of the work (if it exists) within the realm of the conscious. Such deeper meanings cannot be immediately recognized.

Why Panofsky completely reversed the use of existing terminology remains a mystery, but it was probably to accommodate his structure, which in itself is slightly unsatisfactory because of its inability to formulate a satisfactory term for the first level. The three divisions are clearly structured as a paper system, but in reality the speed with which the human mind culturally contextualizes subjects at a pre-iconographic level slightly blurs the three divisions. Considering the cultural associations everyone possesses, and which must be applied at a

conscious or subconscious level, it is difficult to disentangle the various levels into coherent thought processes. Nevertheless, Panofsky's legacy was to influence art-historical studies for many generations. His pioneering work, even in the early twenty-first century, forms the basic principle for iconographical analysis. In Roland Barthes's (1973) semiological system, the terminology and structure of "sign," "signifier," and "signified" was influenced by, and is remarkably similar to, Panofsky's.

Panofsky's theories were also to provide an ordered framework for developing methodologies in subject classification. Even in the early twenty-first century, whether in computerized or manual format, most classification systems structure a tripartite division that, although slightly out of sync with Panofsky's system, nevertheless mirrors it in essence. Such structures differ from Panofsky's in their relationship to user needs.

1. The first of these is usually the broad level descriptor or general subject heading, such as portrait or landscape—an iconographic descriptor at its broadest.
2. The second is the pre-iconographic description of the work—the generic elements in the work, such as bridge, lake, table, and so forth.
3. The third level is the specifics of the work—for example, an identified person's name, the name of a battle or of a bridge—an amalgam of the iconographical and iconological.

Most cataloging systems fail to address iconological analysis, leaving such work to scholarly researchers. One of the basic requirements for iconographic classification is consistency and standardization, and it was this factor that led one of Panofsky's colleagues, Henri van de Waal (1910–1972), the next great iconographer of the postwar period, to discuss with Panofsky in 1948 the principles of iconographical analysis. Their discussions resulted in what is now the most widely used iconographical system in the world, ICONCLASS. This alphanumeric system, published between 1973 and 1985, divides what can be represented into nine divisions, with further subdivisions to the specific. For example, 73C14 is the code for the Burial of St. John the Baptist and is based on the divisions:

- 7: Subjects drawn from the Bible
- 73: Subjects drawn from the New Testament
- 73C: The public life of Christ from baptism until the Passion
- 73C1: Story of John the Baptist
- 73C14: Burial of John the Baptist

Systems may appear in natural language or coded (as in ICONCLASS) and use the construction of subject headings, thesaurus-based terms, or free text descriptions.

CHARLES RUFUS MOREY (1877–1955)

Chairman of the Department of Art and Archaeology at Princeton University, Morey was a historian of early Christian art whose primary field of study was the iconography of Italian art of the pre-700 period. Apart from his scholarly studies, which ranged from research on gold-glass mosaics to early Latin manuscripts and iconographical motifs of the origins of early Christian art, he is best remembered for founding the Index of Christian Art in 1917. As an iconographer he realized that the major obstacle to understanding the development of particular themes and subjects lay in the lack of available knowledge. It was this that led to his establishment of the world's largest iconographically organized archive of medieval art. Morey's studies, while now slightly outdated, demonstrate his belief that the full understanding of a work of art depends on the use of iconography in a contextualized manner. A close friend of Panofsky, Morey believed that iconography was an organic entity that was constantly developing and that could be understood only in relation to what was known at any one time.

With the advent of computerization to art history (and the computer's application to iconographical studies in particular), such systems have proliferated, highlighting the popularity of subject analysis but also increasing the visual material available for scholarly research which has, in many ways, brought about a renewal of interest in iconography. However, no matter how structured or developed the classification system, the inherent difficulties and, ultimately, the impossible task of describing the visual with the verbal remain.

Trends and Developments

Computerization and its application to art history has been the most dominant factor in the popular renewal of interest in iconography. User studies have shown the popularity of accessing subject matter in such venues as museum and gallery databases. There has been a similar renewed interest in scholarly research. Iconography is developing along twin tracks whereby the traditional is being refined with a greater need for detail and new needs are being created with the opening up of new fields. Large-scale iconographical projects have developed in art history with specializations, such as mythology, music, classical and legal material, medicine, and costume, to name just a few. Up to the end of the twentieth century, iconographical studies were largely concerned with Western art and the representational but must now encompass the abstract, stylized, non-Western, and nonrepresentational.

Generalities will no longer suffice; more detail is required that reflects the study of minutiae now demanded by scholarship. With such details, specific iconographic subfields, which had hitherto been neglected or treated only in passing, have assumed greater importance. Among these are such issues as gender, race, gesture, color, and politics. A number of these concepts have developed in response to new art-

historical concerns. With the opening up of art history into new fields of research, we have also moved into non-Western art and an iconography that was never extensively researched. Islamic, Judaic, Chinese, and Indian art forms are now being studied from an iconographical and iconological perspective; consequently there is a need to develop a suitable terminology and to apply different approaches that theories such as Panofsky's cannot encompass. Whereas in the past iconographical studies dealt largely with classical, medieval, or religious subjects, the whole field of study has opened significantly and now reflects a number of disciplines, not just the more classically oriented. Iconography is responding to a widening field of scholarship. In all of these developments, and especially in its associations with other disciplines, the humanistic background of iconographical research is being reinforced and extended.

If iconography has changed, so has the way in which it is used. We have moved beyond iconographical interpretation into issues of reception that, in many ways, are an extension of Panofsky's cultural contextualization. Now, however, there is greater focus on the specific work (and what we can learn from it) than on the national or cultural contexts and their relationship to subject matter, which was Panofsky's premise for understanding iconology. We are now attempting to understand not just the hidden meaning behind a specific theme or motif but also how subjects are received and understood by the viewer. The new focus of iconography demands that viewers transpose themselves to the period of creation and reception and operate at a spiritual level that moves beyond the work of art itself. It is disappointing that the majority of iconographical studies fails to consider form and function—factors

HENRI VAN DE WAAL (1910–1972)

Born in Rotterdam, van de Waal began his studies in 1929 at the University of Leiden, which was to be his academic home for the rest of his career. He received his Ph.D. in 1940 for a study on the seventeenth-century Batavian revolt. As a writer he is best known for his iconological study on three centuries of representing Dutch national history, *Drie eeuwen vaderlandsche geschieduitbeelding 1500–1800: Een iconologische studie* (The Hague, 1952), which, although ready for the printer in 1942, was not published until 1952 as the typescript was destroyed by the Germans during the occupation of the Netherlands. While interned in a prisoner of war camp, he began to formulate his theories on structuring a system for iconographic classification that eventually was called ICONCLASS and was published between 1973 and 1985. After the war van de Waal was named director of the University of Leiden's print room and was later made professor of art history there. His classification system is based on Panofsky's pre-iconographic and iconographic levels with nothing iconological in the structure. Factually based, it merges form and content and is now the most widely used iconographical classification system in the world.

that are pivotal to understanding the meaning of any work holistically.

Despite the application of the term to disciplines other than the visual, iconography remains very much within the province of the art-historical world. Its popular use in relation to textual, musical, political, religious, theatrical, or dramatic studies, to name just a few of the disciplines to which it has been applied, is nearly always based on visual material within those fields. Its use is therefore less clearly defined in such fields although, as a concept, there seems no reason why it should not be applied even at all three of Panofsky's levels. Iconography still remains highly dependent on the need to find a textual support for its subject matter—a characteristic that has impeded research. The overriding need to find a textual basis, even where none may exist, has created an unreal association between the verbal and the visual. Iconographical scholarship, especially that of the medieval period, has looked for sources for the visual among a variety of documents, from the legal to the poetic, when no visual relationship may exist. But even if still text-driven, iconography has fortunately moved away from the need to find the earliest example of whatever theme or subject is being studied.

Chronological or developmental stages in the history of a motif are no longer seen as being of paramount importance. There have been some trends to extend iconographical significance to reflect an even wider application beyond what has hitherto been defined. Terms such as *aboutness* or *relatedness* denote concepts and ideas beyond the iconological. Brought about largely through the application of computers to iconographical studies, such terms reflect the need to extend meaning to the absolute. Unsatisfactory in meaning and application, they attempt to extend the iconological significance of a work

to what are perceived to be broader, yet related, iconological concepts that, like the terms themselves, are highly subjective and may not be supported by factual evidence. If iconology was believed to have separated art from form and content, this new direction threatens to put such relationships even further into the background.

See also Aesthetics; Arts; Classification of Arts and Sciences, Early Modern; Context; Hierarchy and Order; Interdisciplinarity; Language and Linguistics; Logic; Symbolism; Visual Culture; Visual Order to Organizing Collections.

BIBLIOGRAPHY

- Baca, Murtha, ed. *An Introduction to Art Image Access: Issues, Tools, Standards, Strategies*. Los Angeles: Getty Research Institute, 2002.
- Barthes, Roland. *Mythologies*. Selected and translated from the French by Annette Lavers. New York: Hill and Wang, 1972.
- Bazin, Germain. *Histoire de l'histoire de l'art: De Vasari à nos jours*. Paris: A. Michel, 1986.
- Beilmann, M. "Hans Van De Waal (1910–1972)." In *Altmeister Moderner Kunstgeschichte*, edited by Heinrich Dilly. Berlin: D. Reimer, 1990.
- Bialostocki, Jan. "Iconografia e Iconologia." In *Enciclopedia universale dell'arte*, vol. 7. Venice: Istituto per la collaborazione culturale, 1962.
- . *Stil und Ikonographie: Studien zur Kunstwissenschaft*. Cologne, Germany: DuMont, 1981.
- Bolvig, Axel, and Phillip Lindley, eds. *History and Images: Towards a New Iconology*. Turnhout, Belgium: Brepols, 2003.
- Cassidy, Brendan, ed. *Iconography at the Crossroads: Papers from the Colloquium Sponsored by the Index of Christian Art, Princeton University, 23–24 March 1990*. Princeton, N.J.: Princeton University Department of Art and Archaeology, 1993.

- Dvořák, Max. *The History of Art as the History of Ideas*. Translated by John Hardy. London and Boston: Routledge and Kegan Paul, 1984.
- Eliade, Mircea. *Images and Symbols: Studies in Religious Symbolism*. Translated by Philip Mairet. New York: Sheed and Ward, 1961.
- Émile Mâle: *Le symbolisme chrétien: Exposition*. Vichy, France: La Bibliothèque, 1983.
- Ferretti, Silvia. *Cassirer, Panofsky, and Warburg: Symbol, Art, and History*. Translated by Richard Pierce. New Haven, Conn.: Yale University Press, 1989.
- Foskett, Antony Charles. *The Subject Approach to Information*. London: Bingley; Hamden, Conn.: Linnet, 1981.
- Friedman, John B., and Jessica M. Wegmann. *Medieval Iconography: A Research Guide*. New York: Garland, 1998.
- Heckscher, William. "The Genesis of Iconology." In *Stil und Überlieferung in der Kunst des Abendlandes*, 239–262. Berlin: Gebr. Mann, 1967.
- Heidt Heller, Renate. *Erwin Panofsky: Kunsttheorie u. Einzelwerk*. Cologne and Vienna: Böhlau, 1977.
- Holly, Michael Ann. *Panofsky and the Foundations of Art History*. Ithaca, N.Y.: Cornell University Press, 1984.
- . "The Origin and Development of Erwin Panofsky's Theories of Art." Ph.D. diss., Cornell University, 1981.
- Hourihane, Colum, ed. *Insights and Interpretations: Studies in Celebration of the Eighty-Fifth Anniversary of the Index of Christian Art*. Princeton, N.J.: Princeton University Press, 2002.
- Kaemmerling, Ekkehard, ed. *Ikonographie und Ikonologie: Theorien, Entwicklung, Probleme*. Bd. 1: *Bildende Kunst als Zeichensystem*. Cologne: DuMont, 1979.
- Lavin, Irving, ed. *Meaning in the Visual Arts: Views from the Outside: A Centennial Commemoration of Erwin Panofsky 1892–1968*. Princeton, N.J.: Princeton University Institute for Advanced Study, 1995.
- Lavin, Marilyn. *The Eye of the Tiger: The Founding and Development of the Department of Art and Archaeology, Princeton University, 1883–1923*. Princeton, N.J.: Princeton University Press, 1983.
- Meiss, Millard, ed. *De artibus opuscula XL: Essays in Honor of Erwin Panofsky*. New York: New York University, 1961.
- Molanus, Johannes. *Traité des saintes images: De picturis et imaginibus sacris*. Paris: Cerf, 1996.
- Panofsky, Erwin. *Meaning in the Visual Arts: Papers in and on Art History*. Garden City, N.Y.: Doubleday, 1955.
- . *Studies in Iconology: Humanistic Themes in the Art of the Renaissance*. New York: Oxford University Press, 1939.
- Porter, A. Kingsley. "Spain or Toulouse? and Other Questions." *Art Bulletin* 7 (1924): 4.
- Ripa, Cesare. *Iconologia*. Edited by Piero Buscaroli. 2 vols. Turin, Italy: Fògola, 1986.
- Smyth, Craig Hugh, and Peter Lukehart, eds. *The Early Years of Art History in the United States*. Princeton, N.J.: Princeton University Department of Art and Archaeology, 1993.
- Straten, Roelof van. *An Introduction to Iconography*. Translated by Patricia de Man. Langhorne, Pa.: Gordon and Breach, 1993.
- Waal, Henri van de. *ICONCLASS, an Iconographic Classification System*. Completed and edited by L. D. Couprie et al. Amsterdam: n.p., 1985.

Colum Hourihane

IDEALISM. The term *idealism* in its broadest sense denotes the philosophical position that ideas (mental or spiritual

entities) are primary and lie at the very foundation of reality, knowledge, and morality, while non-ideal entities (such as physical or material things) are secondary and perhaps even illusory. Strands of idealistic thought can be found in ancient and medieval philosophy, but modern idealism begins in the wake of René Descartes (1596–1650), whose method of doubt problematized the relation of the mind (or spirit or ideas) to the material world and thus raised questions about how ideas "inside" the mind can be known to interact with or correspond to any material, extended thing "outside" the mind.

Early Modern Idealism: Leibniz and Berkeley

The idealism of Gottfried Wilhelm Leibniz (1646–1716) arose largely in response to questions raised by Descartes about the relation between mental substances and physical substances. According to Leibniz, real substances do not and cannot interact, because to be a substance is to be independent of the influences of other substances (but no finite substance is altogether independent of God, who is the ground and cause of all finite substances, including ourselves). Furthermore, Leibniz argued that every genuine substance must be utterly non-composite or simple (i.e., not made of parts), because the ongoing unity and existence of any being made of parts depends on causes outside of the being itself (and such dependence contradicts the very definition of substance). Accordingly Leibniz held that no genuine substance can be material, because matter is essentially composite, which means that matter cannot be substantially or independently real. Leibniz thus concluded that substances must be percipient, or have perceptions, because the only way in which a substance can be utterly simple and yet reflect diversity within itself is through the undivided activity of perception. Leibniz's idealism can be summed up in the proposition that "to be is to be a substance, and to be a substance is to be percipient." For Leibniz, the real world is simply the totality of all such non-interacting ("windowless") and percipient substances (called "monads"), and our experience of the material world is to be explained idealistically: to be a substance is to be percipient, and the perceptions belonging to any one substance accurately reflect the states of all other substances, not because there is any real interaction among substances but because God has ordained a "pre-established harmony" among all finite substances and their perceptions.

If modern philosophy is divided into two main schools of thought—"rationalism" and "empiricism"—then Leibniz is a "rationalist" idealist, while George Berkeley (1685–1753) is an "empiricist" idealist. Berkeley began with John Locke's empiricist premise that the mind does not possess innate ideas but acquires ideas only through sensory experience. Like Locke, Berkeley also held that the mind has immediate or direct perception only of its own ideas. But unlike Locke, Berkeley denied that the mind's immediate perception of its own ideas can give it indirect knowledge of material things outside of it. Berkeley further insisted that "an idea can be like nothing but an idea" (*Principles*, part 1, section 8), and so we can never know whether the immaterial ideas in our minds resemble or accurately depict material things outside of our minds. Furthermore, Berkeley argued, there is something self-contradictory

in the proposition that objects of perception can exist without being perceived. In order to avoid skeptical or altogether absurd conclusions, Berkeley argued, one must abandon belief in the independent existence of material things and become an idealist or “immaterialist.” For Berkeley, the ideas that we have of sensible things are not *caused* in us by independently existing material things; rather, these ideas simply *are* the sensible things themselves. But sensible things have continued existence—even when we finite minds are not perceiving them—because they continue to exist in the mind of God, whose perception of things not only causes the sensible things to exist but also from time to time causes them to be perceived by us. Thus for Berkeley, our perception of sensible things is nothing other than our perception of ideas in God, and sensible things have an orderly, predictable, and enduring existence because of the wisdom and goodness of God. For Berkeley, then, the immaterialist view of reality not only refutes skepticism but also provides indirect theoretical support for theism. Far from seeking to reduce the real world to the status of “mere” ideas, the real aim of Berkeley’s immaterialism is to elevate “mere” ideas to the status of the real world.

Kant’s Transcendental Idealism

Immanuel Kant (1724–1804) famously wrote that his “transcendental idealism” arose in response to the radical skepticism of David Hume (1711–1776; see *Prolegomena*, p. 260). Unlike Berkeley, Hume doubted not only the independent existence of material objects but even the objective validity of concepts that still remained central to Berkeley’s immaterialist system, such as the concepts of causality and God. Kant recognized that these and other metaphysical concepts could be neither verified nor falsified by recourse to experience alone; however, Kant did not simply reject metaphysics (as Hume had done) but sought to determine the legitimacy and scope of metaphysics by asking the prior question of what reason might justifiably claim to know a priori (that is, independent of all experience).

For Kant, the question of the legitimacy and scope of metaphysics is intimately linked to the question of the possibility of “synthetic a priori judgments.” As synthetic, such judgments extend our knowledge beyond our mere concepts of things, and as a priori, they have necessary and universal validity. Prior to Kant, the empiricists had argued that all synthetic judgments must be a posteriori (that is, based on experience), while Leibniz and Leibnizians had argued that even seemingly synthetic judgments are not really synthetic, because all the predicates belonging to any particular thing can in principle be discovered through an analysis of the mere concept of the thing. The Leibnizian option was unacceptable to Kant, because it entailed that human sensibility is not essentially different from (but is simply a confused form of) human understanding, and thus that human knowing is different in degree, but not in kind, from divine knowing. The empiricist option was unacceptable because, for Kant, judgments based on experience (a posteriori judgments) could never yield knowledge about what is necessarily and universally the case. Against both sides, Kant argued that synthetic a priori knowledge is possible for us, because we possess a kind of sensibility (or intuition) that is not

merely empirical (a posteriori) but a priori. More specifically, we possess the a priori forms of intuition—space and time—where space is the form of all outer sense, and time is the form of all inner sense. For Kant, no object can be given to us (and thus we can have no access to objects beyond our mere concepts), except through the a priori forms of space and time, which are the “subjective conditions” of our own mode of intuiting things. Kant also argued that we possess a priori concepts or “categories” of the understanding which—like the a priori forms of intuition—are not derived from experience but rather which make our experience of objects possible in the first place. Indeed, Kant argues, there would be no such thing as “objects” for us if we did not make judgments applying our own a priori concepts (or categories) to the sensible manifold that is intuited by us through our own a priori forms of space and time. Kant concludes that the “objects” we know through the a priori forms of intuition and categories of the understanding are not “things-in-themselves” (they are not things as they might exist apart from our own a priori conditions of knowing) but only appearances.

Kant’s denial that we can have knowledge of “things-in-themselves” is not meant to imply that the empirical objects of ordinary experience (what Kant calls appearances) are “unreal” or merely illusory. For Kant, the objects of ordinary experience are certainly real, for “the real” is simply that which exercises some degree of influence on our sensibility (*Critique*, A 165; B 208). But while objects of ordinary experience are empirically real, Kant insists that they are “transcendentally ideal” (and not transcendentally real), which is to say that they are not to be identified with anything beyond—or anything that transcends—the bounds of possible experience or the a priori subjective conditions that make such experience possible in the first place. Simultaneously embracing both “transcendental idealism” and “empirical realism,” Kant claims to have shown how we are justified in making synthetic a priori knowledge claims and in employing concepts that are neither derived from nor verified through experience. But just as Kant’s transcendental idealism entails the distinction between things-in-themselves and appearances, it also entails a distinction between the legitimate and illegitimate employment of pure (a priori) reason. For Kant, we can legitimately pursue a limited “metaphysics of experience,” and we can legitimately make synthetic a priori knowledge claims about objects of possible experience. For example, the concept of “causality” (even though “pure” and underived from experience) remains objectively valid when applied to things that can be intuited by us under the a priori conditions of space and time. But Kant also argues that we cannot legitimately pursue metaphysics or make synthetic a priori claims regarding objects that transcend all possible experience. Furthermore, he argues that the attempt to make knowledge claims about the non-sensible objects of traditional metaphysics (for example, God, the soul, and the world as a whole) inevitably leads reason into illusion and self-contradiction. But while we cannot obtain objectively valid theoretical knowledge of such non-sensible objects, our *ideas* regarding such objects (for example, our idea of God) may continue to play a legitimate role in guiding our search for complete knowledge in our theoretical pursuits and the complete good in our moral pursuits.

Idealism, from Kant to Fichte and Schelling

In the years following its public promulgation, Kant's transcendental idealist philosophy was the object of widespread excitement but also much critical scrutiny. Three interrelated problems (or perceived problems) would prove to be significant for the subsequent development of German idealism. First, critics argued that Kant failed to derive or "deduce" the forms of intuition and the categories of the understanding in a systematic and rigorous way, and as a result his critical system could claim only contingent or inductive (as opposed to universal and necessary) validity for itself. Second, critics claimed that Kant's inadequate derivation of the forms of intuition and categories of the understanding committed him to a series of unacceptable dualisms, all of them rooted (directly or indirectly) in the dualism between sensibility and understanding (for example, the dualisms between intuitions and concepts, activity and passivity, receptivity and spontaneity, the a priori and a posteriori, knowledge and belief, theoretical reason and practical reason). Third, critics argued, Kant's strict separation of sensibility and understanding made it impossible for him to account for the receptive character of human knowing except by reference to "things-in-themselves" that allegedly exist apart from the human knower and thus render the activity of human knowing finite, dependent, and passive; but this postulation of things-in-themselves contradicts the spirit of Kant's own transcendental idealism, according to which we cannot know anything about things-in-themselves, including what role—if any—they play in rendering human knowing finite, dependent, and passive.

In the midst of ongoing debates about Kant's transcendental idealism, the young Johann Gottlieb Fichte (1762–1814) became convinced that the Kantian system was essentially correct but stood in need of a more systematic formulation and rigorous defense. First, Fichte argued that it was wrong to think of the "faculty of thinking" or the "mind" or the "self" as if these terms referred to a substrate that underlies our mental operations and persists even in the absence of actual cognitive activity. To think of the self in this way, he claimed, is to regard it as an unknown "thing in itself" that has existence even apart from its being known, and such a view is inimical to transcendental idealism. Fichte went on to argue that the self is nothing other than the free, uncoerced activity of "self-positing" or "self-awareness" and that this very activity can serve as the single, foundational principle from which one could rigorously derive all the other conditions of synthetic a priori knowing, including even the self's apparent dependence on things outside of it. More specifically, Fichte argued that the self would have no occasion to reflect back on itself, and thus it could never even *be* a self if it did not also take itself to be finite and partly determined by a "not-self" outside of it. In other words, Fichte held that even the apparent dependence of human knowing on supposedly independent, unknowable things-in-themselves could be explained on the basis of the necessary conditions of the self's own activity of self-positing. He went on to assert that the not-self, without which the self could not even *be* a self, must ultimately be understood as another free self, thereby arguing for the necessity of belief in other selves (or intersubjectivity) as a condition of the possibility of the self's own self-positing. In practical philosophy,

Fichte also took a step beyond Kant, arguing that the idea of God is necessary for our moral purposes but also that this idea in fact signified nothing other than the moral order of the world itself.

Friedrich Wilhelm Joseph Schelling (1775–1854) was an early follower of Fichte but eventually distanced himself from the Fichtean claim that a properly critical philosophy can begin only with the activity of the self-positing self. By 1799 Schelling was arguing (along with Fichte) that one could derive the not-self (or "nature") from the self-positing activity of the self, but also (against Fichte) that one could equally derive the self-positing activity of the self from the not-self (or "nature"). In subsequent years Schelling departed even farther from Fichte, explicitly rejecting the Fichtean claim that the distinction between subject and object (self and not-self) is a distinction that can be made only by and within subjectivity itself. In effect Schelling argued that Fichte was right to relativize Kant's rigid distinction between subject and object (or correlatively, between understanding and sensibility, or concepts and intuitions) but wrong to achieve such relativization by locating the distinction within subjectivity alone. For Schelling, the distinction between subject and object is not merely subjective but arises only from within an "absolute identity" that is neither subject nor object but both at once. Furthermore, Schelling held, this absolute identity cannot be discursively demonstrated or conceptually articulated (because demonstration and conceptualization already presuppose a subject-object split) but can only be apprehended immediately in an intellectual intuition or (according to Schelling's later thought) an aesthetic intuition. According to Fichte, Schelling's appeal to immediate intuition and his claim that unconscious nature is continuous with and provides the conditions for the emergence of conscious subjectivity could only signal a return to pre-critical, pre-Kantian metaphysics. But Schelling insisted that his "identity philosophy" incorporated the truths of transcendental idealism, while also moving beyond Kant's and Fichte's "subjective idealisms" to a more comprehensive and satisfactory "absolute idealism." This absolute idealism, Schelling argued, did not uncritically presuppose any dualisms between subject and object, freedom and nature, or human agency and God, but rather explained all such dualisms as mere moments within the absolute's own process of internal self-differentiation.

Hegelian Idealism and Its Aftermath

In 1801 the virtually unknown Georg Wilhelm Friedrich Hegel (1770–1831) published a short book entitled *The Difference between Fichte's and Schelling's System of Philosophy*, in which he argued that Schelling had rightly criticized Fichte's "subjective idealism." But by 1807, with the publication of his *Phenomenology of Spirit*, Hegel had begun to criticize Schelling for reasons that were to become determinative for the development of his own version of absolute idealism. First of all, Hegel argued against Schelling that the pathway to a truly "scientific" absolute idealism could not be based merely on an immediate intuition (whether intellectual or aesthetic) but instead had to be conceptually articulated and discursively mediated. Indeed Hegel referred to his own *Phenomenology* as the "ladder" by means of which readers could be led discursively from

the standpoint of ordinary consciousness to that scientific consciousness or “absolute knowing” (see *Phenomenology*, p. 14). Second, and contrary to what might be implied by Schelling’s insistence on immediate intuition, Hegel argued that the discursive pathway to absolute idealism is not external to, but constitutes an integral part of, the very truth of absolute idealism. For Hegel, then, Schelling was correct to claim that previous expressions of the subject-object identity within the absolute (for example, in nature and in earlier forms of philosophy) contained the conditions of the emergence of the subjectivity that eventually grasps the truth of absolute idealism; however, Schelling was wrong to hold that his being correct about this could be ascertained through an immediate intuition. For Hegel, quite simply, one could not know that absolute idealism is true if one did not conceptually recollect the previous forms of thought leading up to it. Because of this, Hegel also held that previous forms of thought do not lead just accidentally or haphazardly to his own thought but rather find their necessary consummation only within his absolute idealism. Third, Hegel agreed with Schelling that a true idealism must not simply presuppose the traditional dualisms of subject and object, freedom and nature, or human agency and God (thus Hegel held that our own coming-to-be conscious of the truth of absolute idealism is not essentially separable from God’s own coming-to-be God). But because of his commitment to conceptual rigor and discursive articulation, Hegel went on to argue that the denial of these traditional dualisms required the development of a new and “dialectical” logic, one that would demonstrate how all finite things reflect within themselves the fundamental yet contradictory identity-in-difference of Being and Nothing (*Logic*, p. 85). All things are in themselves contradictory, Hegel argued, and so Kant was wrong to try to eliminate or contain such contradiction by introducing his distinction between appearances and things-in-themselves (*Logic*, p. 237).

Hegel’s idealism represents the most systematic and comprehensive version of post-Kantian idealism, for it contained within itself not only a new dialectical logic but also very detailed philosophies of nature, history, art, law, and religion. Not long after Hegel’s death, however, his idealistic philosophy became the object of a sustained materialist critique and transformation, primarily at the hands of Ludwig Feuerbach (1804–1872), Karl Marx (1818–1883), and Friedrich Engels (1820–1895). Most famously, Marx and Engels sought to transform Hegel’s dialectical idealism into a form of “dialectical materialism.” They agreed with Hegel that existing reality is fundamentally dialectical and in contradiction with itself, but against Hegel they argued that reality’s basic contradictions are rooted not in merely conceptual determinations (such as the identity-in-difference of Being and Nothing) but rather in the material conditions underlying all forms of precommunist social and economic organization. They went on to assert that systems such as Hegel’s tended to perpetuate the destructive contradictions at work in precommunist society insofar as these systems tended to regard such contradictions as merely ideal and—worse still—as necessary to the proper unfolding of the history of thought. But just as Hegel had argued that a recollective conceptual journey through incomplete forms of thought is necessary to the very truth of absolute idealism, so

too Marx and Engels argued that an actual material journey through incomplete forms of social organization (feudalism, mercantilism, and capitalism) is necessary to emergence of the truly just communist society that is yet to be. In spite of this materialist critique, Hegelian idealism enjoyed an energetic revival in Anglo-American philosophy during the late nineteenth and early twentieth centuries. The three most important post-Hegelian British idealists were Thomas Hill Green (1836–1882), Francis Herbert Bradley (1846–1924), and Bernard Bosanquet (1848–1923), while their most important American counterpart was Josiah Royce (1855–1916).

See also *Empiricism; Epistemology; Hegelianism; Marxism; Rationalism.*

BIBLIOGRAPHY

PRIMARY SOURCES

- Berkeley, George. *A Treatise Concerning the Principles of Human Knowledge*. Edited by Jonathan Dancy. Oxford: Oxford University Press, 1998.
- Fichte, Johann Gottlieb. *Early Philosophical Writings*. Translated and edited by Daniel Breazeale. Ithaca, N.Y.: Cornell University Press, 1988.
- . *Science of Knowledge*. Translated by Peter Heath and John Lachs. New York: Cambridge University Press, 1982. Parenthetical citations refer to the pagination of Fichte’s *Gesamtausgabe*, edited by I. H. Fichte, which is also indicated in the margins of this English translation.
- Hegel, Georg Wilhelm Friedrich. *The Difference between Fichte’s and Schelling’s System of Philosophy*. Translated by H. S. Harris and Walter Cerf. Albany: State University of New York Press, 1977.
- . *Phenomenology of Spirit*. Translated by A. V. Miller. New York: Oxford University Press, 1977.
- . *Science of Logic*. Translated by A. V. Miller. New York: Humanities Press, 1976.
- Kant, Immanuel. *Critique of Pure Reason*. Translated by Paul Guyer and Allen Wood. New York: Cambridge University Press, 1997. Parenthetical citations refer to the A and/or B pagination of the Akademie edition, which is also indicated in the margins of this English translation.
- . *Prolegomena to Any Future Metaphysics That Will Be Able to Come Forward as Science*. New ed, translated by Paul Carus and revised by James W. Ellington. Indianapolis: Hackett, 1977. Parenthetical citations refer to the pagination of the Akademie edition, which is also indicated in the margins of this English translation.
- Leibniz, Gottfried Wilhelm. *Philosophical Essays*. Translated by Roger Ariew and Daniel Garber. Indianapolis: Hackett, 1989. The views described in this entry are to be found especially in Leibniz’s “Monadology” and “Discourse on Metaphysics.”
- Marx, Karl. *Selected Writings*. Edited by David McClellan. Oxford: Oxford University Press, 1977.
- Schelling, Friedrich Wilhelm Joseph. *System of Transcendental Idealism*. Translated by Peter Heath. Charlottesville: University of Virginia Press, 1978.
- ##### SECONDARY SOURCES
- Ameriks, Karl, ed. *Cambridge Companion to German Idealism*. Cambridge, U.K., and New York: Cambridge University Press, 2000.

- Baur, Michael, and Daniel O. Dahlstrom, eds. *The Emergence of German Idealism*. Washington, D.C.: Catholic University of America Press, 1999.
- Beiser, Frederick C. *The Fate of Reason: German Philosophy from Kant to Fichte*. Cambridge, Mass.: Harvard University Press, 1987.
- . *German Idealism: The Struggle against Subjectivism, 1781–1801*. Cambridge, Mass.: Harvard University Press, 2002.
- Harris, H. S. *Hegel's Development*. Vol. 1: *Toward the Sunlight (1770–1801)*. Vol. 2: *Night Thoughts (Jena 1801–1806)*. Oxford: Clarendon, 1972, 1983.
- Hylton, Peter. *Russell, Idealism, and the Emergence of Analytic Philosophy*. Oxford: Clarendon, 1990.
- Neuhouser, Frederick. *Fichte's Theory of Subjectivity*. Cambridge, U.K., and New York: Cambridge University Press, 1990.
- Pinkard, Terry. *German Philosophy 1760–1860*. Cambridge, U.K., and New York: Cambridge University Press, 2002.
- Pippin, Robert B. *Hegel's Idealism: The Satisfactions of Self-Consciousness*. Cambridge, U.K., and New York: Cambridge University Press, 1989.
- Taylor, Charles. *Hegel*. Cambridge, U.K., and New York: Cambridge University Press, 1975.

Michael Baur

IDEAS, HISTORY OF. The “history of ideas,” phrase and concept, goes back almost three centuries to the work of J. J. Brucker (1696–1770) and Giambattista Vico (1668–1744) in the early eighteenth century, followed in the nineteenth century by Victor Cousin (1792–1867) and his eclectic and “spiritualist” philosophy. The story begins with Brucker’s *Historia doctrina de ideis* (1723), which surveyed the Platonic doctrine, and Vico’s criticism, which rejected the idea of a Greek monopoly on ideas. For Vico philosophy was joined to religion in a larger and older tradition of wisdom and theology, “queen of the sciences,” which, he wrote, “took its start not when the philosophers began to reflect [*riflettere*] on human ideas” (as, he added, in the “erudite and scholarly little book” recently published by Brucker) “but rather when the first men began to think humanly.” Thus the history of ideas began not with Plato but with myth and poetry, and this poetic wisdom was the basis not only for Plato’s theory of ideas but also for Vico’s “history of ideas,” which was one face of his “New Science.” Victor Cousin and his followers also took a broad view of the history of ideas, from antiquity down to modern times.

The history of ideas was given new life in the twentieth century, especially under the guidance of Arthur O. Lovejoy (1873–1962), one of the leading American philosophers of this time. Even before Lovejoy the phrase had been applied to a series of volumes published by the philosophy department of Columbia University between 1918 and 1935, which were devoted to “a field . . . in which it appears that ideas have a history and that their history is influenced by contact with lines of experience not commonly called philosophical.” Lovejoy was more deliberate in applying the phrase to what he regarded as a new discipline distinct from the history of philosophy and the “new history,” championed by James Harvey Robinson

(1863–1936) and his followers. The History of Ideas Club at the Johns Hopkins University (where Lovejoy taught), which began meeting from 1923, was the scene of papers given by many distinguished scholars. The classic work in the field that since 1919 Lovejoy had been calling the “history of ideas” was his William James lectures in Harvard, which were published in 1936 as *The Great Chain of Being*.

In the history of philosophy, according to Lovejoy, “is to be found the common seed-plot, the locus of initial manifestation in writing, of the greater number of the more fundamental and pervasive ideas, and especially of the ruling preconceptions, which manifest themselves in other regions of intellectual history” (p. 8). Yet Lovejoy also aspired to make the history of ideas an interdisciplinary enterprise, accommodating also literature, the arts, and the natural and social sciences. Nor were Lovejoy’s “unit-ideas” limited to formal concepts, for he also wanted to accommodate “implicit or incompletely explicit assumptions or more or less unconscious mental *habits*, operating in the thought of an individual or a generation”; “dialectical motives,” or methodological assumptions (nominalist or “organismic,” for example) also inexpressible in propositions; metaphysical pathos (which awakened particular moods, for example); and ideas associated with particular sacred words and phrases intelligible through semantic analysis. All of these “ideas,” which were regarded as the expression of whole groups and ages, were interpreted mainly by literary texts, especially poetry, from several national traditions, in keeping with the international and interdisciplinary thrust of Lovejoy’s agenda.

In Lovejoy’s program the history of ideas extended its sway over no fewer than twelve fields of study, beginning with the history of philosophy and including the history of science, religion, the arts, language, literature, comparative literature, folklore, economic, political, and social history, and the sociology of knowledge. These fields were all disciplinary traditions in themselves; the novelty was treating them in an interdisciplinary and synthetic way for larger purposes. For Lovejoy (writing in the dark year 1940) the final task of the history of ideas was “the gravest and most fundamental of our questions, ‘What’s the matter with man?’”

Lovejoy’s colleague George Boas (1891–1980) expanded on the idealist implications of his methods. For Boas ideas are basic meanings that lie behind—and that evolve independently of—words. “The history of ideas is not confined to historical semantics,” he wrote and “a dictionary aims only to give the meaning of words, not of ideas, and sometimes a single idea may have two names” (1969, p. 11). Yet these are assumptions that cannot be expressed or communicated except through words and historical semantics—a paradox that neither Lovejoy nor Boas resolved, or chose to confront. As they acknowledged, “The history of any idea, or complex of ideas, is best presented through the citation of the *ipsissima verba* of the writers who have expressed it.”

Lovejoy’s agenda found an institutional basis when the *Journal of the History of Ideas (JHI)* was founded in 1940, the first issue being prefaced by his “reflections,” which suggested the orientation of this periodical more or less down to the present, especially in terms of “influences”—classical on modern

thought, philosophical ideas and scientific discoveries on all areas of study, other pervasive ideas such as evolution, progress, primitivism, and various ideas of human nature, on historical understanding. This program was also reflected in the old *Dictionary of the History of Ideas*, edited in 1968 by Philip P. Wiener, first editor of the *JHI* (and succeeded, if not replaced, by the present work).

The history of ideas had counterparts in other European traditions, including German *Ideengeschichte*, *Geistesgeschichte*, and especially *Begriffsgeschichte*, and French *mentalités*. In the later twentieth century all of these approaches were affected by the “linguistic turn,” which shifted attention from unproblematic “ideas” to language and discourse, since ideas, as Jorge Luis Borges (1889–1986) wrote, “are not, like marble, everlasting,” and as Ludwig Wittgenstein (1889–1951) put it, “The limits of my language mean the limits of my world.” Not that Lovejoy was unaware of such problems, for long before he had pointed out “the role of semantic shifts, ambiguities, and confusions, in the history of thought and taste,” and he remarked that “nearly all of the great catchwords have been equivocal—or rather, multivocal.” For this reason Lovejoy took pains to distinguish the varied meanings behind keywords such as *nature*, *progress*, *perfectibility*, *romanticism*, and *pragmatism*, as well as more inflammatory terms of ideological debate.

In the later twentieth century the history of ideas was invaded and shaken by a number of intellectual movements, including hermeneutics, reception theory, psych-history (and -biography), deconstruction, poststructuralism, constructivism, the new historicism, cultural materialism, the new cultural history, Derridean textualism, and various efforts of the “social history of ideas.” Following the Nietzschean notion of “the interpretive character of all that happens” and the impact of literary theory, the history of ideas in its classic, spiritualist form also entered into decline, being superseded (except among philosophers) by intellectual history and deeper concerns of language and historical context as well as material culture.

One line of post-Marxian criticism was launched by Michel Foucault, who rejected a number of unreflective rubrics such as tradition, influence, development and evolution, spirit, pre-given unities and links, and especially the notion of the self-conscious agent, the “sovereign subject,” and “authorial presence,” which underlie the imaginary vehicle of “ideas.” In the course of his intellectual iteration Foucault shifted from ideas to “discourse,” from history to “archaeology,” then to Nietzschean “genealogy,” from development to “rupture,” and from spirit or mentality to “episteme” and so to dismantle the history of ideas and to unmask the ideological surface of past and present culture. In his “grammatology” Jacques Derrida carried the critique of ideas beyond language to the world of textuality and intertextuality as the ultimate context of historicity and civil society. In the wake of such “litero-philosophy” many recent intellectual historians, including Hayden White, Dominick LaCapra, Hans Kellner, Roger Chartier, and Frank Ankersmit have distanced themselves from the old tradition of the history of ideas, though without entirely abandoning it.

Intellectual history can no longer be studied without attention to these warnings about unexamined premises of the human sciences. Yet “ideas” remain an essential shorthand for history as well as philosophy and other human sciences, and the history of ideas continues in channels both new and old, with methodological debates recurring across the range of interdisciplinary studies. And the critical pursuit of the history of ideas, or intellectual history, continues not only among historians of culture but also among scholars in the history of philosophy, literature, art, science, and the human sciences.

See also Cultural History; Enlightenment; Historicism; Humanism; Language, Linguistics, and Literacy; Philosophy: Relations to Other Intellectual Realms; Science, History of; Tradition.

BIBLIOGRAPHY

- Boas, George. *The History of Ideas: An Introduction*. New York: Scribners, 1969.
- Boas, George, et al. *Studies in Intellectual History*. Baltimore: Johns Hopkins Press, 1953. Includes studies by Arthur O. Lovejoy, George Boas, Harold Cherniss, Ludwig Edelstein, Leo Spitzer, Gilbert Chinard, Philip Wiener, Dorothy Stimson, Erich Auerbach, Carl Becker, Charles Beard, Niels Bohr, John von Neumann, Hans Baron, Owen Lattimore, Lionel Venturi, Samuel E. Morison, Americo Castro, Charles Singleton, Hajo Holborn, Don Cameron Allen, Basel Willey, Alexandre Koyré, and Eric Vogelien.
- Foucault, Michel. *The Archeology of Knowledge*. Translated by A. M. Sheridan Smith. New York: Pantheon, 1972.
- Kelley, Donald R. *The Descent of Ideas: The History of Intellectual History*. Aldershot, U.K., and Burlington, Vt.: Ashgate, 2002.
- . “Intellectual and Cultural History: The Inside and the Outside.” *History of the Human Sciences* 15 (2002): 1–19.
- . “What Is Happening to the History of Ideas?” *Journal of the History of Ideas* 51 (1990): 3–25.
- Kelley, Donald R., ed. *The History of Ideas: Canon and Variations*. Rochester, N.Y.: University of Rochester Press, 1990.
- LaCapra, Dominick, and Steven L. Kaplan, eds. *Modern European Intellectual History: Reappraisals and New Perspectives*. Ithaca, N.Y.: Cornell University Press, 1982.
- Lovejoy, Arthur O. *Essays in the History of Ideas*. Baltimore: John Hopkins Press, 1948.
- . *The Great Chain of Being: A Study of the History of an Idea*. Cambridge, Mass.: Harvard University Press, 1936.
- Lovejoy, Arthur O., and George Boas. *Primitivism and Related Ideas in Antiquity*. Baltimore: John Hopkins Press, 1935.
- Studies in the History of Ideas*. Edited by the Department of Philosophy of Columbia University. 3 vols. New York: Columbia University Press, 1918, 1925, 1935. Includes papers by John Dewey, Frederick Woodbridge, John Hermann Randall, Richard McKeon, Sidney Hook, Herbert Schneider, and Ernest Nagel.
- Tobey, Jeremy L. *The History of Ideas: A Bibliographical Introduction*. Santa Barbara, Calif.: Clio, 1975–1977.
- Wiener, Philip P., ed. *Dictionary of the History of Ideas*. 6 vols. New York: Scribners, 1968.
- Wilson, Daniel J. *Arthur O. Lovejoy and the Quest for Intelligibility*. Chapel Hill: University of North Carolina Press, 1980.

Donald R. Kelley

IDENTITY.

This entry includes two subentries.

Identity of Persons

Personal and Social Identity

IDENTITY OF PERSONS

General problems about identity had been discussed long before the early modern period, but the problem of personal identity in the form in which it is so widely discussed today has its origin in John Locke's (1632–1704) chapter "Of Identity and Diversity," which he added to the second edition of his *Essay Concerning Human Understanding* (1694). Indeed, most early twenty-first-century views on the issue were anticipated in the seventeenth and eighteenth centuries.

Seventeenth Century

A standard topic in medieval philosophy was the search for a principle of individuation—that is, the question about what it is that makes an individual (object or person) the individual it is and distinguishes it from all other individuals of the same kind. Indeed, the medieval disputes formed a major part of the background for the early modern discussions about the issue. But from about the middle of the seventeenth century onward most philosophers (for example, Thomas Hobbes, Robert Boyle, Locke) neglected the issue of individuation and focused on identity over time instead—that is, on the question about the requirements for an individual's remaining the same over time, although that individual may have undergone some change. Also, there was a marked shift in the discussions away from a primarily ontological to a more subjective treatment of the topic. Our concepts of those things whose identity is in question came to be regarded as crucial for dealing with problems of individuation and identity. In Locke this move is connected to his view that we cannot know the real essences of substances. For Locke the question of how much a thing can change without losing its identity can be answered only with respect to "nominal essences"—that is, with respect to our abstract or "sortal" ideas of those beings whose identity is under consideration.

Early modern philosophers considered the issue of the identity of persons over time to be of special importance, as it is central to theological issues such as the doctrine of life after death and related moral questions. But for most of those thinkers (such as René Descartes) who believed that the soul is an immaterial substance, there was no real problem of personal identity at all. They argued that personal identity consists in the identity of a mental substance or soul and that the identity of the mental substance is a direct consequence of its immaterial nature; it is because of its immateriality that the mind is not subject to change and remains the same through time.

Locke's account marked a decisive break with both the Cartesian and Scholastic positions, which identified either the soul or the man (or human being) with the person as a *res* whose individuality and identity is constituted independently of and prior to consciousness. Locke treated the special problem

of personal identity in accordance with his general theory of identity. Therefore, he argued that we need to be clear about the concept of person in order to be able to determine what constitutes the identity of persons. And to be clear about the concept of person, we have to distinguish it from those of thinking substance or spirit, and of man or human being because each of these concepts carries with it different identity-criteria. The identity of the self as man (or human being) consists in the identity of the same organic body. As we do not know the real nature of the soul as substance, personal identity is accounted for in terms of what we know about the self through inner experience or consciousness uniting thoughts and actions. To consider the self as a person is to consider the self with regard to all those thoughts and actions of which it is conscious. Through consciousness we link present with past thoughts and actions, thereby constituting our personal identity. Only with respect to our personal identity are we morally and legally responsible for past actions. This is why Locke said that "person" is a "forensic" term.

Locke's theory aroused controversy soon after its first publication and inspired critics and defenders throughout the eighteenth century. One standard objection was the charge of circularity, urging that consciousness presupposes personal identity and therefore cannot constitute personal identity (John Sergeant, Joseph Butler). However, this charge presupposes the very thing Locke challenged, namely that the person is an object, thing, or substance to which consciousness relates as to an already individuated being. Another standard objection was that Locke's theory is inconsistent with the transitivity of identity because consciousness is not transitive (George Berkeley, Thomas Reid). In Germany, Locke's most important contemporary critic, Gottfried Wilhelm Leibniz (1646–1716), distinguished between the metaphysical identity of the self (as immaterial substance), which is secured a priori by its intrinsic nature or "complete notion," and the moral identity of the self (as person), which is constituted by consciousness (*Nouveaux Essais*, 1704). However, while Locke argued for keeping personal and substantial identity separate, Leibniz maintained that the (personal) identity required for morality could be preserved only by the metaphysical identity of the self as immaterial soul. Through Christian von Wolff (1679–1754), Leibnizian theory dominated philosophy at German universities until about the middle of the eighteenth century.

Eighteenth Century

In eighteenth-century Britain, the most important treatment of the topic is by David Hume (1711–1776) in a famous section of his *Treatise of Human Nature* (1739). Hume rejects the traditional Cartesian view, arguing that through inner experience one can identify only a variety (a "bundle") of distinct perceptions; there is no experiential evidence of a soul that remains the same through time. Hume recognizes, however, that we nevertheless have a "natural propensity" to ascribe unity and identity to the self. He argues that the idea of a unitary and identical mind is to the result of the imagination's connecting successive ideas in such a way as to create the belief that there is an identical self to which all these ideas belong. In the appendix to the *Treatise* Hume reflects critically on his

own discussion of personal identity, relating the problem to his earlier explanation of “the principle of connexion” that “makes us attribute” identity to the mind. But Hume still holds that inner experience and observation reveal only collections or “bundles” of perceptions and that we nevertheless have a “natural propension” to ascribe identity to the self. Hume has mostly been read as reducing the self to its experiences or perceptions and as denying the existence of an essential self beyond the perceptions; but this reading has been criticized in recent commentary. While most eighteenth-century materialist thinkers simply adopted the Lockean view about personal identity, some (Michael Hissmann, Thomas Cooper) started from a Humean position but explicitly argued, unlike Hume, that there is no such a thing as personal identity at all.

Immanuel Kant’s (1724–1804) approach, however, is different in kind from previous theories, as he was not concerned with empirical personal identity. Although Kant commented on empirical questions in some places, he did so in the light of his important distinction between empirical and what he calls “pure” or “transcendental” self-consciousness, or apperception, in the *Critique of Pure Reason* (1781). Unity and identity of self-consciousness are required for any thought to be possible at all. The identity of transcendental self-consciousness is “original” because it “precedes a priori all my determinate thought.” Empirical consciousness, by contrast, “is in itself diverse and without relation to the identity of the subject.” Kant makes use of this distinction in his critique of traditional rationalist metaphysics of the self or soul, known as “rational psychology.” Its aim, according to Kant, is to show by way of a priori reasoning that (among other things) the self is a simple substance or soul and numerically identical at different points of time. But he argues that even the substantiality of the soul could not be inferred from the consciousness that I am the subject of all my thoughts. For knowledge of objects, including knowledge of the self as object, requires experience. In his moral philosophy Kant distinguished moral personality from both the empirical and the transcendental self and attempted to show that the idea of moral-practical freedom of the self has objective reality. In German idealism, too, the issue of empirical personal identity through time was not a major concern. However, both Kantian and empiricist examinations of consciousness and identity continued to appear simultaneously with the speculations of the idealists.

Twentieth and Twenty-First Centuries

In the twentieth and early twenty-first centuries the issue of personal identity has continued to be a major theme especially in Anglo-American analytical philosophy. The debate is mainly between those who favor bodily continuity and those who favor psychological continuity as constituting personal identity. There is, however, considerable variety within the two main positions. Thus, some proponents of the psychological continuity view assign special importance to some rather than other psychological relations (such as memory). Since the 1970s the debate has focused on a revival of reductionist accounts of personal identity according to which selves are nothing over and above people’s bodies and their mental lives. For Derek Parfit the common-sense view that regards personal identity as significant is mistaken. Rather, what matters are psychological

relations that are normally but not necessarily connected with the personal identity relation. By arguing that personal identity is not “what matters” Parfit undermines notions, such as responsibility, that presuppose personal identity. The debate about Parfit’s reductionism has also sparked off a revival of Kantian arguments about identity. It is argued that the subject should be regarded primarily as an agent and not as a mere locus of experience, and that this emphasis on the concept of agency leads to nonreductionist conclusions about personal identity: the identity of the self as agent is a necessity of practical reason. Another important feature of recent debates in the reductionist context is the introduction of a four-dimensional view of persons. On this view, which goes back to Willard van Orman Quine (1953), persons (as well as physical objects) are extended not only in space but also in time and thus can be said to have temporal parts. That is to say, at one point of time only part of me exists, in the same way in which the parts of my body exist only in their respective spatial regions. The four-dimensionalist view has been criticized from within the analytical tradition as conceptually incoherent and as inconsistent with our common-sense way of talking and thinking about things and persons.

Feminist philosophers have argued that analytical philosophers’ reliance on a distinction between psychological and bodily continuity is in effect “marginalizing the body,” and they promote instead a view according to which selves are embodied, discontinuous, malleable, and socially constructed beings (James, pp. 31–32). The most influential account of personal identity in Continental philosophy has been developed by Paul Ricoeur in terms of the notion of narrativity. According to this account, our personal identity is not given to us or constituted metaphysically prior to or independently of our activity of making sense of our own self by telling ourselves a story about our own lives. Only this narrative links actions into one and the same person. The view according to which a person creates his or her identity by forming an autobiographical narrative has recently been taken up in analytical discussions.

See also Identity: Personal and Social Identity; Responsibility; Society.

BIBLIOGRAPHY

- James, Susan. “Feminism in Philosophy of Mind: The Question of Personal Identity.” In *The Cambridge Companion to Feminism in Philosophy*, edited by Miranda Fricker and Jennifer Hornsby. Cambridge, U.K.: Cambridge University Press, 2000.
- Korsgaard, Christine. “Personal Identity and the Unity of Agency: A Kantian Response to Parfit.” *Philosophy and Public Affairs* 18 (1989): 101–132.
- Martin, Raymond, and John Barresi, eds. *Personal Identity*. Oxford: Blackwell, 2002.
- Noonan, Harold. *Personal Identity*. 2nd ed. London: Routledge, 2003.
- Oderberg, David S. *The Metaphysics of Identity over Time*. New York: St. Martin’s Press, 1993.
- Parfit, Derek. *Reasons and Persons*. Oxford: Clarendon, 1984.
- Quine, Willard van Orman. “Identity, Ostension, and Hypostasis.” In his *From a Logical Point of View: Nine Logico-Philosophical Essays*. 2nd ed. rev. New York: Harper and Row, 1963.

- Ricoeur, Paul. *Oneself As Another*. Translated by Kathleen Blamey. Chicago and London: University of Chicago Press, 1992.
- Thiel, Udo. "Individuation." In *The Cambridge History of Seventeenth-Century Philosophy*, edited by Daniel Garber and Michael Ayers. Cambridge, U.K.: Cambridge University Press, 1998.
- . "Personal Identity." In *The Cambridge History of Seventeenth-Century Philosophy*, edited by Daniel Garber and Michael Ayers. Cambridge, U.K.: Cambridge University Press, 1998.
- . "Self-Consciousness and Personal Identity." In *The Cambridge History of Eighteenth-Century Philosophy*, edited by K. Haakonssen. Cambridge, U.K.: Cambridge University Press, 2005.

Udo Thiel

PERSONAL AND SOCIAL IDENTITY

Although identity has deep roots in social psychology, sociology, bridges between them (e.g., symbolic interactionism), and related disciplines, the explicit distinction between personal and social identity, within social psychology at least, can be traced to J. C. Turner's seminal article "Towards a Cognitive Redefinition of the Group" (1982). This formed the basis for self-categorization theory (SCT), in which personal and social identity is most explicitly articulated.

The concept of social identity had been developed earlier in social identity theory (SIT), a theory of intergroup relations that attempted to define a level of self-definition (social identity), that corresponded to the level of analysis of intergroup behavior in intergroup contexts. To this end Henri Tajfel conceived of an interpersonal-intergroup continuum that captured the range of situations relevant to behavior as individuals versus group members. In intergroup contexts the social identity corresponding to membership of the relevant group or social category structured perception, being, and behavior. Tajfel defined social identity as "that part of an individual's self-concept which derives from his membership of a social group (or groups), together with the value and emotional significance attached to this" (p. 63). This was an important step in showing that being and behavior did not always reflect a fixed or individual self, but that self-definition varies with social context, becoming defined at the group level in intergroup contexts. As such, SIT represented an important and welcome shift from the individualistic and essentialist analyses of intergroup relations (discrimination, prejudice, intergroup conflict) that had gone before (for instance, in terms of the authoritarian personality, frustration-aggression, and so forth). The notion that in intergroup contexts individuals see others, and indeed themselves, primarily (and in extreme cases, purely) as representatives of the salient social categories at play—a process later labeled "depersonalization" by self-categorization theory—is an important and lasting contribution of SIT.

Strictly speaking, however, social identity theory continued to conceive of social identity as part of "the" self-concept (as the quote from Tajfel suggests) and this has also tended to be how approaches to the self within social psychology generally viewed social identity or the "collective self." The contribution

of self-categorization theory (SCT) was to address the issue of levels of self more directly and make an explicit distinction between personal and social (read "group level") identity, or levels of self-categorization. Although SIT had talked of interpersonal contexts, it did not refer to personal identity as such, but only to individual level behavior. Many subsequent writers and researchers have however (erroneously) attributed the notion of personal identity to social identity theory. Although it may have been there in spirit, if not in explicit form, Tajfel's interests lay primarily in developing the concept of social identity, so he bracketed this off from more general issues of self and self theory.

The consequence of the personal/social identity distinction of SCT was threefold. First it disputed the notion of a unitary or fixed self-structure ("the" self concept). Second, it explicitly avoided the privileging of either personal or group identity (group identity does not have to be nested within a more general individual self-concept), seeing them as dependent on context (an interactionist position). Third, just as there may be multiple social identities or group self-categorizations corresponding to situated group memberships, in principle there may also be multiple "personal" identities corresponding to the range of situations, roles, and relationships in which individuals find themselves.

This last point has rarely been stated and is perhaps least generally understood. Even among users of SCT, personal identity is still widely seen as a unitary construct, the global sum of the individual's characteristics, at least those residual characteristics not tied to particular group memberships. However, this more unitary conceptualization of personal identity is difficult to distinguish from more essentialist notions of personality, which treat the individual's makeup as relatively fixed, stable, and insensitive to context. From the perspective of self-categorization theory at least, there is no reason why the contextual sensitivity of group identity should not apply equally to personal identity, making personal identities just as multiple in principle (if not more so, given the limited range of social categories) than social qua group identities. From this analysis there is also a strong sense in which both social and personal identities are "social" to the degree that they may be constructed and constituted in situ by the local comparative context.

Contextualism, Interactionism

The idea that personal and group identity can be seen in a radically contextualist and antiessentialist way was presaged by the ideas of the sociologist Georg Simmel. From a traditional self-theory perspective one might conceive of the individual self as being defined by a list of traits, as well as behaviors, roles, group memberships, and so forth. At one level it might be tempting to define "personality traits" as part of personal identity, and group memberships as part of social identity. However, following Simmel (and SCT), this would again depend on the social context. The trait intelligence could be a personal property (especially where it distinguishes the individual from other individuals), however it could also form the basis for a (situated) group identity (for example, in distinguishing intellectuals from "philistines"). Similarly, a group membership

label (such as a chess player or a Scot) may be seen as a feature of personal identity when there is no systematic grouping of people with these features in common in the current social context. In an interpersonal or intragroup context (for instance, a cruise party) these group labels become features that allow individuals to see themselves as individually distinct from others, helping to define personal identity. However, when the characteristics are shared with others, and used to differentiate from an outgroup, they become group defining features of social identity.

This analysis also points to the mechanism by which social identity (but also personal identity) becomes salient. Previously, following social identity theory, social identity was regarded as being salient in intergroup contexts (such as during intergroup conflict) although this rather begs the question of what counts as an intergroup context. SCT offered a cognitive/perceptual analysis of identity salience based on Jerome Bruner's notion "perceptual readiness" (or "accessibility") and "fit" applied to categorization processes generally. Following Penelope Oakes, who further developed Bruner's concept, one source of category salience is, therefore, the degree to which a group is socially differentiated from another in terms of its attributes. For example, a group that is sociable but not intellectual would differ from a group that is intellectual and unsociable. The social comparison would be high in comparative fit (or *meta-contrast*, to use Turner's term) and the social category should become salient. If these group differences are associated with known stereotypes, then the social categorization would also display high "normative" fit, further enhancing the salience of group differences. For example, a group of hairdressers (sociable but not intellectual) differs from a group of chess players (intellectual but not sociable), in an expected way (stereotypically).

Importantly, as Simmel's analysis also suggests, both identities and their contents (self- or ingroup stereotypes) are highly context sensitive. Whether an Asian woman categorizes herself (or is categorized by others as such) as Asian or female may depend on the outgroup present (males or Caucasians, for example). Whether psychology students see themselves as sociable or intellectual may vary depending on whether they compare themselves with physics students or school leavers.

Social stereotypes (as shared constructs about groups) are ostensibly less applicable to the mechanisms in which personal identity (and its relevant content) is made salient, but the comparative principle remains the same. A personal identity and its particular contents will become salient through differentiating comparisons with others in the social frame of reference (individuals may see themselves as powerful and competent in comparison with their younger siblings, but the opposite in comparison with a university professor).

Commitment, Culture, and the Relation between Personal and Social Identity

This analysis also starts to reveal the close relationship between personal and social identities. From the perspective of self-categorization theory, similar processes apply in activating personal and social identities but at a different level of analysis or

abstraction. Self-categorization theory distinguishes subordinate (interpersonal), intermediate (intergroup), and superordinate (supragroup or interspecies) levels of analysis. The principle of "functional antagonism" states that any given level of categorization, to the extent that it becomes salient, will inhibit other competing identities. This is seen as controversial in certain respects, suggesting that people cannot simultaneously countenance more than one identity, seemingly ruling out dual or compound identities. However, this is less problematic when salience is conceived as a relatively automatic and ephemeral process that can shift quickly with comparative context, and be overridden by conscious awareness and strategic processes. Moreover, in principle there is no limit on the complexity or idiosyncrasy of identities, and SCT explicitly eschews the sociological assumption that the imposed social categories (those that the researcher or experimenter prescribes or might assume are operative) are the ones that are genuinely psychologically relevant for the participant in research. This is an empirically contingent question.

This analysis suggests that context largely determines the activation of personal or social identity. It also suggests a somewhat divorced relationship between personal and social identity, enhanced by the functional antagonism metaphor. However, there are likely to be strong individual differences and individual inputs into this process, which is consistent with SCT as an interactionist theory in the sense of person-situation interaction. One important factor that is likely to determine the activation of levels of identity, and specific social identities is the concept of commitment. At the group level, commitment refers to the degree of identification with a particular group, and high identification is likely to enhance the accessibility of that self-categorization, even when the consequences of embracing this identity is negative or threatening. This is important because it is precisely when the group is threatened that it most needs its group members to support it. It is also important, however, to see group identification in a dynamic way, as an outcome of, as well as an input into, group process; otherwise, the metatheory reduces back to the individualism of personality theories.

Just as commitment to group identities can affect the social identities that are activated and used, so commitment to personal identity (or identities) can be argued to do the same. Indeed some have argued that there is a "motivational primacy" that generally favors personal identity over group identity, and, more contingently, others have argued that the personal self or identity is inherent to Western societies. The motivational primacy debate has argued that the individual self is more basic than the collective self because of evidence that people switch to a social identity when the personal identity is threatened, but not vice versa. However, this research can be criticized on a number of levels. First, the research tends to pit a *generalized* individual self against *specific* social identities, confounding comparisons. Second, as the response of high identifiers faced with threat to their group identities has shown, lack of switching when threatened can be read as evidence of commitment, and not that the identity is secondary. Some research that attempts to calibrate the general importance of personal versus social identities, although at odds with the

contextualist spirit of SCT, also provides evidence that the general priority given to personal identity compared to social identity in Western countries, is not true of all categorizations and cultures.

This point serves as a reminder that there is much cross-cultural work that sheds important light on the personal-social identity distinction and the complex and contingent relation between them. Although SCT has the most explicit and perhaps radical analysis of the personal versus social identity distinction it is not the only theoretical framework or research program to address this distinction, although the terminology is not always identical. Many researchers refer to the individual versus collective self or the private versus collective self. In particular, researchers interested in cultural differences in social relations and the self, particularly between individualist and collectivist cultures, have been keen to emphasize forms of selfhood that are less individualistic, less grounded in the Cartesian notions of the preformed individual self, as separate, independent, egoistic, and so forth. However, these approaches do not always distinguish between the personal and social identity, so much as blur the boundary between the two, suggesting that in collectivist cultures the connection of the individual (qua personal identity), is much more chronically bound up with and connected to the group (the family, work relations, and other social networks). It is not clear, therefore, that the personal-social identity distinction of self-categorization theory has quite the same analytic resonance in say, Chinese culture.

In the tradition of social cognition research some of these approaches see personal and social identities as separate cognitive structures (as representing different stores or “baskets” to use the analogy of D. Trafimow et al.). This argument forms a challenge for SCT, which argues that the content of these two levels of identity is difficult to pin down because they are so context-dependent and dynamic.

Caveats, Criticism, and Extensions

One criticism that is sometimes leveled at the self-categorization analysis of group identities in particular (but by implication also personal identity) is its cognitive and perceptual focus, and a consequent neglect of motivational and affective processes. Second, constructionist themes that recognize individual and collective activity around defining identities and bringing them to life are also relatively neglected. It is worth pausing to consider these issues.

The (individual) self-literature identifies a series of self-motives or needs (such as self-evaluation and self-enhancement, but also accuracy motives, such as self-verification) that can be evoked to complement and question a purely perceptualist reading of personal and social identity. Self-motives such as accuracy and self-verification are well captured by the emphasis in SCT on social reality as a basis for social perception and stereotyping. Self-evaluation and self-enhancement motives are less clearly apparent in SCT although enhancement and positive distinctiveness motives at the group level are well addressed in social identity theory. SIT proposes that, at least to the extent that people internalize their social identities and identify with the group to some degree, that they will strive

for a positive group distinctiveness in which their own group is seen as distinct and better than a comparison group.

This idea has been operationalized as the self-esteem hypothesis, which has generated much research but remains somewhat controversial because it is not clear whether the positive group distinctiveness premise can or should be reduced to the more individualistic concept of self-esteem. Social identity theory does predict that groups will tend to differentiate themselves most strongly from similar outgroups in order to gain or maintain group distinctiveness. This raises potentially interesting conflicts with SCT, which seems to imply intergroup differentiation resulting from group difference (i.e., comparative fit, meta-contrast).

Marilynn Brewer’s optimal distinctiveness theory (ODT) is another theoretical approach to personal and group identity that addresses distinctiveness motives. ODT defines distinctiveness here in terms of relative group size rather than in relation to the similarity of out groups as in SIT. It argues that distinctive groups simultaneously address the need to be included and to differentiate oneself from others, with the result that relatively small (distinctive) groups are best placed to address both these needs.

Whereas social identity theory and optimal distinctiveness theories provide a motivational dimension to group being behavior, primarily around distinctiveness processes, intergroup emotion theory (IET) attempts to introduce a more differentiated analysis of the emotional relations between groups that colors the nature of intergroup relations and the specific behaviors (or *action tendencies*, to use the language of emotion theorists) evoked by particular intergroup relationships (i.e., governed by an appraisal or status or power differences). As such, once again there is an attempt to extend the analysis of emotion operating at the interpersonal level (and this relation to personal identity) to the intergroup level as applied to social identity. This analysis suggests that as members of groups, individuals have emotional reactions to other people in terms of their group memberships. This analysis has been helpful in informing the subtly different forms of discrimination and prejudice that can occur, in terms of anger, contempt, envy, schadenfreude, and so forth.

Another criticism that can be leveled at the cognitive-perceptual emphasis of SCT, but also many related approaches to group identity within social psychology, is the danger of reifying social categories (and thus self-categorizations). Even though social categories are seen as radically tied to context and comparison in SCT, there seems little room for the agents (individuals and indeed groups) in determining categorizations that appear to predefine comparisons. The agency of individuals in helping to construct and shape identities, to negotiate these in context, and to change their position and meaning through collective struggle is not always captured through the perceptualist prism of theorizing. Once again, this is more clearly addressed in social identity theory, which was conceived as a theory of social change, and indeed where Tajfel conceived of social identity (in addition to the substantive definition offered earlier) as an intervening variable in the process of social change.

However, it could be argued that the nature of social identity—as being transformed as well as being transformative—is not fully acknowledged or theorized in the social identity approach. This is perhaps not so surprising because self-categorization theorists in particular have tended to define their project in opposition to radical versions of social constructionism, which, in line with postmodernist thinking, seem to question the social reality that is such a strong basis of the social identity approach. However, some theorists in the SIT/SCT tradition have tried to show that social categories and social identities are not givens but are often contested and fought over, especially in contexts of political conflict and struggle. This can then radically transform the meaning of social identities, and indeed can have implications for personal identity (one's sense of oneself abstracted from the group context). In other words, it is possible to think of social and personal identities not just as descriptive statements of comparative content in the status quo ("being"), but prescriptive attempts to change one's context and indeed the meaning of self or identity ("becoming"), that themselves become transformed through social action.

See also **Identity: Identity of Persons; Identity, Multiple; Person, Idea of the.**

BIBLIOGRAPHY

- Brewer, Marilynn B. "The Social Self: On Being the Same and Different at the Same Time." *Personality and Social Psychology Bulletin* 17 (1991): 475–482.
- Bruner, Jerome S. "On Perceptual Readiness." *Psychological Review* 64 (1957): 123–152.
- Oakes, Penelope J. "The Salience of Social Categories." In *Rediscovering the Social Group*, edited by John C. Turner et al. New York: Blackwell, 1987.
- Sedikides, Constantine, and Marilynn B. Brewer, eds. *Individual Self, Relational Self, Collective Self: Partners, Opponents, or Strangers?* Philadelphia: Psychology Press, 2001.
- Simmel, Georg. *The Web of Group Affiliations*. Glencoe, Ill.: Free Press, 1955.
- Simon, B. "Self and Group in Modern Society: Ten Theses on the Individual Self and the Collective Self." In *The Social Psychology of Stereotyping and Group Life*, edited by Russell Spears et al., 318–335. Cambridge, Mass.: Blackwell, 1997.
- Spears, Russell. "The Interaction between the Individual and the Collective Self: Self-Categorization in Context." In *Individual Self, Relational Self, Collective Self: Partners, Opponents, or Strangers?*, edited by Constantine Sedikides and Marilynn B. Brewer, 171–198. Philadelphia: Psychology Press, 2001.
- Tajfel, Henri. "Social Psychology of Intergroup Relations." *Annual Review of Psychology* 33 (1982): 1–39.
- Tajfel, Henri, ed. *Differentiation between Social Groups: Studies in the Social Psychology of Intergroup Relations*. London: Academic Press, 1978.
- Tajfel, Henri, and Turner, J. C. "The Social Identity Theory of Intergroup Behavior." In *Psychology of Intergroup Relations*, edited by Stephen Worchel and William G. Austin, 7–24. Chicago: Nelson Hall, 1986.
- Trafimow, D., H. C. Triandis, and Sharon G. Goto. "Some Tests of the Distinction Between the Private Self and the Collective Self." *Journal of Personality and Social Psychology* 60 (1991): 649–655.

Turner, J. C. "Towards a Cognitive Redefinition of the Group." In *Social Identity and Intergroup Relations*, edited by Henri Tajfel, 15–40. New York: Cambridge University Press, 1982.

Russell Spears

IDENTITY, MULTIPLE.

This entry includes three subentries:

Overview

Asian-Americans

Jewish Multiple Identity

OVERVIEW

Within Western thought the subject—that is, the self as a thinking, feeling, psycho-physiological entity—has been traditionally defined as a centered consciousness, characterized and unified by one self-defining identity. Within this tradition, a centered subjectivity was long thought to exist and function independently of the social contexts surrounding it, without significant influence from those contexts. Later, the centered subject came to be regarded as socially constructed in and through social contexts, yet still rendered whole by a single self-defining identity or identity-grounding element that would center the subject in any and all circumstances.

Multiple identity, on the other hand, is one specific conceptualization of the more general idea that the subject is not centered, but instead decentered and multiple. Such a decentered subjectivity can encompass many different, perhaps even contradictory, identities, and is not necessarily centered by one self-defining or "true" identity. Rather, since identities are socially constructed and constructing, their specific number and character are a function of the various forms of socialization that forge the subject over time, as well as of the lifeworlds in which he or she participates. Consequently, the multiple identities of a subject (both social and personal) are relevant to and engaged in specific social milieus and are manifest in a context-dependent manner. Since subjects engage different and multiple identities in response to the social contexts in which they find themselves at a given moment, no one identity is a priori or necessarily more central, self-defining, or true than any other.

The Critique of the Subject

The idea of a decentered subjectivity composed of multiple, socially constructed and context-dependent identities began to emerge during the late nineteenth and early twentieth centuries in the writings of a variety of thinkers including William James (1842–1910), Sigmund Freud (1856–1939), and the critical theorists Max Horkheimer (1895–1973) and Theodor Adorno (1903–1969). These and other thinkers initiated a widespread reevaluation of the philosophy of the subject in the West, and during the twentieth century the "critique of the subject" was debated across a wide array of academic disciplines. Over time the general idea of a decentered multiple subject gained increasingly wide acceptance. With this shift, more specific conceptualizations of it, such as *mestiza* consciousness and

multiple identity, emerged to attempt to integrate the multiplicity, diversity, and contradiction into the philosophical understandings of the subject and identity. Such theoretical formulations have generated new philosophical questions, questions that still remain matters of inquiry and debate.

Early modern conceptions of the subject. Early modern conceptions of a centered subjectivity can be traced in part to Cartesian dualism in which the mind and its thinking essence were seen as functioning independently of the body and the

material world (René Descartes; *Discourse on Method*, 1637; and *Meditations*, 1641). The writings of Immanuel Kant (1724–1804) also oriented modern thought on the subject. On traditional readings of his philosophy, Kant defined the self as a fully self-transparent, self-conscious, self-consistent, and transcendent free will—what is commonly understood as an autonomous ego. For Kant, the autonomy of the subject depended on the self-legislation of the will (i.e., on living by rules that one gives to oneself). Thus the Kantian subject possessed free will only to the extent that the social dynamics

surrounding the self did not dictate its thoughts and actions. Ideally, therefore, this Kantian noumenal or transcendental self was guided or centered by a consistent, rational set of universal principles that the subject held independent of, perhaps even despite, its surroundings. In this sense, the Kantian subject could be described as unencumbered (not socially constructed or embedded), centered (as a single psychic entity made whole by its orientation to the universal principles of right), and unitary (internally consistent, with uniformity and conformity toward its centering elements).

Modernist critiques of the centered subject. Critiques of the Kantian account of the subject emerged from a variety of quarters, on a range of grounds. Often referred to collectively as the “critique of the subject,” these criticisms are not, as is sometimes thought, limited to postmodernist critiques of the Enlightenment project. On the contrary, modernist thinkers who endorsed many Enlightenment principles were among the earliest to reject the Kantian account of the subject. The writings of Max Horkheimer and Theodor Adorno, for example, fall into this category. Like others in the Frankfurt School and Critical Theory tradition, Horkheimer and Adorno retained the Enlightenment’s commitment to rational reflection as a critical means to social justice and social transformation. Yet, they also rejected the exclusionary logic of Enlightenment reason.

In their critique of Enlightenment reason and the conception of the unencumbered, centered, and unitary subject, Horkheimer and Adorno contend in the *Dialectic of Enlightenment* (1947) that the “Enlightenment behaves toward things as a dictator toward men. He knows them in so far as he can manipulate them [and] . . . [i]n the metamorphosis the nature of things, as a substratum of domination, is revealed as always the same” (p. 9). For Horkheimer and Adorno, this logic of identity—this logic of “same” within the Enlightenment tradition and its conceptions of the “unity of the subject” and “its correlate, the unity of nature” (p. 10) homogenized and manipulated the self and nature through a denial of the multiplicity and chaos inherent in both. They argued that by using a logic of identity to mask the unruly multiplicity of the self and nature and by vilifying that multiplicity as unreason, Enlightenment thought ultimately distorted and concealed the very human subjectivity that it sought to advance and protect. Extending this argument to his critique of the Kantian subject, Adorno stressed in *Negative Dialectics* that a viable account of the self must attend to the connections between ethical action and the “nonidentity” of the self. For Adorno, the diversity, multiplicity, and nonidentity of the self distinguishes it from the social forces that form it, for “[w]hatever stirs in a man contradicts his unity” (p. 277).

Freudian and psychoanalytic critiques of the subject. Horkheimer and Adorno’s critiques of the centered subject were not unrelated to those of Sigmund Freud who, like Horkheimer and Adorno, remained committed to various aspects of the Enlightenment project while nonetheless rejecting the Enlightenment conception of the centered, unified subject. Freud’s theory of the unconscious differentiated the self into the ego, id, and superego, and divided it also into the conscious and unconscious. This differentiation rejects the idea

that the subject is centered by a single, fully self-conscious, self-transparent, or self-defining identity and ego. Freud, in short, “decentered” the self by theorizing its fundamentally divided character. Later, Jacques Lacan (1901–1981) influentially echoed and extended Freud’s critique of the centered, unitary, and unencumbered autonomous ego. Lacan stressed that by asserting the ego’s mastery of the world through its separation from the world, the idea of a unified ego served as a shield from reality. This comforting shield—the fantasy of ego—imposed a false unity and rigidity onto the self that hid the more multiple and fragmented character of subjectivity.

Postmodernist and poststructuralist influences. Freudian and Critical Theory critiques of the subject represent attempts to usefully amend, rather than abandon all aspects of the Enlightenment project. Such critiques decentered the subject by regarding it as divided in character. They also insisted on its multiplicity and its chaos, thus rejecting the idea of the subject as a uniform or self-consistent whole. In addition, postmodernist and poststructuralist critiques of centered subjectivity have been advanced within a wide variety of scholarly fields. These critiques of the subject have often been combined with more general rejection of the Enlightenment project with its insistence on universal truth, reason, necessary human progress, and in particular the tendency of Enlightenment thought to privilege a white male European worldview as the universal standard of truth and rationality.

Among the earliest and most influential of these critiques of the centered subject were those of Friedrich Nietzsche (1844–1900), who related the “chaos in oneself” to the process of self-remaking, a self-overcoming that he took to be the key to escaping the homogenizing morality of the West’s religious and Enlightenment traditions (1966). For Nietzsche, subjectivity is characterized by diversity—and it is the subject that can secure human freedom and excellence over time.

The Linguistic Turn and the Social Construction of the Subject

Deep shifts in language philosophy are also among the converging intellectual currents that have fostered a rethinking of the subject as decentered and multiple. Wittgensteinian language philosophy, as well as the works of postmodernist and poststructuralist thinkers such as Jacques Derrida (b. 1930) and Michel Foucault (1926–1984), insist on the centrality of language as the necessary and primary medium of thought and action. With this in view, the formation of social relations and groups, cultural norms and practices, and ultimately the formation of subjectivity itself, is seen as a function of language-mediated processes. This linguistic turn has challenged past philosophical dependence on “universal truths” and “essential” or “natural” characteristics in favor of the ongoing social construction of the self and society as specificities in time and place.

In this way, the linguistic turn contributed significantly to the reconfiguration of the subject by casting it as something formed by, embedded in, and cogenerating of complex sets of language-mediated social dynamics. In turn, this view of subjectivity suggests, by extension, that where the subject and its identities are formed in and through multiple and diverse social

dynamics, and that the subject will, likewise, become multiple and diverse in character. Still further, to argue that the subject is entirely and *only* a product of language-mediated social construction suggests that there is nothing else constitutive of subjectivity beyond what is socially given to it in and through the linguistic, and partially material, processes of social construction. So divergent from Western tradition is this last point that it has been, and at times remains, a matter of particular controversy.

Feminist, ethnic, and postcolonial formulations of multiple identity. In addition to the philosophical traditions discussed above, the idea of a decentered and multiple subject enjoys wide currency in Ethnic Studies, as well as feminist and postcolonial thought. Collated here under the term “multiple identity,” specific conceptualizations of a decentered and multiple subjectivity in these scholarly domains utilize a wide diversity of terminology and varying theoretical formulations, yet often display broad similarities. The tradition is long. W. E. B. Du Bois (1868–1963) first linked the experience of multiple identity to the history of interracial conflict in *The Souls of Black Folk*, published in 1903. Calling it a state of “double consciousness” Du Bois described black subjectivity as something in which “[o]ne ever feels his twoness—an American, a Negro; two souls, two thoughts, two unreconciled strivings; two warring ideals in one dark body, whose dogged strength alone keeps it from being torn asunder” (p. 17).

For Du Bois, this grappling with the identity contradictions of double consciousness replicate, within the microcosm of the subject, the large-scale societal and political struggles of blacks against their subordination by whites. Du Bois highlighted how these struggles profoundly shaped the formation of the black subject—the very souls of blacks—because in the social context of America, racial subordination barred black men and women from understanding themselves through the lens of their own ethnic group alone. Rather the subordination of blacks “only lets him [the black man or woman] see himself through the revelation of the other world” (p. 16); the “white world” with its norms of racial privilege and exclusion against which the “black world” is constructed. Du Bois wrote, “it is a peculiar sensation, this double-consciousness, this sense of always looking at one’s self through the eyes of others, of measuring one’s soul by the tape of a world that looks on in amused contempt and pity” (pp. 16–17).

Du Bois’s idea of double consciousness still resonates at times in the works of contemporary black thinkers and in writings on racism in America. In addition, postcolonial thinkers have extended similar logic to the formation of subjectivity in the context of colonial oppression. Developing conceptions of “hybridity,” for example, postcolonial theorists such as Homi Bhabha have focused on the way that colonial and postcolonial dynamics have contributed to the politicized and diverse social construction of specific subjectivities resulting in multiple and often contradictory forms of identification.

The idea of a decentered and multiple subject also finds favorable expression in a wide array of works by feminist thinkers. Over the past twenty years many feminist theorists working from various perspectives have stressed the “fragmentation” of

the subject and the ability of subjects to live in “multiple subject positions.” Among them, Latina feminist thinkers Gloria Anzaldúa (1924–2004) and María Lugones have developed the concept of “mestiza consciousness,” which describes the conditions that forge multiple identities and the experiences of living them in everyday life. Their particular formulation has been taken up by other philosophers to help address the philosophical questions that yet remain with respect to decentered subjectivity.

New Philosophical Challenges

The breadth of scholarship utilizing some formulation of multiple identity has firmly established its place in contemporary Western thought. However, many philosophical and practical questions regarding decentered multiple subjectivity remain to be fully theorized, and the general rethinking of the subject, which began more than a century ago, is still perhaps best thought of as an ongoing project. For example, some commentators continue to conflate the idea of a decentered and multiple subject with the clinical manifestations of a rare and controversial psychological disorder called Dissociative Identity Disorder. Close scrutiny of the clinical evidence indicates that there is little overlap between philosophical theories of a decentered subjectivity and such disorders. Yet, the use of imprecise terms such as “fragmented” and “multiple” continues to invite such comparisons, and to muddy the waters.

Such issues have justified calls for more detailed theories of decentered subjectivity. Feminist theorists Jessica Benjamin and Jane Flax (both with a background in clinical psychology) some time ago stressed that existence of disorders involving extremely severe fragmentation (i.e., a nearly total lack of interconnection) among identities, although very rare, makes it essential to distinguish such ailments from new theoretical frameworks through more precise theorizing of the decentered multiple subject. They have thus challenged theorists to identify exactly what elements make a decentered and multiple subjectivity hang together as a functional psycho-physiological unit. If the decentered subject is not centered by a single identity, what specifically is the relationship among the subject’s different identities? Is there something that makes multiple identities cohere as a subjectivity, and if so, what does that coherence, if any, hinge on?

Similar questions are also posed by the work of those philosophers who accept the idea of a socially embedded or “situated” and constructed subject, but who continue to reject the idea of a fully decentered and multiple subjectivity. From such a perspective, the socially constructed subject remains centered by some dimension that, once it is produced through linguistically mediated processes, stands as a self-defining and self-centering element that is not context dependent, but instead consistently centers the subject within all of the various social contexts that it enters. Among those who take this general approach, the precise element that is thought to center the subject differs widely. Some regard the situated self as centered by a self-defining self-narrative. Others center and unify the constructed subject with a single identity or a single moral orientation that guides the self. Still others see the subject as centered through a procedure of “choosing” the subject, which renders some element as a central or true identity. A very few

others continue to hold the view that there is some centering element of subjectivity that is prelinguistic.

Recognizing the need for further clarity, a number of feminist philosophers have persisted in highlighting the subject's multiplicity and complexity by working to further refine our understanding of the relationship among the multiple identities within a decentered subjectivity. One promising approach to this can be found in Latina feminist philosophy, and particularly in the work of María Lugones. Lugones has drawn upon and extends the work of Gloria Anzaldúa, whose conception of "mestiza consciousness" has been one of the most widely influential accounts of a decentered and multiple subjectivity to date. In brief, in *Borderlands/La Frontera: The New Mestiza*, Gloria Anzaldúa theorizes "mestiza consciousness" as arising from the social construction of subjectivity in and through different sets of social relations including, but not limited to, relations of class, ethnicity, race, gender, sexuality, nationality, religion, region, language community, and subculture. Living thus embedded in a multitude of conflicting social relations of culture, class, and sexuality, Anzaldúa's *mestiza* gains a multiple or "dual identity" with which the subject lives in multiple lifeworlds. Similar to Du Bois's double consciousness, Anzaldúa describes, as an example, how Mexican Americans are often constructed by and identify (at least partly) with both Mexican and Anglo American cultures—often struggling with the prevailing hierarchies between those two cultural systems. The result is a Chicano/a subjectivity with multiple identities produced within the interplay two interrelated cultures.

Such multiple identities are different, distinct, and sometimes even contradictory. Yet, they can also intersect in ways associated with the societal level dynamics that constructed those identities, including perhaps relations of subordination and privilege, conflict, contradiction, and differentials of power, access, and voice. The multiple identities constructed in and through these elements are often related in ways that mirror those constructing elements. The *mestiza* is forced by these dynamics (as components of identity formation and identity performance) to engage with the conflicting worldviews and complexities that comprise her multiple identities. Anzaldúa's *mestiza* thus moves among and negotiates her multiple identities at times by shifting among them, at other times by syncretizing competing perspectives into positions greater than the "severed parts" from which they were forged. The ability to negotiate, to move between, or to syncretize the different value systems of her multiple identities is what Anzaldúa calls *la Facultad*.

Working with Anzaldúa's conception of *mestiza* consciousness, María Lugones emphasizes in "Purity, Impurity, and Separation" (1994) that the multiple identities that make up *mestiza* consciousness are not entirely fragmented but rather are interconnected and mutually conditioning even as they remain distinct (a point consistent with the common feminist emphasis on the intersection of race, class, and gender). Like Anzaldúa, Lugones stresses the complexity of the social relations in which the subject is embedded and constructed. She underscores in still stronger terms than Anzaldúa however, how these social relations of subordination and privilege intersect.

Philosopher Cheshire Calhoun has applied Lugones's work on *mestiza* consciousness to theorize exactly how a decentered subjectivity that engages multiple identities in a context dependent manner can possess agency and act with integrity toward the sometimes competing moral and political value systems that inhere in those multiple identities. Diana Meyers has also employed Lugones's approach to the intersection of multiple identities. Calling it "intersectional identity," Meyers has argued that Lugones's model of subjectivity offers an important basis from which to generate a new conception of autonomy that departs from the Enlightenment tradition and integrates key feminist tenets.

Implications of Multiple Identity

If full conceptualization of multiple identity is still a philosophical work in progress, then even more wide open are conclusions as to its practical implications. For many, the consequences are not yet fully apparent. Others suggest that the implications of concepts such as multiple identity are generally negative, particularly with respect to how the subject can function in contexts calling for moral and political judgment. Critical of the idea of decentered subjectivity, Alasdair MacIntyre has claimed, "[t]his divided self has to be characterized negatively, by what it lacks. It is not only without any standpoint from which it can pass critical judgments on the standards governing its various roles, but it must also lack those virtues of integrity and constancy that are prerequisites for exercising the powers of moral agency" (pp. 324–325). Others find the idea of multiple identity useful for the purposes of critique, but useless for producing or theorizing political or social transformation.

In contrast, advocates of various models of multiple identity often have high hopes for its social and political relevance. Scholars across disciplines have long contended that decentered multiple subjectivity is not only a practical reality, but potentially an enormously positive factor in broad-scale political interactions, particularly in the midst of deepening social diversity. Some political theorists have suggested that a decentered, multiply constituted, contradictory self is highly conducive to democratic politics. Bonnie Honig, for example, suggests that the internal conflict and struggle within a decentered self harbors important potential for democratic practices. For Honig,

decentered subjects . . . have the power to energize their social democracies, while pressing upon them claims to justice, fairness, fidelity and ethicality on behalf of those differences to which social democratic regimes tend to become deaf in their eagerness to administer to represented identities that are established, stable, and familiar. (p. 273)

The range of issues for which multiple identity is of possible significance is wide. Iris Marion Young, Yen Le Espiritu and others have connected multiple identity with social group diversity, the dynamics of political coalition building, political participation, and group politics. Others have underscored the role of multiple identity in political identification and in

transnational politics, and Paul Barry Clarke has argued that the multiplicity of the subject is a necessary characteristic of the ideal citizen within deeply diverse democratic regimes. Sociologist Mary Romero has argued that paying attention to the lived experience of multiple identity can better illuminate the power relations affecting Latinos within American society. Other scholars addressing the dynamics of mixed race/ethnic heritage, diverse ethnic identification, and the American mixed-race movement contend that multiple identity may play a role in breaking down the politicized dichotomies of race in America. The complexities of multiple identity are also relevant to new legal approaches to social conflict such as Critical Race Theory.

Articulating her own hopes for its broad implications, Gloria Anzaldúa has argued that in practice the multiple identities of mestiza consciousness can better position the subject for social and political critique and for bridging social cleavages of race, sex, and gender in a manner that could “bring us to the end of rape, of violence, of war” (p. 80). While such expectations may prove overly optimistic, the ultimate validity of these and other assessments of multiple identity need to be explored through additional research and theorizing. The intriguing possibility that important social and political implications could be derived from thinking of the subject as de-centered and multiple will no doubt foster further development of the ideas surrounding multiple identity.

See also *Critical Race Theory; Democracy; Identity: Personal and Social Identity; Mestizaje; Universalism.*

BIBLIOGRAPHY

- Adorno, Theodor. *Negative Dialectics*. Translated by E. B. Ashton. New York: Continuum, 1990. Reprint of 1973 translation.
- Anzaldúa, Gloria. *Borderlands—La Frontera: The New Mestiza*. San Francisco: Spinster/Aunt Lute Books, 1987.
- Benhabib, Seyla. *Situating the Self: Gender, Community, and Postmodernism in Contemporary Ethics*. New York: Routledge, 1992.
- Benjamin, Jessica. “The Shadow of the Other (Subject): Inter-subjectivity and Feminist Theory.” *Constellations* 1, no. 2 (1994): 231–254.
- Butler, Judith. *Gender Trouble: Feminism and the Subversion of Identity*. New York: Routledge, 1990.
- Du Bois, W. E. B. *The Souls of Black Folks*. Greenwich, Conn.: Fawcett, 1961.
- Espiritu, Yen Le. “The Intersection of Race, Ethnicity, and Class: The Multiple Identities of Second-Generation Filipinos.” *Identities* 1, no. 2–3 (1994): 249–273.
- Honig, Bonnie. “Difference, Dilemmas, and the Politics of Home.” In *Democracy and Difference: Contesting the Boundaries of the Political*, edited by Seyla Benhabib, 237–277. Princeton, N.J.: Princeton University Press, 1996.
- Horkheimer, Max, and Theodor W. Adorno. *Dialectic of Enlightenment*. New York: Continuum, 1991.
- Lugones, María. “Purity, Impurity, and Separation.” *Signs* 19 (1994): 458–479.
- MacIntyre, Alasdair. “Social Structures and their Threats to Moral Agency.” *Philosophy* 74 (1999): 311–329.
- Meyers, Diana. T. “Intersectional Identity and the Authentic Self? Opposites Attract.” In *Relational Autonomy*, edited by

- Catriona Mackenzie and Natalie Stoljar, 151–180. New York: Oxford University Press, 2000.
- Ricoeur, Paul. *Oneself As Another*. Chicago: Chicago University Press, 1992.
- Romero, Mary. “Life as the Maid’s Daughter: An Exploration of the Everyday Boundaries of Race, Class, and Gender.” In *Challenging Fronteras: Structuring Latina and Latino Lives in the U.S.*, edited by Mary Romero, Pierrette Hondagneu-Sotelo, and Vilma Ortiz, 195–209. New York: Routledge, 1997.
- Taylor, Charles. *Sources of the Self: The Making of the Modern Identity*. Cambridge, Mass.: Harvard University Press, 1989.
- Zack, Naomi. *American Mixed Race: The Culture of Microdiversity*. Lanham, Md.: Rowman and Littlefield, 1995.

Edwina Barvosa-Carter

ASIAN-AMERICANS

Although Filipinos lived in the United States in the sixteenth century, the first large Asian group in the modern era arrived in the United States in the nineteenth century. Since then two inclinations have simultaneously characterized how Asian-Americans’ ethnic identity has been viewed. One tendency has been to look at their identity either in terms of a collective panethnic identity as “Asian-Americans” or an ethnic-specific identity, such as “Filipino-American.”

The second tendency is rooted in the fact that ethnic identity is both a concept applied to a cultural group (a group that shares assumptions about the world and ways of interpreting and interacting) and a sense of connection created by that group. That tendency has been for exogenous views (that is, perspectives of those outside Asian-American communities) to differ from endogenous views (that is, perspectives within Asian-American communities) about the meaning and significance of ethnicity. Both tendencies have arisen because, like race, a concept rooted in ideology more than morphology, ethnicity is not simply a direct reflection of what exists; it is a concept created for various uses.

Endogenous and Exogenous Perspectives

The designation of nineteenth- and twentieth-century Asian immigrants as “Asians” was not a label Asians brought to the United States. By the beginning of the twentieth century, most Asian immigrants were either Chinese, Japanese, Korean, or Filipino, and they self-identified either in ethnic-specific terms or even more precisely (for example, in terms of a Chinese province). By helping immigrants find work and deal with racism, ethnic-specific loan associations, churches, and other formal and informal organizations reinforced an endogenous ethnic-specific identity.

Nevertheless, collective identities were quickly imposed exogenously (by white Americans). Occasionally panethnic identities were actively protested, as in the case of Japan’s opposition to segregated, so-called Oriental schools, where all California Asians were to be educated. Usually, however, Asian-Americans had no say, and exogenous panethnic identities dominated.

The impulse for this exogenous emphasis on a collective identity sprang from the categorization of various Asian groups

as from one, nonwhite race. For centuries the West viewed nonwhite races generally as “Others”—“not us” and more specifically “nonwhite.” It viewed Asians, in particular, as alike in their fundamental and extreme contrast to Westerners. Once Asian-Americans were classified as a racial Other, additional distinctions between them were usually dismissed as irrelevant. Prohibitions against naturalized citizenship and entry into unions as well as other actions designed to restrict Asian-Americans’ socioeconomic mobility and political power put Asians into similar socioeconomic circumstances, which further reinforced beliefs about their similarity.

Gradually, though, suspicion and fear of the racial “Other” and differences in the power and foreign policy of Asian countries spurred exogenous efforts to make ethnic-specific distinctions, often mirroring differences in the immigrants’ nationality. These changing perceptions produced an array of classifications by the Census Bureau which, at various times, categorized Asian-Americans as nonwhite, Other, Oriental, or in ethnic-specific terms.

Reflecting public concerns, the Census Bureau has long focused more attention on distinguishing between nonwhite than between white Americans. Accordingly, at a time when U.S. relations with Asian countries varied widely, the 1930 census distinguished between white, “Negro,” Hindu, Indian, Chinese, Filipino, Korean, Japanese, and all others—which was, Sharon Lee points out in “Racial Classification in the U.S. Census: 1890–1990” (1993), a striking number of distinctions between Asians then constituting less than 0.25 percent of the U.S. population and at a time when the United States had basically stopped further immigration of Asians.

Fear of the racial Other, coupled with a belief in white racial supremacy, led to preemptive efforts to undermine a coalescing of Asian workers under a panethnic identity. Asian workers on white-owned Hawaiian plantations, for instance, were residentially segregated and paid on ethnic-specific pay scales. Similarly Asian-Americans were pitted against other minorities, as in the case of Filipinos replacing striking African-American railroad workers; doing so promoted and sustained the economic superiority of white Americans while undermining the development of a collective identity and political mobilization with other minorities.

Throughout the nineteenth century and much of the twentieth century, the white American public viewed Asian-Americans as inferior, all-alike Others. This view was created from portrayals established for self-serving purposes. Much as portrayals of enslaved African-Americans were self-serving reflections of the slaveholders’ desire to minimize contradictions between their self-concept as good Christians and their treatment of the enslaved, self-serving characterizations of Asian-Americans were created by plantation owners paying Asians less per hour than white workers, by missionaries reporting the reasons they failed to convert Asians, and by competing workers. Because of the belief that Asians were homogeneous Others, portrayals of the first Chinese immigrants (as sneaky, for example) were extended to subsequently immigrating Asian groups, such as the Japanese and Koreans. Much like musical, television, and movie depictions do now, popular magazine serial and minstrel

show depictions of almost interchangeable Chinese, Japanese, or Filipinos propagated an identity as homogenous Others.

In the early 2000s dominant exogenous views of Asian-Americans still emphasized Otherness. In a world divided into mutually exclusive and oppositional East versus West and in a country typically imagined as either white or black, Asian-Americans are usually classified as essentially Asian and foreign (which is the reason Asian-Americans are never said to have “all-American good looks”).

The culture forming the supposed basis of their ethnic identity has been exogenously depicted as Oriental—a mystic, unchanging, centuries-old, anachronistic if not mythical culture supposedly deeply ingrained in the twenty-first century’s Asian-Americans, who have been only superficially influenced by experiences in the United States. Explanations of European-Americans’ behaviors in the early twenty-first century typically bypass reference to three-hundred-year-old influences on Western culture as too far removed from current motives to be pertinent; but caricatures of Asian-Americans in terms of 2,500-year-old Confucian thought—gross equation of Asian-American cultures to a vague Orientalized past—are commonplace. Yet for many U.S.-born Asian-Americans, a sense of connection to ethnic ancestors in Asian countries is a stretch of the imagination; Orientalization is a fiction akin to feeling connected to Adam and Eve and eclipses the ethnic identities Asian-Americans actually create.

Orientalizing portrayals also oversimplify. The varied cultural backgrounds of Chinese-Americans—with ancestors from Cambodia, Hong Kong, Laos, the People’s Republic of China, Taiwan, Thailand, and Vietnam as well as differences in socioeconomic status and acculturation—expose the faulty assumption that an Asian-American group, much less Asian-Americans generally, can be defined in terms of a single (much less Orientalized) culture. Because their ancestors came at different times in history, various Asian-American groups are not creating and redefining an ethnic identity from the same experiences in America.

Nevertheless, inaccurate exogenous portrayals still dominate because Asian-Americans’ perspectives are usually unsought. Representations of Asian-Americans’ lives are either absent (for example, in the curriculum) or distorted (for example, by mass media), resulting in caricatures that racially marginalize Asian-Americans as foreign, out-of-step, ancillary, and irrelevant.

Panethnic Identity

Although Asian-Americans initially saw themselves in ethnic-specific terms, they gradually developed a panethnic identity. Endogenous panethnic Asian-American identities first developed in Hawaii before World War II. Ethnic-specific strikes by Asian farm laborers were only partially effective. Seeing that exploitative plantation owners were pitting them against each other and that their unfair wages and poor living conditions were linked, the workers organized powerful panethnic, islandwide strikes whose success reinforced a panethnic identity. Panethnic identities developed further as the second Asian generation in Hawaii reached voting age: Asians and native Hawaiians formed voting blocs to unseat racist politicians.

After World War II, foreign relations among Asian countries were no longer undercutting pan-Asian-American relations as they had earlier. Spurred by the civil rights movement, a panethnic identity, with its potential for increased political voice about community concerns, began to develop in the 1960s on the U.S. mainland.

A collective identity as “Asian-Americans” was not difficult to form then. Groups were never asked to abandon an ethnic-specific identity. Due to restrictions on the immigration of Asians, 79 percent of Asian-Americans just before the 1965 Hart-Celler Immigration Act were either Chinese- or Japanese-Americans who shared many similarities as U.S.-born descendants of immigrants who came before a series of racist immigration laws essentially stopped Asian immigration and experienced similar race-based discrimination. Their political affiliations were not as varied as now among Asian/Pacific Islanders. In addition they were frequently seen as almost interchangeable by non-Asian-Americans in terms of racial and cultural Otherness, education and crime levels, and the tendency to avoid bumptiousness.

“Asian/Pacific Islander,” a modern panethnic label, encompasses roughly thirty groups, including many, such as Thai, Burmese, and Samoans, who were not in the United States in the nineteenth century. The 1965 Immigration Act, the first to drop racial criteria, resulted in an increase in Asian immigration and a panethnic population that includes more cultures and more varied cultures than ever. In this sense, Asian-Americans’ panethnicity has expanded.

Nevertheless, ethnic-specific identities still predominate. A panethnic identity that subsumes varied cultures and ancestral nationalities can be difficult to sustain, partly because it downplays endogenously apparent cultural and social differences. The varied groups now do not share many of the historically similar experiences of the pre-1965 Asian-American population. Even though asserting a panethnic identity might enable Asian-Americans to expand and mobilize resources, strengthen their political voice, and elicit more responsiveness from society, it can also exaggerate tendencies to direct hostile feelings about one Asian-American group to Asian-Americans generally.

Much like their counterparts centuries ago, immigrants arrive now with an ethnic-specific identity, reinvigorating the tendency to sustain such identities. However, the immigrants find that in addition to being considered, for example, Koreans, they are viewed as Korean-Americans, Asians, Asian-Americans, and Asian/Pacific Islanders.

After being longtime U.S. residents, they may add a panethnic identity, as do some U.S.-born Asian-Americans. However, those who do not usually do not oppose a panethnic identity; they do not see its usefulness.

The term *Asian-American* is both older and more widely used than *Asian/Pacific Islander*, but both are part of a never-ending process of creating and challenging identities. Even the issue of who should be included in the panethnic identity is questioned. For example, the Census Bureau, reflecting input from scholars, classifies East Indians as Asian, but the public

often rejects their inclusion as Asian-Americans on the grounds that they do not seem to be the same race, much less the same ethnicity, as other Asian-Americans.

Grouping Asian-Americans and Pacific Islanders is also contested. On the one hand, inclusion of Pacific Islanders may make their political voice louder to the larger society than it would have been otherwise; on the other hand, distinguishing the groups would more accurately reflect differences in cultural background, identity, and social needs and might produce more focus on their concerns. For Pacific Islanders, as for many Southeast Asians, panethnic stereotypes (such as the inaccurate model minority stereotype) have sometimes caused society to overlook their needs and exclude them from equal-opportunity programs.

The Ongoing Creation of Identities

Whether a panethnic identity is invoked sometimes depends on the context. Accordingly a young Korean-American man might think of himself as Korean when with his grandparents, Korean-American while at a Korean-American church, and Asian-American when thinking about whom to casually date. Selectively porous and elastic ethnic boundaries create multiple, simultaneous identities.

Those multiple forms of ethnic identity are created in the context of other identities, such as socioeconomic status, residential region, gender, and degree of acculturation or multinational identity, which add to the complexity and change the meaning, relevance, and significance of ethnic identity. Ethnicity for Korean-Americans in Los Angeles’s Koreatown has a different meaning than it does for Korean-Americans in Bismarck, North Dakota; a wealthy Chinese-American man and a poor Filipina-American picture bride experience their ethnicity differently.

The consequences of ethnicity create meanings. For example, when the mid-nineteenth-century Foreign Miner’s tax (as high as 98 percent of income) was applied only to Chinese miners, the meaning of being (a miner who was) Chinese was that one would be subjected to unfair taxes. In the early twenty-first century some young Asian-Americans see their ethnicity as a way of consciously connecting with their parents; a few see it as a passport to gang membership; still others see it as a source of self-esteem.

Adding to the complexity, *ethnicity*, like *culture*, is often used as a sugarcoated code word for *race*. Using *ethnicity* in this way makes events seem to be innocent reflections of ethnic differences rather than racial bias or socioeconomic opportunities, promotes the impression that racism is irrelevant to the lives of Asian-Americans, and deflates attempts to change racial inequities.

Compounding the complexity and changing meaning of ethnic identity is the difference between the ethnic identity of Asian-Americans and European-Americans, both as an attributed concept and as a choice individuals make when identifying themselves. European-Americans’ ethnic identity is regarded as largely irrelevant—to the point that many do not even know their full ethnic background.

Ethnic identifications of Asian-Americans occur more often than for European-Americans because they are perceived as more relevant to the former. Indeed experience has shown that when Asian-Americans identify themselves simply as “Americans,” that identification is commonly rejected as inadequate. Despite America’s purported embrace of ethnic diversity, so-called hyphenated Americans (such as Chinese-Americans or Asian-Americans) frequently find that a hyphenated identity is sometimes objectionable as well. As the historian James Loewen pointed out in his book *Lies My Teacher Told Me* (1995), racists like Woodrow Wilson interpreted the hyphenation as a sign of treachery. Others claim the hyphenated term, which places ethnicity first, makes ethnicity more important than nationality. (Actually in the term *Asian-American*, *Asian* is just an adjective modifying the more important noun, *American*.) In the face of such criticism and misunderstanding, people struggle to create an ethnic identity.

Contrary to most assumptions, ethnicity is “not a way of looking back at the [country from which ancestors came; rather it is] a way of being American” (Greeley, p. 32). In that spirit, Japanese-Americans rarely learn the intricacies of a Japanese tea ceremony; instead, they have created ways of being American with a nod toward their background. As Fukiko Uba Odanaka recounted (in a personal communication), in the 1930s, when Japanese-Americans were not allowed on school teams, she and some friends created female basketball teams paralleling teams created for young Japanese-American males in the early twenty-first century. Since then organizational sponsors have seen thousands of Japanese-American boys and girls play in basketball leagues, which have become a central cultural activity among West Coast Japanese-Americans. The leagues create cohesion while giving youngsters who go to schools that have few Japanese-Americans the opportunity to learn Japanese-American values and interaction styles. Rather than being an unambiguous demographic indicator of ancestry, ethnic identity has many contrary, complex, changing meanings, and its created significance changes accordingly.

See also Critical Race Theory; Cultural Revivals; Loyalties, Dual; Race and Racism: Reception of Asians to the United States.

BIBLIOGRAPHY

- Andersen, Margaret L., and Patricia Hill Collins. *Race, Class, and Gender: An Anthology*. 4th ed. Belmont, Calif.: Wadsworth, 2001.
- Ferrante, Joan, and Prince Browne Jr. *The Social Construction of Race and Ethnicity in the United States*. 2nd ed. Upper Saddle River, N.J.: Prentice Hall, 2001.
- Fong, Timothy P., and Larry H. Shinagawa. *Asian-Americans: Experiences and Perspectives*. Upper Saddle River, N.J.: Prentice Hall, 2000.
- Greeley, Andrew M. “The Ethnic Miracle.” *Public Interest* 45 (fall 1976): 20–36.
- Lee, Sharon. “Racial Classification in the U.S. Census, 1890–1990.” *Ethnic and Racial Studies* 16, no. 1 (1993): 75–94.
- Loewen, James W. *Lies My Teacher Told Me: Everything Your American History Textbook Got Wrong*. New York: Simon and Schuster, 1995.

- Okiihiro, Gary Y. *The Columbia Guide to Asian American History*. New York: Columbia University Press, 2001.
- Omi, Michael, and Howard Winant. *Racial Formation in the United States from the 1960s to the 1990s*. 2nd ed. New York: Routledge, 1994.
- Tuan, Mia. *Forever Foreigners or Honorary Whites? The Asian Ethnic Experience Today*. New Brunswick, N.J.: Rutgers University Press, 1998.
- Uba, Laura. *Asian-Americans: Personality Patterns, Identity, and Mental Health*. New York: Guilford, 1994.
- . *A Postmodern Psychology of Asian Americans: Creating Knowledge of a Racial Minority*. Albany: State University of New York Press, 2002.
- Williams-Léon, Teresa, and Cynthia L. Nakashima. *The Sum of Our Parts: Mixed-Heritage Asian Americans*. Philadelphia: Temple University Press, 2001.

Laura Uba

JEWISH MULTIPLE IDENTITY

As a collective that has lived and created its history for the most part not merely in diaspora but among a vast array of “host” peoples, Jewry across the generations has been powerfully marked by the need to negotiate, on the one hand, elements of identity understood to be shared with all Jews at all times and places and, on the other hand, cultural motifs and practices shared with their non-Jewish neighbors.

Sephardim and Ashkenazim

The medieval Jewish view divided the world between Edom (Christendom) and Ishmael (the realm of Islam), and the Jewish world was likewise bifurcated (for example, by Maimonides) into *Galut Edom* (Jews under the cross) and *Galut Ishmael* (Jews under the crescent). More broadly, and continuing throughout roughly the second Christian millennium, most of the Jews of the world have generally been understood to belong to two major subgroups. One group is called *Sephardim*, a term derived from the Hebrew name of Spain. The term originally denoted only Iberian Jews, but after the expulsion of Jews from the Iberian Peninsula in 1492, it was colloquially expanded to include all the Jewish communities of the circum-Mediterranean, Middle East, and North Africa. The second group is known as *Ashkenazim*. This term is derived from the Hebrew word designating the German lands and was used to describe virtually all the Jewish communities of northern, western, and eastern Europe, who shared the Yiddish idiom until the modern era. Until the nineteenth century, the former group was more numerous, but the Ashkenazi population increased dramatically in the modern era. Since the establishment of the state of Israel, however, scholars and activists have worked to promote the collective identity and cultural heritage of Arabic-speaking Jews as distinguished, on the one hand, from the “true” Sephardim (Ladino-speaking communities that trace their origin to Iberia) and, on the other, from the largely secular Ashkenazim who founded the central Zionist institutions. It is also understood in the early twenty-first century that the bifurcation of Jewishness into Sephardic and Ashkenazic identities occluded the stubborn persistence of Jewish communal identities in widely scattered parts of the

world such as Ethiopia, India, and China, and of nonrabbinic Jewish groups, most notably the Karaites.

Fundamentals and Contingencies

Understandably, what is emphasized in the religious liturgy, in traditional literature, and in contemporary collective memory are the supposedly “constant” marks of Jewish identity: study and adherence to the laws of the Bible and (especially) the Talmud and other rabbinic glosses and codices; observance of the weekly Sabbath and the festivals that mark the annual (lunar) calendar; solidarity with Jews in distant places, especially those whose safety is threatened at any particular time; and a shared understanding that Zion is both the origin and the eschatological destination of all Jews everywhere.

Continuity of Jewish identity in diaspora can be traced not only to the existence of these texts and rituals as a “portable homeland” but also to policing of the bounds of identity from within (through autonomously governing communal structures) and without (through social discrimination and restrictive legislation enacted by Christian and Muslim religious and secular officials). Moreover, any Jew in the premodern world who strayed too far from competence in Jewish culture risked a painful loss of status. Hence the story of the village Jew so illiterate that his fellow congregants mocked him as “Zalmen the goy [gentile].” When the rabbi admonished them not to be so cruel, they complied but in a way that dug even deeper, calling him instead “Zalmen the Yid [Jew].”

However, the tradition also acknowledges that Jewish ability to identify as, if not necessarily empathize with, non-Jews is also of value to the Jewish community and its survival. The story recited by Jewish communities each year on the festival of Purim is exemplary here: The emperor Ahasuerus in ancient Persia holds a contest to find the most beautiful woman in the kingdom and make her his queen, and the Jewish girl Esther is selected. Throughout the selection process and the beginning of her reign, she conceals from the emperor the fact of her Jewish birth, only revealing it as she denounces the author of a plot to kill all the Jews of the empire. A clear moral of this story is that at certain times, an individual’s pretending not to be Jewish can benefit the entire community.

Questions of Gender

Jewishness is often implicitly conflated with maleness since participation in ritual and in textual study was often limited to males. Indeed, like most group identities, especially perhaps in the West, Jewishness is explicitly patriarchal. However, for centuries Jewishness as an identity transmitted at birth has been determined matrilineally. The contribution of women to the transmission and constant renewal of Jewishness is often articulated only in response to feminist critiques of traditional sexism, but there should be no question that women’s role as educators and shapers of the sensibilities of new Jewish generations has always been indispensable.

Modernity and Beyond

Under the pressures of modern secularizing and state-building tendencies, the unique mix of a sense of core unity and adaptive

flexibility that sustained Jewish diasporic communities for millennia was massively weakened. Among both Jews and non-Jews, the collective identity of autonomous communities came to be seen as inimical to modernity. Debates raged for decades as to whether Jewish identity was primarily religious, national, or racial; and movements for reform, the establishment of a Jewish nation-state (in Palestine or elsewhere), and the elimination of Jewish difference through intermarriage and assimilation were promoted accordingly. From the Enlightenment until the rise of European fascism, it was commonly believed that it was possible for Jews to identify both with their co-religionists everywhere and with fellow citizens of their countries of residence.

Since World War II, it has been a commonplace that the twin pillars of shared Jewish identity are the memory of Nazi genocide and identification with the Jewish state of Israel. However, since the last decades of the twentieth century these emphases have been countered, or at least balanced, by a renewed engagement with the Jewish textual tradition and by a reinvention of the liturgical and ritual tradition, both placing more emphasis than ever before on the goal of making women equal participants in Jewish identity. These phenomena, along with the dramatic regeneration of Orthodox Jewish communities, demonstrate the continued vitality of Jewish capacities for the negotiation of multiple Jewish and human identities.

See also *Diasporas: Jewish Diaspora; Judaism*.

BIBLIOGRAPHY

- Biale, David, ed. *Cultures of the Jews: A New History*. New York: Schocken, 2002.
- Gilman, Sander L. *Jewish Self-Hatred: Anti-Semitism and the Hidden Language of the Jews*. Baltimore and London: Johns Hopkins University Press, 1983.
- Goldberg, David Theo, and Michael Krausz, eds. *Jewish Identity*. Philadelphia: Temple University Press, 1993.
- Zimmels, H. J. *Ashkenazim and Sephardim: Their Relations, Differences, and Problems as Reflected in the Rabbinical Responsa*. Hoboken, N.J.: Ktav, 1996.

Jonathan Boyarin

IMAGES, ICONS, AND IDOLS. Placing the words *images*, *icons*, and *idols* together as the subject of an entry that seeks to articulate the perspective of world culture suggests their intimate relationship. Such a grouping also demands that an emphasis be placed on the particular role biblical religions have had in the development and use of the last two terms, the ideas of “icon” and “idol” that play off each other and highlight a central idea of the “image” in the three traditions—Judaism, Christianity, and Islam—commonly characterized as monotheistic. While all three terms have come to be used by scholars in their analysis of many cultures, the terms *icon* and *idol* have a specific and central place in the discourse on images in the cultural history and the history of ideas in the West. The notion of idol and idolatry was carried to many parts of the world with the Christian and Muslim mission movements and entered local vocabularies through this means.

Sacred Image

The representation of gods, saints, and heroes, of mythic events and of formative historical events, has been a widespread phenomenon in the history of religion. Conventional notions suggest that some religions, for example Islam and prophetic Judaism, are aniconic, meaning that they are against the use of idols or images. At the iconic end of the spectrum we find Mahayana Buddhism and Hinduism, traditions in which images articulate, order, and fill the sacred spaces of both temple and home. Scholars who adopt such a schematic approach place Protestantism, Vedism, and ancient Buddhism toward the aniconic end of the scale and Roman Catholicism, Eastern Orthodoxy, and the religions of ancient Egypt, Greece, and Rome toward the iconic end.

The historical study of religion, however, has shown that the understanding and use of images have been complex and have shifted in emphasis in various periods. Hinduism and its daughter Buddhism both appear to have started out without the use of images and grew into iconic faiths over many generations. The phenomenological study of religion shows that the veneration of images by a devout woman or man may vary, even dramatically, from what is said about the importance of the image or even about its sacred character. Theravada Buddhists, for example, may say that the image of the Buddha is simply a “representation” and that the historical Buddha died like any other person and is therefore obviously not present in any way in the image. Yet, they bow with reverence and make offerings to statues of the Buddha even if they encounter them in unexpected places far outside the traditional environment of the sacred. In a given tradition at any given moment, one often finds that the attitude toward images runs a remarkable spectrum of belief. Among Orthodox Christians entering a church for the Divine Liturgy on a Sunday morning, there will be many who take candles to the front of the church and offer them in memory as they pause to pray before the icons. Some will speak of the icon as miraculous while their neighbor will note its pedagogical role as a visual scripture or hagiography and others will say the icon is a “window of divine grace” or, in the case of the icon of Jesus Christ, an “embodiment of God” and witness to the Incarnation.

The image may also be understood as divine. Stilpo, a fourth-century-B.C.E. citizen of Athens, was banished for teaching that the Greek sculptor Phidias’s statue of Athena was not a goddess, and the ninth-century South Indian mystic Andal is said to have married an image of Vishnu and miraculously been absorbed into the God’s embrace. Images may become divine when they are initiated in and through a ritual. When images arrive for installation in Hindu temples they are initiated through the ritual of *prana partista*, and the “breath of God enters them” never to be removed. In ancient Egypt the high priest would enter the temple chamber in the morning ritual and take the statue of the god from its resting place, clean, clothe, and feed the deity and then retire from this most holy place until the following morning.

Perhaps one of the most widespread practices is the use of images as a focus for veneration with a clear sense that they function as a reminder of the deity’s characteristics, inviting

one to offer both one’s struggles and joys, concerns and thankfulness, through prayer, meditation, or devotion. For the devotees the image is a way of engaging the holy. This, of course, makes the image sacred but not in and of itself a deity.

Icon as Revelation

While the Greek word for image, *eikōn*, has entered the common vocabulary of the English speaking world as *icon* and is applied to everything from pictures identifying computer programs to symbols from archaic cultures, it is in the Orthodox Christian tradition that iconography has received its highest articulation and where it occupies a central place in the life of worship. Holy icons are central to Orthodox theology and worship and developed over the better part of a millennium into a distinct form of liturgical art. In devout Orthodox households, whether in New York City or Romanian villages, one finds the “beautiful corner” with its icon of Christ and the Theotokos (“Birth-giver of God,” or Virgin Mary) and various other icons adorned with linen drapery. A vigil lamp or candle may burn in front of the icons. In Orthodox churches the whole space is often completely decorated with icons, painted in fresco or secco, arranged according to a canonical program. The iconostasis bridging the nave and the altar area of the church holds various key icons both on the screen itself and on its various doors. The axis of the iconographic program in the church is formed by the large painting or mosaic of Christ the “All Ruler” (*Pantocrator*) in the central dome and the Theotokos in the apse of the church. The porch is also painted, and in some Orthodox churches, particularly in Romania, the exterior of the church is covered with frescoes of saints, biblical and other sacred narratives, and occasionally images of pagan luminaries from Socrates to Petrarch.

An icon table close to the entrance or inside the church will hold the icon appropriate to the feast or saint’s day according to the liturgical calendar. When the faithful enter the church they customarily venerate the image, making the sign of the cross and often lighting a candle as they pray for the living and the dead.

This highly articulated tradition of icon use is the result of generations of theological reflection in the Christian East. It was largely taken for granted until various Byzantine emperors initiated two iconoclastic periods, 730–787 and 813–843. During these periods an attempt, largely successful, led to the destruction of all images in churches in the empire.

The iconoclasts were not enemies of art but rather took exception to the presence of all images of Christ, the Theotokos, and saints in the church. The emperors at the forefront of this movement continued to promote imperial imagery on coins and banners throughout the empire. A striking parallel may be found in both the Soviet Union and the United States of America, where iconoclastic cultures have flourished along with the extravagant use of images of political figures in public places.

The controversy during this period was essentially dogmatic and centered on the heart of the Orthodox theological proclamation of the incarnation of God in Jesus Christ. It was rooted

in the persistence of Hellenistic spiritualism represented by Origen (?185–?254) and Christian forms of Neoplatonic thought seeking a return to pre-Christian notions of the separation of the spirit and matter. The followers of the iconoclastic movement saw the image as an obstacle to prayer and the spiritual life because the image was made out of “crude matter” and because its emphasis on the human body failed to privilege and grant the elevated place rightfully belonging to the spirit. This movement denied the Gospel witness to the incarnation of God in Jesus Christ as a restoration of all human beings to the divine image proclaimed in the Genesis account of creation.

This state-sponsored iconoclasm (literally “image smashing”) was countered by John of Damascus (c. 675–749), Germanus I, patriarch of Constantinople (c. 634–c. 732), and Theodore Studites (759–826), who marshaled scripture and theological thinking in favor of the use of icons in Christian worship. John of Damascus argued that God was the first and original image-maker of the universe and that the son of God was the living image of God in his very nature. Since Paul in the Epistle to the Colossians had written, “He is the image of the invisible God” (Col. 1:15), the worship of the icon of Jesus Christ was not idolatrous, because, in the oft-quoted formula of Saint Basil of Caesarea (c. 329–379) in *De Spiritu Sancto* (On the Holy Spirit), “The honor paid to the image [the Son] passes over to the prototype [the Father].” The Orthodox doctrine of the veneration of icons calls the faithful, not to a veneration of art or images in general, but to the veneration of the image of a person whose life has been sanctified and who has come to union with God through divine grace. It is a realization of Christ’s words in the Gospel, “The kingdom of God is within you” (Luke 17:21). The icon expresses the Gospel precisely because it is a manifestation of the human nature having recovered its fullness in the divine life. It represents the patristic formula “God became man so that man might become God.”

Orthodox iconography centers on the human person and its canons require that all that is depicted be rooted in the human story shown from the perspective of the human being’s recovery of holiness. Icons are not “art” in the usual sense but liturgical aids to prayer orienting the mind and heart of the faithful to the kingdom of God, fulfilling Christ’s words, “The glory which thou has given me I have given to them” (John 17:22).

The Orthodox veneration of images was called for by the revelation of the enfleshment of God. While the early Christian thinkers agreed that the God of the Hebrew Bible could not be portrayed, they went on to argue that since Christ is the incarnation of God and had taken on the fullness of human nature, it would be a denial of the Incarnation to refuse to portray Christ in images. Sacred images are a conjoining of the human and divine spheres and serve as indicators and vehicles of the kingdom of God, of all creation transfigured in Christ. The apologists for the icon used the arguments of earlier church fathers who had written on the Scriptures and sacraments and deployed these in favor of images. The biblical texts have long been talked about as a network of types, pointers,

and connections to the presence of the “Word made flesh” in Jesus Christ. These arguments received their official sanction by the Seventh Ecumenical Council at Nicaea in 787 and the icons were restored to the church permanently in 843 following a second series of iconoclast emperors.

Idol and Idolatry

The English word *idol* is a translation of the Greek word for “image,” *eidōlon*. The word *idolatry* combines *eidōlon* with the Greek word for “adoration,” *latreia*. The concept of idols and idolatry is central to the biblical narrative and to Jewish, Christian, and Islamic tradition. The richest home of this concept is in the Hebrew Scriptures, where we find the prophets engaged in a running polemic against the pagan worship of aspects of creation rather than of the Creator, and against the erecting, under Canaanite influence, images to Yahweh. The prophets address the predilection of the children of Israel to create images of divine beings in order to worship them, turning away from the proper worship of the “one Lord of all history.” The second commandment of the Decalogue (Exod. 20:4–6; Deut. 5:8–10; cf. Lev. 26:1; Deut. 4:15–23) prohibits the making of images of anything “in the heavens above, or the earth below, or the waters beneath the earth.” This commandment passes into the Christian New Testament and on to the strict monotheism of Islam, where the concept forms one of the Five Pillars of the faith.

The word *eidōlon* is used seventy times in the Greek Septuagint to translate sixteen different Hebrew words, while the Latin Vulgate uses *idolum* 112 times and its corollary *simulacrum* thirty-two times to translate fifteen Hebrew words. The Hebrew Bible uses thirty different nouns in references to idols and names forty-four pagan deities throughout its various narratives. While the word *idol* or *idolatry* is not found in the Gospels, *eidōlon* appears in many of the Epistles of the Apostle Paul and in the book of Revelation. The Bible’s preoccupation with idolatry rests on the notion that the many images of deities that have flourished in human culture are false, images in “word and stone,” and that those who follow after them are engaged in a fantasy at best. In the writings of the Apostle Paul the word *idol* takes on the connotation of deception that is the work of demons who deceive the human mind and heart about their proper nature.

The polemic against idolatry continues in an unbroken stream in the Christian tradition in both the Greek and Latin apologists and church fathers. Saint Justin (c.100–c.165) in his first *Apology* speaks of the error in creating human forms to replicate the divine, the lack of soul in base substance, and of how artisans and thieves use such objects to deprive people of their money. Clement of Alexandria (c. 150–between 211 and 215) wrote his *Protreptikos* to persuade those who worshiped the embodiment of pagan mythic figures of the origin of such cultic practice. Partly inspired by Plato, Clement argues that such images are the result of the deification of human beings created by artists to honor kings. The gravity of such worship, Clement argued, is that it replaces the human compulsion to worship the true God with invented demons that are at best mere wood and stone and at worst excite the human passions.

TO SEE HER FACE

I had met the local Hindu priest on two occasions in the 1970s. He had walked me through his plans for a new temple to serve the eclectic community of people with roots in India who had come to live in Edmonton, Alberta, Canada, and discussed how he planned to shape the sanctum sanctorum to accommodate the various devotions of a mixed community of Shaivites and Vaishnavites. Now we sat together in his home just to the right of his shrine to the Shakti, the Feminine Divine Energy and manifestation of Shiva, the deity that had captured his attention many years ago and come to shape his personal devotion. It was my first time in his home and our conversation had moved from his own spiritual formation in Ludhiana, India, through the trauma of the stillbirth of his first child and his entering the Shi Ramakrishna mission in England seeking solace for the loss of this child. He spoke of growing up under the influence of the Arya Samaj movement, of its iconoclasm as well as its place in the Vedic renaissance in India in the nineteenth century and how he came to devote himself to the ritual life centered

on *murti*, the image of deities. He had talked affectionately about the worship of deities at some length and then, rather abruptly, turned to speak about the goal of the Hindu life: to finally come to worship the formless form, the Eternal Absolute beyond embodiment. This, he told me, would finally lead to *moksha*, the liberation that is the final release from the cycle of rebirth. After he had spoken for a considerable time on the formless form, distinguishing it from what he called “idol worship,” I said to him that while this was a powerful idea I did not quite understand how it sat with his deep and faithful devotion to the beautiful embodiment of Shakti, a devotion he offered to her each morning and evening. What does the formless form have to do with her who is so beautifully formed and who has so completely won your affections? Tears filled his eyes. “In this life, in this round, all I hope for is just once to see her face. Just once to truly glimpse her beauty.”

SOURCE: From the author’s field notes.

When the Visigoths under Alaric conquered Rome on 24 August 410 C.E. the pagan subjects of the city accused their Christian neighbors of bringing the event about by destroying the worship of the gods. The Christians had chased away the divine protectors of the ancient and glorious city. Saint Augustine (354–430) was called upon to answer this charge in what proved to be the last great apologetic work against paganism, *The City of God*. He begins with a critique of the Roman gods and the mythology that had shaped the identity of Romans for centuries and then examines the arguments of Varro, Cicero, Seneca, Euhemerus, Apuleius, and Plato. Augustine argues that idols are not neutral inventions but are harmful precisely because they are created out of the heart and mind, a manifestation of human aspiration, ambition, and illusion. In his works *On Christian Doctrine* and *On True Religion* he continues his substantial psychoanalysis of how the demonic, born of the human mind, takes on a character of its own. Idols are not without power for they receive life and force from the invisible numen born of their origin in human misunderstanding. While idols are false gods and as such not gods, they represent the enormous struggle in the human heart and mind to apprehend the truth about human nature, creation, and the divine.

The great controversies such as iconoclasm and the Protestant Reformation illustrate the struggle within the church over

what constitutes idolatry. In the sixteenth and seventeenth centuries various Protestant theologians accused Roman Catholicism of replacing the proper worship of the divine with the idolatrous worship of Mary and the saints. The worship of idols has remained a perennial concern in various denominations of the Christian church as they expanded into Africa, Asia, and North America.

Islam and Shirk

Muslims around the world, both in the mosque and in their daily prayers, chant the creedal statement: “God is most great. There is no god but Allah. Muhammad is the Prophet of God.” The Koran constantly speaks of God as the One, Al-Wahid, and the Prophet Muhammad’s singular passion was to root out idolatry and the indigenous forms of polytheism in the Arab communities of his day. For Muhammad and for faithful Muslims ever since, the heavens and the earth are established on what we read in sura 112 of the Koran, “Say: He is God alone: God the eternal. He begetteth not, and he is not begotten; and there is none like unto him.”

In the religious world of Islam any association of other beings with God or of any human attribute with what belongs to God alone is the gravest of sins. *Shirk*, this type of grave sin, finds its polar opposite in *tauhid*, the declaration central

to Muslim belief and prayer of the unity of God, a unity declared in faith and lived out in private and public life.

Muhammad inherited the opposition to idolatry from the Judeo-Christian tradition and saw Abraham as the prototype of the faith in one God. Abraham's firstborn son Ishmael faithfully followed in his father's footsteps in his rejection of local idols. Considerable attention is given in the Koran to Abraham's destruction of idols and Moses' attempt to call his people back to the worship of the one God (sura 26:69–83; 21:53/52–70; 25:3–5/4; 7:134/138). The propensity to associate a god or gods with God represents the gravest human struggle and Islamic law is clear and absolute about its many dangers and manifestations.

Idolaters are to be shunned and Muslims are called to fight against them (sura 9:36). One must never marry an idol worshiper and one must protect children from their influence. Idolatry is an insult to God for only God is the creator of the world and God is beyond image or representation.

In the last half of the twentieth century, archaeological work at the third-century Jewish synagogue at Dura Europos in eastern Syria helped us appreciate that the absolute prohibition of images in the law of Moses did not deter Jews contemporary with early Christianity from painting sacred images in their places of worship. Carl Kraeling argues that the Dura synagogue was one of the finest synagogues in ancient Judaism and that its decorative paintings are a forerunner of Byzantine art. While this discovery has demanded that scholars of *image*, *icon*, and *idol* become more complex in their application of these terms, it remains the case that the cultural history and history of ideas in the West, in Jewish, Christian, and Muslim circles, has been significantly shaped by the debate on the nature and meaning of images. This debate continues in the contemporary Protestant church considering what decorative program to adopt, as it does periodically in public discussion when an art gallery or a film shows images of Jesus Christ, the Virgin Mary, or a prophet that deconstruct some of the public's expectations.

See also *Iconography; Orthopraxy; Religion; Sacred Places; Sacred Texts.*

BIBLIOGRAPHY

- Augustine, Saint, Bishop of Hippo. *The City of God against the Pagans*. Translated and edited by R. W. Dyson. Cambridge, U.K.: Cambridge University Press, 1998.
- Basil, Saint, Bishop of Caesarea. *On the Holy Spirit*. Translated by David Anderson. Crestwood, N.Y.: New York: St. Vladimir's Seminary Press, 1980.
- Belting, Hans. *Likeness and Presence: A History of the Image before the Era of Art*. Translated by Edmund Jephcott. Chicago and London: University of Chicago Press, 1994.
- Coomaraswamy, A. K. *Coomaraswamy*. Edited by Roger Lipsey. Princeton, N.J.: Princeton University Press, 1977.
- Daniélou, Alain. *Hindu Polytheism*. New York: Bollingen Foundation, distributed by Pantheon, 1964.
- Eliade, Mircea. *Images and Symbols: Studies in Religious Symbolism*. Translated by Philip Mairet. New York: Sheed and Ward, 1961.
- Florovsky, George. "Origen, Eusebius, and the Iconoclastic Controversy." *Church History* 19 (1950): 77–96.

- Goblet d'Alviella, Eugène. "Les origines de l'idolatrie." In his *Croyances, rites, institutions*. Vol. 2. Paris: P. Geuthner, 1911.
- Grabar, André. *Early Christian Art: From the Rise of Christianity to the Death of Theodosius*. Translated by Stuart Gilbert and James Emmons. New York: Odyssey, 1969.
- Grabar, Oleg. *The Formation of Islamic Art*. New Haven, Conn.: Yale University Press, 1973.
- John of Damascus, Saint. *On the Divine Images: Three Apologies against Those Who Attack the Divine Images*. Crestwood, N.Y.: New York: St. Vladimir's Seminary Press, 1980.
- Kraeling, Carl H. *The Synagogue*. 2nd ed. New York: KTAV, 1979.
- Lossky, Vladimir. *In the Image and Likeness of God*. Edited by John H. Erickson and Thomas E. Bird. Repr. Crestwood, N.Y.: Saint Vladimir's Seminary Press, 1985.
- Moore, Albert C. *Iconography of Religions: An Introduction*. Philadelphia: Fortress, 1977.
- Nicéphorus, Saint, Patriarch of Constantinople. *Discours contre les iconoclastes*. Translated by Marie-José Mondzain-Baudinet. Paris: Klincksieck, 1989.
- Ricoeur, Paul. *The Rule of Metaphor: Multi-Disciplinary Studies of the Creation of Meaning in Language*. Translated by Robert Czerny, with Kathleen McLaughlin and John Costello. Toronto and Buffalo, N.Y.: University of Toronto Press, 1978.
- Theodore Studites, Saint. *On the Holy Icons*. Translated by Catharine P. Roth. Crestwood, N.Y.: St. Vladimir's Seminary Press, 1981.
- Trubetskoi, Evgenii Nikolaevich. *Icons: Theology in Color*. Translated by Gertrude Vahar. New York: Saint Vladimir's Seminary Press, 1973.
- Ward, Keith. *Images of Eternity: Concepts of God in Five Religious Traditions*. London: Darton, Longman, and Todd, 1987.

David J. Goa

IMAGINATION. The idea of imagination is sometimes thought of as a product of the Enlightenment. However, although it only came to full flower in the seventeenth, eighteenth, and nineteenth centuries, its roots are much more ancient.

Biblical Beginnings

Given the stern admonition of the second commandment of the Decalogue against the making of images of anything "in the heavens above, or the earth below, or the waters beneath the earth" (Exodus 20:4; Deuteronomy 5:8), it is ironic that the idea of *imagination* probably found its earliest expression in the first chapter of Genesis. In the biblical accounts of creation, two different words are used: in the first account, *bara*, implying *creatio ex nihilo* (Genesis 1:27); in the second, *yatsar*, by which man is created from the dust of the earth (Genesis 2:7). The first power is reserved to God alone; the second—the power to reshape existing matter—is shared with humankind. Thus the Hebrew word for imagination comes to be *yetser*, the ability to share in the divine creative power.

For humankind, however, *yetser* is not always used for good: "the imagination of man's heart is evil from his youth" (Genesis 8: 21; and see Genesis 6: 5). Thus the rabbinical

tradition came to distinguish between the evil imagination (*yets'er hara*), often associated with sexual desire, and the good imagination (*yets'er hatov*), which “opens up history to an I-Thou dialogue between man and his Creator” (Kearney, p. 47).

Non-Western Traditions

The Sufi tradition of Islam offers an analogue of imagination in the concept of *barzakh*, referring to “the whole intermediate realm between the spiritual and the corporeal.” Since this world of imagination is “closer to the World of Light” than the corporeal world (Chittick, p. 14), it can give valid knowledge of higher reality. In the Buddhist tradition there is no systematic view of imagination; the Sanskrit word for it is *prtibha* (“poetic genius”), but it is not given much emphasis in Buddhist thought. Hinduism, on the other hand, offers in the Vedic tradition a highly developed view of imagination as both the transcendent power by which the gods create and sustain the harmony of the universe, and the human faculty by which the human artist, priest, or sage recognizes and celebrates this harmony. It is, in short, the imagination that “joins the human spirit with ultimate reality itself” (Mahoney, p. 2).

Ancient Greece

In the ancient Greek tradition, too, the idea of imagination is closely bound up with divine power and prerogatives. In the pre-philosophical era it is most dramatically expressed in the myth of Prometheus, whose theft of fire from heaven brought the creative energy of the gods to humankind. It is only in the work of Plato and Aristotle, however, that the idea is brought to some level of conceptual clarity. Although Plato’s earliest dialogues espouse a firm idealism inherited from Parmenides, by the time of the *Republic* he has begun to see the need to bring together the material, phenomenal world and the world of ideas. The imagination (*phantasia* or *eikasia*), if used in aid of reason can attain to, and even express, universal ideas. By the time of the *Phaedrus* and the *Timaeus*, Plato sees that imaginative representation “recalls to mind those eternal forms of Beauty which are the innate possessions of the soul and the objects of its contemplation” (Bundy, p. 58). Aristotle’s more pragmatic approach shifts the focus from metaphysical foundations to form and function, from objective to subjective. Thus imitation (*mimesis*) is for him an inductive and psychological process rather than a divinely inspired intuition. It was his emphasis rather than Plato’s that was to predominate in the Western tradition until the eighteenth century.

Medieval and Renaissance Views

There are wide divergences in medieval views of imagination. Although one finds in such synthetic thinkers as St. Augustine of Hippo (354–430) and St. Thomas Aquinas (1225–1274) (and later in the poetry of Dante [1265–1321]) attempts to reconcile the idealism of Plato and the Neoplatonists with the more psychological approach of Aristotle, it is the latter that generally finds favor among faculty-oriented Scholastic philosophers. For all this, though, a Platonic undercurrent often remains—as in Aquinas and in the Jewish philosopher Moses ben Maimon (Maimonides; 1135–1204)—to explain the intrinsic relationship between the material world and the

transcendent, the human and the divine. Arab philosophers of the period, notably Avicenna (Ibn Sina; 980–1037), tend to give priority to imagination over intellect in achieving true knowledge, while the Western tradition invariably insists that imagination must remain under the control of intellect. However, imagination (*imaginatio* and *phantasia* are used synonymously in Aquinas) is crucial for most of the medieval Scholastics as a means of expressing the analogical relationship between the sensible world and transcendent reality.

In the Renaissance, the *Vita nuova* and *Divina commedia* of Dante and *De imaginatione sive phantasia* of Giovanni Pico della Mirandola (1463–1494) may fairly be taken as representative. All three draw heavily from Scholastic philosophy, and although Dante is, like his master Aquinas, an Aristotelian, both are more deeply interested in the possibilities of vision than in the epistemological process itself. Thus, in part through them, the Platonic tradition continues into succeeding generations, with such theorists as Sir Philip Sidney (1554–1586) in his *Apology for Poetry*. Even as he strongly emphasizes the teaching role of poetry in achieving “virtuous action,” using Plato’s ideas for a moral purpose, Sidney keeps alive the Platonic emphasis on imaginative vision.

The Enlightenment

If the European Enlightenment did not invent the idea of imagination, it certainly brought it to its fullest articulation, broadening its reach to include not only literature and the arts, along with philosophy and theology, but also political and social theory and even science. It became during the eighteenth century, in short, a crucial tool in virtually every area of intellectual life.

Until this time, intellectual inquiry had tended to focus on humankind’s relationship with God, with nature, and with others. Thinkers like Thomas Hobbes (1588–1679), however, began to look inward, to consider the processes of human perception, the psychological dimensions of human experience, bringing to bear the empirical method that was to become increasingly important throughout the eighteenth century. Imagination for Hobbes was an active, creative faculty, not a mere passive receiver of impressions; it is the power that shapes our thoughts and sense impressions into unity, even into a coherent view of the world. Even John Locke (1632–1704), however much he might deplore imagination as “illusory,” emphasized the unifying activity of the mind; later, David Hume (1711–1776), for all his skepticism, viewed the imagination as the power that brought together thought and feeling. Clearly the way was being paved for later thinkers like Coleridge, who would see imagination as the unifying power in human perception and creativity.

Even as Hobbes pushed forward the “Aristotelian” dimensions of imagination, probing the processes of the mind, his contemporary Shaftesbury (Anthony Ashley Cooper, 3rd Earl of Shaftesbury, 1671–1713) emphasized the Platonic heritage. Standing in the line of sixteenth-century Cambridge Platonists like Henry More and Ralph Cudworth, he also returned to the works of Plato and his Neoplatonic successors. While Hobbes focused on empirical knowledge, Shaftesbury was



Engraving by Gustave Doré for Dante's *Paridiso*, 1868. Although Dante subscribed to Aristotle's belief that imagination was a physical process rather than a spiritual one, in his works he nonetheless preferred to explore the vast and often mystical possibilities of inner vision. © BETTMANN/CORBIS

interested in the human grasp of the ideal and of spiritual reality. The result, at least for British intellectual history, was a richly balanced legacy for the Romantic thinkers who followed.

But the influence of Hobbes and Shaftesbury, along with that of other English and Scottish philosophers, reached far beyond England. Shaftesbury was introduced into Germany by Gottfried Wilhelm von Leibniz (1646–1716) and remained a lasting influence there throughout the eighteenth century, while the empiricist psychology of Hobbes, Locke, and others was eagerly welcomed in the German universities.

The two great thinkers on imagination in Germany are Johannes Nikolaus Tetens (1736–1807) and Immanuel Kant (1724–1804), who “stand like two colossi in their concepts of imagination” (Engell, p. 118). The contribution of Tetens, under the influence of the Scottish philosopher Alexander Gerard (1728–1795), was to widen the scope of imagination to make it central in all human perception, from the immediacy of sense perception to the complex creative act of the artist, thus laying the groundwork for what would later become Coleridge’s distinction between primary and secondary imagination. Tetens was also insistent, as later Romantic theorists would be, that imagination is as crucial for the scientist and the philosopher as for the poet or painter.

Kant’s role in the development of the idea of imagination, under the influence of Tetens, was to synthesize two currents of thought, reflecting the ancient tension between Platonic and Aristotelian views of the world: an idealist strain deriving from such thinkers as Leibniz, Christian von Wolff (1679–1754), Shaftesbury, Baruch Spinoza (1632–1677), and Friedrich Jacobi (1743–1819), and the more empirical line of Hobbes, Locke, Hume, and other British empiricists (see Engell, p. 128–29). Although he never clarified his thought to his own (or indeed to anyone else’s) satisfaction, Kant’s more transcendentalist analysis of imagination in the second edition of the *Critique of Pure Reason* and later in the *Critique of Judgment* is centrally important for the emerging Romantic period, in that Kant never lost sight of the role of objective perception even as he emphasized the formative and productive power of the human mind. Although he will use different terms for it (*Einbildungskraft*, *Phantasie*) and although the balance shifts throughout his life, imagination in Kant brings together with considerable success the sensible and the ideal worlds, the empirical and the transcendent.

Romanticism

Friedrich Wilhelm Joseph von Schelling (1775–1854), looking back at Kant’s work a generation later, judged that Kant, by failing to demonstrate the validity of human perception, had left a dichotomy between the human mind and external reality. His own *Naturphilosophie* was meant to heal that rupture, and imagination played a central role in his endeavor. It was crucial for Schelling that imagination was both human and divine. God possesses imagination in its fullness, and the divine imagination (*die göttliche Einbildungskraft*) is “the generating power of the universe” (Engell, p. 304). The human imagination shares in this faculty, though on a lower level: ordinary mortals in the power to perceive unity in the multiplicity

of our experience; the creative genius in the ability to create new unity out of existing things. Imagination is not apart from nature, it is present as a power in nature from the beginning of creation. Here the distinction between *natura naturata* and *natura naturans*, inherited from the medieval Scholastics, is important. *Natura naturata* is the created sensible object, whether it be a natural being or the product of a human creative act—a poem or painting or piece of music. The *natura naturans* is the active power of imagination itself, a quickening spirit giving life and energy to all being, including the human mind; it is, in effect, God present as an active force in the world. Thus imagination, as the *natura naturans*, is the living link not only between the human mind and the external world but between the created world and the transcendent.

The Romantic poet and thinker Samuel Taylor Coleridge (1772–1834), although he wrote no single treatise on the imagination, is arguably the central figure in its modern development. He drew heavily on most of the major work that preceded him, including the biblical, classical, and medieval sources, as well as the most important thinkers of the century before him such as Leibniz, Tetens, and Kant and contemporaries like Schelling. Coleridge offered no system to support his view of imagination, but the insights and arguments scattered throughout his works finally yield a coherent and important perspective. His most influential work of literary theory and criticism is his *Biographia Literaria* (1817), in which he both acknowledges his debts to such thinkers as Kant and Schelling and at times diverges significantly from them. His *locus classicus* on imagination (chapter 13) distinguishes between primary and secondary imagination, and between imagination and fancy. Primary imagination is “the living Power and prime Agent of all human Perception, and as a repetition in the finite mind of the eternal act of creation in the infinite I AM.” The secondary is “an echo of the former, co-existing with the conscious will”; it “dissolves, diffuses, dissipates, in order to re-create.” The lesser faculty of fancy is only a “mode of Memory,” dealing with “fixities and definites,” with sensible realities rather than with “ideas.” This view of imagination is clearly similar to Schelling’s: primary imagination is the faculty by which all human beings shape their experience of the world into meaningful perception; secondary imagination is the artist’s ability to create new shapes and meaning out of existing material. It is also similar in its strong affirmation of the relationship between the human and divine imaginations: the human creative act participates in the infinite creative act of God, from which it derives its power.

Coleridge’s view of imagination is intimately related to his conception of *idea* and *symbol*. An idea is a suprasensible reality incarnated in sense images; it is the product of all the human faculties—reason, understanding, sense—working under the unifying power of the imagination. An idea “cannot be conveyed but by a symbol” (chapter 9), which is a product of the imagination. As Coleridge writes in the *Statesman’s Manual* (1816), symbols are “the living educts of the Imagination; of that reconciling and mediatory power, which incorporating the Reason in Images of the Sense . . . gives birth to a system of symbols, harmonious in themselves, and consubstantial with

the truths, of which they are the conductors.” Coleridge’s conception differs significantly from Kant’s, in that the ideas thus incarnated, including such ideas as God and immortality, are not merely regulative (as in Kant) but are truly constitutive of reality.

Other important Romantic explorations of imagination include the prophetic poetry of William Blake (1757–1827) and the *Defence of Poetry* of Percy Bysshe Shelley (1792–1822), both of which affirm the transcendent reach of imagination, and so are generally congruent with Coleridge and William Hazlitt’s (1778–1830) essays and the letters of John Keats (1795–1821), which offer a more secular view but still affirm the unifying power of imagination.

Twentieth Century

The transcendentalist view of imagination that came to full flower in the early nineteenth century was seriously questioned by existentialist philosophers like Søren Kierkegaard (1813–1855), Friedrich Nietzsche (1844–1900), Martin Heidegger (1889–1971), and Jean-Paul Sartre (1905–1980). For them, the humanist values implicit in the Romantic idea of imagination as affirmative and redemptive were no longer tenable

in a modern world of violence and inhumanity. Negation and angst replaced the affirmations of humanism. In their wake, postmodernist thinkers like Jacques Lacan (1901–1981), Michel Foucault (1926–1984), and Jacques Derrida (b. 1930) further undermined the Romantic idea of imagination by questioning or denying a valid relationship between image and reality. As Derrida put it, there is no “*hors-texte*.”

For all this, however, there have remained strong and serious countervailing voices—philosophers like Hans-Georg Gadamer and Emmanuel Levinas, theorists like Paul Ricoeur and Walter Ong, critics such as George Steiner and Geoffrey Hartman, who affirm (in Ong’s phrase) the “presence of the Word” and the possibilities of transcendence. Most important of all, artists still create in poetry, in paint, in music, in drama, and in film, and there continue to be those who reflect on this creative work and affirm its human value and the unifying power of the imagination that shaped it. Given its long history and its continuing force, the idea of imagination seems likely to endure.

See also Creativity in the Arts and Sciences; Existentialism; Kantianism; Metaphysics; Naturphilosophie; Neoplatonism; Philosophy of Mind; Platonism; Romanticism in Literature and Politics; Scholasticism.

BIBLIOGRAPHY

- Abrams, M. H. *The Mirror and the Lamp: Romantic Theory and the Critical Tradition*. London: Oxford University Press, 1953.
- Bantly, Francisca Cho. *Embracing Illusion: Truth and Fiction in The Dream of the Nine Clouds*. Albany: State University of New York Press, 1996. Although there is no formal concept of imagination in Buddhism, chapter one articulates helpfully the Buddhist “ontology of illusion.”
- Barth, J. Robert. *The Symbolic Imagination: Coleridge and the Romantic Tradition*. 2nd ed. Bronx, N.Y.: Fordham University Press, 2001.
- Bate, Walter Jackson. *From Classic to Romantic: Premises of Taste in Eighteenth-Century England*. Cambridge, Mass: Harvard University Press, 1946.
- Bundy, Murray Wright. *The Theory of Imagination in Classical and Mediaeval Thought*. Urbana: University of Illinois Press, 1927.
- Chittick, William C. *The Sufi Path of Knowledge: Ibn al-‘Arabi’s Metaphysics of Imagination*. Albany: State University of New York Press, 1989. A clear and useful study of the imagination in Islam.
- Engell, James. *The Creative Imagination: Enlightenment to Romanticism*. Cambridge, Mass.: Harvard University Press, 1981. The definitive study of imagination during the period of its fullest development.
- Kearney, Richard. *The Wake of Imagination: Toward a Postmodern Culture*. London and New York: Routledge, 1988. A comprehensive survey and analysis of the idea of imagination from the Hebrew scriptures to postmodernism.
- Mahony, William K. *The Artful Universe: An Introduction to the Vedic Religious Imagination*. Albany: State University of New York Press, 1998. A thorough study of imagination in the Hindu tradition.
- McFarland, Thomas. *Originality and Imagination*. Baltimore: Johns Hopkins University Press, 1985.
- Todorov, Tzvetan. *Theories of the Symbol*. Translated by Catherine Porter. Ithaca, N.Y.: Cornell University Press, 1982.

Tracy, David. *The Analogical Imagination: Christian Theology and the Culture of Pluralism*. New York: Crossroad, 1981.

Warnock, Mary. *Imagination*. Berkeley: University of California Press, 1976.

Wellek, René. *Immanuel Kant in England, 1793–1838*. Princeton: Princeton University Press, 1931.

J. Robert Barth

IMMORTALITY AND THE AFTERLIFE. Modern thinkers often begin their discussions of immortality and the afterlife with Plato, (c. 428–348 or 347 B.C.E.) which makes sense given that his *Republic* is one of the most influential works in Western philosophy. However, his view on immortality is not as straightforward as some take it to be. Book X of the *Republic* contains the Myth of Er, which puts forward the view that souls exist in separation from the body after death and that when separated from bodies, souls are omnipotent. This allows Plato to provide some footing for the view that knowledge is merely recollection of what we already know, a view discussed in his dialogue *Meno*. But as with his teacher, Socrates (c. 470–399 B.C.E.), Plato’s “views” are not always consistent.

Indeed, in the early twenty-first century, Nicholas Smith has argued that Plato’s views in the *Republic* seem to be intended to provoke thought rather than to set forth consistent views. As such, we should not be surprised that in Plato’s work another “view” of immortality can be found. Plato’s *Symposium* offers this alternative view. Here Plato’s Socrates recounts Diotima’s speech on true love, which puts forth the notion of being pregnant in body and in soul. This latter pregnancy gives birth to wisdom as its offspring (*Symposium* 208e1–209a4), which is immortal. This view is strikingly similar to Aristotle’s in *De Anima* (430a23–24, 408b13–29, 413b24–27), where he argues that while the soul does not survive the death of the body, the active intellect does. He argues that active intellect is eternal and immortal; it produces ideas and in so doing reproduces itself in much the same way that the body produces physical offspring and in so doing reproduces itself. In this way, modern thinkers may be overreading Plato’s view on immortality. The death of the individual involves the cessation of function for that individual, but the life of that person does not end if he or she has produced offspring, if that person has been pregnant in body or soul.

Early Judaic tradition held very similar views of immortality. These views held that immortality was reached through the survival of one’s children and people (though there were vague references to a netherworld known as Sheol). The first emergence of a notion of bodily resurrection did not come until the Jews encountered the Greeks, who began to make successful incursions into the Middle East in the late fourth century B.C.E. Then righteous Jews killed in battle were promised bodily resurrection (Isa. 27:19), which helps to explain the prohibitions on cremation and the various rituals of Jewish burial (Moed Katan 3:5, Deut. 21:24, Amos 2:1). Of course, the statement at Genesis 3:19 that the body begins with dust and ends as dust runs counter to the view of bodily

resurrection, but this reflects the earlier view that bodily resurrection does not occur.

The basis of Christianity, of course, is bodily resurrection. Paul’s first letter to the Corinthians states this view very clearly: “Now if Christ is preached as raised from the dead, how can some of you say that there is no resurrection of the dead?” (1 Cor. 15:12). However, this central teaching of Christianity is not necessarily so obvious to contemporary Christians. Contemporary Christians, according to Oscar Cullman, tend to confuse the Christian teaching of bodily resurrection with the Platonic/Aristotelian view of the immortal soul (or part of the soul). For Cullman, the doctrine of the immortality of the soul depends upon the resurrection of the dead. The immortality of the soul view cannot be held without the bodily resurrection view.

Strictly speaking, then, for Christianity the soul is not immortal. It dies with the body and is resurrected at the end of time. Hence the connections drawn between any presumed body/soul duality in Plato or Aristotle and the Christian view of afterlife via resurrection must be faulty. Connections between immortality of soul and other religious views, however, are quite strong. Indeed, discussions of the transmigration of souls (or reincarnation) significantly predate Plato. Empedocles of Acragas, who was born in the early fifth century B.C.E., was known to have said: “For I have already been once a boy and a girl, a bush and a bird, and a leaping journeying fish” (Kirk, Raven, and Schofield, p. 319). Xenophanes reports that Pythagoras held similar views, leading to an argument against mistreating any living thing as it may contain the soul of a loved one (p. 219). Herodotus claims that the first people to postulate “the doctrine that the soul of man is immortal” were the Egyptians (p. 219). It is not clear, however, that the Egyptians really were the origin of the immortal soul view, and it is even less likely that they originated a view of reincarnation. Beliefs in the transmigration of souls probably originated in the East and eventually made their way to the Greeks, Romans, Egyptians, and so on.

For Hindus, for example, life on earth is characterized by a cycle of birth, death, and rebirth, a cycle that ends only once spiritual enlightenment is attained. The type of rebirth one can expect is based on the quality of one’s “karma.” Karma is caused by the actions of a person and it is good when it is objective or unattached to the interests or benefit of the actor. This is then grounded in “dharma,” which means the path of righteousness or duty or obligation or virtue or many other similar notions. The word *dharmā* itself comes from Sanskrit and means to sustain or to hold. In this way, dharma is understood to be the sustenance of the universe, and good karma then becomes acting in accord with the cosmos. Righteousness, understood as selflessness, is the order of the cosmos, and release from the cycle of birth, death, and rebirth comes as a result of communing with this order. The views of Buddhism and Sikhism are very similar, even incorporating some of the same principles (e.g., karma and dharma), though at times in subtly different ways.

Interestingly, some modern philosophers have developed views that rather closely follow Eastern views of karma and

dharmā, though no direct connection seems to exist. Immanuel Kant, for example, claims that for an action to be moral, it must be undertaken from a motive that is exclusive of the interests of the actor—a motive of duty or obligation to act according to a self-willed universal law. This position closely resembles karmic action grounded in dharmā but, interestingly, it carries with it no connection to the divine, immortality, or an afterlife. Other philosophers in the Western tradition, however, have tried to compel good action by highlighting its consequences for the actor. John Locke's view of the state of nature, for example, depends upon the view that good actions on earth will be rewarded with good consequences in the afterlife, while evil actions will be divinely punished.

In more recent times, we have become rather incredulous toward such arguments. John Hick spoke about this in his 1977 Ingersoll Lecture on the Immortality of Man. He argued that many of his "thoughtful theological contemporaries" felt "that talk of an afterlife is not only too improbable factually, but also too morally and religiously dubious, to constitute a proper branch of Christian belief" (p. 2). As a result of the takeover of scientific reasoning, we have found it increasingly difficult to fathom a "belief in a post-mortem life" (p. 2). Indeed, cognitive science has made it difficult for us to conceive of a mind/brain duality, much less a soul/body duality, which means that the notion of the personality living beyond the death of the body becomes unfathomable to the modern scientific mind/brain. And so even some Christian theologians (such as Wolfhart Pannenberg and Gordon Kaufman) have argued that modern science makes belief in the idea of the immortality of the soul "untenable" (Pannenberg, 1970, 1968; Kaufman). Hick vehemently disagrees with such views, arguing in part that they cannot possibly be consistent with a Christian viewpoint (or, indeed, any other viewpoint that contains a belief in divine consciousness) because the belief in God depends upon a belief in a divine consciousness that is separate from any sort of embodiment.

These same theologians, Hick reports, have also argued that the afterlife principle, while problematic in factual terms, is actually damaging in moral terms. Here Hick is not referring to the Marxian view that a promise of immortality allows people to become inured to their misery here on earth as they count on eternal splendor in the afterlife (and a similar perspective can be found with respect to beliefs in reincarnation). Rather, he calls attention to the idea "that the concern for personal immortality (whether by the resurrection of the body or the immortality of the soul) is a selfish and thus a basically irreligious concern" (p. 5). We might say, then, that the problem with the belief in personal immortality is that it causes us to focus on selfish concerns rather than on selfless ones. Indeed, the Hindu or the Sikh or the Buddhist might raise just such an objection, since good karma relies on selfless actions.

In fact this is precisely the point Hick makes. He says that the problem does not lie with the principle of the afterlife but instead with the way we think about the afterlife. Drawing on the many similarities between Christianity, Judaism, Islam, Hinduism, and Buddhism, Hick concludes that the Christian view of the afterlife is too limited because it encourages us to

think that we have one mortal life in which to get things right and that failing to do so will lead to eternal damnation of the self. This is a view that is too individualized to cohere with Christian tenets (as well as the tenets of the other major religions). It makes more sense to rely on the basic principles of the world's major religions regarding (1) the potentialities of the human spirit (e.g., as child of God in Judeo-Christian tradition, as a potential Buddha capable of liberation in nirvana, as in communion with Brahman and thus a liberated soul while still on earth); (2) the realization that attaining deeper human potential "is not a matter of perpetuating but rather of transcending our present self-enclosed individual existence" (e.g., Jesus' teaching of love of others before self, Judaism's obedience to the Torah, Islam's submission of the ego to Allah's will, etc.); (3) the present conscious ego, which "must voluntarily relinquish its own self-centered existence" and the purpose of all the world's major religions, which "is to carry men and women through this momentous choice" (Hick, pp. 6–8).

Given these connections, Hick encourages Christianity to consider the possibility that this mortal life is not our only mortal life. Rather, since the goal is to actualize the potentiality of the human spirit to transcend its self-enclosed existence, Christian religion needs to incorporate the idea that mortal life was intended by God to engage a learning process leading it toward the goal of self-transcendence, and until this is accomplished, mortal life and death must continue for each individual consciousness. This view is strikingly familiar, since it seems to be an argument for reincarnation. But Hick's view differs from the Eastern view insofar as it postulates the idea that our different mortal lives occur in different worlds (perhaps even different dimensions?) until we make the proper "momentous" choice, a choice that will depend in part on the conditions in which the mortal life is lived.

This raises an interesting point. Perhaps our current world provides a terrible context for those of us currently living our mortal lives. Living in a world that valorizes individual choice in a social and economic environment that lauds competition between individuals for scarce resources and rewards because such competition makes our production more efficient, we may be in perhaps the worst milieu for the encouragement of self-transcendence. Hick's argument, then, seems to require that religion actually play a part in altering the mortal context, so that we might become capable of the self-transcendence that the major religions support. The implications of this are staggering, though not especially surprising given that many have argued that religion's cousin, philosophy, ought to play just such a role (Aristotle and Marx come immediately to mind). What is surprising is that few, if any, contemporary philosophers would make such an argument, in spite of the fact that this is a role to which philosophy (before the death of metaphysics) seems particularly well suited.

See also Buddhism; Christianity; Death; Heaven and Hell; Hinduism; Judaism; Platonism.

BIBLIOGRAPHY

Ackrill, J. L., ed. *A New Aristotle Reader*. Princeton, N.J.: Princeton University, 1987.

- Cobb, John B., Jr. "The Resurrection of the Soul." *Harvard Theological Review* 80 (1987): 213–227.
- Cooper, John M., ed. *Plato: Complete Works*. Indianapolis: Hackett, 1997.
- Cullman, Oscar. "Immortality of the Soul or Resurrection of the Dead?" *Theologische Zeitschrift* 2 (1956): 126ff.
- Hick, John. "Present and Future Life." *Harvard Theological Review* 71 (1978): 1–15.
- Kant, Immanuel. *Ethical Philosophy: The Complete Texts of Grounding for the Metaphysics of Morals, and Metaphysical Principles of Virtue, Part II of the Metaphysics of Morals*. Translated by James W. Ellington; introduction by Warner A. Wick. Indianapolis: Hackett, 1983.
- Kaufman, Gordon D. *Systematic Theology: A Historicist Perspective*. New York: Scribners, 1978.
- Kirk, G. S., J. E. Raven, and M. Schofield. *The Presocratic Philosophers: A Critical History with a Selection of Texts*. 2nd ed. Cambridge, U.K., and New York: Cambridge University Press, 1983.
- Moltmann, Jürgen. "Resurrection as Hope." *Harvard Theological Review* 61 (1968): 129–147.
- Pannenberg, Wolfhart. *Jesus—God and Man*. Translated by Lewis L. Wilkins and Duane A. Priebe. London: S.C.M. Press, 1968.
- . *What Is Man? Contemporary Anthropology in Theological Perspective*. Translated by Duane A. Priebe. Philadelphia: Fortress Press, 1970.
- Smith, Nicholas D. "Images, Education, and Paradox in Plato's Republic." In *Recognition, Remembrance, and Reality: New Essays on Plato's Epistemology and Metaphysics*, supplement to *Apeiron* 33 (2000): 126–140.

Tim Duvall

IMPERIALISM. See Empire and Imperialism.

IMPRESSIONISM. Impressionism was an artistic movement that originated in France in the 1860s and 1870s. In 1874, painters including Claude Monet, Camille Pissarro, Auguste Renoir, Alfred Sisley, Berthe Morisot, Edgar Degas, Armand Guillaumin, and Paul Cézanne participated in the first of eight independent Impressionist exhibitions held until 1886. They were eventually joined by Gustave Caillebotte and the American Mary Cassatt. Closely identified with the Impressionists was Edouard Manet, whose controversial works of the 1860s led the mostly younger Impressionists to consider him their leader, even though he refused to exhibit in their shows. The painter Frédéric Bazille was also associated with the group but was killed during the Franco-Prussian War, before he could join in the exhibitions he helped conceive.

Impressionist Practice and Purpose

Impressionism transformed the Western conception of landscape painting from timeless and nostalgic idealizations of distant places to accurate and brilliantly colored representations of existing, often familiar sites seen at specific moments. Responding to calls for modernity and naturalism—to reflect the environments of contemporary (French) humanity—the

Impressionists recorded their peers at both work and play. Although today we take for granted the practice of painting on the spot directly from observation, in the nineteenth century that commitment was controversial. It was inseparable from debates over the role of modern subjects in art (as opposed to classical ones), accompanied by pejorative comparisons to photography, which was considered mechanical, hence noncreative. Impressionist practices were also fraught with political connotations, conditioned by the new prosperity and related democratic aspirations. With their views of specifically contemporary activities, whether in Parisian cafés, on beaches or in flowery fields, or of the economic life on waterways, railways, and boulevards, the Impressionists made their paintings sensitive and inclusive reflections of modernity.

The name Impressionism was coined, following the first Impressionist exhibition, by a satirical critic named Louis Leroy. He made fun of Monet's *Impression: Sunrise* (1873, Musée Marmottan, Paris) a sketch-like view of the harbor of the painter's native Le Havre: "*Impression*: I was sure of it. I was telling myself, since I'm so impressed, there must be an impression in it. And what freedom, what ease in handling! A sketch for wallpaper is more finished than that there seascape!" Another name, *Intransigents*, though eventually abandoned, referred to a broader revolutionary significance. Following the Paris Commune (1871) by just a few years, the Impressionists elicited memories of radical politics because of their independent movement and their free and broken brushwork, which challenged the official art salons' monopoly on public exhibitions and defied the traditional craft of academic art, which taught careful draftsmanship and polished finishing.

Although there are wide variations in Impressionist style, especially when comparing the relatively traditional handling of Degas (*A Carriage at the Races*, 1869, Museum of Fine Arts, Boston) to the fragmented brushstrokes of color that Monet and Renoir (*La Grenouillère*, 1869, Nationalmuseum, Stockholm) developed side by side on the banks of the river Seine, the artists shared a commitment to the representation of modern life based on exacting observation of their own world. For those like Monet, Pissarro (*Red Roofs*, 1877, National Gallery, London), and Sisley (*The Bridge at Villeneuve-la-Garenne*, 1872, Metropolitan Museum of Art, New York), who painted primarily landscapes, working out of doors or *en plein air*, was an important step away from the artifices of the studio. Their more urban colleagues Manet (*A Bar at the Folies Bergère*, 1883, Courtauld Institute, London) and Degas surveyed the dance halls and the Opéra, as well as shops and boulevards for scenes of pleasure and material consumption, while the female Impressionists, Morisot (*The Cradle*, 1872, Musée d'Orsay, Paris) and Cassatt (*Little Girl in a Blue Armchair*, 1878, National Gallery of Art, Washington, D.C.), given the limitations of their access to the primarily male public world, developed a flair for domestic scenes.

For many, modernity was exemplified by countryside locations and sporting activities (Caillebotte, *Rowers on the Yerre River*, 1877, private collection). But Monet, Guillaumin (*Bridge over the Marne at Nogent*, 1871, Metropolitan Museum of Art, New York), Pissarro, and Cézanne (in his early years) included



***Impression: Sunrise* (1873) by Claude Monet. Oil on canvas.** Monet was arguably the most well-known of the Impressionists, and his painting technique became the hallmark of the movement. The term *Impressionist* was coined by a skeptical art critic reviewing Monet's *Impression: Sunrise*. © 1999 ARTISTS RIGHTS SOCIETY (ARS), NEW YORK / ADAGP, PARIS. REPRODUCED BY PERMISSION OF THE ARTISTS RIGHTS SOCIETY, INC.

as a counterpart to leisure scenes evidence of the productivity, infrastructure, and technologies that underlay French progress in the new industrial age. Indeed, the poet Charles Baudelaire, while lamenting the loss of taste occasioned by the rise of the bourgeoisie, urged modern artists to somehow capture the essence of their world, which for him was one of constant change, including the flow of crowded commercial avenues and socializing at sidewalk cafés. In addition, the productive processes and speed associated with factories and train travel were as much a part of the landscape of modern vision as were ladies on beaches and promenades among poppy fields. The liberal art critic Jules Castagnary actually called for a modern landscape that would reflect contemporary progress built on democratic change.

Neo-Impressionism and Beyond

Implicit in the word *impression* are two ostensibly opposed concepts: that of the rapid glance or instinctive judgment and that of the exact imprint, as in a photographic impression. Hence Impressionism could appear to some, such as Leroy, a shoddy

and unskilled practice, whereas to others the intuition that light is the basis of vision, and color its medium in art, was scientifically true. In addition, Impressionism's commitment to direct observation and its evocation of progressive change are generally associated with the spirit of positivism, a contemporary philosophy developed by Auguste Comte and applied to art by his disciple and specialist in the psychology of perception, Hippolyte Taine. Comte's quasireligion of progress based on scientific attitudes was followed by Taine's deterministic theories on the history of art. Their ideas might be stated as the relationship between art and its immediate physical and social environment, expressed through the empirical perceptions of the talented individual. Their follower, the novelist Émile Zola, a childhood friend of Cézanne, through whom he met the Impressionists, wrote famously that "art is no more nor less than a corner of nature seen through a temperament."

The association between these ideas and Impressionism can be gauged by the neo-Impressionist critique of their achievement. Certain artists of the next generation, especially Georges Seurat (*Sunday Afternoon on the Island of La Grande Jatte*, 1886,

Art Institute of Chicago), according to the critic Félix Féneon, sought to make Impressionism more socially responsible and democratic by developing a collective technique accessible to all. Seurat's dot-dash or pointillist method reduced the labor of painting to a repeatable formula, while at the same time creating the sensation of duration over time rather than a spontaneously grasped instant. On both grounds, neo-Impressionism claimed greater objectivity, thus challenging the individualist basis of Impressionist naturalism in favor of a shared and more permanent, hence more classical, vision. Through Seurat's eyes, then, Impressionism celebrated merely momentary, superficial pleasures and casual, intuitive craft rather than the mental and physical concentration derived from rational calculation and rigorous effort. This moralizing argument fit a political critique of bourgeois society that came to be associated with avant-garde painting of both the Right and the Left after Impressionism.

By contrast, while adhering always to the Impressionist model of painting directly from the motif with dabs of color, Paul Cézanne also managed to transcend the Impressionist sense of moment to produce what he called "a more lasting art, like that of the museums" (*Montagne Sainte-Victoire*, c. 1882, Metropolitan Museum of Art, New York). In ways more fruitful than Seurat, his increasing abstraction led toward future styles of the twentieth century, especially Cubism.

In the other arts, however, Impressionism's impact was limited. The sensitive, mobile surfaces of Auguste Rodin's bronze sculptures caught the light in ways associated with Impressionism. Claude Debussy's music came to be called Impressionist because it challenged past styles and evoked certain motifs in nature associated with Impressionist painting. In the literature of Henry James, the term refers to the literal naturalism of settings described in so much detail that it both overwhelms and yet concentrates our anticipation of the narrative.

In painting, almost every country had its Impressionist school; the British and the American, with their direct ties to Monet's circle, were the strongest. In later art, the abstract expressionism of artists like Jackson Pollock has been traced to Claude Monet's late *Water Lilies*, and the contemporary painter Joan Mitchell, who spent much time near Monet's former residence in Giverny, has been called an "abstract Impressionist." However, perhaps the greatest legacy of Impressionism is that it is the most popular style for so many amateur art colonies and Sunday painters, who celebrate both nature and leisure while working hard to develop their personal techniques.

After all the memoirs, biographies, and correspondence written by the painters and their contemporaries, Impressionism studies began in earnest with John Rewald, who used such documents to trace the Impressionist painters almost day by day and site by site. Interpretations of their art, however, remained within the legend of revolutionary aesthetic innovation and celebration of its seminal step toward modernist departures from literal representation.

The first writer to take seriously the social dimension to Impressionism's significance was Meyer Schapiro in his lectures at Columbia University and in a few short articles. He

was followed by Robert L. Herbert, whose disciples in particular have stressed the relationship between the artists and the history and significance of places they inhabited. At the same time, the social art historian T. J. Clark has focused on Impressionist paintings as documents of the changing physical environment and its social implications. Feminist scholars led by Linda Nochlin have focused on the female Impressionists as well as on the role of women as subjects of the male Impressionist gaze. Finally, a number of younger scholars have explored the relationship between Impressionism and politics.

See also Arts; Modernism; Nature; Visual Culture.

BIBLIOGRAPHY

- Berson, Ruth. *The New Painting: Impressionism 1874-1886: Documents*. 2 vols. San Francisco: Fine Arts Museums of San Francisco, 1996.
- Brettell, Richard. *Impression: Painting Quickly in France, 1860-1890*. New Haven and London: Yale University Press, 2000.
- Callen, Anthea. *Techniques of the Impressionists*. London: Orbis, 1982.
- Clark, Timothy J. *The Painting of Modern Life: Paris in the Art of Manet and His Followers*. Princeton: Princeton University Press, 1984.
- Herbert, Robert L. *Impressionism: Art, Leisure and Parisian Society*. New Haven and London: Yale University Press, 1988.
- Moffet, Charles S. *The New Painting: Impressionism 1874-1886*. San Francisco: Fine Arts Museums of San Francisco, 1986.
- Rewald, John. *A History of Impressionism*. 4th revised ed. New York: Museum of Modern Art, 1973.
- Rubin, James H. *Impressionism*. London: Phaidon, 1999.
- Tinterow, Gary, and Henri Loyrette. *Origins of Impressionism*. New York: The Metropolitan Museum of Art, 1994.

James H. Rubin

INDIGENISMO. The term *indigenismo* encompasses a diverse array of intellectual production concerning the indigenous peoples of Latin America. The twentieth century in particular witnessed an explosion of literary, critical, and visual work on the figure of the Indian. It should be made clear from the outset that the term, although most closely associated with Mexico and Guatemala and especially with the Andean region during the first half of the twentieth century, is applicable to Latin America's diverse nations and histories, including those not typically viewed as influenced by indigenismo. This broad geographical and historical scope stems from the wide appeal of indigenismo's central, self-declared objective: the defense and vindication of the continent's indigenous peoples. This objective distinguishes indigenismo from idyllic and idealized representations of the Indian with which Latin American cultural history is rife, as evidenced by, for example, Romanticism-inflected Indianist works of the nineteenth century. Indianism tended to portray the Indian in a sentimental light and did not address the social plight of indigenous peoples in modern Latin America. *Cumandá* (1879) by Ecuador's Juan León Mera (1832-1894) illustrates Indianism's tendency to portray the Indians as part of an idealized past and thus to ignore their contemporary presence.

Though extraordinary, the life of José Carlos Mariátegui (1894–1930) illustrates the contradictions that riddle indigenismo. Impoverished mestizos from the provinces, the young Mariátegui and his family emigrated to Lima, Peru's capital city, in hopes of bettering their social condition. Having dropped out of grade school in order to work, the crippled Mariátegui rose to prominence within the growing journalism industry with virtually no formal education. He did not turn his full attention to the problem of the Indian until his return from Europe in 1923, when he famously stated that his exile had allowed him to see Peru for the first time. This vision, filtered through his study of Marxism, led to his groundbreaking *Siete ensayos de interpretación de la realidad peruana* (1928; reprint. Mexico: Era, 1993), in which he declared:

la literatura indigenista no puede darnos una versión rigurosamente verista del indio. Tiene que idealizarlo y estilizarlo. Tampoco puede darnos su propia ánima. Es todavía una literatura de mestizos. Por eso se llama indigenista y no indígena. Una literatura indígena, si debe venir, vendrá en su tiempo. Cuando los propios indios estén en grado de producirla. [indigenista literature cannot give us a rigorously truthful version of the Indian. It has to idealize and stylize him. Nor can it give us his own soul. It is still a literature made by mestizos. That is why it is called indigenista and not indigenous. An indigenous literature, if it is to come, will come when it is ready. When the Indians themselves have the capacity to produce it.] (p. 306)

Conscious of his place within this dynamic, Mariátegui facilitated the forging of an indigenous voice through his publication of *Labor*, (1928–1929) a paper for the working class, and through his encouragement of indigenous self-organization.

In contrast to Indianism, indigenismo defines itself through its critical stance vis-à-vis the dominant society that exploits and debases indigenous peoples and their cultures. Clearly, this perspective has not been unique to modernity. Indigenismo finds foundational antecedents in the accounts of figures such as Bartolomé de las Casas (1474–1566) and el Inca Garcilaso de la Vega (1539–1616), who, respectively, denounced the ills visited upon Indians by the Spanish colonizers and praised the integrity and complexity of the Inca Empire in the face of accusations of its barbarity. Other sympathetic works on the Indian can be found in the eighteenth and nineteenth centuries, including Clorinda Matto de Turner's (1854–1909) *Aves sin nido* (1889; Birds without a nest) and Narciso Aréstegui's (1818–1892) *El Padre Horán* (1848). The critic Efraín Kristal considered the latter to be the first indigenista work. These works evidence the outrage typical of indigenista works as well as their authors' willingness to challenge such structures of authority as the church and the government. Thus, the vindication of the Indian through the indictment of social and political institutions was already in place at least as early as the mid-nineteenth century. Later indigenistas were equally in debt to figures such as Manuel González Prada (1848–1918) who was the first, in works such as "Discurso en el Politeama" (1888; Speech in the Politeama), to call for social revolt in order to rectify the abuses committed against the indigenous peoples.

The 1920s and 1930s

While indigenismo should and must be contextualized among the many discourses on the Indian produced during the colonial and Republican periods, its defining moment occurs with the explosion of voices on indigenous matters in the 1920s and 1930s. The movement's seminal novels, such as Alcides

Arguedas's (1879–1946) *Raza de bronce* (1919; Bronze race), Jorge Icaza's (1906–1978) *Huasiyungo* (1934), and Ciro Alegría's (1909–1967) *El mundo es ancho y ajeno* (1941; Broad and alien is the world), should nevertheless not overshadow the significant and arguably as important critical and scholarly production on the Indian in the same period. Works such as José Carlos Mariátegui's (1894–1930) *Siete ensayos de interpretación de la realidad peruana* (1928; Seven interpretative essays on Peruvian reality), Pío Jaramillo Alvarado's (1884–1968) *El indio ecuatoriano* (1936; The Ecuadorian Indian), Hildebrando Castro Pozo's (1890–1945) *Nuestra comunidad indígena* (1924; Our indigenous community), and José Vasconcelos's (1882–1959) *Indología* (1926) purported to study "the indigenous question" in a scientific light. These critical works, perhaps more so than their aesthetic counterparts, reveal the ways in which the importation and acquisition of foreign theoretical models fomented new perspectives on the indigenous problem and thereby offered novel solutions. Marxism, for example, played a central role in giving the defense of the Indian a distinctly revolutionary flavor. On the whole, novelistic, poetic, and critical discourses on the Indian had a profound impact on social and political movements, such as the APRA (Alianza Popular Revolucionaria Americana) in Peru and the Mexican Revolution, which sought to challenge the standing political and social order. A full study of the impact of the indigenista project on Latin American politics remains to be carried out. It should also be noted that the indigenistas were generally not progressive in terms of gender and that in fact most indigenismo is rife with stereotypical representations of femininity and masculinity.

The Uruguayan critic Angel Rama has presented the most compelling analysis of the social dynamics behind the

effervescence of indigenismo in the 1920s and 1930s. In his seminal *Transculturación narrativa en América Latina* (1982; Narrative transculturation in Latin America), largely concerned with the problem of representing autochthony in the region, Rama argues that the indigenismo of this period is in fact a product of the rise of the mestizo middle classes to power. In Rama's scheme of things, indigenismo is a kind of Trojan horse that, while addressing authentic social concerns regarding the Indian, nevertheless makes inroads against the dominant land-owning oligarchies to the benefit of mestizos—persons of mixed European and American Indian ancestry—and not especially the indigenous peoples. This observation reveals a crucial feature of indigenismo that has been taken for granted by most criticism, although notably not that of Mariátegui and his interlocutor Luis Alberto Sánchez (1900–1994). It demonstrates that while indigenismo claims to speak of the Indian's plight, it is in fact a phenomenon that occurs almost entirely within the majority mestizo culture of the continent. In the end, then, indigenismo benefits what Rama calls *mesticismo*, or the empowerment of the mestizo.

This observation rests primarily on the cultural and social heterogeneity that undergirds indigenismo. Indigenismo's mode of production reiterates the paradox at the center of the indigenistas' intellectual production: through its expression in the dominant language and culture, it tends to exclude those very subjects it represents. As such, indigenismo should be viewed less as a window on the indigenous people of Latin America and more as a complex example of how intellectuals have imagined alterity, or otherness, in the continent. Indigenista production can and must be read against the grain, as it certainly provides a vast and detailed portrait of the urban mestizo middle classes at the beginning and throughout much of the twentieth century. Indeed, the more recent writers in the indigenista tradition, including Rosario Castellanos (1925–1974), Miguel Angel Asturias (1899–1974), and José María Arguedas (1911–1969), have since 1950 transformed the indigenista vision into one that increasingly considers the role of indigenous culture in relation to mestizo society.

See also *Mestizaje*.

BIBLIOGRAPHY

- Aquézolo Castro, Manuel, ed. *La polémica del indigenismo*. Lima: Mosca Azul, 1976.
- Cornejo Polar, Antonio. *Literatura y sociedad en el Perú: La novela indigenista*. Lima: Lasontay, 1980.
- Kristal, Efraín. *The Andes Viewed from the City: Literary and Political Discourse on the Indian in Peru (1848–1930)*. New York: Lang, 1987.
- Mariátegui, José Carlos. *Seven Interpretive Essays on Peruvian Reality*. Translated by Marjory Urquidí. Austin: University of Texas Press, 1971.
- Rama, Angel. *Transculturación narrativa en América Latina*. Hanover, N.H.: Ediciones del Norte, 1982.

Jorge Coronado

INDIVIDUALISM. Individualism endorses the principle that the ends or purposes of the human individual possess

dignity and worth that take precedence over communal, metaphysical, cosmological, or religious priorities. While individualism may appeal to certain metaphysical or epistemological schools of thought such as nominalism or empiricism, it will be treated here as primarily a moral and/or political doctrine. Individualism is commonly seen by both its proponents and opponents to be the creation of the modern Western world, a development of Enlightenment liberal values.

The term *individualism* was first coined in the nineteenth century, initially around 1820 in French, and then quickly spread to the other European languages. In its origins, the term's connotations were pejorative: Joseph de Maistre (1753–1821) equated “individualism” with the “infinite fragmentation of all doctrines,” and Félicité Robert de Lamennais (1782–1854) treated it as indistinguishable from anarchy. The language of individualism was picked up and widely spread by the followers of Claude-Henri Saint-Simon (1760–1825). In Germany, England, and the United States, however, the negative overtones were soon stripped away. In Germany individualism became closely associated with the aspirations of Romanticism, in England, with utilitarianism and laissez-faire economics, and in America with the core political and social values of democracy and capitalism.

Concentration on the linguistic diffusion of individualism overlooks the fact that many cultures outside the Atlantic world at many times before the nineteenth century have promulgated doctrines that were individualistic in inclination. Moreover, it should not be forgotten that many who champion individualism count tendencies inherent in modernity itself among the chief threats to the individual. Thus, a full study of the history of individualism requires a survey of a broad range of thinkers and writings.

Ancient Sources

The major schools of classical Indian religion and philosophy generally upheld the doctrine of karma, the idea that an individual's status in the present life is a function of one's deeds in previous lives. This entailed not only that the soul was separable from the body—indeed, any body—but that it had a specific identity that transcended even corporeal death. Karma thus implied deep individual responsibility for one's actions and a system of assigning merit and demerit in the future depending on how one lives one's life in the present. That moral judgment is embedded in dharma—a universalistic system of absolute moral duties—is irrelevant. It still remains central to Indian thought that individual deeds are the wellspring of the moral system. For many Indian schools, and especially for Buddhists and Jainists, spiritual purification and eventual union with the Ultimate stem solely from the personal efforts of the individual. The right path is laid out, but it is up to the individual to follow it.

China produced doctrines that echoed the Indian emphasis on the individual. Confucius (551–479 B.C.E.) challenged both egalitarianism and hierarchical naturalism as explanations of human character. Although people are born with equal capacities, only some achieve superior moral standing because the individual's moral qualities are dependent on practice and

education. Confucius's follower Meng-Tzu (c. 371–298 B.C.E.; romanized as Mencius) elaborated this position by stipulating that environment and instruction are insufficient as explanations for why only some individuals attain superiority; in his view many simply “throw themselves away,” choosing not to adopt the path to righteousness, beneficence, and wisdom. Attainment of superiority thus rests in part on something like self-determination. Daoism, particularly Neo-Daoism, also evinced respect for individuality. The Daoist belief that each thing possessed its own nature could be interpreted not merely to pertain to natural species or types but to individual characters. According to the Daoist Chuang Tzu (fourth century B.C.E.), the freedom and peace of the spirit occur solely through knowledge of one's own inner nature, a position that, in turn, requires equal recognition and respect on the part of each person for the nature of one's fellow creatures. This focus on the nature of the individual was crystallized in the Neo-Daoist concentration on the particularity of human natures.

Self-knowledge was also the path to one's individuality for the Greek philosopher Socrates (469–399 B.C.E.), who sought to live by what he claimed as his personal motto, “Know yourself.” Accordingly, he maintained that virtue and other forms of knowledge cannot be taught or communicated directly from one person to another. Rather, each individual must discover what is true for him- or herself. But if wisdom is incommunicable, the philosopher may still question other human beings in order to prod them to realize the falsity that they embrace and to stimulate them in the process of self-questioning that yields self-knowledge. In Plato's *Apology* Socrates describes himself as a “gadfly” who annoys fellow Athenian citizens with his difficult and embarrassing questions and reveals their ignorance. Socrates' trial and death at the hands of the Athenian democracy has often been held up as a noble self-sacrifice in the cause of individualism against the conformity of the masses.

Socrates was not alone among Greek thinkers in proposing a version of individualism. Democritus (c. 460–c. 370 B.C.E.) emphasized the atomic nature of all matter and, thus, licensed a conception of humanity that emphasized the discrete character of individual creatures. In turn, this theory of individuation has been shown by recent scholars to have direct political overtones that favored the Athenian democracy. The Sophist Protagoras of Abdera (c. 485–420 B.C.E.) upheld the doctrine that “man is the measure,” which he interpreted as a moral principle, as well as an epistemological one, that supported the individual as the source and standard of human virtue.

Revealed Religion

Christianity contributed doctrines of the freedom of the will and personal salvation that added a further dimension to human individuality. Created as equal persons in God's image, human beings enjoy inherent dignity by virtue of the divine flame that burns within their souls. Christian moral teaching replaced status, race, gender, occupation, and all other markers of social difference with one's individual orientation toward God as the determinant of the ultimate disposition of one's soul. While Judaism had conveyed some overtones of personal salvation, the dominant relation with God was

conditioned by the divine covenant with the Jewish people as a whole. In contrast, Jesus' message was directed to all people who were open to his words and treated them as individuals capable of receiving divine grace and blessing. Every person, as one of God's created, could, through individual effort and renunciation of worldly concerns, render him- or herself worthy for salvation.

The implicit individualism of early Christian moral theology was reinforced by later thinkers such as St. Augustine of Hippo (354–430 C.E.). According to Augustine, all human beings possess the capacity to choose between good and evil and to choose to accept or to turn away from the divine will. Of course, the objects between which one chooses are not of equal worth. Rejecting God by preferring one's own desires yields dissatisfaction and unhappiness in one's earthly life as well as the misery of eternal damnation, whereas submitting to God properly expresses one's divinely granted freedom, the correct use of the will with which human beings have been endowed. Nevertheless, it remains up to the individual (even up to the moment preceding death) to decide whether to submit to or renounce God's offering. The individual is the final and ultimate source of the destiny of his or her own soul.

Islam did not entirely share Christianity's affinity for personal freedom of the will, emphasizing instead a strict adherence to religious law, namely, *shari'a*. Yet the Koran did uphold human freedom, so Muslim teaching maintained that it was the individual, not God, who was responsible for sin. Likewise, the Koran offered a vision of personal salvation that was far more embodied and carnal than Christianity's. Thus Islam, too, adopted important elements of individualism.

Despite the common perception of medieval Europe as monolithic and hostile to expressions of individualism, the period did much to extend the idea of human individuality. In law, the concept of human beings with personal rights and liberties was expressed in both secular and religious documents. In public life, the principle of individual consent to the imposition of political power (captured in the ubiquitous phrase “What touches all must be approved by all”) was articulated. In moral philosophy and theology, the conception of the rational will, which defined the individual as the primary unit of analysis, was elevated to axiomatic status. Regardless of the institutional and ecclesiastical barriers to individualism, scholars have repeatedly looked to Latin Christian Europe as a source for individualism.

The Reformation and the Aftermath

These medieval tendencies came to fruition during the sixteenth and seventeenth centuries, so that individualism in the modern world deserves to be understood as a culmination of far earlier intellectual trends. The Reformation brought not only a challenge in practice to the unity of the Christian Church but also a transformation of important theological categories. Martin Luther (1483–1546) insisted on the unique presence of God alone in the conscience of believers, with the implication that the faithful Christian is responsible directly and immediately to God. The consequence of this teaching—while perhaps recognized only fleetingly by Luther and his

followers—was that salvation did not depend on submission to the authority of the priesthood or the church. Nor did it fall to the secular power, to which pertained the control of bodies and behavior, to discipline the souls of subjects. Thus, whether intentionally or not, Luther opened the door to claims of public respect for liberty of conscience and eventually individual freedom of worship.

In the generation after Luther, inferences about personal freedom of religion were deduced by reforming thinkers. Sebastian Castellion (1515–1563) published pseudonymously a treatise entitled *De haereticis, an sint persecuendi* (On heretics, whether they are to be persecuted) in response to John Calvin's organization of the burning of a fellow Christian theologian for heresy at Geneva. Castellion argued that Christian belief must be held with sincere conviction. Hence, clerics and magistrates must refrain from persecution of convinced Christians who cling to doctrines that do not coincide with official teachings. Castellion maintained that the individual Christian's duties extend to forbearance of the free and honest faith of one's fellows even in the face of disagreements of understanding and interpretation.

In the seventeenth century, the individualism implicit in confessional pluralism would become more pronounced. For instance, Baruch Spinoza (1632–1677) claimed a broad application for the right to liberty of thought and belief without interference from a sovereign power's (or a church's) determination of the truth or falsity of one's ideas. Pierre Bayle (1647–1706) asserted that all forms of persecution (innocuous as well as harsh) of religious diversity encourage hypocrisy and erode social order. An erring conscience, if it be held in good faith, deserves as much protection as a correct one—a principle that Bayle extended even to atheists.

John Locke (1632–1704) proposed liberty of individual conscience as justified in the case of most Christian (and perhaps some non-Christian) rites. For Locke, the role of the magistrate should be confined to the maintenance of public tranquility and the defense of individual rights rather than the care of the soul. Hence, Locke's *Letter concerning Toleration* (1690) defended a vision of the church as a purely voluntary association that a believer was free, according to conscience, to enter or leave at will. Locke crystallized a key Reformation shift: the idea that one's religious confession is a matter of individual choice rather than institutional imposition.

The evolving acceptance of individualism paralleled changes in other European cultural, social, and political practices and attitudes. The invention of the printing press and movable type in the mid-fifteenth century immeasurably enhanced the ability of individuals to spread their ideas and made it possible for a larger public to access the written word. Demands were heard for freedom of the press (literally and figuratively) from censorship by clerical and secular authorities alike. While republican values that promoted civic virtue over personal choice retained a hold on public discourse, political liberty in geographically extensive regimes with monarchic institutions tended to be conceived in terms of individual freedom rather than civic populism. Hence, it is at this time and place that the origins of the bundle of individualist doctrines known as liberalism are found.

Liberalism and Individualism

Thomas Hobbes (1588–1679) generally is identified as the most important direct antecedent of modern individualist philosophy. In his *Leviathan* (1651), Hobbes ascribed to all individuals natural liberty (as well as equality) on the basis of which they are licensed to undertake whatever actions are necessary in order to preserve themselves from their fellow creatures. Hobbes believed that the exercise of such natural liberty logically leads to unceasing conflict and unremitting fear so long as no single sovereign ruler exists to maintain peace. The exchange of chaotic natural freedom for government-imposed order requires renunciation of all freedoms that humans possess by nature (except, of course, self-preservation) and voluntary submission to any dictate imposed by the sovereign. Yet, even under the terms of Hobbes's absolute sovereignty, individuals are deemed to remain at liberty to choose for themselves concerning any and all matters about which the ruler has not explicitly legislated.

Locke begins his mature political theory in the *Second Treatise of Government* (1689) with the postulation of the divinely granted liberty of all individuals, understood in terms of the absolute right to preserve one's life and to lay claim to the goods one requires for survival. Arguing against the patriarchal doctrine of Sir Robert Filmer (1588–1653), Locke insists that no natural basis—neither paternity nor descent—justifies the submission of one person to another. Rather, each individual is the proprietor of his or her (divinely endowed) physical and mental talents, abilities, and energies. The individual thus constitutes the basic unit of social and political analysis for Locke, who is sometimes considered the proponent of the doctrine of “possessive individualism” par excellence.

In contrast to Hobbes, Locke maintains that the natural condition of individual proprietorship can be maintained tranquilly because human beings are deemed sufficiently rational that they can and do generally constrain their free action under the terms of the laws of nature. Hence, should people choose to enter into formal bonds of civil society and authorize a government in order to avoid the “inconveniences” and inefficiency of the precivil world, the only rule worthy of consent is that which strictly upholds and protects the liberty they naturally possess. According to Locke, any government that systematically denies to its subjects the exercise of their God-given liberty (as Hobbes's sovereign would do) is tyrannical and cannot expect obedience.

Individualism and Modern Society

The eighteenth and nineteenth centuries witnessed an emerging role for the individual that culminated in the appearance of the language of individualism. One strand in the intensified interest in the individual was the rise of capitalism as an economic system that emphasized the individual both as the holder of self-interest and as the foundation of all legal rights. Perhaps the most famous early advocate of economic individualism was Adam Smith (1723–1790). Although Smith is sometimes labeled the first great economist of capitalism, he preferred to describe his system in terms of “natural liberty,” arguing that the welfare of society is best served when every individual seeks his or her own advantage without reference

to any overarching scheme of goodness or justice. When individuals are left to their own devices, Smith held, the ensuing system possesses an inherently self-adjusting quality that will ensure the maximum satisfaction of individual desires.

The apotheosis of individualism may be found in the utilitarian doctrine, formulated most clearly by Jeremy Bentham (1748–1832), that social policy should promote the greatest good for the greatest number of people. This idea rested on the principle that all individual estimations of utility deserve equal treatment and respect in comparison with all others. Hence, no person could claim that his or her calculation of happiness counted for any more or less than another's. A truly democratic society should treat the wishes and desires of each of its individual members with the same dignity, without regard for moral judgments concerning the content of those aims. Bentham elaborates the basic insight of Smith to cover the full range of political and social programs and institutions.

Although liberalism could seem to take individualism for granted, the extreme egalitarianism of the utilitarian position, coupled with the events of the French Revolution (1789–1799), made many thinkers (including those of a liberal stripe) nervous. Edmund Burke (1729–1797) was concerned that the spread of democratic equality and the breakdown of the organic social order would lead to the fragmentation of persons into atomized individuals lacking any sense of identity or place. He scorned the individual's "private stock of reason" in comparison with the wisdom of history, fearing that the glorification of individuality presaged the crumbling of regard for the tradition-bearers of social authority, such as the monarchy, the nobility, and the church. Under such circumstances, Burke predicted (presciently, as it turns out) that authoritarian forms of government would step into the breach and provide an artificial identity for individuals as a remedy for their extreme alienation.

The French social commentator Alexis de Tocqueville (1805–1859) similarly believed that an excess of democratic equality bred individualistic isolation in which people retreat from public life into families and small groups of interested combines. The unavoidable results of individualism are egoism, the suppression of all virtues, and the concession of political deliberation to the "tyranny of the majority"—conclusions reached on the basis of his observations of American as well as French modes of democracy. In Tocqueville's view, America's avoidance of the corrosive effects of individualism (at least in the early nineteenth century) stemmed from its valorization of liberty over equality as the basis of social relations. Note that true liberty is not, for Tocqueville, individualistic.

Karl Marx (1818–1883) occupies an interesting position in the history of individualism. Although Marx is commonly regarded as a holistic social thinker, he in fact repeatedly asserted that individual self-realization was the standard against which social relations should be judged. In his early writings, he condemned capitalism for the alienating and dehumanizing impact that it exercised on individual workers, while in the *Communist Manifesto* (1848) he called for a system of equitable distribution of the fruits of labor on the grounds that the

precondition of the liberty of each is the liberty of all. Like his predecessor Jean-Jacques Rousseau (1712–1778) and his contemporaries, such as the anarchist Jean-Pierre Proudhon (1809–1865) and the utopian Charles Fourier (1772–1837), Marx believed that communal equality constituted the necessary prerequisite for the flourishing of free individuals.

John Stuart Mill (1806–1873) shared some elements of nineteenth-century skepticism about mass democratic society, but his writings crystallized the understanding of individualism still widely shared in Western societies. According to Mill's important essay "On Liberty" (1859), the interests of humanity are "progressive," in the Enlightenment sense that human beings seek material and moral improvement. Mill holds that the societies that are most likely to promote this goal—societies that he terms "civilized"—share the common factor of defending and promoting individual liberty. Individualism—understood as experimentation with lifestyles and ideas—challenges uncritically received sureties and broadens the basis of human knowledge. Borrowing from Tocqueville, Mill admits that democratic society contains the potential to dampen or even forbid many expressions of personal liberty that stand at odds with mass tastes or beliefs. In contrast to Tocqueville, however, Mill maintains that individualism stands on the side of liberty, not equality. A free society supports individualism.

The trend toward the foregrounding of the individual continued in the work of Friedrich Nietzsche (1844–1900). Nietzsche reviled the "herd mentality" of modern mass society, which espouses conformity and mediocrity as the highest aspirations of humanity. He proposed, instead, that an individual might attain the "transvaluation of values," by which he meant that one could generate authentically for one's self the unique principles that would guide oneself and oneself alone. Principles of this higher sort cannot be imposed or taught by one to another. Rather, the authentic individual must discover in a radically individualized way those precepts that realize his or her own valuation. Nietzsche drew no explicit political theory from this because politics, as the realm of imposition of coercive authority over others (the "will to power"), was incompatible with the deep individualism that he advocated.

Persisting Debate

The twentieth and early twenty-first centuries have witnessed the spread around the globe of a culture that valorizes the human individual. Expressions of this individualism have been, however, extremely diverse. The philosophical and literary school of existentialism found a vast audience among both intellectuals and popular audiences during the middle of the twentieth century. The existentialists—the best known of whom were Martin Heidegger (1889–1976) and Jean-Paul Sartre (1905–1980)—proclaimed the radically individualistic situation of human beings. In particular they focused on the profound nothingness of death—the one element of human existence that each person necessarily experiences uniquely and individually, since no one can die another person's death—as a way of clarifying the condition of human Being. Positing the nonexistence of God, existentialism asserts that each individual must *create* meaning in his or her life through acts of personal will.

Dependence on other people or institutions—priests, philosophers, governments, or even family and friends—for meaning leads to inauthentic forms of existence. Because death cannot be escaped, inauthenticity ultimately reveals itself in the confrontation with one's own mortality. Each and every individual must eventually face the question, "Why do I exist?" And only in the deeds one freely performs does an authentic response arise.

Under the growing influence of economic thought, individualism has also been promoted under the guise of the logic of market relations. Libertarians such as Friedrich von Hayek (1899–1992), Robert Nozick (1938–2002), and, more popularly, Ayn Rand (1905–1982) proposed schemes of society that radically limited the power of the state and permitted broad scope for individual choice in all spheres of life. Each adopted a different starting point for these doctrines: for Hayek it was a quasi-utilitarian model of laissez-faire economics, for Nozick Lockean natural rights theory, and for Rand an original philosophical system that she called "objectivism." Yet, each thinker proposed that governmental regulation of the individual, and thus constraint on free choice and autonomy, amounted to a denial of authentic humanity.

In its avowedly neoclassic turn against Keynesian welfare economics, recent economic thought reinforces much of the individualism of the libertarian school (Hayek, of course, is well known as a leading economist as well as a political philosopher). Neoclassic economics holds that growth and efficiency within markets depends on the maximization of individual rational satisfaction. When political institutions (or presumably any other extrinsic factors) impinge on choice by limiting options or regulating competition, the perfect flow of information that the free market produces is impeded and inefficiency is introduced. The salient assumption of this economic theory is that individuals are rational satisficers or maximizers; that is, they are the best (indeed, the only legitimate) source of decisions about what is best for themselves. Neoclassic economics, broadly construed, embraces rational egoism and hedonism as the only psychological premises that comport with the principles of free markets. The economic model has in turn been appropriated by other social sciences, such as political science, under the name of "public choice" or "rational choice" theory.

Of course, individualism remains a controversial idea. No less than Saint-Simon and his followers, modern communitarians worry about the socially corrosive effects of individualism, as evinced by rising levels of crime, political alienation, and unrestricted consumerism. In a widely acclaimed recent empirical analysis of social capital in America, Robert D. Putnam (b. 1940) has argued that the phenomena Tocqueville once identified as bulwarks against social decay in American democracy—in particular, local-level voluntary associations and community-based activities—are increasingly disappearing. Americans are "bowling alone" (to employ Putnam's own central image of rampant individualism) rather than joining leagues or social clubs to pursue common interests. Leaving aside its empirical dimensions, Putnam's provocative thesis raises for communitarians the specter of whether a social order composed of monadic units can sustain the values of democratic politics.

See also Alienation; Free Will, Determinism, and Predestination; Identity; Person, Idea of the; Personhood in African Thought; Responsibility; Society; State, The; Utilitarianism; Utopia.

BIBLIOGRAPHY

- Black, Anthony. "Society and the Individual from the Middle Ages to Rousseau: Jurisprudence and Constitutional Theory." *History of Political Thought* 1 (1980): 145–166.
- Coleman, Janet, ed. *The Individual in Political Theory and Practice*. New York: Oxford University Press, 1996.
- Engelmann, Stephen G. *Imagining Interest in Political Thought: Origins of Economic Rationality*. Durham, N.C.: Duke University Press, 2003.
- Farrar, Cynthia. *The Origins of Democratic Thinking: The Invention of Politics in Classical Athens*. Cambridge, U.K.: Cambridge University Press, 1988.
- Hobbes, Thomas. *Leviathan*. Edited by Edwin Curley. Indianapolis: Hackett, 1984.
- Locke, John. *Letter concerning Toleration in Focus*. Edited by John P. Horton and Susan Mendus. London: Routledge, 1991.
- . *Two Treatises of Government*. Edited by Peter Laslett. Cambridge, U.K.: Cambridge University Press, 1988.
- Lukes, Steven. *Individualism*. Oxford: Oxford University Press, 1973.
- Macfarlane, Alan. *The Origins of English Individualism: The Family, Property, and Social Transition*. Oxford: Blackwell, 1978.
- Macpherson, C. B. *The Political Theory of Possessive Individualism, Hobbes to Locke*. Oxford: Oxford University Press, 1962.
- Marx, Karl. *The Marx-Engels Reader*. Edited by Robert C. Tucker. New York: Norton, 1978.
- Mill, John Stuart. *On Liberty in Focus*. Edited by John Gray and G. W. Smith. London: Routledge, 1991.
- Plato. *The Apology of Socrates*. In *Five Dialogues*, translated by G. M. A. Grube. Indianapolis: Hackett, 1981.
- Putnam, Robert D. *Bowling Alone*. Cambridge, Mass.: Harvard University Press, 2000.
- Tocqueville, Alexis de. *Democracy in America*. Edited by J. P. Mayer. New York: Harper, 1969.

Cary J. Nederman

INTELLECTUALS. *See* **Intelligentsia.**

INTELLIGENCE, ARTIFICIAL. *See* **Computer Science.**

INTELLIGENTSIA. An abundance of studies on the subject of intellectuals has focused on societal differences and disparate issues, and featured a wide array of eras, cultures, and practices. A comparison by Raymond Williams between the French tradition of the intellectual engaged in public issues and the more reserved role ascribed to his or her English counterpart attests to this difference among societies. It has become customary to associate intellectual activity with the ideas of modernity and universality that arose during the Enlightenment.

However, the nature, configuration, and functions of that activity have evolved considerably since the eighteenth century, covering a range of subjects that are as diverse as the intelligentsia's areas of influence, forms of expression, and objects and goals. As the scholar and critic Edward Said (1935–2003) observed:

The proliferation of intellectuals has extended even into the very large number of fields in which intellectuals—possibly following on [Antonio] Gramsci's pioneering suggestions in *The Prison Notebooks*, which almost for the first time saw intellectuals, and not social classes, as pivotal to the working of modern society—have become the object of study. . . . There are thousands of different histories and sociologies of intellectuals available, as well as endless accounts of intellectuals and nationalism, and power, and tradition, and revolution, and on and on. Each region of the world has produced its intellectuals and each of those formations is debated and argued over with fiery passion. There has been no major revolution in modern history without intellectuals; conversely, there has been no major counter-revolution without intellectuals. (p. 8)

Intelligentsia and Society

Although the intellectual world's diversity and multiplicity have been recognized, the question of the precise nature of intellectual activity continues to be debated. The early-twenty-first-century controversy over scientific research in France provides an excellent example with which to consider the question of the intelligentsia within the particular context of globalization. In this conflict, the parties involved are, on one side, researchers who have accused the French government of taking an anti-intellectual stance in making budget cuts and putting severe limits on scientific research, and, on the other, government policy makers who label such protestors as ideologues. And, in the debate that seems to have developed ever since the Dreyfus affair—an event that is commonly associated with the coining of the word *intellectual* and that pitted artists, journalists, and other intellectuals against the two most powerful institutions in French society, the army and the government—the polarization of the Left (progressives and liberals) and the Right (conservatives and reactionaries) has taken shape in the public arena with new intellectual figures (here considered as actors) and focusing on intelligence (conceived of as a resource). Some intellectuals who are opposed to this polarization have denied an identification with the role of the intellectual and any relationship to government that that implies. The principal promoter of this middle path, Alain Finkielkraut, justifies his position in refusing to be defined as an intellectual, saying that intellectuals in the early-twenty-first-century “only enter the public arena to accuse the guilty.” He takes issue with the petition denouncing “the war on intellectualism” launched against the French government by the magazine *Les Inrockuptibles*.

In contrast to Finkielkraut, Said insists on the rebellious role of the intellectual, as one who questions more than he or she sanctions—“The intellectual as exile and marginal, as

amateur, and as the author of a language that tries the truth to power.” Said also noted that, in English, “the word ‘intellectual’ was [usually associated with] ‘ivory tower’ and ‘sneer.’” The negative connotations of the term are underlined by Raymond Williams in *Keywords: A Vocabulary of Culture and Society*. Until the middle of the twentieth century, unfavorable uses of *intellectual*, *intellectualism*, and *intelligentsia* were dominant in English, and, according to Said, “it is clear that such uses persist” (pp. xiv, x).

The contemporary controversy over the identity and goals of the intellectual, by way of the references and history that the controversy summons up, emphasizes questions about the nature and political economy of intelligence in its relationship to society and the public arena. Two questions in particular recur repeatedly in this debate. The first is whether or not intellectual work and activist intervention are compatible, and if the intellectual has a duty to declare a position for or against the important issues of the day. The second is whether or not the intellectual has the means and legitimacy to intervene in the public debate. The arguments triggered by the negative assessment by researchers and cultural figures of the politics of the French government are not new. On the contrary, they are part of a long tradition that has shaped the function, role, representation, and actions of intellectuals in contemporary society, in their variety, their clashing and changing trajectories, and the conflicts that they bring or incite.

The controversies involve political, cultural, and moral questions as much as they do issues relating to the influence of language, traditions, and historical conditions on intellectual intervention. More precisely, it is a question of determining whether, in taking positions, the intellectual must make clear his or her relative independence, or take a position aligned with a political party, church, or cultural group. Should the intellectual express support for a universalist tradition disdainful of all local cultural roots and all references to a particular place, belief, or community? If one accepts that every intellectual has a particular audience and belongs to a particular culture, what establishes him or her as an intellectual is the ability to think and act independently from them. The possibility of moving between sticking to what is familiar (staying within one's historical community) and being open-minded (embracing the universalist tradition), speaking out in public or retreating to the ivory tower, seems to have contributed to the identity of the intellectual and the utilization of intelligence in all human societies.

Of course, styles, grammars, and degrees of prolificness are not all similar as marks or emblems, even if the historical path of the West has become established as the metanarrative and the inescapable point of reference with respect to human universality. Despite this, whether in agreement with the Western model or dissenting from it, different practices have flourished since the opening of the world to European imperialism, addressing Western hegemony in light of particular aspects of dominated societies (colonial and postcolonial) or peripheral societies (China and Japan, for example), striving to create alternative visions. The emergence of these new voices, the diversification of intellectual horizons, whether

colonial or postcolonial or embracing non-European nationalisms, and the cultural, ethnic, religious, and racial emphases that distinguish human societies, continue to give rise to an extraordinary metamorphosis in intellectual identity. As a result, the most basic intellectual foundations and the assumption of a fixed point around which everything revolved have been called into question. Whereas the philosophical ideas of the Enlightenment seemed to have succeeded in dividing rational intelligence from feelings, personal life from public life, the twentieth and twenty-first centuries have seen configurations of greater complexity, a diversity of intellectual vehicles, sources, and individuals and groups who declare themselves to be (or are regarded as) intellectuals.

Definitions

Edward Said's *Representations of the Intellectual: The 1993 Reith Lectures* offers an excellent starting point for defining this type. Among the supporting materials on which Said relies are two well-known books, *Quaderni del carcere* (1947; *Prison Notebooks*) by Antonio Gramsci (1891-1937) and *La trahison des clercs* (1927; *The Treason of the Intellectuals*) by Julien Benda (1867-1956). These texts were written in different circumstances but with identical concerns, relating to the appearance of theories and practices that contradict or threaten the transcendent values of truth, justice, and humanity. After comparing Benda and Gramsci—who “clash fundamentally” over the issue of who qualifies as an intellectual (for Benda, it is a small group of clerks chosen in a draconian manner; for Gramsci, all individuals are intellectuals, even if not all perform such a function in society)—Said proposes a simple definition of *intellectual*: “An individual endowed with a faculty for representing, embodying, articulating a message, an attitude, philosophy, or opinion to, as well as for, a public” (p. 9). The intellectual's vocation is manifested in the consummate art of representation through words, writing, teaching, and participation in the media, including radio, television, and the press.

It is not disputed that the mission of the intellectual is to advance human knowledge and freedom. It is the differences in thoughts and beliefs that are important and often irreconcilable in determining who should be in command of this task, to what ends, and with what means. But who are these intellectuals whose nature is revealed by the role that they play or that society assigns them? Gramsci made a distinction between two types: on the one hand, the traditional intellectuals, priests, teachers, administrators, who ensure the cohesion of the hegemonic culture, while renewing, generation after generation, these traditional roles; and on the other hand, the “organic” intellectuals who, while a part of civil society, maintain a sometimes strained relationship with it. They are in the service of the social classes or enterprises that organize them and mobilize them to defend particular interests. They are, to borrow a phrase from the French philosopher Jean-Paul Sartre, engaged in society.

Benda was concerned with a category that he identified as a small group of erudite people, guardians of an irreproachable morality: a “conscience of humanity” responsible for administering the empire of justice and truth that transcends

the world in which they live. In Benda's vision, intellectuals have the responsibility of denouncing corruption, defending the weak, and defying oppressive authority. In this sense, they are agents of a mission that, if betrayed, has harmful effects on society. The values that they try to secure and preserve, because they apply to all peoples and nations, carry a seal of universality, for they are transcendent, transhistorical, transnational, and transcultural.

In the early twentieth century, Gramsci and Benda traced the spread of intellectualism and the identifying elements that marked the intellectual; the definitions in use at the beginning of the twenty-first century are variations based on their ideas, to which have been added a consideration of the emergence and consolidation of power, of wealth, and of the ascendance of new professions engaged in intellectual pursuits. In effect, in the early twenty-first century the term *intellectual* is applied to all activities connected with the production and circulation of knowledge as described by Gramsci; as noted by Said, “broadcasters, academic professionals, computer analysts, sports and media lawyers, management consultants, policy experts, government advisers, authors of specialized market reports, and indeed the whole field of modern mass journalism itself . . . have vindicated Gramsci's vision” (p. 7). Located there is the creative tension present at the heart of the mission and the demands of the intellectual, caught between the rebellion against and constant questioning of the hegemonic culture and support for the latter in order to ensure “order and continuity in public life” (p. 27).

Régis Debray has provided an excellent history of the intellectuals in modern France. Debray's discussion is divided into three historical periods: Between 1880 and 1930, the figure of the intellectual was solidly attached to institutions, none more so than the university; as professionals devoted to teaching and research, intellectuals found in these institutions effective protection against the church and its power. Between 1930 and 1968, the university lost its privileged place in the intellectual firmament, at least in the representation of the intellectual figure; in that function it was superseded by publishing houses, in which intellectuals and publishers formed “a new spiritual family,” as Debray aptly described the relationship, citing such “family” members as Sartre, André Gide, Simone de Beauvoir, the Gallimards, and André Malraux. After 1968 this spiritual family broke up; intellectual engagement in the political sphere and the public arena took a new turn and created new idioms. Mao Zedong's China replaced the USSR as the ne plus ultra of socialism. Discourses and practices took to the fields or factories before moving on to editorial offices or radio and television production, government ministries, literary or film work. Debray strongly criticized this transformation, which enlarged intellectuals' sphere of influence while at the same time endangering their authority, for their reliance on their peers gave way to a search for a captive audience: “By extending the reception area, the mass media have reduced the sources of intellectual legitimacy, with wider concentric circles that are less demanding and therefore more easily won over. . . . The mass media have broken down the closure of the traditional intelligentsia, together with its evaluative norms and its scale of values” (pp. 71, 81).

Even though the history related by Debray applies to France, from his study one can draw the general conclusion that the power and legitimacy of intellectuals derive as much from the institutions with which they are affiliated and from the influence that they are able to exert as a result as they do to their individual authority. For example, describing the situation of intellectuals in the United States, Alvin Gouldner emphasizes the considerable increase in the areas of expertise that one could categorize as “intellectual” and the development of a culture of critical discourse for each of those categories. Beyond those identified by Said and Debray, he cites such late-twentieth-century additions as military strategist and international lawyer, which, like publisher and writer, utilize a specialized vocabulary that is shared only with peers of these disciplines. The French philosopher and social critic Michel Foucault (1926–1984), commenting on this enlargement of the intellectual sphere to include new kinds of practitioners, pondered the consequences of replacing the universalist intellectual—the kind that Benda and Gramsci had been concerned with—by the specialist, whose expertise justified his or her intervention in other spheres, the public arena in particular.

Challenges to Traditional Discourse

The studies outlined above emphasized the transformations of the intellectual sphere, the diversification of its principal practitioners, and changes in vocabulary, kinds of expertise, and institutional configurations or means of representation. Challenging the universality of the West’s historical path (as much through racial as sexual distinctions) opened a space in which to deploy other narrations and different forms of intellectual engagement. Feminist, civil rights, and colonialist and post-colonialist social movements that have arisen in opposition to Western conceptions of universality and modernity have striven to set precise goals for intellectuals. The questions that preoccupy thinkers, in Africa as in Asia, are whether or not there will be, on the one hand, changes to accepted bodies of knowledge and the traditional role of indigenous intellectuals, and, on the other hand, the nativization of modern Western procedures and forms of learning and intellectual intervention in societies where Western modes of reference have been imposed. For Africa and the black diaspora, there are two excellent texts: Frantz Fanon’s *Les damnés de la terre* (1961; *The Wretched of the Earth*) and Robin Kelley’s *Freedom Dreams: The Black Radical Imagination*. The latter succinctly captures the assault by newcomers on the universalist metanarrative:

Social movements generate new knowledge, new theories, new questions. The most radical ideas often grow out of a concrete intellectual engagement with the problems of aggrieved populations confronting systems of oppression. For example, the academic study of race has been inextricably intertwined with political struggles. Just as imperialism, colonialism, and post-Reconstruction redemption politics created the intellectual ground for Social Darwinism and other manifestations of scientific racism, the struggle against racism generated cultural relativist and social constructionist scholarship on race. The great work of W. E. B. Dubois, Franz Boas, Olivier Cox, and many others were invariably shaped by social

movements as well as social crises such as the proliferation of lynching and the rise of fascism. Similarly, gender analysis was brought to us by the feminist movement, not only by the individual genius of the Grimke sisters or Anna Julia Cooper, Simone de Beauvoir, or Audre Lorde. Thinking gender and the possibility of transformation evolved largely in relationship to social struggle. (p. 9)

Kelley is interested in the connections between intellectual practices and social movements, whereas Fanon is concerned with the mission of the colonized intellectual in the context of the struggle for national independence and social revolution. He shows how the man or woman of culture—the intellectual—in this context, using historical sources, strives to systematically counter the thesis of the barbarism of precolonial societies in order to re-create a community, his nation and state. Fanon shrewdly presents the different phases in the maturing of the nationalist intellectual, who begins by assimilating the colonial culture of his masters and ends with revolutionary combat, through which he or she is transformed into a guide of the people, producing a body of intellectual work that furthers revolutionary nationalist goals. Between these two poles, there is an intermediate phase of discovery of the self—a creative moment when the intellectual celebrates his or her people, history, and legends reinterpreted through the prism of an aesthetic and a worldview borrowed from the West. More sophisticated than the rigid orthodoxy of Fanon is the relatively soulful approach of Paul Robeson (1898–1976), which has given rise to a plan of liberation that takes into account emotion (exemplified by the West African poet Léopold Sédar Senghor) and poetic knowledge (as seen in the West Indian poet Aimé Césaire). Robeson transformed the idea of Western modernity by subverting the rationalist ideas of the Enlightenment in order to restore Negro spirituality to the portrait of European civilization. In an article from 1936, “Primitives,” Robeson—who, according to Kelley, blamed the Enlightenment for the rise of fascism—wrote that the Enlightenment’s focus on rationality and intellect removed spirituality from European civilization and, in doing so, led to its ultimate failure. Robeson believed that to save Western civilization, spirituality and art needed to be restored to a central position in social life and that American Negroes, who knew Western culture yet retained the “core cultural values of their ancestral homeland,” were uniquely qualified to do so.

Another noteworthy branch of later intellectual history is that of Chinese intellectuals who, at the beginning of the twentieth century, tried to respond to the challenges of Western modernity. At the forefront of this mission was a group who went under the name the May Fourth Movement. “In May Fourth discourse,” observe Leo Ou-fan Lee and Merle Goldman in their introduction to *An Intellectual History of Modern China*, “The modern intellectual stands in privileged position vis-à-vis Chinese society and the Chinese people—as the former’s moral conscience and reformist advocate and the latter’s voice. Despite the May Fourth’s revolutionary nature, the intellectual elite position vis-à-vis society resonated with that of their literati ancestors. Like them, they saw themselves as the rejuvenators of Chinese culture, which they believed was the

key to China's salvation" (p. 4). Thus, Lee and Goldman point out that the balancing act noted in the West and in nationalist and postcolonial traditions also occurred in China from the beginning of the twentieth century up to the changing ideologies of the Chinese Revolution under various figures, a role pioneered by intellectuals during the Cultural Revolution (1966–1976). The reforms of the 1980s and the opening up of China to certain forms of capitalist production seem to have had similar overall effects on intellectuals there as in the rest of the world, namely enlargement and diversification of the kinds of intellectual activity being practiced. According to Lee and Goldman, "Chinese intellectuals at the end of the twentieth century had turned themselves into scholars, technocrats, cultural producers, business people, and entertainers, but they were no longer social prophets, the agents of national salvation, or visionary leaders of change as they had been throughout most Chinese history and even into the Mao era until Mao brutally suppressed them" (p. 8).

Response to Orthodoxy

There are numerous examples throughout the world that show, in the diversity of intellectual approaches, appropriations, and rejections of Enlightenment rationality, acute tendencies toward fragmentation. Today, conflicts of unprecedented violence have resulted from intellectual, philosophical, and religious constructions stemming from narrow-minded orthodoxies. In setting off ethnic and religious subsets of the public sphere, customs and codes have been installed forbidding rebellion, questioning, and dissent. One could therefore take up the invitation to reflection and to critical dialogue offered by the Iranian philosopher Abdolkarim Soroush. In an interview with Farish Noor, Soroush commented on renewing and rebuilding intellectual engagement at the beginning of the twenty-first century. Although his particular concern is Muslim intellectuals, his message is of universal significance:

Modern Muslim intellectuals are, in a sense, a hybrid species. They emerged in the liminal space between modern ideas and traditional thought. We have seen the emergence of such figures in many Muslim countries that have experienced the effects of colonization and the introduction of a plural economic and educational system. They have their feet planted in their local traditions as well as the broader world of the modern age. As such, they are comfortable in both, handicapped by neither. The modern Muslim intellectual is one who is not daunted by the task of delving into his or her religious knowledge for critical answers and solutions to the present. Such intellectuals are better able to do so because they are not the product of a traditional educational system, which is narrow and rigid. They are not bound by traditional norms and rules of religious discursive activity, because they are not really part of that particular narrow tradition. Unlike the traditional ulama [learned men], who never go beyond the texts that they read, the modern intellectual will be able to read deeper into the text in a critical, imaginative manner.

See also *Education; University*.

BIBLIOGRAPHY

- Benda, Julien. *The Treason of the Intellectuals*. Translated by Richard Aldington. New York: Norton, 1969.
- Césaire, Aimé. "Poetry and Knowledge." In *Refusal of the Shadow: Surrealism and the Caribbean*, edited by Michael Richardson; translated by Krzysztof Fijalkowski and Michael Richardson. London and New York: Verso, 1996.
- Chakrabarty, Dipesh. *Habitations of Modernity: Essays in the Wake of Subaltern Studies*. Chicago: University of Chicago Press, 2002.
- Debray, Régis. *Teachers, Writers, Celebrities: The Intellectuals of Modern France*. Translated by David Macey. London: NLB, 1981.
- Fanon, Frantz. *The Wretched of the Earth*. Translated by Constance Farrington. New York: Grove, 1965.
- Gouldner, Alvin W. *The Future of Intellectuals and the Rise of the New Class: A Frame of Reference, Theses, Conjectures, Arguments, and an Historical Perspective on the Role of Intellectuals and Intelligentsia in the International Class Contest of the Modern Era*. New York: Seabury, 1979.
- Gramsci, Antonio. *Selections from the Prison Notebooks of Antonio Gramsci*. Edited and translated by Quintin Hoare and Geoffrey Nowell Smith. New York: International, 1972.
- Halter, Marek. "Les Amis Intellectuels de Jean Pierre Raffarin." *Le Monde Week End*, 14–15 March 2004, p. 1.
- Kelley, Robin D. G. *Freedom Dreams: The Black Radical Imagination*. Boston: Beacon, 2002.
- Maclean, Ian, Alan Montefiore, and Peter Winch, eds. *The Political Responsibility of Intellectuals*. Cambridge, U.K., and New York: Cambridge University Press, 1990. See especially the essay by Ernest Gellner, "La trahison de la trahison des clercs."
- Noor, Farish A., ed. "The Responsibilities of the Muslim Intellectual in the 21st Century: Interview with Abdolkarim Soroush." In his *New Voices of Islam*. Leiden, Netherlands: ISIM, 2002.
- Ory, Pascal, and Jean-François Sirinelli. *Les Intellectuels en France, de l'Affaire Dreyfus à nos jours*. Paris: A. Colin, 1986.
- Ou-fan Lee, Leo, and Merle Goldman, "Introduction: The Intellectual History of Modern China." In *An Intellectual History of Modern China*, edited by Merle Goldman and Leo Ou-fan Lee. Cambridge, U.K., and New York: Cambridge University Press, 2002.
- Said, Edward W. *Representations of the Intellectual: The 1993 Reith Lectures*. New York: Pantheon, 1994.
- Schalk, David L. *War and the Ivory Tower: Algeria and Vietnam*. New York: Oxford University Press, 1991.
- Williams, Raymond. *Keywords: A Vocabulary of Culture and Society*. Rev. ed. New York: Oxford University Press, 1985.

Mamadou Diouf

INTENTIONALITY. Intentionality is that feature of many mental states by which they are *directed at* or *about* or *of* objects and states of affairs in the world. So, for example, if I have a belief, it must be a belief that such and such is the case. If I have a desire, it must be the desire that such and such should be the case. If I have an intention, it must be the intention that I do something. *Intentionality* is a technical term not to be confused with the ordinary English words *intend* and *intentional*. Intending in the sense of intending to do something

is just one kind of intentionality, along with hunger, thirst, belief, desire, fear, hope, pride, shame, love, hate, perception, memory, and so on.

Intentionality and Its History

The concept of “intentionality” in this modern sense was reintroduced into philosophy by Franz Brentano (1874), who took the notion from the medieval scholastics. Brentano used the German expression *Intentionalität*, derived from the medieval Latin *intentio*, which meant what we nowadays call an intension or concept and which comes from the classical Latin *tendere*, meaning to aim at something. Brentano thought that intentionality was “the mark of the mental,” and because he thought that intentionality could not be reduced to anything physical, dualism seemed to follow; a world of intentional phenomena, the mind, is distinct from the world of physical phenomena.

Edmund Husserl (1900), a student of Brentano and the inventor of phenomenology, made the investigation of intentionality his main philosophical project. Husserl’s method was to suspend the assumption that there is a real world on the other side of our mental acts (this suspension he called the *époché*, or phenomenological reduction) and examine the structure of and thus the intentionality of the acts themselves (this structure he called the *noema*, plural *noemata*). In Anglo-American philosophy, the topic of intentionality was introduced in large part by Roderick Chisholm (1957). Chisholm was influenced by Brentano and attempted to produce a linguistic criterion of intentionality. In addition to his writings on the subject, he edited a collection of works by Brentano, Husserl, and others (Chisholm, 1960) and conducted a lengthy published correspondence on the topic with Wilfrid Sellars (Chisholm and Sellars, 1958).

Two Mistaken Theories of Intentionality

In his early work, Brentano thought that every intentional state must have an intentional object. If, for example, I believe that the mail carrier arrives at 11 A.M., then it seems that the object of my belief is the mail carrier. But what is the intentional object when a child believes that Santa Claus comes on Christmas Eve? There is no such person as Santa Claus, so what is the child’s belief directed at? Brentano thought that to provide an intentional object in such cases, we have to postulate it inside the intentional state itself. Brentano called this mode of existence “intentional inexistence.” This is an error. The statement, “Santa Claus comes on Christmas Eve” has a meaning but does not thereby succeed in referring to Santa Claus because there is no such thing to refer to; and likewise the belief that Santa Claus comes on Christmas Eve has an intentional content but does not have an intentional object. Brentano was confusing intentional content with intentional object. By definition every intentional state has an intentional content but not every intentional state has an intentional object. An intentional state has an intentional object only if something fits or satisfies the intentional content.

A second error is to suppose that there is some essential connection between intentionality with a “t” and intensionality with an “s.” Intensionality with an “s” is a property of sentences by

which they fail certain tests for extensionality. The most famous test is called “Leibnitz’s law” or the “substitutability of identicals.” If two expressions refer to the same object, then one can be substituted for the other, without loss or change of truth value. Thus, if *a* equals *b*, and *a* has property *F*, then *b* has property *F*. But for some sentences about intentional states, this law does not hold. So, for example:

- 1. Sam believes that Caesar crossed the Rubicon;
and
- 2. Caesar is identical with Mark Anthony’s best friend;

do not imply that:

- 3. Sam believes that Mark Anthony’s best friend crossed the Rubicon;

because Sam might not know or might disbelieve that Caesar is Mark Anthony’s best friend. The sentence about the intentional state is intensional with an “s” but it does not follow from this that the state itself is intensional with an “s.” Chisholm and others have tried to make the intensionality of sentences about intentional states into a criterion of intentionality and thus make intentionality seem to be a linguistic phenomenon. But the effort failed. There are intensional sentences that do not report intentionality and reports of intentionality that are not intensional. For example, 4 is intensional but not about intentionality:

- 4. Necessarily, 9 is greater than 7;
- 5. The number of planets equals 9.

But it does not follow that:

- 6. Necessarily the number of planets is greater than 7.

Sentence 7 is about intentionality but is not intensional.

- 7. Sam saw the Eiffel Tower; and
- 8. The Eiffel Tower is the tallest iron structure in Paris.

do imply:

- 9. Sam saw the tallest iron structure in Paris;

even if Sam does not know the truth of 8.

If intensionality is not a sure test for intentionality, what then is the relation between them? Sam’s belief that Caesar crossed the Rubicon represents the state of affairs that Caesar crossed the Rubicon. But the report of Sam’s belief does not represent that state of affairs; rather it reports what is going on in Sam’s head. The report is a representation of a representation. So the truth of the report requires that the way that Sam represents Caesar be truly reported, and hence substitution fails, for the substitution of a different representation may not truly report what is in Sam’s head (Searle, 1983).

The Relation of Intentionality to Consciousness

Every intentional state is mental, but not every conscious mental state is intentional. For example, one may have feelings of anxiety that do not have any intentional content. One is not anxious about any particular thing; one just has a general undirected feeling of anxiety. Such a state is conscious and therefore mental without being intentional. If Brentano was wrong that intentionality is the mark of the mental, this leads to the larger question: What exactly is the relation between intentionality and consciousness? The answer is that there is a very heavy overlap but the two are not coextensive. At any given point in my life, many of my intentional states are unconscious. For example, I can believe that in 2004 George W. Bush was president even when I am not thinking about it or when I am asleep. And many of my conscious states are not intentional, as, for example, the undirected anxiety that I mentioned above.

There does, however, seem to be a close connection between intentionality and consciousness in the following respect: Whenever someone has an intentional state that is unconscious, as when one is sound asleep, we understand it as that particular intentional state only in virtue of the fact that it is the kind of thing that can become conscious. A person might be unable to bring intentionality to consciousness because of being asleep or because of brain damage or repression, for example; but our understanding of an intentional state as a mental state is dependent on our being able to conceive of that state as occurring in consciousness.

The Irreducibility of Intentionality

For philosophers who reject dualism, intentionality, like consciousness, has always been an embarrassment. How is it possible in a purely physical world, in a world composed of physical particles in fields of force, that there could be such a thing as mental aboutness or directedness? Many philosophers think it is impossible, and they have made various efforts to reduce intentionality to some materialist basis or to eliminate it altogether. Hence in the *behaviorist* period in the philosophy of mind, many philosophers (e.g., Ryle, 1949) felt that having a state of belief or desire was simply a matter of being disposed to behave in certain ways under certain stimulus conditions. Later on, *functionalist* theories of mind (e.g., Armstrong, 1993) tried to analyze intentional states in terms of causal relations to input stimuli and external behavior. A more recent variation on functionalism is to try to identify intentional states with computational states. The idea of *computationalism* is that the brain is a digital computer and the intentional states are just states of the computer program (Crane, 2003).

All of these efforts fail because they try to reduce intentionality to something else. But it is not something else. I believe the way to avoid dualism while recognizing the reality and irreducibility of intentionality is to recognize that intentionality is a biological phenomenon like growth or photosynthesis or digestion. If we ask the question in the abstract: How can an animal have a belief about some distant object? that may seem like an extremely difficult question, but if we ask the more directly biological question: How is it possible

for an animal to see anything or to feel hungry or thirsty or frightened? then it does not seem so difficult. We can build more sophisticated forms of intentionality, such as belief and desire and imagination, on the more biological basic forms such as perception and intentional action.

The Structure of Intentionality

Four concepts are essential for understanding the structure and functioning of intentionality (Searle, 1983). First, the distinction between intentional content and psychological mode; second, the notion of direction of fit; third, the notions of conditions of satisfaction; and fourth, the holistic network of intentionality.

The distinction between intentional content and psychological mode. Every intentional state consists of an intentional content in a certain psychological mode. You can see this clearly by keeping intentional content constant while varying the mode. Thus, I can *believe* that you will leave the room, *wish* that you will leave the room, and *wonder whether* you will leave the room. In each case the state consists of a *propositional content*, which we will represent by the variable p , in a certain psychological mode, which we will represent with an M . The structure, then, of these intentional states is $M(p)$. Because the contents of these intentional states are entire propositions, they are sometimes called, following Bertrand Russell, “propositional attitudes.” Not all intentional states have an entire proposition as their content, as one might simply admire George Washington, or love Sally Smith. Here the intentionality is directed at an object, but it does not have a whole propositional content. Its form is not $M(p)$ but $M(n)$.

Direction of fit. The propositional content of the intentional state will relate to reality in different ways depending on the mode in which that content is presented. Thus beliefs, like statements, are supposed to be true, and they are true in virtue of the fact that they accurately represent some state of affairs in the world. They have what we can call the *mind-to-world direction of fit*, or *responsibility of fitting*. Desires and intentions, on the other hand, are not designed to represent how things are in fact but how we would like them to be or how we intend to make them be. Such intentional states have the *world-to-mind direction of fit* or *the world-to-mind responsibility for fitting*. Some intentional states take the preexisting fit for granted. Thus, for example, if I am sorry that I offended you or I am glad for your good fortune, in each case I take for granted the truth of the proposition that I offended you or that you have had good fortune, and I have an attitude about the state of affairs represented.

Conditions of satisfaction. Where the intentional state does have a direction of fit, such as belief, desire, perception, or intention, we can say that the intentional state is a representation of its conditions of satisfaction. Just as the belief will be satisfied if and only if it is true, so the desire will be satisfied if and only if it is fulfilled, and the intention will be satisfied if and only if it is carried out.

The network of intentionality. Intentional states do not come to us in isolated atoms but as part of a holistic network

of intentionality. This is perhaps most obvious in the case of the emotions. In order, for example, that someone be angry at another person, he or she must have a set of beliefs and desires. He or she will typically believe the other person has done some harm, will desire that the harm had not been done, will desire to harm, or express disapproval of the person at whom he or she is angry, and so on. Intentional states do not come to us individually and do not function in an atomistic form, but rather one has one intentional state only in relation to other intentional states. This holistic network is essential even for the functioning of simple beliefs.

So, for example, one can believe that in 2004 George W. Bush was president of the United States only if one has a rather large number of other beliefs. One must believe at least a certain number of things such as that the United States is a republic, that it elects presidents, that its president serves for a certain number of years, that presidents have certain powers and responsibilities, and so on. One way to describe this feature is to say that any intentional state functions, it determines its conditions of satisfaction, only in relation to a network of other intentional states. Most philosophers today accept some form of holism as opposed to atomism. A controversial extension of holism is the view that the whole network functions only against a background of taken-for-granted abilities and presuppositions that are not themselves intentional (Searle, 1983).

The Determination of Intentional Content

Parallel to the question of how intentionality is possible at all is the question: How is it possible that intentional states have the particular content that they do? What makes my belief that in 2004 George W. Bush was president about George W. Bush, for example, and not about his brother, Jeb, or his father, George H. W. Bush, also named "George Bush," or about anything else?

There are two common answers to this in contemporary philosophy: a traditional answer called internalism, according to which the contents of the head are sufficient to fix intentional content; and a relatively recent answer (from the 1970s) called externalism, according to which the contents of the head are not sufficient. Some outside causal (Putnam, 1975) or social (Burge, 1979) relations not represented in the heads of intentional agents are also essential. The argument for externalism is always that two agents might have the same thing in their head and yet have different intentional contents. For example two agents might have the same thing in their heads associated with the word *water*, but if one agent had a causal history originating with H₂O and the other had a history originating in some different but perceptually similar chemical, they would have different contents associated with the word even though the brains states were identical.

The reply given to this by the internalists is that in such cases the intentional content is determined indexically by indicating relations to the head or heads in question. By *water*, each person means the type of substance that he is familiar with or that his community has baptized as *water*. The situation is exactly like identical twins, each of whom thinks, "I am

hungry." The contents in their heads may be of exactly the same type, but they determine different intentional contents, because the same indexical expression "I" refers to different people. It refers to whoever utters or thinks it. On this view there is nothing external about indexical intentional content. Type identical intentional contents may have different conditions of satisfaction because of internal indexical content. The dispute between externalism and internalism is very much alive.

Intentional Causation

Explanations of human behavior rely essentially on the causal functioning of intentionality. When we say "Jones voted for the Republicans because he wanted lower taxes and believed the Republican candidate would produce lower taxes," we are giving a causal explanation in terms of the intentionality of desire and belief. This form of causal explanation is important not only in practical affairs but also in theoretical accounts of human behavior in the social sciences such as sociology, political science, and economics.

Such disciplines necessarily use an intentionalistic explanatory apparatus that is in several ways quite different from that of the natural sciences. First, in explanations appealing to intentional causation, the intentional content in the explanation must match the intentional content that is actually functioning causally in the mind of the agent. So the explanation, Jones "wanted lower taxes" must match Jones's desire: "I want lower taxes," and this content functions causally. This is quite unlike physics, where the content of the explanation reports a cause, such as gravity, but the content as content does not function causally. Second, explanations using intentional causation are subject to constraints of rationality in a way that physical forces are not. And third, typical intentionalistic explanations allow for free will in a way that is unlike explanations in classical physics. When I say the ball fell because of the force of gravity, the explanation is deterministic in the sense that given the forces acting on it, there is no other way the ball could have behaved. But if I say Jones voted for the Republicans because he wanted lower taxes, the explanation is not deterministic in form. It does not imply that Jones could not have acted otherwise in that situation.

Intentionality, along with consciousness, is the main problem in contemporary philosophy of mind, and under the name *information processing*, it is the main topic of cognitive science.

See also *Causation; Consciousness; Philosophy*.

BIBLIOGRAPHY

- Armstrong, D. M. *A Materialist Theory of the Mind*. London: Routledge, 1993.
- Brentano, Franz Clemens. *Psychologie vom empirischen Standpunkt*. Leipzig: Dunker and Humblot, 1874. Published in English as *Psychology from an Empirical Standpoint*. London: Routledge and Kegan Paul, 1973. Excerpted in Chalmers, 2002.
- Burge, T. "Individualism and the Mental." In *Midwest Studies in Philosophy*. Vol. 4. Edited by P. French, T. Uehling, and H. Wettstein. Minneapolis: University of Minnesota Press, 1979. Reprinted in Rosenthal, 1991.

- Chalmers, David J. *The Philosophy of Mind: Classical and Contemporary Readings*. Oxford: Oxford University Press, 2002.
- Chisholm, R. *Perceiving: A Philosophical Study*. Ithaca, N.Y.: Cornell University Press, 1957. Excerpted in Chalmers, 2002, and Rosenthal, 1991.
- , ed. *Realism and the Background of Phenomenology*. Glencoe, Ill.: Free Press, 1960.
- Chisholm, R., and W. Sellars. "Intentionality and the Mental." In *Minnesota Studies in the Philosophy of Science*. Vol. 2. Edited by H. Feigl, M. Scriven, and G. Maxwell. Minneapolis: University of Minnesota Press, 1958.
- Crane, Tim. *The Mechanical Mind: A Philosophical Introduction to Minds, Machines, and Mental Representation*. 2nd ed. London: Routledge, 2003.
- Dreyfus, Hubert, ed., in collaboration with Harrison Hall. *Husserl, Intentionality, and Cognitive Science*. Cambridge, Mass.: MIT Press, 1982.
- Husserl, Edmund. *Logische Untersuchungen*. 2 vols. Halle: Max Niemeyer, 1900. Published in English as *Logical Investigations*. Translated by J. N. Findlay. London: Routledge and Kegan Paul, 1970.
- Putnam, Hilary. "The Meaning of 'Meaning.'" In *Mind, Language, and Reality*. Vol. 2 of *Philosophical Papers*. Cambridge, U.K.: Cambridge University Press, 1975. Excerpted in Chalmers, 2002.
- O'Connor, Timothy, and David Robb, eds. *Philosophy of Mind: Contemporary Readings*. London: Routledge, 2003.
- Rosenthal, David M., ed. *The Nature of Mind*. New York: Oxford University Press, 1991.
- Ryle, Gilbert. *The Concept of Mind*. London: Hutchinson, 1949.
- Searle, John R. *Intentionality: An Essay in the Philosophy of Mind*. Cambridge, U.K.: Cambridge University Press, 1983.
- . "Minds, Brains and Programs." *Behavioral and Brain Sciences*, 3 (1980): 3. Reprinted in Rosenthal, 1991, and O'Connor and Robb, 2003.
- . *The Rediscovery of the Mind*. Cambridge, Mass.: MIT Press, 1992.

John R. Searle

INTERCESSION IN MIDDLE EASTERN SOCIETY.

The notion of intercession (*shafa'a*) is present within Muslim religious tradition as well as Muslim and Middle Eastern social and political culture. Intercession implies a special intervention or act of patronage providing favors, power, victory, or, in the religious variety, redemption from the terrible fate of sinners. Although there have been some objections, historic and modern, to this idea, it is frequently ascribed to the prophet Muhammad, his family, and the angels, as well as other Muslim holy men and women. For instance, the relics of the imam Husayn, the Prophet's grandson, are visited by the Shia in Damascus, and three famous pious women—Sayyida Zaynab, Sayyida Ruqayya, and Sayyida Nafisa—function as the patron saints of the city of Cairo. Pilgrims' prayers and entreaties call for intercession and blessing. Such visitations or requests of holy figures are made throughout the Muslim world, the Middle East, and North Africa. Intercession is also sought from certain key Sufi leaders and poets via ritual, recitation, or visitations.

The primary aim of Prophetic intercession is to save Muslim sinners on the Day of Judgment when all souls will be considered, and former earthly status, wealth, or power will be meaningless. His intercession, confirmed in the Koran (17:29), could prevent the believer from slipping off the Straight Path, a bridge spanning Hell. The traditions that ascribe the potential for intercession to the prophet Muhammad emphasize his exemplary nature.

According to one, humankind sought an intercessor on the Day of Judgment from among the prophets. Each was asked, and all but Jesus believed that they had themselves sinned, and all of the prophets but Muhammad replied that they feared for themselves. Yet God told Muhammad, who is the only human to have been forgiven his sins, that he might ask what he willed, and so may intercede on behalf of the Muslim community. *Shafa'a* is thus an aspect of Muhammad's "grace." In addition, various traditions relate the Prophet's miraculous night journey (*isra*) and ascension to heaven (*mi'raj*) that established his relationship with the chain of prophecy, and during which he interceded with God to reduce the number of daily prayers required of Muslims from fifty to five. Even non-Muslims recognized the Prophet's rights of intercession, according to another tradition about a Jewish tribe who called for intercession in the name of the Prophet before a major battle and were subsequently victorious over their foes.

All four Sunni Muslim legal schools agreed that the Prophet could intercede for sinners, although Muslims must strive to cleave to the Straight Path on their own. Muhammad's intercession, in other words, is intended for sinners, not the pious. Related practices, like the uttering of the *salawat sharifa*, the phrase usually translated as "bless him and grant him peace," at every mention of the Prophet's name is believed to obtain the blessing of angels and might aid intercession.

In Shii Islam, the concept of *shafa'a* and its correlate, *tawassul* (attainment of an objective or achievement of purpose), is extended to the family of the Prophet, the *ahl al-bayt*. The Prophet is supposed to have said to his daughter Fatima that on the Day of Judgment she would intercede for women, and he for men, and furthermore that every person who had wept over the tragic death of Husayn would be taken by the hand and led into Paradise. Many other traditions including several ascribed to Ja'far al-Sadiq (Muhammad's great-great-grandson and the sixth Shii imam) prescribe weeping and mourning on Ashura, the day of remembrance of Husayn's death, and state that paradise is the reward for those who weep. Consequently, in Shiism, martyrdom is also linked to the notions of intercession and redemption.

In both Sunni and Shii Islam, the notion of intercession is related to other practices in which the prophet Muhammad is venerated, such as the celebration of his birthday, and to the literature and poetry written in his praise. A thirteenth-century poet, Muhammad al-Busiri, a member of the Shadhiliyya mystic order, refers constantly to *shafa'a* in his famous poem known as "al-Burda":

Our Prophet, who commands and prohibits and not a single one

Is more truthful than he is saying No or Yes;
 And he is the beloved for whose intercession one hopes
 In every horror and hazardous undertaking. (Schimmel,
 p. 185)

In Suleyman Chelebi's *mevlut* (c. 1400) a chorus begins each line with "Welcome" as in "Welcome O intercessor of the worlds," and each refrain proclaims "If you want to be rescued from Hellfire / Utter the blessings over him with love and [longing] pain." (Schimmel, p. 155). Similar references occur in countless lyrics for the Prophet and songs celebrating the hajj or pilgrimage. The concept is closely entwined with the emotional entreaties of the Sufi *dhikr*, or ceremony of remembrance, and their *inshad* (sung poetry).

The early Islamic philosophical school known as the Mu'tazila disputed the idea of Prophetic intercession because they believed that it diminished the absolute justice of God. And although the medieval jurist and polemicist Ibn Taymiyya accepted the traditions concerning Prophetic intercession, his spiritual descendants in the modern world, the Wahhabiyya of Saudi Arabia, have disputed the notions of *shafa'a* and *tawassul*, as have other modernizing reformers. Some hold that granting such powers to the Prophet or other holy figures is akin to the polytheistic practices of the pre-Islamic period. The Wahhabis interpret the Koran (2:25) to mean that because only God can grant permission for intercession, this will only be gained by a monotheist, and that the devotion to dead saints is misguided. Such reformers also object to the use of amulets or jewelry with Koranic inscriptions (or for the Shia, sometimes the image of 'Ali and the prophet Muhammad). Believers wear and bestow such items on each other in the hopes that they will confer *baraka* ("blessing"), similar to the charismatic blessing of a dead saint.

The Prophet's intercession is described as being connected to his *baraka* and is described as being made of divine light itself. Similarly, the *baraka* of the other Muslim holy figures is sought and thought to bring about this light-infused intercession, whether through the action of the believer at a visitation to a holy place, such as an Imamzadeh for the Shia, or in the use of language that creates an emotional bridge to the *baraka* of a text and its author.

Intercession in Middle Eastern societies is not limited to the religious sphere. Other social and political practices reflect the reliance on intercession of the powerful in Muslim and even in non-Muslim Middle Eastern societies. In the social sphere, powerful or prestigious figures have served as mediators for conflicts, interceding for each party until resolution was achieved. In political life, the concept of intercession led to the dominance of particular elites, in what was known as the politics of patronage in the nineteenth and twentieth centuries as well as during earlier periods.

The *zu'ama* (literally chieftains, elite leaders) of Lebanon, or urban Syria, as well as politicians in Egypt and elsewhere sponsored clients and expected their political loyalty in return for favors. It was important for the less socially and politically powerful to locate patrons, obtain their "influence," or find an

intermediary (a *wasta* or "link") who could do so. This has lent an aura of corruption, fatalism, and violence to the political process, as people doubted that anything could be accomplished without such an intermediary. It is not unreasonable to speak of a parallel between the temporal and religious reliance on intercession. On a psychological level, the strength or efficacy of one's connections can contribute to feelings of security. Some argue that such dependence has obstructed populist tendencies and democratization. Intercession has been a major factor in social and political life, even where mass parties have been established, as in Egypt, Iraq, or Syria, cementing the cultural belief that the strength of one's connections was invariably more significant than talent, merit, or energy.

See also *Islam*.

BIBLIOGRAPHY

- Ayoub, Mahmoud. *Redemptive Suffering in Islam: A Study of the Devotional Aspects of 'Ashura in Twelver Shi'ism*. The Hague: Mouton de Gruyter, 1978.
- Gilsenan, Michael. *Lords of the Lebanese Marches: Violence and Narrative in an Arab Society*. Berkeley: University of California Press, 1996.
- . *Saint and Sufi in Modern Egypt: An Essay in the Sociology of Religion*. Oxford: Clarendon, 1973.
- Nasr, Seyyed Hossein, Hamid Dabashi, and Seyyed Vali Reza Nasr, eds. *Shi'ism: Doctrines, Thought and Spirituality*. Albany: State University of New York Press, 1988.
- Reeves, Edward B. *The Hidden Government: Ritual, Clientelism, and Legitimation in Northern Egypt*. Salt Lake City: University of Utah Press, 1990.
- Schimmel, Annemarie. *And Muhammad Is His Messenger: The Veneration of the Prophet in Islamic Piety*. Chapel Hill: University of North Carolina Press, 1985.
- Waugh, Earl H. *The Munshidiin of Egypt: Their World and Their Song*. Columbia: University of South Carolina Press, 1989.

Sherifa Zuhur

INTERDISCIPLINARITY. The development of innovative and creative ideas in the academy is taking place in the early 2000s largely across departmental and disciplinary divides. Intradisciplinary practice tends to be microfocused and piecemeal. Innovation proceeds intradisciplinarily, where it proceeds at all, mostly in small if not minute increments. Departmental institutionalization itself has been transforming, prompted by interdisciplinary practice. This is the case whether one considers the sciences or humanities, technology development or the arts, or the social or applied sciences. Universities continue to organize themselves around discrete departments of mathematics, physics, biology, or computer science, schools of engineering, and professional colleges, to be sure. Science research, however, tends to occur collectively and collaboratively. Laboratories (for example, in bioinformatics or in nanoscience) require teams of researchers with more or less wide-ranging field training, methodologies, techniques, and technological expertise. Experiments, discoveries, and research outcomes in the sciences may be attributed to the individual

lab as much as to the traditional disciplines or departmental structures. Departments profit too from the results of these interdisciplinary research labs (not least from the external grant funding they generate). Hiring in the sciences consequently is often made between multiple departments and increasingly with interdisciplinary research goals in mind.

Where the sciences have been largely fearless in leading, the social sciences and the humanities have tended to follow, if for their own reasons. Schools or colleges of constitutively interdisciplinary applied social science programs have become increasingly popular, often supplemented by resident historians or philosophers or, increasingly, cultural analysts. A similar mutually constitutive relationship has been unfolding in U.S. universities between core humanities departments and interdisciplinary humanistic inquiry.

While interdisciplinarity has become *de rigueur*, at least rhetorically, more widespread acknowledgment and institutional credit nevertheless has been much slower in the making. An interdisciplinary model, humanistic or social scientific or more compellingly erosive of that divide, requires a shift from largely contained and constrained, field-specific themes and methods to problem- or issue-based objects of analysis, more or less unbounded questions, and multifaceted methodologies. This latter disposition likewise tends to be less figured around national imaginaries or boundaries than has largely been the case in many humanistic fields in the past. It concerns itself consequently more with contact, flows of ideas, and cultural intersections than with the cultural heritage of nationally defined and fixed products.

This newly emergent model accordingly can be considered an intellectual byproduct of globalization. Social thinking and the humanities as a result have been transformed in unexpected and unpredictable ways. For example, the renaissance of classical studies in the early twenty-first century has flowed from the merging of traditional linguistic and historical studies of specifically located areas in the ancient world with archaeology enhanced by new techniques of digital imaging and an expansive political geography. These interactive developments have transformed the map of the ancient world by asking questions posed by critical race theory, gender studies, or post-colonial theory in addition to the more traditional interrogations of objects, texts, and images from the period in question. Similarly, the latter-day emergence of oceanic or regional studies is a function not only of the implosion of area studies but also of the perceived limits of disciplinary determinations in the face of complex thematic and problem-driven research foci.

Humanities and Social Sciences

The humanities have characteristically taken themselves as revealing what it is to be human and humane, just as the social sciences have long reproduced what they have presupposed as normative models of psychology, sociality, governmentality, even historicity. Together they have purported to teach what it means to be rational and reasoned, cultured and moral, social and political, learned and worldly. The institutional history of what has been conceived as “the humanities,” and perhaps of social thinking more broadly, has always been

deeply inflected with, if it was not founded on, dominant class and ethnonational determination. It has been a difficult revelation, then, that prior to at least World War II, and really well into the 1970s, the dominant trends in the humanities and social sciences throughout the Anglo-European academy as well as in universities worldwide that are founded on the Anglo-European (and more recently American) model(s)—and often part of a colonial project—for the most part were little more than expressions of European culture, society, and governance.

Even this way of putting it is misleading, for it was not European culture, sociality, and political structure in some broad articulation that was taken to represent intellectual, moral, cultural, and political superiority. Rather, it was the sociocultural articulation of historical layers and tissues of connection between dominant national configurations within the European orbit. Philosophy and classics, English, Romance languages (principally French and Italian) and German, and even history not only embody their own particular histories; they are taken, even—one could say especially—in their dominant ethnonational articulation, to represent the march of history as such. The “best that had been thought and written” had a distinct and delimited geolinguistic and intellectual range. Anything—and the intellectual life of anywhere beyond the English, French, and German, prompted by earlier influences of the Italian and Greek—was either rendered invisible or arrogantly dismissed as exotic, quaint, or simply inferior.

Creating Disciplines

The definitions and elaborations of the terms of the human, the humane, and the humanistic were the stuff principally of the dominant disciplines in the humanities—philosophy and classics, national languages and literatures, history, and art history. The terms of the psychological, social, political, and cultural, by extension, were the domain of the social sciences. The prevailing objects of analysis in the humanities accordingly were conceptual, linguistic, artifactual, or textual; those in the social sciences were largely empirical (at least in the broad sense, both quantitative and qualitative). In both cases, objects and methods of analysis were distinctly disciplinarily driven and far from universal, as they more often than not assumed themselves to be. By the middle of the twentieth century, these disciplines tended to be self-contained and self-referential, methodologically streamlined, if not singular. Disciplinary training consisted of analytical, epistemological, and methodological apprenticeship. This included the ability not only to apply the analytic apparatus and methodology thought properly constitutive of the discipline but also to determine what was considered, from inside the discipline, to be the right questions to ask. This after all was what it meant to acquire (a) discipline.

Intellectual hegemony within the humanities and social sciences was never complete nor was it ever completely stable. Intellectual resistances, for example, emerged in the 1930s, complementing the political ones. Entangled intellectual and political countermovements ebbed and flowed between the 1930s and 1960s. Intellectual diversification within and across the academy was boosted by the growing class, ethnic, racial,

and gendered diversification of those entering at least the American university in the wake of World War II, bolstered initially by the GI Bill and then by the rising tide of middle-class aspirations. These developments unleashed novel interests and demands for different knowledges and new forms of representation that cut across the traditional epistemological organization known as disciplines. It is this rich mix that has come to be recognized as “interdisciplinarity.”

Often implicitly, sometimes overtly, this emerging interdisciplinarity assumed humanistic configuration from its inception, even when not specifically noted as such. The University of Chicago’s influential “Great Books” program insisted that any understanding of basic human problems had to be informed by “a select number of classic ancient and modern texts” independent of their disciplinary origin. What discipline, precisely, is responsible for the standard Great Books syllabus that includes Aristotle and Aquinas, Shakespeare, Tolstoy, Hegel, and Freud? Chicago’s Committee on Social Thought, while proposed primarily by social scientists in 1941, singles out contributions that would ordinarily be called “humanities” as the basis and preparation for serious intellectual work. In fact, this humanistic basis for inquiry is so much a given that it is not even labeled as such.

Many scholars working in the academy in the intervening decades have reached for new constructs that could encompass the intellectual and social energies, interests, and problematics of their day while providing foundations that are both historically and culturally expansive. This imperative toward humanistic interdisciplinarity recalls the nineteenth century, when, as Lisa Lattuca argues, many intellectuals insisted on more expansive forms of inquiry not organized along the strict(ly) disciplinary lines being routinized, regularized, and institutionalized by college administrators concerned to develop “coherent and integrated courses of study.” And yet nineteenth-century versions, while precursors, are really “pre-disciplinary,” to use William Newell’s term, not really amounting to interdisciplinarity (Lattuca, pp. 5–6). The disposition was perhaps there, though not quite yet the thick institutionalization of disciplines to which interdisciplinarity is a response, a resistance, a need, a challenge. Graduate and professional education and certification at the end of the nineteenth century also helped to create disciplinary boundaries, structures, and institutional bureaucracies that concretized intellectual borders. These developments served over time to transform complicated and interwoven histories of ideas (the blurred boundaries between science, anthropology, philosophy, and literature, for example) into discrete “departments” with specialized training and networks of professional affiliation (including learned societies and journals) along with the criteria of credentializing to which they gave rise and which in turn further reified disciplinary determinations.

Toward Interdisciplinarity

The new material and human arrangements brought about by globalization, long-standing processes dramatically intensified and speeded up since the end of World War II, have contributed substantially to the changing intellectual borders of disciplines. This has prompted perhaps the increasing emphasis

on the “social” rather than the “science” of many social scientists, the turn to ethnography by a growing number of humanists, and the appreciation of affective aesthetic and expressive forms by many in both the humanities and the social sciences. The interdisciplinarity to which this points is not some other word for “pluralism” but rather is emerging as a result of the difficult, entangled, and ongoing problems that demonstrate the need to find better interpretive tools and complex models of cultural and human exchange and new arrangements of knowledge. As with any paradigm shift, these new structures of thinking about novel and emergent global arrangements inevitably illuminate ancillary areas of inquiry—including many different configurations of premodern studies that have taken on new focus and energy by contact with post-colonial and global theory. If culture is the traditional site of the humanities, humanities has traditionally restricted culture to its national delimitations. By contrast, contemporary interdisciplinarity takes up culture as a critical diagnostic for comprehending life in the wake of globalization. It registers the contradictions and complexes of globalization, offering horizons for understanding through reflection and interpretation. It denaturalizes sedimented ways of knowing by offering novel categories of analysis and comprehension and new catalogs of cultural archive.

This broadened frame, in turn, has begun to erode the wider boundaries between the humanities and social sciences just as newly emerging questions have begun to soften the traditionally hard lines between the sciences, technology, the humanities, the social sciences, and even the arts. The National Science Foundation in the United States, for instance, is insisting in the early 2000s that proposals for engineering new digital technologies demonstrate their constitutive human and community benefits, a mandate that in turn is driving new collaborative engagements between technologists, humanists, social scientists, lawyers, and artists to mutually transformative effect.

Disciplinarity, then, is an institutional creation, forged out of specific histories, in specific places. It has offered an anchor in the face of increasing epistemological dubitability as disciplinary influences and effects have traveled, circulating between metropolitan and colonial sites. What has come to be marked as interdisciplinary practice prompts objects of analysis more diffuse and multiplicitous, more fully prompted than those disciplinarily driven. These objects of analysis are less likely (at least thus far) to be implied by the histories of their intellectual practice and range. Rather, interdisciplinary objects of analysis in social, cultural, and humanistic thinking tend to be concerns identified as abundant in social and cultural life in various geopolitical sites. That the objects and modes of analysis can no longer simply be said to be fueled by the extension of European interests and assumptions is indicative as much of the shift in intellectual dispositions as it is a function of dramatic developments in globalized arrangements of capital and, consequently, of persons. Interdisciplinary practice that has become such an index of contemporary thinking is marked accordingly by the appeal of multiple methodologies and by broader scope and styles of question.

Models for Interdisciplinarity

There has been a good deal of what one might call the mantric recourse to interdisciplinarity as something that ought to be done in the humanities and theoretical social sciences. And yet the seminal work on conceiving the nature and scope of interdisciplinary work confirms the extensive representational power of the sciences. The natural sciences especially, complemented by the empirical social sciences, have provided the dominant model for the nature of interdisciplinarity. This has been at once liberating and delimiting. In some instances science interdisciplinarity has been robust. Information science and policy and genomic research, policy, and ethics offer two good examples. But there are other models of interdisciplinarity not well served by the model of science. The report of the Gulbenkian Commission on the Restructuring of the Social Sciences, "Open the Social Sciences" (1996), rightly points out that the humanities in some formations may be far more interdisciplinary in fact than the empirical social sciences. Jeffrey Sachs rightly insists in a *New York Times Magazine* interview discussing his commitment to "sustainable development" that interdisciplinarity is the only way to solve world problems. The need, he asserts, is "to focus not on the disciplines but on the problems and to bring together five main areas in an intensive dialogue: the earth sciences, ecological science, engineering, public health, and the social sciences with a heavy dose of economics" (Sachs, p. 45). Jeffrey Sachs notwithstanding, economics is hardly the model of interdisciplinarity that one should strive to emulate. Political economy, for instance, has suffered in the shadow of its more positivistic cousin. There are practices and ways of thinking about interdisciplinarity, and so models for it are not narrowly reducible to the prevailing conceptions in the sciences and empirical social sciences.

While some scientists embrace a vigorous interdisciplinary perspective, it is not unusual to find scientists referring both conceptually and in their exemplification of interdisciplinary practice exclusively to the sciences—biology, chemistry, the cognitive sciences, and so forth. Humanists often speak with equal and equally intense insularity: interdisciplinarity all too often is delimited to literature and history, with a grudging nod perhaps to anthropology or a facile invocation of sociology or political economy. It is important, then, to pay attention to the fact that there are different conceptions, models, and practices of interdisciplinary venture. Of particular interest are the robust senses of interdisciplinarity across the more traditional divides between the humanities, the sciences, the applied sciences and technology, the arts, and the social sciences.

These shifts are evidenced by the fact that the regime of interdisciplinarity has occasioned tremendous changes in habits of reading. Under the *ancien régime* of robust disciplinarity, reading was driven mostly from *within* the discipline. This included who and what one read (or at least professed to have read) and discussed within seminars and colloquia, at departmental affairs, in oral dissertations, and so on. A scholar was socialized into and by the disciplinary bounds of reading and through conversation around and about these sets of readings. It is revealing to notice that in the late twentieth century this boundedness of reading broke down rather dramatically. Twenty-first-century scholars read with little, or far less,

attention to disciplinary constraint and concern, more readily drawing on work that speaks to the problematics and themes with which they are concerned. Work in literature might readily draw on historical studies, obviously, but also on reading from women's or critical gender or race studies, from visual studies, art history, and philosophy traditionally conceived, as well as from sociology or politics or anthropology. The history and philosophy of science are no longer the only endeavors in the humanities to engage with the sciences, as the distinctions between nature and culture and the social and biological increasingly blur, and one looks for new languages of representation and novel vocabularies of reference. Science and technology studies are the natural outgrowth of this convergence of interests. The first generation of digital humanities that has focused almost exclusively on digital collections of cultural heritage, important as they have been, are now leading to more robust, mutually transformative engagements between engineering, information technology, humanities, and the arts.

Obstacles to pedagogy. One obstacle to vigorous interdisciplinary pedagogy concerns methodological and epistemological considerations. There is, of course, the pedagogical tension between the clean slate proposed by John Locke (1632–1704) and the historicity associated with the legacy of Wilhelm Dilthey (1833–1911). It is difficult to train students in interdisciplinary modes of analysis and thought when they have yet to grasp the intellectual histories, historically prevailing questions, and thematics prompting the interdisciplinary disposition to begin with. It is no doubt easier to introduce rigorous interdisciplinary modalities in teaching at the graduate level than at the undergraduate level, notwithstanding the consideration that less-formed minds tend to be more open to new possibilities. And a good part of the restraint on interdisciplinary pedagogy has to do with the fact that teaching in universities and colleges tends so largely to be ordered around disciplinarily organized departments with relatively few possibilities provided for recognized and credited cross-disciplinary pedagogical partnerships.

There are various ways to sharpen the contrast between disciplinarity and interdisciplinarity. One of course is methodological. But there are also deep epistemological distinctions. Disciplines produce knowledge according to different criteria than does interdisciplinary practice, and they credentialize that knowledge on different grounds. There does seem to be a contrast between the positive sciences, broadly conceived, as engaging in the practice of "looking for" and the humanities, for which "thinking about" or reflection, for want of better terms, is the driving modality. Disciplinarity, relatedly, is often thought to produce so-called positive knowledge through constraint and boundedness, a "knowing that," to use Gilbert Ryle's (1900–1976) term, in contrast to a "knowing how." Interdisciplinarity, no doubt, can sometimes be as limited and specialized as any disciplinary project, if one is simply bringing to bear different methodologies on one highly focused question or problem (a commonplace of multidisciplinary experiment in the sciences). The sort of robust interdisciplinarity for which we are making an argument here concerns ways of combining different methodologies and approaches in seeking new yet still systematic ways to address large and complex problems not susceptible to analysis (or solution) from a single perspective.

The humanities often embrace affective aspects of intelligence, such as imagination, play, improvisation, and serendipity, as much as they embrace conventional rationalist forms of inquiry, such as logic, analysis, deconstruction, and critique. They value aesthetics as much as politics. The romance of these artful aspects, after all, revealing of one of the two major humanistic traditions, prompts a loosening of disciplinary bounds, further softening entrenched lines between humanities and the arts.

Mark Gibson and Alec McHoul talk relatedly of the constitutive incompleteness of disciplines. In large part a product of disciplinary boundedness, insularity, self-containment, and (often productive) delimitations, this constitutive incompleteness suggests epistemological partiality on the part of disciplines, both a necessarily incomplete and a relatedly one-sided knowledge of the object in question. From within the boundaries one knows an object as no more than the discipline would have it. Epistemological curiosity, if not the epistemological drive to complete knowledge, to know it all, so to speak, suggests too an epistemological push or ontological pull beyond disciplinary boundaries. This dispositive draw—the “need” of the knowing subject, qua knowledge, to know it all, the “necessity” of the object to be known—conjures or points to the beyond that might critically be called interdisciplinarity.

Less grandiosely, Kenneth Wissoker has suggested that interdisciplinarity varies by discipline: questions asked of an object of analysis, methods considered legitimate, and the conceptual apparatus deemed appropriate vary from one discipline to another, and so the practice of interdisciplinarity prompted from different disciplinary sites will vary accordingly. Interdisciplinarity prompted or practiced from within disciplines is likely to look different from interdisciplinarity the starting points for which are, say, problem- or issue-promoted (where the problem or issue is not simply discipline-specific).

Interdisciplinarity as a Critical Project

This raises the question whether it is possible to think of interdisciplinarity as cast adrift from any particular discipline, not simply the view from nowhere but from the point of transience, migration, betweenness. Is there an interdisciplinary practice not fixed or bounded by the disciplines but prompted from those spaces and gaps and interstices the disciplines inevitably fail to exhaust, their blind spots, even in their overlap? But what then is the force of the “*inter*” in interdisciplinarity (as opposed to focusing on the disciplines to which interdisciplinarity is a contrast)? What happens in the intellectual, conceptual, methodological spaces between disciplines? What is suggested here is a redirected focus for interdisciplinarity, from the disciplines between which there is exchange to the exchange to which the disciplines contribute and themselves change as they do.

Conceived thus, it may be asked whether interdisciplinarity is, or should be, committed first and foremost to a critical project. The preceding line of argument suggests it is. If so, a prime feature of such a critical project would be antireductionism. Very often reductionism and disciplinarity are bound up with each other, predicated thus always on its object of

critique. Disciplines by definition are reductive. To know an object through or via the discipline is to know it reduced to the parameters determined by disciplinary constraints, conceptual, methodological, or theoretical. If knowledge through disciplines is perspectival in this way, interdisciplinarity seeks to pluralize the sources, perspectives, dispositions, and determinations of knowledge. If disciplinary knowledge seeks objectivity through constraint, interdisciplinarity seeks knowledge through relationalities.

To learn a discipline, it might be said, is to learn a language. It is not enough simply to learn the vocabulary, though that surely is necessary. This means that keen attention also must be paid—especially—to what could be called the syntax and semantics of the discipline, and to the cultures it conjures and projects. Approached in this way, the contrast between disciplinarity and interdisciplinarity may begin to be discerned. To become fluent interdisciplinarily is not simply to learn more than one language, to multiply the syntactical and semantic structures and cultures known. Rather, it means to assume a different, if related (even derivative), mode of speaking, to inhabit a different culture, and in that inhabitation to see differently. It is in more than an idle sense to learn—to inhabit—a creole culture (and perhaps to be treated as creoles so often have).

It follows from all of this that there is not simply a singular correct or proper (form of) interdisciplinarity. There are, in short, interdisciplinarity rather than one interdisciplinary model or method. Were interdisciplinarity to become the currency of the academy, as Marjorie Garber has warned, it would tend to the conventional, to devolve into its own kind of disciplinarity. Heterogenizing the practices and their institutional arrangements encourages, by contrast, renewed possibilities, promotes institutional settings sustaining rather than delimiting robust knowledge promotion, even invites a more heterogeneous inhabitation of the academy. Such interdisciplinary institutional arrangements would come and go, transact and transform in vigorous relation to the vicissitudes of the problematics—the objects of study and analysis—for which they exist and serve to illuminate. Such robust interdisciplinarity are seen as relational, flexible and transformative, self-confident and open-ended, suggestive and servicing, rather than deterministic and delimiting. Historically grounded without being historicist, they are heterogeneous and not reductionistic in assumption and scope, pluralizing and radically nonessentializing, facing heterogeneous worlds with curiosity, generosity, and sensitivity rather than with narrow introspection and incessant denial. Such robust interdisciplinarity, vigorous without being arrogant, engaged without being imperialistic, look to make connections across every area of the university—including the sciences, engineering, and the professional schools in their reach.

See also *Cultural Studies; Science; Technology; University*.

BIBLIOGRAPHY

- Garber, Marjorie. *Academic Instincts*. Princeton, N.J.: Princeton University Press, 2001.
- Gibson, Mark, and McHoul Alec. “Interdisciplinarity.” In *A Companion to Cultural Studies*, edited by Toby Miller, 23–35. Oxford: Blackwell, 2001.

Klein, Julie Thompson. *Crossing Boundaries: Knowledge, Disciplinarity, and Interdisciplinarity*. Charlottesville: University of Virginia Press, 1996.

———. *Interdisciplinarity: History, Theory, and Practice*. Detroit: Wayne State University Press, 1990.

Lattuca, Lisa R. *Creating Interdisciplinarity: Interdisciplinary Research and Teaching among College and University Faculty*. Nashville: Vanderbilt University Press, 2001.

Sachs, Jeffrey. "Poor Man's Economist: Questions for Jeffrey Sachs." *New York Times Magazine*, 12 December 2002, 45.

Wissoker, Kenneth. "Negotiating a Passage between Disciplinary Borders." *Chronicle of Higher Education*, 14 April 2000, 4–6.

David Theo Goldberg

Cathy N. Davidson

INTERNAL COLONIALISM. The term *internal colonialism* defines a condition of oppression or subordination, often of one ethnic group over another (as in the subordination of Mexicans in the United States at the conclusion of the U.S.-Mexican War of 1846–1848). Some view the term as a counterposition to the claim that all people in the United States "are immigrants." For example, *immigrant* does not describe accurately the lives of people of Mexican origin living in the territory known today as the southwestern United States. Many residents of what is now New Mexico and Texas trace their ancestry back to the 1600s. For them, the term *immigrant* does not reflect their history or relationship to the United States and it mischaracterizes the place of native-born Mexican-origin peoples. Moreover, in relation to other ethnic groups, immigrant status fails to reflect accurately the histories of African slave descendants, nor does it do justice to relocated and disrupted Native peoples.

Because the general claim that all Americans are of immigrant stock is problematic, the nature of Mexicans' status in the United States must be supplemented with other terms or concepts. For Mexicans, or Chicanos and Chicanas, as their descendants are termed today, the term *internal colonialism* is applied by social scientists and others to understand the historical and cultural conditions or experiences that were a direct result of the actions of governments. Because of the conditions in the 1840s, many Mexicans and Native peoples suddenly found themselves residents, though not citizens, of a new government and its structures. In view of the fact that these people had been "colonized" by a contiguous power, that is, the larger and more prosperous United States, and they owned or lived on land considered highly desirable, Chicana and Chicano scholars, as well as others sensitive to the history of this ethnic group, began to apply the term *internal colonialism* to describe how people were locked into certain jobs, how the economy that developed particularly in the Southwest relied on an organized system of subordinator and subordinated.

Other scholars have more recently differentiated the ways in which workers in the Southwest differ from one region to another, and a more nuanced understanding of differences and similarities is therefore achieved. An example would be how urban people and rural people differed during any period, or

how men's and women's values changed, and not always in tandem. While internal colonialism might help explain various features of a lived experience, in a period of hostile warfare between two nations, for example, it cannot explain all aspects of culture, politics, or philosophies and religions.

At times, internal colonialism is set against colonialism, with the latter viewed as older and more authoritarian, that is, more rigid in structure and organization. In the early twenty-first century, however, the fact of colonization itself is rarely questioned; that is, it is assumed that Mexican-origin and to some extent indigenous/Native peoples were colonized by a nation-state still in its formative years (beginning in the Southwest around 1803 and extending up to the time of the war's outbreak in 1846). It might be useful to think of internal colonialism as less organized than colonialism in its reach, but its impact was felt by people across a spectrum of classes and social locations. Even wealthy merchants of Mexican origin in Santa Fe were forced to accept a new authority in the form of judges, military officials, and federal appointees in a newly-imposed court system after 1848. Before long, internal colonialism assured their subordination. For women, the same applied. No longer able to bring lawsuits, retain property in their own names, or retain their family names or lands, women suffered a diminishment in their status as well.

Colonized from within by a government or power greater than that which had once existed would be another way to approach how useful internal colonialism is to nonimmigrant, Mexican-origin people of the Southwest and far West. The United States brought Protestant, English-based institutions, as well as schools and businesses, when it created a pathway toward California. Accompanying the movement of goods, products, and English-speaking people were racial ideologies, political orientations, and doctrines that specified why Mexicans and Native Americans could not hold public office, travel freely, own businesses, or live their lives independent of wages earned working for others. The concept of "manifest destiny" decreed that people of the white, Anglo "race" were superior to Mexicans and Indians. The legal codes developed in the United States and forcibly applied to all the colonized territory that had once belonged to Mexico, along with the violence of lynchings and deportations that continued into the twentieth century, conveyed an important message about internal colonialism. The fear and terror evidenced in actions against Mexicans based on their race, for example, lynchings that would number more than 500 between 1850 and 1920, reveal the way internal colonialism operated on what was essentially a "frontier" territory.

To understand the significance of this concept means more than just debating whether it explains fully how racism and oppression operated; it means taking seriously the history of exclusion and its enforcement among ethnic groups or races judged to be inferior to white, Anglo-Saxon, and European-origin peoples. In that sense, the phrase and idea of internal colonialism are useful for unraveling the history of the Southwestern and Western United States. Scholars in the early twenty-first century recommend consideration as well about colonialism or transnational capital movement, that is, global

capitalism, and not just focus on internal colonialism; but the everyday, lived experiences of many ethnic groups that can be understood through a deeper comprehension of internal colonialism. Although the term does not explain racial or gender relations fully, it introduces the idea that politics and economics worked together to displace and replace residents of a territory and then continued this practice as immigrants began repopulating the former Mexican north after the war with Mexico had long since ended.

The demographic reclamation of the same territory proceeding in the early twenty-first century in a process of immigration and migration is ironic to the extent that what the United States most disliked, that is, people of color determining their own futures, is an ongoing process and consequence of these earlier wars and the displacements they introduced, whether social, religious, political, or economic. Internal colonialism thus continues to fuel a much larger, global issue, that of the mass movement of people toward industrial capitalist centers or toward the developed urban nation-state. Because the impact of these currents is so strong in such places as Los Angeles, Phoenix, Houston, and the Southern United States as well as in the Midwest (where people of Mexican origin now reside in record numbers), defining the operations of internal colonialism is useful. Local and global developments demand it.

See also *Assimilation; Colonialism; Identity, Multiple; Loyalties, Dual; Migration.*

BIBLIOGRAPHY

- Almaguer, Thomás. *Racial Fault Lines: The Historical Origins of White Supremacy in California*. Berkeley: University of California Press, 1994.
- Barrera, Mario. *Race and Class in the Southwest: A Theory of Racial Inequality*. Notre Dame, Ind.: University of Notre Dame Press, 1979.
- Blauner, Robert. *Racial Oppression in America*. New York: Harper and Row, 1972.
- Hechter, Michael. *Internal Colonialism: The Celtic Fringe in British National Development*. With a new introduction and appendix by the author. New Brunswick, N.J.: Transaction Publishers, 1999.
- Montejano, David. *Anglos and Mexicans in the Making of Texas, 1836–1986*. Austin: University of Texas Press, 1987.

Deena J. González

INTERNATIONAL ORDER. The image of a peaceful, orderly world where men and nations resolve their differences without war, where the lion lies down with the lamb, has haunted humankind for millennia. Roman law expressed the gulf between the ideal and the reality concisely by contrasting the condition of man living under the *ius naturale*, the natural law, a world of peace and harmony, with the human condition as it actually was under the *ius gentium*, the law of nations, a condition that included war and conflict. The very creation of government at the lowest level was the beginning of efforts to create order at least within a small area, to establish

an order within which people could live peacefully with one another by accepting a set of rules that shaped their relations with one another. At the next level, there is the need to create rules that enable neighboring societies to get along with one another. At the ultimate level, there was the desire to create a peaceful world order that would bring all the nations of the world into a peaceful, harmonious relationship.

In the history of the Western world, there is a long tradition of attempts to create some kind of international order. One of the major obstacles to the creation of such an order stemmed from the fact that ancient political thought identified the small, independent city-state as the ideal environment for the development of the human personality. The freedom associated in theory with life in the city-state, however, posed a threat to order because of the wars among these states. On the other hand, there were empires, powerful states consisting of a ruling group dominating a number of conquered societies and maintaining order but at a price that the Greeks would not accept.

From a modern perspective, the Greek world, violent and even chaotic as it often was, was superior to the orderly Persian world because it was associated with freedom, democracy, and creativity. Yet the golden age of Athens ended in a disastrous war, and the age of creativity and democracy died with it. A lesson that the Greek experience might teach is that empires last longer and maintain an orderly world longer than small city-states can, but they do so at a price that many would deem too high.

The Greek and Roman World

The Greek world did produce one solution to the tension between freedom and order, that is between city-state and empire, when Philip of Macedon (d. 336 B.C.E.) and his son, Alexander the Great (d. 323 B.C.E.), created a great empire stretching from Greece to the Indus Valley. At the core of that empire were the Greek city-states that Philip had conquered and united. He saw himself as bringing the Greek world to the fullest stage of development, creating a unified world order under Greek leadership. According to his biographer Arrian (second century C.E.) writing several centuries later, Alexander aimed at creating an empire that brought peace to the regions he had conquered but that would be administered by the Greeks. The goal was to create a *cosmos polis*, a world community in which all the members shared the sense of unity and brotherhood that the members of a traditional city-state shared. If Alexander had lived, he might have created a vast peaceful and orderly world community under a single imperial ruler. His early death, however, destroyed any possibility that such a community would actually be created. In the years after Alexander the Great's death, one school of Greek philosophers, the Stoics, followers of Zeno of Citium (c. 335–c. 263 B.C.E.), did develop the concept of mankind as forming a single community. This concept flourished subsequently among the Romans and, apparently, even helped shape the Christian notion of mankind as ultimately forming a single community.

The most extensive example of a stable international order in the ancient Western world was the Roman Empire. In the

course of its history, first as the Roman Republic expanding to bring all of Italy south of the Po River under a single government and then in a series of wars, first against the Carthaginians in the West and then against the Macedonians and Greeks in the East, the Romans brought the entire Mediterranean basin under their control. By the time of the first emperor, Augustus (r. 27 B.C.E.–14 C.E.), Roman jurisdiction ran from northern England to the Syrian Desert and from the Rhine River south to the Atlas Mountains and the Sahara. The network of roads that the Romans constructed enabled them to keep the peace within the empire by dispatching troops rapidly when rebellion arose among the conquered peoples.

The Roman imperial order, the *Pax Romana*, succeeded because it relied not simply on Roman troops but on the Roman ability to obtain the cooperation of the leaders of the societies that they conquered. The peace treaty signed at the end of a war with Rome often held out to the leading men among the conquered people the possibility of Roman citizenship, that is membership in the ruling elite of the Roman world, to those who accepted the new order. This practice gave many of the conquered peoples a vested interest in keeping the peace. At the same time, the Romans generally abstained from interfering in the internal affairs of the states that they conquered, thus reducing possible points of conflict.

The gradual decline of the Roman Empire in the West beginning in the fourth century meant the end of the *Pax Romana*. Any possibility of a stable international order was lost as the Roman government collapsed and new populations moved into the lands that the Romans once ruled. The Carolingian Empire of the eighth and ninth centuries was a failed attempt to restore the peaceful order of the ancient Roman imperial world on Christian principles. In reality, however, there was no longer any possibility of a single dominant power exercising jurisdiction over a large region.

The Medieval Christian Conception of International Order

As a series of small kingdoms emerged in Europe out of the ruins of the Carolingian world, a new conception of international order emerged, the notion that there is a natural right order of the world that human understanding could comprehend. This new approach conceived of human society as hierarchical, with lesser societies subordinate to higher ones. Recognition of the natural right order and the acceptance of a society's place within that order was the key to international harmony. To a great extent those who saw the world in these terms differed only on the issue of who would head the hierarchical structure and mediate international conflicts, the Holy Roman Emperor or the pope. Supporters of the imperial position argued that the Christian Roman emperor was the true *dominus mundi*, the Lord of the World, and the kings of Europe were rulers of what were in effect provinces of the empire. The other view was that the pope as the spiritual head of Christian society was the head of an international society and that he was the ultimate regulator of international order. These competing views about the leadership of Christian society provided one of the fundamental elements of the medieval church-state conflict.

By the thirteenth century, the papal vision of a Christian world order came to dominate, because the emperors could not impose their claim to suzerainty over the kings of Europe. Increasingly kings claimed that within their own kingdoms they possessed the powers attributed to the emperor in the empire, that is they were claiming to be sovereign and therefore not subject to any other temporal ruler. They could not, however, claim exemption from papal jurisdiction. The papal legal system, the canon law, operated throughout the entire Western Christian world, and the pope acted as the *judex omnium*, the judge of all Christians, even emperors and kings. With regard to international order, the papal approach assumed that all serious issues fell under the jurisdiction of the canon law so that international conflicts, clearly among the most serious of issues, should be brought to the papal court for adjudication. One consequence of the papal conception of the world was that several thirteenth-century popes intervened in conflicts between Christian kings in order to prevent wars and to keep the peace. Another aspect of medieval thought on international order concerned Christian relations with non-Christian societies, especially Muslim societies. The emergence of Islam in seventh-century Arabia led to the creation of the *Dar al-Islam* ("the abode of Islam"), a Muslim cultural and social order that contended with Christendom militarily and spiritually for the next thousand years along a line that stretched from eastern Europe, through the Near East, and across North Africa and into Spain. Was it possible for Christians to live at peace with such neighbors? In practice, throughout the Middle Ages, Christians and Muslims engaged in trade throughout the Mediterranean, demonstrating that peaceful relations were possible under some conditions. Furthermore, until the eleventh century, Christian pilgrims were generally able to go on pilgrimage to the Holy Land and visit the places associated with the life of Christ, even though Palestine had been in Muslim hands since the fall of Jerusalem in 638.

The call for a crusade to free the Holy Land in 1095 was a crucial turning point in relations between Christians and Muslims, because Christians claimed the right to regain possession of Christian lands previously conquered by the Muslims as well as the right to protect themselves against advancing Muslim armies. The crusade was also seen as a means for developing a peaceful Christian world by diverting the violence to the frontier with the Muslims. At the same time, however, the crusaders also contributed to the deepening split within the Christian world between the Latin Church of Europe and the Greek Church of the Byzantine Empire. They did this by refusing to restore the lands they conquered from the Muslims to Byzantine control and by imposing the Latin ritual and Latin bishops on the Christian peoples of the East, peoples that adhered to versions of Christianity deemed heretical by the papacy.

In the mid-thirteenth century, Pope Innocent IV (r. 1243–1254), a leading canon lawyer, outlined a kind of world legal order under papal direction. He argued that the pope was the ultimate judge of all humankind, judging men and women according to the law to which they were subject. Thus, the pope judged Christians according to the canon law, Jews according to the Law of Moses, and all other people by the terms of the

natural law that is accessible to all rational human beings. Such a vision was impossible to realize even within Christian Europe, but the canon lawyers may have been the first thinkers to conceive of all humankind as ultimately forming a community with a universal legal order and therefore the first thinkers to suggest the possibility of a formal set of rules to regulate international relations. Subsequently, a leading ecclesiastical thinker, Nicholas of Cusa (1401–1464), published his *De Concordantia Catholica*, an outline of the medieval Christian conception of an orderly world, a world in which every kingdom and principality, Christian and non-Christian, functioned within its proper place.

A second medieval approach to the problem of international order appeared in the *De Monarchia* of the poet Dante Alighieri (1265–1321). Like the ecclesiastical conception of world order, Dante conceived of mankind as a single community but under the jurisdiction of the Holy Roman Emperor who was, according to Roman Law, the *dominus mundi*, the Lord of the World. Dante's primary interest was in regulating relations among the European states in order to end the constant round of wars.

During the Middle Ages, discussions of world order did not progress beyond the theoretical level. These theories assumed that humankind potentially formed a single human community subject to enforceable universal legal standards and functionally organized in a hierarchically constructed system under papal or imperial leadership. Such theories were based on a limited knowledge of the actual geography of the earth and its inhabitants. Around 1500, two events radically undermined these medieval theories of world order: the voyages of Columbus and the Protestant Reformation. Columbus's voyages revealed to Europeans for the first time the vastness of the sea and the diversity of the earth's population. The Protestant Reformers rejected the papacy and the entire ecclesiastical structure that the popes headed and therefore rejected the hierarchical conception of world order associated with it. These developments reshaped discussions of world order, dividing discussion into several distinct topics. These included: order among the nations of Europe; access to and jurisdiction over the sea; and the rights of the peoples of the New World in the face of European expansion.

The New World in the European International Order

The initial attempt to create a stable international order after Columbus's first voyage came in the form of three papal bulls that Pope Alexander VI (1492–1503) issued in 1493. These bulls, known by the opening words of the first of them, *Inter caetera*, divided the world along a line from the North Pole to the South Pole one hundred leagues west of the Azores and the Cape Verde Islands. To the east of that line, the pope granted the Portuguese complete jurisdiction, authorizing them to occupy lands held by the Muslim enemies of the Christian world and to support missionary efforts among the newly encountered peoples. In order to support these efforts, the Portuguese were granted a monopoly of trade with the peoples of these lands and of the route to Asia by way of circumnavigating Africa. The Spanish were granted the same privileges west of the line, guaranteeing them a monopoly of what was then

believed to be the westward route to Asia. No other Christian could enter these regions without the express permission of the ruler to whom the region was assigned.

Inter caetera was only the latest in a series of bulls going back to 1420 that had sought to regulate relations between the Portuguese and the Spanish as they expanded out into the Atlantic, seeking a route to Asia. During the fifteenth century, these two kingdoms had fought a series of wars that spilled over into the Atlantic, where both kingdoms laid claim to various island chains. In the course of settling these disputes, a series of popes had issued bulls regulating relations between these kingdoms in the Atlantic, assigning responsibility for specific islands to each kingdom and making each ruler responsible for Christianizing the peoples encountered there. *Inter caetera* did the same thing on a larger scale. Alexander VI's bulls also provided a justification for the European conquest of the New World. If the inhabitants interfered with Europeans who came peacefully to trade or to preach the Christian faith or if they engaged in practices that violated the natural law, European rulers had the right to send in troops to protect the merchants and missionaries and to punish violations of the natural law.

The Catholic position on world order received its fullest exposition in the works of a number of Spanish theologians, philosophers, and lawyers in the sixteenth and seventeenth centuries. The most famous of these authors were Francisco Vitoria O. P. (1486–1546) and Francisco Suarez S. J. (1548–1617). Vitoria approached the problem of international order from a position that we would now associate with human rights. That is, did the Europeans have the legal right to conquer and occupy the Americas, or did the inhabitants of the New World have legal right to their lands and did they have the right to govern themselves free of outside intervention? Finally, even if the inhabitants of the New World did have rights, were they subject to the natural law and could their violations of that law justify their conquest?

By challenging the papacy's conception of a hierarchically constructed Christendom, Protestant Reformers provided a basis for reconsidering the nature of international order. In the first place, the religious wars of the Reformation spelled the end of both papal and imperial claims to some form of leadership of European and even world society. The Peace of Westphalia (1648) ending 150 years of German wars of religion had no role for the pope and reduced the imperial office to a ghost of its former self. The notion of a unified Christendom ended, replaced by a group of what came to be identified as sovereign nation-states. These states rejected any notion of overlordship, papal or imperial, in their own internal affairs. Peace among the states of Europe would be achieved by political arrangements that the participating governments made among themselves. The key to such arrangements was the balance of power, that is, alliance networks designed to prevent any one country from dominating Europe.

International Order and the Law of the Sea

The second area of concern was jurisdiction over the seas. Could the sea be owned or, at the very least, could anyone

assert jurisdiction over the sea in order to prevent others from entering as Alexander VI had asserted in *Inter caetera*? The debate about possession of the sea drew the most attention from European scholars, because the discovery of the size and extent of the world's oceans significantly changed the nature of the debate about world order. Instead of armies of foot soldiers conquering new lands, the new empires of the early modern world, with the exception of Spain, were primarily concerned with trade and not with the acquisition of large amounts of territory. They were seaborne empires. Alexander VI's allocation of spheres of responsibility to the Portuguese and Spanish, if accepted by all European rulers, would have blocked overseas expansion except for those whom these two nations allowed into the regions allotted to them. The early years of the seventeenth century saw the publication of a number of legal treatises on the law of the sea. The Portuguese scholar Serafim de Freitas (c. 1570–1633) wrote a lengthy treatise on the legitimacy of Portuguese claims to monopoly of trade in the Indian Ocean on the basis of the papal grant. John Selden (1584–1684), an English scholar, argued that although the pope had no right to allot the seas to specific Christian monarchs, various European states had long-standing claims to possess parts of the sea. The most important work on the topic of the sea was Hugo Grotius's (1583–1645) *Mare liberum* (The freedom of the seas; 1609). Obviously defending Dutch claims to the right to travel anywhere in the peaceful pursuit of trade, Grotius argued that the seas were open to all and that no ruler had the right to exclude anyone from any sea.

International Order and Sovereign Nation-States

Like Alexander VI, Grotius's goal was to reduce the conflicts among the various European nations that were beginning to assemble overseas empires but without recourse to a universal ruler such as the pope or the Holy Roman Emperor. His *De iure belli ac pacis* (Concerning the law of war and peace; 1625) was a lengthy analysis of the causes of war that ultimately proposed rules for international relations that would not end all wars but, if followed, reduce their number. Increasingly, the issues associated with international order and dealt with in terms of international law came to focus almost exclusively on relations among European nations to the exclusion of any participation by other nations in the creation of international order. The building blocks of this international order were the sovereign nation-states that were developing in Europe and were expected to work in concert to maintain that order. Grotius's work marked a withdrawal from the conception of all mankind forming a single community subject to the terms of the natural law under the leadership of emperor or pope.

During the seventeenth and eighteenth centuries a number of important European thinkers developed theories of international law designed to mitigate if not end the horrors of war. These theorists, Samuel Pufendorf (1632–1694), Emmerich de Vattel (1714–1767), Immanuel Kant (1724–1804), to name only the most famous, sought to create an international order that did not depend on belief in God but on a purely rational analysis of the human situation in keeping with the secular rationalism of the Enlightenment.

During the nineteenth century a new stage of thinking and practice regarding international order developed. At the Congress of Vienna (1814–1815) the major powers, England, Prussia, Russia, Austria (later joined by France), formed the Quadruple Alliance and claimed responsibility for maintaining peace in Europe. Seeing the possibility of revolutions influenced by French revolutionary thought as the greatest threat to peace, these countries asserted the right to restore rulers ousted by revolutionary means as a way of stabilizing European politics. A series of congresses between 1818 and 1822 settled peacefully disputes that might otherwise have led to war, but these efforts faded after 1822 when the English withdrew from participation. Toward the end of the nineteenth century, however, Otto von Bismarck, the German chancellor, sponsored a conference in Berlin (1884–1885) to regulate European entry into Africa so that the rush to obtain African land did not lead to wars among the competing European states. This was the last gasp of the European congress system for regulating international affairs.

International Order in the Twentieth Century

In 1898, Tsar Nicholas II of Russia called for a meeting of the leaders of nations in order to develop a process for peacefully resolving international disputes. For the first time, the nations considered suitable for inclusion within the international legal order included non-European states such as the United States and Japan. Representatives of twenty-six nations met the next year at The Hague and signed an agreement promising to seek peaceful resolution of conflicts and established the International Court of Arbitration as a vehicle for achieving this. They also entered into an agreement regarding the laws of war. In 1907 there was a second meeting to discuss other issues. One of the fears motivating this interest in peaceful resolution of interstate conflicts was the growth of alliance networks that eventually divided Europe into two major blocs, one headed by Germany, the other led by France and England. Because of these alliance networks, what might have been a conflict between two states could escalate into a large-scale war as the countries involved called upon their allies to support them, something that did occur in August 1914. The weakness of the Hague meetings was that recourse to the court established there relied on the willingness of the parties to take that route rather than war. The court lacked any power to force states to come before it or, for that matter, to enforce any decisions it might reach.

During the twentieth century, the theory and the practice of international order attempted to reconcile several conflicting issues. The first of these dealt with the tension between a desire to incorporate all the nations of the earth into a single coherent system for the settlement of international disputes and a recognition of the fact that a few nations dominated international affairs militarily and politically. A second conflict arose from the desire to enforce adherence to internationally recognized standards of state behavior even in internal matters while recognizing the sovereign status of every state. Finally, there was the difficulty of determining generally acceptable standards of state behavior in a world composed of states with quite different cultural traditions.

The most famous twentieth-century approach to world order came out of the Versailles Peace Conference after World War I. President Woodrow Wilson, whose 14 Points outlined what he believed to be the causes of the war and what he saw as the steps necessary to prevent such a war from occurring again, proposed as the key to world peace a League of Nations that would be open to all states throughout the world and would be capable of enforcing peace. Although egalitarian at the level of the General Assembly in which each member state had one vote, at the highest level there was a council composed of representatives of the five great powers—France, England, Italy, Japan, and the United States—supplemented by representatives of four other powers elected by the General Assembly. Wilson's plans for an international order were frustrated by the national interests of the various countries involved, by the refusal of the U.S. Senate to vote in support of membership in the League, and by the refusal to admit Germany and Russia. This meant that three of the most powerful countries in the world were outside of the orderly world network that the League of Nations was supposed to create.

During the 1920s, there were various attempts to create a peaceful international order by executing treaties that would bind nations to seek peaceful solutions to conflicts. Germany, for example, signed a series of treaties that bound it to accept the borders established at the end of World War I and to accept arbitration in those cases where there were conflicts with neighboring countries. The Kellogg-Briand Pact (1927) bound signatories to use arbitration to settle disputes, and, in 1930, the major naval powers signed a treaty in London to regulate the size of navies and regulating submarine warfare. These treaties and others entered into during the 1920s suggested to some observers that a legally based international order was coming into being. No means were created, however, for enforcing adherence to these treaties.

In addition to resolving conflicts among European nations, the post-World War I era saw the development of efforts to regulate relations among the nations of the rest of the world and to assist in the development of these nations. Former German colonies in Africa were assigned to various European powers. Other areas, lost to the collapsing Ottoman Empire, Syria and Iraq, for example, became independent states but under the supervision of France and England, respectively. These arrangements were made under the direction or mandate of the League of Nations and were expected to end once these countries had become fully developed modern states and therefore capable of participation in the network of states that controlled international order.

The experience of the 1930s, however, demonstrated that international order, especially where it concerned the interests of the major nations, could not be secured without the use of force. The failure of the French to secure support for the occupation of the Ruhr in 1923 marked the last attempt to use force to ensure German adherence to the terms of the Versailles Treaty. When Adolf Hitler repudiated the treaty's limitations on the size of the German armed forces in 1935, the League of Nations took no steps to enforce adherence to the treaty. Likewise, there was no forceful reaction the following year when

the Germans reoccupied the demilitarized Rhineland in violation of the treaty.

The efforts at establishing international order that were made after World War II were designed to avoid the problems associated with the post-World War I settlement. The United Nations (UN), formally created in October 1945, was established to maintain the unity of the countries that won the war. Like the League of Nations, the United Nations consisted of two houses, the General Assembly where each nation had one vote and the Security Council that consisted of five permanent members and six elected by the General Assembly. Membership in the UN grew rapidly from the initial 51 members to more than 160 in 2003. Some saw the UN as paving the way for a world government that would maintain world order, but there were a number of forces that worked against such an outcome, above all, the division of the world into two large political blocs identified with the North Atlantic Treaty Organization (NATO) and the Warsaw Pact. These two large military and political blocs in turn not only confronted one another directly, they also competed for support from the so-called Third World nations of Asia and Africa. To a great extent, world order in the post-World War II era was created by the tension between the two great power blocs.

In the face of increasing demands for independence and self-government, a number of new states emerged. Decolonization, as this process was termed, was expected to lead to the creation of new sovereign states that would easily fit into the state-based international order that was being constructed under the aegis of the United Nations. The UN was actively involved in efforts to resolve border disputes generated by the collapse of the colonial empires. Some of these interventions succeeded in avoiding war by partitioning the disputed territory between the two claimants and then using troops from neutral countries as a permanent buffer between the conflicting groups.

The demolition of the Berlin Wall in 1989 marked the end of the division of the world into two large blocs and generated a great deal of discussion of what some termed a New World Order. In political terms, this meant the victory of Western liberal, capitalistic democracy; in practice, it meant uncontested American world leadership. Francis Fukuyama's *The End of History and the Last Man* (1992) articulated the view that with the fall of the Berlin Wall, the "end point of mankind's ideological evolution" had been reached, as liberal democracy survived the greatest challenge it had ever faced. One implication of this argument was that as all the nations of the world adopted the liberal democratic and capitalistic way of life, a stable, orderly world of political order composed of nation-states along European lines would emerge. In reality, of course, this has not happened. In contrast to the vision of a peaceful international order that Fukuyama presented, Samuel Huntington has argued that the twenty-first century will see conflict not between nation-states but between cultural blocs with different conceptions of international order.

The beginning of the twenty-first century reveals several kinds of development relevant to the formation of a peaceful world order. The first of these is the unchallenged role of the

United States in world affairs. President George W. Bush asserted American responsibility for maintaining a terrorist-free international order and a willingness to act alone if necessary. Detractors increasingly labeled the United States an empire with all of the negative meanings attached to that term. At one level, the expansion of the European Union is a response to American power, unifying European states into a bloc capable of playing a significant role in the international order.

There is also renewed emphasis on humankind as forming a world community subject to universally applicable and enforceable standards of humanitarian behavior. In some cases, UN judgments are enforced by troops of member nations operating under the UN flag. In other cases, however, elements of this development operate separately from the United Nations. The establishment of an International Criminal Court at The Hague in 1998 is one sign of an effort to enforce universal standards outside of the UN framework. This court deals not with states but with individual officials, military and civilian, whose actions violated international standards and follows in the steps of the war crimes trials held at Nuremberg and Tokyo at the end of World War II.

The current trend is toward some form of international order that enforces adherence to standards of behavior through a legal and institutional structure that includes all humankind, a somewhat hierarchical structure that reflects the realities of political power. The power and leadership role of the United States is recognized, but these are restrained by the existence of the United Nations and the international legal order. Furthermore, the sovereignty of states, a fundamental element of international law since the seventeenth century, has been undermined as the United Nations has issued documents on human rights. These documents charge the UN with defending the rights of citizens when their rulers oppress them, even authorizing humanitarian intervention under UN auspices to protect the citizens from their own government. It remains to be seen, however, whether these various elements of international order will coalesce into a formal, permanent structure providing both order and freedom for all humanity.

See also Christianity; Empire and Imperialism; Hierarchy and Order; Nationalism; Peace; War.

BIBLIOGRAPHY

PRIMARY SOURCES

- Brown, Chris, Terry Nardin, and Nicholas Rengger, eds. *International Relations in Political Thought: Texts from the Ancient Greeks to the First World War*. Cambridge, U.K., and New York: Cambridge University Press, 2002.
- Office of the United Nations High Commissioner. *Human Rights: A Compilation of International Instruments*. Vol. 1, part 2: *Universal Instruments*. New York: United Nations, 1993.
- Scott, James Brown, ed. *Classics of International Law*. 22 vols. Washington, D.C.: Carnegie Endowment for International Peace, 1911–1950. Many of the leading writers on international law are represented in this series, which was reprinted by Oceana Publications in 1964.

SECONDARY SOURCES

- Bull, Hedley. *The Anarchical Society: A Study of Order in World Politics*. New York: Columbia University Press, 1977.
- Bull, Hedley, Benedict Kingsbury, and Adam Roberts, eds. *Hugo Grotius and International Relations*. Oxford: Clarendon, 1990.
- Fukuyama, Francis. *The End of History and the Last Man*. New York: Free Press, 1992.
- Huntington, Samuel P. *The Clash of Civilizations and the Remaking of World Order*. New York: Simon and Schuster, 1996.
- Jackson, Robert H. *Quasi-States: Sovereignty, International relations and the Third World*. Cambridge, U.K., and New York: Cambridge University Press, 1990.
- Keene, Edward. *Beyond the Anarchical Society: Grotius, Colonialism and Order in World Politics*. Cambridge, U.K., and New York: Cambridge University Press, 2002.
- Kissinger, Henry A. *A World Restored; Metternich, Castlereagh, and the Problems of Peace, 1812–22*. Boston: Houghton Mifflin, 1957.
- Muldoon, James. *Popes, Lawyers, and Infidels: The Church and the Non-Christian World, 1250–1550*. Philadelphia: University of Pennsylvania Press, 1979.
- Murphy, Cornelius F., Jr. *Theories of World Governance: A Study in the History of Ideas*. Washington, D.C.: Catholic University of America Press, 1999.
- Sewell, Sarah B., and Carl Kaysen. *The United States and the International Criminal Court: National Security and International Law*. Lanham, Md.: Rowman and Littlefield, 2000.
- Tuck, Richard. *The Rights of War and Peace: Political Thought and the International Order from Grotius to Kant*. Oxford and New York: Oxford University Press, 1999.

James Muldoon

INTERPRETATION. The problem of interpretation is as old as the written record, even as old as the capacity for human beings to disagree fundamentally. It was raised by Plato. It marked many a conflict in early Christendom. From the Middle Ages to early modernity, cultural texts proliferated. Interpretation was the task of those who were in charge of biblical exegeses and of those who judged a text's originality, authenticity, and truthfulness. As interpretation became an increasingly prominent feature of the modern conundrum, questions about a work's truth and authenticity also prompted the development of philological methods of analysis. Toward the end of the eighteenth century, however, the older concerns for religious authenticity began to give way to a modern hermeneutics that raised new questions about making historical interpretations. In this period Kantian philosophy championed the centrality of the human subject as the foundational problem for all cognition. In addition, the problem of art and the role, function, and purpose of the artist, the concern for the "inner life" (*kultur*) (Elias), and the rise of modern selfhood (Taylor) began to affect the study of meaning. By the nineteenth century, philological approaches gave way to a reflexive concern for how epistemology, and more specifically, history, was to be conceptualized, approached, and thus interpreted. This new impulse marked the rise of modern hermeneutics and gave it a special role in understanding how the problem of interpretation is grappled with in the twenty-first century.

The rise of modern hermeneutics is often attributed to the writings of Friedrich Schleiermacher (1768–1834). Moving beyond philology, exegeses, and art criticism, he posed a new challenge: to understand culture and lived experience. Schleiermacher asked how a denizen of one historical era might understand the meaningful experience of a life or cultural text from another. He shifted hermeneutics toward the problem of experience within a context and argued that a viable interpretation had to proceed through an identification with the subject under study. In doing so, he posed the problem of historical hermeneutics—the challenge of understanding the meaning held by historically situated actors. Thus, with Schleiermacher, the new conditions placed in context took precedence over the ritual incantation of dogma, received truths, and essences. The concerns of the modern social sciences and humanities owe much to the rise of a historically reflexive hermeneutics.

In the nineteenth century, Wilhelm Dilthey (1833–1911) expanded *methodological hermeneutics*, which sought to produce systematic and scientific interpretations by situating a text in the context of its production. According to Dilthey, all manner of cultural texts—poetry, the spoken word, art, human action—are meaningful expressions with “mental contents” and human intentionality, and thus worthy of understanding (*verstehen*) through critical study. Meanings are also the product of historical constraint; the content and values of cultural texts reflect the period and location of the subject. Understanding thus involves the methodological construction of the *hermeneutical circle*—the connections that lead from the analysis of a cultural text to the author’s life and the historical context in which the author is located, and then back to the cultural work.

In the twentieth century, Martin Heidegger (1889–1976) and Hans-Georg Gadamer (1900–2002) championed a *philosophical hermeneutics* by shifting concerns toward an understanding of existential meaning, in which being in the world can be grasped as a direct and unmediated condition of authenticity and subjectivity. One’s knowledge and experience constitute a present horizon, which is the fundamental ground on which understanding takes place. This horizon, however, can be extended through exposure to the discourses of others, thus bringing one’s own views into relief. It is through language as the core of human activity that subjects share their subjectivity, the basis of traditions, and their evaluation. Understanding has a potentially dynamic quality: it can proceed from one horizon to an emergent horizon, but is nonetheless bound to the traditions embedded in history.

Later, Jürgen Habermas (1929–) challenged Gadamer’s relativism by arguing for a self-reflexive *critical hermeneutics* that aims at a comprehensive reconstruction of the social world. Gadamer had claimed a universality for hermeneutics; no form of knowledge can escape the limitations of interpretation and its ties to deeper traditions. Habermas rejected this constraint on interpretation and argued that the human communication process contains transcendental elements. We are not trapped in nature or history because we can know and thus transform our language. In the structure of language, autonomy

and responsibility are posited for us. By overcoming the systematic distortions, the legacies of history and tradition that are embedded in language, we are able to envision an emancipated society whose members’ autonomy and mutual responsibility can be realized through the development of nonauthoritarian dialogue and reciprocity.

The issues opened up by modern hermeneutics shaped the way interpretation is conceptualized, approached, and carried out in interdisciplinary studies. Indeed, the boundaries between the social sciences and the humanities have never been so porous as they are in the twenty-first century. Just as literary studies influence anthropology and cultural studies, literary theory reaches toward social theories. The convergence and confluence of questions and issues is more characteristic than the maintenance of disciplinary boundaries. With the rise of modern hermeneutics, the problem of interpretation took on a social and historical dimension, which allowed this new concern with meaning to be assimilated by anthropology, literary studies, and later, cultural studies, reception and audience studies, and aspects of feminist theory. By tracking the history of interpretation, we gain an appreciation for the interdisciplinary developments of interpretive theorizing in the twenty-first century.

The Hermeneutic and Interpretive Impulse in the Rise of Social Studies

Karl Marx (1818–1883) did not address the problems defined by Dilthey, but his approach to the problem of historicism was in some ways continuous with historicist hermeneutics. Marx’s theories also had a major impact on social scientific approaches to the study and interpretation of history. Georg Wilhelm Friedrich Hegel (1770–1831), the nineteenth-century German idealist philosopher whose views Marx modified, saw history as the unfolding manifestation of the human spirit. According to Hegel, the human spirit will eventually reach a truly revolutionary stage in which it will be able to see through itself for the first time. This radical philosophical view of spirit developing a consciousness of itself was transformed by Marx into sociological language. Knowledge and consciousness can be socially constituted and grounded only in a distinct human subject. But such a reflexive and revolutionary consciousness will not develop in just any subject. The subject and the knowledge for this development has to be special—that is, specially located in history. For Marx, this historical process can be realized only through the embodied consciousness of a human subject whose social and historical location provides it with the privilege to achieve such awareness. This subject is the *proletariat*—the social class within modern capitalism that embodies the historical forces that will provide it with the capacity to see itself as an object produced by history (Marx and Engels). In this manner, Marx turned the problem of epistemology (the problem of knowledge) into a historicist sociology. All forms of knowledge are expressions of human activity and practice, and such knowledge can be grasped only as manifestations of the historical conditions in which they take their social form. In essence, culture, ideology, ethics, religion—the entire enterprise of knowledge making—is a reflection of the historical mode of human production, a process ultimately

rooted in human labor. This history remains unseen, ungrasped, misunderstood, misrepresented by ideology. Thus estrangement or alienation—the inability to see the underlying reality—characterizes human history and can be overcome only by the historical rise of a human subject situated in ways that enable this kind of critical consciousness to take hold.

Much criticism has been leveled at how Marx privileged economic and material aspects at the expense of the cultural realm. Certainly, the problem of culture was not a central concern for Marx. Culture was relegated to the “superstructure” where ideas, values, ethics, and ideology circulated as fictitious echoes and reflections of the “real” activity of labor and the materialist dimensions of the class struggle. Yet Marx’s views are crucial to the modern enterprise of interpretation, especially in the idea that subjects, actors, and texts cannot exist as autonomous entities or things in themselves, but are rather fundamentally immersed in social and historical contexts. In this manner, Marx’s sociology, notwithstanding trenchant criticism, consistently challenged interpreters to understand that practices and texts are inseparable from social and historical conditions. The implications for interpretation were profoundly expanded. The most discrete activity was to be connected to the broader material, social, and historical formation. Whether it be a specific tool or element of technology, a cultural ritual, a poem, a scientific treatise, or a social institution under examination, the interpretive task is to understand the element in relation to a social totality (mode of production). Marx’s seminal view—the historicist view of all things in the human world—remains a vibrant aspect of twenty-first century interpretation.

In contrast to Marx’s theories, the sociology of Émile Durkheim (1858–1917) marked the rise of the cultural approach to the social sciences in which the study of symbolic production is central. For Durkheim, the underlying phenomenon to be interpreted is *solidarity*. Only through *representations* is human solidarity and society made visible and open to sociological interpretation. Thus, when cultural and religious solidarity is violated, the preeminent indicator of the collective response is repressive/penal law. Punishment expiates the sense of violation. In Durkheim’s sociology the realm of cultural life is brought into view and interpreted through the study of symbolic and semiotic practices that express the underlying cultural cohesion but also govern and maintain it. This makes Durkheimian sociology a fundamentally interpretive enterprise. The social and cultural realm can be grasped only through symbolic production, because it is instantiated in and organized through it. Although Durkheim insisted on a social reality instantiated through routine cultural practices that sociology was to ascertain, his major contribution to modern cultural interpretation was his emphasis on the formal study of representations.

The hermeneutic insistence on identifying with the inner logic of a socially embedded subject also shares some traits with what the Scottish moralists David Hume (1711–1776) and Adam Smith (1723–1790) called human “sympathy” (A. Smith). It is in Max Weber (1864–1920), however, that historical hermeneutics finds a direct link to sociology. For Weber, the

primary challenge for sociological interpretation is to decipher the modes of meaning and the forms of rationality characteristic of social activity. These forms of organized meaning ultimately have a cultural dimension, but for Weber the task was to grasp them as modes of *rationality*. The formulation and interpretation of modes of rationality provide the sociological keys to understanding the everyday practices of individuals engaged in organized activity. Drawing on the ideas of Dilthey and Heinrich Rickert (Hughes), Weber argued for a sociology that places interpretation at its core. According to Weber, “interpretive sociology considers the individual and his action as the basic unit, as its ‘atom.’ . . . The individual. . . is the upper limit and the sole carrier of meaningful conduct. . . . Such concepts as ‘state,’ ‘association,’ ‘feudalism,’ and the like, designate certain categories of human interaction. Hence it is the task of sociology to reduce these concepts to ‘understandable’ action, that is without exception, to the actions of participating individual men” (Gerth and Mills, p. 55). Weber synthesized both earlier hermeneutic currents as well as Marxian historicism. Yet he did not share Marx’s faith in a notion of history that operates inexorably and fatefully to create a privileged subject (the proletariat) and instead placed the emphasis on the underlying rationality that makes every cultural formation a sociologically interpretable phenomenon.

With the work of Karl Mannheim (1893–1947), the problem of interpretation took a formidable turn toward the “sociology of knowledge.” Mannheim shared the concerns of Dilthey, Marx, and Edmund Husserl, who insisted that the act of knowing and interpreting is always bound to social conditions. Thus, for Mannheim all knowledge was *partial* knowledge. Because of social context, a group can achieve a certain interest-based quality of understanding and generate in turn knowledge and truth claims based on views from its vantage point. These claims, however, can be understood (sociologically) only as elements in a *pluralist* arena of competing views, which are also *relative* to their location, social position, and point of view. The interpretation of a cultural expression thus hinges not only on the intrinsic meanings held by actors and subjects but also on a comprehension of the limits imposed by the location and conditions of the subject’s social origins. Consistent with pluralist and relativist aspects of Franz Boas’s anthropological writings, Mannheim’s sociology of knowledge insisted that cultural views—statements, beliefs, values, literary productions, and so forth—always bear the stamp of their context.

The Interdisciplinary Challenges of Interpretation

The determinant importance of the social and cultural context that runs from hermeneutics to classic social theory, and certainly from Dilthey to Mannheim, and which shapes as well the way we understand values and meanings held by social actors and the social and cultural texts they produce, continues as part of the formidable framework even within twenty-first century theories of interpretation. This is especially true for the historical importance granted to the context in which cultural texts emerge and are read, appropriated, used, and interpreted and to the limitations such a context imposes. Yet new issues and tensions within interpretive theories have taken

hold. They may not represent a serious rupture in relation to earlier paradigms, however, or a revolutionary upheaval in intellect, but may merely be a difference in analytical emphasis.

The work of Michel Foucault (1926–1984), whose intellectual profile cuts across the social sciences and the humanities, had a major impact on interpretation. In a move as profound as Marx’s positing of the concept of *mode of production*, Foucault insisted that what is at play in the realm of history and human affairs is the construction of discursive regimes that govern every enterprise of knowledge making. In this regard, knowledge and power remain inextricably coupled and constitute the most productive dimensions of human activity. Foucault questioned the very modern category of knowledge and the assumption that knowledge is the product of neutral tools of investigation. According to him, the production of all knowledge is carried out in the constitutive effectivity of the discursive forms that make the knowledge enterprise possible. Thus there is no escape from the forms and modes of discourse; they condition and shape what becomes knowledge. In this regard, Foucault’s views undermine the notion that rationality has a universal, transcendental, and foundational status allowing it to claim the transcendental privilege of ascertaining truth. Because of the conditions of discourse, the idea of Truth as a reality to be grasped “out there” through the deployment of the discursive schemas of language must give way to the study of what discourse actually produces—“truth effects.” This antifoundational approach conditions every act of interpretation, casting it into the position of a continual reflection on its very capacity to frame the problem of meaning. The task set by Foucault is to comprehend the *idea* of truth and the constructive effects such an idea has on the forms and organizations of social and historical life. He argued that epistemology must be replaced by a genealogy of knowledge forms. Like Mannheim’s sociology of knowledge, the study of discursive forms can yield an understanding of what Foucault called *epistemes* (Mannheim used the term *Weltanschauung*, or “worldview”)—a horizon of historicity that represents the cumulative frameworks of knowledge production but is also open to historical ruptures and the ensuing transformations. Likewise, Foucault’s insistence on discursive forms as the principal arena for social and historical analysis has links to French sociology’s emphasis on representations.

Foucault’s influence can be seen in the way cultural interpretation has taken on new perspectives and issues. In the early twentieth century, the problem of culture was largely seen as the prerogative of anthropologists. In the twenty-first century, however, every discipline within the social sciences and the humanities takes culture as a major concern. It is worth noting that within anthropology, the very notion of culture as a set of practices that exist “out there” and can be studied objectively by the social scientist has given way somewhat to a more reflexive notion of culture as a peculiarly problematic intellectual construction. Anthropologists are no longer solely interested in studying the culture of others; they also want to study and interpret culture. This additional interest has its roots in Claude Lévi-Strauss’s insistence (drawing from Ferdinand de Saussure, who in turn drew from Durkheim) that culture

operates like language and should therefore be studied similarly. The so-called linguistic turn was fully evident in the late 1970s in the work of the anthropologist Clifford Geertz (1926–) who, though not influenced by Foucault, nonetheless recast culture primarily as the construction of narratives. The anthropological shift from a concern with a “culture out there” to a preoccupation with the *constitutive* power of narrative and discursive forms is noteworthy in the work of James Clifford and George Marcus, among others, who emphasize the narrative dimension of *writing* social science and view cultural interpretation as inextricably tied to the act of inscription. As cultural texts, writings in the social sciences do not so much “discover” the social as construct narratives that in turn condition the social world.

In the wake of Foucault’s views, literary theory has converged with social theory around the problem of historical interpretation. This can be seen in the theories affiliated with New Historicism which, in keeping with historicist hermeneutics and the sociology of knowledge, argues that formalist, text-centered approaches to literature need to be replaced by methods that include the social and political circumstances of their production (Greenblatt; Gallagher; Mitchell). In a synthesis of Marx and Foucault, literature is conceptualized not as a distinct category of human production to be studied as an isolated phenomenon but as a historically embedded form. As a situated cultural product, literature can reveal the ideological contours of its conditions of production. A literary work can therefore mean different things to different people who do not share the same context. The shift in the problem of interpretation toward the social conditions that govern cultural appropriation has also influenced the study of the uses of literature and cultural texts. Reader-response theory (Tompkins), theories of interpretive communities (Fish), and reception theory (Holub) do not begin with the presumption that texts have meanings but instead emphasize the social and subjective dimensions of how texts are read and appropriated, an approach that resembles the “uses and gratifications” approach in mass media studies. Texts are thus subordinated to readers and audiences and the social frameworks and dispositions they bring to the act of interpreting cultural texts.

New Historicism is sometimes criticized for conflating history and text and for projecting contemporary issues onto situations from the past. History is not necessarily the cause and source of a literary work; instead, the ties between history and text are reduced to a dialectically recursive problem. The text is interpreted as product and production, end and source of history. In this regard, New Historicism reflects the influence Louis Althusser’s structuralist theories of ideological reproduction have had on literary theory and his insistence that all cultural production is “structured in dominance.” Contemporary theoretical problems are also sometimes “read back” into a historical context where they may not apply, as when modern social categories are used as analytical devices for interpreting subjects in a quite different historical epoch. Althusserian theories of ideological reproduction can be seen in the important subcultural studies carried out within the field of British cultural studies that emerged in England in the late 1970s and early 1980s. Paul Willis’s ethnographic work exemplified the

desire to restore a subject-sympathetic analysis of participants in the rich world of subcultures, especially youth subcultures. While this approach privileged the voices and views of his subjects, thus giving the study of a subculture a more human dimension, the subjects of his study—working-class youth—struggle for a sense of self, autonomy, and dignity only to contribute culturally and unwittingly to their own domination.

The attention to subjects is mired in the constraints of history and social location. But subject-centered interpretive theory also has its redemptive impulses. From the 1970s on, much historical work has retrieved the social lives of various groups hitherto ignored by historiography. Some aspects of feminist theories of interpretation exemplify this retrievalist impulse. While the larger horizon of feminist theory, in its analysis of society and history, has mainly addressed the subjugation of women, there are attempts to recast the narrative of perpetual domination by highlighting subjects in ways that emphasize their capacity for critical resistance. This approach to locating and interpreting critical subjectivity moves toward a revisionist feminist epistemology that begins with a *situated knower* who has *situated knowledge* that reflects her perspectives (D. Smith). Known as “standpoint theory,” this view has similarities to Mannheim’s sociology of knowledge, but the conceptual framework shares more with the ideas of the cultural theorist Georg Lukács (1885–1971). It was Lukács who argued that a subject’s location in society and history provides a “standpoint” that can give epistemological ground to the critical study of consciousness. As a Marxist, Lukács had a historically privileged subject in mind—the proletariat. In early feminist standpoint theory, the privileged historical category shifted from class to gender, and the problem of a gendered subject’s knowledge was itself a gendered historical formation (D. Smith; Harstock). The attempt to establish a single feminist standpoint, however, has given way to postmodern theory’s pluralist concerns and the acknowledgment of multiple, epistemologically informative situated standpoints (Harding; Collins; Alarcon; Sandoval).

Twenty-first century theories of interpretation reflect significant cross-disciplinary reflection. Although there is merit in approaching the problem of interpretation from distinct disciplines, it is apparent that the boundaries that divide the disciplines *within* the humanities and the social sciences, and the divisions that occur *between* the humanities and the social sciences, are obfuscatory. Interpretation has become the core problem within the study of culture; and culture, in turn, has come to occupy a vast area traversing every discipline within the humanities and the social sciences. For these reasons, the problem of interpretation will quite likely continue to be one of the more formidable, persistent, and challenging issues of intellectual inquiry well into the future.

See also *Cultural Studies; Hermeneutics; Interdisciplinarity*.

BIBLIOGRAPHY

Alarcon, Norma. “The Theoretical Subject(s) of This Bridge Called My Back and Anglo-American Feminism.” In *The Postmodern Turn*, edited by Steven Seidman, 40–52. Cambridge, U.K.: Cambridge University Press, 1997.

- Althusser, Louis. “Ideology and Ideological State Apparatuses.” In his *Lenin and Philosophy and Other Essays*, translated by Ben Brewster. New York: Monthly Review Press, 1971.
- Clifford, James, and George E. Marcus, eds. *Writing Culture: The Poetics and Politics of Ethnography*. Berkeley: University of California Press, 1986.
- Collins, Patricia Hill. *Black Feminist Thought: Knowledge, Consciousness, and the Politics of Empowerment*. Boston: Unwin Hyman, 1990.
- Dilthey, W. “The Rise of Hermeneutics.” Translated by T. Hall. In *Critical Sociology: Selected Readings*, edited by P. Conner-ton, 104–116. Harmondsworth, U.K.: Penguin, 1976. Excerpted from W. Dilthey, “Die Entstehung der Hermeneutik” (1900), in his *Gesammelte Schriften*, 317–320, 323–331. Leipzig: B.G. Teubner, 1923.
- Durkheim, Émile. *The Division of Labor in Society*. Translated by George Simpson. New York: Free Press, 1933.
- . *The Elementary Forms of the Religious Life*. Translated by Joseph Ward Swain. London: Allen and Unwin, 1915.
- Elias, Norbert. *The Civilizing Process*. 1939. Vol. 1. Translated by Edmund Jephcott. New York: Urizen Books, 1978.
- Fish, Stanley. *Is There a Text in This Class? The Authority of Interpretive Communities*. Cambridge, Mass.: Harvard University Press, 1980.
- Foucault, Michel. *The Archaeology of Knowledge*. Translated by A. M. Sheridan. New York: Harper and Row, 1972.
- . *Discipline and Punish: The Birth of the Prison*. Translated by Alan Sheridan. New York: Vintage Books, 1979.
- . *The History of Sexuality*. Translated by Robert Hurley. New York: Vintage Books, 1980.
- Gallagher, Catherine. *The Industrial Reformation of English Fiction: Social Discourse and Narrative Form, 1832–1867*. Chicago: University of Chicago Press, 1985.
- Geertz, Clifford. *The Interpretation of Cultures: Selected Essays*. New York: Basic Books, 1973.
- Gerth, H. H., and C. Wright Mills, eds. and trans. *From Max Weber: Essays in Sociology*. New York: Oxford University Press, 1946.
- Greenblatt, Stephen. *Renaissance Self-fashioning: From More to Shakespeare*. Chicago: University of Chicago Press, 1980.
- Habermas, Jürgen. *Knowledge and Human Interests*. Translated by Jeremy J. Shapiro. Boston: Beacon Press, 1971.
- Harding, Sandra. *Is Science Multicultural? Postcolonialisms, Feminisms, and Epistemologies*. Bloomington: Indiana University Press, 1998.
- Harstock, Nancy. “The Feminist Standpoint: Developing the Ground for a Specifically Feminist Historical Materialism.” In *Feminism and Methodology: Social Science Issues*, edited by Sandra Harding. Bloomington: Indiana University Press, 1987.
- Holub, Robert C. *Reception Theory: A Critical Introduction*. London: Methuen, 1984.
- Hughes, H. Stuart. *Consciousness and Society: The Reorientation of European Social Thought, 1890–1930*. New York: Vintage Books, 1958.
- Lukács, Georg. *History and Class Consciousness*. Translated by Rodney Livingstone. Cambridge, Mass.: MIT Press, 1971.
- Mannheim, Karl. *Ideology and Utopia: An Introduction to the Sociology of Knowledge*. Translated by Louis Wirth and Edward Shils. New York: Harcourt, Brace, 1936.
- Marx, Karl, and Frederick Engels. *Basic Writings on Politics and Philosophy*. Edited by Lewis S. Feuer. New York: Doubleday, 1959.

- Mitchell, W. J. T., ed. *The Politics of Interpretation*. Chicago: University of Chicago Press, 1983.
- Sandoval, Chela. *Methodology of the Oppressed*. Minneapolis: University of Minnesota Press, 2000.
- Schleiermacher, Friedrich. *Hermeneutics and Criticism and Other Writings*. Translated and edited by Andrew Bowie. New York: Cambridge University Press, 1998.
- Smith, Adam. 1759. *The Theory of Moral Sentiments*. Edited by Knud Haakonssen. New York: Cambridge University Press, 2002.
- Smith, Dorothy E. *The Everyday World as Problematic: A Feminist Sociology*. Boston: Northeastern University Press, 1987.
- Taylor, Charles. *Sources of the Self: The Making of the Modern Identity*. Cambridge, Mass.: Harvard University Press, 1989.
- Tompkins, Jane P., ed. *Reader-Response Criticism: From Formalism to Post-Structuralism*. Baltimore: Johns Hopkins University Press, 1980.
- Willis, Paul. *Learning to Labor: How Working Class Kids Get Working Class Jobs*. New York: Columbia University Press, 1981.

Jon Cruz

ISLAM.

This entry includes four subentries:

Africa
Shii
Southeast Asia
Sunni

AFRICA

It was the long, drawn-out confrontation of the seventh century C.E. between the emerging Islamic caliphate and the declining Roman Empire over the Mediterranean African shores, and the subsequent breakdown of the empire, that created favorable conditions for the establishment of the two earliest Islamic frontier provinces in North Africa: Egypt and Tunisia. But the establishment of these two provinces did not, by itself, lead to immediate large settlements of immigrant Muslims, or to dramatic transformations in African communities. Yet, barely six hundred years after the death of the prophet Muhammad, various African communities and chieftains had either adopted Islam as a court religion or incorporated Muslim practices into their religious systems. Grasping the cultures and structures of these Islamized and Islamizing communities is indispensable to understanding the development of Islam in Africa. However, space does not permit a detailed examination of each of these communities. For our purposes it is sufficient to identify the major frontier communities through which Islam made inroads into Africa, to give a brief summary of the main controversies in Islamic philosophical outlook, to examine the types of African social forces that appropriated it, and to make a few observations that seem relevant for an understanding of the current signs of regeneration of Islam in modern Africa.

Muslim Frontier Communities

After striking its roots in Egypt and in the far West, Islam was carried into the fringes of black Africa by indigenous tribesmen.

Through the foundation of trading centers, the movement of populations, and the affiliation with local ruling elites, Muslim influence in the interior of the region was strongly felt. In their eleventh-century search for gold, Berber nomadic tribesmen reached the area of upper Niger, which was inhabited by the Mande-speaking peoples (Malinke). Following their ruler, a sizable number of them embraced Islam. With the favorable political environment and the flourishing trans-Saharan trade, a Muslim community also flourished and became an important link between the older Islamic world north of the Sahara and the African interior southwards as far as the fringes of the forest. It was under this Islamic influence that the medieval empires of Ghana, Mali, and Songhay had functioned and prospered. Throughout the fourteenth century, a number of competent Muslim chiefs were able to create a considerable domestic power base and to cultivate strong relations with the older Muslim world, especially Egypt, Morocco, and Arabia.

Like the Berber in the north, the Christian Nubians of the Nile resisted the Muslim-Arab invasion and delayed the advance of Islam for centuries, although an Islamic state had been securely established in adjacent Egypt since the seventh century. It was only through persuasion and trade that Arab tribesmen and merchants were able to penetrate far beyond Aswan, which was used, like al-Qurawan in Maghrib, as a frontier garrison to protect the Muslims against the raids of the Nubians and the Beja. Although there was no deliberate policy of spreading Islam to the south, the gradual settlements and intermarriages between the Arabs and Nubians began a process of Arabization and Islamization that laid the foundations for the subsequent institutionalization of Islam. The discoveries of significant gold mines in the eastern region, and the intensive traffic caused by the religious pilgrimage known as the hajj, led to the rise of the Red Sea ports and to the flourishing of Muslim communities within them.

Apart from gold mines, the east African coast, which comprises what are today Eritrea, Ethiopia, Djibouti, and Somalia, had experienced constant exposure to Islamic influence since the seventh century. Persian and Arab traders were active in the region for centuries, and through them Islam infiltrated the area through the Red Sea ports of Badi, Aidab, and Suakin. Consequently a string of Muslim enclaves and settlements arose and extended from the Gulf of Aden to Mozambique. However, a variety of factors halted the advance of these communities into the hinterland (present-day Kenya, Tanzania, Uganda, Rwanda, and Burundi), and it was not until the nineteenth century that their Islamic influence reached Malawi and the Congo basin.

Searching for ivory, some pioneering Arab merchants from the east coast of Africa, especially Zanzibar, ended up within these central African regions. Trade in ivory had, however, become inseparable from the slave trade in which those Arabs were involved as intermediaries between indigenous slave traders and Europeans. But trade in ivory and slaves brought Africans, Arabs, and the European colonial powers to loggerheads. The Arabs' presence in central Africa was eventually broken during the European scramble for Africa, which had negative effects on the advance of Islam in that region.

Interestingly, the same institution of slavery that hampered the advance of Islam in central Africa generated numerous incentives to Islamic conversion in southern Africa. Between the late seventeenth and early nineteenth centuries, European colonialists, mainly Dutch, brought tens of thousands of slaves from Madagascar, the Indian subcontinent, and the Indonesian archipelago into South Africa. Although Christians, these European slavers did not evangelize among their slaves—such a practice would have held out the promise of legal and social equality. Discouraged from becoming Christians, some slaves turned to Islam and, together with exiled Muslim imams and political prisoners who were expelled from the same region, laid the foundations for an alternative Islamic culture and community.

Looking at the relatively rapid growth of Islam in African public life, one might think that Islam was an ideology of the rulers, or even a royal religion, as indeed some scholars have thought. Overemphasizing the role of tribal chiefs and traders, some scholars have also maintained that the spread of Islam was due not so much to a recognition on the part of the converts of the intrinsic qualities of the faith as to the desire for fame and wealth.

Traders and chiefs were important external agents of Islamization, but their efforts would have made little headway without two important internal factors: the self-propagating system of rituals that bind the individual worshipers and the scholar-led, mass-oriented Sufi brotherhoods that bridge the gap between government and society. If we are to understand the deeper Islamic influence in Africa, we must look beyond political institutions and ideologies into the Islamic system of worship, the centers of learning, and the social structures they stimulate.

Islam was not introduced to the common people as either theology or law but as a system of worship. After uttering the *Shihada* (a public declaration of faith) and learning to perform the obligatory rituals, a person would normally be designated a Muslim regardless of the adequacy of his knowledge about the theological and ethical implications of the faith. Simple as they may appear to be, these pillars of worship would ultimately bring in the other parts of the Islamic system, that is, the social and moral, and the political. The hajj, which entails an annual journey to Mecca, is a case in point. African pilgrims used to take the trans-Sahara route from central Africa to Tripoli or Egypt, or, alternatively, travel from the Chad region through Darfur, crossing modern-day Sudan to Massawa or Sawakin at the Red Sea. Such annual, collective spiritual journeys were instrumental in educating African Muslims and deepening their Islamic consciousness. The hajj would, necessarily, expose them to other peoples and cultures and give them prestige and influence in their own local communities. Upon completing his hajj and returning home, a person would usually be more committed to Islam and acquire, in the eyes of other believers, a kind of mystical aura; he might even become a focus of spiritual attraction. Through him and through his fellow travelers, new ideas would be introduced and new attitudes would be established. But before we can understand how Islam transformed ideas and attitudes, we must briefly examine the wider Islamic philosophical outlook.

Islamic Philosophy

Islamic philosophy flowered as a later development of Islamic thought. It was preceded by the *kalam* (disputation) science, the discipline of confirming the Muslim creed and defending it against subversive factions. It originated in the theological controversies of the eighth century over God's unity and attributes. Like the Jewish scripture, the Koran also emphasizes the unity of God, the resurrection of the dead, and the accountability of man. But it is the first article—the unity of God—that has come to occupy a central place in Muslim philosophical and theological thinking.

The earliest problematic question dealt with the relationship between God and his attributes, that is, whether God is one without division or quality, or one in essence but multiple in attributes. Debating this issue brought in some of the centuries-old ontological and epistemological questions, such as: What is the nature of God's existence? Does God, for instance, exist as a concept in one's mind, or does he also exist in an extra-mental (or supernatural) reality? And in any case, what is the relationship between God and man, and between God and the world, and how can a human being know him and understand his commands?

The debate could have continued peacefully had not the Mu'tazilites, who took an extreme rationalist position, resorted to force. Converting the Abbasid caliph al-Ma'mun to their cause, they gained a hold on the highest positions in the caliphate and used that power to impose their views. The Islamic world at large was shocked by the way they treated their opponents, especially Ahmad ibn Hanbal (780–855), an eminent scholar and founder of one of the four schools of Islamic law, who was subjected to flogging and imprisonment because of his opposition to the Mu'tazilites' views on the nature of God's speech.

Distancing themselves from the repulsive Mu'tazilite politics and extreme interpretations, most jurists took a middle position, making an honest effort to keep close to the Koranic and Sunna texts *bila kaifa*, that is, without asking a "how" question. Their aim was to shift the debate from theology to jurisprudence and law. Rather than focusing on God's attributes and essence, attention should be directed, they argued, to man's behavior and actions in compliance (or lack thereof) with God's law. But when al-Ash'ari (c. 873–935) dramatically broke away from the Mu'tazilites, returned to the moderate position of the people of the *Sunna*, and, thus, dealt the death blow to Mu'tazilism, followers of the orthodox schools of law lent him their support. The Ash'arite school became the theological representative of the mainstream Sunni Muslims.

With the rise of Ash'arism some theological issues lost their appeal, though new ones have emerged, for instance, concerning the question of perception as an independent source of knowledge in contrast to revelation. Like the Mu'tazilites before them, most of the Ash'arite scholars argued that perception is a source of knowledge. None of them, however, maintained (as did the ancient Greek materialists and modern crude Western empiricists) that perception is the only source of knowledge. According to Ash'arism, knowledge that is

derived from the senses is legitimate, but it must be subordinated to the revealed truth, if certainty is to be attained.

In this view, revelation has an epistemological as well as a social function. In addition to illuminating the wider picture of oneself, the world, human existence, and ultimate human ends, it also serves to free the individual from irrational fear of natural forces, and instills in him a tendency to attempt a systematic understanding of these forces and their impact on human life. The revealed vision, moreover, liberates the individual from subordination to the ego and ethnocentrism and the dehumanization of the other that hinders rational argument and understanding.

But this balance between the revealed vision and the inquisitive mind has not always been maintained. In contrast to the Sunnis, who struggle to maintain a distinction between God and humans, the Shia contend that the distance that separates God from human souls is the source of all evil. Engulfed in matter, and cut off from their origins, human souls have no hope of being saved except through knowledge (*irfan*). But the redeeming knowledge, wherein God reveals himself and his divine designs, is attainable only through the guardians whom God assigns to accompany the prophets. Prophets bring the outer (*zahir*) divine command, whereas the guardians initiate people into the *batin*, or inner commands.

Borrowing this element of *batin*, the Sufis, on the other hand, developed a slightly different theory of knowledge. For them, understanding the divine sources of Islam rests neither in holy guardians nor in language, but on the “people of reality” (*ahl al-haqiqah*). They maintained that the Koran includes certain divine secrets and subtleties (*asrar wa lata'if*) that only the people of reality—Sufis—are capable of understanding.

It was mainly due to such tendencies of *batini* (esoteric) interpretations that a barrier of mistrust developed among Shia, Sufi, and Sunni jurists in Islamic history. Instead of debating the nature of God’s attributes, the new questions for debate asked what it means for a term to have a specific meaning, and how one can know that a statement is true. These questions led eventually to the evolution of the philosophy of language, mysticism, logic, and jurisprudence as new Islamic disciplines. Opposing these Shia and Sufi trends of interpretation, most Sunni jurists resorted to the tradition of the Prophet and classic Arabic usage of language, employing the first as an explicit code of conduct and the second as an objective code of meaning. Both were meant to restrict extreme tendencies of interpretation.

Closely related to these debates was the issue of the source of moral knowledge and obligation. Conceiving God as the ultimately wise and just Being, the Mu’tazilites refused to establish a relation between God and evil. Endowed with a free will, they argued, humans are the authors of their own actions and ought to be rewarded or punished accordingly. Moral judgment and knowledge, in their view, stems from human reason, which can independently distinguish between good and bad.

For Sunni scholars, it was all very well to emphasize a person’s capacity to reason. What they found objectionable,

however, was the assertion that human reason is the sole criterion of truth and behavior, or that by following the dictates of reason alone one can be virtuous and attain happiness. This tinge of Aristotelian rationalism was thought to be irreconcilable with Islam’s sources of guidance, reason, and revelation.

It is curious, however, that the Mu’tazilites’ philosophical method, as well as some of the unresolved problems they left behind, have become, despite their political defeat, an important source of intellectual ferment in Muslim thought. Some of the issues they raised persisted and were pursued, with more moderation, by other eminent linguists, commentators, and philosophers. And most of those—Ibn Tufayl, Ibn Rushd and Ibn Khaldun, among others—appeared in the Muslim West (North Africa and medieval Spain) and not in the East, as might be assumed.

Indigenous Vehicles of Islamization

The political movements and philosophical trends that prevailed in the older Islamic world did not immediately sway African Muslims. Even the process of linguistic and ethnic Arabization, in which the indigenous peoples acquired Arabic as their language and connected themselves in the Arab tribal system, did not take hold immediately, nor did it proceed equally in all regions. Nevertheless, it must be recognized that the level of Arabization that took place had a huge impact in transmitting the new Islamic outlook—words, ideas, and behavior usually being interconnected.

Similar to the performance of hajj that we have mentioned earlier, learning the Arabic language (and writing in it) had also become an important instrument for linking the fledgling African religious elites, especially in the relatively stable mosque-colleges that emerged in the western, eastern, and central regions of the continent, enriching and authenticating a genuine Islamic civilization. In some of these mosque-colleges, works of al-Muhasibi, the famous Sufi of Baghdad (c. 751–857), and al-Ghazali (1058–1111), the Sufi and Ash’ari theologian, were required readings. It should also be noted that the traditional rift between the *ulama* (doctors of law) and the Sufis, which prevailed in the older Muslim regions, had been mitigated in these new African centers of learning. Along the eastern coast and the Nile, the Arabized and Islamized Nubians, Beja, and Somalis developed, since the fourteenth century, indigenous Sufi brotherhoods that succeeded in blending law with Sufism. Maliki and Shafi’i jurists did, in some cases, embrace Sufism.

The traditional Islamic principle affirming that the *ulama* are the heirs of the prophets had nearly been actualized in the African situation. African Muslim *ulama* had truly become the points of intersection of religious and political ideas, activism, ethnicity, and intellectualism. The groups that coalesced around the *ulama* would usually become the indigenous vehicles through which Islam acquired its significance as a basis of political power and resource mobilization. The reasons for this are not hard to find.

The scholar serves mainly as a spiritual mentor who helps the people, through sessions of recitation and meditation, to

relate to God. Demands for spiritual help necessitate close contact and regular sessions with the scholar during which certain litanies (*dhikr*) are chanted, thus sharing in the blessing of the Koran and the Prophet. In these ways the scholar shapes individual behavior. Moreover, the *ulama* would naturally, as scholars, investigate, describe, analyze, and explain, but as citizens most of them would be deeply embedded in the social and political structures of their communities. Their scholarship would not be disconnected from their social and political activities and commitments. This is what gave some of them particular force, encouraging political groups and movements to identify with them and with their ideas.

To make this clearer we may take the example of Muhammad ibn Sahnun, of the Qairawan mosque-college, who was responsible for the promotion of Malikism in Africa. The Qairawan, where he and his disciples taught, became the citadel of Sunnism. Some of their works (for example, the *Mudawana*, the *Risala*, and the *Mukhtasar*) have become important sources of Islamic thought and have had the greatest influence on African Muslim communities. The Maliki trend took a more serious turn when Ibn Tumart (c. 1080–1130), a Berber from South Morocco (Masmuda tribes), and one of his Zenati followers and successors, Abd-al-Mumin, mobilized their followers and founded the greatest empire in the Muslim West that ruled from 1147 to 1269.

It is therefore reasonable to contend that most Islamic social and political movements that had a significant impact on African communities were the outgrowth of a type of *ulama*-tribal alliance. The rise of Shiism in North and West Africa; the expansion of Malikism and the Sufi brotherhoods; and the revolutionary (jihadist) movements are prominent examples of the crucial role of the *ulama*-tribal alliances.

But Islam was not alone in shaping African communities or determining their future development. By the end of the nineteenth century, the entire African continent (with the exception of Ethiopia and Liberia) was shared out among the European colonial powers. In line with the secular modernization begun by the colonialists, Arabic was replaced by French in West Africa, and by English in Central, East, and South Africa. These and similar drastic colonial policies not only undermined the centuries-old Islamic educational system (and the religious elites that relied on it) but ushered in a new, westernized African elite that wielded enormous power out of its connections with the colonial state and/or the Christian missionaries.

With the internalization of secular values, and the incorporation of African communities into the international economy, older bases of legitimacy were challenged and new value systems and ideologies began to compete for people's minds. That cultural and economic experience, as well as the fractured, postcolonial social structures that remain, constitute the major challenge to African Muslims today. Whether this apparently complete secular modernization process will continue to strangle Muslim communities—thus provoking an imminent counterinsurgence of Islamic fundamentalism and providing it with needed resources of resistance—or manage to break these communities' cultural isolation and revive a wider

meaning of human existence that Islam itself impresses on its believers, remains to be seen.

See also Africa, Idea of; Colonialism: Africa; Communication of Ideas: Africa and Its Influence; Education: Islamic Education; Islam: Shii; Islam: Sunni; Philosophies: Islamic; Philosophy of Religion; Religion: Africa.

BIBLIOGRAPHY

- Hamdun, Said. *Ibn Battuta in Black Africa*. Princeton, N.J.: Markus Weiner, 1994.
- Harbeson, John W., and Donald Rothchild, eds. *Africa in World Politics: Post-Cold War Challenges*. Boulder, Colo.: Westview, 1995.
- Klein, Martin A. *Islam and Imperialism in Senegal: Sine-Saloum*. Stanford, Calif.: Stanford University Press, 1968.
- Levtzion, Nehemiah, and Randall Pouwels, eds. *The History of Islam in Africa*. Athens: Ohio University Press, 2000.
- Lewis, I. M., ed. *Islam in Tropical Africa*. Oxford: Oxford University Press, 1966.
- Saad, Elias N. *Social History of Timbuktu: The Role of Muslim Scholars and Notables, 1400–1900*. Cambridge, U.K.: Cambridge University Press, 1983.
- Sells, Michael, ed. and trans. *Early Islamic Mysticism*. New York: Paulist Press, 1996.
- Sulaiman, Ibraheem. *A Revolution in History: The Jihad of Usman Dan Fodio*. New York: Mansell, 1986.
- Watt, W. Montgomery. *Islamic Philosophy and Theology: An Extended Survey*. Edinburgh: Edinburgh University Press, 1962.

Eltigani Abdelgadir Hamid

SHII

Shiis, representing the largest sectarian division of Islam after Sunnism, make up roughly one-tenth of the world population of Muslims. The label Shia, which originally referred to the "partisans" of 'Ali, the Prophet Muhammad's cousin and son-in-law, designates various groups in Islamic history united by a belief that the leader of the Muslim community, termed *caliph* or *imam*, should be a member of the Prophet Muhammad's family (*ahl al-bayt*). The Shia first formed an identifiable movement in Islamic history during the First Civil War (*fitna*), which tore the Muslim Community apart between 656 and 661 C.E. According to Shii doctrine, 'Ali was meant to assume leadership of the Community upon the Prophet's death in 632, the Prophet having explicitly designated him as his successor, but the jealousy and ambition of his enemies prevented him as a succession of three other leaders, Abu Bakr (632–634), 'Umar (634–644), and 'Uthman (644–656), were chosen instead. The Shiis are divided into several sects according to the historical line of imams they accept as legitimate, the most important being the Twelvers, Zaydis, and Ismailis.

A common misconception, based on the fact that Iran is today predominantly Shii, holds that Iran is the historic "homeland" of Shii Islam. However, the truth is that Medina and southern Iraq are the original centers of Shii Islam, which spread from there to other areas in the Muslim world. The heyday of the Shiis was in the tenth and eleventh centuries,

when dynasties representing the three main Shii sects, Twelvers, Zaydis, and Ismailis, succeeded in conquering most of the Muslim world. For over a century, the Fatimids (Ismaili) controlled Egypt, Syria, the Hijaz, Tunisia, and for a time Sicily. The Hamdanids and other lesser Twelver dynasties controlled northern Syria and Iraq, the Buwayhids (Zaydis/Twelvers) controlled much of Iran and Iraq, Zaydi dynasties controlled areas around the Caspian and Yemen, and the Qaramitah controlled eastern Arabia. Between the eighth and the fifteenth centuries, Shiis in Iran formed the majority in a number of smaller towns such as Qum, Kashan, Aveh, and Sabzevar, and a significant minority in certain major cities such as Rayy and Nishapur. Altogether, though, they probably represented no more than 20 percent of the Iranian population. This situation changed after 1501, when Shah Ismail I conquered the city of Tabriz, founded the Safavid dynasty, and declared Twelver Shiism the religion of the empire. The Safavids (1501–1736) promoted Shii Islam through patronage and propaganda, and over the next several centuries, most Iranians converted. Conversely, former Shiite populations have either disappeared or dwindled in a number of areas, particularly following the fall of the Fatimids and other Shiite dynasties of the tenth, eleventh, and twelfth centuries, and regular persecution by subsequent Sunni powers, including the Zengids, Ayyubids, Mamluks, and Ottomans. The Shiite populations of Tunisia, Egypt, the Hijaz Arabia, such parts of Syria as the city of Aleppo, and parts of northern Iraq either converted or migrated to other areas.

Twelver Shiism, the largest Shiite sect, represents the overwhelming majority in Iran and a slim majority in Iraq, Lebanon, and Bahrain. Significant Twelver Shii minorities are found in Syria, Kuwait, eastern Saudi Arabia, Afghanistan, Pakistan, Azerbaijan, and both northern and southern India. Zaydi Shiis, important in Iraq and northern Iran in the ninth to the eleventh centuries, have for long been confined to Yemen and Yemeni diaspora communities. Ismaili Shiis, who controlled Egypt and much of the eastern Mediterranean between the tenth and twelfth centuries, dispersed after the fall of the Fatimid caliphate in 1171, establishing strongholds in Iran and Syria, and became famous as the Assassins during the Crusades. Their reign of terror ended with conquests by the Mongols and the Mamluks. Although small communities remain in Syria and Iran, the bulk of Ismailis ended up in Bombay and Gujarat in India, with smaller communities in Pakistan, Tajikistan, Yemen, and diaspora communities in Africa, Europe, Canada, and elsewhere.

Shiism as a movement bursts into full view with the assassination of 'Uthman and the ensuing civil war. In 656 'Uthman was assassinated in Medina by Muslims angered by his open nepotism in making appointments to lucrative governorships in the newly conquered provinces. At this point, 'Ali was chosen as caliph, but soon met opposition from the Umayyah clan, the Prophet's widow 'A'isha, and others, who accused him of complicity in 'Uthman's assassination. War ensued, pitting 'Ali's supporters, centered in Kufa in Iraq, against forces in Basra and Syria. In 656, 'Ali's forces met those of 'A'isha, Talha, and al-Zubayr just outside Basra in the "Battle of the Camel," so called because 'A'isha joined the fray in an

armored palanquin mounted on her camel 'Askar. 'Ali's forces killed Talhah and al-Zubayr, captured 'A'isha, and returned her to Medina in humiliation. The following year, 'Ali lost the battle of Siffin in the Syrian desert after his deputy bungled arbitration with the agent of Mu'awiya, the governor of Damascus. A large group of 'Ali's supporters, angered that he had submitted to arbitration, left him at this point. Known as the Kharijis (or Kharijites, "deserters"), they became 'Ali's bitter enemies. 'Ali retreated to Kufa and defeated a Kharijite army at Nahrawan in 658. In 661, he was assassinated by the Khariji ibn Muljam in Kufa. His supporters recognized his eldest son Hasan as their leader, but Hasan soon entered into a truce with Mu'awiya, renouncing his claim to the caliphate, and the war ended. The Muslim community was reunited under one regime; Mu'awiya became caliph of the entire community by default; the capital was moved to Damascus; and, when Mu'awiya designated his son Yazid as his heir, the Umayyad dynasty (661–750) was established. Doctrinally, however, the Muslim community would remain divided into three main groups, 'Ali's supporters (the Shia), enemies of 'Ali who had originally supported him but renounced their allegiance at Siffin (the Kharijis), and the main body of his opponents, the Umayyads and their supporters.

Throughout Umayyad rule, the Shia engaged in periodic uprisings against the illegitimate caliphs, rebelling in the name of various members of *ahl al-bayt*. The most famous of these incidents is the revolt of Husayn, 'Ali's second son, on the death of Mu'awiya and the accession of his son Yazid in 680. Husayn was summoned to Kufa to lead the revolt. He set out from Medina with a small contingent, but Umayyad forces halted him in the Iraqi desert, preventing him from reaching his supporters in Kufa. Rather than surrender, Husayn and his followers fought; most were slaughtered, and Husayn's head was delivered to Yazid in Damascus. The martyrdom of Husayn and his followers is retold and reenacted by the Shia on 'Ashura, the tenth day of Muharram, the first month of the Islamic calendar. Four years later, Kufan Shia known as al-Tawwabun ("the Penitents") led a revolt, reflecting their dedication to the cause of Husayn and their regret that they had not come to his aid. In 686, Mukhtar al-Thaqafi led an initially successful revolt in the name of Muhammad b. al-Hanafiyya, another son of 'Ali, holding Kufa in 686–687. In 740, Zayd, a grandson of Husayn, led a revolt in southern Iraq and was defeated and killed. 'Abd Allah b. Mu'awiya, a great-grandson of Muhammad's cousin Ja'far, led yet another insurrection (744–747).

The Abbasid revolution that toppled the Umayyads in 750 began in part as a Shii movement, adopting the slogan *al-rida min al-bayt*, "the acceptable candidate from the family of the Prophet." Upon victory, a descendant of the Prophet's uncle 'Abbas assumed rule as caliph. In a clear pro-Shii move, the new dynasty established its capital in Iraq, first at Wasit, then at Baghdad, founded in 761. The Abbasids, however, soon turned on their Shii allies and eventually took over the Umayyads' role as illegitimate rulers and the nemesis of Shii aspirations. Muhammad al-Nafs al-Zakiyya ("the Pure Soul") led a Shiite revolt against the Abbasids in 762. The Abbasid period would witness countless more revolts in the name of

'Alid leaders. Attempts at reconciliation, the most notable being al-Ma'mun's appointment of 'Ali al-Rida, the eighth imam of the Twelver Shii line, as his successor in 816, were short-lived.

Conflict over leadership of the community and over succession among rival Shii claimants to the imamate gave rise to theological doctrines and concepts that would remain important throughout Islamic history. In the course of the eighth century the Shia developed the doctrines of the imam's *'isma* ("infallibility" or "divine protection from sin"), and *nass*, the theory that the imam must be explicitly designated by his predecessor, with divine sanction. The *ghulat* ("extremists") developed beliefs that the imam did not die but went into occultation (*ghayba*) or that he would return (*raj'a*) as a messianic figure (*mahdi*) before the apocalypse. Others claimed that the imam shared in prophetic authority, had status equal to that of the Prophet, possessed divine qualities, or manifested divinity through divine infusion (*hulul*). Some "extreme" concepts, particularly occultation, would become standard doctrine in the main divisions of the Shia in later centuries. A second set of issues had to do with the status of the Prophet's Companions. To bolster the legitimacy of 'Ali, the Shiites used hadith reports and historical accounts concerning the first three caliphs, 'A'isha, and many other Companions to impugn their characters, casting them as sinners, incompetent leaders, or outright unbelievers. The Sunnis, on the other hand, adopted a compromise position, using similar accounts to uphold the view that the Companions, both those who had supported 'Ali and those who were opposed to him, were all exemplary. The Shiite position, while certainly exaggerated over time, readily admits the seriousness of the conflicts that wracked the early Muslim community, whereas Sunni historiography has often endeavored to cover them up or explain them away.

Shiites share with Sunnis the main holy days of the Islamic calendar: 'Id al-Adha ("the Feast of the Sacrifice") on the tenth of the twelfth month, Dhu al-Hijja, coinciding with the culmination of the annual pilgrimage rites in Mecca, the fast of Ramadan, the ninth month of the calendar, together with the ensuing 'Id al-Fitr ("Breaking the Fast"), and the birthday of the Prophet Muhammad. Distinctly Shiite holy days include Ashura, the tenth of Muharram, the first month of the calendar, which commemorates Husayn's martyrdom. Ceremonies performed on this day and during the ten days leading up to it include emotional readings of the story of Husayn's martyrdom, processions in which the participants chant slogans, rhythmically beat their chests, flagellate their backs, and on occasion lacerate their backs or foreheads, and *ta'ziyah* passion plays, reenactments of the Battle of Karbala', often in great detail. This is followed on Safar 20 by the *arba'in*, the forty-day mourning ceremony for Husayn's death, the most important date of the year for pilgrimage (*ziyarah*) to Karbala'. 'Id al-Ghadir, on the 18th of Dhu al-Hijja, commemorates the speech Prophet Muhammad made at Ghadir Khumm on the return trip from the Farewell Pilgrimage to Medina in which he designated 'Ali his heir as leader of the Muslim community. In addition, the Shiite calendar includes birthday celebrations for the imams, the most important of which are 'Ali's birthday and the birthday of the Twelfth Imam. Pilgrimages

to the imams' tombs and to the tombs of their descendants are an important feature of Shiite ritual life.

A number of significant differences exist between Sunni and Twelver Shiite law and ritual practices. Shiites often add to the *shahadah* or fundamental Islamic creed, "There is no god but God, and Muhammad is God's Messenger" a third clause, *'Aliyyun waliyyu Llah* ("Ali is God's ward/ally/supporter"). They include in the call to the dawn prayer the phrase *hayya 'ala khayral-'amal* ("Come to the best of works") in place of the phrase *as-salatu khayrun min al-naum* ("Prayer is better than sleep") used in Sunni tradition. In questions of ritual purity, the Shiites hold that one may wipe one's inner shoes (*khuffayn* meaning "socks" or "slippers") rather than washing one's feet, when they have not been soiled since last washed. In prayer, Shiite men generally hold their hands down at their sides when in standing position, rather than clasping them in front of the chest or belly, as Sunnis do. They commonly join the noon and afternoon prayers in one session and the sunset and evening prayers in one session, praying daily in three sessions rather than in five. Many Shiites set a *mubr* ("seal"), a baked clay tablet made of earth from Karbala', before them when praying, touching their foreheads to it when they prostrate. They consider the tarawih, extra prayers by Sunnis at night during the month of Ramadan, as a heretical innovation. Shiite dietary law is a bit more strict than that of the Sunnis. They do not allow the believer to eat meat slaughtered by Jews and Christians and agree with Jewish dietary law in prohibiting shellfish (any seafood without scales) and rabbit. Shiites have some stricter requirements for the pronouncement of unilateral divorce by the husband—there must be two male witnesses for it to be valid. They also allow *mut'ah*, a type of marriage that is undertaken for a fixed duration stipulated in the contract and that Sunnis consider forbidden. Finally, Shiite inheritance law differs substantially from Sunni inheritance law in that it negates the rights of the *'asabah* or agnate relatives (the deceased's brothers, paternal uncles, and cousins) to receive any surplus left over after dividing the set shares of the inheritance, favoring the nuclear family and, significantly, daughters instead. The *khums*, or fifth, that must be paid according to Sunni law on war booty and the product of mines is generalized to a type of income tax payable to the imam or his representative, meaning, for many centuries now, one of the top Shiite legal authorities. The *khums* funds are divided into six shares, of which three go to support the descendants of the Prophet, who cannot receive ordinary alms, and three go to support religious education and the poor and afflicted in general.

In theology, the Twelver and Zaydi Shiites have largely adopted Mu'tazili doctrines; this sets them apart from the Sunnis, who have generally adopted Ash'ari and Hanbali doctrines on such questions as God's justice. The Shiites hold that God is obligated to act justly, conforming to the definition of good and evil arrived at through rational inquiry. Sunni theology generally sees this as limiting God's power and presuming to dictate to God something that cannot be known with certainty and remains inscrutable to humans.

The question of the imamate was early subsumed under the purview of theology, as were questions of the status of the

Prophet's Companions and other prominent figures in early Islamic history. This has been historically the biggest bone of contention between the Shiis, who deplore the actions of certain Companions, including the first three caliphs—Abu Bakr, 'Umar, and 'Uthman—and some of the Prophet's own wives, including 'A'isha and Hafsa; other Companions, such as Talhah and al-Zubayr; and Mu'awiyah for usurping the position of leadership of the Community, which rightly belonged to 'Ali, or for opposing 'Ali, his allies, or the later imams. The Sunni position is one of compromise. All early figures are praised, despite the conflicts that definitely occurred, and the first four caliphs are all accepted as the best of the Companions, in descending order of excellence. For this reason Shiites are continually accused in the medieval sources of *rafd* and *sabb*, meaning rejection of the Companions' exalted status, blasphemy against them, and vituperation or cursing of them. On the Shiite side there developed an extensive literature on the foibles and defects of 'Ali's enemies among the Companions as well as of the injustices they perpetrated. Some of these undoubtedly preserve kernels of authentic material, but many may derive from later exaggeration, including stories designed to prove the extreme cowardice and conniving of Abu Bakr and 'Umar as opposed to 'Ali's outlandish feats of bravery, or suggestions that 'Umar prevented the dying Prophet Muhammad from dictating his will and testament.

By the eleventh century, Twelver Shii jurists made strong claims that, during the prolonged occultation, certain roles of the imams naturally devolved on them. Much later, in the sixteenth century, this idea would be justified by the claim that the jurists as a group, and, more specifically, the leading jurist(s) of the age, were in effect the "general deputy" (*al-na'ib al-'amm*) of the occulted imam. Although they had not developed this theory of the general deputyship, Twelver jurists of earlier centuries, such as al-Shaykh al-Mufid (d. 1025), al-Sharif al-Murtada (d. 1044), and al-Shaykh al-Tusi (d. 1067), argued that duties of judging between litigants, the holding of Friday prayer, collection of *khums* funds, and so on, could indeed be held in the absence of the imam by virtue of the jurists' authority. Al-Karajaki (d. 1057) goes so far as to term Twelver scholars "intermediaries" between the imam and Shii laypeople.

In the seventeenth and eighteenth centuries, there was a significant challenge to the authority of Twelver scholars qua jurists by the Akhbari movement, which denied that expertise in legal interpretation, with rational and extra-scriptural bases, could justify religious authority. The Akhbari movement met resounding defeat by the end of the eighteenth century, and in the process their opponents, the Usulis, made very strong arguments for the jurists' authority, stressing their ability to perform *ijtihad* (independent investigation of the law) and stressing their exclusive authority. One may see the development in the nineteenth and twentieth centuries of the concept of *wilayat al-faqih*, or the comprehensive authority of the jurist, as an extension of this move to bolster the jurists' authority. Khomeini, the most outspoken proponent of this doctrine, and author of a work by that title based on his 1971 lectures, held that the leading Twelver jurist was, as the general deputy of the imam, entitled not only to take over some

of the "religious" prerogatives of the imam, such as the collection of *khums*, but also to take over political rule itself. This radical extension of Twelver doctrine later became the basis for the constitution of the Islamic Republic of Iran, which designated the office of rahbar, or leader, to be held by the leading Twelver jurist of the age and concentrated in that figure tremendous political powers, including command of the armed forces and the right to appoint the members of the Shura Council.

See also *Islam: Sunni; Religion: Middle East*.

BIBLIOGRAPHY

- Amir-Moezzi, M. A. *The Divine Guide in Early Shi'ism: The Sources of Esotericism in Islam*. Translated by David Streight. Albany: State University of New York Press, 1994.
- Arjomand, S. A. *The Shadow of God and the Hidden Imam*. Chicago: University of Chicago Press, 1984.
- Bill, J. A., and J. A. Williams. *Roman Catholics and Shi'i Muslims: Prayer, Passion, and Politics*. Chapel Hill: University of North Carolina Press, 2002.
- Crone P., and M. Hinds. *God's Caliph: Religious Authority in the First Centuries of Islam*. New York: Cambridge University Press, 1986.
- Daftary, F. *The Isma'ilis: Their History and Doctrines*. New York: Cambridge University Press, 1990.
- Donaldson, D. M. *The Shi'ite Religion*. London: Luzac, 1933.
- Goldziher, I. *An Introduction to Islamic Theology and Law*. Translated by Andras and Ruth Hamori. Princeton, N.J.: Princeton University Press, 1981.
- Halm, H. *Shiism*. Edinburgh: Edinburgh University Press, 1991.
- Kohlberg, E. *A Medieval Muslim Scholar at Work, Ibn Tawus and His Library*. New York: E. J. Brill, 1992.
- Madelung, W. *The Succession to Muhammad: A Study of the Early Caliphate*. New York: Cambridge University Press, 1997.
- McDermott, M. J. *The Theology of al-Shaykh al-Mufid*. Beirut: Dar el-Machreq, 1978.
- Modarressi Tabata'i, H. *An Introduction to Shi'i Law: A Bibliographical Study*. London: Ithaca Press, 1984.
- Modarressi, H. *Crisis and Consolidation in the Formative Period of Shi'ite Islam*. Princeton, N.J.: Darwin Press, 1993.
- Momen, M. *An Introduction to Shi'i Islam: The History and Doctrines of Twelver Shi'ism*. New Haven, Conn.: Yale University Press, 1985.
- Moussavi, A. K. *Religious Authority in Shi'ite Islam: From the Office of Mufti to the Institution of Marja'*. Kuala Lumpur: International Institute of Islamic Thought and Civilization, 1996.
- Newman, A. J. *The Formative Period of Twelver Shi'ism: Hadith as Discourse Between Qum and Baghdad*. Richmond, Surrey, U.K.: Curzon, 2000.
- Richard, Y. *Shi'ite Islam: Polity, Ideology, and Creed*. Translated by Antonia Nevill. Cambridge, U.K.: Blackwell, 1995.
- Sachedina, A. A. *Islamic Messianism: The Idea of the Mahdi in Twelver Shi'ism*. Albany: State University of New York Press, 1981.
- Stewart, D. J. *Islamic Legal Orthodoxy: Twelver Shiite Responses to the Sunni Legal System*. Salt Lake City: University of Utah Press, 1998.
- Watt, W. M. *The Formative Period of Islamic Thought*. Edinburgh: Edinburgh University Press, 1973.

D. J. Stewart

SOUTHEAST ASIA

The Muslim population of Southeast Asia is in excess of 250 million. It is the religion of the majority in Indonesia and Malaysia, with significant minorities in Singapore, Thailand, and the Philippines.

Islam has a five-hundred-year history in this region. Importantly, it was not imposed by conquest but freely adopted, initially by royal and upper classes and then percolating down to the masses. Of course its progress has been uneven, despite organized missionary efforts that began in the seventeenth century and continue into the early twenty-first century. However, the result has been that Islam in Southeast Asia is expressed in local idioms reflecting local cultural norms. These variations do not mean that the basics of revelation are or have been abandoned but that localized expressions incorporating indigenous philosophies are primary. To “know Islam” is thus to know the local forms.

Literature and Philosophy

The tradition of writing on these subjects dates from the seventeenth century. It is firmly within the Islamic tradition and consists of translation and commentary on the fundamentals of doctrine, accounts of the life of the Prophet, and, most important, speculative work on the outer limits of the permissible in doctrine—sometimes subsumed under the rubric of “Sufi” texts. This speculative work is the major distinctive feature of Southeast Asian Islam and is often explained as a reaction to or accommodation with preexisting Hindu or Buddhist religious philosophies. Whatever the reason, this way of thinking about religion has persisted into the twenty-first century. The Arabic texts are mediated through the languages of the area (Malay, Indonesian, and cognates) and have become intensely localized.

One example of this distinctive development of Islam is the idea of gnosis originally expressed by Hamzah Fansuri, who taught in the seventeenth century that the believer could be one with God. That idea resonates in the early twenty-first century in Aceh in Sumatra (as well as other places), where something like 15 to 20 percent of state fatwas concern “heresy,” in this case gnosis. This is an incredibly high figure, and the texts involved take us back to the seventeenth century. But a reaction to this idea began in the 1850s and continues in the twenty-first century; “purity” of doctrine has become a priority, inspiring a return to the uncontaminated sources, the Koran and the sunna. The literature and philosophy deriving from these sources, especially since the 1920s and 1930s, is minimalist or, some would say, “scripturalist.” Its main characteristic is rejection of cultural complexity combined with a (perhaps) excessive respect for literal translations from the original Arabic. While this may be conducive to “purity,” it is also impractical in daily life. The tension between culture and purity is ongoing and, at the beginning of the twenty-first century, largely unmediated. Increasingly the proponents from each side are becoming disengaged from each other; there is little communication, let alone attempts at mutual understanding. Each side produces its own literature and each claims its own authenticity.

Law

Before the establishment of Dutch and British rule (from about 1800), the Muslims of Southeast Asia had sophisticated polities based on Muslim state practice in the Middle East. From thence were derived theories and practices of sovereignty, legitimacy of rule, public order and duty, and the distribution and exercise of power. However, the European powers replaced this tradition with colonial (“Western”) principles, chief among which was the conviction that God was not necessary to validate government. Islam, and Islamic law and government, was reduced in status. From being the foundation of the state it became just a religion like any other. It had no public presence.

The Dutch in the Netherlands East Indies (now Indonesia) saw Islam as a political and military threat. Their solution was to deny the religion any credible public presence, and an important aspect of this effort was to deny *shari‘a* (Islamic law) by subordinating it to custom (*adat*), thus reducing its status to just a personal law. In time, however, the *shari‘a* did receive limited recognition, which it retains in contemporary Indonesia. It is now a state-sponsored Compilation of Islamic Law (1991) administered through religious courts. Together these changes have successfully secularized the classical *shari‘a*, which is now in a form unrecognizable to a classical scholar.

The same result has been achieved in Malaysia (formally British Malaya). Here a few selected rules of family law and trusts have been incorporated into English law precedents and statutes. These are a direct colonial legacy, and in contemporary Malaysia they are the *shari‘a* that is administered in religious courts of restricted jurisdiction. Because Malaysia is a federation, each state has its own legislation, and thus *shari‘a* varies from place to place, but the variations are not major. The main point to understand is that anyone trained in Anglo-American law can read and understand the *shari‘a* in this form, whereas a classically trained *qadi* (judge) would be completely at a loss.

In short, for Southeast Asia, the *shari‘a* has been redefined in secular terms, for administration by the state. It is not now necessary to know Arabic or the classical texts.

Islam and the State

With the ending of colonial repression in the 1950s, it became possible once more for Islam to have a public face in Indonesia and Malaysia. As well as establishing the religious courts and statutes of *shari‘a*, both states introduced ministries or departments of religion and councils of muftis or ulema (authorities in Islamic law) and, most importantly, permitted political parties that promoted Islam as an ideology suitable for the nation-state. Religion became and remains an alternative to secular constitutionalism, although it has never been clear what an “Islamic state” would be, except that God’s revealed truth would be fundamental. Neither Indonesia nor Malaysia describes itself as “Islamic” but rather as states populated by “a Muslim majority.”

The Malaysian constitution says that “Islam is the religion of the Federation” (Article 3), but it also establishes freedom

of religious belief and observance (Article 11). In practice there is no compulsion in religion. At the same time, a significant Islamic political party, the Pan-Malaysian Islamic Party, centered in the northeastern Malay Peninsula, a quite poor area, has been locally successful in elections. It appeals to "Islam," but this is not defined; the reason for the party's success is a justifiable resentment against lack of development. The religious card is hence quite potent for a Muslim audience, though it can be overplayed. For example, draft Islamic criminal law bills have been produced in the provinces of Kelantan and Trengganu that seek to introduce the seventh-century Arabian punishments (amputations, stoning) into modern Malaysia. They are unconstitutional, and they represent a definition of Islam that, as the 2004 elections showed, is soundly rejected. The present and future of Islam does not lie in these barbarisms, but such theologically illiterate interpretations remain potent justifications of extremism.

In Indonesia, Islam has no place as such in the constitution but is subsumed into the "belief in one God" principle, which encompasses all religions. The years since independence have seen debate between secular and religious interests regarding the status of Islam, and it remains unresolved. However, unlike Malaysia, Indonesia does have many (over eighty) mass movement organizations founded on Islam. The largest, the Nahdlatul Ulama, based in East and Central Java, represents a "traditionalist" (Arabic-based) interpretation of religion. The smaller Muhammadiyah promotes a "modernistic" agenda through which the individual, by an effort of rational thought, can find the true meaning of religion. Neither of these movements, founded in the early twentieth century, is directly affiliated with any political party, but both are immensely influential because they own and run kindergartens, schools, universities, hospitals and clinics, and a wide variety of social outreach programs. There are other, smaller groups that perform similar functions.

Both Malaysia and Indonesia have a huge publishing industry devoted to Islam. Quality is highly variable and ranges from short, simple texts (mostly addressed to women on religious duty to husband and family) to complex expositions of law, philosophy, and the relation between Islam and the state. Books on the latter topic have increased greatly in number since the mid-1990s. The important point is that this vibrant literature has come to form a new, local "Southeast Asian Islam." It is written by locals for a local audience and both reflects and adds to an Islam that is distinct in its politics, laws, and social and literary expressions.

Muslim societies in Southeast Asia are agrarian, rapidly modernizing, and engaging in democratic forms of government. Huge social and intellectual tensions are widespread in the twenty-first century, and Islam is at the heart of these tensions in all of Southeast Asia. As a consequence, one must be time- and place-specific in defining Islam; there is no simplistic monolith to be accepted or rejected.

See also *Law, Islamic; Mysticism; Islamic Mysticism in Asia; Religion: East and Southeast Asia; Sufism; Westernization: Southeast Asia.*

BIBLIOGRAPHY

- Hefner, Robert. W., and Patricia Horvatic, eds. *Islam in an Era of Nation-States*. Honolulu: University of Hawaii Press, 1997.
- Hooker, M. B. *Indonesian Islam: Social Change through Contemporary Fatawa*. Sydney, Australia: Allen and Unwin, 2003.
- Hooker, M. B., ed. *Islam in South-East Asia*. Leiden, Netherlands: Brill, 1983.

M. B. Hooker

SUNNI

The term *Sunni* is an adjective formed from the noun *sunna* (plural *sunan*), an ancient Arabic word meaning "customary practice." Although in the pre-Islamic world of tribal Arabia the word *sunna* referred generally to the time-tested and widely accepted customs of a tribe, in the Islamic period the term came to refer specifically to the customary practices or "way" of the prophet Muhammad and the first generation of pious Muslims. Eventually the adjective *Sunni* came to describe the largest of the three primary sectarian divisions among Muslims: Sunnis, Shiites, and Kharijites.

Accounting for nearly 90 percent of the world's Muslims, Sunnis emphasize their commitment to both the precedents established by the Prophet and the unity of the historic community (referred to in Arabic as either the *umma* or the *jama'a*). The term *Sunni* is actually an abbreviation of the fuller expression *ahl al-sunna wa-l-jama'a*, "the people of the [Prophet's] way and the community." Of course nothing in this self-description by the majority of Muslims should convey that either Shiites or Kharijites see themselves as any less committed or faithful to the Prophet's way.

Early History

In the mold of great Hebrew prophets, Muhammad combined both political and religious authority as the leader of the early Islamic community (*umma*). On his death in 632 the Prophet left no clear message as to how leadership of the Muslim community should devolve after him. Initially, therefore, divisions among Muslims were prompted by disputes over succession to the leadership of the community, rather than by doctrinal differences. The first five successors to the Prophet were, in fact, elevated in different ways to leadership of the community, reflecting the ambiguity among early Muslims about the Prophet's intentions regarding succession.

The majority position, which eventually appropriated the appellation *Sunni* to describe itself, held that in the absence of a clear message detailing an alternative arrangement, the Prophet intended for the Muslim community to proceed in selecting its leaders according to ancient Arab tribal custom. Traditionally, tribal leaders were selected from a relatively small pool of respected senior figures within the tribe. Once consensus on a new leader was achieved through deliberations of the tribal council, the choice of a new leader was confirmed by the public offering of an oath of allegiance, known as the *bay'a*, to the new leader by senior clan leaders within the tribe.

The earliest accounts suggest that following the Prophet's death, the early Muslim community in Medina was initially

thrown into confusion even about whether or not the Prophet intended the Muslim community to remain unified under a single leader, combining both political and religious authority, or whether each tribe was expected to revert to selecting its own tribal chief. The matter was temporarily, though not decisively, resolved when 'Umar ibn al-Khattab, a highly respected figure among the Prophet's inner circle, offered the public *bay'a* to Abu Bakr, the Prophet's oldest and closest friend. This dramatic gesture convinced other leading figures to quickly follow suit in offering the *bay'a* to Abu Bakr. However, during his two-year reign Abu Bakr was engaged in re-extending authority over various tribes throughout Arabia that believed their submission to the Muslim state ended with Muhammad's death.

There was no doubt among the early Muslims that although the Prophet's successors would continue his function as political and religious leader of the *umma*, they would not continue his prophetic role. The Arabic term used among Sunnis to designate the successors of the Prophet is *khalifat rasul al-lah* (deputy of the Prophet of God), from which the English term *caliph* is derived. Sunnis recognize four legitimate caliphal successors to Muhammad: Abu Bakr (r. 632–634), 'Umar (r. 634–644), 'Uthman ibn 'Affan (r. 644–656), and 'Ali ibn Abi Talib (r. 656–661), who are collectively referred to among Sunnis as the "Rightly Guided Caliphs" (*al-khulafa' al-rashidun*). Following the assassination of the last of these four caliphs in 661, the governor of Syria, Mu'awiya (r. 661–680), was successful in establishing the Umayyad dynasty, which ruled over the early Islamic empire for nearly a century. Although the Umayyads, like many dynasties that succeeded them, also claimed the title of caliph, subsequent Muslim historiography tended to refer to the Umayyad rulers as *muluk* (kings) to indicate that the political authority they exercised lacked the legitimacy of religious leadership over the *umma*, which the first four caliphs enjoyed.

Exact details of the succession disputes that established the three main divisions among Muslims are now clouded by centuries of partisan accounts, but the broad outlines are clear. During the first two decades after the Prophet's death, probably about the time of the accession of the third caliph, 'Uthman, in 644, a minority party among Muhammad's companions began to champion the cause of 'Ali ibn Abi Talib as the rightful successor to the Prophet. 'Ali was the first cousin and later son-in-law of Muhammad. He was also the son of Abu Talib, in whose house the Prophet had been raised after he was orphaned at age six. 'Ali clearly enjoyed a very close personal relationship to Muhammad, probably analogous to a devoted younger brother, and he is reported to have been the first male convert to Islam. Although 'Ali did not contest the elevation of the first three caliphs before him, the early histories make clear that 'Ali and his supporters resented his being passed over in favor of 'Uthman in 644. Devoted support to the cause of 'Ali survived his own assassination in 661 and was transferred to his two sons through the Prophet's daughter Fatima: al-Hasan (c. 625–669) and al-Husayn (c. 626–680).

The supporters of 'Ali and his heirs became known as *shi'at 'Ali*, "the party of 'Ali," from which the abbreviated *shia*

(Shiite) comes. Over time the Shiites developed an elaborate doctrine rejecting the Sunni claim that the Prophet had left no clear message about succession after his death. Based on their own interpretation of a widely accepted statement made by the Prophet during his farewell pilgrimage to Mecca, the early Shiites asserted that Muhammad in fact left a very clear message that succession to the combined political and religious leadership of the Muslim community rightfully lay with 'Ali and his two sons through the Prophet's daughter Fatima. Shiites, therefore, rejected the first three caliphs, on whose memory they are known to invoke curses, in favor of 'Ali ibn Abi Talib and his descendents, whom they refer to as imams, rather than caliphs. In the early twenty-first century Shiites account for nearly 10 percent of the world's Muslims.

Kharijites, the smallest of the three major divisions among Muslims (currently less than 1 percent), also arose out of these early succession struggles. When 'Ali was elevated to the caliphate following the assassination of the third caliph, 'Uthman, in 656, the new caliph faced several challenges to his authority. The most serious opposition came from the governor of Syria, Mu'awiya, a cousin of the murdered third caliph, who suspected 'Ali of complicity in the death of his kinsman. Mu'awiya refused to give the *bay'a* (oath of allegiance) to 'Ali, which quickly led to battle between 'Ali's forces and the Syrian garrison. When stalemate was reached between the two sides, 'Ali reluctantly agreed to a call for arbitration in hopes of ending bloodshed between Muslims. Although the arbitration process ultimately proved futile, the very fact that 'Ali had accepted arbitration, rather than allow God to decide matters on the battlefield, prompted a group of 'Ali's own supporters to withdraw from among his ranks. Forced to make an example of these deserters, 'Ali's forces engaged and massacred them at the Nahrawan canal in Iraq in 658. Among Sunnis this group of deserters became known pejoratively as Khawarij, meaning "those who go out." In revenge for the massacre at the Nahrawan canal, 'Ali was himself assassinated by a Kharijite in 661. Like the Shiites and the Sunnis, the Kharijites eventually developed their own elaborate doctrine of the caliphate and their own legal schools. Essentially, the Kharijites held a radically egalitarian view of who was qualified to serve as caliph. They also came to hold an extreme view that any caliph who failed to apply or abide by the holy law of Islam forfeited both his office and his life—an idea that has inspired many modern Islamic political extremists.

The evolution and elaboration of each of these three major sectarian divisions among Muslims occurred slowly over time and did not spring wholly formed from these early disputes over succession. Each sect would also eventually generate numerous of their own subsects and divisions, which underscores the frequently unappreciated historical fact that the formation of Islam as a whole unfolded over centuries, not decades. Furthermore, the critical geographical location where the formation of Islam occurred between the mid-seventh and the mid-tenth centuries was not Arabia, but rather Syria and Iraq. The primitive form of Islam that came out of Arabia with the early Muslim conquests of the mid-seventh century, therefore, possessed very little of the sophisticated theological or legal superstructure recognized as so central to the tradition

today. The fact that Islam came fully into formation in Iraq and Syria is significant because this area had long served as the frontier between the two great Mediterranean civilizations of late antiquity, Rome and Persia. As the new Islamic order began to take shape in this dynamic region between great empires, it drew important inspiration from both of the great civilizations that had previously dominated the Mediterranean world.

Unlike the earlier Christian experience, where slow conversion over nearly three centuries preceded the exercise of political power beginning in the reign of Constantine (r. 306–337), the early Islamic state came to dominate a vast empire in a remarkably short period. Within a century of the Prophet's death, Muslim armies had reached southern France in the west and northern India in the east. The rapidity of the early Muslim conquests, combined with the fact that Islam and the civilization that it inspired were still in formation, presented the Umayyad rulers of the first unified Muslim empire with enormous challenges. Faced with the task of administering a vast empire before the superstructure of Islamic law, institutions, political thought, and theology was yet in place, the Umayyads were compelled to make a variety of pragmatic administrative decisions that were effective but hardly uniform in character. Essentially, the Umayyads tended to confirm prevailing practice, whatever that might be, in the eclectic and far-flung empire they ruled from their capital in Damascus.

Unfortunately for the Umayyads, much of what eventually became accepted Sunni theory and practice of law, government, and administration was defined in opposition to whatever exigency-driven expediencies the Umayyads felt compelled to employ in ruling their empire. Not only does this circumstance explain the generally unfavorable evaluation of the Umayyads in subsequent Muslim historiography, but it also contributed greatly to the coalescence of opposition to the Umayyad dynasty, which resulted in their overthrow and replacement by the Abbasids in 750.

Under the Abbasids (750–1258), especially during the first three centuries of their rule, classical Islamic civilization reached fruition. Their new capital of Baghdad was by all accounts not only a fabulous city in its own right, but it was also a great magnet for artists, belletrists, craftsmen, and thinkers from throughout the Islamic world. It was thus during this golden age of early Abbasid rule that the distinctive and characteristic forms of classical Islamic thought and institutions took definitive shape.

By the mid-ninth century the political fragmentation of the universal empire was too advanced for the Abbasids to check. From this point forward, the political unity of the Islamic *umma* would remain an ideal for Muslims but not a practical reality as a host of local powers and regional empires asserted themselves. By this point, however, the basic outlines of classical Islamic thought and institutions were well enough established that they flourished even without the benefit of political unity that the universal empire had once afforded. This was a remarkably vibrant and highly cosmopolitan civilization of great cities, closely linked by shared religion and language, as well as by extensive crisscrossing trade networks and frequent

artistic and intellectual exchange. Rival courts competed with each other in patronizing philosophers, scholars, theologians, jurists, physicians, craftsmen, writers, master builders, and poets, all of whose creativity and genius reflected positively on their benefactors. In this sense the political fragmentation of the universal empire from the mid-ninth century onward probably contributed greatly to the diverse and vibrant creativity of this period by ensuring multiple sources of patronage in all fields of learning and creative production. The economic vitality of Islamic civilization, with its vast and ever-expanding trade networks stretching from East Asia to the Atlantic and from sub-Saharan Africa to Central Asia, ensured an unparalleled level of wealth and further expanded the patronage base well beyond royal courts.

Principal Doctrines and Ritual Practice

Islam falls squarely within the tradition of Abrahamic monotheism and shares certain parallels with both Judaism and Christianity. As explained above, the three major sectarian divisions among Muslims did not originate in doctrinal disagreements. Although certain doctrinal differences among them developed over time, these do not affect essential core beliefs, which are shared universally by Muslims.

At the heart of Islamic theology lies an uncompromising and absolute belief in the unity of God, whom Muslim and Christian speakers of Arabic alike refer to as Allah. The Islamic doctrine of the oneness of God, referred to as *tauhid* in Arabic, forms the first half of the Muslim profession of faith: "There is no god, but God." The Koran is quite specific in its rejection of the Christian doctrine of the Incarnation, and Muslim theologians have traditionally shared the skepticism of their Jewish colleagues about the genuineness of Christian monotheism.

To associate anything else with God, or to submit to anything other than God, is *shirk* (polytheism), the one sin that God does not forgive. Idolatry in the Muslim understanding involves far more than worshiping pagan deities, and *shirk* occurs whenever people place their own personal desires above the will of God.

The God of Koranic revelation is, like the God of the Hebrew Bible, both the creator of the universe and the ultimate judge before whom all people will eventually be called to account at the end of time. These dual qualities of creator and judge help to explain why the Koran stresses both God's mercy and wrath.

Muslim theologians distinguish between the transcendent essence of divinity, which is unknowable, and the attributes of God, which are manifest in the cosmos. In discussing these divine attributes, classical Muslim theologians usually referred to the "Beautiful Names of God." Although the attributes, or names, of God are frequently paired in contrasting qualities (e.g., "He who gives life" and "He who brings death"), the "names of mercy" are said to dominate the contradictory "names of wrath."

Having created the universe, God ordains an order or law according to which all things rightfully submit. Submission to

the will of God, in fact, is central to veneration of the divine—in which the entire created cosmos is properly engaged. Ironically, humanity, which stands at the apex of the created universe, is almost uniquely endowed with the capacity to something less than full submission to God's will. Like Jews and Christians, Muslims believe that humanity comprises a very special part of creation, being created in the image or "form" of God. This unique attribute of human beings affords humanity the possibility of realizing its noble calling—serving as God's deputies on earth (*khalifat allah fi'l-ard*). Because human beings possess the ability throughout their lives to submit to things other than God, it is on the sincere extent of his submission that each person will be judged by God at the end of days. The awesome and inescapable reality of Judgment itself is dealt with in great detail in the Koran, as are the alternative destinations of paradise and hell to which the judged are ultimately consigned.

The ultimate sign of God's mercy is the fact of divine guidance, which has come to humanity through the agency of prophets (*anbiya'*, singular *nabi*). Beginning with the first man, Adam, and concluding with Muhammad, God has sent prophets bearing revelation outlining the divine will for mankind. Unfortunately, the human capacity for ignoring and twisting the revelations of God is limitless, which necessitates God's correcting and restating revelation by sending subsequent prophets. With Muhammad and the Koran, however, Muslims believe, humanity has the corrected and most complete version of God's revealed word. And assertion of the prophetic role of Muhammad forms the second half of the Muslim profession of faith. The Koran reflects God's considerable impatience with the human capacity to corrupt the divine message, which is underscored by warnings that God's patience in this regard is at an end, and hence there will be no further divine revelation. Muhammad, therefore, is understood as the "seal of the prophets."

The Koran, as the complete and perfected word of God, made manifest in the world through the prophetic agency of Muhammad, is the earthly version of a heavenly archetype existing eternally with God. It must be emphasized here that Muslims understand the Koran not as the word of Muhammad, somehow inspired by God, but as the absolute word of God himself. In this sense, Muslims see Islam as "the religion of the Book." They likewise regard Jews and Christians as "people of the Book," because they are believed to have also received genuine, though incomplete, divine revelation. The actual content of both the Hebrew Bible and the Christian New Testament, however, have historically held very little interest for Muslims because not only are they incomplete, but Muslims believe that Jews and Christians either willfully or carelessly corrupted the content of the divine scripture they received.

The fact that Christians and Jews were recipients of genuine revelation, however, has historically implied for Muslims that neither Jews nor Christians could be forcibly converted to Islam. This same prohibition against forcible conversion was later applied to various other religious communities that Muslims identified as genuinely monotheistic. Polytheists,

however, did not fare so well, and were forcibly converted, on pain of death or enslavement, particularly in the early Islamic period.

Although Christians, Jews, and other monotheists, referred to collectively as *dhimmis*, or "protected peoples," were not routinely compelled to convert to Islam, they were frequently subjected to various disabilities, such as the payment of a special tax known as the *jizya*, and indignities, such as sumptuary laws, designed to encourage their conversion to Islam. Although this limited tolerance that medieval Muslim societies traditionally afforded other monotheistic faiths would not satisfy contemporary sensibilities, by comparison with such institutions as the Inquisition in Christian Europe, Islamic tolerance of other monotheistic faiths was indeed remarkable.

The refusal of Christians and Jews to recognize the prophecy of Muhammad was viewed by Muslims as willful disobedience of God, which should not be ignored but actively challenged. This sense of responsibility for the fate of the souls of others was very much part of a larger understanding Muslims traditionally had, that they were specifically commanded by God to "command what is good, and forbid what is evil" in the world. Muslims in the classical period suffered no doubts about the answer to Cain's rhetorical question in the Book of Genesis: they clearly understood that they were indeed their brother's keeper.

The word *Islam* itself in Arabic conveys a notion of inner peace that humans can only achieve through sincere submission to the will of God. The most obvious demonstration of this submission to God is expressed in what are frequently referred to as the five pillars of Islamic faith: devout and public profession of faith (*shihada*), the ritual performance of worshipful prayer (*salat*) at five appointed times each day, the annual giving of alms to the poor (*zakat*), annual fasting (*sawm*) from before sunrise until sunset throughout the Islamic month of Ramadan, and the performance of a pilgrimage (*hajj*) to Mecca at least once during one's life, assuming health and finances permit. It must be stressed, however, that these ritual obligations only demarcate the most basic outlines of submission to God's will. Devout Muslims see themselves as engaged in a profound struggle to submit their own wills to God's law in every aspect of life. In fact, they frequently refer to this inner struggle as the greater jihad.

Practice, Law, and Authority

The scope of God's law, the *shari'a*, is as expansive and as comprehensive in Islam as is halakah in Judaism. In fact, all human actions and interactions fall into and are analyzed by Muslim jurists in one of five categories: (1) actions that God specifically commands (such as fasting and five daily performances of prayer); (2) actions that God encourages but does not insist upon (such as charity beyond what the *zakat* requires); (3) neutral actions about which God is indifferent; (4) discouraged but not prohibited actions (such as divorce); and finally (5) forbidden actions (such as murder and drinking alcohol). In very much the same manner as rabbinic law, Islamic jurists submit all actions to careful analysis in an effort to determine the will of God. Ultimately, submission to God lies

in the considerable effort that devout believers invest in ensuring that all of their actions are measured in the light of and conform to the *shari'a*. This emphasis on the correctness of action among the faithful in both Judaism and Islam distinguishes these traditions as orthopractic and sets them both apart from Christianity, with its historic emphasis on orthodoxy, the correctness of doctrine, among believers.

Although Muslims, like Jews, historically focused primarily on faithful adherence to God's law, it is important to note that the *shari'a* is not in any sense a uniform legal code. Rather it is a legal framework within which considerable disputation occurs. Basing their analysis primarily on the Koran and extensive collections of reports, known as *hadith*, about what the Prophet did and said, as well as several subsidiary sources of divine law, Muslim jurists generated an immense body of jurisprudence over the centuries in their efforts to discern and apply the specific content of divine law.

Because Sunnis, unlike Shiites, never developed a clerical order or hierarchy, there was no body or institution in Sunni Islam charged with establishing definitively which legal opinions were authoritative and which were not. Again, very similar to the rabbinic system, jurisprudence in Sunni Islam is remarkably decentralized. The opinions of certain jurists gain authority over time as they are cited positively by subsequent jurists in their own legal opinions. Legal reasoning among Sunnis divided itself into a number of "schools" of jurisprudence known as *madhabib* in Arabic, of which four survive: Hanafi, Shafi'i, Hanbali, and Maliki. Although both the approach to legal reasoning and the specific content of law in each school do not vary greatly, there are some important differences among them. As a general rule these legal schools predominate regionally (for example, Malikis in North Africa and Hanbalis in northern and central Arabia). Shiites and Kharijites developed their own legal schools.

The decentralized character of authority in Sunni jurisprudence extends more broadly to the entire field of religious knowledge. Because there is neither a formal clergy nor any ordination process among Sunni religious scholars, referred to collectively in Arabic as the '*ulama*' (Anglicized as *ulema*), the educational process through which individuals gained admission to the class of religious scholars traditionally tended to be highly personal. Again, much like the rabbinic system, promising students sought and were granted permission to study under recognized authorities. Upon the completion of their studies they received a certificate from the master certifying their competence in whatever field of religious science they had studied with him.

Like Judaism and Christianity before it, Islam was profoundly affected by its encounter with Hellenistic thought. By the early Abbasid period, speculative theology among Sunnis was dominated by a series of competing schools that emerged in response to various major doctrinal debates among the ulema over such issues as predestination versus free will, whether the Koran was created or coexistent with God, and the extent to which the Koran should be interpreted literally or metaphorically. The assistance of politically powerful patrons was frequently sought by partisans in these contentious

debates among the ulema to ensure the persecution of their opponents.

Islamic mysticism, usually referred to as Sufism, like law, theology, and philosophy, also played a major role in shaping Sunni spirituality from an early date. In Sufism authority also tended to be both highly diffuse and personal in character. By the mid-thirteenth century an elaborate series of mystical brotherhoods, known as *tariqas*, emerged and replaced an earlier, more informal collection of individual mystics surrounded by their disciples. Under the *tariqa* system, with each brotherhood having its master and established rule of esoteric development, a greater measure of conformity to normative Sunni doctrine among mystics was finally achieved—to the great relief of mainstream Sunni ulema, who were frequently troubled by the more exuberant and ecstatic expressions of mystical gnosis among the Sufis.

The great mystical brotherhoods of the later Middle Ages also attracted large followings among all sectors of the population. Many people were especially attracted by the public veneration of great mystical saints, known in Arabic as *awliya'* (singular *wali*), "the friends of God," especially at the site of their tombs. In a religious system where prophetic revelation ended decisively with Muhammad's death in 632, *wilaya*, or sainthood, offered an important opportunity for mediation with God. Although many Sunni jurists opposed the cult of the saints, others found ways to accommodate this highly popular practice within the framework of normative Sunni practice.

Despite the fact that political and religious authority were theoretically unified for Sunnis in the office of caliph, as a practical matter, after the breakdown of centralized power in the Abbasid period, effective political power passed to and was monopolized by various regional dynasties and other secular political forces, which, nonetheless, frequently maintained the fiction that they were ruling in the name of the caliph. Philosophers, such as Abu Nasr al-Farabi (c. 878–c. 950), articulated elaborate theories of the caliphate and its qualifications long after caliphs ceased wielding effective political power. Thus the office of caliph continued to symbolize the ideal unity of the Muslim *umma* for Sunnis in a reality characterized by political fragmentation. Although the ulema class frequently decried the failure of secular political authorities to rule in accordance with the *shari'a*, the religious establishment came to see their primary role as guardians of the *shari'a* in a world without effective caliphs. Whenever possible they sought to pressure political authorities to adhere more closely to the *shari'a*, but the ulema effectively recognized a de facto division between political and religious authority from the Abbasid period onward.

See also Death and Afterlife, Islamic Understanding of; Jihad; Law, Islamic; Mysticism: Islamic Mysticism; Philosophies: Islamic; Religion: Middle East; Religion and the State: Middle East; Sufism.

BIBLIOGRAPHY

Berkey, Jonathan P. *The Formation of Islam: Religion and Society in the Near East, 600–1800*. Cambridge, U.K.: Cambridge University Press, 2003.

- Cook, Michael. *Commanding Right and Forbidding Wrong in Islamic Thought*. Cambridge, U.K.: Cambridge University Press, 2000.
- . *Early Muslim Dogma*. Cambridge, U.K.: Cambridge University Press, 1981.
- Donner, Fred M. *The Early Islamic Conquests*. Princeton, N.J.: Princeton University Press, 1981.
- Ernst, Carl W. *Sufism: An Essential Introduction to the Philosophy and Practice of the Mystical Tradition of Islam*. Boston: Shambhala, 1997.
- Hallaq, Wael B. *A History of Islamic Legal Theories*. Cambridge, U.K.: Cambridge University Press, 1997.
- Hawting, G. R. *The First Dynasty of Islam: The Umayyad Caliphate AD 661–750*. London: Croom Helm, 1986.
- Hodgson, Marshall G. S. *The Venture of Islam: Conscience and History in a World Civilization*. 3 vols. Chicago: University of Chicago Press, 1974.
- Lapidus, Ira M. *A History of Islamic Societies*. 2nd ed. Cambridge, U.K.: Cambridge University Press, 1988.
- Madelung, Wilferd. *Religious Trends in Early Islamic Iran*. Albany, N.Y.: Bibliotheca Persia, 1988.
- . *The Succession to Muhammad: A Study of the Early Caliphate*. Cambridge, U.K.: Cambridge University Press, 1997.
- Morony, Michael G. *Iraq After the Muslim Conquest*. Princeton, N.J.: Princeton University Press, 1984.
- Murata, Sachiko, and William C. Chittick. *Vision of Islam*. New York: Paragon House, 1994.
- Renard, John. *Seven Doors to Islam: Spirituality and the Religious Life of Muslims*. Berkeley: University of California Press, 1996.
- Taylor, Christopher S. *In the Vicinity of the Righteous: Ziyara and the Veneration of Muslim Saints in Medieval Egypt*. Leiden, Netherlands: Brill, 1999.
- Watt, W. Montgomery. *The Formative Period of Islamic Thought*. Oxford: Oneworld, 1998.

Christopher S. Taylor

ISLAMIC SCIENCE. History of science in non-Western societies is often either disregarded—because it is not linked with that in Western societies—or disfigured into a member of a chain of transmission that links antiquity with Latin Christendom. Rather than attempt to fit Islamic science into the history or notions of Western science, this essay examines the relationships between various scientific disciplines in Islamic societies and other intellectual, cultural, and social fields in these societies. The word *sciencels* is used as a rendition of the Arabic plural *'ulum* of *'ilm* because in many historical sources this plural designates a group of scholarly disciplines (religious, philological, philosophical, mathematical). The singular alone often stands for religious knowledge. In combination with a qualifier, for instance *hisab* (calculation) or *nujum* (stars), it names particular scholarly disciplines—for example, arithmetic or astronomy. The survey is divided into three parts that demarcate important shifts and changes in the history of science in Islamic societies: the mid-eighth to the eleventh centuries; the twelfth to the mid-fifteenth centuries; and the mid-fifteenth to the nineteenth centuries.

Mid-Eighth to the Eleventh Centuries

Healers with some kind of hospital training and adepts of alchemy were already active in the time of the Prophet and

under the Umayyad dynasty (661–750) of Damascus. The earliest preserved fragments of and references to Arabic astronomical and astrological texts are from 679 and 735. Historians of science, medicine, and philosophy, however, disagree as to whether all writings ascribed to the alchemist and Sufi Jabir ibn Hayyan (c. 721–c. 815) were indeed his own or rather composed by later authors.

Translation movement. The major breakthrough as far as philosophy and the ancient sciences are concerned occurred from the mid-eighth to the first third of the ninth centuries under the Abbasid dynasty (750–1258). During these decades, the extraordinary “translation movement” started and gained solid footing. The movement covered different kinds of scholarly heritage (Iranian, Indian, Byzantine, Hellenistic, Hellenic) whose transfer into Arabic flourished over different periods.

Translations were a major aspect of scholarly culture in several Islamic societies until the early eleventh century. Previous scholarship saw the reasons for this movement primarily in practical needs of physicians, astrologers, and patrons as well as in an intellectual superiority of the non-Muslim communities that persuaded the Muslims to acquire their knowledge and standards of debate. Dmitri Gutas proposes a different view in *Greek Thought, Arabic Culture* (1998). He points to the suppression of intellectual activities in the centers of the Byzantine Empire after the sixth century and the preservation of the heritage among persecuted and marginalized Christian minorities, whose status and liberty of movement changed drastically after the conquest of their lands by Arab Muslim armies. The second factor Gutas emphasizes is the need for legitimacy-creating measures by Abbasid caliphs at two points of their dynastic history (after 750 when they had successfully conquered the Umayyad empire and after 819 when al-Ma'mun decided to return to Baghdad after his successful overthrow of his brother, the caliph al-Amin in 813). In both instances, Gutas believes, the two caliphs, al-Mansur (r. 754–775) and al-Ma'mun (r. 813–833), chose to implement a cultural politics that favored translations of foreign knowledge. In the case of al-Mansur the emphasis was on Persian knowledge, although the caliph had already commissioned the acquisition of Greek scientific manuscripts, while in the case of al-Ma'mun the translation of Greek texts was primary. The purpose of this politics was to lend al-Mansur the legitimizing aura of Sassanian royalty and to bind his Persian allies more closely to his rule. Al-Ma'mun, on the other hand, strove to foster the alliances he deemed necessary by means of devaluating the reputation of the only surviving pre-Islamic enemy of substantial power, Byzantium, and hence this enemy's right to claim imperial rule in the Mediterranean world.

Astrologers and physicians. The first known scholars of the Abbasid court were astrologers and physicians, mostly from western Persia. They lent their expertise for determining the auspicious day for building Baghdad in 762 and for treating sick caliphs and their wives. They calculated horoscopes and composed astrological histories. They were the first translators mostly of Pahlavi (a group of Iranian languages and dialects used from 300 B.C.E. and 900 C.E.) but also of some Greek and Syriac texts on astrology, logic, medicine, astronomy, mathematics, ethics, and wisdom sayings.

Descendants of Byzantine nobles, clergymen of various Orthodox churches in Mesopotamia (present-day Iraq) and Syria, and members of the Sabian communities of northern Mesopotamia began to participate in these translations during the later decades of the eighth century. Until the end of the ninth century, many books were translated twice, or even three times, because of conflicting approaches to what constituted a good translation and what or who mattered more—language or scientific content, the author or the translator. These translations were executed and interpreted within the set of ideas and practices that developed during the eighth and the early ninth centuries. An example is Qusta ibn Luqaal-Ba'labakki's (fl. 860–900) rendering of Diophantes' number theory in the technical language of algebra found in the book of Abu Ja'far Muhammad ibn Musa Al-Khwarizmi (fl. c. 780–840). On the other hand, the translations were a major component of a process that transformed the set of earlier ideas and practices into new, often hybrid forms. An example is the combination of Indian and Ptolemaic concepts, methods, and parameters in astronomical handbooks of the so-called Sindhind tradition—that is, the tradition based indirectly on the *Brahma-sphuta-siddhanta* (628) by Brahmagupta (598–c. 665).

Science at court. From the ninth to the eleventh centuries, most students of the ancient sciences earned their living as scholars at courts, as itinerant scholars, and as merchants, or they lived from their family fortunes. Mathematicians were often either astrologers or physicians. Occasionally they also served as secretaries and historians. The social and cultural acceptance of the ancient sciences is expressed by the high ranks given to several leading scholars at various courts in the center of the Abbasid empire and its provinces. They acted as teachers of princes, table companions of caliphs and viziers, courtly ambassadors, and heads of delegations of city notables charged to negotiate credits, war, and peace with their feuding sovereigns. In the ninth century, they presented their scientific results as letters to princely students and viziers, as answers to friends and critics, as interpolations to and comments on translated pre-Islamic books, and as treatises that focused on a particular set of research questions. Cross-confessional cooperation was another major feature of scholarly life and applied to both scholars and patrons.

Beginning in the second half of the tenth century, new Islamic dynasties evolved inside and outside the Abbasid empire. This political, religious, and cultural diversification produced more possibilities for patronage and scholarship. Scientists introduced new forms of communication, such as the exchange of letters between scholars in far away towns through riding messengers. Long-distance cooperation also included shared research activities, such as observations of eclipses. The mobility of scientists increased too. They wandered between regions as far away as modern Uzbekistan and Syria and worked at several courts and for different patrons.

The new forms of scholarly life spread the sciences over the large territories of the Islamic world and enabled other dynasties to formulate their own cultural politics. In al-Andalus on the Iberian Peninsula, for instance, the heirs of the only Umayyad prince who had survived the Abbasid massacre of his

family supported scientific activities as part of their anti-Abbasid foreign politics. At their court, the relationship between the newly arriving sciences and the previously established Maliki branch of Sunni jurisprudence was tense. Since the early ninth century, poets, sponsored by the emirs, had espoused astrology disapproved by Maliki scholars. As Mònica Rius has shown, the conflicts between poets and jurists were not motivated solely by legal concepts of right and wrong but included power struggles, issues of reputation, and courtly politics. She believes that despite Maliki condemnations, astrology became an obligatory element in the courtly educational canon.

In the late tenth and early eleventh centuries, a new type of scholar emerged in Andalusia who taught parts of Maliki law together with number theory. Maslama ibn Ahmad al-Majriti (d. 1008) is the first known scholar of this group. He and his students recalculated, edited, modified, and criticized astronomical tables devised in Baghdad, in particular those by al-Khwarizmi and al-Battani (c. 858–929). Their successors, such as the judge Sa'id al-Andalusi (1029–1070) and his collaborator al-Zarqallu (c. 1030–1099), compiled and calculated new astronomical handbooks such as the Toledan Tables, the Alphonsine Tables, and many others. One of the multiple changes that these Andalusian scientists introduced was a new longitude of Cordoba, which shortened the Ptolemaic length of the Mediterranean Sea almost to its correct size. Other changes included theoretical and conceptual innovations such as cycles that regulate the obliquity of the ecliptic or a corrected Ptolemaic lunar model.

Fine arts. The ancient sciences and their proponents in Islamic societies also stimulated the fine arts. Illuminated Byzantine manuscripts on pharmacy, medicine, and mechanics as well as illustrated Sassanian historical books inspired the art of the book in Islamic societies. The first preserved illuminated Arabic manuscripts on medicine, pharmacology, astrology, astronomy, and natural history are from the twelfth and early thirteenth centuries. But astrologers of previous centuries, such as 'Abd al-Jalil al-Sijzi (c. 950–c. 1025) or 'Abd al-Rahman al-Sufi (903–998), already had persuaded central Asian and Persian princes to sponsor the scientific treatises and occasionally also their illumination.

Philosophers and mathematicians. The relationship between philosophers and mathematicians was rather strained during the ninth century, mainly due to the conflicts that raged between the philosopher al-Kindi (d. c. 870) and the three Banu Musa: Muhammad, Ahmad, and al-Hasan. The conflicts concerned questions of content and style as much as they revolved around issues of patronage, courtly power, and cultural superiority. Notwithstanding, a few mathematicians of the ninth century, such as Thabit ibn Qurrah (d. 901), wrote about philosophical subjects. Al-Kindi, as did philosophers in antiquity, applied Aristotelian notions to his discussions of mathematics. Other, anonymous writers strove to harmonize Euclid's (fl. c. 300 B.C.E.) geometry with Nicomachus of Gerasa's (fl. c. 100 C.E.) number theoretical philosophy by reinterpreting book 2 of the *Elements* as dealing with mixed arithmetical-geometrical objects (bricks) rather than lines and surfaces, which were in this view objects of a lower ontological status.

In the second half of the tenth and early eleventh centuries, things started to change. The Persian mathematician and astronomer Abu al-Wafa' al-Buzajani (940–998) lent his support to the secretary and philosopher Abu Hayyan al-Tawhidi (d. 1023) at the Buyid court in Baghdad. Ibn al-Haytham (965–1042) in Basra and Cairo and Omar Khayyám (1048–1131) in Balkh, Bukhara, and Samarkand engaged in serious philosophical study and writing.

Science and religion. The relationship between the ancient sciences and religious disciplines covered conceptual as well as practical aspects. In the eighth century, a newly emerging faction among the religious scholars, the Mu'tazilites, began to use mathematical and philosophical arguments in discussions of matter and movement. Representatives of Ash'ari kalam, founded against Mu'tazili doctrines in the early tenth century, participated in debates about number theory, physics, astronomy, and astrology and wrote about such themes. Mathematicians in the ninth century such as al-Khwarizmi tried to relate their fields of knowledge to religion. Opening his book on algebra by advertising the new discipline as an appropriate tool for merchants, he ended it with an exposé of algebraic solutions for legal problems. While this is usually seen as a further aspect of applied mathematics, it also reflects the mathematician's participation in the not-yet-finished process of codifying Abu Hanifa's (699–767) school of law. Anonymous readers of Euclid's *Elements* added to the definition of a solid in book 11 that "it is all that has a corpse" (*kull ma labu juththa*), alluding to discussions of whether God was or had a body.

The cornerstone of the efforts to apply mathematics and astronomy to Muslim religious practice was to find the *qibla*, the direction toward Mecca, and to determine the prayer times. Ahmad b. 'Abdallah al-Marwazi called Habash al-Hasib (c. 770–c. 870), Abu l-'Abbas al-Fadl al-Nayrizi (d. c. 922), and al-Battani (c. 850–929) used methods such as the analemma of Hellenistic geometry to find exact solutions or spherical triangles and the Indian sine function to find approximate solutions. The visibility of the new moon and possibly the issue of the beginning of the world also belong in this context. Ibn al-Nadim ascribed a lost treatise touching on the latter question to Muhammad (d. 872), the eldest of the Banu Musa.

Mathematicians, astronomers, and astrologers. Mathematicians, astronomers, and astrologers held different views about what was important, valuable, and feasible in their disciplines. Thabit ibn Qurrah interpreted al-Khwarizmi's algebra in terms of book 2 of Euclid's *Elements* on particular geometrical constructions. Al-Karaji (d. c. 1030), like Thabit ibn Qurrah, placed geometry over algebra because he regarded it as the science that guaranteed certain knowledge. Al-Hasan ibn Musa (d. after 870) was accused of inventing solutions to mathematical problems without having done what was proper—reading all books of the *Elements*. Ibrahim b. Sinan (908–946, a grandson of Thabit ibn Qurrah), Abu Sahl al-Kuhi (tenth–eleventh centuries), al-Sijzi, Abu l-Jud b. al-Layth (tenth–eleventh centuries), al-Biruni (973–1048), and others struggled with one another about the appropriate methods for

solving difficult mathematical problems and the deficiencies of certain forms of analysis and synthesis, two major geometrical methods since antiquity.

The sharp debates that surrounded the twin disciplines of astronomy and astrology ranged from the two standard challenges of lacking reliability and religious heterodoxy to the kinds of philosophical foundations necessary for a well-functioning astrology, the appropriate demonstrative methods, and the relationship to astronomy. George Saliba argues that these debates motivated astronomers in the ninth century to set up a new kind of astronomy or mathematical cosmography, *'ilm al-hay'a*, that aimed at drawing clear fences between a mathematically sound discipline of the heavens and astrology (2002). Similarly, F. Jamil Ragep, who thinks that two different kinds of *'ilm al-hay'a* emerged, sees the more general type aiming at setting a mathematical science of the heavens apart from ancient *astronomia* or *'ilm al-nujum* (science of the stars) that included astrology. The other, more restricted project of *'ilm al-hay'a* evolved as a specific genre that strove to harmonize physical, that is, philosophical, principles and mathematical models of planetary movements and included the mathematical description of the earth (1993). As the works of Thabit ibn Qurrah and al-Hasan al-Nawbakht (d. c. 920) illustrate, a third realm of debate focused on Ptolemy's (second century C.E.) work and the various new astronomical tables, in particular the *Zij al-Mumtazan* (The corrected tables). These and other tables were calculated by al-Ma'mun's court astronomers Yahya b. Abi Mansur (d. c. 830), Khalid b. 'Abd al-Malik al-Marwarrudhi (first half of the ninth century), al-'Abbas al-Jawhari (first half of the ninth century), Habash al-Hasib, and others on the basis of astronomical observations. While Thabit ibn Qurrah explained and propagated specific theories and methods from Ptolemy's *Almagest*, he apparently held the "Corrected Tables" in less esteem.

David A. King, Julio Samsó, and B.R. Goldstein believe that the debates that surrounded and permeated the new tables caused the gradual elimination of Persian and Indian elements from Islamic astronomy in favor of Ptolemaic theory. The debates also led to the replacement of some Ptolemaic parameters such as the obliquity of the ecliptic by new observational results and to the abandonment of certain Ptolemaic beliefs, such as the immobility of the solar apogee or the impossibility of annular solar eclipses. Al-Hasan al-Nawbakht, in contrast, wrote a disputation against Ptolemy's planetary models as well as against the Platonic stance that the cosmos was a living, rational being. His rejection of Ptolemy and Plato may have been linked to his political-religious preference of the quietist Shia in opposition to the Shii revolutionary wing of the period, the Batiniyya.

Major themes and achievements. Major mathematical, astronomical, mechanical, and optical themes and achievements of these four centuries concern the gradual emergence of a new, distinctly Islamic trigonometry; the use of analysis and synthesis; the construction of the side of a regular heptagon; the study of conic sections; efforts to solve specific problems of number theory such as the so-called theorem of Fermat; the creation of a geometrical as well as a numerical theory of

cubic equations; the determination of centers of gravity as well as of specific weights; the study of the law of the lever and the construction of balances; the introduction of a new theory of seeing, reflection, and refraction; the interpretation of the moon's light; the construction of burning mirrors; and the physical foundation of mathematical astronomy. This vibrant pursuit of theoretical themes fostered an atmosphere in which claims to invention, innovation, and novelty thrived. Experimentation was regarded as a means to achieve new insights and build new theories. Ibn al-Haytham carried out experiments for solving optical questions, for deciding between alternative explanatory approaches, and for modeling astronomical processes. Abu Sahl al-Kuhi used thought experiments for finding new results for geometrical questions related to mechanics. Criticizing predecessors and compatriots was a favored stylistic means to establish credibility and claims to priority and to propagate new results.

Parallel to the attention directed toward theoretical aspects of science, much work went into practical fields such as calculating calendars and horoscopes; determining geographical coordinates; teaching the basics for calculating exchange rates, wages, business transactions, and the hire of labor; surveying fields and properties; and determining surfaces and volumes used in architecture and for ornamental decorations. Leading mathematicians such as Abu al-Wafa and Ibn al-Haytham wrote about these practical subjects, as did a number of religious scholars, such as the founder of the Ash'ari kalam, Abu al-Hasan 'Ali al-Ash'ari (873 or 874–935 or 936) and his eminent follower 'Abd al-Qahir al-Baghdadi (d. 1038). The two mathematicians also contributed to the new field of magic squares—that is, squares filled with numbers in a way that the sum of each column equals the sum of each row as well as each diagonal. Abu l-Wafa', Ibn al-Haytham, and later writers created methods for constructing pair and impair magic squares of higher order, partitioned magic squares, or bordered magic squares. Over the centuries, magic squares attracted the attention of scholars who were interested in mathematics as well as that of writers, mystics, artisans, sultans, military leaders, and ordinary people who applied magic squares—from the most elementary to the very large and fairly complex—to protect themselves from all sorts of misfortunes.

Twelfth to Mid-Fifteenth Centuries

Substantial changes in the context of the sciences took place between the twelfth and the mid-fifteenth centuries. They resulted from the adoption of the *madrasa* (Muslim institution for higher education) as an appropriate means for achieving cultural, religious, legal, and social purposes by the Sunni Turkish and Kurdish dynasties of the Saljuqs, Zangids, Artuqids, and Ayyubids since the second half of the eleventh and during the twelfth century. Scholarly opinions about the place of the sciences and philosophy in this institution vary profoundly. Some such as George Makdisi argue that they were denied access to institutionalized teaching and could be at best taught privately, occasionally having even to go into hiding. Others, for example Seyyed Hossein Nasr, point to the integration of logic, philosophy, astronomy, arithmetic, and geometry into the Persian *madrasas*. They see this process as limited

to Persia. J. Lennart Berggren takes a middle position by stressing that certain parts of the mathematical sciences, such as elementary arithmetic and algebra, became fully integrated into the legal teaching. Several others have shown that in contrast to the belief in a religiously motivated marginalization of the sciences, new professional and disciplinary settings emerged that led to a flourishing high theory (planetary models), the invention and construction of new scientific instruments (new types of astrolabes, quadrants, and compounds with compasses), and a vigorous practice of solving astronomical problems central for Muslim religious ritual.

The new profession of the *muwaqqit* (timekeeper) focused on the mathematical and astronomical treatment of problems of religious ritual and on instruments. The *muwaqqits* were attached to mosques and *madrasas* mainly in Syria, Egypt, the Maghrib, Andalusia, and under the Ottomans also in Anatolia and the Balkans. The new disciplinary realm, that of the rational sciences, combined certain religious studies with some of the ancient sciences. In a gradual process, parts of logic, epistemology, metaphysics, physics, astronomy, and geometry were assimilated to kalam (rational theology), *usul al-din* (the fundamentals of religion), and to a lesser extent to *usul al-fih* (the fundamentals of law). The assimilation took place either by integrating these elements into the religious disciplines themselves or by teaching them together by the same professor to the same group of students.

The search for new planetary models that superseded those of Ptolemy and were the basis for the work of Nicolaus Copernicus (1473–1543) was almost exclusively sponsored through princely patronage until the thirteenth and early fourteenth centuries, when it experienced a new period of innovation through the works of Mu'ayyad al-Din al-'Urdu (d. 1260), Muhyi l-Din al-Maghribi (d. c. 1290), Nasir al-Din al-Tusi (1201–1274), and Qutb al-Din al-Shirazi (1236–1311). The Mongol adaptation of the *madrasa* to the needs of an itinerant court and the spreading inclination among religious scholars of southern Mesopotamia and western Persia to include in their education the study of philosophy and the mathematical sciences apparently led to the later integration of planetary models in the courses taught at Persian *madrasas* and in textbooks on kalam. As a result, major religious scholars from the fourteenth century onward also wrote on *'ilm al-hay'a* and contributed to improving the models.

As in the case of the *muwaqqit*, the discussions on astronomical theory did not spread over the entire Islamic world. They took place mainly in Persia between the thirteenth and the early sixteenth centuries with some extension to Anatolia, Syria, central Asia, and India, where it lasted occasionally until the eighteenth century. But parts of this theory, for instance the so-called Tusi-couple, spread to Byzantium and Andalusia, and among Jewish circles of southern France and Italy. The submission of large parts of Asia under Mongol rule in the second half of the thirteenth and the first third of the fourteenth century ensured a vivacious exchange of scientific texts, instruments, and methods between the Islamic east and China. Texts on medicine, agriculture, and astronomy were translated either into Persian or into Chinese and commented on in

Uighur and Tibetan. Chinese tables based on Islamic ancestors were discussed and modified in Korea.

Mid-Fifteenth to Nineteenth Centuries

Between the late fourteenth and the early sixteenth centuries, the geographical, political, ethnic, religious, and cultural properties of the Islamic world underwent new, profound changes. Andalusia was gradually lost to invading Christian forces. New, powerful dynasties rose in central Asia (Timurids), Anatolia, Greece, and the Balkans (Ottomans), Persia (Safavids), and north and central India (Mughals). Merchants carried Islam farther east to Sumatra, Java, Bali, and the Philippines. The new imperial dynasties and several smaller Muslim Indian dynasties built their own intellectual landscapes by translating Arabic scientific, geographical, philosophical, historical, literary, and religious texts into Persian and Turkish, Persian texts into Turkish and Sanskrit, and Sanskrit texts into Persian. They sponsored new artistic programs of illuminated works on natural history, astrology, astronomy, geography, history, and literature. Their scholars integrated in these emerging canons written, pictorial, and oral elements of the new sciences that evolved in the Renaissance and during the seventeenth century in Catholic and Protestant Europe. These cultural activities were linked with a conscious religious politics that often took recourse to philosophical concepts and debates. Parallel therewith, various efforts aimed to reform military and educational institutions, to introduce new technologies from Catholic and Protestant Europe, and to apply newly invented methods of observation and measurement to well-known disciplines such as geography and cartography.

Over several centuries, the processes of exchange went in multiple directions, linking the various Islamic societies with one another and with several countries in Christian Europe. Alliances between Christian and Muslim rulers against their immediate enemies, whether Christian or Muslim, were the norm rather than the exception, as was the hiring of scholars, mostly physicians, of different religious creed at the courts in Fez, Istanbul, Agra, or Hyderabad. Colonial expansion of Portugal, Great Britain, the United Provinces of the Netherlands, France, and Russia at different moments in time determined the form and the content of the alliances, not only with respect to weapons, fortress building, military strategy and tactic, and trade but also with regard to scholarly travel, cartographic measurements, astronomical observations, hiring of foreign professors, founding of new teaching institutions—meant first to complement the older educational system and later to replace it—and the creation of botanical gardens. British, French, and Russian colonial supremacy in the nineteenth century, while pursuing different objectives and politics, finally led to the abolishment of Islamic scholarly institutions and knowledge in most of India, central Asia, and northern Africa and to its replacement by those of the colonizers.

See also *Communication of Ideas: Middle East and Abroad; Education: Islamic Education; Islam; Mathematics; Religion: Middle East; Religion and Science; Science.*

BIBLIOGRAPHY

- Berggren, J. Lennart. "Islamic Acquisition of Foreign Sciences: A Cultural Perspective." In *Tradition, Transmission, Transformation: Proceedings of Two Conferences on Pre-Modern Science Held at the University of Oklahoma*, edited by F. Jamil Ragep and Sally P. Ragep with Steven Livesey, 263–284. Leiden, Netherlands, and New York: Brill, 1996.
- Brentjes, Sonja. "On the Location of the Ancient or 'Rational' Sciences in Muslim Educational Landscapes (AH 500–1100)." *Bulletin of the Royal Institute for Inter-Faith Studies* 4, no. 1 (2002): 47–72.
- Dhanani, Alnoor. *The Physical Theory of Kalām: Atoms, Space, and Void in Basrian Mu'tazili Cosmology*. Leiden, Netherlands, and New York: Brill, 1994.
- Gutas, Dimitri. *Greek Thought, Arabic Culture: The Graeco-Arabic Translation Movement in Baghdad and Early 'Abbasid Society (2nd–4th/8th–10th centuries)*. London and New York: Routledge, 1998.
- Haq, Nomanul. *Names, Natures and Things: The Alchemist Jābir ibn Hayyān and his Kitāb al-Ahjár (Book of stones)*. Dordrecht Netherlands, and Boston: Kluwer 1994.
- King, David A. In *Synchrony with the Heavens: Studies in Astronomical Timekeeping and Instrumentation in Medieval Islamic Civilization*. Vol. 1, *The Call of the Muezzin*. Leiden, Netherlands, and Boston: Brill, 2004.
- . "On the Role of the Muezzin and the *Muwaqqit* in Medieval Islamic Society." In *Tradition, Transmission, Transformation: Proceedings of Two Conferences on Pre-Modern Science Held at the University of Oklahoma*, edited by F. Jamil Ragep and Sally P. Ragep with Steven Livesey, 285–346. Leiden, Netherlands, and New York: Brill, 1996.
- King, David A., Julio Samsó, and B. R. Goldstein. "Astronomical Handbooks and Tables from the Islamic World (750–1900): An Interim Report." *Subhajl, Journal for the History of the Exact and Natural Sciences in Islamic Civilisation* 2 (2001): 9–105.
- Langerman, Y. Tzvi. "Medieval Hebrew Texts on the Quadrature of the Lune." *Historia Mathematica* 23 (1966): 31–53.
- Makdisi, George. *The Rise of Colleges: Institutions of Learning in Islam and the West*. Edinburgh: Edinburgh University Press, 1981.
- Nasr, Seyyed Hossein, and Oliver Leaman, eds. *History of Islamic Philosophy*. London and New York: Routledge, 1996.
- Ragep, F. Jamil. "Freeing Astronomy from Philosophy: An Aspect of Islamic Influence on Science." *Osiris* 16 (2001): 49–71.
- Ragep, F. Jamil, ed. "Nasīr al-Dīn al-Tūsī's Memoir on Astronomy (al-Tadhkira fī 'ilm al-hay')." In *Sources in the History of Mathematics and Physical Sciences* 12, edited by G. J. Toomer. 2 vols. New York: Springer-Verlag, 1993.
- Sabra, Abd al-Hamid I. "The Appropriation and Subsequent Naturalization of Greek Science in Medieval Islam: A Preliminary Report." *History of Science* 25 (1987): 223–243. Reprinted in *Tradition, Transmission, Transformation: Proceedings of Two Conferences on Pre-Modern Science Held at the University of Oklahoma*, edited by F. Jamil Ragep and Sally P. Ragep with Steven Livesey, 3–27. Leiden, Netherlands, and New York: Brill, 1996.
- . "Science and Philosophy in Medieval Islamic Philosophy: The Evidence of the Fourteenth Century." *Zeitschrift für Geschichte der arabisch-islamischen Wissenschaften* 9 (1994): 1–42.
- Saliba, George. *A History of Arabic Astronomy: Planetary Theories during the Golden Age of Islam*. New York: New York University Press, 1994.

———. “Islamic Astronomy in Context: Attacks on Astrology and the Rise of the *Hay’a* Tradition.” *Bulletin of the Royal Institute for Inter-Faith Studies* 4, no.1 (2002): 25–46.

van Dalen, Benno. “Islamic Science and Chinese Astronomy under the Mongols: A Little-Known Case of Transmission.” In *From China to Paris: 2000 Years Transmission of Mathematical*

Ideas, edited by Yvonne Dold Samplonious, Joseph W. Dauben, Menso Folkerts, and Benno van Dalen, 327–356. Stuttgart, Germany: Frans Steiner Verlag, 2002.

Sonja Brentjes



J

JAINISM. Famous for its promotion of nonviolence and often paired with Buddhism as one of ancient India's two greatest dissenting religions, Jainism is currently professed by roughly 0.4 percent of the population of India. Its adherents are prominent in business, and some of modern India's wealthiest and most powerful families are Jains. Jain communities are divided between a majority of lay men and women and a much smaller mendicant elite of peripatetic monks and nuns. The mendicants are a source of teaching and blessings for the laity, who in turn supply them with food and other forms of support. A disagreement over monastic discipline underlies the division between Jainism's two main sects: the *Shvetambaras* (white-clad), whose monks and nuns wear white garments, and the *Digambaras* (space-clad), whose monks wear no clothing.

Origin

Jainism first emerged into historical visibility in the sixth century B.C.E. when it was one among many religious movements of the period that stressed world renunciation and rejected the religious culture and ritualism of the Brahman priestly class. Western scholars often single out Mahavira (who lived, according to *Shvetambara* tradition, from c. 599–527 B.C.E.) as Jainism's founder. The Jains, however, maintain that Jainism's teachings are eternal and uncreated, and consider Mahavira to have been only the most recent of an infinite series of great Jain teachers. In fact, although Jainism's roots predate Mahavira, he played a key role in defining doctrines and practices that became central to Jainism as it evolved. Viable monastic communities with lay followings formed and grew after Mahavira's death. Patronized mainly by newly emerging urban classes (especially merchants) Jainism spread in two directions from its region of origin in the Ganges River basin: down India's eastern coast into the south and westward in the direction of Mathura. The division between the *Svetambaras* and *Digambaras* crystallized in the fifth century C.E. The south ultimately became the heartland of the *Digambaras*; there they flourished and found royal patronage, especially in Karnataka. The *Shvetambaras* became prominent in the west, especially in what is now Gujarat and Rajasthan.

Canonical Texts

Although their soteriological beliefs are basically the same, the *Shvetambaras* and *Digambaras* possess separate bodies of scripture. All Jains believe that their most ancient scriptures, known as the *Purvas*, have been lost, and that existing texts represent only a remnant of Mahavira's actual teachings. The *Shvetambara* canon, usually said to consist of forty-five texts, probably assumed its present form in the fifth century C.E. Its most

important texts are the twelve *Angas* (or limbs, one of which has been lost) and twelve *Upangas* (subsidiary limbs); they deal with a vast range of subjects, including doctrine, monastic discipline, duties of the laity, cosmography, and much else. The *Digambaras* reject the *Shvetambara* canon as inauthentic. Their most important texts, each containing material on the soul and the nature of its bondage, are two: the *Shatkhandagam* (Scripture in Six Parts), dating from the second century C.E., and a slightly later work entitled *Kasayaprabhata* (Treatise on the Passions).

Doctrine

The term Jain (in Sanskrit, *Jaina*) means someone who venerates the *jinas*. *Jina* (conqueror) in this context refers to one who, by conquering desires and aversions, achieves liberation from the bondage of worldly existence. Achieving such liberation is the object of Jain belief and practice.

Jains believe that the cosmos contains an infinite number of immaterial and indestructible souls (*jivas*). In common with other Indic traditions, the Jains also believe that each soul is reborn after death, and that the type of body it inhabits depends on the moral character of its deeds in past lives. According to Jainism, souls exist in every cranny of the cosmos: they inhabit the bodies of deities, humans, the inhabitants of hell, and plants and animals, and are also present in earth, water, fire, and air. Because the cosmos was never created, each soul has been wandering from one embodied state to another from beginningless time, and will continue to do so for infinite time to come unless it achieves liberation.

The cause of the soul's bondage is karma (action), which in other Indic religious traditions refers to the process by which one's good or bad acts give rise to consequences to be experienced in one's present or subsequent lives. The Jains, however, maintain that karma is an actual material substance (often likened to a kind of dust) that pervades the cosmos; it adheres to the soul, and the encumbrance of accumulated karmic matter is responsible for the soul's continuing rebirth. Karmic matter is drawn toward the soul by volitional actions, and its adhesion to the soul is a consequence of the emotional state of the actor. The passions, especially those of desire and aversion, create a moisture-like stickiness that causes karmic matter to build up on the soul.

To achieve liberation, therefore, one must avoid attracting more karmic matter and shed one's already existing accumulations. This is a complex and arduous process that begins with the awakening of faith in Jain teachings and ends with the

removal of the last vestiges of the soul's burden of karmic matter. The liberated soul then rises to the abode of liberated souls at the top of the cosmos, where it will exist for all of endless time to come in a condition of omniscient bliss.

Avoiding violence is essential to one's progress toward liberation. Because violent actions are associated with the passions that contribute to the influx and adhesion of karmic matter, Jains are strongly committed to nonviolence (*ahimsa*). At a minimum, Jains should be vegetarian. Observant Jains avoid even vegetarian foods deemed to involve excessive violence in their acquisition or preparation. Root vegetables such as potatoes are proscribed because they are believed to contain multiple souls. Such restrictions are most onerous for monks and nuns who are debarred from activities that run the risk of harming even the humblest and most microscopic of living things. Lay Jains have been attracted to business precisely because buying, selling, and banking are activities that do not involve physical violence.

Ascetic practice is also essential to the attainment of liberation. Often likened to a fire that burns away karmic matter, ascetic practice subdues harmful passions that bring about the influx and adhesion of karmic matter and removes already existing karmic accumulations. Jain mendicants are renowned for the severity of their asceticism, and even lay Jains are expected to engage in periodic fasts and other ascetic practices.

The Jains maintain that the truth of their beliefs is guaranteed by the omniscience of their teachers. Known as *tirthankaras* ("ford-makers") or *jinas*, they are human beings who attained omniscience by their own efforts and without the guidance of other teachers, and who, before becoming fully liberated, imparted liberating knowledge to others. The Jains maintain that our section of the cosmos is subject to an eternally repeating cycle of world improvement and decline. Each ascent and descent is immensely long, and in each cycle exactly twenty-four *tirthankaras* successively appear. We are currently nearing the end of a descending era, and Mahavira was the twenty-fourth and hence the final *tirthankara* of our era and part of the cosmos. No new *tirthankaras* will appear until the next ascending period.

The concept of omniscience, seen as a natural quality of the soul when unoccluded by karmic matter, underlies Jainism's celebrated doctrine of epistemological relativity. Known as *syadvad* (the doctrine of "may be"), it holds that in contrast with omniscient knowledge, which incorporates all points of view simultaneously, ordinary knowledge discloses only partial glimpses of reality.

Contemporary Jainism

Although it was once a proselytizing religion and continues vigorously to promote vegetarianism and animal welfare, Jainism has become a religion into which one is born by virtue of birth in a particular family, lineage, or caste. The castes to which Jains belong are typically merchant castes, although there are many Jains in other occupations, including agriculture. The Jains cannot be said to constitute a single community. Even in situations where they live in close proximity,

relations between *Shvetambaras* and *Digambaras* are usually minimal because they belong to different castes, and are frequently adversarial, especially because of disputes over control of sacred sites claimed by both sects.

A major recent development in Jainism is the emergence of a diaspora-based religious subculture. The spread of Jainism beyond the subcontinent has been inhibited historically by the requirement that monks and nuns travel only on foot, but in recent times the number of Jains living outside India has risen to around 100,000, most of whom live in North America, Great Britain, and Africa. The difficulty of practicing Jainism in the traditional way abroad has led to a weakening of sectarian differences. It has also given rise to a tendency to stress the contemporary relevance of Jainism by downplaying traditional soteriology and capitalizing on Jainism's emphasis on nonviolence and vegetarianism by recasting the tradition in an eco-religious and environmentalist mold.

See also Asceticism: Hindu and Buddhist Asceticism; Buddhism; Heaven and Hell (Asian Focus); Hinduism; Immortality and the Afterlife; Nonviolence.

BIBLIOGRAPHY

- Babb, Lawrence A. *Absent Lord: Ascetics and Kings in a Jain Ritual Culture*. Berkeley: University of California Press, 1996.
- Banks, Marcus. *Organizing Jainism in India and England*. Oxford: Clarendon, 1992.
- Carrithers, Michael, and Caroline Humphrey, eds. *The Assembly of Listeners: Jains in Society*. Cambridge, U.K.: Cambridge University Press, 1991.
- Cort, John E. *Jains in the World: Religious Values and Ideology in India*. New York: Oxford University Press, 2001.
- Dundas, Paul. *The Jains*. 2nd ed. London: Routledge, 2002. A comprehensive overview of Jainism and an excellent introduction to the subject.
- Jaini, Padmanabh S. *The Jaina Path of Purification*. Berkeley: University of California Press, 1979. The standard general study of Jainism.
- Laidlaw, James. *Riches and Renunciation: Religion, Economy, and Society among the Jains*. Oxford: Oxford University Press, 1995.

Lawrence A. Babb

JAPANESE PHILOSOPHY, JAPANESE THOUGHT.

To write about Japanese intellectual history is to take part in the lasting Japanese scholarly tradition of recalling the past in order to make sense out of the present, that is, the writing of Japanese history. These histories, official or nonofficial, are structured around key ideas reflecting the intellectual life of a particular period. Constituting a rational effort at legitimizing the power of the elites, these histories also have a more reflective and critical dimension offering insights about the social, political, and religious dimensions of a particular period. What becomes clear through these histories is that Japanese identity is rooted in the construction of a virtual "other" source of fear and admiration. That "other," whether it is China,

the West, or the United States, serves as an incentive to the construction of a Japanese “self.” The Japanese “self” is not the result of an imitation or a reproduction of an exterior model, but the result of a long and painful interior process of realizing that what is idealized in the “other” is in fact the essence of Japanese culture. For example, the *Kojiki* (712 C.E.; Record of ancient matters) and the more voluminous *Nihon shoki* (720 C.E.; Chronicles of Japan), expose the prestigious genealogy of the leaders of the Japanese kingdom. These historical records were created after encountering Chinese culture and are meaningful as long as they can be contrasted with Chinese historical records. The sense of excellence and uniqueness emphasized by these histories is not exclusivist or isolationist but relational and agonistic. When later on during the twentieth century the “other” became the “West,” historians forged the image of a Japanese “self” as a model of Asian civilization, rivaling the Western one.

From the short-term horizon of the Heisei era (the name *Heisei*, meaning “peace everywhere,” was introduced in 1989 by the emperor Akihito after the death of his father, the emperor Showa [Hirohito]), the other is still the West and more precisely the West as an idealized United States. However, a strong conviction that it is time for Japan to establish a new order has surfaced in the early twenty-first century through the traditional and symbolic call for reformation (Jap. *kaizo* or *kaikaku*).

All levels of twenty-first-century Japanese society are affected by a confused but real desire for reform. Still, one has difficulties in grasping what precisely are the key ideas that would guide the effort toward the building of a new Japanese identity. The Heisei era is one of paradoxes and uncertainties generated by a long-lasting economic crisis, a lack of leadership, a sense of insecurity, a loss of moral and religious incentives, and above all a younger generation that values impermanence (*mujō*). In that context, education and new means of communication are calling back to memory aspects of the Japanese past. Under the initiative of the Ministry of Education, new history textbooks have been written, but they are the object of continuing controversies. Replacing the traditional *monogatari* (romantic tales), novels, comic books, and movies nourish a popular taste for what is exotic and perceived as unique in the Japanese past, that is, geomancy (*onmyōdo*), romantic tales, and biographies of religious leaders. The weakening of political, academic, and scientific authority as well as the discrediting of leftist revolutionary ideals have reopened the debate on Japanese culture. The Japan of the Heisei era is experiencing a postcolonial, postwar, post-Marxist, postmodern phase. After the aborted attempts to restore the intellectual tendencies characterized by the theorization on “Japaneseness” (*Nihonjin ron*), the intellectual discourse has shifted to the notion of “belonging”: how does one belong to Japan? What has probably been underestimated about twenty-first-century Japanese thought is the effect the new concept of globalization has had on the Japanese imagination. This concept is in fact very disorienting because it radically transforms the perception of space and renews the reflection on belonging. Globalization does not seem to be compatible with the establishment of a virtual other, reopening the questioning about what makes one Japanese.

The Production of Thought: Writing as Philosophy

When the Silk Road and other trade roads were flourishing, when the Han Empire and the Korean kingdoms entertained relations with the emerging Yamato kingdom, not only goods and ideas, but also a new means of communication—the Chinese writing system—reached the Japanese islands. The mastering of reading and writing Chinese characters gave to the populations living on the Japanese islands a new conception of space and time: educated Japanese could now belong to the vast thinking network that had brought together Indian, Chinese, and many other inspiring cultural centers. A few hundred years later, the *Utsuho monogatari* (976–983) mentions for the first time the word *kana* (provisional names) to speak about a writing system derived from *mana* (perfected names), that is, the original Chinese characters. The invention of the *kana* writing system was interpreted during the Edo era (1600–1867) and up to twenty-first-century Japan as a symbol of Japanese cultural unity, independence, and superiority. Some twenty-first-century scholarship has criticized such an approach and offers new readings of Heian creativity. These new studies tend to emphasize hybridity and hierarchy as the key factors involved in the formation of the classical Japanese community. The *kana* system has never been a mere tool to transcribe phonemes and was never really thought of as independent from the *mana* system. These studies underline the importance of looking at the Japanese writing system as a whole entity ensuring the intelligibility of inscription. In brief, a study of Japanese thought requires an in-depth study of the working out of “philosophies of writing” shared by cultures using Chinese characters. From the Heian period (794–1185) up to contemporary Japan, Japanese have been using an ever-increasing variety of writing systems in order to preserve the intelligibility (not to be confused with clarity or efficiency) of written communication. The combination of Chinese characters, *kana* scripts, Sanskrit syllabary, and, later, the Western alphabet in the Japanese writing system is a constant reminder of the importance of inscription as a symbol of the complex correspondence between the social, political, and cosmological orders.

At the time of the formation of the Japanese writing system, the power and authority received through the mastering of the art of calligraphy gave to Heian scholars the possibility of uniting the social order of the kingdom with the cosmological order found in Buddhist texts. Furthermore, the reading of written works gave to Japanese scholars the sense that texts written in the past were the ultimate source of authority and perfection from which the present derived its legitimacy. Finally, written works gave access to Buddhist teachings, adding new figures such as Sanskrit letters to symbolize new types of associations.

The Capital City as the Space of Thought Production

Originality, clarity, or imitation cannot serve as guiding ideas for studying Japanese thought in the first centuries of the Heian era. Japanese scholars are part of a network in which intellectuals of the past and present influence one another. Thinking insightfully is bound to a space of rivalry. This is why, very early on, the Japanese court organized carefully

planned contests between its best intellectuals (Buddhists, Confucians, Nativists) for the production of an insightful intellectual space. Thus, from a Western perspective the modes of production of ideas in Japan are quite original. After the encounter with Chinese literature, one of the favored means of conceptualization became poetry. Even in the most philosophical commentaries on Buddhist teachings, poems appear in the text as unique and powerful modes of conceptualization. Later on, other written works combine poetry and prose and develop in the forms of popular tales. All these written works share in common an appeal to the senses of the readers. Ideas have to be embodied in order to be understood and to influence modes of life.

The production of ideas requires a space and that space is symbolized by the “capital city” (*miyako*). Protected from evil forces, that sacred and pure space allows the formation of the quintessence of Japanese thought. This is why a study of Japanese thought is bound to be a study of the representations of the city in general and of the capital city in particular. Heijo, Heian, Kamakura, Edo, Tokyo are not just names of capital cities but emblems of unique symbolic structures allowing the production of thought.

Time as a Gift of Nature

Another important factor in the production of ideas in Japan is an element of stability assuring the basic structure of the understanding of time. The temperate climate of the islands with their five seasons (autumn, winter, spring, rainy, summer) generates a cyclical notion of time. Japanese poetry and literature created a rich set of symbols characterizing each one of the five seasons. The description of the passing of seasons and their return is associated with the Japanese landscape. Mountains, plains, and rivers change according to seasons and offer the senses a unique experience of time. Historical figures like the Buddha or Christ, the founding of the Japanese kingdom at a particular point in time, or important historical events have never structured the basic experience of time shared by the Japanese. Among the many symbols that are used to represent their experience of time, rice is definitely the most important. Rice appears as the symbol of an enduring identity, a “Japaneseness” that is not so much handmade but given by natural forces, that must be offered, eaten, or drunk in order to assure the communion among Japanese, including the sharing of thoughts.

Periodization of Japanese Intellectual History

Japanese intellectual history can be roughly divided into four periods, Buddhism, Confucianism, the Western Canon, and the Heisei era. Each period is characterized by the production of a “virtual other” and a “canon.”

China and the Buddhist canon. The Japanese inherited from the kingdoms of Korea and China a great variety of texts belonging to different traditions, namely, Confucian, Buddhist, and Daoist. However, during the first period of Japan’s intellectual history, literati chose the sacred texts of Buddhism as the most authoritative. During that period the major centers of learning were Buddhist monasteries and the most influential thinkers were Buddhist monks. Buddhist teachings rely on

a common set of sutras that are used by all Mahayana traditions, the most important sutras being the Flower Garland (*Kegon*) and the Lotus (*Hoke*). The teaching of Buddhism also relied on a variety of Chinese commentaries, mainly those of late Mahayana (Mahyamika and Yogacara). One of the characteristics of Japanese Buddhism is that, while it is highly intellectual, it is also down to earth and often very practical, thus appealing not only to the literati but also to ordinary Japanese. Buddhist teachings are not confined to the highly sophisticated treatises produced by Kukai (774–835), who transmitted the Shingon tradition to the Japanese, or by the monks of the Tendai tradition. Works such as the *Nihonryōiki*, written by the Nara monk Kyokai in the early Heian period, spread Buddhist principles to ordinary Japanese. Contrary to what is often said, Buddhism did not wait until the Kamakura period (1185–1336) to become popular. Sophisticated and popular Buddhist works contributed to the harmonization of religious teachings and practices by incorporating former Japanese beliefs (*bonjisuijakusetsu* and *ryobushinto*). Through the deeds and stories of the monks, Japanese as a whole took Buddhist cosmology—the theory of karma, the theory of the six worlds (*rokudo*), Buddhist piety, Buddhist architecture, and Buddhist rituals—as their norm. The study of the *Genji monogatari* (early 1000s C.E.; *Tale of Genji*), as well as other *monogatari* of the Heian period also show that Japanese writers used the concept of impermanence and instability (*mujo*) to characterize their perception of nature and society.

During the twelfth century, dissonant voices began to disturb the harmony of Heian society. The military were opposed to the rich and grandiose capital city of Kyoto and preferred the modest and rustic “tent government” (*bakufu*) of Kamakura. To the hierarchical distribution of the Heian system, a new age favoring the nonhierarchical and the provisional had succeeded. On the Buddhist side, dissident monks, most of them trained in the Tendai tradition, abandoned the traditional Buddhist centers to experiment with new forms of practices. Among many other Buddhist monks, Kakuban (1095–1143), Jien (1155–1225), Myoe (1173–1232), Honen (1133–1212), Shinran (1173–1262), Eisai (1141–1215), Dogen (1200–1253), and Nichiren (1222–1282) addressed—each one in a very creative way—the new concern that Buddhist teachings might have entered a period of decay (*mappo*). The rich debates affecting all the Buddhist traditions had remarkable effects on Japanese Buddhism. However, the Buddhist traditions were now offering such a variety of cosmologies, visions of the perfect society and understandings of the human, that Buddhist texts could no longer be the authoritative canon. After a short encounter with Western thought that accompanied the arrival of Jesuit missionaries, the Japanese literati constructed a new authoritative canon.

China and Confucianism: Tokugawa Japan

Years of war and social chaos ended in the year 1600 at the battle of Sekigahara. The return of peace under the Tokugawa leadership opened a new era of intellectual creativity on the Japanese islands. The predominant concern of the Tokugawa elite was the maintenance of a peaceful and harmonious society; they emphasized human responsibility in the formation

and maintenance of such a society. In order to achieve that goal, the intellectual discourse had to be rational, pragmatic, humanistic, and focused on social concerns. During the first Tokugawa century, the official discourse found inspiration in three intellectual traditions: Nativism (Shinto), Buddhism, and Confucianism. The new order drew its legitimization using insights from these three traditions, combining them in a very creative way. At the beginning of the Tokugawa era, a ruling class did not yet exist. Intellectuals were to create that virtuous ruling class of warriors, invent its new symbols, and sacralize the new order. While Buddhism and Shinto played an important role in creating a new “common sense” among peasants, craftsmen, and merchants for the legitimization of the warrior class hegemony, Confucianism produced a great variety of concepts to nourish the intellectual discourse of the elites. The genius of the Tokugawa leaders was to never name their organic intellectuals but use for their own advantage the insights of competing intellectual traditions in search of official recognition.

One of the characteristics of the new intellectual setting of the Tokugawa era was new developments in Confucian studies. Fujiwara Seika (1561–1619) and Hayashi Razan (1583–1657) were among the first Japanese intellectuals who presented Confucianism as a useful philosophical instrument for justifying the new Tokugawa policies. Over the centuries, the Japanese had received from China and Korea a variety of Confucian teachings. Japanese intellectuals of the early Tokugawa period began a process of critical analysis of the Confucian intellectual tradition. Through a process of selection and creation, they developed original types of teachings adapted to their cultural and social environment. Some of these Confucian scholars focused on human relationships of loyalty, cooperation, and obedience to superiors. Others offered the ethical incentives for the class of loyal and unselfish civil servants of the new era. Emphases on education, ceremonial, and tradition became a trademark of Confucian scholarship. Furthermore, the development of Confucian teachings included a severe criticism of Buddhism and Daoism as being too otherworldly, irrational, and opposed to Japanese tradition. Thus, Confucian scholars played an important role in the revival of Nativist or Shinto teachings. Other Confucian scholars like Nakae Toju (1608–1648) and Yamazaki Ansai (1618–1682) renewed Confucian teachings by emphasizing the importance of practicing Confucian virtues based on the notion of an “innate moral intuition” culminating in unique interpretations about the meaning of sincerity (*makoto*). The appropriate pedagogy for teaching Confucian moral virtues thus became an important theme of debate. Meanwhile, other intellectuals such as Yamaga Soko (1622–1685) defended the importance of Shinto as the only way for Japanese to put into practice the virtues that were so important to maintain the unity and peace of the kingdom. At the end of the seventeenth century, literati like Ogyu Sorai (1666–1728) criticized neo-Confucian interpretations. This marked a return to original Confucian teachings and offered the possibility to renew the reflection on virtues by abandoning relativist positions and by opening the search for eternal and natural virtues.

The critical analysis of Confucian canonical texts and the realization that the latest development in Confucian thinking

might not be the most insightful, generated a movement of return to original texts that affected the entire intellectual landscape at the end of the seventeenth century. The School of Ancient Meaning (*Kogaku*) started by Ito Jinsai (1627–1705) focused on the direct study of the Confucian classics starting with the Analects. In parallel, the National Learning movement (*Kokugaku*), which specialized in the search for purely Japanese sources, unspoiled by Chinese influence, was inaugurated by Motoori Norinaga (1730–1801). This also opened a new reflection on Japaneseness around the key notions of human emotions: love, sorrow, longing, and regret. Motoori saw the superiority of Japanese thinking in the proper usage of emotions and sensibility.

In the eighteenth century, the debates between Confucian, Shinto, and Buddhist scholars were slowly corroded by the encounter with Western scholarship and the development of Dutch or Western learning (*Rangaku*). The growing awareness among many scholars of the suffering and poverty of ordinary people in Japan, the lack of medical progress, and the need for technical improvements, encouraged scholars to study what was seen at the time as the extraordinary achievement of Western scholarship. The growing skepticism toward the importance of Chinese learning came paradoxically from the reading of the Chinese translations of major Western authors and gave Japanese scholars their first incentive toward “modernization.” These Chinese translations also exposed Japanese literati to Western philosophy.

The West and the Western Canon: Meiji, Taisho, and Early Showa

During the nineteenth century, interest in Western rational discoveries and scientific and technological advances increased. The industrial revolution, which had led to radical political transformations and the formation of powerful and growing empires, became a source of inspiration for renewing Japanese institutions. Japan entered a phase of intense reflection on its own identity that served as the foundation for its modern intellectual history. This period is characterized by a tension between the “traditional” and the “modern” leading to the new beginnings of the Meiji era. Notions like civilization, enlightenment, progress, and success captured the imagination of a new generation of intellectuals. Western learning was no longer encountered through Chinese translations. The encounter was now without any intermediary, through attending classes taught by foreign scholars or by being sent to foreign universities. However, Japanese intellectuals found themselves in a paradoxical situation. On the one hand, they understood that without acquiring Western science and technology, Japan would become a colony of Europe the way China had become one. On the other hand, they wanted to protect Japanese identity and proclaim Japanese uniqueness and superiority. Debates about abandoning the Chinese script, about adopting one European language as the national one, and about making Christianity the national religion of a modern Japan, show how much the creative imagination of Japanese literati was again at work. With the Meiji era a turn to European philosophy began and the word *tetsugaku* was finally forged to mark the Japanese interest in that new discipline. The main centers

for philosophical studies were the University of Tokyo and Kyoto University. Included among the most famous philosophers of the time were Kitaro Nishida (1870–1945), Hajime Tanabe (1885–1962), Keiji Nishitani (1900–1990), and Tetsuro Watsuji (1889–1960). The Japanese literati looked at Western philosophy as part of a larger whole including religion, science, and literature. For these four philosophers and also for most Japanese intellectuals, there was no antagonism between philosophy, religion, and Japanese culture. One of their important contributions is their reflection on the inner self. During the post–World War II period, questions about the involvement of Japanese thinkers in the support of imperialistic ideology shadowed the philosophical contributions of these philosophers. It is only very recently that intellectuals have shown a new interest in the first Japanese contributions to world philosophy. During the same period, in Buddhist circles, the philosophy of Georg Wilhelm Friedrich Hegel was actively studied in order to defend the position that Mahayana Buddhism, especially Kegon and Tendai, could serve as a bridge between Western and Eastern thought.

The defeat and the occupation of Japan by foreign troops inaugurated a new period of reflection, this time centered on repentance. In philosophical circles, thinkers like Hajime Tanabe reflected on collective responsibility, repentance, and the new opportunities the defeat was giving to the Japanese people. However, in the fall of 1945, a new Japan was just a potentiality, and fierce debates about what that new Japan should consist of centered on the notion of democracy. Most intellectuals turned to Marxism or Christianity in order to think about that new Japan, and they developed philosophies of action. The most fascinating contribution of the period is on “subjectivity” (*shutaisei*). The Korean War and later the Vietnam War gave a second occasion for Japanese intellectuals to clarify their position about war, violence, and peace. At the end of the 1950s, an awareness that Japan had been able to modernize its economy and society in a matter of a few decades and had entered a phase of Westernization was felt by many intellectuals. The following decades were characterized by a turn to economy. After a period of social conflict and agitation in the universities, Japan emerged as a model of economic success. Democratic Japan had become one of the strongest economies in the world and Japanese society was the focus of the attention of Western and other Asian countries. However, many intellectuals expressed their doubts that the economic miracle has been matched with a parallel cultural development. Japan had become rich and powerful but with what kind of soul?

Toward a Post–U.S. and Postnormative Canon: The Heisei Era

The Japan of the Heisei era has undergone a new period of inquiry in order to express what Japaneseness is about. The fact that many Japanese live a good part of their lives in foreign countries, that there are a growing number of Japanese children with a parent who does not have Japanese nationality, and the growing awareness that some parts of the non-Japanese population have lived in Japan for generations, are among the factors that generate some uneasiness when one attempts to define Japaneseness. Japan may have reached a pe-

riod in its history where there is no longer the possibility of defining the self through an other such as China or the West. Japan may have entered a period that requires the creation of a “mythic Japan” as another source of creativity for constructing the Japanese self. In many ways, Japan has become foreign to itself, thus allowing the possibility for a completely new Japanese identity to emerge.

See also Confucianism; Daoism; Education: Japan; Religion: East and Southeast Asia; Shinto.

BIBLIOGRAPHY

- Abe, Masao. *A Study of Dōgen: His Philosophy and Religion*. Edited by Steven Heine. Albany: State University of New York Press, 1992.
- Bolcker, H. Gene, and Christopher I. Starling. *Japanese Philosophy*. Albany: State University of New York Press, 2001.
- Breen, John, and Teeuwen Mark, eds. *Shinto in History: Ways of Kami*. Honolulu: University of Hawai'i Press, 2000.
- Hakeda, Yoshito S., trans. *Kūkai: Major Works*. New York: Columbia University Press, 1972.
- Heisig, James W. *Philosophers of Nothingness: An Essay on the Kyoto School*. Honolulu: University of Hawai'i Press, 2001.
- Inagaki, Hisao. *The Three Pure Land Sutras*. Kyoto: Nagata Bunshodo, 1994.
- Jansen, Marius B. *The Making of Modern Japan*. Cambridge, Mass., and London: Harvard University Press, 2000.
- Kasulis, Thomas P. *Intimacy or Integrity: Philosophy and Cultural Difference*. Honolulu: University of Hawai'i Press, 2002.
- LaFleur, William R. *The Karma of Words: Buddhism and the Literary Arts in Medieval Japan*. Berkeley and London: University of California Press, 1983.
- Lamarre, Thomas. *Uncovering Heian Japan: An Archaeology of Sensation and Inscription*. Durham, N.C., and London: Duke University Press, 2000.
- Nelson, John K. *Enduring Identities: The Guise of Shinto in Contemporary Japan*. Honolulu: University of Hawai'i Press, 2000.
- Nosco, Peter, ed. *Confucianism and Tokugawa Culture*. Princeton, N.J.: Princeton University Press, 1984.
- Ohnuki-Tierney, Emiko. *Rice as Self: Japanese Identities Through Time*. Princeton, N.J.: Princeton University Press, 1993.
- Payne, Richard K., ed. *Re-Visioning “Kamakura” Buddhism*. Honolulu: University of Hawai'i Press, 1998.
- Tanabe, George J. *Myōe the Dreamkeeper: Fantasy and Knowledge in Early Kamakura Buddhism*. Cambridge, Mass.: Harvard University Press, 1992.
- Tanabe, George J., Jr., and Willa Jane Tanabe, eds. *The Lotus Sutra in Japanese Culture*. Honolulu: University of Hawai'i Press, 1989.
- Wakabayashi, Bob Tadashi, ed. *Modern Japanese Thought*. Cambridge, U.K.: Cambridge University Press, 1998.

Thierry Jean Robouam

JIHAD. *Jihad*, in Islam, is an idea of action. The Arabic word literally means “striving.” When followed by the modifying phrase *fisabil Allah*, “in the path of God,” or when this phrase is absent but assumed to be in force, *jihad* has the specific sense of fighting for the sake of God and religion. Other Arabic words are closely related in meaning and usage,

including *ribat*, which also refers to a kind of building associated with ascetic and mystical gatherings.

Jihad refers first to a body of legal doctrine. The manuals of Islamic law all contain a section called “Book of Jihad” or something similar. Here is something like what Western jurisprudence calls *ius in bello*, law governing the conduct of war—declaration and cessation of hostilities, treatment of non-belligerents, division of spoils, and so on. One also finds something like *ius ad bellum*, the right to enter a state of war. At the same time, however, jihad is more than a set of juridical principles. Historians must take it into account when they consider political mobilization and contested authority within many Islamic societies. Above all, jihad has never ceased changing, right down to our own day.

Jihad has both an external and an internal aspect. The external jihad is physical combat against real enemies. The internal or “greater” jihad is a struggle against the self in which one suppresses one’s base desires and then, perhaps, rises to contemplation of higher truth. Most modern Western writing on the jihad considers the spiritualized combat of the internal jihad as secondary and derivative, despite all the importance it eventually acquired in Muslim thought and society. However, much of Muslim opinion in our day favors the opposite view.

The Koran

Considered to be literally the word of God as conveyed to the world through the Prophet Muhammad (570?–632 C.E.), the Koran is the single most important source for the doctrine and practice of jihad. However, when one puts together the relevant passages of the Koran, one finds apparent contradictions or, at any rate, differences in emphasis. The many themes relating to fighting and jihad in the Koran include calls for self-restraint and patience in propagating the faith (16:125–128); permission to engage in defensive war (22:39–41); permission to wage in offensive war within certain traditional limits, including those of the ancient Arabian “holy months,” during which fighting was suspended (2:194, 217); calling on the believers to “slay the idolaters wherever you find them,” unless they “repent and perform the prayer and pay the alms,” as in the famous “sword verse” (Koran 9:5; translation per Arberry 1:207); the requirement to subdue the “people of the Book,” that is, Jews and Christians (Koran 9:29); evidence of internal tension and reluctance to fight (Koran 2:216; “Fighting has been prescribed for you, though you dislike it”).

These themes are commonly related to a chronological narrative about the life of Muhammad and the earliest Islamic community. For many Islamic jurists, the principles that prevail are the ones associated with the later parts of this narrative. For example, at some point in the narrative God permits warfare, but only in limited circumstances. Afterward, when conditions have changed, God provides a new ruling that allows the conduct of warfare with fewer restrictions. In juridical terms, the later ruling abrogates or supersedes the earlier one. From the point of view of literary narrative, however, such chronological schemes encounter difficulties in the details of the Koranic text.

Narratives

One finds sustained, connected narratives about the earliest Islam in Arabic books on Muhammad’s life (called *sira*, “the way”) and on the early community and its wars (called *maghazi*, “raids”) as well as in works of Koranic exegesis and in the *hadith*, which one may define as reports of authoritative sayings and deeds attributed to the Prophet or to those around him. In the form in which they exist, these works date from the ninth century C.E. or later. Here one finds that the last part of Muhammad’s life, after the Emigration (*Hijra*) from Mecca to Medina in 622, was devoted largely, though not entirely, to the conduct of war.

In year 2 of the Hijra (624), at a place called Badr, a raiding expedition turned into a full confrontation with Muhammad’s kin and adversaries, the Quraysh of Mecca. Divine intervention came in the form of angels fighting on the Muslim side—this is how the *maghazi* narratives interpret several passages in the Koran regarding Badr, the first full battle of Islam and a great victory. Once Muhammad achieved final victory in his war against Mecca, he sent expeditions against Byzantine frontier defenses in the north, and he may have been planning an extensive campaign against Palestine and Syria. However, he died (in 632) before this campaign could get under way. The works of *sira* and *maghazi* place these narratives squarely in the foreground, providing a kind of salvation history (*Heilsgeschichte*). The *hadith*, by contrast, directs all eyes toward the Prophet, who, with epigrammatic precision, dictates the Example (*Sunna*) through his actions and words. Here one finds the doctrine of the jihad enunciated clearly, together with eloquent exhortations to perform jihad.

Early Conquests

In the decades following Muhammad’s death, the Arab Muslims conquered Arabia, Syria, Palestine, Iraq, Egypt, and Iran; Central Asia, North Africa, Spain, and other regions came soon afterward. Among the explanations for these successful conquests, an important point of difference involves the jihad. Were these conquests “Islamic” or “Arab”? According to the “Islamic” view, the Muslims fought because God commanded them to do so. They were motivated by neither fear nor greed but by a desire to propagate the faith. “Arab” explanations, on the other hand, which prevailed among Western specialists until fairly recently, looked at conditions in ancient Arabia. By the seventh century, it was thought, desiccation and desertification had reduced many of Arabia’s centers of civilization to ruins; meanwhile the peninsula suffered from overpopulation. Inevitably the Arabs felt pressure to migrate, raid, or conquer. More recently others have emphasized the political aspects of the conquests. It is increasingly clear, however, that religion and jihad did take a major role.

Martyrdom

Non-Muslim observers attributed the zeal of the Muslim fighters to the promise of heaven that the new religion made to those who died in battle. In the Koran those who die in combat in the path of God are “alive with God,” enjoying the delights of paradise, which include marriage to dark-eyed maidens. The *hadith* and Islamic law declare that these dead

warriors are martyrs. As in Christianity, the word *martyr* originally meant “witness” (Greek *martyrs*, Arabic *shahid*). However, there are differences. The Jewish and Christian martyr was passive and refused to employ violence. In Islam the martyr is one who takes up arms. Islamic law also recognized non-combatant types of martyrs. For Shi‘i Islam, martyrdom is associated with the revered descendants of the Prophet through his daughter Fatima and his cousin and son-in-law ‘Ali, many of whom died at the hands of oppressive (Muslim) rulers. For the Sunni majority, however, armed struggle has most often been at the heart of the concept of martyrdom.

Treatment of Non-Muslims

Arabic sources for the early conquests report agreements between conquerors and conquered, including the famous “Pact of ‘Umar.” The “people of the Book” (who were eventually considered to include Zoroastrians in addition to Jews and Christians) are granted protection of their persons and property and are allowed to practice their religion with certain constraints. They must pay *jizya*, which at first meant a collective tribute but which soon referred to a poll tax levied on individuals and households, derived from Koran 9:29 (“Fight those who believe not in God and the Last Day and [who] do not forbid what God and His Messenger have forbidden—such men as practice not the religion of truth, being of those who have been given the Book—until they pay the tribute [*jizya*] out of hand and have been humbled”) (translated by Arberry, 1:207).

Here are the foundations of the *dhimma*, the “protection” of non-Muslims who live under the rule of Islam. People living under this protection could not be enslaved and were free to pursue whatever professions they liked. However, non-Muslims living outside the lands of Islam could be and often were captured and enslaved. Forced conversion was not allowed, following a clear Koranic principle (2:256) and in fact happened only in exceptional instances. Islamic jurists represented the world as divided between an Abode of Islam (*Dar al-Islam*) and an Abode of War (*Dar al-Harb*). Since the only legitimate sovereign is God and the only legitimate form of rule is Islam, the rulers of the Abode of War are mere tyrants, and the normal state of affairs between the two abodes is war. The Muslim state—in classical theory its leader, the imam—may conclude a truce with those rulers for a maximum of ten years but not a permanent peace. Some jurists added an intermediate Abode of Truce, but this did not alter the territorial character of the doctrine of jihad. This doctrine does not aim at the immediate conversion of populations or individuals but rather at the extension of God’s rule over all the world, until “the religion is God’s entirely” (Koran 8:39).

The Obligation of Jihad

Warfare and territorial expansion were a priority for the rulers of the early Islamic state. Soon, however, jurists raised the question of individual participation. Is jihad an obligation that each must perform to the best of his or her ability, like pilgrimage and daily prayer? There was broad consensus that volunteering for the armies was a meritorious act. From a practical, military point of view, however, these undisciplined volunteers could create more problems than they solved. In Islamic law

the problem was resolved in the doctrine of “obligation according to sufficiency,” associated with the great jurist al-Shafi‘i (767–820). This doctrine declares that the obligation of jihad may be considered fulfilled so long as a sufficient number of volunteers perform it. However, if a military emergency occurs and the enemy threatens the lands of Islam, then the obligation falls upon each individual.

Many people sought to participate in the jihad through residence in frontier regions and in fortified strongholds (often called *ribats*), whether for a limited period or for a lifetime. These included jurists, ascetics, mystics, and others in search of religious merit and knowledge, in addition to people seeking simply to fight the enemy. It is here, along Islam’s many frontiers, that the jihad acquired its social expression. In many cases it is not known whether people were engaged in devotional practices, the transmission of learning, or combat or guard duty against the enemy. For many of them, jihad consisted precisely in the combination of all these. “Internal” and “external” jihad were thus always present. In this way the jihad was a basic element—social and political as well as rhetorical—in the rise and success of a long series of Islamic dynasties and states, including that of the Almoravids in Morocco and Spain in the eleventh and twelfth centuries, the Ottomans from the fourteenth century until the twentieth, and many more.

Resistance and Reform

When the European colonial powers arrived in several Islamic countries in the nineteenth century, resistance against them involved the jihad and usually failed. When successful resistance eventually emerged, it was through secular, nationalist ideologies. Meanwhile Muslim thinkers in several countries took a new look at the jihad, seeking to make it compatible with what they saw as progress and modernity. A new body of juridical work defined the jihad as defensive warfare, while an “Islamic law of nations” presented the eighth-century al-Shaybani (750–803 or 805), an Islamic jurist who wrote a book of the law of war, on a par with the seventeenth-century Grotius. In this way the relations of Islamic and non-Islamic states became placed firmly on a basis of peace.

Islamism and Fundamentalism

This recognition of the modern state infuriated certain other thinkers who declared their own societies to be Islamic in name only; in reality, they said, these societies lived in *jahiliyya*, coarse ignorance, the condition of ancient Arabia before the coming of Islam. They summoned all Muslims to the jihad, calling this an individual (not a collective) obligation because of the gravity of the situation. Unlike the modernist reformers, they had no qualms about “offensive” jihad, which one of their books, by Muhammad ‘Abd al-Salam Farag, called “the neglected duty.” However, they concentrated their fury against the modern Middle Eastern state rather than non-Muslim powers. After the assassination of President Anwar Sadat in October 1981, radicals were driven abroad or deep underground in Egypt and other countries.

The 1990s brought a new, international turn. Osama bin Laden’s fatwas of 1996 and 1998 call upon Muslims to set

aside the war against the corrupt regimes in their own countries to fight the common enemy. Like other radical Islamists of modern decades, bin Laden identified the enemy as a “Crusader–Zionist” alliance, but he singled out the leader of the alliance, the United States, for special attention. This new, global jihad has vague, grandiose political projects that it postpones until some remote future time. Its real concern is to attract attention and arouse passions through spectacular acts of terrorism. The practitioners of this new jihad often begin with little knowledge of their own religion and its texts and are drawn by a desire for violence, destruction, and revenge. This desire coincides with one of the most shocking aspects of the new jihad, its promotion of suicide and the indiscriminate killing of noncombatants, including women and children, actions that the classical doctrine generally condemns and that have appeared in Islamic history only in marginal episodes.

As fundamentalists, these practitioners of the new jihad have little interest in what has happened since the mid–seventh century; when they look to the past, it is mostly to the Prophet’s Medina and the earliest Islam. For these and other reasons, while it is certainly useful for us to know about the classical doctrine and about the long, complex history of the jihad within Islamic societies, one must not think that such knowledge will on its own lead to an understanding of the circumstances and conditions of the new, global jihad. These must be sought first of all in the world of the twenty-first century.

See also *Anti-Semitism: Islamic Anti-Semitism; Ethnicity and Race: Islamic Views; Fundamentalism; Islam; Law, Islamic; Sacred Texts: Koran.*

BIBLIOGRAPHY

Arberry, A. J. *The Koran Interpreted*. New York: Macmillan, 1955.
 Bonner, Michael. *Les origines du jihad*. Paris: Editions du Téraèdre, forthcoming. English-language version also forthcoming.
 Donner, Fred McGraw. *The Early Islamic Conquests*. Princeton, N.J.: Princeton University Press, 1981.
 Firestone, Reuven. *Jihād: The Origin of Holy War in Islam*. New York: Oxford University Press, 1999.
 Kepel, Gilles. *Muslim Extremism in Egypt: The Prophet and Pharaoh*. Translated by Jon Rothschild. Berkeley and Los Angeles: University of California Press, 1986.
 Kohlberg, Etan. “Medieval Muslim Views on Martyrdom.” *Mededeelingen der Koninklijke Akademie van Wetenschappen* 60, no. 7 (1997): 279–307.
 Morabia, Alfred. *Le Ghîhâd dans l’Islam médiéval: Le “combat sacré” des origines au XI^e siècle*. Paris: Albin Michel, 1993.
 Peters, Rudolph. *Islam and Colonialism: The Doctrine of Jihad in Modern History*. The Hague and New York: Mouton, 1979.
 Roy, Olivier. *L’Islam mondialisé*. Paris: Editions du Seuil, 2002. To appear in English as *Global Islam*. New York: Columbia University Press, forthcoming.

Michael Bonner

JOUISSANCE. French psychoanalyst Jacques Lacan’s (1901–1981) use of the term *jouissance*, like most other Lacanian concepts, shifts over the years and can be difficult to pin down. Translating from the French, *jouissance* can be ren-

dered literally as “enjoyment,” “both in the sense of deriving pleasure from something, and in the legal sense of exercising property rights” (Evans, p. 1). The term has sexual connotations as well, also meaning orgasm in French.

Lacan’s Early Work: *Jouissance* as Pleasure

Lacan’s first use of the term *jouissance* can be found in the seminar of 1953–1954, where it appears just twice (1998, pp. 205 and 223) and is used only in relation to Hegel’s dialectic of the master and the slave. Here Lacan equates *jouissance* with pleasure, noting the “relation between pleasure [*jouissance*] and labour” and notes that “a law is imposed upon the slave, that he should satisfy the desire and pleasure [*jouissance*] of the other” (1998, p. 223). Until Seminar IV (1956–1957), *jouissance* as simply “pleasure” is Lacan’s only and infrequent use of the term.

In his early work, Lacan’s notion of *jouissance*, although not a Freudian term, has parallels to Freud’s concept of the drive. After 1957, the sexual connotations of the word move to the forefront, and in 1958 he first uses *jouissance* to refer explicitly to orgasm. Thus, in 1958, Lacan speaks of “masturbatory *jouissance*,” which he attributes to the phallic stage and the “imaginary dominance of the phallic attribute” (1977, p. 282).

Lacan’s Work of the Late 1950s and 1960s: *Jouissance* Versus Pleasure

After 1958, Lacan begins to distinguish between *jouissance* and pleasure. This can be found in Seminar VII (1960–1961), where Lacan discusses *jouissance* as an ethical stance in relation to Kant and Sade. In this phase of his work, *jouissance* comes to figure as that which Freud referred to as “beyond” the pleasure principle or, as Lacan puts it, “*jouissance* . . . is suffering” (1992, p. 184). In relation to Kant’s example of the man who refuses a night of pleasure with a woman if the price to be paid is death, Lacan remarks that, although that may be true for the man in pursuit of pleasure, the man in pursuit of *jouissance* (as the figures of de Sade’s are) will accept death as the price to be paid for *jouissance*: “one only has to make a conceptual shift and move the night spent with the lady from the category of pleasure to that of *jouissance* . . . for the example to be ruined” (1992, p. 189). In the acceptance of death as the price, the subject experiences *jouissance*, in which “pleasure and pain are presented as a single packet to take or leave” (1992, p. 189).

Despite these earlier references, it is not until 1960 that Lacan gives his first structural account of *jouissance*. In “Subversion of the Subject,” he posits pleasure as that which “sets the limits on *jouissance*” (1977, p. 319). The sacrificing of *jouissance* also becomes here, for the first time, a necessary condition for subjectivity—the subject, by submitting him- or herself to the symbolic order must sacrifice some *jouissance*, since “*jouissance* is forbidden to him who speaks” (1977, p. 319). In this Lacan rewrites Freud’s theory of the castration complex: “Castration means that *jouissance* must be refused” (1977, p. 324). The sacrificed (or “alienated”) *jouissance* becomes the object, that which is the cause of desire but never attainable.

Lacan in the 1970s: Masculine and Feminine *Jouissances*

Finally, in the 1970s, especially in Seminar XX (1972–1973), Lacan brings to the forefront his distinction between masculine and feminine *jouissance*. Although he had discussed *jouissance* in conjunction with femininity as early as 1958, it is only in *Encore* that Lacan first comes to speak of a qualitatively different type of feminine *jouissance*. He posits feminine *jouissance* against that of the phallic, termed the “*jouissance* of the Idiot” (1998, p. 81). In *Encore*, Lacan defines phallic *jouissance* (which he sometimes refers to as sexual *jouissance*) as that which “is marked and dominated by the impossibility of establishing as such . . . the One of the relation ‘sexual relationship’” (1998, p. 6–7). Lacan’s use of the term *One* refers to mathematical logic (Frege), to the Platonic myth of the lovers’ unity in the *Symposium*, and to the (presumed) unity of the (male) subject in a philosophical sense. Phallic *jouissance* is thus seen as a barrier to these forms of unity. Or, to put it another way, “[P]hallic *jouissance* is the obstacle owing to which man does not come . . . to enjoy woman’s body, precisely because what he enjoys is the *jouissance* of the organ. . . . *Jouissance*, qua sexual, is phallic—in other words, it is not related to the Other as such” (1998, pp. 7 and 9). The term *Other* here refers both to the linguistic Other and to the Other sex—woman. It is precisely man’s experience of phallic or sexual *jouissance* that “covers or poses an obstacle to the supposed sexual relationship” (1998, p. 9).

Although women have, according to Lacan, access to a *jouissance* that is beyond the phallus, men, by virtue of the fact that it is “through the phallic function that man as whole acquires his inscription” (1998, p. 79), have to make do with inadequate phallic or sexual *jouissance*, one that causes him to be unable to “attain his sexual partner . . . except inasmuch as his partner is the cause of his desire” (1998, p. 80). A further cause of the inadequacy of phallic *jouissance* is its incompatibility with feminine *jouissance*, thus posing an obstacle to the sexual relationship.

Feminine *jouissance* differs from masculine or phallic *jouissance* through its relation to the Other, especially the Other sex, which for Lacan means woman. Although in his earlier work, Lacan attributed to women a *jouissance* associated with the phallic stage and the clitoris (1977, p. 282), his work of the 1970s moved away from that position. In particular, Lacan posits for women a specifically feminine *jouissance* that is “beyond the phallus” (1998, p. 74). Women have access *both* to phallic, or sexual, *jouissance*, and to a supplementary form of *jouissance* by virtue of being not wholly subsumed by the phallic function as men are: “being not-whole, she has a supplementary *jouissance* compared to what the phallic function designates by way of *jouissance*” (1998, p. 73). It is, however, impossible to know anything about this other *jouissance* other than that some women (and men) experience it. Lacan’s paradigmatic example of feminine *jouissance* is that of mystics such as Hadewijch d’Anvers, Saint John of the Cross, and Saint Teresa, thus relating feminine *jouissance* to God. As he asks in relation to mysticism, “Doesn’t this *jouissance* that one experiences and knows nothing about put us on the path of existence? And why not interpret one face of the Other, the God face, as based on feminine *jouissance*?” (1998, p. 77).

In his later uses of the term *jouissance*, one can see just where Lacan parts ways with Freud. First, in his claim that “there is no sexual relationship,” Lacan asserts the inherent failure of genital sexuality, which Freud did not do. Finally, through his description of a specifically feminine *jouissance*, one that implies a different type of sexual satisfaction for women, Lacan’s later work does away with Freud’s notion of libido’s being only masculine.

Feminist and Political Applications of *Jouissance*

Feminists and cultural critics have appropriated Lacan’s term and refined it for their own purposes. Among feminists, *jouissance* is most often used by French feminists. The two most prominent are Julia Kristeva and Luce Irigaray. Similarly to Lacan, both also discuss a specifically feminine *jouissance*, related to the mother and woman’s body. Kristeva views *jouissance* as bound up with the maternal and the semiotic *chora* and views art as “the flow of *jouissance* into language” (p. 79). Irigaray, in a manner almost as cryptic as Lacan’s, also claims that women experience two types of *jouissance*: a phallic one and one “more in keeping with their bodies and their sex” (p. 45).

In terms of the political, theorists such as Slavoj Žižek and Tim Dean have picked up on Lacan’s remarks in *Television* regarding racism, the melting pot, and the *jouissance* of the Other to view social problems such as ethnic hatred or homophobia as motivated by resentment of the (ethnically or sexually) Other’s *jouissance*.

See also *Body, The; Other, The, European Views of Sexuality*.

BIBLIOGRAPHY

PRIMARY SOURCES

- Irigaray, Luce. “The Bodily Encounter with the Mother.” Translated by David Macey. In *The Irigaray Reader*, edited by Margaret Whitford, 34–46. Cambridge, Mass.: Blackwell, 1991.
- Kristeva, Julia. *Revolution in Poetic Language*. Translated by Margaret Waller. New York: Columbia University Press, 1984.
- Lacan, Jacques. *Écrits: A Selection*. Translated by Alan Sheridan. New York: W. W. Norton, 1977.
- . *The Seminar of Jacques Lacan. Book I: Freud’s Papers on Technique 1953–54*. Edited by Jacques-Alain Miller. Translation and notes by John Forrester. New York: W. W. Norton, 1988.
- . *The Seminar of Jacques Lacan. Book VII: The Ethics of Psychoanalysis 1956–1960*. Edited by Jacques-Alain Miller. Translation and notes by Dennis Porter. New York: W. W. Norton, 1992.
- . *The Seminar of Jacques Lacan. Book XX: Encore. On Feminine Sexuality: The Limits of Love and Knowledge 1972–73*. Edited by Jacques-Alain Miller. Translation and notes by Bruce Fink. New York: W. W. Norton, 1998.
- . *Television: A Challenge to the Psychoanalytic Establishment*. Edited by Joan Copjec. Translated by Denis Hollier, Rosalind Krauss, Annette Michelson, and Jeffrey Melhman. New York: W. W. Norton, 1990.

SECONDARY SOURCES

Dean, Tim. *Beyond Sexuality*. Chicago: University of Chicago Press, 2000.

Evans, Dylan. "From Kantian Ethics to Mystical Experience: An Exploration of Jouissance." In *Key Concepts of Lacanian Psychoanalysis*, edited by Dany Nobus, 1–28. New York: Other Press, 1998.

Žižek, Slavoj. *For They Know Not What They Do: Enjoyment as a Political Factor*. New York: Verso, 1991.

———. *Looking Awry: An Introduction to Jacques Lacan Through Popular Culture*. Cambridge, Mass.: MIT Press, 1991.

Brenda L. Bethman

JUDAISM.

This entry includes two subentries:

Judaism to 1800

Modern Judaism

JUDAISM TO 1800

As a religion developing over three millennia, Judaism changed, diversified, and acculturated to many cultural and spiritual environments, while maintaining at the same time some basic characteristics. In the following, an attempt is made to describe both the continuities and the variations characteristic of the various forms of Judaism up to 1800.

Four main concepts organize the majority of the developments in this period: memory, corporate personality, performance, and order. A traditional form of mentality, Jewish culture has been oriented toward an accumulative understanding of the development of literature and has preserved much of the earlier forms of literature, though strongly reinterpreted, as part of homogenizing enterprises in search of cohesion.

Beginning in the Middle Ages, Judaism developed into a complex ray of processes that combine biblical, rabbinic, and speculative trends in different ways and proportions. The biblical trend is represented by materials that constitute the biblical literature of the first millennium B.C.E. and is concerned basically with what happened in history and what is the best religious behavior, understood as the commandments of God.

The rabbinic trend deals with literatures, primarily interpretive narratives that began to appear in the first millennium C.E., that aim to explicate the biblical materials: the Mishnah (compiled c. 200 C.E.) and the Talmuds (Palestinian, c. 400, and Babylonian, c. 500) deal with the codification of the biblical commandments, and with detailed explanations of how to perform them, while most of the Midrashic literatures interpret the historical parts of the Bible, that is, what happened and how, and what is missing in the elliptic biblical style.

During the second millennium C.E., philosophical and mystical forms of Judaism emerged. These can be described as speculative, since they put a stronger emphasis on the question *why* than did the biblical and rabbinic writings. Drawing from

a variety of Greek, Hellenistic, Arabic, and Christian sources, and sometimes even from Hindu ones, more comprehensive accounts of the meaning of Judaism, including new theologies and anthropologies, were articulated by Jewish thinkers.

Forms of Memory

Identity is a matter of memory. Selective as both individual and collective memory is, it moves to the center those events and acts that are conceived of as most important. Naturally these change with time. For example, in biblical Judaism the remembrance that the Israelites belong to God, who saved them from Egypt, was a major religious concern. Rituals that celebrate this belonging, like the donning of the phylacteries, the special garments known as tallith, the mezuzah, and circumcision—what I call the “envelope of reminders”—were emphasized and remained part and parcel of later forms of Judaism. Rabbinic literature, however, conceived of the will of God as embedded in the Torah, or inliterated in the way H. A. Wolfson understood this term, and the memorization of the Torah moved to the center of rabbinic spirituality. To be sure, the biblical ideals did not disappear, but the structures of remembrance and reminders in rabbinic literature became more complex.

These two forms of Judaism envisioned the approach to the divine as involving the entire human personality. The anthropology that inspires these literatures is more integrative, meaning that they take into consideration the importance of both bodily and psychological aspects of man. In medieval forms of Judaism, a third form of memory becomes important, in which remembrance was less mediated by concrete activities—related to the “envelope of reminders” or the study of the canonical book—but was related to thinking and concentrating on God as an intellectual concept, on nature as the manifestation of his attributes, and on God’s names.

The biblical, rabbinic, and contemplative/mystical (or speculative) stages of Judaism convey quite a similar picture: remembrance and forgetting represent the two poles of the positive and negative evaluations, which are applied to those values that organize the different types of Judaism surveyed above. In the Hebrew Bible, the will of God is the central religious factor, and it informs the course of history, especially the Jewish one. Therefore, the Israelites see in history, though not in it alone, a manifestation of the divine will; and the remembrance of this will and its linkage to the fate of the Jewish nation is crucial. The change in history, in the form of the liberation of the Israelites from Egypt, constitutes a formative moment that should be remembered in order to make the linkage with the redeeming God. Most of the literature created in the biblical period is concerned solely with a sacred history, while the more general events that took place after the destruction of the Second Temple were conceived of as peripheral from the religious point of view, a view shared by rabbinical, philosophical, and kabbalistic authors. Historical writings are scant and played a marginal role in the general economy of Judaism.

Concepts of Corporate Personality

Biblical forms of Judaism share a concept of a unified mythical body of the people of Israel, made up of the individual

Israelites. Identity is attained by participation in the broader group, which is the main bearer of identity. In the pseudepigraphic intertestamental texts, and in many Hebrew discussions from late antiquity and the Middle Ages, Israel is sometimes described as an angel appointed over the nation. In rabbinic literature, this corporate personality was sometimes called *Knesset Yisrael*, the assembly of Israel, a concept close to the contemporaneous *Ecclesia*, and *Kelal Yisrael*, the entire people of Israel, was described by dicta like “All the [individuals belonging to] Israel are friends” or alternatively, “are warrant of each other.” One of the main assumptions in this layer of thought is the common experience shared at the Sinaitic revelation, on the one hand, and the concept of an elect people on the other hand. This corporate personality is understood both as an organic internal cohesion and as separated from all the other nations. In some kabbalistic forms of Judaism since the Middle Ages, this cohesion is portrayed as depending on a union between Israel, God, and the Torah. Some more philosophically oriented forms of Judaism conceived of man as essentially the intellect and, consequently, of Israel as an intellectual attainment.

The destiny of this corporate personality is imagined to be a central issue of human history in general, and the vicissitudes of the Jews are related to their disobedience of the divine imperatives, which attracts divine intervention in the course of history and nature. Thus matters related to exile and redemption, including the various concepts of *Messiah*, are related to the centrality of corporate personality. According to some rabbinic views, the exile is not only a matter of the Jewish people, but God too—or sometimes his presence, the *Shekhinah*—participates in it. The historical vicissitudes are seen not as accidents, unrelated or meaningless events, but as part of a broader story that gravitates around the ritual order, namely the fulfillment of the divine will by a very definite national entity, whose emergence and continuity is one of the main concerns of these literatures

The Centrality of Ritual Performance

In most of its historical forms up to 1800, Judaism was a halakocentric religion. The main religious activity was the performance of the 613 commandments, addressed to the God of Israel. Halakah, a central concept in traditional Judaism, stands for the regulations of the details of religious behavior. Made up of interpretations of biblical and then rabbinical discussions, halakah represents the most vast and influential literature in Jewish culture. However, while addressing the concrete aspects of performance, it rarely addresses the religious goals of this behavior—these questions are discussed in the speculative literatures. Until modern Judaism, halakic behavior was the basic skeleton of Jewish life, though the details—the customs and much more their meaning—changed over centuries.

The two main religious rituals performed in public, prayer and reading of the Torah, are paramountly vocal. The halakic regulation to recite them is an essential part of their performance. (Anthropologically speaking, any thick description of Judaism should pay close attention to the role played by the voice in the communal rites.) However, as far as the vast majority of members of communities are concerned, there is no

reason to assume that an awareness of any of the above three models was instrumental in significantly shaping religious experience. What is described in the literature deals primarily with conceptualizations and experiences of small elites, rather than with widespread understandings of Jewish practices. Indeed, according to some few examples, in which the vocal aspects of prayer were conceived of as secondary, preference was given to the mental aspects of prayer, as implied for example by Moses ben Maimon (Maimonides; 1135–1204) and his followers. Adding important forms of spiritualized versions of Judaism, this Neoaristotelian thinker—and before him the eleventh-century Bahya ibn Paqudah—had a strong impact on some aspects of the internalization of religious life in Judaism.

Nevertheless, the more common experiences, based on vocal religious activities, created communities that were characterized, at least for those periods in which the rites were performed, by a shared sonorous ambiance. More than the praying, Jews were united by their sharing the same semantic world—they became a group by experiencing a rhythm of life punctuated by the same sounds. Eminent representatives of more intellectually inclined versions of Kabbalah and Hasidism even attributed a surplus role to loud recitation, rather than a mere compliance with a halakic regulation. This means that, despite the acceptance of axiologies, which elevated mental processes to a very high status, even outstanding representatives of elite Jewish mysticism (though not all of them) maintained the importance of vocal activities rather than devalue them, as some philosophers did. More interesting than this apotheosis of the loud study of the Talmud and the mouthing of the Torah, which continued classical rabbinic regulations, is the ascent of the loud study of kabbalistic books. For example, evidence has emerged regarding the loud study of the book of the *Zohar* in northern Africa beginning in the late sixteenth century.

Though there can be no doubt that loud study and prayer were intended to improve the memorization of the studied text—unlike the halakic reading of the Torah and prayer—the result was the same: sounds became an integral part of ritual in rabbinic academies as they were in synagogues. The active participation in the formation of a sonorous ambiance that encompasses the entire community with an actualization of canonical texts may be considered a formative experience for the group. The sonority created during these Jewish rituals distinguishes them from the greater solemnity that is characteristic of many rituals related to reading of sacred texts. The sonority is not a unison of coordinated voices that are consonant to each other. Musically speaking, it more often resembles cacophony than symphony. Indeed, the traditional study of the Torah or prayer, and even the ritualistic loud reading of the Torah, often took place in an ambiance dominated by discordant voices. This participation in very loosely coordinated vocal activity is characteristic of a community that cooperates in a major project, but allows, or at least bears, the individuals that study and pray in their own rhythms.

Different Forms of Order in Judaism

In the context of Judaism, *order* refers to a sequel of homogeneous signs, events, or actions whose knowledge and enactments have meanings beyond their immanent one.

Biblical and rabbinic literatures. In the biblical and rabbinic literatures, three types of order are discernible: the ritual, the literary, and the historical. The ritual order, which is the most important, is shared by the two bodies of literatures. The assumption is not only that the Jewish rites are quintessential from the religious point of view, but also that their performance has wider implications, like the descent of rains, according to the biblical view, or the enhancement of the divine power according to the rabbinic view. However, it is not clear how precisely the affinities between performance and wider effects are related. The absence of detailed and systematic explanatory discussions is characteristic of the apodictic propensity of rabbinic writings.

The literary order—which refers to the intense and repeated study of the Hebrew Bible, the Mishnah, and the Talmud—became a central preoccupation among Jews, and even God was imagined to participate in it. Torah, the Hebrew language, and divine names were conceived of as perfect beings that were used in order to create reality and that might also be used by man in order to impact reality. Though the biblical texts and, later on, the rabbinic ones embody both ritual and literary order, the literary order has a specific dimension, that of dense textuality. This means that not only the messages but also the precise details of the document that conveys them, are of paramount importance.

The common denominator of these types of order is the centrality of human action and fate in the universe, that is, the historical order. Objective structures that are not primarily oriented toward the well-being of man—like the invisible Platonic Ideas or the Aristotelian God as intellect—cannot be considered quintessential from the religious point of view. Furthermore, while the Greek conceptions of the cosmos were basically static, gravitating around concepts of perfections, the Jewish orders, which have human fate as the main topic, are much more dynamic.

Speculative literatures. The nature of intermediary structures—like divine attributes, known as *middot*, the divine Glory, decadic structures, or angelic structures—and their specific orders play only secondary roles in the biblical and rabbinic literatures, but they are manifest in literatures that were, for the rabbinic authors, secondary, like the *Heikhalot* literature, or some forms of Jewish magic from late antiquity, like *Sefer ha-Razim* (Book of the mysteries). These forms of order are basically nonconstellated, that is, they operate without substantial speculative superstructures or orders.

Most of the Kabbalists were religious figures whose conservative propensities were amply testified in their literary activity and sometimes in the records of their lives. They contributed to the emergence of types of ontological concatenations (linkages or chains) between various aspects of reality in manners unknown to or marginal to rabbinic Judaism. The concatenation of supernal orders and rites created structures similar to myth-and-ritual views, although the supernal orders do not uniformly assume the form of mythical narrative.

Jewish speculative literatures that emerged in the Middle Ages, including works on Hebrew grammar and on poetics,

and first accounts of scientific thought in Judaism, were in a constant search for comprehensive forms of order. This was also true of philosophical works, including the first systematic descriptions of the divine realm, of human psychology, and of the concept of nature. Attempting to organize the various views on some of those topics found in early Jewish literatures, medieval Jewish thinkers used categories previously absent from Judaism. Words for *theology*, *metaphysics*, *psychology*, *nature*, and *science*, did not exist in the Hebrew and Aramaic of biblical and rabbinic literatures, so the use of these categories of thought necessitated linguistic innovation. Some Jewish thinkers had to attenuate the more personalistic, voluntaristic forms of order. Different as the various forms of Jewish philosophy, grammar, science, or kabbalistic literatures are, they share nevertheless a pathos for stable forms of order operating not only in the realm of objective nature, but also in the structure of language and of the human psyche, and in the realm of religious activities.

The idea of sympathetic affinities between the different levels of order created modes of integration that were new to Judaism. Not only was the world conceived of as an organized universe, a cosmos, but also even God was attracted within this integrated system and was conceived of as a part of it. This was already obvious in the Greek systems in which God or gods were not only generative but also paradigmatic concepts: Aristotle's metaphysics, which describes God as an intellect, created an axiology in which the human act of intellection becomes paramount. Sympathetic magic of Neoplatonic and Hermetic extraction, which relates human acts to astral processes, is another example of an integrated system. Both modes of integrated thought were adopted in some forms of medieval Judaism, including by different forms of Kabbalah.

The pathos for integrated orders also generated more specifically Jewish expressions. The most widespread is the assumption, found in the theosophical-theurgical school of Kabbalah, that human actions, the commandments or the *mitzvot*, correspond to the divine structure, designated as a system of ten *sefirot* (or creative forces). This dynamic correlation presupposes the possibility of the impact of human acts in the lower realm on the higher entities, that is, a theurgical impact. In another example, each of the supernal divine attributes was conceived of as governing a corresponding celestial sphere, a theory I call *theo-astrology*.

The Kabbalists thought they possessed knowledge of forms of order unknown to, or hidden from the eyes of, other Jewish masters, and that this knowledge, and the use of it were part of their superiority as religious persons. Unlike the rabbinic treatment of the *mitzvot* as basically nonconstellated by metaphysical structures, most Kabbalists subordinated them to supernal entities and processes, thus creating more comprehensive frames. This tendency to create hierarchies and ontological chains of being by connecting in an active manner between analogical levels of reality is especially evident in the philosophical and kabbalistic resort to the concept of *hishtalshelut*, or *shalshelut*, terms pointing to intradivine chains of emanation. Many of the Kabbalists created an *imaginaire* of the universe permeated by many concatenations, analogies, occult

affinities, detailed sympathies, intricate subordinations, and hierarchies, most of which are absent from the rabbinic literatures. What is characteristic of many of these emanational chains is their flexibility—that is, their dependence on human religious acts below—and thus their vulnerability. Unlike the idea of the great chain of being (described in Arthur Lovejoy's classic study), which is characterized by its static nature—that is, its total independence of human acts—many of the kabbalistic descriptions assume mutual influence between the performance of the ritual and the supernal constellations that govern that performance.

The transition between the biblical and rabbinic literatures and the medieval speculative literatures, thus, is characterized by the transformation from a nonconstellated to a constellated approach. The different speculative constellations constitute different forms of attributing meaning to modes of religiosity that were more concerned with shaping a religious *modus operandi* than with establishing systematic worldviews. These creations of meaning were attained by constructing narratives that confer on ritualistic acts and on mystical techniques the possibility of transcending the situation of relative disorder in the external world, in the human psyche, or within divinity, thus attaining a superior order. Far from avoiding the strictures of the rabbinic life, most Kabbalists actually added customs and demanded a more intense performance of all the religious precepts understood as being fraught with special mystical valences. This effort of attributing special import to human religious deeds has much to do with the process of creating new systems of affinities evident in the voluminous kabbalistic literature dealing with the rationales of the commandments.

See also *Dialogue and Dialectics: Talmudic; Judaism: Modern Judaism; Mysticism: Kabbalah*.

BIBLIOGRAPHY

- Idel, Moshe. *Kabbalah: New Perspectives*. New Haven, Conn.: Yale University Press, 1988.
- Idel, Moshe, and Mortimer Ostow. *Jewish Mystical Leaders and Leadership in the Thirteenth Century*. Northvale, N.J.: Aronson, 1998.
- Kraemer, David Charles. *The Jewish Family: Metaphor and Memory*. New York: Oxford University Press, 1989.
- Myers, David N., and David B. Ruderman. *The Jewish Past Revisited: Reflections on Modern Jewish Historians*. New Haven, Conn.: Yale University Press, 1998.
- Ruderman, David B. *Jewish Thought and Scientific Discovery in Early Modern Europe*. Detroit: Wayne State University Press, 2001.
- Zolty, Shoshana. *And All Your Children Shall Be Learned: Women and the Study of Torah in Jewish Law and History*. Northvale, N.J.: Aronson, 1993.

Moshe Idel

MODERN JUDAISM

Judaism has never been monolithically uniform. Made irreducibly complex by 3,500 years of turbulent history, it resists simplification. Its data refuse to be straitjacketed or handled

dispassionately. Impartial attempts to understand it are easily spoiled by the partisan sympathies and deeply held antagonisms it activates in observers. Consider a mere sampling of the evidence. Its implications startle. In 1920, the American automotive industrialist Henry Ford articulated a widely held opinion that was infected by virulent strains of secular anti-Semitism without which the Holocaust would have been impossible: "Poor in his masses, [the Jew] yet controls the world's finances. . . . The single description which will include a larger percentage of the Jews than members of any other race is this: he is in business . . . the Jew is gifted for business" (Mendes-Flohr, p. 513). Vast numbers of Jews, however, were politically active in the labor union movement and on the Left. Four years earlier, Rosa Luxemburg, born to a Jewish family in Poland, an ardent socialist and leader of the Communist Party in Germany, acknowledged "that I have no separate corner in my heart for the ghetto: I feel at home in the entire world wherever there are clouds and birds and human tears" (Mendes-Flohr, p. 262). In 1930, Bertha Pappenheim, a religiously observant German-Jewish woman, a pioneering feminist and energetic social worker, explained that "women [in contrast to men] showed a ready understanding to relate the command to love your neighbor to modern times. . . . Out of a new congruence of German cultural elements and Jewish civilization grew a spiritual substance of greatest importance . . . These women who did not know how Jewish they were through their inherited spirituality became strong pillars of the feminist movement" (quoted in Mendes-Flohr, p. 288).

Similar divergence over other fundamental issues abounds. In 1885, a Conference of Reform Rabbis gathered in Pittsburgh. Echoing the rationalist ideals of the Enlightenment, they declared that "we consider ourselves no longer a nation but a religious community . . . ever striving to be in accord with the postulates of reason" (Mendes-Flohr, p. 468). In 1917, Ozjasz Thon, a Polish Zionist from Kraków, broadcasting the zeal that ultimately led to the establishment of the State of Israel in 1948, announced that "the Jews are a nation, not a religious sect" (Mendelsohn, p. 17). Further complicating the challenge of defining Judaism, in 1966, in the refuge of Belgium, Jean Amery, a survivor of the Nazi death camps in Auschwitz, the son of a Catholic mother and a Jewish father, wrote: "The necessity and impossibility of being a Jew, that is what causes me indistinct pain" (Mendes-Flohr, p. 292). In 1913, Gustav Landauer, a German-Jewish intellectual, echoing the ideals of romanticism embraced by countless Jews, proclaimed that "I feel my Judaism in the expressions of my face, in my gait, in my facial features, and all these signs assure me that Judaism is alive in everything that I am and do" (Mendes-Flohr, p. 276). In 1926, Sigmund Freud, the founder of psychoanalysis, confessed that "what bound me to Jewry was (I am ashamed to say) neither faith nor national pride, for I have always been an unbeliever and was brought up without any religion. . . . But plenty of other things remained to make the attraction of Jewry and Jews irresistible—many obscure emotional forces . . . as well as a clear consciousness of inner identity, the safe intimacy of a common mental construction" (Mendes-Flohr, p. 278). The juxtaposition of these divergent, contradictory voices is cautionary and instructive. Judaism is elusive.

Lexicons reflect this reality. Meticulously preserving popular usage and conventional wisdom, they report that Judaism signifies a religion, faith, set of theological beliefs and ceremonial practices, culture, nation, race, people, polity, tradition, heritage, or ethnic identity. The long string of terms is baffling. It fails to note whether the terms are neutrally descriptive or ideologically prescriptive. This failure wreaks conceptual havoc. Many of the string's terms are ambiguous; others are anachronistic. In combination, several of the terms are logically incoherent or mutually exclusive. The search for clarity seems doomed.

For scholarly purposes, Judaism may nevertheless be characterized as the sum total of symbiotic interactions between the Jews and their diverse geographical, sociopolitical environments. Perceived in this strictly descriptive, all-inclusive light, Judaism appears to have completed three phases of pre-modern development: ancient Near Eastern; Greco-Roman; and medieval, both Christian and Islamic. Currently, Judaism is undergoing its latest phase, the modern. As the contradictory voices cited above suggest, the modern phase may be the most tumultuous, fragmented, and poignant of all.

Like Judaism, modernity is irreducibly complex. Scene of utopian achievement and apocalyptic terror, modernity resists simplification. It swarms with counterpoint and paradox: unprecedented prosperity and abject deprivation, revolutionary reform and conservative reaction, egalitarian liberation and fascist brutality. Modernity simultaneously produces satisfied customers and frustrated discontents. Its beneficiaries and victims offer radically different assessments of its character. Jews have been both beneficiary and victim; they bear witness of a different kind. Historians nevertheless tend to agree that modernity is coterminous with the emergence of the bourgeoisie, the rise of the centralized nation-state, and the subsequent establishment of global hegemony in the West, in places such as Europe and North America.

Modernity may be said to have originated with the French, American, and Russian revolutions. Acting on the belief that "all men are created equal," the revolutions reordered society. They outlawed the denial of citizenship, special taxes, demeaning sumptuary regulations, and physical ghettos that had segregated Jews from society for centuries. The revolutions abolished the privileges of the agrarian-based aristocracy. They retrenched or eliminated the direct influence of clergy on public governance. Modernity may also be said to owe its temper to capitalism and its muscle to ongoing revolutions in science, technology, and industrialized productivity. These revolutions have transformed all aspects of life, especially the spheres of labor, communication, medicine, and warfare. In turn, the opportunistic combination of capitalism, nation-state, and technology spawned diverse modes of thinking: secularism, naturalism, materialism, and cultural relativism together with their dialectical counterparts, religious fundamentalisms, and variously insatiable appetites for the certainty of metaphysical absolutes.

Dynamics of Westernization

In North Africa and the Middle East, for example, where vast populations of Jews had lived for centuries in premodernity as

dhimmis, one of several protected minorities, modernity witnessed the dismemberment and balkanization of the Islamic Ottoman Empire, establishment of European colonies, Westernization of the local cultures, subsequent wars of liberation, and eventual establishment of newly formed, autonomous states. The process was well under way in the 1820s when Georg Wilhelm Friedrich Hegel lectured on the philosophy of history. His words reek with Eurocentric propaganda. Hegel declared that Islam had surpassed Judaism's ethnic particularism by embracing universalistic ideals. He then acknowledged medieval European debts to Islamic "science and knowledge, especially that of philosophy." He also noted Europe's contemporary appreciation of Islamic "noble poetry and free imagination." Capping the argument, Hegel reversed directions. Performing feats of imperious Orientalism, he lambasted the "East" and triumphantly erased Islam from the later stages of history: "But the East itself. . . sank into the grossest vice. The most hideous passions became dominant . . . At present, driven back into its Asiatic and African quarters . . . Islam has long vanished from the stage of history at large, and has retreated into Oriental ease and repose" (Hegel, p. 360).

As with Islam, so too with Judaism. Hegel's remarks expose the underlying pressures that have shaped and reconfigured Judaism for the past three hundred years. Dangling numerous incentives, the West circulated an interlocking set of guidelines: To reap the benefits of unprecedented prosperity after earning and being granted legal emancipation, the Jews would have to eliminate the "Oriental" habits that Westerners find odious. The Jews must modernize, accommodate, secularize, adapt, acculturate, integrate, and assimilate. Convert to Christianity, if they will. Remain Jewish, if they must, but let them heed the counsel offered in 1866 by Judah Leib Gordon, the Russian Hebrew poet, who wrote: "Be a man abroad and a Jew [in the privacy of] your tent, A brother to your [European] countryman and a servant to your [European] king" (Mendes-Flohr, p. 384). Be universalistic in outlook and education. Let the Jews preserve and continue to nurture only those elements of their premodern, rabbinic culture that conform to European tastes in science, philosophy, and the arts of "noble poetry and free imagination." Jews must dismantle traditional communal structures that privilege aristocratic leadership. Jews must retrench or eliminate the direct influence of the rabbinate on public governance. If it pleases, let them re-enter "history at large" by wholeheartedly joining the contemporary nation-states of the West. Failing that, either for lack of interest in capitalism and global hegemony or because of virulent anti-Semitic backlash, let them re-enter "history at large" by creating an autonomous Jewish nation-state based on Western models.

Like all the other premodern societies that have encountered the hegemonic West in recent times, the Jews adhered to these guidelines, with varying degrees of resistance and success. Like all these others and the West itself, Judaism became a perpetual site of cultural demolition, construction, and renovation. Like them all, like memory itself, Judaism became a tangled work in progress where nostalgia for the past and hope for the future jostled for attention.

The pace, extent, and contour of modernization differed from one geographical location to another. Jews living in the heartland of the West—in France, North America, England, and Germany—were the first to be legally emancipated, culturally integrated, and professionally diversified. Pioneers, they underwent the crisis of transformation and adjustment long before their kin living in East Europe. In turn, the Jews of Europe became the beneficiaries of modernity earlier than their kin living in the peripheries of modernity situated in colonial North Africa and the Middle East. Alas, between 1933 and 1945, the Jews of Europe also suffered the worst of modernity's evils. The Jews fell victim to the dialectical waste products of liberal attempts to reform society: xenophobia and racism leading to bureaucratically managed and technologically enabled mass murder, genocide, the Holocaust.

Wherever they resided, the Jews were buffeted by an array of centrifugal and centripetal forces compelling them to formulate a livable equation that balanced loyalty to the past with openness to the present. The proportion of continuity and discontinuity with premodern Judaism differed in each of the equations. No single equation enjoyed universal consent. As the juxtaposition of contradictory voices cited above suggests, the equations provoked controversy. Among the Jews who preferred life in the Diaspora and identified Judaism primarily with religion, the spectrum of opinion and practice included Reform, Reconstructionist, Conservative, Orthodox, ultra-Orthodox, and Hasidic varieties. Among the Jews who identified Judaism primarily with nationalism, the spectrum of opinion and practice included political, cultural, Socialist, Marxist, utopian, and religious Zionists of every stripe imaginable. Among the Jews, like Freud, who identified Judaism primarily with a cultural heritage or a set of ethical ideals, the spectrum of opinions and practices defies description.

In the traumatic midst of adjusting to Westernization, the Jews availed themselves of every tool available to make sense of their predicament and to stabilize their fluctuating fortunes. In the realms of philosophy and theology, the Jews flocked to rationality and romanticism, pragmatic naturalism and religious existentialism, sober positivism and exuberant mysticism, taking freely and modifying extensively what they needed from the resources of premodern Jewish tradition as well as from Immanuel Kant, Friedrich W. Schelling, Hegel, Karl Marx, Friedrich Nietzsche, Martin Heidegger, Ludwig Wittgenstein, John Dewey, Jacques Derrida, and the entire host of speculative virtuosi. In the realms of literature, music, and art, they participated fully in both the avant-garde and in the popular rear. In their ranks stand Heinrich Heine, Shmuel Yosef Agnon, Sholem Aleichem, Franz Kafka, Marc Chagall, and Arnold Schoenberg. Composing in every language, they uncovered the depths of humanity and mapped the enigmas of Jewish selfhood. In the realms of scholarship, other Jewish intellectuals invented the strictly academic, scientific study of Judaism. In all these realms, as in the realms of innovative political organization and religious experimentation, the unsettling and creative traces of modernity are unmistakable.

See also *Diasporas: Jewish Diaspora; Genocide; Ghetto; Identity, Multiple: Jewish Multiple Identity; Judaism;*

Judaism to 1800; Orientalism; Religion; Religion and the State.

BIBLIOGRAPHY

PRIMARY SOURCES

- Hegel, Georg W. F. *The Philosophy of History*. Translated by J. Sibree. Amherst, N.Y.: Prometheus Books, 1991.
- Hertzberg, Arthur, ed. *The Zionist Idea: A Historical Analysis and Reader*. New York: Atheneum, 1984.
- Mendes-Flohr, Paul, and Jehuda Reinharz, eds. *The Jew in the Modern World: A Documentary History*. New York: Oxford University Press, 1995.

SECONDARY SOURCES

- Alter, Robert. *After the Tradition: Essays on Modern Jewish Writing*. New York: Dutton, 1969.
- Ezrahi, Sidra Dekoven. *Booking Passage: Exile and Homecoming in the Modern Jewish Imagination*. Berkeley: University of California Press, 2000.
- Guttman, Julius. *Philosophies of Judaism: A History of Jewish Philosophy from Biblical Times to Franz Rosenzweig*. Translated by David W. Silverman. New York: Schocken Books, 1973.
- Hodgson, Marshall G. S. *The Gunpowder Empires and Modern Times*. Vol. 3 of *The Venture of Islam: Conscience and History in a World Civilization*. Chicago: University of Chicago Press, 1974.
- Mendelsohn, Ezra. *On Modern Jewish Politics*. New York: Oxford University Press, 1993.
- Meyer, Michael. *The Origins of the Modern Jew: Jewish Identity and European Culture, 1749–1824*. Detroit: Wayne State University Press, 1967.
- Peskowitz, Miriam, and Laura Levitt, eds. *Judaism since Gender*. New York: Routledge, 1997.

Kalman P. Bland

JUSTICE.

This entry includes three subentries:

- Overview*
Justice in American Thought
Justice in East Asian Thought

OVERVIEW

Virtually everyone becomes involved in disputes about justice at some point. Sometimes our involvement in such disputes is rooted in the fact that we believe ourselves to be victims of some form of injustice, such as job discrimination; sometimes our involvement is rooted in the fact that others believe us to be the perpetrators or at least the beneficiaries of some form of injustice affecting them, such as unfair taxing policies. Elimination of the injustice may require drastic reform, or even revolutionary change in the political system, such as took place in the Soviet Union, Eastern Europe, and South Africa. In other cases, redress of the injustice may require only some electoral pressure or administrative decision, such as that required to end a war, for example, the Vietnam War. Whatever the origin and whatever the practical effect, disputes about justice

are difficult to avoid, especially when dealing with issues that have widespread social effects like access to employment opportunities, distribution of income, structure of political institutions, and use of the war-making capabilities of a nation.

Reasonable resolutions of such disputes require critical evaluation of the alternative conceptions of justice available to us. Philosophical debate at the beginning of the twenty-first century supports five major conceptions of justice: (1) a libertarian conception, which takes liberty to be the ultimate political ideal; (2) a socialist conception, which takes equality to be the ultimate political ideal; (3) a welfare liberal conception which takes contractual fairness or maximal utility to be the ultimate political ideal; (4) a communitarian conception, which takes the common good to be the ultimate political ideal; and (5) a feminist conception, which takes a gender-free society to be the ultimate political ideal.

All of these conceptions of justice have features in common. Each has requirements that belong to the domain of obligation rather than to the domain of charity; differences arise as to where the line between these domains should be drawn. Each is concerned with giving people what they deserve or should rightfully possess; disagreements exist about what those things are. Each is secular rather than religious in character because for justice to be enforceable it must be accessible to all who apply for it; only a conception of justice that is based on secular reason rather than on religious faith could have that accessibility. Each is thought to apply cross-culturally in virtue of its being accessible to everyone on the basis of reason alone. These common features constitute a generally accepted core definition of justice. What we need to do, however, is examine that part of each of these conceptions of justice over which there is serious disagreement in order to determine which, if any, is most defensible.

Libertarian Justice

Libertarians frequently cite the work of F. A. Hayek (1899–1992), particularly his *Constitution of Liberty* (1960), as an intellectual source of their view. Hayek argues that the libertarian ideal of liberty requires “equality before the law” and “reward according to market value” but not “substantial equality” or “reward according to merit.” Hayek further argues that the inequalities due to upbringing, inheritance, and education that are permitted by an ideal of liberty actually tend to benefit society as a whole. In basic accord with Hayek, early-twenty-first-century libertarians define “liberty” as “the state of being unconstrained by other persons from doing what one wants.” This definition limits the scope of liberty in two ways. First not all constraints, whatever the source, count as restrictions on liberty; the constraints must come from other persons. For example, people who are constrained by natural forces from getting to the top of Mount Everest have not been deprived of liberty in this regard. Second the constraints must run counter to people’s wants. Thus people who do not want to hear Beethoven’s Fifth Symphony do not have their liberty restricted when other people forbid its performance, even though the proscription does in fact constrain what the former are able to do.

Given this definition of liberty, libertarians go on to characterize their moral and political ideal as requiring that each

person should have the greatest amount of liberty commensurate with the same liberty for all. From this ideal, libertarians claim that a number of more specific requirements, in particular a right to life, a right to freedom of speech, press, and assembly, and a right to property, can be derived.

The libertarian’s right to life is not a right to receive from others the goods and resources necessary for preserving one’s life; it is simply a right not to be killed. So understood, the right to life is not a right to receive welfare. In fact there are no welfare rights in the libertarian view. Accordingly the libertarian’s understanding of the right to property is not a right to receive from others the goods and resources necessary for one’s welfare, but rather a right to acquire goods and resources either by initial acquisition or by voluntary agreement.

By defending rights such as these, libertarians can support only a limited role for government. That role is simply to prevent and punish initial acts of coercion—the only wrongful actions in the libertarian view.

Libertarians do not deny that having sufficient goods and resources to meet basic nutritional needs and basic health care needs is a good thing, but they do not believe that government has a duty to provide such goods and resources. Libertarians claim that some good things, such as the provision of welfare and health care to the needy, are requirements of charity rather than justice. Accordingly failure to make such provisions is neither blameworthy nor punishable.

A basic objection to the libertarian conception of justice is its claim that rights to life and property, as the libertarian understands these rights, derive from an ideal of liberty. Why should we think that an ideal of liberty requires a right to life and a right to property that excludes a right to welfare? A libertarian understanding of a right to property might well justify a rich person depriving a poor person of the liberty to acquire the goods and resources necessary for meeting the latter’s basic nutritional needs. How then could we appeal to an ideal of liberty to justify such a deprivation of liberty? Surely we could not claim that such a deprivation is justified for the sake of preserving a rich person’s freedom to use the goods and resources he or she possesses to meet luxury needs. By any neutral assessment, the liberty of the deserving poor not to be interfered with when taking from the surplus possessions of the rich what they require to meet their basic needs should have priority over the liberty of the rich not to be interfered with when using their surplus possessions to meet their luxury needs. But if this is the case, then a right to welfare, and possibly a right to equal opportunity as well, would be grounded in the libertarian ideal of liberty.

Socialist Justice

In contrast with libertarians, socialists take equality to be the ultimate political ideal. In the *Communist Manifesto* (1848), Karl Marx (1818–1883) and Friedrich Engels (1820–1895) maintain that the abolition of bourgeois property and bourgeois family structure is a necessary first requirement for building a society that accords with the political ideal of equality. In the *Critique of the Gotha Program* (1891), Marx provides a

much more positive account of what is required to build a society based upon the political ideal of equality. Marx claims that the distribution of social goods must conform, at least initially, to the principle from each according to his/her ability, to each according to his/her contribution. But when the highest stage of communist society has been reached, Marx adds, distribution will conform to the principle from each according to his/her ability, to each according to his/her need.

At first this conception might sound ridiculous to someone brought up in a capitalist society. How can people be asked to contribute according to their ability if income is distributed on the basis of their needs and not on the basis of their contributions?

The answer, according to a socialist conception of justice, is to make the work itself as enjoyable as possible. As a result, people will want to do the work they are capable of doing because they find it intrinsically rewarding. For a start, socialists might try to get people to accept existing, inherently rewarding jobs at lower salaries—top executives, for example, would work for \$300,000, rather than the much higher salaries they can actually command. Ultimately socialists hope to make all jobs as intrinsically rewarding as possible, so that when people are no longer working primarily for external rewards and are making their best contributions to society, distribution can proceed on the basis of need.

Socialists propose to implement their ideal of equality by giving workers democratic control over the workplace. They believe that if workers have more to say about how they do their work, they will find their work intrinsically more rewarding. As a consequence, workers will be more motivated to work because the work itself will be meeting their needs. Socialists believe that extending democracy to the workplace will necessarily lead to socialization of the means of production and the end of private property. Socialists, of course, do not deny that civil disobedience or even revolutionary action may be needed to overcome opposition to extending democracy to the workplace.

Even with democratic control of the workplace, some jobs, such as collecting garbage or changing bedpans, probably cannot be made intrinsically rewarding. Socialists propose to divide up such jobs in an equitable manner. Some people might, for example, collect garbage one day a week, and then work at intrinsically rewarding jobs for the rest of the week. Others would change bedpans or do some other unfulfilling job one day a week, and then work at an inherently rewarding job on the other days. By making jobs as intrinsically rewarding as possible, in part through democratic control of the workplace and an equitable assignment of unrewarding tasks, socialists believe people will contribute according to their ability even when distribution proceeds according to need.

Another difficulty raised concerning the socialist conception of justice involves the proclaimed necessity of abolishing private property and socializing the means of production. It seems perfectly possible to give workers more control over their workplace while the means of production remain privately owned. Of course private ownership would have a somewhat different character in a society with democratic control of the workplace, but it need not cease to be private ownership.

After all, private ownership would also have a somewhat different character in a society where private holdings, and hence bargaining power, were distributed more equally than they are in most capitalist societies, yet it would not cease to be private ownership. Accordingly we could imagine a society where the means of production are privately owned but where—because ownership is so widely dispersed throughout the society and because of the degree of democratic control of the workplace—many of the criticisms socialists make of existing capitalist societies would no longer apply.

Welfare Liberal Justice: The Contractarian Perspective

Finding merit in both the libertarian ideal of liberty and the socialist ideal of equality, welfare liberals attempt to combine both liberty and equality into one political ideal that can be characterized as contractual fairness or maximal utility.

A classical example of the contractual approach to welfare liberal justice is found in the political works of Immanuel Kant (1724–1804). Kant claims that a civil state ought to be founded on an original contract satisfying the requirements of freedom (the freedom to seek happiness in whatever way one sees fit as long as one does not infringe upon the freedom of others to pursue a similar end), equality (the equal right of each person to restrict others from using his or her freedom in ways that deny equal freedom to all), and independence (the independence of each person that is necessarily presupposed by the free agreement of the original contract).

According to Kant, the original contract, which ought to be the foundation of every civil state, does not have to “actually exist as a fact.” It suffices that the laws of a civil state are such that people would agree to them under conditions in which the requirements of freedom, equality, and independence obtain. Laws that accord with this original contract would then, Kant claims, give all members of society the right to reach any degree of rank that they could earn through their labor, industry, and good fortune. Thus the equality demanded by the original contract would not, in Kant’s view, exclude a considerable amount of economic liberty.

The Kantian ideal of a hypothetical contract as the moral foundation for a welfare liberal conception of justice was further developed by John Rawls (1921–2002) in *A Theory of Justice* (1971) and in *Justice as Fairness: A Restatement* (2001). Rawls, like Kant, argues that principles of justice are those principles that free and rational persons who are concerned to advance their own interests would accept in an initial position of equality. Yet Rawls goes beyond Kant by interpreting the conditions of his “original position” to explicitly require a “veil of ignorance.” This veil of ignorance, Rawls claims, has the effect of depriving persons in the original position of the knowledge they would need to advance their own interests in ways that are morally arbitrary.

According to Rawls, the principles of justice that would be derived in the original position are the following:

1. Each person has the same infeasible claim to a fully adequate scheme of equal basic liberties, which scheme is compatible with the same scheme of liberties for all; and

2. Social and economic inequalities are to satisfy two conditions: First they are to be attached to offices and positions open to all under conditions of fair equality of opportunity; second, they are to be to the greatest benefit of the least advantaged members of society (the difference principle).

Rawls holds that these principles of justice would be chosen in the original position because persons so situated would find it reasonable to follow the conservative dictates of the “maximin strategy” and maximize the *minimum*, thereby securing for themselves the highest minimum payoff and because these principles express an ideal of reciprocity.

Rawls’s defense of a welfare liberal conception of justice has been challenged in a variety of ways. Some critics endorse his contractual approach while disagreeing with him over what principles of justice would be derived from it. These critics usually attempt to undermine the use of a maximin strategy in the original position. Other critics, however, have found fault with the contractual approach itself. Libertarians, for example, challenge the moral adequacy of the very ideal of contractual fairness because it conflicts with their ideal of liberty.

This second challenge to the ideal of contractual fairness is potentially more damaging because, if valid, would force its supporters to embrace some other political ideal. The challenge, however, would fail if the libertarian ideal of liberty, when correctly interpreted, can be shown to lead to much the same practical requirements as are usually associated with the welfare liberal ideal of contractual fairness.

Welfare Liberal Justice: The Utilitarian Perspective

One way to avoid the challenges directed at a contractarian defense of welfare liberal justice is to find some alternative way of defending it. Historically utilitarianism has been thought to provide such an alternative defense. Under a utilitarian view, the requirements of a welfare liberal conception of justice can be derived from considerations of utility in such a way that following these requirements will result in the maximization of total happiness or satisfaction in society. The best-known classical defense of this utilitarian approach is that presented by John Stuart Mill (1806–1873) in *Utilitarianism* (1863).

In chapter 5 of this work, Mill surveys various types of actions and situations that are ordinarily described as just or unjust, and concludes that justice simply denotes a certain class of fundamental rules, the adherence to which is essential for maximizing social utility. Thus Mill rejects the idea that justice and social utility are ultimately distinct ideals, maintaining instead that justice is in fact derivable from the ideal of social utility.

Nevertheless a serious problem remains for the utilitarian defense of welfare liberal justice. There would appear to be ways of maximizing social utility overall that do an injustice to particular individuals. Think of the Roman practice of throwing people to the lions for the enjoyment of all those in the Colosseum. This unjust practice arguably maximized social utility overall.

Rawls makes the same point somewhat differently. Since utilitarianism sees society as a whole as if it were just one person, it treats the desires and satisfactions of separate persons as if they were the desires and satisfactions of just one person. Thus, according to Rawls, utilitarianism fails to preserve the distinction between persons.

But is Rawls right? Suppose we were to interpret utilitarianism to be constrained by the “ought” implies “can” principle, according to which people are not morally required to do what they lack the power to do or what would involve so great a sacrifice that it would be unreasonable to ask, and/or in cases of severe conflict of interest, unreasonable to require them to abide by. So constrained, utilitarianism would not impose unreasonable sacrifices on individuals, and so would not then have the consequences to which Rawls objects.

Communitarian Justice

Another prominent political ideal defended by contemporary philosophers is the communitarian ideal of the common good. As one might expect, many contemporary defenders regard the communitarian conception of justice as rooted in Aristotelian moral theory. In the *Nicomachean Ethics* (c. 335–322 B.C.E.), Aristotle (384–322 B.C.E.) distinguishes between different varieties of justice. He first distinguishes between justice as the whole of virtue and justice as a particular part of virtue. In the former sense, justice is understood as what is lawful, and the just person is equivalent to the moral person. In the latter sense, justice is understood as what is fair or equal, and the just person is one who takes only a proper share. Aristotle focuses his discussion on justice as a part of virtue, which further divides into distributive justice, corrective justice, and justice in exchange. Each of these varieties of justice can be understood to be concerned with achieving equality. For distributive justice it is equality between equals; for corrective justice it is equality between punishment and the crime; and for justice in exchange it is equality between whatever goods are exchanged. Aristotle also claims that justice has both its natural and conventional aspects: This twofold character of justice seems to be behind Aristotle’s discussion of equity, in which equity, which is a natural standard, is described as a corrective to legal justice, which is a conventional standard.

Note that few of the distinctions Aristotle makes seem tied to the acceptance of any particular conception of justice. One could, for example, accept the view that justice requires formal equality, but then specify the equality that is required in different ways. Even the ideal of justice as giving people what they deserve, which has its roots in Aristotle’s account of distributive justice, is subject to various interpretations. An analysis of the concept of desert would show that there is no conceptual difficulty with claiming, for example, that everyone’s needs should be satisfied or that everyone deserves an equal share of the goods distributed by society. Consequently Aristotle’s argument is primarily helpful in clarifying the distinctions that can be made within the concept of justice without committing oneself to any particular conception of justice.

Rather than discussing the particular requirements of communitarian justice, proponents have frequently chosen to

defend it by attacking other concepts. They have focused their criticism on the welfare liberal conception of justice.

Alasdair MacIntyre, for example, argues, in “The Privatization of the Good” (1990), that virtually all forms of liberalism attempt to separate rules defining right action from conceptions of the human good. MacIntyre contends that these forms of liberalism not only fail but have to fail because the rules defining right action cannot be adequately grounded apart from a conception of the good. For this reason, MacIntyre claims, only some version of a communitarian theory of justice that grounds rules supporting right action in a complete conception of the good can ever hope to be adequate.

But why not view most forms of liberalism as attempts to ground moral rules on part of a conception of the good—specifically, that part of a conception of the good that is more easily recognized, and should be publicly recognized, as good? For Rawls, for example, this partial conception of the good is a conception of contractual fairness, according to which no one deserves his or her native abilities or his or her initial starting place in society. If this way of interpreting liberalism is correct, then, in order to evaluate welfare liberal and communitarian conceptions of justice properly, we would need to do a comparative analysis of their conceptions of the good and their practical requirements. Moreover there is reason to think that once the practical requirements of both liberal and communitarian conceptions of justice are set out, they will be quite similar.

Feminist Justice

Defenders of a feminist conception of justice present a distinctive challenging critique to defenders of other conceptions of justice. In his *The Subjection of Women* (1869) Mill, one of the earliest male defenders of women’s liberation, argues that the subjection of women was never justified but was imposed upon women because they were physically weaker than men; later this subjection was confirmed by law. Mill argues that society must remove the legal restrictions that deny women the same opportunities enjoyed by men. However Mill does not consider whether because of past discrimination against women it may be necessary to do more than simply remove legal restrictions: He does not consider whether positive assistance may also be required.

Usually it is not enough simply to remove unequal restrictions to make a competition fair. Positive assistance to those who have been disadvantaged in the past may also be required, as would be the case in which some competitors were unfairly impeded by having to carry ten-pound weights for part of a race. To render the outcome of such a race fair, it may be necessary to transfer the weights to other runners, and thereby advantage the previously disadvantaged runners for an equal period of time. Similarly positive assistance, such as affirmative action programs, may be necessary to enable women who have been disadvantaged in the past to compete fairly with men.

In *Justice, Gender, and the Family* (1989), Susan Okin argues for the feminist ideal of a gender-free society. A gender-free society is a society where basic rights and duties are not assigned on the basis of a person’s biological sex. Since a

conception of justice is usually thought to provide the ultimate grounds for the assignment of rights and duties, we can refer to this ideal of a gender-free society as feminist justice.

Okin goes on to consider whether Rawls’s welfare liberal conception of justice can support the ideal of a gender-free society. Noting Rawls’s failure to apply his original position-type thinking to family structures, Okin is skeptical about the possibility of using a welfare liberal ideal to support feminist justice. She contends that in a gender-structured society, male philosophers cannot achieve the sympathetic imagination required to see things from the standpoint of women. According to Okin, original position-type thinking can only really be achieved in a gender-free society.

Yet while Okin despairs of doing original position-type thinking in a gender-structured society, she herself does a considerable amount of just that type of thinking. For example, she claims that Rawls’s principles of justice “would seem to require a radical rethinking not only of the division of labor within families but also of all the nonfamily institutions that assume it” (p. 104). She also argues that “the abolition of gender seems essential for the fulfillment of Rawls’s criterion of political justice” (p. 104). Okin’s own work indicates that people can engage in original position-type thinking and her reasons for arguing otherwise are not persuasive. It is not necessary that all people have the capacity to put themselves imaginatively in the position of others, just that some have the ability to do so. Some people may not be able to do original position-type thinking because they have been deprived of a proper moral education. Others may be able to do original position-type thinking only after they have been forced to mend their ways and live morally for a period of time.

Even among those in our gendered society who are, generally, capable of a sense of justice, some may not be able to do original position-type thinking with respect to the proper relationships between men and women and may acquire the ability only after laws and social practices shift significantly toward a more gender-free society. Others may have the ability to think in this way, having effectively used the opportunities for moral development available to them to achieve the necessary sympathetic imagination.

Conclusions

What conclusions should we draw from this discussion of libertarian, socialist, welfare liberal, communitarian, and feminist conceptions of justice? Is MacIntyre’s opinion, described in *After Virtue* (1981), that such conceptions of justice are incommensurable and, hence, there is no rational way of deciding between them correct? Many philosophers have challenged this view, and even MacIntyre, in *Three Rival Versions of Moral Enquiry* (1990), has significantly qualified it, contending that it is possible to argue across conceptions of justice.

One could also conclude that *if* the ideal of liberty of libertarian justice can be shown to require the same rights to welfare and equal opportunity that are required by the welfare liberal conception of justice, and *if* the communitarian critique of welfare liberalism can be rebutted, that it may then be possible to reconcile, at a practical level, the differences between

welfare liberal justice, socialist justice, and feminist justice. To reasonably resolve our disputes about justice, we then need only understand the shared practical requirements of these conceptions of justice and simply act upon them.

It can be argued, however, that even if these conceptions of justice can be reconciled in practice, such reconciliation would not have cross-cultural validity because the discussion derives primarily from Western philosophical traditions. While this objection cannot be fully addressed in the absence of a detailed examination of non-Western conceptions of justice and morality, there is good reason to think that, like the results of a well-reasoned discussion of mathematics derived from Western sources, this discussion of conceptions of justice also has cross-cultural validity. The conceptions of justice considered here arguably run the full gamut from least demanding (libertarian justice) to most demanding (socialist justice). Egoism is less demanding than libertarian justice, but it is not a moral view because egoism entails a rejection of morality. Pure altruism is more demanding than socialist justice, but no conception of justice could require us to sacrifice ourselves to the degree that pure altruism does; pure altruism goes beyond the requirements of justice and morality. If libertarian justice and socialist justice, and those conceptions that purportedly fall in between, can all be practically reconciled in the way suggested, there is good reason to think that the argument is valid not only for Western philosophical traditions but cross-culturally as well.

See also *Liberalism; Marxism; Virtue Ethics*.

BIBLIOGRAPHY

- Aristotle. *Nicomachean Ethics*. Bk. 5. Translated by Martin Ostwald. Indianapolis: Bobbs-Merrill, 1962.
- Hayek, Friedrich. A. *The Constitution of Liberty*. Chicago: University of Chicago Press, 1960.
- Jaggar, Alison M. *Feminist Politics and Human Nature*. Totowa, N.J.: Rowman and Allanheld, 1983.
- Machan, Tibor. *The Passion for Liberty*. Lanham, Md.: Rowman and Littlefield, 2003.
- MacIntyre, Alasdair. *After Virtue*. Notre Dame, Ind.: University of Notre Dame Press, 1981.
- . “The Privatization of the Good.” *Review of Politics* 52 (1990): 1–20.
- . *Three Rival Versions of Moral Enquiry*. Notre Dame, Ind.: University of Notre Dame Press, 1990.
- Marx, Karl, and Engels, Friedrich. *The Communist Manifesto*. n.p., 1848. First published in English by Friedrich Engels in 1888.
- Mill, John Stuart. *The Subjection of Women*. Indianapolis: Hackett, 1988.
- . Chapter 5 in his *Utilitarianism*. Indianapolis: Hackett, 2001.
- Nielson, Kai. *Liberty and Equality*. Totowa, N.J.: Rowman and Allanheld, 1985.
- Nozick, Robert. *Anarchy, State and Utopia*. New York: Basic Books, 1974.
- Okin, Susan. *Justice, Gender, and the Family*. New York: Basic Books, 1989.
- Rawls, John. *Justice as Fairness: A Restatement*. Cambridge, Mass.: Harvard University Press, 2001.
- . *A Theory of Justice*. Cambridge, Mass.: Harvard University Press, 1971.

Sommers, Christina. *Who Stole Feminism?* New York: Simon and Schuster, 1994.

Sterba, James P. *Justice for Here and Now*. New York: Cambridge University Press, 1998.

James P. Sterba

JUSTICE IN AMERICAN THOUGHT

Justice appears as a paradoxical concept in the history of the United States. On the one hand, it has been absent as a rallying cry in the major struggles that have shaped, and continue to shape, the plurality of identities of the American nation. The concept “justice” is not prominent in the Declaration of Independence or in the Constitution. It was not the cornerstone of the abolitionist movement, the Civil War, the women’s suffrage movement, or the civil rights movement. It did not surface in the demands of Native Americans against the encroaching and overwhelming force of local states and the federal government. Nor does it carry major weight in the pro-statehood movement that is still hoping to move Puerto Rico away from its colonial status and to see the island as a state of the American union. In contrast to the Platonic Republic, in which justice is viewed as the central virtue of an ideal society, justice seems to appear as an afterthought, as in the last sentence in the pledge of allegiance.

On the other hand, justice has infused the political ideas and practices that define the American society, and it should not be confined exclusively to the arena of legal procedures. Rather, justice has been refracted through the ideas of rights, liberty, equality, democracy, state institutions, and other concepts that have dominated the moral language of American citizens or the people who wanted to become, or were forced into the framework of, American citizenship. The absence of clear definitions of justice guiding public discussions since the arrival of the Puritans takes a different meaning when the theoretical inquiry focuses on the multiplicity of dimensions entwined with justice.

These dimensions include: a providential understanding of a communal identity; the conception of individuality; the relationship between individuals and the government; the view of political power and the proper nature of the state; the protections and bulwarks in the judicial sphere; and justice as the first principle that ought to guide both the individual’s life and governmental policies. All these dimensions place a high premium on rights, but the relationship between rights and justice is clarified by looking at the link between liberty and justice. This link presupposes that people must be free to choose rules of justice, but then justice is understood as the principle that delineates the scope of liberty, which means that justice defines the boundaries of rights. The refracted and yet ubiquitous presence of justice in American thought helps to explain why John Rawls’s philosophy, which dominated American liberalism in the last three decades of the twentieth century, portrayed justice as the standard by which to measure both a well-ordered society and a just citizen.

Puritan Conceptions of Justice

Though the Mayflower Compact (1620) stresses the importance of “just and equal Laws,” John Winthrop’s sermon “A

Modell of Christian Charity” (1630) is a reasonable point of departure in examining justice in the American context. This sermon is important not only for the location where it was delivered—on the ship *Arabella* en route to a new continent—but also for the distinction between mercy and justice as well as for its emphasis on an ordered and tightly knit community predicated on mutual assistance. According to the principle of mercy, Christians must help their brothers and sisters beyond their ability in order to fulfill the gospel. But in lending means of subsistence and forgiving debts, justice intervenes. If a Christian brother, for instance, possesses the resources to repay a debt, “thou art to looke at him, not as an Act of mercy, but by way of Commerce, wherein thou arte to walke by the rule of Justice . . .” (p. 32). When the probability of a debt being repayed is null, Christians ought to lend according to the rule of mercy, which expects nothing. Along similar lines, whether the loan was an act of mercy or of justice, when the borrower has nothing to pay back, “thou must forgive him (except in cause where thou hast a surety or a lawful pledge)” (p. 33). In this way, if there is a “lawful pledge,” justice overrules mercy.

The association of justice, commerce, and a lawful pledge delimits justice to the sphere of agreements and contracts sanctioned by the law. Though this view seems to narrow significantly the scope of justice, the refraction principle shows itself when the text is examined in more detail. At the end of his sermon, Winthrop presents the well-known analogy of the pilgrims as a “city upon a Hill.” But it must be emphasized that the city upon a hill does not refer to the original biblical reference found in the Gospel according to Matthew. In Winthrop’s reasoning, the context of the phrase is provided by the Israelites on their journey to the promised land. As in the Israelites’ case, Winthrop’s arguments center upon a covenant between God and the Christian community, and God will expect a strict compliance with the “Articles contained in it . . .,” for otherwise “wee shall surely perishe out of the good Land whether wee passe over this vast Sea to possesse it. . .” (p. 43). In other words, the relationship between God and Winthrop’s fellow travelers is one ruled by justice in the form of a covenant, and an intrinsic part of this justice was the possession of the land where they would live.

Seen from this perspective, justice is no longer limited to contractual relations between persons. Rather, the boundaries encompassing justice widen substantially. At the same time, a covenant that carries the high penalty of divine wrath is ominous for all people who are outside the particular community Winthrop is addressing. Justice thus straddled two conflicting points of departure. The city upon the hill echoes the love Winthrop found in the gospel, while the covenant belonged to the Hebrew warriors who were to possess a land already inhabited. The New Testament “law of grace” and the Old Testament justice were inseparable. The mention of the city upon a hill is preceded by an explicit reference to God’s command to Saul to destroy Amalek. In other words, the textual transplantation preceded the cultural transplantation. Justice, then, had two dimensions: a secular one defined by legal contracts among individuals as well as a providential dimension manifested in a covenant between God and a community bonded by shared beliefs.

The double character of Winthrop’s conception of justice insisted on the individual’s obligation to comply with his or her contracts and gave the community a privileged position in its dealings with non-Christians and even with Christians who did not share the same doctrinal tenets. Unity and fragmentation emerged as two central components that would be present in the understanding and application of justice. Winthrop’s view of love anticipated this conclusion. Love stems from the fact that people see in others what they see and cherish in themselves. In this way, the root of otherness, as a standpoint that demands the conversion and “civilization” of non-Christians, or as the establishment of boundaries to keep outsiders at bay, was thus inscribed in the view of justice sketched in Winthrop’s famous sermon. The “Dedham Covenant” (1636), a document specifying the form of government in the town of Dedham, Massachusetts, was more eloquent in describing the quest of unity and how exclusion was part of this quest. In section two, the limits of admittance into the community were specified: “That we shall by all means labor to keep off from us all such as are contrary minded, and receive only such unto us as may be probably of one heart with us . . .” (p. 68).

Several years earlier, Virginia had already put into place a system of legal clauses that contained both a mix of exclusion and a call for fairness. The “Articles, Laws, and Orders, Divine, Politic, and Martial for the Colony in Virginia” (1610–1611) stipulated that no man “of what condition soever shall barter, trucke, or trade with the Indians, except he be thereunto appointed by lawful authority upon paine of death.” (Article 15, p. 319). In the following article, the colonists were forbidden from despoiling any “Indian” who would come to trade, and the punishment would also be death (Article 16). By 1619, freemen were allowed to trade with the Indians, but offensive or defensive weapons could not be part of these commercial transactions.

The twofold nature of unity and exclusion should not obfuscate other features that would have a deep influence in the evolution and conceptualizations of the idea of justice. The “Plymouth Oath of Allegiance and Fidelity” (1625) contained an oath given to the governor and members of the council in which they would swear to administer justice “equally & indifferently without respect of persons.” (p. 34) The same principle of impartiality is present in the “Pilgrim Code of Law” (15 November 1636) and runs consistently in the founding documents of the early settlements. The historical evidence thus shows that the English philosopher John Locke’s (1632–1704) arguments about consent and impartial laws as the cornerstones of a political and just society were already present in the ideas animating the Puritans of the early colonies, the same ideas that permeated their providential and secular understanding of justice.

During King Philip’s War (1674–1677), between the New England colonists and the Indian tribes in the region, the providential character of justice showed the consequences of its privileged standpoint. Increase Mather would remind his listeners that their unfaithfulness was the cause of the violent upheaval that threatened them. But he saw the destruction of the

heathens as an act that abided with the justice expected from a people ruled by a providential design. For the war was just, and the army was executing “the vengeance of the Lord upon the perfidious and bloody Heathen” (p. 107).

Providential View of Justice

The same providential view of justice that erected boundaries against outsiders and allowed Mather to justify the obliteration of a community of Native Americans also called for universal descriptions that would later haunt institutions tethered to partiality and particularity. That is to say, it was contradictory to use a universal language of justice to justify political institutions and then attempt to circumvent and ignore the consequences of this language. The phrase “all men are created equal,” a phrase that belongs to the domain of justice, could not be used to justify slavery. In his 1858 debates with Stephen Douglas, Abraham Lincoln could confidently use the Declaration of Independence and the Constitution to oppose the extension of slavery. This task was fraught with obstacles, though. The universality of categories pertaining to justice transformed the American Constitution into a battleground of competing conceptions of morality and conflicting views of the relationship between individuals and the government. For William Lloyd Garrison, the Constitution was a covenant with hell that vitiated its potentiality for individual liberty. Frederick Douglass followed, at first, the Garrisonian view, but he concluded that the founders had bestowed enough room to challenge the institution of slavery. In his speech of May 28, 1856, addressing the radical abolition party convention in New York, Douglass said: “This Constitution sets forth several propositions, which, if carried out, would abolish slavery. What are they? The Constitution declares its object to be ‘to form a more perfect union.’ How can you form a more perfect union with slavery? . . . The Constitution is declared to be established for the people, and who are the people? The men and women of the country. We are part of the people” (pp. 389–390).

While Douglass found refuge in the universal goals that the Constitution clearly pursued, Ralph Waldo Emerson and Henry David Thoreau invoked transcendental categories that were congenial to the providential view of justice. In his opposition to slavery, Emerson saw the universe, nature, power, justice, and the moral order as transcendental realities of a divine unity. The universe, Emerson wrote in 1845, “is not bankrupt: still stands the old heart firm in its seat, and knows that, come what will, the right is and shall be. Justice is for ever and ever” (p. 36). The planter’s predicament is always unsafe, no matter how powerful he might appear to be. Nature fights against him, and “as power is always stealing from the idle to the busy hand, it seems inevitable that a revolution is preparing at no distant day to set these disjointed matters right” (p. 37). In the twentieth century, Martin Luther King, Jr., followed Douglass’s footsteps and resorted to the universality embedded in the American conception of justice to challenge civil inequalities, and to fulfill Emerson’s hope of setting right matters that were still “disjointed.”

The providential covenant as a central component of the American conception of justice has shown a remarkable

resistance to the passing of time. In 1795, Bishop James Madison painted the providential character in a language that was more emphatic than Winthrop’s. God had thrown a veil upon the American continent in order “to conceal it from the nations of the east,” thus saving America from the ravages of tyranny and inequality that went untrammelled in the European nations. The veil would not be lifted until the emergence of “a new race of men” that would be responsible for the redemption of humankind. “It is in America,” Bishop Madison declared, “that the germs of the universal redemption of the human race from domination and oppression have already begun to be developed” (p. 1312). In 1820, Daniel Webster echoed similar themes in his “Plymouth Oration,” and in 1900, Albert Beveridge, the Republican senator from Indiana, portrayed the divine plan that was in the offing.

In addressing the question of acquiring and administering territories whose population, he opined, was not yet ready for self-government, Beveridge asserted that God “has marked the American people as His chosen nation to finally lead in the regeneration of the world” (p. 704). “[O]ur place, therefore, is at the head of the constructing and redeeming nations of the earth” (p. 712).

It is worth noticing that the emphasis on redemption, covenant, natural rights, and government evinced a duty to carry out the designs of divine justice refracted through human institutions. The secular and providential notions of justice thus complemented one another. While the emphasis on legal contracts might have led individuals to seek their own interests, the providential covenant would bring them back to their public duty. It is in this providential notion that one finds the centrality of a legitimate government anchored upon the principle of consent.

The Individual and the State

Another sphere of justice revolves around the proper role of state power and the relationship between individuals and their government. The Federalists bestowed on the American intellectual landscape the best articulation of justice in connection with social order and public institutions. The Federalist view made clear that the institutional framework ought to exist to protect the basic rights of citizens, and property stood out as one of the most important personal rights. Clearly, the root of the centrality of property was derived from Locke’s reasoning in the *Second Treatise of Government* (1690), which postulates a civil or political society founded on just laws, which are not available in a state of nature, no matter how rational men could be or how harmoniously they might work together. Even in this scenario, common rules of justice, accepted as part of a free compact, were necessary to avoid the vagaries of the individual’s judgment. As already indicated, in the first half of the seventeenth century, the Pilgrims anticipated Locke’s reasoning. In “Federalist Paper number 10,” however, James Madison was more explicit than Locke. Justice, according to Madison, was needed to regulate the potentially lethal conflicts arising from disagreements on property. This regulation envisaged the rise of factions as inevitable, but sought to contain its effects by dispersing those factions through the whole society.

It might appear that Madison's vision of a society fragmented into different factions would be a denial of Winthrop's concern for a strong community. But this is not the case. Winthrop's community was one among many others and, in this sense, it might be seen as a faction in Madison's use of the term. In a nutshell, Madison argues that the diversity of factions would be the warranty against the prospect of a tyrannical majority. In a fragmented milieu, this majority would lack the means to arise, let alone to succeed. Hence the Lockean need of a central government that was conceived as the embodiment of a just social order seeking to regulate the disparity of interests. The anti-federalists consistently applied the logic of fragmentation. Just as a fragmented society was a guardrail against a tyrannical majority, so also a fragmented legislature would cancel the proclivity to factionalism. Hence a government in which all the classes of society should be represented as both the Federal Farmer and Brutus, two of the leading voices in the anti-federalist cause, insisted.

The slavery question that led to the Civil War (1861–1865) was the lightning bolt that limned the fissures underlying the moral and political landscape of the American society. Even when Lincoln's paramount concern was the preservation of the Union, and both the thirteenth and fourteenth amendment sought to create a new juridical reality for all people born under the jurisdiction of the United States, justice, understood as a set of principles and regulations serving as the moral compass of both individuals and public institutions, became more fragile and malleable. Neither women nor Native Americans were part of the notion of citizenship implicit in the post-civil war constitutional amendments. And in a series of decisions, the Federal Supreme Court reinstated inequalities and legal boundaries that the fourteenth amendment wanted to remove.

In the *Slaughterhouse Cases* (1873), the Supreme Court established a distinction between citizens of the United States and citizens of particular states, and concluded that Congress lacked power to regulate state actions in matters of local government, property, and civil rights. In other words, the court reasserted the "disjointed matters" that Emerson had mentioned in 1845. According to the legal doctrine of the *Slaughterhouse Cases*, the states, not the federal government, would be final arbiters in controversies pertaining to the same issues that had led to the Civil War. It would not take long to show how the purview of the state would perform when dealing with the rights of black citizens. In *United States v. Cruikshank* (1876), a case involving the murder of African-American citizens in Colfax, Louisiana, the sane court struck down the conviction of three white men. Writing for the majority, Chief Justice Morrison R. Waite found that the right of the victims to "peaceably assemble," as well as their right not to be deprived of life and liberty without due process, had not been violated. Furthermore, Waite argued that the power to initiate prosecution for murder belonged, exclusively, to the states. This was another way of saying that the dominant beliefs of particular states would prevail. If the states decided not to act, there would be no crime. In the *Civil Right Cases* (1883), the Supreme Court upheld racial segregation in public places, and in *Plessy v. Ferguson* (1895), put the seal of legality not only

on segregation, but also on the social inequalities that the fourteenth amendment intended to overcome.

These cases show that the providential view of justice of the puritans was superseded by all the ramifications embedded in the very first phrase of the preamble to the Constitution: "We the people . . ." It was a phrase that departed from the self-evident truths so prominent in the Declaration of Independence. And this phrase carried a foreboding about the unstable and precarious role of natural law arguments in the American conception of justice. More than a democratic sentiment, "We the people . . ." expressed the design of a secular order without any transcendental anchors. Since the phrase, along with the whole constitutional text, would receive its authoritative interpretation from a political institution presiding over a society that blurred the line between diversity (in which there are some common links) and fragmentation (in which common links are absent), the outcome would be far too evident. It is ironic that Representative John A. Bingham, Republican from Ohio, referred to the universal and "higher laws" principles that he saw inscribed in the Declaration of Independence when he argued for the need of the Fourteenth Amendment, while the Supreme Court would resort to the particular beliefs of the states when eroding the clear meaning of this amendment.

The fractures of a social order continued unabated in the early twentieth century, especially with the territorial expansion of the American empire. The newly acquired territories after the Hispano-American War (1898) would be excluded from the constitutional protections available to white citizens.

In the *Cherokee Nation v. Georgia* (1831), the Supreme Court abandoned the providential view of justice, and upheld rights emanating from an idea of cultural superiority; namely, upheld rights stemming from the power to define and impose a definition of a superior culture. In the *Plessy* case the Supreme Court mangled the constitutional meaning in order to demarcate a new reality that justified segregation and inferior citizenship. Thus, the trajectory of the United States Supreme Court clearly suggests that the idea of justice as a dimension of natural law has stood on precarious grounds and not played any significant role in legal controversies concerning minority groups. Natural law served neither Native Americans nor African-Americans. Natural law presupposes an agreement on universal principles of morality, an agreement that, in a context of moral and cultural fragmentation, was nowhere to be found. Native Americans had to be civilized. A civil war was needed to alter the juridical classification of African-Americans. Yet, natural law arguments continue to lurk in judicial decisions addressing private conduct or decisions. The right of privacy seems to be the closest area whose underpinning insinuates natural law principles.

John Rawls

As Gordon Wood argues, the pluralism so dear to the anti-federalists triumphed in the short run and became the dominant conception of politics in the American society. It was in the context of this pluralism that John Rawls developed and polished what turned out to be the most influential theory of

justice in the intellectual vistas of American society during the last three decades of the twentieth century.

With the publication of *A Theory of Justice* (1971), John Rawls set out to establish the institutional framework and the moral principles of a well-ordered society conceived in perpetuity. He did this by constructing an imaginary scenario that he called the “original position” and designing the parties who were to deliberate about the agreement that would rule their society. The arguments were then premised on the social-contract tradition to the extent that the end of deliberation was to reach a binding agreement for present and future generations. In the first version of his theory, Rawls saw the agreement on justice as a paradigm that would apply to all societies. In the original position, “a veil of ignorance” covers the parties, which means that they lack knowledge about their gender, race, social status, philosophical beliefs, and religious beliefs. In other words, they are selves that, placed in a context of fairness, would arrive at a fair agreement. This is why Rawls calls his theory “justice as fairness.” The assumption is that the lack of knowledge about personal and social features would lead the parties to advocate an institutional arrangement that would benefit all of them. The original position brings forth a basic agreement on two principles of justice: the principle of equal liberties and the difference principle. In *Justice as Fairness. A Restatement* (2001), Rawls offers his last articulation of these principles:

- a. Each person has the same inalienable claim to a fully adequate scheme of equal basic liberties, which scheme is compatible with the same scheme of liberties for all; and
- b. Social and economic inequalities are to satisfy two conditions: first, they are to be attached to offices and positions open to all under conditions of fair equality of opportunity; and second, they are to be to the greatest benefit of the least-advantaged members of society (the difference principle). (pp. 42–43)

The principle of equal liberties protects constitutional essentials that will be settled once and for all. There is no need to deliberate about them. The difference principle sets a goal, which is to maximize the long-term expectations of the least advantaged members of society over the long run. This maximization, Rawls believes, is achieved by providing a social minimum to the disadvantaged. It is worth mentioning that the right of property does not count as one of the constitutional essentials. Rawls even defends the creation of a distributive branch with the responsibility of watching over society to rein in excessive inequalities, though what counts as excessive is not specified.

In a second version of his theory, Rawls abandoned the quest of universality and declared that the parties were representatives of democratic citizens; namely, historical members of a particular society. His theory depended not on a metaphysical view of persons as empty shadows but on the political culture of the United States. In *Justice as Fairness: A Restatement*, Rawls says that his theory takes into account three

kinds of contingencies: social class, “native endowments,” and “good or ill fortune.” In light of this political culture, Rawls believes, there are two intuitive ideas that will justify the choice of his two principles of justice. The first idea stands for the moral equality of all citizens, while the second defends a system of fair cooperation. Bound together, these two intuitive ideas are seen as already embedded in the political vocabulary and practices of a constitutional democracy. More importantly, they are completely free of what Rawls calls “comprehensive moral doctrines,” which are doctrines that seek to provide all or partially encompassing answers to the deepest questions surrounding the meaning, if any, of life and the human good.

In the three decades after the publication of *Theory*, Rawls expanded and modified his arguments in several areas, while leaving intact its basic tenets. The most important upshot of his reflections was the articulation of what he called “political liberalism,” a liberalism that is bereft of questions of truth, the human good, and any transcendental realm; that is, it eschews any form of comprehensive doctrines. These doctrines are seen as belonging to the private sphere, and citizens should not use them in deliberations about justice. Furthermore, justice is expected to supersede the injunctions of comprehensive doctrines even in the private domain.

Under the aegis of political liberalism, the emphasis is not so much on distributive justice as it is on the quest of an overlapping consensus embracing all reasonable doctrines that may flourish in a constitutional democracy. Political liberalism is deeply aware of the fact of pluralism in modern times and the impossibility of having a universal agreement on a single conception of the human good. Hence the need of fair principles of justice to achieve the overlapping consensus Rawls seeks to undergird stability. Rawls assumes that “justice as fairness” is capable of commanding the kind of support a theory of justice needs to provide stability. He further assumes that, in a well-ordered society, citizens see themselves as fully cooperating members of society over their whole life. The terms “reasonable” and “fully cooperating” mean that people will see the two principles of justice as moral principles, abide by their outcomes, and use them in choosing and revising their conceptions of the human good.

Rawls’s theory is vulnerable to a question that “justice as fairness” leaves unanswered: how could the second principle maximize people’s long-term expectations when all Rawls expects from the state is the allocation of a social minimum? This question leads to a problem that haunted the Rawlsian view. In both *Theory* and *Political Liberalism* Rawls accepts that his well-ordered society is compatible with the existence of large economic inequalities. As long as the constitutional essentials are preserved and the difference principle is in operation, these inequalities will not tarnish the moral character of a Rawlsian society. Though the issue of large inequalities is present in *Justice as Fairness: A Restatement*, Rawls introduces the following modification. Instead of writing about maximizing the long-term expectations of the least advantaged over the long run, he writes about “an appropriate interval of time” in which the expectations mentioned above should be maximized.

Other theories of justice. Though John Rawls's theory of justice set the context for discussions of justice in the last three decades of the twentieth century, it was not the only theory advanced. Ronald Dworkin developed his own theory that he calls "Equality of Resources." This theory insists that, without the need of resorting to an original position, people ought to be aware of the true cost of their life-plans for other people, and to be willing to redesign these life-plans when they go beyond the fair share of resources available to all citizens. Unfortunately, Dworkin is not clear about the criteria and the institutions that will decide what a "fair share" of resources is and when the individual is taking more than what this "fair share" demands. Iris Marion Young brought to the fore an alternative conception of justice that relies not on an abstract equality but on the recognition that different groups have different needs and, accordingly, may require unequal allocations of public resources. At first sight, this view seems to reject the universal understanding of justice that imbued the Rawlsian philosophy, but, ultimately, Young advocates general rules of justice to regulate the competing interests of a group-based politics.

Communitarianism and Liberalism

During the 1980s, the American conception of justice revolved around the conflicting arguments of liberalism and communitarianism. The ensuing debates had at their core the role of visions of the human good and the question of how the individual's identity is formed, and not issues of distributive justice. Michael Walzer, Michael Sandel, and Alasdair MacIntyre stood out as thinkers who challenged the Rawlsian view and its design of a situation in which selves who are bereft of any contingent traits are expected to arrive at a universally binding agreement on justice. On this issue, the communitarian side won the day. Rawls admitted that the parties to the original position are representatives of democratic citizens, thus introducing a substantial element of contingency into his assumptions. On the further issue of the need of shared values to sustain a just order, the communitarian standpoint also prevailed. Rawlsian justice obtains guidance and derives its principles from the common values that distinguish the constitutional democracy of the United States.

But for all its insistence on how conceptions of the human good ought to guide visions of justice, communitarianism did not muster enough theoretical resources to deal with the fact that, in contemporary societies, multiple and opposing views of the human good are fated either to accept one another or to compete for supremacy via state power. This is not to say that the different versions of political liberalism articulated, among others, by John Rawls and Charles Larmore, fared better. In Rawls's and Larmore's theories, the agreement on principles of justice has an important rider. The agreement is only concerned with people who may hold reasonable conceptions of the human good. And a reasonable conception is one that accepts the principles of justice. Communitarianism excludes conceptions of the human good at variance with the dominant views of a particular society, and contemporary liberalism excludes comprehensive doctrines that justice has not certified as reasonable. Yet, the liberal argument that, in a context

ridden by conflictive ideas, an agreement on principles of justice is more feasible than one on a conception of the human good, remains unassailable.

The end result is circularity, which according to Richard Rorty is the most that can be expected in a world devoid of ultimate foundations. Individuals ought to justify their principles, Rorty argues, not by invoking a transcendental realm or a universal or true morality, but by referring to those principles and institutions that have proven, so far, to provide stability and respect for people. A conception of justice should be described by making reference to its outcomes, and these outcomes ought to be described by referring back to the principles of justice.

Michael Walzer was the only philosopher who put forward a communitarian version of justice. Walzer's theory distances itself from the Rawlsian paradigm by positing a diversity of social goods that obtain their meaning from their society and inhabit different social spheres. These spheres are not meant to cross their boundaries. The sphere of need is not the sphere of desert and, accordingly, they should not be judged according to a single criterion. Similarly, a social good in one sphere should not carry any import in another or, in Walzer's words, should not be "convertible." Wealth in the economic sphere should not be translated into more political power or access to better health care. He calls his theory "complex equality" as a contradistinction to "simple equality," which is the term he uses to describe Rawlsian justice. In simple equality, the state needs to intervene frequently to curtail any hindrances that may undermine the difference principle. In complex equality, "the autonomy of distributive spheres" is vindicated, and individuals, not the state, would have "local monopolies," but social conflicts would be diffused across the social and political spectrum. Local monopolies refer to the goods some people may control. Physicians, through their education, experience, and talents, control their areas of expertise. But it does not follow that this monopoly entails power to determine people's needs. These needs ought to be defined by the community. "Equality," Walzer writes, "is a complex relation of persons, mediated by the goods we make, share, and divide among ourselves; it is not an identity of possessions. It requires then, a diversity of distributive criteria that mirrors the diversity of social goods" (p. 18). The demarcation of the spheres of justice will depend on the dominant morality of a particular society. While Rawls argues that his arguments belong in the realm of ideal theory, Walzer goes into historical examples to buttress his theoretical reflections.

Moral Context of Justice

The last word on the moral context of justice in American thought might belong to William Connolly and Alasdair MacIntyre. Connolly defends an agonistic ethos in which a person's identity, the same identity that the Puritans saw as fixed by God's grace, could recognize its contingent character. In this recognition, Connolly sees a conversation in which cherished assumptions about the individual's character and the United States' foundations would be open to redefinitions and negotiations. MacIntyre did not feel at home in this conversation, which in his view is sequestered by a liberal marketplace

of ideas regulated by justice. In his discussion of virtue, he envisages a rather dark horizon for the American intellectual landscape. Current times, he argues, are analogous to the era when the Roman Republic dwindled and finally fell. As in those times, citizens should retreat from the public sphere and move to small communities that may share the same conception of the human good. This, again, is the fragmentation that has been a constitutive element of the American landscape. Rawls himself is not free from the suspicion that his theory, though envisioning a stable interplay between a multiplicity of social unions, is ridden, too, by a fragmented ethos.

Indeed, Rawls's theory treads its way along two paths that are prone to deny one another. There is a strong sense of community to the extent that members of particular groups see their worth as being determined by the appreciation they receive from others. For self-esteem, in Rawls's view, does not depend on the individual's convictions, but on the external approval of his or her peers. This is similar to Winthrop's understanding of love, which is an "apprehension of some resemblance in the things loved to that which affects it . . . soe a mother loves her childe, because shee throughly conceives a resemblance of herself in it" (p. 37). As in the Puritan context, the Rawlsian sense of community requires clear delimitations. Since a Rawlsian society may have large inequalities that, through envy, may bring havoc to stability, the plurality of associations comes to the rescue. These associations tend "to reduce the visibility, or at least the painful visibility, of variations in men's prospects. . . . The various associations in society tend to divide it into so many noncomparing groups, the discrepancies between these divisions not attracting the kind of attention which unsettles the lives of those less well placed" (Rawls 1971, p. 537).

From John Winthrop's message that the rich and the poor ought to accept their place as part of a divine order, to the Federalist recognition of the unavailability of factions, the anti-federalist advocacy of a fragmented legislature, and John Rawls's call to avoid the "painful visibility" of "variations in men's prospects" by dividing society into "noncomparing groups" that would not intersect in their respective paths, unity and fragmentation stand as consistent strands in the way justice has been woven into the inner fabric of American thought. In this consistency, "justice as fairness" appears as a dim echo of the arguments John Winthrop put forward aboard the *Arabella*.

See also Abolitionism; Philosophies, American; Philosophy, Moral; Modern; Pluralism; Populism; Pragmatism.

BIBLIOGRAPHY

- Beveridge, Albert J. "In Support of an American Empire." U.S. Senate. 56 Cong. 1 sess., 704–712.
- Connolly, William. *Identity/Difference: Democratic Negotiations of Political Paradox*. Ithaca: Cornell University Press, 1991.
- Douglass, Frederick. *The Life and Writings of Frederick Douglass: Supplementary Volume*. Vol. 5: 1844–1860. Edited by Philip S. Foner. New York: International Publishers, 1975.
- Dworkin, Ronald. "What Is Equality? Part 2: Equality of Resources." *Philosophy and Public Affairs* 10, no. 4 (fall 1981): 283–345.
- _____. "What Is Equality? Part 3: The Place of Liberty." *Iowa Law Review* 73, no. 1 (October 1987): 24–50.
- Larmore, Charles. *Patterns of Moral Complexity*. Cambridge, U.K.: Cambridge University Press, 1987.
- "Letters I, III–IV." In Alexander Hamilton, James Madison, and James Jay, *The Federalist: With Letters of Brutus*, edited by Terence Ball, 453–465. Cambridge, U.K.: Cambridge University Press, 2003.
- "Letters II, V." In *The Complete Anti-Federalist: Writings by the Opponents of the Constitution*, edited by Herbert J. Storing, selected by Murray Dry, 60–65. Chicago: Chicago University Press, 1981.
- Locke, John. *A Second Treatise of Government*. Edited by C. B. Macpherson. Indianapolis: Hackett, 1980.
- Lutz, Donald S., ed. *Colonial Origins of the American Constitution: A Documentary History*. Indianapolis: Liberty Fund, 1998. See especially: "Articles, Laws, and Orders, Divine, Politic, and Martial for the Colony in Virginia. 1610–1611," pp. 314–326; "Laws Enacted by the First General Assembly of Virginia, August 2–4, 1619," pp. 327–335; "[Agreement Between the Settlers of New Plymouth] (The Mayflower Compact). November 11, 1620," pp. 31–32; "Plymouth Oath of Allegiance and Fidelity (1625)," pp. 33–34; "Pilgrim Code of Law, November 15, 1636," pp. 61–67; "Dedham Covenant. 1636," pp. 68–69.
- MacIntyre, Alasdair. *After Virtue*. 2nd ed. Notre Dame: University of Notre Dame Press, 1984.
- Madison, James. "Federalist Paper No. 10." In Hamilton, Madison, and Jay, *The Federalist: With Letters of Brutus*, edited by Terence Ball, 40–46. Cambridge, U.K.: Cambridge University Press, 2003.
- Madison, James (Bishop). "Manifestations of the Beneficence of Divine Providence towards America." In *Political Sermons of the American Founding Era, 1730–1805*, edited by Ellis Sandoz, 1305–1320. Indianapolis: Liberty, 1991.
- Mather, Increase. "A Brief History of the War with the Indians in New England." In *So Dreadfull a Judgment: Puritan Responses to King Philip's War, 1676–1677*, edited by Richard Slotkin and James K. Folsom, 81–163. Middletown, Conn.: Wesleyan University Press, 1978.
- Rawls, John. *Justice as Fairness: A Restatement*. Edited by Erin Kelly. Cambridge, Mass.: Harvard University Press, 2001.
- _____. *Political Liberalism*. New York: Columbia University Press, 1993.
- _____. *A Theory of Justice*. Cambridge, Mass.: Harvard University Press, 1971.
- Rorty, Richard. *Contingency, Irony, and Solidarity*. Cambridge, U.K.: Cambridge University Press, 1989.
- Sandel, Michael. *Liberalism and the Limits of Justice*. Cambridge, U.K.: Cambridge University Press, 1982.
- Walzer, Michael. *Spheres of Justice: A Defense of Pluralism and Equality*. New York: Basic Books, 1983.
- Winthrop, John. "A Modell of Christian Charity." In *American Sermons. The Pilgrims to Martin Luther King Jr.*, 28–43. New York: The Library of America, 1999.
- Wood, Gordon S. "Interests and Disinterestedness in the Making of the Constitution." In *Beyond Confederation*, edited by Richard Beeman, Stephen Botein, and Edward C. Carter II, 69–107. Chapel Hill: University of North Carolina Press, 1987.
- Young, Iris Marion. *Justice and the Politics of Difference*. Princeton, N.J.: Princeton University Press, 1990.

Roberto Alejandro

JUSTICE IN EAST ASIAN THOUGHT

East Asian thought should include a wide range of Japanese, Korean, and Chinese concerns covering more than twenty-five hundred years of history. This article is limited to the Chinese sphere, and its primary focus is on the preimperial period (before 221 B.C.E.).

How issues related to justice have appeared in the preimperial Confucian (“Ruist”) and Daoist traditions involves both historical and philosophical investigation. While penal codes (“corrective justice”) were enforced even by the ancient sage, Confucius (Master Kong; 551 B.C.E.–479 B.C.E.), the political emphasis of Confucian scholars in general was to support an elitist system where humane forms of fairness provided flexible standards for determining the appropriate distribution of opportunities and goods (“distributive justice”) and so sought to lessen the need for corrective justice. Early Daoist philosophical texts advocated an alternative way, something like a benign form of anarchism. Their rulers would be compassionate, frugal, and unobtrusive, allowing every person within the kingdom to follow the Way (*Dao*) in a spontaneous and uncontrived manner.

In what follows, central themes and institutions related to justice that appeared within Confucian and Daoist teachings in preimperial China will be explained and evaluated, followed by brief comments about later developments.

Preimperial Confucianism

Three persons stand out as fulcrum figures in preimperial Confucian developments: the pioneer sage, Confucius; the apologist, Mencius (Master Meng; c. 371 B.C.E.–c. 289 B.C.E.); and the secular rationalist, Master Xun (Xunzi; active c. 298 B.C.E.–c. 230 B.C.E.). While the influence of Confucius’s life and teachings overshadows the other two, the latter pair produced more systematic worldviews, including questions related to justice that continue to have historical significance.

Confucius, or “Master Kong.” Records about political policies and concepts in ancient China began at least five hundred years before Confucius, but his teachings provided the first philosophical basis for its ideological and institutional development. His political vision rested on these earlier sagely antecedents but sought to provide moral and political justifications for reestablishing the monarchical form during his own instable age. Conceiving of a ritually articulate group of intellectuals who could balance the interests of smaller political states and establish a larger and harmonious kingdom, Confucius promoted cultivated humaneness (*ren*) as the necessary cultural foundation for the king, government ministers, and his people. Any person who achieved this exemplary status knew how to properly subdue selfish interests in order to perform ritually appropriate services according to their given roles and duties (*Analects* 12:2). All these ritual actions (*li*)—whether among humans or toward spirits including a supreme deity known as “Heaven”—were consequently conditioned upon a sense of rightness (*yi*). Propriety between humans should always seek an appropriateness intuited through analogical projection (*shu*) and faithful consistency (*zhong*). Embodied in these two methods was a generalized sense of

Tzu-lu said, “If the Lord of Wei left the administration of his state to you, what would you put first?” The Master said, “If something has to be put first, it is, perhaps, the rectification of names. . . . When names are not correct, what is said will not sound reasonable; when what is said does not sound reasonable, affairs will not culminate in success; when affairs do not culminate in success, rites and music will not flourish; when rites and music do not flourish, punishments will not fit the crimes; when punishments do not fit the crimes, the common people will not know where to put hand and foot.”

SOURCE: Confucius, *Analects* 13:3, translated by D. C. Lau (Harmondsworth, U.K.: Penguin, 1979).

personhood, though ancient traditions indicate how Confucius recognized limitations in their application to women, slaves, and angry persons (*Analects* 14:34, 17:25).

Some scholars feel that this account of ritual-based personhood offers a generalizable humane alternative to modern human-rights-based litigation. So, for example, while Confucius did mediate in litigations (*song*), he sought to create social conditions where they would not be needed (*Analects* 12:13). In defining the roles of rulers and ministers, he de-emphasized punishments (*xing*), seeking that they humanely fit the crimes rather than produce fear of authority (*Analects* 2:3; 4:11; 13:3). Nevertheless, later Confucian teachings in the *Book of Rites* advocated moral justifications for blood-revenge as a putative principle supported by Confucius, illustrating limits to this elitist form of fairness in later imperial history.

Mencius, or “Master Meng.” Political justifications for humane government were explored at greater length in the *Mengzi*, a work named after Mencius. Cultivated humaneness and rightness became twin virtues grounding all moral and political life, nurtured initially in familial relationships and extendable into other appropriate social ties. Both virtues were intended to be augmented by wise elaborations, ritual articulateness, and harmonious music (*Mengzi* 1A:7; 4A:27). Significantly, a society dominated by a humanely cultivated lifestyle would entail in Mencius’s philosophy various claims and liabilities within relationships, even to the extent that a tyrannical ruler could be resisted and justifiably deposed (*Mengzi* 1B:1, 3). Maintaining rightness (*yi*) was more important than life itself, whenever dilemmas forced a choice between them (*Mengzi* 6A:10). In this emphasis there are tendencies toward asserting a humanely inspired form of social justice, based on a positive account of human nature.

According to Mencius, all persons are defined as humans because they possess four basic moral sensitivities without which they could not appropriately participate in human society: compassion, shame, respect or yielding, and discerning between right and wrong (*Mengzi* 2A:6; 6A:6). When these inward sensitivities are nurtured into full-fledged virtues (humane cultivation, rightness, propriety, and wisdom), any willing person becomes exemplary and may attain sagely status. Once these virtues are embodied in exemplary persons and leaders, social obligations are fulfilled and beneficent forms of government can be realized and sustained. The crucial social transformations they would inspire would be nurtured by worthy officers and cultivated scholars. This would result in a harmonious society expressing just and accountable relationships.

Mencius also offered details about how this elitist form of social justice would operate. He envisioned opportunities for fair treatment by providing public education and coordinating publicly and privately owned farming, so that government institutions were sustained by appropriately cultivated personnel and sufficient material resources, and no one family was overburdened by taxes. While there is no indication that these institutions were ever realized in his own time, they do reveal how Mencius's philosophy could bear a populist flair. Never democratic in polity, his political philosophy manifested demophilic (*minben*) principles of regal concern for commoners, and so set limits to any ruler's authority by arguing for these moral restraints within a kingdom.

These early Confucian scholars promoted justice as arising from virtues cultivated among a chosen elite, in some ways like Plato's conception of a righteous city-state in his *Republic*. Aristotle's support for limited democracy also suggests that justice should produce harmony between different classes within society, but these early Confucian philosophers preferred monarchy, and their vision of social harmony was not worked out in detail. Both early Confucian and Greek visions of social justice rely on rational criticisms and selective adoptions of received traditions, but the former relies more heavily on sagely precedents, while the latter promoted rational development through education and practices leading to ethical competence. Clearly, the predominance of a rational method and rationalized ideal of human nature in Plato's discussion is qualified by the early Confucians' multidimensional account of human nature based on a harmony of emotive and rational constituents. Here Aristotle and these early Confucians have much in common, but Aristotle retains a preference for rationalized understandings of ethics and social justice, while the Confucians placed more emphasis on basic emotional sensitivities. All of them nevertheless agreed that the best form of society would be achieved through the guidance of cultivated rulers imbued with the virtues they promoted.

Master Xun. Unlike previous Confucian philosophers, Master Xun conceived of ritual and role attunements as a result of teaching rather than of internal personal cultivation, so that sociocultural values were inculcated rather than nurtured from within. Believing that human beings were naturally bad, Master Xun highlighted the roles of cultural change agents—sages, teachers, good friends—in educating willing persons. He explained

differences in cultivated attainments and social roles as a result of different intellectual capabilities and various degrees of courage (*Xunzi* 23). Consequently, his account of *yi* aligns well with Platonic understandings of justice: an enlightened ruler (*ming jun*) must clearly distinguish class divisions and their appropriate roles, supporting them by ritual principles, righteous laws, and uniform administrative policies (*Xunzi* 10). Standards of distributive justice, while providing certain privileges to the elite leadership class, operate generally under utilitarian conditions: the whole society (*qun*) is always more important than the ruler or any other member or clique within it. Consequently, what is good is “correct, in accord with natural principles, peaceful, and well-ordered”; what is bad is “wrong through partiality, wickedly contravenes natural principles, [is] perverse, and rebellious” (*Xunzi* 23). These standards are also applied economically in considering distribution of limited resources, fully recognizing that the ruler and the people will either thrive or devolve together because, even in spite of their class differences, each one constitutes only a part of the social whole.

Master Xun manifestly employs a more rationalized methodology in accounting for varieties in human personalities, social classes, and roles, as well as the methods for attaining and maintaining social order. In spite of his utilitarian standards for administering distributive justice, his use of criminal justice is still inspired by a humanely cultivated ideal, that all persons can ultimately be transformed and become sagely. In this way he balances punitive and distributive justice by means of a rational appeal to a more secularized, but still firmly ritually oriented, form of harmonious society.

Given the importance of ritual orientations for Confucian society, women and slaves seem clearly to have been relegated to subservient roles in many settings. Ritual formalization became complete in the imperial period, greatly influenced (somewhat paradoxically) by the female politician Ban Zhao (c. 48–c. 120). These restrictive rites and their attendant values set the stage for later nonegalitarian developments.

Preimperial Daoism

Both the historical identification of Old Master (Laozi) and the nature of the famous Daoist text normally associated with him, *Dao de jing*, have become controversial topics of debate. Rather than some ancient text scripted by a mysterious pioneering recluse, the book of *Laozi* is now generally associated with the same period as the *Zhuangzi*, appearing during the fourth century B.C.E. Nevertheless, political themes are a major aspect of the eighty-one chapters of this Daoist scripture, whether in its standard or earlier forms. In the case of the *Zhuangzi*, it is the first seven chapters of the book that are considered most representative of the historical person, Master Zhuang (c. 369 B.C.E.–286 B.C.E.). These early Daoists' views of society have been put into sharper contrast by developments within the so-called Huang-Lao school occurring in the fourth and third centuries B.C.E., which provided mediating and positive social doctrines carrying much influence during the early imperial period.

Dao de jing and the Zhuangzi. The form of social justice found in the *Dao de jing* has been described as a benevolent

anarchism, but in fact it does speak of sagely rulers and supports some overriding moral and political values within Dao-centered communities. Taking spontaneity and noninterference as major principles of communal life, the text vigorously opposes artificial impositions of Confucian elitist values (such as sageliness, wisdom, humaneness, rightness) or other utilitarian interests (such as military aggressiveness or social benefits), since all of these are considered to be contrived restraints that harm the people (ch. 19). Instead it urges all, including the ruler, to have “little thought of self and as few desires as possible.” Under these conditions, people will be able to lead Dao-centered lives without interference, being naturally kind and faithful, and so will become self-transformed. Whether a large or small political state, each takes a “lower position” (ch. 61) and so they become harmonized through mutual responsiveness rather than aggressiveness. Images of an ideal state suggested that the people would live simply, being contented with what they have, and so may even live and die in a place without ever leaving it (ch. 80). This is because a Daoist ruler would be exemplary in embodying “three treasures”: compassion, frugality, and “not daring to take the lead” in the community (ch. 67). So unobtrusive is this way of ruling that people would feel all things move naturally, and would only know the fact that the ruler is there. Any other form or ruling (whether by charisma, fear, or rules) could not achieve the personal peace and social harmony that the Daoist ruler attains by unobtrusive and spontaneous action (*wu wei*). Daoist justice of this sort is therefore manifest in stoic-like naturalness, for the Way will be followed by avoiding extremities and learning the paradox that greater and lasting strength lies in what is putatively weak. Guided by sympathetic and frugal leadership, people living within Dao-centered communities would be unconcerned about any rationalized worldview and its attendant values, such as penal codes and rules regarding possessions. Among other values promoted by Daoists, feminine qualities were raised to a new height, defining the fecundity of the Dao in maternal terms. As a consequence, roles for women and feminine values in general were enhanced within early Daoist circles, but this would change later when Daoist religious ethics gradually adjusted to Confucian precedents.

In the *Zhuangzi* there is a vigorous skepticism at work, challenging any attempt to go beyond the principle of noninterference. Expressing sarcastic opposition toward government and other social institutions, the “Inner Chapters” (the first seven chapters) view these matters regularly from a transcendent perspective. Narrow pettiness and self-inflicted harm are the regular results of government policies. This is a Rousseau-like vision: humans who follow the Way can be free and creative, but society has imposed institutional shackles that make this impossible. As a consequence, Master Zhuang supports a more anarchistic vision of a simple life expressed in radical egalitarianism, letting everyone live by means of the Way according to their own inclinations and without external restrictions.

The Huang-Lao school. Archeological discoveries in the 1970s stimulated further consideration of another facet of Daoist reflection, one that developed more positive doctrines of governance and rightness. Living about the time of Masters

Zhuang and Xun, intellectuals from the state of Qi developed a mediating approach to earlier Daoist doctrines. They understood the secret of life and governance by responsiveness to proper timing, and so sages and institutions must be responsive to the natural changes that occur over time. Consequently, institutions that are outdated (such as Confucian rites) should be reformed to become suitable. Their worldview included the idea that laws and institutions could emerge from an understanding of the Way, and would necessarily reflect the needs of people as well as historical change in society. Political life continued to assert that the ruler be spontaneous and unobtrusive, but this was because appropriate institutions and laws were in place, and ministers were taking care of the administrative details associated with them. In this way, the Huang-Lao tradition advocated a version of justice closer to the position of Master Xun, but without its rationalized and utilitarian emphases.

Subsequent Developments

Once the Qin dynasty was established and a greatly enlarged Chinese imperial state was brought into being (221 B.C.E.), standards of ethical and political life shifted gradually from legalistic and Huang-Lao forms of life to a dominant Confucian cultural standard. For most of the 2,200-year-long imperial period, Confucian advocates dominated the political arena. Nevertheless, the Huang-Lao school did have a revival and development during the third and fourth centuries, especially as seen among the writings of “neo-Daoists” or advocates of Abstruse Learning (*Xuánxué*). They envisioned the “lone transformation” (*dubua*) of all persons, developing a theme advocated by Master Zhuang. This included a radical form of egalitarianism, but also advocated a reformist vision of changing institutions according to the times and conditions of life.

The most outstanding contributions to Confucian traditions came during the Song dynasty (ninth to twelfth centuries). Confucian scholars then promoted a form of political justification that based all social values on heavenly patterns (*tianli*), resembling many aspects of a natural-law system of ethics and governance. Justice was then determined by alignment with patterns of heavenly harmony and was rationalized in a rigorous manner by Zhu Xi (1130–1200), whose interpretive precedents became the standard Confucian teachings for much of the subsequent seven hundred years. Under these more expansive cosmological influences, the roles of women became framed within a set of more subordinate conditions associated with universal symbols systematically denoting the passiveness and receptivity of earth, flexibility, coolness, fecundity, and hiddenness. Family rituals were established by Zhu Xi that formalized these relationships in a manner that reflected patriarchal values and that had been less systematic during earlier centuries. Though mothers in particular were highly honored within systems of filial allegiance, their own roles within the family were largely restricted. This became all the more entrenched in general society during the Ming and Qing dynasties (fourteenth to early twentieth centuries).

Alternative Confucian visions included remarkably advanced democratic ideals opposing imperial policies in Huang

Zongxi's (1610–1695) writings—ideals that were never realized and became justifications for revolution in 1911—and the utopian egalitarian vision of a great commonwealth (*datong*) advocated by the influential reformer, Kang Youwei (1858–1927). This latter vision was unusual in both its pseudoscientific idealism, promoting government-sponsored eugenic reconstructions of human societies, and its advocacy of a radical egalitarian worldview based on a relatively hedonistic ethic, thus offering much more freedom to women than had been previously considered proper or feasible.

Law and Justice during the Ming and Qing Dynasties

Legal codes during the last two dynasties of imperial China were framed under values undergirding patrifamilial order and class differences. In principle, lands belonged to a family in perpetuity, but when faced with the need for survival many commoners sold these lands under leases that often brought privilege and power to the already wealthy. Courts did uphold reclaiming these properties, as a form of traditional justice, when the previously needy families had overcome their difficulties, but otherwise debts were in principle to be paid. Only in the case of economic desperation, hinging on basic survival, were compromises reached, mostly outside of court. These compromising tendencies, however, led to situations in which women could be sold as daughters, wives, or widows in order to raise adequate funds to meet basic needs. Though a woman might be able to return to her natal home if other needs were demonstrated, she was seen always as a passive agent in a social context where men's choices dominated. So, for example, a married woman could be expelled from marriage and sent to her natal home for seven basic reasons under these patrifamilial assumptions: barrenness (especially, bearing no male child), licentiousness, negligence in the care of her parents-in-law, talkativeness, theft, jealousy, and chronic illness. Though female virtues could also be employed legally to protect a woman's dignity, such an endeavor regularly required extensive evidence, and the burden of proof was often costly in both social and personal terms. In this regard, traditions generally supported patrifamilial structure, so that women were disadvantaged in inheritance, personal choices, and political options. Major legal changes in these areas began to take place only after 1911 with the advent of republican China.

See also *Confucianism; Daoism; Law; Legalism, Ancient China*.

BIBLIOGRAPHY

PRIMARY SOURCES

Legge, James. *The Chinese Classics*. Oxford: Clarendon, 1893–1895. A standard rendering and authoritative interpretation of the *Four Books* and three ancient Confucian canonical scriptures by this famous Scottish missionary-scholar.

———. *The Sacred Books of China*. Oxford: Clarendon, 1879–1891. Six volumes in the *Sacred Books of the East*, edited by F. Max Müller. Vols. 3, 16, 27, 28, 39, 40. Revised and new translations of Confucian and Daoist canonical scriptures.

SECONDARY SOURCES

- Bontekoe, Ron, and Marietta Stepaniants, eds. *Justice and Democracy: Cross-Cultural Perspectives*. Honolulu: University of Hawai'i Press, 1997. Includes helpful articles on Asian and comparative perspectives.
- Cheng, Chung-ying, et al. Special Issue on Rawlsian and Confucian Justice. *Journal of Chinese Philosophy* 24, no. 4 (December 1997). Consists of six separate articles addressing different aspects of this comparison.
- Feng, Youlan. *A History of Chinese Philosophy by Fung Yu-lan*. 2 vols. Translated by Derk Bodde. Princeton, N.J.: Princeton University Press, 1952–1953.
- Huang, Philip C. C. *Code, Custom, and Legal Practice in China: The Qing and the Republic Compared*. Stanford, Calif.: Stanford University Press, 2001. Describes actual cases, including accounts about land ownership, handling of debts, old age provisions, and dynamic and oppressive elements in stipulations related to women in general society.
- Lee, Lily Xiao Hong. *The Virtue of Yin: Studies on Chinese Women*. Broadway, Australia: Wild Peony, 1994. Poignant stories about Chinese women, including an essay on Ban Zhao.
- Lee, Seung-Hwan. "Was There a Concept of Rights in Confucian Virtue-Based Morality?" *Journal of Chinese Philosophy* 19 (1992): 241–261. Seminal article claiming that rights-like concepts did exist in ancient Confucian texts and were norms for practice in ancient Chinese societies.
- Liú Zéhuá, ed. *Zhōngguó Zhèngzhì Sixiang Shi*. Hangzhou, China: Zhejiang People's Press, 1996. 3 vols. A thorough study covering twenty-five hundred years of Chinese political thought, including Confucian, Daoist, and Buddhist contributions.
- Peerenboom, Randall P. "Confucian Justice: Achieving a Humane Society." *International Philosophical Quarterly* 30 (1990): 17–32. A comparative philosophical analysis of a secularized version of justice from a Confucian-inspired vision of humane society.
- Pfister, Lauren F. "A Study in Comparative Utopias—K'ang Yu-wei and Plato." *Journal of Chinese Philosophy* 16, no.1 (1989): 59–117. Showing points of comparison between Plato and certain Confucian themes embodied in an unusual work by this nineteenth-century Chinese intellectual and reformer.
- Sim, May. "Aristotle in the Reconstruction of Confucian Ethics." *International Philosophical Quarterly* 41, no. 4 (2001): 453–468. Showing points of comparison between Aristotle and early Confucian traditions.
- Wood, Alan T. *Limits to Autocracy: From Sung Neo-Confucianism to a Doctrine of Political Rights*. Honolulu: University of Hawai'i Press, 1995. Provides constructive comparisons between European medieval natural rights ideologies and Song dynasty (tenth to twelfth centuries) principle-centered Confucian political ideology.

Lauren F. Pfister
Fèi Lèrén



K

KANTIANISM. The philosophy of Immanuel Kant (1724–1804) radically transformed the rationalism and empiricism of the seventeenth and eighteenth centuries and has set many of the problems for epistemology, metaphysics, and philosophy of science, moral and political philosophy, aesthetics, philosophy of history, and philosophy of religion ever since. Almost all philosophy after Kant could be divided into either “Kantianism” or “anti-Kantianism,” but it is natural to reserve the term *Kantianism* to designate the philosophy of Kant himself, his immediate followers, and a variety of movements in the late nineteenth century and the twentieth century that have explicitly identified themselves with Kant.

Immanuel Kant

Kant developed his philosophy after thirty years of reflection on foundational problems in contemporary natural science; on the rationalism of René Descartes (1596–1650), Gottfried Wilhelm Leibniz (1646–1716), and Christian Wolff (1679–1754); on the critique of rationalism by Christian August Crusius (c. 1715–1775) and David Hume (1711–1776); and on the political and educational views of Jean-Jacques Rousseau (1712–1778). Kant presented his mature views in the *Critique of Pure Reason* (1781, substantially revised in 1787), the *Critique of Practical Reason* (1788), and the *Critique of the Power of Judgment* (1790); in the *Prolegomena to Any Future Metaphysics* (1783) and *Groundwork of the Metaphysics of Morals* (1785); in two detailed works applying his general principles, the *Metaphysical Foundations of Natural Science* (1786) and the *Metaphysics of Morals* (1797), comprising a “Doctrine of Right” and a “Doctrine of Virtue”; and in polemical works such as *Religion within the Boundaries of Mere Reason* (1793), a bold argument that the central concepts of Christianity can have only symbolic value for pure reason, and *The Conflict of the Faculties* (1798), an argument for the freedom of philosophical thought.

In these works, Kant argued that both ordinary experience and natural science rest on informative but certain principles, or “synthetic a priori cognitions,” such as that every event we can place at a determinate position in time must be linked to antecedent events by causal laws, which we can explain only by supposing that they reflect the forms of our own thought, in particular the spatial and temporal forms of our intuitions or perceptions and the logical categories of our understanding that we impose on our experience. But by the same token, these forms of intuition and thought can determine only how things appear to us, not how they are in themselves (Kant called this doctrine “transcendental idealism”). Kant then ar-

gued that when we conceive of the soul, the world as a complete whole, or God, we overstep the limits of our sensory perception and can have no genuine knowledge of such things.

However, the gap between appearance and things in themselves that explains the certainty of the application of the fundamental principles of our knowledge to the former also makes it at least possible for us to conceive of, if not know, the latter, particularly to conceive of ourselves as being free to make moral choices that may seem inconsistent with the determinism of our actions in the empirical world and of a God who is the author of laws of nature that are ultimately consistent with the laws of morality. Kant argued that the latter are given by our own pure practical rather than theoretical reason and that we can know them without any appeal to God; the laws of morality are discerned by pure reason as necessary to achieve autonomy, the independence of our actions from determination by the mere inclinations of ourselves or others.

Kant then argued that the fundamental principle of justice is that each person must be allowed the maximal freedom of action consistent with a like allowance for all others and that we have ethical duties to promote the free and effective use of our capacities to set and pursue our own ends and those of others, which cannot be coercively enforced within the political sphere. Finally, Kant argued that our pleasures in the beautiful and the sublime are experiences of the disinterested freedom of the imagination from constraint by the direct demands of science and morality, but also that as an experience of freedom of the imagination, aesthetic experience is indirectly conducive to moral and political development. He also argued that a teleological view of nature as a purposive system, while of merely heuristic value for the pursuit of natural science, is also a morally valuable perspective on the world and our place within it.

First Response

Kant’s work immediately produced both acclaim and hostility. It was first popularized by the 1786 *Letters on the Kantian Philosophy* by Karl Leonhard Reinhold (1757–1823), but by 1789 Reinhold had turned against Kant’s dualisms—his distinctions between sensibility and understanding, between appearances and things in themselves, and between theoretical cognition and practical reason—and initiated the attempts to derive all of philosophy from a single principle that would be taken up in the “absolute idealism” of Johann Gottlieb Fichte (1762–1814), Friedrich Wilhelm Joseph Schelling (1775–1854), and Georg Wilhelm Friedrich Hegel (1770–1831). Other thinkers remained closer to Kant, especially the poet

and historian Friedrich Schiller (1759–1805), who, in “On Grace and Dignity” (1793) and the *Letters on the Aesthetic Education of Mankind* (1795), argued for a greater confluence between our inclinations and our moral principles than Kant thought possible without being tempted by the monism of the absolute idealists. Johann Wolfgang von Goethe (1749–1832) was also deeply affected by Kant’s third critique in the development of his own conception of nature.

Neo-Kantianism

Hegel’s dominance of German philosophy in the 1820s through the 1840s ended the first wave of Kantianism, but the version of Kantianism propounded by Arthur Schopenhauer (1788–1860) in the *Fourfold Root of the Principle of Sufficient Reason* (1813) and *The World as Will and Representation* (1818) became influential after 1848 and prepared the way for a tremendous resurgence in the influence of Kant in German philosophy beginning in the 1860s. The “neo-Kantian” movement begun at that time dominated German philosophy until the 1920s. This movement took many forms. The scientist Hermann Helmholtz (1821–1894) gave a psychological interpretation of Kant’s conception that the mind brings its own innate structure to perception, which influenced research into perception well into the twentieth century. But within academic philosophy, the two main forms of neo-Kantianism were the Marburg and Heidelberg schools.

The main representatives of the Marburg school were Hermann Cohen (1842–1918), Paul Natorp (1854–1924), and Ernst Cassirer (1874–1945). Cohen made his reputation with a series of commentaries on Kant’s three critiques, published between 1871 and 1889, and then with his own system of philosophy, published between 1902 and 1912. He also published *The Religion of Reason out of the Sources of Judaism* (1919), an influential work on Judaism modeled on Kant’s *Religion*. Cassirer’s main work was the three-volume *Philosophy of Symbolic Forms* (1923–1929; trans. 1953–1957 with a fourth volume posthumously published in 1996). The Marburg school developed Kant’s idea that we bring to both ordinary experience and more formalized science presuppositions reflecting the structure of our own thought; but especially by the time of Cassirer the school also recognized that we bring a multiplicity of such principles to our experience and that they may change over time. Cassirer’s views were to some extent paralleled by those developed by the British philosopher Robin George Collingwood (1889–1943) in his *Essay on Philosophical Method* (1933) and *Essay on Metaphysics* (1940), although Collingwood did not call himself a neo-Kantian.

The chief representatives of Heidelberg neo-Kantianism were Wilhelm Windelband (1848–1915) and Heinrich Rickert (1863–1936). They stressed Kant’s distinction between the principles of theoretical and practical reason and focused attention on our projections of values as well as knowledge into our experiences. Rickert developed the philosophical views of the school in *The Limits of Concept Formation in Natural Science* (1896–1902; trans. 1986) and *Science and History* (1899; trans. 1962). Both Windelband and Rickert also stressed the difference between the methods of natural science and history and thereby greatly influenced the methodological thought of

the sociologist Max Weber (1864–1920), especially his theory of “ideal types” and his distinction between fact and value in the practice of social science.

Kant in the Later Twentieth Century

Kantianism in the early twentieth century was not limited to the self-designated neo-Kantian schools, however. The 1928 *Logical Structure of the World* (trans. 1967) by Rudolf Carnap (1891–1970) was clearly a modernization of Kant’s theory of our application of the forms of logic to the raw data of our experience, as was the nearly contemporaneous *Mind and World Order* (1929) by the American Clarence Irving Lewis (1883–1964), who was himself influenced by the many Kantian elements in the works of Charles Sanders Peirce (1839–1914). The main revival of interest in Kant in the Anglo-American world came after World War II, however. In Britain, a great revival of Kantian philosophy was stimulated by two books by Sir Peter Strawson (1919–), *Individuals: An Essay on Descriptive Metaphysics* (1959) and *The Bounds of Sense: An Essay on Kant’s Critique of Pure Reason* (1966). Strawson based his appropriation of Kant on a theory of meaning, arguing that a subject can apply the concept of his own self only in contrast to a concept of an objective world, while Jonathan Bennett (1930–) stayed closer to Kant in his *Kant’s Analytic* (also 1966), arguing that it is our judgments about our own experience that can be confirmed only within a structure of judgments about the external world.

The work of Strawson and Bennett initiated a major debate about “transcendental arguments” in the United States as well as Britain that continued into the twenty-first century. Meanwhile, in the United States interest in Kant was independently inspired by the work of Wilfrid Sellars (1912–1989), whose famous attack upon the “myth of the given” in his “Empiricism and the Philosophy of Mind” (1956) was clearly intended as an alternative to C. I. Lewis’s version of Kant and whose *Science and Metaphysics: Variations on Kantian Themes* (1968) presented a Peircian version of Kant using the resources of contemporary philosophy of language.

The strongest influence of Kant on contemporary philosophy, however, was mediated by the political philosopher John Rawls (1921–2002), whose *A Theory of Justice* (1971) was Kantian in both method and substance. Rawls argued that principles of distributive justice should be chosen in an “original position” of impartiality that models Kant’s conception of universality and that the principles that would be so chosen would prioritize equal liberty over other forms of equality, reflecting Kant’s emphasis on autonomy as the fundamental moral and political value. Rawls’s work has inspired a great deal of further work on Kantian moral and political philosophy in Britain and the United States and has also been influential in Germany, although there an independent version of Kantianism, the theory of Jürgen Habermas (1929–) that political principles should be chosen in an “ideal communicative situation” has also been widely influential.

See also *Continental Philosophy; Idealism; Metaphysics; Philosophy*.

BIBLIOGRAPHY

- Beiser, Frederick C. *The Fate of Reason: German Philosophy from Kant to Fichte*. Cambridge, Mass.: Harvard University Press, 1987.
- . *German Idealism: The Struggle against Subjectivism, 1781–1801*. Cambridge, Mass.: Harvard University Press, 2002.
- Bennett, Jonathan. *Kant's Analytic*. Cambridge, U.K.: Cambridge University Press, 1966.
- . *Kant's Dialectic*. London and New York: Cambridge University Press, 1974.
- Carnap, Rudolf. *The Logical Structure of the World: Pseudoproblems in Philosophy*. Translated by Rolf A. George. Berkeley: University of California Press, 1967.
- Cassirer, Ernst. *An Essay on Man: An Introduction to the Philosophy of Human Culture*. New Haven, Conn.: Yale University Press, 1944.
- . *The Philosophy of Symbolic Forms*. Vols. 1–3 translated by Ralph Manheim. Vol. 4 edited by J. M. Krois and D. P. Verene. New Haven, Conn.: Yale University Press, 1953–1956 and 1996.
- . *Substance and Function; and, Einstein's Theory of Relativity*. Translated by William Curtis Swabey and Marie Collins Swabey. Mineola, N.Y.: Dover Publications, 2003.
- Cohen, Hermann. *Religion of Reason: Out of the Sources of Judaism*. Translated with an introduction by Simon Kaplan. Introductory essay by Leo Strauss. New York: Frederick Ungler, 1972.
- Guyer, Paul, ed. *The Cambridge Companion to Kant*. Cambridge, U.K., and New York: Cambridge University Press, 1992. A multiauthored introduction to main themes in Kant's philosophy with an extensive bibliography.
- Habermas, Jürgen. *Knowledge and Human Interests*. Translated by Jeremy J. Shapiro. Boston: Beacon Press, 1971.
- . *Moral Consciousness and Communicative Action*. Translated by Christian Lenhardt and Shierry Weber Nicholsen. Introduction by Thomas McCarthy. Cambridge, Mass.: MIT Press, 1990.
- . *The Theory of Communicative Action*. Translated by Thomas McCarthy. Boston: Beacon Press, 1984–1987.
- Herman, Barbara. *The Practice of Moral Judgment*. Cambridge, Mass.: Harvard University Press, 1993.
- Hill, Thomas E., Jr. *Dignity and Practical Reason in Kant's Moral Theory*. Ithaca, N.Y.: Cornell University Press, 1992.
- . *Human Welfare and Moral Worth: Kantian Perspectives*. Oxford and New York: Oxford University Press, 2002.
- . *Respect, Pluralism, and Justice: Kantian Perspectives*. Oxford and New York: Oxford University Press, 2000.
- Kant, Immanuel. *The Cambridge Edition of the Works of Immanuel Kant*. Edited by Paul Guyer and Allen W. Wood. 16 vols., 12 published as of 2004. Cambridge, U.K.: Cambridge University Press, 1992–. The standard English translation of all of Kant's published works as well as extensive selections from his lectures, correspondence, and posthumous material.
- . *Kants gesammelte Schriften*. Edited by the Royal Prussian, subsequently German, then Berlin-Brandenburg Academy of Sciences. 29 vols., 28 published as of 2004. Berlin: Georg Reimer, subsequently Walter de Gruyter and Co.: 1900–. The standard German edition of Kant's writings.
- Köhnke, Klaus Christian. *Entstehung und Aufstieg der Neukantianismus: Die deutsche Universitätsphilosophie zwischen Idealismus und Positivismus*. Frankfurt am Main, Germany: Suhrkamp, 1986. Translated without endnotes as *The Rise of Neo-Kantianism: German Academic Philosophy between Idealism and Positivism*. Translated by R. J. Hollingdale. Cambridge, U.K., and New York: Cambridge University Press, 1991.
- Korsgaard, Christine M. *Creating the Kingdom of Ends*. Cambridge, U.K., and New York: Cambridge University Press, 1996.
- Lewis, Clarence Irving. *Mind and the World-Order: Outline of a Theory of Knowledge*. New York: Dover, 1956.
- Nell (O'Neill), Onora. *Acting on Principle: An Essay on Kantian Ethics*. New York: Columbia University Press, 1975.
- O'Neill, Onora. *Constructions of Reason: Explorations of Kant's Practical Philosophy*. Cambridge, U.K., and New York: Cambridge University Press, 1989.
- Pinkard, Terry. *German Philosophy 1760–1860: The Legacy of Idealism*. Cambridge, U.K., and New York: Cambridge University Press, 2002.
- Rawls, John. *A Theory of Justice*. Rev. ed. Cambridge, Mass.: Harvard University Press, 1999.
- . "Kantian Constructivism in Moral Theory." In his *Collected Papers*, edited by Samuel Freeman. Cambridge, Mass.: Harvard University Press, 1999.
- Rickert, Heinrich. *The Limits of Concept Formation in Natural Science: A Logical Introduction to the Historical Sciences*. Edited and translated by Guy Oakes. Abridged ed. Cambridge, U.K., and New York: Cambridge University Press, 1986.
- . *Science and History: A Critique of Positivist Epistemology*. Translated by George Reisman. Princeton, N.J.: Van Nostrand, 1962.
- Sellars, Wilfrid. *Science and Metaphysics: Variations on Kantian Themes*. London: Routledge and Kegan Paul, 1968.
- Strawson, P. F. *The Bounds of Sense: An Essay on Kant's "Critique of Pure Reason"*. London: Methuen, 1966.
- Strawson, P. F. *Individuals: An Essay in Descriptive Metaphysics*. London: Methuen, 1959.
- Wiley, Thomas E. *Back to Kant: The Revival of Kantianism in German Social and Historical Thought, 1860–1914*. Detroit: Wayne State University Press, 1978.
- Wood, Allen W. *Kant*. Malden, Mass.: Blackwell, 2005. An excellent short introduction to Kant's philosophy.

Paul Guyer

KINSHIP. See **Monarchy.**

KINSHIP. Kinship—which can be initially described as the study of the links between people established on the basis of descent, marriage, or adoption—has been a defining domain of anthropological investigation since the inception of this discipline in the last twenty years of the nineteenth century. The detailed description of the complexities of kinship systems was for many decades considered essential to the understanding of non-Western societies. This field went through an intense phase of restructuring from the end of the 1970s to the late 1990s as a result of major paradigmatic shifts within the discipline of anthropology, such as the cultural turn, feminism, and political economy. In the early twenty-first century kinship studies, profoundly redefined, have experienced a re-

vival, also in light of tremendous technological changes, such as the emergence of new reproductive technologies, the development of genetics, new family forms, the gay and lesbian movement, immigration, globalization and such correlated phenomena as transnational adoption that have opened new frontiers to anthropological investigation.

The publication of *Systems of Consanguinity and Affinity* (1870) and *Ancient Society* (1877) by Lewis Henry Morgan have traditionally been recognized as steppingstones in the history of anthropological kinship. In line with his evolutionary thinking, Morgan saw kinship as a social institution identifying the earlier steps of societal organization. In other words, kinship was presented as the epicenter of so-called primitive societies' social organization. According to this line of reasoning, kinship was less central in modern societies. Territoriality, the social contract, and the state dominated modern society. As a result, politics and the economy, as distinct fields of social action, regulated important aspects of modern women's and men's lives. Morgan's work is representative of a certain understanding of what were then called primitive societies. He saw them as societies based on blood (kinship), a view that dominated anthropology until the early 1970s. Morgan also established the approach that would characterize anthropological studies of kinship for several decades; that is, the emphasis on kinship terminology and the partition of kinship as a field in a number of constitutive "blocks"—that is, descent, marriage, postmarital residence, inheritance, and so on.

Kinship maintained its centrality in the history of the discipline until the cultural turn in anthropology in the 1970s. Kinship was indeed a central theme of investigation within functionalist and structuralist paradigms. Kinship allowed scholars to answer some fundamental sociological questions. It offered a plausible explanation of the problem of the maintenance of social order in the absence of state-based organizations. Indeed, anthropological knowledge came to question a well-established tradition of Western political thought that had identified in the state the only viable solution for the maintenance of social order and discipline.

One major systematic trend within the traditions of kinship studies is represented by descent theory, the dominant paradigm until the mid-1960s (Kuper, 1982). Classic examples of this approach are *African Political Systems*, *The Nuer*, and *The Political System of the Anuak*. Proponents of descent theory presented non-Western societies as based on their kinship organization. According to this view, a person's place in society was largely determined by his or her position within the kinship system. Crucial was the determination of an individual's position within the line of filiation privileged by a given society (descent). Anthropologists singled out various principles of descent—unilineal with its patrilineal (through the father's line) and matrilineal (through the mother's line) variants and double (through both lines of descent). Non-Western societies were seen as emphasizing one particular line of descent whose analysis was believed to unpack their social mechanisms and account for the maintenance/reproduction of the social order. Thus in the classic studies of the Tallensi (e.g., Fortes, 1949) or the Nuer (Evans-Pritchard, *The Nuer*, 1940),

the modalities of kinship organization and the functioning of descent as a structuring principle were presented as central to understanding these societies, their boundaries, and their internal equilibrium.

Key within functionalist and structural-functionalist approaches was the distinction between de facto descent (biological descent) and de jure descent (the lines of descent a society effectively recognized). In other words, anthropologists distinguished between facts of nature and the selection or play with natural facts of which each kinship system was the recognized expression. Each society was seen as characterized by an emphasis on certain genealogical links and a disregard for others. Thus in a matrilineal society a father's position was generally perceived as marginal. Meanwhile a mother and her relatives, in particular the mother's brother, were seen as the center of a child's social life and largely determine his or her future prospects.

Many functionalists and structural-functionalists claimed to investigate the domain of the social as separate from other domains of social analysis, namely the biological and the psychological. Building on the work of French sociologist Émile Durkheim, they were concerned with the delimitation of objects and methods of enquiry exclusive to the social sciences (with some notable exceptions, of course, such as Bronislaw Malinowski and his theory of needs and corresponding cultural institutions). Despite their intentions, later research has demonstrated that they were often unaware of the biologism that tainted some of their own theoretical constructions. As David Schneider and other anthropologists after him have highlighted, the realm of nature (natural kinship) was left out from traditional anthropological accounts. Yet each kinship system, with varying degrees of adherence, was seen as reflecting certain aspects of the natural order, but the latter was taken as a given and thus unquestioned realm. However, conceptions of nature and its relations to culture vary and change over time, across and within societies. An important contribution in this direction was constituted by the publication of *Nature, Culture, and Gender* by Carol MacCormack and Marilyn Strathern in 1980, which showed the inapplicability of Western dichotomies between culture and nature, men and women cross-culturally, and the historical variation of such constructs within the West.

As Janet Carsten (2004) has highlighted, anthropologists' study of kinship did not entail an interest in domestic life or other forms of connectedness aside from genealogical links, thus excluding the study of women, children, alternative forms of solidarity, or the more intimate aspects of sexuality from anthropological accounts. This gap can also partly be explained by the belief that non-Western people were deemed not to have an individualized Western sense of self but were seen as identifying with the collectivities they belonged to (read descent groups), with the latter seen as corporate entities (which found collective expression in their male elders). In addition, only the more public aspects of kinship (the so-called politico-jural aspects) were of privileged interests to anthropologists. Within kin-based societies, kinship defined people's economic, religious, and political rights and

obligations.

Claude Lévi-Strauss, the leading proponent of the structuralist turn in French anthropology and beyond, introduced in the 1960s a conflicting paradigm known as alliance theory. Influenced by structural linguistics, Lévi-Strauss turned his attention not to descent but to marriage, the latter interpreted as a system of exchange and communication. In his theoretical constructs marriage is presented as the matrix of the kinship social order. Marriage produces at once two fundamental classes of kin, consanguineal kin (blood relatives) and affinal kin (in-laws). In the course of marriage transactions, women “serve” as the vectors via which social alliances are established (a perspective whose androcentric bias feminist anthropologists will readily point out). By renouncing to marry their own sisters (via the imposition of the incest rule) and by agreeing to marry other men’s sisters outside of their own biological family, men establish the foundations of human society.

According to Lévi-Strauss, kinship marks the overcoming of the state of nature (determined by the rule of the biological) and the imposition of the cultural order by humans. In this sense kinship is a cultural universal—that is, something shared by all societies—although its content varies across cultures. By unpacking the systems of marriage and unveiling their deeper logic, Lévi-Strauss came to complement British anthropologists’ privileged attention on descent. However, his reliance on linguistic structuralism enabled him to further capture the symbolic quality of human life and distance himself further from the biologism of functionalist and structural-functionalist accounts.

An important turn in kinship studies was marked by the publication of David Schneider’s work. In *American Kinship: A Cultural Account* (1968) and *A Critique of the Study of Kinship* (1984), Schneider developed an important critique of the study of kinship, one that ultimately laid the foundations for contemporary approaches to the study of kinship. According to Schneider, kinship studies were mostly the expression of anthropologists’ ethnocentric biases and disciplinary preoccupations. The centrality of biological reproduction was indeed a character identifying Western perspectives on kinship. Indeed, within a number of other societies, such as the Yap of the West Caroline Islands, it is “hard work” that cements what we would call kinship ties, not biology. It followed that kinship as a field of study was the outcome of the biases of Western scientists who once carved out a predefined interpretive scheme based on their own experience of kinship and then proceeded to investigate other societies, thus missing local understandings of kinship and the relationship between social and natural aspects of kinship (as well as the usefulness of such categories in the analysis of a specific society/culture).

A number of lines of research emerged from this initially seemingly devastating critique. This of course happened after a critical reassessment of Schneider’s symbolic theory. Indeed, several aspects of this have been questioned by successive generations of anthropologists. Schneider’s view of culture as an integrated whole and his exclusive focus on symbols are now seen as too schematic and limited (Stone, 2004). Twenty-first

century anthropologists typically share a more complex and less bounded understanding of culture, an attention to practice and processes in addition to meanings, and a keen interest in the social construction of science (a topic left unresolved in Schneider’s writings as Carsten [2000] clarifies). Post-Schneiderian kinship is characterized by the inclusion of the study of Western kinship systems. This is partly due to the realization that an increased understanding of a researcher’s own cultural assumptions and social practices is a powerful strategy to come to terms with researchers’ biases, as well as changes in the object and methods of anthropological studies. In addition, nature is no longer taken for granted. Indeed, changing conceptions of nature and the varying relationships between culture and nature are regarded as central topics in order to understand kinship within Western and non-Western societies.

Post-Schneiderian kinship studies are often characterized by the insertion of kinship into a wider analytic field. Indeed, kinship studies have benefited from the insights of feminist anthropology, historical anthropology, and postmodern anthropology.

The feminist turn in anthropology in the mid-1970s (that is, the study of the much-neglected study of gender in a cross-cultural perspective) brought new life to anthropology as a discipline and to kinship studies in particular. The relationship between gender and kinship was the topic of Jane Collier and Sylvia Yanagisako’s edited collection *Gender and Kinship: Essays Towards a Unified Analysis* (1987). These authors argued for a unified theory of gender and kinship. Indeed, they suggested that gender relations and gender asymmetries are central to the understanding of kinship systems cross-culturally (see also Yanagisako and Delaney). For instance, how would one understand, within the patrilineal Bamana families of Mali, women’s differential positions and their limits and possibilities as mothers, daughters, and sisters if gender and kinship are not taken into consideration. The coupling of studies of gender, kinship, power, and inequality has contributed much to a renewed interest in anthropology. These studies also reflect the decline of the traditional separation between social studies and social activism, disclosing indeed a well-formulated agenda for the expansion of human rights. (See, for instance, the 2004 statement by the American Anthropological Association in support of gay and lesbian marriage at http://www.aaanet.org/press/ma_stmt_marriage.htm.)

Particularly rich is the study of new reproductive technology (NRT) (Strathern, *After Nature*, 1992 and *Reproducing the Future*, 1992; Ginsburg and Rapp; Ragone and Winndance Twine). The study of NRT has led people in Western societies to begin to deconstruct traditional distinctions between nature and culture/choice, given that NRTs have widened human possibilities of intervention and modification of what were once believed unchangeable biological phenomena. Similarly, the growing body of literature on gays and lesbians cross-culturally has led to a more complex understanding of the complexity of gender, which once were viewed more simplistically (see, for instance, Weston). It has also promoted new understanding of people’s mediations with Western dictates of kinship.

Political economy and later developments (for example, historical anthropology) have added an important dimension to the study of kinship. From the path-breaking work by Jack Goody (1958) that included attention to the temporal dimension in the study of kinship, as well as the work of Esther Goody on marriage as a process (1962), the work of Claude Meillassoux on kinship and the formation of social inequalities (1981) to more recent accounts of political and economic processes that look for more satisfactory mediations between neo-Marxist and interpretive analyses (for example, work by McClintock; Cooper and Stoler), that kinship phenomena do not stand in a vacuum; instead they simultaneously reflect and affect wider societal trends. Kinship is indeed a privileged site for societal reproduction and the construction of local, ethnic, and national identities. (See, for instance, Kahn on NRT in Israel or De Jorio on kinship and politics in postcolonial Mali.)

In sum, early-twenty-first-century studies highlight the importance of local conception of kinship and the impact of such constructs on people's identity formation. Some anthropologists look at kinship as conceived in the West as a specific network of relatedness whose generality and interest should be ascertained in the course of open-ended fieldwork. Other trends also consist of broader approaches to the study of kinship (e.g., in the context of larger paradigms such as political economy), the inclusion of relatively recent developments (NRT), or traditionally excluded phenomena such as sexuality and third genders, thus contributing to new understandings of different lifestyles and cultural traditions.

See also **Anthropology; Family; Gender Studies; Anthropology.**

BIBLIOGRAPHY

- Broch-Due, Vigdis, Ingrid Rudie, and Tony Bleie, eds. *Carved Flesh/Cast Selves: Gendered Symbols and Social Practices*. Oxford: BERG, 1993.
- Butler, Judith. *Bodies that Matter: On the Discursive Limits of "Sex."* New York: Routledge, 1993.
- . *Gender Trouble. Feminism and the Subversion of Identity*. New York: Routledge, 1990.
- Carsten, Janet. *After Kinship*. New York: Cambridge University Press, 2004.
- . *Cultures of Relatedness*. New York: Cambridge University Press, 2000.
- Carsten, Janet, and Stephen Hugh-Jones, eds. *About the House: Lévi-Strauss and Beyond*. New York: Cambridge University Press, 1995.
- Collier, Jane F., and Sylvia J. Yanagisako, eds. *Gender and Kinship: Essays Towards a Unified Analysis*. Stanford, Calif.: Stanford University Press, 1987.
- Comaroff, John L. *The Meaning of Marriage Payments*. New York: Academic, 1980.
- Cooper, Frederick, and Ann Laura Stoler, eds. *Tensions of Empire: Colonial Cultures in a Bourgeois World*. Berkeley: University of California Press, 1997.
- De Jorio, Rosa. "Women's Organizations, the Ideology of Kinship, and the State in Postindependence Mali." In *New Directions in Anthropological Kinship*, edited by Linda Stone. Lanham, Md.: Rowman and Littlefield, 2001.
- Evans-Pritchard, Edward E. *The Nuer: A Description of the Modes of Livelihood and Political Institutions of a Nilotic People*. Oxford: Clarendon, 1940.
- . *The Political System of the Anuak of the Anglo-Egyptian Sudan*. London: Lund, 1940.
- Feinberg, Richard, and Martin Ottenheimer. *The Cultural Analysis of Kinship: The Legacy of David M. Schneider*. Urbana: University of Illinois Press, 2001.
- Franklin, Sarah, and Susan McKinnon, eds. *Relative Values: Reconfiguring Kinship Studies*. Durham, N.C.: Duke University Press, 2001.
- Fortes, Meyer. *The Web of Kinship among the Tallensi*. London: Oxford University Press, 1949.
- , ed. *Marriage in Tribal Societies*. Cambridge, U.K.: Cambridge University Press, 1962.
- Fortes, Meyer, and E. E. Evans-Pritchard, eds. *African Political Systems*. London: Oxford University Press, 1940.
- Fox, Robert. *Kinship and Marriage: An Anthropological Perspective*. Baltimore: Penguin, 1967.
- Foucault, Michel. *The History of Sexuality*. New York: Pantheon, 1978.
- Ginsburg, Faye D., and Rayna Rapp, eds. *Conceiving the New World Order: The Global Politics of Reproduction*. Berkeley: University of California Press, 1995.
- Goody, Esther. "Conjugal Separation and Divorce Among the Gonja of Northern Ghana." In *Marriage in Tribal Societies*, edited by Meyer Fortes. Cambridge, U.K.: Cambridge University Press, 1962.
- Goody, Jack. *The Development of the Family and Marriage in Europe*. Cambridge, U.K.: Cambridge University Press, 1983.
- . *The Oriental, the Ancient, and the Primitive: Systems of Marriage and the Family in the Pre-Industrial Societies of Eurasia*. New York: Cambridge University Press, 1990.
- , ed. *The Developmental Cycle in Domestic Groups*. Cambridge, U.K.: Cambridge University Press, 1958.
- Gottlieb, Alma. *The Afterlife Is Where We Come from: The Culture of Infancy in West Africa*. Chicago: University of Chicago Press, 2004.
- Haraway, Donna. *Primate Visions: Gender, Race, and Nature in the World of Modern Science*. New York: Routledge, 1989.
- . *Simians, Cyborgs, and Women: The Reinvention of Nature*. New York: Routledge, 1991.
- Hutchinson, Sharon Elaine. "Identity and Substance: The Broadening Base of Relatedness Among the Nuer of Southern Sudan." In *Cultures of Relatedness*, edited by Janet Carsten. Cambridge, U.K.: Cambridge University Press, 2000.
- Kahn, Susan Martha. *Reproducing Jews: A Cultural Account of Assisted Conception in Israel*. Durham, N.C.: Duke University Press, 2000.
- Kelly, Raymond. *Constructing Inequality: The Fabrication of a Hierarchy of Virtue Among the Etoro*. Ann Arbor: University of Michigan Press, 1993.
- Kuper, Adam. *The Invention of Primitive Society: Transformation of an Illusion*. London: Routledge, 1988.
- . "Lineage Theory: A Critical Retrospect." *Annual Review of Anthropology* 11 (1982): 71–95.
- Lévi-Strauss, Claude. *The Elementary Structures of Kinship*. Translated from the French by James Harle Bell, John Richard von Sturmer, and Rodney Needham, editor. Boston: Beacon Press, 1969.
- McClintock, Anne. "No Longer in a Future Heaven." In her *Imperial Leather: Race, Gender, and Sexuality in the Colonial Con-*

- text. New York: Routledge, 1995.
- MacCormack, Carol, and Marilyn Strathern, eds. *Nature, Culture, and Gender*. Cambridge: Cambridge University Press, 1980.
- Martin, Emily. *The Woman in the Body: A Cultural Analysis of Reproduction*. Boston: Beacon, 1987.
- Meillassoux, Claude. *Maidens, Meal, and Money: Capitalism and the Domestic Community*. New York: Cambridge University Press, 1981.
- Morgan, Lewis Henry. *Systems of Consanguinity and Affinity of the Human Family*. Washington, D.C.: Smithsonian Institution, 1870.
- Needham, Rodney. *Rethinking Kinship and Marriage*. New York: Tavistock, 1971.
- Ortner, Sherry. *Making Gender: The Politics and Erotics of Gender*. Boston: Beacon Press, 1996.
- . “Is Female to Male as Nature Is to Culture.” In *Woman, Culture, and Society*, edited by Michelle Rosaldo and Louise Lamphere. Stanford, Calif.: Stanford University Press, 1974.
- Peletz, Michael. “Kinship Studies in Late Twentieth-Century Anthropology.” *Annual Review of Anthropology* 24 (1995): 343–72.
- Ragone, Helena, and France Winddance Twine, eds. *Ideologies and Technologies of Motherhood: Race, Class, Sexuality, Nationalism*. New York: Routledge, 2000.
- Rosaldo, Michelle, and Louise Lamphere, eds. *Woman, Culture, and Society*. Stanford, Calif.: Stanford University Press, 1974.
- Schneider, David. *American Kinship: A Cultural Account*. Englewood Cliffs, N.J.: Prentice-Hall, 1968.
- . *A Critique of the Study of Kinship*. Ann Arbor: University of Michigan Press, 1984.
- Stack, Carol. *All Our Kin: Strategies for Survival in a Black Community*. New York: Harper and Row, 1975.
- Stone, Linda. “Contemporary Directions in Kinship.” In *Kinship and Family: An Anthropological Reader*, edited by Robert Parkin and Linda Stone. Malden, Mass.: Blackwell, 2004.
- . ed. *New Directions in Anthropological Kinship*. Lanham, Md.: Rowman and Littlefield, 2001.
- Strathern, Marilyn. *After Nature: English Kinship in the Late Twentieth Century*. Cambridge: Cambridge University Press, 1992.
- . *Reproducing the Future: Essays on Anthropology, Kinship, and the New Reproductive Technologies*. New York: Routledge, 1992.
- Weston, Kath. *Families We Choose: Lesbians, Gays, Kinship*. New York: Columbia University Press, 1991.
- Yanagisako, Sylvia J., and Carol Delaney, eds. *Naturalizing Power: Essays in Feminist Cultural Analysis*. New York: Routledge, 1995.

Rosa De Jorio

KNOWLEDGE. Four words of ancient Greek are important to the first philosophical discussions of knowledge in the Western tradition. In a given context any of them might be translated with the word “knowledge”: *epistēmē*, *technē*, *mētis*, and *gnōsis*.

Epistēmē names the most philosophical idea of knowledge: contemplative, disinterested, logical knowledge of truth and reality. Such knowledge is not merely true; it is self-certifying, indubitable, a rock-solid foundation on which to build scien-

tific understanding. That was important. Philosophical thinking begins with the idea that belief or opinion (*doxa*) is not knowledge even if it happens to be true. *Doxa* is changeable, especially in a city, where people may be swayed by sophists and demagogues. Through its root (*histēmi*, “to stand firm, to set up”), *epistēmē* evokes ideas of firmness and stability. That is what the philosophers sought in the best and highest knowledge: an immovable point no persuasive speech can overturn.

Stoic philosophers defined *epistēmē*-knowledge as “apprehension (*katalepsis*) that is safe and unchangeable by argument,” according to the *Florilegium* (extracts from Greek authors compiled by Joannes Stobaeus in the late fifth century). About two generations earlier, Plato (c. 428–348 or 347 B.C.E.) had put forward his highly influential vision of philosophical progress from *doxa*, the opinions of the crowd, to the correct opinion (*orthodoxos*) of specialists, and finally the summit, *epistēmē*, the best and highest knowledge. In the *Theaetetus*, what sets *epistēmē* apart from true opinion is called an *aitias logismos*, a reasoned account, explaining why the knowledge is and must be true. In the *Republic*, however, what sets *epistēmē*-knowledge apart from *doxa* is the object that it apprehends—a Form or Idea. Opinion cannot turn into knowledge because the “objects” of opinion are ultimately incoherent particulars for which no reasoned account is possible. Plato also explains how the Form of the Good is the cause of things being knowable at all. It is not the presence of a Form as such that makes *epistēmē*-knowledge possible; rather, it is the Form’s place in the cosmic system. Form becomes logical and Ideas intelligible only when grasped in the light of the whole (the Good).

The philosophers did not invariably construe *epistēmē* as disinterested. The ordinary sense of the word is simply to have a good understanding of a thing, anything, archery, for instance. Aristotle (384–322 B.C.E.) divided *epistēmē* into three parts: theoretical (science and philosophy), practical (ethics, economics, politics), and productive, an *epistēmē* he called *technē*. *Technē* (from which *technology*, *technique*, and so on) refers to the knowledge of a recognized expert, like a physician, musician, or carpenter. Such knowledge is skillful, artful, reliable, specialized, and usually organized in professional associations. Plato explored the comparison of *epistēmē* and *technē*, using the words interchangeably in some dialogues. Could the best and highest knowing be some kind of art? One difficulty is that *technē*-knowledge aims at something concrete—a ship, a healthy human, a drama. The objects of philosophical *epistēmē*, however, are not these mundane artifacts, but the eternal Forms in which particulars merely participate. A further difficulty is that *technē*-knowledge can be used for good or ill alike. Such knowledge is instrumental, serving other ends, and the effectiveness of technique is no guarantee that the ends are good, whereas *epistēmē* is knowing in the light of the Good itself. This intrinsic value for knowledge of truth became traditional in Western thought, seldom questioned until Friedrich Wilhelm Nietzsche (1844–1900) at the end of the nineteenth century.

Mētis is cunning, clever, effective knowledge, as exemplified by the mythical figures of Odysseus and Daedalus. This knowledge combines flair and wisdom, subtlety and deception,

By A.D. 600 each inhabitable island of the south and central Pacific had been discovered and settled. . . . Magellan [1480–1521] traversed the whole Pacific from the tip of South America; he never sighted any land until he reached the Marianas, just east of the Philippines. Not only had Pacific islanders discovered and settled all the suitable islands of the Pacific, but there is solid linguistic, ethnobotanical, and archaeological evidence that they made two-way voyages among them. They sailed, for example, between Tahiti and Hawaii and back again, a distance over three thousand miles of open sea. All this was done by stone age people without writing, charts, or navigational instruments of any kind. In spite of a long series of fanciful theories of lost continents, primitive navigational instincts, and accidental drift voyages, we now know the secret of what made Pacific Island voyaging possible. *The secret was knowledge.* The navigational abilities of Pacific Islanders depended on a profound general knowledge of the sea, the sky and the wind; on a superb understanding of the principles of boat-building and sailing; and on cognitive devices—all in the head—for recording and processing vast quantities of ever changing information.

SOURCE: C. O. Frake, “Dials: A Study in the Physical Representation of Cognitive Systems.” In *The Ancient Mind: Elements of Cognitive Archaeology*, edited by Colin Renfrew and E. B. W. Zubrow, pp. 123–124. Cambridge, U.K.: Cambridge University Press, 1994. (Emphasis added).

resourcefulness and mastery of many skills. Far from disinterested or contemplative, it proves its value most concretely, especially in situations that are shifting or ambiguous, where art outweighs the force of violence. The philosophers either pass over the qualities of *mētis*-knowledge or mention them with hostile irony. Plato (in *Gorgias* and *Philebus*) condemns the inexactitude, oblique procedures, cunning, and guesswork. Everything about *mētis*-knowledge confirms its limitation to the shadow theater Plato famously depicted our life as being. The philosopher seeks to penetrate those shadows to an immortal knowledge of the changeless Source of change.

Gnōsis usually has the sense of an intelligent grasp of a thing or situation. In the common account of Heraclitus (c. 540–c. 480 B.C.E.), Parmenides (515 B.C.E.), and Plato, only one who fully *knows* (*gignōskein*) can be sure to have grasped a thing as it veritably is. All that is required to transform this *gnosis* into the lauded philosophical *epistēmē* is the rational account by which we understand things in the light of the Good and the Whole. The so-called *Gnostics* were heretical sects of the early common era. They conceived of knowing as an immersion into the divine energy, to be possessed and transformed by it. The *gnōsis* sought by the Gnostics is an *epignōsis*, or knowledge of the self, its origin and destiny, a supernatural superknowledge that is supposed to save our lives.

The European Middle Ages divide into two parts, before and after about 1200. The thought of the first period is broadly Platonic, a legacy of St. Augustine (354–430). Later medieval

thought benefited from the recovery of the works of Aristotle and the Islamic commentators. Augustine’s outlook is notably Plato’s: the senses depreciated in favor of immutable truths directly intuited, and a grudging admission of practical knowledge (*technē*) as a lower use of reason directed not toward wisdom but practical necessity. Human knowledge is possible because God illumines our minds, showing us the divine ideas, the archetypes of phenomena.

The most original, if not influential, medieval philosopher of knowledge is Roger Bacon (c. 1214–c. 1292). Interested in problems that would occupy Galileo three hundred years later (especially falling bodies and optics), he anticipated the Italian astronomer’s conviction that the solutions to these and other scientific problems lies in mathematics: “He who is ignorant of mathematics cannot know the other sciences nor the affairs of the world” (*Opus majus* 4.1). Even more against the scholastic grain was his enthusiasm for experiments: “He who wishes to rejoice without doubt in regard to the truths underlying phenomena must know how to devote himself to experiment” (*Opus majus* 4.1).

Thomas Aquinas (1225–1274) dominates the later period. He was the greatest of medieval Aristoteleans. Aristotle had argued that the object of the *epistēmē*-knowledge (*scientia* for Thomas) is immutable and necessary, incapable of being otherwise. Such knowledge is true and certain, being deduced from first principles. A thing is known when we learn its cause, and it is not known without the certainty of deduction from

principles, confirming that the thing could not possibly be any other way. As John Buridan (c. 1300–1358) explains, “Science differs from opinion because . . . opinion does not judge with certainty but with fear and science judges with certainty and without fear” (*Questions on the Nicomachean Ethics of Aristotle*). This remains the view of practically all the European philosophers down to René Descartes and John Locke.

Modernity

The early modern philosophers of the seventeenth century accepted most of ancient thought about knowledge. The clear and distinct ideas that alone count as knowledge for René Descartes (1596–1650) are not notably different from the reasonable account that is Plato’s criterion of *epistēmē*-knowledge. Even supposedly “empirical” philosophers like John Locke (1632–1704) assume that there is a strict and proper sense of knowledge that requires nothing less than rational certainty.

The break with tradition came from outside philosophical epistemology, in the new experimental natural philosophy of Galileo Galilei (1564–1642), Robert Boyle (1627–1691), Isaac Newton (1642–1727), and others. The first attempt to describe the experimental method was by Francis Bacon (1561–1626). The most influential account, however, is in Immanuel Kant’s *Critique of Pure Reason* (1781). Kant famously explains how concepts are empty without a content they acquire from experience, and how sensations are chaotic noise without a priori concepts we bring to the process of understanding. In this account, empirical knowledge is a synthesis, a mental construction, combining what the senses offer with concepts that, in their broadest features, are a priori forms of human understanding.

Conceiving of knowledge as something put together in the service of understanding suggests that the control of experience may be a more important cognitive goal than the fidelity (or “correspondence”) of a disinterested representation. This idea was explored in the nineteenth century by Arthur Schopenhauer (1788–1860) and Nietzsche. Further reflection on scientific experiments confirmed a similar view. What we learn from experiments is how to produce highly controlled effects, not how things are “in themselves,” apart from the experimental intervention. This idea of knowledge as an external force of control was taken up by the Vienna positivists, including Ernst Mach (1838–1916), and the American Pragmatists—Charles Sanders Peirce (1838–1914), William James (1842–1910), and John Dewey (1859–1952), who reached conclusions not dissimilar to those of Nietzsche.

Sociology of knowledge. Twentieth-century thinkers influenced by Auguste Comte (1798–1857) and Karl Marx (1818–1883) proposed a sociological theory of knowledge. The first premise of these theories is that no knowledge is entirely autonomous in structure or development from the group that produces it. How one looks at data, how one construes given facts, what one takes seriously, depend on social position. Karl Mannheim’s seminal *Ideologie und Utopie* (1929; translated as *Ideology and Utopia*, 1936) argued that social circumstances determine both what we seek to know and the validity of knowledge attained. Later accounts abandon

the idea of *validity*, rejecting the philosophical distinction between knowledge and *doxa*, an ideal subject matter for sociology.

Skepticism. For much of the twentieth century, philosophical discussion of knowledge was preoccupied with the problem of skepticism. Originally, *skeptikos* meant an inquirer, and later came to refer to followers of the Greek philosopher Pyrrho of Elis (c. 360–c. 272 B.C.E.). Their school flourished in the classical world between 100 B.C.E and 200 C.E. These Sceptics taught the radical suspension of judgment, liberating the self of dogmatic convictions (and all convictions are dogmatic), as the way to mental tranquility (*ataraxia*). The point of skeptical arguments is to instill doubt about the most obvious matters, to show that belief is futile. Nothing can be proved because anything can be proved. There is no argument so convincing that an equally convincing argument for the opposite cannot be constructed. Mental peace lies in getting over the vanity of knowledge.

Skepticism fell into decline after Roman times. By the Middle Ages the school and its arguments were forgotten. This situation changed abruptly in the latter sixteenth century, when long-lost texts of ancient skepticism were republished. From then on skepticism played a role in early modern thought, especially in the work of Michel de Montaigne (1533–1592), Descartes, Pierre Bayle (1647–1706), and David Hume (1711–1776). Yet Kant and Georg Wilhelm Friedrich Hegel (1770–1831) both suppose they have overcome skepticism or shown it to involve a mistake, and for most of the nineteenth century skeptical problems were not much discussed in Euro-American philosophy.

In the twentieth century the so-called Analytic philosophers rediscovered skeptical problems as ideal for their methods of precise, rigorous, often logically formalized argumentation. Their problem is to prove the objectivity of knowledge, which usually means refuting the skeptic, who asks how you know that you are not dreaming, or are not a brain in a vat, or that the universe did not come into existence a minute earlier, complete with your faulty memories. The presumption is that unless we can prove *that* we can prove nothing, and unless something is *proved* there is no objective knowledge. Over a period of two thousand years, then, skepticism changed from being a way of life, as it was for Pyrrhonians, to a mood and method of self-knowledge in Montaigne and Descartes, to a technical problem for the most formidably technical work since high-Medieval scholasticism.

The Linguistic Turn

The linguistic turn in twentieth-century philosophy refers to the rising influence of logical positivism (especially the work of Rudolf Carnap [1891–1970]), as well as positivism’s discontents (Willard Van Orman Quine [1908–2000]), heretics (Ludwig Wittgenstein [1889–1951]), and satellites (Bertrand Russell [1872–1970], Karl Popper [1902–1994]). The movement began in German-speaking countries in the 1930s but rose to predominance in English-language philosophy after World War II. It mingled with an independently evolved linguistic analysis and so-called ordinary-language philosophy, as

in the work of George Edward Moore (1873–1958), J. L. Austin (1911–1960), and Gilbert Ryle (1900–1976). For all these thinkers, everything in philosophy is a matter of language. The problem of knowledge is a problem of semantic analysis: how is the word used? What is the language game, the logic of the concept?

Gettierology. In a widely discussed article, “Is Justified True Belief Knowledge?” (1963), Edmund Gettier claimed to prove that knowledge is not conceptually equivalent to justified true belief. Gettier’s paper shows the style of the then-new analytic approach, using contrived scenarios as logical counterexamples to the definition of *knowledge* as justified true belief. The counterexamples usually work by drawing a reasonable inference from a justified though false belief, inferring something true by accident. Suppose I believe that a neighbor, Jones, owns a Ferrari. I have evidence: it is parked by his house, I see him in it, and so on. Because I believe Jones owns a Ferrari, and because Jones is my neighbor, I infer that *a neighbor* owns a Ferrari. Jones, however, does not own the car, which is owned by my neighbor on the other side, who, unknown to me, works with Jones. Still, it is true that *a neighbor* owns a Ferrari, and I believe that truth on good evidence. I have a justified true belief, but do I know that a neighbor owns a Ferrari? To most people it seems wrong to say so, especially since the neighbor I am thinking of is not the neighbor who owns the automobile. Apparently, then, knowledge is not justified true belief.

Gettier’s argument spurred an academic industry. The problem was to render the justified-true-belief formula invulnerable to Gettier-type cases, or replace this “classical” definition of knowledge with something equally plausible and immune to counterexample. Nothing memorable came of it. And contrary to what is often said, the definition of knowledge as justified true belief is not in any sense “classical.” It has never been widely accepted and first entered philosophical discussion (in Plato’s *Theaetetus*) as a *refuted* theory.

Between Gettier-inspired concerns about the analysis of knowledge and the project of refuting the skeptic, epistemologists fell into two broad camps, depending on whether they considered knowledge to require an element of justification or understanding, or whether, contrary to tradition, true belief might be enough. The idea that knowledge requires only true belief, provided the cause of the belief is appropriate or reliable, is known as *externalism*. Such theories reject the traditional assumption that knowledge requires the knower to understand the reason why a belief is true. They thereby finesse both the Gettier problem and the problem of skepticism. If knowing does not require understanding, then neither must a person who knows be able to refute the skeptic. And if knowledge does require that the cause of belief be reliable, even if the reasons for trust are unknown to the knower, then Gettier-scenario counterexamples fail due to an unreliable source for the (accidentally) true belief.

The heyday of linguistic philosophy had passed by 1980. The movement had led to little in the theory of knowledge. Pure conceptual or semantic analysis was largely abandoned. Exchanging those discredited methods for the richer data of

the sciences, Quine called for a “naturalized epistemology.” The idea was to reframe the theory of knowledge in terms of empirical hypotheses about the neurological, cognitive, and evolutionary matrix of human knowledge. Quine’s project attracted many followers, and Analytic philosophers formed new and often quite deep alignments with scientific research in these areas.

A second trend in post-linguistic-analysis philosophy is a movement of internal critique, a deconstructive diagnosis of epistemology as a pseudoproblem. Wittgenstein inspired this turning of philosophy upon itself, claiming to find conceptual confusion and intellectual neurosis everywhere. The autocritique of epistemology was led by Richard Rorty’s *Philosophy and the Mirror of Nature* (1979). Rorty finds the very idea of a “theory of knowledge” premised on an untenable concept of mental representation as a kind of “correspondence” or “isomorphism” with things in themselves.

Evolutionary epistemology. The word *cognition* relates to the ways in which people (and other species) draw information from the world, combine and interpret it, and make decisions about the information. Identifying this cognitive, information-processing function with *knowledge* seemed to open the way to a biological, evolutionary theory of knowledge, as by Konrad Lorenz (1903–1989). Later evolutionary accounts usually make two claims. The first is that human knowledge is an evolved adaptation, an outcome of natural selection. The second is that *any* adaptation of *any* species is a kind of knowledge, that evolutionary adaptation is the *primary* way of knowing the world. In these accounts an insect’s camouflage coloration is knowledge of its environment; the fleshy water-conserving cactus stem “knows” that water is locally scarce; the shape of the hummingbird beak expresses knowledge of the structure of the flowers it lives on. Human knowledge is a special case of this primary and ubiquitous biological knowledge of adaptation.

Feminism. By the latter twentieth century feminism had established a presence in the academy, criticizing and developing theories in several areas of philosophical research, including the theory of knowledge. Most feminists have nothing good to say about what has been done in epistemology. Presuming to speak in a universal voice, philosophical theories of knowledge are gendered and do not know it. Feminists challenge epistemology’s concept of knowledge (as objective, transcendent, disinterested) and its conception of the knower (as autonomous, self-interested, isolated). They deepen the discontent of the postpositivist philosophy of science and urge points similar to the sociologists of knowledge. Distinctive is the attention to early experience, emotion, racism, class, and, above all, gender as vectors of knowledge repressed from a sexist epistemology.

Continental Philosophy

For much of the latter twentieth century philosophy in the Western countries was divided into two camps, usually called Analytic and Continental. The division is not a happy one for many reasons, not least because the idea of dividing philosophy this way is an invention of the positivists, foisted upon an

otherwise heterogeneous selection of mostly French and German thinkers who often had little in common. Continental research did not pursue the theory of knowledge with anything like the industry of the Analysts. Many agreed with Hegel's assessment that the whole idea of a theory of knowledge (which would presumably itself be knowledge) is naive and superfluous.

Habermas. Three European thinkers are exceptions to the tendency to dismiss the theory of knowledge. One is German social philosopher Jürgen Habermas (b. 1929) and his work *Knowledge and Human Interests* (1968). By "human interests" Habermas means orientations of thought and action rooted in the fundamental evolutionary conditions of our species, which he reduces to the interests of work, social interaction, and emancipation. He describes three categories of possible knowledge corresponding to these interests: (1) instrumental, technical knowledge, expanding our power of control; (2) knowledge of language or, more broadly, of language games and cultural traditions, which orient people in common action; and (3) critical-social knowledge about political legitimacy and subordination. The conditions of objectivity differ in each case. When we are interested in a device that works, objectivity has one meaning; when interested in a social interaction, for instance a negotiation, objectivity requires different criteria. And when our interest is in emancipation, we require knowledge of the real conditions of social power in a given society. Social-scientific methods should take their objectivity from this emancipatory interest and not imitate the differently funded objectivity of the natural and technological sciences.

Liotard and Foucault. Jean-François Lyotard's widely read *The Postmodern Condition* (1979) was subtitled *A Report on Knowledge*. Under the conditions of what he calls postmodernity, knowledge has become discontinuous, catastrophic, nonrectifiable, and paradoxical. Getting used to knowledge in such a condition should refine our sensitivity to differences and reinforce our ability to tolerate incommensurables. Another French thinker contributing influential ideas about knowledge is Michel Foucault (1926–1984). The point of his neologism "power/knowledge" is to indicate a reciprocity linking the production and circulation of knowledge with the political economy of government. Power and knowledge flourish together, confirming each other, reproducing each other's authority. Power so entrained with knowledge need not falsify or repress any truth that may be discovered, nor must research sacrifice scientific credibility merely because it owes a debt to coercive social power. To reach these conclusions, however, Foucault had to reduce knowledge to socially prestigious discourse, the arbitrary output of an institutional "discursive apparatus," generating statements its authorities take seriously. There is in this account no more to "knowing" than who gets to say what and say it impressively enough to leave a trace, to have an effect, to make a legible difference in the archive.

Knowledge and Truth

That knowledge must be true is a longstanding presupposition of Western thought. Yet there are many instances of knowledge that cannot be called true. These include knowledge expressed in technological objects like a bridge or satellite, or in

works of art and the imagination. A technological artifact or a work of art is not true (or false) in the way a proposition is. In the face of this discontinuity between knowledge and truth, one may question whether truth properly has the value for knowledge philosophers tend to suppose, or one may make subtle distinctions, dividing knowledge so as to preserve the necessary truth of its best and highest instances. Unsurprisingly, philosophers prefer to distinguish and preserve. Where ancient philosophy distinguished a scientific *epistēmē* from the *technē* of art and craft, twentieth-century analysts discovered a "semantic" or "conceptual" distinction between *knowing how* and *knowing that*.

This distinction is not a neutral analysis. It may be no more than a linguistic rationalization for the assumption that knowledge must divide along lines of intrinsic truth and mere instruments. Western thought consistently ignores, misdescribes, and underappreciates the knowledge involved in art and technology. The philosophers seldom have a good word for artisanal *technē*-knowledge, or the ingenuity and cunning (*mētis*) of the architect or hunter. Although these other knowledges are indispensable to human existence, that very thing has seemed to make them base, materialistic, unsuited to higher minds. To the philosophers, how-to (or *technē*) knowledge is routine, mechanical, and thoughtless, while knowledge of truth is a disinterested grasp of nature and reality.

Philosophers even preferred to invent new concepts of truth rather than reconsider whether the best and most important knowledge has to be true. Kant's theory suggested (though not to Kant) that truth may not be a matter of "correspondence" between thought and reality but merely a coherence of experience. The pragmatists took experimental knowledge as exemplary and promptly introduced a new theory of truth, defining it in terms of "working." It would be equally logical, however, to simply *drop* the condition of truth on the best sort of knowledge.

Certainly there is *some* difference between knowing that the earth rotates around the sun (a true proposition) and knowing how to play the flute (a skill or art). But is the difference one in kinds of knowledge? What is obviously different about them is how the knowledge is expressed. In one case by producing a proposition, in the other by a musical performance. But that is a difference in the artifacts that express knowledge, and does not prove a difference in what makes these examples of knowledge at all. In both cases the knowledge concerns artifacts, constructions of ours, whether propositions or musical performances. And in both cases these artifacts must rate as notable accomplishments. Not just any true proposition expresses knowledge; it has to be informative, important, an insight or discovery. And not just any playing constitutes knowledge (mastery) of the flute.

Helio-centric astronomy and musical artistry are therefore not so different *as knowledge*. Whether we speak of *knowing that* (such and such is true) or *knowing how*, we are qualifying capacities for performance at a certain high level with artifacts of some kind. As examples of knowledge, a surgical operation or a bridge may serve as well as any scientific truth.

Their quality as knowledge depends not on their truth but on other, equally rare qualities of artifactual construction. Knowledge has much less to do with theory and truth than philosophers assume. What makes knowledge desirable and worth cultivating is the enhancement it brings to the effectiveness with which we operate in an artifactual environment. *Knowing how* and *knowing that* are not different kinds of knowledge. They are different kinds of use for different artifacts, all expressing the only kind of knowledge there is: a human capacity for superlative artifactual performance.

See also ***Learning and Memory, Contemporary Views; Logic; Mind; Philosophy.***

BIBLIOGRAPHY

- Allen, Barry. *Knowledge and Civilization*. Boulder, Colo.: Westview, 2004. Develops account of knowledge as superlative artifactual performance.
- . *Truth in Philosophy*. Cambridge, Mass.: Harvard University Press, 1993. Discusses ideas of truth in Nietzsche, Heidegger, and other Continental philosophers.
- Elias, Norbert. *Norbert Elias on Civilization, Power, and Knowledge: Selected Writings*. Edited and with an introduction by Stephen Mennell and John Goudsblom. Chicago: University of Chicago Press, 1998.
- Everson, Stephen, ed. *Companions to Ancient Thought*. Vol. 1, *Epistemology*. Cambridge, U.K.: Cambridge University Press, 1990.
- Feenberg, Andrew, and Alastair Hannay, eds. *Technology and the Politics of Knowledge*. Bloomington: Indiana University Press, 1995.
- Harding, Sandra, and Jean F. O'Barr, eds. *Sex and Scientific Inquiry*. Chicago: University of Chicago Press, 1987.
- Laudan, Rachel, ed. *The Nature of Technological Knowledge: Are Models of Scientific Change Significant?* Dordrecht, Netherlands: Reidel, 1984.
- Machlup, Fritz. *Knowledge: Its Creation, Distribution, and Economic Significance*. 3 vols. Princeton, N.J.: Princeton University Press, 1980–1984.
- Marglin, Frédérique Apffel, and Steven A. Marglin, eds. *Decolonizing Knowledge: From Development to Dialogue*. Oxford: Oxford University Press, 1996.
- . *Dominating Knowledge: Development, Culture, and Resistance*. Oxford: Oxford University Press, 1990.
- McCarthy, E. Doyle. *Knowledge As Culture: The New Sociology of Knowledge*. New York: Routledge, 1996.
- Mignolo, Walter D. *Local Histories / Global Designs: Coloniality, Subaltern Knowledges, and Border Thinking*. Princeton, N.J.: Princeton University Press, 2000. A contribution from post-colonial cultural studies.
- Moser, Paul K., ed. *Oxford Handbook of Epistemology*. Oxford: Oxford University Press, 2002.
- Renfrew, Colin, and E. B. W. Zubrow, eds. *The Ancient Mind: Elements of Cognitive Archaeology*. Cambridge, U.K.: Cambridge University Press, 1994.
- Tanesini, Alessandra. *An Introduction to Feminist Epistemologies*. Malden, Mass.: Blackwell, 1999.
- Wuketits, Franz M. *Evolutionary Epistemology and Its Implications for Humankind*. Albany: State University of New York Press, 1990.

Barry Allen



L

LANDSCAPE IN THE ARTS. The *Oxford English Dictionary* defines landscape as both a verb and a noun, signifying not simply its multiple references in vernacular and specialized parlance or its active and passive modes but more importantly the varying perceptions of landscape as an artistic, cultural, and religious entity. Among the definitions of landscape as a noun, the *OED* proffers first “A picture representing natural inland scenery, as distinguished from a sea picture, a portrait, etc.” Further definitions include “The background of scenery in a portrait or figure-painting,” “A distant prospect: a vista,” and significantly, “The object of one’s gaze.” While as a transitive verb, landscape proposes “to represent as a landscape; to picture, depict.” This verbal form further connotes “to lay out (a garden, etc.)” as a landscape. Western art history classifies landscape as both iconography and theme; that is, as a series of signs and symbols that form the visual

vocabulary that is encoded with specific meanings, such as the metaphor of the “errand into the wilderness,” or the Garden of Eden. As a topic, landscape is either the subject matter of a painting or a series of prominent elements in a painting that coordinate the diversity of public understanding of the idea of “landscape.” The early nineteenth-century transformation of landscape into an acceptable category of painting by the academy equal to history and portraiture signaled a shift in Western cultural and religious values.

Traditionally landscape is designated by such explanatory signifiers as pastoral, ideal, naturalism, and picturesque. Further, landscape is discussed as a background, a symbolic element, a historical setting, and a motif, so that the visual diversity of the paintings that form this visual essay are all appropriately identified as landscape paintings. The journey in the history



Overwhelmed by the natural world. *Monk by the Sea* (1809) by Caspar David Friedrich. Oil on canvas. PHOTO CREDIT: BILDARCHIV PREUSSISCHER KULTURBESITZ/ART RESOURCE, NY

of the idea of landscape—from the symbolic stylization found in classical Egyptian frescoes and early Christian mosaics to the awesome sublimity of Caspar David Friedrich's *Monk by the Sea* (1809–1810; Schloss Charlottenberg, Berlin) and Georgia O'Keeffe's *Red Hills, Lake George* (1927; Phillips Collection, Washington, D.C.)—are interwoven with artistic, cultural, economic, political, and religious influences. Perhaps the most significant issue to be considered is whether or not any discussion of landscape painting is privileged as Western in orientation and classifications, especially following the attitudinal metamorphosis toward landscape shaped first by Edmund Burke's eighteenth-century treatise on the sublime and reaffirmed by Immanuel Kant's discussion of the sublime in his *Critique of Judgment* (1790). Essentially Kant argued that the sublime was premised upon the immeasurable extent and stunning intensity of nature and the sense of awe that these expressions of *dynamis* effect in humanity. The amalgamation of terror and delight edged simultaneously from the sight of such phenomena as fulminating cataracts and colossal mountains, thunder and lightning, volcanoes and hurricanes, elicits both a fascination with and a distrust of nature.

The Dictionary of Art (1986) has a major entry of nearly one hundred pages under the rubric of "landscape painting" that details the history and variations of landscape painting in the West and references descriptions of landscape as either a motif or a category in discrete entries dedicated to the world beyond the West, for example, China. This is not to suggest that landscape painting in the West is not a significant or an enormous entry topic in its own right but rather to recognize that the universality of landscape as a visual recording of human attitudes and perceptions of the natural world has been abbreviated. Therefore the tradition of defining and describing landscape requires reformulation of it as a pandemic idea. With that in mind, this essay will discuss origins and modern examples of landscape in Europe and the United States as well as in Japan and China. Whether rendered as ideal or real, harmonious or discordant, bucolic or refined, the landscape communicates solace, spiritual grandeur, and space for solitude.

Panoramic depictions of the subtle but expansive beauty of nature are incorporated into the landscape designs and themes found on Japanese screens. Sequential visual episodes are depicted upon individual panels, which when encountered as a unity create an effective visualization of the natural order, with its coordination of foreground, sky, middle ground, and flora and fauna. As a public or private form of display, these Japanese screens may be unfolded either in full or in segments, providing an ever-renewing composition of natural elements. Varying in size from personalized miniature screens to public monumental exhibition screens, the visual image extends from right to left in a horizontal flow of natural symbols ranging from cherry blossoms to gnarled branches to recognizable species of birds. As in Chinese landscape paintings, the most distinctive element of the Japanese landscape screen is the void or empty space for "no-thing-ness," which offers a spatial threshold for contemplation and quietude, for refreshment and solace.

The dramatically unique depiction of a diminutive, almost miniature, human figure in solitary contemplation of the

limitless and enveloping expanse of sky, sea, and sand in Friedrich's *Monk by the Sea* stunned its original Western viewers. The minimizing of the natural elements to a state of abstracted essences transformed the conventional relationship between humanity and nature as the monk stands silently, almost belittled before the void. The traditional Western presentation of human dominion over nature had been reversed so that nature overpowers this "everyman," who is confronted by the enormity of the emptiness before him. Hypothesizing that Friedrich, who never ventured out of his native country, would not have seen or been influenced by the Eastern religio-aesthetic that informs the Japanese landscape, it is necessary to consider the cultural and artistic route to this singular yet artistically significant presentation of communion with nature by a Western painter. Even without any contact with the Eastern idea of landscape, Friedrich's new vision transformed the Western visual tradition of depictions of saints seated as the prominent subject in size, scale, and placement within a canvas. The normative pattern both of design and iconography was to site a large—usually out-of-proportion figure in comparison to the landscape imagery—human form in such a position as to garner the viewer's immediate attention thereby reaffirming human dominion over nature. Friedrich, on the other hand, eliminates all elaborate details and symbols within the frame of this painting; thereby, he creates and controls the visual emphasis on the atmospheric conditions and the immensity of nature. The miniaturized rendering of the monk required the viewer's complete attention to be located, perceived, and introduced almost to the shock of the viewer. The subject is no longer that of attesting to the human dominion over nature but rather that of the power of nature.



An atmosphere of mystery. *La Tempesta* (*The Tempest*; 1507–1508) by Giorgione. Oil on canvas. GALLERIA DELL'ACCADEMIA, VENICE, ITALY. © THE ART ARCHIVE/DAGLI ORTI

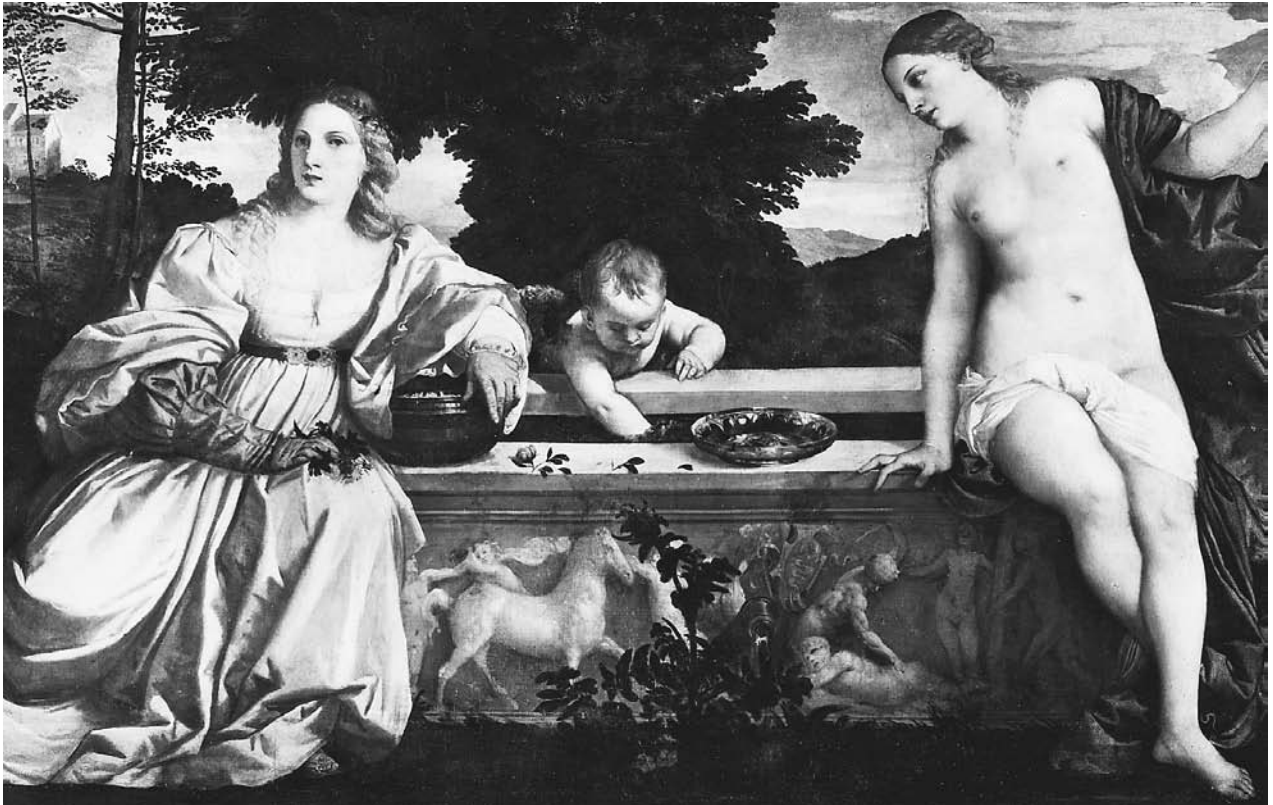

A dual interpretation of landscape. *Sacred and Profane Love* (c. 1515) by Titian. Oil on canvas.

The Path toward Landscape

Throughout the course of Western history, the concept of landscape and the technique of painting changed, interchanged, and exchanged with social, political, and religious modifications. Classical Egyptian art privileges depictions of the human figure and human activities over the landscape, which is more often than not included to provide a background or setting for an event or activity. The classical Greeks were biased toward humanism, human values, and, thereby, the human figure, so that feelings or artistic expressions of nature were as a background or historical setting. Although disputed among scholars, the connections between Hellenistic poetry and art may signal the origin of both landscape painting and of the concept of *amoenus*, or the “lovely place,” a term thought to have been introduced by Theocritus (c. 310–250 B.C.E.). The Romans, however, who might be aptly defined as hesitant in their depictions of nude human figures, greatly admired nature and the landscape. Roman poets sang of the delights and beauty of the countryside and natural realm, and writers including Horace, Pliny the Elder, Ovid, Vitruvius, and Virgil discussed the mutualities between the image and the poetry of landscape, with Virgil identified as the originator of the concept of the Georgic landscape. The finest examples of the visualizing of the Roman idea of the landscape are found in the decorative walls covered with illusionistic landscape that redefined the size and borders of individual rooms. During the early Christian and Byzantine periods, presentations of the landscape were related in terms of decorative designs and symbols. These were bifurcated: paradisaical gardens or the wilderness exile were

rendered through a symbolic vocabulary of flora and fauna, topographical elements, and human presence.

While the Middle Ages saw a retrieval of classical naturalism in presentations of the landscape, symbolic codings of nature, especially in the metaphorical paradise garden, continued. Medieval attention to the landscape involved the introduction of meteorological properties. Renaissance attitudes toward the landscape were divided between idealization and visual poetry, with an artistic concern for the interplay of light and spatial relations. With the religious and cultural revolution known as the Reformation and its southern European correlative, the Counter-Reformation, landscape painting began its journey toward an independent genre, as evidenced by Albrecht Dürer’s employment of the term *landschaft* and the contemporary appearance of the *paese* in the Italian center for landscape painting, Venice. The secularization of the arts in the Reformed countries emphasized the turn to history, portraiture, still-life, and genre themes, which included landscape. Dutch landscape painting in particular experimented with effective displays of light and weather and was fostered by the Calvinist dictum that God’s largesse is manifested in the natural world. The economic prosperity of the rising middle class created a new audience and patronage for landscape paintings in northern Europe. The next major shift in the idea of landscape came in the eighteenth century with the delicate pastoral formulated by Jean-Antoine Watteau. In the nineteenth century the famed Kantian turn to the subject and his discussion of the sublime conjoined with a



Human as subordinate to nature. *Harvesters* (1565) by Pieter Bruegel the Elder. Oil on panel. THE GRANGER COLLECTION, NEW YORK

variety of technological advances in painting, the economic and societal ramifications of the Industrial Revolution, and the political modifications of revolution and democratic governance to support first the development of romantic landscape, then realist and impressionist landscape by midcentury, and expressionist and abstract landscapes at the end of the century. The twentieth century, with its cultural and religious pluralism, provided new lenses affected by science, technology, and societal revolutions through which the landscape could be interpreted no longer as a major artistic topic but as a nostalgic vision of spiritual values. Landscapes of the late twentieth and early twenty-first centuries were affected by ecological concerns, computer technology, and the development of specialized movements such as land art. From the middle of the nineteenth century to the present, Western art was first challenged and then influenced by the development of photography; similarly the technological advances of moving pictures, television, and computer art have re-formed the modes through which landscape is perceived and imaged.

Despite the variations in attitudes, interpretations, and perceptions of the landscape in Western painting, there are two consistent and fundamental modes of artistic representation employed by Western artists: classic and romantic. Essentially the classic type reorders and enhances nature in an expression

of emotion tempered by technical perfectionism evidenced by smooth surface, measured if not invisible individual brush strokes, and careful delineation between colors, forms, and figures often identified as painting with a hard line. The romantic landscape is characterized by its visioning of the undisciplined and savage dimensions of nature as connotative of the sacred mysteries of the divine, signified by textural variations in the layering of and brushwork for paint and the indecipherable borders between colors, forms, and figures identified as painting with a soft line. The art historian Joshua C. Taylor counseled that what is here identified as the classic has prevailed during periods of economic, political, and social unrest whereas the romantic style has been favored during times of economic, political, and social stability.

Two works from the Renaissance era provide an important series of visual comparisons that can be “read” to clarify the classic and romantic modes: Giorgione’s *La Tempesta* (*The Tempest*; 1507–1508; Galleria dell Accademia, Venezia) and Titian’s *Sacred and Profane Love* (c. 1515; Galleria Borghese, Rome). Neither of these two paintings is a dedicated landscape painting; rather, they incorporate nature into the background, Giorgione more speculatively than Titian. The theme and subject of Giorgione’s mysterious *La Tempesta* remains an encoded secret, as it appears to be without a narrative, historical, mythic,



A pastoral landscape with figures. *Departure from the Island of Cythera* (1717) by Jean-Antoine Watteau. Oil on canvas. THE ART ARCHIVE/MUSÉE DU LOUVRE PARIS/DAGLI ORTI (A)

religious, or cultural referent. Such a task of aesthetic discernment should reveal the meaning of this painting and the relationships among the three human figures and between the human elements and nature. The juxtaposition of an undressed nursing mother holding her suckling child at her right breast with a standing, fully dressed male pilgrim may signify everything and nothing. The mysterious positioning of the indecipherable human figures and their story (stories) within the boundaries of this canvas are secondary to the physical presentation that Kenneth Clark identifies as “the quintessence of poetic landscape.” The creation of space within Giorgione’s canvas is enhanced by a series of triangular intersections of topographical and architectural elements that lead the viewer’s eye into the center space, which then evaporates into the wafting storm clouds. This mixture of hard- and soft-line effects evokes an atmospheric aura of ambiguity and heightened emotion as the storm either approaches or passes over.

Titian’s equally difficult-to-interpret canvas is visually divided between the characteristics of sacred and profane love represented anthropomorphically by the two female figures, one dressed, the other nude. This same dialectic is signified in the two attitudes toward landscape, as untouched natural vegetation flourishes behind the elegant figure of sacred love while an idyllic pastoral vista proffers its mannered display behind

the classical figure of profane love. Titian’s ability to present both approaches to the landscape connotes his artistic recognition of the symbolic values attributed to nature.

The visual transition evident from Pieter Brueghel’s *Harvesters* (1565; The Granger Collection, New York) to Jean-Antoine Watteau’s *Departure from the Island of Cythera* (1717; Musée du Louvre, Paris) to John Constable’s *Salisbury Cathedral from the Bishop’s Grounds* (1825; Metropolitan Museum of Art, New York) provides a progression toward the idea of pure landscape in Western painting. Paralleling this evolution in attitudes to the landscape are the economic and social influences of the move from an agrarian to a mercantile to an industrialized society. Brueghel’s harvest scene follows the medieval tradition of the “labors of the month” first captured in cathedral carvings and adapted later in the fourteenth century into richly elaborate paintings. Brueghel’s harvesters incorporate those currently at work and those at rest. The canvas is bifurcated by a diagonal path that separates the reapers who are integrated into the tall hay on the left side of the canvas from those who rest under the shade of a single tall tree in the right foreground. The right-hand side of Brueghel’s canvas displays the cut hay either onto rectangular or tentlike forms. The distant background is also divided into a mannered mountain vista on the left and a verdant wilderness on the right. Although premised, one could



Awesomeness of nature. *Salisbury Cathedral from the Bishop's Grounds* (c. 1825) by John Constable. © GEOFFREY CLEMENTS/CORBIS

argue, upon scriptural passages related to the Fall, *Harvesters* is devoid of mythological, political, or literary referent, and yet the familiarity of the theme makes commentary unnecessary and its appeal immediate and widespread. Brueghel has moved the viewer beyond the landscape as symbolic setting or backdrop for a painting to the landscape as subject, with its allusions to the eternal passing of the seasons and the vastness of space. The abundance of nature herein affirms the transition to a situation in which the human is subject to nature.

On the other hand, Watteau's ethereal re-visioning of the pastoral landscape emphasizes soft colors and lines as the large group of revelers crosses the undulating horizon line. This famed rendering of a romantic idyll incorporates handsome couples who apparently will attend the *fête galante*. The freshness and informality of the artist's vision is highlighted by his development of a new genre painting of a pastoral landscape with figures. Demonstrating his debt to Giorgione and the evocation of a poetic mood, Watteau positions his strolling lovers in a garden setting in which the division between foreground and background is a semicircular arrangement of figures over a gentle central knoll. The background vista, like that of

Giorgione, is softer in line and color as the floating wispy clouds fuse with the lofty trees and airy mountains. The idyllic garden then becomes simultaneously a setting for an event and the event itself as the poetic tranquility, fluidity, and atmosphere create an aura of intimacy and magic much like the enchanted gardens of classical and medieval landscape painting.

Constable's sunlit pastoral landscape is one of his many simple and quiet scenes anchored in his childhood memories of life in Suffolk. In this version of Salisbury Cathedral, he divides the canvas both horizontally and vertically to highlight the painting's centerpiece—the cathedral building itself. On the narrow pathway on the left side of the canvas are diminutive male and female figures walking together away from the viewer, while two rows of grazing cows are located on the right-hand side in parallel relationship to the strolling couple. The association between humanity and nature veers toward a recognition of the awesomeness and mystery of the romantic landscape. Constable's use of sunlight predetermines his disposition toward the heightened color of fresh greens, bold brushwork, and the meteorological modulations between stability and



Humanity's spiritual relationship to the natural world. *Two Men in Contemplation of the Moon* (1819–1820) by Caspar David Friedrich. Oil on canvas. PHOTO CREDIT: ERICH LESSING / ART RESOURCE, NY

change. Like his contemporaries, this British artist was torn between science as a mode of observation of nature and religion as the center of values. As this painting demonstrates, however, restitution of a moral high ground was his clear choice. Nature, thereby the landscape, is the direct messenger of God's divine providence, and landscape painting conveys moral ideas and values.

This transformation from Brueghel's agrarian landscape with its overt partnership between humanity and nature to Watteau's ethereal enclosed garden in which humanity continued in a major role and finally to Constable's resplendent pastoral in which the human figure is so diminished as to be noticeably absent is signified by the transition from populated to nonpopulated. The journey toward landscape, then, is a process of both definition and liberation.

Landscape East and West

Expanding the art historian Benjamin Rowland's now classic comparative discussions of *Art in East and West* (1954), we recognize that landscape is not simply a Western idea or artistic

theme. Indeed, for Chinese, Korean, and Japanese artists, landscape was a primary artistic motif centuries earlier than in the West, and their religious and cultural attitudes interpreted nature and thereby landscape as an independent topos at least from the early tenth century. Perhaps best represented by the Chinese name, *shanshui*, or "mountains and water," this Eastern esteem for landscape was predicated upon more than an appreciation or respect for nature, its awesome wonders, and its universal processes; there was also a recognition of the place of humanity within the natural world. It was believed that a retreat or temporary withdrawal from society or "the modern" into a situation permitting contemplation of nature—countryside, mountains, or desert—facilitated a revelation of the ever-present pervasive spirit of the universe. Thus the idea of the landscape was as a retreat for renewal of an individual's mind and refreshment of the spirit. However, this landscape, which had its own life force, was not to be depicted as an illustration, that is line for line, form for form; rather, the real essence of the landscape was to be captured in a style prophetic of "the romantic." The distinction is simply understood if the Greek signifies the West and the Chinese the East. Where the

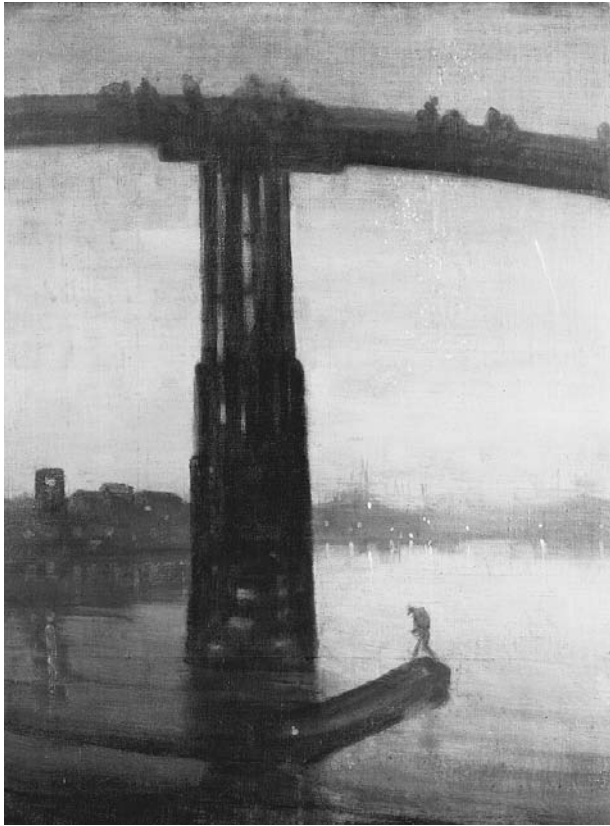

A visual harmony of tones and forms. *Old Battersea Bridge* (1872–1875) by James Abbott McNeill Whistler. Oil on canvas. TATE GALLERY, LONDON. © THE ART ARCHIVE

Greek sought the personification (or anthropomorphization) of a grove or a tree, the Chinese saw a manifestation of the divine through the labors of the universal spirit.

Consider, for example, the renowned Chinese *shanshui* of *Sage Contemplating the Moon* by Ma Yüan (1200; Kuroda Collection, Tokyo), in which the economy of line and classic asymmetrical composition extends an invitation to the viewer to participate in the quietude and meditation of the reclining sage entranced within his contemplation of the vast emptiness before him and the singular present of the full moon. A potential Western conversation partner is Caspar David Friedrich's romantic vision of *Two Men Contemplating the Moon* (c. 1830; Metropolitan Museum of Art, New York). As beautiful a visual recording of this mysterious partnership between the two men and nature is, and as carefully as the viewer is invited through the painterly convention of interlocuter figures to participate in this experience, the visual differences between the Eastern and Western images are telling and help the viewer to recognize the cultural distinctions in the idea of landscape. Both paintings express the emotive power of the human connection with nature and the spirituality of this relationship. Both paintings could be classified within the Western category of romantic, with their soft edged forms, artistic focus on the evocation of mood, and presentation of nature mysticism.

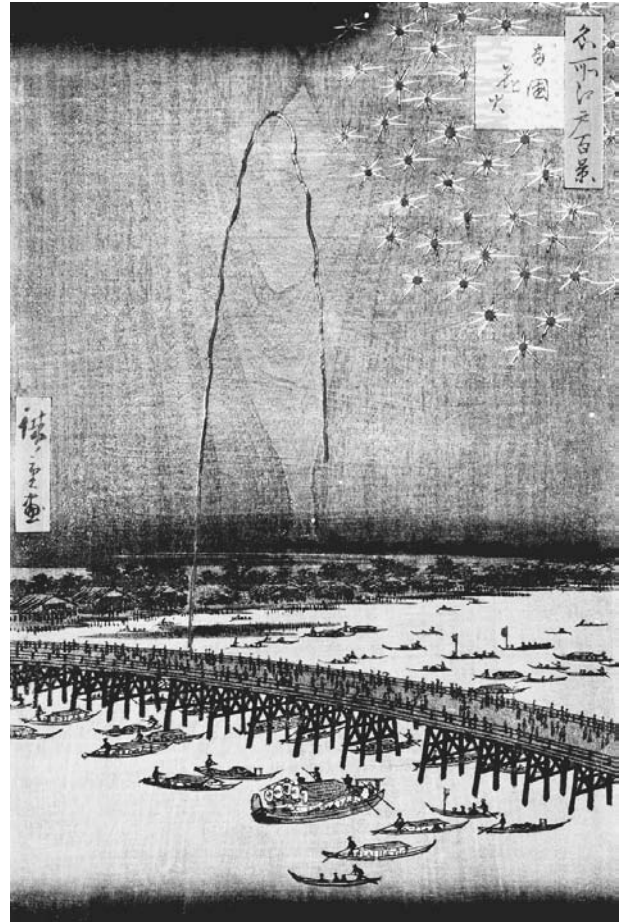

Flatness of landscape, figures, and fireworks. *Fireworks at Ryōgoku Bridge* (mid-nineteenth century) by Hiroshige. © CHRISTIE'S IMAGES/CORBIS

However, Friedrich designed a series of internal spatial connectives between the mountainous foreground, the evergreen and gnarled empty trees, the distant mountainscape, and the two men that so clutter the canvas as to obscure the focus on the moon and thereby of the spiritual potential of nature. Further, his inclusion of two men who appear almost as partners in physical stature and social position suggests a common search for, and thereby discussion and explication of, the meaning of this encounter. Alternatively, Ma Yüan offers a simpler, more restrained vision of a mountainous landscape that includes a distorted gnarled tree and two men. However, these two men are separated not simply by the internal topographical barrier of a small mountain but also by their own physical size and social status. There is no internal conspiracy between them; rather, the sage and the boatman contemplate, each in his own way, the mystery and spiritual power of nature—the sage by concentrating on the moon, the boatman on the mountain. The large internal space given over by the artist to the void provides a sense of both the monumental vastness of the night sky and the place of the human within the context of the natural world. Further, this void provides a space in which the viewer, like the contemplative sage, can write her own story. One additional



Mountains surreal, yet geologically precise. *The Virgin of the Rocks* (c. 1483) by Leonardo da Vinci. Oil on wood. © NATIONAL GALLERY COLLECTION. REPRODUCED BY KIND PERMISSION OF THE TRUSTEES OF THE NATIONAL GALLERY, LONDON/CORBIS

and perhaps ironic difference to note is that Friedrich employs a horizontal canvas and Ma Yüan a vertical one. Normally the former would be described as accessing the aesthetics of immanence and the latter the aesthetics of transcendence. However, this is open to debate, as these two paintings create internal attitudes toward the relationships of humanity with nature and of the human with the spirit.

Reversing the horizontal and vertical references is another comparison of Eastern and Western romantic views of landscape in James Abbott McNeill Whistler's *Old Battersea Bridge* (1872–1875; Tate Gallery, London) and Hiroshige's *Fireworks at Ryūgoku Bridge* (1858; Fogg Art Museum, Cambridge, Mass.). Perhaps this visual consideration of the universal elements of landscape is enhanced by the fact that the American expatriate painter had seen, owned, and was influenced by Japanese woodblock prints such as Hiroshige's prior to his painting of the *Old Battersea Bridge*. *Japonisme* swept through Paris, especially among the artistic circles Whistler frequented, beginning in the late 1850s and reaching a fervor in the



An interplay of vertical and horizontal forms. *Mont Sainte-Victoire* (1902–1904) by Paul Cézanne. Oil on canvas. PUSHKIN MUSEUM, MOSCOW, RUSSIA. © ALEXANDER BURKATOWSKI/CORBIS

mid-1860s. *Japonisme* was a major influence on the development of both Impressionism and the art for art's sake movement. Whistler, foremost among all his Impressionist, symbolist, and art for art's sake colleagues, was affected by the visual principles and religio-aesthetics of Japan. Although much of the Japanese woodblock art and pottery that entered the European and American markets was made for export, thereby not necessarily within the proper boundaries of theme, design, and execution for a Japanese audience, Whistler had a discerning eye, and his own approach to painting was transformed by the finest among such objects.

Hiroshige's depiction of a summer fireworks display is visualized at early evening when the bridge is covered with diminutive figures who stand above the water and mountains almost like birds looking down on the natural environment. The foreground and background of the print is divided by the vertical lines forming the Ryūgoku Bridge, with the fireworks boats and the boats with passengers viewing the display, almost obliterating the river waters. The bridge also partially obscures a series of mountains and beaches in the background. The falling lights of the fireworks are condensed into a small segment of the night sky, yet again diffused by the bridge. The internal tonal arrangement of soft, neutral colors works in tandem with the complex patterning of lines and curves to create on first glance an abstract pattern distinguished by the character of "flatness." The details of the fireworks, the varied audiences, and even parts of the natural environment became homologous elements in the visual pattern of colors and forms. A work such as Hiroshige's requires careful looking, as the first glance suggests an unpopulated landscape.

Whistler's painting is even more abstract in its presentation of form and figure. He sought to create a visual harmony of tones and forms that create a mood similar to that evoked in a listener by music, even unto his minimizing of titles to musical parallels: *Old Battersea Bridge* is among his "Nocturnes."



The enchanted garden. *Humay and Humayun in a Garden* (c. 1430). Manuscript illumination. PHOTO CREDIT: GIRAUDON/ART RESOURCE, NY

To attain this effect he minimized the details, colors, forms, and lighting in paintings such as this, which he also distanced from a narrative. Through his presentation of the atmospheric relations of water, earth, and sky in a moment of poetic enchantment, Whistler invites the viewer to contemplation of the spirituality of landscape. However, what Whistler has also created here is a new vision, or perhaps a retrieval, of the classic mode, of the landscape of symbolic potential.

One of the major distinctions between Eastern and Western presentations of the landscape is the void. In the Chinese *shanshui* (landscape painting) the visual emphasis is as much upon the void as it is upon the sparsity of detailed renderings of botanical and topographical forms. Despite the economy of line, these paintings project the visual effect of nature. The placement of the majority of pictorial imagery left of center balances the void right of center to comprise the traditional asymmetrical composition favored by Chinese, Korean, and Japanese artists. However, the void has multiple roles, including a spiritual threshold for preparation to encounter the universal spirit and an aesthetic invitation to participate in this image of contemplation by painting or writing the viewer's own story in this otherwise empty space. The important socio-political function is clarified when a landscape with an empty poetry hall is contrasted to a landscape with the poetry hall filled in. The texts written into the poetry hall record the thinking of those who have contemplated the image with great care and, when the calligraphy includes seals, those of rank who saw the image in situ. The verses provide the viewer with a recognition of what others have experienced in front of this painting, perhaps as a spiritual guide or entry point for viewers who find images disturbing but words comfortable. Neither of these *shanshui* is a precise transcription of what this natural vista looks like; each depicts the spirit or essence of this landscape episode in the world of nature.

When these *shanshui* are compared with Western paintings in which the mountains perform a central, if not dominant, role, it becomes apparent that the fundamental distinction between East and West is in the spiritual and symbolic significance of the idea of landscape. The mountain connotes a variety of Western symbolic references, ranging from the classical Mediterranean "home of the gods" to the Hebraic monumental setting for conversations with Yahweh to the Christian site of transfiguration. The Chinese attitude toward the mountain is also multivalent and ranges from a site for celestial activity to a symbol of permanence and immensity. Shrouded in mist, clouds, or shadows, the mountains dissolve into a delicately splendid form that speaks to the senses rather than the intellect as the essence of the landscape.

Consider, for example, the surrealistic mountain formations found in the art of Leonardo da Vinci, which provide both a form of geological precision and an aura of mystery. His investigations of nature, and thereby his depictions of the landscape, were premised upon careful observation of the natural world and the anatomy of vision. Leonardo captured the rhythm and quiet energy of plants, water, and light. His passion for scientific investigation may have led him to the prominent inclusion of atmospheric blues in his renderings of the landscape, as in *The Virgin of the Rocks* (c. 1483; The National Gallery, London). The surreal shapes of the background mountains and

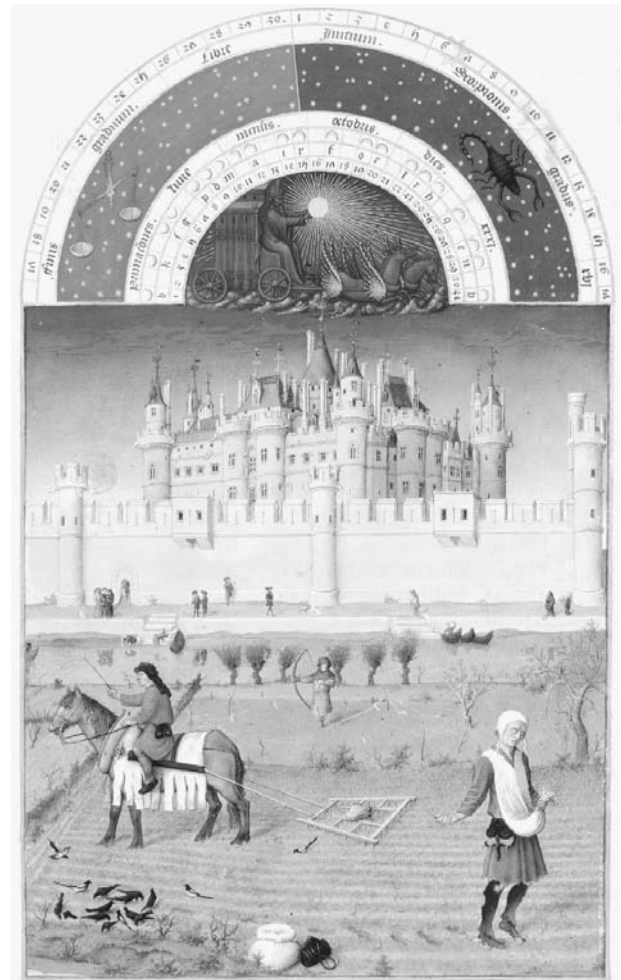

After the Fall: the earth as a place of exile. *October*, calendar miniature from *Les Très Riches Heures de le Duc de Berri* (1413–16) by the Limbourg Brothers. PHOTO CREDIT: RÉUNION DES MUSÉES NATIONAUX/ART RESOURCE, NY

surrounding rock distinguish this as a Western landscape premised upon the Greek principle of the personification: visual parallels between the rocks and human figures are evident in the gesturing hands and fingers and other extremities. By contrast, the Chinese strove to present the living spirit that vitalized the mountain in a painterly vision of mystical and lyrical aestheticism.

Paul Cézanne's *Mont Sainte-Victoire* (1902–1904; Pushkin Museum, Moscow) provides a Western approach to imaging the harmony of and within nature. A technical exercise in the interplay between vertical and horizontal forms, Cézanne's painting is divided into the traditional tripartite foreground, middle ground, and background. However, he creates a new way of understanding this perspectival relationship as his use of line and color moves the viewer's eye back and up toward Mont Sainte-Victoire, which is the object of his gaze. His experiments with brushwork provided him with the skill to create a rapid, loose brush stroke that results in an internal interplay between surface and depth, so that the viewer experiences a sense of perspective, depth, mass, and volume when there isn't any.



America as the “new Eden.” *The Oxbow: The Connecticut River Near Northampton* (1836) by Thomas Cole. Oil on canvas. METROPOLITAN MUSEUM OF ART, NEW YORK CITY. GIFT OF MRS. RUSSELL SAGE. © FRANCIS G. MAYER/CORBIS

Nonetheless, his explorations of the vista and monumentality of Mont Sainte-Victoire resulted in a series of regulated and erudite renderings of the landscape far removed from the spiritual attachment to nature fundamental to *shanshui*.

Attitudes toward the Landscape

A series of universal attitudes toward the idea of landscape in painting can be found in Eastern and Western cultures through the centuries. These are identified through the motifs of garden/paradise, space/place, awesomeness/sublimity, and form/formlessness. These attitudes relate to developments in religious values, philosophy, economics, and politics as well as to technological and stylistic changes in the arts.

Garden/paradise. Traditionally understood to be derived from the Persian for “a walled enclosure,” the paradise, particularly the paradise garden, is a widespread visual motif among world cultures and mythologies. Oftentimes synonymous with the enchanted garden, the paradise garden signifies first and foremost a place of safety where love and friendship can thrive. The glorious details of its flowery meadows, sweet aromas, shade-giving trees, and gentle animals are important, especially in its connotation as a metaphor of the heavenly paradise. The motif of the garden denotes both a space of beauty and vegetation and, in a number of religions, the site of the origins of humanity. A major metaphor for the earthly paradise,

the Garden of Eden was first the home of Adam and then of Eve, in which all the terrestrial gifts of the creation were abundant until the primordial couple fell from God’s favor and was expelled from the garden.

Early Christianity reformulated the classical perception of the natural world as a place of delight into a metaphor for our exile from the garden. Thus early Christian artists formulated an image of landscape as a symbolic paradise, as seen in the glistening apse mosaic featuring heaven and earth in the *Transfiguration* (c. 548; San Apollinaris in Classe, Ravenna, Italy). The highly stylized trees and plants are in keeping with the early Christian concern with flatness as an attribute distinguishing image from idol. The decorative glorification of the natural world denotes what Kenneth Clark identified as the “landscape of symbols” present in this Ravenna mosaic alluding to the lost but not forgotten garden. The garden motif was regularly contrasted to the desert and/or the wilderness in early Western monotheism; the “land of milk and honey” was the earthly locale providing a foretaste of the heavenly paradise.

During the twelfth century, the enchanted garden motif was reformed and aligned with the Christian *hortus conclusus* (enclosed garden) and the Islamic enclosed garden, as exemplified by the Master of the Upper Rhine’s *Paradise Garden* (1410; Städelches Kunstinstitut, Frankfurt) and the manuscript

illumination of *Humay and Humayun in a Garden* (c. 1430; Musée des Arts Décoratif, Paris). In the former, the normative medieval elements of a garden are fused with the Hellenistic poetic *amoenus*, or “lovely place,” as the delicate sights and smells of flowers—including the singular form of thornless rose that medieval Christianity reserved as the sign of the Virgin’s

“enclosed garden”—and other flourishing vegetation create a visual delight. The Christ Child merrily plays music as his mother reads peacefully in this place of love, comfort, and safety. Similarly the earthly Humay and Humayan find happiness in both their pronouncements of love and in the enchanting setting for their rendezvous. This flower-filled garden is surrounded by a series of appropriately decorated screens that extend the floral and arboreal patterns against a romantic night sky. The presumably perfumed atmosphere, tender bird songs, shade-giving trees, and cool water of these enclosed gardens continue their visual analogies to the lost paradise of Adam and Eve.

The earth as a place of exile is fundamental to the medieval motif of the “labors of the months,” which eventually was transformed into the fifteenth-century illuminations in books of hours, in particular, those of the Limbourg Brothers such as *October* from *Trés Riches Heures de le Duc de Berry* (1413; Musée Condé, Chantilly). The Limbourg Brothers here combine the “lost garden” motif with the result of the Fall, that is, that humans must toil in the fields. So as one man rides a horse to till the earth and another sows the winter seed in front of the then Palais du Louvre, the viewer experiences the sensation of the enclosed garden, because the wall in the background can be interpreted as a closing off of the farmed lands from the world of aristocratic and political activity. The passing of the seasons is highlighted by the astrological calendar that frames the top of this illuminated page. Further, the Limbourg Brothers connect the natural with the spiritual in their concern for the meteorological effects of the changing



A merging of the awesome and the sublime. *Icebergs (The North)* (1860) by Frederic Edwin Church. Oil on canvas. PHOTO CREDIT: ART RESOURCE, NY



Chaos of nature meets the constancy of the natural world. *Under the Wave off Kanagawa* from *Thirty-six Views of Mount Fuji* (1830–1835) by Katsushika Hokusai. © HISTORICAL PICTURE ARCHIVE/CORBIS

We are surrounded with things which we have not made and which have a life and structure different from our own: trees, flowers, grasses, rivers, hills, clouds. For centuries they have inspired us with curiosity and awe. They have been objects of delight. We have come to think of them as contributing to an idea which we have called nature. Landscape painting marks the stages of our conception of nature.

SOURCE: Kenneth Clark, *Landscape into Art* (1979 [1946]), p. 1.

seasons, evidenced by the costuming and postures of the farmers as well as by the landscape. That which had been the happy home of the primordial couple has become the site of exile for their descendants, who must contend with the challenges of nature's bounty and powers.

Space/place. The notion of space in landscape is twofold, that is, it occurs both inside and outside the frame. Further,

there is a philosophic if not psychological reality to the transformation of space into place. This idea of land as space and place is promoted in the work of the geographer Yi-Fu Tuan. The activity of transforming space into place encompasses the acts of identification, naming, possession, and privileging. Perhaps, as in the journey toward landscape, the path toward place is a metaphor for the process of individuation. Further, the spatial relationships within and without the frame have implications beyond the vista of a landscape.

Thomas Cole's now classic rendering of *The Oxbow: The Connecticut River near Northampton* (1836; Metropolitan Museum of Art, New York) is a multivalent reading of the idea of landscape in nineteenth-century American art. A diagonal line runs from the painting's lower right corner upward toward the swirling storm clouds in the upper left corner. To the left of this diagonal line Cole's landscape is a classic display of the wilderness: untamed and unmannered, with lushly green vegetation, decaying broken trees, and a storm-filled sky signaling the tempestuous conditions of nature. Correspondingly the landscape to the right of the diagonal is basked in sunlight, carefully managed and arranged, implicitly under human dominion and exuding a sense of serenity and silence. The founder of the Hudson River School of painters and later also of writers, Cole is further identified as the first American landscape painter. A devout Christian, Cole used his renditions of the landscape as a visual mode of moral and spiritual reflection. Knowing the date of this



A passionate vision of landscape. *The Starry Night* (1889) by Vincent van Gogh. Oil on canvas. MUSEUM OF MODERN ART, NEW YORK CITY. LILLIE P. BLISS BEQUEST. © THE ART ARCHIVE/ALBUM/JOSEPH MARTIN

painting, it becomes necessary to consider the effect of the economic disasters of 1835 and the then-common reading of this painting as an omen of future disasters, most notably the Civil War. *The Oxbow* is also a depiction by Cole of America as the “new Eden,” an artistic and literary motif popular in the early period of American landscape painting that both offered a connection to the European tradition of landscape painting and served as a vehicle for an American “Christian” art.

However, it is Cole’s development and evolution of the intersecting concepts of space and spatial relations into “a place” that characterizes this idea of landscape in America. As a horizontal canvas, *The Oxbow* offers its viewers a peripheral range of vision as well as the traditional foreground, middle ground, and background. The meteorological effects of the stormy and thunderous clouds on the left of the center diagonal, and of the available sunlight with a series of soft clouds on the right, reflect a modernizing of the Limbourg Brothers’ point of correspondence. Providing his viewer with a horizon line through which one can enter into this wilderness and pastoral landscape, Cole did not forget that Western characteristic

necessity of the presence of the human. Toward the lower right-hand corner, as the wild vegetation begins to soften into the mannered presentation of the river and the farmed pastures, the disciplined viewer spies a white and red umbrella slanting away from the now decipherable diminutive portrait of the artist.

The twentieth-century painter Georgia O’Keeffe dedicated the last years of her life to the depiction of the landscape in the American Southwest. However, earlier in life she painted landscapes reflecting the places where she lived, including Texas, New York City, and Lake George. Influenced by the modernist ethos that incorporates Oriental (as in Chinese and Japanese) art and philosophy, her paintings such as *Red Hills, Lake George* (1927; The Phillips Collection, Washington, D.C.) are minimized presentations of economical delineations of forms that express the ideas and evoke the emotions that characterize the artist’s theme. Like Cole, she leaves an empty space in the upper sky that can be correlated to the void in Chinese and Japanese landscapes. Further, her use of hot- and cool-toned colors, in coordination with the simplicity of her forms, leads us to experience the essence of her idea of the landscape.

Physically small in scale and squarer in shape than *The Oxbow*, O'Keeffe's painting creates the visual sensation of a wide-open space with the intersecting "v" formations of mountains. The viewer is without an entry point but comes to the recognition that this is a new way of seeing and expressing the idea of the landscape: the viewer is standing within the frame.

Awesomeness/sublimity. The expression of energy and power found in the landscape is delineated by the categories of the awesome and the sublime. Depictions of extraordinary meteorological events, natural disasters, and spiritual intensity in landscape capture the essence of these categories. The nineteenth-century American painter Frederic Edwin Church created an image merging the awesome and the sublime in *The Icebergs (The North)* (1861; Dallas Museum of Art). Overcast by an aura of solitude and silence, *The Icebergs* draws viewers into the eerie blue-green water, the reflected colored lights on the other icebergs, and the almost surreal iceberg formations reminiscent of Leonardo's rock. One may not even initially see the broken, half-sunk ship frozen in the wintry waters of the north, the only sign of human presence.

Katsushika Hokusai's *Mount Fuji Seen below a Wave at Kanagawa* from his *Thirty-six Views of Mount Fuji* (Tokugawa period, 1830–1835; Museum of Fine Arts, Boston) communicates a moment of simultaneous awe and terror. The dramatic energy of the inland sea is seen in the large, threatening waves, most significantly in the tallest ocean wave, which curls over with such intensity that it froths with foam and dwarfs Mount Fuji, which is visible in the background. The frothing waves extend talons of water and foam that reach out to overturn the boats cascading over the curvilinear water slides. Despite all these raging waters and potentially overturned boats, Mount

Fuji, the sacred mountain, stands calmly, majestically, and reassuringly in the distant background. The awesome and the sublime fuse into an image that at once captures nature's swirling energies and its stability.

Vincent van Gogh's *The Starry Night* (1889; Museum of Modern Art, New York) coordinates warm and cool colors with an intensity of line to express a passionate vision of the landscape. The undulating swirls electrify the night sky, enhancing the white, blue-white, and yellow circles of "fire" that traverse the upper realm of this canvas. The large yellow crescent moon in the upper right corner is balanced by the flamelike vertical cypress trees in the lower left corner. The country village unfolding beyond these two reference points is accentuated by the church that stands almost at the center of the frame. The rhythm of the internal forms creates an atmosphere of spiritual intensity and reawakens the primordial awe at the vast magnificence and limitless powers of the natural world.

Form/formlessness. The common perception is that natural objects such as trees, mountains, and flowers should be depicted accurately in Western painting. Representational forms, that is, those recognizable through their resemblance to what is seen in everyday life, are the most comfortable to the human eye and the least threatening to the human psyche. However, abstracting forms in order to artistically distill the essence of the thing or idea became an artistic convention in Western landscape most prominently with the influence of *Japonisme* in the 1860s. Thus a formless style of characterization became a visual mode for evoking emotion and response from viewers. Although a new practice among Western landscape painters, this "formlessness," or abstraction, had been common to Eastern artists almost from the inception of interest in nature as an

universal reflection of spiritual values. Fuyake Roshu's *Utsunoyama: The Pass through the Mountains* (Edo period, 1699–1757; Cleveland Museum of Art) incorporates highly stylized but nonrepresentational forms for his mountains, vegetation, and river. This patterning of undulating masses, curvilinear flattened forms, and decorative vegetal shapes present the essence of landscape in a dynamic yet challenging mode.

Translated into Western art first by Whistler and then by the Impressionists, this artistic interest in formlessness, or “formless form,” reached new heights in the late nineteenth century with paintings such as Paul Gauguin's *The Day of the God (Manaha no Atua)* (1894; Art Institute of Chicago). In this work, one of the paintings influenced by his Tahitian sojourn, the exotic is referenced not simply by title or attitude toward the human figure but also the expressive quality of Gauguin's colors. In this canvas he clearly merges form with formlessness in the abstractions of landscape in the foreground, where the discarded garments of the ritual celebrants are almost indistinguishable from the topography and the pool of water.

Pursuing the idea of landscape as a merger of form and formlessness one step further, Salvador Dalí painted images

such as *The Persistence of Memory* (1931; Museum of Modern Art, New York) in which the viewer's normal concept of proportion is also skewed, as for example in the larger-than-life-size limp watch that hangs over a bare branch of a diminutive tree. Objects fuse with anthropomorphic elements in this landscape of dreams, as the formless foreground is absorbed into the recognizable forms of the lake and mountainside by Dalí's home in Port Lligat, Spain. In this way he coordinates the known with the unknown, dream with reality, and form with formlessness within the idea of landscape.

Scholarship on the Landscape

Formal discussions of the idea of landscape date, as mentioned earlier, to the philosophic and poetic texts from the classical era of Greece and Rome. In the early Christian era, however, beyond scriptural and patristic references to landscape as the garden, the wilderness, the land of milk and honey, or the desert, little attention was given to either landscape as an art form or as nature until the time of Francis of Assisi (1181 or 1182–1226), who retrieved and reshaped the pre-Christian understanding of the beauty of the natural order as a reflection of God.

Giovanni Paolo Lomazzo (1538–1600) is recognized as the first author to discuss formally an aesthetics of landscape through his distinction of “privileged places” and “places of delight” in his *Trattato dell'arte della pittura, Libro VI* (1584). Seventeenth-century commentaries by Roger de Piles, André Félibien, and Samuel van Hoggstraten, among others, continued to define, classify, and elevate the idea of landscape in art. The eighteenth century produced significant philosophic reflections on the idea of landscape, particularly with relation to the sublime, by Edmund Burke, William Gilpin, Uvedale Price, and Immanuel Kant. Curiously, nineteenth-century painters wrote more influential texts on landscape than philosophers or theologians, including Caspar David Friedrich, John Constable, and Thomas Cole, although the writings of John Ruskin and Ralph Waldo Emerson would be formative on later aesthetics of landscape. With the advent of the twentieth century, critical assessments of the idea of landscape, particularly in painting, began to appear; however, most were limited to studies of “modern” attitudes toward landscape.

There is no single classic study of the theme of the idea of landscape either in the arts or more specifically in painting throughout the history of either Eastern or Western culture.

However, classic studies such as Michael Sullivan's *The Birth of Landscape Painting in China* (1962) and Barbara Novak's *Nature and Culture* (1980) consider the development of landscape painting in relation to a specific geographic location or chronological period. Kenneth Clark's singular *Landscape into Art* (1946) is an observant analysis of the cultural concepts of landscape in Western culture with a subthesis that the artistic move to landscape as a recognized category of “high art” corresponds to the secularization of Western culture and values.

A variety of intriguing texts including Leo Marx's now classic *The Machine in the Garden: Technology and the Pastoral Ideal in America* (1964) and Yi-Fu Tuan's *Space and Place: The Perspective of Experience* (1977) provide lenses through which to expand the boundaries of art-history-based analyses of landscape. Similarly Robert Rosenblum's *Modern Painting and the Northern Romantic Tradition: From Friedrich to Rothko* (1975), Denis E. Cosgrove and Stephen Daniels's edited volume *The Iconography of Landscape: Essays on the Symbolic Representation, Design, and Use of Past Environments* (1988), and any of Barbara Novak's texts provide specialized studies integrating theological, cultural, scientific, and philosophic influences on the meaning and presentation of landscape in painting.

Why does a virtuous man take delight in landscapes? It is for these reasons: that in a rustic retreat he may nourish his nature; that amid the carefree play of streams and rocks, he may take delight; that he may constantly meet in the country fishermen, woodcutters, and hermits, and see the soaring of the cranes, and hear the crying of the monkeys. The din of the dusty world and the locked-in-ness of human habitations are what human nature habitually abhors; while, on the contrary, haze, mist, and the haunting spir-its of the mountains are what human nature seeks, and yet can rarely find.

SOURCE: Kuo His, *An Essay on Landscape Painting*, trans. Shio Sakanishi (1936), p. 30.

The reality of both the interdisciplinary motif and methodology for the study of this theme, that is, the idea of landscape (through painting), has been emphasized by Western scholars within the categories of Western art and cultural studies. The most creative work being done appears to come from the research and curatorial presentation for special exhibitions. For example, the reader should consult *The Natural Paradise: Painting in America, 1800–1950* (1976), edited by Kynaston McShine; *American Light: The Luminist Movement, 1850–1875* (1980), edited by John Wilmerding; and *American Sublime: Landscape Painting in the United States, 1820–1880* (2002), edited by Andrew Wilton and T. J. Barringer.

See also **Arts: Overview; Chinese Thought; Classicism; Creativity in the Arts and Sciences; Gender in Art; Humanity in the Arts; Iconography; Japanese Philosophy, Japanese Thought.**

BIBLIOGRAPHY

- Apostolos-Cappadona, Diane. *The Spirit and the Vision: The Influence of Christian Romanticism on the Development of 19th-Century American Art*. Atlanta, Ga.: Scholars Press, 1995.
- Appleton, Jay. *The Symbolism of Habitat: An Interpretation of Landscape in the Arts*. Seattle: University of Washington Press, 1990.
- Cafritz, Robert C., Lawrence Gowing, and David Rosand. *Places of Delight: The Pastoral Landscape*. Washington, D.C.: Phillips Collection in association with the National Gallery of Art, 1988. Exhibition catalog.
- Clark, Kenneth. 1946. *Landscape into Art*. New York: Harper and Row, 1979.
- Cosgrove, Denis E., and Stephen Daniels, eds. *The Iconography of Landscape: Essays on the Symbolic Representation, Design, and Use of Past Environments*. Cambridge, U.K., and New York: Cambridge University Press, 1988.

- Hawes, Louis. *Presences of Nature: British Landscape, 1780–1930*. New Haven, Conn.: Yale Center for British Art, 1982. Exhibition catalog.
- Kemal, Salim, and Ivan Gaskell, eds. *Landscape, Natural Beauty, and the Arts*. Cambridge, U.K.: Cambridge University Press, 1993.
- Langmuir, Erika. *Landscape*. London: National Gallery, 1997.
- Lee, Sherman E. *Chinese Landscape Painting*. 2nd ed. Cleveland: Cleveland Museum of Art, 1962.
- Marx, Leo. 1964. *The Machine in the Garden: Technology and the Pastoral Ideal in America*. New York: Oxford University Press, 2000.
- McShine, Kynaston, ed. *The Natural Paradise. Painting in America, 1800–1950*. New York: Museum of Modern Art, 1976. Exhibition catalog.
- Nasgaard, Roald. *The Mystic North: Symbolist Landscape Painting in Northern Europe and North America, 1890–1940*. Toronto: Art Gallery of Ottawa in association with University of Toronto Press, 1984. Exhibition catalog.
- Novak, Barbara. “Defining Luminism.” In *American Light: The Luminist Movement, 1850–1875*, edited by John Wilmerding, 23–29. Washington, D.C.: National Gallery of Art, 1980. Exhibition catalog.
- . *Nature and Culture: American Landscape and Painting, 1825–1875*. New York: Oxford University Press, 1980.
- Nygren, Edward J., Bruce Robertson, and Amy R. Meyers. *Views and Visions: American Landscape before 1830*. Washington, D.C.: Corcoran Gallery of Art, 1986. Exhibition catalog.
- Redford, Scott. *Landscape and the State in Medieval Anatolia: Seljuk Gardens and Pavilions of Alanya, Turkey*. Oxford: Archaeopress, 2000.
- Rosenblum, Robert. *Modern Painting and the Northern Romantic Tradition: Friedrich to Rothko*. New York: Harper and Row, 1975.
- Sullivan, Michael. *The Birth of Landscape Painting in China*. London: Routledge and Kegan Paul, 1962.
- Sutton, Peter C., and Albert Blankert. *Masters of Seventeenth-Century Dutch Landscape Painting*. Boston: Museum of Fine Arts, 1987. Exhibition catalog.
- Tuan, Yi-Fu. *Space and Place: The Perspective of Experience*. Minneapolis: University of Minnesota Press, 1977.
- Turner, A. Richard. *The Vision of Landscape in Renaissance Italy*. Princeton, N.J.: Princeton University Press, 1966.
- Visions of America: Landscapes as Metaphor in the late Twentieth Century*. Denver: Denver Art Museum, 1994.
- Warnke, Martin. *Political Landscape: The Art History of Nature*. Cambridge, Mass.: Harvard University Press, 1995.
- Wilton, Andrew, and T. J. Barringer. *American Sublime: Landscape Painting in the United States 1820–1880*. Princeton, N.J.: Princeton University Press, 2002.

Diane Apostolos-Cappadona

LANGUAGE AND LINGUISTICS. Estimates of the number of languages spoken on earth at the turn of the twenty-first century range between four and six thousand. Considering that this number has been rapidly declining for the last couple of centuries, there must at one time have been many more languages, perhaps upwards of ten thousand. Of the languages spoken in the twenty-first century, a few have tens or hundreds of millions of speakers spread over enormous stretches

of land, while most languages have severely restricted population distribution. No matter exactly how many different languages there are or how many speakers each of them has, the multiplicity of human speech patterns is staggering, and any attempt to reduce this overwhelming plethora of sounds, meanings, and structures to a finite set of rules and procedures is both daunting and humbling. Yet that is precisely the charge that linguists take as their solemn duty. No wonder that linguistics is probably the most contentious of all academic disciplines; there is no easy, transparent mechanism for bringing order to the wild proliferation of human speech (not to mention writing).

The varieties of linguistic experience are so profuse as to defy accurate enumeration: grammar, syntax, etymology, phonology, phonetics, morphology, psycholinguistics, anthropological linguistics, sociolinguistics, educational linguistics, taxonomy, philology, historical linguistics, lexicography, and so on. It would be futile to attempt any sort of exhaustiveness with regard to the branches and sub-branches of this protean discipline. What is more, each division and subdivision of linguistics has its own generation after generation of leading lights. Thousands of linguists have left their imprint on the field, but here it will be possible to mention only a few of those who represent major trends, particularly in the realm of thought (both about the discipline itself and about human beings and their world).

Philosophers, Grammarians, and Neogrammarians

Throughout most of human history, the study of language has been subsumed under philosophy. The distinction between philosophical linguistics and linguistic philosophy is subtle but telling: Is the driving concern language or philosophy?

The Austrian-born English philosopher Ludwig Wittgenstein (1889–1951) was instrumental in bringing language-related questions to the fore for those who were not professional linguists. He accomplished this in two respects: (1) discussions on the philosophy of language, and (2) elaboration of logical theories. Wittgenstein was a protégé of Bertrand Russell (1872–1970), absorbing features of the analytic philosophy of Russell and Gottlob Frege (1848–1925), but fundamentally posing a whole series of innovative questions of his own devising. Wittgenstein's genius is enshrined in his *Logisch-philosophische Abhandlung* (*Tractatus Logico-Philosophicus*, 1922), a brilliant work that is only about seventy-five pages in length. Despite its extreme brevity, the *Tractatus* manages to raise provocative questions concerning the nature of language, logic, ethics, death, and other, often disturbing, topics. How is language possible? How does a sequence of words come to mean something? How can it be understood? For Wittgenstein, a sentence is a depiction of reality, thus he presents what might be called a picture theory of language. The *Tractatus* deals, above all, with the limits of language: "What can be said can only be said by means of a proposition, and so nothing that is necessary for the understanding of *all* propositions can be said." (In such statements by Wittgenstein, "said" means "represented.") The limits of language correspond to the limits of thought, hence there are certain things that cannot be thought, which accounts for the famous last sentence of the book: "Whereof one cannot speak, thereof one must be silent."

In *Tractatus*, Wittgenstein expressed the idea that there was a unifying essence beneath the diversity of language, and that the philosopher strives to discern this essence. In his posthumously published *Philosophische Untersuchungen* (Philosophical investigations, 1953), he had come to the conclusion that this supposed underlying essence was illusory. Rather, one demolishes obsessive concern with such perplexing questions as knowledge, intuition, and assertion by simply describing what one experiences in the daily use of language. In short, throughout his philosophical studies, Wittgenstein was perpetually in quest for *das erlösende Wort* ("the redemptive word").

Another important British thinker who followed the later Wittgenstein in pursuing philosophical analysis through detailed study of mundane language was John Langshaw Austin (1911–1960). Austin maintained that linguistic analysis can solve philosophical problems, but was opposed to the language of formal logic as contrived and incomplete. According to Austin, daily language is actually more subtle and complex than formal logic, and hence better able to get at the crux of critical issues. His approach helped to underscore the significance of language for philosophy.

One tradition of thought in which philosophy and concern with language are given almost equal weight is semiotics. Simply stated, semiotics (or semiology) is the study of signs and their diverse applications. The notion of *sign* is fundamental to the study of language, but its protean ubiquity (including for nonlinguistic purposes) makes it extraordinarily difficult to define. One of the earliest sign theories is that of St. Augustine of Hippo (354–430) as enunciated in *De Doctrina Christiana*: "A sign is a thing that causes us to think of something beyond the impression the thing itself makes upon the senses." The semiotic frame of reference is vast, being designed to encompass all other types of inquiry, but it became an independent mode of investigation with the American philosopher Charles S. Peirce (1839–1914). Originally a logician, Peirce did not offer a systematic presentation of his major principles and frequently changed his doctrines. He basically contended that all human experience could be organized at three levels that, roughly stated, are felt qualities, experiential effect, and signs, the latter being the abstract class of all sensorially perceived "signals" that refer to the same object or phenomena.

The German mathematician, logician, and philosopher Gottlob Frege contributed to the early development of semiotics by adding, among other things, the crucial distinction between *Sinn* ("sense") and *Bedeutung* ("meaning"). Frege enunciated the principle of *compositionality* whereby a sentence can be described according to the functional interdependence of the meanings of its appropriately formed elements.

In his *Foundations of the Theory of Signs* (1938), another American philosopher, Charles W. Morris (1901–1979), offered a tripartite organizational scheme for semiotics: syntax (the interrelations among signs), semantics (the relation between signs and the objects they designate), and pragmatics (the relationship between the sign system and the user). Morris collaborated with the German scholar Rudolf Carnap (1891–1970), who developed an ideal language that became a model for semioticians. A major figure in the development of

symbolic logic was the Polish-American scholar Alfred Tarski (1902–1983), who is well known for his concept of truth in formalized languages.

Semiotics was further developed in the monumental work of another German thinker, Ernst Cassirer (1874–1945), entitled *Philosophie der symbolischen Formen* (The Philosophy of symbolic forms, 1923–1929). Cassirer recognizes the vital role of language in articulating and conceptualizing a preexisting reality, but his project is primarily philosophical. He emphasizes that human beings are *animal symbolicum* (“the symbol-creating animal”), not merely because of their ability to manipulate verbal language itself, but also because of their creation of other symbolic spheres: art, myth, religion, science, history, and so on.

Semiotics and grammar converged in the synthesis of the American logician Richard Montague (1930–1971), who followed in the path of Frege, Tarski, and Carnap. Based upon the semantics of formal languages, Montague grammar puts forward the premise that there is no theoretically relevant difference between artificial (formal) and natural (human) languages. Therefore, the logical structure of natural languages may be described through universal algebra.

Having pursued the philosophical path thus far, this article now follows the grammatical thread. Classical grammarians were concerned with prescriptive principles. This suited the sharply defined structure of Indo-European languages. It is one of the perennial questions of linguistics, however, whether such principles apply equally well (or at all) to non-Indo-European languages. China had its own sort of language studies, known as *xiaoxue* (“minor learning,” in contrast to *daxue* [“major learning”], which signified ethics), for at least two millennia. An early philosopher named Xun Zi (c. 310–210 B.C.E.), moreover, had elaborated a doctrine of “names” that bore striking similarity to doctrines about language expressed by Plato (c. 428–348 or 347 B.C.E.) in his “Cratylus.” But it was not until the end of the nineteenth century that Literary Sinitic (Classical Chinese) was forced into a Latin grammatical mold—and it fit very badly. This question of the appropriateness of classical Western grammar for non-Indo-European languages shall return below (both directly and under the guise of universal grammar). For the moment, however, the focus will be on Western grammars for Indo-European languages.

The Modistae (also known as Modists and speculative grammarians), who flourished around Paris from about 1260 to 1310, wrote medieval treatises on the *modi significandi* (“modes of signifying,” the semantic and deictic functions of words and word classes). They were generally Aristotelian in their aim to explain language, not simply to describe it, and had a large impact on the terminology and systematicity of later grammarians.

After having investigated grammars for various specific languages (Greek, Latin, Hebrew, Spanish, etc.), Claude Lancelot (1615?–1695), professor at the Petites Écoles of Port-Royal des Champs, in collaboration with Antoine Arnauld (1612–1694) wrote the *Grammaire générale et raisonnée* (1660), often referred

to as *Grammaire de Port-Royal*. This is a general grammar that enunciates certain principles that presumably govern all languages and are meant to define language in general, while individual languages are thought to be particular cases of the universal model. By and large, eighteenth-century grammarians followed in the footsteps of their Port Royal predecessors. Lancelot and Arnauld imply, and later grammarians (for example N. Beauzée) specify, that communication of thought by means of speech demands that the latter be a sort of “picture” or “imitation” of thought (cf. Wittgenstein). That is to say, the function of language is to be a representation of thought. Already in the seventeenth century, Gottfried Wilhelm von Leibniz (1646–1716) and other thinkers subscribed to the belief in the imitative value of language sounds. This leads to the consideration of the place of phonology in the history of linguistics.

In comparing Old Norse, Greek, and Latin, the Danish linguist Rasmus Rask (1787–1832) had discovered regular sound differences. In 1822, the German philologist and folklorist Jacob Grimm (1785–1863) construed these differences as systematic sound changes that had led to the development of Germanic as a separate branch of Indo-European. This recognition became enshrined as Grimm’s Law (also referred to as the Germanic sound shift) and was a major milestone in the evolution of linguistics as a rigorously scientific discipline.

The neogrammarians (*Junggrammatiker* in German, also known as the Leipzig School), subscribed to positivistic atomism. During the 1870s, they arose in staunch opposition to the metaphysical and biological approaches to language then current. Their name was actually a pejorative term applied to them by the older generation of traditionalists in language studies. The school is said to have its inception from the publication of Karl Verner’s (1846–1896) celebrated explanation of apparent exceptions to Grimm’s Law in 1877, of August Leskien’s (1840–1916) postulation of the inviolability of sound laws in relation to declension in 1876, of Karl Brugmann’s (1849–1919) studies on the morphology of Indo-European, and of Hermann Paul’s (1846–1921) *Prinzipien der Sprachgeschichte* (Principles of the history of language) in 1880. They insisted upon the absolute autonomy of phonology from syntax and semantics, with phonology having the most important position. Their main aim was to describe historical change, plus they had an overriding interest in diachronic aspects of language and the development of precise methods of reconstruction. The structuralists and transformationalists of the twentieth century criticized virtually all of the basic premises of the neogrammarians, yet the neogrammarians arguably did more to establish linguistics as an independent science (in the strictest sense of the term) than any other school.

The Structuralist Era

The father of structuralism (and many would say of the modern science of linguistics) was the Swiss linguist Ferdinand de Saussure (1857–1913). But Saussure was a reluctant father whose seminal *Cours de linguistique générale* (Course in General Linguistics, 1916) was edited and posthumously published by two colleagues and a student who assiduously took notes at his lectures. The peculiar nature of its composition has resulted

in a work that is fraught with contradictions and puzzling self-doubts cheek by jowl with superbly confident, dogmatic assertions. Despite all the vagaries of its composition, *Cours de linguistique générale* is a hugely influential work and has probably done more to establish linguistics as an independent discipline than any other single book.

Although Saussure had a background in the historical study of language and had made significant advances in the understanding of the Indo-European vowel system, he was unusually critical of neogrammarian philology, which he accused of being overly absorbed in diachrony (that is, issues of the evolution of languages). Saussure also criticized traditional grammarians for neglecting entire aspects of language and for lacking overall perspective, but allowed that their method was fundamentally correct and that they properly emphasized synchrony. Hence, whereas the discipline of historical linguistics that grew up in the nineteenth century was almost wholly diachronic in its orientation, linguistics in the first half of the twentieth century—following the lead of Saussure—became a largely synchronic enterprise. It was not long before European structuralism crossed the Atlantic to become the predominant methodology of American linguistics.

The German-born American anthropologist Edward Sapir (1884–1939) was responsible for many enduring concepts in linguistic research. Author of the landmark volume *Language* (1921), Sapir emphasizes that language is tightly linked to culture. For Sapir, language is an acquired function of culture rather than being biologically determined. This view is diametrically opposed to that of the transformationalists (see below), who believe (but have not proved) that human beings possess a genetically determined predisposition for language—including many of its most specific and distinguishing features—that is already present at the moment of birth. Sapir is undoubtedly correct when he points out that, sans society, an individual will never learn to talk in meaningful terms—that is, to communicate ideas to other persons within a given community. This can easily be demonstrated by observation of feral or mentally abused children and in children suffering from autism or other psychological disorders that affect the acquisition and manipulation of language. Similarly, infants who are born into one linguistic environment but are adopted into a completely different linguistic environment will obviously not grow up speaking the language of their biological parents. If there is any “hardwiring” of linguistic abilities, it occurs around puberty, after which time it becomes increasingly difficult to attain full fluency in a second language or to lose all ability in one’s mother tongue. Sapir, of course, could not have foreseen the degree to which the transformationalists would divorce language from its social and cultural matrix, but he would undoubtedly have been horrified by this turn of events and would have regarded it as a fallacious approach to language. While Sapir may not be around to point out the speciousness of the transformationalists’ so-called LAD (Language Acquisition Device, also styled the “language module,” “language instinct,” and so forth), which stipulates hardwired language ability at birth, that has been done ably by Jerome Bruner (b. 1915) with his cognitive learning theory that builds on the cultural-cognitive developmental model of the Russian psychologist Lev Vygotsky (1896–1934).

Although Leonard Bloomfield (1887–1949) was a contemporary and colleague of Sapir, and the two are widely regarded as the founders of American structuralism, they were quite dissimilar in temperament and outlook. Whereas Sapir was more dramatic and imaginative, Bloomfield tended to be methodical and preferred as much as possible to rely strictly upon evidence in formulating his positions. In 1914 he wrote *Introduction to the Study of Language*, which in later editions was called simply *Language* (1933). Bloomfield was responsible for an enormously influential synthesis that brought together three earlier traditions of language study (historical, philological, and practical), and forged them into a coherent whole. He was fiercely determined to establish linguistics as a science. In particular, he wished to distinguish linguistics from the speculative philosophers who assumed that the structure of their own language embodied universal forms of human thought or even the cosmic order. In addition to the speculative philosophers, Bloomfield censured the grammarians of the old school tradition who strove to apply logical standards to language, ignoring actual usage in favor of prescriptive rules. Bloomfield was especially critical of those who took the features of Latin as the normative form of human speech. He was much more favorably disposed toward the grammatical studies of the ancient Indians because the latter were themselves excellent phoneticians who had also developed an intelligent systematization of grammar and lexicon.

In Europe, structuralism did not remain a monolithic linguistic monopoly. The Prague School (which grew out of the Prague Linguistic Circle) is a branch of structuralism, but with a difference. The members of this school hold language to be a system of functionally related units and focus on the observation of linguistic realia at discrete moments. They are interested in language change, not in maintaining a strict dichotomy of *langue* and *parole* (linguistic system versus linguistic utterance)—a key tenet of Saussure—or of synchrony and diachrony. The starting point of the Prague School is to clarify the function of the various elements of actual utterances. The Prague School has made a lasting impact upon many areas of modern linguistics, particularly with regard to the analysis of the sounds of language and their effect in literature.

Another noteworthy structuralist school is the Copenhagen Linguistic Circle. One of its leading theoreticians was Louis Hjelmslev (1899–1965), whose *Prolegomena* (1943; English edition 1953) is intended as a series of preliminary statements essential for the formulation of any theory of language. Laying down the most basic ground rules for linguistics, Hjelmslev faults the humanities for being overly descriptive and insufficiently systematizing. He is opposed to the confusion of philosophy of language with theories of language. Hjelmslev views language as a self-sufficient totality of its own. He foresees the emergence of an “algebra of language,” which he calls “glossematics.” This novel linguistic approach, which strongly emphasizes form, is intentionally designed to distinguish the ideas of the Copenhagen School from more traditional forms of structural linguistics, such as those of the Prague School. Hjelmslev does adhere to Saussure’s basic principles of structuralism, but attempts to make his theory more axiomatic, having been influenced by the logical empiricism of Alfred North

Whitehead (1861–1947), Russell, and Carnap. With the ostensible goal of eliminating confusion between the object (language) being studied and the methodology used to describe it, Hjelmslev tries to create noncontradictory descriptive terminology by employing carefully crafted abstractions and mathematical logic.

Around the middle of the twentieth century, Morris Swadesh (1909–1967), a student of Sapir, devised a statistical method for determining the family relationships of languages and the probable dates of their separation from a common parent. This technique, which is called lexico-statistics or glottochronology, is premised upon the idea that the vocabulary of a language is replaced at a constant rate, much like the steady radioactive decay of carbon-14 that is used to date organic remains. The Swadesh lists select a core vocabulary of one hundred or two hundred words consisting of body part terms, lower numerals, pronouns, primary kinship terms, common flora and fauna, words for ordinary topographical features, and so forth. Widely used in the 1960s and 1970s, glottochronology provoked an emotional debate, with all manner of objections being raised against it: the rate of decay is not universal, cognates may be partial and may or may not be recognizable, even core terms may be borrowed, and so forth. Despite the outcry, glottochronology is still employed, but in mathematically increasingly complex and conceptually more sophisticated models. For example, a geographical dimension may be incorporated into the tree, and more careful attention is paid to historical reconstruction.

Another controversial legacy of structuralism that continues to attract attention is the Sapir-Whorf hypothesis concerning the relationship among language, thought, and culture developed by Benjamin Lee Whorf (1897–1941), who was also a student of Sapir and who based his hypothesis on the approach of his mentor. The Sapir-Whorf hypothesis has two main facets: (1) linguistic determinism (the language one uses conditions the way one thinks), (2) linguistic relativity (the complex of distinctions made in a given language are unique and not to be found in any other language). Both of these facets are somewhat at odds with the Bloomfieldian notion (broadly ascribed to by modern linguists) that all languages—like all people—are equal in their ability to express whatever thoughts their speakers need or want to convey. Whorf did intensive work on North American indigenous languages that have dramatically different grammatical and lexical properties from Indo-European languages, so it is altogether comprehensible that his intimate familiarity with their distinctive outlooks would lead him to develop the hypothesis that he did. While the two main facets of the hypothesis would appear to be innocuous, commonsense propositions, they are anathema to certain sectors of the modern political spectrum. Furthermore, continuing the tinctorial theme, the strong form of the Sapir-Whorf hypothesis (that a given language determines the thought and perception of its speakers) is seen by many to have been refuted by the study of Brent Berlin and Paul Kay on basic color terms and their supposed universality (1969). The conclusions of Berlin and Kay, however, have not gone unchallenged: John A. Lucy and Richard Shweder have demonstrated significant behavioral differences in regard to color

perception on the part of speakers of different languages. In any event, the Sapir-Whorf hypothesis should be easily testable by extensive investigation of the thought patterns of individuals who are thoroughly bilingual (or multilingual) in markedly dissimilar languages. Simply asking such individuals whether it is easier to think certain thoughts in a given language than in another language, or whether it is impossible to think the thoughts of one language in another language, should go far toward determining the validity of the Sapir-Whorf hypothesis.

The Transformational Generative Insurrection

Few would disagree that Noam Chomsky (b. 1928) was the dominant figure in linguistics from the late 1950s through the 1970s. Two early works, *Syntactic Structures* (1957) and *Aspects of the Theory of Syntax* (1965), laid the foundations and set the tone for Chomsky's linguistic project that has lasted (albeit in increasingly attenuated versions) into the twenty-first century. From the very beginning of his career, Chomsky adopted a highly combative stance against his intellectual and ideological opponents. Since Chomsky is a clever debater, he usually wins his arguments, and this has been one of the main factors in his meteoric rise. Chomsky's highly polemical orientation spills over into many nonlinguistic fields. Although he has been remarkably prolific writing about language-related matters, Chomsky's publications on a wide range of politically sensitive topics would appear to be still more numerous.

In general, Chomsky is favorably disposed to traditional grammar but is hostile to structural linguistics. His hostility to the structuralists seems to stem from their emphasis on anthropologically grounded fieldwork and formal description of numerous languages, which is in stark contrast to his own psycho-philosophical orientation and nearly exclusive attention to English. Chomsky is opposed to reliance on what he calls "discovery procedures" and "objective methods," opining that linguists are simply awash in the particularities of data unless they possess profound notions of linguistic theory to guide them. For Chomsky, theory is clearly more important than data, intuition more desirable than induction. Chomsky is an introspective mentalist who believes that the methodological purity and attention to minutiae of the structuralists and behaviorists prevents them from asking the big questions about language that really count.

Chomsky posits a perfectly competent, ideal speaker-hearer whose actual linguistic performance may display deviations from rules but who is capable of correctly analyzing the underlying processes of language. This accounts for his well-known concept of generative grammar, a synonym for transformational grammar, which is made up of formal operations that are said to mediate between the deep structure underlying linguistic utterances and the surface structure of the sentences that are actually produced by a speaker. Transformational-generative grammar (hereafter TGG) is asserted to be a universal grammar that is supposedly innate in all human beings.

As a complement (or rather supplement) parallel to the mastery of internalized generative grammar of the individual, Chomsky posits an externalized universal grammar that

possesses profound regularities. Although he is strongly in favor of determining linguistic universals, Chomsky is vague about how this is to be accomplished. Chomskyan linguistics also touches upon other areas, such as Cartesian rationalism (to reinforce his faith in innateness), and has evolved into other forms, most notably government and binding theory, which focuses on modularity of syntax. Yet all of the elaborations and refinements of the 1970s and 1980s only serve to underscore the concerns that Chomsky had already embraced in the 1950s and 1960s. By the 1990s, while still residually influential, Chomsky's linguistics program had essentially run its course and was badly fragmented in its second generation. A few younger disciples, such as Steven Pinker, however, still carry the torch.

The last main restatement of Chomsky's theories was his minimalist program that followed government-binding theory and principles and parameters theory. This final designation gives the distinct impression that the Chomskyan insurrection has at last imploded, ending with a whimper, not with a bang.

Chomsky claims that one of the chief inspirations for his generative grammar was the concept of language as "activity" (Greek *energeia*) rather than as a "(static) entity" (Greek *ergon*) waiting to be surveyed in its entirety. This view of the dynamic, "continuously self-generating" processes inherent in language is attributed to Wilhelm von Humboldt (1767–1835) and has become a linchpin of what is now called ethnolinguistics.

Chomsky was a student of Zellig Harris (1909–1992) and borrowed extensively from the analytical procedures that the latter devised. To be sure, it was Harris who had developed the concept of linguistic transformation, which he borrowed from mathematics, and this was the crux of the entire Chomskyan enterprise. The distinction was that Harris worked within the structuralist paradigm, whereas Chomsky rejected it. Chomsky began by giving the impression that he was following Harris's still fundamentally Bloomfieldian approach, but soon made clear that it was his intention to extend it. Not long thereafter, he launched attacks against all of the main pillars of American structuralism: positivism, behaviorism, and descriptivism.

The most vulnerable was behaviorism, which maintains that psychology should be based solely on observable, measurable phenomena. Bloomfield applied these guidelines to linguistics, holding that language researchers should concentrate on observable, precisely describable verbal behavior and refrain from unnecessary theorizing. In 1957, the Harvard psychologist B. F. Skinner (1904–1990) published *Verbal Behavior*, which attempted to interpret language in strictly behaviorist terms. In that same year, Chomsky penned a harsh denunciation of Skinner's book, with the result that many young linguists were persuaded to embark upon theorizing as a safer path than that of mere observation, description, and measurement.

But all was not peace and calm within Chomsky's own camp, which we may refer to as transformational-generative linguistics (TGL). Disputes had begun to erupt within TGL already during the 1960s and 1970s, some of them quite nasty. There is no point in chronicling the vitriolic arguments that took place during this period. Suffice it to say that, at base,

many of them had to do with how to handle linguistic structures that were larger and more complicated than the phrase.

The most productive departure from the TGL camp is that of George Lakoff, who, together with Mark Johnson and his collaborators, has led the development of conceptual metaphor and cognitive linguistics. Lakoff was one of the early generative semanticists who questioned the validity of syntactic deep structure. This led him to formulate metaphor as a schema in the Kantian sense. One of the most fascinating aspects of cognitive linguistics and conceptual metaphor theory is that it is data-driven, not theory-driven. That is to say, it has to be (empirically) responsible to meaning making as it occurs in human communication, which is why meaning exists in the first place. Consequently, grammar cannot be conceived of as an algorithmic process that proceeds regardless of the constituent meanings. Furthermore, if human meaning making uses the same elements and principles (namely, conceptual metaphor and blending), then all aspects of human creation—literature, religion, history, philosophy, art, music, science, even mathematics—are constituted by these elements and principles, and subject to analysis through them. Cognitive linguistics, conceptual metaphor, and conceptual blending have been adopted by a second generation of students who are every bit as enthusiastic about it as were the second generation of adherents to TGG back in the 1960s and 1970s. They believe that this new, interdisciplinary approach to language will revolutionize our understanding of ourselves and our world. The fact that their numbers are growing impressively indicates that, to a certain extent, they may well be right.

Other Voices

Although structuralism and TGL were respectively paramount in the first and second halves of the twentieth century, this is by no means to say that competing approaches were lacking. During the period when structuralism dominated linguistics, other interesting approaches to language proliferated. One that caught the popular imagination was that of general semantics, a philosophical movement originated by the Polish-American philosopher and mathematician Alfred Korzybski (1879–1950). Korzybski, who once famously declared that "The map is not the territory," called for a heightened awareness of the conventional relationship between words and the things to which they refer. It was his intention to promote clear thought (to free human beings from the "tyranny of words," as enunciated by one enthusiast) and thereby to improve systems of communication. That is to say, it should be recognized that language does not directly reflect reality. Indeed, the structure of language may be said to distort our perception of reality. This deficiency can be remedied by insight into the nature of mundane language and, further, by the creation of more refined language that is structured in the same way reality is. Korzybski's fundamental ideas are spelled out in *Science and Sanity: An Introduction to Non-Aristotelian Systems and General Semantics* (1933). General semantics was further popularized by S. I. Hayakawa (1906–1992), whose *Language in Thought and Action* (1938) has been a bestseller for decades. After serving in the United States Senate from 1977 to 1983, Hayakawa founded U.S. English, Inc., which is dedicated to making English the official language of the United States.

Also showing how politics and linguistics can become tightly intertwined is a nonstructuralist school of a very different sort. Marrism, founded in the 1920s by the Soviet archeologist and linguist Nikolai Y. Marr (1865–1934), was quintessentially Marxist in holding that all linguistic phenomena are purely a reflection of economic functions and social forces (superstructure). Marr considered Caucasian as the proto-language of Europe (the so-called Japhetic theory), which oddly coincided with German racist theories of Johann Friedrich Blumenbach (1752–1840). Joseph Stalin (1879–1953) (who, incidentally, had much to say about language), however, put an end to Marr's influence on Soviet linguistics when in 1950 he refuted the superstructure theory of language, declaring that it was independent of human productivity.

Politics aside, there were plenty of other nonaligned linguistic practitioners during this period, both in Europe and in America. Bringing together the philological exactitude of Antoine Meillet (1866–1936) with the conceptual grandeur of Georges Dumézil (1898–1986), the French scholar Émile Benveniste (1902–1976) was the author of the redoubtable *Le vocabulaire des institutions indo-européennes* (1969; English trans. *Indo-European Language and Society*, 1973). In it, employing what has been referred to as ethnosemantics (or ethnographic semantics), he strove to “elucidate the genesis” of the vocabulary of Indo-European institutions in six fundamental realms: economy, kinship, society (status), authority (especially royalty and its prerogatives), law, and religion. Benveniste was particularly interested in the religious doctrines of the Indo-Europeans.

J. R. Firth (1890–1960) was one of the chief founders of linguistics in Great Britain. He held the first chair in general linguistics in England, which was established at the School of Oriental and African Studies of the University of London in 1944. Firth is noted for his development of prosodic phonology, and insisted on analyzing both sound and meaning in context. Furthermore, Firth held that no single system of analytical principles and categorization could adequately account for language; different systems are required for different situations. Unlike most theorists, but very much like Benveniste, Firth recognized the importance of religion for the history of linguistics. Himself an Orientalist, Firth acknowledged the great merit of early Indian grammars (the first in the world) and the tremendous significance of Sanskrit for understanding the development of Indo-European. At the same time, he admits that the classical grammarians (Panini for Sanskrit, Dionysius for Greek, Priscian for Latin) were not concerned with the vernacular. Firth is thus also one of the few major linguistic theoreticians who is aware of the great gulf between classical and vernacular languages, a subject that awaits future research.

One of Firth's outstanding students, M. A. K. Halliday (b. 1925), countered Chomsky on many points, including the central concept of competence, against which Halliday adduces the notion of “meaning potential.” This is defined in terms of culture, to which Halliday is unusually sensitive, not mind. He possesses a keen sense of the social functions of language and its existential acquisition during childhood. Halliday developed a grammatical theory according to which language is

viewed as an intersecting set of categories and scales operating at different levels. He is also responsible for creating systemic functional grammar, which is particularly well adapted to non-Indo-European languages.

In the United States, one of the most estimable twentieth-century linguists whose work lay outside of both structuralism and TGL is Kenneth Lee Pike (1912–2000). His *Language in Relation to a Unified Theory of the Structure of Human Behavior* (1967) is a massive, ambitious tome. In keeping with the combative atmosphere pervading the discipline, Pike speaks of the “battle ground” of language study and his determined efforts to promote thoroughgoing changes in language theory. Pike's theoretical work (he is also celebrated for his achievements in applied linguistics) derives from an attempt to describe empirical data drawn from a literally worldwide range of languages in the absence of a satisfactory grounding in contemporary linguistic theory. It was due to his search for a theoretical basis that would permit him to analyze and make sense of a vast amount of empirical data that he developed his brand of tagmemics. (A tagmeme is normally defined as the smallest functional grammatical element of a language. It is parallel in usage to the morpheme [the smallest functional lexical unit of a language] and the phoneme [the smallest functional phonological unit of a language].)

Pike's tagmemic approach differs from mainstream American linguistics in various technical respects, but above all in its complexity. A key feature of Pike's thinking about language is that he abandons the Saussurian distinction between *langue* and *parole*. His reason for doing so was because the large amounts of materials that he and his collaborators collected showed that speech itself was highly standard, an analytical characteristic that was normally reserved for formal, written language according to the mainstream view. As elaborated by Pike, tagmemics remained an important branch of American structuralism, but he distanced himself from other leading linguists of his day in striving to describe linguistic regularities in accord with sociocultural behavior instead of abstract models. Part of the methodology of tagmemics was determined by the sheer necessity of the chief task that its practitioners faced: translating the Bible into previously unwritten, unresearched, “esoteric” languages. Pike goes further in combining tagmemes to form syntagmemes, thus enabling him to engage in advanced syntactical analysis. Pike's most profound and far-reaching contribution to the history of ideas, however, is his application of etic and emic analysis to linguistic research. This distinction between the material and functional study of language had an enormous impact upon anthropology and other fields, albeit often in poorly understood and badly distorted guises.

After a couple of decades in which theoretical research reigned supreme, the restoration of empirical studies of language was furthered in the 1970s and 1980s with the inauguration of discourse studies. A landmark in this development is *Strategies of Discourse Comprehension* (1983), co-authored by Teun van Dijk, a linguist, and Walter Kintsch, a psychologist. A salient feature of their work is its interdisciplinary quality, requiring linguistic and computer analysis of texts, experiments in psychology laboratories, sociological field studies, and so

forth. They also relied on literary scholarship, classical poetics and rhetoric, Russian formalism, and Czech structuralism, as well as sociolinguistics, ethnography, and folklore studies. All of these approaches were integrated under the umbrella of “the wide new field of cognitive science.”

A linguistic loner who has had a remarkable impact on the classification of languages is Joseph H. Greenberg (1915–2001). Greenberg started out as a language typologist. Language typology identifies ideal types (for example, agglutinative, [in]flexional, isolating, etc., but there are, of course, many other characteristics that must be taken into account) and proceeds to group individual languages under these categories. Greenberg’s fame rests in part on his seminal contributions to synchronic linguistics and his indefatigable quest to identify language universals. His typological approach contrasts with that of genetic classification, which is premised on delineating the development of languages from older precursors. Greenberg was always collecting data, which he copied down in countless notebooks. Known as a “lumper” (as opposed to a “splitter”) par excellence, in 1955 Greenberg reduced more than 1,500 African languages to just four supergroups. Later he would ascribe all of the indigenous languages of the Americas to just three main waves of migrants, whereas they had formerly been grouped into hundreds of families. Greenberg achieved these nearly miraculous feats through the application of what he styled mass lexical comparison or multilateral comparison. Mainstream linguists were outraged, with one of the most distinguished among them publicly calling for Greenberg to be “shouted down.” At stake were sacrosanct issues of methodology relating to phonology, etymology, and other vital components of linguistics. Undaunted, Greenberg dedicated the last years of his life to the study of Eurasiatic, which brought together all of the languages of Europe and Asia (and then some—except isolates) and was similar to earlier proposals for Nostratic, minus certain African languages.

In linguistics and language studies, writing is often overlooked. When attention is devoted to writing, it is usually minimized as secondary to speech. The Akkadian specialist I. J. Gelb (1907–1985) aimed to lay the foundations for a new science of writing that he called grammatology. This approach would not be merely descriptive, as were earlier histories of writing. In his classic work, entitled humbly and plainly *A Study of Writing* (1952), Gelb attempted to establish general principles governing the use and evolution of written forms of language through comparative and typological analysis. His is the first, and still the only, work to present a universal theory of all known writing systems. Gelb was able to achieve this considerable synthesis by distinguishing clearly between fore-runners of writing and writing proper, and by distinguishing further between word-syllabic systems, syllabaries, and alphabets.

In the opinion of those who are involved in computational linguistics, the most important development since the 1980s has been to resurrect the use of statistical methods for analyzing distributional evidence. This general approach was pioneered by Zellig Harris in the early 1950s, but starting around 1955, his student Chomsky simultaneously cast doubt on the viability of such methods and presented a different vision of

how to proceed, employing a more axiomatic approach based on explorations in formal language theory. The “cybernetic underground” began skirmishes in the engineering hinterlands during the 1980s and took over computational linguistics entirely by the 1990s. By the early twenty-first century, psycholinguistics had largely succumbed, though there are pockets of resistance. Plain or unhyphenated linguistics is increasingly influenced by statistical methods, both in methodology and in terms of the empirical techniques that are used.

The phonetician Mark Liberman is responsible for building gigantic corpora of data that are used to solve both theoretical issues and practical problems of great merit (such as voice recognition by cybernetic-electronic devices). Many of the brightest minds in linguistics are now laboring quietly at the task of figuring out how to enable human beings and machines to talk to each other. One of the leading theoreticians engaged in this area of research is Roland Hausser, whose *Foundations of Computational Linguistics: Man-Machine Communication in Natural Language* (1999) offers a prescient look at what the future holds in store with regard to the human-machine interface.

One of the most exciting new realms of investigation in historical linguistics is the application of genetics. According to Luigi Luca Cavalli-Sforza, one of the leading researchers in this field, the genes of modern populations contain a record of the human species stretching back 100,000 years. What is more, conclusions drawn from the study of modern genetic material are now being corroborated by direct recourse to ancient DNA. It is striking that genetic and linguistic trees match each other closely, and archeological data provide further confirmation of the movements and intricate interrelationships of ancient peoples.

Conclusion

Although human beings have for millennia taken an intense interest in the languages they speak, modern linguistics has gradually developed as an independent discipline (some would be willing to call it a science) only during the past few centuries. Hundreds of major figures have contributed to this development, and thousands of others have had a significant impact upon linguistics and its host of subfields. It has been possible here only to introduce briefly some of the main ideas of several of the individuals who have been instrumental in making language study what it is at the beginning of the twenty-first century. In many cases, it has been possible to do little more than mention some of their names and their areas of expertise to signal to the interested reader the necessity of investigating further the full range of their work. Scores of other truly outstanding linguists have not even been mentioned at all.

Linguistics is a vibrant, unsettled field, one in which passions run high. In the end, as with so much else pertaining to the intellectual pursuits of humankind, it is evident that a goodly portion of the contradictions and energy that suffuse linguistics can be attributed to the perennial dichotomy between the Aristotelian and the Platonic, between unity and infinity, between the fox and the hedgehog.

See also Language, Linguistics, and Literacy; Language, Philosophy of.

BIBLIOGRAPHY

- Aronoff, Mark, and Janie Rees-Miller, eds. *The Handbook of Linguistics*. Malden, Mass.: Blackwell, 2001.
- Beaugrande, Robert de. *Linguistic Theory: The Discourse of Fundamental Works*. London: Longman, 1991.
- Bloomfield, Leonard. *Language*. New York: Henry Holt, 1933.
- Bright, William, ed. *International Encyclopedia of Linguistics*. 4 vols. Oxford: Oxford University Press, 1992.
- Bussmann, Hadumod. *Routledge Dictionary of Language and Linguistics*. Translated and edited by Gregory P. Trauth and Kertin Kazzazi. London: Routledge, 1996.
- Cavalli-Sforza, Luigi-Luca. *Genes, Peoples, and Languages*. Translated by Mark Seielstad. New York: North Point, 2000.
- Chomsky, Noam. *Aspects of the Theory of Syntax*. Cambridge, Mass.: MIT Press, 1965.
- . *Syntactic Structures*. The Hague: Mouton, 1957.
- Comrie, Bernard. *Language Universals and Linguistic Typology: Syntax and Morphology*. 2nd ed. Chicago: University of Chicago Press, 1989.
- Crystal, David. *The Cambridge Encyclopedia of Language*. Cambridge, UK: Cambridge University Press, 1987.
- DeFrancis, John. *Visible Speech: The Diverse Oneness of Writing Systems*. Honolulu: University of Hawaii Press, 1989.
- Dixon, R. M. W. *The Rise and Fall of Languages*. Cambridge, U.K.: Cambridge University Press, 1997.
- Fauconnier, Gilles, and Mark Turner. *The Way We Think: Conceptual Blending and the Mind's Hidden Complexities*. New York: Basic Books, 2002.
- Gelb, Ignace J. *A Study of Writing: The Foundations of Grammar*. Rev. ed. Chicago: University of Chicago Press, 1963.
- Givón, Talmy. *On Understanding Grammar*. New York: Academic Press, 1979.
- Goody, Jack. *The Logic of Writing and the Organization of Society*. Cambridge, U.K.: Cambridge University Press, 1986.
- Greenberg, Joseph H. *Language Typology: A Historical and Analytical Overview*. The Hague: Mouton, 1974.
- Harris, Zellig S. *Methods in Structural Linguistics*. Chicago: University of Chicago Press, 1951.
- Hausser, Roland R. *Foundations of Computational Linguistics: Man-Machine Communication in Natural Language*. Berlin: Springer, 1999.
- Johnson, Mark. *The Body in the Mind: The Bodily Basis of Meaning, Imagination, and Reason*. Chicago: University of Chicago Press, 1987.
- Koerner, E. F. K., and R. E. Asher, eds. *Concise History of the Language Sciences: From the Sumerians to the Cognitivists*. New York: Pergamon, 1995.
- Labov, William. *Sociolinguistic Patterns*. Philadelphia: University of Pennsylvania Press, 1972.
- Lakoff, George. *Women, Fire, and Dangerous Things: What Categories Reveal about the Mind*. Chicago: University of Chicago Press, 1987.
- Lakoff, George, and Mark Johnson. *Metaphors We Live By*. Chicago: University of Chicago Press, 1980.
- . *Philosophy in the Flesh: The Embodied Mind and Its Challenge to Western Thought*. New York: Basic Books, 1999.
- Langacker, Ronald. *Foundations of Cognitive Grammar*. 2 vols. Stanford, Calif.: Stanford University Press, 1987–1991.
- Lapschy, Giulio, ed. *History of Linguistics*. 4 vols. London: Longman, 1994.
- Mair, Victor H. "Ma Jianzhong and the Invention of Chinese Grammar." In *Studies on the History of Chinese Syntax*, edited

- by Chaofen Sun. *Journal of Chinese Linguistics Monograph Series* 10 (1997): 5–26.
- Malmkjaer, Kirsten, ed. *The Linguistics Encyclopedia*. London: Routledge, 1991.
- Ong, Walter J. *Orality and Literacy: The Technologizing of the Word*. London: Methuen, 1982.
- Pinker, Steven. *The Language Instinct*. New York: Morrow, 1994.
- Robins, R. H. *A Short History of Linguistics*. 4th ed. London: Longman, 1997.
- Sapir, Edward. *Language: An Introduction to the Study of Speech*. New York: Harcourt, Brace, 1921.
- Saussure, Ferdinand de. *Cours de linguistique générale*. 4th ed, Edited by Charles Bally and Albert Sechehaye with the collaboration of Albert Reidlinger. Paris: Payot, 1949.
- Steiner, George. *After Babel: Aspects of Language and Translation*. Oxford: Oxford University Press, 1975.

Victor H. Mair

LANGUAGE, LINGUISTICS, AND LITERACY.

Language and writing are not the same (although people now confuse them), and the former is far older than the latter. Human spoken language developed late in the Paleolithic, probably 100,000–120,000 years ago, whereas true writing—the representation of language, element by element, in a permanent medium—was not invented until about 5,200 years ago.

Language

Our current estimate of when language itself evolved is based on skeletal evidence for a swift evolutionary push toward the modern human vocal tract during the Upper Paleolithic. These changes—away from the throat, tongue, and mouth configuration typical of other primates—made rapid spoken speech possible while making it easier to die of obstructed air passages (choking, etc.). Such difficulties for the individual must have been well offset for the species by the survival benefits of rapid, voluntary, and abstract communication, one of humankind's most powerful "ideas." Indeed, language's most important design characteristics are that it is:

1. voluntary (unlike the call systems of other primates, speech is initiated from the voluntary part of the motor cortex);
2. arbitrary (we can talk even about things that do not exist, allowing us to solve hypothetical problems and form abstractions; language is not tied to immediate reality);
3. productive (we can use already known vocabulary and syntactic patterns to generate an infinite supply of new messages, not to mention new vocabulary and patterns);
4. largely linear (messages unfold rapidly through time, a choice that places major constraints on the details of language design); and
5. two-way (individuals can both produce and understand messages).

As a result of being arbitrary, languages must be learned. Only the propensity to learn language is instinctive, not the individual languages themselves. Hence, babies must have a long period of apprenticeship to learn to communicate linguistically, a fact equally true of spoken tongues and visual languages like American Sign Language (ASL). (ASL has all the structural features and design complexities of a spoken language, only in a different—and equally evanescent—medium.) Research shows that children deprived of early exposure to linguistic communication (which happens sometimes with deaf babies) do not develop the neurological structures in the brain necessary for handling the complexities of language later.

Because languages are arbitrary, they change constantly, adapting easily to the changing world of things to talk about and social messages to send. As a result of this constant change, speakers of a single language who move away from each other will change their systems differently, a process that may continue until we perceive them as speaking different dialects or even (after many centuries) different languages. This process is called *language divergence* and leads to what linguists call *language families*.

The members of a language family are simply changed later forms of what was once one language. For example, the speakers of Latin fanned out across the Roman Empire 2,000 years ago, but after the breakup of the empire, when travel became dangerously difficult, the local versions of Latin began to diverge, producing the so-called Romance language family, consisting notably of Italian, French, Spanish, Portuguese, and

Romanian (along with several other dialects and languages, less well known because they have fewer speakers). But Latin itself was a changed later form of yet older languages, going back to something we call proto-Italic (for lack of knowing what its speakers called it), and even further back to one we call proto-Indo-European.

Linguistics

Modern linguistics—the scientific study of language in all its aspects—began in the eighteenth and nineteenth centuries with the investigation of just such historical questions. The 2,500 years of continuous written records of Latin and the Romance languages provided one useful “laboratory” in which language change could be observed. The brothers Grimm (Jacob Grimm [1785–1863] and Wilhelm Grimm [1786–1859]), in recording verbatim their famous collection of German folktales, accidentally created another linguistic data set in which they kept noticing interesting relations among the Germanic dialects of the crones who recounted the tales. Elsewhere, other scholars were noting the more distant relations among Greek, Latin, Sanskrit, and other languages we now recognize as Indo-European.

Eventually linguists realized that the relationships between languages within a family were in certain ways regular (if complex), especially in how their sounds changed. This fact allowed scholars to begin to reconstruct forms of the ancestor languages, even when those forms were not attested in writing. To facilitate this linguistic reconstruction, they needed to

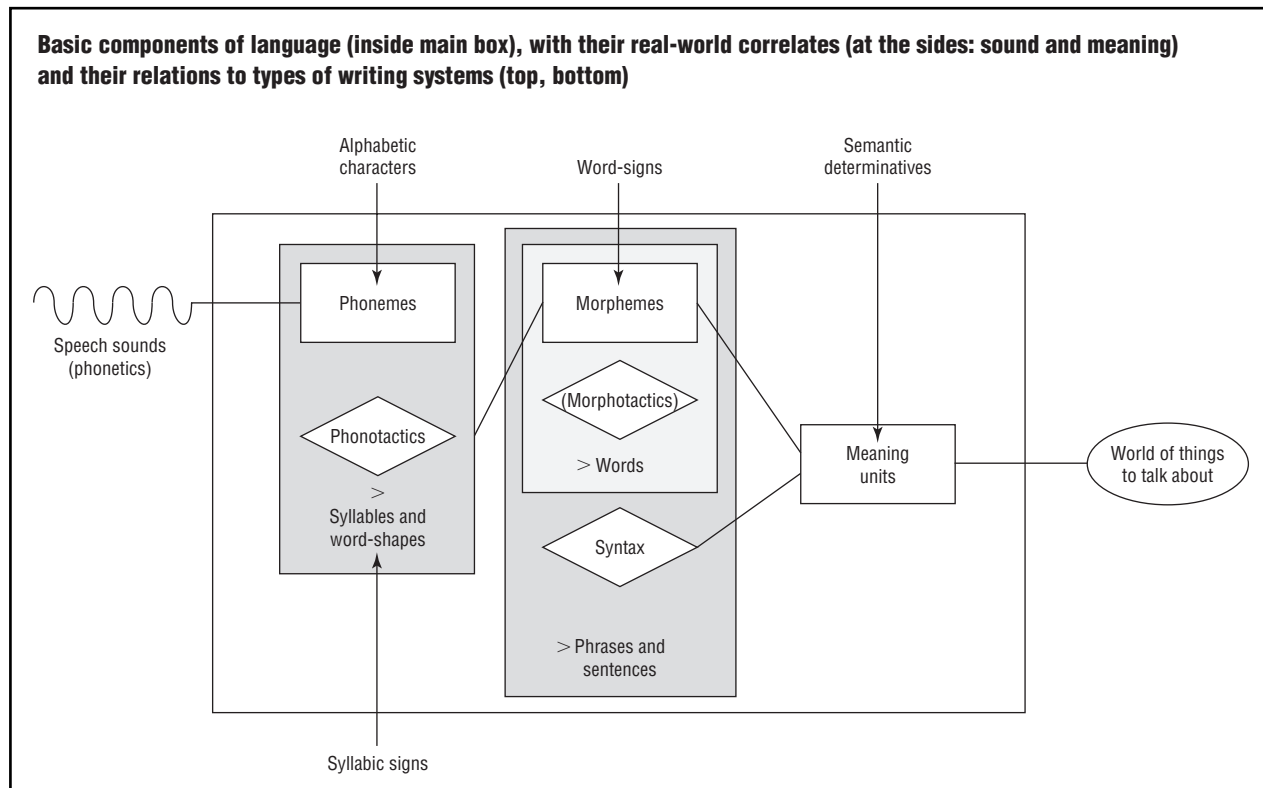

SOURCE: Courtesy of the author

study the structural properties of each language, since, before they could compare thoroughly, they had to know in detail what they were comparing. In this way, the systematic study of the synchronic (as opposed to historical) features of languages was added to the field of linguistics around 1900.

The most basic components of a spoken language, all needing study, are the speech sounds themselves (*phonetics*), the system of using certain sounds to tell words apart in a given language (traditionally called *phonemics*, although other approaches to sound contrast are sometimes used), the forms of words (*morphology*), the structures by which words are combined into phrases and sentences (*syntax*), and the meaning components (*semantics*). In the mid-twentieth century, linguists began to explore beyond the sentence level to analyze the structure of discourse, poetry, formulaic speech, and other large units.

Nineteenth-century European scholars were not the first people, of course, to inquire about language history or structure. (For example, around the fifth or fourth century B.C.E., the Indian scholar Panini compiled a thorough grammar of Sanskrit, including what amounts to an excellent structural analysis of its sounds.) But it is their work on which modern linguistic science is principally based. They, in turn, were continually spurred on by the masses of inscriptions that archaeologists were turning up, many in unknown and unreadable scripts.

Writing

The most important scripts deciphered in the nineteenth century were Mesopotamian cuneiform and Egyptian hieroglyphics. Their importance came from the fact that they belonged to the two oldest traditions of true writing: the representation of connected linguistic structures rather than only single concepts or situations.

Jean François Champollion (1790–1832) deciphered Egyptian hieroglyphics in the 1820s. Using the Rosetta Stone discovered in 1799, he recognized that the hieroglyphic pictures represented the successive elements of a normal language (some phonological, some semantic) and not some sort of lost religious magic, since the Rosetta Stone clearly had the same message in Egyptian hieroglyphics, Demotic (everyday Egyptian script), and Greek. Champollion's progress was greatly speeded when he recognized that the language in question was the immediate ancestor of Coptic, the still-used religious language of a Christian sect in Egypt and, therefore, a version of a known language.

Cuneiform required more of a team effort, in part because "it" turned out to be more than one script, and because even the mainstream version had serviced several languages over nearly 3,000 years and had evolved considerably in form during that time. *Cuneiform* means "wedge-shaped" and refers to a whole family of scripts written by impressing wedge-shaped marks into clay with a stylus. The first breakthroughs occurred in the 1840s, and scholars gradually disentangled the various scripts and languages, from later to earlier (although some, like Elamite, remain undeciphered because we do not know enough about the language family represented). Most of the languages written in cuneiform belonged to the Semitic language family, although at least one (Hittite) was Indo-European and several belonged to still other families.



Ancient cuneiform engraved into stone. Cuneiform writing was utilized for thousands of years by the purveyors of many varied languages, making it difficult to decipher. Progress was achieved in the mid-nineteenth century thanks to the work of several different scholars. © DIEGO LEZAMA OREZZOLI/CORBIS

In fact, the very first language written in cuneiform was not Semitic, it was Sumerian, a language that we still cannot relate conclusively to any other known language or family. Sumerian cuneiform writing first appeared in the early cities of Mesopotamia (Iraq) late in the fourth millennium B.C.E.

Origin of Writing

Although many nations have claimed to have invented writing from scratch, only one culture in the Eastern Hemisphere, Mesopotamia, can show in its archaeological record the long series of steps needed to develop this significant invention. It is easy to invent a writing *system* once someone points out that language can be represented in a permanent form by making visible squiggles, each standing for a word or sound. But the notion that *one can write at all* is far more difficult to conceive the first time, truly one of the world's great ideas. Evidence shows that such an abstraction did not come easily. To trace its origin in the Near East, we must go back another 5,000 years to 8000 B.C.E., to early Neolithic sites in Syria and Iraq.

The Neolithic, or New Stone Age, differs from the Paleolithic, or Old Stone Age, in that people now had domestic plants and animals, permanent open-air settlements, and stone tools ground to a fine edge instead of merely chipped. At a number of Neolithic Near Eastern sites, along with evidence for early experiments in architecture and weaving, we find experiments with clay: hundreds of tiny balls, cones, disks, and other simple geometric shapes, which archaeologists at first took for children's game pieces. We now know they were used for keeping accounts of livestock, grain, and other possessions, each shape denoting a different commodity and each animal or unit of goods tallied by a separate piece of clay. Thus, five disks with crosses might correspond to five sheep, and three balls to three measures of grain.

The developmental history of this accounting system (which soon spread across the Near East and into southeast Europe), together with linguistic reconstructions indicating the lack of abstract number words (for example, *six*, *seven*, *eight*) in any

language prior to 3000 B.C.E., indicate that Stone Age peoples did not have an abstract notion of number yet. Lacking number words, they counted simply by matching the animals or jars in question to an equal number of concrete tokens. (Such systems continue to be used in a few societies.) With a simple Neolithic economy, this was sufficient for keeping track of things, although, apparently for security against swindlers, the Mesopotamians added the habit of sealing the little clay tokens of a transaction into a clay ball onto which each token had been impressed once. (This enabled everyone to see what the account was, but no one could snatch or add tokens.) But when, in fourth-millennium Mesopotamia, people began gathering in huge cities and needed to redistribute goods for labor in complex ways, they were forced to devise a more powerful and more flexible system.

The later history of writing systems shows that each new idea for restructuring writing to make it more efficient (such as moving from word writing to syllabic writing, or from syllabic to alphabetic) came from a new group learning the old way of doing things and saying, in effect, “There’s got to be a better way.” Just as each new generation of children restructures slightly the language data learned from its elders, so systems of writing and notation have been restructured by those with a fresh view. The same presumably happened here.

About 3100 B.C.E., in the Mesopotamian city of Uruk, we suddenly see a new “take” on the meaning of the impressions on the clay envelopes holding tokens. Before, the impression of a small cone meant a small measure of grain and that of a big cone meant a larger measure of grain (which happened to equal sixty of the little measures, just as a gallon happens to equal sixteen cups in our system). But now the small cone was reinterpreted as meaning “1” and the big cone as “60,” and another measure in-between (similar to our quart) was reinterpreted as “10” (since it was equal in volume to ten of the smallest unit). With these impressed shapes reinterpreted as designating the *number* intended, however, the scribe now had to specify separately the *object* being counted. At that moment, the system developed into two types of signs: one kind for abstract numbers, the other for names of objects. The latter corresponded to the vocabulary words of language. Thus, if we want to speak of four rings, we don’t say “ring ring ring ring” (or write “oooo,” which is how the Neolithic scribes did it); we use only two words, one for the number (*four*) and another for the object (*rings*). To write this as “4 o” would then correspond unit-for-unit to the words we speak.

The only problem with this system was that words for abstract numbers did not exist. Because we see such words hastily cobbled into being at just this time, we know that they must have been forced into existence by the reinterpretation of the impressed tokens. Now humans had two new ideas to expand upon: the notion of abstract numbers (numbers independent of any particular thing being counted), and the notion that the impressed patterns could correspond to the successive words in a spoken phrase or sentence (*four rings*).

Drawing little pictures to denote words like *ring* or *tree* (pictograms) was fine, but what do you do with grammatical words and other unpicturables like *the* and *or*? The easiest way was to use sound-alikes (homonyms or near homonyms), as in the modern game of charades. Thus, if one did this in English, *or*

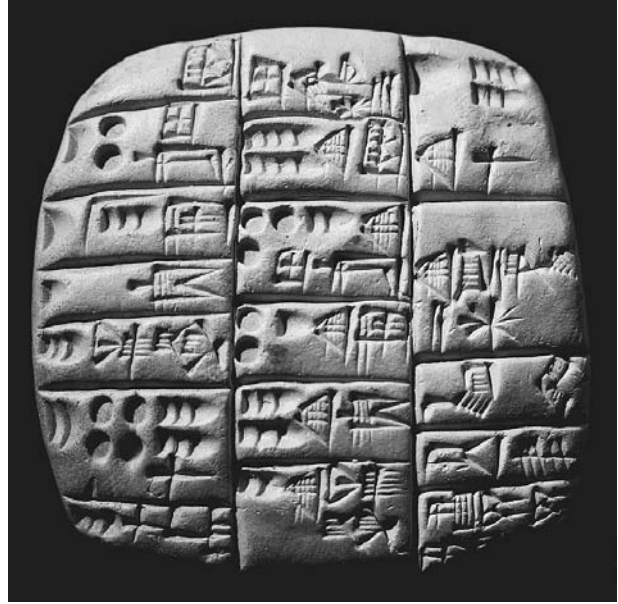

Sumerian clay tablet showing livestock tally. Sumerian was the first language represented in cuneiform script. In Mesopotamia, around 3100 B.C.E., a new system evolved in cuneiform wherein some shapes represented numbers and others represented objects. © GIANNI DAGLI ORTI/CORBIS

could be denoted by a picture of an oar, and so on. (This game, called *rebus writing*, was easier to play in Sumerian than in English because most Sumerian words were only one syllable long.) To tell which word with that sound was meant, scribes began adding extra signs to give clues to the semantic realm. Thus the “oar” pictogram might have a schematic tree beside it when it meant “oar,” warning the reader to pick the word sounding that way that denoted something wooden (eliminating *or* and *ore*). In this way the script gradually became adequate for representing anything in the language, although it was centuries before grammatical words were consistently written along with the “content” (lexical) words. As this writing system became more adequate, it also became more unwieldy, requiring the student to learn hundreds of signs.

Spread of Writing and Literacy

Other early scripts were equally large and unwieldy, and their structures give some clues to their origins. The Egyptians appear to have gotten the idea that *one could write with pictograms and rebuses* from the Mesopotamians around 3100 B.C.E., almost as soon as the Mesopotamians invented true writing, and then made up their script themselves, basing some signs on traditional proprietary marks and drawing pictures for others. So far we lack evidence showing the Egyptians working up step by step to the abstract notion of writing, and we know they borrowed a number of other cultural ideas from Mesopotamia at exactly this period, so this hypothesis of borrowing is the best one we have to date. The Egyptian push to write, unlike that in Mesopotamia, seems to have been chiefly religious rather than economic, especially the desire to preserve personal names for an eternal afterlife. The very earliest

Egyptian inscriptions that have come down to us are names of kings and pharaohs.

Egyptian writing maintained its predominantly religious character to the very end, even though faster cursive forms of the script were eventually devised for writing mundane secular documents. But the Egyptian script never became simpler, retaining its many hundreds of signs until it fell out of use in Roman times.

The Chinese script, which began to blossom during the first great dynasty of China, the Shang (1500–1100 B.C.E.), appears so much later than cuneiform or Egyptian hieroglyphics, in a period when Chinese already contained loan words from Iranian and possibly other Indo-European languages from the West, that probably the script was jump-started like Egyptian, by diffusion of at least the idea that one could write. The signs themselves seem to have been created indigenously, but the writing system closely resembles the Near Eastern scripts in being composed of several hundred pictograms, rebuses, and semantic determinatives. On the other hand, archaic Chinese (like Sumerian) contained mostly words of one syllable, so the Chinese were in a convenient position to (re)invent for themselves the notion of rebuses.

When a script contains hundreds of signs and considerable ambiguity, an individual must devote enormous time and energy to becoming literate. In early societies this had two major consequences: (1) scribes/writers were specialists (fully supported by the rest of society with food, etc.), and (2) there were very few of them. In other words, literacy was not something that many could attain, and, with so few writers, only the most important things got written down. For the Mesopotamians the important topic initially was economic transactions, for the Egyptians, religious matters pertaining to eternity, and, for the Chinese, oracles about future events. Gradually other matters—both religious and secular—came to be recorded, but the cost of educating scribes was always a bottleneck, while the past investment by each of these cultures in their systems made throwing them out unthinkable.

Such was not the case for neighboring cultures. Over and over neighbors restructured these systems as they borrowed them, usually recasting them in such a way as to make the writing more efficient. Living with the Sumerians in Mesopotamia were speakers of various Semitic dialects, such as Akkadian. When Sargon of Akkad took over Mesopotamia soon after 2400 B.C.E., his scribes took the Sumerian pictograms at their *phonetic value alone* (no meaning whatsoever implied) in order to spell out their native Akkadian syllable by syllable (syllabic signs). Conceptually, this was a big step forward because there are so few sounds in a language compared to the huge number of words. Unfortunately, the scribes only went halfway, retaining many Sumerian pictograms as a shorthand for Akkadian words, since a Sumerian word required only one sign, in general, whereas Akkadian words, which typically contained two to five syllables, required many more. So, although the Semitic scribes had made a major conceptual breakthrough (one that the Chinese never made), it remained for others to benefit from this simplification.



Hieroglyphs from the *Book of the Dead*, in the Tomb of Ramesses VI, Valley of the Kings, Thebes, Egypt. First deciphered by Jean François Champollion in 1822, hieroglyphs represent one of the earliest types of true linguistically structured forms of writing. Hieroglyphs are descended from Coptic, an ancient religious language. © GIANNI DAGLI ORTI/CORBIS

The Hittites, an Indo-European group in Anatolia (modern Turkey), attempted to simplify the Sumerian system. When they borrowed cuneiform they dropped most of the duplicate ways of writing a given syllable, whittling down the syllabary to just over one hundred basic signs. But these scribes, too, found it handy to keep the Sumerian pictograms as shorthand for many of their vocabulary words, which on average were even longer than Akkadian words. (If you had to write out absolutely everything by hand, with no word processor, photocopier, or even typewriter, you, too, would look for *faster* ways to write, even if the *system* ended up more complex.)

The people of the Aegean, however, when they borrowed the idea that one could write, eliminated everything except the notion of signs for syllables, creating their own sign-shapes from scratch. They also simplified the notion of “syllable” from the four sorts used in cuneiform (V, CV, VC, CVC, where V = vowel, C = consonant) to two (V, CV), which meant they could manage with a mere eighty or so signs. (Well, almost: for economic accounts, they also used a roster of single signs—pictograms or ideograms—for each different commodity, but these signs were not mixed together with syllabic signs to form a sentence.) This sort of system took much less time to learn and made it possible, at least theoretically, for

more people to become literate in their spare time. The people of Minoan Crete, who used this system for a short time in the mid-second millennium B.C.E., left us elegant inscriptions on jewelry and stone, economic accounts on clay, and graffiti on walls and pottery, suggesting widespread literacy. Unfortunately, they wrote most of their texts on perishable materials that have not survived.

A similar reinterpretation, leading to an even more radical simplification, occurred in the Sinai peninsula, around 1900 B.C.E., where Semites from the north encountered Egyptians from the south at the local copper and turquoise mines. The Semites apparently saw the Egyptian writing system and learned something of its structure, but concluded, "There must be a simpler way." The Egyptian script, unlike cuneiform, did not specify the vowel that a syllabic sign was to convey, only the consonant(s). So when the Semites, like the Minoans, pared away all the duplicate ways of writing syllables, they found themselves with a mere twenty-some signs, specifying that many different consonants.

This new script, the so-called Sinitic consonantal syllabary, was clearly based on Egyptian sign-shapes at first, and it had a tremendous advantage: anyone could learn this tiny number of signs in a few hours. Spelling consisted simply of sounding out the words as one wrote, so spelling did not need to be learned as such. The drawback, of course, was the ambiguity for readers. The writer knew what spoken vowels were intended, but *th rdr hd t gss thm*, leaving much potential ambiguity, unless writers wrote only for their own use. This may have been the dominant use, however, because variants of this simple script quickly spread up the coast all the way to Syria. Along the way it generated what became the Hebrew, Phoenician, Ugaritic, Aramaic, and Arabic scripts (and more), all of which are/were consonantal syllabaries, and generated a much wider range of uses, implying wider literacy.

We know all these scripts are related because they all use(d) the same canonical order of signs for teaching the script, an order ancestral to our modern alphabetical order. One clear and early document of this sort is a tablet from a schoolroom in the city of Ugarit, on the coast of Syria, in which the signs have been modeled for the pupil in this standard order. Because Syria was heavily influenced by Mesopotamian culture, the letters are written with wedge-shapes on clay, but those shapes have nothing to do with the shapes of signs in mainstream cuneiform. Only the cheap clay medium was borrowed.

The final step in developing the most efficient possible writing system was to add separate signs for vowels, eliminating the guesswork without adding many more signs. Remarkably, this step was first taken around 1400 B.C.E. in Ugarit, six centuries before the Greeks produced their alphabet. The structure of Hamito-Semitic languages is such that vowels are not so important for determining the basic semantic contents of a message as they are in virtually all other languages. (It is surely no accident, therefore, that it was Semites who made the big step in simplification to the consonantal syllabary.) But Ugarit had two main linguistic populations: Western Semites and Hurrians. The Hurrian language belonged to yet another family, centered in the Caucasus to the north. The Hurrian

merchants, searching for a better way, reused a sign here and added a sign there to obtain the vowel signs they needed to write their language readably.

As they did so, however, the system cracked into two entirely new types of signs—signs for single vowels and signs for single consonants—such that the latter were no longer signs for entire syllables (of a consonant plus an implied vowel). Each sound in the language now had a sign of its own, and each sign represented a single sound (the definition of a true alphabet). Now readers could read unambiguously what the writer wrote, and for only the cost of learning a couple of dozen symbols.

Unfortunately, this brilliant idea was almost immediately lost in the massive destructions curtailing the Bronze Age (1200 B.C.E.), and it remained for the Greeks to reinvent the same step around 800 B.C.E. as they pondered the ambiguous consonantal syllabary still used by Phoenician traders. The canonical order of the Sinitic script thus passed to the Greeks and is still visible despite the reuse of some unneeded consonantal signs as vowels, the addition of a few letters, and the retention of some unnecessary signs. The Greeks passed one version of their alphabet to the Etruscans, who passed it to the Romans—each time with minor modifications. With a few more changes in medieval times, it came down to us today as the "Roman" alphabet. (The Cyrillic alphabet used in Eastern



Greek funerary stele. Limestone, fourth-third century B.C.E. The Roman alphabet used in North and South American countries and those of Western Europe is based on one version of an ancient Greek alphabet that was passed through the Etruscans to the Romans. © ARCHIVO ICONOGRAFICO, S.A./CORBIS

Europe branched off in medieval times directly from the Greek alphabet.)

Alphabetic Literacy

The simplicity of the alphabet should have meant that now everyone would learn to read and write. Yet the evidence tells a somewhat different story: everyone *could* learn to write, but for centuries few did. Early Greek inscriptions are few, mostly labels and short dedications. The first person we know who used writing systematically to record everything he wanted to “make note of” was the great Athenian statesman Solon, living around 600 B.C.E., who apparently kept personal notes of what he learned abroad and what he thought about political matters. This is a use of writing not seen before, but soon to become commonplace. (The fragmentary nature of our evidence may, of course, have hidden some other earlier examples in other scripts—one might suspect the Third Dynasty Egyptian genius Imhotep (fl. c. 2650 B.C.E.) of similar practices—but clearly such a use was not common elsewhere.) When Solon had something he thought important for his countrymen to remember, he habitually put it into verse so they could memorize it easily, a fact indicating that most of the population was *not* literate.

By 500 B.C.E., however, citizens of Athens (that is, those inhabitants who were free and male) were expected to know how to read the public notices and write their own ballots, although anecdotes show that not all could. And throughout the fifth century—the Golden Age of Athens—literature was still primarily oral, still experienced communally in the theater, as the great dramas of Aeschylus (c. 525–456 B.C.E.), Sophocles (495–406 B.C.E.), Euripides (484?–406 B.C.E.), and Aristophanes (c. 448–385 B.C.E.) attest. Written copies of the plays were, however, increasingly available. Our first reference to a new form of literacy, reading to oneself for one’s own idle pleasure, occurs in Aristophanes’s *The Frogs*, written in 405 B.C.E., in which a not very bright Athenian citizen says he was sitting around on shipboard between practice maneuvers reading one of Euripides’s tragedies to himself. In fact, at this time both Aristophanes and Socrates (469–399 B.C.E.) voiced concern over the rise of mass literacy, worrying that a flood of written information would cause people to forget the important things of life.

Then the flood hit: from then on great drama on the stage was replaced in Greek society by great books to be read—the philosophical works of Plato (427–347 B.C.E.) and his successors (which start, interestingly, as “oral” dialogues in form, although too deep to be fully appreciated in one hearing). And there were new types of lesser works, such as novels to be read purely for fun. A major watershed had been crossed.

The new literacy entailed new problems. How could so many literate people obtain the works they wanted to read? Copying by hand was very slow, so the idea of libraries, where numerous readers could share copies, was conceived. The famous library at Alexandria (destroyed in the mid-seventh century C.E.), although the largest, was only one of many. But with increasing amounts to read, people wanted to be able to read faster, so in Roman times letter shapes became simpler and more regular, allowing the eye to take in and distinguish the letters more rapidly.

In the West, most of this progress was lost with the destruction of the Roman Empire around 400 B.C.E. by illiterate hordes. Literacy retreated to the monasteries, where the storing, copying, and reading of books became sacred tasks. Letter shapes ceased to be clean and simple, since now the criteria were different. The desire to shorten the task of copying (rather than speed the reading) led to complex ligatures and other methods of abbreviation, while serifs, curlicues, and other scriptal flourishes embellished the page even as they impeded easy recognition.

Books had been printed in China since at least 868 B.C.E. (and probably earlier), using carved wooden blocks, but Johannes Gutenberg’s (c. 1397–1468) idea of printing with movable type, in the mid-1400s, changed all that. His first printed books are very difficult to read, but simplicity of letter design returned quickly as easier access to books fostered greater literacy, and greater literacy, together with the possibility of multiple copies, fostered more new texts to read. The Renaissance of learning, already started among the rich merchants of southern Europe, could now blossom fully.

But there was a new bottleneck: the high cost of a printing medium. Vellum and parchment were very expensive and paper a little-explored craft (although invented long ago by the ancient Egyptians and Chinese). With the invention of pulp paper late in the eighteenth century, however, books could be printed so cheaply that even lower-class workers could afford them, carrying in their pockets not just novels but printed manuals for the increasingly complex machines they had to operate. In a sense, it was manuals printed on pulp paper that fueled the Industrial Revolution. In the twentieth century, people were so inundated with printed materials that computers were invented to manage the glut, and those computers are inevitably changing patterns of literacy once again.

See also Communication of Ideas: Orality and the Advent of Writing; Diffusion, Cultural; Language and Linguistics; Prehistory, Rise of; Reading.

BIBLIOGRAPHY

- Barber, E. J. W. *Archaeological Decipherment: A Handbook*. Princeton, N.J.: Princeton University Press, 1974. Discusses history, theory, and methods of archaeological decipherment.
- . *The Mummies of Ürümchi*. New York: Norton, 1999. Discusses literature on early Chinese loans from Iranians and other evidence for early trans-Eurasian contact.
- Daniels, Peter, and William Bright. *The World’s Writing Systems*. Oxford: Oxford University Press, 1996. An encyclopedia of all known writing systems.
- Deacon, Terrence W. *The Symbolic Species: The Co-Evolution of Language and the Brain*. New York: Norton, 1997. Physical evidence for human development toward language, including evidence from brain studies for change to voluntary speech centers.
- de Saussure, Ferdinand. *Cours de linguistique générale*. Paris: Payot (1964 reprint of 1915 original). First major treatise on descriptive linguistics; early analysis of language as arbitrary and linear.
- Friedrich, Johannes. *Extinct Languages*. Translated by F. Gaynor. New York: Philosophical Library, 1957. Story of all the

- major decipherments (including Egyptian and cuneiform), written by one of the decipherers of Hittite.
- Gelb, Ignace J. *A Story of Writing*. 2nd ed. Chicago: University of Chicago Press, 1963. Analytical history of the development of scripts.
- Hockett, Charles. *A Course in Modern Linguistics*. New York: Macmillan, 1958. Chapter 64 contains an important discussion of arbitrary and productive properties of language.
- Justus, Carol. "Indo-European Numerals Since Szemerényi." In *The Emergence of the Modern Language Sciences*, Vol. 2: *Methodological Perspectives and Applications*, edited by S. Embleton, J.E. Joseph, H.-J. Niederehe, 131–152. Philadelphia and Amsterdam: John Benjamins, 1999. Discussion of lack of number words in early languages and the process of their introduction.
- Lieberman, Philip. *Uniquely Human: The Evolution of Speech, Thought, and Selfless Behavior*. Cambridge, Mass.: Harvard University Press, 1991. Discusses evidence for the rapid push toward a vocal tract usable for speech.
- Pedersen, Holger. *The Discovery of Language: Linguistic Science in the Nineteenth Century*. Translated by J. W. Spargo. Bloomington: Indiana University Press, 1959. Development of historical linguistics, with discussion of key discoveries of scripts and texts, and the basic theories generated about the language families of much of the world.
- Schmandt-Besserat, Denise. *Before Writing*, Vol. I: *From Counting to Cuneiform*. Austin: University of Texas Press, 1992. Development of the Near Eastern token system into writing and numbers.

E. J. W. Barber

LANGUAGE, PHILOSOPHY OF.

This entry includes two subentries:

Ancient and Medieval
Modern

ANCIENT AND MEDIEVAL

Only in recent times has philosophy of language been considered a distinct branch of philosophy. But ancient and medieval philosophers had different, sophisticated theories about the relation between language—both individual words and whole sentences—and reality, and the thirteenth century saw one of the most thorough attempts ever to give an abstract, analytical account of the grammar of a natural language.

Words and Things: Plato and Aristotle

In the *Cratylus*, the one dialogue he devoted exclusively to questions about language, Plato (c. 428–348 or 347 B.C.E.) contrasts two ways of explaining how words link with things. Is it purely a matter of “convention and agreement,” so that “whatever name you give to something is the right one”? Or are some words naturally suited to stand for certain given things? Superficially, Plato certainly seems to lend support to the latter, naturalist answer, exploring through usually fanciful etymology how words can be analyzed into significant elements (for instance, *psuchos*—soul—“derives” from *echei*—has/

holds—and *phusin*—nature), and even attributing aspects of meaning to the sounds of individual letters. Yet Plato also points, by irony and more directly, to the inadequacies of such naturalism. Other philosophical schools, such as the Stoics and Epicureans, held to a naturalist view without such reservations.

But not Aristotle (384–322 B.C.E.). He was clearly a conventionalist: a name is “a spoken sound significant by convention.” But how do such spoken sounds link with the world? In *On Interpretation* (16a), Aristotle writes that

Spoken sounds are symbols of affections in the soul, and written marks symbols of spoken sounds. But what these are in the first place signs of—affections of the soul—are the same for all; and what these affections are likenesses of—actual things—are also the same.

Aristotle’s semantic scheme, in which things are signified by words only through the intermediary of thoughts or mental images (“affections of the soul”), is underwritten by his psychology and metaphysics. Human beings know about the world through being affected by the forms that account for things being as they are: the heat of a hot stone, for instance, or the humanity that makes someone a human. Aristotle is therefore justified, to his own way of thinking, in supposing that although words vary from language to language, the mental signs they stand for are the same for all people and can correspond directly with the objects themselves.

Sentences and Facts: Aristotle and the Stoics

Aristotle’s aim in thinking about language was not merely to look at the relation of naming-words to things, but to explain how words combine to form assertoric sentences, which can be true or false. *On Interpretation* studies the functions of nouns and verbs and the mechanism of predication in some detail, but Aristotle remains rather vague about how sentences as a whole link up with reality. In the *Categories* (14b) he talks of what makes a sentence true (what we might call a state-of-affairs) as a *pragma*—a vague word, meaning act, thing, or matter.

In the following centuries, it was the Stoics who gave deeper consideration to the semantics of sentences. They distinguished between signifiers (words and groups of words as utterances: for instance *Dion*), name-bearers (for instance, Dion himself), and significations. They called these significations *lekta* (“sayables”) and understood by them the states-of-affairs revealed by utterances (for instance, Dion’s standing, the *lekton* of “Dion stands”). From this description, it sounds as if the Stoics had an ontology that included both things and states-of-affairs, and the latter were called *lekta* because they neatly filled the role of being what assertoric sentences signify. The concept of *lekta* may well have originated in this way, but there are two important qualifications to consider. First, the Stoics held that not only complete assertoric sentences, but also other types of sentences, such as commands and questions, have their *lekta*; and also that, in addition to these complete *lekta*, there are incomplete *lekta*, which are the meanings of predicates (for instance, standing, the *lekton* of “stands”). Second, the Stoics were materialists, and they considered *lekta* to be not merely incorporeal but not even to exist.

Abelard and the Early Middle Ages

Early medieval philosophers were deeply influenced by the semantic scheme of *On Interpretation*. The way in which Boethius (c. 480–c. 524) discussed it in his commentaries (early sixth century) linked with ideas they found in the writings of St. Augustine of Hippo (354–430) to suggest the following, widely accepted basic scheme: written language signifies spoken languages, which in turn signify a mental language common to all humans, and the terms of this mental language signify things in the world. In medieval texts signification is usually therefore a causal, psychological relation: *w* signifies a thing *x* if and only if *w* causes a thought of *x* in the mind of a competent speaker of the language. There were, however, other influences, especially the grammatical writings of Priscian (fl. 500 C.E.), who was heavily influenced by Stoic theories.

By the eleventh century, there was already a strong philosophical interest in questions about language. For example, St. Anselm of Canterbury (1033 or 1034–1109) wrote a dialogue about the problems caused by a word such as *grammaticus*, which means “grammarian” but also has the adjectival sense of “grammatical”: is *grammaticus* a substance, then, or a quality? In Peter Abelard’s (1079–?1144) logical writings (c. 1115–1125) the semantics of both words and sentences receive careful and searching attention. Abelard accepts the usual psychologico-causal understanding of signification, but his nominalism—the view that nothing except particulars exists—made it problematic. He accepts that predicates signify universals, and then (in accord with his theory) goes on to identify these universals with what are not things—mental images or, in the latest version of his theory, a thought-content. Abelard also developed an account of the semantics of sentences. Assertoric sentences signify what he calls *dicta* (literally, “things said”)—by which he means states of affairs or (on some occasions, something nearer to) propositions. *Dicta*, however, are not things; they are, literally, nothing. The parallel with the Stoics’ *lekta* is striking, although direct influence does not seem possible. Thirteenth-century thinkers talked of sentences signifying *enuntiabilia* (things able to be said), and some fourteenth-century thinkers use the term *complexe significabilia* (complexly significables)—in both cases bringing themselves even closer to the meaning of the Stoics’ term.

Speculative grammar. Speculative grammar was a striking, though short-lived, episode in medieval thinking about grammar. Its outstanding exponents, Boethius and Martin of Dacia, and Radulphus Brito, were arts masters at the University of Paris in the period from approximately 1250 to 1300. They aspired to give grammar the universality demanded of an Aristotelian science and, although they worked entirely with Latin, they believed that the underlying structure they were uncovering was that of any language, although each language represented it using different combinations of sounds.

At the basis of speculative grammar is the Aristotelian semantics, which aligns things in the world, thoughts, and words. The speculative grammarians held that there are modes of being (properties of things, such as being singular or plural, active or passive) and, parallel to these, modes of thinking (as when the intellect thinks of a thing as being singular or plural,

and so on). The modes of signifying (*modi significandi*—from whence the term *modistic grammarians* or *modists*) parallel these modes of being and of thinking. So, a first imposition links a sound with a certain sort of thing, and this root becomes a part of speech by being given *modi significandi* that first of all make it into one of the parts of speech (noun, verb, and so on) and then add features such as case and number (for nouns) or tense and person (for verbs). The modists’ assumption is that the Latin grammatical categories are precisely molded to the general structure of reality, which is captured accurately in thought.

The terminists and Ockham. A little earlier in the thirteenth century, logicians at Paris and Oxford were busy developing a different approach to the relation between words and things, the theory of the properties of terms, which was given its most popular exposition in the *Tractatus* (the so-called *Summulae logicales*) of Peter of Spain (Pope John XXI; d. 1277). The theory of the properties of terms concerns the way in which nouns refer in the context of a sentence. One distinction (in the terminology of the English logician William of Sherwood) is between material supposition, where a word refers to itself (“Man has three letters”)—a medieval equivalent of quotation marks—and formal supposition, where it refers to something in the world. Formal supposition can be either simple or personal: in simple supposition, a word refers to a universal (“Man is a *species*”), whereas in personal supposition it refers to particulars in various different ways, which the terminists further distinguished. The theory provided for the (personal) supposition of a word to be “ampliated” or “restricted” by its context. By adding *white* to *man*, one restricts the supposition of *man* to just those men who are white; by making it the subject of a future-tense verb, one will restrict the supposition of the noun to men in the future. Expressions like “think of” and “it is possible that” amplify the reference of nouns in their scope to include all thinkable or possible such individuals.

Terminism did not fit the interests of mid- and late-thirteenth-century thinkers, but it was revived again in the fourteenth century. William of Ockham (c. 1285–?1349) uses it, in an adapted form, in setting out one of the most elaborate medieval theories about mental language. William is so fully committed to the idea of our thoughts being naturally structured in a language-like (indeed, Latin-like) way, that he breaks the Aristotelian mold and holds that, rather than words signifying thoughts, both words (natural language) and thoughts (mental language) signify reality in much the same way. Since Ockham—like Abelard before him—was a nominalist, he could not accept the usual idea that simple supposition is of universals: according to him, a word has simple supposition when it supposits for a mental term, but does not signify it.

Linguistic Diversity: Dante and the Arabs

The mainstream Western medieval tradition of thought about language concentrated on a single language, Latin. By doing so, it gained the advantage of allowing philosophers to see more clearly the large, abstract questions that concern the relation of any language to the mind and to reality. It also suffered, because scholars (as appears strikingly in the case of the speculative grammarians) simply assumed that features in fact special to the structure of Latin were universal to every language. By

the later Middle Ages, however, there was at least some analytical investigation of the facts of linguistic diversity. The great poet Dante Alighieri (1265–1321), writing his *On Eloquence in the Vernacular* in Latin to defend writing in Italian, tried to explain how all languages derive from the original tongue spoken by Adam, and how they have changed and developed.

Things were very different in the Arabic tradition. During the eighth and ninth centuries, a great quantity of Greek scientific and philosophical work was translated into Arabic. In the earliest period, at least, those thinkers in Islam who thought of themselves as followers of the Greek philosophers tended to play down the value of grammatical study. Their attitude led to a famous confrontation in 932 between the grammarian Abu Sa'ïd al-Sirafi and the philosopher Abu Bishr Matta. While Matta held that logic provided a universal key to thinking, al-Sirafi's contention was that Greek logic is based on the Greek language: writers in Arabic need, rather, to study their own language. The contrast with thirteenth-century Latin thought is piquant. There, grammar was made into a sort of universal linguistic logic; here logic itself is argued to be as particular as the grammars of different languages.

See also *Language and Linguistics; Language, Linguistics, and Literacy; Philosophy: Historical Overview and Recent Developments*.

BIBLIOGRAPHY

PRIMARY SOURCES

- Aristotle. *'Categories' and 'De interpretatione.'* Translated by J. L. Ackrill. Oxford: Oxford University Press, 1974.
- Long, A. A., and D. N. Sedley. *The Hellenistic Philosophers*. 2 vols. Cambridge, U.K.: Cambridge University Press, 1987.
- Peter of Spain. *Language in Dispute: An English Translation of Peter of Spain's Tractatus*. . . . Translated by Francis P. Dinneen. Amsterdam and Philadelphia, Benjamins, 1990.

SECONDARY SOURCES

- Abed, S. B. "Language." In *History of Islamic Philosophy*, edited by Seyyed Hossein Nasr and Oliver Leaman, vol. 2, 898–925. London and New York: Routledge, 1996.
- Barnes, J., and D. Schenkeveld. "Linguistics: 'Part II, 6.1'" In *The Cambridge History of Hellenistic Philosophy*, edited by Keimpe Algra et al., 177–216. Cambridge, U.K.: Cambridge University Press, 1999.
- Ebbesen, S. "Language, Medieval Theories of." In *Routledge Encyclopedia of Philosophy*, 10 vols, edited by Edward Craig, 389–404. New York: Routledge, 1998.
- Everson, Stephen, ed. *Language*. Cambridge, U.K.: Cambridge University Press, 1994.
- Rosier, Irène. *La grammaire spéculative des modistes*. Lille, France: Presses universitaires de Lille, 1983.

John Marenbon

MODERN

Although discussions of language in seventeenth- and eighteenth-century philosophy foreshadowed many issues that came to full bloom in the twentieth century, before the twentieth

century language was thought to have a secondary role in understanding the special place human beings have in the world. The fundamental concern was the problem of knowledge. How is it possible for human beings to have knowledge of the world? The solution for both rationalists and empiricists was to be found in the nature of mind since, as was universally held, all we can know directly are the ideas of our own minds. To solve this problem of knowledge, philosophers had to account for how we grasp generalities (and not just particulars) and how we determine which of our ideas represent the world truly.

Language was seen as the public conventional medium for communicating private thought. A simple denotational theory of meaning predominated. The meanings of words are their denotations, the objects that the words stand for or denote, or the ideas of particular objects. Proper names, like "Silver," denote particular objects. There was great controversy over what general terms, like "horse," denote. Three major positions emerged: (1) realism or Platonism, the view that general terms name real abstract objects (horsiness); (2) conceptualism, the view that terms stand for abstract ideas or concepts (the concept of horsiness); and (3) nominalism, the view that a term is general if it denotes more than one particular object. The important problem concerned the nature of abstract ideas. The solution to the problem of general words would follow from this.

Founders of the Twentieth-Century "Linguistic Turn"

In the twentieth century, Anglo-American philosophy took "the linguistic turn." Instead of seeking solutions to problems of knowledge and thought in an examination of the nature of our ideas, philosophers looked to the nature of language. This great shift began with Gottlob Frege's foundational work in mathematical logic.

Logical Syntax and Semantics

Well into the nineteenth century, Aristotelian logic dominated. Logic was seen as the study of thought itself. Gottlob Frege (1848–1925) revolutionized our conception of logic and its relation to thought and language. Frege's key insight was to see that formal arithmetic modeling can be used to display the structure of language. Just as " $x + y = z$ " expresses the form of all instances of addition through the use of variables (x , y , z) and a special sign for the addition function ($+$), so language can be modeled. "Horses are mammals" can be written in a special concept-script (*Begriffsschrift*) that displays the different roles that the constituent words play in the sentence, " $(x)(Hx \rightarrow Mx)$." This is done in a way that abstracts from the meaning of any particular sentence. The new logic, thus, distinguishes the formal features of language from meaning, laying the groundwork for the tripartite distinction between syntax, semantics, and pragmatics.

Syntax concerns the rules for combining expressions into well-formed sentences within the language while *semantics* gives us a theory of the meanings of words and sentences. On this view, language is a formal object that consists of a finite interpreted lexicon and a finite set of recursive rules for combining lexical items. Recursive rules are rules that can be

applied repeatedly. This permits the construction of any of an infinite array of possible sentences. The lexicon consists of several kinds of terms—proper names, predicates, and relations, each distinguished by its distinctive role within a sentence. This conception of language, which continues to dominate discussion, is a *representational theory of language*, for it treats the essence of language as the representation of possible states of the world using finite resources. *Pragmatics* studies whatever practical and contextual aspects of language use are left.

Frege's semantic theory. In trying to apply the traditional denotational theory of meaning to language, Frege identified a number of problems. One of the most important arises with "contingent identity" statements. The sentences "The Morning Star is the Morning Star" and "The Morning Star is the Evening Star" have different "cognitive values." If meaning is just a matter of denotation, then it is hard to see how this could be so. Frege's theory distinguishes two kinds of meaning: *reference* (what the term denotes) and *sense* (the mode of presenting the denoted object). Each meaningful expression must have both a sense and a referent. Names ("Walter Scott") and definite descriptions ("the author of *Waverley*") denote particular objects by way of their mode of presenting the object. The sense of a predicate expression is the mode of presenting a concept, the referent of the expression. Questions about the nature of, and relation between, sense and reference have been at the center of philosophy of language ever since.

Logical analysis. Frege came to logic and the philosophy of language through concerns with the foundations of mathematics. Bertrand Russell (1872–1970) and Ludwig Wittgenstein (1889–1951) shared this concern but saw the new logic as the key to philosophy in general. Both held that the new logic would enable philosophy to break with its metaphysical tradition, by showing that metaphysics had resulted from mistakes and confusions rooted in a failure to understand language properly. One must distinguish between the surface grammar of ordinary sentences and the underlying logical form of these sentences. The new logic is the means for characterizing this deep structure (or logical form), a structure hidden by surface grammatical form. Logical form is reached through a process of *logical analysis*.

Russell's classic example of an analysis that removed puzzlement was his treatment of definite descriptions. It was thought that definite descriptions ("the author of *Waverley*") should be treated like proper names; to be meaningful they must refer to some particular. But this creates a problem for non-referring definite descriptions like "the present king of France." This is a meaningful phrase and yet there is no individual answering to this description. Russell's solution was to argue that the underlying logical form of the expression is quite different from what it appears to be on the surface. Analysis reveals that the sentence "the present king of France is bald" has the logical form of "There is one and only one person such that that person is now king of France and is bald." Russell's analysis eliminates the apparently referring expression "the present king of France." Correctly analyzed, this puzzling sentence turns out to be merely false.

Wittgenstein took this idea even further. In his first work, *Tractatus Logico-Philosophicus* (1922), Wittgenstein argued that all sentences (in any language whatsoever) have a *determinate* meaning. A sentence says that things are thus-and-so. Wittgenstein took this to imply that any sentence must be analyzable into a set of "elementary" sentences composed of constituent words that denote simple objects. Complex sentences are just functions of combinations of elementary sentences. Strings of words that look like sentences, but resist analysis, are not really sentences at all. They are nonsense. Only the sentences of ordinary factual talk and the natural sciences are meaningful. Ethical, aesthetic, and religious statements, though important to our lives, are strictly meaningless. Most (if not all) traditional philosophy is nonsensical on this view.

Logical Positivism and Its Challengers

The next important step was taken by a number of leading physicists, mathematicians, and philosophers who formed a group in Vienna known as the Vienna Circle. The Vienna Circle was committed to a repudiation of metaphysics in favor of science, and they saw in the ideas of Frege, Russell, and Wittgenstein the philosophical foundation for their movement. They embraced a philosophy of "logical positivism." At the heart of this movement was the thesis, known as the *principle of verification*, that only sentences making empirically confirmable claims are meaningful at all. Unverifiable sentences are nonsense. In the 1930s, many positivists had to flee Austria and Germany. As émigrés, they exercised a profound influence on philosophy in the English-speaking world.

Challenges to the positivist conception of language. The 1950s and 1960s saw a reaction against the positivist theory of language. The challenge had two sources: the ordinary language movement of Oxford University and a powerful critique of the very idea of meaning by the American philosopher W. V. O. Quine of Harvard.

Ordinary language movement. Wittgenstein's *Philosophical Investigations* (1953) and J. L. Austin's writings were the mainsprings of the ordinary language movement. These philosophers retained the positivist suspicion of metaphysics as confused theorizing, but they rejected the celebration of science at the expense of all other forms of understanding and its theory of language. Wittgenstein and Austin, in their different ways, argued that the theories of language represented by Frege, the *Tractatus*, and the positivist movement are themselves as confused as the metaphysical theories they deride. One of the striking consequences of the verificationist theory of meaning is that ordinary objects, from pigs to chairs to electrons, are logical constructions out of our sensory experiences, a view called "phenomenalism." Phenomenalism is the theory that all empirical sentences are analyzable into sets of sentences about actual and possible observations that would confirm (or disconfirm) the truth of the sentence. Meaning is ultimately rooted in sensory experience. "This is a penny" is thus analyzable into a set of experiential sentences: "this is copper-colored, round, hard and cool; or this is copper-colored, elliptically shaped, hard and cool; or . . ." The full analysis would consist of a potentially infinite disjunction of experiential sentences, one for each possible experience of a penny.

Critics argued that the positivist theory is belied by the realities of ordinary language. They used nuanced descriptions of our actual uses of language to challenge the claims both that language has an underlying logical form revealed through analysis and that referential theories of meaning, and phenomenalism in particular, are correct. Early referential theories state that the semantic relation between words and the world is fixed by ostensive definitions, that is, by naming an object. But ostensive definition cannot fix meaning since any object has many distinct properties, which the ostensive definition in itself does not distinguish. Defining “horse” by pointing to Silver does not show whether the expression is intended to be a proper name or to pick out Silver’s horsiness or his being four-legged or white. So, it is concluded, reference cannot explain meaning, but presupposes it.

Meaning seems better explained in terms of how words are used in connection with our actions and interactions with the world and each other. Meaning is not the denoted object, but the use to which the word is put in practice. This idea of meaning as use brings with it a *holistic* conception of meaning rather than the *atomistic* conception of referential theories of meaning. A number of different positions developed within this movement: (1) Some advocate a use theory of meaning, which replaces the idea of language as a single systematic totality with that of an array of overlapping ways of using language. It replaces the search for necessary and sufficient experiential conditions for the applicability of an expression in favor of criterial grounds, where *criteria* constitute necessarily good evidence for the presence of some object while nonetheless falling short of entailment of the presence of that object. (2) J. L. Austin and others introduced the speech act theory of language, according to which the act of utterance and the context within which it occurs is the starting point for a theory of meaning. This too leads to a holistic conception of meaning and blurs the distinction between what belongs to semantics (the meanings of our words) and what belongs to pragmatics (the background and contextual considerations that inform actual speech). (3) Lastly, there are those who see in the ordinary language critique of the representational picture a rejection of the possibility of theorizing about language at all. There can only be the diagnosis of error in any such attempt.

Quine’s philosophy of language. The second great challenge to the dominant picture of language comes from W. V. O. Quine (1908–2000) with his critique of the distinction between *analytic* and *synthetic* truth (“Two Dogmas of Empiricism,” 1951) and his more general attack on the very idea of meaning (*Word and Object*, 1960). Sentences that are analytically true are true solely in virtue of the meanings of the constituent words. The truth of synthetic sentences, on the other hand, is a function both of the meanings of the words and of the nature of the world. It is the difference between “Bachelors are unmarried” and “Sam is a bachelor.” Quine argues that the sentences we accept as true hang together holistically in a “web of belief” that can be adjusted at any point. He concludes that there is no point in classifying some sentences as true by meaning and some as empirical.

In *Word and Object*, Quine introduces what proves to be the greatest challenge to the dominant view. With “the museum

myth of meanings” (words as labels for objects) fully discredited, we must look at language in a new way. The way to understand meaning is to ask what translation preserves. Much translation is customary, so we should look at *radical translation*. The situation of radical translation is one in which the linguist seeks to translate a language that is wholly alien to him. We find that there is no uniquely correct way to specify the translations of the unknown language into the known language (“the indeterminacy of translation”) and no way to specify determinately what objects or properties the terms refer to (“the inscrutability of reference”). Further Quine attacks the idea that language has a logical form that is captured by formal logic. He argues that such an ideal is at best the regimentation of a part of our language. Quine’s challenge set the agenda for the 1960s and 1970s.

Philosophy of Language since Quine

Donald Davidson (1926–2003) builds on Quine’s project, developing his own interpretationist theory of language. Davidson argues that truth is the fundamental semantic notion and that meaning is given by specifying the truth conditions for a sentence. This specification can only be achieved by a method of radical interpretation, which requires treating the speaker as holding mostly true beliefs. This approach differs from the representationalist picture in the following ways: Reference is not the fundamental semantic relation between language and the world, but a derivative relation; meaning and belief are interdependent—there is no way to separate them in a principled fashion; the method of radical interpretation requires, as a normative constraint, that the speaker be rational.

The 1990s brought a defense of inferentialist theories of meaning against representationalist theories. On an inferentialist view, the meaning of a sentence is a matter of the inferential relations that acceptance incurs. Instead of thinking of a sentence as representing a state of affairs, we should think of the sentence as entitling and committing the utterer to say and believe other things. To assert “Horses are mammals” is thereby to be committed to holding true “Horses are warm-blooded” and to rejecting as false “Horses lay eggs.”

New theories of reference. The second reaction to Quine was the construction of new theories of reference that are held to avoid the problems of the simple denotational theory. These are causal theories of reference and “direct reference” theories. Causal theories of reference identify the reference relation between words and properties with causal relations. Direct reference theories state that the object or property referred to just is the meaning of the expression; the reference relation is not explained by way of ostensive definition or some special causal chain. Both approaches free the notion of reference from necessarily involving some kind of mental act. Saul Kripke introduced key elements of both theories in his highly influential book *Naming and Necessity* (1972). There he maintains that referring terms “rigidly designate” their objects. Once an object has been baptized, that name denotes its object in any possible world in which the object (is specified to) occur(s). What secures the link for those who have no direct relation to the object is the socially transmitted causal chain that extends from the baptism to subsequent uses of the name. Kripke extended

his theory of rigid designation and socially sustained causal chains to natural kinds as well as individuals.

Realism vs. Anti-Realism. This debate concerning the nature of reference and whether it can explain the meaningfulness of language is at the heart of a philosophical debate that dominated the 1980s and continues to be felt. In the 1980s, the great metaphysical debate between realism and idealism was recast in terms of the relation between language and the world. This debate concerns both how reference and truth should be understood and whether the correct theory of meaning for language is a *truth-conditional theory* or an *assertability conditional theory*. A truth-conditional theory holds that the meaning of a sentence just is the truth condition for that sentence. An assertability conditional theory of meaning states that the meaning of a sentence is given by its assertability conditions, namely, the conditions by which one can recognize the statement is true. These are distinct versions of the representationalist picture of language. This debate became focused on vying theories of truth. Michael Dummett, the leading defender of the assertability conditional account, characterized the difference between realist and antirealist positions in terms of whether a statement could be meaningful and yet transcend any possible evidence for its truth or falsity.

This interest in truth as a semantic value has generated a lively debate. Both the realist and the antirealist hold substantive theories of truth. The realist identifies the truth of a sentence with its corresponding to the facts. The antirealist assesses truth in terms of coherence with other sentences and our recognitional capacities. Challenging both of these positions are “deflationary” theories of truth. Such theories deny that truth has a substantive nature (whether correspondence or coherence). The truth predicate is a device for semantic ascent, for moving from the sentence “snow is white” to the sentence “the sentence ‘snow is white’ is true.” There are things that one can say by talking about sentences that are not easily said in other ways.

Other issues. The 1990s saw a number of developments. Most important was the debate between inferentialist theories of language and representationalist theories. Other important issues concerned the nature of “vague” predicates like “bald” that have fuzzy borders (is the “fuzziness” a feature of the property itself or our ignorance?), the compositionality of meaning (is it essential to the explanation of meaning?), innate rules of grammar, and the infinite reach of language. Many of these issues have become highly technical and specialized, but they are all in the service of the great debates about the general character of language and meaning.

See also *Language and Linguistics; Language, Philosophy of; Ancient and Medieval; Linguistic Turn*.

BIBLIOGRAPHY

- Austin, J. L. *How to Do Things With Words*. Edited by J. O. Urmson. Oxford, U.K.: Clarendon Press, 1962.
- . *Philosophical Papers*. Edited by J. O. Urmson and G. J. Warnock. Oxford, U.K.: Clarendon Press, 1961.
- Ayer, A. J. *Language, Truth, and Logic*. 2nd ed. New York: Dover Publications, 1946.

- Brandom, Robert. *Making It Explicit: Reasoning, Representing, and Discursive Commitment*. Cambridge, Mass.: Harvard University Press, 1994.
- Davidson, Donald. *Inquiries into Truth and Interpretation*. Oxford, U.K.: Clarendon Press, 2001.
- Dummett, Michael. “What Is a Theory of Meaning? I and II.” In his *The Seas of Language*. Oxford, U.K.: Clarendon Press, 1993.
- Frege, Gottlob. “Begriffsschrift” and “On Sense and Reference.” In *Philosophical Writings of Gottlob Frege*, edited by Peter Geach and Max Black. Oxford, U.K.: Blackwell, 1969.
- Kripke, Saul A. *Naming and Necessity*. Cambridge, Mass.: Harvard University Press, 1972.
- Quine, W.V.O. “Two Dogmas of Empiricism.” In his *From a Logical Point of View: 9 Logico-Philosophical Essays*. New York: Harper & Row, 1961.
- . *Word and Object*. Cambridge, Mass.: MIT Press, 1960.
- Russell, Bertrand. “Lectures on Logical Atomism.” In *Logic and Knowledge*, edited by Robert Charles Marsh. London: George Allen and Unwin, 1956.
- . “On Denoting.” In *Logic and Knowledge: Essays, 1901–1950*, edited by Robert Charles Marsh. London: George Allen and Unwin, 1956.
- Wittgenstein, Ludwig. *Philosophical Investigations*. Translated by G. E. M. Anscombe. New York: Macmillan, 1953.
- . *Tractatus Logico-Philosophicus*. Translated by D. F. Pears and B. F. McGuinness. London: Routledge and Kegan Paul, 1975.

Meredith Williams

LAW. The development of law and jurisprudential ideas since the 1970s represents a significant change from the conventional models that had earlier dominated the province of legal theory in the history of ideas. This entry focuses on two salient theoretical emphases that have continued to influence developments of conventional legal theory and postmodern paradigms of legal thought: the analytical tradition, and the jurisprudence inspired by the revolt against formalism, or legal realism.

Twentieth-Century Schools

Within the received tradition, the rules-based model (which regards law as a pure science), identified with Herbert Lionel Adolphus (H. L. A.) Hart (1907–1992) and the Oxford school of analytical positivism, was subjected to both strong internal critique and important development by such figures as Ronald Dworkin, a Yale law professor who later became professor of jurisprudence in Oxford. Dworkin’s redevelopment of the analytical model focused centrally on the development of a powerful rights-based theory of law. The approach moved the consideration of conventional legal theory strongly in the direction of the moral foundations of political community. This created an awkward fit for analytical positivism, which traditionally strove to separate law from moral discourse, that is, to radically distinguish the law that *is* from the law that *ought* to be. Dworkin’s work led him to stress the principle that the foundations of a rights-based approach to law are indeed rooted in the values of equal respect and dignity, the core moral

precepts in a political community committed to taking rights seriously.

Responses to legal realism. In the United States the dominant version of legal realism (an intellectual movement that advocates policy-oriented jurisprudence informed by developments in social and behavioral sciences, such as psychology and anthropology), which had reached its apex in American legal culture prior to World War II, also remained influential. The general criticism leveled at legal realism argued that an approach to adjudication that is result-selective and that only makes sense from an external observer's point of view is flawed. It compromises the conventional view of law and in particular undermines its special juridical character rooted in the ubiquity and special characteristics of rules governing social and legal relations. This criticism reflects the idea—implicit in pragmatic approaches to philosophy—that law, like all human relations, should be conceived in terms of process.

Three distinctive responses to legal realism developed in the United States. The first was an acceptance of a rules-rights-based approach to law from an internal point of view, with the corresponding conclusion that the foundations of any legal theory from an external point of view (an about-law point of view) was simply incompatible with a professional internal perspective of law based on rules. This critique gave analytical jurisprudence an important place not only in developments in the United States, but more broadly in the general development of legal theory.

The second response, associated primarily with the Harvard Law School, is known as the legal-process school. At Harvard, Henry M. Hart Jr. (1904–1969) and Albert M. Sacks (1920–1991) focused attention on the nature of adjudication from the point of view of a principle of institutional competence. Instead of asking the classical questions of analytical jurisprudence: “What is a valid law?” and “By what criteria might we objectively determine what a valid law is?,” they asked a different question, namely, “What is a legal question?” They were particularly interested in the objective indices used to distinguish administrative, executive, legislative, or indeed more broadly, political questions from those distinctively legal. This approach provided more flexibility and focused, so to speak, on law as a process requiring a continuing definition and redefinition of legal/professional roles, distinguishing these roles from other roles in the broader processes of settling community disputes. A central feature was the principle that one could still use an objective standard to interpret either what the law is or what falls within the scope of judicial competence. In this sense, analytical jurisprudence and the legal-process school shared a deep commitment to the role of objectivity in law.

Doubtless, ideology could influence the nature of the indicators used to either broaden or narrow the scope of what an appropriate judicial role is or should be. It cannot, therefore, be said that the legal-process approach settled deep ideological differences about the role of law in governing human relations. Rather, it provided a framework that justified greater flexibility in managing the tasks of judicially settling disputes while maintaining fidelity to the importance of objectivity in law.

Morton J. Horwitz summarizes the essential challenge to which the legal-process school responded as follows:

The legal process school sought to absorb and temper the insights of Legal Realism after the triumph of the New Deal. Its most important concession to Realism was in its recognition that doctrinal formalism was incapable of eliminating discretion in the law. The task was instead to harness and channel that discretion through institutional arrangements.

The third response, generally associated with the Yale Law School, is known as “Law Science and Policy.” It was identified with the political scientist Harold D. Lasswell (1902–1978) and the international lawyer Myres S. McDougal (1906–1998). These scholars were deeply influenced by legal realism, but were dissatisfied with the implication that at the end of the day legal realism might lead to legal nihilism. Their initial collaboration, which came during World War II, resulted in the 1943 publication of “Legal Education and Public Policy: Professional Training in the Public Interest.” In this article, they raise the broad question of what the purpose of professional training is and, indeed, how professional training relates to the public interest. In this view, the professions are not neutral, but rather have a great deal to do with the nature and quality of the system of public order a society promotes and defends. From this article, they developed a system of jurisprudential thought for a free society and developed a wide range of specific applications of their theory to international law. Their work in international law became identified with the so-called New Haven School of International Law.

Jurisprudence in this view had a radically different, but distinctively scientific orientation. Jurisprudence was to be a theory for inquiry about law. The theory had a deliberate focus on policy- and decision-making. Indeed, law would now be defined as a process of authoritative and controlling decision-making wherein members of the community seek to clarify and implement their common interests. The approach would be radically context-sensitive, it would be problem-oriented, goal-guided, multidisciplinary, and solution-oriented. Among the central elements of this jurisprudential emphasis was the meaning it gave to the task of problem definition. Law, in this view, is not about the scope of different rules created by current or past elites, or about how to interpret or reconcile contradictory rules created by the same legal sources. A problem is to be observed from the perspective of the subjectivities of individuals involved in social interaction in society itself. In short, human beings in society are making subjective demands for value allocations, and these demands often reproduce social conflict for which the community provides institutional mechanisms specialized with whatever degree of efficacy for responding to them. Thus, law is one of the specialized mechanisms in social organization that responds to the raw, subjective claims of individuals in the larger social process.

By focusing the lens of legal inquiry on individual subjectivities, that is to say perspectives, for example, of identity, demand, and expectation, the Law Science and Policy approach

radically changed the starting point of the central ideas required for legal inquiry. This had large-scale impacts on the development of ideas within the framework of legal culture. Lasswell's work in the social sciences and his collaboration with McDougal also anticipated the later development of post-modernism in the social sciences and its particular application to law, influenced by such theorists as Michel Foucault (1926–1984), Jacques Derrida (b. 1930), Jacques Lacan (1901–1981), and Jürgen Habermas (b. 1929).

Since human subjectivities are the central raw materials from which human problems evolve, and if law is a response to these problems, then human subjectivities are a critical element in a realistic and comprehensive understanding of jurisprudence and law. When, for example, human beings make distinctively economic demands, we bring in the relevance of microeconomic theory. When we consider that the rules and doctrines of the past in virtually all legal cultures have been largely made by men, we see that we must account for women's perspectives in law, which leads to the development of feminist conceptions of jurisprudence. Critical conceptions of jurisprudence, such as critical legal studies and critical race theory, as well as Lat/Crit theory (a branch of critical race theory), such as it is, have entered the discourse about legal culture as a result of the breach in the edifice of legal objectivism identified with conventional legal theory, as well as the legal process perspective.

The Law Science and Policy approach is a theory *about* and *not of* law. The insistence on a theory about law was a cardinal tenet of legal realism and was central to unpacking confusions of vantage point generated by both participants (decision-makers and claimants) and observers who represent a degree of scientific detachment required for the scientific study of law. However, the most direct influence of the McDougal-Lasswell school was in the area of international law, which they styled the public order of the world community. It is, of course, not the case that all of international law reflects their basic tenets; however, their work has had substantial influence on how international law is conceived and on the salience and importance of many of its important doctrines.

International Law

McDougal, Lasswell, and W. Michael Reisman sought to apply jurisprudential insights and ideas directly to the study of international law. Apart from the relevance of context, the problem orientation, and the salience of multiple methods of inquiry about law, their approach stressed the importance of specific intellectual criteria for the study of jurisprudence in international law. These criteria included goal-thinking, trend-thinking, scientific-thinking, predictive-thinking, and alternative-thinking. The approach was also explicit in articulating the standards by which one could compare and evaluate all systems of legal thought. These criteria included the procedures used to maintain and establish a clear observational vantage point, the critical importance of focusing both comprehensively and specifically on the actual processes of policy and decision, the development and use of critical intellectual tasks, and the importance of the provisional postulation of fundamental public-order goals. These criteria could be applied in the study of a national system or the entire global system.

The central feature of the New Haven School of International Law was its insistence on universality and comprehensiveness. This approach coincided with the creation of new states out of the debris of colonial rule. The new states were not always new. They were often old and dependent. In order to stake a claim for statehood, doctrines had to be invented and supported by contemporaneous developments in international law and jurisprudence. Nationalist elites seeking freedom from colonial rule would stake a claim to self-determination and independence. This claim of course would be an attack on sovereignty, or at least the colonial version of it. American idealism in the form of Wilsonian internationalism succeeded after World War II in making German colonies a sacred trust of civilization while at the same time paying service to colonial hegemony. Thus, for example, German South West Africa, which was conquered by South Africa in 1917, was given to South Africa to administer as a special international mandate. The precedent created here was that colonial rule was not altogether to be insulated from international responsibility, in particular the sacred trust for the well-being of the inhabitants. After World War II, the dominant victorious allies, namely the United States and the Soviet Union, shared a common objective, supported for radically different reasons, that colonialism become obsolete. The United Nations was created, and a part of its growing mandate was to facilitate decolonization, self-determination, and independence.

The paradox of claims to resist colonial rule was that they were also claims to weaken the sovereignty idea in international law. If self-determination and independence were supported by international legal precepts, then international support for the integrity of sovereignty would be constrained by these competing claims. In short, sovereignty admits limitation, particularly limitations based on international obligations. Thus, the sovereignty idea began to evolve within the framework of a global constitutive process, as expressed in the theories of the New Haven School.

Problems of Sovereignty

The model for expanding the community of nation-states became the model of a sovereignty-dominated world order, which included the new Afro-Asian sovereigns. This model was largely Eurocentric, and its juridical roots are often identified with the Peace of Westphalia (1648). The claims about sovereignty now represented a paradox. Colonial sovereignty was to be seen as weaker and permeable: "soft sovereignty," as it were. However, the new sovereigns were based on political foundations that were both internally and externally vulnerable. The same elites who demanded a weak version of sovereignty to justify decolonization were now demanding something akin to an absolutist version for national survival. In short, they were frequently demanding a form of sovereignty identified with the international legal culture prior to World War II, a version largely unconstrained by respect for international obligations (hard or thick sovereignty).

The problems of weakening sovereigns coincided with the Cold War, and the hegemon could find surrogates to spearhead strategic interventions intended to weaken sovereigns ostensibly identified with one superpower or another. The

normative status of sovereignty thus generated two powerful contradictory trends. The first trend was the high priority given to principles of sovereign equality and nonintervention. The second was the high priority given to the imperatives of international legal obligation and the competence to intervene when fundamental international values, such as peace, security, and humanitarian values, are compromised.

Thus, while the nation-state system was still expanding in the early 2000s—with approximately 192 sovereigns—sovereignty, in fact, was changing, as nations found that in giving up some sovereignty, they, in effect, *strengthen* their sovereignty. The expansion of NATO (North Atlantic Treaty Organization) is an illustration of this phenomenon; the development in the direction of the European Constitution is a further example; and the development of the African Union Constitution is a major doctrinal shift in the dynamic of sovereignty. This suggests that the political and juridical conceptions of sovereignty had the possibility of embracing theoretical reification and practical obsolescence, or becoming more refined, flexible, fluid, and relevant to the practicalities of governance.

The importance of understanding the context in which sovereigns are created, maintained, and possibly changed is a reflection of the insistence in legal theory that international sovereignty itself is the outcome of problems of power in the international system. What is apparent in the complex global network of institutions and participant actors is that there are many active participants in this process, such as international, continental, and regional organizations, and private-sector institutions of business, capital, and labor, as well as the vast organization and partial structure of nongovernmental operators and individuals who constitute national and global civil society. Therefore, it will be seen that the meaning of sovereignty itself derives not so much from state absolutism, but from the ways in which global society constructs and orders political identity and participation through sovereigns and other institutions of global salience.

Statehood. The concept of sovereignty in the twenty-first century is, of course, tied to the concept of statehood. For a state to be recognized in international law, the state must meet certain practical and normative requirements. The first set of criteria relates to practical matters of power and control. The state must have control over territory, people, and institutions of governance, and must be competent to handle the international environment.

These matters are often collapsed into what is sometimes known as the declaratory theory of recognition. In order to become a member of the United Nations, a state must not only meet these criteria, but it must also meet certain normative standards. It must indicate a willingness to respect and honor the principles on which the United Nations is founded, including respect for peace and security, the rule of law, human rights, and more. In practice, governments have—from time to time—unilaterally indicated that certain states do not maintain standards of behavior consistent with the concept of international obligation. Thus, the United States has a list of states it regards as “terrorist,” and has expanded this notion to include what it calls “rogue states.” This indicates the beginning

of a discourse that is more substantive with regard to the nature of the state itself and therefore the nature of sovereignty. Thus, the notion emerges of the abuse of sovereignty, and some writers have suggested that descriptive typologies of states could include such descriptions as failed states, anarchic states, genocidal states, homicidal states, rogue states, drug-influenced states, organized-crime-influenced states, kleptocratic states, terrorist states, authoritarian states, garrison or national security states, totalitarian states, and democratic rule of law states. Behind this discourse is the evolving notion of sovereignty itself. The older idea of sovereignty was identified with state absolutism. Among the elements of the new concept are the ideas and ideals of transparency, responsibility, and accountability in the analysis of both sovereignty and the state.

Sovereignty and the International Order

Sovereignty is ambiguously defined in the Charter of the United Nations. The first principle holds that the charter derives its legitimacy from the people of the earth-space community, but the constitutional scheme is weighted heavily in favor of the state-sovereignty paradigm, and limits, in some significant measure, the role of nongovernmental participation. Membership is open to sovereign states only. However, the basis of sovereignty is further clarified in the International Covenant on Civil and Political Rights. Individuals who constitute the “people” according to Article 16 “shall have the right to recognition everywhere as a person before the law.” Article 18 specifies the people’s right to freedom of thought; Article 19 stresses the people’s “right to hold opinions without interference” and that the people “shall have the freedom of expression;” and Article 25 puts stress on the right to participate in the political welfare of the State, and the universal rights to vote and to participate in public service.

Thus, a significant change created by the UN Charter (along with subsequent practice) is that the conceptual basis of sovereignty is rooted not only in the monopoly of effective power, but also is predicated on authority and legitimacy, which are rooted in the expectations of people. The Declaration on the “Guidelines on the Recognition of New States in Eastern Europe and in the Soviet Union” made recognition and sovereign acceptance into the European community of states, subject to strong normative standards of international justice. The Guidelines include “respect for the provisions of the Charter of the UN and the commitments subscribed to in the Final Act of Helsinki and in the Charter of Paris, especially with regard to the rule of law, democracy and human rights.” The Summit of the Americas Declaration of Principles and Plan of Action articulated that democracy is the sole political system that guarantees respect for human rights and the rule of law. The 1990 Charter of Paris is another important expectation-creating instrument wherein sovereignty is predicated in the will of the people. Participating states affirmed their respect for human rights protections and fundamental freedoms as “essential safeguards against an over-mighty State.” Democracy is “based on the will of the people” and is the “foundation of human respect” (pp. 193–194).

These examples illustrate that fundamental expectations of the nature of the state, including its sovereignty and governance,

are being conditioned by what scholars call a right to democratic governance. The idea is that the formal historic requirements for the de facto recognition of a state have been enhanced by the normative constraints and demands of critical symbols of authority associated or identified with the human right to democratic governance. These demands include transparency, responsibility, accountability, and a commitment that the rule of law must be an intrinsic component of the nature, scope, and practical functions of sovereignty.

The newer meaning of sovereignty, which ties control to authority and to decision-making, also raises the question about how power and authority (i.e., governance) and decision-making are constituted in the global environment. For example, there are nation-states with constitutions in Africa. There is also the Constitution of the African Union, which is a form of constitutionalism with linkages to the constitutions of African member states. In Europe, nation-states are tied together in an economic and political union. Each nation-state has its own constitution, which is an overt indicator of how governance is constituted in the state, but the continental linkages of these states are to a larger political and economic community, and a draft constitution has been formulated that will obviously have linkages to the constitutional scheme within each state.

At a more inclusive level, all of these developments (national and continental) have evolved complex constitutional orders, which fall under the umbrella of the global constitution: the Charter of the United Nations. It will be very obvious that sovereignty now involves complex clusters of competence; some competences are shared, and smaller states (pooling their economic and political capital) might now have a larger say in the important decisions affecting them in the larger international environment than would be the case if they were acting as individual, isolated sovereigns. However, collected powers also require submission to the rules of the game. In short, in the early twentieth century, sovereignty can be described as a strengthened expression of its former self to some degree, but it is nevertheless much changed.

Sovereignty and the International Community

The conceptual positioning of national sovereignty within the framework of constituting authority and control permits us now to see the importance of the fact that there are many other participants in the global community, power, and constitutive process. As a technical matter, the question of whether an international organization, such as the United Nations, could have an international legal personality for the purpose of suing another state at the international level was decided by the World Court in a case called *The Reparations Case*. In this case, the World Court recognized that even though the United Nations was not a state, it was nonetheless an organization with an international legal personality and the right to sue or otherwise act in the international environment within the framework of its constituted competence.

It was the Nuremberg Tribunal that, in fact, opened the breach to the possibility that individuals might have some sovereignty in the international legal environment. The Nuremberg defendants were made directly accountable for war crimes and

crimes against humanity under international law. But these defendants were also given the right to a fair trial under international law. They not only had duties under international law, but they could also exercise rights. Thus the narrow principle was established that individuals could have rights directly under international law; for some purposes, the individual could exercise these rights and, thus, rights and duties in international law were not confined to formal sovereign entities. Two important developments were born of these events. The first was the development of the human-rights provisions in the UN Charter through the Universal Declaration of Human Rights (UNDHR) and the extensive treaty-based regime for the protection of global and regional human rights. The preamble of the UNDHR states that member states recognize:

[T]he inherent dignity and . . . the equal and inalienable rights of all members of the human family is the foundation of freedom, justice and peace in the world . . . [and] disregard and contempt for human rights have resulted in barbarous acts which have outraged the conscience of mankind, and the advent of a world in which human beings shall enjoy freedom of speech and belief and freedom from fear and want has been proclaimed as the highest aspiration of the common people . . . [and that] it is essential, if man is not to be compelled to have recourse, as a last resort, to rebellion against tyranny and oppression, that human rights should be protected by the rule of law.

The second development was that in the aftermath of the Cold War, two ad hoc tribunals were established to try governmental officials and others for humanitarian and grave human-rights violations. The relative successes of the International Criminal Tribunal for the Former Yugoslavia (ICTY; 1993) and the International Criminal Tribunal for Rwanda (ICTR; 1994) provided a renewed impetus for the creation of an International Criminal Court (1998), which was indeed established. It is therefore critical that we see the development of international legal order since the 1970s as having finally been able to capitalize on the revolutionary breakthrough established at Nuremberg, where it was determined that individuals could not hide behind the veil of the state when they committed horrendous crimes against the peace and against humanity. For example, Article 7 of the Statute of the International Tribunal for the Former Yugoslavia and Article 6 of the Statute of the International Tribunal for Rwanda harmonize on the issue of individual criminal responsibility. Both state that:

1. A person who planned, instigated, ordered, committed or otherwise aided and abetted in the planning, preparation or execution of a crime referred to in articles 2 to 5 of the present Statute, shall be individually responsible for the crime.
2. The official position of any accused person, whether as Head of State or Government or as a responsible Government official, shall not relieve

such person of criminal responsibility nor mitigate punishment.

3. The fact that any of the acts referred to in articles 2 to 5 of the present Statute was committed by a subordinate does not relieve his superior of criminal responsibility if he knew or had reason to know that the subordinate was about to commit such acts or had done so and the superior failed to take the necessary and reasonable measures to prevent such acts or to punish the perpetrators thereof.
4. The fact that an accused person acted pursuant to an order of a Government or of a superior shall not relieve him of criminal responsibility, but may be considered in mitigation of punishment if the International Tribunal determines that justice so requires.

With regard to Yugoslavia, the former president of that country was tried in The Hague in the early 2000s, and in Rwanda, high governmental officials had already been convicted. The question is, what do these events mean for the history of ideas?

These ideas establish the revolutionary principle that, both politically and juridically, the international community may directly hold governmental officials to account (in certain circumstances) and punish them accordingly. It also establishes that the conditions of governance, such as transparency, responsibility, and accountability, are integral features of the authority foundations of the state, and therefore the normative foundations of the state itself have changed on a continuum that moves from state absolutism to rooting governance and constitutionalism in the foundations of authority. What is even more critical as a complement to these developments is the growth not simply of human-rights law, but of human rights as an integral part of governance and constitutionalism and as a deeply rooted expectation in the political and legal culture of the global community. What is important in these developments is that the human-rights culture finds strong intellectual roots in the development of rights-based jurisprudence, as well as in the jurisprudence that roots law in fundamental policy. The rights-based approach seeks to ensure that individual rights are taken seriously. The policy-based approach insists that law be responsive to the claim, the identity, and the fundamental expectation of the individual participation in the international legal and political environment. Central to each concept is the idea of fundamental respect, which is seen as the heart of responsible constitutionalism and accountable sovereignty, and which is fundamental to all human rights.

Human Dignity

Central problems emerged—at least in theory—with regard to how to justify the principle of respect as the cornerstone of the principle of human dignity. It is unclear whether the concept of human dignity can itself be objectively justified, and indeed modern philosophers have even suggested that at a fundamental level, human values about dignity may be

incommensurable. Apparently conflicting values might have to be contextualized (or more deeply analyzed) in light of broader, more abstract formulations of value judgment. Thus, values including power, respect, rectitude, affection, enlightenment, well-being, skill, and wealth must be construed in terms of their enhancement of a more abstract human-dignity postulation. The policy-maker seeking the development of universal dignity must develop technical methods of decision-making, including sophisticated standards of construction and interpretation. Perhaps at this operational level, practical lawyers, social scientists, and real-world policy-makers must render decisions regarding how to integrate what are often regarded to be ostensibly conflicting values and norms in order to genuinely enhance the universal ethic of human dignity.

The South African Constitutional Court, for example, dealt in 1998 with a political party's claim regarding the "Truth and Reconciliation" statute that provided individuals who would otherwise have been prosecuted for human-rights violations with amnesty; essentially, this party contested the constitutionality of the statute and regarded it as a grave violation of international law. The Constitutional Court was confronted with a mechanism to explore truth and guide reconciliation that comprised a critical foundation for the internal peace and security of the entire Republic of South Africa, as well as of the effort to afford each South African political freedom. This statute, however, was in ostensible conflict with universally accepted tenets of international law, which do not accept excuses to mitigate the commission of grave crimes against humanity. It is possible to argue that the ethic of universal respect and human dignity demands universal compliance, but at what cost?

To ensure that respect, humanitarian law, and democratic entitlement are continuously adhered to and honored demands in-depth analysis and delicacy with regard to the process of decisional interventions. Rules of construction and interpretation painstakingly pieced together articulate, for example, that even if a peremptory norm of international law comprises an *erga omnes* obligation, it should be appraised and applied to enhance similar rights, which might also have to be accommodated. The currency underlying the ethic of human dignity is that it affords practical decision makers standards and goals that permit the transformation of regional, continental, and international law into a greater approximation of the standards and goals embodied in the United Nations Charter.

Principle of equality. A central element in the development of the respect-human dignity precept is that it is rooted in the principle of equality. The principle of equality has a longstanding normative basis in the rule of law. For example, rule-governed behavior works on the principle of equality, namely, that rules cover like cases, regardless of identity, status, or personality. The more normative expression of the equality principle is established in the idea that all participants are formally equal before the law. Practical experience suggests, however, that even if formal equality is embraced it too often entrenches hierarchy, a lack of equity, and a depreciation of substantial justice. The specific way in which the international legal system approached the equality principle was a clear-cut recognition that the business of why World War II was fought

was, in part, rooted in the racialism and Herrenvolkism of the Nazis. It would therefore be no surprise that both the preamble and the purposes of the UN Charter would codify not simply the importance of human rights, but would establish that racial and gender equality were crucial to a meaningful expression of the human-rights principle. Two of the most important covenants that reflect the specific development of the equality principle are the 1965 International Convention on the Elimination of All Forms of Racial Discrimination (ICERD) and the 1980 Convention on the Elimination of All Forms of Discrimination Against Women (CEDAW).

International human-rights law has also made criminal the practice of seeking to destroy groups of human beings in whole or in part based on race, nationality, ethnicity, and religion as labels of identity. Thus, the very first human-rights treaty following World War II made genocide a human-rights crime. The full development of the equality principle in international law has also permitted regional developments and has deeply influenced constitutional development on the principle of equality. The race relations convention, for example, goes further than the idea of formal equality in race relations. It specifically holds that affirmative action to achieve substantive equality is not unfair or prohibited discrimination. It cannot be said that the public order of the world community has achieved a community in which both substantive and formal equality are, in fact, realized. However, enormous developments have been stimulated by the development of the equality principle at the international level through the prism of universal human rights. This rise has served as a base of power for important levels of social activism within the framework of civil society to improve the condition of women discriminated against because of sex, as well as minorities discriminated against because of race.

Globalization

One of the most important factors influencing international society in the early 2000s is the principle of globalism. The impact of globalism on sovereignty is fueled by the vast growth in the flow of goods, services, capital, and labor across state and national lines. This process has been dramatically accelerated by the communications revolution, and the impact on state sovereignty suggests that these global forces have seriously weakened the territorial boundaries of states. This intense flow of values across state and national lines also invited instant comparison and appraisal. As barriers to human interaction have been liberalized, what has been the social benefit and the social cost? There is no clear answer to this question. We know, for example, that without the communications revolution, it is possible that the global HIV/AIDS pandemic might have been containable. Thus, following the SARS (Severe Acute Respiratory Syndrome) outbreak of 2003, dramatic limitations were placed on communication to prevent the disease from spreading globally.

If nation-state barriers are not as salient, other barriers in the global age challenge the concept of global equity and fairness. While the world has generated more wealth than mankind has ever before achieved, the conditions of impoverishment throughout huge sections of the planet suggest a global

economic apartheid rather than a global vista of improved and shared equity. It is widely recognized that a planet that is radically divided between the haves and the have-nots, in which there is an acceleration of short-term gains for the haves and an acceleration of poverty and deprivation for the have-nots, will ultimately result in the depreciation of all. In short, underdeveloped as the concept of global equity is, it may be the cornerstone upon which the improvement of the global condition of deprivation is built, not because this is necessarily a spiritually beneficial thing, but because the long-term prosperity—and possibly the survival—of the human race may depend on it. The history of ideas in the future will therefore be challenged by the ideological and jurisprudential relevance of the concept of equity and whether equity can be the critical lever that provides us with universal concepts of respect and freedom in a global commonwealth of dignity.

See also Authority; Critical Race Theory; International Order; Justice; Sovereignty; State, The.

BIBLIOGRAPHY

- Charter of Paris for A New Europe, 21 November 1990. In *International Legal Materials* 30 (1991): 190 ff. Also available at www.ejil.org.
- Convention on the Elimination of All Forms of Discrimination against Women, *opened for signature* Mar. 1, 1980, G.A. Res. 34/180, U.N. GAOR, 34th Sess., Supp. No. 46, at 193, U.N. Doc. A/34/46 (1979), 1249 U.N.T.S. 13, *reprinted in* 19 I.L.M. 33 (1980) (entered into force on Sept. 3, 1981). One hundred sixty-three states are party to the treaty. Also available at www.un.org.
- Dworkin, Ronald. *Taking Rights Seriously*. Cambridge, Mass.: Harvard University Press, 1977.
- . “‘Natural’ Law Revisited.” *University of Florida Law Review* 34 (1982): 165–188.
- Finnis, John. *Natural Law and Natural Rights*. New York: Oxford University Press, 1980.
- Hart, H. L. A. *The Concept of Law*. Oxford: Clarendon, 1961.
- Hart, Henry M. Jr., and Albert M. Sacks. *The Legal Process: Basic Problems in the Making and Application of Law*. Prepared from the 1958 tentative edition by and containing an introductory essay by William N. Eskridge Jr. and Philip P. Frickey. Westbury, N.Y.: Foundation, 1994.
- Horwitz, Morton J. *The Transformation of American Law, 1870–1960: The Crisis of Legal Orthodoxy*. New York: Oxford University Press, 1992.
- International Convention on the Elimination of All Forms of Racial Discrimination, Dec. 21, 1965, 660 U.N.T.S. 195 (entered into force on Jan. 4, 1969; and for the United States on Nov. 20, 1994). One hundred fifty-two states are party to the treaty. See U.S. Department of State, *Treaties In Force* 427 (1997). Also available at www.unhchr.ch.
- International Covenant on Civil and Political Rights, U.N.G.A. Res. 2200 A (xxi), 999 U.N.T.S. (Dec. 16, 1966); *International Legal Materials* 6 (1967): 368 ff. Also available at www.unhchr.ch.
- Lasswell, Harold D. *Politics: Who Gets What, When, How*. New York: McGraw-Hill, 1936.
- Lasswell Harold D., and Myres S. McDougal. *Jurisprudence for a Free Society: Studies in Law, Science, and Policy*. Boston: Nijhoff, 1991.

- . “Legal Education and Public Policy: Professional Training in the Public Interest.” *Yale Law Journal* 52 (1943): 203 ff.
- Marmor, A. “An Essay on the Objectivity of Law.” In *Analyzing Law: New Essays in Legal Theory*, edited by Brian Bix. Oxford: Clarendon, 1998.
- McDougal, Myres S. “The Comparative Study of Law for Policy Purposes: Value Clarification As an Instrument of Democratic World Order.” *Yale Law Journal* 61 (1952): 915 ff.
- McDougal, Myres S., Harold D. Lasswell, and W. Michael Reisman. “Theories about International Law: Prologue to a Configurative Jurisprudence.” *Virginia Journal of International Law* 8 (1968): 188 ff.
- . “The World Constitutive Process of Authoritative Decision.” In *The Future of the International Legal Order*. Edited by Richard A. Falk and Cyril E. Black. Princeton, N.J.: Princeton University Press, 1969.
- Nagan, Winston P. “Conflicts Theory in Conflict: A Systematic Appraisal of Traditional and Contemporary Theory.” *New York Law School Journal of International and Comparative Law* 3 (1982): 343 ff.
- . “Dunwoody Commentaries: Not Just a Descending Trail: Traversing Holmes’ Many Paths of the Law.” *Florida Law Review* 49 (1997): 463 ff.
- Rawls, John. *A Theory of Justice*. Cambridge, Mass.: Harvard University Press, 1971.
- Statute of the International Tribunal for the Former Yugoslavia, adopted at New York, May 25, 1993, S.C. Res. 827, U.N. SCOR, 48th Sess., 3217th mtg., at 1–2, U.N. Doc. S/RES/827 (1993), reprinted in *International Legal Materials* 32 (1993): 1159 ff. Also available at www.un.org.
- Statute of the International Tribunal for Rwanda, adopted at New York, Nov. 8, 1994, S.C. Res. 955, U.N. SCOR, 49th Sess., 3453d mtg., U.N. Doc. S/RES/955 (1994). Reprinted in *International Legal Materials* 33 (1994): 1598 ff. Also available at www.icttr.org.
- Stacy, Helen M. *Postmodernism and Law: Jurisprudence in a Fragmenting World*. Burlington, Vt.: Dartmouth, 2001.

Winston P. Nagan

LAW, ISLAMIC. Islam, like Judaism and unlike Christianity, is a nomocracy, a religion of the law as opposed to theology. It is evident from the Koranic text that sacred law is a crucial feature of the covenants that God establishes, through prophets, with the various nations of mankind. Prophets are united by their main directive, to worship God alone, by their moral exhortations, and by accompanying miracles proving that their messages are of divine and not human origin. Some prophets also bring with them a Scripture: the Koran mentions the *Scrolls* of Abraham, the *Torah* of Moses, the *Psalms* of David, and the *Gospel* of Jesus. Some prophets also bring with them a new sacred law. In the Koran, the term that corresponds to this sacred law is *din*, now the ordinary term for “religion” in Arabic, and individual fundamental laws are termed *hudud Allah* (“God’s limits”). However, the term for the sacred law that gained general acceptance from early Islamic history on is the *shari’a* (“the way, or path”), parallel to the Jewish term for the sacred law, *halacha* (also “the way, or path”). The *shari’a* is Islamic sacred law taken in toto: the

idealized system of all religious obligations God has imposed on believers.

Muslim scholars of the sacred law devote themselves to discovering the rulings of the *shari’a*, in effect seeking to determine God’s intentions concerning the specific obligations of believers on the basis of available evidence. Law as a branch of academic study or as a product of human discourse is termed *fiqh* (literally, “understanding”). A jurist or specialist in law is termed *faqih* (“one who understands, is perspicacious.”) The goal of the jurist is to determine reliably, given a set of circumstances—including time, place, identity of the legal agent, and so on—the legal status of particular possible acts. There are five main categories for the legal assessment of acts: forbidden (*haram*; e.g., marrying one’s aunt); disfavored but allowed (*makruh*; e.g., a husband’s repudiation of his wife without cause); indifferent (*mubah*; e.g., eating raisins); recommended but not obligatory (*mustahabb*; e.g., a man’s marrying as soon as he can afford to do so); and obligatory (*wajib*; e.g., supporting one’s elderly parents, fasting during the day in Ramadan). Other legal assessments, such as valid (*sahih*) and invalid (*batil*), do not apply to acts, but to contracts of sale or marriage contracts, for example. Islamic law is also a moral system; it is intended to preserve morality and not simply mete out justice. It does so by maintaining a stable social order, whereby the five cardinal values of religion, life, offspring, property, and rationality are conserved.

By the late eighth and early ninth centuries C.E., from which date the earliest extant compendia of the points of law, such as the *Kitab al-umm* of Muhammad b. Idris al-Shafi’i (d. 820), Islamic law was already a sophisticated science with a substantial tradition behind it. In such works, the law was organized into chapters in a more or less standard order, falling into three main sections: *‘ibadat* (“devotions”), including ritual purity, prayer, almsgiving, fasting, the pilgrimage, and related topics; *mu’amalat* (“transactions, contracts”), including sales, debt, rental, pawning and mortgage, partnership, loans, inheritance, marriage, divorce, slavery, gifts, endowments, etc.; and *ahkam* (“verdicts”), including payment of indemnity for injuries, criminal punishments, and court procedure. Obviously, the law includes not only topics directly related to religious devotions and rituals but also general topics of family, commercial, and criminal law. Not all legal issues were addressed by the jurists in their theoretical writings, and even some that were rarely enforced by them. For example, Islamic penal law only prescribes punishments for six specific crimes: adultery or fornication, false accusation of adultery or fornication, robbery, drinking intoxicants, and banditry. Other offenses, except injury and murder, which are covered by *lex talionis*, or the payment of indemnity, are subject to discretionary punishments that may be determined by the ruler or the judges he has appointed. For this reason, large bodies of extra-religious law were created by various dynasties, the most developed example being that of the *qanun* of the Ottoman Empire, which covered many areas of public, fiscal, administrative, and criminal law. Islamic jurisprudence recognizes that not all areas are covered by the scriptural law, and it is generally held that *urf*, or the custom of a particular locale, may serve as the basis of law as long as it does not contradict other legal principles. Custom has played a particularly

important role in commercial arrangements, which varied widely from one area of the Muslim world to another.

As in Rabbinic Judaism, in Islam it was primarily expertise in the law that endowed one with religious authority. Although legislative authority, the right to set the law itself, theoretically belongs to God alone, interpretive or declarative authority belongs to the jurists, on the grounds that their interpretations represent the closest possible assessment of God's will with regard to legal questions. Other groups have claimed religious authority in the course of Islamic history, including theologians, mystics, and charismatic leaders, but the jurists have succeeded in establishing and justifying their authority as a group more than any other ever since the tenth century C.E. Nevertheless, the jurists regularly assumed the existence of an Islamic polity under a Muslim sovereign with absolute political authority. In a historical compromise, the jurists carefully delimited the sphere within which the sovereign could exercise his authority, granting him a great deal of latitude in public law, such as taxation and public safety, while endeavoring to maintain the jurists' own control over private law, including marriage, divorce, sales, and so on. There therefore exists something akin to a split between church and state, but it is between private and public law, and both the jurists and the rulers justify their position on claims to religious authority and divine sanction.

Islamic law differs from the common law in some important respects. In the Islamic judiciary system, there are no lawyers (i.e., advocates for the plaintiff or defendant), nor is there a jury. Trials are conducted by the judge, and the plaintiff and defendant represent themselves. They may call witnesses or produce evidence as needed. The decision is up to the judge alone, though he may consult other jurists, experts, and so on. Attached to the judge's court were one or more notary-witnesses (*shahid*) and a document clerk. Their function was to serve as character witnesses for the people of their district, draw up and execute legal documents, record the court proceedings, and certify the judge's verdicts and other documents. However, court decisions or judges' verdicts do not have law value; they do not set precedent, as in the common law system. Law value resides in the jurists' theoretical elaboration of the law, found in *fatwas* ("consultative legal opinions" or "answers to legal questions"). The *fatwa* is a responsum to a legal question posed by a lay petitioner (*mustafti*) to a legal expert or issuer of legal opinions (*mufiti*). The problem may be potential or actual, but the answer is not binding on the petitioner, in contrast with a judge's verdict, which must be carried out. It is this process of legal consultation and response, followed by the open debate of disputed questions among the available authorities, that creates new law. Nor were there traditionally any codes in Islamic law, in contrast with the Napoleonic legal system, and, surprisingly, with Rabbinic law since the sixteenth century, which has treated the *Shulchan Aruch* by Joseph Karo more or less as a code. All later development of the law is presented in the form of commentaries on that law. Scholarship to date has emphasized that Islamic law is a jurists' law, developed by the jurists themselves without governmental interference. It was therefore relatively uninfluenced by rulers' edicts and decrees. It was, however, shaped by two crucial institutions that have lasted from the tenth and eleventh centuries until the modern period: the *madhhab*,

which one may render variously as "legal school," "jurists' guild," or "tradition of legal study," and the *madrasa*, or college of law.

Legal Literature and Institutions

The origins of Islamic law are obscure, mostly because many seminal works have been lost. As mentioned earlier, the oldest extant legal compendia show that the study of the law was already quite sophisticated; there are indications that its systematic formulation dates back to the first half of the eighth century. It is likely that it was significantly influenced in its early stages by Roman provincial, Byzantine, Sassanian, and Rabbinic law. A few specific instances of influence have been suggested, such as P. Crone's study on the law of the patronate, but scholarship in this field is still in its infancy. The theoretical development of the law seems to have taken off in Iraq under the Abbasid caliphate (750–1258 C.E.). By 900 C.E., all the main genres of legal literature had been established, including extensive legal compendia (*mabsut*), epitomes of the points of law (*mukhtasar*), collections of model legal documents (*shurruṭ*, *wathā'iq*), collections of model court records (*mahadir*, *si-jillat*), manuals for judges (*adab al-qadi*, *adab al-qada'*), collections of responsa (*fatawa*, *masa'il*), and manuals of jurisprudence or legal method and interpretation (*usul al-fiqh*).

In the course of the ninth and tenth centuries, the *madhhabs*, or schools of law, were formed, in an attempt, it has been claimed, to maintain autonomy from the caliph and exclude the dogmatic theologians and sectarian groups from religious authority. They had no charters, patents, or membership lists; their organization was informal. Nevertheless, by the mid-tenth century, it became impossible to study and teach Islamic law without belonging to one of the established schools. Six legal *madhhabs*, each named after a famous jurist of the past, gained recognition in Sunni Islam: the Hanafi *madhhab*, named after Abu Hanifah (d. 767); the Maliki *madhhab*, named after Malik b. Anas (d. 795); the Shafi'i *madhhab*, named after Muhammad b. Idris al-Shafi'i (d. 820); the Hanbali *madhhab*, named after Ahmad b. Hanbal (d. 855); the Dawudi or Zahiri *madhhab*, named after Dawud b. Khalaf al-Isbahani (d. 884); and the Jariri *madhhab*, named after Muhammad b. Jarir al-Tabari (d. 923). The projection of the institution back to the time of these jurists is anachronistic except in the case of al-Tabari, and perhaps Dawud b. Khalaf. The Dawudi and Jariri *madhhabs*, although important in the tenth century, dwindled and died out in the eleventh; the four remaining *madhhabs* survived until modern times. In general, the jurists of the *madhhabs* recognized each other's traditions as legitimate and their opinions on disputed legal questions as equally valid. Together, the four surviving legal *madhhabs* have represented Sunni legal orthodoxy, an idea confirmed by such historical developments as the establishment of four chief judgeships, one for each *madhhab*, under the Mamluks (1250–1517) in Egypt and Syria. They played the crucial role in shaping legal interpretation and the transmission of legal knowledge, and at the same time provided a strong element of continuity and homogeneity in Islamic society over space and time.

Closely related to the *madhhab* was the institution of the *madrasa*, or college of law, which began in the eleventh century in Baghdad with the founding of the Nizamiyya in 1067 and subsequently spread throughout the Muslim world. The

madrasa was usually a building that provided space for teaching large classes as well as lodging for students, often on an upper story. It was supported by a perpetual endowment (*waqf*) that generated income from the produce of agricultural land or the rent from a row of shops, for example. These funds paid the salaries of the overseer of the endowment (*nazir*, *mutawalli*), the professor of law (*mudarris*), the repetitor (*mùid*), and other staff, as well as student stipends, repairs, and other expenses. Generally, the *madrasa* was devoted in the endowment deed (*waqfiyya*) to the law of one of the four *madhhabs* and had one professor who taught the law of that *madhhab*. Stipends were also provided for students who studied the law of that particular *madhhab*. *Madrasas* soon became the most important institutions of learning in the Muslim world. They tended to exclude the teaching of the Greek sciences, including philosophy, medicine, astronomy, and so on, relegating their teaching to private settings, and to accept the teaching of other religious sciences, such as Arabic grammar, rhetoric, hadith, scriptural commentary, and so on, but as ancillary to the study of the law. The system of legal education that developed in conjunction with the *madhhab* and the *madrasa* involved three main levels: ancillary studies in Arabic grammar, rhetoric, and related fields; intermediate study of the legal tradition of the *madhhab*; and advanced study on the disputed questions of the law (*khilaf*). Disputation and dialectic (*jadāl*) were major foci of the advanced law student's training; they played an important role in the elaboration of the law. Certainly by the thirteenth century, but possibly earlier, the completion of legal study was recognized by the conferral of a diploma termed the *ijazat il-iftā' wa'l-tadris* ("authorization to grant legal responsa and teach law"), granted by a master jurist to his student.

Jurisprudence: The "Sources" of the Law

Overall, the main focus of Muslim jurists has been the interpretation of scripture. Classical Sunni Islamic jurisprudence has at its heart a theory of four "roots," or bases, of the law, generally listed as (1) the Koran, (2) the *Sunna* of the Prophet Muhammad, (3) consensus (*ijma'*), and (4) legal analogy (*qiyas*). The Koran is granted pride of place as a legal source, yet many do not realize how little of the law is based on the text of the Koran itself. Muslim jurists reckoned that only five hundred verses of the Koran, about one-thirteenth of the entire text, have legal content. A genre of legal literature styled *Ayat al-ahkam* ("The Verses of Legal Rulings") developed that was a commentary on these verses in particular, extracting the legal content. Of these verses, many are not very specific, such as the many commands to hold prayer and give alms that do not specify how, when, and where to perform these actions.

In addition to the Koran, early jurisprudence relied on *Sunna*, which seems to have originally meant the general or time-honored usage of the community, and *ra'y*, which at this stage meant "sound opinion" or "considered opinion." With the work of al-Shafi'i, and generally for Sunnis in the course of the ninth century, it became standard theory that there was not one scripture in Islam, but actually two. The definition of *Sunna* narrowed to refer to the usage of the Prophet, and then further narrowed to mean "the usage of the Prophet as established

by *hadith*," oral reports concerning the Prophet's statements and behavior transmitted from the Companions, early Muslims who were eyewitnesses of the Prophet's mission. These reports were gathered and published in collections arranged according to the Companion transmitters (*musnad*), or in collections arranged for easy reference by jurists according to the standard chapters of the law (*sunan*). Six collections, dating from the middle to late ninth century, came to be recognized as more or less canonical by Sunni Muslims of all *madhhabs*: the *Sahih*s of al-Bukhari (d. 870), Muslim (d. 875), and al-Tirmidhi (d. 892), and the *Sunan* of Ibn Majah (d. 886), Abu Dawud (d. 888), and al-Nasa'i (d. 915). In the ninth and tenth centuries, the relative importance of hadith as a body of scripture was highly contested. Some rationalist jurists threw it out completely; most rationalists restricted the use of individual reports severely, setting very stringent requirements for establishing its authenticity. Many traditionalists, on the other hand, based their understanding of the law almost entirely on hadith reports and sought thereby to emulate the Prophet's *sunna*, or exemplary behavior, as closely as possible, even in everyday matters such as trimming one's mustache and letting one's beard grow long, or using a *miswak* twig as a sort of toothbrush. They set out to avoid all innovations, *bid'a* in opposition to *sunna*, which could lead one into error. Even these traditionalist scholars realized that many hadith reports were forged: some hadiths spoke for and against sectarian and other theological positions that had only arisen generations after the Prophet. Others contained translations of Bible verses or other Jewish or Christian lore. They devised criteria for establishing the authenticity of hadith reports, but most of these were formal, probabilistic criteria, based on examination of the authorities in the chain of transmission (*isnad*) of the hadith report. If they were all known to be reliable and each could have met the preceding person in the chain, then the report was considered formally reliable, even if the text itself was recognized to be odd.

In the genre of *usul al-fiqh*, Islamic jurisprudence developed sophisticated scriptural hermeneutics, focusing on the interpretation of God's address (*khitab Allah*) to mankind, in which He conveyed the law. Particular attention was paid to commands (*awamir*) and prohibitions (*nawahi*) in the text, for they establish obligations and set up legal boundaries. Several concepts were developed to cope with apparent contradictions in the text, including abrogation, according to which a later proof-text canceled out the legal effect of an earlier proof-text, the distinction between general and particular proof-texts, which allowed jurists to distinguish the intended audience or set of legal agents to which a particular command was addressed. Over the centuries, the discussions of these topics grew more and more elaborate and linguistically sophisticated, anticipating a number of theories of modern linguistics and philosophy by many centuries.

The third "source" of the law according to classical Sunni jurisprudence was consensus, usually defined as "the unanimous agreement of legal authorities of a given generation on a particular legal." This has often been confused with popular opinion, but is in essence the agreement of the community of interpretation constituted by qualified master jurists, after debate has subsided. The existence of consensus is established

through the absence of dissent. The legal questions subject to consensus, together with the disputed questions, on which a number of authoritative variant opinions are held, form the range of orthodox opinion.

The fourth "source" of the law has been variously designated as *qiyas* ("legal analogy") or *ijtihad* ("exhaustive investigation"). They both came about in an attempt to eschew *ra'y* ("considered opinion") as a source of the law and to tie elaboration of the law more closely to scripture. By the tenth century, and particularly in traditionalist circles, *ra'y* came to take on the pejorative meaning "completely unfounded or idiosyncratic opinion," as opposed to its early usage. All four Sunni *madhhabs* eventually renounced *ra'y* and accepted *qiyas*. *Qiyas*, in its simplest form, is an analogy tying the ruling of Y to the ruling of X based on a crucial similarity, termed the *'illa* ("cause") of the ruling. For example, it is established from the Koranic text that drinking alcoholic beverages is forbidden, but there are no scriptural texts that apply to other drugs, such as hashish or opium. If jurists could show (1) that God declared drinking alcoholic beverages forbidden specifically because they intoxicate and (2) that hashish and opium intoxicate in a manner similar to alcohol, then the consumption of hashish or opium should also be forbidden. The jurists of the short-lived Zahiri *madhhab* rejected *qiyas* altogether, arguing that it is impossible for humans to assign a cause to God's legal declarations without explicit designation in scripture. To do so is to usurp God's legislative power. *Qiyas* also came to serve as a general rubric encompassing a number of logical arguments, many of which were not actually based on analogy, including *reductio ad absurdum*, *a fortiori*, and other logical arguments.

Ijtihad (literally, "effort") is the term used to describe the process of legal interpretation undertaken by a qualified expert in jurisprudence. Such an expert is termed a *mujtahid* and is forbidden from adopting the opinions of other experts on authority (*taqlid*). Only a layman, or a jurist who is not fully qualified, is permitted to perform *taqlid*. A great deal of controversy surrounds the term *ijtihad*; it was until recently commonplace to claim that "the gate of *ijtihad*" was closed long ago, as early as the ninth or tenth century, and that from that time forward, "independent" interpretation was forbidden. This is not true. Those who claimed that the gate of *ijtihad* was closed meant that it was forbidden or impossible to establish a new legal *madhhab*, not that there was a moratorium on independent thought. Manuals of jurisprudence throughout the middle ages and up until the present have stressed the necessity of performing *ijtihad* on the part of the qualified jurist, and Muslim jurists have been addressing novel issues in the law and coming up with new interpretations throughout history. Nevertheless, it is true that many jurists felt that their interpretative leeway had narrowed considerably by the late middle ages and that they were constrained by the tradition of their own *madhhab* in ways that earlier jurists had not been.

By the eleventh and twelfth centuries, Sunni jurists had come to accept the role of probability in legal interpretation. In the absence of clear scriptural prooftexts, the individual jurist, after exhaustive investigation of a legal question, professed that answer that was preponderant in his mind. This

opinion did not rest on certitude (*yaqin*) but on strong presumption (*ghalabat al-zann*). Although it was not guaranteed to be correct, the *mujtahid* was not held to have sinned for coming up with the wrong answer as long as he had investigated the topic exhaustively, and the lay petitioner was permitted to perform his religious obligations according to this opinion. Probable answers to legal questions acquired authority in the absence of a certain answer.

The Modern Period

In the modern era, traditional Islamic law and its institutions have been eclipsed by secular law and institutions at the hands of the colonial powers and modern nation-states. In most Muslim nations, the endowment properties that supported legal education have been confiscated by the government and put under the control of a government ministry. The professors and others who teach and work in these institutions have become government employees. Secular education has radically reduced the importance of the *madrasas* in the contemporary world. There has been a widespread application of Western legal codes, whether the Napoleonic code or the related Swiss code, on the law of modern nation-states in the Muslim world, especially in the areas of commercial and criminal law. The only areas that have remained under the purview of Islamic law in most countries are family law, including marriage, divorce, inheritance, and related topics. In these areas, the flexibility of the law has been radically reduced by attempts to establish a standard code. In British India, for example, the *Hidaya* by al-Marghinani (d. 1196), *Minhaj al-talibin* by al-Nawawi (d. 1277), and *Shara'i' al-Islam* by al-Muhaqqiq al-Hilli (d. 1276) were chosen to serve as the law codes for Hanafi Sunnis, Shafi'i Sunnis, and Twelver Shiis, respectively.

At the same time, beginning in the nineteenth century, Muslim reformers such as Muhammad 'Abduh, Rashid Rida, and others attempted to reform Islamic law from within. Approaches have varied widely. Some thinkers have criticized the insularity of the individual *madhhabs*, arguing for a sustained study of comparative law (*fiqh muqaran*) within traditional institutions. Other methods include choosing freely (*takhayyur*) among the opinions of past authorities, or combining the legal doctrines of various *madhhabs* to come up with an appropriate solution, a process termed *talfiq* ("patching, piecing together"). These last methods have been used in many actual reforms of Islamic family law, such as the well-known reform of Anglo-Muhammadan law that drew on the Maliki tradition to alter Hanafi marriage law so as to facilitate access to divorce for women in bad marriages. Other, more radical thinkers have argued that the law of the *madhhabs* should be jettisoned altogether and that a new Islamic law should be derived directly from the scripture, from the Koran alone, or from that portion of the Koran that was revealed at Mecca. These radical reforms have met with little success, as most movement in the Muslim world today seems to be in the opposite direction. In Saudi Arabia, Iran under the Islamic Republic, Afghanistan under the Taliban, and Sudan, various forms of Islamic law have been applied. In addition, Islamist political groups throughout the Muslim world are clamoring for application of the *shari'a* in an attempt to fend off Western cultural influence, fight corruption, and engender public morality and social

justice. The classical legal system has not lost its vitality, and, given the centrality of a divinely ordained law to Islam, it cannot easily be replaced or substituted.

See also *Islam; Law; Sacred Texts: Koran*.

BIBLIOGRAPHY

- Anderson, J. N. D. *Law Reform in the Muslim World*. London: Athlone Press, 1976.
- Coulson, Noel J. *A History of Islamic Law*. Edinburgh: Edinburgh University Press, 1964.
- Crone, Patricia. *Roman, Provincial, and Islamic Law: The Origin of the Islamic Patronate*. Cambridge, U.K.: Cambridge University Press, 1987.
- Hallaq, Wael B. *A History of Islamic Legal Theories: An Introduction to Sunni Usul al-Fiqh*. Cambridge, U.K.: Cambridge University Press, 1997.
- Johansen, Baber. *Contingency in a Sacred Law: Legal and Ethical Norms in the Muslim Fiqh*. Boston: Brill, 1999.
- Kamali, Mohammad H. *Principles of Islamic Jurisprudence*. Cambridge, U.K.: Islamic Texts Society, 1991.
- Makdisi, George. *The Rise of Colleges: Institutions of Learning in Islam and the West*. Edinburgh: Edinburgh University Press, 1981.
- Melchert, Christopher. *The Formation of the Sunni Schools of Law, 9th–10th Centuries C.E.* Boston: Brill, 1997.
- Reinhart, A Kevin. *Before Revelation: The Boundaries of Muslim Moral Thought*. Albany: State University of New York Press, 1995.
- as-Sadr, Muhammad Baqir. *Lessons in Islamic Jurisprudence*. Translated by Roy Parviz Mottahedeh. Oxford: Oneworld Press, 2003.
- Schacht, Joseph. *Introduction to Islamic Law*. Oxford: Clarendon, 1964.
- . *The Origins of Muhammadan Jurisprudence*. Oxford: Clarendon, 1950.
- Weiss, Bernard. *The Search for God's Law: Islamic Jurisprudence in the Writings of Sayf al-Din al-Amidi*. Salt Lake City: University of Utah Press, 1992.
- . *The Spirit of Islamic Law*. Athens: University of Georgia Press, 1998.

D. J. Stewart

LEADERSHIP. Although there are seemingly as many descriptions of leadership as there are men and women who fill leadership roles, most meaningful definitions echo the one commonly ascribed to former U.S. president Harry S. Truman: leadership is the ability to get others to willingly move in a new direction in which they are not naturally inclined to move on their own. While the related but distinct concept of *authority* has since antiquity been a subject for scholarly analysis, the field of *leadership theory and development* has emerged more recently. It is primarily an American phenomenon, although its influence has quickly spread across continents.

Leadership in Historical Context

Of the myriad forms of human and social capital, leadership may be the most rare and precious. One can point to hundreds of companies that were collapsing despite legions of consultants and new plans and policies, until finally its chief executive officer

was removed, a new head was brought in, and the company turned around as though by magic. History abounds with similar examples among armies, universities, churches, and nations.

Conversely, the untimely loss of a talented and effective leader can prove disastrous for the organization she was leading. Try as they may, a succession of new leaders cannot stem the inexorable decline of the very same organization that a few months or years before was at the peak of health and vitality.

Moreover, sometimes whole societies lose their ability to produce great leaders. There are numerous cases of societies that lost their earlier, highly developed culture and retrogressed to a more primitive way of life. In some of these cases, external factors such as invasion or drought played a role, but in many cases it would seem that the retrogression was due to a failure of will and a lack of leadership.

History's Slaves or History's Masters?

A striking contrast in worldviews about leadership can be found in the writings of Leo Tolstoy, who believed that history shapes and determines leaders, versus those of Thomas Carlyle, who believed that leaders shape and determine history. In his epilogue to *War and Peace*, Tolstoy contended that kings and generals are history's slaves. Tolstoy believed that leaders merely ride the crests of historical waves that have been set in motion by myriad forces beyond these leaders' control or comprehension. "Every act of theirs, which appears to them an act of their own free will," wrote Tolstoy, "is in an historical sense involuntary and is related to the whole cause of history and predestined from eternity."

On the other side is Carlyle, the nineteenth-century British historian and essayist, who was convinced that "history is the biography of great men," the greatest of them being kings. The very word *king*, Carlyle contended, derives from the ancient word *Can-ning*, which means "Able-man" (although his etymology can be disputed). In Carlyle's view, the Ablemen (and Ablewomen) of the human species direct the course of history and determine humanity's destiny.

Leadership as a Skill

Learned examinations of the lives of great leaders abound, among them Arrian's *History of Alexander* and Plutarch's *Parallel Lives*, bona fide leadership manuals have been relatively rare; only a few have survived the centuries, among them Niccolò Machiavelli's *The Prince* and Sun Tzu's *The Art of War*. Most such works were military in nature, where meritocracies tended to flourish.

Popular opinion through the ages has typically held that leadership flows from the throne of the gods to a privileged few, as evidenced by most societies' willing subjection to and adulation for inherited royalty. In the biblical account contained in the first book of Samuel, the Israelites beg Yahweh to abandon his plans for a pure theocracy, asking in exchange not for democracy but for "a king to lead us." The equation began to change at the end of the global tendency toward dynastic succession and the advent of republican government and other broad meritocracies.

Currently, in an era that can be considered far more Carlylean than Tolstoyan in its worldview, the analysis of living and dead authorities has given way to a dramatic development: the belief that leaders can and should be trained. The worldwide explosion of leadership study and leadership development is an even more recent phenomenon, launched primarily at American universities. Beginning in the 1960s, the most informed academic opinions held that leadership could be taught effectively if prevalent past assumptions about human nature could be overcome. The concept grew in popularity through the 1970s and 1980s, and the result by the turn of the twenty-first century was a \$250 billion industry—the amount spent annually on management training and executive education around the world.

Leadership theory and development was to a degree an offshoot of inquiry into organizational life, as industry and government bureaucracies evolved rapidly, with figures such as Vienna-born economist and management editor Peter Drucker forging roles as key commentators. Theories of organizational life gradually gave way to theories of leadership as an exalted vocation.

Once scholars began not only to assess the impact of leaders but to dissect the traits that fueled their success, a legion of authors and consultants rose up to offer seven habits, ten techniques, or twenty secrets of top leaders. Eventually American corporations, universities, and even secondary schools began setting aside funds for leadership development programs.

The Rise of Contemporary Leadership Theory

Theories of leadership in any period are driven by a set of convictions and hopes on the part of the theorist. One conviction is that rapid societal evolution makes it imperative to keep one's pulse on social changes and their implications for how groups of human beings can best be led, an inherent assumption in the writings of leadership theorist Rosabeth Moss Kanter and numerous other scholars. A competing view is that human nature is static and unchanging and that the lasting lessons of history provide surer instruction in leadership than do the passing ripples of modernity. Ironically, the exemplars of this view are relatively ancient figures such as Lao Tzu and Machiavelli.

A core Western assumption about leadership is that leaders who succeed have "vision," a tangible end goal toward which they and their followers can strive. But countless Eastern leaders have been more influenced by the worldview of Lao Tzu, who observed, "A good traveler has no fixed plans and is not intent upon arriving. . . . Let go of fixed plans and concepts, and the world will govern itself" (Lao Tzu, chapters 27 and 57).

In a related manner, some maintain that the leader must be an idealist set on speaking to that which is highest, while others hold that a leader must be a realist who is aware of human limitations. Plato contended in *The Republic* that:

until philosophers are kings, or the kings and princes of this world have the spirit and power of philosophy, and political greatness and wisdom meet in one, and those

commoner natures who pursue either to the exclusion of the other are compelled to stand aside, cities will never have rest from their evils.

Yet as though he were responding directly to Plato, Machiavelli soberly observed in *The Prince* almost two thousand years later:

Many have imagined republics and principalities which have never been seen or known to exist in reality; for how we live is so far removed from how we ought to live, that he who abandons what is done for what ought to be done will rather bring about his own ruin than his preservation; for a man who strives after goodness in all his acts is sure to come to ruin, since there are so many who are not good. Hence it is necessary that a prince who is interested in his survival learn to be other than good, making use of this capacity or refraining from it according to the need.

The collective tendency has tilted toward idealism in recent decades. This shift is not a current echo of Plato's philosopher-king. It is, rather, an expression of *democratic* ideals, positing an assumption that intrinsic in human nature is a capacity to lead that only need be unearthed and cultivated in order to flourish.

The participative management and leadership style ascendant in the late twentieth century was exemplified by the work of Douglas McGregor of the Massachusetts Institute of Technology (MIT). In his landmark work, *The Human Side of Enterprise* (1960), McGregor distinguished between a traditional Theory X, which fundamentally viewed humanity in a negative light (the view classically ascribed to Machiavelli), and a newly emerging Theory Y, which viewed human beings in a more positive light. Given Theory X's assumption that human beings are essentially flawed and resistant to work, a successful leader presumably needed to manage them in an authoritarian manner, with rigorous controls.

McGregor heralded his new Theory Y, which demonstrated that human beings are far more willing to invest themselves in their work if it bears personal meaning. If they can escape the suffocation of being overmanaged and begin to make a collaborative investment through their labor, they will bring untapped new fountains of creativity and energy to an organization or cause. The democratic model of organizational leadership began to develop, with its flattened organizational pyramids and concepts such as empowerment and shared vision.

Unlike the so-called hard sciences, the tenets of the social sciences cannot readily be subjected to the test of falsification, and, as a consequence, are often viewed with suspicion. Nevertheless, since the mid-1950s, the social sciences produced a large number of attractive theories of leadership. Management expert Tom Peters noted that Warren Bennis's work at MIT during the 1960s "foreshadowed—and helped bring about—the early twenty-first century's headlong plunge into less hierarchical, more democratic and adaptive institutions, both public and private." Bennis, a protégé of McGregor, found

among other things that hierarchical and autocratic approaches were the best way for teams to carry out simple tasks, while democratic and collaborative approaches were the best way for teams to carry out complex tasks. In such cases, all team members experienced a high average level of contentment in their work, unlike in hierarchical arrangements, where the top person enjoyed maximum contentment and the others experienced minimum contentment.

American corporations were shaped most dramatically by such new models. The gradually increasing tendency toward participative management received a kick-start in the 1980s, when American and European business executives came to admire their Japanese counterparts. Japanese industry was remarkable for its emphasis on the group rather than the individual, and for team processes and a participative work style. Not out of idealism but out of pure self-interest, Western managers began to adopt similar practices. Within a few years, programs for and courses in leadership theory and development were more often housed in American universities' business schools than in departments of political science, psychology, history, or social science. For many years this resulted in an amoral emphasis on technique rather than ethics—in other words, democratic leadership was good for the bottom line as opposed to being intrinsically right—although some business-school-based experts such as Bennis and James O'Toole championed a more deontological approach.

By the last decade of the twentieth century, few successful American leaders in any profit-seeking or not-for-profit organization had avoided participating in at least one seminar, visioning session, or strategic-planning task force built on democratic management principles. However, the good intentions of democratically inclined managers and consultants collided with the limitations of human nature—and a wave of satire (as evidenced in the “Dilbert” comic strip) and public cynicism followed. This cynicism, or frustrated idealism, offers a study in contrasts with Machiavelli's brutal unsentimentality, which had seemingly been discredited by modern practitioners of democratic management and leadership. Machiavelli was above all a coolly detached student of human nature. His repeated advice to leaders was to believe in the *reality* of human nature, as opposed to what they *wished* it were.

Quoted again more widely in an era of renewed global realpolitik, Machiavelli has proved to be neither inerrant nor irrelevant. He illustrated sides of human nature that must be closely examined by every leader, painful though that process may be. The good news for leaders is that there are nobler facets of human nature that have just as great a chance of asserting themselves as those identified by Machiavelli. As such, his greatest legacy may be his ability to help leaders develop a more integrated understanding of human nature and leadership.

Theories in Flux

Just as popular and scholastic leadership theory has been shaped and reshaped by the epochs of industrialization, bureaucratization, the communications revolution, and the widespread entry of women into management, leadership theory

will continue to undergo changes, determined in part by prevailing societal values such as idealism or realism.

Through it all, a middle ground appears to exist between Tolstoy's persuasive fatalism and Carlyle's enthusiastic activism. It may well be that this world is largely Tolstoyan, subject to historical forces that no man or woman can fully measure and analyze and the consequences of which no person can fully predict. To that extent, leaders are in fact history's slaves. However, Carlyle's Ablemen (and Ablewomen) have still made an impact on the course of human events; their decisions have had a lasting influence on the world, so that historical determinism has never quite had the final word.

Finally, leadership tends to be remarkably situational and contingent: what works for one person at one point in time will not necessarily work for everyone else or even for that person at a different time. Thus, in a very real sense, leadership is an art, not a science. Effective management may be a science (though that too is questionable), but effective leadership is most certainly an art. In this sense, leadership is more akin to music, painting, and poetry than it is to more routinized endeavors. And just as there is no comprehensive theory of art, there is no comprehensive theory of leadership.

Every leader is therefore locked in a moment-to-moment struggle with the context and circumstances of his own place and time. This excruciating yet exhilarating aspect of leadership is what makes the study of great historical figures so timelessly appealing—and, in this democratic age, makes millions of would-be leaders such eager students of this peculiar calling.

See also *Authority*; *Machiavellism*; *Power*.

BIBLIOGRAPHY

PRIMARY SOURCES

- Arrian. *The Campaigns of Alexander*. London: Penguin, 1976.
- Bible, The. The life of David, in I and II Samuel; Jesus, in Matthew; and Paul, in Acts. Various editions, including the Revised Standard Edition.
- Confucius. *The Analects*. Translated by Arthur Waley. New York: Vintage, 1989.
- Dante. *The Divine Comedy*. Translated by John Ciardi. New York: Norton, 1977. Significant for its portrayal of the full range of human triumphs and foibles.
- Lao Tzu. *The Tao Te Ching*. Translated by Stephen Mitchell. New York: Perennial, 1992.
- Machiavelli, Niccolò. *The Prince*. Translated by George Bull. New York: Bantam, 1984. One of the most enduring and significant leadership manuals, with some fifty editions currently in print.
- Plato. *The Republic*. New York: Oxford University Press, 1951.
- Shakespeare, William. *Hamlet*. New York: Oxford University Press, 1998. Shakespeare's plays offer insight into the human condition and human motivations, a deep understanding of which is required for leadership. *Hamlet*, in particular, gives humanity a terrifying look inside itself.
- . *Othello*. New York: Oxford University Press, 2002. Offers a view of how a leader is undone by an evil lieutenant.
- Sophocles. *Antigone*. Translated by Richard Emil Braun. New York: Oxford University Press, 1990. Notable for its display of the pitfalls of rigidity in a leader.

Sun Tzu. *The Art of War*. Translated by Ralph D. Sawyer. Boulder, Colo.: Westview Press, 1994.

SECONDARY SOURCES

Bennis, Warren. *On Becoming a Leader*. Reading, Mass.: Addison Wesley, 1989.

Carlyle, Thomas. *On Heroes, Hero Worship, and the Heroic in History*. New York: Ginn and Co., 1902. Notable for its theory of leadership in contrast to that of Tolstoy.

Drucker, Peter. *The Essential Drucker: Selections from the Management Works of Peter F. Drucker*. New York: HarperBusiness, 2001. A significant modern leadership book.

Kanter, Rosabeth Moss. *The Change Masters: Innovations for Productivity in the American Corporation*. New York: Simon and Schuster, 1983.

———. *When Giants Learn to Dance: Mastering the Challenge of Strategy, Management, and Careers in the 1990s*. New York: Simon and Schuster, 1989.

McGregor, Douglas. *The Human Side of Enterprise*. New York: McGraw-Hill, 1960.

O'Toole, James. *Leading Change: The Argument for Values-Based Leadership*. New York: Ballantine, 1996.

Tolstoy, Leo. *War and Peace*. Translated by Louise and Aylmer Maude. New York: Oxford University Press, 1931. Of interest for its theory of leadership, in contrast to that of Carlyle.

Steven B. Sample

LEARNING AND MEMORY, CONTEMPORARY VIEWS.

People have long wondered how best to characterize learning and memory. Most people typically conceive of memory as a place in which information is stored. As Henry Roediger has noted, this spatial metaphor has dominated the study of memory: “We speak of storing memories, of searching for and locating them. We organize our thoughts; we look for memories that have been lost, and if we are fortunate, we find them” (1980, p. 232). Aristotle compared memory to a wax tablet, Plato invoked the image of an aviary, and St. Augustine of Hippo suggested similarities to a cave. Increasingly, the metaphors involved the most recent or most impressive technological accomplishment, as with René Descartes and his analogy to the water-powered automata in the French royal gardens and later by comparisons to the gramophone (an updating of the wax-tablet metaphor) and then a telephone exchange.

The so-called “cognitive revolution” that began in the mid-1950s ushered in the information-processing approach to the study of learning and memory. The main metaphor became the computer; people were seen as general-purpose processors of information capable of manipulating internal representations. As with computers, there was an emphasis on the interaction between hardware and software, usually relabeled structure and process, respectively. By the end of the 1960s, the standard view of memory was the modal model (after the statistical term *mode*) with its set of stores, registers, and buffers. Structuralist views continue to use the spatial metaphor and emphasize a memory system in which information is stored. According to these accounts, the store in which a memory resides determines the mnemonic properties.

An alternative to the structural approach is the proceduralist approach, which views memory not so much as a thing that is stored but rather as the result of a process. As David Wechsler put it, “Memories are not like filed letters stored in cabinets. . . . Rather, they are like melodies realized by striking the keys on a piano” (p. 151). The melodies are a by-product of pressing keys just as memory is a by-product of processing information. According to this account, the processing performed at encoding and retrieval determines the mnemonic properties.

Consider the essential difference between these two accounts. Within the modal model of the 1960s and early 1970s there were three memory structures: a sensory register, short-term memory (STM), and long-term memory (LTM). Information is first briefly registered in the appropriate sensory buffer, visual information in iconic memory, auditory information in echoic memory, and so on. These buffers hold raw physical information in an unanalyzed form for a very short period of time, perhaps 250 milliseconds. Additional processing is required to convert the information from its sensory form to a more durable representation that is held by short-term memory. Short-term memory serves mainly as a buffer in which information can be temporarily stored and has a limited capacity, usually given as 7 plus or minus 2 items. Items in short-term memory decay over time unless rehearsed; rehearsal is also the way in which information gets copied into long-term memory. Long-term memory is the main memory system and stores all knowledge. It has no known capacity limitations. Whereas information loss from short-term memory is thought to be permanent, it is unclear whether there is permanent loss from LTM.

Table 1 summarizes the essential points from the structuralist point of view. When an item is in STM, it will be stored using an acoustic code (how the word sounds), the capacity will be limited to 7 plus or minus 2 items, and the items will decay within about twenty seconds. In contrast, when an item is in LTM, it will be stored using a semantic code (what the word means), the capacity will be (almost) unlimited, and the item may very well never be forgotten.

A proceduralist would agree with almost everything the structuralist has proposed, except that the proceduralist would ask the following question: What does the top row in the table add to our understanding? In other words, we could delete the top row and still have a complete and accurate description of memory. When words are processed based on how they sound, there will be a very small capacity and the information will not be available for very long. When words are processed based on what they mean, however, there will be an enormous capacity, and the information will be available for a long time.

The divergence between the structuralist and proceduralist approaches has grown since the 1970s. One current debate concerns whether memory is best characterized as a set of

	STM	LTM
Format	Acoustic	Semantic
Capacity	7 ± 2	Infinite (?)
Duration	20 s	Infinite (?)

independent systems—a continuation of the spatial metaphor—or as a set of interrelated processes (see, for example, Foster and Jelicic). This more modern structuralist approach has greatly changed the modal model and generally names five different memory systems. The proceduralist approach has refined the idea of memory as a by-product of processing to focus on the relationship between the processing performed at encoding and the processing performed at retrieval.

The Structuralist Approach

Typically, structuralists are concerned not only with delineating the number of memory systems but also in locating them within the brain. Advocates of the systems approach identify five major memory systems: working memory, semantic memory, episodic memory, the perceptual representation system, and procedural memory.

Working memory is a system for the temporary maintenance and storage of internal information and can be thought of as the place where cognitive “work” is performed. It has multiple subsystems, most notably one for the processing of verbal or speech-like stimuli and another for the processing of visual-spatial information. Each features a store (the phonological store and the visual-spatial sketchpad) and a maintenance process that offsets decay (articulatory control process and the visual scribe). Unlike short-term memory, the capacity limit is based on a trade-off between the rehearsal process and decay.

Semantic memory refers to memory for general knowledge and includes facts, concepts, and vocabulary. The term is somewhat misleading, however, as it implies storage of only semantic information, which is not the case. Rather, the distinguishing feature of this system is the lack of conscious awareness of the learning episode. In contrast, episodic memory is the system that does provide this awareness of the learning episode and thus enables the individual to “travel back” mentally into his or her personal past, to use Endel Tulving’s term. As an example of the difference, consider the fact—picked hopefully for its obscurity—that Samuel Beckett is the only first-class cricket player to win a Nobel Prize (he played for Dublin University and won the 1969 Nobel Prize for Literature). Imagine that two weeks from now you happen to participate in a conversation about Nobel Prizes, and you recall the above information about Samuel Beckett. If you remember reading the information in this book, where you were, whether it was hot or cold, or anything else about the episode other than the mere facts, then the information is said to be in episodic memory. If you remember only the fact itself, then the information is said to be in semantic memory.

All three of these systems are part of declarative memory, which is contrasted with procedural memory, the fourth proposed major memory system. Declarative memory is concerned with knowing “that” rather than with knowing “how.” For example, if you know that two plus two equals four, the information is said to be in declarative memory. By contrast, if you know how to ride a bicycle, that information is said to be in procedural memory. One distinction is that you can usefully communicate declarative information but not procedural

information: simply telling someone how to ride a bicycle (explaining balance, pedaling, and steering) does not work.

Finally, the perceptual representation system is a collection of non-declarative domain-specific modules that operate on perceptual information about the form and structure of words and objects. Although currently the dominant approach, the structuralist conception of memory is not without its problems.

First, there is little agreement on what the criteria should be for a memory system, let alone agreement on the number of systems. In particular, there are no criteria that result in producing just the five systems named above. The most well-specified criteria for determining whether two systems are separate were proposed by David Sherry and Daniel Schacter in 1987: (1) functional dissociations: an independent variable that has one effect on a task thought to tap system A either has no effect or a different effect on a task thought to tap system B; (2) different neural substrates: system A must depend on different brain regions than system B; (3) stochastic independence: performance on a task that taps system A should be uncorrelated with performance on a task that taps system B; and (4) functional incompatibility: a function carried out by system A cannot be performed by system B.

Henry Roediger, Randy Buckner, and Kathleen McDermott have shown how recall and recognition meet the first three of these criteria: the variable word frequency produces functional dissociations (high-frequency words are recalled better than low, but low-frequency words are recognized more accurately than high); neuropsychological dissociations between recall and recognition are observable in amnesiac subjects; and numerous studies have found essentially no correlation between performance on the two tests. A thought experiment suggests that recall and recognition might also demonstrate functional incompatibility: memory for odors is a function that is well supported by recognition (consider the case of Marcel Proust) but not very well supported by recall.

Second, the proposed systems have not yet been anatomically isolated (although it remains an empirical question whether they will be), and even when isolation is found, the results are often equivocal. For example, many studies show that retrieval in episodic tasks involves right prefrontal activation, whereas retrieval of semantic information involves left prefrontal activation. This neuropsychological distinction, however, reverses when the two tasks are equated for difficulty: retrieval of semantic information now produces larger amounts of right frontal activation than the episodic task.

Third, this view does not account for the general pattern of decline seen when normally healthy people get older. One would expect a systematic relationship between tasks that shows a decrement in performance and the underlying system. For example, one might expect that episodic memory might deteriorate faster than semantic memory. In fact one finds no such relationship. Performance on some episodic tasks is unaffected, whereas performance on some semantic tasks is quite impaired. Rather, the pattern of performance loss is better described based on the processes, especially those at retrieval.

The Proceduralist Approach

The modern incarnation of the proceduralist approach began with the levels of processing framework of Fergus Craik and Robert Lockhart. Rather than viewing memory as something that is stored in a system, they viewed memory as the by-product of performing processing. Because the emphasis is on processing rather than on structure, Craik and Lockhart argued that the most informative research will occur when the experimenter has control over the processing and that therefore researchers should use an incidental learning procedure. The experimenter might ask the subject to judge whether two words rhyme or to judge which of two words has the most pleasant associations. The learning is “incidental” in that the subject is unaware that the material being processed will be tested later on and so is not intentionally trying to remember the information. The type of processing performed at retrieval can also be manipulated.

The basic premise of the transfer-appropriate processing account of memory is that memory will be best when the processing performed at encoding is appropriate given the processing demands required at test. For example, if you processed how an item sounds at encoding but the test emphasizes the meaning of the item, performance will be worse than if your processing focused on how the item sounds at both encoding and retrieval or than if your processing focused on the meaning of the item at both encoding and retrieval. This view offers an explanation for why intent to learn is not an important factor in subsequent tests of learning and memory: if a person uses an inappropriate process, performance will be poor regardless of the intent to learn.

This idea applies very generally. For example, context-dependent memory refers to the observation that memory can be worse when tested in a new or different context relative to performance in a condition in which the context remains the same at both encoding and retrieval. Context can refer to mood (such as happiness at both encoding and retrieval, sadness at both encoding and retrieval, or a mismatch) or to physical location (for example, underwater at both encoding and retrieval, on land at both encoding and retrieval, or a mismatch). One practical implication for divers is that if they memorize decompression tables on land, they may not remember them very well when needed, underwater. The idea is that if you are happy, you are likely to have quite different processing than if you are sad. Neither mood is inherently better (from a memory perspective); the point is that the results of processing while in a sad mood are different from the results of processing while in a happy mood.

One problem with the transfer-appropriate processing view is determining exactly which processes are being used. Larry Jacoby introduced the process dissociation technique, in which a subject is asked to perform two tasks. The experiment is set up so that on one task, two processes can contribute to memory performance, but on a second task, the processes work in opposition. Using this procedure, one can estimate the relative contribution of each process. It remains an empirical question whether this will result in a sufficiently detailed description of the various processes that can be used.

Dynamic Memory

In addition to the divergence between the structuralist and the proceduralist views, another major difference between memory research now and memory research in the 1960s and 1970s is the emphasis on the dynamic, reconstructive nature of memory. Long gone is the library metaphor in which memory was like a book in a library that just sat on a shelf. Instead, memories are seen as being dynamically constructed and changed according to the current available information. It is now well documented that people can even remember things that never happened.

Memory is now viewed as inherently reconstructive. This term emphasizes that at the first retrieval attempt, one constructs a memory from all available information. At the second retrieval attempt, the memory is constructed again. Consider what happens when an event is retrieved and then retrieved a second time. At the first retrieval attempt, you will have two sources of information: memory of the event itself and general knowledge. At the second retrieval attempt, you have three sources of information: memory of the event itself, general knowledge, and memory of your first retrieval.

This process is nicely illustrated from experiments that intentionally try to implant a memory of an event that did not happen. For example, Ira Hyman and F. James Billings asked their subjects, college students, to recall as much information as they could about events from their early childhood. Each subject was asked about two to four events that actually occurred (according to the subject’s parents) and one event that did not occur. This event supposedly happened when the subject was five years old and concerned going to a wedding and knocking over the punch bowl, spilling some punch on the bride’s parents. Originally only 3 percent recalled the wedding episode, as it had not occurred. Two days later the subjects were again asked to recall as much as they could, and this time 27 percent indicated remembering the event. Subjects were also asked to rate their confidence in the accuracy of their memory. There was no difference in the confidence ratings for real or made-up events.

This is not an isolated finding. People who read a story and were then told that the main character of a story was Helen Keller were likely to remember reading the sentence, “She was deaf, dumb, and blind,” even though that sentence was not presented. A student in one of my memory classes had a memory of a favorite pet golden retriever. After hearing my lecture on this topic, she checked with her parents: the dog had died two years before she was born. Apparently she had heard stories about the dog and had seen slides featuring the dog and was attributing memory of these as memory of real events.

Studies from the eyewitness memory literature show that eyewitnesses readily incorporate information from questions into their recollections of events. Unless there is objective evidence available, there is no way of assessing the accuracy of recollection of an eyewitness: they may be very accurate, very inaccurate, or somewhere in the middle. Among the many factors that do not predict subsequent accuracy are the duration of the event; the emotional intensity of the event; the unusualness of the event; the number of details that can be recalled;

the confidence expressed about the memory; and the delay between the event and the subsequent questioning.

Memory then is fundamentally active, dynamic, and reconstructive. Like other cognitive processes, memory processes recruit information from a variety of sources, including from memory of the event itself as well as from generic knowledge, memory of past recollections of the event, and even inferences, with the goal of constructing a sensible, coherent memory.

See also *Computer Science; Language and Linguistics; Psychology and Psychiatry*.

BIBLIOGRAPHY

- Baddeley, Alan D. *Working Memory*. New York: Oxford University Press, 1986.
- Craig, Fergus, and Robert Lockhart. "Levels of Processing: A Framework for Memory Research." *Journal of Verbal Learning and Verbal Behavior* 11 (1972): 671–684.
- Foster, Jonathan K., and Marko Jelicic, eds. *Memory: Systems, Process, or Function?* New York: Oxford University Press, 1999.
- Hyman, Ira E., and F. James Billings. "Individual Differences and the Creation of False Childhood Memories." *Memory* 6 (1998): 1–20.
- Jacoby, Larry. "A Process Dissociation Framework: Separating Automatic from Intentional Uses of Memory." *Journal of Memory and Language* 30 (1991): 513–541.
- Neath, Ian, and Aimée M. Surprenant. *Human Memory: An Introduction to Research, Data, and Theory*. 2nd ed. Belmont, Calif.: Thomson/Wadsworth, 2003.
- Parkin, Alan J. "Component Processes versus Systems: Is There Really an Important Difference?" In *Memory: Systems, Process, or Function?* edited by Jonathan K. Foster and Marko Jelicic, 273–287. Oxford: Oxford University Press, 1999.
- Roediger, Henry L. "Memory Metaphors in Cognitive Psychology." *Memory and Cognition* 8 (1980): 231–246.
- Roediger, Henry L., Randy L. Buckner, and Kathleen B. McDermott. "Components of Processing." In *Memory: Systems, Process, or Function?* edited by Jonathan K. Foster and Marko Jelicic, 32–65. New York: Oxford University Press, 1999.
- Schacter, Daniel L., Anthony D. Wagner, and Randy L. Buckner. "Memory Systems of 1999." In *The Oxford Handbook of Memory*, edited by Endel Tulving and Fergus I. M. Craik, 627–643. New York: Oxford University Press, 2000.
- Sherry, David F., and Daniel L. Schacter. "The Evolution of Multiple Memory Systems." *Psychological Review* 94 (1987): 439–454.
- Tulving, Endel. *Elements of Episodic Memory*. New York: Oxford University Press, 1983.
- Wechsler, David B. "Engrams, Memory Storage, and Mnemonic Coding." *American Psychologist* 18 (1963): 149–153.

Ian Neath

LEGALISM, ANCIENT CHINA. Legalism (*fa jia*) is a label applied since the second century B.C.E. to a group of Chinese thinkers of the Warring States period (453–221 B.C.E.). The label is doubly misleading: first, because the thinkers concerned did not necessarily consider themselves members of a unified intellectual current, much less a common school of

thought; and second, because the notion of law (*fa*), albeit important, is by no means central in the thought of all these thinkers. Legalism is thus not a scientific category but rather a scholarly convention.

Major sources for Legalist thought are the works attributed to the leading Legalist thinkers, Shang Yang (d. 338 B.C.E.), Shen Buhai (d. 337 B.C.E.), Shen Dao (fl. late fourth century B.C.E.), and Han Feizi (d. 233 B.C.E.), as well as portions of the Warring States collectanea, the *Guanzi* and *Lüshi chungiu*. Of these only the first has undisputed Legalist credentials, while the intellectual affiliation of the others is constantly questioned. These disputes notwithstanding, we may discern several major approaches that characterize these thinkers and texts and distinguish them from contemporary intellectual currents. First, all of them sought to strengthen the state versus society through the perfection of a centralized bureaucratic mechanism. Second, Legalists adopted a ruler-centered perspective, which held that reinforcing the ruler's authority was crucial for social stability and that this authority should be absolute and limitless. Third, the Legalists rejected the authority of the past and favored institutional and intellectual innovations to match rapid changes in the sociopolitical situation. Fourth, they rejected the priority of moral values over practical considerations advocated by most of their rivals and adopted a pragmatic and often cynical stand toward political issues. Finally, since major Legalist thinkers had rich experience as administrators, military advisers, and diplomats, their writings are often dominated by practical issues to the extent that some modern critics question their philosophical credentials altogether. Paraphrasing Marx, it may be said that while other philosophers often sought to explain the world, the Legalists did their best to change it—and indeed achieved remarkable results.

Shang Yang

Shang Yang is the major Legalist thinker and statesman. As a chancellor of Lord Xiao of Qin (r. 361–338 B.C.E.), he initiated a series of profound reforms that turned the relatively weak and peripheral state of Qin into the strongest power and the eventual conqueror and unifier of the Chinese world. Shang Yang's views are presented in the *Shang jun shu* (Book of Lord Shang); although parts of the book were composed after his death, the text reflects to a significant extent Shang Yang's legacy.

Shang Yang aimed to turn Qin into a powerful state through two parallel and interconnected processes: encouraging agricultural production and strengthening military prowess. To achieve these goals he advocated a clear system of rewards and punishments, according to which aristocratic ranks would be granted for high grain yields and for military merits, while high taxation would be applied against merchants and other "parasites," and harsh penalties would be imposed on those who fled the battlefield and on their relatives. He claimed that rational management of state funds and allocating more resources for reclaiming the wastelands would promote agricultural production, while military achievements would be attained through abandoning any pretension of moral behavior on the battlefield: "When you undertake whatever the enemy is ashamed to do, you will benefit."

Shang Yang's major concern was to assist the ruler to subdue and overcome his people. The people are inherently selfish and stupid, and they do not know how to attain prosperity and peace. Hence a uniform legal system of rewards and punishments is needed to bring order. The punishments should be severe: imposing harsh penalties for the slightest violations of the law can prevent the appearance of capital offences. Only by frightening the people, establishing a system of collective responsibility and mutual surveillance, can the ruler eliminate crimes and achieve peace for the citizens. This ultimately moral goal should be attained therefore through overtly immoral means.

Shang Yang ridiculed traditional culture, moral values, and beliefs in harmonic relations between the ruler and his subjects. All these are bygone ways, appropriate perhaps in the remote past but meaningless in the current age of constant warfare and internal struggles. The only meaningful lesson from the past is that wise rulers changed their laws and regulations to accord with changing circumstances. Shang Yang constructed an evolutionary model of social development, from a kin-based order toward a legal-based one; later Legalist thinkers adopted and further modified this model.

Shang Yang succeeded in creating a harsh and intrusive state that deeply penetrated society and eliminated or weakened previously autonomous social units, such as lineage and the agricultural commune. His success, admitted even by his rivals, explains his appeal, despite his overt attacks against the intellectuals, whom he called parasites and whose moral and intellectual credentials he constantly sought to undermine. In the long run, however, these anti-intellectual philippics backfired against Shang Yang and his followers, turning Legalism into an overtly negative label among the members of educated elite.

Shen Buhai

Shen Buhai, Shang Yang's contemporary, was a chancellor in the state of Han. Reportedly his administrative reforms restored stability in this state and made it a model of efficiency for the rest of the Chinese world. Indeed where Shang Yang is associated with the law (*fa*), Shen Buhai's hallmark was the development of technique of rule (*shu*). Shen Buhai's book was lost and partly reconstructed from remaining quotations in the nineteenth century.

Shen ridiculed the traditional emphasis on harmonious relations within the ruling apparatus and warned the ruler that his worst enemy would not "batter in barred doors and gates" but would rather be one of the ministers "who by limiting what the ruler sees and restricting what the ruler hears, seizes his government and monopolizes his commands, possesses his people and takes his state." Rather than trusting his deceitful aides, the ruler should establish a strict system of surveillance over his ministers. He should divide the tasks between the officials, inspect their performance, and prevent a horizontal flow of information between them. To maximize his power, the sovereign must strictly preserve his prerogatives as a chief decision maker but should never interfere in the everyday administrative routine that is the task of the ruled. Shen's system, perfected and modified by others, contributed greatly toward the establishment of an efficient bureaucracy on Chinese soil.

Han Feizi

Han Feizi, the last and most sophisticated of the Warring States' Legalist thinkers, is credited with synthesizing Shang Yang's and Shen Buhai's achievements. He furthermore based his philosophy of law on solid metaphysical foundations, borrowing ideas from the Daoist classic the *Laozi* (or *Dao de jing*). The monistic transcendent power of Dao ("Tao," the Way) is embodied in the ruler, whose authority is hence limitless and unquestionable. The principles (*li*) of Dao are manifested in the law, which thus becomes the constant and unshakable foundation of human society. Social hierarchy also reflects cosmic principles and so is similarly unassailable.

Philosophical sophistication notwithstanding, Han Feizi's fame derives from his astute and cynical analyses of political and social laws and practices. Politics are a battlefield in which deceit and treachery are common, and mutual trust and morality are an anomaly. The ruler should trust neither the people nor his aides, neither his kin nor his closest friends. This candor is revealing because, being a minister himself, Han Feizi actually claimed that he also cannot be trusted. This contradiction between Han Feizi's ideas and his personal aspirations ultimately led to a personal tragedy: after he arrived at the state of Qin, Han Feizi was imprisoned and executed as a potential spy for his Han homeland. Later the king of Qin reportedly admired Han Feizi's teachings and regretted his decision. Han Feizi thus did not witness the ultimate triumph of his ideology, which came shortly after his death with the imperial unification of 221 B.C.E.

Later Legalism

The triumph of Legalism in the Qin empire (221–207 B.C.E.) was to a certain extent a Pyrrhic victory. Qin's harsh treatment of independent thinkers, which culminated in the burning of privately held book collections, backfired against the Legalist ideology, which lost its popularity among the educated elite. Although Legalist methods and ideas remained influential throughout the imperial millennia, the rulers overtly rejected Legalists' cynicism and anti-intellectualism and their emphasis on constant innovation. In the twentieth century the Legalists' ideas of the powerful state strongly appealed to modern intellectuals, and the school's fame reached its peak during the pro-Legalist campaign in the People's Republic of China in the early to mid-1970s. After Mao Zedong's death in 1976, however, the tide reversed again, and the Legalist contribution to traditional China's polity was again deemphasized.

See also *Chinese Thought; Confucianism; Machiavellism; Mohism.*

BIBLIOGRAPHY

- Creel, Herrlee G. *Shen Pu-hai: A Chinese Political Philosopher of the Fourth Century B.C.* Chicago: University of Chicago Press, 1974.
- Fu, Zhengyuan. *China's Legalists: The Earliest Totalitarians and Their Art of Ruling.* Armonk, N.Y.: Sharpe, 1996.
- Han Feizi jijie.* Compiled by Wang Xianshen. Beijing: Zhonghua shuju, 1998. Collected commentaries on Han Feizi.
- Han Fei-tzu: Basic Writings.* Translated by Burton Watson. New York: Columbia University Press, 2003.

Shang jun shu zhui zhi. Edited by Jiang Lihong. Beijing: Zhonghua shu ju, 1986.

Wang, Hsiao-po, and Leo S. Chang. *The Philosophical Foundations of Han Fei's Political Theory*. Monograph no. 7 of the Society for Asian and Comparative Philosophy. Honolulu: University of Hawai'i Press, 1986.

Zheng, Liangshu. *Shang Yang ji qi xuepai*. Shanghai: Gu ji chu ban she, 1989.

Yuri Pines

LEISURE. See **Wealth**.

LESBIAN STUDIES. See **Gay Studies; Queer Theory**.

LIBERALISM. It is widely agreed that fundamental to liberalism is a concern to protect and promote individual liberty. This means that individuals can decide for themselves what to do or believe with respect to particular areas of human activity such as religion or economics. The contrast is with a society in which the society decides what the individual is to do or believe. In those areas of a society in which individual liberty prevails, social outcomes will be the result of a myriad of individual decisions taken by individuals for themselves or in voluntary cooperation with some others.

Liberalism in the political sphere cannot be a simple application of individual liberty, because decisions have to be taken collectively and are binding on all. Political liberalism means, first, that individual citizens are free to vote for representatives of their choice and to form voluntary associations to promote their ideas and interests in the realm of collective decision-making. Second, it means the adoption of constitutional procedures for limiting government power and making it accountable to the citizens.

Liberal Practice

In discussing liberalism, it is important to distinguish between liberal practices and liberal theories. Liberal practices are those institutional and customary arrangements that support individual liberty. Of prime importance are individual legal rights to engage in certain activities such as to practice the religion of one's choice, to use one's property and labor as one pleases, and to enjoy freedom of opinion, expression, association, and movement. Political rights and constitutional procedures designed to put limits on government power, such as the independence of the judiciary, the separation of legislative and executive power, freedom of the press, and electoral accountability, are liberal practices insofar as they are designed to protect or express individual liberty.

Individual nonpolitical rights are necessarily limited by the equal rights of others. A religion or other association, or a use of property, that violates the rights of others, cannot be protected. Individual rights may also be limited by consideration of the public good, such as limits on public meetings that will

produce disorder. A liberal account of such public-good constraints must limit them to whatever arrangements are necessary to protect a liberal society.

In talking about individual rights, it is essential to note, in order to understand liberalism, that the liberal individual is a human being not otherwise differentiated by status, class, race, religion, or gender. This formulation describes an ideal—implicit in liberalism and eventually standardly affirmed—rather than the actual practice of liberalism as it originally developed. With respect to the latter, many individual rights were variously restricted in different countries: universally at first to men, in America to white men. Nevertheless, the standard justifications for the exclusions were the incapacity of the excluded class of human beings to make effective use of the liberal freedoms or their existence as a threat to the established liberal order. In this way, it was still possible to say that all human beings capable of freedom and not threatening public order were entitled to rights.

As the practice of particular societies, liberal individual rights, although proclaimed as the rights of human beings, would be restricted to members of that society and to resident aliens only under the developing provisions of international law. The standard justification for such limitations was that the rights could be given practical effectiveness only through the legal and political systems of particular states. Liberal practices emerged in the states of northern Europe and North America in the course of the seventeenth and eighteenth centuries and contributed substantially to their dynamic international power through the early twenty-first century despite the life-threatening challenges to them in the twentieth century by the fascist and communist powers. The liberal societies of the West, above all the United States, have given liberalism as a practice and a theory a dominant status in the contemporary world.

While the aforementioned legal and institutional arrangements are important for the constitution of a liberal society, they are not enough. A fully liberal society requires a tolerant public opinion as well. This is one of the main points of John Stuart Mill's famous essay *On Liberty* (1859), in which he seeks to defend individuality and difference from the coercive pressure of public opinion.

Liberalism as a social practice is a matter of degree along three dimensions. First, a society may be more or less liberal according to how many aspects of its life are governed by the principle of individual liberty. A society may be very liberal in matters of belief but illiberal in the economic and/or the political sphere or conversely. It may be liberal in all these areas but illiberal with regard to sexual conduct. Second, a society may be more or less liberal with regard to each of these spheres. It may allow only a limited degree of economic freedom or a limited degree of freedom of belief. Finally, a society may be more or less inclusive of its adult population in the scope of the liberal freedoms.

Liberal Theories

Liberal theories are theories designed to show that the liberal organization of society is the best for human beings with

regard to their fundamental nature and interests. The Western intellectual tradition includes several discourses of major importance that have this aim. It is widely held that the principles of liberalism can be traced back to the seventeenth-century natural rights and social contract theorists who attach primary significance in just interaction between persons to an equal individual liberty and who derive the constraints of organized society from an agreement by individuals to submit to such constraints for the sake of the protection of their liberty and other natural rights.

A radically different type of liberal theory, which was very scornful of the idea of natural rights, was the utilitarian one. This flourished in the nineteenth century, particularly in Great Britain, and remains influential in English-speaking countries. This theory holds that the best organization of society is the one that produces the greatest amount of utility or happiness, taking equally into account every individual's utility. Such a theory is liberal only insofar as it argues, as the classic British utilitarians did, that the liberal order of society would best satisfy the utilitarian principle.

The theory that has been most influential in liberal thought on the continent of Europe and also on contemporary thought in English-speaking countries is that of Immanuel Kant (1724–1804) and German idealism. This theory seeks to provide a rational deduction of the natural rights principle of equal individual liberty from human beings' capacity for autonomy, which is understood as a capacity to govern one's conduct by laws or principles that one freely imposes on oneself.

Modern Western political theory from the seventeenth century is largely dominated by liberal ideas. Even thinkers who have been thought to be fundamentally illiberal, such as Thomas Hobbes (1588–1679), Jean-Jacques Rousseau (1712–1778), Edmund Burke (1729–1797), and Georg Wilhelm Friedrich Hegel (1770–1831) are really illiberal, if at all, only in regard to the state and not in regard to society. A liberal society may, thus, be supported on very different theoretical bases within Western thought, including religious ones. Indeed, the dominant status of liberalism in the contemporary world, together with the high importance attached to recognizing the equal worth of non-Western cultures, has led to many attempts to construct support for liberal practices from within religious systems of belief. Thus, there exist forms of liberalism that can be called Confucian, Islamic, and Buddhist.

The Historical Development of the Liberal Idea

From the discussion of liberalism above, one might assume that the term itself came into use in seventeenth-century northern Europe. In fact the term *liberal* was first used in connection with politics in Spain in the early nineteenth century to describe a political movement whose object was to establish constitutional constraints on government power. The term rapidly came to be applied to movements and ideas aimed at promoting individual liberty of choice, and it is now generally considered reasonable to use the term retrospectively to describe thinkers such as John Locke (1632–1704), Adam Smith (1723–1790), and many others whose thought exhibited this character.

Natural rights theories. As claimed earlier, liberalism was nurtured in the natural rights doctrines of the seventeenth century. The Dutch scholar Hugo Grotius (1583–1645) is widely held to be the main innovator of the modern doctrine, and his mode of theorizing, involving the idea of a prepolitical state of nature and a social contract as the ground for political society, was taken up and given major formulations by Hobbes and Locke in England and Benedictus de Spinoza (1632–1677) and Samuel von Pufendorf (1632–1694) on the European continent. The reason for holding these theories to be the ground in which liberalism grew is that they start with a presumption in favor of individual liberty and limit liberty only to protect the equal rights of others or to provide the public order considered necessary to secure everyone's liberty to the greatest extent. These theorists refer to other natural rights besides liberty, as in Locke's classic formulation of rights to life, liberty, health, and possessions. All these rights, however, are to be understood as negative in character. The rights to life and health are rights not to be deprived of one's life or health by the actions of others and are thus rights to go about one's business as one thinks fit without being killed or injured. The right to possessions is again a negative right not to be hindered in the exercise of one's liberty to acquire possessions in order to preserve and enhance one's life. Furthermore, all individuals are held to have the natural right to govern themselves in accordance with their own judgment of their entitlements under natural law.

All these theorists recognize that constraints on individual liberty are necessary if people are to enjoy the maximum of equal liberty in a peaceful society, so it is rational for them to agree to establish a political society on the basis of their natural interests in liberty. This is a new and essentially liberal mode of thinking about a just society, because the aim is to leave people as free as possible to form their own lives as they think fit compatibly with a peaceful and orderly society. The contrast is with conceptions of just order that are based on a substantive conception of the good. In the latter view, one starts with a conception of how human beings should live in order to achieve the good life, such as that of Plato, and then organizes society politically to enable its members to realize this end. Individual liberty, in such a view, is only what is left over after the structure of the good life is in place.

The natural rights theorists explicitly adopted the primacy of liberty conception because they were especially impressed by the quarrelsome nature of human beings and by the devastating consequences of the contemporary disputes over religion involving Protestants and Catholics and the skepticism about the good that could thereby be engendered. These theorists' aim, therefore, was to construct a minimal social ethics that all could agree on while leaving as much room as possible for each to decide for him- or herself what to believe and how to live. Of course, it is always possible to say that the liberal view of just interaction still involves a conception of the good life, namely one of maximum equal liberty. But this is a very thin conception of the good that leaves people as free as possible to make their own choices.

The natural rights theorists developed the central ideas of a liberal *society*. Their politics, however, was in many cases far

from being liberal. Despite the grounding of political society in a social contract and thus apparently basing it on the consent of all, Grotius, Hobbes, and Pufendorf defended absolute monarchy, while Locke and Spinoza restricted political rights to property owners. A crucial argument of the absolutists was that, although the ruler's authority was based on a contract, the contract necessarily involved the surrender by the contractors of their natural right to interpret the natural law for themselves to the sovereign whose judgment could not subsequently be questioned without undermining political society itself and returning everyone to a lawless state of nature. It is for this reason that Hobbes, and later the conservative thinker Burke, can appear to be so illiberal. Although they do not deny that human beings have natural interests in an equal liberty and that sovereigns are well advised to respect that liberty, sovereigns cannot be held to account for not respecting it. Hence, their subjects' enjoyment of their liberties can only be at the discretion of the ruler or the political traditions of the society.

The partial political liberalism of Locke is presented as an attack on the absolutists and consists of making the government responsible to the property owners who are taxed to support it and who are held to be the more rational members of society; and additionally an embryonic version of the idea of the separation of government powers in different hands. Nevertheless, absolute sovereignty still lurks in Locke's theory insofar as citizens who are aggrieved at the actions of a legitimately constituted government have to appeal to the members of political society as a whole whose decision, in principle by majority will, is presented as necessarily binding. Thus, Locke's political theory contains an unelaborated majoritarian democratic principle that could be and was seized on by more radical thinkers and movements concerned to develop the egalitarian implications of liberal rights to promote political democracy.

Rousseau can be understood as one of these radical egalitarian Lockean thinkers in some respects, and his theory was very influential in inspiring the French revolutionaries of the late eighteenth century. But Rousseau is rarely regarded as a liberal. This is largely because his theory of the general will and his belief in direct rather than representative democracy were seen, especially in the light of the actions of the French revolutionaries and through the criticism of the early-nineteenth-century French liberal thinker Benjamin Constant, as wholly antipathetic to individual liberty. He is said to identify liberty with participation in collective decision-making rather than individual choice. However, this is to misunderstand the general will. The general will is supposed to be aimed inherently at securing laws that equally protect the individual liberty of all. Insofar as it is a collective will through participation in which all persons equally impose general laws with a liberal character on themselves and others, its collective nature and positive conception of freedom is merely the necessary political element in a self-governing liberal society.

Rousseau does depart radically from the economic liberalism implicit or explicit in most natural rights theorists of the seventeenth and eighteenth centuries. For Rousseau the equality element in the doctrine of equal rights requires a rough

equality of all as property owners and an opposition to capitalist ownership and market society. Because the foundational liberal principle affirms both the equality and liberty of all, Rousseau's interpretation of it would seem to be a possible one while its egalitarian commitments have become more and more influential.

Other notable figures in the democratic development natural rights theory are Thomas Paine (1743–1809) and the Marquis of Condorcet (1743–1794). They played noteworthy parts in the political revolutions that transformed America and France at the end of the eighteenth century and produced important theoretical works justifying a liberal-democratic order.

Utility-based liberalism. Rights-based liberalism has two apparent weaknesses: It is not clear where the natural rights come from, and no principled account of conflicts involving rights is given or seems to be possible. Utilitarian-based liberalism offers a single solution to both. The principle of utility, which tells moral agents to do those acts that will produce the greatest amount of utility, is interpreted by the great liberal utilitarians to mean that one should act to bring about a society in which individuals enjoy the standard liberal rights enumerated earlier in this entry. At the same time what to do when rights conflict is to be settled by appeal to the principle of utility, which establishes a suitable hierarchy of rights in such cases.

The most important liberal utilitarians are Jeremy Bentham (1748–1832) and Mill. To get a defense of liberalism from the principle of utility, Bentham adopts a number of secondary principles reflecting the fundamental interests of individuals. One of these is that individuals are the best judges of their own interests. So, there must be a presumption on the part of government that social outcomes will be better if individuals are left as free as possible to decide for themselves what to believe and do. His other secondary principles were those of security (or liberty), subsistence, abundance, and equality. Security of person and property involves the protection of people's liberty while ensuring that both subsistence and the possibility of abundance are best accomplished by leaving people free economically. Equality, arising from the fact that in the utilitarian calculus each is to count for one and no one for more than one, might suggest redistribution from rich to poor were that not to conflict in an unacceptable way with the operation of the other secondary principles and so is outweighed by them.

Unlike most of his contemporary rights-based liberals, Bentham believed that the only way of ensuring that governments followed policies that best promoted the general utility rather than their own interest was to establish a representative democracy. He thought that the great majority would see that their interests lay in the institution of a liberal society and polity, a view repudiated by those partially political liberals who doubted that non-property owners could be trusted to support liberty because they lacked the necessary independence and rationality.

Mill introduced significant modifications to the liberal theory he inherited from Bentham. One of these is his extension of the liberty principle, which requires persons to be allowed to pursue their own good in their own way so long as they do

not harm others, to cover the coercive pressure of public opinion mentioned earlier. Furthermore, the area of conduct falling within this principle includes what Mill calls experiments in living. People should be encouraged to experiment (so long as they do not harm others) in order to promote the long-term utility of the human race. Underlying these views is a belief in the fundamental importance of individuality to a person's happiness. This is the capacity to make choices for one's life that express one's own individual nature. A liberal society will be one that promotes the development in its members of this capacity. Adult human beings and whole societies will not necessarily manifest it and can benefit up to a point from the tutelage of others.

Kant and post-Kantian liberal idealism. Kant, the deeply anti-utilitarian and still very influential German philosopher, identifies human beings' capacity for autonomy as the grounds for claiming the existence of a natural right to an equal liberty. Autonomy is the capacity to govern oneself by freely imposing rational laws on the operation of one's natural inclinations. In following one's inclinations even through rational calculation, one is bound by causal laws operating independently of one's will. One is free and self-determining only insofar as one's end is rational and self-imposed. One achieves this in willing principles that are universal and apply to everyone. In subjecting one's natural self-interested maxims of conduct to the requirement of a universal legislation for its own sake and not for any advantage, one is treating rational being in oneself and others as an end in itself and of absolute worth. The laws one wills from that perspective will be ones that could be willed by every rational human being, who is not only a rational being but also a natural one. One will then be participating as an equal legislator in willing rational laws to govern the pursuit by each of his or her natural ends.

Among the fundamental laws such beings will legislate is one bestowing the universal right to an equal liberty. Human beings as rational beings embodied in a particular natural being are ends in themselves, and this means that their will insofar as it is rational and thereby conforms to rational universal law must not be coerced but must be left free to pursue its natural ends as it chooses. To the extent that a person's will violates the equal freedom of another, however, that will itself may be coerced, and in order to ensure the precision and effectiveness of this fundamental law, human beings must rationally will their entry into political society and their formation of a public order and sovereign will.

Kant's significance lies not so much in his working out the implications of the principle of equal liberty but in his invention of a new rational ground in autonomy for it. Contemporary liberals who still seek to provide justifications for preferring liberalism to other social and political schemes are largely either Kantians or utilitarians, with Kantians for the moment predominating.

Post-Kantian idealism, most elaborately developed by Hegel in Germany but also influential in Britain in the second half of the nineteenth century through the writings of Thomas Hill Green, Francis Herbert Bradley, and Bernard Bosanquet, historicizes and socializes the Kantian scheme. The

general idea is that historical forms of society and the reflective philosophies that arise in them are the result of the struggle of human beings to grasp and actualize the free will inherent in their nature as rational beings. This struggle culminates in the development of a liberal civil society and a partially liberal state. A liberal self-organizing civil society in which all persons are responsible for their own life economically and socially is necessary to develop in all the idea and partial actualization of their autonomy. This society, however, can exist only within the framework of a system of legislation that is the ultimate locus of the self-determining free will of human beings through their participation in and identification with the general will of the state. This theory socializes the individualist character of the liberal philosophy, because although individuals are the beings within which free will is realized, this is achieved only through their development in and membership of liberal social forms.

Twentieth-century liberalism and the influence of Rawls.

A striking characteristic of twentieth-century political theory is its loss of belief in the possibility of finding rational foundations for moral and political prescriptions. Adherence to liberal or antiliberal principles became a matter of espousing an ideology.

Liberal practices were, nevertheless, deeply embedded in English-speaking societies but, as it turned out, less so in the societies of Continental Europe, above all Germany and Russia. In those nations, in the chaos of the aftermath of World War I and the economic misfortunes of the 1920s and 1930s, the powerful antiliberal political movements of fascism and communism seized power, destroyed the forms of liberal society, and threatened the very survival of liberalism in the Western world. The victory of the liberal states (together with the Soviet Union) in World War II led to their strong reaffirmation of the individualist values of liberalism. This was least marked in the economic sphere, where the apparent industrial success of Stalinist Russia encouraged many Western and developing states to adopt extensive policies of economic socialism in the form of the nationalization of major industries. The postwar liberal states also for the most part greatly expanded the provision of state welfare to their subjects. While such policies were contrary to the principles of classical liberalism, they were perfectly justifiable under the revision of liberal theory that took place in the second half of the nineteenth century.

Political and moral theory remained marooned in the swamp of ideological contestation largely between liberalism and communism until the publication of John Rawls's *A Theory of Justice* in 1971 and the collapse of the other great antiliberal power in the 1980s (that is, the Soviet Union). The former generated an extraordinary revival of political theory based on the belief that Rawls had invented a new rational justification of liberalism. Rawls supposes that persons engaged in social interaction have the need and the desire to justify their actions to those affected by them and that this justification must take the form of everyone agreeing from an initially fair position to a set of cooperative principles that will then be seen to be fair. The initially fair position is one in which the contractors are understood to be free and equal persons—free

because they have the capacity to form conceptions of the good and govern themselves by these conceptions, and equal because no one has any more power than another to secure favorable terms for him- or herself. The contractors would choose two principles. The first is a principle of equal liberty by which each is to have as much liberty as is compatible with a like liberty for all. This principle takes priority over the second principle, which is concerned with fair equality of opportunity and the distribution of income and wealth. With regard to the latter Rawls holds that the contractors would choose that distribution that maximizes the long-run position of the worst-off group in society. These principles are commonly taken to justify a liberal welfare state with a leaning toward egalitarian outcomes.

One of Rawls's main claims about liberalism is that it is a method of political cooperation that is neutral between different conceptions of the good. Rawls believes, as did the original natural rights theorists, that human beings differ and tend to quarrel disastrously about the good. Any attempt to establish a coercive state on the basis of a particular conception is bound to generate conflict and be unfair to those holding different conceptions because there is no way of conclusively establishing the truth of any one conception. Liberalism, as Rawls understands it, and as presented in this entry, is a way of achieving peaceful social cooperation on the basis of agreement on principles that leave people as free as is compatible with allowing a like freedom to others.

In *A Theory of Justice*, however, Rawls claims that the ultimate ground for accepting his liberalism is that it expresses the Kantian idea of free and equal autonomous persons cooperating together in a social order. Rawls later came to accept the criticism that to base the theory on a Kantian conception of autonomy, which some persons could reasonably reject, violated the neutrality of the scheme. So in *Political Liberalism* (1993) he holds that the burdens of judgment regarding the good are such that it is unreasonable to seek to impose one's own conception on others by making it the basis of the state's order. But this claim raises the question of whether the unreasonableness of imposing one's conception of the good is solely pragmatic or whether it is based on principle, and, if the latter, what that principle is if it is not the Kantian one. Taking the former view would force one to abandon the belief that Rawls has effectively countered the general twentieth-century skepticism regarding foundations.

Some Issues in Liberal Theory and Practice

Liberalism has deep internal tensions primarily between the claims of equality and those of liberty arising from its equal commitment to both these principles. The tensions are held by some thinkers who are not well-disposed towards liberalism to be contradictions that prevent liberalism from living up to its own principles. Some of these issues are discussed briefly below together with some important distinctions between types of liberalism.

Liberalism and cultural difference. Liberalism prides itself on its toleration of cultural and other differences. Some cultural groups, however, are internally illiberal. They do not

treat their members as free and equal autonomous individuals with rights but as having identities defined by their membership in and place within the group, and by relation to the group's values. They are communal selves rather than individual ones. People so identifying themselves cannot easily flourish in liberal society by taking advantage of its freedoms. Hence, it is said that liberalism cannot treat such minority cultures fairly in accordance with its own principles.

Liberalism can tolerate such groups provided that they do not harm others and provided that their members are free to leave without suffering unjust discrimination. The problem is whether persons formed in such groups are really free to leave unless they have had a liberal education that enables them to think of themselves as individuals with the power and right of choice. But if they do think of themselves in this way, they will no longer be the communal selves they were. The liberal education of its members would undermine the group's illiberal identity and force it to reconstitute itself in liberal terms. It is clear also that illiberal groups could not be specially represented in the political realm without turning that realm from a principled association into what would be at best a pragmatic compromise between conflicting groups. There is no reasonable compromise between liberalism and illiberalism. In the end one must seek to show the superiority of a liberal society by appealing to some foundational principle and by reiterating that there is no possible social scheme compatible with a principled order that is more tolerant of difference than liberalism.

A more modest claim for the special recognition of cultural difference would be that of cultural minorities whose values are not incompatible with liberalism but whose members are disadvantaged relative to the majority in terms of their ability to compete on fair terms to obtain the benefits of liberal society. The demand would be in part for the preferential treatment of the members of such groups so that they could enjoy fair equality of opportunity. But this would not be to give special recognition to the culture as such but to its members as disadvantaged individuals. Some cultural minorities might also reasonably claim to be given symbolic public recognition as distinct and loyal members of the polity in public ceremonies celebrating the history of the nation and the contributions of its various citizens.

Liberalism and women's difference. In the beginning, feminism was just the application of liberal principles to women. Women were conceived as having fundamentally the same nature and interests as men and thereby entitled to the same rights.

Radical feminists from the 1970s, however, opposed the liberal assimilation of women's claims on the grounds that the liberal conception of the person did not reflect women's nature. This nature had been obscured by millennia of patriarchal rule and needed liberation from patriarchal society before its true content could be revealed. But whatever it turned out to be, the radical feminists were certain that it would not be a liberal individual. They held that whereas the liberal individual was based on impersonal rationality and abstraction, women's ethical life was rooted in her body and its emotions.

Insofar as women's difference amounts to an illiberal nature opposed to liberal man, the same issues are raised as those that occur in the cultural case, although compounded by the fact that men and women would seem to have to live together in the private realm if the race is to be satisfactorily continued. Women cannot be treated as a self-reproducing cultural group. Nevertheless, illiberal women could be specially represented in the public sphere. Yet, this would turn it once again into a reasonable compromise between the representatives of conflicting values.

Women could, of course, be seen as a disadvantaged group whose members need preferential treatment in order to achieve fair equality of opportunity. But this is not incompatible with liberalism. Some contemporary women writers claim that it is incompatible on the grounds that if women are given special treatment because of their difference, for example, their maternal being, then liberalism's claim to treat all persons equally without respect for gender will be breached. Nevertheless, because the ground for special treatment is to achieve fair equality of opportunity for different individuals in regard to their different circumstances, this argument seems invalid.

The radical feminists believe in a special women's nature was subverted by the postmodernist feminists, who reject the idea of essential selves. Identities are socially produced and always subject to challenge and change. This view would seem to make it impossible to claim that women as such are oppressed in patriarchal or liberal society because there is no such thing as women as such. Nevertheless, postmodern feminists believe that it is still possible within particular discourses to resist established conventions and develop alternative discourses regarding women. But to what end is unclear.

Economic liberalism. Economic liberalism is the view that the best economic order is a free market. This view may be justified by utilitarian considerations, as in those of Bentham, or by a combination of natural rights and utilitarian consequences, as in the theory of Adam Smith.

Fundamental to Smith's view is the idea of a natural order. This is the social order that develops when individuals are allowed to pursue their interests through specialization and exchange of goods and services. It is an expression of human beings' natural right to liberty. But it is also the best way for a society to promote the accumulation of wealth and national power.

Individuals are motivated in the natural order by the desire to improve their material condition, and given a suitable economic environment competition among them will normally produce beneficial consequences. Such an environment requires the free movement of labor, capital, and goods; many buyers and sellers; sound information among buyers and sellers; security of person and property; and the abolition of monopolies, tariffs, and government regulation of production and consumption. Yet Smith acknowledges that there exists a class of public goods that it is the function of government to provide, including the administration of justice, defense, and education.

Smith is not blind to the defects of the liberal economic individual and society but thinks liberal society is still preferable to aristocratic society. In particular, he deplores the condition

of the poor but believes that their only hope lies in the accumulation of wealth. Furthermore, he distrusts the capacity and interests of the poor to make political decisions in the general interest, which he identifies with the system of liberal liberty. So, like many other early liberals, he wants a liberal polity to be restricted to property owners.

Smith is the founder of classical economics, which is committed to free markets and hence economic liberalism. Another major figure in this school is David Ricardo (1772–1823), whose *Principles of Political Economy and Taxation* dominated the subject until the end of the nineteenth century. However, in Ricardo the subject becomes more technical and abstract and less concerned with its connections with liberal values more generally.

Economic liberalism of the Smithian kind is commonly thought to have been practiced by the British government during the nineteenth century and to a lesser extent by others. But this is far from being unqualifiedly true. The British government interfered in market outcomes during this period by regulating working conditions, trade unions, and the rates of utility companies, and by imposing an income tax and maintaining a monopoly of the money supply. The general spirit of economic liberalism is better described as a strong presumption in favor of laissez faire unless it was clear that intervention was to the general benefit.

Classical and revisionist liberalism. Classical liberalism is the liberalism that prevailed mainly in northern Europe and North America up to the second half of the nineteenth century. It consisted of minimal government intervention in economy and society. But it was by no means politically democratic, especially in Europe where liberals were for the most part and for a long time strongly resistant to the inclusion of the propertyless in the benefits and burdens of a liberal polity. Its principles received notable political expression in the declarations of the rights of man and the citizen of the American and French Revolutions at the end of the eighteenth century, while the extremes of the latter revolution confirmed many middle-class liberals in their hostility to democracy. Because of its economic and political association with the middle classes, classical liberalism can easily be represented as the ideology of the capitalist class, a position taken by Karl Marx (1818–1883) and other socialists. As presented in this entry, however, the fundamental tenets of classical liberalism go far wider and deeper than that claim implies. This is shown by the way the application of its principles was revised in the course of the nineteenth century to accommodate what most liberals came to accept as inevitable, namely the arrival of democracy.

The revision in practice took the form of increasing government intervention in the economy to protect the interests and promote the welfare of workers. Government resources, obtained through general taxation, are used to provide for the basic needs of the population. The revision in liberal theory that justified the change to big government involved a shift from the belief of the classical liberals that normal adult human beings would automatically have developed the capacity to exercise their freedom in their own interests to the view that this capacity needed suitable economic, educational, and

social conditions for its development—a belief found in the works of Mill and especially the nineteenth-century idealists. If individuals cannot provide these conditions for themselves, then fellow citizens must do so through state action. In general the move is to a greater emphasis on the equality aspect of equal liberty, as exemplified in Rousseau's thought, a change requiring more protection for workers and the poor.

Rather than as an abrupt and radical break, this revision of classical liberalism should be considered a movement along a continuum of possible social forms, all based on the liberal principle of equal liberty. At one extreme of this continuum is libertarian anarchy with no government at all, which is followed by the minimal state as described above in Smith's theory, and increasing levels of government intervention all the way to the government ownership of the means of production at the other extreme. The latter can still be called liberal provided that individual freedom prevails in all but the economic realm and that economic socialism is understood as the best means of assuring an equal liberty. Classical liberalism shares with revisionist liberalism the belief that government intervention can be justified if it works out to the general advantage.

Liberalism and nationalism. Liberalism and a weak form of nationalism developed together. Liberalism was a way of organizing society for the benefit of its members in a manner that promoted, better than any alternative, the society's harmony, prosperity, and power in a world of independent states. The nation here is just the collection of people organized in a state and thereby sharing common interests in their peace, prosperity, and power.

A strong form of nationalism holds that a nation is an ethnocultural group sharing a common ancestry, history, and culture and that membership in such a group is fundamental to the identity and value of the individual. Nationalism in this sense is totally antithetical to liberalism, for which individual identity is deeper than national identity.

A form of nationalism intermediate between the two is to be found in Mill and the contemporary thinker David Miller. According to this view a democratic liberal state will work better—be more harmonious and just—if the great majority share a nationality in the ethnocultural sense.

Liberalism has also been allied with imperialism. The argument here is that the rule of a liberal state over other peoples, such as the rule of Britain over India, may be justified if it serves to develop the subject peoples' capacity to become self-governing individuals and a self-governing people—in other words to develop in them the culture of liberalism. It is held by some that cultural imperialism of this kind, if not political imperialism, has been pursued by the Western powers after World War II through the United Nations program on Human Rights. Ultimately, the only justification for pursuing a liberal program domestically or internationally is that liberalism describes a better way for human beings to live together than any alternative because it better expresses and actualizes their fundamental nature and interests.

See also *Conservatism; Constitutionalism; Democracy; Enlightenment; Utilitarianism.*

BIBLIOGRAPHY

PRIMARY SOURCES

- Bentham, Jeremy. *The Works of Jeremy Bentham*. Vol. 1. Edited by John Bowring. 1838–1843. Reprint, New York: Russell and Russell, 1962.
- Condorcet, Marie Jean Antoine Nicolas Caritat, Marquis de. *Sketch of a Historical Picture of the Progress of the Human Mind*. Translated by June Barraclough with an introduction by Stuart Hampshire. New York: Noonday Press, 1955.
- Constant, Benjamin. "The Liberty of the Ancients Compared with That of the Moderns." 1819. In *Political Writings*, edited and translated by Biancamaria Fontana. Cambridge, U.K.: Cambridge University Press, 1988.
- Grotius, Hugo. *The Law of War and Peace*. 1625. Translated by Francis W. Kelsey. Indianapolis: Bobbs-Merrill, 1962.
- Hegel, Georg Wilhelm Friedrich. *Elements of the Philosophy of Right*. 1821. Edited by Allen W. Wood and translated by H. B. Nisbet. Cambridge, U.K.: Cambridge University Press, 1991.
- Hobbes, Thomas. *Leviathan*. 1651. Reprint, edited by Richard Tuck, Cambridge, U.K.: Cambridge University Press, 1996.
- Kant, Immanuel. *The Groundwork for the Metaphysics of Morals*. 1785. Edited by Thomas E. Hill Jr. and Arnulf Zweig and translated by Arnulf Zweig. Oxford: Oxford University Press, 2002.
- . *The Metaphysical Elements of Justice*. 1797. Translated by John Ladd. Indianapolis, Ind.: Bobbs-Merrill, 1965.
- Locke, John. "A Letter concerning Toleration." 1689. Reprint, in *John Locke: "A Letter concerning Toleration," in Focus*, edited by John Horton and Susan Mendus. London: Routledge, 1991.
- . *Two Treatises of Government*. 1690. Reprint, edited with an introduction and notes by Peter Laslett, Cambridge, U.K.: Cambridge University Press, 1988.
- Mill, John Stuart. *On Liberty*. 1859. Reprint, edited by Gertrude Himmelfarb, New York: Penguin, 1982.
- Paine, Thomas. *The Rights of Man, Common Sense and Other Political Writings*, edited with an introduction and notes by Mark Philp. Oxford: Oxford University Press, 1998.
- Pufendorf, Samuel. *On the Duty of Man and Citizen According to Natural Law*. 1673. Edited by James Tully and translated by Michael Silverthorne. Cambridge, U.K.: Cambridge University Press, 1991.
- Rawls, John. *Political Liberalism*. New York: Columbia University Press, 1993.
- . *A Theory of Justice*. Cambridge, Mass.: Harvard University Press, Belknap Press, 1971.
- Ricardo, David. *The Principles of Political Economy and Taxation*, with an introduction by Donald Winch. London: Dent, 1973.
- Rousseau, Jean-Jacques. "*The Social Contract*" and *Other Later Political Writings*. Edited and translated by Victor Gourevitch. Cambridge, U.K.: Cambridge University Press, 1997.
- Smith, Adam. *An Inquiry into the Nature and Causes of the Wealth of Nations*. 1776. Reprint, edited by R. H. Campbell, A. S. Skinner, and W. B. Todd, Oxford: Clarendon Press, 1976.
- Spinoza, Benedictus de. *Tractatus theologico-politicus*. 1670. In *The Political Works*, edited and translated by A. G. Wernham. Reprint, Oxford: Clarendon Press, 1958.

SECONDARY SOURCES

- Arblaster, Anthony. *The Rise and Decline of Western Liberalism*. Oxford: Basil Blackwell, 1984.

- Barry, Brian. *Culture and Equality: An Egalitarian Critique of Multiculturalism*. Cambridge, U.K.: Polity Press, 2001.
- de Ruggiero, Guido. *The History of European Liberalism*. Translated by R. G. Collingwood. 1927. Reprint, Gloucester, Mass.: Peter Smith, 1981.
- Freedon, Michael. *The New Liberalism: An Ideology of Social Reform*. Oxford: Clarendon, 1978.
- Girvetz, Harry K. *The Evolution of Liberalism*. New York: Collier, 1963.
- Grapp, William D. *Economic Liberalism*. New York: Random House, 1965.
- Gray, John. *Liberalism*. 2nd ed. Minneapolis: University of Minnesota Press, 1995.
- Hobhouse, L. T. *"Liberalism" and Other Writings*. Edited by James Meadowcroft. Cambridge, U.K.: Cambridge University Press, 1994.
- Kymlicka, Will, ed. *The Rights of Minority Cultures*. Oxford: Oxford University Press, 1995.
- Laski, Harold J. *The Rise of European Liberalism*. 1936. Reprint, with a new introduction by John Stanley. New Brunswick, N.J.: Transaction Publishers, 1997.
- Miller, David. *On Nationality*. Oxford: Oxford University Press, 1995.
- Phillips, Anne, ed. *Feminism and Politics*. Oxford: Oxford University Press, 1998.
- Tamir, Yael. *Liberal Nationalism*. Princeton, N.J.: Princeton University Press, 1993.
- Weedon, Chris. *Feminism, Theory, and the Politics of Difference*. Oxford: Blackwell, 1999.

John Charvet

LIBERATION THEOLOGY. The broad definition of liberation theology stresses the interrelatedness of differing structures of oppression and domination. Liberation from oppressive structures necessarily involves political, economic, social, racial, ethnic, and sexual aspects. As a paradigm, liberation theology today places explicit emphasis on assessing different forms of human oppression and suffering, and liberation from them, as layers in a complicated process.

Liberation theology is one of the most significant currents in modern theology. Because of its multidisciplinary and its emphasis on social, political, and ecclesial praxis, it has come to have importance far beyond academic theology or institutional churches. Liberation theology can be defined either narrowly or broadly. In the former sense, it is limited to Latin American liberation theology (*teología de la liberación, teologia da libertação*), born of a specifically Latin American context in the late 1960s. In the broader sense, liberation theology also includes other theological currents, most importantly black theology (mostly in the United States and South Africa), feminist theology, and variations of Asian and African liberation theologies. In the latter sense, it would be even more accurate to speak of theologies of liberation in the plural. Among different liberation theologians, this understanding of liberation theology as plural, heterogeneous, and global (with multifaceted local expressions) is common. There are also non-Christian theologies of liberation, even if the term sometimes is not fully accurate in all contexts. However, there has also been dialogue

between Christian and Jewish, Muslim, and Hindu theologians of liberation. This article will concentrate on Christian liberation theologies in the broader, global meaning.

It is often wrongly assumed that liberation theology first appeared in Latin America and then spread to other continents and contexts. Some classical works on black theology (for example, James Cone's *A Black Theology of Liberation*, 1970) and feminist liberation theology (Rosemary Ruether's *Liberation Theology*, 1972) were published at about the same time as the first major works of Latin American liberation theology, such as Gustavo Gutiérrez's *Teología de la liberación* (1972). It is more accurate to say that the term *liberation theology* arose simultaneously in different contexts. The different theologies within the liberation theology movement have had some dialogue with each other, most importantly in the context of the Ecumenical Association of Third World Theologians (EATWOT), founded in 1976. Counted among "Third World theologies" are liberation theologies inside the First World, especially the United States. Liberation theologians have learned from each other through critical dialogue: for example, the critique of the meagerness of the analysis of racism and sexism and the emphasis on economic and class issues at the cost of cultural elements in Latin American liberation theology; or for a feminist theology from industrialized countries that has been slow to admit that white, educated, and affluent women are a small minority.

Each liberation theology, whether black, feminist, or Latin American, is characterized by its distinctive viewpoint, but what they all share is a commitment to social justice. To some extent, all liberation theologies are situated in contemporary political struggles and movements (such as different human rights movements against Latin American dictatorships, the U.S. civil rights movement, and feminist movements in different countries and regions). Liberation theologians usually refer to this as praxis, not only as their aim or objective, but also as their point of departure.

Liberation theology stems from the conviction that giving priority to the poor and the oppressed in theology and in the church, and the concrete defense of their rights in different societies, is a central, if not the most central, element of the Christian faith. Christian liberation theologies aim their critical analysis not only at society but at the church and theology as well in order to judge to what extent they are accomplices in maintaining structures of domination.

Liberation theologies understand theology as critical reflection on the presence of the divine within different liberation struggles. This reflection is accomplished with the help of both sacred scriptures and tenets of the faith tradition, as well as other disciplines, in order to understand the root causes (and ways of eradication) of phenomena such as poverty and racism.

The concept *contextual theology* has been used interchangeably with liberation theology. It has been claimed that because all human activity, including the study of theology, is born in a particular context, all human activity is contextual. However, contextual theology has been used mainly to designate the changing character of Christianity as it took root outside the Western

world. In this sense, contextual theology would be a wider term than liberation theology, Latin American liberation theology, for example, being just one form of contextualized theology from a particular colonized and Christianized part of the world. In the sense that the term contextual theology refers to a local political, social, and religious context—for example, Ghana or the Philippines—it is a narrower term than liberation theology, which stresses a global struggle against different systems of domination.

No single article can do justice to the contemporary richness of different liberation theologies, such as Dalit theology (India), gay and lesbian liberation theologies, *minjung* theology (Korea), indigenous peoples' theologies and spiritualities of liberation all over the globe, and the Palestinian theology of liberation, among others. In the remainder of this essay, to the discussion will be limited to Latin American liberation theology, black theology, and feminist theology.

Latin American Liberation Theology

The Catholic Church was, for centuries, one of the pillars of Spanish power in Latin America, which was Christianized more than five hundred years ago, unlike other areas later colonized by European countries. The circumstances that made liberation theology possible have deep historical roots; however, there are some more immediate causes, both secular and ecclesial.

The generally conflictive atmosphere, and the rise of authoritarian military dictatorships all over Latin America in the 1960s and 1970s, created the conditions in which the Roman Catholic Church had to take a political stance regarding growing violations of human rights, deepening poverty, and organized, armed guerrilla struggle, culminating in some cases in a successful popular revolution (Cuba in 1959 and Nicaragua in 1979). An influential idea behind early liberation theology was the dependency theory, according to which the main reason for the poverty and underdevelopment of the Third World was its dependency on industrialized countries, which were largely developed through the use of, and profit from, dependent regions. Theologically, liberation theology was a radicalization and contextualization of the influence from European political theology and, certainly, in a tradition as long as Christianity itself, of prophetic denunciation of injustice and oppression and declaration of freedom and liberation to those suffering from them.

The Second Vatican Council (1962–1965) of the Roman Catholic Church established a global opening of the church to society and had an extremely important influence especially on Catholic churches in North America and Latin America. Ecumenically, the World Council of Churches took steps that encouraged Protestant churches to commit themselves to issues of social justice, especially the eradication of poverty. In Latin America, the Latin American Catholic Bishops' Conference (CELAM, *Consejo Episcopal Latinoamericano*) met in Medellín, Colombia, in 1968, a meeting often interpreted as a critical point in the departure of the Catholic Church (as an institution) from its five-hundred-year-old relationship to the state. The church formally made “a preferential option for the poor” and aspired to become “a church of the poor.” Some of the first important Catholic liberation theologians were Gustavo Gutiérrez, Leonardo Boff, Juan Luis Segundo, Hugo

Assmann, Jon Sobrino, and Pablo Richard; on the Protestant side were theologians such as Rubem Alves, José Míguez Bonino, and Elsa Tamez.

At the grassroots level, priests, pastors, nuns, and laypeople started to work with the rural and urban poor, forming ecclesial base communities, or *comunidades eclesiales de base* (CEBs), in which people learned to interpret their everyday realities in the light of their Christian identity and faith. In some countries, such as Nicaragua and Brazil, the local CEBs played an important sociopolitical role.

According to Gutiérrez, liberation theology is “a critical reflection on praxis in the light of the Word of God.” While there is a clear Marxist influence in liberation theologians' use of the concept of praxis, the Vatican's claim that liberation theology is camouflaged Marxism is exaggerated. Liberation theologians interpreted both Christianity and the Latin American situation from a new perspective, that of the colonized “Christian South,” in which the majority of people lived in widespread poverty under extremely repressive governments. The method of liberation theology—to give primacy to praxis over theological speculations—has influenced nearly all contemporary theology.

In the 1990s, the influence of both liberation theology and the CEBs has diminished, partly due to the growing presence of Pentecostalism and the rise in Protestant churches in Latin America. Also, the Catholic Church has become much more conservative during the papacy of John Paul II, leaving very few liberation-theological bishops, such as Helder Camara of Brazil and Oscar Romero of El Salvador in the 1970s and 1980s, in the Latin American Catholic Church. At the same time, ever-deepening poverty and the globalization of market economies, issues of sexism and racism, and ecological concerns raise both old and new questions for liberation theologians. An analysis of idolatry as well as of the common roots of Western theology and economy (for example, the sacrificial elements in both) has led to some of the new developments that have deepened the original insights of liberation theology. Capitalism as religion and the “necessary” production of victims as a basically theological belief have been theorized by Franz Hinkelammert and Hugo Assmann. Christianity should always side with the victims and defend their lives, which is why liberation theology is also called the theology of life, *teología de la vida*, reflecting on the meaning of the God of life, *el Dios de la vida*.

Liberation theology today might best be seen as forming part of the so-called globalization critique, which, along with theories and practices of alternative globalization, tend to bring together actors and theories from both the First and Third Worlds in order to create alternatives to contemporary economic policies. A lack of democratic control of economic policies, poverty, ecological disasters, the concentrated control of natural resources, and the concomitant issues of sexism and racism, remain as issues.

Black Theology

Black theology in the United States arose out of the civil rights and black power movements of the 1950s and 1960s.

However, its historical roots go back to the beginning of African slavery in the United States and the founding of black independent Baptist and Methodist churches in the late eighteenth and early nineteenth centuries. Important contributors to this literature are James H. Cone, J. Deotis Roberts, and Gayraud S. Wilmore. "In a racist society, God is not color blind," says James Cone. Also, if all humans were created in the image of God, it must not only mean that black people are created in God's image, as are whites, but also that "God is black." In a related sense, "blackness" is a category in black theology similar to that of "poverty" in Latin American liberation theology. To be black, or poor, is to be conscious both of one's oppression and of one's authentic humanity.

As in other liberation theologies, black women's voices, and their critique, have been central for the later development of black theology. In the United States, African-American feminist theologians prefer to call their work *womanist theology*, after a term borrowed from the African-American writer Alice Walker. Important Christian womanist theologians are Delores Williams, Jacquelyn Grant, and Katie G. Cannon. Most U.S. black and womanist theologians are Protestant. In a racist and sexist society, black women cannot prefer one identity at the cost of the other: they are marginalized both as women and as a racial minority.

As in the United States, the struggle against institutionalized racism, often legitimized by religious beliefs, has been the source of black theology in Africa, especially South Africa. Reformed Christianity in South Africa has been one of the ideological pillars of apartheid, the repressive political system of that country for decades, which is why black theology in the South African context has been different from that in the United States. Important black South African theologians such as Desmond Tutu, Allan Boesak, and Manas Buthelezi have often also been leaders in the churches and in movements against apartheid. A black theology of liberation, *la teología negra de la liberación*, including a feminist version, is also being developed in the Latin American and Caribbean context.

Feminist Theologies

By virtue of its large and varied racial and ethnic minorities, the United States has produced the largest variety of feminist theologies. At the same time, theologies from the United States are not only not applicable in other parts of the world but also often reflect the specific historical and cultural circumstances of that country. Thus, Latina feminist theology (exemplified by María Pilar Aquino from the Catholic tradition and Daisy Machado from the Protestant), womanist theology, *mujerista* theology (including Latina female theologians such as Ada María Isasi-Díaz and Yolanda Tarango), Native American, and Asian-American feminist theologies (for example, Kwok Pui-lan and Chung Hyun Kyung), have been influenced by feminist thinking from other contexts and countries, but also reflect the situation of women from ethnic and racial minorities in the United States. It is sometimes difficult to draw a clear line between Latin American and U.S. Latino or Asian and Asian-American theological production because individual theologians often have spent parts of their lives in both their countries of origin and in the United States.

Some important white North American feminist theologians who have done groundbreaking work are Elizabeth Schüssler Fiorenza and Rosemary Radford Ruether (Catholic), Mary Daly (post-Christian), Judith Plaskow (Jewish), and Letty M. Russell (Protestant). Schüssler Fiorenza and Ruether also explicitly define themselves as liberation theologians.

In Europe, scholars such as Catharina J. M. Halkes, Elisabeth Moltmann-Wendel, and Mary Grey identify themselves as feminist liberation theologians. The European Society for Women in Theological Research has been an important forum for the development of European feminist theologies. Both in Europe and the United States, there are also feminist theologians (after *thea*, Greek for "goddess") who depart from the Judeo-Christian tradition by reclaiming different goddess traditions. Many feminist theologians in different parts of the world include eco-feminist and ecological concerns in their work.

All feminist theologies share the importance of the analysis of sexism in different religious traditions, women's exclusion from both theology and positions of power in religious institutions, and the often explicitly religious legitimization of the subordination of women. Many burning ethical issues, such as abortion and violence against women, cannot be adequately assessed without a critical feminist theological analysis of the religious underpinnings of ethical thinking; and dialogue with feminist theories from other fields is also important.

See also **Authoritarianism: Latin America; Christianity; Feminism; Human Rights; Marxism: Latin America; Poverty; Religion: Latin America; Religion and the State: Latin America; Womanism.**

BIBLIOGRAPHY

- Boff, Leonardo. *Igreja, carisma e poder*. Petrópolis, Brazil: Vozes, 1981.
- Cone, James H. *A Black Theology of Liberation*. Maryknoll, N.Y.: Orbis, 1990.
- Cone, James H., and Gayraud S. Wilmore, eds. *Black Theology: A Documentary History*. 2 vols. 2nd rev. ed. Maryknoll, N.Y.: Orbis, 1993.
- Ellacuría, Ignacio, and Jon Sobrino, eds. *Mysterium Liberationis: Conceptos fundamentales de la teología de la liberación*. 2 vols. San Salvador: UCA Editores, 1991.
- Fabella, Virginia, and R. S. Sugirtharajah, eds. *Dictionary of Third World Theologies*. Maryknoll, N.Y.: Orbis, 2000.
- Gibellini, Rosino, ed. *Paths of African Theology*. Maryknoll, N.Y.: Orbis, 1994.
- Gutiérrez, Gustavo. *Teología de la liberación: Perspectivas*. Salamanca: Sígueme, 1972.
- Isasi-Díaz, Ada María, and Fernando F. Segovia, eds. *Hispanic/Latino Theology: Challenge and Promise*. Minneapolis: Fortress, 1996.
- King, Ursula, ed. *Feminist Theology from the Third World: A Reader*. Maryknoll, N.Y.: Orbis, 1994.
- Pieris, Aloysius. *An Asian Theology of Liberation*. Maryknoll, N.Y.: Orbis, 1988.
- Ruether, Rosemary R. *Liberation Theology: Human Hope Confronts Christian History and American Power*. New York: Paulist Press, 1972.
- . *Sexism and God-talk: Toward a Feminist Theology*. Boston: Beacon, 1983.

Schüssler Fiorenza, Elisabeth. *In Memory of Her: A Feminist Theological Reconstruction of Christian Origins*. New York: Crossroad, 1983.

Thislethwaite, Susan B., and Mary P. Engel, eds. *Lift Every Voice: Constructing Christian Theologies from the Underside*. San Francisco: Harper and Row, 1990.

Eliina Vuola

LIBERTY. Liberty is an integral concept in Western political and social thought. Liberty as an inalienable social and political attribute of individuals emerged in the formation of the modern political discourse in the West. Since Georg Wilhelm Friedrich Hegel (1770–1831) the concept has often been categorized in a threefold manner: moral liberties (freedom of moral choice, such as freedom of conscience), civil liberties (freedom of individuals as constituting members of a civil society, such as freedom of speech) and political liberties (freedom of individuals in relation to the state, such as freedom of political association), all being attributes of individuals. Pre-modern Europe, by contrast, did not necessarily attribute liberties to individuals but to social relations and communities. Non-Western worlds did not produce an idea equivalent to liberty in their own intellectual traditions. Around the nineteenth century, however, they assimilated the Occidental idea of liberty primarily as a concept denoting the independence of the nation state rather than the liberties of individual human beings. In what follows we shall survey Western conceptions of liberty chronologically, and discuss the Islamic, Indian, Chinese, and Japanese variations of it.

Ancient Conceptions

Liberty or freedom (*eleutheria*) in ancient Greece denoted the status of the free man and woman as opposed to that of the slave. The division between free persons and slaves was deemed to be a social and natural institution. Free status was identified by a set of various rights and privileges. Hence, liberty was exclusive and could not be shared by every individual. Indeed, one of the rights of free individuals was to own other individuals as slaves. Similarly, the political freedom of a community also denoted the subjugation of other communities under its control. The preservation of an individual's liberty was not considered to be inconsistent with the deprivation of another's, and this was also the case with a political community. In addition, the Greek (especially Athenian) concept of liberty entailed equality of political rights and freedom of male political participation in the public sphere.

In his philosophical framework, Plato (c. 428–348 or 347 B.C.E.) left little room for liberty or freedom. Liberty was not a constituent element of human dignity, and freedom of thought was nothing other than the freedom to be incorrect, that is, a greater chance to deviate from the objective truths. Aristotle's (384–322 B.C.E.) definition of liberty resembles the contemporary notion; for him, the general essence of freedom is being one's own person for one's own sake rather than belonging to another. What discriminates the slave from the free man, then, is not that he is restricted in his actions and

subject to coercion but that everything he does is done to serve the interest of someone else. Whether Aristotle enshrined individual freedom in the sense of personal autonomy is a contentious issue. The place of autonomous practical rationality in his ethics becomes problematic when set against his claim of the individual's subordination to the state (*polis*). Aristotle's alleged dearth of interest in personal autonomy would be consistent with the reduction of the individual to a mere part of the state, while the recognition of personal autonomy in the Aristotelian ethical system would not.

The Roman idea of liberty (*libertas*) was a civic right acquired under positive law; namely, it was a constituent of the membership of the civic body (citizenship). Roman civil law was applicable to citizens of Rome only; noncitizens were ruled by the law of nations. Roman liberty was by definition a positive right that was guaranteed (but could also be withdrawn) by the law. Law-abiding citizens enjoyed the liberty of a Roman citizen and, before the law, all the citizens were equal. The slave was legally defined as a thing (*res*)—rather than person (*persona*)—and was subject to the mastery of another person.

In the final days of Roman republicanism, Cicero (106–43 B.C.E.) significantly related forms of government with the idea of liberty. He drew on the Polybian discourse on the change of constitutions and characterized each form of polity according to the degree of liberty attributed to it. Cicero's notion of liberty was equality of juridical rights, not equality before the law. He considered that democracy was marked by the excess of liberty granted to the ruled, and he recommended a just equality proportionate to *dignitas* (reputation or merit).

Early Christian ideas of liberty concerned interior disposition, which contrasted sharply with Greek and Roman ideas of liberty. St. Augustine of Hippo's (354–430 C.E.) discourse on freedom revolved around the idea of free will. Just as God is by definition unwilling and incapable of sin, so Adam, before the Fall, knew the distinction between good and evil and had the God-given power to choose the good alone. After the Fall, however, Adam and his descendents were motivated to choose evil. At the heart of Augustine's conception of liberty was the incapability of sin. From this perspective, individuals, who are "free" in the this-worldly sense are no more free than slaves. In terms of sinful humanity, neither "free" persons nor slaves have the right to be free in this world: the liberty of humans can only be achieved eschatologically.

Medieval Conceptions

Medieval Europe, it is often argued, is an insignificant period in the history of liberty. And yet "liberty" (*libertas* or *franchise*) is a word that can be found in a wide range of medieval documents: charters, plea rolls, theological treatises, and polemical writings. Liberty was, in medieval Europe, widely and primarily grasped as territorial immunity from seigneurial justice. The exclusion of public judges from an individual's land was the privilege attached to and exercised in the landlord's territory, and it could only be granted by a higher authority that acknowledged the capacity to act as a holder of a court or to be a judge.

The *libertas* and franchise, however, were privileges, and their recipients were often communities. They were not the rights of individual citizens. Indeed, medieval European society has been described as consisting of tightly bound corporate groups, in which individuals were absorbed, and liberty was often attributed to such groups rather than individuals. Should “liberty” be supposed to be an attribute of individuals, it might appear difficult to narrate a medieval history of liberty. But the “discovery of the individual” is now traced back to the world of intellectuals, higher clergy, and aristocracy in the twelfth century. Accordingly, recent research has denied that liberty as an attribute to individuals was not known in medieval Europe. Liberties as individual rights were also known in terms of personal freedom from, say, arbitrary imprisonment and extortion of money for release. This idea of individual liberties can be found in the record of royal justices and parliaments. Article 39 of the Magna Carta (1215) stipulated that “no free man should be captured and imprisoned or disseized or outlawed or exiled or in any way harmed except by a lawful tribunal of his peers and by the law of the land.” King John (r. 1199–1216) was compelled to concede to the requests of the rebellious barons and accepted that royal legislative and judicial authority was limited not only by the divine and natural law but also by his need to obtain counsel and consent of his subjects. In the fourteenth century, the privilege was not limited to the aristocracy as “free men” but to all: no men of whatever estate or condition he may be was to be captured and imprisoned unlawfully. Historians are divided over the significance of the charters of liberties. While the charters appear to offer new liberties, some scholars argue that they merely acknowledged freedoms that had already been enjoyed *de facto* by individuals as well as communities.

Similar conceptual change took place in the sphere of political and legal theory. It is well known that Henry de Bracton (d. 1268) noted the concept of liberty in Roman law as “the natural power of every man to do what he pleases, unless forbidden by law or force.” Thomas Aquinas (c. 1224–1274) maintained that by nature all human beings were both free and equal. Aquinas’s concept of liberty denotes the individual’s capacity for free choice, in which one is master of oneself, as opposed to servitude, a markedly Aristotelian conception. The English philosopher William of Ockham (c. 1285–?1347) was perhaps the greatest champion of individual liberty before the Renaissance and the Reformation. His ecclesiastical protest against the heretical doctrine of papal absolutism culminated in his assertion of the liberty of evangelical law, which may be grasped as volitional freedom of moral choice. Also Ockham’s “nominalist” outlook rejected the quintessentially medieval idea of corporation, thus attributing what he called “right and liberties granted by God and nature” to all individual humans rather than any fictitious groups. His discourse on natural rights and individual liberty has long been considered as the “semantic revolution” of the medieval language of rights. His intrinsically destructive anarchism, it was argued, anticipated the collapse of medieval Latin Christendom followed by the Reformation. Recent research, however, has shown that Ockham’s notion of right as the subjective power of an individual’s volition originates in the writings of canon lawyers in the twelfth century, such as Ugucione da Pisa (d. 1210), who

held that human rationality included a capacity for moral discernment.

Modern Conceptions

Niccolò Machiavelli (1469–1527) has often been considered as a theorist of political leadership, a founder of modern political science, or a preacher of amoral power politics. Recent scholarship, however, has increasingly paid attention to his republicanism, describing him as a theorist of political liberty. His *Discorsi sopra la prima deca di Tito Livio* (1535; trans. *Discourses on the First Ten Books of Livy*) discussed why the city of Rome attained supreme greatness, and liberty was considered as a means to such greatness. The work, filled with references to Roman writers such as Livy, Cicero, and Sallust, is interpreted as an assertion of republican liberty. Machiavelli grasped liberty as the counter-concept of slavery, which parallels his contrast between the free way of life and tyranny. According to him, the preservation of liberty is closely related to the maintenance of a particular form of polity because the enslavement of a political community will inevitably jeopardize individual freedom. The liberty of individual citizens can only be secured if the political community is maintained in a state of liberty. In this sense, coercion to a specific type of polity does not obstruct but rather warrants freedom, and coercion and the Machiavellian concept of liberty are not mutually exclusive. This maintenance of a free commonwealth in turn requires the individual citizen’s service to the common good, which can be motivated through the cultivation of civic virtues. This republican idea of liberty was influential among the English Puritan writers in the seventeenth century including James Harrington (1611–1677) and John Milton (1608–1674), and America’s Federalists in the eighteenth century.

Thomas Hobbes (1588–1679) has been regarded as no more a defender of liberty than Machiavelli, and yet his conception of liberty, in sharp contrast to Machiavelli’s, was no less important in the history of the concept. Hobbes’s notion of human freedom was characterized by the absence of external impediments: he discerned when an individual is not hindered to do whatever he has the will, desire, or inclination to do. Hobbes rejected freedom of the will; for him, to say that the will is free is nothing other than to say that a form of internal motion is not constrained from moving by something external, and this was absurd. According to him, liberty “properly called” is what he called “natural liberty,” that is, under the “natural” condition, humans have no legal obligations; they are capable of exercising powers without being physically prevented or compelled. In the Hobbesian world of nature, then, one can maximize the enjoyment of liberty when one is alone: a radical and extreme departure from the ancient conception that is embedded in a political and social context. The “artificial” condition of humans, under which people give up their natural liberties and live under human law is in sharp contrast to the natural condition. Liberty we can enjoy under the artificial condition was called the “liberty of subjects,” which is identified with the absence of legal prescriptions; hence, “artificial” liberties. Unlike Machiavelli, Hobbes dismissed the idea that the preservation of individual liberty requires the maintenance of a particular type of regime. There is no such thing as a “free” commonwealth because all the commonwealths have laws. To enter subjection to civil rule, however, did not require the complete



Liberty Leading the People (1830) by Eugène Delacroix. Oil on canvas. After the Enlightenment, many authors began to focus on the constraints that society often placed on freedom. Prior to this, freedom was viewed more as the purview of communities as a whole rather than that of individual citizens. LOUVRE, PARIS, FRANCE. © THE ART ARCHIVE/DAGLI ORTI

renunciation of natural liberty; indeed, natural liberties, for instance, to preserve oneself, were inalienable natural rights.

It has been argued that liberty as a universal God-given attribute rather than a privilege determined by political and social institutions is a distinctively “modern” notion. Indeed, the ancient concept of liberty was inconceivable apart from the political and social context, while the modern one was free from such contexts and was rather linked to metaphysical views about the nature of humans. In such modern views, liberty is prior to any political or social arrangements. However, recent research has traced its origin back into medieval Scholastic discourse; hence, the distinction between “modern” and “premodern” concepts of liberty is increasingly blurred and contentious. Seen in this light, Sir Robert Filmer’s (d. 1653) attack on the “modern” idea of natural liberty by asserting the naturalness of subjection to an absolute monarch was a radical break with the long-established tradition. Filmer derived his vision of patriarchal monarchy from Adam’s unlimited dominion over his spouse

and offspring. The traditional theory of natural liberty, for Filmer, identifies liberty with license and would allow the members of society to withdraw their obedience as it pleased them, thereby making social order unstable. John Locke (1632–1704) defended the older idea of natural liberty against Filmer’s criticism by demonstrating the rationality of liberty. Liberty was the will or power to do or not to do what was willed and it gains a moral dimension when it is exercised through identifying the will with the dictates of the reason or intellect that discovers objective good in the natural law. According to Locke, law and freedom are not mutually exclusive; unlike Hobbes, following the law constitutes the fulfillment of liberty. Locke thus restored the nexus between liberty and moral order that was severed by Hobbes. In contrast to Hobbes and Filmer, moreover, Locke attributed to the state the function of assuring the protection of its citizen’s “property” including civil and religious liberty.

In criticizing the malaise of inequality in the despotism of the *ancien régime*, Jean-Jacques Rousseau (1712–1778) was

perhaps the most eloquent proponent of the idea of liberty in modern Europe. Rousseau considered that human beings enjoyed freedom in the “natural” state where social and political customs and institutions were nonexistent. The emergence and development of society, however, created moral and political inequality and undermined human beings’ “natural” virtue, freedom and equality, which, in his view, culminated in the France of his day. Rousseau thus reclaimed human freedom by asserting popular sovereignty. In participating in the making of the law, men would obey themselves through obeying the law. The kernel of Rousseau’s idea of liberty was thus self-mastery, namely every individual’s unlimited sovereignty. This conception of liberty transformed the function of the state. In contrast to Locke, who separated religion and morality from politics, Rousseau held that the state might become the constitutive element of the intellectual and moral development of man. This doctrine of liberty influenced Immanuel Kant’s (1724–1804) idea of freedom. In their passionate celebration of liberty commentators like Benjamin Constant (1845–1902) discerned the potential danger of legitimating totalitarian tyranny or charismatic dictatorship exemplified by the experience of Jacobinism.

Before the Enlightenment the idea of liberty revolved around its relationship to the moral order on the one hand and the relationship between state and individuals or society on the other. After the time of the revolutions at the turn of eighteenth and nineteenth centuries, however, a new perspective was introduced in the discourse on liberty. The pre-Enlightenment perspective overlooked the fact that individual freedom could be constrained and even undermined by power of society, as opposed to the external constraints represented by the state. This problem, which Jeremy Bentham (1748–1832) first highlighted in his defense of homosexuality and Alexis de Tocqueville (1805–1859) discussed in his *Democracy in America* (1835, 1840), was the main subject of John Stuart Mill’s (1806–1873) incisive and extensive criticism in *On Liberty* (1859). Mill’s work was primarily written in protest against the coercive force of moralism that pervaded Victorian society. What Mill called the “tyranny of the majority” captured and criticized the coercive reality of public opinion that was intolerant of any dissidence, eccentricity, and difference. Hence, he limited the authority of society over individuals from his utilitarian perspective; interference with other individual’s activities is permitted only if they are likely to cause definite harm to some other persons, thereby violating their social rights. The flip side of this idea was the assertion of the freedom of thought. “If all mankind minus one, were of one opinion, and only one person were of the contrary opinion, mankind would be no more justified in silencing that one person, than he, if he had the power, would be justified in silencing mankind.” This defense of freedom of thought and speech was rooted in his emphasis on individuality and self-development, which formed an antithesis to the Protestant ethic of self-restraint. Mill’s criticism of the “tyrannical” force of social custom also crystallized in his assertion that the women should be liberated from the “subjection” to the men.

Contemporary Conceptions

Modern liberalism regarded liberty as a property of each individual, thereby conceptualizing it as free from politics. Hannah

Arendt (1906–1975) criticized this “anti-political” conception of liberty and preached a return to the ancient political notion. For Arendt, freedom was something “disclosed” in the collective action of individuals toward a shared goal; freedom and the act of exercising power are synonymous, not mutually exclusive. Arendt’s celebration of political practice in the polis of ancient Greece resulted in an assertion of republican freedom.

Although Arendt’s conception increasingly received serious attention, what has determined the paradigm of the discourse on liberty since the middle of the twentieth century was Isaiah Berlin’s (1909–1997) 1958 lecture “Two Concepts of Liberty,” which was later published in *Four Essays on Liberty* (1969). Its basic framework is easy to draw: Berlin distinguished between positive and negative liberty. Positive liberty denotes rational self-determination or autonomy, while negative liberty denotes the absence of constraints imposed by others. Despite its simplicity, however, Berlin’s conceptualization was controversial and required further clarification. In 1969 he reformulated the concept by introducing two questions. Negative freedom can be determined by answering the question: “How much am I governed?” By contrast, the positive concept can be determined by the answer to the question: “By whom am I governed?” Thus Berlin offered a revised definition of negative liberty: “not simply the absence of frustration (which may be obtained by killing desires), but the absence of obstacles to possible choices and activities.” Berlin’s negative freedom concerns “opportunity for action rather than action itself,” which was labeled later by Charles Taylor (b. 1931) as an “opportunity-concept.”

Berlin acknowledged positive freedom as “a valid, universal goal,” and yet his goal was to suggest the potential danger that positive liberty could readily be turned into the principle that legitimizes oppression, thereby demonstrating why negative liberty was preferable. Positive freedom as self-mastery, according to him, generates a metaphysical fission of the self into a “higher,” “real,” or “ideal” self and a “lower,” “empirical,” or “psychological” self. When the “higher” self is identified with institutions, churches, nations, races, and so forth, the doctrine of positive freedom turns into a doctrine of authority, or at times, of oppression. Berlin’s discourse forms an intriguing parallel to Benjamin Constant’s dual concept of liberty. Constant made a distinction between ancient and modern notions of freedom. He argued that liberty for the ancients was the freedom to participate collectively in the exercise of sovereignty, while liberty for the moderns was the freedom from interference by the community. Constant criticized Rousseau’s unlimited notion of sovereignty—he read Rousseau’s texts as supporting despotism. The resemblance between Constant’s criticism of modern liberty and Berlin’s caution about “positive” freedom is striking, and yet they differed significantly. Constant grasped modern liberty as the inalienable right of individuals, while Berlin’s positive freedom is “choice among alternatives or options that is unimpeded by others” (John Gray). Constant’s modern freedom and despotism are mutually exclusive, while Berlin’s freedom and despotism can coexist.

Berlin’s negative liberty was underpinned by his commitment to pluralism. For Berlin, the absence of constraint covers

a diverse and conflicting range of values from good to evil. Berlin never tried to reconcile colliding and incommensurable values and rejected any principle that claims to resolve the conflicts. This position forms an intriguing contrast with that of Joseph Raz, who defended negative freedom, by anchoring the moral basis of freedom in autonomy. For Raz, the value of free choice-making is determined by its contribution to the positive freedom of autonomy, which is the intrinsic value. Berlin refuses to give negative freedom such an instrumental status; namely, he celebrates negative freedom as the intrinsic value.

The criticism against the negative concept of liberty highlights the notion's indifference to opportunities or choices. Charles Taylor argues that freedom is important to us because we are purposive beings; hence, we discriminate external obstacles (and, therefore, opportunities available to us as the result of the absence of the external obstacles) according to their significance. The restrictions of religious practice, for instance, may be deemed a serious obstacle and hence a significant threat to liberty, while more traffic lights may not be perceived as serious blow to our freedom. Furthermore, obstacles are not necessarily external; we may be fettered by feelings such as shame or fear or by two conflicting desires (for instance the choice between career and marriage), and we have to discriminate between our motives. Actions arising out of irrational fear or spite cannot be said to be free. Thus Taylor suggests that the negative notion as an "opportunity-concept" is seriously flawed, and abandons one of the important elements of liberalism, that is "self-realization."

Berlin's negative concept of liberty did not only attract criticisms but also found a loyal heir in John Rawls; he understood liberty as freedom from interference. Rawls did not offer an explicit general definition of liberty, but his attribution of the exalted status of liberty, which constituted one of the two principles of justice, is noteworthy. According to the first principle, "Each person is to have an equal right to most extensive scheme of equal basic liberties compatible with a similar system of liberty for others." Rawls was very specific about "basic liberties," which included "political liberty (the right to vote and to be eligible for public office) together with freedom of speech and assembly, liberty of conscience and freedom of thought, freedom of the person along with the right to hold (personal) property, and freedom from arbitrary arrest and seizure as defined by the rule of law." The priority of these liberties does not allow any of them to be sacrificed except for the sake of liberty.

In addition to the arguments surrounding Berlin's thesis, a "third" concept of liberty has emerged. Intellectual historians, including J. G. A. Pocock and Quentin Skinner, have explored the republican (or "neo-Roman") concept of liberty in early modern republican discourses, and the political philosopher Philip Pettit has theorized republicanism with a focus on the new notion of liberty as nondomination. Hannah Arendt's republican ideals were inspired by political practice in ancient Greece and the American Revolution, while this "third" concept of liberty does not originate in Arendt's vision but rather derives from sixteenth-century Italian humanism and seventeenth-century English republicanism.

Domination, according to Pettit, is exemplified by the relationship of master to slave or master to servant. The "third" concept of liberty proposed by Pettit is neither "non-interference" nor "self-mastery" but "non-domination" that requires that no one has the capacity to interfere on an arbitrary basis in the choices of the free person. Liberty as nondomination differs from the positive notion in that the former emphasizes avoiding interference rather than achieving participation. Yet, republican liberty also differs from the negative concept. Domination occurs without actual interference; and republican liberty would repudiate the presence of a master who did not actually interfere, while the negative concept of liberty would not. Republican liberty rejects arbitrary interference, and what is required for non-arbitrariness in the exercise of power is not consent to the power, as is often claimed by the contractarian theorists, but "the permanent possibility of effectively contesting it." Institutionalized contestability, Pettit argues, would promote "the absence of uncertainty, the absence of a need to defer strategically to the powerful, and the absence of a social subordination to others."

Quentin Skinner participates in the debate from an entirely different angle: he has revised the history of the concept, thereby offering a third concept of liberty that contemporary political philosophers have overlooked. Skinner's case studies of the history of the concept of republican liberty range from Machiavelli to seventeenth-century republican writers including John Milton. Skinner's notion of neo-Roman liberty underlines that it opposes dependence or slavery rather than coercion, on the one hand, and that it requires a specific institutional arrangement, namely the "free state," on the other. The former point represents an antithesis to the Rawlsian narrower notion of liberty as natural rights, and coercion as the antonym of liberty, while, as for the latter, Skinner departed from Berlin who asserted that liberty is independent of the forms of polity.

In the early 1990s Francis Fukuyama proclaimed the "end of history," in a work by the same title, marked by the victory of liberal democracy and market capitalism. Although the number of "liberal democracies" is steadily increasing worldwide, one can hardly say that the notion of liberty is universally shared. Indeed, the civilizations outside the Occidental world did not embrace liberty as a social and political concept until the encounter with Western ideas, especially in the middle of the nineteenth century. The reception of these ideas was, largely speaking, lukewarm at best and, more often, hostile. In addition, those who favored the Western idea confronted the following two problems: one was doctrinal—how to relate a foreign idea to their own intellectual traditions—and the other was semantic—how to translate the word "liberty" into their own language.

Islamic World

The Arabic word for liberty or freedom is *hurriyya*, stemming from *hurr*, meaning "free." "Free" as a legal term signified the opposite of "slave," while it denoted, as an ethical term, "noble" character and behavior. The legal concept of freedom, which was already known to the pre-Islamic world, continued to be used in Muslim jurisprudence. *Hurriyya* occupied an important

place also in metaphysics: one of the significant repercussions of Sufism on political thought was the retreat from politics. The Sufist doctrine of renunciation maintained that poverty, self-humiliation and complete surrender of personality was the highest value of life, which underpinned the apolitical character of the doctrine. Accordingly, a Sufi mystic philosopher, Ibn al-Arabi (1165–1240), defined *hurriyya* as “slavery to God,” namely freedom from everything but God. Personal freedom was valued within the religious, moral, and customary sphere determined by the *umma* (Islamic community of believers), yet it was never considered to be an absolute moral value. Thus *hurriyya* never enjoyed exalted status as a fundamental political value.

It was Ottoman Turkey in the eighteenth century that introduced the Western ideas of liberty to Islam. The treaty of Küçük Kaynarch in 1774 between Russia and Turkey established the free and independent status of the Crimean Tatars from the two countries. The Turkish term first used for liberty, however, was not *hürriyet*, derived from the Arabic *hurriyya*, but *serbestiyet*. *Serbest* is a Persian word, meaning “exempt,” “untrammelled,” and “unrestricted”; accordingly, *serbestiyet* denotes the absence of limitations or restrictions. This negative concept of liberty does not convey such meanings as citizenship or participation to government. The use of *serbestiyet* in a political context dates from the early fourteenth century and was a commonplace in political discourse by the late eighteenth century. Celebrated Ottoman ambassadors, such as Azmi Efendi and Morali Esseyid Ali Efendi, used *serbestiyet* in terms of political liberty in their memoranda.

Hurriyya entered the Islamic political lexicon in 1798 when Napoléon Bonaparte arrived in Egypt and addressed the Egyptians in Arabic on behalf of the French Republic “founded on the basis of freedom and equality,” and the term *hurriyya* was chosen for the translation of “freedom.” Again, the Ottomans made a significant contribution to the widespread political use of the term. Sadik Rifat Pasa (1807–1856) was one such writer. He observed that European prosperity derived from political conditions such as security of life and property and freedom. Rifat’s *Concerning the Condition of Europe*, which was written during his sojourn in Vienna, represents the early Ottoman reception of the Western idea of political liberty. But his understanding of liberty was limited to the security of subjects from arbitrary coercion by the government, not the right to participate in it. Rifat also introduced the new language of rights into his largely traditional framework of Islamic political thought.

The Ottoman assimilation of the concept of political liberty was accelerated by the rise of a new Turkish literary movement led by the Young Ottomans including Ibrahim Sinasi (1826–1871), Ziya Pasa (1825–1880), and Namik Kemal (1840–1888). Their popular weekly journal *Hürriyet* was launched in 1868. Perhaps Namik Kemal is the most systematic of these thinkers; he was the first to correlate the ideas of human right and parliamentary government so as to achieve a new vision of freedom and self-government. Heavily influenced by the writings of Montesquieu and Rousseau as well as the practice of the French Third Republic and the British

parliamentary system, Kemal attempted to marry the language of modern liberal-parliamentary democracy to Islamic political language. For the first time in the history of Islamic political thought, popular sovereignty was based on the liberty of the individual. However, the tyranny of Abdülhamid II (1842–1918) stifled the Ottoman pursuit of liberty.

Egypt under British rule assimilated liberal political thought quite independent of the Turkish experience. Ahmad Lutfi al-Sayyid (1872–1963) was probably the most systematic exponent of Islamic liberalism. Under the influence of Mill, Lutfi al-Sayyid squarely situated freedom at the center of this thought. For him, freedom meant absence of unnecessary control by the state: a negative concept of liberty. Freedom was “the necessary food for our life,” the human’s inalienable natural right: it was a necessary condition for humans to be human in the fullest sense. Hence, Lutfi al-Sayyid celebrated limited government: political and legal arrangements and institutions that safeguard liberty were the “natural” and “true” form of government. An opponent of pan-Islamism and Arab nationalism, Lutfi al-Sayyid was also concerned with the freedom of the nation. He argued for the liberation of Egypt from foreign rule. In this context, liberty and independence were considered almost synonymous.

India

Liberty in the sense of spiritual liberation from the cycle of birth and death was a key idea in Indian thought. The liberty of the individual in civil or political society was foreign to classical Indian political thought. The equivalent to the idea of civil rights can be found in the ancient literature of Smritis, but it differed significantly from the Western idea in that the former was considered to belong exclusively to the upper classes (especially the order of the Brahmanas).

The idea of liberty came to the fore of Indian political thinking with the encounter with the modern West, epitomized by the intellectual contributions of Mahatma Gandhi (1869–1948) and Manabendra Nath Roy (1887–1954). Gandhi’s idea of liberty was framed in the idea of *swaraj*, a multifaceted concept of the utmost importance in his thought. *Swaraj*, literally meaning “self-rule,” was also used by Gandhi to signify national independence and the political, economic and spiritual freedom of the individual. As was the case with the “modern” Islam, national independence was closely related to the idea of liberty, meaning collective freedom from alien rule. Gandhi, however, did not conceptualize it negatively. National independence, framed in the idea of *swaraj*, was not merely freedom from foreign rule but also self-government. Gandhi’s commitment to political freedom turned him into a defender of rights, and yet he refused to base the peace and security of collective life on rights. He always placed individual duty (dharma) and social and moral interdependence above rights because, for him, rights were the consequence of the fulfillment of duties. Gandhi considered his celebrated *satyagraha* (passive resistance) as the performance of his duties and hence also as a method of securing rights by personal suffering. Gandhi’s conception of liberty also entailed an economic dimension: it denoted freedom from poverty. He attacked the contemporary reality of poverty by practicing voluntary

poverty in order to demonstrate solidarity with the poor, while he criticized technology-oriented industrialization for its imperialistic exploitation of the masses. Although Gandhi located liberty in a political and economic context, his notion of liberty was also spiritual: self-rule through the practice of virtues toward self-realization. Gandhi's novelty lies in the fact that to the notion of spiritual freedom, which was derived from the classical Indian tradition, he added political, economic, and social dimensions. This perspective derived from Gandhi's internal dialogue between the Western Utopian thought represented by Henry David Thoreau (1817–1862), John Ruskin (1819–1920), Ralph Waldo Emerson (1803–1882), and Leo Tolstoy (1828–1910) and the classical Indian thought manifested in the Hindu devotional work the *Bhagavad Gita*.

Whereas Gandhi's leadership of the Hindu masses was enormously influential and successful, Manabendra Nath Roy's gained no popular appeal. Roy's political position changed over time from nationalism, then to communism, and finally to radical humanism. His colorful but unsuccessful commitment to the Indian freedom movement, however, was guided consistently by an ardent desire for individual freedom. The intellectual context of Roy's political and literary activity was, unlike that of Gandhi, distinctively Westernized, markedly severed from the Indian traditions. Roy defined freedom as the "progressive disappearance of all restrictions on the unfolding of the potentialities of individuals," and anchored the desire for freedom in biological nature. His conception of liberty was radically negative to the extent that individual freedom and social responsibility were mutually exclusive. Roy considered liberty to be dependent upon the mind of the individual rather than external conditions, and yet his belief in popular sovereignty as an inalienable right determined his preference for people's direct political participation in parliamentary democracy.

China

The Chinese language did not know a word for "liberty" before the nineteenth century. The modern translation of "liberty," *ziyou* (meaning, literally, self-determination), had to be coined in response to the reception of Western ideas. The closest classical term, *ziran* (meaning, literally, "the natural"), denoted a Taoist sense of harmony with nature. This is not to say that the idea of personal freedom was totally foreign to classical Chinese philosophy. Confucian belief in human perfectibility, however, concerned interior spiritual freedom, differing from the Western political and social concept. Likewise, freedom as a right was not conceptualized until the nineteenth century. Kang Youmai (1858–1927) was one of the first Chinese intellectuals who introduced the Protestant idea of free will. His *Complete Book of Substantial Principles and General Laws* (written between 1885 and 1887) described human beings as owners of the "right of autonomy" (*zizhu zhi quan*), thereby adopting the language of rights.

The Chinese encounter with the Western idea of liberty may well be illustrated by the translation of the works of nineteenth-century English intellectuals by Yan Fu (1854–1921). He became widely known for his translation of T. H. Huxley's *Evolution and Ethics*, which introduced evolution theory to the

Chinese intellectual world at the turn of nineteenth and twentieth centuries. Deeply inspired by Herbert Spencer's (1820–1903) concept of social organism, Yan Fu maintained that the individual's pursuit of self-interest would generate a Darwinian struggle for survival that should result in the evolution of a more harmonious society. Yan Fu claimed to have derived from Spencer his own notion of human freedom denoting the release of an individual's "energy." His Spencerian liberalism was a radical departure from the orthodox Confucian ethic that regarded the pursuit of self-interest as the source of evil, while his translations also distorted the original meaning of other writings from the West. One such case is his translation of Mill's *On Liberty*: Yan Fu bent Mill's original conception of liberty to meet his own political purposes. Mill considered liberty of the individual as an end in itself. However, Yan Fu's Spencerian outlook produced a distorted understanding of Mill's concept as a means to the advancement of the people's virtue and intellect, ultimately to achieve the freedom of the state.

One of the powerful promoters of individual liberties (*ziyou*) and rights (*quanli*) in the Late Qing China was Liang Qichao (1873–1929). He absorbed a wide range of Western philosophy and social sciences through Japanese translations, but he endeavored to anchor the ideas of liberty and rights in the Confucian intellectual heritage. It has been debated how the Chinese reception of social and political concepts and discourses from the modern West relates to classical Chinese traditions. For instance, freedom of thought is at the heart of contemporary Western liberal democracy, while "harmony and unity of thought" (*tongyi sixiang*) is celebrated in post-socialist China. This contrasting attitude toward freedom of thought has received scholarly attention in connection with the lingering Confucian tradition.

Japan

In modern Japanese, "liberty" is normally translated *jiyu*. The Japanese first encountered the idea of liberty in Dutch, *vrijheid*, and the translator could not find any proper translation, leaving it untranslated. Indeed, when Western scholarship flooded into the Japanese intellectual scene through the translation of works such as Samuel Smiles's *Self Help* (1859) and Mill's *On Liberty*, "liberty" was commonly recognized as a difficult word to translate. After a variety of translations were attempted, *jiyu* survived as the only term widely used today. Unlike the case in China, *jiyu* had already existed in the Japanese vocabulary before Japan's exposure to the Western idea of liberty; however, the first Japanese translators of "liberty" were not entirely convinced with their choice of the term. Fukuzawa Yukichi (1834–1901) is arguably responsible for the proliferation of the word, and yet he noted that *jiyu* (and any other Japanese word) failed to capture the precise meaning of liberty. According to the contemporary usage, *jiyu* signified "selfishness," "arbitrariness," and "emancipation of human desire"—in a word "license." The moral connotation of *jiyu* was rather negative. Some maintain that the notion of *jiyu* is rooted in the Taoist idea of formless but freely moving spirit, while others see its affinity to the National Learning (*kokugaku*) emphasis on human desire, as the novelist and poet Ihara Saikaku (1642–1693) once wrote: "Humans are the desires with four

limbs.” The first translators’ concern with possible misunderstanding and misconceptions soon became real: although *jiyu* became a buzz word in the 1880s when the Freedom and People’s Rights Movement (*jiyu minken undo*) reached its height, the majority of intellectuals and political leaders who supported the movement grasped *jiyu* in terms of “license.” Consequently liberalism was considered to be a licentious ideology.

The leaders of the Japanese Enlightenment often understood the concept of *jiyu* in connection with the independence of their country as a nation state. The liberty and independence of the state were the focus of debate, whereas civil liberties often escaped the attention of intellectuals. The indifference to civil liberties forms the background to the state’s oppression of free speech and academic enquiry. In 1919, Morito Tatsuo (1888–1984), of the Faculty of Economics in Tokyo Imperial University, published an article on the social thought of the anarchist Pyotr Kropotkin (1842–1921), and the authorities filed charges against him and the editor of the journal that published the paper. Morito was expelled from the university and imprisoned. Minobe Tatsukichi (1873–1948) of the Faculty of Law at Tokyo Imperial University was known for his view that the emperor was an organ of the state. In 1935, his “organ theory,” which had gained wide support in the academic community, suddenly became the object of public condemnation. Minobe was compelled to resign from the Membership of the House of Peers, and his books were banned and burned. These incidents did not merely represent the state’s oppression of intellectual freedom, but also reflected the public’s skepticism toward the mistranslated “liberty.” The widespread confusion of *jiyu* with license had prevented the Japanese from appreciating the value of civil liberties, and heavily discredited liberalism until Japan’s disastrous defeat in 1945.

See also **Autonomy; Enlightenment; Equality; Human Rights; Liberalism; Sovereignty; State, The.**

BIBLIOGRAPHY

- Angle, Stephen C. *Human Rights and Chinese Thought: A Cross-Cultural Inquiry*. Cambridge, U.K.: Cambridge University Press, 2002.
- Berlin, Isaiah. *Four Essays on Liberty*. Oxford: Oxford University Press, 1969.
- Bhattacharjee, G. P. *Evolution of Political Philosophy of M. N. Roy*. Calcutta: Minerva Associates, 1971.
- Black, Antony. *The History of Islamic Political Thought from the Prophet to the Present*. Edinburgh: Edinburgh University Press, 2001.
- Coleman, Janet. *A History of Political Thought from Ancient Greece to Early Christianity*. Oxford: Blackwell, 2000.
- . *A History of Political Thought from the Middle Ages to the Renaissance*. Oxford: Blackwell, 2000.
- Constant, Benjamin. *Political Writings*. Translated by Biancamaria Fontana. Cambridge, U.K., and New York: Cambridge University Press, 1988.
- de Bary, Wm. Theodore, and Weiming Tu, eds. *Confucianism and Human Rights*. New York: Columbia University Press, 1998.
- Ghoshal, U. N. *A History of Indian Political Ideas: The Ancient Period and the Period of Transition to the Middle Ages*. Oxford: Oxford University Press, 1966.
- Gray, John. *Isaiah Berlin*. London: HarperCollins, 1994.
- Harding, Alan. “Political Liberty in the Middle Ages.” *Speculum* 55 (1980): 423–443.
- Hourani, Albert. *Arabic Thought in the Liberal Age, 1798–1939*. Cambridge, U.K., and New York: Cambridge University Press, 1983.
- Howland, Douglas. *Translating the West: Language and Political Reason in Nineteenth-Century Japan*. Honolulu: University of Hawai’i Press, 2002.
- Lewis, Bernard. *The Emergence of Modern Turkey*. 3rd ed. Oxford: Oxford University Press, 2002.
- . *The Political Language of Islam*. Chicago: University of Chicago Press, 1988.
- Mill, John Stuart. *On Liberty, with The Subjection of Women, and Chapters on Socialism*. Edited by Stefan Collini. Cambridge, U.K.: Cambridge University Press, 1989.
- Miller, James. *Rousseau: Dreamer of Democracy*. New Haven: Yale University Press, 1984.
- Parel, Anthony J., ed. *Gandhi, Freedom and Self-Rule*. Lanham, Md.: Lexington Books, 2000.
- Pelczynski, Zbigniew, and John Gray, eds., *Conceptions of Liberty in Political Philosophy*. London: Athrone Press, 1984.
- Pettit, Philip. *Republicanism: A Theory of Freedom and Government*. Oxford: Clarendon Press, 1997.
- Rawls, John. *A Theory of Justice*. Cambridge Mass.: Belknap Press, 1971.
- Raz, Joseph. *The Morality of Freedom*. Oxford: Clarendon Press, 1986.
- Schwartz, Benjamin. *In Search of Wealth and Power: Yen Fu and the West*. Cambridge, Mass.: Belknap Press, 1964.
- Skinner, Quentin. *Visions of Politics*. 3 vols. Cambridge, U.K., and New York: Cambridge University Press, 2002.
- Taylor, Charles. “What’s Wrong with Negative Liberty?” In *Philosophical Papers 2: Philosophy and the Human Sciences*. Cambridge, U.K.: Cambridge University Press, 1985.
- Tierney, Brian. *The Idea of Natural Rights: Studies on Natural Rights, Natural Law, and Church Law, 1150–1650*. Atlanta: Scholars Press, 1997.
- Tully, James. *An Approach to Political Philosophy: Locke in Contexts*. Cambridge, U.K.: Cambridge University Press, 1993.
- Wakabayashi, Bob Tadashi, ed. *Modern Japanese Thought*. Cambridge, U.K.: Cambridge University Press, 1998.
- Wood, Neal. *Cicero’s Social and Political Thought*. Berkeley and Los Angeles: University of California Press, 1988.

Takashi Shogimen

LIFE. Throughout recorded history human beings have recognized the qualitative difference between the living and non-living worlds, the animate and inanimate. Placing that recognition on solid, rational footing or giving it a quantitative basis has remained a major challenge, however. What exactly makes a living being so different from one that is nonliving? Living organisms carry out oxidation, for example, but so does a candle when it burns; living organisms grow from some sort of seedlike beginning to a larger form, but so does a crystal in a supersaturated solution; some organisms move, but others, like plants, do not; organisms reproduce (that is, make copies of themselves), but so do some molecules in the chemical process known as autocatalysis; viruses, probably the most confusing of all forms of matter in this regard, can enter living

cells, reproduce themselves, break out of the cell, and infect other cells, yet they can also be crystallized and placed on a shelf for decades, only to become reactivated when placed in a solution in contact with host cells. In short, no single criterion or set of behaviors can unequivocally be said to distinguish living from nonliving matter. Yet there is also little doubt in most cases when we encounter a living organism. Life is characterized by a whole set of activities or functions, no one of which is unique but which collectively set living organisms apart from other physical entities.

In the history of Western thought, attempts to define life have been characterized by a series of alternative or dialectically opposed approaches that have reflected changing philosophical, cultural, and economic conditions. These alternative approaches will be described briefly and then applied to various aspects of the characterization of life.

Idealist versus Materialist Conceptions of Life

One of the oldest debates about the nature of life centered on whether living organisms functioned by means of a nonphysical process that lay outside material nature and therefore could not be fully understood by rational investigation or whether they could be understood in terms of everyday natural processes. The view that dominated the ancient and medieval worlds, known philosophically as idealism, claimed that living beings were qualitatively different from nonliving, representing a special set of categories whose “essence” existed only in the mind of the Creator. Associated particularly with the philosophy of Plato (c. 428–348 or 347 B.C.E.), this idealistic perspective claims that rational understanding of the essence of life is philosophically impossible, since by definition the categories of each unique species exist not in the material world but only in the nonmaterial, essentialist categories conceived by the Creator. Idealists did not deny the material reality of living organisms but only claimed that the essence of living organisms could never be understood by human investigation. Most idealists saw life as originating from a special, supernatural process of creation by a nonmaterial being.

The diversity of living organisms observed in the world was always viewed as a product of the creation of separate essences known as species, which were absolute and immutable. The biologist’s role was to try to understand the essence as much as possible by examining individual representatives of the species and determining their common or essential features. Variation among individual members of a species was recognized of course but was viewed as natural deviations from the “essence” in the same way that any given piece of pottery can be viewed as a deviation from the potter’s mold. The Platonic tradition thus became the basis for the Western idealistic view of “life” in the biological sense, informing questions not only about the functionality of organisms but also about their origin.

Idealism continued to form a backdrop to discussions of the nature and origin of species in the eighteenth and nineteenth centuries in the works of the taxonomist Carolus Linnaeus (Carl von Linné; the so-called “father” of taxonomy), the anatomist and paleontologist Georges Cuvier, and others who continued to see species as fixed entities formed by special creation. The

“scientific creation” movement in the United States in the 1970s and 1980s and “intelligent design” arguments in the early twenty-first century are yet more manifestations of idealistic thinking, because they are based on the claim that creation by supernatural (nonmaterial) processes has occurred and is as theoretically valid as theories of descent with modification by material processes, such as gene mutation, selective agents of the environment, and differential fertility. “Intelligent design” is idealistic in that it postulates a supernatural, nonmaterial “designer” to explain the structure, function (adaptation), and diversity of organisms.

A second approach to understanding life, known as materialism, denies that living organisms have any special status in the physical world, maintaining that they are material beings, more complex than other entities in the universe but not immune to rational study. To materialists, all aspects of living organisms can potentially be understood by the same processes—known at present or knowable in the future—that govern all physical systems. Materialists have generally rejected all accounts of the origin of life by supernatural processes or nonmaterial “Creators.” Historically the study of living systems has been characterized by the gradual retreat of idealistic in favor of materialistic approaches to understanding the nature of life.

Mechanistic materialism. A long-standing debate among materialists has concerned whether and to what degree it is possible to treat organisms as simply special, complex kinds of machines or whether they are qualitatively different from machines, due to characteristics such as the ability to self-replicate or repair themselves, control their internal environment by self-regulating feedback loops, and so on. Mechanists argue that the basic principles on which machines function—matter in motion, transformation of energy, chemical reactions—are also at work in living organisms and provide a way of understanding life in accordance with the same laws of physics that govern nonliving systems.

Proponents of mechanistic thinking advocate the idea that complex entities are composed of separate, dissociable parts; that each part has its own characteristics that can only be investigated separately from other parts; that the functioning of the whole organism or machine is a result of the sum of its interacting parts and nothing more; and finally, that changes in the state of a machine or organism are the result of factors impinging on it from the outside (for example, machines and organisms decline in function due to physical wear and tear over time).

With the advent of the scientific revolution in the sixteenth and seventeenth centuries, living organisms came to be seen for the first time as truly mechanical entities functioning physically like machines and chemically like alchemical retorts. The “mechanical philosophy,” as it was called, was a version of mechanistic materialism, describing organisms in terms of levers, pulleys, and chemical combustions. William Harvey (1578–1657) compared the animal heart to a pump, with valves to insure one-way flow; Giovanni Borelli (1608–1679) described flight in birds as the compression of a “wedge” of air between the wings as they moved upward; and René Descartes (1596–1650) described the contraction of muscles as due to a hydraulic flow of “nervous fluid” down the nerves

into the muscle tissue. This view persisted through the Enlightenment, which made the mechanical analogy explicit in its obsession with “automata,” models of birds, insects, and humans that moved by a series of windup gears and levers, drank from dishes of water, flapped their wings, or crowded.

In the nineteenth and twentieth centuries mechanistic views again gained considerable support with the school of Berlin medical materialists, spearheaded by the physicist Hermann von Helmholtz (1821–1894). In a famous manifesto of 1847, Helmholtz and his colleagues Ernst Brücke and Emil Du Bois-Reymond stated emphatically that living organisms have no special “vital force,” and thus research on organisms should be based only on the known laws of physics and chemistry. Life was, to the medical materialists, a manifestation of matter in motion. Their successor in the next generation, the German-born physiologist Jacques Loeb, after moving to the United States published a new version of the materialists’ manifesto as the widely read book *The Mechanistic Conception of Life* (1912). With a blatant mechanistic, materialist bias, Loeb declared that organisms moving unconsciously toward a light source were “photochemical machines enslaved to the light” and that life could ultimately be explained in terms of the physical chemistry of colloidal compounds. Though somewhat extreme, such claims emphasized that the biologist needed to probe “life” with the tools of physics and chemistry, not abstract or metaphysical conceptions.

Holistic materialism. Opposed to the mechanistic view is a philosophy known as holism. While some forms of holism, especially in the early twentieth century, had a mystical, idealistic quality about them (associated in particular with Ludwig von Bertalanffy [1901–1971] and Jakob von Uexküll [1864–1944] in Germany and Pierre Teilhard de Chardin in France), holistic views within a materialist framework have become more and more common since the 1960s. The holistic materialist view maintains that while organisms (or any complex systems, for that matter) are indeed only material entities, they acquire special properties by virtue of their multiple levels of organization (from the atomic and molecular to the organismic and population) and through the interactions of their parts.

What is missing from the mechanistic view, to holistic thinkers, is the description of each component of a system in terms not only of its isolated properties but also of its interactions with others. The characteristics derived from such interactions are known as “emergent properties” and function at a higher level of organization (including the parts and their interactions) than the individual parts alone. A cell can carry out certain functions in isolation (in a culture dish), but the many different functions it carries out as part of a tissue (a group of like cells) represent a higher level of organization. Individual nerve cells, for example, can depolarize when stimulated and release neurotransmitters at their terminal ends, thus acting like neurons; but when integrated into a nerve network, they function to stimulate a whole set of other neurons that can lead to complex outcomes, such as coordinated muscle contraction or thought, which would be emergent properties of the complex, integrated system. Holistic materialists do not admit supernatural or metaphysical explanations, only the

insistence that complex systems are more than the sum of their individual parts.

Dialectical materialism. A particular version of holistic materialism known as dialectical materialism emerged in the later nineteenth century in the work of Karl Marx (1818–1883) and Friedrich Engels (1820–1895) and was further developed in the twentieth century by Karl Kautsky (1854–1938) and Gyorgy Plekhanov (1856–1918) in the Soviet Union and J. B. S. Haldane (1892–1964) and others in Britain and subsequently by Richard Lewontin and Richard Levins (*The Dialectical Biologist*; 1985) in the United States. Dialectical materialists maintain not only that the whole is greater than the sum of its parts and that complex systems have various levels of organization, each with its own emergent properties, but also that such systems are always in flux, changing dynamically due to the interaction of opposing forces within them. Thus organisms move developmentally through their life cycle in a constant struggle between the opposing forces of anabolism (building up of molecules, tissues) and catabolism (the breaking down of molecules and tissues). Ultimately the forces of catabolism win out, and death follows. Similarly evolution can be seen as change in a species over time due to the interaction of the opposing forces of heredity (faithful replication) and variation (unfaithful replication). Constant temperature in homoeothermic organisms is maintained by the interaction of heat-generating and heat-dissipating processes. A dialectical materialist view of life particularly emphasizes the dynamic, ever-changing nature of living systems.

Holistic approaches to “life”—dialectical or otherwise—have become increasingly prominent in certain areas of the life sciences since the 1980s, for example, in physiology (especially the study of homeostatic feedback systems), in neurobiology (brain and behavior in particular), and in population biology and ecosystems work, where any useful understanding of the system must take into account numerous variables and their interactions. The advent of the computer in the study of such systems has aided greatly in providing ways of handling the immense amount of data that such investigations must utilize. Growing out of this revived holistic movement is an increasingly prominent field known as “systems science” or in some quarters as “the study of complexity.”

Methodological Debates about the Study of Life

A corollary of the philosophical contrast between mechanistic and holistic materialist conceptions of life is the distinction between reductionist and integrative methodologies. Reductionism, closely allied to mechanistic materialism, is the view that the proper way to study organisms is to take them apart and examine and characterize their individual components in isolation under strictly controlled external conditions. For example, to study the way in which the heart functions, a reductionist would remove the organ from the body and place it in a chamber where temperature, pH, and concentration of other ions could be held constant. Integrative biologists argue that the reductionist approach is a necessary if insufficient approach to understanding complex systems. The heart in the intact animal, they point out, is connected to nerves, blood vessels, and other organs and thus is subject to neural and

hormonal influences that cannot be understood from investigation of the heart in an isolated chamber. According to proponents of holism, it is necessary to devise methods for studying component parts in the living state, in the context of the whole organism of which they are a part (*in vivo*), as opposed to studying them only as isolated entities (*in vitro*).

A component of the methodological debate between reductionism and holism is the debate between the strictly observational and the experimental approach to living systems. Proponents of strictly observational studies, such as the Austrian animal behaviorist Konrad Lorenz (1903–1989) from the 1930s to the 1960s, argue that living systems must be studied in their natural context and that when experimenters bring organisms into the laboratory under highly artificial (controlled) conditions, they create an environment so foreign to the organisms that the information obtained is an artifact and of limited use. In contrast, proponents of experimentation, such as the behaviorist Daniel Lehrman, point out that restricting investigations to only what can be observed under “natural” conditions limits the kinds of questions the investigator can ask and the kinds of information that he or she can obtain. Such debates have surfaced in fields such as ecology, evolution, and animal behavior, where field investigators have often claimed that laboratory conditions are so different from those the organisms experience in the wild that the information obtained can have little relevance to how the organism functions in its natural habitat. Experimentalists argue that those who limit their work strictly to field observation have no ways to test their theories and consequently can never develop a rigorous, scientific explanation. Of course as many scientists and philosophers have pointed out, the approaches, like those of reductionism and holism, are actually complementary. Nonetheless, debates on reductionism and holism, observation and experimentation, have continued to resurface and influence the development of biology down to the twenty-first century.

Unity and Diversity in Living Organisms

Another important aspect of life is its vast diversity built on a base of underlying unity. For example, organisms as outwardly dissimilar as a bacterium, a human, and an oak tree are all composed of the same basic structural element, the cell, which in turn have many similar subcellular and molecular components. All eukaryotic cells (those cells of higher organisms that have a membrane-bound nucleus) contain mitochondria (organelles that carry out oxidation and thus provide energy), Golgi apparatus (a membrane system involved in packaging newly synthesized proteins), endoplasmic reticulum (a complex system of internal membranes), and ribosomes (small structures that form the site of protein synthesis). Simpler cells known as prokaryotes (bacteria, blue-green algae, and so forth), while lacking mitochondria and other organelles, contain ribosomes and share all the basic molecular infrastructure with eukaryotes. For example, both prokaryotes and eukaryotes have their hereditary information encoded in the molecule of deoxyribonucleic acid (DNA), transcribe that message into messenger RNA (mRNA), and translate that message into proteins in exactly the same ways. Furthermore the language in which the DNA code is written is the same in all organisms: as a triplet in which specific sequences of three out of four possible bases (adenine, thymine, guanine, and cytosine) specify

each of the twenty amino acids that make up all proteins in the living world. Thus beneath apparent diversity lies a major infrastructure of unity. How to interpret this obvious contradiction has motivated a wide variety of views of the nature of life since at least the early twentieth century.

The Molecular and Biochemical View of Life

Deriving from the reductionism-holism debate, an important issue from the 1930s onward has been the extent to which living systems are ultimately reducible to molecules and chemical reactions. Biochemical definitions of life surfaced in the late nineteenth century with the discovery of enzymes as “living ferments” and became particularly prominent during the heyday of biochemical work (in England and Germany from 1920 to 1939) on enzyme-catalyzed pathways for synthesizing or degrading the major molecules in living systems. Many biochemists, flushed with success in elucidating the multistep pathways for fermentation or oxidation, attempted to define life in terms of enzyme catalysis. They held that what differentiated living from nonliving systems was the rapidity with which enzyme-catalyzed reactions and energy conversions could take place and the precision with which they could be controlled. The cell, one biochemist argued, is nothing more than a bag of enzymes. The biochemical view of life paid little if any attention to cell structure and organization, focusing almost exclusively on metabolic pathways, their interconnections, reaction kinetics, and energetics.

In the decades following the working out of the double helical structure of DNA by James D. Watson and Francis Crick in 1953, the biochemical definition of life was replaced by, or encompassed within, what came to be called the molecular view of life. The molecular view was more comprehensive than the biochemical, including the study of the three-dimensional structure of molecules, such as hemoglobin and myoglobin, and attention to cell structure and its relation to function, using techniques such as electron microscopy, ultracentrifugation, electrophoresis, fluorescence dyeing, and later confocal microscopy. Paradigmatic along these lines were detailed investigation of the structure of hemoglobin, the oxygen-carrying molecule in animal blood, and the discovery of its allosteric changes (positional shifts) in structure as it alternately bonds to and releases oxygen. The molecular and biochemical views of life tended to be highly reductionist, seeing life as merely a manifestation of molecular structure. Nonetheless, the molecular view did emphasize the importance of understanding life in terms of molecular configurations and the ways various molecules interacted chemically in such living processes as respiration, photosynthesis, protein synthesis, cell-to-cell communication, and signal transduction (the way a cell responds internally to receiving a specific message from the outside).

A particularly prominent aspect of the biochemical and molecular views of life has been the field of abiogenesis or the origin of life. Beginning with the work of the Russian biochemist A. I. Oparin (1894–1980) in the 1930s through that of Sidney Fox (1912–2001) from the 1950s to the 1990s, Stanley Miller in the 1950s, and Cyril Ponnampereuma in the 1970s, investigations as to how living systems might have originated on the primitive earth (or other extraterrestrial bodies) have gained considerable attention. Oparin showed that simple globular

formulations that he called coacervates (formed from gum arabic and other organic substances in an aqueous medium) could perform simple functions analogous to living cells (movement, fission). Miller's experiments in the early 1950s demonstrated that basic amino acids, sugars, and other organic compounds (formic acid, urea) could be produced from components of what was hypothesized to have been the earth's early atmosphere (ammonia, carbon dioxide, water vapor, and hydrogen), thus giving credence to the view that life could indeed have originated on earth by simple biochemical processes. Later work of Fox and others on how the basic building blocks of organic matter (amino acids, simple sugars, nucleotides, and glycerides) could have become organized into macromolecules and basic cell structures showed that the origin of the next level of organization up from the molecule, the cell and its components, could be studied by experimental means. These investigations gave considerable support to the view that life is truly an expression, though an emergent one, of the basic properties of all matter, as understood through the analysis of atomic and molecular structure.

See also *Behaviorism; Biology; Creationism; Determinism; Development; Ecology; Evolution; Historical and Dialectical Materialism; Life Cycle; Materialism in Eighteenth-Century European Thought; Natural History; Nature; Naturphilosophie; Organicism; Science, History of; Sexuality; Suicide.*

BIBLIOGRAPHY

- Allen, Garland E. "Dialectical Materialism in Modern Biology." *Science and Nature* 3 (1980): 43–57.
- . *Life Science in the Twentieth Century*. New York: Wiley, 1975.
- Bertalanffy, Ludwig von. *Problems of Life*. New York: Harper, 1960. Translation of vol. 1 of *Das Biologische Weltbild* (1949).
- Coleman, William. *Biology in the Nineteenth Century: Problems of Form, Function, and Transformation*. New York: Wiley, 1971.
- Fru-ton, Joseph S. *Proteins, Enzymes, Genes: The Interplay of Chemistry and Biology*. New Haven, Conn.: Yale University Press, 1999.
- Hall, Thomas S. *Ideas of Life and Matter*. 2 vols. Chicago: University of Chicago Press, 1969.
- Harrington, Anne. *Reenchanted Science*. Princeton, N.J.: Princeton University Press, 1996.
- Lenoir, Timothy. *The Strategy of Life: Teleology and Mechanism in Nineteenth-Century German Biology*. Dordrecht, Netherlands: Reidel, 1982.
- Mayr, Ernst. *The Growth of Biological Thought*. Cambridge, Mass.: Belknap Press, 1982.
- Oparin, A. I. *Life: Its Nature, Origin, and Development*. Translated by Ann Sygne. New York: Academic Press, 1961.

Garland E. Allen

LIFE CYCLE.

This entry includes three subentries:

Overview

Adolescence

Elders/Old Age

OVERVIEW

The Sphinx, according to an ancient Greek tale, was a monster with the face of a woman, the body of a lion, and gigantic wings. Sent by the goddess Hera to punish the city of Thebes, she sat on a hilltop and stopped passersby, posing them a riddle: "What has one voice, and is four-footed, two-footed, and three-footed?" Every time the Thebans gave a wrong answer, she devoured one of them—including Haemon, the king's son. Only Oedipus, a stranger traveling through town, was able to give the correct answer: "Man."

The riddle makes allusion to the life-cycle: man travels "four-footed" (i.e., on hands and knees) as an infant, on two feet as an adult, and "three-footed" (with the aid of a cane) in old age. To solve it, it is necessary to think of a man both as a singular individual—with "one voice"—and as a being who changes form over time. Apparently the puzzle was widely known in the ancient Mediterranean, a bit of folk wisdom that gradually made its way into Oedipus's tale. (It is not to be found in written versions before 600 B.C.E., including that of Hesiod [fl. c. 700 B.C.E.]) Its depiction of a normative life course casts an oblique shadow over Oedipus's own, for by solving the puzzle and reclaiming the king's prize—his own mother as a bride—he twists the normal sequence of the generations into grotesque and tragic form.

The notion of the life cycle, then—that there are stages in life through which every individual must pass—is old and widespread. And, as in this tale, it is both descriptive and prescriptive: It describes inevitable physiological changes that are readily observable in humans as in all living things, but it also suggests that one ought to move through life in a certain prescribed manner. This dual meaning can be found in examples far removed in time and space from Oedipus, as for example in two of the greatest examples of early American literature: *Primeros Memoriales*, written in Nahuatl in Mexico by Bernardino de Sahagún (1499–1590) between 1558 and 1561, and *Nueva corónica y buen gobierno*, completed by Felipe Guaman Poma de Ayala (1538?–1620?) in Peru in 1615 and likewise primarily written in a Native American language, Quechua. Each of these books is an act of cultural translation that presents an imperial society of the Americas—Aztec and Inca, respectively—as their authors wish Spanish readers to see them. In each of them, we find detailed, carefully illustrated presentations of the stages of human life. Guaman Poma depicts first ten stages of a man's life, then ten stages of a woman's; curiously, he begins each with the adult in his or her prime, which he calls the "first road"; he then progresses through to old age, then lists in reverse order the four stages of youth, ending with infancy. Sahagún likewise depicts women and men in separate but equivalent sequences; and his Nahuatl informants, like Guaman Poma, emphasize productive labor more than simple physiological change. At each point except for the very beginning and the very end, women and men are shown performing the work appropriate to their time of life. For women in both empires, these stages are defined in terms of textile production, with adult women weaving at looms, while youngsters and the elderly spin. This emphasis upon work—possibly intended to show the contributions that citizens were expected to make to the state—underlines the normative quality of the

concept of the life cycle; Sahagún's artists and writers also passed judgment on leisure activities, indicating that while drunkenness and idleness were acceptable in the old, they were to be condemned in the young. In European art, the moralizing version of the life cycle can be seen in the series of engravings by William Hogarth (1697–1764), “The Harlot's Progress” (1732) and “The Rake's Progress” (1735)—humorous visions of the life sequence gone awry.

But of course, the life cycle can also be seen not as a set of expectations, but as an inevitable and even a tragic fate. This vision of the life course often emphasizes the notion of the life course as a cycle: that is, as occurring within a circular, natural form of time rather than the linear historical time invented by humans. As such, it often calls upon metaphors from nature, such as the seasons of the year; and in turn, it becomes a metaphor for the life of a society or an empire, which like the human body may be born, grow, mature, sicken, and die. Although it employs few metaphors from nature, a classic evocation of the life cycle as a circle is to be found in *As You Like It* by William Shakespeare (1564–1616), first performed in 1599 and first published in 1623. The famous soliloquy spoken by Jaques that begins “All the world's a stage” presents seven stages in the life of man, with the end marking a return to the beginning:

All the world's a stage,
 And all the men and women merely players:
 They have their exits and their entrances;
 And one man in his time plays many parts,
 His acts being seven ages. At first, the infant,
 Mewling and puking in the nurse's arms.
 And then the whining schoolboy, with his satchel
 And shining morning face, creeping like a snail
 Unwillingly to school. And then the lover,
 Sighing like a furnace, with a woeful ballad
 Made to his mistress' eyebrow. Then a soldier,
 Full of strange oaths and bearded like the pard,
 Jealous in honour, sudden and quick in quarrel,
 Seeking the bubble reputation
 Even in the cannon's mouth. And then the justice,
 In fair round belly with good capon lined,
 With eyes severe and beard of formal cut,
 Full of wise saws and modern instances;
 And so he plays his part. The sixth age shifts
 Into the lean and slipper'd pantaloon,
 With spectacles on nose and pouch on side,
 His youthful hose, well saved, a world too wide
 For his shrunk shank; and his big manly voice,
 Turning again toward childish treble, pipes
 And whistles in his sound. Last scene of all,
 That ends this strange eventful history,
 Is second childishness and mere oblivion,
 Sans teeth, sans eyes, sans taste, sans everything. (2.7.139)

In art, literature, and mythology, then, the life cycle is a powerful theme, played both for comedy and tragedy. With the modern emergence of the social sciences, this concept has continued to fascinate and trouble scholars because of its dual grounding in nature and culture. On the one hand, childhood,

maturity, and old age are physiological processes that most humans will experience; on the other hand, cultural norms and expectations about what these phases mean and how they should be lived—and even whether the stages of childhood and adolescence are distinct from adulthood—vary tremendously across time and space. Each of these periods, childhood, adolescence, and old age, has given rise to its own social science literature. Within each, debates about what, if anything, is transhistorical and what must be seen only within its own cultural context have provided lively and stimulating conversations, as exemplified by the tremendous public attention accorded to Margaret Mead's *Coming of Age in Samoa* (1928) and Philippe Ariès' *Centuries of Childhood: A Social History of Family Life* (1962), two of the best-known examples of works that challenged prevailing conceptions about our experience of the life cycle.

See also *Cycles; Life Cycle: Adolescence; Life Cycle: Elders/ Old Age.*

BIBLIOGRAPHY

- Ariès, Philippe. *Centuries of Childhood: A Social History of Family Life*. Translated by Robert Baldick. New York: Knopf, 1962.
- Guaman Poma de Ayala, Felipe. *Nueva corónica y buen gobierno*. Caracas, Venezuela: Biblioteca Ayacucho, 1980.
- Mead, Margaret. *Coming of Age in Samoa*. New York: Morrow, 1928.
- Sahagún, Bernardino de. *Primeros Memoriales*. Norman: University of Oklahoma Press, 1993.

Mary J. Weismantel

ADOLESCENCE

Many social historians have argued that *adolescence* emerged as a distinct life stage only with the advent of industrialization. Using case studies from regions where the historical record is plentiful, such as France, England, and the United States, scholars contend that prior to the industrial revolution, the physical processes of maturity did not necessarily signal a change in life status for the individual. Rather, adolescence as a distinctive stage in the life course emerges only in societies where certain social characteristics are present. While the processes are complex, in general the characteristics include the formation of an indeterminate period of “dependence” on parents that occurred most often in urbanizing areas where old rules about land inheritance and marriage were obsolete, child labor was unnecessary or of questionable value, and where investing in children's education became profitable. Noting that prior to the mid-nineteenth century there was no word for “adolescence,” historians point out that words such as “child” might be used to encompass children as young as eight or as old as nineteen or, in the transition stages prior to industrialization, the word *youth* often referred to semi-independent unmarried children who were often removed from their parents' homes to work on large estates. While the concept of adolescence first emerged among the middle classes (those who could afford to send children to school and not to the sweatshop), by the end of the nineteenth century, adolescence had become “democratized” (Gillis) in western societies, and teenagers of all social classes were experiencing this life stage.

Conceptualizing Adolescence

While the necessary link between industrialization and a life stage of adolescence is debatable (see Schlegel below) what is clear is that by the twentieth century the term *adolescence* and the understanding that it represents a life stage that is distinct from both childhood and adulthood was thoroughly embedded in European and North American thinking. Usually linked to the years just after puberty and before marriage, adolescence was not only seen as a unique and distinctive life stage but it was identified as one that posed particular problems and concerns. In 1904 the psychologist G. Stanley Hall published a two-volume set succinctly titled *Adolescence* that attempted to set forth current theories about this “vast and complex theme” (Hall, p. xix). While Hall’s work on adolescence was nothing if not prodigious, his most controversial claim was essentially that “ontogeny recapitulates phylogeny” or, in other words, that the psychic development of each individual mirrors and re-creates the evolutionary stages of the species. If this is true, then the behaviors associated with adolescence, which at the time were often referred to as filled with “storm and stress,” were rooted in nature and therefore were assumed to be universal. Hall’s theories on adolescence, and in particular his concern for describing it as a universal stage of human development, were inspired in part by popular theories of the age concerning both physical and social evolution. Indeed, Hall claims in the concluding chapter of his second volume that “savages” “in most respects are children, or, because of sexual maturity, more properly, adolescents of adult size” (Hall, vol. 2, p. 649).

For several decades before and after the publication of Hall’s *Adolescence*, social theorists were interested in developing ways to incorporate evolution as a conceptual tool for understanding human behavior and cultural difference. Most of their arguments centered on two interconnecting themes: how cultural and social differences could be explained through an evolutionary model; and how much of human behavior could be explained by evolutionary inheritance, or biology. Both of these themes easily qualify as “racist” by twenty-first-century standards, with their emphasis on white, Western civilization (and behaviors) as the apex of social evolution, while “primitive” societies or “races” were held to represent “earlier” stages along the evolutionary trajectory.

By the early decades of the twentieth century, evolutionary theories dominated the social sciences and influenced social policies through ideas such as eugenics. In anthropology, human societies were described as following “natural” laws and many believed that the “history of mankind is the history of nature” (Stocking, 1968, p. 116). A leading theorist of the time, E. B. Tyler, argued both for delineating how different societies could be understood as models of the different stages of a unilinear evolutionary process, and for the concept of the “psychic unity of mankind” (p. 115), which claimed that humans share an evolutionary history and therefore a uniform “nature.” Human nature, therefore, was inextricably linked to biology.

Anthropological Critique

The most important anthropological critique of the social evolutionary model came from Franz Boas, who published *The*

Mind of Primitive Man in 1911. Boas used extensive ethnographic data to make an argument for the separation of culture from biological determinism and the importance of diffusion, rather than evolution, in the formation of cultural traits. Boas became best known for the concept of “cultural relativism,” which argues against judging a culture by outside standards. As he states in the conclusion of *The Mind of Primitive Man*, “Then we shall treasure and cultivate the variety of forms that human thought and activity has taken, and abhor, as leading to complete stagnation, all attempts to impress one pattern of thought upon whole nations or even upon the whole world” (1932 ed., p. 272). Over time, Boas attracted a wide range of students who studied with him at Columbia University and by the 1920s his theory that culture is historically created, not evolutionarily structured, became the dominant paradigm in American anthropology.

By 1924 Boas had successfully argued for the importance of cultural diffusion—the sharing of ideas between cultures—as an important mechanism of culture change, but he was still looking for ethnographic data to demonstrate how culture specifically influences the psychological development of individuals and creates distinctive patterns of behavior. In particular, Boas decided that a study of adolescence would be a useful way to demonstrate how culture, not nature, patterns human behavior. He chose one of his young graduate students, twenty-three-year-old Margaret Mead, to conduct a study in Samoa; her assignment was to determine whether adolescence was filled with the same troubles in the South Seas as it was in America. Mead was trained in psychology and she knew Hall’s work well. As she explains in her book *Coming of Age in Samoa* (1928), she embarked on that research to answer the question: “Are the disturbances which vex our adolescents due to the nature of adolescence itself or to civilization?” In other words, what takes primacy? Nature or nurture?

While Mead did not overly concern herself with defining “adolescence,” it is clear from many of her conclusions that she closely associates adolescence with the years directly surrounding puberty; nevertheless, her conclusion that “there are no great differences” between girls in adolescence and those about to enter it or who have just left it, downplays its significance as a Samoan life stage. Noting the general “casual” nature of Samoan society, Mead argued that adolescence is not filled with “storm and stress” but rather this was a period of orderly maturing interests and activities (1961 ed., p. 157). Maturing girls in Samoa had few restrictions placed on their sexual encounters, few judgments passed on the behaviors, and negligent pressure to prepare for an unseen future. This, she argued, created an adolescence that was peaceful and enjoyable. Comparing the United States to Samoa, Mead noted that American youths “grow up in a world of dazzling choices” and that all choices are “the half-ripened fruit of compromise” (p. 205). Addressing educators directly, Mead used her Samoan research to call for changes in the expectations and pressures put on American adolescents.

Mead’s book, which was intentionally written for the “educated layman,” became a best-seller and positioned Mead to become one of the most important and influential voices in

American anthropology, and in American society, for the next five decades. Among Mead's most noteworthy contributions were her works on childhood (*Growing Up in New Guinea*, 1930) and gender roles (*Sex and Temperament in Three Primitive Societies*, 1935) both of which continued the argument that cultures create patterns of behaviors in consistent and holistic ways.

Mead's conclusions about the role that culture plays in shaping the experience of adolescence were never seriously challenged until 1983 when Derek Freeman, an Australian anthropologist, wrote *Margaret Mead and Samoa: The Making and Unmaking of an Anthropological Myth*. Freeman, who studied Samoa, albeit several decades after Mead, argued that Mead was a "cultural determinist," who ignored any ethnographic evidence that did not support her contention that culture (not biology) is primarily responsible for human behavior. Freeman argued that adolescence was in fact stressful in Samoa and defended an "interactionist" perspective that interpreted behavior as a result of the intersection of biology and culture. Freeman's book sparked controversy both in anthropology and outside because it directly attacked Mead's evidence but also because it attempted to reinvigorate the nature/nurture debates that had remained relatively sidelined in cultural anthropology. Mead was dead by the time Freeman's book was published so could not defend her own work. However, her reputation, which was only partially constructed from her early work, was never seriously in jeopardy.

By 2000 the dust had settled, with no one on either side effectively convincing the other of the truth of their sides' claims. Given the importance, or at the very least, the prominence of Margaret Mead in the development of American anthropology, it is paradoxical that the study of adolescence in anthropology did not flourish at all in the second half of the twentieth century. In fact, it stagnated. While the study of childhood was continued in a limited but impressive fashion (most notably at Harvard), and gender studies blossomed after the 1970s, the systematic study of adolescence all but disappeared in anthropology until the 1990s. While mention might be made of youths or adolescents in longer ethnographic studies, there were no titles in anthropology focusing exclusively on adolescents for several decades. Indeed, even Freeman's attack on Mead was directed toward her conclusions about the primacy of culture in human development, and was never intended as a serious contribution to the study of adolescence. The study of adolescents did not disappear from academia, but was continued by psychologists, child development specialists, historians, and sociologists. Two important sociological studies about teens in America that furthered Mead's general sociocultural orientation were Hollingshead's *Elmtown Youth*, which focused on teenagers in 1942 and 1943, and *Growing Up in River City*, a longitudinal study of teens in the postwar boom.

Contemporary Perspectives

While the approaches to certain questions had been significantly refined by the 1980s and 1990s when anthropologists once again began to study adolescence, these studies can still generally be separated into those that seek to find some

universals across cultures in the adolescent experience, and those studies that attempt to provide in-depth context for "youth" culture in specific places. In the first case, biology or evolution (understood broadly) is assumed to play some role in the experience of adolescence, while in the other, situating cultural contexts is of exclusive concern.

The two dominant voices for the first perspective are Alice Schlegel and Herbert Barry III. Schlegel (an anthropologist) and Barry (a psychologist) published *Adolescence: An Anthropological Inquiry* in 1991. Arguing for an ethological perspective, in their case reflecting upon observations of primate groups to inform questions and buttress conclusions, Schlegel and Barry assume that adolescent behaviors are both "antecedent," that is, linked to earlier socialization and development and "situational"—influenced by the particular conditions of adolescence. Moreover, Schlegel and Barry argue that reproduction, in particular the (often extended) gap between sexual maturity and social adulthood, is a "key issue" in understanding how adolescence is managed and understood cross-culturally. In this view, biology (in the form of sexual maturity and the necessities of reproduction) and culture (which rarely allows for the full assumption of adult roles at puberty) intersect, literally creating this life stage. In their thinking, neither biology nor culture should be given explanatory primacy.

Schlegel and Barry's methodology consists primarily of reviewing existing cross-cultural ethnographic works that discuss adolescence—if only briefly—and coding for a select number of variables. Their statistical analysis of 173 societies for boys and 175 for girls points to both regularities and differences in adolescence across cultures. For example, the authors argue for the universality of the life stage of adolescence and refute the contention that it is linked exclusively to industrialization. They also point out the ways in which adolescence differs for boys and girls within a culture, and the variable degrees of discord in the adolescent period that can exist between them.

The 1990s also saw the emergence of a number of journal articles, edited volumes, and book length ethnographies that focused on adolescence, or "youth culture." The shift in terminology from *adolescence* to *youth culture* is not arbitrary but reflects the growing emphasis on seeing adolescents as producers of culture, not just as individuals awkwardly situated between culturally sanctioned life stages. The term *youth culture* itself is not new and comes from the sociologist Talcott Parsons who argued in 1942 that middle-class American teens lived in a distinctive cultural world. In today's usage, youth culture has come to mean that teens are viewed as social agents who impact their cultures in meaningful ways (Wulff).

Studies of youth culture are diverse and cover a wide range of topics, but they reflect some of the larger concerns of late twentieth and early twenty-first century anthropology. First, they reflect the shift away from viewing culture as holistic and consistent as described by Mead and others, toward an understanding of culture as "contested" and represented by multiple perspectives and voices. Women, minorities, and even youths are fully part of cultures, yet they may have distinctive interpretations and perspectives on that culture, and act upon that culture accordingly. Second, studies of youth culture reflect a

concern for the ways power impacts social organization and cultural expression. Youth are not only influenced by larger societal power structures such as race, class, or gender; they produce, respond to, and manipulate power in different ways (Caputo; Sharp). Finally, youth culture studies are also influenced by anthropology's increasing interests in the processes of globalization and transnationalism (see Kathleen Hall). Teens are often the first to embrace media and technology, they may be the only ones in their migrant families to speak the dominant language or, because of transnational migration, they may find a stunning disjuncture between their experiences as adolescents and the experiences of their parents. "Youth culture" is now seen as responsive and dynamic and worthy of study in its own right.

The study of adolescence in anthropology has been one in which the disciplinary debates between nature and nurture have played out with intense fervor, but also one that represents the fruit of disciplinary cross-fertilization. From the outset, anthropological studies of adolescence have built upon and contributed to debates in multiple disciplines, most especially sociology, psychology, history, and more recently cultural studies. Beginning with Mead, some anthropological work has contributed to public policy debates, most especially in education. While the study of adolescence lay relatively dormant in anthropology for many decades, the resurgence of studies on adolescence such as Schlegel and Barry's signal an attempt to unite divergent perspectives while those on "youth culture" seek to bring the study of young people back to the center of anthropological theorizing.

See also *Diffusion, Cultural; Evolution; Gender*.

BIBLIOGRAPHY

- Boas, Franz. *The Mind of Primitive Man*. Reprint. New York: Free Press, 1938. Originally published in 1911.
- Caputo, Virginia. "Anthropology's Silent 'Others': A Consideration of Some Conceptual and Methodological Issues for the Study of Youth and Children's Culture." In *Youth Cultures: A Cross-Cultural Perspective*, edited by Vered Amit-Talai and Helena Wulff. London and New York: Routledge, 1995.
- Côté, James E. *Adolescent Storm and Stress: An Evaluation of the Mead-Freeman Controversy*. Hillsdale, N.J.: L. Erlbaum, 1994.
- Freeman, Derek. *Margaret Mead and Samoa: The Making and Unmaking of an Anthropological Myth*. Cambridge, Mass.: Harvard University Press, 1983.
- Gillis, John R. *Youth and History: Tradition and Change in European Age Relations, 1770–Present*. New York: Academic Press, 1981.
- Hall, G. Stanley. *Adolescence*. 2 vols. New York: D. Appleton and Company, 1904.
- Hall, Kathleen D. *Lives in Translation: Sikh Youth as British Citizens*. Philadelphia: University of Pennsylvania Press, 2002.
- Havighurst, Robert J., et al. *Growing Up in River City*. New York: Wiley, 1962.
- Hollingshead, August De Belmont. *Elmtown's Youth: The Impact of Social Classes on Adolescents*. New York: Wiley, 1949.
- Mead, Margaret. *Coming of Age in Samoa: A Psychological Study of Primitive Youth for Western Civilization*. Foreword by Franz Boas. Reprint. Morrow, 1961. Originally published in 1928.
- Schlegel, Alice, and Herbert Barry III. *Adolescence: An Anthropological Inquiry*. New York: Free Press, 1991.

Sharp, Lesley A. *The Sacrificed Generation: Youth, History and the Colonized Mind in Madagascar*. Berkeley: University of California Press, 2002.

Stocking, George W. Jr. *Race, Culture and Evolution: Essays in the History of Anthropology*. New York: Free Press, 1968.

———, ed. *The Shaping of American Anthropology, 1883–1911: A Franz Boas Reader*. New York: Basic Books, 1974.

Wulff, Helena. "Introducing Youth Culture in its Own Right: The State of the Art and New Possibilities." In *Youth Cultures: A Cross-Cultural Perspective*, edited by Vered Amit-Talai and Helena Wulff. London and New York: Routledge, 1995.

Ann Miles

ELDERS/OLD AGE

The study of the human life cycle is primarily a study of the aging process. The question of why humans age has long intrigued social and biological scientists. While a fountain of youth has yet to be discovered, public health and hygiene interventions have lengthened the human life expectancy greatly over the course of the past hundred years. And yet life expectancy varies greatly within and between societies, relating to their relative socioeconomic status, gender, reproductive history, and environment, among other factors. Biologists have estimated the human life span to be approximately 120 years; however, there are no well-documented lives of this length. This discrepancy between life expectancy and life span raises the important and complex relationship between biological and cultural determinants of aging. In effect, an understanding of the life cycle and human aging is predicated upon exploring these determinants of physical, cognitive, and social decline in later life.

All societies possess some mechanism by which to denote or mark stages in the life cycle—in particular, the transition from youth to adult and from adult to elder. Anthropologists have enumerated many formal age classification systems. Age classification systems such as age sets—groups of persons born within a set number of years and considered to be the same age—are more rigid and formalized among horticulturalist and pastoralist societies; industrialized societies tend to have less formalized mechanisms to denote elder status and often rely upon physical and chronological markers of aging. Gerontologists also conceptualize age in terms of age grades, cohorts, and social age. Age grades are status differences predicated on culturally defined social ages. Cohorts are generations of people who experience similar historically defining moments that shape their experience. Social age is a way of grouping elders based on particular cultural experience, such as retirement, widowhood, or grandparenthood.

Social Theories of Aging

Leo Simmons's is the first major work to explore the relationship between culture and the experience of old age. Using existing ethnographic works, Simmons evaluated the effects of selected societal traits on the social roles, treatment, and status of the aged across seventy-one globally distributed tribal groups. This work set the stage for further investigation into the sources of cross-cultural variation in the status of older people. In part drawing upon Simmons's work, Donald Cowgill and Lowell

Holmes formulated one of the first substantive theories on variation in the life cycle and aging processes. This collection drew upon ethnographic examples from both tribal- and state-level societies and theorized that modernization was the driving force behind the wide range in elder treatment. As societies become increasingly drawn toward modernization, the productive and social roles available to older adults concomitantly grow fewer and less prestigious. With modernization, the status of elders decreases, the proportion of elders within society increases, and the responsibility for elder care is transformed from a domestic to a public sphere; cross-culturally, all elders are channeled into less physically demanding roles, and all cultures place a high value on a good and long life. Critics of modernization theory point to the ethnocentric bias inherent in modernization's naturalization of Western social structure.

The differentiation between what is biological and what is cultural in the aging process continues to drive research into the experience of aging as well as social theories of the aging process. Older adults' disengagement from social and economic life was first understood as a natural process predicated upon decreasing physical and mental capacities; later theories emphasized the importance of reciprocal relationships in determining an elder's likelihood of social withdrawal. Marxist approaches postulated that elders' circumscribed relationship to the means of exchange was the underlying cause of their social alienation. Carroll Estes's groundbreaking work on the "aging enterprise" introduced and explicated the political economic production of elders' relative disadvantage. The aging enterprise is the invention of new needs for the elder population, which are provided by new technologies, services, medications, and goods. This process exploits elders' economic and political power and works to isolate them further from the rest of society.

The 1980s brought a new direction in life-cycle research, one that focused less upon macrosocial functionalism and the ways in which elders as a group function within society and instead directed attention toward the effects of lifelong experiences and social locations on the status and experience of older age. The double-jeopardy hypothesis proposes that elders are first disadvantaged by age and that this disadvantage is intensified by other layers of their identity, such as ethnicity, gender, or sexual preference. In contrast, the life-course perspective seeks to understand elders' status as a product of their lifelong interaction with systems of discrimination and privilege as well as their individual personal experiences. The experience of older age is often positively affected by elders' social support system or their social networks. Social support networks can be characterized by the amount of reciprocity among members, the intensity of exchange, the complexity or number of activities performed by members, or the level of interconnectedness among different members of the network. Elders who possess intense, complex, reciprocal, and dense social networks experience greater social integration and may have greater relative status within the elder population.

Elders' relative status in society may often be predicated upon the various roles they fulfill. Some roles, such as grandparent, provide a high status, while other roles available to elders, such as the sick role, connote low status. All societies possess some

unwritten rules for which roles are accessible to older adults. These age norms, while generally not formalized, can serve as a form of social control to discourage older adults from engaging in activities deemed unfit for their age. Another term used to describe this phenomena is "social clock," the culturally defined time of life for particular social activities to be performed. Marriage, employment, childbirth, grandparenthood, and death are just a few of the human activities governed by social clocks.

Aging as Stigma

While the status of older adults varies cross-culturally, in the United States and other industrialized nations, elders are ascribed low status. This low status may be attributed to the cultural associations of elders with disease, disability, death, and dying. In the United States, the emphasis on independence, autonomy, and bodily integrity casts persons who deviate from the norm as morally and socially suspect. The sick, disabled, dying, and elderly are often stigmatized and socially isolated. Undoubtedly elders experience these negatively valued states more often than any other age group; however, the cultural value of any one of these experiences depends upon a particular sociohistorical and cultural context. For instance, immigrant and minority subcultures in the United States may accord far greater prestige and importance to elders than is found in the dominant culture.

Many social scientists in aging studies have examined how to forestall or decrease disability and disease among older adults in order to improve their quality of life and ensure prolonged social integration. Activity theory was one of the first approaches to understanding elders' social experience. Activity theory asserts that older adults have better lives if they maintain a high level of varied activities. Somewhat commonsensical, activity theory does not address the underlying reasons for relinquishment of activities. This shortcoming may open the possibility of "blaming the victim"—if elders have a poor quality of life, it is because they chose to disengage from their social roles and activities.

Disengagement theory is a response to activity theory and seeks to remove the blame for relinquishment of activities from individual elders and instead houses responsibility within human biological change. It proposes that the biological changes accompanying the aging process naturally disincite elders toward continued participation in the productive spheres. However, disengagement theory has the potential to conflate aging with senescence and works to naturalize the segregation of older adults within society. Continuity theory might be conceived as a middle-of-the-road approach. It explains the circumscribed social experience of older adults as a product of role continuity. The roles one acquires as an adult do not change, and as elders age and relinquish physically or mentally demanding spheres, the remaining roles available to them become more rigidly claimed and new roles are not sought after. Continuity theory does not explain why some elders continue to seek new experiences and skills.

Critical and Constructionist Perspectives on Aging

The work that Estes began with *The Aging Enterprise* experienced a resurgence of activity in the later 1990s and the early

twenty-first century. Critical gerontology aims to examine the sociopolitical processes and policies that conspire to disadvantage certain classes of people disproportionately. As a group, elders are often economically and socially disadvantaged, but critical theorists deepen the investigation of disadvantage by pointing to the heterogeneities within the elder population. Hence critical perspectives are often feminist ones, theories that investigate the ways in which women are systematically denied access to avenues of privilege. Critical theorists also explore the ways in which other markers of identity—race, ethnicity, native language, sexuality, disability, HIV status, educational attainment, employment history, or social class—intersect with age to exacerbate age-related disadvantage. Feminist gerontologists have been particularly vocal within critical gerontology in the study of gender bias in state-sponsored pension systems, health insurance programs, biomedical research, and paid and unpaid caregiving.

The constructionist perspective also gained steam from the late 1980s onward. Constructionists step back from an attempt to explain the totality of the aging experience and instead examine specific facets of experience in an effort to understand the roots of social problems or cultural beliefs. Constructionists differ from critical scholars (though they are in no way exclusionary of the others) in that their focus is on the cultural determinants of disadvantage rather than sociopolitical or economic systems. Many scholars within this vein turn toward narrative analysis to help explain the experiences of elders. Elders' narratives allow for an individual level of analysis as well as providing a means by which elders can be conceptualized as active agents in the creation of meaning and value in their lives rather than as products of political economic systems.

Geroanthropology: A Cross-Cultural and Holistic Inquiry

Jennie Keith characterizes geroanthropology as a tripartite endeavor consisting of the anthropology of old age, old age within anthropology, and the anthropology of age. Early and contemporary ethnographic works that did not focus on the experience of elders but rather referred to the knowledge and wisdom of elders as repositories and keepers of cultural traditions comprise "old age in anthropology." The anthropology of old age is represented by texts that seek to explore the experience of older adults across cultural or national boundaries. Works by Jay Sokolovsky and Margaret Lock represent just a few of the recent texts in this genre. The anthropology of age seeks to understand aging as a social and biological process and does not focus entirely on the end product of aging per se but looks to elders as active participants and creators of the meaning and experience of later life. All three of these endeavors have been dramatically influenced by three widespread processes: the demographic transition, globalization, and the medicalization of aging.

The world's population is aging, but demographic profiles differ widely among nations. The populations of the United States, Canada, and Western Europe are widely known to be "graying," yet the proportions of the populations that are grandparents in nations such as China, Kenya, or Mexico pose entirely different social and economic questions. Industrialized

nations view their "aging problem" to be primarily one of social services, health care, and cost containment, whereas nations within sub-Saharan Africa struggle with ways to support elders who are caring for orphans of the HIV pandemic. China, the nation with the largest population in the world, will be facing a caregiver shortage of huge proportions due to shrinking family size and because its elders are concentrated in rural areas with fewer young adults to provide, informally or formally, caregiving support. The demographic transition is often thought to be of concern only to industrialized nations that have the longest life expectancies; however, elders in many nations are suffering the effect of low status and lack of support.

Globalization is often bandied about as a ubiquitous covering term referring to the confluence of goods, labor, and information traveling across national borders, but it is not often considered particularly germane to gerontological research. In fact, however, increased economic globalization since the mid-1980s has had an enormous impact on the status and quality of life of the world's elders. Among other things, globalization has decreased job security, decreased employment-related health and retirement benefits, increased the seasonal migration of low-paid workers, upset local economies, and increased international disease transmission. These changes have forced low-income workers to remain in the workforce longer in order to provide economic support for their households, have raided the retirement funds of those middle-income families who had planned for retirement, and have often increased the cost of prescription drugs and other health care products vital to elders. Globalization is often conceived as an economic boon to national economies and a harbinger of prosperity, but it has also worked to exacerbate the existing systems of relative disadvantage for elders.

Estes was one of the first scholars to point out the trend toward the medicalization of aging. Medicalization, broadly defined, is the transformation of behaviors, bodily states, or bodily functions from a state of naturalness or idiosyncratic or cultural behavior to disease states that can be defined, diagnosed, and perhaps treated. It has been characterized as a form of social control and a tool for the expansion of cultural hegemony. Medicalization affects health insurance policies, the quality of life of those living or working in long-term care facilities, the economic security of unpaid caregivers, notions of self and identity, and access to choice of healing modality. It is an interactional process that occurs between social structures, patients, health care providers, or medical technologies. However, medicalization is steeped in the legitimacy and authority accorded biomedicine. The authority and dominance of the biomedical model in the United States limits the range of appropriate responses to disease. Once medicalized, a disease is appropriately treated as a medical, physical (or psychiatric) problem. Further, medicalization does not necessarily imply an opportunity for efficacious treatment or health improvement. Alzheimer's disease, for example, could be considered a newly medicalized interpretation of senility in older adults. Those who are diagnosed with Alzheimer's are given the stigma and gravity of the diagnosis but are then offered limited caregiver support, pharmacological treatment, or long-term care assistance.

Geroanthropology has been profoundly changed by demographic transition, globalization, and medicalization. The demographic transition forces gerontologists to examine elders' status and quality of life cross-culturally while questioning ethnocentric ideas regarding the definition of old age, retirement, caregiving, and grandparenthood. Globalization has complicated cross-cultural research as national and cultural boundaries are increasingly understood as dynamic and historically contingent products of competing international political and cultural forces. Cultural ideas and beliefs are shared via electronic media at an unprecedented rate, and the values associated with specific cultural groups become taxed under new forms of economic exploitation or pressure. Medicalization has substantively changed the scope of geroanthropology. It has also compelled social-scientific researchers to couch their projects in terms of biomedical categories, contributing to an increasing emphasis upon short-term, problem-, or crisis-oriented research rather than longitudinal or prospective studies. This may have the unintended effect of further stigmatizing diagnosed persons as being artificially divorced from society.

These processes have encouraged gerontological research to work toward problem-solving rather than theory-building and ironically may have compartmentalized the experiences of elders while working toward their increased status and social integration. Research with or of the aged or about the aging process itself must remain as holistic as possible in order to encapsulate the complexity of social and physical experience at the end of life. The status of elders varies within and across cultural groups. The current study of cross-cultural variation tends not to focus on documenting these differences but instead looks at the effects of privilege and disadvantage on particular classes of elders in specific situations or alternatively examines meanings and values elders create as active participants in society.

See also Cycles; Family; Generation; Life Cycle: Overview; Life Cycle: Adolescence; Wisdom, Human.

BIBLIOGRAPHY

- Amoss, Pamela T., and Stevan Harrell, eds. *Other Ways of Growing Old: Anthropological Perspectives*. Stanford, Calif.: Stanford University Press, 1981.
- Bengston, Vern L., and K. Warner Schaie, eds. *Handbook of Theories of Aging*. New York: Springer, 1999.
- Browne, Colette V. *Women, Feminism, and Aging*. New York: Springer, 1998.
- Cohen, Lawrence. "Old Age: Cultural and Critical Perspectives." *Annual Reviews of Anthropology* 23 (1994): 137–158.
- Cowgill, Donald O., and Lowell D. Holmes. *Aging and Modernization*. New York: Appleton-Century-Crofts, 1972.
- Estes, Carroll L. *The Aging Enterprise*. With contributions by Philip R. Lee, Lenore Gerard, and Maureen Noble. San Francisco: Jossey-Bass, 1979.
- Fry, Christine L., ed. *Aging in Culture and Society: Comparative Viewpoints and Strategies*. New York: Praeger, 1980.
- Keith, Jennie. "The Best Is Yet To Be: Toward an Anthropology of Age." *Annual Reviews of Anthropology* 9 (1980): 339–364.
- Kertzner, David I., and Jennie Keith, eds. *Age and Anthropological Theory*. Foreword by Matilda White Riley. Ithaca, N.Y.: Cornell University Press, 1984.

Lock, Margaret. *Encounters with Aging: Mythologies of Menopause in Japan and North America*. Berkeley: University of California Press, 1993.

Simmons, Leo W. *The Role of the Aged in Primitive Society*. Hamden, Conn.: Archon Books, 1970.

Sokolovsky, Jay, ed. *The Cultural Context of Aging: Worldwide Perspectives*. 2nd ed. Westport, Conn.: Bergin and Garvey, 1997.

Samantha Solimeo

LINGUISTICS. *See Language and Linguistics.*

LINGUISTIC TURN. "Where word breaks off no thing may be": this is the line from a poem by Stefan George repeatedly cited by Martin Heidegger to indicate his version of the linguistic turn, which affected many philosophers in the early twentieth century—literary scholars already having made the turn, whether consciously or not (Heidegger, p. 60). The phrase "linguistic turn" is actually Gustav Bergman's, given new currency by Richard Rorty, but the phenomenon is far from unprecedented. Friedrich Nietzsche's idea of "the infinite interpretability of all things" is an analogy drawn from language, and a century earlier there was what H. G. Gadamer called "Herder's ill-fated criticism of the Kantian transcendental turn"—that is, his "metacriticism" of Immanuel Kant, which Jacques Derrida likewise recalled. Renaissance humanism, too, was in part a linguistic—a philological, a rhetorical, and a literary—protest against the excessive abstraction of Scholasticism, following the lead of the ancient Sophists and orators.

The "linguistic turn" has been made by many philosophical movements by now, even analytical and Marxist philosophy, and as usual this has been done in the search for foundations and a universal standpoint from which to pass judgments on the human condition. Linguistic criticism certainly undercuts the spiritual world of ideas; but "language," when divorced from the particularities of different linguistic traditions, can also be "reified" and made into a philosophical fetish. Martin Heidegger speaks of language but in practice regards German and Greek (rather than, say, Sanskrit or Chinese) as closer to Being than any other. His former pupil Gadamer, while regarding hermeneutics as universal, is more self-critical, speaking of "trying to draw out of one's mother tongue new ways of thinking." The implication is that there is not only no *Ding an sich* (thing in itself) but also no *Geist an sich* (spirit) and moreover that "there is no meaning where expression fails." Language is the ocean in which we all swim—and whatever our dreams of rigorous science, we are fishes before we can become oceanographers.

Literary Aspects

The linguistic turn was apparent in other connections, one the "new rhetoric" of the past generation, which draws attention to the habits and conventions of language, like Michel Foucault calling into question the control of speakers and writers over their own discourse. The arts of speaking and writing are both

based on conscious imitation, but every literate person is moving in linguistic channels carved by predecessors, deposited in the memory, and repeated in different contexts. Particular languages produce semantic fields that make possible communication and dialogue; and linguistic usage—particular topoi, copulas, and word combinations—has its own inertial force that acquires meaning apart from the intentions of users. This is one reason for being wary of the “intentional fallacy” in interpreting texts.

One of the most impressive vistas opened up by the linguistic turn is the modern philosophy of hermeneutics in the form given by Gadamer, who, following Heidegger, extended the line of thought in the direction suggested not by Friedrich Nietzsche (as did Heidegger and Derrida) but rather by Wilhelm Dilthey. Rejecting revolutionary ruptures as a condition of understanding, Gadamer preserved belief in a kind of continuity making communication and “dialogue” possible not only between speakers but also over time. There are no absolute beginnings, no understanding without prejudice, without “forestructures of understanding” provided by language and the “life-world.” Pursuing Friedrich Schleiermacher’s old quest for “the I in the Thou,” Gadamer accepts the horizon-structure of experience but doubles it to accommodate the contexts of the past as well as the inquiring present. Language is a continuum making interpretation possible, but it does not permit the sort of retrospective mind reading assumed by the “empathy” of Romantic hermeneutics. That meaning must always be constructed in the present is the hermeneutical condition of Gadamer’s kind of historicism. To understand, in short, is always to understand differently.

An important offshoot of hermeneutics is reception theory, or reception history (*Rezeptionsgeschichte*), which follows Gadamer’s line by shifting attention from writing to reading. In fact intellectual history is more concerned with the original intention of authors and meaning of their texts than with their “fortune” in later contexts. What Paul Ricoeur calls the “semantic autonomy” of texts is the condition of the interpretations and misinterpretations that accompany the reception of writings. For Ricoeur the poles of interpretation are the hermeneutics of tradition and the hermeneutics of suspicion, the first locating the position of Gadamer (and of Arthur Lovejoy), who seeks an experience of tradition, the second that of Foucault, who is devoted to the critique of ideology. For Gadamer “tradition” and continuity make possible the common ground of understanding and communication that, via ideas, connects present and past (the Western past); for Foucault they mean entrapment in or complicity with ideology and a denial of the ruptures between the successive epistemes that represent decipherable codes (critically fabricated *Weltanschauungen*) of culture and patterns of underlying power relations.

Textualism

The linguistic turn prompted another and more severe tactic, which was the textualist turn. In this literary/philosophical game of one-upmanship Derrida substituted the transcendent phenomenon of language by the visible presence of “writing,” through which—or rather through the hyper-textualist device

of “traces”—he attempts not only to operate in the “margins” of texts but also speak in the realm of the unspeakable and in effect to “get behind the back of language” (in Gadamer’s terms) and of philosophical discourse. Taking writing as the condition of knowledge is itself a traditional move, as illustrated in the Renaissance preoccupation with *littera* (*letteratura*) and *scriptura* and, more conspicuously, in the tradition of rabbinical (but also of Protestant) scholarship.

In this and other metalinguistic maneuvers of deconstruction, Derrida surpasses even Heidegger in claiming to be a “beginning thinker”—in the goal of transcending criticism or even, as in the notorious (non-)confrontation with Gadamer, dialogue. The very idea of situating Derrida’s own writing in the history of philosophical thought, declares one devotee, “would amount to defusing its alterity and explosive potential.” To be effective, it seems, cultural criticism, like philosophy, must be beyond the horizons of historical inquiry. Breaking with tradition is itself traditional in philosophical thought, as this Derridean adds, though without suggesting that the break and the “alterity” occur in the medium of rhetoric, or writing, rather than a transcendent tradition of thinking (in Derridean terms a transcendental state of “*différance, née différence*”)—or an antitradition of deconstruction—that is itself set beyond language, criticism, and perhaps even history.

Foucault, too, sought to transcend language and “the history of historians,” hoping, with the help of his episteme, to uncover the structures of society and relations of power underlying social practice and discourse, but historians have questioned the methods and especially his attitude toward historical evidence. For Foucault learning does not enjoy high priority; and whether or not he himself was, by intention or vocation, a historian, his opinion was that history was too important to leave to such. Foucault had more important things on his agenda. Criticisms of the concept of episteme (and of “practice” and “discourse”) must be of the same order as criticisms of other such collective abstractions as spirit (*Welt- or Volksgeist*), *Weltanschauung*, *mentalité*, and other shorthand devices for grouping apparent homologies in various areas of behavior within a particular cultural horizon. Like Marxism, Freudianism, and Critical Theory, including the work of Jürgen Habermas, it is another effort of getting “behind the back of language,” which had for centuries been the dream of “philosophy as a rigorous science.”

Intellectual History

This is also to some extent the noble dream of the German approach to intellectual history that succeeded old-fashioned *Geistesgeschichte* or *Ideengeschichte* (history of thought, history of ideas). Like the French *mentalités*, German “history of concepts” (*Begriffsgeschichte*) is an effort to reconstruct an intellectual field through the history of terms and families of terms like the English study of “keywords.” In fact *Begriffsgeschichte* is a species of cultural history focusing on semantic change and the social and political context of ideas, and its program depends on metahistorical considerations to determine the meanings behind the keywords being analyzed. This enterprise began in the early 1970s, before databases like Proteus and ARTFL made possible a much more extensive searching of semantic

fields, but it has nonetheless greatly enriched the practices of intellectual and social history.

The linguistic turn in women's studies allowed for the awareness of gender constructs throughout historical records as well as in the limited questions of historians. Words such as *masculinity*, *femininity*, and *androgyny* became keywords as gender studies scholars began new inquiries into the history of ideas. A last new frontier of intellectual history at the end of the twentieth century is the effort to understand cultures not only past but also alien. Philosophy has not been much concerned with alterity, what Michel de Certeau calls "heterology," which has been faced by historians, anthropologists, archaeologists, mythographers, and other outward- and backward-looking scholars. "The course of history does not show us the Becoming of things foreign to us," argued Georg Wilhelm Friedrich Hegel, "but the Becoming of ourselves and of our knowledge." But the hermeneutical philosophy of his contemporary Schleiermacher sought the *thou* as well as the *I*—the Other as well as the *We*—and this aim has been carried on and intensified by more recent followers. It is here that the methods of "anthropology," which had been found suspect by Immanuel Kant and Foucault alike, again become relevant, especially the interpretive anthropology of Clifford Geertz, which depends on a language model rather than a natural science model of understanding and that has made its way also into historical studies. Language is the "house of being," in Heidegger's famous aphorism, and the history of ideas, too, has taken up residence here.

See also *Language and Linguistics; Language, Linguistics, and Literacy; Language, Philosophy of.*

BIBLIOGRAPHY

- Gadamer, H.-G. "Die Begriffsgeschichte und die Sprache der Philosophie," *Arbeitsgemeinschaft für Forschung des Landes Nordrhein-Westfalen* 170 (1971).
- Heidegger, Martin. *On the Way to Language*. Translated by Peter D. Hertz. San Francisco: Harper and Row, 1982.
- Jay, Martin. "Should Intellectual History Take a Linguistic Turn?" In *Modern European Intellectual History: Reappraisals and New Perspectives*, edited by Dominick LaCapra and Steven L. Kaplan. Ithaca, N.Y.: Cornell University Press, 1982.
- Koselleck, Reinhart. *Futures Past: On the Semantics of Historical Time*. Translated by Keith Tribe. Cambridge, Mass.: MIT Press, 1985.
- Nelson, John S., Allan Megill, and Donald N. McCloskey, eds. *The Rhetoric of the Human Sciences: Language and Argument in Scholarship and Public Affairs*. Madison: University of Wisconsin Press, 1987.
- Richter, Melvin. *The History of Political and Social Concepts: A Critical Introduction*. New York and Oxford: Oxford University Press, 1995.
- Ricoeur, Paul. *Interpretation Theory: Discourse and the Surplus of Meaning*. Fort Worth: Texas Christian University Press, 1976.
- Rorty, Richard, ed. *The Linguistic Turn: Recent Essays in Philosophical Method*. Chicago: University of Chicago Press, 1967.
- Schrift, Alan D. *Nietzsche and the Question of Interpretation: Between Hermeneutics and Deconstruction*. New York: Routledge, 1990.
- Scott, Joan Wallach. "Gender: A Useful Category of Historical Analysis." In her *Gender and the Politics of History*. Rev. ed. New York: Columbia University Press, 1999.

Smith, Bonnie G. *The Gender of History: Men, Women, and Historical Practice*. Cambridge, Mass.: Harvard University Press, 1998.

Williams, Raymond. *Keywords: A Vocabulary of Culture and Society*. London: Fontana, 1976.

Donald R. Kelley

LITERARY CRITICISM. When the definitive account of post-1960s intellectual technologies is written, the history of literary movements will constitute a key chapter. Perhaps paradigmatic of the closing decades of the twentieth century in its dramatic shifts and realignments, literary criticism at the opening of the twenty-first century shows all the earmarks of specialized knowledge, professionalization, and market maneuvering that have successfully permeated the precincts of human activity in advanced industrial society since the end of World War II. Virginia Woolf's "common reader," for all intents and purposes, has disappeared, replaced by professional practitioners trained in the efficacies of "close reading" and highly conscious of a critical landscape represented by "schools" of criticism, from mythic to Marxist, from structuralist to feminist, from psychoanalytic to poststructuralist. Deconstruction and postcolonial critiques have joined a range of cultural studies that encompass race, gender, and sexual orientation. With allied movements in linguistic, rhetorical, narrative, and semiotic theory, criticism at the turn of the twenty-first century accommodates the study of ethics regarding nonhuman species as well as conduct toward the environment. English and American literature at the university level cut across interdisciplinary formations; thus, the English department, situated in the humanities, could as easily play host to the analysis of legal documents, congressional legislation, aspects of the medical archives, and the fashion modes of hairdressers, as to the recurrence of images of senescence in William Shakespeare's sonnets, or the irreality of closure in Toni Morrison's novels, or the rhythm of repetition in William Faulkner's fiction. The field of literary criticism is a growth industry, its latest paradigm shift related to global transformations brought on by the terrorist attacks of 11 September 2001. Regarding its susceptibility to change, then, the critical field offers a good example of centrifugal movement.

Literary criticism had rather complicated beginnings, apparently unrelated to the project of literary study. Richard Ohmann argues in *English in America: A Radical View of the Profession* that the "technology of the Industrial Revolution gave *knowledge* a new and central place in the business of making a living" (p. 264; emphasis added). The modern American university is dynamically linked to the centrality of knowledge, "the regularizing of technical innovation, and the bending of knowledge to profit" (p. 266). An older technological model, with industries localized in the domestic sphere and skills transmitted from generation to generation, through hands-on experience, was displaced onto the site of the factory, which brought the worker together with the organizational talent of the manager and the stochastic innovations of the entrepreneur. As Ohmann explains, this new model required "a high concentration of special and theoretical knowledge, of the capacity to

create more knowledge as needed, and of the managerial skill to bring this about.” If these changes necessitated the systematization of knowledge, as well as its spread across “a large and diverse corps of people whose main work is generating, communicating, and developing ideas” (p. 271), then the modern university of the late nineteenth century would become fully complicit with the new social order and its growing market demands. The university would answer both the will and the imperative to knowledge and the demand for skills in an increasingly national population.

According to Ohmann, then, the humanistic project and its situation in the modern university springs from *material* grounds. Ohmann’s work is subtitled “a radical view,” playfully reinforced by the book’s original cover collage, which superimposes the facial images of Edgar Allan Poe and Karl Marx. The graphic conveys the interarticulations of the aesthetic and materialist realms, and poses the conditions by which it is possible to understand not only the role of the university and the ascent of ideas in a market economy, but also the specific performances of criticism and theory. Not at all an oppositional movement to a “business civilization,” the view usually taken by humanists, the “business” of the English department, for Ohmann, is compatible with the rationalizations of the “technostructure” and owes its prosperity to that structure’s interventions.

Terry Eagleton pursues the provenance of literary criticism and theory back to the “rise of English” and the modern sense of literature that emerged with the English Romantics of the nineteenth century. A counterweight to the alienation of workers bred by the ravages of the industrial revolution, the literature of the Romantics “appears as one of the enclaves in which the creative values expunged from the face of English society by industrial capitalism can be celebrated and affirmed” (p. 19). The Romantics’ “creative imagination” was enlisted on the side of the “intuitive, transcendental scope of the poetic mind” (p. 19) and marshaled in the interest of a “living criticism of those rationalist or empiricist ideologies enslaved to ‘fact’” (p. 19). The literary work as a “mysterious organic unity” was opposed “to the fragmented individualism of the capitalist marketplace,” and whereas the latter yields rational calculation, the former offers spontaneity. In time, the literary artifact would emerge “as an ideal model of human society itself” (p. 22).

Under the impact of scientific development and the related decline of religious sentiment, literature became in this context a decisive moral and aesthetic regimen: according to one of Eagleton’s sources, English literature would in time be solicited “to save our souls and heal the State” (p. 23). From Matthew Arnold on, “English,” in a period of religious decline, “is constructed as a subject to carry the ideological freight of social cohesion” (p. 24). The “poor man’s Classics,” English literature marked the route to a liberal, humanizing education, first institutionalized as an academic course of study in unexpected venues—not in England’s great universities, Eagleton contends, but in the “Mechanics’ Institutes, working men’s colleges and extension lecturing circuits” (p. 27). Installed in the British curriculum during the final quarter of the nineteenth

century, English literary studies commenced as a “subject fit for women, workers, [and, given England’s colonial project] those wishing to impress the natives” (p. 29).

Though Eagleton’s and Ohmann’s respective accounts of the development of English critical studies are contrastive, what they have in common is the attempt to put in perspective the relationship between manifestations of the creative and imaginative impulses as curricular objects and the material and political bases on which the former are predicated. Not some glorious abstraction, English, which will become the place of habitation of literary criticism and theory, belongs, one way or another, to the industrial phase of capital. Either as a preserve of creative values or as an elaboration of a radically transformed scene of labor, English in the twentieth century would supersede the old, time-honored trivium of the curricula of the Middle Ages—grammar, logic, and rhetoric.

The New Criticism

In 1930 Harper and Brothers published *I’ll Take My Stand: The South and the Agrarian Tradition*, by Twelve Southerners, which might be considered the central doctrinal statement of the Fugitives literary circle and advanced the names of some of the founding personalities of what became the New Criticism in the United States. John Crowe Ransom, whose *New Criticism* (1941) named the movement, the poet Allen Tate, the fiction writer Andrew Nelson Lytle, and the critic and fiction writer Robert Penn Warren, among others, contributed essays to this collection, and there is a good deal of justification to support the view that the New Criticism, running conceptually parallel to Russian formalism, did not exhaust itself for decades to come; if one concludes that “close reading,” or concentration on the text of a literary work, constitutes a minimal condition for the performance or practice of literary criticism, then its strategies would be adaptable to all the “schools” of criticism. In other words what began as a value peculiar to a certain social formulation was transformed into standard operating procedure: the practitioner is no longer focused on “close reading,” but does it automatically. Close reading is considered so “natural” a posture to the work of the critic that whatever else he or she might do with a conceptual object or “hermeneutic demand” is predicated on its facilities. Terry Eagleton argues that close reading involves both a “limiting” and a “focusing of concern”—both because it excises superfluities—considerations such as the length of Tennyson’s beard, for example—and because it enforces, among other things, “the illusion that any piece of language . . . can be adequately studied or even understood in isolation” (p. 44). In any case, for some critics, close reading is an act of reification, or the treatment of the literary work “as an object in itself” (p. 44).

M. H. Abrams describes the autonomous object as a “heterocosm,” or “second nature”: it is “an end in itself, without reference to its possible effects on the thought, feeling, or conduct of its readers” (pp. 35, 327). If, as Eagleton suggests, the poetic object for the New Critics “became a spatial figure rather than a temporal process” (p. 48), then the texts that one associates with the heterocosm, “chartered” by the Coleridgean imagination, makes the critical process itself as demanding as the thing it is interpreting: irony, ambiguity, paradox, and ambivalence

are highly valued poetic practices for the New Critics and will yield, in turn, an appreciation for textual “density” and “complexity” as the watchword of value. The idea is that the poem, in rendering disparate things to harmony, in Shelley’s formulation, achieves a dynamic stillness among competing linguistic and imagistic elements.

That a poem could be imagined to body forth such a beautifully orchestrated outcome makes it the model of a perfected world, well out of reach then and now. But *I’ll Take My Stand* sketches the social and political presuppositions against which some of the early New Critics were operating and how poetic perfection might have provided them with a strategy of retreat from the realm of realpolitik in an era of global depression. These southern intellectuals were on the cultural defensive, given the South’s defeat in the Civil War; General Robert E. Lee’s surrender at Appomattox had occurred in 1865, only sixty-five years before the appearance of the manifesto. It is not difficult to imagine that the “political unconscious” of the “twelve southerners” could engage with, up close and personal, their own historical memory: Robert Penn Warren’s contribution to the volume, “The Briar Patch,” bristles with all the energy of revelation, illuminating Penn Warren’s great anxiety—the industrial/technological transformations homing in on the South: “The chief problem for all alike [the Negro and the white] is the restoration of society at large to a balance and security which the industrial regime is far from promising to achieve” (p. 264). Although what appears to be nostalgia for the full range of social relations imagined as complementary to the “agrarian tradition” runs through the entire volume, the unsigned “statement of principles” (the introduction) could easily be read in concert with “The Briar Patch,” or even anticipatory of it. Written in opposition to the “American industrial ideal,” *I’ll Take My Stand* argues boldly in its introduction that the “capitalization of the applied sciences has now become extravagant and uncritical; it has enslaved our human energies to a degree now clearly felt to be burdensome” (p. xi). Labor relations in this new order also fall under the microscope, as do the new means of production: “The act of labor as one of the happy functions of human life has been in effect abandoned, and is practiced solely for its rewards” (p. xiii). Just so, the apologists for industrialism “have been obliged to admit that some economic evils follow in the wake of the machines,” yet the remedies that they propose “are always homeopathic,” insofar as they “expect the evils to disappear when we have bigger and better machines, and more of them” (p. xiii).

A series of consequences follow from the new relations, and a crucial number of them point toward the cultural indices: “We receive the illusion of having power over nature, and lose the sense of nature as something mysterious and contingent” (p. xiv). If the delicate balance between humans and nature has been upset by the “machine in the garden,” then it follows that for the Fugitives, art, as well as religion, is dependent on “a right attitude to nature” (p. xv). “Neither the creation nor the understanding of works of art is possible in an industrial age except by some local and unlikely suspension of the industrial drive” (p. xv). “Under the curse of a strictly-business or industrial civilization,” life’s amenities “suffer.” Furthermore, a community must find a way to extricate itself from

the toils of industrialism, the “evil dispensation,” as the failure to do so is not only the mark of pusillanimity, but the loss of political genius and the embrace of impotence (p. xx). Despite themselves, context insistently bore down on the New Critics, although, surprisingly, some of them would be keenly attuned to it: “We cannot recover our native humanism by adopting some standard of taste that is critical enough to question the contemporary arts but not critical enough to question the social and economic life which is their ground” (p. xvi).

Bill Readings argues that F. R. Leavis in England and the New Critics in the United States would have “an enormous impact on the educational system” transatlantically (p. 84). According to Readings, the radical claim “for the benefits of literary scholarship was accompanied by a massive attention to the training of secondary school teachers who went out from the University entrusted with a sense of their mission to uphold literary culture” (p. 84). The impact of the new literary scholarship was hardly limited to teacher training, but profoundly altered the exercise of reading by removing the tasks of evaluation and canon-making from the precincts of common sense; in other words, pronouncements on the modern text—the poetry of T. S. Eliot and Ezra Pound, the fiction of James Joyce, for example—would become the vocation of the professional critic, who would read literary passages not only against the context of the text in which it was embedded, but with attention to the “total context provided by the [author’s] work” (Brooks and Warren, p. 1616). Because criticism would become the province of the professionally trained, canonicity and how to determine the canonical would take on capital significance for American criticism. Readings contends that the New Criticism generated disagreement about the canon precisely because the latter was, in fact, “the surreptitious smuggling of *historical* continuity into the study of supposedly discrete and autonomous artworks” (p. 84; emphasis added). The New Criticism brought to fruition a development that quite probably began with the proliferation of “little magazines”—Harriet Monroe’s *Poetry*, which Venture launched in 1912, became a promoter of modern poetry—and the culture of literary salons on both sides of the Atlantic, flourishing as early as the 1910s. The artistic entrepreneurial spirit of Bloomsbury, the London intellectual circle dominated by Leonard and Virginia Woolf, as well as the intense collaborative energy central to some literary masterworks, such as Eliot’s *Waste Land* (1922), strongly shaped by Pound, prepared the basis of reception for the very notion of the art work as autonomous. In fact, the stirrings across the range of the “seven arts”—in literature, painting, music, modern dance, drama and the stage, photography, and the new kid on the block, cinema, all heralded the heady transformation and new persuasions at work. For poetry and literary criticism, the New Critics would give the impulse a name: modernism.

Formalism and Beyond. It might come as a matter of surprise for some readers that according to Lee Lemon and Marion J. Reis, “During the 1920s a group of Russian critics urged the separation of literature and politics [which] challenges our popular clichés about Soviet control of literary theory” (p. ix). In their succinct account of Russian formalist criticism, Lemon and Reis go on to observe that the early work of the Russian formalists and the America New Critics demonstrated certain

concepts and strategies in common, among them: (1) “an attack against traditional academic scholarship”; (2) a critical theory that drives a corridor between literature and other disciplines of the human sciences, such as history, philosophy, and sociology; and (3) a strategy of literary investigation that would advance the “analysis of structure” in the place of discourse about “background, social usefulness, or intellectual content” (p. x). Literary critical performance would later annul the breach with related disciplines, not so much by “going over” to them, but by “translating” their content, in effect, into literary values and analogues, as is the case with poststructuralism, which gained ground from the 1970s on. But the isolation of structure, beginning with the formalists and the New Critics, enables the emergence of a conceptual object that gains a precision of focus comparable to the scientific object.

The wedding of formalism and the New Criticism, never officially pronounced as such, provided a merger called “formalism” that dominated literary study on both sides of the Atlantic from the 1930s through the late 1960s. The aims of this prolific period of theorization are perhaps most poignantly captured in the titles of certain works that attempt to configure literary study as a “system”—René Wellek and Austin Warren’s *Theory of Literature* (1942) and Northrop Frye’s *Anatomy of Criticism* (1957), for example. More pointed investigations in genre theory—the meaning of poetry, the development of the novel and short story, studies in allegorical, symbolic, and mythic modes, as well as inquiries into the “grammar of motives,” the “rhetoric of motives,” and the “philosophy” of literary form—all mark this period as one of the most distinct and distinguished chapters in the history of the modern humanities, but they also help to establish the foundations of what was referred to earlier as a centrifugal movement in literary study. In other words, formalism brings about the *institutionalization* of the study of literature and language, both in the academy and in the marketplace of ideas. But it also opens onto the possibilities of a broader application of literary method across the universe of signs. The not entirely playful or lighthearted complaint from scholars outside the field that personnel in English believe that they can “read” anything is not exactly misplaced; there is an ascendant logic operative here that grants primacy to the word/words. If the Russian formalists, as early as the period of the Russian Revolution, had been influenced by the enormous impact of the science of modern linguistics—primarily by way of Roman Jakobson—then the “structuralist turn,” via Parisian intellectual circles, would integrate linguistic method and ideas into new systems of thought.

It would appear to the graduate student in English in 1968 that something quite astonishing was happening on the ground. Change was in the air and coming from a number of different directions, not the least of them political. The ramifications of those changes—the presence of larger numbers of minorities and women, on faculties and in student bodies, at American colleges and universities, as well as the commencement of “multiculturalism” as a mode of scholarly study and address—would reverberate right through the contemporary period. The year 1968 might be regarded as a time of rupture, on the one hand, brought on by the transatlantic youth movement (in the United States, the Vietnam War protest movement ran parallel to the

black nationalist movement and the continuation of the civil rights struggle, while in Europe, particularly in the big cities, students, demanding transformation in the educational system and allied with Labor, especially in the French instance, threatened political order). On the other hand, the literary object, destabilized by a reinvigorated debate on the canon, would seem to displace continuity with formalist and neoformalist persuasions onto questions that had not been asked before, such as How does one read as a woman, or a black person, or a post-colonial subject? Though it appears from the vantage of the early twenty-first century that these transformations occurred all at once, it is fair to say that they systematically unfolded over the last three decades of the twentieth century, falling out in a kind of domino pattern. As new legislation had been required to reinforce equal protection for minorities in public accommodations and at the ballot box, rights initially secured by the “citizenship” amendments (the Fourteenth, Fifteenth, and Sixteenth Amendments) to the U.S. Constitution, gender equality in access to higher education followed by legislative mandate. The entire panoply of multicultural occasions swam in its wake. While it would be appropriate to regard the 1960s protest movements in light of global development subsequent to the end of World War II, the isolation of intellectual currents in this sea of change is instructive.

Just as John Crowe Ransom’s *New Criticism* in 1941 heralded a paradigm shift that had been well under way for at least two decades, Richard Macksey and Eugenio Donato’s *The Languages of Criticism and the Sciences of Man: The Structuralist Controversy* (1971), which introduced to an English-speaking scholarly audience many of the themes that would come to dominate critical inquiry for the next few decades, pointed to a radical shift in the humanities repertoire. Macksey and Donato’s table of contents contains the names of many of the major continental thinkers whose projects would model the new scholarship, from René Girard, Georges Poulet, and Lucien Goldmann to Roland Barthes, Tzvetan Todorov, Jacques Lacan, and Jacques Derrida. Though the volume was not published, originally, until 1971, the event that engendered it had taken place during the fall of 1966 at the Humanities Center of the Johns Hopkins University. Supported by a grant from the Ford Foundation, this international symposium brought together more than one hundred humanists and social scientists from the United States and eight other nations. According to Macksey and Donato, the symposium initiated “a two-year program of seminars and colloquia which sought to explore the impact of contemporary ‘structuralist’ thought on critical methods in humanistic and social studies” (p. xv). The purpose of the symposium was not to consolidate an orthodox view on structuralist method and thinking, but, rather, “to bring into an active and not uncritical contact leading European proponents of structural studies in a variety of disciplines with a wide spectrum of American scholars” (p. xv). The 1966 convocation marked a turning point in the way that literary studies would be configured, and it also enabled the interdisciplinary extension of the latter in the direction of “cultural studies.”

Perhaps the single most radical mark of the “structuralist turn” is the “death” of the subject, which opened the way to

critical practices, deconstruction prominent among them, in the contemporary era. But the fate of the subject might be thought of as the consequences, or end results, of a series of premises that begin with the concept of “system,” which Culler describes as “behind the event, the constitutive conventions behind any individual act” (1975, p. 30). If the prestige and success of the science of linguistics had had an enormous impact on literary study, then it would find application to other cultural and material phenomena on two fundamental grounds: First, cultural phenomena are constituted of objects and events that are riddled with meaning. Such events are, therefore, signs, and signs, as Ferdinand de Saussure (one of the preeminent founders of modern linguistics) contended, are made up of *signifiers* (auditory images that match a concept) and *signifieds* (strings of signifiers that yield meaning). Because cultural phenomena behave like language in yielding meaning, one can, then, in Culler’s words, “investigate the system of relations that enables meaning to be produced” (p. 4). The science of signs, or semiology, was therefore enabled by the insights of linguistics. Second, the event in question is not only rule bound, but its rules cohere in an entire ensemble of relations: According to Culler, “Rules . . . do not regulate behavior so much as create the possibility of particular forms of behavior” (p. 5). The best example, interestingly enough, comes out of lived experience: the English speaker has unconsciously mastered a host of complex operations called language competence; but the utterances that she will speak over a lifetime do not exhaust the *possibilities* of sentence formation in the English language (or any other), nor do such utterances even use up the *potential* formations that this individual speaker could generate. Following on the distinction between *la langue* (“a system, an institution, a set of interpersonal rules and norms”) and *la parole* (“the actual manifestations of the system in speech and writing”), structuralism was able to posit *systematicity* across the universe of signs, from fashion modes and food consumption to the conduct of poems, novels, and films (Culler, 1975, p. 8). By investigating the rules behind material manifestations and events and what ensemble of relations they were configured in, the structuralist, at least in theory, could reconstruct how things come *to mean*.

When the French theorist Michel Foucault argued the “death” of “Man,” or his “end,” he was not talking about a nuclear holocaust, but, rather, the displacement of an anthropomorphic centrality onto theories of the constructed character of human and social events; in other words, the human subject, though events pass through him and have meaning for him by way of institutional and conventional practices, is not the autonomous being that Hegelian metaphysics had posited; he is instead the *outcome* of cultural forces and processes not only beyond his control, but beyond his knowledge. The radical nature of this proposition is perhaps most poignantly demonstrable in language itself: As Culler attests, “Individuals choose when to speak and what to say . . . but these acts are made possible by a series of systems which the subject does not control” (1975, p. 29). Therefore, “I” do not speak so much as “I” am “spoken,” or enter into a system of human and social relations on which the individual “I” is entirely dependent. When these influences are juxtaposed with the innovations of Sigmund Freud and psychoanalytic practice and theorization

in the wake of Freud’s *Interpretation of Dreams* (1900) and its revelation of the *symptom* in dreams and the neurosis, then we reach the Lacanian synthesis of psychoanalysis, heavily influenced by structuralist thought. In the *Four Fundamental Concepts of Psycho-analysis*, Jacques Lacan would assert that the unconscious (the privileged site of the Freudian mental theater) is “structured like a language” (p. 20). Moreover, even “before strictly human relations are established, certain relations have already been determined” (p. 20). Lacan calls these preestablished or prior relations “supports,” offered by nature and “arranged in themes of opposition.”

Deconstruction and Beyond

It would be difficult to overstate the implications of (1) the recession of the subject of the humanities, (2) the emphasis on systematicity and process, and (3) the flattening out of the literary object in a vast sea of textual properties and equalities; in the aftermath of structuralism, between the mid-1960s and the mid-1970s, “literary criticism” would become one of a number of critical foci that joined a textualized universe wholly explicable by a generous term called “theory.” Texts of philosophy, history, anthropology, and psychoanalytic practice, among other writings deemed to have powerful explanatory value, mixed and mingled in the corridors of criticism with uncustomary abandon, “guests,” as it were, of the English department and the departments of comparative literature and modern languages. Bridges between these allied disciplines were supplied by a widespread importation of the writings of continental thinkers, particularly the French contingent. Of prime importance to these developments were the philosophy and methodology of deconstruction, articulated through a critique of modern philosophy by Jacques Derrida, in his *De la Grammatologie* (1967; *Of Grammatology*), a work that was enormously influential to the development of theory in the poststructuralist period.

Deconstruction casts its gaze at the dominant trend lines of metaphysical philosophies that posit the centrality of the *logos* (the word) and the presence of speech/voice; through a “double gesture,” as Jonathan Culler explains it, the deconstructionist project seeks to *reverse* the classical oppositions of philosophical writings at the same time that it exploits or uses them. By way of such reversals, deconstruction effects a displacement of the philosophical system. Deconstruction is carried out primarily as paradoxical procedure because it undermines “the hierarchical oppositions on which it relies” (1982, p. 86). One might think of deconstruction, then, as “the story of reading” writing (1982, p. 35), insofar as it ultimately holds that writing is a “writing-in-general,” an “archi-écriture,” or a “protowriting which is the condition of both speech and writing in the narrow sense” (1982, p. 102). It seems that the key displacement executed by deconstruction is that of the “origin,” or “beginnings”; as origin recedes, “transcendence” follows in its wake. If the “origin” of the “word” is taken as leading figures of thought to be displaced in the classical schemata, then a universe of oppositions opens up, splitting off positives and negatives, truth and falsity, presence and absence, good and bad, superior and inferior. The negatives can be lined up under one rubric and the positives under another, or the degraded class of objects over and against the transcending ones. By contending that these punctualities are the

result of the manipulations of language, or the effects of the play of signification, rather than the hallmarks of truth, deconstruction posits *différance* (a French neologism) as the condition of meaning—an interminable interpretation and analysis, or in Culler's words, an "act of differing which produces differences" (p. 97). *Différance*, as a paronomastic device, contains deferral (or cancellation of closure), as well as difference, in the sense of *differing from*. From Saussurian linguistics, the deconstructionalist reinforces the notion that *meaning* works by *signification*, but the latter is driven not by the meeting of opposites, but by the annulment of the latter. In other words, we can only account for the bombardment of differing elements. For example, a "tree," the sign vehicle, is a "tree" because something else is "not-tree," and so on, ad infinitum.

Interestingly, some of the best examples of the play of difference are presented in the "Sense-Certainty" segment of Georg Wilhelm Friedrich Hegel's *Phenomenology of Mind* (1807), and in the vertiginous exceptions of Plato's *Parmenides*. The "now" that Hegel turns over, for instance, is not something under the thumb and pinpointed, since it is a continuity that "grows" into the present, ever passing into the "not-now," both the future and the has-been (p. 152). That simple "now," according to Hegel, is "therefore not something immediate, but something mediated." It might appear that this tedious activity of discrimination would sustain only esoteric appeal, but in truth, it seems convertible into a powerful heuristic tool or "speculative instrument," insofar as it also calls into question the entire repertoire of the mundane, of the domination and dogma of "common sense," "reality," "what we all know and believe," and the limitless orthodoxy of "*what is*"—"that which everywhere, that which always, that which by all." Furthermore, if truth no longer has a guarantor in an undivided origin, then we are doomed to, or liberated from, *essences*—or the gold buried beneath the dross, as the philosopher Louis Althusser would have it—to the entanglements of *existence*.

The contemporary women's movement or the critique of knowledge undertaken by the black studies project, and deconstruction, are not customarily spoken of in the same breath, but if the latter is thought of as the inscription of an *attitude* toward the symbolic enterprise, then it might be seen as the perfect context for a radically altered humanities academy. If origin is questionable, then it follows that canons will be, as well, and once canons are toppled, then an entire ensemble of hierarchical operations (one gender over another, one dominant race and its "others") might be rendered moribund, or at least brought down to size.

The curricular objects of women's studies and African American, Marxist, and postcolonial critiques are the newest epistemologies of the humanities academy, both enabled by poststructuralist methodologies and going well beyond them. The repertoire of critical inquiries on sexuality, the New Historicism, and a range of cultural studies constitute the most exciting developments in a field generally known in the opening years of the twenty-first century simply as "theory." From Chicago to China, one of the languages that speaks across the cultures is that of "theory," now a global language of scholars in the humanities.

See also *Continental Philosophy; Formalism; Literary History; New Criticism; Postmodernism; Psychoanalysis*.

BIBLIOGRAPHY

- Abrams, M. H. *The Mirror and the Lamp: Romantic Theory and the Critical Tradition*. Oxford and New York: Oxford University Press, 1953.
- Adams, Hazard, ed. *Critical Theory Since Plato*. New York: Harcourt Brace Jovanovich, 1971.
- Althusser, Louis, and Étienne Balibar. *Reading Capital*. Translated by Ben Brewster. London: Verso, 1979.
- Ashcroft, Bill, Gareth Griffiths, and Helen Tiffin, eds. *The Post-colonial Studies Reader*. London and New York: Routledge, 1995.
- Baker, Houston A., Jr. *Blues, Ideology, and Afro-American Literature: A Vernacular Theory*. Chicago: University of Chicago Press, 1984.
- Barthes, Roland. *Mythologies*. Selected and translated by Annette Lavers. New York: Hill and Wang, 1972.
- . *S/Z: An Essay*. Translated by Richard Miller. Preface by Richard Howard. New York: Hill and Wang, 1974.
- Brooks, Cleanth, and Robert Penn Warren. "The Reading of Modern Poetry." In *American Poetry and Prose*, edited by Norman Foerster. 4th ed. Boston: Houghton Mifflin, 1957.
- Burke, Kenneth. *A Grammar of Motives*. New York: Prentice-Hall, 1945.
- . *The Philosophy of Literary Form: Studies in Symbolic Action*. 3rd ed. Berkeley: University of California Press, 1974.
- . *A Rhetoric of Motives*. New York: Prentice-Hall, 1950.
- Culler, Jonathan. *Structuralist Poetics: Structuralism, Linguistics, and the Study of Literature*. Ithaca, N.Y.: Cornell University Press, 1975.
- . *On Deconstruction: Theory and Criticism after Structuralism*. Ithaca, New York: Cornell University Press, 1982.
- De Man, Paul. *Allegories of Reading: Figural Language in Rousseau, Nietzsche, Rilke, and Proust*. New Haven, Conn.: Yale University Press, 1979.
- . *Blindness and Insight: Essays in the Rhetoric of Contemporary Criticism*. 2nd rev. ed. Minneapolis: University of Minnesota Press, 1983.
- Derrida, Jacques. *Of Grammatology*. Translated by Gayatri Chakravorty Spivak. Baltimore: Johns Hopkins University Press, 1976.
- Drake, William, ed. *The First Wave: Women Poets in America 1915–1945*. New York: Macmillan, 1987.
- Eagleton, Terry. *Literary Theory: An Introduction*. Minneapolis: University of Minnesota Press, 1983.
- Empson, William. *Seven Types of Ambiguity*. 2nd ed. London: Chatto and Windus, 1947.
- . *Some Versions of Pastoral*. New York: New Directions, 1974.
- Feldstein, Richard, and Judith Roof, eds. *Feminism and Psychoanalysis*. Ithaca, N.Y.: Cornell University Press, 1989.
- Fletcher, Angus. *Allegory: The Theory of a Symbolic Mode*. Ithaca, N.Y.: Cornell University Press, 1964.
- Foucault, Michel. *The Archaeology of Knowledge*. Translated by A. M. Sheridan Smith. New York: Pantheon, 1972.
- . *The Order of Things: An Archaeology of the Human Sciences*. New York: Vintage, 1973.
- Frye, Northrop. *Anatomy of Criticism: Four Essays*. Princeton, N.J.: Princeton University Press, 1957.

- Gasché, Rodolphe. *The Tain of the Mirror: Derrida and the Philosophy of Reflection*. Cambridge, Mass.: Harvard University Press, 1986.
- Gates, Henry Louis, Jr. *The Signifying Monkey: A Theory of Afro-American Literary Criticism*. New York: Oxford University Press, 1988.
- Goldberg, David Theo, ed. *Multiculturalism: A Critical Reader*. Oxford, U.K., and Cambridge, Mass.: Blackwell, 1994.
- Grossberg, Lawrence, Cary Nelson, and Paula A. Treichler, eds. *Cultural Studies*. New York: Routledge, 1992.
- Guha, Ranajit, ed. *A Subaltern Studies Reader, 1986–1995*. Minneapolis: University of Minnesota Press, 1997.
- Hegel, G. W. F. *The Phenomenology of Mind*. Translated by J. B. Baillie. 2nd ed. London: Allen and Unwin; New York: Macmillan, 1931.
- Hirsch, Marianne, and Evelyn Fox Keller. *Conflicts in Feminism*. New York: Routledge, 1990.
- I'll Take My Stand: The South and the Agrarian Tradition, by Twelve Southerners*. New York and London: Harper and Brothers, 1930.
- Jakobson, Roman, and Morris Halle. *Fundamentals of Language*. 2nd rev. ed. The Hague: Mouton, 1971.
- Jameson, Fredric. *The Political Unconscious: Narrative as a Socially Symbolic Act*. Ithaca, N.Y.: Cornell University Press, 1981.
- . *Postmodernism; or, The Cultural Logic of Late Capitalism*. Durham, N.C.: Duke University Press, 1991.
- Kester-Shelton, Pamela, ed. *Feminist Writers*. Detroit: St. James Press, 1996.
- Lacan, Jacques. *The Four Fundamental Concepts of Psycho-analysis*. Edited by Jacques-Alain Miller. Translated by Alan Sheridan. New York: Norton, 1978.
- Lemon, Lee T., and Marion J. Reis, trans. *Russian Formalist Criticism: Four Essays*. Lincoln: University of Nebraska Press, 1965.
- Macksey, Richard, and Eugenio Donato, eds. *The Languages of Criticism and the Sciences of Man: The Structuralist Controversy*. Baltimore: Johns Hopkins University Press, 1971.
- Napier, Winston, ed. *African-American Literary Theory: A Reader*. New York: New York University Press, 2000.
- Nicholson, Linda J., ed. *Feminism/Postmodernism*. New York: Routledge, 1990.
- Ohmann, Richard. *English in America: A Radical View of the Profession*. New York: Oxford University Press, 1976.
- Readings, Bill. *The University in Ruins*. Cambridge, Mass.: Harvard University Press, 1996.
- Richards, I. A. *Speculative Instruments*. Chicago: University of Chicago Press, 1955.
- Said, Edward W. *Orientalism*. New York: Vintage, 1979.
- Saussure, Ferdinand de. *Course in General Linguistics*. Edited by Charles Bally and Albert Reidlinger. Translated by Wade Baskin. New York: Philosophical Library, 1959.
- Spillers, Hortense J. *Black, White, and in Color: Essays on American Literature and Culture*. Chicago: University of Chicago Press, 2003.
- Wall, Cheryl A. *Changing Our Own Words: Essays on Criticism, Theory, and Writing by Black Women*. New Brunswick, N.J.: Rutgers University Press, 1991.
- Warren, Robert Penn. "The Briar Patch." In his *I'll Take My Stand: The South and the Agrarian Tradition, by Twelve Southerners*. New York and London: Harper and Brothers, 1930.
- Wellek, René, and Austin Warren. *Theory of Literature*. 3rd ed. New York: Harcourt, Brace, 1956.
- Wheelwright, Philip. *The Burning Fountain: A Study in the Language of Symbolism*. Rev. ed. Bloomington: Indiana University Press, 1968.
- Wimsatt, W. K., Jr. *The Verbal Icon: Studies in the Meaning of Poetry*. Lexington: University of Kentucky Press, 1954.

Hortense J. Spillers

LITERARY HISTORY. History traces the passage of men and women through time. Literary history charts their developments and experiments in writing in the hope that global discourse will be stimulated and cultures come to understand one another. It relates, compares, and categorizes the poetry, prose, drama, and reportage of authors at various periods. The process started when the artistic deployment of language (poetry, polemic, drama, and stories) began to inspire a significant following. There arose a "culture of response" or a body of people—priests, scholars, educators, and fellow writers—who extolled select works and ensured their preservation in archives and public buildings. In this manner a "canon" or corpus of writing was put together that was deemed significant in relation to the culture because it reflected nationalistic bias, religious, political, or aesthetic partiality. The "models" or frameworks of admission altered as knowledge progressed, printing became widespread, and attitudes and styles of writing changed. Around the world separate cultures evolved their own criteria, forms, and traditions, ranging from doctrinal works such as Buddhist sutras and Vedic hymns to Japanese dance-drama (the Noh plays) and Chinese operatic drama or chuanqui. Within such works were found ideas that had a lasting effect.

In the Western model, for instance, Plato (c. 428–348 or 347 B.C.E.) believed poetry was merely imitative, but Aristotle (384–322 B.C.E.) praised its imaginative truth, while Homer thought his inspiration "God given"—standpoints that were echoed and debated down the centuries. After the Greeks and Romans, many critical ideologies emerged in Europe, invoking morality, passion, and truth to life and authorial intention, but it was not until the twentieth century that the sound of theories clashing drowned the traditional debate between critic and author (a debate that did not much affect the public who continued to read books for pleasure). Ironically the shift of spotlight from creator to commentator climaxed in a critical task force that sought to detonate its own foundations or "deconstruct" the very language of its discourse. Ostensibly radical, this was no more than a revival of an ancient revolt. For language from the start had always sought to analyze or "argue" the authority of its being, just as man had always sought to challenge the authority of God. From the beginning, literary history tended to be presented as a sequential progression—a dialogue or "confrontation" between successive ages and schools of writing, one "great book" or "genius" spurring another, starting with texts concerned with man's status in the universe, specifically his mortal limitations as opposed to the immortal gods.

Early interest focused on myth, out of which emerged the hero who stood taller than the rest, loyal, brave, and fabulously

resilient. The Sumerian *Epic of Gilgamesh* tells of a swaggering young prince who defies the gods, bonds with another warrior-hero, and meets the fate that such a rebellion inevitably courts. It ends with a massively moving death lament. Gilgamesh *has* to die in order that he retain his humanity. If he did not, he would be a god and forfeit that essential *realism*, or truth to the mutable world, that is the hallmark of great literature.

The Greeks showed a similar preoccupation with gods and heroes. If their analysis went deeper, they too held by laws in which the overreacher—the man who commits an irreversible act against nature—is abandoned to the Furies (primitive avenging spirits), who demand he be sacrificed in order to maintain the status quo. This is notable in Greek tragedies, especially Sophocles' *Oedipus Rex*, whose harsh, unrelenting climax is often viewed as pitiless. With respect to such forms, Aristotle introduced an ethical dimension when he analyzed the rhetorical devices and idioms of the fourth century B.C.E. in his *Poetics*, a foundation-stone for students of literature (as well as Hollywood scriptwriters), for it launched the notion of plot or *mythos* as a device conveying unity of theme and action. Crucially, the concepts *mimesis* and *catharsis* were defined, the first positing language as imitation and the second dealing with the emotional purgation—a mix of horror and pity—arising in the spectator of a powerful tragedy. Aristotle's compatriot, Plato, denied the highest truth to literary art, seeing literature as too attractively persuasive. As for the Greek myths, with their stunning organic imagery and metamorphoses, they inspired every age of literature, perpetually updated and adapted as novels, operas, and plays.

The Religious Imperative

Equally far-reaching, in Europe, was the impact of Christianity. With its volatile mix of stories, poems, and sacred and prophetic texts, the Bible provided a moral groundwork that formed the basis for hagiographies, sermons, and devotional verses. The book of Genesis unlocked “Logos,” the divine word or sacred seal of inspiration: thus, being literally “God given,” language was able to transcend the clasp of mortality and enshrine the numinous. Literature was annexed for the promulgation of doctrine. A library was an institution that preserved sacred texts rather than a place where a commoner might go and acquire knowledge. The one great rebel was Satan, who, having been expelled from Heaven, pursued his counteroffensive among the fallen and fallible of the world.

With the spread of monotheism, the relationship of man to God dominated prose and poetry. In the early medieval period, fables, histories, and courtly tales of love and chivalry predominated. Stories were promoted as exempla, designating a suitable way to behave in order to draw down grace or, alternatively, court damnation. However, in the *Phaedrus*, Plato had placed art a rung below “truth,” being a product of materiality rather than spirit. Hence it could never be wholly trusted.

So that the Bible should hold absolute authority, this doctrine was modified by the Scholastics (c. 800–1400), whose era of crippling, devotional studiousness was shattered by the

Renaissance of the fifteenth and sixteenth centuries—an amazing upsurge in learning that held fast to classical models (Plato, Aristotle, and Cicero's rules of rhetoric) yet managed to accommodate a vast influx of new ideas—from science, natural history, philosophy, theology, botany, mechanics, anatomy, and engineering. Literary art promoted a worldview with God and his angels at the top, a spiritual cartography that found its acme in Dante's *Divine Comedy*, in which love was the redeeming force and every station of saint and sinner had their precise place and part.

Naturally a great deal of literature was the preserve of monks and scholars who tended to propagate heroes of a devotional bent. By the time of the Reformation (1517), this mold showed signs of cracking. Eventually it was superseded by a new type of psychological truth, typified in England by the dramas of an emergent laity that included men such as Shakespeare, Christopher Marlowe, and Ben Jonson, writers who portrayed characters—villains, nobles, and commoners—bursting with painful, turbulent contradictions hinting at the inadequacy of religion in engaging human dilemmas.

Enlightenment and Romanticism

The Enlightenment of the seventeenth and eighteenth centuries is often vaunted as the age of reason. But it was also an age of passion, profound thinking, and revolutionary zeal, allied to a robust practicality, Aristotelian in outlook. John Locke (1632–1704) evolved a theory of the personality and a far-sighted, liberal political philosophy. Less idealistic, Thomas Hobbes wrote *Leviathan* (1651), a masterly analysis of man's place with regard to nature and society. Religion remained institutionally entrenched (if a little shriveled by the skepticism of David Hume) and the dominant literary mode, classic in character and reformist in outlook, found its outlet in urbane, sometimes sardonic stylists like Voltaire (1694–1778) and Diderot (1713–1784) in France. Equally puncturing of pretensions were the heroic couplets of Alexander Pope and John Dryden in England and novelists like Samuel Richardson and Henry Fielding, portraying social rather than God-seeking characters engaging in intrigues and amours.

The French Revolution brought republicanism, in which commoners replaced kings, and taxes were more evenly distributed. But military aspirations rampaged across Europe and Russia until the defeat of Napoléon Bonaparte. The Romantics of the late eighteenth and early nineteenth centuries were caught up in this spirit of rebellion. *Liberty* was the shibboleth of the poets William Wordsworth, Lord Byron, and Percy Bysshe Shelley—a word hoarding spiritual and political connotations. Language no longer favored the noble above the plain, for it was thought that the artist's intention elevated the subject matter. German Romanticism followed in the wake of the English initiative and, like its forerunner, throbbed with nature, passion, and intrigue but with an added spicing of wit and sexuality.

Where the Romantics had shown a preoccupation with themes like murder, intrigue, and incest, the nineteenth century developed the skills of everyday observation. Above all, it was the age of realism in the novel, embodied in the psychological

narratives of Leo Tolstoy, Fyodor Dostoyevsky, Charles Dickens, and George Eliot: multilayered fictions set in worlds so convincingly realized that they seemed to reflect life as *experienced* rather than imagined. It was also a time of the professional man of letters who, at intervals, appraised the state of culture, typical English examples being Matthew Arnold and John Ruskin, the first a poet of distinction and the second a social critic and art historian. Victorian poetry was marked by a facile, routine romanticism that finally darkened and putrefied: hence the morbidity of content, the gothic shadow falling over some of the works of Robert Browning (1812–1889), Alfred, Lord Tennyson (1809–1892), and Edgar Allan Poe (1809–1849).

The final decade of the nineteenth century was enlivened by the walk-on of the decadents, who started in France but quickly spread over the English Channel, espousing a doctrine similar to the symbolists: that art was free to treat whatever subject it saw fit, whether pernicious or virtuous. Art for art's sake (a slogan translated from the French of the philosopher Victor Cousin) was the byword, emancipating the creator—if he or she so wished—from conscience or morality. The decadents liked to celebrate small, exquisite instants in small, exquisite poems, sipping at life as if it were a rare wine.

From Masterpiece to Text

With the advent of the twentieth century came a shift from elitism to inclusivism. Despite the elite radicalism of factions such as the modernist who sought to break with the past and incorporate in their projects the staggering breakthroughs in science, anthropology, medicine, and psychology, the citadel of high culture was opening its gates. In the same way that the people of various countries were demanding a government in which their opinions could play a central role, literature became more democratic, spawning free libraries, open scholarships, and popular editions. Eventually there spread an awareness that all facets of culture, oral or written, constitute a “text,” and the traditional fixation on a corpus of “masterpieces” was a blinkered way of evaluating culture.

A noted leveler was the psychologist Sigmund Freud (1856–1939), who showed how people tend to think and act the same—that all are dominated by hidden urges. Each man and woman has a subconscious in which sexual desires bubble and fume and are liable to spill over in erratic or outrageous behavior—ideas that opened the floodgates of creativity and literary experiment, unleashing the “stream of consciousness” technique, in which a rush of unpunctuated, sometimes loosely associated words are made to stand for dreaming or thought-play, notable exponents of the latter being James Joyce, Virginia Woolf, and William Faulkner.

As experiment brewed in artistic circles, elsewhere the dream of freedom was degenerating into tyranny and nightmare. In the Soviet Union, Joseph Stalin wrested power in 1924, followed by Adolf Hitler in Germany in 1933. Both the Communist and Nazi regimes banned free speech. In Russia, novelists were condemned as “insufficiently ideological” or as putting self before state, and in Germany the works of select writers were ritually burned as “Jewish” or “decadent.” Literature was promoted as an extension of a cause, much as it had

been during the Middle Ages. Whereas Nazism had effectively died out after World War II, the Communist dream persisted through the writings of Karl Marx (1818–1883), whose ideas pioneered an influential school of literary criticism.

Marx's thesis was that the worker, alienated from his product by contractual enslavement, had no status and was there solely to serve his master. And, of course, to him the master was equally remote, unsolid, and this notion of invisibility or “nonpresence” takes us to the core of modern literary theory: the author as anonymous ghost haunting the boundaries of his or her text.

For just as science at the turn of the century was breaking matter into tinier and tinier particles, literary criticism was separating the finer elements of language, analyzing units of sound and syntax. The theories of Ferdinand de Saussure (1857–1913) identified sequences of self-contained signs whose parts could be isolated into vocal utterances (*parole*) and the abstract structure that organized them (*langue*). Saussure was a major influence on the Russian formalist movement, which had its inception in 1914 at Saint Petersburg, headed by the critic Viktor Shklovsky (1893–1984), who fused symbolist ideas with his own manifesto, demanding autonomy for the text, discarding any social role for literature, and cultivating metaphor, mystery, and radical perception.

This propensity to focus on language, its emotional and figurative charge, was also a precept of the New Criticism that developed in England and the United States after World War I. Treating a poem or novel as a self-contained artifact, this approach took the text apart in a precise, clinical manner, paying attention to aesthetic balance, the interplay and opposition of imagery, excluding social and biographical factors that existed beyond the page. The overall unity of the work—how parts were orchestrated to harmonize or counterpoint one another—was considered as indicative of its quality in the “Western tradition,” which held by formal standards of excellence.

With emphasis on the autonomy of texts, words drifted from their anchorage in the physical. Signifiers were seen as signaling to each other rather than the reader. This reached its apotheosis in the writings of Jacques Derrida (b. 1930), who subverted the notion of a single meaning. The author was not a spider presiding over a web of words. No, he was a fly trapped in it—unaware that his work held messages at odds with the stance he thought he had taken. What critics of the past had done was “privilege” various angles and themes, taking in current thought and social mores, but their readings were more acts of faith than rational appraisals. Derrida drastically hinted that the totalitarianization of meaning—the obsession with a single clear authorial intention—found a counterpart in the inflexible rationalism of the Nazi death camps.

Such theories began to infuse the novel, which started to question its own fictive illusion, just as had the German playwright Bertolt Brecht (1898–1956) when he sought to separate the political message from the drama by exaggerating the elements of artifice and so creating a sense of “alienation.” So-called metafiction was produced that ridiculed the procedures of novel writing and, in one instance (B. S. Johnson's

1964 novel *Albert Angelo*), had the angry author breaking through the page shouting, “O fuck all this lying!” At last, Narcissus had smashed the mirror.

Guilt and Contrition

Aside from innovation, propaganda, and linguistic debate, the twentieth century was an age of guilt and contrition. The guilt was based on a dawning awareness of the elitism of Western culture. Contrition took the form of an eagerness to make good the oversight by broadening the definition of literature and including in its field hitherto silent minorities whose voices initially took the form of protest, their cultures having been so long patronized that the “imaginative” content needed longer to emerge. In 1925 the educator and critic Alain Locke (1885–1954) issued a manifesto to young black American artists, challenging them to draw upon the power of African art as avant-garde artists in Europe had done. However, many of those to whom he appealed had not even been to Africa, and to them it was as much a place of fantasy as it was to the white men. Africa was grasped in terms of distance, vastness, and a savage sensuality—qualities that writers like D. H. Lawrence (1885–1930) had strained to capture. Negritude had its origin in the Caribbean and was defined by poets like Léopold Sédar Senghor, who conveyed a sense of anger and injustice in torn, surreal images.

Another minority impacting on current thought were women writers who mobilized to form a cultural force after World War II, key texts being Simone de Beauvoir’s *The Second Sex* (1949) and Kate Millet’s *Sexual Politics* (1970). The matter had earlier been raised in Virginia Woolf’s *A Room of One’s Own* (1929), but the tone was now combative, attacking the patriarchal roots of the Western canon and drawing attention to female writers whose stature had been overlooked or denied. Such efforts stimulated a massive wave of gender-based critiques—gynocriticism—that analyzed and tried to reshape the culture that, as they saw it, was based on male bias and partiality.

With the interest in hitherto marginalized groups and communities came an increased recognition of the political and economic factors that permeate culture and leave their impress. Insights like these gave rise to the New Historicism, a mainly American school of criticism, Marxist in flavor, that used texts to pinpoint the political and social conditions, the ideologies and judgments that, inevitably, color and bias writing—in opposition to the Romantic view of the author being a wellspring of unpolluted inspiration. The critic analyzes oddments, small, previously ignored details and facts, typical yet eloquent, exposing literature as a tool of history.

Contemporary Dilemma

By the twenty-first century, the Western model of literary history had been dramatically extended, taking in Asia, Africa, Australia, South America, the South Pacific, and the Arab world. Its approach had been criticized as a series of “generalizations” working through contrasts and continuities—an “institutionalized subjectivity,” as the French critic Roland Barthes would have it. (And yet, many believed, such a summary or “distortion” is inevitable if information is to be condensed

within a certain remit.) It infers an almost kinetic impact between literary movements, whereas a scientist might argue this is not *how things happen*, merely a habit of human perception. Is the model then valid? Or is it a piece of illusionism, a series of traditionally accepted linkages? This is the type of question literary history had begun to ask of itself. Having broadened its scope to encompass the world, it was almost the history of everything (“everything” and therefore “nothing,” some critics might say).

Thus previous classifications were being reexamined and fresh approaches made, considering not just the text but, for example, the prevalent institution, the critical orthodoxy or heterodoxy, in which it was first received. Threads of movements such as classicism, romanticism, and naturalism, together with critical theory, were being redefined within a pattern that, inevitably, will grow more intricate and extensive as the field of study reaches out to the vernacular, cinematic, and oral, where previously it had focused on the canonical. The new methodology will go far beyond the aesthetic, developing an increasingly comparative methodology, moving between past and present, drawing on disciplines like sociology, economics, and politics.

This epic inclusiveness generates anxiety as well as excitement among its practitioners, who must trace vibrations from reader to society, from society to politics, from politics to the world. Keeping literary history up to date is like being both cannibal and victim, devouring past texts in the hope of completion, only to be swallowed in turn by the recorders of futurity.

See also *Literary Criticism; Literature*.

BIBLIOGRAPHY

- Aristotle. *Poetics*. Translated by Malcolm Heath. London and New York: Penguin, 1996. A friendly, accessible rendering that reads well.
- Auerbach, Erich. *Mimesis: The Representation of Reality in Western Literature*. Translated by Willard R. Trask. Princeton, N.J.: Princeton University Press, 1953. Analytical classic demonstrating how great works of literature stand in relation to their times.
- Blake, N. F. *An Introduction to the Language of Literature*. New York: St. Martin’s, 1990. Aims to define what sets “literature” apart.
- The Cambridge History of Literary Criticism*. 9 vols. Cambridge, U.K., and New York: Cambridge University Press, 1989–2001. Authoritative reference series.
- Derrida, Jacques. *Writing and Difference*. Translated by Alan Bass. Chicago: University of Chicago Press, 1978. Key text of deconstructionism.
- Lodge, David, ed. *Modern Criticism and Theory: A Reader*. London and New York: Longman, 1988. Both this book and the one below contain useful introductions and selections of source material.
- . *Twentieth Century Literary Criticism: A Reader*. London and New York: Longman, 1972.
- Norris, Christopher. *The Truth about Postmodernism*. Oxford and Cambridge, Mass.: Blackwell, 1993. A counteroffensive to the “heresies” of postmodern culture.

Saussure, Ferdinand de. *Course in General Linguistics*. Edited by Charles Bally and Albert Reidlinger. Translated by Wade Baskin. New York: Philosophical Library, 1959. Foundation stone of linguistics.

Paul Newman

LITERATURE.

This entry includes two subentries:

Overview

African Literature

OVERVIEW

Almost all senses of the English word *literature* and its cognates in other Indo-European languages can eventually be traced back to the act of scratching (on a piece of leather or on clay, stone, wood, wax, pottery, lead, or papyrus). But this primitive act very quickly became associated with superior development: civilization.

The Appearance of Literacy

The word goes back first to the Latin *litteratura* (writing, grammar) and *litteratus*, which denote learnedness derived from writing, or literacy, and then to *littera*, or letter. (The French *littérature* has the same roots.) It is conjectured that the Greek root of the Latin *littera* is *diphthera*, meaning a leather hide prepared for inscription. In his *Institutio oratoria*, Quintilian (c. 35–c. 100 C.E.) uses the word *litteratura* as a translation of the Greek *grammatikē* (Wellek). As such, it represents the art of the letter (*gramma*), which would denote the ability to read and write and hence the rules or “grammar” governing this ability. But the Greek word for writing, *grammata*, also means “scratchings”—its Indo-European root, *gerebh-*, means “to scratch.” The English verb *to write* derives from the Germanic *writan*, also meaning “to scratch.” The English word *Scripture*, like the German *Schrift* (a *Schriftsteller* is a literary person), can be traced back to the Latin verb *scribere*, “to write,” and then to the Indo-European root *skeri-*, from which come a host of words having to do with cutting. The Indo-European *skeri-* has a variant form *krei-*, denoting separation, sifting, and discrimination, from which comes the Greek *krinein*, meaning “to judge,” and later English words such as *critic* and *criterion*. One of the meanings of *sker-* is excrement, hence something worth knowing how to avoid. One can discover in literature’s philological beginnings nascent forms of nearly the entire family of ideas that would come to be associated with the word *literature*: letters, writing, literacy, learnedness, discrimination, distinction, criticism, and judgment. Because, almost everywhere, writing and reading—unlike speech, acquired in infancy—were skills that demanded time and effort to acquire, literature, more or less by its nature, had its beginnings among groups that not only were socially empowered to make distinctions (priests, scribes, bards, chiefs) but also were socially distinguished by the very fact of being literate.

As Barry Powell observes, it has long been a puzzle why the narratives generally considered the oldest examples of Western literature, Homer’s *Iliad* and *Odyssey*, have all the structural

characteristics of advanced, literate societies yet contain no mention of writing itself. The one reference to “baneful signs”—not yet *grammata*, or writing—in the story of Bellerophon (*Iliad* 6.157–211) came to Homer from the Levantine East, as did many other elements of the Homeric epics, and it may suggest that the poet whose version of the *Iliad* was finally written down did not yet understand what writing was. Literature in any guise came late to the West: the written forms of the Homeric epics date from around the time of the invention of the Greek alphabet, c. 800 B.C.E., while reference to written documents appear regularly in much older narratives from Egypt and the Near East, c. 1800 B.C.E.

The oxymoron *oral literature* has been used to describe unwritten compositions in story, poetry, or song, transmitted with many variations over time, though the rubric remains mired in much dispute (Lord). People have most likely told stories about themselves, their gods, their heroes, and the creatures, both real and imagined, surrounding them from the beginnings of language, and such storytelling is still an integral part of what is meant by the term literature. But the process by which supposedly oral compositions like Homeric epic poetry came to be written down is unknown. Similarly, while the extant Bible is largely a mix of documents assembled piecemeal from preexisting (and now lost) documents, oral accounts must have been part of many biblical stories. Abraham may have existed as early as 2000 B.C.E., Moses around 1200 B.C.E., but no written account of them survives from before the sixth century B.C.E. Well before the Latin word *litteratura* existed, Homer’s epics and Hesiod’s *Theogony* already included what is now recognized as a wide range of genres or modes of writing, from the skillfully entertaining to the legal, philosophical, historical, and religious. If oral traditions that survived into the modern period are any guide, oral performances designed for entertainment employed a range of structural devices and tropes that helped define what came to be called “literary” language. A general consensus arose in the late twentieth century that alphabetic writing made possible whole ways of thinking not available to nonliterate societies (for different approaches, see Ong and Goody). Certainly literacy seems to have facilitated military conquest and administrative authority. But it is hard to know precisely how the psychological or cultural consequences of alphabetic writing in the West, beginning in Mesopotamia, differed from those of writing in China, which had a quite distinct history; or how much of what is called the “literariness” of novels, poems, and plays ultimately derives from preliterate oral performance or perhaps from the innate structure of human consciousness.

In Sumeria and Egypt and in China written documents and ways of talking about writing appear earlier. Writing first appears in Sumer c. 3400 B.C.E. with the inscription of shapes into clay for the purpose of counting objects, though the use of smaller objects themselves as tokens is much older. At a certain point, perhaps first via pictures (pictograms) and then via increasingly abstract symbols, phonetic units came to be linked to written ones, and writing came to be considered the legible form of speech. It can be said that the earliest (cuneiform, logographic) literary texts could not actually be “read,” since one still needed aural instruction to be able to pronounce the radically

incomplete sequence of signs. The epic story of Gilgamesh survives in several different language families (Sumerian, Semitic, and Indo-European) and scripts (cuneiform and Luwian), the longest version from the seventh century B.C.E., the earliest from perhaps the fourteenth century; the hero-king himself seems to have existed in the third millennium. Chinese script may be even older than the Sumerian and certainly dates from at least the second millennium. In Chinese, unlike the phonetic writing that developed in Sumeria and then in the Greek and Latin alphabet, one finds in the same sign a phonetic element and a nonphonetic element, or semantic “radical.”

Literature in the Early West

The Hellenistic Greeks had a robust sense of the different kinds of writing within the idea of *grammata*. In book 10 of the *Republic*, Plato distinguished sharply, for example, between philosophy (dialectic), which he championed, and poetry, which he wanted to ban because of its propensity to settle for superficial views of things and to stir the emotions unnecessarily. Aristotle’s treatises *Interpretation* (comprising grammar and logic), *Rhetoric*, and *Poetics* are some of the earliest examples of criticism. His *Poetics* is generally considered the founding text of literary interpretation in the West, though the term explicated by Aristotle is not *grammata* but *poiēsis*, which means “making” or “creating” as well as “poetry” and “poem.” Nevertheless, the treatise clearly sets out a theory of literary genres and thoroughly anatomizes one of them—tragic drama—to demonstrate its essential structure; its psychological effects on its audience; its bases in Greek culture and myth; its distinctness from history and philosophy as well as from other types of poetry, such as epic and lyric; its ability to give pleasure and to reveal truth; and its relation to fate and the gods. Aristotle’s ideas have remained touchstones throughout the history of literature in the West, and it would be fair to say that the academic study of literature would not be the same without them. They were revived in a dogmatic form by the French in the seventeenth century and are still routinely taught in the twenty-first century.

Romans such as Cicero used the term *litteratura* to mean both writing itself and learning. It was the early church fathers of the second century, such as Tertullian in *De spectaculis*, who distinguished between sacred and profane writing—*scriptura* versus *litteratura*—within the Christian tradition and who elevated the former above the latter for several centuries. During this period, the profane term *litterature* and its cognates appear to have had little currency. In the British Isles there is a small canon of Anglo-Saxon poetry beginning in the late sixth century. With the exception of *Beowulf*, a narrative poem assembled from earlier sources in the seventh or eighth century, the development of a major classical genre, such as epic, seems to have been hindered for a time by the dominance of Christianity. In France literacy and learning were revived by the court of Charlemagne (742–814), king of the Franks from 768 until his death and Holy Roman emperor (from 800), but the legend of Charlemagne is handed down in various forms before the epic *La chanson de Roland* appears in early twelfth-century medieval France. The twelfth-century *Poema del Cid*, perhaps the most important of early Spanish epics, embellishes

in courtly, Christian terms the deeds of a noble, eleventh-century Castilian soldier of fortune.

The patristic Scripture-literature hierarchy was vigorously challenged by Dante Alighieri (1265–1321) in *De vulgari eloquentia* (1304–1309), a treatise defending “eloquence in the vernacular,” albeit written in Latin and perhaps with Quintilian as a model. Dante argued, first, that profane literature could be read with the same seriousness and interpreted along the same lines as Scripture, and second, that morally serious profane literature could be written not only in Latin, which was then the language of statecraft and high culture throughout Europe, but also in the vernacular, that is, in the commonly spoken regional languages. Such regional languages were assumed at the time not to be governed by the rules of grammar and hence not to be suitable for important matters. Although Dante’s ideas had a negligible influence in his day, his vision of vernacular literature would be realized in the subsequent rise of distinct national cultures following the fragmentation of Roman Catholic hegemony in Europe. Martin Luther’s early sixteenth-century Reformation and perhaps more important, the translation of the Bible into modern languages prepared the ground for the later idea that literature, whether historical, philosophical, or imaginative, embodied distinct national spirits. Still, the study of vernacular literatures would not occur in most European academies until the nineteenth century.

In a fourteenth-century Scottish version of the lives of the saints, the word *lateratour* is used to mean essentially what its Latin root had meant for Quintilian and Cicero: familiarity with books, including the polite learning and elite cultural status associated with literacy. In 1513 Henry Bradshaw wrote in verse of “the comyn people symple and neclygent, / Whiche without lytterature and good informacyon / Ben lyke to Brute beestes” (vol. 2, p. 4). Something of Bradshaw’s “good informacyon” persists in one of the secondary modern meanings of the term literature, which allows the term to denote the totality of written material on a given subject, as when one speaks of the literature on a particular medical treatment, or the literature on child development. In the part of the sixteenth-century school curriculum called the trivium, designed to teach both spoken and written Latin, grammar was intimately related to rhetoric and logic: to have “literature” was to write both persuasively and rationally. This academic synthesis, based on the study of Latin and Greek, persisted into the nineteenth century and also governed the early study of vernacular languages. Theater, both in the Elizabethan London of Shakespeare and in the fashionable seventeenth-century Paris of Corneille and Racine, supplied early intimations of the idea of literature in its primary modern sense: imaginative writing pursued as a vocation and for profit. It is in this context that in 1635 Cardinal Richelieu founded the Académie Française, an essentially literary academy, for which Charles Perrault proposed in 1666 a section devoted to “belles lettres,” to include grammar, eloquence, and taste. By 1710 the phrase “belles lettres” is used by Jonathan Swift in an issue of the *Tatler* magazine to denote a profession on a par with history and politics. On the whole, literature bears its traditional, inclusive meaning through most of the eighteenth century, as exemplified by Voltaire’s definition of *littérature* in his

BY WAY OF COMPARISON: *LITERATURE* IN CHINESE

The word for literature in Chinese (*wenxue*) is an ancient term revived for twentieth- and twenty-first-century needs. In a Chinese schoolroom or bookstore, *wenxue* designates a familiar activity: the reading of poetry, plays, and novels augmented by criticism and the study of some historical and philosophical works for pleasure and instruction. The properties of *wenxue* map precisely onto those of European literature. This is not a coincidence or an astonishing parallel between diverse cultures but rather a case of influence, the contagion of modernity: the categories of thought that have framed the institutions of literature in the West since about 1800 also contributed toward reforming and refounding modern East Asian cultures.

Confucius (551–479 B.C.E.) described two of his students as *wenxue*. *Wen* means “writing,” “documents,” or “culture” in an extended sense, including customs and ritual; *xue* means “learning.” Hence Confucius has always been understood as saying that the strong point of these two disciples was in documentary knowledge, as opposed to others who specialized in policy or argumentation. *Wenxue* has been used as a metonym for scholars or schoolmasters as well as for the activities they engage in, primarily the preservation, interpretation, and transmission of written records. The vast and meticulously administered empire of China had a constant need for such literate men. Periodic examinations held at local, provincial, and imperial levels qualified and requalified candidates for office. The subjects covered in these examinations varied from reign to reign, but policy essays and poetic composition were prominent during most of the fifteen hundred-year history of the examination system.

It was not until the seventeenth century that *wenxue* began to be used, but only rarely, as a catchall term for polite or imaginative letters, as opposed to other kinds of writing. It seems that the impetus for the specialization of the term was given by foreign missionaries who wrote, both in

the reports they sent home and in their Chinese evangelical texts, that the Chinese Empire was unique in selecting its high officials on the basis of literary attainment. From an internal Chinese point of view, the world of letters was multifarious, including every kind of verbal artistry and application, but not divided into the subspecies of verbal art and instrumental communication. That distinction came to be canonical for external reasons.

In the late nineteenth century, as the Meiji Restoration set Japan on a course of determined centralization and westernization, new Japanese educational institutions redistributed the many fields of letters to include foreign languages but to exclude most practical or scientific subjects. The term adopted for the faculty of humanities was *bungaku*—the Japanese pronunciation of the Chinese characters for *wenxue*. Within the humanities, *bungaku* specifically referred to literary disciplines, as distinguished from philosophical or historical studies. On the Asian mainland, as the Qing dynasty gave way to the People’s Republic of China in 1911 the original Chinese term made a triumphal return—probably on the lips of Chinese revolutionaries who had studied in Japan—as an object of knowledge, a species of publication, a career path, and a division of learning. The definition and reform of this emergent field was a particular concern of the intellectuals associated with the May Fourth (1919) Movement, whose vision of a “Chinese Renaissance” implied a democratic political order, a scientific epistemology, and a national literature written in the vernacular. The imperial order of letters, in which elegance of expression was—without explicit differentiation—a resource to be wielded in the exercise of power as well as a social mark of distinction and a private amusement, had vanished. As in Europe, the new divisions of learning heralded a new society populated by a new kind of person.

Haim Saussy

BY WAY OF COMPARISON: *LITERATURE* IN ARABIC

The semantic range of the Arabic word *adab*, which in modern usage designates literature in the specialized sense of artistic writing, has shifted considerably over time. As an intellectual standard of cultivation, the notion of *adab* came into being after the emergence of poetry, the cardinal genre of Arabic literature, called “the register of the Arabs” (Allen, p. 104). The Arabic ode in the pre-Islamic era, originating in oral forms and possibly in song, followed an aesthetic that appealed primarily to the listener and had tightly codified tropes. The figure of the poet was associated with “divine inspiration”; the poet was seen as the tribal spokesperson, one who praised the tribe’s illustrious past and hurled invective at its enemies. The connection between poetry and patronage, which predates Islam, grew after the establishment of the new religion: the shift to urban life and the espousal of eulogistic poetry by rulers and the administrative aristocracy as an enhancement of their prestige and power modified without at first annulling the role of the tribal poet. This new poet was the client of a given court, and poetry began to address new themes. It is speculated that etymologically *adab* referred to standards of conduct, to customs, and to enrichment. But the word “came to mean ‘high quality of soul, good upbringing, urbanity, courtesy’ . . . corresponding to the refining of bedouin ethics and customs as a result of Islam,” as well as urbanization, the emergence of a city-bred elite and administrative class, and contact with other cultures (Gabrieli, p. 175). The term gradually acquired an additional “intellectual meaning” and “came to imply the sum of knowledge which makes a man courteous and ‘urbane’” (Gabrieli, p. 175). Such “profane culture” was “at first strictly national” and later, through contact with other cultures, developed from “Arab humanitas, into humanitas without qualification” (Gabrieli, p. 175). Although its primary significance is now homologous with the modern idea of literature in English—that is, imaginative writing—*adab* can

still also be used to denote “good manners” and “refinement.”

Derived from early prose antecedents, such as the compilations of the Prophet Muhammad’s biography and of traditions associated with the pre-modern corpus, *adab* (the tradition of belles lettres written in classical Arabic) includes poetics, biography, historical and geographical writings, travelogues, rhetoric, compilations of entertaining anecdotes, and monographs. Debate about the origin of the modern Arabic novel has hinged on whether it is an imported genre or one that draws on indigenous antecedents, especially elite ones, such as the *maqamah* (“assembly,” a form of fictional narrative in rhyming prose; also poetry and quotations from poetry). Scholarly discussions have tended to overlook popular antecedents such as *The Thousand and One Nights*, a collection of Arabian tales of unknown origin probably collected in Egypt in the fourteenth to sixteenth centuries with a Persian frame narrative that is first mentioned in the tenth century C.E. In his study of the origins of modern Arabic *narrative discourse* (a term he uses to cover the short story, novel, and drama), Sabry Hafez approaches the issue through “intertextuality” rather than “genealogy.” Tracing the “cultural revival” in modern Egypt and the Levant back to the eighteenth century, before Napoléon’s occupation of Egypt, Hafez demonstrates that these new genres emerged through a complex and dynamic process based in socioeconomic and cultural changes. These included increasing urbanization, improved means of transport, the printing press, and education as well as “the rise of national and political consciousness, journalism and the contact with European culture and thought,” largely through translation (Hafez, p. 64). The result was a new reading public with a different worldview and a demand for narrative texts. Such conditions encouraged writing that drew on a wide range of codes and literatures, writing that would eventually lead to the emergence of modern narrative forms.

Hala Halim

Dictionnaire philosophique (1764–1772)—“a knowledge of the works of taste, a smattering of history, poetry, eloquence, and criticism”—though by this time one can sense the semantic gravitation of the word toward its emerging and narrower modern meaning (Wellek). Not until the late eighteenth century, however, was the word *literature* actually used more narrowly to designate imaginative writing per se, that is, the genres of poetry, fictional narrative, and drama.

The Modern Idea of Literature

In 1777 Samuel Johnson (1709–1784) was invited to compose critical essays for an edition of English poets, beginning with Geoffrey Chaucer (c. 1342–1400), then being prepared by London booksellers. Once the anthology—which was shortened to begin with the early seventeenth-century poet Abraham Cowley—was complete, Johnson’s fifty-two introductions were published separately as *Lives of the English Poets* (1779–1781). In his portrait of John Milton, Johnson still used literature in the classical sense of learning or erudition, observing that the great poet “had probably more than common literature, as his son addresses him in one of his most elaborate Latin poems” (vol. 1, p. 85). But when introducing Cowley, Johnson gave the term a significance that would become central by the early twentieth century. Johnson described Thomas Sprat, Cowley’s biographer, as “an author whose pregnancy of imagination and elegance of language have deservedly set him high in the ranks of literature” (vol. 1, p. 1). By the early nineteenth century, a period marked by the prominence of the entrepreneurial author-publisher Sir Walter Scott (1771–1832), the idea that literature refers primarily to a particular *kind* of writing—imaginative—also meant that the word could signify a particular professional occupation. Isaac Disraeli (1766–1848), father of Benjamin Disraeli, used the word in this new, narrower sense when he wrote in 1823, “Literature, with us, exists independent of patronage or association” (vol. 2, p. 407). The primary modern meaning of literature—autonomous, professional, imaginative writing designed for a market economy—had emerged.

At almost the same time that literature was beginning to signify primarily the imaginative genres of poetry, fiction, and drama, two complementary semantic changes were occurring. The first is that the word was being used to designate the total body of writing defined by national (or at least linguistic) origin. Thus Johann Gottfried von Herder (1744–1803) published a book called *Über die neuere deutsche Litteratur* (On the more recent German literature) in 1767, and L’abbé Antoine Sabatier de Castres published a book called *Les trois siècles de notre littérature* (Three centuries of our literature) in 1772, which became *Les trois siècles de la littérature française* (Three centuries of French literature) in subsequent editions. In 1836 Robert Chambers (1802–1871) produced *A History of English Language and Literature*. Such texts both contributed and responded to a political sensibility in the eighteenth and nineteenth centuries that had begun to categorize cultural artifacts in national terms. By the late nineteenth century this way of looking at literature, and especially imaginative literature, would be normalized. The study of modern literature (as opposed to Greek and Latin) came to be used in the schools

to standardize linguistic usage; to elevate the culture of populations with little access to classical learning; to produce social integration across the divisions of economic class; and to provide a basis for a national collective consciousness (Weber).

The second semantic change in the word literature is a reflection of the idea of “aesthetics” in the eighteenth century. Since antiquity, claims had been made that the arts, including poetry and drama, were rational and rule governed, quite despite their aura of divine inspiration. Both Aristotle and Horace, in different ways, made these claims. On the whole, so did neoclassical French critics of the seventeenth century such as Nicolas Boileau. With the third earl of Shaftesbury, and especially the version of his ideas found in Francis Hutcheson’s *Inquiry into the Origin of Our Ideas of Beauty and Virtue* (1726), English moral philosophy based on the sentiments began to translate the older idea of “good taste” in terms of a specific, subjective “aesthetic intuition” present in both the “genius” of artistic creation and the perception of beauty. For Shaftesbury and Hutcheson, the sensation of the beautiful became nothing less than the path by which all the traditional antinomies of philosophy—subject versus object, innate ideas versus empirical learning, necessity versus contingency, reason versus passion—can be overcome. In Germany, with Alexander Baumgarten (1714–1762) and especially Immanuel Kant (1724–1804) and his *Critique of Judgment*, the project emerges of a specific science or philosophy of beauty that emphasizes the disinterested and universal nature of the human response to beauty (Cassirer, pp. 275–360). The Greek word *aesthēsis*, which had covered a range of meanings, including sensation, perception, feeling, knowledge, and consciousness, came to be *aesthetics*, used exclusively to refer to our response to beauty. In the 1790s Friedrich Schiller (1759–1805) wrote his *Letters on the Aesthetic Education of Man*, which outlines a project for making the education of the aesthetic sensibility the central component of a wholesale moral and political reform of humanity. Along with the other arts, literature became a part of that project, though often the term *poetry* or *poetics* (as in Aristotle’s treatise) was still used to denote the artfulness of literature. For Georg Wilhelm Friedrich Hegel (1770–1831), lecturing on aesthetics in the 1820s, art evolves in human history from more material to less material forms, from architecture to sculpture to poetry, as it approaches the ideal of reason. But this means that poetry becomes the most elevated Romantic art form only by virtue of becoming pure sound: poetry is the least burdened by matter, that is, by written *letters*. It is as if the putative oral basis of literary art had for Hegel returned to become its highest form.

Along with the nationalizing of imaginative literature in the nineteenth century—a development that was the dominant institutional form of literary studies in the twentieth-century academy—two complementary ideas arose. The first is the idea of *Weltliteratur* (world literature) used by Johann Wolfgang von Goethe (1749–1832) when commenting in 1827 on his translation of Torquato Tasso (1544–1595). It is a vague but visionary term suggested by the ideal of universal humanity promulgated during the French Revolution and embodied more ambiguously by Napoléon’s subsequent attempt to “liberate” Europe, Asia, and the Middle East by force. The second

is the notion of “comparative literature,” which began to be used in the early nineteenth century, perhaps in imitation of concurrent scholarly movements, such as “comparative anatomy,” “comparative philology,” and other comparative enterprises in history, philosophy, and anthropology. Abel-François Villemain gave a course of lectures at the Sorbonne in the 1820s in which he used the term *littérature comparée*, and two German journals appeared later. *Zeitschrift für vergleichende Literatur* (Journal of comparative literature), edited by Hugo von Meltzl de Lomnitz, was published between 1877 and 1888, and *Zeitschrift für vergleichende Literaturgeschichte* (Journal of comparative literary history), founded in 1866 by Max Koch, was published until 1910.

Contemporary Developments

In some ways, “world” literature predates the nationalizing of literary traditions, since the classical and medieval period is quite polyglot and multicultural. But world literature and comparative literature were given new life in the late twentieth century by the awareness of the historical power of European imperialism and the rise of postcolonial literatures in India, Africa, South America, Asia, and the Middle East and later by the emphasis on globalization as a cultural phenomenon. The fate of specifically *national* imaginative literatures hangs in the balance. At the same time, two other critical perspectives on literature served to challenge once again what the term means. On the one hand, the Romantic idea of literature as the vehicle of aesthetic sensibility was called into question to emphasize the political function of the literary text, especially in terms of class, gender, and race. On the other hand, the idea that imaginative literature represents a kind of writing qualitatively distinct from philosophical writing or historical writing was also radically questioned. The paradoxical result is that the word *literature* at the beginning of the twenty-first century in many ways has begun to recover some of the inclusive significance that was lost when it was narrowed to fit nationalist and aesthetic sensibilities during the Enlightenment. Literature once again refuses to be confined to national borders or to be defined by the imaginative and the aesthetic. With the arrival in the 1990s of electronic literature, produced and consumed with the help of computers, the traditional medium of literature in print or manuscript—the book—acquired a potentially powerful rival. The root idea of literature as writing, that is, the scratching (or printing or typing) of marks into an impressionable material, may well be superseded by the flash of digital impulses across video screens.

See also Aesthetics; Autobiography; Biography; Genre; Language and Linguistics; Language, Linguistics, and Literacy; Narrative; Oral Traditions.

BIBLIOGRAPHY

- Allen, Roger. *The Arabic Literary Heritage: The Development of Its Genres and Criticism*. Cambridge, U.K.: Cambridge University Press, 1998.
- Beeston, A. F. L., et al., eds. *Arabic Literature to the End of the Umayyad Period*. Cambridge, U.K.: Cambridge University Press, 1983.
- Bradshaw, Henry. *The Life of Saint Werburge of Chester*. Edited by Carl Horstmann. Millwood, N.Y.: Krauss Reprint Co., 1975.

- Cassirer, Ernst. *The Philosophy of the Enlightenment*. Translated by Fritz C. A. Koelln and James P. Pettegrove. Princeton, N.J.: Princeton University Press, 1951.
- Damrosch, David. *What Is World Literature?* Princeton, N.J.: Princeton University Press, 2003.
- Disraeli, Isaac. *Curiosities of Literature*. 3 vols. London: G. Routledge and Co., 1858–1859.
- Elman, Benjamin A. *A Cultural History of Civil Examinations in Late Imperial China*. Berkeley: University of California Press, 2000.
- Gabrieli, F. “Adab.” *The Encyclopaedia of Islam: New Edition*. Vol. 1. Edited by H. A. R. Gibb et al., 175–176. Leiden, Netherlands: Brill, 1960.
- Goody, Jack. *The Logic of Writing and the Organization of Society*. Cambridge, U.K.: Cambridge University Press, 1986.
- Hafez, Sabry. *The Genesis of Arabic Narrative Discourse: A Study in the Sociology of Modern Arabic Literature*. London: Saqi Books, 1993.
- Johnson, Samuel. *Lives of the English Poets*. 3 vols. Edited by George Birkbeck Hill. Oxford: Clarendon, 1905.
- Liu, Lydia H. *Translingual Practice: Literature, National Culture, and Translated Modernity, China, 1900–1937*. Stanford, Calif.: Stanford University Press, 1995.
- Lord, Albert Bates. *The Singer of Tales*. Cambridge, Mass.: Harvard University Press, 1960.
- Ong, Walter. *Orality and Literacy: The Technologizing of the Word*. New York: Methuen, 1982.
- Powell, Barry B. *Writing and the Origins of Greek Literature*. Cambridge, U.K.: Cambridge University Press, 2002.
- Saussy, Haun. *Great Walls of Discourse and Other Adventures in Cultural China*. Cambridge, Mass.: Harvard University Asia Center, 2001.
- Voltaire. *Dictionnaire philosophique*. Introduction, notes, and annexes by Béatrice Didier. Paris: Impr. Nationale Editions, 1994.
- Weber, Eugen. *Peasants into Frenchmen: The Modernization of Rural France, 1870–1914*. Stanford, Calif.: Stanford University Press, 1976.
- Wellek, René. “Literature.” In *Dictionary of the History of Ideas*, edited by Philip P. Weiner. New York: Scribners, 1973–1974.

Vincent P. Pecora

AFRICAN LITERATURE

African literature is best understood within the context of Ali Mazrui’s categorization of African historical experience as a “triple heritage”: Africa as a space produced by endogenous historical traditions, Arab/Islamic influences, and Western Judeo-Christian influences. This triple heritage has produced a literature characterized by a tripod identity, based on its relationship to each element. Africa’s indigenous heritage is of its rich oral traditions. The Arab/Islamic heritage is associated with the written literatures of North Africa and parts of East and West Africa. The Arabic and Western aspects of Africa’s triple heritage reflect the continent’s experience with the historical trauma of conquest, evidenced by such events as the Arab invasion of North Africa and West Africa, the trans-Atlantic slave trade, and colonialism. The Western/Judeo-Christian heritage has shaped the literature written in English, French, and Portuguese.

Oral Tradition

Oral tradition comprises the specialized verbal art forms—proverbs, riddles, chants, lyric poetry, tales, myths, legends, and epics—through which African societies have ensured cultural continuity. It is the repository of a community's core values, philosophies, mysteries, rituals, and, most importantly, memory. It survives by virtue of transmission from one generation to another by word of mouth. Performance is its most important distinguishing feature. It exists only in its moment of actuation, when performer and audience come together in a quasi-spiritual engagement. The performer draws his or her materials from the collective ancestral lore familiar to the audience; distinctiveness comes with innovation and inventiveness, delivery, and command of language.

Ruth Finnegan sparked the most significant controversy on the status of oral tradition when she concluded, in her influential *Oral Literature in Africa* (1970), that Africa had no epic. Isidore Okepwho's *The Epic in Africa* (1979) and *Myth in Africa* (1983) became crucial to the institutional and conceptual legitimization of those genres against the backdrop of the Finnegan controversy. Allied to the development of a robust critical apparatus on African oral tradition was the process of recording the various oral genres—folktales, proverbs, riddles, myths, praise poetry, epics, and sagas—for posterity. Birago Diop's (1906–1989) *Les contes d'Amadou Koumba* (1947; Tales of Amadou Koumba) and *Les nouveaux contes d'Amadou Koumba* (1958; New tales of Amadou Koumba) and Bernard Dadié's (b. 1916) *Le pagne noir* (1955; The black cloth) have become classics of the folktale genre. The Sundiata, Mwindo, Ibonia epics and the Ozzidi saga are also extant in significant textual versions.

Written Literature

Africa's written literature could easily span close to five thousand years, depending on the persuasion of various commentators. Thinkers in the Afrocentric tradition trace the antecedents of African written literature to such touchstones as the scribal tradition of ancient Egypt, the Arabic poetic tradition, which began roughly with the Arab conquest of Egypt in the seventh century C.E., the spread of that tradition to the Maghreb and West Africa from the ninth century C.E., which culminated in the development of Hausa Islamic/Arabic verse from the seventeenth century on.

The twentieth century witnessed the blossoming of a generation of North African writers whose craft combined centuries of Arab narratological conventions and Western influences. These writers either write in Arabic and have influential translations of their works in English and French, or they write directly in the two European languages. Of those whose works attained international recognition in English are the Egyptians Naguib Mahfouz and Nawal El Saadawi. Mahfouz's deft handling of historical realism, his inimitable depiction of quotidian life in Cairo turned his fiction into an important opus of Arab imagination and earned him the Nobel prize for literature in 1988, while Saadawi's transgressive novels have become some of the most important feminist works in the twentieth century.

The modern novel in French came much later in the Maghreb. The Algerian, Kateb Yacine's *Nedjma* (1956), is

usually considered the first significant work of the fiction from the Francophone Maghreb, even though the Moroccan, Driss Chraïbi had published a novel, *Le passé simple* (The simple past), two years earlier. North Africa fiction in French soon blossomed with internationally acclaimed writers such as Tahar Ben Jelloun, Abdelhak Serhane, Abdelkébir Khatibi, and Assia Djebar. Djebar's expansive fictional opus, which explores wide-ranging themes such as the trauma of French colonization of Algeria, the brutal war of liberation, and the condition of women in the context of religion and tradition, has become the quintessence of North African literature in French.

With regard to subsaharan Africa, discussions of written literatures tend to take the late nineteenth century as a rough starting point. Indigenous language literatures evolved as a consequence of missionary activity during this period. Missionaries established churches and schools and introduced forms of orthography into local languages to facilitate translations of religious literature. As a result, indigenous language literatures blossomed in western, central, eastern, and southern Africa in the nineteenth and the first half of the twentieth centuries. The Yoruba fiction of Nigeria's D. O. Fagunwa (1903–1963) and the Sotho fiction of Lesotho's Thomas Mofolo (1876–1948) are notable examples.

European language literature, usually referred to as modern African literature, is the dominant African literature. Although the violence of colonialism and the attendant sociopolitical ruptures it occasioned in Africa constitute the background of modern African literature, texts have evolved over several decades and across numerous genres in a manner that allows for the identification of divergent thematic and ideological clusters, all of which underscore modern African literature's investment in the representation of the African experience.

Négritude poetry was the medium through which modern African literature came to international attention in the twentieth century. The Négritude movement grew out of the encounter of young African intellectuals and their black Caribbean counterparts in Paris in the 1920s and 1930s. The Senegalese Léopold Sédar Senghor (1906–2001), the Martinican Aimé Césaire (b. 1913), and the Guyanese Léon-Gontran Damas (1912–1978) were the avant garde of the movement. Négritude philosophy involved a coming into consciousness of the condition of one's blackness in the racist European context of the time and the validation of Africa as the matrix of a proud black race after centuries of European misrepresentation. Damas's *Pigments* (1937) was the first volume of poetry to properly signal the birth of the Négritude movement, but Césaire's *Cahier d'un retour au pays natal* (1939; Notebook of a return to the native land) became its bible. Senghor's *Chants d'ombre* (1945; Shadow songs) and *Hosties noires* (1948; Black hosts) transformed the movement into a full-blown aesthetic phenomenon. However, the full dimensions of Négritude angst were not recorded until the publication of David Diop's (1927–1960) *Coups de pilon* (1956; Pounding).

Poetry comparable in stature with Négritude poetry did not come out of Anglophone and Lusophone (Portuguese-speaking) Africa until the period of the 1960s–1980s. Wole Soyinka (b. 1934), Christopher Okigbo (1932–1967), Gabriel Okara

(b. 1921), John Pepper Clark (b. 1935), Kofi Awoonor (b. 1935), Lenrie Peters (b. 1932), Taban Lo Liyong (b. 1938), Okot P'Bitek (1931–1982), Kwesi Brew (b. 1928), Dennis Brutus (b. 1924), Agostino Neto (d.1979), and Antonio Jacinto (1925–1991) were the leading lights of Anglophone and Lusophone African poetry. Okigbo's collection, *Limits* (1964), is representative of this phase of African poetry.

The African novel also developed within the ambit of historical reevaluation, cultural nationalism, political contestation, and anticolonial protest. Although modern African fiction started with the publication of the Ghanaian Joseph Casely-Hayford's (1866–1930) *Ethiopia Unbound* (1911), it was not until Amos Tutuola's (1920–1997) *The Palm Wine Drunkard* appeared in 1952 that Anglophone West African fiction attained international recognition. Francophone Africa's first novel, René Maran's (d. 1960) *Batouala*, was published to considerable acclaim in 1921 and went on to win the prestigious prix Goncourt. *Batouala* owed its fame to Maran's vivid portrayal of the effects of French colonial rule in Africa as well as his evocative and humanizing descriptions of African life and its environment.

The novel came of age in Francophone Africa from the 1950s onward when writers such as Camara Laye (1928–1980), Seydou Badian (b. 1928), Mongo Beti (1932–2001), Ferdinand Oyono (b. 1929), Sembene Ousmane (b. 1923), Cheikh Hamidou Kane (b. 1928), Ahmadou Kourouma (1927–2003), Williams Sassine (b. 1944), Sony Labou Tansi (1947–1995), Henri Lopès (b. 1937), Alioum Fantouré (b. 1938), and Tierno Monenembo (b. 1947) arrived on the scene. The thematic spectrum of these writers is broad and their range reveals the shifts that occurred in the sociopolitical dynamics of their informing contexts, particularly the tragedy of one-party states and military dictatorships that became the rule in postcolonial Francophone Africa. For instance, Laye's *L'enfant noir* (1953; *The African child*) is a powerful bildungsroman that explores the growing up of an African child who loses the values of his traditional society in a world permeated by European values. In *Le pauvre Christ de Bomba* (*The poor Christ of Bomba*) and *Une vie de boy* (*Houseboy*), both published in 1956, Beti and Oyono, respectively, deploy critical satire to expose the hypocrisies of the colonial situation. Ousmane brings class analysis to the crisis of colonialism in *Les bouts de bois de dieu* (1960; *God's bits of wood*).

However, it was Chinua Achebe's (b. 1930) *Things Fall Apart* (1958) that placed African fiction in the ranks of twentieth-century greats. In *Things Fall Apart*, the epic dimension of Africa's contact with the West, a preoccupation of much of modern African literature, reaches its philosophical and aesthetic peak. Much of Anglophone West African fiction explores versions of Achebe's themes either as collective sociopolitical fissures in a changing world or as individual dramas of alienation. Cyprian Ekwensi (b. 1921), T. M. Aluko (b. 1918), Elechi Amadi (b. 1934), Onuora Nzekwu (b. 1928), John Munonye (b. 1929), Wole Soyinka, Kofi Awoonor, Ayi Kwei Armah (b. 1939), Ngugi wa Thiong'o (b. 1938), Kole Omotoso (b. 1943), and Festus Iyayi (b. 1947) all became major Anglophone West African novelists in the period from the 1960s through the 1980s. While Armah adds a humanist/universal dimension to the drama of man's alienation from his

environment in *The Beautiful Ones Are Not Yet Born* (1968), Ngugi offers a Marxist exploration of the African experience of colonialism and neo-colonialism in *A Grain of Wheat* (1967) and *Petals of Blood* (1977).

Apartheid and race relations are the background of Southern African fiction. Peter Abrahams (b. 1919), Richard Rive (1931–1989), Es'kia Mphahlele (b. 1919), Lewis Nkosi (b. 1936), Alex La Guma (1925–1985), and the Afrikaner novelists, J. M. Coetzee (b. 1940) and André Brink (b. 1935), all produced novels emblematic of the South African situation. Abraham's *Mine Boy* (1946), Rive's *Emergency* (1964), Alex la Guma's *A Walk in the Night* (1962), and J. M. Coetzee's *Waiting for the Barbarians* (1980) document the scale of the human tragedy created by apartheid in South Africa.

African drama is perhaps the genre that has explored the resources of oral tradition most effectively as a result of the ontological linkages between the two: African religious ceremonies—rituals, sacrifices, festivals, funerals, christenings—are forms of drama and the roots of that modern African genre. Wole Soyinka, Wale Ogunyemi (1939–2001), Ola Rotimi (1938–2000), Femi Osofisan (b. 1946), Bode Sowande (b. 1948), and Olu Obafemi (b. 1950) have all written plays exploring the full range of human experience within the cosmic order and within the material contexts of colonialism, neo-colonialism, and the self-imposed tragedies of the African post-colonial order. Soyinka's plays, the most notable of which are *A Dance of the Forest* (1963) and *Death and the King's Horseman* (1975), explore the entire range of these thematic preoccupations. In South Africa, drama proved to be one of the most versatile cultural instruments in the antiapartheid struggle because of its immediate accessibility to a large audience. The South African dramaturgy of Athol Fugard (b. 1932) comes closest to Soyinka's in terms of artistic accomplishment and thematic range.

Women's Writing

African women arrived on the literary scene much later than their male counterparts. Cultural impediments to the education of women, coupled with the Western sexism of the colonial system, kept girls out of the earliest missionary schools. Flora Nwapa's (1931–1993) *Efuru* (1967) was Anglophone Africa's first female novel. Other Anglophone female novelists include Buchi Emecheta (b. 1944), Ama Ata Aidoo (b. 1942), Ifeoma Okoye Zaynab Alkali (b. 1955), Nadine Gordimer (b. 1923), Maryam Tlali (b. 1933), Bessie Head (1937–1986), and Grace Ogot (b. 1930). Some women also became accomplished playwrights, Efua Sutherland (b. 1924), Zulu Sofola (b. 1938), and Tess Onwueme (b. 1955) being the most famous. Thérèse Kuoh-Moukoury's (b. 1938) *Rencontres essentielles* (2002; *Essential encounters*) is the first novel to be published by a Francophone woman. But women's fiction from that part of Africa did not fully take off until the 1970s when two Senegalese women, Aminata Sow Fall (b. 1941) and Mariama Bâ (1929–1981), arrived on the scene.

Because women's writing arose out of the desire to introduce a female perspective to the sociopolitical vision of Africa portrayed by male writers and to address issues relative to

female subjectivity in order to expose the cultural impediments to female agency, African women writers have treated a wide range of themes. The position and role of women as mothers and daughters within the institution of marriage, especially polygamy, the encumbrances attendant on societal/traditional role prescriptions for women, female circumcision, and gender inequality are all themes explored in such classics as Emecheta's *The Joys of Motherhood* (1979), Aidoo's *Our Sister Killjoy* (1966), and Bâ's two novels, *Une si longue lettre* (1979; So long a letter) and *Un chant écarlate* (1981; Scarlet song).

Children of the Postcolony

A new generation of writers attained international recognition beginning in the mid-1980s. The most important factor that distinguishes them from earlier generations is that most of them, but for a few born in the late 1950s, were born after 1960, the year that African nations began to achieve independence. The political reality of these writers is that of the failed African postcolony, something that prompted the Francophone novelist, Abdourahman Waberi (b. 1965), himself a new writer, to describe them as "les enfants de la postcolonie" (children of the postcolony). Difficult socioeconomic conditions in the continent have forced most of the new writers to relocate to the West. Exile, migration, deracination, home, and diasporic identity issues are the major themes of the displaced. Female writers have been very visible in this group: Tsitsi Dangarembga (b. 1959), Yvonne Vera (b. 1964), Ammah Darko (b. 1956), and Chimamanda Adichie (b. 1977) have all achieved international recognition. Their male counterparts, Helon Habila (b. 1967), Chris Abani (b. 1967), Moses Iseigawa (b. 1963), Ike Oguine, and Okey Ndibe (b. 1960) have all published internationally acclaimed novels as well. The Cameroonian, Calixthe Beyala (b. 1961), is the most successful of the Francophone authors in this generation. Other notable Francophone writers include Sami Tchak (b. 1960), Daniel Biyaoula (b. 1957), Alain Patrice Nganang (b. 1970), Alain Mabanckou (b. 1966), and Fatou Diome (b. 1968).

Debates and Critical Engagements

A rich critical tradition developed early around modern African writing. Francophone Africa had journals such as *Présence Africaine* (African presence), *Peuples noirs, peuples africains* (Black peoples, African peoples), *Abbia*, and *L'Afrique littéraire et artistique* (Literary and artistic Africa). Anglophone Africa had a wider array of early journals: *Black Orpheus*, *The Conch*, *The Horn*, *The Muse*, *Drum*, *Okike*, *Transition*, *Ba Shiru*, and *African Literature Today*. While most of these journals no longer publish, *Notre Librairie* (Our bookstore) and *Research in African Literatures* remain the most important. Furthermore, writers became implicated in the early process of elaborating a critical tradition by engaging critics or one another in debates ranging from the question of critical standards to the role of the writer in society. Chinua Achebe's *Morning Yet on Creation Day* (1975), Wole Soyinka's *Myth, Literature, and the African World* (1976), and Ngugi wa Thiong'o's *Decolonising the Mind* (1986) are some of the most important contributions to African literary criticism.

One of the earliest debates concerned the definition of African literature. The writers and critics who gathered in

Uganda in 1963 faced the fundamental question of determining who qualified as an African writer and what qualified as African writing. The high point of the ensuing debate was the famous essay by Obi Wali, "The Dead End of African Literature" (1963), in which he declared that the literature written in European languages did not qualify as African literature. This was the beginning of the ongoing atavistic language debate. Although Achebe countered Wali's position, Ngugi embraced it, transforming the call for a return to African languages into a critical crusade that has lasted for more than three decades.

Another important debate concerned the issue of who was better qualified to critique African literature: the Western or the African critic. The high point of this debate occurred in *African Literature Today* between the American, Bernth Lindfors, and the Nigerian, Ernest Emenyonu. Lindfors had written an unflattering essay on the fiction of the Cyprian Ekwensi. Emenyonu wrote a fiery rejoinder, questioning the aptitude of Lindfors as a Western critic. The next big debate occurred in 1980, when the troika of Chinweizu, Onwucheka Jemie, and Ihechukwu Madubuike published their famous book, *Toward the Decolonisation of African Literature*, condemning the overwhelming recourse to Western literary models and forms by writers such as Soyinka and urging a return to African traditions. With the explosion of postcolonial and postmodernist theories in the West at the end of the twentieth century, African critics became engaged in debating the appropriateness of applying those theories to African literature.

See also *Communication of Ideas: Africa and Its Influence; Negritude; Postcolonial Theory and Literature; Third World Literature.*

BIBLIOGRAPHY

- Almeida, Irène Assiba d'. *Francophone African Women Writers: Destroying the Emptiness of Silence*. Gainesville: University Press of Florida, 1994.
- Beier, Ulli, ed. *Introduction to African Literature: An Anthology of Critical Writing from Black Orpheus*. London: Longmans, 1967.
- Cazenave, Odile. *Femmes rebelles: naissance d'un nouveau roman africain au féminin*. Paris: L'Harmattan, 1996.
- Chevrier, Jacques. *Littérature nègre*. Paris: Armand Colin, 1974.
- Dathorne, O. R. *African Literature in the Twentieth Century*. London: Heinemann, 1975.
- Gikandi, Simon, ed. *Encyclopedia of African Literature*. London: Routledge, 2003.
- Irele, Abiola. *The African Experience in Literature and Ideology*. London: Heinemann, 1981.
- . *The African Imagination: Literature in Africa and the Black Diaspora*. Oxford: Oxford University Press, 2001.
- Jahn, Jaheinz. *A History of Neo-African Literature: Writing in Two Continents*. Translated by Oliver Coburn and Ursula Lehrburger. New York: Grove, 1969.
- Kesteloot, Lilyan. *Les écrivains noirs de langue française: naissance d'une littérature*. Brussels, Belgium: Université Libre de Bruxelles, 1965.
- Larson, Charles R. *The Ordeal of the African Writer*. London: Zed, 2001.
- Mazrui, Ali. *Africans: A Triple Heritage*. Boston: Little, Brown, 1986.

- Miller, Christopher. *Nationalists and Nomads: Essays on Francophone African Literature and Culture*. Chicago: University of Chicago Press, 1998.
- Moore, Gerald. *Seven African Writers*. London: Oxford University Press, 1962.
- Mphahlele, Ezekiel. *The African Image*. London: Faber, 1962.
- Oyèwùmí, Oyèrónké, ed. *African Women and Feminism: Reflecting on the Politics of Sisterhood*. Trenton, N.J.: Africa World Press, 2003.
- Pieterse, Cosmo, and Donald Munro, eds. *Protest and Conflict in African Literature*. London: Heinemann, 1969.
- Wauthier, Claude. *The Literature and Thought of Modern Africa*. Translated by Shirley Kay. London: Pall Mall, 1966.

Pius Adesanmi

LOGIC. Logic is the study of correct reasoning. A host of philosophical themes have clustered around this central concern: the nature of truth and validity, of possibility and necessity; the semantics of words, sentences, and arguments; and even questions about substances and accidents, free will and determinism.

Aristotle

Aristotle (384–322 B.C.E.) was the first person to formulate an explicit theory of correct reasoning, as he himself claimed in *Sophistical Refutations*. He owed a good deal to the exploration into forms of argument carried out in the course of argument contests, such as those illustrated by Plato in some of his Socratic dialogues. Book 8 of his own *Topics* reads like a handbook for contestants, and the *Topics* as a whole is designed to teach its readers how to construct “dialectical” arguments: arguments that, in keeping with the idea of a real contest, use generally accepted premises that will be granted by the interlocutor. In an argument, says Aristotle, “when certain things have been laid down, something other than what has been laid down necessarily results from them.” This definition captures the idea of logical consequence, and in his *Prior Analytics* Aristotle develops his “syllogistic,” a formal theory of logical consequence, which he applies to “demonstrations,” arguments in which the premises must not be merely accepted, but true.

Syllogisms (in the narrow sense considered in the *Prior Analytics*) consist of three assertoric sentences, two of them premises, from which the third, the conclusion, follows. In an assertoric sentence, something is “predicated” of a subject, and a predicate can stand in one of just five relations to a subject: it may be its definition, its genus (“Man is an animal”), its differentia (the element of the definition that differentiates things of one species from another: “Man is rational”), an accident (a characteristic the particular thing happens to have: “Socrates is curly-haired”), or its characteristic property (a feature that all and only things of the subject’s species have, but is not part of its definition: “Man is able to laugh”).

The two premises of a syllogism share a common (“middle”) term, and they have “quantity” (universal/particular) and “quality” (affirmative/negative). They may be, then, universal affirmative (A-sentences: “Y belongs to every X”), universal

negative (E-sentences: “Y belongs to no X”), particular affirmative (I-sentences: “Y belongs to some X”), or particular negative (O-sentences: “Y does not belong to some X”). Depending on the position of the middle term—predicate of both premises (“third figure”), subject of both premises (“second figure”), or subject of the first, predicate of the second (“first figure”)—from some combinations of two A, E, I, and O sentences as premises, there follows an A, E, I, or O sentence as a conclusion—and this conclusion follows purely in virtue of the form of the argument. (Although ancient logicians rarely used false premises as their examples, they too made their conclusions follow logically.) So, for example, in the first figure, the patterns AAA, EAE, AII, and EIO are valid arguments. First-figure syllogisms were held by Aristotle to be self-evident: for example, Mortal belongs to every man (every man is mortal); man belongs to every philosopher; thus mortal belongs to every philosopher. Aristotle also shows how second- and third-figure syllogisms can be reduced to first-figure ones, using a set of conversion rules.

Aristotle’s other logical works both fill in the discussions in the *Topics* and the *Prior Analytics* and introduce new philosophical dimensions. *On Interpretation* discusses assertoric statements and their relations (such as contradiction and contrariety). It also proposes a basic semantics, in which sentences are signs for thoughts, and thoughts for things, and it ventures into difficult questions of possibility and necessity. If it is true that there will be a sea battle tomorrow, then how can we avoid the unpalatable conclusion that it is a matter of necessity that the battle will take place tomorrow? The *Posterior Analytics* uses the theory of demonstration as a basis for a theory of scientific knowledge. The *Sophistical Refutations* explore fallacious but apparently valid arguments. The *Categories* has, in part, the aspect of a preface to the *Topics*, but it is in part a work of metaphysics—a forerunner of Aristotle’s treatise of that name.

The Stoics

The Stoics developed a logic different from Aristotle’s, and to a large extent independently from him. Their greatest logician, Chrysippus, lived from about 280 to 206 B.C.E. and, as with most of the Stoics, his thought has mostly to be reconstructed from reports and fragments in later writers. Whereas Aristotelian syllogistic is a term-logic, Stoic logic was propositional: it explored the relations between what they called “assertibles”—that is to say, sentences that can be used to make assertions. Assertibles can be simple (“It is day”) or complex (“If it is day, it is light”/ “It is day or it is not light”). The argument forms classified by the Stoics involve one complex and one simple assertible: for example, “If it is day, it is light. It is day. So, it is light.” This is the first of five “indemonstrables”—basic argument forms—distinguished by Chrysippus. The Stoics had a schematic way of representing the indemonstrables—what they called their “modes”—using ordinal numbers. The four remaining modes of the five indemonstrables are (2) If the first, then the second; not the second; so not the first; (3) Not both the first and the second; the first; so not the second; (4) Either the first or the second; the first; so not the second; (5) Either the first or the second; not the first; so the second. Since the assertibles could be either negative or positive, and the

complex assertible could itself include complex assertibles (“If both the first and the second, then the third”), there was quite a wide range of indemonstrable argument schemes. But Stoic logic was not limited to them. Nonindemonstrable forms of argument could be valid, and the Stoics had a theory of “analysis” in which, using certain basic rules (*themata*) and, if wanted, additional theorems, the nonindemonstrable arguments were shown to be made up of demonstrable ones or of conversions of them.

Stoic logicians also explored modal concepts. One of their main starting points was provided by the fourth-century B.C.E. Megaric logician Diodorus Cronus, who formulated a “Master Argument,” the subject of many attempts at reconstruction by modern historians, which attempts to show that, from the premises that true past propositions are necessary, and that an impossibility never follows from what is possible, it follows that nothing is possible except what is or will be true. The Stoic logicians rejected the argument by querying one or other of its premises, and Chrysippus developed his own understanding of possibility and necessity.

The Neoplatonists

Although Aristotle’s pupil and successor, Theophrastus (c. 372–c. 287 B.C.E.), wrote extensively on logic, and Alexander of Aphrodisias (fl. c. 200 C.E.) cultivated Aristotelian logic, the most important enthusiasts of Aristotelian logic were, surprisingly, the Neoplatonists, from Porphyry (c. 234–c. 305) onward. Porphyry wrote an introduction (*Eisagoge*) to the *Categories*, which itself became for later students a part of the Aristotelian logical corpus (known as the *Organon*), and he wrote extensive commentaries on Aristotle’s logical works. Despite his Platonic metaphysics, Porphyry believed that logic, which is concerned with the world of appearances that is the subject of normal discourse, should be studied in strictly Aristotelian terms. Although later Neoplatonic commentators, following the lead of Iamblichus, tended more to introduce their characteristic metaphysical ideas into discussions of logic, Porphyry’s approach was transmitted to the medieval Latin West by Boethius (c. 480–c. 524), who translated into Latin most of the *Organon* and wrote commentaries on some of it and logical textbooks on topical argument (the late ancient development of the *Topics*), division, and on syllogisms.

The Medieval Latin West, 790–1200

The study of logic was revived in the Latin West at the court of Charlemagne; his adviser, Alcuin, wrote the first medieval logical textbook (*On Dialectic*) in about 790. Logic was central to the intellectual life of medieval Europe in a way that it had not been in antiquity, and has not been since the Renaissance. Yet, until the 1130s, medieval logicians made do with what became known as the *logica vetus* (“old logic”): just Porphyry’s *Eisagoge*, Aristotle’s *Categories* and *On Interpretation*, and Boethius’s commentaries and textbooks. They had only the most limited access to the Stoic tradition, through mentions by Boethius and the *On Interpretation* of Apuleius (second century C.E.). Ninth-century authors, such as John Scotus Erigena, were interested especially in the *Categories*—its metaphysical aspects and the question, raised by Augustine

and by Boethius, of whether any of the ten categories distinguished by Aristotle apply to God. Anselm of Canterbury (1033 or 1034–1109) was a gifted logician who explored and questioned the Aristotelian doctrine of the *Categories* and made imaginative use of the ideas on possibility and necessity in *On Interpretation*.

In the twelfth century, the *logica vetus* was the central concern of the flourishing Paris schools. Peter Abelard (1079–1142), the greatest logician of the time, developed a nominalist metaphysics on its basis and elaborated a semantics to explain how sentences that use universal words (such as “Socrates is a man”) are meaningful although there are no universal things, only particulars. Abelard also excelled in more purely logical matters. Starting from the hints and misunderstandings he found in Boethius, he rediscovered propositional logic and, in his *Dialectica* (c. 1116), he explored in great depth the truth conditions for conditional (“if . . . then . . .”) sentences. Abelard was thus able to pioneer the analysis of sentences that are of ambiguous interpretation in terms of propositional logic, an aspect of logic that became especially popular from the 1130s onward, when *On Sophistical Refutations* and then the rest of Aristotle’s logic (the *logica nova*—“new logic”) became available. And he is one of the few logicians ever to have examined the logic of impersonal sentences, such as “It is good that he came today.”

The Medieval Latin West, 1200–1500

From the middle of the twelfth century, logicians developed various branches of their subject, known as the *logica modernorum* (“contemporary logic”), that had not been treated specially, or at all, in antiquity. Peter of Spain’s widely read *Tractatus* (often called *Summulae logicales*) illustrates how parts of the *logica modernorum* had developed up until about the 1230s. There was a lull in interest and innovation in logic for nearly a century, but in the first half of the fourteenth century writers at Oxford, such as Walter Burley (d. 1344/45), William of Ockham (d. ?1349), Thomas Bradwardine (d. 1349), and William of Heytesbury (d. 1372/23), and, in Paris, John Buridan (d. after 1358) revived the branches of the *logica modernorum* and brought them to new levels of sophistication. The *Logica magna* (Great logic) of Paul of Venice (d. 1429) is a vast record of these achievements.

Some branches of the *logica modernorum* grew directly from the mid-twelfth-century interest in fallacies. For example, *sophismata* were a sort of disputation, involving a master and his pupils, built around sentences that either are apparently false but can be interpreted so as to make them true (e.g., “The whole Socrates is less than Socrates”) or at least are open to different interpretations (e.g., “Every man is”). The ambiguities usually centered around the use of what were called “syncategorematic” words—words other than ordinary nouns, adjectives, and verbs with their own referential content: for instance, “only,” “except,” “all,” “begins,” “ceases”—and specialized treatises were devoted to studying these syncategoremata. Another type of disputation, “obligations,” involved trying to force an opponent who has agreed to defend a particular statement into a self-contradiction, while following a very strict set of rules for what statements may be accepted or must be rejected. Liar paradoxes (“What I am

now saying is false”)—“insolubles”—formed another branch of study. In the theory of the “properties of terms” a highly elaborate theory was developed about the reference of words depending on their function within a sentence. Propositional logic was elaborated in treatises on what were called “consequents” (*consequentiae*), although it remains questionable how far the approach was purely propositional.

Aristotle’s texts and methods were not, however, forgotten in the later Middle Ages. Aristotelian syllogistic, studied earlier through Boethius’s textbooks, could now be learned directly from the *Prior Analytics*. It was a basic tool for almost every medieval philosopher or theologian, and a set of mnemonics (“bArbArA,” “cElArEnt,” etc.) were devised to enable students to remember the valid patterns. *On Interpretation* continued to be central to discussions about possibility, necessity, and divine prescience, and the *Posterior Analytics* provided the criteria for organizing branches of knowledge as diverse as grammar and theology.

Medieval Islam

Logic was no less important for Islamic than for Christian philosophers and theologians. By the time of al-Farabi (c. 878–950), the first important Islamic logician, the whole of Aristotle’s logical *Organon* was available in Arabic—far more material, then, than in the Latin West at this period, especially since the Arabic logicians tended to follow the habit of late antiquity in regarding the *Rhetoric* and the *Poetics* as parts of the *Organon* and assigning to them their own characteristic modes of argument, to contrast with demonstrative argument as taught in the *Analytics* and dialectical argument in the *Topics*.

Al-Farabi, who worked in Baghdad, Damascus, and elsewhere, saw his task as a logician to represent Aristotle faithfully, although this task involved him in a number of interpretations that went beyond the letter of the text. He was also concerned to vindicate logic in face of the grammarians, who doubted the need for this additional discipline; earlier in the tenth century, there had been a famous debate between the grammarian Abu Sa’id as-Sirafi and the logician Abu Bisr Matta, in which Abu Sa’id seems to have had the upper hand.

The great Persian philosopher Avicenna (Ibn Sina; 980–1037) respected al-Farabi and was also an ardent Aristotelian, but his approach to logic differed. In semantics, he rejected al-Farabi’s theory that logic is concerned with expressions insofar as they signify meanings. Rather, he claimed, logic deals with meanings that classify meanings—so-called “second intentions.” In his approach to syllogistic, Avicenna was far more inclined than al-Farabi had been to pursue his own train of analysis and accommodate Aristotle to it. For example, in modal logic he proposed a number of different readings of modal sentences: they could be taken absolutely (as in “God exists”) or according to a condition—for example, “while something exists as a substance” (as in “man is necessarily a rational body”) or “while something is described in the way it is” (as in “all mobile things are changing”).

Logic continued to be studied in Islam because it was accepted by theologians as useful to their discipline rather than—as they often thought with regard to other areas of Aristotelian

philosophy—a dangerous rival to it. Particularly important was the endorsement of al-Ghazali (1058–1111): whereas he wrote a work specifically designed to attack other areas of Aristotelian philosophy, he was himself the author of two short logical works, based on Avicenna. In the next century, Averroës (Ibn Rushd), who worked in Muslim Spain, followed al-Farabi (and the general direction of all his own work as the commentator par excellence on Aristotle) in seeking a greater fidelity to Aristotle, but it was Avicenna who remained the dominant influence on later Islamic logic.

See also *Aristotelianism; Neoplatonism; Philosophy; Philosophy, History of; Scholasticism; Stoicism*.

BIBLIOGRAPHY

PRIMARY SOURCES

- Aristotle. *The Complete Works of Aristotle*. Edited by Jonathan Barnes. Vol. 1. Princeton, N.J.: Princeton University Press, 1984.
- . *Prior Analytics*. Translated by Robin Smith. Indianapolis: Hackett, 1989.
- Kretzmann, Norman, and Eleonore Stump, eds. *Logic and the Philosophy of Language*. Vol. 1 of *The Cambridge Translations of Medieval Philosophical Texts*. Cambridge, U.K.: Cambridge University Press, 1988.
- Peter of Spain. *Summulae logicales*. Translated by Francis P. Dinneen. Amsterdam and Philadelphia: Benjamins, 1990.

SECONDARY SOURCES

- Barnes, Jonathan, Suzanne Bobzien, Mario Mignucci, and Dink M. Schenkeveld. “Part 2: Logic and Language.” In *The Cambridge History of Hellenistic Philosophy*, edited by Keimpe Algra et al. Cambridge, U.K.: Cambridge University Press, 1999. Excellent, up-to-date survey.
- Kretzmann, Norman, Anthony Kenny, and Jan Pinborg, eds. *Cambridge History of Later Medieval Philosophy*. Cambridge, U.K.: Cambridge University Press, 1982. Pages 101–381 contain the most complete available account of medieval logic in the Latin West.
- Marenbon, John. *Boethius*. New York: Oxford University Press, 2003. See pages 17–65. Includes bibliography for Greek Neoplatonic tradition.
- Martin, C. J. “Embarrassing Arguments and Surprising Conclusions in the Development of Theories of the Conditional in the Twelfth Century.” In *Gilbert de Poitiers et ses contemporains*, edited by Jean Jolivet and Alain De Libera. Naples: Bibliopolis, 1987. Discusses Abelard and the twelfth-century rediscovery of propositional logic.
- Smith, Robin. “Logic.” In *The Cambridge Companion to Aristotle*, edited by Jonathan Barnes. Cambridge, U.K.: Cambridge University Press, 1995. Excellent bibliography on pp. 308–324.

John Marenbon

LOGIC AND PHILOSOPHY OF MATHEMATICS, MODERN. This article surveys many of the main positions that have been held in the logic and philosophy of mathematics from around 1800 up to recent times. Most attention

Axiomatized logics are far removed from the normal use of logic. In teaching and practice “natural deduction” has recently gained much popularity: state the “local” premises, and deduce conclusions from them using rules for introducing and eliminating connectives. The name was introduced in the 1930s by Hilbert’s follower Gerhard Gentzen.

is given to symbolic logics of some kind. No position has been definitive; indeed, especially over the last seventy years the variety has continually increased. To compensate for this article’s lack of exhaustiveness, the bibliography is wide-ranging.

The Revival of Logic from the 1820s, and Its Algebraic Flourishing

Some major philosophers gave logic a high status in the seventeenth and early eighteenth centuries; in particular, Gottfried Wilhelm von Leibniz advocated it as a *lingua characteristica*, with an attendant *calculus ratiocinator*, while John Locke took it as a case of *semeiotiké*, the theory of signs. The subject did not flourish, however; thus, while René Descartes stressed rules for correct thinking and deduction, and Immanuel Kant viewed logic as analytic knowledge (with mathematics as synthetically a priori), neither philosopher gave logic itself much attention. Most figures in all disciplines were content to appeal to Aristotelian syllogistic logic, while mathematicians normally saw the *Elements* of Euclid as the apotheosis of rigor.

The revival in logic came from an unexpected quarter: the *Elements of Logic* (1826) by the English theologian Richard Whately. Within a decade four more editions of this treatise had appeared, and various contemporaries commented at length. The strength of the reception is puzzling, for Whately did not advocate any radical new stances; nevertheless, interest in logic increased considerably and some notable advances occurred, especially the quantification of the predicate (1827) of George Bentham, in which Aristotle’s modes were greatly extended by admitting forms such as *all As are some Bs*.

These advances attracted the mathematician Augustus De Morgan, who from the 1840s symbolized in an algebraic manner the forms of syllogistic modes and the relationships between them. He also studied the logical form of the proofs in Euclid, and came away rather perplexed; for the flow of argument in Euclid involved far more than logical deductions. A more sweeping change to logic was effected by George Boole, who started out from a new algebraic principle. Take a “universe of discourse” (his phrase) I of, say, boxes, and divide it into the class x of black ones and the complementary class $(I-x)$ of nonblack ones. Then lay down the basic laws obeyed by x , including the novelty that x together with x is the same as x . Make deductions by formulating algebraically relationships between classes x, y, \dots and using the laws and attendant theorems to find as a

deduction the relationships between say, y and the other classes. Boole elaborated his method especially in *The Laws of Thought* (1854), where syllogisms occupied only the last chapter on logic. Finally, in 1860 De Morgan enriched syllogistics with a logic of (two-place) relations: at last the failure properly to handle, for example, *John is older than Jack* had been recognized.

The contributions of these two English algebraists were distinct: the American logician Charles S. Peirce conjoined them from the 1870s. One of his major insights, arrived at with his student O. H. Mitchell, was to individuate the “quantifier,” both the existential *there is an X such that . . .* and the universal *for all X . . .*, and to stress the importance of watching quantifier order. Continuing the algebraic style, Peirce and Mitchell regarded these quantifiers as generalizations of logical disjunctions and conjunctions respectively. The interpretation of quantifiers was to be an enduring theme in the philosophy of logic. Their logic was extended, especially as an algebra, by the German Ernst Schröder in his vast *Vorlesungen über die Algebra der Logik* (1890–1905).

Many others wrote upon logic, especially in Britain; I note three figures. John Stuart Mill’s *System of Logic* (1843, and many later editions), while not tied to syllogistics, relied much on it for an analysis of reasoning and deduction; mathematicization was absent, but in Mill’s account of “induction,” which we would regard as philosophy of science, he touched upon probability theory. Mill was broadly aligned to British empiricism: by great contrast, an influential “neo-Hegelianism” later became popular in academic circles. Francis H. Bradley’s *Principles of Logic* (1883), its landmark, is an idealistic meditation upon the basic laws of logic (such as that of the excluded middle), judgments, and the reconciliation of thesis and antithesis in synthesis. Finally, Lewis Carroll produced some rather dull books on logic (1886; 1896); but in his *Alice* books (1865; 1871) he had brilliantly anticipated several concerns of those logicians of the next century who were to launch a new tradition that came to eclipse the algebraic logicians.

Set Theory and the Rise of Mathematical Logic

Especially from the 1820s with the Frenchman Augustin Louis Cauchy, mathematicians had become more sensitive to the need for rigor in proofs, carefully stating assumptions and definitions and formulating theorems in conditional form. Cauchy’s approach was refined from the 1860s by the lectures at Berlin University of Karl Weierstrass. The main context was the calculus and its extension into mathematical analysis. Two consequences are of special import.

First, in the early 1870s the German Georg Cantor began to develop set theory, initially treating points and numbers but later as a general treatment of collections of things; he even claimed that sets enabled him to define the natural numbers, and by implication to reduce mathematics to sets. His theory differed from the traditional part-whole theory that dates back to the Greeks and that was used by, for example, the algebraic logicians; for Cantor distinguished membership of objects in a set from the inclusion of subsets of objects within it. More controversially, he also incorporated a mathematical theory of the “actual infinite,” showing that infinities came in different sizes.

Second, from the 1880s the Italian mathematician Giuseppe Peano began to symbolize as much as possible not only the notions of mathematical analysis (including set theory) but also the logical connectives and predicates with quantification. Thereby he launched “mathematical logic” (his name, in the sense usually adopted today). With an impressive school of followers he came to handle a wide range of mathematical theories this way, and enchanted the young Englishman Bertrand Russell, who came across him in 1900. Russell quickly added a logic of relations to mathematical logic, and converted Cantor’s claim that set theory could ground mathematics into the “logicist” thesis (a name provided later by Rudolf Carnap) that mathematical logic could ground sets and thereby (much) mathematics. Russell also found that the German Gottlob Frege had already asserted this thesis for arithmetic and some parts of mathematical analysis, though in a Platonist spirit very different from his own empiricism.

So much for the good news. The bad arrived soon afterwards, in the form of a paradox now named after Russell: a certain set was a member of itself if and only if it was not. Paradoxes are at least a nuisance in mathematical theories: when the theory in question encompasses logic itself, their presence is a disaster. Eventually Russell produced an articulation of logicism in *Principia Mathematica* (1910–1913), written with Alfred North Whitehead; but his and other paradoxes were avoided rather than solved, and by an unwieldy and epistemologically questionable “theory of types”: the ensemble of objects was divided into individuals, sets of individuals, sets of sets of individuals, . . . , ordered pairs of individuals, . . . , and so on, and membership was severely restricted.

Axiomatics and the Rise of Proof and Model Theories

Meanwhile, contentment with Euclidian rigor was dissolving. From the 1860s non-Euclidean geometries had been accepted as legitimate theories, especially due to the insights of Bernhard Riemann. In addition, various mathematicians, including Peano, had noticed that Euclidian geometry itself needed several more axioms than Euclid had stated.

These developments made mathematicians still more aware of finding and expressing the assumptions involved in a theory. Another stimulus was the rise in importance of algebras (for example, among several, Boole’s), each with its own basic laws. David Hilbert, the leading mathematician of his generation, studied geometries and algebras intensively, and was led around 1900 to seek for a mathematical means of studying axiom systems. He found it in “metamathematics” (his later name for it), in which a system was examined to establish its completeness, consistency, and independence.

One of Hilbert’s axioms for geometry was a meta-assumption that the other axioms supplied all the objects required. This soon led the young American mathematician Oswald Veblen to consider two different sets of objects satisfying an axiom system; if the members of each could be put in one-one correspondence, then the system was “categorical.” The study of (non-)categoricity enriched model theory considerably.

Set theory itself was influenced by these developments, for in 1908 Hilbert’s follower Ernst Zermelo axiomatized it. His

With the re-creation of their country after World War I, the Poles produced a remarkable cohort of logicians, with Jan Łukasiewicz and Stanisław Leśniewski as leaders, Łuand Tarski perhaps the most dominant figure. While Hitler saw to its demise, several members emigrated; for example, Tarski was a major figure later in the development of model theory.

system included his own discovery, the “axiom of choice,” a nonconstructive assumption that some colleagues found doubtful. A strong debate broke out; most participants agreed that the axiom was unavoidable. However, it was unacceptable for “constructivist” mathematicians, who admitted only procedures that built up mathematical objects in explicit stages: for them the axiom was outlawed, along with some standard proof methods such as by contradiction (to prove theorem T , assume $\textit{not-T}$ and get into a logical mess). The most prominent figure in this tradition was the Dutch mathematician L. E. J. Brouwer, who elaborated his alternative “intuitionistic” mathematics especially in the 1920s. At that time Hilbert’s metamathematical program was in its definitive phase; but in 1927 Brouwer derided it as “formalism,” a misleading name that Hilbert himself never used but that has regrettably become standard.

Gödel, Tarski, and the Individuation of Metatheory

More bad news for Hilbert arrived in 1931, when the young Austrian Kurt Gödel proved that his metamathematical program could not be achieved for arithmetic with quantification over integers, and thus a fortiori for almost all acclimatized mathematical theories T ; for Gödel showed that, in order to prove the consistency of T , its metamathematics had to be richer in assumptions than T itself rather than poorer, as Hilbert had hoped. This theorem was a corollary of another one, which torpedoed logicism by showing that there was a proposition M statable within T but neither provable nor disprovable; thus T , assumed to be consistent, was undecidable.

In addition, Gödel’s proof-method soon led to a focus on recursion and to computability as conceived by the Englishman Alan Turing, thus launching a link between logic and computing. Finally, for Gödel’s proofs to work the distinction between T and its metatheory had to be observed rigidly, as a central feature of both metamathematics and metalogic. The Polish logician Alfred Tarski also stressed this distinction around this time, for formal systems in general; his motive was treating as metatheoretic the (meta-)proposition that a proposition was true if it corresponded to the facts.

Logics and Pluralism from the 1940s

The consequences of Gödel’s theorems were profound. For example, logicism was replaced, especially by the American W. V. Quine, by elaborate systems of set theory and logic such as those

developed in Quine's *Mathematical Logic* (1940); however, Russellian reductions of the former to the latter were not claimed.

Quine adhered to classical logic, with its two truth-values. But nonclassical logics gained adherents from the 1930s. The American C. I. Lewis had been a pioneer already in the 1910s, when he advocated "modal logics," where necessity and possibility were adjoined in various ways to truth and falsehood, as a means of clarifying the undoubtedly messy treatment of implication in *Principia Mathematica*. But from the 1930s these logics were viewed as viable alternatives to classicism in their own right. Another notable adherent was Gödel's friend Carnap, especially with his *Meaning and Necessity* (1947).

Since then logics classical and nonclassical have proliferated enormously, with their metalogics; many connections have been forged with computer science and aspects of semantics and linguistics. Notable among many cases are deontic logic, with its focus on sentences using "ought" and applications to law; temporal logics, seeking means to formulate deductions such as *John eats; thus John will have eaten*; many-valued logics, allowing for values other than true and false; non-monotonic logic or defeasible reasoning, defined by the property (in the simplest case) of propositions A , B , and C that given $A \therefore C$, then $A \text{ and } B \therefore C$ does not hold; paraconsistent logics, where various heresies are entertained, such as paradoxical propositions being both true and false; and fuzzy logic and set theory, where the vagueness of *John is very tall* is itself studied mathematically, initially by engineers rather than professional logicians.

This last topic bears upon control theory, which became associated with the discipline of cybernetics during the 1950s; logics of some kind were used in areas such as machine learning and brain modeling. Such concerns then developed further within the field of artificial intelligence, and were involved also in topics such as the representation of knowledge, automated theorem proving, and the relationship between complexity and recursion. These and very many more topics are now also linked to theoretical computer science, where many (meta)logics are used, with further connections to programming, formal and natural languages, and linguistics.

Partly due to these connections a renaissance of interest has occurred in higher-order logic, where quantification is executed over predicates as well as individuals. This revises a practice followed freely by Frege and by Russell and Whitehead. Theories of types have also been revived, appearing in several of the above contexts.

Philosophies of Mathematics

Especially since World War II, new philosophies have emerged separate from logicism, formalism, and intuitionism. One kind is called naturalism, in which mathematical objects are said to be accessible to ordinary sense perception. Forms of Platonism are advocated, partly inspired by the enthusiasm of Gödel. Disaffection from concerns with mathematical truth has stimulated conventionalism; Henri Poincaré was an eminent early advocate. Versions of constructivist mathematics have been developed, broadly following the same prohibitions as Brouwer's but avoiding his peculiar philosophy; Erret Bishop was a notable

figure. Structuralism emphasizes the ubiquity of structures, perhaps to excess; mathematics has them rather than *is* them.

Most of this philosophy is by and for philosophers; the mathematical content is usually limited to set theory and/or arithmetic, even among empiricists who claim to attend to mathematical practice. In particular, little is said about the creation and development of mathematical theories in the first place. Here the eminent Hungarian Georg Polya was an important contributor, with books such as *Mathematics and Plausible Reasoning* (1954) discussing themes such as proofs themselves modifying old theorems and motivating new ones. A rather neglected area is the philosophy of mechanics and (classical) mathematical physics, despite the attraction of physical interpretation as well as rigor and proof.

By contrast, quantum mechanics has gained much attention, partly in connection with the philosophy of probability, which has a rather separate history. What kind of knowledge is expressed by *the probability that the next throw of the die will be 5 is 1/6*? Influential answers include the logical (it is a deduction from axioms), propensity (it is an assertion about the die and also its environment), subjective or Bayesian (it is a rational belief, drawing upon prior performance), and frequency (it is the limiting case of evidence drawn from long runs of throws).

Concluding Remark

Whately would be astonished at the current range and variety of logics. However, there is often still a considerable professional distance between logicians and both mathematicians and philosophers; in the mid-1930s an Association of Symbolic Logic was created to provide a venue and a journal for those active in the field. Now perhaps too many logical and philosophical flowers are blooming, and many may wither for want of genuine need. One area of exploration is metametalogic and metametaphilosophy of mathematics, which have been largely ignored so far.

See also *Logic; Quantum*.

BIBLIOGRAPHY

- Abramsky, S., Dov Gabbay, and T. S. E. Maibaum, eds. *Handbook of Logic in Computer Science*. 5 vols. Oxford and New York: Oxford University Press, 1992–2000.
- Aspray, William, and Philip Kitcher, eds. *History and Philosophy of Modern Mathematics*. Minneapolis: University of Minnesota Press, 1988.
- Barwise, Jon, ed. *Handbook of Mathematical Logic*. Amsterdam and New York: North-Holland, 1977.
- Benacerraf, Paul, and Hilary Putnam, eds. *Philosophy of Mathematics: Selected Readings*. 2nd. ed., Cambridge, U.K., and New York: Cambridge University Press, 1983.
- Fraenkel, Abraham. *Abstract Set Theory*. Amsterdam: North-Holland, 1953. Outstanding bibliography.
- Gabbay, Dov, and F. Guenther, eds. *Handbook of Philosophical Logic*. 1st ed. 4 vols. Dordrecht and Boston: Reidel, 1983–1987. 2nd ed., much expanded, in progress. Dordrecht: Kluwer, 2000–.
- Grattan-Guinness, Ivor. *The Search for Mathematical Roots, 1870–1940: Logics, Set Theories, and the Foundations of Mathematics*

- from Cantor through Russell to Gödel. Princeton: Princeton University Press, 2000.
- Grattan-Guinness, Ivor, ed. *Companion Encyclopedia of the History and Philosophy of the Mathematical Sciences*. 2 vols. London: Routledge, 1994. Reprint, Baltimore: Johns Hopkins University Press, 2003. See especially Part 6.
- Haack, Susan. *Philosophy of Logics*. Cambridge, U.K.: Cambridge University Press, 1978.
- Jacquette, Dale, ed. *Philosophy of Mathematics: An Anthology*. Oxford and Malden, Mass.: Blackwell, 2002.
- Kitcher, Philip. *The Nature of Mathematical Knowledge*. New York: Oxford University Press, 1983.
- Kneale, William, and Martha Kneale. *The Development of Logic*. Oxford: Clarendon, 1962.
- Krüger, Lorenz et al., eds. *The Probabilistic Revolution*. 2 vols. Cambridge, Mass.: MIT Press, 1987.
- Priest, Graham. *Beyond the Limits of Thought*. Cambridge, U.K.: Cambridge University Press, 1995.
- Shapiro, Stewart, ed. *The Limits of Logic*. Aldershot, U.K.: Dartmouth, 1996. Source book, mainly oriented around model theory and higher-order logics.
- van Heijenoort, Jean, ed. *From Frege to Gödel: A Source Book in Mathematical Logic, 1879–1931*. Cambridge, Mass.: Harvard University Press, 1967.

I. Grattan-Guinness

LOVE, WESTERN NOTIONS OF. In the West, probably more has been written about love than any other topic except the nature of God. There is, however, no consensus on what the word *love* or *amor*, *agape*, *Liebe*, *eros*, or hundreds of other terms signifies. It is clear, however, that it is more than a simple animal urge to procreate. Harry Harlow, for example, demonstrated that mother love was essential to the normal development of infant monkeys, and that infants deprived of love and nurturance became disturbed, unhappy adults, unfit for monkey society. But love is much more than the feelings of a mother for a child, although mother love has usually been regarded as much more intense than that of a father. Among other things the term *love* has been used to describe the feelings of a child toward a parent, one's feelings for friends and comrades, a religious yearning for transcendence, an entirely materialistic desire for physical sexual gratification, and the list could go on.

Love in Western History

One kind of love that might best be called romantic love has been the gift or curse to the world of Western culture. This is a phenomenon that at its simplest might be described as the practice of choosing one's mate based on personal preference, rather than societal obligations. Such a concept emerged in the Middle Ages, and the true lover as described by Andreas Capellanus in his twelfth century *De Amore* is continually and without interruption obsessed by the image of his beloved. Capellanus also wrote that love was an inborn suffering that proceeded from the sight of, and excessive thought on, the form of the opposite sex.

This was a different view of love than had existed previously in Western culture, although there are hints of it in

earlier societies and cultures. In Judaism the closest approach to erotic love appears in the Song of Solomon:

I am my beloved's, and my beloved is mine. . . . (6:3)
 Many waters cannot quench love, neither can the floods
 drown it. . . . (8:7)

Greek myths include scenes of passionate sexual attraction but for the most part, after the successful sexual liaison, the male god goes on to seek other candidates. The tale of Eurydice and Orpheus emphasizes, however, that love in the Greek world was far more complex than simple sexual conquest. The deeper meanings of love appear in discussion by the eighth-century B.C.E. Greek writer Hesiod, who held *eros* or love to be the essential creative urge that brought the universe into being. A somewhat different view is put forth in the fourth century B.C.E. by Plato, who has Socrates explain in the *Symposium* that the lover is attracted to his beloved because he sees reflected there the higher realm of eternal truth. Love in this case is the bridge between the mundane and the transcendental, the wellspring from whence all meaningful human values derive. In the same dialogue, Plato has Aristophanes explain that the search for a lover is driven by a search to find part of oneself. This is because people were originally androgynes who were split apart because of their rebellion against the Olympian gods. Thus finding one's love was no less than the recovery of an original unity of souls.

The object of this original form of Platonic love could be of the same or different sex, although Plato makes a clear distinction between the love of youths and the love of women, with the former being held much higher than the latter kind. In fact Greek literature from the poets to the playwrights was essentially misogynistic with much of the erotic literature male focused.

In Roman society, where women had a higher standing than in Greece, the general conclusion of the first century B.C.E. lyric poets Catullus, Tibullus, and Propertius was that love (and women) inevitably brought misery to man. Lucretius, a contemporary of the poets, agreed that love made one miserable, and his solution was to eradicate love. He admitted that while a particular mistress might be faultless, a man could still free himself from the pangs of love by reflecting that in her physical nature his love object was no different from all other women. Ovid, another contemporary, built up the charms of sexual love in his *Ars amoris* (*Art of Love*) but in its sequel, *Remedia Amoris*, he shows how to counteract the attractions of a mistress and solve the problems of love. Both the Romans and the Greeks tended to separate love from marriage.

While Christianity emphasized love, it was love of humanity or of god (*agape*), not *eros* or sexual love. Such a love appeared in the Song of Solomon, and it is a strong theme in early Christian literature (see Bynum, 1982) and later in the surviving letters and prayers of St. Catherine of Sienna (1347?–1380), who portrayed the crucified Jesus as the supreme sign and pledge of divine love and as motive for ours. As Christianity became institutionalized, sexuality, one of the base points of love in the Greek and Roman classics, was

downplayed. It certainly was not necessarily involved in marriage, which was a pragmatic affair that united scions of two families and their possessions. As Caroline Walker Bynum notes in her *Holy Feast, Holy Fast*, medieval female saints before the twelfth century tended to be charity-giving queens who obediently married and used their influence and wealth to perform good deeds, often ending up in the cloisters. This began to change in the twelfth century with the development of what might be called romantic love, and it is this concept that came to dominate Western notions of love.

Romantic Love

Scholars have spent a good deal of time and energy in trying to trace the source of romantic love to Islamic lyric poetry, to Greek Platonism, to Ovid, to heretical Christian Cathars—apparently all contributing factors—but extremely influential in the period was the rise of the female patron of literature and arts. Literature is molded by the type of audience it has. In much of the past the audience that counted most was male. It was the men who had the money to hire poets to sing their praises and to recount the epic stories of war as well as the successful conquests of females. When prose developed it was men who were usually literate since so many obstacles were put into the path of women who wanted to be educated. During the Middle Ages, when the most literate group was the clergy, women and love had very little place in their literature. Nonetheless, women could be patrons of literature and it was this patronage that some, including the present authors, believe was a major factor in the development of romantic love.

Sidney Painter speculated in the 1940s upon a scenario in which a hungry minstrel who was wandering about the duchy of Aquitaine came to a castle where he hoped that his tales of battles and his tumbling tricks would earn him a good dinner. The lord of the castle, however, was absent, and the lady who acted as his hostess found his endless stories of battles rather tiring and boring and his tumbling unattractive. It somehow occurred to the poet that his stay in the castle would not be very long nor would his meals be particularly enjoyable unless he managed to gain her attention. Being very inventive he composed a song in praise of the lady's beauty and virtue and described their effect on him in rather glowing terms. This pleased the lady, who rewarded him with a better bed and more ample food. He and others got the message.

On this scene came William IX (1071–1127), count of Poitou and duke of Aquitaine, who thought such romantic songs might prove a pleasant accompaniment to his numerous triumphs over feminine virtue. The duke's accounts of his amorous adventures proved as interesting to his friends as his stories of battle, and with the example of a powerful prince who ruled one-third of France to spur it on, the fashion grew and expanded. One of the great patrons of chivalric love literature was Eleanor of Aquitaine (1122–1204), the granddaughter and heir of the duke and later the queen of England. Her role of patroness was continued by her daughters, Marie, countess of Champagne, and Alix, countess of Blois, as well as other women. A few women contributed to the love literature on their own, as did Heloise in her love letters to Abelard in the twelfth century. Marie de France wrote more traditional chivalric love literature

in the late twelfth century, but she did not differ significantly from her male poets in their description. The love literature penned by Christine de Pizan (c. 1365–c. 1430), on the other hand, has led to her being described as an early feminist.

Romantic love was originally associated with knighthood and chivalry, and in poems and stories love was pictured as a despairing and tragic emotion that drove the lover to accomplish great deeds of daring to perform for his beloved as well as for the Christian God. In theory true love was unattainable love, that is, it was not to be consummated by sexual intercourse; in fact, the female object of the love was usually married to a man other than her beloved, and the theory reflected the real situation of the noble ladies who acted as patrons. Adultery probably occurred in some cases, but unattainable love was the dominant theme. The medieval romantic love espoused by the French poets spread and was profoundly embraced throughout Europe in a way that reached directly into daily life. The concept erected impassable barriers between us and the classical past or the Oriental present.

As the theme of romantic love developed, modifications in the ideal took place, and sexual intercourse and ultimately marriage became an integral and sometimes necessary part of the conception of love. How often either took place in the past is debatable. Clearly until recently romantic love remained separate from marriage. Marriage was a contractual obligation while love was entirely voluntary. True love might well become adulterous but it need not end up that way. Romantic love, however, became an ideal and it became a major theme of song, poetry, and literature of Western culture.

Protestantism with its emphasis on marriage and hostility to celibacy gave companionate marriage a theological stamp of approval. Henry Smith, an English Puritan preacher, wrote in his 1591 *Preparative to Marriage*: “the mate must be fit: it is not enough to be virtuous, but to be suitable . . . So shall the man be pleased which finds a wife according to his own heart, whether he be rich or poor . . . like a pair of glove, or a pair of hose are like; so man and wife should be like, because they are a pair of friends.”

Catholicism, even though it placed renewed emphasis on abstinence and celibacy, never quite lost the idea of romantic love embedded in the literary tradition. Both Catholic and Protestant countries saw an increase of love literature, especially of references to romantic love in guides to proper manners and mores, magazines and newspapers, often accompanied by warnings to young women not to be persuaded into giving up their virtue to sweet-tongued suitors.

The eighteenth century saw the popularization of love with a steady increase of love literature in the New World and the Old. Even in an arranged marriage such as that in Oliver Goldsmith's 1773 play, *She Stoops to Conquer*, a parental choice in mates is sold to the daughter, Kate Hardcastle, in romantic terms. By the nineteenth century in England and America, romantic writers, according to Peter Gay, saw it as their historic mission to re-enchant the world with love. Love was not only a reinvigoration of ancient and medieval traditions but the triumph of impulse over pragmatism. The Romantics, such as Percy Bysshe

Shelley (1792–1822) and Lord Byron (1788–1824), lived as they wrote. By reunifying physical and spiritual love, they believed they established a harmony between the body and mind.

As arranged marriages declined, and the ability of individuals able to make their own decisions concerning a marriage partner increased, romantic love was increasingly seen as the basis for marriage. The work of English novelists such as John Galsworthy (1867–1933) and the real-life experience of George Eliot (Mary Ann Evans; 1819–1880) demonstrated that despite romantic love's strong pull, reality often intervened. Still, the ideal persisted. With the twentieth century, and the world of new inventions and institutions such as the automobile, motion pictures, and public coeducational high schools, romantic love received renewed vigor. If Clara Bow could go from being a Brooklyn waif to a Hollywood starlet, and if she could play a department store clerk who marries a millionaire in the movies, then young women everywhere wanted to emulate her. Romantic love had crossed all class barriers.

Inhibiting full-blown romantic love, however, were always the consequences, namely the fear of pregnancy. With the development of the birth control pill and the widespread dissemination of contraceptive information, romantic passion could be verified or rejected by sexual experience with few qualms. Was romantic love different from simple sexual impulse? After centuries of literary and philosophical explanations, love became a major research field for the emerging social sciences.

“Scientific” Analysis of Love

In a sense Sigmund Freud (1856–1939) had begun this investigation. He had challenged the Christian-philosophical ideal of transcendental, universal love. For him, the urge to love came from the self, born out of base instinct. Freud's id was, in many ways, a revival of the Greek idea of love as an unreasoning furor. While his ideas were soon challenged, Freud was important for placing love more or less on the dissecting table, a subject for research and discussion. Others such as Havelock Ellis had joined the efforts to reexamine love and sex. Psychologists entered the field in the 1960s through efforts to distinguish different types of love. Elaine Hatfield, one of the pioneers, argued that people themselves distinguished several types of love and might do so at different times in their life cycle. Passion, she said, is pleasurable but the strong emotion involved creates the potential for relationship instability. Lovers want stability and often desire friendship as well as passion. Romantic love in effect remained complicated by reality.

Another psychologist, R. J. Sternberg, put forth a triangular theory of love involving intimacy, passion, and commitment, but also recognized that this did not describe all cases and that a sudden burst of passion and commitment could appear at a first meeting. Others, such as John Bowlby, developed an elaborate theory of human infant attachment as the precursor of and foundation for human love.

Not surprisingly, some researchers have found that men and women differ somewhat in their descriptions of love. They note a tendency for men to describe themselves as more involved in game-playing while women describe themselves as

more friendship-oriented, practical, yet dependent. Men idealize an altruistic love more than women do, while women are more realistic. Both, however, emphasize the importance of passionate love. This phenomenon is no longer, if it ever was, confined to the Western world. According to W. R. Jankowiak and others, romantic love is everywhere.

The actual physiology of love has also been investigated. Intense love physiologically has been found to be distinct from sexual arousal, something that was often assumed in the past but is now demonstrated. Love, it now seems, evolved in tandem with two other primary neural systems: the sex drive and adult male-female attachment. The sex drive, according to this theory, evolved to motivate individuals to seek sexual union with appropriate mating partners, while the romantic attraction evolved to enable individuals to prefer and pursue a specific partner, whether male or female, since the same reaction is noted in homosexual and heterosexual individuals. In fact, as the literature of the past is reprinted without the censorship of earlier generations, homosexual love has come to play a significant role in the romantic literature of love as well. Lillian Faderman's 1981 study *Surpassing the Love of Men* broadly traces the literary history of romantic friendship and love between women from the Renaissance to the present. As the debate over gay and lesbian marriages in the first decade of the twentieth century would indicate, homosexual and heterosexual love are driven by the same forces.

Though love in popular fiction and accounts seem to belong to the young, love spans all of human life. Most studies have shown that friendship and passionate love are positive predictors of marital satisfaction across the life span. Love, in fact, has come to be regarded by most researchers as fundamentally important to humanity. It has a strong biological basis that is undoubtedly influenced by cultural developments. Love, it seems, is in a sense what makes the world go round.

See also *Emotions; Friendship; Marriage and Fertility, European Views; Sexuality.*

BIBLIOGRAPHY

- Bowlby, John. *Attachment and Loss*. Vol. 1. New York: Basic Books, 1969.
- Bullough, Vern L., and Bonnie Bullough. *The Subordinate Sex*. Champagne: University of Illinois Press, 1973.
- Bynum, Carolyn Walker. *Holy Feast and Holy Fast: The Religious Significance of Food to Medieval Women*. Berkeley: University of California Press, 1987.
- . *Jesus as Mother: Studies in the Spirituality of the High Middle Ages*. Berkeley: University of California Press, 1982.
- Capellanus, Andreas. *The Art of Courty Love*, translated and edited by John Jay Parry. New York: Columbia University Press, 1941.
- De Rougement, Denis. *Love in the Western World*, translated by Montgomery Belgion. New York: Harcourt Brace, 1940.
- Faderman, Lillian. *Surpassing the Love of Men*. New York: Morrow, 1981.
- Gay, Peter. *The Naked Heart*. New York: Norton, 1995.
- . *The Tender Passion*. New York: Oxford University Press, 1986.
- Harlow, Harry F. *Learning to Love*. New York: Jason Aronson, 1974.

- Hatfield, Elaine. "Passionate and Companionate Love." In *Psychology of Love*, edited by Robert J. Sternberg and Michael L. Barnes. New Haven: Yale University Press, 1988.
- Hatfield, Elaine, and Richard L. Rapson. *Love and Sex: Cross Cultural Perspectives*. Boston: Allyn and Bacon, 1996.
- Hopkins, Andrea. *The Book of Courtly Love: The Passionate Code of the Troubadours*. San Francisco: Harper, 1994.
- Jankowiak, William, ed. *Romantic Passion: A Universal Experience?* New York: Columbia University Press, 1995.
- Jankowiak, W. R., and E. F. Fischer. "A Cross-Cultural Perspective on Romantic Love." *Ethnology* 31 (1992): 149–155.
- Lewis, C. S. *The Allegory of Love: A Study in Medieval Tradition*. New York: Oxford University Press, 1958.
- Lucretius. *De Rerum Natura*, edited and translated by W. H. D. Rouse. London: Heinemann, 1924.
- Montgomery, Marilyn, and G. T. Sorell. "Differences in Love Attitudes Across Family Life States." *Family Relationships* 46 (1997): 55–63.
- Murstein, Bernard L. *Love, Sex and Marriage through the Ages*. New York: Springer 1974.
- Ovid. *Ars Amoris*, edited and translated by J. H. Mogley. London: Heinemann, 1962.
- Painter, Sidney. *French Chivalry*. Baltimore: Johns Hopkins Press, 1947.
- Sternberg, R. J. "A Triangular Theory of Love." *Psychological Review* 93 (1986): 119–135.

Vern L. Bullough
Kenneth Mondschein

LOYALTIES, DUAL. Loyalty is devotion to a cause and is marked by faithfulness, a sense of just purpose, and a willingness to serve in spite of any suffering that may result from service. Dual loyalty involves simultaneous obligations, express or implied, to two parties, with the second party typically constituting a state. Multiple loyalties can threaten the security and survival of a state. Nationality may affect political allegiance by prompting immigrants to place the interests of their country of origin over the welfare of their adopted home. Religion may influence loyalty when those people holding minority religious views feel a loyalty to their faith that is greater than the duty owed to their country. Soldiers fight and citizens pay taxes out of loyalty, a fact that has led many states to link dual loyalties with treason.

Ancient World

The question of loyalty is an age-old one. In ancient Greece, Socrates (c. 470–399 B.C.E.) remained loyal to the laws of the state even though they were unjust and resulted in his death. Plato (c. 428–348 or 347 B.C.E.), identifying internal political conflict as a far stronger test of loyalty than a foreign war, demanded the death penalty for any citizen who turned against the gods or the state. Aristotle (384–322 B.C.E.) argued that loyalty based upon usefulness or pleasure, such as that accorded a tyrant or corrupt politician, disappeared as soon as the motives vanished. None of these ancient philosophers addressed the question of dual allegiance except in the form of conflict between loyalty to the state and loyalty to family members or friends.

As long as the people of a state shared the same religion, loyalty involved allegiance to rulers or forms of government. The rise of Christianity threatened this type of loyalty by presenting a strong competing claim for allegiance. In the Bible, early Christians are recorded as asking Jesus Christ for guidance on dual loyalties. They were advised that no compromise was possible where spiritual matters were involved. Duty to God involved obedience to all of the commandments with any act of disloyalty categorized as sinful.

The Christian Era

After the ascendancy of Christianity to a position of worldly power, the issue of loyalty to God became entangled with the problems of loyalty to the church as an institution with influence in the world. The theologian Saint Augustine (354–430) believed that the church should be the supreme ruler of all Christian nations. Underpinning Saint Augustine's idea of the unity of Christendom was the notion that secular kings owed loyalty to the pope, the earthly leader of Christianity. This idea of rule by the church did not appeal to the secular world, and history records a divergence of views about the proper role of the church. Saint Thomas Aquinas (1225–1274), the most prominent of the dissenters, made a sharp distinction between a person's loyalty to God and to an earthly superior by declaring a right to resist tyranny.

The Renaissance and Reformation witnessed the emergence of dual loyalties as the hold of the Catholic Church weakened and power concentrated in the hands of European monarchs. The Italian political theorist Niccolò Machiavelli (1469–1527) did not rely upon religion to justify loyalty but instead advised rulers to use cruelty to keep subjects united and faithful. The first loyalty tests grew out of the development of a new religious-political system during this time. When in the 1530s Henry VIII split with the Catholic Church and elevated Protestantism in England, he needed to identify and intimidate his opponents to maintain power. Loyalty tests weakened domestic enemies by forcing them to publicly declare allegiance to the English monarchy. As late as the seventeenth century, they would be required of Catholics settling on English land in the New World.

Enlightenment and Revolution

The idea that the divine right of kings mandated loyalty began to die in the seventeenth century. Thomas Hobbes (1588–1679) tied loyalty to passion and self-interest by arguing that the power of a state derived from fear of disorder. He saw no personal loyalty to a monarch, only allegiance to the person providing peace and security. John Locke (1632–1704), perhaps the most widely read political philosopher of the eighteenth century, built upon Hobbes's idea of a contract. Locke stated that the right to govern derived from the consent of the governed. People gave loyalty to a government that governed justly, protected property, and ensured certain liberties. If a government violated the natural rights of the individual, it reneged on its contract and forfeited the loyalty of its subjects.

In proclaiming the Declaration of Independence in 1776, the founding fathers of the United States relied upon the ideas of Locke. The British government had violated its contract with the American people, thereby forfeiting any right to

allegiance. The American stance on loyalty would be duplicated throughout the world as newly liberated peoples used the Declaration as a model for their own definitions of loyalty. Allegiance would be not to a king or a section of land but to the purpose of protecting citizens against the exercise of abusive power by government officials.

Various political regimes, such as that of Henry VII (r. 1485–1509) and the new American state, have demanded tests for allegiance, typically during wartime. Whenever a political culture or institution is firmly established and feels no threat to itself from any quarter, the question of loyalty is pushed to the background. All kinds of doctrines that are hostile to the culture may be tolerated. However, if the culture feels its existence is threatened, there may be vigorous attempts to gain complete political conformity. Requirements and loyalty tests are instituted.

Loyalty played a primary role in structuring the American Revolution in the form of tests that became widespread throughout the many years of political upheaval. With the population evenly divided between supporters of the king, supporters of liberty, and those committed to neutrality, a means had to be devised to create unity. These loyalty tests, often just a public voicing of support for the revolutionaries, helped spur the creation of an American patriotism and accelerated the development of a decade of discontent by placing Americans in increasingly extreme stances regarding allegiance to the British crown. Such positioning finally made independence inevitable by creating an American identity. Both John Adams (1735–1826) and George Washington (1732–1799) viewed such statements of faithfulness as the cornerstone of discipline for troops and the source of national spirit for civilians.

Modern Era

Dual loyalty has formed a political threat in the modern era because difference is only acceptable between national identities and not within them. The modern state sought to instill political loyalties in order to maintain territorial concentrations of power. In doing so, it came into competition with communal centers of loyalty. These ethnic, religious, and regional ties resisted the state's declaration of power and rights as seen among the Aborigines of Australia, the Jews of the diaspora, and the Kurds of southwest Asia. Such expressions of dual loyalty threatened national unity by presenting the image of a divided community.

While many political regimes retain a fear of multiculturalism and attack dual loyalty, this concept of allegiance is becoming superseded by the idea of shared loyalties. The twentieth-century transportation and communication revolutions enabled immigrants to maintain close ties with their countries of origin and maintain multiple cultural identities. The many countries granting dual citizenship recognize the shared loyalties of these immigrants. The challenge for governments is to be able to distinguish between those immigrants who are benign and those who pose a security threat.

See also Americanization, U.S.; Assimilation; Identity, Multiple; State, The.

BIBLIOGRAPHY

- Cecil, Andrew R. *Equality, Tolerance, and Loyalty: Virtues Serving the Common Purpose of Democracy*. Dallas: University of Texas, 1990.
- Hyman, Harold M. *To Try Men's Souls: Loyalty Tests in American History*. Berkeley: University of California Press, 1959.
- Shain, Yossi. *The Frontier of Loyalty: Political Exiles in the Age of the Nation-State*. Middletown, Conn.: Wesleyan University Press, 1989.
- Waller, Michael, and Andrew Linklater, eds. *Political Loyalty and the Nation-State*. London: Routledge, 2003.
- Yuh, Ji-Yeon. *Beyond the Shadow of Camp: Korean Military Brides in America*. New York: New York University Press, 2002.

Caryn E. Neumann

LYSENKOISM. *Lysenkoism* is a censorious name for a movement that demands either censure or faith in *agrobiology*, as Soviet agronomist Trofim Denisovich Lysenko (1898–1976) called his aggressive creation. He also named it *Michurinism*, in tribute to the plant breeder Ivan V. Michurin, who won fame with claims of improving fruit while scorning genetics. *Obscurantist* (*mrakobes*), the word a geneticist flung at Lysenko in 1935, recurs even when scholars bend over backward to avoid censure. Lysenkoism defies efforts to disentangle claims of scientific knowledge from assertions of practical authority and from the use of state power to achieve progress.

The Rise of Lysenkoism

The movement emerged as Joseph Stalin's "revolution from above" (1928–1932) forced peasants into collective farms, where the dream of a leap to scientific agriculture suffered practical failure. Lysenko saved the dream with a string of recipes for quick solutions of long-standing problems. He was a poorly trained agronomist with great talent for snap judgments, grand claims, and celebrity. "Vernalization," his breakthrough to fame, began as a scheme to moisten and chill seeds for protection against drought and freezing, with tests on a few plots, crude theorizing about stages in plant development and about heredity, testimonials by some agricultural officials, a rush to mass use on collective farms, journalistic hype—and telltale silence on long-term results. Yet the movement thrived until the 1950s.

Farm bosses quietly discarded Lysenko's recipes, but he had new ones, with crude theorizing pitted against standard science to justify mass campaigns for rapid triumphs that could not otherwise be won. Lysenko argued that the Soviet Union could not afford to lose time conducting preliminary small-scale testing, but had to keep moving forward, applying theories to the masses while still working out the methods in the laboratory. His view of theory and practice fit in with Stalin's "great break," a leap from reasoned arguments over planning to furious drives toward blue-sky goals, most famously summed up in Stalin's 1931 speech to business managers: "We are fifty or a hundred years behind the advanced countries. We must race through that distance in ten years. Either we do it, or they will crush us." In 1941 Nazi armies that had subdued Western Europe struck the Soviet Union, winning a victory that proved the wisdom of berserk modernization. Pragmatists who

would dispute that logic must confront tyrannical pragmatism in a context of backwardness: willful drive combined with brush-off or jail (or death) for specialists offering reasoned warning. That is how farming by fiat gained the reassurance of science in Lysenkoism, until long-term self-defeat grew obvious to political bosses, who rehabilitated standard science and its specialists, posthumously in some cases.

By 1939 Lysenkoists ruled many institutes of biological science; universal rule was decreed in 1948, at a highly publicized conference where Lysenko announced that the Communist Party's Central Committee endorsed his speech. Stalin himself had edited the speech, but Lysenko was not allowed to boast of that. Long after, when the system fell apart and archives opened, a historian found Lysenko's draft with red lines and marginal notes by Stalin. Stalin deleted, with sarcasm, a claim that science, like ideology, is divided into bourgeois and proletarian camps. In 1950 he published that rule: science is *not* divided by class conflict. He ignored his own much-publicized urging of practical men to tolerate no caution from specialists, to "smash" what is "old and dying in science." Such zigzags between willfulness and restraint are blips on a Communist trajectory through faith in swift modernization and social justice to frustration and apostasy.

Criticism

The highest leaders started to back away from Lysenkoism in the 1950s, when a recipe for tree planting failed Stalin's "Great Plan for the Transformation of Nature." Saplings in clusters did not thin themselves for the greater good of shelter belts, as Lysenko's "Soviet Darwinism" had predicted. Massive die-off occurred, a practical fiasco that was only hinted at in public, lest faith in authority be shaken. But biologists were allowed to revive their dispute with Lysenko's denial of competition within species. They could even hope for larger freedom implied by Stalin's startling decree of separation between science and ideology.

Stalin published that criticism of his own system in 1950, challenging specialists to make tests of free thought within their fields, though power remained centralized and violent. The hazards of such boldness within a despotic system kept most specialists quiet and still hinder historians' recognition that Communist bosses learned by bossing, with enormous waste and cruelty. Stalin's efforts to avert self-defeat by calling for criticism from below foreshadowed greater efforts of that sort by his successor, Nikita Khrushchev, and eventually by Mikhail Gorbachev, who pushed criticism of the old system to the limit in the 1980s. The death of Stalin in 1953 set his lieutenants into retreat from mass terror and worship of a "chief" (*vozhdl'*) as methods of rule and into easing of thought control, with growing confusion over such willful practicality as Lysenko boasted of. Khrushchev helped revive genetics, ordered farm specialists to tell him when he was wrong, and scolded those who criticized his campaign for planting maize all over the country. He had grown it at his dacha. He also rebuked ministers of agriculture for ignoring Lysenko's final recipes: training cows to increase butterfat and composting earth with fertilizer before spreading. "Harebrained scheming" was the laconic explanation that the Central Committee gave out in 1964 for the abrupt dismissal of Khrushchev. Genetics was

fully reestablished in research and education, but an exposé of its repression was stifled. A meeting of experts demolished Lysenko's butter and earth schemes, ignoring his angry reminders of past testimonials by practical bosses. He was retired to one farm. Without power, his movement melted away.

Lysenkoism and Human Evolution

Issues of human heredity entered the furor over Lysenkoism in the late 1930s, when the ideological bureaucracy condemned any interest in the topic as racism, if not Nazism. Even medical genetics fell under the ban until the 1960s, when the field revived in defiance of Lysenko's dismissal of genes. The closest Lysenko himself ever came to issues of human heredity was to brush aside the whole topic: "Man, thanks to his mind, ceased long ago to be an animal." That statement was a caricature of the rule that the emergence of *Homo sapiens* marks a transition from biological to sociocultural evolution. Major issues in biology and historical sociology are entangled in that rule, as Soviet Marxists discovered in the 1920s. In the 1930s ideological bureaucrats stifled further thought about human evolution and about ideas of progress; lifeless scholasticism served a faith that was withering away.

In any case the common tendency of Marxists, East and West, has been to separate social from biological evolution. The human breed is declared equally gifted in all its races and classes, which need only a suitable environment to show the common potential. A contrary faith ascribes social ranking to inherited experience of rule and submission. But an upper-class master-race bias can also make use of arguments denying that acquired characters are inherited; one need only assume that genes determine place in the social hierarchy. Any way one turns it, ideology shapes beliefs and reasoning about winners and losers.

Genetics actually supports apologists of no nation, race, or class. Precise science favors a vague egalitarianism: individual differences in hereditary capacities are far greater than average group differences may prove to be. Lysenkoism had nothing to say on such issues; it simply ignored them. But ideas of progress drove its claim of practicality, its support by Soviet men of power, and their disillusion and return to faith in world science as worked out by autonomous specialists. The presumptive utility of such science, a major reason for its flourishing, involves a dogma of universality, a belief that claims of knowledge which win out in developed contexts are practically useful everywhere. That dogma is weakly challenged by talk of "ethnoscience" or "indigenous knowledge" as anthropologists try to be respectful in studying, say, rain dancing and belief in its influence on weather. The challenge by Lysenkoism was strong, for proponents seized on its boast of superseding the science of advanced countries.

See also **Biology; Eugenics; Evolution; Genetics; Science, History of; Social Darwinism; Totalitarianism.**

BIBLIOGRAPHY

Hudson, P. S., and R. H. Richens. *The New Genetics in the Soviet Union*. Cambridge, U.K.: English School of Agriculture, 1946.

- Joravsky, David. *The Lysenko Affair*. Cambridge, Mass.: Harvard University Press, 1970.
- Lysenko, Trofim D. *Agrobiolgy*. Moscow: Foreign Language Publishing House, 1954.
- Medvedev, Zhores A. *The Rise and Fall of T. D. Lysenko*. Translated by I. Michael Lerner. New York: Columbia University Press, 1969.
- Rossianov, Kirill O. "Editing Nature: Joseph Stalin and the 'New' Soviet Biology." *Isis* 84 (1993): 728–745.
- Soyfer, Valery N. *Lysenko and the Tragedy of Soviet Science*. Translated by Leo Gruliow and Rebecca Gruliow. New Brunswick, N.J.: Rutgers University Press, 1994.
- Steele, Edward J., Robyn A. Lindley, and Robert V. Blanden. *Lamarck's Signature: How Retrogenes Are Changing Darwin's Natural Selection Paradigm*. Reading, Mass.: Perseus, 1998.

David Joravsky

new dictionary of the history of ideas

EDITORIAL BOARD

Editor in Chief

Maryanne Cline Horowitz, *Occidental College*
University of California, Los Angeles

Associate Editors

Jonathan Berkey, *Davidson College*
Zvi Ben-Dor Benite, *New York University*
Benjamin A. Elman, *Princeton University*
George Esenwein, *University of Florida, Gainesville*
Cary J. Nederman, *Texas A&M University*
Vassiliki Betty Smocovitis, *University of Florida, Gainesville*
Neferti Tadiar, *University of California, Santa Cruz*
Mary J. Weismantel, *Northwestern University*
Paul Tiyambe Zeleza, *Pennsylvania State University*

Advisors

Diane Apostolos-Cappadona, *Georgetown University*
Edwina Barvosa-Carter, *University of California, Santa Barbara*
Nupur Chaudhuri, *Texas Southern University*
Kostas Gavroglu, *University of Athens, Greece*
Donald R. Kelley, *Rutgers University*
Zine Magubane, *University of Illinois, Urbana-Champaign*
J. B. Schneewind, *Johns Hopkins University*
Blair Sullivan, *University of California, Los Angeles*
Reed Ueda, *Tufts University*

Librarian Advisory Board

Mary W. George, *Princeton University*
Suzy Szasz Palmer, *University of Louisville*

Editorial Assistant

Lisa Griffin

new dictionary of the history of ideas

maryanne cline horowitz, editor in chief

volume 4

Machiavellism to Phrenology



CHARLES SCRIBNER'S SONS

An imprint of Thomson Gale, a part of The Thomson Corporation

THOMSON
—★—™
GALE



New Dictionary of the History of Ideas
Maryanne Cline Horowitz, Editor in Chief

©2005 Thomson Gale, a part of the Thomson Corporation.

Thomson and Star Logo are trademarks and Gale is a registered trademark used herein under license.

For more information, contact
Thomson Gale
27500 Drake Rd.
Farmington Hills, MI 48331-3535
Or you can visit our Internet site at
<http://www.gale.com>

ALL RIGHTS RESERVED

No part of this work covered by the copyright hereon may be reproduced or used in any form or by any means—graphic, electronic, or mechanical, including photocopying, recording, taping, Web distribution, or information storage retrieval systems—without the written permission of the publisher.

For permission to use material from this product, submit your request via Web at <http://www.gale-edit.com/permissions>, or you may download our Permissions Request form and submit your request by fax or mail to:

Permissions Department
Thomson Gale
27500 Drake Road
Farmington Hills, MI 48331-3535
Permissions Hotline:
248-699-8006 or 800-877-4253, ext. 8006
Fax: 248-699-8074 or 800-762-4058

Since this page cannot legibly accommodate all copyright notices, the acknowledgments constitute an extension of the copyright notice.

While every effort has been made to ensure the reliability of the information presented in this publication, Thomson Gale does not guarantee the accuracy of the data contained herein. Thomson Gale accepts no payment for listing; and inclusion in the publication of any organization, agency, institution, publication, service, or individual does not imply endorsement of the editors or publisher. Errors brought to the attention of the publisher and verified to the satisfaction of the publisher will be corrected in future editions.

LIBRARY OF CONGRESS CATALOGING-IN-PUBLICATION DATA

New dictionary of the history of ideas / edited by Maryanne Cline Horowitz.

p. cm.

Includes bibliographical references and index.

ISBN 0-684-31377-4 (set hardcover : alk. paper) — ISBN 0-684-31378-2 (v. 1) — ISBN 0-684-31379-0 (v. 2) — ISBN 0-684-31380-4 (v. 3) — ISBN 0-684-31381-2 (v. 4) — ISBN 0-684-31382-0 (v. 5) — ISBN 0-684-31383-9 (v. 6) — ISBN 0-684-31452-5 (e-book)

1. Civilization—History—Dictionaries. 2. Intellectual life—History—Dictionaries.

I. Horowitz, Maryanne Cline, 1945–

CB9.N49 2005
903—dc22

2004014731

This title is also available as an e-book.

ISBN 0-684-31452-5

Contact your Thomson Gale sales representative for ordering information.

Printed in the United States of America

10 9 8 7 6 5 4 3 2 1

CONTENTS

Volume 1

List of Articles

Preface

Historiography

Reader's Guide

NEW DICTIONARY OF THE HISTORY OF IDEAS

Abolitionism–Common Sense

Volume 2

Reader's Guide

Communication of Ideas–Futurology

Volume 3

Reader's Guide

Game Theory–Lysenkoism

Volume 4

Reader's Guide

Machiavellism–Phrenology

Volume 5

Reader's Guide

Physics–Syncretism

Volume 6

Reader's Guide

Taste–Zionism

List of Contributors

Index

EDITORIAL AND PRODUCTION STAFF

Project Editors

Mark LaFlaur, Scot Peacock, Jennifer Wisinski

Editorial Support

Kelly Baiseley, Andrew Claps, Alja Collar, Mark Drouillard,
Kenneth Mondschein, Sarah Turner, Ken Wachsberger,
Rachel Widawsky, Christopher Verdesi

Art Editor

Scot Peacock

Chief Manuscript Editor

Georgia S. Maas

Manuscript Editors

Jonathan G. Aretakis, John Barclay, Sylvia Cannizzaro,
Melissa A. Dobson, Ted Gilley, Gretchen Gordon,
Ellen Hawley, Archibald Hobson, Elizabeth B. Inserra,
Jean Fortune Kaplan, Christine Kelley, John Krol,
Julia Penelope, Richard Rothschild, David E. Salamie,
Linda Sanders, Alan Thwaites, Jane Marie Todd

Proofreaders

Beth Fhaner, Carol Holmes, Melodie Monahan,
Laura Specht Patchkofsky, Hilary White

Cartographer

XNR Productions, Madison, Wisconsin

Caption Writer

Shannon Kelly

Indexer

Cynthia Crippen, AEIOU, Inc.

Design

Jennifer Wahj

Imaging

Dean Dauphinais, Lezlie Light, Mary Grimes

Permissions

Margaret Abendroth, Peggje Ashlevitz, Lori Hines

Composer

GGIS Information Services, York, Pennsylvania

Manager, Composition

Mary Beth Trimper

Assistant Manager, Composition

Evi Seoud

Manufacturing

Wendy Blurton

Senior Development Editor

Nathalie Duval

Editorial Director

John Fitzpatrick

Publisher

Frank Menchaca

READER'S GUIDE

This Reader's Guide was compiled by the editors to provide a systematic outline of the contents of the New Dictionary of the History of Ideas, thereby offering teachers, scholars, and the general reader a way to organize their reading according to their preferences. The Reader's Guide is divided into four sections: Communication of Ideas, Geographical Areas, Chronological Periods, and Liberal Arts Disciplines and Professions, as indicated in the outline below.

COMMUNICATION OF IDEAS

Introduction to History of Communication of Ideas

Communication Media

GEOGRAPHICAL AREAS

Global Entries

Africa

Asia

Europe

Middle East

North America

Latin and South America

CHRONOLOGICAL PERIODS

Ancient

Dynastic (400 C.E.–1400 C.E.)

Early Modern (1400–1800 C.E.)

Modern (1800–1945)

Contemporary

LIBERAL ARTS DISCIPLINES AND PROFESSIONS

Fine Arts

Humanities

Social Sciences

Sciences

Professions

Multidisciplinary Practices

Especially Interdisciplinary Entries

COMMUNICATION OF IDEAS

This category is the newest aspect of the *New Dictionary of the History of Ideas*; cultural studies, communications studies, and cultural history are moving the disciplines in this direction.

Introduction to History of Communication of Ideas

The following entries focus on the media humans have used to communicate with one another.

Absolute Music
Aesthetics: Asia
Architecture: Overview
Architecture: Asia
Arts: Overview
Astronomy, Pre-Columbian and Latin American
Bilingualism and Multilingualism
Borders, Borderlands, and Frontiers, Global
Calendar
Cinema
City, The: The City as a Cultural Center
City, The: The City as Political Center
Communication of Ideas: Africa and Its Influence
Communication of Ideas: Asia and Its Influence
Communication of Ideas: Europe and Its Influence
Communication of Ideas: Middle East and Abroad
Communication of Ideas: Orality and Advent of Writing
Communication of Ideas: Southeast Asia
Communication of Ideas: The Americas and Their Influence
Consumerism
Cultural Revivals
Cultural Studies
Dance
Diffusion, Cultural
Dress
Dualism
Education: Asia, Traditional and Modern
Education: Global Education
Emotions
Experiment
Garden
Gesture
Humor
Iconography
Images, Icons, and Idols
Japanese Philosophy, Japanese Thought
Language and Linguistics
Language, Linguistics, and Literacy
Learning and Memory, Contemporary Views
Mathematics
Media, History of
Metaphor
Migration: United States
Modernity: Africa
Museums
Music, Anthropology of

READER'S GUIDE

Musical Performance and Audiences
Oral Traditions: Overview
Oral Traditions: Telling, Sharing
Political Protest, U.S.
Practices
Protest, Political
Reading
Realism: Africa
Reflexivity
Relativism
Representation: Mental Representation
Resistance
Resistance and Accommodation
Rhetoric: Overview
Rhetoric: Ancient and Medieval
Ritual: Public Ritual
Ritual: Religion
Sacred Places
Text/Textuality
Textiles and Fiber Arts as Catalysts for Ideas
Theater and Performance
Third Cinema
Totems
Tradition
Translation
Virtual Reality
Visual Culture
Visual Order to Organizing Collections

Communication Media

This is a listing of the types of historical evidence the author used in writing the entry. While entries in the original Dictionary of the History of Ideas were to a great extent the history of texts, the entries in the New Dictionary of the History of Ideas are generally the cultural history of ideas, making use of the records of oral communication, visual communication, and communication through practices, as well as the history of texts, in order to show the impact of the idea on a wide variety of people.

ORAL

The selective list below contains the entries that give the most coverage to historical examples of the oral transmission and transformation of ideas.

Civil Disobedience
Civil Society: Europe and the United States
Communication of Ideas: Orality and Advent of Writing
Cosmopolitanism
Cultural Capital
Determinism
Dialogue and Dialectics: Socratic
Dialogue and Dialectics: Talmudic
Dream
Emotions
Empire and Imperialism: Europe
Equality: Overview
Etiquette
Fascism
Harmony
Magic
Masks
Media, History of
Millenarianism: Latin America and Native North America

Music, Anthropology of
Musical Performance and Audiences
Musicology
Nomadism
Oral Traditions: Overview
Oral Traditions: Telling, Sharing
Populism: United States
Psychoanalysis
Public Sphere
Republicanism: Republic
Rhetoric: Overview
Ritual: Public Ritual
Ritual: Religion
Slavery
Theater and Performance
Tragedy and Comedy
Trope
Wisdom, Human
COMMUNICATION THROUGH HIGH TECHNOLOGY MEDIA (radio, television, film, computer, etc.)
Absolute Music
Africa, Idea of
Alienation
Americanization, U.S.
Anticolonialism: Africa
Anti-Semitism: Islamic Anti-Semitism
Architecture: Overview
Avant-Garde: Overview
Bilingualism and Multilingualism
Bioethics
Calculation and Computation
Capitalism: Overview
Capitalism: Africa
Censorship
Chicano Movement
Cinema
City, The: The City as a Cultural Center
City, The: The City as Political Center
Colonialism: Southeast Asia
Communication of Ideas: Africa and Its Influence
Communication of Ideas: Asia and Its Influence
Communication of Ideas: Europe and Its Influence
Communication of Ideas: Middle East and Abroad
Communication of Ideas: Orality and Advent of Writing
Communication of Ideas: Southeast Asia
Communism: Latin America
Composition, Musical
Computer Science
Consciousness: Overview
Consumerism
Cosmopolitanism
Creativity in the Arts and Sciences
Critical Theory
Cultural Studies
Death
Demography
Development
Dream
Dress
Dystopia
Empire and Imperialism: United States
Environmental History
Expressionism
Fascism
Fetishism: Fetishism in Literature and Cultural Studies

Field Theories
 Futurology
 Game Theory
 Gay Studies
 Gender: Gender in the Middle East
 Gender in Art
 Genetics: Contemporary
 Genetics: History of
 Genocide
 Genre
 Geography
 Globalization: General
 Harmony
 Hinduism
 History, Economic
 Human Capital
 Iconography
 Intelligentsia
 Jihad
 Jouissance
 Judaism: Modern Judaism
 Language and Linguistics
 Law
 Learning and Memory, Contemporary Views
 Life
 Life Cycle: Elders/Old Age
 Literary Criticism
 Literature: Overview
 Literature: African Literature
 Loyalties, Dual
 Lysenkoism
 Maps and the Ideas They Express
 Masks
 Mathematics
 Media, History of
 Medicine: Europe and the United States
 Medicine: Islamic Medicine
 Meme
 Memory
 Modernism: Overview
 Modernism: Latin America
 Modernity: East Asia
 Motherhood and Maternity
 Motif: Motif in Music
 Music, Anthropology of
 Musical Performance and Audiences
 Musicology
 Nuclear Age
 Occidentalism
 Pan-Arabism
 Parties, Political
 Physics
 Political Protest, U.S.
 Political Science
 Postmodernism
 Power
 Presentism
 Privacy
 Probability
 Progress, Idea of
 Propaganda
 Property
 Protest, Political
 Public Sphere
 Quantum

Reading
 Reform: Europe and the United States
 Reform: Islamic Reform
 Relativity
 Representation: Mental Representation
 Resistance
 Rhetoric: Overview
 Science Fiction
 Sexuality: Overview
 Social History, U.S.
 Society
 State, The: Overview
 Symbolism
 Taste
 Technology
 Third Cinema
 Third World
 Totalitarianism
 Victorianism
 Virtual Reality
 Visual Culture
 War and Peace in the Arts
 Westernization: Africa
 Westernization: Middle East
 Women and Femininity in U.S. Popular Culture
 Work
 World Systems Theory, Latin America

VISUAL

Each of the following entries in the *NDHI* either evocatively describes ideas, includes a visual image of an idea, or provides historical examples of societies visually transmitting and transforming ideas.

Abolitionism
 Aesthetics: Africa
 Aesthetics: Asia
 Aesthetics: Europe and the Americas
 Alienation
 Altruism
 Ambiguity
 Americanization, U.S.
 Ancestor Worship
 Animism
 Anti-Semitism: Overview
 Apartheid
 Architecture: Overview
 Architecture: Africa
 Architecture: Asia
 Arts: Overview
 Arts: Africa
 Asceticism: Hindu and Buddhist Asceticism
 Asceticism: Western Asceticism
 Asian-American Ideas (Cultural Migration)
 Assimilation
 Astrology: Overview
 Astronomy, Pre-Columbian and Latin American
 Authoritarianism: Latin America
 Autobiography
 Avant-Garde: Militancy
 Aztlán
 Barbarism and Civilization
 Beauty and Ugliness
 Behaviorism

READER'S GUIDE

Bioethics
 Black Atlantic
 Black Consciousness
 Body, The
 Bushido
 Calculation and Computation
 Calendar
 Cannibalism
 Capitalism: Overview
 Capitalism: Africa
 Causation
 Censorship
 Change
 Chemistry
 Childhood and Child Rearing
 Cinema
 City, The: Latin America
 City, The: The City as a Cultural Center
 City, The: The City as Political Center
 City, The: The Islamic and Byzantine City
 Civil Disobedience
 Classicism
 Classification of Arts and Sciences, Early Modern
 Colonialism: Southeast Asia
 Common Sense
 Communication of Ideas: The Americas and Their Influence
 Communication of Ideas: Asia and Its Influence
 Communication of Ideas: Europe and Its Influence
 Communication of Ideas: Orality and Advent of Writing
 Communication of Ideas: Southeast Asia
 Composition, Musical
 Computer Science
 Consciousness: Overview
 Consumerism
 Continental Philosophy
 Cosmology: Asia
 Cosmopolitanism
 Creativity in the Arts and Sciences
 Critical Race Theory
 Critical Theory
 Cultural Capital
 Cultural History
 Cultural Revivals
 Cultural Studies
 Cycles
 Cynicism
 Dada
 Dance
 Death
 Death and Afterlife, Islamic Understanding of
 Demography
 Demonology
 Determinism
 Development
 Diasporas: African Diaspora
 Diasporas: Jewish Diaspora
 Dictatorship in Latin America
 Discrimination
 Diversity
 Dream
 Dress
 Dystopia
 Ecology
 Education: Europe
 Education: Islamic Education
 Emotions
 Empire and Imperialism: Europe
 Empire and Imperialism: United States
 Empiricism
 Encyclopedism
 Enlightenment
 Environment
 Environmental History
 Epistemology: Ancient
 Epistemology: Early Modern
 Equality: Overview
 Equality: Racial Equality
 Essentialism
 Ethnicity and Race: Anthropology
 Ethnicity and Race: Islamic Views
 Ethnocentrism
 Etiquette
 Eugenics
 Europe, Idea of
 Everyday Life
 Evil
 Expressionism
 Extirpation
 Family Planning
 Fascism
 Fatalism
 Feminism: Overview
 Feminism: Chicana Feminisms
 Feminism: Third World U.S. Movement
 Fetishism: Overview
 Fetishism: Fetishism in Literature and Cultural Studies
 Feudalism, European
 Field Theories
 Form, Metaphysical, in Ancient and Medieval Thought
 Foundationalism
 Friendship
 Futurology
 Game Theory
 Garden
 Gender: Overview
 Gender: Gender in the Middle East
 Gender in Art
 Genetics: Contemporary
 Genetics: History of
 Genius
 Genocide
 Geography
 Geometry
 Gesture
 Ghetto
 Globalization: Asia
 Globalization: General
 Greek Science
 Harmony
 Hate
 Health and Disease
 Heaven and Hell
 Heaven and Hell (Asian Focus)
 Hedonism in European Thought
 Heresy and Apostasy
 Hinduism
 History, Economic
 History, Idea of

- Honor
 Honor, Middle Eastern Notions of
 Humanism: Chinese Conception of
 Humanity: African Thought
 Humanity: European Thought
 Humanity in the Arts
 Humor
 Hygiene
 Iconography
 Idealism
 Ideas, History of
 Identity: Identity of Persons
 Identity, Multiple: Overview
 Identity, Multiple: Jewish Multiple Identity
 Images, Icons, and Idols
 Imagination
 Impressionism
 Intentionality
 Interdisciplinarity
 Islam: Shii
 Islamic Science
 Jainism
 Jihad
 Jouissance
 Knowledge
 Landscape in the Arts
 Language, Linguistics, and Literacy
 Law, Islamic
 Leadership
 Learning and Memory, Contemporary Views
 Liberty
 Life Cycle: Overview
 Life Cycle: Elders/Old Age
 Literary History
 Love, Western Notions of
 Machismo
 Magic
 Maps and the Ideas They Express
 Masks
 Mathematics
 Matriarchy
 Mechanical Philosophy
 Media, History of
 Medicine: Europe and the United States
 Medicine: Islamic Medicine
 Memory
 Men and Masculinity
 Mestizaje
 Metaphor
 Microcosm and Macrocosm
 Migration: United States
 Millenarianism: Islamic
 Millenarianism: Latin America and Native North
 America
 Minority
 Miracles
 Modernism: Overview
 Modernism: Latin America
 Modernity: Overview
 Modernity: Africa
 Monarchy: Overview
 Monasticism
 Motherhood and Maternity
 Motif: Motif in Music
 Museums
 Musical Performance and Audiences
 Musicology
 Mysticism: Chinese Mysticism
 Mysticism: Christian Mysticism
 Myth
 Nation
 Nationalism: Overview
 Natural History
 Naturalism
 Naturalism in Art and Literature
 Naturphilosophie
 Negritude
 Newtonianism
 Nomadism
 Nuclear Age
 Nude, The
 Occidentalism
 Organicism
 Orthodoxy
 Pacifism
 Pan-Asianism
 Paradigm
 Paradise on Earth
 Periodization of the Arts
 Person, Idea of the
 Perspective
 Philosophies: American
 Philosophies: Feminist, Twentieth-Century
 Philosophy: Relations to Other Intellectual Realms
 Phrenology
 Physics
 Political Protest, U.S.
 Population
 Postmodernism
 Practices
 Pre-Columbian Civilization
 Prejudice
 Privacy
 Property
 Protest, Political
 Psychoanalysis
 Public Sphere
 Pythagoreanism
 Queer Theory
 Race and Racism: United States
 Reading
 Realism
 Relativism
 Religion: Indigenous Peoples' View, South America
 Religion and Science
 Religion and the State: Latin America
 Renaissance
 Representation: Mental Representation
 Representation: Political Representation
 Republicanism: Republic
 Resistance
 Resistance and Accommodation
 Responsibility
 Ritual: Public Ritual
 Ritual: Religion
 Romanticism in Literature and Politics
 Sacred and Profane
 Sacred Places
 Science, History of
 Science Fiction

READER'S GUIDE

Scientific Revolution
Sexuality: Overview
Sexuality: Sexual Orientation
Shinto
Slavery
Social History, U.S.
Sophists, The
Sport
Subjectivism
Superstition
Surrealism
Symbolism
Syncretism
Taste
Terror
Text/Textuality
Theater and Performance
Theodicy
Third Cinema
Third World Literature
Toleration
Totalitarianism
Totems
Trade
Tragedy and Comedy
Treaty
Untouchability: Menstrual Taboos
Utilitarianism
Utopia
Victorianism
Virtual Reality
Visual Culture
Visual Order to Organizing Collections
Volunteerism, U.S.
War
War and Peace in the Arts
Westernization: Southeast Asia
Witchcraft
Witchcraft, African Studies of
Women and Femininity in U.S. Popular Culture
Women's History: Africa
World Systems Theory, Latin America
Yin and Yang

PRACTICES

Most of the entries in the *NDHI* discuss how specific societies habituated people to specific ideas. This selective list includes the entries on schools of thought and practice, religions, and political movements, as well as the entries on distinctive practices.

Abolitionism
Afropessimism
Agnosticism
Alchemy: China
Alchemy: Europe and the Middle East
Anarchism
Ancestor Worship
Animism
Anticolonialism: Africa
Anticolonialism: Latin America
Anticolonialism: Middle East
Anticolonialism: Southeast Asia
Anticommunism: Latin America
Antifeminism

Anti-Semitism: Overview
Anti-Semitism: Islamic Anti-Semitism
Apartheid
Aristotelianism
Asceticism: Hindu and Buddhist Asceticism
Asceticism: Western Asceticism
Astrology: Overview
Astrology: China
Atheism
Avant-Garde: Militancy
Behaviorism
Black Consciousness
Buddhism
Bureaucracy
Bushido
Cannibalism
Capitalism: Overview
Capitalism: Africa
Cartesianism
Character
Chicano Movement
Chinese Thought
Christianity: Overview
Christianity: Asia
Cinema
Citizenship: Naturalization
Civil Disobedience
Classicism
Classification of Arts and Sciences, Early Modern
Colonialism: Africa
Colonialism: Latin America
Colonialism: Southeast Asia
Communication of Ideas: Orality and Advent of Writing
Communism: Europe
Communism: Latin America
Communitarianism in African Thought
Computer Science
Confucianism
Conservatism
Constitutionalism
Cosmopolitanism
Creationism
Critical Theory
Cultural Capital
Cultural Studies
Cynicism
Dance
Daoism
Deism
Dialogue and Dialectics: Socratic
Dialogue and Dialectics: Talmudic
Discrimination
Diversity
Eclecticism
Ecumenism
Empire and Imperialism: Overview
Empire and Imperialism: Americas
Empire and Imperialism: Asia
Empire and Imperialism: Europe
Empire and Imperialism: Middle East
Empire and Imperialism: United States
Empiricism
Epicureanism
Equality: Overview
Etiquette

- Eugenics
 Everyday Life
 Existentialism
 Extirpation
 Fascism
 Fatalism
 Feminism: Overview
 Feminism: Africa and African Diaspora
 Feminism: Chicana Feminisms
 Feminism: Islamic Feminism
 Feminism: Third World U.S. Movement
 Fetishism: Overview
 Feudalism, European
 Game Theory
 Genocide
 Ghetto
 Gift, The
 Gnosticism
 Health and Disease
 Hegelianism
 Hinduism
 Humanism: Renaissance
 Humanism: Secular Humanism in the United States
 Human Rights: Overview
 Human Rights: Women's Rights
 Interpretation
 Islam: Africa
 Islam: Shii
 Islam: Southeast Asia
 Islam: Sunni
 Jainism
 Japanese Philosophy, Japanese Thought
 Jihad
 Judaism: Judaism to 1800
 Judaism: Modern Judaism
 Kantianism
 Law
 Leadership
 Legalism, Ancient China
 Liberalism
 Liberation Theology
 Machiavellism
 Magic
 Manichaeism
 Maoism
 Marxism: Overview
 Marxism: Asia
 Marxism: Latin America
 Masks
 Mechanical Philosophy
 Medicine: China
 Medicine: Europe and the United States
 Medicine: India
 Medicine: Islamic Medicine
 Migration: Migration in World History
 Monarchy: Overview
 Monasticism
 Multiculturalism, Africa
 Museums
 Music, Anthropology of
 Musical Performance and Audiences
 Musicology
 Myth
 Nationalism: Overview
 Nationalism: Africa
 Nationalism: Cultural Nationalism
 Nationalism: Middle East
 Neoplatonism
 Nihilism
 Nomadism
 Nonviolence
 Orthodoxy
 Orthopraxy: Asia
 Orthopraxy: Western Orthopraxy
 Pacifism
 Pan-Africanism
 Pan-Arabism
 Pan-Asianism
 Pan-Islamism
 Pan-Turkism
 Paradigm
 Phrenology
 Physics
 Platonism
 Political Protest, U.S.
 Polytheism
 Population
 Populism: Latin America
 Positivism
 Practices
 Pragmatism
 Pseudoscience
 Psychoanalysis
 Psychology and Psychiatry
 Public Sphere
 Punishment
 Race and Racism: Asia
 Race and Racism: Europe
 Race and Racism: United States
 Radicals/Radicalism
 Rational Choice
 Reading
 Realism: Africa
 Reflexivity
 Reform: Europe and the United States
 Relativism
 Religion: Overview
 Religion: Africa
 Religion: African Diaspora
 Religion: East and Southeast Asia
 Religion: Indigenous Peoples' View, South America
 Religion: Latin America
 Religion: Middle East
 Republicanism: Latin America
 Republicanism: Republic
 Resistance
 Resistance and Accommodation
 Responsibility
 Revolution
 Ritual: Public Ritual
 Ritual: Religion
 Romanticism in Literature and Politics
 Sacred and Profane
 Scholasticism
 Science: Overview
 Scientific Revolution
 Secularization and Secularism
 Segregation
 Skepticism
 Slavery

READER'S GUIDE

Socialism
Socialisms, African
Sophists, The
Sport
Stoicism
Subjectivism
Suicide
Superstition
Symbolism
Syncretism
Temperance
Terror
Theater and Performance
Time: Traditional and Utilitarian
Totalitarianism
Totems
Trade
Tradition
Tragedy and Comedy
Tribalism, Middle East
Untouchability: Overview
Untouchability: Menstrual Taboos
Untouchability: Taboos
Utilitarianism
Visual Order to Organizing Collections
Volunteerism, U.S.
Westernization: Africa
Westernization: Middle East
Westernization: Southeast Asia
Witchcraft
Witchcraft, African Studies of
Work
Yoga
Zionism

TEXTUAL

Every entry in the *New Dictionary of the History of Ideas* used texts. The following is a list of entries that focused mainly on the history of a succession of texts. Each academic discipline has a succession of major authors with whom later practitioners of the discipline build upon and respond to creatively. The historian of a discipline—such as the history of political philosophy, literary history, or the history of science—considers the responses of thinkers and practitioners of a discipline to the major earlier texts in the discipline. In tracing the origin, development, and transformation of an idea, the historian of ideas considers thinkers' responses to texts from a variety of disciplines.

Agnosticism
Alchemy: Europe and the Middle East
Algebras
Altruism
America
Analytical Philosophy
Aristotelianism
Asceticism: Hindu and Buddhist Asceticism
Autobiography
Autonomy
Biography
Bureaucracy
Capitalism: Overview
Cartesianism
Casuistry

Causality
Censorship
Change
Chinese Thought
Civil Disobedience
Class
Communitarianism in African Thought
Conservatism
Continental Philosophy
Cosmology: Cosmology and Astronomy
Creolization, Caribbean
Crisis
Cycles
Death and Afterlife, Islamic Understanding of
Deism
Dialogue and Dialectics: Socratic
Dialogue and Dialectics: Talmudic
Eclecticism
Encyclopedism
Epistemology: Ancient
Epistemology: Early Modern
Equality: Gender Equality
Eschatology
Essentialism
Existentialism
Experiment
Falsifiability
Fatalism
Fetishism: Fetishism in Literature and Cultural Studies
Form, Metaphysical, in Ancient and Medieval Thought
Free Will, Determinism, and Predestination
General Will
Generation
Genius
Genre
Geometry
Gift, The
Globalization: Asia
Gnosticism
Good
Greek Science
Happiness and Pleasure in European Thought
Heaven and Hell
Hegelianism
Hermeneutics
Hierarchy and Order
Hinduism
Historical and Dialectical Materialism
Historicism
Historiography
History, Idea of
Humanism: Africa
Humanism: Chinese Conception of
Humanism: Renaissance
Humanity: Asian Thought
Human Rights: Overview
Idealism
Ideas, History of
Identity, Multiple: Overview
Identity: Identity of Persons
Imagination
Immortality and the Afterlife
Individualism
Intelligentsia
Jouissance

Judaism: Judaism to 1800
 Justice: Overview
 Justice: Justice in American Thought
 Justice: Justice in East Asian Thought
 Kantianism
 Knowledge
 Language, Philosophy of: Ancient and Medieval
 Language, Philosophy of: Modern
 Legalism, Ancient China
 Liberalism
 Liberty
 Literature: African Literature
 Materialism in Eighteenth-Century European Thought
 Mechanical Philosophy
 Medicine: China
 Metaphor
 Metaphysics: Ancient and Medieval
 Metaphysics: Renaissance to the Present
 Microcosm and Macrocosm
 Mind
 Modernity: East Asia
 Mohism
 Moral Sense
 Motif: Motif in Literature
 Mysticism: Chinese Mysticism
 Mysticism: Christian Mysticism
 Mysticism: Kabbalah
 Natural Law
 Natural Theology
 Naturalism
 Naturphilosophie
 Negritude
 Neocolonialism
 New Criticism
 Nihilism
 Organicism
 Orientalism: Overview
 Orthopraxy: Western Orthopraxy
 Paradigm
 Phenomenology
 Philosophies: African
 Philosophies: Islamic
 Philosophy: Historical Overview and Recent Developments
 Philosophy, History of
 Philosophy, Moral: Ancient
 Philosophy, Moral: Medieval and Renaissance
 Philosophy, Moral: Modern
 Philosophy and Religion in Western Thought
 Philosophy of Mind: Ancient and Medieval
 Philosophy of Religion
 Pietism
 Platonism
 Poetry and Poetics
 Political, The
 Postcolonial Theory and Literature
 Practices
 Pragmatism
 Prehistory, Rise of
 Progress, Idea of
 Psychoanalysis
 Queer Theory
 Race and Racism: Overview
 Rationalism
 Reading

Realism: Africa
 Reflexivity
 Relativity
 Religion: Overview
 Representation: Political Representation
 Republicanism: Republic
 Romanticism in Literature and Politics
 Sacred Texts: Asia
 Science: East Asia
 Science, History of
 Science Fiction
 Social Capital
 Social Contract
 State of Nature
 Stoicism
 Structuralism and Poststructuralism: Overview
 Structuralism and Poststructuralism: Anthropology
 Taste
 Text/Textuality
 Toleration
 Treaty
 Truth
 Universalism
 Utopia
 Virtue Ethics
 Wealth
 World Systems Theory, Latin America

GEOGRAPHICAL AREAS

Global Entries

EXEMPLARY GLOBAL ENTRIES

Anthropology
 Atheism
 Bilingualism and Multilingualism
 Black Atlantic
 Christianity: Overview
 Communication of Ideas: Orality and the Advent of Writing
 Constitutionalism
 Critical Theory
 Dance
 Environmental History
 Eurocentrism
 Feminism: Overview
 Fundamentalism
 Garden
 Historiography
 History, Economic
 Humanity in the Arts
 Identity, Multiple: Jewish Multiple Identity
 International Order
 Islam: Shii
 Islam: Sunni
 Life Cycle: Elders/Old Age
 Magic
 Maps and the Ideas They Express
 Marxism: Overview
 Mathematics
 Migration: Africa
 Migration: Migration in World History
 Migration: United States
 Monasticism
 Music, Anthropology of

READER'S GUIDE

- Musical Performance and Audiences
Nuclear Age
Pan-Africanism
Peasants and Peasantry
Person, Idea of the
Polytheism
Postcolonial Theory and Literature
Property
Protest, Political
Religion and the State: Africa
Resistance and Accommodation
Ritual: Religion
Sacred Places
Secularization and Secularism
Slavery
Sovereignty
Superstition
Syncretism
Temperance
Third Cinema
Third World Literature
Tradition
Treaty
Witchcraft
Women's Studies
- ENTRIES ON AT LEAST THREE GEOGRAPHIC
AREAS OR A GLOBAL TOPIC
- Abolitionism
Aesthetics: Africa
Africa, Idea of
Alchemy: China
Alienation
Animism
Anthropology
Anticolonialism: Africa
Anticolonialism: Latin America
Anticolonialism: Southeast Asia
Antifeminism
Architecture: Overview
Arts: Overview
Arts: Africa
Asceticism: Hindu and Buddhist Asceticism
Astrology: Overview
Atheism
Authoritarianism: Overview
Authority
Autobiography
Barbarism and Civilization
Bilingualism and Multilingualism
Bioethics
Biography
Black Atlantic
Body, The
Borders, Borderlands, and Frontiers, Global
Buddhism
Calculation and Computation
Calendar
Cannibalism
Capitalism: Overview
Capitalism: Africa
Censorship
Childhood and Child Rearing
Cinema
Citizenship: Overview
City, The: The City as a Cultural Center
Civil Disobedience
Civil Society: Europe and the United States
Colonialism: Africa
Colonialism: Southeast Asia
Communication of Ideas: Africa and Its Influence
Communication of Ideas: Middle East and Abroad
Communication of Ideas: Orality and the Advent of
Writing
Computer Science
Consciousness: Overview
Corruption in Developed and Developing Countries
Cosmology: Asia
Cosmopolitanism
Creativity in the Arts and Sciences
Creolization, Caribbean
Critical Theory
Cultural Capital
Cultural Studies
Dance
Death
Deism
Democracy
Demography
Demonology
Dependency
Diasporas: African Diaspora
Diasporas: Jewish Diaspora
Discrimination
Diversity
Dream
Dress
Dualism
Ecology
Economics
Ecumenism
Education: Global Education
Education: Islamic Education
Empire and Imperialism: Overview
Empire and Imperialism: Asia
Empire and Imperialism: Europe
Empire and Imperialism: Middle East
Empire and Imperialism: United States
Environment
Equality: Overview
Equality: Gender Equality
Equality: Racial Equality
Ethnicity and Race: Anthropology
Ethnocentrism
Ethnography
Evil
Family: Family in Anthropology since 1980
Family Planning
Fascism
Feminism: Africa and African Diaspora
Feminism: Islamic Feminism
Feminism: Third World U.S. Movement
Fetishism: Overview
Friendship
Futurology
Gay Studies
Gender: Overview
Gender: Gender in the Middle East
Gender in Art
Gender Studies: Anthropology
Generation

- Genius
 Genocide
 Geography
 Ghetto
 Globalization: General
 Hate
 Heaven and Hell
 Honor
 Human Capital
 Humanism: Chinese Conception of
 Humanity: African Thought
 Human Rights: Overview
 Human Rights: Women's Rights
 Iconography
 Identity, Multiple: Overview
 Images, Icons, and Idols
 Immortality and the Afterlife
 Intelligentsia
 Islam: Africa
 Islamic Science
 Jihad
 Judaism: Modern Judaism
 Justice: Overview
 Kinship
 Landscape in the Arts
 Language, Linguistics, and Literacy
 Law
 Liberation Theology
 Liberty
 Life Cycle: Overview
 Life Cycle: Adolescence
 Literature: Overview
 Machiavellism
 Masks
 Matriarchy
 Media, History of
 Medicine: China
 Meditation: Eastern Meditation
 Men and Masculinity
 Millenarianism: Overview
 Millenarianism: Latin America and Native North America
 Minority
 Miracles
 Modernism: Overview
 Modernism: Latin America
 Modernity: Overview
 Modernity: Africa
 Modernization Theory
 Monarchy: Overview
 Motif: Motif in Music
 Museums
 Musicology
 Mysticism: Chinese Mysticism
 Myth
 Nation
 Nationalism: Overview
 Nationalism: Africa
 Native Policy
 Negritude
 Neocolonialism
 Nihilism
 Nomadism
 Nonviolence
 Occidentalism
 Oral Traditions: Overview
 Organicism
 Orientalism: Overview
 Orientalism: African and Black Orientalism
 Orthodoxy
 Orthopraxy: Asia
 Other, The, European Views of
 Pacifism
 Paradise on Earth
 Peace
 Periodization
 Periodization of the Arts
 Perspective
 Philosophies: African
 Philosophy: Historical Overview and Recent Developments
 Philosophy: Relations to Other Intellectual Realms
 Philosophy, Moral: Africa
 Political Science
 Population
 Postcolonial Studies
 Practices
 Prehistory, Rise of
 Prejudice
 Presentism
 Privatization
 Pseudoscience
 Race and Racism: Overview
 Reading
 Reflexivity
 Religion: Overview
 Religion: East and Southeast Asia
 Religion: Latin America
 Religion and the State: United States
 Representation: Political Representation
 Republicanism: Republic
 Rhetoric: Overview
 Ritual: Public Ritual
 Sacred and Profane
 Scarcity and Abundance, Latin America
 Science: Overview
 Segregation
 Sexuality: Overview
 Social Capital
 Society
 Sport
 State, The: Overview
 Structuralism and Poststructuralism: Anthropology
 Symbolism
 Third World
 Time: China
 Toleration
 Totalitarianism
 Totems
 Trade
 Translation
 Travel: Travel from Europe and the Middle East
 University: Overview
 University: Postcolonial
 Untouchability: Overview
 Untouchability: Menstrual Taboos
 Untouchability: Taboos
 Victorianism
 Visual Order to Organizing Collections
 War

READER'S GUIDE

War and Peace in the Arts
Westernization: Africa
Westernization: Southeast Asia
Wisdom, Human
Work
World Systems Theory, Latin America

Africa

ENTRIES FOCUSING ON AFRICA

Aesthetics: Africa
Anticolonialism: Africa
Architecture: Africa
Arts: Africa
Authenticity: Africa
Black Atlantic
Capitalism: Africa
Colonialism: Africa
Communication of Ideas: Africa and Its Influence
Communitarianism in African Thought
Democracy, Africa
Diasporas: African Diaspora
Ethnicity and Race: Africa
Feminism: Africa and African Diaspora
Globalization: Africa
Humanism: Africa
Humanity: African Thought
Islam: Africa
Literature: African Literature
Migration: Africa
Modernity: Africa
Multiculturalism, Africa
Mysticism: Mysticism in African Thought
Nationalism: Africa
Pan-Africanism
Personhood in African Thought
Philosophies: African
Philosophy, Moral: Africa
Realism: Africa
Religion: Africa
Religion: African Diaspora
Religion and the State: Africa
Sociability in African Thought
Socialisms, African
Sufism
Westernization: Africa
Women's History: Africa
Witchcraft, African Studies of

ENTRIES THAT CONSIDER AFRICA

Abolitionism
Africa, Idea of
African-American Ideas
Afrocentricity
Afropessimism
Ancestor Worship
Anthropology
Apartheid
Arts: Overview
Bilingualism and Multilingualism
Black Consciousness
Buddhism
Christianity: Overview
Civil Disobedience
Civil Society: Responses in Africa and the Middle East
Communication of Ideas: Orality and Advent of Writing

Creolization, Caribbean
Critical Theory
Dance
Demography
Dependency
Diasporas: Jewish Diaspora
Discrimination
Dress
Ecology
Empire and Imperialism: Europe
Empire and Imperialism: Middle East
Environmental History
Equality: Racial Equality
Ethnography
Eurocentrism
Family: Modernist Anthropological Theory
Fascism
Feminism: Overview
Feminism: Islamic Feminism
Fetishism: Overview
Genocide
Globalization: General
Historiography
History, Economic
Humanity in the Arts
Identity, Multiple: Jewish Multiple Identity
International Order
Islam: Shii
Islam: Sunni
Jainism
Kinship
Law
Liberation Theology
Life Cycle: Elders/Old Age
Machiavellism
Magic
Maps and the Ideas They Express
Masks
Mathematics
Men and Masculinity
Migration: Migration in World History
Migration: United States
Minority
Modernism: Overview
Motherhood and Maternity
Museums
Music, Anthropology of
Negritude
Neocolonialism
Nomadism
Oral Traditions: Overview
Orientalism: African and Black Orientalism
Pacifism
Peasants and Peasantry
Person, Idea of the
Philosophies: Islamic
Polytheism
Postcolonial Studies
Postcolonial Theory and Literature
Property
Protest, Political
Race and Racism: Overview
Religion: Latin America
Religion and the State: United States
Resistance and Accommodation

Ritual: Religion
 Sacred and Profane
 Sage Philosophy
 Segregation
 Slavery
 State, The: The Postcolonial State
 Syncretism
 Temperance
 Third Cinema
 Third World
 Third World Literature
 Time: Traditional and Utilitarian
 Toleration
 Totems
 Treaty
 Tribalism, Middle East
 University: Postcolonial
 Untouchability: Menstrual Taboos
 Victorianism
 War
 Wisdom, Human
 Witchcraft
 Womanism
 Women's Studies
 Work
 World Systems Theory, Latin America

Asia

ENTRIES FOCUSING ON ASIA

Aesthetics: Asia
 Alchemy: China
 Anticolonialism: Southeast Asia
 Architecture: Asia
 Authoritarianism: East Asia
 Buddhism
 Causation in East Asian and Southeast Asian Philosophy
 Chinese Thought
 Chinese Warlordism
 Christianity: Asia
 Colonialism: Southeast Asia
 Communication of Ideas: Asia and Its Influence
 Communication of Ideas: Southeast Asia and Its Influence
 Confucianism
 Consciousness: Chinese Thought
 Consciousness: Indian Thought
 Cosmology: Asia
 Daoism
 Education: Asia, Traditional and Modern
 Education: China
 Education: India
 Education: Japan
 Empire and Imperialism: Asia
 Examination Systems, China
 Globalization: Asia
 Heaven and Hell (Asian Focus)
 Hinduism
 Humanism: Chinese Conception of
 Humanity: Asian Thought
 Islam: Southeast Asia
 Jainism
 Japanese Philosophy, Japanese Thought
 Justice: Justice in East Asian Thought
 Landscape in the Arts

Legalism, Ancient China
 Literature: Overview
 Maoism
 Marxism: Asia
 Medicine: China
 Medicine: India
 Meditation: Eastern Meditation
 Modernity: East Asia
 Mysticism: Chinese Mysticism
 Mysticism: Islamic Mysticism in Asia
 Orthopraxy: Asia
 Pan-Asianism
 Pan-Turkism
 Philosophy: Historical Overview and Recent Developments
 Race and Racism: Asia
 Religion: East and Southeast Asia
 Sacred Texts: Asia
 Science: East Asia
 Time: China
 Time: India
 Westernization: Southeast Asia
 Women's History: Asia

ENTRIES THAT CONSIDER ASIA

Algebras
 Ancestor Worship
 Anthropology
 Anticolonialism: Africa
 Architecture: Overview
 Arts: Overview
 Asceticism: Hindu and Buddhist Asceticism
 Asian-American Ideas (Cultural Migration)
 Astrology: China
 Astronomy, Pre-Columbian and Latin American
 Atheism
 Autobiography
 Barbarism and Civilization
 Beauty and Ugliness
 Bilingualism and Multilingualism
 Biography
 Body, The
 Borders, Borderlands, and Frontiers, Global
 Bushido
 Calculation and Computation
 Cannibalism
 Censorship
 Childhood and Child Rearing
 Christianity: Overview
 Cinema
 Civil Disobedience
 Civil Society: Responses in Africa and the Middle East
 Communication of Ideas: Middle East and Abroad
 Communication of Ideas: Orality and the Advent of Writing
 Constitutionalism
 Cosmopolitanism
 Creativity in the Arts and Sciences
 Critical Theory
 Cultural Revivals
 Cycles
 Dance
 Deism
 Demography
 Demonology
 Dependency

READER'S GUIDE

Diasporas: African Diaspora
Diffusion, Cultural
Dream
Dress
Dualism
Ecumenism
Education: Global Education
Education: Islamic Education
Empire and Imperialism: Europe
Empire and Imperialism: Middle East
Empire and Imperialism: United States
Environment
Environmental History
Ethnography
Eurocentrism
Evil
Family: Family in Anthropology since 1980
Family Planning
Fascism
Feminism: Overview
Field Theories
Friendship
Fundamentalism
Garden
Gay Studies
Gender Studies: Anthropology
Generation
Genetics: Contemporary
Genocide
Globalization: General
Health and Disease
Heaven and Hell
Historiography
History, Economic
Human Capital
Humanity in the Arts
Hygiene
Iconography
Identity, Multiple: Asian-Americans
Identity, Multiple: Jewish Multiple Identity
Images, Icons, and Idols
Imagination
Immortality and the Afterlife
Individualism
Intelligentsia
International Order
Islam: Shi'i
Islam: Sunni
Islamic Science
Kinship
Language, Linguistics, and Literacy
Liberty
Life Cycle: Overview
Life Cycle: Adolescence
Life Cycle: Elders/Old Age
Machiavellism
Magic
Maps and the Ideas They Express
Marxism: Overview
Masks
Mathematics
Matriarchy
Migration: Migration in World History
Migration: United States
Miracles
Modernism: Latin America
Modernity: Africa
Modernization Theory
Mohism
Monarchy: Overview
Monasticism
Monism
Motherhood and Maternity
Motif: Motif in Music
Museums
Musical Performance and Audiences
Musicology
Nation
Neoliberalism
Nomadism
Nonviolence
Nuclear Age
Nude, The
Occidentalism
Organicism
Orientalism: Overview
Orthodoxy
Pacifism
Paradise on Earth
Peace
Peasants and Peasantry
Periodization
Person, Idea of the
Perspective
Philosophy: Relations to Other Intellectual Realms
Political Science
Population
Postcolonial Studies
Postcolonial Theory and Literature
Practices
Prehistory, Rise of
Privacy
Property
Protest, Political
Race and Racism: United States
Reading
Religion: Overview
Religion and the State: United States
Resistance and Accommodation
Revolution
Rhetoric: Overview
Ritual: Public Ritual
Ritual: Religion
Sacred and Profane
Sacred Places
Secularization and Secularism
Sexual Harassment
Sexuality: Sexual Orientation
Shinto
Slavery
Society
Sovereignty
Sport
Suicide
Superstition
Syncretism
Taste
Temperance
Terror
Textiles and Fiber Arts as Catalysts for Ideas

Third Cinema
 Third World
 Third World Literature
 Toleration
 Totems
 Trade
 Translation
 Treaty
 University: Postcolonial
 Untouchability: Overview
 Untouchability: Menstrual Taboos
 Untouchability: Taboos
 Victorianism
 Virtue Ethics
 Visual Order to Organizing Collections
 War and Peace in the Arts
 Wisdom, Human
 Witchcraft
 Women's Studies
 Work
 World Systems Theory, Latin America
 Yin and Yang
 Yoga
 Zen

Europe

ENTRIES FOCUSING ON EUROPE

Architecture: Overview
 Capitalism: Overview
 Christianity: Overview
 Classification of Arts and Sciences, Early Modern
 Colonialism: Africa
 Colonialism: Latin America
 Colonialism: Southeast Asia
 Communication of Ideas: Europe and Its Influence
 Communism: Europe
 Consumerism
 Dada
 Democracy
 Dialogue and Dialectics: Socratic
 Dialogue and Dialectics: Talmudic
 Education: Europe
 Empire and Imperialism: Overview
 Empire and Imperialism: Europe
 Encyclopedism
 Enlightenment
 Epistemology: Ancient
 Epistemology: Early Modern
 Epistemology: Modern
 Eurocentrism
 Europe, Idea of
 Existentialism
 Expressionism
 Fascism
 Feudalism, European
 Greek Science
 Happiness and Pleasure in European Thought
 Hedonism in European Thought
 Historical and Dialectical Materialism
 Humanism: Europe and the Middle East
 Humanism: Renaissance
 Humanity: European Thought
 Judaism: Judaism to 1800
 Judaism: Modern Judaism
 Landscape in the Arts

Literature: Overview
 Love, Western Notions of
 Marxism: Overview
 Materialism in Eighteenth-Century European Thought
 Mechanical Philosophy
 Medicine: Europe and the United States
 Metaphysics: Ancient and Medieval
 Metaphysics: Renaissance to the Present
 Monarchy: Overview
 National History
 Orthopraxy: Western Orthopraxy
 Other, The, European Views of
 Pan-Turkism
 Philosophy: Historical Overview and Recent Developments
 Philosophy, Moral: Ancient
 Philosophy, Moral: Medieval and Renaissance
 Philosophy, Moral: Modern
 Philosophy and Religion in Western Thought
 Philosophy of Mind: Ancient and Medieval
 Pythagoreanism
 Race and Racism: Europe
 Regions and Regionalism, Eastern Europe
 Religion and the State: Europe
 Scientific Revolution
 Victorianism

ENTRIES THAT CONSIDER EUROPE

Abolitionism
 Absolute Music
 Aesthetics: Europe and the Americas
 Africa, Idea of
 Afrocentricity
 Agnosticism
 Alchemy: Europe and the Middle East
 Algebras
 Alienation
 Altruism
 Ambiguity
 America
 Americanization, U.S.
 Analytical Philosophy
 Anarchism
 Animism
 Anthropology
 Anticolonialism: Africa
 Anticolonialism: Latin America
 Anticolonialism: Middle East
 Anticolonialism: Southeast Asia
 Antifeminism
 Anti-Semitism: Overview
 Anti-Semitism: Islamic Anti-Semitism
 Apartheid
 Architecture: Africa
 Aristotelianism
 Arts: Overview
 Arts: Africa
 Asceticism: Western Asceticism
 Assimilation
 Astrology: Overview
 Atheism
 Authoritarianism: Overview
 Authority
 Autobiography
 Autonomy
 Avant-Garde: Overview

READER'S GUIDE

Avant-Garde: Militancy
Barbarism and Civilization
Beauty and Ugliness
Behaviorism
Bilingualism and Multilingualism
Biography
Biology
Black Atlantic
Body, The
Borders, Borderlands, and Frontiers, Global
Buddhism
Bureaucracy
Calculation and Computation
Calendar
Cannibalism
Cartesianism
Casuistry
Causality
Causation
Censorship
Change
Character
Chemistry
Childhood and Child Rearing
Christianity: Asia
Cinema
Citizenship: Overview
Citizenship: Naturalization
City, The: The City as a Cultural Center
City, The: The Islamic and Byzantine City
Civil Disobedience
Civil Society: Europe and the United States
Civil Society: Responses in Africa and the Middle East
Class
Classicism
Common Sense
Communication of Ideas: Africa and Its Influence
Communication of Ideas: Middle East and Abroad
Communication of Ideas: Orality and the Advent of Writing
Communication of Ideas: Southeast Asia
Composition, Musical
Computer Science
Consciousness: Overview
Conservatism
Consilience
Constitutionalism
Continental Philosophy
Corruption
Cosmology: Cosmology and Astronomy
Cosmopolitanism
Creationism
Creativity in the Arts and Sciences
Creolization, Caribbean
Crisis
Critical Theory
Cultural Capital
Cultural History
Cultural Revivals
Cultural Studies
Cycles
Cynicism
Dance
Deism
Demography
Demonology
Dependency
Determinism
Development
Diasporas: African Diaspora
Diasporas: Jewish Diaspora
Diversity
Dream
Dress
Dystopia
Eclecticism
Ecology
Economics
Ecumenism
Education: Global Education
Education: India
Education: Islamic Education
Emotions
Empire and Imperialism: Asia
Empire and Imperialism: Middle East
Empire and Imperialism: United States
Empiricism
Environment
Environmental Ethics
Environmental History
Epicureanism
Equality: Overview
Equality: Gender Equality
Equality: Racial Equality
Essentialism
Ethnicity and Race: Africa
Ethnicity and Race: Anthropology
Ethnocentrism
Etiquette
Eugenics
Everyday Life
Evil
Evolution
Experiment
Extirpation
Fallacy, Logical
Falsifiability
Family: Modernist Anthropological Theory
Family: Family in Anthropology since 1980
Family Planning
Fatalism
Feminism: Overview
Feminism: Africa and African Diaspora
Feminism: Islamic Feminism
Fetishism: Overview
Fetishism: Fetishism in Literature and Cultural Studies
Field Theories
Form, Metaphysical, in Ancient and Medieval Thought
Formalism
Foundationalism
Free Will, Determinism, and Predestination
Friendship
Fundamentalism
Garden
Gay Studies
Gender: Gender in the Middle East
Gender in Art
Gender Studies: Anthropology
General Will
Generation

- Genetics: Contemporary
- Genetics: History of
- Genius
- Genocide
- Geography
- Geometry
- Gesture
- Ghetto
- Gift, The
- Globalization: Africa
- Globalization: Asia
- Globalization: General
- Good
- Harmony
- Hate
- Health and Disease
- Heaven and Hell
- Hegelianism
- Hegemony
- Heresy and Apostasy
- Hermeneutics
- Hierarchy and Order
- Hinduism
- Historicism
- Historiography
- History, Economic
- History, Idea of
- Honor
- Human Capital
- Humanity in the Arts
- Human Rights: Overview
- Humor
- Hygiene
- Iconography
- Idealism
- Ideas, History of
- Identity: Identity of Persons
- Identity, Multiple: Overview
- Identity, Multiple: Jewish Multiple Identity
- Images, Icons, and Idols
- Immortality and the Afterlife
- Impressionism
- Individualism
- Intelligentsia
- Intentionality
- Interdisciplinarity
- International Order
- Interpretation
- Islam: Africa
- Islam: Shii
- Islam: Sunni
- Islamic Science
- Jainism
- Jouissance
- Justice: Overview
- Kantianism
- Kinship
- Knowledge
- Language and Linguistics
- Language, Linguistics, and Literacy
- Language, Philosophy of: Ancient and Medieval
- Language, Philosophy of: Modern
- Law
- Leadership
- Learning and Memory, Contemporary Views
- Liberalism
- Liberation Theology
- Liberty
- Life
- Life Cycle: Overview
- Life Cycle: Elders/Old Age
- Linguistic Turn
- Literary Criticism
- Literary History
- Logic
- Logic and Philosophy of Mathematics, Modern
- Loyalties, Dual
- Lysenkoism
- Machiavellism
- Magic
- Manichaeism
- Maoism
- Maps and the Ideas They Express
- Masks
- Mathematics
- Matriarchy
- Media, History of
- Medicine: Islamic Medicine
- Meme
- Memory
- Men and Masculinity
- Metaphor
- Microcosm and Macrocosm
- Migration: Africa
- Migration: Migration in World History
- Migration: United States
- Millenarianism: Overview
- Millenarianism: Islamic
- Millenarianism: Latin America and Native North America
- Mind
- Miracles
- Modernism: Overview
- Modernism: Latin America
- Modernity: Overview
- Modernity: Africa
- Modernity: East Asia
- Modernization
- Modernization Theory
- Monasticism
- Monism
- Moral Sense
- Motherhood and Maternity
- Motif: Motif in Literature
- Motif: Motif in Music
- Museums
- Music, Anthropology of
- Musical Performance and Audiences
- Musicology
- Mysticism: Christian Mysticism
- Mysticism: Kabbalah
- Mysticism: Mysticism in African Thought
- Myth
- Narrative
- Nation
- Nationalism: Overview
- Nationalism: Africa
- Nationalism: Cultural Nationalism
- Nationalism: Middle East
- Native Policy

READER'S GUIDE

Natural History
 Natural Theology
 Naturalism
 Naturalism in Art and Literature
 Nature
 Naturphilosophie
 Negritude
 Neocolonialism
 Neoliberalism
 Neoplatonism
 New Criticism
 Newtonianism
 Nihilism
 Nonviolence
 Nuclear Age
 Nude, The
 Objectivity
 Obligation
 Occidentalism
 Organicism
 Orientalism: Overview
 Orthodoxy
 Pacifism
 Pan-Africanism
 Pan-Asianism
 Pan-Islamism
 Paradigm
 Paradise on Earth
 Parties, Political
 Patriotism
 Peace
 Peasants and Peasantry
 Periodization
 Periodization of the Arts
 Person, Idea of the
 Perspective
 Phenomenology
 Philosophies: African
 Philosophies: Feminist, Twentieth-Century
 Philosophies: Islamic
 Philosophy: Relations to Other Intellectual Realms
 Philosophy, History of
 Philosophy, Moral: Africa
 Philosophy of Mind: Overview
 Phrenology
 Physics
 Platonism
 Pluralism
 Poetry and Poetics
 Political, The
 Political Science
 Polytheism
 Population
 Positivism
 Postcolonial Studies
 Postcolonial Theory and Literature
 Postmodernism
 Poverty
 Power
 Practices
 Pragmatism
 Pre-Columbian Civilization
 Prehistory, Rise of
 Prejudice
 Presentism
 Privacy
 Probability
 Progress, Idea of
 Propaganda
 Property
 Prophecy
 Protest, Political
 Pseudoscience
 Psychology and Psychiatry
 Public Sphere
 Punishment
 Puritanism
 Quantum
 Queer Theory
 Radicals/Radicalism
 Rational Choice
 Rationalism
 Reading
 Realism
 Realism: Africa
 Reason, Practical and Theoretical
 Reform: Europe and the United States
 Reform: Islamic Reform
 Reformation
 Relativism
 Relativity
 Religion: Overview
 Religion: East and Southeast Asia
 Religion: Latin America
 Religion: Middle East
 Religion and Science
 Religion and the State: Latin America
 Religion and the State: United States
 Renaissance
 Representation: Mental Representation
 Representation: Political Representation
 Republicanism: Latin America
 Republicanism: Republic
 Resistance
 Resistance and Accommodation
 Responsibility
 Revolution
 Rhetoric: Overview
 Rhetoric: Ancient and Medieval
 Ritual: Public Ritual
 Ritual: Religion
 Romanticism in Literature and Politics
 Sacred and Profane
 Sacred Places
 Sage Philosophy
 Scarcity and Abundance, Latin America
 Scholasticism
 Science: Overview
 Science, History of
 Science Fiction
 Secularization and Secularism
 Sexuality: Overview
 Skepticism
 Slavery
 Social Capital
 Social Contract
 Social Darwinism
 Socialism
 Socialisms, African
 Society

Sophists, The
 Sovereignty
 Sport
 State, The: Overview
 Stoicism
 Structuralism and Poststructuralism: Overview
 Structuralism and Poststructuralism: Anthropology
 Subjectivism
 Suicide
 Superstition
 Surrealism
 Symbolism
 Taste
 Technology
 Temperance
 Terror
 Terrorism, Middle East
 Textiles and Fiber Arts as Catalysts for Ideas
 Theodicy
 Third Cinema
 Time: Traditional and Utilitarian
 Toleration
 Totalitarianism
 Trade
 Tragedy and Comedy
 Translation
 Travel: Travel from Europe and the Middle East
 Treaty
 Trope
 Truth
 Universalism
 University: Overview
 University: Postcolonial
 Untouchability: Overview
 Untouchability: Menstrual Taboos
 Untouchability: Taboos
 Utilitarianism
 Utopia
 Virtue Ethics
 Visual Order to Organizing Collections
 Volksgeist
 Volunteerism, U.S.
 War
 War and Peace in the Arts
 Wealth
 Westernization: Africa
 Westernization: Middle East
 Westernization: Southeast Asia
 Wildlife
 Wisdom, Human
 Witchcraft
 Witchcraft, African Studies of
 Women's History: Africa
 Women's Studies
 Work
 World Systems Theory, Latin America
 Zionism

Middle East

ENTRIES FOCUSING ON THE MIDDLE EAST

Alchemy: Europe and the Middle East
 Anticolonialism: Middle East
 Civil Society: Responses in Africa and the Middle East
 Communication of Ideas: Middle East and Abroad
 Death and Afterlife, Islamic Understanding of

Dialogue and Dialectics: Talmudic
 Education: Islamic Education
 Empire and Imperialism: Middle East
 Feminism: Islamic Feminism
 Gender: Gender in the Middle East
 Honor, Middle Eastern Notions of
 Humanism: Europe and the Middle East
 Intercession in Middle Eastern Society
 Islam: Shii
 Islam: Sunni
 Islamic Science
 Judaism: Judaism to 1800
 Judaism: Modern Judaism
 Law, Islamic
 Literature: Overview
 Medicine: Islamic Medicine
 Monarchy: Islamic Monarchy
 Nationalism: Middle East
 Pan-Arabism
 Pan-Islamism
 Pan-Turkism
 Philosophies: Islamic
 Religion: Middle East
 Religion and the State: Middle East
 Sufism
 Terrorism, Middle East
 Tribalism, Middle East
 Westernization: Middle East
 Zionism

ENTRIES THAT CONSIDER THE MIDDLE EAST

Africa, Idea of
 Algebras
 Anthropology
 Antifeminism
 Anti-Semitism: Overview
 Anti-Semitism: Islamic Anti-Semitism
 Architecture: Overview
 Architecture: Africa
 Aristotelianism
 Arts: Africa
 Astrology: Overview
 Astrology: China
 Atheism
 Authoritarianism: Overview
 Authority
 Barbarism and Civilization
 Bilingualism and Multilingualism
 Biography
 Calendar
 Childhood and Child Rearing
 Christianity: Overview
 City, The: The Islamic and Byzantine City
 Class
 Communication of Ideas: Africa and Its Influence
 Communication of Ideas: Europe and Its Influence
 Communication of Ideas: Orality and the Advent of Writing
 Computer Science
 Constitutionalism
 Cosmopolitanism
 Creativity in the Arts and Sciences
 Critical Theory
 Dance
 Deism
 Demography

READER'S GUIDE

Demonology
Dependency
Diasporas: African Diaspora
Diasporas: Jewish Diaspora
Dream
Dualism
Ecumenism
Empire and Imperialism: Europe
Environment
Ethnicity and Race: Islamic Views
Eurocentrism
Evil
Family Planning
Feminism: Overview
Feminism: Africa and African Diaspora
Free Will, Determinism, and Predestination
Friendship
Fundamentalism
Garden
Gay Studies
Gender in Art
Ghetto
Gift, The
Gnosticism
Hate
Health and Disease
Heaven and Hell
Heresy and Apostasy
Historiography
Humanity in the Arts
Iconography
Identity, Multiple: Jewish Multiple Identity
Images, Icons, and Idols
Imagination
Immortality and the Afterlife
Intelligentsia
International Order
Islam: Africa
Jihad
Language, Linguistics, and Literacy
Language, Philosophy of: Ancient and Medieval
Liberty
Life Cycle: Elders/Old Age
Literature: African Literature
Logic
Manichaeism
Maps and the Ideas They Express
Mathematics
Matriarchy
Microcosm and Macrocosm
Migration: Africa
Migration: Migration in World History
Millenarianism: Overview
Millenarianism: Islamic
Minority
Miracles
Monarchy: Overview
Motherhood and Maternity
Museums
Musicology
Mysticism: Islamic Mysticism
Mysticism: Islamic Mysticism in Asia
Mysticism: Kabbalah
Mysticism: Mysticism in African Thought
Nation
Nationalism: Cultural Nationalism
Nihilism
Nomadism
Nonviolence
Nuclear Age
Organicism
Orientalism: Overview
Orientalism: African and Black Orientalism
Orthodoxy
Orthopraxy: Western Orthopraxy
Pan-Africanism
Paradise on Earth
Peace
Perspective
Philosophies: African
Philosophy, Moral: Medieval and Renaissance
Philosophy of Mind: Ancient and Medieval
Political Science
Polytheism
Postcolonial Studies
Postcolonial Theory and Literature
Property
Prophecy
Protest, Political
Pythagoreanism
Reform: Islamic Reform
Religion: East and Southeast Asia
Religion and Science
Religion and the State: Africa
Religion and the State: Europe
Religion and the State: United States
Resistance and Accommodation
Rhetoric: Overview
Sacred Places
Sacred Texts: Koran
Science, History of
Scientific Revolution
Secularization and Secularism
Sexual Harassment
Sexuality: Islamic Views
Slavery
Sovereignty
Suicide
Superstition
Syncretism
Temperance
Textiles and Fiber Arts as Catalysts for Ideas
Theodicy
Third Cinema
Third World Literature
Toleration
Totalitarianism
Totems
Travel: Travel from Europe and the Middle East
Treaty
University: Overview
Untouchability: Menstrual Taboos
Untouchability: Taboos
Visual Order to Organizing Collections
Westernization: Africa
Westernization: Southeast Asia
Wisdom, Human
Women's History: Africa
Women's Studies
World Systems Theory, Latin America

North America

ENTRIES FOCUSING ON NORTH AMERICA

African-American Ideas
 America
 Asian-American Ideas (Cultural Migration)
 Black Atlantic
 Chicano Movement
 Christianity: Overview
 Civil Society: Europe and the United States
 Communication of Ideas: The Americas and Their Influence
 Consumerism
 Democracy
 Education: North America
 Empire and Imperialism: Americas
 Empire and Imperialism: United States
 Ethnohistory, U.S.
 Feminism: Chicana Feminisms
 Feminism: Third World U.S. Movement
 Humanism: Secular Humanism in the United States
 Identity, Multiple: Asian-Americans
 Judaism: Modern Judaism
 Justice: Justice in American Thought
 Landscape in the Arts
 Medicine: Europe and the United States
 Migration: United States
 Millenarianism: Latin America and Native North America
 Native Policy
 Philosophies: American
 Political Protest, U.S.
 Populism: United States
 Race and Racism: United States
 Reform: Europe and the United States
 Religion and the State: United States
 Volunteerism, U.S.

ENTRIES THAT CONSIDER NORTH AMERICA

Abolitionism
 Aesthetics: Europe and the Americas
 Africa, Idea of
 Afrocentricity
 Altruism
 Americanization, U.S.
 Analytical Philosophy
 Anthropology
 Anticolonialism: Latin America
 Anticolonialism: Southeast Asia
 Antifeminism
 Asceticism: Western Asceticism
 Assimilation
 Astronomy, Pre-Columbian and Latin American
 Atheism
 Authoritarianism: Latin America
 Authority
 Autobiography
 Aztlán
 Beauty and Ugliness
 Behaviorism
 Bilingualism and Multilingualism
 Bioethics
 Biology
 Body, The
 Borders, Borderlands, and Frontiers, Global
 Buddhism
 Calculation and Computation

Cannibalism
 Causation
 Censorship
 Childhood and Child Rearing
 Cinema
 Citizenship: Overview
 Citizenship: Cultural Citizenship
 Citizenship: Naturalization
 City, The: The City as a Cultural Center
 Civil Disobedience
 Colonialism: Latin America
 Communication of Ideas: Africa and Its Influence
 Communism: Latin America
 Computer Science
 Conservatism
 Consilience
 Constitutionalism
 Continental Philosophy
 Cosmopolitanism
 Creationism
 Critical Race Theory
 Critical Theory
 Cultural Capital
 Cultural Revivals
 Cultural Studies
 Dance
 Death
 Deism
 Demography
 Diasporas: African Diaspora
 Diasporas: Jewish Diaspora
 Discrimination
 Diversity
 Dream
 Dress
 Dualism
 Dystopia
 Ecology
 Economics
 Ecumenism
 Education: Global Education
 Emotions
 Empire and Imperialism: Asia
 Empiricism
 Enlightenment
 Environment
 Environmental Ethics
 Environmental History
 Equality: Overview
 Equality: Gender Equality
 Equality: Racial Equality
 Essentialism
 Ethnicity and Race: Anthropology
 Ethnocentrism
 Ethnography
 Eugenics
 Eurocentrism
 Everyday Life
 Evil
 Evolution
 Family: Modernist Anthropological Theory
 Family: Family in Anthropology since 1980
 Family Planning
 Feminism: Overview
 Feminism: Africa and African Diaspora

READER'S GUIDE

Feminism: Islamic Feminism
Fetishism: Overview
Fetishism: Fetishism in Literature and Cultural Studies
Field Theories
Foundationalism
Friendship
Fundamentalism
Game Theory
Garden
Gay Studies
Gender: Overview
Gender: Gender in the Middle East
Gender in Art
Gender Studies: Anthropology
Generation
Genetics: Contemporary
Genetics: History of
Genius
Genocide
Ghetto
Globalization: Asia
Globalization: General
Hate
Hegelianism
Historiography
History, Economic
Human Capital
Humanity: European Thought
Humanity in the Arts
Human Rights: Overview
Ideas, History of
Identity: Identity of Persons
Identity: Personal and Social Identity
Identity, Multiple: Overview
Identity, Multiple: Jewish Multiple Identity
Impressionism
Intentionality
Interdisciplinarity
Internal Colonialism
International Order
Interpretation
Islam: Shii
Jainism
Justice: Overview
Kantianism
Language and Linguistics
Language, Philosophy of: Modern
Law
Leadership
Learning and Memory, Contemporary Views
Liberation Theology
Life
Life Cycle: Adolescence
Life Cycle: Elders/Old Age
Linguistic Turn
Literary Criticism
Literary History
Loyalties, Dual
Machismo
Magic
Maps and the Ideas They Express
Marxism: Overview
Marxism: Latin America
Masks
Mathematics
Matriarchy
Media, History of
Meme
Men and Masculinity
Mestizaje
Migration: Africa
Migration: Migration in World History
Millenarianism: Overview
Mind
Minority
Modernism: Latin America
Modernity: Overview
Monasticism
Motif: Motif in Music
Museums
Music, Anthropology of
Musical Performance and Audiences
Myth
Narrative
Nation
Nationalism: Overview
Nationalism: Africa
Natural History
Natural Theology
Naturalism
Neocolonialism
Neoliberalism
New Criticism
Nihilism
Nuclear Age
Objectivity
Obligation
Occidentalism
Orientalism: African and Black Orientalism
Orthodoxy
Other, The, European Views of
Pacifism
Pan-Africanism
Paradigm
Parties, Political
Periodization
Person, Idea of the
Philosophies: Feminist, Twentieth-Century
Philosophy: Relations to Other Intellectual Realms
Philosophy of Mind: Overview
Pluralism
Political Science
Population
Positivism
Postcolonial Studies
Postcolonial Theory and Literature
Postmodernism
Practices
Pragmatism
Prehistory, Rise of
Prejudice
Presentism
Privacy
Probability
Progress, Idea of
Property
Protest, Political
Pseudoscience
Psychology and Psychiatry
Quantum

Queer Theory
 Race and Racism: Overview
 Rational Choice
 Reading
 Reflexivity
 Relativism
 Relativity
 Religion: Latin America
 Religion and Science
 Renaissance
 Representation: Mental Representation
 Representation: Political Representation
 Resistance
 Resistance and Accommodation
 Responsibility
 Rhetoric: Overview
 Ritual: Religion
 Scarcity and Abundance, Latin America
 Science, History of
 Science Fiction
 Secularization and Secularism
 Segregation
 Sexual Harassment
 Sexuality: Overview
 Sexuality: Sexual Orientation
 Slavery
 Social History, U.S.
 Sovereignty
 Sport
 State, The: Overview
 Subjectivism
 Suicide
 Superstition
 Syncretism
 Taste
 Technology
 Temperance
 Terrorism, Middle East
 Time: Traditional and Utilitarian
 Totems
 Trade
 Treaty
 Trope
 Truth
 University: Postcolonial
 Utilitarianism
 Victorianism
 Visual Culture
 Visual Order to Organizing Collections
 War
 War and Peace in the Arts
 Westernization: Southeast Asia
 Wildlife
 Witchcraft
 Womanism
 Women and Femininity in U.S. Popular Culture
 Women's Studies
 World Systems Theory, Latin America

Latin and South America

ENTRIES FOCUSING ON LATIN AND SOUTH AMERICA

Anticolonialism: Latin America
 Astronomy, Pre-Columbian and Latin American
 Authoritarianism: Latin America

Black Atlantic
 Colonialism: Latin America
 Communication of Ideas: The Americas and Their Influence
 Communism: Latin America
 Creolization, Caribbean
 Empire and Imperialism: Americas
 Marxism: Latin America
 Millenarianism: Latin America and Native North America
 Modernism: Latin America
 Native Policy
 Populism: Latin America
 Pre-Columbian Civilization
 Religion: Indigenous Peoples' View, South America
 Religion: Latin America
 Religion and the State: Latin America
 Republicanism: Latin America
 Scarcity and Abundance, Latin America
 World Systems Theory, Latin America

ENTRIES THAT CONSIDER LATIN AND SOUTH AMERICA

Abolitionism
 Aesthetics: Africa
 Africa, Idea of
 America
 Ancestor Worship
 Animism
 Anthropology
 Arts: Overview
 Atheism
 Authenticity: Africa
 Authoritarianism: Overview
 Autobiography
 Aztlán
 Bilingualism and Multilingualism
 Borders, Borderlands, and Frontiers, Global
 Calculation and Computation
 Cannibalism
 Chicano Movement
 Christianity: Overview
 Cinema
 Citizenship: Overview
 Citizenship: Cultural Citizenship
 Citizenship: Naturalization
 Critical Theory
 Cultural Capital
 Dance
 Demography
 Demonology
 Dependency
 Diasporas: African Diaspora
 Diffusion, Cultural
 Discrimination
 Diversity
 Empire and Imperialism: United States
 Environmental History
 Ethnohistory, U.S.
 Evil
 Extirpation
 Family Planning
 Fascism
 Feminism: Overview
 Feminism: Africa and African Diaspora
 Feminism: Chicana Feminisms

READER'S GUIDE

Fetishism: Overview
Friendship
Gender in Art
Genetics: Contemporary
Historiography
History, Economic
Honor
Humanity in the Arts
Identity, Multiple: Overview
Identity, Multiple: Jewish Multiple Identity
Indigenismo
Internal Colonialism
International Order
Liberation Theology
Life Cycle: Overview
Life Cycle: Elders/Old Age
Machiavellism
Machismo
Magic
Maps and the Ideas They Express
Masks
Mathematics
Matriarchy
Media, History of
Men and Masculinity
Mestizaje
Migration: Africa
Migration: Migration in World History
Migration: United States
Minority
Modernism: Overview
Modernization Theory
Motherhood and Maternity
Motif: Motif in Music
Museums
Music, Anthropology of
Nationalism: Africa
Negritude
Orthopraxy: Western Orthopraxy
Pan-Africanism
Peasants and Peasantry
Periodization of the Arts
Perspective
Phrenology
Political Protest, U.S.
Polytheism
Population
Postcolonial Studies
Postcolonial Theory and Literature
Practices
Prehistory, Rise of
Property
Protest, Political
Race and Racism: Overview
Religion: African Diaspora
Resistance and Accommodation
Revolution
Rhetoric: Overview
Ritual: Public Ritual
Ritual: Religion
Secularization and Secularism
Segregation
Slavery
Sport
State, The: Overview

Structuralism and Poststructuralism: Anthropology
Surrealism
Syncretism
Temperance
Third Cinema
Third World
Third World Literature
Trade
Treaty
University: Overview
University: Postcolonial
Visual Order to Organizing Collections
Witchcraft
Women's Studies
Work

CHRONOLOGICAL PERIODS

This section is divided according to five periods in world history: Ancient, Dynastic, Early Modern, Modern, and Contemporary. Use this section together with the section on Geographical Areas.

Ancient (before 400 C.E.)

ENTRIES FOCUSED ON THE PERIOD

Buddhism
Consciousness: Chinese Thought
Consciousness: Indian Thought
Democracy
Dialogue and Dialectics: Socratic
Epicureanism
Gnosticism
Greek Science
Hinduism
Justice: Justice in East Asian Thought
Language, Linguistics, and Literacy
Microcosm and Macrocosm
Orthopraxy: Asia
Orthopraxy: Western Orthopraxy
Poetry and Poetics
Sacred Places
Sacred Texts: Asia
Sophists, The
Textiles and Fiber Arts as Catalysts for Ideas
Time: China
Time: India
Yin and Yang

ENTRIES WITH EXAMPLES FROM BEFORE 400 C.E.

Generally the examples in this category are from the ancient Middle East, Europe, or Asia.

Aesthetics: Asia
Aesthetics: Europe and the Americas
Africa, Idea of
Alchemy: China
Alchemy: Europe and the Middle East
Algebras
Ambiguity
Anarchism
Anthropology
Anti-Semitism: Overview
Architecture: Overview

- Architecture: Africa
 Architecture: Asia
 Aristotelianism
 Arts: Overview
 Asceticism: Western Asceticism
 Astrology: Overview
 Astrology: China
 Atheism
 Authority
 Autobiography
 Barbarism and Civilization
 Beauty and Ugliness
 Biography
 Biology
 Body, The
 Borders, Borderlands, and Frontiers, Global
 Bureaucracy
 Calendar
 Casuistry
 Causality
 Causation
 Causation in East Asian and Southeast Asian Philosophy
 Censorship
 Change
 Character
 Childhood and Child Rearing
 Chinese Thought
 Christianity: Overview
 Christianity: Asia
 City, The: The City as a Cultural Center
 City, The: The City as Political Center
 City, The: The Islamic and Byzantine City
 Civil Society: Europe and the United States
 Class
 Classicism
 Classification of Arts and Sciences, Early Modern
 Communication of Ideas: Asia and Its Influence
 Communication of Ideas: Europe and Its Influence
 Communication of Ideas: Middle East and Abroad
 Communication of Ideas: Orality and Advent of Writing
 Communication of Ideas: Southeast Asia
 Communication of Ideas: The Americas and Their Influence
 Composition, Musical
 Confucianism
 Constitutionalism
 Corruption
 Cosmology: Asia
 Cosmology: Cosmology and Astronomy
 Cosmopolitanism
 Creationism
 Creativity in the Arts and Sciences
 Creolization, Caribbean
 Cycles
 Cynicism
 Dance
 Daoism
 Death
 Demonology
 Development
 Diasporas: Jewish Diaspora
 Dream
 Dress
 Dualism
 Eclecticism
 Ecumenism
 Education: Asia, Traditional and Modern
 Education: China
 Education: Europe
 Education: India
 Emotions
 Empire and Imperialism: Overview
 Empire and Imperialism: Asia
 Environment
 Epistemology: Ancient
 Equality: Overview
 Eschatology
 Essentialism
 Etiquette
 Eurocentrism
 Europe, Idea of
 Evil
 Evolution
 Experiment
 Fallacy, Logical
 Fatalism
 Form, Metaphysical, in Ancient and Medieval Thought
 Foundationalism
 Free Will, Determinism, and Predestination
 Friendship
 Fundamentalism
 Garden
 Gay Studies
 Gender in Art
 Generation
 Genre
 Geography
 Geometry
 Gesture
 Gift, The
 Good
 Happiness and Pleasure in European Thought
 Harmony
 Health and Disease
 Heaven and Hell
 Heaven and Hell (Asian Focus)
 Hedonism in European Thought
 Hegemony
 Heresy and Apostasy
 Hierarchy and Order
 Historiography
 History, Idea of
 Humanism: Chinese Conception of
 Humanism: Europe and the Middle East
 Humanity: African Thought
 Humanity: Asian Thought
 Humanity: European Thought
 Humanity in the Arts
 Human Rights: Overview
 Humor
 Hygiene
 Ideas, History of
 Identity, Multiple: Jewish Multiple Identity
 Images, Icons, and Idols
 Imagination
 Immortality and the Afterlife
 Individualism
 International Order
 Interpretation

READER'S GUIDE

Jainism
 Judaism: Judaism to 1800
 Justice: Overview
 Knowledge
 Landscape in the Arts
 Language, Philosophy of: Ancient and Medieval
 Leadership
 Legalism, Ancient China
 Liberty
 Life
 Literary History
 Literature: Overview
 Literature: African Literature
 Logic
 Love, Western Notions of
 Loyalties, Dual
 Machiavellism
 Manichaeism
 Maps and the Ideas They Express
 Marriage and Fertility, European Views
 Mathematics
 Matriarchy
 Mechanical Philosophy
 Media, History of
 Medicine: China
 Medicine: Europe and the United States
 Medicine: India
 Medicine: Islamic Medicine
 Meditation: Eastern Meditation
 Memory
 Men and Masculinity
 Metaphor
 Metaphysics: Ancient and Medieval
 Migration: Migration in World History
 Millenarianism: Overview
 Miracles
 Mohism
 Monarchy: Overview
 Monasticism
 Monism
 Motherhood and Maternity
 Museums
 Music, Anthropology of
 Musical Performance and Audiences
 Mysticism: Chinese Mysticism
 Mysticism: Christian Mysticism
 Narrative
 Nation
 Natural Law
 Nature
 Neoplatonism
 Nomadism
 Nonviolence
 Nude, The
 Organicism
 Orthodoxy
 Other, The, European Views of
 Pacifism
 Paradigm
 Paradise on Earth
 Patriotism
 Peace
 Periodization
 Periodization of the Arts
 Perspective
 Philanthropy
 Philosophies: African
 Philosophies: Islamic
 Philosophy: Historical Overview and Recent Developments
 Philosophy: Relations to Other Intellectual Realms
 Philosophy, Moral: Ancient
 Philosophy, Moral: Medieval and Renaissance
 Philosophy and Religion in Western Thought
 Philosophy of Mind: Ancient and Medieval
 Physics
 Platonism
 Pluralism
 Political, The
 Political Science
 Poverty
 Prehistory, Rise of
 Presentism
 Prophecy
 Punishment
 Pythagoreanism
 Rationalism
 Reading
 Reason, Practical and Theoretical
 Reform: Europe and the United States
 Reformation
 Religion: Overview
 Religion: Africa
 Religion: East and Southeast Asia
 Religion and the State: Europe
 Renaissance
 Representation: Political Representation
 Republicanism: Republic
 Resistance
 Responsibility
 Revolution
 Rhetoric: Overview
 Rhetoric: Ancient and Medieval
 Ritual: Public Ritual
 Science: East Asia
 Scientific Revolution
 Shinto
 Skepticism
 Slavery
 Society
 Sovereignty
 Sport
 State of Nature
 Stoicism
 Suicide
 Superstition
 Syncretism
 Taste
 Text/Textuality
 Toleration
 Totalitarianism
 Tragedy and Comedy
 Translation
 Travel: Travel from Europe and the Middle East
 Treaty
 Trope
 Truth
 University: Overview
 Untouchability: Overview
 Untouchability: Menstrual Taboos

Virtual Reality
 Virtue Ethics
 Visual Order to Organizing Collections
 War and Peace in the Arts
 Wealth
 Wildlife
 Witchcraft
 Work
 Yoga
 Zen

Dynastic (400 C.E.–1400 C.E.)

ENTRIES FOCUSED ON THE PERIOD

Astronomy, Pre-Columbian and Latin American
 Buddhism
 Death and Afterlife, Islamic Understanding of
 Dialogue and Dialectics: Talmudic
 Feudalism, European
 Heresy and Apostasy
 Motif: Motif in Literature
 Orthopraxy: Western Orthopraxy
 Sacred Places
 Sacred Texts: Asia
 Sacred Texts: Koran
 Scholasticism
 Textiles and Fiber Arts as Catalysts for Ideas

ENTRIES WITH EXAMPLES FROM THE PERIOD
 400 C.E.–1400 C.E.

Aesthetics: Asia
 Africa, Idea of
 Alchemy: China
 Alchemy: Europe and the Middle East
 Algebras
 America
 Anti-Semitism: Overview
 Anti-Semitism: Islamic Anti-Semitism
 Architecture: Overview
 Architecture: Africa
 Architecture: Asia
 Aristotelianism
 Arts: Overview
 Asceticism: Western Asceticism
 Astrology: Overview
 Astrology: China
 Authority
 Autobiography
 Aztlán
 Barbarism and Civilization
 Beauty and Ugliness
 Biography
 Biology
 Body, The
 Borders, Borderlands, and Frontiers, Global
 Bureaucracy
 Bushido
 Calculation and Computation
 Calendar
 Casuistry
 Causality
 Causation in East Asian and Southeast Asian Philosophy
 Change
 Childhood and Child Rearing
 Chinese Thought
 Christianity: Overview
 Christianity: Asia

City, The: The City as a Cultural Center
 City, The: The Islamic and Byzantine City
 Civil Disobedience
 Civil Society: Europe and the United States
 Class
 Classicism
 Classification of Arts and Sciences, Early Modern
 Communication of Ideas: Africa and Its Influence
 Communication of Ideas: Asia and Its Influence
 Communication of Ideas: Europe and Its Influence
 Communication of Ideas: Middle East and Abroad
 Communication of Ideas: Orality and Advent of Writing
 Communication of Ideas: Southeast Asia
 Communication of Ideas: The Americas and Their
 Influence
 Composition, Musical
 Confucianism
 Consciousness: Indian Thought
 Consilience
 Constitutionalism
 Corruption
 Cosmology: Asia
 Cosmopolitanism
 Creationism
 Creativity in the Arts and Sciences
 Daoism
 Death
 Democracy
 Demonology
 Diasporas: Jewish Diaspora
 Dream
 Dualism
 Eclecticism
 Ecumenism
 Education: Asia, Traditional and Modern
 Education: China
 Education: Europe
 Education: India
 Education: Islamic Education
 Education: Japan
 Empire and Imperialism: Overview
 Empire and Imperialism: Asia
 Encyclopedism
 Equality: Overview
 Eschatology
 Ethnicity and Race: Islamic Views
 Etiquette
 Eurocentrism
 Europe, Idea of
 Evil
 Examination Systems, China
 Experiment
 Fallacy, Logical
 Feminism: Islamic Feminism
 Form, Metaphysical, in Ancient and Medieval Thought
 Free Will, Determinism, and Predestination
 Friendship
 Garden
 Gay Studies
 Gender: Gender in the Middle East
 Gender in Art
 Gesture
 Gift, The
 Globalization: Asia
 Good

READER'S GUIDE

- Happiness and Pleasure in European Thought
 Harmony
 Health and Disease
 Heaven and Hell
 Hegemony
 Hierarchy and Order
 Hinduism
 Historiography
 History, Idea of
 Honor, Middle Eastern Notions of
 Humanism: Africa
 Humanism: Chinese Conception of
 Humanism: Europe and the Middle East
 Humanity: Asian Thought
 Humanity: European Thought
 Humanity in the Arts
 Human Rights: Overview
 Hygiene
 Iconography
 Identity, Multiple: Jewish Multiple Identity
 Images, Icons, and Idols
 Imagination
 Immortality and the Afterlife
 Individualism
 Intentionality
 International Order
 Interpretation
 Islam: Africa
 Islam: Shii
 Islam: Sunni
 Islamic Science
 Jainism
 Japanese Philosophy, Japanese Thought
 Jihad
 Judaism: Judaism to 1800
 Knowledge
 Landscape in the Arts
 Language, Philosophy of: Ancient and Medieval
 Law, Islamic
 Liberty
 Literary History
 Literature: Overview
 Logic
 Love, Western Notions of
 Loyalties, Dual
 Manichaeism
 Maps and the Ideas They Express
 Marriage and Fertility, European Views
 Mathematics
 Medicine: China
 Medicine: Europe and the United States
 Medicine: Islamic Medicine
 Metaphor
 Metaphysics: Ancient and Medieval
 Microcosm and Macrocosm
 Migration: Africa
 Migration: Migration in World History
 Millenarianism: Overview
 Millenarianism: Islamic
 Millenarianism: Latin America and Native North America
 Miracles
 Monarchy: Islamic Monarchy
 Monarchy: Overview
 Monasticism
 Monism
 Motif: Motif in Music
 Musical Performance and Audiences
 Mysticism: Chinese Mysticism
 Mysticism: Christian Mysticism
 Mysticism: Islamic Mysticism
 Mysticism: Islamic Mysticism in Asia
 Mysticism: Kabbalah
 Nation
 Natural Law
 Natural Theology
 Neoplatonism
 Nomadism
 Nude, The
 Objectivity
 Organicism
 Orthodoxy
 Other, The, European Views of
 Paradigm
 Paradise on Earth
 Patriotism
 Peace
 Peasants and Peasantry
 Periodization
 Periodization of the Arts
 Perspective
 Philanthropy
 Philosophies: African
 Philosophies: Islamic
 Philosophy: Historical Overview and Recent Developments
 Philosophy, Moral: Medieval and Renaissance
 Philosophy and Religion in Western Thought
 Philosophy of Mind: Ancient and Medieval
 Physics
 Platonism
 Poverty
 Pre-Columbian Civilization
 Prophecy
 Protest, Political
 Race and Racism: Asia
 Reform: Islamic Reform
 Religion: Africa
 Religion: East and Southeast Asia
 Religion: Middle East
 Religion and the State: Europe
 Religion and the State: Middle East
 Religion and the State: United States Renaissance
 Representation: Political Representation
 Republicanism: Republic
 Responsibility
 Revolution
 Rhetoric: Overview
 Rhetoric: Ancient and Medieval
 Ritual: Public Ritual
 Scientific Revolution
 Sexuality: Islamic Views
 Shinto
 Skepticism
 Sophists, The
 Sovereignty
 Stoicism
 Sufism
 Suicide
 Superstition

Syncretism
 Taste
 Terror
 Time: Traditional and Utilitarian
 Toleration
 Totalitarianism
 Tragedy and Comedy
 Translation
 Travel: Travel from Europe and the Middle East
 Tribalism, Middle East
 University: Overview
 Untouchability: Menstrual Taboos
 Virtual Reality
 Virtue Ethics
 Visual Order to Organizing Collections
 War
 War and Peace in the Arts
 Wealth
 Women's History: Asia
 Work
 Yoga
 Zen

Early Modern (1400–1800 C.E.)

ENTRIES FOCUSED ON THE PERIOD

Astronomy, Pre-Columbian and Latin American
 Cartesianism
 Casuistry
 Empiricism
 Humanism: Renaissance
 Idealism
 Identity: Identity of Persons
 Kantianism
 Materialism in Eighteenth-Century European Thought
 Mechanical Philosophy
 Moral Sense
 Naturphilosophie
 Newtonianism
 Phrenology
 Protest, Political
 Reformation
 Renaissance
 Scientific Revolution
 Theodicy
 Time: Traditional and Utilitarian
 Westernization: Middle East

ENTRIES WITH EXAMPLES FROM THE PERIOD

1400–1800 C.E.
 Abolitionism
 Aesthetics: Africa
 Aesthetics: Asia
 Aesthetics: Europe and the Americas
 Africa, Idea of
 African-American Ideas
 Agnosticism
 Alchemy: Europe and the Middle East
 Algebras
 Ambiguity
 America
 Ancestor Worship
 Anticolonialism: Latin America
 Antifeminism
 Anti-Semitism: Overview
 Apartheid
 Architecture: Overview

Architecture: Asia
 Aristotelianism
 Arts: Overview
 Arts: Africa
 Asceticism: Western Asceticism
 Astrology: Overview
 Atheism
 Authoritarianism: Latin America
 Authority
 Autobiography
 Autonomy
 Aztlán
 Barbarism and Civilization
 Beauty and Ugliness
 Biography
 Biology
 Body, The
 Borders, Borderlands, and Frontiers, Global
 Buddhism
 Bureaucracy
 Bushido
 Calculation and Computation
 Calendar
 Cannibalism
 Capitalism: Overview
 Capitalism: Africa
 Causality
 Causation
 Causation in East Asian and Southeast Asian Philosophy
 Censorship
 Change
 Character
 Chemistry
 Childhood and Child Rearing
 Chinese Thought
 Christianity: Asia
 Christianity: Overview
 City, The: The City as a Cultural Center
 City, The: Latin America
 Civil Disobedience
 Civil Society: Europe and the United States
 Civil Society: Responses in Africa and the Middle East
 Class
 Classicism
 Classification of Arts and Sciences, Early Modern
 Colonialism: Africa
 Colonialism: Latin America
 Colonialism: Southeast Asia
 Common Sense
 Communication of Ideas: Africa and Its Influence
 Communication of Ideas: The Americas and Their Influence
 Communication of Ideas: Asia and Its Influence
 Communication of Ideas: Europe and Its Influence
 Communication of Ideas: Middle East and Abroad
 Communication of Ideas: Orality and Advent of Writing
 Communication of Ideas: Southeast Asia
 Communism: Europe
 Composition, Musical
 Computer Science
 Confucianism
 Consciousness: Overview
 Conservatism
 Constitutionalism

READER'S GUIDE

Consumerism
 Context
 Continental Philosophy
 Corruption
 Cosmology: Asia
 Cosmology: Cosmology and Astronomy
 Cosmopolitanism
 Creationism
 Creativity in the Arts and Sciences
 Creolization, Caribbean
 Crisis
 Critical Theory
 Cultural History
 Cycles
 Death and Afterlife, Islamic Understanding of
 Deism
 Democracy
 Dependency
 Determinism
 Development
 Diasporas: African Diaspora
 Diasporas: Jewish Diaspora
 Dictatorship in Latin America
 Dream
 Dress
 Dualism
 Dystopia
 Eclecticism
 Ecology
 Economics
 Education: Asia, Traditional and Modern
 Education: China
 Education: Europe
 Education: India
 Education: Islamic Education
 Education: Japan
 Education: North America
 Empire and Imperialism: Americas
 Empire and Imperialism: Asia
 Empire and Imperialism: Middle East
 Encyclopedism
 Enlightenment
 Epistemology: Early Modern
 Equality: Overview
 Equality: Gender Equality
 Equality: Racial Equality
 Eschatology
 Essentialism
 Etiquette
 Eurocentrism
 Europe, Idea of
 Everyday Life
 Evil
 Evolution
 Examination Systems, China
 Experiment
 Extirpation
 Fascism
 Fetishism: Overview
 Field Theories
 Foundationalism
 Free Will, Determinism, and Predestination
 Friendship
 Garden
 Gay Studies
 Gender in Art
 General Will
 Genius
 Genre
 Geography
 Geometry
 Gesture
 Ghetto
 Gift, The
 Globalization: Africa
 Globalization: Asia
 Globalization: General
 Gnosticism
 Good
 Harmony
 Health and Disease
 Hedonism in European Thought
 Hierarchy and Order
 Historiography
 History, Idea of
 Honor
 Honor, Middle Eastern Notions of
 Human Capital
 Humanism: Africa
 Humanism: Chinese Conception of
 Humanism: Europe and the Middle East
 Humanism: Secular Humanism in the United States
 Humanity: African Thought
 Humanity: Asian Thought
 Humanity: European Thought
 Humanity in the Arts
 Human Rights: Overview
 Humor
 Hygiene
 Iconography
 Identity, Multiple: Overview
 Identity, Multiple: Jewish Multiple Identity
 Imagination
 Immortality and the Afterlife
 Indigenismo
 Individualism
 International Order
 Interpretation
 Islam: Africa
 Islam: Shii
 Islam: Southeast Asia
 Islam: Sunni
 Islamic Science
 Japanese Philosophy, Japanese Thought
 Judaism: Judaism to 1800
 Judaism: Modern Judaism
 Justice: Overview
 Justice: Justice in American Thought
 Knowledge
 Landscape in the Arts
 Language, Linguistics, and Literacy
 Leadership
 Liberalism
 Liberty
 Life
 Life Cycle: Overview
 Literary History
 Literature: Overview
 Logic
 Love, Western Notions of

- Loyalties, Dual
 Machiavellism
 Magic
 Maps and the Ideas They Express
 Marriage and Fertility, European Views
 Mathematics
 Medicine: Europe and the United States
 Medicine: Islamic Medicine
 Men and Masculinity
 Mestizaje
 Metaphor
 Metaphysics: Renaissance to the Present
 Microcosm and Macrocosm
 Migration: Africa
 Migration: Migration in World History
 Migration: United States
 Millenarianism: Overview
 Millenarianism: Islamic
 Millenarianism: Latin America and Native North America
 Mind
 Modernity: Africa
 Monarchy: Overview
 Monarchy: Islamic Monarchy
 Monasticism
 Monism
 Motif: Motif in Literature
 Motif: Motif in Music
 Museums
 Mysticism: Christian Mysticism
 Mysticism: Kabbalah
 Nation
 National History
 Native Policy
 Natural History
 Natural Law
 Natural Theology
 Nature
 Neoplatonism
 Nomadism
 Nude, The
 Objectivity
 Obligation
 Oral Traditions: Overview
 Organicism
 Orientalism: Overview
 Orthodoxy
 Orthopraxy: Western Orthopraxy
 Other, The, European Views of
 Paradigm
 Paradise on Earth
 Patriotism
 Peace
 Periodization
 Periodization of the Arts
 Perspective
 Philanthropy
 Philosophies: American
 Philosophies: Feminist, Twentieth-Century
 Philosophy: Historical Overview and Recent Developments
 Philosophy: Relations to Other Intellectual Realms
 Philosophy, History of
 Philosophy, Moral: Africa
 Philosophy, Moral: Medieval and Renaissance
 Philosophy, Moral: Modern
 Philosophy and Religion in Western Thought
 Philosophy of Mind: Overview
 Philosophy of Religion
 Physics
 Pietism
 Platonism
 Pluralism
 Poetry and Poetics
 Political Protest, U.S.
 Political Science
 Polytheism
 Poverty
 Power
 Pre-Columbian Civilization
 Prehistory, Rise of
 Presentism
 Probability
 Progress, Idea of
 Propaganda
 Property
 Prophecy
 Punishment
 Puritanism
 Pythagoreanism
 Race and Racism: Asia
 Race and Racism: Europe
 Radicals/Radicalism
 Rationalism
 Reason, Practical and Theoretical
 Reform: Europe and the United States
 Reform: Islamic Reform
 Relativity
 Religion: Africa
 Religion: African Diaspora
 Religion: East and Southeast Asia
 Religion: Indigenous Peoples' View, South America
 Religion: Latin America
 Religion and Science
 Religion and the State: Europe
 Religion and the State: Latin America
 Religion and the State: Middle East
 Religion and the State: United States
 Representation: Political Representation
 Republicanism: Latin America
 Republicanism: Republic
 Resistance
 Resistance and Accommodation
 Responsibility
 Revolution
 Rhetoric: Overview
 Ritual: Public Ritual
 Ritual: Religion
 Romanticism in Literature and Politics
 Scarcity and Abundance, Latin America
 Scholasticism
 Science: Overview
 Science, History of
 Secularization and Secularism
 Sexuality: Overview
 Sexuality: Islamic Views
 Shinto
 Skepticism
 Slavery
 Social Contract

READER'S GUIDE

Society
Sovereignty
Sport
State of Nature
Stoicism
Sufism
Suicide
Superstition
Syncretism
Taste
Temperance
Terror
Text/Textuality
Toleration
Totalitarianism
Tradition
Tragedy and Comedy
Translation
Travel: Travel from Europe and the Middle East
Treaty
Tribalism, Middle East
Trope
Truth
Universalism
University: Overview
Untouchability: Taboos
Utopia
Virtue Ethics
Visual Order to Organizing Collections
Volkgeist
Volunteerism, U.S.
War and Peace in the Arts
Wealth
Westernization: Middle East
Westernization: Southeast Asia
Witchcraft
Women's History: Africa
Work
World Systems Theory, Latin America

Modern (1800–1945)

ENTRIES FOCUSED ON THE PERIOD

Alienation
Altruism
Americanization, U.S.
Analytical Philosophy
Avant-Garde: Overview
Avant-Garde: Militancy
Black Atlantic
Bureaucracy
Chicano Movement
City, The: Latin America
Civil Disobedience
Consumerism
Continental Philosophy
Democracy
Empire and Imperialism: Europe
Eugenics
Evolution
Existentialism
Expressionism
Fascism
Field Theories
Fundamentalism
Futurology

Globalization: Africa
Globalization: Asia
Globalization: General
Hegelianism
Hegemony
Historicism
Humanism: Secular Humanism in the United States
Impressionism
Internal Colonialism
Kantianism
Life
Linguistic Turn
Literary History
Logic and Philosophy of Mathematics, Modern
Maoism
Marxism: Overview
Marxism: Asia
Marxism: Latin America
Media, History of
Modernism: Overview
Modernism: Latin America
Modernity: Overview
Modernity: Africa
Modernity: East Asia
Modernization
Modernization Theory
National History
Nationalism: Overview
Nationalism: Africa
Nationalism: Cultural Nationalism
Nationalism: Middle East
Naturalism
Naturalism in Art and Literature
Naturphilosophie
Neocolonialism
Neoliberalism
Orientalism: African and Black Orientalism
Pan-Africanism
Pan-Arabism
Pan-Asianism
Pan-Islamism
Pan-Turkism
Parties, Political
Phenomenology
Philosophies: Feminist, Twentieth-Century
Phrenology
Populism: Latin America
Populism: United States
Positivism
Pragmatism
Protest, Political
Psychoanalysis
Psychology and Psychiatry
Quantum
Realism
Realism: Africa
Relativism
Relativity
Science Fiction
Secularization and Secularism
Segregation
Sexuality: Sexual Orientation
Sociability in African Thought
Social Darwinism
Socialism

- Socialisms, African
- Structuralism and Poststructuralism: Overview
- Structuralism and Poststructuralism: Anthropology
- Subjectivism
- Surrealism
- Technology
- Third World
- Time: Traditional and Utilitarian
- Totalitarianism
- Utilitarianism
- Victorianism
- Westernization: Africa
- Westernization: Middle East
- Westernization: Southeast Asia
- Work
- Zionism
- ENTRIES WITH EXAMPLES FROM THE PERIOD
1800–1945
- Abolitionism
- Absolute Music
- Aesthetics: Africa
- Aesthetics: Asia
- Aesthetics: Europe and the Americas
- Africa, Idea of
- African-American Ideas
- Agnosticism
- Alchemy: China
- Alchemy: Europe and the Middle East
- Algebras
- Ambiguity
- America
- Anarchism
- Ancestor Worship
- Animism
- Anthropology
- Anticolonialism: Africa
- Anticolonialism: Latin America
- Anticolonialism: Middle East
- Anticolonialism: Southeast Asia
- Antifeminism
- Anti-Semitism: Overview
- Anti-Semitism: Islamic Anti-Semitism
- Apartheid
- Architecture: Overview
- Aristotelianism
- Arts: Overview
- Arts: Africa
- Asceticism: Western Asceticism
- Asian-American Ideas (Cultural Migration)
- Assimilation
- Atheism
- Authenticity: Africa
- Authoritarianism: Overview
- Authoritarianism: East Asia
- Authoritarianism: Latin America
- Authority
- Autobiography
- Barbarism and Civilization
- Beauty and Ugliness
- Behaviorism
- Bilingualism and Multilingualism
- Bioethics
- Biography
- Biology
- Body, The
- Borders, Borderlands, and Frontiers, Global
- Buddhism
- Bushido
- Calculation and Computation
- Capitalism: Overview
- Capitalism: Africa
- Cartesianism
- Casuistry
- Causality
- Censorship
- Change
- Character
- Chemistry
- Childhood and Child Rearing
- Chinese Warlordism
- Christianity: Overview
- Christianity: Asia
- Cinema
- Citizenship: Overview
- Citizenship: Naturalization
- City, The: The City as a Cultural Center
- City, The: The Islamic and Byzantine City
- Civil Society: Europe and the United States
- Civil Society: Responses in Africa and the Middle East
- Class
- Classicism
- Colonialism: Africa
- Colonialism: Latin America
- Colonialism: Southeast Asia
- Common Sense
- Communication of Ideas: Africa and Its Influence
- Communication of Ideas: The Americas and Their Influence
- Communication of Ideas: Asia and Its Influence
- Communication of Ideas: Europe and Its Influence
- Communication of Ideas: Middle East and Abroad
- Communication of Ideas: Orality and Advent of Writing
- Communication of Ideas: Southeast Asia
- Communism: Europe
- Communism: Latin America
- Composition, Musical
- Computer Science
- Confucianism
- Consciousness: Overview
- Conservatism
- Constitutionalism
- Context
- Corruption
- Corruption in Developed and Developing Countries
- Cosmology: Asia
- Cosmology: Cosmology and Astronomy
- Cosmopolitanism
- Creationism
- Creativity in the Arts and Sciences
- Creolization, Caribbean
- Crisis
- Critical Theory
- Cultural Capital
- Cultural History
- Cultural Revivals
- Cycles
- Dada
- Dance
- Death
- Death and Afterlife, Islamic Understanding of

READER'S GUIDE

Deism
 Democracy: Africa
 Dependency
 Determinism
 Development
 Diasporas: African Diaspora
 Diasporas: Jewish Diaspora
 Dictatorship in Latin America
 Diffusion, Cultural
 Discrimination
 Diversity
 Dream
 Dress
 Dystopia
 Ecology
 Economics
 Education: Asia, Traditional and Modern
 Education: China
 Education: Europe
 Education: Global Education
 Education: India
 Education: Islamic Education
 Education: Japan
 Education: North America
 Emotions
 Empire and Imperialism: Asia
 Empire and Imperialism: Middle East
 Empire and Imperialism: United States
 Empiricism
 Environmental Ethics
 Environmental History
 Epistemology: Modern
 Equality: Overview
 Equality: Gender Equality
 Equality: Racial Equality
 Eschatology
 Essentialism
 Ethnicity and Race: Africa
 Ethnicity and Race: Anthropology
 Ethnicity and Race: Islamic Views
 Ethnography
 Etiquette
 Eurocentrism
 Europe, Idea of
 Everyday Life
 Evil
 Examination Systems, China
 Experiment
 Falsifiability
 Family: Modernist Anthropological Theory
 Family Planning
 Feminism: Overview
 Feminism: Africa and African Diaspora
 Feminism: Chicana Feminisms
 Feminism: Third World U.S. Movement
 Fetishism: Overview
 Fetishism: Fetishism in Literature and Cultural Studies
 Formalism
 Foundationalism
 Friendship
 Game Theory
 Gay Studies
 Gender: Gender in the Middle East
 Gender in Art
 Gender Studies: Anthropology
 General Will
 Generation
 Genetics: Contemporary
 Genetics: History of
 Genius
 Genocide
 Genre
 Geography
 Geometry
 Gesture
 Ghetto
 Gift, The
 Gnosticism
 Good
 Happiness and Pleasure in European Thought
 Harmony
 Health and Disease
 Hermeneutics
 Historical and Dialectical Materialism
 Historiography
 History, Economic
 History, Idea of
 Honor, Middle Eastern Notions of
 Human Capital
 Humanism: Africa
 Humanism: Chinese Conception of
 Humanism: Europe and the Middle East
 Humanity: African Thought
 Humanity: Asian Thought
 Humanity: European Thought
 Humanity in the Arts
 Human Rights: Overview
 Humor
 Hygiene
 Iconography
 Idealism
 Ideas, History of
 Identity: Identity of Persons
 Identity, Multiple: Overview
 Identity, Multiple: Asian-Americans
 Identity, Multiple: Jewish Multiple Identity
 Imagination
 Immortality and the Afterlife
 Indigenismo
 Individualism
 Intelligentsia
 Intentionality
 Intercession in Middle Eastern Society
 International Order
 Interpretation
 Islam: Africa
 Islam: Shii
 Islam: Southeast Asia
 Islamic Science
 Japanese Philosophy, Japanese Thought
 Jihad
 Jouissance
 Judaism: Modern Judaism
 Justice: Overview
 Justice: Justice in American Thought
 Justice: Justice in East Asian Thought
 Kinship
 Knowledge
 Landscape in the Arts
 Language and Linguistics

- Language, Linguistics, and Literacy
 Language, Philosophy of: Modern
 Law
 Law, Islamic
 Leadership
 Learning and Memory, Contemporary Views
 Liberalism
 Liberty
 Life Cycle: Adolescence
 Life Cycle: Elders/Old Age
 Literary Criticism
 Literature: Overview
 Literature: African Literature
 Love, Western Notions of
 Loyalties, Dual
 Lysenkoism
 Magic
 Maps and the Ideas They Express
 Marriage and Fertility, European Views
 Masks
 Mathematics
 Matriarchy
 Medicine: Europe and the United States
 Medicine: India
 Medicine: Islamic Medicine
 Memory
 Men and Masculinity
 Mestizaje
 Metaphor
 Metaphysics: Renaissance to the Present
 Microcosm and Macrocosm
 Migration: Africa
 Migration: Migration in World History
 Migration: United States
 Millenarianism: Overview
 Millenarianism: Latin America and Native North America
 Mind
 Minority
 Monarchy: Overview
 Monarchy: Islamic Monarchy
 Monasticism
 Monism
 Motherhood and Maternity
 Motif: Motif in Literature
 Motif: Motif in Music
 Multiculturalism, Africa
 Museums
 Music, Anthropology of
 Musical Performance and Audiences
 Musicology
 Mysticism: Kabbalah
 Mysticism: Mysticism in African Thought
 Myth
 Narrative
 Nation
 Native Policy
 Natural History
 Natural Theology
 Nature
 Negritude
 New Criticism
 Nihilism
 Nonviolence
 Nude, The
 Objectivity
 Obligation
 Occidentalism
 Oral Traditions: Overview
 Organicism
 Orientalism: Overview
 Orthodoxy
 Orthopraxy: Western Orthopraxy
 Other, The, European Views of
 Pacifism
 Paradigm
 Patriotism
 Peace
 Peasants and Peasantry
 Periodization
 Periodization of the Arts
 Person, Idea of the
 Philanthropy
 Philosophies: African
 Philosophies: American
 Philosophy: Historical Overview and Recent Developments
 Philosophy: Relations to Other Intellectual Realms
 Philosophy, History of
 Philosophy, Moral: Africa
 Philosophy, Moral: Modern
 Philosophy and Religion in Western Thought
 Philosophy of Mind: Overview
 Philosophy of Religion
 Physics
 Platonism
 Pluralism
 Poetry and Poetics
 Political Protest, U.S.
 Political Science
 Political, The
 Polytheism
 Population
 Postcolonial Studies
 Poverty
 Power
 Practices
 Prehistory, Rise of
 Prejudice
 Presentism
 Privacy
 Probability
 Progress, Idea of
 Propaganda
 Property
 Pseudoscience
 Punishment
 Puritanism
 Queer Theory
 Race and Racism: Overview
 Race and Racism: Asia
 Race and Racism: Europe
 Race and Racism: United States
 Radicals/Radicalism
 Rational Choice
 Rationalism
 Reading
 Reason, Practical and Theoretical
 Reflexivity
 Reform: Europe and the United States

READER'S GUIDE

Reform: Islamic Reform
Regions and Regionalism, Eastern Europe
Religion: Overview
Religion: Africa
Religion: African Diaspora
Religion: East and Southeast Asia
Religion: Indigenous Peoples' View, South America
Religion: Latin America
Religion: Middle East Religion and the State: Africa
Religion and Science
Religion and the State: Europe
Religion and the State: Latin America
Religion and the State: Middle East
Religion and the State: United States
Renaissance
Republicanism: Latin America
Republicanism: Republic
Resistance
Resistance and Accommodation
Responsibility
Revolution
Rhetoric: Overview
Ritual: Public Ritual
Ritual: Religion
Romanticism in Literature and Politics
Sacred and Profane
Sacred Places
Sage Philosophy
Scarcity and Abundance, Latin America
Science: Overview
Science, History of
Sexuality: Overview
Sexuality: Islamic Views
Shinto
Skepticism
Slavery
Social Capital
Social History, U.S.
Society
Sophists, The
Sovereignty
Sport
State of Nature
State, The: Overview
Sufism
Suicide
Superstition
Symbolism
Syncretism
Temperance
Terror
Text/Textuality
Toleration
Totems
Trade
Tradition
Translation
Travel: Travel from Europe and the Middle East
Treaty
Trope
Truth
Universalism
University: Overview
Untouchability: Overview
Untouchability: Menstrual Taboos

Untouchability: Taboos
Utopia
Virtual Reality
Visual Culture
Visual Order to Organizing Collections
Volksggeist
Volunteerism, U.S.
War
War and Peace in the Arts
Wealth
Wildlife
Wisdom, Human
Witchcraft
Witchcraft, African Studies of
Women's History: Africa
Women's History: Asia
World Systems Theory, Latin America

Contemporary

ENTRIES FOCUSED ON THE PERIOD

African-American Ideas
Americanization, U.S.
Anticolonialism: Africa
Anticolonialism: Latin America
Anticolonialism: Middle East
Anticolonialism: Southeast Asia
Anti-Semitism: Islamic Anti-Semitism
Apartheid
Bioethics
Black Atlantic
Black Consciousness
Buddhism
Bureaucracy
Capitalism: Africa
Chicano Movement
Citizenship: Naturalization
Civil Disobedience
Communitarianism in African Thought
Consumerism
Continental Philosophy
Creationism
Critical Race Theory
Critical Theory
Cultural Studies
Democracy
Dress
Dystopia
Empire and Imperialism: Europe
Empiricism
Eugenics
Field Theories
Fundamentalism
Futurology
Gay Studies
Gender: Overview
Genetics: Contemporary
Globalization: Africa
Globalization: Asia
Globalization: General
Historicism
Humanity: African Thought
Human Rights: Overview
Human Rights: Women's Rights
Internal Colonialism
International Order

Jihad
 Liberation Theology
 Liberty
 Life
 Linguistic Turn
 Literary History
 Logic and Philosophy of Mathematics, Modern
 Maoism
 Marxism: Overview
 Marxism: Asia
 Marxism: Latin America
 Media, History of
 Modernization
 Modernization Theory
 Nationalism: Overview
 Nationalism: Africa
 Nationalism: Cultural Nationalism
 Nationalism: Middle East
 Neocolonialism
 Neoliberalism
 Nuclear Age
 Orientalism: African and Black Orientalism
 Pan-Africanism
 Pan-Arabism
 Pan-Asianism
 Pan-Islamism
 Pan-Turkism
 Paradigm
 Parties, Political
 Personhood in African Thought
 Phenomenology
 Philosophies: Feminist, Twentieth-Century
 Poetry and Poetics
 Populism: Latin America
 Populism: United States
 Positivism
 Postcolonial Studies
 Postcolonial Theory and Literature
 Postmodernism
 Pragmatism
 Presentism
 Privatization
 Protest, Political
 Psychoanalysis
 Psychology and Psychiatry
 Quantum
 Queer Theory
 Realism: Africa
 Relativism
 Relativity
 Science Fiction
 Segregation
 Sexual Harassment
 Sexuality: Sexual Orientation
 Sociability in African Thought
 Social Darwinism
 Socialisms, African
 Structuralism and Poststructuralism: Overview
 Structuralism and Poststructuralism: Anthropology
 Subjectivism
 Technology
 Terrorism, Middle East
 Text/Textuality
 Theater and Performance
 Third Cinema

Third World
 Totalitarianism
 Virtual Reality
 Virtue Ethics
 War
 Westernization: Africa
 Westernization: Southeast Asia
 Witchcraft
 Womanism
 Women and Femininity in U.S. Popular Culture
 Women's Studies
 Zionism

ENTRIES WITH EXAMPLES FROM THE PERIOD
 SINCE 1945 (especially since the 1970s)

Absolute Music
 Aesthetics: Africa
 Aesthetics: Asia
 Aesthetics: Europe and the Americas
 Africa, Idea of
 Afrocentricity
 Afropessimism
 Agnosticism
 Algebras
 Alienation
 Altruism
 Ambiguity
 America
 Analytical Philosophy
 Anarchism
 Animism
 Anthropology
 Antifeminism
 Anti-Semitism: Overview
 Architecture: Overview
 Architecture: Africa
 Arts: Overview
 Arts: Africa
 Asceticism: Western Asceticism
 Asian-American Ideas (Cultural Migration)
 Assimilation
 Atheism
 Authenticity: Africa
 Authoritarianism: Overview
 Authoritarianism: East Asia
 Authoritarianism: Latin America
 Authority
 Autobiography
 Autonomy
 Avant-Garde: Overview
 Aztlán
 Barbarism and Civilization
 Beauty and Ugliness
 Behaviorism
 Bilingualism and Multilingualism
 Biography
 Biology
 Body, The
 Bushido
 Calculation and Computation
 Cannibalism
 Capitalism: Overview
 Cartesianism
 Casuistry
 Causality
 Causation

READER'S GUIDE

Censorship
Change
Character
Childhood and Child Rearing
Christianity: Overview
Christianity: Asia
Cinema
Citizenship: Overview
Citizenship: Cultural Citizenship
City, The: The City as a Cultural Center
City, The: The City as Political Center
City, The: The Islamic and Byzantine City
Civil Society: Europe and the United States
Civil Society: Responses in Africa and the Middle East
Classicism
Colonialism: Africa
Colonialism: Southeast Asia
Communication of Ideas: Africa and Its Influence
Communication of Ideas: Asia and Its Influence
Communication of Ideas: Southeast Asia
Communism: Europe
Communism: Latin America
Composition, Musical
Computer Science
Confucianism
Consciousness: Overview
Conservatism
Consilience
Context
Corruption
Corruption in Developed and Developing Countries
Cosmopolitanism
Creolization, Caribbean
Crisis
Cultural Capital
Cultural History
Cultural Revivals
Cycles
Dada
Dance
Death
Death and Afterlife, Islamic Understanding of
Deism
Democracy: Africa
Demography
Demonology
Dependency
Determinism
Development
Diasporas: African Diaspora
Diasporas: Jewish Diaspora
Dictatorship in Latin America
Diffusion, Cultural
Discrimination
Diversity
Dream
Dualism
Ecology
Economics
Ecumenism
Education: Europe
Education: Global Education
Education: Islamic Education
Education: North America
Emotions
Empire and Imperialism: Middle East
Empire and Imperialism: United States
Enlightenment
Environment
Environmental Ethics
Environmental History
Epistemology: Modern
Equality: Overview
Equality: Gender Equality
Equality: Racial Equality
Essentialism
Ethnicity and Race: Africa
Ethnicity and Race: Anthropology
Ethnicity and Race: Islamic Views
Ethnocentrism
Ethnography
Ethnohistory, U.S.
Etiquette
Eurocentrism
Europe, Idea of
Evil
Existentialism
Experiment
Falsifiability
Family: Modernist Anthropological Theory
Family: Family in Anthropology since 1980
Family Planning
Fascism
Fatalism
Feminism: Overview
Feminism: Africa and African Diaspora
Feminism: Chicana Feminisms
Feminism: Islamic Feminism
Feminism: Third World U.S. Movement
Fetishism: Overview
Fetishism: Fetishism in Literature and Cultural Studies
Formalism
Foundationalism
Free Will, Determinism, and Predestination
Friendship
Game Theory
Gender: Gender in the Middle East
Gender in Art
Gender Studies: Anthropology
Generation
Genetics: History of
Genius
Genocide
Geography
Ghetto
Gift, The
Gnosticism
Good
Happiness and Pleasure in European Thought
Harmony
Hate
Health and Disease
Hegelianism
Hermeneutics
Hierarchy and Order
Hinduism
Historical and Dialectical Materialism
Historiography
History, Economic
History, Idea of

- Honor, Middle Eastern Notions of
 Human Capital
 Humanism: Africa
 Humanism: Europe and the Middle East
 Humanism: Secular Humanism in the United States
 Humanity: European Thought
 Humanity in the Arts
 Humor
 Ideas, History of
 Identity: Identity of Persons
 Identity: Personal and Social Identity
 Identity, Multiple: Overview
 Identity, Multiple: Asian-Americans
 Identity, Multiple: Jewish Multiple Identity
 Imagination
 Immortality and the Afterlife
 Impressionism
 Intelligentsia
 Intentionality
 Intercession in Middle Eastern Society
 Interdisciplinarity
 Islam: Shii
 Islam: Southeast Asia
 Jainism
 Japanese Philosophy, Japanese Thought
 Jouissance
 Judaism: Modern Judaism
 Justice: Overview
 Justice: Justice in American Thought
 Kantianism
 Kinship
 Knowledge
 Landscape in the Arts
 Language and Linguistics
 Language, Philosophy of: Modern
 Law
 Law, Islamic
 Leadership
 Learning and Memory, Contemporary Views
 Liberalism
 Life Cycle: Adolescence
 Life Cycle: Elders/Old Age
 Literary Criticism
 Literature: African Literature
 Lysenkoism
 Machiavellism
 Machismo
 Magic
 Maps and the Ideas They Express
 Marriage and Fertility, European Views
 Masks
 Mathematics
 Matriarchy
 Medicine: China
 Medicine: Europe and the United States
 Medicine: Islamic Medicine
 Meditation: Eastern Meditation
 Meme
 Memory
 Men and Masculinity
 Mestizaje
 Metaphor
 Metaphysics: Renaissance to the Present
 Migration: Africa
 Migration: Migration in World History
 Migration: United States
 Millenarianism: Overview
 Millenarianism: Islamic
 Millenarianism: Latin America and Native North America
 Mind
 Minority
 Modernism: Latin America
 Modernity: Overview
 Modernity: Africa
 Modernity: East Asia
 Monarchy: Overview
 Monasticism
 Monism
 Moral Sense
 Motherhood and Maternity
 Motif: Motif in Literature
 Motif: Motif in Music
 Multiculturalism, Africa
 Museums
 Music, Anthropology of
 Musical Performance and Audiences
 Musicology
 Mysticism: Mysticism in African Thought
 Narrative
 Nation
 Native Policy
 Natural Law
 Natural Theology
 Nature
 Negritude
 New Criticism
 Nihilism
 Nomadism
 Nonviolence
 Objectivity
 Obligation
 Occidentalism
 Oral Traditions: Overview
 Organicism
 Orientalism: Overview
 Orthodoxy
 Pacifism
 Patriotism
 Peace
 Peasants and Peasantry
 Periodization of the Arts
 Person, Idea of the
 Perspective
 Philanthropy
 Philosophies: American
 Philosophy, History of
 Philosophy, Moral: Africa
 Philosophy, Moral: Modern
 Philosophy and Religion in Western Thought
 Philosophy of Mind: Overview
 Philosophy of Religion
 Pluralism
 Political Protest, U.S.
 Political Science
 Population
 Poverty
 Power
 Practices
 Prejudice

READER'S GUIDE

Privacy
Probability
Progress, Idea of
Propaganda
Property
Pseudoscience
Public Sphere
Punishment
Race and Racism: Overview
Race and Racism: Asia
Race and Racism: Europe
Race and Racism: United States
Radicals/Radicalism
Rational Choice
Reading
Reason, Practical and Theoretical
Reflexivity
Reform: Europe and the United States
Reform: Islamic Reform
Regions and Regionalism, Eastern Europe
Religion: Africa
Religion: African Diaspora
Religion: Indigenous Peoples' View, South America
Religion: Latin America
Religion: Middle East
Religion and Science
Religion and the State: Africa
Religion and the State: Latin America
Religion and the State: Middle East
Religion and the State: United States
Renaissance
Representation: Mental Representation
Representation: Political Representation
Resistance
Resistance and Accommodation
Responsibility
Ritual: Public Ritual
Ritual: Religion
Sacred Places
Sacred Texts: Koran
Sage Philosophy
Science: Overview
Science: East Asia
Science, History of
Scientific Revolution
Secularization and Secularism
Sexuality: Overview
Sexuality: Islamic Views
Shinto
Skepticism
Slavery
Social Capital
Social Contract
Social History, U.S.
Society
Sophists, The
Sovereignty
Sport
State, The: Overview
State, The: The Postcolonial State
State of Nature
Superstition
Surrealism
Symbolism
Syncretism

Taste
Terror
Third World Literature
Toleration
Totems
Trade
Tradition
Translation
Treaty
Tribalism, Middle East
Trope
Truth
Universalism
University: Overview
University: Postcolonial
Untouchability: Overview
Untouchability: Menstrual Taboos
Untouchability: Taboos
Utilitarianism
Utopia
Visual Culture
Visual Order to Organizing Collections
War and Peace in the Arts
Wealth
Wildlife
Wisdom, Human
Witchcraft, African Studies of
Women's History: Africa
Women's History: Asia
Work
World Systems Theory, Latin America

LIBERAL ARTS DISCIPLINES AND PROFESSIONS

This section is in accord with the university divisions of the Liberal Arts into Fine Arts, Humanities, Social Sciences, and Sciences and the graduate programs of the professions of Law, Medicine, and Engineering. The sample of Interdisciplinary Programs are listed under their most common university grouping. For example, Fine Arts includes Performance Arts; Social Sciences includes Women's Studies and Gender Studies, as well as Ethnic Studies; Sciences includes Ecology and Geology, as well as Computer Sciences; Humanities includes programs of Communication, Language, and Linguistics. Meanwhile, the growth of interdisciplinary programs reflects the increasing overlap between studies listed under the labels of Fine Arts, Humanities, Social Sciences, and Sciences. A discipline or interdisciplinary program only appears once, but an entry may appear under the several disciplines and interdisciplinary programs that influenced the scholarship of the article. Titles that appear in bold indicate entries that are especially suited as an introduction to the discipline.

Under the category Multidisciplinary Practices, there are entries on the many methods, techniques, theories, and approaches that have spread across the disciplines. The Multidisciplinary Practices help explain the contemporary trend of interdisciplinarity for which the history of ideas has long been known. At the end of this Reader's Guide is a listing of a number of entries that overlap three of the four divisions and a listing of entries that overlap all four divisions.

Fine Arts

VISUAL STUDIES

Absolute Music
Aesthetics: Africa
Aesthetics: Asia
Aesthetics: Europe and the Americas
 Ambiguity
 Anthropology
 Architecture: Overview
 Architecture: Africa
 Architecture: Asia
 Arts: Overview
 Arts: Africa
 Asceticism: Hindu and Buddhist Asceticism
 Asceticism: Western Asceticism
 Avant-Garde: Overview
 Avant-Garde: Militancy
 Aztlán
 Beauty and Ugliness
 Body, The
 Buddhism
 Change
 Chinese Thought
 Cinema
 City, The: Latin America
 City, The: The City as a Cultural Center
 City, The: The Islamic and Byzantine City
 Classicism
 Classification of Arts and Sciences, Early Modern
 Communication of Ideas: Asia and Its Influence
 Composition, Musical
 Consumerism
 Context
 Cosmopolitanism
 Creativity in the Arts and Sciences
 Cultural History
 Dada
 Death
 Dream
 Dress
 Dystopia
 Environmental Ethics
 Environmental History
 Everyday Life
 Expressionism
 Extirpation
 Fascism
 Fetishism: Overview
 Garden
 Gay Studies
 Gender in Art
 Genre
 Geography
 Geometry
 Gesture
 Ghetto
 Globalization: Asia
 Heaven and Hell (Asian Focus)
 Hinduism
 History, Idea of
 Humanity: European Thought
 Humanity in the Arts
 Humor
 Iconography
 Ideas, History of

Images, Icons, and Idols
 Imagination
 Impressionism
 Islamic Science
 Kantianism
 Knowledge
 Landscape in the Arts
 Life Cycle: Overview
 Literary History
 Literature: Overview
 Maps and the Ideas They Express
 Masks
 Matriarchy
Media, History of
 Medicine: Europe and the United States
 Mestizaje
 Modernism: Overview
 Modernism: Latin America
 Modernity: Africa
 Modernity: East Asia
 Monarchy: Overview
 Motherhood and Maternity
 Museums
 Musical Performance and Audiences
 Musicology
 Mysticism: Chinese Mysticism
 Mysticism: Christian Mysticism
 Naturalism in Art and Literature
 Negritude
 Nude, The
 Occidentalism
 Organicism
 Pan-Africanism
 Paradise on Earth
Periodization of the Arts
 Perspective
 Philosophy: Historical Overview and Recent Developments
 Political Protest, U.S.
 Postmodernism
 Pre-Columbian Civilization
 Protest, Political
 Psychoanalysis
 Pythagoreanism
 Realism
 Realism: Africa
 Religion: Africa
 Renaissance
 Representation: Mental Representation
 Ritual: Public Ritual
 Sacred Places
 Sacred Texts: Asia
 Science: East Asia
 Science, History of
 Science Fiction
 Social History, U.S.
 Sport
 Surrealism
 Symbolism
 Syncretism
 Taste
 Text/Textuality
 Textiles and Fiber Arts as Catalysts for Ideas
 Third Cinema
 Victorianism

READER'S GUIDE

Virtual Reality
 Visual Culture
 Visual Order to Organizing Collections
 War and Peace in the Arts
 Westernization: Southeast Asia
 Women and Femininity in U.S. Popular Culture
 Yin and Yang

MUSIC

Absolute Music
 Aesthetics: Africa
 Aesthetics: Asia
 Authenticity: Africa
 Avant-Garde: Overview
 Cinema
 Classicism
 Classification of Arts and Sciences, Early Modern
 Communication of Ideas: Africa and Its Influence
 Composition, Musical
 Context
 Cosmopolitanism
 Dada
 Dance
 Empire and Imperialism: United States
 Formalism
 Generation
 Genre
 Harmony
 Hinduism
 Humanism: Africa
 Humanism: Chinese Conception of
 Humor
 Iconography
 Identity, Multiple: Jewish Multiple Identity
 Judaism: Judaism to 1800
 Knowledge
 Learning and Memory, Contemporary Views
 Love, Western Notions of
 Modernism: Overview
 Motif: Motif in Music
Music, Anthropology of
Musical Performance and Audiences
Musicology
 Mysticism: Chinese Mysticism
 Orientalism: Overview
 Pan-Asianism
 Pietism
 Political Protest, U.S.
 Postmodernism
 Protest, Political
 Pythagoreanism
 Realism: Africa
 Religion: Africa
 Religion: African Diaspora
 Resistance
 Resistance and Accommodation
 Society
 Sophists, The
 Symbolism
 Taste
 Text/Textuality
 Third Cinema
 Virtual Reality
 Visual Order to Organizing Collections
 Westernization: Africa

PERFORMANCE ARTS (includes drama, dance, oratory, ritual, and ceremony)

Absolute Music
 Aesthetics: Africa
 Aesthetics: Asia
 Alienation
 Americanization, U.S.
 Ancestor Worship
 Anthropology
 Arts: Overview
 Asceticism: Hindu and Buddhist Asceticism
 Asceticism: Western Asceticism
 Astronomy, Pre-Columbian and Latin American
 Authenticity: Africa
 Autobiography
 Avant-Garde: Overview
 Body, The
 Cannibalism
 Censorship
 Cinema
 Civil Disobedience
 Civil Society: Europe and the United States
 Communication of Ideas: Africa and Its Influence
 Communication of Ideas: Asia and Its Influence
 Communication of Ideas: Orality and Advent of Writing
 Communication of Ideas: Southeast Asia
 Composition, Musical
 Confucianism
 Context
 Cosmopolitanism
 Creolization, Caribbean
 Cultural Capital
 Cynicism
 Dada
Dance
 Determinism
 Dialogue and Dialectics: Socratic
 Dialogue and Dialectics: Talmudic
 Dictatorship in Latin America
 Dream
 Dress
 Emotions
 Empire and Imperialism: Europe
 Environment
 Equality: Overview
 Ethnicity and Race: Anthropology
 Etiquette
 Everyday Life
 Expressionism
 Extirpation
 Fascism
 Feminism: Chicana Feminisms
 Fetishism: Overview
 Fetishism: Fetishism in Literature and Cultural Studies
 Game Theory
 Gay Studies
 Gender: Overview
 Gender in Art
 Generation
 Genre
 Gesture
 Harmony
 Hinduism
 History, Economic

- History, Idea of
 Honor
 Humanism: Africa
 Humanism: Chinese Conception of
 Humanity: African Thought
 Humor
 Ideas, History of
 Identity, Multiple: Jewish Multiple Identity
 Images, Icons, and Idols
 Intelligentsia
 Islam: Shii
 Islam: Sunni
 Jouissance
 Judaism: Judaism to 1800
 Knowledge
 Language and Linguistics
 Language, Philosophy of: Modern
 Law, Islamic
 Leadership
 Learning and Memory, Contemporary Views
 Life Cycle: Overview
 Literary Criticism
 Literary History
 Literature: African Literature
 Love, Western Notions of
 Magic
 Manichaeism
 Masks
 Media, History of
 Medicine: China
 Medicine: Islamic Medicine
 Meditation: Eastern Meditation
 Men and Masculinity
 Metaphor
 Millenarianism: Islamic
 Millenarianism: Latin America and Native North America
 Modernism: Overview
 Modernity: Overview
 Modernity: Africa
 Motif: Motif in Music
 Music, Anthropology of
 Musical Performance and Audiences
 Musicology
 Mysticism: Chinese Mysticism
 Mysticism: Islamic Mysticism in Asia
 Mysticism: Kabbalah
 Myth
 Narrative
 Nation
 Nationalism: Middle East
 New Criticism
 Nomadism
 Nuclear Age
 Oral Traditions: Overview
 Orientalism: Overview
 Orthodoxy
 Orthopraxy: Asia
 Pan-Turkism
 Periodization of the Arts
 Person, Idea of the
 Philosophies: African
 Philosophies: American
 Philosophies: Feminist, Twentieth-Century
 Philosophies: Islamic
 Philosophy: Historical Overview and Recent Developments
 Philosophy, Moral: Ancient
 Philosophy of Mind: Ancient and Medieval
 Pietism
 Poetry and Poetics
 Political Protest, U.S.
 Populism: United States
 Postmodernism
 Practices
 Pre-Columbian Civilization
 Propaganda
 Protest, Political
 Psychoanalysis
 Punishment
 Queer Theory
 Reading
 Realism: Africa
 Reflexivity
 Reform: Europe and the United States
 Relativism
 Religion: Africa
 Religion: African Diaspora
 Religion: East and Southeast Asia
 Religion: Indigenous Peoples' View, South America
 Religion: Latin America
 Religion: Middle East
 Religion and the State: United States
 Republicanism: Republic
 Resistance
 Resistance and Accommodation
 Responsibility
Rhetoric: Overview
Rhetoric: Ancient and Medieval
 Ritual: Public Ritual
 Ritual: Religion
 Romanticism in Literature and Politics
 Sacred Places
 Sacred Texts: Asia
 Sexuality: Overview
 Shinto
 Slavery
 Society
 Sophists, The
 Sport
 Stoicism
 Subjectivism
 Superstition
 Surrealism
 Symbolism
 Syncretism
 Taste
 Temperance
 Text/Textuality
Theater and Performance
 Third Cinema
 Third World Literature
 Time: China
 Time: India
 Toleration
 Totalitarianism
 Totems
 Tragedy and Comedy
 Translation
 Trope

READER'S GUIDE

Untouchability: Menstrual Taboos
Utilitarianism
Victorianism
Virtual Reality
Volunteerism, U.S.
Westernization: Middle East
Westernization: Southeast Asia
Wisdom, Human
Witchcraft
Witchcraft, African Studies of
Yin and Yang
Yoga

Humanities

COMMUNICATION, LANGUAGE, AND LINGUISTICS

Aesthetics: Africa
Aesthetics: Asia
Africa, Idea of
Afrocentricity
Agnosticism
Algebras
Americanization, U.S.
Analytical Philosophy
Anthropology
Anticolonialism: Africa
Asceticism: Hindu and Buddhist Asceticism
Asceticism: Western Asceticism
Astronomy, Pre-Columbian and Latin American
Authenticity: Africa
Avant-Garde: Overview
Avant-Garde: Militancy
Aztlán
Barbarism and Civilization
Beauty and Ugliness
Behaviorism
Bilingualism and Multilingualism
Body, The
Borders, Borderlands, and Frontiers, Global
Buddhism
Calculation and Computation
Calendar
Cannibalism
Casuistry
Censorship
Chinese Thought
Cinema
Civil Disobedience
Classification of Arts and Sciences, Early Modern
Colonialism: Southeast Asia
Communication of Ideas: Africa and Its Influence
Communication of Ideas: The Americas and Their Influence
Communication of Ideas: Asia and Its Influence
Communication of Ideas: Europe and Its Influence
Communication of Ideas: Middle East and Abroad
Communication of Ideas: Orality and Advent of Writing
Communication of Ideas: Southeast Asia
Computer Science
Consumerism
Context
Continental Philosophy
Cosmopolitanism
Creolization, Caribbean
Critical Theory
Cultural Capital

Cultural History
Cultural Revivals
Cultural Studies
Cynicism
Dance
Democracy
Determinism
Dialogue and Dialectics: Socratic
Diasporas: Jewish Diaspora
Dictatorship in Latin America
Diffusion, Cultural
Discrimination
Diversity
Dream
Dress
Ecumenism
Education: Asia, Traditional and Modern
Empire and Imperialism: Asia
Empire and Imperialism: Europe
Empire and Imperialism: United States
Empiricism
Encyclopedism
Epistemology: Ancient
Epistemology: Early Modern
Epistemology: Modern
Ethnicity and Race: Africa
Ethnicity and Race: Anthropology
Ethnicity and Race: Islamic Views
Etiquette
Eurocentrism
Everyday Life
Examination Systems, China
Extirpation
Fallacy, Logical
Feminism: Overview
Feminism: Chicana Feminisms
Fetishism: Overview
Fetishism: Fetishism in Literature and Cultural Studies
Feudalism, European
Formalism
Gender: Gender in the Middle East
Gender in Art
Geometry
Gesture
Globalization: Asia
Globalization: General
Greek Science
Harmony
Hegemony
Hermeneutics
Hinduism
History, Economic
History, Idea of
Humanism: Africa
Humanism: Chinese Conception of
Humanism: Europe and the Middle East
Humanism: Renaissance
Humanity: African Thought
Human Rights: Overview
Idealism
Ideas, History of
Identity: Identity of Persons
Identity, Multiple: Overview
Identity, Multiple: Jewish Multiple Identity
Indigenismo

- Intelligentsia
 Interdisciplinarity
 Interpretation
 Islam: Africa
 Islam: Southeast Asia
 Islam: Sunni
 Islamic Science
 Japanese Philosophy, Japanese Thought
 Jihad
 Jouissance
 Judaism: Judaism to 1800
 Kantianism
 Kinship
 Knowledge
Language and Linguistics
Language, Linguistics, and Literacy
 Language, Philosophy of: Ancient and Medieval
 Language, Philosophy of: Modern
 Law
 Liberty
 Life Cycle: Overview
 Linguistic Turn
 Literary Criticism
 Literary History
 Literature: Overview
 Literature: African Literature
 Machismo
 Magic
 Maps and the Ideas They Express
 Masks
 Materialism in Eighteenth-Century European Thought
 Mathematics
 Matriarchy
 Media, History of
 Medicine: Europe and the United States
 Medicine: India
 Meme
 Mestizaje
 Metaphor
 Metaphysics: Renaissance to the Present
 Migration: Africa
 Migration: United States
 Millenarianism: Latin America and Native North America
 Mind
 Minority
Modernism: Overview
 Modernity: Overview
 Modernity: Africa
 Monarchy: Overview
 Motherhood and Maternity
 Motif: Motif in Literature
 Motif: Motif in Music
 Multiculturalism, Africa
 Music, Anthropology of
 Musical Performance and Audiences
 Musicology
 Mysticism: Chinese Mysticism
 Mysticism: Christian Mysticism
 Mysticism: Islamic Mysticism in Asia
 Mysticism: Kabbalah
 Mysticism: Mysticism in African Thought
 Narrative
 Nation
 Nationalism: Overview
 Nationalism: Middle East
 Native Policy
 Natural History
 New Criticism
 Nomadism
 Objectivity
 Occidentalism
Oral Traditions: Overview
 Organicism
 Orientalism: Overview
 Orthodoxy
 Pacifism
 Pan-Africanism
 Pan-Arabism
 Pan-Asianism
 Pan-Turkism
 Paradigm
 Patriotism
 Periodization of the Arts
 Person, Idea of the
 Personhood in African Thought
 Philosophies: African
 Philosophies: American
 Philosophies: Feminist, Twentieth-Century
 Philosophies: Islamic
 Philosophy: Historical Overview and Recent Developments
 Philosophy of Mind: Overview
 Philosophy of Mind: Ancient and Medieval
 Philosophy of Religion
 Poetry and Poetics
 Political Protest, U.S.
 Positivism
 Practices
 Pre-Columbian Civilization
 Prejudice
 Presentism
 Privacy
 Probability
 Progress, Idea of
 Propaganda
 Protest, Political
 Pseudoscience
 Psychology and Psychiatry
 Public Sphere
 Punishment
 Pythagoreanism
 Quantum
 Queer Theory
 Race and Racism: Asia
 Race and Racism: Europe
 Race and Racism: United States
 Reading
 Realism
 Realism: Africa
 Reflexivity
 Relativism
 Relativity
 Religion: Africa
 Religion: African Diaspora
 Religion: East and Southeast Asia
 Religion: Indigenous Peoples' View, South America
 Religion: Latin America
 Religion: Middle East
 Religion and the State: Latin America

READER'S GUIDE

Religion and the State: Middle East
Representation: Mental Representation
Republicanism: Republic
Resistance
Resistance and Accommodation
Responsibility
Rhetoric: Overview
Ritual: Public Ritual
Ritual: Religion
Romanticism in Literature and Politics
Sacred and Profane
Sacred Places
Sacred Texts: Asia
Sacred Texts: Koran
Sage Philosophy
Science: East Asia
Science, History of
Sexual Harassment
Sexuality: Overview
Sexuality: Sexual Orientation
Shinto
Slavery
Social History, U.S.
Society
Sophists, The
Sport
State, The: Overview
Stoicism
Structuralism and Poststructuralism: Overview
Structuralism and Poststructuralism: Anthropology
Subjectivism
Superstition
Surrealism
Symbolism
Syncretism
Technology
Temperance
Text/Textuality
Textiles and Fiber Arts as Catalysts for Ideas
Theater and Performance
Third Cinema
Third World Literature
Time: India
Time: Traditional and Utilitarian
Toleration
Totalitarianism
Totems
Trade
Tragedy and Comedy
Translation
Travel: Travel from Europe and the Middle East
Treaty
Trope
Truth
Untouchability: Taboos
Utilitarianism
Victorianism
Virtual Reality
Visual Culture
Visual Order to Organizing Collections
Westernization: Middle East
Westernization: Southeast Asia
Wisdom, Human
Witchcraft
Witchcraft, African Studies of

Womanism
Women and Femininity in U.S. Popular Culture
Yin and Yang
LITERATURE
Absolute Music
Aesthetics: Africa
Aesthetics: Asia
Aesthetics: Europe and the Americas
Africa, Idea of
African-American Ideas
Alienation
America
Anticolonialism: Africa
Anti-Semitism: Overview
Architecture: Asia
Asceticism: Hindu and Buddhist Asceticism
Authenticity: Africa
Autobiography
Avant-Garde: Overview
Aztlán
Biography
Buddhism
Bushido
Casuistry
Chinese Thought
Cinema
Classicism
Classification of Arts and Sciences, Early Modern
Colonialism: Africa
Communication of Ideas: Africa and Its Influence
Communication of Ideas: Asia and Its Influence
Communication of Ideas: Europe and Its Influence
Communication of Ideas: Middle East and Abroad
Communication of Ideas: Orality and Advent of Writing
Communication of Ideas: Southeast Asia
Consciousness: Overview
Continental Philosophy
Corruption
Cosmopolitanism
Creativity in the Arts and Sciences
Critical Race Theory
Critical Theory
Cultural Studies
Dada
Dialogue and Dialectics: Socratic
Dream
Dystopia
Education: Islamic Education
Empire and Imperialism: Europe
Enlightenment
Etiquette
Europe, Idea of
Evil
Examination Systems, China
Existentialism
Expressionism
Extirpation
Fascism
Feminism: Overview
Feminism: Chicana Feminisms
Feminism: Third World U.S. Movement
Fetishism: Fetishism in Literature and Cultural Studies
Formalism
Friendship
Futurology

- Game Theory
 Gay Studies
 Gender: Overview
 Gender: Gender in the Middle East
 Generation
 Genius
Genre
 Globalization: Asia
 Gnosticism
 Heaven and Hell
 Heaven and Hell (Asian Focus)
 Hedonism in European Thought
 Hermeneutics
 Hinduism
 Historiography
 History, Economic
 History, Idea of
 Honor, Middle Eastern Notions of
 Humanism: Africa
 Humanism: Chinese Conception of
 Humanism: Renaissance
 Humanity: African Thought
 Humor
 Ideas, History of
 Identity, Multiple: Jewish Multiple Identity
 Imagination
 Indigenismo
 Individualism
 Intelligentsia
 Interdisciplinarity
 Interpretation
 Islam: Africa
 Islam: Shii
 Islam: Sunni
 Islamic Science
 Japanese Philosophy, Japanese Thought
 Jouissance
 Judaism: Judaism to 1800
 Judaism: Modern Judaism
 Language and Linguistics
 Language, Philosophy of: Ancient and Medieval
 Language, Philosophy of: Modern
 Law, Islamic
 Leadership
 Life Cycle: Overview
 Linguistic Turn
 Literary Criticism
Literary History
 Literature: Overview
 Literature: African Literature
 Love, Western Notions of
 Magic
 Manichaeism
 Marxism: Overview
 Marxism: Latin America
 Masks
 Matriarchy
 Medicine: China
 Medicine: Islamic Medicine
 Memory
 Men and Masculinity
 Mestizaje
 Metaphor
 Metaphysics: Renaissance to the Present
 Microcosm and Macrocosm
 Millenarianism: Overview
 Millenarianism: Islamic
 Millenarianism: Latin America and Native North America
 Modernism: Overview
 Modernism: Latin America
 Modernity: Overview
 Modernity: East Asia
 Mohism
 Monarchy: Overview
 Motherhood and Maternity
 Motif: Motif in Literature
 Motif: Motif in Music
 Musicology
 Mysticism: Chinese Mysticism
 Mysticism: Christian Mysticism
 Myth
 Narrative
 Nation
 Nationalism: Africa
 Naturalism
 Naturalism in Art and Literature
 Nature
 Negritude
New Criticism
 Occidentalism
 Oral Traditions: Overview
 Organicism
 Orientalism: Overview
 Orientalism: African and Black Orientalism
 Pan-Africanism
 Pan-Asianism
 Person, Idea of the
 Phenomenology
 Philosophies: African
 Philosophies: American
 Philosophies: Feminist, Twentieth-Century
 Philosophies: Islamic
 Philosophy: Historical Overview and Recent Developments
 Philosophy, Moral: Ancient
 Philosophy, Moral: Medieval and Renaissance
 Pietism
 Platonism
Poetry and Poetics
 Political Protest, U.S.
 Postcolonial Studies
 Postcolonial Theory and Literature
 Postmodernism
 Practices
 Privacy
 Property
 Prophecy
 Protest, Political
 Psychoanalysis
 Queer Theory
 Race and Racism: Europe
 Reading
 Realism: Africa
 Religion: Africa
 Religion: African Diaspora
 Religion: East and Southeast Asia
 Religion: Indigenous Peoples' View, South America
 Religion: Latin America
 Religion: Middle East

READER'S GUIDE

- Religion and the State: United States
Renaissance
Republicanism: Republic
Resistance and Accommodation
Rhetoric: Overview
Rhetoric: Ancient and Medieval
Ritual: Public Ritual
Romanticism in Literature and Politics
Sacred Texts: Asia
Sacred Texts: Koran
Sage Philosophy
Scholasticism
Science Fiction
Science: Overview
Sexuality: Overview
Slavery
Social History, U.S.
Society
Sophists, The
State of Nature
Stoicism
Structuralism and Poststructuralism: Overview
Surrealism
Symbolism
Syncretism
Text/Textuality
Theater and Performance
Third World Literature
Toleration
Totalitarianism
Tragedy and Comedy
Translation
Travel: Travel from Europe and the Middle East
Trope
Utopia
Victorianism
Virtue Ethics
Visual Order to Organizing Collections
War and Peace in the Arts
Wisdom, Human
- RELIGION**
Abolitionism
Aesthetics: Africa
Aesthetics: Asia
Africa, Idea of
Agnosticism
Alchemy: China
Alchemy: Europe and the Middle East
Alienation
Altruism
Americanization, U.S.
Ancestor Worship
Animism
Antifeminism
Anti-Semitism: Overview
Anti-Semitism: Islamic Anti-Semitism
Architecture: Overview
Architecture: Asia
Aristotelianism
Arts: Overview
Arts: Africa
Asceticism: Hindu and Buddhist Asceticism
Asceticism: Western Asceticism
Assimilation
Astrology: Overview
- Astrology: China
Astronomy, Pre-Columbian and Latin American
Atheism
Authority
Autonomy
Bioethics
Body, The
Buddhism
Calendar
Cannibalism
Capitalism: Overview
Cartesianism
Casuistry
Causality
Causation in East Asian and Southeast Asian Philosophy
Censorship
Change
Chinese Thought
Christianity: Overview
Christianity: Asia
City, The: Latin America
City, The: The Islamic and Byzantine City
Civil Disobedience
Civil Society: Europe and the United States
Classification of Arts and Sciences, Early Modern
Colonialism: Southeast Asia
Communication of Ideas: Africa and Its Influence
Communication of Ideas: Asia and Its Influence
Communication of Ideas: Middle East and Abroad
Communication of Ideas: Orality and Advent of Writing
Communication of Ideas: Southeast Asia
Composition, Musical
Confucianism
Consciousness: Indian Thought
Conservatism
Continental Philosophy
Corruption
Cosmology: Asia
Cosmology: Cosmology and Astronomy
Cosmopolitanism
Creationism
Cultural History
Dance
Daoism
Death
Death and Afterlife, Islamic Understanding of
Deism
Demonology
Dialogue and Dialectics: Talmudic
Diasporas: Jewish Diaspora
Dictatorship in Latin America
Diversity
Dream
Dress
Dualism
Ecology
Ecumenism
Education: Asia, Traditional and Modern
Education: Europe
Education: Islamic Education
Education: Japan
Empire and Imperialism: Overview
Empire and Imperialism: Americas
Empire and Imperialism: Europe
Enlightenment

- Environment
 Environmental Ethics
 Environmental History
 Epicureanism
 Epistemology: Early Modern
 Epistemology: Modern
 Equality: Overview
 Eschatology
 Ethnicity and Race: Islamic Views
 Etiquette
 Europe, Idea of
 Everyday Life
 Evil
 Evolution
 Existentialism
 Expressionism
 Extirpation
 Family: Family in Anthropology since 1980
 Fascism
 Fatalism
 Feminism: Overview
 Feminism: Africa and African Diaspora
 Feminism: Chicana Feminisms
 Feminism: Islamic Feminism
 Fetishism: Overview
 Form, Metaphysical, in Ancient and Medieval Thought
 Free Will, Determinism, and Predestination
 Friendship
 Fundamentalism
 Gay Studies
 Gender: Gender in the Middle East
 Gender in Art
 General Will
 Genetics: Contemporary
 Genocide
 Ghetto
 Gift, The
 Globalization: Asia
 Gnosticism
 Good
 Harmony
 Health and Disease
 Heaven and Hell
 Heaven and Hell (Asian Focus)
 Hedonism in European Thought
 Heresy and Apostasy
 Hermeneutics
 Hierarchy and Order
 Hinduism
 Historicism
 Historiography
 History, Idea of
 Honor
 Honor, Middle Eastern Notions of
 Humanism: Africa
 Humanism: Chinese Conception of
 Humanism: Renaissance
 Humanism: Secular Humanism in the United States
 Humanity: African Thought
 Humanity: Asian Thought
 Humanity: European Thought
 Humanity in the Arts
 Human Rights: Overview
 Iconography
 Ideas, History of
 Identity: Identity of Persons
 Identity, Multiple: Jewish Multiple Identity
 Images, Icons, and Idols
 Imagination
 Immortality and the Afterlife
 Individualism
 Intelligentsia
 Intentionality
 Intercession in Middle Eastern Society
 Interdisciplinarity
 Islam: Africa
 Islam: Shii
 Islam: Southeast Asia
 Islam: Sunni
 Islamic Science
 Jainism
 Japanese Philosophy, Japanese Thought
 Jihad
 Jouissance
 Judaism: Judaism to 1800
 Judaism: Modern Judaism
 Kantianism
 Kinship
 Knowledge
 Language and Linguistics
 Language, Philosophy of: Ancient and Medieval
 Law, Islamic
 Liberation Theology
 Life
 Literary History
 Love, Western Notions of
 Magic
 Manichaeism
 Marriage and Fertility, European Views
 Marxism: Overview
 Marxism: Latin America
 Masks
 Materialism in Eighteenth-Century European Thought
 Matriarchy
 Medicine: Europe and the United States
 Medicine: Islamic Medicine
 Meditation: Eastern Meditation
 Men and Masculinity
 Metaphor
 Millenarianism: Overview
 Millenarianism: Islamic
 Millenarianism: Latin America and Native North America
 Minority
 Miracles
 Modernity: Overview
 Mohism
 Monarchy: Overview
 Monarchy: Islamic Monarchy
 Monasticism
 Monism
 Motherhood and Maternity
 Motif: Motif in Music
 Multiculturalism, Africa
 Museums
 Music, Anthropology of
 Musical Performance and Audiences
 Mysticism: Chinese Mysticism
 Mysticism: Christian Mysticism
 Mysticism: Islamic Mysticism

READER'S GUIDE

Mysticism: Islamic Mysticism in Asia
 Mysticism: Kabbalah
 Mysticism: Mysticism in African Thought
 Myth
 Nation
 Nationalism: Cultural Nationalism
 Nationalism: Middle East
 Naturalism
 Natural Law
 Natural Theology
 Newtonianism
 Nomadism
 Nonviolence
 Nude, The
 Obligation
 Organicism
 Orientalism: Overview
 Orientalism: African and Black Orientalism
 Orthodoxy
 Orthopraxy: Asia
 Orthopraxy: Western Orthopraxy
 Other, The, European Views of
 Pacifism
 Paradise on Earth
 Parties, Political
 Peace
 Periodization of the Arts
 Person, Idea of the
 Personhood in African Thought
 Perspective
 Philanthropy
 Philosophies: African
 Philosophies: American
 Philosophies: Feminist, Twentieth-Century
 Philosophies: Islamic
 Philosophy: Historical Overview and Recent Developments
 Philosophy: Relations to Other Intellectual Realms
 Philosophy, Moral: Africa
 Philosophy, Moral: Medieval and Renaissance
 Philosophy, Moral: Modern
 Philosophy and Religion in Western Thought
 Philosophy of Mind: Ancient and Medieval
 Philosophy of Religion
 Physics
 Pietism
 Platonism
 Political Protest, U.S.
 Polytheism
 Population
 Poverty
 Practices
 Pre-Columbian Civilization
 Privacy
 Propaganda
 Prophecy
 Protest, Political
 Pseudoscience
 Psychoanalysis
 Punishment
 Puritanism
 Pythagoreanism
 Race and Racism: Europe
 Rationalism
 Reading
 Reflexivity
 Reform: Islamic Reform
 Reformation
 Relativism
 Religion: Overview
 Religion: Africa
 Religion: African Diaspora
 Religion: East and Southeast Asia
 Religion: Latin America
 Religion: Middle East
 Religion and Science
 Religion and the State: Africa
 Religion and the State: Europe
 Religion and the State: Latin America
 Religion and the State: Middle East
 Religion and the State: United States
 Renaissance
 Representation: Political Representation
 Republicanism: Latin America
 Resistance and Accommodation
 Responsibility
 Rhetoric: Ancient and Medieval
 Ritual: Religion
 Romanticism in Literature and Politics
 Sacred and Profane
 Sacred Places
 Sacred Texts: Asia
 Sacred Texts: Koran
 Scholasticism
 Secularization and Secularism
 Sexuality: Islamic Views
 Shinto
 Skepticism
 Slavery
 Sophists, The
 Subjectivism
 Sufism
 Suicide
 Superstition
 Symbolism
 Syncretism
 Temperance
 Theodicy
 Time: China
 Time: India
 Time: Traditional and Utilitarian
 Toleration
 Totalitarianism
 Totems
 University: Overview
 Untouchability: Overview
 Untouchability: Menstrual Taboos
 Untouchability: Taboos
 Utilitarianism
 Victorianism
 Visual Order to Organizing Collections
 Volunteerism, U.S.
 War
 War and Peace in the Arts
 Westernization: Africa
 Westernization: Middle East
 Westernization: Southeast Asia
 Witchcraft
 Witchcraft, African Studies of
 Yin and Yang

- Yoga
 Zen
 Zionism
 PHILOSOPHY
 Absolute Music
 Aesthetics: Asia
 Aesthetics: Europe and the Americas
 Africa, Idea of
 African-American Ideas
 Afrocentricity
 Agnosticism
 Alchemy: China
 Algebras
 Alienation
 Altruism
 Ambiguity
 Analytical Philosophy
 Anticolonialism: Africa
 Antifeminism
 Architecture: Overview
 Architecture: Asia
 Aristotelianism
 Asceticism: Hindu and Buddhist Asceticism
 Asceticism: Western Asceticism
 Astronomy, Pre-Columbian and Latin American
 Atheism
 Authenticity: Africa
 Autonomy
 Avant-Garde: Militancy
 Bioethics
 Black Consciousness
 Body, The
 Buddhism
 Cartesianism
 Casuistry
 Causality
 Causation
 Causation in East Asian and Southeast Asian Philosophy
 Censorship
 Change
 Character
 Chemistry
 Chinese Thought
 Christianity: Overview
 Civil Disobedience
 Civil Society: Europe and the United States
 Civil Society: Responses in Africa and the Middle East
 Class
 Classification of Arts and Sciences, Early Modern
 Common Sense
 Communitarianism in African Thought
 Confucianism
 Consciousness: Overview
 Consciousness: Chinese Thought
 Consciousness: Indian Thought
 Conservatism
 Consilience
 Context
 Continental Philosophy
 Corruption
 Corruption in Developed and Developing Countries
 Cosmology: Asia
 Cosmopolitanism
 Creationism
 Critical Race Theory
 Critical Theory
 Cultural History
 Cycles
 Cynicism
 Dance
 Daoism
 Death
 Deism
 Democracy
 Democracy: Africa
 Determinism
 Dialogue and Dialectics: Socratic
 Dream
 Dress
 Dualism
 Dystopia
 Eclecticism
 Education: China
 Education: Global Education
 Education: Japan
 Emotions
 Empiricism
 Enlightenment
 Environment
 Environmental Ethics
 Environmental History
 Epicureanism
 Epistemology: Ancient
 Epistemology: Early Modern
 Epistemology: Modern
 Equality: Overview
 Equality: Gender Equality
 Equality: Racial Equality
 Essentialism
 Ethnocentrism
 Eugenics
 Everyday Life
 Evil
 Existentialism
 Expressionism
 Fallacy, Logical
 Falsifiability
 Family Planning
 Fascism
 Fatalism
 Feminism: Overview
 Feminism: Africa and African Diaspora
 Feminism: Chicana Feminisms
 Feminism: Islamic Feminism
 Field Theories
 Form, Metaphysical, in Ancient and Medieval Thought
 Foundationalism
 Free Will, Determinism, and Predestination
 Friendship
 Gender: Gender in the Middle East
 Gender in Art
 General Will
 Genetics: Contemporary
 Genetics: History of
 Geometry
 Gift, The
 Globalization: Asia
 Gnosticism
 Good
 Greek Science

READER'S GUIDE

- Happiness and Pleasure in European Thought
 Harmony
 Health and Disease
 Heaven and Hell (Asian Focus)
 Hedonism in European Thought
 Hegelianism
 Hegemony
 Hermeneutics
 Hierarchy and Order
 Hinduism
 Historical and Dialectical Materialism
 Historicism
 Historiography
 History, Idea of
 Humanism: Africa
 Humanism: Chinese Conception of
 Humanism: Europe and the Middle East
 Humanism: Secular Humanism in the United States
 Humanity: African Thought
 Humanity: Asian Thought
 Humanity: European Thought
 Human Rights: Overview
 Human Rights: Women's Rights
 Idealism
 Ideas, History of
 Identity: Identity of Persons
 Identity, Multiple: Overview
 Identity, Multiple: Jewish Multiple Identity
 Immortality and the Afterlife
 Impressionism
 Individualism
 Intelligentsia
 Intentionality
 Interdisciplinarity
 International Order
 Islam: Africa
 Islam: Sunni
 Islamic Science
 Jainism
 Japanese Philosophy, Japanese Thought
 Jouissance
 Judaism: Modern Judaism
 Justice: Overview
 Justice: Justice in American Thought
 Justice: Justice in East Asian Thought
 Kantianism
 Knowledge
 Language and Linguistics
 Language, Philosophy of: Ancient and Medieval
 Language, Philosophy of: Modern
 Law
 Liberalism
 Liberty
 Life
 Linguistic Turn
 Literary Criticism
 Literary History
 Logic
 Logic and Philosophy of Mathematics, Modern
 Magic
 Manichaeism
 Maoism
 Marxism: Overview
 Marxism: Latin America
 Materialism in Eighteenth-Century European Thought
 Mathematics
 Mechanical Philosophy
 Medicine: China
 Medicine: Europe and the United States
 Meditation: Eastern Meditation
 Memory
 Metaphor
 Metaphysics: Ancient and Medieval
 Metaphysics: Renaissance to the Present
 Microcosm and Macrocosm
 Mind
 Modernism: Latin America
 Modernity: Overview
 Mohism
 Monism
 Moral Sense
 Music, Anthropology of
 Musicology
 Mysticism: Chinese Mysticism
 Myth
 Narrative
 Natural History
 Natural Law
 Natural Theology
 Naturalism
 Nature
 Naturphilosophie
 Neoplatonism
 Newtonianism
 Nihilism
 Nonviolence
 Nuclear Age
 Objectivity
 Obligation
 Occidentalism
 Organicism
 Orientalism: Overview
 Orthopraxy: Asia
 Other, The, European Views of
 Pacifism
 Pan-Africanism
 Paradigm
 Parties, Political
 Peace
 Person, Idea of the
 Personhood in African Thought
 Phenomenology
 Philanthropy
 Philosophies: African
 Philosophies: American
 Philosophies: Feminist, Twentieth-Century
 Philosophies: Islamic
 Philosophy: Historical Overview and Recent Developments
Philosophy: Relations to Other Intellectual Realms
 Philosophy, History of
 Philosophy, Moral: Africa
 Philosophy, Moral: Ancient
 Philosophy, Moral: Medieval and Renaissance
 Philosophy, Moral: Modern
 Philosophy and Religion in Western Thought
 Philosophy of Mind: Overview
 Philosophy of Mind: Ancient and Medieval
 Philosophy of Religion
 Physics

- Pietism
 Platonism
 Pluralism
 Poetry and Poetics
 Political Protest, U.S.
 Political Science
 Population
 Populism: United States
 Positivism
 Postcolonial Studies
 Postmodernism
 Poverty
 Practices
 Pragmatism
 Presentism
 Privacy
 Probability
 Progress, Idea of
 Protest, Political
 Pseudoscience
 Punishment
 Pythagoreanism
 Quantum
 Queer Theory
 Race and Racism: Overview
 Radicals/Radicalism
 Rational Choice
 Rationalism
 Reading
 Realism: Africa
 Reason, Practical and Theoretical
 Reflexivity
 Reform: Europe and the United States
 Relativism
 Relativity
 Religion: Overview
 Religion: East and Southeast Asia
 Religion: Middle East
 Religion and Science
 Religion and the State: United States
 Renaissance
 Representation: Political Representation
 Resistance
 Responsibility
 Rhetoric: Overview
 Romanticism in Literature and Politics
 Sacred Texts: Asia
 Sage Philosophy
 Scholasticism
 Science: Overview
 Science: East Asia
 Science, History of
 Scientific Revolution
 Secularization and Secularism
 Sexual Harassment
 Sexuality: Overview
 Skepticism
 Sociability in African Thought
 Social Darwinism
 Socialisms, African
 Society
 Sophists, The
 State of Nature
 Stoicism
 Structuralism and Poststructuralism: Overview
- Subjectivism
 Suicide
 Surrealism
 Symbolism
 Taste
 Text/Textuality
 Theodicy
 Time: China
 Time: India
 Toleration
 Totalitarianism
 Translation
 Truth
 Universalism
 Utilitarianism
 Victorianism
 Virtue Ethics
 Visual Culture
 Visual Order to Organizing Collections
 Volksgeist
 Volunteerism, U.S.
 War
 Wildlife
 Wisdom, Human
 Witchcraft
 Witchcraft, African Studies of
 Womanism
 Yin and Yang
 Yoga
 Zen
- EDUCATION
 Abolitionism
 Aesthetics: Africa
 Aesthetics: Asia
 Afrocentricity
 Altruism
 Americanization, U.S.
 Anthropology
 Anticolonialism: Africa
 Anticolonialism: Southeast Asia
 Antifeminism
 Anti-Semitism: Overview
 Apartheid
 Architecture: Overview
 Aristotelianism
 Asceticism: Hindu and Buddhist Asceticism
 Authenticity: Africa
 Authoritarianism: Latin America
 Behaviorism
 Bilingualism and Multilingualism
 Biology
 Black Consciousness
 Body, The
 Buddhism
 Bushido
 Calculation and Computation
 Capitalism: Overview
 Capitalism: Africa
 Character
 Childhood and Child Rearing
 Chinese Thought
 Christianity: Asia
 Citizenship: Naturalization
 City, The: The City as a Cultural Center
 Civil Society: Europe and the United States

READER'S GUIDE

Classification of Arts and Sciences, Early Modern
 Communication of Ideas: Africa and Its Influence
 Communication of Ideas: Asia and Its Influence
 Communication of Ideas: Europe and Its Influence
 Communication of Ideas: Southeast Asia
 Composition, Musical
 Confucianism
 Consciousness: Chinese Thought
 Consciousness: Indian Thought
 Cosmopolitanism
 Creationism
 Creolization, Caribbean
 Cultural Capital
 Cultural Revivals
 Cultural Studies
 Dance
 Daoism
 Death and Afterlife, Islamic Understanding of
 Democracy: Africa
 Dialogue and Dialectics: Socratic
 Dialogue and Dialectics: Talmudic
 Diasporas: Jewish Diaspora
 Diffusion, Cultural
 Discrimination
 Diversity
 Dress
 Eclecticism
Education: Asia, Traditional and Modern
Education: China
Education: Europe
Education: Global Education
Education: India
Education: Islamic Education
Education: Japan
Education: North America
 Emotion
 Empire and Imperialism: Asia
 Empire and Imperialism: Europe
 Empire and Imperialism: United States
 Enlightenment
 Environmental Ethics
 Environmental History
 Epicureanism
 Epistemology: Ancient
 Epistemology: Early Modern
 Epistemology: Modern
 Equality: Overview
 Ethnicity and Race: Anthropology
 Etiquette
 Examination Systems, China
 Experiment
 Extirpation
 Family Planning
 Fascism
 Feminism: Overview
 Feminism: Africa and African Diaspora
 Feminism: Chicana Feminisms
 Feminism: Islamic Feminism
 Gender: Gender in the Middle East
 Generation
 Globalization: Asia
 Good
 Greek Science
 Harmony
 Health and Disease
 Hermeneutics
 Hinduism
 Historical and Dialectical Materialism
 Historiography
 History, Economic
 Human Capital
 Humanism: Chinese Conception of
 Humanism: Europe and the Middle East
 Humanism: Renaissance
 Humanity: Asian Thought
 Hygiene
 Ideas, History of
 Identity, Multiple: Jewish Multiple Identity
 Individualism
 Interdisciplinarity
 Interpretation
 Islam: Africa
 Islam: Southeast Asia
 Islam: Sunni
 Islamic Science
 Japanese Philosophy, Japanese Thought
 Jihad
 Jouissance
 Judaism: Judaism to 1800
 Judaism: Modern Judaism
 Justice: Justice in East Asian Thought
 Kantianism
 Kinship
 Knowledge
 Language and Linguistics
 Language, Linguistics, and Literacy
 Learning and Memory, Contemporary Views
 Life Cycle: Overview
 Life Cycle: Adolescence
 Life Cycle: Elders/Old Age
 Literary Criticism
 Loyalties, Dual
 Maoism
 Maps and the Ideas They Express
 Marxism: Overview
 Masks
 Matriarchy
 Medicine: Europe and the United States
 Men and Masculinity
 Mestizaje
 Metaphor
 Minority
 Modernity: Overview
 Modernity: Africa
 Modernity: East Asia
 Modernization Theory
 Mohism
 Motherhood and Maternity
 Multiculturalism, Africa
 Museums
 Music, Anthropology of
 Musical Performance and Audiences
 Musicology
 Mysticism: Chinese Mysticism
 Mysticism: Islamic Mysticism in Asia
 Mysticism: Kabbalah
 Nation
 Nationalism: Africa
 Natural History
 Negritude

- Neoplatonism
- Newtonianism
- Nuclear Age
- Nude, The
- Objectivity
- Occidentalism
- Oral Traditions: Overview
- Organicism
- Orientalism: Overview
- Orthodoxy
- Pan-Arabism
- Pan-Asianism
- Paradigm
- Periodization of the Arts
- Philosophies: American
- Philosophies: Feminist, Twentieth-Century
- Philosophies: Islamic
- Philosophy: Historical Overview and Recent Developments
- Philosophy, History of
- Philosophy, Moral: Ancient
- Philosophy, Moral: Medieval and Renaissance
- Philosophy, Moral: Modern
- Philosophy of Mind: Ancient and Medieval
- Physics
- Platonism
- Political Protest, U.S.
- Population
- Populism: United States
- Practices
- Pragmatism
- Prejudice
- Privacy
- Propaganda
- Protest, Political
- Pseudoscience
- Psychoanalysis
- Punishment
- Queer Theory
- Reading
- Realism: Africa
- Reason, Practical and Theoretical
- Reflexivity
- Reform: Islamic Reform
- Reformation
- Relativism
- Religion: East and Southeast Asia
- Religion: Middle East
- Religion and the State: Europe
- Religion and the State: Latin America
- Religion and the State: Middle East
- Religion and the State: United States
- Renaissance
- Representation: Political Representation
- Republicanism: Republic
- Resistance
- Rhetoric: Overview
- Rhetoric: Ancient and Medieval
- Ritual: Public Ritual
- Sacred Places
- Sacred Texts: Asia
- Sage Philosophy
- Scholasticism
- Science: East Asia
- Segregation
- Sexuality: Overview
- Skepticism
- Slavery
- Sociability in African Thought
- Social Capital
- Social History, U.S.
- Sophists, The
- Sport
- State, The: Overview
- Stoicism
- Subjectivism
- Sufism
- Superstition
- Temperance
- Theater and Performance
- Third Cinema
- Third World Literature
- Time: China
- Totalitarianism
- Tragedy and Comedy
- University: Overview
- University: Postcolonial
- Untouchability: Menstrual Taboos
- Untouchability: Taboos
- Utilitarianism
- Utopia
- Victorianism
- Visual Order to Organizing Collections
- Volunteerism, U.S.
- War and Peace in the Arts
- Westernization: Africa
- Westernization: Middle East
- Westernization: Southeast Asia
- Wisdom, Human
- Women's History: Africa
- Women's Studies
- Yoga
- Zen

Social Sciences

WOMEN'S STUDIES AND GENDER STUDIES

- Abolitionism
- Aesthetics: Asia
- African-American Ideas
- Anarchism
- Anthropology
- Antifeminism
- Asceticism: Western Asceticism
- Autobiography
- Beauty and Ugliness
- Biography
- Black Atlantic
- Body, The
- Capitalism: Africa
- Censorship
- Chicano Movement
- Childhood and Child Rearing
- Christianity: Overview
- Cinema
- Class
- Colonialism: Africa
- Colonialism: Southeast Asia
- Communication of Ideas: Southeast Asia
- Composition, Musical
- Confucianism

READER'S GUIDE

Consumerism
Continental Philosophy
Creativity in the Arts and Sciences
Critical Race Theory
Critical Theory
Cultural Studies
Dance
Death
Death and Afterlife, Islamic Understanding of
Democracy: Africa
Demography
Diversity
Dress
Dystopia
Economics
Education: Asia, Traditional and Modern
Education: China
Education: Europe
Education: Islamic Education
Education: North America
Emotions
Environmental History
Equality: Overview
Equality: Gender Equality
Essentialism
Etiquette
Eugenics
Eurocentrism
Everyday Life
Existentialism
Family: Modernist Anthropological Theory
Family: Family in Anthropology since 1980
Family Planning
Fascism
Feminism: Overview
Feminism: Africa and African Diaspora
Feminism: Chicana Feminisms
Feminism: Third World U.S. Movement
Fetishism: Overview
Fetishism: Fetishism in Literature and Cultural Studies
Friendship
Gay Studies
Gender: Overview
Gender: Gender in the Middle East
Gender in Art
Gender Studies: Anthropology
Genius
Genre
Hate
Historiography
History, Economic
Honor
Honor, Middle Eastern Notions of
Human Capital
Humanism: Renaissance
Humanity: Asian Thought
Humanity: European Thought
Human Rights: Women's Rights
Humor
Iconography
Identity: Identity of Persons
Identity, Multiple: Overview
Impressionism
Intelligentsia
Interdisciplinarity
Internal Colonialism
Interpretation
Islam: Shii
Jouissance
Justice: Overview
Kinship
Knowledge
Law
Law, Islamic
Legalism, Ancient China
Liberalism
Liberation Theology
Life Cycle: Adolescence
Literary History
Literature: African Literature
Love, Western Notions of
Machismo
Marriage and Fertility, European Views
Masks
Matriarchy
Medicine: Europe and the United States
Men and Masculinity
Mestizaje
Minority
Modernism: Overview
Motherhood and Maternity
Music, Anthropology of
Musicology
Mysticism: Christian Mysticism
Narrative
Nude, The
Orientalism: African and Black Orientalism
Orthodoxy
Pan-Africanism
Periodization of the Arts
Philosophies: African
Philosophies: American
Philosophies: Feminist, Twentieth-Century
Philosophy: Historical Overview and Recent Developments
Poetry and Poetics
Political Protest, U.S.
Population
Postcolonial Studies
Postcolonial Theory and Literature
Postmodernism
Pre-Columbian Civilization
Privacy
Progress, Idea of
Propaganda
Prophecy
Protest, Political
Psychoanalysis
Public Sphere
Queer Theory
Radicals/Radicalism
Reading
Reflexivity
Relativism
Religion: Africa
Religion: African Diaspora
Renaissance
Republicanism: Latin America
Resistance and Accommodation
Rhetoric: Ancient and Medieval

- Ritual: Public Ritual
- Ritual: Religion
- Romanticism in Literature and Politics
- Science: Overview
- Science, History of
- Science Fiction
- Scientific Revolution
- Secularization and Secularism
- Sexual Harassment
- Sexuality: Overview**
- Sexuality: Islamic Views**
- Sexuality: Sexual Orientation**
- Shinto
- Slavery
- Social Contract
- Social History, U.S.
- Sport
- State, The: The Postcolonial State
- Structuralism and Poststructuralism: Overview
- Subjectivism
- Symbolism
- Universalism
- University: Overview
- Untouchability: Menstrual Taboos
- Utopia
- Victorianism
- Virtue Ethics
- Visual Culture
- Visual Order to Organizing Collections
- Volunteerism, U.S.
- War
- Witchcraft
- Witchcraft, African Studies of
- Womanism
- Women and Femininity in U.S. Popular Culture
- Women's History: Africa
- Women's History: Asia
- Women's Studies**
- Work
- ETHNIC STUDIES**
- Abolitionism
- Absolute Music
- Africa, Idea of
- African-American Ideas
- Afrocentricity
- America
- Americanization, U.S.
- Ancestor Worship
- Anthropology
- Anticolonialism: Africa
- Anticolonialism: Southeast Asia
- Anti-Semitism: Overview
- Anti-Semitism: Islamic Anti-Semitism
- Apartheid
- Architecture: Africa
- Arts: Overview
- Assimilation
- Astronomy, Pre-Columbian and Latin American
- Authenticity: Africa
- Autobiography
- Aztlán
- Barbarism and Civilization
- Bilingualism and Multilingualism
- Black Atlantic
- Black Consciousness
- Body, The
- Borders, Borderlands, and Frontiers, Global
- Cannibalism
- Capitalism: Overview
- Capitalism: Africa
- Chicano Movement
- Cinema
- Citizenship: Cultural Citizenship
- City, The: Latin America
- City, The: The City as a Cultural Center
- City, The: The City as Political Center
- Civil Disobedience
- Class
- Colonialism: Africa
- Colonialism: Latin America
- Colonialism: Southeast Asia
- Communication of Ideas: Southeast Asia
- Communitarianism in African Thought
- Composition, Musical
- Consumerism
- Context
- Cosmopolitanism
- Creolization, Caribbean
- Critical Race Theory
- Critical Theory
- Cultural Capital
- Cultural Revivals
- Cultural Studies
- Dance
- Death
- Demography
- Diasporas: African Diaspora
- Diasporas: Jewish Diaspora
- Diffusion, Cultural
- Discrimination
- Diversity
- Dress
- Education: North America
- Empire and Imperialism: Europe
- Empire and Imperialism: Middle East
- Environmental History
- Equality: Overview
- Equality: Racial Equality
- Essentialism
- Ethnicity and Race: Africa**
- Ethnicity and Race: Anthropology**
- Ethnicity and Race: Islamic Views**
- Ethnocentrism
- Ethnography**
- Ethnohistory, U.S.
- Eugenics
- Eurocentrism
- Extirpation
- Family Planning
- Fascism
- Feminism: Overview
- Feminism: Africa and African Diaspora
- Feminism: Chicana Feminisms
- Feminism: Third World U.S. Movement
- Fetishism: Overview
- Fetishism: Fetishism in Literature and Cultural Studies
- Gender Studies: Anthropology
- Generation
- Genetics: Contemporary
- Genocide

READER'S GUIDE

Gesture
 Ghetto
 Gift, The
 Hate
 Hinduism
 History, Economic
 Honor
 Humanity: European Thought
 Humor
 Hygiene
 Iconography
 Identity, Multiple: Overview
 Identity, Multiple: Asian-Americans
 Identity, Multiple: Jewish Multiple Identity
 Indigenismo
 Intelligentsia
 Interdisciplinarity
 Internal Colonialism
 Islam: Africa
 Jouissance
 Judaism: Modern Judaism
 Kinship
 Law
 Liberation Theology
 Life Cycle: Adolescence
 Literary History
 Literature: African Literature
 Loyalties, Dual
 Machismo
 Marxism: Latin America
 Mathematics
 Matriarchy
 Men and Masculinity
 Mestizaje
 Migration: Africa
 Migration: Migration in World History
 Migration: United States
 Minority
 Modernism: Overview
 Modernity: Africa
 Motherhood and Maternity
 Multiculturalism, Africa
 Music, Anthropology of
 Musical Performance and Audiences
 Mysticism: Kabbalah
 Nation
 Nationalism: Overview
 Nationalism: Africa
 Nationalism: Cultural Nationalism
 Nationalism: Middle East
 Native Policy
 Naturalism
 Negritude
 Nomadism
 Nuclear Age
 Occidentalism
 Orientalism: Overview
 Orientalism: African and Black Orientalism
 Orthodoxy
 Other, The, European Views of
 Pan-Africanism
 Pan-Asianism
 Pan-Islamism
 Pan-Turkism
 Patriotism
 Periodization of the Arts
 Person, Idea of the
 Philosophies: African
 Philosophies: American
 Political Protest, U.S.
 Population
 Populism: United States
 Postcolonial Studies
 Postcolonial Theory and Literature
 Postmodernism
 Practices
 Pre-Columbian Civilization
 Prehistory, Rise of
 Prejudice
 Privacy
 Protest, Political
 Psychoanalysis
 Queer Theory
 Race and Racism: Overview
 Race and Racism: Asia
 Race and Racism: Europe
 Race and Racism: United States
 Reading
 Realism: Africa
 Reflexivity
 Regions and Regionalism, Eastern Europe
 Relativism
 Religion: African Diaspora
 Religion: Indigenous Peoples' View, South America
 Religion: Latin America
 Religion: Middle East
 Republicanism: Latin America
 Resistance and Accommodation
 Ritual: Religion
 Sage Philosophy
 Scarcity and Abundance, Latin America
 Secularization and Secularism
 Segregation
 Sexuality: Overview
 Shinto
 Slavery
 Socialisms, African
 Sport
 State, The: The Postcolonial State
 Superstition
 Symbolism
 Syncretism
 Terror
 Third Cinema
 Third World
 Third World Literature
 Time: Traditional and Utilitarian
 Totalitarianism
 Totems
 Trade
 Translation
 Treaty
 Untouchability: Menstrual Taboos
 Untouchability: Taboos
 Utopia
 Victorianism
 Visual Culture
 Volksgeist
 Volunteerism, U.S.
 War

- Westernization: Africa
 Westernization: Southeast Asia
 Wisdom, Human
 Witchcraft, African Studies of
 Womanism
 Women and Femininity in U.S. Popular Culture
 Women's History: Africa
 Women's Studies
 Work
 World Systems Theory, Latin America
 Zionism
- HISTORY**
- Aesthetics: Europe and the Americas
 Afrocentricity
 Afro pessimism
 Altruism
 Americanization, U.S.
 Anthropology
 Anticolonialism: Latin America
 Anticolonialism: Southeast Asia
 Anti-Semitism: Overview
 Architecture: Overview
 Architecture: Africa
 Asceticism: Hindu and Buddhist Asceticism
 Authoritarianism: Latin America
 Autobiography
 Autonomy
 Aztlán
 Barbarism and Civilization
 Biography
 Buddhism
 Capitalism: Overview
 Change
 Childhood and Child Rearing
 Chinese Thought
 City, The: The City as a Cultural Center
 Classification of Arts and Sciences, Early Modern
 Colonialism: Africa
 Colonialism: Latin America
 Colonialism: Southeast Asia
 Consciousness: Overview
 Conservatism
 Context
 Continental Philosophy
 Cosmology: Asia
 Creolization, Caribbean
 Crisis
 Cultural History
 Cultural Revivals
 Cultural Studies
 Cycles
 Dance
 Determinism
 Diasporas: African Diaspora
 Diasporas: Jewish Diaspora
 Dictatorship in Latin America
 Diffusion, Cultural
 Dress
 Ecology
 Economics
 Education: Europe
 Empire and Imperialism: Overview
 Empire and Imperialism: United States
 Enlightenment
 Environmental History
- Ethnography
 Ethnohistory, U.S.
 Eurocentrism
 Everyday Life
 Evil
 Extirpation
 Fascism
 Fatalism
 Feminism: Overview
 Feminism: Third World U.S. Movement
 Feudalism, European
 Futurology
 Gender in Art
 Generation
 Genius
 Genre
 Geography
 Globalization: Asia
 Hegelianism
 Hermeneutics
 Historical and Dialectical Materialism
 Historicism
Historiography
 History, Economic
History, Idea of
 Honor
 Iconography
 Ideas, History of
 Identity, Multiple: Jewish Multiple Identity
 Intelligentsia
 Intentionality
 Interdisciplinarity
 Internal Colonialism
 International Order
 Interpretation
 Islamic Science
 Japanese Philosophy, Japanese Thought
 Jihad
 Judaism: Judaism to 1800
 Knowledge
 Language and Linguistics
 Leadership
 Learning and Memory, Contemporary Views
 Life Cycle: Elders/Old Age
 Linguistic Turn
 Literary Criticism
 Literary History
 Literature: African Literature
 Love, Western Notions of
 Machiavellism
 Maoism
 Marxism: Overview
 Marxism: Asia
 Marxism: Latin America
 Matriarchy
 Media, History of
 Memory
 Mestizaje
 Metaphor
 Migration: Africa
 Migration: Migration in World History
 Millenarianism: Overview
 Millenarianism: Islamic
 Millenarianism: Latin America and Native North America

READER'S GUIDE

Modernism: Latin America
Modernity: Overview
Modernity: Africa
Modernity: East Asia
Modernization
Modernization Theory
Motif: Motif in Literature
Music, Anthropology of
Musicology
Narrative
Nation
Nationalism: Overview
Nationalism: Africa
Native Policy
Negritude
Nomadism
Nuclear Age
Occidentalism
Oral Traditions: Overview
Pan-Asianism
Paradigm
Patriotism
Peasants and Peasantry
Periodization
Periodization of the Arts
Philosophies: Feminist, Twentieth-Century
Philosophy: Historical Overview and Recent Developments
Philosophy, History of
Philosophy of Religion
Poetry and Poetics
Political Protest, U.S.
Polytheism
Postcolonial Theory and Literature
Postmodernism
Power
Practices
Pragmatism
Pre-Columbian Civilization
Presentism
Privacy
Progress, Idea of
Protest, Political
Public Sphere
Queer Theory
Race and Racism: Asia
Reading
Realism: Africa
Reflexivity
Reform: Europe and the United States
Reformation
Regions and Regionalism, Eastern Europe
Relativism
Religion: East and Southeast Asia
Religion: Indigenous Peoples' View, South America
Religion: Middle East
Religion and the State: United States
Renaissance
Republicanism: Latin America
Republicanism: Republic
Resistance
Responsibility
Revolution
Ritual: Public Ritual
Sacred Texts: Asia
Scarcity and Abundance, Latin America
Science: Overview
Science, History of
Scientific Revolution
Sexuality: Overview
Skepticism
Slavery
Social Capital
Social Darwinism
Social History, U.S.
Society
Sophists, The
Sport
State of Nature
Structuralism and Poststructuralism: Overview
Subjectivism
Surrealism
Syncretism
Technology
Theater and Performance
Theodicy
Third World
Time: China
Time: India
Time: Traditional and Utilitarian
Toleration
Totalitarianism
Trade
Treaty
Trove
Utopia
Victorianism
Visual Order to Organizing Collections
Volkgeist
War
War and Peace in the Arts
Westernization: Middle East
Westernization: Southeast Asia
Witchcraft
Witchcraft, African Studies of
Women's History: Africa
Women's History: Asia
World Systems Theory, Latin America

ANTHROPOLOGY AND SOCIOLOGY

Aesthetics: Asia
Aesthetics: Europe and the Americas
Africa, Idea of
Alienation
Altruism
Americanization, U.S.
Ancestor Worship
Anthropology
Anti-Semitism: Overview
Architecture: Overview
Architecture: Africa
Asceticism: Hindu and Buddhist Asceticism
Asceticism: Western Asceticism
Astronomy, Pre-Columbian and Latin American
Aztlán
Barbarism and Civilization
Beauty and Ugliness
Bilingualism and Multilingualism
Body, The
Borders, Borderlands, and Frontiers, Global
Buddhism

- Calendar
 Cannibalism
 Capitalism: Overview
 Character
 Childhood and Child Rearing
 Chinese Thought
 Cinema
 Citizenship: Cultural Citizenship
 City, The: The City as a Cultural Center
 Civil Society: Europe and the United States
 Colonialism: Latin America
 Colonialism: Southeast Asia
 Communication of Ideas: Orality and Advent of Writing
 Communication of Ideas: Southeast Asia
 Communitarianism in African Thought
 Composition, Musical
 Context
 Continental Philosophy
 Cosmopolitanism
 Creativity in the Arts and Sciences
 Creolization, Caribbean
 Cultural Capital
 Cultural History
 Cultural Revivals
 Cultural Studies
 Dance
 Death
 Death and Afterlife, Islamic Understanding of
 Demography
 Demonology
 Development
 Diasporas: African Diaspora
 Diasporas: Jewish Diaspora
 Diffusion, Cultural
 Discrimination
 Diversity
 Dream
 Dress
 Ecology
 Environment
 Environmental Ethics
 Environmental History
 Ethnicity and Race: Africa
 Ethnicity and Race: Anthropology
 Ethnocentrism
Ethnography
 Ethnohistory, U.S.
 Etiquette
 Eugenics
 Eurocentrism
 Europe, Idea of
 Everyday Life
 Extirpation
 Family: Modernist Anthropological Theory
 Family: Family in Anthropology since 1980
 Family Planning
 Fascism
 Feminism: Overview
 Feminism: Third World U.S. Movement
 Fetishism: Overview
 Gender Studies: Anthropology
 Generation
 Genetics: Contemporary
 Genetics: History of
 Gesture
 Ghetto
 Gift, The
 Globalization: Asia
 Hinduism
 Historiography
 History, Economic
 History, Idea of
 Honor
 Honor, Middle Eastern Notions of
 Humanism: Chinese Conception of
 Humanity: African Thought
 Humanity: European Thought
 Humor
 Ideas, History of
 Identity: Personal and Social Identity
 Identity, Multiple: Asian-Americans
 Identity, Multiple: Jewish Multiple Identity
 Intelligentsia
 Intentionality
 Interdisciplinarity
 Interpretation
 Jouissance
 Judaism: Modern Judaism
 Kinship
 Knowledge
 Language and Linguistics
Life Cycle: Overview
Life Cycle: Adolescence
Life Cycle: Elders/Old Age
 Linguistic Turn
 Literary Criticism
 Machiavellism
 Magic
 Manichaeism
 Marriage and Fertility, European Views
 Marxism: Overview
 Masks
 Matriarchy
 Meditation: Eastern Meditation
 Memory
 Men and Masculinity
 Mestizaje
 Metaphor
 Migration: Migration in World History
 Migration: United States
 Minority
 Motherhood and Maternity
 Motif: Motif in Music
 Music, Anthropology of
 Musical Performance and Audiences
 Musicology
 Mysticism: Chinese Mysticism
 Myth
 Nation
 Native Policy
 Natural History
 Occidentalism
 Oral Traditions: Overview
 Organicism
 Orientalism: African and Black Orientalism
 Orthodoxy
 Orthopraxy: Asia
 Other, The, European Views of
 Peasants and Peasantry
 Person, Idea of the

READER'S GUIDE

- Philosophies: Feminist, Twentieth-Century
 Philosophy, Moral: Africa
 Phrenology
 Pluralism
 Polytheism
 Postcolonial Theory and Literature
 Postmodernism
 Power
 Practices
 Pre-Columbian Civilization
 Prehistory, Rise of
 Prejudice
 Presentism
 Privacy
 Psychoanalysis
 Public Sphere
 Queer Theory
 Race and Racism: Asia
 Reading
 Reflexivity
 Reform: Europe and the United States
 Relativism
 Religion: Overview
 Religion: Africa
 Religion: African Diaspora
 Religion: Latin America
 Religion: Middle East
 Representation: Mental Representation
 Resistance
 Resistance and Accommodation
 Ritual: Public Ritual
 Ritual: Religion
 Sacred and Profane
 Scarcity and Abundance, Latin America
 Sexuality: Overview
 Sexuality: Sexual Orientation
 Social Capital
 Social Darwinism
 Social History, U.S.
 Society
 Sport
 State of Nature
 Structuralism and Poststructuralism: Overview
 Structuralism and Poststructuralism: Anthropology
 Subjectivism
 Superstition
 Surrealism
 Symbolism
 Syncretism
 Textiles and Fiber Arts as Catalysts for Ideas
 Theater and Performance
 Time: Traditional and Utilitarian
 Toleration
 Totalitarianism
 Totems
 Trade
 Tradition
 Tragedy and Comedy
 Tribalism, Middle East
 Trope
 Untouchability: Menstrual Taboos
 Untouchability: Taboos
 Utilitarianism
 Victorianism
 Virtue Ethics
 War and Peace in the Arts
 Westernization: Southeast Asia
 Wisdom, Human
 Witchcraft
 Witchcraft, African Studies of
 Women's History: Africa
 Work
 World Systems Theory, Latin America
 Yin and Yang
POLITICAL SCIENCE (emphasizing political philosophy)
 Abolitionism
 Absolute Music
 Africa, Idea of
 African-American Ideas
 Afrocentricity
 Afropessimism
 Alienation
 Altruism
 America
 Americanization, U.S.
 Anarchism
 Anthropology
 Anticolonialism: Africa
 Anticolonialism: Latin America
 Anticolonialism: Middle East
 Anticolonialism: Southeast Asia
 Anti-Semitism: Overview
 Anti-Semitism: Islamic Anti-Semitism
 Apartheid
 Architecture: Overview
 Architecture: Africa
 Architecture: Asia
 Asceticism: Western Asceticism
 Asian-American Ideas (Cultural Migration)
 Assimilation
 Astronomy, Pre-Columbian and Latin American
 Authoritarianism: Overview
 Authoritarianism: East Asia
 Authoritarianism: Latin America
 Authority
 Autobiography
 Avant-Garde: Militancy
 Aztlán
 Barbarism and Civilization
 Bilingualism and Multilingualism
 Bioethics
 Black Atlantic
 Black Consciousness
 Borders, Borderlands, and Frontiers, Global
 Bureaucracy
 Bushido
 Calculation and Computation
 Cannibalism
 Capitalism: Overview
 Capitalism: Africa
 Casuistry
 Censorship
 Chicano Movement
 Childhood and Child Rearing
 Chinese Warlordism
 Christianity: Overview
 Christianity: Asia
 Citizenship: Overview
 Citizenship: Cultural Citizenship
 Citizenship: Naturalization

- City, The: Latin America
 City, The: The City as a Cultural Center
 City, The: The City as Political Center
 Civil Disobedience
 Civil Society: Europe and the United States
 Civil Society: Responses in Africa and the Middle East Class
 Colonialism: Africa
 Colonialism: Latin America
 Colonialism: Southeast Asia
 Common Sense
 Communication of Ideas: Europe and Its Influence
 Communication of Ideas: Middle East and Abroad
 Communication of Ideas: Southeast Asia
 Communication of Ideas: The Americas and Their Influence
 Communism: Latin America
 Communism: Europe
 Communitarianism in African Thought
 Composition, Musical
 Computer Science
 Confucianism
 Consciousness: Overview
 Consciousness: Chinese Thought
 Conservatism
 Constitutionalism
 Continental Philosophy
 Corruption
 Corruption in Developed and Developing Countries
 Cosmopolitanism
 Creolization, Caribbean
 Critical Race Theory
 Cultural Studies
 Cycles
 Cynicism
 Dada
 Dance
 Daoism
Democracy
 Democracy, Africa
 Demography
 Dependency
 Determinism
 Dialogue and Dialectics: Socratic
 Diasporas: African Diaspora
 Diasporas: Jewish Diaspora
 Dictatorship in Latin America
 Discrimination
 Diversity
 Dress
 Dystopia
 Ecology
 Economics
 Education: China
 Education: Global Education
 Education: India
 Education: Japan
 Education: North America
 Empire and Imperialism: Overview
 Empire and Imperialism: Americas
 Empire and Imperialism: Asia
 Empire and Imperialism: Europe
 Empire and Imperialism: Middle East
 Empire and Imperialism: United States
 Environmental Ethics
 Environmental History
 Equality: Overview
 Equality: Gender Equality
 Equality: Racial Equality
 Ethnicity and Race: Africa
 Ethnicity and Race: Anthropology
 Ethnicity and Race: Islamic Views
 Etiquette
 Eugenics
 Eurocentrism
 Europe, Idea of
 Evil
 Examination Systems, China
 Existentialism
 Expressionism
 Extirpation
 Fallacy, Logical
 Family Planning
 Fascism
 Feminism: Overview
 Feminism: Africa and African Diaspora
 Feminism: Chicana Feminisms
 Feminism: Islamic Feminism
 Feminism: Third World U.S. Movement
 Fetishism: Overview
 Feudalism, European
 Friendship
 Fundamentalism
 Futurology
 Game Theory
 Garden
 Gay Studies
 Gender: Gender in the Middle East
 Gender in Art
 General Will
 Generation
 Genetics: Contemporary
 Genocide
 Ghetto
 Globalization: Africa
 Globalization: Asia
 Globalization: General
 Good
 Happiness and Pleasure in European Thought
 Heaven and Hell
 Heaven and Hell (Asian Focus)
 Hegelianism
 Hegemony
 Hinduism
 Historical and Dialectical Materialism
 Historiography
 History, Economic
 History, Idea of
 Honor
 Honor, Middle Eastern Notions of
 Human Capital
 Humanism: Chinese Conception of
 Humanism: Europe and the Middle East
 Humanism: Renaissance
 Humanism: Secular Humanism in the United States
 Humanity: African Thought
 Human Rights: Overview
 Human Rights: Women's Rights
 Hygiene
 Ideas, History of

READER'S GUIDE

- Identity, Multiple: Overview
- Identity, Multiple: Asian-Americans
- Identity, Multiple: Jewish Multiple Identity
- Individualism
- Intelligentsia
- Intentionality
- Intercession in Middle Eastern Society
- Interdisciplinarity
- Internal Colonialism
- International Order
- Islam: Africa
- Islam: Shii
- Islam: Southeast Asia
- Islam: Sunni
- Islamic Science
- Japanese Philosophy, Japanese Thought
- Jihad
- Jouissance
- Justice: Overview
- Justice: Justice in American Thought
- Justice: Justice in East Asian Thought
- Kantianism
- Kinship
- Knowledge
- Language and Linguistics
- Law
- Law, Islamic
- Leadership
- Legalism, Ancient China
- Liberalism
- Liberation Theology
- Liberty
- Life Cycle: Elders/Old Age
- Literary Criticism
- Literary History
- Literature: Overview
- Literature: African Literature
- Lysenkoism
- Machiavellism
- Machismo
- Maoism
- Maps and the Ideas They Express
- Marriage and Fertility, European Views
- Marxism: Overview
- Marxism: Asia
- Marxism: Latin America
- Masks
- Mathematics
- Matriarchy
- Medicine: Europe and the United States
- Meme
- Men and Masculinity
- Mestizaje
- Migration: Migration in World History
- Migration: United States
- Millenarianism: Islamic
- Millenarianism: Latin America and Native North America
- Minority
- Modernism: Overview
- Modernism: Latin America
- Modernity: Overview
- Modernity: Africa
- Modernity: East Asia
- Modernization
- Modernization Theory
- Mohism
- Monarchy: Overview**
- Monarchy: Islamic Monarchy
- Motherhood and Maternity
- Motif: Motif in Literature
- Multiculturalism, Africa
- Music, Anthropology of
- Musical Performance and Audiences
- Musicology
- Mysticism: Chinese Mysticism
- Myth
- Narrative
- Nation
- Nationalism: Overview
- Nationalism: Africa
- Nationalism: Cultural Nationalism
- Nationalism: Middle East
- Native Policy
- Natural Law
- Naturalism
- Negritude
- Neocolonialism
- Neoliberalism
- New Criticism
- Newtonianism
- Nihilism
- Nomadism
- Nonviolence
- Nuclear Age
- Objectivity
- Obligation
- Occidentalism
- Organicism
- Orientalism: Overview
- Orientalism: African and Black Orientalism
- Orthodoxy
- Orthopraxy: Asia
- Pacifism
- Pan-Africanism
- Pan-Arabism
- Pan-Asianism
- Pan-Islamism
- Pan-Turkism
- Paradigm
- Parties, Political
- Patriotism
- Peace
- Periodization of the Arts
- Person, Idea of the
- Personhood in African Thought
- Philanthropy
- Philosophies: American
- Philosophies: Feminist, Twentieth-Century
- Philosophies: Islamic
- Philosophy: Historical Overview and Recent Developments
- Philosophy, History of
- Philosophy, Moral: Africa
- Philosophy, Moral: Ancient
- Philosophy, Moral: Modern
- Philosophy of Religion
- Phrenology
- Pluralism
- Political Protest, U.S.

- Political Science**
 Political, The
 Population
 Populism: Latin America
 Populism: United States
 Postcolonial Studies
 Poverty
 Power
 Practices
 Pre-Columbian Civilization
 Prejudice
 Presentism
 Privacy
 Privatization
 Probability
 Progress, Idea of
 Propaganda
 Property
 Protest, Political
 Pseudoscience
 Psychoanalysis
 Public Sphere
 Punishment
 Puritanism
 Pythagoreanism
 Quantum
 Queer Theory
 Race and Racism: Overview
 Race and Racism: Asia
 Race and Racism: United States
 Radicals/Radicalism
 Rational Choice
 Reading
 Realism
 Realism: Africa
 Reason, Practical and Theoretical
 Reflexivity
 Reform: Europe and the United States
 Reform: Islamic Reform
 Regions and Regionalism, Eastern Europe
 Relativism
 Religion: Africa
 Religion: African Diaspora
 Religion: East and Southeast Asia
 Religion: Latin America
 Religion: Middle East
 Religion and the State: Africa
 Religion and the State: Europe
 Religion and the State: Latin America
 Religion and the State: Middle East
 Religion and the State: United States
 Renaissance
 Representation: Political Representation
 Republicanism: Latin America
 Republicanism: Republic
 Resistance
 Resistance and Accommodation
 Responsibility
 Revolution
 Rhetoric: Ancient and Medieval
 Ritual: Public Ritual
 Romanticism in Literature and Politics
 Sacred and Profane
 Scarcity and Abundance, Latin America
 Science, History of
 Science Fiction
 Secularization and Secularism
 Segregation
 Sexual Harassment
 Sexuality: Overview
 Sexuality: Islamic Views
 Sexuality: Sexual Orientation
 Shinto
 Skepticism
 Slavery
 Sociability in African Thought
 Social Capital
 Social Contract
 Social History, U.S.
 Socialism
 Socialisms, African
 Society
 Sophists, The
 Sovereignty
 Sport
 State, The: Overview
 State, The: The Postcolonial State
 State of Nature
 Stoicism
 Subjectivism
 Sufism
 Suicide
 Superstition
 Surrealism
 Symbolism
 Syncretism
 Technology
 Temperance
 Terror
 Terrorism, Middle East
 Third Cinema
 Third World
 Third World Literature
 Time: China
 Time: Traditional and Utilitarian
 Toleration
 Totalitarianism
 Trade
 Translation
 Treaty
 Tribalism, Middle East
 University: Postcolonial
 Untouchability: Menstrual Taboos
 Untouchability: Taboos
 Utilitarianism
 Utopia
 Victorianism
 Virtue Ethics
 Visual Order to Organizing Collections
 Volksgeist
 Volunteerism, U.S.
 War
 War and Peace in the Arts
 Wealth
 Westernization: Africa
 Westernization: Middle East
 Westernization: Southeast Asia
 Wildlife
 Witchcraft
 Witchcraft, African Studies of

READER'S GUIDE

- Women's History: Africa
Work
World Systems Theory, Latin America
Zionism
- ECONOMICS**
Abolitionism
Africa, Idea of
African-American Ideas
Afropessimism
Alienation
Altruism
Anarchism
Anthropology
Anticolonialism: Africa
Anticolonialism: Latin America
Anticolonialism: Middle East
Anticolonialism: Southeast Asia
Anti-Semitism: Islamic Anti-Semitism
Apartheid
Architecture: Africa
Arts: Africa
Asceticism: Western Asceticism
Asian-American Ideas (Cultural Migration)
Assimilation
Astronomy, Pre-Columbian and Latin American
Authoritarianism: East Asia
Authoritarianism: Latin America
Avant-Garde: Militancy
Bioethics
Black Atlantic
Black Consciousness
Bureaucracy
Bushido
Calculation and Computation
Capitalism: Overview
Capitalism: Africa
Chicano Movement
Cinema
City, The: The City as a Cultural Center
City, The: The City as Political Center
City, The: The Islamic and Byzantine City
Civil Society: Europe and the United States
Civil Society: Responses in Africa and the Middle East
Class
Colonialism: Africa
Colonialism: Southeast Asia
Communication of Ideas: Africa and Its Influence
Communication of Ideas: Middle East and Abroad
Communication of Ideas: Southeast Asia
Communism: Europe
Communism: Latin America
Composition, Musical
Confucianism
Consumerism
Corruption in Developed and Developing Countries
Critical Race Theory
Cultural Capital
Cultural History
Cultural Studies
Democracy: Africa
Demography
Dependency
Diasporas: African Diaspora
Diasporas: Jewish Diaspora
Dictatorship in Latin America
- Diffusion, Cultural
Discrimination
Diversity
Dress
Dystopia
Economics
Education: China
Education: Global Education
Empire and Imperialism: Americas
Empire and Imperialism: Asia
Empire and Imperialism: Europe
Empire and Imperialism: Middle East
Empire and Imperialism: United States
Environmental Ethics
Environmental History
Equality: Overview
Equality: Gender Equality
Equality: Racial Equality
Eugenics
Eurocentrism
Europe, Idea of
Everyday Life
Examination Systems, China
Family: Modernist Anthropological Theory
Family Planning
Fascism
Feminism: Overview
Feminism: Africa and African Diaspora
Feminism: Chicana Feminisms
Feminism: Islamic Feminism
Feminism: Third World U.S. Movement
Fetishism: Overview
Fetishism: Fetishism in Literature and Cultural Studies
Feudalism, European
Futurology
Game Theory
Generation
Genetics: Contemporary
Ghetto
Gift, The
Globalization: Africa
Globalization: Asia
Globalization: General
Good
Hegelianism
Hegemony
Hinduism
Historical and Dialectical Materialism
Historicism
Historiography
History, Economic
History, Idea of
Human Capital
Human Rights: Women's Rights
Ideas, History of
Identity, Multiple: Asian-Americans
Indigenismo
Individualism
Intelligentsia
Intentionality
Internal Colonialism
Interpretation
Islam: Africa
Islam: Sunni
Islamic Science

- Jainism
- Japanese Philosophy, Japanese Thought
- Jihad
- Justice: Overview
- Justice: Justice in American Thought
- Law, Islamic
- Leadership
- Liberalism
- Liberation Theology
- Life Cycle: Elders/Old Age
- Literary Criticism
- Maoism
- Maps and the Ideas They Express
- Marriage and Fertility, European Views
- Marxism: Overview
- Marxism: Asia
- Marxism: Latin America
- Mathematics
- Migration: Africa
- Migration: Migration in World History
- Migration: United States
- Minority
- Modernity: Africa
- Modernity: East Asia
- Modernization
- Modernization Theory
- Motherhood and Maternity
- Nationalism: Africa
- Native Policy
- Naturalism
- Neocolonialism
- Neoliberalism
- Nomadism
- Nuclear Age
- Occidentalism
- Orthopraxy: Asia
- Pan-Africanism
- Pan-Asianism
- Parties, Political
- Peasants and Peasantry
- Philanthropy
- Philosophies: American
- Philosophy, History of
- Political Protest, U.S.
- Political Science
- Population
- Populism: Latin America
- Populism: United States
- Postcolonial Studies
- Poverty
- Practices
- Pre-Columbian Civilization
- Presentism
- Privacy
- Privatization
- Probability
- Progress, Idea of
- Property
- Protest, Political
- Pseudoscience
- Public Sphere
- Punishment
- Puritanism
- Race and Racism: United States
- Radicals/Radicalism
- Reason, Practical and Theoretical
- Reform: Europe and the United States
- Religion and the State: Africa
- Religion and the State: Latin America
- Renaissance
- Representation: Political Representation
- Republicanism: Republic
- Resistance
- Resistance and Accommodation
- Responsibility
- Ritual: Public Ritual
- Ritual: Religion
- Scarcity and Abundance, Latin America
- Secularization and Secularism
- Segregation
- Sexual Harassment
- Sexuality: Islamic Views
- Slavery
- Social Capital
- Social Darwinism
- Social History, U.S.
- Socialism
- Sport
- State, The: Overview
- State, The: The Postcolonial State
- Technology
- Terrorism, Middle East
- Third Cinema
- Third World
- Third World Literature
- Time: China
- Time: Traditional and Utilitarian
- Totalitarianism
- Trade
- Translation
- Travel: Travel from Europe and the Middle East
- Treaty
- Untouchability: Taboos
- Utilitarianism
- Victorianism
- Visual Culture
- Volunteerism, U.S.
- War and Peace in the Arts
- Wealth
- Westernization: Africa
- Westernization: Middle East
- Westernization: Southeast Asia
- Women and Femininity in U.S. Popular Culture
- Women's History: Africa
- Work
- World Systems Theory, Latin America
- Zen
- Zionism
- GEOGRAPHY
- Africa, Idea of
- America
- Anthropology
- Architecture: Overview
- Barbarism and Civilization
- Borders, Borderlands, and Frontiers, Global
- Capitalism: Overview
- Chinese Warlordism
- Cultural Studies
- Diffusion, Cultural
- Economics

READER'S GUIDE

Environment
Environmental History
Ethnicity and Race: Anthropology
Ethnicity and Race: Islamic Views
Eurocentrism
Feudalism, European
Geography
Ghetto
Globalization: Asia
Globalization: General
History, Economic
History, Idea of
Identity, Multiple: Jewish Multiple Identity
Islamic Science
Maps and the Ideas They Express
Mathematics
Migration: Africa
Migration: Migration in World History
Migration: United States
Minority
Nation
Nationalism: Africa
Natural History
Nomadism
Occidentalism
Orientalism: Overview
Pan-Africanism
Pan-Asianism
Perspective
Population
Privacy
Race and Racism: Asia
Race and Racism: United States
Regions and Regionalism, Eastern Europe
Religion: Indigenous Peoples' View, South America
Sacred Places
Scarcity and Abundance, Latin America
Third Cinema
Third World
Travel: Travel from Europe and the Middle East
Victorianism
Westernization: Southeast Asia
World Systems Theory, Latin America

Sciences

HISTORY OF SCIENCE, EARLY (entries focused on early ideas about nature and the human relationship with nature)
Alchemy: China
Alchemy: Europe and the Middle East
Anthropology
Aristotelianism
Asceticism: Hindu and Buddhist Asceticism
Astrology: Overview
Astrology: China
Astronomy, Pre-Columbian and Latin American
Change
Confucianism
Consciousness: Chinese Thought
Cosmology: Asia
Daoism
Ethnicity and Race: Africa
Ethnicity and Race: Anthropology
Ethnicity and Race: Islamic Views
Greek Science

Harmony
Hierarchy and Order
Hinduism
Humanism: Chinese Conception of
Humanity: African Thought
Ideas, History of
Lysenkoism
Magic
Manichaeism
Medicine: China
Medicine: India
Metaphysics: Ancient and Medieval
Mysticism: Chinese Mysticism
Myth
Natural Theology
Naturphilosophie
Organicism
Paradigm
Person, Idea of the
Philosophies: Islamic
Philosophy: Historical Overview and Recent Developments
Philosophy of Religion
Phrenology
Pseudoscience
Race and Racism: Europe
Race and Racism: United States
Religion: Indigenous Peoples' View, South America
Religion and Science
Ritual: Religion
Sacred Places
Science: East Asia
Segregation
Sexuality: Sexual Orientation
Slavery
Superstition
Syncretism
Time: China
Time: India
Untouchability: Menstrual Taboos
Witchcraft
Yin and Yang

HISTORY OF SCIENCE, MODERN AND CONTEMPORARY (entries focused on the origins of modern or contemporary ideas in the physical, chemical, biological, mathematical, or earth sciences)

Agnosticism
Algebras
Behaviorism
Body, The
Calendar
Cartesianism
Causation
Causation in East Asian and Southeast Asian Philosophy
Chemistry
Communication of Ideas: Middle East and Abroad
Computer Science
Context
Continental Philosophy
Cosmology: Cosmology and Astronomy
Creationism
Creativity in the Arts and Sciences
Cultural History
Demonology
Determinism

- Development
- Ecology
- Education: Islamic Education
- Empiricism
- Enlightenment
- Environment
- Environmental History
- Epistemology: Early Modern
- Equality: Racial Equality
- Everyday Life
- Experiment
- Falsifiability
- Free Will, Determinism, and Predestination
- Health and Disease
- History, Economic
- Idealism
- Islamic Science
- Kantianism
- Knowledge
- Life
- Linguistic Turn
- Mathematics
- Mechanical Philosophy
- Medicine: Europe and the United States
- Medicine: Islamic Medicine
- Metaphor
- Museums
- Nature
- Newtonianism
- Nuclear Age
- Objectivity
- Philosophies: African
- Philosophies: Feminist, Twentieth-Century
- Philosophy, History of
- Philosophy of Mind: Overview
- Philosophy of Mind: Ancient and Medieval
- Physics
- Platonism
- Poetry and Poetics
- Positivism
- Prehistory, Rise of
- Probability
- Progress, Idea of
- Pythagoreanism
- Quantum
- Race and Racism: Asia
- Rationalism
- Reason, Practical and Theoretical
- Reflexivity
- Reform: Europe and the United States
- Relativity
- Renaissance
- Scholasticism
- Science: Overview
- Science, History of**
- Scientific Revolution**
- Sexuality: Overview
- Social Darwinism
- Social History, U.S.
- Technology
- Victorianism
- Visual Order to Organizing Collections
- PSYCHOLOGY
- Absolute Music
- Aesthetics: Asia
- Aesthetics: Europe and the Americas
- Alchemy: Europe and the Middle East
- Alienation
- Altruism
- Ambiguity
- Ancestor Worship
- Animism
- Anthropology
- Anti-Semitism: Overview
- Asceticism: Hindu and Buddhist Asceticism
- Asceticism: Western Asceticism
- Authoritarianism: East Asia
- Beauty and Ugliness
- Behaviorism
- Bioethics
- Biography
- Biology
- Body, The
- Buddhism
- Cartesianism
- Character
- Cinema
- Communitarianism in African Thought
- Composition, Musical
- Computer Science
- Consciousness: Overview
- Consciousness: Chinese Thought
- Consciousness: Indian Thought
- Consumerism
- Context
- Continental Philosophy
- Creativity in the Arts and Sciences
- Cultural Studies
- Dada
- Dance
- Daoism
- Death
- Demonology
- Determinism
- Diffusion, Cultural
- Discrimination
- Dream
- Emotions
- Empiricism
- Epistemology: Early Modern
- Epistemology: Modern
- Ethnicity and Race: Africa
- Eugenics
- Everyday Life
- Existentialism
- Feminism: Overview
- Fetishism: Overview
- Fetishism: Fetishism in Literature and Cultural Studies
- Form, Metaphysical, in Ancient and Medieval Thought
- Foundationalism
- Friendship
- Gay Studies
- Gender: Overview
- Gender: Gender in the Middle East
- Gender in Art
- Gender Studies: Anthropology
- Gesture
- Harmony
- Hate
- Health and Disease

READER'S GUIDE

Heaven and Hell
Hinduism
Humanism: Secular Humanism in the United States
Humanity: African Thought
Humanity: European Thought
Identity: Identity of Persons
Identity: Personal and Social Identity
Identity, Multiple: Overview
Identity, Multiple: Asian-Americans
Images, Icons, and Idols
Imagination
Immortality and the Afterlife
Impressionism
Indigenismo
Intentionality
Jainism
Jouissance
Kinship
Knowledge
Language and Linguistics
Learning and Memory, Contemporary Views
Life
Life Cycle: Elders/Old Age
Literary Criticism
Love, Western Notions of
Machismo
Magic
Manichaeism
Masks
Medicine: China
Medicine: Europe and the United States
Meditation: Eastern Meditation
Memory
Men and Masculinity
Metaphor
Metaphysics: Renaissance to the Present
Mind
Modernism: Overview
Modernity: Overview
Modernity: Africa
Modernity: East Asia
Monarchy: Overview
Monism
Motherhood and Maternity
Musical Performance and Audiences
Mysticism: Chinese Mysticism
Mysticism: Islamic Mysticism in Asia
Myth
Narrative
National History
Nationalism: Overview
Naturphilosophie
Negritude
Objectivity
Person, Idea of the
Personhood in African Thought
Philosophies: Islamic
Philosophy, Moral: Modern
Philosophy of Mind: Overview
Philosophy of Mind: Ancient and Medieval
Philosophy of Religion
Phrenology
Political Science
Prejudice
Presentism
Privacy
Probability
Progress, Idea of
Protest, Political
Psychoanalysis
Psychology and Psychiatry
Punishment
Queer Theory
Realism: Africa
Reflexivity
Religion: Africa
Religion: African Diaspora
Religion: Indigenous Peoples' View, South America
Religion: Latin America
Religion and Science
Representation: Mental Representation
Resistance and Accommodation
Responsibility
Ritual: Public Ritual
Sexuality: Overview
Sexuality: Sexual Orientation
Slavery
State of Nature
Structuralism and Poststructuralism: Overview
Subjectivism
Superstition
Surrealism
Symbolism
Syncretism
Temperance
Text/Textuality
Third Cinema
Toleration
Totalitarianism
Tragedy and Comedy
Untouchability: Menstrual Taboos
Untouchability: Taboos
Utilitarianism
War and Peace in the Arts
Witchcraft
Witchcraft, African Studies of
Womanism
Women and Femininity in U.S. Popular Culture

BIOLOGICAL SCIENCES
Agnosticism
Altruism
Ancestor Worship
Anthropology
Antifeminism
Asceticism: Hindu and Buddhist Asceticism
Asceticism: Western Asceticism
Beauty and Ugliness
Behaviorism
Bioethics
Biology
Body, The
Buddhism
Cannibalism
Cartesianism
Casuistry
Classification of Arts and Sciences, Early Modern
Composition, Musical
Computer Science
Consciousness: Overview
Consilience

- Creationism
 Critical Race Theory
 Death
 Demography
 Determinism
 Development
 Dystopia
 Ecology
 Emotions
 Environmental Ethics
 Environmental History
 Epistemology: Early Modern
 Equality: Racial Equality
 Ethnohistory, U.S.
 Eugenics
Evolution
 Family: Modernist Anthropological Theory
 Family: Family in Anthropology since 1980
 Family Planning
 Feminism: Overview
 Game Theory
 Garden
 Gender: Overview
 Gender: Gender in the Middle East
 Gender in Art
 Gender Studies: Anthropology
Genetics: Contemporary
Genetics: History of
 Genocide
 Gesture
 Greek Science
 Health and Disease
 Heaven and Hell
 History, Idea of
 Humanism: Secular Humanism in the United States
 Humanity: African Thought
 Hygiene
 Identity: Identity of Persons
 Immortality and the Afterlife
 Intentionality
 Islamic Science
 Jainism
 Jouissance
 Kinship
 Learning and Memory, Contemporary Views
 Life
 Life Cycle: Adolescence
 Life Cycle: Elders/Old Age
 Lysenkoism
 Machiavellism
 Marriage and Fertility, European Views
 Masks
 Materialism in Eighteenth-Century European Thought
 Mechanical Philosophy
 Medicine: China
 Medicine: Europe and the United States
 Medicine: Islamic Medicine
 Meme
 Memory
 Men and Masculinity
 Mestizaje
 Monarchy: Overview
 Motherhood and Maternity
 Musical Performance and Audiences
 Natural History
 Naturalism
 Natural Theology
 Nature
 Naturphilosophie
 Negritude
 Organicism
 Other, The, European Views of
 Periodization of the Arts
 Person, Idea of the
 Perspective
 Philosophies: Islamic
 Philosophy of Mind: Ancient and Medieval
 Phrenology
 Population
 Prehistory, Rise of
 Probability
 Progress, Idea of
 Psychoanalysis
 Psychology and Psychiatry
 Punishment
 Queer Theory
 Religion: Indigenous Peoples' View, South America
 Representation: Mental Representation
 Science: East Asia
 Science, History of
 Sexuality: Overview
 Sexuality: Sexual Orientation
 Sociability in African Thought
 Social Darwinism
 Sport
 State of Nature
 Subjectivism
 Superstition
 Temperance
 Terror
 Text/Textuality
 Totems
 Untouchability: Menstrual Taboos
 Utilitarianism
 Victorianism
 Visual Order to Organizing Collections
 War and Peace in the Arts
 Wildlife
 Women and Femininity in U.S. Popular Culture
PHYSICAL SCIENCES
 Agnosticism
 Alchemy: China
 Astrology: China
 Astronomy, Pre-Columbian and Latin American
 Calculation and Computation
 Calendar
 Causality
 Causation
 Causation in East Asian and Southeast Asian Philosophy
 Change
 Chemistry
 Classification of Arts and Sciences, Early Modern
 Computer Science
 Consciousness: Overview
 Consilience
 Cosmology: Asia
 Cosmology: Cosmology and Astronomy
 Creationism
 Cycles

READER'S GUIDE

Ecology
 Empiricism
 Environmental Ethics
 Environmental History
 Epistemology: Early Modern
 Ethnohistory, U.S.
 Experiment
 Falsifiability
 Field Theories
 Form, Metaphysical, in Ancient and Medieval Thought
 Geography
 Geometry
 Greek Science
 Harmony
 Hinduism
 History, Economic
 Islam: Sunni
 Islamic Science
 Japanese Philosophy, Japanese Thought
 Knowledge
 Language, Philosophy of: Modern
 Life
 Literary History
 Logic and Philosophy of Mathematics, Modern
 Maps and the Ideas They Express
 Materialism in Eighteenth-Century European Thought
 Mathematics
 Mechanical Philosophy
 Metaphysics: Renaissance to the Present
 Microcosm and Macrocosm
 Monism
 Myth
 Natural Theology
 Naturalism
 Nature
 Naturphilosophie
 Newtonianism
 Nuclear Age
 Paradigm
 Periodization of the Arts
 Philosophies: Islamic
 Philosophy: Historical Overview and Recent Developments
 Philosophy, History of
Physics
 Positivism
 Power
 Pragmatism
 Probability
 Progress, Idea of
 Psychoanalysis
 Pythagoreanism
 Quantum
 Rationalism
 Realism: Africa
 Reason, Practical and Theoretical
 Relativity
 Religion: East and Southeast Asia
 Religion: Indigenous Peoples' View, South America
 Religion and Science
 Science: Overview
 Science: East Asia
 Science, History of
 Scientific Revolution
 Sophists, The

Stoicism
 Subjectivism
 Superstition
 Time: China
 Time: India
 Victorianism
ECOLOGY AND GEOLOGY
 Aesthetics: Asia
 Anthropology
 Architecture: Overview
 Architecture: Asia
 Astronomy, Pre-Columbian and Latin American
 Authoritarianism: Overview
 Bioethics
 Biology
 Borders, Borderlands, and Frontiers, Global
 Calendar
 Capitalism: Overview
 City, The: Latin America
 City, The: The City as a Cultural Center
 City, The: The Islamic and Byzantine City
 Creationism
 Death
 Dystopia
Ecology
 Education: Global Education
Environment
 Environmental Ethics
 Environmental History
 Evolution
 Feminism: Overview
 Garden
 Genetics: Contemporary
 Genetics: History of
 Genocide
 Geography
 History, Economic
 History, Idea of
 Hygiene
 Impressionism
 Landscape in the Arts
 Life
 Life Cycle: Elders/Old Age
 Lysenkoism
 Machiavellism
 Maps and the Ideas They Express
 Matriarchy
 Medicine: Islamic Medicine
 Memory
 Migration: Migration in World History
Natural History
 Nuclear Age
 Organicism
 Periodization of the Arts
 Political Protest, U.S.
 Prehistory, Rise of
 Presentism
 Protest, Political
 Religion: Latin America
 Ritual: Religion
 Scarcity and Abundance, Latin America
 Science, History of
 Social Darwinism
 Totems
 Untouchability: Menstrual Taboos

- Utopia
- Visual Order to Organizing Collections
- Wildlife
- Witchcraft
- Witchcraft, African Studies of
- World Systems Theory, Latin America
- CHEMISTRY**
- Alchemy: China
- Alchemy: Europe and the Middle East
- Biology
- Chemistry**
- Classification of Arts and Sciences, Early Modern
- Computer Science
- Consciousness: Overview
- Development
- Experiment
- Genetics: Contemporary
- Genetics: History of
- Health and Disease
- Islamic Science
- Life
- Materialism in Eighteenth-Century European Thought
- Mechanical Philosophy
- Medicine: Europe and the United States
- Mysticism: Chinese Mysticism
- Paradigm
- Philosophies: Islamic
- Physics
- Quantum
- Science: East Asia
- Science, History of
- MATHEMATICS**
- Absolute Music
- Aesthetics: Europe and the Americas
- Algebras**
- Analytical Philosophy
- Astronomy, Pre-Columbian and Latin American
- Beauty and Ugliness
- Calculation and Computation
- Causation
- Causation in East Asian and Southeast Asian Philosophy
- Chemistry
- Classification of Arts and Sciences, Early Modern
- Computer Science
- Cosmology: Cosmology and Astronomy
- Death
- Demography
- Economics
- Empiricism
- Environmental History
- Equality: Overview
- Experiment
- Fallacy, Logical
- Falsifiability
- Foundationalism
- Futurology
- Game Theory
- Generation
- Genetics: Contemporary
- Genetics: History of
- Genocide
- Geometry**
- Harmony
- History, Economic
- Humanism: Chinese Conception of
- Islamic Science
- Knowledge
- Language, Philosophy of: Ancient and Medieval
- Language, Philosophy of: Modern
- Language and Linguistics
- Logic and Philosophy of Mathematics, Modern
- Mathematics**
- Newtonianism
- Perspective
- Philosophies: Islamic
- Philosophy: Historical Overview and Recent Developments
- Physics
- Political Science
- Positivism
- Prejudice
- Probability
- Pythagoreanism
- Quantum
- Rationalism
- Reading
- Reason, Practical and Theoretical
- Relativism
- Relativity
- Representation: Mental Representation
- Scientific Revolution
- Social History, U.S.
- Sophists, The
- Truth
- COMPUTER SCIENCE**
- Calculation and Computation**
- Computer Science**
- Consciousness: Overview
- Futurology
- Game Theory
- Genetics: Contemporary
- Genetics: History of
- Geography
- History, Economic
- Interdisciplinarity
- Language and Linguistics
- Learning and Memory, Contemporary Views
- Maps and the Ideas They Express
- Mathematics
- Privacy
- Probability
- Social History, U.S.
- Virtual Reality
- Professions**
- MEDICINE**
- Alchemy: China
- Alchemy: Europe and the Middle East
- Americanization, U.S.
- Ancestor Worship
- Anthropology
- Asceticism: Hindu and Buddhist Asceticism
- Asceticism: Western Asceticism
- Astrology: China
- Bioethics
- Biology
- Body, The
- Casuistry
- Chemistry
- Childhood and Child Rearing

READER'S GUIDE

- Computer Science
 Creativity in the Arts and Sciences
 Death
 Demography
 Determinism
 Diversity
 Environment
 Environmental History
 Eugenics
 Feminism: Overview
 Feminism: Third World U.S. Movement
 Gay Studies
 Gender: Overview
 Gender Studies: Anthropology
 Genetics: Contemporary
 Genetics: History of
 Greek Science
Health and Disease
 Hinduism
 Humanity: African Thought
 Humor
 Hygiene
 Iconography
 Islam: Sunni
 Islamic Science
 Life
 Life Cycle: Elders/Old Age
 Literary Criticism
 Magic
 Mathematics
Medicine: China
Medicine: Europe and the United States
Medicine: India
Medicine: Islamic Medicine
 Meditation: Eastern Meditation
 Miracles
 Motherhood and Maternity
 Music, Anthropology of
 Mysticism: Chinese Mysticism
 Narrative
 Naturphilosophie
 Philosophies: Feminist, Twentieth-Century
 Philosophies: Islamic
 Phrenology
 Population
 Privacy
 Psychoanalysis
 Psychology and Psychiatry
 Pythagoreanism
 Queer Theory
 Religion: Africa
 Religion: African Diaspora
 Religion: East and Southeast Asia
 Religion: Indigenous Peoples' View, South America
 Ritual: Religion
 Science: East Asia
 Science, History of
 Sexuality: Overview
 Skepticism
 Superstition
 University: Overview
 Untouchability: Menstrual Taboos
 Utilitarianism
 Victorianism
 Visual Culture
 Visual Order to Organizing Collections
 Volunteerism, U.S.
 Westernization: Africa
 Witchcraft
 Women and Femininity in U.S. Popular Culture
 Yin and Yang
- LAW**
- Abolitionism
 African-American Ideas
 Altruism
 Anticolonialism: Africa
 Anticolonialism: Latin America
 Anticolonialism: Southeast Asia
 Antifeminism
 Anti-Semitism: Islamic Anti-Semitism
 Apartheid
 Asian-American Ideas (Cultural Migration)
 Assimilation
 Authoritarianism: Overview
 Authoritarianism: East Asia
 Barbarism and Civilization
 Bioethics
 Black Consciousness
 Cannibalism
 Capitalism: Overview
 Capitalism: Africa
 Casuistry
 Censorship
 Citizenship: Overview
 Citizenship: Cultural Citizenship
 Citizenship: Naturalization
 City, The: The Islamic and Byzantine City
 Civil Disobedience
 Civil Society: Europe and the United States
 Colonialism: Southeast Asia
 Consciousness: Chinese Thought
 Constitutionalism
 Context
 Corruption in Developed and Developing Countries
 Creationism
 Critical Race Theory
 Cultural History
 Cultural Revivals
 Deism
 Democracy
 Democracy: Africa
 Dialogue and Dialectics: Socratic
 Dialogue and Dialectics: Talmudic
 Dictatorship in Latin America
 Discrimination
 Diversity
 Education: Islamic Education
 Empire and Imperialism: Overview
 Empire and Imperialism: Europe
 Empire and Imperialism: United States
 Environmental History
 Equality: Overview
 Equality: Racial Equality
 Ethnicity and Race: Anthropology
 Ethnicity and Race: Islamic Views
 Europe, Idea of
 Extirpation
 Fallacy, Logical
 Falsifiability
 Family Planning

- Fascism
 Feminism: Overview
 Feminism: Africa and African Diaspora
 Feminism: Islamic Feminism
 Feudalism, European
 Gender: Gender in the Middle East
 General Will
 Genetics: Contemporary
 Genetics: History of
 Genocide
 Ghetto
 Globalization: Africa
 Good
 Hate
 Heresy and Apostasy
 Hinduism
 Honor, Middle Eastern Notions of
 Human Rights: Overview
 Humanism: Secular Humanism in the United States
 Iconography
 Identity, Multiple: Jewish Multiple Identity
 Indigenismo
 Individualism
 Intentionality
 Interdisciplinarity
 International Order
 Islam: Africa
 Islam: Shi'i
 Islam: Southeast Asia
 Islam: Sunni
 Jihad
 Judaism: Judaism to 1800
 Justice: Overview
 Justice: Justice in American Thought
 Justice: Justice in East Asian Thought
 Kinship
 Language and Linguistics
Law
Law, Islamic
 Learning and Memory, Contemporary Views
 Legalism, Ancient China
 Liberalism
 Liberty
 Life Cycle: Elders/Old Age
 Literary Criticism
 Loyalties, Dual
 Marriage and Fertility, European Views
 Masks
 Matriarchy
 Migration: United States
 Minority
 Modernity: Overview
 Monarchy: Overview
 Monarchy: Islamic Monarchy
 Motherhood and Maternity
 Mysticism: Islamic Mysticism
 Narrative
 Nation
 Nationalism: Cultural Nationalism
 Nationalism: Middle East
 Native Policy
 Natural Law
 Nonviolence
 Nuclear Age
 Obligation
 Person, Idea of the
 Philanthropy
 Philosophies: American
 Philosophies: Feminist, Twentieth-Century
 Philosophies: Islamic
 Philosophy: Historical Overview and Recent Developments
 Philosophy, Moral: Ancient
 Political Protest, U.S.
 Population
 Postcolonial Studies
 Power
 Privacy
 Progress, Idea of
 Property
 Protest, Political
 Punishment
 Queer Theory
 Race and Racism: United States
 Reason, Practical and Theoretical
 Reform: Europe and the United States
 Regions and Regionalism, Eastern Europe
 Relativism
 Religion: African Diaspora
 Religion: Middle East
 Religion and the State: Africa
 Religion and the State: Europe
 Religion and the State: Middle East
 Religion and the State: United States
 Representation: Political Representation
 Republicanism: Republic
 Resistance
 Responsibility
 Rhetoric: Ancient and Medieval
 Ritual: Public Ritual
 Sacred Texts: Koran
 Segregation
 Sexual Harassment
 Sexuality: Overview
 Sexuality: Islamic Views
 Sexuality: Sexual Orientation
 Skepticism
 Slavery
 Sociability in African Thought
 Social Contract
 Socialisms, African
 Society
 State, The: Overview
 State, The: The Postcolonial State
 State of Nature
 Stoicism
 Subjectivism
 Sufism
 Suicide
 Temperance
 Toleration
 Totalitarianism
 Treaty
 University: Overview
 Untouchability: Taboos
 Utilitarianism
 Victorianism
 Virtue Ethics
 Visual Order to Organizing Collections
 Volunteerism, U.S.
 War and Peace in the Arts

READER'S GUIDE

Westernization: Africa
Westernization: Middle East
Westernization: Southeast Asia
Wildlife
Witchcraft
ENGINEERING
Alchemy: China
Alchemy: Europe and the Middle East
Architecture: Overview
Architecture: Africa
Architecture: Asia
Beauty and Ugliness
Biology
Calculation and Computation
Capitalism: Overview
Capitalism: Africa
Cinema
City, The: Latin America
City, The: The City as a Cultural Center
City, The: The City as Political Center
City, The: The Islamic and Byzantine City
Communication of Ideas: Southeast Asia
Computer Science
Diffusion, Cultural
Dystopia
Ecology
Empire and Imperialism: Europe
Environmental History
Epistemology: Early Modern
Experiment
Futurology
Gender Studies: Anthropology
Genetics: Contemporary
Genetics: History of
Genocide
Geometry
Globalization: General
Greek Science
Harmony
Historical and Dialectical Materialism
History, Economic
Humanism: Secular Humanism in the United States
Interdisciplinarity
Japanese Philosophy, Japanese Thought
Knowledge
Literary Criticism
Maps and the Ideas They Express
Mathematics
Mechanical Philosophy
Meme
Modernity: Overview
Modernity: Africa
Modernity: East Asia
Modernization
Modernization Theory
Motherhood and Maternity
Music, Anthropology of
Musical Performance and Audiences
Mysticism: Chinese Mysticism
Newtonianism
Nomadism
Nuclear Age
Occidentalism
Perspective
Power

Presentism
Privacy
Progress, Idea of
Protest, Political
Reform: Europe and the United States
Relativity
Science, History of
Science Fiction
Technology
Textiles and Fiber Arts as Catalysts for Ideas
Totalitarianism
Victorianism
Virtual Reality
Visual Culture
War and Peace in the Arts
Westernization: Middle East
Westernization: Southeast Asia
World Systems Theory, Latin America

Multidisciplinary Practices

The *New Dictionary of the History of Ideas* has many entries that discuss the methods by which scholars and researchers pursue knowledge. The entries below discuss approaches, methods, and practices that have influenced many disciplines.

ENTRIES ON MULTIDISCIPLINARY PRACTICES THAT ORIGINATED IN ANCIENT TIMES

Aesthetics: Asia
Africa, Idea of
Algebras
Anthropology
Architecture: Overview
Architecture: Asia
Aristotelianism
Astrology: Overview
Biology
Body, The
Buddhism
Casuistry
Causality
Censorship
Classicism
Classification of Arts and Sciences, Early Modern
Composition, Musical
Cosmology: Asia
Creationism
Creativity in the Arts and Sciences
Daoism
Development
Dialogue and Dialectics: Socratic
Dualism
Eclecticism
Education: China
Education: Europe
Epistemology: Ancient
Equality: Overview
Essentialism
Eurocentrism
Experiment
Fallacy, Logical
Fetishism: Fetishism in Literature and Cultural Studies
Form, Metaphysical, in Ancient and Medieval Thought
Fundamentalism
Gender in Art
Genre

- Geometry
 Greek Science
 Harmony
 Health and Disease
 Hierarchy and Order
 Hinduism
 History, Idea of
 Humanism: Europe and the Middle East
 Humor
 Ideas, History of
 Imagination
 Interpretation
 Knowledge
 Language, Philosophy of: Ancient and Medieval
 Life
 Literary History
 Literature: African Literature
 Logic
 Maps and the Ideas They Express
 Mathematics
 Medicine: China
 Medicine: Europe and the United States
 Medicine: India
 Memory
 Metaphor
 Metaphysics: Ancient and Medieval
 Monism
 Museums
 Music, Anthropology of
 Musical Performance and Audiences
 Mysticism: Chinese Mysticism
 Narrative
 Nature
 Orthodoxy
 Orthopraxy: Asia
 Orthopraxy: Western Orthopraxy
 Paradigm
 Periodization
 Perspective
 Philosophies: African
 Philosophies: Islamic
 Philosophy: Historical Overview and Recent Developments
 Philosophy and Religion in Western Thought
 Physics
 Platonism
 Presentism
 Progress, Idea of
 Pythagoreanism
 Rationalism
 Reading
 Reason, Practical and Theoretical
 Religion: Overview
 Responsibility
 Rhetoric: Overview
 Rhetoric: Ancient and Medieval
 Sacred Places
 Sacred Texts: Asia
 Science: East Asia
 Scientific Revolution
 Skepticism
 Sophists, The
 Syncretism
 Taste
 Text/Textuality
 Toleration
 Translation
 Trope
 Truth
 Virtual Reality
 Wisdom, Human
 Yin and Yang
- ENTRIES ON MULTIDISCIPLINARY PRACTICES OF MORE RECENT ORIGIN
 Absolute Music
 Aesthetics: Africa
 African-American Ideas
 Afrocentricity
 Analytical Philosophy
 Astronomy, Pre-Columbian and Latin American
 Avant-Garde: Militancy
 Behaviorism
 Bilingualism and Multilingualism
 Bioethics
 Black Atlantic
 Calculation and Computation
 Class
 Conservatism
 Consilience
 Continental Philosophy
 Critical Race Theory
 Critical Theory
 Cultural Studies
 Dada
 Dialogue and Dialectics: Talmudic
 Dream
 Dystopia
 Economics
 Education: Global Education
 Education: Islamic Education
 Empiricism
 Encyclopedism
 Environmental Ethics
 Environmental History
 Epistemology: Early Modern
 Epistemology: Modern
 Ethnicity and Race: Anthropology
 Ethnocentrism
 Ethnography
 Ethnohistory, U.S.
 Examination Systems, China
 Expressionism
 Family: Modernist Anthropological Theory
 Feminism: Overview
 Fetishism: Overview
 Field Theories
 Formalism
 Futurology
 Game Theory
 Gender: Gender in the Middle East
 Generation
 Genetics: Contemporary
 Genetics: History of
 Geography
 Hegelianism
 Hermeneutics
 Historicism
 Humanism: Africa
 Humanism: Renaissance
 Iconography

Idealism
 Identity: Identity of Persons
 Intentionality
 Interdisciplinarity
 Japanese Philosophy, Japanese Thought
 Language, Philosophy of: Modern
 Language and Linguistics
 Law, Islamic
 Learning and Memory, Contemporary Views
 Linguistic Turn
 Literary Criticism
 Logic and Philosophy of Mathematics, Modern
 Masks
 Metaphysics: Renaissance to the Present
 Mind
 Modernism: Overview
 Modernism: Latin America
 Modernization
 Modernization Theory
 Motif: Motif in Literature
 Motif: Motif in Music
 Mysticism: Kabbalah
 Myth
 Naturalism
 Naturalism in Art and Literature
 Naturphilosophie
 Newtonianism
 Objectivity
 Oral Traditions: Overview
 Orientalism: Overview
 Philosophies: Feminist, Twentieth-Century
 Philosophy, Moral: Africa
 Philosophy of Religion
 Phrenology
 Poetry and Poetics
 Polytheism
 Positivism
 Postcolonial Studies
 Postmodernism
 Power
 Practices
 Pragmatism
 Prejudice
 Probability
 Pseudoscience
 Psychoanalysis
 Queer Theory
 Realism
 Realism: Africa
 Reflexivity
 Regions and Regionalism, Eastern Europe
 Relativism
 Relativity
 Religion: Indigenous Peoples' View, South America
 Religion and Science
 Representation: Mental Representation
 Romanticism in Literature and Politics
 Sacred Texts: Koran
 Sage Philosophy
 Scholasticism
 Science: Overview
 Science, History of
 Science Fiction
 Secularization and Secularism
 Social Capital

Social History, U.S.
 State, The: Overview
 Structuralism and Poststructuralism: Overview
 Structuralism and Poststructuralism: Anthropology
 Subjectivism
 Symbolism
 Third Cinema
 Totems
 Tradition
 Universalism
 Utilitarianism
 Visual Culture
 Volksgeist
 Women's Studies

Especially Interdisciplinary Entries

The most interdisciplinary entries synthesized knowledge by using the methods and focusing on the topics of practitioners of several disciplines. Very few entries listed below are in only one division. Common pairs for the history of ideas are social sciences and humanities, social sciences and sciences, and humanities and sciences. In the early twenty-first century there is generally a recognition of the common overlap of the social sciences with the humanities; social scientists may take ethical and literary factors into consideration and humanists may incorporate societal contexts into their work. The presence of psychology in the sciences, as well as the quantitative nature of some social sciences work, creates an overlap of social sciences with sciences. Another interesting overlap is between humanities and sciences—topics that in antiquity were treated as philosophy or religion are now investigated by those following scientific methods.

SOCIAL SCIENCES, SCIENCES, AND FINE ARTS

Architecture: Africa
 Geography
 Phrenology
 Virtual Reality

SCIENCES, FINE ARTS, AND HUMANITIES

Enlightenment
 Epistemology: Early Modern
 Feminism: Third World U.S. Movement
 Field Theories
 Geometry
 Globalization: Asia
 Text/Textuality

FINE ARTS, HUMANITIES, AND SOCIAL SCIENCES

Aesthetics: Africa
 Alienation
 Americanization, U.S.
 Anticolonialism: Africa
 Arts: Overview
 Arts: Africa
 Authenticity: Africa
 Autobiography
 Avant-Garde: Overview
 Aztlán
 Censorship
 Chinese Thought
 City, The: The Islamic and Byzantine City
 Civil Disobedience
 Civil Society: Europe and the United States
 Colonialism: Southeast Asia
 Communication of Ideas: Africa and Its Influence
 Communication of Ideas: The Americas and Their Influence

Communication of Ideas: Asia and Its Influence
 Communication of Ideas: Orality and Advent of Writing
 Cultural Capital
 Cultural History
 Cynicism
 Dialogue and Dialectics: Socratic
 Dialogue and Dialectics: Talmudic
 Diasporas: Jewish Diaspora
 Dictatorship in Latin America
 Etiquette
 Everyday Life
 Expressionism
 Extirpation
 Fascism
 Feminism: Chicana Feminisms
 Gay Studies
 Gender Studies: Anthropology
 Genre
 Ghetto
 Honor
 Humanity in the Arts
 Humor
 Identity, Multiple: Jewish Multiple Identity
 Images, Icons, and Idols
 Islam: Shii
 Landscape in the Arts
 Leadership
 Life Cycle: Overview
 Linguistic Turn
 Literature: African Literature
 Maoism
 Millenarianism: Islamic
 Millenarianism: Latin America and Native North America
 Minority
 Modernism: Latin America
 Musicology
 Mysticism: Christian Mysticism
 Mysticism: Islamic Mysticism in Asia
 Mysticism: Kabbalah
 Mysticism: Mysticism in African Thought
 Nation
 New Criticism
 Nude, The
 Oral Traditions: Overview
 Orientalism: Overview
 Orthodoxy
 Orthopraxy: Asia
 Pan-Africanism
 Pan-Asianism
 Pan-Turkism
 Philosophies: African
 Philosophies: American
 Philosophy, Moral: Ancient
 Populism: United States
 Postmodernism
 Practices
 Pre-Columbian Civilization
 Realism
 Religion: Africa
 Religion: Middle East
 Religion and the State: United States
 Renaissance
 Resistance

Romanticism in Literature and Politics
 Sage Philosophy
 Shinto
 Society
 Taste
 Theater and Performance
 Theodicy
 Third World Literature
 Wisdom, Human
HUMANITIES, SOCIAL SCIENCES, AND SCIENCES
 Afropessimism
 Alchemy: China
 Alchemy: Europe and the Middle East
 Altruism
 Antifeminism
 Asceticism: Hindu and Buddhist Asceticism
 Asceticism: Western Asceticism
 Astrology: China
 Astrology: Overview
 Borders, Borderlands, and Frontiers, Global
 Calculation and Computation
 Calendar
 Capitalism: Overview
 Capitalism: Africa
 Cartesianism
 Casuistry
 Causality
 Causation
 Causation in East Asian and Southeast Asian Philosophy
 Character
 Chicano Movement
 Childhood and Child Rearing
 Confucianism
 Consciousness: Chinese Thought
 Consciousness: Indian Thought
 Consilience
 Cosmology: Asia
 Cycles
 Daoism
 Demography
 Demonology
 Discrimination
 Dress
 Dualism
 Education: Islamic Education
 Empiricism
 Equality: Racial Equality
 Ethnicity and Race: Africa
 Ethnohistory, U.S.
 Fallacy, Logical
 Foundationalism
 Futurology
 Genetics: Contemporary
 Genetics: History of
 Genocide
 Health and Disease
 Hermeneutics
 Historical and Dialectical Materialism
 Hygiene
 Intelligentsia
 Internal Colonialism
 Islam: Africa
 Jainism
 Japanese Philosophy, Japanese Thought
 Kinship

READER'S GUIDE

- Law, Islamic
 Machiavellism
 Machismo
 Medicine: China
 Medicine: India
 Meme
 Memory
 Mestizaje
 Modernization Theory
 Motif: Motif in Music
 Museums
 Music, Anthropology of
 Nationalism: Africa
 Natural History
 Naturalism
 Negritude
 Objectivity
 Philosophy, History of
 Philosophy, Moral: Modern
 Philosophy of Religion
 Population
 Positivism
 Pragmatism
 Prejudice
 Presentism
 Privacy
 Probability
 Quantum
 Race and Racism: Overview
 Race and Racism: Asia
 Race and Racism: Europe
 Reason, Practical and Theoretical
 Religion: Overview
 Religion and Science
 Science: Overview
 Scientific Revolution
 Segregation
 Sexuality: Islamic Views
 Sexuality: Sexual Orientation
 Skepticism
 State of Nature
 Structuralism and Poststructuralism: Overview
 Time: China
 Time: India
 Truth
 Universalism
 University: Overview
 Wildlife
 World Systems Theory, Latin America
- FINE ARTS, HUMANITIES, SOCIAL SCIENCES, AND SCIENCES**
 Absolute Music
 Aesthetics: Asia
 Aesthetics: Europe and the Americas
 Ancestor Worship
 Anthropology
 Architecture: Overview
 Architecture: Asia
 Astronomy, Pre-Columbian and Latin American
 Beauty and Ugliness
 Bilingualism and Multilingualism
 Bioethics
 Body, The
 Cannibalism
 Change
 Chemistry
 Cinema
 City, The: The City as a Cultural Center
 City, The: The City as Political Center
 Classification of Arts and Sciences, Early Modern
 Communication of Ideas: Southeast Asia
 Composition, Musical
 Computer Science
 Consciousness: Overview
 Consumerism
 Context
 Continental Philosophy
 Cosmopolitanism
 Creationism
 Critical Theory
 Cultural Studies
 Dance
 Death
 Determinism
 Dream
 Dystopia
 Ecology
 Emotions
 Empire and Imperialism: Europe
 Environment
 Environmental Ethics
 Environmental History
 Equality: Overview
 Equality: Gender Equality
 Ethnicity and Race: Islamic Views
 Eugenics
 Examination Systems, China
 Feminism: Overview
 Fetishism: Overview
 Fetishism: Fetishism in Literature and Cultural Studies
 Friendship
 Game Theory
 Gender: Gender in the Middle East
 Gender in Art
 Generation
 Greek Science
 Harmony
 Heaven and Hell
 Hinduism
 History, Economic
 History, Idea of
 Humanity: African Thought
 Ideas, History of
 Identity, Multiple: Overview
 Intentionality
 Interdisciplinarity
 Islam: Sunni
 Islamic Science
 Kantianism
 Knowledge
 Language and Linguistics
 Learning and Memory, Contemporary Views
 Life
 Literary Criticism
 Literary History
 Love, Western Notions of
 Magic
 Manichaeism
 Maps and the Ideas They Express
 Masks

- Mathematics
 Matriarchy
 Medicine: Europe and the United States
 Medicine: Islamic Medicine
 Meditation: Eastern Meditation
 Men and Masculinity
 Metaphor
 Modernism: Overview
 Monarchy: Overview
 Modernity: Africa
 Modernity: East Asia
 Motherhood and Maternity
 Musical Performance and Audiences
 Mysticism: Chinese Mysticism
 Myth
 Narrative
 Newtonianism
 Nomadism
 Nuclear Age
 Occidentalism
 Organicism
 Paradigm
 Periodization of the Arts
 Person, Idea of the
 Philosophies: Feminist, Twentieth-Century
 Philosophies: Islamic
 Philosophy: Historical Overview and Recent Developments
 Poetry and Poetics
 Political Protest, U.S.
 Progress, Idea of
 Property
 Protest, Political
 Pseudoscience
 Psychoanalysis
 Punishment
 Pythagoreanism
 Queer Theory
 Reading
 Realism: Africa
 Reflexivity
 Reform: Europe and the United States
 Relativism
 Religion: East and Southeast Asia
 Religion: Indigenous Peoples' View, South America
 Religion: Latin America
 Representation: Mental Representation
 Resistance and Accommodation
 Responsibility
 Ritual: Public Ritual
 Ritual: Religion
 Sacred Places
 Science: East Asia
 Science, History of
 Science Fiction
 Sexuality: Overview
 Social History, U.S.
 Sophists, The
 Sport
 Stoicism
 Subjectivism
 Superstition
 Surrealism
 Symbolism
 Syncretism
 Temperance
 Third Cinema
 Toleration
 Totalitarianism
 Totems
 Tragedy and Comedy
 Untouchability: Menstrual Taboos
 Untouchability: Taboos
 Utilitarianism
 Utopia
 Victorianism
 Visual Culture
 Visual Order to Organizing Collections
 Volunteerism, U.S.
 War and Peace in the Arts
 Westernization: Middle East
 Westernization: Southeast Asia
 Witchcraft
 Witchcraft, African Studies of
 Yin and Yang



M

MACHIAVELLISM. *Machiavellism*, a word that goes back to the late sixteenth century, is a name for the theory and practice of amoral politics. In its ideal, simply abstract sense, it is not meant to coincide exactly with the views or practices of any historical individual, even Niccolò Machiavelli (1469–1527) himself. When Machiavelli praises the citizens of the ancient republic of Rome as noble and public-spirited, he is no Machiavellian. Consistent Machiavellism is unconstrained by custom, ideal, or conscience and aims only at the expedient means, lawful or not, to gain desired political ends. War is thought not only often expedient but necessary to maintain a people's vigor. The absence of moral restraint is reinforced by the fixed opinion that human beings are by nature weak, inconstant, selfish, and inclined to evil. Expositions of Machiavellism often take the form of advice for a ruler, who is regarded as indispensable to the state, and the welfare of ruler and state are considered to be identical. Aimed at practice rather than theory, the literature of Machiavellism is filled with amoral strategies to gain the ruler's ends.

Small-Scale Societies and Kingdoms

"Stateless" societies have no formal structure of government or any formal authorities. Anthropologists have made it clear that there are very few stateless societies in which violence is rare. Machiavellian deception makes its appearance wherever vengeance is taken and wars are fought. The best-known account of a violent, often deceptive people is Napoleon Chagnon's often controverted description of the Yanomamö, who live on the borderland between Brazil and Venezuela. In their chronic wars between villages, they make use of what is translated as "dastardly tricks." What was actually a raiding party once came to a village under the pretense of teaching the men of the village how to pray to a spirit that gives machetes and cooking pots. When the villagers knelt to pray to the spirit, the raiders killed them.

War, generally on Machiavellian principles, is frequent among the more organized societies called "chiefdoms." An anthropologist who studied warfare in the chiefdoms of both Oceania and North America found that it has been frequent and acute. Thus Fiji had many ruthless rulers and ruthless wars, while in North America, warfare in the form of small-scale raids seems to have been inseparable from tribal culture. In New Guinea, the surest route to leadership was by means of bold or sly killing. Some societies favored ambushing, some the destruction of property or kidnapping, and some the driving away or exterminating of the enemy. Stealthy, often treacherous raiding was usual.

In considering the Machiavellian traits of kingdoms or empires, one should at least mention those of South and Central America and Africa. The Incas justified their conquests by the claim that all other peoples had originated from them and therefore had to serve them, give them much of their wealth, and provide them—without showing any signs of grief—with children for sacrifices. The Aztecs' belief that the sun and the powers of the earth would die unless fed with human blood created a need for sacrificial victims and the wars to provide them. That Machiavellism was involved is proved by the fact that most of the victims were from other tribes, whose towns the Aztecs wrecked, whose fields they burned, and whose people they raped and murdered.

Among the African kings, the one best known for ruthlessness was Shaka (c. 1787–1828). By the conquest of many nearby peoples, he created the Zulu empire. Purposely enigmatic and frightening, and informed by a network of spies, he was as ruthless within his own country as outside it. When he gave orders to exterminate all the members of a tribe, he explained that he did so because otherwise the children would grow into possible enemies. Any relative or important person he had any reason to suspect was killed. His justification for his cruelty was that only the fear of death made it possible to hold together the many unruly clans of what would one day be a nation.

Ancient China

In Chinese tradition, Machiavellian thought and practice is associated with Legalism. Insisting on laws that apply impartially to persons of every status, Legalism provides techniques for a ruler to keep control over both officials and subjects. The first famous Legalist, Lord Shang (d. 338 B.C.E.), preached the doctrine that society could be controlled by means of penalties. When he succeeded in becoming the chief administrator of the state of Qin, he divided the population into units of five or ten persons, each responsible for the actions of all the others. Anyone failing to report an offender was to be cut in two at the waist, while someone who did report offenders was to be rewarded as if he had decapitated an enemy. Those who devoted themselves successfully to the fundamental occupations, tilling or weaving, would have their taxes remitted, but those who made socially unhelpful profits, in trade and the crafts, or were poor out of laziness would be confiscated as slaves.

A country that is strong, Shang said, can remain so only by continuing to wage war, while a country administered, as Confucians preferred, with the help of history, music, filial piety, and brotherly love, sinks into poverty or falls to its enemies.

Above all, he said, a government must promote order by means of rare but consistent rewards and frequent, consistent, severe punishments. Governed by the fear of punishment, people will obey the laws, be virtuous, and be kept happy by what they are allowed to enjoy.

The great Confucian Xunzi (c. 310–c. 215 B.C.E.) influenced the thought of the Legalists by insisting that a nation's power depends on its wealth and therefore on its inhabitants' frugality and devotion to the wealth-producing occupations, especially agriculture. He also insisted, like the Legalists, on the need for law with fixed standards of punishment and on the view, contrary to that of his Confucian predecessor Mencius, that people are by nature evil. Their nature, he says, needs to be forced into shape, so that only correct education can make them good.

Xunzi's student Han Feizi (c. 280–233 B.C.E.) argued that the ruler, out of love, should work against the natural disorderliness and self-indulgence of the people. Penalties bring order and rewards bring chaos, so penalties are the beginning of love. A state can function properly, he held, only if it has ingrained lines of command and obedience. The ruler must take many precautions to retain his rule because it is dangerous for him to trust anyone. The ruler's son, if trusted by the ruler to an incautious extreme, will be used by evil ministers to carry out their private schemes. To detect the more subtle kinds of subversion, the ruler must get the people to watch one another and be implicated in one another's crimes. To gain his own ends, the emperor should remain enigmatic and not reveal his intentions to his subordinates. Government can no longer be based on the Confucian virtues or on the model of familial relations. "The most enlightened method of governing a state is to trust measures and not men."

Li Si (c. 280–208 B.C.E.), like Han Feizi, was a student of Xunzi. Li Si was the paradigmatic Legalist because it was he who taught the king of Qin how "to swallow up the world and to rule with the title of Emperor." Appalled by his attacks on Confucian tradition, Chinese historians describe the First Emperor as a cruel, suspicious megalomaniac who by the intelligent use of force, slavery, and the conscripted labor of citizens created the great empire of China out of the motley of its many small states. In collaboration with the indefatigable First Emperor, Li Si created a unified culture, including a standardized Chinese, and a political hierarchy fully subordinate to the emperor. But Li Si is one of the greatly hated figures of Chinese history because, in order to escape criticism based on traditional standards, he tried to destroy very nearly the whole of Chinese literature and so, in effect, to destroy the tradition's moral basis and cultural continuity. To this end, in 213 B.C.E. he ordered that all books, except those on practical subjects such as medicine, divination, and agriculture, be gathered and burned. A year later, there occurred the episode—not the direct doing of Li Si—that to traditional Chinese has been the most extreme example of malignant politics: the execution of 460 scholars, who, according to Chinese tradition, were buried alive in a common grave. In the course of the later history of China, legalistic doctrines and practices were often incorporated into the ruling Confucianism.

Ancient India

Violence and treachery make a frequent appearance in the great Indian epics, the *Mahabharata* and the *Ramayana*, in which the ideal is that of a righteous king with obedient people. In the most usual Indian view, the king is related to the gods and should be revered as such. A wise man in the *Mahabharata* asks what a state without the protection of a king would be like and imagines robbers at work, women abducted, and the strong roasting the weak like fishes on a spit. The self-evident moral of such a fear is that to have no king is worse than to have to have the worst king.

The Indian science that deals explicitly with politics is Arthashastra, literally "the science that deals with *artha*, the means of subsistence." This definition turns out to be equivalent to "the science of politics." The oldest, most developed of the books dealing with the subject is the *Kautilya Arthashastra*. Its author, whose name or pseudonym, Kautilya, means "craftiness," is usually identified with Chanakya, the crafty adviser of Candragupta, who about 321 B.C.E. defeated the Nandas and created the first great Indian empire.

The *Kautilya Arthashastra* is a dryly written manual of government from the standpoint of a king's adviser. It urges the king to care for the welfare and loyalty of the farmers and of the Brahmans and priests. Religions should be respected, Kautilya says, but used for political purposes. For a successful king, he thinks, warfare is the most natural activity. Running through every subject treated in the *Arthashastra* is a concern with the safety of the king. Everyone is under suspicion, from the queen and the crown prince to the king's ministers and citizens.

To translate a pervading suspiciousness into administrative terms, Kautilya recommends an extraordinarily detailed system of domestic and foreign spying and subversion. Each agent is given a cover story, carries out the required spying, including spying on high officials, and reports back to a special station, where the report is put into code. Only a report confirmed by three spies is accepted. Spies who make mistakes are done away with quietly.

Indian literature reflects the attitudes both of Arthashastra and, more often, of those who oppose it for moral reasons. The *Arthashastra's* cynical wisdom was exported from India by the stories of the *Panchatantra* (The five books), probably compiled by about 500 C.E. and translated into some sixty languages. By means of the *Panchatantra*, Kautilya's point of view took on the imagination and humor of folktales and taught the world at large what it implicitly always knew.

Europe

The most famous European Machiavellian was, of course, Niccolò Machiavelli, and his most famous, most Machiavellian book was *Il principe* (1513; The prince). Like his other works, it was nourished by his personal experience, especially as a diplomat, and by the literature of ancient Greece and Rome. Machiavelli must have been familiar with Thucydides's ability to report on history in an objective, amoral spirit, as in the famous dialogue in which the representatives of Athens say to those of Melos that in human affairs the question of justice enters only where there is equal power to enforce it, and that

the powerful exact what they can and the weak grant what they must. Machiavelli knew Cicero's *De officiis* (On duties), which discusses the same political problems that he does, though with usually milder, more moral conclusions. Like Machiavelli, Cicero asks whether it is better for a ruler to be feared or loved—loved, Cicero concludes—and uses the image imitated by Machiavelli of the ruler as either a lion or a fox. Both Cicero and Machiavelli agree that a ruler must curb himself so as to escape hatred.

Machiavelli's Machiavellian views are that present-day human beings are incorrigibly changeable, ungrateful, and insincere; control of government therefore requires the use of force, so the ruler should be capable of leading his state in war and should be ready to abandon honesty and mercy when they interfere with effective rule. Put metaphorically, because humans act like wolves, the ruler must be the lion, and because humans do not keep their word, the ruler must also play the fox, though never openly. Knowing that humans are evil, the ruler should not be troubled by the cruelty that keeps his subjects united and loyal. But the wise ruler will keep a balance between reckless trust and the extreme distrust that unrestrained cruelty causes.

Francesco Guicciardini (1483–1540), a Florentine historian and politician and (at times) Machiavelli's friend, never became as famous as Machiavelli even though he was just as hard-headedly amoral as a political thinker, maybe even more canny, and rather more skeptical. His advice on public relations is always to deny what one does not want to be known and, regardless of even the most convincing contrary evidence, to sow doubt in people's minds by boldly stating what one wants to be believed. Mercy should be shown only when practically useful. No one who understands political life would ever show mercy when it endangers the fruit of a victory, but when it costs nothing to be merciful, mercy is politically advisable.

Guicciardini criticizes Machiavelli for reading contemporary events too often in the light of unrevealing Roman precedents. History is too mutable, he says, for us to learn much from it except not to expect any reward for good behavior or any success from the use of intelligence. The best we can do, according to him, is to maintain our dignity.

Machiavelli's *Prince* aroused interest, most of it indignant, everywhere, with the result that Machiavelli's name became a byword for evil. In Shakespeare's *Henry VI* (part 3), the future Richard III boasts that he can murder while he smiles, wet his cheeks with artificial tears, orate, deceive, conquer, change shapes, "and set the murderous Machiavel to school." As king, in *Richard III*, this self-proposed tutor of Machiavelli is finally destroyed, like Machiavelli's hero, Cesare Borgia, by failing to control his lust for power.

A few almost contemporary philosophers praised Machiavelli's ideas. Michel de Montaigne (1533–1592) refers to him in his essay "On Presumption" and says that Machiavelli is one of those writers who prefers the good of the state to his fidelity and conscience. Almost always, says Montaigne, there is some gain in a breach of faith, as in all other wicked acts. The wretchedness of the human condition is such, Montaigne goes

on, "that we are often driven to the necessity of using evil means to a good end." He sympathizes with a prince whose conscience does not allow him to do what is essential for his own preservation or the preservation of his people but doubts that such a prince will get the favor of God that he deserves ("On the Useful and the Honorable"). Though lying is to Montaigne an "accursed vice," he is ready to say that "to deprive wiliness of its rank . . . would be to misunderstand the world," and that anyone whose morals are conspicuously higher than those of his time "must either distort and blunt his rules" or "have nothing to do with us."

Francis Bacon (1561–1626), who experienced both high office and political disgrace, said that he was indebted to Machiavelli as one of those "who openly and unfeignedly declare or describe what men do, and not what they ought to do." His own aphorisms often have the disabused flavor of Machiavellism. In his essay "Of Simulation and Dissimulation," he concludes that it is best "to have openness in fame and opinion; secrecy in habit, dissimulation in seasonable use, and a power to feign if there be no remedy." Like all Machiavellians, he insists that greatness does not come to any nation that does not "directly profess arms."

Of the other philosophers close in time to Machiavelli, those most like him in their negative estimate of ordinary humans are Thomas Hobbes and Benedict de Spinoza. Hobbes (1588–1679), who does not mention Machiavelli at all, makes similar negative estimates of human behavior. But unlike Machiavelli, in *Leviathan* he belittles the idea of learning from past experience and wants his theory to be a carefully structured, syllogistic science. Spinoza (1632–1677) praises Machiavelli in his *Tractatus Politicus* (Treatise on politics) as a wise man who, because he is wise, must have had a moral purpose. He explains Machiavelli's text as probably meant to show "the folly of attempting—as many do—to remove a tyrant when the causes which make a prince a tyrant cannot be removed, but become rooted more firmly as the prince is given more reason to be afraid." Or, Spinoza says, perhaps Machiavelli wanted to show how careful a free people should be in entrusting its welfare completely to one man, who has to go in daily fear of plots and "is forced in self-defense to plot against his subjects rather than to further their interests." Rather like Machiavelli, Spinoza says that humans are by nature subject to great anger, envy, and the like and so are by nature enemies to one another. However, he adds, echoing Machiavelli's *Discourses*, it is not the inherent wickedness of the subjects of a commonwealth that leads to rebellions, wars, and contempt for the law but "the corrupt condition of the commonwealth" that has framed its laws ineptly; for "citizens are not born, but made." Spinoza also believes that a person can break his promise "by the right of nature," that is, the right of self-preservation.

Georg Wilhelm Friedrich Hegel (1770–1831) was an interestingly qualified admirer of Machiavelli. He thought that Germany, which, like Machiavelli's Italy, had difficulties in becoming a united nation, also needed Machiavelli's advice. Machiavelli, he said, had no special interest in advising a tyrant but in correcting an impossible political situation. For Machiavelli's "great and true conception produced by a genuinely

political head” expresses his understanding that, under the circumstances, the “Prince” had no choice but to secure his own power as a tyrant by all the violent means that are usually considered to be crimes. The acts are justified by the vision of the sovereignty and independence of the people, the *Volk*, which depend on the destruction of the lesser local authorities. But when the tyrant’s work is done, he automatically appears as a despot, and “then, it is the tyrant-slayers who are heroes.”

Machiavellian Rule

The assessments of Machiavelli himself are still mixed. The more favorable ones may be exemplified by that of the twentieth-century philosopher Ernst Cassirer, who wrote that Machiavelli’s accomplishment lay in not allowing his personal feelings and ideals to affect his political judgment, which was “that of a scientist and a technician of political life.” But whatever the verdict on Machiavelli the person, the Machiavellism of which he wrote pales in the face of the massive attack on conventional morality by the twentieth century’s great tyrants, Stalin, Hitler, and Mao.

Machiavellian behavior has been integral to the political and social life of every culture. One of the reasons why it is found everywhere is the universal need for a social system with an effective leader. When it is not clear what authority, if any, is to be obeyed, the result is uncertainty, social friction, wasted effort, dissatisfaction, and the willingness to follow any leader who promises to overcome the threat of chaos. In any case, morality proves to be easy to equate with conformity to the demands of leaders, however careless they may be of compassion and of truth. The individual conscience proves to be at its most elastic when leaders and followers assume that the cause they serve is of such surpassing importance that deception or cruelty in its behalf is in fact a moral virtue. Such a hope for a better society ordinarily requires that those who appear to be obstructing it should be identified and proclaimed to be its enemies.

See also *Political Science; Power; State, The; War.*

BIBLIOGRAPHY

- Bodde, Dirk. *China’s First Unifier: A Study of the Ch’in Dynasty as Seen in the Life of Li Ssu*. Leiden: Brill, 1938.
- Chagnon, Napoleon A. *Yanomamö*. 5th ed. Fort Worth, Tex.: Harcourt Brace, 1997.
- Ghoshal, U. N. *A History of Indian Political Ideas*. London: Oxford University Press, 1959.
- Gilbert, Felix. *Machiavelli and Guicciardini*. Princeton, N.J.: Princeton University Press, 1965.
- Guicciardini, Francesco. *Selected Writings*. Edited by Cecil Grayson and translated by Margaret Grayson. London: Oxford University Press, 1965.
- Haas, Jonathen, ed. *The Anthropology of War*. Cambridge: Cambridge University Press, 1990.
- Kautilya. *The Kautilya Arthashastra*. Translated by R. P. Kangle. 2nd ed. 3 vols. Bombay: University of Bombay, 1969.
- Lewis, Mark Edward. *Sanctioned Violence in Early China*. Albany: State University of New York Press, 1990.
- Machiavelli, Niccolò. *The Chief Works, and Others*. Translated by Allan Gilbert. 3 vols. Durham, N.C.: Duke University Press, 1965.

- . *The Prince*. Translated by Robert M. Adams. Rev. ed. New York: Norton, 1992.
- Meinecke, Friedrich. *Machiavellism*. Translated by Douglass Scott. New Haven, Conn.: Yale University Press, 1957.
- Scharfstein, Ben-Ami. *Amoral Politics: The Persistent Truth of Machiavellism*. Albany: State University of New York Press, 1995.
- Spinoza, Benedict de. *The Political Works*. Translated by A. G. Wernham. Oxford: Oxford University Press, 1958.
- Walter, E. V. *Terror and Resistance*. New York: Oxford University Press, 1969.

Ben-Ami Scharfstein

MACHISMO. Machos are not born; they are made. For the same reason, the term *machismo* refers to a concept that has been invented and not to a primordial cultural trait of any particular group of people. In the United States, machismo was “discovered” by social scientists and feminists much as the New World was “discovered” by Europeans five centuries earlier: U.S. scholars and feminists noticed gender oppression in Mexico and the rest of Latin America and announced that it was a particular cultural trait among Spanish-speaking men.

Although some believe machismo has ancient roots common in all “Latin” cultures since Roman times, others argue that it is an ideology that originated uniquely in Andalusia, Spain, and was carried over the Atlantic Ocean during the Spanish Conquest. There is even an opposite theory positing that machismo was indigenous to the pre-Columbian Western Hemisphere. In fact, the term *machismo* has a very short word history dating back only a few decades in the twentieth century.

This does not mean that what scholars today call sexism is new to the Americas, or that inequality based on sexuality and gender difference—today recognized under rubrics like homophobia and misogyny—are of recent vintage. But like the expression sexism, the term machismo is new.

Perhaps the most complicated aspect of the idea of machismo stems from the fact that until fairly recently the term may have been more broadly used in the United States than in many parts of the Spanish-speaking world. Although elsewhere in the world *macho* always has had a negative connotation when referring to humans—it originates in a term that designates the male of an animal species (*hembra* being the female)—in Latin America the term has a somewhat different history. Only in the 1990s did the term come into vogue more broadly in Latin America; earlier it was mainly utilized to refer to culturally determined forms of masculinity by intellectuals and activists involved in examining and struggling against oppressive regimes grounded in ideas and relations of gender/sexuality systems in journalistic writing, social science studies, and feminist critique of the oppression of women and gays.

Pegging extreme sexism to one or another culture is a dead-end at best, and a racist subterfuge at worst. In the contemporary United States the machismo mystique is regularly employed to imply that somehow Spanish-speaking men, and especially Spanish-speaking heterosexual men, are more prone

than men from other cultural backgrounds to sexist language, actions, and relationships. This is in large part a result of scholarship by U.S. academics, including anthropologists and sociologists, who have gone to Mexico and other parts of Latin America to study questions of family, kinship, and gender/sexuality and through this research have developed interpretations and paradigms consistent with hegemonic notions of studying down—that is, looking at populations that have been marginalized and oppressed (as opposed to “studying up”; that is, examining the ruling classes)—and finding political, social, and cultural fault with oppressed others.

In Latin America, the term *macho* usually must be distinguished from that of *machismo*. Macho has different meanings in different social circumstances: sometimes it refers simply to the male of a species, whether animal or plant. In other cultural contexts “to be macho” can have contradictory connotations: for older generations this may refer to something positive for men to emulate, so that a macho man is one who is responsible for the financial welfare of his family, whereas for younger men to be macho can refer to culturally stigmatized behavior like beating one’s wife, and thus in order to differentiate themselves from this kind of stigmatized practice many men of these younger generations would not readily refer to themselves as macho.

The term *marianismo* was created, in almost biblical style, in machismo’s image: it was not good for the macho to be alone, so in 1973 a North American academic invented *marianismo*. *Marianismo* has done damage to our understanding of gender relations and inequalities among Latin American and U.S. Latina women similar to the damage done by machismo among Latin American and U.S. Latino men. Now discredited, *marianismo* was originally an attempt to examine women’s gender identities and relationships within the context of inequality, by developing a model based on a religious icon (María), the quintessential expression of submissiveness and spiritual authority. This notion of Latin American women is grounded in a culturalist essentialism that does far more than spread misinformed ideas: it ultimately promotes gender inequality. Both *marianismo* and machismo have created clichéd archetypes, fictitious and cartoonish representations of women and men of Latin American origin. If a Mexican man, for instance, is abusive and aggressive, he will be labeled a macho. If a Mexican woman quietly endures such an abusive relationship, her behavior is automatically examined within the *marianismo* paradigm. But if a white man and a white woman display similar behavior, they are seldom analyzed in so cavalier and simplistic a fashion.

What is more, frequently these traits of machismo and *marianismo* are pegged in particular to working class men and women, as if those from the middle and upper strata were too sophisticated for their lives to be captured by such crude academic groupings. As theoretical categories, therefore, machismo and *marianismo* are not only culturally chauvinist but elitist as well. The machismo-*marianismo* paradigm represented an expression of a widespread intellectual colonial mentality in the behavioral and social sciences that remained dominant and unchallenged for far too long.

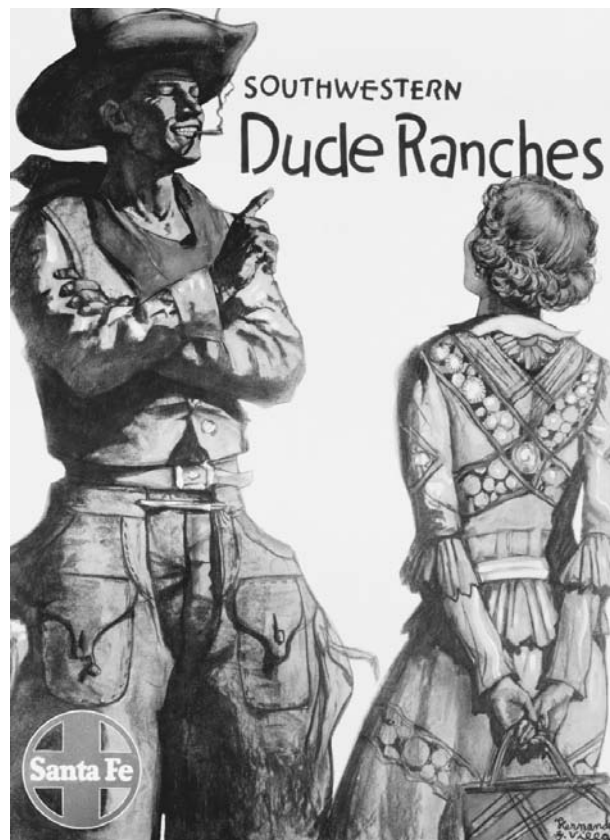

Poster by Hernando G. Villa advertising dude ranches, 1938. Although the term *machismo* is generally specific to Latin America, the concept has also spread to the United States where the connotation suggests physical toughness, masculinity, and old-fashioned family values. © SWIM INK/CORBIS

As a contemporary idea, machismo has long since entered popular discourse, including among the Latino/a populations in Latin America, the United States, and elsewhere. Indeed in the twenty-first century, Latino/a cultures are commonly defined from within as inherently macho. As such machismo has become a critical aspect of Latino/a identity politics, even when, as in this case, the cultural characteristic in question is held to be a negative set of ideas and practices.

The etymology of the idea of machismo thus has roots in political and social concerns of the late twentieth century. The origin of the term is found in texts, especially journalistic, social science, and feminist dissections of Mexican men and Latinos in general in this period. The popularization of machismo as an epithet for Spanish-speaking males of the species coincided with the rise of second-wave feminism and, later, cultural identity politics in which supposedly immutable cultural traits were linked, as if genetically, to men with one or another geographic and/or class ancestry.

The origins of the term give an indication of its future as an idea: to the extent that hegemonic ideologies and ways of constructing knowledge about Latin America and Latinos

remain unchallenged, including with regard to gender relations and inequalities, it will be possible to continue employing machismo in a stereotypical fashion and as an expedient label for complex social interactions. If, on the other hand, the idea of machismo and that of its even more problematic would-be opposite, *marianismo*, are recognized and discarded as antiquated paradigms invented to explain and teach about gender inequality in Latin American and Latino/a societies, then the idea of machismo could be short-lived. Machismo as a shorthand for sexism may have come into journalistic, social science, feminist, and popular vogue for a variety of reasons, including the well-intentioned desire to criticize gender inequality and oppression. The continued employment of this hackneyed term can only reflect the persistence of an elitist and racist model to understand gender inequities among women and men of Latin American origin.

See also *Feminism; Gender; Gender Studies; Anthropology*.

BIBLIOGRAPHY

- de Barbieri, Teresita. "Sobre géneros, prácticas y valores: Notas acerca de posibles erosiones del machismo en México." In *Normas y prácticas: Morales y cívicas en la vida cotidiana*, edited by Juan Manuel Ramírez Sáiz, 83–106. Mexico City: Universidad Nacional Autónoma de México, 1990.
- Fuller, Norma. "Reflexiones sobre el machismo en América Latina." In *Masculinidades y equidad de género en América Latina*, edited by Teresa Valdés and José Olavarría, 258–266. Santiago, Chile: FLACSO/UNFPA, 1998.
- González-López, Gloria. *Erotic Journeys: Mexican Immigrants and Their Sex Lives*. Berkeley: University of California Press. Forthcoming.
- Gutmann, Matthew C. *The Meanings of Macho: Being a Man in Mexico City*. Berkeley: University of California Press, 1996.
- Paredes, Américo. "The United States, Mexico, and Machismo." In his *Folklore and Culture on the Texas-Mexican Border*, edited by Richard Bauman, 215–234. Austin: University of Texas Press, 1993.
- Zinn, Maxine Baca. "Chicano Men and Masculinity." In *Men's Lives*, edited by Michael A. Messner and Michael S. Kimmel, 24–32. 5th ed. Boston: Allyn and Bacon, 2001.

Gloria González-López
Matthew C. Gutmann

MAGIC. Magic is the performance of acts or rites that are intended to influence a person, object, or event. It can also be performed to counter other magic. Magical acts or rites are usually performed with the assistance of mystical power. People who engage in the different activities magic encompasses can be called magicians, shamans, healers, sorcerers, or priests/priestesses. In some societies the knowledge required and the ability to perform magic are restricted to specialists who have undergone extensive training, while in other societies they are available to the common person and are learned as part of the enculturation process. In early-twenty-first-century anthropological discourse magic is generally considered to be a dimension of religious thought and practice and to be an aspect of culturally influenced understandings about causality, while in

popular culture magic is often associated with superstition and used to refer to ideas and practices considered to be false and inferior. Divination is frequently identified with magic. It concerns the attempt to learn or discover information that is not accessible to most human beings through acts of skilled interpretation and the use of mystical power. The information discovered can be used to inform an act of magic but divination is not itself the act of influencing people, objects, or events.

Since the early twentieth century, scholars writing on magic have been interested in a variety of issues that concern its instrumental effects, social functions, psychological functions, symbolic attributes, and the forms of thought that characterize it. Their inquiries and theories have offered a range of ways to approach the study of magic, have made important contributions to the development of the disciplines of philosophy and anthropology, and continue to raise central questions about the limitations of language and culturally influenced perception in the interpretation of less familiar ideas and practices. The study of magic presents contemporary scholarship with a rich history on which to build theories of intersubjective understanding. An analysis of the intellectual and epistemological history of Western thought about magic reveals patterns of ethnocentrism. Awareness of these constructions offers the possibility of advancing methods of cross-cultural and cross-society comparison in addition to the creation of theories that more fully address the range of ideas and practices that can be considered in magic.

Vocabularies used to describe the practitioners, outcomes, and qualities of magic seem to gain popularity for certain periods of time, evolve in ways that reflect the concerns of particular disciplines, and come to be associated with specific geographic areas of the world. Witchcraft and sorcery, for example, have been used predominantly in the social sciences to refer to harmful or destructive uses of magic. Another example is the relatively limited use of the term shamanism in anthropological literature to practitioners of magic in Northern Europe and the Americas. In addition, shamanism assumes that magical acts can have both harmful and helpful consequences. Anthropological literature that concerns practitioners of magic in Africa has often relied on the term *healing* to refer to helpful magic, and *witchcraft* to refer to harmful magic. In an attempt to develop a more universal vocabulary and to avoid some of the topical and regional associations carried by the terms *witchcraft* and *sorcery*, some scholars prefer only to use the term *magic*.

Magic, Religion, and Science

Of particular interest to intellectual history is the way that the terms magic and religion have been used in a social evolutionary framework to mark differences between the Western and non-Western, the advanced and backward, civilized and primitive cultures, and to characterize Christian and non-Christian religions. Many scholarly ideas are based on a set of assumptions about the differences between magic and religion, placing greater importance on the achievements of religion and greater value on its truth claims. These ideas bear some similarity to distinctions offered in the Old Testament and in early Christian theology. Some scholarly ideas address the difference

between magic and science, where the latter is viewed in more positive terms. In the nineteenth and part of the twentieth century anthropological discussions of magic, religion, and science were heavily influenced by evolutionary theories and debates about the nature of scientific reasoning and practice. They also tended to rely on the understanding that magic involved the manipulation of mystical forces and beings, was used to achieve practical goals, and was intended to affect the natural world.

E. B. Tylor (1832–1917) and James G. Frazer (1854–1941) made some of the most important early contributions to the study of magic and religion, although both relied on ethnographic information that was limited in geographic scope and lacked extensive contextualization.

In contrast to a number of previous ideas holding that magic is an undeveloped and primitive form of thought, Tylor found that magic required a rational process of analogy based on understanding the links between cause and effect. He was also interested in its symbolic properties. He did, however, emphasize the differences between thought in magic and thought in science, for he called magic a “pseudoscience” that was incorrect and deluded. His point was that people involved in magic could not differentiate between causal relationships achieved through magic, and causal relationships that occur in nature. Although he thought that both magic and religion could exist together in any given society, he proposed that magic diminished as human institutions advanced and therefore associated scientific thought with more noteworthy human achievements.

Frazier’s understanding of the relationship between magic and religion was structured according to a linear evolutionary framework composed of three forms of thought: magical, religious, and scientific. He postulated that magical thought, the earliest stage of human development, was replaced by religious thought as people observed its failures and came to believe that they could propitiate gods in order to control nature. Religious thought was then replaced by scientific thought as human beings understood natural laws.

Frazier is also noted for his insights about the thought processes that magic involves. His ideas about causality in magical thought continue to be important to arguments about differences in forms, or systems, of thought in various cultures. He observed that magic was based on two sets of assumptions about the way magic worked, which he called laws. The first was the law of similarity (characterized by homeopathic or imitative magic) and the second was the law of contact (characterized by contagious magic). In homeopathic magic he stated that “like produced like,” where a thing with a property or quality similar to another thing was thought to be able to influence it. In contagious magic, a thing in physical contact with another thing was thought to be able to influence it later and at a physical distance. He observed that scientific reasoning involved a comparable thinking process, or “association of ideas,” and for that reason viewed magic and science as fundamentally different from religion, which involved human beings’ propitiation of superior powers.

By the turn of the century the writings of scholars with a sociological orientation increasingly became more important.

They based the distinction between magic and religion on its function and on the context of its performance. For Marcel Mauss (1872–1950), magic was private and secret, and did not contribute to group activities and organizations. Émile Durkheim (1858–1917) similarly viewed magic as an individual practice in contrast to religion, which he saw to be collective. Max Weber (1864–1920) was interested in comparing the practice of magic and religion in precapitalist and capitalist societies. He observed that magic was dominant in precapitalist societies, and was on the decline in capitalist societies along with what he called the increased “rationalization of economic life.”

The Functions and Effects of Magic in Classic Anthropological Works

The early contributions of Wilhelm Wundt (1832–1920) and R. R. Marett (1866–1943) drew attention to the psychological motivations and effects of magic. Wundt, who viewed magic as a stage in the development of religion, found that the impetus to practice magic came from human beings’ fear of nature and efforts to influence it. Marett saw magic as a way for humans to address emotions stemming from insecurity and to gain courage and confidence.

Beginning with the work of Bronislaw Malinowski (1884–1942) in the Trobriand Islands of Melanesia during World War I, the insights that anthropologists brought to the study of magic were based on long-term field observations and were undertaken by the writers themselves. Along with the work of his contemporary, Alfred Radcliffe-Brown (1881–1955), he greatly contributed to anthropology’s developing body of thought on methods and standards for fieldwork. With extensive examples from his study, Malinowski found that magic in the Trobriand Islands addressed particular kinds of problems that were specific and practical. These he distinguished from the larger concerns of human life that he identified with religion.

For Malinowski, the many functions of magic included human beings’ attempts to increase the probability of success in important activities, and increase confidence to undertake them. Magic opened up possibilities for human action. He did not view magic as a characteristic of particular kinds of societies, but thought that it could be found when human beings were confronted with a lack of knowledge or ability to control something important to their lives. Malinowski also observed that magic had social and moral functions that led to better cooperation among group members. In addition, it gave people access to what he referred to as “miracles,” events that were unexpected or unlikely, thus giving them hope.

Addressing the question of the difference between magical and natural causality, Malinowski showed that the Andamanese used magic to supplement the actions of the natural world. In their horticultural and sailing activities they both relied on their own knowledge and skills, and used magic to assist them to handle unexpected events. Malinowski did not present magic, religion, and science in an evolutionary framework, but considered them as aspects of cultural systems. His approach acknowledged that the Andamanese had empirical knowledge and did not assume that magic was apart from, or a replacement for, effective activity in the world.

The work of Radcliffe-Brown among the Andamanese also provided new standards of research for the study of magic and religion. Like Malinowski, he was able to demonstrate the many social functions of magic. One of his greatest contributions was to elaborate on the term *mana*, the word for magical knowledge and power that has the potential to be both dangerous and beneficial. Objects and substances possess mana, and human beings acquire mana through their relationship with spirits.

Radcliffe-Brown observed that the Andamanese used mana as a way of distinguishing transformations in social positions. During times of transition, the dangerous aspects of mana are dominant, requiring people to observe taboos. Radcliffe-Brown stressed that the function of these ideas and the rituals associated with them was to support group collaboration and interdependence. Compared to Malinowski, he placed even greater emphasis on the social value of ritual rather than on its instrumental effects.

E. E. Evans-Pritchard (1902–1973) extended the study of the social and political context of magic. His research among the Azande of the Sudan was published in *Witchcraft, Oracles, and Magic among the Azande* (1937), a work that continues to stimulate scholarly debate and reinterpretation. His analysis of magic and witchcraft not only acknowledged their strategic uses, but permitted a more complex understanding of the relationship of witchcraft and magic to social and political institutions. He reveals that it was only men and members of the elite in Azande society who were authorized to use certain forms of magic and oracles that could identify those responsible for witchcraft. While these issues were not his central concern, his detailed and comprehensive description of Azande life allows readers to identify the implications of magic for gender relations and to support political and economic power.

One of his greatest contributions was to present magic as part of a “ritual complex” and stress their relationship rather than to focus attention on categorical distinctions. For Evans-Pritchard, magic, witchcraft, oracles, and divination worked as an integral whole and could not be understood alone. In his account of Azande ideas and practices, he showed that magic, oracles, and divination were used to address witchcraft. Oracles and divination provided information about the source of witchcraft, and magic was employed to counter it. Because the Azande used magic primarily in response to the mystical power of other human beings, and not to change nature, Evans-Pritchard did not consider the comparison of magic with science to be relevant.

One of the results of Evans-Pritchard’s detailed ethnographic work was to convey the pervasive uses of magic and witchcraft in the everyday lives of the Azande. Including both the act of engaging in rituals and ways of apprehending their world, magic and witchcraft were presented as an integral part of Azande culture. Evans-Pritchard also provided information about the contents of magical acts that could be similarly compared to those in European magic. He described how the plant and animal substances used in magic were considered to be inert until activated by the verbal spells of the owner, and explained that the Azande called these substances medicines. He contested the established notion that magic was primarily used to change the natural world with his discovery that, for the

Azande, magic was used to counter the magic of others, and was therefore an activity that was largely identified with protection. He also pointed out that it was used to punish people who misused magic, a function that was considered moral.

Thought, Logic, and Rationality in Magic

Early-twenty-first-century discussions that attempt to characterize the forms, or modes of thought in different cultures, as well as their reliance on magic, often retrace debates around the work of Lucien Levy-Bruhl (1857–1939). His ideas have implications for a series of complex questions concerning the way culture can shape thought, providing an individual with either limitations or extended possibilities. Levi-Bruhl proposed that there was a major distinction between the thought of European and preliterate people, which he termed “primitive mentality.” He stressed that the difference was due to the content of the ideas and causal understandings in culture, and was not the product of different mental capacity. He termed the modes of thought that characterized each as scientific and prescientific (or prelogical), respectively. He proposed that “primitive” societies tended to use mystical or supernatural explanations for unexpected occurrences. He contended that this form of thought does not permit a kind of logic that challenges or tests it. The thought process has an internal consistency and rationality, but does not follow the rules of scientific thinking and does not differentiate between what Levi-Bruhl called the natural and supernatural.

Some of Evans-Pritchard’s most important contributions followed from an attempt to address Levi-Bruhl’s distinction between forms of thought. Evans-Pritchard associated Azande common sense with empirical observation and science. This allowed him to contrast what he called “empirical thought” and “mystical thought,” which included magic. A central point in his discussion of magic and witchcraft was that Azande thought is founded on rational processes and empirical knowledge of their world.

His ideas offered a radical departure from the preoccupation of previous literature with the dichotomy between magic and science, and between thought that either was or was not scientific. Following Levi-Bruhl’s observation that the body of collective representations in cultures with prescientific thought limited possibilities for the thought system’s self-critical appraisal, Evans-Pritchard used examples from his Azande material to explain how this took place. Azande responses to the failure of magic to achieve the desired result were not to question their technique or knowledge, but to question the specific acts of the magician and to assume that other magic conducted to counter theirs was stronger. These and other explanations, which Evans-Pritchard termed “secondary elaborations of belief,” did not require the Azande to confront the failure of their explanation, nor the failure of their entire system of thought. This, he said, was responsible for the continuation of the belief in magic despite evidence that it was fallacious. Evans-Pritchard characterized these systems as “closed systems of thought.” He observed that they were only able to operate in limited ways that did not extend beyond their own parameters. Certain forms of scientific reasoning therefore would be outside the paradigm.

Robin Horton elaborated on this issue by contrasting open and closed systems of thought. He offered that open systems had the ability to either prove or disprove particular causal relationships between acts and natural consequences. Closed systems did not encourage the verification of what was hypothesized, and the result was that the thought system continually supplied ways of accounting for particular successes or failures.

The Role of Analogy and Metaphor

Returning to the question of how thought can be similarly compared from one culture to another, and the notion that forms of thought that appear to display differences might have underlying similarities, the contributions of Claude Lévi-Strauss (b. 1908) and Stanley Tambiah (b. 1929) are particularly useful. Accepting Frazer's observation that in both magic and science relationships of cause and effect are based on analogies, Lévi-Strauss proposed that magic could be understood as a subcategory of analogical thought, and worked on the assumption that a metaphor follows natural laws. Like most early twenty-first-century scholars, he views magic, science, and religion to occupy aspects of thought and practice in all societies.

Tambiah has taken the study of magic and analogy much farther than any other scholar. Tambiah finds that analogical reasoning is a quality of both magic and science, but claims that they involve different kinds of analogies. Science, he argues, makes an analogy between known causal relationships and unknown causal relationships. Following Lévi-Strauss, he finds that magic relies on the use of a particular kind of analogy, but he emphasizes the importance of the transfer of meaning from the physical procedures in magic to a referent in the natural world. Magic offers human beings something that science does not: creative possibilities. He also observes that magic extends meaning into practical activity. The meanings produced through ideas and practices of magic are therefore central to an understanding of the workings of culture and society.

Lévi-Strauss made another important observation about the differences between magic and religion. Taking both to be categories of thought, rather than terms that referred to different contents, he proposed that the terms were used by Western thinkers to make distinctions between their own thought and what he called "outside" thought. This outside thought was designated as inferior to domestic thought. Emphasizing that neither have particular contents or meanings, and that Western thought arbitrarily provides its own subject matter, Lévi-Strauss advocated the dissolution of the category known as magic.

Magic and Modernity

Early-twenty-first-century scholarship has expanded its views on how to study magic and how to frame its object of analysis. Peter Pels (2003) observes that the practice of scholars to frame magic as the opposite of modernity has had effects that are just now being addressed. As modern discourses work to distinguish magic from the modern they also create what he calls "correspondences and nostalgias." He and other scholars such as Jean Comaroff and John Comaroff (1993) and Michael Taussig (1997) have been increasingly interested in elaborating on the

specific forms that magic takes in modernity. Taussig addresses the question of how state power is experienced and understood by citizens of Columbia, where he conducted research. He finds that state power relies on different forms of magic to not only inspire awe from citizenry, but to conceal its deceptions and violence.

Conclusions

A central concern in the intellectual history of magic and religion is modernity. This requires an understanding of how Western scholarship has created grand narratives that present Western societies and their political projects, notably colonialism, in a favorable light. It is clear that one of the most distinctive elements of Europe's construction or imagination of itself has been its self-designation as civilized and progressive. The simultaneous construction of other groups of people as the opposite—backward, primitive, and undeveloped—was assisted by discourses in the social sciences, philosophy, and religious studies.

The theories and assumptions about magic that scholars have used, particularly in writings prior to the work of Lévi-Strauss, demonstrate particular patterns. The ways that they chose to contrast and compare material from different cultures and societies often created an opposition between Western and non-Western, advanced and backward, and civilized and primitive cultures. When magic was contrasted with religion, it was viewed to be less comprehensive and focused on practical ends, rather than ontological or existential ones. When placed in contrast to science it was seen to be either limited or incorrect, since it did not contain a logic that could test its propositions nor question its own premises. In early-twenty-first-century analyses, magic has been compared favorably to science, and there is a general assumption that it works toward an understanding of the natural world and relies on analogical reasoning. Most scholars view magic as an aspect of religion that exists in all societies. It can be viewed as part of everyday life, guiding thought and action.

People in societies across the globe have been influenced by Western thought on magic, with its attending characterizations of culture. Magic has been present in the discourses of colonial rule, Christian conversion, educational institutions, state administrative organizations, and development policies. Whether the thought comes from popular culture or scholarly investigations, the production and reproduction of dichotomies, that according to Lévi-Strauss present what is "outside" as inferior, continue to present problems for scholarship. Despite the relative lack of theoretical reflections and ethnographic works on magic prior, early-twenty-first-century scholarship is poised to extend the terrain of what can be considered to be magical and to conceptualize the new forms that magic takes in modernity.

See also Demonology; Miracles; Superstition; Witchcraft.

BIBLIOGRAPHY

PRIMARY SOURCES

Evans-Pritchard, E. E. *Witchcraft, Oracles and Magic among the Azande*. 2nd ed. Oxford: Clarendon, 1950.

- Durkheim, Émile. *The Elementary Forms of Religious Life*. Edited and translated by Karen Fields. New York: Free Press, 1995.
- Frazer, James. *The Golden Bough: A Study in Magic and Religion*. Abr. and rev. ed. Old Tappan, N.J.: Macmillan, 1985.
- Levi-Bruhl, Lucien. *Primitive Mentality*. Translated by Lilian Clare. London: Macmillan, 1923.
- Lévi-Strauss, Claude. *The Savage Mind*. Chicago: University of Chicago Press, 1966.
- Malinowski, Bronislaw. *Magic, Science and Religion and Other Essays*. Garden City, N.Y.: Doubleday Anchor Books, 1954.
- Mauss, Marcel. *A General Theory of Magic*. Translated by Robert Brain. London: Routledge and Kegan Paul, 1972.
- Radcliffe-Brown, Alfred Reginald. *The Andaman Islanders: A Study in Social Anthropology*. Cambridge, U.K.: Cambridge University Press, 1922.
- Tambiah, Stanley Jeyaraja. *Magic, Science, Religion, and the Scope of Rationality*. Cambridge, U.K.: Cambridge University Press, 1990.
- Taussig, Michael T. *The Magic of the State*. New York: Routledge, 1997.
- Thomas, Keith. *Religion and the Decline of Magic*. New York: Scribners, 1971.
- Tylor, Edward Burnett. *Religion in Primitive Culture*. Vol. 2. Gloucester, Mass.: Peter Smith, 1970.

SECONDARY SOURCES

- Bowie, Fiona. *The Anthropology of Religion: An Introduction*. Oxford: Blackwell, 2000.
- Lehmann, Arthur C., and James E. Myers, eds. *Magic, Witchcraft, and Religion: An Anthropological Study of the Supernatural*. 4th ed. Mountain View, Calif.: Mayfield, 1997.
- Morris, Brian. *Anthropological Studies of Religion: An Introductory Text*. Cambridge, U.K.: Cambridge University Press, 1987.
- Pels, Peter. "Introduction: Magic and Modernity." In *Magic and Modernity: Interfaces of Revelation and Concealment*, edited by Birgit Meyer and Peter Pels. Stanford, Calif.: Stanford University Press, 2003.

Diane Ciekawy

MANICHAEISM. Manichaeism is a now-extinct religious system characterized by dualism, asceticism, and an acute sense of worldwide mission. It originated in the teaching of Mani (216–277 C.E.), a Parthian raised in Mesopotamia in an Aramaic-speaking Jewish-Christian community known as the Elchasaites. He experienced visions in his youth that made him aware of a pantheistic presence in the world that he felt called upon to help liberate from its suffering. He broke with the Elchasaites (c. 240 C.E.), visited India, and upon his return to Mesopotamia formed his own religious community. He proselytized throughout the Persian Empire, and sent his disciples further afield to India, central Asia, and the Roman Empire. By the time of his death as a prisoner of the Persian king, Mani had succeeded in establishing a well-organized institutional structure that spread and preserved his teachings for a thousand years, despite nearly constant persecution.

Manichaeism arose in a highly cosmopolitan culture, in full awareness of antecedent west Asian religions such as Zoroastrianism, Christianity, and various pagan and Gnostic sects, as

well as the Hindu, Jain, and Buddhist traditions of South Asia. According to Manichaean teaching, Mani was the last of a series of divinely inspired prophets that included Zoroaster, the Buddha, and Jesus Christ. These divine messengers were sent periodically to particular regions of the earth to reform the true message from the corruption of time, an idea found also in Islam and the Baha'i faith. Mani brought the latest restatement of truth, and took the novel precaution of committing it to writing himself, rather than trusting his disciples to hand it down correctly. The rich Manichaean literary and artistic tradition is now reduced to fragments discovered in the twentieth century in China and Egypt, precariously supplemented for the modern researcher by polemical accounts from the religion's enemies.

Doctrine

Manichaean doctrine is premised on a material and ethical dualism. The known cosmos is a mixture of two antithetical realms of being, originally separate and eternally incompatible. The realm of light is a wholly good, harmonious universe in which God, the father of greatness, dwells with innumerable light beings, which are one with him in substance and character. The realm of darkness is a wholly evil, chaotic universe dominated by a king of darkness and his female counterpart. At the beginning of time, the realm of darkness perceives and covets the realm of light and attacks it, unaware of the harm that contact with it will bring to itself. The prescient father of greatness fends off this aggression by putting forth a series of emanations to act out a strategy of containment and ultimate reparation of light and darkness. In the primordial battle, one of these emanations enters into mixture with darkness, constraining it and forestalling a breach of the boundaries of the realm of light. This mythological background explains the evident condition of the known cosmos, in which everything is a mixture of conflicted substances and forces, engaged in a perpetual struggle for mastery. The point of Manichaean instruction is learning to identify oneself with the forces of light and goodness and striving for their ultimate reparation from entanglement with darkness and evil.

Manichaeism is closer to Zoroastrian dualism than to Gnostic or Platonic varieties in that it avoids a spirit-matter dichotomy. Both light and darkness have material as well as spiritual properties, and even the most subtle forces are usually treated in materialistic terms. Manichaeism also shares with Zoroastrianism an activist mythology and ethic, rejecting the notion of a sinful "fall" of the soul in favor of the idea of a voluntaristic "leap" of the soul in the service of God's purposes. In other details, Manichaeism has greater affinity to Indian thinking, for example in seeing souls not only in human beings, but in all living things, even in rocks and dirt. For the Manichaeans, the soul is a collective entity, a consubstantial emanation of the deity, broken up into individuals only temporarily through mixture with evil. Humans are only one small part of a universal process of struggle and liberation of the world soul. This world soul carries with it all positive properties, such as life, growth, beauty, and brightness, whereas evil contributes to the mixture only death, decay, ugliness, and gloom. Whereas for Zoroastrians the goal is to expel evil from

this world, the Manichaeans see this world as unperfectable, a temporary scene of conflict and suffering from which ultimate escape is envisioned. In this respect, Manichaeism has a common outlook with Buddhism and Jainism, as well as the more eschatological and ascetic strains of Christianity.

Based on these ideas, Manichaean practice entailed a rigorous behavioral code, designed to avoid harming the world soul in all things as much as possible, as well as ritual practices intended to aid the process of its liberation. Outbursts of anger, impatience, stupidity, greed, hatred, and violence attest to the mixture of evil with good in the human body. The evil elements must be identified for what they are, repented, resisted, and ultimately overcome by the Manichaean. Due to a number of adventitious factors, individuals have different capacities for this task, and consequently the community is divided into two grades. The first, that of the elect, was made up of those men and women willing and able to take on the most vigorous form of self-discipline, involving celibacy, poverty, and a wandering life preaching the faith. These had the ability to transmute material elements within their bodies, freeing soul fragments from the food brought to them, as well as the potential to achieve liberation at death. Those unable to adopt this life were called auditors, who remained engaged in hearth and home, but supported the elect while striving for advancement in the faith through moral growth and a better rebirth.

Later History

In the seventh century C.E., both the rise of Islam and the arrival of Manichaeism in China brought the religion into contact with new spiritual ideologies. Islam and Manichaeism had little in common doctrinally apart from minor elements of their shared west Asian heritage, which also contributed their common ritual patterns of prayer and fasting. Yet more speculative forms of Sufism and Shiism within Islam certainly drew on Manichaeism for ideas about the soul's affinity to God and transmigration. In China, Manichaean missionaries were able to draw upon, and perhaps help foster, developments within popular religion akin to Manichaean concepts. In Taoism, these included dualistic categorization of the cosmos and physiological alchemy, while in Buddhism they involved the ideas of a Pure Land (a realm of light and harmony as a goal of liberation from this world) and of Buddha Nature (an inherently pure nature in all things).

Manichaeism enjoyed a renaissance in west Asia under the tolerant Umayyad regime (661–750 C.E.), while the conversion and sponsorship of the Uygur Empire and its successor states in central Asia (c. 760–1100 C.E.) afforded secure conditions there, as well as within China, over which the Uygurs exerted strong political influence for a time. Such respites were short-lived. When public existence became untenable, Manichaeans found it convenient to take on the guise of Christians, Muslims, Buddhists, and Taoists, while maintaining their distinct doctrines and practices in secret. The suspicion of secret Manichaeans within these other religions probably far exceeded their actual number, duration, or influence. But it is possible that lingering traces of Manichaean ideas and practices in popular religion contributed to sectarian developments within Christianity, such as the Cathars of Italy and France

and the Bogomils of the Balkans, as well as within Islam, Buddhism, and Taoism. Nevertheless, the institutional structures and distinct identity of Manichaeism gradually eroded under relentless persecution, until the last remnant communities dissolved in southern China sometime in the fifteenth or sixteenth centuries.

See also Asceticism; Christianity; Dualism; Evil; Good; Heresy and Apostasy; Jainism.

BIBLIOGRAPHY

- BeDuhn, Jason David. *The Manichaean Body: In Discipline and Ritual*. Baltimore: Johns Hopkins University Press, 2000.
- Gardner, Iain, ed. *The Kephalaia of the Teacher: The Edited Coptic Manichaean Texts in Translation with Commentary*. Leiden, Netherlands: Brill, 1995.
- Koenen, Ludwig, and Cornelia Römer. *Der Kölner Mani-Kodex: Über das Werden seines Leibes*. Opladen, Germany: Westdeutscher, 1988.
- Lieu, Samuel N. C. *Manichaeism in the Later Roman Empire and Medieval China*. 2nd ed. Tübingen, Germany: Mohr, 1992.
- Ries, Julien. *Les études manichéennes: Des controverses de la Réforme aux découvertes du XXI^{ème} siècle*. Louvain-la-Neuve, Belgium: Centre d'histoire des religions, 1988.
- Sundermann, Werner. *Der Sermon von der Seele (Berliner Turfantexte XIX)*. Turnhout, Belgium: Brepols, 1997.

Jason David BeDuhn

MAOISM. *Maoism* is not a term that is easy to define. While it is common sense that Maoism refers to the vision, ideology, and political viewpoint of Mao Zedong (1893–1976), it is difficult to pinpoint the specific contents and basic features of Mao's conceptual world in the context of the evolving course of the Chinese Communist revolution. Despite Mao's adoption of Marxist-Leninist terminology, his ways of thinking had been deeply penetrated by Chinese thought and culture. In the People's Republic of China, it is "Mao Zedong Thought," instead of Maoism, that designates Mao's ideas, strategies, and policies. During the post-Mao era, the Chinese Communist Party (CCP) leadership, in an effort to legitimize the Chinese Communist state, emphasized that Mao Zedong Thought included only those of Mao's ideas and theories that had stood the test of practice, and that the "scientific system of Mao Zedong Thought" was the product of the collective wisdom of the Party leadership, rather than Mao's sole creation. Beyond China, many radical revolutionary movements and organizations have professed loyalty to a variety of self-proclaimed versions of Maoism, even long after Mao's death.

Essential Features

This essay takes Mao's own expressions of his thoughts as the basis for defining Maoism. While the contributions of Mao's CCP comrades are acknowledged, they are not regarded as an integral part of Maoism if Mao himself did not accept or adopt them. In identifying the basic features of Maoism, moreover, it is essential to test them against the development of Mao's thoughts as a historical process. Indeed, unless Mao's own

changing ideas are carefully examined, it is impossible to grasp the essence and basic features of Maoism.

Maoism as utopian vision. At its core, Maoism is first and foremost a utopian vision. Throughout Mao's political career, he fought for the ideal of universal justice and equality "all under heaven." This vision derived at one level from Mao's Sinitification of Karl Marx's concept of a communist society, yet it was also compatible with the age-old Confucian ideal of a "society of great harmony." Despite the vision's central position in Mao's conceptual realm, Mao was never able to define clearly the path and the means by which it would be turned into reality. The extraordinary ambiguity of Maoism as a utopian vision provided, on the one hand, space for Mao and his comrades to develop the CCP's ideology, strategies, and policies given the changing requirements of the Chinese revolution, and, on the other, created serious internal tensions in the Maoist system—especially when Mao's ideals proved unable to stand the test of people's lived experience.

Maoism as political ideology. Maoism is also a political ideology, representing Mao's theories and methodologies about how China and the world should be transformed in revolutionary ways. Three important features distinguished Mao's concept of revolution from other revolutionary theories in the tradition of Marxism-Leninism.

First, Mao's perception of revolution was characterized by a unique notion of permanentness in time and unlimitedness in space. In particular, Mao persistently emphasized the necessity of "continuing the revolution" after the CCP seized power in 1949. However, Mao's notion of permanent revolution was by no means a simple repetition or minor alteration of earlier formulations by Marx, Lenin, or Trotsky. While adopting such Marxist discourse as the "law of historical development" to justify his revolution, Mao often used the Chinese term *tianxia* ("all under heaven") to define the space in which the revolution should occur. The *tianxia* concept had its historical/cultural origin in the long development of Chinese civilization—implying that the Chinese way of life was the most superior in the known universe. Used in connection with *tianxia* was the Chinese word *geming*—a term that in modern times would be adopted to represent the concept "revolution." The original meaning of *geming* was that violent means must be used to deprive a ruler of heaven's mandate to rule. In employing *tianxia* to define the space in which *geming* should occur, Mao, in a China-centered manner, at once attached the qualities of permanentness and unlimitedness to his perceived revolution.

Second, Mao's perception of revolution reflected the profoundly voluntaristic belief that human consciousness, rather than the material conditions of society, would determine the orientation of historical development. For Mao, an essential condition for a revolution was the consciousness and will on the part of the "great masses" to carry out revolutionary changes. In the final analysis, whether a revolution should be judged a success or a failure depended on whether it had created a new order in the hearts and minds of the people.

Third, and closely connected with the above two features, the Maoist notion of revolution put greater emphasis on

destruction than on construction. Indeed, Maoism proved more ready to deal with tasks of destroying the "old" than to cope with missions of constructing the "new." Mao believed firmly that "no construction happens without destruction; only when destruction is under way does the process of construction begin." Not surprisingly, Mao's revolution was one of the most violent and destructive in history, not only during the stage of "seizing political power," but in the stage of "continuous revolution" as well.

Maoism as revolutionary strategies and tactics. Maoism also represents a series of strategies and tactics concerning how to make, enhance, and sustain the revolution. Mao certainly was a theorist and a man of ideas; but he also viewed himself as a practitioner and a man of action.

The central mission of Maoist revolutionary strategies concerned mass mobilization. In particular, Mao emphasized the importance of taking the peasants as the main force of the Chinese revolution. This clearly distinguished Maoism from the urban, working-class-centered mobilization strategies favored by orthodox Marxism-Leninism. Yet Mao's dependence on peasants drove him into a fundamental dilemma in furthering his "continuous revolution" after 1949. While adhering to the populist belief that the peasants' spontaneous "revolutionary initiatives" represented a natural source of the "revolution after revolution," Mao was simultaneously obsessed by the "petty bourgeois tendency" of the peasants in practical life. When the "socialist planning economy," which made industrial development the top priority, encountered resistance from the peasants, Mao argued that "a serious question is how to educate the peasants."

In Mao's own summary of his revolutionary strategies, he highlighted armed struggle, united front, and the Party's leadership role as the three keys that led the Chinese revolution toward victory. A firm believer in the idea that "political power grows out of the barrel of a gun" (*Selected Works*, vol. 2, p. 224), Mao invested great energy in developing strategies and tactics for waging revolutionary wars with both domestic and international aims. He summarized the basic principle of guerrilla war as "when the enemy advances we retreat to avoid him, when the enemy stops we harass him, when the enemy is tired we attack him, and when the enemy retreats we chase after him" (*Mao Zedong wenji*, vol. 1, p. 56). He also emphasized the importance of "making everyone a soldier" in waging a "people's war." The "united front" strategy was designed to "unite with all of those who can be united" in order to fight against the primary and most dangerous enemy. The adoption of this strategy in international affairs was often influenced by the traditional Chinese concept of "checking one barbarian by borrowing strength from another." In emphasizing the importance of the Party's leadership role, Mao originally embraced Lenin's "democratic centralism." However, with the deepening of his revolution he increasingly obscured the distinction between his own leadership role and that of the Party. Consequently, in his later years Mao openly celebrated the "correct personality cult," making enhancement of the cult of himself a crucial condition for the ongoing revolution.

In practice, Mao often interwove his ideas and plans with the discourse of revolutionary nationalism. Constantly

appealing to the Chinese people's "victim mentality"—which was unique in the sense that it reflected the sharp contrast between the Chinese people's collective memory of their nation's glorious past and their perception of its experience of humiliation in modern times—Mao found a powerful source that continuously rendered help to legitimize his programs of transforming China and the world.

The above features of Maoism, to be sure, both persisted and evolved over the course of Mao's long career. In order to achieve a genuine understanding of these features, therefore, it is essential to undertake a historical review of the shaping of Mao's worldview, as well as of the development of Mao's thought.

Shaping of Mao's Revolutionary Worldview

Mao was born into a peasant family at Shaoshan village in Hunan Province on 26 December 1893. During his childhood Mao demonstrated a rebellious and challenge-oriented character, as reflected in his frequently conflicted relationship with his father. In his early education at the village school, he read Confucian classics (which laid the foundation of his life-long habit of using Chinese classics as a reference for strategy and policy making). But he devoted his heart and soul only to the tales of rebelling peasants fighting against the exploitative and corrupt bureaucracy (as in the popular novel *Water Margin* by Shi Nai-an). At the age of seventeen, he left home to pursue further study in Changsha, Hunan's provincial capital, where he was further exposed to the rebellion-oriented cultural environment of Hunan province. All of this helped shape Mao's belief that "rebellion is by nature legitimate."

Turning to Marxism-Leninism. When Mao encountered the world beyond his home village, he saw a China that had been sinking into an ever-deepening national crisis in the face of incursions by the Western powers and Japan. Like many of his contemporaries, Mao was eager to find ways to save China and make the country strong. But he was never simply a nationalist. In search of means to save China, he not only pursued insights from China's own rich intellectual tradition, but also exposed himself to knowledge from the West, demonstrating a keen interest in such Western concepts as liberalism, democratic reformism, anarchism, and individualism. With the emergence of the iconoclastic "New Culture Movement" in the mid-1910s, Mao became increasingly critical of the Chinese past, contending that without thoroughly transforming Chinese culture no political and social reform could succeed. Yet he did not view wholesale Westernization as China's salvation. Unlike those of his contemporaries who traveled to Europe and Japan in order to "seek truth," Mao believed firmly that the key to solving the problems facing China must be sought in China itself.

In the wake of the anti-imperialist "May Fourth Movement" and under the influence of the Russian Bolshevik Revolution, Mao experienced the decisive intellectual turn toward Marxism-Leninism in 1919–1920. With only a vague understanding of such terms as "class struggle" and "proletarian dictatorship," Mao emphasized the "people's great unity" as a necessary condition for bringing about fundamental transformations "all under heaven." Taking the creation of universal justice and equality as a core mission, Mao envisioned that his

revolution would have to be carried out and completed by a "new human being" (*xinmin*), and that China would have to be transformed at the same time that the rest of the world was being transformed. With those ideas in mind, Mao became a founding member of the CCP in 1921.

Development of Mao's Thought to 1949

Until 1927, Mao did not rate as an outstanding leader of the CCP, and he made no original theoretical contribution to the Chinese revolution. In 1926–1927, Mao wrote a "Report on the Peasant Movement in Hunan," which represented a first step in his designation of peasants as the main force of the Chinese revolution. At the time, however, the report had little impact on the CCP's overall strategies.

Creating a rural-centered pattern of Communist revolution. The CCP's setbacks following Jiang Jieshi's (Chiang Kai-shek; 1887–1975) bloody counterrevolutionary coup in April 1927 released Mao from the confines of old doctrines. In order to escape the purge by the Nationalist government, Mao moved to the countryside, where he organized the Red Army and waged a violent "Land Revolution." Challenging the notion that a Communist revolution would have to be carried out by urban proletarians, Mao found the necessity and possibility—within the Chinese context—of creating a rural-centered pattern of Communist revolution. Supporting this idea lay both pragmatism and romanticism. On the one hand, Mao sensed that China's conditions precluded an urban-centered Communist revolution; on the other, he perceived that China's backwardness made it easier for a revolution carried out by the peasants—the most oppressed and, therefore, the most revolutionary group in society—to succeed.

From the beginning this Maoist pattern of revolution encountered skepticism from many CCP leaders as well as from the Comintern in Moscow. Not until the mid- and late 1930s, when the Red Army had lost its base areas in southern China and barely survived the Long March, did Mao's military genius and political wisdom come to be recognized by his comrades. Following the outbreak of the Anti-Japanese War (1937–1945), Mao, in the caves of Yan'an, found both the need and the time for theoretical elaboration.

The Yan'an years: theoretical buildup. In Maoism's development, the Yan'an years (1937–1946) represented a crucial stage. In the early Yan'an period, Mao wrote some of his most significant works, including "On Practice" and "On Contradiction." Examining the relationship between theory and practice, Mao emphasized that the former must always be tested by the latter. For Mao, this meant that Marxism should not be treated as "empty abstraction," but should be "imbued with Chinese characteristics" and "used in accordance with Chinese peculiarities." In discussing "contradiction," Mao highlighted the importance of catching the "principal contradiction" and, even more importantly, "the principal aspect of the principal contradiction." In this manner Mao virtually challenged the Marxist orthodoxy of historical materialism. He argued that, although the economic foundation generally determined the superstructure (such as politics, ideology, and culture), in specific situations—especially when the development

of the economic foundation was hindered by the superstructure—“political and cultural transformations become the principal aspect of the principal contradiction.” This voluntarism in Mao’s conceptual world cohered with his belief that a Communist revolution in China need not be restricted by the country’s backward social and economic conditions.

In the late 1930s and early 1940s, Mao developed a more comprehensive design for the Chinese revolution, contending that it would develop in two stages: first a “new democratic revolution” and second a “socialist revolution.” The mission of the first stage was to overthrow the reactionary old regime and establish a Communist-led government that would unify all patriotic social classes. The second stage of the revolution would transform state and society, resulting in China’s transition to a socialist and later communist society. Mao emphasized that, without the first stage, the second stage would be impossible; and without the second stage, the first stage would be meaningless. By introducing the concept of a “new democratic revolution,” Mao created broader maneuvering space for the CCP to adapt its strategies and policies to the practical situation in China. In the meantime, he made it clear that his revolution was already setting China on the path toward socialism and, eventually, communism.

The Yan’an years: making of the Yan’an Way. The Yan’an years also witnessed Maoism’s further development as the CCP’s dominant ideology. The “Rectification Movement” occupied a central position in this process. The movement allowed Mao to purge his opponents within the Party leadership, as well as to consolidate the CCP’s independence from Moscow’s control. As a result, the Mao cult entered the CCP’s mainstream discourse. In 1945, the Party’s constitution formally designated Mao Zedong Thought as its official ideology.

At a deeper level, the Rectification Movement offered a proving ground for Mao’s grand plans of transforming Party members into “new human beings.” Through carefully designed procedures of “criticism and self-criticism,” Party cadres were required—even forced—to expose and eliminate the “small-self” in their innermost world. These procedures, reinforced by the egalitarian environment in Yan’an during the years of war and revolution, created the myth of the “Yan’an Way”—that the “revolutionary spirit” inspired by Mao had played and would continue to play a decisive role in enabling the Party to overcome all kinds of difficulties in order to achieve its goals.

The CCP’s experience in the 1940s further solidified Maoism as the Party’s dominant ideology. China’s victory over Japan in 1945 was accompanied by the Party’s winning political influence and military strength unprecedented in its history. In the late 1940s the CCP successfully carried out a revolutionary civil war against the Nationalist government, defeating a seemingly much stronger enemy within three short years. Mao could then claim that the path toward victory had been paved by the “Yan’an Way.”

Development of Mao’s Thought after 1949

When the CCP seized power in 1949, Mao announced to the whole world that “we the Chinese people have stood up.” Yet

he also emphasized that this was merely “the completion of the first step in the long march of the Chinese revolution,” and that carrying out the “revolution after the revolution” represented an even more fundamental and challenging mission. How to prevent the revolution from losing momentum emerged as Mao’s primary concern.

Mao’s “post-revolution anxiety.” In the mid-1950s, as the nationwide “socialist transformation” (nationalizing industry and commerce and collectivizing agriculture) neared completion, Mao sensed that many of the Party’s cadres were becoming less enthusiastic about furthering the revolution. After the failure of the “Great Leap Forward” in 1958–1959, Mao realized that his revolution was losing crucial “inner support” even among the party elite. In the last decade of his life, when he pushed China into the “Great Proletarian Cultural Revolution,” Mao found that a majority of the CCP elite were unable—or unwilling—to follow the development of his thinking. Mao was preoccupied by a pivotal challenge: how could he bring about transformations “all under heaven”? Facing him was a paradox deeply rooted in the challenge itself: he had to find the means for transforming the “old” world from the very “old” world that was yet to be transformed. This profound “post-revolution anxiety” played a crucial role in shaping Maoism’s post-1949 development.

In search of a Chinese model of socialism. A major theoretical challenge facing Mao after 1949 was a question that he had previously had little time and opportunity to contemplate: What is socialism, and how could one build socialism in China? In Mao’s initial search for answers, he paid special attention to the “Stalin model”—the only existing model of building socialism from which he could learn.

With completion of land reforms and elimination of the gentry-landlord class in 1953, Mao and the CCP immediately followed the “Stalin model” for carrying out “transition to socialism.” By 1956, a highly centralized system of “planning economy” had emerged following the introduction of the First Five-Year Plan. The CCP’s Eighth Congress announced in September 1956 that, with the Communist state now possessing the major means of production, class struggle no longer figured as the principle contradiction in Chinese society. Therefore, China had entered the stage of socialist construction.

While many Party cadres were excited about this “great victory of socialism,” Mao sensed a decline in revolutionary vigor among his comrades. In order to create new momentum for the continuous revolution, as well as to pursue China’s central position in the international Communist movement, he was determined to go beyond the “Stalin model” and to push for a more aggressive and unconventional model of socialism. In the wake of the Soviet leader Nikita Khrushchev’s (1894–1971) de-Stalinization campaign and the Hungarian revolution of October 1956, Mao introduced his theory that “class struggle exists in a socialist society.” He contended that the conflict between the bourgeoisie and the proletariat continued in the sphere of the superstructure even after the economic foundation had been transformed. This formed the context in which Mao turned the “Letting One Hundred Flowers Blossom” campaign into the “Anti-Rightist” movement in the

summer of 1957, in which more than 300,000 intellectuals were branded as “class enemies.” He also brought this “ideological struggle” to the Party leadership itself and criticized Zhou Enlai (1898–1976) for his opposition to “rash advance in socialist construction.” Still with no clear definition of socialism, Mao was ready to launch in China the most radical experiments in the name of socialism and communism.

The Great Leap Forward. The year 1958, which witnessed the dramatic “Great Leap Forward,” was pivotal in Maoism’s development. Early in the year, Mao formally introduced the thesis of “one revolution after another . . . being carried out uninterrupted.” In explaining why China should and must be elevated rapidly to a higher stage of social development, Mao referred to two basic conditions: the revolutionary enthusiasm of the masses and the backwardness of the Chinese economy. Revealing again the voluntarism and romanticism at the root of his conceptual world, Mao proclaimed: “China’s 600 million people have two remarkable characteristics: poor and blank. That may seem like a bad thing, but it is really a good thing. Poor people want change, want to do things, want revolution. . . . The newest and most beautiful picture can be painted on a blank sheet with no blotches on it” (*Jianguo vilai Mao Zedong wengao*, vol. 7, pp. 177–178).

In the summer of 1958, Mao and the CCP leadership announced that “the realization of a Communist society in China is not far away.” For the purpose of rapidly increasing China’s industrial and agricultural production, Mao and the Party mobilized millions and millions of ordinary Chinese to make steel in “backyard furnaces,” and to work on miscellaneous construction and irrigation projects. What excited Mao most was that tens of thousands of “people’s communes” were founded throughout the country. In Mao’s vision, these communes, by combining “economic, cultural, political, and military affairs” into one entity, and by practicing “compensation according to need” through a public dining system, opened the door to a communist society. At one point, Mao even raised the question of abolishing the “bourgeois right,” arguing that it was time to eliminate the inequality caused by the practice of “compensation according to work.”

In order to enhance popular support for his extraordinary mass mobilization efforts, Mao ordered the Chinese Communist artillery forces to bombard the Nationalist-controlled Jinmen islands in the heyday of the Great Leap Forward. Although this caused a serious international crisis between China and the United States, Mao was unafraid, arguing that international tension had a “good side of it” as it could “bring about the awakening of many people” and was therefore beneficial to the revolution.

Mao’s utopian expectations collapsed with the failure of the Great Leap Forward, which caused one of the worst human tragedies in twentieth-century history. It is estimated that 20 to 30 million people starved to death in a nationwide famine during the 1959–1961 period. For the first time in Communist China’s history, the myth of Mao’s “eternal correctness” was called into question.

The great Sino-Soviet polemic debate. The disastrous consequences of the Great Leap Forward resulted in a major

setback in Mao’s political career. With Mao relegated to the “second line” in 1960–1962, the CCP leadership adopted more moderate and flexible policies designed for economic recovery and social stability. However, Mao never intended to abandon the theory and practice of continuous revolution. When the Chinese economy began to recover in 1962, Mao called upon the Party “never to forget class struggle.” This time, he was determined to turn the party and state that he himself had created and ruled into the target of his revolution.

Within this context the great Sino-Soviet debate erupted in the early 1960s. In the mid-1950s, Mao had already charged that Khrushchev, with his de-Stalinization efforts, risked discarding the banners of both Stalin and Lenin. Mao had further criticized Khrushchev’s strategy of “peaceful coexistence,” claiming that it obscured the fundamental distinction between revolution and counterrevolution, between communism and capitalism. Meanwhile, Mao also contended that Moscow had long carried out a policy of “great power chauvinism” toward China, characterizing Moscow as a threat to Chinese sovereignty and independence. Thus Mao effectively linked his challenge to Moscow’s leading position in international communism to the theme of safeguarding China’s national security interests. During the Sino-Soviet polemic of the 1960s, Mao further asserted that socialism in the Soviet Union had been gradually eroded by an emerging “bureaucratic capitalist class.” With such “capitalist roaders” as Khrushchev controlling the party and state, he concluded, capitalism had been restored in Soviet society. In elaborating these “lessons of the Soviet Union,” Mao emphasized that China also faced the danger of “restoration of capitalism” if its own “capitalist roaders” were not exposed and rooted out. With Mao’s push, China’s domestic politics and social life were again rapidly radicalized along with the escalation of the Sino-Soviet debate.

The Cultural Revolution. Mao’s efforts to instill a new social order in people’s hearts and minds reached new heights when the “Great Proletarian Cultural Revolution” began in the summer of 1966. Mao initiated the Cultural Revolution for two interrelated purposes. First, he hoped that it would allow him to find new means of promoting the transformation of China’s party, state, and society in accordance with his ideals. Second, he sought to use it instrumentally to enhance his much weakened authority and reputation. Both in real life and in Mao’s conceptual realm, those two purposes were interwoven—for Mao believed that his preeminent leadership would best guarantee the success of his revolution.

By carrying out the Cultural Revolution, Mao easily achieved the second goal, making his power and authority absolute during the Cultural Revolution years. But the Cultural Revolution failed to bring him any closer to achieving the first goal. Although the mass movement released by the Cultural Revolution destroyed Mao’s opponents and, for a period, the “old” party-state control system, it proved unable to create the new form of state power that Mao so much desired for creating a new society. When the mass practice of “fight self, criticize revisionism” turned into superficial “ritual procedures,” and when Mao acted to restore and enhance the state’s harsh control over society, millions of ordinary Chinese developed a

profound “crisis of faith.” Consequently, the economic stagnation and political cruelty prevailing in China made the people disillusioned with the ultimate benefits of Mao’s ideals and plans. By Mao’s own standard, the legitimacy of his continuous revolution was called into serious question as it failed the test of ordinary people’s lived experience.

In the last years of his life, it became evident that Mao’s revolutionary enterprise had lost the people’s inner support. Even Mao himself realized this. To the visiting American journalist Edgar Snow he lamented that he was “a lone monk walking the world with a leaky umbrella.”

Maoism Buried in Post-Mao China

Mao died on 9 September 1976. China has since experienced a profound derevolutionization process. The post-Mao CCP leadership discarded the Mao cult, contending that while in a general sense Mao remained a great Marxist-Leninist, he had committed mistakes throughout his career. In particular, the Party repudiated the Cultural Revolution and abandoned Mao’s theory and practice of continuous revolution. Following the pragmatic “cat theory”—“white cat, black cat, so long as it catches rats, it is a good cat”—Deng Xiaoping (1905–1997) unleashed in the late 1970s a new “age of reform and opening to the outside world.” Deng’s gradual introduction of a “market-oriented socialist economy” brought about phenomenal economic growth in China, but it also created new divisions between rich and poor within Chinese society. Maoist egalitarianism was undermined both as an ideal and a social reality. As a result, the legitimacy of the Chinese Communist regime was further called into serious question.

Against this background, the post-Mao CCP leadership has made strenuous efforts to redefine the essence of Maoism. While claiming that Mao Zedong Thought was not merely Mao’s creation but, rather, the contribution of the Party leadership’s collective wisdom, the CCP discarded Mao’s ideal of transforming China into a land of universal justice and equality, and abandoned Mao’s practice of striving for revolutionary changes “all under heaven.” In the meantime, Mao’s legacy has been represented primarily in nationalistic and patriotic terms. The greatest achievements of Mao’s revolution, according to the post-Mao CCP leadership, lay in the fact that it unified China, industrialized the country, and revived its greatness in world affairs. Maoism as a utopian vision, a revolutionary ideology, and a revolutionary way of transforming China and the world has effectively disappeared in post-Mao China’s official discourse.

Maoism beyond China

Maoism was never exclusively a Chinese phenomenon. In the late 1940s and early 1950s, when the Chinese Communist revolution achieved nationwide victory, Communist parties in such Asian regions and countries as Indochina, Malaya, and Burma claimed to take Mao Zedong Thought as the ideological guide for their own revolutions. In the 1960s, following the great Sino-Soviet debate, the international Communist movement was divided. Some parties (such as the Albanian Labor Party) and many deviating factions within the Communist parties of different nations advocated Maoism, claiming it to

be the “third milestone” in the development of Marxism-Leninism. In most cases, those parties and factions embraced the Maoist doctrines of conducting violent revolution as the only legitimate way to overthrow capitalism’s national and global dominance. They also became the CCP’s allies in the “anti-revisionist struggle” against Moscow.

This situation changed drastically with the Chinese-American rapprochement in the early 1970s and, especially, after Mao’s death in 1976. Mao’s decision to improve relations with the “U.S. imperialists” offended many “Maoist” parties and factions elsewhere, causing them (such as Albania) to denounce Mao’s China as an example of “neo-revisionism.”

The post-Mao CCP leadership’s virtual abandonment of Maoism further alienated China from the remaining Maoist parties and factions abroad. When the Khmer Rouge waged a war of survival in Cambodia’s jungle, China supported it not because of its Maoist ideology, but because it played an important role in checking Vietnam, China’s main enemy in Southeast Asia at that time. As for such Maoist revolutionary movements as the Shining Path in Peru and the Maoist guerrillas in Nepal, Beijing offered no support and paid little attention.

Does Maoism have a future? As a revolutionary ideology, Maoism has long withered in China. With the decline of such “Maoist” movements as Peru’s Shining Path, it is difficult for Maoism beyond China to attract large numbers of devotees. But it seems premature to say that Mao’s ideas have forever lost their influence. Some Maoist strategies—such as those concerning mass mobilization and armed struggle—will remain attractive to revolutionaries of generations to come. In a deeper sense, Maoism’s most lasting legacy lies, perhaps, in its utopian vision—one concerning the necessity and possibility of achieving universal justice and equality in human society. The vision’s beauty exists in its ambiguity. Because it was never clearly definable in practical political terms, the vision may have continuing appeal as long as injustice and inequality persist in human life—in China, and in other parts of the world as well.

See also *Historical and Dialectical Materialism; Marxism*.

BIBLIOGRAPHY

- Barmé, Geremie R. *Shades of Mao: The Posthumous Cult of the Great Leader*. Armonk, N.Y.: M. E. Sharpe, 1996.
- Breslin, S. G. *Mao: Profiles in Power*. London and New York: Longman, 1998.
- Chang, Jung, and Jon Holliday. *Mao*. New York: Knopf, forthcoming (2005).
- Cheek, Timothy. *Mao Zedong and China’s Revolutions: A Brief History with Documents*. Boston: Bedford/St. Martin’s, 2002.
- Chen, Jian. *Mao’s China and the Cold War*. Chapel Hill, N.C.: University of North Carolina Press, 2001.
- Dirlik, Arif, Paul Healy, and Nick Knight, eds. *Critical Perspectives on Mao Zedong’s Thought*. Atlantic Highlands, N.J.: Humanities Press, 1997.
- Li, Zhisui. *The Private Life of Chairman Mao: The Memoirs of Mao’s Personal Physician*. Translated by Tai Hung-chao. New York: Random, 1994.
- MacFarquhar, Roderick, Timothy Cheek, and Eugene Wu, eds. *The Secret Speeches of Chairman Mao: From the Hundred*

- Flowers to the Great Leap Forward*. Cambridge, Mass.: Harvard University Press, 1989.
- Mao, Zedong. *Jianguo vilai Mao Zedong wengao* (Mao Zedong's manuscripts since the founding of the People's Republic). 13 vols. Beijing: Zhongyang wenxian, 1987–1998.
- . *Mao Zedong wenji* (A collection of Mao Zedong's works). 8 vols. Beijing: Renmin, 1993.
- . *Selected Works of Mao Tse-Tung*, 5 vols. Beijing: Foreign Language Press, 1965, 1977. Available online at <http://www.marx2mao.org/Mao/Index.html>.
- Meisner, Maurice. *Mao's China and After: A History of the People's Republic*. 3rd ed. New York: Free Press, 1999.
- Schram, Stuart. *The Thought of Mao Tse-Tung*. Cambridge, U.K.: Cambridge University Press, 1989.
- Schram, Stuart, ed. *Mao's Road to Power: Revolutionary Writings, 1912–1949*. 5 vols. Armonk, N.Y.: M. E. Sharpe, 1992–1999.
- Schram, Stuart, ed. *Mao Zedong Unrehearsed: Talks and Letters, 1956–1971*. Harmondsworth, U.K.: Penguin, 1974.
- Schwartz, Benjamin. *Chinese Communism and the Rise of Mao*. Cambridge, Mass.: Harvard University Press, 1951.
- Short, Philip. *Mao: A Life*. New York: Henry Holt, 1999.
- Snow, Edgar. *The Long Revolution*. New York: Random House, 1972.
- . *Red Star over China*. Rev. ed. New York: Random House, 1938.
- Spence, Jonathan. *Mao Zedong*. New York: Viking, 1999.
- Terrill, Ross. *Mao: A Biography*. Rev. and enlarged ed. Stanford, Calif.: Stanford University Press, 1999.
- Wakeman, Frederic, Jr. *History and Will: Philosophical Perspectives of Mao Tse-tung's Thought*. Berkeley: University of California Press, 1973.
- Womack, Brantly. *The Foundations of Mao Zedong's Political Thought, 1917–1935*. Honolulu: University of Hawaii Press, 1982.

Chen Jian

MAPS AND THE IDEAS THEY EXPRESS. Cartography, the art and science of mapmaking, began before the invention of writing and continues to be fundamental to an understanding of the phenomena it represents graphically. Although typically associated with Earth, or parts of this body, its methods are applicable to the delineation of both the microcosm and the macrocosm. Thus, there is mapping of the human brain on the one hand, and the mapping of extraterrestrial space on the other. The unifying concept in mapping is the representation of spatial relationships and their interactions, and nowhere are these approaches more important than in geography. This entry will be concerned mainly with the map as it relates to physical and human geography, although some attention will be paid to extraterrestrial mapping. There will also be some references to GIS (geographical information systems); remote sensing of the environment through aerial and space imagery; and computer graphics (including animation). These are the twenty-first-century developments of more traditional forms of cartography. As Marshall McLuhan has expressed it, maps are one of a select group of media, “without which the world of science and technologies would hardly exist.”

Preliterate and Early Literate Maps

The so-called Bedolina petroglyph (Fig. 1) can be used as an example to illustrate preliterate mapping. This rock carving represents a known, inhabited site in northern Italy and was carved between 2000 and 1500 B.C.E. It was made in different stages in the Bronze and Iron Ages; interestingly, the more abstract symbols (tracks and field boundaries) appear to come from the earlier period, while the more realistic symbols (animals and structures) are from the later epoch. In any case, this plan attests to the basic importance of maps to humankind from early times and illustrates symbolization and other essential map features.

Other examples of preliterate cartography could be cited, but only a small number of such early maps have survived. A much larger corpus of maps of preliterate peoples of later times exists. In Russia in the early part of the twentieth century, a collection of more than one hundred so-called “native” maps was assembled, which included examples from Asia, America, Africa, Australia, and Oceania. They were employed for widely different purposes—from oceanic navigation to ceremonial uses. Likewise, the materials used were diverse, according to those commonly within the resource base of the makers: stone, wood, animal skins, either painted with locally available pigments or carved. It is known that “primitive” societies made maps for practical uses, but also for religious and nonutilitarian purposes.

Similarly, the maps of literate peoples in antiquity are varied in terms of purpose as well as materials employed. They are also more diverse in subject matter than earlier ones: a detailed plan of a garden, c.1500 B.C.E.; a zodiacal map carved in stone, c.100 B.C.E.; and other examples from ancient Egypt. Also from this culture and period are maps on the bases of coffins, which served as “passports” to the world beyond. A very different cartographic genre was the cadastral or land ownership plan, from which it is inferred geometry arose as such property maps, made originally for taxation purposes, were used to reconstruct boundaries, erased by the flooding of the Nile.

Contemporaneous with these Egyptian maps were those from Mesopotamia, mostly using cuneiform symbols on clay tablets. This cartography, however, varied widely according to subject matter and scale: city plans; maps of the rivers Tigris and Euphrates with the surrounding Armenian mountains; and a “world” map featuring a circumfluent ocean, with distant places represented by triangles—only one of these triangles is now intact (Fig. 2). The circumfluent ocean, shown by a circle, is a reminder that the sexagesimal system of dividing this figure, the usual mode employed in mapping to this day, came to the West from Babylon by way of Greece. Babylonian maps also contain written inscriptions.

Earth as a perfect sphere and map projections. In Greece the idea of Earth as a perfect sphere developed gradually. This concept was not, apparently, part of the culture of Egypt or of Mesopotamia, where a plane figure was used to represent the world. By contrast, once the Greeks accepted the idea of a spherical Earth, they attempted to divide the globe in different ways. They recognized parallel climate zones and antipodes, and measured the circumference of the entire globe. The most

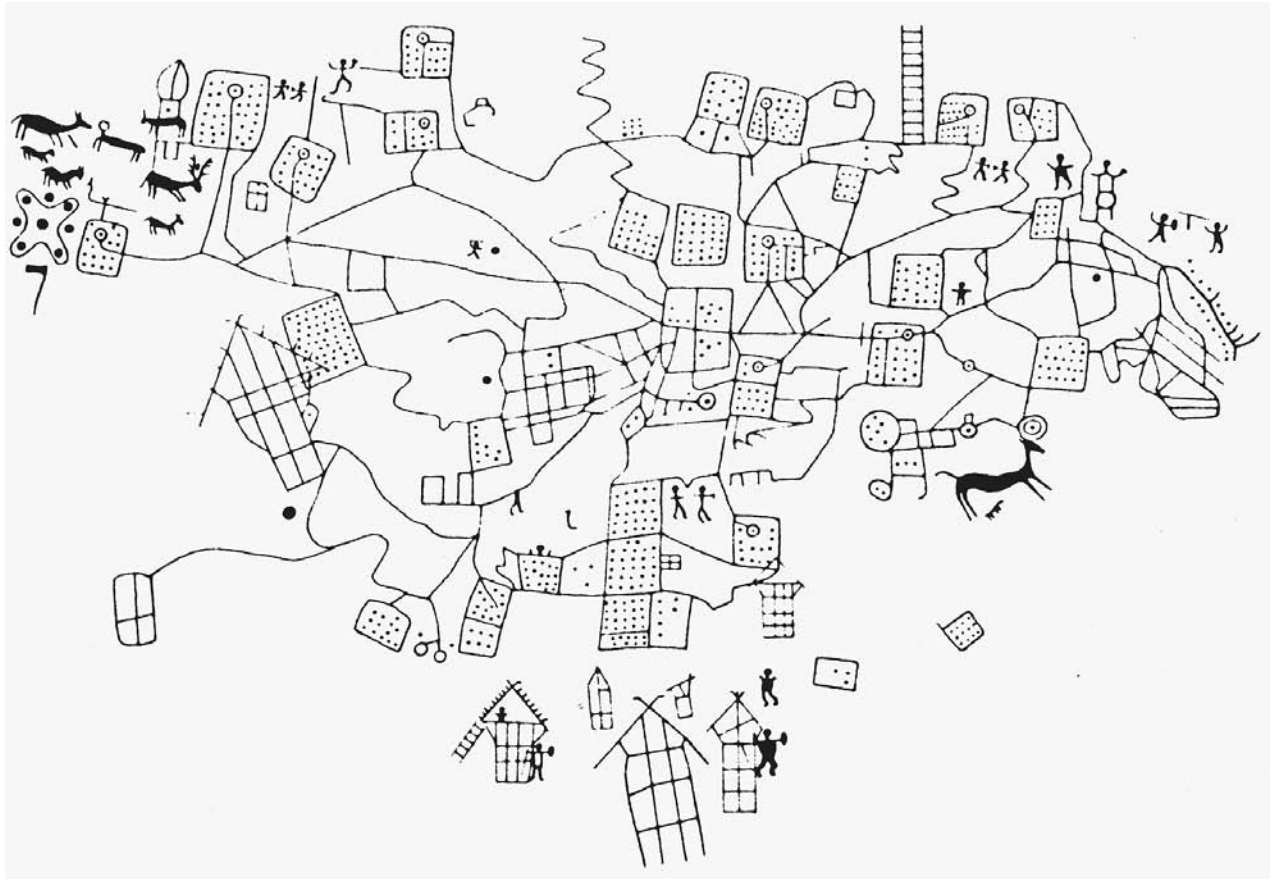

Figure 1. The Bedolina petroglyph. Rock carving, c. 2000–1500 B.C.E. COURTESY OF *IMAGO MUNDI: THE INTERNATIONAL JOURNAL FOR THE HISTORY OF CARTOGRAPHY*

successful attempt of this last was by Eratosthenes (c. 276–c. 194 B.C.E.), who, it is estimated, came within two hundred miles of the correct size of the Earth, a great triumph of antiquity. These developments made possible the invention of map projections (a systematic arrangement of the meridians and parallels of the all-side curving figure of Earth) of which two are credited to Hipparchus (2nd century B.C.E.). He espoused a smaller measure of Earth than that of Eratosthenes, and his projections, the azimuthal (radial from a point) and the stereographic (in which the circles of the Earth are represented by circles on the projection) were at first used only for astronomical purposes.

It is unfortunate that only a few examples of maps of the early Greeks have survived, because their theoretical ideas on geography (expressed in contemporaneous literature) as on many subjects, are of great importance. Apart from maps on a few early Greek coins, one must await the advances of the later Greeks, and the Romans, for visual evidence of their cartographic skills. The greatest cartographer of this later period is the Greek Claudius Ptolemy (2nd century C.E.) who worked in Alexandria and was not, presumably, related to the Egyptian dynasty of that name. Ptolemy (Ptolemaios) accepted a “corrected,” shorter figure of Earth than that of Eratosthenes, which Ptolemy also used as a base for two conic-like projections he devised. It

is not certain whether Ptolemy actually made maps himself, but his list of the coordinates of some eight thousand places and his instructions for mapmaking provided the means for others to do so. In fact, the Ptolemaic corpus was transmitted via Byzantium to Renaissance Italy, where maps were compiled from this much earlier source material. Ptolemaic maps cover about a quarter of the globe, including parts of Europe, Asia, and Africa (Fig. 3). Ptolemy devised both chlamys (cloak-shaped) and simple conic-like projections for his world maps.

Some later Greeks worked under Roman masters, who generally accepted Greek ideas; but the Romans were themselves responsible for mapping some areas not part of the Greek empire, such as Gaul (France). Eminently practical, the Romans extended their rectilinear cadastral surveys (centuriation) over large areas from Britain to North Africa and made maps of their road systems. A remarkable example of the latter is the Peutinger Table (a fourth-century copy survives of this first-century C.E. itinerary map). Some of these ideas filtered down in the Middle Ages to Europeans, who were also consumed with religious iconography on their maps.

Sacred and secular maps. The most important survivor of this genre is the (East-oriented, East at the top) *Hereford*



Figure 2. Early Mesopotamian world map. Clay tablet. COPYRIGHT THE BRITISH MUSEUM

Mapa Mundi (Fig. 4). Made around 1300 C.E., this map of the world known to Europeans in the later Middle Ages combines concepts both sacred and secular and was apparently used for didactic purposes. In addition, there were maps for pilgrimage, which, like the maps of the then-known world, were products of monasteries. Contrasting with this cartography are the portolan (haven-finding) charts of the same period covering the Mediterranean and Black Seas, later extended beyond the limits of these littoral areas. Portolan charts were based on the directions of the magnetic needle, which had apparently been transmitted westward from China, via the Arabs, to the Mediterranean. There, in the later Middle Ages, it was combined with a card of the Greek system of wind directions to produce the magnetic compass. Made with the use of the magnetic compass, the portolan chart features the compass rose, emanating from which are rhumb lines to points of the compass: four, sixteen, and finally thirty-two. The North-oriented portolan charts were of great value in navigation within the Mediterranean but were of lesser use in areas where the cardinal direction of the compass varied greatly from North. The Europeans were soon to encounter such areas in their expansion to the Atlantic Ocean and beyond. Remarkably, portolan charts can be attributed to Christian, Islamic, and Jewish cartographers, sometimes working together.

China and the Arab world. From very early times there was interest in the representation of Earth in the Orient, and there are remarkable parallels between mapmaking in this region and in the Greek world and the Latin West. In the later classical period there was intermittent contact between China and Rome, and most of the then-current cartographic forms are present in both cultures, including maps of land areas and marine charts. In fact, during the European Middle Ages, China was ahead of the West (Fig. 5). Thus the most accurate map of a large geographical area was of China (c. 1100 C.E.), which utilizes a rectangular grid, and depicts the coasts and rivers of the country with great accuracy. Chinese sea charts were at least equal in quality to those of Europe at the time. In addition, map printing in China anticipates that of the West by at least three centuries. However, after 1450 C.E. when long-distance voyaging, which had taken the Chinese to the Persian Gulf and East Africa and perhaps further, was officially discouraged, Oriental mapping became extremely Sino-centric, with the rest of the world represented as peripheral to China. This influence also persisted in Korea and Japan where, however, some innovations in mapping took place especially in the delineation of urban areas and of administrative divisions.

The Arabs, especially after the rise of Islam (7th century C.E.), traveled widely from Iberia to the Orient to proselytize and trade. By sea they reached India and established settlements there and on the coasts of China; overland they controlled a large area from Spain to the Far East. They also inherited Ptolemaic cartographic (and astronomical) ideas, and improved upon them. Thus, to take one notable example, Abd-Allah Muhammad al-Sharif al-Idrisi (1100–1154) made significant contributions to cartography. Born in Morocco, Idrisi, after having traveled extensively, was invited to Sicily by its enlightened Norman king, Roger II. Under this patronage, Idrisi compiled South-oriented maps: of the world known to twelfth-century Islamic travelers, in multiple sheets; a single sheet map of Asia, Europe, and North Africa with parallels on the Greek model of “climata”; and a book of sea charts of use to sailors, “the Sons of Sindbad,” and others. By astronomical observations the Arabs determined the correct length of features such as the Mediterranean Sea, but after this great flowering of mapmaking, like the Chinese of about the same time, the Arabs made no significant progress, and even retrogressed.

Printed Maps of a More Detailed Globe

Meanwhile, Europe was awakening from the long period called the Middle Ages, between classical antiquity and the Renaissance. A map that expresses medieval ideas, while heralding the new era, is the T–O map from Isidore of Seville’s earlier manuscript *Etymologiarum*. (These letters refer to water bodies: the Mediterranean Sea and the Don and the Nile rivers forming the “T” within the “O,” or circumfluent Ocean on these largely landcovered, east-oriented world maps.) It was published in 1472 to become the first map printed in Europe (Fig. 6). Following this, the printed map gradually replaced the manuscript map for most purposes in Europe and elsewhere.

A new approach to mapmaking arose in Europe, building upon earlier cartographic models. Greek texts of Ptolemy’s

Geographia reached Italy from Byzantium c. 1410, and were translated into Latin. Soon maps were made from these instructions, and it became the business of European cartographers to improve upon this late-classical geography, as for example in the 1427 manuscript map of Scandinavia by the Dane, Claudius Clavus. Two major developments in Europe now influenced cartography, as indeed other aspects of life: the independent invention of printing in Europe, and the spread of Europeans around the globe. The (nearly) exactly repeatable representation made possible by the printing press eventually led to a wider dissemination of geographical knowledge, while the contemporaneous discovery of half of the coasts of the world and many islands, in the fifteenth and sixteenth centuries, provided new source material for European cartographers.

The first to utilize these sources and techniques were the mapmakers of the nearly land-locked states of present-day Italy and Germany: The *Bologna Ptolemy*, 1477, twenty-six sheets printed from engraved copper plates; and the *Ulm Ptolemy*, 1486, incorporating Clavus's amendments on a single woodcut print, are examples of this cartography. After a period of coexistence, copper-plate engraving prevailed over the wood-

cut method, and the Low Countries (present Netherlands, Belgium, and the lower Rhineland) became the focus of the new global cartography. The near eclipse of woodcut printing led to the virtual abandonment of color map printing in Europe for three centuries. Copper-plate engraving does not lend itself so well to color printing as does the woodblock method, of which a few examples of colored prints from the Renaissance are extant.

With their explorations along the western shores of Africa, the Portuguese from 1420 on provided a rich source of new coastal and insular information. Likewise, the Spanish provided information about the Americas, following the discoveries by Columbus, 1492–1504, and others. Although attempts were made to keep this intelligence secret, it soon became known through the dissemination of data published mostly by the other Europeans in the form of printed maps and atlases. As indicated, the cartographers of the Low Countries eventually came to dominate this lucrative trade during the sixteenth and seventeenth centuries. Although marine charts were the first products, soon other map subjects were covered: inland provinces, urban centers especially in Europe, historical topics, biblical events, and so forth.



Figure 4. *Hereford Mappa Mundi*, c. 1300 C.E. Drawing on vellum. THE DEAN AND CHAPTER OF HEREFORD AND THE HEREFORD MAPPA MUNDI TRUST

Several individuals and families were involved in this map and atlas production: Abraham Ortelius, *Theatrum orbis terrarum* (1570, and later, in several languages); Gerhard Mercator, with the map projection that bears his name (1569) and

Atlas (1595); Georg Braun (Joris Bruin) and Frans Hogenberg, *Civitates orbis terrarum* (1572, and later); Lucas Janszoon Waghenaer, *De Spiegel der Zeevaerdt* (1584), translated into English as the *Mariner's Mirrour* (1588); and others. There were

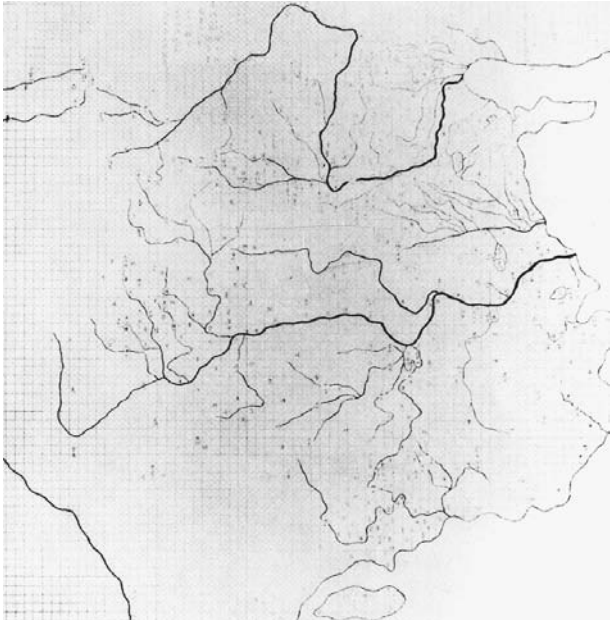

Figure 5. Early map of China with rectangular grid, c. 1137. Carved on stone. REPRINTED WITH THE PERMISSION OF CAMBRIDGE UNIVERSITY PRESS

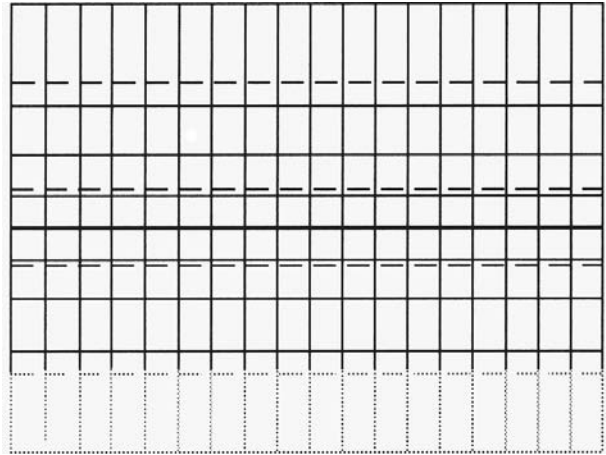

Figure 7. Mercator Projection for world map, 1569.

the graticule (lines of latitude and longitude) invented during this period. A few of these are still in use today, including the Mercator Projection (Fig. 7), on which any straight line is a correct compass direction and thus of great value to navigators, but which has been much misused for mapping Earth distributions, where correct size is important. The English mathematician Edward Wright provided an explication and details for construction of this projection (not given by Mercator) and it was popularized by Robert Dudley and others in the seventeenth century.

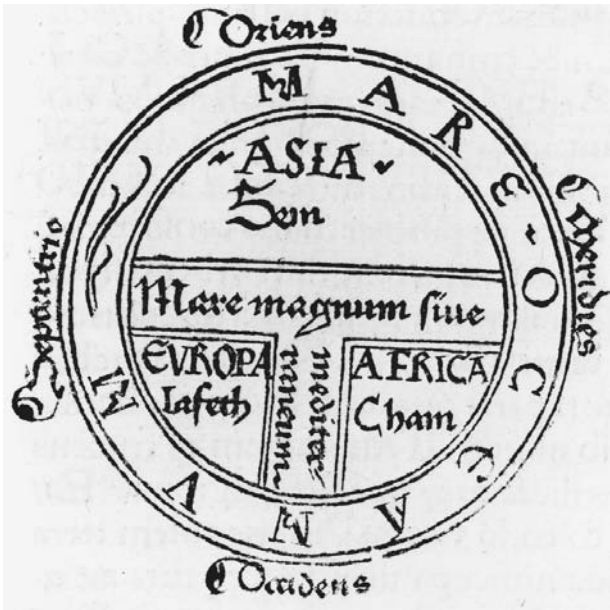

Figure 6. T-O world map from *Etymologiarum* (1472) by Isidore of Seville. BY PERMISSION OF THE BRITISH LIBRARY, IB.5438

many followers and imitators of these pioneers, and some Renaissance maps and atlases, many hand-colored prints from monotone engraved plates, became more decorative than innovative, but are prized as collector's items to this day. The greatest cartographer of the sixteenth century was Mercator, whose projection was one of a dozen new ways of expressing

Early modern academies and innovative methods of representation. The Italian astronomer Giovanni Domenico Cassini (1625–1712) initiated another new approach to map-making when he accepted an invitation to the then recently founded Paris Observatory. Both that institution, and the observatory at Greenwich, England, were established in the middle of the seventeenth century through the sponsorship of the also newly founded Académie Royale des Sciences in France, and of the Royal Society of London, respectively. These academies were to play an important role in the development of a more scientific cartography, which characterized the mapping of the Earth during the following three centuries.

In a period of over one hundred years, four generations of the Cassini family supervised the accurate topographic mapping of France in multiple sheets. The first step was to measure the length of a degree of latitude with great accuracy, which was completed in 1670. From this base, a network of triangles was eventually extended across the whole country. The work of filling in detail, covering more than 180 sheets, was not finished until 1793. One unexpected result of this work, and measurements by French surveying expeditions at the Equator, and at high northern latitudes of Europe, was confirmation of the hypothesis of Isaac Newton that the Earth is an oblate (polar-flattened) spheroid; not a prolate spheroid, or perfect sphere, as proposed earlier. Shortly, detailed topographic surveys were undertaken in other European countries and in their overseas possessions. Thus India, under the British,

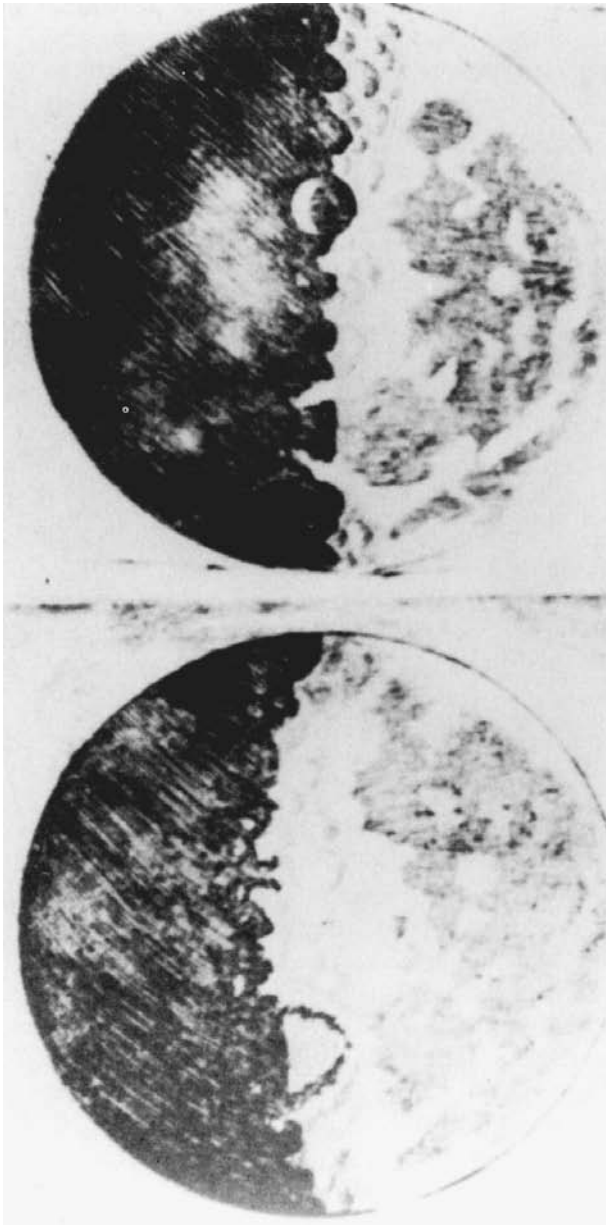

Figure 8. Lunar map by Galileo from *Sidereus nuncius* (1610).

became one of the best surveyed large countries at a fairly early date.

Other directions in which cartography developed in the seventeenth and eighteenth centuries include: astronomical mapping; thematic or special-subject mapping of Earth; the development of new representational techniques; and innovative map projections. The invention of the telescope led to the mapping of the Moon; Galileo's sketch map of 1610 was the bellwether of a large number of other lunar maps (Fig. 8). Other astronomers who made contributions to this new field of mapping include: Franciscus Fontana, Johannes Hevelius, Giambattista Riccioli, and Giovanni Domenico Cassini. Through these scientists the mapping of the side of the Moon

visible from Earth was improved and features named. Thematic mapping had existed before the scientific revolution of the seventeenth century, but a new cartography developed in this period, based on instrumental surveys: maps of wind directions and of magnetism by Edmond Halley; and isobathic (depth) mapping by Nicholas Cruquius are examples of the new scientific cartography (Fig. 9). Innovative methods of representation related to these developments included the isobath and the isogonic line, two of the earliest forms of the contour method, which was so greatly expanded in the following centuries that now there are some fifty types of isoline in use. The development of new and useful map projections also mark this period. A number of mathematicians were involved in the invention of different ways of representing the Earth on a grid or graticule (lines of latitude and longitude). In this regard particularly important were the equal-area projections of the German-Swiss Johann Lambert (1728–1777), arguably the most prolific inventor of map projections of all time. These advances continued as new overseas areas were “discovered” and mapped, facilitated by improved ships, and the solution of the problem of determining longitude at sea. The resolution of this age-old enigma in the late eighteenth century was owing to the invention of the marine chronometer, one of several devices that profoundly affected navigation and cartography.

Nineteenth Century: General and Thematic Mapping

The nineteenth century was a period of consolidation and diversification. Except for the polar regions, the main coastlands and islands of the world had been explored and charted at least at the reconnaissance level by 1800. However, much remained to be delineated, especially in the continental interiors (except Europe, which was reasonably well mapped by this date). Expeditions, mostly originating in Europe, were dispatched to all parts of the world in the nineteenth century, and small-scale general mapping became a large part of the activity of geographical societies that were founded at this time. Similarly in the Americas, interior areas were explored and mapped, at first in a provisional manner, but using instrumental surveys. Thus the world's great rivers, inland seas and lakes, mountain ranges, deserts, and so forth appeared on general sheets and atlas maps, and geography became an important school, college, and university subject.

Along with this was an interest in thematic cartography, in which distributions of phenomena hitherto little known were investigated and mapped. The beginning of regular censuses in this period in many countries provided a large body of mappable data, especially on the human population. Soon demographic maps were produced, and so-called qualities of population also received attention from cartographers—disease (as in the highly informative maps of deaths by cholera in London of Dr. John Snow), crime, poverty, and so forth. Land-use maps of crops, forest cover, and urban forms soon followed, but perhaps the most remarkable development at this time was in geologic mapping.

Geologic mapping. Great scientists turned their attention to studying the strata of the earth, as mines and canal and railroad cuts revealed the earth's substrate. Those associated with the new science of geology included James Hutton (1726–1797) in

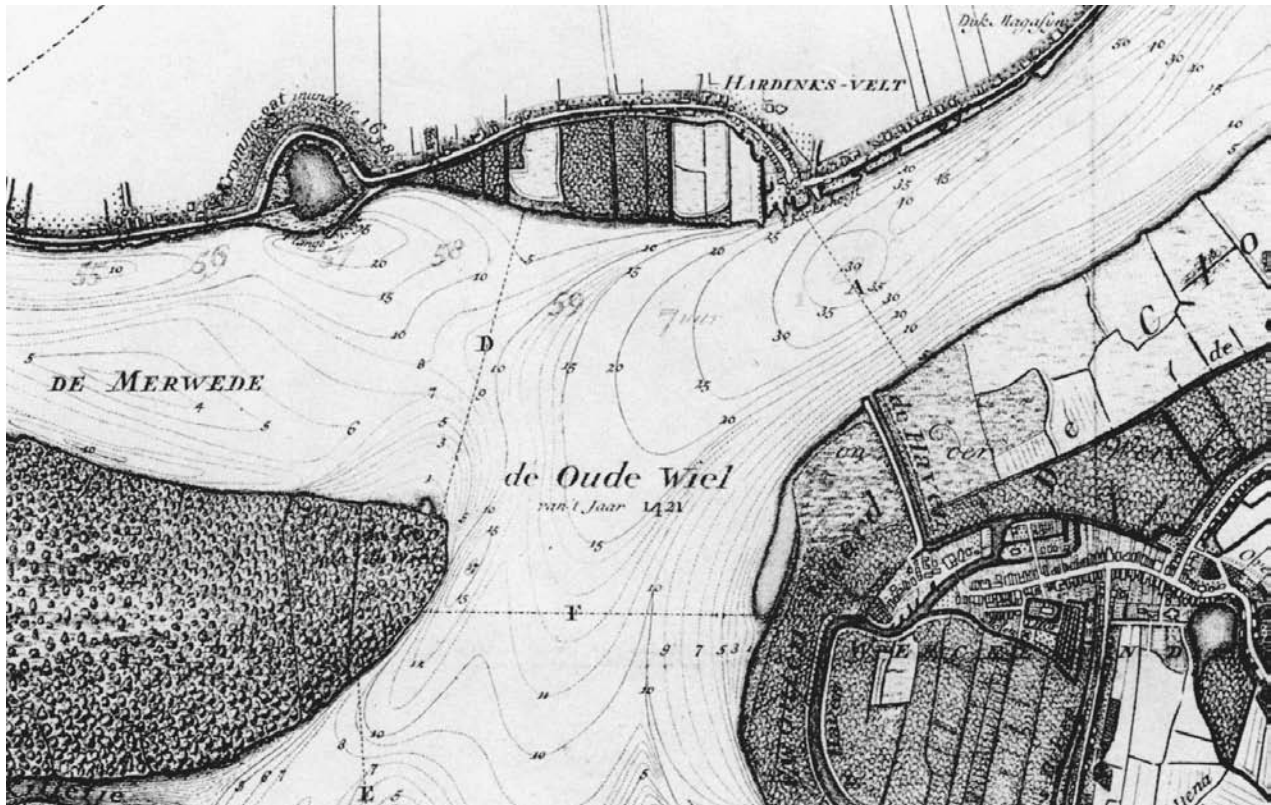

Figure 9. Section of 1729 isobathic chart of the Merwede River by Nicholas Cruquius.

Scotland, Abraham Gottlob Werner (1749–1817) in Germany, and Georges Cuvier (1769–1832) in France. But it was a contemporary of these natural philosophers, the English civil engineer William Smith (1769–1839), who is credited with successfully correlating fossils with associated strata. Smith used conventional colors and notations for rock types, based on age and lithology, and thus greatly advanced geological mapping (Fig. 10). So influential was Smith's work that when a federal, general topographical mapping agency was founded in the United States (much later, in 1879), it was named the United States Geological Survey (USGS), in contrast to the earlier, military or quasi-military topographic surveys in the Old World.

A man with vision large enough to put all of the preceding geographical knowledge into a logical framework was the Prussian Alexander von Humboldt (1769–1859) in his *Kosmos*; his fellow Prussian, Carl Ritter (1779–1859), was a great geographical educator. Both contributed original ideas to cartography: Humboldt with continental maps and profiles, and isothermal diagrams; and Ritter with the concept of altitude tints on general relief maps (this was later formalized with conventional colors for elevation in use today).

The growing United States was the beneficiary of European expertise, as when Humboldt visited Thomas Jefferson, who (like his predecessor in the U.S. presidency, George Washington) was a surveyor and cartographer. It was through Jefferson that the rectangular method of cadastral survey was applied to

the Public Domain, the most extensive example of uniform property mapping in the world. This method contrasts with irregular (metes and bounds) cadastral surveys used in the eastern United States and over most of the land area of Earth. Other Americans made signal contributions to mapping; for example, Matthew Fontaine Maury's (1806–1873) wind and current charts greatly reduced the time taken on long voyages in the period of sailing ships. Great progress was also made in land travel through the railroad, with maps used in determining the best routes and later, when the railways were built, to assist travelers in planning trips.

The traffic-flow maps of Ireland by Henry D. Harness (1804–1883) are especially innovative contributions to transportation geography. More rapid travel in an east-west or in a west-east direction necessitated the development of uniform time zones. This was accomplished in 1884 at an International Meridian Conference held in Washington D.C., when Greenwich (England) was approved as the global Prime Meridian, and the center of the first of twenty-four (one hour) time zones, which were mapped. Lithography, which eventually led to color printing of maps, was also a nineteenth-century innovation as far as cartography was concerned.

Twentieth Century: Changing Technologies

These advances continued and accelerated in the twentieth century through such developments as the airplane and



Figure 10. Section of William Smith's geological map of England (1815).

photography in the first half of the century; and space probes and more exotic imaging in the second half.

Controlled flight. Although balloons were used earlier, it was only after the development of controlled flight, through the airplane in the first decades of the twentieth century, combined with viable photography, that the new science of photogrammetry could be realized. Overlapping vertical aerial photographs could be taken at regular intervals, which, when viewed through a stereoscope, give a remarkably accurate three-dimensional view of Earth. This greatly facilitated geodetic and contour mapping, which gradually displaced other, less quantitative methods of relief representation. As photogrammetry progressed it provided a basis for mapping that was more accurate than was possible previously, and could be accomplished in much less time. It was also possible to map areas without the necessity of field work except perhaps, when feasible, for checking. Such mapping required a big capital investment, so that it became a largely national enterprise, with richer countries sometimes undertaking aerial surveys for poorer ones.

Space. In the second half of the twentieth century (partly as a result of German advances in rocketry in the first half), as well as indigenous programs in those countries, Russia and the United States became the protagonists in a “space race.” But it was the more peaceful applications that advanced cartography particularly. The first science to be improved was meteorology, as weather maps produced on a daily, or an even shorter time frame, revealed patterns that had not previously been appreciated, as well as facilitating weather forecasting on a regular basis. But soon other distributions, such as land use, were imaged and monitored. This was made possible by the Landsat program of the United States, whose low-resolution imagery was made available to all countries. Remarkable Russian contributions included the first images of the previously unobserved side of the Moon. Soon the United States landed humans on this body, from which images of the whole of planet Earth were made. A great many different parts of the electromagnetic spectrum were utilized in space imaging: color, color infrared, ultraviolet, microwave, radar, and so forth, which either singly or in combination revealed remarkable patterns on Earth, and on extraterrestrial bodies. Other countries such as France concentrated on space imaging of smaller areas of Earth with higher resolution. The new science was designated “remote sensing” of the environment.

Topographical and geological mapping. From the earliest years of the twentieth century there had been a desire to have uniform map coverage of the globe. This was proposed by Albrecht Penck (1858–1945), and it became formalized as the International Map of the World (IMW) on the scale of 1:1,000,000 (one unit of the map equals one million units on the Earth). Although supervised by the League of Nations and (partly because some countries failed to cooperate) later by the United Nations, the project was never completed. However, during World War II such coverage was compiled as the World Aeronautical Chart (WAC), and the two projects combined under the supervision of the United Nations (Fig. 11).

Along with these international efforts at mapping, the nations of the world continued their own cartographical activities including, especially, the production of topographic and

geological maps. But on a global basis that coverage is very uneven. The same is true for urban population and transportation mapping, which is largely the responsibility of local agencies, or even private bodies. For example, the automobile or road map, an extremely important cartographic form, is mainly undertaken by oil or tire companies, or by automobile associations in the United States, and other countries. Maps for classrooms and for other educational purposes, in most countries of the world, are likewise the concern of private map companies. This has made commercial cartography highly varied in quality, but also sometimes surprisingly innovative. It is unlikely that government-sponsored cartography alone would have produced such artistic products as the global-perspective renderings of Richard E. Harrison, the natural color relief maps of Hal Shelton, or the simulated three-dimensional isometric urban cartography of Herman Bollmann. Similarly, the statistical maps of László Lácó or the economic maps of W. William-Olsson are the product of freelance or university-based cartography. Likewise some of the most innovative projections of modern times are the work of non-government employed cartographers, including in the United States, R. Buckminster Fuller and J. Paul Goode, but such individuals are sometimes funded by government grants. The printing of maps was also advanced by color photolithography from high-speed presses at this time.

Exploration and mapping. In the twentieth century two large realms of Earth were systematically explored and mapped: the polar areas and the deep oceans. This was made possible by modern technology and, often, great human effort. Although the Northeast Passage (north of Asia) was navigated by the Baron Nils Adolf Nordenskiöld (1832–1901) in 1878–1879 in his ship *Vega*, the Northwest Passage (north of North America) was not traversed completely by ship until 1903–1906, by Roald Amundsen (1872–1928). The North Pole, or a close approximation to it, was attained over land and ice by Robert Peary (1856–1920) and the African-American Matthew Henson in 1909. These explorers were too rushed to engage in mapping, but they were later followed by aviators who had cameras and better views of the polar landscape, provided by the airplane. Nordenskiöld spent his later years collecting and studying old maps (an interest of many professional cartographers, and others).

Antarctica was little known until the twentieth century, when explorers from a number of countries made concerted efforts to explore and map the “Great White Continent.” Amundsen reached the South Pole in late 1911, and Robert Scott (1868–1912) and his party died in returning from his attempt early the next year. These efforts did not lead immediately to a profound understanding of Antarctica, which was greatly advanced, however, by cartography during the International Geophysical Year (IGY) in 1958. This enhanced knowledge was made possible in part by photogrammetry, as was the 1953 conquest of Mount Everest by Edmund Hillary and the Sherpa Tenzing Norkey (1914–1986) a little earlier.

Another realm, the world’s oceans, has also yielded its secrets grudgingly. Except for coastal areas, little was known of the oceans’ depths until sonic sounding (from c. 1950 on) revealed the rich variety of forms of this greater part of Earth’s lithosphere. The continuous trace, or profile, which is recorded

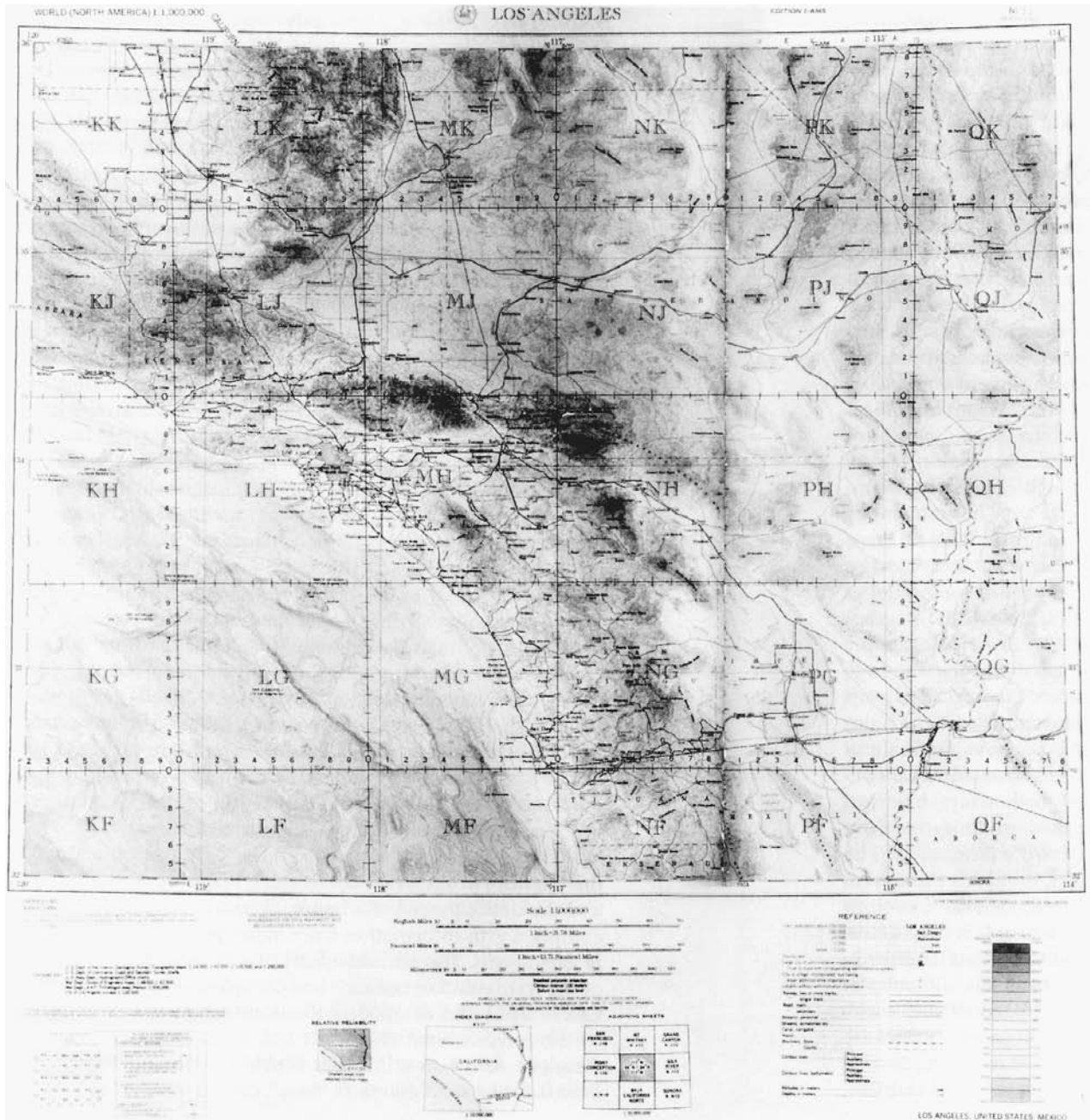

Figure 11. Map of Los Angeles, California, derived from the International Map of the World. U.S. GEOLOGICAL SURVEY

while a ship is in motion by sonar can be converted into map form revealing, for example, the profound deeps and continuous ridges of underwater areas. This cartography also confirmed the highly controversial, but now generally accepted, theory of continental drift or displacement. Cartography is so important that it can be said that a geographical discovery may not be accepted as valid until it has been authenticated by mapping.

Computer mapping. There is a close correspondence between progress in cartography and the general development of

science and technology. Thus, the computer has transformed cartography since the early 1980s as much as, or more than, printing, flight, and photography did at earlier times. The computer permits manipulation of large data banks and the production of maps made without benefit of hands. It also facilitates the making of animated maps for illustrating the dynamics of areal relationships. In this way a fourth dimension has been added to cartography—time. More maps are probably now viewed on screens, whether animated or not, than in any other medium.

This short survey of cartography has discussed how maps have conveyed ideas and represented phenomena of a wide variety of distributions. They have recorded important achievements of humankind from considerations of the shape of the earth to setting foot on the lunar surface. Preliterate as well as advanced societies have contributed to the art and science of mapping. In fact, cartography is a barometer of the progress of humankind and a reflection of changing technologies. Thus it has been advanced by inventions such as printing and flight, but also by geographical exploration and statistical methods. In the twenty-first century further dramatic developments in this ancient field of endeavor will continue and increase.

See also *Africa, Idea of; America, Idea of; Geography; Perspective; Representation.*

BIBLIOGRAPHY

- Bagrow, Leo. *History of Cartography*. Revised and enlarged by R. A. Skelton. Cambridge, Mass.: Harvard University Press, 1964.
- Brown, Lloyd A. *The Story of Maps*. Boston: Little, Brown, 1949.
- Campbell, Tony. *The Earliest Printed Maps, 1472–1500*. Berkeley and Los Angeles: University of California Press, 1987.
- Coppock, J. T., and D. W. Rhind. "The History of GIS." In *Geographical Information Systems*, 2 vols., edited by David J. Maguire, Michael F. Goodchild, and David W. Rhind. New York: Longman, 1991.
- Dilke, O. A. W. *Greek and Roman Maps*. Ithaca, N.Y.: Cornell University Press, 1985.
- Harley, J. B., and David Woodward, eds. *The History of Cartography*. Vol. 1. Chicago: University of Chicago Press, 1987. This is the first volume of an ongoing multivolume project.
- Howse, Derek, and Michael Sanderson. *The Sea Chart*. Newton Abbot, U.K.: David and Charles, 1973.
- Kain, Roger J. P., and Elizabeth Baigent. *The Cadastral Map in the Service of the State*. Chicago: University of Chicago Press, 1992.
- McLuhan, Marshall. *Understanding Media*. New York: McGraw-Hill, 1964.
- Parry, R. B., and C. R. Perkins. *World Mapping Today*. Boston: Butterworths, 1987.
- Shirley, Rodney W. *The Mapping of the World, 1472–1700*. London: New Holland, 1993.
- Skelton, R. A. *Explorers' Maps*. London: Routledge and Kegan Paul, 1958.
- Snyder, John P. *Flattening the Earth: Two Thousand Years of Map Projections*. Chicago: University of Chicago Press, 1993.
- Thrower, Norman J. W. *Maps and Civilization: Cartography in Culture and Society*. 2nd ed. Chicago: University of Chicago Press, 1999.
- Wallis, Helen, and Arthur H. Robinson, eds. *Cartographical Innovations: An International Handbook of Mapping Terms to 1900*. Tring, U.K.: Map Collector Publications, in association with the International Cartographic Association, 1987.

Norman J. W. Thrower

MARIANISMO. See *Machismo*.

MARRIAGE AND FERTILITY, EUROPEAN VIEWS.

Prior to the nineteenth century, the image of the patriarchal family was a crucial component of both moral injunction (as in the Judeo-Christian fourth commandment to "honor thy father and mother") and political organization. Marriage was the keystone in the arch of social solidarities; it also signaled the creation of a new reproductive unit. For the individuals involved, marriage was at once a moment of social and personal transformation. To be married was an essential attribute of adult status. However the sexual bond at the core of these marriages was more problematic.

Judeo-Christian Tradition

Its inheritance of intertestamentary Judaism, more particularly from the radical fringes that had a fanatical devotion to self-abnegation and ritual purity, gave ancient Christianity a profoundly ambivalent attitude toward the body and sexuality. As Saint Paul wrote to the Corinthians, it was better to marry than to burn with desire (1 Cor. 7:33). Marital sexual relations were given a grudging acceptance although it was made clear that holy activity was incompatible with them: "Do not refuse each other except by mutual consent, and then only for an agreed time, to leave yourselves free for prayer" (1 Cor. 7:5). This ambivalence towards sexuality was emphasized in Saint Paul's message to fathers: "He that giveth his daughter in marriage doeth well, but he that giveth her not doeth better" (1 Cor. 7:38). The Pauline ideology of sexual austerity was later confirmed within the newly established, fourth-century Church by such powerful prince-bishops as Ambrose of Milan, who was Augustine's patron and mentor. He observed, "Marriage is honourable but celibacy is more honourable; that which is good need not be avoided, but that which is better should be chosen."

Although the continuities with its original religious milieu are striking so, too, were the changes—Christianity radically broke away from its Judaic and pagan inheritance in separating descent from reproduction. Christianity was from its beginnings a religion of revelation that believers joined by being reborn in Christ's grace. For Christians, therefore, expectations of salvation were not linked with lineage nor were the achievements of ancestors passed on to descendants. Because charisma was not transmitted, Christians were not enjoined to maintain the patriline as a religious task nor were they expected to continue the cult of the dead through physical or fictitious descendants. Its novel restrictions on the ancient practices of endogamy, adoption, and concubinage made it more difficult for the propertied classes in the Roman Empire to transfer property within the family over generations because it closed the option of creating tight, endogamous knots of restricted elementary families within which wealth could be secured in the face of demographic uncertainties.

The early modern European family system was related to the unique Christian emphasis on rebirth in Christ. This religious concept wrapped both family life and sexuality in the institutional structure of the Church. The central position of baptism in Christian society was driven by the logic of its theology that every Christian was born carnally and in sin but was then reborn spiritually in Christ's grace. Baptism was a

second birth that provided a rite of entry into the Church and full citizenship in the secular world.

This holy relationship and the accompanying incest taboos found fertile soil north of the Alps where they were grafted onto Frankish kinship systems. Papal decretals, royal capitularies, episcopal statutes, canonical collections, penitentials, and sermons continuously reiterated the point that spiritual kinsmen/women were sexually off-limits to one another. In this way, the northwest European system of family formation decisively turned its back on inherited traditions of endogamy.

Puberty and Marriage

Historical demographers have provided further evidence that the early modern, northwestern European practice of deferred marriage among women was not common in earlier periods among Mediterranean populations in which few girls seem to have delayed marriage much beyond puberty. In ancient Mesopotamia, for example, teenaged girls were married to adult men in their thirties as was the case among the Jews whose intimate lives have been chronicled in the remnants of the Cairo genizah. One gains some appreciation of the rabbinical injunction to early marriage for women from the following extract from the Mesopotamian Talmud: "Concerning the man who loves his wife as himself, who honors her more than himself, who guides his sons and daughters in the right path, and arranges for them to be married around the period of puberty, of him it is written: *Thou shalt know that thy tent is at peace.*"

Among the Romans—or at least the elite—there was a pronounced inequality in spousal marriage ages. Girls who had just reached menarche were frequently married to men in their mid-twenties. Similar findings—based on Inquisition registers, Renaissance taxation records, marriage contracts from the Toulouse area, and fourteenth-century Macedonian documents—have all described a situation in which teenaged girls were married to men ten years their senior. Early ages at first marriage for women continued to be a characteristic of eastern Europe and many parts of the Mediterranean basin as late as 1900.

Consensual Unions

The emergence of the discrete, single-family household was a landmark, which coincided with the Church's insistence on consensual unions. It separated the couple from its wider networks of clan and lineage thereby making the reproduction of families into an affair of two individuals although for most propertied peasants this was more a matter of ideology than everyday life. But because the vast majority of the peasantry was neither sufficiently well endowed with land nor likely to be subject to the same manorial controls, a treatment of the solid core of the customary tenants must be balanced with an even-handed consideration of those who were marginal, downwardly mobile, and often free.

There is little evidence to suggest that seignorial authorities arranged the peasantry's marriages or intervened in their family formations. If anything, in fact, the opposite appears closer to the mark. The peasantry may have been valued because of their ability to breed but the choice of partner seems

to have usually been their own concern. The lord's concern was to make sure that extramanorial marriages did not deplete his landed estate by draining it of present and future labor power and revenue sources. In this way, the marital horizons for the customary tenantry were limited by the political framework of feudalism, which bore down with unequal pressure on sons and daughters, and much more heavily on the first-born than on younger siblings. It was not enough to discover an attractive match; it was also necessary to find a suitable match. Marriage negotiations involved a four-sided decision-making process—two individuals and two sets of parents—in which no one player had veto-power: It was probably as difficult for a young woman to resist the imprecations of her parents as it was for a young man to sway his. If all these conditions were met, then courtship would lead to marriage; and marriage would lead to the creation of a new family unit.

Oddly the personal, sexual, and marital freedom of noninheriting younger siblings must have acted as a solvent on the restrictive powers of the older generation. Their sociability, seemingly characterized by flirtatious behavior and a casual attitude toward premarital sex and illegitimacy, was the concern of moralists and the fear of parents. The generational battle in the homes of the peasant patriarchs could not have been uninfluenced by this social milieu—sons and daughters had in their disposition over themselves a card of their own to play. Moreover this youthful card was enhanced by the Church's rules of consensual marriage, which sanctioned clandestine unions. Because a troth (promise) made a binding marriage in the eyes of the Church, the best-laid plans of a peasant patriarch could come unstuck if he was blind to the urges of his son or his daughter. This suggests that the culture of maypoles, youth guilds, dancing, festivals, games, and even the solemnities of the Church's ritual calendar all gave a measure of bargaining power to those who had reached puberty. It further suggests that parental power was not absolute, even if it was backed by the threat of disinheritance.

Having entered the marriage market and picked an appropriate partner, the courtship process slid into a familiar sequence of customary conventions.

After the hand fasting & makyng of the contracte, the church goyng & weddyng shulde not be deffered to long, lest the wicked sowe hys vngracious sede in the mene season. . . . For in some places ther is such a maner, wel worthy to be rebuked, that at the hand fastyng there is made a great feast & superfluous bancket, & even the same night are the two hand fasted persones brought & layd together, yea certayne wekes afore they go to the church. (Howard, p. 349)

In cases where property was a paramount concern, marriage contracts were drawn up and earnest money was exchanged. These details were often recorded in the full publicity of the manor court. Occasionally eager peasant patriarchs enlisted the court's services while their children were still infants. But such instances are exceptional—the Church forbade child marriage since it was considered impossible for a minor to give his/her informed consent.

Marriage Covenant

The couple's marriage covenant had several dimensions—first there was the settlement of material goods and landed property; second there was the public trothplight by which the couple announced their intentions; and third there was the wedding in the Church and the ring ceremony. In most cases, these three stages followed one another in an orderly succession. However there was no need for a settlement, a *public* trothplight, or a clerically sanctioned wedding. In terms of both the common law and the Church, a *private* agreement between the two partners was sufficient to constitute a legal, Christian marriage.

Why, then, did publicity surround each and every one of the three stages? First marriage was a rite of passage—from dependency to adulthood in the eyes of the couple's family and the wider community; second publicity sanctioned the match and was a means of granting approval to it; third publicity eliminated hidden impediments to a successful marriage, such as previous agreements and duplicitous scheming, by bringing the agreement into full view; fourth publicity and approval gave the match both legal and moral standing before the law and the Church; fifth publicity legitimated all subsequent children of their union; and sixth publicity and communal approval enabled the servile population to enlist the Church on their side in the event that seigniorial authorities tried to thwart their choice of marriage partners.

It is stretching matters to suggest that peasant marriages were characterized by "rough equality" (Power, p 75). The peasants' marital economy was a "partnership in which each person contribute[d] a specialized skill that complements the other" (Hanawalt, p. 17). These women were expected to do a double day of labor and were without independent civil rights within the peasant community. It was, for all intents and purposes, impossible for women to act in the public sphere. If this was a "partnership," then it was an unequal one. The expectation of "partnership" played a significant role in joining together men and women of roughly similar ages. And, most likely, this expectation was a crucial ingredient in making consent on the part of the prospective husband and wife something more than lip service. Bad as it was, gendered inequality in feudal society was still an improvement for women compared to the earlier situation in pre-Christian antiquity when monogamy was uncommon, adultery was frequent, and divorce was routine. Furthermore for the unfree, marital breakup was subject to the impulse of the spouses' masters, while the servile population surrendered humiliating payments for "wife-rent" to their lords.

Later Marriage

Prior to the advent of parish registers in the sixteenth century, very little is known about ages at first marriage for either men or women. Surveying the published statistical evidence from fifty-four studies, Michael Flinn describes an early modern northwestern, Europe family system in which the average age at first marriage for women fluctuated around twenty-five. Flinn does not provide measurements to assess the spread of the distribution around this midpoint, but other studies have determined the standard deviation to be about six years meaning that about two-thirds of all northwest European women married for the first time between twenty-two and twenty-eight. A few teenaged brides were counterbalanced, as it were, by a

similar number of women who married in their thirties. Perhaps one woman in ten never married. In the demographer's jargon, that tenth woman was permanently celibate. This unique marriage strategy was vitally important for two reasons: First it provided a "safety valve"—or margin for error—in the ongoing adjustment between population and resources that characterized the reproduction of generations and social formations; and second it meant that the role of women was less dependent and vulnerable insofar as they were marrying as young adults, not older children.

The Demographic Revolution of the eighteenth century produced a declining age at first marriage for women and a tremendous drop in the number who were "permanently celibate." In the preindustrial, demo-economic system of reproduction, about three-fifths of all families were likely to have had an inheriting son while another fifth would have had an inheriting daughter. Thus about one-fifth of all niches in the landed economy became vacant in each generation. In the seventeenth century, infrequent, late marriage was connected with low levels of illegitimacy whereas in the post-1750 period, frequent, early marriage was associated with skyrocketing levels of illegitimacy and bridal pregnancy. The demographic implications of cottage industrialization were as much the result of more frequent marriages, by more people, as of earlier and more fertile ones. In addition rural industrialization permitted married couples to stay together, while previously marriages were fragmented—and wives and children deserted—because the plebeian family's economic base was weak and subject to cyclical strains. Industrialization permitted cottagers, who formed the backbone of many handicraft industries, to move into new zones of economic and social freedom, which translated into stabilization of their marriages.

There were other effects that resulted from independent shifts in the mortality schedule; not the least being the changing configuration of the age-pyramid, which rapidly broadened at its base. Better chances of child survival combined with the diminishing chance of marital breakup to swell the lower age groups at the end of the eighteenth century. Generations followed one another more quickly. This factor played no small role in contributing to the maintenance of high fertility rates.

Domesticity versus Men's Work

The family production unit's reliance on its own labor power merely served to expose it, nakedly, when the terms of trade swung violently against it after the mid-nineteenth century. Simple, repetitive tasks by which women and children had contributed significantly to the domestic economy of the peasant household inexorably declined in the face of competition from, first, specialized producers and, next, factory-based manufacturing. One of the most significant additions to the domestic economy was provided by spinning—an activity of women and children; the mechanization of spinning in the last decade of the eighteenth century effectively demolished this cottage industry at the moment when population growth was creating increasing stress on the income of the semi-proletarian households. The birth pangs of industrial society sent shock waves into the very core of the cottagers' lives; the family work unit was inexorably superseded.

Women and children were doubly marginalized from the world of work. Gendered roles and age-stratified activities replaced the mutuality of the cottage. The ideology of domesticity provided the key entry-point for the new culture of bread-winning respectability.

Not only does it (i.e., agricultural labour) almost unsex a woman in dress, gait, manners, character, making her rough coarse, clumsy and masculine; but it generates a further very pregnant mischief by infitting or indisposing her for a woman's proper duties at home.

This quotation from the "Report on the Employment of Children, Young Persons and Women in Agriculture" (1867), a British document, resonates in the reader's ears. At the heart of the writers' concerns is a worry that the supposed "natural" character of rural, proletarian women was threatened by "masculine" work. Such women would not only be "unsexed" but also socially deranged since they would be indisposed to "a woman's proper duties at home." Powerful as this prescription might have been, it was essentially beside the point because such working women had never conformed to bourgeois expectations nor did they give "femininity" more importance than family subsistence needs, which were always their primary focus.

In contrast to the rough-and-ready morality of the field and street, female mentalities were reeducated to make the cozy hearth a proper home. Work was reclassified as a masculine endeavor; masculinity was tested in the labor process and judged by the harmony of domestic discipline and its respectable independence. Propriety was to be the moral property of women who were reformulated as model wives and mothers. The vice of the bad home, and the virtue of the good home, could be just as easily translated to descriptions of the good and bad wife: one was chaotic, promiscuous, unsettled, sensual, dirty, and unhealthy; the other was orderly, modest, stable, rational, clean, and well. And what was true of the wife in her home determined the family also.

In French towns of Lille, Mulhouse, Rouen, and Saint Chamond—as in the English coal-mining region of County Durham—the proliferation of proletarians disturbed social policy makers. Nineteenth-century social reformers regarded the menacing features of urban, industrial society to reside in a realm of human behavior removed from the public theaters in which working-class challenges to the status quo usually took place. Malthusian social policy has ever since been based on the understanding that the disorderly family was the problem while the ordered married family was the solution to the population question. The personal was politicized. The working-class family's profligacy—its population power—was thus the outer/public face of its inner/private lack of control.

Reduction in Family Size

The organization of national social systems of education and welfare during the last decades of the nineteenth century combined with the spread of public health measures, which radically changed children's chances of survival, to provide the historical context in which the ongoing revolution in the family was keyed by the decline in fertility. The average English woman

marrying in the 1860s had 6.16 children; her daughters, marrying in the 1890s, had an average of 4.13 children; her granddaughters, marrying in the 1920s, had on average 2.31 children. The decline of marital fertility was both an innovation and an adjustment; it not only responded to macrolevel changes in social organization but also represented one of the primary ways in which individual men and women acted to make their own history. Not only were the numbers of children dropping dramatically—and almost all of these children surviving infancy—but the period of the family cycle devoted to child-raising was likewise abridged. The very nature of married life changed in response to these demographic innovations.

Some demographers have explained this phenomenon in terms of a shift from "quantity to quality" in relation to the time, energy, and resources devoted to each individual child; but something else was at work. A Manchester woman's 1945 observation weaves together several threads into something like a whole cloth: "People wish to have a small family on account of public opinion which has now hardened into custom. It is customary—and has been so during the last twenty-five years or so—to have two children and no more if you can avoid it. A family of five or six children loses in prestige and, some think, in respectability. It is on behalf of their children that parents feel this most keenly" (Mass-Observation, pp. 74–75). She captures, first the temporality of change ("During the past twenty-five years or so"—namely, since the end of World War I); second the reconstruction of mentalities that have "now hardened into custom"; third the interpenetration of the public and the private, neatly encapsulated by the use of those notoriously elastic terms "public opinion" and "respectability"; fourth "on behalf of their children" joins the sentimentalization of childhood together with the exigencies of human-capital formation; and fifth that it is both "parents"—the respectable husband and his Malthusian wife—who decide together to control their fertility within marriage.

Fertility control was possible without the active involvement of both husbands and wives—the widespread prevalence of abortion stands in testimony to the studied indifference of many men—but the sentimentalization of the family made it more likely that methods of control would come within the parameters of conjugal agreement. Because most of the decline in marital fertility was the product of two ancient practices—coitus interruptus and abstinence—it is clearly important to pay close attention to the changing temper of communication between husbands and wives. Cultural forces, especially the "regendering" of the marital union, both narrowed the scope of the marital union and intensified its internal dynamics. The texture of the intimate relationship within marriage was not just important in its own right but also of crucial significance in reconstructing attitudes to the quality of married life, particularly in relation to the importance of parenting. In contrast to older images that emphasized the importance of work and kinship alliance, modern marriage was portrayed as the romantic union of two individuals. The modern family of "mom, dad, and the kids" was based on the idea that romance was not inimical to marriage and the experience of childhood was massively reimaged by this transition to privacy, domesticity, and, above all, child-centeredness.

New Status to Wedding

Indeed in the course of modernization—roughly coinciding with urbanization, industrialization, and the rise of the modern state, that is, from about 1750, and with increasing intensity after 1870—there was a gradual elevation in the importance of the wedding. In the earlier social formations, the wedding was the final stage in a marriage process by which two people pledged themselves to one another in the full view of family, friends, and community. The rise of mass society had the curious effect of denying publicity to the marriage while creating a need for it. In the urban world, the newly independent couple re-created the big wedding that had characterized village life. “Stag parties,” “hen parties,” and “showers” became common and, among an increasingly secular population, the church wedding became an important festivity in the course of the twentieth century. Most women were profoundly influenced by this invented custom that has had a powerful impact on popular consciousness. Mass media—magazines and, above all, movies—glorified the white wedding to make it into a social ideal, not only a right of passage but also a statement of social and individual respectability. This respectability was, of course, deeply gendered as those women who became “brides” were decked out in a glossy, flowing white satin dress and veiled in lace; their outward appearance emphasized purity and innocence upon entering the married state.

Different Family Arrangements

Yet just as the image of the white wedding was at its zenith, in the third quarter of the twentieth century, other forces were at work redefining the culture of marriage. The modern sentimental marriage is, in the early twenty-first century, widely perceived to be in crisis. Since the late-twentieth century, society seems to be in the process of making a different social system in a global world, one whose ripples can be felt in the most personal organization of private experience. In the world past, pluralism was the product of uncontrollable demography abetted by the rigidity of social hierarchies; in the world of the early-twenty-first century, by way of contrast, familial pluralism appears to be the product of centrifugal forces of individualism that castigate the traditional marriage as being both repressive and antisocial.

If, as Jean-Louis Flandrin suggests, the early modern state pivoted on the “government of families,” and if, as Jacques Donzelot relates, the modern state practices “government through the family,” then it can be argued that in the early twenty-first century the evolution is towards another configuration—government without the married family. The language of the sentimental family, as well as the invented custom of public weddings, has been borrowed indiscriminately by people whose private lives were cloaked in this time-honored disguise. Even though the majority of both males and females regard the nuclear family as the sentimental site for parenting, one in four births takes place out of wedlock. Single-parent households (usually headed by women) have become so prevalent that as many as 50 percent of children may live apart from their fathers at some time in their lives. More marriages are terminated by divorce than by death. A sociological discussion estimated that there are as many as 200 different “family”

arrangements recognized by Americans and Europeans. (Bernardes, p. 192–195). In the early twenty-first century, American religious and political leaders are also grappling with demands for same-sex marriage, yet another indication of the transformation of the institution. Indeed the debate itself, which has raised issues of inheritance, parenting, care for the sick and dying, immigration and citizenship, romance, love, and the desire for weddings as rites of passage and public events, reveals the contradictory definitions of marriage and the many purposes that this institution continues to fulfill.

At the beginning of the twenty-first century, then, the loss of prescriptive unanimity is thus a matter of fact. Those who mourn that loss cannot forget the sentimental family; yet the cost exacted by modern memory is that socially nostalgic conservatives have mistaken the image of the sentimental family for the continuity and contradictions of past realities.

See also Childhood and Child Rearing; Demography; Family; Gay Studies; Love, Western Notions of.

BIBLIOGRAPHY

- Bernardes, Jan. “Do We Really Know What “The Family” Is?” In *Family and Economy in Modern Society*, edited by Paul Close and Rosemary Collins. Basingstoke, U.K.: Macmillan, 1985.
- Brown, Peter. *The Body and Society*. New York: Columbia University Press, 1988.
- Donzelot, Jacques. *The Policing of Families*. New York: Pantheon Books, 1979.
- Duby, Georges. *The Knight, the Lady, and the Priest: The Making of Modern Marriage in Medieval France*. Translated by Barbara Bray. New York: Pantheon Books, 1983.
- Flinn, Michael W. *The European Demographic System, 1500-1820*. Baltimore, Md.: Johns Hopkins University Press, 1981.
- Flandrin, Jean-Louis. *Families in Former Times: Kinship, Household and Sexuality*. Translated by Richard Southern. Cambridge, U.K.: Cambridge University Press, 1979.
- Foucault, Michel. *The Care of the Self*. Vol. 3 of his *History of Sexuality*. Translated by Robert Hurley. New York: Vintage Books, 1986.
- Gillis, John. *For Better, For Worse: British Marriages, 1600–Present*. New York: Oxford University Press, 1985.
- Goitein, Shelomo D. *The Family*. Vol. 3 of his *A Mediterranean Society*. Berkeley: University of California Press, 1978.
- Goldberg, Peter Jeremy Piers. *Women, Work, and Life Cycle in a Medieval Economy*. Oxford: Clarendon, 1992.
- Goody, Jack. *The Development of Marriage and the Family in Europe*. Cambridge, U.K.: Cambridge University Press, 1983.
- Hanawalt, Barbara. *The Ties that Bind: Peasant Families in Medieval England*. New York: Oxford University Press, 1986.
- Herlihy, David, and Christiane Klapisch-Zuber. *Tuscans and their Families: A Study of the Florentine Catasto of 1427*. New Haven, Conn.: Yale University Press, 1985.
- Hopkins, Keith. “The Age of Roman Girls at Marriage.” *Population Studies* 18 (1965): 309–327.
- Howard, George Elliott. *A History of Matrimonial Institutions*. Vol. I. Chicago: University of Chicago Press, 1904.
- Ladurie, Emmanuel Le Roy. *Montaillou: Cathars and Catholics in a French Village, 1294–1324*. Translated by Barbara Bray. London: Scholar Press, 1978.

- Laiou-Thomadakis, Angeliki E. *Peasant Society in the Late Byzantine Empire: A Social and Demographic Study*. Princeton, N.J.: Princeton University Press, 1977.
- Laqueur, Thomas. *Making Sex: Body and Gender from the Greeks to Freud*. Cambridge, Mass.: Harvard University Press, 1990.
- Laribiere, G. "Le mariage a Toulouse aux XIVe et Xve siècles." *Annales du Midi* 79 (1967): 334–361.
- Lee, James, and Wang Feng. *One Quarter of Humanity: Malthusian Mythology and Chinese Realities*. Cambridge, Mass.: Harvard University Press, 1999.
- Mass-Observation. *Britain and Her Birth-Rate*. London: J. Murray, 1945.
- Mitterauer, Michael. "Christianity and Endogamy." *Continuity and Change* 6 (1991): 295–333.
- Power, Eileen. *Medieval Women*. Cambridge, U.K.: Cambridge University Press, 1975.
- Roth, Martha. "Age at Marriage and the Household: A Study of Neo-Babylonian and Neo-Assyrian Forms." *Comparative Studies in Society and History* 29, no. 4 (1987): 715–747.
- Saller, Richard. "European Family History and Roman Law." *Continuity and Change* 6 (1991): 335–346.
- Scammell, Jean. "Freedom and Marriage in Medieval England." *Economic History Review*, 2nd ser. 27 (1974): 523–537.
- Smith, Richard. "The People of Tuscany and Their Families: Medieval or Mediterranean?" *Journal of Family History*, 6 (1981): 107–128.
- Smith, Thomas C. *Nakahara. Family Farming and Population in a Japanese Village, 1717–1830*. Stanford: Stanford University Press, 1977.

David Levine

MARXISM.

This entry includes three subentries:

Overview

Asia

Latin America

OVERVIEW

Few sets of ideas are richer and more conflicted than those that have been put forward under the heading of Marxism. Marxism's founder, the German philosopher Karl Marx (1818–1883), had a wide-ranging curiosity about many aspects of humankind and a stamina matching his curiosity. But as the American philosopher Sidney Hook pointed out in his article on Marxism in the 1973 edition of the *Dictionary of the History of Ideas*, Marxism is more than simply "the ideas of Karl Marx" (vol. 3, p. 146); it also includes a vast array of thinking that took its point of departure from Marx. Indeed, Hook suggested that what Marx (and his friend, Friedrich Engels [1820–1895]) really meant is "by far not as significant as what they have been *taken* to mean" (p. 147). However, it seems clear that an understanding of both the original and the derived ideas is needed for an adequate understanding of Marxism.

The Critical Project of Karl Marx

Marx fits within a wider group of Western thinkers who, beginning in the seventeenth century, offered new, secularized answers to the old questions, What is the good life for human beings? and, How is that life to be attained? In part, Marx was a laughing heir of the eighteenth-century Enlightenment—a thinker far more optimistic about human prospects than almost all his predecessors. Yet there is also a basso profundo in his thinking, a sense of the immensity of pain and suffering that will be needed before humans can hope to become the free, autonomous, rational, loving, creative, communal beings that he hoped would eventually make their way on the earth.

Among major predecessors of Marx's social theory are Thomas Hobbes (1588–1679), John Locke (1632–1704), Jean-Jacques Rousseau (1712–1778), and Adam Smith (1723–1790). Marx was also influenced by conceptions of the self associated with the German Romantic tradition. Many intellectual tendencies found their way into his thinking through the philosopher Georg Wilhelm Friedrich Hegel (1770–1831), whose lectures (published shortly after his death) and books sought to cover the entire range of human culture. Further, although Marx's orientation was relentlessly secular, there are residues in his thinking of some religious conceptions. He continued, in a secular and universalized form, Christian conceptions of perfection. Further, as Warren Breckman has shown, his notion of humanity emerged from a theological debate concerning the personality of God.

Marx was born in Trier in the Rhineland region, which after the defeat of Napoléon in 1815 was ruled by conservative Prussia. Marx's father was obliged to convert from Judaism to Lutheranism in order to keep his position as a lawyer in the local court system. In 1835 Karl went to university—first to Bonn, the next year to Berlin. Although for career reasons his father wanted Marx to study law, Karl quickly gravitated to philosophy. He found the law too limiting, and he also believed for a time that, by pointing out inadequacies in existing institutions, philosophy could help bring about progressive change in Germany.

Hegel. From 1837 onward Marx absorbed from Hegel's writings, as well as from the generalized Newtonianism then dominant, a particular understanding of what a properly rational, scientific knowledge of the world requires (Megill, chap. 1). Such an understanding, Marx held, must be universal in form and must generate necessary rather than merely probable knowledge. Further, Hegel regarded human history as a rational process of intellectual and cultural advance, analogous to the progress of knowledge that he saw in the history of philosophy, and Marx adopted this view also. Hegel held that philosophy advances by means of rational debate (called "dialectic" in Greek). Sharpening Hegel, Marx interpreted dialectic as requiring critique of the existing order.

After finishing his doctoral dissertation, on ancient philosophy, in 1841, Marx became an oppositional journalist. In October 1843 he moved to Paris, which was the center of European radicalism and the largest city on the European continent. Here he coedited a critical journal that was to be smuggled into Germany. He also intended to complete a critique of

Hegel's political theory and to write a political history of revolutionary France. Meanwhile, in the streets, bars, cafés, and meeting rooms of Paris he discovered the revolutionary agent that he concluded would overthrow the existing order—the working class or, as he called it, the proletariat.

Estrangement (alienation). By July 1844 Marx had abandoned political theory and political history (although he never abandoned political activism, to which he devoted intense time and energy). Instead he turned to a critique of economics. In his “Economic and Philosophical Manuscripts” (May/June–August 1844; published 1932) and in related manuscripts, Marx analyzed the claims of such economists as David Ricardo (1772–1823) and James Mill (1773–1836). Notably, he criticized them for ignoring the “estrangement” (or alienation) that he saw workers as subjected to in a private-property-based economic system. Workers do not find either gratification or the possibility of self-development in their work. The products of their labor become a means for oppressing them. They become estranged from each other.

Marx borrowed the notion of estrangement from the critical theologian Ludwig Feuerbach (1804–1872). In his *Essence of Christianity* (1841), Feuerbach had argued that religion estranges human beings from their best qualities, which are attributed to God, Christ, and so on. Religion therefore needs to be superseded by a this-worldly humanism. Marx's innovation was to apply Feuerbach's critique of religion to economic theory and economic life.

Marx also contended, although elliptically, that the system of private property and exchange (buying and selling) is irrational: it is unplanned, it results in an unpredictable rise and fall of prices, and it has no intelligible historical progression.

History of production and needs. In January 1845 Marx moved to Brussels. In collaboration with the young businessman Engels, who had recently become his friend, he wrote *The German Ideology* (1845–1846; published 1932). Part 1, mostly Marx's work, sketches out a rational history of humankind, focused not on philosophy but on humans' actions to wrest a living from the material world. Using their intelligence, human beings develop their “productive forces,” which improve over time. More advanced productive forces continually come into conflict with the retrograde forms by which society and production are organized (later, Marx and Engels would call these forms “relations of production”). History up to now, Marx and Engels held, has been dominated by class conflict: famously, they declared in their revolutionary pamphlet *The Communist Manifesto* (1848) that “the history of all hitherto existing society is the history of class struggles.” In their view, these struggles are all ultimately rooted in conflict between forces and relations of production.

Marx (and Engels) also asserted that history would culminate in a socialist society that would function without a political state and without private property and exchange. However, they offered only sketchy accounts as to how this society would actually operate.

The revolutions of 1848 and an analysis of capitalism. The revolutions of 1848 disappointed Marx, for the established order proved remarkably successful in thwarting political—let

alone social—reform. Marx responded to the disappointment by turning to a serious analysis of “the capitalist mode of production.” Now living in London, he began in 1851 to study the economy systematically. After a massive effort of research, he published *Capital (Das Kapital)*, volume 1, in 1867. Although never finished, *Capital* is rightly regarded as Marx's most important work. In it, he attempted to penetrate beneath the arbitrary, merely surface phenomena of economic life to what he saw as capitalism's deep structure.

Adding to his earlier claims about estrangement, Marx in *Capital* focused to a greater degree than earlier on what he saw as the irrational and exploitative aspects of capitalism. Under capitalism, he held, workers are necessarily exploited—that is, they are deprived of the “surplus value” that their labor creates. Exploitation, he contended, is unavoidable as long as the capitalist system (oriented to private property and the market) exists.

Most subsequent economists rejected Marx's claim that labor is the sole creator of value, as well as his related assumption that the value of a commodity somehow exists objectively in the commodity. However, two of Marx's general contentions have not yet been proved false. First, he was persuaded that capitalism has a built-in dynamism, a tendency to transform its own conditions of production. Indeed, in *The Communist Manifesto* he and Engels were perhaps the first to sketch out the process of worldwide capitalist expansion and transformation that we now call “globalization.” Second, he held that exploitation under capitalism does not arise from the good or bad intentions of individuals, but is systemic. Position in the system, not greater intelligence or harder work, is the most likely explanation for why the coffee futures trader in New York makes vastly more money than the small coffee producer in Central America.

Necessity of revolution. The convinced, root-and-branch Marxist claims that capitalism must be destroyed because it necessarily brings with it estrangement, exploitation, and a disorderly irrationality (overproduction, underconsumption, boom-and-bust economic cycles). The root-and-branch Marxist holds that piecemeal reform of the system is insufficient to solve these problems. He or she also holds that capitalism will be destroyed—it is doomed to collapse.

Insistence that capitalism cannot be reformed and that the proletariat (the industrial working class) is the revolutionary class that will destroy it were the two touchstones of Marx's thinking from 1843–1844 onward. To be sure, in his later years Marx suggested that in some countries revolution might occur by electoral rather than by solely violent means, and Engels shared this view. But this was not a rejection of revolution, which in Marx's lexicon equates not to violence, but to a radical transformation of the dominant economic and social system however achieved.

A conceptual treasure-trove. Marx wrote interestingly on more topics than the ones noted above. His letters, published works, and manuscripts contain many false starts, curiosity-driven meanderings, pregnant suggestions, intelligent analyses, incipient but never fully developed theories, and journalistic

commentaries on current events, as well as reservations concerning some of his own views. He was often insistently dogmatic, and yet at other times surprisingly flexible. Toward the end of his life, he rebelled against a dogmatic tendency that he detected among some of his followers, declaring "I am not a Marxist."

Doctrinal Marxism

During the 1880s and 1890s Marxism became doctrine in many European labor and working-class political organizations. Its scientism accorded with the spirit of the age. Its prediction that capitalism cannot escape economic crisis seemed congruent with the so-called Great Depression of 1873–1896. Marxism spread through the German Social Democratic Party after the chancellor, Otto von Bismarck, instituted the antisocialist laws (1878), and in the wake of the party's legalization (1890) became its official ideology (1891). Although in other countries Marxism was less prominent, by around 1900 it was certainly the most influential left-wing ideology in Europe.

The main intellectual basis of doctrinal Marxism was Engels's version of Marx. Engels embedded Marx's analysis and critique of capitalism in a general view of history, which he in turn embedded in an ontological theory. As a theorist, Marx himself was mainly concerned with understanding the "economic law of motion of modern society" (*Capital*, 1st ed. preface), and after 1845 he rarely thought in more general terms. But in *Socialism: Utopian and Scientific* (1880) and other writings, Engels portrayed Marx as the discoverer of a general theory of history, which Engels called "the materialist conception of history" or "historical materialism" (terms never used by Marx). Engels also contended that "scientific socialism" includes a theory of reality in general, according to which reality is material and dialectical (conflict-driven). Marx himself never put forward such a theory.

In Engels's version, Marxism claimed to be an all-embracing science. Whereas other socialisms are utopian, Marxism has the measure of the world as it is. In his 1883 "Speech at Marx's Graveside," Engels declared that Marx had discovered "the law of development of human history," just as Darwin had (allegedly) discovered the law of development of organic nature. In an age enamored of natural science, such claims were the way to popularity. But the result was to downplay Marx's early concern with human activity or praxis and his critique of estrangement. Relatedly, Engels misrepresented Marx's relation to Hegel.

Doctrinal Marxism to 1914

Leszek Kolakowski has referred to 1889–1914, the period of the second Socialist International, as "the golden age" of Marxism. The Socialist International was an organization, founded at a congress in Paris in 1889, that aimed to encourage cooperation among the socialist parties of the different European countries. Admittedly, in this period Marxism began to acquire something of the rigid and schematic character of a catechism, but among both Marxists and people who were just interested in Marxism, serious discussion of unclear points nonetheless took place. These included such questions as the

following: If there is a law of development of human history, how does it operate? Does an explicitly normative or ethical dimension need to be added to "scientific socialism"? How is the economic "base" related to the legal, political, and cultural "superstructure"? Is socialism the inevitable outcome of capitalist development, or is it only one possibility? Is reform a worthy goal, or should Marxists focus entirely on revolution? Should socialist parties form alliances with non-socialist parties? How violent will the revolution be? Can a socialist worldview legitimately make use of non-Marxian resources?

Most (perhaps all) exponents of Marxism agreed that the goal of human history is some sort of exploitation-free society without class or other kinds of divisions, with a full development of science and technology and true freedom. The disagreements were about how this goal was to be achieved.

Revisionism and antirevisionism. Marx predicted that capitalism would collapse under the combined weight of its economic difficulties and the proletariat's uprising against it. But by the late nineteenth century it was clear that economic upswing and actual or anticipated gains from trade unions and socialist parties were keeping revolution on the back burner. Few workers were revolutionary. In spite of its official Marxism after 1891, the actual orientation of German Social Democracy was deeply reformist. In response to this reality, the party activist and journalist Eduard Bernstein (1850–1932) argued in *Die Voraussetzungen des Sozialismus und die Aufgaben der Sozialdemokratie* (1899; translated as *Evolutionary Socialism* [1909]) that the collapse of capitalism is neither imminent nor inevitable, that the number of property owners is increasing, and that socialism is more likely to be achieved by gradual reform within capitalism than by revolution. Although a large minority of German Social Democrats agreed with Bernstein, such party leaders as Karl Kautsky (1854–1938) and August Bebel (1840–1913), as well as theorists outside Germany, excoriated Bernstein's "revisionism." Bernstein's opponents rightly saw that revolution was central for Marx. They were anxious to maintain unity and commitment in the socialist movement. And Bernstein's claims did not have anything like apodictic certainty. Even much later than 1899 it remained plausible to believe that capitalism was doomed, as the flourishing of Marxism during the 1930s depression shows.

Marxist theorists and party leaders, as well as other interested observers, responded to Bernstein in various ways. Kautsky repeated the increasingly hackneyed claim that the necessary development of the historical process will lead to revolution, a position that relieved Social Democrats of any need to act to bring the revolution about. The French social theorist Georges Sorel (1847–1922) scorned both Bernstein and orthodox Marxists like Kautsky and contended for a revolutionary movement committed to what Sorel called "the myth of the general strike," that would see its goal as a total, apocalyptic transformation of the world. The Russian revolutionary V. I. Lenin (1870–1924) opted for a centralized, vanguard party that would guide the too-hesitant proletariat toward revolution. The German (also Jewish-Polish) Social Democrat Rosa Luxemburg (1870–1919) polemicized against party bureaucracy and against Leninist top-down centralism, and in

the face of massive contrary evidence put her faith in spontaneous revolt by the proletariat. The French socialist leader Jean Jaurès (1859–1914) supported Kautsky against Bernstein, and held that socialism would come about by revolution. But at the same time he was a natural conciliator and a moralist, having none of the characteristics of a revolutionary.

Kantian Marxism. Another type of Marxism in this period modified or even abandoned Marxist (actually Engelsian) historical theory. The Italian philosopher Antonio Labriola (1843–1904) anticipated a heterodox strand in post-1917 Marxism in his attempt to show that Marxism takes its point of departure from human praxis, or action, which he saw as including all aspects of human life, including intellectual activity. Other Marxist thinkers insisted (contra both Engels and Marx himself) that Marxism needs a normative dimension, the movement of history being irrelevant to what human beings *ought* to desire. The influential school of “Austro-Marxists,” involving such figures as Max Adler (1873–1937), Otto Bauer (1881–1938), and Rudolf Hilferding (1877–1941), adopted this position.

The Austro-Marxists also argued against the Leninist tendency to reduce theoretical ideas to mere weapons in the class struggle: instead, they held that Marxist theory ought to appeal to all rational minds. They likewise linked Marxism to a Kantian moral universalism. Like other Kant-inclined Marxists elsewhere, they held that socialism and the Kantian ideal of a “kingdom of ends” are congruent. Individual human beings should never be treated as mere means toward the development of some higher good. Such views were far distant from the theory and practice of Leninism.

After 1914: Leninism and Marxism-Leninism

The rise of Leninism dramatically changed the complexion of Marxism. As Neil Harding has argued, Marxism in its guise as “a theory and practice of revolutionary transformation” was virtually dead by 1914 (p. 114). Although many Marxists still made use of revolutionary rhetoric, the advance of political democracy, economic improvement, and the failure of class polarization to occur militated against revolutionary action. But in August 1914, World War I began, and all the national parties in the Socialist International supported their respective governments in the war crisis, although they had sworn not to do so. Lenin, head of the revolutionary Bolshevik wing of the Russian Social Democratic Party, was enraged at the apostasy of virtually all “orthodox” Marxists. More than this, he quickly came to see the war as marking the total bankruptcy of capitalist civilization, which in his view had forfeited its right to exist.

In response to the crisis of 1914, Lenin, living in exile in Switzerland, formulated a distinctive version of Marxism, which first took shape in his pamphlet *Imperialism, the Highest Stage of Capitalism*, written in Zurich in 1915–1916 and published in Russia in April 1917, after he had returned there in the wake of the February Revolution. By a combination of intelligence, a focus on essentials, brilliant organization, ruthlessness, and luck, Lenin and his colleagues, notably Leon Trotsky (1879–1940), seized power in the October 1917 revolution (actually, more a coup d'état than a revolution), and held onto

it. The regime that they established in the former Russian Empire (reconstituted as the Union of Soviet Socialist Republics [USSR] in 1922) promoted the Leninist interpretation of Marxism as the authoritative version. Later, under the auspices of Joseph Stalin (1879–1953), the authoritative version came to be known as “Marxism-Leninism.”

In the period of the Cold War, the world was dominated by a bipolar conflict between “the West” and “the Communist world.” Communist regimes claimed to take their inspiration from the so-called “classic writers of Marxism-Leninism.” At a minimum these included Marx himself, Engels, and Lenin. (Other figures also achieved canonical authority where they had the power to impose it, notably Stalin and Mao Zedong [1893–1976].) For much of the twentieth century it was overwhelmingly Marxism-Leninism that defined Marxism, and the fate of Marxism-Leninism was closely tied to the fate of the USSR. Even now the popular image of Marxism most often simply reproduces the Marxist-Leninist version. There are even theorists who claim that there is no “authentic Marx” apart from Lenin.

Lenin before Leninism. The central problem that faced Lenin before 1914 was the problem of how socialist revolution was to be brought about in Russia, where industry, by 1900, had barely developed and where most of the population were illiterate peasants of diverse nationalities. In the face of this problem and in response to disagreements within the Russian Social Democratic Party, Lenin, in his 1902 pamphlet *What Is to Be Done?*, laid great emphasis on party organization. Attacking Russian colleagues who celebrated a “spontaneous” awakening of the proletariat and who denigrated “theory” and “method,” he argued that workers left to their own resources cannot go beyond a “trade union consciousness.” Only with guidance from a centrally organized party of professional revolutionaries in possession of the right (Marxist) theory can the proletariat rise up to revolutionary consciousness and action.

Some commentators have seen Lenin’s position as involving a kind of conspiratorial Jacobinism or Blanquism foreign to the spirit of Marx himself. (Blanquism was so named after the French activist Louis Auguste Blanqui [1805–1881], an advocate of the forcible seizure of political power by professional revolutionaries.) But this criticism is mistaken. First, in 1902 and even much later, Lenin held that the success of revolution in Russia depended on socialist revolution also breaking out in the more advanced countries to Russia’s west. Second, Marx himself faced, in his early years, the problem of how revolution was to come to Germany, which at that time was economically backward in comparison to France, Belgium, and England. In the same essay in which he announced his “discovery” of the proletariat, he also asserted emphatically that revolution will come to Germany when philosophy (theory) allies itself with the oppressed proletariat’s practical experience. Marx did not claim that the oppressed weavers of Silesia would become conscious of their situation on their own (Marx, “Introduction” to *A Contribution to the Critique of Hegel’s “Philosophy of Right,”* published February 1844). In short, only the intelligentsia is capable of revealing to the proletariat the true meaning of its own experience.

Capitalism and imperialism. Lenin's immediate reaction to the outbreak of World War I was to engage in "a doctrinaire restatement of the fundamentals of Marxism" (Harding, p. 77). He then turned to an attempt to reconstruct the deep roots of Marxism in Hegel's thought, which led him to conclude that his fellow Marxists had failed to understand Marx's dialectical method, which always looks to find contradictions in existing reality.

Lenin also concluded that other Marxists had failed to understand the actual situation of capitalism in its contemporary guise. In Lenin's view, capitalism had now entered into the stage of state-directed violence. Its economic contradictions were such that they could only be overcome, temporarily, by an imperialist expansion enabling the extraction of super-profits from less-developed countries. Capitalism now constituted a world system, and Lenin argued that the system was destined to break at its weakest link, which was most likely to be at the periphery—for example, Russia. Thus, on returning to Russia in April 1917, Lenin felt justified in proclaiming that a socialist—and not just a bourgeois—revolution was underway.

Leninism and science. Lenin's views altered to some extent in the difficult years from 1917 to his death in 1924. The complexities must be left aside here. The central point is that notions of open discussion and mass participation quickly disappeared from the horizon of the regime. Rather, the party, and in particular its highest leaders, came to substitute for the proletariat, which itself amounted to only a small part of the population of the USSR.

The theoretical justification for this development was to be found ultimately in Marx's commitment to science. It is not for nothing that in December 1920 Lenin announced that "Communism is Soviet power plus electrification of the whole country" ("Soviet [worker-council] power" quickly faded, however). In theory, all decisions were to be made on the basis of expert, scientific knowledge, and politics was to fade from view. In practice, the attempt to impose decisions on the country—to make the country conform to the theory—was undoubtedly an important reason why the USSR under Stalin became a tyranny the likes of which had never before been seen.

In the canonical form that it acquired by the late 1930s, Marxism-Leninism claimed to offer the explanatory key to all of reality. The term associated with this monism was "dialectical materialism" (coined by the Russian Marxist G. V. Plekhanov [1857–1918] in 1890). Unimportant before 1917, in the Soviet period dialectical materialism became a widely used shorthand term for Marxism, in large measure as a result of Stalin's efforts. According to dialectical materialism, an inexorable developmental process permeates all of reality. The struggles that occur in human history are merely one manifestation of this process. We are thus in a position to know that history will lead, with utter inevitability, through the travails of the present to the sunny uplands of socialism.

It is often assumed that Marx himself was a "dialectical materialist." The theory of dialectical materialism was originated by Engels. It is not articulated in any of Marx's own writings. Both Marx and Engels claimed that Marxian socialism was

scientific, but it was Engels who intuited that many potential adherents of Marxism were looking for an all-embracing worldview. Purporting to explain everything, dialectical materialism aimed to displace all competing worldviews, notably religion. To its adherents, it offered a sense of certainty. In Stalin's calculation, this sense of certainty served the interests of the bureaucratic tyranny that he established over the USSR.

Advance and retreat of Marxism-Leninism. Marxism-Leninism prescribed a way out of backwardness through revolution, science, and rationality that many intellectuals in Asia, Africa, and Latin America found appealing. For over half a century it had a significant following in the "underdeveloped" world. However, few Marxist-Leninist regimes came into being independently of the direct application of military force by the USSR. In order to succeed, revolutionary movements needed a favorable concatenation of circumstances and an indigenous cadre of militants willing to adjust their message to suit the audience. This did happen in China. In 1926 urban workers made up only 0.5 percent of the Chinese population. As Mao Zedong saw in his prescient "Report on the Peasant Movement in Hunan" (1927), the party had to appeal to the peasantry. The People's Republic of China came into being in 1949 as a result of a successful mobilizing of a revolutionary peasantry. Meanwhile, in the wake of World War II the Soviet Union and its victorious army imposed Marxism-Leninism on Eastern Europe.

At the beginning of the twenty-first century, the fundamental fact confronting doctrinal Marxism was the all but total disappearance of Marxist-Leninist regimes and movements. Over the course of a generation and more, the Soviet Union became more and more sclerotic and then, in 1991, collapsed, having already lost its Eastern European satellites in 1989. Meanwhile, the People's Republic of China turned toward participation in the market following the "Reform and Opening" process initiated by Deng Xiaoping in the late 1970s. By 2004, only a few countries, notably Cuba and North Korea, were still claiming to be built on Marxist-Leninist principles.

As for large-scale Marxist or Marxist-Leninist political movements, by 2004 none existed. When the Leninist regime in the USSR was being consolidated, some elements of European social democracy set themselves up as the avowedly democratic wing of Marxism in opposition to Leninism. But social democracy's Marxism became attenuated over time, eventually disappearing into a generalized commitment to social welfare and to some measure of social and economic egalitarianism.

Marxism beyond Doctrinal Marxism

A large body of Marxian writing and reflection lies beyond the framework of doctrinal Marxism. Until World War II almost all of this "independent Marxism"—as we might call it—emerged within the framework of, or at least in close dialogue with, doctrinal Marxism. After World War II, this changed, for much Marxian reflection was carried out in essential independence from both official Marxism-Leninism and from whatever Marxist residues remained in the social democratic movement. In addition to independent Marxists, there were many scholars and intellectuals who deplored Marxian

perspectives without accepting Marxism as a whole and usually without even considering themselves Marxists. This is a tradition that goes back to the early twentieth century. By the end of the twentieth century it was certainly the dominant mode of serious intellectual work and reflection in a Marxist register. Of course, one encounters a difficulty here, for at this point one reaches the boundary of what can legitimately be called Marxism.

Existential Marxism. Another difficulty is that of characterizing in a general way the Marxisms that diverge from doctrinal Marxism. Beyond social-democratic and Marxist-Leninist Marxisms, Hook identified a third, post-1945 variant: existential Marxism. In doing so he inflated the significance of a relatively minor school of mainly French Marxists. Still, Hook's category does point in the direction of at least two significant developments in post-1945 Marxism. First, after about 1950, much effort went into reinterpreting Marx in the light of the "Economic and Philosophical Manuscripts," which revealed a "humanist" Marx different from the Marx of Marxism-Leninism. While Marx was no existentialist, his early interest in estrangement and in activity do reveal affinities with existentialism. Second, an important development since World War II among persons sympathetic to Marxism has been the impulse to work in the mode of "Marxism and . . ."—combining Marxism with something else, whether method, school, commitment, or discipline. In offering an existentially inflected Marxism in his *Critique of Dialectical Reason* (1960), the French philosopher Jean-Paul Sartre (1905–1980) was operating in just this sort of combinatory mode. A German-Jewish refugee to the United States, Herbert Marcuse (1898–1979), engaged in a similar effort, variously combining a Marxian perspective with Freud (*Eros and Civilization*, 1955) and with vaguely Heideggerian notions of an oppressive modernity (*One-Dimensional Man*, 1964). Other combinations involved less an attempt to combine Marxism with some other perspective than an attempt to apply Marxism to an implied object of study. It was a potentially unending intellectual game, for one could pair Marx with other partners virtually at will: a short list includes feminism, structuralism, psychoanalysis, ecology, anthropology, history, literary criticism, literary theory, film studies, and cultural studies. Although it involves much question-begging, the game still continues.

Western Marxism. Other commentators have identified a tradition of "Western Marxism." "Western Marxism" is largely a post hoc imposition. Still, the category can help us to see common features in a large body of Marxist theory that first emerged as a challenge to Engelsian and Leninist versions of Marxism. The unintended founder of Western Marxism was György Lukács (1885–1971), whose *History and Class Consciousness: Studies in Marxist Dialectics* (1923) was actually written in defense of "orthodox Marxism." But in the midst of defending orthodox Marxism, Lukács emphasized two concepts that were to be important for Western Marxism. One was estrangement (which he intuited in Marx without having read the then-unavailable "Economic and Philosophical Manuscripts"). The other was totality. The gist of this latter concept is the claim that the correct understanding of any reality requires that one first understand it as a *whole* (which among other things, involves understanding its place within the historical process),

rather than arriving at conclusions about it solely by induction from particulars. Lukács held that bourgeois empiricists, as well as some Marxists, had failed to understand this point. A second theorist often seen as a founder of Western Marxism was Karl Korsch (1886–1961), who in *Marxism and Philosophy* (1923) and other writings emphasized that Marxism is primarily concerned with human practice (praxis) and, like Lukács, criticized positivist or empiricist versions of Marxism.

Other theorists commonly associated with so-called Western Marxism include Karl Korsch (1886–1961), Antonio Gramsci (1891–1937), Ernst Bloch (1885–1977), Herbert Marcuse, Henri Lefebvre (1905–1991), Sartre, Maurice Merleau-Ponty (1908–1961), and the "Frankfurt School" theorists Walter Benjamin (1892–1940), Max Horkheimer (1895–1973), and Theodor Adorno (1903–1969). What is most striking about the "Western Marxists" is that none of them focused on Marxism's basic socioeconomic claims. They either directly assert or implicitly assume the truth of these claims, but they never see the need to show that they are true in fact. For example, Lukács emphatically saw the proletariat as the "identical subject-object" of history, but he never did the work to show how this must be so. The omission was made easier by the fact that Western Marxists focused overwhelmingly on culture, social consciousness, and ideology rather than on economics. For example, Gramsci is best known for his notion of hegemony, a kind of updated notion of ideology; Benjamin was a brilliant cultural and literary critic; and Adorno offered a cutting analysis of "the culture industry."

One historian of Western Marxism, Martin Jay, has noted that a loss of confidence in the validity and usefulness of Western Marxism occurred by the late 1970s, after a brief period in which it had attracted some young, leftist, mainly American academics. The reasons for this deflation are no doubt complex, as are the reasons for the decline of Marxism generally. One crucial consideration is that thinking persons can hardly go on begging the question as to the truth of a theory's basic claims for long before doubts need to be addressed. It is "no accident," as a Marxist might say, that such figures as Jürgen Habermas (b. 1929), scion of the Frankfurt School, and Agnes Heller (b. 1929), Lukács's most distinguished student, took issue, sooner or later, with Marxism.

By the 1970s, commitment to Marxism was not easy to maintain, for there had been too much experience contrary to Marx's hopes and predictions. Marx's claim that capitalism was doomed to collapse in a proletarian revolution had to face both the failure of any unified proletariat to appear and the fact that the institutions of capitalist society had managed to muddle through again and again. Marx's claim that socialism would be better than capitalism had to face both the experiential disconfirmation offered by actually existing communist states, and a serious argument, first articulated by Ludwig von Mises in 1920, to the effect that a complex nonmarket economy cannot operate efficiently, because markets are indispensable information-gathering mechanisms (see Steele).

Analytical Marxism. Although various claims central to Marxism no longer seem tenable, Marxism has a legitimate survival in at least two respects. First, Marxism exists as a set of suggestions for research, for Marx offered many specific

claims and suggestions concerning modern society and politics. Some of these are false, as Richard Hamilton has shown. But others, particularly when reformulated as abstract theoretical claims to be tested in specific present-day contexts, remain alive in current social science. For example, Marxism has been influential in recent thinking about international political economy—hardly surprising, in the light of Marx and Engels’s early insistence on capitalism’s global character. It has influenced thinking about state power, a theme emphasized by the Marxist political theorists Ralph Miliband (1924–1994) and Nicos Poulantzas (1936–1979) and picked up by others subsequently (see Aronowitz and Bratsis). It has influenced thinking about democratization—in particular, the thinking of those political scientists concerned with the relation between class structure and democracy. Finally, it has helped to inspire empirical research into the workings of class in modern society.

A question that arises in relation to such studies is: How Marxist are they? Clearly, they are not Marxist by the standards of revolutionary Marxism, since they are academic studies and not attempts to promote the revolution (at most, such researchers hope to encourage reform). But since in 2004 there exist virtually no active Marxian revolutionaries apart from the small circle of Nepalese Maoists, this is a high standard. By less stringent standards, such studies may well be Marxist in a looser sense—in the sense of taking Marx seriously, working within a tradition of Marxism, using Marxian language, and maintaining a normative commitment to the values of freedom, equality, and human dignity. Certainly, in the late 1970s a small but lively group of Anglo-American academics began to identify themselves as “analytical” or “rational choice” Marxists (see Roemer, Wright, and Wright et al.). However, insofar as their investigations were integrated into fields or subfields in political science, economics, sociology, and so on, these tended to become “research” rather than “Marxist research.”

Thus one meets again a boundary, where what is valid in Marxism passes over into an intellectual territory that is no longer Marxist. Some writers, notably Ernesto Laclau (b. 1935) and Chantal Mouffe (b. 1943) have called this territory “post-Marxism” (see Sim). In the eyes of such writers, post-Marxism involves a reformulation of Marxism in order to accommodate such “movements” as poststructuralism, postmodernism, and second-wave feminism. Here Marxism appears, not as a set of analyzable propositions, but, in a much more attenuated guise, as a form of critique and of hope from which almost all specifically Marxian claims have disappeared. This is the second way in which Marxism continues to have a legitimate survival in the twenty-first century.

See also **Capitalism; Communism; Economics; Hegelianism; Kantianism; Maoism; Revolution; Socialism.**

BIBLIOGRAPHY

PRIMARY SOURCES

Lenin, V. I. *The Lenin Anthology*. Edited by Robert C. Tucker. New York: Norton, 1975. Possibly the best one-volume anthology.

Marx, Karl, and Friedrich Engels. *Collected Works*. 50 vols. New York: International Publishers, 1975–2004. Imperfectly edited

and omits some manuscript writings, but indispensable for English-readers.

———. *Karl Marx, Friedrich Engels Gesamtausgabe (MEGA)*. Berlin: Dietz, 1972–1999. Berlin: akademie-Verlag, 1999–. Meticulously edited; will make all previous editions obsolete. Eventually 114 vols. Not to be confused with the “Old MEGA” (1927–1935).

———. *The Marx-Engels Reader*. Edited by Robert C. Tucker. 2nd ed. New York: Norton, 1978. Possibly the best one-volume anthology.

www.marxists.org. Makes freely available a large collection of works by many authors, beginning with Marx and Engels.

SECONDARY SOURCES

Aronowitz, Stanley, and Peter Bratsis, eds. *Paradigm Lost: State Theory Reconsidered*. Minneapolis: University of Minnesota Press, 2002. Marx’s theory of the state, updated.

Avineri, Shlomo, *The Social and Political Thought of Karl Marx*. London: Cambridge University Press, 1968. Slightly outdated but still useful.

Bottomore, Tom, ed. *A Dictionary of Marxist Thought*. 2nd ed. Oxford and Cambridge, Mass.: Blackwell, 1991. Articles on major topics in Marxism.

Breckman, Warren. *Marx, the Young Hegelians, and the Origins of Radical Social Theory: Dethroning the Self*. New York: Cambridge University Press, 1999. Shows connections between theological and sociopolitical concerns in the background to Marx.

Carver, Terrell, ed. *The Cambridge Companion to Marx*. Cambridge, U.K.: Cambridge University Press, 1991. Articles on various aspects of Marx’s theoretical project.

Draper, Hal. *The Marx-Engels Cyclopedia*. Vol. 1: *The Marx-Engels Chronicle: A Day-by-Day Chronology of Marx and Engels’s Life and Activity*. Vol. 2: *The Marx-Engels Register: A Complete Bibliography of Marx and Engels’ Individual Writings*. Vol. 3: *The Marx-Engels Glossary: Glossary to the Chronicle and Register, and Index to the Glossary*. New York: Schocken, 1985–1986. Indispensable for serious research on Marx.

Fehér, Ferenc, Agnes Heller, and György Márkus. *Dictatorship over Needs*. Oxford: Basil Blackwell, 1983. Critical analysis of the “command” society that was Soviet-style socialism.

Hamilton, Richard. *The Bourgeois Epoch: Marx and Engels on Britain, France, and Germany*. Chapel Hill: University of North Carolina Press, 1991. Attacks Marx and Engels’s historical claims.

Harding, Neil. *Leninism*. Durham, N.C.: Duke University Press, 1996. Succinct, highly critical account.

Hook, Sidney. “Marxism.” *Dictionary of the History of Ideas*. 5 vols. New York: Scribners, 1973–1974. Vol. 3, pp.146–161. A clear account, reacting against Stalinism. Can also be accessed at www.historyofideas.org.

Jay, Martin. *Marxism and Totality: The Adventures of a Concept from Lukács to Habermas*. Berkeley: University of California Press, 1984. Charts a course through “Western Marxism.”

Kolakowski, Leszek. *Main Currents of Marxism: Its Rise, Growth, and Dissolution*. Vol. 1: *The Founders*. Vol. 2: *The Golden Age*. Vol. 3: *The Breakdown*. Translated by P. S. Falla. Oxford: Oxford University Press, 1981. A critical account. Vol. 2 is the best volume; its coverage is unduplicated elsewhere.

McLellan, David. *The Thought of Karl Marx: An Introduction*. 3rd ed. Edited by David McLellan. London: Macmillan, 1995. Discusses major themes in Marx’s thinking, with illustrative

- Marx texts; also links writings to Marx's biography. Convenient, succinct.
- Megill, Allan. *Karl Marx: The Burden of Reason (Why Marx Rejected Politics and the Market)*. Lanham, Md.: Rowman and Littlefield, 2002. Impact of Hegelian philosophy on Marx.
- Roemer, John, ed. *Analytical Marxism*. Cambridge, U.K., and New York: Cambridge University Press, 1986. Essays by G. A. Cohen, Jon Elster, and others.
- Sassoon, Donald. *One Hundred Years of Socialism: The West European Left in the Twentieth Century*. New York: New Press, 1996. Socialism, Marxist and not, in twentieth-century Western Europe.
- Siegel, Jerrold E. *Marx's Fate: The Shape of a Life*. 1978. Reprint, University Park: Pennsylvania State University Press, 1993. The most intellectually serious biography.
- Sim, Stuart. *Post-Marxism: An Intellectual History*. London and New York: Routledge, 2000. Residues of Marxism after the collapse.
- Steele, David Ramsay. *From Marx to Mises: Post-Capitalist Society and the Challenge of Economic Calculation*. La Salle, Ill.: Open Court, 1992. Implications of von Mises's argument against non-market socialism.
- Wright, Erik Olin. "What Is Analytical Marxism?" In *Rational Choice Marxism*, edited by Terrell Carver and Paul Thomas, 11–30. University Park: Pennsylvania State University Press, 1995. Definition and defense of analytical Marxism.
- Wright, Erik Olin, Andrew Levine, and Elliott Sober. *Reconstructing Marxism: Essays on Explanation and the Theory of History*. London and New York: Verso, 1992. Analytical reconstruction of Marxism.
- Young, Robert J. C. *Postcolonialism: An Historical Introduction*. Oxford, and Malden, Mass.: Blackwell, 2001. Discusses role of Marxism in anticolonial struggles.

Allan Megill

ASIA

The writings of Karl Marx offer both a critique and a celebration of modern capitalism. On the one hand, Marx presented a devastating moral indictment of the capitalist exploitation of labor and the drowning of all human relationships in "the icy waters of egotistical calculation." On the other, Marx saw capitalism as a necessary and progressive phase of historical development, yielding the essential material and social prerequisites for socialism—modern industry and the proletariat.

The proposition that socialism presupposes capitalism was seen as universally valid. "The bourgeoisie, by the rapid improvement of all instruments of production," Marx wrote in *The Manifesto of the Communist Party* (1848), "batters down all Chinese walls. . . . It compels all nations on pain of extinction, to adopt the bourgeois mode of production. In one word, it creates a world after its own image."

In this mid-nineteenth-century anticipation of the late-twentieth-century phenomenon of "globalization," Marx assumed that the precapitalist countries of Asia were destined to follow the Western capitalist path of development. They would do so under the universalistic pressure of Western imperialism. While imperialism was morally detestable, it was historically progressive, breaking apart stagnant "Asiatic" societies

unable to move into modern history on their own. In universalizing capitalism, imperialism was laying the basis for an international socialist future.

Japan

It was entirely logical that Japan should have been the first Asian country where Marxism took root. Japan was the earliest Asian land to embark on a program of capitalist development. In the 1890s, in response to the social tensions of Meiji modernization, Japanese intellectuals imported Marxism along with a variety of other proscribed Western socialist theories. By the time of the Russo-Japanese War of 1904–1905, Marxism established itself as the dominant socialist theory. And the preeminent version of Marxism was the economically deterministic doctrine of Karl Kautsky (1854–1938).

The early Japanese Marxists often intermingled anarchist and utopian socialist ideas with their Marxian beliefs. It was not until the Russian Revolution of 1917 that Marxism found coherent political and intellectual expression. The Japanese Communist Party (JCP), founded in 1922, became the carrier of the Leninist version of Marxism while the Japanese Socialist Party largely based itself (in its various incarnations) on the more orthodox Marxist teachings of Kautsky. But Japanese Marxism in the 1920s and 1930s, partly because of severe state repression, was less influential as a political than an intellectual movement. By the late 1920s, Marxist influences were dominant in the economics departments of elite Japanese universities. The celebrated 1927–1937 debate on the nature of Japanese capitalism was a major contribution to international Marxist scholarship.

The rise of militarism and fascism in the 1930s led to the wholesale jailing of Marxists and the virtual total suppression of Marxian ideas. With the defeat of the fascist regime in 1945, Marxist intellectual and political life revived under the American occupation. Marxist theory became highly influential in economic and historical scholarship. Marxism found vigorous political expression in the small but influential Communist Party and also in the much larger Japanese Socialist Party (JSP). The JSP, which gained substantial electoral support, was hindered in its bid for power by a long-standing division between Marxist-Leninists and social democrats. A further political obstacle was the general prosperity yielded by Japan's phenomenal economic growth, which eroded Marxist influence. However, the stagnation of Japanese capitalism since 1990 perhaps augurs well for the reinvigoration of Japanese Marxism.

China

It was primarily in Japan that Chinese students and political exiles learned about Western socialism. In the first decade of the twentieth century, young Chinese intellectuals were attracted to a wide range of socialist ideologies, especially to the anarchist ideas of Pyotr Kropotkin (1842–1921) and Mikhail Bakunin (1814–1876), but also to various forms of "utopian socialism." There was some intellectual interest in Marxism, and fragments of the writings of Karl Marx and Friedrich Engels were translated into Chinese as early as 1907. But while there were many Chinese anarchists, there were no Chinese converts to Marxism prior to the Russian Revolution of 1917.

It is not difficult to understand why Marx struck few responsive chords among Chinese intellectuals who were increasingly attracted to Western socialist doctrines. Marxist theory, in its orthodox form, taught that a well-developed capitalist economy was an essential prerequisite for socialism. But China was an overwhelmingly agrarian land with little modern industry and only a tiny urban working class. What Marxism conveyed to nationalistic Chinese intellectuals, increasingly alienated from traditional culture and attracted to Western socialist visions, was the disheartening message that they could only wait patiently on the political sidelines while capitalist forces of production did their historical work.

Marxism gained its first substantial appeal in China under the twin impact of the 1917 Bolshevik Revolution and China's May Fourth Movement of 1919. The messianic appeals of the Russian Revolution did not strike the Chinese intellectual world as a "thunderbolt," as Mao Zedong later claimed, but it did arouse sympathetic interest, not least of all because Chinese intellectuals had felt a certain kinship with backward Russia since 1905. It also produced China's first Marxists, including Li Dazhao at Beijing University, soon to be a co-founder of the Chinese Communist Party.

The Bolshevik Revolution also brought to China the Leninist version of Marxism, which made the doctrine far more relevant to an economically backward land than orthodox Marxian teachings. The Leninist theory of imperialism provided a place for economically backward lands in the world revolutionary process, thus helping to satisfy nationalist and politically activist impulses. It provided an important revolutionary role for peasants in an overwhelmingly agrarian society. And the concept of the "vanguard" party, which assigned a decisive historical role to the "consciousness" of the intelligentsia, had enormous appeal.

Yet the Russian Revolution and Leninism would have had a much more limited appeal had it not been for the westernizing May Fourth Movement (c. 1915–1921), which burst into political activism shortly after World War I. The cynical betrayal of Chinese interests (in favor of Japanese imperialism) at the Versailles Peace Conference of 1919 led to widespread disillusionment with Western liberalism, opening the way for Marxian influences. Marxism received its main political expression in the Chinese Communist Party (CCP), formally established in 1921, although Marxism also significantly influenced the Nationalist Party of Sun Yat-sen and politically independent Chinese scholars.

There was little distinctive about Chinese Marxism in the early history of the CCP (1921–1927). The official ideology was Marxism-Leninism, as interpreted in Moscow and conveyed by the Comintern. In accordance with official ideology, the CCP found its main base in the urban proletariat and pursued a "two-stage" revolutionary policy, with a "bourgeois-democratic" phase preceding the socialist phase. In the first stage, the CCP was the junior partner in a Comintern-arranged tripartite alliance with the Nationalist Party of Sun Yat-sen and the Soviet Union. But the mass movement of workers and peasants proved too socially radical for the limited nationalist aims of the alliance, which were confined to national unification and

independence. The result was that the Nationalists, now led by Chiang Kai-shek, turned their Soviet-built army against their Communist allies in 1927, violently crushing the popular movement of workers and peasants. The Communists who survived the carnage fled to the more remote areas of the countryside. The suppression of Communist organizations in the cities in 1927 opened the way for the emergence of "Maoism" as a rural-based Marxian revolutionary strategy.

What came to be celebrated as "The Thought of Mao Zedong" was a doctrine that evolved over two decades of rural revolutionary warfare, culminating in the establishment of the People's Republic in 1949. Maoism, far from being "orthodox" or "hardline" Marxism as frequently characterized in the West, was marked by its departures from the premises of both original Marxism and Leninism. First, Maoism was based on the belief that the peasantry is the principal revolutionary class, even though lip service was ambiguously paid to the principle of "proletarian leadership." This was logically accompanied by a celebration of the virtues of rural life and a suspicion that cities were the breeding grounds of political conservatism and moral corruption. Maoism, thus, inverted the Marxist (and Leninist) conception of the relationship between town and countryside in the making of modern history.

Maoism not only strayed from Marxism in turning to the countryside but was also profoundly non-Leninist in celebrating the spontaneity of peasant revolt. While Mao appreciated the efficacy of Leninist principles of organization, he never accepted the intellectual basis of Lenin's "vanguard party"—the insistence that the "consciousness" of the intelligentsia had to be imposed on the "spontaneous" movement of the masses.

Mao's unique strategy of revolution was profoundly non-Marxist not only in the belief that the truly revolutionary class was the peasantry, but also in its conception that the revolution would take the form of a military struggle. Rather than the seizure of state power, the Maoist notions of "people's war" and "protracted warfare" envisioned that the expansion of the Red Army would permit the gradual building of nuclei of revolutionary political power in the rural areas. Ultimately, Maoists envisioned that the forces of revolt in the countryside would "surround and overwhelm" the conservative cities.

One of the pervasive features of Maoism was its voluntarist belief that human consciousness was the decisive factor in history. The Maoist maxim that "men are more important than machines" betrayed a striking lack of confidence in the "objective laws" of history proclaimed in Marxist theory, although the latter were ritualistically repeated in official texts. But the actual belief was that socialism was not dependent on any Marxian-defined level of economic development; rather, the historical outcome would be determined by the spiritual qualities of the people and their leaders.

The incorporation of Chinese nationalism into the Chinese version of Marxism enabled Mao to harness popular patriotic sentiments to the Communist cause during the decisive Yanan phase of the revolution, which coincided with the Japanese invasion of China (1937–1945). It made the Chinese Communist Revolution as much a war of national liberation as a social revolution.

Perhaps the most profound Maoist departure from the logic of Marxism was a pervasive populist-type belief in the advantages of backwardness. China's alleged condition of being "poor and blank," Mao believed, was a source of great moral purity and revolutionary energy that foreshadowed China's imminent leap to a socialist utopia. It was a totalistic rejection of the Marxist (and Leninist) insistence that socialism must be based on the material and cultural accomplishments of capitalism.

Such Maoist revisions of the inherited body of Marxist-Leninist theory, which were celebrated as the "Sinification of Marxism," were ideological preconditions for the peasant-based revolution that brought the Communists to power in 1949. But they left only tenuous intellectual ties between Maoism and Marxism.

In the end, Maoism sowed the seeds of its own demise. Maoist political methods and values, which continued to bear the birthmarks of its backward rural environment, became increasingly anachronistic in a rapidly industrializing society. It was thus inevitable that Mao's successors would purge Chinese Marxism of its more radical and utopian elements. They first returned to a more orthodox Marxist emphasis on the determining role of economic forces in history. What followed was the ritualization of Maoism, whose vocabulary was retained—but only in the form of nationalistic slogans severed from the actual policies that have generated a capitalist-type economy. The final chapter in the history of Maoism has seen its reduction to a nostalgic pop culture phenomenon—such as the opening of expensive Mao-themed restaurants and the sale (over the Internet) of old Mao badges and other memorabilia of the Cultural Revolution.

Yet if Maoism is exhausted, this is not necessarily the case for other forms of Marxism. The rapid development of capitalism in recent decades has yielded a massive industrial working class and an equally large *Lumpenproletariat* of migrant laborers. Many of the illegal trade unions that have attempted to speak on behalf of these highly exploited groups have done so in classic Marxist terms. It would be a grand irony of modern history if the greatest challenge to the Communist state appears in the form of a working-class movement proceeding under a Marxist banner.

Vietnam and Southeast Asia

In Southeast Asia, Marxism found its main political expression in Vietnam and, abortively, in Indonesia. Vietnamese Marxism was bound up with nationalism from the outset. In the early post-World War I years, Ho Chi Minh (1890–1969), the preeminent figure in the history of the movement who was initially attracted by the nationalist appeals of the Leninist theory of imperialism, became a founding member of the French Communist Party. Ho united several small Vietnamese Marxist-oriented parties into the Indochina Communist Party in 1930, but the party (and Marxism in general) were suppressed by the French colonial administration, forcing Ho to operate largely from abroad until World War II.

In 1941, the Vichy-controlled French colonial regime in Vietnam began active collaboration with the Japanese army.

The conditions were thus created for the ICP to emerge as the organizer of nationalist resistance to foreign domination—in the form of the Viet Minh, established in 1941 as an antifascist united front that took on an increasingly military character. While the Viet Minh was broadly based, it was Communist controlled—and its leader Ho Chi Minh became the symbol of Vietnamese nationalism. Adopting guerilla warfare tactics, Communist-led military forces successively fought the Vichy French colonial regime, the Japanese army in 1945, the post-war French colonial administration, and eventually the United States in a war that lasted more than three decades. The Communist victory in 1975 was essentially the triumph of Vietnamese nationalism. Marxism-Leninism, the official ideology, lent a social revolutionary dimension to the movement. But nationalism was always at the heart of its goals and appeals.

The Communist success in Indochina was not replicated elsewhere in Southeast Asia. Indonesia offers a particularly striking contrast. The Indonesian Communist Party, organized under the influence of Dutch Marxists in the 1920s, was among the earliest and largest Marxist parties in Asia. But the party's identification with ethnically Chinese Indonesians, its pro-Beijing sympathies, and its hostility to Islam undermined its nationalist credentials. Thus, the Communist bid for power in 1965 was crushed by the Indonesian army operating under nationalist and Islamic banners. Neither Indonesian Marxism nor Communism survived the bloodbath that took an estimated half-million lives, mostly ethnic Chinese.

Elsewhere in Southeast Asia, the main political manifestations of Marxism took the form of abortive Communist-led guerrilla insurgencies. Hostility to ethnic Chinese, as well as to China, was a major factor in the failure of Communist movements in Malaysia, Thailand, and Burma. Only in the Philippines, where Chinese migrants are socially well-integrated, does a Communist insurgency continue to simmer.

India

The diverse political implications of Marxism in Asia are suggested by comparing India with China. The two are countries of similar size and population, and both were impoverished agrarian lands in the mid-twentieth century. Yet while a Marxian-based political movement came to power in China and carried out the most massive of modern social revolutions, Marxian-oriented parties have been of marginal significance in India.

The difference cannot be attributed to a better understanding of Marxist theory by Chinese intellectuals. Propelled by the nationalist appeals of the Leninist theory of imperialism, Marxist ideas spread widely among Indian intellectuals in the wake of World War I, at the same time they did in China. Indeed, Marxism probably had a broader and deeper intellectual impact in India than in China because of the accessibility of English Marxist sources.

Although the Indian Communist Party was not formally established until 1926, radical Marxist groups flourished in the major cities from the early 1920s. However, the ICP was banned by the British colonial regime and its leaders were often jailed. Marxist and Communist influences were covertly expressed

through the Indian National Congress of Mahatma Gandhi (1869–1948) and Jawaharlal Nehru (1889–1964), which monopolized Indian nationalist resistance to British rule, winning the support of the peasantry as well as most urban social groups.

The failure of the ICP to emerge as a serious nationalist force relegated it to a relatively minor role in India's political life. Communist support of the British during World War II, demanded by the Comintern's antifascist united front policies, underscored the Indian party's lack of nationalist credentials. Nor were the ICP's prospects enhanced by the factionalism that plagued the Marxian movement in the post-independence period. The main (but not the only) division was between pro-Moscow and pro-Beijing parties following the Sino-Soviet split of 1958. The factional cleavage between "Marxist-Leninists" and "Maoists" highlighted the failure of the ICP to develop a distinctive form of Marxism suited to specifically Indian social conditions and cultural traditions. This failure, in turn, confined the various Marxian parties to a combined total of less than 10 percent of the electoral vote, although the Communists were able to win sufficient support to lead reformist coalition governments in the states of Kerala and West Bengal. In all, however, while Marxism has had a significant impact on Indian intellectual life, its political expression has been feeble.

Conclusion

It would be futile to generalize about the role of Marxism in the several dozen historically and culturally distinct countries of Asia. However, two brief observations might be ventured. First, Marxian-inspired movements in Asia have been politically successful only where they have come to express popular nationalist feelings and aspirations, as has been the case in China and Vietnam. This does not mean that Marxian Communism in Asia can be reduced to a species of nationalism, but a genuine nationalist content and appeal clearly has been an essential precondition for political success. In view of the original doctrine's internationalist message, this is one of the great ironies of the history of Marxism in the modern world.

Second, where Communists have come to power, Marxism, essentially a critique of capitalism, paradoxically has functioned as an ideology of economic development whose social outcome is a capitalist-type economy. This is clearly the case in China, and appears to be the likely fate of Vietnam.

See also *Capitalism; Communism; Historical and Dialectical Materialism; Marxism: Overview*.

BIBLIOGRAPHY

- Bernstein, Gail Lee. *Japanese Marxist: A Portrait of Kawakami Hajime, 1876–1946*. Cambridge, Mass.: Harvard University Press, 1976.
- Carrère d'Encausse, Hélène, and Stuart R. Schram. *Marxism and Asia: An Introduction with Readings*. London: Allen Lane, 1969.
- Duus, Peter, and Irwin Scheiner. "Socialism, Liberalism, and Marxism, 1901–31." Vol. 6, chap. 13, *The Cambridge History of Japan*, edited by Peter Duus. Cambridge, U.K.: Cambridge University Press, 1988.
- Hammer, Ellen J. *The Struggle for IndoChina*. Stanford, Calif.: Stanford University Press, 1954.

- Meisner, Maurice. *Li Ta-chao and the Origins of Chinese Marxism*. Cambridge, Mass.: Harvard University Press, 1967.
- . *Marxism, Maoism, and Utopianism: Eight Essays*. Madison: University of Wisconsin Press, 1982.
- Overstreet, Gene D., and Marshall Windmiller. *Communism in India*. Berkeley: University of California Press, 1960.
- Scalapino, Robert A. *The Japanese Communist Movement, 1920–66*. Berkeley: University of California Press, 1967.
- Scalapino, Robert A., and Dalchoong Kim. *Asian Communism: Continuity and Transition*. Berkeley: University of California Press, 1988.
- Schram, Stuart R. *Mao Tse-tung*. New York: Simon and Schuster, 1967.
- Schwartz, Benjamin. *Chinese Communism and the Rise of Mao*. Cambridge, Mass.: Harvard University Press, 1951.
- . *Communism and China: Ideology in Flux*. Cambridge, Mass.: Harvard University Press, 1968.
- van der Kroef, Justus M. *Communism in South-east Asia*. London: Macmillan, 1981.
- Young, Marilyn B. *The Vietnam Wars, 1945–1990*. New York: HarperCollins, 1991.

Maurice Meisner

LATIN AMERICA

Throughout the twentieth century, Latin Americans wrestled with the enduring problems of foreign domination, social inequality, and poverty. Marxist popular movements, political parties, and intellectuals were often key players in these struggles, forming an important basis for trenchant social critique, mass social movement, and revolutionary organization. Even in countries where Marxist ideas, parties, and organizations never developed a mass following or consistent electoral presence, they exercised a broad influence on social movements, politics, and culture. Latin American Marxism cannot be abstracted from this broader social, political, and intellectual ferment. Despite the insistence of many Marxist political parties and regimes on ideological unity, the history of Latin American Marxism has been characterized by creative engagement, partisan debate, and heterodoxy.

Antecedents and Origins

This ferment is reflected in how Latin American Marxists tell their own history. Although Marxist parties and popular organizations, *strictu sensu*, did not exist until the 1920s, many of the popular icons of latter-day Marxist movements have been drawn from earlier generations and other traditions of social struggle. Heterodox Marxist intellectuals have tended to echo radical currents in nineteenth-century liberalism, which suggested that village and ethnic communitarian traditions might be a foundation for radical social transformation. To some extent, these Jacobin intellectuals merely ratified a kind of organic popular liberalism, in which local and regional parties and militias sought to parlay their defense of community into broader visions of national transformation (and sometimes into effective guerrilla resistance to foreign invasions); the degree of contact and mutual influence between popular liberals and urban Jacobins is still an open question. The late nineteenth and early twentieth centuries also saw the beginnings

of a strong anarchosindicalist and socialist movements in Latin America's nascent urban working classes, which were the foundation for many early communist parties in the 1920s.

The first communist parties in Latin America were founded in the wake of the Russian Revolution of 1917, but they maintained a strong bent toward ideological heterodoxy. In Brazil, for example, former anarchists formed a communist party in 1922, although many of their delegates were vetoed at Comintern congresses. The Mexican Communist Party, the first Comintern section in Latin America (and the first communist party outside Russia), became a de facto training ground for activists in the ruling Partido Revolucionario Institucional; murals by Communist Party members David Alfaro Siqueiros and Diego Rivera still adorn government buildings. In 1928 the prominent Marxist theorist José Carlos Mariátegui founded the Partido Socialista del Perú (PSP). Mariátegui insisted that Marxist ideas needed to be adapted to the distinctive reality of Latin America, particularly its indigenous traditions, and he rejected Leninist notions of party centralism. The PSP affiliated with the Comintern only after Mariátegui's death.

One of the most original Marxist thinkers in Latin America, Mariátegui gave a distinctive Marxist cast to the broad-based political movement known as *indigenismo*, which sought to ensure the rights of contemporary Native American peoples and to vindicate Latin America's indigenous past. Mariátegui initially worked with the Alianza Popular Revolucionaria Americana (APRA) of Haya de la Torre and shared the APRA's characterization of the "Indian problem" as a social and political issue rather than a moral or racial one. But Mariátegui also insisted on working-class agency and insisted that socialism was not alien to Peru's indigenous peoples, viewing the pre-Hispanic Inca empire as a form of primitive communism. Anticipating many of Chairman Mao Tse-tung's ideas, he insisted that socialist revolution would result from a long "accumulation" of forces. Indeed, in the 1980s and 1990s the Maoist Sendero Luminoso claimed Mariátegui as a founding ancestor, although this legacy continues to be contested vigorously by other left opposition movements and intellectuals.

1929–1959: International Crises and the Search for Common Ground

Despite the independence of many Latin American Marxist thinkers, international developments also continued to shape Marxist ideas in Latin America. The global economic crash of 1929 reinforced the Comintern's turn toward ultraleftism, and in many countries communist parties broke with allies in reformist unions and organizations, established rival organizations, and vigorously contested the state. The resulting repression drove many of these parties into semiclandestine status; an attempted insurrection in El Salvador ended in catastrophe, with more than ten thousand killed. In 1935 the rise of fascism prompted the Comintern to call for a "popular front" of proletarian parties and the antifascist bourgeoisie. During World War II, Latin American communist parties also abandoned their earlier anti-imperialism in favor of a broad international alliance against fascism. They also built alliances with right-wing groups and local dictators such as Batista in Cuba and Somoza in Nicaragua. In Chile, the Popular Front of

communist, socialist, and radical parties won the presidency in 1938 and pursued a program of moderate reform. In many other countries, however, communist parties lost ground to populist regimes or other left opposition movements.

The wholesale repression of communist parties—and the aggressive intervention of the United States—encouraged Latin American communists to continue alliances with liberal and democratic parties in the postwar years. Marxist intellectuals embraced Latin American liberals' age-old enthusiasm for national "development," combining sophisticated critiques of global political economy with vague tropes of modernity. Latin American poverty, they held, stemmed from its economic dependency on the United States, whereby Latin American economies exchanged raw materials for manufactured goods at disadvantageous terms. They tended to view the development of a capitalist industrial economy and urbanized society as a prerequisite for socialist revolution. In some instances, Marxist intellectuals revived Simón Bolívar's dream of a broad alliance of Latin American nations, which would permit the development of economies of scale and the political strength to stand up to an aggressive United States.

Other Marxist intellectuals, particularly in the Caribbean, emphasized connections with anticolonial struggles in other parts of the world as well as the struggle for racial justice in the United States. This trend was exemplified by C. L. R. James, whose work remains important in both international Marxist theory and cultural studies. Born in the then-English colony of Trinidad, C. L. R. James's initial focus was on his native Caribbean, and his early work included social-realist fiction set in West Indian slums as well as his classic study of the 1793 slave revolt in Saint Domingue (Haiti), *The Black Jacobins* (1938). He also wrote two key works on Marxist theory and practice, *Notes on Dialectics* (1948) and *State Capitalism and World Revolution* (1950). His *Mariners, Renegades, and Castaways* (1953) analyzed the relations among *Moby Dick's* narrator, the ship's captain, and its expert "Third World" crew. *Mariners* anticipated James's involvement in revolutionary decolonization movements in Africa, the Caribbean, and Latin America, as well as among African Americans in the United States. It also presaged the broader internationalism of Latin-American Marxists following the Cuban Revolution.

Foquismo

Latin American communist parties tended to remain chary of insurrectionary strategies and labor radicalism in the postwar years. Indeed, the most militant opposition often came from other left dissidents. In Cuba, where the Communist Party had initially collaborated with the U.S.-backed military regime of Fulgencio Batista, the leadership of a nascent revolutionary movement emerged from the populist Ortodoxo Party (Partido del Pueblo Ortodoxo), and it was inspired as much by the romantic ideal of the revolutionary *atentat* (a spectacular act of revolutionary violence that was meant to inspire mass insurrection) as by Leninist notions of party organization. The movement's victory in 1956 was a puzzle for many Latin American Marxists as much as for U.S. cold warriors, as was the subsequent radicalization of the Cuban revolutionary regime. In the face of U.S. economic blockade and

a CIA-sponsored invasion attempt, the revolutionary government in Cuba proclaimed its Marxist-Leninist orientation and accepted the Soviet Union's political support, military protection, and economic backing. Despite the Soviet Union's increased leverage, however, the revolution's leadership continued to depart from Marxist-Leninist orthodoxy.

In the years following the revolution, the revolutionary *co-mandante* Ernesto "Ché" Guevara elaborated a new theory of revolution known as *foquismo*, in which the revolutionary *foco*, a small cell of guerrillas in the countryside, replaced the vanguard party. Ché's theory contained an implicit criticism of most Latin American communist parties, which had all but abandoned revolutionary violence. Latin American revolution was not simply a possibility, *foco* theory held, but also a moral imperative. Revolutionaries must create "subjective" conditions for revolution rather than awaiting the proper objective conditions. The rural peasantry, rather than the urban proletariat, was the seedbed of socialist revolution. Similarly, a socialist, anti-imperialist revolution was a prerequisite for national economic development, rather than the other way around. In Ché's view, the Cuban Revolution was a beachhead for a broader Latin American revolution; the Andes would become the Sierra Maestra of South America.

Ché is conventionally portrayed as a romantic counterpoint to the authoritarian turn of the Cuban Revolution and the Soviet Union. Indeed, in his final years Ché did publicly clash with the Soviet Union and—less publicly—with Fidel Castro, and *foquista* guerrillas elsewhere in Latin America often clashed with mainline communist parties. But Ché's insistence on the centrality of the revolutionary *foco* also helped underwrite the exclusion of other groups that had been instrumental in Batista's overthrow and a rigid intolerance of political heterodoxy. Inspired by Ché's writings and example, a generation of young revolutionaries sought to establish guerrilla *focos* throughout Latin America, often without any advance political work, local ties, or knowledge of the terrain. Almost all of these expeditions ended in ignominious defeat—most notoriously Ché's own expedition to Bolivia—and later rural guerrilla movements, including the *foquista* movements that had survived the repression of the late 1960s and 1970s, tended to abjure Guevara's insurrectionary strategy in favor of a "prolonged people's war" like those waged in Vietnam and China.

One of the most severe critiques of *foquismo* came from Abraham Guillén, a Spanish Civil War veteran living in Argentina and Uruguay. In his *Estrategia de la guerrilla urbana* (1966), Guillén echoed Ché's call for popular insurrection and Latin American liberation on a continental scale, but he also insisted that the movement would be led by urban proletariat rather than the rural peasantry. During the 1960s and 1970s, urban guerrilla movements emerged throughout Latin America, most famously the Argentine Montoneros and the Uruguayan Tupamaros. None of these movements were strictly Marxist in orientation, and they often drew their leadership from the left wing of national populist movements as well as communist dissidents. Indeed, like *foquista* guerrillas, they tended to clash with mainline communist parties, which often viewed voluntarist and insurrectionary strategies as little more than

dangerous adventures. After Ché's death at the hands of CIA-backed counterinsurgency forces—and under pressure from the Soviet Union—the Cuban government, too, abandoned its earlier support of revolutionary *focos* and sought a rapprochement with other Latin-American governments.

The 1970s and After: New Heterodoxies

Where possible, mainline communist parties tended to support a moderate strategy of trade unionism and broad electoral alliances. In 1970 the Chilean Marxist Salvador Allende was elected president at the head of a shaky coalition of radical, socialist, and communist parties. The Chilean Unidad Popular (UP) embarked on a modest program of social reforms within a constitutional framework. Strategic industries such as coal and steel were nationalized. With the government's sometimes reluctant backing, workers began seizing factories and transforming them into social property, including properties of U.S.-based multinationals such as Ford and ITT. The government also embarked on a far-reaching agrarian reform; by 1973, 60 percent of Chile's agricultural land had been expropriated and distributed to peasants. Nonetheless, the opposition maintained control of the Chilean congress, and the UP itself was deeply divided. United States economic sanctions and sabotage by producers, landowners, and merchants led to inflation and shortages, undermining the UP's support from an already skittish middle class. From the beginning the United States worked for Allende's overthrow, and on 11 September 1973, his government was toppled in a CIA-sponsored military coup.

One of the more novel movements of the 1970s was the marriage of older traditions of social Catholicism and popular religiosity with Marxist ideas and political organization. In what has become a foundational text of this "liberation theology," the Peruvian priest Gustavo Gutiérrez founded a new reading of biblical and church writings in Marxist dependency theory. Other religious activists—most famously the Colombian priest Camilo Torres and the Nicaraguan *padre* Ernesto Cardenal—embraced an insurrectionary strategy and participated in armed revolutionary movements. Many other priests and pastoral lay workers helped members of marginal *barrios* and villages form affinity groups known as *comunidades eclesiales de base* (CEBs), viewing popular communitarian ideals as a revindication of the primitive church. Founding their work in a process of participatory education known as *concientización* (roughly, "consciousness-raising" or "conscience-raising"), radical religious activists encouraged CEB members to apply biblical writings to their own concrete social reality.

Other communitarian traditions continued to be instrumental in Marxist ideas and movements in the final decades of the twentieth century. In Nicaragua, the Frente Sandinista de Liberación Nacional (FSLN), a broad, if shaky, coalition of Marxist guerrilla movements and liberal dissidents, overthrew the brutally repressive Somoza dictatorship in 1979. The movement's heterogeneity, its deep roots in autochthonous liberal and communitarian traditions, and the somewhat lukewarm support of Cuba and the Soviet Union meant that the Sandinista government tended to abjure Leninist party organization in favor of liberal principles of electoral democracy. It also engaged in a moderate program of land reform

(generally along cooperative rather than collectivist lines), improved education and other public services, and enacted progressive social legislation. The Sandinista government survived an eleven-year CIA-sponsored campaign of intimidation, assassination, and sabotage that cost Nicaragua more than thirty thousand lives, and in 1990 it peacefully ceded power to the liberal opposition following an internationally supervised democratic election.

The years following the disintegration of the Soviet Union were a period of retrenchment in Latin America's Marxist left. The fall of the Soviet Union, the aging of the revolutionary elite, and the coming of age of a postrevolutionary generation forced the Cuban government to adopt a program of economic flexibility and Guevarist moral incentives, opening limited spaces for private entrepreneurs and developing ties with European social democracies. In much of the rest of Latin America, the economic crises at the end of the twentieth century and beginning of the twenty-first changed the profile of the Marxist left's social bases, displacing much of the rural poor, impoverishing the urban working class, and weakening the middle class. At the same time, the transnational movement of people, information, capital, and commodities—and the negotiation of bilateral and multilateral trade agreements—spurred a new transnational focus in the Marxist left.

On 1 January 1994, the same day the so-called North American Free Trade Agreement went into effect, the Ejército Zapatista de Liberación (EZLN) captured four municipalities in the southern Mexican state of Chiapas—and captured, too, the world's imagination through its creative use of political theater, mass media, and the Internet. Founded some eleven years earlier, the EZLN's founders had adopted the classic Maoist strategy of “prolonged people's war,” forming ties with communities in the Chiapas highlands and learning the local Tzotzil language. Unlike Peru's Sendero Luminoso, however, which shared the EZLN's focus on an indigenous social base and initial Maoist strategy, the EZLN abandoned Marxist schemes of revolutionary organization, adopting a democratic decision-making process and turning leadership over to indigenous communities. Like many other Latin American popular movements in the 1980s and 1990s, the EZLN foreswore armed seizure of power in favor of “armed negotiation,” seeking a democratic opening in Mexico's political system and legal protections for its indigenous communities. In this regard it was perhaps inspired by recent Latin American guerrilla movements, which during the 1990s were able to negotiate democratic openings in their respective countries.

The EZLN shared with other contemporary Marxist-influenced popular movements and Marxist thought an outspoken opposition to the neoliberal hegemony in Latin America and around the world. These movements continued to draw from other popular traditions of community and protest as well as recent analyses of imperialism and modernity. Despite the near-disappearance of Latin American communist parties by the start of the twenty-first century, Marxist critiques of poverty, inequality, and foreign domination—and Marxist-inspired social movements—remained powerful influences in Latin American scholarly debates and political struggles.

See also *Communism: Latin America; Dictatorship in Latin America; Marxism: Overview.*

BIBLIOGRAPHY

- Allende Gossens, Salvador. *Chile's Road to Socialism*. Edited by Joan E. Garces, translated by J. Darling, introduction by Richard Gott. Baltimore, Md.: Penguin, 1973.
- Angell, Alan. “The Left in Latin America since c. 1920.” In *Latin America since 1930: Economy, Society, and Politics*. Vol. 6 of *Cambridge History of Latin America*, edited by Leslie Bethell. New York: Cambridge University Press, 1984.
- Carr, Barry, and Steve Ellner, eds. *The Latin American Left: From the Fall of Allende to Perestroika*. Boulder, Colo.: Westview Press, 1993.
- Castañeda, Jorge G. *Utopia Unarmed: The Latin American Left after the Cold War*. New York: Knopf, 1993.
- Chomsky, Aviva, Barry Carr, and Pamela Maria Smorkaloff, eds. *The Cuba Reader: History, Culture, and Politics*. Durham, N.C.: Duke University Press, 2003.
- Guevara, Ernesto Ché. *Guerrilla Warfare*. Introduction to the Bison Books edition by Marc Becker. Lincoln: University of Nebraska Press, 1998.
- Guillén, Abraham. *Philosophy of the Urban Guerrilla: The Revolutionary Writings of Abraham Guillén*. Translated and edited with an introduction by Donald C. Hodges. New York: Morrow, 1973.
- Gutiérrez, Gustavo. *A Theology of Liberation: History, Politics, and Salvation*. Translated and edited by Sister Caridad Inda and John Eagleson. Maryknoll, N.Y.: Orbis Books, 1988.
- James, C. L. R. (Cyril Lionel Robert). *The C. L. R. James Reader*, edited and with an introduction by Anna Grimshaw. Cambridge, Mass., and Oxford: Blackwell, 1992.
- Löwy, Michael. *Marxism in Latin America from 1909 to the Present: An Anthology*, edited and with an introduction by Michael Löwy; translated from Spanish, Portuguese, and French by Michael Pearlman. Atlantic Highlands, N.J.: Humanities Press, 1992.
- Marcos, Subcomandante. *Shadows of Tender Fury: The Letters and Communiqués of Subcomandante Marcos and the Zapatista Army of National Liberation*. Translated by Frank Bardacke, Leslie López, and the Watsonville Human Rights Committee, California; introduction by John Ross; afterword by Frank Bardacke. New York: Monthly Review Press, 1995.
- Mariátegui, José Carlos. *Seven Interpretive Essays on Peruvian Reality*. Translated by Marjory Urquidi; introduction by Jorge Basadre. Austin: University of Texas Press, 1971.

Michael Werner

MASKS. The Western term for an object that transforms a face, *mask*, derives from the Arabic word *maskhara*, “to transform into an animal or monster.” This term was derived from the term *msk*, used in the middle Egyptian period to denote “second skin.” In Arabic, it became *msr*, which meant “to Egyptianize,” referring to the ubiquitous practice among Egyptians of masquerading, as the Arabs noted (Nunley and McCarty, p. 15). Masks, however, were an integral component in the development of human culture and social evolution long before the term *mask* ever existed. A lion-headed human figure

carved from mammoth ivory found in France has been dated to at least 30,000 B.C.E., from the later Aurignacian (Upper Paleolithic) period. Moreover, masked images of humans have been found on Mimbres pottery (ninth to thirteenth centuries) in the American Southwest and in painted images on rock surfaces in Australia, Africa, and Siberia.

Origins

Given that masks and the performance complex of masking, known as the masquerade, are found in practically all cultures at one time or another, there must be some fundamental reasons for the emergence of such a cultural practice. The development of shamanism seems to go hand in hand with masking and masquerading. As humans began to observe nature empirically, including their own behavior, parts of the puzzle explaining reality appeared to be missing. Explanations for disease, drought, floods, lightning strikes, and aberrant human behavior were sought in the invisible world where the actions and forces of spirits, like subatomic particles, figured prominently in the phenomena of the visible world.

The development of the abstract concept of spirit may have many sources. One plausible hypothesis suggests that, as humans began to recognize themselves and other animals in temporary reflections, they concluded that such appearing and disappearing images were the counterparts of beings existing in an invisible world and that everything in the visible world had a spiritual counterpart in the invisible world. A bison, for example, had a spirit force that remained active in the invisible world after the animal was hunted down and killed. These early peoples believed that the bison's spirit had returned to this world and been reborn in the flesh. An incipient shamanic cosmology eventually mapped the perceived universe with the salient domains being the sky, earth, and water. Food, weather, fertility, and life itself depended on these realms.

Humans associated particular animals with the realms each inhabited. An eagle was associated with the sky and sun, a jaguar with the earth and darkness, and a salmon with water and life. They also observed transformations along the path of the sun, which produced day and then night as that star passed to the invisible world. The motion of the sun also produced the seasons and, by extension, the "seasons" of humans. Birth was equated with spring, maturity with summer, old age with fall, and death with winter. These transformations were believed to be controlled by invisible forces.

How did humans connect masking and the masquerade to these unseen forces? The answer is partly found in the development of human cognition during ancient times, which found a way of accounting for real-world events that continues in some traditional societies. As hunters and gatherers, humans were an integral part of the "natural environment." They carefully observed the behavior of all animals. People as well as groups of people, such as clans, assumed the attributes of these animals (totemism). Some people moved like deer, looked stocky like bears, or were mean-spirited like swans. Some were bullish (as described by Sean StandingBear, Osage oral historian and artist). Other people, however, shared the traits of many creatures and were thought to be

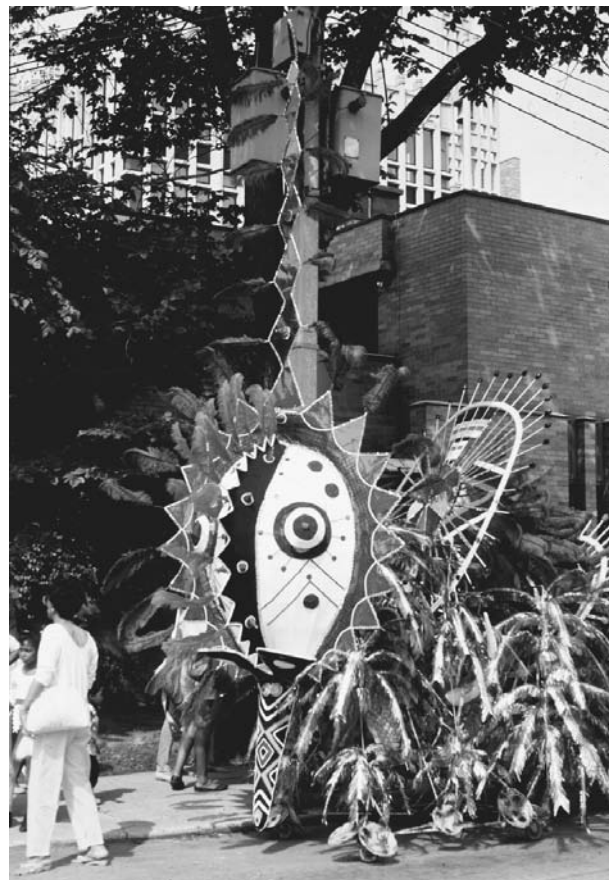

African costume designed by Wallace Alexander for CARIBANA Festival, Toronto, Ontario, 1986. Masks are an integral part of dress for festivals and special occasions around the world. Masquerades serve many functions, such as marking seasonal changes, celebrating rites of passage, and paying homage to ancestral ties. COURTESY OF JOHN NUNLEY

capable of shape-shifting. As people allied themselves with certain animals, their totems, they had the right to wear masks and perform as those animals. By wearing the mask of a jaguar, for example, a clan could enter the invisible underworld and communicate with the jaguar's forces in order to prepare for war. Another person might perform in a whale mask and enter the invisible world in the depths of the ocean to ask the whales to give up some of their own in order for humans to have a safe and successful whale hunt. The tensions humans felt between the invisible and visible domains could be resolved for a while in the masquerade performance and its associated rituals.

By creating different constellations of masking, communities created their own social identity. When a person or group commits to a masking identity, one is transformed; "I am not myself," as the African art historian Herbert Cole (1995) has phrased it. When everyone involved in the masquerade adopts this belief we, as humans, have reinvented who we were and are. Thus, reinvention through the masquerade became a principle vehicle for creating culture and social identity.

While other animals often seem unaware of their reflected image, for example, when they drink from a lake or pond, humans have long observed their image, particularly the face in reflective surfaces, including water and shiny hard surfaces. By manipulating their image with paint, feathers, body scarification, and tattoos, people consciously reinvent who they are in order to strengthen social bonding and group identity, both crucial to survival. Interestingly, human facial expressions, controlled by the competing voluntary and involuntary parts of the brain, also affect social bonding. The involuntary part of the brain lies in the older “primitive” portion, where it competes with the voluntary portion. This tug-of-war is often visible in the way human facial expressions suddenly change. For example, when hearing that someone secretly hated has fallen on hard times, one’s voluntary facial expression—the aspect that can be controlled—may communicate, “That’s too bad. I’m so sorry.” But, toward the end of that expression, the involuntary part of the brain takes over and an incipient smile becomes apparent.

Lying is simply a manipulation of facial expressions, voice modulation, and body language to ensure social bonding in both the long and short terms. Similarly, the use of a mask freezes the facial expression and eliminates this kind of ambivalence. Thus, a person wearing a mask while circumcising a young boy is protected by the steady gaze of the mask, which hides his true expression at an emotionally volatile time. The masks worn by executioners perform the same function.

Gender also adds to the understanding of the origins of masks and masquerades. In ancient times, men invented masks as decoys to take advantage of an animal and to become the animal in order to communicate with its spirit for cooperation in the hunt. Moreover, the entire masquerade complex includes men making masks, dancing as the masqueraders, sacrificing blood to the masks, and the symbolically violent act of drumming, which is for a man to strike with his hand or club the skin of an animal stretched over a wood cylinder. These active behaviors, so prevalent in traditional societies and in some contemporary ones, are regarded as men’s work. Women, on the other hand, are expected to perform long-term nurturing tasks, patiently and less obviously, compared to men’s actions.

The Functions of Masking

Masquerades have many functions, yet they appear to cluster into particular categories. There are masks associated with rites of passage such as adolescents’ initiations, other age-related ceremonies, and death. Masking in seasonal festivals and renewal rituals is associated with the earth’s fertility and the path of the sun as it appears to us from Earth. In other masquerades, men play women, generally as the maiden, mother, and crone. Masks also evolved into theater as, for example, in ancient Greece or the Noh drama of Japan. In some sports and in hazardous occupations, masks are worn to protective the face.

As people change physically, especially at adolescence, old age, and death, masking rituals are performed to mark the transition and make it safe. Adolescent energy, for example, can be dangerous and destabilizing to society. To insure a safe transition, groups of young boys, for example, may be gathered

and kept away from their village for long periods of time while they are taught the ways of masculine adulthood. Masquerades are performed in order to teach the adolescents and to communicate to the village that the transition has been blessed by the appropriate spirits in the invisible world and is a success. Frequently, masks that accompany the dead in burial are placed over the face or head, thus assuring their safe journey or passage through the underworld and to a place where their spirits can assist, not hinder, their people in the visible world.

Other masquerades celebrate the changes of the seasons, which are associated with renewal and fertility. The Corpus Christi masking festivals of Ecuador celebrate the fertility of Christ’s body and its positive impact on the fertility of crops and the harvest. Musical bands play as the processions of masqueraders move through the streets of Pujilí. The many plastic dolls on the mask superstructures serve as metaphors for fertility. The mirrors reflect the powerful light of the sun, which makes all life possible. Urban festivals, such as Carnival and its pre-Lenten celebrations, were all at one time associated with fertility.

In Bulgaria, masquerades are intimately associated with agriculture and human fertility, while in Basel, Switzerland, and Trinidad and Tobago there is far less emphasis on fecundity and more interest in the renewal of social and individual identities. These festivals often address local political, health, and economic issues, as well as global themes concerning war and other events reported in the popular media.

Within most masquerade festivals, only men play the roles of women, which fall into three categories: the maiden, mother, and crone. In general, men play women’s roles, first because men monopolize the masking process, and second, in order to communicate to both sexes the kinds of behavior they believe are appropriate for women. Maringuila maidens in the masquerades in Michoacán, Mexico, represent idealized beauty and how young women should conduct themselves in public.

Among the Yoruba Gelede of West Africa and in some Latin American countries, men dress as mothers and convey, through the round forms of their costumes and masks, women’s promise of fertility and ability to bring stability to society. The two-faced Gelede mask reminds participants that each person has an inner and outer self, and that it is the inner face that keeps the outer appearing cool and collected during stressful times (Nunley, 1996, p. 1782).

Men have always feared old women, most likely because the latter cannot give birth and are no longer sexually desirable. Old women might, from the men’s point of view, pose a threat to society, as they are often accused of witchcraft. Thus males play the crone to neutralize the potential destructive force they fear.

Masks are also associated with physical and spiritual dangers, in other words offense and defense. Shamans in full ritual dress, including masks, enter the invisible world on behalf of clients or even an entire community to eliminate dangers posed by disease, weather, particular people, or enemy communities. A Siberian shaman once wore such ritual dress while dancing to the rhythm

of a drum and the rattling sound of his medicines and metal objects attached to his garment. While spinning and mimicking the flight of birds, he once traveled in the invisible world and dealt effectively with both good and bad spiritual forces, thus protecting his clients. Likewise, an Oku sorcerer's ritual dress, complete with a hooded bird mask, fulfilled the same function.

In industrial societies space suits and helmets (masks) are used to protect astronauts on their flights into space. Like the shaman, who could look back on the visible world from his spiritual space, the astronauts looked back from the moon and showed the world from a new perspective. Looking back at the world from the moon, people learned how small and interconnected the world is and, as well, its vulnerability. The environmental movement was inspired by this realization.

Masks are also used in theater and in films. Greek theater masks, which evolved from the old Dionysian cults, were concerned with death, rebirth, and fecundity. They were worn by actors who played specific roles in the tragedies. In Asia, masks are frequently found in live theater in the great epics about Hindu deities, Japanese Noh theater, Chinese New Year pageants, and in Balinese street theater celebrating the exploits of the forceful crone known as Rangda. In Western films such as *Star Wars* or the popular television series *Star Trek*, masks cover the faces of beings from other galaxies as well as cyborgs, characters that are both biological and mechanical.

Masks and masquerades are inextricably linked to the development of culture and human identity. In the ludic performances of masks, social bonding occurs and roles are defined on many levels, including gender. Masks play to the spirits of the invisible world; they are the "x" commodity in the equations of the many worldviews invented by humans. Masks have existed from ancient times to space explorations. While masquerades were and are integral components of traditional societies, they have found new meanings and purposes in film, sports, and modern warfare. I am a soldier, I am a hockey goalie, I am Darth Vader, I am the spirit of the bison: in other words, "I am not myself," a conceptual tool that has led to individual and social reinvention, the essence of being human.

See also Animism; Dress; Gender Studies; Anthropology; Gesture; Identity: Personal and Social Identity; Religion; Ritual; Theater and Performance; Totems; Tragedy and Comedy.

BIBLIOGRAPHY

- Brockett, Oscar G. *History of the Theatre*. Boston: Allyn and Bacon, 1995.
- Bullough, Vern L., and Bonnie Bullough. *Cross-Dressing, Sex, and Gender*. Philadelphia: University of Pennsylvania Press, 1993.
- Burch, Jr., Ernest S. "War and Trade." In *Crossroads of Continents: Cultures of Siberia and Alaska*, edited by William W. Fitzhugh and Aron Crowell, 227–240. Washington, D.C.: Smithsonian Institution Press, 1988.
- Coe, Michael D. *The Jaguar's Children: Pre-Classic Central Mexico*. New York: The Museum of Primitive Art, 1965.
- Cole, Herbert M., ed. *I Am Not Myself: The Art of African Masquerade*. Los Angeles: Museum of Cultural History, University of California at Los Angeles, 1985.
- DeMott, Barbara. *Dogon Masks: A Structural Study of Form and Meaning*. Ann Arbor, Mich.: UMI Research Press, 1980.
- Drewal, Henry John, and Margaret Thompson Drewal. *Gelede: Art and Female Power among the Yoruba*. Bloomington: Indiana University Press, 1983.
- Duchartre, Pierre-Louis. *The Italian Comedy*. Translated by Randolph T. Weaver. New York: Dover Publications, 1966.
- Eliade, Mircea. *Shamanism: Archaic Techniques of Ecstasy*. Translated by Willard R. Trask. Princeton, N.J.: Princeton University Press, 1964.
- Esser, Janet Brody, ed. *Behind the Mask in Mexico*. Santa Fe: Museum of New Mexico Press, 1988.
- Ferris, Lesley. *Acting Women: Images of Women in Theatre*. New York: New York University Press, 1989.
- Gennep, Arnold van. *Rites of Passage*. Translated by Monika B. Vizedom and Gabrielle L. Caffé. Chicago: University of Chicago Press, 1961.
- Hammoudi, Abdellah. *The Victim and Its Masks: An Essay on Sacrifice and Masquerade in the Maghreb*. Translated by Paula Wissing. Chicago: University of Chicago Press, 1993.
- Ivanov, S., and V. Stukalov. *Ancient Masks of Siberian Peoples*. Text in English and Russian. Leningrad: Aurora Art Publishers, 1975.
- James, Edwin Oliver. *Seasonal Feasts and Festivals*. New York: Barnes and Noble, 1961.
- King, Barbara J. *The Information Continuum: Evolution of Social Information Transfer in Monkeys, Apes, and Hominids*. Santa Fe: SAR Press; distributed by the University of Washington Press, 1994.
- Lévi-Strauss, Claude. *The Way of the Masks*. Translated by Sylvia Modelski. Seattle: University of Washington Press, 1982.
- Marshack, Alexander. *The Roots of Civilization: The Cognitive Beginnings of Man's First Art, Symbol and Notation*. Mount Kisco, N.Y.: Moyer Bell, 1991.
- McCarty, Cara. *Modern Masks and Helmets*. Pamphlet. New York: Museum of Modern Art, 1991.
- Napier, A. David. *Masks, Transformation, and Paradox*. Berkeley: University of California Press, 1986.
- Nunley, John W. "Cover Story." *Journal of the American Medical Association* 276, no. 22 (December 11, 1996): 1782.
- . *Moving with the Face of the Devil: Art and Politics in Urban West Africa*. Urbana: University of Illinois Press, 1987.
- Nunley, John W., and Cara McCarty. *Masks: Faces of Culture*. St. Louis, Mo.: St. Louis Art Museum and Abrams Publishing, 1999.
- Nunley, John W., and Judith Bettelheim. *Caribbean Festival Arts: Each and Every Bit of Difference*. St. Louis, Mo., and Seattle: The Saint Louis Art Museum and University of Washington Press, 1988.
- Oliver, Douglas L. *Oceania: The Native Cultures of Australia and the Pacific Islands*. Vol. 1. Honolulu: University of Hawai'i Press, 1989.
- Pani, Jiwan. *World of Other Faces: Indian Masks*. New Delhi, India: Ministry of Information and Broadcasting, 1986.
- Phelan, Peggy. "Crisscrossing Cultures." In *Crossing the Stage: Controversies on Cross-dressing*, edited by Lesley Ferris, 155–170. London and New York: Routledge, 1994.
- Sarachchandra, E. R. *The Folk Drama of Ceylon*. 2nd ed. Colombo, Ceylon: Department of Cultural Affairs, 1966.
- Slattum, Judith. *Balinese Masks: Spirits of an Ancient Drama*. San Francisco: Chronicle Books, 1992.
- Thackeray, J. F. "New Directions in the Study of Southern African Rock Art." *African Arts* 26, no. 1 (January 1993): research note.

Turner, Victor W. *The Ritual Process: Structure and Anti-Structure*. Chicago: Aldine Publishing, 1969.
Walker, Barbara. *The Crone: Woman of Age, Wisdom, and Power*. New York: Harper and Row, 1985.

John Nunley

MATERIALISM IN EIGHTEENTH-CENTURY EUROPEAN THOUGHT. *Materialism* is the generic name of a variety of doctrines that deny the existence of non-material substances. Materialism may be either a metaphysical or a methodological concept. In its most coherent and radical form, it is a type of *monism*, the metaphysical position stating that there is only one principle—matter and its properties—in terms of which all reality is to be explained.

In the eighteenth century, materialism developed into a philosophy and gained a following that continues into the present day. Some eighteenth-century materialist philosophers were downright atheists. A few philosophers, such as the Stoics or Thomas Hobbes, while not atheists, held that God is corporeal. Others preferred some form of *deism*, the idea that a transcendent, noninterventionist God rules the world through constitutive laws of nature. For them, materialism was a methodology to follow when inquiring about the natural world, rather than a complete metaphysical commitment.

Materialism should not simply be identified with the Enlightenment, the eighteenth-century cultural movement that endorsed an understanding of the natural world, including humankind, based exclusively on reason, with no possibility of appeal to the supernatural. The Enlightenment included a secular interpretation of ethics and politics. While materialistic trends were an important part of the Enlightenment, its scope and philosophical commitments were far broader and more varied, involving an agenda that was political as well as philosophical including, in the case of several important thinkers, a straightforward belief in a God who acts in the world.

Seventeenth-Century Background

Eighteenth-century materialism in a sense is an extension of the seventeenth-century mechanical philosophy that was the hallmark of the scientific revolution. The mechanical philosophy offered a worldview in which matter and the natural laws of motions were supposed to explain all phenomena. In the seventeenth century, only Thomas Hobbes (1588–1679), in *Leviathan* (1651) and other works, and (in a much more problematic way) Baruch Spinoza (1632–1677) went so far as to argue that the mechanical philosophy could explain all the aspects of mental life. Later in the century, such monistic views, as well as trends that were inherent in the philosophy of René Descartes (1596–1650), such as the reduction of nonhuman forms of life to automata, developed the form of materialism that was characteristic of the eighteenth century.

Despite the coherence of Hobbes's materialism, the authors who were most fundamental to the passage from seventeenth-century mechanical philosophy to eighteenth-century materialism were Isaac Newton (1642–1727) and John Locke

(1632–1704). Isaac Newton was a multifaceted, iconoclastic figure. He can hardly be called a materialist in any metaphysical sense. However, the impressive results he achieved in physics gave an impulse to methodological materialism in science and well beyond. John Locke's *Essay concerning Human Understanding* (1690; 4th edition published in 1700) developed a sensationalist psychology, based on the idea that sense perception and mental mechanisms of reason, usually in the form of calculation and association, explain all mental life without the need to postulate any nonmaterial substance. Locke famously debated whether material things (such as rocks) could think. He concluded that God could have created thinking matter and was opposed by Bishop Edward Stillingfleet (1635–1699). Locke's position was later then taken up by Anthony Collins (1676–1729) against Samuel Clarke (1675–1729). A follower of Newton, Clarke is well known because of his controversy with Gottfried Wilhelm von Leibniz (1646–1716).

Another relevant source of ideas came from the French-based seventeenth-century movement of the libertines, or freethinkers (not meant as a compliment), who opposed religious oppression, and who, often in anonymous publications, defended the free use of reason against the suffocating Catholic Counter-Reformation. Libertines challenged religious authority in morals and politics, using ideas inspired mainly by the materialism of the ancient atomistic, Epicurean, and skeptical traditions. To this movement belong authors as different as Pierre Gassendi (1592–1655) and Cyrano de Bergerac (1619–1655). The anonymous *Theophrastus redivivus*, published around 1660, espoused the most radical theses of libertinism, such as atheism, materialism, and a form of ethical Epicurean hedonism.

The Eighteenth Century

The eighteenth century was an age of prodigious scientific learning. While the seventeenth century's philosophical milieu was influenced mainly by physics (mechanics and cosmology), the eighteenth century became especially fascinated with chemistry, or the constitution of matter, and by the phenomenon of life and its forms of organization. In this sense, materialist philosophers and scientists were strongly motivated to explain the complexities and diversities of life without reference to divine intervention.

The diversity of life had been unprecedentedly systematized by Carolus Linnaeus (1707–1778), whose *Systema naturae* (System of nature) was published in 1735; however, biological diversity was well known long before the eighteenth century, and the discoveries explorers made around the world drew the attention of many scientists. The ideas of evolution and adaptation had begun to gain momentum, championed in different forms by Buffon and by Diderot. Between the end of the eighteenth century and the beginning of the nineteenth, evolution of species was a concept that, though rejected by most, was part of the scientific debate with the works of Jean-Baptiste Lamarck (1744–1829) and Erasmus Darwin (1731–1802). They both struggled with an account of life and diversity based on adaptation to a changing environment and competition for resources.

Another major scientific figure was Antoine-Laurent Lavoisier (1743–1794). Known as the scientist who began the chemical

revolution by changing the concept of *chemical element* and discovering *oxygen*, which term he coined, Lavoisier developed a new physicochemical nomenclature that stressed the quantitative aspects of combining chemical elements. While Lavoisier was not particularly philosophical, his revisions of the structure of chemical knowledge, and thus of matter theory, brought about a change in the understanding of matter and the mechanisms by which it worked. In this sense, Lavoisier was like many other scientists in the eighteenth century: while maybe not metaphysical materialists themselves, they helped develop a scientific methodological materialism that could support a metaphysical alternative to religion and traditional dualism. Lavoisier, who was a tax collector for the royal government, was guillotined in 1794 during the French Revolution.

French Materialism

François Marie Arouet, better known as Voltaire (1694–1778), endorsed Locke's sensationalism and argued against Spinoza and Nicolas Malebranche (1638–1715) in his *Dictionnaire philosophique* (1764; Philosophical dictionary) and *Lettres anglaises ou philosophiques* (1734; English or philosophical letters). He also became very popular as an apologist for Newton, with his *Éléments de la philosophie de Newton* (1738; Elements of Newton's philosophy). Voltaire opposed institutionalized religion and intolerance based on superstition, and, although not an atheist, he supported the rationalistic deism. His famous *Candide* (1759) is a witty and ironic, though simplistic, lampoon of Leibniz's metaphysics of the best of all possible worlds.

His mistress and patron of the great French salon, Madame Émilie du Châtelet, who, with his aid, translated Newton's *Principia mathematica* into French, was also a prominent supporter of Newtonianism and did much to publicize these new scientific views. They were both forced to flee Paris in 1747. Once in Berlin, Voltaire entered a dispute with his old friend and protégé Pierre-Louis Moreau de Maupertuis (1698–1759), the president of the Berlin Academy and author of *Venus physique* (1745; The physical Venus) and *Système de la nature* (1751; System of nature).

Paul-Henri-Dietrich d'Holbach's (1723–1789) most famous book, *Système de la nature, ou des loix du monde physique et du monde moral* (1770; The system of nature, or the laws of the physical and moral world), was published under the name of J. B. Mirabaud. Following the tenets of Epicurean atomism, the book derided religion and espoused an atheistic, deterministic materialism: all causation was reduced to patterns of motion, man became a machine devoid of free will, and religion was excoriated as not just untrue, but dangerous. *Système social* (1773; Social system) placed morality and politics in a utilitarian framework: duty was reduced to prudent self-interest. D'Holbach used his inherited fortune to support Diderot's *Encyclopédie* project, writing many articles for these volumes himself and translating from German.

George Louis Leclerc, comte de Buffon (1707–1788) was appointed to the French Academy of Science in 1734; in 1739 he became superintendent of the Royal Botanical Garden (Jardin du Roi; present-day Jardin des Plantes). Buffon was given the task of completing a catalog of the royal collections in natural

history, which he transformed into a project to produce an account of the whole of nature. This became his great work, *Histoire naturelle, générale et particulière* (1749–1804; General and particular natural history), which was the first modern attempt to systematically present all existing knowledge in the fields of natural history, geology, and anthropology in a single publication. Buffon criticized the Swedish naturalist Linnaeus for the artificiality of his taxonomy of plants and animals. Buffon opposed metaphysics in science, denied divine intervention in nature, and was Newtonian in believing that knowledge should be derived from observations of natural phenomena. He held that what separated humans from animals was reason alone, through their use of language. He was the first to reconstruct a geological history, including a discussion of nature and a theory of the age of the earth, in a series of stages in *Histoire et théorie de la terre* (1749; History and theory of the Earth), and in *Époques de la nature* (1778; Epochs of nature), he proposed the theory that the planets had been created in a collision between the sun and a comet. His theory of the age of the Earth incensed religious opponents. Buffon divided matter into vital and nonvital, balancing an overall Newtonian physical framework with vitalistic tendencies (though rejecting nonmaterial substances). So, he opposed the idea that life was a form of organization of matter. On the other hand, life being a property of matter (of "organic molecules"), it does not require any explanatory principle external to matter. Buffon believed in spontaneous generation as resulting from aggregation of organic molecules present in the environment; his theory was criticized by Lazzaro Spallanzani (1729–1799), whose experiments confirmed Francesco Redi's (1626–1697) rejection of spontaneous generation.

The outcry following publication of Julien Offroy de La Mettrie's (1709–1751) materialistic views in *Histoire naturelle de l'âme* (1745; Natural history of the soul) forced his departure from Paris. In Holland, in 1747, he published *L'homme machine* (The man-machine), which was publicly burned, even in that notoriously liberal environment. La Mettrie then fled to Berlin to ask for the protection of Frederick II of Prussia (r. 1740–1786). La Mettrie, in opposition to Descartes, held that matter was not only extended, but also endowed with an inherent principle of motion and that it could have sensations. Humans were infinitely more complex than lower machines, yet they were still machines. La Mettrie suggested that atheism and an ethics of hedonism were the only proper paths toward human happiness.

Claude Adrien Helvétius (1715–1771) in his *De l'esprit* (1758; On the spirit) explains all of human reason as being based on sensation (like Locke and Condillac). Like La Mettrie, Helvétius placed humans on a continuum with animals. Helvétius also adumbrated a somewhat Epicurean ethical system based on self-interest, pleasure, and pain. His book provoked an outraged reaction both in the court and in the schools; both the Sorbonne and the Parlement of Paris condemned it. Despite Helvétius's public recantation, it was burned publicly (along with the works of other philosophes like Voltaire). Helvétius, like La Mettrie, was welcomed at the Prussian court in Berlin.

Étienne Bonnot de Condillac (1715–1780) maintained an empirical sensationalism based on the principle that

observations made by sense perception are the foundation for all human knowledge. The ideas of his *L'essai sur l'origine des connaissances humaines* (1746; Essay on the origins of human knowledge) are close to Locke's, though on certain points, as in rejecting what he took to be Locke's innate ideas of reflection, Condillac modified Locke's position. In his most significant work, the *Traité des sensations* (1754; Treatise on sensations), Condillac denied, for example, that the human mind makes inferences about the shapes, sizes, positions, and distances of objects. Examining each sense separately and the knowledge thereby obtained, he concluded that all human knowledge is sensation transformed by language. Modeled on algebra, language was the underlying principle used to form all higher cognition. In this work he famously analogized man to a statue who gains complex reasoning from its underlying sensations. The importance of language to thought and rational progress is one of the major themes of the Enlightenment. Despite Condillac's materialistic psychology, he believed his views about the nature of religion, especially the reality of the soul, to be consistent with his sensationalism. Condillac's own brand of sensationalism had many followers in Italy. In particular, the jurists Giandomenico Romagnosi (1761–1835), Cesare Beccaria (1738–1794), and Melchiorre Gioia (1767–1829) used his epistemology as a basis for a rationalistic study of jurisprudence and political and social theory.

In 1745 the publisher André Le Breton (1708–1779) approached Denis Diderot (1713–1784) with a proposal to produce a French translation of Ephraim Chambers's *Cyclopaedia*, (first edition, 1728). Together with the mathematician and philosopher Jean Le Rond d'Alembert, Diderot transformed the project into the great *Encyclopédie*. By adhering to strictly rationalistic and materialistic principles, Diderot and d'Alembert saw themselves as forging a weapon against the hold of religion on science and human knowledge. In 1749, Diderot published the *Lettre sur les aveugles à la usage de ceux qui voient* (An essay on the blind for those who can see), remarkable for introducing the first sketch of Diderot's "evolutionary theory" of survival by adaptation. The existence of diversity and monstrosities in nature is explained by a theory of evolution from chaos; the apparent order and adaptation is explained with a probabilistic argument, since nature has time for innumerable trials that lead to growth, increased complexity, and specialization. Only the organisms that became adapted to their environment could survive. Diderot held that our sensory organs, not ideas about essences, should determine our metaphysics. This open endorsement of radical materialism was condemned and, in 1749, led to Diderot's being incarcerated for three months.

Another ugly moment for Diderot came when Helvétius's *De l'esprit*, was condemned to be burned by the Parlement of Paris in 1758, and the *Encyclopédie* itself was formally suppressed. Diderot published the remaining volumes semiclandestinely. Among his philosophical works, special mention may be made of *L'entretien entre d'Alembert et Diderot* (written 1769, published 1830; Conversation between d'Alembert and Diderot), *Le rêve de d'Alembert* (written 1769, published 1830; D'Alembert's dream), and the *Éléments de physiologie* (1774–1780; Elements of physiology). In these works Diderot developed his materialist philosophy and concluded that

simple, reductive mechanical explanations are not sufficient to explain sentient life, without assuming that all matter is potentially sentient and that life and sentience are specialized functions that arise from a higher level of complexity. In *Jacques le fataliste* (1771; Jacques, the fatalist) Diderot gave a common sense solution of the problem of free will: while there are no rational arguments to support free will, he argued that extreme determinism is ultimately self-defeating.

Jean Le Rond d'Alembert (1717–1783) attended a prestigious Jansenist school where he developed a lifelong distaste for religion. After studying law for two years and medicine for one, he finally discovered his passion for mathematics, which he mainly taught himself. In 1739 he read his first paper to the French Academy of Sciences, of which he became a member in 1741. In 1743 he published his *Traité de dynamique* (A treatise on dynamics), containing the famous "d'Alembert's principle," stating that Newton's third law of motion (for every action there is an equal and opposite reaction) is true for both freely moving and fixed bodies. Other mathematical works followed; in particular the development of partial differential equations. In 1745, d'Alembert joined Diderot in the *Encyclopédie* project as editor of the mathematical and scientific sections. In fact, his contribution went much further, including the *Discours préliminaire* (Preliminary discourse) that introduced the first volume in 1751. The introduction endorsed a view of science as a unified and rational enterprise.

Besides the authors mentioned above, it is useful to recall that there was a clandestine literature that offered materialistic responses to Descartes and that most likely contributed to the philosophical educations of the authors listed. Of particular interest, a collection of manuscripts at the Douai library (ms. 702), on which appears the date 1723, and contains, among others, a *Dissertation sur le sentiment des bêtes, l'instinct et la raison, contre les Cartésiens* (Essay on the feelings of animals, instincts and reasons, against Cartesians); *L'essai philosophique sur l'âme des bêtes* (Amsterdam, 1732; Philosophical essay on the soul of animals); and *Principes physiques de la raison et des passions des hommes* (1709; Physical principles of reason and passions of men) by a Dr. Maubec. Most of this literature, while it circulated widely in its day, is still available only in manuscript.

A late-eighteenth-century figure, Pierre-Jean-Georges Cabanis (1757–1808), was a French philosopher, physician, and physiologist who published *Rapports du physique et du moral de l'homme* (1802; Relations of the physical and moral of man). Cabanis, opposing Condillac's sensationalism, explained all of reality, including the mind-body relations in man, in terms of a mechanistic materialism built on the organic needs of an organism and its automatic responses (the irritable properties of tissues). For Cabanis, life was merely an organization of physical forces; "secretions" in the brain, analogous to the liver's secretion of bile, produced thoughts. The concept of *soul* was superfluous, since consciousness was merely an effect of mechanistic processes, and sensibility, the source of intelligence, was a property of the nervous system. Cabanis is best known, however, as a medical reformer who brought new ways of health care and medical education to France.

English Materialism

John Toland (1670–1722) was born Catholic, though he converted to Protestantism and later endorsed Socinianism, which, like Unitarianism, denied the doctrine of the Trinity. He wrote several texts in which he supported a naturalized and historical interpretation of the holy texts and of miracles. In *Christianity not Mysterious* (1696) he claimed that reason is sufficient to explain all religious “mysteries.” In *Letters to Serena* (1704) and *Pantheisticon* (1720), he endorsed a form of pantheism in which God-soul is identical with the material universe. He defended Giordano Bruno (1548–1600), whose pantheistic and materialistic philosophy obviously influenced him. Pantheism was the doctrine that God was everywhere and was all things.

Anthony Collins (1676–1729) was a provocative author who argued, in his *Discourse of Free-thinking* (1713, published anonymously), that free and rational inquiry is the best defense for religion against atheism. In *Inquiry concerning Human Liberty and Necessity* (1715) and *Liberty and Necessity* (1729), he denied free will and defended determinism on the grounds of the necessity of a cause-and-effect relationship between events. He wrote *A Letter to Mr. Dodwell* (1707), to which Samuel Clarke, Newton’s disciple, responded. This led to a two-year correspondence (1706–1708) in which Toland defended the idea that all life and consciousness arises from emergent properties of systems of material particles.

David Hartley (1705–1757) saw himself as carrying out Newton’s scientific project for the human being and offered a physiological explanation for the association of ideas in materialistic terms in his *Observations on Man: His Frame, His Duty, and His Expectations* (1749). Hartley used Newton’s theory of vibrating corpuscular matter and forces of attraction and repulsion as a metaphysical basis for Locke’s associationist psychology. He explained mental life in terms of associations and inhibitions, which themselves were to be explained by attraction and repulsion in the nervous system and the brain. Hartley, however, was a deeply religious thinker who believed that “theopathy,” the love of God, was a natural emotion, and whose depiction of salvation bordered on mysticism.

Joseph Priestley (1733–1804) was a freethinker who formally rejected Calvinism to enter the Unitarian denomination. Priestley is known mainly for his work in physics and chemistry. He consistently pursued science as a rational enterprise based on facts and experimentation, rather than on dogmatic principles. His view of nature was informed by his belief in a benevolent God who operates through laws of nature that become accessible through careful observation. While this belief in God somehow influenced Priestley’s heuristics, his work in chemistry and physics and his political and economic theories were informed by a methodological materialism in which only matter and natural laws were relevant. Between 1772 and 1790, he published six volumes of *Experiments and Observations on Different Kinds of Air* and several papers in the *Philosophical Transactions of the Royal Society*, of which he was a member. He is well known for his contributions to the chemistry of gases, and for his development of a theory of phlogisticated air (which was opposed to Lavoisier’s, who repeated Priestley’s experiments, and rejected the phlogiston theory in favor of his new oxygen theory).

Conclusion

While it is difficult to find philosophically important individual (materialist) thinkers in other European countries, the materialistic current of the Enlightenment and its belief in the virtues of science swept through Europe, influencing, more or less directly, the political life in every country, with the endorsement of various forms of scientific progress and “enlightened” government. The application of science and the scientific method, mostly based on methodological materialist doctrines, became the hallmark of progress (itself an early-eighteenth-century notion). These beliefs brought important changes in urban development, public health, and industry throughout Europe.

The influence of European political and social thought, especially concerning tolerance and education, was also felt by American writers and had a fundamental role in the American Revolution and the writing of the U.S. Constitution. However, no movement endorsing materialism, methodological or metaphysical, can be traced.

See also *Cartesianism; Deism; Enlightenment; Mechanical Philosophy; Monism; Scientific Revolution.*

BIBLIOGRAPHY

- Allen, Richard C. *David Hartley on Human Nature*. Albany: State University of New York Press, 1999.
- Bloch, Olivier, ed. *Le matérialisme du XVIII^e siècle et la littérature clandestine*. Paris, Vrin, 1982.
- Bremner, Geoffrey. *Order and Chance: The Pattern of Diderot’s Thought*. New York: Cambridge University Press, 1983.
- Buchwald, Jed Z., and I. Bernard Cohen. *Isaac Newton’s Natural Philosophy*. Cambridge, Mass.: MIT Press, 2001.
- Cassirer, Ernst. *The Philosophy of the Enlightenment*. Translated by Fritz C. A. Koelln and James P. Pettegrove. Boston: Beacon, 1955.
- Corsi, Pietro. *The Age of Lamarck: Evolutionary Theories in France, 1790–1830*. Translated by Jonathan Mandelbaum. Rev. and updated. Berkeley: University of California Press, 1988.
- Evans, Robert Rees. *Pantheisticon: The Career of John Toland*. New York: Lang, 1991.
- Ferrone, Vincenzo. *The Intellectual Roots of the Italian Enlightenment: Newtonian Science, Religion, and Politics in the Early Eighteenth Century*. Translated by Sue Brotherton. Atlantic Highlands, N.J.: Humanities, 1995.
- Jacob, Margaret. *The Radical Enlightenment: Pantheists, Freemasons, and Republicans*. Boston: Allen and Unwin, 1981.
- Lennon, Thomas. *The Battle of the Gods and Giants: The Legacies of Descartes and Gassendi, 1655–1715*. Princeton, N.J.: Princeton University Press, 1993.
- McNeil, Maureen. *Under the Banner of Science: Erasmus Darwin and His Age*. Wolfeboro, N.H.: Manchester University Press, 1987.
- Reill, Peter Hanns, consulting editor, and Ellen Judy Wilson, principal author. *Encyclopedia of the Enlightenment*. New York: Facts on File, 1996.
- Vartanian, Aram. *Diderot and Descartes: A Study of Scientific Naturalism in the Enlightenment*. Westport, Conn.: Greenwood, 1975.
- . *Science and Humanism in the French Enlightenment*. Charlottesville, Va.: Rookwood, 1999.
- Yolton, John W. *Locke and French Materialism*. New York: Oxford University Press, 1991.

———. *Thinking Matter: Materialism in Eighteenth-Century Britain*. Minneapolis: University of Minnesota Press, 1983.

Peter Machamer
Francesca di Poppa

MATHEMATICS. This article comprises a compact survey of the development of mathematics from ancient times until the early twentieth century. The treatment is broadly chronological, and most of it is concerned with Europe.

Unknown Origins

It seems unavoidable that mathematical thinking played a role in human theorizing from the start of the race, and in various ways. Arithmetic (as the later branch of mathematics became known) would have been one of them, motivated initially by forming integers in connection with counting. But other branches surely include geometry, linked to the appreciation of line, surface, and space; trigonometry, inspired by awareness of angles; mechanics, related to the motion of bodies large and small and the (in)stability of structures; part-whole theory, from consideration of collections of things; and probability, coming from judging and guessing about situations. In all cases the thinking would have started out as very intuitive, gradually becoming more explicit and less particular.

Some of the associated contexts would have been provided by study of the environment (such as days) and the heavens (such as new and full moons), which was a major concern of ancient cultures in all parts of the world; in those times mathematics and astronomy were linked closely. For example, the oldest recognized artifact is a bone from Africa, thought to be about thirty-seven thousand years old, upon which phases of the moon seem to have been recorded.

Among the various ancient cultures, the Babylonians have left the earliest extant evidence of their mathematical practice. They counted with tokens from the eighth millennium; and from the late fourth millennium they expressed numbers and properties of arithmetic in a numeral system to base 10 and handled fractions in expansions of powers of $1/60$. Many surviving artifacts seem to relate to education—for example, exercises requiring calculations of unknown quantities, which correspond to the solution of equations but are not to be so identified. They also developed geometry, largely for terrestrial purposes. The Egyptians pursued similar studies, even also finding a formula (not the same one) for the volume of the rectangular base of a pyramid of given sides. They also took up the interesting mathematical problem of representing a fraction as the sum of reciprocals.

A major mathematical question for these cultures concerned the relationship between circles and spheres and rectilinear objects such as lines and cubes. They involve the quantity that we symbolize by π , and ancient evidence survives of methods of approximating to its value. But it is not clear that these cultures knew that the same quantity occurs in all the relationships.

On Greek Mathematics

The refinement of mathematics was effected especially by the ancient Greeks, who flourished for about a millennium from the sixth century B.C.E. Pythagoras and his clan are credited with many things, starting with their later compatriots: the eternity of integers; the connection between ratios of integers and musical intervals; the theorem relating the sides of a right-angled triangle; and so on. Their contemporary Thales (c. 625–c. 547 B.C.E.) is said to have launched trigonometry with his appreciation of the angle. However, nothing survives directly from either man.

A much luckier figure concerning survival is Euclid (fl. c. 300 B.C.E.), especially with his *Elements*. While no explanatory preface survives, it appears that most of the mathematics presented was his rendition of predecessors' work, but that (some of) the systematic organization that won him so many later admirers might be his. He stated explicitly the axioms and assumptions that he noticed; one of them, the parallel axiom, lacked the intuitive clarity of the others, and so was to receive much attention in later cultures.

The *Elements* comprised thirteen Books: Books 7–9 dealt with arithmetic, and the others presented basic plane (Books 1–6) and solid (Books 11–13) geometry of rectilinear and circular figures. The extraordinary Book 10 explored properties of ratios of smaller to longer lines, akin to a theory of irrational numbers but again not to be so identified. A notable feature is that Euclid confined the role of arithmetic within geometry to multiples of lines (say, “twice this line is . . .”), to a role in stating ratios, and to using reciprocals (such as $1/5$); he was not concerned with lengths—that is, lines measured arithmetically. Thus, he said nothing about the value of π , for it relates to measurement.

The Greeks were aware of the limitations of straight line and circle. In particular, they found many properties and applications of the “conic sections”: parabola, hyperbola, and ellipse. Hippocrates of Chios (fl. c. 600 B.C.E.) is credited with three “classical problems” (a later name) that his compatriots (rightly) suspected could not be solved by ruler and compass alone: (1) construct a square equal in area to a given circle; (2) divide any angle into three equal parts; and (3) construct a cube twice the volume of a given one. The solutions that they did find enlarged their repertoire of curves.

Among later Greeks, Archimedes (c. 287–212 B.C.E.) stands out for the range and depth of his work. His work on circular and spherical geometry shows that he knew all four roles for π ; but he also wrote extensively on mechanics, including floating bodies (the “eureka!” tale) and balancing the lever, and focusing parabolic mirrors. Other figures developed astronomy, partly as applied trigonometry, both planar and spherical; in particular, Ptolemy (late second century) “compiled” much knowledge in his *Almagest*, dealing with both the orbits and the distances of the heavenly bodies from the central and stationary Earth.

Traditions Elsewhere

Mathematics developed well from antiquity also in the Far East, with distinct traditions in India, China, Japan, Korea, and Vietnam. Arithmetic, geometry, and mechanics were again

prominent; special features include a powerful Chinese method equivalent to solving a system of linear equations, a pretty theory of touching circles in Japanese “temple geometry,” and pioneering work on number theory by the Indians. They also introduced the place-value system of numerals to base 10, of which we use a descendant that developed after several changes in adopted symbols.

This system of numerals was mediated into Europe by mathematicians working in medieval Islamic civilization, often though not always writing in Arabic. They became the dominant culture in mathematics from the ninth century and continued strongly until the fourteenth. They assimilated much Greek mathematics; indeed, they are our only source for some of it.

The first major author was al-Khwarizmi (fl. c. 800–847), who laid the foundations of algebra, especially the solution of equations. He and his followers launched the theory using words rather than special symbols to mark unknowns and operations. Other interests in geometry included attempts to prove Euclid’s parallel axiom and applications to optics and trigonometry; an important case of the latter was determining the *qibla* (that is, the direction of Mecca) for any time and place at times of Muslim prayer. Their massive contributions to astronomy included theory and manufacture of astrolabes.

The Wakening Europe from the Twelfth Century

From the decline of the Roman Empire (including Greece) Euclid was quiescent mathematically, though the Carolingian kingdom inspired some work, at least in education. The revival dates from around the late twelfth century, when universities also began to be formed. The major source for mathematics was Latin translations of Greek and Arabic writings (and re-editions of Roman writers, especially Boethius). In addition, the Italian Leonardo Fibonacci (c. 1170–c. 1240) produced a lengthy *Liber Abbaci* in 1202 that reported in Latin many parts of Arabic arithmetic and algebra (including the Indian numerals); his book was influential, though perhaps less than is commonly thought. The Italian peninsula was then the most powerful region of Europe, and much commercial and “research” mathematics was produced there; the German states and the British Isles also came to boast some eminent figures. In addition, a somewhat distinct Hebrew tradition arose—for example, in probability theory.

A competition developed between two different methods of reckoning. The tradition was to represent numbers by placing pebbles (in Latin, *calculi*) in determined positions on a flat surface (in Latin, *abacus*, with one *b*), and to add and subtract by moving the pebbles according to given rules. However, with the new numerals came a rival procedure of calculating on paper, which gradually supervened; for, as well as also allowing multiplication and division, the practitioner could show and check his working, an important facility unavailable to movers of pebbles.

Mathematics rapidly profited from the invention of printing in the late fifteenth century; not only were there printed Euclids, but also many reckoning books. Trigonometry became a major branch in the fifteenth and sixteenth centuries, not only for astronomy but also, as European imperialism developed, for

cartography, and the needs of navigation and astronomy made the spherical branch more significant than the planar. Geometry was applied also to art, with careful studies of perspective; Piero della Francesca (c. 1420–1492) and Albrecht Dürer (1471–1528) were known not only as great artists but also as significant mathematicians.

Numerical calculation benefited greatly from the development of logarithms in the early seventeenth century by John Napier (1550–1617) and others, for then multiplication and division could be reduced to addition and subtraction. Logarithms superseded a clumsier method called “prosthaphairesis” that used certain trigonometrical formulas.

In algebra the use of special symbols gradually increased, until in his *Géométrie* (1637), René Descartes (1596–1650) introduced (more or less) the notations that we still use, and also analytic geometry. His compatriot Pierre de Fermat (1601–1665) also worked in these areas and contributed some theorems and conjectures to number theory. In addition, he corresponded with Blaise Pascal (1623–1662) on games of chance, thereby promoting parts of probability theory.

In mechanics a notable school at Merton College, Oxford, had formed in the twelfth century to study various kinds of terrestrial and celestial motion. The main event in celestial mechanics was Nicolaus Copernicus’s (1473–1543) *De revolutionibus* (1453; On the revolutions), where rest was transferred from the Earth to the sun (though otherwise the dynamics of circular and epicyclical motions was not greatly altered). In the early seventeenth century the next stages lay especially with Johannes Kepler’s (1571–1630) abandonment of circular orbits for the planets and Galileo Galilei’s (1564–1642) analysis of (locally) horizontal and vertical motions of bodies.

The Epoch of Newton and Leibniz

By the mid-seventeenth century, science had become professionalized enough for some national societies to be instituted, especially the Royal Society of London and the Paris Académie des Sciences. At that time two major mathematicians emerged: Isaac Newton (1642–1727) in Cambridge and Gottfried Wilhelm von Leibniz (1646–1716) in Hanover. Each man invented a version of the differential and integral calculus, Newton first in creation but Leibniz first in print. The use here of Leibniz’s adjectives recognizes the superior development of his version. During the early 1700s Newton became so furious (or envious?) that he promoted a charge of plagiarism against Leibniz, complete with impartial committee at the Royal Society. It was a disaster for Britain: Newton’s followers stuck with their master’s theory of “fluxions” and “fluents,” while the Continentals developed “differentials” and “integrals,” with greater success. The accusation was also mathematically stupid, for conceptually the two calculi were quite different: Newton’s was based upon (abstract) time and unclearly grounded upon the notion of limit, while Leibniz’s used infinitesimal increments on variables, explicitly avoiding limits. So even if Leibniz had known of Newton’s theory (of which the committee found no impartial evidence), he rethought it entirely.

Leibniz’s initial guard was largely Swiss: brothers Jakob (1654–1705) and Johann Bernoulli (1667–1748) from the

1680s, then from the 1720s Johann's son Daniel (1700–1782) and their compatriot Leonhard Euler (1707–1783), who was to be the greatest of the lot. During the eighteenth century they and other mathematicians (especially in Paris) expanded calculus into a vast territory of ordinary and then partial differential equations and studied many related series and functions. The Newtonians kept up quite well until Colin Maclaurin (1698–1746) in the 1740s, but then faded badly.

The main motivation for this vast development came from applications, especially to mechanics. Here Newton and Leibniz differed again. In his *Principia mathematica* (1687) Newton announced the laws that came to carry his name: (1) a body stays in equilibrium or in uniform motion unless disturbed by a force; (2) the ratio of the magnitude of the force and the mass of the body determines its acceleration; and (3) to any force of action there is one of reaction, equal in measure and opposite in sense. In addition, for both celestial and terrestrial mechanics, which he novelly united, the force between two objects lies along the straight line joining them, and varies as the inverse square of its length.

With these principles Newton could cover a good range of mechanical phenomena. His prediction that the Earth was flattened at the poles, corroborated by an expedition undertaken in the 1740s, was a notable success. He also had a splendid idea about why the planets did not exactly follow the elliptical orbits around the sun that the inverse square law suggested: they were “perturbed” from them by interacting with each other. The study of perturbations became a prime topic in the eighteenth century, with Euler's work being particularly significant. Euler also showed that law 2 could be applied to any direction in a mechanical situation, thus greatly increasing its utility. He and others made important contributions to the mechanics of continuous media, especially fluid mechanics and elasticity theory, where Newton had been somewhat sketchy.

Mathematics in the Eighteenth Century: The Place of Lagrange

However, Newton's theory was not alone in mechanics. Leibniz and others developed an alternative approach, partly inspired by Descartes, in which the “living forces” (roughly, kinetic energy) of bodies were related to their positions. Gradually this became a theory of living forces converted into “work” (a later term), specified as (force \times traversed distance). Engineers became keen on it for its utility in their concerns, especially when impact between bodies was involved; from the 1780s Lazare Carnot (1753–1823) urged it as a general approach for mechanics.

Carnot thereby challenged Newton's theory, but his main target was a recent new tradition partly launched by Jean d'Alembert (1718–1783) in midcentury and developed further by Joseph-Louis Lagrange (1736–1813). Suspicious of the notion of force, d'Alembert had proposed that it be defined by Newton's law 2, which he replaced by one stating how systems of bodies moved when disturbed from equilibrium. At that time Euler and others proposed a “principle of least action,” which asserted that the action (a mechanical notion defined by an integral) of a mechanical system took its optimal

value when equilibrium was achieved. Lagrange elaborated upon these principles to create *Mécanique analytique* (1788), in which he challenged the other two traditions; in particular, dynamics was reduced mathematically to statics. For him a large advantage of his principles was that they were formulated exclusively in algebraic terms; as he proclaimed in the preface of his book, there were no diagrams, and no need for them. A main achievement was a superb though inconclusive attempt to prove that the system of planets was stable; predecessors such as Newton and Euler had left that matter to God.

Lagrange formulated mechanics this way in order to make it (more) rigorous. Similarly, he algebraized the calculus by assuming that any mathematical function could be expressed in an infinite power series (the so-called Taylor series), and that the basic notions of derivative (his word) and integral could be determined solely by algebraic manipulations. He also greatly expanded the calculus of variations, a key notion in the principle of least action.

As in mechanics, Lagrange's calculus challenged the earlier ones, Newton's and Leibniz's, and as there, reaction was cautious. A good example for both contexts was Pierre-Simon Laplace (1749–1827), a major figure from 1770. While strongly influenced by Lagrange, he did not confine himself to the constraints of Lagrange's book when writing his own four-volume *Traité de mécanique céleste* (1799–1805; Treatise on celestial mechanics). His exposition of celestial and planetary mechanics used many differential equations, series, and functions.

The French Revolution and a New Professionalization

Laplace published his large book in a new professional and economic situation for science. After the Revolution of 1789 in France, higher education and its institutions there were reformed, with a special emphasis upon engineering. In particular, a new school was created, the *École Polytechnique* (1794), with leading figures as professors (such as Lagrange) and as examiners (Laplace), and with enrollment of students determined by talent, not birth. A new class of scientists and engineers emerged, with mathematics taught, learned, researched, and published on a scale hitherto unknown.

Of this mass of work only a few main cases can be summarized here. Joseph Fourier (1768–1830) is noteworthy for his mathematical analysis of heat diffusion, both the differential equation to represent it (the first important such equation found outside mechanics) and solutions by certain infinite series and by integrals that both now bear his name. From the 1820s they attracted much attention, not only for their use in heat theory but especially for the “pure” task of establishing conditions for their truth. New techniques for rigor had just become available, mainly from Augustin-Louis Cauchy (1789–1857), graduate of the *École Polytechnique* and now professor there. He taught a fourth approach to the calculus (and also function and series), based like Newton's upon limits but now fortified by a careful theory of them; although rather un-intuitive, its mathematical merits gradually led worldwide to its preference over the other three approaches.

Ironically, Cauchy's own analysis of Fourier series failed, but a beautiful treatment following his approach came in 1829 from

J. P. G. Dirichlet (1805–1859)—a French-sounding name of a young German who had studied with the masters in Paris. Dirichlet also exemplifies a novelty of that time: other countries producing major mathematicians. Another contemporary example lies in elliptic functions, which Carl Jacobi (1804–1851) and the young Norwegian Niels Henrik Abel (1802–1829) invented independently following much pioneering work on the inverse function by A. M. Legendre (1752–1833).

Jacobi and Abel drew upon a further major contribution to mathematics made by Cauchy when, by analogy with the calculus, he developed a theory of functions of the complex variable $x + \sqrt{-1}y$ (x and y real), complete with an integral. His progress was fitful, from the 1810s to the 1840s; after that, however, his theory became recognized as a major branch of mathematics, with later steps taken especially by the Germans.

Between 1810 and 1830 the French initiated other parts of mathematical physics in addition to Fourier on heat: Siméon-Denis Poisson (1781–1840) on magnetism and electrostatics; André-Marie Ampère (1775–1836) on electrodynamics; and Augustin Jean Fresnel (1788–1827) on optics with his wave theory. Mathematics played major roles: many analogies were taken from mechanics, which itself developed massively, with Carnot's energy approach elaborated by engineers such as Gaspard-Gustave Coriolis (1792–1843), and continuum mechanics extended, especially by Cauchy.

Geometry was also taught and studied widely. Gaspard Monge (1746–1818) sought to develop “descriptive geometry” into a genuine branch of mathematics and gave it prominence in the first curriculum of the *École Polytechnique*; however, this useful theory of engineering drawing could not carry such importance, and Laplace had its teaching reduced. But former student Jean Victor Poncelet (1788–1867) was partly inspired by it to develop “the projective properties of figures” (*Traité des propriétés projectives de figures*, 1822), where he studied characteristics independent of measure, such as the order of points on a line.

The main mathematician outside France at this time was C. F. Gauss (1777–1855), director of the Göttingen University Observatory. Arguably he was the greatest of all, with major work published in number theory, celestial mechanics, and aspects of analysis and probability theory. But he was not socially active, and he left many key insights in his manuscripts (for example, on elliptic functions).

Other major contributors outside France include George Green (1793–1841), who, in *An Essay on the Application of Mathematical Analysis to the Theories of Electricity and Magnetism* (1828), produced a wonderful theorem in potential (his word) theory that related the state of affairs inside an extended body to that on its surface. But he published his book very obscurely, and it became well-known only on the reprint during the 1850s initiated by William Thomson (later Lord Kelvin), who was making notable contributions of his own to the theory.

Midcentury Internationalism

By the 1840s Britain and the Italian and German states were producing quality mathematicians to complement and even

rival the French, and new posts were available in universities and engineering colleges everywhere. Among the Germans, two figures stand out.

From around 1860 Karl Weierstrass (1815–1897) gave lecture courses on many aspects of real- and complex-variable analysis and parts of mechanics at Berlin University, attended by students from many countries who then went home and taught likewise. Meanwhile at Göttingen, Bernhard Riemann (1826–1866) rethought complex-variable analysis and revolutionized the understanding of both Fourier series and the foundations of geometry. Much of this work was published only after his early death in 1866, but it soon made a great impact. The work on Fourier series led Georg Cantor (1845–1918) to develop set theory from the 1870s. On geometry Riemann showed that the Euclidean was only one of many possible geometries, and that each of them could be defined independently of any embedding space. The possibility of non-Euclidian geometries, using alternatives to the parallel axiom, had been exhibited around 1830 in little-recognized work by Janos Bolyai (1802–1860) and Nicolai Lobachevsky (1793–1856) (and, in manuscript, Gauss); Riemann, however, went much further and brought us proper understanding of the plurality of geometries.

Weierstrass emulated and indeed enhanced Cauchy-style rigor, carefully formulating definitions and distinctions and presenting proofs in great detail. By contrast, Riemann worked intuitively, offering wonderful but often proof-free insights grounded upon some “geometric fantasy,” as Weierstrass described it. A good example is their revisions of Cauchy's complex-variable analysis: Weierstrass relied solely on power series expansions of the functions, whereas Riemann invented surfaces now named after him that were slit in many remarkable ways. Among many consequences of the latter, the German Felix Klein (1849–1925) and the Frenchman Henri Poincaré (1854–1912) in the early 1880s found beautiful properties of functions defined on these surfaces, which they related to group theory as part of the rise of abstract algebras.

Another example of the gap between Riemann and Weierstrass is provided by potential theory. Riemann used a principle employed by his mentor Dirichlet (and also envisaged by Green) to solve problems in potential theory, but in 1870 Weierstrass exposed its fallibility by a counterexample, and so methods became far more complicated.

Better news for potential theory had come at midcentury with the “energetics” physics of Thomson, Hermann von Helmholtz (1821–1894), and others. The work expression of engineering mechanics was extended into the admission of potentials, which now covered all physical factors (such as heat) and not just the mechanical ones that had split Carnot from Lagrange. The latter's algebraic tradition in mechanics had been elaborated by Jacobi and by the Irishman William Rowan Hamilton (1805–1865), who also introduced his algebra of quaternions.

Among further related developments, the Scot James Clerk Maxwell (1831–1879) set out theories of electricity and magnetism (including, for him, optics) in his *Treatise on Electricity*

and *Magnetism* (1873). Starting out from the electric and magnetic potentials as disturbances of the ether rather than Newton-like forces acting at a distance through it, he presented relationships between his basic notions as differential equations (expressed in quaternion form). A critical follower was the Englishman Oliver Heaviside, who also analyzed electrical networks by means of a remarkable but mysterious operator algebra. Other “Maxwellians” preferred to replace dependence upon fields with talk about “things,” such as electrons and ions; the relationship between ether and matter (J. J. Larmor, *Aether and Matter*, 1900) was a major issue in mathematical physics at century’s end.

The Early Twentieth Century

A new leader emerged: the German David Hilbert (1862–1943). Work on abstract algebras and the foundations of geometry led him to emphasize the importance of axiomatizing mathematical theories (including the axioms of Euclidean geometry that Euclid had not noticed) and to study their foundations metamathematically. But his mathematical knowledge was vast enough for him to propose twenty-three problems for the new century; while a personal choice, it exercised considerable influence upon the community. He presented it at the International Congress of Mathematicians, held in Paris in 1900 as the second of a series that manifested the growing sense of international collaboration in mathematics that still continues.

One of Hilbert’s problems concerned the foundations of physics, which he was to study intensively. In physics Albert Einstein (1879–1955) proposed his special theory of relativity in 1905 and a general theory ten years later; according to both, the ether was not needed. Mathematically, the general theory both deployed and advanced tensor calculus, which had developed partly out of Riemann’s interpretation of geometry.

Another main topic in physics was quantum mechanics, which drew upon partial differential equations and vector and matrix theory. One of its controversies concerned Werner Heisenberg’s principle of the uncertainty of observation: should it be interpreted statistically or not? The occurrence of this debate, which started in the mid-1920s, was helped by the increasing presence of mathematical statistics. Although probability must have had an early origin in mathematical thinking, both it and mathematical statistics had developed very slowly in the nineteenth century—in strange contrast to the mania for collecting data of all kinds. Laplace and Gauss had made important contributions in the 1810s, for example, over the method of least-squares regression, and Pafnuty Chebyshev (1821–1894) was significant from the 1860s in Saint Petersburg (thus raising the status of Russian mathematics). But only from around 1900 did theorizing in statistics develop strongly, and the main figure was Karl Pearson (1857–1936) at University College, London, and his students and followers. Largely to them we owe the definition and theory of basic notions such as standard deviation and correlation coefficient, basic theorems concerning sampling and ranking, and tests of significance.

Elsewhere, Cantor’s set theory and abstract algebras were applied to many parts of mathematics and other sciences

in the new century. A major beneficiary was topology, the mathematics of location and place. A few cases had emerged in the nineteenth century, such as the “Möbius strip” with only one side and one edge, Riemann’s fantastical surfaces, and above all a remarkable classification of deformable manifolds by Poincaré; most of the main developments, however, date from the 1920s. General theories were developed of covering, connecting, orientating, and deforming manifolds and surfaces, along with many other topics. A new theory of dimensions was also proposed because Cantor had refuted the traditional understanding by mapping one-one all the points in a square onto all the points on any of its sides. German mathematicians were prominent; so were Americans in a country that had risen rapidly in mathematical importance from the 1890s.

Some Reflections

The amount of mathematical activity has usually increased steadily or even exponentially, and the growth from the mid-twentieth century has been particularly great. For example, the German reviewing journal *Zentralblatt Math* published at the beginning of the twenty-first century a six-hundred-page quarto volume every two weeks, using a classification of mathematics into sixty-three numbered sections. To suggest the rate of increase, the other reviewing journal, the U.S. periodical *Mathematical Reviews*, published 3,800 octavo pages in 1980, 7,500 pages a decade later, and 9,800 pages in 2003. It would be impossible to summarize this mountain of work, even up to 1970; instead, some main points are noted relating to the previous sections and to the companion articles on algebras and on logic.

Not only has the amount increased; the variety of theories has also greatly expanded. All the topics and branches mentioned above continue to develop (and also many more that were not noted), and new topics emerge and fresh applications are found. For example, beginning with the 1940s mathematics became widely utilized in the life sciences and medicine and has expanded greatly in economics and other social sciences relative to previous practice.

Much of that work lies in statistics, which after its very slow arrival has developed a huge community of practitioners in its own right. Often it functions rather separately from mathematics, with its own departments in universities.

Another enormous change has been the advent of computing, again particularly since World War II and indeed much stimulated by war work as on cryptography and the calculation of parameters in large technological artifacts. Mathematics plays a role both in the design, function, and programming of computers themselves and in the formulation of many mathematical theories. An important case is in numerical mathematics, where approximations are required and efficient algorithms sought to effect them. This kind of mathematics has been practiced continuously from ancient times, especially in connection with all sorts of applications. Quite often algorithms were found to be too slow or mathematically cumbersome to be practicable; but now computer power makes many of them feasible in “number crunching” (to quote a popular oversimplification of such techniques).

A feature of many mathematical theories is linearity, in which equations or expressions of the form

$(A =) ax + by + cz + \dots$ and so on finitely or even infinitely

make sense, in a very wide range of interpretations of the letters, not necessarily within an algebra itself (for example, Fourier series shows it). But a dilemma arises for many applications, for the world is not a linear place, and in recent decades nonlinear theories have gained higher status, partly again helped by computing. The much-publicized theory of fractals falls into this category.

From the Greeks onward, mathematicians have often been fascinated by major unsolved problems and by the means of solving them. In the late 1970s a proof was produced of the four-color theorem, stating that any map drawn upon a surface can be colored with four colors such that bounding regions do not share the same color. The proof was controversial, for a computer was used to check thousands of special cases, a task too large for people. Another example is “Fermat’s last theorem,” that the sum of the n th powers of two positive integers is never equal to the n th power of another integer when $n > 2$. The name is a misnomer, in that Fermat only claimed a proof but did not reveal it; the modern version (1994) uses modern techniques far beyond his ken.

This article has focused upon the main world cultures, but every society has produced mathematics. The “fringe” developments are studied using approaches collectively known as ethnomathematics. While the cultures involved developed versions of arithmetic and geometry and also some other branches, several of them also followed their own concerns; some examples, among many, are intricate African drawings made in one unbroken line, Celtic knitting patterns, and sophisticated rows of knotted strings called *quipus* used in Mexico to maintain accounts.

A thread running from antiquity in all cultures, fringe or central, is recreational mathematics. Unfortunately, the variety is far too great even for summary here. Often it consists of exercises, perhaps posed for educational use, or perhaps just for fun; an early collection is attributed to Alcuin in the ninth century, for use in the Carolingian Empire. Solutions sometimes involve intuitive probability, or combinatorics to work out all options; with games such as chess and bridge, however, the analysis is much more sophisticated. Several puzzles appear in slightly variant forms in different cultures, suggesting transmission. Some are puzzles in logic or reasoning rather than mathematics as such, and it is striking that for some games the notion of decidability was recognized (that is, is there a strategy that guarantees victory?) long before it was studied mathematically in the foundations of mainstream mathematics.

Lastly, since the early 1970s interest in the history of mathematics has increased considerably. There are now several journals in the field along with a variety of books and editions, collectively covering all main cultures and periods. One main motive for people to take up historical research was their dislike of the normal unmotivated way in which mathematics was (and is) taught and learned; thus, the links between history

and mathematics education are strong. For, despite many appearances to the contrary, mathematics is a human activity.

See also *Algebras; Astronomy, Pre-Columbian and Latin American; Calculation and Computation; Geometry; Logic; Logic and Philosophy of Mathematics, Modern.*

BIBLIOGRAPHY

- Bottazzini, Umberto. *Il flauto di Hilbert*. Turin: UTET, 1990.
- Cajori, Florian. *A History of Mathematical Notations*. 2 vols. La Salle, Ill., and Chicago: Open Court, 1928–1929.
- Cantor, Moritz. *Vorlesungen über Geschichte der Mathematik*. 4 vols. Leipzig, Germany: Teubner, 1899–1908. Classic source of the history of mathematics to 1799.
- Chabert, Jean-Luc, et al., eds. *A History of Algorithms: From the Pebble to the Microchip*. Translated by Chris Weeks. Berlin and New York: Springer, 1999. French original, 1994.
- Cooke, Roger. *The History of Mathematics: A Brief Course*. New York: Wiley, 1997.
- Dauben, Joseph W., ed. *The History of Mathematics from Antiquity to the Present: A Selective Bibliography*. Rev. ed. New York: Garland, 1985. Lewis, Albert, ed. *The History of Mathematics: A Selective Bibliography*. Providence, R.I.: American Mathematical Society, 2000. In CD ROM format.
- Dauben, Joseph W., and Scriba J. Christoph, eds. *Writing the History of Mathematics: Its Historical Development*. Basel, Switzerland, and Boston: Birkhäuser, 2002.
- Dieudonné, Jean, ed. *Abrégé d’histoire des mathématiques 1700–1900*. 2 vols. Paris: Hermann, 1978. Includes a few parts on pure mathematics.
- Dold, Yvonne, et al., eds. *From China to Paris: 2000 Years Transmission of Mathematical Ideas*. Stuttgart: Franz Steiner, 2002.
- Folkerts, Menso, Eberhard Knobloch, and Karin Reich. *Mass, Zahl, und Gewicht*. 2nd ed. Wiesbaden: Harrassowitz, 2001. Much elaborated exhibition catalog.
- Goldstein, Catherine, Jeremy Gray, and Jim Ritter, eds. *L’Europe mathématique: histoires, mythes, identités*. Paris: Editions de la Maison des Sciences de l’Homme, 1996.
- Gottwald, Siegfried, Hans-Joachim Ilgands, and Karl-Heinz Schlote, eds. *Lexikon bedeutender Mathematiker*. Leipzig: Bibliographisches Institut, 1990. Many short biographies.
- Grattan-Guinness, I., ed. *Companion Encyclopedia of the History and Philosophy of the Mathematical Sciences*. 2 vols. London and New York: Routledge, 1994. Reprint, Baltimore: Johns Hopkins University Press, 2003. Material up to the 1930s.
- . *The Norton History of the Mathematical Sciences: The Rainbow of Mathematics*. New York: Norton, 1998. Coverage until World War I.
- Historia mathematica* (1974–). The best single source for new historical writings.
- Klein, Felix, et al., eds. *Encyklopädie der mathematischen Wissenschaften*. 23 vols. Leipzig, Germany: Teubner, 1898–1935.
- Kline, Morris. *Mathematical Thought from Ancient to Modern Times*. New York: Oxford University Press, 1972.
- Kramer, Edna E. *The Nature and Growth of Modern Mathematics*. New York: Hawthorn, 1970.
- May, Kenneth O. *Bibliography and Research Manual of the History of Mathematics*. Toronto: University of Toronto Press, 1973.
- Montucla, Jerome E. *Histoire des mathématiques*. 2nd ed. 4 vols. Vols. 3–4 edited by J. J. Lalande. Paris: Agasse, 1799–1802. Reprint, Paris: Blanchard, 1968.

Pier, Jean-Paul, ed. *Development of Mathematics 1900–1950*. Basel, Switzerland, and Boston: Birkhäuser, 1994. This and the follow-up volume focus mostly on pure mathematics.

———. *Development of Mathematics 1950–2000*. Basel, Switzerland, and Boston: Birkhäuser, 2000.

Roche, John J. *The Mathematics of Measurement: A Critical History*. London: Athlone Press, 1998.

Scriba, C. J., and P. Schreiber. *5000 Jahre Geometrie. Geschichte, Kulturen, Menschen*. Berlin and New York: Springer, 2000.

I. Grattan-Guinness

Matriarchy. Matriarchy is usually defined as a political system in which women are the dominant political actors, as opposed to patriarchy, in which men are the exclusive or primary heads of families, social groups, or political states. But matriarchy has always been a controversial term, since whenever it is mentioned, there are debates about whether matriarchies are imagined utopias or real societies, whether they existed at some time in the distant past or could be re-created in a possible future, and how the definitions of gendered power themselves might have shifted in relation to varying social and historical contexts. The idea of matriarchy has served to inspire a whole series of legends and myths, experiments in alternative lifestyles, feminist spirituality, and woman-centered collectives, but it has long been rejected within mainstream anthropology. In the early twenty-first century new field research in Indonesia, Melanesia, and China has raised new questions about the definition of the term itself, and reinvigorated debates about when—if ever—it can be used responsibly.

Nineteenth-Century Evolutionary Theory

J. J. Bachofen began the modern debate about matriarchy with his 1861 book on “mother right,” in which he argued that one early social formation was a family which traced descent through the mother, and in which “government of the state was also entrusted to the women” (p. 156). Bachofen developed a three-stage model: In the barbaric or hetaeristic stage (from the Greek *hetero*, meaning both), neither men nor women had control, and people engaged in indiscriminate sexual activity, worshipping Aphrodite and valuing the erotic above all else. Then women tired of this system and banded together for their own defense, creating a matriarchy in which Artemis and Athena emerged as the main deities. Agriculture was developed during this period, and so were the stories of Amazons and Furies. Bachofen argued that “matriarchal people feel the unity of all life, the harmony of the universe” (p. 79), and embraced a philosophy of “regulated naturalism” in which maternal love was the basis of all social ties. In the final stage of the development of civilization, men seized control from women, and their struggle to assert their domination was reflected in stories of Zeus triumphing over the Titans, Hades raping Persephone, Perseus slaying the Medusa, and Oedipus killing the Sphinx. Bachofen interpreted mythical accounts of sexual conflict as evidence for a historical transition from matriarchy to patriarchy.

Friedrich Engels developed a materialist version of this theme in *The Origin of the Family, Private Property and the*

State (1884), arguing that matriarchy developed from a situation of group marriage, in which paternity was uncertain so only female blood lines could be traced reliably. Early human societies were presumed to have been egalitarian, and various forms of inequality were introduced in conjunction with the emergence of private property. When property rights came to be invested in men, the development of patriarchy was tied to the birth of capitalism, in which laborers were no longer the owners of the products of their labor.

Anthropologists working on comparative evidence from a number of societies tried to develop a more rigorous definition of matriarchy. E. B. Tylor grouped matrilineal descent with postmarital residence in the wife’s household and evidence that “the wives are the masters” in the family (p. 89), and described the Minangkabau of Indonesia as one possible matriarchy. He later reconsidered this position and decided that the term maternal family would be preferable to matriarchy, since “it takes too much for granted that the women govern the family” (p. 90). Lewis Henry Morgan’s intensive studies of the Iroquois documented political institutions in which women played important roles, and his *Ancient Society* (1877) formed the basis of Engel’s speculations. But as more field studies of matrilineal societies were completed, few of them seemed to have anything approaching female rule over men, and by 1921 Robert Lowie’s *Primitive Society* concluded that there was no evidence that women had ever governed the primitive equivalent of the state.

Twentieth-Century Gender and Kinship Studies

In *Matrilineal Kinship* (1961), David Schneider reexamined several decades of scholarship on the subject and concluded that “the generalized authority of women over men, imagined by Bachofen, was never observed in known matrilineal societies, but only recorded in legends and myths. Thus the whole notion of matriarchy fell rapidly into disuse in anthropological work” (p. viii).

The possibility of matriarchy was also denied in one of the founding texts of feminist anthropology, Michelle Rosaldo and Louise Lamphere’s *Women, Culture and Society* (1974), which started with an infamous (and later retracted) assertion of the universality of male dominance: “It seems fair to say, then, that all contemporary societies are to some extent male-dominated, and although the degree and expression of female subordination vary greatly, sexual asymmetry is presently a universal fact of human and social life” (p. 3).

Twenty years after that statement was published, several contributors to the Rosaldo and Lamphere book specifically recanted this assertion, but none of them went so far as to embrace the idea of matriarchy. Sherry Ortner writes that in the early 1970s, when interest in feminist anthropology began to grow, she and many other anthropologists were asked about matriarchies: “Was it not the case, people wanted to know, that there were societies in which women had the kind of powers and authority men have in our own society? With a reasonable degree of unanimity, anthropologists said no. Well, then, continued the questioners, weren’t there matriarchies in the past? Here there was somewhat less unanimity among the anthropologists,

but by and large no professional scholar in the field was willing to make a strong claim for any past matriarchies either” (p. 139). But she noted that the anthropological consensus fell apart completely when the issue of egalitarian societies was raised. Revisiting her own argument that women’s closeness to nature was used as a universal structural principle to justify their subjugation, she later explained that gender egalitarian societies may indeed exist, but “the egalitarianism is complex, inconsistent, and—to some extent—fragile” (p. 175).

Ortner’s later position is nuanced in relation to late twentieth-century terminology, which distinguishes between cultural ideologies and cultural practices, and looks at “gender hegemonies” rather than gender dominance. A belief that men are superior to women may be posited in mythology or even institutionalized in the formal ranking of social groups, but it is never total. In many cultures, women have a great deal of power that actually counterbalances claims of male prestige, and notions of charisma and social value are always subject to individual adjustments and reevaluations. Women can in fact have significant amounts of power, authority, autonomy, and prestige in systems where men are the formal leaders, and systems that appear “hegemonically egalitarian” may also contain subtle ways to give men the edge over women in a number of informal contexts.

Joan Bamberger’s contribution to *Women, Culture, and Society* argued specifically that myths and legends about female rule were told not because they reflected a previous history of matriarchy (as Bachofen believed) but instead as “social charters” for male dominance. Looking in some detail at a series of myths about the rule of women in Amazonian societies, she found that the myths themselves justify the rule of men “through the evocation of a vision of a catastrophic alternative—a society dominated by women. The myth, in its reiteration that women did not know how to handle power when in possession of it, reaffirms dogmatically the inferiority of their present position” (p. 279). Men stole the sacred objects that gave women supernatural power, and women have since been “forever the subjects of male terrorism,” so that these “myths of matriarchy” are in fact arguments for patriarchy.

It is possible that Bamberger’s interpretation of myths of matriarchy is a more astute reading of Western mythmakers than of indigenous traditions. The myths and legends that Bachofen surveyed were indeed told in patriarchal Rome and Greece in order to justify the abandonment of matrilineal kinship and certain female-centered cults. But the idea of a simple reversal of gender roles within a similar system of domination and control may obscure other possibilities, which are not so easily reducible to a looking glass inversion of male domination and female subjugation.

Virginia Woolf echoed Bamberger’s argument when she wrote in *A Room of her Own*:

Women have served all these centuries as looking glasses possessing the magic and delicious power of reflecting the figure of men at twice its natural size. . . . Whatever may be their use in civilized societies, mirrors are essential to all violent and heroic action. That is why Napoleon and Mussolini both insisted so emphatically on the inferiority

of women, for if they were not inferior, they would cease to enlarge. That serves to explain in part the necessity that women so often are to men.” (p. 37)

Early-twenty-first-century research suggests that there is a much wider range of social alternatives than the simple binarism invoked by the terms matriarchy and patriarchy. Looking for a chimeric inversion of Western forms of male domination—which are, as Woolf notes, accentuated in the specific contexts of fascism and imperial conquest—is too limiting, since not all societies treat male/female relations in terms of colonization or domestication. Inequality can be constructed through sexual difference, but when this happens it is useful to recall Marilyn Strathern’s argument that gender appears not as an immutable construct, but as a transactable one: “The difference between men and women becomes a vehicle for the creation of value, for evaluating one set of powers by reference to another” (p. 210).

Examined from this perspective, gender as a principle of contrast for social classification does not carry a consistent positive or negative valuation as part of its conceptual baggage. As Third World women and “native anthropologists” become more involved in academic discussions of gender equality, many of them criticize what they call the “false utopias” of the search by European-American feminists for hope and inspiration from exotic others. As Shanshan Du argues: “Ironically, by projecting diverse utopian ideals into cross-cultural studies, the declaration of the non-existence of gender-egalitarian societies became a self-fulfilling prophecy. After all, there is always an unbridgeable gap between a utopian fantasy and a real society because the latter never operates on seamlessly coherent principles” (p. 4). She notes the example of the Crow Indians, who have many egalitarian institutions and ideologies, and where women are at least as prominent as men in many significant rituals. However Western anthropologists described the Crow as “male dominant” because of the existence of a menstrual taboo, although later studies have shown that menstrual taboos are complex and can also serve to empower women and grant them access to certain spiritual powers. Du calls this a “Eurocentric bias” which sets its own standards for sexual “political correctness” and is not sensitive to contextual meanings and configurations.

Alternatives to Matriarchy: Matrism, Gender Egalitarianism, and Diarchy

In order to expand the conceptual tool kit of anthropologists for understanding gender relations in other societies, several writers have proposed alternative terms designed to avoid the simplifications implied by matriarchy. Riane Eisler argues in *The Chalice and the Blade* (1987) that patriarchy and matriarchy are “two sides of the same coin,” because both of them involve “the ranking of one half of humanity over the other” (p. xvii). She prefers a partnership model that is “primarily based on the principle of linkage rather than ranking,” so that gender differences between men and women can be spoken of in ways that do not equate them with either inferiority or superiority. Instead of matriarchy and patriarchy, Eisler proposes the term *gylany* for societies where gender relations follow the partnership model, and *androcracy* for others characterized by male

dominance and ranking relations. Her title derives from symbols for these two paradigms: the chalice, symbolizing life begetting, community, and sharing; and the blade, symbolizing the power to take rather than give life—the militaristic ideal to establish and enforce domination. She represents the Neolithic as an era of peace when people worshipped the goddess, which was then destroyed by the invasion of Hebrews and “Kurgans.” The blade came to displace the chalice, and men came to displace women as the central power in the society.

These terms have not been widely adopted, and they are based on the work of Marija Gimbutas, who has excavated hundreds of female figurines from the period 7000 to 3500 B.C.E., which she interprets as mother goddesses. Several archaeologists, such as Ruth Tringham and Margaret Conkey, have argued that her interpretations are highly speculative, but they have had tremendous popular appeal, and her ideal of an early cult of a fertility deity represented as a large, possibly pregnant, woman has been widely disseminated. Gimbutas writes critically of the “indolent assumption” that ancient societies must have resembled those of the present, and presents her own theory that these figurines were produced by groups of people whose social forms she describes as “matristic”:

Indeed we do not find in Old Europe, nor in all of the old world, a system of autocratic rule by women with an equivalent suppression of men. Rather, we find a structure in which the sexes are more or less on equal footing. . . . [T]he sexes are “linked” rather than hierarchically “ranked.” I use the term matristic simply to avoid the term matriarchy, with the understanding that it incorporates matriliney. (p. 324)

Gimbutas’s work provides an archaeological argument for ideas about the importance of goddesses in early Europe that have also been developed by Robert Graves (1946), and many contemporary neopagans (Adler; Pike). Graves argued that goddess worship coincided with the time when calendars were primarily determined by the moon, and noted the correspondence of the lunar and menstrual cycles, and that the Earth Mother was associated with the Moon Goddess. He traced the changeover to patriarchy with the changeover to the solar calendar and the worship of a solar deity. His work is more a poetic vision of artistic inspiration than a work of scholarship, and has been widely discredited.

Eisler and Gimbutas consider themselves “revisionist” historians who have brought together neglected evidence of a nurturant, female-centered society, but they (like the nineteenth-century evolutionary theorists) base this universalist theory solely on evidence from Europe and the Middle East. Even within that area, their scholarship has been widely criticized as biased, selective, and unscientific, and most anthropologists consider their work to present a view of the “matrist” past as unlikely as their utopian vision of a partnership future. The phenomenon of these revisionist feminist visions is itself of great interest, however, and has proved important in inspiring the neopagan movement, Wicca, and best sellers such as *The DaVinci Code*.

Anthropologists have invoked a number of other terms that are close to matriarchy but not exact equivalents: David Hicks describes the patrilineal Tetum of Viqueque, East Timor as having “a maternal religion,” in which men dominate the affairs of the upperworld, but women play a central role in rituals of death, birth, and regeneration. Annette Weiner (1976) describes the Trobrianders of Papua New Guinea as giving value and autonomy to women through their matrilineal institutions, while men travel from island to island to seek renown and political positions of power. She has specifically argued that Bronislaw Malinowski failed to pay attention to certain crucial ways in which Trobriand women played important roles in their society because he focused too exclusively on a male-dominated politics:

The discovery that Trobriand women have power and that women enact roles which are symbolically, structurally, and functionally significant to the ordering of Trobriand society, and to the roles that men play, should give us, as anthropologists, cause for concern. . . . We have allowed ‘politics by men’ to structure our thinking about other societies; we have let ourselves believe that, if women are not dominant in the political sphere of interaction, their power remains at best peripheral.” (227–228)

Others have been more assertive in presenting case studies that directly counter ideas of pervasive inequality. Maria Lepowsky claims to have discovered on Sudest Island “a sexually egalitarian society that challenges the concept of the universality of male dominance and contests the assumption that the subjugation of women is inevitable” (p. vii). The example of the Vanatinai shows, she argues, that gender equality is possible when there is little emphasis on class, rank, age grades, or other forms of social stratification. The decentralization of political power allows for the equal treatment of all categories of individuals, allowing for a much greater sense of personal autonomy for both women and men, and little formal authority of any one person over another. Strength, wisdom, and magical power are valued as characteristics that enhance communal solidarity, and individuals who have these may become “big women” or “big men” without gender bias. Descent is matrilineal, but its influence is buttressed by gender blind institutions like a bilocal pattern of postmarital residence, in which married couples live alternately with their two natal families for many years. So this egalitarianism is defined more by a respect for idiosyncrasy and the absence of formal structure than by a positive value attached to women.

Studies of bilateral societies in Indonesia where gender receives relatively little emphasis, such as the Wana of Sulawesi (Atkinson) or the Meratus of Kalimantan (Tsing), also document a lack of any formal ideology about male supremacy, and ideas of gender crossing (male “pregnancy,” female shamans speaking in male voices) that suggest gender is not conceptualized as fixed. Ortner (1996) compares these to the example of the Andaman Islanders, who had a clear but balanced division of labor (men hunted, women gathered), and a spiritual world in which supernatural beings of both sexes played significant,

generally complementary, and sometimes reversible roles, with one deity of variable—but usually female—gender who seemed to represent fertility. All of these societies can be described as gender balanced and flexible, in which men and women were allowed to participate equally in all forms of social relations, but men nevertheless tended to emerge as leaders in some of these domains.

Feminist scholars such as Ortner, Atkinson, and Tsing stress religion and ideology in their portraits, while scholars in the Marxist tradition build on the work of Engels to argue that nonstratified societies in which both sexes have control over the means of production and their own labors are gender egalitarian. Eleanor Leacock (1978) argues that many precapitalist societies were egalitarian, and Karen Sacks (1979) suggests that, when relating to each other as siblings rather than spouses, men and women can be institutionally equal even in patrilineal, patrilocal societies.

Two early-twenty-first-century ethnographies by Chinese scholars bring together Marxist and symbolic approaches to argue that gender equality is possible and often found in the minority groups of the Chinese highlands. Shanshan Du's *Chopsticks Only Work in Pairs* (2001) stresses complementarity among the Lahu people in Yunnan and the importance of the husband-wife dyad in kinship, labor, and social leadership. She argues that mythology and religion reflect a "dyadic world view," based on cooperation between men and women, since "a single chopstick cannot pick up food" (p. 30). Lahu origin myths feature cross-sex twins who combine male and female attributes in an image of overarching power. While her account places heavy value on the marital unit, Cai Hua's *A Society without Fathers or Husbands: The Na of China* (2003) looks at another group near the Burmese border where brothers and sisters live their whole lives together, raising the sister's children, and reproduce through short term "visits" which are never socially sanctioned as marriage. This arrangement does give women greater autonomy than the traditional Confucian family, and also challenges the usual anthropological orthodoxy about the universality of male-female pair bonding. Hua argues that in this society "sexuality is not a piece of merchandise but a purely sentimental and amorous matter that implies no mutual constraints" (Hua, p. 181). The Na, like the famous Nayar of India studied by Kathleen Gough (Schneider and Gough), are matrilineal, and have resisted communist efforts to bring them into mainstream values. The sibling relationship defines the household completely, and visiting lovers have no connection with the family, have no responsibilities, and do not acknowledge their fatherhood; the children, in turn, do not know their fathers.

Another alternative to matriarchy that works with dyads and sibling symbolism is diarchy, which some scholars grouped with egalitarian structures as a form of "partnership societies." Diarchic societies are marked by a pervasive system of symbolic gender dualisms, "an ideology of balanced powers" in which the members of the male/female pair are ordered by difference and interdependence, rather than dominance and subjugation (Hoskins, 1988, p. 51). A doctrine of mutuality and shared concerns is expressed in ideas of delegation and oscillating rule.

European travelers to the Amazonian jungle and the New Guinea highlands encountered "myths of matriarchy" that presented an apparent confirmation of their own fantasies of Amazon warrior princesses and Melanesian "free love." But travelers in the Indonesian archipelago who visited the islands of Sumba, Flores, Timor, and Savu found a mixture of matrilineal and patrilineal groups who shared an ideology of dual governance often expressed as a "male ruler" and "female ruler," or—even more paradoxically—a man specifically referred to as a woman who held a position of sovereignty. This pattern had first been documented in Indian kinship, where Georges Dumezil described the idea that "sovereignty aligns itself in two planes, at once antithetical and complementary," and it is also found in Chinese and Vietnamese popular religion. The division between spiritual authority and temporal power was predicated on the conceptual opposition between female and male, in a pattern also familiar in Polynesia.

The complementarity of diarchic systems operates with the principles of male and female as abstract entities, and associates them with ideas of a proper balance of action and passivity. Women are typically associated with origins, fertility of the earth, and human reproduction, while men are associated with military and executive power, differentiation, and rank. Diarchic divisions assign to the female principle an equal role in the creation of the world, but at times the passivity of their role as Earth Mother may seem to place real women at a disadvantage, bound by the restrictions inherent to their ritual prominence. Among the Kodi of Sumba, for instance, the conceptually female priestess of the Sea Worms is secluded for several months before the rice harvest to protect the crop. In the early-twenty-first-century, a man, who is both empowered and restricted by the central symbolic role he plays, is cast as the priestess.

Gender dualism, which can be defined for comparative purposes by the formal requirement that a female and male component be included in each unifying hierarchical entity, is found throughout Eastern Indonesia. It occurs in patrilineal as well as matrilineal societies, and coexists with polygyny, occasional violence against women, and male leadership, so it is not necessarily a vision of gender equality, but it does highlight interdependence and complementarity. The importance of opposite sex couples, portrayed as parents, siblings, or ancestors, in Eastern Indonesian sexual imagery is an index of the value given to heterosexual relations, and what can only be called a vision of sexual union—the bringing together of male and female in an act of pleasure, release, and potential reproduction.

Are the Minangkabau a Modern Matriarchy?

In 2002 Peggy Sanday revived controversies about the anthropological use of the term matriarchy by titling her study of Minangkabau gender relations *Women at the Center: Life in a Modern Matriarchy*. Well aware that the term had been rejected by serious scholars for about a century, she provocatively decided to challenge this usage with an argument that matriarchy should be redefined to correspond to the usage of a Dutch-Indonesian term (*adat matriarchaal*) used by roughly 8 million Minangkabau to describe their own customs. The Minangkabau are one of the world's largest matrilineal societies, and

they are also almost all committed Muslims in the nation with the largest Islamic population in the world. While Sanday describes the term as an “indigenous category,” its early-twenty-first-century use is obviously the hybrid result of several centuries of dialogue with European traders, scholars, and administrators, who have long been intrigued by the mixture of matriliney and Muslim piety found in the Minang homeland in Sumatra, Indonesia.

Sanday argues that

the definition of matriarchy as the control of political power by women should be abandoned in favor of a definition emphasizing the role of maternal symbols in webs of cultural significance. The focus should be on the structure and content of dominant gender symbols, not just the linked relationship between the sexes as Eisler suggests. The partnership is important, but it alone does not define matriarchy because there are at least three types of symbolic structures representing gender in partnership societies: egalitarian, diarchic and matriarchic. Egalitarian structures are those in which gender differences are not symbolically marked, although sex differences may play a role in the division of labor. Diarchic societies are marked by a pervasive system of symbolic gender dualisms, Matriarchic structures, like those of the Minangkabau, are based on a maternal model. In all three, although the content of the symbols differ, male and female function as two equal halves of the larger whole and neither dominates the other. (p. 236)

The Minangkabau have been the focus of many anthropological and historical studies, but no other contemporary scholar has chosen to describe them as matriarchic. While Sanday’s claims are based on long-term ethnographic research, her colleagues have not for the most part been convinced that such a change in terminology is needed or helpful.

Sanday notes that her usage is in some ways a return to the original Greek meaning of the term. The root *matri*, from the Latin *mater*, means “mother, nurse, origin, source,” while the suffix *archy*, from the Greek *arche*, refers to “beginning, foundation, source of action, first principle,” and also the idea of “political power, rule, control of the state” (p. 237). Sanday says Minangkabau customs correspond to the first meaning, while they do not fulfill the conditions of the second. She calls for a new cross-cultural definition of matriarchy as “cultural symbols and practices associating the maternal with origin and center of the growth processes necessary for social and individual life” (p. 237). According to this definition, many of the societies studied by gender researchers—the Trobriand Islanders, the Vanatinai of Sudest Island, the Crow Indians, the Lahu and Na of southern China, and the Tetum of Viqueque, Timor—might qualify as matriarchies, since they do emphasize maternal symbols and nurturance, although in many other ways they are quite different from each other.

The use of matriarchy as an umbrella term for societies that value women’s reproductive and nurturing powers seems too broad to be of much use for comparative purposes. What

Sanday wants to call matriarchic has been described by Annette Weiner as “woman focused” (1976), by Sherry Ortner as an “egalitarian hegemony,” by Karen Sacks as a “sister-based society,” and by Eleanor Leacock as a “precapitalist form of sexual equality.” It is also close to the sacred ideals of the Okinawans of Japan (Sered), the dualistic Kodi of Sumba (Hoskins, 1993, 1998), and the highland Wana and Meratus of the Indonesian islands of Sulawesi and Kalimantan (Atkinson; Tsing). All of these examples provide evidence for diversity of gender relations that cannot be reduced to a simple stereotype of male supremacy, but which are also stubbornly idiosyncratic and unlike each other in important ways. Anthropology has long been a celebration of difference, and while it does need a comparative vocabulary, this vocabulary is only helpful if it is very rigorously defined. Expanding the notion of matriarchy beyond its largely discredited nineteenth-century significance does not seem to advance this process.

See also **Family; Feminism; Gender; Kinship; Motherhood and Maternity; Womanism.**

BIBLIOGRAPHY

- Atkinson, Jane. “How Gender Makes a Difference in Wana Society.” In *Power and Difference: Gender in Island Southeast Asia*, edited by Jane Atkinson, and Shelly Errington, 59–94. Stanford, Calif.: Stanford University Press, 1990.
- Bachofen, J. J. *Myth, Religion and Mother Right: Selected Writings of J. J. Bachofen*. Translated by Ralph Manheim. Princeton, N.J.: Princeton University Press, 1967.
- Bamberger, Joan. “The Myth of Matriarchy: Why Men Rule in Primitive Society.” In *Women, Culture, and Society*, edited by Michelle Rosaldo, and Louise Lamphere, 263–280. Stanford, Calif.: Stanford University Press, 1974.
- Buckley, Thomas, and Alma Gottlieb, eds. *Blood Magic: The Anthropology of Menstruation*. Berkeley: University of California Press, 1988.
- Du, Shanshan. “Chopsticks Only Work In Pairs”: *Gender Unity and Gender Equality among the Lahu of Southwest China*. New York: Columbia University Press, 2002.
- Engels, Friedrich. *The Origin of the Family, Private Property and the State*. 1884. Reprint, with an introduction and notes by Eleanor Leacock. Translated by Alan West. New York: International Publishers, 1972.
- Eisler, Riane. *The Chalice and the Blade: Our History*. Cambridge, Mass.: Harper and Row, 1987.
- Gewertz, Deborah, ed. *Myths of Matriarchy Reconsidered*. Oceania Monographs. Sydney, Australia: University of Sydney, 1988.
- Gimbutas, Marija. *The Civilization of the Goddess: The World of Old Europe*. San Francisco: HarperSanFrancisco, 1991.
- Graves, Robert. *The White Goddess: A Historical Grammar of Poetic Myth*. London: Creative Age Press, 1948.
- Hicks, David. *A Maternal Religion: The Role of Women in Tetun Myth and Ritual*. Special report no. 22. DeKalb, Ill., and Detroit, Mich.: Northern Illinois University, Center for Southeast Asian Studies, 1984.
- Hoskins, Janet. *Biographical Objects: How Things Tell the Story of People’s Lives*. Routledge Press, 1998.
- . *Blood Mysteries: Beyond Menstruation as Pollution*. Special issue of *Ethnology* XLI, no. 4 (2002).
- . “Matriarchy and Diarchy: Indonesian Variations on the Domestication of the Savage Woman.” In *Myths of Matriarchy Re-*

- considered, edited by Deborah Gewertz, 34–57. Oceania Monographs. Sydney, Australia: University of Sydney Press, 1988.
- . *The Play of Time: Kodi Perspectives on Calendars, History, and Exchange*. Berkeley: University of California Press, 1993.
- Hua, Cai. *A Society Without Fathers or Husbands: The Na of China*. Translated from the French by Asti Hustvedt. New York: Zone Books, distributed by MIT Press, 2001.
- Leacock, Eleanor. “Interpreting the Origins of Gender Inequality: Conceptual and Historical Problems.” *Dialectical Anthropology* 7 (1983): 263–284.
- Lepowsky, Maria. *Fruit of the Motherland: Gender in an Egalitarian Society*. New York: Columbia University Press, 1993.
- Morgan, Lewis Henry. *Ancient Society*. 1877. Reprint, edited and with an introduction by Lesley White. Cambridge, Mass.: Belknap Press of Harvard University Press, 1964.
- Ortner, Sherry. *Making Gender: The Politics and Erotics of Culture*. Boston: Beacon Press, 1996.
- Pike, Sarah. *Earthly Bodies, Magical Selves: Contemporary Pagans and The Search for Community*. Berkeley: University of California Press, 2001.
- Rosaldo, Michelle, and Louise Lamphere. “Introduction.” In *Women, Culture and Society*, edited by Michelle Rosaldo and Louise Lamphere, 3–15. Stanford, Calif.: Stanford University Press, 1974.
- Sacks, Karen. *Sisters and Wives: The Past and Future of Sexual Equality*. Westport, Conn.: Greenwood Press, 1979.
- Sanday, Peggy Reeves. *Women at the Center: Life in a Modern Matriarchy*. Ithaca, N.Y.: Cornell University, 2002.
- Schneider, David. “Introduction: The Distinctive Features of Matrilineal Descent Groups.” In *Matrilineal Kinship*, edited by David Schneider and Kathleen Gough, 1–29. Berkeley: University of California Press, 1961.
- Strathern, Marilyn. “Conclusions.” In *Dealing with Inequality: Analysing Gender Relations in Melanesia and Beyond*, edited by Marilyn Strathern. Cambridge, U.K.: Cambridge University Press, 1987.
- Tringham, Ruth, and Margaret Conkey. “Rethinking Figurines: A Critical View from Archaeology of Gimbutas, the ‘Goddess’ and Popular Culture.” In *Ancient Goddesses: The Myths and the Evidence*, edited by Lucy Goodison, and Christine Morris, 22–45. Madison: University of Wisconsin Press, 1999.
- Tsing, Anna Lowenhaupt. “Gender and Performance in Meratus Dispute Settlement.” In J. Atkinson and S. Errington, eds. *Power and Difference: Gender in Island Southeast Asia*, edited by Jane Atkinson, and Shelly Errington. Stanford: Stanford University Press, 1990.
- Tylor, E. B. The Matriarchal Family System. *Nineteenth Century* 40 (1896): 81–96.
- Weiner, Annette B. *Women of Value, Men of Renown: New Perspectives in Trobriand Exchange*. Austin: University of Texas Press, 1976.

Janet Hoskins

MATTER AND FORMS OF MATTER. See **Physics**.

MECHANICAL PHILOSOPHY. The mechanical philosophy was a philosophy of nature, popular in the seventeenth century, that sought to explain all natural phenomena in terms

of matter and motion without recourse to any kind of action at a distance (cause and effect without any physical contact). During the sixteenth and seventeenth centuries, many natural philosophers rejected Aristotelianism, which had provided the form of and foundations for natural philosophy at least since the thirteenth century. The mechanical philosophy, which was rooted in ancient Greek atomism, was one candidate for a new philosophy. Atomism was the theory that everything in the material world consists of imperceptible, solid, indivisible bits of matter—atoms—that move about in empty space. Not all mechanical philosophers were strict atomists, but they attempted to explain all natural phenomena in terms of the configurations, motions, and collisions of small, unobservable particles of matter. A central doctrine of the mechanical philosophy was the theory of primary and secondary qualities, according to which matter is really endowed with only a few primary qualities and all others (such as color, taste, or odor) are the result of the impact of the primary qualities on human sense organs. Nature was thus mechanized and most qualities were considered subjective.

Background

The mechanical philosophy derived from the views of the Greek philosopher Epicurus (341–271 B.C.E.), who sought the key to the good life. He considered the good life to be one that maximizes pleasure and minimizes pain. Epicurus believed that the greatest sources of human unhappiness, apart from bodily pain, are fear of the gods and anxiety about punishment after death. To eliminate these causes of distress, he sought to explain all natural phenomena in naturalistic terms—the chance collisions of material atoms in empty space (his version of atomism), thus eliminating the gods’ interference in human lives. He claimed that the human soul is material, composed of atoms that are exceedingly small and swift. The Epicurean soul did not survive death. Thus there is no reason to fear punishment in the afterlife. Epicurus believed that the atoms have always existed and that they are infinite in number. Epicureanism, while not strictly atheistic, denied that the gods play a role in the natural or human worlds, thus ruling out any kind of divine intervention in human life or providence in the world. Because of its reputation as atheistic and materialistic, Epicureanism fell into disrepute during the Christian Middle Ages. The writings of Epicurus and his Roman disciple Lucretius (c. 96–c. 55 B.C.E.) were recovered and published during the Renaissance, which began in fourteenth-century Italy.

Following the development of heliocentric astronomy in the late sixteenth and early seventeenth centuries, many natural philosophers believed that Aristotelianism, which rests on geocentric assumptions, could no longer provide adequate foundations for natural philosophy. Among the many ancient philosophies that were recovered by Renaissance humanists, Epicurean atomism seemed particularly compatible with the spirit of the new astronomy and physics. Early advocates of the mechanical philosophy included David van Goorle (1591–1612), Sebastian Basso (fl. 1550–1600), Galileo Galilei (1564–1642), and various members of the Northumberland Circle of which Walter Warner (c. 1557–c. 1642), Thomas Harriot (1560–1621), and Nicholas Hill (c. 1570–1610) were members. Although each of

these men favored some version of atomism, none of them developed a systematic philosophy. Isaac Beeckman (1588–1637), a Dutch schoolmaster, advocated a mechanical view of nature and wrote about it extensively in his private journal, which was not published until the twentieth century. Beeckman's personal influence was enormous, however, and he was instrumental in encouraging a pair of French natural philosophers, Pierre Gassendi (1592–1655) and René Descartes (1596–1650), to adopt the mechanical philosophy.

Major Advocates of the Mechanical Philosophy

Gassendi and Descartes published the first systematic and the most influential accounts of the mechanical philosophy. Their treatises spelled out the fundamental terms of the mechanical philosophy and functioned as programmatic statements, describing what such a philosophy would look like in practice. Although both men agreed that all physical phenomena should be explained in terms of matter and motion, they differed about the details.

Gassendi believed that God had created indivisible atoms and endowed them with motion. The atoms, colliding in empty space (the void), are the constituents of the physical world. In his massive *Syntagma philosophicum* (published posthumously in 1658; Philosophical treatise), Gassendi set out to explain all the qualities of matter and all the phenomena in the world in terms of atoms and the void. He argued for the existence of the void—a controversial claim at the time—on both conceptual and empirical grounds, appealing to recent barometric experiments of Evangelista Torricelli (1608–1647) and Blaise Pascal (1623–1662). The primary qualities of Gassendi's atoms were size, shape, and mass. He attempted to explain all the qualities of bodies—light, color, sound, taste, smell, heaviness, and lightness—in atomic terms. Among the qualities he included were the so-called occult qualities, which seemed to involve action at a distance and had generally resisted explanation in mechanical terms. After laying the foundations for his philosophy, Gassendi gave an account of the entire creation: the heavens, the inanimate world, the animate world, and the human soul.

Writing in the manner of a Renaissance humanist, Gassendi saw himself as the restorer of the philosophy of Epicurus. Deeply concerned with Epicurus's heterodox ideas, Gassendi, a Catholic priest, sought to modify ancient atomism so that it would be acceptable to seventeenth-century Christians. Accordingly, he insisted on God's creation of a finite number of atoms, on God's continuing providential relationship to the creation, on free will (both human and divine), and on the existence of an immaterial, immortal human soul that, he claimed, God infuses into each individual at the moment of conception.

Gassendi was not a materialist. He argued for the existence of an incorporeal, immortal soul and also believed in the existence of incorporeal angels and demons. In addition to the immaterial, immortal soul, Gassendi claimed that there exists a material, sensible soul, composed of very fine and swiftly moving particles. This material soul (which animals also possess) is responsible for vitality, perception, and the less abstract aspects of understanding. The material soul is transmitted from one generation to the next in the process of biological

reproduction. Gassendi's ideas were brought to England by Walter Charleton (1620–1707) and popularized in France by François Bernier (1620–1688).

Although Descartes also articulated a full-fledged mechanical philosophy in his *Principia philosophiae* (1644; Principles of philosophy), his ideas were quite different from Epicurean atomism. Impressed by the rigor of mathematical reasoning and Galileo's mathematization of physics, Descartes wanted to develop a mathematical approach to the mechanical philosophy. In contrast to Gassendi's atomism, Descartes was a plenist, claiming that matter fills all space. He claimed that matter is infinitely divisible, thus denying the existence of both atoms and the void. He believed that matter possesses only one primary quality, geometrical extension. This belief provided foundations for his attempted mathematization of nature. Descartes drew a sharp distinction between matter and mind, considering thinking to be the essential characteristic of the mind. Like Gassendi's doctrine of the immortal soul, Descartes's concept of mind established the boundaries of mechanization in the world.

Descartes attempted to deduce the laws of motion—the conservation of motion and the principle of inertia—from first principles. From the laws of motion, he attempted to derive mathematical laws of impact. Although these laws were inadequate, even in seventeenth-century terms, their prominent place in his system reflects their importance in a mechanical philosophy, according to which contact and impact are the only causes in the physical world. Having established the physics that he considered fundamental to his system, Descartes proceeded to give mechanical explanations of all the phenomena in the world, including cosmology, light, the qualities of material things, and even the human body.

Like Gassendi, Descartes intended his philosophy to replace Aristotelianism. He hoped that the Jesuit colleges would adopt the *Principia philosophiae* as a physics textbook in place of the Aristotelian texts still in use. His hopes were dashed posthumously, however, when the Roman Catholic Church condemned his book in 1662 and then placed it on the Index of prohibited books one year later, in response to his attempt to give a mechanical explanation of Real Presence (the doctrine holding that Christ is actually present in the Eucharist).

William Harvey (1578–1657), a medical practitioner and teacher, inspired Descartes's mechanical philosophy by his experimental proof of the circulation of the blood, published in *Exercitationes Anatomicae de Motu Cordis et Sanduinis in Animalibus* (1628). Harvey's natural philosophy was actually more Aristotelian than mechanical, a point manifest in his work on embryology, in which he adopted an Aristotelian explanation of generation—epigenesis, according to which the embryo is formed from the fluids contributed by both parents in the process of reproduction. Nevertheless, impressed by Harvey's use of mechanical analogies to describe the flow of blood, Descartes attempted to develop a complete physiology based on his own mechanical principles. Gassendi was not convinced by Harvey's evidence and rejected the circulation of the blood.

Another mechanical philosopher, Thomas Hobbes (1588–1679), was the specter haunting more orthodox natural

philosophers. Hobbes's philosophy seemed—to the seventeenth-century reader—to be materialistic, deterministic, and possibly even atheistic. In *The Elements of Philosophy* (1642–1658), Hobbes propounded a complete philosophy—of matter, of man, and of the state—according to mechanistic principles. Although the details of his mechanical philosophy were not very influential among natural philosophers, his mechanical account of the human soul and his thoroughly deterministic account of the natural world alarmed the more orthodox thinkers of his day. His claims underscored their fears that the mechanical philosophy would lead to materialism, deism, and even atheism.

Later Developments

Gassendi and Descartes set the agenda for the next generation of natural philosophers, who accepted mechanical principles in general, believing that they had to choose between Gassendi's atomism and Descartes's plenism. Robert Boyle (1627–1691), Christiaan Huygens (1629–1695), and Isaac Newton (1642–1727), among the most prominent natural philosophers of the second half of the seventeenth century, developed their philosophies of nature in this context.

Boyle is best known for his attempt to incorporate chemistry within a mechanical framework. His corpuscular philosophy—which remained noncommittal on the question of whether matter is infinitely divisible or composed of indivisible atoms—was founded on a mechanical conception of matter. His reluctance to commit himself about the ultimate nature of matter reflected his concern about the atheism still associated with Epicureanism as well as his recognition that some questions lie beyond the ability of human reason to resolve. Material bodies are, according to Boyle, composed of extremely small particles, which combine to form clusters of various sizes and configurations. The configurations, motions, and collisions of these clusters produce secondary qualities, including the chemical properties of matter. Boyle conducted many observations and experiments aiming to demonstrate that various chemical properties can be explained mechanically. He performed an extensive series of experiments with the newly fabricated air pump to prove that the properties of air—most notably its “spring”—could be explained in mechanical terms.

Huygens followed Descartes in attempting to mathematize physics and the mechanical philosophy. He applied this approach to create a wave theory of light, a mathematical analysis of centrifugal force, and an improved theory of impact. He applied mathematics to physical problems far more successfully than had Descartes.

Newton, whose reputation rests on his achievements in mathematical physics and optics, accepted the mechanical philosophy from his student days at Cambridge University. A notebook written in the mid-1660s shows him thinking about natural phenomena in mechanical terms and designing thought experiments for choosing between Cartesian and Gassendist explanations of particular phenomena. A number of phenomena—including gravitation, the reflection and refraction of light, surface tension, capillary action, and certain chemical reactions—persistently resisted explanation in purely mechanical terms. Failing in the

attempt to explain them by appeal to hypotheses about submicroscopic “aethers,” Newton was led to the view that there exist attractive and repulsive forces between the particles composing bodies. This idea came to him from his alchemical studies. Newton's most notable discovery, the principle of universal gravitation, which provided a unified foundation for both terrestrial and celestial mechanics and which marks the culmination of developments started by Nicolaus Copernicus in the mid-sixteenth century, demanded a concept of attractive force. The concept of force, which seemed to some contemporaries to be a return to older theories of action at a distance that had been banished by the mechanical philosophy, enabled Newton to accomplish his stunning mathematization of physics and thereby fulfill the primary goal of the mechanical philosophy.

In the decades after Newton's death, the worst fears of the Christian mechanical philosophers of the seventeenth century came true. John Locke (1632–1704) argued for the reasonableness of Christianity, and his environmentalist analysis of the human mind—which grew directly from the ideas of the mechanical philosophers—implied the denial of the Christian doctrine of original sin. Deism and natural religion flourished both in England and on the Continent.

Debates about theories of generation became inextricably connected to philosophical and theological implications of the mechanical philosophy. While advocates of epigenesis tended to adopt vitalistic theories of life, theories that invoked some kind of nonmechanical entity to explain the properties of living things, another theory of generation, known as preformationism, seemed to be more compatible with the mechanical philosophy. Preformationism maintained that all living things existed within their ancestors, created by God at the beginning of life with a precise moment established for each one to emerge and become alive. Although preformationism was compatible with both divine providence and the doctrine of original sin, it also raised the specter of materialism that haunted the mechanical philosophy.

Some of the French philosophes, notably Julien Offroy de La Mettrie (1709–1751) and Paul-Henri-Dietrich d'Holbach (1723–1789), espoused atheistic materialism and also adopted vigorously anticlerical and antiecclesiastical views. David Hume (1711–1776) undermined the possibility of natural religion and a providential understanding of the world by demonstrating the invalidity of the standard arguments for the existence of God, particularly the argument from design that had played such a crucial role for the seventeenth-century mechanical philosophers. Newtonian mechanics rose to great heights, having shed the theological preoccupations of its creator. These developments culminated in the work of Pierre Simon Laplace (1749–1827), who articulated a clear statement of classical determinism and was able to demonstrate that the solar system is a gravitationally stable Newtonian system. When asked by Napoléon Bonaparte what role God played in his system, Laplace is reputed to have replied, “I have no need for that hypothesis.”

See also Aristotelianism; Cartesianism; Humanism; Newtonianism.

BIBLIOGRAPHY

- Dobbs, Betty Jo Teeter. *The Janus Faces of Genius: The Role of Alchemy in Newton's Thought*. Cambridge, U.K.: Cambridge University Press, 1991.
- French, Roger. *William Harvey's Natural Philosophy*. Cambridge, U.K.: Cambridge University Press, 1994.
- Garber, Daniel. *Descartes' Metaphysical Physics*. Chicago: University of Chicago Press, 1992.
- Hutchison, Keith. "What Happened to Occult Qualities in the Scientific Revolution?" *Isis* 73, no. 2 (1982): 233–253.
- Kargon, Robert Hugh. *Atomism in England from Hariot to Newton*. Oxford: Clarendon Press, 1966.
- Lüthy, Christoph, John E. Murdoch, and William R. Newman, eds. *Late Medieval and Early Modern Corpuscular Matter Theory*. Leiden, Netherlands: Brill, 2001.
- Mintz, Samuel I. *The Hunting of Leviathan: Seventeenth-Century Reactions to the Materialism and Moral Philosophy of Thomas Hobbes*. Cambridge, U.K.: Cambridge University Press, 1962.
- Osler, Margaret J. *Divine Will and the Mechanical Philosophy: Gassendi and Descartes on Contingency and Necessity in the Created World*. Cambridge, U.K.: Cambridge University Press, 1994.
- Westfall, Richard S. *The Construction of Modern Science: Mechanisms and Mechanics*. New York: Wiley, 1971.
- . *Never at Rest: A Biography of Isaac Newton*. Cambridge, U.K.: Cambridge University Press, 1980.

Margaret J. Osler

MEDIA, HISTORY OF. The term *media history* is almost a tautology when the historic is distinguished from the prehistoric by the presence of recording media. History is always already mediated. A distinct domain of historiography whose object is human communication technologies will to this extent always be tempted to assimilate all human history to itself. Among late-twentieth- and early-twenty-first-century media historians, this principle has advanced to the stage at which alternative programs for understanding human activity—terms such as society, culture, economy, and power—appear as either abstractions lacking the empirical bases of media and mediation, or as derivatives of them. Media history, it can be argued, explains society, culture, and politics better than those concepts explain media.

Periodization

The most common periodization employed distinguishes at the minimum oral and literate phases, indicating that oral communication (along with gesture, dance, potlatch, and other features of orality) are to be included as media. Aristotle's definition of the human being as the *zoon politikon* clearly regards humans as properly belonging to a polis or community, but also indicates that humans are distinguished by communication since, as Claude Lévi-Strauss was at pains to demonstrate, and as the Latin etymologies suggest, there can be no conception of a community without communication, and vice versa. To this extent media history must be one of the central disciplines of the human sciences, embracing not only literary and linguistic studies, but sociology, political science, economics, and the discipline of history itself.

The story of media history is the tale of the long struggle for existence of a materialist understanding of human interaction. The central challenge has been (and remains) the task of shedding idealist conceptualizations like society and culture in favor of tracing the embodied forms in which they are constructed and lived. However, this project is hampered by the sheer scope of the enterprise. The practice of media history takes two major forms: the macroscopic address to the vast accumulation of human media artifacts on the one hand, and detailed investigations of specific conjunctures in the history of specific media on the other. The former is constantly plagued by the temptation of vast generalization, the latter constrained to merely local findings whose contribution to a general theory of media history is therefore rarely clear.

Like that of all historiography, the objective of media history is to understand historical process. The majority of media historians are explicit in adding that the reason for undertaking this task is to guide the emergence of future media or to warn against the outcomes of long- or short-term trends, a linear model with associations to teleologies of both progress and apocalypse. Umberto Eco distinguishes between apocalyptic and "integrated" scholars of the media. The former blame not individual media texts but whole media technologies for the loss or destruction of older values; the latter embrace everything new as proof of progress toward some ultimate good. In the work of the best-known among media historians, Marshall McLuhan (1911–1980), the narrative of evolution has an interestingly spiral dimension, returning in heightened form to its oral origin in the figure of the electronic "global village" (pp. 166–167). A noted Joyce scholar, McLuhan may have derived the spiral form of history from Joyce's source, Giambattista Vico (1688–1744). Be that as it may, he shares with other teleological media historians a mystical belief in eternal return or in millenarian thought that responds to a heartfelt longing for historical symmetry.

McLuhan's spiral might be seen as syncretic, even atavistic. His teacher, Harold Innis, perhaps as a result of his experience of trench warfare in Europe, had a far simpler and more immediately political teleology. Innis divided media into heavy, durable media like stone tablets, suited to carrying ideas through time, and light, ephemeral media like parchment, more suited to spatial dissemination. Though the oral tradition had a strongly conservative function before the invention of writing, afterwards its role became one of swift adaptation. Concluding his study *Empire and Communications*, Innis calls for "determined efforts to recapture the vitality of the oral tradition" (p. 170), appealing to the traditions of common law to equilibrate what, in 1950, appeared as the triumph of spatial over temporal media. Integrated critics are rarely so openly committed to utopian political projects for reform or remaking of the media. An avowed belief in the inevitability of progress is once again a widespread phenomenon, not only in the pages of hip corporate culture magazines like *Wired* but especially among respected scholars of digital media, most of all those who, like Roy Ascott, are also committed teachers and creative activists.

Technology and the “General Accident”

Even less convinced of the need for or efficacy of planning and action are the apocalyptic critics, foremost among them today Jean Baudrillard and, increasingly, Paul Virilio. Baudrillard traces media history in four phases: (1) it is the reflection of a profound reality; (2) it masks and denatures a profound reality; (3) it masks the absence of a profound reality; (4) it has no relation to any reality whatsoever: it is its own pure simulacrum (Baudrillard, 1994, p. 6 and 1983, p. 11). In later writing Baudrillard, like Debord, suggests that, far from integration, we are doomed to the disintegration of media and world alike. Since Baudrillard concentrates only on the representational functions of the media, he is blind to their communicative roles and is determinedly centered on the industrialized world. Widely read when television was still the dominant medium, his work has been eclipsed in the rise of telecommunication toward hegemony among media in the early twenty-first century. More persuasive, perhaps because less nihilistic, Paul Virilio argues that the invention of railways was also the invention of the train wreck, that of automobiles of the car crash, and that the assimilation of all our media into a unified digital circulation leads inexorably to what he calls the rapidly approaching “general accident.” Prefigured by the atom bomb and the information bomb, the genetic bomb is the latest cataclysm waiting to occur, all of them motivated by and dependent upon the mass mediation of speed and the concomitant abolition of time. The proximity of Virilio’s conclusions to those of Innis is deceptive: where Innis saw the grounds for active engagement in the reconstruction of contemporary media, Virilio sees an unavoidable Armageddon.

Innis and McLuhan are not the only figures who ground contemporary media history. Unwelcome because of his Nazi heritage, Martin Heidegger (1889–1976) is nonetheless the silent foundation of much continental media history. In his 1954 essay on “The Question Concerning Technology,” technology figures on the one hand as an ordering of materials, an instrumental relation to the world that blocks our understanding of it. On the other hand, as a collection of devices that ensure survival, technology is ultimately in the service of humankind becoming the one species in whom the coming-to-being of the world can be realized.

Technology at its best thus serves its own ultimate over-coming (a conclusion distressingly close to Heidegger’s ideological consorts in the Nazi Party). In Virilio’s terms, the data crash is the necessary precondition for the self-realization of the world. In another essay, Heidegger prefigures Virilio’s critique of the sedentarization of Western society, blaming television for “the abolition of every possible remoteness” (1971, p. 165). The industrialization of media in the form of standard delivery systems (an unchanging receiver frames all the changing content of television), unlimited replicability, and instantaneous broadcast appear to apocalypics as signals of a collapse, of reality or humanity or both, into an undifferentiated and unchanging sameness. A similar thought undergirds some theories of cultural imperialism and globalization. The apparent novelty of the position is undermined by a reading of Plato’s *Phaedrus*, where Socrates tells the story of Thamus’s indignant critique of writing when the new technology was

brought to him by Theuth: “What you have discovered is a receipt for recollection, not for memory. And as for wisdom, your pupils will have the reputation for it without the reality” (p. 184). Like Plato, Heidegger appears to believe in some form of original sin inhering in the medium he critiques. This thought is more nearly explicit in Heidegger’s pupil Hans-Georg Gadamer, who notes, for example, that “Literary art can be understood only from the ontology of the work of art, and not from the aesthetic experiences that occur in the course of the reading” (p. 161). This holds true not only of a text that retains its integrity regardless of the form in which it is read or performed, but of the written medium from the beginning.

Historical and Technological Media

A more subtle strand of media history than this blunt confrontation of integrated and apocalyptic critics arises in the work of the Frankfurt School, the most influential essay here being Walter Benjamin’s “Work of Art in the Age of Mechanical Reproduction” (1969). Benjamin’s periodization does not concern the transition from oral to literate but from the unique object to serial production, and his concern is with the consequent loss of “aura,” of sanctity and intrinsic value, which media artifacts undergo as a result. Confronting the rise of fascism and contesting the Stalinization of Popular Front cultural policy in the 1930s, Benjamin argues for both the utopian capacities of popular media and the necessity to engage with them as vanguard arenas of creative endeavor. Perhaps the most significant response appears in a letter responding to the draft manuscript written by Theodor Adorno, arguing that popular and avant-garde are “torn halves of an integral freedom to which, however, they do not add up” (1977, p. 123). In his joint work with Max Horkheimer and in other later writings, Adorno elaborates and develops this insight into media history, concluding in 1953 that under contemporary conditions, “people become welded to the unavoidable . . . television makes once again into what they already are, only more so” (1998, p. 50). This vision of industrial and technological media in the service of the status quo is more thoroughly historicized in Jürgen Habermas’s influential account of the formation and deformation of the public sphere, created at the time of the European Enlightenment through the power of the printing press, and distorted into mere opinion polling in the age of mass circulation newsprint, radio, and television. A similar thesis, inspired more specifically by the analysis of reification in Georg Lukacs, is expressed by the French situationist Guy Debord, for whom the age of commodity production had, between the Wall Street crash of 1929 and the late 1960s, given way to an age of spectacle. Where earlier media formations had served to gather people into communities, to conserve traditions, and to propagandize new ways of living, spectacular media serve to promote an endless round of imaginary desires that in turn maintain endless overconsumption through which the overproduction required for the survival of capitalism can be regulated. Unlike Baudrillard, Debord—a convinced Hegelian—believed in the necessity of a dialectical resolution to this sham culture.

Ubiquitous Media

Such macroscopic accounts of media history must be balanced against the increasing amount of scholarship devoted to

unearthing and revaluing the histories of specific moments in the history of media. Many textbooks and most popular print, online, and televisual accounts of media history share the linear model of progress (for example, color is an advance on black and white, sound an advance on silent cinema) and a focus on individual contributions. Historians engaged in revaluing the evolution of specific technologies like cinema sound (Crafton) and widescreen technologies (Belton) have made clear the nonlinear evolution of media technologies and techniques, while individual careers have been revalued in the context of publicity campaigns and the emergence of research and development as a core activity of communications industries since the late nineteenth century.

Increasingly, major corporations have been seen as agents of historical change (see, for example, Sanjek and Sanjek), and companies like the BBC and Disney have both official and unofficial historians publishing on them. The digital media have spawned a publishing industry devoted to histories of companies, sectors, software, infrastructure, components, and research institutes. The United Kingdom was the first country to produce a multivolume history of its cinema industry, begun by Rachel Low in 1948. Similar projects now exist or are in progress for many other countries, including France, Germany, and the United States, while loose groupings of researchers are advancing parallel projects on print and electronic media in a number of countries around the world.

The history of print media has been revolutionized by the work of Lucien Febvre and Henri-Jean Martin, Roger Chartier, and Elizabeth Eisenstein, among others, and the role of print in the colonizing and decolonizing processes has attracted especially significant work. Less obvious media formations such as news agencies have also attracted both company and sector histories. Much work has been done to refocus the broad-brush approach to the transition from oral to literary cultures in Europe, Latin America, Africa, and Polynesia, and major work has been undertaken on the links between media, the relations between media and transport technologies, and shared infrastructures like libraries. Such patient and passionate archival research has made it far more difficult to generalize or to repeat unexamined truisms. This has been particularly important to activists and scholars of the globalization process and the transitions from state-run to commercial models of print and broadcasting.

Current Studies in Media History

Two scholars, both of whose careers bridge Latin American politics and French academia, have made sterling progress toward bridging the gap between the macro and micro scales of media history. Régis Debray, best known perhaps for his account of guerrilla war with Che Guevara, has proposed a mediological analysis that, while repeating the linear model first outlined by McLuhan, does so in the context of a materialist philosophy that both derives from and critiques Marxism. Debray argues for a practice that concentrates on the infrastructures and materials of communication. Rather than study the literary style of a correspondence, for example, he points toward the pens, paper mills, postal delivery system, even the rearing of horses on which the delivery of mail depended,

arguing that Voltaire's letters are unthinkable outside a centralized and militarized state. In a series of books published during the 1990s, Debray draws together an eclectic if rather Eurocentric collection of detailed cases in support of a general thesis critical of both idea- and individual-centered historiography. In their place he suggests a multiply overlapping formation of different media usages associated with material practices like the organization of political parties or compulsory schooling. The practice of law and parliamentary democracy require specific media formations that guide and shape their capacities. Epochal changes, however, do not eradicate earlier forms. Like Jay David Bolter and Richard Grusin, Debray argues for the remediation of old media form and content by new technologies. Like Gadamer, he argues that mediation abides in objects, not in their relations; like Friedrich Kittler he sees particular media practices as the basis of the defining discourse networks of particular periods; and like Raymond Williams he believes that Marxism's "superstructure" of ideas is entirely material. His achievement is to have synthesized these earlier arguments into a practice with a powerful political project ahead of it.

Media history also includes critical reflection on its own past. In some ways more radical than Debray, the work of the Chilean exile Armand Mattelart has been instrumental both in accounting for the movement of thought about the media and in the materialization of such thinking in media practice and policy. Like Virilio, Mattelart is convinced of the interrelation of transport, military, and media technologies and is highly critical of the intellectual traditions that have severed media communication from the communication of goods and people. Far less exclusively bound than Debray to the history of Western media, Mattelart has made major contributions to the study of global media over thirty years and has provided radical revaluations of earlier historiography and theoretical accounts, crucially in arguing for a more integral approach to understanding the networks of interaction between transport, production, and communication. Debray and Mattelart suggest ways of rejoining the meticulous assessment of specific moments with the large-scale analysis of historical processes that in some ways echo an earlier tradition in technology and design history marked by the names of Lewis Mumford and Siegfried Giedion. Mattelart is explicit in drawing inspiration from the former. The latter, well known in industrial design circles, has much to tell contemporary scholars about historical methods appropriate to the field. Part of the challenge of media history is to recover from obscurity the work of earlier generations and to revalue the work of cultural historians like E. P. Thompson and George Rudé in the light of the new object of media history.

Popular and occasionally academic histories of the "social impacts" of media, whether of whole media technologies or of specific media artifacts and genres, suffer from the lack of any known society without media. Moreover, any new medium is always mediated by other media and is held by many historians to have older media for its initial content. Polemics blaming media have been rife since Shakespeare's time, when ballads and broadsheets were blamed for apprentice riots. Rock and roll, comic books, video, and video games have been more recent

targets in the West, and television, radio, music, fashion, and Western technological media generally have been blamed in Islam. Norbert Elias suggests a more subtly functionalist approach, writing of popular songs that “the emotional need behind them, born of the impossibility of finding in scanty leisure time the relationships which working life precludes, is absolutely genuine” (p. 34). The attribution of values to specific media is a significant element of media history. It is unclear whether prestigious media like oil painting became male preserves due to their prestige, or whether women’s media like watercolors lost prestige because of their femininity. Both processes probably occurred. Mass culture, in the sense of industrially produced media, has a history of identification with femininity. Novel reading, television, and telephony are among the domestic and private consumer forms that have been strongly feminized. On the other hand, Sadie Plant argues that network computing and mobile telephony correspond respectively to weaving and knitting, women’s media par excellence, explaining women’s high levels of participation in Internet and wireless telecoms. A key task for media history remains that of explaining why human communication, ostensibly the vehicle of democracy and evolution, has so often been restrictive, oppressive, exploitative, and exclusive.

It would appear from the oldest creation myths that keeping secrets and lying have been features of communication since the beginning. Elias proposes the rise of priestly hierarchies as a source of privileged access to key media such as writing and architecture. Jared Diamond adds the proposal that even before recorded history, possession of writing technology was a source of power for would-be conquerors, and that successful enemies adopted the technology for their own. Certainly differential access to specific media was an intrinsic element of rule in India where, as Homi Bhabha points out, the colony was governed by writing, while the United Kingdom’s Parliament ran on speech. Both print and broadcast media have been explicitly deployed in the interests of nation-building from Hitler’s Germany to Jawaharlal Nehru’s and Indira Gandhi’s India, just as standardization of dialects and eradication of minor languages had been a routine activity of nationalist revolutions throughout Europe in the eighteenth and nineteenth centuries. Since communication appears to be an inalienable quality of human societies, and given the lengthy history of intercultural communication at least in the Old World, it seems most likely that media historians must investigate the blockages, delays, and destructions of media flows as much as their origination and propagation.

Among the specific areas where this work might be undertaken are the fields of advertising, marketing, public relations, and propaganda. As an indication of the difficulty of these terms, however, it is important to recall the etymology of *propaganda*: the Vatican office devoted to the propagation of the faith. The modern term has little meaning before the age of mass literacy and broadcast media, even though José Antonio Maravall argues for its relevance to the Spanish Baroque and John Beverley to the colonial period in Latin America. But although there is archeological evidence of street signs among the ruins of Pompeii, it is misleading to understand them as advertising or public relations in any recognizable sense. Such practices evolved in step

with the emergence of mass consumption in the nineteenth century and are deeply grounded in contemporary information-gathering devices. The emergence of contemporary bureaucracies, distinguished from the Baroque clerisy precisely by their modern media (filing cabinets, adding machines, typewriters), is in turn integral to the conception of the public as a body of consumers to whom both political and commercial messages can be delivered. The radical expansion of the commodity form into leisure activities in the later nineteenth century, a process ongoing in the opening up of the People’s Republic of China in the early twenty-first century, required not only mass manufacture and mass literacy but the mass distribution of a repertoire of shared codes, conventions, and desires stemming from the managerial mode of bureaucracy emergent in such communication sectors as the railways and the department store. Certainly the industrialized media deployed techniques derived from the ancients: rhetoric, spectacle, shock, sensuality. The application of concepts of efficiency to communications, however, seems to date no earlier than the Counter-Reformation in Europe, though a case can be made for its significance in the far earlier Confucian bureaucracy in China, where the difficulty of the writing system and the exclusive nature of education were used to limit radically all access to communications systems, including the mails and navigable rivers. It is this admixture of efficiency that characterizes the contemporary industrial communications sector as, in Horkheimer’s terms, instrumental.

At the same time, when even as sophisticated a thinker as Félix Guattari can assert that “domestic life is being poisoned by the gangrene of mass-media consumption” (p. 27), it is important to consider the role of media not only in constructing concepts of domesticity, but in their subversion. Media are not single, nor exclusively industrialized and instrumental. Critics of globalized media, including Ulf Hannerz, Dayan Thussu, Arjun Appadurai, David Morley and Kevin Robins, and Annabelle Sreberny-Mohammedi and her colleagues emphasize that media not only inform contemporary audiences on issues as large as global warming and as particular as human rights abuse; they also provide vehicles, however limited, for democratic participation and creativity, and globalized industrial media are counterbalanced by diasporan cycles of music, stories, art forms, and political messages operating as informal marginalia to the corporate music business, the Internet, fashion, and the postal service. Even where instrumental media are concerned, the history of audiences indicates a complex work of attention and signification undertaken by viewers, readers, listeners, and participants perpetually ready to convert the proclamations of power into carnival, satire, and rebellion. The significant rise in both the numbers of global organizations and participation in them likewise suggests that media processes remain at least as complex as in former epochs, and therefore can be considered to continue to exist as historical processes.

In conferences during 2000, film archivist Paolo Cherchi Usai estimated that nine billion hours of moving image media were being generated annually. Add to this photographs, print, Web sites, e-mails, let alone conversation, and the information produced in any one year is beyond the reach not just of any one scholar, but of the whole community of media historians. Seen from this standpoint, “the media” as object of study

VILÉM FLUSSER

The work of Vilém Flusser, which has begun to be translated into English in the last decade, is destined to have a major impact on media history. Exiled from his native Prague in 1939, Flusser turned his exile in Brazil and later in France into the grounds of a radical philosophy of freedom. Linking information theory with phenomenology, Flusser argues that pre-history's image-based media were mythic in tone and magical in orientation. They intended to control the world by picturing it. The invention of the alphabet created a new mode of control: lineal, causal, and ultimately scientific. In the invention of photography, he sees the return of the mythic image, but this time an image not of the world but of texts. Rather than image the world, film, television, photography, and computer-generated imaging depict scientific knowledge, philosophical arguments, political beliefs, and commercial messages.

Since writing marks the beginning of history, the technical image marks its end. The

post-historical image is programmed by the texts that precede it, and in turn programs its end users. Every new image is a step toward the exhaustion of information, understood as the improbability of a given message in a particular system. Every new photograph both exhausts the stock of possible photographs still to be taken and adds to the assimilative power of the photographic apparatus. The task of photographers, and by extension all who work in the technical media, is to work at the level of information, program, code, and apparatus to increase the level of improbability. As writing loses its centrality, humanity loses the historical consciousness of linear causality. The resultant universe is entropic in information theory and absurd in phenomenological thought. The task, then, of experimentation in media and of media history alike is to create meaning in the face of randomness and freedom in the face of its necessity.

appear impossibly huge. At the same time, media history, and media theory and criticism, with honorable exceptions, have failed to address some key areas, notably amateur media, consisting of diaries, photo albums, letter writing, and Web sites, and workplace media, including bookkeeping, filing, cash registers and adding machines, cartography, and professional software. Equally, again with honorable exceptions, the focus has been largely on the developed world seen from Eurocentric positions. Acquainted as they are with the irreparable loss of much if not most early film, radio, and television, archivists are painfully aware that their inevitable sampling must respond not only to current but to future research agendas, and that in addition to content, it is increasingly necessary to archive hardware and documentation. The study of humans as the communicative species becomes both more materially feasible and more challenging, the richer and more archivable our communications become.

See also *Authority; Cinema; Communication of Ideas; Globalization; Representation: Political Representation; Technology; Third Cinema.*

BIBLIOGRAPHY

Adorno, Theodor W. *Critical Models: Interventions and Catchwords.* Translated by Henry W. Pickford. New York: Columbia University Press, 1998.

- . "Letters to Walter Benjamin," 18 March 1936, in *Aesthetics and Politics*, by Ernst Bloch et al., 120–126. London: New Left Books, 1977.
- Baudrillard, Jean. *Simulacra and Simulation.* Translated by Sheila Faria Glaser. Ann Arbor: University of Michigan Press, 1994.
- . *Simulations.* Translated by Paul Foss, Paul Patton, and Philip Beitchman. New York: Semiotexte, 1983.
- Benjamin, Walter. "The Work of Art in the Age of Mechanical Reproduction," in his *Illuminations*, 217–251. Edited by Hannah Arendt. Translated by Harry Zohn. New York: Schocken, 1969.
- Briggs, Asa, and Peter Burke. *A Social History of the Media: From Gutenberg to the Internet.* Cambridge: Polity, 2002. Contains a valuable bibliography.
- Debord, Guy. *The Society of the Spectacle.* Rev. ed. Detroit: Black and Red, 1977.
- Debray, Régis. *Cours de médiologie générale.* Paris: Gallimard, 1991.
- Elias, Norbert. "The Kitsch Style and the Age of Kitsch," in *The Norbert Elias Reader: A Biographical Selection*, edited by Johan Goudsblom and Stephen Menell, 26–35. Oxford and Malden, Mass.: Blackwell, 1998.
- . *The Symbol Theory.* London: Sage, 1991.
- Flusser, Vilém. *Towards a Philosophy of Photography.* Translated by Anthony Matthews. London: Reaktion, 2000.
- Gadamer, Hans-Georg. *Truth and Method.* 2nd rev. ed. Translation revised by Joel Weinsheimer and Donald G. Marshall. London: Sheed and Ward, 1989.

- Guattari, Félix. *The Three Ecologies*. Translated by Ian Pindar and Paul Sutton. London and New Brunswick, N.J.: Athlone, 2000.
- Heidegger, Martin. *Poetry, Language, Thought*. Translated by Albert Hofstadter. New York: Harper and Row, 1971.
- Innis, Harold A. *Empire and Communications*. Revised by Mary Q. Innis. Toronto: University of Toronto Press, 1972.
- Mattelart, Armand. *The Invention of Communication*. Translated by Susan Emanuel. Minneapolis: University of Minnesota Press, 1996.
- McLuhan, Marshall, and Quentin Fiore. *The Medium Is the Massage: An Inventory of Effects*. Harmondsworth, U.K.: Penguin, 1967.
- Plato. "Phaedrus," in *The Essential Plato*, translated by Benjamin Jowett. New York: Book of the Month Club, 1991.
- Sanjek, Russell, and David Sanjek. *American Popular Music Business in the 20th Century*. Oxford and New York: Oxford University Press, 1991.
- Winston, Brian. *Media, Technology, and Society, a History: From the Telegraph to the Internet*. London: Routledge, 1998. Contains a valuable bibliography.

Sean Cubitt

MEDICINE.

This entry includes four subentries:

China

Europe and the United States

India

Islamic Medicine

CHINA

"Classical Chinese medicine" refers to the cumulative practices and abstract doctrines passed down by a small literate minority in China beginning in the first century B.C.E. As in any traditional society, this elite knowledge has made up only a small part of China's health care practices, which include self-therapy, family therapy, and ritual and religious curing. Since 1949, as these elements have changed and their balance has shifted, state-regulated medical practice has come gradually to be divided between biomedicine and a greatly modernized form of the classical art generally called traditional Chinese medicine, or TCM, and hybrids of the two.

Literature

More than ten thousand medical books survive from imperial China (221 B.C.E.–1911 C.E.). These include a small number of doctrinal works with a large accumulation of commentaries and scholarly studies; works on nosology and diagnosis; a great many formularies, most of which systematically set out therapeutic methods; collections of materia medica, which over the last millennium tended to incorporate compound drug formulas; collections of the medical case records of physicians; as well as more or less distinct genres for gynecology, pediatrics, and external medicine. Since the 1950s, scholars in China have edited, annotated, and reprinted many significant early works, and have translated some of the most important into the

modern vernacular. Scholars in Asia and elsewhere have used this literature to throw light on a wide range of Chinese ideas, ranging from ethics to gender.

Doctrines

In most of early medieval Europe, only a few classical medical treatises survived, primarily in the libraries of monastic institutions, and most medical practitioners had little education. The outcome was a split between theory and practice. In China there was no such split. Almost all of the literature, including works on doctrinal foundations, was written by practitioners.

Excavated writings on medical divination (from c. 316 B.C.E.) and on medicine (from c. 205 B.C.E.) show traces of a gradual separation of both from popular ritual healing, which had a strong occult component. The first collection of mature classical writings is the *Yellow Emperor's Inner Canon* (*Huangdi nei jing*, c. first century B.C.E.). It was one of a number of foundational works but the others of the same period have been lost. Although physicians through history considered the *Inner Canon* a coherent two-part treatise, David Keegan has shown that it incorporates many separate texts from different sources, some of which comment on, elaborate on, or disagree with others. The various understandings of the body, health, illness, and therapy contained in the work are inconsistent in many respects. Still, all its component text understand the body to be an ensemble of processes that, in health, remain in harmony with those of the cosmos. Reconciling the discrepancies in this most authoritative of classics in order to present a single picture was the goal of several doctrinal works over the next two centuries.

The *Inner Canon* defined what remained the chief characteristics of medicine: It was process-oriented and relational. Medicine treated a complex ensemble of life processes. Diagnosis was generally a matter of identifying abnormal states of the body as a whole (although, given the diversity of practitioners, the training of many allowed no more than proceeding from a list of symptoms to the name of a disorder). Even physicians who treated particular local symptoms did so from the viewpoint of the whole. Wounds were disorders in the same sense as fevers; they affected not only the lesion but all body processes. Body and mind, complementary aspects of a single organism, were bound to affect each other. Because a disease was a process, doctors had to determine its stage and anticipate its evolution. Medical thinkers defined concepts in relation to others; yang was never an absolute property, but implied a relationship to something else that, in the particular pair, was yin. A young woman might be yin in a discussion of gender relations that compares her with a male, but yang in comparison with an aged man who lacks her vitality.

The conviction that both the state and the body are microcosms that partake in the dynamic order of the universe emerged in political theory, moral philosophy, and medical thought over the last three centuries B.C.E. Intellectuals built these doctrines on the concept of *qi*, which was both the basic material that filled the universe and formed individual things, and the vitality that maintained body states and brought about change. The *Inner Canon* integrated this notion with that of yin and yang and the five phases (*wuxing*). It interpreted the

former as paired, opposed, but complementary aspects of *qi*, and the latter as five aspects of it, permitting a finer analysis of interaction in cyclic change. This synthesis became ubiquitous in the history of Chinese ideas. Within medicine, additional analytic categories, especially threefold and sixfold ones, made possible a sophisticated organization of knowledge.

Authors built up a model of fivefold and sixfold systems of vital function that stored and circulated *qi* throughout the body. The supply of *qi* was partly inborn and partly metabolized from air (i.e., ambient *qi*) and food. These systems were named for the main viscera. Unlike in the European understanding, organs were not considered processing stations, but rather bureaucratic offices responsible for order and control of spontaneous processes.

The main principle of health was the unimpeded circulation of *qi*; blockages and stases led to pain and dysfunction. The normal body's relation to its environment was equally important; it had to be open to air and food, but closed to pathogens, and it had to excrete what it could not assimilate without allowing leakage of the body's own *qi*. Medicine from the earliest times also incorporated the value of moderation, not only in conduct but in thought. Just as sensual indulgence could open the way to invasion by pathogens, jealousy or longing could generate medical disorders.

Therapy

Physicians largely depended on opposition therapy, but could modulate it in sophisticated ways. Once the practitioner knew the character of the disorder, he chose therapies to oppose and overcome the imbalance by strengthening the body's functions or attacking the pathogenic agent. The physician's tools included modifications of diet and exercise, massage and manipulation, and a great variety of drugs (over eighteen hundred, mineral and animal as well as botanical, in the great *Bencao gangmu* [1596; *Systematic materia medica*]), as well as acupuncture (inserting needles at certain locations on the circulation pathways to adjust the movement of *qi*) and moxibustion (burning cones of leaf pulp to stimulate these locations more intensely).

Modernization

Biomedicine had little influence on health care in China until after 1949. At that point there were too few qualified personnel to provide basic medical care for the whole population. The government of the People's Republic organized a network of schools to train doctors of traditional Chinese medicine (*Zhongyi*) and a system of modern medical schools. Both trained secondary-school graduates. The Cultural Revolution, from the mid-1960s to the mid-1970s, brought the two closer as those in power demanded that physicians in each sector be trained more than negligibly in the other. This demand also incorporated in the curricula of the TCM schools modern subjects such as anatomy and biochemistry. The government's policy of pushing for synthesis led to textbook interpretations of the old functional discourse in new frameworks close to Western anatomical, lesion-centered views.

The basic education of physicians in imperial China was a matter of memorizing, and learning to apply the methods of

reasoning and treatment in classical writings. But by 1980, few secondary-school graduates learned to read classical Chinese. The classics necessarily played a small part in their medical courses, and their confidence in the use of such traditional concepts as *qi*, yin and yang, and the five phases lessened. By 1980 symptom-based diagnosis that drew on biomedical concepts had become common among young practitioners. Therapy increasingly added to traditional remedies both standard packaged formulas and biomedical drugs. By 2000, medical-school teachers and their pupils were using many styles of synthesis involving traditional and modern medicine—recapitulating the diversity of medical reasoning and practice in previous centuries.

See also *Medicine: India; Science: East Asia; Yin and Yang.*

BIBLIOGRAPHY

- Furth, Charlotte. *A Flourishing Yin: Gender in China's Medical History, 960–1665*. Berkeley: University of California Press, 1999. On medical care for women and childbirth, with a chapter on women as healers.
- Keegan, David. "Huang-ti nei-ching: The Structure of the Compilation, the Significance of the Structure." Ph.D. diss., University of California, Berkeley, 1988.
- Lloyd, Geoffrey, and Nathan Sivin. *The Way and the Word: Science and Medicine in Early China and Greece*. New Haven, Conn.: Yale University Press, 2002.
- Scheid, Volker. *Chinese Medicine in Contemporary China: Plurality and Synthesis*. Durham, N.C.: Duke University Press, 2002. Important, well-informed study.
- Sivin, Nathan. *Traditional Medicine in Contemporary China: A Partial Translation of Revised Outline of Chinese Medicine (1972); with an Introductory Study on Change in Present-day and Early Medicine*. Ann Arbor: University of Michigan, Center for Chinese Studies, 1987.

Nathan Sivin

EUROPE AND THE UNITED STATES

Organized societies such as Babylon and ancient Egypt supported the practice of professional medicine, including surgery, but it was in Greece that European or, more cosmically, Western medicine first emerged after the fifth century B.C.E., when the classic texts began to appear.

Ancient Greece and Rome

The ancient Greeks had many ways of healing the sick. Plant gatherers and drug sellers, especially of herbal medicines, were the key people in the establishment of the vast Greek pharmacopoeia. Women healers had their own special categorization. And there were two groups making up a motley crew specializing in diagnosis and treatment calling on the gods and their evil relatives. One constant in Greek medicine was the existence of religious medicine, practiced in the sanctuaries of Asclepius, the Greco-Roman god of medicine. The heritage of Asclepius continues to survive in his professional symbol, the caduceus (one snake only). The medicine of the gods used declamation, singing, and music to speed up the healing process. Ancient Greeks, heavily invested in the "irrational,"

had more in common with Catholics who go to Lourdes for cures than with rationalist skeptics.

Hippocratic medicine. The most famous document in medical history, the Hippocratic Oath (c. 400 B.C.E.), which established a model of ethical and professional behavior for healers, invoked all the gods, beginning with Apollo. When did the epistemological rupture between mythical thinking and the sort of thinking flattered as scientific, implying a rupture between sacred and scientific healing, take place? The traditional answer is that the change occurred or at least is evident in the Hippocratic corpus, a diverse collection of sixty-odd works by different authors beginning in the sixth century B.C.E., cobbled together about 250 B.C.E. in the library at Alexandria. (A scholarly industry keeps changing the dates of composition of the works and squabbling about textual authenticity.) In the ongoing creation of the Western medical myth it is Hippocrates (the mythic father, also a real person living c. 460–370 B.C.E.) and his followers, who are given credit for establishing the rationalistic basis of scientific medicine. The text *On the Sacred Disease* (c. 410 B.C.E.) denies that epilepsy is a sacred disease, assigning it a natural etiology within the humoral paradigm based on the four body fluids: phlegm, yellow bile, black bile, and blood. (Epilepsy was caused by phlegm convulsing the body as it struggled to free itself from being blocked in the air passages.)

This Hippocratic corpus is notorious for having developed the theory of humors (*chymoi*), which provided a grid for many medical systems over the centuries. *On the Nature of Man*, an anatomical and physiological treatise, went farthest among the Hippocratic writings in the acceptance of the theory of the four humors. According to humoralism, a person's physical and mental qualities are determined by the four chief fluids of the body, thus making it possible to explain health and disease in humoral terms, with health being an overall balance of the four humors. An upset in this balance, with too much or too little of a humor or two, produces disease. The grid of the system was composed of the humors associated with four organs and the qualities or nature of their products. The heart is associated with blood, warm and moist; the brain with phlegm, cold and moist; the liver with yellow bile, warm and dry; and the spleen with black bile, cold and dry. A sick person could correct an imbalance by taking substances characterized by the opposite qualities. In this scheme both people and medicinal substances had complexions and temperaments, that is, a defining humoral composition. The qualities of the humors were thought to correspond to the qualities of the basic elements of the universe: air, water, fire, and earth. This unified theory of humanity in the universe proved so satisfactory to the Western mind that the medical part of the theory was accepted, though much mangled, up through the eighteenth century. The theory "provided the 'reasons' for techniques of evacuation . . . such as venesection [blood-letting], cupping, cathartics, emetics, sneezing, sweating, [and] urination and so on" (Ackerknecht, p. 53). In the flexible Hippocratic humoral grammar the number of humors varied from one text to another. These humors also existed in a healthy person, though invisible to the medical gaze in this case.

The Hippocratic treatise *On Regimen* gave a great deal of attention to diet in the context of an active, well-regulated life.

People absorb food and air, which become part of them and are also the main cause of internal diseases. Wine, which Louis Pasteur later classified as a food, was also an ideal item of medication, for it could be prescribed in many forms and was the best of excipients for the many herbs at the doctor's disposal. Taken pure or mixed with other ingredients, wine could be tailored to individual constitutions. The text *Affections* praised wine and honey for both sick and healthy people. Wine could be mixed with honey or even milk. Greek civilization generally required that wine be cut with two or three parts water to one part wine, but the medical canon permitted the doctor to prescribe it pure or in a variety of mixtures, according to the seasons. In winter the heat and dryness of a small amount of pure wine could counter the baleful effects of humidity and cold. Sometimes doses were quantified, sometimes not.

Galen. By the third century B.C.E., Greek civilization had spread through the Mediterranean basin, blossoming brilliantly in Alexandria, where Ptolemy I ruled from 323 to 285 B.C.E. Hellenistic or Alexandrian medicine placed much emphasis on anatomy and physiology, with Herophilus of Chalcidon (c. 330–c. 260 B.C.E.) and Erasistratus of Chios (fl. 330–250 B.C.E.) providing a mechanistic description of the organs of the human body; humoral theory played only a minor role. Dissection became an important tool in the advancement of medical knowledge, leading to the discovery of new organs such as the prostate and establishing the importance of the brain within the newly represented nervous system. Both theories and sects pullulated in Greek medicine, including groups now classified as empiricists, rationalists, and methodists. Healers became more clearly professional, though they were still trained privately rather than institutionally. By the time Rome conquered the Greek world in the second century B.C.E., Greek medicine was already leavening the simpler medical thought of the conqueror. Greek was a technical language designating diseases, remedies, and instruments for which words had not yet been invented in Latin, but sometimes with the arrival of new works in medicine and in botany Greek terms drove out Latin words in professional discourse. Many of the Roman healers were not citizens, and some were even slaves without civil rights, thus ensuring low social status for most physicians.

The most famous doctor in the history of medicine between Hippocrates and Sigmund Freud was a Greek practicing in the Roman Empire. Other names (Aretaeus of Cappadocia and Soranus and Rufus of Ephesus, for example) earn a paragraph or so in medical history books but only in the shadow of Galen (129–216 C.E.). After arriving in Rome in 161 he gained a reputation in treating upper-class patients, became physician to the imperial family, and pioneered in sports medicine as official physician to the gladiatorial school. He was one of the greatest scribblers in the history of medicine; the classical philologist Ulrich von Wilamowitz-Moellendorff (1848–1931) called him a windbag. He produced works running the gamut from *On Bones for Beginners* to his more philosophical work, *On the Therapeutic Method*. Much was just lifted wholesale from other authors. Galen believed that the physician is a philosopher as well as a healer. A good case can be made for Galen's being "the central figure in the development of the Western tradition of medicine," as Vivian Nutton points out, especially in

his transmission of a Galenized Hippocratic gospel to posterity (p. 58). The great clinician, perpetuator of the tradition of bedside medicine, at least for his wealthy clients, stands out also for his discoveries through experiments on animals and for diagnosis and surgery. Dissection of human corpses and, possibly, vivisection of living criminals had gone out of style, with animals replacing the cadavers and victims. Galen left significant errors for other great minds to correct—in clinical medicine as well as in physiology and anatomy. His legacy was eclipsed by the breakup of the empire accompanied by economic and urban decline.

The Medieval World

With the rise of Christianity in late antiquity, medicine gave a greater role to religion; miracles became more important than enemas. Earlier medieval Christianity did preserve a certain amount of learned medicine in encyclopedias, and the creation of “great texts” gave a coherence and canonic orthodoxy to an ossified Galenism that survived into the seventeenth century. Folk or popular medicine was also incorporated into medical literature, though it is doubtful that it was practiced more widely than in antiquity. In terms of remedies, there was a great deal of overlap between popular and professional medicine. The *Liber simplicis medicinae* (Book of simple medicine, c. 1150–1160) by the famous healer Hildegard von Bingen provided an encyclopedia of these traditional remedies, many herbal and some fantastic, for numerous ailments.

Arabic-Islamic medicine. During the Middle Ages the most dynamic and learned European medicine was Arabic or Arabic-Islamic, though there is little in the Koran about medicine. Arabic medicine down to the eighth century was based on popular practices using a *materia medica* of natural items, organic and inorganic, including camel urine as a general tonic. Urine (along with feces) was also an important ingredient of European *Dreckapotheke* (filth pharmacy). Greek humoral medicine, based on a secular culture, probably survived among the elite in cities of the eastern part of the Roman Empire, even after the Arab conquests. Greek medicine revived in ninth-century Baghdad, chiefly as a result of a translation of Greek texts into Arabic. The works of Galen, the medical culture hero, became the vehicle of Hippocratic medicine in the Eastern and Western caliphates, especially in Muslim Spain.

By the eleventh century, a vast body of translations with commentaries was augmented by an original medical literature in Arabic. Arab-Islamic medicine produced remarkable summaries based on a wide range of sources. As in the written history of Western medicine, historiography tends to emphasize the importance of great physicians, both for their clinical acumen and for the famous works they spawned. Among the great Persians were the philosopher-physician al-Razi (c. 865–925), a critical disciple of Galen; the prolific Avicenna, (Ibn Sina; 980–1037), author of the *Canon* or the medical code, a million-word everything-you-need-to-know for doctors; al-Zahrawi, who wrote a classic text on surgery (mostly cautery in Arab-Islamic medicine); Averroës (Ibn Rushd; 1126–1198); and Moses ben Maimon (Maimonides; 1135–1204), who ended up in Cairo as court physician to Saladin (1138–1193). Razi’s work *On Measles and Smallpox* was still useful enough

to be published in English by the Sydenham Society in 1848. Spread over a vast empire, Arab-Islamic medicine vastly expanded the healer’s pharmacological arsenal with drugs and remedies from Persian and Indian sources, created the first pharmacies, and laid the chemical (alchemical) foundations of modern pharmacy. The vocabulary of European languages was considerably enriched by this activity and by the creation of medical discourse. Medical education was still mostly a private affair, except in the hospital, an important fixture in cities. Roman hospitals had been restricted to soldiers and slaves; Islamic hospitals open to all (a pious hope) were real medical institutions. In 1365 Granada established the first European mental hospital, following the pioneering institutions in other Islamic countries. It looked as if Greek medical glories had been restored and improved.

How it all came to an end is open to debate. Erwin Ackerknecht explained the decline of Arab-Islamic medicine in Gibbonian terms: early Arab tolerance was submerged in Islamic fanaticism. Just add the triumph of the barbarians and one has a crude version of Edward Gibbon’s (1737–1794) model of the decline and fall of the Roman Empire. Christians conquered Cordova in 1236; the Mongols sacked Baghdad in 1258; the Ottoman Turks conquered the Levant—Constantinople fell in 1453—and swept into the Balkans and the Mediterranean. Arab civilization declined after the thirteenth century, but the old medical system survived, especially in the Ottoman Empire, until the nineteenth century and continues to survive in a form known as Yunani medicine (*Unani tibb*, Greek medicine) on the Indian subcontinent. What influence Arab-Islamic medicine had on the rise of the medical profession in medieval Europe is open to speculation, but it is clear that Arab medicine exercised a powerful intellectual influence on the revival of Greek medicine in the early medieval period.

Medieval physic. This revival of formal medicine in the West began in the southern Italian town of Salerno, a dynamic, multiethnic place under Norman power; the town is a hundred miles south of the great monastery of Monte Cassino, whose library held a collection of medical texts, and which stimulated an interaction with Salerno. The teachers at the medical school in Salerno developed a good curriculum, founded on their translations of the great texts of Greek (from Arabic) and on Arab medicine. Constantine the African (Constantinus Africanus; c. 1020–1087) was instrumental in transmitting a Galenized Hippocrates to the Latin world with its new concepts, couched in a new technical vocabulary, in anatomy and physiology. By the thirteenth century, an enriched Arabic-tinted medical Latin identified medicine as a separate and elite discipline—and a few centuries later provided medical discourse for Molière. The new medical canon, flattered as the *Little Art of Medicine* (Articella) in the sixteenth century, was based on a group of translated works, especially Constantine’s version of the *Liber ysagogarum* (Medical questions) or introduction of *Hunayn ibn Ishaq al ibadi* (Johannicius). This work became the basis for the medical teaching of the difficult art of diagnosis and of the gamble of therapy—Constantine’s book on drugs, the *Antidotarium*, expanded the therapeutic repertoire. This introductory book emphasized the therapeutic need to regulate

Galen's "six nonnaturals" (food and drink; sleep and waking; environment; evacuation, including sexual; exercise; and mental state) in order to preserve the natural humoral balance in the body, thus avoiding illness, or to restore balance, thus curing an illness. This emphasis on regimen or lifestyle was made famous in the popular *Regimen sanitatis salernitanum*, a book of verses perhaps concocted by Arnau de Villanova (c. 1235–1312), physician to the high and mighty (popes and kings) and professor at the University of Montpellier. Many popular works adopted this holistic framework in giving advice to the sick and those trying to stay healthy.

With the economic revival of Europe in the period 1200–1350, there appeared an age of construction in hospitals and universities as society invested in the care of the sick and the production of clergy, lawyers, teachers, and doctors. Medical education, when it was organized in places such as Bologna and Montpellier, was a long, tedious affair (about ten years) attempted by few. Padua, degree mill of the age, granted nine medical and surgical degrees in 1450; it had a large faculty of sixteen. Europe probably produced enough physicians to treat elite patients and to discourse with them in the Aristotelian lingo they both had ingested in the faculties. The rest of the population cured themselves or depended on charlatans (not necessarily a pejorative designation) or empirics of varying degrees of ignorance and skill. Neither doctor nor empiric could do much in dealing with smallpox, influenza, insanity, leprosy (a popular diagnosis in the eleventh and twelfth centuries), and the Bubonic plague (1347–1351), which killed off about a quarter of the European population. The wise doctor limited himself to dietetics, according to the Galenic gospel of the "nonnaturals," some drugs, and a bit of minor surgery. With a degree and well-heeled patients, he could become rich. There was not much competition. In 1454 Vienna, with a population of fifty thousand, had eleven M.D.s.

Medieval surgery. Surgery, often identified as a craft, has sometimes been promoted to the status of an intellectual adventure. It was certainly a dangerous though not necessarily fatal adventure to have surgery in pre-Listerian times. Roman surgery can appear "remarkably modern," meaning comparable to the surgery of the 1970s (Nutton, p. 57). Great surgeons such as John Bradmore (d. 1402), John of Arderne (c. 1307–1370), and Henri de Mondeville (c. 1260–1320) were remarkably successful in carrying out dangerous operations, some on the battlefield, often improving on ancient techniques. It is not surprising that mortality rates were high; what is surprising is the survival of a patient exposed to massive infection. The ancient technique of using wine to irrigate wounds and incisions is probably one part of the explanation. Surgeons liked to write as well as cut. The leading surgeons produced classic texts, thus following in the literary Hippocratic-Galenic tradition. Outside Italy surgery may not have been a respectable part of the curriculum, but from the twelfth century on, leading surgeons were closer to physicians than to barber-surgeons and empirics; in some towns cooperation between all groups was more striking than clashes. Even snarling Parisian surgeons and physicians could come to a limited agreement in 1210 over dissections. While the doctor envied the surgeon's skill, the surgeon lusted after the doctor's cultural capital and

academic baggage. The social status of surgery was helped by the official role of the surgeon in autopsies for investigations of homicide and in the public dissection of criminals. The growing importance of anatomy (including the dissection of human corpses) in medical education during the fourteenth century also promoted the surgeon. Medicine and surgery had become part of society in an unprecedented way as a result of the new governmental function of practitioners and the related development of institutions.

Renaissance Medicine

In the sixteenth century, Greek medicine was reborn yet again but with a difference. The upside of the fall of Constantinople was an influx of Greek scholars and manuscripts into Italy. A scholarly industry soon developed for the study of ancient Greece and for the publication of the works forming the basis of Western civilization, including medicine. In 1525 the Aldine Press in Venice published Galen's complete works in Greek. (In the sixteenth century 590 different editions of Galen were published.) The next year Aldine also published the Hippocratic corpus. New Latin translations soon appeared for the Greekless. Medical humanism was on a solid footing; what the return to a true Galenism meant for the practitioner and patient is not clear, except for a new emphasis on the etiology of disease and the tailoring of therapy to a profile of the individual patient. Clinical bedside teaching—its origins are piously traced back to Hippocrates—was integrated into medical education at Padua in 1578 by Giambattista da Monte (1498–1552), who was also keen on method as the key to knowledge and practice. Galen's *Method of Healing*, brought up to date by the professors, could put doctors on an infallible path to correct diagnosis and treatment. All they had to do was look in a *practica*, or crude physician's handbook, whose professorial prolixity often reduced its usefulness.

The new anatomy. Historians agree on the main developments in Renaissance medicine: first, the revival of a modestly revised Galenism; second, the related renewal of anatomy, which was linked to the flourishing artistic culture in Italy. Artists used the knowledge from dissection as the conceptual foundation of the new art. Anatomical texts illustrated by artists displayed a representational, natural body rather than the pedagogical schematic model of medieval texts. Michelangelo collaborated with Realdo Colombo (1516?–?1559), who in 1548 became professor of anatomy at the Papal University in Rome. A great deal of the new work in anatomy was concerned with modifying Galen, who had sometimes extrapolated from animal to human anatomy, as in the case of the five-lobed liver. The major demolition job on Galen was done by one of his most fervent disciples, Andreas Vesalius (1514–1564), who in 1537 moved to Padua, took his degree and, though an academic physician, became lecturer in anatomy and surgery. Influenced by the Bolognese model, Vesalius increased his dissecting activity—a sympathetic judge increased his supply of cadavers of executed criminals—and by lecturing while dissecting, he integrated physician, anatomist, and surgeon and gave a coherence to the subject. In 1543 Vesalius published *De humani corporis fabrica* (On the fabric of the human body), a great classic of descriptive anatomy. This book



The Anatomy Lecture of Dr. Nicolaes Tulp (1632) by Rembrandt. Oil on canvas. The study of anatomy dates back as early as 1600 B.C.E. In the fifth century B.C.E., the Greek physicians Herophilus and Erasistratus made the first substantial progress in the field by confirming many bodily functions through dissection. © FRANCIS G. MAYER/CORBIS

was “the first proper account of *human anatomy*” (Wear, p. 275); the artistic but scientifically precise illustrations were a key part of the text. By his teaching and book, Vesalius eventually changed the way doctors understood the human body, ensured the triumph of an anatomical method based on dissection and observation, and left future investigators plenty of problems to solve within the emerging physiological paradigm. Galenic views on the blood and the heart, or his cardiovascular system, came to be recognized as seriously flawed. The new model was completed *grosso modo* in 1628, when William Harvey (1578–1657) published *An Anatomical Essay Concerning the Movement of the Heart and Blood in Animals* (*De motu cordis*).

The Harveian Revolution (Seventeenth Century)

Until the seventeenth century, medicine operated within the context of the Galenic blood system, or rather, two blood systems. Using chyle (concocted in the stomach from food), the liver produced venous blood, which moved through the veins to various parts of the body to provide for nourishment and growth. The heart was the source of arterial blood, a concoction of venous blood, and *pneuma* (vital air, the stuff of life), which also moved

through the body as needed. The venous blood seeped from the right side to the left side of the heart through invisible pores in the interventricular septum. The air came from the lungs via the venal artery (today’s pulmonary vein). Blood did not return to the heart but was consumed: no circulation. This coherent, rational system, concordant with major therapies, also explained mental functions by diverting a little arterial blood for conversion into animal spirits (highly refined spirituous air) to flow through the nervous system.

Movement of the heart and blood. Harvey was a Cambridge man who took his medical degree at Padua, where he worked under Girolamo Fabrici (Fabricius ab Aquapendente; c. 1533–1619), the first anatomist to discuss the venous valves (*De venarum ostioliis*; 1603). By the time Harvey arrived in Padua, Galen’s model had been seriously damaged, though no one had thrown Galen’s works into a bonfire, as Paracelsus had supposedly done with Avicenna’s *Canon* in 1527. Vesalius had denied the origin of the vena cava in the liver and, in the second edition of *De humani corporis fabrica*, the theory of the porous septum in the heart. After some vivisectionist experiments, Columbo argued for the pulmonary transit, or

movement of blood through the lungs, and also described accurately the action of the heart in systole and diastole. Other anatomists confirmed these discoveries.

On his return to England, Harvey practiced in London, becoming one of the city's most famous doctors and after 1618 one of the royal physicians. *De motu cordis* does not introduce its great novelty, the circulation of the blood, until chapter eight, and then only apologetically in an Aristotelian, vitalistic framework. Unlike René Descartes (1596–1650), Harvey was not a mechanist. His work was based on dissection, vivisection, and a famous quantitative experiment in which he measured the amount of blood passing through the heart in a given time, thus showing that the system had to circulate the same blood or explode. Of course Harvey's argument on circulation was incomplete because he could not see the capillaries, though he inferred their existence; Marcello Malpighi (1628–1694) used a microscope to discover them in a frog's lungs (*On the Lungs*, 1661). Robert Hooke (1635–1703) as well as an Oxford group pinpointed the importance of the mixing of air and blood in the lungs. (An explanation of respiration, completing the system, was not possible before the chemical revolution of the late eighteenth century.) Galenic physiology, with the liver as a blood-making organ, became untenable, as Jean Riolan the Younger (1580–1657) recognized in a weak scientific attack on Harvey, who had little trouble in showing it to be nonobservational nonsense. Physicians were too conservative to abandon the Galenic practice of venesection, and this points to a problem of new medical science: the development of a related therapy is usually in the future, leaving doctor and patient both victims of the old science with its traditional therapeutics.

Paracelsus: Crude chemotherapy. The end of Galen's iconic status was balanced by a revival of Hippocrates, the perfect cover for an attack on orthodoxy. Paracelsus (Bombast von Hohenheim; 1493–1541) denounced learned medicine but praised Hippocrates, a curious patron for his brand of medicine based on the Christian religion, magic, astrology, observation, and personal experience. Ackerknecht called him a “medical Doctor Faustus” (p. 108). Paracelsus's cosmic “doctrine of signatures” identified the curative power of plants according to their resemblance to the organ affected; this was a pretty standard belief in popular medicine as well. In his natural philosophy, the Aristotelian-Galenic system of qualities, elements, and humors was replaced by a chemical fantasy associating substances with principles of solidity (salt), inflammability (sulfur), and spirituousness (mercury). Specific remedies of this chemical therapy cured specific diseases, whose agents might be poisons from the stars or from minerals on earth. Paradoxically, the advocate of the idea of a chemical etiology of and cure for diseases is the culture hero of alternative medicine. He was antiestablishment. Reading deeply into the book of nature, he concluded that therapy should be based on the principle of “like cures like”: applying what is suitable to the affected part, rather than following Galenic therapeutics based on the principle of opposition. Paracelsus had many followers, the most famous being Jan Baptist van Helmont (1579–1644), master of medical chemistry (iatrochemistry) and defender of the ontological concept of disease, meaning

that every disease has its own unique principle and therefore a specific treatment. The theory was useful in attacking blood-letting as a debilitating practice based on the erroneous idea that plethora causes disease. But like its Galenic enemy, Paracelsus iatrochemistry declined in the second half of the seventeenth century. The choleric Harvey, no friend of chemistry, regarded the Paracelsans as “shitt-breeches.”

Sydenham: Bedside medicine. Unlike Harvey, Thomas Sydenham (1624–1689) was on the winning side in the English Civil War. Unlike Harvey, he did not have any scientific manuscripts for soldiers to destroy. Sydenham, an Oxford man scornful of learned medicine, advocated observation and the bedside tradition. His hero was Hippocrates, reinvented as an inspiring clinical spirit at the bedside. The “English Hippocrates” believed in specific remedies for diseases; cinchona bark against the ague (benign tertian malaria), for example. Unlike Harvey, Sydenham, accepting Francis Bacon's (1561–1626) philosophy of science, was interested in classifying diseases, epidemic fevers in particular; the botanical model was useful here in his attempt to develop a clinical medicine for the London masses who suffered from the ague from March to July. In the midst of these conceptual upheavals on the functioning of the body and the nature of diseases, therapeutics changed little, except that a “new” disease like syphilis might require a “new” and horrible treatment (mercury). Herbal remedies continued in both popular and professional use. The old humoral procedures of bleeding, purging, induced vomiting, blistering, and cupping survived in the medical repertory. No wonder Sydenham admitted that without opium, medicine was a cripple. (Sydenham's laudanum contained 200 grams of opium, 100 grams of saffron, and 15 grams each of cinnamon and of cloves in 100 grams of Malaga wine.) Sydenham doubted that using the microscope or studying anatomy would advance medicine. Prophecy should be left to the prophets.

From Enlightened to Clinical Medicine

The age of Enlightenment (and revolution), even in medicine, is how historians conceive of the eighteenth century. Centers of new or innovative medicine shifted over the centuries: ancient Athens and Rome, Salerno, Montpellier, Edinburgh, Leiden, Vienna, London, Paris, New York, and so forth. After the medieval creation of universities, learned or academic medicine, often connected to a clinic or a hospital, played a major role in reorienting medicine in theory and sometimes in practice. In spite of the profession's hero worship of Hippocrates, what was going on in faculties of medicine by the late seventeenth century had little to do with classical medicine. At Leiden, then “the medical center of the world” (Ackerknecht, p. 130), teaching was organized on the basis of subjects rather than the teachings of the great doctors; bedside teaching and the dissection of corpses had also become important. Hermann Boerhaave (1668–1738) was at the center of the new dispensation. His students included the founders of the great centers of clinical medicine in Edinburgh and Vienna. Boerhaave, inspired by experimental natural philosophy, concocted a hydraulic model of the body with a corresponding mechanistic explanation of disease. His mighty text



Illustration of physician René-Théophile-Hyacinthe Laënnec (1781–1826) tending to a patient, after 1816 painting by Theobald Chartran. During the late eighteenth century, medicine began to progress into an institutionalized occupation, rather than just a societal system, and accredited doctors began to rise in prestige.

The Institutes of Medicine (1708) ran through ten editions and endured a few translations into vernacular tongues. In 1724 Boerhaave wrote up a famous case history of a male who had died of a ruptured esophagus. It can be argued that this was the first modern form of this literary genre, covering the patient’s history, a physical examination, a diagnosis, the course of disease, and an autopsy. Boerhaave developed a modern medical curriculum with a sequence of natural science, anatomy, physiology, and pathology, complemented by clinical instruction in a twelve-bed ward. This looks like the birth of that elusive entity the clinic; Michel Foucault insists that it was a protoclinic, for Boerhaave still struggled in the “old age of the clinic” (Foucault, ch. 4).

Pathological anatomy. It had become clear that death could give insight into disease, possibly even establish its cause. Though tedious to use because of its two correlating indexes, the prolix work *On the Sites and Causes of Disease* (1761), by the Paduan anatomist Giovanni Battista Morgagni (1682–1771), achieved part of its noble aim of establishing a connection between the patient’s symptoms and the lesions of the diseased organ in the corpse. Morgagni logged in some seven hundred autopsies. A new etiology of disease shifted it from a general theory to a specific organ, a site, where lesions

produced by morbid changes in the organ could be matched with symptoms of disease in the patient. The London doctor Matthew Baillie (1761–1823) carried this anatomo-pathology further in a famous work on *Morbid Anatomy . . .* (1793), which provided classic textbook descriptions of diseases, including cirrhosis of the liver and emphysema.

In Paris the hospital came to dominate medicine through surgery and teaching. At the gigantic Hôtel-Dieu, Xavier Bichat (1771–1802) did six hundred autopsies as a basis for his *Treatise on Membranes* and his book *General Anatomy applied to Physiology and Medicine* (3 vols., 1801). Bichat’s famous, complex theory of tissues, or membranes, shifted the etiology of localized disease from the organ to lesions of specific tissues. This shift allowed a lesion to be more precisely identified according to the particular tissue affected rather than the whole organ: inflammation of the heart was replaced by identification of inflammation of membranes or the muscle itself. “Life, disease and death now form[ed] a technical and conceptual trinity,” as Michel Foucault put it in consecrating “death [as] the great analyst” (p. 144). Death, formerly the domain of the priest, had become part of medicine, and, along with life and disease, integrated into the medical gaze. Or, as Roy Porter puts it in ordinary discourse, Bichat’s “work laid the foundations for nineteenth-century patho[logical] anatomy” (p. 265). Medicine could become a science enabling diagnosis to be more precise. The tool was the modern physical examination (still the doctor’s best diagnostic tool), which consecrated the techniques of inspection, palpation, percussion, and auscultation. The patient’s symptoms and the signs detected by the doctor could be related to the lesions that had been observed in diseased organs. With a galaxy of stars—Jean-Nicolas Corvisart des Marets (1755–1821), René Laënnec (1781–1826), and Pierre Louis (1787–1872) prominent among them—Parisian hospital medicine enjoyed its day in the sun as a model having considerable influence on medical thought and education.

The clinic. What was the clinic? The teaching clinic meant different things in different countries. In France clinical medicine put an emphasis on surgery, chiefly in large city hospitals. Military demand was a powerful stimulus to medical growth in the eighteenth century, and the need for army doctors rose during the French Revolutionary and Napoleonic wars. British clinical education was also mainly an affair of London institutions and provincial hospitals; Edinburgh and Glasgow resembled more the German model. In the German states small university-affiliated clinics and infirmaries provided practical education. The public hospitals of Paris had twenty thousand beds in which to stack, examine, and perhaps cure—an autopsy was more frequent—the city’s vast diseased population. Medicine in Paris distinguished itself by the accessibility of public hospitals to students wanting instruction from great men like Laënnec and experience in bedside medicine and dissection. Lots of corpses were available, for mortality at the Hôtel-Dieu was about 25 percent, two and one half times that of most English hospitals. Foreign students and doctors found Restoration Paris a profitable place in which to learn the latest French medical fashion; on returning home, they carried versions of the French model with them to many

cities, including Vienna, Boston, and even London. London, whose population reached a million and a half by 1831, developed large teaching hospitals. Paris, whose population did not reach a million until 1846, was notorious for its concentration of patients and after the 1830s the development of medical specialization. The bedside tradition foundered when dozens or even many more students crowded round the patient's bed to receive the master's instruction. More profitable instruction was to be had from private courses organized by Parisian doctors. Limits on numbers were also imposed through elite selection in intern and extern examinations. The lecture shifted to the amphitheater. In spite of the fame of Paris hospital medicine, a student got a better education in private instruction by a great man, perhaps even Laennec, who gave a private course in the small ward of a big hospital, thus providing the advantages of both pedagogical worlds.

From Clinical to Laboratory Medicine

Medicine was transformed institutionally, practically, and intellectually in the century after the 1750s. Medicine evolved from a cultural system to an occupation, as the practitioners of professional medicine grew in prestige and began to dominate their rivals, the charlatans or empirics of popular medicine.

Physiology. One of the striking intellectual developments of this period was the emergence of physiology as an autonomous experimental science, probably first in France through the work of Bichat, François Magendie (1783–1855), and Claude Bernard (1813–1878). Physiology distinguished itself by the use of operative or experimental surgery, which might be seen as a mutation of an ancient tradition running from the Alexandrian school through Galen to the Italian schools and Harvey. Much knowledge was gained; many animals were sacrificed. With the advent of Bernard, the historian passes into a different conceptualization of the development of medicine: from pathological anatomy in the hospital to medicine in the laboratory. Medicine seemed in danger of becoming obsessed with the pathological, always a danger in the doctor's world of disease. Bernard's physiological medicine showed how essential it was to understand the normal as well as the pathological, indeed, that there is only a narrow divide between them. Understanding the functions of an organ became central to understanding a disease. For example, Bernard's experimental demonstration of the role of the liver in making glycogen and in regulating glucose levels in the blood provided the basis for understanding diabetes—an alteration or disorder in a normal function produced the lesion or disease. (The new world of internal secretions later gave rise to the science of endocrinology.) Such discoveries could only occur in a controlled laboratory experiment on an animal. Bernard's view was similar to that of Rudolf Virchow (1821–1902): "Disease is nothing but life under altered circumstances." Imitating Virchow, Canguilhem (p. 100) made a brilliant diagnosis: "Diseases are new ways of life."

Medical science in Germany. In the middle of the nineteenth century the center of medical excitement and interest began to shift from Paris to German centers, where heavy investment in higher education had begun to pay large research dividends. The history of medicine at this point becomes of

necessity rather Whiggish as discovery after discovery has to be cataloged, and the practice of medicine itself seems to have improved. Some of the progress was driven by instruments, especially the microscope, which had been of no interest to Bichat but was indispensable to Virchow, pathologist and Progressive politician. The great unifier of physiology and pathology, Virchow developed the medical implications of cell theory. To understand diseases, one had to understand the cell. From Morgagni's emphasis on the organ to Bichat's concentration on tissues to Virchow's consecration of the cell (*Cellular Pathology*, 1858), medicine, like the other sciences, turned increasingly microscopic. The whole patient would soon be hard to find, but the German model of medical science became universally admired and imitated, especially in a few select American institutions (Johns Hopkins, Harvard, and the Universities of Pennsylvania and of Michigan). Of course it would be a while before the chasm between laboratory and hospital (and physician) would be bridged and the hospital would begin "to resemble a factory" (Porter, p. 347).

The immediate influence that experimental physiology had on the practicing physician is not easy to assess; the impact of sciences such as chemistry (in anesthesiology), microscopy, and bacteriology was much clearer by the end of the nineteenth century. Over the long haul no doubt physicians came to place considerable reliance on various physiological instruments to record and analyze data. Most of these instruments, like the kymograph, were invented and developed in the German states. The stethoscope replaced the urinal as the symbol of the profession. A much-improved microscope became indispensable to medical and biological research in the second half of the nineteenth century and, with the white coat, the accessory of the successful doctor. Wilhelm Conrad Roentgen discovered X-rays in 1895, and by the 1920s diagnostic medicine embraced X-rays for large masses of people. Physics was becoming an essential part of medicine, which by the early 2000s was integrated into the world of engineering and physics through CAT and PET scans and magnetic resonance imaging in order to model the structure and functioning of the body.

Women doctors. The autonomous and monopolistic organization of the medical profession under governmental protection is a late development in the history of medicine, essentially post-Revolutionary (1789). Universities assumed the primary role in medical education, though private schools or institutes and, above all, hospitals played major roles in Britain and France. Medical history teems with women healers, but they were not admitted to medical schools until the late nineteenth century, with resistance holding out until the early twentieth century in Germany. Fortunately for Russian Jewish women, Switzerland's facilities were open, beginning with the University of Zurich in 1864. The mobilization and slaughter of male doctors in both world wars helped increase the number of women doctors, though Nazi Germany dealt a blow to the movement that had made one-fifth of the German medical profession female by 1933. After World War II, female enrollments in medical schools rose and continued to rise to near equality of the sexes (in numbers only) in the profession by the early twenty-first century. Not welcome in certain specialties such as surgery, women tended to go into

[After recalling his agreements with Galen and Colombo, Harvey declares his belief in the circular movement of the blood, views so] novel . . . that in speaking of them, I . . . dread lest all men turn against me. . . . However, the die has now been cast, and my hope lies in the love of truth and the clear-sightedness of the trained mind. . . .

We have as much right to call this movement of the blood circular as Aristotle had to say that the air and rain emulate the circular movement of the heavenly bodies.

This organ [the heart] deserves to be styled the starting point of life and the sun of our microcosm just as the sun deserves to be styled the heart of the world. For it is by the heart's vigorous beat that the blood is moved, perfected, activated, and protected from injury and coagulation. The heart is the tutelary deity of the body, the basis of life, the source of all things, carrying out its function of nourishing, warming, and activating the body as a whole.

SOURCE: William Harvey, *The Circulation of the Blood and Other Writings*, trans. Kenneth J. Franklin, with an introduction by Andrew Wear (London: J. M. Dent and Sons, 1963), pp. 46–47.

general practice and areas of specialization such as bacteriology, anaesthesia, pediatrics, neuropsychiatry, dermatology, and nonsurgical gynecology.

The rise of psychiatry. An enormous number of drugs were available to healers from Hippocrates to Magendie, whose *Formulary* of 1821 introduced the notion of chemical purity into the pharmacopoeia. In the *materia medica* in use before the 1950s there is a striking absence of psychotropic drugs; the first, lithium, used to treat manic depression, dates from 1949. (Phenobarbital had been found effective against epileptic seizures in 1912.) So how did doctors treat mental disease? The answer is that they did nothing for most of medical history. “Madness” was generally not the province of the doctor, but of the churches and the family. “Madhouses” were generally charitable or religious institutions with medical connections until the nineteenth century, when the treatment of the insane evolved into a specialized branch of medicine. The development of psychiatry was accompanied by the rise of the “new” asylum—new because of its practice of a humane treatment of the mentally ill. Politicians in the late-eighteenth-century French state, converted to the scientific gospel, became convinced that madness could be cured, with the hospital functioning as a healing machine. Ideologue doctors such as Pierre-Jean-Georges Cabanis (1757–1808) provided epistemological (that is, scientific) respectability for medicine by emphasizing its roots in classification and a content related to sensationalist psychology.

The moral treatment, made famous by Philippe Pinel (1745–1826) at Bicêtre, the Salpêtrière, and Charenton,

indulged in sympathetic but firm handling and even theatrical performances by the actor-inmates. “A historic transformation . . . in Paris” (Weiner, p. 275): the mentally ill were recognized as human beings with natural rights, and mental illness was classified as a curable disease. Doctors soon invented new categories of disease out of the old simple divisions of insanity; perhaps the most notorious new disease was Jean-Etienne Esquirol's (1772–1840) concoction of monomania. Esquirol's work *Mental Illnesses*, a classic text, was published in 1838, the year the government voted to create a national asylum system. The treatment of the insane became a matter of a scientific management of the mind and emotions rather than the traditional bleeding and purging of the body. Psychiatry arrived in the faculty of medicine in Paris in 1882, when the neurologist Jean-Martin Charcot (1825–1893) was appointed professor of diseases of the nervous system. There is no evidence that all this science and institutional growth contributed to a higher cure rate for patients suffering from the old mental diseases or even the new ones such as neurasthenia and hysteria, which some doctors attributed to industrial civilization. A desperate Western psychiatry indulged in thousands of lobotomies between 1935 and 1950.

As with clinical medicine, psychiatry in Germany (and Austria) differed from psychiatry in France and Britain in being connected directly with research-related university medicine, particularly neurology. Wilhelm Griesinger (1817–1868), professor of psychiatry and neurology in Berlin, developed a department for the study of mental disorders and founded the *Archiv für Psychiatrie und Nervenkrankheiten* (1868). Sigmund Freud (1856–1939) specialized in clinical neurology, but he

A physiological laboratory, therefore, should now be the culminating goal of any scientific physicians' studies. . . . Hospitals, or rather hospital wards, are not physicians' laboratories, as is often believed; . . . these are only fields for observation; there must be what we call clinics, since they determine and define the object of medicine, i.e., the medical problem; but while they are the physician's first study, clinics are not the foundation of scientific medicine; physiology is the foundation of scientific medicine because it must yield the explanation of morbid phenomena by showing their relations to the normal state. We shall never have a science of medicine as long as we separate the explanation of pathological from the explanation of normal, vital phenomena.

. . . In leaving the hospital, a physician . . . must go into his laboratory; and there by experiments on animals, he will seek to account for what he has observed in his patients, whether about the action of drugs or about the origin of morbid lesions in organs or tissues. There . . . he will achieve true medical science. Every scientific physician should, therefore, have a physiological laboratory. . . . The principles of experimental medicine . . . [are] simply the principles of experimental analysis applied to the phenomena of life in its healthy and its morbid states.

SOURCE: Claude Bernard, *An Introduction to the Study of Experimental Medicine*, trans. Henry Copley Greene, with an introduction by Lawrence J. Henderson (New York: Collier Books, 1961), pp. 174–175.

recognized the bankruptcy of the old organic psychiatry, which attributed mental disorders to structural disease in the brain. Pinel had similarly become disillusioned with the hope of finding lesions in the brains of the mentally diseased. Freud's new dynamic psychiatry with its radical views of the human personality is probably the most influential and most controversial medical paradigm in the history of Western civilization and its discontents. The success of the "talking cure," or psychoanalysis, in treating mental disorders provided the basis for modern psychotherapy, but much of psychiatry has since followed the biochemical path to Prozac and other psychotropic drugs. The ideology of most German (and French) psychiatrists was scientific materialism, with their medical science being basically neurological and neuropathological. Medicine loves classification: German psychiatry was obsessed by it. The twenty-first century's bible of the profession, the *Diagnostic and Statistical Manual of Mental Disorders* (DSM-IV; 4th edition, 1994) has its origin in the classification of mental disorders done by Emil Kraepelin (1856–1926), who drew on the work of several other men of method. To venture beyond the current DSM paradigm and DSM-IV framework, the powers in mental health issued *A Research Agenda for DSM-V* in 2002.

Did science matter? Concluding his book on nineteenth-century scientific medicine, W. F. Bynum asked "Did science matter?" The answer is yes. Consider surgery. No branch of

medicine changed more radically than surgery during the second half of the nineteenth century. Surgery itself had been socially and cognitively (through the study of anatomy) transformed by 1790. Surgery joined medicine as a liberal profession, that is, a group in possession of scientific or esoteric knowledge, transmitted through institutions; recognized by the state, the profession also controlled admission to its ranks and tried to control the practice of medicine within certain areas. The French doctorate in surgery, introduced in 1749, required a thesis in Latin, which nicely hid professional secrets from the *polloi*. Reform of French medical education in 1794 integrated surgery into the regular training of doctors.

With the growing importance of the hospital and the increasing prestige of pathological anatomy, the professional status of surgeons soon equaled that of physicians. Whether chloroform did "a lot of mischief" by enabling "every fool to become a surgeon" (Sir Patrick Cullen, in Bernard Shaw's *Doctor's Dilemma*, 1906) is open to question. But it is certain that the cult of the surgeon could not have emerged at the end of the nineteenth century without anesthesiology. In 1846 the first amputation with a patient under ether was done in Boston; the next year James Y. Simpson (1811–1870), professor of obstetrics, first administered chloroform at the Infirmary in Edinburgh. The incorporation of bacteriology into surgical practice was equally important to the cult.

The wish-fulfillment can be detected . . . easily in . . . dreams. . . . A friend of mine . . . said to me one day: “My wife has asked me to tell you that she had a dream yesterday that she was having her period. You can guess what that means.” The fact that this young married woman dreamt that she was having her period meant that she had missed her period. I could well believe that she would have been glad to go on enjoying her freedom a bit longer before shouldering the burden of motherhood. It was a neat way of announcing her pregnancy.

SOURCE: Sigmund Freud, *The Interpretation of Dreams*, trans. James Strachey (New York: Avon Books, 1965), p. 159.

Germ theory. The medical acceptance of germ theory is a complex story. Since disease killed more soldiers than bullets, army doctors, desperate for an etiology and a therapy, were among the first to embrace the gospel of germs. The antiseptic, then aseptic practices of Joseph Lister (1827–1912)—Lister’s system—was inspired by his reading a paper on fermentation by Louis Pasteur (1822–1895). Listerism was accepted most enthusiastically in German-speaking areas, where there was also a striking development of surgery of the abdominal, thoracic, and cranial cavities, and, more controversial, the female reproductive system. Pasteur, accepting the idea that fermentation, putrefaction, and infection are related, developed a germ theory of infection. What distinguished his theory was a set of brilliant if controversial experiments on wine diseases, chicken cholera, anthrax, and rabies. Without understanding the immune system—researchers are still investigating how it works—Pasteur and his colleagues developed vaccines to prevent disease. Development of immunization against rabies (such as Creutzfeldt-Jacob disease, a frightening but minor killer) made it possible for Pasteur to collect enough funds to establish the Institut Pasteur (1888).

Bacteriology was largely a German creation. Robert Koch (1843–1910) identified major killers such as the tuberculosis and cholera bacilli and codified a method for investigating the etiology of infections. His students went on to identify the microorganisms causing a large number of diseases (diphtheria, typhoid, gonorrhea, and syphilis, among others) Koch spent the period from 1896 to 1907 in Africa studying its diseases; partly as a result of European invasions that displaced populations, millions of Africans suffered from helminth (intestinal worm) infections, in addition to germ and viral diseases. Many other medical researchers of the imperial powers also spent time in areas where tropical diseases presented a challenge not to be found in Europe. The germ-theory model of disease with its simple etiology did not work for diseases such as yellow fever and malaria; the parasitological model required the concept of a vector such as the mosquito. If the prion, which has no nucleic acids (DNA and RNA), causes bovine spongiform encephalopathy (BSE, popularly known as “mad cow disease”) and its human form, the “new” Creutzfeldt-Jacob disease, then a new model of infection will appear in medicine.

With four institutes named after him, the imperious Koch went on to glory, though not so great as that of Pasteur, with whom he squabbled over the great germs of the day. Supported by well-developed chemical and pharmaceutical industries, German scientists were able to pioneer in serum therapy (antitoxins) and chemotherapy, whose most famous product might have been the arsenical compound salvarsan (not a magic bullet) for treating syphilis. More useful drugs to come out of Germany included chloral hydrate, aspirin, and phenobarbital. But no drug has ever been more useful or cheaper than quinine, the extract of the bark of the cinchona tree, used in fighting malaria, still one of the great killer diseases.

Public health. So what was the effect of all this progress in medical science on public health? Mortality did decline in the second half of the nineteenth century, particularly deaths from tuberculosis, scarlet fever, diphtheria, typhus, typhoid, cholera, and smallpox (mostly before 1850 in this case). The decline started before effective medical means could combat these diseases. Nonmedical factors seem to explain why people lived longer: first, improved nutrition, which made people more resistant to diseases such as tuberculosis; second, the attenuated virulence of some microbes, such as the diphtheria bacillus; third, effective public health measures such as supplying towns and cities with safe water, installing sewage systems, and clearing slums. The effect of the Malthusian check of infectious disease on population growth was severely reduced if not eliminated. The introduction of antibiotics lowered mortality even further. Sulfa drugs, the first effective step toward the control of bacterial diseases, became widely available only in the early 1940s and penicillin shortly after.

The Twentieth Century: Science, State, and Business Whiggish authors justifiably rave about the “stupendous progress” of medicine in the twentieth century; it was also the century that witnessed the greatest medical crimes in history.

Medical murder and human experimentation. Enthusiastically serving scientifically deluded politicians and bureaucrats, a large number of doctors turned medical research into a large-scale immoral and deadly science in the Japanese empire,

KOCH'S POSTULATES (FORMALIZED IN 1882)

That the organism could be discoverable in every instance of the disease;

That, extracted from the body, the germ could be produced in a pure culture, maintainable over several microbial generations;

That the disease could be reproduced in experimental animals through a pure culture removed by numerous generations from the organisms initially isolated;

That the organism could be retrieved from the inoculated animal and cultured anew.

SOURCE: Roy Porter, *The Greatest Benefit to Mankind: A Medical History of Humanity*, (New York and London: Harper Collins, 1997), p. 436.

the United States, and, above all, in Nazi Germany. Adopting eugenic policies, Nazi doctors and their collaborators sterilized hundreds of thousands of mentally handicapped and sick persons, epileptics, and alcoholics. Other countries—Sweden and the United States, for example—also pursued sterilization policies. Patients in mental hospitals were starved and, during World War II, gassed. A racial agenda supported cost-effective medicine. Human experimentation carried out by doctors flourished in certain death camps. Beginning with the postwar Nuremberg Code, international declarations have outlawed such medical horrors. A nonethical medicine has a murderous potential; so it is back to Hippocrates, the phoenix of Western medicine, who was also Heinrich Himmler's medical hero.

Medical progress. By the end of the twentieth century, European medicine was remarkably similar to but not identical with American medicine in terms of clinical science, medical research, and surgery; it was different in its relations with the market economy, in the state's provision of universal primary medical care as a basic service, and in its cultural values. For considerably less cost, Europeans were just as healthy and, in many groups, enjoyed greater longevity than Americans. "Big medicine," which includes giant hospitals, often including extensive imaging and laboratory facilities, enormous bureaucracies, global drug companies, and large medical schools, was of course just as much a feature of the European as the American scene. Nowhere is this clearer than in the "war on cancer," the most useful of diseases in the promotion of the modernization of medicine; cancerology became the growth model of big medicine. The conceptual basis of medicine has changed radically since the eighteenth century. The changes can all be blamed on discoveries in genetics, immunology, neurology, endocrinology, pharmacology, and, the stepchild of medical education, nutritional science.

Still, science cannot escape being part of culture. Even in the new surgical fields that have opened up in organ transplantation and in cardiology, certain cultural differences

distinguish medical practice in different countries. German doctors, loving the heart above all other organs, are much more inclined to use drugs than surgery in treating cardiovascular diseases. The number of coronary bypass operations per 100,000 people in 1998 was 202 for the United States, 90 for Germany, and 35 for the United Kingdom; the last figure probably reflected a generally bad state of cardiovascular care. French doctors seem much more concerned with the functioning of the liver than doctors in other cultures; they are also much more conservative in recommending hysterectomies. French doctors are too generous with the use of ionizing radiation—825 procedures per 1,000 inhabitants—nearly twice as many procedures as in Britain. Wherever one looks, health is a major European growth industry. There is no shortage of disease, including hypochondria. Every age seems to have its "epidemic"—in the early twenty-first century, it is HIV-AIDS. And with the doctor accepting the modern idea that a well person is only an insufficiently diagnosed patient, and genetic medicine aiming to define genetically determined disease susceptibility in individual patients, the normal may become, as in Jules Roman's famous play *Knock*, the profitable pathological.

See also *Alchemy; Biology; Health and Disease; Psychology and Psychiatry; Science*.

BIBLIOGRAPHY

- Ackerknecht, Erwin H. *A Short History of Medicine*. Baltimore, Md.: Johns Hopkins University Press, 1982. Whiggish and opinionated; students like its brevity.
- Bonner, Thomas Neville. *Becoming a Physician: Medical Education in Britain, France, Germany, and the United States, 1750–1945*. New York: Oxford University Press, 1995.
- Bynum, W. F. *Science and the Practice of Medicine in the Nineteenth Century*. Cambridge, U.K.: Cambridge University Press, 1994. An essential book on the nineteenth century.
- Canguilhem, Georges. *The Normal and the Pathological*. Translated by Carolyn R. Fawcett. New York: Zone Books, 1991. Published in French, 1996.

- Cantor, David, ed. *Reinventing Hippocrates*. Aldershot, U.K.: Ashgate, 2002.
- Conrad, Lawrence I., et al. *The Western Medical Tradition, 800 B.C. to 1800 A.D.* Cambridge, U.K.: Cambridge University Press, 1995.
- Dally, Ann. *Women under the Knife: A History of Surgery*. New York: Routledge, 1992.
- Debus, Allen. *The French Paracelsians: The Chemical Challenge to Medical and Scientific Tradition in Early Modern France*. Cambridge, U.K.: Cambridge University Press, 1991.
- Evans, Richard J. *Death in Hamburg: Society and Politics in the Cholera Years, 1830–1910*. Oxford: Clarendon, 1987.
- Foucault, Michel. *The Birth of the Clinic: An Archeology of Medical Perception*. Translated by A. M. Sheridan Smith. London: Tavistock, 1973. Published in French, 1963.
- Gay, Peter. *Freud: A Life for Our Time*. New York: Norton, 1988.
- Geison, Gerald L. *The Private Science of Louis Pasteur*. Princeton, N.J.: Princeton University Press, 1995.
- Gelfand, Toby. *Professionalizing Modern Medicine: Paris Surgeons and Medical Science and Institutions in the Eighteenth Century*. Westport, Conn.: Greenwood, 1980.
- Goldstein, Jan E. *Console and Classify: The French Psychiatric Profession in the Nineteenth Century*. 2nd ed. Chicago: University of Chicago Press, 2001.
- Hannaway, Caroline, and Ann La Berge, eds. *Constructing Paris Medicine*. Atlanta: Rodopi, 1999.
- Kevels, Bettyann Holtzmann. *Naked to the Bone: Medical Imaging in the Twentieth Century*. New Brunswick, N.J.: Rutgers University Press, 1997.
- Kiple, Kenneth F., ed. *The Cambridge World History of Human Disease*. Cambridge, U.K.: Cambridge University Press, 1993.
- Lesky, Erna. *The Vienna Medical School of the Nineteenth Century*. Translated by L. Williams and I. S. Levij. Baltimore, Md.: The Johns Hopkins University Press, 1976.
- Nutton, Vivian. "Roman Medicine, 250 BC to AD 200." In *The Western Medical Tradition, 800 BC to AD 1800*, by Lawrence I. Conrad et al., 39–70. Cambridge, U.K.: Cambridge University Press.
- Payer, Lynn. *Medicine and Culture: Varieties of Treatment in the United States, England, West Germany, and France*. New York: Holt, 1996. Amusing and incisive analysis of the cultural foibles of medicine.
- Porter, Roy. *The Greatest Benefit to Mankind: A Medical History of Humanity*. New York: W. W. Norton, 1998. For a survey of the field.
- Ramsey, Matthew. *Professional and Popular Medicine in France, 1770–1830: The Social World of Medical Practice*. Cambridge, U.K.: Cambridge University Press, 1988.
- Risse, Guenter B. *Mending Bodies, Saving Souls: A History of Hospitals*. New York: Oxford University Press, 1999.
- Romain, Jules. *Knock ou la triomphe de la médecine*. Paris: n.p., 1924. This play (1923), made famous by Louis Jouvet in the role of Knock, enjoyed a revival on the Paris stage in the early 2000s with Fabrice Lucchini as Knock.
- Weiner, Dora B. *The Citizen-Patient in Revolutionary and Imperial Paris*. Baltimore: Johns Hopkins University Press, 1993.

Harry W. Paul

INDIA

The historical record for Indian civilization begins in the third millennium B.C.E., with the Indus Valley culture, but beyond

evidence of a good knowledge of the plant and animal environment, little information can be recovered concerning the healing traditions of this time. Simple ideas related to disease and healing can be found in greater abundance in the corpus of religious hymns called the Vedas, composed originally in an old form of Sanskrit during the early to mid-second millennium B.C.E. These ideas have much in common with religious materials worldwide: a concern with hostile demons, curses, and poisoning, and a detailed awareness of the plant world as a source of healing herbs. Outside the metropolis in India today, such ideas continue to form a prominent part of health-related beliefs and activities. Considering health as, in Georges Canguilhem's words, "a margin of tolerance for the inconsistencies of the environment," such practices and ideas can be seen as a perfectly reasonable and indeed rational extension of the use of a continuum of efforts—from prayer to warfare—as means for creating an acceptable environment in which to live.

Systematic Medicine

Structured systematic thought about medicine in India can first clearly be detected in sayings of the Buddha. In the *Samyuttanikaya* (4.230–231), part of the Buddhist canon (c. 250 B.C.E.), the Buddha is represented as contradicting the view that suffering is caused only by the effects of bad karma. He says that it is caused by eight factors: bile, phlegm, wind, and their pathological combination, changes of the seasons, the stress of unusual activities, external agency, as well as the ripening bad karma. This is the first moment in documented Indian history that these medical categories and explanations are combined in a clearly systematic manner, and it is these very factors that later became the cornerstone of classical Indian medical theory, or ayurveda (Sanskrit, "the knowledge for long life"). Great encyclopedias of medicine were composed in India during the centuries before and after the time of Christ, and these works brought together not only treatises on anatomy, including embryology, diagnosis, surgery, epidemics, pharmacology, and so forth, but many reflective philosophical passages discussing, for example, the origin of the human being, the rules of medical debate, methods for the interpretation of technical terminology and scientific expression, and so forth.

The two best-known compendia to survive from this era go under the names of their editors, Sushruta and Caraka. All this work was synthesized in the early seventh century C.E. into the great work *The Heart of Medicine* by the Sindhi author Vagbhata. This work became the textbook par excellence for ayurveda, the Sanskrit equivalent of Avicenna's *Canon*, and every bit as influential as that work. The later history of Sanskrit medical literature is a mixture of further works of grand synthesis and the proliferation of works on specialized topics and manuals for the working physician. Innovation took place both in the content and the form of the medical literature. By the nineteenth century, when European medical education and practice began to have a decisive impact in South Asia, Indian students who chose to specialize in medical studies were being exposed to a tradition of sophisticated medical reasoning and theory almost two thousand years old. This tradition was embodied in its practitioners and the literature they preserved through energetic and wide-ranging manuscript copying,

which included multilingual dictionaries of materia medica, allegorical medical dramas, toxicological manuals, and veterinary texts, in addition to more predictable reference and teaching works. Hindu and Muslim physicians sometimes worked side by side, though their practices remained distinct.

Medical Concepts and Therapies

The systematic doctrines of ayurvedic medicine included a humoral theory somewhat akin to that of Hippocrates and Galen. Indian medicine admitted three humoral substances, namely, wind, bile, and phlegm. However, a certain indecision is visible within the tradition as to the status of blood, which shared with the humors the critical feature of being able to cause illness through becoming corrupt, and blood is sometimes implicitly included as a fourth humor. Disease was classified in several interesting and useful ways, and a system of triage was developed that guided the physician to focus on treatable and curable cases, while discouraging involvement with patients who were clearly in the grip of terminal conditions. Several thousand plants were known for their medicinal values, and described in terms of a pharmacological typology based on flavors (six types), potency (usually two: hot and cold), postdigestive flavorings (usually three), and pragmatic efficacy (used when the effect of a medicine is not adequately defined by the earlier categories). This typology formed a system of interlocking correspondences and antipathies with the system of humors and other physiological categories as expressed through the vocabulary of pathology.

Sanskrit medical treatises recommended a wide range of therapeutic techniques, including herbal drugs, massage, sauna, exercise, diet (including the use of meat broths and other nonvegetarian tonics), bloodletting (including leeching), simple psychotherapy, and surgery. One important group of five specific therapies became established early. According to Caraka, these were: emetics, purgation, two types of enema, and nasal catharsis. Sushruta replaced one of the enema treatments with bloodletting. Other authors added sweating and massage, as well as other therapies, into what became historically an increasingly important and elaborate complex of treatments. This “five therapies” treatment is still popular and important today. The theories and techniques described in this tradition were widely known and practiced by learned physicians and their staffs and students all over India. Of course, as in all parts of the world, there were many quacks and charlatans, a problem explicitly discussed in the very earliest Sanskrit medical writings.

Surgery

Surgery had a different history from the other parts of traditional medicine. The compendium of Sushruta includes many chapters on the training and practice of surgeons. The early date of this treatise and the great accuracy, insight, and detail of the surgical descriptions are most impressive. One can infer that the surgical profession had developed over several generations at least and had arrived at an advanced stage. Surgeons were thought of as a separate group of practitioners from the more normative herbal healers, yet for some unknown reason, their tradition was recorded in the Sanskrit language and integrated into the medical corpus. This legacy was then passed

down the centuries as part of ayurveda. However, the actual practice of surgery did not survive in the same way. The early and medieval historical sources of India gives us almost no evidence of advanced surgery being practiced. By the time foreign observers from China, and later Afghanistan and Europe, begin to describe India, Sushruta's surgery had all but vanished. A few barber-surgeon practitioners preserved limited skills in couching for cataract and bone-setting, and even in types of plastic surgery, but these were no longer integrated into the learned practice of classical Indian medicine. Early European surgeons were in much demand in India from their arrival in the sixteenth century onward, although by contrast European physicians were not sought after, and the flow of knowledge about simples and drugs was from East to West.

Modernization and Globalization

Under first the Moghul and then the British colonial powers, indigenous Indian medicine survived as it always had, mainly through support from patients and the community, but with occasional patronage from the state, with education and practice being devolved and decentralized, often taking place at the family level. During the twentieth century, ayurveda assumed an important role as an icon of national identity during the independence struggle. After independence, the government of India adopted the traditional systems of Indian medicine, including ayurveda, Islamic Unani medicine, yoga, and the South Indian Siddha tradition and provided a state-sponsored structure of education and practice on the model of Western medicine. To these indigenous traditions were also added homeopathy and naturopathy, both adopted and tightly integrated as part of “Indian” health care and administered by the same department within the Ministry of Health and Family Welfare. At the start of the third millennium, a process of globalization—similar to that which took place earlier with yoga—has begun to occur also with ayurveda. In diaspora ayurveda is changing and adapting, as it moves from its premodern role in India to a new position as one part of a portfolio of alternative and complementary therapies offered alongside modern biomedicine.

See also **Medicine: China; Yoga.**

BIBLIOGRAPHY

- Dash, Vaidya Bhagwan. *Fundamentals of Āyurvedic Medicine*. Vol. 85, Indian Medical Science series. Rev. and enlarged. Delhi: Sri Satguru Publications, 1999.
- Government of India, Ministry of Health & Family Welfare. “Indian Systems of Medicine and Homoeopathy: A Gateway for Information.” Available on the Internet at <http://indianmedicine.nic.in/>.
- Jolly, Julius. *Indian Medicine* (1951). Translated by C. G. Kashikar. 3rd ed. New Delhi: Munshiram Manoharlal, 1994.
- Langford, Jean M. *Fluent Bodies: Ayurvedic Remedies for Postcolonial Imbalance*. Durham, N.C.: Duke University Press, 2002.
- Meulenbeld, Gerrit Jan. *A History of Indian Medical Literature*. 5 vols. Groningen: E. Forsten, 1999–2002.
- Mukhopadhyay, Alok, ed. *State of India's Health*. New Delhi: Voluntary Health Association of India, 1992.
- Sharma, Priya Vrat. *Caraka-Sambhita: Agnivesa's Treatise Refined and Annotated by Caraka and Redacted by Drdhabala (text with*

- English translation*). 4 vols. Varanasi, Delhi: Chaukhambha Orientalia, 1999–2001.
- . *Suśruta-Sambhitā, with English Translation of Text and Dalhana's Commentary Alongwith [sic] Critical Notes*. 3 vols. Vol. 9, Haridas Ayurveda series. Varanasi, India: Chaukhambha Visvabharati, 1999–2001
- van Alphen, Jan, and Anthony Aris, eds. *Oriental Medicine: An Illustrated Guide to the Asian Arts of Healing*. London: Serindia, 1995.
- Wujastyk, Dominik. *The Roots of Āyurveda: Selections from Sanskrit Medical Writings*. 3rd ed. London and New York: Penguin, 2003.
- Zysk, Kenneth G. *Asceticism and Healing in Ancient India: Medicine in the Buddhist Monastery*. 2nd ed. Vol. 2, *Indian Medical Tradition*. Delhi: Motilal Banarsidass, 1998.

Dominik Wujastyk

ISLAMIC MEDICINE

Islamic medicine refers to the range of health-promoting beliefs common to and actions taken in Muslim societies, whether by Muslims or others. As with other traditional medical systems, Muslim medicine was composed of several subsystems, each involving a unique etiology and practice and each enjoying a different legitimacy. These subsystems were not independent of each other and none enjoyed complete hegemony. In the Muslim context this means that humoralism, folklore, and prophetic medicines were all present in the medical therapeutic scene.

Theories Composing Muslim Medicine

Popular medicine was sanctioned by custom, a wide consensus from below, not by any religious, judicial, or scientific authority. This medical folklore in itself took many forms and was the outcome of diverse pre-Muslim cultural traditions (such as those of Arabs, Greeks, Persians, and Berbers) and differing ecological environments with their distinctive medical problems as well as flora and fauna from which medication was prepared.

By contrast, what Muslims call prophetic medicine (*al-Tibb al-Nabawi*) does not rely on custom. Instead it originated from (and therefore is sanctioned by) the sayings of the Prophet Muhammad. These sayings, in which Muhammad gave his opinions on medical practices, constituted the basis for a distinctive medical system from the ninth century onward. The Shiites entrust the imams, the descendants of Muhammad's family and therefore the spiritual leaders of the community, with extraordinary healing abilities as part of their supernatural attributes; thus in Shiism the role of Muhammad as healer is downplayed. But in general the field of prophetic medicine engaged many of the most renowned scholars of their time (for example, the Egyptian Jalal al-Din al-Suyuti, d. 1505). Among the population at large, medical rites and practices were connected with live and dead saints. Certain individuals were (and still are) believed to possess extraordinary healing powers, so that visiting them or their graves was believed to be medically beneficial.

Mechanical medicine, based on the humoralism inherited from Greek antiquity, constitutes the third tradition. This

medicine is based on the well-known idea of four elements: a physical and philosophical metatheory according to which everything in nature is a mixture of fire, earth, air, and water. Each element embodies two of the four qualities of hot, cold, dry, and moist. The human body was understood to correspond with this model, because it is a microcosmos of nature. The body consists therefore of four humors, or fluids, the physiological blocks of the body: blood (air), phlegm (water), black bile (earth), and yellow bile (fire). In case of illness, which is a state of imbalance in the body, it was up to the humoralist physician to diagnose which of the four humors was in excess or deficient. The physician then proceeded to recommend a course of treatment, usually by diet, to correct or counterbalance the offending humor. Excess in black bile, for example, known to be cold and dry, necessitated adding warmth and moisture artificially. This tradition asserted its legitimacy by drawing on scientific treatises of the sages of antiquity, as mediated through the intellectual and literary discourses of famous Muslim medical figures.

Hospitals

One of the unique features of Muslim medicine was the use and development of hospitals (*bimarsitans* or *dar al-shifas*). Hospitals were founded in most major Muslim cities, starting in Baghdad, the capital of the Muslim empire, in the ninth century, and reached an especially high standard during Mamluk and Ottoman periods (from the thirteenth century). Muslim hospitals were urban charitable institutions funded by endowments (*waqfs*) that offered free treatment to the sick by an expert medical staff. In contrast to their European counterparts, Muslim hospitals were “true” hospitals in that they were designed to offer the sick expert medical treatment by professionals, whereas many premodern European hospitals (mainly in the medieval Latin West) usually restricted themselves to spiritual aid and substance to exhausted and convalescent people.

Ages of Translations

Muslim medicine has always been in contact with other medical systems through translations of medical treatises. The translation movement has worked in both directions; that is, both to and from Muslim languages. Muslim Galenic medicine owed much of its origin to a massive move to translate from Greek to Arabic in the ninth century. This was part of the general introduction of Hellenic culture and science into the Muslim world. Most of the translations were done via mediator languages, mostly Syriac and to some extent Persian. Translators, many of whom were Christians (such as the famous Husayn ibn Ishaq), enjoyed caliphal patronage. Al-Ma'mun (reigned 813–833) should be given special mention for sponsoring the great library of Baghdad, *Bayt al-Hikma* (literally, “House of Wisdom”), which was the center of intellectual activity at the time. Although we associate the Age of Translation with Hellenic medicine, during the ninth century traditional Indian medicine (Ayurveda) was translated into Arabic as well, either directly from Sanskrit or by way of Persian. In the long run, however, it was Hellenic medicine that became dominant in the caliphal court.

Muslim doctors were the custodians of Hellenic medicine, which they expanded, corrected, systemized, and summarized

(for example, in the fields of pharmacology, ophthalmology, pathology, and many others). In anatomy, for example, Ibn al-Nafis (d. 1288) is credited with describing the circulation of blood in the lungs for the first time. He formulated this description through logical deduction rather than clinical observation. Many Muslim medical texts were translated into European languages during the later Middle Ages. Thus many Muslim physicians became known to Europe, as well as otherwise “lost” texts from antiquity. Figures like Abu Bakr Muhammad ibn Zakariya al-Razi (d. 925), Abu Qasim al-Zahrawi (d. 1013), and Ibn Sina (d. 1037) were famous in Europe by the Latinized form of their names (Rhazes, Albucasis, and Avicenna, respectively), and their treatises became standard medical texts well into the eighteenth century.

In the early modern period another move to translate medical texts occurred, again from European to Muslim languages. This time nonhumoral concepts were introduced to Muslim medicine. A prime example of a physician who applied the concepts of European medicine is Salih ibn Sallum, from Aleppo (d. 1670), the head physician of the Ottoman Empire, who was influenced by Paracelsus (d. 1541), the German-speaking physician who was the first to treat patients with chemical rather than botanic or natural medications. Ibn Sallum’s work in Arabic was soon translated into Ottoman Turkish. Translation of European texts accelerated in the following centuries, especially during the nineteenth century, when many European texts were translated into Muslim languages as part of the move from traditional medicine to Western biomedicine.

Changes from the Nineteenth Century Onward

Beginning with the late eighteenth century, major political and socioeconomic transformations have occurred in the Muslim world that profoundly changed medicine and public health. European medicine was introduced on a much larger scale in various ways. Students were sent to universities in Europe to learn medicine. In addition, medical schools were shaped according to the Western model, at which European professors taught European medicine in French, were founded in all major capitals of the Middle East during the first half of the nineteenth century. The first was established in 1827 near Cairo, followed shortly by a military medical school in Istanbul. The third, another military medical school, was included in a polytechnic school founded in Tehran in 1850–1851.

Despite the profound Westernization of medical theory and the medical establishment in the Muslim world, traditional Muslim medicine is still being practiced. It is not found in the state-run hospitals or in universities, but it is present at the popular level. Religious circles promote prophetic medicine, and in recent years many traditional texts have been reprinted and Internet websites devoted to this subject have been set up.

See also Islamic Science; Medicine: China; Medicine: Europe and the United States; Medicine: India.

BIBLIOGRAPHY

Adivar [Adnan], Abdülhâk. *La Science chez les Turcs Ottomans*. Paris, 1939. More recent editions exist in Turkish, such as

Osmanlı Türklerinde İlim. 5. basım. Istanbul: Remzi Kitabevi, 1991.

Conrad, Lawrence I. “Arab-Islamic Medical Tradition.” In *The Western Medical Tradition 800 BC to AD 1800*, edited by Lawrence I. Conrad et al. Cambridge, U.K.: Cambridge University Press, 1995. A good introduction that renders the classic by Manfred Ullman up to date.

Dols, Michael W. *Medieval Islamic Medicine: Ibn Ridwan’s Treatise “On the Prevention of Bodily Ills in Egypt.”* Berkeley: University of California Press, 1984. A translation of an eleventh-century medical treatise by an Egyptian physician that reflects Muslim humoral medical knowledge of the period.

———. *Majnûn: The Madman in Medieval Islamic Society*. Oxford: Clarendon, 1992. A study of madness in Muslim society that also includes the medical aspects of this social and cultural phenomenon.

Elgood, Cyril. *A Medical History of Persia and the Eastern Caliphate from the Earliest Times until the Year A.D. 1932*. Cambridge, U.K.: Cambridge University Press, 1951.

———. *Safavid Medical Practice or the Practice of Medicine, Surgery and Gynaecology in Persia between 1500 A.D. and 1750 A.D.* London: Luzac, 1970.

Ullman, Manfred. *Islamic Medicine*. Edinburgh: Edinburgh University Press, 1978.

Miri Shefer

MEDITATION, EASTERN. Many religious traditions have practices that could possibly be labeled *meditation*. In Judaism, Christianity, and Islam, these practices are usually associated with prayer, contemplation, or recitation of sacred texts. In the religious traditions of the Native Americans, Australian aboriginals, Siberian peoples, and many others, what could be identified as meditation techniques are incorporated within the larger rubric of shamanism. It is, however, in the religions of Asia that meditation has been most developed as a religious method. Meditation has played an important role in the ancient yogic traditions of Hinduism and also in more recent Hindu-based new religious movements such as Maharishi Mahesh Yogi’s Transcendental Meditation program. But it is most especially in the monastic or “elite” forms of the various traditions of Buddhism (Theravada, Tibetan/Vajrayana, and Ch’an/Zen) that meditation techniques have taken center stage and have been developed to the highest degree of sophistication and complexity.

Meditation can be loosely defined as a mental regimen or discipline designed to promote concentration and the capacity for what is called “one-pointedness” (*ekagrata*) of mind. There are many different meditation methods and many different recommended objects on which to meditate. Some traditions emphasize breathing exercises that focus the mind on inhalation and exhalation; others instruct the practitioner to meditate on the subtle workings of his or her own mind. Still others emphasize concentration on certain symbols (such as cosmic representations known as *mandalas* or *yantras*) or on sacred sounds called mantras. In some traditions it is God or one of the gods (or one of the Buddhas or bodhisattvas) upon which one meditates, while in others it is a problem or puzzle (the *Zen koan*)

or a topic of an analysis such as death or attachment to the physical body. In yet other meditations it is a virtuous emotion or quality such as renunciation, compassion, or loving-kindness upon which one meditates, and in still others it is simple mindfulness or awareness (the constant watchfulness entailing “being here, now”) that is emphasized.

But fundamentally all forms of meditation have as their goal the ability to concentrate for long periods of time single-pointedly and intensely on the object of meditation. The mind is sometimes likened to a pool of water that is muddy and turbulent; the goal of meditation is to calm the mind so as to be able to see its true nature clearly. Alternatively, the goal of meditation is said to be the suspension of ordinary discursive thought and the attainment of a state whereby all dualities are transcended—especially the distinction between the perceiving and thinking subject and the object of perception or thought. In any event, Hindu and Buddhist texts alike claim that the perfection of the ability to meditate well and for long periods of time will help produce in the practitioner high spiritual states of awareness, supernatural powers, wisdom and insight into the true nature of reality, and finally, salvation itself (*moksha* or nirvana, both of which entail liberation from ignorance, suffering, and rebirth).

The practice of meditation in India goes back to at least the middle of the first millennium B.C.E. and probably much earlier. The ancient Hindu mystical and philosophical texts called the Upanishads refer to meditation, and the early texts of Buddhism assume its existence as a technique taught by a wide variety of religious teachers. By the time of the turn of the Common Era, if not centuries before, meditation had become highly systematized in both Hindu and Buddhist traditions.

In all the meditation traditions originating in ancient India, emphasis is placed on finding a quiet, solitary place (the wilderness, a monastery, or an ashram or retreat) and assuming a sitting posture that will be conducive to meditation. The most famous of these postures, or *asanas*, is the “lotus position,” whereby the meditator sits with legs folded and feet resting on the thigh or knees. The hands are kept folded in the lap or in a special gesture called a *mudra*, and the eyes are kept closed or slightly open in an unfocused, downward-looking gaze. The back is kept straight to enhance alertness and to help the “inner channels” of the mystical body open up and run smoothly.

In Hinduism, meditation is most frequently encountered as part of a more general practice of yoga. In the *Yoga Sutras* of Patanjali, the classical source on ancient Indian yoga dating to around 200 or 300 C.E. and perhaps earlier, meditation techniques are basically indistinguishable from the practice of yoga. For Patanjali, one might say, yoga *is* meditation. Yoga is defined as the “cessation of the turnings of thought” (*Yoga Sutras* 1.2), implying the ability to control even the subtlest example of the mind’s activity.

Patanjali organizes the practice of yoga into eight “limbs” or parts (*ashtanga*). The first two limbs of yoga entail living a life guided by moral principles and personal observances. The third limb of yoga encompasses the physical postures, which have as their purpose to prepare the body for the meditation

techniques that follow. The fourth limb is control of the breath, which “makes the mind fit for concentration” (*Yoga Sutras* 2.53). The regulation of the breath is followed by “withdrawal of the senses,” the disengagement of the sense organs with their objects and the turning inward of thought. This allows the yogin to develop the final three limbs or stages: concentration (“binding thought in one place”), meditation (unwavering attention on an object), and pure contemplation or *samadhi*, defined as “meditation that illumines the object alone, as if the subject were devoid of intrinsic form” (*Yoga Sutras* 3.1–3). These last and culminating stages of the yogic practice are “internal” (as opposed to the “external” limbs that came before) and when they are “focused on a single object constitute perfect discipline” (*Yoga Sutras* 3.4, 7).

Various techniques for “fixing” the attention (*trataka*) were developed in later esoteric Hindu traditions, all of which were meant to induce the trance state called *samadhi*. In some cases the practitioner was instructed to fix his or her attention on certain places in the body—the crown of the head, the spot between the eyebrows, the tip of the nose, the navel, and so on—in order to gather one’s mental energy at a single point. In other instances, the practitioner was instructed to focus on a small object such as a speck on the wall or a mustard seed, or to stare at a distant object to the exclusion of all others in one’s purview, or to focus on one or another of the Sanskrit letters or some other image. Meditation on those powerful, sacred sounds known as *mantras* (the most famous of which is “*om*”) was especially common. In the theistic sects, the object of meditation was often the deity. In the Bhagavad Gita, for example, the practitioner is advised to sit quietly, fix one’s sight on the tip of the nose, and meditate on Krishna.

But it is especially in the Buddhist traditions that stem from India (and were then spread throughout Asia) that meditation becomes absolutely central. Gautama Buddha was said to have achieved his enlightenment through the method of meditation, and ever since, meditative concentration, together with ethics and wisdom or insight, has been the pivot of Buddhist practice. Early Buddhist texts list a set of forty possible topics of meditation (in Pali, *kammatthana*). Some are labeled “devices” (meditation on the elements, or on shapes or colors) that help the meditator fix his or her concentration on a particular image. Another topic is designated “recollections,” whereby the meditator recalls the virtues of the Buddha, the dharma (the teachings of the Buddha), or the *sangha* (the Buddhist community) or is reminded of his or her own mortality through a meditation on death’s inevitability.

Yet another set of meditation topics is designed to wean the meditator from attachment to the physical body. He or she is encouraged to concentrate on the repulsive and impermanent characteristics of the body or of food (and what happens to it as it is digested), or is urged to focus on various aspects of a decomposing corpse. Still another kind of meditation recommended in the early texts of Buddhism concerns what are known as the “four stations of Brahma” or the “four immeasurables”: friendliness or loving-kindness, compassion, empathetic joy, and equanimity or even-mindedness. These meditation topics are sometimes recommended to meditators of different personalities

or proclivities. For a devotional type of person, for example, meditation on the Buddha or the Sangha might be most appropriate, whereas for a sensual type of mediator the most effective topic might be the disgusting nature of the human body.

Buddhist traditions analyze the results of meditation into eight stages of increasingly subtle states of consciousness called the “absorptions” or “trance” states of higher consciousness (in Pali, *jhana*; in Sanskrit, *dhyana*). These are, it is said, the states of mind the Buddha passed through in deep meditation on his way to enlightenment. The first is described as a mental state of detachment from sensual pleasures and craving, in which, however, the discursive intellect is still active. In the second state, the mind grows more still, concentration increases, discursive thought ends, and great joy and peace arise. The third stage is characterized by the transcendence of sensual joy itself and the attainment of equanimity, which brings about a higher form of bliss, and by the diminishing of the sense of self as the subject of this experience. The fourth trance state is where consciousness of all duality abates and one achieves the “utter purity of mindfulness,” which lies beyond all words. The second set of four even subtler states of mind are called the “formless” *jhanas* because they are based on contemplation of formless subjects: the infinity of space, the infinity of consciousness, nothingness, and “neither perception nor nonperception.” The last of these is where subject and object are nearly indistinguishable and all pairs of opposites are totally transcended.

Such deep states of concentration are to be linked, however, with “insight” (in Pali, *vipassana*; in Sanskrit, *vipashyana*) into the true nature of reality in order to produce the state of liberation the Buddhist meditator seeks. When combined with the ability to focus deeply on the object of meditation, the analysis of reality reveals it to be impermanent, without essence or “self,” and thoroughly bound up in suffering. It is these deep insights into the true nature of reality, gained through the ability to concentrate in meditation, that will lead the seeker to “release,” or the “extinguishing” of ignorance and suffering (nirvana), just as such techniques brought the Buddha to his enlightenment.

The Mahayana traditions equally emphasize the importance of meditation and most especially the combination of the ability to focus the mind one-pointedly (what is sometimes here called “calm abiding” or *shamatha*) and the penetration or insight into the true nature of reality termed *vipashyana*. Such a potent synthesis is said to lead the meditator to a realization of the “emptiness” (*shunyata*) of intrinsic existence of all things. Nothing, according to this view, has existence independently or has a self-nature; everything exists only dependently or nominally. Such a realization of emptiness in deep meditation becomes the impetus for the meditator’s own enlightenment.

In the various Mahayana traditions, meditations designed to attain the realization of emptiness range from attempts to empty the mind completely of all conceptual thought, to the stripping away of all conceptual imputations of reality and then analyzing what is left, to even more radical techniques to shock the discursive mind out of its complacency so as to recognize its true, innate, and intuitive “Buddha nature.” Among the most famous of these latter meditative tools is the *koan* used

in the Ch’an/Zen schools of Buddhism. The *koan* is a kind of a riddle or puzzle designed to break down ordinary ways of thinking and jolt the meditator into the wholly different mindset of “enlightenment” (Japanese *satori*).

Other Mahayana traditions are more devotional in their emphasis. Here, meditation takes the form of fixing the mind on the Buddha or bodhisattva to whom one is devoted and whom one asks for help. In these traditions, prayers or *mantras* become the centerpiece of meditation practice, or the name of one of the Buddhas or bodhisattvas is invoked repeatedly. The recitation of the phrase *namu amida butsu* (“Homage to Amida Buddha”) in the Japanese Pure Land sects is an example of this kind of meditation. In some of these devotional Buddhist traditions, certain Sutras or sacred texts are thought to have such salvific power that the mere repetition of the text or even just chanting the condensed verbal essence or title of the Sutra will produce efficacious results in the meditator. In the Pure Land sects of Buddhism, meditation sometimes revolves around complex visualizations of one or another of the “paradises” or “pure lands” of the Buddhas and bodhisattvas in the hopes of attaining a rebirth there.

Meditation, a feature of many traditional religions, is becoming part of secular life in the modern world. Meditation techniques seem to produce states of mind that Western scientists are beginning to think may very well have measurable effects on the mental and physical health of the meditator. Sports trainers, coaches, and psychologists utilize visualization techniques to help professional athletes perform better. The reduction of anxiety that comes from the ability to focus and calm the mind in meditation is now generally recognized, and meditation is sometimes integrated into the workplace to help workers deal with stress. Neuroscientists and doctors are finding not only that accomplished meditators can achieve states of focused attention and concentration far beyond what scientists previously thought was possible but also that meditation seems to have a positive effect on the nervous, immune, and endocrine systems. Meditation, for centuries practiced primarily by monks and ascetics in Asia, is increasingly being mainstreamed in the West as a technique that promotes relaxation, better attention and concentration, the reduction of stress, and general good health.

See also Asceticism: Hindu and Buddhist Asceticism; Buddhism; Hinduism; Yoga.

BIBLIOGRAPHY

- Conze, Edward. *Buddhist Meditation*. New York: Allen and Unwin, 1956.
- The Dalai Lama. *Stages of Meditation*. Root text by Kamalashila; translated by Geshe Lobsang Jordhen, Losang Choephel Ganchenpa, and Jeremy Russell. Ithaca, N.Y.: Snow Lion, 2003.
- Humphreys, Christmas. *Concentration and Meditation: A Manual of Mind Development*. Baltimore: Penguin Books, 1968.
- King, Winston L. *Theravāda Meditation: The Buddhist Transformation of Yoga*. University Park: Pennsylvania State University Press, 1980.
- Thera, Nyanaponika. *The Heart of Buddhist Meditation (Satipattāna): A Handbook of Mental Training based on the*

Buddha's Way of Mindfulness, with an Anthology of Relevant Texts Translated from the Pali and Sanskrit. 1st U.S. ed. New York: Citadel, 1969.

Wallace, B. Alan. *The Bridge of Quiescence: Experiencing Tibetan Buddhist Meditation.* Foreword by H.H. the Dalai Lama. Chicago: Open Court, 1998.

Wayman, Alex, trans. *Calming the Mind and Discerning the Real: Buddhist Meditation and the Middle View, from the Lam rim chen mo Tson-kha-pa.* New York: Columbia University Press, 1978.

Zahler, Leah, ed. *Meditative States in Tibetan Buddhism: The Concentrations and Formless Absorptions.* London: Wisdom, 1983.

Brian Smith

MEME. *Meme* is indeed an interesting and apt subject to include in a dictionary of the history of ideas, for it is nothing less than a meta-concept for describing the transmission of knowledge among persons and cultures. Memetics—the study of memes—is, briefly stated, evolutionary theory applied to ideas. The word itself was coined by the British biologist Richard Dawkins in his 1976 book *The Selfish Gene* as a neologism derived from *mimeme* (that which is imitated) and *gene*. However, Dawkins's insight was presaged by William S. Burroughs's observation that "language is a virus from outer space" and by the work of thinkers ranging from the dadaists to Jacques Derrida, who, in seeking to transcend language and textuality, recognized the role that language and ideas play in controlling human behavior. In the late twentieth century and early twenty-first century, however, memetics has drawn its strongest supporters from the rather more literally minded camp of computer scientists and devotees of Internet culture—not only because the memetic model of human intelligence is similar to the programming of a computer but because memes are a useful metaphor for describing certain phenomena that occur in the online world.

Cultures, Dawkins observed, evolve much as organisms do, and he conceptualized memes as ideas that guide human behavior just as a snippet of genetic code can guide instinctual mating or dominance behaviors. Much like genes, memes arise in response to a new stressor in the environment and evolve in response to changing conditions:

all life evolves by the differential survival of replicating entities. . . . I think that a new kind of replicator has recently emerged. . . . It is still in its infancy, still drifting clumsily about in its primeval soup, but already it is achieving evolutionary change at a rate that leaves the old gene panting far behind. The new soup is the soup of human culture. (Dawkins, pp. 191–192)

A meme can be a concrete technology, such as a technique for making a stone spearhead, or an entirely abstract idea, such as "kingship" or "jihad." Examples of memes range from methods of making pottery and building arches to songs and stories, to tastes in clothing and fashion, to even more sophisticated behaviors, such as manufacturing hydrogen bombs,

which require a "meme complex" or group of mutually reinforcing memes—in this case, the concepts of metalworking, atomic theory, and explosives.

As the result of natural selection, some memes become rare or are altogether eliminated from the "meme pool," the collective sum of a society's knowledge; they can also be overwritten by an invading group's memes. For instance, few twenty-first-century Native Americans know techniques that were indispensable to their pre-Columbian ancestors, such as flint-knapping or making a fire with the bow-and-drill method. Some memes (such as "cooking") survive because they are generally useful; others (such as "sports cars") trigger hard-wired evolutionary imperatives, such as "food" or "sex" or "danger"; still others use more insidious means to ensure their own survival. For instance, chain letters, though intrinsically useless, have managed to be successfully passed on for decades because they contain instructions for their own reproduction and because they successfully exploit the human desire to get something for nothing, while evangelical religions (to give another example of a self-perpetuating meme) emphasize the virtues of proselytizing.

These latter cases serve to illustrate an important point of Dawkins's conceptualization, namely, the parasitic quality of memes. Lacking any physical way of reproducing themselves, memes survive and grow by imitation or by transmission from mind to mind. The transmission may occur through the observation and copying of a certain behavior or technique; it may occur as a craft is taught to an apprentice or as a farmer shows his or her son how to shear sheep; or it may be verbal, as by a professor's lecturing or assigning reading to her or his students. The participants need not speak the same language, as was the case with American GIs learning judo in occupied Japan. The transmission may be by force, such as the spread of the meme complexes of Islam and Christianity by conquest; or it can be by trade and indirect influence, such as the spread of classical Greek and Chinese ideas and motifs through the ancient Mediterranean and East Asia, respectively. Certain ideas are more easily imitated, or more contagious, than others; these are the memes that tend to be selected for survival, irrespective of the benefits to the individual they infect; in fact certain memes (such as celibacy or kamikaze missions) may be detrimental to the host's genetic survival but are nonetheless highly successful at reproducing themselves. Thus a viral contagion is a more apt metaphor to describe the meme than is sexual reproduction—a comparison Dawkins also used to describe the genetic code itself. To extend the metaphor, one is "infected" by an idea as a cell is by a pathogen, and one is compelled to carry the idea to others so that it may reproduce itself. Much like a computer virus, information begets information.

The Selfish Meme

Even memes like "celibacy" and "kamikaze mission," while detrimental for their individual hosts, may nonetheless be beneficial for the meme pool at large. As Matt Ridley so eloquently explains in his 1996 book *The Origins of Virtue*, magnanimous social behavior is nonetheless often guided by the self-interest of all involved. Like ants, human beings seem to have evolved

to be genetically hardwired to cooperate. Successful memes can build on this tendency. For instance, few animals, including humans, are munificent to those outside their immediate group or tribe, but the “patriotism” meme, by giving us a way to conceptualize an entire nation as an extended tribe, is one way of explaining the phenomenon of the growth of nation-states—or “imagined communities,” as Benedict Anderson put it in his 1983 book of the same title. Thus even memes that are detrimental to the individual can confer an evolutionary advantage; to build on the example of patriotism, groups with memes that promote extensive cooperation (such as Caesar’s Roman legions) will tend to outcompete groups who do not (such as the tribes of Gaul). *Dulce et decorum est pro patria mori* (It is sweet and proper to die for one’s country).

One of the most philosophically depressing implications of memetic theory is that it is our memes, not human genius and creativity, that are the guiding force in history. Just as Dawkins reduced biological organisms to a vehicle for the self-perpetuation of genetic material, so it is with memes. Our various behaviors, from building cathedrals to writing novels, can be viewed as nothing more than our memes attempting to survive and grow. “Memes might come to be viewed explicitly as the primary actors in the drama of human history, exerting an ironfisted control precisely analogous to that of Richard Dawkins’s ‘selfish genes’ in the pageant of biological evolution,” as James Gardner put it in his article “Memetic Engineering” in the May 1996 issue of *Wired* magazine. Such an idea is tremendously troubling for notions of free will. Gardner continued:

A meme-focused vision of culture and consciousness acknowledges forthrightly that memes are not mere random effluvia of the human experience but powerful control mechanisms that impose a largely invisible deep structure on a wide range of complex phenomena—language, scientific thinking, political behavior, productive work, religion, philosophical discourse, even history itself.

Memetic Engineering

To add to the confusion, the modern world has seen an unprecedented multiplication and proliferation of memes, with mass media being the preeminent transmission vector. Some of these memes are devised with rational ends, such as advertising consumer products; others are devised solely as play; others are “junk” memes. Hula hoops, the Burma Shave billboards of the 1950s, the slogan “There’s always room for Jell-O,” the synthesizer intro to the 1984 song “Jump” by Van Halen, or the three-note “by Men-nen” jingle, while of no use to those they infect, are excellent examples. The Internet in particular is a virtual memetic petri dish, with examples such as the nonsensical phrase “all your base are belong to us” (from a badly translated 1988 Japanese video game called *Zero Wing*) spontaneously arising on message boards in 2000, spreading from mind to mind via the ether and then dissipating, not unlike a particularly virulent disease burning its way through the population.

Thus the idea of memetic engineering consists not only in choosing which memes to be influenced by but also in

counterpropaganda and countersloganeering designed to purge from the meme pool those ideas deemed deleterious to society at large. The essential component in memetic engineering is faith in human reason to discern the most advantageous memes. Dawkins himself expressed a secular humanist optimism when he wrote, “We, alone on Earth, can rebel against the tyranny of the selfish replicators” (p. 201). (Of course, from another perspective, this could be seen as just another Darwinian struggle, with the meme for “secular humanism” trying to crush its competitor for mindshare, the meme for “theocracy.”)

One example of the deployment of this idea is the activist Andrew Boyd’s Billionaires for Bush (or Gore) campaign, which used the ironic, parodical image of the superwealthy taking to the streets in support of their candidates in order to “piggyback” on mainstream media coverage of the 2000 U.S. presidential election and thus call attention to social issues neglected by the candidates. The idea of memetic engineering was both popularized and taken to its logical end by the 1992 science fiction novel *Snow Crash* by Neal Stephenson. Though the actual word *meme* never occurs in the book, the plot makes clear reference to Dawkins’s work. The title, for instance, refers to a key element in the book’s plot, a literal “mind virus” modeled after a computer virus that is capable of destroying a user’s mind through merely being seen on a computer screen. The resolution involves a clay tablet from ancient Mesopotamia, on which are recorded syllables in an ancestral ur-language (reminiscent of ideas of the “deep structure” of language popularized by Noam Chomsky and others) that can program human beings, like robots, into performing tasks for those who know how to wield the power. *Snow Crash* is frequently cited in meme circles as an example of the power of memes taken to the nth degree.

Criticism of Memetic Theory

Despite the cult popularity of the idea, memetic theory is hardly discussed in recent texts on evolutionary psychology and linguistics. The prevailing consensus seems to be that the meme is a nice metaphor but one that has perhaps been taken too far. Memes, after all, are hard to define, quantify, and measure; their very existence is somewhat nebulous, inferable but not scientifically verifiable.

Some have also assailed memes not only as bad science but as reactionary politics. The complexity of human development is overly reduced into nonmaterialist, quasi-mystical, pseudo-scientific terms, which in turn are only a new Kabbalah, a recasting of age-old ideas of angels and demons and magic words that can control reality. Many also question the memetics community’s frequent, almost reflexive, assaults on religion, which they characterize as nothing more than preprogrammed, irrational memetic replication. Moreover the idea of human behavior as nothing but the programming of snippets of information is troubling to many—and not only those who still maintain a belief in free will. To hold with a radical memetic view of human behavior is to ignore the factors of economics, environment, and politics in history. As such, memetics is a fascinating and promising protoscience but further research and experimentation is needed before it can become a full-fledged discipline in its own right.

See also *Computer Science; Genetics; Ideas, History of*

BIBLIOGRAPHY

- Aunger, Robert. *The Electric Meme: A New Theory of How We Think*. New York: Free Press, 2002.
- Blackmore, Susan. *The Meme Machine*. New York and Oxford: Oxford University Press, 1999.
- Boyd, Andrew. "Truth Is a Virus: Meme Warfare and the Billionaires for Bush (or Gore)." In *The Cultural Resistance Reader*, edited by Stephen Duncombe. New York: Verso, 2002.
- Dawkins, Richard. *The Selfish Gene*. New ed. Oxford and New York: Oxford University Press, 1989. Originally published in 1976.
- Gardner, James. "Memetic Engineering." *Wired* 4.05 (May 1996). Available at <http://www.wired.com/wired/archive/4.05/memetic.htm>.
- Journal of Memetics*. Available at <http://jom-emit.cfpm.org/>.
- Ridley, Matt. *The Origins of Virtue*. New York: Penguin Books, 1996.
- Stephenson, Neal. *Snow Crash*. New York: Bantam, 1992.

Kenneth Mondschein

MEMORY. The history of the idea of memory is associated with the cultural uses of two kinds of memory, episodic and semantic. Episodic memory concerns the conscious recall of particular events. Interest in its nature dates from antiquity, and mnemonic techniques for strengthening memory's resources, known as the "art of memory," were developed as rhetorical skills. Semantic memory deals in tacit understandings—habits of mind and implicit knowledge on the boundary between the conscious and the unconscious. In modern times, scholars have treated it as a realm apart from episodic memory in light of a newly discovered awareness of the significance of the social contexts of collective memory.

The Ancient Art of Memory

In ancient Greek mythology, Mnemosyne, the goddess of memory, was revered as mother of the Muses of the arts and sciences. Ever since, students of memory have acknowledged memory's creative power to evoke the imaginative forms through which humankind represents the reality of its experience. The ancient idea of memory was grounded in the concept of mimesis, according to which memory and imagination are reverse sides of the creative act of "imitating nature." In the primarily oral culture of ancient Greece, the rhapsodes were renowned for their prodigious powers of memory, which allowed them to sing the Homeric epics, the repositories of the Greek heritage and the foundation of Greek cultural identity. But the use of memory in oral tradition was uncritical, and scholars have made much of the differences between the intuitive poetic storytelling of rhapsodes and the studied analytical use of memory among the literate rhetoricians of an incipient manuscript culture.

A changing conception of memory, therefore, is coeval with the passage from primary orality to manuscript literacy (beginning about the seventh century B.C.E.), which permitted a newfound critical perspective on memory's nature. By late antiquity, the idea of memory as remembered episode had

come to be closely associated with the art of memory, a rhetorical technique of displacement for accurately recalling facts and stories worthy of remembrance. The art located data difficult to remember within easily remembered imaginary structures of places and images. The discovery of this method for associating the unfamiliar with the familiar is attributed to the Greek poet Simonides of Ceos (556–468 B.C.E.) and was developed especially by Roman rhetoricians. The *Rhetorica ad Herennium* (82 B.C.E.), attributed by some to Cicero, is the oldest such manual to have survived from antiquity. Throughout the Middle Ages and Renaissance, the art found expression in ever more complex mnemonic schemes, until it was marginalized by new encyclopedic reference books for storing knowledge in the emerging print culture of the Enlightenment.

The English historian Frances A. Yates (1899–1981) was the first modern scholar to analyze the history of the intellectual uses of mnemonic technique. She grounds this critical perspective in two seminal conceptions of memory derived from ancient Greek philosophy, one formulated by Plato (c. 428–348 or 347 B.C.E.), the other by Aristotle (384–322 B.C.E.). Plato emphasized the power of memory to open pathways to the archetypes of transcendental knowledge. Aristotle presented a down-to-earth analysis of memory's powers of recognition and recall and described mnemonics as a guarantor of the capacity of a well-ordered mind to hold fast to its learning. Yates was especially interested in the ambition the Neoplatonist rhetoricians of the Renaissance had to construct imaginary memory palaces whose architectural structures were purported to mirror those of an ideal universe and so to provide hermetic keys to correspondences between earthly and transcendental realities. But the rise of empirical science in the seventeenth century undercut the art of memory's idealist presuppositions, and while the art remained an elegant technique for the rhetorical display of erudition, it was soon acknowledged that its methods led only to a philosophical dead end.

Modern Memory and Personal Identity

The spread of print literacy by the eighteenth century transformed the cultural understanding of episodic memory. In print culture, collective knowledge could be easily preserved in readily accessible, alphabetically indexed reference books, rendering obsolete the practical applications of the art of memory in information retrieval. The psychological effect was to free memory for personal reflection on formative life experience, particularly that of childhood. The idea of memory thenceforth came to be closely allied with autobiographical soul-searching. The prototypes for this genre of self-analysis were the *Confessions* (1762) by the French philosopher Jean-Jacques Rousseau (1712–1778) and the *Prelude* (1805) by the English poet William Wordsworth (1770–1850). But for early twentieth-century readers, the most poignant introspective evocation of the past was that of the French writer Marcel Proust (1871–1922), who, in his multivolume novel *In Search of Lost Time* (1913–1927), marveled at the way an impromptu experience of sensory recall could spontaneously awaken the brilliant immediacy of an entirely forgotten cultural world. For the literati of the modern age, recovered memory was perceived to be the surest route to the discovery of the deep sources of personal identity.

Memory reconceived as the search for self was given a scientific foundation by the Austrian physician Sigmund Freud (1856–1939). Just as Plato had recourse to memory as a means for lifting the soul to an awareness of an ideal world, so Freud aspired to employ memory to open passageways leading to truths hidden in the unconscious. He invented psychoanalysis as a therapeutic technique for helping his patients cope with their neuroses, which he attributed to repressed memories of trauma earlier in their lives. Freud thought of the unconscious psyche as a subterranean archive where forgotten memories of unresolved issues pressed their unanswered claims on the conscious mind in ways that impaired its capacity to deal with present realities. In recovering repressed memories, patients would come to recognize the sources of their inner conflicts and so gain self-knowledge that would enable them to act more effectively in their present endeavors. Like the art of memory, Freud's psychoanalytic technique used the principle of displacement. Seemingly innocuous dreams, "screen memories," and slips of the tongue were often place markers for trauma in an individual's life history, providing clues to more troubling memories buried in the unconscious. The skilled psychoanalyst could help patients recover them.

The Social Frameworks of Collective Memory

In the early twentieth century, near the time when Freud's findings were being popularized, sociologists began to inquire into the nature of semantic memory as a realm of remembrance of a different order—socially conditioned memory, often tacitly understood. Here the memory was considered in its social context, as subject to social and cultural influences. The French philosopher Henri Bergson (1859–1941) prepared the way at the turn of the twentieth century by pointing out the difference between the memory of specific events and the memory of enduring attitudes, a distinction he correlated with that between the moment and duration. The French sociologist Maurice Halbwachs (1877–1945) elaborated a more complete theory of collective memory during the 1920s. For him, collective memory is a function of social power, and its expression varies with the social settings in which we find ourselves. We localize images of the past within imaginary frameworks that conform to our social understanding. For that reason, collective memory is provisional until it is evoked within specific social contexts, and its form and strength is relative to the social forces that impinge on our present circumstances. Without such social props, collective memory cannot survive. Halbwachs was especially insightful about how commemorative practices assimilate specific images of episodic memory into the idealized structures of semantic memory. As for its place in the history of ideas, Halbwachs's theory draws on the method of the art of memory to demonstrate how the strategic mobilization of commemorative monuments in mnemonic landscapes reinforces officially sanctioned collective memory.

The Fragility of Memory in a Postmodern Age

In the twenty-first century, we know more about memory than ever before, but trust its resources less. The idea of memory, conceived as the keystone of identity for the nineteenth century, has been reconceived as the debris of lost identities, the free-stones of aging memory palaces that have fallen into ruins. Since the last quarter of the twentieth century, the topic has inspired

intense interest among historians, literary critics, folklorists, sociologists, anthropologists, psychologists, and neurobiologists. Across the curriculum, scholars are as one in noting that memory is easily and often remodeled, almost always distorted, and hence unreliable as a guide to the realities of the past. The idea of memory, therefore, is noteworthy for its fragility, vulnerable as it is not only to the vagaries of the mind but also to social, political, and cultural forces that would alter or obliterate it.

On the edge of fragile memory lies nostalgia, the most elusive of memory's protean forms and one beginning to receive critical attention. An admixture of sweetness and sorrow, it expresses a longing for a vanishing past often more imaginary than real in its idealized remembrance. Nostalgia exercised a powerful appeal in the Romantic sentiments of the nineteenth century, tied as it was to regret over the passing of ways of life eroded by economic and social change, a generalized popular enthusiasm for innovation, and rising expectations about what the future might hold. Nostalgia was the shadow side of progress. Chastened by the disappointments of the twentieth century, however, the idea of progress has fallen on hard times, and nostalgia presents itself as an even more diffuse longing for a fantasy world that never existed (for example, the classless society in Communist propaganda). So reconceived, nostalgia has come to be criticized as a dangerous surrender to anarchistic illusion that contributes to memory's vulnerability to exploitation and misuse.

Situated at an interdisciplinary crossroads, the idea of memory has yet to promote an exchange between humanists and scientists, though they make their way along converging avenues of research. Scientists have moved away from Freud's claim about the integrity of memory's images. Steady research in psychology over the course of the twentieth century exposed the intricacies of the mental process of remembering, which involves complex transactions among various regions of the brain. For psychologists, remembering is conceived as a dynamic act of remodeling the brachial pathways along which neurons travel as they respond to sensory stimuli. The images of memory are encoded in neural networks, some in short-term and some in long-term configurations, and so are mobilized as conscious memories in multifold and continually changing ways. Memory resides in these ephemeral expressions, and its images are constantly subject to revision in the interplay of well-established patterns and chance circumstances that governs recall.

Some neuroscientists propose that memory is an adaptive strategy in the biological life process. Drawing on Charles Darwin's theory of natural selection, the American neuroscientist Gerald Edelman (1929–) argues that there is a selective process by which memory cells cluster in the neuronal groups that map neural pathways. He identifies two repertoires of such clusters in the gestation of the brain, one, primarily genetic, in embryo, and the other, primarily adaptive, after birth. They establish the categories of recognition through which the brain thenceforth processes external stimuli, though these categories are continually modified as the brain adapts to new life experience. In this sense, each act of recollection is a creative process that entails a reconfiguration of synaptic connections. There is an intriguing analogy between Edelman's two stages of memory cell formation

and the mnemonist's two-step reinforcement of memory in repertoires of places and images. There is a resonance as well between Edelman's notion of the brain's mapping of neural pathways and Halbwachs's conception of the topographical localization of social memory. Both affirm the constructive nature of the act of memory in the interplay of recognition and context.

Cultural Contexts of Memory in the Twenty-First Century

Among contexts contributing to the idea of memory's fragility in the twenty-first century, one might highlight the following:

The one-way transit to amnesia in the pathologies of dementia. The degree to which the workings of memory elude research in the biological sciences is dramatized by the difficulties of understanding the perplexing diseases that lead to the deterioration of memory in old age. Freud's faith in the prospect of memory retrieval is difficult to reconcile with the insurmountable barriers erected by the ravages of dementia. An unfortunate by-product of longevity in the affluent Western world has been an increasing susceptibility to the maladies of memory impairment with advancing years. Alzheimer's disease is the most dreaded among an array of forms of dementia that rob victims of their memories and by consequence of their identities. Here there can be no recall of the past from the oblivion imposed by neurological degeneration. Alzheimer's disease has come to serve as a cultural metaphor for twenty-first century fears of trends that promote not only personal but also social amnesia.

Media and the eclipse of tradition in mass culture. The twenty-first century is characterized by its present-mindedness, but ironically has little regard for the presence of the past. We live in a consumer society whose interest lies in using and then discarding the resources of the present, not conserving them for future generations. Tradition, once valued as the bequest of the wisdom of past generations to the present one, is dismissed as trivial to the manufactured pursuit of immediate gratification in which the hallmarks of tradition are redeployed as the kitsch of consumerism, divested of the social and cultural frameworks that once defined social identity.

The media work their pervasive influence thanks to a revolution in the technologies of communication in the late twentieth century. The invention of new forms of electronic communication—notably the personal computer, linked by the Internet to a worldwide web of memory banks in cyberspace—so vastly expanded the capacity and facilitated the ease of information retrieval that it reshaped both perception and learning in ways analogous to those that accompanied the transition from orality to literacy (during which the art of memory was invented), and then from manuscript to print culture (when the interconnection of memory and personal identity was established). In this respect, the organization of knowledge on computer screens and Internet Web pages departs from its linear organization in print culture, to be reconfigured spatially on Web sites and in icons reminiscent of the places and images of the art of memory. Temporal models (timelines) are replaced by spatial ones (hyperlinks among Web sites).

The revolution in media communication accelerated the fraying of older forms of social and cultural identity. The media mold

images in pervasive and homogeneous ways by virtue of their expanded control of the networks of communication, and favor tendentious publicity over deliberation. The media deepen present-mindedness, since their imperative is to publicize images of recent events as quickly as possible before moving on to others even more recent and enticing in their prurient interest. They evoke a sense of immediacy in which the past is glossed over and the future reduced to idle speculation. The mnemonic power of forms of publicity to incite interest prevails over the force of ideas, undermining the value of cultural traditions that once provided sure reference points of collective identity.

A reluctance to mourn. In the late twentieth century, historians too turned avidly to research on memory, more specifically to the relationship between memory and the dissolving cultural identities of the postmodern age. Whereas scholars of the nineteenth century had looked to formative beginnings, those of the late twentieth century were more interested in irresolute endings. During the 1970s, social historians such as Philippe Ariès, Pierre Chaunu, and Michel Vovelle launched studies of changing attitudes toward death and mourning across several centuries, in some sense as a response to the denial of death and the difficulties of mourning common in the late twentieth century. For comparison, Ariès portrayed the nineteenth century as a golden age of mourning. He noted newly intense expressions of personal mourning, made manifest in lavish funeral rituals and ornate commemorative monuments in cemeteries reconceived as gardens for meditation. Mourning in the nineteenth century confirmed personal identity by integrating the rituals of private mourning into well-established public traditions. The twentieth century, he claimed, was conspicuous for its reluctance to face death's realities and its diminished capacity to devote time and intensity to the process of coming to terms with the loss of loved ones.

The politics of memory. Historians soon extended their inquiry to encompass public commemoration—what the U.S. psychologist Peter Homans has characterized as the mourning of symbolic loss. During the 1980s, historical scholarship addressed the politics of memory, especially as it was displayed in the nineteenth-century commemorative practices that solemnized the building of nation-states in their use of icons of sacred moments (for example, national holidays) and avatars of patriotism (such as “founding fathers”). Given the challenges facing the nation-state in an age more acutely aware of the need for global perspectives on humankind, the historians' perspective on the making of national memory tended to dwell on its present-minded politics and geographical parochialism. Such research drew heavily on Halbwachs's theory of collective memory, as historians sought to rein in memory's claims on the past. In parallel with the efforts of philosophers and literary critics to deconstruct the forms of cultural discourse, historians sought to expose the building blocks from which practices of public commemoration had been constructed. They juxtaposed and to some degree reduced the reverential task of commemoration to its efficacious use in consolidating political allegiances.

Eric Hobsbawm and Terence Ranger's *The Invention of Tradition* (1983) and Pierre Nora's *Les lieux de mémoire* (1984–1992) stand out as pioneering studies in this field. Both seek

to expose memory's role in the making of political identities that have become suspect in their biases and whose appeal at the turn of the twenty-first century began to wane. Nora's book on the making of the French national memory provided a method for digging through the accumulating layers of memories that contributed to the making of political identity over long periods of time. It inspired a host of studies dealing with like political uses of memory in countries around the world.

Traumatic memories of atrocities. The twentieth century witnessed episodes of genocide and mass destruction on a scale that traumatized entire populations into collective repression. Reckoning with these unhappy memories demanded a new approach. Concerned that the worst atrocities might be glossed over and forgotten, historians undertook an inquiry into a relationship of a different order between memory and history. These investigations reiterated Freud's thesis about the necessity of "working through" the trauma of repressed memory to uncover harsh and painful truths about crimes against humanity. They concluded that some memories cannot be easily tamed by history, and that they maintain their singularity at the limits of history's powers of representation. Memories of the Holocaust of European Jewry are the most studied among them.

The problems involved in historicizing the memory of the Holocaust was the subject of the much-publicized "historians' controversy" in Germany during the 1980s. One group of historians contended that it was time to place the Holocaust in historical context. Another countered that no extant conceptual framework is adequate for doing so. It argued for the importance of the preliminary task of gathering testimony from Holocaust survivors still struggling to come to terms with their painful memories. Meditating on the differences between memory and history, the Israeli historian Saul Friedländer (b. 1932) wondered whether history could ever do justice to the existential meaning the Holocaust held for its victims. His question is whether the immediacy of memory can ever be reduced to the selective perspectives and conceptual abstractions of historical interpretation. He suggests that traumatic memory may be a realm of human understanding whose meaning is to some degree incommensurable with historical explanation. The conversation among historians about the limits of history's claims on traumatic memory lingered into the 1990s, and the European Holocaust served as a point of departure for studies of other instances of genocide in the late twentieth century, the memory of which presented obstacles to adequate historical interpretation.

History's Claims on Memory: A Remedy or a Poison?

The dispute about the relationship between memory and history was put in philosophical perspective by the French phenomenologist Paul Ricoeur (b. 1913). After reviewing the many routes of scholarly inquiry into the idea of memory at the turn of the twenty-first century, he closes his analysis with a meditation on the concerns of the historians of the Holocaust about history's premature claims on memory. In considering why history must first beg pardon of memory, he guides our attention to Plato's philosophical dialogue *Phaedrus*, an evocation of the debate among the ancients about differences between the remembered and the written word that provides an analogy with the current debate about memory's relationship to history. In this dialogue,

Plato's teacher Socrates ruminates on whether efforts to tame memory to the critical perspectives of writing have merit. He poses the question: Is writing as an aid to memory a remedy or a poison? The written word can be a remedy in the sense that it secures knowledge in an enduring form. But it does so by setting limits on the depiction of the past and so discards with a certain finality alternate ways of evoking its presence. Memory, by contrast, may at any moment rescue the past from oblivion. Its uses reside not only in its resources for preservation but also in those for creation. Its virtue lies in its ontological claim to body forth the imaginative forms that make conscious knowledge of human experience possible. History at its best deepens human understanding in its accurate reporting and intelligent interpretation of the past, and it strives to be conclusive. But memory's fidelity to the experience of the past is the basis of its openness toward the future, and it resists closure. Memory stands "as a little miracle" in its distinctive capacity to trigger the creative imagination in a way no other faculty of mind can.

The U.S. intellectual historian David Gross (b. 1940) adapts that insight to consider the status of memory in the twenty-first century. He notes the readiness of society to consign to oblivion all that stands in the way of present-minded expectations. He sorts out the intellectuals of late modernity into those who would discard and those who would value the past remembered. He highlights modern "rememberers" who have argued persuasively for the importance of the past to their present concerns—among them Proust and Freud, but also the nineteenth-century German philosopher Friedrich Nietzsche (1844–1900) and the twentieth-century German literary critic Walter Benjamin (1892–1940).

Benjamin in particular fascinated scholars because of his aphoristic insight into memory's remedy for the deficiencies of the timeworn claims of the modern vision of history on the contemporary age. Especially provocative is his interpretation of the painting *Angelus Novus* (1920) by the surrealist artist Paul Klee, a tableau of the angel of history looking back sadly on the events of the modern age, not as milestones of civilization's advance but rather as remnants of its failed projects and endless disappointments. A disillusioned socialist nostalgic for the heroics of the nineteenth-century revolutionary tradition, Benjamin longed for memory's spark to jump-start an alternative future. Neglected memories, he maintained, respond to our imaginative gaze like heliotropes opening to the sun.

Although assailed by all the pressures of present-minded perspectives that deny the importance of recollecting the past, the rememberers appeal to the present age by calling to mind the striking diversity and rich complexity of past human experience, and so deepen understanding of the timefulness of the human condition in its manifold meanings. Memory's claim on the past, they argue, lies in its creative capacity to resurrect lost worlds worthy of our consideration. Their insight recalls the ancients' reverence for the goddess Mnemosyne, who out of the eons of humankind's lost primordial past brought into consciousness the imaginative forms from which all the arts and sciences would spring.

See also Autobiography; Death; Ritual: Public Ritual; Tradition.

BIBLIOGRAPHY

- Ariès, Philippe. *The Hour of Our Death*. Translated by Helen Weaver. Oxford: Oxford University Press, 1991.
- Boym, Svetlana. *The Future of Nostalgia*. New York: Basic Books, 2001.
- Edelman, Gerald M. *Neural Darwinism: The Theory of Neuronal Group Selection*. New York: Basic Books, 1987.
- Gillis, John R., ed. *Commemorations: The Politics of National Identity*. Princeton, N.J.: Princeton University Press, 1994.
- Gross, David. *Lost Time: On Remembering and Forgetting in Late Modern Culture*. Amherst: University of Massachusetts Press, 2000.
- Havelock, Eric. *Preface to Plato*. Cambridge, Mass.: Harvard University Press, 1963.
- Hobsbawm, Eric, and Terence Ranger, eds. *The Invention of Tradition*. Cambridge, U.K.: Cambridge University Press, 1983.
- Homans, Peter, ed. *Symbolic Loss: The Ambiguity of Mourning and Memory at Century's End*. Charlottesville: University Press of Virginia, 2000.
- Hutton, Patrick H. *History as an Art of Memory*. Hanover, N.H.: University Press of New England, 1993.
- Matsuda, Matt K. *The Memory of the Modern*. New York: Oxford University Press, 1996.
- Nora, Pierre, ed. *Les lieux de mémoire*. 3 vols. Paris: Gallimard, 1984–1992.
- Olney, James. *Memory and Narrative: The Weave of Life-Writing*. Chicago: University of Chicago Press, 1998.
- Ricoeur, Paul. *La mémoire, l'histoire, l'oubli*. Paris: Editions du Seuil, 2000.
- Rosenfield, Israel. *The Invention of Memory: A New View of the Brain*. New York: Basic Books, 1988.
- Roth, Michael, and Charles Salas, eds. *Disturbing Remains: Memory, History, and Crisis in the Twentieth Century*. Los Angeles: Getty Research Institute, 2001.
- Schacter, Daniel L. *Searching for Memory: The Brain, the Mind, and the Past*. New York: Basic Books, 1996.
- Yates, Frances A. *The Art of Memory*. Chicago: University of Chicago Press, 1966.

Patrick H. Hutton

MEN AND MASCULINITY. Most human cultures, perhaps all, have accounts of gender relations, explaining and illustrating what it is to be a woman or a man, and how women and men are interrelated. The forms taken by these accounts vary greatly—ancestor myths, moral exhortation, exemplary narratives, drama, social science, philosophical speculation, and visual imagery. In many, there is a specific account of the domain of men, the characteristic activities of men, and the psychological traits of manhood.

Stories of Men

The earliest surviving text of classical Greek civilization centers on the deeds of ruling-class men, informed by a conflict over men's rights to women. Homer's *Iliad* presents a vivid picture of a military encampment and a besieged city, with warrior-heroes roaming the countryside, carrying off women and occasionally massacring the population of a captured town. War is undoubtedly men's affair, and both courage and military skill

are tests of manhood. The business of men in these stories is to rule, cultivate land, found cities, and fight. Greek legend includes warrior women, but they are exotic figures. The central women in Homer's tales are Helen, the wandering queen who was fought over by the men, and Andromache and Penelope, archetypes of domestic faithfulness.

Yet Homer is no admirer of pure brawn. The mighty but slow-witted Ajax is of limited interest in the *Iliad* and becomes almost a comic figure in later Greek literature. The hero Achilles is an invincible fighter but is at the center of the story precisely because he is also highly emotional, takes offense, and refuses to fight. The hero of the *Odyssey* is perfectly capable of slaughter—Penelope's suitors ultimately get the same treatment as Helen's. But Odysseus is far more famous for his quick wit and his ability to talk his way out of trouble.

Attic drama of the fifth century B.C.E. tells a string of stories about men, power, and violence. They include the conscience-stricken Oedipus, the proud and rigid Creon, the vengeful Orestes, the prying Pentheus, and the faithless Jason. Classical Hellenic literature thus presents a spectrum of images of men. The texts complicate, and often call into question, the central image of the warrior-prince, which nevertheless remains an ideal, a point of reference.

It was the uncomplicated image of the warrior-prince that passed down into modern European tradition as an ideal of masculinity, reshaped by feudalism. In Sir Thomas Malory's fifteenth-century reworking of the Arthurian legends, for instance, the presumed context is always one of fighting or preparation for fighting. Although Malory's *Morte D'Arthur* presents variations in the style of warriorhood—some of the knights are cool and others are hot-blooded, some are painfully honest and others treacherous—skill in battle is always the vital test of the “worshipful” knight. Yeomen and villeins are another question to Malory, but among his elite, there is only one male character who is not part of the armed competition for “worship”—the unaccountable prophet/witch Merlin. Arthur himself, it is easily forgotten, was a bastard even in the mainstream legend, and pulling a sword from an anvil was hardly an established form of royal election. He had to establish his claim to kingship by mass killings—“passynge grete slaughter,” in Malory's phrase—in a protracted civil war.

Historic images of warrior-heroes were handed down, and reworked as somewhat more widely available ideals, in European modernity. The point is made in a British popular song of the eighteenth or nineteenth century:

Some talk of Alexander, and some of Hercules,
Of Hector and Lysander, and such great names as these,
But of all the world's brave heroes, there's none that can compare,
With a tow row row, with a tow row row, to the British Grenadier.

So it had already been in Shakespeare, with his archetype-soldier,

Full of strange oaths, and bearded like the pard,
Jealous in honour, sudden and quick in quarrel,

Seeking the bubble reputation
Even in the cannon's mouth. (*As You Like It*, 2.7.150–153)

Questioning Masculinity

The word *masculine* (as a synonym for *male*) is a very old word in English. It was used by Chaucer in the fourteenth century. However, the terms *masculinity*, *masculinize*, and *masculinism* came into common use in English only in the late nineteenth century. This change in language signaled a rather different way of looking at men and their position in the world.

This change was part of the cultural response made, in the bourgeois society of the industrialized countries, to the women's suffrage movement, and to the broad challenge by first-wave feminism to Victorian-era patriarchy. The bourgeois society of imperial Europe (and its offshoots in colonies, notably in the United States) had taken the separation of men's and women's spheres to an extreme. It defined not only war as men's business but also property, knowledge, government, and, in many contexts, even waged work as such. In this context the concept of masculinity had a slightly conservative flavor, suggesting that social inequalities were rooted in permanent differences of the character of men and women. Many thinkers of the time assumed that these were based in the imperatives of biological evolution.

The term *masculinity* not only had antifeminist overtones, it had a clinical flavor as well. Femininity in men was seen as a source of sexual crime, especially (though not exclusively) homosexuality. Masculinity in women was also seen as a kind of pathology, especially threatening to their capacity to bear children.

From the start, however, this idea was contested. Not only women of the suffrage movement, but also men like John Stuart Mill (1806–1873) and Lester Ward (1841–1913) supported equality between women and men, convinced that social progress would iron out most of the differences between men's and women's lives (see the documentary history by Kimmel and Mosmiller).

Vaerting

In the next generation, the pioneering German educator Mathilde Vaerting (1884–1977) produced in *The Dominant Sex* (1923) perhaps the most revolutionary theory of gender ever written. She argued that masculinity and femininity were not fixed characteristics but reflected the fact that we lived in a male-dominated society—a *Männerstaat* (men's state). In societies where women held power, she argued, men showed the very characteristics that Western bourgeois society saw as quintessentially feminine. Masculinity or masculine characteristics, to Vaerting, were thus not expressions of the male body, and had nothing whatever to do with evolutionary forces. They were the consequences of social power structure and of this alone.

Vaerting based her arguments on a social learning theory, common among progressive educators at the time. She traced gender patterns in institutions such as the legal system (anticipating a later generation of sociological research on gender). Among other consequences of her perspective was a remarkable

prediction of the men's liberation movement, which appeared fifty years later.

Vaerting's ideas did attract some attention in the 1920s. But first-wave feminism was in decline, Vaerting lost her academic position when fascism came to power in Germany, and it was in other currents of thought that the questioning of masculinity was carried forward.

Freud

It was the work of the Austrian physician Sigmund Freud (1856–1939), more than anything else, that disrupted the apparently natural object "masculinity" and made an enquiry into the process of its construction possible.

Freud's ideas about masculinity developed in three steps. The first came in his initial statements of psychoanalytic principles: the idea of continuity between normal and neurotic mental life, the concepts of repression and the unconscious, and the method that allowed unconscious mental processes to be read through dreams, jokes, slips of the tongue, and symptoms. Freud understood that adult sexuality and gender were not fixed by nature but were constructed through a long and conflict-ridden process. The Oedipus complex, an emotional tangle of middle childhood involving desire for one parent and hatred for the other, was the key moment in this development. What precipitated the oedipal crisis, for boys, was rivalry with the father and terror of castration. Here Freud identified a formative moment in masculinity and pictured the dynamics of a formative relationship.

In his theoretical writing, Freud complicated this picture. Homosexuality, he argued, is not a simple gender switch, and "a large proportion of male inverts retain the mental quality of masculinity." Freud suggested that masculine and feminine currents coexist in everyone. Adult masculinity was a complex, and in some ways precarious, construction. In his longest case history, the "Wolf Man," Freud pushed behind the Oedipus complex to find a pre-oedipal, narcissistic masculinity that underpinned castration anxiety.

In a final stage, Freud developed his account of the structure of personality, in particular the concept of the superego, the unconscious agency that judges, censors, and presents ideals. The superego is formed, in the aftermath of the Oedipus complex, by internalized prohibitions from the parents. Freud gradually came to see it as having a gendered character, being crucially a product of the child's relationship with the father, and more distinct in the case of boys than of girls. This provided the germ of a theory of the patriarchal organization of culture, transmitted from one generation to the next through the construction of masculinity.

Adler

The potential in Freud's work for a radical critique of masculinity was apparent very early. It was taken up by Alfred Adler (1870–1937), a socialist psychiatrist convinced of the importance of social factors in disease. He was one of Freud's first and most important professional supporters but broke with him in 1911, partly over the analysis of masculinity.

Adler's argument started from the familiar polarity between masculinity and femininity but immediately emphasized the feminist point that one side of the polarity is devalued in culture and

associated with weakness. Children of both sexes, being weak vis-à-vis adults, are thus forced to inhabit the feminine position. Submission and striving for independence occur together in a child's life, setting up an internal contradiction between masculinity and femininity. In normal development, some kind of balance is struck. But if there is weakness, there will be anxiety that motivates an exaggerated emphasis on the masculine side of things. This "masculine protest," in Adler's famous phrase, is central to neurosis, resulting in overcompensation in the direction of aggression and a restless striving for triumphs.

Adler considered the masculine protest to be active in both normal and neurotic mental life. The masculine protest was a feature of women's psychology as well as men's but was overdetermined by women's social subordination. In men it could become a public menace. Adler took a highly critical view of dominating masculinities, commenting on "the arch evil of our culture, the excessive pre-eminence of manliness."

World War I left Adler in no doubt about the connections between masculinity, power, and public violence. His 1927 book, *Understanding Human Nature*, made a clearer statement of a psychoanalytic case for gender equality than was found anywhere else until the 1970s.

Other Psychoanalysts

Other psychoanalysts contributed to the argument about femininity and masculinity, though none gave the issue so central a place. Karen Horney (1885–1952) pointed to the importance of "the dread of woman," originating in fear of the mother, in the depth psychology of men. Carl Jung (1875–1961) speculated in *The Relations Between the Ego and the Unconscious* that masculinity and femininity functioned as opposites within personality, in a kind of balance: "The repression of feminine traits and inclinations causes these contrasexual demands to accumulate in the unconscious" (p. 187). This idea, filtered through Jung's later theory of archetypes, resurfaced in the 1980s and became the key theme of a popular therapeutic movement in the United States.

After the 1920s, psychoanalysis moved far to the right on most issues, and discussion of the theory of gender was no exception. When psychoanalysts became popular writers on gender issues in the 1950s, their message identified mental health with gender orthodoxy. The course toward adult heterosexuality, which Freud had seen as a complex and fragile construction, was increasingly presented as a nonproblematic, natural path of development. Anything else was seen as a sign of pathology, especially homosexuality, which was declared inherently pathological, the product of disturbed parent-child relationships. Psychoanalysis as a practice became increasingly a technique of normalization and attempted to adjust its patients to the existing gender order—as is shown in Kenneth Lewes's excellent history of psychoanalytic ideas about male homosexuality. It was only after the impact of feminism in the 1970s that the critical potential in psychoanalytic ideas about gender was rediscovered.

Sex Differences and Ethnography

The first important attempt to create a social science of masculinity centered on the idea of a male sex role. Its origins go back to late-nineteenth-century debates about sex difference,

when resistance to women's emancipation was bolstered by a scientific doctrine of innate sex difference. The first generation of women who entered U.S. research universities not only violated the doctrine of female mental inferiority, they also questioned its presuppositions by researching the differences in mental capacities between men and women. They found very few.

This scandalous result triggered an enormous volume of follow-up research, which has flowed from the 1890s to the present and covered not only mental abilities but also emotions, attitudes, personality traits, interests—indeed, everything that psychologists thought they could measure. The main results have not changed. Sex differences, on almost every psychological trait measured, are either nonexistent or fairly small. When groups of studies are aggregated by the statistical technique of meta-analysis, it is more likely to be concluded that some sex differences in psychological characteristics do exist. These, however, are often influenced by social circumstances.

The idea of a social interpretation of sex differences came principally from anthropology. This new discipline was, after psychoanalysis, the main intellectual force that relativized Western concepts of masculinity and femininity. Ethnographers such as Bronislaw Malinowski (1884–1942) and Margaret Mead (1901–1978) published detailed accounts of non-Western societies that were very widely read in the 1920s and 1930s. In these cultures, men and women were seen to behave in ways that were intelligible and consistent, yet very different from the patterns familiar in metropolitan bourgeois society. Mead's *Sex and Temperament in Three Primitive Societies* (1935), in particular, showed men following radically different ideals of conduct in different cultural contexts. The models of heroic masculinity familiar in Western literature were, it seemed, specific to the West.

From anthropology, also, came the idea of the functional interrelatedness of a society and the idea of a social role within it. In the 1940s and 1950s these ideas were applied to sex difference research and gave birth to the term "sex role," which in time passed into everyday speech.

The Male Sex Role

The usual conception of "sex role" is that a man or a woman enacts a general set of expectations attached to their sex. There are always two sex roles in any cultural context, one male and the other female. Masculinity and femininity are quite easily interpreted as internalized sex roles, the products of socialization. The reason why this socialization occurs, according to structural-functionalist sociology and anthropology, is that it is necessary for the stability or reproduction of the society as a whole. Sex differences in behavior (which are persistently exaggerated in the sex role literature) are thus explained on the small scale by social learning, on the large scale by the functioning of society.

Most often, sex roles are seen as the cultural elaboration of underlying biological sex differences. But the idea of a biological base can be dispensed with. The most sophisticated statement of sex role theory was made in the mid-1950s by Talcott Parsons, the leading sociological theorist of the time. In Parsons's argument, the distinction between male and female sex roles is treated as a distinction between "instrumental" and "expressive" roles in the family (when considered as a small group).

The idea that masculinity is the internalized male sex role allows for social change. Change was a central theme in the first detailed discussions of the male sex role that appeared in U.S. social science journals in the 1950s. The most notable was a paper by Helen Hacker called “The New Burdens of Masculinity,” which suggested that expressive functions were now being added to instrumental functions. Men were thus expected to show interpersonal skills as well as being “sturdy oaks.” For the most part, however, the first generation of sex role theorists assumed that the roles were well-defined, that socialization went ahead harmoniously, and that sex role learning was a thoroughly good thing. Successful internalization of sex role norms contributed to social stability, mental health, and the performance of necessary social functions.

Men’s Liberation and the Critique of Sex Roles

The new feminism in the 1970s did not abandon the concept of sex roles, but it reevaluated their meaning. It was argued that the female sex role was inherently oppressive and that role internalization was a means of fixing girls and women in a subordinate position. Almost immediately, a parallel analysis of the male sex role appeared. By the mid-1970s there was a small but much-discussed men’s liberation movement in the United States, and a small network of men’s consciousness-raising groups in other developed countries as well. A minor publishing boom developed in books about the “problem” of men and also in papers in counseling and social science journals. Their flavor is indicated by one title: “Warning: The Male Sex Role May Be Dangerous to Your Health.”

The picture of the male sex role in most of this literature was conventional and typically middle class, emphasizing traits such as inexpressiveness, orientation to careers, and competitiveness. Authors pointed to the role of commercial sports, such as football, in creating popular images of competitive, aggressive masculinity. They pointed to highly stereotyped representations of men in film and television genres such as the western, the war movie, the gangster movie, and the cop serial, not to mention advertisements such as the famous “Marlboro Man” campaign.

There was some attempt to outline a process of change. The American psychologist Joseph Pleck, one of the most prolific writers in this field, contrasted a traditional with a modern male role. Much of the writing in the United States in the 1970s encouraged men toward the modern version, recommending therapy, consciousness-raising groups, political discussion, role-sharing in marriage, or self-help.

By the 1980s, intellectual weaknesses in the sex role concept were acknowledged, and political divisions in the men’s movement had become wide. The antisexist and profeminist tendency of the early men’s liberation groups were contested by men’s rights groups who were antagonistic to feminism and by a therapeutic movement that took a very different view of masculinity, partly based on a late revival of Jung. Political ambivalence was inherent in the framework of sex roles. There is a basic tendency in sex role theory to understand men’s and women’s positions as consensual and complementary—a point made explicit by Parsons’s theory of instrumental (masculine)

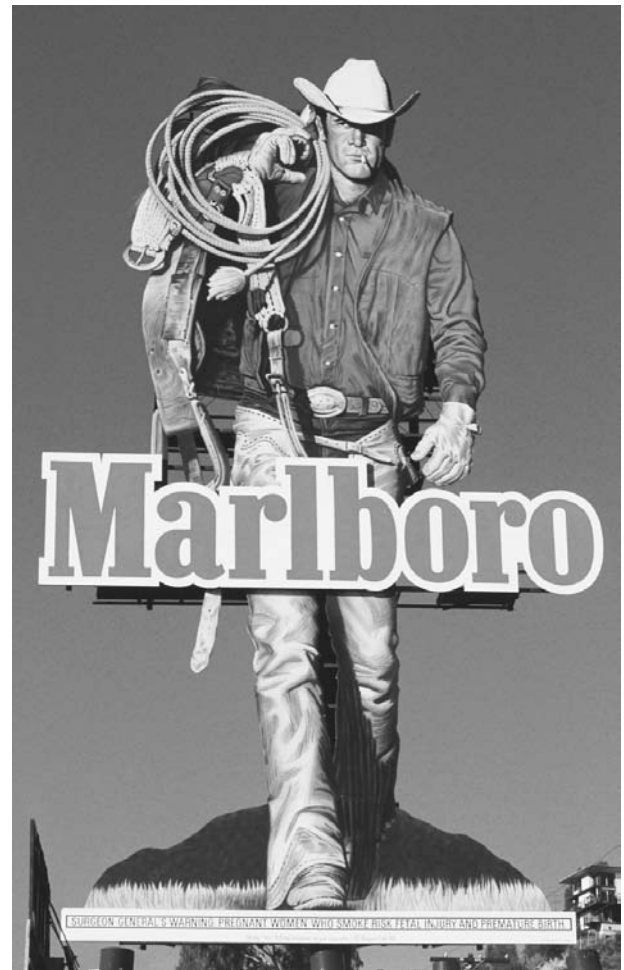

Billboard advertising Marlboro cigarettes, 1988. In the United States during the 1970s, a small movement sprang up to protest stereotypical male role models in society. Marlboro’s advertising campaign, which featured masculine, rugged cowboys was singled out as an offender. © CARL & ANN PURCELL/CORBIS

and expressive (feminine) orientations. Attempts by Pleck and others to create a nonnormative sex role theory proved unsuccessful in the long run.

Gay Liberation and Queer Theory

The most effective political mobilization among men around gender and sexual politics was the gay liberation movement that took shape around 1968–1970 in the United States and eventually became worldwide. Gay men mobilizing for civil rights, personal safety, and cultural space have acted on the basis of a long experience of oppression by heterosexual men. The term *homophobia* was coined around 1970 to describe this experience. A central insight of gay liberation is the depth and pervasiveness of homophobia, closely connected with dominant forms of masculinity.

Straight men’s homophobia involves real social practices, ranging from job discrimination to media vilification to

imprisonment, and sometimes to murder. These practices draw social boundaries, defining approved masculinity by its difference from the rejected. Theorists such as Dennis Altman in *Homosexual: Oppression and Liberation* (1972) regarded the oppression of homosexuals as part of a larger enterprise of maintaining an authoritarian social order and often saw it as connected to the oppression of women. Yet gay men have also noticed a certain fascination with homosexuality on the part of straight men. This knowledge was behind the slogan “Every straight man is a target for gay liberation!”

Gay liberation coincided with the emergence of visible gay communities in many cities of the developed world. From the 1970s on, these communities have been the sites of public manifestations of gay identity, ranging from the election of gay politicians to street parties and gay pride marches. For example, by the 1990s the annual lesbian and gay Mardi Gras parade had become the most popular street event in the social life of Sydney, attracting a huge straight audience. Styles of self-presentation in gay communities have shifted with time, from traditional “camp” behavior to the parodic butch masculinity of the late-1970s “clones,” changing again with the impact of the HIV/AIDS epidemic in the 1980s, the diversification of sexual subcultures, and the rise of “queer” sensibility in the 1990s.

Gay liberation, both in theory and practice, made a crucial difference to contemporary thought about masculinity. Gay culture makes visible alternative ways of being a man. Gay politics responds to, and thus makes visible, oppressive gender relations between groups of men. Gay men’s collective knowledge includes gender ambiguity, tension between bodies and identities, and contradictions in and around masculinity.

Many of these themes were picked up in queer theory, a new style of lesbian and gay theorizing that emerged under the influence of poststructuralism in the 1990s. In a diverse trend of thought rather than a formal body of doctrines, queer theorists have challenged the notion of fixed gender or sexual identities, thus challenging the basis of gay community politics. They have identified homoerotic subtexts throughout Western culture and have criticized feminist gender theory as being based on an unexamined heterosexism. Applied to men and masculinity, in texts such as David Buchbinder’s *Performance Anxieties* (1998), queer theory questions the naturalness of the category “men” and sees masculine identity not as the settled foundation of behavior but as something always insecure, constantly being created in performance.

Social Construction

The contemporary field of masculinity research, alternatively known as men’s studies or critical studies of men, was created when several impulses in the 1980s moved discussions decisively beyond the sex role framework. One was the continuing development of theories of gender, both structuralist and poststructuralist, which provided more sophisticated models of the gender relations in which men are located and masculinity is constituted.

A second impulse was provided when the coexistence of multiple masculinities was recognized—a move strongly influenced by gay thought. A third impulse was a new wave of empirical research in sociology, history, and cultural studies. This research

has been very diverse in subject matter but has generally had a local character. Its main focus has been the construction of masculinity in a particular milieu or moment: a printing shop in Great Britain, a professional sports career in the United States, a group of colonial schools in South Africa, drinking groups in Australian bars, a working-class suburb in Brazil, or the marriage plans of young middle-class men in urban Japan. Its characteristic research style has been ethnographic, making use of participant observation, open-ended interviewing, or discursive analysis of texts in popular culture. The primary research task has been to give close descriptions of processes and outcomes in the local site. This body of research was systematized in the mid-1990s in R. W. Connell’s *Masculinities*.

This “ethnographic moment” in masculinity research developed first in the English-speaking world, mainly in Australia, the United States, and Great Britain. In central and northern Europe, where feminist and gay research had also taken an early interest in the gender practices of men, there was more emphasis on survey research, such as the well-known “Brigitte study,” based on a national survey in Germany in 1984–1985, sponsored by a women’s magazine and conducted by feminist sociologists Sigrid Metz-Göckel and Ursula Mueller. There was also a focus on the ways men are positioned in relation to gender equity policies, a concern that has continued in Scandinavia to the present. The results of this great social experiment have recently been drawn together by the Norwegian sociologist Oeystein Holter, emphasizing that in favorable circumstances men can and do change their gender practices. In the same region, an interest developed in using masculinity research to uncover the roots of violence, which in recent years has become one of the most important fields of application of masculinity research internationally.

The picture that emerged from this research differed significantly from older ideas of the male sex role and even more from conceptions of “natural” masculinity. One of the key achievements of this research was to document the diversity of masculinities. There is not just one pattern of masculinity, good in all times and places. Different cultures vary, some being much more peaceable than others. Within a single society—even within a single community or institution—there will be different patterns of masculinity, different recognizable ways of “being a man.” Just as we now recognize the diversity of family forms, so we also now recognize that there are likely to be different constructions of masculinity in different social class settings, different ethnic communities, and different regions.

Hegemonic Masculinity

But different masculinities do not sit side by side as alternative lifestyles that men can freely choose. There are definite relationships between different masculinities. Most importantly, there are relationships of hierarchy and exclusion. In most communities there is a specific pattern of masculinity that is more respected than others. The hegemonic pattern of masculinity is often associated with national identity, celebrated in popular films and sports, presented as an ideal to the young, and constantly used as a basis of advertising. Other patterns of masculinity exist but do not attract the same respect—indeed, some forms of masculinity are actively stigmatized.

A good deal of debate has surrounded the concept of “hegemonic” masculinity. In some usages, it has turned into the concept of a fixed identity or stereotype, not very different from the old model of the male sex role. In others, however, it is recognized that only a minority of men actually embody a hegemonic model. Yet the hierarchy around this version of masculinity can be an important source of conflict and violence among men.

Recent social research also stresses that masculinity exists not only as a pattern of personal life, but also impersonally in communities, institutions, and cultures. Collective definitions of manhood are generated in community life, and are likely to be contested—and change—as the situation of a community changes, for instance with the decline of industrial employment or changing definitions of marriage, such as attempts in the early years of the twenty-first century to include same-sex domestic partnerships or gay marriage within the legal systems of some of the developed countries. Organizations such as armies and corporations embed particular hegemonic patterns in their organizational cultures, and mass media circulate particular icons of masculinity while discrediting others.

Historical and sociological research has produced convincing evidence that masculinities change over time. Men’s patterns of conduct, and beliefs about gender issues, do not change with dramatic speed. But research has shown significant generational shifts, for instance in sexual behavior, and in beliefs about men’s and women’s roles in society.

Change is to be expected because of the contradictions and tensions in gender relations. These give rise to a complex field of masculinity politics—mobilizations among different groups of men, some of them challenging for the hegemonic position in the local gender order, some defending more limited agendas. This conception is crystallized by Michael Messner in *The Politics of Masculinities* (1997).

Global Perspectives

Until recently, most of the research on, and debate about, masculinity has been about men in First World countries. We need to think beyond this context; and even within it, we need to consider the situation of local masculinities in a global context. Global history and contemporary globalization must be part of our understanding of masculinities. Individual lives are powerfully influenced by geopolitical struggles, imperialism and colonialism, global markets, multinational corporations, labor migration, and transnational media. Not only ethnographic but postcolonial studies are important for understanding the cultural dynamics of contemporary masculinities.

There has been some research on immigrant men in First World contexts. However, up to the 1980s little research was carried out on masculinities in Third World and/or postcolonial countries, and what was done was affected by Eurocentrism. In his excellent ethnographic study of men in Mexico City, *The Meanings of Macho* (1996), Matthew Gutmann criticizes the tendency of Anglo researchers to characterize Latino men as “macho.” More recent studies have acknowledged the great variety of masculinities throughout the Latin American world. For example, a remarkable series of studies coordinated

by José Olavarría, focused in Chile but involving researchers in other countries, has documented diversity in relation to identity, fatherhood, violence, and sexuality. Olavarría’s exploration of the dilemmas of Chilean youth as they attempt to construct a path toward fatherhood in a country undergoing globalization is particularly important.

More work is now being done in other regions outside the metropole—for example, by Japanese and Middle Eastern scholars. The importance of race and class in shaping gender patterns is strikingly shown in southern Africa. By the late 1990s, South Africa had the highest rates of violent death and rape in the world, the second highest number of gun-related homicides, and one of the world’s highest rates of HIV infection. These are connected with a turbulent gender politics in which different patriarchies contest, and different agendas for reform are found. South African masculinities, as shown by Robert Morrell’s collection, *Changing Men in Southern Africa* (2001), are both diverse and contested.

In the contexts of the developing world, as Morrell points out, gender work on men and masculinities must focus on very different issues from those in the developed world. For this reason, researchers in postcolonial contexts do not necessarily adopt theories of hegemonic masculinity or of new masculinities on the Western model. The idea of the “new man” popular in First World media has little relevance beyond the lives of such white, middle-class, urban men. How to make use of the new research is still uncertain. A controversy has developed about how men ought to be included in research and policy about gender and development. As Sarah White shows in a recent review of the argument, complex political issues arise here in a field that has sought, with some recent success, to place women’s interests on the agenda of development agencies.

Attention is now being turned to the patterns of masculinity in transnational agencies and institutions. There is some reason to think that older models of bourgeois masculinity, embedded in local ruling classes and conservative cultures, are being replaced by a transnational business masculinity. Compared with older hegemonic masculinities, the new model is more individualist, liberal in relation to sexuality and social attitudes, and oriented to power through markets rather than through bureaucratic domination. This model has been criticized, and plainly the interplay of masculinity with globalization needs much more investigation.

At the same time, as the return to military intervention abroad by the U.S. government suggests, there is cultural and political space for a reassertion of “hard” masculinities. The unevenness and relentlessness of change on a world scale are well captured in the 2001 volume *A Man’s World? Changing Men’s Practices in a Globalized World*, edited by Bob Pease and Keith Pringle. The issues reviewed in this article are currently the subject of active debate and research, with global issues an important focus.

See also *Anthropology; Character; Cultural Studies; Equality; Gender; Identity; Personal and Social Identity; Machismo; Natural Law; Queer Theory*.

BIBLIOGRAPHY

- Adler, Alfred. *Understanding Human Nature*. 1927. Translated by C. Brett. Oxford: Oneworld, 1992.
- Altman, Dennis. *Homosexual: Oppression and Liberation*. London: Lane, 1974.
- Buchbinder, David. *Performance Anxieties: Re-producing Masculinity*. Sydney: Allen and Unwin, 1998.
- Connell, R. W. *Masculinities*. Berkeley: University of California Press, 1995.
- Freud, Sigmund. *The Case of the Wolf-Man: From the History of an Infantile Neurosis*. San Francisco: Arion, 1993. Reprinted from the standard edition of the *Complete Psychological Works of Sigmund Freud*, v. 17. London: Hogarth, 1917.
- Gutmann, Matthew. *The Meanings of Macho: Being a Man in Mexico City*. Berkeley: University of California Press, 1996.
- Hacker, Helen Mayer. "The New Burdens of Masculinity." *Marriage and Family Living* 19 (August 1957): 227–233.
- Holter, Oeystein Gullvag. *Can Men Do It? Men and Gender Equality: The Nordic Experience*. Copenhagen: Nordic Council of Ministers, 2003.
- Homer. *The Iliad*. Translated by Michael Reck. New York: IconEditions, 1994.
- Jung, Carl G. "The Relations Between the Ego and the Unconscious." In *Collected Works*. Vol. 7. London: Routledge and Kegan Paul, 1953.
- Kimmel, Michael S., and Thomas E. Mosmiller, eds. *Against the Tide: Pro-Feminist Men in the United States, 1776–1990, a Documentary History*. Boston: Beacon, 1992.
- Lewes, Kenneth. *The Psychoanalytic Theory of Male Homosexuality*. New York: Simon and Schuster, 1988.
- Malory, Thomas. *Works*. Edited by E. Vinaver. Oxford: Oxford University Press, 1971.
- Mead, Margaret. *Sex and Temperament in Three Primitive Societies*. 1935. New York: William Morrow, 1963.
- Messner, Michael A. *The Politics of Masculinities: Men in Movements*. Thousand Oaks, Calif.: Sage, 1997.
- Metz-Göckel, Sigrid, and Ursula Mueller. *Der Mann: Die Brigitte-Studie*. Weinheim: Beltz, 1986.
- Morrell, Robert, ed. *Changing Men in Southern Africa*. London: Zed, 2001.
- Olavarría, José. *Y todos querían ser (buenos) padres: varones de Santiago de Chile en conflicto*. Santiago: FLACSO-Chile, 2001.
- Parsons, Talcott, and Robert F. Bales. *Family, Socialization and Interaction Process*. London: Routledge and Kegan Paul, 1956.
- Pease, Bob, and Keith Pringle. *A Man's World? Changing Men's Practices in a Globalized World*. London: Zed, 2001.
- Pleck, Joseph H. *The Myth of Masculinity*. Cambridge, Mass.: MIT Press, 1981.
- Vaerting, Mathilde. *The Dominant Sex: A Study in the Sociology of Sex Differentiation*. 1921. Westport, Conn.: Hyperion, 1980.
- White, Sarah C. "Did the Earth Move? The Hazards of Bringing Men and Masculinities into Gender and Development." *IDS Bulletin* 31, no. 2 (April 2000): 33–41.

R. W. Connell

MESTIZAJE. The concept of *mestizaje* expresses the tensions, contradictions, and ambiguities of its birth in the New World. More important, it is a concept that continues to have spiritual and aesthetic dimensions. *Mestizaje* refers to racial and/or

cultural mixing of Amerindians with Europeans, but the literal connotation of the word does not illuminate its theoretical applications and its more recent transformations. Since its inception in the New World and during those moments when race was a significant factor in social standing, *mestizaje* has been invoked to remedy social inequality and the misfiring of democracy.

Origins

In 1925 José Vasconcelos, the Mexican philosopher and educator, wrote *La raza cósmica* both to challenge Western theories of racial superiority and purity and to offer a new view about the mixing of African, European, and indigenous peoples in Mexico and throughout Latin America. The essay was an effort to undercut the maligned position of indigenous people and their material domination since the conquest, but it was unable to break completely from the civilizing motives of New Spain. *Mestizaje* was the political ideology of modern national identity, unity, and social progress. Yet Vasconcelos's vision pointed to Iberian culture, particularly Christianity, as the source for modernization and progress. Mexican nationalism has continued to construct its citizens as mestizos.

The material and ideological weight of the conquest was also difficult to shake in earlier formations of *mestizaje*. Even while under Spanish rule, criollos exalted the Aztec or Inca past and condemned the conquest, but their celebration of *mestizaje* did not include the elimination of economic domination, political disempowerment, and cultural genocide of indigenous populations. Throughout New Spain, claims of *mestizaje* were meant to indicate a bond against the *peninsulares*, the Spanish settlers with exclusive rights to high political office, and to legitimate creole equality with *peninsulares* at home and in Europe. Other classifications of mixture in the caste system were not exalted, and the status of mulattos and others was not reconsidered. Historians agree that during the colonial, independence, and revolutionary periods, *mestizaje* functioned to reduce cultural, linguistic, and political diversity in Mexico and to authorize the privileged status of ruling elites. In short, the original concept emphasized the assimilation and appropriation of indigenous cultures and the promise of progress and justice through Europe. As such, hybridity was cloaked under the banner of national unity. For the Mexican philosopher Octavio Paz (1914–1998), however, the trauma of *mestizaje* serves as a symbol of illegitimacy, a concept he develops in *Labyrinth of Solitude* (1961) and a foundation of his argument on Mexican national character.

Chicanos and Mestizaje

In contrast, contemporary expressions of *mestizaje* emphasize hybrid cultural experiences and the relations of power. The social position of contemporary thinkers somewhat explains the late-twentieth-century formulations of *mestizaje*. Whereas Mexican philosophers were members of the dominant sectors of society, Chicana and Chicano social critics, artists, and creative writers who reformulated *mestizaje* beginning in the late 1960s did not enjoy such a place in the United States or Latin America. In multiple genres, the earliest Chicano articulations of *mestizaje* were a strategy of affirmation, liberation, and identity.

Mexican Americans join three historical moments and expand the original concept of *mestizaje*. The first event occurred in 1521

with the Spanish conquest of the Aztec Empire; *el segundo mestizaje* (the second cultural mixing) occurred at the end of the Mexican-American War (1846–1848), in which the United States annexed over half of Mexico's territory; and the third event is the contemporary cultural interchange among Chicanos and European Americans. All three moments originate in disempowerment and suggest a rebirth. Particularly since the second historical moment, Chicanos and Chicanas have positioned *mestizaje* as an alternative to the social contract of assimilation. In making parallel the historical legacies of the seventeenth and nineteenth centuries, *mestizaje* no longer serves a pluralist agenda. In the United States, it functions as an antidote to modern anti-Indian and anti-Mexican sentiments, and although alliances with Native American populations in the American Southwest have been formed, they do not continue to anchor Chicano thought in the same way that Mexico's indigenous and pre-Columbian civilizations inform Chicano and Chicana *mestizaje*.

Chicano *mestizaje* enacts a void and a congested condition. For example, the poem "I Am Joaquin" (1967) by Rodolfo "Corky" Gonzales expresses a fusion of two opposites, Mexico and the United States, which are blended to form a third cultural experience: Chicano. The hybrid Chicano is neither Mexican nor American. Artists such as Amado Peña (with "Mestizo," silkscreen, 1974) and Emanuel Martinez (with "Mestizo Banner," silkscreen on canvas, 1967) produced the fusion in graphic form with a mestizo tripartite head in which two profiles faced left and right and were united in the third face in frontal position. Other artistic and scholarly proposals overdetermined a gendered *mestizaje*, emphasizing select indigenous characteristics and a masculine repertoire.

Critique and Reformulation

While social analysts agree that *mestizaje* has recuperative properties for Mexican Americans and that it successfully challenges Paz's diagnosis of a mixed nation as pathological, the neoindigenous emphasis can be ironically similar to Western distortions of native peoples, as both rely on a timeless, primordial culture. Chicano/a social critics such as Norma Alarcón and Chon A. Noriega point out that this use of *mestizaje* constructs a "pure" origin and relies on a static and unchanging past. The essentialist disposition of *mestizaje*, particularly the romantic neoindigenous perspective, clashes with the reality of Native American experiences as well as indigenous social and political struggles throughout the Americas. Furthermore, as Chicana feminists point out, an essentialist view of Mexican-origin people in the United States also distorts differences and inequalities within said communities. Chicana feminist challenges to patriarchy and homophobia helped to develop the critique of essentialism, and this had a lasting effect on the contemporary notion of *mestizaje*.

In her foundational book, *Borderlands/La Frontera: The New Mestiza* (1987), Gloria Anzaldúa fleshes out and complicates *mestizaje*. Performing a postmodern style that mixes autobiography, poetry, mythology, historical document, and documentation into theoretical proclamation, she problematizes conventions of race, nation, sexuality, and gender, drawing attention to fluidity within identity rather than a singular subject position. According to Anzaldúa, *mestizaje* is the demystification of social boundaries

and territorial borders. Thus conceived, the spaces between cultures and nations are porous and flexible. However, it is not just her acknowledgment of internal complexities that makes a *mestiza* consciousness significant. Anzaldúa does not imagine distinctions in opposition to each other but acknowledges concurrent identities, shifting strategies, and capacities for change.

The reformulated concept is more successful at challenging the premise of white racial superiority, purity, and essentialism. *Mestizaje* is a source of creativity, survival, and triumph. Unlike Mexican and Chicano cultural-nationalist formulations of *mestizaje*, Anzaldúa acknowledges all combinations and the places of contradiction that can result. Always synthesizing, *mestizaje* is a force of movement, combination, and transformation. Her own thinking about *mestizaje* fuses with the Nahuatl concept of *nepantla* (middle place or place of passage), thereby adding the potential for agency within the concept.

Spread and Influence

Nonlinear thought and unfixed identities have intellectual and political appeal for numerous fields, especially those also influenced by poststructural and postmodern schools of thought. Because of the liberatory dimensions of the concept of *mestizaje*, it is widely used in postcolonial, ethnic, and feminist studies and Latino theology. Most credit Anzaldúa with creating the aperture for understanding and theorizing about the ability to have multiple social perspectives and positions with concrete material forms of oppression or privilege.

The scholars Chela Sandoval and Emma Pérez, as well as the Latino theologian Virgilio Elizondo, explore the implications of *mestiza* consciousness for U.S. Third World feminists, including Chicana feminists and Latino Catholic congregations, respectively. For Elizondo, *mestizaje* is divine grace, which elevates the spiritual qualities of *mestizaje* as articulated by Vasconcelos but without the Eurocentric imperative. *Mestizaje* becomes the existence that resurrects humanity, and all have the potential for salvation since Elizondo ultimately describes all cross-cultural contacts as *mestizaje*. Expansions of the concept by Elizondo and others have been met by intense criticism. Most Latino theologians, such as María Pilar Aquino and Gloria Inés Loya, present its historical specificity as an important term of its experience and path to salvation. The recuperative properties of *mestizaje* are significant for postcolonial scholars. Both Chicana feminists Pérez and Sandoval reveal how the new *mestizaje* offers a political method or compass for mobilizing oppositional forms of consciousness that will produce equity. It is a method that develops and exceeds the modes of assimilation, revolution, supremacy, and separatism, each of which is a strategy unable to reconcile or allow for the multiple social positions and perspectives as delineated by Anzaldúa.

By the early twenty-first century, the concept of hybridity and cross-cultural contact had permeated social science and humanities scholarship. It also continued to travel North, and French-Canadian scholars relate it to *métissage* (French; "mixed blood"). Whether universal or not, the contemporary reconfiguration explores sites of convergence and disjuncture with attention to the pressure of power, and its meaning can be used to assess the distance between *mestizaje* and *métissage*. Nevertheless, reformulations of *mestizaje* have recuperative

power for those maligned by nation and empire, sexism and homophobia, material and political displacement. If the analysis of intercultural exchange includes attention to ambiguity and contradiction, *mestizaje* can continue to offer a strategy of resistance and liberation in the twenty-first century.

See also *Creolization, Caribbean; Ethnicity and Race; Identity, Multiple*.

BIBLIOGRAPHY

- Alarcón, Norma. "Chicana Feminism: In the Tracks of 'the' Native Woman." In *Living Chicana Theory*, edited by Carla Trujillo, 371–382. Berkeley, Calif.: Third Woman Press, 1998.
- Anzaldúa, Gloria. *Borderlands/La Frontera: The New Mestiza*. San Francisco: Spinsters/Aunt Lute, 1987.
- Aquino, María Pilar, Daisy L. Machado, and Jeanette Rodríguez. *A Reader in Latina Feminist Theology: Religion and Justice*. Austin: University of Texas Press, 2002.
- Elizondo, Virgilio. *The Future Is Mestizo: Life Where Cultures Meet*. Rev. ed. with a new foreword by Sandra Cisneros and introduction by David Carrasco. Boulder: University Press of Colorado, 2000.
- Gonzales, Rodolfo "Corky." "I Am Joaquin." In *Latinola Thought: Culture, Politics, and Society*, edited by Francisco H. Vázquez and Rodolfo D. Torres, 75–87. Lanham, Md.: Rowman and Littlefield, 2003.
- Noriega, Chon A. "Between a Weapon and a Formula: Chicano Cinema and Its Contexts." In *Chicanos and Film: Representation and Resistance*, edited by Chon A. Noriega. Minneapolis: University of Minnesota Press, 1992.
- Loya, Gloria Inés. "Pathways to a Mestiza Feminist Theology." In *A Reader in Latina Feminist Theology: Religion and Justice*, edited by María Pilar Aquino, Daisy L. Machado, and Jeanette Rodríguez, 217–240. Austin: University of Texas Press, 2002.
- Paz, Octavio. *The Labyrinth of Solitude: Life and Thought in Mexico*. Translated by Lysander Kemp. New York: Grove Press, 1961.
- Pérez, Emma. *The Decolonial Imaginary: Writing Chicanas into History*. Bloomington: Indiana University Press, 1999.
- Sandoval, Chela. "Mestizaje as Method: Feminists-of-Color Challenge the Canon." In *Living Chicana Theory*, edited by Carla Trujillo, 352–370. Berkeley, Calif.: Third Woman Press, 1998.
- Vasconcelos, José. *The Cosmic Race: A Bilingual Edition*. Translated and annotated by Didier T. Jaén; afterword by Joseba Gabilondo. Reprint, Baltimore: Johns Hopkins University Press, 1997.

Karen Mary Davalos

METAPHOR. Metaphor, traditionally defined as the transference of meaning from one word to another, is perhaps the most intensely and variously studied instance of figurative language. This is so because metaphor enjoys two distinct primary aspects, presenting itself as (1) a form (a discrete, replicable linguistic structure, conceivable as extrinsic to thought) and (2) a power (a cognitive operation issuing from an intrinsic and inherently creative mental faculty). Aristotle (384–322 B.C.E.), who begins the Western tradition's systematic investigation of metaphor, is the first to address the trope's double nature. On the one hand, he treats metaphor in the context

of style (implicitly rendering it secondary to invention, the first of the five parts of rhetoric), as deviation from the ostensible clarity of everyday language that is subject to rules of propriety. On the other, he calls metaphor "a kind of enigma" and claims that for the verbal artist "the greatest thing by far is to have a command of metaphor" because "this alone cannot be imparted by another; it is the mark of genius, for to make good metaphors implies an eye for resemblances" (1961, p. 104).

The dominant Aristotelian idea of metaphor is not, however, either a balanced opposition or mixture of metaphor's two primary aspects. Of the two, Aristotle chooses to emphasize the formal view—perhaps because it confirms the primacy of reason and cooperates with his systematic and pedagogical motives. The philosophical and cultural consequences of Aristotle's formal emphasis are substantial and lasting: along with cultural and intellectual traditionalism, this emphasis holds that the office of language is mimetic, that of representing the world. From such a notion of language follows the implication that the truth and value of verbal art is measured by its fidelity to an unchanging, external, and therefore communally explicable reality.

The Classical System

The Aristotelian privileging of metaphor's formal aspect and its attendant assumptions, emphases, and procedures are together amplified and reified by his classical inheritors. In this tradition, metaphor's creative aspect tends to be viewed with suspicion. For instance, in *De oratore* (55 B.C.E.; On oratory), through a fabular comparison between metaphor and clothing, Cicero (106–43 B.C.E.) articulates a view of language as a form of ethical conduct that must not stoop to don the potentially corruptive finery of metaphor: "For just as clothes were first invented to protect us against cold and afterwards began to be used for the sake of adornment and dignity as well, so the metaphorical employment of words was begun because of poverty, but was brought into common use for the sake of entertainment." Cicero uses his comparison to caution us against "borrowing" fancy metaphors because they suggest "poverty" of thought and expression (p. 121–123). But it is largely through Cicero's precise, nuanced discussion of the proper and improper forms and uses of intentionally shaped language that his motive to civilize the power of metaphor is transmitted, inspiring the anonymous author of the *Rhetorica ad Herennium* (first century B.C.E., Rhetoric to Herennius) and Quintilian (c. 35–95/6 C.E.), author of *Institutio oratoria* (first century C.E.; Institutes of oratory).

Quintilian's terminological and conceptual precision expands the formal context within which metaphor may be understood. Because his primary interest is pedagogically useful classification, Quintilian chooses to treat metaphor as a member of the tropes, which involve "the artistic alteration of a word or phrase from its proper meaning to another" (p. 301). Treating metaphor as a member of a class of similar forms allows Quintilian to note metaphor's uniqueness without committing himself to an equal exploration of both its aspects. For example, while he allows that metaphor is the "commonest and by far the most beautiful of tropes," and praises it for "accomplishing the supremely difficult task of providing a name for anything" (p. 303), he restricts an attribution of cognitive agency to the tropes as a class: "The changes involved [in the use of

tropes] concern not merely individual words, but also our thoughts and the structure of our sentences” (p. 301–303). It is noteworthy that here, in the midst of explicating a system whose formal emphasis diminishes metaphor’s creative aspect, Quintilian states that tropes *in themselves* can play a serious role in thinking. Though muted, this connection between figured language and cognition anticipates the ground from which springs the Middle Age’s most important contribution to ideas about metaphor: the notion that, when interpreted correctly, the ambiguities and excesses of figured language involve human understanding with a superior order of knowledge and being.

The Middle Ages

The institutionalization of Christianity required the preservation of classical learning, including Greco-Roman ideas of metaphor. However as Erich Auerbach points out in *Mimesis: The Representation of Reality in Western Literature* (1968), the passage from classical to Christian civilization involved a radical change in the context within which figured language was understood. Because the classical system depended upon a precise delineation and separation of elements, Auerbach sums up its emphasis as “aesthetic-stylistic.” In contrast, the Christian “ethico-theological” emphasis assumes the merging of hitherto distinct styles and foregrounds a decidedly un-Roman urgency concerning interpretation. To the early Christian fathers, figured language represented a formidable theological problem. The scriptures contain many figures and ambiguities, and Christ often chooses to teach through metaphor and parables—but the classical technology of eloquence (particularly how it defines and achieves the high style, language that moves the audience to action) is pagan and elite, neither holy nor humble.

In line with the classical tradition, which he resourcefully defends throughout *De doctrina christiana* (396–426; On Christian doctrine) as being essential for proper scriptural interpretation, Augustine (354–430) discusses metaphor as a trope. It is, however, how he defines a sign that clearly indicates the Christian break from the past: “A sign is a thing which, over and above the impression it makes on the senses, causes something else to come into the mind as a consequence of itself” (p. 535). For Augustine, words (the most important human signs) have an intrinsic power that may exceed the limits erected by the classical doctrine of mimetic fidelity and enforced by the Greco-Roman insistence on decorum. Augustine’s view of words as signs helps him to renew and meld the two aspects of metaphor that Aristotle delineated and his classical inheritors further isolated from each other.

The Renaissance

In step with sweeping material and social changes, including the Reformation and a gathering intellectual consensus that the universe and the mind similarly follow the laws of logic, a new context for understanding the relationship between thought and language was developing. Peter Ramus’s (1515–1572) challenge to the Scholastic status quo represented this new context and prepared the way for the Enlightenment’s cult of reason and pursuit of a language free from the excesses and ambiguities of figured language. Ramus replaces the transcendent Augustinian sign with stark syllogism and calls for a thorough

reorganization of the rhetorical system. As pertains to metaphor, Ramism’s most consequential features are the tightly related assumptions that (1) thought follows the rules of logic and (2) language, because of its vital role in thinking, must be plain and clear. From the Ramist perspective, metaphor has no place in serious discourse and, thus, the nature and tension between its two aspects is rendered moot. However, despite its antimetaphorical outlook, Ramism did not stifle either the flowering of Renaissance rhetoric or subsequent investigations of metaphor. Because the culture of early modern Europe was, in many respects, as medieval (traditional and collectively minded) as it was modern, oratory and poetry were highly respected and widely practiced. Thus Elizabethan and metaphysical metaphors, such as those invented by Shakespeare and Donne, tend to strike an organic balance among three elements: tradition, the age’s increasing emphasis on logic as a basis for artistic invention, and its discovery of a new model of subjectivity distinguished by a personal struggle for self-knowledge and self-determination.

Similar to Ramus, Francis Bacon (1561–1626) was an enemy of Scholasticism and a champion of reason and an unadorned language capable of serving it. In contrast to Ramus, however, Bacon was skeptical of the syllogistic process because, as he writes in *The New Organon* (1620), “the syllogism consists of propositions, propositions consist of words, words are symbols of notions.” “Our only hope” of knowing nature, the truth of things and ourselves, Bacon asserts, “lies in . . . true induction” (p. 41). The foundations of his method—which inspired the British Royal Society’s call for a scientific plain style in language and influenced a range of later philosophers, including Giambattista Vico (1688–1744)—is rooted in the principle that true knowledge comes of what one has “observed in fact or in thought of the course of nature. Beyond this he neither knows anything nor can do anything” (Bacon, p. 39). To Bacon, then, the knowledge that comes of metaphor and other figures of speech number among the “Idols” that confuse human kind, leading us into error. It is Bacon’s dream of a scientific language, one enabling the direct perception and undistorted discussion of reality through the control and exclusion of tropes and figures, that predicts and helps lay the ground for the Enlightenment’s general perspective of metaphor.

The Enlightenment

John Locke (1632–1704), one of the Enlightenment’s most representative thinkers, born into a culture increasingly defined by a belief in the verity of empirical science and its procedures, solves the problem of metaphor by rejecting both of its aspects. In *An Essay Concerning Human Understanding* (1690), Locke holds that the foundations of thought are simple ideas, which are obtained through direct sense impressions. From this perspective, words should refer to things and the most that may be expected of language is that it further discursive “Order and Clearness.” As for metaphor and “all the [other] artificial and figurative application of Words Eloquence hath invented, [these] are for nothing else but to insinuate wrong *Ideas*, move the Passions, and thereby mislead the Judgment” (Locke, p. 508). In order to get at the “true ideas upon which the inference depends,” Locke advises that from language one should

“strip” the “superfluous ideas” evoked by tropes and figures, and then “lay the naked *Ideas* on which the force of the argumentation depends, in their due order.” Thus confronted with “true ideas” in their natural order, the mind easily perceives the truth of things and their relations (Locke, p. 676).

To Locke, metaphor’s enigmatic power to create images and ideas is so corrupting of thought that he entirely exiles it from his model of consciousness and (correct) philosophical process. Of course, neoclassical thinkers, such as Voltaire (1694–1778) and Samuel Johnson (1709–1784), continued to use and productively discuss figured language—but in a context whose emphases denied relativism and forestalled the exploration of categories such as the primitive and the irrational.

Giambattista Vico’s (1668–1744) views are a notable exception to the late-Enlightenment outlook and its limited and generally dismissive idea of metaphor. Although not influential in his lifetime, Vico’s ideas clearly anticipate aspects of the Romantics’ intense interest in and philosophical linking of poetic language, primitivism, and psychological and historical relativism. Vico’s thought thus demonstrates both the continuities and differences between Enlightenment and Romantic thinking about metaphor.

Romanticism

As reflected in *La scienza nuova* (1725; *The new science*), Vico sees language as a social construction intimately involved with cognitive development and epistemology. Because society has changed—moving from an original theological stage, through a heroic epoch, to a present-day civilized, humanistic order—so, too, have language and human nature altered. Articulating ideas similar to those espoused by later, Romantic philosophers, such as Jean Jacques Rousseau (1712–1778) and Johann Gottfried von Herder (1744–1803), Vico postulates that, during the theological epoch (which has its analog in individual cognitive development), humans shared a primitive, metaphorically rich language, which was later complicated and variegated through cultural pressures and the advance of rational thinking. Rather than the opposite or absence of thought, figurative language demonstrates an elemental mode of thinking that Vico calls “poetic logic.”

Samuel Taylor Coleridge (1772–1834) serves as a particularly influential specimen of Romantic thinking about metaphor. Neoplatonic in inclination and influenced by Vico, Rousseau, and the German Romantics, Coleridge famously distinguishes between imagination and what to him is the inferior mode of fancy, thereby clarifying his age’s impatience with the limits of empirical knowledge. To Coleridge, imagination is a creative, connective power that unites nature and the poet, whose genius is realized through “organic,” original form rather than “mechanic,” derivative form. Coleridge defines poetry—and thus the exercise of its modes, such as metaphor—as a self-expressive activity whose object (pleasure) is opposed to that of science (truth).

Although Coleridge maintains that poetry enables a view of nature superior to that obtained through scientific inquiry, his system effectively treats poetry and science as complementary opposites: each (paradoxically) capable of discovering, through its

specific symbolic activity, aspects of the reality that simultaneously undergirds and lies beyond symbols. Coleridge’s Neoplatonic view of nature and its potential accessibility through human inquiry were not, however, shared by all Romantic thinkers. In particular, Friedrich Nietzsche (1844–1900) unequivocally states that human beings are “indifferent” and even hostile to “pure knowledge,” to the “thing in itself.” More important, Nietzsche denies that language—and by way of extension, any symbolic activity—is capable of revealing any meaning beyond that which it constructs. From this anti-essentialist perspective, the truths obtained through language are “illusions,” members of a “worn out” “army of metaphors.” Nietzsche is not, however, recycling a Ramist or Baconian position: To him a metaphor-free language is as impossible as a value-free science. In Nietzsche’s opinion, metaphor and reality are so entwined as to be synonymous.

The Twentieth Century

With few exceptions, the twentieth century’s consequential ideas of metaphor may be classified as Romantic because: (1) the trope is held to be cognitively and linguistically essential; and (2) its form and power are treated as an organically related unit. One crucial distinction between Romantic and twentieth-century ideas of metaphor, however, is that the latter summarily rejects transcendence, the notion that symbolic activity gives human beings access to supernatural knowledge and being. The origins of this rejection are manifold, but its primary engine and context is modern, disciplinary science. In this particular context, metaphor strongly tends to be viewed as an embedded phenomenon, as functioning within a cognitive, linguistic, or social system of such complexity that its elements and operations are generally accessible only to specialists—thus the contentious variety and intellectual weight of most contemporary ideas of metaphor.

Sigmund Freud (1856–1939) and Roman Jakobson (1896–1982) helped found and define structuralism, which, despite challenges mounted by poststructuralist thinkers beginning in the 1960s, continues to dominate contemporary theories of metaphor. Freud, best known as the founder of psychoanalysis, sees metaphor as a verbal elaboration and symptom of the elemental psychological process of condensation. Jakobson, drawing upon the theories of Ferdinand de Saussure (1857–1913) and through his work with persons suffering from aphasic disorders, proposes a functional synonymy between metaphor and the associative process, in his view one of the two basic operations used by the mind to construct language.

The structuralist approach to metaphor is not, however, exclusive to Freud, Jakobson, and their direct inheritors, thinkers as diverse in outlook as Jacques Lacan (1901–1981), Claude Lévi-Strauss (b. 1908), and Julia Kristeva (b. 1941). An alternative current of structural attention to metaphor is represented by the work of Stephen C. Pepper (1891–1972) and a set of like-minded scholars who constitute what may be called the “Vicoian school.” Rather than embedding metaphor in a psycholinguistic system, in *World Hypotheses: A Study in Evidence* (1942), Pepper projects metaphor onto the history of thought, which he views as a series of distinct “world hypothesis,” each “determined by its root metaphor” (p. 96). The philosopher and historiographer Hayden White (b. 1928)

similarly embeds metaphor in the social fabric, considering the metaphorical process as the ground for one of four modes of historical understanding. A related understanding of metaphor is offered by Thomas Kuhn (1922–1996), who proposes the concepts of the “paradigm” and the “paradigm shift” as instruments for illuminating the relationship between changes in worldview and the process of scientific discovery.

Because structuralist argumentation, like that of traditional philosophy and science, generally presupposes a separation between the object of study and the dyad of investigator and method, it tends toward universalizing claims. Thus structuralism has helped stimulate the growth of a sophisticated alternative context for thinking about metaphor, one directly inspired by Nietzsche’s militant rejection of objectivity, consistency, and unexamined systematic thinking. Jacques Derrida (b. 1930), the architect of deconstruction and a primary disseminator of poststructuralism, cautions against the abstractions produced by and upon which metaphysical systems are built. In the essay “White Mythology” (1972), Derrida holds that metaphor is a “metaphysical concept” created when “primitive” meanings are renamed and “circulated” in philosophical discourse. Hence his claims that “philosophy . . . is a . . . process of metaphorization” whose verity depends upon effacing its metaphorical roots (p. 210–211).

The formulation and widespread dissemination of post-structuralist ideas signals a broad and definite movement away from the traditional view of language as mimetic and the consequent treatment of intentional figuration as supplementary to thought and expression. For instance, through an interdisciplinary blend of philosophy, linguistics, cognitive science, and intercultural comparison, George Lakoff and Mark Johnson have moved the metaphorical function beyond language and, thus, beyond questions of representation. To these thinkers, “our ordinary conceptual system . . . is fundamentally metaphorical in nature” (p. 3), grounded in the universal and yet particular facts of the body.

Working within (and beyond) the discipline of anthropology, James W. Fernandez offers an approach to metaphor that, similar to Lakoff and Johnson’s, assumes the trope’s embedment and the intellectual obligation to foreground principles of cultural relativism. To Fernandez, metaphor is a “strategic predication” of identity that “leads to performance.” Rather than identifying metaphor as either a cognitive, linguistic, or structural abstraction (classifications that similarly encourage metaphor’s division into two aspects), Fernandez understands metaphor in much the same way that Henry Louis Gates Jr. (b. 1950) conceives the practice of “signifyin(g)” in African-American culture. Like “signifyin(g),” metaphor is a lived strategy, one that plays a key, mediating role in the mutual construction of identity, emotions, and the immediate social matrix. While it is impossible to predict the larger consequences of the ongoing shift in ideas of metaphor, the work of comparativists like Earl Miner (1927–2004) suggests that future understandings of metaphor will be all the richer because they will spring from and advance dialogue between heretofore intellectually separated traditions and cultures.

See also *Genre; Literature; Narrative; Rhetoric.*

BIBLIOGRAPHY

- Aristotle. *Aristotle’s Poetics*. Translated by Samuel H. Butcher. New York: Hill and Wang, 1961.
- . *The Rhetoric of Aristotle*. Translated by Lane Cooper. Englewood Cliffs, N.J.: Prentice-Hall, 1988.
- Auerbach, Erich. *Mimesis: The Representation of Reality in Western Literature*. Translated by Willard R. Trask. Princeton, N.J.: Princeton University Press, 1968.
- Augustine. “On Christian Doctrine.” Translated by J. F. Shaw. In *A Select Library of the Nicene and Post-Nicene Fathers*, 1st series, edited by Philip Schaff. Vol. 2 of *St. Augustine*. Grand Rapids, Mich.: Eerdmans, 1956, reprint.1983. Originally published in 1887.
- Bacon, Francis. *The New Organon*. In *The New Organon and Related Writings*. Edited with an introduction by Fulton H. Anderson. New York: Liberal Arts Press, 1960.
- Cicero. *De oratore*. 2 vol. Translated by Edward W. Sutton and Harris Rackham. Cambridge, Mass.: Harvard University Press, 1942.
- Coleridge, Samuel Taylor. *Biographia Literaria: or Biographical Sketches of My Literary Life and Opinions*. Edited by George Watson. Rutland, Vt.: Charles E. Tuttle, 1991.
- Derrida, Jacques. “White Mythology: Metaphor in the Text of Philosophy.” In his *Margins of Philosophy*, translated by Alan Bass. Chicago: University of Chicago Press, 1982.
- Fernandez, James W. *Persuasions and Performances: The Play of Tropes in Culture*. Bloomington: Indiana University Press, 1986.
- Gates, Henry Louis, Jr. *The Signifying Monkey: A Theory of African-American Literary Criticism*. New York: Oxford University Press, 1989.
- Hawkes, Terence. *Metaphor*. London: Methuen, 1972.
- Kristeva, Julia. “Freud and Love: Treatment and Its Discontents.” Translated by Léon S. Roudiez. In *The Kristeva Reader*, edited by Toril Moi. New York: Columbia University Press, 1986.
- Lakoff, George, and Mark Johnson. *Metaphors We Live By*. Chicago: University of Chicago Press, 1980.
- Locke, John. *An Essay concerning Human Understanding*. Edited by Peter H. Nidditch. New York: Oxford University Press, 1979.
- Nietzsche, Friedrich. “On Truth and Lie in an Extra-Moral Sense.” In *The Portable Nietzsche*, translated by Walter Kaufman. New York: Penguin, 1982.
- Ong, Walter J. *Ramus, Method and the Decay of Dialogue: From the Art of Discourse to the Art of Reason*. Cambridge, Mass.: Harvard University Press, 1983.
- Ortony, Andrew, ed. *Metaphor and Thought*. 2nd ed. New York: Cambridge University Press, 1993.
- Pepper, Stephen C. *World Hypotheses: A Study in Evidence*. Berkeley: University of California Press, 1942.
- Quintilian. *Institutio oratoria*. 4 vols. Translated by Harold E. Butler. Cambridge, Mass.: Harvard University Press, 1996.
- Ricoeur, Paul. *The Rule of Metaphor: Multi-disciplinary Studies of the Creation of Meaning in Language*. Translated by Robert Czerny with Kathleen McLaughlin and John Costello. Toronto: University of Toronto Press, 1977.
- Vico, Giambattista. *The New Science of Giambattista Vico*. Rev. and abr. ed. Translated by Thomas Goddard Bergin and Max Harold Fisch. Ithaca, N.Y.: Cornell University Press, 1968.

Cristopher Hollingsworth

METAPHYSICS.

This entry includes two subentries:

Ancient and Medieval
Renaissance to the Present

ANCIENT AND MEDIEVAL

In the early twenty-first century *metaphysics* is a term used fairly loosely to describe philosophical investigation of the fundamental constituents of reality. But, in the Middle Ages, there was great debate about what was the subject of metaphysics, and that controversy had ancient roots.

What Is Metaphysics?

The word *metaphysics* is taken from the title, given by an editor in antiquity, to a treatise (or, rather, a set of material, not all of which belongs together) by Aristotle (384–322 B.C.E.): the word may have been chosen just because the work was placed after (*meta*) the physics, or it may have meant that the work deals with things beyond the physical. Aristotle does, in most of the *Metaphysics*, seem to believe that he is engaged in a single, distinctive enterprise of “first philosophy”—but he characterizes its aim in a number of different, and arguably incompatible, ways: it is the study of first principles, or of being qua being, or the investigation of substance, or its main concern is with immovable substances, that is to say, with the gods. This final, theological aspect led many later ancient philosophers to envisage the *Metaphysics* as an investigation, not of being in general, but of the highest sort of supra-sensible being—an approach that fitted the overwhelming concern of late antique philosophers with the intelligible world and the general wish to syncretize Aristotle and Plato.

In the Middle Ages, the question of the subject-matter of metaphysics became more problematic. The two greatest medieval Islamic philosophers, Avicenna (Ibn Sina; 980–1037) and Averroës (Ibn Rushd; 1126–1198), knew Aristotle’s *Metaphysics* well. Avicenna held that God could not be the subject of metaphysics, because it is in metaphysics that the existence of God is demonstrated, and no science can demonstrate the existence of its own subject. Metaphysics, therefore, has as its subject being qua being. Averroës disagreed. He held that the existence of God is demonstrated in physics, and so metaphysics can be regarded as the study of the first being, the separate substance that, as final cause, is the mover of all things.

Avicenna’s view predominated among the Christian Scholastics, who saw metaphysics primarily as the study of being in general (*ens commune*) rather than of a particular, special being. But Duns Scotus (c. 1266–1308), at least, was willing to say that God is a sort of being, and so is considered in metaphysics along with all other beings. Thomas Aquinas’s (c. 1224–1274) position had been, perhaps, more nuanced. God is not, he thought, contained under the notion of being in general, but he is included within metaphysics in that he is the cause of being in general, which the subject studies.

Form in Metaphysics

One central notion in metaphysics (understood in a broad sense, and going back to before the word was invented) is that

of form. Plato (c. 428–348/7 B.C.E.) reasoned that there could be no knowledge of the objects of everyday experience, but merely opinion about them, because they are constantly changing and cannot be said to be, but merely to become. The objects of knowledge, he thought, must be unchanging things—what he called “Forms” or “Ideas.” Although Platonic Forms can be grasped only through the powers of the intellect, not by the senses, they are by no means merely mental entities, but independently existing realities, as a result of participation in which the objects of sense perception have the characteristics they do—so, for example, beautiful things are beautiful by virtue of participating in the Form of Beauty (or, as Plato sometimes says, in Beauty Itself). Beyond this, Plato gives rather different accounts of the Forms from dialogue to dialogue, and even within the same dialogue. In perhaps his most famous discussion of them, in the central books of the *Republic*, he presents a supreme Form, the Form of the Good, which is understood only after years of intellectual training. The other Forms, Plato says, depend on the Form of the Good and are grasped properly only once the Form of the Good is grasped. In the *Timaeus*, Plato shows the universe being constructed as an ensouled living thing, according to the pattern of the Ideas.

Aristotle’s account in his *Metaphysics* of how things are constituted also uses the notion of Form, but it is treated very differently. The Forms Aristotle discusses are those of types of natural things, divided according to natural kinds. For instance, one natural kind is Man, another is Horse. According to this hylomorphic account, each man is a man by virtue of the Form of humanity, and each horse a horse by virtue of the Form of equinity. These Aristotelian Forms are not, like Plato’s Forms, independent single entities in which many particular sensible things participate. Rather, a particular member of a natural kind—this man, for instance—is a concrete whole composed of matter and Form. Yet the Form that makes him a man is the same as the Form by which any other man is a man. By grasping this Form with our intellects, we have a universal notion of Man, which we are able to use in formulating scientific truths, not about this or that man, but about Man in general.

In the Middle Ages, Plato’s Theory of Forms in its pure state had very few adherents. But an adapted version of it, which goes back to Philo (c. 13 B.C.E.–45/50 C.E.), the Hellenistic Jewish thinker, was extremely popular: the Forms are said to be in the mind of God. Thinkers as diverse as Augustine, Eriugena, Abelard, and Aquinas used this idea as one of the ways of describing God’s relation to created things. It was not until William of Ockham (c. 1285–?1349), in the early fourteenth century, that this picture was seriously questioned. Adoption of this version of Platonic Ideas still left Aristotelian hylomorphism as the main way of explaining the constitution of concrete things, and there was a vigorous debate in the twelfth century about whether (on the basis of the version of Aristotle’s theory proposed in his *Categories*) Forms in reality are really universal, or are universal merely in the way they are used in human thought and language. In the thirteenth and fourteenth centuries, hylomorphism was the basis (following Aristotle’s *On the Soul*) for the theory of intellectual cognition. The Form that makes, for example, a horse a horse informs the

matter-like potential intellect of the person who intellectually grasps the notion of horse.

Two Main Questions of Medieval Metaphysics

Another important debate in later medieval metaphysics was about whether essence—the sort of thing something is—and existence (*esse*)—the fact of the thing’s actually existing—are really distinct. Aquinas held that they are, and that in everything except God there is a real composition between them. This theory allows Aquinas, who does not believe that every creature is a composite of matter and form, to identify one sense in which nevertheless God alone is noncomposite. Not many of his successors followed him, however, in this insistence that the distinction between essence and existence is real. Some, such as Duns Scotus, held the distinction to be more than mental, but less than real, while Ockham argues that “essence” and *esse* mean the same thing.

The same thinkers also considered whether “being” in a general sense is a notion under which fall both God and his creatures. Aquinas insisted that the notion applies only analogically (and so equivocally) to God, on the one hand, and created things on the other. Scotus (followed by many fourteenth-century thinkers) argued for a subtle form of univocal predication of “being,” although he fully acknowledged that God’s infinite way of being is unlike that of any creature.

See also *Aristotelianism; Form, Metaphysical, in Ancient and Medieval Thought; Metaphysics: Renaissance to the Present*.

BIBLIOGRAPHY

PRIMARY SOURCES

Aristotle. *Metaphysics*. In *The Complete Works of Aristotle*, edited by Jonathan Barnes. Vol. 2. Princeton, N.J.: Princeton University Press, 1985. Translations with extensive philosophical annotation of individual books of the *Metaphysics* can be found in the Clarendon Aristotle Series, published by Oxford University Press.

Plato. *Dialogues*. Various translations are available.

Aquinas, Thomas. *Selected Philosophical Writings*. Edited and translated by Timothy McDermott. Oxford and New York: Oxford University Press, 1993. Contains a number of passages central to Aquinas’s metaphysics, including the whole of *De ente et essentia*, 90–113.

SECONDARY SOURCES

Barnes, Jonathan. “Metaphysics.” In *The Cambridge Companion to Aristotle*, edited by Jonathan Barnes, 66–108. Cambridge, U.K., and New York: Cambridge University Press, 1995.

Dumont, S. “Henry of Ghent and Duns Scotus.” In *The Routledge History of Philosophy*, Vol. 3: *Medieval Philosophy*, edited by John Marenbon, 291–328. London and New York: Routledge, 1998. The chapter is almost entirely on their metaphysics.

White, Nicholas P. “Plato’s Metaphysical Epistemology.” In *The Cambridge Companion to Plato*, edited by Richard Kraut, 277–310. Cambridge, U.K.: Cambridge University Press, 1992.

Wippel, John F. “Essence and Existence.” In *Cambridge History of Later Medieval Philosophy: From the Rediscovery of Aristotle*

to the Disintegration of Scholasticism, 1100–1600, edited by Norman Kretzmann, Anthony Kenny, and Jan Pinborg, 385–410. Cambridge, U.K., and New York: Cambridge University Press, 1982.

John Marenbon

RENAISSANCE TO THE PRESENT

Metaphysics, in its most basic sense, is an account of what exists. It may include accounts of what sorts of things exist; of what really exists as opposed to what merely appears to exist; of what exists necessarily rather than by accident; of what it is that underlies everything else; or of the most general laws governing existing things. This article will describe some of the most important metaphysical positions that have appeared since the Renaissance and, where space permits, some of the reasons that have motivated the philosophers who hold them. The dates given for different eras are particular to this discussion. They name the year of birth of the earliest philosopher covered in each section and the year of death of the latest.

The Renaissance (1433–1617)

Better and more widely available texts of the writings of Plato mark the Renaissance. The new, widespread distribution of Platonic and Neoplatonic works, due in large part to the work of Marsilio Ficino (1433–1499) led to a major revival of those views. One of Ficino’s most influential views is his account of a hierarchy of perfection among existing things in which the highest thing, God, possesses the most perfection and the lowest thing, the body, the least.

The philosophy of the Renaissance remained, however, generally Scholastic. That is, it was dominated by Aristotelian views as codified by medieval commentators. Among Scholastics, Francisco Suárez (1548–1617) is notable for offering a definition of metaphysics as the science of being qua being, which distinguishes metaphysics from less lofty accounts of accidental features of existing things and focuses inquiry on the nature of being itself. Suárez’s seminal work, *Disputationes metaphysicae* (1597), also offered an original account of the metaphysical status of universals, in which it is true that only individual things exist but contrary to nominalism—the view that universal terms are merely labels for arbitrary collections of individuals—it is also true that universals are abstractions from nonconventional similarities among individuals.

The Early Modern Period (1561–1753)

Early modern metaphysics is in large part a response to the challenges that dramatic advances in physics and astronomy presented for theology and Aristotelian philosophy. Francis Bacon (1561–1626) is the figure who perhaps best marks the transition between Renaissance and early modern philosophy. Bacon’s major work, *The New Organon*, as its title suggests, was an attempt to supplant Aristotle’s authority. Two doctrines of that work form the basis of many of the period’s debates. First, Bacon asserted that a traditional part of metaphysics, the inquiry into the final causes, or purposes, of nature, is barren, thereby divesting natural science of an important theological element. Second, Bacon denied that forms,

FINAL CAUSES

[The mind] falls back on things that are more familiar, namely final causes, which are plainly derived from the nature of man rather than of the universe, and from this origin have wonderfully corrupted philosophy. (Bacon, 1620, p. 44)

When dealing with natural things we will, then, never derive any explanations from the purposes which God or nature may have had in view when creating them and we shall entirely banish from our philosophy the search for final causes. (Descartes, 1647, vol. 1, p. 202)

Nature has no end set before it, and . . . all final causes are nothing but human fictions. (Spinoza, 1660s? *Ethics* I Appendix)

Whatever Descartes may have said, not only efficient causes, but also final causes, are to be treated in physics, just as a house would be badly explained if we were to describe only the arrangement of its parts, but not its use. (Leibniz, 1702, pp. 254–255)

May I regard purpose-like orderings as intentions. . . ? Yes, but . . . it must not matter at all whether you say, “God has wisely willed it so” or “Nature has wisely so ordered it.” (Kant, 1781, p. 620)

[Spirit] is in itself the movement which is cognition—the transforming of the in-itself in that which is for-itself, of substance into subject. (Hegel, 1807, p. 488)

understood as abstract natural kinds, are principally what exists. Metaphysics, on Bacon’s view, is the study of first and formal causes in nature. It is, in short, the study of the most general laws or reasons by which natural events may be understood.

René Descartes (1596–1650) followed Bacon in denying that explanations in terms of final causes are appropriate in the sciences. He defended the existence and perfection of God but focused his metaphysics, as Bacon did, on providing an account of the natural world. In his most important philosophical works, *Meditations on First Philosophy* (1641) and *Principles of Philosophy* (1644), he argued that there are two basic kinds of substances or things with independent existence: minds and bodies. Any substance is characterized by a property necessary for its existence, which Descartes called in different places its nature, essence, or attribute. The nature of mind is thought; of body, extension. Substances have, in addition, properties that are not essential to them and that they can gain or lose without themselves going out of existence. Such properties are called modes or affections.

Descartes’s metaphysics is best known for one argument and a problem that the argument generates. He argued that

the existence of the self can be known for certain just because, at the very time one doubts the proposition “I exist,” one is at the same time thinking and therefore existing (Descartes, vol. 1, pp. 194–195). From this argument, often referred to as “the cogito,” Descartes eventually concluded that the essence of mind—and so perhaps of the person—is thought. However, it is clear that people have and are intimately aware of their own bodies. The mind-body problem arises from an attempt to give an account of human nature. Are people essentially, minds, bodies, or both? Moreover, if people are both, the relationship between mind and body needs to be explained. For Descartes, this latter problem was especially difficult. He endorsed a view of perfection in the world much like that of Ficino, in which minds are much more perfect than bodies, so he had to explain in his theory of perception how something less perfect apparently causes changes in something more perfect.

Benedictus, or Baruch, de Spinoza (1632–1677) published during his lifetime a well-received commentary on Cartesian philosophy. Many of his best-known metaphysical positions, which are found in their most mature form in his posthumously published *Ethics*, can be understood as reactions to Cartesianism. Spinoza identified God with Nature and

defended against Cartesian dualism a substance monism in which God is the only substance (EIp14) and possesses all attributes (Spinoza, EId6), including both extension and thought. Spinoza rejected any purpose in nature. (Spinoza is cited here in the customary fashion. For example, EIIp7 means *Ethics*, Part II, proposition 7.) He defended, largely against Descartes, necessitarianism (EIp33), the view that things could not have been any other way than the way they are, and universal determinism (EIp28–Ip29), in which every existing mode is the effect of some efficient cause. Spinoza addressed the mind-body problem by means of the doctrine known as parallelism, in which mind and body do not interact (EIIp7). Instead, the chain of causes and effects may be understood equally well as a chain of exclusively mental or exclusively physical events.

John Locke (1632–1704), whose philosophy is, much like Bacon's, an attempt to vindicate mechanistic science, adopted a slightly different notion of substance. For Locke, substances are much the same things as Cartesian substances—persons, God, angels, and ordinary material objects. Substances are so designated, however, not because of their independent existence but because they form a substratum for clusters of properties in which those properties inhere and which can survive change in those properties. Although Locke, like his predecessors, described modes at length, he considered them properly ideas rather than properties of substance. The important, knowable properties of substance, in his view, are qualities. In his *Essay concerning Human Understanding*, Locke famously (or notoriously) defended Robert Boyle's (1627–1691) distinction between primary qualities, such as extension, which really are in substances, and secondary qualities, such as white, which are mere powers to produce certain sensations in people (Locke, 2.8.12–13). This doctrine may be a result of Locke's attempt to ground corpuscularian physical theories, in which extension and other primary qualities were supposed to explain color perceptions and other secondary qualities.

Gottfried Leibniz (1646–1716) was perhaps the most sophisticated metaphysician of the early modern period. He read his predecessors and contemporaries widely and engaged with their views in a variety of contexts. Leibniz was by temperament conciliatory, and his sympathy toward Scholasticism emerges most clearly in his attempt to reintegrate final causes into metaphysics, both at the level of scientific explanation and at the very general level (pp. 52–55). Leibniz's fundamental metaphysical principle, the Principle of Sufficient Reason, is the doctrine that there is reason for every state of affairs. At the most general level, this reason must be in terms of God's purposes: God chooses that the world be this world rather than other possible worlds because this one is the best of all possible worlds (pp. 96–97). The Principle of Sufficient Reason formed the basis for some powerful criticisms of Newtonian physics. It is also the principal target of Voltaire's satire, *Candide*.

From at least the 1680s, Leibniz understood substances in grammatical terms, as subjects of predication that cannot themselves be predicated of something else. For example, "a king" can be either the subject or predicate of a proposition, so it is not substance; "Alexander," however, can only be a subject, so Alexander is a genuine substance (pp. 41–42). Because Leibniz

KANT'S "COPERNICAN REVOLUTION" IN METAPHYSICS

Up to now it has been assumed that all our cognition must conform to the objects; but all attempts to find out something about them a priori through concepts that would extend our cognition have, on this presupposition, come to nothing. Hence let us once try whether we do not get farther with the problems of metaphysics by assuming that objects must conform to our cognition, which would agree better with the requested possibility of an a priori cognition of them, which is to establish something about objects before they are given to us. (B xvi, p. 110)

conceived of each substance as a complete concept or a subject with a comprehensive list of true predications of it, he denied that substances change. So he denied, at the strictly metaphysical level, causal interaction among substances (p. 47). His grammatical conception of substance caused him to endorse a version of idealism, the view that substances cannot be material (p. 79) and in 1714 the theory of monads, his mature metaphysics in which all things either are or are composed of simple, indivisible, inalterable, indestructible, perceiving things.

George Berkeley (1685–1753) formulated an influential version of idealism. He was influenced by Leibniz's views on material objects and also by the Cartesian Nicolas Malebranche's (1638–1715) criticisms of accounts of causal influence among bodies. His most explicit target, however, was Locke's version of the distinction between primary and secondary qualities. Berkeley argued that Locke was right to think that sensations such as pain and white that are caused in people do not resemble their objects but that Locke had no reason for thinking that the perception of extension and other purported primary qualities is different. In either sort of case, one has access only to one's sensations, and these are certainly ideas. Berkeley identified ordinary objects and the physics of ordinary objects, then, as concerning ideas rather than their cause, which can only be God.

David Hume (1711–1776) followed Berkeley in construing ordinary objects as ideas (1.2.6). He was, however, skeptical about the causes of ideas and indeed is best known for his skepticism about causality generally. Hume denied that any sort of necessary connection could be known through experience and so denied all causal connections of the sort asserted by many of his predecessors. He redescribed causal relations as laws concerning the causal conjunction of events of one sort with events of the other. Hume has traditionally been understood as moving from causal language in the description of nature, in which

THE REJECTION OF METAPHYSICS

[Pragmatism] will serve to show that almost every proposition of ontological metaphysics is either meaningless gibberish,—one word being defined by other words, and they by still others, without any real conception ever being reached,—or else is downright absurd. (Peirce, “What Pragmatism Is”)

The fundamental faith of the metaphysicians is the faith in opposite values. . . . one may doubt, first, whether there are any opposites at all, and secondly whether these . . . opposite values . . . are not perhaps merely foreground estimates, only provisional perspectives, perhaps even from some nook, perhaps from below. (Nietzsche, section 2)

The non-theoretical character of metaphysics would not be in itself a defect. . . . the danger lies in the deceptive character of metaphysics; it gives the illusion of knowledge without actually giving any knowledge. This is why we reject it. (Carnap, “The Rejection of Metaphysics,” from *Philosophy and Logical Syntax*, 1934, section 5)

events of one sort are said to cause events of another sort, to the language of laws, in which, more modestly, events of one sort are said to follow events of another sort with lawlike regularity.

German Idealism (1724–1831)

German idealists attempted to preserve causal laws and other necessary truths about objects by emphasizing the role of the self in understanding objects. As the movement developed, figures such as Gottlieb Fichte (1762–1814) went further, arguing that, in a sense, the self creates objects.

Immanuel Kant (1724–1804), in his *Critique of Pure Reason*, defended the view, largely against Hume, that there are basic a priori laws, including causal laws, governing all objects of experience. Kant’s “Copernican Revolution” in metaphysics changed the focus of metaphysical inquiry from nature exclusively to the thinking self as it understands nature. He argued that there are concepts—Categories—and space and time—Forms of Sensible Intuition—by which one understands and experiences things. Because one cannot but think things under these Categories and Forms, they are a priori conditions of different kinds of thought and therefore form the basis for judgments of necessity. Kant described his view as “transcendental idealism” because, although the Categories and Forms make possible objectively valid and necessary laws governing objects of experience, they cannot be ascribed to objects except insofar as those objects are experienced.

In experience, Kant rescued the traditional metaphysical distinction between form and matter: form is the a priori aspect of experience that mind imposes on matter in cognition. The inquiry into the nature of objects independent of experience by means of concepts, however, which Kant understood as the

project of traditional metaphysics, cannot produce knowledge. However, Kant allowed that such inquiry, which he called “dialectic,” is founded upon important human interests, such as the quest to understand practical freedom or to find purposiveness or systematic unity in nature.

Georg Hegel (1770–1831) held that ultimately only spirit is real. Hegel argued that history, in particular the history of human society, is a history of dialectical thought. Hegel, then, moved mind out of the individual altogether and eventually into an account of stages of human consciousness that are at once a kind of progression of reasoning, steps of psychological development, and social structures. *Dialectic* had a very different meaning for Hegel from that which Kant gave it. Hegel retained a focus on the process of reasoning that characterized Kant’s dialectic and continued to consider the question of the invalidity of particular applications of a concept. The invalidity of a particular kind of reasoning is, however, of interest principally not because it makes a category mistake in applying concepts inappropriately but as itself a flawed way of being or experiencing objects in the world, which, because of its flaws, leads also to a particular new way of being.

The End of Metaphysics (1839–1980)

Kant himself rejected metaphysics, considered as an attempt to know objects outside experience. Forms of that position characterized three major recent philosophical movements that drew on his emphasis on the thinking self and his devotion to empiricism.

American Pragmatism. This movement emphasized, following Kant and in some cases Hegel, the role of concepts in experience. John Dewey (1859–1952) argued that concepts distort our understanding of the unity of nature. Charles Peirce

(1839–1914) similarly took conceptual analysis to demonstrate that the propositions of traditional metaphysics are nonsensical. William James (1842–1910) defended the use of concepts and took metaphysics to be the task of understanding why people organize experience the way they do. Some traditional metaphysical notions remained in American Pragmatism. Peirce, for example, defended an account of generals, a theory of natural kinds. However, the movement was generally critical of traditional, a priori metaphysics.

Phenomenology and existentialism. These movements, which started perhaps with the works of Nietzsche, emphasized the importance of perspective for undermining or perhaps reassessing metaphysics.

Phenomenology is the study of things as one experiences them. In *Ideas*, Edmund Husserl (1859–1938) argued that this project requires setting aside questions of existence, which amounts to making questions of metaphysics secondary to questions of experience. Martin Heidegger (1889–1976), slightly differently, made questions of existence, or being, just questions of experience. The study of being is not, for Heidegger, then, the study of the being of fundamental things in the universe that are independent of experience but instead the study of the being of things as they are experienced and, perhaps more important, formed and conceived by the thinker. Existentialism, perhaps best known from the works of Jean-Paul Sartre (1905–1980), in the most general terms is the conclusion, from either of these positions, that there are no metaphysical facts about the world, with the result that if one really needs such facts, as Kant suggested, one must either create them or insist upon what one has no claim to know.

Logical positivism. Ludwig Wittgenstein (1889–1951) and Rudolf Carnap (1891–1970) derived, largely from Kant, the view that knowledge is only of objects of experience. Logical positivists held, furthermore, that as terms apply meaningfully only to objects of experience, metaphysical claims are not merely false or mistaken but nonsensical. The movement was largely responsible for making language and its meaning the focus of a great deal of recent philosophical inquiry in metaphysics and also in epistemology and ethics.

Twenty-First-Century Developments

It is difficult to predict the debates and positions for which the early twenty-first century era will be remembered. A result of the focus on language and meaning produced by logical positivism is perhaps that many important metaphysical debates at the beginning of the twenty-first century have centered not on the question of what existence is or is like generally but on the question of whether particular sorts of things exist. A response to the positivist challenge to ethics, for example, has been to claim that terms in ethics are meaningful in the sense that they refer to real, existing things in the world, good and evil. In modal metaphysics, questions about the meaningfulness of possibility have produced debates over the metaphysical status of possible worlds: are possibilities real, and if so, how are they different from actual existents? Finally, the mind-body problem, now recast as the question of the relationship between the mind and the brain, and the existence

of general or natural kinds, often a problem for set theory, have remained hotly debated matters.

The tradition of phenomenology and existentialism has given way to the movements of structuralism and deconstructionism. Proponents of these methods might, like many phenomenologists, deny that they study anything like traditional metaphysics. Structuralists abstract from the genesis and subject of a particular kind of world or experience and analyze it as a product of thought, or text, without a thinker, who, it is argued, is irrelevant to meaning. Deconstructionism is the view that largely as a result of the fact that texts are created by thinkers, the relevant structures are binary and can be understood in terms of opposition within the structure. The aim of deconstruction is to show how, like the self and the world for Fichte, the opposed units in the structures depend upon one another.

See also *Knowledge; Philosophy; Pragmatism.*

BIBLIOGRAPHY

- Bacon, Francis. *The New Organon*. Edited by Lisa Jardine and Michael Silverthorne. Cambridge, U.K.: Cambridge University Press, 2000.
- Carnap, Rudolf. *Philosophy and Logical Syntax*. Bristol, U.K.: Thoemmes Press, 1996. This most recent edition is out of print. The work is widely available online.
- Descartes, René. *The Philosophical Writings of Descartes*. 3 vols. Translated by John Cottingham, Robert Stoothoff, Dugald Murdoch, and Anthony Kenny. Cambridge, U.K.: Cambridge University Press, 1991.
- Hegel, Georg. *Phenomenology of Spirit*. Translated by A. V. Miller. Oxford: Clarendon Press, 1977.
- Husserl, Edmund. *Ideas Pertaining to a Pure Phenomenology and to a Phenomenological Philosophy. First Book: General Introduction to a Pure Phenomenology*. Translated by D. Cairns. Dordrecht: Kluwer, 1988.
- Kant, Immanuel. *Critique of Pure Reason*. Translated and edited by Paul Guyer and Allen W. Wood. Cambridge, U.K.: Cambridge University Press, 1998.
- Leibniz, Gottfried. *Philosophical Essays*. Edited and translated by Roger Ariew and Daniel Garber. Indianapolis: Hackett, 1989.
- Locke, John. *An Essay concerning Human Understanding*. Edited by Peter Nidditch. Oxford: Clarendon, 1975.
- Nietzsche, Friedrich. *Beyond Good and Evil*. Translated by Walter Kaufman. New York: Vintage Books, 1966.
- Peirce, C. S. "What Pragmatism Is." *Monist* 15, no. 2 (1905): 161–181.
- Spinoza, Benedictus de. *The Collected Works of Spinoza*. Vol. 1. Edited and translated by Edwin Curley. Princeton, N.J.: Princeton University Press, 1985.

Michael LeBuffe

MICROCOSM AND MACROCOSM. Microcosm and macrocosm are two aspects of a theory developed by ancient Greek philosophers to describe human beings and their place in the universe. These early thinkers viewed the individual human being as a little world (*mikros kosmos*) whose

composition and structure correspond to that of the universe, or great world (*makros kosmos*, or *megas kosmos*). *Kosmos* at this time meant “order” in a general sense and implied a harmonious, and therefore beautiful, arrangement of parts in any organic system; hence it also referred to order in human societies, reflected in good government. Comparisons between society and the human being, as well as society and the universe, were varieties of microcosmic theory. These analogies enjoyed a long life, first in the Mediterranean region during antiquity and later throughout Europe during the Middle Ages. The ideas were commonplace during the Renaissance and early modern times but lost their plausibility when a mechanistic model of the universe became dominant in the seventeenth and eighteenth centuries.

Origins

The most fully developed version of the idea in antiquity was made by Plato (427?–347 B.C.E.), but fragmentary evidence indicates that philosophers before him articulated some version of it. The idea may have begun as an archetypal theme of mythology that the pre-Socratic philosophers reworked into a more systematic form. Unfortunately, it is impossible to reconstruct their thinking in much detail, and clear references attributing the doctrine to Democritus (c. 460–c. 370 B.C.E.) and Pythagoras (c. 582–c. 507 B.C.E.) are quite late, dating to the fifth and ninth centuries C.E., respectively. Some form of the idea seems to have been common among most ancient cultures. Since comparisons of human beings and the universe were made in India and China, the concept may ultimately be of Asian origin; but the available sources do not indicate that the theory in Greece was the result of cultural diffusion. Among extant Greek texts, the term first appears in the *Physics* of Aristotle (384–322 B.C.E.), where it occurs in an incidental remark (*Physics* 8.2, 252b). Plato did not use the terminology when he developed the idea.

Plato

In the *Philebus* (28d–30d), Plato argued that human beings and the universe are both composed of an elemental body and a rational soul, and that just as the human body derives from the universe’s body, the human soul must derive from the universe’s soul. The universe is, therefore, not only an orderly system but an intelligent organism as well. Plato expounded this theme at greater length in the *Timaeus* (29d–47e), where he explained how the structure of the human being parallels that of the universe through certain correspondences in body and soul. Just as the body of the universe is spherical, and its soul is composed of orbits along which the planets wander, so too the soul of the human being is composed of orbits along which its emotions rove, and it inhabits the head, which is spherical. The rest of the human body exists merely to serve the head.

Unlike the macrocosm, which contains all things and is immortal, and hence has no need of sensory or digestive organs or limbs for locomotion, the microcosm is only a part of the whole, and its existence is threatened by the surrounding elements, so that it needs such additional parts to perceive and avoid danger and to replenish the nutrients it loses. Furthermore, the external disturbances that threaten the microcosm cause the orbits of its soul to be disrupted, throwing its

emotions into disarray. Yet when the disordered microcosm observes the heavens, it sees there the orderly motions of the planets following the orbits of the macrocosmic soul. With the aid of philosophical study, it becomes aware of the correspondence between itself and its great counterpart. Having attained this insight, the microcosm realizes that just as the universe employs reason to govern the planets, it too should employ reason to govern its emotions. In this way the microcosm overcomes its inner discord and prepares its soul for a return to the heavens from which it came.

The Body Politic

In the *Republic* (Book 4), Plato united the microcosmic theme with the pre-Socratic tendency to view cosmology in political terms when he discussed his model of an ideal city-state in order to explore the nature of the human soul. The structure of each is tripartite and hierarchical. The class of philosopher-kings corresponds to reason (located in the head), the warrior class corresponds to irascibility (located in the breast), and the worker class corresponds to appetite (located in the belly). If the city or the soul is to function in harmony, the lower parts must obey the higher, and the higher must guide prudently. This organic notion of the body politic exerted an extraordinary appeal. St. Paul of Tarsus used it to describe the church as the mystical body of Christ (1 Corinthians 12, et al.), and medieval thinkers such as John of Salisbury (c. 1110–1180), in the *Polycraticus*, and Marsilius of Padua (c. 1270–c. 1342), in the *Defensor pacis*, presented their political ideas within its framework. Theories of the body politic remained strong in early modern times, even inspiring the *Leviathan* of Thomas Hobbes (1588–1679).

The common contemporary use of organic analogies to describe the nation or the country is, therefore, an inheritance from earlier macrocosmic metaphors. This way of thinking was not confined to the West. It was, for example, reflected in the Indian Vedas, which explained the caste system by way of an anatomical analogy according to which each level of the social order sprang from a bodily part of Brahma, the Hindu creator-god.

Hellenism and Late Antiquity

Among the Hellenistic philosophers, the Stoics preserved the idea of the universe as a living organism, but the human being as a miniature image of it did not, apparently, interest them as much. The Middle Platonists also accepted the existence of a world-soul and, like the Stoics, considered it divine. The Neoplatonist Plotinus (205–270 C.E.) refined this idea and called the human being “an intelligible world” (*Enneads* 3.4.3) who, like the universe, is an intellect that governs a soul that animates a material body. Later Neoplatonists, believing that the correspondences between microcosm and macrocosm, if properly invoked, would allow them to draw upon hidden reserves of psychic energy immanent in the living universe, employed a form of ritual magic called “theurgy” to assist them in their spiritual aspirations. Others less spiritually inclined, however, hoped to use these cosmic sympathies to manipulate the world for material benefit or to predict the course of future events. Astrologers employed the theory of melothesia—that each sign

of the Zodiac corresponds to a specific part of the human body—in the practice of medicine.

The broad appeal of the microcosm is reflected in its adoption by Jews, Christians, Gnostics, Manichaeans, and the authors of the Hermetic corpus (attributed to Hermes Trismegistus). The Jewish philosopher Philo of Alexandria (c. 20 B.C.E.–c. 50 C.E.) somewhat anticipated Plotinus by calling man “a miniature heaven” (*On the Creation* 27.82). He preferred, however, to compare the human being with God, since Scripture taught that man and woman were made in God’s image and likeness (Genesis 1:26–27); he reasoned, therefore, that human souls govern their bodies in much the way that God governs the physical world (*On the Creation* 23.69). Philo employed unusual terminology, substituting for *mikros kosmos* the expression *brachys kosmos*, or “short world,” which appeared later as *brevis mundus* in the Latin works of Calcidius (*Commentary on Plato’s Timaeus*, 202; third or fourth century C.E.) and Macrobius (*Commentary on Cicero’s Dream of Scipio*, 2.12; fl. c. 430 C.E.).

Jewish and Muslim Theories in the Middle Ages

Medieval theories of the microcosm developed separately in the three religious traditions, but there were some points of contact between Jews and Muslims. The Talmud and the Midrash included a few microcosmic references, and the theory was very prominent in the mystical tradition known as the Kabbalah. The earliest kabbalistic text, the *Book of Creation* (*Sefer Yetzirah*); perhaps composed between the third and sixth centuries C.E.), observed correspondences between the letters of the Hebrew alphabet, features of the physical world, and the human body. The thirteenth-century *Book of Splendor* (*Zohar*) taught that the first emanation in the creative process is the cosmic man (Adam Kadmon), through whom the rest of creation emanates, so that terrestrial human beings are modeled on an ideal form that provides the pattern for all of creation.

Arabic influence may have inspired two Jewish philosophers, Ibn Gabirol (Avicbron, c. 1021–c. 1058) in his *Fountain of Life*, and Ibn Sadiq (1075–1149) in his *Microcosm*, to combine microcosmic speculation with the Delphic maxim, “Know thyself”; both demonstrated how self-knowledge leads to knowledge about the universe. Although Maimonides (1135–1204) found fault with certain aspects of microcosmic theory in his *Guide for the Perplexed* (1.72), he nevertheless accepted much of it.

The most remarkable development of the microcosm among the Muslims appeared in the encyclopedia known as the *Epistles* (*Rasa’il*) of the Brethren of Purity (*Ikhwan-al-Safa*) in the city of Basra during the tenth and eleventh centuries. While two of its fifty-two treatises are devoted to microcosm and macrocosm, correspondences between the two worlds are noted throughout the work as it traces the procession of creatures from God and their mystical return to God through human understanding. Al-Biruni (973–c. 1051) accepted the microcosmic model, while Ibn Sina (Avicenna, 980–1037) made it the foundation of his theory of medicine.

Greek Christian Theories

Although the ancient idea of the microcosm appealed to many Christian thinkers, their view of the macrocosm as an

inanimate structure created by God *ex nihilo* at the beginning of time led to major alterations of the ancient theory. Most conspicuously, the world-soul was omitted or interpreted allegorically as a reference to God’s providential care for the created world. Although Greek Christians, unlike the Latins, had direct access to the ancient sources, they were ambivalent about the pagan philosophical heritage.

Gregory of Nyssa (c. 335–c. 394) criticized the comparison of humanity with the universe (*De hominis opificio*, 17), stressing, like Philo, that it was more appropriate to compare humanity with God; but he nevertheless retained a modified version of the theory. Cosmas Indicopleustes, a sixth-century Greek from Alexandria in Egypt, rejected the idea of a spherical world in his *Christian Topography*, since he considered Moses’ tabernacle a symbolic representation of the universe. He nevertheless accepted the idea that humanity contains the universe within itself and therefore thought the pagans were right to have called man a microcosm (Book 7).

Greek theologians tended to view humanity as a mediator who united the material and spiritual worlds by virtue of being the only creature to possess both a body and a rational soul; at this critical juncture in the chain of being, humanity shared some characteristic with every kind of creature and thus represented the entire universe. The Greek fathers influenced the anthropology of the Irish Neoplatonist, John Scot Eriugena (c. 800–c. 877), but the idea of the microcosm in the Latin West was received mainly through Calcidius and Macrobius, and disseminated by the encyclopedist Isidore of Seville (c. 560–636; *De natura rerum*, 9.2) and the Venerable Bede (673?–735; *De temporum ratione*, 35).

Latin Christian Theories

Latin terminology generally assumed comparative forms—“lesser world” (*minor mundus*) and “greater world” (*maior mundus*)—although it also adopted the Greek loanwords *microcosmus* and *macrocosmus* (or more commonly *megacosmus*). Latin treatments of the microcosm were generally superficial until the twelfth century, but certain distinctive features did appear before then. Although Augustine of Hippo (354–430) preferred the comparison of humanity to God, he developed a theory of the seven ages of man and the world, which was a projection of the seven days of creation and the seven stages of the human life cycle onto history (*De Genesi contra Manichaeos*, 1.22.33–1.23.41). Pope Gregory the Great (c. 540–604) offered a concise and oft-repeated formula that combined the microcosm with the concept of the Chain of Being, whereby humanity was thought to contain all of creation because it shares simple existence with stones, life with plants, sensation with beasts, and reason with angels (*Homiliae in Evangelium*, 29).

Under Gregory’s influence, Jesus’ injunction to preach to “all creation” (Mark 16:15) was commonly interpreted as a reference to the human race in its status as an epitome of the created world. Robert Grosseteste (c. 1175–1253) later suggested in several works that the Incarnation not only fulfilled a redemptive role but also reconciled the creator to all creatures, since God became the creature who embodies all

creation. This cosmological role of the Incarnation was restated by Nicholas of Cusa (1401–1464) in *Learned Ignorance* (*De docta ignorantia*, 3.3).

The microcosm received special attention in the Latin West during the twelfth century, when a revival of Platonism coincided with a keen interest in the natural world and new confidence in the power of human reason. The most extraordinary product of this fusion was the *Cosmographia* of Bernardus Silvestris, written about 1147 in two books entitled *Megacosmus* and *Microcosmus*, which depict the creation of the two worlds by Neoplatonic emanations, personified as characters in a mythological drama. The intellectual atmosphere that fostered such creative approaches to old ideas also influenced spiritual meditation, which is evident in Hildegard of Bingen's (1098–1179) *Book of Divine Works* and in the allegorical commentary on Genesis by Godfrey of Saint-Victor (c. 1125–1194). Microcosmic thinking had always been implicit in monastic studies of Genesis that compared the human soul to the physical world by viewing God's work during the six days of creation figuratively, as stages of spiritual progress that the monk should pursue. Godfrey noted the similarity between the ancient theory and the medieval hermeneutical method and made the connection explicit by entitling his book *Microcosmus*.

Early Modern Theories and Aftermath

The scholasticism of the thirteenth and fourteenth centuries had little use for highly malleable metaphors, and it was not until the Platonic revival of the Renaissance that the microcosm again received substantial attention. Although Ernst Cassirer argued that Renaissance thinkers significantly redefined the microcosm (*The Individual and the Cosmos in Renaissance Philosophy*, trans. 1964), one must acknowledge that the fifteenth-century philosophers actually owed more of a debt to medieval conceptions than Cassirer supposed, as observed by Bernard McGinn (*The Golden Chain*, 1972). For instance, Nicholas of Cusa's christological use of the microcosm had already been outlined by Robert Grosseteste (as noted above), and although Giovanni Pico della Mirandola (1463–1494) offered a sustained discussion of the microcosm in his *Heptaplus* (a commentary on the creation-account in Genesis), much of his contribution in that work consisted of bringing together different currents of microcosmic theory (a testament to his wide reading and powers of synthesis). Although a new application of the ancient theory was made by Paracelsus (1493?–1541), his innovation promoted an alchemical theory of medicine rather than philosophical conceptions of the self.

Despite a surge of interest in the microcosm during the early modern period, reflected in a wide range of disciplines, the theory did not lead to new discoveries and it was gradually relegated to the margins of science and philosophy along with the "occult" disciplines that maintained an affinity to it. One of the last major statements of the theory on the verge of its abandonment by most philosophers and scientists was Robert Fludd's (1574–1637) impressively illustrated *History of the Macrocosm and Microcosm* (*Utriusque cosmi, maioris scilicet et minoris ...historia*, 1617–1621); it is significant that Fludd's grand synthesis was regarded as a bible of Rosicrucianism, a mysterious movement associated with occultism.

The microcosm continued to inspire esoteric thinkers and opponents of modern materialism, such as the theosophist H. P. Blavatsky (1831–1891), who combined the microcosm with evolution in *The Secret Doctrine* (1888), and the anthroposophist Rudolf Steiner (1861–1925), whose lectures on the two worlds, delivered in 1910, were later published as *Makrokosmos und Mikrokosmos* (1933). Although the idea of the microcosm as a synonym for humanity became untenable among mainstream thinkers by the eighteenth century, the word itself was retained as a reference to any subsystem, in which sense it is commonly used today.

See also **Christianity; Neoplatonism; Organicism; Platonism.**

BIBLIOGRAPHY

PRIMARY SOURCES

- Bernardus Silvestris. *The Cosmographia of Bernardus Silvestris*. Translated by Winthrop Wetherbee. New York: Columbia University Press, 1973.
- Hildegard of Bingen. *Hildegard of Bingen's Book of Divine Works, with Letters and Songs*. Edited by Matthew Fox. Santa Fe, N.M.: Bear and Company, 1987.
- Ibn Sadiq, Joseph. *The Microcosm of Joseph Ibn Sadiq*. Critically edited by Saul Horowitz; translated by Jacob Haberman. Madison, N.J.: Fairleigh Dickinson University Press, 2003.
- Pico della Mirandola, Giovanni. *On the Dignity of Man, On Being and the One, Heptaplus*. Translated by Charles Glenn Wallis, Paul J. W. Miller, and Douglas Carmichael. Indianapolis: Bobbs-Merrill, 1965.

SECONDARY SOURCES

- Allers, Rudolf. "Microcosmus: From Anaximandros to Paracelsus." *Traditio* 2 (1944): 319–407.
- Altmann, Alexander. "The Delphic Maxim in Medieval Islam and Judaism." In *Biblical and Other Studies*, edited by Alexander Altmann, 196–232. Cambridge, Mass.: Harvard University Press, 1963.
- Boas, George. "The Microcosm." In *The History of Ideas: An Introduction*, 212–238. New York: Scribners, 1969.
- Conger, George Perrigo. "Cosmic Persons and Human Universes in Indian Philosophy." *Journal and Proceedings of the Asiatic Society of Bengal New Series*, 29 (1933): 255–270.
- . *Theories of Macrocosms and Microcosms in the History of Philosophy*. New York: Russell and Russell, 1967. Reprint of a Columbia University dissertation from 1922.
- Dales, Richard C. "A Medieval View of Human Dignity." *Journal of the History of Ideas* 38 (1977): 557–572.
- Finckh, Ruth. *Minor Mundus Homo: Studien zur Mikrokosmos-Idee in der mittelalterlichen Literatur*. Göttingen: Vandenhoeck and Ruprecht, 1999.
- Guthrie, W. K. C. "Man's Role in the Cosmos. Man the Microcosm: the Idea in Greek Thought and its Legacy to Europe." In *The Living Heritage of Greek Antiquity*, 56–73. European Cultural Foundation. The Hague: Mouton, 1967.
- McGinn, Bernard. *The Golden Chain: A Study in the Theological Anthropology of Isaac of Stella*. Washington, D.C.: Cistercian Publications, 1972.
- Nasr, Seyyed Hossein. *An Introduction to Islamic Cosmological Doctrines: Conceptions of Nature and Methods Used for Its Study by the Ikhwan-al-Safa, al-Biruni, and Ibn Sina*. Albany: State University of New York Press, 1993.

- Norford, Don Parry. "Microcosm and Macrocosm in Seventeenth-Century Literature." *Journal of the History of Ideas* 38 (1977): 409–428.
- Saxl, F. "Macrocosm and Microcosm in Mediaeval Pictures." In *Lectures*, Vol. 1, 58–72. London: Warburg Institute, 1957.

Robert Ziolkowski

MIGRATION.

This entry includes three subentries:

Africa
Migration in World History
United States

AFRICA

Historically, migration has been a way of life in Africa. Over the generations African people have migrated in response to demographic, economic, political, and other factors, including environmental disasters and conflicts. The histories of many African communities record their migratory movements from one area to another or the incursions of more powerful migrant groups who conquered and reorganized their societies. These large movements across the continent have accounted for the rapidity of the spread of new ideas and changes in culture.

Migration in Africa has been of three types: intra- and inter-country (internal) movements of people *within* the continent; movement from outside *into* the continent; and movement *from* the continent outward.

Internal Migration

Although the most prominent movement within the continent in historic times probably was that of the Bantu-speaking peoples, there have been many different movements of peoples from one region of the continent to another and over many centuries. Because of a population explosion that is yet to be fully understood, Bantu-speaking peoples have spread over most of the continent south of the equator. Bantu migrations were reflected in the expansion of Bantu languages in several parts of East, Central, and Southern Africa. Other examples of major intracontinental migration include that of the nomadic Bedouin Arab peoples, the Banu Hilal and the Banu Sulaym, into the Maghreb beginning from the second half of the eleventh century. They initiated a massive movement, infiltrating the cultivated lands while spreading westward from Tunisia to Morocco. The arrival of the Bedouin Arabs provoked a rapid Arabization of the Maghreb region. A high proportion of the Berbers were assimilated to the Arabs through intermarriage, and Arabic became the lingua franca for most of the population. In the mountainous areas, including the Atlas range in Morocco and the Kabylie mountains of Algeria, however, the Berbers maintained their language and culture, together with a fierce spirit of independence.

Intraregional migration also took place in West Africa. Hausaland, for example, was a major recipient of large-scale

migration, with peoples and groups coming from different directions and at different times for different purposes. Sources of migration into the Hausa country were the Sahel in the north, Bornu in the east, and the regions of the late Mali and Songhay empires in the west. The Fulani, who reached Hausaland from the west, were the most prominent immigrants into the region. The vast majority of Fulani immigrants were nomadic pastoralists in search of new and better grazing for their cattle, although there were also some Muslim clerics among them. Other migrant groups included the Tuareg, who were mostly pastoralists and who showed little interest in territorial occupation and settlement. Migrants from Bornu included refugees, aristocrats, merchants, and scholars who settled in all parts of Hausaland. Other immigrants were the Wangara/Dioula; the Songhay fishermen, who settled in the Lower Rima River Valley; and the Arab and Berber merchants and scholars who came from North Africa and the Timbuktu area and began entering the region in the second half of the fifteenth century, about the same time as the Fulani. The influx into the region was connected with the growing prosperity of the Hausa states and the adoption of Islam by further groups and strata of the urban population.

The dominant trend in internal migration in more recent times has been the movement from rural to urban areas. Contact with Western Europe facilitated the emergence of new towns and other urban centers that served as colonial administrative centers or as economic or industrial centers. Many capital cities of West African countries developed as artificial ports built on vacant or sparsely populated sites. These administrative, industrial, and commercial centers all experienced rapid growth during the years of colonial rule, with implications for migration. The new towns developed certain characteristics that contrasted sharply with the traditional culture. An improved physical environment—sanitary facilities, roads, street lighting, health services—combined with other rudiments of urbanism to provide the background to the rural-to-urban migration that was a hallmark of the colonial period. This prompted the "bright lights" theory of migration (that is, that rural-to-urban migrants tended to be attracted by the new facilities in the towns). However, empirical studies—such as the one on Tukulor migration to Dakar (Diop)—confirm that rural-to-urban migration was neither the outcome of an attraction to the city nor youthful rejection of traditional values. Rather, it resulted from serious and persistent underdevelopment in the communities of origin of the migrants. In the case of Tukulor migration from the Senegal River Valley, money sent back to the village by the new city dwellers was crucial to maintaining a minimum standard of living in the valley.

But regional economic disparities were not the only factors that prompted internal migration, particularly in the colonial times and after. The transformation of agriculture during this period that resulted from the creation of large plantations by the colonizers in certain regions of the continent was a major factor. The new plantations required a substantial labor force that was not always available locally. The required movement of population was often achieved by force. Colonial intervention in the mining sector prompted similar forceful movement of the people, achieved through policies designed to drive

peasants from their land and attract them to the mining areas. Moreover, colonial fiscal measures, particularly the introduction of the head tax payable in cash, also gave rise to migration. It was impossible for most rural families to raise the necessary sums from the village, and this necessitated the migration of one or more members of a household to the city. In other instances, villagers fled the tax by migrating to neighboring territories.

Intra- and intercountry migrations remain a prominent feature of African life. The persistence is partly the outcome of the fact that migrants have always considered the various subregions as single economic units within which trade in goods and services flowed. But more important, intraregional migration has been sustained by the persistence and intensification of widespread poverty, the deteriorating economic situation, and the consequences of the various macroeconomic adjustment measures. In addition, conflicts and environmental degradation, particularly in the Sahel regions, desertification, and cyclical famines have further aggravated the pressure for migration from poorer to relatively prosperous regions of the continent. The deteriorating economic situation and pressures have also affected in recent times the traditional labor-importing countries, including Gabon, Côte d'Ivoire, Zimbabwe, and Nigeria. The inability of their economies to continue accommodating clandestine labor migrants was at the root of the various expulsion measures directed at foreign nationals at different times. On the other hand, the violent conflicts that have plagued the political landscape of many African countries—Burundi, Rwanda, Liberia, Sierra Leone, and recently, Côte d'Ivoire—as well as the Horn of Africa have produced massive waves of refugees who sought sanctuary in neighboring African countries. Many have chosen to remain as migrants in the countries of their sanctuary even after conflicts have ceased in their homelands.

Immigration into Africa

In modern times, the major movements into the continent have been of European settlers into northern Africa and of European and Asian settlers in Southern and East Africa. The Dutch migrations into Southern Africa began in 1652, when a European settlement was established by the Dutch East India Company at the Cape of Good Hope. The colony was intended to serve merely as a refreshment station for the company's ships on their way to India and was originally peopled by the company's servants. But with the decision to allow some of these people to settle as free citizens owning their own farmlands, the Dutch (Boer) population in the region began to swell, and soon a deliberate policy of increasing the settler population was instituted to strengthen it against possible attacks. More Dutchmen arrived as well as a party of French Protestant Huguenots fleeing religious persecution in France. The French refugees lost their language and became absorbed into the predominantly Dutch population. As most were farmers, this meant that more land was needed as the population increased. From the coast, the settlers later moved inland to the Highveld region, where, in the nineteenth century, a series of military conflicts occurred between them and the Bantu speakers. The Dutch—and the absorbed French refugees—constituted about one-third of the

European population and were the ancestors of many modern white South African families. Other major European settlements took place in the nineteenth century: the British were dominant in modern-day KwaZulu/Natal Province of South Africa as well as in Zambia, Zimbabwe, and the East African highlands; the Germans were predominant in modern Namibia; and the Portuguese were in Angola and Mozambique.

When the European colonies were first founded, there was no conscious policy of introducing racial discrimination and settler rule. However, the presence of large settler populations later affected the pace of political developments in these territories, and the achievement of self-government and independence by the African peoples of South Africa, Namibia, Zimbabwe, Angola, and Mozambique was delayed. The struggles for independence and majority rule became the source of much bitterness and violence between races in Southern Africa. On the other hand, the growth of Arab nationalism and the emergence of Morocco, Algeria, and Tunisia—North African countries with vast European settler populations—as independent states led to the return of between one and two million colonists to their European homelands in the late 1950s and early 1960s.

Emigration from Africa

Probably the greatest outward regional movement of people in human history was that of Africans to the Americas and the Caribbean during the period of the slave trade from the sixteenth to the nineteenth century. Estimated figures of Africans forcibly uprooted from their homelands, largely from West Africa and to a lesser extent from Angola, range from fifteen to twenty million. Substantial numbers of these died in the appalling conditions of the trans-Atlantic passage. The slave trade was also active on the east coast of Africa, particularly on the island of Zanzibar. Although the composite effect of the loss of this considerable size of manpower is yet to be fully quantified and appreciated, there is no doubt that it retarded the African continent's development. At the same time, these forced migrants made substantial contributions to the development of the New World.

In recent years a combination of factors, including the worsening economic situation of most African countries, perennial conflicts, and environmental degradation, have provoked a new outward movement of Africans from the continent. The stressful socioeconomic environment created by the retrenchment of public sector workers in states across the continent implementing diverse programs of structural adjustment, the decline in real incomes, and the hostile political environment occasioned by the consolidation of autocratic regimes in several states have combined to generate and sustain pressures that trigger the outflow of professional and skilled persons on a scale hitherto not experienced. This migration has been to Europe, North America (United States and Canada), and the Gulf states. Some Africans have also found their way to Asian and Pacific countries. This phenomenon has come to be described in the literature and general discourse as the *brain drain*. Thousands of highly skilled migrants, including doctors, nurses, lecturers, teachers, engineers, scientists, technologists, and other

professionals, have moved from a number of African countries to the destination states attracted by relatively higher salaries and better working and living conditions. This is in addition to movements from poorer to relatively richer regions of the continent. Also, many students in various disciplines failed to return to their home countries from these richer countries at the end of their training.

The stressful socioeconomic environment has produced other survival strategies that affect contemporary migration patterns and gender roles in the continent. Clandestine migration, an age-old phenomenon, has reached new proportions as young migrants are adopting more sophisticated, daring, and evasive methods to enter the countries of the North—even as these destination states continue to tighten their border controls. Many clandestine migrants enter the host states as tourists or students and later work and live there without officially changing their status. Others travel via intermediary countries, where they obtain false documentation for a fee. Another phenomenon is autonomous female migration, which is equally a response to deepening poverty in the subregion. With several families forced to adopt migration as a coping mechanism of the last resort, the traditional male-dominated, long-term, and long-distance migratory streams are becoming increasingly feminized. A significant proportion of females now migrate independently to fulfill their own economic needs rather than simply joining a husband or other family members. Higher educational attainment among females has also enhanced their mobility and their propensity to migrate both locally and internationally.

Explaining African Migration

Although the most common explanations are those focusing on the economic dimensions, a general survey of the literature on demographic mobility reveals numerous economic, sociological, and demographic attempts to explain the initiation of internal and international migration. Migration is seen as a response to both endogenous and exogenous variables. These variables are, in sum, the overall effects of sociocultural, economic, political, and psychological conditions on the migrant. The decision to migrate is thus a response to one or many of the variables and the location of such variables. The sociologist describes migration in relation to the nature and magnitude of its social and cultural dimensions, the destination, and the sending area. The economist, on the other hand, reflects on the occupational and employment status, pressure of demand and supply, and relationships among wage, income, and price levels. Demographic explanations relate all the variables to the prospect of measurement and control of migration and its effect on growth and development.

Given Africa's cultural, linguistic, and economic variations, and its vast country-to-country differences, a systematic analysis of any aspect of its social behavior can be a difficult enterprise. Analysis of its migration behavior is no less challenging. When applied to the African situation, accepted theories of migration reveal the need for the development of models that distinguish between developed and developing countries. Indeed, a number of explanatory models have been developed in the literature seeking to explain internal and

international migration of labor in undeveloped countries. Three of these are especially suited to the African situation. These are the Todaro's, Mabogunje's, and Byerlee's models.

Todaro's model is a modification of the neoclassical economic (human capital) theory of migration. The theory posits that migration is the consequence of individual cost-benefit calculation. Todaro proceeds by affirming that migration is based on rational economic calculations and argues that the decision of the individual to migrate is usually a response to rural-urban differentials in expected rather than actual income earnings. This model assumes that the potential migrant selects a location that maximizes expected gains from migration. This was the first explanatory attempt emphasizing that potential migrants should base the decision to move on rational calculation of differences in expected earnings.

Mabogunje's model constitutes the second approach at explaining migration in Africa. The model is a creative adaptation of the world systems model in which Mabogunje asserts that rural-urban migration in Africa is controlled by systematic interrelationships of rural-urban control systems, rural-urban adjustment mechanisms, and the positive or negative flow of information about migration. The model identifies the *push* and the *pull* sides of migration. Local economic conditions that affect the pool of migrants constitute the push side. The size of this pool is affected by social practices, customs, community organization, and inheritance laws in the sending community. Wage rates and job opportunities emanating from the urban system constitute the pull side of migration, and these determine whether individuals in the pool of potential migrants would migrate.

In a modification of the human capital approach, Byerlee adopts a cost-benefit economic model in which he considers migration as the outcome of a cost-return calculation. Byerlee posits that the decision to migrate will be made when the perceived returns of migration exceed the perceived costs. The model goes beyond the conventional cost-return analysis of the human capital approach as it includes elements of the social system. It also explicitly identifies determinants of rural and urban incomes and introduces risks and other psychic costs into the migration decision-making process.

All three approaches have made significant contributions to a conceptual understanding of the migration process in Africa. Todaro's model provides a good explanation for labor migration in Africa, as it recognizes the unequal and uneven distribution of economic and social development between regions of the same country and among countries as a primary determinant of migration. The strength of Mabogunje's approach lies in its macrosystem emphasis, given its recognition of the economic, cultural, and social relationships between rural and urban areas. Mabogunje's model is particularly helpful in understanding the impact of family and community organization on migration. Byerlee's conceptualization of the motivation for migration in Africa has also contributed significantly to a conceptual understanding of migration in the region.

Despite their theoretical contributions, all three models fail to deal adequately with several elements of migration,

including forced migration. With regard to historically more recent migration patterns, the models fail to deal with non-wage urban income, which accounts for an increasing proportion of urban employment.

One element of migration that has assumed increasing importance in recent years is the large-scale international migration of skilled persons from Africa to relatively more developed regions of the world. Attempts to provide explanatory models for understanding the motivation for this phenomenon confirm that the behavior of the so-called highly trained migrants, including scientists, engineers, artists, and intellectuals, is fundamentally determined by the same kind of motivations and market forces as those of less highly trained migrants. However, interpretations of the effect of the migration of highly skilled workers on the developing sending countries differ. Most economists are agreed that although some degree of mobility is necessary if developing countries are to integrate into the global economy, large-scale losses of skilled workers are detrimental to developing countries and pose the threat of a brain drain.

Neoclassical models of economic development hold that brain drain has adverse effects on the development of the sending country, slowing down the GDP growth rates and adversely affecting those who remain. Consequently, poverty and inequality are likely to increase. More recent economic theory—the endogenous growth theory—also predicts that emigration of highly skilled workers reduces economic growth rates. In contradistinction, another theoretical variant holds that at some optimal level of emigration (greater than none but not too much), sending countries actually benefit. It is argued that the possibility of emigrating to higher-wage countries may stimulate individuals to pursue higher education in anticipation of migrating to secure, better-paid work abroad. The consequence is the development of a large pool of better-trained human capital in the sending country. The implication is that there may be an “optimal level of emigration” or a “beneficial brain drain.” Empirical analysis offers some support for the various theoretical expectations.

Conclusion

Human migrations in historic times have transformed the entire aspects of lands and continents and the racial, ethnic, and linguistic composition of their populations. Migration in Africa has had similar consequences. The peopling of the continent and the consolidation of its racial, ethnic, and linguistic landscape certainly cannot be totally separated from the consequences of the various migratory movements.

See also *Diasporas: African Diaspora; Migration: Migration in World History*.

BIBLIOGRAPHY

- Adepoju, Aderanti. “Fostering Free Movement of Persons in West Africa: Achievements, Constraints, and Prospects for Intra-regional Migration.” *International Migration* 40 (2002).
- . *New Conceptual Approaches to Migration in the Context of Urbanization: Case of Africa South of the Sahara*. Liège, Belgium: IUSSP, 1978.

- Afigbo, A. E., et al. *The Making of Modern Africa: The Nineteenth Century*. Vol. 1. Essex, U.K.: Longman, 1986.
- Allen, Chris, and Gavin Williams, eds. *Sociology of Developing Countries in Sub-Saharan Africa*. London: Macmillan, 1982.
- Amin, Samir, ed. *Modern Migrations in Western Africa*. New York: Oxford University Press, 1974.
- Arthur, John A. “International Labor Migration Patterns in West Africa.” *African Studies Review* 34 (1991): 65–87.
- Byerlee, D. “Rural-Urban Migration in Africa: Theory, Policy and Research Implications.” *International Migration Review* 8 (1974): 543–566.
- Caldwell, J. C. *African Rural-Urban Migration: The Movement to Ghana's Towns*. New York: Columbia University Press, 1969.
- DeJong, G., and Robert W. Gardner, eds. *Migration Decision Making*. New York: Pergamon, 1981.
- Diop, A. A. B. “Enquête sur la Migration Toucouleur à Dakar.” *Bulletin de l'IFAN*. Ser. B., no. 22 (1960): 393–418.
- Gaude, J. *Causes and Repercussions of Migration: A Critical Analysis*. Geneva: International Labour Office, 1976.
- Harris, J., and M. Todaro. “Migration, Unemployment and Development: A Two-Sector Analysis.” *American Economic Review* (March 1970): 126–142.
- Jackson, J. A. *Migration*. Cambridge, U.K.: Cambridge University Press, 1969.
- Jansen, C. J., ed. *Readings in the Sociology of Migration*. Oxford: Pergamon Press, 1970.
- Lowell, B. Lindsay, and A. Findlay. *Migration of Highly Skilled Persons from Developing Countries: Impact and Policy Responses—Synthesis Report*. International Migration Papers 44. Geneva: International Labour Office, 2002.
- Mabogunje, A. L. “Historical Geography: Economic Aspects.” In *UNESCO: General History of Africa: Methodology and African Prehistory*, vol. 1, edited by J. Ki-Zerbo. Berkeley: University of California Press, 1981.
- . “Systems Approach to a Theory of Rural-Urban Migration.” *Geographical Analysis* 2 (1970): 1–17.
- Murdock, G. P. *Africa: Its Peoples and Their Culture History*. New York: McGraw-Hill, 1959.
- Ricca, S. *International Migration in Africa*. Geneva: International Labour Office, 1989.
- Sjaastad, L. A. “The Costs and Returns of Human Migration.” *Journal of Political Economy* 70 (1962): 80–93.
- Swindell, K. “Labour Migration in Underdeveloped Countries: The Case of Sub-Saharan Africa.” *Progress in Human Geography* 3 (1979): 239–257.
- Todaro, M. “A Model of Labour Migration and Urban Unemployment in Less Developed Countries.” *American Economic Review* 59 (1969): 138–148.
- Wallerstein, I. “Migration in West Africa: The Political Perspective.” In *Urbanization and Migration in West Africa*, edited by H. Kuper. Berkeley: University of California Press, 1965.
- Zachariah, K. C., and J. Condé. *Migration in West Africa: Demographic Aspects*. New York: Oxford University Press, 1981.

Sola Akinrinmade

MIGRATION IN WORLD HISTORY

Migration is a central aspect of human existence. This is evident from the debate about the origins of the human species, which spread, according to the evidence, from Africa across all continents. On the level of ideas and prejudices, this has resulted

in racialized debates about white distinctiveness and Afrocentrism. In prehistoric times, some thirty to forty thousand years ago, human beings migrated from the tricontinental Eurasia-Africa across a land bridge into the Americas and across the seas to Australia. Migration meant diversification of cultures and physical features. Whole peoples, but also clans and groups, continued to migrate throughout the millennia. While Asia's population was settled some sixty-five hundred years ago, in Europe whole peoples continued to migrate until some twelve hundred years ago, often moving from east to west. In Africa, the southward spread of sub-Saharan Bantu-speaking peoples continued to even more recent times.

Once the movement of whole peoples came to an end, migration of members of ethnocultural groups and individuals led to genetic and cultural mixing: Manchu moved southward into China; Norsemen (and -women) moved from Scandinavia eastward along the rivers to the Moskva region where they formed the society of the Rus, and westward along the coasts where they settled in Normandy, in parts of the isles later called "British," and, further southward, in Sicily and Palestine; Slavic and Germanic peoples interacted in central Europe; in the Americas the southward movement of First Peoples resulted in a differentiation into major cultural regions and language groups; in the southeast Asian islands, exchanges of population involved sophisticated sea voyaging; and in Africa pastoralists moved into areas of agriculturalists. In customary male-centered thought, such movements have often been interpreted as the expansion of warrior males and subjugation of "lesser"—more correctly, less armed—peoples. Recent genetic scholarship has revised this imagery: Arriving men, dominant as oppressors, had children with local women, and both genetically and culturally women became dominant. In the case of the Anglo-Saxon conquest of the Celtic-settled (British) islands, the Celtic women's genetic heritage and cultural practices have had a stronger impact than the lore of strong Anglo-Saxon men, as later British historians had believed.

Patterns of Migration

Until recently, no worldwide periodization of migration since Mediterranean antiquity had been attempted, though specific movements were well-studied. The composition and character of migration was influenced by cultural practices in the society and religious creed of origin. Greek migration in the Mediterranean world was one of artisans, traders, and cultural elites resulting in a process of Hellenization. The Roman Empire's expansion was one of soldiers and the imposition of rule; it brought South European and North African men to northern Europe. One of its military officers, a man from sub-Saharan Africa, became Christian Europe's Saint Mauritius (also called Saint Maurice, d. c. 286). The spread of Islam occurred through traveling merchants and, to some degree, through military action. These migrant Arabs and their religious culture equalized social relations among Hindu Indians because they knew no castes, but they hierarchized gender relations because women's status was lower in Islamic societies than in Hindu societies. In China migrating agriculturalists, as if forming a distinct ethnocultural group, were designated as "Han." Their regions of settlement were interspersed with

those of long-settled cultural groups. In Africa, major east-west movements of people in the Sahel zone resulted in the formation of states, empires, and urban cultures. In Australia, multiple societies, later generically termed *Aboriginal*, emerged by separation rather than overlay or penetration. In the Americas some societies developed agricultural practices and became geographically stable, while others pursued hunting and remained mobile. All were connected through long-distance trading and some, seemingly, through exchange of spiritual concepts and scientific observation of celestial phenomena.

In the Eurasian-African world, patterns of migration changed in the period from the mid-fifteenth to mid-sixteenth century. By the 1440s populations had recovered from the demographic shrinkage imposed by the great plagues of the latter 1340s. In imperial China, the bureaucracy decreed an end to overseas contacts. To 1435, fleets of ships, vastly superior to European vessels, had carried expeditions of up to about thirty thousand men (and women) along the coasts of the South Asian subcontinent and to the East African ports. In the social hierarchy of Chinese society, merchants ranked low, and those who, from the southern provinces distant from the court, continued to trade overseas developed a Southeast Asian diaspora that lacked state support. In contrast, the Iberian Portuguese court provided financial and military backing to sailors and merchants who sent trading expeditions to the northwest African coast. They and, later, other Europeans developed fortified trading posts, "forts," wherever they gained a bridgehead. By the 1440s, the first enslaved Africans were brought to Portugal. Underemployed seafarers of the declining Italian port cities, Cristoforo Colombo (Christopher Columbus) and Giovanni Caboto (John Cabot) among them, migrated to the Atlantic coast. Relying on lore and knowledge of Breton, Basque, Bristol, and Icelandic sailors, and encouraged by the changing view of the earth as a globe rather than a disk, they explored westward routes aiming to reach the riches of Asia, whether China or India. Thus, a barrier on this route, the Americas, became part of the European's mental maps. In North European annals the existence of a Vinland had been chronicled since the time of the Norse voyages. Only Australia was still absent from this view of the world.

From 1550, the wealth of some of the Asian and Central and South American societies, the political-military power of the somewhat economically marginal European societies, and the transfer of germs from Eurasia to the Americas resulted in vast demographic changes: (1) the near genocide of many peoples of the Americas and the resettling of that region with immigrants from many European societies; (2) the usage of men and women from many cultures of sub-Saharan Africa as enslaved labor by European-origin investors in the process of establishing the subtropical plantation belt; and (3) the European military-commercial exploitation of the peoples of the Indian Ocean region and, subsequently, those of East Asia. As a result, several hemispheric and near-global migration systems emerged. From Europe, merchants and military as well as administrative personnel migrated outward. Their arms and purchasing power induced migration of producers and common laborers. Where they established mines or plantations—also called "factories in the fields" (Wolf)—they needed large

numbers of workers but were not willing to pay wages or provide working conditions acceptable to local populations. In densely populated Asia, they forced men and women to work the fields. In Latin America they immobilized surviving earlier populations as agricultural worker families under the *encomienda* labor distribution system or forced them to migrate hundreds of miles to labor in the silver mines under the *mita* system.

Through the postcontact epidemics and wars of annihilation, however, the peoples of the Americas had been decimated, and thus traders from most European coastal states initiated a mass importation of enslaved laborers from Africa with the help of slave-catching coastal societies in West and, to a lesser degree, East Africa. Through investment and superior armament the European colonizer migrants established the South Atlantic African-American forced slave migration system. To fill the demand for tropical produce they transported some 9.8 million men and women to the Americas from about 1500 to the 1870s. This is a downward revision from earlier estimates of fifteen million. Another two million died during the so-called transatlantic middle passage. Additional millions perished during capture and on the routes to the African coast. This trafficking in human beings depleted the population base in West and Central Africa. In addition to the chattel slavery in the Atlantic world, societies of the Indian Ocean also used slaves for services and in commerce. Figures are difficult to ascertain.

The mixing between European colonizer men and Asian, Latin American, and Afro-American women, frequently through rape but more often through hierarchical consensual unions, led to the emergence of new peoples in the Americas and of smaller groups in Africa and Asia (in a process known as ethnogenesis). Conceptualizing these new peoples was difficult. In European thought of the times, those born in the colonies were “creoles” and inferior to “pure” European-born people. In the minds of European colonials, however, those born of European-origin parents considered themselves European and preferred to apply the term *creole* to people born of culturally mixed backgrounds and with shades of skin construed as “dark” or “black”—similar to the use of such terms as *mestizo* or *mulatto*. Whereas religion and craft had served to define identities before the beginning of colonization, the ideologues of Christianity and of exploitation increasingly made color of skin (race) and genetically defined ethnic groups the marker of belonging. “Race,” however, was lived differently in Anglo and Latin colonial societies: strict racial separation ruled in the former, intermixing and hierarchization of shades of skin color in the latter.

In the nineteenth century, when the Afro-Atlantic forced migration system came to an end, the demand for labor was filled by an Asian contract labor system and by a transatlantic proletarian mass migration from Europe. Mainly Indians and Chinese were brought to plantations and mines under five-year contracts, in a system that has been called “a second slavery” (Tinker). This system lasted until the early twentieth century. Simultaneously, free Chinese and other Asian migrants developed a transpacific migration system from the late 1840s on. The largest of these systems, the European–Atlantic one, at first encompassed two routes, from southern Europe to Latin America and from western, northern, and, later, eastern Europe to

North America. Italian labor migrants integrated the routes in the 1880s. From 1815 to the 1930s some fifty-five million men and women moved westward, some seven million returning to their cultures of origin. In addition, the agricultural migration from European Russia to the southern belt of Siberia and the labor migration within European Russia coalesced into a Russo-Siberian migration system, in which some ten million men and women moved eastward and even larger numbers moved to the industrializing cities. While the nineteenth century is considered the century of proletarian mass migrations, the rate of migration per thousand people was higher in seventeenth-century industrializing societies such as the Netherlands and Sweden. Contrary to widespread ideas, even peasant societies have never been sedentary; in each generation, sons and daughters who could no longer be fed on the parental land had to move elsewhere to eke out a living in marginal agriculture or in urban wage labor. The farmers of the nineteenth-century migrations cultivated new fertile plains in North America, southern Russia, Argentina, and Australia, and their mass production of grain led to a collapse of world market prices and, consequently, to a worldwide agricultural crisis that forced millions more to leave the land for urban jobs.

In the twentieth century, wars and the depression after 1929 reduced labor migrations. Warfare and fascism in Europe generated huge numbers of refugees. From the 1950s on, the politically decolonizing but economically dependent societies of the southern hemisphere became refugee-generating states. Exclusion and border controls in the advanced industrial (and white) societies of the northern hemisphere as well as discriminatory terms of trade led to “global apartheid” (Richmond). Labor needs of the northern economies were filled by south–north migrations from both the Mediterranean and Caribbean basins. The search for more options and better lives led nonwhite people to migrate toward the industrial and social security states of the north, if necessary without documents or, from the point of view of the receiving societies, as “illegals.” To such migrations the North American societies have responded more openly, proving more willing to grant amnesties than European societies (derided in some circles as “fortress Europe”). In other parts of the world, regional systems of migration emerged: internally in China, to the oil-producing states of the Persian Gulf, in West Africa, and elsewhere. By the beginning of the twenty-first century, migration systems had become even more multifocal than in the past.

Throughout history women’s options to migrate were restrained by male-imposed concepts of gender roles. With permanent settlement, however, communities of migrants demanded and continue to demand the presence of women for family formation and the building of networks. Women have always been part of migrations; from the 1930s on they even formed a slight majority of those heading for North American societies. Both refugee migration and the demand for service labor led to a feminization of migration in the last decades of the twentieth century.

Governmental Policies

Governmental policies on migration have evolved in stages. Before the coming of colonialism, merchants, small producers,

dockworkers, and sailors were free to migrate between the ports of the trade emporia of the Indian Ocean, and cultural communities of migrants were often granted self-administration. In European societies, the shift from dynastic systems to nation-states resulted in a massive deterioration of migrants' status. In dynastic systems, incoming migrants negotiated their status with the ruler and were usually free to practice distinct customs and use their own language, provided they promised loyalty. The Protestant French Huguenots of the sixteenth and seventeenth centuries are the best example. Nation-states, however, postulated unity or even uniformity of culture and demanded that incoming migrants renounce their own culture, religion, and language—or, in short, assimilate. The elevated position of the “nationals” over resident “minorities” and immigrant “ethnics” stood juxtaposed to the republican ideal of equality before the law. Passports, a late-nineteenth-century invention of nation-states, along with border controls and immigration legislation, excluded ever-larger categories of potential migrants from entering a society. Racial thought contributed to exclusion, and fear of class struggles led to increased control over labor migrations. Through the early twenty-first century, nation-states have still not overcome this “otherizing” of newcomers. Rather than being admitted to citizenship, newcomers are labeled “aliens,” “foreigners,” temporary laborers, or, euphemistically, guest workers. The common notion of “guests” does not imply using them as cheap workers, to be sent home whenever an economic downswing results in a diminished need for labor. Such practices have also been adopted by West African societies, especially Ghana and Nigeria, as well as by the oil-producing states of the Middle East.

Public opinion has classified newcomers according to religion, power, economic pursuit, and, only recently, color of skin. In many-cultured societies—the Ottoman Empire being the best example—cultural groups of peoples governed themselves through their religious rulers, and newcomers, such as the Jews, who were expelled from the Iberian societies after 1492, were incorporated under these principles. In China, imperial officials from afar provided but a thin overlay of resident populations, and people lived according to their own customs. In the nineteenth-century Habsburg “monarchy of many peoples,” nationalizing tendencies and investment strategies reduced such self-determination of cultural groups. While conflicts have always occurred, the marginalization and otherizing practices of the late nineteenth and twentieth centuries paralleled the nation-states' cultural homogenization policies.

Global versus Nationalist Perspectives

Research has only recently achieved a global perspective on migration. Into the 1970s, nationalist historians assumed that *emigrants* depart from a nation-state and arrive as *immigrants* in ethnic enclaves of the receiving nation-state. Since then, this dichotomous perspective and terminology has been replaced by the neutral term *migrant*: People may move over short distances, for example, from rural to urban environments; or seasonally, as harvest laborers, from infertile hilly regions to farms in fertile valleys and plains; or to urban positions as female domestics, apprentices, or day laborers. People migrate over medium distances to specific segments of labor markets or to

available agricultural lands within a state (internal migration), in borderlands (intercultural migration, for example, from China to Mongolia), or across international borders. Because nation-states counted migrants only at such borders, international migration caught the attention of nation-state socialized scholars much more so than the less documented internal migration. The latter, however, included the whole process of urbanization, marriage migration, and industrialization and has been far more voluminous. Population registers of cities, parish records, and marriage lists provide the evidence.

The emigration–immigration dichotomy also assumed one-directional, one-time moves. Migrants, however, may move seasonally, for several years or for their working life. They may return regularly or occasionally. They may repeat the process of migration several times. Some migrations, such as those of early modern European artisans, Chinese transport laborers, and women earning money for a dowry, are circular: the migrants traverse short or long distances but finally return to their community of origin. Some migrations occur in stages, with a part of the intended trajectory undertaken at a time, for example, first to a nearby market city, then, with new wage earnings, to a port city, and finally to an overseas destination. Given that migration is costly, not only because of the cost of transport but also because during the voyage no income can be earned, many families decide to send one member with high earning capacity first. Then, in sequential or chain migration, other family members or friends follow whenever the “first-comer” is able to send money for travel or, at least, provide temporary shelter and access to a job. Such “free” migrations occur within economic and social constraints in the society of origin. Migrants pursue better options in their selected receiving society; for women this often involves less restrained gender roles.

Forced migrations, which encompass slavery, contract labor, and forced labor on the one hand and refugee migration on the other, have been studied separately. The distinction is both justified and misleading. Forced migrants have few opportunities to acculturate according to their own interests, whether within the slavery system in the Americas or in twentieth-century German, Russian, and Japanese labor camps. But in order to survive forced labor regimes, they have to develop strategies to make conditions physically and spiritually bearable. Refugees are “unwilling” migrants and often look back to the expelling society in hopes that changes will occur permitting their return. Because they are often not welcome in receiving societies and frequently receive no material support, they—like voluntary migrants—have to insert themselves into the receiving economy.

A further fallacy of the nationalist approach to migration has been the assumption that people are essentially monocultural. Such scholars have considered migrants to be uprooted, in limbo between cultures, and incapable of adjusting to their new sociocultural environment. Since the 1980s, however, sociological and historic research has shown that while involuntary migrants may be uprooted, voluntary ones develop individual and social capital and act in supportive networks that permit continuity as well as change. They live transculturally

rather than ensconced in ethnic ghettos; they need the ability to function in more than one society.

Thus, many societies across the ages have sought migrants as innovators, connectors, or simply additional human capital. Many migrants, in turn, have sought independence from parents, constraining social norms, and dire economic circumstances by moving between one state or society to another.

See also *Asian-American Ideas (Cultural Migration); Borders, Borderlands, and Frontiers, Global; Creolization, Caribbean; Diasporas; Ethnicity and Race; Slavery; State, The.*

BIBLIOGRAPHY

- Appleyard, Reginald T., ed. *International Migration Today*. 2 vols. Paris: Unesco, 1988.
- Bade, Klaus J. *Migration in European History*. Translated by Allison Brown. Oxford: Blackwell, 2003.
- Cohen, Robin, ed. *The Cambridge Survey of World Migration*. Cambridge, U.K.: Cambridge University Press, 1995.
- Curtin, Philip D. *Cross-Cultural Trade in World History*. Cambridge, U.K.: Cambridge University Press, 1984.
- Fawcett, James T., and Benjamin V. Cariño, eds. *Pacific Bridges: The New Immigration from Asia and the Pacific Islands*. Staten Island, N.Y.: Center for Migration Studies, 1987.
- Gungwu, Wang, ed. *Global History and Migrations*. Boulder, Colo.: Westview Press, 1997.
- Hoerder, Dirk. *Cultures in Contact: World Migrations in the Second Millennium*. Durham, N.C.: Duke University Press, 2002.
- . "From Migrants to Ethnics: Acculturation in a Societal Framework." In *European Migrants: Global and Local Perspectives*, edited by Dirk Hoerder and Leslie Page Moch, 211–262. Boston: Northeastern University Press, 1996.
- Isajiw, Wsevolod W. *Understanding Diversity: Ethnicity and Race in the Canadian Context*. Toronto: Thompson Educational, 1999.
- Kritz, Mary M., Lin Lean Lim, and Hania Zlotnik, eds. *International Migration Systems: A Global Approach*. Oxford: Clarendon, 1992.
- Massey, Douglas S., et al. "Theories of International Migration: A Review and Appraisal." *Population and Development Review* 19, no. 3 (1993): 431–465.
- Moch, Leslie Page. *Moving Europeans: Migration in Western Europe since 1650*. 2nd ed. Bloomington: Indiana University Press, 2003.
- Pan, Lynn, ed. *The Encyclopedia of the Chinese Overseas*. Richmond, U.K.: Curzon Press, 1999.
- Parnwell, Mike. *Population Movements and the Third World*. London: Routledge, 1993.
- Richmond, Anthony H. *Global Apartheid: Refugees, Racism, and the New World Order*. Toronto: Oxford University Press, 1994.
- Tanner, Helen Hornbeck, ed. *The Settling of North America: The Atlas of the Great Migrations into North America from the Ice Age to the Present*. New York: Macmillan, 1995.
- Wolf, Eric R. *Europe and the People without History*. Berkeley: University of California Press, 1982.
- Tinker, Hugh. *A New System of Slavery: The Export of Indian Labour Overseas, 1830–1920*. London: Oxford University Press, 1974.

Dirk Hoerder

UNITED STATES

Amerindians, Pilgrim fathers, immigrants, slaves, Asian-Americans, Hispanics—all denote historical population groups in the United States and in the Americas, but each group is placed in a different frame of reference. All of them arrived as migrants with norms, values, and belief systems of their ancestors and premigration society as a whole. Before immigrating they also had experienced culture-specific material ways of life. They arrived at particular historic conjunctions and developed lifeways specific to the region or city in which they settled.

First Americans

Some thirty to fifty thousand years ago, peoples from Asia migrated across a land bridge, today's Bering Strait, into North America and beyond. Distinct linguistic groups and several complex cultures emerged, such as Hohokam farming and Pueblo culture in the southwestern mesas and a mound-building culture in the Ohio Valley. After 1492 the native populations of the Americas were gradually decimated by a combination of Eurasian germs and Old World arms. By the 1830s Amerindians had been forced to vacate all lands east of the Mississippi, and the U.S. Supreme Court had designated them as *domestic dependent* nations without sovereignty. By the 1870s white Americans had begun to speak of a "vanishing race," imagining Amerindians as the generic horse-mounted Plains "Indian." Though Helen Hunt Jackson's *A Century of Dishonor* (1881) initiated a public debate about the denigration of native peoples' cultures, the Dawes General Allotment Act (1887) dissolved tribes—a term for cultural groups that suggests a primitive stage of development—based on the notion (implemented in 1924) that citizenship could only be conferred on individuals. Native Americans were confined to reservations, denied self-government, and deprived of their cultural practices. European-Americans developed the idea that "Indians" were dependent on government handouts. Over the next century, however, migration to the cities by native people and resistance by the American Indian Movement led to a slow reversal of government policies by the 1970s. Armed struggle, legal action, and self-organization by and on behalf of Native Americans forced U.S. governmental institutions and public opinion to revise their notions of "Indians" and to accept varying degrees of Native American self-determination.

Old World Migrants

Europeans from Scandinavia reached North America around 1000, and transpacific contacts probably also occurred early. Lasting European contact seems to have begun with the establishment of Basque, English, and Portuguese fisheries off the Newfoundland shores. In the mid-sixteenth century invasion forces as well as settlers from New Spain had reached present-day New Mexico. The territories of the north, known for their fur economies, were targeted by numerous large European mercantile companies and dynasties. The gentlemen adventurers in Virginia and the religious colonizers in New England would eventually provide a profitable return on the investments of such companies that financed their voyages. Since demand for male and female laborers exceeded the available migrants, several European states established a system of indentured servitude by which poor men and women sold their labor for a number of years in return for passage to North

American or Caribbean colonies. Such redemptioners were free after serving for a period of between three and seven years. This system of bound white labor ended in the 1820s, although “free” departure under severe economic constraints lasted.

Racial and Religious Hierarchy

To increase the labor supply in the southern colonies of North America and in the Caribbean colonies, men and women from Africa were transported to the Americas and sold as slaves. To the 1830s more Africans than Europeans arrived in the Americas. The forced migration of African people occurred in stages, thus preventing them from reestablishing their lives in terms of ethnocultural groups. African Americans were relegated to a status as *domestic dependents*. The American concept of *e pluribus unum* applied only to freeborn white Europeans, who were the model of Michel Crèvecoeur’s new American man (*Letters from an American Farmer*, 1782). Twentieth-century scholarship reconceptualized the process of the (re)peopling of the Americas, examining not just the history of free migration but that of involuntary (economically induced) migration, forced migration, and destruction of the Amerindians.

Migration to the United States during the nineteenth century, from the end of the Napoleonic Wars in 1815 to the beginning of World War I in 1914, has traditionally been divided into two stages that involved two different regions of origin and thus two different “racial” groups: an early agrarian “old” immigration from west-central and northern Europe and an urban “new” immigration from eastern and southern Europe starting in the mid-1880s. The distinction dates from the late nineteenth century, when the darker-complected “new immigrants” were considered racially inferior. The Eurocentric perspective covers the vast majority of newcomers, but importation of enslaved Africans, outlawed in 1808, continued illegally. Chinese of several cultural groups from the empire’s southern provinces and other migrants from Asia arrived from the mid-1840s in Pacific Coast cities as merchants, prospectors, and credit-ticket laborers. The racial hierarchy of white America was extended to Mexican-Americans following territorial gains of the Treaty of Guadeloupe Hidalgo. The process of hierarchization included religion along with race, placing non-Christian Africans, “heathen” Chinese, and Roman Catholic “papists” in categories below that of white Anglo Protestants.

Only one-third of the migrants to the United States in the 1840s were agriculturalists. Eastern European farming families first arrived in the 1840s, while the northern European industrial laborers came after the 1880s. On average the male-female ratio stood at 60 to 40. The new states in the West sought to increase their economic potential and revenues, and the fast-growing industries in the East actively recruited newcomers from Europe. Railroad construction companies did the same in Asia. An anti-immigrant or nativist movement emerged in the 1850s; exclusion of “the Chinese”—a summary term for people from different cultures and dialects from the empire’s southern provinces—which was first attempted in 1879, became law in 1882. The designation *immigrant*, once reserved for newcomers from Europe and contrasted to *sojourners* from Asia, reveals a dichotomy, with *emigrants* as the complementary term used in Europe. Agrarian settler families, who sold their possessions before

departing for America, could hardly return to their native lands, but labor migrants often came as temporary workers. Return migrants, estimated at 7 million from the 1820s to the 1930s, were not counted by the U.S. Bureau of Statistics before 1907: The image of “immigration country” captured statisticians’ minds and prevented them from even looking for returnees. The emigrant–immigrant dichotomy also hides internal migrants: Europe’s societies of origin experienced far more internal migration than emigration; like the North American societies, most were labor-importing ones. U.S. internal migration, rather than being merely a westward colonization and mining movement, involved west-east rural-to-urban migration, the so-called Great Migration of African-Americans from southern agriculture to northern industries, as well as numerous other smaller moves.

Twentieth Century

Similarly problematic is the cultural classification of European migrants into “ethnic groups,” a differentiation denied “Asians,” “Indians,” or “Negroes.” European migrants were regionally diverse, nation-states having only come into being in the nineteenth century. Thus the nation-to-ethnic-enclave paradigm constituted an ahistoric simplification. At the end of the century biological-racist classifications (scientific racism) were increasingly applied to European newcomers from eastern Europe (“dark”), from Italy (“olive”), or of Jewish faith and excluded nonwhite populations from other continents altogether. While U.S. gatekeeper elites demanded Anglo conformity or assimilation, newcomers suggested a “melting pot” concept, a term that became popular after Israel Zangwill’s play of that title of 1908. The prescription for Anglo conformity excluded by definition peoples from Europe’s peripheries. Conceptual exclusion was paralleled by legal exclusion. Congress enacted restrictions on the open-door policy of admission to the United States starting in the 1880s. Further restrictions were legislated in 1917 and 1924. To access other labor reserves, men from Mexico were admitted under specific provisions covering temporary labor. With the closing of the front door facing the Atlantic, a back door on the Rio Grande was opened. The Pacific door was left ajar for merchants and students, in the interest of trade and cultural expansion. When scientific racism subsided, the paradigm of uprootedness emerged as a new hierarchization. While immigrants were recognized as “making the American people” (Handlin), immigrants in general and the Irish in particular were considered as suspended between cultures and thus in need of help with assimilation. Many European immigrants of the late 1940s and 1950s had in fact been uprooted but by war and forced labor camps—earning status as displaced persons—rather than by migration.

The 1965 Immigration and Nationality (Hart-Celler) Act intended to end discrimination of migrants based on skin color or cultural origin. A merit-based point system favored skilled, professional, and highly educated men and women in order to boost U.S. economic performance. The underlying assumption that Europeans could meet the new immigration criteria was wrong, and the composition of migration to the United States changed totally. Transatlantic migration subsided after Europe’s recovery from the devastations of World War II with the exception of departures from southern European societies

and refugees from the socialist countries. In contrast, transpacific migration from developed societies in Asia with high educational performance increased and surpassed transatlantic migration by the 1970s. Wage differentials—sometimes offset by cost-of-living levels—attracted men and women from low-wage societies in Asia. A humanitarian aspect of the point system and the citizenship legislation permitted highly qualified migrants to bring relatives regardless of their levels of qualification and English-language skills. U.S. soldiers stationed in Southeast Asia during the Vietnam War led to the first “war bride” migration, and in the aftermath of Vietnam large numbers of refugees arrived in the United States in the mid-1970s. A further, but temporary, incentive for Chinese to migrate to the United States was the return of Hong Kong to the People’s Republic of China in 1997.

Intracontinental northbound migration from Mexico and the Caribbean as well as from other Latin American states surpassed transpacific migration in the 1980s. Mexican laborers and laboring families continued to be recruited seasonally or without legal work documents. Puerto Rican (internal) and other Caribbean (external) migrants arrived in large numbers; Cuban exiles were hosted, while Haitian refugees were rejected. U.S. governmental support for right-wing regimes in several Latin American states resulted in an exodus of political refugees. While Asian-Americans, Mexican-Americans, and Hispanics in general created civil rights movements, advocates of “whiteness” initiated another racial debate about “the browning” of the United States and generated new calls for conformity. Undocumented migrants, upon whom certain economic sectors relied, were offered legitimization, that is, were given legal status. From the mid-1960s on scholarship on the subject of migration departed from the ethnic-group and migrant-dislocation paradigms. Scholars observed the ability of migrants to function and negotiate in two cultures, to create relations between cultural groups, to fuse multiple elements into multicultural lives and hybrid forms of expression. The perspective of women’s studies brought inclusion of migrant women—since the 1930s about one-half of all migrants to the United States—into the historical narrative (Gabaccia). However, race and culture continued to be reflected in scholarship. The experiences of African-Americans were studied separately under the heading of slavery, while research on Asian or Hispanic migrants utilized the model of European experience. Migrant origins, once nationalized, both as regards communities of origin and destinations, were regionalized as well as integrated into continental, hemispheric, or global migration systems (Gilroy; Hoerder; Ruíz; Takaki). Nation- or multicultural-state superstructures lost centrality of position in the analysis but remain important in establishing legal and institutional frames for admission (or rejection) and inclusion (or exclusion). Emphasis on exchange between cultural groups and on negotiating identities is reflected in concepts of diasporic belongings and societal embeddedness as well as in transnational or transcultural capabilities to chart life projects and develop ways of everyday life under conditions of high mobility (Portes; Rumbaut; Foner).

See also *America; Assimilation; Black Atlantic; Diasporas; Slavery.*

BIBLIOGRAPHY

- Berkhofer, Robert F., Jr. *The White Man’s Indian: Images of the American Indian, from Columbus to the Present.* New York: Vintage, 1979.
- Conniff, Michael L., and Thomas J. Davis. *Africans in the Americas: A History of the Black Diaspora.* New York: St. Martin’s Press, 1994.
- Delgado, Richard, and Jean Stefancic, eds. *The Latinola Condition: A Critical Reader.* New York: New York University Press, 1998.
- Foner, Nancy. *From Ellis Island to JFK: New York’s Two Great Waves of Immigration.* New Haven: Yale University Press, 2000.
- Gabaccia, Donna. *From the Other Side: Women, Gender, and Immigrant Life in the U.S., 1820–1990.* Bloomington: Indiana University Press, 1994.
- Gilroy, Paul. *The Black Atlantic: Modernity and Double Consciousness.* Cambridge, Mass.: Harvard University Press, 1993.
- Handlin, Oscar. *The Uprooted.* New York: Grosset and Dunlap, 1951.
- Hing, Bill Ong. *Making and Remaking Asian America through Immigration Policy, 1850–1990.* Stanford, Calif.: Stanford University Press, 1993.
- Hoerder, Dirk, ed. *Labor Migration in the Atlantic Economies: The European and North American Working Classes during the Period of Industrialization.* Westport, Conn.: Greenwood Press, 1985.
- Jackson, James H., Jr., and Leslie Page Moch. “Migration and the Social History of Modern Europe.” In *European Migrants: Global and Local Perspectives*, edited by Dirk Hoerder and Leslie Page Moch. Boston: Northeastern University Press, 1996.
- Kelley, Robin D. G., and Earl Lewis, eds. *To Make Our World Anew: A History of African Americans.* New York: Oxford University Press, 2000.
- Portes, Alejandro, and Rubén G. Rumbaut. *Legacies: The Story of Immigrant Second Generation.* Berkeley: University of California Press, 2001.
- Ruíz, Vicki L. *From Out of the Shadows: Mexican Women in Twentieth-Century America.* New York: Oxford University Press, 1998.
- Rumbaut, Rubén G., and Alejandro Portes. *Ethnicities: Children of Immigrants in America.* Berkeley: University of California Press, 2001.
- Takaki, Ronald T. *Strangers from a Different Shore: A History of Asian Americans.* Boston: Little, Brown, 1989.
- Thernstrom, Stephan, ed. *Harvard Encyclopedia of American Ethnic Groups.* Cambridge, Mass.: Belknap Press of Harvard University, 1980.
- Zhou, Min, and James V. Gatewood, eds. *Contemporary Asian America: A Multidisciplinary Reader.* New York: New York University Press, 2000.

Dirk Hoerder

MILLENARIANISM.

This entry includes three subentries:

Overview

Islamic

Latin America and Native North America

OVERVIEW

Millenarianism refers to religious beliefs about a thousand-year period at the end of the world. This period, the millennium (from two Latin words, *mille*, thousand, and *annum*, year), is described in the Bible's Book of Revelation (20:1–6). Millenarians, while believing that Christ's Second Coming will usher in this earthly kingdom for the faithful, differ on the timing of the millennium. Some (premillennialists) believe Christ will return before the perfect age, while others (postmillennialists) expect that Christ will return after the elect have established the millennium either by preaching the gospel or by fire and sword. Millenarianism is synonymous with millennialism. A closely related term, *chiliasm*, (based on the Greek word for a thousand) is similar in meaning but sometimes has the association of the violence needed to bring about this thousand-year period. While individuals may quietly embrace millenarian beliefs, characteristically it has been through larger movements that millenarian hopes get expressed most dramatically.

Origins of Millenarianism

The roots of millenarianism are in apocalyptic literature. Ancient Near Eastern myths depict a great battle between good and evil, but explicit apocalyptic literature first appears in both the Jewish and Christian Scriptures of the Hellenistic period, from approximately 200 B.C.E. to approximately 100 C.E. The Book of Revelation (its Greek name, Apocalypse, means unveiling or revelation and provides the generic term for consolation literature and supplies much of the imagery of millenarianism) was written in 92–96 C.E. Apocalyptic writings, such as Second Isaiah (chapters 40–55), Isaiah (24–27), and Daniel (2:13–45, chapters 7–12), sought to comfort believers in times of difficulty and to put contemporary suffering in perspective. God would enable his suffering faithful, his elect ones, to triumph and have dominion over their enemies.

The earliest Christian communities arose amid Jewish apocalyptic thinking and Jewish renewal movements such as the Maccabees and Zealots. The earliest Christian literature reflects this eschatological expectation. St. Paul repeatedly refers to the Parousia, the Lord's Second Coming (1 Thess. 2:19, 3:13, 4:15, 5:23). The synoptic Gospels (Matthew, Mark, and Luke) similarly reflect the concerns of the first generation of Christians, for example, recalling how Jesus began his ministry with an urgent proclamation of the imminence of the end times and the coming of the Kingdom: "The time is fulfilled, and the kingdom of God is at hand" (Mark 1:15). Early Christians were convinced the Second Coming would occur in their lifetime.

The Book of Revelation, written in response to the unexpected persecution of Christians as well as the nonappearance of the Parousia, uses mysterious symbols, striking images, and visions to provide for suffering believers assurance of the Lord's imminent return, restoration of order in the cosmos, and a final victory with a new creation. Satan would be bound and the saints would reign with Christ for a thousand years (20:1–6).

Millenarian Movements

The first major millenarian movement after the early Christian communities was Montanism. Montanus, its founder,

sought to restore the enthusiasm of the early period of the church. Montanus's movement began about 172 C.E. He expected the Lord to return to Pepuza and Tymion, two small towns in Asia Minor. The New Jerusalem would soon descend to earth and the thousand-year reign of Christ would begin. Montanus encouraged his followers to live in strict asceticism to prepare for this Second Coming. The church turned against Montanus because millenarianism was not central in Christian doctrine and because ecstatic prophecy and private interpretation undermined church discipline.

St. Augustine of Hippo (354–430) effectively closed the door on millenarian speculation for centuries by writing against the kind of literal interpretation of Scriptures that promised a physical paradise on earth. But early in the Middle Ages Joachim of Fiore (1130 or 1135–1201 or 1202) reopened the door for many apocalyptic and renewal movements, such as the Spiritual Franciscans and the Fraticelli. Joachim believed his own age was in crisis and preached that human agency would contribute to bringing the church through to the final stage of history, the age of the Holy Spirit.

In many instances millenarian hopes and expectations became intertwined with political and social aspirations and resulted in a violent mix—especially when reform efforts, blocked by rigid church and secular authorities, became radical and extreme. Such a situation occurred, for instance, in the fifteenth century in Bohemia and Moravia, when the Hussite reform movement, blended with inchoate nationalistic feelings and social tensions, became the Hussite Revolution, which in turn spawned the radical millenarian movement of the Taborites. Using religious images and millenarian beliefs, Taborites created a short-lived millenarian society that fought violently against the forces sent to crush it.

In sixteenth-century Germany Lutheran reforms triggered a sense of liberation as well as disorientation amid social and religious changes. Just as Martin Luther used apocalyptic imagery to portray the pope as the Antichrist, Thomas Müntzer portrayed Luther as the Beast of the Apocalypse because Luther was countering Müntzer's reformist efforts. Müntzer committed himself to social and religious revolution, believing any who opposed this process of the last days must be violently annihilated. Anabaptist groups channeled reform hopes into efforts to establish a new golden age. Some groups preached a nonviolent awaiting for the end times, while other segments developed a fanatical millenarianism as authorities opposed them. In Münster the Anabaptists set up the new Kingdom of Zion, which came to a violent and bloody end in 1535.

At the end of the sixteenth century and early in the seventeenth, the political and religious conditions in England prompted a wave of millenarian interest and excitement. English Puritans increasingly interpreted biblical prophecies about calamities and the Second Coming as referring to contemporary situations. Learned men tried to decipher from Scripture the date when the end of the world might arrive. The most radical of English millenarians were known as the Fifth Monarchy Men (from the vision recounted in the Book of Daniel, chapter 7). In the early eighteenth century France's Camisards or "French Prophets" sought from the Catholic king some

tolerance for their Protestant culture and practices. The Camisards believed their sufferings were part of God's plan for the coming of the millennium. Lay prophets, including many children, amid physical manifestations of shaking and convulsions, revealed that the Judgment Day was soon approaching, that the reign of the Beast of the Apocalypse would soon end.

Millenarianism in North America

North America was especially fertile soil for the growth of millenarian movements and ideas. English Puritans brought millenarianism with them to American shores with the apocalyptic vision of being God's instruments in establishing the New Kingdom. John Winthrop, the governor of Massachusetts Bay Colony, expressed the Puritan aspiration of building a revolutionary city, a New Jerusalem, "coming down out of heaven from God" (Rev. 21:10). Early Puritan divines such as Joseph Cotton and Increase Mather continued the tradition of learned speculation about the date the millennium would begin and how the conversion of the Jews must precede the Second Advent of Christ. A not-inconsiderable part of American optimism and expansionism rested on beliefs about being God's elect and about the qualities of the earthly paradise.

William Miller, born in 1782 in Massachusetts, scrutinized the Scriptures and reconfigured biblical chronology. If the world began in 4004 B.C.E. and lasted 6,000 years, Miller concluded that "sometime" between 1843 and 1844 would be the end of the world. His pamphlet about the Second Coming of Christ and his reign convinced upwards of fifty thousand Americans that time would run out in 1844.

Of course, the world did not end, and the Great Disappointment of 1844 fragmented the Millerite movement. The diversity of responses to the nonappearance of the end included efforts to recalculate and "adjust" the prophetic dates of Jesus's Second Coming. Seventh Day Adventists and Jehovah's Witnesses evolved from the discouragement and divisions of Millerism. They, along with the Mormons, another fast-growing American religion, have explicit millenarian expectations, implying the lasting appeal of millenarian hopes.

Although most millenarian terms, images, and ideas originated within ancient Judaism and early Christianity, millenarianism has echoes in other religions and in cults. At its core, millenarianism offers the idea of history as progressing toward a transformed world. This nourishes the ever green yearning for an end of suffering and oppression and hardship. It is not surprising, then, that anxious and "deprived" people continue to look for signs that a new age is dawning. This human aspiration for a transformed world can then be discerned not only behind a variety of utopias and ideas about society, including those of Karl Marx or Hitler's Thousand Year Reich, but also in such contemporary millenarian cults as the People's Temple, the Branch Davidians, Heaven's Gate, and AUM Shinrikyo.

See also *Christianity; Eschatology; Judaism; Puritanism; Utopia.*

BIBLIOGRAPHY

Baumgartner, Frederic J. *Longing for the End: A History of Millenarianism in Western Civilization.* New York: St. Martin's, 1999.

Barkun, Michael. *Crucible of the Millennium: The Burned-Over District of New York in the 1840s.* Syracuse, N.Y.: Syracuse University Press, 1986.

Kaminsky, Howard. *A History of the Hussite Revolution.* Berkeley and Los Angeles: University of California Press, 1967.

Landes, Richard A., ed. *Encyclopedia of Millennialism and Millennial Movements.* New York: Routledge, 2000.

Laursen, John Christian, and Richard H. Popkin, eds. *Millenarianism and Messianism in Early Modern European Culture.* Vol. 4: *Continental Millenarians: Protestants, Catholics, Heretics.* Boston: Kluwer, 2001.

McGinn, Bernard, ed. *The Encyclopedia of Apocalypticism.* Vol. 2: *Apocalypticism in Western History and Culture.* New York: Continuum, 1998.

St. Clair, Michael. *Millenarian Movements in Historical Context.* New York: Garland, 1992.

Wessinger, Catherine Lowman. *How the Millennium Comes Violently: From Jonestown to Heaven's Gate.* New York: Seven Bridges, 2000.

Michael St. Clair

ISLAMIC

Millenarianism in Islam is a major theme that runs through the entire gamut of classical Islamic civilization. Although the Koran itself does not propose a millenarianism, as its major theme is eschatological and otherworldly, starting from the end of the seventh century C.E., the tradition literature (*hadith*) contains visions of a messiah and of a messianic age. The earliest messianic figure in Islam was probably Jesus, who was taken up to heaven by God—rather than crucified (Koran 3:55) as in Christianity—with the understanding that he would return at the end of the world; the more prevalent figure, however, was that of the Mahdi, the rightly guided one. This title began to appear attached to prominent political and religious figures by the middle of the seventh century, but the predictions concerning him received their present form during the period of the Abbasid revolution (740–749): the Mahdi will arise in the east, in the region of Khorasan (today eastern Iran and Afghanistan), raise an army, march through the Iranian plateau to Iraq and establish his messianic kingdom there after purifying the Muslim world of evil. This scenario mirrored the Abbasid rise to power closely and served to legitimize their revolution. By contrast, the figure of Jesus remained in Muslim apocalyptic beliefs primarily to fight and slay the Dajjal (the Antichrist), who will appear prior to the messianic kingdom and test the Muslims. Jesus will return from heaven at the advent of the messianic age, slay the Dajjal near Jerusalem, and then pray behind the Mahdi.

By contrast, the Shiite messianic vision was based upon the return of the Twelfth Imam (descended from the Prophet Muhammad), who went into occultation in 874. The Twelfth Imam will arise either in the east, as in the Sunni version, or in Mecca in some other versions and will similarly purify the Muslim world and take vengeance upon those who have oppressed the Shiites. However, in both the Sunni and the Shiite versions, the messianic age is not an extensive one; Sunnis believe that it will last between five and nine years, while Shiites allow for the possibility of twenty to forty years and, in some versions, up to

three hundred years. For the most part, this period is characterized by the messianic tradition, “He will fill the earth with righteousness and justice just as it has been filled with unrighteousness and injustice” (Cook, 2003, p. 137). The specifics of this tradition are not fleshed out, however, and its powerful message remains available for any movement to use.

Starting with the Abbasids (747–1258), a wide range of both Sunni and Shiite Muslim dynasties and rulers have used messianic or millenarian slogans or visions to justify their rule. The first seven Abbasid rulers all took messianic titles for their regnal names and spread the idea that their rule was the promised messianic kingdom. As the Abbasid dynasty lost power through the ninth century, other rulers appropriated or manipulated these beliefs. Many rulers gained legitimacy through the tradition that “at the turn of every one hundred years God sends a renewer to renew His religion.” This renewer, the *mujaddid*, was for the most part a religious figure, but the renewal movements spawned by his activities often had political ramifications as well.

In 899 the sevens Shiites (those who accepted seven imams descended from the Prophet Muhammad), also known as the Ismailis, proclaimed their messianic kingdom in North Africa. The dynasty they produced, the Fatimids, eventually moved to Egypt, where they founded Cairo in 969 and for a time provided serious competition with the Abbasids for primacy in the Muslim world. Like most Muslim dynasties founded on messianic claims, there was a transition after the first couple of rulers to a nonmessianic form of legitimacy. After the fall of the Abbasids in 1258 at the hand of the Mongols, Muslim dynasties all over the Middle East used messianic legitimacy to found their rule. This took several forms, the first of which was the traditional messianic religious form, conforming closely (or at least as closely as possible) to the traditions. A good example of this is the Safavid dynasty of Persia (1499–1736), which converted the Persian people (for the most part) to Shiism. This dynasty reached its peak in a wave of expectation keyed to the Muslim year 1000 (1591–1592 C.E.). Immediately after the passing of this date, the Safavids brutally suppressed their extremist followers, the Kizilbash, and thereafter ruled without recourse to messianic themes.

Another paradigm employed more secular messianic themes, such as universal justice (also present in Islam) and stability. The best example of this trend was the Ottoman dynasty (c. 1300–1918), especially under Sulayman the Magnificent (1520–1566), who was known as Sulayman the Law-Giver (Fleischer, 1992). Yet other rulers more marginally Muslim, such as Timur (Tamerlane; c. 1336–1405), employed millenarian themes taken from the world of astrological calculations and called themselves *Sahib-i Qiran* (the Lord of the Auspicious Conjunction). This term and its cognates implied that the world of the stars (governed, of course, by God) had conferred special favor upon Tamerlane and other Turkish and Persian rulers who used it and thereby had the “mandate of heaven” for their rule.

Not all millenarians were successful, and some of the more prominent failures left very conspicuous marks on Muslim history. The messianic revolt of Muhammad al-Nafs al-Zakiyya,

a descendent of the Prophet Muhammad, in Medina in 762, for example had a profound influence upon the shaping of the tradition of the appearance of the Mahdi despite the fact that the revolt itself was a failure. Many other movements were characterized by outlandish or exaggerated predictions or, while occasionally serving to vent popular frustrations, fizzled politically. A good example of this type of movement was the Syrian belief in the Sufyani, a descendent of the early caliph Mu‘awiya bin Abi Sufyan (602–680), who was supposed to appear and liberate the Syrians. No less than fourteen different appearances of people claiming to be the Sufyani can be documented from history, all of them ending tragically.

Millenarianism in Islam is far from dead. The messianic ideals surrounding the Mahdi, the religious renewal of the *mujaddid* and the fear engendered by the Dajjal are quite common in contemporary Muslim apocalyptic literature. A great deal of apocalyptic speculation was attached to the year 1400 (1978–1979 C.E.), when major upheavals occurred around the Muslim world, including the messianic revolt of Muhammad al-Qahtani and Juhayman al-Utaybi at the Holy Mosque in Mecca and the Islamic Revolution in Iran. According to the authoritative treatise of Jalal al-Din al-Suyuti (d. 1505), *al-Kashf ‘an mujawizat hadhibi al-umma al-alf* (Revelation of this Community’s Passing of the Thousand-Year Mark), the end of the world should be expected around the year 1500 (2076 C.E.). Most early twenty-first-century apocalyptic tracts feature scenarios and dates that are built around his prediction. Mahdi figures continue to appear with regularity, and contemporary radical Islam includes messianic expectations for a proposed revival of the caliphate and a united Muslim state.

Scholarship on the subject of Islamic millenarianism has been primarily confined to Shiite movements. One important work is Abdelaziz Sachedina’s *Islamic Messianism*, which examines early Shiite ideals and beliefs. Wilferd Madelung has published a number of studies on the subject of Sunni and Shiite apocalyptic and messianic traditions, primarily building upon the early work of Nu‘aym bin Hammad al-Marwazi (d. 844). Messianic themes among dynasties are usually to be found in historical works and have yet to be studied as a whole. David Cook’s *Studies in Muslim Apocalyptic* covers many of the basic themes of Muslim apocalyptic and messianic belief; his 2003 work, *Contemporary Muslim Apocalyptic Literature*, presents the literature current at the turn of the twenty-first century.

See also Islam; Millenarianism: Latin America and Native North America; Millenarianism: Overview; Mysticism.

BIBLIOGRAPHY

- Cook, David. *Contemporary Muslim Apocalyptic Literature*. Syracuse, N.Y.: Syracuse University Press, 2003.
- . *Studies in Muslim Apocalyptic*. Princeton, N.J.: Darwin Press, 2002.
- Fleischer, Cornell, “The Law-Giver as Messiah: The Making of the Imperial Image in the Reign of Suleyman.” In *Suleyman the Magnificent and His Time: Acts of the Parisian Conference Galeries Nationales du Grand Palais 7–10 March 1990*, edited by Gilles Veinstein, 159–177. Paris: École des Hautes Études en Sciences Sociales, 1992.

Madelung, Wilferd. "Apocalyptic Prophecies in Hims during the Umayyad Age," *Journal of Semitic Studies* 31 (1986): 141–185.

Sachedina, Abdulaziz Abdulhussein. *Islamic Messianism: The Idea of Mahdi' in Twelver Shi'ism*. Albany: State University of New York Press, 1981.

al-Suyuti, Jalal al-Din. *al-Kashf 'an mujawizat hadbihi al-umma al-alf*. In his *al-Hawi li-1 -Fatawa*. Beirut: Dar al-Fikr, n.d.

David Cook

LATIN AMERICA AND NATIVE NORTH AMERICA

The history of humankind is replete with the desire for better times, a more just order, and leaders who can bring their people into a better world, often having to defeat or destroy a world that is viewed as unjust and inequitable. These desires have frequently been fueled by faith or have taken specifically religious forms; and in addition have often been organized around or contained elements of ethnicity, identity, and race.

Old World Origins

In the area stretching from Asia Minor through Europe and into regions colonized by political and religious powers emanating from these areas—such as the New World—these desires have often been linked to the Judeo-Christian tradition. These beliefs and desires and the movements they have generated have become popularly known as millenarianism or chiliasm (a word of Greek origin). However, as one of the most noted scholars of the subject, Norman Cohn, has pointed out, "These movements have varied in tone from the most violent aggressiveness to the mildest pacifism and in aim from the most ethereal spirituality to the most earthbound materialism; there is no counting the possible ways of imagining the Millennium and the route to it" (p. xiv).

The term *millenarianism* comes from the belief by some Christians that Christ will return to earth and establish a kingdom in which he will reign over a society that is blessed spiritually and materially and in which the enemies of this Christian fold will be defeated. This rule, it is believed, will last for a thousand years—a millennium—before the faithful or Saints will ascend to heaven while those who are seen as evildoers will suffer eternal damnation. Hence the belief in the coming millennial earthly paradise of Christ became known as millenarianism. The actual concept of millenarianism, however, predates Christ. Long before Christians separated from Jews, the idea of a prophet or Messiah—a powerful, wise, and just ruler of the faith—was a part of Jewish belief in the coming of a world where the longed-for order was restored.

While a belief in the coming of the Messiah alone is not necessarily millenarian, when it is attached to persecution or the desire to attain a proper and just order, it can become millenarian. Hence during the centuries and decades before and after the birth of Christ, when Jews were suffering persecutions, were not self-governing, or were divided by class and other interests, numerous millenarian movements and leaders emerged. For instance, in the second century B.C.E., a time of crisis for Jews, the Book of Daniel was written in which Daniel dreams that the enemies of the Jews are destroyed and an everlasting kingdom is established with dominion over all.

While millenarian movements enjoyed some popularity within the early Christian Church in the first three or four centuries C.E., these movements, in both the Greek and Western churches, were eventually considered heretical. This was especially true after the official church became more tied to the state. In the early Christian world, many people led difficult lives and were strongly influenced by accounts such as those in the New Testament Book of Revelation, in which an angel descends to earth, seizes the Devil, and binds him for a thousand years: "Also I saw the souls of those who had been beheaded for their testimony to Jesus and for the word of God, and who had not worshiped the beast or its image. . . . They came to life again, and reigned with Christ a thousand years" (Rev. 20:4).

From the late eleventh century to the sixteenth century, millenarianism became a more common phenomenon in certain regions of Europe that were experiencing change in the traditional order. Norman Cohn argues, "The areas in which the age-old prophecies about the Last Days took on a new, revolutionary meaning and a new, explosive force were the areas of rapid social change—and not simply change but expansion: areas where trade and industry were developing and where the population was rapidly increasing" (p. 22). In this world of growing disorder, complexity, and insecurity, millenarian ideas were often blended with antagonisms of class, religion, and identity that imbued these movements with a revolutionary character that could appear threatening or hopeful, depending on one's position in society and relationship to the movement.

Movements such as the People's Crusade and the Shepherd's Crusade witnessed the rising of poor and marginalized people against elites and Jews. The Calabrian abbot Joachim de Fiore used biblical study, especially of the Book of Revelation, to develop a model for understanding history and for creating a vision of the final period of life on earth. These Judgment Days, or Last Days, involved a world where social classes had been leveled, governing structures and church did not exist, and people led a "spiritual" existence that freed them from work because in this spiritual form they did not require food. Surprisingly, the church did not repress this movement even though Christ was not at the center of this new interpretation. Hence from at least the thirteenth century on, even in the Christian tradition, millennial views existed without Christ.

It is in this tradition that scholars in the modern period have increasingly used millenarianism as a tool to study and explain movements that seek to redeem societies and rescue them from rapid social change, colonial incursions, and loss of traditional meaning; this tool also helps in understanding millenarian movements such as the Anabaptists, the Ranters, and others in Europe. While in the modern period Norman Cohn saw certain medieval and early modern millennial movements in Europe as the deep roots of modern communism and Nazism through movements such as that of Thomas Müntzer and the Shepherd's Crusade, studies of the New World have focused on millenarian movements of the poor and oppressed seeking a measure of control, hope, and dignity in their lives and cultures.

Importance in Latin America and Native North America

These movements and interpretations of them are especially prominent among the native peoples of the Americas and those who study them. In the late-eighteenth- and early-nineteenth-century United States, Tecumseh, a leader of the Shawnee nation, and his brother Tenskwatawa, known as “The Prophet,” organized Shawnee and other tribes of the Midwest in a movement to reject European ways, return to their old traditions, and end warfare between native peoples. This was part of their effort to drive out nonindigenous peoples and restore a new indigenous order based on the old ways. Tecumseh, who had studied the Bible, even injected European religion into the fray when he asked how white people could be trusted when they had nailed Jesus Christ to a cross.

The Ghost Dances of the U.S. West in the late nineteenth century represented another form of millenarianism. Indigenous peoples of the western plains, who had been severely battered by waves of settlers, the Indian wars fought by the U.S. government, and the destruction of the buffalo herds, called upon their gods to restore power to them. Often overcome with a spirit, these peoples felt imbued with the power to defeat their enemies and redeem their world.

Latin America has also been the source of important millennial movements, including those in which native peoples challenged the European-dominated order. In Peru, in the wake of massive deaths due to European diseases and the encounter with European colonialism, the Taki Onqoy (Dancing Sickness) movement of the 1560s saw the reemergence of old regional gods such as those that lived in mountains, rocks, and in water, but not the gods or leaders of Inca imperialism. These older regional leaders and gods promised salvation to those who were taken by the spirit, but the name Taki Onqoy, or Dancing Sickness, was given to the movement by those who observed its impact on the behavior of those imbued with the spirit who wished to renounce everything that was European and drive out the Europeans as well as other people and things not native to the Andes.

In Chiapas, Mexico, in the early 1700s a millenarian movement arose among the Tzeltal people in response to a vision of the Virgin, who appeared and told them to drive out all nonnative peoples. Some of these highland Maya even proclaimed themselves to be the true Christians while referring to the Europeans as Jews, thus putting the Europeans outside the realm of those protected by the Christian God.

Perhaps the greatest of New World millenarian movements, and one which may still be ongoing, is that of Inkarrí. According to this belief, which was important in validating the revolutionary upheaval of Túpac Amaru in the 1780s, the Inca was to be reborn from the buried but regenerating head (symbolic or real) of an earlier Inca. When the time is right, the Inca will reemerge to lead the indigenous people of the Andes (who are sometimes also referred to as Incas) in the restoration of a more just and equitable social order. The Inkarrí movement is still culturally alive and people are still waiting.

See also *Millenarianism: Islamic; Mysticism; Religion; Sacred Texts*.

BIBLIOGRAPHY

- Cohn, Norman. *The Pursuit of the Millennium*. 2nd ed. New York: Harper and Row, 1961.
- Flores Galindo, Alberto. *Buscando un Inca*. Lima, Peru: Instituto de Apoyo Agrario, 1987.
- Gosner, Kevin. *Soldiers of the Virgin: The Moral Economy of a Colonial Maya Rebellion*. Tucson: University of Arizona Press, 1992.
- Stavig, Ward. “Túpac Amaru, the Body Politic, and the Embodiment of Hope: Inca Heritage and Social Justice in the Andes.” In *Death, Dismemberment, and Memory: Body Politics in Latin America*, edited by Lyman Johnson. Albuquerque: University of New Mexico Press, 2004.
- . *The World of Túpac Amaru: Conflict, Community, and Identity in Colonial Peru*. Lincoln: University of Nebraska Press, 1999.
- Szeminski, Jan. *La utopía tupamarista*. Lima: Fondo Editorial de la Pontificia Universidad Católica del Perú, 1984.
- Thornton, Russell. *We Shall Live Again: The 1870 and 1890 Ghost Dance Movements as Demographic Revitalization*. Cambridge, U.K.: Cambridge University Press, 1986.
- Wright, Ronald. *Stolen Continents*. Boston: Houghton Mifflin, 1992.

Ward Stavig

MIND. The science of mind is the empirical and theoretical search for the foundations of our mental lives. Unlike other subjects of scientific investigation, such as stars or rocks, human mental lives defy easy definition. Yet few would dispute that such a definition would have to encompass consciousness, emotions, reasoning, language, memory, and perception. As far back as ancient Greece, one can find accounts of how these faculties are produced by the body or the soul. But it was only in the seventeenth century that they became subjects of modern scientific investigation. In the subsequent centuries, scientists have sought to dissect the mind into its components, and to assign those components to different structures of the brain. While a full history of the science of mind would demand thousands of pages, a survey of a few key topics can give a sense of its development.

The Mind Before Neurology

To many readers, the relationship between the brain and mind may be obvious, but that has not always been the case. In 1652, for example, the philosopher Henry More (1614–1687) declared that the brain “is no more capable of thought than a cake of suet or a bowl of curds” (Zimmer, p. 5).

Medieval and Renaissance physicians sought to understand the mind with a mix of Christian theology and Greek philosophy. They believed the body, for example, was divided into three anatomical regions, each designed for its own soul. The vegetative soul in the liver was responsible for desires and appetites. The heart housed the vital soul, which produced passions and action.

The rational soul, not surprisingly, was a more complicated matter. Since it was immaterial and immortal, it could not reside in one specific place in the body. But its faculties—such

as reason, memory, and imagination—were believed to be carried out by “animal spirits” that supposedly swirled within three hollow chambers in the head known as the ventricles.

Anatomy, then, was the study of the houses of the souls. But anatomy alone was not enough to account for the life of the mind. Physicians also had to understand the fluids that coursed through the body. Known as the four humors (black bile, yellow bile, blood, and phlegm), these humors needed to be balanced for good health; if they fell out of equilibrium, they brought disease. Humors also gave each individual his or her temperament, be it the sad detachment of melancholy or the swift rage of cholera. As the humors became corrupted or moved to the wrong place in the body, they could cause epilepsy or alter the temperament, even leading to madness. Physicians sought to cure many psychological disorders by bringing the humors back in balance, typically with bleeding and purging, or by applying herbs.

During the Renaissance, these theories of souls and humors were vigorously debated. And yet in all these arguments, the brain was strangely absent. The substance of the brain—now recognized as consisting of billions of neurons trading complex signals—was seen as nothing more than phlegm. This is understandable when one considers how delicate the brain is. Without preservatives or refrigeration, a brain quickly decays after death, while muscles and bones remain available for further study.

Descartes’s Ambiguous Legacy

This “pre-cerebral” view of the mind disappeared in the 1600s, in the wake of advances in physics, anatomy, and chemistry. Galileo Galilei (1564–1642) and other natural philosophers challenged the physics of Aristotle (384–322 B.C.E.), replacing it with a new “mechanical philosophy” in which mechanical forces acting on atoms or other small particles produced all physical change. In the 1630s the French philosopher René Descartes (1596–1650) used the new mechanical philosophy to offer a novel description of the body. He no longer relied on vegetative or vital souls to produce the body’s functions. Instead, he proposed that the body was made of particles that obeyed the laws of physics. A body was no different from a mechanical doll: neither needed a soul to drive its movements. Instead, Descartes envisioned nerves as a system of cords and inflating tubes that mechanically produced involuntary movements.

Descartes managed to take a crucial step towards a science of the nervous system, despite the fact that he was woefully confused about the brain. He accepted the medieval notion of spirits flowing through the ventricles. He even used it to determine where the rational soul was located. For Descartes, it was obvious that the pineal gland, which was believed to dangle over the ventricles, had to be where the rational soul influenced the spirits, steering them toward different nerves in order to produce voluntary movements.

This scenario, as strange as it may seem to the modern reader, accorded with Descartes’s overall philosophy. He believed that nature, including the human body, was composed solely of passive matter. The human mind, on the other hand,

was completely immaterial and not subject to the laws of nature. Thus Descartes required a site where the immaterial and material could intersect. The pineal gland fit all of these requirements. It would take a separate revolution in anatomy before the brain could be appreciated as more than a bowl of curds.

Thomas Willis and the Birth of Neurology

The modern study of the body’s functions began with the work of the English physician William Harvey (1578–1657). Harvey trained at the University of Padua, where he learned Aristotle’s methods of comparative zoology and functional anatomy. He returned to England and eventually became a royal physician to James I and Charles I, during which time he discovered the circulation of the blood.

As important as this discovery was, however, Harvey’s methods were even more significant. He did not rely solely on Galen (129–c. 199 C.E.) or some other ancient source. Rather, he searched for confirmation of his hypothesis in comparative studies on animals and through experiments. By the 1650s, young natural philosophers were emulating Harvey, not Aristotle, as they studied the liver, lungs, and other organs of the body. And in the early 1660s, a group of Harvey’s disciples applied his methods to the brain.

These natural philosophers were led by an Oxford physician named Thomas Willis (1621–1675). A royalist soldier during the English Civil War, Willis had been rewarded at the Restoration with an appointment as professor of natural philosophy at Oxford. He used the new position to embark on a bold project—to seek out the hiding place of the mind. Based on a decade of previous research, including dissections, chemical experiments, and medical observations, Willis decided that the most promising way to study the mind was to make a careful study of the brain.

Willis enlisted a number of colleagues, including his junior medical partner Richard Lower (1631–1691) and his young friend Christopher Wren (1632–1723). They dissected brains of humans, dogs, sheep, and other animals, and Willis recorded their work in his 1664 book *The Anatomy of the Brain*, the first major work on the brain ever written. Over the next eight years he would rely on both his anatomical discoveries and his careful bedside observations to write *Pathologiae Cerebri* (Cerebral pathology), a book on convulsive disorders, and *Two Discourses Concerning the Soul of Brutes*, on neurological and psychological disorders.

Together, this trilogy stands as a defining moment in neuroscience. (Indeed, Willis even coined the word *neurology*.) Willis dismissed Descartes’s notions of the pineal gland and ventricles, demonstrating that these chambers could not possibly house the spirits. The brain itself was the site of mental functions, Willis argued, and he carried out experiments to show that different functions were localized in different regions. Instead of Descartes’s speculative sketch of involuntary movements, he offered a far more accurate account of reflexes.

Willis also added chemistry to Descartes’s mechanical nervous system. As a young physician, Willis had been strongly

influenced by the work of alchemist-physicians such as Paracelsus (1493–1541) and Jan Baptista Van Helmont; he also worked with the Irish chemist Robert Boyle (1627–1691) in 1650s Oxford. Willis envisioned the brain as an alembic (an apparatus alchemists used to distill substances), and he conceived of the brain's disorders as disorders of chemistry. He saw epilepsy, for example, not as demonic possession, but as uncontrolled explosive reactions in the brain and nerves.

In the decades around the turn of the twenty-first century, neuroscientists looked back at Willis's work with growing admiration. He has even been called the Harvey of the nervous system. Not only did Willis create a masterful theory of the brain, but in his writings scientists can see the first clinical descriptions of a wide range of neurological conditions, ranging from myasthenia gravis to narcolepsy. By the late seventeenth century, the work of Willis and continental anatomists such as Nicolaus Steno (1638–1686) and Franciscus de Bo Sylvius (1614–1672) had led most physicians to accept the basic tenets of neurology.

Nineteenth Century Investigation: Broca and Donders

Neurology advanced during the 1700s and early 1800s, as researchers discovered electricity's role in the nervous system and mapped out reflex pathways between the spine and limbs. But Willis's most ambitious project—to work out the foundations of the mind—did not see major advances until the mid-1800s. The huge technical challenge of studying many aspects of human cognition certainly was responsible for some of the delay. But the Cartesian dualism that lingered into the nineteenth century also acted as a brake on progress. Many researchers continued to believe that the mind was a unitary, immaterial entity. It was therefore impossible to discover its components, as had been done with the heart or the lungs. According to one prominent French neurologist in the 1800s, to divide the soul was to deny it.

A growing number of scientists rejected this claim during the nineteenth century. The concept that humans were the product of evolution—first broached in the 1700s and brought to fruition by Charles Darwin (1809–1882) in the following century—implied that the faculties of the mind were the product of evolution as well. Scientists began to divide the soul, as it were, and in the process they established the foundations of cognitive neuroscience. The work of two researchers in particular, Pierre-Paul Broca (1824–1880) and Frans Cornelius Donders (1818–1889), illuminate the scientific shift that occurred in the mid-1800s.

In 1861, the French physician Broca treated a man who suffered a stroke. The patient could understand language but could not speak, except for one sound, “tan.” (The patient became known as Tan.) After Tan's death, Broca followed Willis's example and autopsied his patient's brain. Tan's brain was damaged in the left frontal lobe. Other patients with the same difficulty in speaking exhibited damage in the same place. Broca demonstrated that a restricted part of the brain was responsible for a restricted aspect of human mental life—specifically, the ability to produce speech.

At the same time that Broca was doing this work, the German ophthalmologist Donders was dissecting the mind in

a radically different—yet complementary—way. In the early 1800s, physiologists and physicists began to study the performance of people in simple tasks, such as recognizing colors and shapes. These tests, the researchers hoped, would reveal the inner workings of the mind without any recourse to anatomical details. In the 1860s Donders performed one of the most elegant of these tests. He first measured how long it took for people to react to seeing a light come on. In his second experiment, one of two differently colored lights could turn on, and his subjects had to indicate which color had come on. He found that it consistently took 50 milliseconds longer to discriminate colors than to perceive the presence of a light. Essentially, Donders was doing in time what Broca was doing in space: He was isolating and studying a specific mental function.

In the twenty-first century, cognitive neuroscientists continue to employ the methods of Broca and Donders, albeit with more sophisticated technology.

Cognitive Neuroscience

Cognitive neuroscience, which focuses on how the mind emerges from the brain, first developed as a discipline in the 1960s. Unlike Willis or Broca, contemporary cognitive neuroscientists can build on the extraordinary advances in the understanding of the brain that took place in the late nineteenth and twentieth centuries. For example, it is now accepted that the brain is composed of several billion neurons, which project a trillion branches to contact other neurons. Neurons carry information as electrical impulses, and communicate with other neurons by releasing a variety of chemicals known as neurotransmitters.

Cognitive neuroscience has also gained great strength from new technologies that provide high-resolution information about brain activity. Consider one technology known as functional magnetic resonance imaging (fMRI). fMRI represents a modern twist on the investigative methods of Willis, Broca, and Donders. A human subject lies with head surrounded by a large, doughnut-shaped magnet. The magnet's powerful field causes some molecules in the subject's brain to release radio waves. Detectors pick up these signals, which a computer uses to reconstruct the structure of the brain. Additional analysis of this data can reveal movements of blood in the brain, which reliably indicate highly active regions of the brain.

A complex cognitive task, such as reading or recalling a person's face, involves many regions of the brain. In order to isolate components specific to these tasks, scientists borrow Donders's subtraction method. They scan the brains of their subjects as they perform one task, and then have them perform second task that is almost—but not quite—identical to the first. The scientists then study the fMRI scans for brain activity produced by the second task that are not produced by the first task as well.

Consider, for example, the ability to understand other people's thoughts and intentions (known as *mentalizing*). Psychologists and neuroscientists are fascinated by this ability because it appears to be unique to humans and may therefore represent a crucial innovation in the social evolution of the

human species. Psychologists have also demonstrated that autistic people do a poor job of mentalizing. Yet despite this deficit, they can still develop other skills such as mathematics and music. This pattern suggests that mentalizing is not the result of a general-purpose intelligence, but is instead a distinct, modular function of the brain that can be selectively disabled.

In 2001, British researchers found support for this hypothesis with the help of fMRI. They designed an experiment based on the game of “rock, scissors, paper.” In each round, two players simultaneously choose one object. Rock beats scissors, scissors beat paper, and paper beats rock. The subjects lay in a brain scanner and played the game on a computer screen. In some cases, they were told they were playing against a computer; in other cases, they thought their opponent was a person. In fact, the researchers generated a random sequence of choices. The only difference lay in the attitude of the subjects. As the researchers confirmed in interviews after the study, when subjects thought they were playing against a person, they tried to figure out their opponent’s strategy.

Scans revealed some regions that became active in both versions of the game. But the researchers also found a handful of small regions in the brain that were only active when the subjects thought they were playing against a person. One region has been shown in other studies to integrate information from face and hand movements. Another region is active during emotional experiences, and a third distinguishes self from non-self.

These results illuminate a general lesson of cognitive neuroscience: Most complex functions of the mind, such as mentalizing, are not carried out in a single region of the brain. Instead, a network of regions works together, integrating their activities. This realization has immediate practical implications. The deficit in mentalizing found in autistic people, for example, may not be the result of a lesion to a particular region of the brain. Instead, it may result from damage to the connections between the components of the mentalizing network.

Aspects of Mind

Contemporary cognitive neuroscience has made important strides in analyzing the mind. Three areas of particularly intense research are perception, emotion, and consciousness.

Perception. Contemporary cognitive neuroscience focuses on aspects of mind that are both important and scientifically tractable. A vast amount of research has been carried out on perception, and in particular, on vision. Researchers have repeatedly demonstrated that the mind does not simply perceive a photograph-like representation of the world. That would demand far more information than the brain can handle. Even if the mind could cope with such a torrent of data, it would probably miss the most important aspects of what is seen—for example, a carelessly driven car lurching onto the road.

Instead, the visual perception system searches for certain patterns. If one sees a few fragmentary lines aligned together, the lines are automatically perceived as a single edge. Different parts of the visual system are tuned to different patterns; some neurons are most sensitive to movement, for example, while

others are sensitive to contrasts. These regions are arranged in a pathway, with the first regions along the pathway handling simple processing and then passing on information to regions that can recognize more abstract information, such as faces.

Emotion. Among the investigations of the mind, emotions have posed a particularly difficult challenge. Medieval European thinkers ascribed many of the states called emotions to souls residing in the heart and liver, or to the four humors. Descartes helped to render these explanations obsolete, but his dualism posed problems of its own. Having divided the human being into two distinct substances—body and mind—he had to struggle to find an explanation for emotions. Emotions clearly affect the body, raising heart rate, causing one to blush, and so on. And yet humans also generally used their powers of reason to reach goals, which can be motivated by emotions. Fear of a fire, for example, might spur someone to figure out the fastest way out of a burning building. So somehow emotions must be able to influence the soul, despite the soul being made of a separate substance than the body.

Descartes envisioned passions as purely physical phenomena that could influence the mind by acting on the pineal gland, the soul’s intersection with the body. The function of the passions, Descartes argued, was to dispose the soul to want the things that are useful, and to dispose the body to make the movements that would help to acquire those things. But he also argued that passions can cause suffering and thus need to be mastered by the soul. Descartes defined this mastery as wisdom.

Contemporary neuroscientists are weaning themselves from Descartes’s dualism in their studies of emotions. They recognize human emotions as having a long evolutionary history. Emotions originated hundreds of millions of years ago as adaptive responses that simpler animals produced in response to a changing environment. Signs of danger, for example, triggered releases of hormones that prepared animals to fight or flee. Signs of potential reward (such as food or a mate) triggered release of neurotransmitters that caused feelings of anticipation and heightened attention.

While human emotions share a common ancestry with reactions in other animals, they are modified for the peculiarities of the human species. Fear is a case in point. Humans and other vertebrates rely on a region of the brain known as the amygdala to produce a sense of fear and vigilance. Rats learn to fear a flash of light if it reliably precedes an electric shock; remove their amygdala, and they never make the association. Humans with lesions in the amygdala also fail this test. But brain imaging shows that the human amygdala is also extremely sensitive to facial expressions. It takes only a few hundredths of a second for the amygdala to respond to an angry face, long before one becomes consciously aware of perceiving it. This is not surprising, given that humans are an intensely social species.

Emotions are also intimately involved in the most abstract thinking of which humans are capable. For example, Antonio Damasio (b. 1944) of the University of Iowa has shown that lesions to an emotion-associated region called the orbitofrontal cortex can lead to poor decision making. Damasio hypothesizes

that normally people are guided by emotional reactions to memories of relevant experiences in the past.

Consciousness. While cognitive neuroscientists have made great strides in identifying the components of the mind, they have much left to learn about their integration. Perhaps the most powerful example of this challenge is consciousness. Neuroscientists long shied away from the question of consciousness, feeling that it was impossible to formulate a scientific program to study it. At the close of the twentieth century, though, they began to overcome their reticence and began making serious attempts to solve this mystery.

Consciousness refers to people's awareness of themselves and of their own experiences. At the same time, philosophers also see in consciousness a feature known as qualia: the subjective experience generated in each person's brain. To appreciate the difficulty of studying qualia, imagine a neuroscientist who lacks color vision, seeing the world only in black and white. Imagine that she succeeds in learning everything there is to know about how the retina transfers information about different frequencies of light to the brain, and how the brain processes that information. But she does not know what it is like to experience the sight of red, or any other color. These qualia remain beyond her reach.

Despite these conceptual obstacles, neuroscientists are beginning to study consciousness. Some are using fMRI to compare the human brain in different states of consciousness. For example, scientists can measure the differences in the brain before it is aware of seeing an object and afterwards. They can also compare unconscious processing of sensory information versus conscious processing. In another line of research, scientists place electrodes on a subject's scalp in order to take high-resolution recordings of brain waves, looking for changes in frequencies that might represent signatures of consciousness.

Such studies do not pinpoint a "consciousness organ" in the brain. Rather, they offer an increasingly detailed picture of neural activity that correlate with conscious experiences. In one model that has emerged from this work, brain waves produced in different parts of the brain become synchronized during consciousness, producing a "global workspace" in which the processes going on in different parts of the brain are united.

There are a number of other models that are being explored, however, and none has emerged as a clear favorite over the others. Some researchers have suggested that the study of consciousness in the twenty-first century is like the study of hurricanes in the 1800s. Nineteenth-century meteorologists could collect very little data in order to understand and predict hurricanes. They could take readings of air pressure, winds, and rainfall at a few weather stations, and then try to extrapolate those results. Only when weather satellites were launched into orbit were meteorologists able to see an entire hurricane and track it across the Atlantic. In order to produce a satisfying theory of consciousness, scientists may have to wait for the arrival of satellites for the mind.

See also *Behaviorism; Biology; Body, The; Cartesianism; Determinism; Dream; Dualism; Genius; Humanity;*

Imagination; Knowledge; Medicine; Person, Idea of the; Psychology and Psychiatry.

BIBLIOGRAPHY

- Albright, Thomas D., et al. "Neural Science: A Century of Progress and the Mysteries That Remain." *Cell* 100 Supplement (2000): S1–55.
- Brazier, Mary Agnes Burniston. *A History of Neurophysiology in the 19th Century*. New York: Raven Press, 1988.
- Churchland, Patricia Smith. *Neurophilosophy: Toward a Unified Science of the Mind-Brain*. Cambridge, Mass.: MIT Press, 1986.
- Damasio, Antonio. *The Feeling of What Happens: Body and Emotion in the Making of Consciousness*. New York: Harcourt Brace, 1999.
- Descartes, René. *The Passions of the Soul*. Translated and annotated by Stephen Voss. Indianapolis: Hackett, 1989.
- Finger, Stanley. *The Minds Behind the Brain: A History of the Pioneers and Their Discoveries*. Oxford: Oxford University Press, 2000.
- French, Robert K. *Dissection and Vivisection in the European Renaissance*. Aldershot, U.K.: Ashgate, 1999.
- Gallagher, Helen, and Chris D. Frith. "Functional Imaging of 'Theory of Mind.'" *Trends in Cognitive Sciences* 7(2003): 77–83.
- Gaukroger, Stephen. *Descartes: An Intellectual Biography*. Oxford: Clarendon, 1995.
- Gazzaniga, Michael, Richard B. Ivry, and George R. Mangun, eds. *Cognitive Neuroscience*. 2nd edition. New York: Norton, 2002.
- Koch, Christof. *The Quest for Consciousness: A Neurobiological Approach*. New York: Roberts, 2004.
- Martensen, Robert L. *The Brain Takes Shape: An Early History*. Oxford: Oxford University Press, 2004.
- Pinker, Steven. *How The Mind Works*. New York: Norton, 1997.
- Young, Robert M. *Mind, Brain, and Adaptation in the Nineteenth Century: Cerebral Localization and its Biological Context from Gall to Ferrier*. Oxford: Clarendon, 1970.
- Zimmer, Carl. *Soul Made Flesh: The Discovery of the Brain—And How It Changed the World*. New York: Free Press, 2004.

Carl Zimmer

MINORITY. The term *minority group* and its opposite, *majority group*, have been widely used both among social scientists and the general public in recent decades. In social scientific (and often popular) use of these terms, they do not usually refer per se to a numerical minority or majority. Rather, the social-scientific meaning of a minority group is a group that is assigned an inferior status in society, one that enjoys less than its proportionate share of scarce resources. Frequently, minority group members are discriminated against, and in some cases they are severely and systematically exploited for economic gain by the majority group, as illustrated in U.S. history by enslavement of African-Americans and by the taking of land from American Indians and from Mexicans who settled in what became the U.S. Southwest.

Usually, a minority group is defined on the basis of a relatively permanent and unchanging status and on the basis of being different—often visibly—from the majority group. This

definition includes minorities based on ascribed statuses such as race, ethnicity, and gender and other statuses that are difficult or impossible to change, such as sexual orientation and disability. It also includes groups with common identities that are deeply held and relatively unlikely to change, most commonly religious or linguistic groups. When minority status is assigned on the basis of race or ethnicity, it often involves groups that have been conquered or colonized in the past, as is the case, in the United States, of African-Americans, Mexican-Americans and Puerto Ricans, and American Indians. In these instances, the degree of subordination experienced by the groups tends to be particularly intense. It is notable, for example, that the present and historic status of the four aforementioned groups is significantly more disadvantaged than that of most immigrant groups in the United States. For all types of minority groups, it is typically true that (1) the group is different in some way that is regarded as socially significant from those who hold the dominant influence in society, and (2) on the basis of that difference the group is assigned to a subordinate or disadvantaged status.

Widening the Definition

The concept of minorities has existed for over a century, and until the 1960s and 1970s the term generally referred to national or ethnic minorities in heterogeneous nation-states. In the 1960s and 1970s, the range of characteristics used to identify minority groups widened (e.g., gender, disability, sexual orientation), and the practice of defining minority groups primarily on the basis of power and status disadvantages became common. The focus on disadvantages is evident in the writings of Schermerhorn (1970), who argued that minority groups should be defined on the basis of relative size and power. A group disadvantaged with respect to both size and power, in Schermerhorn's definition, was a minority group, while a group advantaged in both regards was a majority group. A large group without power was referred to as *mass subjects*, while a small group with power was called an *elite*. In common usage, however, the term *mass subjects* is rarely used in the early twenty-first century. While *elite* is more widely used, it is usually employed in an economic and political sense without a direct tie to race, ethnicity, religion, language, or other characteristics commonly associated with minority and majority groups. It is, however, usually true that elites, as referred to in this sense, are members of dominant or advantaged racial, ethnic, religious, and linguistic groups.

While it is usually true that minority groups are numerical minorities, this is not always the case, as is illustrated by the subordinate status of women in the United States and, until recently, blacks in South Africa. Although Schermerhorn's term *mass subjects* might be a more appropriate label for such groups, they are more commonly referred to as having a minority status, referring to their subordinated position with regard to power, status, and economic opportunities. Although over 80 percent of the South African population is black, the political system was, until the mid-1990s, completely under the control of a small white numerical minority (but a majority group in the social-scientific sense) since the country was created in 1949. Racial separation and discrimination were written into the laws

at that time, and these laws remained in effect for forty years. In the early twenty-first century South Africa is a representative democracy, and the black numerical majority is in political control. Yet, in another sense, blacks still remain a minority group in South Africa, since the economic wealth of the country remains largely controlled by whites.

Another instance of a numerical majority that is a sociological minority group is women in the United States. Women make up slightly over half of the U.S. population but relatively few hold offices in the nation's higher political governing bodies (such as the U.S. Congress). Even at the start of the twenty-first century, full-time working women are paid only about 76 percent of the wages of similarly educated working men (U.S. Census Bureau, 2003). Thus, even though they are a numerical majority, women have in many ways been relegated to a subordinate role in American society. Accordingly, they can be regarded as a minority group in the social-scientific sense.

A helpful way to think about minority and majority groups, suggested by Norman Yetman (1991, p. 11), is to consider minority as a synonym for *subordinate*, and majority as a synonym for *dominant*.

Minority Status and the Individual

Discussion thus far has focused on groups because minority or majority status is defined on the basis of belonging to an identifiable group in society. An individual may be black, or Muslim, or female, or gay, or a non-English speaker, or have a disability. In each case, such an identity or social characteristic will identify that individual as belonging to a group with a collective disadvantage or a group that is the object of collective discrimination, exploitation, or stigma. However, although minorities are defined on the basis of groups, the consequences are very real for individuals (Goldman, 2001). It is individual human beings who are denied employment, schooling, or housing because of their race, disability, or sexual orientation, persecuted because of their religious beliefs, ridiculed because of their language, or underpaid because of their sex.

In the early twenty-first century, there has been some criticism of the term *minority* (Wilkinson, 2002). A number of objections have been raised, including the following: (1) since such status is not defined on the basis of numbers, *minority* is not a correct term; (2) the term *minority* can be a negative label and defines the groups so labeled from the standpoint of the dominant group; (3) groups with little in common, such as African-Americans and white women, are lumped together under one rather meaningless label; (4) the criteria used to define minorities are ambiguous and inconsistent; (5) the statuses that form the basis of defining minority groups include both true ascribed statuses and statuses that involve an element of choice (e.g., religious belief); and (6) the term *minority* obscures the very real impacts of racial, gender, and other forms of discrimination, using an ill-defined term to focus on groups rather than on systemic discrimination. Despite these genuine difficulties with the term, it continues to be used widely, both in social science and in popular terminology. A search of the EBSCO Academic Search Elite database in May 2003 yielded 11,822 hits on the

term *minorities*. One reason for this common use (though also a point of objection from critics of its scientific validity) is that it has been reified through governmental protections for a wide range of groups labeled as “minorities.” In addition—at least in the social sciences—there is general agreement on the experiences that lead a group to be considered a minority group. These experiences include victimization, discrimination, exploitation, and political and economic disadvantage. While each group considered a minority experiences these processes in a unique way, all such groups experience them to a greater or lesser degree. Moreover, possible alternative terms also pose problems: it is not clear, for example, that *subordinate* conveys a more positive image than *minority*. The purpose, if not always the consequence, in using such terms in social science is not to convey negative connotations, but rather to describe a similar situation—minority or subordinate status—that is experienced by a number of different groups.

See also *Discrimination; Ethnicity and Race; Identity; Prejudice*.

BIBLIOGRAPHY

- Blauner, Robert. *Racial Oppression in America*. New York: Harper and Row, 1972.
- Goldmann, Gustave. “Defining and Observing Minorities: An Objective Assessment.” *Statistical Journal of the UN Economic Commission for Europe* 18, nos. 2/3 (2001): 205–216.
- Killian, Lewis M. “What or Who Is a ‘Minority?’” *Michigan Sociological Review* 10 (1996): 18–31.
- Schermerhorn, Richard A. *Comparative Ethnic Relations: A Framework for Theory and Research*. New York: Random House, 1970.
- U.S. Census Bureau. “Current Population Survey—Annual Demographic Survey. Table PINC-05. Work Experience in 2001—People 15 Years Old and Over by Total Money Earnings in 2001, Age, Race, Hispanic Origin and Sex.” Available on the World Wide Web at <http://ferret.bls.census.gov/macro/032002>.
- Wilkinson, Doris. “The Clinical Irrelevance and Scientific Invalidity of the ‘Minority Notion’: Deleting It from the Social Science Vocabulary.” *Journal of Sociology and Social Welfare* 29, no. 2 (2002): 21–34.
- Yetman, Norman R. *Majority and Minority: The Dynamics of Race and Ethnicity in American Life*. 5th ed. Boston: Allyn and Bacon, 1991.

John E. Farley

MIRACLES. Miracles, miracle workers, and their stories are found in the life and literature of all ancient societies and are not limited to religious texts. In ancient Greece figures like Epimenides, Pythagoras, and Apollonius of Tyana were all renowned for working miracles. To this day, healing remains the form that most claimed miracles take, and many of these miracles are associated with visitations to the shrines of saints. In Africa, India, parts of Asia, and Latin America, miracles remain an important and powerful dimension of “primal” religions and cults. Indeed, miraculous healings and exorcisms are the characteristic features of the world’s fastest-growing form of

Christianity: Pentecostalism. Contrary to secularization theorists, belief in God—and in miracles—have not disappeared with the advance of science and the rationalization of Western societies. For example, opinion polls at the close of the second millennium showed that nearly 90 percent of Americans believed in God, 84 percent believed in miracles, and nearly half (48 percent) said they had experienced a miracle in their own lives or in the life of someone else (*Newsweek*, 1 May 2000, p. 57).

Viewed historically, miracles and their stories were recognized and accepted long before systematic efforts to define what a miracle is. This is not surprising since the cultures that produced the scriptures sacred to the world’s major religions—in this entry, Hinduism, Buddhism, Judaism, Christianity, and Islam—did not regard nature as a closed system operating according to its own laws and therefore impervious to the action of God or the gods. Nonetheless, they recognized miracles as extraordinary occurrences. Thus, one classic definition, from Thomas Aquinas in the thirteenth century, holds that “those things are properly called miracles which are done by divine agency beyond the order commonly observed in nature.” The medieval Jewish scholar Moses Maimonides (1135–1204) thought that miracles—especially those in the Bible—were designed by the creator for very specific purposes and, though contrary to the observable laws of nature, were instituted at the beginning of creation as part of God’s divine plan. For Deists and other Enlightenment thinkers of the eighteenth century, nature was considered to be subject to immutable laws that even God cannot abrogate. As Voltaire famously put it: “It is impossible that the infinitely wise Being has made laws in order to violate them. He has made this machine [the universe] as good as he could.” Still influential is David Hume’s argument that not only are miracles impossible, but also that “No testimony is sufficient to establish” that a miracle has occurred.

Miracles as Narrative Constructions

But “nature” and its “laws” are notoriously loose, historically conditioned concepts, and the constructs of contemporary sciences correspond to no one’s sense of “the order commonly observed in nature.” Far more useful and descriptive in any cultural context is the biblical understanding of miracles as “signs and wonders” (Hebrew, *otot u-mofetim*). Viewed this way, a miracle (from the Latin *miraculum*) is an event that astonishes beholders (wonder) and at the same time conveys meaning (sign). Absent the sign factor, it is impossible to distinguish miracle from mere coincidence. Since signs are always signs of something, we can say that a miracle is an unusual event that discloses the meaning and power of the transcendent within the world of time and space.

From this definition it follows that miracles are always narratively constructed. To take a common example: if a terminally ill patient is suddenly cured and attendant physicians can find no cause in medicine or science to explain the cure, the patient or others may claim that the patient’s sudden restoration to health is the result of prayer to God for a miracle. That is, they explain the otherwise inexplicable by fashioning a story. This is precisely what happens within the Vatican’s Congregation for the Causes of Saints, the most rigorously methodological source of contemporary miracles and their stories. Once church

officials are satisfied that a candidate for sainthood exhibited extraordinary virtue, they require two posthumous miracles attributed to the intercession of the candidate as a sign from God that the deceased candidate truly is now with God in the afterlife. Only after a board of physicians concludes that an unexpected healing has no known scientific cause does a board of theologians consider whether the healing is also a “divine sign.”

Miracles in Sacred Scriptures

The best-known miracles are those found in the scriptures of the major world religions, and in the sacred biographies of the saints, sages, and spiritual masters who embody and extend scriptural precedents. When experienced as events embedded in religious traditions, miracles tend to define themselves as stories that in some way repeat or echo previous miracles within the same tradition. For example, the Hebrew Scriptures (for Christians, the Old Testament) contains so many and various kinds of miracles—divine rescues, healings, feedings, punishments and blessings, even raisings of the dead and one ascension (of Elijah) into heaven—that it can fairly be regarded as the repository of most of the forms that miracles take in the later Jewish, Christian, and Muslim traditions.

Within the Hebrew Scriptures themselves, later books deliberately recall earlier miracle stories. For example, there are 120 repetitions and allusions to the ancient Israelites’ divinely provided crossing of the sea of reeds, the great deliverance miracle in the Book of Exodus. When the prophet Elisha picks up the mantle of his predecessor, Elijah, the power to produce similar miracles passes with it. When Jesus heals the sick and raises the dead, these miracle stories echo the miracles of Elijah and Elisha, though Jesus does them on his own authority. Likewise in the Book of Acts, the apostles Peter and Paul work the same kind of miracles that Jesus did, but they do so in his name and through the power of the Holy Spirit. Although in the Koran the prophet Muhammad notably refuses to work miracles, the story of his ascension (*mi’raj*) into heaven, a narrative developed out of a Koranic verse (Q. 17:1), replicates and surpasses the ascensions of Elijah and Jesus. This same story also provides the model of the mystical path followed by later Muslim mystics who are the chief miracle-workers in Muslim tradition.

In Buddhism, miracle stories are tied directly to Buddhist teachings as manifestations of their power to liberate. Thus the Buddha’s first disciples collectively repeat the miracles of the master as they progress along the path to perfect enlightenment. In the Puranas (“ancient tales”), a vast and very popular collection of sectarian scriptures composed and edited between the second and seventeenth centuries C.E., the miracles of Lord Krishna not only echo previous stories of earlier Vedic gods but also have the power to establish in his devotees the ability to replicate the experiences of Krishna, in some cases by becoming Krishna himself.

From this it can be seen that miracles achieve their meaning as signs through specific narrative traditions. Conversely, narrative traditions—to a large extent—determine which kinds of extraordinary events are recognized as miracles and which are not. Thus, in order to understand the significance of many scriptural

miracles, one must know what previous miracles are being replicated, echoed, or superceded. But there are important exceptions in Islam. In the Koran, Muhammad says “the signs [*aya*, meaning miracles] are with God alone;” the greatest sign is the Koran itself, every Arabic verse (*sura*) of which Muslims regard as the actual words of Allah. But the miracles attributed to Muhammad (*mu’jizat*) are all found elsewhere, chiefly in the hadith (roughly, “the traditions”) of the Prophet, considered second only to the Koran in importance. However, in the various authoritative collections of the hadith, Muhammad’s miracles tend to be merely listed apart from any interpretive narrative context. This arrangement suggests that miracles were incidental to the life and importance of the Prophet and may have been included in the hadith for the apologetic purpose of demonstrating that Muhammad, like Jesus, Moses, and other prophets of Allah before him, possessed the power to work miracles. Thus, among the three monotheistic traditions, Islam makes a formal and linguistic distinction between the miracles produced as signs by God and the miracles attributed to the prophets, whereas in Judaism and Christianity the distinction is informal: in the Bible, the power to work miracles belongs to God as the creator and sustainer of the world, but beginning with Moses that power passes to the prophets. In the New Testament, Jesus not only heals and raises the dead, like earlier Jewish prophets, but also exercises power over nature (as in calming storms and walking on water), a sign of his divinity since the power to control nature belongs to God alone.

In the various religious and philosophical traditions collectively known as Hinduism, miracles are usually understood as manifestations of innate divine power. Here we must distinguish between the miracles of God or gods, principally Shiva, Vishnu, and the latter’s many avatars (especially Krishna and Rama) and the miracles of the saints or renunciates in a long line of ascetics reaching back to the fabled sages (*rishi*) of the Vedic period (1500–500 B.C.E.). Stories of the gods and their avatars belong to the great and complex tapestry of Hindu mythology and need not concern us here. Far more relevant to the Hindu understanding of miracles are the stories told of the saints.

Just as the Hindu deities can descend in human forms (avatars), so the Hindu saints can, through the practice of asceticism (*tapas*), rise to godlike status. Thus the saint is often understood to be a “god-man” or a “goddess woman” by virtue of having “realized” the divinity innate in all human beings. In this context, a miracle is a manifestation of supernormal powers (*siddhi*) acquired as a function of attaining ever purer forms of consciousness (*samadhi*) through meditation and physical austerities. A classic treatment of the *siddhi* is the Yoga Sutra of Pantanjali, where the list of supernormal powers includes knowledge of previous lives; clairvoyance; knowledge of the moment when one will die; control over and thus freedom from one’s bodily systems; the ability to levitate and transverse great distances in a moment’s time; the power to expand or shrink one’s body; and so forth.

Although the Buddha rejected the traditional practices of Indian ascetics, Buddhism incorporates the same understanding of miracles as supernormal powers that Pantanjali outlined.

The main difference is that there is no “self” to be realized in Buddhist teachings—it is the last and greatest of illusions—which is why the Buddha taught his disciples not to display their acquired powers before the laity: to do so would manifest pride and so trap them in yet another form of attachment to self. Yet after his own enlightenment the Buddha did perform many miracles, some of them more fantastic than any attributed to Hindu god-men. But he did so for evangelistic purposes, secure in the knowledge that he had liberated himself from all attachments.

Although miracles are found in all religions, in none of them are they considered a substitute for faith or commitment to a spiritual path. As signs, they point to different meanings according to traditions, and so may be seen as boundary stories separating one religious tradition from another. As wonders, miracles continue to elicit curiosity, if not always belief. An old Hasidic saying nicely captures the ambivalence that has always attended miracles and their stories: “He who believes all these tales is a fool, but anyone who cannot believe them is a heretic.”

See also *Mysticism; Religion; Sacred Texts*.

BIBLIOGRAPHY

- Aquinas, Thomas. *The Summa Contra Gentiles of Saint Thomas Aquinas*. Translated by the English Dominican Fathers from the latest Leonine edition. Book 3. London: Burns, Oates and Washburn, 1923–1929.
- Gallup, George, Jr., and Jim Castelli. *The People's Religion: American Faith in the 90's*. New York: Macmillan, 1989.
- Hume, David. “Of Miracles.” In *Enquiries Concerning Human Understanding and Concerning the Principles of Morals*, edited by L. A. Selby-Bigge. 3rd ed. Oxford: Clarendon Press, 1975.
- Meier, John P. “Miracles and Modern Minds.” In *A Marginal Jew: Rethinking The Historical Jesus*. Vol. 2: *Mentor, Message, And Miracles*. New York: Doubleday, 1994.
- Voltaire. *Philosophical Dictionary*. Translated and edited by Peter Gay. New York: Basic Books, 1962.
- Woodward, Kenneth L. *The Book of Miracles: The Meaning of the Miracle Stories in Christianity, Judaism, Buddhism, Hinduism, Islam*. New York: Simon and Schuster, 2000.
- . “The Science of Miracles and the Miracles of Science.” In *his Making Saints: How the Catholic Church Determines Who Becomes a Saint, Who Doesn't, and Why*. New York: Simon and Schuster, 1996.

Kenneth L. Woodward

MODERNISM.

This entry includes two subentries:

Overview

Latin America

OVERVIEW

A movement of indeterminate origin and span, modernism nevertheless retains the distinctiveness of a major episode in the history of culture. Its most renowned manifestations

performed a radical break with the dominant arts of the nineteenth century. They were direct provocations to prevailing norms: norms of beauty, of the representational integrity of the human body, of the continuity of forms, of the consolations of progress, of secure reception by an audience. Despite striking differences, these artifacts were quickly recognized as part of a broad cultural transformation. They incited popular outrage, putting the category of “art” into question and forcing the issue of “difficulty.” The emergence of modernism is inseparable from the active controversy that was an inescapable aspect of its development.

Distinctions among modernization, modernity, and modernism remain indispensable: modernization as the condition of social, economic, and technological change; modernity as the lived social experience of these transforming conditions; and modernism as the cultural activity situated within and alongside these other dimensions. That no secure origin of modernism can be offered is a reflection of its complex relations. The process of modernization—uneven industrialization, the widening of empire, the spread of technologies, the emergence of class society, the struggle for the rights of women—has no fixed starting point, nor does the experience of modernity, the sensation of being unmoored from a continuous past or uprooted from an organic community.

Despite the indeterminacy at its limits, the period known as high modernism, roughly bound by the years 1890 through 1930, achieves historical definition. It does so through the magnitude and extremity of artistic experiment, the proliferation of public gestures (such as exhibitions and manifestos), the attentions of the press, the growing international circulation of experimental texts and ideas, and the widening consciousness of cultural and social change. Any single characteristic of modernism can be traced far back in cultural history. What distinguishes the movement is the convergence of multiple tendencies, including the exploration of such negative states as violence, irrationality, and nihilism alongside the affirmation of art as a redemptive possibility.

Immediate antecedents of high modernism are many and diverse. Charles Baudelaire (1821–1867), in the poems of *Les Fleurs du mal* (1857) as well as in his essays, introduced preoccupations taken up repeatedly over subsequent decades: a fascination with and revulsion from the modern city, an encounter with transgressive eroticism, an acceptance of evil, a delight in artifice (especially through the figure of the dandy), and a commitment to the craft of lyric poetry and the power of the Symbol. Whereas Baudelaire enacted his encounter with modernity in compact poetic forms, Richard Wagner (1813–1883) promoted radical transformation on the grand scale. He aimed for a complete reconstruction of nineteenth-century opera, based on his vision of the *Gesamtkunstwerk*, the “total work of art” that combines drama, music, dance, and stage-setting. Wagner’s demand for spectacular dramatic gesture, his investment in large mythic narrative, and his creation of the Bayreuth festival represent efforts to renovate culture through the public force of art.

The symbolic and mythic projects of Baudelaire and Wagner developed in parallel to a newly austere realism that

often looked to experimental science as a model. The paintings of Gustave Courbet (1819–1877), including *The Stone Breakers* (1849) and *The Burial at Ornans* (1850), refused pictorial idealism, representing workers and common citizens in ordinary dress and everyday poses. Gustave Flaubert (1821–1880), whose *Madame Bovary* (1857) epitomized the new realism, wrote that art “must rise above personal emotions and nervous susceptibilities. It is time to endow it with pitiless method, with the exactness of the physical sciences” (p. 195). Beginning in the 1870s, Henrik Ibsen (1828–1906) composed a series of plays—*A Doll’s House*, *Ghosts*, *The Pillars of Society*—that insisted on a “realist” analysis of middle-class ideals and that generated uproar throughout Europe. In their methods as their subjects, Courbet, Flaubert, and Ibsen pursued the unmasking of illusion and the hard-won claims of truthful fiction.

Although these figures differed in their work and their legacies, each prepared for the advent of high modernism. The decisive event was the emergence of an oppositional culture. It was only when singular provocations became related to one another, sometimes loosely, sometimes closely, that modernity recognized modernism and modernists became conscious of their historical possibility. There was no modernism without individually audacious artifacts, but equally no modernism without exchanges among artists and relationships among their works.

Impressionism, Symbolism, Oppositional Culture

Impressionism became a visible and contentious movement in the 1870s when a group of young French painters, including Claude Monet, Camille Pissarro, Berthe Morisot, Alfred Sisley, and Jean Renoir, gave several controversial exhibitions in Paris. Their break with academic painting and their commitment to everyday life followed Courbet, but they went further in the attempt to render the visible world as they experienced it subjectively: unstable, evanescent, and elusive. As significant as the new pictorial style was the collective aspect of Impressionism. Like the short-lived Pre-Raphaelite Brotherhood that had appeared in London in the 1850s, Impressionism generated hostility in part because the alliance among artists suggested a viable alternative to cultural orthodoxy.

A second French movement, more significant and sustained, was symbolism, which emerged in the 1880s. Stéphane Mallarmé (1842–1898) and Paul Verlaine (1844–1896) were presiding figures, and Arthur Rimbaud (1854–1891) was the legendary seer who had disappeared from France. The symbolists looked back to Baudelaire and resisted the dominance of realism, especially in its more extreme manifestation in the naturalist novels of Émile Zola (1844–1896) and the Goncourts (Edmond [1822–1896] and Jules [1830–1870]). Symbolism offered the rituals of the poetic enigma: evocative music, not descriptive reference. “To *name* the object,” wrote Mallarmé, “is to destroy three-quarters of the enjoyment of the poem” (p. 869). The poetic Symbol could be a sound, a scent, or a memory incarnating the invisible meanings of the world or intimating a mystery beyond the senses. Much symbolist polemic was a refusal of modernization (science, urbanism, mass politics, and the dislocations of individual experience). Apart from the success of individual poems, such as Mallarmé’s *L’Après-midi d’un faune* or Rimbaud’s *Le Bateau*

ivre, the importance of symbolism was that it offered an aesthetic counterworld. It was at once an artistic program and a social formation.

In Britain a critical lineage stretching from John Ruskin and Matthew Arnold to Walter Pater brought the idea of “culture” close to the symbolist vision of an alternative universe of value. A disciple of Pater, Arthur Symonds (1865–1945) helped to introduce symbolism to the English-speaking world, presenting it as a fulfillment of literature’s highest responsibilities: “for in speaking to us so intimately, so solemnly, as only religion had hitherto spoken to us, it becomes itself a kind of religion, with all the duties and responsibilities of the sacred ritual” (p. 9). He introduced Mallarmé to W. B. Yeats (1865–1939), who also imagined a literature imbued with the force of religion and resistant to a mechanized social world and materialist philosophy. Yeats looked to magic and the occult, as well to the folklore and fairy tales of Ireland. His responsiveness to such a range of countertraditions suggests the extent of the division between the new literary movements and the modernizing social world around them.

Nineteenth-century cultural movements emerged within the broader context of modernity: in particular, the recognition of class conflict in postrevolutionary Europe. The European-wide revolutions of 1848 established modern society as a struggle between competing groups. It is often noted that the term *avant-garde* began with political and military meanings and only transferred its reference to the arts in the nineteenth century. Many artists had joined the revolutionary struggles, not only in 1848 but also in the Paris Commune of 1871. The turn away from politics is a striking feature of much late-century culture, with symbolism as a defining example; yet the political struggle generated possibilities for historical change that affected even those artists who refused the call of politics.

The Assertion of Modernism, 1890–1914

The reaction against symbolism began early, and even as its influence was passing to other national cultures, it attracted stringent critique. In the 1890s symbolism often became identified with decadence, in which the austere experiments of Mallarmé gave way to easier rhythms of yearning and escape. The tableau of the weary poet cultivating the sensations of dream became a European-wide image, vulnerable to caricature and dismissal. J. K. Huysmans’s *À Rebours* (1884) helped to inspire Oscar Wilde’s *The Picture of Dorian Gray* (1891), which dramatized but also ironized the languid life of decadence, the vocation of the senses. Wilde is a decisive figure, one who in his life and work carried Decadence into the public world and who detached himself from it through wit, irony, and paradox. When Wilde went to trial in 1895, the encounter between oppositional culture and the canons of respectability became vivid and painful. His conviction, imprisonment, and early death revealed the entanglements of modernism within the social world it refused.

The turn of the century brought a perceptible change in artistic and literary movements. The symbolist poet, committed to ritual incantations of the suggestive word, gave way to the young, assertive artist, eager to contend with aesthetic

convention and social orthodoxy. When Pablo Picasso (1881–1973) painted a brothel tableau in *Les Femmes d'Alger* (1907), with its harsh forms, its sexual brazenness, its direct encounter with the eyes of the viewer, he enacted the turn from weariness to confrontation. In *A Portrait of the Artist as a Young Man*, James Joyce's Stephen Dedalus sets himself as the antagonist of a sluggish culture, daring to echo Satan's "Non Serviam." Arnold Schoenberg's *Pierrot Lunaire* (1912) conveyed the shock of atonality to Western music, attracting tones of outrage to match its experiment in dissonance. In his first Futurist manifesto (1909) Filippo Tommaso Marinetti asserted, "No work without an aggressive character can be a masterpiece" (p. 41). He toured Europe, celebrating an escape from the exhausted past into the speed and violence of modern technology.

There had been precursors of this emphatic confrontationalism too. Rimbaud had made scorn for mediocrity a founding principle of his verse. Vincent Van Gogh (1853–1890) released the intensity of color to create intensities of affective assault. But the context that prepared for high modernism was wider than literature and the arts. The unsettled life at the end of the nineteenth century was not simply the background of high modernism; it became an ongoing concern for an intellectually self-conscious movement intent to reengage the world. Major influences included the revolutionary theory of Karl Marx transmitted through post-Marxist theorists in Europe; Friedrich Nietzsche's critique of Christianity in favor of the "overman" and the will to power; Sigmund Freud's psychoanalytic exposition of the unconscious, dreams, bisexuality, and neurosis; James George Frazer's comparison of pagan rituals and modern life in *The Golden Bough*; and Henri Bergson's arguments for an experience of pure duration available only to the deep self. These ambitious theories conflicted on many points: Marx's social vision against Freud's pessimistic view of instinctual conflict and Bergson's strictly philosophic approach, Frazer's scholarly assimilation of primitive and modern attitudes in contrast to Nietzsche's tense demand for a transvaluation of all values. What they shared was a sense of radical transformation. High modernism participated in this active theoretical milieu, in which it seemed that every basis for human self-understanding was under reconsideration. Intellectual life was often an essential element in the art, and the centrality of manifestos in high modernism is another register of the intellectual character of the movement. New artifacts did not appear as isolated provocations; they arrived within a dense context of essays, reviews, and manifestos that connected the making of modernist artifacts to the unfolding of modern theory.

Outside the realm of theoretical writing stood the power of social events. The development of a large reading public and mass democracy incited a modernist anxiety over popular culture recurrent through the period. The conflict between the sexes, including the image of the New Woman and the militant demand for female suffrage, challenged the representation of sexuality in the visual arts, the structure of the marriage plot, and poetic lyricism. This was also the new age of European imperialism, and whether empire became part of the focal subject matter, as with Joseph Conrad and E. M. Forster, or remained unacknowledged, it formed an inescapable cultural context. The political environment sometimes inspired arts to

social engagement, as in the feminist writings of Virginia Woolf or in the political theater of Vsevolod Meyerhold and Bertolt Brecht; just as often it created styles of resistance or right-wing reaction, as in the later works of T. S. Eliot, Ezra Pound, or Wyndham Lewis. In either case, the success of left-wing parties, the threat of revolution in Germany, and its success in Russia meant that experimental artists worked within a milieu of political hopes and fears.

High Modernism and the Avant-Garde, 1914–1930

The devastations of World War I created a social trauma that lasted a generation and intensified the ambitions of the arts. Beginning shortly before the war and continuing through the following decade, an astonishing variety of technically audacious works appeared. A community of artists, readers, viewers, editors, and curators created a receptive context encouraging ever more experimental work, including the move to abstraction in the fine arts (Wassily Kandinsky in painting, Henri Gaudier-Brzeska and Vladimir Tatlin in sculpture); the development of new cinematic styles (Sergei Eisenstein, Fritz Lang, Dziga Vertov); the architectural revolution of Le Corbusier (modern materials in abstract forms); the theatrical extravagance of the *Ballets Russes* accompanied by the music of Igor Stravinsky; the twelve-tone technique of Schoenberg; and the experiments in narrative consciousness of Marcel Proust, James Joyce, Virginia Woolf, and William Faulkner. This profusion has been called the "the last *literary season* of Western culture" (Moretti, p. 209). A claim of modernism to historical distinctiveness rests first of all on the sheer abundance of formally provocative art and the wide attentiveness to it.

A frequently noted aspect of modernist form is its fragmentation: the dissolution of continuity in speech, wholeness in the body, consecutiveness in narrative. The one- or two-lined lyrics of imagism, the abrupt focal shifts in the work of Gertrude Stein, the disintegration of the face in analytic cubism, the rapid editing in the cinema of Sergei Eisenstein and Dziga Vertov, all present decomposing forms shorn of the usual contexts of meaning. "Image," "vortex," "moment," "epiphany" were some of the names given to these radiant fragments. A prominent concern then became the passage from these shorter forms, however resonant, toward more encompassing structures: longer poems, more capacious novels, larger paintings, more ambitious films and music. The later phase of modernism, which contains some of its most striking artifacts (Eliot's *The Waste Land*, Picasso's *Three Musicians*, Joyce's *Ulysses*, Eisenstein's *October*, Schoenberg's unfinished *Moses und Aron*), turns toward synthetic forms that might arrange fragments into broader patterns. The use of myth was a dominant resource for Joyce, Eliot, and Stravinsky; in Eliot's formulation, the mythic method gave a form of order that made "the modern world possible for art." Eisenstein's development of cinematic montage, the conceptual and metaphoric linking of separate images, was another manifestation of synthesis.

Was high modernism then a new aesthetic order or a new antiorder? This question circulated among artists and their critics. Despite the theoretical justifications brought forward to explain the difficult art, it is clear that modernist masterworks contained much that was contingent and resistant to

explanation. The sheer eruptive energies, the sense of play, the pleasure in accident, and the linguistic and visual anarchy cannot be safely ordered as examples of a new “method.” The implications of this disruptive aesthetics were most fully drawn by the avant-garde groups that developed during and after the war, especially expressionism, dadaism, and surrealism. These groups differed significantly, but they shared a commitment to aesthetic radicalism and direct public challenge. In Germany a group of poets, painters, and filmmakers began to work under the heading *expressionism*, aiming not to receive the world’s impressions but to express irrational and intuitive states of mind. They opened the visual world to exaggeration, heightened gesture and emotion, and deformed space and time in their refusal of a corrupt social order. Beginning in Switzerland and spreading quickly to France and Germany, dadaism saw the war as marking the failure of civilization and developed the practice of antiart as a gesture of defiance. In 1916 Hugo Ball opened the Cabaret Voltaire in Zurich, where performances included cacophonous music, nonsense poetry, comic recitation, and costumed theatricality. Dada put in question the most central assumptions of Western art: its seriousness, its coherence as an artifact, its separation from the everyday social world. The dissolution of dada in the early 1920s led some of its members to join André Breton’s surrealism, which emphasized the recovery of repressed sources of the imagination and their release into arational art. Rimbaud’s call for a derangement of the senses was one major influence; Freud’s theory of the unconscious was another. Automatic writing, hallucination, and dreams were seen as instruments of liberation from a constrained and destructive reality. Many of the surrealists, like many of the Dadaists, understood their place within the avant-garde as part of a more general program of political and cultural revolution.

Useful distinctions have often been made between the high modernism of Yeats, Eliot, Rilke, Joyce, Proust, and Mann, deeply committed to the integrity of the artifact, and the “historical avant-garde” constituted by these socially active movements that questioned the coherence of art and its withdrawal from social life. Historically attentive scholarship has shown, however, that these are not rival camps or opposing sides of a cultural dyad. Within high modernism one finds both signs of radical indeterminacy in form and strong statements of social engagement. Ezra Pound’s assertion that “the artists were the antennae of the race” (p. 67) represents a characteristic modernist demand, sometimes from the political right and sometimes from the left, for social change founded on the basis of revolutionary art. Similarly, within the avant-garde, one finds scenes of consolidation, where the discord resolves into determinate artifacts. The “avant-garde” and “high modernism” are best seen as moments within the conditions of cultural modernity: an ongoing dialectic between openness and indecidability, on the one hand, and formal integrity, on the other.

Modernism after High Modernism

The later history of the movement involved its circulation into new cultural settings around the world, where it met other forms of modernity and became at once an influence and an object of resistance. The Harlem Renaissance, an efflorescence of

African-American literature after World War I, emerged out of local and national contexts—specifically, the consolidation of cultural possibility in New York after the Great Migration northward. It generated experimental forms (for instance, in Jean Toomer’s *Cane*), but it also accommodated traditional styles, as in sonnets of Claude McKay. The Harlem Renaissance was not a product of high modernism; rather, it was a parallel movement, intersecting and diverging, that obliges us to recognize a wider, more differentiated history of cultural modernity.

Late-twentieth- and early-twenty-first-century scholarship has shown how modernism played a double-sided role in the national independence movements before and after World War II. The European provenance of celebrated masterworks could make them appear distant and oppressive, tainted by the imperial past. But within the context of the traditional curriculum of the colonial schools, Modernism was also taken as a force of resistance to a canon still derived from nineteenth-century achievement. In the work of Chinua Achebe in Nigeria or Ngugi wa Thiong’o in Kenya complicated double inheritance appears: modernism is at once acknowledged and appropriated, but it has no special privilege alongside other literary aims. It combines with storytelling traditions and national aspirations (Gikandi, 1987). Other studies have shown that in the Caribbean the formal techniques refined by modernism converged with styles of experiment associated with the hybrid history of the islands (Gikandi, 1992). The “creolization” of everyday speech created regional contexts for modernist art, and the conditions of social conflict brought resistance to the elite prestige of European high modernism.

Modernism came to no definite end. The call to “make it new,” the use of formal discontinuity, the willingness to compose and present difficult works of art, all continued through the end of the twentieth century. But in the last half of that century, the assimilative power of culture diminished the challenge of such work. A movement that had offered an oppositional principle and a call for transformation found itself part of the routine of shock, celebrity, and fashion.

See also Avant-Garde; Dada; Expressionism; Impressionism; Naturalism in Art and Literature; Realism; Surrealism; Symbolism.

BIBLIOGRAPHY

- Baker, Houston, Jr. *Modernism and the Harlem Renaissance*. Chicago: University of Chicago Press, 1987.
- Berman, Marshall. *All That Is Solid Melts into Air: The Experience of Modernity*. New York: Simon and Schuster, 1982.
- Bürger, Peter. *Theory of the Avant-Garde*. Translated by Michael Shaw. Minneapolis: University of Minnesota Press, 1984.
- Butler, Christopher. *Early Modernism: Literature, Music and Painting in Europe 1900–1916*. Oxford: Clarendon, 1994.
- Calinescu, Matei. *Five Faces of Modernity: Modernism, Avant-garde, Decadence, Kitsch, Postmodernism*. Durham: Duke University Press, 1987.
- Eliot, T. S. “‘Ulysses,’ Order and Myth.” In *Selected Prose*, edited by Frank Kermode. New York: Harcourt Brace Jovanovich; Farrar, Straus and Giroux, 1975.
- Felski, Rita. *The Gender of Modernity*. Cambridge, Mass.: Harvard University Press, 1995.

- Flaubert, Gustave. *The Selected Letters of Gustave Flaubert*. Edited and translated by Francis Steegmuller. New York: Farrar, Straus and Young, 1953.
- Gikandi, Simon. *Reading the African Novel*. London: James Currey, 1987.
- . *Writing in Limbo: Modernism and Caribbean Literature*. Ithaca, N.Y.: Cornell University Press, 1992.
- Gilbert, Sandra M., and Susan Gubar. *No Man's Land: The Place of the Woman Writer in the Twentieth Century*. New Haven, Conn.: Yale University Press, 1988.
- Kenner, Hugh. *The Pound Era*. Berkeley: University of California Press, 1971.
- Levenson, Michael. *A Genealogy of Modernism: A Study of English Literary Doctrine, 1908–1922*. New York: Cambridge University Press, 1984.
- Marinetti, Filippo Tommaso. *Selected Writings*. Edited by R. W. Flint. New York: Farrar, Straus and Giroux, 1972.
- Moretti, Franco. *Signs Taken for Wonders: Essays in the Sociology of Literary Forms*. Translated by Susan Fischer, David Forgacs, and David Miller. London: New Left Books, 1983.
- Perloff, Marjorie. *The Poetics of Indeterminacy: Rimbaud to Cage*. Princeton, N.J.: Princeton University Press, 1981.
- Pound, Ezra. *ABC of Reading*. New Haven, Conn.: Yale University Press, 1934.
- Sheppard, Richard. *Modernism-Dada-Postmodernism*. Evanston, Ill.: Northwestern University Press, 1999.
- Rainey, Lawrence. *Institutions of Modernism: Literary Elites and Public Culture*. New Haven, Conn.: Yale University Press, 1998.
- Symons, Arthur. *The Symbolist Movement in Literature*. New York: E. P. Dutton, 1919.

Michael Levenson

LATIN AMERICA

Modernism (sometimes referred to as *modern art* or, even less precisely, as *modernity* in the arts) is a term for various experimental languages in the arts with multiple meanings and conflicting aims, and was ascendant from the 1880s to the 1960s (although certain artistic techniques and tactics of early modernist art, such as collage and photomontage, have enjoyed a potent afterlife since the 1960s, especially in Latin America at moments of social insurgency).

According to one of the most famous versions of the history of modernism, associated especially with the writings of critic Clement Greenberg from the 1930s through the 1980s, modernism is an essentially Euro-American phenomenon; but this was never an accurate story about modernism and has been decisively overturned by the debate around postmodernism since the late 1980s. Greenberg has been a very prominent voice about modernism in the United States, with a certain following among Latin American critics like Marta Traba. In perhaps his most well-known definition, “Modernist Painting” (1965), he tried to limit modernism to little more than an engagement with the “essential” material properties of the medium by linking it to Western positivism. (Revealingly, positivism was the prerevolutionary ideology of the dictatorship of Porfirio Díaz in Mexico, even as this school of thought enjoyed considerable hegemony in the West long after the “post-colonial” Revolution of 1910.)

The unduly reductionist view of modernist painting championed by Greenberg was then qualified by a whole series of noteworthy scholars, including Dore Ashton, Thomas Crow, Rosalind Krauss, and Charles Harrison in the West. They respectively demonstrated how modernism from the beginning had carried on a dialogue at once both positive and negative with mass culture as well as popular culture, how modernism was less about a literal focus on the brute materials of a given medium and more about a self-critical look at the inherited languages with which modernist artists had to work, and, finally, that modernist art’s activation of the spectator’s faculties is meant “to confront the occasions of fantasy and distraction with the requirements of imagination and critical self-awareness” (Harrison, p. 154).

The historical coordinates for the advent of international modernism between 1880 and 1940 have been incisively plotted in a paper by Perry Anderson entitled “Modernity and Revolution.” In it he noted that “modernism . . . flowered in the space between a still usable classical past [of official academicism], a still indeterminate technical present [when the ‘machine age’ was still replete with radical possibilities], and a still unpredictable political future [when the prospect of revolution was more proximate than it had ever been]” (p. 105). Indeed, this triangulated field of forces—a contested academic art representing the old regime; the possibility of technological innovation, not necessarily along capitalist lines; and an insurgent political movement that called for revolutionary change—is precisely what spawned the “epic modernism” of the Mexican Mural Movement from 1922 to 1940 and thus inaugurated modernism as a potent force in the visual arts throughout the Americas.

In contrast to Greenberg’s assertion, modernism does not emerge in a linear artistic progression along national lines; instead there are several different multinational conceptions of modernism (and with them, divergent views of its relation to postmodernism) that have arisen within several geographic regions (including not only Latin America, but also Asia and Africa). Modernism’s trajectory is more accurately described as a delta with numerous destinations around the globe, rather than as a one-lane highway with only one stop terminating in the West.

At once international in character and yet also unavoidably regional by nature, metropolitan modernism has been paradoxically linked through the arts either to cultural forms of marginalized groups in the West (such as those of Eastern European émigrés, Latinos, African-Americans, and Native Americans) or to so-called peripheral nations in the Third World, as in Latin America. For Raymond Williams in *The Politics of Modernism* (1989), it was in “a generation of ‘provincial’ immigrants to the great imperial capitals that avant-garde formations and their distanced, ‘estranged’ forms have their matrix” (p. 14).

An adequate description of Latin American modernism, then, must begin by considering the various definitions of modernism that have arisen within specific contexts, as well as by distinguishing modernism as a cluster of renovative and self-reflexive languages in the arts from modernity. The latter is instead a social experience that has been generated by

modernization, which is a globalizing economic program centered in the West. All three of these historic phenomena have existed in complicated, asymmetrical relation to each other.

The Origin of “Modernism” in Latin America

Far from originating solely with intellectuals from metropolitan Western Europe, the term “modernism” first surfaced in print in the writings of a major author from a small “underdeveloped” country in Central America. It was in the late 1880s that the celebrated Nicaraguan poet Rubén Darío (1867–1916) first published the term *modernism* (or *modernismo* in Spanish). The earliest known appearance in print worldwide of this term was in 1888 in Darío’s essay “La literatura en Centroamérica” (*Revista de arte y cultural*, Santiago, Chile), when he discussed how author Ricardo Contreras was then using “*el absoluto modernismo en la expresión . . . [de] su estilo compuesto*” (“absolute modernism in expression . . . through his synthetic style”). Subsequently, Darío published the word *modernismo* a second time in an article entitled “Ricardo Palma (Perú, 1833–1919),” which appeared twice in 1890: first, in the Peruvian journal *El Perú Ilustrado* (Lima), on 8 November 1890, and second, in the Guatemalan publication *Diario de Centro-América* (Guatemala City). Thus, by 1899, the *Real Academia Española* had incorporated the word *modernismo* into the latest edition of the *Diccionario de la Lengua* (Madrid, 1899)—although the proliferation of meanings triggered by Darío’s usage of the term defied any lexicographical effort at a fixed definition.

This beginning was a prophetic one, for modernism in the arts, both here and elsewhere, has generally occurred at the historic intersection between competing cultures uneasily linked by colonial lineaments, yet starkly divided by the uneven nature of capitalist modernization. Often modernism has thus responded “nationally” to a set of unsettled transnational relationships, but it has generally done so in a cosmopolitan spirit of internationalism that moves beyond national boundaries. Such was the case not only in Nicaragua during the time of Rubén Darío, but also in India during “the age” of Rabindranath Tagore and Mahatma Gandhi or Nigeria in the period of painter Aina Onabolu (1882–1962). It was also true in turn-of-the-century Paris, during *la belle époque*, that obviously existed in tense relation to France’s contemporary colonial empire in Central Africa.

Although it hardly enjoyed common usage in either the English- or French- or German-speaking artworlds before the mid-1950s (when a group of critics, including Clement Greenberg, began defining it in English), the term *modernism* was invoked, defined, and debated in the Spanish-speaking world beginning in the 1890s on both sides of the Atlantic. In many countries, though, whether in the Americas or in Europe, the most common term for modernism in the teens or twenties was simply *the new art* (*el arte nuevo*, or *die neue Kunst*), while in the 1930s and 1940s, the most common designation of modernist art was “modern art” (*arte moderno*, *l’art moderne*, and *moderne Kunst*). In Spanish discourses, the term *modernismo* was, quite confusingly, used both to refer the Modernist movement and as the generic name for various modernist movements. This explains the recourse to *modernidad*—which in English would literally be translated as “modernity,” although

in fact *modernidad* would be better translated more broadly in English as “modernism.” An early example of the latter usage would be in a well-known 1926 essay by muralist Diego Rivera about the photographs of Edward Weston and Tina Modotti, which artistically demonstrated the “*modernidad extrema de la plástica [del arte]*,” that is, an “extreme modernism”—not “extreme modernity” in the arts—in English.

A similar imprecision in terminology occurred in routine usage from the late nineteenth century until the 1960s, both in the Americas and in Europe, of the term *avant-garde* or *arte de la vanguardia*—which was then assumed to be a mere synonym for those attributes of painting and the other visual arts articulating *modernism* (or *modernidad*). This was clearly the case in the very first modernist manifesto by the Mexican muralists, when David Alfaro Siqueiros in May 1921 made “*3 llamamientos de orientación actual a los pintores y escultores de la nueva generación americana*” (“Three appeals for orientation right now among the painters and sculptors of the new American generation”) in the journal *Vida-Americana: Revista Norte, Centro y Sud-Americana de Vanguardia*. In the public appeal, Siqueiros wrote of how: “*VIVAMOS NUESTRA MARAVILLOSA EPOCA DINAMICA! amemos la mecanica moderna que nos pone en contacto de emociones plasticas inesperadas . . . Abandonemos los motivos literarios. HAGAMOS PLASTICA PURA*” (“We are living in our marvelously dynamic epoch! We love the modern technology that we are placing in contact with unexpected artistic emotions . . . We are abandoning literary motives. Let us make pure visual art”). Revealingly, this two-page manifesto that equated “pure painting”—that is, painting freed of literary references and based on an evocation of “*la vie moderne*” in the machine age—with the “*arte del futuro*” of “*la vanguardia*” was accompanied by a frontispiece that featured a cubist painting from 1914 by Diego Rivera, the first major, internationally recognized modernist painter produced by Latin America.

Thus Siqueiros clearly assumes that these formalist concerns of the modernist movements featuring post-literary painting are entirely synonymous with *avant-garde* art. In three much later essays by the art critic Clement Greenberg, comparable assumptions prevail, yet to more conservative political ends, and far more restrictive aesthetic aims: “*Avant-garde and Kitsch*” (1939), “*Towards a Newer Laocoon*” (1940), and the aforementioned “*Modernist Painting*” (1965).

As Latin America’s earliest *avant-garde* movement, *modernismo* was first limited largely to literature: essays, poetry, and short stories. Such was the case with Rubén Darío’s now legendary *Azul . . .* (1888; *Azure . . .*), which conjoined the innovative self-critical splintering of poetic language (based on enjambment and mid-line caesura) with broader critical reflections on the process of modernization. At issue was a heterogeneous new cultural force that linked self-consciously French-influenced vanguard language with period tropes from an agrarian-based Central America and unlikely recollections of little-known pre-Columbian cultural traditions. This tightly intertwined dynamic of formal disjunction and thematic displacement was summed up by Darío in *Prosas Profanas* (1896; *Lay hymns*). In this controversial text, he both called for an inward-looking revivification of poetic language in the most

modern terms and insisted on an outward-looking reengagement with the precolonial past, since “If there is a [new] poetry in nuestra America, it is to be found in the old things.”

Following the lead of Cuban author José Martí (1852–1895), another modernist poet (who also led the movement for national liberation in Cuba against Western colonialism), Darío interwove modernist texts with thematic references to anti-imperialism and to a racial harmony only possible in a postcolonial future. An exemplary and still well-known poem in that vein is found in Darío’s *Cantos de vida y esperanza* (1905), in a piece entitled “To Roosevelt.” In it, he challenged the United States, as “*el futuro invasor de la América ingénuca que tiene sangre indígena*” (“the future invader of the ingenuous America that has indigenous blood”). As such, the colossus of the North, with its cynical fusion of the cult of Hercules and the worship of money, was critically contrasted with the other Americas, “*la América nuestra, que tenía poetas / desde los viejos tiempos de Netzabualcoyotol.*” In this text, the modernism of Darío, and others, responded to the critique of Euro-American-centrism first voiced in the celebrated anti-positivist *Kulturkritik* by Uruguayan author José Enrique Rodó (1872–1917), namely, *Ariel* (1900).

Only after the word *modernism* crossed the Atlantic from Latin America to discover Europe, first Barcelona, then Paris, did it start designating certain formal strategies and thematic concerns in the visual arts that were linked to the literary project of Rubén Darío. The term *modernismo* (*modernisme* in French) or *arte modernista* (*l’art moderniste*) was used in the beginning to refer to such famous architectural projects by Antoni Gaudí as *Parque Guell* (1900–1914) and *Sagrada Família* (1883–1926), in the fin-de-siècle city where both Pablo Picasso and Diego Rivera would work in the early twentieth century. It was this cosmopolitan city in Spain, as much as Paris proper, that would help to spawn such early modernist masterworks as Picasso’s 1907 *Les Femmes d’Alger (O. J.)* (named for a street in Barcelona) and Rivera’s distinctive corpus from 1913 to 1917 of “Anáhuac Cubism,” as Justino Fernández would so aptly call it in reference to the indigenous Mexican content of Rivera’s work. In the case of Gaudí, for example, the term *modernismo* constituted both a distinct tendency within modernism proper and a point of departure for advancing other types of modernism as well, such as cubism. Indeed, almost all of the key formal tactics for every other variety of modernism were deployed in Gaudí’s singular modernist artworks, like *Parque Guell* and *Sagrada Família*: (1) a collage aesthetic featuring a mosaic of ruins or shards; (2) a multilateral sense of history based upon uneven development; (3) a multicultural *mestizaje* (hybridity) ranging from African components to pan-European elements; (4) a critique of capitalist modernization; and (5) an anti-imperialist aspiration (in this instance, one interlinked with the Catalan autonomy movement).

As for the ideologically charged use of the fragment to explain the historical import of modernism in the visual arts, we need only recall how Mexican painter Diego Rivera defined the unsettling language of cubism as “a revolutionary movement . . . [that] broke down forms as they had been seen for centuries, and was creating out of the fragments new forms, new objects, new

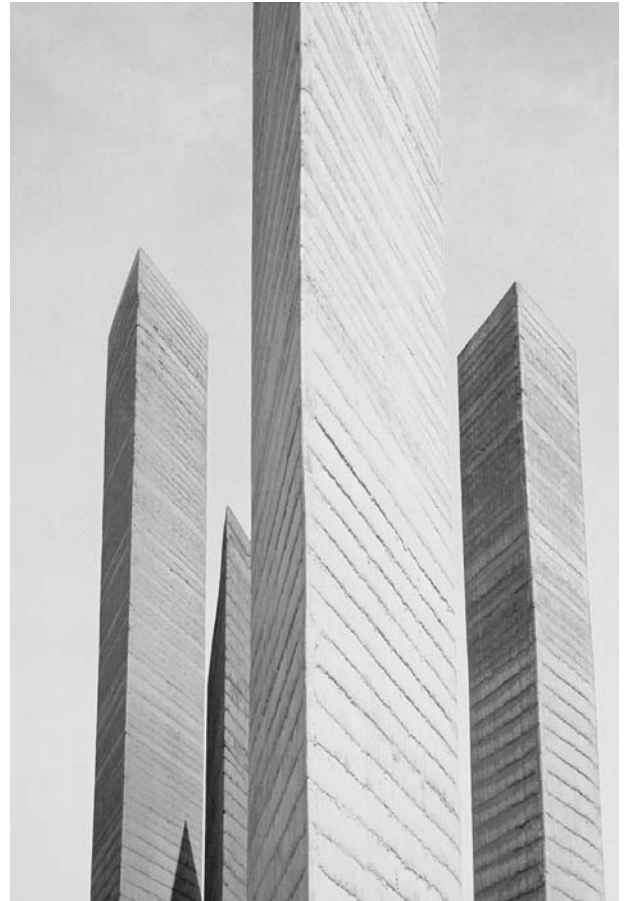

The Towers of Satellite City (constructed 1957), designed by Mexican architect Luis Barragan (1902–1988). Resembling abstract skyscrapers, the cement towers of this public artwork ascend over the Queretaro highway in Mexico City as a startling example of Latin American modernism. © RENE BURRI/MAGNUM PHOTOS

patterns, and—ultimately—new worlds” (trans. by March). Later, art critics would illuminate how *arte modernista*, like that of the cubist “collages” by Rivera, with their distinctive uses of modernist space, constituted a critique of the actual mechanics for pictorial logic in Western art. As Rosalind Krauss would point out in the 1980s, two of the key artistic strategies to develop out of collage space were figure/ground reversals and the restless transposition of negative space into positive form, so that no visual sign would exist without the attendant eclipse or negation of its natural referent. In this manner modernism, particularly as manifested in cubism, ended up critically exploring through a critique of artistic languages the preconditions of mainstream Western—that is, colonial—modes of representation.

As such, the modernist contestation by Latin American artists of Euro-American cultural hegemony is what permitted Diego Rivera to recruit cubism and several other artistic traditions, both modern and premodern, on behalf of the Mexican Revolution, when he (along with José Clemente Orozco, David Alfaro Siqueiros, Fernando Leal, and others) created an

“epic modernism” during the Mexican mural renaissance from 1922 to 1940. Signs of this emergent “revolutionary modernism” (Rivera called it “*la revolución de arte moderno*”) already surfaced in such cubist period paintings in 1915 as *Paisaje Zapatista: El Guerrillero and Retrato de Martín Luis Guzmán* (a Mexican novelist who served with Pancho Villa). In that sense, one could justifiably recall the observation of Mexican writer Antonio Caso that Diego Rivera was to the modernist visual art of Latin America what Rubén Darío had been to modernist poetry from Latin America.

Modernism and Postmodernism

It is worth noting that, as was true of the term *modernism*, there was a south-to-north movement for circulating the word *postmodernism* (or *postmodernismo*). The latter first emerged in the Hispanophone literary world, in 1934, when it was coined by author Federico de Onís. He did so in *Antología de la Poesía Española e Hispanoamericana (1882–1933)*, where he identified modernism as a worldwide movement in response to the “crisis of Western Civilization.” De Onís contrasted a conservative artistic tendency within modernism, which he christened “postmodernism,” in contradistinction to an “*ultra-modernismo*.” The latter, linked to writers like Jorge Luis Borges from Argentina, was then reintensifying the most radical features of modernism, in a second wave of the original movement. Revealingly, it was only in the 1950s that the centrist Spanish term *postmodernism* would resurface in the English-speaking world—after which it then was redefined as a “radical development” and became a generalized cultural phenomenon in the arts “around the world” over the next three decades.

The art critic Hal Foster pointed out in a now-famous anthology entitled *The Anti-Aesthetic: Essays on Postmodern Culture* (1983) that postmodernism emerged not just as a “new set of styles” that chronologically superseded those of modernism. Rather, some tendencies of postmodernism have often been another way of reengaging critically with the competing legacies of international modernism, thus being yet another subaltern or dissenting phase of modernism proper in the form of “resistant post-modernism.” Hence, in the period since 1900, there has been a concerted move by advanced critical theorists both to redefine modernism along postcolonial lines and to resituate the historical trajectory of modernism worldwide in response to the “new world order” (without, in either case, denying the ongoing neocolonization now being sanctioned by Western imperialism). Two noteworthy reconsiderations of modernism from “outside the West” encapsulate this hotly contested historiography of modernism and postmodernism: *La Modernidad después de la postmodernidad* (1990; *Modernity after postmodernity*) by the Argentine author Nestor García Canclini and “Postmodernity as Modernity’s Myth” (2001) by the Slovenian philosopher Slavoj Žižek.

Conclusions

In Latin America and elsewhere in the “postcolonial world,” the confining, Eurocentric position of Greenberg was then more broadly reworked through critiques by such notable thinkers as Juan Acha of Peru, Gerardo Mosquera of Cuba,

Partha Mitter of India, Rasheed Araeen of Pakistan, Olu Oguibe of Nigeria, and Kobena Mercer of the United Kingdom. In all of these cases, and others, they reminded us that a “post-colonial” redefinition of modernism (along with modernity and modernization), one that is adequate to the demands of the historical present, has only now begun to be written.

See also *Aesthetics: Europe and the Americas; Arts: Overview; Modernity: Overview; Postmodernism*.

BIBLIOGRAPHY

- Anderson, Perry. “Modernity and Revolution.” *New Left Review* (March/April 1984): 96–113.
- Ashton, Dore. *A Fable of Modern Art*. New York and London: Thames and Hudson, 1980.
- Berman, Marshall. *All That Is Solid Melts Into Air: The Experience of Modernity*. New York: Simon and Schuster, 1982.
- Buchloh, B. H. D., Serge Guilbaut, and David H. Solkin, ed. *Modernism and Modernity*. Halifax: Nova Scotia College of Art and Design, 1982.
- Bürger, Peter. *The Decline of Modernism*. University Park: Pennsylvania State University Press, 1992.
- Clark, T. J. *Farewell to an Idea: Episodes from a History of Modernism*. New Haven, Conn.: Yale University Press, 1999.
- Craven, David. *Diego Rivera as Epic Modernist*. New York: G. K. Hall, 1997.
- . “The Latin American Origin of ‘Alternative Modernism.’” In *The Third Text Reader*, edited by Rasheed Araeen, Sean Cubitt, and Ziauddin Sardar, 24–35. London and New York: Continuum, 2002.
- Crow, Thomas. “Modernism and Mass Culture.” 1980. In his *Modern Art in the Common Culture*. New Haven, Conn.: Yale University Press, 1996.
- Darío, Rubén. *Prosas profanas*. Madrid: Mundial, 1896.
- Eder, Rita. “El muralismo mexicano: Modernismo y modernidad.” In *Modernidad y modernización en el arte Mexicano*, edited by O. Debrouse, 67–81. Mexico City: Museo Nacional de Arte, 1991.
- Fernández, Justino. *Arte Moderno y Contemporáneo de México*. 1952. Mexico City: Universidad Nacional Autónoma de México, 1994.
- Foster, Hal, introduction. *The Anti-Aesthetic: Essays on Postmodern Culture*. Port Townsend, Wash.: Bay Press, 1983.
- Fracina, Francis, ed. *Pollock and After: The Critical Debate*. 2nd ed. London: Routledge, 2000. Includes the essays “Avantgarde and Kitsch” and “Towards a Newer Laocoon” by Clement Greenberg.
- García Canclini, Néstor. *Modernidad después de Postmodernidad*. Mexico City: Siglo XXI, 1990.
- Greenberg, Clement. “Modernist Painting.” 1965. Reprinted in *Modern Art and Modernism: A Critical Anthology*, edited by Francis Fracina and Charles Harrison, 5–10. New York: Harper and Row, 1982.
- Harrison, Charles. “Modernism.” In *Critical Terms in Art History*, edited by R. S. Nelson and R. Shiff, 142–155. Chicago: University of Chicago, 1996.
- Henrique Ureña, Max. *Breve historia del modernismo*. Mexico City: Fondo de Cultural Económica, 1954.
- Manrique, Jorge Alberto. “La vanguardia de Diego Rivera.” *Diego Rivera Hoy*, 25–32. Mexico City: Palacio Nacional de Bellas Artes, 1986.
- Mitter, Partha. “Modernism in India.” In his *Indian Art*, 189–200. Oxford: Oxford University Press, 2001.

- Morgan, Robert C. "The Delta of Modernism." In his *The End of the Art World*. New York: Allworth Press, 1998.
- Poggioli, Renato. "Modernity and Modernism." In his *Teoria dell'arte d'avanguardia*, 216–220. 1962. Translated as *The Theory of the Avant-Garde* by Gerald Fitzgerald. Cambridge, Mass.: Harvard University, 1968. 216–220.
- Rivera, Diego. *My Art, My Life*. Translated by Gladys March. New York: Dover Press, 1991.
- . *Textos de Arte*. Mexico City: Universidad Nacional Autónoma de México, 1996.
- Siqueiros, David Alfaro. "3 llamamientos . . ." *Vida-Americana: Revista Norte, Centro y Sud-Americana de Vanguardia* 1, no. 1 (May 1921): 2–3.
- Williams, Raymond. *The Politics of Modernism: Against the New Conformists*. London and New York: Verso, 1989.
- Žižek, Slavoj. "Postmodernity as Modernity's Myth." *Polygraph* no. 13 (2001): 39–58.

David Craven

MODERNITY.

This entry includes three subentries:

Overview
Africa
East Asia

OVERVIEW

Modernity is best understood as a condition, rather than as the designation for some particular period of time. Aspects of the modern condition can arise at any time and place, but they are most generally associated with historical trends arising out of Cartesian philosophy, industrial capitalism, revolutionary politics, and the cultural changes of the turn of the nineteenth century. The main lesson to be learned from the postmodernism of the late twentieth century is that the tensions of modernity are still with us.

Of course, the term *modern* has narrower uses in particular fields of human endeavor, including especially art and architecture. The use of the term in the sense discussed here, as a syndrome of conditions associated with the modern mode of human life, is relatively recent. The French revolutionaries, for example, did not think of themselves as modern. When characterizing the more forward-thinking aspects of his time, the philosopher Immanuel Kant (1724–1804) did not call them modern or even enlightened, but described the late eighteenth century as undergoing a process of enlightenment. Classically, the term *modern* contrasts the present day as opposed to some time in the past, or more specifically, it contrasts ancient times with the modern times subsequent to them, as in Bernard of Chartres's famous twelfth-century description of moderns as dwarves sitting on the shoulders of giants. *Modern* may also apply as an adjective denoting novelty, as in the phrase "modern conveniences."

From a general point of view, however, modernity should be understood as a condition, mentality, or syndrome presenting characteristic dilemmas to human beings that remain both defining and unresolvable. Elements of the modern condition

include rejection of traditional authority, a progressive rather than cyclical notion of time, individual and collective emancipation, a broadly empiricist orientation toward understanding the world, and what John Dryzek has called a Promethean outlook that regards all difficulties as technical problems to be mastered through human endeavor. As a heuristic, contrasts with unmodern conditions may be useful, as in Jürgen Habermas's point that "before the French Revolution, before the workers' movements in Europe, before the spread of formal secondary education, before the feminist movement . . . the life of an individual woman or man had less worth—not regarded from our own point of view, of course, but from the contemporary perspective" (p. 106). The modern horrors of the twentieth century, however, should cause one to be careful to apply these distinctions to elements of human practice, rather than to specific individuals or groups. The impulse to define some people along a premodern/modern axis, itself an outgrowth of characteristically modern impulses toward rational social management, should be resisted, whether the people are described as characteristically modern, as Richard Wagner said of the Jews, or as characteristically premodern, as European colonists considered aboriginal residents of the New World. The tension in this very practice of defining modernity in people and practices, with its disparate results ranging from attempted extermination to processes of emancipation, respectively, reveals the inescapably dialectical nature of the modern condition.

Indeed, an accelerated and socially powerful process of conceptual change constitutes a key element of the modern condition. Reinhart Koselleck has argued that in modernity, "political and social concepts become the navigational instruments of the changing movement of history. They do not only indicate or record given facts. They themselves become factors in the formation of consciousness and the control of behavior" (p. 129). Koselleck illustrates this process with the quintessentially modern concept of emancipation: once the reflexive verb, to emancipate oneself, gained currency beyond its origins among philosophers and literati and began to be used widely among participants in the revolutionary politics of late-eighteenth-century France, it became linguistically impossible, as it were, to defend the institutions of the Old Regime. The linguistic turn in philosophy and social theory attests to the modern role of language as constituting experience itself. Martin Heidegger (1889–1976) argued that language illuminates specific, comprehensive modes of being in the world; Hans-Georg Gadamer (1900–2002) later refined this idea with the idea that human beings move within "horizons" of linguistic prejudgments. Philosophers as different as Habermas, Ludwig Wittgenstein, and Hannah Arendt have explored the potential for commonalities in language usage to overcome seemingly fundamental barriers among human beings.

Modern theorists do not agree about the role played by historical subjects in effecting the conceptual changes that seem to drive a constantly evolving public sphere. Whereas Georg Wilhelm Friedrich Hegel (1770–1831) spoke abstractly of the progress of *Geist* (mind, consciousness, spirit) and Michel Foucault (1926–1984) revealed the socially constructed nature of the concepts and practices that constrain human beings, Karl Marx (1818–1883) and his followers argued that false consciousness could be overcome, while Sigmund Freud

(1856–1939) and his successors sought to overcome the damage done to individual mental health by modern social pressures through psychoanalysis. Some lines of modern argument are characterized by progressive optimism regarding the power of enlightened human reason, once freed from the shackles of tradition, to remake society according to rational principles. Jeremy Bentham (1748–1832) and his fellow utilitarians, for example, supported a slate of social reform programs, including birth control and humane treatment of prisoners, based on their application of the principle of the greatest happiness for the greatest number to society at large. In another indication of the dialectical tensions inherent in modernity, Bentham's rationalist vision of prison reform, originally intended to redeem the inherent worth and social value of every individual, even those abandoned to the horrors of the premodern prisonhouse, has evolved, as Foucault has demonstrated, into a near-totalitarian vision of social control over the resisting individual. Bentham's modern design for a prison, the "panopticon," has become the blueprint for the present-day "supermax" vision not of rehabilitation, but of central control.

Alexis de Tocqueville's (1805–1859) seminal thinking about this dynamic between modern egalitarian democracy and quasi-despotic central control happened to begin with a study of the early-nineteenth-century American prison system, which in Pennsylvania and New York exemplified Benthamite reformist principles. In *Democracy in America*, Tocqueville warned his fellow Europeans that democratic equality was not a passing fad, that although it broadened opportunities for the masses, it threatened national and individual greatness, and that without a strong network of intermediate institutions, democracy was likely to resolve into centralized administrative despotism. Tocqueville's dystopian vision contrasts with Bentham's progressivist faith in reason's beneficence: modern individuals in American democracy may be free of the old tyrannies of class and king, but they are subject to new forms of despotism rooted in their very freedoms. Like John Stuart Mill (1806–1873), Tocqueville argued that modern social mobility requires individuals to devote most of their energy to economic well-being, to the exclusion of more noble pursuits. Worse, without the traditional intermediaries of the estates checking the central power of the state, democracies will tend toward ever more powerful government. As modern individuals torn by accelerating social pressures become alienated from their premodern social support systems, they are vulnerable to domination by "an immense tutelary power . . . which alone takes charge of assuring their enjoyments and watching over their fate. It is absolute, detailed, regular, far-seeing, and mild. It would resemble paternal power if, like that, it had for its object to prepare men for manhood, but on the contrary, it seeks only to keep them fixed irrevocably in childhood . . . can it not take away from them entirely the trouble of thinking and the pain of living?" (p. 693).

What Habermas calls the "enlightenment project" thus doubles back on itself. Whereas for Kant, republican government (that is, government responsible to the people) forms an essential part of the emancipation of human beings to autonomy, for Tocqueville this same institution could lead to autonomy's opposite, to the infantilization of the population under a paternal power far worse than any premodern royalist

opposed by the likes of John Locke and Thomas Jefferson. Jean-Jacques Rousseau (1712–1778) had identified this irony of modernity already in the eighteenth century. In his first *Discourse* he outlines the many sacrifices human beings have had to make to become modern, including even the possibility of authentic relations with each other. However, for Rousseau there is no going back: modern consciousness, once achieved, cannot be forgotten but must enable modern human beings to devise new institutions for achieving a modern kind of authenticity. Similarly, the English poet William Wordsworth (1770–1850) complained in an 1807 sonnet of the loss of authentic relations among newly rational modern human beings:

The world is too much with us; late and soon,
Getting and spending, we lay waste our powers:
Little we see in Nature that is ours;
We have given our hearts away, a sordid boon!
The Sea that bares her bosom to the moon;
The winds that will be howling at all hours,
And are up-gathered now like sleeping flowers;
For this, for everything, we are out of tune;
It moves us not. —Great God! I'd rather be
A Pagan suckled in a creed outworn;
So might I, standing on this pleasant lea,
Have glimpses that would make me less forlorn;
Have sight of Proteus rising from the sea;
Or hear old Triton blow his wreathèd horn.
(Sonnet No. 18).

The loss of the old gods, of traditional ways and of the comforts of an unquestionable worldview worried Wordsworth, the German poet Friedrich Hölderlin (1770–1843), and many others, but presented an opportunity to those modern thinkers seeking to replace the Old Regime with rational modes of human being. Chief among these were Marx and Engels, who noted with pleasure that in modern life "all fixed, fast-frozen relations, with their train of ancient and venerable prejudices and opinions, are swept away, all new-formed ones become antiquated before they can ossify. All that is solid melts into air, all that is holy is profaned, and man is at last compelled to face with sober senses, his real conditions of life, and his relations with his kind" (p. 68). Marx's optimism was undergirded by his faith in the power of reason; he expects human "sober senses" to point out the direction to progress. Nietzsche has a similar diagnosis of the origins of contemporary institutions in the interests of the few, but no accompanying expectation that the application of modern human reason can end this dynamic:

With the aid of such images and procedures [as flaying and quartering criminals], man was eventually able to retain five or six "I-don't-want-to's" in his memory, in connection with which a *promise* had been made, in order to enjoy the advantages of society—and there you are! With the aid of this sort of memory, people finally came to "reason"! —Ah, reason, solemnity, mastering of emotions, this really dismal thing called reflection, all these privileges and splendors man has: what a price had to be paid for them! how much blood and horror lies at the basis of all "good things"! (p. 42)

Faced with the failure of received ideas, and without the optimistic view that modern reason could replace previous illegitimate modes of life with authentic modes, Nietzsche calls on (at least some) modern human beings to embrace the disorientation that comes with recognition of the modern condition, and to create their own sets of values.

Such a solution has obvious shortcomings when it comes to social coordination. Most observers of the collapse of traditional values felt less exhilarated than paralyzed, waiting for the inevitable new mode of collective human being. The Irish poet Yeats, in his 1921 work "The Second Coming," an exquisitely modern poem, both formally and in its content, worries thus:

Turning and turning in the widening gyre
The falcon cannot hear the falconer;
Things fall apart; the centre cannot hold;
Mere anarchy is loosed upon the world,
The blood-dimmed tide is loosed, and everywhere
The ceremony of innocence is drowned;
The best lack all conviction, while the worst
Are full of passionate intensity.

Surely some revelation is at hand;
Surely the Second Coming is at hand.
The Second Coming! Hardly are those words out
When a vast image out of *Spiritus Mundi*
Troubles my sight: somewhere in sands of the desert
A shape with lion body and the head of a man,
A gaze blank and pitiless as the sun,
Is moving its slow thighs, while all about it
Reel shadows of the indignant desert birds.
The darkness drops again; but now I know
That twenty centuries of stony sleep
Were vexed to nightmare by a rocking cradle,
And what rough beast, its hour come round at last,
Slouches towards Bethlehem to be born?

The quintessentially modern poem depends on a fundamentally premodern concept of time: for Yeats, time is not progressive, but cyclical. Modernity as a human condition is characterized by such ironies: as democratic politics empowers the subject, social scientific research demonstrates the subject's disempowerment; as modern political thought looks to abstraction to resolve premodern injustices, that most particular institution of the national state is the main agent against them; as modern science enables increasing technical mastery of nature, it simultaneously demonstrates nature's mastery over individuals.

Small wonder, then, that antimodern movements of nearly infinite variety have sprung up around the globe in recent years. Responding to the arguments of Max Horkheimer, Theodor Adorno, and many others sympathetic to the critique of modernity, Habermas has argued that

only further enlightenment . . . has grown from the devastation of enlightenment. . . it is only through reason

that we can determine the limits of our rationality. *This* is the fundamental figure of Kantian thought that was definitive for modernity. And modernity can't just be peeled off like a dirty shirt. It's in our skin. We find ourselves in a condition of modern life: we didn't freely choose it; it is existentially unavoidable. But for the opened eyes of modernity, this condition also implies a challenge, and not just a disaster. (p. 94)

See also *Democracy; Enlightenment; Modernism; Public Sphere; Utilitarianism.*

BIBLIOGRAPHY

- Benjamin, Walter. *Illuminations: Essays and Reflections*. Edited and with an introduction by Hannah Arendt. New York: Schocken Books, 1969.
- Berman, Marshall. *All That Is Solid Melts into Air: The Experience of Modernity*. New York: Simon and Schuster, 1982.
- Foucault, Michel. *Discipline and Punish: The Birth of the Prison*. Translated by Alan Sheridan. New York: Vintage, 1979.
- Freud, Sigmund. *Civilization and Its Discontents*. Translated and edited by James Strachey. New York: Norton, 1989.
- Habermas, Jürgen. *The Past as Future*. Translated and edited by Max Pensky. Lincoln and London: University of Nebraska Press, 1994.
- Horkheimer, Max, and Theodor Adorno. *Dialectic of Enlightenment*. Translated by John Cumming. New York: Continuum, 1989.
- Kant, Immanuel. "An Answer to the Question: What Is Enlightenment?" In *Practical Philosophy*, edited by Mary Gregor. New York: Cambridge University Press, 1996.
- Koselleck, Reinhart. *The Practice of Conceptual History: Timing History, Spacing Concepts*. Translated by Todd Samuel Presner and others. Stanford, Calif.: Stanford University Press, 2002.
- Marx, Karl, and Friedrich Engels. *The Communist Manifesto*. Edited by John E. Toews. Boston: Bedford/St. Martins, 1999.
- Nietzsche, Friedrich. *On the Genealogy of Morality*. Edited by Keith Ansell-Pearson. Translated by Carol Diethe. New York: Cambridge University Press, 1994.
- Tocqueville, Alexis de. *Democracy in America*. Translated by Harvey C. Mansfield and Delba Winthrop. Chicago: University of Chicago Press, 2000.
- Wordsworth, William. *The Complete Poetical Works*. London: Macmillan, 1888.

Elisabeth Ellis

AFRICA

The debates and controversies over modernity, from its origins in sixteenth- and seventeenth-century western Europe to the various sites of its deployment following the formation of colonial empires, have given rise to an abundance of literature. Non-Western societies, by and large, in the formation of their cultural, political, economic, and social identities and their reactions to it, have appropriated or not, accommodated or not, resisted or not, in many different ways, what is usually referred to as the project of modernity (or modernization). Associated at first with colonization, and then with independence, modernity involves an understanding of several issues connected with modes of

thought, action, and belief, the legitimacy and effectiveness of which are fed by absolute faith in human progress, thanks to the power of science and technology. This creative tension between a way of being (the philosophical dimension of modernity) and of acting (modernization, which involves concrete advances in the realms of social and economic, political and legal, military and health policy, with the aim of transforming agrarian peoples and non-Western communities into urban, industrial societies) is at the heart of the dispute between the partisans and opponents of an understanding of modernity as the exclusive sign of civilization, established and defined by Europe.

The philosopher Jürgen Habermas, supported by the arguments of Max Weber, established a strong internal link between modernity and Western rationalism. This led to the erosion of religious concepts and the emergence in Europe of a secular culture via both laicization and modernization. Habermas suggests that the concept of modernization proposed in the 1950s comprises a set of cumulative procedures that reinforce one another, such as the capitalization and mobilization of resources, the development of the forces of production, increasing productivity of workers, establishment of political power and formation of national identities, dissemination of the notion of the right to political participation, the growth of forms of urban life, public education, and the secularization of values and norms.

However, in the historical, anthropological, and sociological literature, the terms *modernity*, *modernization*, and, occasionally, *liberalism* are often interchangeable. Opposing the idea of modernity as a strictly European development set forth by Habermas is the approach of numerous authors who are non-European or who work on the periphery of non-European societies. They emphasize its pluralistic character and its responsiveness to local environments. Benjamin Schwartz, a scholar examining Chinese history, stresses two revealing signs of the ambiguous nature of modernity: first, the crises, shocks, and convulsions that have destabilized Western societies and have strongly influenced and redefined Western modernity, both in terms of its basic content and its having been put to the test nationally during and after World War I; and the multiple versions of modernity, in particular the Soviet Marxist version. Two other fundamental issues should be considered: Modernity is a preoccupation of intellectuals, centered on questions of tradition and development, with a focus on the description and understanding of certain practical procedures and ways of thinking and feeling; when modernity leaves the realm of the intellectuals and takes on the aspect of modernization, it involves practical problems of economic development. Modernity thus became a word connoting order and mobilization, a goal to work toward. Schwartz invites us to proceed by a double movement: first, accepting that modernity does not refer to a simple entity or to a homogeneous admixture of manifestations, practices, or modes of thought, neither in its place of origin nor in non-European cultures. And similarly, it is not any kind of complete or synthetic whole; rather, it is crossed with horizontal tensions and conflicts “among the various currents and countercurrents of the modern world” (Schwartz, p. 54). It is therefore necessary to pay close attention to the lively debates among the

intellectuals in their specific historical context. In fact, for intellectuals in developing nations, in China at the beginning of the twentieth century, or in areas under colonial domination in Asia and Africa, the essential concern is to find the resources indispensable to the preservation of a community identity in their complex relationships to the past, in their traditions, and in the “European canon.” In the case of Africa, novelists have tried to present these clashing trajectories, as exemplified by Cheikh Hamidou Kane in *L'aventure ambiguë* (English trans., *Ambiguous Adventure*) and Laye Camara in *L'enfant noir* (1954; English trans., *The Dark Child*).

Signs of Modernity

The signs of modernity are considered here together, from the historical circumstances of European nations' global colonial expansion, and from the indigenous reading of the signs of this economic, political, and cultural hegemony that are expressed by the project of the civilizing mission. The civilizing mission rests on the promise of universal reason and emancipation that, prompted by the philosophers of the Enlightenment, is associated with modernity, progress, and the powerful capacity for destruction possessed by irrational and unreasonable practices, in the struggle between science and rationality on the one hand, and faith and religion on the other. According to P. Selinow, there are three pillars supporting this modernity: capitalism, analyzed by Karl Marx; bureaucracy, analyzed by Max Weber; and the norms, forms, and procedural regulations of modern society studied by Michel Foucault. In addition to this definition of modernity as a unique moment in the history of Western civilization, of which the principal signs are the scientific and technological progress of the industrial revolution and the economic and social transformations of capitalism, there is an approach that envisages modernity as an aesthetic concept. Though limited, this approach may help us trace the many changing ways in which non-Western societies have tried to understand, appropriate, resist, or define the efforts at modernization as they have been presented or understood. This is the case, for example, of Chinese literature, which was dominated in the first half of the twentieth century by an obsession with the notion that China was afflicted with a spiritual malady that created a break between tradition and modernity. Tradition was regarded as the source of the Chinese malady, and modernity was seen by intellectuals as a revolt against tradition and as a possible source of new solutions.

To this dichotomy of tradition/modernity one can add others, such as agrarian/industrial, authority/liberty, and prescientific thought/scientific thought. The case of China, as with Bengali intellectuals confronted with colonial domination by the British, illustrates the adoption and utilization of the language and categories available in (or proposed by) the “European canon” in order to assimilate, evaluate, select, and/or reject the new ideas from the West—that is, in establishing a correlation between the material gains and progress associated with the European presence and the moral decadence of indigenous sociability, civility, and religiosity.

Whereas Europeans view the history of modernity as a progressive triumph of Enlightenment ideas, in non-Western societies it is seen as beginning with colonial conquest, which is

now regarded as being part of the same movement in enlightened places and in regions of total darkness.

Colonial Modernities

There are two important issues in the development of colonial modernities: the interpretation of manifestations of modernity in the process of imperial expansion, on the one hand, and the place assigned to indigenous people in the colonial enterprise, on the other. Regarding the former, authors such as C. L. R. James focus on the modernity of slavery in the Atlantic economies at the beginning of the modern period; similarly, others suggest that the Indian peasant is not an anachronism in a modernized colonial world but a veritable contemporary of colonialism, an indispensable member of modernity. The complicity between colonial history and modernity is precisely the cause of the circumstances underlying the statement, “The same historical process that has taught us the value of modernity has also made us the victims of modernity” (Chatterjee, pp. 8–9). This strong correlation has its origin in numerous attempts to reinterpret the manifestations of modernity from indigenous impressions of it, by trying to jettison certain of these signs while recognizing the revisionist efforts to which it is heavily subjected in non-Western societies. Such a perspective is notably more apparent in studies on India and China than in those on Africa. One observes in the former an abundance of qualifications that result from opposing the idea of modernity as a strictly European development and affirming it as a multivalent phenomenon. Partha Chatterjee provides the best insight on this point in his definition of an Indian (or rather, Bengali) modernity as “our modernity.”

The many authors who have joined this debate after Chatterjee emphasize the ways in which non-Western societies remake modernity in their own images, revising rationality and capitalism by transforming general formulas and formulations in terms of their own interests, ideals, and enterprises—political, economic, and social. It is essential to recognize that in the case of Africa, the debate is less intense today than it has been. It does not necessarily take the same theoretical and epistemological approaches that color the writings in the social sciences on India and China, to give just two examples. It has always been presented as a double figure, each of which takes various forms, the pair tradition/modernity and the demands, expectations, and aspirations of development through the economic and social compensation by modern, industrial Europe. This figure, which does not always reflect democratic structures, secularism, or equality between the sexes, among other things, is part of a series of attempts to transform African societies by “modernizing bureaucrats” in the final phase of colonial domination. In Africa and among blacks in general, as has already been mentioned, writers and cultural critics—more than historians and social scientists—have drawn connections between Africa and Europe, whether in terms of conflict (Aimé Césaire, Camara Laye, and Cheikh Hamidou Kane) or a fruitful dialogue (Léopold Sédar Senghor and Ousmane Socé Diop). Only one author, Cheikh Anta Diop, a Senegalese philosopher, taking a brutal, ironic approach, reverses this problematic double. He has made a name for himself as a radical dissident and

has struggled to rethink and revise the genealogy of modernity to counter the notion of it as a strictly European development. On the contrary, he asserts, Europe has evolved under the aegis of Africa; it became rational by following the example and teachings of Africa, the mother of civilizations and the originator of modernity, which emerged along the banks of the Nile during the time of the Egyptian pharaohs.

This revision of the history of human rationality erases the boundary between traditional African societies and modern European societies. At the least, the idea of extreme difference between the two is interpreted as an ideological strategy for establishing the mission of civilizing native populations and the enterprises of colonization. By reintroducing Africa as a participant in the development of rationality and modernity, Cheikh Anta Diop reconfirms Africa as producer and consumer of modernity. Not many other African authors share his view, although it has been embraced by partisans of Afrocentrism, especially in the United States. On the contrary, at the heart of the debates, which intensified during the years of nationalism—after World War II to the 1970s—in the era of globalization, the crucial question is how to interpret the complex and paradoxical relationship between culture and modernization. At issue are the conflict-ridden associations between modernity and colonial cultures and violence, and the cultural and psychological renaissance that accompanied the founding of postcolonial nations and states. Two historians, J. F. A. Ajayi and Jacqueline Ki-Zerbo, have responded to this in the same way. Ajayi suggests that the colonial enterprise failed in its desire to erase the African past, having never succeeded in changing the path of African history or the strength and prevalence of African initiative. Ki-Zerbo warns against the assimilation and appropriation of the history and culture of others, which cannot provide any guarantee of success in terms of development and modernization. Among the novelists, Kane emphasizes the ambiguity of the venture. The Grande Royale, who argues for the education of the young people of the kingdom of Diallobés against his brother, the king and religious leader of the community, gives two reasons: to understand why the colonizers, even though they were in the wrong, were able to defeat them; and to enable his people to gain technological expertise. His reading considers that neither morals nor the values of authenticity can save one from domination. The experience at school and university of Samba Diallo, the book’s main character, and his delving into the Koran and texts by the philosophers of the Enlightenment do not open any doors to him other than those of solitude and death, which sanctions failure, and of assimilation and hybridization. Kane is even more explicit in his theoretical texts.

In contrast, Socé Diop, in his novel *Karim* (1935), relates with gusto the metamorphoses of the main character, Karim, who assumes multiple identities, including an accountant trained at a French school, a Senegalese Muslim from Saint-Louis (the oldest French colonial settlement in Africa) educated in the traditions of Islam and the values of the Wolof aristocracy, a dancer and charmer cognizant of urban opportunities and colonial chances. For each identity, Diop gives Karim a corresponding clothing style, dance steps, a manner of being and acting that are superimposed with close attention to French,

African, and Islamic teachings and practices on issues of aesthetics and rhythm, dress, love, and sex. Karim represents the celebration of a hybrid form of being, rejecting the draconian choice that would have lethal consequences for the “ambiguous adventure.” The approach taken by Socé Diop is shared by “the translators of colonial modernity” analyzed by Simon Gikandi.

Gikandi describes superbly the dilemma of constructing an indigenous culture that embraces the colonial political economy both internally and externally, and examines the production of colonial modernity through a never-ending negotiation between the desire to maintain the integrity and autonomy of colonized societies and the willingness to face up to the European presence and its political economy (pp. 23–41). Taking as an example the kingdom of Buganda (today the nation of Uganda), he shows how the elite adopts Christianity as a key element in developing a certain modernity, regarded as one way of participating in the colonial culture. Similar characteristics detected and analyzed by Gikandi, beginning with the account of the voyage of Ham Mukasa (*Uganda's Katikiro in England*) are found in the ethnographic and religious writings of David Boilat and in the militant intervention of Augustin Diamacoune Senghor, leader of Senegal's Casamance independence movement, who used the colonial culture to “develop”—in the photographic sense—indigenous moral values and religious beliefs. Through these different figures, people involved in such causes became interested in reorienting the ways of expressing and of satisfying the desires generated by colonial modernity toward indigenous ends. They tried in various ways to alter the very nature of the “colonial canon” by infusing it with their voices, passions, and anxieties, so that it would present them not as objects of European intervention but as the subjects of their own cultural destiny (Gikandi, in Mukasa's *Uganda's Katikiro*, p. 21).

This way of thinking led to the perception of the dual nature of tradition and the realities it conceals, involving both a constant reinvention of the colonial canon and an ever-shifting horizon due to the ceaseless work of translation, appropriation, and selection. By means of this work, the colonial experience is turned into an indigenous opportunity. The only question that troubles the carriers or translators of modernity is that of defining the colonial culture of modernity (including Christianity) in isolation from the “enlightenment” of the Christian message and colonial modernity, from the repressive, controlling mechanism of political power, and from its very authoritarian economic and cultural manifestations.

To understand the African debate on modernity is, in large measure, to identify the different ways in which the “package” (the concept and the different constructions that it has given rise to) and the numerous realities that it conceals have circulated in Africa, in various historical circumstances. The latter have been shaped by methods of appropriation, forms of opposition, and resistance, but perhaps still more fundamentally by demands and expectations regarding what is understood or proposed by the term. It still has to be made clear, as James Ferguson has suggested, that this modernity has a concrete meaning, reflecting subdivisions, pensions, and family allowances. The African modernity that he analyzes was a preoccupation for

certain groups in colonial and postcolonial African societies: political leaders, union leaders, students, specialists as well as workers in economic development. Modernity thus became synonymous with development and material progress.

This reading of the term *modernity* subscribes to the colonial objective of impeding Africa's modernity; especially after World War I, restrictions imposed by colonial authorities led to the politics of retribalization, assimilation, and the containment of the “carriers of modernity.” The colonialists tried to hold them back by claiming all the fruits—material, cultural, spiritual, economic, and political. On this question, the case of the Tsawana people, studied by Jean and John Comaroff, demonstrates the perpetual production of a modernity that is a constant source of tensions between, on the one hand, the adoption of the material elements of colonial culture (clothing, architectural styles, sanitation) and, on the other hand, their consequences under the appearance of new forms of individuation that progressively threaten the customs of the community, especially spiritual and therapeutic traditions. According to the Comaroffs, it is precisely the shock between missionary will and the processes of resistance, selection, and alteration that the Tsawana people go through, successively or simultaneously, that has created modernity. It derives in some way from what the West and the colonial enterprise call *modern*, the first manifestation of which was the mission to civilize the native peoples, and the last of which was modernization. These have linked the colonial enterprise and the nationalist struggle and its pursuit of development and achieving parity with Western economies. The emblems of the colonial enterprise are roads, commerce, and sanitation; the nationalist emblems are schools, community clinics, and electricity.

Among the best available analyses of colonial modernity are the groundbreaking studies by two experts on the French colonial empire, Louis-Hubert Lyautey (1854–1934) and Joseph-Simon Gallieni (1849–1916), the former on Morocco and Indochina, the latter on the Sudan and Madagascar. According to Paul Rabinow, the oscillation between the extremes of colonial modernization and continuing poverty within a framework of authenticity is not an exclusive characteristic of the autochthonous elite of African colonial societies. Gallieni, for example, established a definitive correspondence between pacification and modernity. In contrast to Lyautey's cultural relativism, he was a universalist. He did not by any means imagine that one might regard the lack of sanitation and the nondistinction among domestic space, work space, and livestock pen as anything other than signs of a lack of civilization. For him, “the sign of civilization was a busy road; the sign of modernity was hygiene” (Rabinow, pp. 149–150). Here, the meaning of modernity is, by colonial logic, constructed around elements such as security, communications lines, agriculture, commerce, and population growth.

It is difficult to determine where this chaotic journey will end. The paths and detours that it has taken reflect the great difficulty involved in making sense of a concept that is so prevalent in everyday conversations and in philosophical, political, moral, aesthetic, and cultural analyses, and increasingly in the economic realm as well. The questions regarding the genealogy

of the concept of modernity and its different forms, from its initial appearance to its commonplace deployment and the subsequent debates about it, have provoked numerous examinations of its heuristic value, its effects in terms of status in the narrative and scientific fields, its limits, possibility of application, and the different manipulations that it offers to those who lay claim to it, adapt it, or reject it. As much as the imaginations it recaptures, the historical traces it carries, the uses and abuses it has undergone, the possible or probable futures that one accords it partake of different modes of reference. And it is precisely for that reason that no one challenges it for having lost, during this journey, its capacities for setting in order or disorder realities, as much descriptive as figurative. For others, despite its epistemological and narrative weaknesses, reflecting a quasi-impossibility of relating other histories and conveying other circumstances, modernity is simultaneously a horizon line, a point of anchorage, a mode of being, and a means of constructing a geography of people, of cultures, of aesthetic forms. It is probably this plasticity that makes it what it is, always different, always debated, as expected, plural and unstable, between, on the one hand, European modernity and its desire to remake the world in its image or according to its dictates, and, on the other hand, the never-ending processes of rewriting, reinterpreting, and/or retreating from other societies.

See also **Colonialism; Modernity: Overview; Nationalism; Postcolonial Studies.**

BIBLIOGRAPHY

- Ajayi, J. F. A. "Colonialism: An Episode in African History." In *Colonialism in Africa*, edited by L. H. Gann and Peter Duignan. 5 vols. Cambridge, U.K.: Cambridge University Press, 1969–1975.
- Appadurai, Arjun. *Modernity at Large: Cultural Dimensions of Globalization*. Minneapolis: University of Minnesota Press, 1996.
- Boilat, David. *Esquisses Sénégalaises*. 1853. Reprint, Paris: Karthala, 1984.
- Calinescu, Matei. *Faces of Modernity: Avant-garde, Decadence, Kitsch*. Bloomington: Indiana University Press, 1977.
- Camara, Laye. *The Dark Child*. Translated by James Kirkup and Ernest Jones. New York: Farrar, Straus, and Giroux, 1969.
- Chakrabarty, Dipesh. *Habitations of Modernity. Essays in the Wake of Subaltern Studies*. Chicago: University of Chicago Press, 2002.
- Chatterjee, Partha. *Our Modernity*. Dakar: Codesria, 1997.
- Comaroff, Jean, and John L. Comaroff. *Of Revelation and Revolution*. Vol. 2: *The Dialectics of Modernity on a South African Frontier*. Chicago: University of Chicago Press, 1997.
- , eds. *Modernity and Its Malcontents. Ritual and Power in Postcolonial Africa*. Chicago: University of Chicago Press, 1993.
- Diop, Cheikh Anta. *Nations nègres et culture: De l'antiquité nègre égyptienne aux problèmes culturels de l'Afrique noire d'aujourd'hui*. Paris: Présence Africaine, 1955.
- Diouf, Mamadou. *Histoire du Sénégal: Le modèle islamo-wolof et ses périphéries*. Paris: Maisonneuve and Larose, 2001.
- Ferguson, James. *Expectations of Modernity: Myths and Meanings of Urban Life on The Zambian Copperbelt*. Berkeley: University of California Press, 1999.
- Giddens, Anthony. *The Consequences of Modernity*. Stanford, Calif.: Stanford University Press, 1990.
- Gikandi, Simon. *Maps of Englishness: Writing Identity in the Culture of Colonialism*. New York: Columbia University Press, 1996.
- Habermas, Jürgen. *Le Discours Philosophique de la Modernité*. Paris: Gallimard, 1988.
- Hall, Stuart. "A Conversation with Stuart Hall." *Journal of the International Institute* (fall 1999): 15.
- Kane, Cheikh Hamidou. *Ambiguous Adventure*. Translated by Katherine Woods. London: Heinemann, 1972.
- Kelly, J. "Alternative Modernities to 'Modernity': Getting Out of the Sublime Modernist." In *Critically Modern: Alternatives, Alterities, Anthropologies*, edited by Bruce M. Hauff. Bloomington: Indiana University Press, 2002.
- Lee, Leo Ou-fan. "The Quest for Modernity, 1895–1927." In *An Intellectual History of China*, edited by Merle Goldman and Lee Ou-fan Lee. Cambridge, U.K.: Cambridge University Press, 2002.
- Mitchell, Timothy, ed.. *Questions of Modernity*. Minneapolis: University of Minnesota Press, 2000.
- Mukasa, Ham. *Uganda's Katikiro in England*. With notes and an introduction by Simon Gikandi. Manchester, U.K.: Manchester University Press, 1998.
- Ong, A. "Anthropology, China and Modernities: The Geopolitics of Cultural Knowledge." In *The Future of Anthropological Knowledge*, edited by Henrietta L. Moore. London and New York: Routledge, 1996.
- Rabinow, Paul. *French Modern. Norms and Forms of the Social Environment*. Reprint, Chicago, University of Chicago Press, 1995.
- Schwartz, Benjamin I. *China and Other Matters*. Cambridge, Mass.: Harvard University Press, 1996.

Mamadou Diouf

EAST ASIA

Modernity (*kindaisei* in Japanese, and *xiandaixing* in Chinese) is a relatively recent term in the intellectual vocabulary of East Asia, becoming current only after World War II. Differing conceptions of "the modern" start much earlier, when terms long available in both languages acquired new connotations, as the region felt the impact of the West. The classical Chinese *jin* (close, nearby) provided the root for the Japanese *kinsei*, or "recent epoch," popularized in the sense of "modern period" by translations of European works in Meiji time. It was soon replaced by *kindai* to free Buddhist implications in *sei*. These came to China as loanwords *jinsai* and *jindai*, but gave way to *xiandai* in the early 1920s, indicating not "recent" but "present" age. Although intellectual exchange between the two countries was intense after the Opium War (1840–1842), ideas relating to the "modern" in fact developed along distinctive trajectories.

At the same time, certain shared features have been unmistakable. The notion of the modern, coming to the region accompanied by the military violence of Western imperialism, acquired a strongly spatial, not just temporal, force. It meant learning from the West in both enlightenment and material advance, and struggling for equal position with the West in national, cultural, and intellectual terms. This implied an inevitable element of borrowing or imitation, bringing with it anxieties of collective identity. Moreover, the very process of

modernization brought unintended—or even uncontrollable—changes to social life, turning “modernity” into part of an unprecedented daily experience that demanded articulation. Consequently, hard claimed universal ideas have been constantly challenged by local experience, and the relation between universal aspiration and particular attributes is never stable. These were issues that have preoccupied thinkers in the region down to the present.

Civilization and Enlightenment: Meiji Japan (1868–1912)

The Meiji Restoration set the stage for the first major bid of modernization. The driving force behind the program was the determination to secure *fukoky kyōhei*—rich country, strong army. But Meiji culture contained other aspirations as well. The most popular catchwords of the early Meiji years—*bunmei kaika*, “civilization and enlightenment”—were significantly different. The most forceful crusader for them was the prolific writer Fukuzawa Yukichi (1835–1901), who coined the term *bunmei* itself. His books *Seiyō Jijō* (1866–1870; Conditions in the West, 3 vols.) and *Bunmeiron no gairyaku* (1876; Outline of a theory of civilization) sold numerous copies. According to Fukuzawa, “civilization can be defined as that which advances man’s knowledge and virtue” with an open future; presently, Japan was only “semideveloped” (*hankai*), compared to Europe and the United States, a condition that defined the task in hand. Contrasting East and West, he wrote that “there must be some fundamental difference in the education of the Western and Eastern peoples. In the education of the East, so often saturated with Confucian teaching, I find two points lacking: that is to say, the lack of studies in ‘number and reason’ [science] in material culture, and the lack of the idea of independence in the spiritual culture” (*The Autobiography of Fukuzawa Yukichi*).

Fukuzawa’s original teaching, influenced by John Stuart Mill (1806–1873), emphasized the values of personal independence and a disciplined but free individuality as bases for a modern society, and the need for public diversity of viewpoints. However his commitment to enlighten the “uncivilized” led him to embrace policies of Japanese imperial expansion that followed European and American examples. Coining the term *datsua nyūō* (de-Asianization and joining Europe), he said that “our country cannot afford to wait for the enlightenment of our neighbors and to co-operate in building Asia up. Rather, we should leave their ranks to join the camp of the civilized countries of the West” (“Datsua ron,” 1885, On de-Asianization). By the end of his life, Fukuzawa had abandoned his earlier support for “people’s rights” and expressed boundless enthusiasm at Japan’s military victory over China.

In 1886, the twenty-three-year-old Tokutomi Sohō (1863–1957) published his hugely successful *Shōrai no Nihon* (The future Japan). Announcing that “the democratic trend is the world trend,” the book conveyed a new and more intense sense of the pace of modernity and the ceaseless transformations it would require of his countrymen. “The future of reform is reform, but what sort of reform will it be? What sort of reform should it be? After the deluge comes the deluge. But what sort of deluge will it be? What sort of deluge should it be? Time

flies faster than electricity.” Looking forward to a more industrial and mercantile version of modernity, inspired by John Bright (1811–1889) and Herbert Spencer (1820–1903), he argued that Japan’s vocation was to emerge from “a natural commercial nation” to become “an industrial country; and as a natural consequence . . . a democratic country.”

Tokutomi had few doubts of the ability of his cohort to make the necessary changes, claiming confidently in his journal *Kokumin no tomo* (Friends of the nation) the next year: “The old men of the past are gradually making way for the young men of the New Japan. Oriental phenomena are on their way out; Occidental phenomena are beginning. The period of destruction is at an end and the age of building is soon to start.” This was the age of the utopian political novels, too, with plots set in future times as in *Shin Nippon* (1886; New Japan, by Ozaki Yukio, 1859–1954) and *Setchūbai* (1886; Plum blossoms in snow, by Suchiro Tetchō, 1849–1896) finding an enthusiastic reception. Such enthusiasm easily turned to nationalism, as it did in Tokutomi’s case, once the Sino-Japanese war started in 1894. Thereafter, he remained an ardent supporter of the ultranationalist cause.

By the end of the Meiji period, to the cancellation of liberal political stirrings, on one side, as reforming intellectuals were absorbed into the ideology of a militarized state, corresponded on the other side the distress of lonely individuals, unanchored in the new society, as a central experience in the arts. The foremost novelist of the period, Natsume Sōseki (1867–1916), gave striking expression to this theme in his fiction, rejecting naturalist conventions. Sōseki had little confidence in the results of Japanese modernization. Scornful of both Western imitation and nationalist swagger, he told himself in 1902: “People say that Japan was awakened thirty years ago, but it was awakened by a fire bell and jumped out of bed. It was not a genuine awakening but a totally confused one. Japan has tried to absorb Western culture in a hurry and as a result has not had time to digest it” (Sōseki’s diary, 16 March 1902). He feared the worst from this force-fed diet. In his essay *Gendai Nihon no kaika* (1912; The enlightenment of modern Japan), Sōseki predicted:

If by dint of physical and mental exertions, and ignoring all the difficulties and sufferings of our precipitous advance, we succeed in covering in half the time it took the more prosperous Westerners to arrive at the same stage of specialization, the consequences will indeed be serious. We will be able to boast of a fantastic acquisition of knowledge, and will inevitably suffer a nervous collapse from which there will be no recovery.

Belated Enlightenment: China (1880s–1920s)

On the East Asia mainland, ideas of modernity developed later. In Korea, most enlightenment thinkers were trained in Japan, and these became the leading spokespersons for modernizing reforms in the late nineteenth century, and, when Korea eventually fell to Japanese colonialism in 1910, for a cultural nationalism and political independence. Chinese thinking about modernity, by contrast, was shaped by a tenacious Confucian view of the world, intertwined with erratic strands of

Buddhism and Western learning, and was marked by the persistent failure of efforts to reform the late Qing state for most of the nineteenth century. The result was a development in which enlightenment discourse was overshadowed by utopian constructions.

The leading reformer of the period, Kang Youwei (1858–1927), was a generation younger than Fukuzawa, but his ideas were notably less Westernized. In the early 1880s, Kang envisaged the emergence in another hundred years of equal rights for all human beings, phasing out the Confucian hierarchy between emperor and ministers, between gentry and commoners, and between men and women. But by the 1890s, the vague notion of a “public agreement” that would “lead every living being into the paradise of supreme happiness” (*Kangzi nei wai pian*, 1884, Kangzi: Inter and outer chapters) had given way to an accommodating monarchism that promised to give present society a stage of “well being” (*shengping, xiaokang*), en route to a “grand peace” (*taiping*) of the whole world of “great harmony” (*datong*). The vision of progress in it offered utopian constructions dressed in Confucian discourse as a remedy to China’s modern crisis.

The thinker-translator Yan Fu (1853–1921) was responsible for introducing Social Darwinism into China with a translation of T. H. Huxley’s *Evolution and Ethics*, significantly rendered as *Tianyan lun* (1895; On Heavenly evolution). Convinced of the need for the Chinese to understand the implications of “the survival of the fittest,” Yan warned his countrymen: “The weak invariably become the prey to the strong, the stupid invariably become subservient to the clever” (*Yuan-qiang*, 1895, On strength). In an essay entitled “*Lun shi bian zhi ji*” (1895, On the urgency of change in the world), he noted that “[t]he greatest difference in the principles of West and East, that which is most irreconcilable, is that the Chinese love the ancient and ignore the present, whereas Westerners strive for present to overcome the past.” Here what is modern in his evolutionary horizon was still more a matter of geographical contrast than of temporal advance. As time moved on, through the chaos of the early Republic, Yan became disillusioned with the idea of evolution itself.

The first to tackle problems of modernity more directly was Kang’s disciple, Liang Qichao (1873–1929), who fled to Japan after the failed attempt at state reform in the summer of 1898. With far more access to works by Meiji thinkers and Japanese translations of Western literature, he wrote that the effect of reading them was as if “suddenly seeing the sun in a dark room and drinking on an empty stomach” (“Lun xue riben wen shi yi,” 1899, On the benefit of learning Japanese). Here were the models for the modernization of China. Reconfiguring the crisis of the time, Liang effectively replaced “Western” with “new” as a defining adjective for the tasks of the time. In his article “Shanonian Zhongguo shuo” (1900, On young China), he wrote: “What has made China today a senile giant is the evil deeds of dying old men.” The task of creating a new China fell to the young, and he enumerated all the fields—from morality and laws to institutions and conventions—that required recasting by them in “an independent spirit” (*Xinmin shuo*, 1902–1906, Discourse on the new citizen). He also called for a “new history” and “new novel,” publishing a utopian fiction of his own, *Xin Zhongguo*

weilai ji (The future of new China) in 1902, while advocating a monarchical constitution under the Manchu rule.

Liang’s call for a new historiography was challenged by the classical scholar Zhang Binglin (1868–1936), who argued that Confucius should be seen as the first great Chinese historian, founding a tradition of historical studies that retained its validity to the present. “Instead of persuading people to worship Confucianism as a religion, we should encourage them to treasure the history of the Han nation” (1906). Politically a resolute revolutionary committed to the overthrow of the Manchu court, Zhang sought intellectually to tie the nationalist movement to pre-Qing traditions: “Historical events and relics can move patriotic feelings.” The ensuing debate between the two showed the persistent classical sense of the past that had to be overcome before “modern times” could be successfully conceptualized in China.

It was not until the following decade that these parameters changed to that similar to, but almost half a century later than, Fukuzawa’s *bunmei kaika*, in both essence and scale. The two leading intellectuals of the period, Chen Duxiu (1879–1942) and Hu Shi (1891–1962), launched a sweeping campaign against Chinese traditions in the name of democracy and science in 1917, in a movement that culminated in the May Fourth Incident against the post-World War I Versailles Peace Conference in 1919. Hu Shi insisted on a “critical attitude” and the need to “revalue all values” (*Xin sichao de yiyi*, 1919, The significance of the new thought) in the light of modern reason. Chen Duxiu declared:

In support of Mr. Democracy, we must oppose Confucian teaching and rites, the value of chastity, old ethics and old politics. In support of Mr. Science, we must oppose old arts and old religions. In support of both Mr D and Mr S, we must oppose the “national essence” and old literature. . . . How many upheavals occurred and how much blood was shed in the West in support of Mr D and Mr S, before these two gentlemen gradually led Westerners out of darkness into the bright world. We firmly believe that only they can resuscitate China and bring it out of all the present darkness of its politics, morality, scholarship and thought. (*Xin qinqnian zui-an zhi dabian*, 1919, In defence of the *New Youth* against accusations)

It was in the urgency of this perspective that the semantic shift of the term for “modern” from *jindai* to the more sharply present-focused *xiandai* occurred.

It was left to China’s greatest writer of the period, Lu Xun (1881–1936), to consciously hold skepticism while fighting under the banner of Mr. D and Mr. S against conformist tendency. One of the first in China to introduce literary works from weak and colonized countries in Europe and Asia, he most valued the patriotic affection and fighting spirit expressed by the people. Similarly, he quoted Byron and Nietzsche repeatedly as the model for noncompromised struggle. He attacked those who “dream not about the future, only in the present,” and warned those optimistic about modernity that “the most painful experience in

life is to wake up from a dream and find no road to follow” (“Nala zouhou zenyang,” 1923, Now Nora is after leaving [the Doll’s House]). With a clear understanding that no ready model for imitation was available, Lu Xun envisaged life in constant struggle of paving new roads: “What is a road? It is what comes out from tramping over where there was no road, paved out from where there were brambles only.” It was also to rejuvenate “human being’s potential in longing for perfection” (“Gusiang,” 1921, Hometown) to march forward regardless of how difficult, how seemingly hopeless the future ahead might be.

Urban Cosmopolitan Modernity (1920s–1930s)

In interwar Japan a new kind of consciousness of modernity crystallized, around the scenes, rhythms, and sensations of big-city life, which spread to China some ten years later. This was the modern not of institutions or technologies but of the experience of life Charles Baudelaire (1821–1867) and Arthur Rimbaud (1854–1891) had celebrated in Europe. The 1920s saw a wave of translations of modernist literature from the West, and formal experiments by Japanese writers. Successive literary schools contended against each other, virtually all of them taking individualism as a given, with aesthetics of existential fragmentation and a mixture of fascination and repulsion for the transient surfaces of metropolitan life. The one ingredient, important in the West, that was missing from this modernism—it would be true of the Chinese variant as well—was the European anguish at loss of religious faith. The solitude of humankind in a world without God was never a major theme of East Asian modernism.

The most influential of its currents in Japan was the New Sensationalism—associated with Yokomitsu Riichi (1898–1947) and early Kawabata Yasunari (1899–1972)—which Kawabata defined as “Expressionism in epistemology and Dadaism in formal expression” (“Shinshin sakka no shin keikō kaisetsu,” 1924, An explanation on the new tendency among young writers). The New Sensationalism came to Shanghai in the late twenties and early thirties. Yokomitsu entitled his first full-length novel *Shanghai*. It was in these years that the term *xiantai* became ubiquitous in fashion magazines and avant-garde journals alike, and that—as in Japan—the idea of a specifically aesthetic modernism arrived, associated with the breaking of formal conventions and social taboos, erotic or otherwise.

In both cases, cosmopolitan influences were celebrated and even worshiped, but in general without the revolt against “philistinism” or the spirit of rebellion against the established order that marked much of Western modernism. Yokomitsu’s sense of universal cosmopolitanism ended with his “melancholy journey” to Europe in 1936, where a pilgrimage turned into disillusion, and he subsequently “returned” to the nationalist course, reaching the same end, via a different path, as Fukuzawa decades earlier. But something of the same feel for the urban landscape was also shown by the Chinese leftist writer Mao Dun (1896–1981) in his novel *Ziye* (1933; *Midnight*), which covered a wide range of lurid scenes in Shanghai in a style not dissimilar to that of the New Sensationalists. Despite China’s national crisis by the late thirties, the younger generation’s fascination with modernism continued into the war years, especially in poetry, before fading away in the 1950s.

“Overcoming Modernity” (1940s–1950s)

Intellectual reactions against modernity started early in East Asia, and were not confined to traditionalists. Alarm at the “madness” or “lost soul” of modern industrialism and militarism was soon expressed by enlightenment intellectuals in both China and Japan. Touring Europe after World War I, Liang Qichao (1873–1929) was shocked by what he found:

Countless total strangers live together, sharing the same market or factory, with absolutely no links of affection to each other, merely relations of material interest. Most people own no property, depend on wages only, and lack any roots for survival, like a withering lotus. Social complexity exceeds anyone’s capacity for orderly responses to it, over-stimulating and exhausting the nervous system. After work, there is need for play, but abruptly it is time to work again; day and night there is no rest. Desires multiply constantly, the price of goods rises uninterrupted, life becomes harder and harder, competition fiercer and fiercer. (*Ou you xin ying lu*, 1920, Impressions from my European journey)

Yet he believed China, as a latecomer to modernity, still had a chance to draw its own critical lessons from European development; he had converted to the May Fourth conviction of science and democracy as the prerequisite of entry into the modern world.

At virtually the same time, the philosopher and reformer Liang Shuming (1893–1988) set out a severe critique of contemporary Western societies in his book *Dongxi wenhua jiqi zhexue* (1921; *The cultures of East and West and their philosophies*), attacking their separation of man and nature, individual and society. After the catastrophe of World War I, the world had arrived at a point where it had to alter direction. In Liang Shuming’s view, this meant shifting from the agonistic reason, guided by intuition, of the “cultural will” of the West, to the intuition guided by reason of the Chinese cultural will—this was where the world was now heading—and eventually to the valuation of faith and devaluation of desire that was Indian cultural will. The modern society that had emerged in the West was a necessary step in this long-run development, and the spirit of democracy and science it had brought was precious. But a better civilization was possible beyond it.

The challenge to uncritical images of modernity issued by the two Liangs led to a series of controversies in China in the 1920s, in which the resources of traditional Chinese learning in a time dominated by Western configurations of human knowledge and the potential for an alternative path of modern development for China were hotly debated. Although Liang Shuming was subsequently considered a precursor of neo-Confucianism in late-twentieth-century China, at the time he was true to the May Fourth generation, becoming an active proponent and organizer of agrarian cooperatives, and like Liang Qichao in the same period advocating a variant of socialism as a remedy for China’s ills.

Japan. In Japan, probing of the dilemmas and paradoxes of modernity began already in the Meiji period, and has lasted

to this day. In the 1890s, the Christian thinker Uchimura Kanzō (1861–1930) questioned the purpose of his country's headlong drive to join the ranks of the West:

Can present-day civilization compensate for the loss of the independence of our souls through modernization? Are the steam engine, radio, champagne, torpedoes, and guns better than peace? Does civilization mean spending six billion dollars to maintain standing armies of two and a half million soldiers in Europe, producing anarchists and increasing nervous disorder? (“Kyūanroku,” 1893, A record of search for peace)

But by Taishō times, Uchimura's dissent was directed more at his fellow intellectuals than at the government:

I rejoice at the news that the government has a plan to restore Chinese studies in school. It is not the time to argue over the difference between the ideas of the West and the East. What we should do now is to destroy modern man [*kindai-jin*] and modern ideas [*kindai-shiso*]. (“Hibi no shōgai,” 1924, Daily life)

There was an echo here, however distorted, of Liang Shuming's desire to counter temporal divisions with a call for spatial unity.

Stark counterpositions of West and East nonetheless persisted—even for those who despised *kindai jin* and *kindai-shiso* no less than Uchimura—throughout the interwar and war years. For in this period the Meiji aspiration of climbing up the rungs of a hierarchical world order of “civilization” was replaced, on the one hand, by spatially stressed notions of a plurality of cultures and ethnicities, under the catchphrase of a “return to Japan.” On the other hand, Fukuzawa's vision of enlightened individuals acting with a spirit of independence gave way to fear of the modern decadence of an ill-informed individualism that was the captive of a debased mass culture. At the same time, images of socioeconomic modernity itself became much more divided. In the 1870s it was taken for granted that there was just one basic model of civilization, even though the Meiji oligarchs had borrowed selectively from the West. By the 1930s this was no longer possible. Russian Communism, Italian Fascism, American capitalism, and German Nazism offered a range of completely different models of state and society.

Against this background, a symposium that would have enormous resonance was held in Kyoto in the summer of 1942, shortly after the outbreak of the Pacific War. Modeled on League of Nations symposia chaired by Paul Valéry in the 1930s, notably on “The Future of the European Spirit,” this Japanese forum brought together philosophers from the Zen-and-new-Kantian influenced Kyoto School founded by Nishida Kitarō (1870–1945), writers from the Japan Romantic School Society, to discuss the problem of “Overcoming Modernity” (*kindai no chōkoku*). The political context of the symposium—Japanese fascism—featured prominently in the discussions, but these did not adhere to any rigid ideological

agenda, ranging over many aesthetic, philosophical, cultural, and social issues. Modernity had to be overcome, some argued, because the failures of capitalism, democracy, and liberalism had led inevitably to the war. But was modernity simply a European or American phenomenon? Others doubted it, pointing to a Japanese modernity compounded of indigenous and foreign elements alike. By the end, the chairman of the symposium concluded it had failed in its task.

Yet, after World War II, the symposium became a landmark for intellectual inquiry into Japan's modern history and its future. This outcome was primarily due to the work of Takeuchi Yoshimi (1910–1977) in the early 1950s, who extracted its quest from the compromised setting of wartime Japan, and “re-functioned” it for an anti-imperialist politics in postwar Japan. Significantly, Takeuchi was the major Japanese editor and translator of Lu Xun. Writing after the Communist victory in China, he contrasted the trajectory of the Chinese Revolution with the Japanese experience of a military-fascist regime followed by American occupation. Yet, throughout East Asia modernity had been the result of imperial violence by the West that forced it upon the East, in a continuous process in which until 1949 the West had always claimed victory. Truly to overcome that modernity in Japan required a “double resistance”—resisting both the external imposed reason and the internal denial of the defeat of which it was the outcome. Such resistance was the task of the citizens of a politically responsible nation (*minzoku*), to exercise their independent subjectivity (*shutaisei*). It was not antimodern. “If I were asked what is resistance,” he wrote, “the only answer I have is, ‘It is what you find in Lu Xun.’” (“Chūku kindai to Nihon no kindai,” 1948, China's modern and Japan's modern; in later collections the title changes to “Kindai towa nanika,” What is modernity).

In postwar Japan, subjectivity had become one of the central terms of political debates over the recent past, as intellectuals sought to understand the human agents of social change in the processes of modernization and Japan's war experience. Maruyama Masao (1914–1996), a leading thinker of the Occupation period, rejected the existential interpretation of subjectivity of the Kyoto School, which continued as a major influence in the 1950s. During the war, Maruyama had invoked Fukuzawa as a thinker who “could never conceive of national independence in the absence of individual autonomy” (“Fukuzawa ni okeru chitsujō to ningen,” 1943, The order and humane in Fukuzawa); and in his path-breaking essay *Chōkōkashugi no ronri to shinri* (1946; “The logic and psychology of ultranationalism”) he attributed the disastrous course of Showa politics to the “collective irresponsibility” of an elite drifting to war in the name of a mystified imperial rule transcending temporal or spatial boundaries, and commanding the passive obedience of its subject-citizens (*kokumin*).

A true democratic revolution in postwar Japan, Maruyama contended, required the “establishment of a modern personality,” capable of responsible decision making. His ideal here was Max Weber's (1864–1920) ethic of responsibility, as set out in *Politics as a Vocation* (1918). This was an admiration shared by his contemporary Otsuka Hisao (1907–1996), an economic historian who energetically appropriated Weber's

theory of the Protestant ethic as a model for the kind of self-discipline needed to build a robust civil society in Japan. In their different ways, Maruyama's championship of the "modern personality" and Takeuchi's call for resistance by the *minzoku* opened a new page of critical thinking in Japan. The themes of modernity or its overcoming were taken up by many others in subsequent decades and have lingered in various contexts as a persistent theme in Japanese thinking to this day.

The issue of a politically responsible citizenry, resonant in Maruyama and Takeuchi, reappeared in Korean intellectual life during the 1970s. Paik Nak-chung (b. 1938), a leading literary critic, advocated a "national literature" (*minjok munhak*), the modernity of which is defined by its opposition to Korea's North-South division, and its openness to the world at large from a Third World position. Paik has since actively promoted an independent, creative national subjectivity, in a series of debates on modernism, postmodernity, and globalization.

Modernization and Postmodernity: Ongoing Debates

If *modernity* and *modernization* were characteristically Weberian concerns, they had little place in Marxist thinking, since their generality blurs the distinction between capitalism and socialism as forms of postfeudal society that is central to Marx's theory of history. Thus the major historical controversy within the communist movement in the two countries developed quite independently of debates over modernity, and without reference to them. The Chinese Revolution might be objectively responsible for a vast modernization of the country, but for a quarter of a century the notion itself was essentially foreign to its vocabulary.

With the strong reaction against the Cultural Revolution (1966–1976) that came in the early seventies, this changed. The government adopted the slogan of the "Four Modernizations": industrial, agricultural, techno-scientific, and defense. In time the function of this semantic shift became increasingly clear—to cancel the long-held distinction between socialism and capitalism, as Mao had feared. But in doing so, it reopened the classic "wound" in the concept itself, which was first painfully exposed in Meiji times. Was modernity just a "rich country and a strong army," as the quartet of official goals implied? Dissidents did not think so. In 1978, Wei Jingsheng (b. 1950) called for a "fifth modernization"—the institution of political democracy—and was punished with a long prison sentence. Rapid economic growth and political repression have continued to date.

By the 1990s, debates on postmodernity had reached China, but in the early 2000s the principal stake in discussion remained the concept of modernity itself. The historian of theology Liu Xiaofeng (b. 1956) in his work *Xiandaixing shehui lilun xulun* (1996; A preface to social theory of modernity) believes that modernity manifests itself in the form of a social structure, whose inherent contradictions can never be put to rest by actions of "overcoming," but will regenerate themselves endlessly, and which is European in origin only through a series of historical accidents. Other countries then initiated modern processes of social change under external pressure, albeit with their own varied historical legacies. Since the late Qing

period most Chinese intellectuals, Liu argues, failed to grasp the logic of modernity because they tended to accord priority to the nation instead. In his view, the moralistic party-state that came into being after 1949 is now decaying, and to fill the vacuum it has left, a religious community needs to be rebuilt through religion at the local level, both in order to protect individual freedoms and to ensure an ethical basis for people to cope with an ever-changing society. The modern human without God must find salvation in religion again.

Approaching the issue from another perspective, the intellectual historian Wang Hui (b. 1959) worked for more than a decade on his study *Xiandai Zhongguo sixiang de xingqi* (2003; The rise of modern Chinese thought). In this work he traces the origins of ideas of modernity in China back to the eleventh century, with the aim of showing that capitalism can hardly lay claim to everything that is today associated with the modern. Himself the author of a work on Lu Xun, he champions a spirit of resistance, similar to that in Takenuch, though without emphasizing the "double," to mystifying discourses of global modernization, and the historical teleology that he argues they always entail, with an obligatory class structure and empty representative institutions at the end of the road. Alternative modernities remain necessary and possible, even if these will now require a different international order, sustaining national innovations, rather than crushing them in a neoliberal straitjacket.

In Japan, on the other hand, the success of postwar capitalist development did not put an end to questioning of modernity. Among significant debates, one centered on literature. Karatani Kōn (b. 1941), in his study *Nihon kindai bungaku no kigen* (1980; *Origins of Modern Japanese Literature*) emphasized the "nearness" of the "origins" of Japanese modernity, instead of tracing it to a genealogically distant past. Pointing to a global simultaneity of multinational modern experience, he sought to unravel the historical specificity of the Japanese case. Karatani almost immediately drew sharp disagreement from a number of Japanese scholars, including Kamei Hideo (b. 1937), who charged him with disregarding the continuities in the Japanese experience of modernity. For Kamei, exclusive attention to a uniformly identified "modernity" has suppressed the multiple possibilities latent in the flourishing creativities of Meiji Japan, which developed out of Edo culture and still require an intellectual effort to recover. The national component of modernity, projected by Takeuchi, acquired a new level of depth for inquiry.

With the consumer boom of the eighties, many intellectuals began to wonder whether Japan was not witnessing a new way of "overcoming the modern"—entrance into postmodernity. In a famous intervention, Asada Akira (b. 1957) has given the interlinked problems of subjectivity and historicity a critical postmodern twist. Drawing playful inspiration from Nishida Kitarō, he has contrasted a senile capitalism in Europe, under the sway of transcendental traditions, and an adult capitalism in America, marked by an inner-directed sense of individual responsibility, with an infantile capitalism in Japan, displaying the "nearly purely relative competition exhibited by other-directed children." Asada has described the postindustrial psyche of

Japanese society in the following way: “Children are running around, each as fast as possible, at the front lines of the history of capitalism as infantilization proceeds. They are enveloped by a ‘place’ whose age is hardly known—the ‘place’ that is trans-historical in the sense Nishida demonstrated” (1989). Debates on modernity in East Asia have plainly not yet run their course.

See also *Empire and Imperialism; Modernism; Nationalism*.

BIBLIOGRAPHY

- Alitto, Guy. *The Last Confucian: Liang Shu-ming and the Chinese Dilemma of Modernity*. Berkeley: University of California Press, 1979.
- Arima Tatsuo. *The Failure of Freedom: A Portrait of Modern Japanese Intellectuals*. Cambridge, Mass.: Harvard University Press, 1969.
- Asada, Akira. “Infantile Capitalism and Japan’s Postmodernism: A Fairy Tale.” In *Postmodernism and Japan*, edited by Masao Miyoshi and H. D. Harootunian. Durham, N.C.: Duke University Press, 1989.
- Denton, Kirk A., ed. *Modern Chinese Literary Thought: Writings on Literature, 1893–1945*. Stanford, Calif.: Stanford University Press, 1996.
- Doak, Kevin Michael. *Dreams of Difference: The Japan Romantic School and the Crisis of Modernity*. Berkeley: University of California Press, 1994.
- Fukuzawa Yukichi. *Outline of a Theory of Civilization*. Translated by David A. Dilworth and G. Cameron Hurst. Tokyo: Sophia University, 1973.
- Harootunian, Harry. *Overcome by Modernity: History, Culture, and Community in Interwar Japan*. Princeton, N.J.: Princeton University Press, 2000.
- Hu, Shih. *The Chinese Renaissance: The Haskell Lectures, 1933*. Chicago: University of Chicago Press, 1934.
- Jansen, Marius B. *The Making of Modern Japan*. Cambridge, Mass.: Belknap, 2000.
- Kamei, Hideo. *Transformations of Sensibility: The Phenomenology of Meiji Literature*. Translated, edited, and with an introduction by Michael Bourdaghs. Ann Arbor: Center for Japanese Studies, University of Michigan, 2002.
- Karatani Kōjin. *Origins of Modern Japanese Literature*. Translation edited by Brett de Bary. Durham, N.C.: Duke University Press, 1993.
- Keene, Donald. *Dawn to the West: Japanese Literature of the Modern Era, Fiction*. New York: Holt, Rinehart, and Winston, 1984.
- Koschmann, J. Victor. *Revolution and Subjectivity in Postwar Japan*. Chicago: University of Chicago Press, 1996.
- Lee, Leo Ou-fan. *Shanghai Modern: The Flowering of a New Urban Culture in China, 1930–1945*. Cambridge, Mass.: Harvard University Press, 1999.
- Maruyama, Masao. *Thought and Behavior in Modern Japanese Politics*. London and New York: Oxford University Press, 1969.
- Sakai Naoki. *Translation and Subjectivity: On Japan and Cultural Nationalism*. Minneapolis: University of Minnesota Press, 1997.
- Schwartz, Vera. *The Chinese Enlightenment: Intellectuals and the Legacy of the May Fourth Movement of 1919*. Berkeley: University of California Press, 1986.
- Seymour, James D., ed. *The Fifth Modernization: China’s Human Rights Movement, 1978–1979*. Stanfordville, New York: Human Rights Publishing Group, 1980.

Shi, Shu-mei. *The Lure of the Modern: Writing Modernism in Semi-colonial China, 1917–1937*. Berkeley: University of California Press, 2001.

Spence, Jonathan D. *The Search for Modern China*. New York: Norton, 1990.

Tokutomi, Sohō. *The Future Japan*. Translated and edited by Vinh Sinh, with Matsuzawa Hiroaki and Nicholas Wickenden. Edmonton, Canada: University of Alberta Press, 1989.

Wang, Hui. *China’s New Order: Society, Politics, and Economy in Transition*. Edited by Theodore Hutters. Cambridge, Mass.: Harvard University Press, 2003.

Chaohua Wang

MODERNIZATION. The term *modernization* conjures images of social change in the direction of general improvement over the past. In contemporary social sciences, the notion has been the basis of a theoretical orientation—variously referred to as modernization theory, approach, paradigm, or framework—to the study of the development of Third World or underdeveloped societies. The conception of development as a process of modernization gained prominence in the period after World War II, but its popularity ebbed in the 1960s. There were rival definitions of modernization in the social sciences; this entry, however, will be concerned mainly with the use of the term for a general theoretical orientation—a set of linked assumptions framing analysis of and debates about the nature and challenges of development. In this regard modernization was a historically unique type of social change, which was inexorable, transformational in its effects, and progressive in its consequences. The main institutional pillars for modern society were industrialism and the nation-state.

A product primarily of American social science, the modernization approach was inspired by two important and concurrent developments of the postwar era, the disintegration of European colonial empires and the Cold War. The emergence of many new nations out of the ashes of European colonial empires generated unprecedented intellectual and policy interest in their economic, political, social, and cultural makeup and development. With the United States and the Soviet Union as the two superpowers and respective leaders of the Western and Eastern blocs, the Cold War was, among other things, a competition between two ideologies—liberal capitalism versus socialism—each claiming to be the superior path to modernity. This ideological contest framed the superpowers’ rivalry for the allegiances of developing countries. Modernization theory, directly or indirectly, was concerned with resolving the problems of underdevelopment by promoting market-based economies and pluralistic political systems. The approach thus appeared to be scholarship guided by and in support of specific Western policy objectives. The intellectual roots of modernization theory lie in pre-Socratic Western thinking about social change, and more immediately in the European Enlightenment of the seventeenth and eighteenth centuries, which gave birth to modern social sciences. The Enlightenment embodied a critique of the “Old Order,” when European societies were at the threshold of industrialization and exposed to social dislocations that would only intensify. Convinced of the inevitable demise of the old feudal

order and of absolutism, Enlightenment intellectuals propounded the “Idea of Progress,” a dogma about the immanence and desirability of change. In opposition to defenders of the Old Order, of social arrangements governed by and political authority legitimated by religion and tradition, they argued that rational knowledge of society, based on scientific investigation and freed from religious dogma and superstition, was possible and represented a superior form of knowledge. Once validated and acted on, such knowledge would advance the material and cultural emancipation of society. The founders of modern social sciences, prominent among them Karl Marx, Émile Durkheim, and Max Weber, were products of the Enlightenment and enamored of the idea of progress as a universal historical process leading to a single modernity. In Marx’s famous theory of history, for example, societies progressed through modes of production—primitive communism, slavery, feudalism, capitalism, and communism—and their corresponding political structures. In general, nineteenth-century evolutionary theories of social change were equally all-embracing, relied on dichotomous conceptions in which societies were characterized as composed of traditional and modern attributes, and saw social change as a process of structural changes resulting in the preeminence of the attributes of modernity. However conceived, emergent industrial societies and modern nation-states of the West represented the most advanced stage of societal transformation. They predicted the future of underdeveloped societies, the majority of which at the close of the nineteenth century had effectively been colonized by European states.

Modernization theory adopted the narrative of progress of nineteenth-century evolutionary theories of social change. It dispensed with the racist overtones of many, which tended to separate societies into “civilized” and “savage” and doubted the possibility of development of the latter. Adopting the nation-state as its main unit of analysis, the theory defined development as an endogenously driven process and maintained that modernization was a goal attainable by all societies. Retaining but elaborating the dichotomous conceptions of earlier evolutionary theories, the modernization approach conceived of underdeveloped societies as comprising traditional and modern sectors. The traditional sector was rural and agrarian, its sociopolitical organization defined by religion, superstition, primordial loyalties, and similar forces. In contrast, the modern sector was urban, its economy dominated by industry; social standing was determined by economic position (social class) and hence the result of personal achievement, and secularism defined the organization of social relations and public life. In effect, this equated development with the increasing Westernization of underdeveloped societies through elaboration of market-based economies and liberal, pluralistic political systems. One of the most famous articulations of the approach, W. W. Rostow’s *The Stages of Growth: A Non-Communist Manifesto*, made this explicit. Modeling his analysis on Marx’s theory of history, but blunt about his intention to present liberal capitalism as the superior path to modernity, Rostow argued that economies progressed through five historical phases: traditional, preconditions for takeoff, takeoff, drive to maturity, and the age of high mass consumption. Contrary to Marx, who saw capitalism as a way station to the ultimate modern society—stateless communism—Rostow argued that high-mass-consumption society, of which

the United States was the most fully realized incarnation, was the end of the modernization process.

In general, the two key conditions for successful modernization were economic growth through industrialization and modernizing elites with the “psychocultural attributes” to guide their societies through the process. Modernization of underdeveloped societies could be realized in a shorter period than had been the case for Western societies. In bequeathing ex-colonies with modern economic enclaves and Westernized elites, colonial rule had laid the foundations for accelerating the process. Interestingly, the narrative of progress that undergirded the approach resonated with the nationalist aspirations of Third World elites. The promise of development of their societies served as a ubiquitous trope for the legitimization of their power. Although they adopted different ideological positions, modernization for them was fundamentally about the elaboration of the two projects of economic development through industrialization and nation-state building.

The modernization approach was subjected, as the 1960s unfolded, to increasingly blistering criticism, brought on by the realities of Third World societies, which mocked its excessive optimism. The record of economic growth in developing societies was at best mixed, and what growth occurred appeared to be accompanied by increases in mass poverty and economic inequality. Whereas modernization theory presumed economic growth that expanded social groups and engendered behavioral changes that favored the emergence of pluralistic political systems, instability and authoritarian rule appeared to be the norm. Against this backdrop, criticisms centered on the theory’s ideological character, its limitations as a conceptual framework, and its contributions to the foreign policy objectives of—especially—the American government. The ethnocentrism of the approach, with its dichotomous constructs like “tradition” and “modern”—transparently, abstractions from vague and generalized images of the nature of changes in Western societies attending the rise of industrialism and the modern nation-state—drew fire. Based on such ideal types, the approach imagined the historically contingent experiences of Western societies as relevant to all societies. Moreover, in implying that “modern” and “traditional” were self-contained, it lacked definitional specificity and was of dubious analytical value, for social structures and relations in all societies were complex, shaped by the interpenetration of traditional and modern attributes, however defined. This was obviously the case in developing societies that had felt the impact of European colonization.

For conservative critics, such as the political scientist Samuel Huntington, the ethnocentrism and teleology of modernization theory made it a poor guide to public policy. The conjecture of an unproblematic causal link between economic development and the advance of pluralistic political systems encouraged a moralistic approach to policy toward the developing world, which promoted democracy even if it was not necessarily in the best interest of the United States. The social dislocations caused by economic development fed political instability; therefore, the creation of political order—the institutionalization of political authority—was a precondition for

economic development and democracy. According to this argument, the main objective of American policy toward the developing world ought to be support of regimes that are capable of maintaining order and amicably disposed toward America's economic and strategic interests.

Radical critics, on the other hand, such as dependency and world system theorists, dismissed modernization theory as well as its conservative critics as engaged in providing intellectual justification for American imperial designs. In adopting the nation-state as the primary unit of analysis and positing modernization as a primarily endogenously driven process, they were both guilty of misleading representation of underdevelopment as an "original condition." Capitalism was a hierarchically organized global system, with nations or regions belonging to the core, semicore, or periphery of the system. The pace and pattern of development of "national" economies were contingent on the manner of incorporation and position of countries or regions within the world capitalist system and its corresponding hierarchy of nation-states. The underdevelopment of peripheral Third World societies followed from their incorporation, through colonialism, as subservient members in the world capitalist system and the shaping of their economies to serve the interests of dominant core states. Their governing elites were not altruistic agents of progressive social change but groups primarily interested in advancing their class interests. This they did in part by the use of state power to create and manage beneficial alliances between themselves and foreign capitalists. For radical critics, then, modernization theory and its conservative critics were both advocating an approach to development that favored the expansion of the world capitalist system.

In the 1980s, modernization theory and its radical alternatives were queried by many influenced by the postmodernist turn in cultural and social analysis. For this new group of critics, variously labeled postmodernist, poststructuralist, or post-development theorists, modernization theorists and their radical critics had more in common than they dared to admit, for their understanding of development was rooted in the dogma of linear progress. Consequently, they were equally guilty of advocating, in the name of development, policies that fostered the repression and disempowerment of marginalized groups in Third World societies, whose right to determine their own futures they denied. The combined weight of criticisms leveled against it robbed modernization theory of its allure. But despite the changing conceptual and normative vocabularies at the twentieth century's end, modernization theory's goal of a world of receding mass poverty and disease and of social and political interactions marked by civility instead of incessant conflict remains a pivotal concern in development analysis.

See also Dependency; Modernization Theory; Progress, Idea of; World Systems Theory, Latin America.

BIBLIOGRAPHY

- Engerman, David C. et al., eds. *Staging Growth: Modernization, Development, and the Global Cold War*. Amherst: University of Massachusetts Press, 2003.
- Frank, Andre. "The Sociology of Development and the Underdevelopment of Sociology." 1967. In *Dependence and*

Underdevelopment, edited by James Cockcroft et al. Garden City, N.Y.: Anchor, 1972.

Huntington, Samuel. "The Change to Change: Modernization, Development, and Politics." In *Comparative Modernization: A Reader*, edited by Cyril Black. New York: Free Press, 1976.

Janos, Andrew C. *Politics and Paradigms: Changing Theories of Change in Social Science*. Stanford, Calif.: Stanford University Press, 1986.

Lee, Raymond. "Modernization, Postmodernism, and Development." *Current Sociology* 42, no. 2 (1994).

Rostow, Walt W. *The Stages of Economic Growth: A Non-Communist Manifesto*. Cambridge, U. K., and New York: Cambridge University Press, 1960.

Tipps, Dean. "Modernization Theory and the Comparative Study of Society: A Critical Perspective." *Comparative Studies in Society and History* 15, no. 2 (1973): 199–226.

Dickson Eyoh

MODERNIZATION THEORY. For roughly one decade until the second half of the 1960s, modernization theory was in vogue in the social sciences, especially in the United States. The word *modernization* appeared widely in titles, the concept was commonly invoked in efforts to explain long-term change, and it figured in critiques of Marxist theory and discussions of Cold War differences over how newly independent countries should develop. If much of social science analysis at the time was seen as narrow, studies dressed in the mantle of modernization theory attracted attention as meeting an academic quest for cross-disciplinary breadth and a political imperative for lessons to disseminate around the world. Over the following two decades, an entirely different atmosphere arose; modernization theory became a target of far-flung criticism. It was attacked as an ahistorical effort to impose a U.S. or Western model, disregarding obstacles resulting from the actual world order. Many rejected any theory for postmodernist reasons, while others preferred neo-Marxist or world systems theories that put the blame for underdevelopment on the United States. It became popular to dismiss modernization studies as antithetical to solid social science analysis without bothering to mention any serious efforts to apply it systematically or the fact that, even under attack, many took for granted the lingering value of the theory as a framework for understanding modern development.

As the Cold War ended, the debate over modernization theory was rejoined, only to fade gradually in the face of rising disagreements over globalization. Some argued that the fall of communism at last supported the predictions about the danger of deviating sharply from requirements specified in the theory, while others replied that the failure of "shock therapy" and other abrupt changes in Russia and beyond proved once again that the theory was incorrect. Was failure of the socialist model at last proving that the modernization theorists were correct, or was failure of economic advice a sign that a Western model could not be transferred? Later, debates about globalization revisited many of the same themes as modernization theory. A half century after the theory burst into the academic limelight, social scientists are again weighing the pros and

cons of opening to the outside world, political reform in order to improve state capacity and responsiveness, economic integration into a global division of labor, a breakdown of social barriers, and a knowledge orientation that maximizes absorption of information. At the same time, opinion is split on whether what is demanded includes a full-scale embrace of Western notions of individualism, democratic politics, and limited state management, or whether these features are not inherent in the model.

Defining Modernization Theory

Disagreements about what modernization theory is and what has been learned from comparisons bedevil discussions between users and critics. Those who applied the theory often failed to be specific or to supply supporting explanations to establish it as a powerful set of generalizations in the forefront of cross-disciplinary social science analysis, while critics usually neglected to define the theory precisely or to make an effort to balance its merits against alleged shortcomings. Although the theory exerted a huge impact on the disciplines of history, political science, and sociology, and on thinking about capitalism versus socialism, East Asia versus Western advanced capitalist countries, and more versus less developed countries, to many its legacy remains confusing, as does its connection to recent globalization theory. Even at the beginning of the twenty-first century, there is little agreement on what modernization theory is and how it has advanced social science analysis.

The theory of modernization normally consists of three parts: (1) identification of types of societies, and explanation of how those designated as modernized or relatively modernized differ from others; (2) specification of how societies become modernized, comparing factors that are more or less conducive to transformation; and (3) generalizations about how the parts of a modernized society fit together, involving comparisons of stages of modernization and types of modernized societies with clarity about prospects for further modernization. Actually, reasoning about all of these issues predated postwar theory. From the Industrial Revolution, there were recurrent arguments that a different type of society had been created, that other societies were either to be left permanently behind or to find a way to achieve a similar transformation, and that not all modernizing societies had equal success in sustaining the process due to differences in economic, political, and other institutions. In the middle of the 1950s, these themes acquired new social science and political casting with the claim of increased rigor in analysis.

In the early post-World War II era, approximately twenty societies were regarded as highly modernized and roughly another ten to twenty were depicted as having passed a threshold on the path to modernization. Definitions of *modernized* varied. Some noted structural features, such as levels of education, urbanization, use of inanimate sources of energy, and fertility. Others pointed to attitudes, such as secularization, achievement orientation, functional specificity in formal organizations, and acceptance of equality in relationships. Conscious of the ethnocentric nature of many earlier explanations for growth in national power and income, social scientists in the 1950s and 1960s generally omitted cultural traits associated closely with

Western history from definitions of modernity. Yet, given the rhetoric of the Cold War and a preoccupation with democracy in U.S. national identity, political institutions became a central factor in many definitions.

Applying Modernization Theory

It is useful to distinguish two approaches to modernization in the heyday of the theory: applications of already identified steps along a unilinear path; and comparisons of variations along a path becoming more diverse geographically, even if long-term convergence was expected in social indicators. The former approach in its extreme form assumes that the histories of latecomers to modernization (after the first-comers had all been steeped in Western culture) are irrelevant, that they can best achieve economic growth and accompanying modernization by rapid democratization and copying of Western institutions, and that notions of the self and social relationships are destined to become much as they are idealized in the United States. Even if few writers explicitly made these arguments, critics insisted that this approach was the essence of modernization theory. In contrast, the latter approach looks for diversity in societies along the path of modernization, argues that historical legacies shape divergent paths to political and other institutions, and suggests that social relations can be expected to differ as well, even as some convergence occurs.

Clashing views of the Soviet Union may have underscored the two approaches to modernization at a time when Cold War divisions were uppermost in many minds. On the one side were those who expected the Soviet system to collapse. High rates of industrial growth and the ability to project national power presumably would amount to little when the people aspiring for freedom and the economy riddled with inefficiencies reached an impasse. From this perspective on modernization there was only one model, and any seeming alternatives did not merit comparative study. The universal model assumed a high degree of individualism, an intense quest for democracy, and an economy that allowed for little state intervention. If, for a time, a mobilizing state could produce rapid economic growth, this did not signify modernization and could not be sustained.

On the other side were those who recognized efforts to reform the Soviet system as well as the rise of East Asian societies that did not fit the supposedly universal model. They argued that levels of individualism vary, states differ in their involvement in society, and social relations historically have reflected different regional traditions. While modernization in some respects is a "universal social solvent," there is notable variation even among societies labeled the "West." The Soviet Union had the potential to concentrate on science and technology in education and the workplace in order to advance a new elite, while providing social welfare benefits to motivate a broader mass of the population. If totalitarianism only produces temporary results, then a technocracy based on rising interest groups could lead to more balanced modernization and eventual convergence with Western societies, where social welfare benefits and central coordination were gaining ground. A comparative approach to modernization theory began with studies of socialist countries, and, after Soviet reforms

stagnated under Leonid Brezhnev (1906–1982; in power 1964–1982), shifted to East Asian countries and especially Japan.

In the 1970s and 1980s, the two orientations in comparative modernization studies contended with theories on the left and the right. The comparative study of East Asia, highlighting first Japan's model of modernization and then the Confucian development model, faced the dependency school and related arguments centered on Latin American cases. In contrast to the insistence of the Latin Americanists that societies integrated into the global system of capitalism were doomed to remain in the periphery, locked into an unfavorable division of labor that perpetuates backwardness, the East Asianists affirmed the opportunities within the world system for an industrious population led by farsighted state policies. Studies of Japanese modernization pointed to benefits from the family system that supported educational achievement, workplace dedication, and long-range planning; the school and examination system that encouraged intense learning and competition as well as loyalty in the classroom, which could be transferred to the enterprise; and the workplace system that favored lifetime employment for a large segment of the workforce, seniority wages, enterprise unions, and competition among firms under administrative guidance from state ministries. While debates proceeded over how much these unusual aspects of modernization would withstand forces of convergence as Japan reached a higher stage of modernization and openness to foreign competition, the comparisons stressed that significant differences could shape development even in countries whose per capita income ranked at the top of the world.

The dependency theorists were guilty of ahistorical analysis, arguing that the Confucian cultures in East Asia that had produced extraordinary premodern levels of literacy, urbanization, meritocratic governance, and commercial development did not matter. Yet politicians and vested interests in some East Asian countries who lauded Asian values and resisted reforms that would broaden democracy and openness to outside influences were guilty, too, of slanted analysis, ignoring the argument of modernization theory that convergence continues, and more complex societies at higher stages of modernization, with greater openness to foreign competition and influences, must give voice to younger generations espousing new values. Critics of modernization theory on the left insisted that struggle against an oppressive world system (not domestic consolidation around shared values) would be necessary, dismissing comparisons that alleged different pathways to success.

The collapse of the traditional socialist model and then the Soviet Union brought to the fore the other struggle between comparative modernization studies and established social science schools, this time of a more conservative character. The comparativists had long argued that the unbalanced nature of socialist modernization would lead to far-reaching reforms. As China experienced economic success through its reforms, these comparativists pointed to policies that work and lessons that the Chinese had drawn from their emphasis on learning from modernization theory, beginning in the late 1970s under the slogan "the four modernizations." Analysts attributed transformation under the Soviet leader Mikhail Gorbachev (b. 1931;

in power 1985–1991) less to pressure from the United States than to a domestic search to rekindle economic growth by activating Soviet society and joining the world economy. When early reforms failed and the emphasis shifted to democratization and more radical measures, social scientists diverged in their response. Many economists and political scientists who considered the Soviet system a failure prescribed universal solutions with little regard for the legacies of Russian society and the Soviet social contract. This was quite different from the thrust of comparative modernization studies that considered the Soviet record of unbalanced development and the high level of dependency on the state of various groups, suggesting reforms that built on this existing foundation. "Shock therapy" became the symbol of imposing an external model without regard for comparative study that points to different pathways based on historical circumstances.

Globalization Theory

Globalization theory is essentially modernization theory bolstered by greater emphasis on international integration and the power of external forces to induce rapid change. Again, one finds generalizations about individual modernization, adoption of attitudes in favor of personal choice for marriage, divorce, choice of work, migration, and views of authority. One also may observe organizational adaptation, with formal organizations transforming their roles in a market environment where a civil society is gaining ground and individuals are free to enter and leave. Likewise, state authority becomes subject to checks and balances, limited in creating monopolies and denying access to the outside world. If modernization theory emphasized competition among nations that would oblige, sooner or later, domestic adjustments, globalization theory stresses the powerful effects of the flow of resources, information, and people across national boundaries. The urgency of meeting the competition is accelerating, but the fundamental changes identified by modernization theory continue to occur.

Critics of globalization theory, both from the left and the right, repeat the accusations raised against modernization theory. Many on the left see it as justification for neo-imperialism or U.S. hegemonism, leading to unfair results, including one-sided gains and negative consequences for cultural diversity and the environment. On the right, there is continued fear that compromises will have to be made with others who follow different models, watering down national distinctiveness or sovereignty. Instead of comparing different approaches to globalization and accepting the need for all sides to adjust as competition proceeds in unpredictable ways, many prefer either to reject the process as inherently flawed or to insist that control by only one party must be ensured. As seen in a half century of modernization theory, politicized approaches to far-reaching questions of social change as well as narrow rejection of generalized social science analysis leave many critics unprepared to keep the focus on how to draw on empirical evidence and comparisons to keep improving existing theory. The theory of modernization may not have remained popular, but its message endures: states reorganize in an increasingly competitive environment; the quest for international power and economic growth leads to substantial changes in domestic policies; societies continuously adjust to economic growth and global

integration; and the result is growing convergence, but there may be multiple models and sharp backlashes from those fearful or unsuccessful in the process.

Contemporary Theories

As in the Cold War era, there are three prevailing theories of global evolution at the beginning of the twenty-first century. The Marxist school that equated modernization reforms with promotion of imperialism and social class exploitation has transformed into a broader left-leaning agenda, appealing to conflict against the United States and its elitist allies as a mechanism for more just economic distribution and more checks in global political development. The target of globalization more clearly pinpoints the problem of an imposed foreign model reducing cultural diversity and autonomy, raising the profile of nationalism over the old theme of class struggle.

The hegemonic globalization school may be less vocal, but it is not hard to comprehend the meaning of its warnings of threats that can only be addressed in a world mobilized under clear leadership and newly attuned to containing political development that allows security dangers to emerge. Its neoconservative message calls for imposing a single model, more than comparing alternative approaches of nations and regions while accepting the virtues of diversity.

As developed in comparative studies and by the multilateral globalization school, modernization theory accepts that convergence is a long-term process that must remain incomplete as societies seek solace in what makes them distinctive. The quickening pace of technological change will fuel accelerated integration, and there will be dangers of increased interdependence and vulnerability that will demand more security cooperation. Yet the driving forces of the global system will remain states competing to gain an advantage in boosting their economies and national power. In the context of growing world integration, states will still be in competition to capitalize on modernization and shape the global system.

See also *Globalization; International Order; Modernization.*

BIBLIOGRAPHY

- Black, Cecil Edwin. *The Dynamics of Modernization: A Study in Comparative History*. New York: Harper and Row, 1966.
- Black, Cecil Edwin, et al. *The Modernization of Japan and Russia: A Comparative Study*. New York: Free Press, 1975.
- Ingelhart, Ronald. *Modernization and Postmodernization: Cultural, Economic, and Political Change in 43 Societies*. Princeton, N.J.: Princeton University Press, 1997.
- Inkeles, Alex, and David H. Smith. *Becoming Modern: Individual Change in Six Developing Countries*. Cambridge, Mass.: Harvard University Press, 1974.
- Jansen, Marius B., ed. *Changing Japanese Attitudes toward Modernization*. Princeton, N.J.: Princeton University Press, 1965.
- Levy, Marion J., Jr. *Modernization and the Structure of Societies: A Setting for International Affairs*. Princeton, N.J.: Princeton University Press, 1966.
- Roberts, Timmons, and Amy Hite, eds. *From Modernization to Globalization: Perspectives on Development and Social Change*. Oxford: Blackwell, 2000.

Rozman, Gilbert, ed. *The Modernization of China*. New York: Free Press, 1981.

Wu, Eric, and Yun-han Chu, eds. *The Predicament of Modernization in East Asia*. Taipei: National Cultural Association, 1995.

Gilbert Rozman

MOHISM. Mohism is a school of thought named after its founder, Mozi (or Mo Di; c. 460–390 B.C.E.). Mozi was the first known thinker to challenge systematically the ideas of Confucius (Kong Fuzi; 551–479 B.C.E.) and his followers and to provide an alternative vision of the ideal society and state. One of the most prominent intellectual currents of the Zhanguo (Warring States; 453–221 B.C.E.) period, Mohism declined rapidly soon after the imperial unification of 221 B.C.E., to be rediscovered by modern scholars in the first decades of the twentieth century.

Sources

The Mohists' ideas are presented in a book that bears the name of the school's founder. The so-called core chapters (8–37) may have been produced during Mozi's lifetime or immediately thereafter, and are believed to reproduce his original thought. These chapters present ten major Mohist doctrines, each of which is discussed in three versions; the subdivisions are believed to reflect different traditions within the Mohist movement. Later portions of the *Mozi* deal with epistemological questions (chapters 40–45) and military theory (52–71) and tell anecdotes about Mozi and his disciples (46–51). These chapters were produced between the fourth and the second centuries B.C.E. by the later Mohists, reflecting major developments within the Mohist school.

The *Mozi* suffered considerably in the process of its transmission: no less than eighteen chapters were lost, others were significantly damaged, and almost ten chapters (1–7, and probably 38–39) are considered to be forged by later transmitters. The book was restored due to the meticulous efforts of scholars from the eighteenth century on, although proper arrangement of many portions is still subject to heated scholarly debate. Several Mohist treatises are included in the Warring States' collectanea, such as the *Lüshi chungiu* (c. 240 B.C.E.); valuable information about Mohist thought is also present in the writings of the Mohists' opponents, such as Zhuangzi (fl. late fourth century B.C.E.), Xunzi (c. 298–c. 230 B.C.E.), and Han Feizi (c. 280–233 B.C.E.), as well as in the Han period texts (206 B.C.E.–220 C.E.).

Mozi

Few reliable details are known of the life of Mozi. Most scholars agree that he was a person of relatively humble origin from one of the eastern Chinese states (either Song, Qi, or Lu). Like Confucius, he traveled through neighboring states in search of better appointments, but apparently to no avail. Even more than Confucius, he succeeded as an educator and organizer, turning his followers into a tight ideological group that remained active throughout the Chinese world for almost two centuries.

Mozi's sociopolitical views are a curious blend of utopian idealism and sober pragmatism. On the utopian side Mozi promulgated the egalitarian principle of "universal love" (or "concern for everyone," *jian'ai*) as a remedy to social and political fragmentation. He rejected the attachment to an individual's state and lineage, as well as to the self, suggesting instead an ideal society where all the people under Heaven would share extra labor, extra products, and proper teachings. This society would be maintained by a highly centralized state, which would implement universal surveillance to disclose deviant subjects and rectify them. The state would be ruled by a morally perfect individual, who would select his officials on the basis of their morality and then impose universal standards of benevolence (*ren*) and righteousness (*yi*) down to the lowest social levels. The unity, therefore, would be ideological and not only political.

On the more practical level, Mozi suggested a series of measures to improve the functioning of the state and the life of its populace in the immediate future. First, he proclaimed strong opposition to offensive wars, which he rejected both on moral grounds and as an inexcusable waste of public resources. The opposition was not only theoretical, as Mohists reportedly organized a kind of universal intervention force that promised military support to the weak states against their powerful and aggressive neighbors; this may explain the great interest displayed by later Mohists in questions of defensive warfare. Second, Mozi argued that improved livelihood would be attained only through reduction of needless expenses, such as those associated with lavish burials and extravagant ritual music. This rejection of mortuary rites and ritual music—the hallmark of the centuries-old aristocratic culture—reflects Mozi's staunch opposition to the pedigree-based social order. This opposition is prominent in the third of his major recommendations, namely the establishment of meritocratic instead of the aristocratic rule. A person's social rank and emoluments should be determined exclusively by his intellectual abilities and moral outlook: "If there is an able person even among peasants, artisans or merchants, he must be promoted, granted high rank, rich emoluments and an appointment . . . hence officials will not be forever noble; the people will not be forever base." "Promoting the worthy" (*Shang xian*) became the hallmark of Mozi's political recommendations.

Mozi proposed triple justification for his radical departures from the established sociopolitical patterns. First, he argued that his recommendations would benefit everyone, and hence should be adopted due to purely utilitarian considerations. Second, Mozi made painstaking efforts to prove that his views reflect the true legacy of the ancient sage kings. Third, in sharp distinction to most other thinkers from the Warring States period, Mozi sought supernatural support for his claims. He argued that the moral order he advocated is in perfect accord with the intent of the supreme deity, Heaven, which "wants justice and detests injustice." Heaven is assisted in upholding universal morality by multiple deities that act as minor guardians of Heaven's intent and also constantly intervene in human affairs to punish the vicious and reward the righteous.

Scholars in China and abroad continue to disagree over whether Mozi was a true believer or a mere manipulator of the

others' religious beliefs. Aside from emphatic statements in favor of Heaven's just intent, Mozi displays a more sober approach when he rejects the possibility of blind fate and calls upon humans to rely on themselves, disregarding possible extrahuman intervention in their lives. Moreover, Mozi's explicitly instrumental approach toward Heaven's intent, which he defines as a tool to judge world rulers, raises further doubts as to his piety.

Later Mohists

For several generations after Mozi's death his disciples maintained their effective organization and remained intellectually active. The focus of their interest, however, gradually shifted from sociopolitical issues to epistemological questions. Mozi was the first to display interest in modes of argumentation, proposing three criteria for the validity of his doctrines: their origins in the legacy of the ancient sage kings, their corroboration by people's everyday experience, and their usefulness in everyday affairs. Later Mohists further developed the art of argumentation, which led them to focus on many previously unexplored issues, such as logic, the relation of names to reality, the validation of knowledge in face of changing circumstances, and so on. Six chapters of the *Mozi* (40–45) summarize their views, remaining the richest source for the largely extinct logical approaches in ancient Chinese thought. The sophistication of Mohists' argumentation had, however, a negative impact on their school. First, the increasingly active search for abstract truth fueled ideological confrontations among the Mohists, which resulted in inevitable splits. Second, preoccupied with epistemological issues, the Mohists turned their backs on political issues, becoming partly irrelevant in contemporaneous intellectual life. As a result, although at the end of the Warring States period Mohism was still defined as "bright learning," its appeal was shrinking. From the second century B.C.E. Mohists largely disappeared from the intellectual scene, although some of their ideas, such as reducing conspicuous consumption and advancing those worthy to the top of political apparatus, had a lasting impact on Chinese thought and Chinese political culture in general.

See also *Chinese Thought; Confucianism; Legalism, Ancient China*.

BIBLIOGRAPHY

- Graham, A. C. *Divisions in Early Mohism Reflected in the Core Chapters of Mo-tzu*. Singapore: Institute of East Asian Philologies, 1985.
- . *Later Mohist Logic, Ethics, and Science*. Hong Kong: Chinese University Press, 1978.
- Maeder, Erik W. "Some Observances on the Composition of the 'Core Chapters' of the *Mozi*." *Early China* 17 (1992): 27–82.
- Mo tzu. *Basic Writings*. Translated by Burton Watson. New York: Columbia University Press, 1963.
- Mozi jiao zhu*. Compiled by Wu Yujiang. Beijing: Zhonghua shu ju, 1993. Collated glosses on the *Mozi*.

Yuri Pines

MOLECULAR BIOLOGY. See *Genetics*.

MONARCHY.

This entry includes two subentries:

Overview

Islamic Monarchy

OVERVIEW

Monarchy derives from a Greek term that refers literally to rule by one person (as distinct from oligarchy, rule by the few, or democracy, rule by the people). Among political systems of a post-tribal nature, monarchy is certainly the most common form of human governance globally throughout human history. While the modern Western world tends to venerate non-monarchic constitutions of the past—such as the city empires of Athens and early Rome, and, to a lesser extent, Babylonia—this elides the near-ubiquity of one-man rule. And while modern authoritarian or despotic regimes are not usually considered to be monarchies, they nevertheless contain elements associated with monarchic rule. The persisting appeal of monarchic governments may stem largely from the perception that, in contrast to populist and self-governing systems, they are more stable and more successful at maintaining peace and order. (This is perhaps encapsulated in Benito Mussolini's [1883–1945] famous declaration that in fascist Italy, under his quasi-monarchic leadership, the trains run on time.) Regardless of whether such a position is empirically true, it has been central to the ideology of monarchy.

The nearly universal acceptance of monarchic rule, at least until recent times, obscures important differences in the ways in which such regimes have been classified and legitimated. Monarchies are by no means of a piece in either their theory or their practice. Important questions remain open to dispute, including: whether the king should be dynastic or elected, and if the latter, by whom; whether in dynastic systems, women should be admitted to succession or men only, or indeed whether succession may even pass through a female line; and whether (and under what circumstances) a king may be removed from power, and if so, in what way. When viewed from this perspective, monarchy ought hardly to be treated as a singular phenomenon at all. Rather, examination of the diverging conceptions of the foundation and source of monarchic power yields recognition of the highly diverse principles upon which ideas about the nature of monarchy have rested over time and across cultural and geographical divides.

Religion

Assessed from a global perspective, perhaps the most common justification given for the rule of a single person is religious. Even in this category, however, many different approaches are available. The ancient Egyptians regarded their kings to be deities, albeit lesser gods in the pantheon. By virtue of his divinity, the Egyptian monarch was qualitatively superior to and at a remove from those over whom he reigned, and his powers were “absolutely absolute,” to use Samuel Finer's phrase. Consequently, the king of Egypt was the undisputed owner of all the territories under his control and the master of his subjects, who were all equally inferior to him. The surviving cultural artifacts from three millennia of Egyptian monarchy, such

as architecture, paintings, and written treatises, all reinforce this absolutistic image of royal divinity.

The Romans also deified their emperors in the later stages of their empire, proclaiming them to be *dominus et deus* (“lord and god”). This has sometimes been considered to be a result of the influence of so-called oriental or Eastern monarchic ideas. But it is difficult to gauge how seriously this deification (and attendant absolutist language) ought to be taken, given the persistence of earlier Roman ideas of citizenship and legality. The ideological structure supporting the Chinese dynasties of antiquity, by contrast, approached the Egyptian model more closely. Confucius (c. 551–479? B.C.E.) lent philosophical credence to the long-standing doctrine that while emperors were not themselves deities, they enjoyed the “Mandate of Heaven” in their occupation of the imperial throne. Of course, this mandate did not ensure that the emperors would not be overthrown in a palace coup (any more than the divinity of Egyptian kings protected them against dynastic replacement). Rather, the mandate was an ever-shifting imprimatur that depended upon the emperor's conformity with the fundamental dictates of virtue and equity, in particular the practice of benevolence, according to Confucius.

The monotheistic Abrahamic religions all subscribed to the notion of the divine ordination of kings to some extent. Although the earliest government of the Israelites was a sort of proto-republican federated constitution, the shift to a monarchic regime described in Jewish scripture arose from God's assent to a popular plea for a king so that Israel might resemble the other nations of the region. Israelite monarchy thus emerged as a divine appointment, and kings remained subject to the judgment of God. Once Christianity reached an accommodation with the Roman Empire in the early fourth century, the emperor came to be viewed as a divine agent—free to sin, of course, but a servant of the Heavenly Lord even when he went astray. Christian authors often deployed a microcosmic argument to bolster monarchy: just as God was the king of His creation, so the monarch resembled the supreme master of the universe. Islam also involved religion in the defense of monarchy. In the early history of Islam, the caliph was held to be the agent of God insofar as his conquests facilitated the spread of the Muslim religion and he enforced adherence to the rites of the faith. During a later era, the caliphate was charged in theory, if not in practice, with the imposition of the punishments for violations of *shari'a* (the vast body of Islamic law).

Naturalism

More mundane explanations of a monarch's authority emerge out of images and analogies drawn from nature. In many cultural traditions, the ruling position of the head (or sometimes the heart) in the human body is regarded as an analogue of the monarch. Royal dominion is thus licensed by or in accordance with the observable natural world. One finds this position evinced in East and South Asian writings, such as the *Arthashastra* of Kautilya (fl. late 300s B.C.E.), as well as in Western thought from antiquity through modern times. Alternatively, the supposed dominance of a single leader in the nonhuman organic world (such as among bees or other social

creatures) has often been taken as a sign of a natural order subordinate to monarchy. Even the arrangement of the cosmos and the movements of the stars and planets are found to support the monarchic principle.

Perhaps the most widespread naturalistic justification for monarchy, however, is its supposed imitation of the organization of the family. Monarchic government is directly authorized by the presence in the typical family of a father or other male head whose responsibility is to care and provide for all the other members of the household. The rest of the family is expected in turn to submit without question to the superior authority of the father. Confucius insisted that filial piety constituted the quintessential basis of all forms of social relationships, extending as far as the people's obedience to the king. This view enjoyed considerable currency through East Asia well into modern times. Likewise, European authors such as Jean Bodin (1530?–1596) and Sir Robert Filmer (d. 1653) advanced one or another form of the patriarchal thesis.

Modes of Virtue

An alternative to a naturalistic justification of royal rule derives from the view that the monarch should be obeyed on account of the personal qualities that inhere in him, whether these characteristics are physical or psychological or both. Hence many cultures accepted the principle that, in effect, might makes right, in the sense that the warrior who demonstrates the greatest prowess and courage in battle deserves to be revered and obeyed in matters of government. The Greek concept of *aretē* (“excellence” or “virtue”), as espoused in the Homeric epics, epitomized this martial conception of rulership; those who fought gloriously were accorded the greatest deference concerning all political decisions. Similar views can be found in many societies with strong chivalric traditions, such as Japan during the era of the Shogunate or feudal Western Europe during the Middle Ages.

Monarchy might also be justified by the intellectual or moral qualities acquired and refined by a leader. The *Republic* of Plato (427?–347 B.C.E.) speaks of a “philosopher-king” whose competence to govern a city (and even over other philosophers) stems from his preeminence in the exercise of his speculative reason as well as the fully just ordering of his soul. Likewise, Aristotle (384–322 B.C.E.) believed that kingship, as that species of monarchy in which a superlatively virtuous man rules, constituted the ideally best political system, even if he was skeptical that it could be attained in practice. The Roman Marcus Tullius Cicero (106–43 B.C.E.) also believed that among “simple” constitutions, kingship was optimal, as long as the occupant of the royal office remained morally upstanding. Cicero also identified kingship as the chronologically earliest form of human government, since it involves power without a formalized system of laws. But Cicero believed (as did Aristotle) that kingship could readily degenerate into a form of arbitrary rule in the interest of the incumbent, and so he preferred a law-based republican regime.

Niccolò Machiavelli (1469–1527) combined the martial and the psychological elements of monarchy in his *Prince* (written c. 1513–1514 but not published until 1532). Machiavelli stated explicitly that he was addressing a particular sort of

monarch: one who came to power not as the result of heredity or divinity but solely on the basis of his own ability (which Machiavelli called, somewhat perversely, *virtù*). On the one hand Machiavelli claimed that military prowess constituted the salient quality of an effective prince; good “arms” must precede good laws. Yet Machiavelli also held that *virtù* had a psychological dimension, insofar as the prince who succeeds in gaining and retaining his state must shun conventional personal morality and adjust to the circumstances of his position in whatever way is required. Hence, while the “self-made” monarch should try to adhere to the precepts of everyday virtue when he can, he must be prepared to contradict the moral teachings of religion and philosophy at those times when following them would lead to political ruin.

Limited Monarchy?

Most ideas of monarchy assumed or even pronounced the absolute power of the ruler, so that despotism was readily licensed. Yet some attempts were made, especially in Western thought, to constrain the reach of royal office. Religion provided one source of limitation. A monarch who engaged in tyrannical actions could be threatened with divine judgment unless he mended his ways. In its most extreme form, as in the *Polycraticus* (completed 1159) by John of Salisbury (c. 1115/20–1180), God's hand might even reach out to an earthly source (human or otherwise) to punish the evil ruler, permitting tyrannicide as a remedy. Alternatively, thinkers looked to election or other mechanisms of consent to hold the monarch in check. During the Latin Middle Ages, scholastic authors widely debated whether monarchy should be elective or inherited, and in a later era, liberals such as John Locke (1632–1704) sought to confine the authority of monarchs by basing their powers on a preexisting social contract.

The attempt to balance constitutional and absolutist dimensions of monarchy produced some interesting, if not always entirely convincing, theories. In his *Six Books of the Commonwealth* (1576), Bodin insisted upon the unfettered power of the monarch but also claimed that the ruler was strictly limited by natural law in the extent to which he could exercise his royal office. G. W. F. Hegel (1770–1831), in the *Philosophy of Right* (1821), posited a system of constitutional government in which the king possessed a single yet still indispensable function: placing the final stamp of his unique, indivisible will on all legislation and thus rendering a bill into statutory force. Hegel believed that short of such an ultimate declaration of will, members of civil society and their legislative representatives would continue to debate the validity of laws and thus undermine the respect due to legal structures.

One might imagine that monarchy is an outmoded idea in the modern world, given the widespread ideology of democracy. In fact, however, numerous countries are still ruled by monarchic regimes, even in Europe. Allegiance to a monarch in countries such as the members of the Commonwealth, comprising former colonies of the British Empire, remains popular. In the same vein, the public and ongoing expression of grief following the death of Princess Diana of the United Kingdom suggests that royal identity, even if only by marriage, remains a very compelling reason for public attention. It seems unlikely that the monarchic principle is likely to disappear entirely any time soon.

See also *Democracy; Republicanism; Republic; State, The.*

BIBLIOGRAPHY

- Boesche, Roger. *Theories of Tyranny, from Plato to Arendt*. University Park: Pennsylvania State University Press, 1996.
- Brock, Roger, and Stephen Hodkinson, eds. *Alternatives to Athens: Varieties of Political Organization and Community in Ancient Greece*. Oxford and New York: Oxford University Press, 2000.
- Currid, John D. *Ancient Egypt and the Old Testament*. Foreword by Kenneth A. Kitchen. Grand Rapids, Mich.: Baker Books, 1997.
- Eisenstadt, S. N. *The Political Systems of Empires*. New York: Free Press, 1963.
- Finer, S. E. *The History of Government from the Earliest Times*. 3 vols. Oxford and New York: Oxford University Press, 1997.
- Loewe, Michael. *Divination, Mythology and Monarchy in Han China*. Cambridge, U.K., and New York: Cambridge University Press, 1994.
- Mastnak, Tomaz. *Crusading Peace: Christendom, the Muslim World, and Western Political Order*. Berkeley: University of California Press, 2002.

Cary J. Nederman

ISLAMIC MONARCHY

The question of leadership in the Islamic world is a complicated one. Although until recently monarchies were the most common form of government, Muslim understandings of a ruler's role, qualifications, and relationship to religious and worldly authority have been the focus of intense discussion and have shifted radically since a very early period. Literally hours after the death of Muhammad in 632 C.E., disagreements arose about the identity, qualities, and selection of the caliph, or successor to the Prophet (Ar., *khalifah*). Although it was clear that the caliph should function as the political, military, and religious leader of the community, the method of choosing a caliph was ill-defined at first. Many felt that the caliph should possess special religious qualities, whether noteworthy piety, early conversion to Islam, or blood relation to Muhammad. But the first four caliphs—Abu Bakr (r. 632–634), 'Umar ibn al-Khattab (r. 634–644), 'Uthman ibn 'Affan (r. 644–656) and 'Ali ibn Abi Talib (r. 656–661)—all had varied reputations for piety and differing relations to Muhammad, and were chosen in four unrelated fashions.

It was only in 661 at the accession of Mu'awiya that the Umayyad caliphate (661–750) became the first Islamic dynastic and caliphal monarchy. Knowledge of the Umayyad family is difficult to extract from the generally negative portrayal of them in later historical sources, but one criticism of them did highlight the fact that they were considered by some to be temporal kings (Ar., *muluk*), not religious authorities. Although this charge is difficult to evaluate, it may be said that the Umayyads managed to restrict the caliphate to their own family, forming a dynasty of kings whose political and military authority was evident but whose religious authority may well have been in question.

Abbasids

Ultimately resistance to Umayyad rule led to the Abbasid revolution of 749–750. The Abbasid caliphs (750–1258)

traced their descent from Muhammad's uncle 'Abbas, and therefore their claims to legitimacy were considered to be stronger than those of their predecessors, since they were seen as members of the Prophet's house. The Abbasids formed a dynasty in which religious and political power were mingled. According to Muslim thinkers such as Abu Yusuf (d. 798) and al-Mawardi (d. 1058), the Abbasid caliphs needed to possess justice and comprehensive religious knowledge, with which they were to uphold Islamic law and maintain Islamic society.

Caliphs were chosen through a variety of methods, including designation by a ruling caliph, election by a selected body of religious scholars, primogeniture, or any combination of these factors. A caliph had not only to be a member of the Abbasid house but also male, sane, and free of physical restrictions—such as blindness—that might hinder the fulfillment of his duties. While the Abbasids were in power, pre-Islamic Persian ideas about a remote and awe-inspiring monarch were adopted into the Islamic tradition. Eventually the caliph was transformed from the head of the community to the Shadow of God on Earth, elevated far above ordinary people, and supported by an elaborate state bureaucracy and a complicated court protocol.

Military Rulers

The ninth and tenth centuries witnessed the Abbasids' gradual loss of control to military strongmen (emirs, sultans) who were fast becoming the *de facto* rulers in the Islamic world. This period also saw the rise of anti-caliphs, whether the Sunni Umayyads in Iberia (756–1031) or the Ismaili Shiite Fatimids (909–1171) in North Africa. Both developments led to important changes in Islamic theories about rule, for Muslim thinkers were forced to reconcile the new reality of military rule with the purely theoretical superiority of the caliph.

This was accomplished by thinkers such as the celebrated bureaucrat Nizam al-Mulk (d. 1092) and his equally famous contemporary al-Ghazali (d. 1111). Such theorists penned elaborate manuals on the proper behavior of military rulers, who had no claims to religious authority. These works drew on pre-Islamic Persian ideas about the interdependence of kingship and religion, in which neither could exist without the other because religion furnished a base for kingship and kingship protected religion. Combined with this concept was the equally ancient notion of the Circle of Justice, which espoused a belief in the importance of balance within society among four elements: the king, the army, the subjects, and justice. According to this theory, there could be no king without an army, no army without the wealth obtained from subjects, no subjects without justice in the realm, and no justice without a king to uphold it. The military rule of a sultan fit easily into the models provided by the Circle of Justice and the notion of cooperation between religion and kingship; indeed, eventually the earlier designation of the caliph as the Shadow of God on Earth was transferred to the sultan. This model also allowed scholars and statesmen to function as interpreters of Islamic norms. In this way, rule became dominated by military monarchies and regulated by religious scholars, while the caliph became a figurehead who periodically bestowed recognition on the rulers. Pre-Islamic Persian cultural and

literary traditions also contributed the notion of a king of kings (Pers., *shahanshab*), which was easily worked into Islamic ideology.

Turko-Mongol Ideals

These developments were also shaped by Turko-Mongol ideas of kingship, which arrived with nomadic tribes from the central and east Asian steppe in the eleventh century. For Turkic and Mongol nomads, a ruler (Turk., *bey*, *beg*; Turk. and Mongolian, *khan*) was a charismatic military leader who exercised a highly personal style of rule. Often merely a first among equals, he was directly responsible to his own followers and was expected to settle their disputes, lead them militarily, and reward them for their loyalty through the distribution of spoils and wealth. Although nomadic khans were often members of noble families, their positions depended not only on their lineage but also on their own merits.

The more successful khans believed that their charisma had a divine origin, which was often identified with the spirit or spirits of the Enduring Sky, or God (Mongolian, *Tenggeri*; Turk., *Tanrı*). Such divine favor was expressed through a special good fortune (Mongolian, *su*; Turk., *kut*; Pers., *bakht* or *farr*), which was bestowed on particular rulers by Divine Will and which was demonstrated through military victories. Divinely favored rulers were thought to possess special religious or shamanistic powers. An emphasis on nomadic law (Turk., *töre*, *türe*; Mongolian, *yasagh* (*yasa*); Ar. to Ottoman Turk., *kanun*) also formed part of nomadic ideals of rulership, since a nomadic khan was expected to uphold the law. These ideas first entered the Islamic world when the Sunni Muslim confederation of Seljuk Turks conquered Khorasan and the Iranian plateau under the charismatic military leader Tughril Beg (d. 1063), who reached Baghdad in 1055 and established the Great Seljuk dynasty (1055–1157) under the benevolent eye of a powerless Abbasid caliph. (Nizam al-Mulk and al-Ghazali both wrote under Seljuk rule.)

Genghis (Chinggis) Khan

The most nomadic famous recipient of divine favor was the Mongol Temüchin, or Genghis (Chinggis) Khan (d. 1227). Genghis Khan rose from a noble but impoverished background to absolute rule and was thought to possess the power bestowed by God in the form of a divine mandate, which later passed to his descendants. According to the divine mandate, God had granted universal rule to the Chinggisids, who were charged with implementing that rule on earth through territorial conquest. The divine mandate passed to all Chinggisids, male and female, although only men reigned openly; women ruled primarily as regents for their sons. The position of Great Khan was usually limited to the sons of a chief wife, but within this restriction such factors as primogeniture, ultimogeniture, the preference of the current ruler, and the approval of the Genghisid family and the Mongol nobility all could play a role. As a result of this new and powerful model of kingship, the death of the Abbasid caliph al-Musta'sim at Mongol hands in Baghdad in 1258 therefore spelled for many a sea-change in understandings of rule. Despite the hasty revival of an Abbasid caliphate in Cairo (1261–1517), not all Muslims recognized it as legitimate. At first, Muslim kings and their advisors

focused on the military defense of the Islamic world against the pagan Mongol invaders. When the religious scholar Ibn Jama'ah (d. 1333) wrote an advice work in the early thirteenth century, he elaborated in great detail on the king's responsibility for defending the community.

But soon Mongol sovereigns themselves began to convert to Islam and employ Islamic models of kingship. Among these new Muslims were the khans of the Golden Horde in southern Russia and central Asia (1241–1480) and their Ilkhanid cousins in Iran (1258–1335). Their conversions led to important changes in the development of Islamic monarchies, since Muslim Mongols ruled both as divinely chosen descendants of Genghis Khan and as Muslim sovereigns, advised by Islamic scholars. Theories of rule in this era drew not only on the well-established Persian Islamic models but also on Greek philosophical thought, which was embodied by the work of authors such as al-Razi (d. 1256), al-Tusi (d. 1274), and Kashifi (fl. 1494–1495). These ideas envisioned a society divided into four distinct classes: men of the sword, men of the pen, merchants, and cultivators. In this model the ruler functioned as an enlightened philosopher king, whose task was to maintain each class in its proper place through the just application of Islamic law.

Post-Mongol Period

After the political disintegration of Mongol rule in the fourteenth century, new Muslim Turkic monarchies arose and modeled themselves on the Muslim Mongol example. At first they struggled with the dominant Mongol ideology and styled themselves guardians of the Chinggisid heritage by marrying Chinggisid princesses, using Chinggisid puppets, and upholding Mongol law. Later, Turkic dynasties began to replace Genghis Khan with their own noble ancestors and promoted both their own tribal law codes and their own versions of Mongol-style divine favor. Simultaneously they ruled as Muslim military leaders and made use of the well-established themes of justice and order. Among these was the warlord Timur (Tamerlane, d. 1405), who began as a Genghis Khan imitator but also relied on Islamic models of kingship. Timur's own dynasty ultimately grew to rival that of Genghis Khan and reached a conclusion in the career of Babur (d. 1530), founder of the Mughal Empire in northern India (1526–1858). Babur epitomized the Muslim sovereign but also prided himself on his impeccable lineage: his paternal descent was from Timur, and his maternal descent from Genghis Khan.

A long-term problem for Muslim monarchs of nomadic origin was their tribal laws, which posed a potential challenge to Islamic law (Ar., *shari'a*). Under the longest-lived Islamic dynasty, the Ottomans (1281–1923), tribal laws coexisted uneasily with Islamic law until Muslim thinkers under Sultan Kanuni Süleyman (Süleyman "the Lawgiver," r. 1520–1566) reconciled the two into a single coherent legal system (Ar. to Ottoman Turk., *kanun*), which became identified with the Ottoman state in general and the person of Süleyman in particular. Under the Ottomans the Persian and Greek concepts of the ruler as the upholder of justice and order were also linked both to the nomadic idea of the ruler as a lawgiver and to Islamic law itself.

Safavids and Successors

In a more radical development of Turko-Mongol norms, especially the notion of divine favor, the Safavid monarchy in Iran (1501–1736) assumed that the ruler possessed a direct personal connection to God, which allowed him to implement God's will in his kingdom through law. Although the Safavids were eventually succeeded by the tribal dynasties of the Afsharids (1736–1796) under Nadir Shah (d. 1746) in the east, and the Zands (1751–1794) in the west, these successors were seen by some as monarchies of warlords, lacking legitimate claims to rule and devoid of the religious aura that had surrounded the Safavids. Indeed, Zand rulers were never addressed as *king* (Pers., *shah*), and maintained a Safavid puppet until 1773. Subsequently the Turkic tribal Qajar monarchy (1795–1925) eliminated both the Zands and the Afsharids and went on to control Iran as independent kings. Although perfunctorily religious, the Qajars lacked the religious charisma of the Safavids and ruled by drawing on their heroic Turkic history, their former support of the Safavid state, and the Iranian cultural tradition of the king of kings.

Modern Monarchies

In the nineteenth century the Ottoman sultans began to investigate European-style parliamentary monarchies, but this model was not fully established until the abolishment of the Ottoman Empire in 1923 and the creation of the modern republic of Turkey, which replaced the monarch with an elected president and a parliament. Similar in focus were the khedival dynasty of Egypt (1805–1952) and the Hashimite dynasty of Iraq (1921–1958), which also developed into parliamentary monarchies and which were likewise replaced by republican governments.

One particular challenge for twentieth-century monarchies was the concept of secularism, which in some cases removed the religious ideology used by earlier kings to legitimate their rule but left nothing in its place. A noted secular monarchy was the Pahlavi dynasty in Iran (1925–1979), which succeeded the Qajars. The Pahlavis downplayed Islamic ideas in favor of their own pre-Islamic Persian heritage, which combined with their oppressive rule to provoke their overthrow in favor of an Islamic Republic in 1978–1979.

In the early twenty-first century, monarchies in majority countries with an Islamic majority tend to rely on some evocation of religious legitimacy. The al-Saud family of Saudi Arabia and the Hashimite monarchy of Jordan, for example, practice official state versions of Islam and rule with either secular or Islamic law. However, some modern monarchies have been challenged by Islamist resistance groups, which have proposed alternate visions of society in which sovereignty belongs to God alone.

See also *Empire and Imperialism: Middle East; Law, Islamic; Monarchy: Overview.*

BIBLIOGRAPHY

PRIMARY SOURCES

Abū Yūsuf Ya'qūb. *Abū Yūsuf's Kitāb al-Kharāj*. Translated by A. Ben Shemesh. Leiden, Netherlands: E. J. Brill; London: Luzac, 1969.

Ghazali. *Ghazālī's Book of Counsel for Kings (Nas'iat al-mulūk)*. Translated by F. R. C. Bagley. London and New York: Oxford University Press, 1964.

Ibn Jamā'ah, Badr al-Dīn Muhammad. *Tabrīr al-Abkām fī tadbīr ahl al-islam*. Edited by Fu'ād 'Abd al-Mun'im Ahmad Al-Daha. Qatar: Dār al-Thaqāfah, 1988. In Arabic.

Kashifi, Husayn Va'iz. *Akhlaq-i Muhsini; or, The Morals of the Beneficent*. Translated by H. G. Keene. Hertford, U.K.: Austin, 1850.

Mas'udi. *The Meadows of Gold*. Translated and edited by Paul Lunde and Caroline Stone. London and New York: Kegan Paul International, 1989.

Mawardī, 'Alī b. Muhammad. *The Laws of Islamic Governance*. Translated by Asadullah Yate. London: Ta-Ha Publishers, 1996.

———. *The Ordinances of Government*. Translated by Wafaa H. Wahbah. Reading, U.K.: Garnet, 1996.

Najm al-Dīn Rāzi. *The Path of God's Bondsmen from Origin to Return: A Sufi Compendium*. Translated by Hamid Algar. Delmar, N.Y.: Caravan Books, 1982.

Nizām al-Mulk. *The Book of Government; or, Rules for Kings: The Siyar al-Muluk or Siyasat-Namah of Nizam al-Mulk*. 2nd ed. Translated by Hubert Darke. London and Boston: Routledge & Kegan Paul, 1978.

Tusi, Nasir al-Dīn Muhammad. *Akhlaq-i Nasiri*. Edited by Mujtaba Minuvi and Aliriza Haydari. Tehran: Khvarizmi Publishers, 1977. Translated into English as *The Nasirean Ethics, by Nasir al-Din Tusir*. Translated by G. M. Wickens. London: Allen and Unwin, 1964.

SECONDARY SOURCES

Allsen, Thomas T. "Changing Forms of Legitimation in Mongol Iran." In vol. 2, *Rulers from the Steppe: State Formation on the Eurasian Periphery*, edited by Gary Seaman and Daniel Marks. Los Angeles: Ethnographics Press, 1991.

The Cambridge History of Iran. 7 vols. Cambridge, U.K.: Cambridge University Press, 1968–1991.

Cobb, Paul M. *White Banners: Contention in 'Abbāsid Syria, 750–880*. Albany: State University of New York Press, 2001.

Fleischer, Cornell H. *Bureaucrat and Intellectual in the Ottoman Empire: The Historian Mustafa Ali (1541–1600)*. Princeton, N.J.: Princeton University Press, 1986.

Golden, Peter B. "Imperial Ideology and the Sources of Political Unity Among the Pre-Činggisid Nomads of Western Eurasia." *Archivum Eurasiae Medii Aevi* 2 (1982): 37–76.

Hawting, G. R. *The First Dynasty of Islam: The Umayyad Caliphate AD 661–750*. 2nd ed. London and New York: Routledge, 2000.

Inalcik, Halil. "The Ottoman Succession and Its Relationship to the Turkish Concept of Sovereignty." In *The Middle East and the Balkans under the Ottoman Empire: Essays on Economy and Society*. Bloomington: Indiana University Turkish Studies, 1993.

Kostiner, Joseph, ed. *Middle East Monarchies: The Challenge of Modernity*. Boulder, Colo., and London: Lynne Rienner, 2000.

Lambton, A. K. S. "Justice in the Medieval Persian Theory of Kingship." *Theory and Practice in Medieval Persian Government*. London: Variorum Reprints, 1980.

Shaban, M. A. *The 'Abbasid Revolution*. Cambridge, U.K.: Cambridge University Press, 1970.

Woods, John E. "Timur's Genealogy." In *Intellectual Studies on Islam: Essays Written in Honor of Martin B. Dickson*. Salt Lake City: University of Utah Press, 1990.

Anne F. Broadbridge

MONASTICISM. The “idea of monasticism” invites a misconception, because monasticism is not an idea but a practice. It is a discipline of life, encapsulated in a vow to obey a rule. Monasticism is not a theory about the good life, and still less an escape from practicality, but rather a commitment to live according to a rule handed down from a founder. In its classical Western form deriving from St. Benedict (c. 480–547), a rule directs a monastic to spend a lifetime in one cloister under one abbot following one routine. This secluded way of life begets institutions, some of them highly complex, and these in turn nurture the kind of inner life that in the early twenty-first century is called “spirituality.” Monastic *orthopraxy* regulates behavior through conformity to a rule, and contrasts with doctrinal *orthodoxy* that regulates belief through a magisterium or teaching office. Implausible though it may seem, a rule shields monastics from obsession with theorizing. Day in and day out, monastics live an ethos that others may merely preach. To this extent Christian monasticism resembles Rabbinic Judaism. Both pivot on obeying rules, and both tend to disregard niceties of belief. A crucial difference pertains, however. Whereas Jews affirm that the mandates of Torah come from God, Christians acknowledge that any rule comes from a human lawgiver.

History

As a mode of life that vows obedience to a rule, monasticism originated not in the Near East but in India with Siddhartha Gautama the Buddha (c. 563–c. 483 B.C.E.). His rule or *vinaya* governed conduct of life initially for the Buddha’s community or *sangha* of immediate followers. Nine months of the year they wandered, but during the three months of the monsoon they settled in a *vihara* or monastery. Eventually the Buddha delivered a separate rule for women. Parallel phenomena co-existed within Jainism and Hinduism. Christian monasticism emerged six or seven centuries later in the deserts of the Eastern Mediterranean. Although Rabbinic Judaism (together with Islam) repudiates asceticism, Jewish precedents for Christian extremism emerged in a wanderer such as John the Baptist (c. 7 B.C.E.–c. 27 C.E.) or in the Qumran community. Christian ascetics of whom little is known roved the deserts of Syria and Egypt. The lifestyle of these spiritual “athletes” crystallized in figures such as Anthony of Egypt (c. 251–356) and Pachomius (c.290–346). Experience as a soldier equipped Pachomius to write a rule for, as it were, an army-camp of ascetics. By mid-fourth century in Egypt, hermits living alone or in loose groups practiced *eremitical* monasticism, while desert fathers and mothers living in community practiced *cenobitical* monasticism. The head of a consecrated community was called an *abba* (father) or *amma* (mother). From the start monks were copying manuscripts, as they would continue to do for the next twelve centuries. Eastern desert monasticism passed to France through fourth-century intermediaries such as Martin of Tours (c. 316–400), Hilary of Poitiers (401–449), and above all John Cassian of Marseilles (360–435). Epitomized in the disputed figure of St. Patrick (c. 385–461), an Englishman who may have dwelt at Cassian’s houses near Marseilles, Irish monasticism emerged in the mid-fifth century through contact with France. In sixth- and seventh-century Ireland, an island that had never known Roman cities, an

abbot ruled as a kind of tribal chieftain who outranked bishops. No amount of asceticism could, however, prevent Celtic monasticism from collapsing in the Viking raids of the ninth century.

By 450, Eastern Christian monasticism was coalescing not just in the desert but also in cities such as Alexandria, Antioch, and Constantinople, while its Western counterpart kept spreading in self-sufficient rural communities. Monastics lived in an enclosure or cloister that fenced a church, a refectory, a library, dormitories, and subsistence farming. Monasticism produced vastly more varieties in Western Europe than anywhere else. Proliferation of types—notably during two periods, one from 1100 to 1250 and the other from 1520 to 1700—complicates the task of classifying Western monasticism. Fundamental differences separate cloistered orders who, at least until the thirteenth century, preferred to dwell in the country and Mendicant friars who, in the wake of St. Francis of Assisi (1182–1226), frequented cities and towns preaching and begging for alms. Stemming from the Black Monks, who only in the seventeenth century acquired the name of Benedictines, other rural orders were the Carthusians (founded 1084) and the Cistercians (founded 1098). Following the example of the Franciscan friars (organized 1209), thirteenth-century Mendicants came to include three other orders: the Dominicans (organized 1215), who preached against heresy; the Carmelites (organized by the pope in 1247) who originated as hermits on Mount Carmel in Palestine; and the Augustinian Friars (organized by the pope in 1256), whose most famous member was Martin Luther (1483–1546). Whereas the pre-1200 Benedictines had cultivated son-to-father obedience to an abbot, Mendicants cultivated sibling-to-sibling relations to one another. Excelling all these in martial vigor were the warrior monks of Crusader Palestine, including the Knights Templar (who emerged c. 1119 and were dissolved in 1312) and the Knights Hospitaller (who emerged c. 1080 and in 1530 took the name Knights of Malta).

A second crucial distinction differentiates *contemplative* orders founded before 1215 from post-Reformation *active* orders and congregations such as the Jesuits (founded 1540) or Oratorians (founded 1575). The latter comprise not monastics but clerks regular: priests who follow a rule while ministering in the world. Having no lay brothers, the Jesuits and Oratorians are not monastics, and neither are the numerous post-1520 female teaching or nursing congregations such as the Ursulines (founded 1535) or Sisters of Charity (founded 1633). Nevertheless, from 1298 until the early 1970s, canon law obliged women’s congregations in solemn vows to stay cloistered.

A third distinction pertains to Eastern and Western Christianity. In contrast to Western organizational fecundity, Eastern Christian monasticism functions under just one rule: that ascribed to St. Basil the Great (329–379). As a result, Eastern Christian monasticism has upheld one model through sixteen centuries, while Western monasticism has initiated reforms in nearly every generation. To be sure, monastic reform means not launching a fresh departure but rather attempting to install a better version of the past. In Western Christianity the



Monastery on Mount Athos, Greece. The monastic community on Mount Athos is located at the tip of the Chalcidice Peninsula in north-eastern Greece. The first monasteries were built on Mount Athos during the ninth century. © YANN ARTHUS-BERTRAND/CORBIS

idea of monasticism implies constant renewal in quest of a founder's vision or "source experience."

Buddhist monasticism differs structurally from Christian or Hindu forms. When the Buddha founded his religion, he conceived it solely as a monasticism. Lay Buddhism emerged after his lifetime and in Asia still presupposes proximity to a *sangha*. In Christianity and Hinduism, by way of contrast, monasticism competes with many other embodiments of the religion. This means that at least until the late twentieth century, classification of types of Buddhist monasticism amounts to classification of the religion as a whole, whereas classification of Christian monasticism does not. Three major types of Buddhism stand out: (1) In Sri Lanka, Thailand, Burma, Laos, and Cambodia, Theravada or the "Way of the Elders" claims to descend directly from the historical Buddha. It offers to individual monastics rules for working out during this or later lifetimes gradual passage to enlightenment. (2) In India and then in China, Korea, Japan, and Vietnam, Mahayana emerged at least six to eight centuries after the historical Buddha, and the first three of those countries generated numerous schools of thought and practice, each with its own ritual, texts, and lineage of masters. Some schools promised enlightenment to laypeople and not just to monastics, while innovative "pure land" leaders in Japan such as Shinran (1173–1262) discarded monasticism. (3) Starting in the eighth century, Indo-Tibetan Buddhism or Vajrayana fostered many sects or schools in Northern India, Tibet, Nepal, and Mongolia. Under the leadership of the present Dalai Lama (1935–), leader of the Gelukpa school, Tibetan Buddhism has spread throughout the world. Many non-Buddhists in the early twenty-first century mistakenly regard Tibetan forms as synonymous with Buddhism

per se. This misperception overlooks the dozens of schools of Theravada, Mahayana, and Vajrayana that thrive throughout Asia and increasingly in the West.

Twentieth-Century Changes

Asian Buddhism enforces the *vinaya* strictly, not least because that is what the historical Buddha did. In order to promote meditation, traditional Asian Buddhism imposes a life of renunciation—including dietary restrictions, memorization of texts, and attendance at ceremonies—with a stringency that Western adepts often evade. In consequence monastic rigor is diminishing among new Buddhists in North America, Europe, and Australia. Many so-called Western Buddhists appear intent to de-monasticize their religion. As a countertrend, since the 1960s Buddhist and Christian monastics have delighted in comparing their ways of life. The Trappist monk Thomas Merton (1915–1968) and the Dalai Lama helped to initiate joint scholarly meetings and other intermonastic encounters.

In Eastern Christianity, monastics retain authority not least because most bishops come from their ranks. Moreover, liturgies remain quintessentially monastic through use of chant, an unhurried pace, and lay adherence to monastic rules for fasting. Characteristically, Eastern Christianity boasts a "monastic republic" of male monasteries on the Holy Mountain of Athos—the easternmost arm of the Chalcidice Peninsula in northeastern Greece. In order to uphold an autonomy that excludes women, the Holy Mountain enjoys exemption from laws of Greece and of the European Community. No Western monastic site—and least of all the rebuilt Monte Cassino south of Rome—so resoundingly epitomizes the idea of Western



Cloister inside monastery on Mount Athos. Mount Athos enjoys status as a separate political division from the rest of Greece, allowing its collection of monasteries to legally exclude women from the peninsula. No female has been allowed in the community since the eleventh century. © DAVE G. HOUSER/CORBIS

monasticism as Mount Athos does for the Eastern idea. As the English classicist Graham Speake explains, that idea entails a process of inner transformation known as *theosis*, whereby the image of God nurtured in each adept gradually transfigures, indeed divinizes him or her, in body, mind, and spirit.

The prestige of Western monasticism once stood equally high. The period of medieval history from 700 to 1050 is frequently labeled the “Monastic Era,” and the reforms inaugurated by monastic popes such as Gregory VII (1020–1085; ruled as pope 1073–1085) can be viewed as having imposed on all priests the practice of celibacy previously reserved to monastics. Needless to say, Roman Catholic monastics no longer command such attention. To be sure, in Europe pilgrimages to monastic centers such as Santiago de Compostela in northwestern Spain or the shrine of the Black Madonna at Czestochowa in southern Poland draw hundreds of thousands, as do celebrations for youth sponsored by the ecumenical monastery of Taizé, founded in Burgundy during the 1940s. Nevertheless, apart from pilgrimages, the *institutions* of contemplative monasticism engage only a tiny minority of Western Christians, while the *spirituality* that developed there wins ever-greater admiration.

Meanwhile, gender studies has transformed the understanding of the idea of monasticism. This scholarly revolution

can make it embarrassing to read master historians such as the Benedictines’ David Knowles (1896–1974) or Jean Leclercq (1911–1993), who too often wrote as though all monastics were male. Since the 1970s researchers have reclaimed phenomena as diverse as the Desert Mothers of fourth-century Egypt, double houses of male and female monastics in twelfth-century France and England, and the rather widespread acknowledgement before 1100 of the spiritual equality of women and men. The Benedictine Hildegard of Bingen (1098–1179) has come to be hailed widely as one of the most original Christian writers ever. Many have come to deplore the pronouncement of Pope Boniface VIII (c. 1235–1303; ruled as pope 1294–1303) in 1298 that placed under enclosure all women in solemn vows. The constraint remained in force until the early 1970s. As the American historian Jo Ann Kay McNamara and the English philosopher Grace Jantzen, among others, show, almost everywhere in the West women monastics have proven to be at least as creative as men. At first nearly every branch of Eastern Christianity fostered autonomous houses for women, but many of these communities withered under Islamic occupation. In Theravada Buddhism and in Tibetan Buddhism, by way of contrast, a millennium ago women lost permission to receive the highest ordination as nuns (*bhikkuni*), while in Mahayana countries such as China, Japan, and, above all, Korea nuns have held their own.

WHAT DO WE KNOW ABOUT ST. BENEDICT?

A scholarly controversy of utmost delicacy affects interpretation of the reputed founder of Western monasticism, the author of its major rule, St. Benedict of Nursia (c. 480–547). The words of his *Rule* have been pondered in thousands of monasteries, and episodes from his life have animated countless paintings and hagiographies. Regrettably, apart from his *Rule*, all record of St. Benedict and his life comes from a single source, Book II of the *Dialogues*, supposedly written in 593 by Pope Gregory I (c. 540–604; ruled as pope 590–604). That account interweaves miracle stories of a rural wonder-worker with tales of the saint's periods of residence at mountain locations in central Italy such as Nursia, Subiaco, and Monte Cassino. Since the sixteenth century, the authenticity of Gregory's authorship of the *Dialogues* has occasionally been questioned, but never so comprehensively as by Francis Clark in *The Pseudo-Gregorian Dialogues* (1987). Clark argues that Benedict's rule appeared only in 655 in Gaul and around 675 in Britain, being acclaimed only after 717 when Monte Cassino began to be built; and that a clerk in the papal archives ("the Dialogist") compiled the *Dialogues* (first reported to exist in the 680s) and ascribed the document falsely to Gregory I. The Dialogist's "literary patchwork" intersperses miracle legends (some originating after Gregory's death) with eighty genuine Gregorian passages presumably culled from archives in the Lateran Palace. These genuine passages comprise 25 percent of the whole, half of

them in Book IV. The Dialogist recounts prodigies of recluses in a legalistic style quite different from Gregory's own. In themes, allusions, and word frequencies, the *Dialogues* differ from every known work by Gregory. Moreover, the tales glorify many persons, including St. Benedict's sister Scholastica, whom no other text from before 690 so much as mentions. Thus Clark's argument revises the entire account of "Benedictine" monasticism down to the 730s. In his view its true creators were not, as previously believed, monastics at Monte Cassino in the 540s or at the Gregorian papal court of the 590s, but rather Italian and French monastics of the 720s who drew inspiration from the newly available *Dialogues*. As yet only a few Benedictines have accepted this revision, not least because it demolishes their order's foundational narrative. Cognitive dissonance between the 1300-year-old account and Clark's revision remains too acute, but as Clark's sequel *The "Gregorian" Dialogues and the Origins of Benedictine Monasticism* (2003) shows, the tide is beginning to turn. One can no longer affirm the traditional account of how Benedictine monasticism began. All that is known is that a rule ascribed to a certain Benedict had surfaced by the 650s and had begun to establish its preeminence by 720. The idea of Western monasticism no longer enjoys an agreed-upon foundational story. Seldom has a legend accepted for so long dissolved so abruptly. A gigantic task of rethinking looms.

Monasticism as the Institutional Matrix of Spirituality

During the last decades of the twentieth century, postmodernists began to conflate the idea of monasticism with that of *spirituality*. The latter word means a process of inner transformation in the presence of God such as Christian monastics pioneered from the fourth century onward. In the twelfth century the Latin word *spiritualitas* came into use among Cistercians to denote the presence of the Holy Spirit within a monastic. Both the adjective *spiritual* and the noun *mysticism* sprouted in seventeenth-century France to describe inner religious experience of monastics and laity alike. But only in the 1920s did Roman Catholic theologians of asceticism adopt the noun *spiritualité* to denote anyone's experience of the divine within. Although many Eastern Christian monastics hesitate

to apply this Latin-derived word to the process of inner reconditioning that they call *theosis* (i.e., divinization), no one doubts that it was monastics in East and West who propounded what has come to be called "spirituality." The years of postmodernity of the late twentieth and early twenty-first centuries in the West saw treasures from seventeen centuries of monastic interiority exit the cloister and invade the mainstream of religious publishing—for example, in the series *The Classics of Western Spirituality* published since the 1970s by the Paulist Press.

The Dutch literary scholar M. B. Pranger calls into question postmodern infatuation with spirituality by contrasting its eclecticism with the monotony of textual memory within pre-1200

monasteries. The practice of *lectio divina* invited a monastic to nestle inside a text as if it were a cloister, where the mind encountered memories of other scriptural passages. Across a lifetime of rereading the same texts, a monastic recalled previous acts of remembering, as each act of memory condensed previous ones into an eternal moment. Thus *lectio divina* called into being a community of monastic reciters of the same texts, above all of the psalms, the Gospels, and the Rule of St. Benedict. Naturally, no medieval author could have imagined the popularity that monastic writings rooted in centuries of *lectio divina* would attract at the turn of the twenty-first century. Mass marketing undermines the idea of monasticism as a life spent in a reciting community ruminating on a few texts.

Postmodernity has enlarged the community of readers of monastic texts to include nearly everyone who pursues a spiritual quest. Just as Western Buddhists are de-monasticizing the practice of Buddhism, so the “Spirituality Revolution” among Christians in Europe, North America, and Australia is de-monasticizing the legacy of Christian interiority. The very idea of monasticism as lifelong commitment to a rule is being diluted. At a time when texts of monastic origin are read more widely than ever before, consumers of these distillations of the cloistered life probably understand less of the idea of monasticism (i.e., of religious orthopraxy) than ever before. In response to the postmonastic ethos of the early twenty-first century, the idea of spirituality is being de-institutionalized, while texts by monastics are being spiritualized. Scholars such as M.B. Pranger, Marilyn Dunn, Frank Senn, and Kees Waaijman are laboring to re-insert the study of Christian spirituality into a monastic context, where obedience to a rule governs all.

See also *Orthodoxy; Orthopraxy; Practices; Sacred Places.*

BIBLIOGRAPHY

- Clark, Francis. *The “Gregorian” Dialogues and the Origins of Benedictine Monasticism*. Leiden, Netherlands: E. J. Brill, 2003. Updates the controversy and refutes attempted rebuttals of the 1987 work.
- . *The Pseudo-Gregorian Dialogues*. 2 vols. Leiden, Netherlands: E. J. Brill, 1987. Summarized 1:10-30, the argument challenges the authorship of the *Dialogues* traditionally ascribed to Gregory I. See sidebar.
- Dunn, Marilyn. *The Emergence of Monasticism: From the Desert Fathers to the Early Middle Ages*. Oxford: Blackwell, 2000. Covers East and West to c. 650.
- Jantzen, Grace. *Power, Gender, and Christian Mysticism*. Cambridge, U.K.: Cambridge University Press, 1995. Reconceptualizes methodologies for interpreting male and female monastic mystics.
- Johnston, William M., ed. *Encyclopedia of Monasticism*. Chicago and London: Fitzroy Dearborn, 2000. More than 500 articles on Buddhist and Christian monasticism of all periods and places with bibliographies. Whalen Lai’s twelve articles abound in comparisons.
- Kardong, Terrence, OSB. “Who Wrote the *Dialogues of Saint Gregory*? A Report on a Controversy.” *Cistercian Studies Quarterly* 39:1 (2004): 31–39. Endorses Francis Clark’s conclusions and acknowledges the Rule as our sole source of knowledge about Benedict.

McNamara, Jo Ann Kay. *Sisters in Arms: Catholic Nuns through Two Millennia*. Cambridge, Mass.: Harvard University Press, 1996. Compares male and female Christian monastics in depth with massive bibliography.

Mitchell, Donald W., and James A. Wiseman, OSB, eds. *The Gethsemani Encounter: A Dialogue on the Spiritual Life by Buddhist and Christian Monastics*. New York: Continuum, 1998.

Judicious essays by twenty-four authors on a wide range of issues.

Pranger, M.B. *The Artificiality of Christianity: Essays on the Poetics of Monasticism*. Stanford, Calif.: Stanford University Press, 2003. Exhilarating reassessment of modes of reading and remembering among Western Christian monastics to 1700.

Senn, Frank C. *Christian Liturgy: Catholic and Evangelical*. Minneapolis: Fortress, 1997. Delineates Western monastic liturgies in chapters 4–7, 16–18.

Speake, Graham. *Mount Athos: Renewal in Paradise*. New Haven: Yale University Press, 2002. Superbly illustrated volume evokes Orthodox monasticism’s archetypal site.

Waaijman, Kees. *Spirituality: Forms, Foundations, Methods*. Translated by John Vriend. Leuven, Belgium: Peeters, 2002. Reconfigures methodology in light of dozens of case studies of Christian monastics.

William M. Johnston

MONISM. Monism is the doctrine that there is only one principle in terms of which all reality is to be explained. Doctrines differ as to the nature and activity of this principle and its relations to the appearance and experience of multiplicity. Monists explain multiplicity or plurality in the world either as derivative from the one principle or as an illusion. Monism is found in philosophical, religious, and cosmological doctrines. The concept itself is ancient, though the first appearance of the term *monism* in Western philosophy is in Christian von Wolff’s *Logic* (1728).

Religious Systems

Religious monism has two forms: atheism and pantheism. Both deny that there is a transcendent deity. Pantheism posits a deity that is immanent to the world and on which the world completely depends. Atheism states that there is no deity at all. Critics of pantheism sometimes conflate it with atheism, on the grounds that a true God must be transcendent.

Brahmanism. Among the most ancient forms of pantheism is Brahmanism. Many of its main tenets were expressed in the Upanishads and systematized by the Vedanta-sutras. Its beginning is traced to the seventh-century thinker Gaudapada, who denied individuation and plurality. Appearances, as well as individual minds, are only temporary manifestations of the all-soul. Master Sankara (c. 700–750, India), author of commentaries on the Brahma-sutra, on parts of the Upanishads, and on the *Mandukya-karika*, studied with a pupil of Gaudapada. For Sankara, only the Brahman is real, and plurality and difference are an illusion.

Gnosticism. Gnosticism is the name given to various doctrines of salvation through knowledge. The first gnostic sects

were pre-Christian. Scholars argue about Persian Mazdeism, Greek mysteries, Egyptian doctrines, or Babylonian astrology and religions as possible roots of Gnostic thought. Gnosticism came into contact with Judaism and early Christianity, borrowing some names and concepts, though refusing the main tenets. Ancient Gnosticism held that everything flows from one purely spiritual principle. The origins of matter were explained as a flaw in a long line of successive emanations from the one principle. While matter is impure, its existence is temporary: Gnostic eschatology states that ultimately the original unity and purity will be restored. Gnostic sects include the Syrian school and the Alexandrian school (early second century).

Sufism. Only rarely do Judeo-Christian forms of mysticism accept monism. John Scotus Erigena (c. 810–c. 877) in Ireland, Johannes Eckehart (Meister Eckehart; c. 1260–?1327) in Germany, and Nicholas of Cusa (1401–1464) endorsed forms of pantheism. The same is true for Islamic Sufism, which appeared as a reaction to the overly worldly tendencies of Islam in the late seventh century C.E. While most Sufi authors stressed personal discipline, asceticism, and purity as necessary elements to prepare the soul to know and unite with a transcendent God (which hardly qualify them as monist), it is interesting to mention figures that stressed a metaphysical unity of all beings in God. In the thirteenth century, the Spanish-born Ibn al-‘Arabi (1165–1240) created a theory of the “Unity of Being.” According to this theory, all existence is one, a manifestation of the underlying divine reality. Sufi currents that stressed the unity of all reality were present also in Indian Muslim communities in the late sixteenth and early seventeenth centuries. Mainstream Sufi authors reacted against monistic trends, stressing that a unity of vision (the mystical experience) did not correspond to a unity of reality.

Philosophical Systems

In philosophical systems, three forms of metaphysical monism can be identified: materialism, idealism, and neutral monism (in which the first principle is neither matter nor mind).

Neutral monists. Parmenides (b. c. 515 B.C.E.) juxtaposes *doxa* (mere belief or nonbeing) and *aletheia* (truth or being). Being is one, unchangeable, and atemporal, and the experience of change and plurality is illusion. Parmenides’s student, Zeno of Elea (c. 495–c. 430 B.C.E.), argued against the reality of plurality and motion. Plotinus (205–270 B.C.E.), the most famous and influential of the Neoplatonists, held that everything is an emanation from the One, flowing to lower and lower degrees of reality until matter is formed.

Another famous monist was Baruch Spinoza (1632–1677). In his *Ethics* (1677), Spinoza argues that there is at most and at least only one substance, God. His study of René Descartes (1596–1650) and the new science resulted in a metaphysical system where everything is a necessary manifestation (mode) of this single substance, which is conceived under the attributes of extension and thought.

Materialism. Materialists deny the existence of any nonmaterial substance. Materialists are often, but not necessarily, atheists: some, such as the Stoics, or Thomas Hobbes

(1588–1679), held that God is corporeal. Among the earliest forms of materialism was atomism. Leucippus (5th century B.C.E.) and Democritus (c. 460–c. 370 B.C.E.) believed in an infinite number of indivisible bodies (atoms) moving in a void (nonbeing). Their movements, aggregations, and interactions explain every aspect of experience, including mental life. Epicurus (Greece, 341–270 B.C.E.) developed an atomistic ethics, claiming that the pleasures of the mind and the deliverance from passions constitute human happiness. Lucretius’s (c. 100 to 90–c. 55 to 53 B.C.E.) poem *De rerum natura* (On the nature of things) had the most developed exposition of ancient atomism. Other atomist-like schools include the Indian school of Vaisesika, founded presumably by Kasyapa (c. 2nd–3rd century C.E.), which posited an infinity of atoms, of which nine kinds are identified, which constitutes all reality. The Medieval Islamic group of Asharites known as the *mutakallimun* (8th–12th century) held that God was the direct and continuous cause of all created beings (composed of atoms) and of the maintenance of each atom, from instant to instant. This doctrine of atomic time presaged Descartes and the Occasionalists, though without the commitment to a transcendent God.

Seventeenth- and eighteenth-century materialism arose with the scientific revolution’s mechanical philosophy. Most natural philosophers were not materialist monists (because they believed in a transcendent God and in incorporeal souls), yet there are exceptions. Giordano Bruno (1548–1600), who was burned as a heretic, presented a pantheistic system in which the world and its soul are one. Thomas Hobbes in *Leviathan* (1651) developed a geometrical account of natural, human, and political science, where he argued that reality is only bodies in motion and these explain perception, our human ideas and volitions, and the body politic.

During the Enlightenment materialists like Julien Offroy de La Mettrie (1709–1751) and Baron Paul-Henri-Dietrich d’Holbach (1723–1789) wrote about the material and “mechanical” nature of man and rejected any immaterial God. Some Enlightenment philosophers (Denis Diderot, Holbach) were atheists, others opted for deism, or the belief that God acted exclusively through natural laws. The borders between deism, pantheism, or downright atheism were often quite blurred (as in Anthony Ashley Cooper, third earl of Shaftesbury, or Jean Le Rond d’Alembert).

The first half of the nineteenth century saw a strong idealistic and romantic reaction to materialism, yet materialism returned with a vengeance in the second half with the successes of the theory of evolution by natural selection and of Marxism. Karl Marx (1818–1883) focused on economics, yet, in reacting against Hegelian idealism, endorsed a metaphysical materialism and atheism. In Marx, ideas (intellectual contents) are determined and explained through the material, economic processes of production and ownership, upon which rise social and political superstructures.

On the Origin of Species by Means of Natural Selection: Or, The Preservation of Favoured Races in the Struggle for Life (1859) by Charles Darwin (1809–1882) made it possible, in

Richard Dawkins's words in *The Blind Watchmaker*, "to be an intellectually fulfilled atheist." Darwin was held by many to have produced a fully naturalistic and scientifically robust explanation of the nature of life. Darwinian evolution and natural selection were taken to be a serious challenge to explanations of the creation and development of life by a designing God. While many aspects of Darwin's own theory underwent major revisions with the discoveries of molecular biology and genetics, natural selection has lost nothing of its power as an explanatory tool in contemporary evolutionary biology and is used in many fields to explain structures and functions that are seemingly designed.

Idealism. Idealism is metaphysical monism that rejects the existence of matter and founds the experience of matter on the mental. Ancient forms of idealism can be found in Buddhist schools.

The Yogacara (or Vijnanavada) school started around the fifth century C.E. in India. Its central doctrine is that only consciousness (*vijnanamatra*) is real, that thought or mind is the ultimate reality. External things do not exist; nothing exists outside the mind. Ultimately, the purified, undifferentiated state of the mind without objects or thought processes is what constitutes "Buddhahood." Among the principal figures were the brothers Asanga and Vasubandhu.

The Zen, or Chan school was founded by the Indian monk Bodhidharma, who traveled to China around 520 C.E. (according to the tradition). Zen stresses the use of meditation to experience the unity and indistinctness of reality, which cannot be understood otherwise (any form of verbalization or conceptualization falls into the trap of dualism).

In the Western tradition, idealism was reprised by George Berkeley (1685–1753), bishop of Cloyne, who held that all we can know are the ideas in our minds. All objects of perception, including matter, are only ideas produced by God. German idealism started later with Johann Gottlieb Fichte's (1762–1814) transcendental idealism, which he saw as a development of Immanuel Kant's (1724–1804) ideas. For Fichte, God is the All, and particular objects result from reflection or self-consciousness through which the infinite unity is broken up. Friedrich Wilhelm Joseph von Schelling (1775–1854) held that there is a unity between ideal and real. Absolute idealism explains the process of division of consciousness and nature, and their return to unity.

The culmination of German idealism came with Georg Wilhelm Friedrich Hegel (1770–1831), who believed that understanding *Geist* (Absolute Spirit) would overcome all (Kant's) contradictions in the realms of reason and science. *Geist* is the principle of reality that makes the universe intelligible as an eternal cyclical process whereby *Geist* comes to know itself, first through its own thinking, then through nature, and finally through finite spirits and their self-expression in history and their self-discovery in art, in religion, and in philosophy. Later in the century, Hegel's doctrines were developed by a group of English idealists, most notably Francis Bradley and John McTaggart Ellis.

In contemporary philosophy, monism is mostly materialism or physicalism. In psychology and philosophy of mind, it is held by many that the mental is reducible to the physical and may be explained in terms of physical laws. Eliminative materialism (Patricia and Paul Churchland) denies that the mental exists and claims that all "mental" talk will be ultimately eliminated as science progresses. Functionalism is a noneliminativist form of materialism claiming that descriptions of mental events and their intentional natures may be explained by systemic relations among the parts of the material brain (Hilary Putnam and William Lycan).

Anomalous monism (Donald Davidson and John Searle) holds that mental events are ultimately identical to brain states, but that there are no laws (hence *anomalous*) that connect brain states to mental states.

See also Atheism; Deism; Gnosticism; Historical and Dialectical Materialism; Idealism; Materialism in Eighteenth-Century European Thought; Zen.

BIBLIOGRAPHY

- Bakar, Osman. *The History and Philosophy of Islamic Science*. Cambridge, U.K.: Islamic Texts Society, 1999.
- Block, Ned, Güven Güzeldere, and Owen Flanagan, eds. *The Nature of Consciousness: Philosophical Debates*. Cambridge, Mass.: MIT Press, 1997.
- Chittick, William C. *The Self-Disclosure of God: Principles of Ibn al-'Arabi's Cosmology*. Albany: State University of New York Press, 1998.
- Churchland, Paul M. *The Engine of Reason, the Seat of the Soul: A Philosophical Journey into the Brain*. Cambridge, Mass.: MIT Press, 1996.
- Dawkins, Richard. *The Blind Watchmaker*. New York: W.W. Norton, 1986.
- Dennett, Daniel C. *Darwin's Dangerous Idea: Evolution and the Meanings of Life*. New York: Simon and Schuster, 1995.
- Filoramo, Giovanni. *A History of Gnosticism*. Oxford: Blackwell, 1990.
- Lloyd, A. C. *The Anatomy of Neoplatonism*. Oxford: Clarendon, 1990.
- Lusthaus, Dan. *Buddhist Phenomenology: A Philosophical Investigation of Yogacara Buddhism and the Ch'eng Wei-shih Lun*. London: Routledge Curzon, 2002.
- Lycan, William, ed. *Mind and Cognition: An Anthology*. Malden, Mass.: Blackwell, 1999.
- Moran, Dermot. *The Philosophy of John Scottus Eriugena: A Study of Idealism in the Middle Ages*. Cambridge, U.K.: Cambridge University Press, 1989.
- Phillips, Stephen H. *Classical Indian Metaphysics: Refutations of Realism and the Emergence of "New Logic"*. La Salle, Ill.: Open Court, 1995.
- Ruse, Michael. *The Darwinian Revolution: Science Red in Tooth and Claw*. 2nd ed. Chicago: University of Chicago Press, 1999.
- Searle, John. *Minds, Brains, and Science*. Cambridge, Mass.: Harvard University Press, 1984.
- Stern, Robert. *Hegel, Kant, and the Structure of the Object*. London: Routledge, 1990.
- Wallis, Richard T., ed., and Jay Bregman, assoc. ed. *Neoplatonism and Gnosticism*. Albany: State University of New York, 1992.

Westphal, Kenneth R. *Hegel's Epistemological Realism: A Study of the Aim and Method of Hegel's "Phenomenology of Spirit."* Dordrecht: Kluwer, 1989.

*Peter Machamer
Francesca di Poppa*

MORAL SENSE. Sentimentalism, of which moral sense theory was a part, initially had a short run. Until the end of the twentieth century, all the major versions of the theory were produced within a sixty-year period in eighteenth-century Britain. Anthony Ashley Cooper, third earl of Shaftesbury (1671–1713), initiated the sentimental line of thought with his theory that morality is grounded in the reflexive sentiments of the mind, but the idea that human beings possess a specific moral sense, in addition to their external senses, is due to Francis Hutcheson (1694–1746). David Hume (1711–1776) explains the moral sense in terms of more fundamental psychological principles of the mind, especially sympathy. Adam Smith (1723–1790) follows Hume in tracing the moral sentiments to sympathy while dispensing with the idea of a moral sense altogether. Joseph Butler (1692–1752) advocated a compromise between sentimentalism and rationalism, describing the deliverances of conscience as a “sentiment of the understanding.”

The sentimentalists think morality is rooted in human nature in two ways. First, what has moral value are first-order sentiments, the passions and affections that motivate people to act, and actions expressive of these sentiments. Second, what gives these motives their value is our reflective, second-order sentiments; sentiments we have about our own or other people's sentiments. We feel approval or disapproval toward ourselves or others for having and acting on certain first-order sentiments and affections. The eighteenth-century sentimentalists compare moral qualities to secondary qualities such as color that result from our visual apparatus. Because we have a propensity to project color onto objects, we come to think of color as a property of objects themselves. Similarly, we project our approval onto people's motives, which explains why we think virtue is a property of actions themselves and approval is a response to that property. For the sentimentalists, however, an action is virtuous only because we approve of it.

Both sentimentalism and its rival, rationalism, initially developed in reaction to Thomas Hobbes's (1588–1679) moral theory. The rationalists objected to Hobbes's claims that there is no right or wrong in the state of nature, that rightness or wrongness is determined by the sovereign's will, and that morality requires sanctions if it is to motivate us. The sentimentalists took a different tack, opposing what they took to be Hobbes's “selfish” conceptions of human nature and morality. They argued that we are by nature social creatures. Other-regarding affections such as benevolence, gratitude, and compassion are an original and real part of human nature. Butler's criticisms of Hobbes's selfish conception of human nature are held in high repute to this day. The sentimentalists also tried to show that morality has nothing to do with self-interest. Self-interest neither provides the motive to act morally nor explains why we morally approve or disapprove.

By the middle of the century, rationalists and sentimentalists began to argue with each other. The rationalist Samuel Clarke (1675–1729) claimed that our moral ideas spring from reason and that the rational awareness that actions are fit or unfit has the power both to obligate and to motivate us. The sentimentalists objected to both claims. One surprising advantage that the sentimentalists had over the rationalists is that they had a more fully worked-out view of what reason is and does, and they interpreted the rationalists in terms of that theory. On that view, reason is inert in two ways. First, reason's operations are limited to the examination and comparison of ideas, that is, to ascertain facts and to determine a priori relationships. Rationalists and sentimentalists agree that basic moral ideas are simple. On the sentimentalist view, however, reason alone never gives rise to simple ideas, so reason alone cannot be the source of moral ideas. Reason is inert in another way: it cannot by itself give rise to a new motive. All reason does is notice the relations between ideas; noticing a relation cannot move us. Hume infamously added that there are no normative rational standards at all that apply to action. We are no more required by reason to act prudently than we are required to act morally.

Shaftesbury characterizes the reflective moral sense as a tendency to admire and approve what is beautiful in people's motives and characters. Butler agrees that the principle of reflection—or conscience—is an essential part of human nature but argues that Shaftesbury overlooked its most important feature. Conscience, he insists, has authority—a right to rule us—that is independent of its strength or power to move us. Both Shaftesbury and Butler conceive of human nature teleologically, as a system structured to promote good ends—one's own good and the good of other human beings. The constitution that is morally approved of is one appropriately balanced between other-regarding and self-regarding affections. Moral evil results not from evil affections, but from our affections being out of balance. As these philosophers see it, human nature is on the whole good.

Starting with Hutcheson, later sentimentalists began to move toward a more modern scientific conception of human nature as morally indifferent. They thus reject the teleological picture of human nature Shaftesbury and Butler endorsed. They continue, however, to think of our nature as benign. Hutcheson, for example, denies that human beings have such evil affections as disinterested malice.

Hutcheson is famous for two claims. First, taking over Shaftesbury's idea of a reflective sense and embedding it in the empiricist view that simple ideas must come from the senses, he claims that human beings possess a unique moral sense that disposes us to immediately and noninferentially approve and disapprove of people's characters and their actions. He also argues that the only character trait of which the moral sense approves is benevolence. The four cardinal virtues—temperance, courage, prudence, and justice—are virtues, he insists, only when motivated by benevolence. Hutcheson distinguishes three types of benevolence. The morally best kind is calm universal benevolence, which aims at the good of all sentient creatures. The moral sense also approves of benevolence directed

toward smaller groups, such as love of family or country, as well as particular benevolent impulses, such as pity and gratitude, but only if they do not counteract universal benevolence. When Hutcheson turns from a discussion of why we approve or disapprove of certain actions to a discussion of what actions we should choose, he says we should always choose the action that “produces the greatest happiness for the greatest number.” He is the first to enunciate the utility principle.

Even more than Hutcheson, Hume and Smith explicitly aimed at providing a naturalistic explanation of morality, one wholly consistent with the scientific picture of the world. They criticized Hutcheson not only for positing an extra sense but also for failing to explain its origins and workings. The moral project, as they see it, is to discover the fundamental principles of the mind that account for the origin of moral concepts. Both trace the moral sentiments to the operation of sympathy, although they conceive of sympathy differently. For Hume, sympathy is a propensity to feel what other people are feeling, even those wholly unrelated to and removed from us. For Smith, sympathy is the ability to put yourself imaginatively in another’s situation and to feel what you would feel in that person’s place.

Hume’s explanation of moral approval and disapproval begins with our more ordinary loves and hatreds that are violent and vary from person to person. He then describes the process whereby we transform these feelings into a kind of calm, uniform moral love and hatred. On his view of sympathy, we sympathize more easily with people who resemble or are contiguous to us. Although our ability to enter into the feelings of others varies, Hume believes, like most other moral philosophers of this period, that our moral approvals do not. Accordingly, moral approval springs from sympathy but only when we take up a “general” or “common” point of view. There are two regulating features to the general point of view. The first is that we survey a character from the perspective of the person and his or her usual associates. We sympathize then with the person and the people with whom that person regularly interacts, and we judge character traits in terms of whether they are good or bad for these people. The second is that we regulate sympathy by relying on general rules that specify the general effects of character traits. We do sympathize not with the actual effects of a person’s character traits but with their usual tendencies for a person’s regular associates.

Hume offers as an empirical hypothesis the claim that the moral sense approves of motives that are pleasant and useful to agents themselves or to others. Smith criticizes Hume for ignoring another important way in which we judge people’s sentiments. We judge the propriety of people’s reactions—whether they are excessive or weak in relation to their object. When we blame someone for excessive anger we do so not only because of its bad effects on that person or others, but also because it is out of proportion to its object or occasion. Smith explains judgments of propriety in terms of his own distinctive conception of sympathy. We judge the propriety of someone’s reaction by seeing whether his reaction is the same as our vicarious reaction. We imaginatively put ourselves in the other’s shoes and feel what he should feel, given his situation. We then compare his reaction with our vicarious one.

If his actual feeling is excessive compared with the vicarious one we are feeling, we disapprove; if the feeling is similar, we approve. Smith’s account of judgments of propriety is one of his most distinctive contributions to sentimentalism.

Subsequent sentimentalists objected to Hutcheson’s reduction of virtue to benevolence, claiming that we approve of a wide variety of character traits and motives. Butler argued against Hutcheson that utility cannot be the basis of our approval of justice, since we disapprove of such injustices as theft and treachery even in those cases in which they are useful. Hume grants that acts of justice, taken singly, do not always promote the public good, but he argues that what is useful is the system of justice with rules and procedures that everyone is to follow. Hume also accommodated the rationalist idea that the good person does the right thing because she sees it as right. He argues that in the case of justice this is the morally best motive as well as our usual motive.

Although all the sentimentalists believe that we have the capacity to judge ourselves, Smith tries to explain how we acquire this capacity and in so doing become reflective agents. According to him, conscience, or the “man within,” comes from our social nature. We first learn to internalize the judgments others have about ourselves, viewing ourselves through their eyes. But others may misinterpret or misunderstand our motives, praising or blaming us when we do not deserve it. Smith thinks we learn to distinguish the actual praise of others from judgments about whether we are worthy of praise. The sense of moral obligation arises when we internalize the gaze of the ideal spectator—the man within—and try to meet the standards of praiseworthiness he sets for us.

Sentimentalism is enjoying a revival. New versions of the theory have been produced at the end of the twentieth century and the start of the twenty-first, the most prominent of which are the neosentimentalist theories of Simon Blackburn and Annette Baier. Both are followers of Hume, although Blackburn incorporates important elements from Smith. Their main target is Kant, whom they misread as a traditional moral rationalist along the lines of Hume’s main opponent, Samuel Clarke. Traditional moral rationalists were realists: they believed that moral truths are part of the framework of the universe. So for Blackburn the foundational issue of whether morality should be located in sentiment or reason is one that asks whether morality is grounded in the framework of the universe or in that of human nature.

Like Hume and Smith, Blackburn wants to provide a naturalistic theory that is consistent with the scientific worldview. According to his theory, to value something is to have a stable disposition in favor of that thing, a disposition we approve of having and are concerned to preserve. Blackburn believes human beings tend to share the same settled dispositions because we need to coordinate our actions with those of others and because we want to be loveable in their eyes.

Blackburn conceives of morality as a product of human nature, springing from second-order sentiments we have about our first-order sentiments. He explains this characteristically sentimental idea in terms of a “staircase of emotional ascent.”

At the bottom are preferences, simple likes and dislikes. The next step up are our primitive aversions to some kind of action or character. Following Smith and going up another step, Blackburn argues that if you are angry and I come to share your anger, we come to see the matter as a moral one. The sympathetic identification causes us to see the sentiment as legitimate. We take the final step when we are moved to urge others to share the sentiment, effectively treating it as required.

Moral obligation and motivation result from a four-step process. Following Hume, Blackburn thinks the process begins with the natural emotion of love we feel toward certain character traits. We turn that love into moral esteem by taking up what Hume calls the common point of view. We then notice whether we have the character trait or not. Blackburn relies on Smith's theory that we become agents by internalizing the moral gaze of others and on his explanation of how we come to desire not just praise but praiseworthiness. For Blackburn, the latter is the desire to do what is right, so we are motivated to act morally.

Like the earlier sentimentalists, who compare moral properties with secondary qualities, Blackburn gives a projectivist explanation of why morality appears to us as a feature of reality. We tend to project our approval onto people's motives and see it as a property of the motives themselves. This "quasi-realism," as Blackburn calls it, is the aspect of his theory for which he is best known.

Blackburn provides a naturalistic explanation of what we are doing when we use normative concepts. According to him, we are expressing or voicing our values rather than describing something. He thus defends a form of noncognitivism, the view that ethical judgments cannot be true or false, since they do not describe facts. Borrowing the term from Allan Gibbard, he calls this type of noncognitivism "expressivism." The twentieth-century noncognitivists are often thought to be following in the footsteps of the classical sentimentalists. But the eighteenth-century sentimentalists were concerned with the question of where our moral concepts come from rather than with the analysis of moral language. They did not deny that sentences in which moral concepts appear could be true or false.

Blackburn adopts the Humean view that the role of reason is limited to informing us of the facts of the case, including the likely effects of proposed actions. Awareness of these facts will move us, but only if they are tied to some desire or contingent concern of ours. Like Hume, Blackburn denies that there are rational standards governing action. Nevertheless, he argues that there is a perfectly respectable sense in which people may be said to reason about their ends or are criticized for being unreasonable. Reasonableness stands for freedom from certain traits—ignorance, lack of foresight, lack of concern for the common point of view. Those of us who value these traits may condemn someone who lacks these traits as unreasonable.

Baier provides perhaps the most sympathetic and systematic reading of Hume's *A Treatise of Human Nature* in *A Progress of Sentiments*. The progress is a turn from a reliance on pure Cartesian intellect to an attempt to employ philosophically all the capacities of the mind: memory, passion, sentiment, and "chastened intellect." On her reading, Hume's

"carefree" or liberated philosophy is an investigation of the whole mind by the whole mind, in contrast to the Kantian investigation of reason by itself.

Baier sees Hume's moral theory as friendly to women's moral experiences and the inspiration for a new approach to feminist ethics. She thinks Hume anticipated many important elements of feminist ethics. Agreeing with the classical sentimentalists that we are essentially social creatures, she believes, as she thinks Hume did, that relationships are at the heart of morality. She applauds Hume for realizing that the system of justice with its rules and rights is an offspring of family cooperativeness and love. She sees him as one of the first philosophers to emphasize intimate and involuntary relationships and relationships between unequals such as parents and children.

Baier advocates a feminist ethics in which trust underwrites both love and obligation. Her deepest debt to Hume comes from his insight into how trust can come to be progressively enlarged, a view she reconstructs from Hume's account of the artificial virtues and the conventions in which they are embedded. Unless people trust each other, they will have trouble loving each other. To recognize a set of obligations is to trust that those who have the power to impose sanctions will enforce sanctions if obligations are not met. It is to trust a group of people with coercive power. Important questions include whom we should trust as well as distrust. Baier looks at obligation from the point of view of the powerless, not the powerful.

Despite Hume's commitment to naturalism, Baier, along with the neo-Kantian Christine Korsgaard, claim to have found in Hume a general test of normativity that applies to the understanding and the moral sense. Both agree that for Hume the normative problem is not whether our beliefs and values are true in the sense that they correspond to some independent reality. The problem is whether our more unreflective beliefs and values and the faculties that give rise to them can withstand their own reflection without incoherence or self-condemnation. Both argue that, on Hume's view, when the moral sense turns on itself and its operations it survives its own survey; therefore its judgments are authoritative.

See also Natural Law; Philosophy, Moral; Rational Choice; Utilitarianism; Virtue Ethics.

BIBLIOGRAPHY

PRIMARY SOURCES

- Butler, Joseph. *The Analogy of Religion*. London, 1736. Includes *Dissertation of the Nature of Virtue*.
- . *Fifteen Sermons Preached at the Rolls Chapel*. London, 1726. Reprint, *Five Sermons Preached at the Rolls Chapel and A Dissertation Upon the Nature of Virtue*, edited by Stephen L. Darwall. Indianapolis: Hackett, 1983. Contains the five most important of the original fifteen Sermons.
- Hume, David. *Enquiry Concerning the Principles of Morals*. London, 1751. Reprint, edited by L. A. Selby-Bigge and P. H. Nidditch. Oxford: Clarendon, 1975.
- . *A Treatise of Human Nature*. 3 vols. London, 1739–1740. Reprint, edited by L. A. Selby-Bigge and P. H. Nidditch. Oxford: Clarendon, 1985.

- Hutcheson, Francis. *An Essay on the Nature and Conduct of Passions and Affections with Illustrations Upon the Moral Sense*. London, 1728. Reprint, edited by Aaron Garrett. Indianapolis: Liberty Fund, 2002.
- . *An Inquiry into the Original of Our Ideas of Beauty and Virtue*. London, 1725. Reprint, edited by Wolfgang Leidhold. Indianapolis: Liberty Fund, 2004.
- Raphael, D. D., ed. *British Moralists, 1650–1800*. Vols. 1 and 2. Indianapolis: Hackett, 1991. Contains important selections from the sentimentalists as well as their opponents.
- Shaftesbury, Anthony Ashley Cooper, Third Earl of. *Characteristics of Men, Manners, Opinions, Times*. London, 1711. Reprint, edited by Lawrence E. Klein. Cambridge, U.K.: Cambridge University Press, 1999.
- Smith, Adam. *The Theory of Moral Sentiments*. London and Edinburgh, 1759. Reprint, edited by D. D. Raphael and A. L. Macfie. Indianapolis: Liberty Classics, 1982.

SECONDARY SOURCES

- Baier, Annette. *A Progress of Sentiments*. Cambridge, Mass.: Harvard University Press, 1991.
- . *Moral Prejudices*. Cambridge, Mass.: Harvard University Press, 1994.
- Blackburn, Simon. *Ruling Passion: A Theory of Practical Reasoning*. New York: Oxford University Press, 1998.
- Darwall, Stephen. *The British Moralists and the Internal "Ought": 1640–1740*. New York: Cambridge University Press, 1995.
- Gibbard, Allan. *Wise Choices, Apt Feelings: A Theory of Normative Judgment*. Cambridge, Mass.: Harvard University Press, 1990.
- Korsgaard, Christine. *The Sources of Normativity*. New York: Cambridge University Press, 1996.
- Schneewind, J. B. *The Invention of Autonomy*. New York: Cambridge University Press, 1998.
- Schneewind, J. B., ed. *Moral Philosophy from Montaigne to Kant*. Cambridge, U.K.: Cambridge University Press, 2003. Contains selections from moral philosophers from Britain as well as the Continent.

Charlotte R. Brown

MOTHERHOOD AND MATERNITY. Motherhood the world over is commonly understood in terms of a generic terminology. Regardless of country, clime, or class, age-old mythologies in all cultures eulogize motherhood and impart to it an importance that goes well beyond the physical act of birthing. At the level of twenty-first-century popular culture, however, motherhood and maternity have been appropriated by modern-day consumerism, particularly in Western cultures where specialized stores like Mothercare sell fashionable maternity apparel, and Internet sites like The Mothersbliss Shopping Experience offer both goods and advice on mothering. While religious symbolism stresses motherhood as *creation*, modern-day marketing targets the “mother-consumer” to sell fashionable maternity clothing, lingerie, and accessories as a form of “Pregnancy Chic!”

Given all the numerous contextual underpinnings, the concept of motherhood lends itself to a variety of interpretations across culture and historical time. It therefore needs to be analyzed in terms of history, culture, myth, art, and more lately

in terms of the scientific discourses that shape new reproductive technologies and population control policies, all of which focus on women’s bodies and their biological ability to become mothers. This article touches upon all these contexts, drawing illustrations from diverse cultural, social, and geographical locations to point out that motherhood is valorized in all cultures, yet the notions, symbols, and cultural practices that constitute motherhood and maternity are neither homogenous globally nor stable chronologically.

History, Religion, and Myth

Motherhood is wrapped in many cultural meanings. Birthing and nurturing new life physically has led to a conflation of “feminine,” “maternal,” and “feminine spirituality” in many cultures and religious traditions. Motherhood has been painted as a sacred and powerful spiritual path. In literature and in nationalist discourses alike, motherhood is a recurrent theme across cultures.

Religious scriptures and myths place motherhood in an exalted realm. Christian, Judaic, and Hindu religious imagery sentimentalizes and idealizes motherhood. While Madonna images are characteristic to Christianity, conceptualizations of the Devi-Ma (Goddess-Mother) in Hindu tradition are reinforced by the many goddesses in the Hindu pantheon, each epitomizing an attribute (Durga/Kali: strength; Lakshmi: prosperity/abundance; Saraswati: knowledge; etc.). In West African, Afro-Caribbean, and Afro-Brazilian traditions, Yemaya (or Yemalla) is a creation goddess. Often depicted as a mermaid or a beautiful woman, and associated with the moon and ocean, Yemaya governs the household and rules over conception, birth, and ensures the safety of children. Local mythologies suggest that the fourteen Yoruba goddesses and gods spilled forth from Yemaya’s womb, and the breaking of her uterine waters caused a great flood that created the oceans. From her body were born the first human woman and man, who became the parents of all mortal beings on earth.

Although Buddhism does not give motherhood such overwhelming spiritual status and significance, maternal imagery and symbolism are present in the concept of the archetypal female Bodhisattvas, seen as supreme mothers. Tara is compared to a mother with compassion and forbearance; Prajnaparamita is seen as the mother of all Buddhas. Interestingly, the Bodhisattvas (transcendental ideal mothers) are also essentially androgynous—thus distinguishing the Buddhist spiritual tradition from the Christian and the Hindu.

Influenced by religious mythologies and local lore, classical literature from Europe, Africa, and Asia is filled with examples of self-sacrifice in the name of motherhood. While mothers are revered as creators, nurturers, and goddesses, they also inspire awe because they are believed to both protect and destroy. At the heart of the sprawling metropolis Mexico City stands the Monumento a la Madre, a monument commemorating motherhood. Its location and the Spanish inscription on it, “Porque su maternidad fue voluntaria” (because their maternity was voluntary), emphasize the centrality of motherhood in Mexican society. In fact, two of Mexico’s most important mythical figures are mothers, contrasting figures with

origins in Mexican history and mythology. La Malinche (also known as Malintzin), a Mexican Indian princess born around 1500, was given as a slave to Hernán Cortés, the leader of the conquistadors in Mexico. She later bore him a child. Because of this sexual transgression and for her role as mediator between the Spanish and the native Indians, popular mythologies view her as a traitor and a bad mother responsible for the quick defeat of the indigenous peoples and the downfall of the entire Aztec Empire. In contrast, the Virgin of Guadalupe, a Madonna with indigenous features, is seen as incarnating all the values associated with the good Mexican mother: meek, kind, self-sacrificing.

Indeed, in modern societies the concept of mother has commanded popular appeal as a symbol of the nation-state. Nationalist discourses in diverse global contexts deploy the nation-as-mother symbolism to mobilize patriotic sentiments. Love of mother and love of nation have been conflated. The symbolism of the enslaved mother was at the heart of the anti-colonial nationalist struggles, both in India to free Bharat-Mata (Mother India) in the 1940s and in South Africa in the 1980s and 1990s. While patriotic songs and monuments in many countries celebrate the nation-as-mother, there are exceptions. In Russia, for instance, patriotic songs often invoke sentiments of loyalty toward the land of birth (*rodina*), referring to it as *otchestvo* (fatherland).

Although maternal ideals are espoused and valorized in all cultures, in patriarchal societies that uphold a woman's central purpose to be her reproductive function, motherhood and mothering become intertwined with issues of a woman's identity. Essentializing theories that define women in terms of fertility are reinforced socially through many female archetypes (such as the Virgin, Venus, and Mother Earth) that remain bound to women's reproductive functions. Such cultural myths, perpetuated throughout the centuries, enforce the belief that motherhood is an essential part of being a woman. The Mexican writer Rosario Castellanos (1925–1974) pointed out that a Mexican woman does not consider herself to be a real woman unless she has proved herself to be fertile and the “halo of maternity” shines over her. This holds true for most women not only in Mexico but also in Iran, India, China, Korea, and many Latin American societies, where the index of motherhood is used to define “real” women. Given that motherhood becomes a prerequisite for social acceptance in such societies, many non-mothering women experience feelings of rejection and low self-esteem. In cultural practice, this means that patriarchies can deploy notions of motherhood to foster conservative traditions, through which motherhood becomes a means of female control.

Although in many cultures expectations of mothering roles are buttressed by intense social pressure to conform to them, this seems to be driven less by levels of modernity or urbanization than by the status accorded to norms of familial and community cohesiveness in a society. For instance, Japan's highly urbanized, industrialized society continues to perpetuate highly prescriptive notions of motherhood, just as in Egypt, Iran, India, or Afghanistan. Despite differences in economic status and levels of development, all these societies share widely

held beliefs about the importance of family and community linkages. Regardless of whether a particular African society displays a patrilineal or matrilineal kinship system, mothers are the essential building block of social relationships and identities in most African cultures. Because mothers symbolize familial ties and unconditional loyalty, motherhood is invoked even in extrafamilial situations that call upon these values. Women-as-mothers, then, become key players in the maintenance of linkages and acquire important community responsibilities.

Birthing. Given such assumptions about motherhood, the act of birthing is both anxiety-producing and a dramatic moment in what is perceived as the cycle of creation. In many Islamic and Hindu communities, birthing is also associated with rituals of purity and pollution: While these traditions exempt the mother from household chores and burdensome tasks, they also regard her as unclean and force her to live somewhat segregated from community spaces for several days post-childbirth. In many societies in Africa and Asia, among Muslim, Hindu, and Christian families (both urban and rural), daughters still return to their natal family homes late in pregnancy, to be properly cared for and pampered during and after birthing. Given the high maternal and infant mortality rates in most developing countries, birthing is understandably regarded as a dangerous and life-threatening process, the successful completion of which calls for prayer and celebration.

African societies also widely posit birthing with great significance. Feminists in Africa, while conceding that this may at times operate in an oppressive manner, have attempted to recuperate other conceptualizations of motherhood that are empowering for women. Within such conceptualizations, birthing bestows a certain status on women—even mystical powers. Yoruba traditions are a case in point. Among the Yoruba, motherhood confers privileges that hark back to the very foundations of society and women's presumed roles in it. Women symbolize fertility, fecundity, fruitfulness. The Yoruba say, “*Iya ni wura, baba ni jigi*” (Mother is gold, father is a mirror). Mother is gold: strong, valuable, true, central to a child's existence, wise, also self-denying. The Yoruba also believe that *ikunle abiyamo*—the kneeling position that is assumed at the moment of birth—confers spiritual privileges on a mother. Thus there are powers, privileges, and entitlements that come with motherhood—even in the act of birthing.

Stereotypes of “ideal” mothers. Even in Western societies, at least until the postwar years, women were encouraged to produce large families, to find satisfaction and pride in motherhood. However, the nobility and respect assigned to full-time motherhood was still regarded as inferior to male pursuits. Thus, motherhood was simultaneously idealized and denigrated.

The importance of these cultural and religious symbols of motherhood is borne out by the fact that they are repeatedly invoked in art and literature and form part of ongoing mythologies that create icons and idealized stereotypes pervasive in communities. Literary and artistic works through the ages valorize those attributes of motherhood associated with Virgin-identified self-sacrifice, offset by myths of the bad mother, which are just as prevalent. Depictions of self-sacrificing mothers as creators who must bear pain with patience and nurture

selflessly leave no space for mothers as women who feel pain, anger, frustration, or are simply drained by the responsibilities that accompany their mothering roles. Thus good mother stereotypes assist in sustaining a bad mother/good mother dichotomy within which patriarchy condemns the negative maternal feminine image.

Statistics, of course, prove that the universality of motherhood is a myth. Women across the globe are individual, multi-dimensional personalities who defy this super-construct. Their roles and self-perceptions as mothers are mediated by the complicated tapestry of culture, clime, and class that shape them. Feminists in the second half of the twentieth century have aimed to debunk these cultural myths.

Feminist Critiques

Debates over motherhood have been fundamental to feminist movements, whether in the United Kingdom, the United States, Japan, India, or China. In this context, the issues for feminism are numerous. Some of these are analyzed in a historical context below, with references to how literary representations use tropes of motherhood that reinforce patriarchies of race and gender. Finally, contemporary debates on issues such as abortion, the use of reproductive technologies, surrogate motherhood, and single mothers are examined.

Broadly speaking, critiques of motherhood argue that femininity is widely defined in essentialist terms that assume that women have instincts that make them selfless nurturers. Such assumptions, in turn, shape social practices that make women automatically responsible as caregivers. Feminist theorists argue that such myths, constructed by the patriarchy, undergird social practices that eventually restrict women. Although contemporary feminisms have widely vocalized these issues, it is important to recognize that the first formulations on this issue predate twenty-first-century feminism.

The French writer Simone de Beauvoir (1908–1986) argued that women are repeatedly told from infancy that they are “made” for childbearing. While the “splendors of maternity” are forever being sung to her, the drawbacks of her situation—menstruation, illnesses, and even the boredom of household drudgery—are all justified by this “marvelous privilege” she has of bringing children into the world. Beauvoir pointed out that such pervasive socialization shapes women’s desire to “choose” motherhood.

The second-wave feminist movement in the United States (after the 1960s) brought these interrogations to center stage. Feminists argued that throughout human history, maternal experience has been defined and written by patriarchal culture. Religion, art, medicine, psychoanalysis, and other bastions of male power have objectified motherhood, have disregarded female subjectivity, and have silenced the voice of the mother. Feminist activists insisted on middle-class women’s right to work and participate in public life beyond the family (working class and poor women had been working all along, while also raising their families), and, along with this, that mothering was not essential to women’s fulfillment or necessary to every woman’s life.

Feminists in the United Kingdom, North America, and Europe began to challenge the overemphasis on fertility, insisting that the link between childbearing and childrearing is socially manipulative and serves to exclude women from other productive roles. Feminist theorists debunked the social pressures of a mothering role that seeks to control women’s bodies and energy. They argued that such notions limit women’s possibilities to the domestic sphere and restrict their entry into the public domain, thus vitally feeding into patriarchal agendas.

Although the second-wave feminists vocalized the issue of fertility more aggressively than before, it is important to remember that the earliest efforts in this direction were made in the 1920s through activism of the suffragists and women like Margaret Sanger (1879–1966), who founded the American Birth Control League in 1921. Sanger’s movement made an impact in North America, Britain, and India, and forcefully argued for “planned parenthood” as essential to ensure women’s participation in the public domain. Since the work of the second-wave feminists, fertility has remained a crucial part of the feminist agenda.

Literary criticism. Since the 1970s, feminist critics have generated a prolific body of literary criticism that demands an inquiry into the nature of the maternal instinct and the psychology of the mother-child relationship. This task is common to feminism in the West and the widely different cultures of Japan and India. In the 1970s, Japanese feminist critiques began to assert that *bosei* (innate maternal instinct) was a social construct. They sought to demonstrate that modern Japanese conceptions of womanhood as motherhood, of motherhood as something natural and instinctive to women, were artifacts of contemporary society whose construction could be historically interrogated. Contemporary Japanese fiction such as *Child of Fortune* by Yuko Tsushima (1983), about a woman struggling between the reality of motherhood and the expectations of society influenced by an idealized good mother paradigm, presents a stinging critique of rigid and constraining constructions of motherhood.

Along a related trajectory, the work of Marianne Hirsch from the late 1980s captures the spirit of Western feminists’ preoccupation with the literature of matrilineage in conjunction with an ongoing feminist pursuit of retrieving maternal subjectivity. The literary representations of mother-daughter voices in contemporary matrilineal narratives open up a new chapter in the feminist project of repositioning mothers as individuals and as subjects. This repositioning sheds new light in the study of relationality in the field of feminist maternal scholarship.

Feminist scholarship from Latin America has critiqued the implications of local mythologies and motherhood discourses for Latina women. A feminist analysis of the La Malinche/Virgin of Guadalupe dichotomy reveals that the Virgin (symbolizing passivity, tenderness, and self-sacrifice) is central to the construction of femininity in Latin American cultures because she embodies virtues convenient for the patriarchal order. La Malinche—the sexualized, headstrong woman who freely chose her destiny—is dangerous to the patriarchal order and is presented as hateful. Women thus feel compelled to emulate the Virgin, a less threatening figure. In effect, the Virgin

image serves to suppress the threatening or deviant femininity embodied La Malinche—regarded as the Mexican Eve. The Virgin becomes the embodiment of Mexican motherhood, while La Malinche's depraved sexuality becomes a reason to justify the oppression of women.

Motherhood and race. Feminism and the self-reflexive questionings within the women's movement in North America also drew attention to the fact that notions of motherhood are racially specific and conditioned by prevailing social hierarchies. For instance, in North America from the Reconstruction through the Progressive Era, African-American and white women were encouraged to view motherhood as a national racial imperative. The mother-nation symbolism was anchored in a patriotic discourse. Literary representations depict a conflated mother-nation as a protector who also needs protection by her children/citizens, who must ensure the mother-nation's perpetuation by reproducing her progeny. Novels of sexual awakening by Kate Chopin (1851–1904) and Edith Wharton (1862–1937) depict motherhood as personally limiting but racially necessary. Women writers and activists responded to this imperative by using diverse strategies that reflected the broader public debates about race, reproduction, and female agency.

In the American context, it has also been argued that early-twentieth-century depictions of motherhood for African-American women sought to depict mothers as active agents rather than passive instruments of reproduction. However, the narratives also revealed that women's agency as mothers comes at a price and was continually constrained by fixed gender roles and social expectations. The brutalizing effects of slavery marred the joys of black motherhood, as did complications of biracial identity (Berg). Such fictional and nonliterary texts also reflected the early twentieth-century debates over birth control, feminism, and eugenics in the United States, using motherhood and race as key tropes for discussions of social progress and decline. These texts also established that even notions of universal motherhood that fostered cross-racial conversations reinforced social and racial hierarchies.

Feminist critiques from South Africa point out how nationalist and patriarchal causes have appropriated the African-woman-as-mother. This figure has been used to extol the ostensibly unique qualities of nurturance, protectiveness, and altruism of African women, qualities that are often believed to make them morally and culturally superior to Western women. Celebrated in much of the nationalist poetry and prose during the 1950s and 1960s, the African mother recurs in a range of present-day discourses in public and domestic life.

From another context, ethnographic research from Asia and the Pacific shows that maternal experiences vary greatly depending upon historical time and local discourses. For instance, motherhood as embodied experience for women in colonized societies was shaped by colonial policies, missionary influence, and conflicts between Western medicine and biomedical birthing methods. All these shaped the experience of modern mothering in many colonial societies (Ram).

Feminist theorists and writers challenge valorizations of motherhood fostered by conservative patriarchies. However, it

is important to emphasize that feminists do not reject maternity or devalue the woman-centered experience of birthing and mothering. Their project is to interrogate the myths and assumptions that impose oppressive role expectations and erase the reality of maternal experience. Feminist voices seek to liberate motherhood from the institution and the myth that confine it to the narrow playing field of the conventional family, leaving no space for women to choose alternative identities.

Motherhood and Development Discourses

Some of the public debates, campaigning, and policy-making that surround women's relationships to their bodies at the turn of the twenty-first century make evident the extent to which affirmations of motherhood constrain discursive frameworks of justice for women. The American feminist Patricia McFadden identifies this in relation to dominant trends within research, public debate, and policy-making around HIV/AIDS, while Jessica Horn discusses how the patriarchal emphasis on reproductive health anchors perceptions of women's sexual health firmly in stereotypical gender roles and identities (Narayan).

Along another axis, projects like the Population Council's "Save the Mothers Initiative" places attention on motherhood in development discourses. The Safe Motherhood Conference (Nairobi, 1987) of the International Federation of Gynecology and Obstetrics (FIGO) noted with alarm that almost half a million women die each year because of complications related to pregnancy and childbirth. FIGO sought global support, stressing that because 99 percent of maternal deaths occur in the developing countries and among women in the most deprived sections of the population, it was a socially unjustifiable phenomenon.

At the beginning of the twenty-first century, United Nations agencies and the World Bank supported several country projects in Asia, Africa, and Latin America to evolve cost-effective and sustainable ways to reduce maternal mortality and morbidity. Institutions like the London School of Hygiene and Tropical Medicine have maternal programs for conducting research and disseminating information on policy issues related to maternal and child health.

Critics of such population policies, however, argue that mass distribution of hormonal medicines used for population control in developing countries has serious implications for the health of millions of women who are unaware of the long-term impact of these drugs. Feminists also point out that notions of "reproduction" and "reproductive rights" have many possible interpretations, with varying degrees of social impact on gender and family. In the 1960s, the core issues around reproductive rights involved the access to family planning and to information on birth control; in the abortion debates, the right to privacy seems to encompass the right to decide whether to conceive and to carry a fetus to term. Since the 1990s and the struggle against AIDS, reproductive health has won new relevance.

Contentious Debates

In the light of the revolutionary changes that have come about since 1978—when the first test-tube baby, Louise Brown, was born—it is important to touch upon abortion, surrogacy, and

new reproductive technologies (NRTs). Such contemporary issues relating to motherhood have provoked controversies that reflect diverse social and cultural perceptions of motherhood.

Abortion. The conscious decision to medically terminate pregnancy is controversial in religious and political terms in many countries, regardless of levels of modernity. Pro-life groups in the United States and Europe staunchly campaign for the closure of abortion clinics, while for women in contemporary China or India abortion is easy and inexpensive, given the population control policies in these two countries.

Buddhism, Hinduism, Christianity, perhaps all religious and secular philosophies, focus on two central questions relating to abortion: (1) When does the embryo/fetus acquire the property that makes the termination of pregnancy “killing”? and (2) Is abortion, before or after this point, ever justifiable? Orthodox strains in Christianity, Buddhism, and classical Hindu embryology (which maintain that the transmigration of consciousness occurs at conception) believe that all abortion is sin and incurs the karmic burden of killing (in Buddhist and Hindu terms). Before modern embryology, however, in both Buddhist countries and the West, ideas about conception were scientifically inaccurate. Although the findings of modern neuro-embryology provided scientific support for subsequent arguments developed by most Western ethicists to defend abortion, such legacies continue to impede pro-choice campaigns in asserting that any society that values liberty should not control a woman’s reproductive rights by law (Luker).

Whether abortion is ever “justified” relates to whether religious ethics about motherhood are absolutist, utilitarian, or “virtuist” (i.e., seeing the good in the development of personal qualities). The absolutist would regard abortion akin to murder, whatever the justification. The utilitarian would justify it on compassionate grounds (based on the mother’s health or the population crisis or parental inability to raise a child).

Traditional Jewish law (*halakah*) takes a positive stand on procreation and is comparatively lenient regarding the NRTs. In densely populated countries like China, India, or Bangladesh, state-sponsored family planning policies have enhanced the social acceptability of abortion. Japanese society combines both utilitarian and virtue approaches. Widely accepted as a “sorrowful necessity,” abortion is openly ritualized in Buddhist temples selling rituals and statues intended to represent parents’ apologies to the aborted. Some Buddhists have adopted a moderate position: abortion is akin to killing, but women should have that choice. Since most Buddhists support laws that discourage or punish murder, implicitly this position seems to suggest that abortion is either justifiable (when it conflicts with bodily autonomy) or that fetuses are closer in status to animals.

Such reproductive accommodations, while they reduce the impact of oppressive regimes on women’s reproductive autonomy, do not necessarily emerge from debates that incorporate women’s voices. Feminists also point out that pro-life activists (women and men) are not necessarily opposed to capital punishment or killings in war, implying thereby that anti-abortion

positions are motivated by considerations of power and control over women rather than morality. Thus, feminist activists the world over stress that abortion should be viewed as an issue of autonomy, constitutionality, and economic status, rather than simply of ethics.

Surrogate motherhood. Like abortion, surrogate motherhood—which allows for a woman to carry and bear a child for childless couples, mostly as a commercial transaction—is a highly problematic issue. In pitting claims of mothering-as-biological birthing against those of mothering-as-nurturing, it poses ethical, legal, and, some would argue, moral issues. Although new reproductive technologies that enable childless women to raise genetically related offspring increase women’s motherhood options, they are pitted against religious beliefs and conservative ethical systems. By creating alternative forms of parenthood and supplanting sexual intercourse as a means of reproduction, this branch of biomedicine has also unwittingly created challenges to kinship and family law. Ethicists generally view surrogate mothering arrangements in terms of stark moral choices: between the tragedy of infertility on the one hand, and the potential for exploitation of the host mother on the other. Among the many compelling objections, the likely economic exploitation of poor, working-class women by affluent childless couples remains a key concern. There are also concerns that widespread surrogacy would lead to a commodification of infants, while reducing motherhood to paid labor and the woman’s body to an incubator that can be hired through a contract.

New reproductive technologies. Feminist theorists of different persuasions have been critical of the effects of NRTs as “potentially insidious forms of social control” over women’s bodies. Radical feminists believe that by using NRTs, and participating in these technological processes that invade the autonomy of their bodies, women unwittingly aid patriarchy in gaining more control over their bodies. Feminist theorists Jana Sawicki and Donna Haraway, however, advocate a more complex reading of these technologies. For Sawicki, radical feminists ignore the resistance already emerging within this area. Haraway suggests that rather than view this simplistically, one should complicate our theories of experience. Haraway calls for a shift away from dualistic, oppositional thinking that posits technology as solely destructive and fragmentary. In short, Haraway proposes that while it is true that technology can and has been used as a negative force against women, to write it off as unredeemably patriarchal limits feminist thinking when more nuanced perspectives are needed.

Contemporary Redefinitions: Single and Lesbian Mothers

It is evident that notions of motherhood are culturally varied and shift over time. In Japan and in South Asian societies, for instance, where traditional abortion is readily available and relatively free of social stigma, single motherhood is highly stigmatized. In fact, given rising divorce rates in Japan, the institution of single motherhood has become a particularly salient issue for contemporary Japanese feminism. Single motherhood in Japan almost inevitably involves financial and physical hardship, perhaps more consistently than in the West,

given that there is little provision for child support and that even a divorced father usually does not continue to pay child support to the mother when she has custody of the children. Only 10 to 20 percent of divorced Japanese mothers receive regular child support payments. In addition, given the mythologies surrounding the mother's role in childrearing, there tends to be social stigmatization of working mothers in Japanese society, which has historically restricted and problematized conditions of access to daycare and other facilities. Thus, in the Japanese context, there are issues of institutionalized discrimination against single mothers that are intertwined with social perceptions of what constitutes a family.

Other redefinitions of mothering and motherhood have emerged with the turn of the twenty-first century. These new definitions interrogate gender stereotypes and question social constructs of "family." Nontraditional models of mothering by lesbian mothers in North America and Europe have further destabilized received notions of motherhood. Research scholars such as Ellen Lewin have analyzed models of the lesbian mother and lesbian and gay commitment ceremonies in the United States.

Definitions of motherhood and assumptions about its intersection with womanhood have been central to feminist theory in anthropology. Often these ideas draw directly on notions of nature and culture, conflating particular components of motherhood with virtue and authenticity. Insofar as some theorists have presented motherhood as a set of practices, it might be argued that men who undertake basic childrearing and caretaking activities are in some ways "mothers" rather than "fathers." What are the implications of these social realities for enacting cultural notions of motherhood and fatherhood? If men can be mothers, then can the conventional, biologically drawn boundaries of the basic gender categories—female and male—be defended? These questions remain complex and unresolved.

Motherhood in Academia and National Policy

Although millions of women in the world become mothers, motherhood generally is not regarded in academia as a core issue relating to society and the nation-state. Some universities, such as York University in Ontario, Canada, are beginning to study motherhood as an academic discipline, yet much of the research looks at the psychological and sociological aspects. Feminists argue that if motherhood is viewed as a historical experience, it will be evident that it is shaped not just by personal experiences and desires but also by public policy in which the nation-state plays a significant role.

From the discussion above, which draws upon the heritage, traditions, literature, and art from various cultures, it may not be far-fetched to suggest that the failure of institutionalized religions to give women a visible and valid role has traditionally led many women to seek dignity and self-respect, salvation and status, in society through birthing and motherhood, a role and path unique to them. In the new millennium, however, the emerging reality, especially in the industrialized countries, is of a falling birth rate. As millions of women join the global workforce, as more and more women gain control over their lives and bodies, and as motherhood becomes one of many acceptable identities and choices, it would seem that fewer

women become mothers (and those that do raise fewer children). The birth rate in Japan has been falling steadily since the 1970s. On average, the first postwar generation had four children, and the second, two. Trends in Europe are also alarming. Such statistical projections are causing concern to government planners and national policy-makers in many countries. If women increasingly begin to feel that the challenges outweigh the "joys of motherhood," demographers may well predict for the rapidly industrializing world a future of restructured family norms, labor shortages, fewer taxpayers to support a rapidly aging society, and fewer caregivers for the elderly.

See also *Childhood and Child Rearing; Gender; Men and Masculinity; Women and Femininity in U.S. Popular Culture.*

BIBLIOGRAPHY

- Badinter, Elisabeth. *The Myth of Motherhood*. Translated by Roger Degaris. London: Souvenir Press, 1981.
- Baruch, Elaine Hoffmann, Amadeo F. D'Adamo, Jr., and Joni Seager, eds. *Embryos, Ethics, and Women's Rights: Exploring the New Reproductive Technologies*. New York: Haworth Press, 1988.
- Beauvoir, Simone de. *The Second Sex*. Translated by H. M. Parshley. New York: Knopf, 1952.
- Berg, Allison. *Mothering the Race: Women's Narratives of Reproduction, 1890–1930*. Urbana: University of Illinois Press, 2002.
- Copeland, Rebecca. "Motherhood as Institution." *Japan Quarterly* 39, no. 1 (1992): 101–110.
- Chodorow, Nancy. *The Reproduction of Mothering: Psychoanalysis and the Sociology of Gender*. Berkeley: University of California Press, 1978.
- Doer, Edd, and James Prescott, eds. *Abortion Rights and Fetal Personhood*. Long Beach, Calif.: Centerline Press, 1989.
- Hirsch, Marianne. *The Mother-Daughter Plot: Narrative, Psychoanalysis, Feminism*. Bloomington: Indiana University Press, 1989.
- Lewin, Ellen. *Lesbian Mothers: Accounts of Gender in American Culture*. Ithaca, N.Y.: Cornell University Press, 1993.
- Luker, Kristin. *Abortion and the Politics of Motherhood*. Berkeley: University of California Press, 1984.
- McMahon, Martha. *Engendering Motherhood: Identity and Self-Transformation in Women's Lives*. New York: Guilford Press, 1995.
- Narayan, Uma. *Dislocating Cultures: Identities, Traditions, and Third-World Feminism*. New York: Routledge, 1997.
- Oyewumi, Oyeronke, ed. *African Women and Feminism: Reflecting on the Politics of Sisterhood*. Trenton, N.J.: Africa World Press, 2003.
- Parker, Rozsika. *Mother Love/Mother Hate: The Power of Maternal Ambivalence*. New York: Basic Books, 1995.
- Ram, Kalpana, and Margaret Jolly, eds. *Maternities and Modernities: Colonial and Postcolonial Experiences in Asia and the Pacific*. Cambridge, U.K.: Cambridge University Press, 1998.
- Rich, Adrienne. *Of Woman Born: Motherhood as Experience and Institution*. New York: Norton, 1976.
- Sanger, Margaret. *Woman and the New Race*. New York: Brentano's, 1920.
- Sawicki, Jana. *Disciplining Foucault: Feminism, Power, and the Body*. New York: Routledge, 1991.

Smart, Carol, ed. *Regulating Womanhood: Historical Essays on Marriage, Motherhood, and Sexuality*. London: Routledge, 1992.
 Trebilcot, Joyce, ed. *Mothering: Essays in Feminist Theory*. Totowa, N.J.: Rowman and Allanheld, 1984.

Maina Chawla Singh

MOTIF.

This entry includes two subentries:

Motif in Literature

Motif in Music

MOTIF IN LITERATURE

George Steiner has described culture as a matrix of recurrent and interrelated elements, a motor fueled by revolving constants. Broadly speaking, cultural literacy relies on our ability to recognize these constants—in literature, music, painting, or any other form of cultural production—and to work out relationships between them, to translate and recycle the meaning we inherit from them. Thus, the single word *Roncevaux*, voiced offhandedly by one man to another in Ernest Hemingway's *The Sun Also Rises*, can echo for the reader with large themes of betrayal, ambush, rivalry, and national loss—but only if the word is recognized as an allusion to the death trap set treacherously for Charlemagne's twelve peers in the early-twelfth-century *Chanson de Roland*. The tone of Steiner's short reflection on cultural literacy is dire, his main point being that "elementary" allusions and "implicit motifs"—such as *Roncevaux*—go unrecognized even by today's most "privileged students and readers." A small literary element like *Roncevaux*, reused over time in various languages and genres, provides a useful example of a cultural "constant," and recognizing the rich depth afforded by such recycled bits of meaning is in fact a method of comparative literary analysis. *Motif* is one word that can be used to delimit and distinguish an element like *Roncevaux*. But our options are many, and terms prove in practice frequently interchangeable. Steiner writes generally of *topologies*, a term that lumps together and encompasses such overlapping concepts as *topos*, *archetype*, *motif*, and *genre*. Our focus here is on the motif and limits the cultural field to literature. And yet Steiner's more expansive notion of culture as a network of recurring, interrelated constants provides one of the more helpful and lucid introductions to the movement and persistence associated with literary motif, an otherwise ambiguous element in comparative analysis.

Ambiguity

Let us start with the ambiguity that has characterized *motif* since the term first appeared—used in reference to a musical rather than a literary work—in Denis Diderot's *Encyclopédie* of 1765. Even now, defining exactly what constitutes a single motif or a motif sequence in literature continues to be a thorny task for students and scholars alike, in large part because published definitions as well as general use in literary criticism offer very little agreement as to its nature (excepting a general agreement that there is no common agreement). Dictionaries,

encyclopedias, and handbooks have defined *motif* variously as myth, theme, subject, central recurring idea, image, characteristic, symbol, archetype, leitmotiv, or outstanding trait. Adding to the confusion, *theme* and *motif*—potentially incompatible terms to Horst Daemrich—tend to be used interchangeably, strings of motifs often made synonymous with legend and myth. The recurring narrative constant of the insatiable artist, for instance, analyzed as integral to and mutually dependent on the literary tradition of Faust, has been described by Stuart Atkins, without clear distinction of terms, as "motif," "theme," and "myth." General character types (holy hermit, evil dwarf, seer-hag, calumniated wife, warrior king, "flower" or "candle" of knighthood), objects (hero's sword, poet's pen, lover's ring, the Holy Grail), settings (paradise, hell, deserted wasteland, the otherworld, the city), situations (spilled wine, physical blow, quest, game or test, war, marriage), psychological states (madness, hysteria, paranoia), and general attributes (red hair, black eyes, hairy mole, hunchback) can all be traced over time and across genre and discussed as recurring literary motifs. Such lists are potentially endless and not necessarily new (see the Medieval Welsh Triads as well as Stith Thompson's motif-index and Daemrich's handbook). We might even speak of instructional, didactic, or homiletic motifs, as has David F. Johnson; in a study that seeks ultimately to identify the origin of a narrative tradition, Johnson has culled medieval British manuscripts for references to the rewards and punishments of the afterlife, concluding that both the Seven Joys of Heaven motif and its reverse, the Five Horrors of Hell, are Irish (rather than English) homilies. Theorists and scholars have used *motif* to identify narrative elements such as detail, metaphor, image, symbol, idea, and subject matter. The term need not refer exclusively to content elements but can apply to formal elements as well, and motif sequences have been identified as structuring devices, integral to a text's configuration. Helen Vendler's study of "key words" in Shakespeare's sonnets, for instance, demonstrates how motifs provide structural coherence by "firmly connecting" the four units of a sonnet (three quatrains and a couplet); in Vendler's analysis, motifs prove equally essential to the form of a sonnet as to its meaning. (The semiotician A. J. Greimas, as well as two of the most significant modern indexers of literary motifs, Stith Thompson and Elisabeth Frenzel, restrict motifs to content units; Wolpers, Daemrich, and others extend the term's scope into form and structure.) A literary motif, in other words, can be—and has been—defined with great fluidity: as an element of both narrative content and structural form, as a general literary theme, or as a question of the discrete units that make up that theme.

Size

And yet, however frequently equated with larger terms, motifs are invariably "small," autonomous units of meaning. With Werner Sollors, we might consider *theme* to be a text's "aboutness" and motifs the discrete elements that make up its "treatment." Motifs are the "basic components" of literary texts, "small substantial content units," or the "details out of which full-fledged narratives are composed." *Theme* is a structured group of motifs, and "wider thematic potential" is the result of recurring motifs. Thus, the two broken, failed

STITH THOMPSON'S *MOTIF-INDEX OF FOLK-LITERATURE*

The “alphabetical” organization of Thompson’s six-volume motif-index may at first seem counterintuitive. Thompson arranges material into twenty-three index categories—A to Z (excluding I, O, and Y)—but the category headings themselves are not arranged alphabetically. There is no correspondence, in other words, between a category’s letter and its topic—category A collects Mythological Motifs; category B, Animal Motifs; category C, Motifs of Tabu; D, Magic; E, the Dead; F, Marvels; G, Ogres; H, Tests; J, the Wise and the Foolish; K, Deceptions; L, Reversals of Fortune; M, Ordaining the Future; N, Chance and Fate; P, Society; Q, Rewards and Punishments; R, Captives and Fugitives; S, Unnatural Cruelty; T, Sex; U, the Nature of Life; V, Religion; W, Traits of Character; X, Humor; and Z, Miscellaneous Groups of Motifs. Each index category is subdivided, some much more so than others. For a detailed list of the categories and their divisions, see the beginning of volume one: “General Synopsis of the Index,” 29–35.

swords of *Beowulf* can be said to add essential, thematic force to the sense of loss that pervades the poem: Hrunting and Naegling are not in and of themselves what *Beowulf* is about, but as object motifs, in failing the hero in a time of need, they function as distinct elements in the poet’s elaboration of cyclical violence and social disintegration. Likewise, character and setting motifs reverberate throughout the poetry of Charles Baudelaire in ways that build an overall sense of anxiety about mechanized modernity: the idle dawdler (*flâneur*), for one, and the contrasting “traumatophile type”—a man propelled both by irrational fear and by sudden, nervous tics of the body—are both lost in the faceless, phantom masses of Baudelaire’s big-city crowd. While not interchangeable, then, (small) motif and (larger) theme are nonetheless “mutually dependent” aspects of all literature—both integral “constants” that contribute to the intertextual matrix of literary culture.

Etymology: Dynamism

The fluidity of the term *motif*, and its conflation with other concepts, help emphasize the movement, mutability, and persistence that return us both to Steiner’s cultural “motor” and to the root of the word itself. Derived from the Latin verb *movere*, “to move,” and the Medieval Latin noun *motivum*, “cause” or “incitement,” *motif* implies movement, stimulus, and dynamism; a recurring pattern or rhythm of motifs in effect propels narrative action. Motifs move in different ways: they are “mobile sequences” that conduct narrative action within individual texts, and they are also “translingual,” “intertextual migrations” that move between texts and genres through time. Motifs moreover persist—constantly migrating and recycling, but surviving. Thus, George Steiner traces the combined motifs of poet’s death, springtime, and resurrection from Horace, via the early modern poets William Dunbar, Thomas Carew, and John Milton, to Percy Bysshe Shelley and W. H. Auden—

tracking how diverse writers inherited and adapted meaning from classical antiquity into the twentieth century.

King Motifs in the Medieval Arthurian Tradition

Kingship, along with issues of power—who wields it, and how—can be said to obsess literature in general and medieval literature in particular. Take the weak king of Arthurian tradition—discussed by Edward Peters as an example of *rex inutilis* (the useless king) and frequently defined as exemplary of the *roi fainéant* (idle king) of medieval romance. Together with his Knights of the Round Table, he is already lost in decline, sliding toward the betrayal and civil war that will annihilate the Arthurian world. The Arthur of late medieval literature is himself largely absent from narrative action and almost always silent—his court a place of contention; his knights cowardly and his champions far away; his queen physically threatened, kidnapped, and ultimately unfaithful; his servants and realm vulnerable to violence and attack (as, for instance, in the works of Chrétien de Troyes [fl. c. 1170]). Exemplifying the character motif of weak, ineffectual king, this Arthur has persisted in literature, a king who is familiar today through Alfred, Lord Tennyson (*Idylls of the King*), T. H. White (*The Once and Future King*), and John Steinbeck (*The Acts of King Arthur and his Noble Knights*), or via the cinematic creations of Robert Bresson (*Lancelot du Lac*, 1974), John Boorman (*Excalibur*, 1981), or Jerry Zucker (*First Knight*, 1995).

And yet, far from first appearing on the literary scene as weak, Arthur is initially an impressive heir to the warrior kings of early medieval epic. The earliest and most complete literary version of King Arthur, that of Geoffrey of Monmouth, proves to be almost indistinguishable from the likes of *Beowulf*’s Shield Sheafson, a king whose name defines his role as defensive armament to his people, and whose violent leadership is praised in such terms as (in Seamus Heaney’s trans-

lation) “scourge of many tribes,” “wrecker of mean-benches,” and “terror of the hall-troops.” As encapsulated by the *Beowulf* poet, Shield Sheafson “was one good king.” Arthur, too, conquers, and with similar abandon: in the early years of his reign, the fifteen-year-old king defeats all of Britain—exterminating (in Lewis Thorpe’s translation) “without mercy” and with “unparalleled severity” the Saxons, Scots, Picts, and Irish—before expanding his realm with the subjection of Iceland, Gotland, the Orkneys, Norway, Denmark, and Gaul. Moreover, this Arthur delights in close combat and general slaughter. “White hot in the fierceness of his rage,” he laughs as he singlehandedly slays the monster of Mont-Saint-Michel, “driving the whole length of the blade into his head just where his brain was protected by his skull.” Though not explicitly named his nation’s armament, as is Shield Sheafson, Geoffrey’s Arthur is nonetheless memorable both for his sword, Caliburn (the Excalibur of later tradition), and for his shield, on which “was painted a likeness of the Blessed Mary, Mother of God, which forced [Arthur] to be thinking perpetually of her.” When Arthur invokes the Virgin’s name as his battle cry, her apparent blessing enables “unheard of slaughter.” Thus, the savage violence of *Beowulf*’s kingship gains in Geoffrey’s *History* divine sanction and favor.

Interestingly, the sword and shield of Arthur—in Geoffrey’s *History* such forceful sources of the king’s warrior might—are parceled out to knights in later tradition: in Chrétien de Troyes’s *Story of the Grail*, Excalibur is wielded by Gawain rather than by Arthur, and by the end of the fourteenth century it is Gawain rather than Arthur who carries the Virgin Mary emblazoned on his shield. The literary Arthur and the objects that help define his kingship demonstrate how motifs can transform even while persisting; such character and object motifs contribute to and elaborate a changing thematic of kingship, one that moves from praise of the warrior king to general neglect, to a new emphasis on knights and their quests.

What is the point of tracking literary change in a character motif, or of conducting motif-based analysis in the first place? Motifs in and of themselves, after all, are not what literature is about; if we recall Sollors’s distinction made above, they are merely the small elements that treat what literature is about. What exactly gives motif-based analysis methodological force? Even our brief consideration of the figure of King Arthur, of his transformation from inimitable warrior king to weak and inactive ruler in need of knights, allows us to raise much larger thematic questions about the nature of royal power. We can begin, for instance, to chart a literary trend away from the king as heroic conqueror toward a focus on the exploits of champion knights—toward a kind of redistribution and redefinition of power that in fact coincides with actual, historical change. Such wider thematic potential is arguably what makes motif so integral to literary criticism—and so useful to readers, students, and scholars.

Conclusion

It is precisely the persistence through tradition of motif that made motif-based classification such a fundamental aspect of the structural criticism of the mid-twentieth century: dis-

crete, shared units of literature were collected, alphabetized, numbered, and indexed, and relationships between literary genres and periods catalogued by type. A cursory glance at Stith Thompson’s six-volume *Motif-Index of Folk-Literature*, in which Western literature is reduced to twenty-three motif categories organized alphabetically from A (“Mythological Motifs”) to Z (“Miscellaneous Groups of Motifs”), may strike any reader as a vestige of the classification impulse that marked literary methodology of the past. And yet a quick keyword search on WorldCat will yield nearly one hundred “motif-indexes” of literature, very many of them published in the 1990s. Current trends in literary criticism and analysis, even if no longer explicitly indebted to formalist or structuralist vocabulary—and even if the term *motif* is not used—continue to illuminate connections and relationships between texts in ways identifiable as motif-based. Consider Werner Sollors’s discussion of recent “thematic” studies as well as the great number of “treatment of” titles published annually in the bibliography of the Modern Language Association, or the ongoing series issued by the publisher Peter Lang, titled *Studies in Themes and Motifs in Literature*. Although it was in 1993 that Sollors called attention to “the return of thematic criticism,” motif-based analysis, inherently intertextual, interdisciplinary, and comparative, has arguably never gone out of style.

See also *Structuralism and Poststructuralism*.

BIBLIOGRAPHY

PRIMARY SOURCES

- Chrétien de Troyes. *The Complete Romances of Chrétien de Troyes*. Translated by David Staines. Bloomington and Indianapolis: Indiana University Press, 1990.
- Geoffrey of Monmouth. *The History of the Kings of Britain*. Translated by Lewis Thorpe. Harmondsworth, U.K.: Penguin, 1966.
- Heaney, Seamus. *Beowulf: A New Verse Translation*. New York: Farrar, Strauss and Giroux, 2000.
- Sir Gawain and the Green Knight*. Translated by Brian Stone. 2nd ed. Harmondsworth, U.K.: Penguin, 1974.
- Trioedd Ynys Prydein, the Welsh Triads*. Edited by Rachel Bromwich. 2nd ed. Cardiff: University of Wales Press, 1978.

SECONDARY SOURCES

- Atkins, Stuart. “Motif in Literature: The Faust Theme.” In *Dictionary of the History of Ideas: Studies of Selected Pivotal Ideas*, edited by Philip P. Wiener. New York: Scribners, 1973.
- Benjamin, Walter. “On Some Motifs in Baudelaire.” In *Illuminations: Essays and Reflections*, edited by Hannah Arendt. Translated by Harry Zohn. New York: Schocken, 1985.
- Daemmrich, Horst S., and Ingrid G. Daemmrich. *Themes and Motifs in Western Literature: A Handbook*. Tübingen: Francke, 1987.
- Frenzel, Elisabeth. *Motive der Weltliteratur*. 3rd ed. Stuttgart: Kröner, 1988.
- . *Stoffe der Weltliteratur*. 7th ed. Stuttgart: Kröner, 1988.
- Johnson, David F. “The Five Horrors of Hell: An Insular Homiletic Motif.” *English Studies* 5 (1993): 414–431.
- Peters, Edward. *The Shadow King: Rex Inutilis in Medieval Law and Literature, 751–1327*. New Haven, Conn., and London: Yale University Press, 1970.

Steiner, George. "Roncevaux." In *The Return of Thematic Criticism*, edited by Werner Sollors. Cambridge, Mass.: Harvard University Press, 1993.

Thompson, Stith. *Motif-Index of Folk-Literature: A Classification of Narrative Elements in Folktales, Ballads, Myths, Fables, Mediaeval Romances, Exempla, Fabliaux, Jest-Books, and Local Legends*. Rev. ed. 6 vols. Bloomington: Indiana University Press, 1955–1958.

Vendler, Helen. *The Art of Shakespeare's Sonnets*. Cambridge, Mass.: Harvard University Press, 1997.

Kristen Lee Over

MOTIF IN MUSIC

A motif is a small but recognizable musical unit. The motif might consist merely of a series of pitches or a distinctive rhythm, or it might be harmonically conceived; quite often, pitch and rhythm are combined in a motif to create a discrete melodic fragment. No matter what its constituent elements, the motif needs to be repeated before it can be recognized as a unit. The repetition may be nearly continuous, as in the case of an ostinato—a short motif constantly repeated throughout a section of a composition—or the recurrence may be reserved for significant points in the structure of a work. (A form thus linked is often described as cyclical.) A motif needs to have clear boundaries, which might be established by immediately repeating the motif (as in the "Hallelujah" chorus in George Frideric Handel's *Messiah*, 1741), by placing a rest or pause after the motif (as in the beginning of Ludwig van Beethoven's Fifth Symphony, 1807), or by following the motif with contrasting material before repeating it. Although motifs vary in length, they are customarily only a portion of a complete melody.

Many motifs recur in note-for-note repetition, but a motif may be recognized even when modified. The modifications may involve rhythmic alterations (such as augmentation and diminution) and various sorts of melodic changes (including altered intervals or additional ornamentation) as well as retrograde (reversed) presentations or inversions, in which ascending pitches are substituted for descending pitches or vice versa. Sequential treatment, in which the motif is repeated at successively higher or lower pitch levels, is very common during transitional passages within large-scale structures, especially while the tonal focus is changing rapidly.

There is little consistency in terminology when discussing motifs. Some prefer the Anglicized *motive*, which, like *motif*, is derived from the Latin *motus*, the past participle of *movere* (to move). Other analysts use words such as *figure*, *subject*, *clause*, *pattern*, and *segment*. Both Western and non-Western cultures have terms for specialized motifs, such as leitmotifs, mottoes, head motifs, and the like.

Early History of the Motif

It is apparent in the earliest surviving music that composers were aware of the cohesive power of the motif. For example, the medieval sequence *Dies irae* (Day of wrath), a chant later incorporated into the Catholic requiem mass, opens with a descending eight-note melodic motif that unifies the entire chant by reappearing repeatedly through the course of the eighteen

Dies irae



verses. The somber associations of its intervallic patterns, coupled with an ominous text concerning the biblical Judgment Day, have ensured the chant's opening motif a lasting place in music that strives to evoke the supernatural, ranging from Hector Berlioz's *Symphonie fantastique* (1830) to Stanley Kubrick's horror film *The Shining* (1980).

An early assessment of musical motifs appeared in Denis Diderot's monumental *Encyclopédie* in 1765. The *motivo* (as it is called there) is described as the principal thought or idea of an aria and thus constitutes "musical genius most particularly" (Grimm, p. 766a). Similar and expanded descriptions continued to appear on into the twentieth century. In 1906 the music theorist Heinrich Schenker argued that the "fundamental purpose" of a cyclical form is "to represent the destiny, the real personal fate, of a motif or of several motifs simultaneously" (p. 12). He added, "At one time, [the motif's] melodic character is tested; at another time, a harmonic peculiarity must prove its valor in unaccustomed surroundings; a third time, again, the motif is subjected to rhythmic change: in other words, the motif lives through its fate, like a personage in a drama" (p. 13).

Structural Uses of a Motif

Even among those uncomfortable with such anthropomorphic analysis, there is widespread recognition of the motif's role in creating unity within large or disparate pieces. Navajo traditions include an enormous body of Yeibichai songs, representing sacred ancestral spirits. Every one of the songs includes the call of the ancestors, a motif sung to the syllables "Hi ye, hi ye, ho-ho ho ho!" The Quechan tribe, in contrast, sings songs about natural history and lore, grouped into large cycles or series. In their Bird Series, all the songs are related by ending with the same "ha ha ha haaa" motif.

Melodic motifs. Melodic motifs have functioned structurally in many genres of music. The chief architectonic technique used by Renaissance composers of multivoice masses and motets was imitative counterpoint, in which subsequent voices repeated or echoed the opening motif presented by the initial singer. Similarly, in a Baroque fugue, the work begins with a subject that is reiterated in different registers, and the same motif reenters at later points in the work to start new series of imitative entrances.

Opera composers of the seventeenth and eighteenth centuries wrote arias with "motto openings," in which the first phrase of the song was performed by the singer, followed by a contrasting instrumental passage; the vocalist repeated the

same opening phrase but then continued on with the remainder of the aria. In contrast, a single motif may serve as an introductory flourish for an entire set of pieces, such as the multiple movements of some Renaissance masses written in cyclical form, by having each movement begin with the same “head motif” or “motto.”

Another common use of mottoes, especially in instrumental music, is the repetition of a clear-cut opening motif to signal important structural points within a movement. The slow, solemn fanfare that begins the first movement of Beethoven’s “Pathétique” Sonata, Op. 13, is followed by the fast main section—the exposition—but it returns twice to underscore the start of the movement’s development (tonally unstable) and coda (concluding) sections.

Harmonic motifs. Many cultures use certain harmonic motifs to provide a sense of completion or finality. In Western art music, these motifs are often described as cadence “formulas”; one of the most familiar of these is the Plagal (or “Amen”) cadence that concludes hymns and other church music. Because cadence formulas are so ubiquitous, composers frequently embellish and prolong them in elaborate ways.

Harmonic motifs also occur in many styles of jazz music. Jazz performers often take the sequence of harmonies (or chord changes) underpinning a tune and use those borrowed chords as the basis for new melodic improvisations. The chords of George Gershwin’s Broadway show tune “I Got Rhythm” (1930) are an especially popular source; numerous jazz hits have been based on these particular chord changes.

Rhythmic motifs. The organization of rhythm into recognizable groupings is a widespread motivic device. Many music analysts borrow from the vocabulary of poetic meter to describe short patterns of strong and weak pulses in music; thus a short note followed by a longer one would be called an iamb, while a longer note preceding a shorter note is a trochee. It has been traditional in Western literature and music to regard these different rhythms as possessing different emotional qualities.

Cultural customs lead to longer rhythmic patterns in varying contexts. Dances all over the world depend on set rhythmic motifs; a minuet has a different rhythmic pattern than a gavotte or a mazurka. In classical music of India, clap-patterns can be incorporated into a performance in accordance with one of the ancient rhythmic patterns, known as a tala. The complicated layering of much African drumming consists of the simultaneous presentation of diverse rhythmic motifs by various players, often repeated in ostinato fashion.

Representational motifs. In numerous cultures, a motif may carry symbolic meaning. Much of India’s classical music, for example, is based on rāgas. Each rāga combines aspects of a mode—a certain set of pitches—with particular melodic motifs. Rāgas carry extramusical associations, sometimes linked to emotions, divinities, and even particular seasons of the year or times of day. Similarly the leitmotifs (leading motives) that Richard Wagner used in the four music dramas of his opera cycle *Der Ring des Nibelungen* (The ring of the Nibelungs;

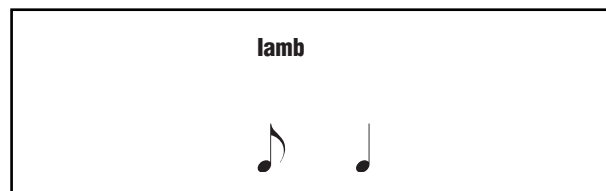

1848–1874) are linked with a person, an object, or even an idea, and were repeated at different points in the work to bring that association back to our minds. For instance, in *Die Walküre* (the second music drama in the cycle), when Wotan refers to a “hero to come,” the orchestra sounds the motif linked with Siegfried (even though at that point Siegfried has not yet been born).

Motifs can also portray more than just characters and objects in a story; at times, motifs have represented composers themselves. Since, in German musical nomenclature, the note B-flat is transcribed as a “B” and B-natural is transcribed as an “H,” Johann Sebastian Bach was able to use a motif based on the letters of his last name as a subject for a fugue. Many other composers have embedded motivic messages into their works through this type of cryptography.

Despite its often tiny size, the motif’s diversity makes it one of the most powerful tools at the disposal of composers and performers. It is one of the few musical characteristics that can be found in virtually all world cultures as well as throughout recorded history. Perhaps most important for listeners, a motif is a device by which music gains cohesion and, often, comprehensibility.

See also **Composition, Musical; Harmony; Motif; Motif in Literature.**

BIBLIOGRAPHY

- Allanbrook, Wye Jamison. *Rhythmic Gesture in Mozart: Le nozze di Figaro and Don Giovanni*. Chicago and London: University of Chicago Press, 1983.
- Grey, Thomas S. “. . . wie ein rother Faden: On the Origins of r’leitmotif as Critical Construct and Musical Practice.” In *Musical Theory in the Age of Romanticism*, edited by Ian Bent. Cambridge, U.K., and New York: Cambridge University Press, 1996.
- Grimm, M. “Motif.” In *Encyclopédie ou Dictionnaire raisonné des sciences, des arts et des métiers*, edited by Denis Diderot and Jean Le Rond d’Alembert. Vol. 10. Neuchâtel, Switzerland: S. Faulche, 1765.
- Houle, George. *Meter in Music, 1600–1800: Performance, Perception, and Notation*. Bloomington and Indianapolis: Indiana University Press, 1987.
- Koch, Heinrich Christoph. *Introductory Essay on Composition: The Mechanical Rules of Melody (Sections 3 and 4)*. Leipzig, Germany, 1787. Translated, with an introduction, by Nancy Kovaleff Baker. New Haven, Conn., and London: Yale University Press, 1983.
- Schenker, Heinrich. *Harmony*. Edited and annotated by Oswald Jonas, translated by Elisabeth Mann Borgese. Chicago and London: University of Chicago Press, 1954.

Yeston, Maury. *The Stratification of Musical Rhythm*. New Haven, Conn., and London: Yale University Press, 1976.

Alyson McLamore

MULTICULTURALISM, AFRICA. Multiculturalism means different things to different people. For some it is directly linked to the politics of recognition and of difference (Taylor). In this regard, it concerns an appreciation of the necessity to deal with diversity in ways that affirm the value of different cultures and to respect the various claims made by minority groups. For others, multiculturalism concerns an explicit policy of protecting particularistic local cultures in the face of hegemonic and global cultures (both Australia and Canada have such self-conscious policies) or it can refer to a loose form of cultural pluralism (Kuper). Since multiculturalism is not a homogeneous concept or practice, it is important to differentiate between multiculturalism as a practical response to diversity and as an aspect of social philosophy advocating particular values with respect to cultural differences. There is no unifying theory of multiculturalism, and its respect for difference finds expression in a variety of political, social, and cultural approaches to problems of diversity.

The concept of multiculturalism does not enjoy widespread currency in African social thought. It is certainly not a topic of debate in early-twenty-first-century intellectual discourse on the continent. There are many reasons for this neglect, but it is undoubtedly connected to the fact that African societies are intrinsically multiethnic and multicultural. Diversity is not a new thing in Africa. Multiculturalism is premised on challenges to hegemonic cultures occasioned by the large-scale migrations of people who may experience alienation, marginalization, and exclusion in the host country. Sweden, for example, was remarkably homogeneous in a cultural sense prior to the influx of migrant laborers in the 1960s. African countries, in contrast, have entirely different histories. By and large, African states were formed by colonialism, usually to serve the interests of the colonists and, therefore, with little attention paid to the precolonial ethnic allegiances and other forms of belonging. These different histories play a critical role in the extent to which the concept of multiculturalism may be relevant in the African context.

Multicultural Problems in Africa

While the concept of multiculturalism has not enjoyed a great deal of scholarly attention in Africa, there are several practices that may fall neatly under its rubric. First, in the process of nation-building following independence, there was a concerted attempt to de-ethnicize the population and to construct a unitary conception of the nation. Second, multiculturalism is used in dealing with minorities, especially indigenous minorities in Africa. Third, it may be relevant in the various efforts at coping with and managing diversity in the workplace. Finally, multiculturalism plays a major role in education.

Even though ethnicity had a profound influence in African politics, the official rhetoric was dedicated to nation-building. Due to the generalized economic and political failures of the postcolonial state in Africa, these efforts have been thoroughly discredited. In the aftermath of massive resource limitations, the way has been opened up for a more explicit assertion of ethnic differences as a basis for economic and political claims. Since these perceived differences may form the basis of violent, sometimes genocidal, clashes between people, the topic of ethnic conflict has received considerable research attention from social scientists. The main area of debate is how to make citizens of everyone under conditions of such diversity and with so many subnational forms of belonging. This relates directly to the necessity of building legitimate polities in Africa in which all people have a sense of inclusion and national loyalties do not contradict cultural pluralism.

Dealing with minorities has become a major preoccupation of the Commission on Human Rights of the United Nations (CHR), which was established by the UN Economic and Social Council soon after the United Nations was formed in 1946. After years of dormancy and lack of effective functioning, in response to demands from below the CHR started to mobilize. A series of workshops, "Multiculturalism in Africa: Peaceful and Constructive Group Accommodation in Situations Involving Minorities and Indigenous Peoples," has been held across Africa over the last three years in Tanzania, Mali, and Botswana. These have served as starting points to provide both a voice for the articulation of people's concerns and a platform for cooperation among them on the basis of their common experiences of exclusion, marginalization, and displacement. It is of concern that, while the last meeting of this group was held in Botswana, the Basarwa/San were being forcibly removed from their ancestral land in the Kalahari.

Managing workplace diversity was at the center of the oppressive methods developed in the mining compounds in South Africa. Since many migrants came from all over southern Africa to work in the mines, the companies devised brutal divide-and-rule methods in an attempt to forestall the development of a common working-class consciousness by insisting on separate ethnic allegiances. In many ways, the apartheid experiment was an example of imposed cultural packaging of people and, in a perverse sense, it could fall under the rubric of multiculturalism in its imposition of cultural difference. The overwhelming emphasis in early-twenty-first-century South Africa, as in most postcolonial African states, is undoubtedly on de-ethnicizing the population in favor of a unitary national concept. However, parallel to this emphasis runs the idea of the promotion, and even celebration, of a rainbow nation, encapsulated constitutionally in the establishment of the Commission for the Protection and Promotion of the Rights of Cultural, Linguistic, and Religious Communities. Whether this represents a retreat into relativism and whether it will have a major impact on South African politics remain to be seen.

Multiculturalism has a profound influence on education in Africa. There are as many different positions on the virtues and vices of multicultural education as there are on multicult-

turalism itself. There is an abiding ambiguity here. Multiculturalism is supposed to promote diversity and contradictory perspectives, yet the goals attendant to these different positions differ sharply from those who are merely concerned with promoting tolerance to those who actively seek social change in the name of equal opportunities for all to learn. The question of language is, of course, of vital importance since it is established beyond all doubt that children perform much better when they are taught in their native language. Whether some people should be accorded special treatment in education because of historical disadvantage and whether, indeed, they should be given special curricula to cope with educational demands remain unresolved issues.

The cultural diversity of Africa has long been recognized. Audrey Richards, for example, provided a detailed account of the linguistic, religious, and cultural differentiation of communities in East Africa in a book presciently entitled *The Multicultural States of East Africa*. One of the contested concepts in multiculturalism is assimilation. An example from Ethiopia provides a unique insight into this policy. Bahru Zewde considers the situation of the Oromo in East Africa in the following manner: “[T]he Ethiopian emperor has three options with regard to the Oromo: enslavement and expropriation, assimilation, and indirect rule.” While the first and the last mentioned are rejected for various reasons, “assimilation therefore remains the only credible and sensible option.” In short, the Oromo should become Amhara since, “two peoples who are allowed to evolve separately will end up forming two different, and perhaps antagonistic, nations” (pp. 132–133). Assimilation thus implies the eradication of difference in favor of the dominant culture. It is essentially a homogenizing project that imposes itself on others on the basis of assumed cultural superiority. It is precisely this kind of cultural chauvinism that multiculturalism seeks to oppose, usually for the sake of the oppressed.

Multiculturalism and Culture

Any discussion of multiculturalism must include a definition of *culture* since multiculturalism literally refers to a plurality or a multiplicity of cultures. In this regard, *culture* refers to the collective material and nonmaterial accomplishments of particular groups, their ways of doing things, and the manner in which these patterns of behavior are transmitted from one generation to the next. A basic truism about culture is that it is never static. In this respect, multiculturalism has to accommodate changes if it is to remain relevant. This is very difficult though because multiculturalism tends to reify culture and freeze people into cultural particularisms on the assumption that certain people need to be treated differently because of their separate cultures. This is problematic because *culture* is then defined as an immutable entity based on primordial origins, and becomes a biological given rather than learned forms of behavior and creativity. Exemplifying this conflation of race and culture, Paul Kelly insists that the movement of “white European immigrants . . . and . . . the movement of non-white [sic] populations” (p. 2) lie at the heart of the reality of pluralism. Put bluntly, it is extremely difficult to emphasize cultural difference without also essentializing culture and ethnic identities, sometimes even understood in racial terms. Once group identities are politicized it

is virtually impossible to avoid packaging people in different categories and ensuring that they remain in their designated spaces. K. Anthony Appiah and Amy Gutman distinguish between cultures and identities but lament that “ethnic identities characteristically have cultural distinctions as one of their primary marks” and “in the United States, not only ethnic but also racial boundaries are culturally marked” (p. 89).

There are many other philosophical and political criticisms of multiculturalism, both as a concept and as a practice. In the first instance, the tendency to categorize people in this manner may lead to greater stereotyping, particularly if special treatment (for example, affirmative action in employment appointments) is expected. While multiculturalism pays a great deal of attention to recognition, it does not accord the problems of redistribution equal weight. In this sense, it does not deal adequately with the ways in which class intersects with other forms of differentiation. Since differences in people almost always imply differences in power and wealth, there is a great challenge for multiculturalism to recognize these inequalities in ways that do not entrench or solidify them, but simultaneously to appreciate that these inequalities are real in their consequences for many people. In this regard, there is a powerful argument that multiculturalists have retreated from economic struggles in favor of cultural struggles for recognition (Fraser).

Probably the greatest challenge for multiculturalism is how it can encourage cultural difference without promoting cultural chauvinism and its counterpart, xenophobia. Its insistence on cultural difference and separation makes the quest for equality elusive because of the reality of cultural hierarchies. The celebration of difference that it advocates rests awkwardly next to the reality of persecution, exclusion, and stereotyping. Thus, when people are recognized, it is their individual identities that should be recognized and not some preconceived caricature of who they should be or how they should behave because of their membership in a particular group. According to Brian Barry, for example, multiculturalism tends to conflate descriptions about the reality of cultural diversity with prescriptions of commitment to the program of normative multiculturalism (p. 22). Finally, there is the problem of how individual human rights can be protected in the context of such a pervasive emphasis on group rights, which raises the fundamental questions of identity and of choice. If cultural difference is so rigorously imposed, then it leaves little room for individual choice. Thus, one of the major issues around the concept of multiculturalism is how it meshes with individual rights because it so clearly emphasizes the recognition and rights of a collectivity. If identity is socially derived from particularistic cultural experiences, then it amounts to an ascribed status that allows for growth and development within the limited purview of the community.

Insofar as *multiculturalism* refers to the value of cultural tolerance and to the celebration of diversity, it has made a positive contribution in broadening narrow horizons and exposing people to the wide range of cultural heritages. However, multiculturalism in the sense of politicized group identities is problematic from the point of view of individual human rights in democracies because treating groups equally is much more difficult than treating individuals equally.

See also *Africa, Idea of; Assimilation; Black Consciousness; Communitarianism in African Thought; Ethnicity and Race: Africa; Identity, Multiple; Internal Colonialism; Migration: Africa; Nationalism: Africa; Pan-Africanism; Postcolonial Studies; Prejudice.*

BIBLIOGRAPHY

- Alexander, Neville. *An Ordinary Country: Issues in the Transition from Apartheid to Democracy in South Africa*. Pietermaritzburg, South Africa: Natal University Press, 2002.
- Appiah, K. Anthony, and Amy Gutmann. *Color Conscious: The Political Morality of Race*. Princeton, N.J.: Princeton University Press, 1996.
- Barry, Brian. *Culture and Equality: An Egalitarian Critique of Multiculturalism*. Cambridge, U.K.: Polity Press, 2001.
- Breytenbach, W. J. "The Protection of Minority Rights in Africa." In *Intergroup Accommodation in Plural Societies: A Selection of Conference Papers with Special Reference to South Africa*, edited by N. Rhoadie and Winifred C. Ewing, London: Macmillan, 1979.
- Fraser, Nancy. "From Redistribution to Recognition: Dilemmas of Justice in a 'Post-Socialist' Age." In *Theorizing Multiculturalism: A Guide to the Current Debate*, edited by Cynthia Willet, 68–93. Oxford: Blackwell, 1997.
- Kelly, Paul. "Introduction: Between Culture and Equality." In *Multiculturalism Reconsidered*, edited by Paul Kelly, 1–20. Cambridge, U.K.: Polity Press, 2002.
- Kuper, Adam. *Culture: The Anthropologists' Account*. Cambridge, Mass.: Harvard University Press, 1999.
- Richards, Audrey I. *The Multicultural States of East Africa*. Montreal: McGill-Queen's University Press, 1969.
- Taylor, Charles. *Multiculturalism and the Politics of Recognition*. Princeton, N.J.: Princeton University Press, 1992.
- Zewde, Bahru. *Pioneers of Change in Ethiopia: The Reformist Intellectuals of the Early Twentieth Century*. Addis Ababa, Ethiopia: Addis Ababa University Press, 2002.

Fred Hendricks

MUSEUMS. It is often assumed that museums have been a permanent feature of society, simply because they contain some of the oldest things in the world. In fact, in their current form, museums are surprisingly recent in origin, almost entirely Western in conception, internally confused about their identity, and unsure of their future role.

Museums in the early twenty-first century claim descent from the Museum in Alexandria established in the third century B.C.E., but this is only partly true. That museum—a Latin word derived from the Greek *mouseion*, meaning seat of the muses—was an attempt to bring all the fields of human knowledge together into one place. Its library was its most famous feature, complemented with a collection of artifacts. Contemporary accounts describe a huge complex of buildings, including seminar rooms and banqueting halls. It was more like a prototype university than a museum.

The British Museum, effectively the mother of all modern museums, was established in 1753 as a direct emulation of the

museum in Alexandria, but this time as a public service, not as an educational institution open only to scholars. Its ambition also was to bring all human knowledge together into one place. Its library, again, was by far its most important feature. The idea that artifacts could be separated from books in the learning process did not emerge until well more than a century later, and then largely for reasons of administrative convenience. It was not until 1998 that the British Library was separated physically from the British Museum, which in the early 2000s is a totally different institution from the one that opened its doors 250 years ago, and yet it still proudly claims that its collection has remained "inviolable" since then. It is in this way that museums create myths about their permanence, though their role has in fact changed out of all recognition over the centuries.

Origins

Museums owe their origins to three traits in human nature: the desire to understand the universe, the wish to appreciate the artifacts museums contain, and the impetus to educate others. Each of these motivations has its own history, but none, by itself, necessitates the creation of a museum. One might, for example, have no more need for the objects used in one's research when what was being sought was found. Many archaeological remains are now replaced in the ground whence they came. If one wants to appreciate something, one will tend to look after it, but that does not mean that one will necessarily want to share it with anyone else, apart from a chosen few. This appears to have been the ethos behind the earliest art gallery in the world, the Pinakothek, established on the Acropolis in Athens in the fifth century

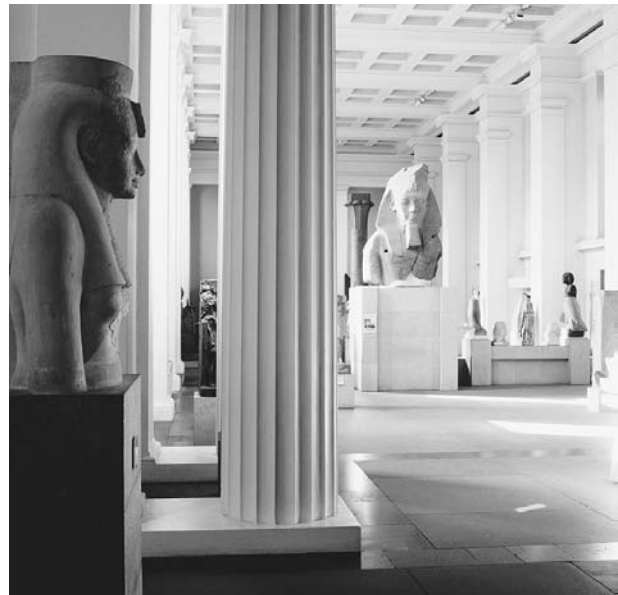

Egyptian exhibit in the British Museum. Founded in 1753, the world-renowned British Museum houses a collection that spans two million years of history. The original incarnation of the museum also boasted an extensive library; the two were divided physically in the late twentieth century. PETER APRAHAMIAN/CORBIS



Caretaker removing a gorilla skeleton from a display case in London's Natural History Museum, 1953. The Natural History Museum began in the eighteenth century as a collection of exhibits in the British Museum. As the collection grew, Superintendent Richard Owen instigated a push for a separate natural history museum, and the new building was completed in 1880. © HULTON-DEUTSCH COLLECTION/CORBIS

B.C.E. As far as can be determined from cursory contemporary accounts (nothing physical remains), the museum had a religious purpose and showed paintings for the initiates—and the gods themselves—to view. Though it might have been open to the general public, it would be two millennia before galleries were specially created with that purpose in mind. It was not until there was a commitment to universal education that the modern concept of the museum took root and flourished.

Museums did not emerge at all in societies where the scientific study of the material world was not valued, for example, in ancient China and India, nor in countries dominated by religions that focused people's attention on the spiritual rather than the material world, such as Christianity during certain periods of its history and, more generally, Islam. Museums sprang from the approach to learning advocated by Aristotle: that people can only learn by studying the world around them and trusting the evidence of their own

eyes, not by listening to others or reading what they have written.

Early Development

Museums only started to develop in the form in which they are currently known at the beginning of the Age of Enlightenment in Europe, when amateur scientists began to collect the material evidence of what was still widely assumed to be God's creation. By the sixteenth century many European noblemen had "cabinets of curiosities" containing the unaccountable wonders of nature, such as fossil teeth (thought to be satanic) and flint tools (thought to be thunderbolts) and, increasingly, natural and cultural artifacts gleaned from the newly discovered far-flung corners of the world. By the seventeenth century some of these collections had begun to be systematically studied and categorized. Ole Worm (1588–1654), a Danish doctor, used his vast collection to prove that so-called unicorn horns actually came from a species of Arctic whale—much to the chagrin of Scandinavian fishermen, who plied a lucrative trade in supplying such wonders.

The approach of these early scientific collectors was, as it had been in ancient Greece, encyclopedic. The mere activity of collecting similar objects together and placing them in some sort of order—the standard way of working in museums even in the twenty-first century—was then an extremely exciting activity. Barriers of accepted thought were being broken on every front. Geological specimens proved that the earth was far older than anyone had imagined, fossils demonstrated the fact of extinction (thought, by most, to be an impossibility within divine creation), and coins revealed the existence of cultures and dynasties previously unknown to history. Without his vast collection of natural history specimens, Charles Darwin (1809–1882) might never have formulated his theory of evolution. Working in the Museum of Northern Antiquities in Copenhagen, Christian Jurgensen Thomsen (1788–1865) developed the system of classifying prehistory according to the material evidence of the ages of stone, bronze, and iron, the names by which they are still known. It is significant that the formation of the British Museum (and library) was exactly contemporaneous with the publication of Denis Diderot's great *Encyclopédie* in France.

During the eighteenth and early nineteenth centuries public museums burgeoned throughout Europe and America, and soon in other societies influenced by them, such as South America, Australia, India, and South Africa. This was in response to two considerable and growing pressures: the new urge to collect and codify all material things, and the public's desire to see all these wonders. In those days the interests of the scholar and the general public were consanguineous. Crowds gathered to see the first stuffed kangaroo or dinosaur bone or the latest archaeological discovery from Peru. The field of enquiry that was opening was so vast that collectors—and therefore museums—soon began to specialize, dividing into subject areas such as natural history and geology, archaeology, and ethnology, which continue to define their form to this day.

Growth

The main impetus behind the extraordinary growth in museums during the last two centuries—few cities around the world are now without several—has been the growing awareness of the importance of public education. The roots of this egalitarian ideal also can be traced back to the Enlightenment, when people such as Diderot believed that knowledge would enable humankind to make the world a better place. His ideas for a national museum were put into practice by the leaders of the French Revolution: in 1792, just nine days after the Bourbon monarchy collapsed, the Louvre, at that time a royal palace, was transformed into a museum with the aim of embracing "knowledge in all its manifold beauty" so that it would, "by embodying these good ideas, worthy of a free people . . . become among the most powerful illustrations of the French Republic." Napoléon Bonaparte was following a time-honored tradition when his armies plundered masterpieces of art from the territories they conquered, particularly in Egypt and Italy, and sent them to the Louvre. (Napoléon was, in this case—at least ostensibly—acting solely in the interests of the people. The Italian treasures were returned after his fall from power.)

Individuals and institutions have, since the earliest times and in almost all cultures, collected rare and precious objects as manifestations of their status. There is archaeological evidence of royal and religious treasuries from ancient civilizations as widespread as Peru, Assyria, Greece, and China. What was new, however, during the Enlightenment, was the idea that these should become public treasuries. The members of the aristocracy of Europe were beginning to allow the general public to visit their collections in the eighteenth century; revolutions merely speeded up the process. The English Civil War, however, had come a century before such ideas had taken hold, and Charles I's extraordinary art collection was simply sold—Britain had to create its own National Gallery, from scratch, in 1824. The Hermitage, though still a royal palace, was first opened to the public in 1852, many decades before the Russian Revolution; its collections had been formed as part of Catherine II the Great's (ruled 1762–1796) strategy to bring education to Russia. The Bolsheviks boosted public collections by giving them religious treasures after religious worship had been outlawed. Many icons are now being returned as the churches reopen following the collapse of the communist regime.

Increasing access to culture dovetailed neatly with the Enlightenment's drive for knowledge. This was the great age of the formation of museums. Its high point, arguably, came in 1846 when James Smithson, a self-effacing English businessman, gave the American government the then celestial sum of half a million dollars to found a museum for "the increase and diffusion of knowledge among men." The Smithsonian Institution is now the greatest museum organization in the world, with its many galleries, most of which are ranged along the Mall in Washington, D.C., devoted to interests ranging from art to aerospace and from natural history to ethnography.

During the nineteenth and early twentieth centuries, the establishment of a museum became not just a response to ed-

ucational need, but a matter of civic pride. This heady mix of political objectives accounts for the worldwide proliferation of museums at that time, from the Australian Museum in Sydney (opened 1828) to the Egyptian Museum in Cairo (1858) to the Museum of the History of China in Beijing (1915), and hundreds of thousands of smaller museums in towns and villages in between.

Museums had another advantage: they attracted tourists. Just as the churches of medieval Europe had competed with each other for relics, so museums sought out the best collections—for tourists, like pilgrims, bring income. Many museums in the late twentieth century were established as part of an economic strategy. Glasgow in Scotland was the first postindustrial city to rebuild itself on the back of an art gallery, the Burrell Collection, which opened in 1983. Gradually museum buildings, such as cathedrals, became beacons of attraction in themselves, which led to the extraordinary flowering of museum architecture in the late twentieth century. The Guggenheim Museum in Bilbao, Spain, designed by Frank O. Gehry and opened in 1997, is world-famous for its titanium-clad curves, though few could describe its collection—but then it is not really a museum so much as a temporary exhibition hall, exhibiting works on loan from its parent museum in New York.

Agencies of Influence

It wasn't long before people began to realize that museums could be used to influence people. The South Kensington Museum in London was created in 1857 specifically to encourage better industrial design in Britain. It was radical in that it combined engineering with art, and valued objects from the past purely for their capacity to inspire the present. It is difficult to quantify how effective it was—William Morris's famous wallpaper designs were directly influenced by its collections—but the museum gradually lost its motivation and in 1893 was split into the Science Museum and the Victoria and Albert Museum, thus creating new categories of museums for science and engineering and the decorative arts.

However, the proactive educational spirit sown by the South Kensington Museum became hugely influential. The push-button displays in the Science Museum were the direct inspiration for the Exploratorium in San Francisco, established in 1969 by Frank Oppenheimer, to help people understand new developments in science. The Exploratorium is not really a museum at all—it doesn't have collections—yet its approach has spawned science centers in almost every major conurbation.

The most radical recent developments in museums have sprung from the desire to educate, rather than to collect. Michael Spock put the old toys in the Boston Children's Museum into storage because he realized his young visitors weren't interested in them. He created a new type of museum in which children could explore the adult world through interactive displays. His methods, particularly his audience participatory programs, have been hugely influential on museums, and new-style children's museums have become almost as widespread as science centers.



Interior of the United States Holocaust Memorial Museum, c. 2001. This museum, located in Washington, D.C., is one of twelve in the U.S. alone dedicated to remembrance of the Holocaust. Chartered in 1980, the institution offers extensive programs, exhibitions, and publications. © PICTURENET/CORBIS

Since the 1960s museums have been transformed by the introduction of modern media such as video and film, audio guides, and computers. It is now possible for museums to catch the imagination of a very wide public, but only a few, as yet, have begun to put their visitors first in this way. Most stick to their old, categorical presentations and assume that their visitors will want to learn about microliths, monstresances, and moths, without asking why they might be interested in such things, let alone if they would prefer to find out about something else. When he was commissioned to create what was to become the Museum of the Jewish Diaspora in Tel Aviv in 1968, Jeshajahu Weinberg, a former theater director, realized that it would not be possible to tell this story using original artifacts, because virtually none existed. He therefore created a display that used no original material at all, only reproductions. But, since it has no collections, it cannot really be categorized as a museum at all.

Weinberg's greatest museum, the United States Holocaust Memorial Museum in Washington, D.C. (opened 1993), uses all the storytelling techniques he developed in Israel together with real exhibits to mesmerizing effect, and attracts two million visitors per year. One reason for the recent proliferation of Holocaust museums (there are twelve in the United States alone in the early 2000s) is that its last living witnesses are being lost. One of the most important roles of museums in the future may be to preserve the evidence of past events, such as the Holocaust, of which it is imperative that they are not forgotten.

Future Challenges

A central issue facing museums in the early twenty-first century is to find ways to use their collections as a means of entertaining and educating a wide public, while developing their role as a resource for research. The felicitous atmosphere of the Enlightenment, when research and public interest coincided, has passed. Museum collections no longer represent, as they did then, the horizon of human understanding. The frontiers of science extend beyond the visible world collectable by museums, and it adds little to the sum of knowledge for museums to go on building up their collections, as most continue to do, according to categories laid down two centuries ago. But objects will still need to be preserved for future study and to make past experiences vividly meaningful to subsequent generations. Museums tend to go on doing what they have always done—adding another Carracci, crustacean, or car—and yet there is no museum about the history of communism (apart from a few remaining Soviet propaganda museums, which only tell one side of the story), or of marketing. Both are manifestations of ideas and practices that have vastly shaped the lives of people living in the early 2000s, and both have vivid material pasts, ideal for museum display. The challenge for museums is to decide what is important for them to collect in the present—because it is on these collections that their future will be built.

See also Arts; City, The: The City as a Cultural Center; Cultural History; Encyclopedism; Enlightenment; Visual Order to Organizing Collections.

BIBLIOGRAPHY

- Asma, Stephen T. *Stuffed Animals and Pickled Heads: The Culture and Evolution of Natural History Museums*. Oxford and New York: Oxford University Press, 2001.
- Coombes, Annie E. *Reinventing Africa: Museums, Material Culture, and Popular Imagination in Late Victorian and Edwardian England*. New Haven, Conn., and London: Yale University Press, 1994.
- Dubin, Steven C. *Displays of Power: Controversy in the American Museum from the Enola Gay to Sensation!* New York: New York University Press, 2000.
- Glaser, Jane R., and Artemis A. Zenetou, eds. *Gender Perspectives: Essays on Women in Museums*. Washington, D.C.: Smithsonian Institution Press, 1994.
- Holo, Selma. *Beyond the Prado: Museums and Identity in Democratic Spain*. Washington, D.C.: Smithsonian Institution Press, 1999.
- Holst, Niels von. *Creators, Collectors, and Connoisseurs: The Anatomy of Public Taste from Antiquity to the Present Day*. London: Thames and Hudson, 1967. Deals only with art collections.
- Hudson, Kenneth. *Museums of Influence*. Cambridge, U.K.: Cambridge University Press, 1987.
- Malraux, André. *Musée imaginaire*. Paris: Gallimard, 1965. Translated as *Museum Without Walls* by Stuart Gilbert and Francis Price. London: Secker and Warburg, 1967.

- McClellan, Andrew. *Inventing the Louvre: Art, Politics, and the Origin of the Modern Museum in Eighteenth-Century Paris*. Cambridge, U.K.: Cambridge University Press, 1994.
- McLoughlin, Moira. *Museums and the Interpretation of Native Canadians: Negotiating the Borders of Culture*. New York: Garland, 1999.
- Norman, Geraldine. *The Hermitage: The Biography of a Great Museum*. London: Pimlico, 1999.
- Schneider, Andrea Kupfer. *Creating the Musée d'Orsay: The Politics of Culture in France*. University Park: Pennsylvania State University Press, 1998.
- Spalding, Julian. *The Poetic Museum: Reviving Historic Collections*. Munich: Prestel, 2002.
- Staniszewski, Mary Anne. *The Power of Display: A History of Exhibition Installation at the Museum of Modern Art*. Cambridge, Mass.: MIT Press, 1998.
- Weil, Stephen E. *A Cabinet of Curiosities: Inquiries into Museums and their Prospects*. Washington, D.C.: Smithsonian Institution Press, 1995.
- Wilson, David M. *The British Museum: A History*. London: British Museum Press, 2002.

Julian Spalding

MUSIC, ANTHROPOLOGY OF. The phrase *anthropology of music* is most closely associated with Alan P. Merriam's 1964 landmark book bearing this title. In this prescriptive text, influential through the 1980s, Merriam defines ethnomusicology as the study of music in culture in relation to the mutual interactions of sound, behavior, and concepts. In consonance with many ethnomusicologists to this day, Mieczyslaw Kolinski (1967) responded that anthropological considerations should not dwarf an emphasis on the study of musical sound, per se, and he took Merriam to task for being too dogmatically anthropological. Kolinski argued that ethnomusicology is, in fact, a field at the juncture of two distinct disciplines: comparative musicology, which is the study of musical styles and systems from different societies, an integral part of general musicology; and musical anthropology, the study of the role music plays in human societies, an integral part of general anthropology. In 1987 Anthony Seeger described his book *Why Suyá Sing* as "a kind of musical anthropology as distinct from an anthropology of music—a study of society from the perspective of musical performance, rather than simply the application of anthropological methods and concerns to music" (p. xiii).

From these statements three general orientations emerge: (a) an emphasis on musical sound, styles, and performance in non-Western societies described in their cultural context; (b) an emphasis on analyzing musical sound and style in dialectic with social processes through the application of anthropological methods and concerns; and (c) an emphasis on social life and processes as studied through musical styles and performance ("musical anthropology"). Ethnomusicology emerged as an independent discipline in the 1950s, and the first two orientations characterize the majority of ethnomusicological work. The third orientation, that which uses musical data to understand social processes, might be

identified with the disciplines of ethnomusicology and/or anthropology, often depending on the disciplinary identity of the scholar.

Anthropologists who focus on music represent a small minority within the discipline and, Bruno Nettl writes, “the practitioners of the types of study labeled as the ‘anthropology of music’ . . . have accounted, I reckon, for less than one-fifth of all ethnomusicologists, but among them have been many of the field’s great leaders” (p. 62). Since the 1980s, the anthropology of music approach probably represents a larger portion of ethnomusicological work, and anthropological methods and theories have provided an important basis for the discipline as a whole throughout its development.

Musical Anthropology

Ethnomusicologists have documented the fact that many societies in the world do not have a single word or concept akin to the English term *music*. Nonetheless, scholars engaged with musical anthropology and the anthropology of music typically use the Western concept to define the boundaries of their study. Anthropologists have approached music in two basic ways: first, as a type of data to further general social theories or models, and second as a basic component of social life that deserves ethnographic description along with other cultural domains. An example of the first type is the Kulturkreis, or German diffusionist school in the decades around the turn of the twentieth century. Musical instruments and measurable musical traits, especially pitch organization, proved attractive data for determining the historical development of cultures and hypothetical contact between distant regions through mapping the distribution of cultural trait and artifact clusters. Anthropologists sought out help from their musicological colleagues such as Curt Sachs in this endeavor. Melville Herskovits used musical data prominently in his work on “Africanisms” in the Americas and in his theories about cultural continuity and acculturation. His study of musical styles and linguistic patterns led him to hypothesize that cultural practices that remain low in focal awareness tend to be more stable in situations of contact.

The defensive tone at the beginning of Robert Plant Armstrong’s *The Affecting Presence: An Essay in Humanistic Anthropology* (1971) suggests that aesthetic systems and emotional experience were not well-accepted concerns in anthropology before this time, but an interest in such topics as *The Anthropology of Experience* (Victor Turner and Edward M. Bruner, eds., 1986), *The Anthropology of the Body* (John Blacking, 1977), and the anthropology of emotion has grown. These topics provide a natural point of intersection for anthropology and music scholarship. David P. McAllester, anthropologist and a founding father of American ethnomusicology, conducted groundbreaking research on Navajo social and aesthetic values through a study of music associated with the Enemy Way ceremony. Steven Feld’s *Sound and Sentiment* (1982), a study of Kaluli myth, song performance, and emotional experience (a classic in the ethnomusicological literature), was widely read by anthropologists and has been particularly influential.

Recently, in relation to globalization, musical data has again appeared as significant to anthropologists for addressing broader theoretical issues. In discussing the cultural homogeneity-heterogeneity dialectic within late-twentieth-century processes of globalization, Arjun Appadurai, for example, writes:

We have a growing series of studies of cultural production worldwide, especially in the areas of music, film, and advertising, which let us look into the sites and institutions through which global commodities are locally interpreted by producers as well as consumers. The study of “world music” by ethnomusicologists is perhaps the best developed of these subfields. In general, these studies have produced a broad consensus that cultural differentiation tends to outpace homogenization, even in this most interactive of economic epochs. (p. 6,269)

The second type of anthropological engagement with music saw music simply as one component of culture that deserved ethnographic description along with other aspects. Merriam notes that “While anthropologists in the earlier history of the discipline almost always included music in their ethnographies, the tradition has become steadily less practiced, particularly over the past decade or two” (p. 18). Bruno Nettl likewise sees a decline in the description of music in anthropology textbooks and monographs generally after the mid-twentieth century. It may be that anthropologists who did not feel technically competent to deal with music simply decided to leave the topic to their ethnomusicological colleagues once this became a viable option. The perceived decline may also be partially a matter of disciplinary definition in that, increasingly after ethnomusicology became established in the late 1950s, anthropologists and specific works that predominantly focused on music simply came to be considered ethnomusicological.

It remains unclear, however, if the generalization about a former prominence and later decline in descriptive musical anthropology really holds. Franz Boas and his followers took a holistic view of culture and often discussed or at least mentioned music, as did Bronislaw Malinowski. George Herzog was an anthropologist so deeply concerned with music that he comfortably fits within comparative musicology. Nettl also cites Melville Herskovits, Robert Lowie on the Crow (1935), and Clark Wissler on the Blackfoot, among others, for including music in their ethnographies. He specifically highlights Margaret Mead’s *Coming of Age in Samoa* (1928) as including a “short but insightful ethnography of music” (p. 63). The level of detail about music in this work, however, is easily matched and exceeded by anthropologists who published studies during the suggested period of decline—including Norman Whitten’s work on *currulao* (an African-derived music-dance tradition from the Pacific coast of Colombia and Ecuador) in *Black Frontiersmen* (1974), Hans Buechler’s study of Aymara panpipe performance in Bolivia as a window to social organization, William Mangin’s work on migrant regional associations in Lima, Bruce Mannheim’s work on Quechua songs, Jose María Arguedas’s

work on mestizo-indigenous relations in Peru, Ellen Basso's study of Kalapalo performance, Richard Price and Sally Price's work in Suriname, Fremont E. Besmer's study of the Hausa Bori cult, Colin Turnbull's discussion of Molimo music among the Mbuti, and Peter Fry's study of nationalism and spirit mediums in Zimbabwe, just to name a few examples. Morton H. Fried's general *Readings in Anthropology*, vol. 2, *Cultural Anthropology* (1968), includes two chapters on music and ethnomusicology—generous if one considers the number of facets of social life that needed to be covered. Conversely, founding father Edward Burnett Tylor's *Religion in Primitive Culture* ([1871] 1958), which considers a realm of life saturated with musical performance, barely mentions music at all. From the Boas camp, Ruth Benedict's *Patterns of Culture* (1934) does not mention music.

Comparative Musicology and Ethnomusicology

The emergence of contemporary ethnomusicology is typically traced to the 1880s. Thomas Edison invented the phonograph in 1887—ethnologist Jesse Walter Fewkes was the first to use the cylinder machine in his fieldwork (with Native Americans in 1890 and 1891). During the 1880s, British physicist and phonetician Alexander J. Ellis developed the cents system that divided the octave into 1,200 equal units and allowed for the measurement and comparison of scales from different societies. Ellis concluded that musical scales were not grounded on natural laws but “capriciously” differed from one society to the next. Thus he introduced the need for a culturally relativistic approach to musical analysis and understanding that became a fundamental cornerstone of ethnomusicological thinking, and that predated Boas's first direct statement about cultural relativism.

In 1885, Guido Adler published an article outlining the field of musicology. Adler divided the study of music into two subfields, historical and systematic musicology, and part of the latter was *Musikologie*—“comparative study [of non-Western music] for ethnographic purposes” (quoted in Nettl, p. 20)—a field that became known as comparative musicology, that grew into contemporary ethnomusicology, and that, along with historical musicology, has become one of the two main branches of musicology. As it has developed, historical musicology is devoted to the study of European and European-derived elite music repertoires and composers with an emphasis on style development as well as studies that describe European elite music in its cultural context. By default, the remainder of the world's musics, including European and American “vernacular” musics, became the defining subject of comparative musicology and later ethnomusicology (e.g., see Kunst, p. 9).

Comparative musicology is most strongly associated with the “Berlin School” (originally based at the Psychological Institute of Berlin), and Carl Stumpf, Erich M. von Hornbostel, and Otto Abraham, and their students and associates including Curt Sachs, Kolinski, George Herzog, and Klaus Wachsmann. In his synthetic discussion, “The Problems of Comparative Musicology” (1905 [1975]), Hornbostel emphasizes the need to compare scales, intervals, and rhythmic organization of the world's peoples; his primary emphasis is

on issues of musical sound, with theorizing about psychological and anthropological issues being secondary—a position maintained by Kolinski and many others.

Drawn generally from anthropological tradition, by the 1950s fieldwork became a basic prerequisite for professional standing in ethnomusicology. The early comparative musicologists, however, had little fieldwork experience and often based their research on recordings made by others—a style of work that became known as *armchair ethnomusicology*. The lack of in-depth fieldwork precluded the type of detailed social-musical analytical integration that began to emerge in the 1970s under the banner *the anthropology of music*.

The Anthropology of Music

Many musicologists maintain a Western aesthetic ideology of autonomous art. Against this backdrop, scholars with an anthropology of music orientation were faced with the challenge of finding theoretical approaches that would help them explain, or at least link, musical style with broader patterns of cultural and social processes. Ethnomusicologists frequently turned to the prominent anthropological theories and problems of any given period for this purpose. Social evolutionism, diffusionism, mapping culture areas, functionalism, problems of acculturation and culture change, structuralism, semiotics, “ethnoscience,” feminist theory, theories of social power, practice theory, and problems of nationalism and globalization, prominently form the historical strata of ideas guiding work in the anthropology of music. Some scholars explicitly combined a variety of theoretical approaches in single publications. While it sometimes appears as if the newest problem or body of theory negates earlier approaches as faulty or outmoded, it is more accurate to view each as a theoretical layer that continues to inform later thinking.

Hornbostel, Curt Sachs, and the widely dispersed scholars influenced by this group (e.g., Carlos Vega in Argentina), are often associated with a social-evolutionist anthropological orientation. This is an oversimplification in that Hornbostel and Sachs, to cite but two examples, contributed to a variety of theoretical discussions and problems, for example, cultural diffusion, music perception, approaches to musical analysis, and the classification of musical instruments, among others. It is probably fairer to say that evolutionist ideas were part of common sense for this generation of scholars. Thus as a reason to study “foreign [contemporary] music” Hornbostel states that “we would like to uncover the remotest, darkest past and unveil, in the wealth of the present, the ageless universal in music; in other words: we want to understand the evolution and common aesthetic foundation of the art of music” (p. 269). In *The Wellsprings of Music*, Sachs views contemporary tribal peoples as “archaic” and as “the surviving tribes of palaeolithic culture” that provide a window to “early music,” yet he also questions evolutionist ideas: “People do not stick to shallow secondal patterns because they stand on the lowest rung of the cultural ladder. . . . Often a person's sex appears to be the shaping power; women seem to prefer a smaller step [melodic interval], just as they do in dancing, while men proceed in larger strides and leaps” (p. 62). While

social-evolutionism and such broad generalizing became largely discredited after the first part of the twentieth century, it might be argued that the evolutionist “primitive–civilized” contrast served as the paradigmatic background for the “traditional–modern” dichotomy that remains in currency, with many of the same problems.

Several ethnomusicologists followed the American anthropological trend of grouping different societies into culture areas. Bruno Nettl created a map of Native North American musical styles following the cultural mapping of anthropologists such as A. L. Kroeber; and Alan P. Merriam created a map of African musical culture areas following Herskovits. Later Alan Lomax attempted to map the world’s musical areas. The musical areas that form the basis of Lomax’s cantometrics project, especially, have been questioned for creating an overly homogenized view of constituent musical cultures based on rather thin data. Nonetheless, in practice the culture area idea, writ large, forms a fundamental basis for organizing courses in ethnomusicology, for defining scholars’ specializations, and in the writing of textbooks and reference works—all typically organized according to geographical units.

During the 1950s and 1960s, practitioners of the anthropology of music embraced functionalism as a way to link music-making to social life. More akin to Malinowski’s approach than A. R. Radcliffe-Brown’s “structural-functionalism,” ethnomusicologists began to emphasize what certain types of music contributed to certain realms of activity—healing, labor, political structure, family life, social cohesion. In *The Anthropology of Music*, Merriam states, “The uses and functions of music represent one of the most important problems in ethnomusicology” (p. 209). In contrast to Kantian ideas that the “aesthetic” and “functional” realms preclude each other, McAllester’s Enemy Way study demonstrated that for many Navajo, the musically “good” or “beautiful” was defined according to its effectiveness for healing, that is, a performance was judged importantly in terms of how well it fulfilled its function. Although few ethnomusicologists after the 1960s would consider themselves functionalists, describing the deeper purposes that music serves remains a basic part of music ethnographies.

During this same time period and through the late twentieth century, an interest in musical change and acculturation echoed anthropological interests. One of the most widely accepted theories of musical acculturation, advocated by Merriam, Richard Waterman, and derived directly from Herskovits, held that musical cultures were more likely to blend together or influence each other if they shared a number of similar traits. Nettl and Margaret J. Kartomi created typologies for the different effects of culture contact. John Blacking published an influential article advocating the search for a unified theory of musical change emphasizing a distinction between change within a musical system and change of the system. Robert Kauffman argued that culture change or acculturation could not be read off surface forms, such as the adaptation of a foreign musical instrument, but rather, that modes of musical practice, organization, and aesthetics were the key variables for assessing culture change.

Practitioners of the anthropology of music loosely adapted Lévi-Straussian structuralism as a key approach in the 1970s and 1980s. Typically, ethnomusicologists were not concerned with Claude Lévi-Strauss’s starting point, the common structure of the human mind. Rather, working on a culture-specific basis, they assumed that there would be deep structural patterns that would shape (surface) cultural practices and forms, creating homologies across different domains of social life. Thus, Charles Keil identified patterns involving circles and angles, in roof designs, visual arts, and in music, and Adrienne Kaeppeler found homologies across different realms of Tongan art and society. Combining the earlier interest in homologies with the Peircian concept of iconicity, Judith Becker and Anton Becker found similar structures in Indonesian calendrical concepts and gamelan music; Steven Feld documented the iconicity of aesthetics, practices, and style across a number of domains of Kaluli social life; and Thomas Turino observed a series of symmetrical structures organized around a centerline in Aymara panpipe and flute ensembles, in Andean weaving, in the conceptualization of agricultural niches, and in the organization of space during festival celebrations.

During the same period, some ethnomusicologists took an interest in the premises and methods of structural linguistics for musical analysis; this represents a different trajectory than Lévi-Straussian structuralism, and the scholars involved tended to hail from the musicological rather than the anthropological side of the discipline. Other ethnomusicological approaches related (sometimes through opposition) to structuralism and linguistics involved “the ethnography of performance,” following sociolinguistics and the “ethnography of speaking,” and the “ethnoscience” approach.

Frequently, the early discussions of “culture contact” and acculturation did not take power relations between the groups into account as a primary variable. Beginning in the 1980s, younger scholars influenced by Marxian ideas, and especially the work of Antonio Gramsci, began to study the effects of asymmetrical power relations and identity politics on musical values and practices. During the 1990s, the study of music in relation to identity politics became a central topic in the anthropology of music. Since social identities are fundamental to political life, and public expressive cultural practices such as music and dance are key to formulating and representing social identities, ethnomusicologists have made major contributions to understanding the dynamics involved—often from a valuable grassroots perspective.

Jane Sugarman’s work documents the fundamental ways musical performance functions in processes of socialization shaping conceptions of gendered identities and roles, and Christopher Ballantine provides an insightful essay on gendered power dynamics in South African popular music. Many others have studied the intersection of ethnicity, race, and class in relation to popular music practices and aesthetics. State intervention in indigenous and popular music has received significant attention. Another prominent ethnomusicological topic has been the effects of political nationalism on music. Finally, the study of transnational or “global” economic processes in relation to the production and reception of

music—especially popular musics and styles within the “world music” rubric—has become a central focus in the anthropology of music.

Whereas European classical music was once deemed the primary type worthy of study, over the last three decades of the twentieth century “world music” classes and textbooks proliferated in response to several intersecting trends. The discourse of multiculturalism has certainly supported the growth of the interest in “non-Western” music. Multiculturalism itself may be seen as a liberal trend that is partially the result of anthropologists and ethnomusicologists advocating cultural relativism for over a century. It is also partially the result of the women’s and civil rights movements’ demand that artistic canons be expanded to include a variety of groups. Simultaneously, multiculturalism also functions as a new type of state strategy (e.g., in contrast to the “melting pot”) to incorporate the variety of immigrant groups into nation-states and to mitigate challenges to the image of national unity.

Commercial music trends have intersected with the work of ethnomusicologists to expand the interest in, and familiarity with, a variety of musics from around the world. A fascination with the “exotic” has long been part of American and cosmopolitan popular culture—examples include nineteenth-century minstrelsy, “Latin” dance crazes and stars like Carmen Miranda throughout the twentieth century, and hippie (and the Beatles’) interest in “Eastern” religion and sitar music. Following the international commercial success of Bob Marley and reggae, new marketing rubrics—“world beat” and “world music”—were adopted in the 1980s to sell a variety of musics from around the world. The more enterprising “world music” fans have turned to the work of ethnomusicologists to expand their knowledge of different styles, and ethnomusicologists have sometimes collaborated in commercial “world music” projects.

Finally, the contemporary discourse of globalism—which might be interpreted as ideologically supporting the expansion and control of trans-state capitalist interests and institutions in the post-Soviet era—has brought new recognition to the work of ethnomusicologists. The discipline has had a global perspective since its inception, but ethnomusicologists’ detailed studies of the wealth of human creativity as well as the profound musical and aesthetic differences among social groups do not support views of an emerging “global culture,” or its likelihood in the near future.

See also *Anthropology; Musicology*.

BIBLIOGRAPHY

- Adler, Guido. “Umfang, Methode und Ziel der Musikwissenschaft.” *Vierteljahrsschrift für Musikwissenschaft* 1 (1885): 5–20.
- Appadurai, Arjun. “Anthropology of Globalization.” In *International Encyclopedia of the Social and Behavioral Sciences*, vol. 9, edited by Neil J. Smelser and Paul Baltes. Oxford: Elsevier Science, 2001.

- Arguedas, Jose María. *Formación de una cultura nacional indoamericana*. Mexico: Siglo Veintiuno Editores S.A., 1977.
- Armstrong, Robert Plant. *The Affecting Presence: An Essay in Humanistic Anthropology*. Urbana: University of Illinois Press, 1971.
- Ballantine, Christopher. “Gender, Migrancy, and South African Popular Music in the Late 1940s and the 1950s.” *Ethnomusicology* 44 (2000): 376–407.
- Basso, Ellen. *A Musical View of the Universe*. Philadelphia: University of Pennsylvania Press, 1985.
- Becker, Judith and Anton. “A Musical Icon: Power and Meaning in Javanese Gamelan Music.” In *The Sign in Music and Literature*, edited by Wendy Steiner. Austin: University of Texas Press, 1981.
- Béhague, Gerard, ed. *Performance Practice: Ethnomusicological Perspectives*. Westport, Conn.: Greenwood, 1984.
- Benedict, Ruth. *Patterns of Culture*. New York: Penguin Books, 1934.
- Besmer, Fremont E. *Horses, Musicians, and Gods: The Hausa Cult of Possession-Trance*. Zaria, Nigeria: Ahmadu Bello University Press, 1983.
- Blacking, John. *The Anthropology of the Body*. London: Academic Press, 1977.
- . “Some Problems of Theory and Method in the Study of Musical Change.” *Yearbook of the International Folk Music Council* 9 (1978): 1–26.
- . *Venda Children’s Songs: A Study in Ethnomusicological Analysis*. Johannesburg: Witwatersrand University Press, 1967.
- Boas, Franz. *The Central Eskimo*. Washington: Bureau of American Ethnology, 1888.
- . “The Limitations of the Comparative Method of Anthropology.” *Science* 4, no. 103 (December 18, 1896).
- Buechler, Hans C. *The Masked Media: Aymara Fiestas and Social Interaction in the Bolivian Highlands*. The Hague: Mouton, 1980.
- Burnett, Robert. *The Global Jukebox: The International Music Industry*. London: Routledge, 1996.
- Christensen, Dieter. “Erich M. von Hornbostel, Carl Stumpf, and the Institutionalization of Comparative Musicology.” In *Comparative Musicology and Anthropology of Music: Essays on the History of Ethnomusicology*, edited by Bruno Nettl and Philip V. Bohlman. Chicago: University of Chicago Press, 1991.
- Ellis, Alexander J. “On the Musical Scales of Various Nations.” *Journal of the Society of Arts*, xxxiii (1885), 3/27: 485–527; 10/30: 1102–1111.
- Erlmann, Veit. *Music, Modernity, and the Global Imagination: South Africa and the West*. New York: Oxford University Press, 1999.
- . “The Politics and Aesthetics of Transnational Musics.” *The World of Music* 35, no. 2 (1993): 3–15.
- Feld, Steven. “Linguistic Models in Ethnomusicology.” *Ethnomusicology* 15 (1974): 353–362.
- . *Sound and Sentiment*. Philadelphia: University of Pennsylvania Press, 1982.
- . “Aesthetics as Iconicity of Style, or ‘Lit-Up-Over Sound-ing’: Getting into the Kaluli Groove.” *Yearbook for Traditional Music* 20 (1988): 74–114.
- Fried, Morton H., ed. *Readings in Anthropology*, Vol. 2 of *Cultural Anthropology*. New York: Thomas Y. Crowell Company, 1968.
- Frith, Simon. *World Music, Politics, and Social Change*. Manchester, U.K.: Manchester University Press, 1989.

- Fry, Peter. *Spirits of Protest: Spirit Mediums and the Articulation of Consensus among the Zezuru of Southern Rhodesia (Zimbabwe)*. Cambridge, U.K.: Cambridge University Press, 1976.
- Herskovits, Melville J. "The Culture Areas of Africa." *Africa* 3 (1930): 59–76.
- . "Problem, Method and Theory in AfroAmerican Studies." *Afroamericana* 1 (1945): 5–24.
- Herzog, George. "A Comparison of Pueblo and Pima Musical Styles." *Journal of American Folk-lore* 49, no. 194 (1936): 284–417.
- Hornbostel, Erich M. von. "The Problems of Comparative Musicology." In *Opera Omnia I*, edited by Klaus P. Wachsmann, Dieter Christensen, and Hans-Peter Reinecke. The Hague: Nijhoff, 1905 [1975].
- Kaeppeler, Adrienne L. "Melody, Drone and Decoration: Underlying Structures and Surface Manifestations in Tongan Art and Society." In *Art in Society: Studies in Style, Culture and Aesthetics*, edited by Michael Greenhalgh and Vincent Megaw. London: Gerald Duckworth, 1978.
- Kartomi, Margaret J. "The Processes and Results of Musical Culture Contact: A Discussion of Terminology and Concepts." *Ethnomusicology* 25 (1981): 227–250.
- Kauffman, Robert. "Shona Urban Music: A Process which Maintains Traditional Values." In *Urban Man in Southern Africa*, edited by Clive Kileff and Wade C. Pendleton. Gweru: Mambo Press, 1975.
- Keil, Charles. *Tiv Song*. Chicago: University of Chicago Press, 1979.
- Kolinski, Mieczyslaw. "Recent Trends in Ethnomusicology." *Ethnomusicology* 11 (1967): 1–24.
- Koskoff, Ellen, ed. *Women and Music in Cross-Cultural Perspective*. New York: Greenwood, 1987.
- Kroeber, A. L. *Cultural and Natural Areas of Native North America*. Berkeley: University of California Press, 1947.
- Kunst, Jaap. *Ethno-musicology: A Study of its Nature, its Problems, Methods and Representative Personalities to which Is Added a Bibliography*. The Hague: Martinus Nijhoff, 1955.
- Lomax, Alan. *Folk Song Style and Culture*. Washington, D.C.: American Association for the Advancement of Science, 1968.
- Lowie, Robert H. *The Crow Indians*. New York: Rinehart, 1935.
- Malinowski, Bronislaw. *The Sexual Life of Savages*. London: Routledge, 1929.
- Mangin, William. "The Role of Regional Associations in the Adaptation of Rural Populations in Peru." *Sociologus* 9 (1959): 23–35.
- Mannheim, Bruce. "Popular Song and Popular Grammar: Poetry and Metalanguage." *Word* 37 (1986): 45–75.
- McAllester, David P. *Enemy Way Music: A Study of Social and Aesthetic Values as Seen in Navaho Music*. Cambridge, Mass.: Peabody Museum, 1954.
- McLeod, Norma, and Marcia Herndon. *The Ethnography of Musical Performance*. Norwood, Pa.: Norwood, 1980.
- Mead, Margaret. *Coming of Age in Samoa*. New York: Mentor Books, 1928 [1949].
- Merriam, Alan P. *The Anthropology of Music*. Evanston, Ill.: Northwestern University Press, 1964.
- . "Definitions of 'Comparative Musicology' and 'Ethnomusicology': An Historical-Theoretical Perspective." *Ethnomusicology* 21 (1977): 189–204.
- . "The Use of Music in the Study of a Problem of Acculturation." *American Anthropologist* 57 (1955): 28–34.
- Moore, Robin. *Nationalizing Blackness: Afro-Cubanismo and Artistic Revolution in Havana, 1920–1940*. Pittsburgh: University of Pittsburgh Press, 1997.
- Myers, Helen. *Ethnomusicology: An Introduction*. New York: Norton, 1992.
- Nettl, Bruno. *Encounters in Ethnomusicology*. Warren, Mich.: Harmonie Park, 2002.
- . *North American Indian Musical Styles*. Philadelphia: American Folklore Society, 1954.
- Nettl, Bruno, and Philip V. Bohlman, eds. *Comparative Musicology and Anthropology of Music: Essays on the History of Ethnomusicology*. Chicago: University of Chicago Press, 1991.
- Noll, William. "Music Institutions and National Consciousness among Polish and Ukrainian Peasants." In *Ethnomusicology and Modern Music History*, edited by Stephen Blum, Philip V. Bohlman, and Daniel M. Neuman. Urbana: University of Illinois Press, 1991.
- Peña, Manuel. "From Ranchero to Jaitón: Ethnicity and Class in Texas-Mexican Music (Two Styles in the Form of a Pair)." *Ethnomusicology* 29 (1985): 29–55.
- Perrone, Charles A., and Christopher Dunn, eds. *Brazilian Popular Music and Globalization*. Gainesville: University Press of Florida, 2001.
- Powers, Harold S. "Language Models and Musical Analysis." *Ethnomusicology* 24 (1980): 1–60.
- Radano, Ronald, and Philip V. Bohlman, eds. *Music and the Racial Imagination*. Chicago: University of Chicago Press, 2000.
- Sachs, Curt. *The Wellsprings of Music*. Edited by Jaap Kunst. The Hague: Nijhoff, 1962.
- Seeger, Anthony. *Why Suyá Sing: A Musical Anthropology of an Amazonian People*. Cambridge, U.K.: Cambridge University Press, 1987.
- Stempfle, Stephen. *The Steelband Movement: The Forging of a National Art in Trinidad and Tobago*. Philadelphia: University of Pennsylvania Press, 1995.
- Stokes, Martin, ed. *Ethnicity, Identity, and Music: The Musical Construction of Place*. Oxford: Berg, 1994.
- Sugarman, Jane. *Engendering Song: Singing and Subjectivity at Prespa Albanian Weddings*. Chicago: University of Chicago Press, 1997.
- Turnbull, Colin M. *The Forest People*. New York: Simon and Schuster, 1961.
- Turner, Victor, and Edward M. Bruner, eds. *The Anthropology of Experience*. Urbana: University of Illinois Press, 1986.
- Turino, Thomas. *Nationalists, Cosmopolitans, and Popular Music in Zimbabwe*. Chicago: University of Chicago Press, 2000.
- . "The State and Andean Musical Production in Peru." In *Nation-State and Indian in Latin America*, edited by Joel Sherzer and Greg Urban. Austin: University of Texas Press, 1990.
- Tylor, Edward Burnett. *Religion in Primitive Culture*, Part II of *Primitive Culture*. New York: Harper and Brothers, 1871 [1958].
- Wade, Peter. *Music, Race, and Nation: Musica Tropical in Colombia*. Chicago: University of Chicago Press, 2000.
- Waterman, Richard. "African Influence on the Music of the Americas." In *Acculturation in the Americas*, edited by Sol Tax. Chicago: University of Chicago Press, 1952.
- Waxer, Lise A. *The City of Musical Memory: Salsa, Record Grooves, and Popular Culture in Cali, Colombia*. Middletown, Conn.: Wesleyan University Press, 2002.

Whitten, Norman. *Black Frontiersmen: A South American Case*. 2nd ed. Prospect Heights, Ill.: Waveland Press, 1974 [1986].
 Zemp, Hugo. "'Are'are Classification of Musical Types and Instruments." *Ethnomusicology* (1978) 22: 37–67.
 ———. "Aspects of 'Are'are Musical Theory." *Ethnomusicology* 23 (1979): 5–48.

Thomas Turino

MUSICAL PERFORMANCE AND AUDIENCES.

Musical performance is an organized presentation of musical sounds (and, arguably, controlled silences), usually for the entertainment, edification, or enrichment of listeners. The parameters of a performance are often determined by culturally understood boundaries—symphony audiences disregard the warming up and tuning of orchestral musicians, whereas listeners to Indian classical music understand the *ālāpa* (a slow, improvisatory exploration of a *rāga*, or traditional melodic pattern) to be an intrinsic part of the performance, if not comprising the entire performance itself. Audiences must be conditioned, therefore, to understand the norms of performance and their own roles as listeners. An Indian audience

might quietly snap along with a *tala* (a traditional rhythmic pattern), whereas the symphony audience is expected to maintain a strict silence until the final section of a multimovement work has concluded. A jazz audience, on the other hand, might chatter and drink beverages during a jazz combo's club performance, but would also respond to individual artistry during the course of a piece by applauding after each improvised solo (as seen in figure 1); an otherwise quiet opera audience would cheer a well-performed aria, and might even, in exceptional cases, demand an encore.

Despite the recognition that there are expected behaviors for performers and audiences, defining "musical performance" is as difficult as the attempt to pinpoint the nature of music itself. The immense diversity of human musical activity has led to a host of attitudes regarding the nature and purpose of musical events. The lines of demarcation between composer and composition, composition and performer, and performer and audience are sometimes almost impossibly blurred. Moreover, no universal standard exists by which to measure "good" performance; this assessment, too, is dependent on variable cultural and aesthetic expectations. However, the ongoing attempts of historians, ethnomusicologists, and philosophers (as well as composers and performers) to articulate and isolate var-



Figure 1. Jazz singer Ella Fitzgerald performs for an audience that includes bandleader Duke Ellington. Photographed in 1948 by Herman Leonard. HULTON ARCHIVE/GETTY IMAGES



Figure 2. Young Greek woman playing an aulos. © BETTMANN/CORBIS

ious parameters of musical activity help us to understand both the diversity and the similarities within musical performances.

Origins and Types of Performance

Without a doubt, performance is the oldest form of musical activity, but its origins are difficult to pinpoint. Steven J. Mithen posits a series of cultural “sparks” during the middle-upper Paleolithic transition, culminating in the first appearances of art objects in Europe some forty thousand years ago. Basing his theories on the work of cognitive scientists, Mithen argues that these sparks resulted from the coalescing of several human intelligences—technical, natural history, social, and linguistic—which in turn opened the door to the development of artistic and religious practices. Although archaeologists have discovered instruments made from mammoth bones in 18,000 B.C.E., the oldest known forms of written music survive on Mesopotamian clay tablets dating from at least 3,000 to 2,000 years B.C.E. Other tablets of the same era make reference to instrumentalists and singers. Ancient Egyptian hieroglyphics, c. 2400 B.C.E., comprise the earliest surviving representations of performing musicians. The ancient Greeks also depicted music-making (and listening); figure 2 portrays a young woman playing the aulos for a reclining male guest. Besides illustrating music as entertainment, Greek iconography also depicts other broad categories of musical performances, such as music for dance and music in support of religious beliefs.

Performance as background activity. The convention of an audience gathering specifically to listen to a scheduled musical event is a relatively modern phenomenon. Historically, much musical entertainment was presented at the convenience of its patrons, while many other forms of music-making were (and still are) almost entirely subordinate to some other fore-



Figure 3. A man dressed as a *komuso* (beggar priest) plays a flute-like *shakuhachi*. Photograph c. 1901–1920. © UNDERWOOD & UNDERWOOD/CORBIS

ground purpose, such as worship, dancing, military maneuvers, and other activities.

Music in religious observance. Cultures all over the world incorporate music into their sacred and ceremonial activities. Jews and early Christians both made use of chant in their devotions, regarding this as a means of uplifting the mind as well as a method of worship. In the Fuke sect of Japanese Buddhism, *komuso* (beggar priests) play the flute-like *shakuhachi* (figure 3), not as an instrument per se, but rather as a spiritual tool that assists its player in reaching enlightenment. In contrast, the West African Ewe people believe they are guided through life by ancestral spirits, so a musician often regards music-making as his destiny, thanks to the inherited spirit of an ancestor who has determined the course of his life. An Ewe funeral is a celebratory affair because its ritual drumming, singing, and dancing enable the soul to become an ancestral spirit. According to Charlotte J. Frisbee, the Navajo Indians make a semantic distinction between “performing,” which is the music-making during ceremonies, and “playing,” which describes all other forms of musical activity. Music is even more deeply imbedded in the intertribal Native American Church; its adherents view music itself as prayer. Music as a function



Figure 4. A field show presented by the marching band of the University of California, Los Angeles. ALYSON MCLAMORE

of religious observance is by no means universal; for instance, music is forbidden in the Algerian Mozabite Muslim sect.

Music and dance. Music is also almost always an essential component of dance (and, indeed, dance and religion go hand in hand in many cultures). Customarily, music is subsidiary to the movements of the dancers, even though it controls (or reflects) their actions to varying degrees. In its simplest form, music for dance maintains the beat and tempo; various other aspects of the musical performance might guide more nuanced gestures. By actions such as foot stamping, whistling, clapping, or singing, the dancers themselves might produce the accompanimental music. Filipino Bontok musicians of Sadanga, Luzon, when playing *gangsá* (flat gongs) sound the gongs with sticks and dance in circles and spirals. More commonly, dancers move while stationary musicians perform, as in a processional Renaissance dance performed at a fifteenth-century Burgundian wedding. The shawm and sackbut players stand in an elevated side gallery apart from the dancers, and their status as “background” performers is reinforced visually by their plain, matching tunics.

Music in the military. Since antiquity, as armies grew too large for vocal commands to be heard, a system of musical signals was adopted by various military groups. Some of these “calls” regulated the soldiers’ daily activities, ranging from the early-morning reveille to the bedtime tattoo; other forms of music passed along orders during battle. Military musical ensembles also supported morale among the troops, and although live musicians have seldom been used during actual warfare since the early twentieth century, many military units still use bands as a public-relations bridge feature, thereby moving their musical performances to the “foreground.” In North America, in particular, the military bands influenced the development of various school ensembles; these ensembles consist of not only stationary “concert” bands of wind players and percussionists, but also marching bands. The mobile marching ensembles perform in two main contexts: street parades, in which they perform music while passing in front of viewers (who therefore hear only a portion of a work before the band passes

out of hearing range), and field shows (see figure 4), in which the band members create elaborate designs and patterns with their bodies while playing.

Music in other contexts. Musical performance has functioned as a backdrop to many other forms of human activity, ranging from lullabies sung to infants to children’s games to banquet music to the elaborate vocal and orchestral performances that entertained strolling patrons in eighteenth-century Georgian pleasure gardens (see figure 5). The French composer Erik Satie was fascinated by the possibilities of what he called *musique d’ameublement* (furniture music), which was intended to be ignored, but found in 1920 that it was difficult to keep audiences talking and moving about while musicians were performing at a drawing exhibition. Nevertheless, modern-day shoppers seem to have little difficulty in ignoring live pianists playing in department stores, undoubtedly conditioned to this lack of response by the prevalence of recorded Muzak and other forms of “canned” environmental music.

Performance as foreground focus. Many cultures that use music for background purposes also host activities in which artistic music-making is the primary focus of the enterprise. Since the music itself commands attention, these endeavors might collectively be labeled “art music,” although the term “classical music” is often used interchangeably. (“Popular music,” in contrast, usually puts less emphasis on artistry and more focus on commercial qualities; in individual cases, of course, the level of artistic achievement in popular music may be extremely high.) In many instances, specialized venues (music rooms, concert halls, theaters) have been built to accommodate performances of art music (in figure 6, see Thomas Mace’s 1676 plans for a dedicated “Musick-Roome”). Nevertheless, within art music’s concert and theatrical presentations, the type of musical activity can vary widely; musicians might improvise freely or provide their own interpretations of traditional repertory, or, at the opposite extreme, they may be endeavoring to recreate a preexisting musical artwork as exactly as possible. Correspondingly, performers are viewed varyingly as free agents, composers’ interpreters or “ambassadors,” and even automatons.

Improvisation as performance. Various music education methodologies, such as Émile Jaques-Dalcroze’s eurythmics or the Orff-Schulwerk pioneered by Carl Orff, allow children to improvise freely on instruments or vocally, which appears to be a natural tendency of childhood exploratory development. In most cultures, however, audiences expect improvisers to be highly trained experts in their media, and thus the improvised portions of performances carry great prestige; the cadenzas in concertos, the “solos” in jazz works, and the *taqsīm* in Arabic and Turkish music are all highlights for listeners. In both Western and non-Western traditions, some performers may study with masters for many years before embarking on their first public improvisations. Performers in other cultures may adopt entirely different attitudes toward improvisation, however; through fasting and self-torture, North American Plains Indians seek visions in which new songs might appear to them, whereas Pima Indians regard improvisation as a process of “un-

raveling” the songs already present in the supernatural world. Of course, due to its spontaneous and unnotated nature, improvisation is one of the most difficult aspects of music to study historically.

Re-creative performance. In contrast to improvisation—or, sometimes, in partnership with it—much musical performance is the (re-)enactment of a piece according to predetermined specifications. In some traditions, the musical works are conveyed via oral transmission and rote mimicry, while other cultures have developed various forms of musical notation to guide performances (see figure 7 for a manuscript excerpt from a chorus of Thomas Linley’s 1777 oratorio *The Song of Moses*). For performers, however, any score—the handwritten or printed record of a composer’s intentions—is incapable of telling the “whole story.” Just as in the case of skilled improvisers, musicians performing from scores usually need substantial prior training to understand the conventions of a particular style of music before they are considered ready for public performance.

Performance Considerations

There is no universal agreement as to what constitutes a musical performance, for the nature of music-making and listening varies greatly from culture to culture. Similarly, the parameters of *good* performance are equally hard to measure.

Many philosophers, historians, and performers have turned their attention to this problem, exploring varied issues of musical aesthetics and historical performance practice.

The quest for perfection No matter what impetus—improvisation or score transmission—has produced a performance of art music, audiences attending these presentations carry with them a set of aesthetic criteria, ranging from specific personal preferences to broad awareness of cultural norms. Listeners evaluate a performance on the basis of their blended personal and collective attitudes, which allows for enormous variety in the perception of a single performance as good or bad. It is impossible for a performer to anticipate and respond to all the individual standards by which his performance might be judged; as Jerrold Levinson quipped, “For a listener who wears earplugs, a very loud performance is the best” (p. 382). Nevertheless, in most instances in which performers bring “to sound” a notated score, their faithfulness to that score is often a leading measure of their success.

Philosophers and critics disagree as to how to measure that faithfulness. The relative imprecision of much early Western notation forces performers to make many basic choices: if a surviving work contains only vocal parts, but iconography from the same time period shows instruments playing alongside singers, should a contemporary conductor choose to double

*The Description
Of a Musick-Roome, Uniforme
With Conveniency for Severall Sorts of
Auditors, Severally plac'd in 12
Distinct Roomes, besides the Mu-
sick-Roome, w^{ch} would haue none
in It besides the Performers.*

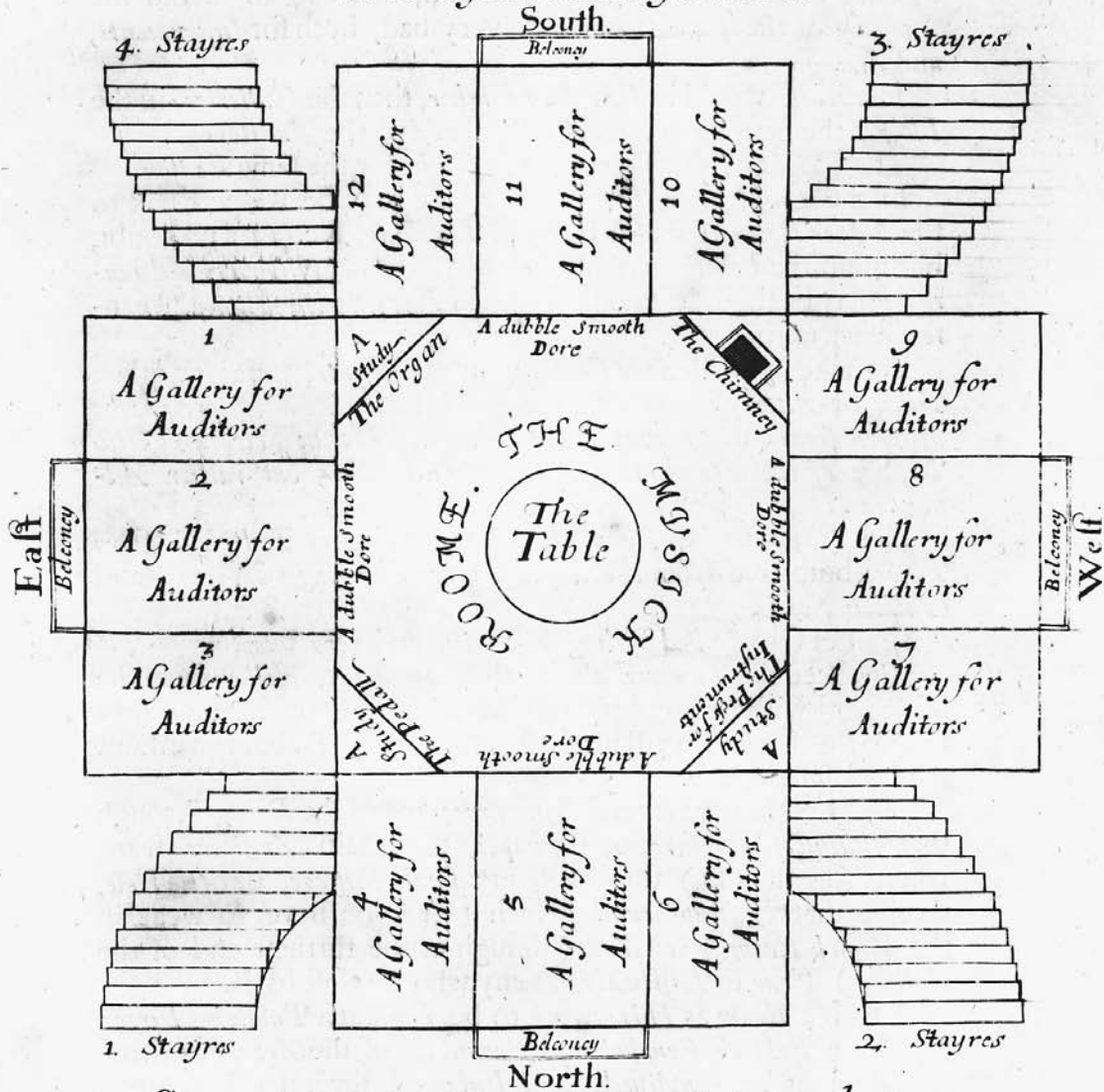

*Supposing the Roome to be six Yards square
The 12 Galleryes would be 3.yards long, and
Better; The 4 Middle Galleryes Somthing
Broader then the Rest, as Here they are.*

Figure 6. Plans for a "Musick-Roome" (1676) by Thomas Mace. BY PERMISSION OF THE HOUGHTON LIBRARY, HARVARD UNIVERSITY



Figure 7. Manuscript excerpt from the oratorio *The Song of Moses* (1777) by Thomas Linley. BY PERMISSION OF THE BRITISH LIBRARY, RM.21.H.9, FOL. 106V

the voices with instruments, despite no written indication to do so? Is this a better—or worse—performance than a presentation limited to voices alone? There has been a growing tendency in recent years to treat the score as sacrosanct, especially in repertoires in which notation is increasingly exact. Many feel that when a musician exercises too much performance freedom, the original work's integrity is at risk of being lost. The philosopher Nelson Goodman takes this attitude to an extreme when he argues, "Since complete compliance with the score is the only requirement for a genuine instance of a work, the most miserable performance without actual mistakes does count as such an instance, while the most brilliant performance with a single wrong note does not" (p. 186). Although most listeners would disagree with Goodman's position, his view is in some ways at the heart of another controversial aspect of music: the goals of performance (or performing) practice.

Performance practice. The last half of the twentieth century witnessed an increasing desire among many musicians to reenact performances of historical works as closely as possible to the way (we think) they were first presented. No one objects to the notion that it is often pleasurable to hear Johann Sebastian Bach's preludes and fugues performed on a harpsi-

chord; the disagreements begin when we ask if it is still pleasurable (or desirable) to perform the same Bach works on a modern piano (see figure 8)—and if we should be allowed to use the pedal while doing so. Designating the attempts at exact reenactments of the past as "authentic" or "historically informed" (or "historically aware") has added heat to the debate. The problem, as Richard Taruskin and others have pointed out, is the invidious implication that a performer who does choose to play Bach on the piano is uninformed and that his performance is inauthentic or, worse, unaware. Moreover, as Paul Henry Lang recognizes, even the most exacting and thorough historical research will leave gaps that must be filled with "our own artistic beliefs and instincts"; he adds, "Unconditional conformity to authenticity in the interpretation of old music, in depending on archival fidelity, may fail in fidelity to the composer's artistic intentions" (p. 179). The conductor James DePreist argues that even living composers who are able to supervise rehearsals are inevitably surprised by the sound of their works in actual performance—"surprised," DePreist maintains, "because the gap between the musical blueprint, that is, the score, and the interpreted sound is a universe of options and potentialities" (p. 11). Looking at the issue of authenticity from another perspective, Peter Kivy discusses the challenge of creating historically aware listeners.

"Liveness" in performance. In the past, there has been an inherent two-fold assumption among Westerners that a performance entails live presentation of music before live listen-

ers. The second component of this view is not universal, as J. H. Kwabena Nketia explains in his study of African music: “A physically present audience . . . is not always necessary . . . since a performance may well be for the benefit of someone who may not actually be present, or simply for the enjoyment of the performers” (p. 33). With the advent of recorded and electronic sound, however, the traditional expectation of “liveness” in the actual presentation of music has also been challenged. Recordings usher in a new host of metaphysical questions: in the case of a multilayered, overdubbed sound creation generated privately in a studio, is there no actual “performance” at all? Or is the artist performing during the process of adding each layer and effect? Or does a performance occur when the final product is transmitted to a listener? Simon Frith argues for the latter condition when he says, “I listen to records in the full knowledge that what I hear is something that never existed, that never could exist, as a ‘performance,’ something happening in a single time and space; nevertheless, it *is now* happening, in a single time and space: it is thus a performance and I hear it as one” (p. 211).

As Philip Auslander notes, a parallel “authenticity” problem exists when a presentation purports to be a live performance, yet in actuality the performers are miming their actions to a prerecorded soundtrack. In the Milli Vanilli scandal of early 1990, the pop singing-dancing duo had won a “Best New Artist” Grammy award, yet it was eventually revealed that not only did they use prerecorded vocals in their concert appearances but they had not been the actual singers on their prize-winning recording. This discovery led not only to the rescinding of their Grammy Award but to widespread American legislation that requires performers who plan to lip-synch during concerts to indicate this fact on advertising posters and on concert tickets. For some listeners, however, this caveat begs the question whether such a performance is “genuine,” and if it is truly as good as a completely live presentation. It is frequently the case that touring productions of Broadway shows use “canned” (prerecorded) orchestral music, rather than sustaining the expense of traveling with a pit orchestra. Not only does such economy make union orchestral musicians unhappy, but it destroys the potential for flexibility during individual performances of the vocal numbers; singers must “keep up” with the recording, and so cannot indulge in nuanced interpretative variations from show to show. Perversely, however, it is precisely to enjoy those idiosyncratic moments that many listeners continue to attend and support live performance. At the same time, in some forms of art music, such as Milton Babbitt’s *Philomel* (1964), composers have created electro-acoustic works in which live musicians perform in coordination with a prerecorded tape or electronic soundtrack. Is a performance “better” when the tape and live music are combined by artistic choice rather than economic motivations? This dilemma is yet another of the many puzzles confronting the assessment of good performance.

Jonathan Dunsby offers the provocative suggestion that the same technological innovations that are complicating our current valuations of performance may also be the impetus for an enormous change in human aesthetic judgment, since they will allow us to overcome the transient nature of our short lifespans. “The past,” he observes, “is *silent*,” but “it is interest-

ing to ask whether technology, in its sound recording, then vision and sound, holography, virtual reality, and who knows what may come next, is generating a fundamental shift in this situation.” He adds,

We may be witnesses, the only direct witnesses there will ever be, to the beginning of the music of the future. Is it not easy to imagine that two thousand years or five thousand years from now people will say that Western music really only got going properly during the twentieth century from which distant time there date the earliest proper sonic and visual records, following that strange ‘mute’ early period of music history that spanned the Greeks . . . to, say, Mahler . . . ? (pp. 15–16)

Dunsby’s notion is a stimulating one, and its implications for performance have not yet been fully addressed. Certainly the ability of mass communication to shrink the globe and to link people (and their musics) has long been recognized; we are entering an age that enables us to join performances of the past to the music of the future. Any contemporary performer who has been influenced by the ideas, techniques, and artistry of long-dead twentieth-century musicians is already aware of the tremendous power of recordings; our aesthetic views now need to catch up. Mankind is not immortal, but through recorded performance we may now be able to live long beyond our time.

See also *Music, Anthropology of; Theater and Performance*.

BIBLIOGRAPHY

- Auslander, Philip. *Liveness: Performance in a Mediatized Culture*. London and New York: Routledge, 1999.
- Béhague, Gerard, ed. *Performance Practice: Ethnomusicological Perspectives*. Westport, Conn.: Greenwood, 1984.
- Berleant, Arnold. *The Aesthetic Field*. Springfield, Ill.: Thomas, 1970.
- Cone, Edward T. “The Pianist As Critic.” In *The Practice of Performance: Studies in Musical Interpretation*, edited by John Rink. Cambridge, U.K.: Cambridge University Press, 1995.
- Davies, Stephen. *Musical Works and Performances: A Philosophical Exploration*. Oxford: Clarendon, 2001.
- DePreist, James. *Art for the Sake of Art: Musical Metamorphoses*. San Diego, Calif.: San Diego State University, 1999.
- Dunsby, Jonathan. *Performing Music: Shared Concerns*. Oxford: Clarendon, 1995.
- Frisbee, Charlotte J. “An Approach to the Ethnography of Navajo Ceremonial Performance.” In *The Ethnography of Musical Performance*, edited by Norma McLeod and Marcia Herndon. Norwood, Pa.: Norwood, 1980.
- Frith, Simon. *Performing Rites: On the Value of Popular Music*. Cambridge, Mass.: Harvard University Press, 1996.
- Goodman, Nelson. *Languages of Art: An Approach to a Theory of Symbols*. 2nd ed. Indianapolis: Hackett, 1976.
- Gracyk, Theodore. *Rhythm and Noise: An Aesthetic of Rock*. Durham, N.C., and London: Duke University Press, 1996.
- Kivy, Peter. *Authenticities: Philosophical Reflections on Musical Performance*. Ithaca, N.Y., and London: Cornell University Press, 1995.
- Lang, Paul Henry. *Musicology and Performance*. Edited by Alfred Mann and George J. Buelow. New Haven, Conn., and London: Yale University Press, 1997.

- Levinson, Jerrold. *Music, Art, and Metaphysics: Essays in Philosophical Aesthetics*. Ithaca, N.Y., and London: Cornell University Press, 1990.
- Mithen, Steven J. *The Prehistory of the Mind: The Cognitive Origins of Art, Religion, and Science*. London: Thames and Hudson, 1996.
- Nettl, Bruno, with Melinda Russell, eds. *In the Course of Performance: Studies in the World of Musical Improvisation*. Chicago and London: University of Chicago Press, 1998.
- Nketia, J. H. Kwabena. *The Music of Africa*. New York and London: Norton, 1974.
- O'Dea, Jane. *Virtue or Virtuosity?: Explorations in the Ethics of Musical Performance*. Westport, Conn.: Greenwood, 2000.
- Taruskin, Richard. "The Pastness of the Present and the Presence of the Past." In *Authenticity and Early Music: A Symposium*, edited by Nicholas Kenyon. Oxford and New York: Oxford University Press, 1988.

Alyson McLamore

MUSICOLOGY. Musicology is the scholarly study of music, where music can be considered either as a fixed object of investigation or as a process whose participants are the composer, the performer, and the listener. As a field of knowledge, it encompasses every aspect of the aesthetic, physical, psychological, and cultural dimensions of the musical art. In practice, consequently, the discipline includes not just music itself—considered either as a fixed object of study or as a process—but also anything that relates to music in any way. Thus, for example, the history of music patronage during the Renaissance is considered to be a musicological topic, as is the history of the development of printing presses able to reproduce music notation. The potentially unlimited scope of the discipline has led one contemporary musicologist to define musicology as “whatever musicologists do as musicologists” (Leech-Wilkinson, p. 216).

Historically, in the Western tradition, musicology has to a great extent been identified with the study of classical music (“art music”), as opposed to popular music. Neither of the terms “classical music” or “art music” is entirely satisfactory. The former is somewhat ambiguous, as it also refers less generally to music written in the Classical style of the late eighteenth and early nineteenth centuries by composers such as Franz Joseph Haydn (1732–1809) and Wolfgang Amadeus Mozart (1756–1791). And the term “art music,” although it is widely in use, carries with it an undesirable and inaccurate connotation of elitism. Throughout this article, the phrase “classical music” is used, somewhat as the lesser of two evils, to refer generally to the notation-based music of the Western high-culture tradition.

Musicology has traditionally been differentiated from ethnomusicology, which in the most general terms is the comparative study of non-Western musics, as well as the study of popular and folk music from both Western and non-Western cultures and subcultures. However, recent developments within musicology (principally, the advent of what is referred to as the “new musicology” and the paradigm shift in musicological methodology described below under “The Critical Method”)

have tended to diminish greatly previously significant differences between the two disciplines. (For an example of traditional ethnomusicological methodology applied to the study of Gregorian chant, see Jeffery, *Re-Envisioning Past Musical Cultures*.)

Subdisciplines of Musicology

The principal subdisciplines of musicology are as follows, briefly defined in the most general terms:

Music history: the careful construction of the historical record on the basis of available data from the past and the subsequent application of a historiographical methodology to that record. Traditionally, scientific historicism, which involves the postulation of historiographical categories such as causal relationships, periodization, and musical styles, has been the preferred methodology of music historians, whose field of investigation has generally been confined to the study of Western classical music (as noted above).

Performance practice and historically informed performance: the investigation of modes of musical performance that are particular to a specific time or place within music history, including methods of interpretation, tuning of instruments, types of musical ornamentation and improvisation, instrumental techniques, and performance conventions. An important late-twentieth-century development within this subdiscipline has been the increased interest, within the Western classical music tradition, in the historically informed performance of early music—that is, music for which an appropriate style of performance must be reconstructed on the basis of historical evidence.

Textual scholarship: generally, the systematic study and description of manuscripts and printed books, and the construction of scholarly editions that, assuming the existence of a most correct or “best” text, list and reconcile variant readings between two or more versions of the text in question. The study of manuscripts involves paleography, the science or art of deciphering and dating handwritten texts; within musicology, this frequently includes the study and transcription of early music notations.

Archival research: the study, for music-historical purposes, of documents issued by governments, churches, or any administrative authority in order to establish an important part of the historical record.

History and theory of music notation: the analysis of the process of translating the acoustical phenomenon of musical sound to the written page, employing both comparative and historical methodologies. (See the sidebar on “Music Notation.”)

Music theory and analysis: the historical study of generalized descriptions of the structure of music and musical sound, both within and outside the Western classical-music tradition. Analysis, which is the de-

tailed examination of individual pieces of music for the purpose of validating existing theoretical constructs or developing new ones, differs from music theory in that its object of investigation is music that has already been composed or performed, rather than the properties of the elements of musical sound or abstract musical principles.

Aesthetics of music: the study of issues of a primarily philosophical character connected to the art of music. Of principal concern is the question of whether or not music has either affective or semantic content. At issue also, given the ephemerality of music, is the ontological status of the musical work of art: does it exist as an ideal object, perhaps the faithful realization in performance of a musical score, or is it better conceived of as a sort of process, without any assumptions of an ideal existence?

Sociology of music: the systematic investigation of the interaction of music and society. This includes not only the ways in which music functions within a particular social context, but also the influence of that social context on characteristics of the musical work (such as genre, structure, form, and harmonic organization) or of the musical process (such as modes of performance and musical values).

Psychology of music: the scientific investigation, using psychological tools, of human musical behavior and cognition, with emphasis on the perception of various properties of musical sound, musical memory, performing and creating, learning and teaching, and the affective processes stimulated by aspects of musical sound. The three principal research orientations are psychophysics, cognitive psychology, and neuropsychology.

Criticism: the evaluation, description, and interpretation of an individual work of music, or of the musical process, according to a wide range of criteria drawn principally from the study of the aesthetics, psychology, and sociology of music. Criticism differs from analysis in its emphasis on music as it is actually heard, rather than on properties of music that can be ascertained in a written score, for example, but not necessarily easily perceived by an audience during the course of a performance.

Acoustics (the physics of musical sound): the science of sound and of the phenomenon of hearing applied to the description of the physical basis of music and to the determination of the nature of musical sound.

Organology: the scientific study of the history of the design and construction of musical instruments. This subdiscipline also addresses the extramusical functions of instruments in historical contexts, technology, and general culture.

Iconography: the study of the visual representation of musical subjects—such as musical instruments and

musicians—in texts, works of art, coins, and other media as a source of historical information about musical instruments, performance practices, biography, and the social and cultural roles of music.

Principal Methodologies for Musicological Research

In the face of a disciplinary definition of virtually unlimited scope and a diverse array of related subjects, the actual practice of musicology is probably best understood in terms of the principal methodologies or investigative paradigms that have been and are currently the bases for the scholarly study of music as it is carried out within each of the major subdisciplines: the scientific historical method, the analytical method, and the critical or interpretive method.

The scientific historical method. “Scientific” historicism—rather than just “historicism,” to distinguish it from what is now commonly known as “new” historicism (see Treidler, “The Historiography of Music,” p. 362)—is the traditional historiographical methodology of music history, taken (as indicated above) to mean the history of Western classical music. It is scientific in the sense that it seeks first to establish an accurate historical record and then, on the basis of that record, to identify patterns of influence and causal relationships that form the basis of the periodization of music historical time and the construction of a diachronic narrative.

Scientific music historiography has as its object of study “the history of music” in its most common sense—that is, the events of the past that can be related in some way to music. Because the investigation begins with whatever historical data are available, the subdisciplines of textual scholarship, archival research, history of music notation, organology, and iconography (as described above) are extremely important to the accurate and efficient construction of the facts and texts (for example, transcriptions or facsimiles of archival documents, biographical information, and scholarly editions) that will comprise the historical record and will serve as the bases of subsequent causal hypotheses. This first, empirical stage of investigation is frequently referred to as “historical positivism.”

In general, once the historical record has been established, the scientific historiographer attempts to establish order among the various facts and texts by constructing plausible causal relationships and historical periodizations. In the case of music historiography, however, there exists at this point a tension between generalizations based on the entire historical record and those based on a consideration of specific pieces of music, objectified as works of musical art and considered to be semi-autonomous in the sense of existing within a continuum of musical works of art that are largely defined by their own internal processes of influence and causality, apart from those of history in general. In simplest terms, it is a question of what music history is about, traditionally a choice between two alternatives: either defining periods of musical history based on the guideposts provided by the lives of great composers (placed within their cultural context) and the schools of composition formed around them, or extrapolating periods defined by musical style from the patterns of influence, types of composi-

tions (genres), and prevalent characteristics observed through the careful formal analysis of the properties of individual works of musical art. In either case, the result remains within the historicist paradigm; and in practice, twentieth-century music historiographers have tended to base their diachronic narratives principally on musical style, a process that permits the inclusion of historical and biographical facts but encourages the conviction that music history is really about the objectified musical work—and is therefore different in essence from other types of historical narratives. An instructive case in point is the extremely popular *History of Western Music* by Donald J. Grout and Claude V. Palisca, now in its sixth edition. A sampling from the table of contents shows a pragmatic mixture of chapters defined, respectively, by stylistic period, composer, genre, and historical grab bag: “Music of the Early Baroque Period,” “Sonata, Symphony, and Opera in the Early Classic Period,” “Ludwig van Beethoven,” “The American Twentieth Century.”

One result of nineteenth-century scientific historicism was the consolidation of what is known as the “musical canon,” a collection of works that are generally regarded as having extraordinary aesthetic value and therefore able to serve as the building blocks of an historical narrative whose subject is the musical work. During the twentieth century, the wide popularity of historical accounts based on style, dealing almost exclusively with the composers and works of the musical canon, resulted in the nearly complete exclusion of minor composers and women and in an increasing emphasis on formal analysis. This emphasis led to, and was in turn nourished by, intense positivist activity in the production of new and more accurate editions of the composers and works of the canon, and answered many open questions about chronology, authenticity, and the process of composition. Thus, it encouraged an even greater focus on the inner workings of individual pieces of music and an increasing absence of any consideration of those pieces of music as historical documents produced within a specific social and political context. By the late 1970s, in fact, German musicologist Carl Dahlhaus, in the Introduction to his study of nineteenth-century music, lamented the decline of history and reasserted the task of a music historiographer as the establishment of “a relation between the aesthetic and the historical substance of works of music” (Dahlhaus, *Nineteenth-Century Music*, p. 1; see also Dahlhaus, *Foundations of Music History*). Similar ideas were expressed at about the same time by the American musicologist Leo Treitler: “Music history is possible only insofar as the historian is able to show the place of individual works in history by revealing the history contained within the works themselves, that is, by reading the historical nature of works from their internal constitution” (Treitler, *Music and the Historical Imagination*, p. 173).

Contemporaneous with these somewhat premature announcements of the triumph of formal analysis over music history was the rise of a flourishing practical application of various positivist historical projects: a branch of performance practice known variously as “the early music movement,” “authentic performance,” “period performance,” and “historically informed performance.” Beginning around 1970, performers of music written during the seventeenth and eighteenth centuries

began to use the data of the historical record—editions, information about period instruments, knowledge of the composer’s intentions, original performance conditions, and so on—to produce performances that were intended to be as historically appropriate as possible. Nourished by a thriving recording industry, the movement soon included music from every period and style, even that of the twentieth century. The movement has been widely criticized on the basis of its claims to authenticity and for what is described as its “essential modernism” (see Kivy, *Authenticities*, and Taruskin, *Text and Act*, respectively). However, it cannot be denied that the historically informed performance movement, which continues to be both vigorous and vital, has generated interest in a wide variety of repertoires and introduced a broad spectrum of possibilities for both performance and hearing. (See Butt, *Playing with History*, for a thorough discussion of issues surrounding historically informed performance.)

The analytical method. The analytical method in musicology begins with a consideration of the music itself—either in written form in a notated musical score or in sounded form in performance—and attempts to identify the structural characteristics of that piece of music in terms of broadly definable elements such as form (including motivic and harmonic analysis), musical detail (such as dynamics and tone quality), and the music’s relationship to a text. In the most straightforward sense, the musical analyst attempts to uncover what it is that makes a piece of music “work” as music. Musicological analysis differs from ethnomusicological analysis in that the latter necessarily places the investigation squarely within a particular cultural context, whereas musicologists may consider the musical work, either in score or in performance, completely removed from its context. As indicated above, musical analysis is related to music theory in that analysis provides the data that can be used to validate existing theories or to construct new ones; it is, as Nicholas Cook observed, “the practical application of theory” (*Music*, p. 93). It is also at least implicitly involved in critical musicology (see “The Critical Method,” below), since the very act of careful analysis of a work of music indicates a prior judgment as to the worth of that music.

Musical analysis, though synchronic rather than diachronic in nature, provides the data that allow the scientific historian to assess the possibility of a causal relationship between the works of two composers, given the existence of stylistic similarities: Did the two composers know each other’s work? Did they come into direct contact? Were they both influenced by a third composer rather than directly by each other? And the historian may be able to determine a chronology of composition of works of one or more composers on the basis of the stylistic information provided by analysis. Likewise, historical information can be of great use to the analyst, who must on occasion step outside of the work itself in order to decide which of several hypothetical structures best fits the music in question.

Whether the music is in musical score or in performance, the question of what is actually being analyzed, the “subject” of analysis, is difficult to answer. Music is by nature ephemeral, not subject to scientific observation and measurement. Should

one concentrate on the musical sound that the composer may have had in mind as he composed the work, or on the sound of a particular performance, or on the work as it is represented in a notated score? In the Western classical-music tradition, the notated score—the written image of a work—is generally used as the starting point for analysis, which may then go on to consider various possibilities of how it might sound. Here again, the analyst often uses the output of the scientific historian, specifically the editions of works and composers produced by textual scholarship and the study and interpretation of music notations (see the sidebar on “Music Notation”).

As mentioned above (in the discussion of scientific historicism), in recent years the popularity of historical accounts based on musical style and the accompanying emphasis on the formal analysis of the inner workings of individual pieces of music gave rise to a feeling among many historical musicologists that the analytical method had to a great extent succeeded in removing the historical component from works of music that were in fact historical documents and should not be considered entirely out of context. In short, the concern was that the two methodologies, rather than existing in peaceful symbiosis, were in danger of becoming a single approach based on formal analysis. Perhaps the most virulent denunciation of this tendency came from the musicologist Joseph Kerman, who objected strongly to the formalist preoccupation of music analysts with the internal structure of the individual work of art, considered as an autonomous entity. “The potential of analysis is formidable,” he wrote, “if it can only be taken out of the hothouse of theory and brought out into the real world” (Kerman, *Contemplating Music*, p. 18). In fact, many of Kerman’s points were well taken, although unquestionably overstated. Much of the structural analysis during the early years of the twentieth century tended to accept uncritically the works of the Western musical canon and to seek analytical methods to explain the “greatness” of these works; in other words, the truly critical dimension was missing. And in the years following World War II, music analysis became increasingly formalist, abstract, and even arcane in nature, using scientific language and symbolism, as well as drawing directly on areas of theoretical mathematics such as set theory.

In the years since 1985, the analytical method has continued in the old directions (which are ably defended in Pieter Van den Toorn, *Music, Politics, and the Academy*), while also—somewhat in response to Kerman’s charge of excessive formalism—moving in new ones that attempt to strike a balance between the consideration of the musical work out of context and an investigation of the historical and social forces evident in that music. Among these new approaches are semiotic analysis; surface rather than structural analysis; a more vigorous investigation into the history of the reception of musical works; and attempts at experimental verification, based on perception, of the importance to the listener of various abstract analytical properties. (See, in this context, the collection of essays included in Cook and Everist, *Rethinking Music*.)

The critical method. The critical method in musicology undertakes the comprehensive interpretation and evaluation of

what a musical work means within all of its contexts—historical, political, sociological, and economic, as well as aesthetic. In this, it differs from the analytical method, which generally considers the work of music to have a partially, if not completely, autonomous status with respect to any of its possible contexts. Scholarly music criticism has a long tradition, but the critical method in musicology has taken on much of its importance as a reaction and a response to Kerman’s previously mentioned attack, in the mid-1980s, on excessive analytical formalism (see “The Analytical Method,” above) and unrealistic historical positivism. With respect to the latter, Kerman and others questioned the assumption by scientific historians of the existence of a unique “best text” (ur-text) that can be reproduced in a scholarly edition, noting that for much early music the concept is anachronistic, and that even nineteenth-century composers such as Beethoven and Chopin were continually making changes to their compositions.

Deploring what he perceived as a substantial gap between academic musicology and the human experience of music, Kerman called for a methodology that would draw upon “all modes of knowledge, including the theoretical and the analytical, the historical and the intuitive, to help achieve a critical response to a piece of music” (Kerman, *Contemplating Music*, p. 154). And indeed, whether in response to Kerman specifically or simply as part of the “postmodernist” climate of the late 1980s and 1990s, the critical method in musicology has come to encompass a variety of historiographies and research methodologies, showing the influence of the literary critical theory of the 1990s as well as recent developments in disciplines such as anthropology and philosophy. This new wave of critical thinking is often included under the omnibus term “new musicology.” Among the most productive and promising are the following, not necessarily mutually exclusive, directions:

Hermeneutic historiography. In answer to criticism of the claims of “certain” knowledge put forth by scientific historians, proponents of a hermeneutic historiography in musicology advocate a synchronic rather than a diachronic historiographical model: that is, narratives based on causal relationships constructed according to the scientific historical method should be replaced by thorough contextual descriptions of a musical work of art, a goal much influenced by the work of the anthropologist Clifford Geertz. The aim of such an investigation, given the wide range of contextual information, is the well-informed interpretation, or exegesis, of all aspects of the creation in a particular time and place of a musical work or of a musical process, involving details and conditions of performance and reception. (See, for example, Small, *Musicking*, especially his Geertzian “thick analysis” of a symphonic concert of classical music.) The issue of the status of the work of music is generally unresolved. Some musicologists argue that contextual interpretation is not enough, that the musical work of art must also be considered with respect to the aesthetic experience that it produces. It must therefore retain some degree of autonomy within its historical context and should be analyzed accordingly. (See, for example, Treitler, “Historiography of Music.”) Others reject entirely the idea of a “close reading”

MUSIC NOTATION

The fundamental aim of music notation is to make a lasting visible indication of musical sound, which is invisible and ephemeral. In this respect, it is intimately related to writing in general; and, in fact, music notation is a technology found in societies that have already developed a script for language. Frequently the elements of that script are used in the music notation. And indeed, wherever they have been developed, systems of music notation fulfill two of the functions of script: conservation and communication. Moreover, just like writing in general, systems of music notation are selective in what they specify, ignoring certain aspects of performance judged to be less significant. For example, just as the written record of a speech provides little information about modes of delivery, music notations generally specify pitch or duration—which can be seen as the analogues of letters and words—but leave unfixed many elements of performance. Western notations are of two major types: instrumental tablature and phonetic or pitch notations. A tablature provides specific instructions for playing a piece of music on a stringed instrument, including proper placement of fingers and performance technique, and sometimes rhythm and the relative duration of notes. Pitch notation is a collection of signs (frequently letters of the alphabet), each representing a specific pitch, and possibly other information such as rhythm and duration.

The earliest surviving notation is from Mesopotamia; and the musical cultures of India, China, Korea, and Japan, as well as the Arabic-speaking cultures, have made extensive use of music notation of various types, principally pitch notation, tablature, and solmization (the system of using syllables to denote the pitches of a musical scale). (See the articles on notation in the *New Grove Dictionary of Music* for a discussion of Western and non-Western music notations.) Western classical music, however, has relied more on notation than any other, because notation is fundamental to the conception of Western

classical music as a collection of enduring works of art, objects that can be replicated in performance but that have a separate fixed existence independent of any specific sonic realization. This is not the case in other musical cultures, or even in non-classical Western musics, which place a higher value on performance and improvisation—on the act of making music—than on a written set of musical instructions.

The metaphor of the musical “object” came into use at some point during the nineteenth century (see Goehr, *The Imaginary Museum of Musical Works*). Prior to that time, imprecision was a generally accepted aspect of music notation, and a piece of music was generally thought of as something that existed only in specific performances made possible by the skill of performers in using a notational “sketch” to produce musical sound. But during the nineteenth century, composers increasingly sought to control performances of their works by means of more specific notation. This led to a view that performers were not “making music” but were “producing” musical works. According to this interpretation, the canon of Western music is a collection of imaginary musical objects (which are given a sense of reality by the fact that they are notated) and temporal experiences (the performances of these musical objects, made possible by the fact that they are notated). In this scenario, the responsibility of performers is to be true to the work (in German, *werktreu*)—that is, true to the intentions of the composer, true to scholarly edition, true to the authentic conditions of performance. These ideas have been challenged on many grounds, as discussed above. Most notably, the actual circumstances of composition indicate that often there is no single “correct” version of a musical work. And the degree of “authenticity” of a performance is difficult if not impossible to assess. These objections notwithstanding, Western classical music is largely conceived not in terms of performance but as a collection of notated musical objects.

of musical text, preferring to base their analysis entirely on a theoretically dialogic (two-way) conversation with the producer through the cooperation of archeological investigation and sympathetic hermeneutics. (See, for example, Tomlinson, *Music in Renaissance Magic*.) The most extreme advocates of this position interpret all musical detail—tonality, form, and so on—culturally.

Studies in gender and sexuality. Beginning in the 1970s, some music historians began to take an interest in writing the history of women in music, a subject that until then had been almost entirely ignored; the resulting studies concentrated largely on the location of sources and the recovery of biographical information. These efforts were followed in the late 1980s and 1990s by the development of serious musicological criticism based on gender. In addition to identifying gender representations in various types of music, writers have used the results of formal analysis to argue that the music itself can produce these representations. Often this type of research has resulted in the destabilization of conventional assumptions about the events of Western music history. For example, Susan McClary, in *Feminine Endings*, has examined music spanning the period from the sixteenth century to the present and has identified the ways in which historically constituted ideas of gender, sexuality, and the body have informed musical procedures. (See Solie, *Musicology and Difference*, for a diverse and fascinating collection of critical writings on gender and sexuality in music.) The emergence of gender criticism in musicology during the 1990s was accompanied by scholarship based on gay and lesbian issues, demonstrating the relevance of issues of sexuality to musical criticism. (See, for example, Brett, *Queering the Pitch*.)

Sociohistoriography. Since the late 1980s, musicologists and other scholars have increasingly studied Western classical music as a type of cultural practice. This rich methodological development includes work such as that of economist Jacques Attali, who, in a study of the political economy of music, argues that music can in fact challenge normative social orders and thus presage social development (Attali, *Noise*; see also Walser, *Running with the Devil*).

Rhetorical historiography. Recently, the very ways in which musicologists present the results of their research, rather than the research methodologies themselves, have come under critical examination. Notably, Daniel Leech-Wilkinson, employing ideas drawn from Pierre Bourdieu (especially *Homo academicus*) and others, argues that the nature of the academic workplace guarantees that the presentation of new research is necessarily influenced by the shared ideology of the group of scholars for whom that research is largely intended (see, *The Modern Invention of Medieval Music*, especially chapter 4, “Evidence, Interpretation, Power, and Persuasion”). Furthermore, paradigm shifts in musicology, like that accompanying the “new” musicology of the late 1980s and 1990s, are more a result of the importance of creativity and novelty to academic promotion than of a successively closer approximation to the “truth” that is the purported goal of musicological research. Rather than viewing this as a drawback, Leech-Wilkinson concludes that rhetorical excellence of the sort that generates interest and creativity among the scholarly

community should be the admitted goal of musicological research.

“Decentered” historiography. Since the late 1980s, many musicologists have questioned the concentration by music historians on the group of works known as the canon of Western classical music (see “The scientific historical method,” above), a concentration that has tended to marginalize or to ignore completely types of music that have in fact been extremely influential in the West and throughout the world. Advocates of the decentralization of music history argue that the very procedures by which scientific historians construct linear chains of causal relationships and ultimately propose periodizations based on elements of musical style are flawed; these historical analyses are diachronic and too narrowly focused, and the tidy narratives that they construct are misleading and should be corrected by a more synchronic and open-minded historiography. Susan McClary, for example, has written, “My history of Western music contains Bach, Mozart, and Beethoven, but it also includes Stradella and the Swan Silver-tones, Bessie Smith and Eric Clapton, k. d. lang, Philip Glass, and Public Enemy” (*Conventional Wisdom*, p. 30). A fine example of decentered historiography is Robert Walser’s detailed study of the heavy metal genre of rock music (*Running with the Devil*). Walser approaches his subject in various ways, integrating methods of musical analysis and cultural criticism; in particular he devotes a chapter to what he calls the “intersection” of heavy metal and Western classical music, comparing the techniques of heavy metal musicians to those of classical musicians (chap. 3).

See also *Absolute Music; Arts; Composition, Musical; Cultural History; Cultural Studies; Harmony; Music; Anthropology of; Musical Performance and Audiences.*

BIBLIOGRAPHY

- Attali, Jacques. *Noise: The Political Economy of Music*. Translated by Brian Massumi. Foreword by Frederic Jameson. Afterword by Susan McClary. Minneapolis and London: University of Minnesota Press, 1996.
- Bourdieu, Pierre. *Homo academicus*. Translated by Peter Collier. Cambridge, U.K.: Polity Press; Stanford, Calif.: Stanford University Press, 1988.
- Brett, Philip, Elizabeth Wood, and Gary C. Thomas, eds. *Queering the Pitch: The New Gay and Lesbian Musicology*. New York: Routledge, 1994.
- Butt, John. *Playing with History: The Historical Approach to Musical Performance*. Cambridge, U.K., and New York: Cambridge University Press, 2002.
- Cook, Nicholas. *Music: A Very Short Introduction*. Oxford and New York: Oxford University Press, 1998.
- Cook, Nicholas, and Mark Everist, eds. *Rethinking Music*. Oxford and New York: Oxford University Press, 1999. Reprint with corrections, 2001.
- Dahlhaus, Carl. *Foundations of Music History*. Translated by J. B. Robinson. Cambridge, U.K., and New York: Cambridge University Press, 1983.
- . *Nineteenth-Century Music*. Translated by J. Bradford Robinson. Berkeley and Los Angeles: University of California Press, 1989.

- Goehr, Lydia. *The Imaginary Museum of Musical Works: An Essay in the Philosophy of Music*. Oxford: Clarendon; New York: Oxford University Press, 1992.
- Grout, Donald J., and Claude V. Palisca, eds. *A History of Western Music*. 6th ed. New York: Norton, 2000.
- Jeffery, Peter. *Re-Envisioning Past Musical Cultures: Ethnomusicology in the Study of Gregorian Chant*. Chicago and London: University of Chicago Press, 1992.
- Kerman, Joseph. *Contemplating Music: Challenges to Musicology*. Cambridge, Mass.: Harvard University Press, 1985.
- Kivy, Peter. *Authenticities: Philosophical Reflections on Musical Performance*. Ithaca, N.Y.: Cornell University Press, 1995.
- Leech-Wilkinson, Daniel. *The Modern Invention of Medieval Music: Scholarship, Ideology, Performance*. Cambridge, U.K.: Cambridge University Press, 2002.
- McClary, Susan. *Conventional Wisdom: The Content of Musical Form*. Berkeley, Los Angeles, and London: University of California Press, 2000.
- . *Feminine Endings: Music, Gender, and Sexuality*. Minneapolis: University of Minnesota Press, 1991.
- Pendle, Karin, ed. *Women and Music: A History*. 2nd ed. Bloomington: Indiana University Press, 2001.
- Small, Christopher. *Musicking: The Meanings of Performing and Listening*. Middletown, Conn.: Wesleyan University Press; Hanover, N.H.: University Press of New England, 1998.
- Solie, Ruth A. *Musicology and Difference: Gender and Sexuality in Music Scholarship*. Berkeley, Los Angeles, and London: University of California Press, 1993.
- Taruskin, Richard. *Text and Act: Essays on Music and Performance*. Oxford: Oxford University Press, 1995.
- Tomlinson, Gary. *Music in Renaissance Magic: Toward a Historiography of Others*. Chicago and London: University of Chicago Press, 1993.
- Treitler, Leo. "The Historiography of Music: Issues of Past and Present." In *Rethinking Music*, edited by Nicholas Cook and Mark Everist. Oxford: Oxford University Press, 1999. Reprint with corrections, 2001.
- . *Music and the Historical Imagination*. Cambridge, Mass., and London: Harvard University Press, 1989.
- Van den Toorn, Pieter C. *Music, Politics, and the Academy*. Berkeley, Los Angeles, and London: University of California Press, 1995.
- Walser, Robert. *Running with the Devil: Power, Gender, and Madness in Heavy Metal Music*. Middletown, Conn.: Wesleyan University Press; Hanover, N.H.: University Press of New England, 1993.

Blair Sullivan

MYSTICISM.

This entry includes six subentries:

- Chinese Mysticism*
- Christian Mysticism*
- Islamic Mysticism*
- Islamic Mysticism in Asia*
- Kabbalah*
- Mysticism in African Thought*

CHINESE MYSTICISM

The term *mysticism* represents a modern approach to a cultural path rooted in antiquity, and given anthropological considerations it is timeless. Mysticism usually concerns any work, study, or praxis that aims at transcendence (the experiencing "self" moving beyond normal limits) or union with the divine. It was (is) often private or even secret, perhaps involving special teachers. To reflect on the experience requires placing it into everyday language and expression.

Mysticism in Chinese thought and society should neither be reified nor reduced to one cultural path or genre of thought. It resonates with some, if not all, ancient Mediterranean practices to which the Greek word *mustikos* (from the word *muo*, to be secret) was applied, as well as with mysticism found among thinkers from Jewish, Christian, and Muslim communities. Chinese society produced its own textual adepts and adherents, both within and outside of religious structures. And there are examples of guarded (in some sense hermetic) pursuits and transmittals of curricula and skills.

Three important aims of Chinese mysticism have been: (1) mantic knowledge and divination; (2) individual enlightenment and/or transcendence; and (3) union and cooperation with divinities. Social contexts range widely: individuals, village groups, and royal courts. A village scholar might employ an artisan-practitioner for mantic insight into his place in the cosmos, and priests might pursue hermetic texts and praxis of a rarefied nature.

China's "Mantic Way": Knowledge through Insight and Technics

The oldest, deepest element within Chinese mysticism is the society's diffuse mantic approach to both special knowledge and everyday life; one may call it the mantic way—enduring to the present. Archaeological work on ancient China has inspired deductions about the impact that mantic pursuits had upon politics, natural philosophy, religions, and technics. David Keightley has argued, via late-Shang royal divination records (around 1200 B.C.E.), that court decisions often were mantically "charged" in order to both detect and induce the influence of ancestors; thus, specialists, operating with divination materials, manipulated the rituals and linguistic processing of the charges not just to show how to act, but to verify that a ruler had acted correctly or had effective ancestral connections.

The mantic way infused all social levels and mundane contexts (court rites, tomb appurtenances and texts, household almanacs, manuals, and situational fortune-telling) and was a basic context for Chinese sciences. In this last regard, a trend developed from about 500 B.C.E. to 200 C.E. toward precision in the mantic arts (for example, numero-astral and calendric devices, and *Yi jing* numerate and correlative theoretics). Courts desired the best-trained and most effective practitioners with their impressive techniques. By Tang and Song times the arts were practiced widely, in urban areas and the countryside, and also became fairly regularized in state offices. Practitioners usually transmitted skills only within their own families. This alloy of intuitive, artisanal knowledge, precision

ANCIENT MYSTICISM EMERGES LATER IN DAOIST TEXTS

“[T]he five tones originate in the breath blown in and out from the mouth. . . . Spread out energy forms the six roots of the senses.” Mystical practice as described in fifth-century Daoist text “Xisheng jing.” Note the reference to ritual music, similar to the deep context of the earlier, non-religious “Wenyan” commentary to *Yi jing*.

SOURCE: *Taoist Mystical Philosophy: The Scripture of Western Ascension*, translated by Livia Kohn. Albany: State University of New York Press, 1991, p. 237.

technics, and protectiveness has cast an aura of “mystery” over arts that Westerners have found attractive, such as *fengshui*, medicine, and astrology. But it is more important to understand how arts and systems were both connected to and made sophisticated outside of the diffuse mantic way.

Self-Cultivation as a Secular Pursuit:

c. 400 B.C.E.–1600 C.E.

“Self-cultivation” shows how a certain praxis grew out of the substrate to become an important cultural artifact. At an early point it became entangled in the catch-all (and confusing) category “Daoism.” By the late 1700s European sinologists began to examine texts haphazardly denominated “Daoist.” For example, the roughly third century B.C.E. commentary to *Yi jing* (The book of changes) titled “Wenyan,” in a passage that discusses “aesthetic grace” (*mei*), reads at one point: “A man of quality: [attuned to basal] yellow [at the] center; transmitting a system-pattern. He uprightly sets [his] position; makes an abode [within his] outline-shape. With [aesthetic] grace on his inside, [he can be] at ease in [his] four limbs.” Interpreters conflated ideas like this with what little they knew of “philosophic Daoism,” which often was seen as a crypto-Legalist Confucianism. In the 1920s Richard Wilhelm translated the foregoing, in part, as “The superior man is yellow and moderate . . . makes his influence felt . . . through reason. . . . His beauty is within” (*The Yi jing*, p. 395), the assumption being that “yellow” referred to moderation and a yielding nature. This relates to late-imperial Confucian ethics and eremitism, but misses important links to an ancient context.

Scholars are now able to apply finer nuances. Since about 1975, archaeology has brought to light manuals, implements, and texts from pre- and early-Han tombs (roughly 400 to 100 B.C.E.) that evidence practices of divination, siting, sexual hygiene, demon-quelling, longevity arts, and mind-evacuation. Examples are “Recipes for Nurturing Life” and “Ten Questions,” texts from the Mawangdui cache. Donald Harper carefully explains that these may have been the practical bases from which later self-cultivation pursuits developed. Such tombs were constructed in an era when imperial courts devoted money and energy to complicated rites programs, which in

turn found parallels in local culture. Thus the commentary passage, above, apropos of the *Yi jing* phrase “yellow lower garment,” actually carries a *mustikos*—objects in closed-off tombs and the secretive, frequently agonistic, court struggles over systems of music and dress. In fact, “Yellow Bell” was the name of an elusive, theoretical pitch regulation for establishing tuning “systems.” Harmonics in turn were seen as “transmitting” cosmic beauty, which emanated from the “man of quality” at the “center”—that is, local royalty or, later, the emperor. The “Wenyan” passage thus glides on the edges of several readings: an indirect, mostly metaphorical exhortation on centering; a paean to court music and the computations of its harmonics experts; an alchemy of nurturing the homunculus emperor (or sage) within oneself; and reconciling inner and outer commitments in one’s public life. Later in the Han period, and with important revivals during Tang and Song (see below), other texts carried self-cultivation forward, with instructions in mystical practice that became more specific.

If the above interpretation of a passage of commentary to *Yi jing* is controversial, nevertheless, self-cultivation is read quite confidently from passages of famous works such as Laozi, Huainanzi, Guanzi, and Zhuangzi that discuss breathing, sitting still, and removal of all perception and emotion. Such readings are seen by Harold Roth to reflect a historical development whose very earliest period emphasized “cosmology and the inner transformation of the individual leading to the attainment of ‘mystical gnosis’” (Roth, pp. 6–9). Through the textual work of Roth, Livia Kohn, and others it is better understood that early China contained a whole culture of self-cultivation, with fairly common terminologies, texts, and aims.

Beginning around 100 C.E., scholar-officials restored and reinterpreted ancient texts. The *Yi jing*, especially its anonymous commentaries (as above), was researched anew, as was the relativistic and transcendent logic of Laozi and Zhuangzi. The second to fourth century scholar-Daoists, often referred to as “neo-Daoists” or “Mystery Adepts,” brought relativist logic and psychological inquiry into public discourse, and many practiced eremitic stances and withdrawals. Most did not identify the ancient traces of mystical praxis per se in their classics, but

FROM MEDIEVAL TANTRA TO MODERN TIMES

The following snippet of recitation (from a 600-year-old text) was performed in the 1990s in Fukien, China, for local Daoist rites: “. . . with complete obedience [to] . . . Perfected Lord Wu/ . . . Wrote talismans, let fall seal-scripts . . . that his Sacred Spell would have awesome power. . . .”

SOURCE: *Taoist Ritual*, translated by Kenneth Dean, p. 93.

their metaphysics and ontology spurred mystical speculation later on among monk-scholars and Daoist revelators.

In this same period, anonymous writings known as “weft-texts” (*wei*) and numero-calendric “charts” (*tu*) were thought to augment hermetically the “warp” of the Confucian classics. Essentially, they were revelatory texts that claimed sage-authorial voice for their political predictions and comments on sociocosmic timing and justice. Beginning about 350 C.E., revealed texts of various types influenced southern Daoist scholars and scriptural communities; and they remain in use in Daoist communities of the early twenty-first century.

Around 1000 C.E. neo-Confucian discussions reclaimed ancient approaches to self-cultivation, this time fully conscious of the mystical program, unlike earlier reclaimers. Many judged Daoist practices as undesirable and the cosmologies and belief-systems of Mahayana Buddhism as anathema; but the influential Shao Yong (1011–1077), for example, borrowed from both, sparking interest among scholar-intellectuals in psychocosmic resonance and correlation, as well as in self-cultivation. In fact, self-cultivation became prominent in the aspirations and writings of Wang Yangming (1472–1529), his disciple Wang Ji (1498–1583), and follower Li Zhi (1527–1602), to name a few. Their mysticism centered around the notion (even praxis) of “innate knowledge”—promoting instinctual mental (and moral) response over the machinations of academic learning. In fact, Wang Yangming wrote of practicing a Zen-like contemplation and the subsequent redirecting of it into political action. His ideas made a deep impact on elite-scholar life for over two hundred years.

The Buddhho-Daoist Melange: Tantra, Zen, and Mediums, 400 C.E.–Present

By about 300 C.E., northern Chinese polity had collapsed under pressure from proto-Turkic invaders. Many northern social and political elite had reestablished themselves in the south, a general area long known for expressions of ecstatic vision and song and escapist literature. When Daoism and Buddhism, as organized monastic-lay communities, flourished in the south, detailed instructions in mystical practice became more frequent, while at the same time the themes and types of practice changed. When the nation was unified under the Tang dynasty in 618, the two religions achieved widespread official sanction.

Buddhism’s Hinayana roots in China (from about 100–300 C.E.) had emphasized mind-body exercises (breathing, counting, and recitation). Mahayana Buddhism, a bit later, shared with Daoist scriptures the desire to impart protection for individuals and communities against demons and apocalyptic chaos. The resulting Buddhho-Daoist melange reflected the entrance (and frequently the forging) of Indic Tantrist technics and scriptures from Tibet and Central Asia. The Buddhist scripture titled *Book of Consecration* (c. 450s) is a collection of various spells, oracles, talismans, and even instructions for rebirth into a heaven of medicinal herbs. It is a total package of Chinese mysticism. Seemingly Indic and Tantric, it is nonetheless solidly Chinese, presenting practices in the mantic way, in self-cultivation and transcendence, and finally tutelary divinities who defend against demonic forces.

The *Book of Consecration* provides the first example of physical implements and practices as tools for transitory union with divinities. This was a new twist, since previously divinities were mainly powerful, official-like beings to whom one petitioned. “Officials to be petitioned” and “gods with whom to gain union” continue in modern Daoist communities throughout the Chinese world. Rites and festivals require chanting for divine intercession, writing of magical calligraphic documents, and direct transmission of divine will through medium-shamans.

In Tang times, “Double Mystery” (*chengxuan*) Daoist priests such as Liu Jinxi (d. c. 640), who resided at a Daoist monastery in Changan and defended Daoism at court debates in the 620s, exhibited Buddhho-Daoist blending. Liu’s *Benji jing* uses a Buddhist debate style as well as notions of the Dao as cosmic deity. Tang Daoists developed the older strains of “self-cultivation” more systematically. Instructions were set out to effect the discarding of all desires, then even the discarding of the state of no-desires, a logical ploy borrowed from Mahayana Buddhism. Chan (Zen) Buddhism matured as a sect from the 700s to 900s, transmitting texts, oral teaching, and even implements in guarded fashion, through disciple-master lineages. Chan rules for meditation were codified, for example, the “Regulations of the Chan School” (1004), and Zongze’s “Principles of Seated Meditation” (1103), which prescribe how to enter the practice room, how to sit, the placing

of the limbs, and the positioning of tongue and mouth for breathing practice.

Conclusion

Chinese mysticism was, and is, a vibrant phenomenon with ancient, secular roots that over time, and via religious enterprises, developed new forms. Not only did Chinese mysticism mix the secular and religious, but also the social range was total. To see this better, one must not think of Chinese mystical practice as simply its tools, for example, alchemically larded manuals of healing and longevity, or *fengshui* (mantic siting). Such arts often draw on China's mantic way by employing instinctive—nontextual, nonmechanistic—skills. The artisan becomes a psychopomp, a shaman leading a client to special knowledge, clarity, or health. And arts were guarded within family groups, which made them in some sense *mustikos*. But they could also be entirely mechanical. One cannot describe as mystical the act of looking up an interpretive symbol inscribed on a calibrated siting compass. Chinese mysticism is best seen in the long arc of textual guides to, and metaphysical supports for, self-cultivation. All three paths interlaced, eventually in the practices of cult communities, and eventually as techniques for establishing relations with divinities.

See also *Buddhism; Confucianism; Daoism; Religion: East and Southeast Asia; Zen.*

BIBLIOGRAPHY

Chang, K. C. *Art, Myth, and Ritual: The Path to Political Authority in Ancient China*. Cambridge, Mass.: Harvard University Press, 1983. An eloquent exploration of the role of ancient shaman-priests in asserting text and symbol as political tools.

Csikszentmihályi, Mark. "Traditional Taxonomies and Revealed Texts in the Han." In *Daoist Identity: History, Lineage, and Ritual*, edited by Livia Kohn and Harold D. Roth, 81–101. Honolulu: University of Hawai'i Press, 2002.

Dean, Kenneth. *Taoist Ritual and Popular Cults of Southeastern China*. Princeton, N.J.: Princeton University Press 1993.

DeWoskin, Kenneth J. *Doctors, Diviners, and Magicians in Ancient China: Biographies of Fang-shih*. New York: Columbia University Press, 1983.

Harper, Donald. "Warring States Natural Philosophy and Occult Thought." Chapter 12 in *The Cambridge History of Ancient China: From the Origins of Civilization to 221 B.C.*, edited by Michael Loewe and Edward L. Shaughnessy. Cambridge, U.K., and New York: Cambridge University Press, 1999.

Harper, Donald. "Warring States, Qin, and Han Manuscripts Related to Natural Philosophy and the Occult." In *New Sources of Early Chinese History: An Introduction to the Reading of Inscriptions and Manuscripts*, edited by Edward L. Shaughnessy, 223–252. Berkeley: The Society for the Study of Early China and The Institute of East Asian Studies, University of California, 1997.

Keightley, David N. "Shang Divination and Metaphysics." *Philosophy East & West* 38, no. 4 (1988): 367–395.

Kohn, Livia. *Early Chinese Mysticism: Philosophy and Soteriology in the Taoist Tradition*. Princeton, N.J.: Princeton University Press, 1992. The first chapter gives a useful anthropological summary of recent discussions on the nature of mysticism.

Roth, Harold. *Original Tao: Inward Training and the Foundations of Taoist Mysticism*. New York: Columbia University Press, 1999.

———. "Psychology and Self-Cultivation in Early Taoistic Thought." *Harvard Journal of Asiatic Studies* 51 (1991): 599–650.

Sivin, Nathan. "State, Cosmos, and Body in the Last Three Centuries B.C." *Harvard Journal of Asiatic Studies* 55, no. 1 (1995): 5–37.

Strickmann, Michel. *Mantras et mandarins: Le bouddhisme tantrique en Chine*. Paris: Gallimard, 1996. Groundbreaking insights into the way Tantric-seeming tools of individual transcendence, demonifugic protection, and salvation wove through Daoism and Buddhism.

———. "The Mao Shan Revelations: Taoism and the Aristocracy." *T'oung Pao* 63 (1978): 1–64.

Wilhelm, Richard. *The I Ching, or Book of Changes*. 3rd ed. Translated by Cary F. Baynes. Princeton, N.J.: Princeton University Press, 1967.

Howard L. Goodman

CHRISTIAN MYSTICISM

Since the Baroque age, the concept of mysticism (first in French, *la mystique*) has been used to describe religious phenomena that can hardly be restricted to a certain geographical space or a certain epoch. These phenomena are primarily symbolic expressions (in act, speech, literature, art, music, etc.), of persons trying to communicate knowledge that has been gained through mystical experiences.

A commonly accepted definition of "mystical experience" does not exist. St. Thomas Aquinas (1225–1274) says that beyond speculation, there is an experimental cognition (*cognitio experimentalis*) of the divine, "thereby a man experiences in himself the taste of God's sweetness, and complacency in God's will" (*Summa theologiae* II/II q.97, a.2, re2). In order to include forms of mysticism that reject the notion of a personal god, one could more generally speak of immediate experiences of divine presence. For an additional clarification of the concept it is still useful to consider the four characteristics of the "mystical state of consciousness" as provided by William James (pp. 294–296):

1. Ineffability: The paramount experiences exceed the intellect, defy verbal expression, and can therefore not be imparted or transferred to others.
2. Noetic quality: Mystical experiences are not mere feelings but also insights and participations in a nonintellectual and nondiscursive knowledge.
3. Passivity: Although the mystic may actively prepare body and mind, the actual experience is rather one of being grasped and held by a superior power.
4. Transiency: Mystical experiences are limited in time and can only imperfectly be reproduced by memory. This last characteristic, however, has been questioned by more recent scholarship, since there are sources that speak of permanent mystical states.

The symbolic expressions as well as the modes of mystical experience are, to a certain degree, predetermined by their social, religious, and intellectual environment. This observation, however, does not contradict the assumption that there is a “numinous” dimension of reality from which all mystical experiences originate. Accounts of mystical states of consciousness occur in every religion, philosophy, and doctrine of wisdom, involving a dimension of divine eternity, which on the one hand transcends the sphere of temporal beings and sense perceptions and, on the other hand, is the ground and source of all being. Besides this ontological presupposition an anthropological one is required. Mystics claim that a feature of human nature—most often identified as the “soul” or its highest parts—is divine or can assume a divine form. Therefore, it can free itself from the bodily and temporal sphere of existence in order to enter the transcendent realm of the divine.

Basic Problems of Christian Mysticism

Christian mysticism inherited most of its ontological and anthropological foundations from the Hellenistic environment from which it emerged. But it also derived a great deal of its imagery and inspiration from the Old Testament, first of all from the Song of Songs. Nevertheless, the original contributions of Christianity must be related to the revelations of the New Testament. The history of Christian mysticism begins with the oldest documents of Christianity, the letters of Paul. The Apostle writes:

I know a man in Christ who fourteen years ago was caught up to the third heaven. . . . And I know that this man . . . was caught up into Paradise and he heard things that cannot be told, which man may not utter. (2 Cor. 12:2–4)

This quotation shows the problems that scholarship on Christian mysticism confronts. Paul’s memory of his mystical ascent seems to lie at the periphery of his religious consciousness. It is his experience as a “man in Christ” and can only be understood as one of the consequences of the Damascus experience, his vision of the Resurrected. The paramount experiences that lie at the foundations of the Christian symbolic universe are not understood as the results of individualistic efforts by religious virtuosos but as the self-revelation of a merciful god. At least in Western Christianity, the paradigm of the saint is not the ascetical hero, who attained mystical states, but the converted sinner, who did not deserve the grace of his calling. The notion of a God who not only created the world but also mediates himself through sending his Son and the Holy Spirit, in other words a God who acts toward man, seems to contradict the mystical notion of an ever-transcendent God that must be approached by meditative ascent.

Moreover, if the climax of God’s self-revelation is the incarnation of his word (logos), how can there be a higher knowledge, gained in an experimental realm beyond language? The union of the soul with the ground of being, which can be regarded as the climax of mystical experiences, seems to undermine the orthodox understanding of divine union, that is

the sacramental union with the body of Christ, provided by the institution of the church. It is therefore no wonder that Christian mystics often fell under the suspicion of heresy and that even modern theologians regard the concept of Christian mysticism as a contradiction in terms. Of course, a closer look at their writings would show that almost all Christian mystics did not doubt that membership in the church, faith in Christ, and the dispensation of divine grace is the presupposition of their ascent. Nevertheless, the tension remains.

History of Christian Mysticism

The tension first became manifest in the mysticism of the Egyptian hermits who, influenced by the Platonic theology of Origen (185?–254? C.E.), felt dissatisfied with the community life of the church and were searching for a more immediate experience of God in the isolation of the desert. In their view, the *parousia*, the presence of Christ, was no longer a historical event but rather a personal encounter and a result of ascetical purification. Until the High Middle Ages, occidental mysticism was limited by the authority of St. Augustine of Hippo (354–430). Other than in his early work, which drew heavily on the mystical Neoplatonism of Plotinus and Porphyry, the church father more and more opposed the self-confident individualism of the ascetics. Rather, he insisted on the general sinfulness of man and God’s autonomous dispensation of grace. But the manifold richness of his experiential world would not allow him to completely abandon the Neoplatonic idea of mystical ascent. Augustine shows the orthodox Western attitude that mystical experience does not necessarily lead to a mystical theology. Rather the awareness of divine presence confirms earlier theological assertions and removes doubts. An account in the *Confessions* (c. 400) betrays its Neoplatonic background as it sketches the parallel ascent through the hierarchies of the ontological order of beings and the anthropological order of human capacities.

And so step by step I ascended from bodies to the soul which perceives through the body, and from there to its inward force, to which the bodily senses report external sensations, . . . From there again I ascended to the power of reasoning to which is to be attributed the power of judging the deliverances of the bodily senses. This power, which in myself I found to be mutable, raised itself to the level of its own intelligence, and led my thinking out of the ruts of habit. It withdrew itself from the contradictory swarms of imaginative fantasies, so as to discover the light by which it was flooded. . . . So in the flash of a trembling glance it attained to that which is. At that moment I saw your “invisible nature understood through the things which are made.” (*Confessions* VII, 17, 23)

Augustine’s “moderate mysticism,” which laid greater emphasis on the mutability and misery of all earthly existence and the limitedness of human knowledge, has been challenged throughout the history of Western Christianity. Influences from Eastern Christianity always provided alternative approaches to mysticism. The most important of these sources were the writings of an unknown (probably Syrian) author,

published around the year 500 under the name of Dionysius the Areopagite (cf. Acts 17, 34). Unlike Augustine, Pseudo-Dionysius provides a mystical theology in the strict sense. His negative (*apophatikē*) theology teaches the contemplative ascent through the realm of language by the successive reduction of words and negation of all positive propositions about God. Its purpose is a translanguistic meditation on and union with the superessential (*hyperousion*) "It."

. . . ascending, we say, that It is neither soul, nor mind, nor has imagination, or opinion, or reason, or conception; . . . neither is standing, nor moving; nor at rest; neither has power, nor is power, nor light; neither lives, nor is life; neither is essence nor eternity, nor time; . . . neither one, nor oneness; neither Deity, nor Goodness; nor is It Spirit according to our understanding; nor Sonship, nor Paternity; nor any other thing of those known to us, or to any other existing being. . . . (*Mystical Theology* V)

The inherent tension of Christian mysticism becomes again manifest because the mystical insights transcend everything that Christian theology teaches about God. The "It" lies in the "overbright darkness" (*hyperphōtos gnōphos*) beyond the essence of the triune God.

St. Bernard of Clairvaux (1090–1153) became the most influential representative of a genuine Christian version of mysticism, the mysticism of love. In his *Sermons on the Song of Songs*, he provides a sophisticated doctrine of four types of love. The highest one is the paradoxical "self-love for God's sake," an ecstatic state in which the self is almost completely annihilated through the union with the divine. On the one hand, Bernard could more easily reconcile his mysticism with the doctrine of grace, since he could understand the mystical ascent as the loving answer of the human soul to the loving call of God. On the other hand, his doctrine implied the degradation of other forms of Christian love. According to Bernard, the love of neighbor belongs to the lowest type of love.

This view was rejected by one of the most singular personalities of medieval Christian thought, Johannes Eckehart, called Meister Eckehart (c. 1260–?1327), a German Dominican. His philosophy was a turn back to the heritage of Neoplatonism and faced vehement opposition by the church. Mystical ascent is not a movement through ever-higher stages of love but an intellectual endeavor. Its end is the contemplation of the "divinity" (*Gottheit*), a higher preexistent unity that precedes and transcends the ontological difference between God and man. Eckehart also insisted on the priority of the active life.

Nevertheless, the mysticism of love dominated female mysticism, which first began to flower in the middle of the twelfth century. Thousands of mostly wealthy married women, who were dissatisfied with their subordinate status in society and the ecclesiastical order of charismas, joined the Cistercians in order to change their "carnal marriage" into a "spiritual marriage" with Christ. In the thirteenth century, the more freely

organized but orthodox movement of the Beguines began to attract many women from all social ranks, primarily in the new urban centers of western Europe. Contemplation of and union with Christ is the typical form of female love mysticism, which ranges from loving compassion with Christ's suffering to explicit accounts of erotic encounters with the Savior. Female mysticism reached an intellectual climax in the writings of the Spanish nun St. Teresa of Ávila (1515–1582). Her symbol of the "interior castle" and its various rooms signifies the different stages of perfection the soul must pass to achieve final perfection and the union with God in the "innermost chamber." Although the exclusion of women from scholastic education was one of its motivations, female mysticism may not be regarded as a feminist protest movement. The more significant currents remained orthodox and did not oppose church authority. Moreover, many of its spiritual leaders were male. Female mysticism, however, shows that contemplative life does not necessarily lead to the renunciation of the active life. Many female mystics were extraordinarily active in charity and politics. One of the best examples is St. Catherine of Siena (1347–1380), who was sent on diplomatic missions and played a mediating role in the Great Schism.

Some other important representatives of Christian Mysticism have not been mentioned so far: St. Gregory of Nyssa (c. 335–c. 394) was one of the most brilliant and influential church fathers of the East and described mystical experience as the "fruition of God." The Flemish mystic Jan van Ruysbroeck (1293–1381), known as the "Ecstatic Teacher" and the "New Dionysius," developed a "spiritual ladder of Christian attainment," consisting of the three steps of active life, inward life, and contemplative life. St. Gregory Palamas (1296–1359) was an important theorist of the Eastern mystical movement of the "hesychasts" and taught the fusion of the soul with divine energies. Johannes Tauler (c. 1300–1361), a German mystic and Dominican monk, emphasized ethical perfection as the presupposition of mystical union. The English female mystic Julian of Norwich (1342–after 1416), insisted on the love and benevolence of God. The unknown English author of *The Cloud of Unknowing* (written around 1375) continued the negative theology of the Areopagite. St. John of the Cross (1542–1591) was the most brilliant of all mystical poets. Edith Stein (1891–1942), a student of phenomenologist Edmund Husserl (1859–1938), developed the inward mysticism of Teresa of Ávila and John of the Cross.

See also *Christianity; Mysticism; Kabbalah; Sacred Texts*.

BIBLIOGRAPHY

PRIMARY SOURCES

- Augustine of Hippo. *Confessions*. Translated with an introduction and notes by Henry Chadwick. Oxford and New York: Oxford University Press, 1991.
- Bernard of Clairvaux. *Selected Works*. Translated with a foreword by G. R. Evans. New York: Paulist, 1987.
- Dupré, Louis, and James A. Wiseman, eds. *Light from Light: An Anthology of Christian Mysticism*. 2nd ed. New York: Paulist, 2001.
- Meister Eckhart. *The Essential Sermons, Commentaries, Treatises, and Defense*. Translated with an introduction by Edmund Colledge and Bernard McGinn. New York: Paulist, 1981.

Pseudo-Dionysius, the Areopagite. *The Divine Names; and, Mystical Theology*. Translated with an introductory study by John D. Jones. Milwaukee, Wis.: Marquette University Press, 1980.
 Teresa of Ávila. *The Interior Castle*. London: Fount, 1995.

SECONDARY SOURCES

Beierwaltes, Werner, Hans Urs von Balthasar, and Alois M. Haas. *Grundfragen der Mystik*. Einsiedeln, Germany: Johannes, 1974.
 James, William. *Varieties of Religious Experience: A Study in Human Nature*. Centenary edition. London and New York: Routledge, 2002.
 Lossky, Vladimir. *Mystical Theology of the Eastern Church*. London: Clarke, 1991.
 McGinn, Bernard. *The Presence of God: A History of Western Christian Mysticism*. New York: Crossroad, 1991–.
 Otto, Rudolf. *The Idea of the Holy: An Inquiry into the Non-rational Factor in the Idea of the Divine and Its Relation to the Rational*. 2nd ed. London and New York: Oxford University Press, 1970.
 Ruh, Kurt. *Geschichte der abendländischen Mystik*. 4 vols. Munich: Beck, 1990–1999.

Matthias Riedl

ISLAMIC MYSTICISM

The mystical dimension of the Islamic religious tradition has roots in the divinely revealed text of the Koran. One passage often pointed to in this regard is the “Light Verse” (24:35), in which God is described as the Light of a blessed lamp, lit by a burning oil “neither of the East nor the West.” One episode from the Koran, involving the prophet Moses, provided key evidence for the mystics’ claim that an unseen world runs parallel to our own. The story describes Moses’ meeting and deferring to one whom God had taught knowledge from His “own presence” (18:65). The understanding is that the prophets have their exoteric missions and knowledge, but that esoteric knowledge has a parallel, if not superior, position.

The earliest mystical practices seem to have been ascetic, probably based on earlier Syrian and Iraqi Christian models. The term *Sufism*, for example, probably derives from the early mystics’ practice of wearing wool (*suf*). A lost collection of biographies of ascetic women from the eighth and ninth centuries has been recovered. This work, by al-Sulami (d. 1021), presents themes such as scrupulous attention to God’s law; excessive crying and fainting in response to one’s guilt or to God’s love; sincerity and control of the material appetites. These and the many other collections of ascetic exemplars that followed could evoke the prophet Muhammad’s own spiritual retreats and supererogatory praying, as preserved in the Koran and the Tradition as precedents.

The concern with the self in this ascetic environment gave rise to theories of spiritual exercise that the aspirant would pursue in order to progress along the path to wisdom, purity, or even the presence of God. Among the most influential teachers and writers of the early period were Hasan al-Basri (d. 728), al-Muhasibi (d. 857), and the poet al-Bistami (d. 875). The tenth and eleventh centuries saw efforts at systematizing these paths, with the composition of a series of manuals describing and explaining such experiences as “extinction of the self in

God,” “trust in God,” “certainty,” “sincerity,” and “repentance.” These manuals (by al-Makki, d. 996; al-Hujwiri, d. 1071; al-Qushayri, d. 1074; and others) also present the mystical teachings of prominent Sufi masters.

Mystical thinking among the Shi’a also begins early. The sixth imam of the Twelver tradition, Ja’far al-Sadiq (d. 765) is taken by the Shi’a (and certain Sunni Sufis) to have been a master of esoteric teaching. The very concept of Shi’a leadership, or *imama*, included esoteric or mystical elements. The vibrant mystical tradition among the Twelver Shi’a, which came to be recognized as one of the religious sciences, would be known as *‘irfan* (literally, “knowledge”).

The twelfth and thirteenth centuries saw the rise of the Sufi brotherhoods, or *turuq* (singular, *tariqa*). The most prominent are probably the Qadiriyya, the Shadhiliyya, the Rifa’iyya, the Naqshbandiyya, and the Chistiyya. As an institution based on the teachings and model of a saintly founder, each *tariqa* would give rise to its own devotional practices, mystical doctrines, and literature. Central among these practices are the *dhikr*, or remembrance of God—a ritual group recitation of the name(s) of God. Along with *dhikr* goes the stylized recitation of long prayers, usually passed down from the founder of the order. Mystical doctrines vary widely. One issue that has been debated recently among scholars is that of “neo-Sufism.” This is the term given to the perceived shift in Sufi practice, from about the middle eighteenth century, which inflated the role of the prophet Muhammad as a figure of devotion. This shift also challenged the traditional structures of the established Sufi brotherhoods and saw itself as reformist.

The heyday of Islamic mystical thought, however, took place outside the brotherhood organizations. Independent thinkers such as Ruzbehan Baqli (d. 1209), Najm al-Din Kubra (d. 1221), Ibn ‘Arabi (d. 1240), Ibn al-Farid (d. 1235), and Jalal al-Din Rumi (d. 1273), provided dynamic mystical perspectives on God, creation, and existence itself. Also, the Koran could be illuminated by mystical exegesis. Ruzbehan Baqli’s writings describe dramatic visions of the divine and the intense experiences these provoke. He also defended the phenomenon of ecstatic utterances (*shatahat*), for which the early Sufi al-Hallaj (d. 922) in particular had been known. Much of this defense rests on the notion that mystical language must be recognized as a reflection of the essentially nonverbal reality that is mystical experience. Kubra’s innovative interpretation of the soul’s mystical ascent associated certain colors with the levels of experience leading to sanctity.

Ibn ‘Arabi’s thought introduces a hermeneutic based on the assumption that an interpretation based on mystical insight is as true as that from any other human perspective. His elaboration of a qualified “oneness of being,” that is, the recognition that only God’s existence stands, has had an immense influence on the mystical tradition. The concept of sanctity (*walaya*) was to undergo dramatic elaboration in his writings. Ibn al-Farid, poet and mystic, composed some of the most sophisticated verses ever in the Arabic language. His great poem, the *Ta’iyya*, reframes classical images such as love and drunkenness to point to the mystic’s experience of and devotion to the divine. The Persian poet Rumi made an even larger

impact with his epic the *Mathnawi*. This collection of fables and wisdom tales presents a sophisticated and humane perspective, which although mystical in approach has a universal appeal.

These thinkers introduced and elaborated a set of concepts that constitute the touchstones of Islamic mysticism. One of these is an extension of the idea of the Light of the prophet Muhammad. This is the Muhammadan Reality, which gave the Prophet a cosmic and existential role to play—quite a leap from the earliest understanding of the man in Islamic tradition. The Muhammadan Reality stands between God and creation, an intermediary similar to the Universal Intellect of the Neoplatonists. The “oneness of being” concept has remained debated, but a fruitful subject for speculation up to the present. The concept of sanctity, and in particular the theory of the identity and nature of the “seal of saints” has provoked much thought among later mystics.

See also *Islam; Miracles; Sacred Texts*.

BIBLIOGRAPHY

- Knysh, Alexander. *Islamic Mysticism: A Short History*. Leiden, Netherlands and Boston: Brill, 2000.
- Schimmel, Annemarie. *Mystical Dimensions of Islam*. Chapel Hill: University of North Carolina Press, 1975.
- Sells, M. *Early Islamic Mysticism: Sufi, Qur'an, Miraj, Poetic and Theological Writings*. Edited and translated by Michael A. Sells. New York: Paulist Press, 1996.
- Trimingham, J. Spencer. *The Sufi Orders in Islam*. New York: Oxford University Press, 1998.

Richard McGregor

ISLAMIC MYSTICISM IN ASIA

There are a number of mystical movements within Islam, but by far the dominant tradition is that of Sufism, one of the most dynamic and interesting dimensions of Islamic religious and cultural expression. *Sufism* is an umbrella term for a variety of philosophical, social, and literary phenomena occurring within the Islamic world. In its narrowest sense, the term refers to a number of schools of Islamic mystical philosophy and theology, to the phenomenon of religious orders and guilds (*tariqat*) that have exerted considerable influence over the development of Islamic politics and society, and to the varied expressions of popular piety and devotion to shrines found throughout the Islamic world. In a wider sense, Sufism is often seen as the spiritual muse behind much of premodern verse in the Islamic world, the idiom of much of popular Islamic piety, the primary social arena open to women's religious participation, and a major force in the conversion of people to Islam in Africa and Asia. The Sufi orders served as educational institutions that fostered not only the religious sciences but also music and decorative arts. Their leaders sometimes functioned as a challenge to the power of the juridic and theological establishment. In modern times (as at other periods in history), the Sufi orders have been praised for their capacity to serve as instruments of religious reform at the same time as they have been vilified for a lack of respect for Islamic law and

for fostering ignorance and superstition in order to maintain control over the community.

The term *Sufism*—or *tasawwuf*, as the tradition is called in Arabic—may derive from the practice of wearing wool (*suf* in Arabic), or possibly from the Arabic word for purity (*safa*). The earliest Sufis spent almost all their waking hours in prayer, and frequently engaged in acts of self-mortification, such as starving themselves or staying up the entire night, as a form of prayer exercise. They renounced their connections to the world and possessed little other than the clothes on their backs. A large percentage of these early Sufis were women, several of whom, such as Rabi'a al-Adawiyya (d. 801), are revered to this day.

History: Early Period

In Muslim understanding the origins of Islamic mysticism in the form of Sufism lie in the life of Muhammad. His earliest biographies emphasize his habit of meditating in a cave and living a life of material simplicity bordering on asceticism, both of which are seen as prototypes of mystical belief and practice in Islam. As an organized movement, Sufism too owes its official origins to Muhammad and his cousin and son-in-law, 'Ali, who is viewed by the majority of Sufis as the first of their kind. Ali was the first male convert to Islam and the man closest to Muhammad in his private life. As such, he is said to have received levels of spiritual guidance from Muhammad that were not available to anyone else. Part of this was a body of mystical knowledge that was passed down through Ali to future generations. The concept of esoteric or mystical knowledge (*'ilm al-batin*, *al-'ilm al-batini*, or simply *al-batin*) became central to the theology of Shiism, one of the two main sectarian divisions in Islam. It also remains at the center of Sufi understanding.

The historically traceable origins of Sufism begin approximately a century after Ali's death. Very little biographical information is available on some of the earliest Muslim ascetic and mystical figures, but they are important for their impact on the development of Sufism. By the late eighth century, members of the school of a famous mystical ascetic named Hasan al-Bari (d. 728) had established a convent (*ribat*) at Abadan, and others had composed important treatises on Sufi etiquette. Important mystical figures of this period include Dhu'l-Nun Misri (d. c. 859), an Egyptian figure who is of importance to the development of Sufism in western Asia because later Sufis quote him frequently, seeing him as a Muslim exponent of the Hellenistic tradition. An Iranian Sufi named Bayazid Bistami (d. 874) became famous for ecstatic utterances (*shathiyat*), which he was the first to use consistently as an expression of Sufi mystical experience. These somewhat scandalous declarations were dramatic statements made to demonstrate the merging of Bistami's individuality with the divine identity. This sense of union with God was the result of a life-long process of self-purification at both a physical and a spiritual level. In his practice of prayer and meditation Bayazid showed strong ascetic tendencies while at the same time ridiculing traditional asceticism because he felt that trying to renounce the physical world was to afford the physical realm an existence that it did not actually possess. The theme of asceticism appears frequently in Iranian Sufism in the

ninth century even though many Sufis, like Bistami, rejected the outward trappings of an ascetic life.

The end of the tenth century marks a transition in the development of Sufism from the early formative period that was characterized by a high degree of individualism in practice and a central focus on asceticism to a classical age wherein there is greater emphasis on organization and systematization. This is also a time when Sufism in western Asia appears somewhat divided between two schools, the first being the Iraqi one (which was transplanted to Nishapur in Iran) and the second being the Khurasani one, centered in northeastern Iran and Afghanistan. The differences between these two schools are not altogether clear and at times appear to have more to do with the theological and legal affiliations of Khurasani Sufis than with any major differences over mystical theory and practice.

The transitional phase of the tenth and eleventh century also witnessed an increased emphasis on the formalization of Sufi doctrine, the canonization of earlier Sufi figures, and an apologetic attempt to show potential Sufis and the society at large that Sufism was in complete harmony with orthodox Islam. Two of the most important figures in this regard are Abu Bakr Kalabadhi (d. between 990 and 995) and Abu 'Abd al-Rahman Sulami (d. 1021).

Kalabadhi is most famous as the author of the *Kitab al-ta'arruf li-madhab ahl al-tasawwuf*, a widely circulated book that attempts to explain Sufi terminology and beliefs and to show the essential orthodoxy of Sufism. Among Sulami's many works his *Tabaqat al-sufiyya* served as a model for many later Sufi biographical works. He also wrote treatises on Sufi ethics, particularly on the concept of Sufi chivalry (*futuwwa*) and on antinomian trends in Islamic mysticism.

Two of the most important mystical figures of the formative period of Sufism in Asia are Khwaja 'Abd Allah Ansari (d. 1089) and Abu Sa'id ibn Abu al-Khayr (d. 1049). They are both central to the development of organized Sufism but represent two distinct models of leadership. Abu Sa'id is perhaps the most colorful of the famous Iranian Sufis of this period. He studied law, theology, and other religious sciences before adopting a contemplative life, which he pursued under the guidance of a master for fifteen years. Following his teacher's death, Abu Sa'id entered into a flamboyant, public phase of his life during which he ran two Sufi centers, one in his home town of Mehana and the other in Nishapur, the biggest city in Iran at the time. Abu Sa'id was accused by his critics of accepting too much money from devotees, living too luxurious a lifestyle, and having attractive young men dance and sing in public. Abu Sa'id is one of the key figures in the earliest evolution of successful Sufi orders and centers.

Khwaja 'Abd Allah Ansari is a Sufi of a very different kind, though comparable in importance to Abu Sa'id. Ansari was a committed polemicist belonging to an important school of Sunni Muslim legal thought. His personal and professional fortunes changed as the religious pendulum swung in different directions. It was toward the end of his life, after he had gone blind and at the urging of his disciples, that Ansari dictated his

main works, including the very popular *Kitab manazil al-sa'irin*, a brief didactic text providing an itinerary for the soul's journey to God. His other important works include a mystical treatise emphasizing the importance of love in the journey toward God.

The period immediately before and after the Mongol invasion of Iran in the early thirteenth century was perhaps the single most vibrant phase in the history of Iranian Sufism. The social and political instability of the era combined with a high degree of intellectual vitality to produce major thinkers and teachers. Undoubtedly the most famous of these is the Andalusian emigré Muhyi al-din Ibn al-'Arabi (d. 1240). Ibn al-'Arabi's mystical and philosophical ideas reshaped much of Sufi thought and, to a large extent, fashioned the language if not always the content of Sufi discussions since his time. His central philosophical idea was that the universe is the physical manifestation of God; as such, it is not entirely distinct from him but represents one of his aspects, the other being his uniqueness. This doctrine came to be known as "Oneness of Being" (*wahdat al-wujud*). The doctrine that God is utterly separate from creation is a central belief of many Muslims for whom Ibn al-'Arabi's teachings represent an unorthodox position. Over the two centuries after his death a modified version of the theory of "Oneness of Being" emerged; named "Oneness of Witnessing," it attempted to reconcile the philosophical aspects of Ibn al-'Arabi's philosophy with common Muslim theological beliefs.

It was in the fourteenth and fifteenth centuries that Islamic mystical ideas and institutions consolidated their positions in South and Central Asia, although mystical thought and Sufi individuals had been common in these regions since the eleventh century. The Naqshbandi Sufi order started in present-day Uzbekistan. Its eponymous founder, Baha' al-din Naqshband (d. 1389), had a tremendous impact on the development of Islam all across Central and inner Asia, as well as in South Asia and the Ottoman Empire. It remains one of the most influential Sufi orders in modern times and is involved in global Muslim debates over the place of religion in modern society.

Of similar importance is the Chishti order, which derives from Mu'in al-din Sijzi (d. 1235), a Sufi master from Afghanistan who settled in the Indian town of Ajmer. The Chishti order had tremendous importance in popularizing Islam among non-Muslim or nominally Muslim Indians, at the same time as Chishti Sufi masters maintained closed relationships with the ruling elite of South Asia. To this day the Chishti order remains notable for its openness to outsiders, in terms of both its warm welcome into its gatherings and its widespread use of music.

Doctrine and Practices

Sufis are motivated by the desire to have a direct, personal experience of God while they are still alive, rather than waiting until after resurrection when, according to Muslim belief, all human beings will share this experience. The direct experience of God is considered so overwhelming as to be indescribable and can only be spoken about in metaphors, the most commonly used ones being those of falling in love and of being intoxicated with wine. These images are frequently encountered in Sufi literature, particularly in poetry, which tries to

express the indescribable joy that Sufis experience through their relationship with God, combined with the heartache of being separated from Him.

The Sufi concept of union with God is expressed in many different ways. The main problem in Sufi philosophical circles is how a mortal human being can unite with the omnipotent, omniscient deity who is unlike us in every way. The union with God is normally called *fana'*, which literally means "destruction" or "annihilation." Sufis believe that in the final stage of an individual's spiritual development, she loses any consciousness of her individual identity and is only aware of the identity of God. In effect, God's identity then replaces the identity of the Sufi.

There is disagreement among Sufis over whether the final spiritual goal of Sufism is to lose one's identity completely in the identity of God or to reach a stage where one's own concerns no longer prevent us from seeing the world in its true nature. A common metaphor for the first approach is to describe the Sufi's individuality as a drop that vanishes into the ocean. It ceases to exist as an identifiable entity but does not actually cease to exist, since it is now part of the vastness of the sea. The latter view, that one sees things more clearly, depicts the human heart (which was the seat of the intellect in medieval Islamic thought) as a mirror that is normally dirty, tarnished by our everyday concerns and petty desires. Through engaging in mystical exercises we effectively polish the mirrors of our hearts and cleanse them to the point that they can accurately reflect the light of God.

The Sufi Path

Sufis believe that average human beings are unable to understand the true nature of spirituality because of their petty concerns. The quest for spiritual understanding in Sufism is seen as a path that each Sufi must travel under the guidance of a teacher or master. This path has many stages, the number and names of which vary according to the school of Sufi thought.

The Sufi path relies on the use of meditation to accomplish its goals. The various Sufi forms of mediation are called *zikr* (or *dhikr*). *Zikr* literally means "repetition," "remembrance," "utterance," or "mentioning" and is a term that appears several times in the Koran. At its most basic level, Sufi *zikr* consists of repeating one of God's names over and over. In Islam, God is believed to have many names that describe some aspect of his nature. Of these, ninety-nine are considered special and are called the "Most Beautiful Names." The purpose of reciting these names is to concentrate wholly on what one is to lose all self-awareness by repeating the *zikr* formula enough times that it permeates one's entire being so that even if the person ceases to actively engage in *zikr*, it continues to be repeated in his heart.

Impact on Literature and the Arts

Islamic mysticism has had a tremendous impact on shaping literature and the arts in Islamic society. This impact has been felt particularly in poetry and music. Mystical poetry has been composed in all languages spoken by Muslims. In Persian in

particular, as well as Turkish, Urdu, and other languages that borrow much of their poetics from Persian, mystical poetry has traditionally represented one of the most important literary genres. Its influence has been so pervasive that almost all premodern love poetry in these languages borrows mystical metaphors, with the result that romantic poetry is ambiguous as to whether it refers to God or an earthly beloved. Complementing mystical poetry is a large literature of allegorical romances.

Among the many excellent mystical poets, the most famous is Mawlana Jalal al-din Rumi (d. 1273), whose three-volume didactic poem *The Masnavi* has been translated into all major Western languages. The Mevlevi Sufi order, which derives from him, is distinctive for the importance it gives to music and dance in its *zikr* practices. The Chishti order also makes extensive use of music in its religious exercises. Called *qawwali*, they involve a group of musicians singing religious songs in Persian or one of the languages of South Asia set to a very rhythmic beat. *Qawwali* music has attained global popularity over the past three decades.

See also **Islam; Mysticism: Islamic Mysticism; Sacred Texts: Koran; Sufism.**

BIBLIOGRAPHY

- Arberry, A. J. *The Doctrine of the Sufis: Translated from the Arabic of Abu Bakr al-Kalabadhi*. New York: Cambridge University Press, 1935. Reprint, 1979.
- Chittick, W. C. *The Sufi Path of Knowledge: Ibn al-'Arabi's Metaphysics of Imagination*. Albany: State University of New York Press, 1989.
- Ernst, C. *The Shambala Guide to Sufism*. Boston: Shambala, 1997.
- Ghazali, Abu Hamid M. al-. *The Alchemy of Happiness*. Translated by C. Field and E. Daniel. London: Octagon Press, 1980.
- Ibn al-Munawwar, M. *The Secrets of God's Mystical Oneness, or, The Spiritual Stations of Shaikh Abu Sa'id*. Translated by John O'Kane. Costa Mesa, Calif.: Mazda, 1992.
- Khan, H. Inayat. *The Mysticism of Sound and Music*. Boston: Shambala, 1991.
- Lewis, F. D. *Rumi Past and Present, East and West: The Life, Teachings and Poetry of Jalal al-Din Rumi*. Boston: Oneworld, 2000.
- Lewisohn, L., ed. *The Legacy of Mediaeval Persian Sufism*. London: Khaniqahi Nimatullahi Publications, 1992.
- Massignon, L. *The Passion of al-Hallaj*. 4 vols. Translated by Herbert Mason. Princeton, N.J.: Princeton University Press, 1982.
- Nizami. *The Story of Layla and Majnun*. Translated by R. Gelpke et al. New Lebanon, N.Y.: Omega Publications, 1997.
- Radtke, B., and J. O'Kane. *The Concept of Sainthood in Early Islamic Mysticism*. Richmond, U.K.: Curzon Press, 1996.
- Schimmel, A. *Mystical Dimensions of Islam*. Chapel Hill: University of North Carolina Press, 1975.

Jamal J. Elias

KABBALAH

Kabbalah is a Hebrew term that has many meanings. Its basic meaning is derived from the root *QBL*, which means to receive, and thus the term means "reception." In rabbinic literature it stands mainly for a tradition that is received orally. However, beginning in the tenth century, testimonies appeared

for a more specific form of Kabbalah: an esoteric tradition dealing basically with details related to divine names. In the beginning of the thirteenth century this esoteric tradition became more common in written sources, and ultimately imposed itself as the main meaning of the noun. This widespread use of the term *Kabbalah* as secret knowledge reflects the emergence of a huge, primarily Hebrew literature that claimed to reflect the secret meanings of Judaism. Numerous authors were designated as *Mequbbalim*, kabbalists, and in their books they resorted to the term *Kabbalah*, which became a technical term.

During the thirteenth century, kabbalistic writings were composed primarily in Southern France, Spain, and Italy. However, kabbalistic thought radiated immediately to North Africa, Germany, and the land of Israel. In the late decades of the thirteenth century and the early decades of the fourteenth century the classic of kabbalistic literature, the book of the *Zohar*, was composed in Castile. It is only after the end of the fifteenth century, with the expulsion of the Jews from the Iberian Peninsula, that full-fledged centers of Kabbalah were established also in North Africa, Poland, Iraq, and especially the land of Israel. In the Galilean town of Safed, kabbalistic literature was represented by the different systems of Moses ben Jacob Cordovero (1522–1570) and Isaac ben Solomon Luria (1534–1572) and their followers. A second peak of kabbalistic creativity developed in the mid-sixteenth century.

Kabbalistic ideas were connected with messianic aspirations from the very beginning, especially in Abraham ben Samuel Abulafia's (c. 1240–after 1291) ecstatic Kabbalah and in some parts of the *Zohar*, as well as in Safedian Kabbalah. In the second half of the seventeenth century these ideas produced certain expectations in some Jewish elite figures, which led to a widespread messianic mass-movement around the figure of Shabbetai Tzevi (Sabbatai Zebi; 1626–1676). Drawing antinomian conclusions from some earlier sources, Tzevi and his prophets and theologians Nathan of Gaza and Abraham Michael Cardozo resorted to a variety of kabbalistic themes in order to foster their messianic beliefs, creating a moment of exhilaration at the beginning of the movement. An ensuing disappointment followed Tzevi's forced conversion to Islam.

Though understood to be an esoteric tradition of Judaism that should not be disclosed to an ordinary Jew and even less to a gentile, at the end of the fifteenth century a gradually expanding Christian Kabbalah became visible. It started in Florence with the succinct theses of Giovanni Pico della Mirandola (1463–1494), and then in the more systematic writings of Johannes Reuchlin (1455–1522) and Heinrich Cornelius Agrippa of Nettesheim (1486–1535), based on various elements from kabbalistic texts, often read in Latin translations made by converts to Christianity. Characteristic of Christian Kabbalah is the integration of the kabbalistic elements—mostly the theosophical, the hermeneutical, and the magical ones, which were separated from their ritualistic background—within structures of thought found in translations of Greek and Hellenistic material prepared and printed during the Renaissance, especially by Marsilio Ficino (1433–1499).

European occultism, like various forms of European theosophy and Freemasonry, had been substantially influenced by kabbalistic thought, as seems to be the case in early Mormonism. The most viable mystical mass-movement created by the popularization of Kabbalah is late Polish Hasidism. This eastern European mystical phenomenon remained the most lasting form of the penetration of Kabbalah in the lives of many nonelitist Jews. Under the combined influence of Kabbalah and Hasidism, concepts like *dibbuk* (possession) and *golem*, or *qelippah* (demonic shell), became part of the beliefs of larger segments of Jewish population in the late eighteenth century.

Types of Kabbalah

The vast literature assumed to belong to Kabbalah, composed in many countries and continents over the span of more than eight centuries, is hardly a unified literary corpus. Many capital divergences may be discerned in the thousands of texts and manuscripts, and it is difficult to offer a definition to cover those corpora. Differing speculative models informed the thought, the praxis, and subsequently also the writings of kabbalists and Hasidic masters. Far from representing a unified or monochromatic line of thought that allegedly has changed throughout history, the diverse kabbalistic literature focused around at least three major models: the theosophical-theurgical, the ecstatic, and the magical-talismanic model. The interplay and interactions between these three models characterize many important aspects of kabbalists' concerns and of kabbalistic creativity.

The three models of kabbalistic thought interpreted the earlier Jewish corpora, the Bible and rabbinic literatures, in novel ways. However, these new interpretations were only rarely totally new impositions of medieval intellectual constructs on older material. The kabbalists claimed that their writings constituted the ancient, hidden Jewish tradition, which contains the essence of Judaism. This contention notwithstanding, the conceptual divergences between the various kabbalistic schools render such an assertion difficult to support. The impact of ancient and medieval material from non-Jewish sources—for example, Hellenistic sources of Neoplatonic, hermetical, and Neopythagorean extraction—is significant and discernible in all the brands of Kabbalah. Most of those sources had been mediated, changed, and sometimes enriched by Muslim authors. In addition to the contribution of those speculative types of materials, medieval kabbalists also developed some modes of thought found in earlier kinds of Jewish written literature, like the rabbinical and the magical ones, and had access to some forms of earlier mythological themes, which have parallels in ancient times and which might have reached them orally.

Theosophical-theurgical model. The most widespread among the kabbalistic models is the theosophical-theurgical. It deals with the different and complex maps of the divine realm—this area of speculation is described by scholars as theosophy—and with the manner in which human religious deeds impact on it—what may be called theurgy. The belief in the impact of the performance of the commandments, or of transgressions, on supernal realms is crucial for the understanding of theosophical-theurgical Kabbalah.

Cardinal for this kabbalistic model is the widespread vision of the realm of the divine as constituted of a series of ten divine powers, designated as *sefirot*, originally a term standing for mystical numbers, and sometimes of a higher power, designated as infinity, *‘Ein Sof*. This is a dynamic system, in which processes of interaction between those powers and themselves, and between human religious activities and some of those divine powers are quintessential for both the divine and human realms.

‘Ein Sof—Infinity

Keter—Crown

Binah—Understanding

Hokhmah—Wisdom

Gevurah—Judgment

Gedulah—Mercy

Tiferet—Splendor

Hod—Majesty

Netzah—Eternity

Yesod—Foundation

Malkhut—Kingship

Some kabbalists assume that the ten *sefirot* constitute the divine essence and that the divine realm is a complex system, while other kabbalists assume that those powers are instruments of the divine activity—creation, revelation, and providence—or vessels mediating the presence of the divine in the extra-divine realms. Fewer kabbalists assume that those *sefirot* constitute the divine presence in the world, while some others assume the presence of those powers within the human soul. The emergence of the system of ten *sefirot* from the higher realm is described in terms of emanation, in Hebrew *‘Atzilut*, or expansion, *hitpashetut*, processes that create some form of chain, *shalshelet*, between the highest divine realm and the lower worlds that are produced by the *sefirot*. In the sixteenth-century Lurianic Kabbalah the divine configurations have even more pronounced anthropomorphic natures, called five *partzufim*, which constitute the main structure of the divine realm.

There are three main ways to explain this affinity between the higher and the lower realms: the isomorphic model, the augmentation model, and the ritualistic reconstitution of the shattered divine world—*tiqqun*. The isomorphic model assumes a structural similarity between the lower and the higher realms, as evident in many texts, and a sympathetic affinity between them, which allows the impact of the lower structure on the higher one. The Torah as a symbol is conceived of as a faithful representation of the divine form. By knowing the correspondences between the two structures, the Kabbalist is able to activate the supernal realm by performing religious rites.

The theosophical-theurgical model informed many of the discussions in Spanish Kabbalah and flourished afterward in an even more vigorous manner in sixteenth-century Safed. This

model assumes that language reflects the inner structure of the divine realm, the *sefirotic* system of divine powers. Language was conceived also as influencing this structure, by means of theurgical activities that aim to restore the harmony within the divine realm. Either in its cognitive-symbolic role or in its theurgical-operational function, language has been conceived by this type of Kabbalah as hypersemantic. This means that not only is the ordinary sense of language maintained by the kabbalists, but its basic function as part of the kabbalistic enterprise is due to a surplus of meaning, which adds semantic fields to that or those designated by the ordinary meaning. The two aspects, the symbolic, or referential, and the theurgical, or performative, should not be conceived as totally independent: the symbolic role of language, namely the concept that it reflects the structure of the divine powers, is often only one face of the coin, whose other face is the use of the symbolic knowledge in order to amend processes taking place within the divine realm.

The scroll of the Torah is conceived of as a graphic symbol of the divine form, and this is the reason why the Kabbalist assumes that it is not only the semantic message involved in it that is religiously important but also the very contemplation of the manner in which the text has been written. This comprehensive symbol constitutes a faithful representation of the entire divine realm within the lower reality—a sort of icon of God, which incorporates all the details of the divine form.

Another widespread symbol is Jerusalem. This city was conceived of in both Biblical and rabbinic sources as the unifying place between the mundane and the divine realms, an omphalic locus. However, because of its geographical distance from most early kabbalists, Jerusalem was the starting point for the transition to guessing the higher divine reality. Still, even in such a case—when the symbolizing reality existed but was distant and essentially unapproachable—the function of the symbol was essentially the same. Jerusalem was still a functioning city during most of the Middle Ages, but was practically unknown, at least in a direct manner, by those Spanish kabbalists who viewed it primarily as a symbol. Jerusalem as a symbol functions on two levels: as a present, available literary symbol it works because of the special nature of the biblical text understood by the kabbalists as reflecting the divine sphere of existence; and on an ontological level, as a *symbolum in factis*, the temporally absent and geographically remote city represents a spiritual and thus cognitively remote divine power. These two separated symbolic channels were supposed to lead to one and the same divine entity, in most of the cases the last *sefirah*, *Malkhut*.

However, in order to understand how two so different entities—a name (a linguistic unit), and a city designated by the name—may help someone to reach the invisible divine power, the Kabbalist would assume that there is a profound affinity between a name and the entity it designates, a phenomenon that can be described as a linguistic immanence. Jerusalem is not merely a conventional name for the city—it summarizes by the structure of the word the very essence of the earthly city and at the same time, points to her supernal, divine counterpart. The triad of a name, a geographical entity, and a superessential, divine attribute that governs both the name and the geographical entity, is therefore a rather com-

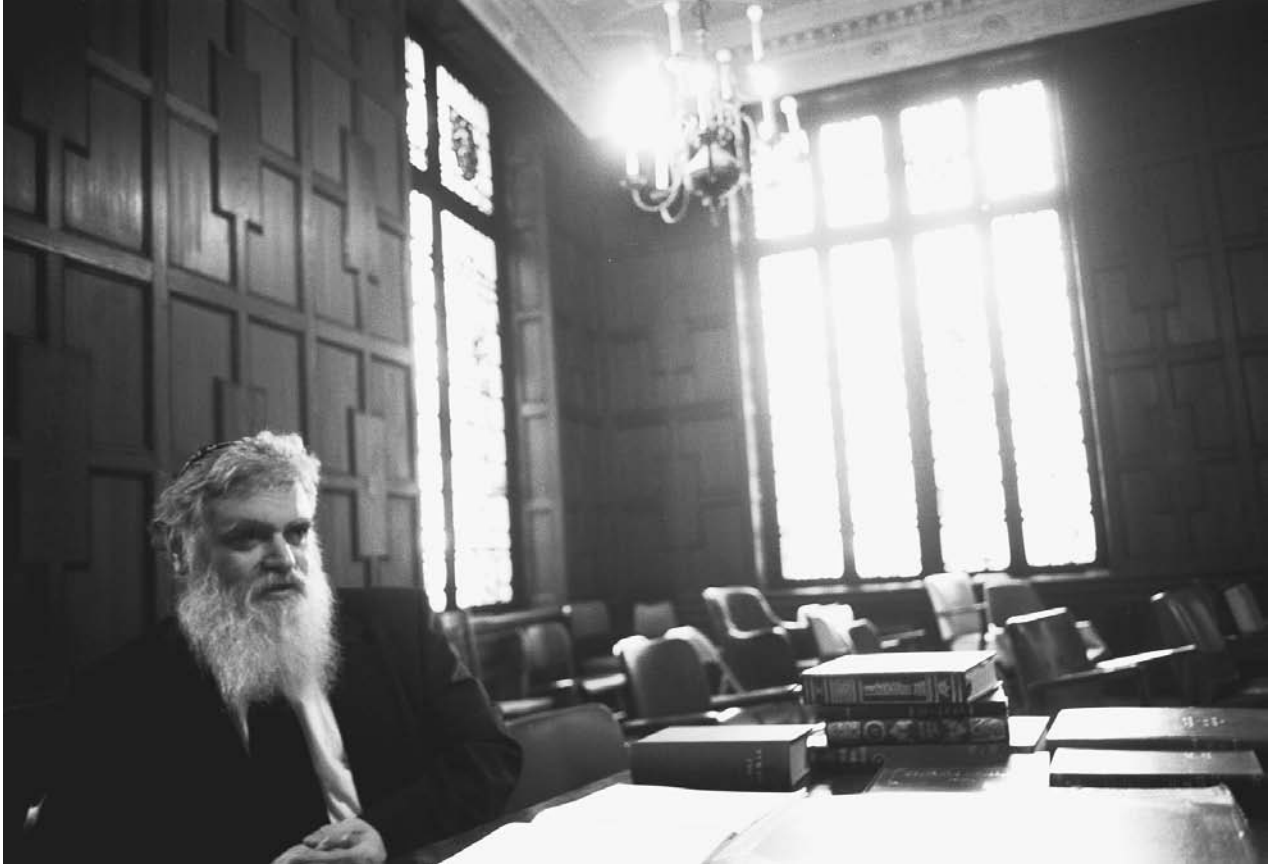

Dov-Der Haskelevich, a Jewish rabbi who makes predictions based on the Kabbalah, New York City, 2000. Prophecies and other paranormal experiences are characteristic of the ecstatic model of kabbalah, which began to appear in the writings of some authors as early as the late thirteenth century. © COONEY REBECCA/CORBIS SYGMA

mon triad that informs many symbolical processes in Kabbalah. However, given the fact that the starting point of the vast majority of kabbalistic symbols is the biblical texts and their intricacies, whose counterparts on the historical or geographical realms were either no longer existent or geographically very remote and beyond the scope of the more ordinary medieval Kabbalist living in Europe, kabbalistic symbolism should be defined as predominantly inspired by authoritative texts and their religious values and as functioning by means of the linguistic units that constitute these texts. Kabbalistic symbolism is fundamentally a code to interpret the canonical texts, while ignoring forms of realia that are divorced from the contents of the sacred scriptures. Rhetoric about the absorbing nature of the Torah is found in the theosophical Kabbalah, and it provides the nexus between claims of symbolizing everything via the absorbing characteristic of the Torah.

The ecstatic model. Ecstasy is a constant of human religious experience, as the wide dissemination of this type of experience in so many cultures demonstrates. Ecstatic experiences became more and more evident in the written documents of Jewish mysticism in the mid-thirteenth century. It seems that a process of adoption and accommodation of paranormal experiences was characteristic of medieval and early modern

Jewish thought, which addressed with a growing seriousness paranormal experiences as legitimate events. The concomitant spread of the Maggidic experiences in the late fifteenth and sixteenth centuries—particularly in the diary of Joseph ben Ephraim Karo (1488–1575), Isaac Luria’s claims of paranormal revelations, and the discussions of cases of possession in the sixteenth century—may bear testimony to the legitimation of their discussion in public rather than to the emergence of new forms of experiences. No movement in Judaism emphasized the importance of the pneumatic experiences, in their most intensive and extreme forms, as did Polish Hasidism.

The ecstatic model is concerned with inner processes taking place between the powers of imagination, the human intellect and the cosmic one, called the agent intellect. This sort of Kabbalah gravitates around the ideal of *devequt*, understood as pointing to moderate or extreme types of union with the Godhead. The other vital parts of this model are devices, or techniques, to ensure the attainment of this ideal. *Hitbodedut*, both as solitude and as mental concentration, *hishtawwut* or equanimity, and linguistic techniques of combining Hebrew letters or contemplating divine names are integral constituents. Paranormal experiences, like revelations and prophecies are congenial to this type of mystical model, and more consonant with it

than to the theosophical-theurgical Kabbalah. The coherence between these concepts and practices rests in an organic continuum between strong mystical techniques and extreme mystical experiences, which include experiences of self-transformation.

The ecstatic model was visible at the end of the thirteenth century and the beginning of the fourteenth century in the writings of some kabbalists, like Isaac ben Shemuel of Acre, Nathan ben Sa'adyah, the author of *Sha'arei Tzedeq, Ner Elohim*, and *Sefer ha-Tzeruf*, and in the sixteenth century in the writings of Yehudah Albotini, Moshe Cordovero (1522–1570), and Hayyim ben Joseph Vital (1542 or 1543–1620). Many of the concepts were disseminated by means of the widespread writings of Cordovero's disciples, though some folios of Abraham Abulafia's Kabbalah were in print as early as 1556. Some of Abulafia's manuscripts were known in the eighteenth century in eastern Europe by both Hasidim and Mitnagedim.

This model, though formulated in a systematic way by a Spanish Kabbalist, was not accepted by the Spanish kabbalists in the Iberian Peninsula. In Safed, however, Cordovero and his students were positively predisposed toward this type of mysticism. He described the major revelation concerning the messianic mission of Tzevi as the result of a path reminiscent of ecstatic Kabbalah. Abulafia's influence may also be discerned in Hasidism.

The ecstatic approach assumes that the Kabbalist can use language and the canonical texts in order to induce a mystical experience by means of manipulations of elements of language together with other components of the various mystical techniques. This approach is much less concerned with divine inner structures, focusing as it does on the restructuring of the human psyche in order to prepare it for the encounter with the divine. The ecstatic theory of language is less mimetic, and thus less symbolic and theurgic, than the view espoused by the theosophical Kabbalah. While the theosophical-theurgical approach to language assumes the paramount importance of information that is either absorbed by the human mind or transmitted by the soul to the divine, in many cases the ecstatic view of language encourages the effacement of knowledge as part of the opening toward the divine. According to ecstatic Kabbalah, language helps cleanse someone's consciousness by breaking, using a mystical technique, the words of the sacred scripture into nonsemantic units. While the theosophical Kabbalah emphasizes the given, structured aspects of language as manifested in the canonical writings, in ecstatic Kabbalah the deconstruction of the canonical texts, and of ordinary language as well, is an important mystical tool for restructuring the human psyche.

Significant for this model is the antinomian feature of the techniques, which means that according to the various descriptions of his paths the rabbinic rites are not essential for achieving the supreme religious experience. Prophecy is the main purpose of Abulafia's entire kabbalistic project, and he conceived himself to be a prophet. The recurrence, at least in principle, of this topic is visible in a Kabbalist who was also well acquainted with the theosophical-theurgical Kabbalah. Isaac Luria, like his teacher Rabbi Nathan, did not have

prophetic claims; his vision of prophecy is quite similar to Abulafia's. The linguistic components of these techniques are of paramount importance. Also conspicuous are the strong individualistic proclivities of this kind of mysticism and the deep influence of philosophy, especially Aristotelianism in the case of Abulafia, and Neoplatonism in the case of his followers. The existence of various elements of the ecstatic model is easily detectable in Neoplatonic philosophy and in Spanish Kabbalah.

The magical-talismanic model. While the two models of Kabbalah surveyed above are represented in distinct kabbalistic literatures, the magical-talismanic model is found in a variety of writings belonging to those models, and only rarely constitutes a literature of its own. Jewish magic is an old lore, having a variety of forms already in late antiquity. Some parts of it survived in Hebrew and Aramaic texts, some had an impact on Hellenistic magic. No doubt early kabbalists were acquainted with Jewish magical texts and appropriated some of its elements, while others criticized them. From the beginning of the fourteenth century, a distinction between two types of Kabbalah gradually came to the fore: Speculative Kabbalah (*Qabbalah 'Iyyunit*) and Practical Kabbalah (*Qabbalah Ma'asit*). In the fifteenth century this distinction appeared several times and in the sixteenth century it became a standard tool for differentiating various types of Kabbalah. The emergence of this distinction may have something to do with the distinction between speculative and practical philosophy, as formulated by Moses ben Maimon (1135–1204).

The greater interest in magical Kabbalah became evident toward the end of the fifteenth century in the writings of both the Spanish and the Italian kabbalists. The extent of the magical influence on Jewish mysticism is an issue that still waits for detailed treatment. There can be no doubt as to the importance of various forms of magic within some of the important forms of Jewish mysticism, starting with the *Heikhalot* literature. The magical view of the Hebrew language is crucial for most of the forms of magic in Judaism and remained influential in numerous texts, especially in Kabbalah. In the Middle Ages under the influence of philosophical views found among the Arabs, an additional explanation appeared, contending that by cleaving to the spiritual celestial source that rules this world—the universal soul—the mystic, or the philosopher, is able to channel the events in the sublunar world. The operation is a spiritual one and takes place in the supernal world. This understanding of magic uses Neoplatonic elements.

In ancient Hellenistic magic, and in Arabic and Jewish medieval magic, the dominant view asserted is that it is possible to attract downward the spiritual forces of the celestial bodies. These spiritual forces—named *pneumata* in Greek, *Ruhaniyyat* in Arabic, and *Ruhaniyyut* in Hebrew—were conceived as being able to be attracted and captured by special types of objects and rituals, whose natures are consonant to features of corresponding celestial bodies.

In fifteenth-century Kabbalah the use of the Hebrew language as a technique to draw down the spiritual force became explicit, and it was increasingly assumed that each and every

sefirah had a spiritual force of its own. Thus, the astrological structure of this model was projected onto the “higher” theosophical structure, thereby diminishing the potential critiques that a strong astrological stand could provoke. While not totally obliterating the astral meaning of the term *ruhaniyyut*, kabbalists attributed to the *sefirotic* realm a structure, which they adopted from astrological thought: on high, a distinction should be made between the more material and the spiritual aspects of reality. It is possible to detect some translations of features of the astral bodies to the corresponding divine powers, the *sefirot*.

While the Arab astrologists differentiated between *haikhalat* and *ruhaniyyat*, the kabbalists introduced this distinction in the realm of the intradivine: the *sefirot* have an external aspect, the vessels named *kelim* and the more inner component, the spirituality of each *sefirah*. Though this division also served other theological goals, the terms used by Yohanan Alemanno (1433–c. 1504) and Moses Cordovero in this context betray their sources. Especially important is the emergence of the term *ruhaniyyot ha-Sefirot*, the spiritual forces of the *sefirot*. This phrase still maintains the concept of a multiplicity in the spiritual world: each *sefirah* possesses a distinct inner power that reflects the specific quality of the respective divine power. This “elevation” of the term *ruhaniyyut* to the rank of divine realm did not supercede the magical use of the term in the writings of those kabbalists who adopted this projection.

While accepted by some kabbalists, the magical-talismanic model was changed in two major points: the theological, actually the theosophical plane, supplanted the celestial-astrological one, whereas the magical practices were substituted, to a great degree, by the Jewish rites and especially by the ritualistic use of the Hebrew language in prayer and in study. This pivotal change took place in a conspicuous way in the writings of Alemanno, S. Alqabetz, and Cordovero. It was part of an attempt to offer an explanation of the efficacy of the commandments in addition to, or different from, the more common theurgical rationales recurrent in the kabbalistic literature.

In adopting the Jewish ritual for the sake of magical attainments, or by interpreting these rites as magically effective, the more difficult philosophical aspects of magic, as an operation performed by acts that are not part of regular behavior, were attenuated to a great extent. The material and spiritual attainments are drawn down by fulfilling the divine will, and not by an attempt to short-circuit the order of nature, or by forcing the divine will. In many cases the term *ruhaniyyut* preserves overtones from its magical sources, while in many other instances, both in Cordoverian Kabbalah and Hasidism, this term designates the ideal, spiritual realm, without maintaining any of the astral-magical meanings.

The essence of Kabbalah involves both the theosophical core, the nature of the *sefirot* and their luminous manifestations (the theoretical Kabbalah), and the experimental factor, the visualization of the colors, which is the essential component of the mystical intention during prayer. As in descriptions stemming from Nahmanides’s (1194–c. 1270) school,

where the supernal realm and the commandments are mentioned altogether, Kabbalah is presented as a synthesis between theosophical and theurgical elements. The culmination of the kabbalistic lore and practice, as envisioned in one of the most influential treatises in its history, assumes that a mystical element is essential, in addition to the knowledge of the map of the divine world.

The magical brand of Kabbalah remained part and parcel of this lore. Nevertheless there are important cases in which kabbalists rejected, or minimized, the importance of the magical aspects of their lore. Astral magic is paramount in the writings of Alemanno and of Cordovero. The astral spiritualities were projected in the intradivine realm and were presented using magical categories. The basic technique in this type of magic is the drawing down of divine powers, or the overflow of the *sefirot*, in accordance with the needs of the magician.

Cordovero was aware of the affinity of his conception to that of astral magic and considered the knowledge of the preparation of amulets or talismans as a revealed gnosis, which serves as an introduction to the knowledge of the Kabbalah. His reluctance to acknowledge the conspicuous affinity of his Kabbalah with a certain type of magic is understandable but it does not detract from the profound similarity and the historical filiation of his Kabbalah to magic. Like Alemanno, Cordovero did not intend to disrupt the natural order by appealing to demonic forces, which could destroy the natural order. Instead he proposed a type of activity that complemented natural activity by adding a dimension of praxis based on laws already in existence but hidden from the eyes of the uninformed. The kabbalistic activity was supernatural not because it intruded into the regular course of events but because its orderliness was superior.

According to other texts, inducing the supernal influx upon the righteous by the combination of letters of the divine names is similar to causing the descent of the overflow of the *sefirot* by employing the color technique. Whereas the names can be conceived as static talismans, there are instances in which there is a dynamic process that induces the spiritual force from above, and it is a dynamic descent that is incited by a combination of letters. The talismanic implications of Abulafia’s techniques were enhanced by some of his disciples, who vigorously introduced the talismanic view of language. Thereby, the human body was conceived as the locus where the divine influx is received and becomes a vessel of the descending influx. It is the mystical-magical technique that may induce an experience of the divine, present in and working through the human body.

A certain shift from the theurgical ideal toward a more magical view, represented by the ideal of drawing upon someone the divine efflux, is evident. As in the case of the acculturation of the hermetic type of magic into the Jewish ritual, the Kabbalist performing the practice of concentration and pronunciation of the combinations of letters is presented as a righteous—that is, as an ideal—religious type. Though not part of the regular ritual, the above technique is nevertheless considered to be a licit practice as it is attributed to an ancient source, and the practitioner is described as a righteous man.

An important development taking place in Cordovero's thought that had deep repercussions later is the vision of the human righteous, the *Tzaddiq*, as functioning in a manner reminiscent of the ninth *sefirah*, *Yesod*, transmitting the influx it receives from the higher to the lower parts of the *sefirotic* realms. The influx is received from the *sefirotic* realm, to which the righteous cleaves, and is transmitted then to others.

In the magical model the world depends upon the higher powers, the spiritual force attracted on the low by the very body of the *Tzaddiqim* and their religious acts as well as the secrets of the Torah. It is a magical universe that is described by Cordovero: the *Tzaddiq* is not only able to change the earthly realm but is also conceived as governing the celestial world. By the dint of the divine soul that dwells in man, the righteous rules over the world because of his cleaving to the world of emanation. This expansion of divine influx depends on the religious behavior, which is instrumental in attracting the "light of the world of emanation" onto all the worlds. Cordovero distinguishes between this type of influence on the world—for him a type of natural magic similar to the view of his Renaissance contemporaries in Italy—which is drastically different from a more radical form of Jewish magic that operates by the virtue of the divine names, and which should be avoided as much as possible.

The drawing down consists of two stages: the intradivine, from the peak to the last *sefirah*, *Malkhut*, a stage that can be designated as a theurgical act, and drawing the influx from the last *sefirah* toward the lower entities, which can be called magic. What is significant is the fact that a ritualistic term and its performance as a ritual act are involved in the process of attracting spirituality downward. The use of the term *hamsbakhah* reflects a magical aspect, which may be a return to a more ancient layer of thought. Cordovero inherited a tradition from a long series of kabbalists who connected two topics: the concept and practice of blessing, *berakhah*, and the drawing down, *hamsbakhah*.

Differences and Overlaps

The three models differ insofar as their objectives: the ecstatic one is concerned with the changes a certain mystical technique may induce in humans; the talismanic model emphasizes the effects someone's ritualistic linguistic acts may have on the external world, while the theosophical-theurgical model is concerned with inducing harmony within the divine realm. These models have been only rarely exposed as completely separate approaches. The ecstatic model was sometimes combined with the talismanic. The theurgical operation, which ensures the continuing pulsation of energy within the divine realm, has sometimes been combined with the magical or talismanic approaches, and drawing the emanation from the higher *sefirot* to the lower ones was followed by causing the descent of this emanation into the extra-divine world. A strongly anthropocentric attitude, the talismanic model envisages the enhancing of the spiritual and material well-being of an individual, and often of the whole religious group, as an important core of religion.

The theosophical-theurgical and the talismanic models assume that, in addition to the semantic aspect of the sacred

text, and of Hebrew language in general, there is an energetic aspect that is also effective, either by affecting the supernal world or, respectively, by attracting it downward. In ecstatic Kabbalah these two aspects are sometimes present but play a relatively marginal role. It recognizes the magical powers of language, though it conceives them as exercising an influence on a lower, inferior level of existence, when compared to the cathartic role language plays in purifying the soul, or the intellect, in order to prepare them for the reception of the supernal effluvia. The talismanic model as exemplified by linguistic magic is a synthesis between the particularistic tendency, characteristic of the theurgical model and the more universalistic tendency of the hermetic sources. Focused on Hebrew words as major tools, the linguistic talismanics and sometimes the ecstatic kabbalists assume that not only Hebrew words, but also Hebrew letters, and especially, what can be called according to them "Hebrew" sounds or phonemes, may serve as talismans. The three models had an impact on the particular understanding of many central issues like the nature of the Messiah, metempsychosis, and cosmic cycles, which have been reinterpreted in accordance to each of these models' logic.

Impact of Kabbalah

Due to the dissemination of Christian Kabbalah, and the impact of modern scholarship of Kabbalah represented in the seminal studies of Gershom Scholem (1897–1982), elements of kabbalistic thought have been integrated in a variety of modern intellectual and literary realms. Well-known figures in European thought had been attracted to Kabbalah, like the seventeenth-century Cambridge Neoplatonists, Gottfried Wilhelm Leibniz (1646–1716), Emanuel Swedenborg (1688–1772), Friedrich Wilhelm Joseph von Schelling (1775–1854), and Salomon Maimon (1753–1800).

In literature Kabbalah influenced writers like William Blake (1757–1827), Franz Kafka (1883–1924), Ivan Gol, Paul Celan (Paul Antschel; 1920–1991), Jorge Luis Borges (1899–1986), Isaac Bashevis Singer (1904–1991), Umberto Eco (b. 1932), and, on the Israeli scene, Shmuel Yosef Agnon (1888–1970), David Shahar (1926–1997), and Uri Tzvi Greenberg, as well as some literary criticism and philosophy of text by Maurice Blanchot (1907–2003), Harold Bloom (b. 1930), Jacques Derrida (b. 1930), George Steiner (b. 1929), and Eco. In modern philosophy kabbalistic elements are conspicuous in the speculative systems of Franz Rosenzweig (1886–1929), Abraham Isaac Kook (1865–1935), Joseph Baer Soloveitchik, Abraham Joshua Heschel (1907–1972), and Emmanuel Levinas (1906–1995).

A revival of interest in Kabbalah was visible at the turn of the twenty-first century in a return of role of kabbalists in some segments of Israeli society, and the resort to kabbalistic ways of thought used by some New Age thinkers in the United States, like Rabbi Zalman Schechter. Even orthodox kabbalists, active basically only in Israel, are inclined now to allow a previously unthinkable large-scale dissemination of this lore in large audiences, by a new politics of printing and teaching.

See also *Christianity; Judaism; Magic; Religion*.

BIBLIOGRAPHY

- Dan, Joseph. *Jewish Mysticism*. Northvale, N.J.: Aronson, 1998–1999.
- Giller, Pinchas. *Reading the Zohar*. New York: Oxford University Press, 2001.
- Ginsburg, Elliot. *The Sabbath in the Classical Kabbalah*. Albany: State University of New York Press, 1989.
- Green, Arthur, ed. *Jewish Spirituality*. New York: Crossroad, 1986–1987.
- Halamish, Mosheh. *An Introduction to the Kabbalah*. Translated by Ruth Bar-Ilan and Ora Wiskind-Elper. Albany: State University of New York Press, 1999.
- Idel, Moshe. *Absorbing Perfections: Kabbalah and Interpretation*. New Haven, Conn.: Yale University Press, 2002.
- . *Hasidism: Between Ecstasy and Magic*. Albany: State University of New York Press, 1995.
- . *Kabbalah: New Perspectives*. New Haven, Conn.: Yale University Press, 1988.
- . *Messianic Mystics*. New Haven, Conn.: Yale University Press, 1998.
- . *The Mystical Experience in Abraham Abulafia*. Albany: State University of New York Press, 1988.
- Liebes, Yehuda. *Studies in Jewish Myth and Jewish Messianism*. Translated by Batya Stein. Albany: State University of New York Press, 1993.
- . *Studies in the Zohar*. Translated by Arnold Schwartz. Albany: State University of New York Press, 1993.
- Ruderman, David. *Kabbalah, Magic, and Science: The Cultural Universe of a Sixteenth-Century Jewish Physician*. Cambridge, Mass., and London: Harvard University Press, 1988.
- Scholem, Gershom. *Kabbalah*. New York: Quadrangle, 1974.
- . *Major Trends in Jewish Mysticism*. New York: Schocken, 1961.
- . *On the Kabbalah and Its Symbolism*. Translated by Ralph Manheim. New York: Schocken, 1965.
- . *On the Mystical Shape of the Godhead*. Translated by Joachim Neugroschel. New York: Schocken, 1991.
- . *Origins of the Kabbalah*. Translated by Allan Arkush. Princeton, N.J.: Princeton University Press, 1987.
- . *Sabbatai Sevi: The Mystical Messiah, 1626–1676*. Princeton, N.J.: Princeton University Press, 1973.
- Tishby, Isaiah, and Fischel Lachower. *The Wisdom of the Zohar*. 3 vols. Translated by David Goldstein. Oxford and New York: Oxford University Press, 1989. An anthology of texts arranged and rendered into Hebrew by Lachower and Tishby, with introductions and explanations by Tishby.
- Wolfson, Elliot R. *Abraham Abulafia—Kabbalist and Prophet: Hermeneutics, Theosophy, and Theurgy*. Los Angeles: Cherub, 2000.
- . *Along the Path*. Albany: State University of New York Press, 1995.
- . *Circle in the Square*. Albany: State University of New York Press, 1995.
- . *Through a Speculum That Shines*. Princeton, N.J.: Princeton University Press, 1994.

Moshe Idel

MYSTICISM IN AFRICAN THOUGHT

The term *mysticism* typically denotes a complex of beliefs and practices related to the personal experience of the di-

Mysticism in indigenous African thought is:

distinct from conceptions of mysticism in Judaism, Christianity, and Islam;

characterized by a social, worldly orientation;

united with indigenous religious practices;

primarily focused on interaction with spirits, rather than the supreme God;

preserved in and transmitted through oral traditions; and

not aimed at unification with the divine through eradication of or purification of the self.

vine. Much, although not all, mystical thought and practice derives from or draws upon formal religious doctrines, emphasizing reflective, introspective, and meditative practices as the keys to cultivating perception and awareness that will ultimately lead to knowledge of and communion with the divine.

When one turns to mysticism in African thought, and specifically to the mystical tenets extant in indigenous religious beliefs and practices, the common Western definition is necessarily altered. *Mysticism* continues to describe the realm of interaction between humanity and the divine or supernatural, but owing to the prevailing nature of indigenous African belief systems, the orientation and manifestations of mystical practices are of a different character. The orientation is social and utilitarian, and the manifestations occur within the structure of indigenous rites; mystical practices aim to fulfill needs in society, and they do not exist as a separate body of practices. This reflects the general African cosmology and understanding of arenas of interaction between humanity and the divine or supernatural.

Cosmology and Interaction

African cosmology, in general, posits three categories of agents: God, spirits, and man. A supreme God, who is the creator of the universe and all that is in it, is acknowledged and revered in indigenous practices, through libations, praises, and proverbs. Although knowledge of his existence is present, the majority of indigenous beliefs and rites do not focus on God, nor do they aim to bring the individual closer to him. God is an acknowledged reality, but a distant, somewhat nebulous one.

In addition to God, there exist other agents, typically referred to as spirits. These spirits are part of the creation, as are humans, but they possess certain powers and abilities. They interact with human beings and have agency in the world.

Man, the third category, is created by God and coexists with the spirits in the world. Human orientation in the world is social, and action to uphold social ties and foster social cohesion is held in high regard and even seen as the primary goal of life. Humans can, through reciprocal affiliation with and worship of spirits, gain access to their power and channel that power for positive or negative ends.

Man does not, in mystical and spiritual endeavors, aim solely to gain knowledge of the supreme creator God through contemplation and negation of worldly existence and self; rather, being socially oriented, a person seeks to obtain utilitarian agency that will foster change in the world. Mystical and spiritual practices in indigenous African traditions do not, therefore, center on the individual in isolation; they maintain social orientation and purpose. The goal of the mystical endeavor is not to obliterate individual consciousness or physicality; it is rather to garner knowledge and power that can be used in the human world.

Individuals and spirits interact with each other. Laypeople may have encounters with spirits, and they may also seek guidance and physical assistance from them. Individuals who are initiated in specific indigenous traditions may mediate the latter form of interaction; individuals can experience the divine or supernatural to only a certain extent without an intermediary. Furthermore, the role of the intermediary is of central importance because that experience alone is not the end; the goal is to acquire and use knowledge to bring about change in human society. In many cases, these practitioners, commonly referred to as priests, are “chosen” by the spirits, as evidenced in physical or spiritual crises. Such crises are seen as signs that the individual should be initiated into the service of a particular spirit. Initiation is characterized by intensive ritualistic, spiritual, physical, and intellectual training, which is carried out in seclusion, under the supervision of an elder priest. Mystical traditions and knowledge, preserved and transmitted orally, are passed from the priest to the initiate and onward.

Once initiated, priests and other practitioners interact with and seek assistance from the spirits for themselves and others. One common method is the possession trance, typically induced through music and dance or consumption of herbs or intoxicants, in which the spirit enters the priest’s body and communicates information to those present. Another common form of interaction is divination, the best-known example being the complex Ifa system among the Yoruba of Nigeria.

Indigenous Religions Compared with Christianity and Islam

The impact of Christianity and Islam on the African continent has been and continues to be profound. In most places, indigenous religious and practices coexist with, and may form new syncretic traditions with, Christianity and Islam. This results, increasingly, in the overlap and combination of mystical practices and trends. Many of these manifestations, readily observable today, take on a form that departs from the “pure” manifestation of African mysticism and is more in line with

the common understanding of mysticism. Nevertheless, in trying to isolate mysticism in indigenous African thought, it becomes apparent that African mysticism is of a different variety than mysticism in Christianity and Islam. To begin with, whereas mysticism in Christianity and Islam primarily focuses on knowledge and communion with the divine, African mysticism focuses on interaction with spirits. Mysticism in Christianity and Islam involves practices such as meditation and asceticism that require the individual to withdraw from the physical world in order to undergo a subjective experience of the divine and the resultant transformation. African mysticism retains a social, worldly focus, deriving its purpose and value from its functionality in effecting change in the society, rather than in the individual only. Christianity and Islam are based on prophetic traditions and written texts. Their respective mystical practices and beliefs have evolved as specific “paths” within the larger traditions, sometimes differing drastically from mainstream practice. These paths have been documented in written form and have developed into types of theology. Indigenous African mysticism is derived from oral traditions that have been evolving over many millennia. In most cases, these traditions are not contained in formal texts and are not associated with prophetic traditions. Mystical practices and beliefs are integrated into the larger, dynamic belief structure, which has no prophetic ideal.

See also *Personhood in African Thought; Religion: Africa; Religion: African Diaspora*.

BIBLIOGRAPHY

- Gray, John. *Ashe, Traditional Religion and Healing in Sub-Saharan Africa and the Diaspora: A Classified International Bibliography*. New York: Greenwood, 1989.
- Idowu, E. Bolaji. *African Traditional Religion: A Definition*. London: S. C. M. Press, 1973.
- Mbiti, John. S. *African Religions and Philosophy*. Oxford and Portsmouth, N. H.: Heinemann, 1988.
- . *Introduction to African Religion*. Oxford and Portsmouth, N. H.: Heinemann, 1991.
- Ray, Benjamin C. *African Religions: Symbol, Ritual, and Community*. Englewood Cliffs, N. J.: Prentice Hall, 1976.

Jerusha T. Lamptey

MYTH. The study of myth across the disciplines is united by the questions asked. The main questions are those of origin, function, and subject matter. *Origin* in this context means why and how myth arises; *function*, why and how myth persists. The answer to the why of origin and function is usually a need, which myth arises to fulfill and persists by continuing to fulfill. What that need is varies from theory to theory. *Subject matter* here means the referent of myth. Some theories read myth literally, so that the referent is the apparent one, such as gods. Other theories read myth symbolically, and the symbolized referent can be anything.

For example, a myth told by the Trobriand Islanders of Melanesia, as described by Polish-born anthropologist Bronis-

law Malinowski (1884–1942) in *Myth in Primitive Society* (1926), says that the world “was originally peopled from underground. Humanity had there led an existence similar in all respects to the present life on earth. Underground, men were organized in villages, clans, districts; they had distinctions of rank, they knew privileges and had claims, they owned property, and were versed in magic lore. One day humans came to the surface and established themselves, bringing with them all their culture to continue it upon this earth.”

According to Malinowski, whose theory will be considered in detail below, this myth was devised to secure support for the social divisions, ranks, and rights that were still to be found among the Trobrianders. Because no people will readily tolerate impositions, this myth was intended to provide a limited kind of justification. It does not assert that the impositions are deserved, but rather that they are traditional and go back even to the time before the proto-Trobrianders emerged from underground. The need being fulfilled is on the part of society itself, not on the part of individuals. Malinowski reads the myth literally: the subject matter is the social life of the Trobriand Islanders, both while underground and once above ground.

It is commonly said that theories of the nineteenth century focused on the question of origin and that theories of the twentieth century have focused on the questions of function and subject matter. But this characterization confuses historical origin with recurrent origin. Theories that profess to provide the origin of myth claim to know not where and when myth first arose but why and how myth arises wherever and whenever it does. The issue of recurrent origin was as popular with twentieth-century theorists as with nineteenth-century ones, and interest in function and subject matter was as common to nineteenth-century theorists as to twentieth-century ones.

Disciplines differ in their definitions of myth. Not all even assume that myth is a story. For political scientists, for example, myth can be a credo or an ideology, which may be illustrated by stories but is not rooted in them. Even when myth is assumed to be a story, disciplines differ over the contents. For folklorists, myth is about the creation of the world. In the Bible, only the two creation stories (Genesis 1 and 2), the Garden of Eden story (Genesis 3), and the Noah story (Genesis 6–9) would thereby qualify as myths. All other stories would instead constitute either legends or folktales. For theories drawn from religious studies, the main characters in myth must be gods or near-gods, such as heroes. Theories from anthropology, psychology, and sociology tend to allow for secular as well as religious myths.

Myth and Science

In the West, the ancient challenge to myth was on ethical grounds: Plato (c. 428–348 or 347 B.C.E.) bemoaned Homeric myths for presenting the gods as practitioners of immoral behavior. The chief modern challenge to myth has come from science.

One form of the modern challenge to myth has been to the scientific credibility of myth. Did creation really occur in a mere

six days, as the first of two creation stories in Genesis (1:1–2:4a) claims? Was there really a worldwide flood? The most unrepentant defense against this challenge has been to claim that the biblical account is correct, for, after all, the Pentateuch was revealed to Moses by God. This position, known as *creationism*, assumes varying forms, ranging, for example, from taking the days of creation to mean exactly six days to taking them to mean “ages.” At the same time, creationists of all stripes tout their views as scientific *as well as* religious, and they enlist scientific evidence to refute “pseudoscientific” rivals such as evolution.

A much tamer defense against the challenge of modern science has been to reconcile myth with that science. Here elements at odds with modern science are either removed or, more cleverly, reinterpreted as in fact scientific. There might not have been a Noah who was single-handedly able to gather up all living species and to keep them alive in a wooden boat sturdy enough to withstand the strongest seas that ever arose, but a worldwide flood did occur. What thus remains in myth is true because it is scientific—modern scientific.

By far the most common response to the challenge of science has been to abandon myth for science. Here myth is taken as an explanation of its own kind, not a scientific explanation in mythic guise. The issue is therefore not the scientific credibility of myth but the compatibility of myth with science. Myth, here a part of religion, is considered to be the “primitive” counterpart to science, which is assumed to be exclusively modern. Because moderns by definition accept science, they cannot also have myth, and the phrase *modern myth* is self-contradictory. Myth is a victim of the process of secularization that constitutes modernity.

The pioneering English anthropologist E. B. Tylor (1832–1917) remains the classic exponent of the view that myth and science are at odds. Tylor subsumes myth under religion and in turn subsumes both religion and science under philosophy. Primitive philosophy is identical with primitive religion. There is no primitive science. Modern philosophy, by contrast, is divided into religion and science. Primitive religion is the primitive counterpart to science because both are explanations of the physical world. The religious explanation is personalistic, the scientific one impersonal. The explanations are incompatible because both are *direct* explanations of the *same* events. Gods operate not behind or through impersonal forces but in place of them. One cannot, then, stack the religious account atop the scientific account.

Modern religion has surrendered the explanation of the world to science and has instead become a combination of metaphysics and ethics, neither of which is present in primitive religion. One now reads the Bible for not for the story of creation but for the Ten Commandments, just as for Plato a bowdlerized Homer (fl. 9th or 8th century B.C.E.) would enable one to do. This irenic position is like that of the American evolutionary biologist Stephen Jay Gould (1941–2002). Yet for Tylor, myths are too closely tied to gods as agents in the world to permit any transformation like that of the rest of religion. Where, then, there is “modern religion,” albeit religion shorn of its prime role as explanation, there are no modern myths.

In pitting myth against science, as in pitting religion qua explanation against science, Tylor epitomizes the nineteenth-century view of myth. In the twentieth century, the trend was to reconcile myth as well as religion with science, so that moderns can retain myth as well as religion.

Closest to Tylor stands J. G. Frazer (1854–1941), the Scottish classicist and fellow pioneering anthropologist. For Frazer, as for Tylor, myth is part of primitive religion; primitive religion is part of philosophy, itself universal; and primitive religion is the counterpart to natural science, itself entirely modern. Primitive religion and science are, as for Tylor, mutually exclusive. But where for Tylor primitive religion, including myth, functions as the counterpart to scientific *theory*, for Frazer it functions even more as the counterpart to *applied* science, or technology. Where for Tylor primitive religion, including myth, serves to *explain* events in the physical world, for Frazer it serves even more to *effect* events, above all the growth of crops. Where Tylor treats myth as an autonomous text, Frazer ties myth to ritual, which enacts it.

The biggest difficulty for Tylor's and Frazer's view of myth as the primitive counterpart to science is that it conspicuously fails to account for the retention of myth in the wake of science. If myth functions to do no more than science, why is it still around?

Reacting against the views of Tylor and Frazer and other members of what he imprecisely calls "the English school of anthropology," the French philosopher and armchair anthropologist Lucien Lévy-Bruhl (1857–1939) insisted on a much wider divide between myth and science. Where for Tylor and Frazer "primitives" think like moderns, just less rigorously, for Lévy-Bruhl primitives think differently from moderns. Where for Tylor and Frazer primitive thinking is logical, just erroneous, for Lévy-Bruhl primitive thinking is plainly nonlogical.

According to Lévy-Bruhl, primitives believe that all phenomena are part of a sacred, or "mystic," realm pervading the natural one. Phenomena become one another yet remain what they are. The Bororo of Brazil deem themselves red araras, or parakeets, yet still human beings. Lévy-Bruhl calls this belief "prelogical" because it violates the law of noncontradiction: the notion that something can simultaneously be both itself and something else.

For Lévy-Bruhl, as for Tylor and Frazer, myth is part of religion, religion is primitive, and moderns have science rather than religion. But where Tylor and Frazer subsume both religion and science under philosophy, Lévy-Bruhl associates philosophy with thinking *freed* from mystical identification with the world. Primitive thinking is nonphilosophical because it is not detached from the world. Primitives have a whole mentality of their own, one evinced in their myths.

One reaction to Lévy-Bruhl was to accept his separation of myth from philosophy but not his characterization of myth as pre-philosophical or pre-scientific. The key figure here was Malinowski. Invoking Frazer, Malinowski argues that primitives are too busy scurrying to survive in the world to have the luxury of reflecting on it. Where for Frazer primitives use myth *in place of*

science, for Malinowski primitives use myth as a *fallback* to science. Primitives possess not just the counterpart to science but science itself. Where science stops, they turn to magic. Where magic stops, they turn to myth—not to secure further control over the world, as Frazer would assume, but to reconcile themselves to aspects of the world that cannot be controlled, such as natural catastrophes, illness, aging, and death. Myth explains how, say, illness arose—a god or a human brought it about—but primitive science and magic try to do something about it. By contrast, myth says that nothing can be done about it.

Reacting both against Malinowski's view of primitives as practical rather than intellectual and against Lévy-Bruhl's view of primitives as mystical rather than intellectual, the French anthropologist Claude Lévi-Strauss (b. 1908) has boldly sought to revive an intellectualist view of primitives and of myth. At first glance, Lévi-Strauss seems a sheer throwback to Tylor. Yet in fact Lévi-Strauss is severely critical of Tylor, for whom primitives concoct myth rather than science because they think less critically than moderns. For Lévi-Strauss, primitives create myth because they think differently from moderns—but, contrary to Lévy-Bruhl, still think and still think rigorously. For both, myth is the epitome of primitive thinking.

Where for Tylor primitive thinking is personalistic and modern thinking impersonal, for Lévi-Strauss primitive thinking is concrete and modern thinking abstract. Primitive thinking focuses on the observable, sensible aspects of phenomena rather than, like modern thinking, on the unobservable, insensible ones. Yet antithetically to Tylor, Lévi-Strauss considers myth no less scientific than modern science. Where for Tylor myth is the primitive counterpart to science per se, for Lévi-Strauss myth is the primitive counterpart to *modern* science. Myth *is* primitive science, but not thereby inferior science.

If myth is an instance of primitive thinking because it deals with concrete, tangible phenomena, it is an instance of thinking itself because it classifies phenomena. Lévi-Strauss maintains that all humans think in the form of classifications, specifically pairs of oppositions, and project them onto the world. Many cultural phenomena express these oppositions. Myth is distinctive in resolving or, more accurately, tempering the oppositions it expresses. Those contradictions are to be found not in the plot but in what Lévi-Strauss famously calls the "structure."

Karl Popper (1902–1994), the Viennese-born philosopher of science who eventually settled in England, breaks radically with Tylor. Where for Tylor science simply replaces it, for Popper science emerges *out of* myth—not, however, out of the *acceptance* of myth but out of the *criticism* of it. By "criticism" Popper means not rejection but assessment, which becomes scientific when it takes the form of attempts to falsify the truth claims made.

Myth and Philosophy

The relationship between myth and science overlaps with that between myth and philosophy. Yet there is an even greater array of positions held on the relationship between myth and philosophy: that myth is part of philosophy, that myth *is* philosophy, that philosophy is myth, that myth grows out of phi-

losophy, that philosophy grows out of myth, that myth and philosophy are independent of each other but serve the same function, and that myth and philosophy are independent of each other and serve different functions.

The most abrupt reaction to Lévy-Bruhl's opposing of myth to both science and philosophy came from the Polish-born anthropologist Paul Radin (1883–1959), who was brought to the United States as an infant. Radin grants that *most* primitives are far from philosophical but observes that so are most persons in any culture. Both the average “man of action” and the exceptional “thinker” types of temperament are to be found in all cultures, and in the same proportion. If Lévy-Bruhl is therefore wrong to deny that any primitives are reflective, Tylor is equally wrong to assume that all are. But those primitives who are get credited by Radin with a philosophical prowess keener than that granted even myth makers by Tylor. Contrary to Tylor, primitives, furthermore, are capable of rigorous criticism. Likely for Radin, as definitely for Popper, the capacity for criticism is the hallmark of thinking.

A far less dismissive reaction to Lévy-Bruhl came from the German-born philosopher Ernst Cassirer (1874–1945). For Cassirer, wholly following Lévy-Bruhl, mythic, or “mythopoic,” thinking is primitive, is part of religion, and is the projection of mystical oneness onto the world. But Cassirer claims to be breaking sharply with Lévy-Bruhl in asserting that mythic thinking has its own brand of logic. In actuality, Lévy-Bruhl says the same and invents the term *prelogical* exactly to avoid labeling mythic thinking “illogical” or “nonlogical.” Cassirer also claims to be breaking with Lévy-Bruhl in stressing the autonomy of myth as a form of knowledge—language, art, and science being the other main forms. Yet Cassirer simultaneously maintains, no differently from Lévy-Bruhl, that myth is incompatible with science and that science succeeds it. For both Cassirer and Lévy-Bruhl, myth is exclusively primitive and science exclusively modern. Still, Cassirer's characterization of myth as a form of *knowledge* puts myth in the same genus as science—not quite where Lévy-Bruhl puts it.

As philosophical as Cassirer's approach to myth is, he never contends that myth *is* philosophy. The theorists who do so are the German theologian Rudolf Bultmann (1884–1976) and the German-born philosopher Hans Jonas (1903–1993), who eventually settled in the United States. They apply to their specialties, Christianity and Gnosticism, a theory from the early, existentialist work of Martin Heidegger (1889–1976).

Myth and Religion

Myth approached from the field of religious studies naturally subsumes myth under religion and thereby directly exposes myth to the challenge to religion from science. Twentieth-century theories from religious studies sought to reconcile myth with science by reconciling religion with science.

There have been two main strategies for doing so. One tactic has been the recharacterization of the subject matter of religion and therefore of myth. Here religion is not about the physical world, in which case it is safe from any encroachment

by science. The myths considered under this approach to religion are traditional myths such as biblical and classical ones, but they are now read symbolically rather than literally. Myth, it is claimed, has been taken to be at odds with science because it has been misread—by those who, like Tylor, read myth literally.

The other tactic for retaining myth in the wake of science has been the elevation of seemingly secular phenomena to religious ones. Here myth is no longer confined to explicitly religious ancient tales. There are now overtly secular modern myths as well. For example, stories about heroes are at face value about mere human beings, but the humans are raised so high above ordinary mortals as to become virtual gods. This approach retains a literal reading of myth but recategorizes the literal status of the agents in myth.

The grandest exponents of a symbolic rendition of traditional religious myths were Bultmann and Jonas. Taken literally, myth for Bultmann is exactly what it is for Tylor and should be rejected as uncompromisingly as Tylor rejects it. But unlike Tylor, Bultmann reads myth symbolically. In his celebrated, if excruciatingly confusing, phrase, he “demythologizes” myth, which means not eliminating, or “demythicizing,” the mythology but instead extricating its true, symbolic meaning. To seek evidence of an actual worldwide flood, while dismissing the miraculous notion of an ark containing all species, would be to *demythicize* the Noah myth. To interpret the flood as a symbolic statement about the precariousness of human life would be to *demythologize* the myth.

Demythologized, myth ceases to be about the world and turns out to be about the human *experience* of the world. Demythologized, myth ceases to be an explanation at all and becomes an expression, an expression of what it feels like to live in the world. The New Testament, when demythologized, contrasts the alienation from the world felt by those who have not yet found God to the at-home-ness in the world felt by those who have found God. Myth ceases to be merely primitive and becomes universal. It ceases to be false and becomes true. It depicts the human condition.

Taken literally, myth, as a personalistic explanation of the physical world, is incompatible with science and is therefore unacceptable to moderns. Once demythologized, however, myth is compatible with science because it now refers at once to the transcendent, nonphysical world and, even more, to humans' experience of the physical one. But to say that myth is acceptable to scientifically minded moderns is not to say why it should be accepted. In providing a modern *subject matter* of myth, Bultmann provides no modern *function*.

Jonas argues that ancient Gnosticism presents the same fundamental view of the human condition as modern existentialism—but of atheistic rather than, as for Bultmann, of religious existentialism. Both Gnosticism and existentialism stress the radical alienation of human beings from the world. Unlike Bultmann, who strives to bridge the gap between Christianity and modernity, Jonas acknowledges the divide between Gnosticism and modernity. Yet for Jonas, Gnostic mythology can still speak to moderns, and not to modern believers, as for

Bultmann, but to modern skeptics. Like Bultmann, Jonas seeks to reconcile myth with science by recharacterizing the subject matter of myth. Yet no more than Bultmann does he offer any function of myth for moderns.

Hagiographical biographies of celebrated figures transform them into near-gods and their sagas into myths. For example, immediately after the First Gulf War, biographies of the American commander-in-chief, “Stormin’ Norman” Schwarzkopf (b. 1934), touted him as the smartest and bravest soldier in the world—so much smarter and braver than anyone else as to make him almost more than human.

The chief theorist here is the Romanian-born historian of religions Mircea Eliade (1907–1986), who spent the last three decades of his life in the United States. Unlike Bultmann and Jonas, Eliade does not seek to reconcile myth with science by interpreting myth symbolically. He reads myth as literally as Tylor does. Unlike Bultmann and Jonas, Eliade does not try to update traditional myths. But rather than, like Tylor, sticking to traditional, explicitly religious myths, he turns to modern, seemingly nonreligious ones. Yet instead of trying to reconcile those myths with science, as Bultmann and Jonas would, he appeals to the sheer presence of them to argue for their compatibility with science: if moderns, who for Eliade no less than for the others have science, also have myth, then myth simply must be compatible with science. Where Bultmann and Jonas argue meekly that moderns *can* have myth, Eliade argues boldly that they *do*. Where Tylor and Frazer assume that myth is the victim of the process of secularization, Eliade argues that only a superficial secularization has occurred.

Myth and Ritual

Myth is commonly taken to be words, often in the form of a story. A myth is read or heard. It says something. Yet there is an approach to myth that finds this view of myth artificial. According to the myth and ritual, or myth-ritualist, theory, myth does not stand by itself but is tied to ritual. Myth is not just a statement but also an action.

The myth-ritualist theory was pioneered by the Scottish biblicalist and Arabist William Robertson Smith (1846–1894). Smith argues that belief is central to *modern* religion but not to *ancient* religion, where instead ritual was central. He grants that ancients doubtless performed rituals only for some reason. But the reason was secondary and could even fluctuate. The reason was a story, or a *myth*, which simply described the origin of the ritual. In claiming that myth is an explanation of ritual, Smith was denying Tylor’s conception of myth as an explanation of the world.

Yet Smith is like Tylor in one key respect. For both, myth is wholly ancient. Modern religion is without myth—and without ritual as well. Myth and ritual are not merely ancient but “primitive.” In fact, for both Tylor and Smith, ancient religion is but a case of primitive religion, which is the fundamental foil to modern religion.

J. G. Frazer developed the myth-ritualist theory far beyond Smith. Frazer, rarely consistent, actually presents two distinct

versions of myth-ritualism. In the first version myth describes the life of the god of vegetation, and ritual enacts the myth describing his death and rebirth. The ritual operates on the basis of the voodoo-like Law of Similarity, according to which the imitation of an action causes it to happen. The ritual directly manipulates the god of vegetation, but as the god goes, so automatically goes vegetation. The ritual is performed when one wants winter to end, presumably when stored-up provisions are running low. A human being, often the king, plays the role of the god and acts out what he magically induces the god to do.

In Frazer’s second version of myth-ritualism, the king is central. Here the king does not merely act the part of the god but is himself divine, by which Frazer means that the god resides in him. Just as the health of vegetation depends on the health of its god, so now the health of the god depends on the health of the king: as the king goes, so goes the god of vegetation, and so in turn goes vegetation itself. To ensure a steady supply of food, the community kills its king while he is still in his prime and thereby safely transfers the soul of the god to his successor. As in the first version, the aim is to end winter, which now is attributed to the weakening of the king.

While this second version of myth-ritualism has proved the more influential by far, it actually provides only a tenuous link between myth and ritual. Instead of enacting the myth of the god of vegetation, the ritual simply changes the residence of the god. The king dies not in imitation of the death of the god but as a sacrifice to preserve the health of the god. What part myth plays here, it is not easy to see. Instead of reviving the god by magical imitation, the ritual revives the god by a transplant.

Outside of religion, the most notable application of the myth-ritualist theory has been to literature. The English classicist Jane Harrison (1850–1928) daringly derived all art, not just literature, from ritual. Using Frazer’s first version of myth-ritualism, she speculates that gradually people ceased believing that the imitation of an action caused that action to occur. Yet rather than abandoning ritual, they now practiced it as an end in itself. Ritual for its own sake became art, her clearest example of which is drama. More modestly than she, fellow classicists Gilbert Murray (1866–1957) and Francis Macdonald Cornford (1874–1943) rooted specifically Greek epic, tragedy, and comedy in myth-ritualism. Murray then extended the theory to the works of William Shakespeare (1564–1616).

Other standard-bearers of the theory have included Jessie Weston on the Grail legend, E. M. Butler on the Faust legend, C. L. Barber on Shakespearean comedy, Herbert Weisinger on Shakespearean tragedy and on tragedy per se, Francis Ferguson on tragedy, Lord Raglan on hero myths and on literature as a whole, and Northrop Frye and Stanley Edgar Hyman on literature generally. As literary critics, these myth-ritualists have understandably been concerned less with myth itself than with the mythic origin of literature. Works of literature are interpreted as the outgrowth of myths once tied to rituals. For those literary critics indebted to Frazer, as the majority are, literature harks back to Frazer’s second myth-ritualist scenario. “The king must die” becomes the familiar summary line.

For literary myth-ritualists, myth becomes literature when myth is severed from ritual. Myth tied to ritual is religious literature; myth cut off from ritual is secular literature, or plain literature. Bereft of ritual, myth can no longer change the world and is demoted to mere commentary.

Perhaps the first to temper the dogma that myths and rituals are inseparable was the American anthropologist Clyde Kluckhohn (1905–1960). The German classicist Walter Burkert (b. 1931) has gone well beyond Kluckhohn in not merely permitting but assuming the original independence of myth and ritual. He maintains that when the two do come together, they do not just serve a common function, as Kluckhohn assumes, but reinforce each other. Myth bolsters ritual by giving mere human behavior a real, not to mention divine, origin: do this because the gods did or do it. Conversely, ritual bolsters myth by turning a mere story into prescribed behavior of the most dutiful kind: do this on pain of anxiety, if not punishment. Where for Smith myth serves ritual, for Burkert ritual equally serves myth.

Ritual for Burkert is “as if” behavior. The “ritual” is not the customs and formalities involved in actual hunting but dramatized hunting. The function is no longer that of securing food, as for Frazer, for the ritual proper arises only after farming has supplanted hunting as the prime source of food. The communal nature of actual hunting, and of ritualized hunting thereafter, functioned to assuage anxiety over one’s own aggression and one’s own mortality, and at the same time functioned to cement a bond among participants. This shift of focus from the physical world to the human world typifies the shift of focus from nineteenth-century theories of myth to twentieth-century ones.

Myth and Psychology

In the field of psychology, the theories of the Viennese physician Sigmund Freud (1856–1939) and of the Swiss psychiatrist Carl Gustav Jung (1875–1961) have almost monopolized the study of myth. Freud’s key discussion of his key myth, that of Oedipus, fittingly occurs in *The Interpretation of Dreams* (1913), for he, and Jung as well, compare myths with dreams.

On the surface, or manifest, level, the story of Oedipus describes that figure’s vain effort to elude the fate that has been imposed on him. Latently, however, Oedipus most wants to do what manifestly he least wants to do. He wants to act out his “Oedipus complex.” The manifest, or literal, level of the myth hides the latent, symbolic meaning. On the manifest level Oedipus is the innocent victim of Fate. On the latent level he is the culprit. Rightly understood, the myth depicts not Oedipus’s failure to circumvent his ineluctable destiny but his success in fulfilling his fondest desires.

Yet the latent meaning scarcely stops here. For the myth is not ultimately about Oedipus at all. Just as the manifest level, on which Oedipus is the victim, masks a latent one, on which Oedipus is the victimizer, so that level in turn masks an even more latent one, on which the ultimate victimizer is the myth maker and any reader of the myth smitten with it. Either is a neurotic adult male stuck, or fixated, at his Oedipal stage of development. He identifies himself with Oedipus and through

him fulfills his own Oedipus complex. At heart, the myth is not biography but autobiography.

The Austrian psychoanalyst Otto Rank (1884–1939), who was Freud’s protégé at the time but who later broke irrevocably with the master, works out a common plot, or pattern, for one key category of myths: those of male heroes. The heart of the pattern is the decision by the parents to kill their son at birth to avert the prophecy that the son, if born, will one day kill his father. Unbeknownst to the parents, the infant is rescued and raised by others, grows up to discover who he is, returns home to kill his father, and succeeds him as king or noble. Interpreted psychologically, the pattern is the enactment of the Oedipus complex: the son kills his father to gain sexual access to his mother.

Mainstream psychoanalysis has changed mightily since Freud’s day. Contemporary psychoanalysts like the American Jacob Arlow (1912–2004) see myth as contributing to normal development rather than to the perpetuation of neurosis. Myth abets adjustment to the social and the physical worlds rather than childish flight from them. Furthermore, myth now serves everyone, not merely neurotics.

The classical Freudian goal is the establishment of oneself in the external world, largely free of domination by parents and instincts. Success is expressed concretely in the form of a job and a mate. Jungians accept that goal, but as that of only the “first half” of life, or from infancy to young adulthood. The goal of the uniquely Jungian second half of life—of adulthood—is consciousness—not, however, of the external world, as summed up by the Freudian term *reality principle*, but of the distinctively Jungian, or collective, unconscious. One must return to that unconscious, from which one has unavoidably become severed in the first half of life, but not to sever one’s ties to the external world. On the contrary, the aim is return in turn to the external world. The ideal is a balance between consciousness of the external world and consciousness of the unconscious. The aim of the second half of life is to supplement, not abandon, the achievements of the first half.

The American mythologist Joseph Campbell (1904–1987) provides the classical Jungian counterpart to Rank on hero myths. Where Rank’s pattern, limited to males, centers on the hero’s toppling of his father, Campbell’s centers on a journey, undertaken by an adult female or a male hero, from the known, human world to the heretofore unknown world of gods. Interpreted psychologically, that journey is an inner, not outer, trek from the known portion of the mind—ordinary, or ego, consciousness, the object of which is the external world—to the unknown portion of the mind—the Jungian unconscious. The successful hero must not only reach the strange, new world but also return. In psychological terms, success means the completion of the goal of the second half of life.

The most influential Jungian theorists of myth after Jung himself have been Erich Neumann (1905–1960) and James Hillman (b. 1926). Neumann systematizes the developmental, or evolutionary, aspect of Jungian theory. Jung himself certainly correlates myths with stages of psychological development, but Neumann works out the stages, beginning with

the “uroboric” stage of sheer unconsciousness and proceeding to the incipient emergence of the ego out of the unconscious, the development of an independent ego consciousness, and the eventual return of the ego to the unconscious to create the self. Neumann’s emphasis on heroism in the first half of life complements Campbell’s devotion to heroism in the second half.

By far the most radical development in the Jungian theory of myth has been the emergence of archetypal psychology, which in fact considers itself post-Jungian. The chief figure in this movement is Hillman. Another important figure is David Miller. Archetypal psychology faults classical Jungian psychology on multiple grounds. By emphasizing the compensatory, therapeutic message of mythology, classical Jungian psychology purportedly reduces mythology to psychology and gods to concepts. In espousing a unified self (or “Self”) as the ideal psychological authority, Jungian psychology supposedly projects onto psychology a Western, specifically monotheistic, more specifically Christian, even more specifically Protestant outlook. The Western emphasis on progress is purportedly reflected in the primacy Jungian psychology accords hero myths and the primacy it accords the ego, even in the ego’s encounter with the unconscious: the encounter is intended to abet development. Finally, Jungian psychology is berated for placing archetypes in an unknowable realm distinct from the known realm of symbols.

As a corrective, Hillman and his followers advocate that psychology be viewed as irreducibly mythological. Myth is still to be interpreted psychologically, but psychology is itself to be interpreted mythologically. One grasps the psychological meaning of the myth of Saturn by imagining oneself to be the figure Saturn, not by translating Saturn’s plight into clinical terms like depression. Moreover, the depressed Saturn represents a legitimate aspect of one’s personality. Each god deserves its due. The psychological ideal should be pluralistic rather than monolithic—in mythological terms, polytheistic rather than monotheistic, or Greek rather than biblical. Insisting that archetypes are to be found *in* symbols rather than outside them, Hillman espouses a relation to the gods in themselves and not to something beyond them. The ego becomes but one more archetype with its attendant kind of god, and it is the soul rather than the ego that experiences the archetypes through myths. Myth serves to open one up to the soul’s own depths.

Myth and Structure

Lévi-Strauss calls his approach to myth “structuralist” to distinguish it from “narrative” interpretations, or those that adhere to the plot of myth. Nonstructuralists deem myth a story, progressing from beginning to end, be the story interpreted literally or symbolically. Where the plot of a myth is that, say, event A leads to event B, which leads to event C, which leads to event D, the structure, which is identical with the expression and resolution of contradictions, is either that events A and B constitute an opposition mediated by event C or, as in the Oedipus myth, that events A and B, which constitute the same opposition, are to each other as events C and D, an analogous opposition, are to each other. Apparently, all oppositions for Lévi-Strauss symbolize the tension between humans as part of nature and humans as part of culture.

Lévi-Strauss is not the only or even the earliest theorist of myth labeled a structuralist. Notably, the Russian folklorist Vladimir Propp (1895–1970) and the French Indo-Europeanist Georges Dumézil (1898–1986) wrote both before Lévi-Strauss and independently of him. The French literary critic Roland Barthes (1915–1980) was a contemporary of Lévi-Strauss but was his own person.

The common plot that Propp deciphers in Russian fairy tales is his structure, which thus remains on the narrative level and is no different from the kind of structure found by Rank and Campbell. By contrast, the structure that Dumézil unravels lies as much beneath the surface level as Lévi-Strauss’s. But it reflects the order of society rather than, as for Lévi-Strauss, that of the mind, and is three-part rather than two-part.

Barthes is concerned with myth as ideology. In Lévi-Straussian terms, he writes to expose the way that French bourgeois culture creates myths to make itself seem natural—a fusion of culture with nature rather than the mere alleviation of the opposition between them. For Barthes, the function of myth is social rather than, as for Lévi-Strauss, intellectual. For Barthes, the structure of myth is its cultural context. By “myths” he means artifacts and activities more than stories. His clearest example is of professional wrestling, which, much more than a sport, is an attempt to alleviate lingering misgivings over the behavior of some French citizens during the Occupation by presenting clear-cut Good (the wrestler) as triumphing over clear-cut Evil (his opponent).

A group of French classicists headed by Jean-Pierre Vernant (b. 1914) have proved the most faithful followers of Lévi-Strauss’s brand of structuralism, though even they have adapted it. Lévi-Strauss has regularly been lambasted for isolating myth from its various contexts—social, cultural, political, economic, even sexual. In his essay on the American Indian myth of Asdiwal, he does provide a detailed ethnographic analysis of a myth. But he does so almost nowhere else. Vernant and his fellow classicists—notably, Marcel Detienne, Pierre Vidal-Naquet, and Nicole Loraux—have taken the analysis of Asdiwal as their model. As the heirs of Lévi-Strauss, these classicists have sought to decipher underlying, often latent patterns in myths, but they have then sought to link those patterns to ones in the culture at large.

Myth and Society

Where for Tylor and Frazer myth deals exclusively, or nearly exclusively, with physical phenomena—flooding, disease, death—for Malinowski myth deals even more with social phenomena—classes, taxes, rituals. Myth still serves to reconcile humans to the unpleasantness of life, but now to unpleasantness that, far from unalterable, *can* be cast off. Here, too, myths spur resigned acceptance by tracing these unpleasantnesses, or at least impositions, back to a hoary past, thereby conferring on them the clout of tradition. Myth persuades denizens to defer to, say, ranks in society by pronouncing those ranks long-standing and in that sense deserved. Here the beneficiary of myth is society, not the individual. The modern counterpart to myths of social phenomena—if for Malinowski moderns lack myths—would be ideology.

As the Frazerian counterpart to Rank and Campbell, Lord Raglan extends Frazer's second myth-ritualist scenario by turning the king who dies for the community into a hero. The function of myth is now as much social as agricultural: inspiring present kings to sacrifice themselves so that their communities will not starve. The French-born, American-resident literary critic René Girard (b. 1923) offers an ironic twist to Raglan. Where Raglan's hero is willing to die for the community, Girard's hero is killed or exiled by the community for having caused the present woes of the community. Indeed, the "hero" is initially considered a criminal who deserves to die. Only subsequently is the villain turned into a hero, who, as for Raglan, dies selflessly for the community. Both Raglan and Girard cite Oedipus as their fullest example, though both scorn Freud. For Girard, the transformation of Oedipus from reviled exile in Sophocles' *Oedipus the King* to revered benefactor in Sophocles' *Oedipus at Colonus* typifies the transformation from criminal to hero.

Yet this change is for Girard only the second half of the process. The first half is the change from innocent victim to criminal. Originally, the community selects an innocent member to blame for the violence that has erupted. This scapegoat, who can be of any rank, is usually killed, though, as with Oedipus, sometimes exiled. The killing is the ritualistic sacrifice. Rather than directing the ritual, as for Frazer, myth for Girard is created *after* the killing to *hide* it. Myth comes from ritual, as for Smith, but it comes to mask rather than, as for Smith, to explain the ritual. Myth turns the scapegoat into a criminal who deserved to die and then turns the criminal into a hero, who has died voluntarily for the good of the community.

Like Burkert, Girard roots myth in sacrifice and roots sacrifice in aggression. Yet like Burkert, myth functions to secure peace and not, as for Frazer, food. Myth deals with the human world; science, with the physical world. This shift of focus again typifies the shift from nineteenth-century theories of myth to twentieth-century ones.

See also **Fundamentalism; Literature: Overview; Psychoanalysis; Psychology and Psychiatry; Religion; Ritual; Religion; Science: Overview; Structuralism and Post-structuralism: Overview.**

BIBLIOGRAPHY

- Arlow, Jacob A. "Ego Psychology and the Study of Mythology." *Journal of the American Psychoanalytic Association* 9 (1961): 371–393.
- Barthes, Roland. *Mythologies*. Translated by Annette Lavers. New York: Hill and Wang, 1972.
- Bultmann, Rudolf. "New Testament and Mythology." In *Kerygma and Myth*, edited by Hans-Werner Bartsch. Translated by Reginald H. Fuller. London: SPCK, 1953.
- Burkert, Walter. *Creation of the Sacred: Tracks of Biology in Early Religions*. Cambridge, Mass.: Harvard University Press, 1996.
- Campbell, Joseph. *The Hero with a Thousand Faces*. New York: Pantheon, 1949.
- Cassirer, Ernst. *The Philosophy of Symbolic Forms*. Vol. 2: *Mythical Thought*. Translated by Ralph Manheim. New Haven, Conn.: Yale University Press, 1955.
- Dumézil, Georges. *Archaic Roman Religion*. 2 vols. Translated by Philip Krapp. Chicago: University of Chicago Press, 1970.
- Eliade, Mircea. *The Sacred and the Profane: The Nature of Religion*. Translated by Willard R. Trask. New York: Harcourt, Brace, 1959.
- Frazer, J. G. *The Golden Bough: A Study in Magic and Religion*. 3rd ed. 12 vols. London: Macmillan, 1911–1915.
- Freud, Sigmund. *The Interpretation of Dreams*. In *Standard Edition of the Complete Psychological Works of Sigmund Freud*. 24 vols. Edited and translated by James Strachey et al. London: Hogarth Press, 1953–1974.
- Girard, René. *Violence and the Sacred*. Translated by Patrick Gregory. Baltimore: Johns Hopkins University Press, 1977.
- Harrison, Jane Ellen. *Ancient Art and Ritual*. London: Williams and Norgate, 1913.
- Hillman, James. *Re-Visioning Psychology*. New York: Harper and Row, 1975.
- Jonas, Hans. *The Gnostic Religion: The Message of the Alien God and the Beginnings of Christianity*. 2nd ed. Boston: Beacon Press, 1963.
- Jung, Carl Gustav. *The Archetypes and the Collective Unconscious*. 2nd ed. Translated by R. F. C. Hull. Princeton, N.J.: Princeton University Press, 1968.
- Lévi-Strauss, Claude. "The Structural Study of Myth." In *Myth*, edited by Thomas A. Sebeok. Bloomington: Indiana University Press.
- Lévy-Bruhl, Lucien. *How Natives Think*. Translated by Lilian A. Clare. London: Allen and Unwin, 1926. Reprint, Princeton, N.J.: Princeton University Press, 1985.
- Malinowski, Bronislaw. *Myth in Primitive Psychology*. New York: Norton, 1926.
- Popper, Karl. *Conjectures and Refutations*. 5th ed. London: Routledge and Kegan Paul, 1974.
- Propp, Vladimir I.A. *Morphology of the Folktale*. 2nd ed. Translated by Laurence Scott. Austin: University of Texas Press, 1968.
- Radin, Paul. *Primitive Man as Philosopher*. 2nd ed. New York: Dover, 1957.
- Raglan, Lord. *The Hero*. London: Methuen, 1936. Reprinted in *In Quest of the Hero*, edited by Otto Rank, et al. Princeton, N.J.: Princeton University Press, 1990.
- Rank, Otto. *The Myth of the Birth of the Hero*. 1st ed. Translated by F. Robbins and Smith Ely Jelliffe. New York: Journal of Nervous and Mental Disease Publishing, 1914. Reprinted in *In Quest of the Hero*, edited by Otto Rank, et al. Princeton, N.J.: Princeton University Press, 1990.
- Segal, Robert A. *Myth: A Very Short Introduction*. Oxford: Oxford University Press, 2004.
- . *Theorizing about Myth*. Amherst: University of Massachusetts Press, 1999.
- Smith, William Robertson. *Lectures on the Religion of the Semites*. Edinburgh: A. and C. Black, 1889.
- Tylor, E. B. *Primitive Culture*. 2 vols. London: Murray, 1871.
- Vernant, Jean-Pierre. *Myth and Thought Among the Greeks*. London: Routledge and Kegan Paul, 1983.

Robert A. Segal



N

NARRATIVE. Although the study of narrative goes back as far as Aristotle's *Poetics*, narrative theory emerged as a distinct field of inquiry only in the second half of the twentieth century. At that point, work on the theory of the novel intersected with structuralism's project of writing the grammar of stories and storytelling. This intersection in turn opened out to other streams of traffic in narrative studies, including the analysis of oral narrative by sociolinguists; reflections on historical narrative by historiographers; and the varied investigations of film scholars, among others. In the early twenty-first century many other disciplines—medicine, law, business, and psychoanalysis, prominent among them—both draw upon and contribute to narrative theory (see sidebar). In this respect, contemporary interdisciplinary thought has undergone a “narrative turn.”

From Novel to Narrative

The most influential figures in the early theorizing of the novel were novelists themselves, particularly Henry James (1843–1916) and E. M. Forster (1879–1970). In “The Art of Fiction” (1888) and in the Prefaces to the New York Edition of his novels (1909–1910), James describes and defends his own novelistic practice. He argues that the artistry of the novel depends on its representation of “felt life,” and, in the Prefaces, he describes, often with rich, extended metaphors, how he came to view the “treatment” (the technique) of his novels as even more important than their “subject” (their characters and situations). More specifically, James explains why he came to prefer the technique of narrating from the consciousness of his central character(s): such treatment highlights the impression of felt life even as it allows him to offer fresh ways of exploring his subjects. James's distinction between treatment and subject is a distinction between the how and the what of the novel that reappears in some form in every major theoretical approach to narrative. James's specific preferences soon became codified by his followers into a set of rules for good novelistic practice: use scenes rather than narrative summaries because they are more impersonal and objective; narrate from the perspective of a central consciousness rather than from the perspective of an external narrator because that treatment involves less rhetoric and more artistry. In short: show, don't tell.

If James is the theorist of treatment (the how), Forster is the theorist of character (one element of the what). In *Aspects of the Novel* (1927), he introduces a distinction between “round” and “flat” characters that is still frequently cited in the early 2000s: Round characters are capable of surprising in a convincing way, while flat characters can be summed up in a single sentence. Forster also distinguishes between story and plot (see sidebar), viewing the first as a kind of necessary evil (“yes, oh dear, yes,

the novel tells a story”), and the second with its inclusion of causality as what makes the recounting of events worthwhile. But he regards character as the most important element of the novel. In fact, he sees plot and character as often in conflict—one requires closure, the other does not—and he laments those novels in which he thinks character is sacrificed for plot.

Contemporaneous with Forster's theorizing, the Russian Formalists, a group including Victor Shklovsky, Boris Eichenbaum, and Yuri Tynanov, develop ideas about the novel that provide an especially interesting comparison with James's. They introduce a more formal and ultimately more influential distinction between the what and the how, identifying the *fabula* as the abstract chronological sequence of events independent of their expression in the *sjuzhet*, the actual presentation of those events in the novel's text. This distinction explains one's intuition that there can be different versions of the same narrative: different *sjuzhets* do not constitute different narratives unless they also are based on different *fabulas*. The Formalists also go James one better by arguing that the purpose of literature in general and the novel in particular is not the representation of felt life but defamiliarization or estrangement: the purpose of literature is to renew or revise our perceptions—in Shklovsky's famous phrase, to make the stone stony. This view leads the Formalists to an account of literary change built on the formal necessity of innovation, especially in the how of the novel: novelistic forms that once provided estrangement gradually lose that effect as they themselves became familiar, and so the inventive novelist discovers new devices of estrangement.

The next significant literary critical approach to form, that of the Anglo-American New Critics, emphasizes the distinctiveness of literary language itself, and so focuses on the image patterns of novels (the how) as containing the key to their thematic concerns (the what) and, thus, their formal artistry. The rivals of the New Critics, the Chicago School neo-Aristotelians, though generally unsuccessful in their effort to unseat New Criticism as the orthodoxy of the critical mainstream, turn out to be more influential than the New Critics in the evolution of narrative theory. R. S. Crane, working without knowledge of the Russian Formalists, develops a concept of plot that distinguishes between its “material action” (the what, roughly equivalent to the *fabula*) and the “plot proper” (the synthesis of what and how in the service of a given purpose and set of effects—roughly equivalent to *sjuzhet*). Crane's student Wayne C. Booth reexamines, from the neo-Aristotelian perspective, the Jamesian rules for novelistic success and repudiates them with a method that transforms Crane's neo-Aristotelian poetics into a rhetoric. In *The Rhetoric of Fiction* (1961), Booth argues that

techniques of showing are as rhetorical as techniques of telling; the choice is not between impersonal art and inartistic rhetoric but rather between different ways of trying to influence the audience—in short, different kinds of rhetorical appeals. More generally, Booth's insight that the novel is rhetorical from top to bottom paves one road for the entry of ethical and ideological approaches to narrative.

Another Russian scholar of the 1920s, Vladimir Propp, provides a model for a different approach to narrative in *The Morphology of the Folktale* (1929). Propp identifies thirty-one functions that occur in invariable order (for example, hero perceives a lack; hero meets a magical agent) in every Russian folktale. But more important than his specific account of the folktale itself is Propp's insight that underlying the surface variety of the folktale is a single deep structure (an *Ur-fabula*, if the reader will). The structuralist narratologists of the 1960s and 1970s, such as Tzvetan Todorov, Claude Bremond, and, in one phase of his work, Roland Barthes, look back to Propp and to Ferdinand de Saussure in their effort to uncover the underlying structures of narrative. Saussure's distinction between *langue*, the abstract system of language that underlies any utterance and makes it intelligible, and *parole*, actual utterances, provides an analogy for the structuralist project of describing the grammar of narrative that makes any given narrative intelligible.

Strikingly the results of these efforts are not a comprehensive grammar but a number of conceptual tools that remain both useful and influential to this day. Chief among these tools are the *story/discourse* distinction, a new version of the what/how distinction, and Gérard Genette's analyses of discourse. Story encompasses the characters, events, and settings (or states, events, and existents) of narrative, and discourse encompasses all the devices for rendering the story in one way rather than another. Genette groups these devices into three main kinds: (1) those of temporality, which include order, duration (the relation between story time and its expression in discourse time, for instance, twenty years may be summarized in a single sentence, just as one minute may be treated in several pages), and frequency (the relation between the number of times an event happens in story and the number of times it is reported in discourse); (2) voice, the answer to the question "who speaks?"; and (3) vision, the answer to the question "who perceives?" Even more significantly, as the link between Propp and the structuralist project suggests, the emergence of narratology makes possible the shift from novel to narrative—that is, storytelling of all kinds—as the central object of study, even if literary fiction narrative retains a special status within the project. Genette, for example, develops his conceptual toolbox from his analysis of Marcel Proust's *A la recherche du temps perdu* (1913–1927; Remembrance of things past). Consequently, in the 1980s the field of narrative theory emerged with a recognizable identity.

Contemporary Narrative Theory: Contextual and Interdisciplinary Models

Even as the field was emerging, it was being affected by the larger "theory revolution" of the last quarter of the twentieth century in two main ways: (1) the field's focus on narrative form expands and becomes complicated through attention to the relations between form and ideology; and (2) as already noted,

the field becomes increasingly interdisciplinary. The discovery and dissemination in the West of the work of Mikhail Bakhtin, another Russian scholar of the 1920s and 1930s, is especially significant in the complication of formal approaches. Bakhtin, in one sense, is as concerned with the form of the novel as Shklovsky or any other Russian Formalist; indeed one of his goals was to earn for the novel as a genre the kind of respect and status accorded to poetry in 1920s Russia. But Bakhtin conceives of the novel's form as inseparable from its ideological component, because he conceives of language as always already ideological. He views any national language (English, French, Russian) not as a unified system but rather as a collection of sociolects or minilanguages, such as the language of the working class, the language of the law, or the language of the academy, each of which carries the values of its group. Bakhtin argues that the novel necessarily draws upon multiple minilanguages and puts them into dialogic relationships with each other; this dialogue among languages is also a dialogue among ideologies.

Feminist narratologists such as Robyn Warhol and Susan Lanser participate in the spirit of Bakhtin's work by linking technique to ideology, though they are most concerned with ideologies of gender and their interests extend beyond novelistic language to other features of narrative discourse, especially the devices and techniques of woman writers and female narrators. Although other ideologically based theoretical approaches such as Marxist theory and postcolonial theory have not yet spawned their own branches of narratology, these theories also contribute to a general understanding of the inseparable connection between form and ideology: Each shows how an author's choice of particular narrative techniques and structures occurs within both a formal and a political context and therefore has both formal and ideological consequences.

Another significant complication of the formal model has been the rise of narrative ethics, itself a subfield of the burgeoning area of ethical criticism. Martha Nussbaum argues that narrative, due to its concrete particularity and its capacity to draw on the cognitive power of the emotions, is, in the hands of a novelist such as Henry James, a site for ethical exploration that rivals the explorations of philosophical ethics. Booth extends the rhetorical approach of *The Rhetoric of Fiction* to the ethical realm by focusing on the quality of one's life in the hours spent reading narrative. More specifically, Booth proposes the metaphor of "books as friends" and suggests the reader can judge the quality of such friendships by attending to the trajectory of desires they invite the reader to follow. Adam Zachary Newton and others develop approaches to narrative ethics through attention to the relation between the specifics of story and discourse, on one hand, and ethical categories derived from philosophers such as Emmanuel Levinas, on the other. James Phelan seeks to extend the work of both Booth and Newton by exploring the ethics of technique as much as the ethical dimension of characters' situations.

Contemporary narrative theory is interdisciplinary in two related ways. As the example of narrative ethics shows, it either brings the insights of other disciplines to the study of narrative or it brings the conclusions of narrative theory to the concerns of other disciplines. In each case, the interdisciplinarity is a two-way street: Not only does philosophical ethics illuminate narrative's

E. M. FORSTER'S KING AND QUEEN AND NARRATIVE ACROSS THE DISCIPLINES

“The king died and then the queen” is a story. “The king died and then the queen died of grief” is a plot. Thus spake E. M. Forster, who also points out that the difference between the two is causality. Theorists have debated the validity of the distinction since Forster proposed it in the 1927, arguing, for example, that the very temporality of “and then” entails causality (or at least invites the reader to supply it) so that the only difference between the two versions is the *explicit* naming of the cause in the second. The debate also includes objections to defining plot solely in terms of causality, since many narrative artists build plots on other principles. Nevertheless the debate itself shows that Forster identified four elements of narrative—character (or agent), event, temporality, and causality—that are essential to the contemporary interest in “narrative across the disciplines.” Because narrative spells out the specific relations among agents, events, time, and causality, it is capable of explaining phenomena that escape more abstract analyses such as those based on science-oriented ideas of general laws. In twenty-first-century culture, with its widespread abandonment of a belief in eternal verities, this capability is of great importance for many disciplines.

Many legal cases, for example, involve disputes about the relation among the agents involved, the temporal order of events, and the causes of those events; judges and juries often render their verdicts according to which side constructs the most convincing narrative about that relation. In medicine, the narrative of an onset of an illness with its particular relation of what the patient did when and for what reason can provide clues to both to the nature of the illness and the appropriate treatment. Furthermore many patients find the opportunity of relating their “illness narrative” to a sympathetic medical professional to be salutary in itself. The talking cure of psychoanalysis is a narrative cure: an analysand comes to recognize how the relation among agents, including herself, events of her past, and their causality are still affecting her and, thus, how she can break the grip of that narrative and write another one for her life. More generally, narrative’s interest in character, event, temporality, and causality provides the basis for claims that people’s identities are constituted by the narratives they tell about their lives. The queen died, in other words, because the event of the king’s death made her own passing the inevitable next event in her narrative of her life.

representations of ethical situations, but those representations have implications for philosophy’s investigations into ethics. Similarly not only does, say, medicine benefit from drawing on narrative theory, but medicine’s use of it has consequences for the field’s ongoing efforts. Among other things, this aspect of interdisciplinarity corrects literary study’s attraction to the experimental or innovative case and helps keep the focus on what seems to be the fundamental elements of narrative’s power (see sidebar).

One of the most promising current interdisciplinary developments is the cognitive approach to narrative taken by such scholars as David Herman. In a sense, this movement is an extension of classical narratology because it also has the goal of giving a comprehensive view of narrative, its elements, and their combinations. But rather than fashioning that comprehensive view by analogy with Saussure’s theory of language, the cognitivists start with the idea that narrative is a way of organizing experience, one that involves, in both its production and consumption, the development of a mental model of that organization. This starting point means that the cognitivists draw upon both the findings of narrative theory broadly conceived—including, for example, classical narratology, rhetorical theory,

and sociolinguistics—and the findings of cognitive science about how the human mind processes information, forms patterns from diverse data, and so on. Whether the cognitive approach succeeds in establishing a new dominant paradigm for understanding narrative or becomes, like classical narratology, a movement that is more significant for its local successes than the achievement of its ultimate goal remains to be seen. But the cognitive project is a telling example of the interdisciplinary nature of contemporary narrative studies and strong evidence, along with the undeniable ubiquity and amazing variety of narrative itself, that the future of narrative theory is very bright.

See also *Formalism; Literary Criticism; New Criticism*.

BIBLIOGRAPHY

- Bakhtin, Mikhail. “Discourse in the Novel.” In his *The Dialogic Imagination*. Translated by Caryl Emerson and Michael Holquist. Austin: University of Texas Press, 1981.
- Barthes, Roland. “An Introduction to the Structural Analysis of Narrative.” Translated by Lionel Duisit. *New Literary History* 6 (1975): 237–272.

- Booth, Wayne C. *The Company We Keep: An Ethics of Fiction*. Berkeley: University of California Press, 1988.
- . *The Rhetoric of Fiction*. Chicago: University of Chicago Press, 1961. Reprint, Chicago: University of Chicago Press, 1983.
- Forster, E. M. *Aspects of the Novel*. New York: Harcourt, Brace, 1927.
- Genette, Gérard. *Narrative Discourse: An Essay in Method*. Translated by Jane Lewin. Ithaca, N.Y.: Cornell University Press, 1980.
- Herman, David. *Story Logic: Problems and Possibilities of Narrative*. Lincoln: University of Nebraska Press, 2002.
- James, Henry. *The Art of Criticism: Henry James on the Theory and Practice of Fiction*. Edited by William Veeder, and Susan M. Griffin. Chicago: University of Chicago Press, 1986.
- Lanser, Susan. *Fictions of Authority: Women Writers and Narrative Voice*. Ithaca, N.Y.: Cornell University Press, 1992.
- Newton, Adam Zachary. *Narrative Ethics*. Cambridge, Mass.: Harvard University Press, 1995.
- Nussbaum, Martha. *Love's Knowledge: Essays on Philosophy and Literature*. New York: Oxford University Press, 1990.
- Phelan, James. *Living to Tell about It: A Rhetoric and Ethics of Character Narration*. Ithaca, N.Y.: Cornell University Press, 2004.
- Propp, Vladimir. *Morphology of the Folktale*. 2nd ed., rev. Translated by Laurence Scott. Austin: University of Texas Press, 1968. Originally published in 1929.
- Saussure, Ferdinand de. *Course in General Linguistics*, edited by Charles Bally and Albert Sechehaye in collaboration with Albert Reidlinger and translated by Wade Baskin. New York: Philosophical Library, 1959.
- Shklovsky, Victor. *Theory of Prose*. Translated by Benjamin Sher. Elmwood Park, Ill.: Dalkey Archive Press, 1990.
- Warhol, Robyn. *Gendered Interventions: Narrative Discourse in the Victorian Novel*. New Brunswick, N.J.: Rutgers University Press, 1989.

James Phelan

NATION. *Natio* derives from the Latin verb to be born (*nasci*) and refers to societies constituted by (assumed) common birth or descent, a meaning akin to the English word *race*.

Prepolitical Usages

In late Roman and early medieval texts, *natio* was less frequently used than *gens*, which also meant groups of common descent, though emphasizing kinship and family rather than race. Another group noun, *populus*, referred to the assembled citizens of a city-state. (*Plebs* referred to people in the negative sense of the masses.) This meaning translated from Greek city-states to the Roman Republic and then to the Roman Empire. Romans used *gens* and *natio* to describe *other* peoples perceived as extended kinship groups or subjects of quasi-religious dynasts.

Such groups were given specific names. Tacitus (c. 55–c. 117) in *Germania* (98 C.E.) named the people (*gens*) of “Germania,” differentiating distinct nations and subnations. However, there was no consistency in relating general labels to specific names. This ethnography was taken over by the late Roman Latin-writing intellectual elite and continued by their successors, the Roman Catholic clergy. The names given to certain territories (England, France, Germany) derive from Latin labels.

The Nation and Political Authority, 1000–1500

The Venerable Bede (673?–735), in the *Ecclesiastical History of the English Nation* chose the name *Anglii* or *gens Anglorum* for the subjects of Christian kings. As Roman Christianity expanded and the number of kingdoms contracted, clerics following Bede fixed the name to one kingdom and its people. Something similar happened with Franks, France, and the French. Why names like French and English survived, others disappeared (Goth, Lombard, Norman), and others attached themselves to the same group (German, Deutsch) is unclear.

Name that prevailed were detached from original connotations of race and kinship. Even before the Norman conquest in 1066, “English” rulers and elites were drawn, and were conscious of being drawn, from beyond the ranks of the Anglo-Saxons. The conquest of 1066 introduced a new ruling class with a clear sense of ethnic identity. Yet the names England and English quickly reasserted themselves. Possible explanations include the facts that Anglo-Saxon institutions were taken over by the new rulers; they married English-speaking women; later rulers identified with the land of their conquest rather than with Normandy.

The political concept of nation referred to monarchy and the ruling class. When the eastern Frankish empire took the name “The Holy Roman Empire of the German Nation,” nation meant the princes and high nobility of the empire. The nation, in becoming political, divested itself of populist elements associated with language and customs. Insofar as descent was claimed, this was dynastic and aristocratic.

Natio was used inconsistently and descriptively in political discourse. Sustained arguments about legitimate rule were couched in terms of religion, dynasty, and privilege. The king of “England” could claim the “French” crown; indeed such a claim by Henry V was recognized in a treaty even though his premature death prevented the agreement coming into effect. Rulers invoked the nation when rejecting jurisdictional claims by the papacy or other princes but dropped it when making such claims themselves. Occasionally they drew upon older ethnographic meanings to appeal to their subjects, though we have no idea how this was received. The word also figured in conflicts between princes and elite subjects, especially when nobles defended privileges as properties of the nation.

Natio was used in many other ways. Delegations to the Council of Constance (1414–1418) and bodies of students at the University of Paris were called nations and given specific names. The word broadly referred to specific groups of foreigners but lacked stable meaning, suggesting it was not disciplined by constant deployment in political arguments. So long as arguments about legitimate political authority excluded notions of equal citizenship and popular participation, the nation remained a marginal concept. Only when *natio* took on attributes of *populus* did it become politically significant.

Making Politics National, 1500–1800

There were two principal ways in which the political concept of nation developed. The first was during the Reformation. Protestants invoked the biblical idea of God’s chosen people, or elect nation, associating this with sacred territory and promised land. It is difficult to gauge the long-term significance of this.

Protestant resistance to authority took mainly sectarian and international forms; salvation was for individuals or small groups. Radical Protestantism was crushed by Catholic and mainstream Protestant regimes before the later emergence of popular national movements. However, by then it was commonplace to combine state, confession, and nation in political arguments.

Second, the growth of state power meant that ever-larger groups were brought into contact with the central government. If government was “national,” then groups deployed that term in political conflict. A significant example is eighteenth-century France. As the crown attacked privileged groups, its publicists portrayed these as factional interests undermining national interests. Those opponents in turn conflated nation with privileged institutions, insisting they were defending “national liberty.” These ideas of national interest and liberty could be combined and extended. Revolutionaries generalized the concept of the nation to *all* subjects of the crown.

New Ways of Thinking about the Nation

The Enlightenment view that human beings choose and construct their institutions, that society and state are contractual associations, and that all human beings are equal, endowed with reason and rights, entailed profound consequences for the concept of nation. It took on qualities of *populus*, extended to the populations of territorial states.

In February 1789 in France, the abbé Emmanuel Joseph Sieyès (1748–1836) published a pamphlet entitled *What Is the Third Estate?* His answer was that it was not one estate among others in a society of privileges, but was *everything*. The actual representatives of the Third Estate, meeting in the Estates-General summoned in 1789, acted out this answer by transforming themselves into the National Assembly and inviting members of the other Estates to join them. The Assembly issued a Declaration of Rights: “The Nation is essentially the source of all sovereignty; nor can any individual or any body of men, be entitled to any authority which is not expressly derived from it” (Article III). The French Revolution abolished privileges and devised political arrangements to realize national sovereignty. Despite the failure of these experiments the notion became entrenched as a basic tenet of modern democracy.

Apart from practical problems of implementing national sovereignty, there was a conceptual difficulty: Who belonged to the nation? If the nation was defined in relation to the state over which it claimed sovereignty, then it should consist of the subjects of that state, with all their accidental differences of customs, beliefs, and conditions. Even this required one to define state boundaries precisely, itself a novel practice. Then one had to devise rules for turning subjects into citizens. Citizens and inhabitants were two different notions. Children and women as well as foreigners were excluded from citizenship. Above all, there was the problem of reconciling nation as the sum of individual citizens with nation as a group bound by ties of culture and values. The Jacobins tried expanding the idea of politics so that these ties flowed from, rather than toward the state, but they failed. It seemed necessary to look beyond politics to find the nation.

This was already happening during the Revolution. Radicals in Paris suggested that Bretons, Basques, and other reactionaries were infected by cultures and languages that made them incapable of appreciating new truths. Conservatives in and beyond France, notably Edmund Burke (1729–1797), argued that revolution was destructive because it ignored the importance of the traditions and customs that made each society (nation) distinct; revolutionaries mistakenly imagined that human reason could design an ideal society and state.

The German thinker Johann Gottfried von Herder (1744–1803) moved from the idea of variety to that of uniqueness. Different languages were not variants on a universal language; human beings had not rationally constructed languages. Each language expressed and transmitted across individuals and generations unique values that embodied the national spirit. The argument could be extended to music, architecture, customs, laws, indeed, to every aspect of society. The Romantic movement promoted the view that societies were organisms; art, the expression of uniqueness; and human beings, bound together by feelings and emotions not by reason and interest.

Two kinds of nation? These two ways of thinking about the nation appear diametrically opposed. One stresses politics, reason, and choice; the other, culture, emotions, and belonging. This distinction has been linked to two kinds of nationalism variously called “western” and “eastern,” “civic” and “ethnic,” “political” and “cultural.” The distinctions differ in important ways but all relate to these opposed ways of thinking. We need to see how such ideas were combined or opposed as the nation became the justification for statehood.

Nation and State in Europe after 1800

The opposed elements combined in many ways. In the first half of the nineteenth century, nationality as citizenship was linked to “high” culture. Basques and Catalans, Welsh and Scots, Bretons and Provençals must become Spanish, British, and French, respectively, to belong to the nation. Educational and other policies were pursued to this end. Such policies were explicitly assimilationist.

The situation was more difficult when one could not link the state to a dominant culture. Habsburg, Romanov, and Ottoman rulers were reluctant to do this. In some regions they confronted subjects with their own elites and high culture, such as the Poles and Magyars. There were also large and culturally subordinate groups, especially Slav speakers. These ranged from peoples with indigenous elites, a literary language, autonomous institutions, and national consciousness to peasant communities with distinct ethnic qualities but without national consciousness. Other areas were splintered into small states with one dominant nationality, above all the German lands and Italian peninsula.

As the nation as the bearer of popular sovereignty became a central political concept, these nonnational states were confronted with difficult questions. The “answer” in the German lands and the Italian peninsula was “unification,” although these unifications included people who did not share in the national culture and excluded people who did.

In multinational empires no single national culture could assimilate others. The Russification project in the Russian Empire failed. The Habsburgs in the western half of the Austro-Hungarian Empire recognized distinct German and Czech nationalities. The Magyars practiced harsh assimilationist policies that alienated subordinate groups. The Ottomans conceded autonomy to Christian subjects but by the late nineteenth century had been expelled from areas claimed for “nations” using names such as Serbian, Greek, Bulgarian, Rumanian. Apologists for these “nations” legitimized political claims in cultural terms: creating a national literature, constructing a confessional identity, elaborating national customs, ceremonies, and histories. Ethnic-cultural ideas figured more centrally than they had in the national movements of dominant cultural groups in western European territorial monarchies.

Linking ethnicity and nationality was one response to problems in multinational empires. Ethnic censuses asked people whether they were Germans or Czech (one could not answer “both” or “neither”). The Austrian socialists Otto Bauer (1882–1938) and Karl Renner (1870–1950) elaborated arguments separating political citizenship from national identity, anticipating contemporary debates on multiculturalism. However, with the collapse of multinational empires at the end of World War I, the stage was set for the ethnic nation-state.

National cultures did not neatly distribute themselves as territorial blocks. Nationalities were brought together, as in Czechoslovakia and Yugoslavia (meaning “south Slav,” a name designed to bridge differences between Croats, Serbs, and Slovenes). National minorities were created. One attempt to address resultant problems was by entrenching minority rights, to be monitored and enforced by the new League of Nations. This failed. Without strong and united support from the major Western powers, the League could not enforce rules. The doctrine of national sovereignty was understood to mean majority rule in a state that recognized no higher authority. The notion of citizenship as a property of *individuals* made it difficult to frame limitations on state power with respect to *groups*.

The Soviet Union had a national policy. Vladimir Ilyich Lenin (1870–1924) recognized the need to gain support from non-Russians. The state was a *union* of republics named by their dominant or “titular” nationality. The state recognized “personal” nationality, embodying this in passports and educational claims. The destruction of all political autonomy under Joseph Stalin (1879–1953) included the autonomy conceded to nationality. Nevertheless, cultivation of national identity and a system of national republics shaped the way the Soviet Union collapsed.

The breakdown of political order in central Europe saw ethnonationalism taken to extremes. Nationalist and racist movements aimed to destroy “inferior” nations or races by expulsion, exploitation, and murder. Arguably, racist justifications for race empire and genocide go beyond the idea of the nation that, if only implicitly, recognizes plurality and difference. However, fascism and Nazism drew upon arguments about the nation.

These extreme forms of ethnonationalism were defeated by 1945, but not before they had altered the map and mentality of Europe. The national states created after 1945 were ethnically

more homogenous than those formed in 1919. Ethnic cleansing continued with the expulsion of Germans from other states. Yet the doctrine of national sovereignty was qualified by the formation of supranational blocs centered on the Soviet Union and the United States, as well as the formation of the United Nations. The title of this organization, as that of its predecessor the League of Nations, equates nation with state.

The Concept of Nation beyond Europe

The United Nations, an association of formally sovereign states, excluded colonies. Colonial nationalists argued for independence in political terms. Imperial powers could not reject democratic arguments, as these legitimized their own states. Racism, even if endemic in Europe and the United States, had been discredited. Imperialists could only argue that circumstances were unpropitious, divisions too acute, indigenous resources for self-rule inadequate.

There were other reasons for making the nation purely political. Boundaries of colonial states were arbitrary, dividing close-knit groups. The small-scale nature of many indigenous groups made it difficult, if not impossible, to identify a dominant culture. Nationalists confined themselves to challenging imperial rule within given boundaries. Hardly any postcolonial state has seen its boundaries change. The most important such case, Bangladesh, took the form of a separation within otherwise unchanged boundaries. Yet tension between nation as culture and as citizenship presented itself in the first important act of postwar decolonization, when Muslim movements achieved the separation of the state of Pakistan from India. The justification was that Muslims constituted a separate nationality.

Internal conflicts within postcolonial states have been explained in terms of cultural difference, variously described as ethnic, tribal, or national. Sometimes federal arrangements have been implemented to try to reduce these conflicts; sometimes there have been civil wars, expulsions, and genocides. However, in other cases a conception of nationality as citizenship has brought unity at the state level, even if multiple ethnic differences remain important.

Contemporary Problems with the Nation

There is tension between nation as citizenship and as culture, but such tension is frequently manageable. In specific cases it is difficult to imagine how, in the foreseeable future, Israelis and Palestinians or Croats and Serbs, for example, could live peaceably together in one state. Equally, it is difficult to see how the world could be stably organized on a thoroughgoing ethnonational basis.

First, there are problems of creating many small states and coping with the geographical intermixing of different nationalities. Second, there is the theoretical problem of what constitutes a nation. Making the nation-state the political norm encourages minorities to formulate demands in the name of the nation. When does a distinct cultural feature qualify for recognition as a separate nation? For some theorists the answer lies not in ethnonational states but in enabling nationalities to live together in one state. One approach seeks to divide political authority between nationalities geographically through federalism or explicit division of powers at the state level. Another

approach is to entrench nationality rights on issues such as language, education, and worship. An alternative to these public recognitions of multiple nationalities is to make a firm public-private distinction, regarding nationality as a private cultural preference and the state as a secular and public authority above such preferences. All these policies confront severe problems and are matters of fierce political and intellectual debate.

For some the nation is banal, equated with existing state, society, and everyday life. For others it is under threat. For a few it is a prison they wish to leave. All these experiences are modern. The premodern political lineage of *natio* relates to *populus*; its premodern cultural lineage to *gens*. The rise of the sovereign, territorial, public, and participatory state made the question “Who are the people/nation?” acute. Once the argument that the nation was the sum of the citizens of the existing state proved inadequate, the search moved on to consider the claims of culture. Nation as a significant political concept represents a series of attempts to answer that modern question.

See also *Citizenship; Ethnicity and Race; Feudalism, European; Sovereignty; State, The*.

BIBLIOGRAPHY

- Cobban, Alfred. *The Nation-State and National Self-Determination*. Rev. ed. London: Collins, 1969.
- Forde, Simon, Lesley Johnson, and Alan V. Murray, eds. *Concepts of National Identity in the Middle Ages*. Leeds, U.K.: School of English, University of Leeds, 1995.
- Greenfeld, Liah. *Nationalism: Five Roads to Modernity*. Cambridge, Mass.: Harvard University Press, 1992.
- Hutchinson, John, and Anthony D. Smith, eds. *Nationalism*. Oxford and New York: Oxford University Press, 1994.
- Kemilainen, Aira. *Nationalism: Problems concerning the Word, the Concept and Classification*. Jyväskylä, Finland: Jyväskylän Kasvatustieteiden tutkimuskeskus, 1964.
- Koselleck, Reinhart, et al. “Volk, Nation, Nationalismus, Masse.” In *Geschichtliche Grundbegriffe: Historisches Lexikon zur politisch-sozialen Sprache in Deutschland*, edited by Otto Brunner, Werner Conze and Reinhart Koselleck, 141–431. Vol. 7. Stuttgart, Germany: E. Klett, 1978.
- Miller, David. *On Nationality*. Oxford and New York: Oxford University Press, 1995.
- Motyl, Alexander, ed. *Encyclopaedia of Nationalism*. 2 vols. Vol. 1: *Fundamental Concepts*. San Diego, Calif., and London: Academic Press, 2001.
- Reynolds, Susan. *Kingdoms and Communities in Western Europe, 900–1300*. New York: Oxford University Press, 1997.
- Scales, Len, and Oliver Zimmer, eds. *Power and the Nation in European History*. London: Palgrave, 2005.
- Smith, Anthony D. *Nationalism and Modernism: A Critical Survey of Recent Theories of Nations and Nationalism*. London and New York: Routledge, 1998.

John Breuilly

NATIONAL HISTORY. The professionalization of history in nineteenth- and twentieth-century European universities was so closely related to the construction of the

nation-state that national histories came to be seen as the only objective form of historical writing—indeed, criticism of national histories was seen not only as unpatriotic, but as a threat to the integrity of the historical profession and its claim to objectivity.

National histories regard the nation-state as the primary unit of historical analysis, and social, economic, intellectual, and other processes are contained within it. The nation is the subject of history, and the object of historical development is the realization of the nation-state. The nation is said to have long existed in a latent state, and its members are regarded as having an unchanging character. In Hegelian fashion, the nation becomes conscious of itself by overcoming obstacles such as linguistic diversity, fragmented trade patterns, and foreign occupation. National histories are morally judgmental and teleological. Specific periods of history are judged—in all senses of the term—according to the degree to which they advanced or retarded the national cause. “Great men” figure prominently in national histories: they act creatively because they understand the movement of history. National histories are also populated with villains—representatives of foreign powers and traitors to the national cause. While noxious in the short term, their efforts are doomed historically.

Nation Building and Professionalization

National histories were written before history was professionalized. Whig historians like Thomas Babington Macaulay (1800–1859) located the English national genius in the development of parliamentary liberty. The Whigs’ French counterparts held that history provided the unifying force that prevented individualism from undermining the social body, and that the Orleanist regime (1830–1848) represented the culmination of French history because it reconciled individual liberty with the national good. Some amateur national historians, influenced by positivism, felt that the triumph of the nation was scientifically inevitable. National histories represented one element in disparate amateur historical writing, which also included social, economic, religious, revolutionary, and women’s history, and which were united by special pleading—often explicit. They were written as much to inspire as to inform.

The professionalization of history in the nineteenth century was predicated, as Lord Acton (1834–1902) put it, upon the removal of the poet and patriot from history. Acton’s hero, Leopold von Ranke (1795–1886), rejected Hegelian teleologies on the grounds that individual periods should be understood in their own terms. The uniqueness of a set of events would be grasped by careful criticism of primary sources and their arrangement into an interpretation. Historians would constitute a profession, endowed with a special ability to understand the past objectively through the mastery of special skills.

In practice, it might be argued, professional historians merely provided scientific authority for existing ideas about the nation-state. Modern universities were created in periods of nation building, for which governments expected historians to provide historical legitimacy. In Prussia the universities expanded after defeat in the Napoleonic wars, in France after defeat at the hands of Prussia in 1870, and in Britain during a

period when global preeminence seemed to be threatened by the rise of Germany and America.

It was not inevitable that nationalism should have acquired a historical dimension. The French revolutionaries (at least in theory) had preached a territorial nationalism, dependent upon the democratic choice of a people to live under a particular government. It was widely believed, however, that abstract rights had led to the dissolution of the social body and to the Jacobin Terror. Even democratic nationalists feared that abstract rights nationalism might permit the overthrow of any government at the behest of the people. A historically rooted nationalism limited a people's freedom to choose and provided a defense against unrestrained individualism, anarchy, and the recourse to despotism.

Moreover, nationalists and national historians were impressed by the pseudo-scientific pretensions of theories of race, Social Darwinism, and group psychology that depicted individuals as products of national and racial origin. But the extent to which individuals were prisoners of their nationality varied. Women, "inferior" races, workers, and peasants were seen as passive embodiments of the nation, who grasped the national idea "instinctively," or through the "fetishization" of national symbols and great men. The active carriers of the national idea were bourgeois men, who alone possessed the ability to understand the national idea rationally. To govern effectively, this elite needed to take account of national character and provide a people with a system of government in keeping with their characteristics. National history became an essential part of training for government, and in societies where gendered separate spheres were an integral part of bourgeois culture, it became an essential attribute of manliness too.

There were also intellectual reasons for privileging the nation-state. Ranke followed Johann Gottfried von Herder (1744–1803) in seeing peoples as "thoughts of God." Through a process of intuition, combined with careful documentary research, the historian could grasp the nation's unique spirit. While the historian could not discern the end of history, God was present in history, and the objective historian could glimpse something of God's divine plan.

Varieties of National History

Historians varied in the extent to which they were willing to endorse the particular version of nationalism espoused by their governments. In Germany professors were appointed by authoritarian conservative governments that monopolized power until 1918, and they shared the ruling nationalist ethos. In Britain political pluralism and the greater autonomy of the universities ensured a more diverse profession, but most historians wrote national histories of one sort or another.

The structures of national histories were flexible enough to encompass many different types of national history, including left and right wing, state and opposition nationalism. For some national historians the core of the nation is parliament, for some the state; for others it is the people defined in linguistic, historical, cultural, ethnic, or other terms. Contest over the meaning of national history was all the greater because professionals have never monopolized the writing of history.

Germany

Ranke's nationalism was relatively benign. He saw all nations as equal before God and urged historians to understand rather than judge. He was also conservative in an age when nationalism was a movement of the revolutionary and democratic left. His *History of Prussia* (1847) depicted Prussia as a territorial state rather than as the precursor of German unity. Nevertheless, Ranke held in *The Great Powers* that "the greatest possible unfolding of the rule of the spirit reveals itself among the most resolute" and believed that history should serve the state. The latter ideas were taken up by the neo-Rankeans of the 1890s. Max Lenz (1850–1932) saw the state as the expression of a people, engaged with other states in a struggle to preserve its uniqueness. He justified the expansionism of the German Reich while claiming to be wholly objective. Lenz's nationalism was not, however, aggressive enough for some extreme nationalists, who attacked both the "caution" and the "narrow specialization" of university historians. Amateur writers like Julius Langbehn (1851–1907) rewrote the history of Germany with a racially defined *Volk*, rather than the monarchical state, as its subject, and developed ambitious schemes for expansion in eastern Europe. Conservative nationalists survived the challenge of the extreme right, just as they did the German Revolution of 1918. Like *Völkisch* historians, the Nazis were critical of the "bloodless objectivism" of the historical establishment, but they too failed to breach the hegemony of the professoriat. While professional historians largely rejected the extreme racism of the Nazis, early medievalists in particular made concessions to the notion that the *Volk* was the agent of history, thus providing historiographical legitimation for Germany's mission in the east. From 1936 the prestigious *Historische Zeitschrift* published a rubric on the history of the "Jewish Question." After 1945 most historians continued to write traditional national history, denying German guilt for the outbreak of the Great War and reducing the Third Reich to a diversion from the normal path in German history. The German destiny was updated to lie in the Western alliance.

This picture was upset only in 1961, when Fritz Fischer published his *Griff nach der Weltmacht: Die Kriegszieldpolitik des kaiserlichen Deutschlands 1914/18* (1961; English trans. *Germany's Aims in the First World War*, 1967). Whereas German historians had traditionally regarded all powers as equally responsible for the outbreak of war in 1914, Fischer claimed that German politicians had consciously risked world war. Furthermore, in a reversal of the usual assumption that foreign policy determined the character of a nation, he argued that both the Great War and the accession to power of Nazism were the result of the attempts of the Prussian aristocracy to preserve a social position threatened by modernization. Neither Fischer nor his many heirs broke with the national framework, however. Borrowing from Max Weber (1864–1920), they assumed a normal pattern of national "modernization" (an updated version of the idea of "progress") and attributed the disasters of German history to the attempts of her leaders to work against the grain of history—they did not act as "great men."

Britain

British historians embraced national histories as enthusiastically as their German counterparts. They assumed an unchanging

national character and rooted the English constitution in the forests of Germany, but they disagreed on whether state or parliament was the vehicle of the national idea. Some historians had much in common with German partisans of power politics. The conservative J. R. Seeley saw Britain's racial destiny in imperial conquest and wrote his *Life and Times of Stein* in 1878. Geoffrey Elton did not speculate on the racial origins of English virtue but felt nevertheless that the English had discovered the perfect blend of order and liberty. In his *Tudor Revolution in Government* (1953), he claimed that the foundations of a unitary modern state had been laid in the 1530s by Thomas Cromwell, chiefly through the removal of the influence of the Catholic Church from government. He added that English rule over the "disordered" and "wild" Irish and Welsh was both beneficial and necessary. Interestingly, Elton, although a vociferous defender of value-free empirical history, argued for the theoretical primacy of political history. It concerned, he said, the ways in which people used their reason to organize society into a "properly constructed, continuously living body"—note again the Hegelian notion that through the development of the state a society becomes conscious of itself. Like Fischer, Elton assumed a necessary process of modernization, and the greatness of Cromwell lay in his ability to realize the meaning of history.

The liberal E. H. Freeman (1823–1892) developed the idea of an innate English love of liberty into a vast Aryan project, and his history of the Norman Conquest took the side of the Anglo-Saxons against despotic French invaders. In the interwar period, in the face of the Nazi threat, George Macaulay Trevelyan wrote a history of England as the home of liberty yet repeated conventional prejudices about the Irish. Postwar left-wing historians abandoned racism but retained the notion of an English predisposition to liberty. For A. J. P. Taylor, German authoritarianism represented the antithesis of Englishness. The crux of his *Origins of the Second World War* (1961) was that Hitler's foreign policy represented a continuation of traditional German national aims. Taylor was a member of the Campaign for Nuclear Disarmament and believed that the peace-loving British were ideally placed to find a middle way between the two superpowers. The Marxist historian E. P. Thompson was also a leading campaigner against nuclear weapons. In "The Peculiarities of the English," Thompson described himself as a "socialist internationalist speaking in an English tongue" (p. 37). In his classic *Making of the English Working Class* (1963), he argued that the English bourgeoisie, frightened by the French Revolution, had betrayed the cause of liberty and failed to carry out a bourgeois revolution. The working class became the bearers of the tradition of the free-born Englishman.

The adaptability of the structures of national historical writing is illustrated by the historical works of opposition nationalists. John Davies's *History of Wales* (1993) is based on the assumption that although Welshness might be expressed in many ways (the author is especially concerned to reconcile industrial English-speaking Wales with rural Welsh-speaking Wales), there is a core national identity. He traces the resistance of "Wales and its attributes" to predictions of imminent oblivion that go back to Tacitus in 100 C.E. "This book," he concludes, "was written in the faith and confidence that the nation in its fullness is yet to be." The nation constitutes the

subject of the historical process, and its realization in the nation-state represents the end of history.

John Davies's book is one of the major sources for Norman Davies's *The Isles: A History* (1999), which attacks the Anglo-centric Whig view of history and predicts the break-up of the British state. The book was welcomed by the Left and condemned by the Right. Yet its structure is typical of national histories, and in its emphasis on the reconciliation of Celt and Anglo-Saxon, and in the author's interest in J. R. R. Tolkien's dream of harmony between races, the book owes something to the new right's vision of a Europe made up of unique peoples. For Norman Davies, Britain has since the fourteenth century consisted of four distinct nations, all integrated into a European culture. The long separation of Britain from Europe, beginning with the Reformation, is an "aberration" in the history of the Isles. Britain returns to its true vocation with membership of the European Union.

Nation and History Today

Challenged by social, demographic, women's, and gender history, national histories no longer occupy the monopolist position they once did. In *The Practice of History* (1967) Geoffrey Elton reacted to the rise of explicitly theoretical social history with a vigorous defense of the objectivity of political history. In fact, the national framework has remained essential to historical writing. The social and women's history of the 1970s and 1980s continued to be written within the confines of nation-states, and much of it, as in Thompson's *Making of the English Working Class*, dealt with the question of national specificities. The impact of poststructuralism upon historical writing has not substantially altered the situation. Poststructuralism has led to suspicion of essentialist definitions of nation, class, and gender but has caused historians to focus upon the historical, and mutual, construction of identities, including national identities. As yet few historians have taken up the critique of national histories advanced by cultural transfer theorists.

The international political climate also sustains interest in national histories. In the Balkans, contemporary diplomats are as ready as their counterparts at Versailles in 1919 to use historical arguments to justify territorial claims. In eastern Europe postcommunist states are engaged in reassessing their pasts—often presenting the communist period as an aberration in the normal path of national development, just as German, Italian, and French historians explained away Nazism, Fascism, and collaboration. The European Union is also tempted by the use of history for purposes of historical legitimation. The Maastricht Treaty (1992) called upon the commission to "bring the common cultural heritage to the fore."

See also *Historiography; Nationalism*.

BIBLIOGRAPHY

- Berger, Stefan. *The Search for Normality: National Identity and Historical Consciousness in Germany since 1800*. New York: Berghahn Books, 2003.
- Berger, Stefan, Mark Donovan, and Kevin Passmore, eds. *Writing National Histories: Western Europe since 1800*. London and New York: Routledge, 1999.

NATIONALISM

- Boer, Pim de. *History as a Profession: The Study of History in France, 1818–1914*. Translated by Arnold J. Pomerancs. Princeton, N.J.: Princeton University Press, 1998.
- Bosworth, R. J. B. *Explaining Auschwitz and Hiroshima: History Writing and the Second World War, 1945–1990*. London and New York: Routledge, 1993.
- Breuille, John. "Historians and the Nation." In *History and Historians in the Twentieth Century*, edited by Peter Burke. Oxford and New York: Oxford University Press, 2002.
- Burleigh, Michael. *Germany Turns Eastwards: A Study of Ostforschung in the Third Reich*. Cambridge, U.K., and New York: Cambridge University Press, 1988.
- Espagne, Michel, and Michael Werner, eds. *Transferts. Les relations interculturelles dans l'espace Franco-Allemand*. Paris: Éditions Recherche sur les civilisations, 1988.
- Kenyon, John. *The History Men: The Historical Profession in England since the Renaissance*. London: Weidenfeld and Nicolson, 1983.
- Slavin, Arthur J., "Telling the Story: G. R. Elton and the Tudor Age." *Sixteenth Century Journal* 21 (1990): 151–169.
- Smith, Bonnie G. *The Gender of History: Men, Women and Historical Practice*. Cambridge, Mass., and London: Harvard University Press, 1998.
- Stuchtey, Benedikt, and Peter Wende. *British and German Historiography, 1750–1950: Traditions, Perceptions, and Transfers*. Oxford and New York: Oxford University Press, 2000.
- Thompson, E. P. "The Peculiarities of the English." In his *The Poverty of Theory*. London: Merlin Press, 1979.

Kevin Passmore

NATIONALISM.

This entry includes five subentries:

Overview

Africa

Cultural Nationalism

Middle East

Nationalism in Music, Europe and the United States

OVERVIEW

Nationalism is one of the most significant political ideas of the nineteenth and twentieth centuries, at the heart of worldwide and local conflicts penetrating every region of the globe. It can be defined simply as a political ideology that aims to bring about or to increase the political representation or power of "the nation" and has appeared in many forms in a wide variety of circumstances. It is first and foremost a theory of political legitimacy, which arose and developed in opposition to various theories that derived political legitimacy from other principles. Firstly, nationalism contested the absolutist claim to the divine right of kings that had supported the monarchies of the European ancien régime, claiming that "the nation" was a more legitimate source of power than a monarch. Secondly, nationalism can be seen in opposition to the Marxist theories that aristocratic or bourgeois supremacy should or will be replaced by the unification of the proletarian lower classes around the world, where class is held to be legitimate, rather than a nation. Marxist theories give economics precedence over

culture and integrate the ideology of nationalism into a class-based understanding of the world by labeling it as a "bourgeois" theory of legitimacy. Thus nationalism in the nineteenth and twentieth centuries can be thought of as one theory of political legitimacy competing with others for acceptance.

In different historical contexts, nationalism has been compatible with a wide variety of other political positions, from nineteenth-century economic liberalism, to fascism in the early twentieth century, and indeed forms of Marxism in the post-colonial debate. It can be argued that much of its power as a mover of people comes from its flexibility and adaptability, which in turn can be attributed to the vagueness of the concept of the "nation" that underlies it. A nation is a group of people identified as sharing any number of real or perceived characteristics, such as common ancestry, language, religion, culture, specific institutions, historic traditions, or shared territory. The members of such a group can identify themselves and the others as belonging to the group, and who have the will or desire to remain as a group, united through some form of organization, most often political. Since no two nations need to be defined in the same way, many different combinations of characteristics may be used as the basis for a national identity at the foundation of a nationalist movement. Nationalism thus exists in a variety of forms, the common feature being the use of a culturally defined national identity in a quest for political representation, legitimacy, or power.

In order to understand the ideology of nationalism, it is helpful to examine several of the historical contexts in which nationalism has played a significant part, and then to turn to several theoretical approaches that have been used to classify and interpret nationalism, including areas of debate.

Historical Manifestations

Nationalism first came to prominence in the Western world during the late eighteenth and early nineteenth centuries. With roots in the Enlightenment, nationalism was proliferated during the French Revolution of 1789 and elsewhere by those who opposed absolutism, seeking the replacement of kings by nations as the source of all legal and political authority. The revolutionaries sought, for example, to bring about a constitutional, legal regime with a national assembly dedicated to representing the citizens of the nation, thereby overthrowing absolutism and the idea of a hierarchical society of privileges based upon birth.

The idea of the legitimacy of the nation was spread around Europe via the Revolutionary and Napoleonic French armies, who both took their ideology with them, as well as provoking "nationalist" reactions to the French conquests. Although following Napoléon's defeat in 1815 the absolute monarchies were restored around Europe, republican nationalism had already penetrated much of the Continent, and for the next half century there were repeated outbreaks of violence in support of popular nationalism. At this stage, many of the nationalists thought of each other as allies, that the fight against absolutism was one that needed to be fought by the many nations and peoples together. Secret societies of democratic, nationalist opposition, such as Young Italy, Young Germany, and Young Ireland, were affiliated with one another in the quest to overthrow absolutism. Wars and revolutions were fought both to



overthrow an absolutist order and to bring about some kind of representative liberal assembly, and at the same time to create individual nation-states, either through the unification of numerous smaller states (such as Italy and Germany) or via the breakup of larger empires (such as Austria-Hungary). During the first half of the nineteenth century, nationalism was primarily supported by the educated middle classes and associated with the economic doctrines of liberalism.

The reaction to invasion during the Napoleonic period sowed the seeds for the type of nationalism that would become more common later in the nineteenth century, when constitutional monarchies and republics had replaced absolute monarchies in most of the European nations. Once absolutism ceased to be the enemy, the common cause of the nationalists disappeared and nation-states found their principal rivals in one another. National leaders concentrated on solidifying their position both with respect to their own populations and with other nations through the championship of their own nation's virtues, often relative to those of other nations.

In each nation-state, national identities were encouraged and developed by national school systems and the proliferation of the symbolism of each nation through flags, anthems, or monuments. Historians such as Jules Michelet (1798–1874) in France, musicians such as Frédéric Chopin (1810–1849) or Giuseppe Verdi (1813–1901), and poets and writers from all over Europe, convinced of their political mission, encouraged

national awareness and gave the weight of their popularity and of their academically recognized publications to their nation's glory. Wars involving the conscription of the common citizens used nationalist rhetoric to motivate their soldiers to fight, and many wars were fought in the name of the defense of nations and of national honor and glory, culminating in Europe in World Wars I and II.

At this stage, nationalism became associated with more right-wing, populist parties who sought to promote their own national cultural values and to increase the power and glory of their nation, often at the expense of other nations or of immigrants, at least rhetorically. This kind of populist nationalism can be understood as more than just patriotism, which is a sentiment of loyalty to the nation to which one belongs, because it includes the beliefs that one's own nation has a higher calling and greater value than other nations.

Nationalism was also a key motivating factor in European imperialist expansion throughout the nineteenth century. However, this very imperialist expansion provoked a nationalist reaction throughout much of the rest of the world. Nationalist ideas of independence were brought by the colonizers, and the occupation and rule by the imperial powers led to the anti-imperial national independence movements. From the principle of self-determination found in Woodrow Wilson's Fourteen Points and used as a basis for the post-World War I international settlement came the theory to support the numerous twentieth-century



wars of national liberation both from colonial powers and from larger states composed of more than one “nation.”

The twentieth century saw innumerable conflicts in which nationalism was a motivating factor, and at the same time it saw the solidification of the system of nation-states as the primary form of social organization throughout the world. The United Nations became the primary international body, and nationhood became the goal of any group seeking to increase its political power.

Theories of Nationalism

In the same way that different nations may be defined according to quite different combinations of cultural characteristics, nationalism has not appeared in a single form, nor has it always conformed to the rough chronology outlined above. Sometimes nationalism emerges as a democratic antiauthoritarian movement, and at other times as a means to promote wars between nations, or obtain the unification or subdivision of territory, or as a force seeking the liberation of a territory from “foreign” domination. Nationalism’s diversity has made it extremely difficult to develop an all-inclusive theory that can explain every historical apparition. Distinctions can be made between reformist, unificatory, and secessionist types, between revolutionary and counterrevolutionary forms, between successive liberal and conservative variants, and between European and colonial manifestations of nationalism. Many of these

systems of classification have as their base a fundamental distinction between two types of nation: civic and ethnic.

Civic and Ethnic Nations

According to this model, civic nations are characterized by the early development of a unified state, a long and shared political history and an emphasis on citizenship, whereas ethnic nations are characterized by threatened elites, early democratization or late modernization, the consolidation of a national culture, xenophobia, and the repressive presence of polyglot empires. The model tends to categorize northern and western European nations such as Britain, France, or the Netherlands as civic, with Germany, Italy, Russia, and nations of the Austro-Hungarian and Ottoman Empires as ethnic. Held occasionally to be “good” and “bad” types of nationalism, the model aimed in part to explain the phenomenon of violent, expansionist, or anti-Semitic nationalism without qualifying all nationalism as negative. Recent work has demonstrated the limitations of this model, as all nationalisms exhibited both civic and ethnic characteristics, and a simple classification is not always helpful.

The Perennialists

The question of how certain cultural characteristics come to be identified as those defining a nation, as well as how they come to exist in the first place, has inspired two scholarly



debates: first the question of invention or preexistence of nations, and second whether nations and nationalism are linked with modernity. The first position with regard to the origins of the common cultural base is that national cultural characteristics exist and are a natural result of humans living in society. This is the position of the “perennialists,” who argue that nations, whether natural or not, have existed as long as humans have lived in “society,” as well as of many nationalists who seek to claim that their nations are “natural,” having existed for many centuries. According to this position, the history of nations and nationalism can be found by tracing the evolution of the cultural characteristics that define each nation and their inscription on the human landscape over time. Even where the characteristics are considered to be symbolic or mythical, they are held to preexist consciousness of them by the members of the nation.

This debate is linked to, but not completely identical with, the question of the existence of nations in the premodern period. Historians such as Adrian Hastings argue that even if they have not “always” existed, nations have existed in Europe for several centuries, and their development is not directly linked to the arrival of modernity. Their arguments are based upon the certain existence and consciousness of large ethnic groupings, as well as the use of the word *nation* by these groups to describe themselves during the Middle Ages.

The Modernists

The opposite position to those who describe nation as perennial is that nations as they are understood now have developed within a particularly modern context and are invented or imagined rather than naturally existing. This is the position of Benedict Anderson, who defines nations as “imagined political communities.” This imagination does not imply “falsity” but only that the reality of national cultural characteristics lies in the perception of them by both the members and those outside of the nation, rather than in an underlying “fact” of their existence independent of any consciousness of them. Further to this idea is the notion that much of the culture defined as national is made up of what Eric Hobsbawm and Terence Ranger have described as “invented” traditions: rituals or symbols that imply continuity with the past and seek, through repetition, to encourage certain patterns of behavior or thinking. According to this position, when examining questions about the nation it is more profitable to begin with nationalism and the nation than with the reality they represent. It is the differing concepts of the nation that eventually, through time, inscribe themselves into the very society that they claim to portray. Ernest Gellner writes that the high culture which characterizes nations is not something that is natural but that must be learned, and nationalism’s roots must be found in the pervading social order rather than in human nature, instinct, or the human psyche. The defined

national culture gradually infuses the rest of the population with the image(s) it has formed of itself.

According to this theory, the modern state is central in this endeavor as a framework within which nationalist movements can operate. It is also necessary as a mechanism to encourage the people's identification with national history and other images, as well as the extension of the national high culture that is at the center of the nation's identity. John Breuilly stresses this role of the modern state and its institutions in the growth of nationalism and argues indeed that the modern state is the most important feature of the political context in which a nationalist movement can arise. This does not imply that nationalism is a direct product of the modern state, only that within the context of such a state nationalism has much greater potential as a political force. Nationalism, seen as a form of political opposition to absolutism within the newly emerging type of state, leads directly to a conflict over organization and sovereignty. The increasing significance of the state, its institutions and administrative structure, as well as its ability to control and manipulate images in the modern period also contribute to the extension of both national ideologies or traditions and the literate culture to the masses once one group of nationalists has gained control.

The development of technology that enables mass communication, rapid travel, and sophisticated record keeping provided nation-states with enhanced resources to preserve the loyalty of populations and also to encourage what Michael Billig has termed *Banal Nationalism* (not "banal" in the sense of unimportant). He refers to the phenomenon of the reinforcement of national identity through numerous unconscious reminders of the nation in all of the small habits of social life, via expanding material culture and through the media. From "national" forms such as income tax or social security to the shape and color of mailboxes, lettering on license plates, vocabulary developed to describe diplomas, jobs, laws or customs, and national weather and news reports, everywhere there are subtle and subconscious reminders of the nation, in such a way as to make that which is national seem natural and given.

Permeating societies at a variety of conscious and subconscious levels, capable of application to any number of combinations of group characteristics, and compatible with a wide range of other political ideologies, nationalism is not yet a political idea that has inspired consensus among those analyzing it. Nevertheless, over two hundred years after its emergence as a political theory, it is still one of the most powerful political forces in the world.

See also Historiography; Nation; National History; Political Science.

BIBLIOGRAPHY

Anderson, Benedict. *Imagined Communities: Reflections on the Origin and Spread of Nationalism*. 2nd ed. London and New York: Verso, 1991.

Baycroft, Timothy. *Nationalism in Europe, 1789–1945*. Cambridge, U.K., and New York: Cambridge University Press, 1998.

Berger, Stefan, Mark Donovan, and Kevin Passmore, eds. *Writing National Histories: Western Europe since 1800*. London and New York: Routledge, 1999.

Billig, Michael. *Banal Nationalism*. London and Thousand Oaks, Calif.: Sage, 1995.

Breuilly, John. *Nationalism and the State*. 2nd ed. Manchester, U.K.: Manchester University Press, 1993.

Gellner, Ernest. *Nations and Nationalism*. Oxford: Blackwell, 1983.

Greenfeld, Liah. *Nationalism: Five Roads to Modernity*. Cambridge, Mass.: Harvard University Press, 1992.

Guibernau, Montserrat. *Nationalisms: The Nation-State and Nationalism in the Twentieth Century*. Cambridge, U.K.: Polity Press, 1996.

Hastings, Adrian. *The Construction of Nationhood: Ethnicity, Religion and Nationalism*. Cambridge, U.K., and New York: Cambridge University Press, 1997.

Hobsbawm, E. J. *Nations and Nationalism since 1780: Programme, Myth, Reality*. Cambridge, U.K., and New York: Cambridge University Press, 1990.

Hobsbawm, Eric, and Terence Ranger, eds. *The Invention of Tradition*. Cambridge, U.K., and New York: Cambridge University Press, 1983.

Smith, Anthony D. *Nationalism and Modernism: A Critical Survey of Recent Theories of Nations and Nationalism*. London and New York: Routledge, 1998.

Woolf, Stuart, ed. *Nationalism in Europe, 1815 to the Present: A Reader*. London and New York: Routledge, 1996. Collection of important primary texts.

Timothy Baycroft

AFRICA

The topic of African nationalism has been repeatedly contested and redefined over the past century. At the end of the nineteenth century, the European powers divided the continent and ruled virtually all of Africa, and African nations lost their sovereignty. During the 1950s and 1960s, when Africans began to seriously resist colonial rule, Africa underwent a major transformation and each colony eventually gained its freedom. Africans, in general, united in hopes of regaining their sovereignty. *Nationalism* originally referred to the process of uniting and regaining freedom from European rule, but it was also defined by pioneer African leaders to mean the creation of new nations as well as their economic and political transformation.

Development of African Nationalism

While a country such as Britain or Germany is viewed as one nation, in reality each contains a variety of nations or peoples. Uniting these various groups through common interests creates a nation. These nations are, as Benedict Anderson writes, "imagined" rather than "real." Anderson explains:

[A nation] is an imagined political community. . . . It is *imagined* because the members of even the smallest nation will never know most of their fellow-members, meet them, or even hear of them, yet in the mind of each lives the image of their communion. (p. 6)

A nation is a created community that believes that, though the community is diverse, as a whole it has a common interest that trumps all other interests; nationalism is the formation of this national identity.

African nationalism attempted to transform the identity of Africans. Rather than seeing themselves as Igbo or Hausa,

Kikuyu or Masai, nationalist leaders wanted Africans to view themselves as Kenyan, Nigerian, and so forth. While the idea appears simple in theory, it proved far more difficult in practice. The colonial powers never considered that the colonies would eventually form sovereign nations, and ethnic groups were treated as separate “tribal” or religious groups so that colonial officials could play them against each other, thereby keeping a colony’s populace divided, and, thus, less likely to work together to overthrow European rule. Various groups continued such practices even after independence, and the African continent in general suffered from religious and ethnic strife during the latter half of the twentieth century.

To compound matters further, the modern boundaries of African nations are not age-old ones recognized for centuries but arbitrary lines decided by European rulers in Germany at the Congress of Berlin in 1885. The events following that Congress are known as the “Scramble for Africa.” Whereas many European nations have one ethnic group, this was not the case for African nations, colonial boundaries throughout Africa were not in alignment with precolonial ones. Colonial borders often split ethnic groups, spreading them into various countries rather than uniting them into single nations. The Somali, for instance, were split up among four colonies. Therefore, when examining African nationalism, one must consider that borders are not “natural” or old, and that every African colony has many different factions.

A major dilemma that confronted early African nationalists was how to retain an African identity while appropriating the positive attributes of Western development. Whether to completely adopt English or French ways, to reject them completely, or find some sort of compromise were questions that Africans had to confront. Some, who realized the strengths of their missionary education and Christianity and were content to perpetuate colonial norms, felt that Africans should strive to mirror European culture and life.

Initially, African nationalist movements were led by middle-class intellectuals. These elites usually had a missionary education and viewed themselves as brokers between colonial officials and the African people. As Basil Davidson observes: “These were minority movements, restricted mostly to the ‘lawyer-merchant class,’ timid in their protests, opposed to any call for mass support” (p. 74). In other words, these early nationalist movements were inherently elitist, not true mass movements, and, thus, were not representative of “the people.” These elites were much wealthier and better educated than their peers, grateful for the advantages bestowed on them by their missionary education, and loyal to the colonial powers. Instead of transferring governing power to the African people, many of these early leaders felt that the colonial state should simply hand over power to them.

Others envisioned an “Africa for Africans” and sought to reclaim Africa for the native peoples. They refused to adopt European values and many aspects of Europe’s cultures, and thought it fruitless to do so. Edward Wilmot Blyden (1832–1912), widely regarded as “the Father of Cultural Nationalism,” felt that Africans must revive their cultures and relearn their traditions from those least influenced by colonial rule. Throughout the period of colonial rule, Africans were

repeatedly told that their cultures were uncivilized, primitive, evil, and barbaric, and that their history began with the arrival of Europeans. Therefore, nationalist leaders had to “decolonize” the African mindset as well as overthrow colonial rule. African nationalists sought to “reeducate” their followers, and began to promote black pride. African foods, music, dress, architecture, and religion were celebrated and promoted as equal to, if not better than, their European counterparts. While these steps may seem minor, nationalists believed that, without such a cultural revival, Africans would forever perceive themselves as inferior to Europeans if they failed to regain the pride and self-worth that colonization had taken away from them.

This return to “tradition,” however, was also problematic because African traditional rituals, leaders, governments, and policies were exploited or manipulated by colonial governments, often unintentionally. As Hobsbawm and Ranger explain:

British administrators set about inventing African traditions for Africans. Their own respect for “tradition” disposed them to look with favour upon what they took to be traditional in Africa. They set about to codify and promulgate these traditions, thereby transforming flexible custom into hard prescription. (p. 212)

Pan-Africanism

A major advance in African nationalist movements came with the Pan-Africanist movement. Though its roots were in early abolitionist movements, Pan-Africanism, which sought to unite Africans and overcome ethnicity by stressing the similarities and connections among all Africans, blossomed in the early twentieth century. Originally led by blacks in America, Britain, and the Caribbean, the movement did not initially fully represent the needs of Africans, but blacks throughout the world came to view themselves in a position similar to those of others of African descent in Britain, the United States, and throughout Latin America.

The two most notable leaders of early Pan-Africanism were Marcus Garvey (1887–1940) and W. E. B. DuBois (1868–1963). Garvey, whose outspoken nature attracted many followers, believed that blacks would never be treated as the equals of whites in America and must return “home” to Africa if they were to be free. DuBois, who had earned a doctorate in history from Harvard in 1896, may be the greatest Pan-Africanist intellectual ever. He argued that Africa had a glorious past and that Africans had deeply influenced Western civilization. He believed that Africa had to be freed from colonial rule if African Americans were to be liberated, and his work sought to end the caricatures of blacks as the “clown of history, football of anthropology, and the slave of industry” (p. ix).

The Great Depression hurt Africa greatly. Employment, especially in rural areas, was scarce. Many migrated from the countryside to urban areas, and the populations of cities swelled. These areas became overcrowded and poverty was rampant. The European powers were ill-equipped to combat these developments because resources and attention were focused on World War II. This furthered discontent and Africans became more disorderly. Bolstered by the influx of returning soldiers,

nationalist movements throughout Africa were energized. By the 1940s, nationalist movements were becoming more radical, and Africans everywhere began to protest colonial rule as they increasingly realized how wrong and oppressive it was.

As the century progressed, the nationalist movements began to attract more people and to wield more influence. Leaders who could relate to and represent more than one group or class became household names and heroes. These leaders mobilized “the people” rather than a select few or one ethnic group. Obafemi Awolowo (1909–1987; Nigeria), Kwame Nkrumah (1909–1972; Ghana), Jomo Kenyatta (1889–1978; Kenya), Julius Nyerere (1922–1999; Tanzania), and Nelson Mandela (b. 1918; South Africa) belong to this new generation of leaders who successfully reached out and enlisted the support of their countries’ population.

The Italian invasion of Ethiopia in 1935 marked a turning point in African history. Ethiopia was Africa’s only truly independent nation. The invasion radicalized African nationalist movements and caused Africans to see themselves as peers and comrades in similar struggles. In general, they felt that Ethiopia symbolized a free, proud, civil, and successful Africa. As long as Ethiopia remained free of colonial domination, many believed that their dream of freedom and independence remained alive and achievable. If Ethiopia fell, however, then the hope for an independent Africa would die with it. Africans across the continent rallied to support Ethiopia, and blacks around the world attempted to supply both military and financial support for the Ethiopian cause.

African Nationalism after World War II

The next significant event in the development of African nationalism was World War II. Nearly two million Africans were recruited as soldiers, porters, and scouts for the Allies during the war. When these soldiers returned home, they returned to colonial states that still considered them inferior. Many veterans had expected that their dedication to colonial governments would be recognized and they would be rewarded accordingly. This was not to be, and these soldiers returned home to conditions worsened by a weak global economy. Because they had fought to protect the interests of the colonial powers only to return to the exploitation and indignities of colonial rule, these men became bitter and discontented.

In 1945, the Pan-African Manchester Congress in England marked a turning point because it attempted to address the needs of all blacks. Pan-Africanism began to stress common experiences of blackness and sought the liberation of all black people around the world. African leaders became more influential in the movement as they used it to attack colonial rule, and the movement would become more African-based after 1945.

Pan-Africanism proved very popular among nationalist African leaders because it offered a way for them to overcome both regionalism and ethnic divides by stressing commonalities and a common oppression. By the 1950s, Pan-Africanism had profoundly influenced almost every African nationalist leader: Kwame Nkrumah, Kenyatta, Nyerere, Kenneth Kaunda (1964–1991; Zambia), Haile Selassie (1892–1975; Ethiopia), Albert Luthuli (c. 1898–1967; South Africa), and Nnamdi

Azikiwe (1904–1996; Nigeria), all were deeply affected by the movement.

Kwame Nkrumah is regarded as the father of “Africanized” Pan-Africanism. Nkrumah detested colonial rule. Schooled in the United States, he was deeply influenced by the African American civil rights struggle, and began to emphasize the similarities between those struggles and those of African peoples. He argued that African workers and peasants needed to reclaim their independence, and advocated the use of force if necessary. For this to happen, Africans had to shed their strong ethnic or religious identities and see themselves simply as black or African rather than Yoruba or Fante. Nkrumah’s intense disdain for colonial rule, zealous enthusiasm for independence, and the ideal of a United States of Africa made him popular among Africans throughout the continent. Nkrumah argued that they could not look to any outside power for support, and believed that foreign economic and political forces eroded African values. He also disagreed with the idea of returning to “African tradition.” Instead, he argued that a new African identity must be created out of Islam, Christian, and traditional cultures.

Nnamdi Azikiwe was a prominent Pan-Africanist and an important thinker. Unlike most Pan-Africanists, Azikiwe rejected various aspects of Africa’s past such as chieftaincy and informal education. He also rejected Nkrumah’s united Africa, and advocated the use of colonial boundaries to define nations. For him, a united Africa meant cooperation, but not an actual unification of the continent. As Nigeria achieved independence and rapidly moved toward regionalism, Azikiwe abandoned his Pan-Africanist ideals for regional politics.

Pan-Africanism reinforced notions of black pride, and African history was used to foster a national identity. Many nationalist leaders stressed past empires (for example, the Mali and Asante), achievements (such as those of great Zimbabwe and ancient Egypt), and leaders (Shaka Zulu [c. 1787–1828] and Emperor Menelik of Ethiopia [1844–1913] among them) as a means to instill pride among African peoples. By stressing the continent’s successes throughout its history, African leaders sought to convince their followers of their own worth and that Europeans were not superior to them. Again, the aim was to restore pride in Africa and create a sense of unity that nations could use to foster nationalism.

African women were major contributors to resistance to colonial rule and the promotion of nationalism. Many argue that women fared the worst under colonial rule. Governments such as those in Rhodesia, Kenya, and South Africa sought to restrict women’s movement and even banned them from urban areas. In rural areas, they were often expected to maintain food production and raise children while their husbands rotted in jails, migrated to other areas in search of wage labor, or fought in wars (both in World War II and various liberation struggles). These women did not idly sit back and allow colonial governments to impinge on their rights, and, in response to their harsh situation under colonial rule, they organized protests, boycotts, workers’ strikes, and demonstrations. In Kenya, Zimbabwe, Algeria, and other areas that attempted armed struggle, women as well as men carried messages, spied,

and prepared meals. Overall, their impact on the anticolonial and nationalist movements throughout Africa was profound.

While Africans were widely successful in fostering nationalism in order to overthrow colonial oppressors, maintaining this unity after independence proved far more difficult. African nationalism was overtly anticolonial. For these nationalist movements, energy was concentrated on gaining freedom rather than planning how to run a country once freedom was achieved. Overthrowing colonial regimes was quite difficult, so these leaders could not afford to spend manpower, funds, and effort planning how to govern their new nations if they were successful.

Postcolonial Nationalism in Africa

Each African nation took a unique path toward independence. Some, such as Algeria, Mozambique, and Zimbabwe, took extreme measures like waging a guerilla war on the colonial state; most countries pursued nonviolent means and achieved a peaceful transfer of power. But there were varying degrees of success. Some countries, such as Ghana, became completely independent while others, such as Congo, continued to depend on Europe, and their independence was superficial rather than absolute.

As the age of independence dawned, African leaders faced the daunting tasks of developing their vastly underdeveloped economies and reversing the economic ills of imperialism. Largely, African nations leaned toward leftist ideologies (such as Marxism and socialism) or capitalism. Because the Soviet Union possessed no African colonies, it was perceived as an ally of anticolonial movements. Nyerere, Nkrumah, Ahmed Sékou Touré (1922–1984), and Muammar Gadhafi (b. 1942; Libya) attempted to “indigenize” leftist doctrines and became the continent’s leading leftist thinkers. They blamed Western capitalists’ imperialism for Africa’s ills, and believed the overthrow of capitalism and imperialism was the only way to truly liberate Africa. Precolonial African societies were based on communalism, and many viewed socialist and Marxist ideologies as a way for African nations to return to their precolonial ways of living because they promised economic equality and a classless society. Others felt that nations on the left, such as Cuba, the USSR, and China, should be looked to as allies and for aid; the leftist powers proved incapable of providing enough aid and support, however, and both socialism and Marxism have been abandoned throughout Africa. Nations that chose capitalism proved equally unsuccessful because African economies were not diverse enough to sustain development. World Bank and structural adjustment programs proposed by the West only worsened Africa’s underdevelopment. The debt of these nations increased exponentially and their economies weakened considerably.

Consequently, African nationalistic ideals of the 1950s and 1960s have waned. African nations have not succeeded in convincing their countries’ populations to put national interests ahead of regional, ethnic, or religious ones. In various parts of Africa, politics has progressed so that leaders must rely on the backing of their own ethnic group, and, if one branches out too far, he or she will be replaced by someone who will better represent interests of the specific ethnic group. In other words, being loyal to one ethnic group, religious faith, or

geographical region can offer protection, but it also creates great divides in society. Ethnic divisions have hurt both nationalism and development in Africa. Countries such as Nigeria, Burundi, Rwanda, Uganda, and Zimbabwe have had their share of ethnic rivalries, civil wars, and genocide. In order to avoid ethnic clashes, some leaders advocated socialism, military rule, or one-party states, but these ideas have failed and such maneuvers have served only to widen ethnic divisions.

Many African nations have failed to maintain a strong sense of nationalism or national identity. Ethnic rivalries, diseases, unemployment, globalization, corruption, greed, and natural disasters have all played major roles in the dire reality that is post-independence Africa. African nationalism of the 1950s and 1960s was overtly anticolonial or anti-European. Once the colonial powers formally pulled out, Africans looked inward to consolidate power and rid themselves of political rivals. Military coups, one-party political systems, widespread corruption, and tyrannical autocrats became the norm.

As a result, numerous scholars have provided many valid criticisms of nationalist movements. Initially, scholars harshly criticized African ruling parties and political systems as they tended to promote corruption, violence, and tribalism as well as sponsoring useless plans for development. Most experts of the 1960s believed that independence would bring about progress and development. By the late 1970s, such optimism had been eradicated, most scholars became pessimistic about Africa’s future, and “Afropessimism” became an ideology of its own. Civil wars, depleted economies, increasing debt, skyrocketing unemployment, and despotic leaders led many to become disheartened and to give up hope.

More recent critiques have been twofold. One type offers deeper analyses of how these negative systems operate and goes beyond identifying the problems in order to fully understand how coups and tyrants can be eliminated. Leroy Vail’s work is an example of this approach. His *The Creation of Tribalism in Southern Africa*, an edited collection of essays, aims to explore why and how tribalism has been employed throughout both the colonial and postcolonial eras. Instead of accepting tribalism as inevitable, Vail discusses how ethnic identities have been manipulated and strengthened over the past century, while demonstrating how the educated elites and the continent-wide movement toward one-party rule promoted tribalism: it was a way for leaders to secure support even when their policies failed. As he puts it, “They concentrate upon its heroes, its historical successes, and its unsullied cultural purity, and are decked out with the mythic ‘rediscovered’ social values of the past” (p. 14). In other words, tribalism and ethnic affiliations became easy ways to achieve or consolidate power when development failed. They have allowed regional nationalism to blossom while weakening national identities as a whole.

The second type of critique emphasizes areas where Africans themselves have succeeded despite such difficult surroundings. Richard Werbner and Terence Ranger document how Africans, in general, react and cope with despotic leaders and harsh political realities. Werbner and Ranger aim “to show how and why the present reconstructions of personal and collective identity, of social subjectivity, and of moral agency draw on the

culturally nuanced resources of social memory for negation, for affirmation, and for playful fun” (p. 4). Their work recognizes agency on the part of the African masses, instead of assuming them to be helpless pawns in the hands of tyrants. While these achievements are not monolithic, acknowledging them does serve to diminish the pessimistic view that Africa is doomed to remain lawless and antidemocracy.

While Africa has failed to develop along the lines of nations such as Japan or the United States, nationalism has not been completely erased. Manifestations of nationalism and national unity are most apparent during times of natural disaster, sporting events, and international crises. For Africa to compete in the twenty-first-century’s global economy, African nations must foster stronger national identities that can be sustained for an extended period. The unity has to be permanent and not as easily dissipated as the attempts of the 1960s. It must also be strong enough to overcome ethnic divisions and rivalries that have plagued the continent since independence. Poverty, AIDS, starvation, globalization, and negative interference by the West may be common problems that will finally unite Africans and foster such nationalism.

See also Africa, Idea of; Afropessimism; Anticolonialism: Africa; Black Atlantic; Black Consciousness; Capitalism: Africa; Colonialism: Africa; Development; Empire and Imperialism; Ethnicity and Race: Africa; Globalization: Africa; Neocolonialism; Pan-Africanism; State, The: The Postcolonial State; Westernization: Africa.

BIBLIOGRAPHY

- Anderson, Benedict R. *Imagined Communities: Reflections on the Origin and Spread of Nationalism*. New York: Verso, 2002.
- Bayart, Jean Francois, Stephen Ellis, and Beatrice Hibou. *The Criminalization of the State in Africa*. Oxford: The African Institute, 1999.
- Boahen, A. Adu. *African Perspectives on Colonialism*. Baltimore: Johns Hopkins Press, 1987.
- Davidson, Basil. *Modern Africa: A Social and Political History*. New York: Longman, 1994.
- DuBois, W. E. B. *The Autobiography of W. E. B. DuBois*. New York: International, 1968.
- Esedebe, P. Olisanwuche. *Pan-Africanism: The Idea and Movement, 1776–1963*. Washington, D.C.: Howard University Press, 1982.
- Falola, Toyin, ed. *Africa, Vol. 4: The End of Colonial Rule, Nationalism, and Decolonization*. Durham, N.C.: Carolina Academic Press, 2002.
- . *Nationalism and African Intellectuals*. Rochester, N.Y.: University of Rochester Press, 2001.
- . *The Power of African Cultures*. Rochester, N.Y.: University of Rochester Press, 2003.
- Hobsbawm, Eric, and Terence Ranger, eds. *The Invention of Tradition*. New York: Cambridge University Press, 2002.
- Hodgkin, Thomas. *Nationalism in Colonial Africa*. New York: New York University Press, 1957.
- Joseph, Richard, ed. *State, Conflict, and Democracy in Africa*. Boulder, Colo.: Lynne Rienner, 1999.
- Mazrui, Ali A., and Michael Tidy. *Nationalism and New States in Africa: From About 1935 to the Present*. Nairobi, Kenya: Heinemann, 1984.

- Nkrumah, Kwame. *Neo-Colonialism: The Last Stage of Imperialism*. New York: International, 1965.
- Vail, Leroy, ed. *The Creation of Tribalism in Southern Africa*. London: James Currey, 1989.
- Webner, Richard, and Terence Ranger. *Postcolonial Identities in Africa*. London: Zed Books, 1996.
- Zachernuk, Philip S. *Colonial Subjects: An African Intelligentsia and Atlantic Ideas*. Charlottesville: University Press of Virginia, 2000.

Toyin Falola
Tyler Fleming

CULTURAL NATIONALISM

Literary critics and historians use *cultural nationalism* to refer to collective practices that form modern political communities within, un sanctioned by, or even undercutting state authority. Such collective practices include the “high” culture disseminated via public media, established in publicly funded institutions such as universities and museums; as well as the “low” culture of popular performance and markets. Cultural nationalism, then, is distinct from patriotism, national literatures, or similar state-referenced collective identities. At present, cultural nationalism figures in discussions of why English literature should be taught in universities, as well as those concerning the content and selection criteria for what is taught as comparative literature. Even though Britain plays a minor role in international trade and politics, Britain’s works of literature continue to serve as the standard of taste and literary value. Bill Ashcroft, Gareth Griffiths, and Helen Tiffin (1989) note that, even when postcolonial societies achieve political independence, the issue of colonialism remains relevant. Early-twenty-first-century historians also use cultural nationalism to discuss affinities, experiences, or practices that serve as the basis for common political views; what unites individuals (who may even carry different passports) could be common language and ethnic identity—even literary and musical tastes, dramatic films, cuisine, and sports spectatorship.

Two references to the definition of culture can serve as starting points for a discussion of cultural nationalism in literature. The first is from Raymond Williams’s *Culture and Society* (1958). His four-part definition considers culture from both humanistic and anthropological perspectives, granting the same importance to those who define cultural practices for the global North’s institutions of higher education, as to those who live culture every day. Williams liberates nationalism from the state and its patriotisms. Those who were denied privileged access to the state and public institutions—women, economic underclasses, and others—participated in forming the nation even though Empire was a fundamental and constitutive part of Europe’s social fabric, intellectual discourse, and the imaginary lives of its citizenry. Politically committed British academics led by Stuart Hall (*Popular Arts* [1965] and *The Young Englanders* [1967]) insisted that ongoing economic and political relations with the postcolonial United States formed “universal” traditions increasingly identified with European-American modernity.

Culture and Nationalism: Separate Ideas

The term *cultural nationalism* has gained increasing acceptance since the late twentieth century. Previously, however, the ideas of culture and nationalism were treated separately.

Jean-Jacques Rousseau (1712–1778) was identified as the father of modern political nationalism, a role he shared with Johann Gottfried von Herder (1744–1803). Culture, that is, as defined before the idea of cultural nationalism was embraced, was closely tuned to Europe’s classical and modern history and philosophies: Etymologies and definitions for culture and civilization could be traced from the classical Mediterranean, including those provided by Giambattista Vico (1668–1744), von Herder, and Immanuel Kant (1724–1804).

Focus on the separate ideas of culture and nationalism continued among certain communities in the late twentieth century. In addition to accepting von Herder on culture, Ernst Gellner (1983) returned to Kant’s ideas regarding Europe’s “modern” ways of thought. Gellner relied on both von Herder and Kant to describe how education imposed “high culture” on industrial societies. National identities were not Europe’s primordial heritage; rather, for Gellner, nationalism was awakened or invented to accomplish the kind of cultural homogeneity industrial society considered necessary: “nations, like states, are a contingency, and not a universal necessity” (p. 6). Elie Kedourie gives von Herder his due with the assertion that nationalism was invented in Europe in the early nineteenth century. For Kedourie, nationalism seemed alien to the non-European world, the residents of which are denied authentic recourse to the claims of the nation: expression of unique character, self-determination, or contribution from their natural genius to humanity’s common fund.

From Europe to a Worldview

In the mid-1970s, observations concerning modern Europe and its ability to represent a universal ideal became increasingly contentious. Thus the discussion in this article turns from Europe’s culture to a worldwide perspective, following a brief detour from structuralist to poststructuralist philosophy, since that transition influenced studies by historians and literary critics of the world outside Europe.

Structural philosophy and linguistics used such binary oppositions as true/false, civilized/savage, culture/nature, modern/primitive, and public/private to decide what was worthy of study, and what was not. These opposing terms were indebted to the same forms of authority that created modern nation-states in Europe, and therefore owe some part of their power to states’ monopoly over coercive force. Jacques Derrida and other poststructuralist philosophers recognize that such binary terms are not equally valued since the term in the structurally dominant position assumes the power to define its opposite. Such hierarchical oppositions grant mind power over nature, cognition privilege over feeling, and reason over desire, as discussed in Derrida’s article, “La Différance” (1972). Feminists adopted similar strategies to conceptualize masculinist authority. For others, the West enjoyed a cultural nationalism not merely over “The Rest,” but at its expense.

Scholars employed in English and comparative literature departments around the world may describe their work as Third World literature, or literature of resistance. Discussions of cultural nationalism cluster around language, genre, and analogy. While postcolonial intellectuals recognize neocolonial economic and political relations, many write in European

languages. Drama and poetry in local languages were central to postcolonial politics of global literature; among prose genres, fiction and travelogue, which are closely tied to European forms, are used for critiques of nineteenth-century modernities. And by means of analogy, the feminine is marked as differentiated from European modernities.

Franz Fanon’s work—in particular, an address to the second Congress of Black Writers and Artists, which met in Rome in 1959, published as a chapter in *Wretched of the Earth* (1963)—asserts that the demand for a national culture and the affirmation of such culture’s existence represents a special battlefield. Reference to the dignity, glory, and solemnity of a past culture rehabilitates the nation when addressing colonialism’s distortion, disfiguration, and destruction of precolonial histories. Yet in discussing Arab cultural nationalism and negritude, Fanon notes the fatally ambiguous position of the native intellectual as it develops through three phases: unqualified assimilation, poetic exoticism, and finally the literature of national struggle. It is the “progress of national consciousness among the people” that “modifies and gives precision to the literary utterances of the native intellectual” (p. 239).

Ngugi wa Thiong’o noted that colonialism entailed a double procedure. Colonialism meant the deliberate discounting or even destruction of the colonized culture, whether its art, dance, religion, history, geography, education, or oratory, as well as the conscious elevation of the colonizers’ language (1986, p. 16). Beginning with the founding authors of liberalism (David Hume, Thomas Jefferson, and Georg Wilhelm Friedrich Hegel), nineteenth-century modernity denigrated the colonized. This system of domination’s final triumph was symbolized by the dominated singing the system’s virtues; the literature Africans penned in European languages was identified as African literature, as if there had never been a literature in the languages of Africa. But writing in African languages will only bring about an African cultural renaissance if these texts convey a struggle to create postcolonial political and economic community.

Michel Foucault’s philosophical/historical work, *Discipline and Punish* (1977), provided flexibility to those working in cultural nationalism outside Europe. Prison authorities, he notes, maintain discipline among the incarcerated through surveillance, normalization, and examination; the written language was essential to the influence of these techniques. The power of writing, Foucault explains, is that description and classification function not as procedures for creating heroes, but for transforming humans into objects and subjects. Taking direction from Foucault, Edward Said found coercive force exercised through those texts describing the predominately Islamic world. The radical otherness of the Islamic world need neither be praised nor condemned; once differentiation has been accomplished, an exemption has been made for universal humanism. Said’s *Orientalism* (1979) was widely read for its ability to forge a link between the literature that described the Orient, and Europe’s exercise of coercive force on overseas territories.

Barbara Harlow queried whether poststructural literary criticisms could be useful outside the cultural traditions that produced them: does “deconstruction” facilitate “decolonization”? Armed struggles for national liberation were and are no more

or less crucial than the struggle for cultural productivity and historical record. In describing the literature of Africa, the Middle East, and Latin America as resistance literature, Harlow notes that such works bear the mark of national liberation movements, that the commitment to political struggle prohibits “academic objectivity” or “scientific dispassion.” Postcolonial literature is always public, never private: “Resistance literature calls attention to itself, and to literature in general, as a political and politicized activity. The literature of resistance sees itself furthermore as immediately and directly involved in a struggle against ascendant or dominant forms of ideological and cultural production” (pp. 28–29).

Frederic Jameson (1987) argues that Third World literatures are distinguished by their use of allegory; in such texts, ostensibly personal issues such as libidinal investment are understood to bear public significance. However Jameson notes the incompleteness of African states’ independence, in that new state structures were not matched with the reconfigured social relationships and consciousnesses formed in revolutionary struggle. Indeed reference to cultural nationalism remains indebted to the new social movements: conscious public activism against militarization and environmental abuse, against class, race, gender, and sexual oppression. As Ella Shohat notes, due to “the collapse of the Soviet communist model, the crisis of existing socialisms, the frustration of the hoped for tri-continental revolution (with Ho Chi Minh, Frantz Fanon, and Che Guevara as talismanic figures) the realization that the wretched of the earth are not unanimously revolutionary (nor necessarily allies to one another), and the recognition that international geo-politics and the global economic system have obliged even socialist regimes to make some kind of peace with transnational capitalism” (p. 100).

Benedict Anderson built on the work of Gellner, Eric Hobsbawm, and Terence Ranger. Hobsbawm most usefully noted that those practices that seek to inculcate norms through reputation, and automatically imply continuity with the past, may be of quite recent origin or even invented. Ranger noted that European militaries and administrations in Africa relied on the practice of disseminating invented traditions. While for Gellner, the word invent meant fabricate or falsify; for Anderson, nations were “created,” “thought out,” or even “imagined” communities. Anderson identifies the nexus of market capitalism and the print industry as the institutional space for development of modern, national languages.

In responding to Anderson, Partha Chatterjee notes that Europe’s history was not that of the rest of the world: historically specific correspondences between economic change and epistemic privilege were unique to European society. Chatterjee identifies three “moments” for nationalist thought, as expressed in literature and political polemic. The first, the moment of departure, is predicated on essential differences between the West and the Rest, noting that while those not living in Europe or North America are deficient in European modernities, that lack is compensated for with spiritual gifts. The second, the moment of maneuver, described as the embrace of modernities antitheses as the national culture, may lie closest to Fanon’s ideals for postcolonial intellectuals. In the third, the moment of arrival, nationalist thought is phrased in its own vocabulary of modernist order. In another work,

Chatterjee notes the rhetorical significance of women’s issues to national movements. The discovery of tradition by nationalist movements relegates “the women’s question” to inner domains. Given the power of European modernist claims in the material sphere, colonial rule threatened the very institutions of home and family. The nationalist project justified selective appropriation of Western modernity along the lines of public/private life, specifying that women’s bodies and the domestic circle would occupy a central position in cultural nationalism.

Gayatri Spivak sharpened poststructuralist thought’s importance for worldwide cultural nationalism. She noted the exclusivity of Immanuel Kant’s metaphor “the turning of the mind to the feeling of the sublime” in *Critique of Judgment* (1790). Where other poststructuralists note the presence of unbalanced power, Spivak argues that universal observations exclude entire categories. The West’s knowledge hegemonies work at two levels enabling cultural imperialism to crush cultural nationalism. At one level, they define the system of concepts by which social and political reality is lived. These concepts need not be consensual or universal in order to be effective. At another level, hegemonies fragment the social order, so that divisions—along boundaries of class, race, and gender—proliferate.

One of the new locations for studies of cultural nationalism was the United States. While the United States witnessed a civil rights movement and university-based protests throughout the 1960s, such disturbances were only indirectly responsible for politicizing the movement for new forms of knowledge in academia. Rather, increasing university enrollment following general prosperity throughout the country meant that history and literature departments continued to hire scholars. The academic profession became more inclusive as international scholars and scholar-activists became tenured. While class-aware, subaltern, and feminist approaches may remain marginalized in Europe (whether shunted to Britain’s new universities or parked in France’s provincial institutions), they are surprisingly well represented in the most richly endowed institutions of the United States.

While discussions of cultural nationalism remain active in scholarly monographs in the early twenty-first century, interest in the subject is also widening in academic publishing. During the 1970s, editors at journals such as *Comparative Studies in Society and History*, the *Journal of African History*, the *Journal of Modern African Studies*, and the *Journal of the History of Ideas* entertained discussions of cultural nationalism. By the 1980s, literary journals such as *Callaloo*, *MELUS*, *Social Text*, the *New German Critique*, *Public Culture*, and *Yale French Studies* printed articles that mingled culture with nationalism; for example, a 1995 issue of *Boundary 2* was titled “Beyond National Cultures.”

See also *Anticolonialism; Colonialism; Orientalism; Other, The, European Views of; Postcolonial Theory and Literature*.

BIBLIOGRAPHY

Anderson, Benedict. *Imagined Communities: Reflections on the Origin and Spread of Nationalism*. London: Verso, 1983.

- Ashcroft, Bill, Gareth Griffiths, and Helen Tiffin. *The Empire Writes Back: Theory and Practice in Post-Colonial Literatures*. New York: Routledge, 1989.
- Chatterjee, Partha. *The Nation and its Fragments: Colonial and Postcolonial Histories*. Princeton, N.J.: Princeton University Press, 1993.
- . *Nationalist Thought and the Colonial World: A Derivative Discourse?* London: Zed Books, 1986.
- Fanon, Frantz. *The Wretched of the Earth*. Translated by Constance Farrington, with a preface by Jean-Paul Sartre. New York: Grove Press, 1963.
- Foucault, Michel. *Discipline and Punish: The Birth of the Prison*. Translated by Alan Sheridan. New York: Pantheon Books, 1977.
- Gellner, Ernest. *Nations and Nationalism*. Ithaca, N.Y.: Cornell University Press, 1983.
- Harlow, Barbara. *Resistance Literature*. New York: Methuen, 1987.
- Hobsbawm, Eric, and Terence Ranger, eds. *The Invention of Tradition*. New York: Cambridge University Press, 1983.
- Jameson, Frederic. "World Literature in an Age of Multinational Capitalism." In *The Current in Criticism: Essays on the Present and Future in Literary Theory*, edited by Clayton Koelb and Virgil Lokke, 139–158. West Lafayette, Ind.: Purdue University Press, 1987.
- Ngugi wa Thiong'o. *Decolonising the Mind: The Politics of Language in African Literature*. Portsmouth, N.H.: Heinemann, 1986.
- Rich, Adrienne. *Dream of a Common Language: Poems 1974–1977*. New York: Norton, 1978.
- Said, Edward. *Orientalism*. New York: Vintage Books, 1979.
- Shohat, Ella. "Notes on the Post Colonial." *Social Text* 31/32 (1992): 99–113.
- Spivak, Gayatri. *A Critique of Postcolonial Reason: Toward a History of the Vanishing Present*. Cambridge, Mass.: Harvard University Press, 1999.

Elizabeth Bishop

MIDDLE EAST

Nationalism is generally regarded as a recent development in the Middle East, a contingent phenomenon produced by the unique conditions of the modern era. Prior to the nineteenth century, concepts of collective identity and allegiance appear to have been defined primarily on the basis of lineage, locale, or religion—communities of sentiment and solidarity either smaller or larger than the nationalisms that subsequently emerged. For the region's agricultural and pastoralist majority, living in largely self-contained village or nomadic communities, one's clan, tribe, or village are presumed to have been the primary objects of self-identification and affiliation. For the area's literate minority, usually urban residents and immersed in a milieu dominated by religion, collective identity was defined by a combination of locale (loyalty to one's city), polity (being a member of the ruling elite), and most vitally religion (self-definition as Muslim, Christian, or Jew). Ethnic or linguistic concepts of identity, on the other hand, were conspicuous by their absence. Terminology illustrates the point. Prior to the twentieth century the word *Turk* denoted a rural resident of Anatolia, not a member of the educated multiethnic elite of the Ottoman Empire. In Arab usage the term *Arab* referred to the wild Bedouin of the desert, not the area's sophisticated urban population.

The Emergence of Modern Nationalisms

The nineteenth century was the seedtime of nationalism in the Middle East. The region's geographic, linguistic, and religious heterogeneity has provided the basis for numerous and competing nationalist movements.

Fueled by their religious distinctiveness and their contacts with the European milieu where nationalism was becoming the hegemonic referent for collective identity, some of the region's Christian minorities developed nationalist movements prior to the region's Muslim majority. Most prominent in this regard were the Maronites of Mount Lebanon and the Armenians of eastern Anatolia, among whom constructs emphasizing their historical separateness and right to political autonomy took hold in the nineteenth century. Thanks to European assistance, Lebanon gained autonomous status within the Ottoman Empire by the 1860s. Such was not the case in historic Armenia, where an active nationalist movement came into conflict with the Ottoman state as well as with the area's Turkish and Kurdish population in the later nineteenth century, and where fear of nationalism led to the mass expulsion and massacre of Armenians by the Ottoman government in the early twentieth.

In both Egypt and Iran, distinct geographical areas existing as autonomous polities with their own ruling structure (Iran since the sixteenth century, Egypt since the early nineteenth) led Westernized Egyptian and Iranian intellectuals to assert the existence of historically unique Egyptian and Iranian "nations" by the later decades of the century. Egyptian nationalism took political form by the later 1870s, when indigenous Egyptian elites sought greater control over an originally Ottoman ruling family and the European financial domination that dynastic extravagance was producing; their movement's slogan "Egypt for the Egyptians" succinctly expresses its overall thrust. Active nationalist activity in Iran dates from the 1890s and was produced by much the same combination of dynastic incompetence and foreign economic penetration; in the Iranian case it generated a formally successful Iranian constitutional movement in the early years of the twentieth century.

For the Turks of Anatolia and the Arabs of the Fertile Crescent, both living under Ottoman rule through the long nineteenth century, the causes producing nationalism were parallel. A precondition for modern Turkish and Arab nationalism was the development of a firm sense of ethnic identity. This was stimulated in the Turkish case by the discoveries of European Turkology, the uncovering of the pre-Islamic history of the Turkic-speaking peoples in Central Asia and beyond that fostered identification with a historic ethnic distinct from both the Muslim community and the multiethnic Ottoman Empire, in the Arab case by the process known as the "Arab Awakening," the blossoming of Arabic literature and history that occurred in the middle decades of the nineteenth century. As elsewhere in the Middle East, increasing elite contact with Europe and a growing awareness of European ideas also played a role. Nationalism is a modular concept, "available for pirating" (to pirate Benedict Anderson's phrase) by all those impressed by Europe and the world supremacy its nations were able to achieve in the modern era.

The catalyst turning a heightened sense of ethnic identity into visible Turkish and Arab nationalist movements was the trajectory taken by the Ottoman Empire over the course of the nineteenth century. On the one hand, the empire's territorial crumbling as European powers established their control over its African dominions and the peoples of the Balkans gained independence raised the possibility of a similar dismemberment of its Asian heartlands, thereby generating a search for an alternative base for viable community. On the other hand, the Ottoman government itself assumed a more reactionary character by the later decades of the nineteenth century. For educated Turks and Arabs, who were absorbing the values of individual liberty and participatory politics from their European mentors, the Ottoman Empire increasingly came to be seen as an undesirable framework for modern life.

Turkish and Arab ethnic nationalism became active movements only in the early twentieth century, specifically in the "Young Turk" era (1908–1918). Among Turks new organizations with an explicitly Turkish emphasis (the Turkish Society, formed 1908; the Turkish Hearth Clubs, formed 1912) emerged; in the press, extravagant ideas of uniting all Turkic-speaking peoples in a ethnically based "Turanian" state were voiced; on the governmental level efforts at increased centralization emphasized the primacy of the Turkish language within the state and sometimes gave precedence to ethnic Turks (although not to the degree once assumed). Similar organizational and intellectual trends occurred in the Arabic-speaking provinces of the Fertile Crescent: new Arab societies with a political agenda (the Ottoman Administrative Decentralization Society, 1912) emerged; demands for Arab autonomy were expressed in the press; and an Arab Congress was held in Paris in 1913 to promote Ottoman decentralization. The continued drive for centralization being undertaken by the Young Turk regime ran counter to what was originally an Arab demand for provincial decentralization. By the eve of World War I, a new trend was developing in the Arab provinces as prominent individuals and secret societies began to think of Arab independence as the only way to avoid subjugation within what politicized Arabs were coming to see as an oppressive "Turkish" state.

Modern Jewish nationalism (Zionism) did not require a similar process of the rediscovery of national distinctiveness. A sense of collective uniqueness and solidarity existed among Jews well before the nineteenth century. This sense was solidified by Judaism's liturgical language (Hebrew), the rich tapestry of distinctive customs, and the shared isolation of and discrimination against Jews living in European countries. An active Jewish nationalist movement based on this sense of distinctiveness was produced on the one hand by the gradual process of emancipation and assimilation experienced by Jews in parts of Europe during the nineteenth century, a process of historical change that also involved the acceptance of modern nationalist concepts, and on the other by growing European anti-Semitism, a phenomenon that led Jews to question their future in national states where powerful movements were now defining Jews as an alien element. In direct response to rising anti-Semitism in the Russian Empire, in the 1880s Zionist societies emerged in eastern Europe and began to organize Jewish immigration to Ottoman Palestine. By the late 1890s an

international organization of Jews, the World Zionist Organization (WZO; established 1897), had been founded "to create for the Jewish people a homeland in Palestine secured by public law" (its founding declaration), and in the years prior to World War I the WZO worked to encourage Jewish migration and the initial development of distinctive Jewish national institutions in Palestine itself.

World War I and Its Settlement

World War I and its settlement had a crucial impact on nationalism in the Middle East. Ottoman entry into the war on the side of the Central Powers led to Ottoman military defeat. At war's end, the victorious allies began the process of partitioning the Ottoman Empire in accord with secret wartime arrangements. The postwar attempt at Allied domination was unsuccessful in the primarily Turkish-speaking Anatolian portion of the empire, where a vigorous Turkish nationalist movement led by the charismatic General Mustafa Kemal (later Atatürk) successfully resisted European domination and in the process abolished the Ottoman Empire and replaced it with the new state of Turkey (1923). Quite a different course of events were obtained in the Fertile Crescent, which Great Britain and France divided between themselves. France received a League of Nations mandate for "Syria" (initially including Lebanon, defined as a separate state in 1920), Great Britain mandates for the territories of "Iraq" and "Palestine" (the latter comprising today's Israel and Jordan). In the process of imperial partition, a nascent Arab nationalist movement that had emerged during the war and established an Arab government in Damascus was crushed by French military action. In Palestine, where the terms of the mandate allowed for large-scale Jewish immigration in order to facilitate the emergence of the Jewish "national home," the postwar settlement also laid the basis for the subsequent emergence of the state of Israel.

The contrast between the course of events in Turkish-speaking Anatolia and in the Arabic-speaking Fertile Crescent deserves emphasis. Turkish nationalism emerged successful out of the turmoil of World War I and its settlement, realizing its goal of the creation of a Turkish national state predicated on the existence of a linguistically based Turkish ethnic community. Nothing succeeds like success; Turkey has remained the object of national self-definition and allegiance for its Turkish-speaking majority ever since its creation in the early 1920s. In the Arab case a nationalist movement similar in genesis and aspiration, but geographically more vulnerable, was eliminated by European force of arms. In its stead the Fertile Crescent was divided into several artificial political units according to imperial fiat. None possessed deep roots; the reality and viability of all were to be deeply contested in the years to come.

Differential Nationalist Trajectories

The several nationalisms considered above have taken very different paths since World War I and its settlement. In Iran the territorially based nationalism that emerged in the nineteenth century remained dominant under the Pahlavi dynasty (1921–1979). It was never fully accepted, however, by more religious Iranians, particularly by the country's powerful Shiite religious hierarchy. In the late 1970s the religious class played a leading

role in overthrowing the secular nationalist government of the shahs. In the 1980s the promotion of worldwide Islamic solidarity and international Islamic revolution became the leitmotif of Iranian foreign policy. In the 1990s, as the Iranian revolution moderated, the concept of Iran as a distinct national community again received greater emphasis. The precise nature and implications of Iranian collective identity is a contested issue at the start of the twenty-first century, part and parcel of the struggle between more liberal and more conservative Iranians.

With the creation of a cohesive independent state in Anatolia, Turkish nationalism largely shed the grandiose visions of pan-Turkic unity that had been expressed by some of its early proponents. Reified and promoted by the government of the new Turkish state during the long ascendancy of Mustafa Kemal Atatürk in the 1920s and 1930s, belief in the construct of a Turkish nation centered in Anatolia gradually disseminated beyond the elite circles in which Turkish nationalism had been born. The post-Atatürk decades have seen intensive debate among Turks as to the orientation of the Turkish state, particularly over the question of the role of religion in public life; but the participants in these debates have by and large not challenged the existence of a Turkish nation. The one partial exception is Turkey's marginalized Kurdish-speaking population, among whom demands for cultural and political autonomy surfaced in the later decades of the twentieth century and generated a prolonged civil war in eastern Turkey in the 1980s and 1990s.

The Zionist movement realized its main goal with the creation of the Jewish state of Israel in 1948. Some religiously oriented groups have never accepted the legitimacy of a Jewish state created as a result of human rather than divine agency. Moreover, fierce debates over the internal character of the state (for example, the role of religion in public life and the relationship of the Palestinian Arab minority to state institutions), as well as over the territorial extent of the state (the fate of the Palestinian-inhabited territories of the West Bank and Gaza Strip occupied by Israel in 1967), have continued to perturb Israeli public discourse. However, these debates occur among a Jewish population the vast majority of whom have accepted Israel as their national community of destiny.

Egypt was granted formal independence by Great Britain in 1922 in response to a nationalist uprising after World War I, and territorially based nationalism remained the dominant political construct in Egypt for most of the three decades of the parliamentary monarchy (1922–1952). Its cutting edge was Pharaonicism, an intellectual movement that posited the existence of a distinctive national character deriving from the ancient Egyptians. From the later 1930s the primacy of this locally based nationalism was challenged by voices that insisted upon Egypt's Arab affiliations and that emphasized the common problem of imperialist domination facing all Arab regions. Thereafter, both Egyptian opinion and Egyptian state policy evolved in a more Arabist direction, especially after the Egyptian revolution of July 1952. Under the leadership of Gamal Abdel Nasser, by the late 1950s Egypt had become the champion of Pan-Arabism. In 1958 it joined with Syria in the major experiment in Arab unity of the twentieth century, the United Arab Republic (1958–1961). The collapse of

the UAR when Syria seceded in 1961 in effect marked the turning point in Egypt's involvement in the Arab nationalist movement. A drift away from commitment to Arab nationalism set in Egypt from the 1960s onward. It accelerated under Nasser's successors Anwar al-Sadat and Hosni Mubarak, both of whose policies have emphasized Egypt as a separate political entity with its own national interests.

The fate of nationalism in the Arabic-speaking lands of the Fertile Crescent since the post-World War I settlement has been complex. In the interwar era the new states created after the war gradually acquired a degree of reality in the minds of their inhabitants. The effectiveness of state consolidation varied from country to country. It was probably strongest in Lebanon, where spokesmen among the country's slight Christian majority expounded an exclusively Lebanese nationalist ideology focused on the country's long history since the era of the Phoenicians as a uniquely "Mediterranean" nation different from other Arabic-speaking lands. It was probably weakest in Syria, where much of the political elite clung to the vision of the united Arab state that had been destroyed by imperialist partition in 1920. Among Palestinian Arabs a distinctive local identity was on the one hand fostered by the conflict with Zionism, but on the other was undercut as Palestinians sought outside Arab solidarity and support in the same struggle.

The process of Arab state consolidation in the Fertile Crescent was uneven. Continuing foreign domination reinforced the perception that the new states created after World War I were artificial entities established to suit imperial interests. An aura of what-should-have-been hovered over Arab politics in the Fertile Crescent, a belief that Arabs had been swindled out of the unity that was their proper destiny. After World War II this disaffection with existing states and belief in the desirability of their replacement by a state uniting most Arabs blossomed into Pan-Arabism, the drive for integral Arab unity that was a central component of Arab politics through the 1950s and 1960s.

The process of territorial state consolidation was facilitated with the recession of Pan-Arabism from the later 1960s onward. Over the decades the expanding institutions of the territorial state (bureaucracy, schools, vested interests) and its new symbols (flags, monuments, national holidays) bound the population to the state and gave greater substance to what had been artificial entities. At the level of policy-making there has been a clear trend away from the pursuit of Arab unity toward the realization of state interests since the 1960s. Wider Arab nationalist sentiments—belief in the existential reality of an Arab nation transcending existing state borders—have not totally faded. There is also an impressive degree of inter-Arab economic and cultural cooperation that has developed over time under the auspices of the League of Arab States and similar agencies. Pan-Arab issues, especially Palestine, are capable of arousing deep emotions across the Arab world. But, in the shifting relationship between the alternative concepts of local/statal allegiance and a broader identification with an Arab nation based on the bonds of language and history, the former appears to be the more prominent tendency at the beginning of the twenty-first century.

After Nationalism?

A significant challenge to nationalism has emerged in the Islamist movements that have gained prominence in recent decades. At the abstract level, the primacy of the religious bond over loyalty to territory, polity, or *ethnie* is basic to Islamist ideology. The formulation of Sayyid Qutb, founding father of Sunni Arab Islamism, states the position starkly: “There is no country for a Muslim except that where the law of God is established. . . . There is no nationality for a Muslim except his belief, which makes him a member of the Islamic community” (*Milestones*, p. 103). In political terms, a considerable measure of sympathy, mutual aid, and collaborative action have marked the relations between Islamist activists and movements originating in different countries. From the galvanizing impact of the Iranian Revolution of 1979 on Islamist activism elsewhere, through international support for the mujahideen opposing Soviet occupation in Afghanistan in the 1980s, to the international makeup and operations of Al Qaeda in the 1990s and after, a revived emphasis on the Islamic *umma* (Arabic, “community” of believers) as the most meaningful community of solidarity and destiny for Muslims has reasserted itself in the contemporary era.

But this is not the whole story. Territorial and ethnic nationalism still have their advocates, ideologues, and public figures who question the political salience of the religious bond and who posit that political behavior should be based on non-religious criteria. The current division of the Muslim world into numerous states inevitably influences the practical articulation of contemporary Islamism. Many Islamist activists accept the reality of existing territorially or ethnically based states and operate within the political field determined by state structures, directing their activism toward infusing existing states with a more Islamic content.

By reasserting the centrality of a previously recessive collective identity, the Islamic resurgence of the late twentieth and early twenty-first centuries has complicated but not totally transformed the nationalist landscape of the Middle East. Sentiments of religious solidarity coexist with territorial, local, and ethnic/linguistic nationalism. The result is a complex, crowded, and unstable universe of imagined communities in which individuals are faced with determining the relevance of alternative referents for self-definition, allegiance, and action.

See also *Pan-Arabism; Pan-Turkism; Zionism*.

BIBLIOGRAPHY

PRIMARY SOURCES

- Antonius, George. *The Arab Awakening*. London: H. Hamilton, 1938. The classic account of the genesis of Arab nationalism.
- Haim, Sylvia G., ed. *Arab Nationalism: An Anthology*. Berkeley: University of California Press, 1962. A lengthy introductory essay followed by excerpts to the 1960s.
- Hertzberg, Arthur, ed. *The Zionist Idea: A Historical Analysis and Reader*. Garden City, N.Y.: Doubleday, 1959. A lengthy introductory essay and a wide range of excerpts from Zionist thinkers.

SECONDARY SOURCES

- Avineri, Sholmo. *The Making of Modern Zionism: Intellectual Origins of the Jewish State*. New York: Basic Books, 1981. A probing intellectual history.
- Dawisha, Adeed. *Arab Nationalism in the Twentieth Century: From Triumph to Despair*. Princeton, N.J.: Princeton University Press, 2003.
- Gelvin, James L. *Divided Loyalties: Nationalism and Mass Politics in Syria at the Close of Empire*. Berkeley: University of California Press, 1998. A pioneering analysis of the relationship of elite and nonelite Arab nationalism.
- Hanioğlu, M. Şükrü. *Preparations for a Revolution: The Young Turks, 1902–1908*. New York: Oxford University Press, 2001. The continuation of his 1995 work.
- . *The Young Turks in Opposition*. New York: Oxford University Press, 1995. A detailed account of the genesis of the main Turkish nationalist movement.
- Jankowski, James, and Israel Gershoni, eds. *Rethinking Nationalism in the Arab Middle East*. New York: Columbia University Press, 1997. Essays suggesting new approaches to the study of nationalisms in the Arab world since World War I.
- Khalidi, Rashid, et. al., eds. *The Origins of Arab Nationalism*. New York: Columbia University Press, 1991. Studies of the development of Arab nationalism up to World War I.
- Khoury, Philip S. *Urban Notables and Arab Nationalism: The Politics of Damascus, 1860–1920*. Cambridge, U.K.: Cambridge University Press, 1983. A thoughtful exploration of the social basis of Arab nationalism.
- Laqueur, Walter. *A History of Zionism*. New York: Holt, Rinehart and Winston, 1972. A comprehensive political and intellectual history of Zionism to 1948.
- Lewis, Bernard. *The Emergence of Modern Turkey*. London: Oxford University Press, 1961. A classic exploration of Turkish political and intellectual history.
- Mottahedeh, Roy. *The Mantle of the Prophet: Religion and Politics in Iran*. New York: Simon and Schuster, 1985. A masterful study of how religious and nationalist thought intertwine.
- Qutb, Sayyid. *Milestones*. Indianapolis, Ind.: American Trust Publications, 1990.
- Sternhell, Zeev. *The Founding Myths of Israel: Nationalism, Socialism, and the Making of the Jewish State*. Translated by David Maisel. Princeton, N.J.: Princeton University Press, 1998. A revisionist interpretation arguing for the nationalist over socialist ideas in Zionism.

James Jankowski

NATIONALISM IN MUSIC, EUROPE AND THE UNITED STATES

Nationalism in music has traditionally been described as a late-nineteenth-century phenomenon associated with countries or regions aspiring to nationhood whose composers strove to wed a national (most often folk-based) musical idiom to existing “mainstream” genres. Some of these accounts begin with Frédéric Chopin (1810–1849), but he is more often understood as “cosmopolitan” or “universal,” a Romantic composer of Polish and French parentage whose work was often based on Polish dance forms but was too early to count as nationalist. Most accounts of musical nationalism start with Russians in the next generation, especially the *moguchaya kuchka*—the “mighty little heap,” or the “mighty five,” including Nikolay Rimsky-Korsakov (1844–1908),

Modest Musorgsky (1839–1881), and Aleksandr Borodin (1833–1887)—and continue with the Czechs Bedřich Smetana (1824–1884) and Antonín Dvořák (1841–1904), the Norwegian Edvard Grieg (1843–1907), and the Finnish Jean Sibelius (1865–1957). Within this narrative line, the rise of a musical form of Impressionism in France and the genesis of a distinctively American music may be seen as late developments, somewhat out of step with general trends.

Yet nationalism has provided the principal cultural and political framework for musical expression within European-based traditions for most of the nineteenth century and has continued to do so up to the present. This tendency has not been widely noted for two main reasons: First, it remained overlooked because of the entrenched habit of considering European music history apart from history more generally, as encouraged by the doctrine of absolute music; and second, the genesis and development of musicology—the discipline entrusted to tell the history of music—were both intimately connected to nationalist ideologies.

Musicology and Nationalism

Music history in the nineteenth century has generally been perceived in terms of “mainstream” traditions continuing from the late eighteenth century, the general rise of Romanticism across these mainstreams, and the splintering into a variety of “nationalist” musics in the later part of the century. But nationalism lay at the heart of all facets of this master narrative, from the maintenance of the “mainstreams” to Romanticism and, most especially, to the narrative perspective. The principal task of historical musicology, for much of the time since about 1850, has been the promotion and development of a historicist canon to support a particular nationalist ideology. Moreover, as European nationalism, especially in Germany and Italy, led to two world wars in the twentieth century, some of its victims who fled to the United States (especially in the 1930s) established the American scholarly tradition in musicology, teaching the same history they had been taught and thus perpetuating the view that the most important musical tradition was German, which was to be understood as the least nationalist and most universal (Bach, Beethoven, Brahms, etc.), trailed by Italian opera and older Italian traditions, a few isolated “cosmopolitan” geniuses such as Chopin, and various “national” schools at the margin of respectability, whose legitimacy was cast in doubt not least because their music was widely enjoyed.

Nationalism and Art

Nationalism holds that a “people,” whether defined in terms of cultural or ethnic roots, constitutes the only legitimate basis for a political state. This belief took root in Europe around the beginning of the nineteenth century, as an outgrowth of German Romanticism, the French Revolution, the Napoleonic wars, and (according to some views) human inclinations. The merger of nationalist feeling and art was accomplished using the model proposed by German poet and philosopher Friedrich von Schiller (1759–1805) of how an artist might project—for those in the urbanized present who stand in imperfect relation to a more ideal past—either a fuller sense of that lost past (through idyll and elegy), a critical account of

the present (through satire), or a believable future restoration. Coupled with the idea of the *Volksgeist* (the spirit of a people) promulgated by fellow German Johann Gottfried von Herder (1744–1803), Schiller’s structure became a recipe for the nationalist artist: the idealized past, for the nationalist, is the past of a “people” who survive into the present (i.e., in the *Volk* of the countryside), and the ideal future for which one strives is a “nation” in which they are restored to their earlier oneness with the land of their past. Images, narratives, and projections that instill belief in a people’s valued past—that is, mythologies—thus quickly became a core ingredient in the artistic advancement of nationalism.

German Nationalism

The early stages of a specifically musical engagement with nationalism may be found in the late-eighteenth-century fascination with folk song, which fed the development of early nineteenth-century German lieder, folk-based chamber songs expressive of a yearning subjectivity. In his lieder, Franz Schubert (1797–1828) placed that subjectivity, often alienated, within a specific landscape, frequently carried within the piano’s figuration. Such placement of people within a landscape became a core strategy of nationalist art, and was more elaborately accomplished in German Romantic Opera, beginning with *Der Freischütz* (1821) by Carl Maria von Weber (1786–1826) and continuing in the next generation with the operas and music dramas of Richard Wagner (1813–1883); particularly effective were Weber’s evocations of the German woods, through horn choirs, and his (and Wagner’s) frequent recourse to mythology. Beethoven’s Ninth Symphony (1824) is implicitly nationalist, but in a forward-looking way, projecting a temporal and geographic fusion of classical Greek ideals (Elysium), “oriental” (“Turkish”) tropes, and modern German Christianity. In the generation following his death, Beethoven became the cornerstone of Germany’s nationalist claims to pre-eminence in music. By the middle of the nineteenth century, older German musical treasures from the past (especially those by J. S. Bach) were being systematically collected, establishing a milestone in the nascent field of musicology. After the Franco-Prussian War (1870–1871) and the unification of Germany that resulted from it, the Festspielhaus in Bayreuth—the opera house designed and built by Wagner—became an enduring monument to “Holy German Art.”

During the same general period, Italy also became unified, led by a movement—the Risorgimento—whose slogan (“Vittorio Emanuele Re D’Italia,” championing a leader of the movement) was based on the letters spelling the name of the foremost Italian composer, Giuseppe Verdi (1813–1901). After the Franco-Prussian war, French composers, who until then competed primarily with Italy, and mainly in the domain of opera, began to engage deliberately with Germany’s proclaimed mastery of instrumental music, at which point various musical nationalisms began to proliferate according to the familiar narrative outlined above.

Features of Nationalist Music

While musical nationalism could adopt a variety of specific profiles according to the “nation” involved, these all had a

number of features in common. Many nationalist musics relied on folk idioms that, however inaccurately, could be claimed as a national heritage. Opera and program music lent themselves easily to national themes; and opera also had recourse to rousing choruses, which could not only evoke the character and presence of a people—most notably “Va, pensiero” in Verdi’s *Nabucco* (1842) and the coronation scene in Mussorgsky’s *Boris Godunov* (1872)—but also cross over into popular currency. Ethnographic studies could either add legitimacy to native folk idioms or form the basis for a nationally conceived exotic “other” to be assimilated and synthesized in national terms. Thus, “Spanish” music provided both Russian and French composers an opportunity to indulge in coloristic orchestration that was itself a source of nationalist pride; such as in *Carmen* (1874) by Georges Bizet (1838–1875) and *Capriccio Espanole* (1887) by Rimsky-Korsakov. Similar use was made of Asian sources (e.g., in Rimsky-Korsakov’s *Scheherazade*, 1888), analogous to the earlier tradition regarding the “Turkish” topic. Eventually, ethnographic research evolved from a kind of colonialist interest in the “other” into another vehicle for nationalist endeavor, with some ethnomusicologists holding that only “authentic” members of a group ought to conduct research into its musical traditions.

The Legacy of Nationalism and the Special Case of the United States

Nationalism must be at least partly blamed for the Holocaust and other instances of “ethnic cleansing” in the twentieth century, given that nationalism’s intense focus on defining an authenticating group identity entailed a corollary focus on what that group was not. The most notorious early instance of this in musical discourse was Wagner’s essay *Das Judentum in der Musik* (1850; rev. 1869), which helped give nationalism a racialized profile it has never lost.

Nationalism has often moved in quite another direction in the United States, which, according to the European model, would have had either to elevate the American Indian as the core part of its authenticating past or to foster an alternative mythology of a “virgin” land settled by Europeans, transformed by their new setting. A third alternative, which has helped absorb the contradictions between the first two, has been to claim some form of “melting pot” nationalist basis; such was Dvořák’s approach in his “New World” Symphony, op. 95 (1893), blending “Negro” melodies (spirituals), Indianist idioms, and a European-based style, in a recipe later taken up by William Grant Still (1895–1978) in his blues-based *Afro-American Symphony* (1930), for example. More central exemplars of American nationalist music are the often nostalgic “New England” idiom of early modernist Charles Ives (1874–1954), the jazz-based concert idiom of George Gershwin (1898–1937), and the “wide-open spaces” idiom of Aaron Copland (1900–1990), which was often allied with an emergent American style of balletic dance. Departing from these “high art” traditions, many have chosen to locate America’s most distinctive musical profile within popular music, either within jazz (“America’s classical music”) or song, which has, historically, absorbed a wide number of influences. In terms of musical nationalism, perhaps the most fully realized

American tradition—based on popular song styles and a variety of mostly assimilationist plots—is that of the American musical, both for the stage and in films.

See also *Absolute Music*; *Musicology*; *Motif*; *Motif in Music*.

BIBLIOGRAPHY

- Applegate, Celia. “How German Is It? Nationalism and the Idea of Serious Music in the Early Nineteenth Century.” *Nineteenth-Century Music* 21, no. 3 (spring 1998): 274–296.
- Beckerman, Michael. “In Search of Czechness in Music.” *Nineteenth-Century Music* 10, no. 1 (summer 1986): 61–73.
- Beller-McKenna, Daniel. “How Deutsch a Requiem? Absolute Music, Universality, and the Reception of Brahms’s Ein deutsches Requiem, op. 45.” *Nineteenth-Century Music* 22, no. 1 (summer 1998): 3–19.
- Gellner, Ernest. *Nationalism*. New York: Weidenfeld and Nicolson, 1997.
- Gossett, Philip. “Becoming a Citizen: The Chorus in Risorgimento Opera.” *Cambridge Opera Journal* 2 (1990): 41–64.
- Hamm, Charles. “Dvořák in America: Nationalism, Racism and National Race.” In his *Putting Popular Music in Its Place*, 344–353. Cambridge, U.K., and New York: Cambridge University Press, 1995.
- Kallberg, Jeffrey. “Hearing Poland: Chopin and Nationalism.” In *Nineteenth-Century Piano Music*, edited by R. Larry Todd, 221–257. New York: Schirmer Books, 1990.
- Kramer, Lawrence. “The Harem Threshold: Turkish Music and Greek Love in Beethoven’s ‘Ode to Joy.’” *Nineteenth-Century Music* 22, no. 1 (summer 1998): 78–90.
- Pederson, Sanna. “A.B. Marx, Berlin Concert Life, and German National Identity.” *Nineteenth-Century Music* 18, no. 2 (fall 1994): 87–107.
- Rumph, Stephen. “A Kingdom Not of This World: The Political Context of E.T.A. Hoffmann’s Beethoven Criticism.” *Nineteenth-Century Music* 19, no. 1 (summer 1995): 50–67.
- Steinberg, Michael P.. *The Meaning of the Salzburg Festival: Austria as Theater and Ideology, 1890–1938*. Ithaca, N.Y.: Cornell University Press, 1990.
- Stokes, Martin, ed. *Ethnicity, Identity and Music: The Musical Construction of Place*. Oxford and Providence, R.I.: Berg, 1994.
- Taruskin, Richard. *Defining Russia Musically: Historical and Hermeneutical Essays*. Princeton, N.J.: Princeton University Press, 1997.
- . “Nationalism.” In *The New Grove Dictionary of Music and Musicians*, edited by Stanley Sadie and John Tyrrell, vol. 17, 689–706. London: Macmillan, 2001.
- Tischler, Barbara. *An American Music: The Search for an American Musical Identity*. New York: Oxford University Press, 1986.
- Weiner, Marc A. *Richard Wagner and the Anti-Semitic Imagination*. Lincoln: University of Nebraska Press, 1995.

Raymond Knapp

NATIVE POLICY. Before Europeans from a variety of countries began arriving on the shores of the two continents of the western hemisphere in the late fifteenth century, there were no “Indians.” At that point in time, millions of human beings, members of hundreds of distinctive societies speaking mutually unintelligible languages, inhabited the lands between Alaska

and Patagonia. The category of person called “Indian” resulted from the imposition of colonial rule by Spain, Portugal, France, England, and Holland upon the diverse societies the Europeans encountered on these two continents. Following European colonialism, the creation of independent republics in what came to be known, by another misnomer, as “the Americas” was also marked by dynamic relations between states controlled by elites of European descent and the peoples called Indians. First colonial regimes and then independent nation-states in Latin America and in North America have been concerned with the classification and regulation of who is Indian and what constitutes “Indianness.” We can call the operationalization of these systems of classification “Indian policy.”

Such a perspective, of course, is necessarily also a historical phenomenon itself. Historians and anthropologists have alternately ignored or obsessed over the indigenous peoples of the Americas that by convention are still called “Indians,” and have gone from understanding Indianness as an identity entirely tangential to the histories of nation-states, to the contemporary approach described above, in which Indianness and state policy are intertwined. Thus, at the same time that we review contemporary anthropological approaches to understanding Indian policy, we must simultaneously reflect upon those perspectives as substantially different from pre-1970 anthropological understandings of Indianness. This entry will discuss how Indian policy has developed in colonial and post-colonial nation-states of Latin America, and compare the evolution of Indian policy in Latin America as a whole with its evolution in the United States, acknowledging that this comparison increasingly parallels the pan-hemispheric struggles of indigenous peoples who themselves are engaging in such comparisons. Finally, describing indigenous struggles within and against the nation-states of the Americas in the twentieth century prefigures where those controversies are headed in the twenty-first.

Anthropology’s Changes

Up until the 1970s, most anthropologists approached Indian communities as discrete cultural units (a classic example would be Redfield and Villa Rojas), and were particularly fascinated by and drawn to those aspects of cultural practice and belief that appeared least influenced, distorted, or destroyed by European colonialism. Anthropologists were spellbound by the mystique of pristine, if not always primitive, Indian cultures—the more isolated and removed from the mainstream of nation-states, the better. Even attempts to move anthropology beyond an obsessive focus upon an “Other” that contrasted with “the West” did not necessarily conceptually reconnect Indians to the world system to which they had historically been joined since the fifteenth century. For example, Eric Wolf’s early taxonomy of peasantries, and much subsequent ethnography of Indian communities as peasant communities, also characterized such communities as discrete and bounded units, albeit in a different analytic light.

A major breakthrough was achieved by June Nash in her study of Bolivian tin miners, who in her work appeared clearly as simultaneously members of the industrial working class and as Indians. Nash elaborated an analysis that did not downplay the distinctively Indian religious and cultural practices of the

miners, their complex political ideological relationship with the Bolivian state, or their emplacement within the capitalist world system. After Nash, it became possible to study Indian communities not only as part of global economic and political systems, but also as part of Latin American nation-states. Describing the policies that such nation-states were developing in response to Indian communities was a logical next step in anthropological work.

Perspectives on Colonialism and Postindependence Latin America

In the 1980s and 1990s, historians and anthropologists alike elaborated new analyses of the colonial and early independence eras in Latin America. These analyses made clear that from the beginning of the Spanish colonial era, ruling elites legislated and implemented policies for governing Indians that consigned them to an exploited, subaltern class position, and distinguished Indians from the non-Indian population. Many scholars also emphasized that the peoples who became known as Indians were not simply passive recipients of the brutalities colonial conquest wreaked upon them. Such scholars portrayed Indian peoples as dynamically responsive to the national and global political and economic systems. This latter point is still controversial, and Orin Starn has shown that well into the 1990s many anthropologists working in the Andes remained wedded to views of Indians that emphasized their cultural discreteness and isolation from nationalist ideologies and identities.

While the conquest indeed precipitated a demographic collapse among all indigenous groups, caused by massacres, enslavement, and pernicious epidemics, many Indian peoples survived through their own efforts. Acknowledging Indians as active makers of their own destinies draws attention to the key differences in how different Indian peoples negotiated the policies imposed upon them by colonial authorities. In the urban centers of the old indigenous empires in Mesoamerica and the Andes, colonial authorities were eager to utilize the labor afforded by their domination of Indian societies, while using the markers of Indian identity to signify subaltern status. These regimes wanted to diminish distinctive Indian identities by converting Indian peoples to Christianity, eliminating their native languages, and controlling Indian lands and resources. Yet they also wanted to maintain a large mass of servile, exploitable laborers. The dual motivations behind colonial Indian policy likely made it possible for Indian communities and leaders to at least partly subvert the intentions of colonial regimes.

Roger Rasnake elaborates the creation of postcolonial Indian authorities and social systems in the regions that became Bolivia, showing that Indians were able to manipulate state policies to achieve forms of local political and cultural autonomy. In colonial Mexico, Claudio Lomnitz-Adler has shown that the semiautonomous communities referred to as the “Indian Republics” of the eighteenth century ultimately “meant that the Spanish system recognized the existence of two nations with political representation within the Spanish state” (p. 267). In the collection edited by Carol Smith, authors writing about colonial Guatemala agree to a certain extent, arguing that the segregationist policies of the Spanish colonial state helped to establish strong Indian communities. In another

quite different region, Joanne Rappaport's work in the Cauca region of colonial Colombia shows that Indian communities subverted the Spanish *resguardo* institution, intended to concentrate and manage the supply of coerced Indian labor to the Spaniards' haciendas (plantations), resulting in the creation of regions of refuge for Indian communities.

Florencia Mallon, a historian, established similar dynamics in the early independence period in both Mexico and Peru, emphasizing the dynamic role of Indian and non-Indian peasants in the making of those two nation-states. By contrast, Smith argues that successive nineteenth-century state forms built the Guatemalan nation around Indian policies that decisively excluded Indians from national identity, even as Guatemala's economy was increasingly developed and incorporated into the global economy. In other countries, nineteenth-century Indian policy aimed to continue, in effect, the work of the conquest by ultimately eliminating Indian ethnic identities. This process of assimilating Indian peoples in Latin America through biological miscegenation and the suppression of sociocultural distinctiveness, which Les Field has elaborated in Nicaragua, has for centuries been called *mestizaje*.

Indian Policies of the Twentieth-Century Nation-States

Shifts in the ways that anthropologists have been analyzing contemporary state policies toward native peoples in Latin America are highlighted in two important anthologies published since the early 1990s. In Joel Sherzer and Greg Urban's collection *Nation-States and Indians in Latin America* (1991), contributors elaborated a galaxy of distinctive Indian identity formations, within the context of national identities. As in colonial times, these national identities have in the main excluded indigenous peoples from full citizenship as Indians, but instead utilized state policy to culturally assimilate Indian peoples to thereby gain full control over Indian lands and resources. In this collection, authors document how Indian identities have resisted state-sponsored assimilation, but also experienced marked transformations of the cultural traits, practices, languages, and symbols that demarcate Indianness.

Twelve years later, the publication of Kay Warren and Jean Jackson's *Indigenous Movements, Self-Representation, and the State in Latin America* (2002) crystallizes the changes among Indian peoples in the interim, as well as the new anthropological responses to current conditions. Contributors in this collection have documented the importance of indigenous political movements as they marshal Indian cultural identities toward the twin goals of auto-representation (for local, national, and global audiences) and reordering the place of Indians in nation-states. The second goal signifies no less than the wholesale reconceptualization of national identities in Latin America, at the formal level of constitutions, political parties, laws, and leadership, as well as at the popular level. This anthology demonstrates anthropologists' commitment to even closer analysis of state policies and their multifarious effects upon Indian peoples.

Two other ethnographies demonstrate the vast differences evolving in state policy toward Indians in Latin America. In Charles Hale's exploration of "contradictory consciousness"

among the Miskitu of the Nicaraguan Atlantic coast, an Indian identity coalesced around opposition to the integrationist policies of the revolutionary Sandinista state. Even though this opposition became the banner for a florescence of Miskitu language and culture, it was allied to the United States' war against the Sandinistas. By contrast, left-wing coalition politics in the Juchitán region of Oaxaca, Mexico, described by Howard Campbell, created the local political conditions for both opposition to the federal Mexican state and the opportunity for Zapotec cultural renaissance. In these ethnographies, it is clear that state policies are having unpredictable effects upon and interactions with Indian peoples and cultures.

Comparisons with Indian Policy in the United States

Comparing the history of Indian policy in Latin America versus that history in the United States is instructive, particularly with respect to the issue of cultural assimilation of Indian peoples through *mestizaje*. *Mestizaje* as an intrinsic part of Latin American state policy profoundly departs from Indian policies in the United States, as elucidated by Les Field and Circe Sturm. In North America, treaty-making between indigenous peoples that began with the British colonial regime and continued under successive U.S. administrations in the eighteenth and nineteenth centuries ultimately created a category of officially acknowledged Indian people, the "federally recognized Indian tribe."

While the federal government has since the 1880s on at least three occasions attempted to disengage from the premise of federal recognition, which more or less accepts the indefinite existence of Indian peoples, these attempts have so far failed to put an end to this officialized status. Federally recognized tribes hold onto a sharply circumscribed, but nevertheless always potentially valuable, set of properties, that is, Indian reservations; furthermore, recognized tribes are authorized to make claims upon various parts of the U.S. federal bureaucracy. Indians who do not live on reservations but are members of recognized tribes can return to their designated reservations and make claims to resources. Even in urban areas, Indians from federally recognized tribes still maintain access to certain federally funded services, such as health and education. These resources are substandard in the estimation of Indians and non-Indians alike, and in no way compensate for the loss of immense territories, not to mention economic and political liberty. For this reason, Indian identities in the United States are closely policed by both federal and tribal authorities; tribal membership is substantiated via genealogy, or blood quantum, and the policies of both the tribes (acting as semiautonomous internal state forms) and the federal bureaucracy are obsessed with counting Indians and allocating resources.

Compared with the United States, state policy in Latin America is much less concerned with policing Indian identities for three reasons. First, whatever rights accrue to being Indian in Latin America are minimal, and wherever such rights exist, they depend upon residence in demarcated Indian communities. Second, popular genealogical theories in Latin America, that is, theories of "blood," encourage *mestizaje* as a means toward social mobility, rather than serving as legitimation for Indian identities as in the United States. Finally, nationalist ideologies in Latin America profoundly stigmatize

THE ANTI-QUINCENTENNIAL

The year 1992 marked the 500th anniversary of Columbus's fateful voyage that initiated the destruction of indigenous civilizations and the rise of nation-states dominated by elites of European descent. Pan-hemispheric organizing among Indian peoples mixed resistance to the plans by many countries in both North and Latin America to treat the anniversary as a cause for celebration, as well as an opportunity to express demands for profound changes in the relationship between Indian and national identities. Ecuador's indigenous confederation, CONAIE, which brings together diverse peoples from the Pacific coastal region, the Andean region, and the Amazon, formulated its demands during a series of uprisings in 1990, 1992, and 1994 (for a full description of the formation and politics of CONAIE, see CONAIE). CONAIE leaders called for a new kind of nation-state—*el estado plurinacional*—in which Indian identities would become by definition central to the nation, and for state policies explicitly intended to build the economic infrastructure for technologically advanced and politically autonomous Indian communities.

Such demands are mirrored in the post-1992 pan-Mayan movement in Guatemala described

by Kay Warren. Similarly, since the beginning of Mexico's Zapatista uprising in 1994, many anthropologists have been concerned to show this movement as both indigenous and national in scope. The economic and political goals enunciated by these indigenous movements in some ways resembled but in other ways markedly diverged from the objectives of the Latin American left in the 1990s. The differences manifested in anthropological analyses as well, with some anthropologists deciding to act as advocates for Indian movements, while others critiqued the Indian movements from Marxist or neo-Marxist perspectives (see, for example, the critical analysis in Alcida Rita Ramos's *Indigenism* [1998]). One area of future anthropological research will likely focus upon what happens when Indian movements in Ecuador, Mexico, Guatemala, and elsewhere achieve even some of their political and economic goals. Will finding a political and economic place in reconfigured Latin American nation-states exacerbate class differentiation and inequalities within and among Indian communities? How will new state policies affect such outcomes?

Indianness, associating it with poverty, ignorance, backwardness, and powerlessness. In the last regard, nationalism in the United States, and state policy over the last two centuries, do concur with state policies in Latin America. Yet without the history of treaties, reservations, and federal recognition that exists in the United States, which with all of its problems still provides a basis for both establishing and maintaining Indian identities, Latin American *mestizaje* has acted as a powerful ideological force aiding and abetting state policies aimed at disenfranchising and disarticulating Indian societies and cultures. Indeed, the struggles of indigenous movements to reconfigure nation-states in Latin America discussed above are aimed precisely at creating political and economic structures that will support the survival of Indian peoples into the future.

Indianness, National Policy, and Anthropology in the Twenty-First Century

Anthropologists sometimes exaggerate and sometimes underestimate the importance of their work and their ideas to “the

real world”—the world of governments and families, health and disease, happiness and despair. But in the case of Indian policy, anthropological knowledge has buttressed and often been the accomplice to national “regimes of truth” about Indian peoples. In the United States, an “official anthropology” funded and sponsored by the federal government has been a historic partner to state Indian policy. In Latin America, such an official anthropology has generally not had the same effects historically, with the exception of Brazil and Mexico. However, the rise of indigenous movements demanding control over lands and resources will likely oblige Latin American governments to act as “gatekeepers” and to utilize anthropological knowledge much more in order to ascertain and legitimize Indian identities in the twenty-first century. Anthropological knowledge in this century will therefore be simultaneously yoked to forging new state-Indian relations and new kinds of Indian policies, while also being engaged in reflective and critical analysis of these new relationships. These often contradictory roles will unfold in both North and Latin America.

See also *Anthropology; Colonialism; Empire and Imperialism; Indigenismo; Mestizaje; World Systems Theory, Latin America.*

BIBLIOGRAPHY

- Campbell, Howard. *Zapotec Renaissance: Ethnic Politics and Cultural Revivalism in Southern Mexico*. Albuquerque: University of New Mexico Press, 1994.
- CONAIE (Confederación de Nacionalidades Indígenas del Ecuador). *Las nacionalidades indígenas en el Ecuador*. Quito: Ediciones Tincui-Abya-Yala, 1989.
- Deloria, Vine, Jr., and Clifford M. Lytle. *The Nations Within: The Past and Future of American Indian Sovereignty*. Austin: University of Texas Press, 1998.
- Dyck, Noel, and James B. Waldram, eds. *Anthropology, Public Policy, and Native Peoples in Canada*. Montreal and Buffalo, N.Y.: McGill-Queen's University Press, 1993.
- Field, Les W. "Blood and Traits: Preliminary Observations on the Analysis of Mestizo and Indigenous Identities in Latin vs. North America." *Journal of Latin American Anthropology* 7, no. 1 (2002): 2–33.
- . *The Grimace of Macho Ratón: Artisans, Identity, and Nation in Late-Twentieth-Century Western Nicaragua*. Durham, N.C.: Duke University Press, 1999.
- Hale, Charles R. *Resistance and Contradiction: Miskitu Indians and the Nicaraguan State, 1894–1987*. Palo Alto, Calif.: Stanford University Press, 1994.
- Lomnitz-Adler, Claudio. *Exits from the Labyrinth: Culture and Ideology in the Mexican National Space*. Berkeley: University of California Press, 1992.
- Mallon, Florencia E. *Peasant and Nation: The Making of Post-colonial Mexico and Peru*. Berkeley: University of California Press, 1995.
- Nash, June. *We Eat the Mines and the Mines Eat Us: Dependency and Exploitation in Bolivian Tin Mines*. New York: Columbia University Press, 1979.
- Ramos, Alcida Rita. *Indigenism: Ethnic Politics in Brazil*. Madison: University of Wisconsin Press, 1998.
- Rappaport, Joanne. *The Politics of Memory: Native Historical Interpretation in the Colombian Andes*. Cambridge, U.K., and New York: Cambridge University Press, 1990.
- Rasnake, Roger Neil. *Domination and Cultural Resistance: Authority and Power among an Andean People*. Durham, N.C.: Duke University Press, 1988.
- Redfield, Robert, and Alfonso Villa Rojas. *Chan Kom: A Mayan Village*. Reprint. Chicago: University of Chicago Press, 1962. Originally published in 1934.
- Sherzer, Joel, and Greg Urban. *Nation-States and Indians in Latin America*. Austin: University of Texas Press, 1991.
- Smith, Carol A., ed. *Guatemalan Indians and the State, 1540 to 1988*. Austin: University of Texas Press, 1990.
- Starn, Orin 1992. "Missing the Revolution: Anthropologists and the War in Peru." In *Rereading Cultural Anthropology*, edited by George Marcus, 152–179. Durham, N.C.: Duke University Press, 1992.
- Sturm, Circe. *Blood Politics: Race, Culture, and Identity in the Cherokee Nation of Oklahoma*. Berkeley: University of California Press, 2002.
- Warren, Kay B. *Indigenous Movements and their Critics: Pan-Maya Activism in Guatemala*. Princeton, N.J.: Princeton University Press, 1998.

Warren, Kay, and Jean Jackson, eds. *Indigenous Movements, Self-Representation, and the State in Latin America*. Austin: University of Texas Press, 2002.

Wolf, Eric R. *Peasants*. Englewood Cliffs, N.J.: Prentice-Hall, 1966.

Les W. Field

NATURAL HISTORY. Natural history, the study of natural objects, has been a feature of all literate civilizations. In the Western tradition, starting with Aristotle, natural history has engaged scholars and has been an important feature of Western literature. The perspective with which writers have approached natural objects, and the aspects of interest to them, have varied as much as their cultures. Natural history has been written about as a form of philosophy, as entertaining literature, and as a form of didactic lesson. Aristotle, Pliny, Albertus Magnus, and Ulisse Aldrovandi's "natural histories" in many ways have little in common other than the objects about which they wrote. In addition, non-Western civilizations have rich literatures that go back centuries, on plants, animals, and minerals. And, anthropologists make the claim that numerous non-literate peoples have developed sophisticated conceptions of the natural world and its objects.

As a scientific discipline, however, natural history has a more restricted domain. When the term *natural history* is used today, it is most often in reference to the subject as it emerged in the mid-eighteenth century. In this modern form, natural history is the systematic study of natural objects (animals, plants, minerals)—that is, naming, describing, classifying, and searching for their overall order. As such, it has been at the heart of the life sciences. The modern scientific discipline of natural history that emerged in the middle of the eighteenth century was closely tied to the careers of two individuals: Carolus Linnaeus and Georges Louis Leclerc, comte de Buffon.

Naturalists, particularly those interested in plants, faced a serious problem at the time. An enormous quantity of material had come into Europe from areas recently explored by colonial powers. Naming and classifying the new plants presented a challenge because they did not fit easily into previously established systems. The Swedish naturalist Carlus Linnaeus (1707–1778) created a classification system for plants that placed them into twenty-four classes according to their number of stamens (male part) and their relative positions. The classes, in turn, were broken down into sixty-five orders primarily on the basis of the number and position of the pistils (female part). He used other characteristics to break the orders into genera and species. Overall, the system was simple, easy to remember, and easy to use.

Of equal importance, Linnaeus also provided a set of rules for naming plants. Before his reform of nomenclature, the scientific names of plants consisted of two parts, a word or set of words that identified a group of plants, and then a string of words that distinguished the characteristics of the plant from other plants. As a result, the scientific name was awkward, and because various writers had used different characteristics to

distinguish different plants, considerable confusion existed. Linnaeus proposed a simple reform that made plant names like human names, a single name common to all the species in a genus, and a second specific name that distinguished the species from others in the genus. He used this binomial nomenclature in his *Species plantarum* (1753; The species of plants) and recorded all the known species of plants in it. Later he extended his approach to animals. His reform quickly caught on and is the basis for contemporary nomenclature.

Although Linnaeus's main goal was the naming and classifying of natural products, he described them as part of a divine order, a balanced and harmonious system. In his mind, every plant and animal filled a particular place in a balanced order and functioned to help maintain it. Carnivores, for example, daily destroyed animals that if not checked would reproduce at a rate that would outstrip their source of food in short order.

While Linnaeus labored in Sweden, to the south, Georges Louis Leclerc, comte de Buffon (1707–1788), worked on a more secular vision of nature, and in a somewhat different manner. Louis XV of France had appointed Buffon as director of his royal garden in Paris. The Jardin du Roi was an institution that provided public lectures in natural history, cultivated a large public garden, and housed the royal collection of natural history objects. Buffon had a brilliant career there: he expanded the physical space to double its former size, increased the collections, and helped make it into the foremost institution for the study of the living world. More important, Buffon set out to prepare a catalog of the royal natural history collection, a standard practice in most large collections. But instead of planning a mere annotated list of the curiosities and rare objects in the collection, Buffon envisioned a much grander project: a complete natural history of all living beings and minerals. Over a period of almost fifty years he published thirty-six quarto volumes containing a theory of the earth, and natural histories of human beings, minerals, quadrupeds, and birds. (The rest was completed by a team of specialists in the two decades after his death.)

Buffon's *Histoire naturelle, générale et particulière* (1749–1789; Natural history, general and particular) comprises an encyclopedia that reflects the goals of the French Enlightenment. In his introductory essays, he elaborated a general philosophy that stressed the importance of observation and claimed that through empirical investigation naturalists might uncover the order in nature. He had little use for the work of people like Linnaeus who devoted their attention to naming and arranging specimens. In contrast, Buffon envisioned natural history to be a general survey of the natural world and an attempt to summarize all available knowledge about it. Also unlike Linnaeus, Buffon did not conceive of natural history as a handmaiden to Christianity, but rather for him nature is a creative natural power responsible for the harmony, balance, and fullness of life. Natural history should be the portrait of nature. Like the physical world, so well described by the Newtonian physical scientists of his day, the living world follows natural laws that investigation would reveal. Buffon's secular vision provided an attractive alternative to Genesis and explains the importance of his reputation in the French Enlightenment.

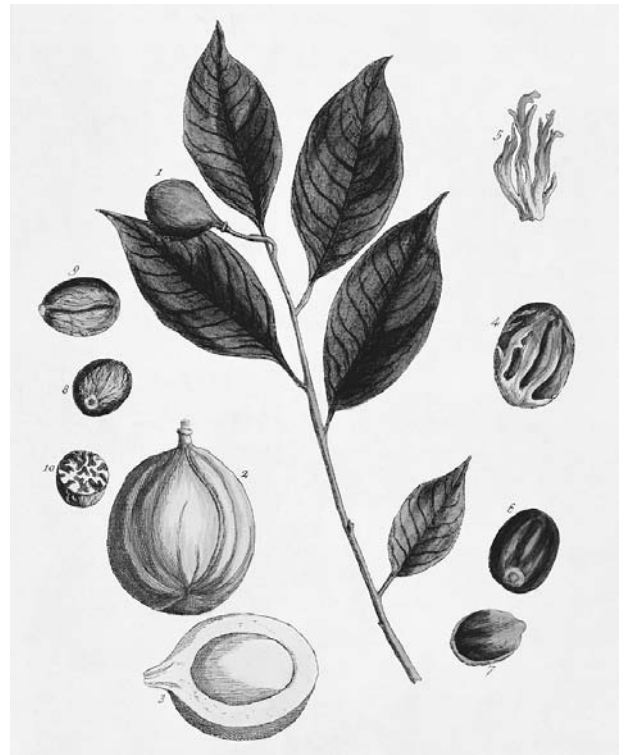

1782 drawing of nutmeg by botanist Elizabeth Blackwell. In the eighteenth century, Swedish naturalist Carolus Linnaeus began classifying plants based on the number and positions of their stamens. He also pioneered the system of binomial nomenclature still used in the twenty-first century to identify individual plants. © STAPLETON COLLECTION/CORBIS

Collections and the Growth of Natural History

Buffon and Linnaeus, although different in perspective, each contributed to molding natural history and inspiring others. They had each relied primarily on natural history collections for their work, rather than going out into the field in search of information. The fourteen thousand species of plants and animals described by Linnaeus, and the extensive accounts of quadrupeds, birds, and minerals that comprise Buffon's thirty-six volumes, reflected the extensive empirical base of knowledge available in private and public collections in the later half of the eighteenth century. But as impressive as the collections were compared to those of the previous century, they were just the beginning. An enormous expansion of natural history collections took place in the early nineteenth century and completely transformed them as well as natural history. Explorers, colonial officials, traveling naturalists, and commercial natural history houses had supplied collectors in the eighteenth and early nineteenth centuries. With the conclusion of the Napoleonic Wars, however, a new wave of European colonial expansion began, one reflecting the vast industrial and commercial revolutions that had been taking place in western Europe. Merchants and governments increasingly sought international markets and commercial products, and with these new developments there came what must have seemed like limitless opportunities for the collection of plants, animals, and

minerals. The resulting new collections were not only larger, but they were more scientifically valuable because trained collectors in the field were instructed in what was of scientific interest. They knew how to adequately preserve specimens and how to label them with appropriate information.

Combined, the new opportunities to collect on a global scale made a new sort of natural history collection possible. Until the end of the eighteenth century, most natural history collections had been primarily amateur ones whose owners were not scientists and who did not publish anything other than the occasional catalog. The reorganization during the French Revolution of the royal garden into a national museum of natural history provided a new model and led to the establishment of the leading natural history collection in the world for many decades. The new public and semi-public museums that were inspired by the Paris museum had professional curators who were active scientists.

Not only did the nature of the collections change in the early nineteenth century, but the number of individuals involved in the study of natural history increased dramatically. In large part, this reflected the many new opportunities that became available for those interested in the subject. Not only were more museums created, with curator positions, but also private companies supplied paid positions for those willing to travel to exotic places to collect specimens. The increase in literacy and the revolution in printing created new markets for those interested in writing for the general public. As a consequence, more people came to be engaged in the study of natural history, and the subject became, overall, more rigorous and more specialized.

Although the specialization in natural history created new specialized subdisciplines, such as ornithology and entomology, the legacy of Linnaeus and Buffon continued to guide research—that is, description, classification, and the search of a general order in nature. New empirical data raised interesting new questions. The carefully collected and labeled specimens that poured into European collections showed interesting patterns of distribution of animals and plants. Fossils from local and exotic quarries led researchers to ponder the relationship of extinct forms to contemporary ones. And the immense number of specimens showed that even within a species there was an astonishingly large amount of variation. What did it all mean?

Maturity of Natural History

The nineteenth century was rich in new theoretical approaches that attempted to explain the vast diversity in nature and the patterns that were emerging. On a more practical level, international commissions were established and worked to produce agreed-upon standards in nomenclature, bringing Linnaeus's goal of unity in naming closer. Museum curators developed taxidermic techniques that eliminated the threat of insect pests and pioneered new methods of display that would culminate in the wonderful dioramas of the American Museum of Natural History in New York, the Biological Museum in Stockholm, and in the hundreds of other large museums that were established. Natural history museums became standard

institutions in all major cities, and the new museums were large, well funded, and well attended. By 1900, there were 250 natural history museums in the United States, 300 in France, and 150 in Germany. Beyond the United States and Europe there were museums from Melbourne to Bombay, from Buenos Aires to Montreal. Along with the development of museums, there was a parallel development of zoological and botanical gardens that displayed and did research on living specimens. These were extraordinarily popular: In its first year, 1828, the Zoological Gardens in London's Regent Park had 130,000 visitors, and over the following decade that number swelled to a quarter of a million a year. By the 1880s, the garden attracted more than 600,000 people a year. With size and public support, the zoological and botanical gardens played new and important roles other than public entertainment and scholarly research. Kew Garden, outside London, functioned in an important manner in the global agricultural network that linked British interests to the transfer of important economic plants such as rubber plants and cinchona trees (important for quinine) throughout the empire. The New York Zoological Society Park pioneered the preservation of endangered species.

Important as these institutional and technical developments were, they have been somewhat overshadowed by the major intellectual synthesis provided by Charles Darwin (1809–1882). His theory of evolution by means of natural selection resolved the leading questions in natural history and also provided an intellectual structure that has proved to be the unifying theory of the life sciences. Like other naturalists of the nineteenth century, Darwin had been struck by the enormous diversity in nature and the interesting patterns of distribution that he and others observed. He was, similarly, curious about the relationship of fossils to living forms, and like many of his contemporaries who were trying to classify large groups, he attempted to sort out the differences between varieties and species. He approached the study of natural history with a secular perspective and sought natural explanations for the questions he asked. In an interesting sense, he combined and synthesized the traditions stemming from Linnaeus and Buffon. He sought the key to a classification and nomenclature system, and was searching for a secular vision of the order in nature. His *Origin of Species* (1859) has served as a model for how to envision and study nature.

Not that everyone agreed with his conclusions or his methods. For several decades scientists debated Darwin's theory. Some, like Louis Agassiz (1807–1873), did not want to break the tie between natural history and religion, while others were disturbed by numerous scientific problems: the age of the earth was not believed to be old enough for the process to have occurred, the theories of inheritance did not adequately explain how variation arose or how it could be transmitted in a way that supported the theory. Those in the medical sciences had been making great strides in investigations by using the experimental method and were elaborating a theory of the body based on an understanding of the cell. It was not clear how Darwin's science fit with that body of research. This latter issue was of special importance because many universities and other institutions were tending to see natural history as "old fashioned" by the end of the century and sought a new synthesis for the

life sciences in the exciting research stemming from the experimental sciences that were elucidating how the body functions.

Modern Synthesis and Contemporary Natural History

Life scientists in the late nineteenth century were agreed that life had evolved over time, but there was considerable disagreement over how that evolution had taken place. Darwin's emphasis on natural selection was thought to be problematic, and a variety of alternatives were proposed. The research on genetics in the early decades of the twentieth century provided tools for a new examination of the subject. Starting with Theodosius Dobzhansky's (1900–1975) *Genetics and the Origin of Species* (1937), naturalists were able to bring together several different lines of research to construct a new theory of evolution, one based on natural selection and the genetics of population change. Like Darwin's earlier theory, the modern synthesis, as the new theory is called, proved widely synthetic. Dobzhansky once wrote that nothing made sense except in the light of evolution, and this very well sums up the tremendous generalizing power of the modern theory. It has brought an evolutionary perspective on traditional subjects like the study of fossils and distribution, or the foundations of classification and nomenclature, as well as subjects like animal behavior, ecology, and conservation biology. With techniques and information from molecular biology, the theory of evolution has been extended to an understanding of evolution on the molecular level.

With contemporary interest in molecular biology, and especially the potential medical applications that it promises, it is easy to lose sight of the importance of natural history today. The unifying theory of the life sciences is still the theory of evolution that emerged from the naturalist tradition and is deeply rooted there. Contemporary naturalists like Edward O. Wilson argue that natural history still provides the vantage point from which to stand back and conceptualize the general order in nature. By studying a particular group from its molecular aspects to its widest ecological dimension, Wilson contends, we can go beyond much of the narrow research and discover general features of life. On a more practical side, natural history provides the tools for examining environmental issues and has been central in the call for preserving the biodiversity of the planet.

Natural history has been at the heart of the life sciences for over two centuries and remains a powerful set of ideas about the study of nature and its order. It has given rise to the major unifying theory of the life sciences, and it remains the repository of what we know about natural objects on the earth.

See also **Biology; Ecology; Environment; Nature; Science.**

BIBLIOGRAPHY

- Allen, David Elliston. *The Naturalist in Britain: A Social History*. Princeton, N.J.: Princeton University Press, 1994.
- Allen, Garland E. *Life Science in the Twentieth Century*. New York: Wiley, 1975.
- Barrow, Mark V., Jr. *A Passion for Birds: American Ornithology after Audubon*. Princeton, N.J.: Princeton University Press, 1998.

- Blunt, Wilfrid. *The Compleat Naturalist: A Life of Linnaeus*. New York: Viking, 1971.
- Browne, Janet. *Charles Darwin: Voyaging*. New York: Alfred A. Knopf, 1995.
- Coleman, William. *Biology in the Nineteenth Century: Problems of Form, Function, and Transformation*. New York: Wiley, 1971.
- Farber, Paul Lawrence. *Finding Order in Nature: The Naturalist Tradition from Linnaeus to E.O. Wilson*. Baltimore: Johns Hopkins University Press, 2000.
- Gunther, Albert E. *A Century of Zoology at the British Museum through the Lives of Two Keepers, 1815–1914*. London: Dawsons, 1975.
- Jardine, N., J. A. Secord, and E. C. Spary, eds. *Cultures of Natural History*. Cambridge, U.K., and New York: Cambridge University Press, 1996.
- Mayr, Ernst, and William B. Provine, eds. *The Evolutionary Synthesis: Perspectives on the Unification of Biology*. Cambridge, Mass.: Harvard University Press, 1980.
- Rothfels, Nigel. *Savages and Beasts: The Birth of the Modern Zoo*. Baltimore: Johns Hopkins University Press, 2003.
- Shteir, Ann B. *Cultivating Women, Cultivating Science: Flora's Daughters and Botany in England, 1760–1860*. Baltimore: Johns Hopkins University Press, 1996.

Paul Farber

NATURALISM. Naturalism was one of a wave of “isms” that swept through the cultural world of the late nineteenth century. Its most vocal advocate was the French author Émile Zola (1840–1902), a prolific novelist, dramatist, essayist, and critic. Highly controversial in the period between the heyday of realism (1830–1860) and the emergence of early forms of modernism at the end of the century, naturalism in France was so closely identified with Zola's fiction that few claimed the label after his death. The widespread translation of his work, however, gave Zola a global influence that led to the emergence of naturalist schools around the world. The influence of Zola's naturalism was particularly prominent in Russia, which in the nineteenth century had very strong cultural ties to France; in western European nations; and in the United States. The naturalist charge in the United States was led by novelist and critic Frank Norris (1870–1902), dubbed “the boy Zola” by contemporary critics. Although Norris is now considered somewhat of a secondary figure in U.S. literature, the naturalist aesthetic he popularized influenced major twentieth-century writers such as Theodore Dreiser, Upton Sinclair, and John Steinbeck.

In popular use, the term *naturalism* is sometimes used to mean fiction that exaggerates the techniques of realism, sacrificing prose style and depth of characterization for an exhaustive description of the external, observable world. Literary critics often accept this view, but add to it a laundry list of features used to identify the naturalist novel:

- a deterministic plot of decline or degeneration, where characters are crushed by the forces of a universe they can neither understand nor control;



1868 Portrait of Émile Zola by Édouard Manet. Oil on canvas. Zola's works turned an unflinching eye on the minutiae of human behavior, and he portrayed his characters with unstinting and often provocative detail. PORTRAIT OF EMILE ZOLA (1840–1902) 1868 (OIL ON CANVAS), MANET, EDOUARD (1832–83)/MUSEE D'ORSAY, PARIS, FRANCE, LAUROS/GIRAUDON/BRIDGEMAN ART LIBRARY/WWW.BRIDGEMAN.CO.UK

- attenuation of exceptional or heroic characters, so that each character is a balance of merits and flaws; the critic Philippe Hamon calls this an “aesthetic of normative neutralization” (p. 102);
- attention to lurid or squalid subject matter, particularly focused on the aspects of human experience conceived to be base or instinctual; main characters are often perverted by uncontrollable appetites, drives, or lusts;
- characters drawn from the working class—in U.S. naturalism particularly, perversion and degeneration are associated with working-class characters;
- a modern or contemporary setting, most often urban or industrial, rather than the geographically or temporally distant settings favored by adventure and romance fiction;
- sociological research by the author, including on-site investigation of a workplace, subculture, or location, expert advice, and incorporation of specialized vocabularies.

This list is derived in large part from Zola's most emblematic (and best-selling) novels, such as *L'assommoir* (1877), *Nana* (1880), *Germinal* (1885), and *La bête humaine* (1890), and closely matches other naturalist monuments, such as Frank Norris's *McTeague* (1899).

Origins of the Term

The precise meaning of the term *naturalism* varies across the disciplines: a literary critic, philosopher, theologian, and political scientist would each use the term in a slightly different way. In its broadest sense, naturalism is a doctrine holding that the physical world operates according to laws discernible through empirical science. The naturalist method, modeled after nineteenth-century innovations in the experimental sciences, involves informed, systematic observation of the material world. For the naturalist thinker, human beings are nothing more than a part of this world—like rocks, plants, and animals, they are subject to the laws of physics, chemistry, and biology, which govern human behavior as inexorably as they govern the natural world. Naturalism is thus materialist and anti-idealist in that it does not recognize the existence of nonmaterial or nonobservable phenomena (such as a spiritual realm or higher moral law); it is also antihumanist in that it grants no exceptional status to human beings. Every action taken by a human being, according to the strict naturalist view, has a cause in the physical plane; human behavior is thus entirely determined by the laws of cause and effect in the material world.

In applying this theory to literature, Zola drew on the work of an older contemporary, the French philosopher, historian, and literary critic Hippolyte Taine (1828–1893). Taine's monumental *Histoire de la littérature anglaise* (1863–1864; History of English literature)—a philosophical treatise disguised as literary criticism—sought to demonstrate that a nation's culture and character are products of material causes; as he put it in a famous quip, “vice and virtue are products, like vitriol and sugar” (p. 3). Taine argued that works of art are the products of three factors: *race*, *moment*, and *milieu*. Taine's English translator renders this phrase as “race, epoch, and surroundings” (p. 12), though the French term *race* is much closer to the English words *nation* or *people* than to *race*. In the analysis of literature, Taine claimed, “we have but a mechanical problem; the total effect is a result, depending entirely on the magnitude and direction of the preceding causes” (p. 13).

Zola's Understanding of Naturalism

While Taine sought to develop a scientific method for the analysis of literature, Zola's naturalism was a method for writing novels; where Taine sought to understand a nation through its literary output, Zola used naturalist philosophy as a basis for creating characters, and with them a portrait of French society in the second half of the nineteenth century. Combining Taine's theories with research developments in the biological and behavioral sciences, Zola conceived of the novel as a laboratory for the study of human behavior under the influence of heredity and environment. By his mid-twenties, having published several novels, he began to plot out his massive life's work, a twenty-novel series entitled *The Rougon-Macquart*—a work to rival the vast *Human Comedy* of Honoré de Balzac (1799–1850), to be based in science rather than intuition.

Zola tirelessly promoted his theories in columns that appeared in newspapers, magazines, and journals. Unfortunately, the most widely anthologized expression of this theory is also among the least thoughtful. This essay, “The Experimental Novel” (1880), is essentially an extended paraphrase of the physician Claude Bernard’s influential 1865 work, *Introduction to the Study of Experimental Medicine*. The essay is now regarded as historically interesting if theoretically naïve, and contemporaries—including former disciples of Zola, such as the author Henry Céard (1851–1924)—ridiculed it as a misunderstanding of Bernard’s work.

To take this essay as representative of Zola’s thinking about naturalism would be a serious error. Naturalism in literature was as much a promotional concept as a literary-critical one, and the range, variety, and energy of Zola’s writing about the term indicates he was perhaps less interested in providing a final definition than in keeping alive the heated debates about naturalism. As a literary critic, theater critic, and essayist, Zola was a provocateur: he was strident, often caustic, and prone to dramatic and sensationalist gestures. Early in his career, Zola came to understand and exploit the value of notoriety; his first volleys of criticism were collected in 1866 under the title *My Hatreds*, and his unrepentant slogan “I am here to live out loud” is still occasionally cited by artists and activists. “The Experimental Novel”—along with many of Zola’s defenses of naturalism—is best understood from this perspective: to criticize the essay for its lack of theoretical rigor is to miss entirely its brilliance as a provocation and a promotion.

If Zola’s criticism is more confrontational than systematic, a broader look at his writing on naturalism nonetheless reveals several consistent ideas. First, Zola often claimed that the lurid, pornographic subject matter of many his novels was incidental to naturalism; what counted was the method—which, as his former disciple Céard observed, could hardly be called “experimental,” but that nonetheless shared the careful, systematic observational methods of the emerging social sciences of psychology, sociology, and anthropology. For audiences that consumed Zola’s novels as quickly as he could write them and for critics and government censors who called naturalism “putrid literature,” the graphic content of the novels was naturalism’s most salient feature, and Zola and his publishers often faced obscenity charges in France and abroad (cheap pulp editions with racy covers appeared in the United States as late as the 1950s). For Zola, however, unflinching analysis was the substance of naturalism.

A second, often overlooked theme that runs throughout Zola’s writing on naturalism is his repeated association of naturalism and democracy. Perplexed scholars have called this connection a double dysfunction, a strange marriage, a paradox: nineteenth-century theories of biological determinism seem hardly compatible with the Enlightenment ideals of citizenship and self-government. In the words of the critic Harold Kaplan, for naturalist literature in the United States, “democracy seemed to require strong idealizations to support free choice” (p. 37). But for Zola, naturalism in literature and democracy in politics were logical, even necessary evolutionary developments. Zola likened the outsized protagonists of Romanticism to kings

and princes, out of place in the modern world. For him naturalism, like democracy, was a representation—faithful if at times unflattering—of the common people.

Critical Debates

Naturalism was politically controversial in its heyday—conservatives called Zola a “literary anarchist,” while liberals saw his work as a “calumny of the people”—and its place in literary history has been hotly debated by scholars. By the mid-twentieth century, three major strands of thinking about naturalism’s legacies had emerged in Europe. In the early part of the century, Zola was adopted by the French left and elevated to the status of one of France’s great writers. Thanks in part to Zola’s courageous role in the Dreyfus affair, a political scandal that rocked France in the 1890s, naturalism—once reviled for its unsympathetic portrayals of the working class—was reassessed as an eye-opening portrait of the exploitation of the weak. As a result Zola, spurned by the literary establishment and prosecuted by the French government during his lifetime, was eventually laid to rest in the Pantheon, France’s secular cathedral to the “Great Men” of France.

Twentieth-century critics who favored the difficult modernist writing of James Joyce or Marcel Proust, however, were suspicious of this popularity. Naturalism’s accessibility and faith in science were incompatible with the modernist turn toward self-consciousness, interiority, opacity, and style; from the modernist perspective, Zola’s naturalism looked like a kind of dead end of realism, an overextension of realist strategies at a time when modernist artists were turning away from representational art forms. As the critic James McFarlane put it, naturalism “exhausted itself taking an inventory of the world while it was still relatively stable, [and as a result] could not possibly do justice to the phenomena of its disruption” (p. 80).

A third response to Zola and naturalism is best represented by the Hungarian philosopher Georg Lukács (1885–1971), a prominent figure in leftist aesthetic debates in Europe in the mid-twentieth century. Lukács affirmed the common antithesis between realism and modernism, but saw naturalism as a form of modernism, not an outgrowth of realism. The differences between naturalism and modernism were, for Lukács, merely superficial differences of style. On a more substantive level—for Lukács, the ideological level—naturalism is a form of modernism. As he put it, “There is a continuity from Naturalism to the Modernism of our day”—a continuity of “underlying ideological principles” (1963, p. 29). In contrast to “critical” realism’s “dialectical unity,” both naturalism and modernism, despite their widely divergent styles, deny the possibility of understanding and action, instead presenting the human condition as one of alienated subjectivity, isolation, and psychopathology. For Lukács, then—in spite of Zola’s courageous politics (see his 1940 essay “The Zola Centenary”)—naturalism was, like modernism, “not the enrichment, but the negation of art” (1963, p. 46).

Naturalism in the United States

Naturalism was a short-lived phenomenon in France, where it was closely associated with Zola himself. Of Zola’s acolytes

(known as the “Médan group, after the location of Zola’s country estate), only one, Guy de Maupassant (1850–1893), has achieved a lasting reputation. Although short-lived, Zola’s influence was global: his work was translated into nearly every language, and writers from Tokyo to Buenos Aires to Moscow saw in his work both a modern sensibility and a fierce critical edge. Scholars have long discussed naturalist literary movements in England, Russia, Germany, and Spain, but are still hard at work mapping naturalism’s influence outside Europe: in the 1990s, two journals devoted to Zola and his legacy, *Excavatio: Nouvelle Revue Émile Zola et le naturalisme* and *Les Cahiers Naturalistes*, published a number of essays tracing naturalist movements, often short-lived, in eastern Europe, Asia, and South America.

The U.S. version of naturalism proved to be more enduring: the novelist Frank Norris succeeded in establishing naturalism as a permanent part of the lexicon of literary critics (in spite of his rather idiosyncratic view of naturalism as a magnification of Romanticism rather than a form of realism). Although naturalism was initially associated with Norris and his contemporaries Stephen Crane (1871–1900) and Jack London (1876–1916), a wide range of authors over the next seven decades have been shown to have been influenced by naturalism. As the U.S. scholar June Howard put it, “the name taken by a clearly defined, relatively short-lived movement in France [became] in America a broad term used by some writers and many critics to characterize a diverse group of works . . . over a long period of time” (p. 30). The critic Donald Pizer, in particular, has mapped naturalism’s influence on twentieth-century U.S. literature.

Although Norris also wrote adventure novels, his *McTeague* (1899), *The Octopus* (1901), and the posthumously published *Vandover and the Brute* (1914) are the touchstones of U.S. naturalism and were strongly influenced by Zola; some critics accused Norris of lifting passages directly from the French novelist. Although Crane’s novella *Maggie: A Girl of the Streets* (1893) is sometimes used to mark the beginning of naturalism in the United States, Norris’s criticism established the term in an American context. Norris also used his influence as a reader at Doubleday to promote naturalism; his most notable success was Theodore Dreiser’s masterpiece *Sister Carrie* (1900), which the publisher pursued on the strength of Norris’s recommendation in spite of his own distaste for the book.

Beginning in the 1980s, U.S. naturalism saw a critical revival, as new theoretical developments led to a fresh perspective on the genre—and indeed, on the notion of genre itself. For traditional literary criticism, focused largely on concerns of aesthetic merit and often, if implicitly, moral value, naturalism had been somewhat of a problem: as a genre, U.S. naturalism privileges blunt artlessness and—like Zola—posits an essentially amoral universe. Critical works such as Walter Benn Michaels’s *The Gold Standard and the Logic of Naturalism*, a tour de force of New Historicism, and June Howard’s *Form and History in American Literary Naturalism*, broadly informed by the theoretical developments of structuralism and post-structuralism, examine naturalism as a complex meditation on cultural contradictions faced by U.S. culture at a pivotal

moment in its history. Michaels, for example, sees both literary naturalism and debates about the gold standard as part of an entire culture’s struggle with the relationship between the material and the ideal—a struggle that, for Michaels, is constitutive of personhood itself. Howard, drawing on the French philosopher Louis Althusser’s notion of ideology, argues that naturalism was one way for turn-of-the-twentieth-century U.S. culture to process threatening contradictions in the social order, such as contradictions between the egalitarian ideals of democracy and prominent social and political inequalities of the period. For Howard, the most notable of these are the dominance of industrial capitalism and the increasingly visible presence of groups—a largely immigrant urban working class, women, and African Americans—seeking to be included as agents in U.S. political life.

See also *Literature; Naturalism in Art and Literature; Realism.*

BIBLIOGRAPHY

- Hamon, Philippe. *Texte et idéologie: Valeurs, hiérarchies et évaluations dans l'œuvre littéraire*. Paris: Presses Universitaires de France, 1984.
- Howard, June. *Form and History in American Literary Naturalism*. Chapel Hill: University of North Carolina Press, 1985.
- Kaplan, Harold. *Power and Order: Henry Adams and the Naturalist Tradition in American Fiction*. Chicago: University of Chicago Press, 1981.
- Lukács, Georg. *The Meaning of Contemporary Realism*. Translated by John Mander and Necke Mander. London: Merlin Press, 1963.
- . “The Zola Centenary.” 1940. In his *Studies in European Realism*, pp. 85–96. London: Merlin Press, 1972.
- Masson, Pierre. *Le Disciple et l'insurgé: Roman et politique à la Belle Époque*. Lyon, France: Presses Universitaires de Lyon, 1987.
- McFarlane, James. “The Mind of Modernism.” In *Modernism: 1890–1930*, edited by Malcolm Bradbury and James McFarlane. New York: Penguin, 1976.
- Michaels, Walter Benn. *The Gold Standard and the Logic of Naturalism: American Literature at the Turn of the Century*. Berkeley: University of California Press, 1987.
- Mitterand, Henri. *Zola et le naturalisme*. Paris: Presses Universitaires de France, 1986.
- Pizer, Donald. *The Theory and Practice of American Literary Naturalism: Selected Essays and Reviews*. Carbondale: Southern Illinois University Press, 1993.
- Schor, Naomi. *Zola's Crowds*. Baltimore: Johns Hopkins University Press, 1978.
- Taine, Hippolyte. *History of English Literature*. Translated by H. Van Laun. New York: Henry Holt, 1879.
- Walcutt, Charles C. *American Literary Naturalism, a Divided Stream*. Minneapolis: University of Minnesota Press, 1956.

Jonathan P. Hunt

NATURALISM IN ART AND LITERATURE. *Naturalism*, a term widely used in the nineteenth century, was employed by novelists, artists, and art critics as a synonym for

realism. But, in fact, *naturalism* was a much more complex term. The term derived from the theory of positivism developed by the French philosopher Auguste Comte (1798–1857). The roots of scientific naturalism, emerging from the eighteenth century and coming to fruition in the nineteenth century, considered knowledge as a pure science that was to be reinforced by a clear understanding of the laws of nature and an objective observation of facts. In the last half of the nineteenth century writers, primarily novelists, subscribed to this innovative positivist view of the world around them.

In the course of the nineteenth century the philosopher Hippolyte Taine applied scientific methods to the study of art and literature. From 1864 to 1884, as a professor at the influential École des Beaux-Arts in Paris, Taine taught students that the character and development of visual culture were determined by two qualities: race and the environment in which art was created. Taine presented the foundation for an evolutionary approach toward human nature and the importance of family genes in determining the ways in which people reacted. Similarly, this author's advocacy of studying the locale or place in which an individual was brought up emphasized societal implications in shaping an individual. Taine's widely read book *The Philosophy of Art* conveyed his beliefs to a broad audience.

Taine's ideas also provided a scientific method for historians that allowed them to understand the past and even predict the future since it was based on immutable historic laws. His approach contributed a foundation upon which contemporary thinkers could build literary and artistic examples of works that were meant to reflect their own era through a factual reconstruction of the "spirit of the time." This need to be "of one's own time" affected writers and visual artists until the end of the nineteenth century and into the twentieth.

The Father of Naturalism

The best-known "proponent of naturalism" was the novelist and French art critic Émile Zola (1840–1902); he was one of the most passionate defenders of Taine's theories, putting them to use in his novels. Zola's foreword to his novel *Thérèse Raquin* (1867) became the fundamental manifesto of literary naturalism. He maintained and enlarged his ideas in his *Experimental Novel* (1880) and *The Naturalist Novelists* (1881), where he advocated that modern literature needed to be as accurate as possible in order to provide a record of "modern history." To Zola, literature could only be truly real if it examined life in a verifiable way, similar to a medical experiment or analysis, where humanity, as an organism, would be able to function only by following predetermined hereditary laws that were to be studied within a very precise social environment. As a careful note taker of the world in which he lived, Zola used the documents he compiled as necessary building blocks in the construction of his novels.

Zola's naturalism created no less a sensation than the earlier realism of Gustave Courbet when he showed his paintings at the Salon in Paris (1850–1851). Very quickly, and certainly by the early 1880s, if not before, literary (and eventually visual) naturalism became the most popular method of creativity



The Haymakers (1877) by Jules Bastien-Lepage. Oil on canvas. Bastien-Lepage (1848–1884) was considered by many to be the pioneer of the naturalist style in painting. Though he died quite young, his work inspired the art of numerous other adherents of naturalism. THE HAYMAKERS, 1877, BASTIEN-LEPAGE, JULES (1848–84)/MUSEE D'ORSAY, PARIS, FRANCE, CREDIT: PETER WILLI/WWW.BRIDGEMAN.CO.UK

throughout Europe. Much of this influence was due to the wide dissemination of literary texts through popular journals. The consistent discussion of Zola's theories by writers and painters in the public eye made it clear by the world's fairs of 1878 and 1889 that naturalism was everywhere; it had become an international phenomenon.

The Early Naturalist Painters

As an art critic, beginning in the 1860s, Zola was a very passionate and effective critic of contemporary art. He profoundly admired the work of the French painter Jules Bastien-Lepage (1848–1884), an artist who was seen at the time as one of the leading naturalist painters, if not the primary painter working in this vein. Many younger painters idolized Bastien-Lepage's work, especially after his early death from cancer. Zola, along with the art critic Albert Wolff, saw Bastien-Lepage as the inheritor of the tradition of Jean-François Millet (1814–1875) and Gustave Courbet (1819–1877). Zola, and to a slightly lesser degree Albert Wolff, affirmed Bastien-Lepage's superiority over the Impressionist painters active at the time, since Bastien-Lepage could, it was believed, factually recreate his impressions in a most organized way. Bastien-Lepage's canvases, such as his *Hay Gatherers* (Musée d'Orsay, Paris) and *Potato Harvesters* (National Gallery of Victoria, Melbourne), because of their sense of the momentary and their large-scale presence, created lively discussion. Critics, and other artists, believed the artist had originated a naturalist painting style that was photographic and environmentally specific. The painter used the landscapes of his native region, the Meuse, for his naturalist reconstructions of rural life.

Bastien-Lepage's work excited the imagination of painters beyond France; he was seen as a pivotal figure in the international naturalist movement. His death was viewed as cataclysmic for the visual arts, and he was assured a position of importance in the creation of a "new style." His canvases became models for emulation in Scandinavia, eastern Europe, England, and the United States, where his example demonstrated that naturalism was a viable and fertile mode of representation.

Using Bastien-Lepage as a touchstone, other painters, including P. A. J. Dagnan-Bouveret, created a heightened naturalism that relied extensively on the use of photography as a tool, an aide-mémoire, without revealing photography as a primary source. Photography became for visual artists what note taking was for the novelist; it allowed them to gather visual facts they could use later in their reconstructions of reality. A number of well-accepted painters created a compelling version of "virtual reality" that deeply engaged the general public, who saw, accurately recorded, elements from their environment and types from society that they knew well.

Another French painter, one linked briefly with the Impressionist movement, was Jean-François Raffaelli (1850–1924). In a series of mostly small compositions, he represented people from the lowest level of society in order to convey authenticity and ugliness. Raffaelli's ragpickers, wanderers, and social outcasts revealed that beauty and strength came from character, no matter where this was found. He helped shift the visual perspective from "ideal nudes" toward the examination of those whose life was unfortunate, similar to many of the types in Zola's novels. Raffaelli's vision of the world suggested that sadness and hopelessness were aspects of life experiences that a modern naturalist painter needed to understand. With Edgar Degas and Gustave Caillebotte, painters with a strong naturalist streak in many of their works, the Impressionist canon was expanded to include themes drawn from urban life, thereby helping to fulfill the call from many art critics of the era that themes from modern life could be found everywhere. In his series of articles on realism published in the review of the same name, Edmond Duranty (1833–1880) foreshadowed Zola's ideas about the position of the artist, writer, or painter vis-à-vis nature. For Duranty, as for Zola, artists should be concerned with the truth, with an exacting study of nature. He called for the artist to portray the practical conditions of human life, the milieu in which people lived, in order to represent the social side of man and the influences that affected him.

Spreading Naturalism

As Zola's novels gained an international following, a large number of imitators appeared who helped promote the naturalist aesthetic in popular literature that was available to the masses. Writers such as Guy de Maupassant (1850–1893) based their stories on Zola's methodology. At the same time, Zola's best-known novels were turned into plays: Nana was one character who dominated the French stage in productions of *L'assommoir* from the 1880s onward; Zola's mining novel, *Germinal*, provided additional evidence of his influence when performed in popular theaters. During the 1890s, a series of

printmakers furthered the appearance of visual naturalism in posters and lithographs published by the ever increasing socialist press. Théophile Steinlen, an avowed radical, saw that such types as the print "The Barge Man" provided an opportunity to comment on the implied threat found in disgruntled wanderers; other images, for the periodical *Gil Blas*, stressed that those who were out of work and destitute could be found everywhere. The plight of the poor became a naturalist battle cry that many artists, in varied artistic media, answered. By using these themes, writers and visual artists enlarged the social dimension of the naturalist movement, which had first brought these types to the fore.

But it was the haunting impact of the environment and of the social milieu on life that remained one of the most trenchant aspects of the naturalist heritage after the turn of the century. In America, in the novels of Theodore Dreiser (1871–1945) or Frank Norris (1870–1902), the influence of Zola's brand of naturalism was paramount. In *Vandover and the Brute* or in the cataclysmic *McTeague: A Story of San Francisco*, Norris's characters were flawed, often overwrought, brutes whose nature was determined by genetic and environmental factors. Their pursuit of money underscored uncontrollable drives; naturalism was now focusing on obsessive traits. Significantly, Norris's novel *McTeague* led to another level of naturalist appeal: the influence on early cinema. When Erich von Stroheim completed his extremely long film *Greed*, based directly on *McTeague*, in 1924, he revealed that the naturalist aesthetic could be transferred to another medium, where it was used as a means of revealing fatal character traits that cast light on the lives of troubled people. In effect, Zola's idea of making art understandable for the masses by creating a detailed narrative had come full circle with the motion picture.

See also Aesthetics: Europe and the Americas; Impressionism; Literary History; Realism; Symbolism.

BIBLIOGRAPHY

- Brown, Frederick. *Zola: A Life*. New York: Farrar Straus Giroux, 1995.
- Egbert, Donald Drew. *Social Radicalism and the Arts, Western Europe: A Cultural History from the French Revolution to 1968*. New York: Knopf, 1970.
- Furst, Lilian R. *Naturalism*. London: Methuen, 1971.
- Gauss, Charles Edward. *The Aesthetic Theories of French Artists: 1855 to the Present*. Baltimore: Johns Hopkins University Press, 1949.
- Guieu, Jean-Max, and Alison Hilton, eds. *Émile Zola and the Arts*. Washington, D.C.: Georgetown University Press, 1988.
- Hauser, Arnold. *Naturalism, Impressionism, the Film Age*. Vol. 4 of *The Social History of Art*. 3rd ed. New York: Routledge, 1999.
- Mitterand, Henri. *Émile Zola: Fiction and Modernity*. Edited and translated by Monica Lebron and David Baguley. London: Emile Zola Society, 2000.
- Nochlin, Linda. *Realism*. Harmondsworth, U.K.: Penguin, 1971.
- Nochlin, Linda, ed. *Realism and Tradition in Art, 1848–1900, Sources and Documents*. Englewood Cliffs, N.J.: Prentice-Hall, 1966.
- Papke, Mary E., ed. *Twisted from the Ordinary: Essays on American Literary Naturalism*. Knoxville: University of Tennessee Press, 2003.

- Sacquin, Michèle, ed. *Zola*. Paris: Bibliothèque Nationale de France/Fayard, 2002.
- Stromberg, Roland N. *Realism, Naturalism, and Symbolism: Modes of Thought and Expression in Europe, 1848–1914*. New York: Walker, 1968.
- Weisberg, Gabriel P. *Beyond Impressionism: The Naturalist Impulse*. New York: Abrams, 1992.
- Weisberg, Gabriel P., ed. *The European Realist Tradition*. Bloomington: Indiana University Press, 1982.

Gabriel P. Weisberg

NATURAL LAW. Natural law theories have a venerable place in the history of philosophy, stretching back to the time of Plato (428–348 or 347 B.C.E.) and Aristotle (384–322 B.C.E.) when the relationship between law and nature first became a central dynamic of discussion in ethics. Since then such theories have provided staple ingredients within each major phase in Western philosophy down to the time of Immanuel Kant (1724–1804) and beyond into the contemporary era. While such accounts have often been short on detailed and practical guidance on right action, the outlook of natural jurisprudence has been highly influential in ensuring a continuous focus on the alleged rationality of the natural world and the constant and uniform accessibility to the human mind of such principles of observed regularity. However, there has always been a tension between the claim that these principles are eternal and unchanging, and the particular forms and uses assigned to natural law: in Ancient Greece the focus was more on the apparently unchanging character of nature and the distressing mutability of actual law; in the medieval age St. Thomas Aquinas (c. 1224–1274) above all emphasized the accessibility of regular patterns in nature to human nature; and in the early modern era natural law theories evolved as responses first to skepticism about the sources of knowledge, and secondly in reaction to the political turbulence that followed the Reformation, which seemed to shatter the easy symmetry between the uniformity of church and state both across Europe as a whole and also within its constituent political units. In each case the position of natural law was ambiguous, both very much of its time, and yet claiming its authenticity and authority from its position outside history.

Natural jurisprudential approaches to ethics have proved difficult to integrate into the historiography of philosophy because of just this same ambiguous relationship to history itself. On the one hand, natural law was viewed as a set of eternal verities presented by God to humanity in finished and perfect shape, and found embodied in the moral and civil order as evidence of its divine fashioning, albeit in a form diminished by the Fall of Man. But on the other hand, natural jurisprudence is a product of the interaction not just of different and succeeding schools of moral philosophy, but also of the interaction of the range of plausible accounts of divine instigation and human response within wider politics and society. So, for example, the neo-Thomist and Lutheran-Aristotelian systems of natural law that evolved in the sixteenth and seventeenth centuries in Spain and Germany were both a reaction to the

new ideological circumstances of the Reformation and Counter-Reformation eras as much as they were internal modifications and realignments within academic institutions of the legacy, above all, of Aquinas and Aristotle. The same epistemological ambiguity runs through the natural law systems of the early Enlightenment era and the interpretation that they laid upon the works of Hugo Grotius (1583–1645) and Thomas Hobbes (1588–1679), which were their foundation and self-conscious inspiration. The writings of Samuel Pufendorf (1632–1694), Gottfried Wilhelm von Leibniz (1646–1716), Christian Wolff (1679–1754), and Christian Thomasius (1655–1728) sought both to anchor themselves in a newly revealed metaphysics that stood outside time, and also to comment powerfully upon and if necessary direct the course of the world of contemporary practical politics.

Natural Law in the Ancient and Medieval World

At the heart of natural law is an attempt to extract general principles out of the confusing multiplicity of legal and social convention; in the Greek world, this was represented by the contrast and tension between those areas of human life governed by contingency and those controlled by the ineluctable force of nature. Given the variability of positive law both across cultures and within them, the question arose of how legal certainty could be identified and located; and immediately battle-lines were drawn between those who held that such a moral law could be found—usually as a divine creation—and those who remained skeptical of such normative claims, and either denied that there was any essential morality, or located it elsewhere. This pattern, which originated with the Sophists, was to be repeated throughout the history of natural law arguments.

Part of the explanation of why Aristotle's writings are regarded as the first important contribution to this discourse is that they adeptly try to reconcile the distinction between nature and convention. He achieves this by elevating human reason as humankind's dominant and defining characteristic, whose proper exercise mediates between what is permanent and what is ephemeral. This is taken up with greater vigor by the Stoics, and by Marcus Tullius Cicero (106–43 B.C.E.) in particular. He regarded human reason as the apex of a rational world order: human nature rather than an innate law outside human beings now provided the ground and basis for distinguishing between positive law and natural law. Moreover, all humans possessed the rational means, when properly exercised, to identify this law unaided by God, whose divine spark reason essentially is. The Stoics also initiated what was to become one of the most influential strands of natural law thinking—namely, the view that one of the core principles of natural law is a sense of broad sociability towards one's fellow humans, tempered though not obliterated by one's own personal priorities.

The rationalism of natural law still runs as a clear thread through the massive *Summa Theologiae* of Aquinas, despite its elaborate metaphysical architecture. Human nature and the rational conclusions that can be generated from it continue to be his point of departure. However, Aquinas is concerned to reinstate divine eternal law within his framework, and that does

lead to some tension within his overall concept of natural law as a bridge between positive and divine law. He tries to overcome this by recourse to a categorical division of natural law into primary and secondary principles, thus making natural law both fixed and mutable simultaneously. This sophisticated synthesis of pre-existing views within a Christian framework proved highly influential, and was continually refined, most notably by the later Spanish Jesuit Francisco Suarez (1548–1617); but ultimately the pressures generated by the Reformation and Thirty Years' War on the one hand and Renaissance skepticism on the other required a reconfiguring of the relationship between divine and natural law, a renewed emphasis on the Stoic formulas, and a fresh initiative to link the core principles of natural law to the emergent law of nations.

Early Modern Germany

In the era that followed the conclusion of the Thirty Years' War in 1648, it was generally held that the combined effects of Renaissance skepticism and the fragmenting effect of endemic confessional strife had destroyed the coherence of pre-existing accounts of political sovereignty. The rights and duties of monarchy, most especially in respect to churches and the enforcement of doctrinal and liturgical uniformity, were left open to question and redefinition as Europe sought to come to terms with the permanence of confessional division and the necessity of its diplomatic recognition. How could sovereignty remain unified and cohesive when religious truth had become fissiparous? How could absolutism be redefined in a way that preserved unity of political decision-making while paying due pragmatic recognition to the complexities of the new European order?

Nowhere were these tensions more visible than in the Holy Roman Empire, the epicenter of the recent military conflict, and the most graphic illustration in its uneasy religious tessellation of the need to find a new legitimization for political sovereignty. It is therefore no accident that it was from this region that there emerged the most systematic attempts to re-unify politics with metaphysics and devise new explanations of the appropriate exercise of political and ecclesiological power by the ruler. The pathbreakers in this respect were Grotius and Hobbes, far more than René Descartes (1596–1650), whose relative silence on morals gave no clear assistance in this area. Grotius was admired and praised above all for showing first in a series of specific works on the legal implications and meaning of colonial acquisition, and second in his larger work of synthesis, *On the Law of War and Peace* (1625), that there were still general principles of natural law that could be discerned right across the spectrum of international customary law. These were accessible to all, and, crucially, would obtain even if God and God's revealed intentions for humankind were taken out of consideration. From Hobbes European readers drew the key arguments of what is generally known now as voluntarism: that laws of general validity arose from the imposition of a unified, sovereign, rational will rather than the progressive discovery of general principles benignly imprinted on humanity's consciousness in the form of innate ideas. It was in the combination of Grotius's arguments in favor of the possibility and content of universal natural law, and Hobbes's insight into

how those laws may be isolated and implemented in contemporary, fragmented practical politics that produced a truly modern theory of natural law, associated with Pufendorf and Thomasius. It evoked in turn a powerful hostile reaction in the work of Leibniz and Wolff, which tried to rework the views of Aquinas in a different idiom.

The contest (for that is what it effectively became) between the voluntarism of Pufendorf and the essentialism of Leibniz was mainly played out within a framework of university disputation, but also spilled over importantly into the public arena in debates over such issues as confessional reunion. At stake here in essence was the way in which the principles of moral knowledge were obtained, an apparently recondite area of learning, but nevertheless one with crucial implications for method in all areas of modern philosophy. In his major work *On the Law of Nature and Nations* (1672), Pufendorf argued that humans gain knowledge of morals in a way that parallels the manner in which they devise languages, that is, through the imposition of categories and meanings to create shared, mutually accessible structures. God may give humans revealed truths, but this forms but one part of human duties; the majority of these duties are devised through unaided reason, which God gave to humans to use in this free fashion. From this initial insight, explicitly grounded in Stoic thought, emerges a complex analytical structure that frames an elaborately contractarian politics weighted heavily through the prudential calculations of individuals in an absolutist direction. It also resulted in a clearly articulated Erastian church politics, vesting the civil power with final control and powers of resolution in religious disputes.

In contrast to this, Leibniz and Wolff regarded the work of Pufendorf and his followers as an attempt to provide practical resolutions of disputes from poorly argued philosophical premises that either guilefully or ineptly justified secular voluntarism. In its place, Leibnizian posited an elaborately conceived metaphysical approach that sought to explain natural law in terms of divine justice and the "charity of the wise," arguing in essence that all practical morality can be derived from the reservoir of truth located in the perfect wisdom of God. Less daring in the practical politics with which it eventuated, Leibnizian natural law nevertheless performed virtuosic surgery on the corpse of Protestant-Aristotelian natural law, ensuring that Wolff's textbooks enjoyed equal credibility and popularity in both Protestant and Catholic universities until the later eighteenth century. Leibniz also pointed out disquietingly secular overtones in the work of the followers of Pufendorf that inhibited their unequivocal acceptance of their work even within Protestant Germany.

Early Modern France

While the grandest systems of natural law emerged in Germany, there was also a sustained focus on ethical discourse of this type among the French Huguenots, exiled by Louis XIV (1638–1715) after the Revocation of the Edict of Nantes in 1685, and forced therefore to construct a new political identity for themselves within a cosmopolitan intellectual framework, rather than that of a state. Their most eloquent writers, such as Jean Barbeyrac (1674–1744) and Jean-Jacques

Burlamaqui (1694–1748), sought to defend a right to religious conscience while retaining a political order that was primarily absolutist in character. The particular circumstances of their ideological preferences therefore led them to develop a proto-liberal language of rights in association with religious toleration that was genuinely original and powerfully influential, not least on John Locke (1632–1704). But the Huguenots also had to confront more directly than any other group of writers the potentially illiberal and austere utilitarian (using that term loosely) aspects of Pufendorfian absolutism, whose voluntarist assumptions sometimes appeared to produce results rather similar to the divine-right absolutism pursued for wholly different reasons by Louis XIV. This was a paradox not lost on Jean-Jacques Rousseau (1712–1778), who, with intimate knowledge of the local Swiss context of these writers, later castigated the Huguenots, and the natural law school as a whole, as a very clear case study in subservience to absolutism and a failure to follow through an analysis of the rights of conscience with sufficient rigor.

In four particular respects, the natural law disputes of the period between 1625 and 1760 left an important philosophical legacy. Firstly, the issues of how far religious toleration was to be permitted, what its political consequences should be, and what were the sources of its intellectual justification were played out within and refracted through the discourse of natural law above all others. Natural law theories therefore provided the framework for the discussion of the major question of the day on the interface between political theory and practical politics. Secondly, although this was not fully intended, the crucial separation of the fields of ethics and moral theology, argued for by Grotius, Pufendorf, and their followers, ultimately resulted in the final downgrading and devaluing of the formal divine content and origin of ethics and the promotion of individuals as separate self-sufficient moral persons capable of undertaking rational voluntary transactions. Thirdly, this Pufendorfian argument produced several very important discussions of the nature of contractarian government, of the right to own property and to pursue economic interactions untrammelled by the state, that powerfully anticipated some of the most radical and influential ideas of the philosophes and of the Scottish Enlightenment. Finally, the natural lawyers' preoccupation with securing links between the law of nature and the law of nations established the view that reason of state arguments were not sufficient in the world of public affairs, thus—ironically—reinstating a link between “eternal” principles of human ethics and the law of nations, just when the link between divine and natural law had been irretrievably severed.

Natural Law and Natural Rights

The disappearance of natural law arguments from mainstream philosophy was not nearly so abrupt in the nineteenth century as is often made out, as can be seen from the curricula and textbooks adopted at many universities. Nevertheless, the combined influence of Kantian idealism and utilitarianism did serve ultimately to undercut several of the key claims of the theorists of the preceding two centuries. In his *Foundations of the Metaphysics of Morals* (1785), Kant essentially generated a fresh account of moral obligation that was located not in the principles

of human nature, but in an autonomous will freely exercising practical reason: Obligation lay not in the harmony of a principle with human nature, but in whether a law could be objectively generalized in relevantly comparable circumstances. Thus it appeared that natural law arguments only yielded empirical “counsels of prudence” about human behavior, not conceptually coherent moral yardsticks. A second blow was struck by Jeremy Bentham (1748–1832), who stressed that there was no “external consideration” that permitted natural jurisprudence to distinguish between one person’s judgment of the law of nature and another’s: natural law had to act as its own circular proof and guarantor, which was unacceptable. Attempts to distill a common set of principles from the infinite variety of the law of nations were bound to fail; he believed it to be far better to move outside the categories of reason and human nature altogether, accept the pluralist nature of human definitions of the good life, and reassert the supremacy of legal positivism, based on accommodating majority preferences. This point was particularly difficult for natural lawyers to answer, given that they had failed to observe how easily their view that knowledge of the law of nature was not reliant on God could slide into a statement that grounds for obeying natural law are not dependent on God either—a conclusion that left no clear criterion of obligation to fall back upon.

However, the eclipse of natural law arguments was by no means complete even at the beginning of the twenty-first century. While natural rights theories have pursued their own separate trajectory towards an assertion of the protection of individual rights as a good in itself, perhaps best embodied in the American philosopher Robert Nozick’s *Anarchy, State and Utopia*, a number of Catholic theorists, most notably the Australian author John Finnis in *Natural Law and Natural Rights*, have reworked the idea of shared goods inherent in human nature, though the content of that list of shared goods and the relationship between them has proved to be controversial. As with the earlier versions of natural law theory that have taken their stand on human nature and its attributes, this version too stands or falls on the richness or poverty of its conception of that human nature, and on the clarity and self-awareness with which human nature is neutrally described or prescribed in relation to other norms at each step in the argument. All such theories explore very difficult philosophical territory because they seek to unify two essentially different projects: to provide specific prudential advice on how best to achieve one’s objectives (implying a recognition that human nature and its needs change in line with historical circumstances in ways that reason alone does not always fully comprehend), together with a parallel recognition that for human insights to be generalized as valid law, they need to be assessed according to a sole and unvarying standard, usually identified as rational truth. Those thinkers who have best overcome these paradoxes, such as the Stoics, Grotius, and Pufendorf, lived in periods of significant social dislocation, but were stimulated to identify and narrow general principles attributable to reason that were also imaginatively rich enough to meet the shifting empirical shoals of their own political and existential crises. That is why they are still worth studying in the twenty-first century, for this juxtaposition of moral philosophy with moral exigencies is a task that is never completed, despite the shift in intellectual

frameworks that makes the natural law era seem so distant and different from that of the present.

See also **Christianity; Human Rights; Scholasticism; Toleration.**

BIBLIOGRAPHY

PRIMARY SOURCES

- Aristotle. *Nicomachean Ethics*. Edited by Roger Crisp. Cambridge, U.K.: Cambridge University Press, 2000.
- Cicero, Marcus Tullius. *De Legibus and De Republica*. Edited by Niall Rudd and J. G. F. Powell as *The Republic and the Laws*. Oxford: Oxford University Press, 1998.
- Finnis, John. *Natural Law and Natural Rights*. Oxford: Oxford University Press, 1980.
- Grotius, Hugo. *De Jure Belli ac Pacis*. 3 vols. 1625. Edited by Francis W. Kelsey and published as *The Law of War and Peace: De Jure Belli ac Pacis*. Indianapolis: Bobbs-Merrill, 1962.
- Nozick, Robert. *Anarchy, State and Utopia*. Oxford: Blackwell, 1974.
- Pufendorf, Samuel. *De Jure Naturae et Gentium*. 1672. Translated by Basil Kennett as *Of the Law of Nature and Nations: Eight Books*. Clark, N.J.: Lawbook Exchange, 2003.
- Thomas, Aquinas St. *Summa Theologiae*. 1265–1273. Reprint, n.p.: Blackfriars; New York: McGraw-Hill, 1964–1976.

SECONDARY SOURCES

- Buckle, Stephen. *Natural Law and the Theory of Property: Grotius to Hume*. Oxford: Oxford University Press, 1991.
- George, Robert P. *In Defense of Natural Law*. New York: Clarendon, 1999.
- Haakonssen, Knud. *Natural Law and Moral Philosophy: From Grotius to the Scottish Enlightenment*. Cambridge, U.K.: Cambridge University Press, 1996.
- Hunter, Ian, and David Saunders, eds. *Natural Law and Civil Sovereignty: Moral Right and State Authority in Early Modern Political Thought*. New York: Palgrave; Cambridge, U.K.: Cambridge University Press, 2002.
- Tierney, Brian. *The Idea of Natural Rights: Studies on Natural Rights, Natural Law, and Church Law, 1150–1625*. Atlanta: Scholars Press, 1997.
- Tuck, Richard. *Natural Rights Theories*. Cambridge, U.K.: University Press, 1979.

T. J. Hochstrasser

NATURAL RIGHTS. See **Human Rights; Natural Law.**

NATURAL THEOLOGY. The primary sense of the term *natural theology* rests on the contrast between natural and revealed knowledge. Natural theology concerns knowledge of the existence and attributes of God arrived at using only the natural faculties of sense and reason. Philosophical arguments for the existence, intelligence, power, and goodness of God based on the order and beauty of the world, or on purely intellectual considerations, are examples of natural theology. Knowledge of God that is based on divine revelation as set down in scripture is the subject of revealed theology.

A central metaphor for the distinction between natural theology and revealed theology is that of the “two books”—the book of God’s word (scripture) and the book of God’s works (nature). The mainstream theological position has always been that the primary source of truth was revelation and that natural reasoning—reading the book of God’s works—can provide ancillary support for revealed truths. Reason can confirm what is already known by faith. Natural theology has, therefore, been a more or less important, and more or less welcome, secondary support for Christian doctrine over the centuries. A constant worry for theologians has been the possibility of relying too heavily on natural theology and thus giving too much away to rationalistic and secular ways of understanding the world and placing insufficient emphasis on the importance of scripture and revelation.

Although the primary sense of “natural” in the phrase “natural theology” is natural as opposed to revealed knowledge, there is a secondary sense that is also important. Works of natural theology produced from the seventeenth to the nineteenth centuries frequently focused on the wonders of the natural world and on developments in natural science. The phrase “natural theology” thus came to stand for a rather particular kind of natural theology—a celebration of the beauty of the natural world and the power, wisdom, and goodness of its Creator, as revealed by the scientific study of nature. This sort of natural theology might also be thought of as a kind of “theology of nature,” to distinguish it from the broader intellectual enterprise of arguing about God independently of revelation.

Natural Theology and the Birth of Modern Science

Although it had roots both in ancient Greek philosophy and in medieval Christian theology (for instance, in Thomas Aquinas’s famous “five ways” of demonstrating the existence of God), the heyday of natural theology was between the seventeenth and nineteenth centuries and was intertwined with the rise of modern science (see Brooke, 2003; Brooke and Cantor).

Nature was investigated and interpreted in new ways in sixteenth- and seventeenth-century Europe. These innovations (which have traditionally been summed up as the “scientific revolution”) included the use of new scientific instruments (such as the telescope, the microscope, and the air pump), a new emphasis on experimentation, and the use of mechanical models to explain natural phenomena. The natural theological genre was one that both allowed practitioners of the new mechanical and experimental philosophy to justify their work to a sometimes skeptical religious establishment and also allowed religious apologists to enlist new knowledge in the service of Christian piety.

Many of the early members of the Royal Society in London (founded in 1660) saw a connection between their experimental investigations and their Christian faith. (Robert K. Merton famously argued that the Puritan religious beliefs of many of the founder members played a key role in shaping the activities of the Royal Society.) Robert Boyle (1627–1691), for instance, as well as conducting important experiments with his air pump to investigate the pressure of air and other gases, wrote on *The Excellency of Theology, Compared with Natural*

Philosophy (1674) and composed a work entitled *The Christian Virtuoso* (1690), subtitled, “shewing that by being addicted to experimental philosophy, a man is rather assisted than indisposed to be a good Christian.” Another early Fellow of the Royal Society whose writings explored the way that the new experimental and mechanical philosophy could be used to support theology was John Ray (1627–1705), whose *The Wisdom of God Manifested in the Works of the Creation* (1691) was to become a classic of the natural theological genre. In this work, Ray argued that since the creativity of God was present throughout the natural world, no part of it was too low or insignificant to be a subject of natural-philosophical study.

The experimental investigation of nature in seventeenth-century England was, then, justified as being to the greater glory of God and for the good of man. The natural theology produced by men such as Boyle and Ray reflected the character of the new natural knowledge they were engaged in producing. Their God was an able mathematician, a geometer, a designer, a mechanic. If the experimental philosopher displayed his ingenuity by designing and constructing a telescope or a microscope, how much more ingenious must be the God who could design and construct the human eye? If the man of science gave evidence of his intelligence by discovering that natural phenomena were governed by elegant mathematical laws, how much more intelligent and powerful must be the God who drew up and laid down those laws?

In his will, Boyle left money to pay for a series of lectures to promote this natural theological vision, which he hoped would prove the truth of the Christian religion “against notorious infidels, viz. Atheists, Pagans, Jews, and Mahometans” (quoted in Brooke, 2003, p. 157). The result was a series of Boyle Lectures, which were delivered for around forty years, annually, starting in the year of Boyle’s death, 1692, when the first Boyle lecturer was Isaac Newton’s friend, the Reverend Richard Bentley (1662–1742). Another Newtonian and theologian, Samuel Clarke (1675–1729), was the Boyle lecturer in 1704–1705.

Natural Theology and Its Critics in the Eighteenth and Nineteenth Centuries

Lectures and treatises in this same natural theological tradition continued to be produced throughout the eighteenth century and into the first half of the nineteenth century, across Europe, but with a particular popularity in Britain. Natural theologians argued from the harmonious, law-governed, architecturally sophisticated, mathematically precise wonders of nature—animate and inanimate—to the existence and attributes of a good, powerful, and intelligent deity. Natural theological works frequently relied on arousing their readers’ aesthetic feelings, but these could then be used in support of very different political programmes, from Joseph Priestley’s and Thomas Paine’s versions of radical republicanism to William Paley’s and William Whewell’s more conservative Anglicanism.

The most famous philosophical critique of natural theology, David Hume’s (1711–1776) *Dialogues Concerning Natural Religion*, appeared, posthumously, in 1779. Although the

use of the dialogue form meant that Hume did not claim any view directly as his own, some have thought that the arguments against natural religion voiced by the skeptical Philo are closest to Hume’s own views. In addition to throwing doubt on the soundness of the analogy between the universe and human artifacts, Philo suggests that if the analogy is to be taken seriously, then the correct inference should be to a cause more closely resembling the cause of human artifacts—namely, a being (or, more likely, a collaborating group of beings) of limited skill and foresight, not a single being of unlimited power and intelligence. Pressing the point even further, Philo asks why the natural theologian, once embarked upon the project of comparing human and divine designers, should not become a perfect anthropomorphite. Why not assert that the deity or deities has eyes, a nose, mouth, ears and so on, he asks.

Although the attacks upon the argument from design put forward in Hume’s *Dialogues* are often seen, in retrospect, as devastating to the natural theological enterprise, that was not how they were perceived at the time. The most famous treatise in the natural theology tradition postdated the *Dialogues* and did not consider the arguments put forward in them to be seriously troubling. This was William Paley’s (1743–1805) *Natural Theology* (1802), which is still considered the classic expression of the argument from natural design to divine designer. The Paleyite version of natural theology, with its focus on adaptation and design, was taken up by the authors of the *Bridgewater Treatises*. It was also the version of natural theology to which the young Charles Darwin (1809–1882) was introduced as a Cambridge undergraduate with a passion for natural history, in the late 1820s.

As the nineteenth century unfolded, however, the natural theology of Paley and the *Bridgewater* authors came under attack from a variety of different directions. Discussions about the intellectual status of natural theology overlapped with debates about the political desirability of church-dominated education. In Britain, for instance, the second half of the nineteenth century saw the Anglican monopoly on the universities and education being gradually eroded. Anglican men of science and their natural theological arguments were gradually displaced by agnostics and secularizers, with their more materialistic interpretations of scientific results, as the leading scientific authorities in Victorian Britain.

There had been, for some time, a radical, anti-Christian strand of natural theology—a deistic sort of natural religion promoted most famously by Thomas Paine (1737–1809) in his *Age of Reason* (1794–1807). On this view natural theology was not a supplement to revealed theology but a self-sufficient alternative to it. Paine argued that the book of nature was the only book that was needed to understand God and his creation. All churches, scriptures, and doctrines were anathema to Paine. Christianity was pilloried as a corrupt and oppressive system, run by a self-serving and power-hungry priesthood. The true theology—as opposed to the immoral superstitions of the churches—was to be found in the results of science and philosophy. Writing in the same freethinking tradition as Paine, but replacing Paine’s deism with outright atheism, the secularist campaigner George Jacob Holyoake

PALEY'S WATCHMAKER

William Paley (1743–1805) was an Anglican clergyman and successful writer whose *Principles of Moral Philosophy* (1785) and *Natural Theology* (1802) were widely read, especially by students, well into the nineteenth century. The central argument of *Natural Theology* was that living things are comparable to mechanical contrivances, such as watches; and just as from a mechanical contrivance we infer a human designer, so, by analogy, from natural contrivances we should infer a divine designer (see Addinall; Brooke, 2003; Nuovo). The opening paragraph of Paley's *Natural Theology*, quoted below, set the tone for the central analogy of the book. The title of Richard Dawkins's 1988 book, *The Blind Watchmaker*, alludes to this argument by suggesting that blind Darwinian processes of variation and natural selection have replaced Paley's divine watchmaker.

In crossing a heath, suppose I pitched my foot against a *stone*, and were asked how the stone came to be there; I might possibly answer, that, for any thing I knew to the contrary, it had lain there for ever: nor would it perhaps be very easy to show the absurdity of this answer. But suppose I had found a *watch* upon the ground, and it should be inquired how the watch happened to be in that place; I should hardly think of the answer which I had before given, that, for any thing I knew, the watch might have always been there. Yet why should not this answer serve

for the watch as well as for the stone? Why is it not as admissible in the second case, as in the first? For this reason, and for no other, viz. that, when we come to inspect the watch, we perceive (what we could not discover in the stone) that its several parts are framed and put together for a purpose, *e.g.* that they are so formed and adjusted as to produce motion, and that motion so regulated as to point out the hour of the day; that, if the different parts had been differently shaped from what they are, of a different size from what they are, or placed after any other manner, or in any other order, than that in which they are placed, either no motion at all would have been carried on in the machine, or none which would have answered the use that is now served by it. . . . This mechanism being observed (it requires indeed an examination of the instrument, and perhaps some previous knowledge of the subject, to perceive and understand it; but being once, as we have said, observed and understood), the inference, we think, is inevitable, that the watch must have had a maker: that there must have existed, at some time, and at some place or other, an artificer or artificers who formed it for the purpose which we find it actually to answer; who comprehended its construction, and designed its use.

(1817–1906), while serving a prison sentence for blasphemy, composed a pamphlet entitled *Paley Refuted in His Own Words* (1847). Holyoake pressed arguments similar to those put forward in Hume's *Dialogues* seventy years earlier. Holyoake's conclusion was that he had shown natural theology to be logically flawed, and thus also shown that revealed theology was groundless (since he held that revealed theology presupposed natural theology). He then went on to denounce Christian religion as a barrier to human progress and demand that it be replaced by a utilitarian and scientific secular morality.

Charles Darwin's explanation in *The Origin of Species* (1859) of how the processes of random variation and natural selection could combine to produce what appeared to be instances of

"design" in the natural world is often described as the final nail in natural theology's coffin. If blind natural forces could create adaptation, then surely no role was left for Paley's God. It was not quite that simple, however. Historians of science have shown that Darwin took over much of the language of natural theology (the discourse of "adaptation" and "design") as well as some of its leading assumptions—such as the idea that every anatomical and behavioral trait should be assumed to have a function. Darwin was certainly no Holyoake. Whatever his own personal doubts about theology, he presented his ideas not as an argument for atheism but as an explanation of how the creator could make new species through the operation of laws rather than through miraculous interventions. Paley's watchmaker-God may have been banished in Darwin's new view of nature, but that had only ever been one of the

THE BRIDGEWATER TREATISES

In February 1829 the Reverend Francis Henry, earl of Bridgewater, died. His will made provision for £8000 sterling to be held at the disposal of the president of the Royal Society in London and used to finance the publication of one thousand copies of a work on the power, wisdom, and goodness of God as manifested in the creation. The result, eventually, was not one but eight such works. These works of natural theology were written by leading religious and scientific figures of the day and were published between 1833 and 1836 (see Addinall; Topham):

1. Thomas Chalmers (1780–1847), *On the Power, Wisdom and Goodness of God as Manifested in the Adaptation of External Nature to the Moral and Intellectual Constitution of Man* (1833).
2. John Kidd (1775–1851), *On the Adaptation of External Nature to the Physical Condition of Man: Principally with Reference to the Supply of His Wants and the Exercise of His Intellectual Faculties* (1833).
3. William Whewell (1794–1866), *Astronomy and General Physics Considered with Reference to Natural Theology* (1833).
4. Charles Bell (1774–1842), *The Hand: Its Mechanism and Vital Endowments in Evincing Design* (1833).
5. Peter Roget (1779–1869), *Animal and Vegetable Physiology: Considered with Reference to Natural Theology* (1834).
6. William Buckland (1784–1856), *Geology and Mineralogy Considered with Reference to Natural Theology* (1836).
7. William Kirby (1759–1850), *On the Power, Wisdom and Goodness of God as Manifested in the Creation of Animals and in Their History, Habits and Instincts* (1835).
8. William Prout (1785–1850), *Chemistry, Meteorology, and the Function of Digestion: Considered with Reference to Natural Theology* (1834).

In 1837 Charles Babbage (1791–1871), the creator of the famous “difference engine” (a calculating machine often cited as the earliest forerunner of the modern computer), wrote an unsolicited *Ninth Bridgewater Treatise*, which argued that a system operated entirely by mathematical laws could result in the appearance of unexpected novelties. Babbage’s suggestion that divine intervention could thus be replaced by the operation of natural laws was explicitly taken up in the evolutionary work *Vestiges of the Natural History of Creation*, published anonymously in 1844 (the author was later revealed to have been the Edinburgh journalist and publisher Robert Chambers), and, more tacitly, in Darwin’s *Origin of Species* (1859).

images of God with which natural theologians had been concerned.

The Twentieth Century

Twentieth-century developments add weight to the view that Darwin’s writings, while requiring theologians to rethink natural theology, did not compel them to abandon it. One of the institutions through which natural theological endeavors were continued was the Gifford lectures. These lectures, set up to promote the study of natural theology, were instituted by the will of Adam Gifford, who died in 1887. Delivered in the Scottish universities of Edinburgh, Glasgow, St Andrews, and Aberdeen, by a range of distinguished philosophers, scientists, historians, and theologians since 1888, the Gifford

lectures have resulted in a lively and ongoing series of natural theological reflections, conceived in the broadest sense. Gifford lecturers have included William James, Nils Bohr, Charles Raven, and Paul Tillich; and, more recently, the physicist and Anglican minister John Polkinghorne, historians of science John Hedley Brooke and Geoffrey Cantor, and the American theologian Stanley Hauerwas.

Discussions of natural theology have, ever since the mid-1930s, been carried out under the shadow of the figure of Karl Barth (1886–1968). In reaction to a 1934 treatise on *Nature and Grace* by Emil Brunner, Barth wrote a response titled simply *No!* In this and other works, Barth (and many others in twentieth-century academic theology who shared his dissatisfaction with nineteenth-century theological accommodations

with scientific rationalism) emphasized the centrality of revelation and a religious relation to Christ. For the Barthian, rational argumentation undertaken on secular foundations could never produce distinctively Christian knowledge, and to suppose that it might was a theological mistake (regardless of whether it was also a philosophical and scientific one). Interestingly, both Barth and Brunner were subsequently Gifford lecturers; Stanley Hauerwas, in his recent Gifford lectures, argues in favor of a form of natural theology reconceived along Barthian lines.

Given the Humean, Darwinian, and Barthian objections to any form of natural theology grounded in the sciences, attempts to revive it in the later twentieth century certainly seemed to be doing so in the face of formidable opposition. Nonetheless, such attempts have been made. In the area of “science and religion,” authors such as Ian Barbour, Arthur Peacocke, John Polkinghorne, Bob Russell, and Nancey Murphy have argued that divine purposes can still be discerned in the findings of modern science. There has been particular interest in the question of whether the “fine-tuning” of the fundamental physical constants of our universe might indicate that it was made by a deity with an interest in creating intelligent life. Another area of lively revived natural theological speculations has been quantum physics.

In the United States, the twentieth century saw the invention of another new variety of natural theology, namely “creation science” or “scientific creationism,” whose advocates continue to resist mainstream neo-Darwinian orthodoxy and to call for “balanced treatment” of Darwinian science and “creation science” in the classroom. In this American controversy, not only the relationship between church and state but also the ancient question of the relationship between the book of nature and the book of scripture continues to be contested. Each group has its own view about this relationship. For creationists, revealed theology (specifically a literalist interpretation of the book of Genesis) and natural theology (specifically an anti-evolutionary interpretation of scientific evidence) concur in teaching that God created separate forms and that humans do not have a common ancestry with other animals. For other Christians, revelation and nature can be brought into harmony by reading Genesis less literally and accepting mainstream science. For others again—those who take a view like Thomas Paine’s—churches and supposed revelations are all nothing more than human creations: the only real source of transcendent knowledge is the study of the natural world, and the most fruitful means of studying it are science and philosophy. It thus continues to hold true that debates about natural theology are closely connected with debates about the relationship between church and state, especially in the area of education.

See also Creationism; Evolution; Mechanical Philosophy; Natural History; Nature; Religion and Science.

BIBLIOGRAPHY

PRIMARY SOURCES

Aquinas, Thomas. *Summa Theologiae*. Translated by the Dominican Fathers. London: Blackfriars, 1964–1981.
 Brunner, Emil, and Karl Barth. *Natural Theology*. Translated from the German by Peter Fraenkel, with an introduction by John

Baillie. London: Geoffrey Bles, 1946. Reprint, Eugene, Ore.: Wipf and Stock, 2002. Comprising *Nature and Grace* by Emil Brunner and the reply *No!* by Karl Barth.

Hume, David. *Dialogues Concerning Natural Religion*. Edited by J. C. A. Gaskin. Oxford: Oxford World’s Classics, 1998. First published 1779.

Paley, William. *Natural Theology; or, Evidences of the Existence and Attributes of the Deity, Collected from the Appearances of Nature*. 1802. Reprint, Oxford: Oxford University Press World Classics Series, 2005.

SECONDARY SOURCES

Addinall, Peter. *Philosophy and Biblical Interpretation: A Study in Nineteenth-Century Conflict*. Cambridge, U.K., and New York: Cambridge University Press, 1991.

Barr, James. *Biblical Faith and Natural Theology*. Oxford: Clarendon, 1993.

Behe, Michael. *Darwin’s Black Box: The Biochemical Challenge to Evolution*. New York and London: Free Press, 1996.

Brooke, John Hedley. “Darwin and Victorian Christianity.” In *The Cambridge Companion to Darwin*, edited by Jonathan Hodge and Gregory Radick. Cambridge, U.K., and New York: Cambridge University Press, 2003.

———. *Science and Religion: Some Historical Perspectives*. Cambridge, U.K.: Cambridge University Press, 1991.

Brooke, John Hedley, and Geoffrey Cantor. *Reconstructing Nature: The Engagement of Science and Religion*. Edinburgh: T. and T. Clark, 1998. See especially section 3.

Buckley, Michael. *At the Origins of Modern Atheism*. New Haven, Conn.: Yale University Press, 1987.

Dawkins, Richard. *The Blind Watchmaker*. London: Penguin, 1988.

Dembski, William. *Intelligent Design: The Bridge between Science and Theology*. Downers Grove, Ill.: Intervarsity Press, 1999.

Desmond, Adrian, and James Moore. *Darwin*. London: Penguin, 1992.

Hauerwas, Stanley. *With the Grain of the Universe: The Church’s Witness and Natural Theology*. Grand Rapids, Mich.: Brazos Press, 2001.

Jaki, Stanley L. *Lord Gifford and His Lectures: A Centenary Retrospect*. 2nd ed. Edinburgh: Scottish Academic Press, 1995.

Merton, Robert K. “Puritanism, Pietism, and Science.” In *Science and Religious Belief: A Selection of Recent Historical Studies*, edited by C. A. Russell. London: University of London Press, 1973.

Numbers, Ronald L. *The Creationists*. New York: Knopf, 1992.

Nuovo, Victor. “William Paley.” In *The Dictionary of Eighteenth-Century British Philosophers*, edited by John Yolton, John Valdimir, and John Stephens. Bristol, U.K., and Sterling, Va.: Thoemmes Press, 1999.

Olding, Alan. *Modern Biology and Natural Theology*. London: Routledge, 1990.

Ospovat, Dov. *The Development of Darwin’s Theory: Natural History, Natural Theology, and Natural Selection, 1838–1850*. Cambridge, U.K., and New York: Cambridge University Press, 1981.

Polkinghorne, John. *Science and Christian Belief*. London: SPCK, 1994. Published in the United States as *The Faith of a Physicist: Reflections of a Bottom-up Thinker*. Princeton, N.J.: Princeton University Press, 1994.

Richards, Robert. *Darwin and the Emergence of Evolutionary Theories of Mind and Behavior*. Chicago: University of Chicago Press, 1987.

Ruse, Michael. *Darwin and Design: Does Evolution Have a Purpose?* Cambridge, Mass.: Harvard University Press, 2003.

Topham, Jonathan. "Beyond the 'Common Context': The Production and Reading of the *Bridgewater Treatises*." *Isis* 89 (1998): 233–262.

Thomas Dixon

NATURE. No interpretation of the idea of nature is good for all people in all places at all times. The interpretive position here reflects pivotal conceptual developments of the nineteenth and twentieth centuries.

Charles Darwin's century brought home forcefully the reality of time, of evolutionary process that ultimately transforms all things. Darwin's contemporary T. H. Huxley believed that evolution forced the question of our place in nature upon us. Twentieth-century science posed a further interpretive challenge. We have reached the end of credible claims to certainty concerning nature. Given uncertainty, open-ended inquiry becomes the hallmark of rationality, and the idea of nature remains inevitably in flux. A third interpretive factor emerges at the intersection of the twentieth and twenty-first centuries. The present cultural trajectory is on a collision course with the evolved biophysical scheme. The interpretive challenge is to account for the predicament of a naturally evolved species whose cultural evolution has led to maladaptive ideas of nature that must be transformed in order to avert biophysical catastrophe.

Nature before Literacy

Arguably, the nineteenth-century discovery of the Paleolithic, the period of human development stretching from about two million to about ten thousand years ago, is exceeded in significance only by the discovery of biological evolution. Ensnared within cultural cocoons of literacy and technology, we believe that paleo-people were stupid savages since they were not literate and possessed only rudimentary technology. There are two rejoinders to such notions. First, the paleo-strata unequivocally confirm that the historical epoch of literacy is a mere moment in a human past stretching across several hundred thousand years. And second, the assumption that we monopolize intelligence and genius is untenable. Our paleo-ancestors were capable of imaginings that rival those of the greatest minds of history.

Nevertheless, any reconstruction of Paleolithic ideas of nature remains conjectural. Interpretation depends on reading "texts" that, rather than being alphabetic, are material artifacts—stone points and knives, cave paintings and megalithic constructions, and tens of thousands of other artifacts. Additional evidence comes from paleo-notions of nature that resonate in surviving aboriginal cultures. Collectively these materials support three conjectures. First, Paleolithic hunter-gatherers realized that there was an order to the world that they inhabited. While the pattern varied seasonally, there was regularity in the movement of animals, in the growth of plants, in the presence or absence of water. Second, paleo-people

believed the inherent order of nature was cyclical, since the world moved in repeating cycles. Third, paleo-people believed their role was to harmonize with rather than change the circumstances of existence.

These conjectures can be challenged across multiple fronts. For example, there is evidence of climatic upheavals that through natural selection eliminated all but the most behaviorally adaptable hominid bands. How, then, could paleo-people believe in a cyclical nature? And yet evidence from the Neolithic strata suggests that the myth of the eternal return and the belief in the Magna Mater (the Great Mother) were foreshadowed during the Paleolithic.

Nature in Antiquity

Antiquity is defined here as a zone of cultural transition at the boundary between the Old and the New Stone Age, the Paleolithic and the Neolithic. Climate change is increasingly accepted as the environmental driver that ended the era of the great hunt. Whereas utility vanished at the margin of portability for paleo-people, the Neolithic brought profound changes to material culture and thus to notions of nature. Sedentarism, the cultivation of cereal grasses, and the domestication of animals transformed human relations to nature. Forests were cleared for fields and building materials. Crops were planted and tended. Rivers were diverted into canals to support irrigated agriculture. Permanent habitation was constructed. Wild creatures, such as bears and wolves, formerly totems with which humans empathically identified, became predators.

Materials for the conceptual reconstruction of ancient ideas of nature can be found in texts marking the passage from oral-ity into alphabetic literacy, such as the Sumerian-epoch *Gilgamesh* and the Old Testament, the latter a primary source for prevailing if conflicting Western notions of nature. The Old Testament manifests two antagonistic ideas of nature. One reflects agriculture, where humankind increasingly asserts its dominion over the earth while paying the price of great toil. The other is that of a world of milk and honey where humans wandered the earth freely, living in an Edenic condition. On either account a creator god is posited as the agency of creation. A cosmos is constructed and populated, culminating on the sixth day with the arrival of Adam and Eve. Life is good, until the original pair fall into temptation and sin. The consequence was expulsion from the Garden, arguably a remembrance of a deep past free of the woes of agricultural existence.

Pre-Socratic Ideas of Nature

Alphabetic literacy changed the way that humans thought of nature. It is the pre-Socratics, the Greeks, and to a lesser extent the Egyptians and Romans, who in their theorizing of nature appear as our kindred spirits, even if we believe their theories are mistaken, in their commitment to rational explanation. A clear line separates pre-alphabetic from post-alphabetic accounts of nature; the mythical accounts of antiquity become topics of derision. Nature increasingly becomes a conceptual entity known only through rational inquiry.

The pre-Socratic philosophers Heraclitus and Parmenides laid down two basic channels in which contemporary ideas still

flow. According to Heraclitus (c. 540–c. 480 B.C.E.), reality is a moving river into which humans cannot step twice. And yet, since total chaos would defeat knowability, he posits the strife of opposites as a limit on chaos. Hot becomes cold, wet becomes dry, winter gives way to summer. The wise person behaves according to these basic insights into evanescence and its limits. Heraclitus's notions resonate with contemporary evolutionary thinkers, systems ecologists, and chaos theorists. Chaos theorists celebrate Heraclitus as the conceptual source of a second scientific revolution in the twentieth century. We can also recognize Paleolithic resonances in Heraclitus, including his notion of nature as a cyclical process with which humans should exist in harmony.

Heraclitus's conceptual antagonist was Parmenides (born c. 515 B.C.E.), who argued that reality does not move since "all is one." The apparent motion of nature was for him just that: appearance and not reality. His immediate followers, such as Zeno, devised the famous paradoxes of motion, such as the tortoise and the hare, that conceptually defeated all challenges until the twentieth century. If the tortoise, however slow, starts ahead of the hare, however fast, and if in any given unit of time the hare closes one-half of the distance to the tortoise, the hare can never pass the tortoise because there will always remain an unclosed interval between them. The appearance, then, that the hare catches and passes the tortoise is a deception—"the way of seeming," as Parmenides termed it, and not the "way of truth." The conceptual truths of nature deny perceptual appearances.

The best-known successors to Parmenides are the atomists, Leucippus and Democritus. Perhaps the first truly modern theorists, they corrected Parmenidean conceptual excess. The variety and phenomena of nature were constituted by the arrangement of many "ones"—that is, the atoms themselves. The perceptions of a changing world could now be admitted without undercutting nature's conceptual knowability. Atomic theory today traces its roots to Leucippus and Democritus.

Nature in Greek Rationalism

All these thinkers pale in comparison with Aristotle (384–322 B.C.E.), the greatest classical theorist. Aristotelian ideas of nature dominated Western civilization until the scientific revolution of the seventeenth and eighteenth centuries. So pervasive is his influence that some believe Western intellectual history is little more than footnotes to his work. Only a partial description showing Aristotle's continuing influence can be included here.

First, Aristotle introduced the category of cause as a key explanatory feature for theorizing nature. He understood the diverse phenomena and different kinds in nature in terms of four causes: the formal, material, efficient, and final. Aristotle's account of causation surpasses the theories of his predecessors. For example, his notion of material cause chimes with the atomism of Leucippus and Democritus, and yet the atoms themselves are neither a final cause, since they have been set into original motion, nor an efficient cause, since they can be rearranged by other factors, including human agency.

Second, Aristotle argued that all motion is a consequence of an original, unmoved mover. Without the unmoved mover

any causal sequence would entail an infinite regress. Aristotle's notion of an unmoved mover, while driven by his logical commitment to avoiding motion that cannot be explained, resonates not only with earlier Hebraic conceptions of a creator god but also with Parmenidean commitments to a final rational explanation for all that is, was, or ever will be. It also resonates with the Heraclitean stream of influence: natural processes and creatures move.

Third, Aristotle offered a theoretical account of living nature manifesting a sensitivity to the explanatory and descriptive requirements of the behavior of plants and animals. These motions could not be explained in the same way as those of inanimate objects. While not an evolutionary thinker in modern terms, he recognized the diversity of natural kinds with their characteristic patterns of reproduction and growth.

The theoretical legacy of the Greeks is highly significant. While it is an exaggeration to say that the period between the fall of Rome and the Middle Ages was a conceptual wasteland, and while descriptive accounts of nature flourished (in astronomy, for example), there were few developments beyond Aristotelian ideas. The Middle Ages brought some conceptual refinements, but no paradigmatic breakthroughs. For example, William of Ockham (c. 1285–1349?) deduced that a simpler explanation was to be preferred to a more complicated explanation when the explanatory power was equal—a logical principle of parsimony known as Ockham's razor. But it is the theorizing of classical Greek civilization that lives on, even if implicitly.

Nature during the Scientific Revolution

Facilitated in part by advances in instrumentation, such as the telescope and microscope, the scientific revolution brought paradigmatic change to the idea of nature. When Galileo Galilei (1564–1642) observed moons orbiting Jupiter on a predictable schedule, the consequences were enormous. Earth could no longer be conceived as the center of the cosmos, as the focal point of a godly creation. Bacteria were first observed by the Dutch naturalist Anton van Leeuwenhoek (1632–1723) in 1683 (although the science of bacteriology had not yet arrived). As with Galileo, so with Leeuwenhoek: the apparent reality of nature visible to the naked eye was not what it seemed.

Changes in instrumentation were accompanied by changes in the powers of mathematical analysis. Working independently, Gottfried Wilhelm von Leibniz (1646–1716) and Sir Isaac Newton (1642–1727) developed what is now called the calculus. The move into conceptual abstraction that began with the Greeks was radically transformed by such mathematics. The scientific idea of nature was more and more represented in terms of equations and laws, devoid of so-called secondary qualities such as color and sound. There was an increasing commitment to Parmenidean tendencies—that is, the reduction of nature to permanence through mathematically described mechanical relations. The hallmark of rationality thus continued in the tradition of Parmenidean One—nature as an unchanging and therefore totally knowable singularity—while admitting to diverse mathematical characterization of natural phenomena.

The scientific revolution is often thought of as culminating in the work of Newton and the view of nature according to what is now termed “classical physics.” But Newton is best understood as both an original thinker and a synthesizer. The work of three other thinkers is indicative of his precursors.

The first of these thinkers was Francis Bacon (1561–1626), aptly characterized as the man who saw through time because he straddled the medieval and modern ages. A practicing scientist, his scientific discoveries are less significant than his radical new ideas concerning nature itself. Science, he realized, was power—power over the natural world. And that power could lead human beings to a second world fashioned according to their wants and desires. Much of the utopian character of our own time, the belief that through the advance of theoretical knowledge and its technological application all problems might be solved, was first articulated by Bacon. His arguments effectively became a legitimating rationale for societal support of the natural sciences. While our rationales are primarily economic, his were ethical. He addressed the ancient problem of the fall into sin, which effectively sundered godly relations between humankind and nature. Toil and suffering, the ruined earth, affliction with drought and storm, insects and disease, were the consequences of the Fall. On the Baconian view a New Jerusalem could be had through the power of science to set nature right again, returning humans to an Edenic condition. Contemporary studies, including those based in critical, feminist theory, argue that the Baconian view of nature reflected an intensely hierarchical and patriarchal society. “Man” (meaning, the male members of the human species) would wrest scientific knowledge from an unwilling and unruly natural world, and through such knowledge gain power over “her.”

The second was Galileo, an Italian physicist and astronomer famous for his encounters with the Inquisition, whose work in physics fundamentally undercut Aristotelian physics. Building on the theoretical work of Nicolaus Copernicus (1473–1543), who overturned geocentrism, Johannes Kepler (1571–1630), who first theorized the laws of planetary motion and the sun’s influence on planetary orbits, and Tycho Brahe (1546–1601), who had achieved unparalleled accuracy in measuring the motions of the heavens, Galileo brought a new mathematical precision to the description of planetary motion (ironically, believing wrongly that the motion was circular rather than elliptical) and to falling material objects. Through his many experiments and observations, Galileo realized that there was but one kind of motion in nature, whether celestial or terrestrial, not two as the Greeks had believed.

Third, the work of the Frenchman René Descartes (1596–1650) had a profoundly important influence on physics. Descartes invented analytical geometry, a technique that allowed the precise description of the trajectories of material bodies in motion—later refined by Newton. His further work on methodology (the method of analysis) was likewise crucial. He argued that the way to understand complex physical phenomena was to reduce them to simpler components until reaching the level of irreducibility. Finally, Descartes argued that the new science of physics, built on mathematical

description and prediction, would make humankind the master and possessor of nature.

Isaac Newton’s Nature

While the advances made by Galileo, Bacon, and Descartes were considerable, history’s judgment is that Newton revolutionized Western thinking, dominating his age much as Aristotle did that of the Greeks. Many of his notions, such as the absolute nature of space and time, were repudiated in the twentieth century. And yet Newtonian ways of thinking rule today’s culture, lying at the heart of our notion of human dignity as control over nature. We have institutionalized notions that nature is little more than atoms in mechanical and therefore predictable motion. So construed, nature becomes nothing but raw material awaiting technological conversion into goods of economic value.

Newton himself was not concerned with such derivations from his ideas, but with nature as matter in motion, especially the movements of the heavenly and terrestrial bodies. His invention of the reflecting telescope, the calculus (which he called his “fluxional method”), and the laws of motion coalesced in an ability to describe physical systems mathematically and thus to make accurate predictions. For Newton material atoms were the fundamental characteristic of nature, bound together by the force of gravity. Newton theorized the law of planetary attraction, which he argued varied inversely to the square of the distance from the sun. However, Edmond Halley (1656–1742) did more to popularize the Newtonian idea of nature than Newton himself. Using a Newtonian reflector and Newtonian physics, Halley calculated the orbit of what is now called Halley’s Comet, accurately predicting its appearance in the night sky in the year 1758.

Classical science, as Newton’s science is now called, and the scientific picture of the world and humankind’s relation to it, became the way that Western civilization understood nature. But several problems with the classical view soon appeared. For one, nowhere in the cognizable world picture did human beings appear—as if nature was devoid of human presence. Further, the Newtonian notion of nature facilitated naive realism, the notion that nature was known without interpretation, as if Newton had given us a “God’s eye” view of nature as the way it was and forever would be. These conundrums continued throughout the twentieth century and remain with us today.

Nature in Darwin’s Century

Classical science assumed that objectivity depended upon the separation of the knowing observer from the world of nature. Charles Darwin’s (1809–1882) theory of evolution upset that assumed separation forever, reinserting humankind into a cognizable view of nature. Darwin’s penetrating insights into the nature of our own humanity—and the importance of language—are effectively a Copernican revolution in our self-understanding of the idea of nature itself. Humankind can no longer be thought of as separate from the cognizable world picture. The status of humankind as something apart from, rather than a part of, nature becomes, after Darwin, increasingly

incomprehensible (consider, for example, Werner Heisenberg [1901–1976], who makes clear that not only are humans embedded within biophysical systems but that our observations themselves profoundly color what can be known).

As with Newton, so with Darwin's precursors, who framed the stage upon which he stood. First, the work of scientists in disparate disciplines, such as geology and paleontology, combined with Darwin's work in natural history, led to what can be termed the discovery of time in four crucial dimensions, beginning with geological time. Irish Archbishop James Ussher (1581–1656) had calculated the age of the Earth, based on biblical interpretation, as no more than 6,000 years. Charles Lyell (1797–1875) heralded the arrival of a scientifically informed grasp of the enormity of geological time. Lyell's theory of very slow but uniform change in the Earth upset the dominant theory of catastrophism—the notion of a ruined Earth as God's punishment for sin. Geological inquiry expanded the notion of time over almost unimaginably large temporal scales: Ussher's estimate was off by nearly six magnitudes.

Second, paleontology disclosed through the discovery of successive layers of the fossil record a continual transformation of the forms of life. The natural world could no longer be rationally understood as frozen into eternal forms, but only as a ceaseless flux. The work of Georges Cuvier (1769–1832) drew in part from the geological law of superposition. Fossilized life forms found in lower strata were necessarily older than those lying above. Cuvier also observed that the various strata themselves had characteristic life forms, suggesting a coming and going of great epochs of life.

Third, Darwin's own studies made clear that the process of natural selection had not only shaped but continued to shape the flora and fauna. His five-year voyage on the HMS *Beagle* provided the data that were soon interpreted as evidence for natural selection over biological time. The adaptive radiation manifest in his famous finches, whose beaks illustrated the evolutionary diversification of forms through adaptation, became an exemplary case study. While Darwin lacked any knowledge of the genetic basis for inheritance of advantageous characteristics, discovered by Gregor Mendel (1822–1882), he clearly understood that natural selection was governed by the principle of survival of the fittest—an idea that the economist Thomas Malthus (1766–1834) had developed in relation to human populations.

Finally, near the end of the century, archeologists discovered the Paleolithic strata, a clear record of cultural transformation as successive generations of humans adapted their lives to the natural world. However dimly, these discoveries coalesced in a dawning awareness that humankind is a naturally evolved species that has moved into culture—a symbolically mediated space from where nature is increasingly and continuously theorized. The ongoing inquiries of prehistoric archeology and paleoanthropology have fundamentally changed both the ways we think of ourselves and our ideas of nature.

Nature in the Twentieth Century

Reflecting the dominant notion of nature as nothing more than atoms—in motion subject to mechanical laws, an unparalleled

fusion of science, technology, and market capitalism colored the twentieth century. During the eighteenth century the Newtonian worldview was translated into an economic theory of marketplace capitalism by Adam Smith (1723–1790). Market societies of the twentieth century believed they possessed the power to bend nature to any and all human purposes. The rational exploitation of nature for human benefit was publicly and privately institutionalized. Wild rivers were tamed, deserts made to bloom, old-growth forests harvested. The apparent mastery of the atom heralded an era of nuclear energy in which power would be too cheap to meter. Modern chemistry promised better living. The “green revolution” offered agricultural plenty to the hungry masses. There would be no Malthusian limits to the growth of human population nor to its steady economic advance. Mirroring the dreams of Bacon's New Jerusalem, cultural progress seemed to be virtually a law of nature.

But perhaps the greatest changes were in the life sciences, especially biology and ecology. Both were profoundly affected by the molecular revolution and the Cartesian belief that complexity must be reduced to analytical simplicity. James D. Watson's and Francis Crick's discovery of the double helix as the structure of DNA in 1953 promised mastery over life itself. Molecular biology, supported by advances in scientific instrumentation, combined with market capitalism to offer the promise of organisms better than those produced by nature. Genetically modified organisms (GMOs) became the rage in the late twentieth century. Biotechnology reinvigorated the Baconian dream of a second world. And yet, as the twentieth century wound down, scientific and other critics raised fundamental questions about the sustainability of a cultural trajectory built around the ideas of the scientific revolution. Classical physics, while theoretically useful, was neither the one, true view of nature nor the final word.

Twentieth-Century Ideas

There is no definitive twentieth-century idea of nature. The turn of the century marked the beginning of a virtual revolution in the work that collectively constitutes the new physics. Albert Einstein's (1879–1955) theory of special relativity challenged the Newtonian notion of absolute space and time. And yet Einstein's theories did not support conceptual relativism. He was a Parmenidean in modern guise. God, in his account, did not play dice with the universe. Einstein dedicated the last half of his life to discovery of what came to be known as God's equation—a mathematical expression of the fundamental reality that explains all that there is, was, or will be.

The middle of the twentieth century might be represented through the work of Werner Heisenberg (1901–1976). If Einstein is a Parmenidean, then Heisenberg's principle of indeterminacy and quantum theory manifest a Heraclitean vision. In his account, the very activity of the observation of nature made a profound difference in what was observed. Physical sciences could achieve relative precision in one measurement only by sacrificing certainty in another. Heisenberg's insights into the atom were equally brilliant. The particles within atoms did not, Heisenberg demonstrated, behave according to Newtonian mechanics. While the picture of nature offered by

classical physics remains useful in certain domains—for example, calculating the trajectories of flying objects or predicting the motions of planets and stars—the Newtonian view has lost intellectual hegemony.

The latter decades of the twentieth century can be represented by work of another Nobel laureate, Ilya Prigogine (1917–2003). Prigogine and many others constitute a rapidly growing epistemic community studying the phenomena of nature that are in disequilibrium—including life itself. After embracing chaos theory, the possibility of definitive description disappears, as does the notion that complex phenomena can be disassembled into constituent parts and then reassembled. Biological and ecological scientists in particular have challenged reductionistic mechanism. The principle of superposition, which underlies the description and explanation of linear phenomena, has been repudiated by the life sciences, where nonlinearity rules.

The implications of such accounts for our idea of nature, as well as the conceptualization of our place in nature, are enormous. The belief that humankind has sure and certain knowledge of nature is untenable. While remaining useful assumptions at some scales of inquiry, atomism, reductionism, and mechanism are not absolutes. Laplacian determinism, the notion that, given sufficient knowledge of nature, sure and certain prediction of the future is possible, has been discredited. Radically new perspectives on the nature of nature and the cosmos itself have started to emerge. Time itself has clearly been recognized as a fourth and absolutely essential dimension of any comprehensive idea of nature.

The notion that humankind has dominion over the evolved world has also been discredited. Our knowledge of nature is limited, more contingency and probability than necessity and certainty. Increasingly the lack of equilibrium in the natural world gives evidence that our present interactions with it are unsustainable over biologically and ecologically meaningful scales of time. Political and economic temporal scales are known to be discordant with nature's temporal horizons. The fragility of humankind's dominion is clearly manifest in multiple dysfunctional relations between cultural and natural systems. Despite the received idea of nature, nature profoundly acts on culture. The idea of nature as a passive material world over which humankind has dominion has failed, gravely intensifying the question of humankind's place in nature. Conceptual developments in areas such as cosmology also lead to a chastened view of our place in nature. The visible material cosmos is a very small portion of reality. Dark matter, as it turns out, while unseen, is as consequential in understanding the cosmos as visible matter.

As the twentieth century ended, the notion of a discord between the culturally dominant idea of nature and nature itself gained credence. The cultural system, which had given birth to and nurtured the idea of nature as passive matter in motion, subject to reductionistic explanation and technological control, began to experience pervasive environmental dysfunctions. The anthropogenic depletion of stratospheric ozone, collapse of oceanic fisheries, deforestation of Amazonia, disruption of global weather patterns, and extinction of biodiversity

posed ominous warnings as well as major conceptual challenges that can only be met by articulating alternative ideas of nature and humankind's place therein.

Nature in the Third Millennium

Clearly, the idea of nature is semantically and conceptually conflicted. If we think of nature as meaningful across multiple temporal and spatial scales, from the cosmic to the subatomic, then we can also understand that our dysfunctional relations are due in part to our lack of either the ability or the commitment to integrate knowledge of nature across scales. Contemporary thinkers argue that the hold of ancient dreams, especially the return to the Garden, must be put behind. And the failed idea of nature inherited from classical science must be replaced by alternative ways of conceptualizing nature and our place therein.

Some of these emerging ideas were first broached in the late nineteenth and early twentieth centuries by alternative voices such as Henry David Thoreau and Aldo Leopold, and then more vigorously in the latter part of the twentieth century by Ilya Prigogine and Edward O. Wilson. Thoreau argued that the best humankind could hope for was a sympathy with the intelligence of nature rather than sure and certain knowledge. Leopold, observing the destruction of nature at an unprecedented scale, argued that humans should think of themselves as citizens of the land community rather than as the conquerors of nature. Near the end of the century Prigogine argued that humankind must, for the first time in its history, engage the evolved complexity of the natural world in dialogue, as a conversational partner. And Wilson made clear that humankind's actions over the first few decades of the new millennium would have profound consequences for the future of life.

As a linguistically reflexive, naturally evolved yet culturally self-conscious species, we might yet find our way into more tenable and less destructive notions of nature. But the challenge is enormous. How might we break free of the notion that we are the dominators of a brute, blind, material world of nature into an idea that leads us to restore some sense of ourselves as natural creatures, living in harmony with nature, while also retaining our distinctive cultural identity? There is no ready answer. Perhaps we will come to know the idea of nature more fully when we have come more fully to realize the enormity of time and our own historicity. There are reasons to think, as we enter the twenty-first century, that humankind might come to embrace an idea of nature that includes ourselves as cognizing subjects within it while not reducing ourselves to it.

See also Aristotelianism; Biology; Development; Ecology; Evolution; Life; Life Cycle; Natural History; Naturphilosophie; Newtonianism; Organicism; Physics; Science, History of; Scientific Revolution; State of Nature.

BIBLIOGRAPHY

- Aczel, Amir D. *God's Equation: Einstein, Relativity, and the Expanding Universe*. New York: Four Walls Eight Windows, 1999.
- Bernstein, Richard J. *Beyond Objectivism and Relativism: Science, Hermeneutics, and Praxis*. Philadelphia: University of Pennsylvania Press, 1983.

- Cohen, I. Bernard. *Revolution in Science*. Cambridge, Mass.: Harvard University Press, 1985.
- Collingwood, R. G. *The Idea of Nature*. Oxford: Clarendon, 1939.
- Darwin, Charles. *The Descent of Man, and Selection in Relation to Sex*. London: John Murray, 1871.
- Einstein, Albert. *Ideas and Opinions*. Translated by Sonja Bargmann. Rev. ed. New York: Modern Library, 1994.
- Evernden, Neil. *The Social Creation of Nature*. Baltimore: Johns Hopkins University Press, 1992.
- Firor, John. *The Changing Atmosphere: A Global Challenge*. New Haven, Conn.: Yale University Press, 1990.
- Glacken, Clarence J. *Traces on the Rhodian Shore: Nature and Culture in Western Thought from Ancient Times to the End of the Eighteenth Century*. Berkeley: University of California Press, 1967.
- Kirk, G. S., J. E. Raven, and M. Schofield. *The Presocratic Philosophers: A Critical History with a Selection of Texts*. 2nd ed. Cambridge, U.K.: Cambridge University Press, 1983.
- Kuhn, Thomas S. *The Structure of Scientific Revolutions*. 2nd ed. Chicago: University of Chicago, 1996.
- Lederman, Leon M. *The God Particle: If the Universe is the Answer, What is the Question?* New York: Dell, 1993.
- Leopold, Aldo. *A Sand County Almanac: With Essays on Conservation from Round River*. San Francisco: Sierra Club Books, 1970.
- Levin, Simon A. *Fragile Dominion: Complexity and the Commons*. Reading, Mass.: Perseus, 1999.
- Mayr, Ernst. *The Growth of Biological Thought: Diversity, Evolution, and Inheritance*. Cambridge, Mass.: Harvard University Press, 1982.
- Merchant, Carolyn. *The Death of Nature: Women, Ecology, and the Scientific Revolution*. New York: Harper and Row, 1980.
- . *Earthcare: Women and the Environment*. New York: Routledge, 1990.
- Oelschlaeger, Max. *The Idea of Wilderness: From Prehistory to the Age of Ecology*. New Haven, Conn., and London: Yale University Press, 1991.
- Prigogine, Ilya. *From Being to Becoming: Time and Complexity in the Physical Sciences*. San Francisco: W. H. Freeman, 1980.
- Prigogine, Ilya, and Isabelle Stengers. *Order Out of Chaos: Man's New Dialogue with Nature*. New York: Bantam, 1984.
- Rees, Martin J. *Our Final Hour: A Scientist's Warning: How Terror, Error, and Environmental Disaster Threaten Humankind's Future in This Century—On Earth and Beyond*. New York: Basic Books, 2003.
- Williams, Raymond. *Keywords: A Vocabulary of Culture and Society*. Rev. ed. New York: Oxford University Press, 1983.
- Wilson, Edward O. *The Diversity of Life*. Cambridge, Mass.: Harvard University Press, 1992.
- . *The Future of Life*. New York: Knopf, 2002.

Max Oelschlaeger

NATURPHILOSOPHIE. *Naturphilosophie* refers both to the specific philosophical program Friedrich Wilhelm Joseph von Schelling (1775–1854) initiated with his *Ideen zu einer Philosophie der Natur* (1797; Ideas for a philosophy of nature) and to the movement during the German Romantic period that Schelling's work is said to have spawned. The context of both is the achievement of Immanuel Kant (1724–1804),

whose philosophical system formed the background against which many of the themes of Romantic thought emerged. In this case, dissatisfaction with Kant's treatment of nature, in which there could be cognition only of the appearances of nature but not of nature-in-itself, provided the occasion for several individuals to attempt to complete what they thought Kant had only begun.

Schelling was by no means the first thinker who departed from Kant's understanding of the natural philosopher's role as a lawgiver to nature. Others from the 1790s who independently of Schelling addressed for various reasons what they saw as the inadequacy of Kant's system where nature was concerned included Franz Xaver von Baader (1765–1841); Carl Friedrich Kiemeyer (1765–1844); Karl August Eschenmayer (1768–1852); and in his dissertation of 1799, Hans Christian Ørsted (1777–1851).

The Work of Schelling

But it was Schelling who set out to locate the knowledge of nature within a larger system of philosophy. He came to this task as a participant in the general philosophical examination of Kant's system that was underway in the 1790s. In addition to those largely sympathetic to Kant, there were others, especially Johann Fichte (1762–1814), who questioned Kant's reliance on the existence of things-in-themselves. Since we cannot have knowledge of things-in-themselves, how could Kant insist that they were the source of the sense data that reason utilized to create knowledge of the world? Schelling's initial sympathy for this critique made it appear that he agreed with Fichte's claim that even the manifold of sense had been produced by us out of our own creative faculty. But in spite of his agreement with Fichte that the possibility of our knowledge of nature did not depend on the existence of Kant's things-in-themselves, it was Schelling's ultimate disagreement with Fichte's reliance on the absolute ego that led to his wish to construct a system of philosophy in which nature retained its own integrity.

At first, in the *Ideen*, Schelling insists merely that our belief in a reality outside ourselves grew up at the same time that our belief in our own existence appeared, that one was as necessary as the other. But this first book is best seen as a preliminary attempt, a beginning to the new enterprise. In it Schelling does not yet himself realize the basic foundation of his later *Naturphilosophie*. The *Ideen* contains, like Baader's work before it, an attack on atomism as an outlook sufficient to capture the depth of nature's reality. In place of atomism Schelling proposed a dynamic conception of underlying polar forces he believed were more up to the task. With these he felt that he could show how what we experience of nature derives from the same source that gives rise to our belief in a nature outside ourselves.

So far he has not gotten outside the mind, since he is here speaking about instances of our belief. But with the rapid appearance of a series of works between 1798 and 1801, in which the work of Benedict de Spinoza (1632–1677) was influential, he would make clean the break from Fichte and insist that the realm of the real has equal status to that of the ideal. It was

these works that inspired many to abandon the viewpoint of Kant in favor of what they saw as the more realistic understanding that Schelling's approach provided.

It was likely while he was writing the *Ideen* that Schelling came to the realization that the realm of the organic, which had been dealt with only cursorily in his first work, altered fundamentally the direction in which he had been going. In the next book, *Von der Weltseele* (1798; *On the world soul*), the new emphasis became clear in the subtitle: *An Hypothesis of Higher Physics to Explain General Organism*. By recognizing that the metaphor for reality was not mechanism but organism, Schelling found a means by which he could overcome Kant's fracturing of human experience into two separate realms. If nature was an organism, then knowledge of organism would include knowledge of nature as a living whole. And that whole would include the life of the mind and soul as well as that of the body. There would not be, as Kant taught, two separate realms, only one of which was accessible to knowledge. For Schelling there was only one realm.

This perspective resonated with many in the early years of the nineteenth century. As a prolific author in Jena, Schelling had become an important member of the famous Romantic circle that had assembled there. He also got to know Johann Wolfgang von Goethe (1749–1832), who spent many hours together with Schelling reading the latter's work. Because of his youth—he was twenty-three when he received the call to Jena—Schelling established a reputation as a successful young genius.

Supporters and Detractors

Physicians were especially drawn to Schelling's focus on nature as an organic whole. Many of them found his emphasis on the organic especially appealing because they felt that healing was impossible without seeing the body in intimate connection to the soul that inhabited it. Of forty readily identifiable sympathizers of Schelling's system, for example, more than 70 percent held medical degrees. Given the development of what has been called an ideology of *Wissenschaft* that accompanied the upsurge of German culture during the latter half of the eighteenth century, scholars have also pointed to the promise some physicians felt that organic *Naturphilosophie* held for medicine. Because in these years medicine suffered from criticism that it lacked the systematic structure enjoyed by other *Wissenschaften*, physicians hoped that the rigorously reasoned program Schelling had outlined in his many works would supply the kind of intellectual foundation medicine needed.

Other natural philosophers were also attracted to Schelling's attempt, as he once said, to give wings to physics, that is, to give the natural philosopher the responsibility to move from particular empirical results to the larger meaning of the entire enterprise of natural science. Regarding nature as a living whole, for example, entailed the assumption that all of nature's forces were interrelated. A number of experimenters from the physical sciences persisted in exploiting this assumption, including Hans Christian Ørsted, whose commitment to the philosophical unity of nature's forces played a direct role in his discovery of electromagnetism in 1820.

While Schelling himself always retained great appreciation of and respect for empirical research, eventually the charge arose, in some cases justifiably, that his followers dealt primarily with the play of speculative ideas and had little interest in the empirical side of natural science. In addition, those still devoted to a Kantian position on nature and natural science, like the philosopher-physicist Jakob Fries (1773–1843), composed informed critiques of Schelling's work.

After the first decade of the century, Schelling turned in his writing to other matters, and his influence as the founder of *Naturphilosophie* waned. By the 1820s there were only a few who were willing to identify themselves as *Naturphilosophen*. Among those who were, however, was Lorenz Oken (1779–1851), who was the motive force behind the emergence of a German scientific community in the modern sense of the term. His founding of the journal *Isis* and his leading role in establishing the Society of German Natural Investigators and Physicians in 1822 were accomplished in spite of his reputation as an unrepentant *Naturphilosoph*.

See also Biology; Kantianism; Life; Medicine: Europe and the United States; Organicism; Philosophy; Physics; Religion and Science; Romanticism in Literature and Politics; Science.

BIBLIOGRAPHY

- Beiser, Frederick. *The Fate of Reason: German Philosophy from Kant to Fichte*. Cambridge, Mass.: Harvard University Press, 1987.
- Bonsiepen, Wolfgang. *Die Begründung einer Naturphilosophie bei Kant, Schelling, Fries und Hegel: Mathematische versus spekulative Naturphilosophie*. Frankfurt am Main: Klostermann, 1997.
- Broman, Thomas. *The Transformation of German Academic Medicine, 1750–1820*. Cambridge, U.K.: Cambridge University Press, 1996.
- Gregory, Frederick. "Kant, Schelling, and the Administration of Science in the German Romantic Era." *Osiris* 5 (1989): 17–35.
- . "Die Kritik von J. F. Fries an Schellings Naturphilosophie." *Sudhoffs Archiv* 67 (1983): 145–157.
- Richards, Robert. *The Romantic Conception of Life: Science and Philosophy in the Age of Goethe*. Chicago: University of Chicago Press, 2002.

Frederick Gregory

NEGRITUDE. An aesthetic and literary movement inaugurated in the 1930s that centers on the creative potential of black consciousness, negritude was one of the premier cultural phenomena of the twentieth century. Curiously, negritude has no originating text as such; it took root and flourished in Paris in the mid-1930s, fed by the writings of two black scholars from the French colonies, Aimé Césaire (b. 1913) of Martinique and Léopold Sédar Senghor (1906–2001) of Senegal. Both of these figures would go on to become major writers, and each would play a leading role in the political life of his respective country of origin. Senghor became the first president of an independent Senegal, and Césaire served simultaneously

as mayor of the Martinican capital, Fort-de-France, and as Martinique's representative to the French National Assembly for more than forty-five years.

Influences

Négritude became internationally recognized with the publication of Césaire's book-length poem, *Cahier d'un retour au pays natal* (Return to my native land) in 1939. The Césaire-Senghor collaboration that led up to this moment was indeed serendipitous. They met as colonial scholarship students in Paris. Each had been strongly influenced by the scope for rehabilitating black history and culture evinced by such recent movements as the Harlem Renaissance, and admired greatly the work of such poets as James Weldon Johnson, Jean Toomer, and Claude McKay. René Menil, a constituent member of the Parisian group that published the radical manifesto *Légitime défense* (Legitimate defense) in 1932, was also a major influence on Césaire, and joined him later in launching the Martinique-based periodical *Tropiques*. The *Revue du monde noir* (Review of the black world), published 1931–1932, introduced them to the work of such writers and educators as Langston Hughes and Alain Locke; they were also influenced by the presence in Paris of the French Guyanese author René Maran, the author of *Batouala*, which had won the French Prix Goncourt in 1921 and was subsequently banned in French African colonies. Together with a group of fellow students, they launched a literary magazine, *L'Étudiant noir* (The black student), which took a militant stand against black cultural assimilation by actively seeking to explore and valorize the singularity of the black cultural experience. The publication inaugurated the use of the word *négritude*, and appeared roughly half a dozen times before closing in 1936. During this period Césaire and Senghor, along with their friend and collaborator, the French Guyanese poet Léon Dumas, culled from these influences a framework for rehabilitating and resituating the articulation of black consciousness and its attendant cultural expression, even within an ongoing context of colonialism and racism.

Philosophy and Practice: Césaire

Drawing on a binary structure that, as we shall see, would ultimately lead to its undoing, *négritude* sought to ground and, indeed, to legitimize the difference of the black aesthetic in a set of biological concepts meant to firmly separate the black experience from the white experience. Initially, however, from an artistic perspective, its founders drew heavily on French surrealism. This radical mode of poetic expression, which first made its appearance in postwar France, afforded a means of discursive liberation from French rationalism through the abandonment of traditional aesthetic and expressive constraints. To this expressive vein must be added the work of Leo Frobenius, whose groundbreaking *Histoire de la civilisation africaine* (1936; History of African civilization) exploded the myth of Negro barbarity as a European invention and was of cardinal importance in allowing the founders of *négritude* scope for a needed valorization of Africa-based civilizations and cultures. This concatenation of beliefs and arguments allowed them to posit that what was unique to the black experience—what separated it from Western subjectivity and provided the basis for the new aesthetic—was a predetermined predilection

for art, emotion, intuition, and rhythm, which were opposed to supposedly Western characteristics of order, reason, and logic. These, then, were the enabling categories of expression that mediated the appearance and argumentation of *négritude*.

In literary terms, and especially in the *Cahier*, which is typically seen as its foundational text, *négritude* functions as an illumination and affirmation of pride in black subjectivity. The sentiments voiced in the poem derive their importance equally from their form and their content as the poet joins lyricism to self-revelation in a rediscovered empathy with his African ancestry. This black subject revels in the rebirth of a black identity that is both historically and culturally grounded; *négritude* becomes a framework for creative cultural expression that valorizes black civilizations past and present and thus, at least in the *Cahier*, goes beyond a reductive essentialism based on biology. Ultimately, what is emphasized is the process of self-discovery and self-actualization, an ongoing voyage into blackness that replaces the static acceptance of colonial inferiority with the active uncovering of viable alternative identities.

Philosophy and Practice: Senghor

Senghor differed from Césaire in both his vision and his practice of *négritude*; for him, opposing the values of Europe to those of the African world led him to valorize life forces as the essential framework grounding his poetic portraits of African civilization. Arriving in Paris in 1928 on a partial scholarship in literary studies, he studied at the Lycée Louis-le-Grand and the Sorbonne. It was during this period that he began to be influenced by his discussions with Césaire, Maran, McKay, and the Haitian author and intellectual Dr. Jean Price-Mars. It was around this time that Senghor formed the belief that blacks could benefit by assimilating European culture without severing themselves from their own cultural origins. He promulgated a return to historical and cultural sources through the cultivation of indigenous languages and traditions, and sought to instantiate this value system through the vocabulary, themes, and symbolism of his published poetry. His *Hosties noires* (Black offerings) and the collection *Anthologie de la nouvelle poésie nègre et malgache de langue française* (Anthology of new black and Malagasy poetry in French) appeared to mark the centennial of the French abolition of slavery in 1948, joining the already-published collections by Césaire in rehabilitating the perceived "primitive" character of black colonial civilizations.

Senghor's primary themes are alienation and exile, along with a recognition of the central role played by the culture and tradition of his African homeland. The importance of the cultural heritage that he was thus able to describe and define for his fellow blacks cannot be overemphasized. This valorization of a cultural patrimony became a catalyst for black self-realization, demonstrating *négritude*'s capacity to engender pride in authenticity and racial difference. Much more so than did Césaire's, Senghor's writing stressed claims for a particular black emotional and psychological experience, an affective rapport that draws on a specifically African relationship to the forces of the universe that are separate and apart from those of the West. Where the black African perceives and internal-

izes in a subjective way (the argument goes), relating to external stimuli in primarily emotional terms, the Westerner, in his turn, relates to the world through analysis and reason. This is not to claim a monopoly on either category for either group, in his view. While not denying the rational power of blacks or the emotive capacities of whites, Senghor does see very real differences in temperament and worldview that determine the ways in which certain cultures view and relate to the world. As limited and reductionist as this argument might seem today, it extended an elaborate and perhaps necessary ontology to the concept of negritude, providing an enabling framework for literally hundreds of African and Caribbean writers to express their vision of their own cultural and historical experience well into the 1960s.

Negritude, then, was in a certain sense a product of its time; despite its own claims to the contrary, its primary shortcoming was perhaps that it drew unconsciously on the binaries of the colonial era. It opened the way for a flood of creative black expression, but it would in time be superseded by alternative approaches to, and theories of, black identity. Critiques that would be leveled at negritude by Frantz Fanon, the Martinican intellectual, and Wole Soyinka, the Nigerian novelist and Nobel laureate, among others, would center on the concept's racial grounding and its implicit essentialisms, contradictions, and limitations. Given the widely varying social and historical situations involved in the development of black culture, any theory that sought to contextualize and mediate this development needed to be deracialized. By moving away from a race-based analysis of culture to one that reflects the range of influences inflecting black historical reality, the differing cultural expressions of black people could be taken into account, catalyzed, and valorized. The theories of Césaire and Senghor would in time give way to those of Glissant and Bernabé, Chamoiseau, and Confiant, among others, acknowledging the opening up of the categories of race and culture whose binary, colonially driven structures established the boundaries of blackness even as they sought to endow them with value and meaning.

See also Africa, Idea of; African-American Ideas; Afrocentricity; Authenticity, Africa; Black Atlantic; Black Consciousness; Colonialism: Africa; Communication of Ideas: Africa and Its Influence; Diasporas: African Diaspora; Humanity: African Thought; Race and Racism.

BIBLIOGRAPHY

- Arnold, A. James. *Modernism and Negritude: The Poetry and Poetics of Aimé Césaire*. Cambridge, Mass.: Harvard University Press, 1981.
- Bâ, Sylvia Washington. *The Concept of Negritude in the Poetry of Léopold Sédar Senghor*. Princeton, N.J.: Princeton University Press, 1973.
- Cailler, Bernadette. *Proposition poétique: une lecture de l'oeuvre d'Aimé Césaire*. Sherbrooke, Que.: Naaman, 1976.
- Confiant, Raphaël. *Aimé Césaire: une traversée paradoxale du siècle*. Paris: Stock, 1993.
- Davis, Gregson. *Aimé Césaire*. Cambridge, U.K.: Cambridge University Press, 1997.
- Eshleman, Clayton, and Annette Smith, trans. *Aimé Césaire: The Collected Poetry*. Berkeley: University of California Press, 1983.

- Popeau, Jean Baptiste. *Dialogues of Negritude: An Analysis of the Cultural Context of Black Writing*. Durham: Carolina Academic Press, 2003.
- Richardson, Michael. *Refusal of the Shadow: Surrealism and the Caribbean*. Translated by Krzysztof Fijalkowski and Michael Richardson. London: Verso, 1996.
- Sartre, Jean-Paul. "Orphée noir." In *Anthologie de la nouvelle poésie nègre et malgache de langue française*. Edited by Léopold Sédar Senghor. Paris: Presses universitaires de France, 1948.
- Scharfman, Ronnie. *Engagement and the Language of the Subject in the Poetry of Aimé Césaire*. Gainesville: University Press of Florida, 1987.
- Senghor, Léopold Sédar. *Négritude et humanisme*. Paris: Seuil, 1964.
- Taylor, Patrick. *The Narrative of Liberation: Perspectives on Afro-Caribbean Literature, Popular Culture, and Politics*. Ithaca, N.Y.: Cornell University Press, 1989.

H. Adlai Murdoch

NEOCOLONIALISM. Neocolonialism can be defined as the continuation of the economic model of colonialism after a colonized territory has achieved formal political independence. This concept was applied most commonly to Africa in the latter half of the twentieth century. European countries had colonized most of the continent in the late nineteenth century, instituting a system of economic exploitation in which African raw materials, particularly cash crops and minerals, were expropriated and exported to the sole benefit of the colonizing power. The idea of neocolonialism, however, suggests that when European powers granted nominal political independence to colonies in the decades after World War II, they continued to control the economies of the new African countries.

The concept of neocolonialism has several theoretical influences. First and foremost, it owes much to Marxist thinking. Writing in the late nineteenth century, Karl Marx argued that capitalism represented a stage in the socioeconomic development of humanity. He believed that, ultimately and inevitably, the capitalist system in industrially developed countries would be overthrown by a revolution of the working class; this would result in the establishment of socialist utopias. In 1916, Vladimir Lenin modified this thesis, claiming that the rapid expansion of European imperialism around the world in the last decade of the nineteenth century had marked the highest stage of capitalism. Presumably, then, the end of imperialism (which Lenin believed would be the result of World War I) would mark the beginning of the end of capitalism. However, neither imperialism nor capitalism came to an end after the war or in future years. European empires persisted well into the 1960s.

With the granting of independence to colonies, a theory of modernization took hold. This suggested that independent countries would begin to develop very rapidly, politically and economically, and would resemble "modern" Western countries. It soon became clear, however, that this was not happening. Postcolonial theorists now sought answers for the

continued underdevelopment of African countries and found a second influence in dependency theory.

Dependency theory first gained prominence as a way to explain the underdevelopment of Latin American economies in the 1960s. It proclaims that underdevelopment persisted because highly developed countries dominated underdeveloped economies by paying low prices for agricultural products and flooding those economies with cheap manufactured goods. This resulted in a perpetually negative balance of payments that prevented underdeveloped countries from ever becoming competitive in the global marketplace. Economic theorists of postcolonial Africa, such as Walter Rodney and Samir Amin, combined the Marxist-Leninist concept of colonialism as a stage of capitalism with the concept of underdevelopment to create the concept of neocolonialism, which Kwame Nkrumah called “the last stage of imperialism.”

According to Rodney and Amin, European countries, and increasingly the United States, dominated the economies of African countries through neocolonialism in several ways. After independence, the main revenue base for African countries continued to be the export of raw materials; this resulted in the underdevelopment of African economies, while Western industries thrived. A good example of this process is the West African cocoa industry in the 1960s: during this time, production increased rapidly in many African countries; overproduction, however, led to a reduction in the selling price of cocoa worldwide. Neocolonial theorists therefore proclaimed that economies based on the production of cash crops such as cocoa could not hope to develop, because the world system imposes a veritable ceiling on the revenue that can be accrued from their production. Likewise, the extraction and export of minerals could not serve to develop an African economy, because minerals taken from African soil by Western-owned corporations were shipped to Europe or America, where they were turned into manufactured goods, which were then resold to African consumers at value-added prices.

A second method of neocolonialism, according to the theory's adherents, was foreign aid. The inability of their economies to develop after independence soon led many African countries to enlist this aid. Believers in the effects of neocolonialism feel that accepting loans from Europe or America proved the link between independent African governments and the exploitative forces of former colonizers. They note as evidence that most foreign aid has been given in the form of loans, bearing high rates of interest; repayment of these loans contributed to the underdevelopment of African economies because the collection of interest ultimately impoverished African peoples.

The forces of neocolonialism did not comprise former colonial powers alone, however. Theorists also saw the United States as an increasingly dominant purveyor of neocolonialism in Africa. As the Cold War reached its highest tensions at roughly the same time that most African countries achieved independence, many theorists believed that the increasing levels of American aid and intervention in the affairs of independent African states were designed to keep African countries within the capitalist camp and prevent them from aligning with the Soviet Union.

If the forces of neocolonialism were so obvious to many theorists at the time, why then could independent African countries not simply recognize them and steer toward economic models that would allow them to be more competitive in the world market? Most students of neocolonialism had theories about the continuing drain of African resources. Perhaps the two most prolific were Kwame Nkrumah and Frantz Fanon. Many theorists and politicians came to espouse the ideas of these two men; a general understanding of the causal theories of neocolonialism may therefore be gained through a brief summary of their writings.

Kwame Nkrumah was a major figure in African politics for more than four decades. Born in Gold Coast (later Ghana) in 1909 and educated in Philadelphia and London, Nkrumah became a powerful leader in the movements for African independence and pan-African unity in the 1930s and 1940s. He became the first president of independent Ghana in 1957 and ruled until 1966, when his regime was overthrown by a military coup. Aside from his political activity, Nkrumah also wrote several books dealing with issues facing contemporary Africa. Of particular importance was his 1965 *Neo-Colonialism: The Last Stage of Imperialism* in which he sought to prove the existence of neocolonial forces in Africa and explain the impediments to overcoming them.

According to Nkrumah, the most important factor allowing for the perpetuation of neocolonialism in Africa was the “balkanization” of the continent that had occurred as a result of European colonialism. Colonizers had broken Africa into dozens of administrative units in order to govern it more effectively, and the colonial boundaries had become the lines within which African countries had been given independence. Nkrumah believed that the interests of Africa were being damaged by the need of each new country to fend for itself. For instance, the fact that each produced and exported its cocoa crop independently was what resulted in lower prices. Nkrumah believed that through African unity and cooperation, the continent could best combat neocolonialism. This required a policy of nonalignment in the Cold War. Believing that Africa had all the resources necessary to achieve true economic independence, Nkrumah promoted inter-African trade, so that the continent could wean itself from Western imports. He also believed that African unity would help to strengthen African countries' bargaining power on the world market, as well as in international politics. If Africans aligned with each other, rather than with the various Western countries that wished to exploit them, the future could be safeguarded. Nkrumah also believed that concerted efforts toward industrialization should complement agricultural and mineral exports in order that African countries become able to produce their own finished goods and reduce their reliance on European and American manufactured products. By enacting such policies, the spell of neocolonialism could be broken, ushering in an era of distinctly African “socialism.” Many African leaders of the day, including Sékou Touré of Senegal and Julius Nyerere of Tanzania, held similar beliefs. Although these men fought diligently for African unity and economic development, their goals were mostly not achieved.

Frantz Fanon offered a different perspective on the dilemma facing independent African countries. Fanon was born in

Martinique, in the West Indies, in 1925. Educated in France, he moved to Algeria in 1953 to practice psychiatry, and soon became embroiled in that nation's violent struggle to gain independence from France. As the Algerian war of independence was nearing its end, Fanon wrote his most celebrated book, *The Wretched of the Earth (Les damnés de la terre)*, in which he discussed, among other things, the causes of neocolonialism in Africa, and the solution he foresaw.

Fanon took much of the basis for neocolonialism for granted, seeing the exploitative tendencies of Western countries as inherent to their capitalist nature. He saw no place for Africa in this system. The African petty bourgeoisie, which had received power from the exiting colonial government, was the primary cause of neocolonialism in Africa. Fanon believed that the Africans who took power at the time of independence had been favored by European powers because they were willing to effect a smooth transition from colonialism to neocolonialism. Since they were generally of the Western-educated middle class who had in many ways benefited from the colonial system, they had the most to gain from a continuation of colonial economic policies. Fanon accused them of collaborating with the colonial power to ensure that the interests of both would continue to be met after the declaration of formal political independence; this class of Africans had betrayed the masses on whose backs the various nationalist movements had been borne. In order to achieve complete and final independence for African countries, "a rapid step must be taken from national consciousness to political and social consciousness" by the masses in order to check the power of the governing class, which had merely replaced the colonial administration as the most direct exploiters of African people. Violent revolution was the only means to drive oppressive neocolonial forces from the world. Fanon's ideology was supported by several political actors in Africa, including Amílcar Cabral of Guinea-Bissau, who warred against a deeply entrenched Portuguese colonial regime until his assassination in 1974.

Of course, neocolonial theory has its detractors as well. Opponents argue that the concept is merely an attempt to continue to blame colonialism for Africa's problems rather than confront the major issues hampering independent African governments, such as corruption, inefficiency, and protectionism. They argue that these problems, more than any systematic process of external exploitation, have been responsible for the poor performance of African economies since independence. Others continue to argue that neocolonialism persists, if in slightly different form. Transnational corporations, such as petroleum and mining companies, and international organizations such as the International Monetary Fund, World Bank, and World Trade Organization are responsible for much of the neocolonial influence in African countries in the early twenty-first century. The activities of these corporations and organizations transcend the boundaries and powers of the traditional nation-state, making it difficult to talk about interregional relationships except in terms of such paradigms as united North (Europe, Canada, and the United States) and underdeveloped and desperate South (Africa, Asia, and Latin America). As the understanding of international and intercontinental relations becomes more and more refined, the idea

of neocolonialism will continue to be revisited. It is for this reason that *neocolonialism* has entered the vocabulary of all students of Third World affairs and is an important concept in the history of ideas.

See also *Anticolonialism; Colonialism; Dependency; Internal Colonialism; Modernization; Modernization Theory; Third World.*

BIBLIOGRAPHY

- Amin, Samir. *Neo-Colonialism in West Africa*. Translated from the French by Francis McDonagh. Harmondsworth, U.K.: Penguin, 1973.
- Falola, Toyin, ed. *Africa (Volume 5, Contemporary Africa)*. Durham, N. C.: Carolina Academic Press, 2003.
- Fanon, Frantz. *The Wretched of the Earth*. Translated by Constance Farrington. New York: Grove Press, 1963. Originally published in French, 1961.
- Museveni, Yoweri K. *What Is Africa's Problem?* Minneapolis: University of Minnesota Press, 2000. Originally published in 1992.
- Nkrumah, Kwame. *Neo-Colonialism, The Last Stage of Imperialism*. New York: International, 1966.
- Rodney, Walter. *How Europe Underdeveloped Africa*. Rev. ed. Washington, D.C.: Howard University Press, 1981. Originally published in 1972.
- Woddis, Jack. *Introduction to Neo-Colonialism*. London: Lawrence and Wishart, 1967.

Toyin Falola
Matthew Heaton

NEOLIBERALISM. The concept of neoliberalism is an interesting one in that, first, it is a label commonly used by its opponents rather than by its adherents. As with all such labels, the tendency for caricature may at times overtake the need for faithful rendition of the underlying idea. As the term implies, neoliberalism refers to what some view as a new form of liberalism, and what others view as a mere reassertion and ascendancy, in intellectual and policy circles, of classical liberalism. Neoliberalism has its roots in classical liberalism, which on the one hand criticized the constraints inherent in the old and dying feudal and mercantilist orders, and on the other hand advocated for political and economic freedom underpinned by a market economy based on private property rights in the form of the newly emerging capitalist mode of production.

History and Meaning

The terms *neoliberal* and *neoliberalism* have been variously used to refer to leading political exponents of the ideology, such as former U.S. president Ronald Reagan (yielding the label "Reaganomics") and former prime minister of the United Kingdom Margaret Thatcher ("Thatcherism"); particular intellectual trends, such as supply-side economics and monetarism, associated with academics such as Milton Friedman (b. 1912); intellectual traditions associated with particular institutions, such as the Chicago School (after the University of Chicago, where most of the leading proponents originated);

the policy stance of particular institutions that have been crucial in promoting its policy implications, such as the Bretton Woods Institutions (the World Bank and the International Monetary Fund, yielding the “Washington Consensus”); or more forthrightly “market fundamentalism” and “neoclassical orthodoxy.” In the developing world, neoliberalism emerged in the form of stabilization and structural adjustment programs (SAPs) that entailed a standard package of the above policy measures regardless of the situation in a given country.

Neoliberalism arose as a major paradigm shift facilitated by the conjuncture of a number of eventualities: persistent and intractable recessions beginning in the 1970s for which standard economic policy tools, primarily based on Keynesianism, appeared ineffectual; the impasse in economic policy at national and global levels; and the unsustainability of some welfare regimes, including those of social democracy, in the developed world in the face of recessionary trends and fiscal constraints. In the context of these developments, proponents of neoliberalism saw the state as the major constraint on the efficient operation of the market and the resuscitation of growth at both national and global levels. Accordingly, neoliberalism directed its criticism against what was seen as an overextended role of the state in the economy consequent upon Keynesianism, socialism, and social democracy. Thus the main thrust of neoliberalism entails the need to roll back the state by restricting its role to the provision of pure public goods and the need to ensure that the state provides the appropriate environment for the market to operate by protecting property rights and associated contractual obligations, facilitating the free mobility of resources within and across nations, and ensuring safety and security.

As the term is applied in the early 2000s, *neoliberalism* refers to an all-embracing economic and political ideology that advocates the supremacy of the market over any alternative social arrangements, viewed from both a comparative and historical perspective, in ensuring the efficient allocation and utilization of scarce resources for the maximum satisfaction of relatively unlimited human wants. The market, based on freedom of choice and respect for private property and individual rights, and underpinned by competition among producers and consumers alike, is seen as the ideal and optimal vehicle for the realization of human ends. Thus neoliberalism leads to the conclusion that individuals, rather than collectives, are the best basis for decision making and that the role of the state (or any similar collective agencies) should be limited to creating and ensuring an environment conducive to individuals freely and competitively making decisions and choosing between alternatives, thereby facilitating and consolidating the expansion of the market and protecting private property rights, and to the provision of pure public goods, which, by definition, cannot be provided for efficiently by the market. This recalls the “invisible hand” notion of the market in enhancing economic welfare articulated by Adam Smith in the eighteenth century in his *The Wealth of Nations* (1776).

Policy Implications of Neoliberalism

The foregoing tenets of neoliberalism are based on certain assumptions. A philosophical assumption is made that human

beings are driven by self-interest (as contended by Adam Smith) and that society is best advised to accommodate this drive since the welfare of society as a whole is best maximized by ensuring that individual self-interest is promoted and satisfied. Politically, neoliberalism accepts that individuals are formally equal and that they possess civil liberties that should be respected and protected, but it insists on the recognition that individuals have different capacities and potentialities which should be allowed to flourish, even if the result is income and wealth. Indeed, inequalities are seen as a major impetus to maximizing individual self-interest because inequalities require greater exertion and effort to acquire the most from the market. The philosophical assumptions about self-interest and freely arrived-at choices under conditions of competition have been relied upon to develop mathematically rigorous economic theories aimed at demonstrating the superiority of the unfettered market as a form of economic organization. In addition, neoliberalism has extended its terrain to the analysis of political and social behavior and arrangements to justify the superiority of the market as the major guarantor of both economic and social welfare, with minimum government involvement.

Some of the key economic policy implications of neoliberalism are found in the following prescriptions, which are rigorously and uncompromisingly promoted by its proponents:

Sound macroeconomic policy: The need for what are referred to as “sound macroeconomic fundamentals” by ensuring stable and predictable prices and positive real interest rates. This requires tight fiscal and monetary policy by ensuring that budget deficits and money supply are assiduously controlled to minimally acceptable minimum levels in relation to gross domestic product. The aim here is to stabilize key indicators of the market such as overall price levels, interest rates, and the exchange rate in the belief that the ensuing stability and predictability of the indicators provide a basis for rational economic behavior and decision making for all economic agents, thereby enhancing overall efficiency.

Trade liberalization: The need for trade liberalization by reducing tariffs and non-tariff barriers and freeing the exchange rate in order to enhance competition internationally.

Labor market flexibility: The call for flexible labor markets, in particular the freedom of entrepreneurs to hire and fire workers at will and to reorganize work as needed; and, for some, the need for the free mobility of labor within and across countries.

Privatization: The need for the state to exit from productive activities that can be undertaken by the private sector by transferring ownership or management functions from the state to the private sector. Over time, neoliberals have been able to drastically circumscribe areas that are seen to be legitimate government activities, thereby expanding those areas that need to be privatized. Thus, for instance, areas such as health, education, provision of water and sanitation, security,

and certain routine administrative functions such as the issuing of licenses, collection of fees and rates, issuing of fines, and so forth, have increasingly been identified as areas that need privatization.

Deregulation: The need to remove any regulations that may act as barriers or constraints to the mobility of goods and services, capital, and labor or that may interfere with the optimal functioning of firms. By the same token, it is demanded of the state that it provide an appropriate regulatory environment for the functioning of the market and the protection of property rights and contracts.

Export-oriented sectoral policies: A policy environment that is neutral in relation to export promotion or import substitution, or preferably biased through the use of narrowly targeted supply-side incentives, in favor of export promotion and integration into the global economy based on open trade and free movement of capital across nations.

The foregoing policies are also seen by neoliberals to be compatible with the increased globalization of economic activities, so that support for neoliberalism and support for increased globalization have become conjoined and indistinguishable.

Effects of Neoliberal Policies

Neoliberalism has also fostered a value chain that begins with theoretical activity in academia and various research institutions and feeds into various institutional vehicles that uphold and promote particular aspects of the neoliberal paradigm, right up to the production and reproduction of policy advisors and implementers who attempt to sustain and implement the policy implications of the paradigm at national and international levels. Neoliberalism has benefited from the support of key national and global-level corporations whose influence is exerted through their ability to shift funds instantaneously across the globe in response to changing environmental conditions, through financing various activities in the value chain and influencing policy in the government of developed countries, and through key multilateral and bilateral financial, trade, and development agencies.

The neoliberal agenda has had a tendency to effectively close out any competing ways of looking at economics and economic policy. At the political level, the promotion of neoliberalism approached tyrannical levels with some governments, such as the United States and the United Kingdom, seeing any challenge to neoliberalism as a challenge to a national way of life—and, indeed, to the protection of this way of life. This has been used as a justification to initiate campaigns for regime change in some countries. More generally, fairly effective sanctions and incentives are deployed throughout the value chain to ensure compliance with, or promotion of, the neoliberal agenda. However, neoliberalism has negatively affected large numbers of people through retrenchments, degradation of work, misuse of the environment, increased poverty, and marginalization of nationalities and households, particularly those in the non-formal sectors of the developing

world, while the net social gains have been spurious and remain quite open to debate. It is clear, however, that some financiers and corporations (and some countries in the developed world) have benefited immensely.

Nevertheless, it appears that neoliberalism has peaked as its presumed benefits have become more questionable and as the ideology is challenged from a number of quarters. The empirical evidence supporting neoliberalism is mixed in the developed world and is particularly dismal in the developing world. In the developed countries, the social implications of neoliberal policies have undermined social safety nets with no viable substitutes emanating from the market. In developing economies, particularly those in Africa, the pursuit of structural adjustment and stabilization programs has not yielded the desired benefits in either inclusive or equitable growth, which should be the aim of development. In these countries neoliberalism has had the consequence of jettisoning any semblance of development or strategic planning that those countries had attempted prior to the adoption of the recent economic reforms, so that the economies are currently in disarray. The early-twenty-first-century consensus on the creative manner in which the East Asian Tigers (Taiwan, South Korean, Singapore, and Hong Kong) combined the roles of the market and a proactive state have also done much to deflate the dogmatic opposition to the state advocated by neoliberals. At the theoretical level, the contributions arising from the new institutional economics, the economics of information, and the economics of risk and uncertainty are beginning to question neoliberal assumptions and prescriptions regarding the role of the state. And at the social and political level, global movements have arisen to challenge neoliberal policies.

In the wake of these challenges, shifts have begun to occur in the neoliberal camp in the early twenty-first century, and new syntheses of approaches have been proposed. The neoliberal agenda has begun to include welfare issues by supporting the promotion of sustainable livelihoods, social safety nets, and poverty reduction. In addition, given that neoliberal policies have tended to be unilaterally imposed, particularly in developing economies, there has been a shift to accommodating popular participation and good governance, as in the development of Poverty Reduction Strategy Papers (PRSP) associated with the Highly Indebted Poor Countries (HIPC) debt initiative of the Bretton Woods Institutions. More generally, there is less of a dogmatic stance on the nature and content of policy packages comprising economic reform initiatives, yielding what has been labeled the “post-Washington Consensus.” At another level, some have worked toward synthesizing lessons from neoliberalism with those from social democracy, resulting in the proposal for a “third way.” Finally, from a philosophical point of view, the assumptions underlying the neoliberal model have also been challenged, particularly as to whether methodological individualism assumed in the model, to the exclusion of other plausible assumptions that could be made, is necessarily the most appropriate or adequate assumption to guide formulation of social theories; and, if it can be contended that a particular proclivity of human beings is natural and inevitable, such a proclivity must necessarily be pandered to as a normative ideal. Thus, while as deductive

theory and approach neoliberalism may appear unchallengeable and highly persuasive, its benefits are increasingly viewed as unsustainable on intellectual, philosophical, social, and political grounds.

See also *Conservatism; Economics; Globalization; Liberalism.*

BIBLIOGRAPHY

- Bond, Patrick, and George Dor. "Neo-Liberalism and Poverty Reduction Strategies in Africa." Discussion paper, Regional Network for Equity in Health in Southern Africa (EQUINET), 2003.
- Chomsky, Noam. *Profit over People: Neoliberalism and Global Order*. New York: Seven Stories Press, 1999.
- Giddens, Anthony. *The Third Way: The Renewal of Social Democracy*. Cambridge, Mass.: Polity, 1998.
- Stiglitz, Joseph. *Globalization and Its Discontents*. London: Allen Lane, 2002.

Guy C. Z. Mhone

NEOPLATONISM. Neoplatonism is a modern term that refers to the philosophical movement that dominated the intellectual life of the Roman Empire from the third to the sixth centuries C.E.; its most prominent representatives were the pagan philosophers Plotinus, Porphyry, Iamblichus, and Proclus. These thinkers strove to elucidate ambiguities in Plato's philosophy with insights drawn from Neopythagoreanism, Aristotelianism, and Stoicism in order to establish a thorough summation of ancient learning. As such, Neoplatonism was the last flowering of pagan philosophy, which flourished until it was supplanted and to a certain degree absorbed by Christian theology. Christian thinkers who were deeply influenced by pagan Neoplatonism are often regarded as Neoplatonists as well, most significantly Augustine of Hippo, the Greek Fathers known as the Cappadocians, Boethius, and the author called Pseudo-Dionysius the Areopagite. The term is often applied to movements during the Middle Ages and Renaissance that were informed by Neoplatonic doctrines. All Neoplatonists, regardless of religious orientation, shared a belief in the superior quality of immaterial reality and regarded Plato as the greatest of ancient philosophers.

Terminology

Neoplatonism initially had a negative connotation. Enlightenment historians developed the term to dissociate the Platonists of the late Roman Empire from Plato, believing that they had distorted his philosophy beyond all recognition by their eclecticism. Jacob Brucker (*Historia critica philosophiae*, 1742–1744) branded them "the Eclectic Sect" before A. F. Büsching (*Grundriß einer Geschichte der Philosophie*, 1772–1774) dismissively suggested the appellation "new Platonists" (*neue Platoniker*). Edward Gibbon similarly disparaged the philosophy of the "new Platonicians" (*History of the Decline and Fall of the Roman Empire*, 1776). The prefix *neo* did not appear in English until the 1830s. Yet the idea of Neoplatonism is, in certain ways, unsatisfactory. It implies a sharp break with the thought of preceding generations, whereas considerable

continuity is evident; moreover, the Neoplatonists did not regard themselves as innovators but as elucidators of the true philosophy established by Plato. The word is now simply a term of convenience denoting a late phase in the reception of Plato's philosophy.

Before Neoplatonism

The Academy founded by Plato went through two major phases. The Old Academy (387–c. 250 B.C.E.) emphasized metaphysics, whereas the New Academy (c. 150–c. 110 B.C.E.) took a skeptical turn and focused on epistemology. The fall of Athens in 86 B.C.E. apparently ended the school, and circa 80 B.C.E. a former member, Antiochus of Ascalon, took the opportunity to found his own "Academy," which revived a dogmatic approach. This development marked the beginning of a phase known as Middle Platonism (c. 80 B.C.E.–c. 250 C.E.), which reaffirmed the centrality of metaphysics and coincided with a turn toward mysticism. In attempting to clarify Plato, the Middle Platonists did not hesitate to borrow ideas from rival schools of philosophy. Although this approach has traditionally been described as "eclectic," John Dillon recommends avoiding the term, since it implies an arbitrary recombination of ideas based on personal preference rather than a thoughtful reformulation made in light of ongoing philosophical discussion, which was surely the motivation behind both Middle Platonic and Neoplatonic adaptations.

Middle Platonists divided reality into three parts: God, the Ideas, and matter. God was subdivided into three hierarchical levels—the Primal God, Mind, and Soul—as outlined in a second-century Platonic handbook by Alcinous. The Ideas, or Platonic Forms, were identified as the thoughts of God. This metaphysical framework was further developed in Neoplatonism.

Plotinus

Plotinus (205–270) is commonly regarded as the founder of Neoplatonism. He studied in Alexandria before founding his own school circa 244 in Rome, where he devised a comprehensive philosophy that has been preserved in the *Enneads*. For Plotinus, philosophy was not exclusively an effort of reasoned argument, since he equated the love of wisdom with assimilation to God, which is possible only through mystical ecstasy—a state Plotinus himself experienced. Discursive reasoning merely assists in attaining this higher end by clarifying what constitutes reality.

Plotinus's ontology reflects his mystical vision. Adapting the Middle Platonists' threefold division of God, Plotinus called the highest level of divinity, or first hypostasis, "the One"—a perfect unity, infinite and unknowable. Its superabundant goodness impels it to emanate existence in a cascading chain of being. As the source of all existence, the One itself actually transcends being. Hence the highest being is the divine Mind, which is emanated directly by the One. This second hypostasis, in which the Ideas are located, further emanates a third hypostasis, which is called Soul as it contemplates the intelligible realm and Nature as it previews what it will produce. Time and the physical world thus emanate from Soul/Nature. The process of emanation ends when being is so

attenuated that a limit is finally reached. This lowest stage of emanation is matter, which exists only potentially. Inasmuch as being is linked with goodness, matter's virtual absence of being is seen as the source of evil. Although matter is not *substantially* evil, since it ultimately emanates from the One, nevertheless evil resides in its state of privation.

Human souls, like the third hypostasis, are divided into a higher part that perceives the intelligible world and a lower part that cares for a material body. The individual soul falls into degradation when it is excessively concerned with material things and forgets its true identity. Philosophy reminds the wayward soul that it is an immaterial substance and thus opens the way for salvation, whereby the enlightened soul chooses to return to the intelligible world, from which it can ascend to the bliss of union with the One.

Later Neoplatonists

Plotinus's legacy was preserved by his pupil, Porphyry of Tyre (c. 232–c. 304), who wrote a biography of the master and published his tractates under the title *Enneads*. Porphyry's own writings include a manual of Plotinian metaphysics (*Sentences*) and commentaries on various texts, including Homer's *Odyssey* (*On the Cave of the Nymphs*) and Aristotle's *Categories* (*Isagoge*). Porphyry took a religious view of the philosophical enterprise and, while denouncing Christianity as an irrational cult, introduced into the Neoplatonic canon the second-century *Chaldean Oracles*, Platonic texts that he regarded as true revelation.

These writings also inspired the Neoplatonist Iamblichus (d. c. 330), who founded what is sometimes called the Syrian school. Iamblichus did not share the optimistic Plotinian view about the ease of salvation; he supplemented philosophy with theurgy—rituals invoking the divine powers for aid. His innovations were adopted by the schools in Alexandria and Athens, the other major centers of Neoplatonism. The inclusion of traditional pagan elements in Iamblichus's system made it attractive to Emperor Julian (331?–363), who promoted Syrian Neoplatonism in his attempt to revive paganism.

The foremost representative of the Athenian school was Proclus (410?–485), who wrote two influential works of systematic metaphysics, the *Elements of Theology* and *Platonic Theology*. He was head of a revived academy, which remained a bastion of paganism, and attacked the Christian doctrine of creation. The Alexandrian school, however, was diverse; it included some Christians, one of whom, John Philoponos (c. 490–570), wrote a rebuttal to Proclus's attack. The Alexandrian school displayed a keen interest in Aristotle, and Philoponos is often regarded as an Aristotelian rather than a Neoplatonist, although his independence of mind makes either characterization questionable. Other noteworthy Neoplatonists were the Athenians Plutarch (d. c. 432), Syrianus (d. c. 437), Damascius (d. after 538), and Simplicius (d. 560) and the Alexandrians Hypatia (d. 415), Hierocles (fifth century), Ammonius (d. after 517), and Olympiodorus (d. after 565).

Ancient Christian Neoplatonism

Since Neoplatonists and Christians shared many common beliefs, the latter sometimes borrowed insights from the former,

in spite of the polemic between them. Among the Latin Fathers, Augustine of Hippo (354–430) remarked in his book *On True Religion* (chap. 7) that one need only change a few words to make Christians of the Platonists. The Greek Fathers, especially the fourth-century Cappadocians (Basil the Great, Gregory of Nazianzus, and Gregory of Nyssa), were similarly responsive to Neoplatonism, since men such as Origen (185?–254?) had already brought Middle Platonism into the Greek theological tradition. Neoplatonism waned, however, as the Roman Empire disintegrated. The emperors after Julian firmly championed the Christian religion, and in 529 Justinian closed the doors of the Academy. Neoplatonism's continuing influence would depend on the tolerance of religious thinkers.

Medieval Neoplatonism

The reception of Neoplatonism during the thousand years of the Middle Ages is an immensely intricate subject, complicated by the mediated nature of the transmission (largely through theological assimilations) and by the division of the Mediterranean world into rival cultural spheres. Hence Neoplatonic adaptation developed differently among Greek and Latin Christians, Muslims, and Jews.

In each culture, enthusiasts tried to reconcile Neoplatonism with their religion. Most extraordinary was the Christianization of Proclus's philosophy circa 500 by a Byzantine using the pen name of Dionysius the Areopagite, the first-century convert of St. Paul (Acts 17:34). This assumed name lent his writings an air of authority that was undeserved yet guaranteed their dissemination. The texts provided instruction in the "affirmative" and "negative" theologies—methodologies for achieving mystical union with God through the use and suppression of symbolic language. The affirmative theology describes what God is by way of analogy, but since God is ultimately unlike anything that exists (for God is beyond being), the alternative theology is required to transcend the limitations of language by negating the analogy. This contemplative process of description and denial prepares the soul for ecstatic union by correcting its misapprehensions about God. The Pseudo-Dionysian texts were translated into Latin and studied in western Europe, where they inspired the ninth-century Neoplatonic system of John Scotus Eriugena (c. 800–c. 877).

Greek Christians were the only group able to read the Neoplatonic texts in the original language, yet this direct access actually increased the difficulty of using the old pagan philosophy in the theologically charged atmosphere of the Byzantine Empire. Philosophers who attempted to further the patristic effort at assimilation sometimes endured accusations of heterodoxy—as did Michael Psellos (1018?–1096?) and John Italos (c. 1023–1085). Arabic culture was at times more tolerant. Muslim thinkers were impressed with Greek philosophy and tended to equate it with its final, Neoplatonic form. Even Aristotle seemed a Neoplatonist, perhaps due to Neoplatonic commentaries that minimized his differences with Plato but also due to the misattribution of certain Neoplatonic texts, such as the *Theology of Aristotle* (extracts from Plotinus) and the *Book of Causes* (extracts from Proclus). The most prominent Muslim Neoplatonist was Ibn Sina (Avicenna, 980–1037), whose works were favorably received before Al-Ghazali (1058–1111)

wrote a critique that prompted a phase of intolerance. Jewish thinkers were also impressed with the Greek heritage, most notably Ibn Gabirol (Avicbron, c. 1021–c. 1058), whose *Fontain of Life* featured Neoplatonic doctrines. Neoplatonism was the main philosophical influence on the Kabbalah of thirteenth-century Provence.

Neoplatonism in the Latin West

Compared with the other three traditions, Latin Christianity was slower in absorbing Neoplatonism, largely due to a paucity of sources, yet it became the most vibrant by the end of the Middle Ages. After Augustine, the principal Neoplatonic thinker was the Roman philosopher Boethius (c. 475–525), who brought Porphyry's *Isagoge* to a Latin audience and presented many Neoplatonic ideas in his own *Consolation of Philosophy*, which became a standard schoolbook. Two commentaries were also significant in the medieval schools: one on Plato's *Timaeus* by Calcidius (third or fourth century, considered by some a Middle Platonist rather than a Neoplatonist), another on the *Dream of Scipio* (an excerpt from Cicero's *Republic*) by the fifth-century Macrobius. The latter provided a concise summary of Plotinian metaphysics, which occasioned a controversy in the eleventh century, featured in Manegold of Lautenbach's *Book against Wolfhelm*.

A cultural revival during the twelfth century led to renewed interest in old texts and an influx of new translations. After thinkers such as Peter Abelard, William of Conches, Thierry of Chartres, and Bernardus Silvestris fruitfully reexamined the Calcidian *Timaeus*, their successors discovered that the newly arriving translations of Aristotle's treatises had more to offer the scholastic enterprise of systematic theology than did the less direct dialogues of Plato, of which only the *Meno* and *Phaedo* were added to the Latin corpus. However, since Aristotle came to the West via the Arabs, he was initially read as a Neoplatonist. Thomas Aquinas (1225–1274) was instrumental in correcting this error when he identified Proclus as the source for the Pseudo-Aristotelian *Book of Causes* after reading a Latin version of the *Elements of Theology* translated in 1268.

Although Aquinas was principally Aristotelian in outlook, his teacher, Albertus Magnus (c. 1200–1280), was partial to Neoplatonism and inspired a Neoplatonic approach in three other Dominican friars: Dietrich of Freiberg (c. 1250–c. 1310), whose interest in the Neoplatonic metaphysics of light inspired him to study optics; Meister Eckhart (c. 1260–c. 1328), the controversial mystic; and Berthold of Moosburg (c. 1300–after 1361), who wrote an extensive commentary on Proclus's *Elements*. Nicholas of Cusa (1401–1464) later drew upon these thinkers, as well as the twelfth-century Platonists and earlier sources, in constructing his own Neoplatonic worldview outlined in *Learned Ignorance* (1440), a reaction against the Aristotelianism dominant in the universities. Petrarch (1304–1374) had already urged a return to Plato, and this tendency within Italian Renaissance humanism culminated in the work of the Florentine philosopher Marsilio Ficino (1433–1499), whose translations and studies of the complete Plato, Plotinus, and other Platonic authors were influential throughout Europe for centuries.

See also **Christianity; Microcosm and Macrocosm; Platonism; Scholasticism.**

BIBLIOGRAPHY

- Armstrong, A. H., ed. *The Cambridge History of Later Greek and Early Medieval Philosophy*. London: Cambridge University Press, 1967.
- Carabine, Deirdre. *The Unknown God: Negative Theology in the Platonic Tradition, Plato to Eriugena*. Louvain, Belgium: Peeters, W. B. Eerdmans, 1995.
- Dillon, John. *The Middle Platonists, 80 B.C. to A.D. 220*. Rev. ed. Ithaca, N.Y.: Cornell University Press, 1996.
- Gersh, Stephen. *Middle Platonism and Neoplatonism: The Latin Tradition*. 2 vols. Notre Dame, Ind.: University of Notre Dame Press, 1986.
- Gersh, Stephen, and Maarten J. F. M. Hoenen, eds. *The Platonic Tradition in the Middle Ages: A Doxographic Approach*. Berlin and New York: Walter de Gruyter, 2002.
- Goodman, Lenn E., ed. *Neoplatonism and Jewish Thought*. Albany: State University of New York Press, 1992.
- Gregory, John. *The Neoplatonists: A Reader*. 2nd ed. London and New York: Routledge, 1999.
- Morewedge, Parviz, ed. *Neoplatonism and Islamic Thought*. Albany: State University of New York Press, 1992.
- O'Meara, Dominic J., ed. *Neoplatonism and Christian Thought*. Albany: State University of New York Press, 1981.
- Tatakis, Basil. *Byzantine Philosophy*. Translated by Nicholas J. Moutafakis. Indianapolis: Hackett, 2003.
- Wallis, R. T. *Neoplatonism*. 2nd ed. London: Duckworth; Indianapolis: Hackett, 1995.

Robert Ziolkowski

NEW CRITICISM. The New Criticism is the name given to the work of a school of formalist-oriented Anglo-American literary critics whose writings appeared in the years following World War I and came to prominence in the 1940s and 1950s. John Crowe Ransom (1888–1974) coined the moniker itself in his 1941 study *The New Criticism*, in which he provided an overview of the work of key “New” Critics, including I. A. Richards (1893–1979), T. S. Eliot (1888–1965), William Empson (1906–1984), and Yvor Winters (1900–1968). Other important critics associated with this school included F. R. Leavis (1895–1978), Kenneth Burke (1897–1993), Allen Tate (1899–1979), Cleanth Brooks (1906–1994), Robert Penn Warren (1905–1989), and René Wellek (1903–1995), to name a few. Arising, in part, as a response to earlier approaches such as comparative philology and biographical and impressionistic criticism, the New Criticism focused on the individual work of literature, usually the poem, as the sole object of study. These critics placed special emphasis on the formalistic aspects of the literary work, highlighting connotative and associative usage of words and the many figurative devices of language that functioned within the poem.

Beginnings in England

The poet and critic T. S. Eliot gave shape to many of the concerns that would eventually coalesce as New Criticism. Eliot articulated a sense of literary tradition that wrenched criticism

away from historical and biographical assessment. In essays such as "Tradition and the Individual Talent," rather than emphasizing the greatness of the individual poet, Eliot stressed the importance of directing criticism upon the poem itself. In turn, the tradition of poetry became the collective vessel through which cultural greatness was transmitted. By distinguishing levels of poetic appreciation, he stressed the benefit of technical appreciation as opposed to the more popular (and coarse) emotional. The aim of the critic was to mine "significant emotion, emotion which has its life in the poem and not in the history of the poet" (Eliot, p. 11). Eliot, then, was establishing a way of reading poetry that acknowledged Western tradition as a continuum dating back to Greek antiquity, in which "art never improves, but that material of art is never quite the same" (p. 6). In doing so, he sought a rigorous, formalist appreciation of art as a corrective to more popular modes of modern culture. Eliot, like later New Critics, hoped to cultivate an understanding of great literature as a countervailing force to the vulgar and degradative thrust of modern mass society.

The emphasis on rigorous technical understanding of the literary work would become the hallmark of New Criticism. Most practitioners generally eschewed explicit formulation of theoretical orientation but, rather, focused on the practical application of certain, specific ways of reading. This orientation was captured in the title of I. A. Richards's 1929 work *Practical Criticism*, in which the notion of criticism was allied with careful or "close" readings of poetic works. Richards used his Cambridge Honors students' responses to poetry to reveal the reading deficiencies of ostensibly well-trained readers. These misreadings allowed him to distinguish four distinct meanings that the critic needed to draw out in order to understand a poem: Sense, Feelings, Tone, and Intention. Such an emphasis on reading as a practice, whose focus was to be directed solely upon formal aspects of the literary object, would become a key trait of New Critical thought.

Indeed, the status of the literary object, isolated from historical and cultural context, would gain strength over the next two decades. The poem was the literary object par excellence, its condensed and intense use of language particularly conducive to close reading. For most of the New Critics poetry *was* literature, and they eschewed more lengthy and convoluted genres such as fiction and drama. In the 1920s, Richards had defined the poem as an autonomous and organic being whose unity as an aesthetic object was essential to its study. In the 1930s and 1940s, critics based in the American South would develop this idea further.

American New Criticism

In the United States, several poets and critics based in the South would pick up on Richards's work. This group, associated with the Agrarian Revival, would elaborate upon close reading and the autonomy of the poem, eventually developing these principles into a full-fledged critical ethos. In the 1930s, John Crowe Ransom's writing on poetry positioned literature against the rapacious force of dehumanizing scientific logic. Considering the Revivalists' opposition to Southern industrialization, the turn to poetry as a means to maintain

contact with a humanistic, organic, and agrarian tradition made sense. Most of the Agrarians shared a sense of distrust in technology and were religious and conservative in their social views. Ransom, Allen Tate, and others saw poetic knowledge as a remedy to an oppressive scientific modernity. For them, poetry offered access to means of human expression and communication that were not available in other, modern discourses.

Organic unity and the heresy of the paraphrase. In the journal *Southern Review*, the editors Cleanth Brooks (1906–1994) and Robert Penn Warren (1905–1989) provided an influential platform for New Criticism. From 1935 to 1942, Brooks and Warren, in addition to raising the profile of Southern writers, also established New Critical principles of criticism as central to American literary studies. In his 1947 work *The Well Wrought Urn*, Brooks brought together many of his previous essays into a key text for the movement. Not only articulating its principles, Brooks also provided exemplary New Critical readings of poetry. In positioning poetic against scientific knowledge, he argued that paradox was characteristic of the unique knowledge of the poem. Unlike science, which sought to eliminate paradox, the poetic work achieved its ontological status through contradictions, oppositions, and ambiguity. Brooks also described the "Heresy of the Paraphrase" in order to highlight the importance of the poetic object as a complete and unified whole. No part of the poem could be read outside of the whole, and the whole was constituted by each individual part. Thus, any summarization or paraphrase of a poem was grossly inadequate, as the internal multiplicities of the poem could not be reduced in such a way. Brooks would, in later work, elaborate upon William K. Wimsatt (1907–1975) and Monroe Beardsley's (1915–1985) concepts of the intentional fallacy and the affective fallacy to reaffirm the organic unity and autonomy of the poem. Aimed at biographical and impressionistic criticism, the former dismissed attempts to gauge the poet's intentions through examination of historical context, whereas the latter argued that the poem is not to be judged based upon its emotional impact on the reader.

Decline of the New Criticism and Continuing Influence

In the years following World War II, New Criticism became a force in Anglo-American literary studies. Its rise was attributed not only to the focus it placed on literature as a discipline unto itself but also to its ease of pedagogical transmission. In an era when universities were flooded with returning soldiers, the New Criticism offered a clear and direct approach to the analysis and appreciation of literature as a rigorous, objective form of study. Several prominent literary critics challenged New Critical methods during its heyday. Alfred Kazin (1915–1998), in the early 1940s, charged that it fetishized formalism. In the latter part of the same decade, R. S. Crane (1886–1967) attacked Brooks and others for their "critical monism," which was exemplified by their slavish adherence to poetry, and primarily lyrical poetry at that. While Brooks responded to this charge by setting his sights on fiction, he was forced to concede that historical context was an important component in the structure of the novel. But it was in the 1960s, with increasing social flux, when New Criticism began

to see its influence diminish. Its ahistorical approach to the study of literature was faulted for depoliticizing literature and, thereby, upholding a political status quo. With increased interest paid to Marxist, hermeneutic, structuralist, and feminist criticism in the 1960s, New Criticism ceded ground to a variety of theoretical and historicist concerns. While in the early twenty-first century the New Criticism is faulted for its limitation of focus and methodological austerity, the impact it has had on the rise of a discipline of literary studies in the United States and that discipline's underlying reliance upon various methods of "close" reading are lasting achievements.

See also *Literary Criticism*; *Literary History*; *Literature*.

BIBLIOGRAPHY

- Brooks, Cleanth. *The Well Wrought Urn*. Norfolk, Conn.: New Directions, 1941.
- Eliot, T. S. *Selected Essays*. New York: Harcourt, Brace and World, 1964.
- Ransom, John Crowe. *The New Criticism*. New York: Harcourt, Brace and Company, 1947.
- Richards, I. A. *Practical Criticism*. 1929. Reprint, London: Routledge and Kegan Paul, 1964.
- Wimsatt, W. K., Jr., and Monroe C. Beardsley. "The Intentional Fallacy." In *The Verbal Icon*. Lexington: University of Kentucky Press, 1954.

Amit Ray

NEW HISTORICISM. See *Literary Criticism*; *Literary History*.

NEWTONIANISM. A standard definition of *Newtonianism* or *Newtonian philosophy* found in early eighteenth-century dictionaries such as John Harris's *Lexicon Technicum* (5th ed., 1736) is: "The doctrine of the universe, and particularly of the heavenly bodies; their laws, affections, etc., as delivered by Sir Isaac Newton." An almost identical definition appears around thirty years later in the *Encyclopédie* of Denis Diderot and Jean le Rond d'Alembert: "Newtonianisme ou philosophie Newtonienne: c'est la théorie du mécanisme de l'univers, & particulièrement du mouvement des corps célestes, de leur lois, de leur propriétés, telle qu'elle a été enseignée par M. Newton" (Newtonianism or Newtonian philosophy: the theory of the mechanism of the universe, and particularly of the motion of the heavenly bodies, of their laws, their properties, as delivered by Mr. Newton).

The authority of Newtonian philosophy was established through the publication of the two major works of Sir Isaac Newton (1642–1727) in natural philosophy, *The Principia* (*Philosophiæ Naturalis Principia Mathematica*, 1687) and the *Opticks* (*Opticks; or, A Treatise of the Reflections, Refractions, Inflections & Colours of Light*, 1704). The former was a work in rational mechanics where Newton aimed to study "the motion that results from any force whatever and of the forces that are required for any motion whatever." His major stake was

to overcome the model of impact that dominated the mechanical philosophy of his time and to introduce the notion of attractive force as a proper dynamic factor of motion. Accordingly, he aimed to explain Kepler's laws through the use of universal attraction and to discard the Cartesian theory of vortices. The latter work was a study in the spirit of mechanical philosophy, where Newton investigated the phenomena of light. He introduced his experimental method and he elaborated the atomistic model of matter. In the successive editions of the work he enriched it with a number of "queries" where he developed his theoretical and metaphysical contemplations about the nature of matter, the various instances of attractive and repulsive force, and the theoretical grounding of experimental induction.

The publication of the *Principia* clearly marked the establishment of a new spirit in European natural philosophy. It is equally clear, though, that Newton's contemporaries differed significantly in the appreciation of his magnum opus. Followers like Edmond Halley (1656–1742) and Voltaire (1694–1778) were so excited by Newton's achievements that they placed him in the highest position of the philosophical firmament of the time. At the same time, however, Christiaan Huygens (1629–1695) was astonished by the fact that such an elaborate synthesis in mechanics was founded upon the notorious notion of universal attraction. Along a similar line, Gottfried Wilhelm Leibniz (1646–1716) accused Newton of turning the entire operation of Nature into a perpetual miracle. Having been nourished by the Cartesian rationalistic tradition, Huygens and Leibniz found that the adoption of attraction by natural philosophers would bring about a reversion to the "occult qualities" of Scholasticism.

Historians assume that the *Principia* is one of the least read documents in the history of ideas. Even in the early eighteenth century influential philosophers like John Locke (1632–1704) and Voltaire adopted its message without having read or understood its technical part. The reputation of the *Principia* was based primarily on the authority of very few competent readers. At the same time, quite a few nonmathematical philosophers made a systematic attempt to bring Newton's message to the general reader. To this purpose, they proceeded with the compilation of comprehensive treatises where they presented an outline of Newtonian mechanics and experimental philosophy.

The *Opticks* was a far more widely read work. A reason for this was its deceptive accessibility. The *Opticks* was not a revolutionary work in the sense the *Principia* was. It was rather a brilliant display of the art of experimentation, and it was often cited as a model of how to approach a difficult problem by experiment and how to conduct precise quantitative experiments. What was important in the *Opticks* from the point of view of the Newtonian synthesis was that Newton elaborated there the most comprehensive public statement he ever made of his experimental method:

As in Mathematics, so in Natural Philosophy, the Investigation of difficult Things by the Method of Analysis, ought ever to precede the Method of Composition

[or Synthesis]. This Analysis consists in making Experiments and Observations, and in drawing general Conclusions from them by Induction, and admitting of no Objections against the conclusions, but such as are taken from Experiments, or other certain Truths. For Hypotheses are not to be regarded in experimental philosophy. . . . By this way of Analysis we may proceed from Compounds to Ingredients, and from Motions to the Forces producing them; and in general from Effects to their Causes, and from Particular Causes to more general ones, till the Argument end in the most general. (*Optics*, 1799, p. 404)

Newtonianism, however, is much more than the direct impact of Newton's two major works on European intellectual life. First of all, Newtonian philosophy was neither a given system nor a definitive synthesis in natural philosophy. It was rather a multifaceted current shaped by the interpretations of Newton's works and, to a significant degree, by the adaptations of these works to various intellectual environments all over the European continent. Moreover, throughout the eighteenth century "Newtonianism" meant much more than a physical theory. It was an amalgam of scientific, political, and religious ideas, which only partially went back to Newton's original works. It was quite common for people who endorsed Newtonian philosophy to have only a vague idea of his mathematical and experimental investigations. Nevertheless, Newton became something of an authority people drew upon in order to resolve matters concerning not only nature's interpretation but also the conduct of man, the function of the state, and the doctrines of religion. Thus, in what follows we will briefly examine the many aspects of Newtonianism in a variety of intellectual contexts that assigned an accordingly variable meaning to the term.

The author of the aforementioned article in the *Encyclopédie* was Jean Le Rond d'Alembert. Being one of the protagonists in the developments that took place in the field of Newtonian natural philosophy in the mid-eighteenth century, he was well aware of the inadequacy of a general definition of Newtonianism. Hence, after the short descriptive definition he gave in the opening of the article, he immediately proceeded with the delineation of a broad spectrum of notions and practices that contributed to the formation of this intellectual current. Some authors, he notes, perceive Newtonian philosophy as a version of "corpuscular philosophy," enriched and corrected by the discoveries of Newton. In this sense, Newtonian philosophy is nothing else than a new philosophy, distinct from the Cartesian, the peripatetic, and the other ancient philosophies of the body. Others perceive Newtonian philosophy as the method Newton employs in his philosophy. This method consists in deriving conclusions directly from the phenomena, without feigning hypotheses, in starting from simple principles, in deducing the primary laws of nature from a small number of selected phenomena, and in using these laws in order to explain all the other natural effects. In this sense, Newtonian philosophy is nothing else than "experimental physics," opposing to the ancient philosophy of the body. Others perceive Newtonian philosophy as the branch of philosophy that examines natural bodies mathematically and applies geometry

and mechanics in the resolution of the respective problems. In this sense, Newtonian philosophy is nothing else than "mechanical and mathematical philosophy." It is clear, thus, that for d'Alembert and his contemporaries, even in the narrow field of natural philosophy Newtonianism means at least three different things: a new philosophy of body, experimental philosophy, and rational mechanics. In fact, all these philosophical and mathematical traditions have a bearing on Newton's own work and mark the distinctive research and philosophical directions that stem from the various pieces of the Newtonian synthesis.

The Philosophy of Body

The "philosophy of body" was deemed a crucial branch of philosophy in the eighteenth century dealing with the nature of matter. According to the traditional Cartesian view, the only essential property of a material body was extension. Figure, position, and motion were only "modes of existence" of an extended being. As a result, all natural effects should be processed on the basis of changes that occur in the shape, the relative positioning, and the motion of the bodies or of their parts. A significant advantage of this approach, according to the proponents of Cartesian philosophy, was that it made clear the distinction between the material agent of natural phenomena and the external cum immaterial causes of motion. This way it was made possible to disengage material bodies from the notorious "occult qualities" they inherited from Renaissance and some aspects of ancient philosophy.

Newtonianism brought about two important transformations to this view: Firstly, it maintained the implicitly theological idea that it is in principle impossible for people to grasp all the qualities of natural bodies. Thus, not only is extension not a unique essential quality of material bodies, but also the few other qualities we are able to know are but a subtotal of the qualities God may have provided the bodies with. Almost all the followers of Newtonian philosophy subscribed to this voluntaristic view of the divine design. Voltaire, Willem Jacob's Gravesande (1688–1742), and Petrus van Musschenbroek (1692–1761)—to mention only the most active of them—insisted on the constitutional inability of human beings to penetrate God's will so as to acquire a definitive knowledge of the nature of material bodies.

The second transformation has to do with a new addition to the list of attributes of natural body, namely the force of attraction. According to the definition of Musschenbroek,

those things which we find to be in all bodies, we call their attributes. . . . Among these attributes there are some, which can never be intended or remitted, and others, which are capable of intension and remission. The former are extension, solidity, inactivity, mobility, a capacity of being at rest or having a figure. The latter are gravity and the power of attraction. (Musschenbroek, p. 10)

It is true that in the course of time, this addition gave much trouble to the proponents of Newtonian philosophy. Even in

the early eighteenth century, it was not clear whether attraction was an inherent active principle of the matter, or a force transmitted through an ethereal substance filling the whole universe. As a result, the supporters of this view were accused of reverting to the “occult qualities,” which had been banished from philosophy thanks to Cartesian philosophy. Concerning this issue, the Newtonians attempted to articulate a moderate philosophical thesis maintaining that attraction was simply a force of unknown origin that dominated the interactions between material bodies:

And lest any one should think, because we do not assign the Cause of the abovemention'd attracting and repelling Forces, that they too are to be reckon'd among the Occult Qualities: We shall say, with the great Newton, we do not consider those Principles, as Occult Qualities, which are imagin'd to arise from the specifick Forms of Things; but as the universal Laws of Nature, by which Things themselves are form'd; for the Phaenomena of Nature shew us, that such Principles do really exist, tho' no one hath explain'd yet what are the Causes of them. ('sGravesande, p. 24)

Concerning the idea that attraction might be an inherent quality of matter, however, things were more troublesome. Such an interpretation of Newtonian dynamics by some supporters of Spinozistic philosophy, like John Toland (1670–1722), favored materialism, which was much repudiated by the “orthodox” Newtonians, as we shall see below.

Experimental Philosophy

The second field where the contribution of Newtonian philosophy was considered decisive was “experimental philosophy.” Newton applied two new principles in this field. Both of them were an outcome of the aforementioned methodological approach he developed in the *Opticks* and the accompanying “queries.”

The first principle was that the only safe way to derive natural laws from the phenomena is to proceed inductively. Hypotheses have no place in this process. Moreover, sticking to this methodological commitment is the only way to protect ourselves from producing natural interpretations built upon “chimerical” suppositions, as was actually the case with Cartesian natural philosophy. “Analysis” (or resolution), as opposed to “Synthesis” (or composition), comprised the core of this method. According to extreme advocates of analytical method, like Abbé Étienne Bonnot de Condillac (1714–1780), analysis was the only correct method of reasoning, because it was taught to humans by nature herself. As a result, even composition would lose its significance: The demonstration of every proposition ought to go over the path of discovery; and the only due method to do so was analysis, not synthesis. It is true that the pronouncement of analytical method has been the source of much confusion, since it has been read by many Newtonians and, evidently, by Newton himself, as if it applies equally to mathematics and to experimental philosophy. On the other hand, however, this same aspect of Newtonian philosophy epitomized the anti-Cartesian stance of many

eighteenth-century scholars and became a cornerstone of the natural theology of the time.

The second element Newton introduced to his contemporary experimental philosophy was the quantitative principle. Some fifty years after the first edition of the *Opticks*, d'Alembert described experiments as processes that aim at intentionally producing new phenomena in order to force nature to disclose her hidden principles. The man who had brought experimental philosophy to its current state was Newton. He had done so by introducing geometry into physics and by unifying experimental practice with mathematical techniques. Thus, he achieved an exact, scrupulous, and innovative science. The object of this science was the study of the general qualities of bodies; observation might help us perceive these properties superficially, but only experiment could bring them forth in a precise and measurable manner. The outcome of this process was the formulation of general quantitative laws, especially for those natural phenomena that were perpetually repeated without making evident their causes or the principles that governed their succession. This same perception, however, was also the limit of Newtonian experimental philosophy: Although Newtonian method was considered the key to unlocking the secrets of nature, from the moment the fundamental laws had become known—as most philosophers believed, in the mid-eighteenth century—the usefulness of experimental physics was rendered limited. Any further investigation of natural effects should come under the field of “mathematical sciences,” that is, rational mechanics.

Rational Mechanics

Rational mechanics was, indeed, the third field where the Newtonian legacy was of major importance. In the seventeenth century, the term *mechanics* had a double meaning. In his preface to the *Principia*, Newton made a clear-cut dichotomy between “practical mechanics” and “rational mechanics.” The former referred to all manual arts people used to practice in varying degrees of exactness. Practical mechanics was closely related to geometry, for geometry “is nothing other than that part of universal mechanics which reduces the art of measuring to exact propositions and demonstrations.” However, this was not the kind of mechanics Newton wanted to deal with. “Since the manual arts are applied especially to making bodies move, geometry is commonly used in reference to magnitude, and mechanics in reference to motion. In this sense, rational mechanics will be the science, expressed in exact propositions and demonstrations, of the motions that result from any forces whatever and of the forces that are required for any motions whatever” (Cohen and Whitman, p. 382). Half a century after the publication of the *Principia*, rational mechanics was a well-established branch of Newtonian physics, clearly distinguished from other aspects of natural investigation. A standard definition of the term implied three significant features:

- Rational mechanics was the mathematical study of motions generated from specific forces as distinguished from statics, which examined the forces of a system being in equilibrium.
- The mathematical analysis employed in rational mechanics should be able to represent the generation of

the trajectories of moving bodies as distinguished from geometry, which sufficed only for the description of static curves.

- The current formulation of rational mechanics was based on the *Principia*, as opposed to practical mechanics, which originated in classical and Hellenistic antiquity.

The major contribution of Newton to the establishment of modern rational mechanics was threefold. First, he introduced the notion of attractive force as a dynamic factor of motion. He did so by mathematically constructing the *modus operandi* of a centripetal force acting as the inverse square of distance; subsequently, he assigned it a natural status by unifying terrestrial and celestial physics on the basis of attraction. His second contribution was that he clearly showed the limits of Euclidean geometry as far as the problems of motion were concerned. Although he himself did not totally reject Euclidean geometry when he composed the *Principia*, the modification of traditional geometry he suggested there, as well as his mathematical studies on “fluxions” and “fluents,” indicated that the only proper mathematical way to treat the problems of motion was infinitesimal calculus. His third contribution was the comprehensive study of celestial mechanics and the explanation of a wide range of celestial phenomena on the basis of universal attraction.

Although the last contribution established Newton as a heroic figure throughout the eighteenth century, the two former did not have an equally straightforward effect on his philosophical profile. There is no doubt that Newtonian mechanics bridged the gap between astronomy and cosmology by presenting a concise physico-mathematical model for the operation of the Keplerian laws. However, the mathematical and ontological foundations of Newton’s synthesis became the object of much discussion on the part of his successors. It is somewhat ironic that the transcription of Newtonian mechanics in the language of infinitesimal calculus was carried out on the basis of the mathematical notation suggested by Leibniz, his major philosophical opponent. In fact, it was characteristic of Newtonian mechanics throughout the eighteenth century that many of the people who undertook the further advancement of Newtonian achievements combined the legacy of the *Principia* with the philosophical and mathematical ideas of Leibniz. The incorporation of the *vis viva*, or living force, theory in many Newtonian treatises that circulated widely on the Continent, along with various attempts aiming to render the laws of motion compatible with the metaphysical principles of Leibniz, were two other instances of this characteristic.

The thorn of Newtonianism, however, was the ontological status of attractive force. Thus, by the mid-eighteenth century quite a few significant mathematicians, like d’Alembert and Lazare Carnot (1753–1823), insisted that the notion of force should be expelled from mechanics. Others, like Johann Bernoulli (1667–1748) and Leonard Euler (1707–1783), suggested that a dynamic factor was, indeed, necessary in mechanics, but they also tried to keep a distance from the metaphysical consequences of such an assumption. In any case,

the major pursuit of the time was the transformation of the Newtonian mechanics so that it might work exclusively on the basis of kinetic laws. This process culminated with the publication in 1788 of *Mécanique analytique*. Joseph Louis Lagrange’s (1736–1813) work was entirely analytical in contrast to the method employed by Newton in the *Principia*, which was entirely geometrical. Lagrange was an admirer of Newton but he was also a disciple of d’Alembert. Thus, he shared with the latter the desire to develop a new science of mechanics that would not need the metaphysically laden concept of force. As a result, his *Mécanique analytique* drew upon d’Alembert’s principle, the conservation of *vis viva*, and the principle of least action, none of which had a counterpart in Newton’s work. Additionally, he applied his method to constrained systems of masses, rigid bodies, and continuous media, which was again a substantial departure from Newton’s preoccupation with the legitimization of centripetal force acting at a distance.

Religion and Politics

Newton was not only a natural philosopher and Newtonianism was not only a scientific theory. Newton was also a pious Christian and an active theologian. Newtonianism, on the other hand, besides its scientific content or because of it, was gradually identified with the rise of a Whig oligarchy and with the new balance of power that resulted from the Revolution of 1687–1689 in England. Thus, soon after the publication of Newton’s two major works, Newtonianism became the cornerstone of a new intellectual program that affected significantly the political and theological trends of the time. The people who set out this program in England were Newton’s friends and supporters, including Richard Bentley, Samuel Clarke, William Whiston, John Harris, William Derham, and Jean Desaguliers. They actively propagandized the idea that Newton’s intellectual achievements provided a perfect model for social order, political harmony, and liberal but orthodox Christianity. Although the promotion of this aspect of Newtonianism employed the technical achievements of Newtonian natural philosophy, the discourse built on this basis was not technical in itself. It was primarily through the Boyle lectures (a series of lectures established in Robert Boyle’s will to defend Christian orthodoxy against the various forms of atheism) that Newton’s followers unfolded the ideological implications of Newtonian science and turned it into a component of moderate Enlightenment.

One major problem with Newtonian philosophy was that it was used by both freethinkers and its religious-minded supporters. The former adopted the mathematical and experimental method as a clue that provided a liberal spirit in the investigation of the natural world; the latter, in addition to this, championed the moral and metaphysical implications of Newton’s thought to wage war against pure rationalists and the various representatives of “irreligious pluralism.” The other major problem, however, was that in the course of this confrontation, the Newtonian philosophy gave rise to a “heretic” approach to Christian theology, which was much denounced by the official Anglican Church.

Freethinkers and materialists of the time picked up those elements of Newtonian philosophy that fitted their perception

of nature. The doctrine of universal gravity was of prominent importance to this process of adaptation. People with a preference for Spinozistic philosophy, like John Toland, gladly adopted this principle, but they suggested that one should perceive gravity as inherent to matter. Thus, in the hands of free-thinkers, the power of gravity provided another evidence that matter is inherently active and offered further support to a purely naturalistic explanation of the universe, devoid of supernatural agencies and occult qualities.

In this atmosphere, even Newton himself was credited with potential atheism. Quite a few Christian thinkers held him responsible for the “misinterpretations” of his theories that resulted in the rejection of divine providence. They cautioned that despite the obvious usefulness of modern science, one should not confuse human knowledge with absolute truth, since the latter becomes known only through revelation. Other thinkers, however, believed not only that Newton’s achievements were in accordance to Christian faith, but also that if the new theories were seen in their proper perspective, they would enhance the belief in a universe created and governed by God. Thus, Samuel Clarke (1675–1729), in order to fight Toland’s views on the inherently active character of matter, drew upon Newton’s argument about the reality of empty space. In his Boyle lectures of 1704 he argued that according to Newton’s own demonstration, the existence of a void space is a necessary consequence of the existence of gravitation. And this void space is, of course, the most clear demonstration that the existence of matter is not necessary.

Clarke’s belief in the existence of an empty space turned out to be decisive to his metaphysical investigations. This belief was firmly based on the notions of absolute space and time introduced by Newton in the scholium to Definition VIII of the *Principia*. Newton had stressed that only absolute space and time are real and Clarke extended this thought by stating that they are “affections which belong, and in the order of our Thoughts are antecedently necessary, to the Existence of all Things.” Space was not a substance in its own right, but from the fact that it is necessarily existent, Clarke inferred that it must be a property of God. This conclusion provided a decisive argument for the necessity of a universal self-existent Being whose attributes are eternity, infinity, and unity. Clarke was well aware, however, that at the theological level there was a potential conflict between the doctrine of Trinity and the view of God’s unity that ensued from the notion of absolute space. Although his initial intention was to fight Toland’s idea that both God and matter could be considered self-existent principles, in the course of the debate he came to entertain serious doubts about the validity of the doctrine of Trinity. Thus, what initially was an argument against materialism led him to a radical reinterpretation of the Bible in favor of Divine unity. By 1711, in the third edition of his Boyle lectures, Clarke had made this interpretation quite explicit, and one year later he culminated his scriptural investigations with the publication of the *Scripture-Doctrine of the Trinity*. The outcome of his analysis confirmed the distinction between the attributes of God and those of the Son; the former belonged to the eternal being and thus were absolute, whereas the latter belonged to a product of the divine will, and therefore were relative.

Newtonian philosophy found itself in the basis of the heterodox theology suggested by Clarke. It is now well-known that Newton himself was also an anti-Trinitarian. William Whiston, another disciple of Newton, publicly supported the same belief at the expense of his academic career. In the uncertain atmosphere of postrevolutionary England, all these manifestations of heterodoxy could not escape the attention of those who defended religious “orthodoxy” and a certain aspect of social order. As a result, Newtonianism was engaged in the political debate of the time. The degree to which the basic concepts of the Newtonian natural philosophy became acceptable by various groups of English society depended on the political and religious affiliations of these groups. The fact that Newtonianism might be viewed as a faction in philosophy caused a major discomfort to those who held “Tory sensibilities.” Political factionalism of the seventeenth century was deemed one of the factors that subverted the political basis of the Stuart monarchy. In this sense, the Newtonian philosophy represented much more than a new trend in the investigation of nature: for a significant part of the English society it symbolized potential social disorder, and Newton was largely held responsible for this. Therefore, words like *attraction* and *inertia*, as well as methodological commitments like experimentalism and the mathematical representation of nature, became part of a polemic.

This was not the case with another aspect of Newtonianism that prevailed on the Continent during the eighteenth century, namely Voltaire’s Newtonianism. It took nearly fifty years for the Newtonian worldview to find its first devoted advocates in France. Pierre Louis Moreau de Maupertuis (1698–1759) was the first who pleaded with his countrymen not to dismiss unwisely the exegetical power of attraction. Subsequently, Voltaire, convinced by Maupertuis’s assurance about the worth of Newton’s synthesis, launched a systematic attempt to familiarize the French educated public with the new natural philosophy. Inevitably, the propaganda for the Newtonian system had to go hand in hand with the undermining of the Cartesian tradition. The French public recognized numerous defects in Descartes’s natural philosophy but they believed that an advancement in philosophy would correct these errors and restore the primacy of Cartesian tradition; under no circumstances were they willing to cure Descartes’s deficiencies by replacing his philosophy with the Newtonian synthesis. Voltaire dated the beginnings of the decline of the “chimerical philosophy” of Descartes in France to 1730. The main objective of his own attack was to secure Newton’s primacy on the basis of the superiority of his analytical method: Newton was superior to Descartes because his discoveries were a product of a systematic inductive investigation of nature confirmed by geometry. Newton never mistook conjectures for truth as was, in fact, the case with Descartes.

An equally important aspect of Voltaire’s undertaking was related to the theological dimension of Newtonian philosophy. Quite unexpectedly, Voltaire proclaimed the superiority of Newtonian theology over the Cartesian conception of God, whose “rational” character might seem, at first glance, more appropriate to the atmosphere of the rational Enlightenment. What basically annoyed Voltaire was the inclination of many followers

of the Cartesian tradition to adopt a quasi atheist stance, in the context of which the universe was the poor product of matter and motion. In Leibnizian philosophy, the counterpart of this stance was a kind of “rational” atheism, since the principle of sufficient reason held good even for God. Newton’s voluntarism was a decisive answer to these stances. The will of God was absolutely impenetrable by human intellect. The universe was not a product of natural or logical necessity but the outcome of God’s unrestrained will. Fallen man had access only to the results of His choices as they were revealed by the order of universe and the laws that govern the natural phenomena.

Voltaire’s interpretation of the Newtonian philosophy became popular in a great part of the European continent. The favorable attitude toward Christian faith and the countering of the Aristotelian and Cartesian dogmatism that ensued from this interpretation was an invaluable tool for those who promoted religious tolerance and moderate political reform. John Locke’s survey of the limits of human knowledge served as the counterpart of this aspect of Newtonianism and comprised the basis of an intellectual current that defended freedom of thought in a variety of sociopolitical environments. As a result, experimental philosophy came to represent far more than a scientific method. It epitomized the ability of citizens to overcome the restrictions of the established authorities without disturbing the social order, to participate in the acquisition of knowledge by their own means, and to establish paradigmatic procedures of social consent that would guarantee human progress and happiness.

See also **Cartesianism; Mathematics; Mechanical Philosophy; Physics; Philosophy.**

BIBLIOGRAPHY

PRIMARY SOURCES

- Algarotti, Francesco. *Sir Isaac Newton’s Philosophy Explain’d for the Use of the Ladies: In Six Dialogues on Light and Colours*. Translated by Elizabeth Carter. 2 vols. in 1. London: Printed for E. Cave, 1739. First Italian edition published 1737.
- Châtelet, Gabrielle-Émilie le Tonnelier de Breteuil, marquise du. *Institutions Physiques adressées à Mr. son Fils*. Amsterdam, 1742. Reprint, Hildesheim, Germany, and New York: Georg Olms Verlag, 1988. First edition published 1740.
- Clarke, Samuel. *The Scripture-Doctrine of the Trinity. In three parts: Wherein all the texts in the New Testament relating to that doctrine, and the principal passages in the liturgy of the Church of England, are collected, compared, and explained*. London: Printed for James Knapton, 1712.
- Cohen, I. Bernard, and Anne Whitman. *Isaac Newton, The Principia. Mathematical Principles of Natural Philosophy. A New Translation*. Berkeley and London: University of California Press, 1999. First Latin edition published 1687.
- Desaguliers J. T. *The Newtonian System of the World, the Best Model of Government: An Allegorical Poem. With a Plain and Intelligible Account of the System of the World, by Way of Annotations . . . To Which is added, Cambria’s Complaint Against the Intercalary Day in the Leap-Year*. Westminster: Printed by A. Campbell for J. Roberts, 1717.
- Gravesande, Willem Jacob ’s. *Mathematical Elements of Natural Philosophy confirm’d by experiments; or, an Introduction to Sir*

Isaac Newton’s Philosophy. Translated by J. T. Desaguliers. 2 vols. London: Printed for J. Senex and W. Taylor, 1720–1721. The Latin original and another English translation made by J. Keill were published in 1720.

- Maclaurin, Colin. *An Account of Sir Isaac Newton’s Philosophical Discoveries*. London: Printed for the author’s children and sold by A. Millar and J. Nourse, 1748. Reprint, New York and London: Johnson Reprint Corporations, 1968.
- Martin, B. *A panegyrick on the Newtonian philosophy: shewing the nature and dignity of the science, and its absolute necessity to the perfection of human nature; the improvement of arts and sciences, the promotion of true religion, the increase of wealth and honour, and the completion of human felicity*. London: Printed for J. Owen, J. Leake, and J. Frederick, 1749.
- Musschenbroek, Petrus van. *The Elements of Natural Philosophy. Chiefly intended for the Use of Students in Universities, by Peter van Musschenbroek, M.D., Professor of Mathematics and Philosophy in the University of Leyden. Translated from the Latin by John Colson, M.A. and F.R.S., Lucasian Professor of Mathematicks in the University of Cambridge*. 2 vols. London: Printed for J. Nourse, 1744. First Latin edition published 1734.
- Newton, Isaac. *Opticks; or, A Treatise of the Reflections, Refractions, Inflections and Colours of Light*. 4th ed. London: Printed for W. Innys, 1730. Reprint, New York: Dover, 1979. First edition published 1704.
- Pemberton, Henry. *A View of Sir Isaac Newton’s Philosophy*. London: Printed by S. Palmer, 1728.
- Toland, John. *Letters to Serena*. London: Printed by B. Lintot, 1704. Reprint, New York: Garland Publications, 1976.
- Voltaire, *The Elements of Sir Isaac Newton’s Philosophy. Translated from the French, revised and corrected by John Hanna, teacher of Mathematics*. London, 1738. Reprint, London: Frank Cass, 1967. First French edition published 1738.

SECONDARY SOURCES

- Cohen, I. Bernard. *Franklin and Newton: An Inquiry into Speculative Newtonian Experimental Science and Franklin’s Work in Electricity as an Example Thereof*. Philadelphia: The American Philosophical Society, 1956.
- Dobbs, Betty Jo Teeter, and Margaret C. Jacob. *Newton and the Culture of Newtonianism*. Atlantic Highlands, N.J.: Humanities Press, 1995.
- Ferrone, Vincenzo. *The Intellectual Roots of the Italian Enlightenment: Newtonian Science, Religion, and Politics in the Early Eighteenth Century*. Translated by Sue Brotherton. Atlantic Highlands, N.J.: Humanities Press, 1995. First Italian edition published 1982.
- Force, James E., and Richard H. Popkin, eds. *Newton and Religion: Context, Nature, and Influence*. Dordrecht and Boston: Kluwer Academic, 1999.
- Gascoigne, John. “From Bentley to the Victorians: The Rise and Fall of British Newtonian Natural Theology.” *Science in Context* 2 (1988): 219–256.
- Guerlac, Henry. *Newton on the Continent*. Ithaca, N.Y.: Cornell University Press, 1981.
- Hankins, Thomas L. *Jean d’Alembert: Science and the Enlightenment*. Oxford: Clarendon, 1970.
- Jacob, Margaret C. *The Newtonians and the English Revolution, 1689–1720*. Ithaca, N.Y.: Cornell University Press, 1976.
- Rattansi, P. M. “Voltaire and the Enlightenment Image of Newton.” In *History and Imagination: Essays in Honour of*

- H. R. Trevor-Roper. Edited by Hugh Lloyd-Jones, Valerie Pearl, and Blaire Worden. New York: Holmes and Meier, 1982.
- Rousseau G. S., and Roy Porter. *The Ferment of Knowledge: Studies in the Historiography of Eighteenth-Century Science*. Cambridge, U.K., and New York: Cambridge University Press, 1980.
- Stewart, Larry. *The Rise of Public Science: Rhetoric, Technology, and Natural Philosophy in Newtonian Britain, 1660–1750*. Cambridge, U.K., and New York: Cambridge University Press, 1992.
- Theerman, Paul, and Adele F. Seeff. *Action and Reaction: Proceedings of a Symposium to Commemorate the Tercentenary of Newton's Principia*. Newark: University of Delaware Press; London: Associated University Presses, 1993.
- Truesdell, Clifford. "A Program toward Rediscovering the Rational Mechanics of the Age of Reason." *Archives for the History of Exact Ideas* 1 (1960): 1–36.

Manolis Patiniotis

NIHILISM. In a history that spans more than two and a half centuries, the term *nihilism* has been employed to denote a wide range of phenomena. It has been variously used to express contempt or horror on the one side, approval and admiration on the other. In the twentieth and twenty-first centuries, it has almost always been an emotional and axiological term, frequently employed to cut off debate on a moral issue by representing a particular position as absolute, totalizing, and extreme.

Early History of the Term

The word *nihilism* is constructed from the Latin *nihil*, "nothing," and the Greek suffix *ism*. In the compendious *Historisches Wörterbuch der Philosophie* (Historical dictionary of philosophy), Wolfgang Müller-Lauter gives 1733 as the earliest known date for the occurrence of the German *Nihilismus* and notes the rise of the word *nihilisme* in France at the end of the eighteenth century.

From the late eighteenth century through the first half of the nineteenth century, nihilism followed a course that scholars have already traced in considerable detail. Enemies of German idealism threw the term at Immanuel Kant and Johann Gottlieb Fichte, for example, protesting against the emptiness of a philosophy that denies the possibility of any reliable contact with the world of things in themselves. As European thought increasingly moved toward dispassionate, secular explanations of religious belief (holding, for example, that such belief is a natural and predictable product of human consciousness or that it reflects a natural, human tendency to generate myths), those seeking to defend traditional faith increasingly leveled the charge of nihilism against secularizing thinkers. David Friedrich Strauss (1808–1874), the famed and much reviled author of *Das Leben Jesu: kritisch bearbeitet* (1835–1836; *The life of Jesus: critically examined*), one of the nineteenth century's many biographies of Jesus, and Ludwig Feuerbach (1804–1872), the equally noted author of the skeptical *Das Wesen des Christentums* (1845; *The essence of Christianity*), were both accused of propagating nihilism. Max

Stirner (pseudonym of Johann Caspar Schmidt; 1806–1856), author of the primary gospel of egoism, *Der Einzige und sein Eigentum* (1845; *The ego and his own*), and pre-Nietzschean messenger of the death of God, has been described as an early nihilist. All such thinkers, it was felt, had reduced to nothing (*nihil*) both faith and its transcendent object.

Nihilism in Russia and As a Russian Export

The term *nihilism* (*nigilizm* in Russian) had been used in Russia early in the nineteenth century, but it burst on the scene with particular force and with an entirely new meaning in January 1862, when Ivan Turgenev (1818–1883) published *Fathers and Sons*. Turgenev's hero, Evgeny Vasil'evich Bazarov, is a man of science, a member of the new generation who has decided that, at least in theory, nothing in the universe lies beyond the explanatory power of the empirical method. He is, in a word, a nihilist. As his callow young friend puts it to members of the older generation (the "fathers"), a nihilist is a man "who approaches everything from a critical point of view . . . who does not bow down before any authorities, who does not accept a single principle on faith, no matter how much respect might surround that principle." Bazarov dissects frogs (the better to understand human beings), denies the value of artistic expression, and is predictably flummoxed when he finds himself hopelessly in love, that is, in a condition that completely defies the very foundation of his materialist worldview.

If nihilism, as Turgenev's hero understood it, comprised both a thoroughgoing materialism and a thoroughgoing anti-aestheticism, it was already possible to find both in the apostle of the new progressive generation, Nikolai Gavrilovich Chernyshevsky (1828–1889), who would gain notoriety in 1863 as the author of the didactic novel *What Is to Be Done?* In his master's thesis, *The Aesthetic Relation of Art to Reality* (1855), Chernyshevsky had denied the existence of beauty as an autonomous quality in art, saying that beauty can be nothing more than life itself. And in *The Anthropological Principle in Philosophy* (1860), he had reduced human freedom and, for that matter, human distinctiveness, to nothing, arguing that individual freedom is an illusion as much in humanity as in the lower forms of animal life. Chernyshevsky would add a third feature to the definition of nihilism in *What Is to Be Done?* The idealized characters in his novel behave in accordance with an odd amalgam of utilitarianism and enlightened egoism, thus reducing traditional ethical values to nothing.

After the publication of *What Is to Be Done?* nihilism as a term or attitude took three principal directions in Russia. First, in literary life, it nurtured the trend toward realism. Dmitry Pisarev (1840–1868), the young critic who in a favorable review of *Fathers and Sons* helped disseminate a positive image of Turgenev's hero, took Chernyshevsky's anti-aestheticism one step farther in the 1860s, devoting a series of essays to the "destruction of aesthetics" and to the promotion of a rigidly realist style in literature. Second, in political life, the term *nihilism* came to be used, often with hostile intent, to describe a group within the revolutionary movement characterized by its unscrupulous methods and its unprincipled aims. Fyodor Dostoyevsky helped popularize this sense of *nihilism* by offering up the savage caricatures of left-wing political operatives

that we see, above all, in *The Devils* (also called *The Possessed*; 1871). The chief “devil” in this book, Peter Verkhovensky, is a self-described nihilist notable for his desire to bring about terrible destruction and for his utter lack of concern about what might follow that destruction. As Peter Verkhovensky’s real-life prototype, the notorious anarchist Sergei Nechaev (1847–1882), had written in the *Catechism of a Revolutionary* (1869), “The revolutionary disdains all doctrinairism and has repudiated all peaceful science. . . . He knows one science only: the science of destruction.” Third, the term *nihilism* came to be used, again in political life, in a sympathetic sense to denote the Russian revolutionary movement broadly speaking. The Russian revolutionary Sergei Mikhailovich Kravchinsky (1851–1895; better known by the pseudonym Sergius Stepniak), after fleeing Russia in 1878, spent much of his life publishing—in English and Italian—apologias for the Russian liberation movement that he broadly termed *nihilism*. And the anarchists Emma Goldman (1869–1940) and Alexander Berkman (1870–1936), both Russian immigrants to the United States, used the term *nihilist* in their memoirs to refer to the heroes of the Russian revolutionary movement, heroes that had inspired them to embark on their own revolutionary careers.

Nietzsche and Nihilism

Had it not been for Friedrich Nietzsche (1844–1900), nihilism—the word and what it came to designate—would no doubt have been very different from what it in fact became. We find an enigmatic reference to “nihilism according to the Petersburg model” (an apparent reference to Turgenev) in part 5 (1887) of *The Gay Science*, but the term occurs in his published writings mostly in connection with philosophies that Nietzsche views as world- or life-denying. In *The Genealogy of Morality* (1887), for example, he offers the term *nihilism* as a synonym for *Buddhism*, meaning a renunciation of the affairs of the world. In *The Anti-Christ* (1888), nihilism is essentially synonymous with “denial of life,” and Nietzsche defines pity, the root sentiment of Christianity, as “the praxis of nihilism.”

The bulk of Nietzsche’s comments on nihilism, however, appear in unpublished writings (the *Nachlass*, or “literary legacy”) from the 1880s. It is here that Nietzsche describes nihilism as a condition in which “the highest values devalue themselves” and in which the answer to the question “Why?” is missing. There are two possible responses to this condition, Nietzsche explains in a notebook he kept in 1887. We may rise up in strength and recognize that existing goals are no longer adequate, establishing new values in place of the older ones, or we may resign in weakness (“Buddhism,” as Nietzsche puts it), thus failing to generate new values. The first response is called “active nihilism,” the second “passive nihilism.”

There has been some debate over the years about whether Nietzsche himself was a nihilist. The debate is misguided. A cursory reading of what Nietzsche says on the subject shows that for him nihilism is alternately a lamentable and a potentially fruitful condition, but in either case a temporary one. Anyone inclined to construe the proclamation that God is dead as an expression of nihilism should remember that Nietzsche declared the religion whose God was allegedly dead to be itself a form of nihilism. Nietzsche’s true legacy was the association



Conspiracy in Russia: A Nihilist Meeting Surprised. Illustration, 1880. In late nineteenth-century Russia, *nihilism* was often used as a pejorative term meant to characterize certain left-wing radicals as dangerous and amoral, but supporters appropriated the same term to refer to the Russian revolutionary movement in a positive fashion. © BETTMANN/CORBIS

of nihilism with values (their absence, their rejection, their synthesis). Future social commentators who invoke the term *nihilism* to mourn the loss of traditional morality may blame or not blame Nietzsche; what they wittingly or unwittingly owe him is a definition that is at least implicit in what they say.

Nihilism and the Twentieth Century’s Ills

From 1936 to 1946, Martin Heidegger (1889–1976) wrote the component parts of what became a two-volume study of Nietzsche. A simple glance at the chapter and subchapter headings will show to what extent nihilism, in Heidegger’s eyes, was fundamental to Nietzsche’s thinking. World War II and the period immediately preceding it were an appropriate backdrop for Heidegger’s sense that we must view Nietzsche’s nihilism in the broader context of what he calls “the end of metaphysics” in Europe. He defines this end as “the beginning of a taking-seriously of that ‘event,’ ‘God is dead.’” As Heidegger sees it, nihilism is one of five “principal headings” (*Haupttitel*) in Nietzsche’s thought, the other four (with which it is inseparably connected) being the revaluation of all prior values, the will to power, the eternal recurrence of the same, and the superman. If Heidegger’s comments on Nietzsche’s nihilism are partly a comment on the contemporary European

Listening to my teacher revived the ghastly sight: the bleeding body, the piercing shrieks, the distorted faces of the *gendarmes*, the knouts whistling in the air and coming down with a sharp hissing upon the half-naked man. Whatever doubts about the Nihilists I had left from my childhood impressions now disappeared. They became to me heroes and martyrs, henceforth my guiding stars.

SOURCE: Emma Goldman, in *Living My Life* (1931), on learning of the flogging of peasants in Russia.

situation, they are also partly a comment on his own earlier work. In his chapter on the five principal headings, for example, Heidegger defines what he calls Nietzsche's "classical nihilism" as "that bringing-to-completion of nihilism in which nihilism considers itself to be released from the necessity of thinking precisely that which its essence constitutes: nihil, nothing—as the veil of the truth of the Being of that-which-is [*des Seins des Seienden*]." A passage like this is probably helpful more to the student of Heidegger's *Being and Time* (1926) than to the student of nihilism.

World War II and the entire history of totalitarianism in the first half of the twentieth century provoked one of the most forceful uses of *nihilism* as a moral and political term. In 1951, Albert Camus (1913–1960) published *L'homme révolté* (Man in revolt; translated into English as *The Rebel*). As Camus put it in the first few pages of his book, "If our age easily allows that murder can have its justifications, it is because of that indifference to life that is the mark of nihilism." The central question becomes whether it is possible to offer a rational justification for murder, as is done in this "age of ideologies." Nihilism has to do with values, as it did for Nietzsche. When Camus comes to show the inner contradiction in "the absurd" (his term for the attitude born of nihilism or "absolute negation"), he has this to say: The absurd is a contradiction "because it excludes value judgments while still wishing to preserve life, whereas to live is itself a value judgment. To breathe is to judge." One might argue that this position represents a *petitio principii* (begging the question), but even so, it is obvious that, to Camus, it serves as a palliative in a world still reeling from the Stalinist purges and the horrors of the Holocaust.

Outside Russian revolutionary circles, *nihilism* has been a term whose alleged exponents rarely embrace it, particularly because it is seldom used favorably. Some scholars have attempted to classify it into several subtypes. Donald A. Crosby, in *The Specter of the Absurd*, sees five types of nihilism: political (essentially the Russian revolutionary sort), moral (in which all moral judgments are rejected as individual or arbitrary), epistemological (in which all truth claims are seen as

purely relative), cosmic (in which the cosmos is seen as meaningless), and existential (in which human existence is seen as pointless). Karen L. Carr, in *The Banalization of Nihilism*, proposes a similar taxonomy. In her view, there are five types of nihilism: epistemological ("the denial of the possibility of knowledge"), alethiological ("the denial of the reality of truth"), metaphysical ("the denial of an independently existing world"), ethical ("the denial of the reality of moral or ethical values"), and existential or axiological ("the feeling of emptiness and pointlessness that follows from the judgment, 'Life has no meaning'").

With categories as broad as these, nihilism can be applied to a host of phenomena associated generally with a loss of values or centeredness. One might even say that nihilism as a label became so popular in the second half of the twentieth century that it was often left unspoken. A famous issue of *Time* magazine in 1966 posed the question "Is God Dead?" in stark red letters against a black background on its cover. In the article, whose immediate inspiration was the rise of the "death-of-God theology" practiced by a particular group of American theologians, John T. Elson reflected on his age as "a time of no religion," cited Søren Kierkegaard (1813–1855) and Nietzsche as prophets of modern godlessness, and offered this comment on modern art: "From the scrofulous hobos of Samuel Beckett to Antonioni's tired-blooded aristocrats, the anti-heroes of modern art endlessly suggest that waiting for God is futile, since life is without meaning."

Many, however, have not hesitated to name the illness. In 1987, for example, Allan Bloom (1930–1992) published his assault on American higher education, *The Closing of the American Mind*. He titled Part 2 of that book "Nihilism, American Style," taking aim at a pathological condition he saw in America both inside and outside the academy: "value relativism." The ultimate culprit is none other than Nietzsche. As Bloom saw it, Nietzsche's target was not only God but modern democracy. Displaying Nietzsche's own fondness for unsubstantiated, sweeping claims, Bloom declares, "Nobody really believes in anything

Although nihilism and its accompanying existential despair are hardly anything but a pose for Americans, as the language derived from nihilism has become a part of their educations and insinuated itself into their daily lives, they pursue happiness in ways determined by that language. There is a whole arsenal of terms for talking about nothing—caring, self-fulfillment, expanding consciousness, and so on, almost indefinitely.

SOURCE: Allan Bloom, *The Closing of the American Mind* (1987).

anymore, and everyone spends his life in frenzied work and frenzied play so as not to face the fact, not to look into the abyss.”

The Future of Nihilism

If the word *nihilism* during the twentieth century was frequently used to denote the condition—and the accompanying feeling of despair—that arises when established and fixed moral values are missing, it is not surprising that it gained currency at a time when much of the world was dominated by ideologies that rejected such values or openly embraced destruction. At the turn of the century, a major political source of obsessive fear in Western Europe and the United States was anarchism. For much of the remainder of the century, it was fascism and communism. At the beginning of the twenty-first century, it appeared to be Islamic fundamentalism. Whatever the phrase “Islamic fundamentalism” might be construed to mean, it is safe to say that, if it indeed represents a threat to the West, it is because of values that are perceived as alien, not because of the loss of all values. At this stage, *nihilism* as a term has perhaps become a mere relic.

See also *Anarchism; Atheism; Existentialism*.

BIBLIOGRAPHY

- Bloom, Allan. *The Closing of the American Mind: How Higher Education Has Failed Democracy and Impoverished the Souls of Today's Students*. New York: Simon and Schuster, 1987.
- Camus, Albert. *The Rebel*. Translated by Anthony Bower. London: H. Hamilton, 1953.
- Chernyshevsky, Nikolai. *What Is to Be Done?* Translated by Michael R. Katz. Ithaca, N.Y.: Cornell University Press, 1989.
- Crosby, Donald A. “Nihilism.” In *Routledge Encyclopedia of Philosophy*, edited by Edward Craig. Vol. 7. London and New York: Routledge, 1998.
- . *The Specter of the Absurd: Sources and Criticisms of Modern Nihilism*. Albany: State University of New York Press, 1988.
- Elson, John T. “Is God Dead?” *Time* 87, no. 14 (April 1966): 82–87.
- Goerdts, W. “Nihilismus.” In *Historisches Wörterbuch der Philosophie*, edited by Joachim Ritter and Karlfried Gründer. Vol. 6. Basel and Stuttgart: Schwabe, 1984.
- Goldman, Emma. *Living My Life*. 2 vols. New York: Knopf, 1931.
- Goudsblom, Johan. *Nihilism and Culture*. Oxford: Blackwell, 1980.
- Heidegger, Martin. *Nietzsche*. Pfullingen, Germany: Neske, 1961.
- Nechayev, Sergei. “The Catechism of the Revolution.” In *Apostles of Revolution*, by Max Nomad. Rev. ed. New York: Collier, 1961.
- Nietzsche, Friedrich. *The Anti-Christ*. In *Twilight of the Idols and The Anti-Christ*. Translated by R. J. Hollingdale. New York: Penguin, 1990.
- . *The Gay Science*. Translated by Walter Kaufmann. New York: Random House, 1974.
- . *On the Genealogy of Morality*. Translated by Maudmarie Clark and Alan J. Swensen. Indianapolis, Ind.: Hackett, 1998.
- Rosen, Stanley. *Nihilism: A Philosophical Essay*. New Haven, Conn., and London: Yale University Press, 1969.
- Turgenev, Ivan. *Fathers and Sons*. Edited and translated by Ralph E. Matlaw. New York: Norton, 1966.

Steven Cassedy

NOMADISM. While numerous types of migrating peoples can be referred to as *nomads*, this entry focuses on *pastoral nomadism*, defined as human cultures that depend solely or primarily on herds of domesticated animals. People in these cultures as a result are required to relocate their homes to new pastures on a regular basis in order to sustain these herds—what anthropologists call *transhumance*. Such nomads are historically represented in three significant regions, all of which are characterized by sufficient grass for animals but insufficient rain and soil quality for sustained agriculture. These regions are Sudanic and East Africa, where herds consisted primarily of cattle and camels; Arabia, southwest Asia, and the Iranian plateau, with herds of camels, sheep, and goats; and the vast steppe region of Central Eurasia, famous for herds of horses.

Nomadic Society and Culture

The necessity of regular migration shapes almost all aspects of nomadic society and culture. While often seen by outsiders as “wandering,” the seasonal migrations of nomadic herdsmen are generally over fixed routes traveling between established pastures and water resources. These migrations begin in spring, as adequate rainfall or snowmelt (or both) open up additional pasturelands. In Central Eurasia, the general pattern was for nomads to move their herds northward as much as 500 miles as the weather warmed, and then to reverse course and work their way south as temperatures cooled. In other areas, nomads covered shorter distances, often following circular routes, or shifting from lower altitudes to higher pastures in mountainous regions. During these migrations the nomad’s animals were vulnerable to dramatic shifts in climate, including droughts and harsh winter freezes, as well as disease. Since they depended on their herds for survival, any significant loss of animals could spell disaster for the nomads themselves.

Socially and politically, most nomadic peoples have been organized according to kinship structures, which generally include legends of origin tracing all members of a particular group to a common ancestor. However, as more recent scholarship has demonstrated, historically these kinship ties have incorporated an element of flexibility, with individuals and even larger groups changing clans due to conflicts and other crisis events. Still, the dominant pattern has been to maintain tight bonds of family loyalty, tested and reaffirmed during economic crisis or during feuds with outsiders. Thus the famous cliché of both scholars and tribesmen themselves: “Me against my brothers; my brothers and me against our cousins; my brothers, cousins, and me against the world.” It is this aspect of nomadic life that was emphasized by the great Muslim social historian Ibn Khaldun (1332–1406) in his discussion of *‘asabiyya* or “group feeling,” which he saw as key to the Bedouins’ success in warfare against outsiders.

Pastoral societies were frequently resistant to large-scale political organization, at least under a single leader, due to the availability of flight as an option when faced with authoritarian claims to power. In fact, many scholars argue that leadership among nomads was often the creation of sedentary powers who sought someone to deal with in their contacts with nomadic peoples. While the general pattern of disunity limited the political power of nomadic peoples, it also served as an



Afghan nomads near Kabul, 1997. Afghanistan is one of several countries that still maintains a substantial nomadic population in the twenty-first century. During the summer, the Afghan nomads graze their herds in the highlands, but as winter approaches they drive the livestock to the lowlands to ride out the inclement weather. AP/WIDE WORLD PHOTOS

effective political adaptation to outside threats, making it much more difficult to conquer nomadic peoples who, lacking a centralized leadership, simply broke up into ever smaller autonomous units rather than concede defeat.

Among the many distinctive features of nomadic culture, military prowess has no doubt historically attracted the most attention. While many have sought to locate the martial skills of nomads within some cultural essentialism or even genetic predisposition, it is hard to sustain the notion that nomads are more war-like than anyone else. Rather, the military advantages of nomadic populations, as shown, for example, by the horse nomads of Inner Asia, derived primarily from a nomadic lifestyle that was in many ways “paramilitary” in its orientation, including the harshness of life on the move, and constant practice in horsemanship and archery while defending one’s herds. This, combined with greater mobility and speed of movement to, within, and (if necessary) away from the battlefield, gave nomadic peoples an advantage over their sedentary opponents.

Relations with Sedentarists

Much has been made historically of the so-called clash between the “desert” and the “sown,” the “barbarians” versus the “civilized,” exemplified even by the ancient Hebrew story of the first murder, when Cain the farmer killed Abel the herdsman. In fact, one must beware false oppositions and note that the relations between pastoral nomads and sedentary societies have, for the most part, been peaceful, symbiotic, and mutually beneficial. Indeed, as Anatoly Khazanov argues, nomadic cultures can be seen as to some extent dependent on sedentary cultures, at least economically, especially as the former became more specialized. Throughout recorded history nomads have provided sedentary populations with items such as horses, furs, meat, and wool, in exchange for grains, luxuries, and other

manufactured goods. These trade relationships have impacted the course of human history in many ways, not the least of which was the role of nomads in supporting and maintaining the so-called silk roads across Eurasia, which served as the conduit of long-distance interactions between sedentary civilizations for centuries.

Still, it is undeniable that the written historical record is dominated by numerous accounts of hostilities between nomadic and sedentary communities. This is due in part to the fact that these records generally emanate from sedentary writers seeking to portray nomads as “the other,” enemies in every sense to sedentary society. At the same time, hostilities were a significant part of the relationship, often initiated by nomads for various reasons. For example, nomads sometimes struck at sedentary regions in an effort to compel the latter to engage in trade. This was particularly true along the border with China, where officials would seek to dominate their nomadic neighbors by denying them access to Chinese markets. In other instances, climatic changes in nomadic regions could lead to overpopulation or, conversely, to loss of herds, driving nomads to invade sedentary areas to fend off starvation. And finally, it is certainly the case that nomads often attacked sedentary communities to obtain loot, especially when the nomads enjoyed clear military superiority.

State and Empire Building

The most significant and lasting influence of nomadic peoples historically has come as a result of supratribal cooperation that led to the conquest of and rule over sedentary states. The two great examples of this are the Arabs from the seventh century and the Inner Asian Turco-Mongolian tribes from the tenth century. In the famous analysis of Ibn Khaldun, the Arabs were able to put aside their differences and unite due to the influence of the non-tribal principle of Islam. Once accomplished, this unified Arab force successfully spread its power from Spain to the Indus.

For the Turco-Mongolian tribes of Inner Asia, who more readily accepted the notion of hierarchical distinctions in their societies, leadership arose from charismatic tribal chiefs and their families, who were then able to form tribal confederations, sometimes numbering in the millions, and spread their power over vast regions. The quintessential example of this type of leadership was the thirteenth century Mongol chieftain Genghis (Chinggis) Khan (who ruled from 1206–1227), under whose leadership the Mongols and their Turkish confederates established the largest land empire the world has ever seen.

For both nomadic Arabs and Mongols, the irony of their success in conquering sedentary regions is that, once they began to rule, the nomads invariably became sedentary themselves, thus leading to the weakening of the state’s initial military power base. Thus began the frequently discussed cycle of powerful nomadic conquerors, growing weaker in successive generations, until finally overthrown by more nomadic elements of their own people or by newly arrived nomads from outside.

Nomadism as a way of life has survived into the twenty-first century, though in much limited scope, due to the fact that nomads are still able to utilize parts of the earth’s environment

that are of no use to anyone else. Still, with the vastly improved technology of sedentary cultures, nomads are not likely to ever again play the central role in history that they once did.

See also *Borders, Borderlands, and Frontiers, Global; Migration; Tribalism, Middle East.*

BIBLIOGRAPHY

- Barfield, Thomas J. *The Nomadic Alternative*. Englewood Cliffs, N.J.: Prentice Hall, 1993.
- Khaldun, Ibn. *The Muqaddimah: An Introduction to History*. Translated by Franz Rosenthal, edited and abridged by N. J. Dawood. Princeton, N.J.: Princeton University Press, 1967.
- Khazanov, Anatoly M. *Nomads and the Outside World*. 2nd ed. Madison: University of Wisconsin Press, 1994. Very rich bibliography.
- Lindner, Rudi Paul. *Nomads and Ottomans in Medieval Anatolia*. Bloomington: Research Institute for Inner Asian Studies, Indiana University, 1983.

William A. Wood

NONVIOLENCE. Gandhian nonviolence (*ahimsa*) is an active civic virtue that habitually disposes individuals, social groups, and political authorities to resist violence through nonviolent means and to resolve conflicts using peaceful methods. It recognizes violence as a fact and nonviolence as a norm of social life. Its normative character arises from the assumed natural sociability of human beings. Its focal point is the good of society, which includes the good of the individual as well. It is an active virtue, inasmuch as it imposes a twofold obligation on its adherents to resist violence in all its forms and to seek effective nonviolent means to resolve conflicts. To be nonviolent in the Gandhian sense, it is not enough to refrain from committing acts of violence; it is equally necessary to take positive steps to remove the causes of violence wherever they are found, whether in the political, social, economic, or religious arena.

In the Indian context, the organized practice of this virtue is called *satyagraha*. Coined by Mohandas Karamchand Gandhi (1869–1948), this Gujarati term means “firmness in adhering to truth”—practical truth. The discovery of the truth underlying a conflict situation by the parties to the conflict is a distinguishing feature of *satyagraha*. The parties to a conflict are considered not so much adversaries as partners in search of a common end. There is no question of one party losing and the other party gaining. On the contrary, the goal is for both parties to make some moral advance for having engaged in a conflict.

Nonviolence may be practiced by individuals or by groups. In either case, it requires careful moral training and the use of appropriate techniques. Its practice may take several forms: noncooperation (if the offending party is the state), boycott (if the offending party is a business or corporation), strikes (in labor disputes), or protest marches, and so forth. Joan Bondurant’s *Conquest of Violence* (1965) and Mark Juergensmeyer’s

Gandhi’s Way (2002) give excellent accounts of the techniques that Gandhi used in the organized exercise of this virtue.

Distinctions

Gandhi makes a number of distinctions that clarify the meanings of nonviolence: active nonviolence distinguished from passive nonviolence, nonviolence as creed distinguished from nonviolence as policy, and the nonviolence of the brave distinguished from that of the morally weak.

Active nonviolence is the disposition to use not only existing nonviolent means in settling disputes, but also to invent new means if the existing ones prove to be ineffective. Its active character makes it a creative and dynamic force in the culture of a given society. Passive nonviolence, by contrast, is a private, monastic virtue whose goal is the spiritual perfection of the individual. In and of itself, it is indifferent to, if not blind to, the violence that exists in society.

Nonviolence as creed prohibits, always and everywhere, the use of violent means to resist violence. Nonviolence of the brave raises the practice of this virtue to a heroic level, making personal suffering, even death, an acceptable consequence of practicing it. Gandhi saw these two forms of nonviolence as options open only to exceptional individuals; he did not make them mandatory for those who practice nonviolence as a civic virtue.

Nonviolence as policy is preeminently a civic virtue. It too is based on a strong moral conviction against the use of violence to resolve conflicts. At the same time, it permits the lawful use of violence in certain circumstances, as, for instance, in the maintenance of public order or public welfare. Also, wars of legitimate self-defense, conducted under strict rules of natural justice and international law, do not violate the norms of nonviolence as policy. Its object is not the total elimination of violence from society—which is taken as being existentially impossible—but the gradual reduction of its frequency and intensity. It stands for a realist, not pacifist, vision of society and polity. However, its practitioners too are obliged to seek, wherever possible, nonviolent ways of resolving conflicts. Finally, the nonviolence of the morally weak is hardly a virtue, since it is practiced for reasons of expediency, not moral conviction.

The Historical Context

The origin and development of Gandhian nonviolence were owed to four forms of violence that Gandhi had to face throughout his career. They were, first, colonialism as practiced in South Africa and India at the turn of the twentieth century; second, the rise of Indian nationalism aligned to terrorism; third, the violent treatment of the untouchables by upper-class Indians; and fourth, the rise of religious extremism in India.

Gandhi viewed colonialism as a product of modern Western civilization (the other product being Marxism). By definition, colonialism legitimized aggressive wars of conquest and condoned the treatment of the colonized as “lesser breeds” without rights. Its twin maxims, he claimed, were “might is right” and the “survival of the fittest.” The immediate context

of the birth of satyagraha (1906) was Gandhi's confrontation with what was perhaps the most violent form of colonialism—that practiced in South Africa.

Although in its early years Indian nationalism adhered to liberal values, by the turn of the twentieth century an extremist faction was turning to terrorist violence as a means of ending colonialism. Terrorist secret societies, such as the Abhinav Bharat (1904) and the Anusilan Samiti (1905), had gained ground in several regions of India. Gandhi was keenly aware of the dangers that political terrorism posed for Indian society.

Although racism was part of the colonial ideology, Gandhi was appalled more by the quasi-racist treatment of India's so-called untouchables by the Indians themselves than he was by the racism of the whites against nonwhites. The eradication of this form of violence from India was one of the major objects of his nonviolent campaigns. The Vykom Satyagraha (1924–1925) was directed specifically against untouchability.

What troubled Gandhi most, however, was the rise of religious extremism in India in the first quarter of the twentieth century. Vinayak Damodar Savarkar's (1883–1966) *Hindutva*, the basic text of Hindu extremism, was published in 1923, and Abul Ala Mawdudi's (1903–1979) *Jihad*, a basic text of modern Muslim fundamentalism, was published in 1927. Both rejected Gandhi's nonviolent vision of society and polity. Gandhi's position was that religious fundamentalism was corrupting both Hinduism and Indian Islam. His philosophy of nonviolence appealed to both moderate Hindus and moderate Muslims, but failed to prevent the partition of India along religious lines.

The Intellectual Context

The ideas that shaped Gandhian nonviolence were drawn both from Western and Indian sources. The trial of Socrates as described in Plato's *Apology* had a profound impact on Gandhi. In 1908 he published a paraphrase of this work in English and Gujarati under the title *The Story of a Soldier of Truth*. Socrates was a model for all those who would resist nonviolently the violence of the state. The ethics of the Sermon on the Mount, as interpreted in Leo Tolstoy's *The Kingdom of God Is within You* (1893), had a lifelong influence on him. Another of Tolstoy's writings, *Letter to a Hindu* (1908), made Gandhi rethink the role of violence in Indian society. Tolstoy had argued that the British were able to hold India by violence because Indians themselves believed in violence as the basis of society. That is why they submitted themselves to their rajas and maharajas, and treated the untouchables with extreme cruelty. Under these circumstances, the complaints of Indians against colonial violence seemed to him to resemble the complaints of alcoholics against wine merchants. The removal of colonial violence would not solve India's problems with violence. They would be solved only if Indians made nonviolence the basis of a new India. Gandhi was so persuaded by the *Letter* that he translated and published it in both English and Gujarati.

Gandhi's study of Western jurisprudence made him a lifelong defender of the idea of the rule of law and the legitimacy of the limited, constitutional state. The fight against violence

needed such a state as its ally. Here Gandhi departed from Tolstoy's radical pacifism that rejected the state as such.

John Ruskin's *Unto This Last* (1860) opened Gandhi's eyes to the hidden structures of violence in industrial capitalism. This work, too, Gandhi paraphrased and published in English and Gujarati (1908) under the title *Sarvodaya* (The welfare of all), a title that he later gave to his own economic philosophy.

Finally, there was the question of nationalism and how to free it from ethnic or religious or terrorist violence. Here he found help in the liberal nationalism of Giuseppe Mazzini, whose *An Essay on the Duties of Man*, published in 1892, became one of the recommended readings for all those who wanted to understand Gandhi's own fundamental work, *Hind Swaraj* (1909).

However, it was Indian philosophical thought that helped Gandhi to integrate the ideas he had absorbed from the West. Here three philosophical traditions were significant. The first was the pacifist tradition of Jainism, as interpreted by Rajchand—businessman, poet and mystic, and a personal friend. His advice was that a nonviolent way of life was possible only if one withdrew from politics and concentrated all one's energies on achieving inner harmony. Gandhi accepted the point about inner harmony but rejected the idea of withdrawing from politics. On the contrary, he sought to link the quest for inner harmony with that for outer harmony in society and polity.

The philosophy of yoga as expounded in the classic text, the *Yogasutra* of Patanjali, had also impressed Gandhi greatly. Like Jainism, it too believed in the incompatibility between maintaining inner harmony and engaging in active politics. However, it had recommended five moral virtues as being necessary for inner harmony. Nonviolence was one of them; the other four were truthfulness, abstention from theft, celibacy, and moderation in the use of material possessions. Gandhi gladly incorporated nonviolence into his ethical system—with one modification. He modified it from being a moral virtue into a civic virtue, thereby making it appropriate for political action.

But the philosophy that influenced him most was that of the *Bhagavad Gita*. He interpreted it as teaching the negative lesson of the futility of war. On the positive side, he interpreted it as teaching that the good life called for the disinterested service of one's fellow human beings, sustained by a deep love of God. Obstacles to the good life came from violence and the undisciplined state of the passions, notably anger, hatred, greed, and lust. Self-discipline therefore was the psychological key to nonviolence.

The philosophical anthropology underlying Gandhi's theory of nonviolence is adapted from that underlying the *Bhagavad Gita*. Humans are composites of body and soul (atman). As such, body force and soul force were both seen as active in human affairs—the first as a fact and the second as a norm. The body was the source of violence and the passions; the soul was the source of sociability and of the knowledge of good and evil. It was because the spiritual soul was a constitutive element of human beings that nonviolence remained the

norm of their behavior. A materialistic view of human life, in Gandhi's view, could not justify, much less sustain, a nonviolent way of life.

The philosophical anthropology of the *Bhagavad Gita* also gave Gandhi's nonviolence its ethical realism. Because humans are composite beings, perfect nonviolence was possible only in the atman's disembodied state, not in its embodied state. In its embodied state, the will to live always brought with it the will to use force in legitimate self-defense. In the embodied state, one must always abstain from culpable violence—that is, offensive violence used for illegitimate gains. Defensive violence used in legitimate self-defense is not judged culpable.

Fields of Nonviolence

Although nonviolence is a universal norm, Gandhi was insightful enough to recognize that its application depended on the nature of the society (or "field," to use his terminology) in which it was to be applied. He distinguished four such fields—the family, the state, the religious community, and the community of sovereign states.

The family, or family-like communities such as the ashram, were best suited to learn the basics of nonviolence. How to treat one another with love and forbearance and how to settle disputes amicably were first learned in the family.

Historically, nonviolence had notable success in liberal states, or colonial states functioning under the supervision of a metropolitan liberal state. Also, it operated well within religions that displayed a capacity for internal self-criticism. That was why it was able to rid Hinduism of untouchability. However, it was less successful in preventing the revival of jihad in South Asia.

In the international field, Gandhian nonviolence operated *suo modo*. Gandhi's philosophy permitted sovereign states the right to use military force in legitimate self-defense. However, a commitment to nonviolence also required them to strive for progressive disarmament and to increase the effectiveness of international organizations. Never a radical pacifist, Gandhi urged sovereign states to experiment with nonmilitary ways of securing national defense such as using "armies without lethal weapons." He did not envision a warless world, but at the same time he held out the possibility of wars becoming less frequent and less destructive.

The "Vast Majority" Principle

Gandhi's thoughts on the future of nonviolence led him to realize that unless the "vast majority" of the people in a state were nonviolent, that state could not be governed nonviolently. The vast majority principle distributed the responsibility for nonviolence equally on the shoulders of the leaders and ordinary citizens; political leaders could promote nonviolence only to the extent that their own people became nonviolent. And their own people could become nonviolent if they—the people—could dismantle, through non-governmental organizations, existing structures of internal violence.

The sociological insight contained in the vast majority principle led Gandhi to write his last major thesis on nonviolence, *Constructive Programme* (1941). In it he analyzed, among other

things, the structures of violence active in Indian society, and concluded that unless Hindus and Muslims in India learned to live in harmony, unless caste violence was set aside, and unless mass poverty was eliminated, there was no chance of India's becoming a nonviolent country.

A corollary of the vast majority principle is that unless a circle of sovereign states became nonviolent in the manner described above, there was no chance of their relations becoming peaceful. Gandhi's vast majority principle is reminiscent of Immanuel Kant's "republican principle," enunciated in his *Perpetual Peace* (1795).

The Impact of Nonviolence

Gandhian nonviolence has affected global culture in four ways. First, it changed for the better aspects of the political culture of particular countries. In India, for example, it influenced the manner in which colonialism was brought to an end and a new political philosophy introduced. In the United States, it had an impact on the civil rights movement led by Martin Luther King Jr.

Second, it inspired many individuals across the world to adopt active nonviolence as their own public philosophy. Those so inspired include the Dalai Lama, Lech Walesa of Poland, Lanza del Vasto of France, Aung San Suu Kyi of Myanmar (Burma), Anglican Archbishop Desmond Tutu of South Africa, Cesar Chavez of the United States, and Thomas Merton, the American Trappist monk.

Third, it contributed to the emergence of several non-governmental organizations worldwide, among them those devoted to disarmament, economic development from below, the green movement, and the dialogue between religions.

Finally, it gave further impetus for nonviolence to become a subject of serious academic study and research in institutions of higher learning throughout the world, notably in the fields of history, sociology, religious studies, theology, and comparative political philosophy.

See also *Colonialism; Hinduism; Jainism; Peace; Resistance and Accommodation*.

BIBLIOGRAPHY

- Bondurant, Joan V. *Conquest of Violence: The Gandhian Philosophy of Conflict*. Rev. ed. Berkeley: University of California Press, 1965.
- Brown, Judith M. *Gandhi: Prisoner of Hope*. New Haven, Conn.: Yale University Press, 1989.
- Dalton, Dennis. *Mahatma Gandhi: Nonviolent Power in Action*. New York: Columbia University Press, 1993.
- Gandhi, Mohandas K. *Gandhi, an Autobiography: The Story of My Experiments with Truth*. Boston: Beacon, 1993.
- . *Hind Swaraj and Other Writings*. Edited by Anthony J. Parel. Cambridge, U.K.: Cambridge University Press, 1997. Contains the text of Gandhi's *Constructive Programme*.
- . *Satyagraha in South Africa*. Stanford, Calif.: Academic Reprints, 1954.
- Juergensmeyer, Mark. *Gandhi's Way: A Handbook of Conflict Resolution*. Berkeley: University of California Press, 2002.

- Merton, Thomas, ed. *Gandhi on Non-violence*. New York: New Directions, 1965.
- Parekh, Bhikhu. *Gandhi*. Oxford: Oxford University Press, 1997. Past Masters series.
- Terchek, Ronald J. *Gandhi: Struggling for Autonomy*. Lanham, Md.: Rowman and Littlefield, 1998.
- Wolpert, Stanley. *Gandhi's Passion: The Life and Legacy of Mahatma Gandhi*. New York: Oxford University Press, 2001.

Anthony Parel

NUCLEAR AGE. The nuclear age began in mid-July 1945 when an 18.6-kiloton nuclear bomb was detonated at the Trinity test site near Alamogordo, New Mexico. Three weeks later, on 6 August 1945, the world became aware of the existence of nuclear weapons when a U.S. B-29 bomber known as *Enola Gay* dropped a nuclear bomb on the Japanese city of Hiroshima. That was followed three days later by the dropping of another bomb on Nagasaki. The term *nuclear age* was coined almost immediately after the two bombs were used. Within days of the Nagasaki bombing, the publisher Pocket Books put out a special primer titled *The Atomic Age Opens*, edited by Gerald Wendt. The phrase *atomic age* remained more common than *nuclear age* through the mid-1950s, but *nuclear age* already enjoyed wide use in 1945. By the end of the year, it had even been inserted into the title of the second edition of a physics textbook by Harvey Brace Lemon. The title of the original edition, published in 1934, was *From Galileo to Cosmic Rays*, whereas the second edition, published in early 1946, was retitled *From Galileo to the Nuclear Age*.

Since those early days, the term *nuclear age* has been incorporated into almost every language as a designation for the international security system that has existed since 1945. Implicit in the term is the notion that the advent of nuclear weapons marked a far-reaching change from the system that existed until 1945. Although scholars have differed in their estimations of the extent to which the system has genuinely changed, few would deny that nuclear weapons have been one of the major elements in international politics since the mid-1940s.

Contending Ideas about Nuclear Weapons

The publication of a volume edited by Bernard Brodie, *The Absolute Weapon: Atomic Power and World Order*, in 1946 marked the first systematic attempt by specialists in international relations to think through the political and strategic implications of the nuclear age. Brodie and his colleagues—F. S. Dunn, P. E. Corbett, Arnold Wolfers, and W. T. R. Fox—sought to determine how warfare and international politics would be altered by nuclear weapons. Their findings prefigured many of the themes that came up over the next several decades in scholarly and official analyses of nuclear arms. Brodie argued that nuclear weapons had made total war obsolete and that U.S. military strategy from then on would have to emphasize deterrence: “Thus far the chief purpose of our military establishment has been to win wars. From now on its

chief purpose must be to avert them. It can have almost no other useful purpose” (p. 5). This view, which adumbrated the U.S. shift to a declaratory policy of “massive retaliation” in the 1950s, was broadly accepted by the other contributors. Brodie and his colleagues left no doubt that, in their view, nuclear weapons had fundamentally changed the nature of world politics and military strategy.

The Soviet Union’s acquisition of nuclear weapons in 1949, and the subsequent emergence of a U.S.-Soviet nuclear stand-off, seemed to strengthen Brodie’s basic point. Nonetheless, from an early stage, his thesis had many detractors. Some analysts argued that Brodie failed to take account of the importance of limited wars, such as those fought in Korea and Vietnam. In two highly acclaimed books, *The Strategy of Conflict* (1960) and *Arms and Influence* (1966), Thomas Schelling elaborated the theory of what he called “compellence,” that is, the use of nuclear threats (and threats of the massive use of conventional weaponry) to coerce the adversary into taking a particular course of action. Schelling contended that nuclear deterrence did not eliminate the need for U.S. policymakers to deal with contingencies short of nuclear war and to think about how to use nuclear weapons to influence political and strategic outcomes.

Schelling also argued that even in relations between the two superpowers, strategy was not obsolete in the nuclear age. One of the other purposes of his books was to develop a better strategy for great-power competition within the context of deterrence. Schelling argued that deterrence of Soviet aggression in Europe or East Asia was crucially dependent on credibility. Unless the threat of retaliation was credible, Soviet leaders would have little reason to yield during a crisis. To cope with this problem, U.S. leaders, Schelling maintained, would have to demonstrate that they were prepared to act in ways that ordinarily would seem irrational. Schelling stressed that by actively preparing to carry out “threats that leave something to chance” (the title of a chapter in *The Strategy of Conflict*), U.S. policymakers would bolster their own credibility and thereby reduce the chance that they would ever be forced to make good on those threats.

Other analysts went a good deal further than Schelling in contesting Brodie’s views about nuclear weapons. Strategic analysts such as Herman Kahn in the 1960s and Colin Gray in the 1970s and 1980s rejected the whole notion of an “absolute weapon.” Kahn and Gray contended that even large-scale nuclear warfare between the two superpowers was not “unthinkable.” They acknowledged that nuclear weapons might induce greater caution on the part of policymakers, but they stressed that this did not mean that the chance of war was zero. On the contrary, Kahn and Gray argued, there was a possibility that nuclear war would break out, and therefore they believed that U.S. policymakers must be prepared to fight such a war and to win it. Gray summed up this view in an article he coauthored in 1980 with Keith Payne. The article stressed that “the United States must possess the ability to wage nuclear war rationally” and must develop “a plausible theory of how to win a war or at least insure an acceptable end to a war.” Gray and Payne urged the U.S. government to “plan



Mushroom cloud caused by atomic bomb, Bikini Atoll, 1946. In the 1940s, scientists began experimenting with atomic devices—the first nuclear weapons—and the first controlled explosion took place in August, 1945, in Alamogordo, New Mexico. © CORBIS

seriously for the actual conduct of nuclear war” and to develop a strategy “to defeat the Soviet Union and do so at a cost that would not prohibit U.S. recovery.” As they saw it, a combination of robust strategic anti-missile and air defenses, a comprehensive civil defense program, and a large and diverse arsenal of nuclear missiles and bombers would ensure victory.

Not surprisingly, the views expressed by Kahn and Gray proved controversial. Stanley Kubrick satirized the nuclear war-fighting school in his 1964 film *Dr. Strangelove*. (Many viewers guessed that the title character was based on Kahn, but Kubrick never confirmed this.) More seriously, critics argued that theories of victory in a large-scale nuclear war rested on untenable assumptions about nuclear weapons and strategic defense technology. In a widely cited article published in early 1982, Wolfgang Panofsky and Spurgeon Keeny maintained that a “effective protection of the population against large-scale nuclear attack is not possible” and that an exchange involving only a few thousand of the more than fifty thousand nuclear weapons deployed by the United States and the Soviet Union “could destroy most of the urban population and destroy most of the industry of both sides.” Even much smaller nuclear exchanges, they added, would have “very severe consequences.” Nuclear war-winning strategies, in their view, were based on “wishful thinking.”

Mutual Assured Destruction

Much of the intellectual debate about the U.S.-Soviet nuclear relationship was encapsulated in the perennial controversy about what became known as Mutual Assured Destruction (MAD). The concept of MAD was first enunciated in the early 1960s when both the United States and the Soviet Union

began deploying large numbers of intercontinental-range ballistic missiles (ICBMs) armed with nuclear warheads. Defense Secretary Robert McNamara and other U.S. officials at the time argued that, in a situation of MAD, any large-scale use of nuclear weapons by either side would provoke retaliation in kind by the other side, resulting in the effective destruction of both. Under this logic, no rational leader on either side could hope to gain a meaningful advantage by starting a nuclear war, and therefore mutual deterrence would prevail. Many observers construed these statements as an accurate reflection of U.S. nuclear doctrine.

The intellectual debate about MAD often was reflected in concerns raised in public discussions and policy circles. The notion that, as Winston Churchill put it, the “safety” of each side rested on the prospect of “mutual annihilation” was a discomfiting one for many Americans. The vulnerability inherent in MAD was in contrast to the relative invulnerability that the United States had always enjoyed by virtue of its geography. The desire to move beyond MAD and restore a sense of invulnerability lay behind periodic attempts to build defenses against ICBMs and submarine-launched ballistic missiles (SLBMs) and to develop more credible nuclear war-fighting strategies. The Strategic Defense Initiative (SDI) of President Ronald Reagan’s administration, announced in 1983 as a program to develop a comprehensive system of protection against ICBMs and SLBMs, was explicitly justified on the ground that indefinite reliance on MAD was too perilous an option.

Critics of these attempts to move beyond MAD, including Keeny and Panofsky, focused on two basic points. First, they argued that MAD was not a mutable doctrine but was instead a codification of the underlying strategic and technical realities.

In their view, MAD followed from the technical nature of nuclear missiles and the inherent vulnerability of urban populations to nuclear destruction. No plausible doctrinal or technological innovations could alter this reality. Second, they maintained that attempts to move beyond MAD were dangerous because they would create the illusion that MAD was a doctrine and could be changed. This misperception, they contended, would increase the risk of nuclear war. Keeny and Panofsky argued that if policymakers erroneously believed it was possible to fight and win a nuclear war without suffering “unacceptable damage,” they might be more willing to risk the use of nuclear weapons.

Unease about MAD also led in a very different direction. From the start of the nuclear age, a relatively small but vocal group of critics insisted that the only acceptable course of action was to ban all nuclear weapons. This school of thought was especially prevalent among scientists and intellectuals associated with the *Bulletin of the Atomic Scientists*, a specialized monthly publication that became famous for its doomsday clock on the cover. In later decades, many intellectuals supporting complete nuclear disarmament became active in ban-the-bomb campaigns and the nuclear freeze movement. Jonathan Schell’s best-selling *The Fate of the Earth* (1982), published at the height of the nuclear freeze movement in the early 1980s, laid out the case for the elimination of nuclear weapons. The book came under harsh criticism from many specialists on nuclear strategy and arms control, but it struck a chord with the U.S. “peace” movement and with a considerable number of ordinary Americans who were concerned about the sharp increase in U.S.-Soviet tensions in the early 1980s. Not until the Cold War drew to an end in the late 1980s and early 1990s—and Washington and Moscow agreed to much sharper reductions in their strategic nuclear arsenals—did the antinuclear weapons movement wane in influence.

Nuclear Thinking in the Post-Cold War World

After the Soviet Union disintegrated at the end of 1991, the formerly antagonistic relationship between Moscow and Washington ceased to exist. The U.S.-Soviet nuclear standoff, which had dominated strategic thinking in the nuclear age, was no longer relevant. Instead, thinking about the nuclear age shifted mainly to issues of nuclear proliferation and efforts to prevent (or dissuade) non-nuclear weapons states from acquiring nuclear arms. Although the United States and post-Soviet Russia continued to possess large numbers of nuclear-armed ICBMs that were maintained at full alert, fears of a large-scale nuclear war all but disappeared. Instead, strategic analysts worried about the possibility of nuclear terrorism and nuclear weapons programs under way in so-called rogue states like North Korea, Libya, Iran, and Iraq under Saddam Hussein.

Some analysts, such as Kenneth Waltz and Shai Feldman, had long argued that nuclear proliferation should be welcomed rather than discouraged. Waltz maintained that nuclear weapons would enable relatively weak states to deter stronger and more aggressive neighbors from attacking them, in much the same way that the United States and the Soviet Union had relied on mutual deterrence to ensure peace between them.

The “optimists” about nuclear proliferation (a label that was later attached to Waltz and others who shared his views) were never particularly numerous, however. In the post-Cold War world, the “pessimists” like Scott Sagan were far more common. In an illuminating exchange with Waltz, Sagan pointed to a number of dangers regarding potential accidents and unauthorized uses of nuclear weapons that would make nuclear war more likely, not less likely, in a proliferated world. Sagan and others also contended that nuclear proliferation would increase the risk that weapons might be diverted to terrorists.

Analysts who wanted to prevent nuclear proliferation differed in their views of how to achieve that goal. Some argued that unless the security concerns of proliferating states were allayed (or at least greatly mitigated), those states would be unlikely to forswear nuclear weapons. They cited the case of India and Pakistan, both of which openly acquired nuclear weapons in 1998 (though India had tested a nuclear bomb as far back as 1974), as an example of the pressures on states to build nuclear weapons in order to deter hostile neighbors. Analysts who subscribed to this view maintained that the best way to prevent nuclear proliferation was to address the underlying security concerns of potentially vulnerable states through international mediation. Other analysts wanted a more active policy to discourage nuclear proliferation. They advocated a “counterproliferation” strategy that would deal with regional security concerns but would also include a variety of sanctions against states that continued to pursue nuclear weapons programs. These sanctions would range from diplomatic pressure to condemnations by the UN Security Council to economic penalties and ultimately to military action. Scholars who believed that military action might, in the end, be desirable argued that Israel’s successful raid in 1981 against Iraq’s Osiraq nuclear plant underscored the importance of not ruling out the military option. Had Israeli jets not bombed the facility, Iraq most likely would have been able to build a nuclear weapon by the late 1980s, well before its program came under aggressive international scrutiny.

The prospect of nuclear terrorism was the other major issue of concern to specialists on nuclear weapons in the post-Cold War world. Contrary to popular wisdom, the threat of nuclear terrorism was not at all new. Concerns about the possibility that a nuclear bomb would be smuggled into a U.S. port had arisen as far back as the mid-1950s. Analysts such as Schelling, Brian Jenkins, and Paul Leventhal had written books and articles about the risk and implications of nuclear terrorism in the 1970s and 1980s. For the most part, however, the question of nuclear terrorism during the Cold War was generally overshadowed by the U.S.-Soviet nuclear standoff. Only in the post-Cold War world, when the U.S.-Soviet confrontation no longer dominated strategic thinking, did analysts devote much greater attention to the terrorist threat. This focus intensified, for understandable reasons, after the large-scale terrorist attacks on the United States on September 11, 2001.

Although experts on nuclear proliferation generally agreed that few if any terrorist groups had the wherewithal to build a nuclear weapon on their own, they warned that a weapon (or at least crucial components, including fissile material) might be

furtively supplied to a terrorist group by a state like North Korea or by a group of rogue scientists. The nuclear-supply trail involving the nuclear weapons programs of both Pakistan and North Korea that came to light in 2004 reinforced these concerns. Most analysts believed that such channels could be closed through concerted international action, but they held out little hope that the risk could ever be fully eliminated. Thus, even after the Cold War ended, the perils of nuclear weapons continued to dominate thinking about the nuclear age.

See also *Peace; Technology; War*.

BIBLIOGRAPHY

- Brodie, Bernard, ed., *The Absolute Weapon: Atomic Power and World Order*. New York: Harcourt Brace, 1946.
- Freedman, Lawrence. *The Evolution of Nuclear Strategy*. 3rd ed. New York: Palgrave Macmillan, 2003.
- Gray, Colin S. *The MX ICBM and National Security*. New York: Praeger, 1981.
- Gray, Colin S., and Keith B. Payne. "Victory Is Possible." *Foreign Policy* 39 (summer 1980): 14–27.
- Herring, Eric, ed. *Preventing the Use of Weapons of Mass Destruction*. London and Portland, Ore.: Frank Cass, 2000.
- Jenkins, Brian M. *Will Terrorists Go Nuclear?* Discussion Paper No. 64. Santa Monica, Calif.: California Seminar on Arms Control and Foreign Policy/RAND Corporation, 1975.
- Kahn, Herman. *Thinking about the Unthinkable*. New York: Horizon Press, 1962.
- . *On Thermonuclear War*. Princeton, N.J.: Princeton University Press, 1960.
- Kaplan, Fred M. *The Wizards of Armageddon*. New York: Simon and Schuster, 1983.
- Keeny, Spurgeon M., Jr., and Wolfgang K. H. Panofsky. "MAD versus NUTS: Can Doctrine or Weaponry Remedy the Mutual Hostage Relationship of the Two Superpowers?" *Foreign Affairs* 60, no. 2 (winter 1981–1982): 287–304.
- Sagan, Scott D., and Kenneth N. Waltz. *The Spread of Nuclear Weapons: A Debate*. New York: Norton, 1995.
- Schelling, Thomas C. *Arms and Influence*. New Haven, Conn.: Yale University Press, 1966.
- . *The Strategy of Conflict*. Cambridge, Mass.: Harvard University Press, 1960.
- Waltz, Kenneth N. *The Spread of Nuclear Weapons: More May Be Better*. London: International Institute for Strategic Studies, 1981.

Mark Kramer

NUDE, THE. Although the English word *nude* is derived from the Latin *nudus* meaning "naked," "bare," it connotes, especially in such phrases as "in the nude" or "The Nude," more than a state of undress; rather it indicates a work of art, a cultural convention, and a socioreligious attitude. The term *The Nude* signifies a Western cultural ideology while nudity is a universal human condition.

The British painter Walter Sickert (1860–1942) is credited with the first art critical discussion of "The Nude" as a formal convention of academic art (1910). Formal academic analyses

were initiated with Kenneth Clark's 1953 Mellon Lectures in the Fine Arts on the meaning and motif of "The Nude" in Western art that he subtitled "a study in ideal form." Clark described the distinction between "The Nude" and "the naked" as a cultural attitude predicated on political, religious, and societal perceptions of the body and human sexuality. The classical Greek was nude while the medieval Christian was naked. The former recognized the body as an embodiment of sacred energy and form interdependent with philosophic and cultural attitudes toward the individual person, human dignity, and creativity. The latter was premised upon the recognition of human finitude and the sinful state in which Christians lived, and thereby affected Christian perceptions of the individual person, human dignity, and creativity.

As a state of both physical nakedness and spiritual power, the nude figure is an elemental component of the cultural legacy of human civilization. The vast differences in the spirit and the reception of both the human body and the meaning of nudity from the prehistoric to modern, from East to West, deepens the layers of cultural accumulations. Nude figures are found in gendered formations of both male and female in the guises of divinities, heroes, warriors, or mythological beings. This iconology is bequeathed visually from Egyptian monuments, Khajuraho reliefs, Cypriote statues, Indian and Persian miniatures, and classical sculptures.

"The Nude" as defined by Clark is not a proper iconographic category, although it appears in Western art both in religious iconography and in a variety of artistic topoi ranging from historical, mythological, biblical, allegorical, narrative, and pornographic themes to genre scenes. "The Nude," however, is a Western type relating concepts of the body, philosophy, religions, and aesthetics that begin with the recognition of "The Nude" as an aesthetic object and as "high art" first in classical Greece and then in the Renaissance.

Portrayals of the human figure as incarnation or manifestation of the deity is a fundamental connector through the arts and religious values of East and West. The Western disposition is premised upon the classical Greek tenet that the idealized perfection of the physical denotes the model of divine beauty. The Eastern classification proceeds from the Indian principle that the creation of supernatural beauty is through abstractions of the physical body. Nonetheless, there are regional interpretations on the meaning of nudity throughout Eastern and Western cultures. In India, nudity suggests simultaneously the sensuality of fertility spirits (female nudity) and supreme yogic control (male nudity); whereas the human body is a didactic illustration of moral and ethical teachings in the Far East, especially with the advent of Confucian ethics.

The decision to depict nudity whether for a male or a female figure is as much a decision of aesthetic and artistic appropriateness as it is a moral issue. For example, many world religions identify those believers who celebrate religious rituals and ceremonies "sky clad," that is, naked. Among Tantrics, the state of being "sky clad" signifies the state of being without rank, caste, or socioeconomic class. For Jains, because the Jain path to enlightenment is through extreme asceticism, there

was a conflict between nudity as a state of purity and the impurity of women. Nudity represented the highest ideal of nonattachment; however, the question was whether women could attain enlightenment and salvation. By 80 C.E., Jainism was divided into two factions over the relationship between nudity, salvation, and women. Digambara advocated the necessity of nudity and extreme asceticism as the path to salvation; and that, because female nudity was unacceptable, there was no salvation for women. Shvetambara recognized that ascetic nudity was not the only salvific path, thereby affirming the possibility of female enlightenment.

Other religious traditions, whether premised on mythology, revelation, or scriptures, identified female nudity as a positive value. For example, “the goddess” was identified as dwelling in her flesh, not in her garments. Her sacred power, as with that of mortal women, was released by a state of nudity, whereas the magic power of gods and men required the condition of being fully clothed as self-definition was concretized in uniforms, badges, and decorations of rank. Body types, attitudes toward the body, and the artistic renderings of the human form reflected religious and societal values as much

as the decision to depict an individual as an identifiable person or as simply a male or female type.

There are four principal philosophic perspectives on “The Nude” in Western culture. The classical perspective is established from the Platonic mathematical foundation of all forms in combination with the Neoplatonic conviction that the human was a symbol of the harmonious arrangement of the universe as a reflection of God. Christianity reversed this view in response to the theological attitudes toward human fallibility, finitude, and original sin as pronounced by Augustine of Hippo (354–430) and Jerome (c. 347–?420). Renaissance philosophers retrieved and reframed the classical definition as epitomized by Leonardo da Vinci (1452–1519), who identified “Man as the measure of the Universe” and envisioned “The Nude” in his *Vitruvian Man* (1492; Gallerie dell’ Accademia, Venice). The modern position is predicated on the liberation of “The Nude” from the boundaries of mythology and religion during the Enlightenment, and finds its fullest expression in Gustave Courbet’s *The Origin of the World* (1866; Musée D’Orsay, Paris).

Survey in Western Culture

Western art and culture have premised “The Nude” upon the classical Greek legacy and Christian transformations until the mid-nineteenth century when the philosophy and political revolution of the Enlightenment bore fruit in realism and the secularization of twentieth-century art movements. The Greek “cult of the nude” was imbued with cultural, philosophic, and religious meaning. Beyond the ideal of divine beauty was the Greek philosophy of freedom and dignity of the individual—nudity was synonymous with integrity. Legendary heroes, ideal figures, mythological personalities, and triumphant warriors were characterized as being “in the nude.” As the first flowering of “The Nude,” Greek art praised what it knew in daily life: the handsome beauty of the male form. Public nudity was a normative condition for men who participated in athletic competitions, exercised at the gymnasium, and partook of the public baths. The Greek ideal of a sound mind and a healthy body was attained in the gymnasium, which was simultaneously a center for education and athletics; all the academies of philosophy had their centers in a gymnasium. Clothes were removed in order to exercise and to be able to think without restraints. The Greek root of gymnasium is *gymnos*, “to be naked, nude, or bare.” Nudity was a condition of physical and mental freedom.

With the advent of Christianity, “The Nude” and the idea of nudity were transformed into reminders of human finitude and guilt, and of the sinful state, especially for women. Augustine of Hippo and Jerome, among other early Church fathers, decried the classical glorification of the human body and denounced the connection between “The Nude” and human sexuality, thereby transmogrifying nudity from a condition of innocence, idealism, and integrity into one of guilt, materialism, and vice.

Descriptions and depictions of “The Nude” in Christian iconography were restricted to scriptural narratives. The biblical narratives recount varied episodes in which nudity is

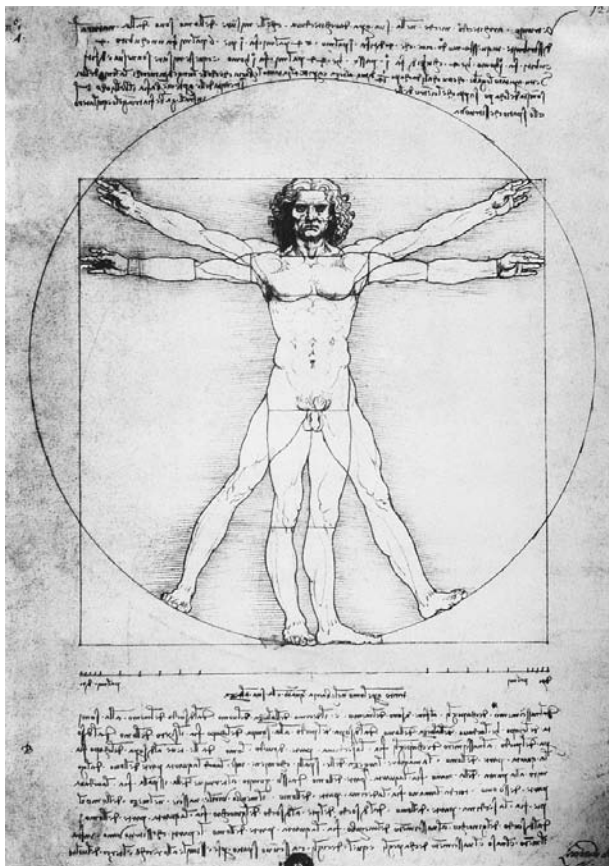

Vitruvian Man by Leonardo da Vinci. Pen, ink, and watercolor. The classical perspective on the nude, said to be represented by da Vinci’s 1492 sketch, held that man symbolized the harmony of God’s universe and a kind of divine beauty and integrity. © CORBIS



Giorgione's *The Sleeping Venus* (c. 1510). Oil on canvas. During the Renaissance, artistic works featuring the nude female figure became popular, although Church authorities disapproved of such frank and revealing treatment of the human body. © ERICH LESSING/ART RESOURCE, NY

appropriate for the story, as in a bathing sequence, and for either men or women. For example, Adam, Eve, Susannah, David, Bathsheba, Salome, and Jesus of Nazareth are depicted in states of total or partial undress. However in Christian iconography nudity embodied more often than not the condition of shame, especially with regard to women as the “daughters of Eve.” The artistic and literary tradition of Western culture, especially Christianity, may be characterized as influenced by the legacy of Eve, and in particular, established the motif of the *femme fatale*, or fatal woman, from the characterization of women as seducers of men as prefigured in the scriptural stories of Eve, Delilah, Bathsheba, Salome, and eventually, even, the Jewish heroine Judith.

The Renaissance recovery of classical philosophy, art, and literature promoted a revival of interest in “The Nude” beyond the confines of scriptural narratives and Christian morality lessons. However, the Renaissance was distanced by centuries of political, social, and economic meliorations from classical Greece and Rome, and even further distanced from the classical philosophy and culture that were the foundation for the classical nude. Although premised upon classical models, Renaissance nudes differed in constructions of musculature and gender. The female nude, with the familiar exception of the *Venus pudica*, was absent from the mainstream of the classical arts. She became a popular motif in the Renaissance arts even up to Giorgione's (1477–1510) creation of the reclining female nude found in his *Sleeping Venus* (1508–1510;

Gemaldegalerie, Dresden). This Renaissance flowering of interest in “The Nude” extended into northern Europe where Albrecht Dürer (1471–1528) fashioned his famous study of the principles of perspective and anatomy in *Artist Drawing a Reclining Nude* (c. 1527: Metropolitan Museum of Art, New York), which affirmed the dichotomy of female passivity and male activity.

The popularity of “The Nude,” whether male or female, among both Renaissance artists and their patrons garnered the attention of ecclesiastical leaders. This impropriety was dramatically decried by the Dominican monk Girolamo Savonarola (1452–1498), whose preaching influenced significant Renaissance artists including Michelangelo (1475–1564) and Botticelli (1445–1510), and ultimately led to the infamous “Bonfire of the Vanities” in the public square in Florence. However, official Church condemnation of “The Nude” was not pronounced until the Council of Trent (1545), and then, only tangentially. From the Tridentine decree forward, artworks intended for the Church were to be inspected and approved by the bishop of each diocese; appropriate local or regional decrees were promulgated clarifying or expanding upon the phrase “all lasciviousness avoided.”

The modern conception of “The Nude” is premised upon the multiple political, social, and cultural revolutions of the late eighteenth and the mid-nineteenth centuries. It found expression in the arts of the realists, such as Gustave Courbet

(1819–1877), and the Orientalists, beginning with Eugène Delacroix (1798–1863) in *Death of Sardanapalus* (1827; Musée du Louvre, Paris), who present the plausibility and eroticism of “The Nude,” especially of the female nude. Freed from confinement of mythology, history, or narrative, the female nude flourished in the arts of the Impressionists, who reinterpreted the classical motif of the bathing Venus into secularized female bathers and who were influenced by Japonisme. (For example, Torei Kayonaga’s depictions of restrained geishas were translated into Édouard Manet’s [1832–1883] defiant prostitutes.) Furthermore, in the nineteenth century, the introduction of female students into art academies and ultimately into life drawing classes began a transformation of the “male gaze” into the “female gaze” whether the subject was a female or male model. Commensurately, the central position of the male nude was diminished, so that from the perspective of late twentieth-century art criticism and feminism to speak of “The Nude” is to speak of the female nude.

The female nude extends beyond the boundaries of allegory and metaphor to become an expression of sexual provocativeness, eroticism, sexual appeal, and potentially, voyeurism throughout twentieth-century art beginning with Pablo Picasso’s (1881–1973) famed *Les Femmes d’Alger* (1907; Museum of Modern Art, New York). “The Nude,” which had been a motif of spiritual and moral uplift for the classical world, was transformed not simply into an image of Christian shame and embarrassment but into a modern object of profane physicality.

The relationship of “The Nude” as both an object and a subject of high art to voyeurism and pornography has been raised since the mid-nineteenth century. As Clark so perceptively noted, there is no innocent depiction of a naked body. Each of us sees through a distinctive but personalized lens, so one person’s aesthetic encounter with “The Nude” is another person’s moment of voyeurism. Further, definitions of pornography shift with cultural attitudes as witnessed in the com-

The English language, with its elaborate generosity, distinguishes between the naked and the nude. To be naked is to be deprived of our clothes, and the word implies some of the embarrassment most of us feel in that condition. The word ‘nude,’ on the other hand, carries, in educated usage, no uncomfortable overtone. The vague image it projects into the mind is not of a huddled and defenseless body, but of a balanced, prosperous, and confident body: the body re-formed.

SOURCE: Kenneth Clark, *The Nude: A Study in Ideal Form* (Mellon Lectures, 1953), p. 3.

mentaries by the American writer Mark Twain or Supreme Court rulings.

Eastern and Western Attitudes toward “Nudity”

Eastern and Western attitudes toward nudity can best be compared through discussions of both the male and the female nude. The former signify the ideal of moral perfection and the latter the vitality of the life principle.

The Greek image of Apollo is that of a standing, aloof, proud, and nude male figure. He is the ultimate ideal athlete. He was anthropomorphized into the *kouros* who is distinguished by his rigid frontal pose accented by arms pressed closely down his sides. This stasis is relieved by the placement of one foot, thereby also the leg, forward from the other to signify human dynamism. The visual combination of ideal male beauty through an identifiable muscular structure and movement provides the viewer with the sensation of a vital man. The Greek ideal of the athlete is the conjunction of physicality and spirituality through the vehicle of “The Nude.”

The Jain image of the ascetic, or *tirthankara*, is that of a superhuman and heroic figure whose broad shoulders and narrowed waist were similar to that of Apollo or the *kouros*. This figuration of a frontal pose with firmly indented arms is balanced by his straight legs. The portrayal of suspended animation fulfills the requirements of the spiritual tenet of *kayotsarga*, or the dismissal of the body, as this yogic trance permits complete withdrawal from all earthly distractions. The Jain image of nudity is a signifier of asceticism and of the spiritual ideal. The identifiable, and thereby natural, muscular structure and intimated movement of the *kouros* promoted divine-human association, while the suppression, thereby abstractions, of muscular structure and motion of the *tirthankara* emphasized his symbolic value.

In both East and West, the female nude is predicated on a cult image that is provocative and sensuous in appeal. The Greek goddess, Aphrodite, was simultaneously the personification of love and beauty and the achievement of the idealized female body. The captivating undulations of the feminine form combined with softness and delicacy of skin and muscle denoted the sensuality necessary for procreation. Greek representations of the topography of the female nude vacillated between depictions of innocence, as in the motif of *The Birth of Aphrodite* (470–460 B.C.E.; Museo Nazionale Romano delle Terme, Rome), and of flirtation, as in the topos of the *Venus pudica* found in the *Medici Venus* (first century B.C.E.; Galleria degli Uffizi, Florence). The body proportions, like those of the Apollo and the *kouros*, were based upon mathematical formulations.

The Indian *yakshi*, the oldest indigenous nature goddess or fertility spirit, signifies fecundity through the abstractions of her nude body. Her spherical breasts, like her ample hips and conspicuous pudenda, are enlarged in mathematical relation to the female frame and head to emphasize feminine sensuality and maternal potential. *Yakshi* are situated in exaggerated

And they were both naked: to wit, Adam and his wife: and were not ashamed.
(Genesis 2:25)

And the woman saw that the tree was good to eat, and fair to the eyes,
and delightful to behold: and she took of the fruit thereof, and did eat, and
gave it to her husband, who did eat.

And the eyes of them both were opened: and when they perceived them-
selves to be naked, they sewed together fig leaves, and made themselves aprons.

And when they heard the voice of the Lord God walking in paradise at
the afternoon air, Adam and his wife hid themselves from the face of the
Lord God, amidst the trees of paradise.

And the Lord God called Adam, and said to him: Where art thou?

And he said: I heard thy voice in paradise; and I was afraid, because I was
naked, and I hid myself.

And he said to him: And who hath told thee that thou wast naked, but
that thou hast eaten of the tree whereof I commanded thee that thou shouldst
not eat? (Genesis 3:6-11)

SOURCE: Douay-Rheims Bible.

postures and positions to denote the erotic abstractions of the female body. The naturalistic harmony of the human standards of feminine beauty found in Aphrodite made both the divine and the human female approachable and tangible, whereas the symbolic abstractions of the nude *yakshi* tempered physicality with yogic restraint.

The Conundrum of Non-Western Culture and the Idea of “The Nude”

Discussions and scholarship on “The Nude” are decidedly Western in form and focus. Ostensibly, this is not a result of Western imperialism but more likely than not the influence of the Western monotheistic traditions with their distinctive morality and defense of the integrity of the one God. For example, Islamic art is normatively interpreted as aniconic, or nonfigural, in its emphasis on geometric abstractions. Although there is no Koranic prohibition against figural art or art, there is clear prohibition of images of either of idols or of God. For some commentators, the absence of the figure, especially the nude figure, is interpreted as a visual sign distinguishing Islam and Islamic art from Christianity and Christian art, which is fundamentally obsessed with Eve’s nakedness and her role in the Fall. By contrast, Eve when she is depicted in Islamic art is the joyous companion of Adam. Commensurately, when those exceptionally rare nude figures

are painted, whether male or female, they appear only in commissioned works of what might be best termed “secular Islamic art.”

However in the non-Western world, attitudes toward nudity and the nude figure are characterized by their naturalness and ease and not categorized as a special art category or motif, except when the arts of Africa, Oceania, or Meso-America are examined with Western criteria. The first reality of nudity as a state of undress, whether ritually required or common to daily life experience, is a universal condition. The second reality of nudity is that neither the art nor religion of these indigenous cultures is monolithic as Western art and monotheism is perceived to be. Rather, for example, African figural art is naturalistic among the Ife and Benin of Nigeria but other African peoples image themselves with simplified and/or exaggerated anatomical features. A third reality of nudity is that differing climates and their resident cultures require a variety of dress in both fabric and style to accommodate native meteorological conditions. So thinner materials and lighter colors are more appropriate to warmer climates while heavier fabrics and darker colors conform to the needs of cooler climates. From the Western perspective, especially that of the nineteenth-century missionaries, the exposed breasts and bare feet of Polynesian or African women were consid-

ered a social affront. Simultaneously for some nineteenth-century European colonialists, the shock of this tribal or societal nudity was the foundation for the myth of “The Noble Savage” as the concept of the *le primitif* was for their twentieth-century counterparts. This Western myth of idyllic innocence and primal energy coincided with a belief that primitive peoples were free of moral constraints and middle-class concerns. However defined, the arts of these varied primitive cultures were highly influential on twentieth-century art from Picasso and Henri Matisse (1869–1954) to the Abstract Expressionists.

Scholarship of “The Nude”

Kenneth Clark, who distinguished between naked and nude with relation to cultural, philosophic, and religious attitudes in the classic and Western Christian worlds, initiated the formal study of “The Nude.” His masterful analysis of the postures, gestures, poses, and body formations of the undressed human figure defined the parameters of analyses on this topic. Whether consciously or not, all following studies on “The Nude,” whether differentiating between the male and the female nude, or looking at both gendered figurations, are dependent upon Clark’s fundamental definition either as a point of departure or argument. John Berger’s investigation of the relationship between the spectator and “The Nude,” particularly the female nude, and that between fine art and modern advertising, was a significant development in the study of “The Nude.”

Since the late 1960s, the establishment of the new scholarship of “the marginalized,” with its origins in the questions of race, gender, class, or ethnicity (Melody Davis, Julia Kristeva, Edward Lucie-Smith, Lynda Nead) has expanded the boundaries of examination. Feminist scholarship, for example,

The painting described is the motif of the reclining Venus:

You enter [the Uffizi] and proceed to that most-visited little gallery that exists in the world—the Tribune—and there, against the wall, without obstructing rag or leaf, you may look your fill upon the foulest, the vilest, the obscenest picture the world possesses—Titian’s Venus. . . . There are pictures of nude women which suggest no impure thought—I am well aware of that. I am not railing at such. What I am trying to emphasize is the fact that Titian’s Venus is very far from being one of that sort. (Mark Twain, *A Tramp Abroad* [1880], 578.)

disproved the cultural concept of a “hermeneutics of aesthetic innocence” and thereby of “The Nude” as neutral. Feminists then proceeded to examine the political and societal minefield of domination and submission when “The Nude” was created by a male artist for a male patron. Further, the critique of *le regard* as the (male) gaze was crucial for feminist and gender scholars who advocated the existence of a female gaze in which women artists painted either male or female nudes to be admired and to stimulate the female viewer. The presumption here is that men and women see, and experience art regardless of the subject matter, the same way; however, the primary question of whether seeing is engendered remains a lacuna. Early-twenty-first-century categories of scholarly conversation, including the issues of the body, the reclining (female) nude, body language, and gesture (Kristeva, Peter Brown, Camille Paglia, Marcia Pointon, Alison Smith), are reframing the central questions of “*who* is ‘The Nude?’” and “*what* is the character of nudity?”

See also *Body, The; Gender in Art; Humanity in the Arts*.

BIBLIOGRAPHY

- Adler, Kathleen, and Marcia Pointon, eds. *The Body Imaged: The Human Form and Visual Culture Since the Renaissance*. New York: Cambridge University Press, 1993.
- Beckwith, Sarah. *Christ’s Body: Identity, Culture and Society in Late Medieval Writings*. London and New York: Routledge, 1993.
- Belting, Hans. *Likeness and Presence: A History of the Image before the Era of Art*. Chicago: University of Chicago Press, 1994.
- Berger, John, et al. *Ways of Seeing*. Harmondsworth, U.K.: Penguin Books, 1972.
- Bowie, Theodore, and Cornelia V. Christenson, eds. *Studies in Erotic Art*. New York: Basic Books, 1970.
- Brown, Peter. *The Body and Society: Men, Women, and Sexual Renunciation in Early Christianity*. New York: Columbia University Press, 1988.
- Clark, Kenneth. *The Nude: A Study in Ideal Form*. Princeton, N.J.: Princeton University Press, 1972. First published in 1956.
- Cormack, Malcolm. *The Nude in Western Art*. Oxford: Phaidon, 1976.
- Davis, Melody D. *The Male Nude in Contemporary Photography*. Philadelphia: Temple University Press, 1991.
- Goldstein, Laurence, ed. *The Male Body: Features, Destinies, Exposures*. Ann Arbor: University of Michigan Press, 1994.
- Lucie-Smith, Edward. *Race, Sex, and Gender in Contemporary Art*. New York: Abrams, 1994.
- . *Sexuality in Western Art*. New York: Thames and Hudson, 1991.
- Miles, Margaret R. *Carnal Knowing: Female Nakedness and Religious Meaning in the Christian West*. Boston: Beacon Press, 1989.
- Mullins, Edwin. *The Painted Witch: How Western Artists Have Viewed the Sexuality of Women*. New York: Carroll and Graf, 1985.
- Mulvey, Laura. *Visual and Other Pleasures*. Bloomington: Indiana University Press, 1989.
- Nead, Lynda. *The Female Nude: Art, Obscenity, and Sexuality*. London and New York: Routledge, 1992.

We can now begin to see the difference between nakedness and nudity in the European tradition. In his book on *The Nude* Kenneth Clark maintains that to be naked is simply to be without clothes, whereas the nude is a form of art. According to him, a nude is not the starting point of a painting, but a way of seeing which the painting achieves.

To be naked is to be oneself.

To be nude is to be seen naked by others and yet not recognized for oneself. A naked body has to be seen as an object in order to become a nude. (The sight of it as an object stimulates the use of it as an object.) Nakedness reveals itself. Nudity is placed on display.

To be naked is to be without disguise.

SOURCE: John Berger, *Ways of Seeing* (1972), pp.53, 4.

Perchuk, Andrew and Helaine Posner, eds. *The Masculine Masquerade: Masculinity and Representation*. Cambridge, Mass.: MIT Press, 1995.

Pointon, Marcia R. *Naked Authority: The Body in Western Painting, 1830–1908*. Cambridge, U.K.: Cambridge University Press, 1990.

Pollock, Griselda and Roszika Parker. *Old Mistresses: Women, Art, and Ideology*. New York: Pantheon Books, 1981.

Rudofsky, Bernard. *The Unfashionable Human Body*. Garden City, N.J.: Doubleday, 1971.

Saunders, Gill. *The Nude: A New Perspective*. New York: Harper and Row, 1989.

Smith, Alison. *The Victorian Nude: Sexuality, Morality, and Art*. Manchester, U.K.: Manchester University Press, 1997.

———, ed. *Exposed: The Victorian Nude*. London: Tate Publications, 2001. Exhibition catalogue.

Steinberg, Leo. *The Sexuality of Christ in Renaissance Art and in Modern Oblivion*. New York: Pantheon, 1983.

Suleïman, Susan Rubin, ed. *The Female Body in Western Culture: Contemporary Perspectives*. Cambridge, Mass.: Harvard University Press, 1986.

Üster, Celâl, ed. *Nude in Art*. Special issue of *P Art and Culture Magazine* 9 (spring 2003): 1–132.

Walters, Margaret. *The Nude Male*. Harmondsworth, U.K.: Penguin Books, 1979.

Diane Apostolos-Cappadona



O

OBJECTIVITY. Objectivity is the idea that the truth can be known independently of viewpoint, perspective, or bias. For example, “Gustav Mahler completed nine symphonies,” is an objectively true statement, independent of the person who utters it. “Gustav Mahler was the greatest composer in history” is not an objective truth—some people would agree, others would disagree, depending on their subjective aesthetic values. Objectivity has often been presented as diametrically opposed to subjectivity, the idea that people’s beliefs and value judgments reflect their individual situation and interests; historicism, the consideration of people’s opinions as reflections of the historical era in which they live; and relativism, which considers all points of view to be equally correct and inevitable.

History of the Term

The terms *subjective* and *objective* were introduced in European medieval philosophy. Their meanings then were nearly the reverse of their current use: *subject* meant that which exists, whereas *object* referred to what is perceived in consciousness. These uses of the terms persisted at least until George Berkeley in the eighteenth century. Lorraine Daston suggests that the current use of the terms was introduced in 1856 by Thomas De Quincey, although the concept of objectivity as knowledge based on fact had already been made in the seventeenth century. Previously, the Aristotelean tradition considered factual knowledge, historical knowledge of specific events, or knowledge of anomalies and novelties inferior to knowledge of “essences” and generalities. Daston attributes to Francis Bacon the novel promotion of facts to a level worthy of natural philosophy. These facts are the precursors of objective knowledge.

Immanuel Kant in his *Critique of Pure Reason* (1781, 1787) is probably responsible more than any other single thinker for spurring a debate about objectivity by “splitting” the world into “things for us” and “the thing in itself” (*Ding an Sich*). Kant analyzed human cognition and concluded that for anything to appear in our consciousness, it must fit into certain innate internal categories such as temporality and causation. It is impossible for us to perceive any phenomenon but within the matrix of these categories. For example, all phenomena must appear in time and be caused by other phenomena. Kant concluded that it is impossible to have knowledge of the world as it is, independent of human observers, beyond our categories, or to use later terminology, objectively.

Much of subsequent philosophy attempted to rise to the Kantian challenge. Phenomenology has attempted to reunite the world by eliminating the distinction between subject and object. Georg Wilhelm Friedrich Hegel (1770–1831) sought

to unite them as aspects of an ideal world spirit that we can know by an act of self-consciousness, because we are parts of this world rather than distinct from it. Edmund Husserl (1859–1938) designed his phenomenology to study pure consciousness through the method of *epoche*, the suspension of belief in subject-object distinction. Husserl claimed that prior to cognitive processes, such as scientific abstraction, that distinguish the objective from the subjective, we live in an immediate asubjective “life-world.” Husserl and his immediate and remote intellectual progeny (Hannah Arendt, Jürgen Habermas) attempted to recapture this lost preobjective life-world. However, their analysis resulted in a new chasm between what they considered to be universal immediate human consciousness and the objective scientific world view.

Conversely, the nineteenth-century school of positivism (Auguste Comte, John Stuart Mill) and the twentieth-century school of logical-empiricism (Ernst Mach, the early Ludwig Wittgenstein, Rudolph Carnap) claimed that the scientific method offers objective knowledge of the world, and therefore philosophy should explicate this method, and other disciplines would do well to use this philosophic blueprint to reform themselves. The logical empiricists shared an analysis of language as composed of distinct units that correspond with distinct chunks of reality. The objective meaning of words or propositions is then their empirical truth condition, a state of affairs in the world. For example “the cat is on the mat” is objectively true if and only if indeed the cat is on the mat.

The objectivity of our beliefs has been criticized by traditions that descend from Karl Marx (1818–1883) and Friedrich Nietzsche (1844–1900). Marx thought that the material conditions of production are the objective aspect of society. Systems of belief merely reflect economic interests. Nietzsche tended to reduce beliefs to power relations. Karl Mannheim (1893–1947), the founder of sociology of knowledge, and Max Horkheimer (1895–1973), one of the founders of the Frankfurt School, concentrated on economic or political influences over apprehensions of reality. Horkheimer argued that it is impossible to produce a metatheory to transcend the limits of a temporal worldview. Later, Michel Foucault (1926–1984) and Bruno Latour showed the dependence of research on social power relations, on what Foucault called discourses.

Contemporary Debates

Since the 1960s the debate about the objectivity of knowledge in English-speaking countries concentrated on explaining the history of science. Thomas Kuhn (1922–1996) and others demonstrated that there are no simple objective scientific facts

because scientific concepts are always embedded in conceptual frameworks, and so are confirmed holistically. After Kuhn, those who believe that science offers objective knowledge attempt to explain scientific change by referring to internal scientific reasons, the interaction between theory and reality. Those who claim that science is at least in some cases not objective, including sociologists of knowledge of “the strong program” (which is based on a critique of traditional philosophy of science), feminists (such as Helen Longino, Miriam Solomon, and Kathleen Okruhlik), and postcolonial thinkers explain scientific change by external social factors. They may be divided into moderates who argue that in many cases science did not adhere to its objective criteria, and radicals who claim that the very ideas of objectivity and rationality reflect the biases of male, heterosexual, and white European scientists.

These debates led contemporary philosophers like Nicholas Rescher to attempt to understand objectivity without referring to the world or truth conditions, to reduce objectivity to universal impersonal reason that should lead to the same cognitive output given the same informational or evidential input. Objectivity then is a general human point of view, avoiding the idiosyncratic.

One of the most influential twentieth-century discussions of objectivity was introduced by Thomas Nagel. He considered objective–subjective propositions to have different degrees of reliance on an individual’s makeup and position in the world. Since there is no “view from nowhere,” a point of view is inevitable. The subjectivity of consciousness is irreducible to its physical properties (the brain). In ethics, moral subjectivism considers moral principles personal; moral objectivism argues that moral judgments are defensible rationally and moral values exist objectively. Nagel considered the good to be subjective and irreducible, since we cannot act impersonally. According to Nagel the problem facing contemporary philosophy is the integration of our subjective-personal and objective-impersonal views of ourselves in the same worldview.

See also *Idealism; Paradigm; Phenomenology; Positivism; Relativism; Science, History of.*

BIBLIOGRAPHY

- Megill, Allan, ed. *Rethinking Objectivity*. Durham, N.C.: Duke University Press, 1994.
- Nagel, Thomas. *The View from Nowhere*. New York: Oxford University Press, 1986.
- Natter, Wolfgang, Theodore Schatzki, and John Paul Jones, eds. *Objectivity and Its Other*. New York: Guilford, 1995.
- Rescher, Nicholas. *Objectivity: The Obligations of Impersonal Reason*. Notre Dame, Ind.: Notre Dame University Press, 1997.

Aviezer Tucker

OBLIGATION. Since Plato wrote of political obligation in his dialogue *Crito*, obligation in general has been of ongoing interest to philosophers. In that dialogue, Socrates argues that he was under an obligation to obey the laws of Athens and comply with a sentence of death. During the course of

the argument, he raises and offers solutions to many of the central issues about obligation that philosophers still puzzle over. For instance, how can obligations have the grip on us that they do—in some cases, so that we are willing to die rather than not fulfill them? What is the nature and justification of moral and legal obligations? Do we have an obligation to obey the state, and if so, why?

The range of issues and positions relating to obligation is vast, given that there are few areas of moral and political philosophy in which obligation does not play a role. In what follows, four topics that have been of particular interest to contemporary philosophers are discussed: (1) the analysis and justification of obligations; (2) legal and moral obligations; (3) obligations, roles, and identities; and (4) agent-relative obligations.

The Analysis and Justification of Obligations

Obligation is normative, concerned with how things should be (not necessarily with how they are). In particular, it is a deontically normative—concerned with duty, or what is permissible, forbidden, and the like—as opposed to axiologically normative, concerned with what is good, bad, better, or worse. A given deontic normative perspective classifies actions, laws, institutions, or whatever as permissible (acceptable) or impermissible (unacceptable, wrong, forbidden). The classifications are interdefinable. For instance, an option is permissible when it is not impermissible, obligatory when permissible and every alternative option is impermissible.

Obligation is a relation with as many as three places: the person or entity who *has* an obligation (call this the *agent*), what that agent is obligated to do (the *performance*), and the person or entity to whom the agent owes the performance (the *object*). Because the object of an obligation is owed the performance, that person or entity has a *right* to it, and when an obligation has an object, obligations and rights are reciprocal: if someone has a right to your ϕ ing, then you have an obligation to ϕ ; and if you have an obligation to someone to ϕ , then that someone has a right to your ϕ ing. Philosophers differ over whether all or just some obligations have objects, and so whether all or just some obligations come with reciprocal rights. For instance, some hold that a person is morally obligated to help others, but this obligation does not give anyone a right to be helped. Often, obligations that do not generate reciprocal rights for their objects are called *imperfect* obligations, while those that do generate reciprocal rights are called *perfect* obligations.

Some obligations are *agent-relative* (or *agent-centered*) and others are *agent-neutral*. Agent-relative obligations are those whose performance contains within its scope an essential reference back to the agent and to the agent carrying out that performance (McNaughton and Rawling, 1991). Hence, such obligations state that the agent is obligated himself to perform some action. An agent-neutral obligation, by contrast, states only that the agent ought to ensure the performance of the action, whether by himself or someone else. For instance, my obligation to help a stranger is really just the obligation that I make sure the stranger is helped—whether by me or by someone nearby does not matter. By contrast, my obligation to go

to my son's birthday party is an obligation that *I* go to his party. I do not discharge that obligation by sending someone else. Likewise, if I promise that *I* will baby-sit your children, the obligation I have undertaken is that *I* baby-sit, not that a baby-sitter of some sort is provided. To the degree that obligations and rights are reciprocal, this distinction in agent-relative and agent-neutral obligations brings with it a distinction in agent-relative and agent-neutral rights. For instance, you have an agent-relative right that I baby-sit if I have promised as much.

What is obligatory is what one *must* do. A citizen has an obligation to obey the law, and so *must* obey the law; it is obligatory for a Boy Scout to keep himself physically strong, thus he *must* do so; parents are under an obligation and so *must* care for their children. Because of this, deontic classifications have been treated as modal notions—as what it is normatively *necessary*, *possible*, or *impossible* to do. Moreover, these modalities are often characterized much like causation and other kinds of necessity, as relations grounded in the governance of laws. Heat must boil water because there is a natural law governing these events; likewise, a Boy Scout must keep himself physically strong because there is a Scouting law governing his actions. Thus, an action is obligatory when a normative law or rule makes it normatively necessary, permissible when a normative law makes it normatively possible, and so on. The differences between moral, legal, etiquette, and club obligations can thus be made out as differences in the sets of normative rules or laws grounding the modal categorization. For instance, a club obligation is an action made necessary by the rules of the club.

An obligation is thus typically held to be an action that is normatively necessary according to some normative rule or law. A normative law, however, does not necessitate one's action, in the way that the law of gravitation makes a person stay on or near the surface of the earth. The laws of a state, club, or morality necessitate one's action not as nature or logic makes things necessary, because it is logically and naturally possible for a person not to act as these laws direct. What is normatively necessary is both logically and naturally not necessary, even if both logically and naturally possible.

For any deontic realm, there will be obligations *within* or defined by that realm, and there may also be obligations not defined by that realm, but whose performance is *regarding* the obligations within that realm—separate obligations to fulfill the obligations laid down by that deontic realm (Green, 1988). For instance, legal systems define certain legal obligations, such as the obligation not to exceed a certain speed on a given road. These are obligations *within* the law. Yet a club, such as the Boy Scouts, may define certain obligations regarding those obligations created within the law. Hence, one obligation of the Boy Scouts is never to fail in one's legal or moral obligations. This is an obligation within one deontic realm, the Boy Scouts, regarding the obligations within a distinct deontic realm, the law. In general, if there is an obligation regarding a given deontic realm (i.e., an obligation to fulfill the obligations laid down by a club, a state, or etiquette), then there must be some second deontic realm independent of it within

which the obligation regarding that realm exists. One of the most important kinds of obligation regarding a deontic realm is the moral obligation to conform to legal obligations, often termed *political obligation*.

Normative laws can make one's actions necessary in a variety of ways. One way in which they might do this is if the laws are created as means to ends that one has. In order to vote, one must register; in order to get badges in the Boy Scouts, one must keep oneself physically strong; and so on. This can be called *instrumental necessity*. Many have thought that the necessity of any obligation must be instrumental. The laws of a state, for instance, would generate obligations for a given person when and only when those laws necessary are necessary for her security and the avoidance of sanctions for disobedience.

Most philosophers, however, have thought instrumental necessity is neither necessary nor sufficient for deontic necessity. It is not sufficient because a law backed up by sanctions alone seems not to be an obligation but rather extortion. The law must at least be in some sense a legitimate law of that deontic realm. Following the legal philosopher John Austin, a mechanism to establish the legitimacy of a normative law or rule can be called a *pedigree*. Systems of normative rules or laws require a pedigree that establishes the legitimacy of those laws or rules in creating a genuine obligation.

Instrumental necessity is not necessary for deontic necessity either. For instance, according to the rules of chess, it is necessary that the bishop stay on his color; this is a normative necessity arising from a rule of chess. But that rule is not backed up by some clause such as “in order to avoid such and such penalty.” The rules of chess are in this sense “categorically” necessary. What is required for deontic necessity are laws that are nonoptional rules of behavior, and that at a minimum have a pedigree that makes them legitimate rules of the system.

Different deontic realms can have different pedigrees, and philosophers have offered different pedigrees for some deontic realms. For instance, philosophers such as St. Thomas Aquinas tied the legitimacy of a state's laws to divine pedigree. Genuine obligations, both within and to the law, arise only from demands conforming to laws God laid down for our nature when he created us. Hence, genuine legal obligations arise only from laws that comport with this natural law. And the moral obligation to obey the law is grounded in our obligation to obey God. The view that the legitimacy of law arises from acts of will, or “voluntarism,” underwent a transformation as the vision of the universe grounded in God's will receded (for recent accounts of the history of modern thought about obligation, see Darwell, 1995, and Schneewind, 1998). Human acts of will—acts of choice, consent, agreement, promise—came to take the place of God's will as a source of authority. Thomas Hobbes and John Locke, for instance, rejected Thomas's view that each person's good naturally comports with the good of others. Although we are naturally entitled to seek our own good, each person's good is at odds with that of others. This conflict inevitably leads to a devastating loss for all as everyone tries to secure their own good at the cost of others. It is only by leaving this natural state that all can secure their good. Each person's natural authority over

himself is transferred to the sovereign or the community, which then comes to possess an authority to enact and enforce laws obligating them. And our obligation to obey those laws is based on something like a promise we have made.

Some version of the law-based source of obligation and some version of voluntarism as a source of the legitimacy of those laws and the obligation to obey has held a dominant position among philosophers since the modern era began. Nevertheless, many have defended nonvoluntarist positions and/or have rejected the model of obligations as actions made necessary by a law. Some, for instance, hold that obligations are a special kind of reason that make actions necessary. Hence, the obligation to obey the law, for instance, is a reason that necessitates obeying it. Among voluntarism's important detractors was David Hume, who had misgivings both about the law-based analysis of obligation and about voluntarism as the required pedigree. Hume argued that consent "has very seldom had place in any degree, and never almost in its full extent" (II.XII. 20). We are born into or find ourselves with obligations. Obligations that we have because of our consent, such as promises, are few and far between. Hume's own view of obligation was complex and hard to deem entirely consistent. Nevertheless, the gist of his view was that deontic necessity should be explained in subjective terms: When I judge that someone has an obligation to perform some action, I judge that there is a admirable motive impelling her to do it. The motive might be unreflective and natural, as is the love of children. Or it may arise from reflection on the advantages of various institutions, such as property or promising. Such a motive gains legitimacy through my approval of it from an impartial point of view.

John Stuart Mill followed the spirit of this pattern of analysis, but focused on external actions rather than internal motives. His still influential account holds that an action is obligatory just in case failure to perform it justifies internal or external sanctions, "if not by law, by the opinion of his fellow creatures; if not by opinion, by the reproaches of his own conscience" (pp. 48–49). The pedigree granting authority to such internal or external punishments in the case of moral and legal obligations is general happiness. As David Lyons (1977) has argued, however, Mill's analysis in terms of justifiably sanctionable behavior is itself quite separate from his view of what justifies such sanctions, namely, the general happiness. Indeed, anarchists argue for a given analysis of political obligation but then deny that any such thing exists on the grounds that no legitimacy can be given for it (see, e.g., Simmons, 1979; Wolff, 1998).

Most philosophical positions separate the legitimacy or authority of a law laying down obligations (moral or legal) from the reason to comply. Whether a rule or law in some deontic realm is valid is one thing; whether a person has reason to comply with its obligations is quite another. The most famous attempt to unify the legitimacy and reason to comply with moral obligations was that of Immanuel Kant. Kant's insight was to view moral obligations as stemming from laws that each person imposes on himself rather than from laws whose origin is external to the agent. In particular, moral laws are requirements stemming from deep inside—from a person's very capacity to act and choose on the basis of reason itself. If the

source of a law was the moral agent himself, that is, if it were created and enacted by the agent's own rational will, then its authority would come from the agent himself, namely, the authority of his own rational will over his actions. Kant referred to this as the "autonomy" of a rational will. Moral obligations, in his view, stem from the demands of our own reason, and it is in virtue of this source that we have reason to comply.

Legal and Moral Obligations

The two most salient deontic realms are law and morality. But how are legal and moral obligations related?

Positivism is the doctrine that our legal and moral obligations are quite distinct, that what the law *is* is a separate issue from what it ought to be. In the form originally propounded by Jeremy Bentham and Austin, legal obligations are generated by commands of the sovereign, or that entity whom society is in the habit of obeying, who is not in the habit of obeying anyone else, and who has the power to sanction noncompliance. H. L. A. Hart showed that this form of positivism is subject to fatal objections. It can account for neither the continuity of legal authority across sovereigns nor the persistence of legal obligation after a given sovereign is gone. Moreover, he noted that it assumes that normative necessity must be instrumental necessity, which, as discussed above, is a mistake. What is needed are nonoptional *rules*, and sanctions are neither necessary nor sufficient for these (such as in the chess example). Part of the problem, Hart thought, was that Austin used *criminal law*, in which the law is a *barrier* to doing certain things, as his model for the whole of the law. *Civil law* (such as the law of contracts), in which law is a solution for various problems that would otherwise exist, is a much better model.

The law, Hart argued, is "a union of primary and secondary rules" (1994, p. 107). Primary rules direct each how to act ("don't eat shellfish," "no one may sit higher than the king," and so on). These rules impose genuine obligations, but not in the way that Austin thought. For Austin, rules are little more than means by which one can predict when the state will harm you. To see a rule in this way is to take an "external" view of it: conforming to the rules has no part in defining one's membership in the society. The first step in having a legal system is to have a system of rules that most take an internal view of, or see as standards of criticism and justification of one's behavior.

Hart argued that problems will inevitably arise in a system composed only of primary rules. First, in such a system, there will be *uncertainty* about whether a rule exists covering many situations and what to do when rules conflict. Second, the system will be too *rigid* to deal with changing circumstances. How will new rules come into and go out of existence? Third, the system will be *inefficient* in enforcing the rules and determining whether they apply in any case. What is required is a system of *secondary rules*, or rules concerning how to determine, introduce, abolish, change, and apply *primary* rules. Most importantly, what is required are *rules of recognition* that identify those features in virtue of which a rule is a rule of the group, to be supported by social pressures of various sorts. Rules of recognition are the sorts of rules that define lawmaking in U.S. state and federal legislatures. Thus, a rule exists as a rule in some

system if its pedigree can be traced to rules of recognition defining legality for that system. Notice that, in contrast to Austin's view, rules can exist even if nobody ever obeys them. As long as a rule is enacted in the right rule-defining and -creating way, it exists. Hart insisted, however, that the rule of recognition itself need not be backed in any sense by any standard of authority, legal or moral. A rule of recognition exists in the sense of an "external statement of fact," that is, if it is generally not disregarded in defining and creating law.

Positivism's stark separation of legal and moral obligation has been challenged most forcefully by Lon L. Fuller and Ronald Dworkin. Fuller argued that if a given system of directives is immoral in a formal sense, then it will fail to be a legal system because it will fail to be a genuine system of rules. A system of directives is arbitrary if it does not conform to principles such as treating like cases alike, making its directives public, or not introducing directives after the fact. And an arbitrary system is not a system of rules. Moreover, a system possessing precisely these nonarbitrary features is also considered to be formally just. Thus, a system of directives that is not formally just is not a system of rules. If legal systems are systems of rules, then it follows that a formally unjust system of directives is not a legal system at all and does not generate legal obligations.

Dworkin's view challenges Hart's positivism by arguing that the law requires more than merely formally moral features. He argues that the actual practice of judges shows that legal systems contain elements from the moral traditions within which they arise and to which a judge's decisions must appeal to be valid. In cases that are not clearly covered by an existing law, judges in his view actually legislate, reaching outside of the law to make laws on the basis of good social policy. Dworkin argued that this does not match either actual or good judicial practice. Legal systems are composed of more than rules. They include principles invoking moral rights and obligations that judges are bound by in deciding cases. Indeed, what litigants are typically claiming is that some principle protecting a right is on their side. For Dworkin, there is always a determinate answer to the question of who has a right. Thus, there is always a determinate solution to legal conflicts to which litigants have a right and the judge is bound to find and deliver. Dworkin's own account of the pedigree of law therefore requires invoking moral principles and so implies that judges do not have discretion to create legal obligations as required by Hart's account. They must find the answer to which litigant's rights to protect, and not by intuition, but by articulating and defending a view of rights. Thus, for Dworkin, there is no sharp separation of legal and moral obligations.

Obligations, Roles, and Identities

The problem of political obligation is the problem of establishing an obligation within the moral deontic realm regarding the legal deontic realm—a moral obligation to obey the law, for instance. Many offer the voluntarist account, that the moral obligation is based on what is in effect a promise. Others think that moral obligations, and *a fortiori* political obligation, are all tied to promoting the overall good. Still others follow Socrates in thinking we owe an obligation of gratitude to the state for preventing harms and facilitating our good.

Some have argued, however, that the whole issue is illusory because "it is part of the concept, the meaning of 'law,' that those to whom it is applicable are obligated to obey it" (Pitkin, p. 214). "U.S. citizen" means "person obligated to comply with U.S. laws." Obligations are in effect parts of our ordinary concepts defining our positions and roles. The seemingly deep question of whether a U.S. citizen is "really" obligated to follow U.S. laws either betrays a confusion about what "U.S. citizen" means or takes the language "on holiday"—that is, uses terms such as *obligation* and *law* outside of the contexts in which they have a meaning.

In the early twenty-first century, this conceptual argument has few adherents on the grounds that it does not dissolve the problem so much as relocate it (see, e.g., Pateman, 1979; Simmons, 1996). Suppose "citizen" *does* just mean "someone with a genuine obligation to conform to the law." Then we may legitimately ask, is anyone genuinely a citizen in this sense? Clearly, the selfsame problem has returned dressed in new clothing. Many, however, agree with the view that obligations come with one's social roles and positions. So although the connection between role and obligation is not *analytic*, it is still true in a deeper substantive sense that to occupy many roles means having certain obligations. The origins of the position are in Georg Wilhelm Friedrich Hegel, and a version of it was defended in F. H. Bradley's famous essay, "My Station and Its Duties." It can be found most prominently in "communitarian" views of such late twentieth-century figures as John Charvet, Margaret Gilbert, Michael Hardimon, and John Horton.

The basic outline of the idea is as follows: the conception of the bare presocial individual who voluntarily takes on various obligations and agreements is illusory, an abstraction. A person *just is* a collection of social roles, a nexus of connections to other roles in a social fabric, very few of which are voluntarily assumed, and none are in any deep sense voluntary. When you tell someone who you are, you tell them about the collection of positions you occupy in a variety of social structures and institutions—a parent, an American, a teacher, a lawyer, an Oregonian, a writer. Your social identity may include your gender, race, and sexual preference. If each person is made up to a significant degree or other by these roles, then we are deeply identified with them, in the sense that we are attached to these positions as "who we are." Each of these roles comes with a set of obligations: To be a parent is to be someone genuinely obligated to care for her child, to be a teacher is to be someone genuinely obligated to instruct students, and so on. The view is thus not that the meaning of the word *teacher* is "someone obligated to instruct," but that what it is to actually occupy this position is to have such a genuine obligation.

This viewpoint has come to enjoy wide acceptance. It faces serious difficulties, however, not the least of which is an analog of the question facing the conceptual argument. For even if to have a certain obligation just is to occupy a certain role, there seems to be a meaningful question about the normative status of that role and the practices that create it—a question of whether one *ought* to occupy that role, and moreover whether its obligations are genuinely binding. A defender of such obligations has to deny that there is any question of what one is

genuinely obligated to do *beyond* what is laid down by one's social positions. The question "Ought I occupy this role and take on these requirements?" can be understood only from the perspective of some *other* role and its requirements. It asks only which social position or role should win out when there is a conflict. No single distinctive question about what one ought or ought not to do can be asked of social positions and their directives in general, because there is no single distinctive position or role that every person has in common with every other person.

In her 1996 book, *The Sources of Normativity*, Christine M. Korsgaard applied a similar strategy to the problem of moral obligation. In her view, this is a requirement stemming from one's "practical identity"—an identity that is constituted by ongoing commitments to act in various ways in various circumstances. Her insight is that the power and legitimacy of obligations are tied to a sense of one's own identities. As mentioned earlier, most of us think that there are some actions about which we say "I would rather die than do that"—that the necessity of some moral obligations is sufficient to put the acceptance of death on the table as an option. Korsgaard takes this talk seriously. If death is the loss of identity, the necessity of obligation comes from the threat of this loss. There are actions one would rather die than perform, or at least things the doing of which would be as good as dying. But combining the idea that death is a loss of identity with the idea that everyone has a multiplicity of identities tied to various positions and roles yields the idea that we might die *as an F*, where *F* names some role or position we occupy. Thus, to be a parent *requires one* to pursue the care of one's child. To stop this pursuit *just is* to give up that practical identity (insofar as this is a "person who cares for her child"), and hence to *die* as a parent. The necessity of parental obligation is thus tied to the persistence of one's identity as a parent. Where Korsgaard differs from the neo-Hegelian turn discussed above is that she holds that some identities are not merely social roles. In particular, our deepest identity—an identity it is impossible for us rationally to lose or throw off—is our identity as a reflective rational agent. This identity, she argues, is constituted by a requirement to respect this reflective agency in oneself and others. Failures of respect are in this way moral deaths, ways of giving up one's identity as a rational agent. This, she contends, explains the special grip or authority of moral obligation.

Agent-Relative Obligations

Much debate in late twentieth-century moral philosophy has been over how deep the distinction between agent-relative and agent-neutral obligations goes and whether the existence of agent-relative obligations is compatible with utilitarian moral theories. Recall that agent-relative obligations seem to have a special attachment to the person whom they bind. This is particularly the case regarding moral obligations: I see children who need caring for and can with no cost to myself care for one but not all. I have a moral obligation to care for one, then, but it does not seem to matter which. Indeed, everything else being equal, any other person in my place would have this obligation too. By contrast, suppose one of the children is my own son. It seems that I ought to care for my son over the other children, that it now matters morally which one I care for and that I do the caring. This is an

agent-relative obligation: I have an obligation that *I* care for *my* son. The puzzle is that every child is equally valuable in objective terms; my son's care has no more and no less intrinsic value than the care of anyone else's child. Of course, he is more valuable *to me*, but that is not an objective measure of his value. Further, it would be abominable for me to care for my own child, but justify it by saying "I can't care for all children, so I flipped a coin and my son won." I seem to have an obligation *to him*, and he has a claim on my care that no other person has. How is that possible if there is no more objective value in my son's care than in the care of any other child?

To take another example, we are morally obligated not to torture. But suppose you could reduce the number of torturings in the world by a few by torturing some one innocent person. It is very tempting to think that you still have an obligation not to torture that person, even if by doing so you could bring about the reduction in torturings. You seem to have here an agent-relative obligation that *you* should not torture, rather than simply an agent-neutral obligation to prevent torturings. How is this possible? Surely if one torturing is evil, two are more evil, three even more so, and so on. Surely you should bring about as little evil as possible in the world. Moreover, if we increase the number of torturings you could prevent, there will be some number at which everyone will relent and say you ought to torture to prevent other torturings. So how could it be wrong to prevent more of the very same ills that one thinks one should bring about oneself, and only in some cases but not others? Much late twentieth-century work on obligation has focused on just this question.

Utilitarianism has been most often associated with the view that there are no genuinely agent-relative obligations, that all of our obligations are agent-neutral. Our fundamental obligation is always to bring about the better state of affairs. This is indeed a very intuitive position: How could it ever be impermissible to bring about the most good? Shouldn't one always do this? Some, such as Samuel Scheffler (1994), have argued that agent-relative *permissions* can be defended, but not agent-relative *obligations*. That is, we can be permitted, but not obligated, to tell the truth even when our lying would bring about more truth-telling. What justifies a permission here for Scheffler is the agent's need to preserve his integrity (or, for Thomas Nagel, his autonomy) as a moral agent. Others have taken a stronger position that there are genuine agent-relative obligations. For example, you have an obligation not to torture even if by torturing you would bring about fewer torturings overall. Nagel argues that such an obligation is justified on the grounds that one must never be led by evil. Whether these or related arguments will ultimately prove successful is an ongoing concern of moral philosophers.

See also Altruism; Law; Philosophy, Moral; Virtue Ethics.

BIBLIOGRAPHY

- Austin, John. *The Province of Jurisprudence Determined*. 1832. Reprint, edited by Wilfrid E. Rumble. Cambridge, U.K.: Cambridge University Press, 1995.
- Bentham, Jeremy. *Of Laws in General*. Edited by H. L. A. Hart. London: University of London, Athlone Press, 1970.

- Bradley, F. H. "My Station and Its Duties." In his *Ethical Studies*. 2nd ed. 1876. Reprint, with an introduction by Richard Wollheim. Oxford: Oxford University Press, 1988.
- Darwall, Stephen. *The British Moralists and the Internal "Ought," 1640–1740*. Cambridge, U.K.: Cambridge University Press, 1995.
- Dworkin, Ronald. *Taking Rights Seriously*. Cambridge, Mass.: Harvard University Press, 1977.
- Flathman, Richard E. *Political Obligation*. New York: Atheneum, 1972.
- Fuller, Lon L. "Positivism and Fidelity to Law: A Reply to Professor Hart." *Harvard Law Review* 71, no. 4 (1958): 630–672. Reprinted in *Philosophy of Law*, 7th ed., edited by Joel Feinberg and Jules Coleman, 67–81. Belmont, Calif.: Thomson/Wadsworth, 2004.
- Gilbert, Margaret. "Group Membership and Political Obligation." *Monist* 76, no. 1 (1993): 119–131.
- Green, Leslie. *The Authority of the State*. Oxford: Clarendon, 1988.
- Hardimon, Michael. "Role Obligations." *Journal of Philosophy* 91, no. 7 (1994): 333–363.
- Hart, H. L. A. *The Concept of Law*. 2nd ed. Edited by Penelope A. Bulloch and Joseph Raz. Oxford: Clarendon, 1994.
- Hume, David. "Of the Original Contract." Part II, Essay XII in *Essays Moral, Political and Literary*, ed. E. Miller. Indianapolis: Liberty Fund, 1987.
- Korsgaard, Christine M. *The Sources of Normativity*. Cambridge, U.K.: Cambridge University Press, 1996.
- Lyons, David. "Mill's Theory of Morality." *Noûs* 10 (1977): 101–120.
- McNaughton, David, and Piers Rawling. "Agent-Relativity and the Doing–Happening Distinction." *Philosophical Studies* 63 (1991): 167–185.
- Mill, John Stuart. *Utilitarianism*. 2nd ed. Reprint, edited, with an introduction, by George Sher. Indianapolis: Hackett, 2001.
- Nagel, Thomas. *The View from Nowhere*. New York: Oxford University Press, 1986.
- Pateman, Carole. *The Problem of Political Obligation*. Chichester, U.K.: Wiley, 1979.
- Pitkin, Hanna. "Obligation and Consent—II." Reprinted in *Concepts in Social and Political Philosophy*, edited by Richard E. Flathman, 201–219. New York: Macmillan, 1973.
- Scheffler, Samuel. *The Rejection of Consequentialism*. Rev. ed. Oxford: Clarendon, 1994.
- Schneewind, J. B. *The Invention of Autonomy*. Cambridge, U.K.: Cambridge University Press, 1998.
- Simmons, A. John. "Associative Political Obligations." *Ethics* 106, no. 2 (1996): 247–273.
- . *Moral Principles and Political Obligations*. Princeton, N.J.: Princeton University Press, 1979.
- Wolff, Robert Paul. *In Defense of Anarchism*. Berkeley and Los Angeles: University of California Press, 1998.

Robert N. Johnson

OCCIDENTALISM. The term *Occidentalism* refers primarily to the many ways in which non-Western intellectuals, artists, and the general public perceive and present the West. Though it seems to be an inversion of Orientalism, it has acquired some unique aspects defying a simple definition. In fact, the practices and discourses of Occidentalism vary a great deal,

from time to time and region to region. If we can arbitrarily divide certain parts of the world into West and East, then the people of the East, like their counterparts in the West, had approached an understanding and knowledge of the West long before such terms as Occidentalism and Orientalism were coined. However, it was largely due to the seminal influence of Edward Said's *Orientalism* that the discussion and use of the term *Occidentalism* gradually, from the 1990s on, gained currency in academic circles. Also, the two discourses not only juxtapose but also overlap with one another, in that the non-Western people do not perceive the West solely on their own cultural terms; rather, given the presence of Western discursive hegemony, they present the West either as a contrast, or an exemplar, reminding one of the principal practices of Orientalism among the Westerners. Different from the Orientalist discourse, which is mostly made by and for the Westerners, however, the Occidentalist discourse is made by non-Westerners for both Westerners and themselves. In the early twentieth century, for example, when a group of Japanese Buddhists attended the World's Parliament of Religion, they exercised, to borrow James Ketelaar's terminology, a "strategic Occidentalism" in promoting Buddhism both at home and to the world. They appropriated elements from Christianity, and Western culture in general, and constructed an image of the West as the contrasting Other. In so doing, they threw into relief the value of Buddhism as a more integral part in Japanese culture. They also emphasized the potentials of Buddhism for complementing Christianity and redressing its shortcomings.

East-West Dialogue and the Other

While the discussion of Occidentalism is often in juxtaposition with that of Orientalism, it can also amount to a criticism of the latter. Edward Said's critique of Orientalist writings and studies raised important questions about the Western hegemonic power in shaping the imagery of the "Orient." But like the Orientalists, as Mohamad Tavakoli-Targhi charges, Said, in presenting his thesis on the Western discursive hegemony, underestimates and overlooks the intellectual power and contribution of the people in the Orient. In his study of the Persianate writings in history and travelogue by Iranians and Indians during the seventeenth and nineteenth centuries, Tavakoli-Targhi notes that prior to the spread of European power, the Asians not only traveled to and wrote about Europe, contributing to Persianate Europology, but they also helped the early European Orientalists to acquire a knowledge of the Orient. In other words, in the exchanges between East and West, the East was not a passive, silent Other, as portrayed by the Orientalists (and also, ironically, as endorsed by Edward Said). Rather, argues Tavakoli-Targhi, the Persianate writers displayed equivalent intellectual capability to engage in cross-cultural communications with their Western counterparts. That the Orientals contributed to the gestation of Orientalism has also been noticed by Arif Dirlik in his study of South and East Asian history, although he casts this contribution in a more critical light.

Moreover, Occidentalism can be used, as Couze Venn has attempted, to describe the rise of Europe in modern times. In this usage, the term no longer refers to the construction of the image of the West only by the non-Western peoples. It now



Still from Zhang Yimou's 1995 film *Shanghai Triad*. In the late twentieth century, Chinese filmmakers like Yimou found critical success outside of their home country for works that depicted a China customized to Western tastes and expectations. ALPHA FILMS/THE KOBAL COLLECTION

also includes attempts by Europeans to turn their historical experience into a universal, hegemonic model. "Occidentalism," states Venn, "thus directs attention to the becoming-modern of the world and the becoming-West of Europe such that Western modernity gradually became established as the privileged, if not hegemonic, form of sociality, tied to a universalizing and totalizing ambition" (p. 19). Engaging in this study of how Europe rose to become the West entails careful examination of the development of capitalism and spread of colonialism, not only during the seventeenth and nineteenth centuries, but also, as Venn suggests, in today's world. The legacy of both are well reflected in such global forms of regulations and organizations as the World Bank, the International Monetary Fund (IMF), and the United Nations. All of them have accompanied the Western hegemony in academic discourses. While different from Edward Said's theory of Orientalism, Couze Venn's study of Occidentalism defined as such suggests a similar interest in revealing the repressive side of modernity. In this regard, Occidentalism extends, as does Said's work, the project of post-colonial critique of the modern world.

If the definition of Occidentalism is complex, this is because the interaction and dialogue between East and West have been

a diverse experience, shaped by different forces under different circumstances. Even if we confine our discussion to the non-Western construction of the Western imagery, it still defies the simple understanding of it as a form of internalized Orientalism, in which the West is perceived as the exemplary Other, or of it as a defensive reaction against the West, in which the West is seen as a devilish Other. In addition to the various attempts to portray the West, Occidentalism has another dimension, or "double reflection" in Meltem Ahiska's analysis, that the non-Western also seeks to imagine how its image is perceived by the West. This is because the Occidentalist discourses often emerged as a result of the Western expansion to the world, which made it urgent and necessary not only for the non-Western to form its national and cultural identity, but also to do so by emulating and extending the Western model. It demands that the non-West seek identification of the West on the one hand in forming its modernity and, on the other hand, draw a line of demarcation between Self and Other in order to bolster its own contradistinctive identity.

China and Occidentalism

In the discussion on Occidentalism, scholars in the China field, including native Chinese scholars living in China and overseas, are quite active. This is perhaps because compared to its neighbors in Asia, China boasts a long historical and cultural entity and, since the mid-nineteenth century when its conflict with the West commenced, has remained quite resilient in resisting the Western influence and maintaining its cultural heritage. This marks a stark contrast to Meiji Japan in which a wholesale Westernization was set in motion almost as soon as the country was opened by and to the West. In China's cultural terrain until today, the China–West dichotomy appears quite salient, which suggests that the Chinese by and large have maintained, despite the ups and downs of their history, a clear self-awareness while constructing their relation with and perception of the West. In the New Culture movement of the early twentieth century, which was often perceived as a radical rupture of the Chinese cultural tradition, this self-awareness remained quite visible. In seeking a national identity, which was a main goal of the movement, the participants not only drew inspiration from the West, but also considered the Soviet experience. Moreover, despite its iconoclastic appearance, the movement did not entirely discard tradition. Instead, it gave rise to the National Studies project, in which the enthusiasm for modern science was translated into an endeavor at identifying similar, indigenous elements in the past.

This keen and persistent self-awareness bore upon the ways in which the modern Chinese imagined and construed the West. In her *Occidentalism: A Theory of Counter-Discourse in Post-Mao China*, Xiaomei Chen has identified two tracks of Occidentalist discourses in modern China. One is called Maoist, or official Occidentalism, in which the West is portrayed as the demon. The other is anti-official Occidentalism, advanced by various groups of the intelligentsia, in which the West becomes a useful metaphor for their critique of domestic oppression. Though the origin of Maoist Occidentalism can be traced back to the second half of the nineteenth century, marked by China's defeats in confronting the Western intrusion, it culminated in

the 1940s and the 1950s as the Communists rose to power and founded the People's Republic of China (PRC). By depicting the West as the imperialist aggressor, it incited nationalist sentiment among the Chinese and instigated their animosity toward the West. In so doing, it enabled the PRC government, in Chen's words, to use this essentialized West "as a means for supporting a nationalism that effects the internal suppression of its own people. In this process, the Western Other is construed by a Chinese imagination, not for the purpose of dominating the West, but in order to discipline, and ultimately to dominate, the Chinese self at home" (p. 5). While Chen's work mainly describes this type of Occidentalism in 1980s China, judging from China's situation today, its practice seems to have not only persisted but also intensified as the country often sees surges of ultranationalistic behavior in its (young) populace. This ultranationalistic, anti-West sentiment is not entirely spontaneous, but has a good deal to do with the PRC government's decades-long nationalist propaganda, which often taps into the historical pride of the people.

Like its counterpart, anti-official Occidentalism also has a history that predated the founding of the PRC. It originated in the New Culture movement of the 1920s, if not earlier, in which the Western idea of democracy was invoked as a means to shore up the fledgling Republic in the face of warlordism and factionalism. In the post-Mao years when the PRC intellectuals reflected critically upon the tragic legacy of the Cultural Revolution (1966–1976), they sought to revisit and revive certain themes of the New Culture movement. This revivalist endeavor gave rise to "a powerful anti-official discourse using the Western Other as a metaphor for a political liberation against ideological oppression within a totalitarian society" (Chen, p. 8). Central to this anti-official Occidentalist discourse was the production of *Heshang* (River elegy), a TV documentary mini-series that aired nationally in China in 1988. It became a cause célèbre in the history of the PRC's TV industry, for while it attracted hundreds and thousands of viewers across social strata, it was also criticized by professional historians and later banned by the government. The criticisms centered on *Heshang's* presentation of Chinese cultural tradition vis-à-vis modern Western culture, or Orient versus Occident, because the producers and writers, elevating the iconoclasm of the New Culture movement to a new level, vilified the Chinese cultural heritage and denied its relevance to modern life. Meanwhile, it glorified Western civilization, praising its openness, adventurousness, and youthfulness, to which the advance of capitalism and technology of the modern world were attributed. This China–West dichotomy was rendered vividly in *Heshang's* cinematic presentation, in which the Yellow River and yellow earth, symbols of Chinese civilization, conveyed a deeply sorrowful feeling of death and stagnation, whereas the West was symbolized by the azure blue ocean, emanating energy and liveliness. These contrasting images appealed to the Chinese audience who, in the aftermath of the Cultural Revolution, were still haunted by the terrible memories of the country's recent past and frustrated by the setbacks in the century-long search for wealth and power. While seemingly a cultural critique, marking a climax of the "Culture Fever" (*wenhua re*) movement prevalent at the time, *Heshang's* Occidentalism was, argues Xiaomei Chen, a counter-discourse to official Occidentalism, because it indirectly and

effectively translated this public frustration into a veiled criticism of the palpable failure of the Communist government.

The divergent ways in constructing the Western imagery in contemporary China underscore that it is important for us to consider the context in which various forms of Occidental discourse have occurred. The attention paid to this context question can also help highlight the essential difference in the constructions of Orientalism and Occidentalism. Different from Edward Said's critique of Orientalism, in which he presents the East-West dichotomy in an invariable manner in order to stress the Western dominance of power, the presentation of the Occidental discourse has shown that such relationships can be quite flexible, depending on the specific sociocultural context. This is because when the Orientals perceive the West, their perception is shaped not only by the international and global climate of the modern world, but also by the domestic context in which such perception is called for. This consideration, too, should be applied to the Orientals' construction of the Self, because such an image is also often constructed and presented under and for the Western gaze. This practice of presenting Self for the Western Other has been given various terms, such as "Orientals' Orientalism," "self-imposed Orientalism," and "cooperative Orientalism." But to the extent that it is predicated on a projection by non-Westerners onto the West on which they set out to present their own cultures, it also amounts to a form of Occidentalism. The Japanese Buddhists' endeavor at promoting their persuasion to the Western world is a good example of this.

A more current example is shown in the success of the "fifth-generation" Chinese movie directors, led by Zhang Yimou, in winning numerous awards for their productions at movie festivals in the West from the 1990s on. What made their success particularly salient as a form of Occidentalism is that while Zhang and others produced works about China and Chinese culture, their productions were often not shown within China. This was sometimes the result of government bans, but a more important reason seemed to be that these movies were originally tailored to the taste of the Western audience. While the moviemakers visualize and represent China, what they actually accomplish is rather an imaginary West based on their own projections. Judging from their successes at Western movie festivals, their understanding of the West and, moreover, their imagination of how China would likely be perceived by the West, are quite correspondent with the reality. However, their presentations of China, ironically, were often not approved by their compatriots back home.

If this exercise of Occidentalism acts on an anticipation of how the Western Other is to gaze at the Self, there seems another way in which the Western Other is shown more accessible and cooperative for the Self. After China opened its doors to the world in the early 1980s, there appeared a series of novels (some of them also made into TV shows) depicting the experiences of Chinese students and immigrants living in the West, such as Zhou Li's *Manhadun de Zhongguo nuren* (1993; A Chinese woman in Manhattan), Yu Heizi's *Bolin de tiaozao* (1993; Fleas in Berlin), and Cao Guilin's *Beijingren zai niuyue* (1994; A native of Beijing in New York). A recurrent theme

in these novels is that in order for a Chinese to succeed in the West, he or she must first know how to approach a thorough understanding of Western lifestyle and culture and adjust his or her life accordingly. But the Other never dominates the Self completely. Rather, it works with the Self in effecting the latter's ultimate success, an end that most of the protagonists managed to achieve. In this presentation, the East and West/Self and Other divide central to Said's critique of Orientalism becomes increasingly blurred. It thus calls for considerations of various contexts in which such conceptions are imagined and construed. This call for historical specificity perhaps marks the most notable contribution that the discourses of Occidentalism have made to our understanding of the world.

See also *Orientalism; Other, The, European Views of*.

BIBLIOGRAPHY

Ahiska, Meltem. "Occidentalism: The Historical Fantasy of the Modern." *The South Atlantic Quarterly* 102, nos. 2/3 (2003): 351–379.

Chen, Xiaomei. *Occidentalism: A Theory of Counter-Discourse in Post-Mao China*. 2nd ed. Lanham, Md.: Rowman and Littlefield, 2002.

Dirlík, Arif. "Chinese History and the Question of Orientalism." *History and Theory* 35, no. 4 (1996): 96–118.

Ketelaar, James. "Strategic Occidentalism: Meiji Buddhists at the World's Parliament of Religions." *Buddhist-Christian Studies* 11 (1991): 37–56.

Snodgrass, Judith. *Presenting Japanese Buddhism to the West: Orientalism, Occidentalism, and the Columbian Exposition*. Chapel Hill and London: University of North Carolina Press, 2003.

Tavakoli-Targhi, Mohamad. *Refashioning Iran: Orientalism, Occidentalism, and Historiography*. Basingstoke, U.K.: Palgrave, 2001.

Venn, Couze. *Occidentalism: Modernity and Subjectivity*. London and Thousand Oaks, Calif.: Sage, 2000.

Q. Edward Wang

ONTOGENY. See *Development*.

ORAL TRADITIONS.

This entry includes two subentries:

Overview
Telling, Sharing

OVERVIEW

The challenge of reconstructing the history of nonliterate or preliterate societies makes necessary the study and interpretation of oral traditions. Many such societies have gone to great extents to preserve and transmit the knowledge of their past in oral forms. The phrase *oral traditions* refers to folklore, legends, tales, taboos, and stories through which knowledge of the past is preserved and transmitted from one generation to

another. Oral traditions must be differentiated from *oral evidences*, which are experiential. Such traditions record the origins, movements, and settlements of peoples; the genealogy and chronology of royalty, priests, and citizens; and the important landmarks in history. Besides, much oral tradition can be gleaned from surviving cultural practices such as burials, rituals, games, and language.

Virtually all societies, including literate ones, have depended on oral traditions for the reconstruction of their histories at one point or other. "Once upon a time" or "long, long ago" are the usual introductions to the oral narratives that European and Native American children heard throughout their childhood and early adolescence. The knowledge of preliterate historical periods is derived in some form from oral accounts. As writing and documentation developed and literacy became widespread, however, this genre of historical recollection became less important in the literate societies. This is because of the presumed unreliability of oral traditions as compared with documents. Indeed, by the nineteenth century, a form of historiographical tradition had become established in Europe that held that only written sources could produce historical reliability. This was not unconnected to the development of archives and the documentary traditions of the medieval European courts. Europe-based historians of the nineteenth century tended to consider that nonliterate societies had no history.

Oral Tradition and the Search for the African Past

Thus, although oral traditions are not peculiar to black Africa; their use as a source for the construction of African history has attracted the most attention. Not many of the continent's peoples developed any extensive form of writing. Thus, the earliest written sources on African peoples were the accounts of European and Arab traders, travelers, and explorers who wrote about their experiences primarily for home audiences, or as personal memoirs. For this reason, many of the historical studies on Africa were considered not history but anthropology. Archaeological findings of early African civilizations were attributed to foreign influences. It is in this context that the British historian Hugh Trevor-Roper contended that Africa had no history apart from the activities there of Europeans and Arabs. This contention drew sharp responses from the intelligentsia on both sides of the Atlantic—including representatives of the evolving colonial African historical consciousness. There is also a sense in which the denigration of the African past was a replication of the European racial and colonial enterprise, referred to by Edward Said as a "race construct" of "otherness," that is, the creation of a negation of the European ideal in conquered and dominated peoples. The challenge for colonial African and indeed intellectual responses to the question of African history was to prove its existence through the only source that seemed available at the time: oral traditions.

Oral Traditions as a Source and as a Method of Historical Construction

African and Africanist historians have professed the value and reliability of oral traditions for the reconstruction of the history of African peoples. Their weaknesses as a source of

historical reconstruction have been argued as no worse than those of other sources of history, including written records. Various processes have been developed for the mitigation of these weaknesses by the methodical gathering and treatment of oral traditions. This has also involved the conceptualization of oral tradition and the classification of the genres that make up oral traditions. Each of these typologies has peculiar treatment types.

Oral traditions, among many African peoples, are more complex, better-organized forms of recording history than the stories and legends of some other preliterate societies. Traditional controls in the form of training and taboos have served to guarantee the reliability of historical accounts. "Palace historians" and griots often occupy hereditary positions, and the training of custodians of a society's history usually begins at an early age. Special occasions such as coronations, burials, births, and other rituals present opportunities to perfect their arts. Stringent sanctions are attached to any distortion of historical accounts. The fact that in such societies crimes and punishments are communal and that physical and spiritual influences guide social compliance provides added checks against manipulation of accounts. Oral traditions have thus been successfully employed to reconstruct the history of many societies in Africa. In Nigeria, the pioneering works of Kenneth Dike—*Trade and Politics in the Niger Delta* (1956)—and Saburi Biobaku—*The Egba and Their Neighbours* (1957, based on a 1951 thesis) relied mainly on gathered oral traditions and have survived much historiographical scrutiny to remain national historical classics. Substantial works on East African history have also depended on the collection and use of oral traditions following the pioneering works of B. A. Ogot. Jan Vansina's seminal theoretical work, *Oral Tradition: A Study in Historical Methodology*, articulated the major theoretical advances for the defense of the use of oral traditions in historical reconstruction. The case for oral tradition was further taken up in his more recent study, *Oral Tradition as History*. Vansina, however, not only makes a case for the validity of oral tradition in historical reconstruction but has produced historical works that fully utilize the method. These include *The Tio Kingdom of the Middle Congo 1880–1892* (1973) and *The Children of Wool: A History of the Kuba People* (1978). Vansina's influence as the foremost theoretician of oral tradition historiography is not in doubt.

The Use of Oral Traditions and Its Critics

There are obvious problems with the use of oral traditions. Critics easily point out that they lack absolute chronology, are extremely selective in their content, and are compromised by possible human errors. William G. Clarence-Smith argued that the value of using oral traditions has been not for their intrinsic worth but sentimental, as they offer African historians the opportunity to present an independent history, "uncontaminated by colonialism." Many of the theoretical advances in oral tradition have focused on how to lessen the impact of these weaknesses. The use of oral traditions demands a distinct professionalism that is not altogether dissimilar to that employed by historians who rely on other, "conventional" sources. Historians employing oral traditions, though, need to acquire additional qualities, including, as Phillips Stevens has com-

mented, intuition, which is not usually required by conventional historians.

Oral traditions have had much wider influence on global historiography than its critics would concede. The emphasis on written sources as the only reliable source of historical reconstruction has mellowed with the acknowledged contributions of other sources of history including archaeology, paleography, and linguistics, as well as oral traditions. An interdisciplinary approach to historical reconstruction has gained much currency among historians. Besides, the debate over oral traditions has also shed some critical light on written documents as sources of history, with a view to strengthening their reliability. It has become realized, for instance, that many written documents are in reality processed oral traditions. The study of oral traditions has developed as a recognized discipline and various projects in the collection and processing of these traditions are being undertaken in research institutions across the world.

See also **Historiography; History, Idea of; Memory; Oral Traditions: Telling, Sharing.**

BIBLIOGRAPHY

- Afigbo, A. E. "Oral Tradition and the History of Segmentary Societies." In *Perspectives and Methods of Studying African History*, edited by Erim O. Erim and Okon E. Uya. Enugu, Nigeria: Fourth Dimension Publishers, 1984.
- Clarence-Smith, William G., and Fernand Braudel. "A Note on the 'École Des Annales' and the Historiography of Africa." *History in Africa: A Journal of Method* 4 (1977): 275–281.
- Curtin, Phillip D. "Oral Traditions and African History." *Journal of the African Folklore Institute* vi, nos. 2/3 (1969): 137–155.
- Oosten, Jarich G., ed. *Text and Tales: Studies in Oral Tradition*. Leiden: Research School CNWS, 1994.
- Stevens, Phillips, Jr. "The Uses of Oral Traditions in the Writing of African History." *Tarikh* 6, no 1 (1978): 21–30.
- Vansina, Jan. "Oral Tradition and Its Methodology." In *UNESCO General History of Africa I: Methodology and African Prehistory*. Edited by Joseph Ki-Zerbo. Paris: UNESCO; London: Heinemann; and Berkeley: University of California Press, 1981.
- . *Oral Tradition as History*. Madison: University of Wisconsin Press, 1985.
- . *Oral Tradition: A Study in Historical Methodology*. Translated by H. M. Wright. Chicago: Aldine, 1965. Originally published in 1961.

Sola Akinrinmade

TELLING, SHARING

For the vast majority of human history, the only way people could transmit information has been by speaking, listening, and remembering. Indeed, the capacity for speech and the connected capacities for learning and remembering might be thought of as the defining elements of human consciousness, shared perhaps with other, now extinct, members of the hominid lineage but not shared with any other existing species. Through speech, humans did more than coordinate cooperation necessary for individual and group survival; they transmitted knowledge. They taught new generations techniques

and ideas. They developed the ability to use abstract and theoretical thinking that allowed them to adapt to new circumstances. They created moral codes that regulated behavior between genders, between generations, between ranks, and between communities, and devised elaborate justifications for these codes. They speculated about the sublime question of the reason for the existence of it all and made up great cosmological explanations that usually placed humanity at the center of some sort of creation. For the vast majority of the at least 100,000 years that *Homo sapiens* has walked the earth (and perhaps longer if earlier hominid species had the power of speech), humans transmitted all of this orally. It would seem then that speaking and listening are the “natural” way humans learn.

Humans used several techniques to help them remember what they had learned. They created objects that served to remind them of the spirits that watched over them and needed succor. They made images of those that had gone before. They portrayed their fears on available rock surfaces. Perhaps most importantly, and in some ways seemingly universally, they used meter and rhyme in language, pitch and syncopation in sound, noises created by the ingenious noisemakers they devised, and the movement of bodies in time to music to remind them of what was important to know.

What they needed to know and to remember, though, changed over time. Humans learned to forget that which seemed no longer important. Knowledge flowed seamlessly from past to present, from the ancestors to the living, from God or the gods to the mortal. What was told always sought relevance with what the hearers of the words lived.

Sometime about five thousand years ago, in Mesopotamia and Egypt, some human societies began to use symbols etched in clay tablets, painted on papyrus scrolls, or carved into stone to record at first basic data. Eventually people developed the ability to use writing to capture the most complex of abstractions and the most beautiful of poetic expressions. Gradually literacy developed in other places and spread to still others. Almost everywhere it was associated with power. Those in power wielded the written word as one of the tools of domination. They determined what was truth, what was history, what God wanted people to do or be. While the struggles among the literate over these issues are the stuff of literate history, for most people knowledge continued to be transmitted orally. Even with the development of printing, the rise of mass literacy, and the spread of “universal” education, many elements of culture and community remain expressed primarily if not wholly in oral form. Especially among communities in some way or another disempowered by the apparatus of literate knowledge, oral tradition remains an important means of transmitting knowledge and maintaining social solidarity.

Oral Tradition

The introduction above sketches an expansive definition of oral tradition, using the term to refer to any form of knowledge transmitted in a regular way between generations verbally. This definition, while broad, does distinguish between oral tradition and oral history. Researchers (who need not be professional historians or scholars) elicit oral history by interviewing

informants. Oral history is information about the past that is spoken only in the context of personal memory. Generally, it includes life histories and personal recollections. It can include information told to an informant by others, such as parents. In the context of collecting oral histories, though, the research may also collect oral traditions.

While the expansive definition also allows for the existence of oral tradition in societies with literacy, oral traditions are usually associated with “preliterate” societies. In such societies, information can be passed on only through oral means. All known societies have oral texts that validate a moral order. Many have texts that depict the proper relationships between groups within a community and often with those outside a community. To the extent that social divisions exist, component groups often have their own form of traditions. In particular, women quite often have a distinctive body of oral texts circulated only among themselves. In addition to traditions that bind a community together, some types of traditions celebrate hierarchy and power. In particular, praise songs—panegyrics—not only signify power and prestige during the honoree’s lifetime but often become eulogies remembered long afterward. Finally, great narratives, epics, and sagas served to tell the story of heroes and founders, of creators and minions.

Even when literacy emerged and spread, knowledge often continued to be transmitted and developed orally. Only elites often had extensive literacy in large parts of the world for long periods of time. While they might codify the epics into scripture and history, oral traditions often remained alive as folk wisdom and oral literature. Sometimes, oral traditions served as ideological justifications for counterhegemonic movements among subject classes or communities. Often, a complex interplay developed between oral and literate traditions. Even after the rise and spread of mass literacy, oral tradition has continued to play an important role in helping create popular, folk, and subaltern identities; however, the interaction between oral and literate in those cases often becomes more intimate and immediate.

The broad definition of oral tradition used here does not deny that there are sharp differences between situations where the only means of transmission of information is through oral communication and those where oral transmission serves as a refuge for a group in some way marked different from the rest of society. This definition, though, sees the differences more in terms of genre and function, than in terms of oral and literate societies or oral and literate people.

Genres in Oral Literature

Scholars working with orally transmitted information have identified a number of broad genres. Scholars define the genres by both function and form. Not every society has each of the genres. Scholars often approach these genres as different types of oral literature (a seeming oxymoron that acknowledges the creative energy involved in the preparation of oral texts), so different are they in form and function. Genres of oral literature include epics and sagas, panegyrics, prose stories, lyric poems, ritual songs, and genealogies. While all transmit knowledge, the genres do have different but sometimes overlapping functions.

Epics and sagas. More narrow definitions of oral tradition often limit it to epics and sagas. Epics, defined by the use of poetics, and sagas, prose, serve as foundational texts for societies. They tell the stories of the culture heroes who create society, of the origins of civilized behavior, of the creation of heaven and earth and the people who populate it. Epics (used hereafter for convenience) sometimes tell history. Other times they reveal God's or the gods' design to humans.

Perhaps the epics best known to Western readers are the *Iliad* and the *Odyssey*, which date in their recorded form to about the eighth century B.C.E. Classical Greek authorities named a bard called Homer as their author. They exhibit, however, characteristics that define them as oral literature. They are recorded as verse with many elements of repetition. While they are historical, as opposed to sacral, they serve as foundation texts for ancient Greek ideas of civilization and culture. They focus on the deeds of "great men" and the ways the gods intervene in the affairs of people. The structure of the *Odyssey*—the plight of a "wanderer" and his spouse who must wait for him—follows a structure found in many other epics in other cultures and times. The question for these epics comes from their transcription. Were they the production of one or two authors who worked with oral literature but made the finished products their own (given, of course, the possibility of changes to the texts in later copies)? Or are the epics in their present form truly composite examples of oral literature in which no guiding author can be seen in form as well as narrative? Such debates have also animated scholars when they consider sacred texts such as parts of both the Old and New Testaments as well as texts from India and China. Clearly, many of these texts, for example the Torah or first five books of the Bible, began as oral literature, functioning as creation myths that define the proper relationship between God and humanity.

Understanding the nature of the question of authorship requires understanding oral traditions, and especially epics, not just as texts but as performances. Over the centuries since Homer and the codification of the Torah, records have come down on the transcription of oral performances and the preparation for them by performers. Each time the song is sung, the tale told, the epic performed, it changes. Bards often served as more than just entertainers. Telling the tale, singing the song involved making a link with the audience, and giving the audience what it came to hear or admonishing the audience for what it has failed to do.

Tellers and performers usually plan such variations in advance to make their point or curry favor with their audience. Jan Jansen tells of witnessing the preparations for the performance—which happens once every seven years—of the Sundiata epic of the Mande people at the shrine of Kamabolon at Kangaba in the Republic of Mali. The epic tells of the founding of the Malian empire in the fourteenth century. The Diabate griots, or bards, members of the clan that supplied Sundiata with his griot, perform the full epic in the sanctuary as it has a new roof placed on it by a newly initiated age group. The only others present in the sanctuary are members of the Kieta, or royal, clan of the old empire. Outsiders may not see or record the actual ceremony. Griots tell the epic itself throughout the

region, but the people hold the version told at Kangaba as the orthodox version, filled with secrets. Jansen, an outsider, attended the many practice sessions for the performance, as did almost anyone who wanted to. He reports that the griots debated quite intensely the wording and arrangement of the performance and the significance of its message. At the performance itself, Jansen noted that the griots cut it somewhat short. The performance, for a collection of royal clan members who had all heard it before, lacked the immediacy of the rehearsals, which featured the necessity both of working out the correct version of the epic among the professionals and of getting it right for the visitors who had come out of interest.

Even in cases where the performer is clearly subordinate to the intended audience, the performance of oral tradition creates a social persona for the performer. In most cases the performance creates society and social norms through linking people, communities, and institutions together. Whether the recitation of the Mansa Jigin, the Mande "gathering of kings," that confirms the centrality of the empire of Mali for the far-flung Mande peoples in diaspora all across West Africa (and in the early twenty-first century, New York and Paris), or the recital of a clan history at a funeral in central Tanzania by the heir to the deceased that recreates the ties of kinship and marriage linking people together across the region, oral traditions as performed generate community.

While epics and sagas are foundational documents akin to scripture in preliterate societies (and indeed scribes have sometimes converted them into scripture), they have component parts that bards stitch together (a direct translation from the ancient Greek of the bard's art). These components comprise some of the other genres of oral tradition. Bards can often recombine or condense or elaborate using these elements in the telling, combining them in different ways to fit audience and occasion. Taken as a whole, an epic is often no more than the most expansive collection of such components held together by the unity of theme and sometimes character.

Panegyrics. One of the most interesting and historic of these genres is the praise poem. This type of poetry, the panegyric, is found in a wide variety of societies. These poems are often composed for specific occasions, as happens among the Xhosa people of southern Africa. However, while the metaphors and similes used in them may sometimes be tropes of deep cultural significance, in particular cases praise poems become linked to particular historic figures, and hence become an important part of a culture's historic memory. The following quote comes from the praise poem of Shaka, the founder of the Zulu kingdom in South Africa in the early nineteenth century:

Shaka went and erected temporary huts
Between the Nsuze and the Thukela,
In the country of Nyanya son of Manzawane;
He ate up Mantondo son of Tazi,
He felt him tasteless and spat him out,
He devoured Sihayo.
He who came dancing on the hillside of the Phuthiles,
And he overcame Msikazi among the Ndimoshes.
He met a long line of hah-de-dahs [ibis birds]

When he was going to destroy the foolish Pongos;
Shaka did not raid herds of cattle,
He raided herds of buck. (Owomoyela, p. 15)

These lines tell of several of the peoples and rulers Shaka conquered. Praise poems can then become one of the building blocks of epics, but in many cases they themselves become the most important form of historic memory. Cases where the elements of oral tradition do not coalesce into epics are more common than those where they do.

Stories. Stories, whether called folktales, fables, or even oral history, often serve the function of oral tradition. People use them to impart moral lessons and to promote a feeling of group solidarity through a sense of common history. They can be told in formal situations, such as initiation rituals or informally, such as around the hearth. Stories often tell moral tales, and sometimes they use structures, plots, and motifs spread quite widely across different cultures. However, with the addition of appropriate cultural detail, they also can refer to very specific episodes in local historical memory. As tellers tell and retell the story, it changes to provide a community with an agreed-upon explanation for the topic of the story. For example, in central Tanzania among the Gogo people, elders tell a story of something they say happened during the most serious famine in their history during World War I. A group of people fled hunger in their village to seek food from the newly established British administration in the wake of the East African campaign. They received no food at the administrative headquarters nor from the merchants in the small town along the rail line. They decided to camp for the night in a dry gully under the railroad tracks before trying to find food again the next day. That night a rainstorm filled the gully, and they all drowned. This author collected twenty-five versions of this story from throughout the region in Tanzania. While some details varied, all but one agreed that it occurred sometime between 1917 and 1919. The one outlier came from an elder who had been a colonial-era chief. He said he had known the people to which this tragedy had occurred and that it had happened not during World War I but during a famine several years later. As he was adamant, knowledgeable, and could name names, this author believes the former chief's oral history is "true." But the oral tradition created by the people out of this event encapsulates a complete explanation of colonial rule in the region. The people were conquered and ruled by Europeans who fought among themselves during World War I and killed many. They were exploited by an ever expanding market economy. Given these disruptions to the social order, they were abandoned by the forces of nature that first brought drought and then killed them with too much rain. Hence, the story became part of an agreed-upon explanation for colonial rule, and in memory they moved it back in time to the worst famine of their history.

As with panegyrics, some societies stitch such stories together to form epics. Stories such as this, though, often stand alone; and many societies never develop full-blown epics. Groups within societies often have their own sets of stories that emphasize their own particular place within society and relationship to other groups in it. Often, for example, women

tell stories markedly different from those told by men, and they often tell them in contexts reserved for women alone. These stories, which may emphasize gender solidarity or debunk the claims made for well-known characters in other stories, are often labeled by men or other dominant groups as fables or as untrue. Just as much as stories told by men or dominant groups, though, they represent an agreed-upon explanation for why the world is the way that it is.

Ritual songs and lyric poetry. Songs and lyric poetry function much like stories in that they focus on particular events or situations. Like stories, they are sometimes historic but often fabulist. They change as bards and singers change them to fit audiences and circumstances. While they are often individual performances, groups can also perform them. The demands of meter and music impose a certain stability on them, especially those performed by groups. Work songs and ritual songs fall into this category. Work songs can consist sometimes of little more than a few lines repeated rhythmically for as long as the task lasts, but they can also impart moral or historic lessons. They can recall individuals or events associated with particular activities.

Ritual songs likewise can impart both historic and moral lessons. Songs performed at sacrifices, at celebrations of life passages, at healing rituals, at divining sessions all can serve the function of oral tradition. Songs or chants used in rituals can call upon historically important people or groups as intercessors with the divine. People often use music and dance to compliment the words of the songs. Dance in particular can act out, as well as act as a mnemonic device for, the story.

Genealogy. Genealogy is the final genre of oral tradition considered here. Genealogies quite literally link the past with the present by charting the ancestors to those still living. Genealogies usually contain more than mere lists of names. Tellers usually include both stories and praise poems for the ancestors as well as often detailed descriptions of relationships between different kin groups. Genealogies, like other forms of oral tradition, change as conditions change. In the long run, genealogies telescope with generations and relatives lost over time. Often, founders remain in the story, but the number of generations between the founder and the present may remain constant. Sometimes genealogies expand, as with king lists that proclaim consistently long reigns. Genealogies also often regularize relationships between generations, especially for holders of positions of authority. Usurpers become legitimate heirs. Inheritance through the female line gets changed to the male line in patrilineal societies and visa versa in matrilineal societies. Finally, genealogies in performance change to fit the circumstances. Social networks become embedded in genealogies as fictive kin relations. Such is the case in central Tanzania, where the principal heir recites the clan genealogy at a funeral. As with other genres, genealogies often make up an important part of epics, with bards stitching them into the narrative to highlight the proper relationship between groups.

The Modern Study of Oral Traditions

Over the course of the last two centuries, scholars have developed three distinct approaches to the study of oral traditions.

One, the oldest, sees oral traditions as “oral literature” or “folklore” and promotes analysis on literary and humanistic elements, often focusing on comparative analysis. The second sees oral traditions as expressions of cultural values and norms. Anthropologists, especially ethnographers, analyze such traditions as functional promoters of group solidarity or structuralist explanations for the workings of society. Scholars working in both of these approaches focus little on the historical veracity of traditions and sometimes argue they contain no historically valid information. Historians, particularly of preliterate societies, on the other hand, attempt to derive from oral traditions historically valid evidence. All three approaches complement one another. Understanding the cultural and historical context of an epic enriches the appreciation of it as literature. Ethnographic analysis requires historical grounding and an understanding of the importance of performance. Historical analysis must take into account both the performative aspects of oral tradition and the cultural structuring that occurs in it.

Two issues, however, often divide students of oral traditions. One is the perceived difference between oral and literate societies. Some scholars argue that literate societies promote entirely different ways of comprehending the world than do those without or with only limited literacy. Oral traditions transmit knowledge in metaphor and ahistorical essences. Critics of this approach maintain that it minimizes the creativity and logical ability of people in preliterate societies. The second main issue dividing scholars is the historical validity of oral traditions. Many suggest they have none, that oral traditions are so attuned to the present that all information about the past is structured beyond relevance. Other scholars argue that properly understood oral traditions do transmit historically valid evidence.

The first field that developed around what is now called oral traditions was that of folklore. Folklorists sought to collect oral texts both from societies perceived as nonliterate as well as from among marginalized groups in literate societies. In the nineteenth century the field became tied with the Romantic project of recovering the “true” culture of the nations of Europe. In its less politicized form, folklore turned to the comparative method, seeking to show relationships between epics and tales found in different parts of the world. Early folklorists tended to work in Western societies, although by the middle of the twentieth century many had begun to work with non-Western oral literatures, bringing their emphasis on textual analysis to oral literatures hitherto the domain of ethnographers.

Folklore studies became the study of oral literature as the works of Milman Parry and his student Alfred Lord dramatically transformed the field in the first half of the twentieth century. Parry and Lord collected epics and songs among the Muslims of Bosnia. Their work, most famously elaborated in Lord’s *Singer of Tales*, generally saw epics as literature composed in performance but based on a formula that used meter to string together episodes and clichés from a common fund of such tales. Each performance, then, is different, and performers do introduce innovation, often to fit a particular audience. Epics, however, retain a broad stability over long periods of time. Lord, in particular, used the *Iliad* and the *Odyssey* as models for epics, and the great questions they sought

to answer concerned the actual “authorship” of such epics. Later scholars, such as Walter Ong and Werner Kelber, brought this approach to biblical studies.

Later scholars have criticized this oral literature approach for emphasizing textual analysis over context. The explicitly comparative approach minimizes the cultural and historically specific circumstances that have called forth the production of oral literature. They have charged that the importance placed on the difference between orality and literacy in the remembrance and performance of oral literature reduces it to a “formula” that denies the creativity of performers and the ways in which oral historians generate their histories.

Anthropologists, especially those engaged in ethnography, have also long used oral traditions as sources for their analyses of cultures and societies. Like folklore, anthropology originated as the study of a phenomenon outside the perceived mainstream of “Western civilization” in the nineteenth century. It began as the study of “primitive” societies. During the twentieth century, it quickly evolved into the study of culture broadly defined. As such, ethnographies have continued to draw heavily on a variety of genres of oral traditions in their efforts to portray culture.

Like folklorists, anthropologists have deemphasized the historicity of oral traditions. They have seen them functionally as means of promoting group solidarity and defining social norms. As such, they have seen them as entirely flexible, altered to suit changing circumstances. By the 1960s, the work of Claude Lévi-Strauss came to dominate such views. His argument that much of culture itself, as well as the expressions that defined and underpinned it, was structurally determined led to such important studies as Luc de Heusch’s *The Drunken King*.

Starting in the late 1950s, the rise of new fields of historical studies led to a movement among historians to reevaluate oral sources for history. In particular, historians engaged in trying to recover a usable past for African societies, as nations on the continent began to emerge from colonialism, turned to oral traditions to recover a precolonial past often derided by colonial sources. Jan Vansina pioneered the collection of oral traditions, by which he meant mostly epics. In addition, the widespread epic tale of the founder of the kingdom of Mali, Sundiata, also attracted scholarly attention. The epic, performed by casted bards, *griots* in French or *jeli* in Mande, among many of the Mande-speaking peoples, tells of the founding of the empire in the thirteenth century and yet continues to be performed as a living oral tradition in the early twenty-first century.

Over the 1960s and 1970s, historians scoured Africa for oral traditions and produced works of incredible subtlety and incredible naïveté. While very few historians argued for the literalness of oral traditions as history, some took a more critical look at the context of the production of oral tradition than others. Ruth Finnegan, a leading folklorist, felt compelled to take historians to task for such naïveté. By the 1980s, historians had refined their approach to oral traditions. Some, such as David William Cohen, had moved close to a structuralist position. Vansina himself reworked his position on the

collection of traditions, and many of his students showcased their work in *The African Past Speaks*, edited by Joseph Miller. Many scholars focused on the range of ways that historical information passed from generation to generation and the uses to which it was put. Since many African societies lack epic traditions, scholars have learned to use historical anecdotes, songs, stories, and life histories in innovative ways to answer questions about the past. These innovations have gone on to inform oral historical approaches in other areas and general historical debates about popular memory and history.

Oral Traditions and the Modern World

In a narrow sense, the rise of mass literacy and its spread (although still incomplete) across the globe has transformed the role of oral traditions in society. Just as happened in ancient Greece around 800 B.C.E., so it has happened repeatedly that when an epic is reduced to writing, it ceases to change. Written versions, with their stability, become orthodox, canonical versions. Yet, to see the gradual decline in importance of oral epics as the end of oral tradition takes much too narrow a view of the importance of the field. In some places, epics retain important functions and continue to be performed. The descendants of the royal griots of Mali who perform the full epic of Sundiata in a ritual reroofing of his shrine every seven years remain adamant that only they know the full version and that the transcriptions made over the years by many writers and scholars are pale glosses on the fullness of the epic.

More to the point, oral traditions in many parts of the world, including many communities in Western, wealthy, and industrialized nations, remain vibrant ways of expressing group solidarity. Oral traditions in the form of stories and songs continue to circulate widely in many communities as alternative takes on the world and its workings. They often express counterhegemonic tendencies and sometimes focus on communalism. They exist in situations where literate and especially formal discourse is dominated by state power.

Oral traditions have served to place humanity in the universe and to explain the workings of the world to humanity. The narrative mode of explanation embodied in the epic is a big part of what makes us human. But also the other genres of oral literature—the song, the riddle, the praise poem, the proverb, the genealogy—help delineate social relationships that define human society. Oral tradition remains the most immediate, the most “natural” way for humans to bring past and present together.

See also *Genre; Language, Linguistics, and Literacy; Reading.*

BIBLIOGRAPHY

- Cohen, David William. “The Undefining of Oral Tradition.” *Ethnohistory* 36, no. 1 (1989): 9–18.
- Finnegan, Ruth H. *Oral Literature in Africa*. London: Clarendon, 1970.
- Heusch, Luc de. *The Drunken King; Or, The Origin of the State*. Translated by Roy Willis. Bloomington: Indiana University Press, 1982.
- Jansen, Jan. “Hot Issues: The 1997 Kamabolon Ceremony in Kangaba (Mali).” *African Studies Review* 31, no. 2 (1997): 253–278.

Kelber, Werner H. *The Oral and the Written Gospel: The Hermeneutics of Speaking and Writing in the Synoptic Tradition, Mark, Paul, and Q*. Philadelphia: Fortress, 1983.

Lord, Albert. *The Singer of Tales*. 2nd ed. Cambridge, Mass.: Harvard University Press, 2000.

Miller, Joseph, ed. *The African Past Speaks: Essays on Oral Tradition and History*. Hamden, Conn.: Archon, 1980.

Owomoyela, Oyekan. *African Literatures: An Introduction*. Waltham, Mass.: Crossroads Press, 1979.

Scheub, Harold. “A Review of African Oral Traditions and Literature.” *African Studies Review* 28, no. 2/3 (1985): 1–72.

Tonkin, Elizabeth. *Narrating Our Pasts: The Social Construction of Oral History*. Cambridge, U.K.: Cambridge University Press, 1992.

Vail, Leroy, and Landeg White. *Power and the Praise Poem: Southern African Voices in History*. Charlottesville: University Press of Virginia, 1991.

Vansina, Jan. *Oral Tradition: A Study in Historical Methodology*. Translated by H. M. Wright. Chicago: Aldine, 1965.

———. *Oral Tradition as History*. Madison: University of Wisconsin Press, 1985.

Gregory H. Maddox

ORGANICISM. Organicism refers to the idea that some object or entity shares an important property or quality in common with a living or animate being. It is related to, although remains distinct from, holism, in the sense that organicist doctrines tend to uphold the view that the living creature is an integrated whole containing precisely the range and number of parts necessary for the maintenance of its existence and for its flourishing. Hence, organicism is closely aligned with the concept of “organic unity.” Organicism enjoys a long intellectual history in a number of fields of endeavor, including metaphysics and logic, aesthetics, theology, and social and political thought. While perhaps most fully articulated by Western thinkers, organic ideas seem to have a global purchase.

Logic and Metaphysics

Plato’s (c. 428–348 or 347 B.C.E.) metaphysical theories constitute an important starting place for organicism in the West. In the *Philebus*, he examined the problem of “how the one can be many, and the many one,” that is, the ways in which diversity comports with unity. The Platonic doctrine of the Forms, as presented in the *Republic*, constituted one such solution. Even when Plato later criticized the failings of his own metaphysical teachings, as in the *Theaetetus*, he remained committed to the principle that the totality is greater than the sum of its parts.

Aristotle (384–322 B.C.E.), in turn, rendered organicist doctrine a precept of logic by asserting that the whole is prior to its parts because it is only possible to conceive of the parts qua parts once one has grasped the whole. Hence, Aristotle maintained that the analysis of any organic unity requires a “decompositional” method that commences with the whole and then dissolves it into its constituent parts precisely in order to discover the contribution that each element makes to the totality. One finds applications of this logical method

throughout the Aristotelian corpus, including his metaphysics, aesthetics, politics, and natural philosophy.

Organicist metaphysics thus stands in stark contrast to metaphysical atomism. The organicist believes that some inhering force—the Good, *telos*—unites beings into a single Being and therefore that apparent clashes or disparities between opposites are entirely illusory. The neo-Platonic doctrine of a concordance or coincidence of opposites follows an organicist track, as does Hegelian dialectical logic.

Aesthetics

While the idea that a work of art was an organic unity whose very “beauty” was constituted by its totality can be traced back to the ancient Greeks (for example, Aristotle’s *Poetics*), this idea enjoyed its culmination in the modern world, especially among the Romantics. Johann Gottfried von Herder (1744–1803) emphasized the idea of an “inner form” that animated a poetic work, a precept that he applied, for instance, to Shakespearean drama. Herder’s disciple, Johann Wolfgang von Goethe (1749–1832), soon adapted his insight. The *Critique of Judgment* (1790) by Immanuel Kant (1724–1804) developed more broadly and explicitly the analogy between a work of art and a living creature, which was developed by German Romantics such as Friedrich Wilhelm Joseph von Schelling (1775–1854) and Friedrich von Schlegel (1772–1829). Georg Wilhelm Friedrich Hegel (1770–1831) declared in his *Lectures on Aesthetics* (posthumously published in 1835) that genuine art required “self-enclosed completion” to be judged beautiful.

The most influential English critics expounded similar doctrines. Samuel Taylor Coleridge (1772–1834) proclaimed that the principle of “unity in multiplicity” constituted the essential feature in human imagination. That is, the genius of imagination was to draw together disparate and even contrary elements into a single, unified, seamless whole. William Blake (1757–1827) seconded this organicist aesthetics, and it was restated regularly by the English as well as Italian schools of neo-Hegelian philosophy of the late nineteenth and early twentieth centuries, represented by figures such as Bernard Bosanquet (1848–1923) and Benedetto Croce (1866–1952).

Theology and Cosmology

Many of the world’s religions and philosophies have regarded the universe as possessing an organic unity as a macrocosm of a living body. For example, Hinduism, Sufism, the Russian philosophy of All-Unity, and numerous strains of Christianity (especially those of a mystical or neo-Platonic bent) display organicist tendencies by viewing the world as a collection of diverse beings that nevertheless possesses an integral unity. In this way, human beings may connect with God by submitting to the purposes found in the larger order of the cosmos; divinity is found in all things and orders diversity.

Perhaps the most controversial example of organic unity within the frame of religion is the Christian doctrine of the Trinity, that is, the idea that God is Three-in-One. Debates about the trinitarian character of divinity have long raged among theologians, who have been repeatedly challenged to explain how God can be composed of a single substance if He

is also three different and distinct beings. (Adherents to more strictly monotheistic doctrines, including Jews and Muslims as well as unitarian Christians, have found this teaching absurd or even polytheistic.) Some version of organicism has afforded trinitarian theologians a way to explain the three-fold yet single nature of God.

Social and Political Thought

Perhaps the most common expression of organicism on a global scale is the analogy between the living body (human or animal) and human community. The so-called metaphor of the body politic may be found in a number of ancient sources, including Asian works such as the *Analecets* of Confucius (551–479 B.C.E.) and the *Arthashastra* of Kautilya (fl. 300 B.C.E.). In all cases, the aim of authors in deploying the analogy is to move beyond a strict hierarchical system of subordination and rule in social relations and to proclaim a principle of “reciprocity.” A reciprocal relation connotes a natural self-regulating harmony or balance between the parts of the organism that aims at a higher goal such as justice within, or the material welfare of, the whole. Thus, the common tendency to equate organic theories of society with hierarchy *per se* is misinformed, although some conceptions of the body politic are stridently hierarchical.

In Western thought, the origins of the body politic can again be traced back to Greece and Rome in the writings of Plato, Aristotle, Cicero, and others. It was during the Latin Middle Ages, however, that the organic metaphor for society became commonplace. In its earliest expression, and perhaps under the influence of Plato’s *Timaeus*, medieval society was divided into a three-fold yet unified functional order of those who fight, those who work, and those who pray. This was later replaced by a more self-consciously organic doctrine, the most influential exponent of which was John of Salisbury (1115 or 1120–1180). His *Policraticus* (completed 1159) contained an extensive account of how each of the organs and limbs of the human body—from the head to the toes—had a direct counterpart in society, from the king all the way down to the peasants and artisans. John’s depiction of the organic community was widely disseminated and repeated by philosophers and political commentators, although many different implications (including surprisingly egalitarian ones) were drawn from it. In 1406, Christine de Pisan (1364–c. 1430) became the earliest author to construct an entire political treatise, *Le Livre du corps de policie* (*The Book of the Body Politic*), around the analogy. Christine made a special point of including advice even to the humblest of subjects—artisans and peasants—that explicitly demonstrated her respect for their contributions to the social whole.

Decline of Organicism

The rise of modern scientific thought and of moral and political individualism profoundly challenged and damaged the organicist outlook. The tendency to consider nature in mechanistic and evolutionary terms devalues the distinctively organic and purposive character of biological creatures, as does the emphasis on the individual as the building block of social institutions. Organicism has been conflated with methodological holism in

logic and metaphysics or, worse still, with collectivism and authoritarianism in politics. Likewise, poststructuralism and other twentieth-century movements in criticism disputed the very uniqueness of the work of art as a cultural form distinct from its surroundings. Still, the popular invocation of phrases such as “body politic” suggests that the inclination to conceive of diversified unities in organicist terms has not completely disappeared from the intellectual stage.

See also *Logic; Metaphysics; Philosophy; Society*.

BIBLIOGRAPHY

- Abrams, M. H. *The Mirror and the Lamp: Romantic Theory and the Critical Tradition*. New York: Oxford University Press, 1953.
- Constable, Giles. *Three Studies in Medieval Religious and Social Thought*. Cambridge, U.K.: Cambridge University Press, 1995.
- Feher, Michael, with Ramona Naddaff and Nadia Tazi, eds. *Fragments for a History of the Human Body*. 3 vols. New York: Zone, 1989.
- Struve, Tilman. *Die Entwicklung der organologischen Staatsauffassung im Mittelalter*. Stuttgart, Germany: Hiersemann, 1978.

Cary J. Nederman

ORIENTALISM.

This entry includes two subentries:

Overview

African and Black Orientalism

OVERVIEW

The Arab-American political activist and professor of European literature Edward Said (1935–2003) durably redefined the term *Orientalism* with the publication in 1978 of his book by the same name. Before Said’s book, Orientalism had two distinct meanings. Both were politically neutral and marginal to the central concerns of the humanities and social sciences. After Said’s *Orientalism*, these two meanings have been collapsed into one that is highly charged politically and central to contemporary debates in the humanities and social sciences, while at the same time covering a smaller historical span than either of the two earlier meanings of the term.

One of the older meanings was the presence of motifs, themes, subjects, or allusions in the music, art, or literature of the Western world that were borrowed from, or meant to evoke or represent, the Orient. For the purpose of these artistic trends, the Orient meant, effectively, the lands immediately to the East and South of Europe: the Ottoman Empire (which included much of Southeast Europe), North Africa, the Arab lands, Iran, and Islamic Central Asia. While these lands have been in recent centuries the core of the Islamic world, Orientalist artists and writers did not separate the Islamic from the earlier ancient Orient in their imaginative constructions. And their interests could run from the current affairs of their own times to far earlier periods. Hence, Gustave Flaubert (1821–1880) wrote of nineteenth-century Egypt in his travel literature, but set his

novel *Salammbô* in ancient Carthage. Similarly, the painter Eugene Delacroix (1798–1863) could exploit the same imagery to portray current events such as the Greek revolt (like most Romantics, he took the Greek, anti-Turkish, side) or the death of the ancient Assyrian ruler, Sardanapalus.

Oriental elements played several important roles in European creative arts. Musicians from Ludwig van Beethoven (1770–1827) and Charles Camille Saint-Saëns (1835–1921) to Nikolai Andreevich Rimsky-Korsakov (1844–1908) and Mikhail Mikhaylovich Ipolatov-Ivanov (1859–1935) borrowed instrumentation or characteristic modes. Writers introduced Oriental tales and settings to create exoticism and/or to gain critical distance from European mores and institutions (for example, the work of Voltaire [1694–1778] and Montesquieu [1689–1755]). Painters sought dramatic exotic subjects, different light, and often also the titillation of harem scenes. But such erotic exploitations were also made of classical antiquity.

The second meaning of Orientalism was the scholarly study, in the West, of the Orient. Scholarly Orientalism was based upon the study of ancient languages, other than Greek and Latin and their modern descendants. This meant Hebrew and the other Semitic languages, including Arabic, as well as Ancient Egyptian and Coptic (along with Assyriology) and eventually Persian and Turkish in their various historical manifestations. Methodologically, such Oriental studies were the extension of Classical studies. Philology was the queen of the sciences and the critical edition carried pride of place among scholarly achievements.

As a scholarly endeavor, Orientalism was pursued in a variety of European countries, as well as the United States. While scholars in some countries were naturally drawn to areas of local interest (for example, Spaniards in the Muslim domination of the Iberian peninsula, Italians in the Muslim occupation of Sicily), the most important sources of Orientalist scholarship were Britain, France, and Germany (with an important U.S. role beginning after World War II). Of these countries, Germany was for many years the most important (and of the three, the most influential in the development of American Orientalism), in line with the general leadership role of German scholarship in the West in the nineteenth and early twentieth centuries.

For most of the years preceding Said, the Middle Eastern response to scholarly Orientalism was mixed, but low-key. Archaeologists were considered in most quarters to be treasure hunters, especially as markets in antiquities (black and otherwise) continued to parallel archeological activities. There was also a widespread suspicion, not always misplaced, that Western scholars in the region were spies for their governments. Yet, despite this, Orientalists were always well down on the list of suspicious foreigners, preceded, for example, by missionaries, Zionists, and the more formal actors of military, political, and economic imperialism. There have always been many in the region who have openly collaborated in the Western scholarly enterprise. Middle Eastern scholars even attended European Oriental congresses at the turn of the twentieth century. Some among Middle Eastern educated elites were

flattered by Western attention to their culture, some bemused, and most indifferent.

The attitudes of Western scholars to the imperialism that characterized so much of the nineteenth and twentieth centuries were also mixed. A few supported it, but many opposed it, taking the sides of the peoples they studied. Among cultural Orientalists, many Romantics (and some socialists such as the followers of Comte de Saint-Simon [1760–1825]) sought a strong East whose powerful spirituality could balance what they saw as the overly materialistic West.

Said conflated the two earlier meanings of Orientalism while associating the new amalgam with Western imperialism in the lands of Islam. For Said, both the cultural Orientalism of artists and writers and the scholarly study of the Middle East were separate facets of the same phenomenon: a hegemonic Western vision of the Islamic world. This vision was not a reflection, however distorted, of a Middle Eastern reality. Instead, it was an entirely Western construct reflecting Western fears and appetites in association with Western imperialism, which it both aided and benefited from. The usefulness of Orientalist knowledge to imperialism was based in its essentials not on the accuracy of practical information but on the notion of Western strength, activity, and superiority contrasted with Oriental weakness and passivity.

The thesis of Orientalism as the handmaiden of imperialism (or the other way around) was reinforced by Said's decision to ignore German scholarship and concentrate instead on British and French and, later, American production. If such a choice does not fit the history of scholarly Orientalism, it fits well the cultural marks that European imperialism left on the Arab world. A knowledge of English or French (and sometimes both) is common among the more Westernized members of the Arab intelligentsia. Many are those (such as Said himself) who received their instruction in French- or English-language schools in the region. German is rarely found outside of Turkey.

The same can be said of Said's choice of epochs. For scholarly Orientalism, the connection with the Ancient Near East was crucial. Arabic and Hebrew were studied together under the intellectual canopy of Comparative Semitics. Not only philologists but also anthropologists thought that studying the Arabs could help them understand the Hebrews of the Bible. In *Orientalism* as well as subsequent writings, Said concentrated on Western attitudes to the region in its Arab and Islamic periods. This, too, reflects cultural politics on the ground. Popular attitudes as well as the dominant political movements have almost always based their sense of identity on the region as it was remade by the great Arab Islamic military (and only later cultural) expansion of the seventh century. This is as true of the Arab nationalism whose influence is waning at the turn of the twenty-first century as it is of the Islamic revivalism simultaneously in the ascendant.

Interest in the pre-Islamic world has virtually no popular existence and is confined to relatively marginal branches of the Westernized intelligentsia and occasional clumsy manipulation by authoritarian governments. It should be noted that during

the heyday of imperialism, local participation in the study of the pre-Islamic East was not always encouraged, although since independence in the mid-twentieth century the situation has been completely reversed.

Focusing on the Arab-Islamic periods and especially on the period of Western imperialism supports the political claims of both Arab nationalists and Islamic revivalists. Attention to the period before the rise of Islam has the opposite effect, and instead could carry grist to the mill of Zionists, since it is on ancient history that the latter base their historical claims.

Said's insistence on the hegemonic implications of intellectual and cultural discourses harks back to Antonio Gramsci (1891–1937). But both the Arab-American professor's focus on discursive practices and their association with power, and his identification of a virtual episteme whose essence remains unchanging while its forms vary superficially, show the influence of Michel Foucault (1926–1984). One difference is that Foucault wrote of the invention of the human sciences while Said treated only a specific application, that of one civilization's vision of another. A second difference would be that in several of his most famous works, Foucault specifically linked intellectual discourses with institutional practices (for example, in medicine and penology). Said, by contrast, leaves the relationship between cultural discourses and specific imperialist practices unarticulated.

As cultural politics, Said's *Orientalism* brought together Zhdanovism, *tiers-mondisme*, and American multiculturalism. Zhdanovism, or intellectual Stalinism, is the extreme version of intellectual engagement. It argues that knowledge must be judged according to whether or not it serves the political interests of the forces of historical progress. In the original version, this meant the interests of the proletariat as confounded with those of the Communist movement and the Soviet Union. Said makes no such bald claim, but his assumption that Orientalist knowledge is vitiated by its association with imperialism, along with his complaint that such scholarship did not represent the historical aspirations of the peoples of the Middle East, leads to Zhdanovist conclusions. And this is certainly how his followers have applied Said's work. *Tiers-mondisme*, as associated for example with the work of Frantz Fanon (1925–1961), substituted the third world for the proletariat of advanced industrial societies as the carrier of historical progress, turning Western imperialism and resistance to it from relatively marginal events to the center of the story of the emancipation of humanity. As an academic practice, American multiculturalism redefines scholarly domains by the ethnic or other identity groups considered the subject of study. At the same time, academic multiculturalism stresses the distinct experiential knowledge of members of the group, implying that they should have a dominant, for some even exclusive, role in the study and teaching of these newly defined subjects. Multiculturalism then intersects with social policy as it blurs the distinction between diversity in the faculty and diversity in the curriculum.

Most reviewers of *Orientalism* found the work to be seriously damaged by errors that showed its general ignorance of the Middle East and scholarship on it. This was even true of reviewers who sympathized with Said's political positions on

the Middle East. Many also called attention to his tendentious arguments and highly debatable interpretive leaps. Yet despite these reviews, Said's extraordinarily dense prose, and his thinly stretched reasonings, *Orientalism* was an international best-seller. It has been translated into numerous languages and made of Said the best-known professor of English in the United States and one of the most influential academics on the world scene. In the field of Middle East studies, his impact was dramatic. Never, it would appear, has a long-established episteme been so swiftly overthrown, or at least never have so many run away from it so quickly. Orientalism became a dirty word. The international Orientalist congress even changed its name.

When Said's book appeared in 1978, Middle East studies in the United States, and to a lesser degree in Europe, was already at a turning point. The old philologically based Orientalism was ceding leadership to the new area studies paradigm supported by massive U.S. government post-Sputnik Cold War expenditures. If the old Orientalism favored ancient and medieval civilizations with their classical languages, the new area studies favored the imperial and post-imperial world while deemphasizing language knowledge. Institutionally, the rivalry was reflected in competition between the American Oriental Society, for the old school, and the Middle East Studies Association, for the new. In this environment, it was relatively easy for the area studies specialists to claim distinction from the Orientalists. And this despite the fact that Said was careful to include the new area studies in his condemnation.

The triumph of anti-Orientalist sentiment operated dialectically with other trends. The European-trained immigrants who founded American Orientalism after World War II largely failed to reproduce themselves. Some circles in the old Orientalism discouraged the participation of natives of the region. New waves of professors came less and less from the old classical languages mode. Increasingly, they were immigrants from the Middle East, aided by the contemporary cult of native-speaker language teachers. Or these professors were Peace Corps veterans who had fallen in love with their country of assignment (especially with Iran), and often with one of its citizens. Such experts were naturally more sympathetic to the political interests of the region they studied. In this, they reflected most area studies in which, with the pointed exception of Communist Eastern Europe, practitioners identified with the causes of chosen regions and were often sharply critical of U.S. government policy. Just as French *tiers-mondisme* was in many ways a reflection of the brutal and divisive Algerian War, American anti-Orientalism was nourished by the sequels of the Vietnam trauma. American elites after the civil rights movement were justifiably sensitive to any charge of racism, and anti-racism became a leading value in American academic circles. This is one of the reasons why anti-Orientalism has had a deeper impact on American scholarly production than that in Europe, despite the latter continent's history of direct imperial administration of the Middle East.

Said's public, and courageous, political assumption of his Palestinian identity and his outspoken defense of the Palestinian cause also strengthened the reception of his ideas. Few knew in those early years that Said grew up in comfortable

circumstances in Alexandria, Egypt, studied in English language schools such as the prestigious Victoria College, and was not at home in the language of his ancestors. The 1980s and 1990s also saw intellectual and academic sentiment in the United States, originally sympathetic to Israel, become increasingly critical of the Jewish state and concerned with the plight of the Palestinians.

Said's intellectual influence was apparent among graduate students in the early 1980s. Those who taught in those years remember the earnest objections to any comments or materials that seemed to cast the Middle East or its peoples in an unflattering light. A number of ideas, based upon Said, became common currency among students who later became professors. Generalizations about the region were vulnerable to opposite critiques. Applying a Western model to the Middle East was Eurocentric. Creating a distinct model for the region was censured as the fabrication of an Oriental essence. Critics who were ignorant of the history of their field of study, or who doubted the cultural and economic reality of the Islamic Middle East, argued that Orientalism (or Middle East studies) was the only field that had created its own object of research before describing it. Charges of reification and reductionism fell like rain.

The intellectual fracas around Orientalism played to predilections in the American academic market, especially the national reluctance to learn foreign languages. A movement dedicated to fighting Western arrogance has had the paradoxical effect of restricting knowledge. The Orientalists were language buffs and commonly worked in more than one Near Eastern language and half a dozen European ones. Their successors do not often have a command of more than one Near Eastern language, and regular use of more than one European language (other than English) is rare. At the same time, the scholarly study of the Western image of the Orient has blossomed from a minor subfield of English or French literary studies into a central area of inquiry, even among scholars of Middle East studies for whom such topics are politically safer and linguistically easier. The unflattering examination of images of the Arabs and the Middle East in American popular culture also flourished. Paradoxically, the Orientalism controversy has shifted relative attention from the region and back to an American society obsessed with identity politics.

But the impact of Professor Said and the *Orientalism* paradigm has gone far beyond Middle Eastern or other Oriental studies. Among scholars of English—and to a lesser degree of other European—literatures, Said was a major if not the most important force behind a shift in emphasis in literary studies. To his supporters, this was a salutary move from formal literary-textual properties to historical situations of creation and reception, from aesthetic interests to political ones. To its critics, this trend represents a license for writing on history and politics by scholars who have neither the background, training, nor methodological awareness provided by the disciplines of history and political science.

Knocking Orientalism off its academic pedestal also led to the creation of a self-consciously new academic subfield: post-colonial studies. Though some historians and anthropologists

have adopted this model, its major intellectual home remains departments of English and, to a lesser extent, those newly created departments and programs of Cultural Studies. The area treated by postcolonial studies is for the most part coterminous with the domain previously assigned to Third-World Studies. The greatest novelty of postcolonial studies is a relative shift of emphasis. On the one hand, by constantly referring to the post-colony, this approach deemphasizes both the earlier precolonial history of the societies in question and the differences in the nature of the imperial impact on different cultures. Postcolonialism emphasizes relations between the colony and the metropole, making imperialism the most important factor in the history of non-Western peoples, just as the term colony expresses the greatest degree of imperial subjugation. At the same time, postcolonial studies have highlighted the increasing interpenetration of Third World and First World societies associated with globalization. Said is generally credited as the godfather of postcolonial studies.

Events of September 2001 inaugurated a new phase in the evolution of Middle Eastern studies in the United States and at the same time in the debate over Orientalism. These 2001 phenomena have done so by accelerating trends already present. The better-known event was the terrorist attacks on New York and Washington, D.C. on September 11, 2001, carried out in the name of Islam. But only a few days before, an international conference against racism that took place in Durban, South Africa, inaugurated a new member into the club of social evils: Islamophobia. As an irrational fear of Islam, or even just a fear of Islam, Islamophobia is the progeny of Said's *Orientalism*.

But the attacks of September 11 were also the most violent expression of larger trends in the Middle East. The popularity of Said and of his works among the relatively secularized branches of the Middle East intelligentsia has masked the fact that the positions championed by Said—cultural openness and progressive politics combined with vigorous anti-imperialism and anti-Zionism—have lost ground to a frequently reactionary Islamic revival in religion and politics. Middle East experts did pay some attention to this trend, but they tended to underestimate its importance, its reactionary nature, and its capacity for violence. Ironically, this underestimation was at least partly caused by the effects of the Orientalism controversy. On the one hand, scholars were reluctant to broadcast bad news from the region. On the other hand, the attack on the Orientalists discredited, by association, everything they stood for. This included knowledge of the more classical forms of Arabic. Said's work accelerated the trend, already present in area studies, to shift Arabic instruction in American and European universities from the more classical to the more modern versions of the language, sometimes going so far as to seek to replace the modern literary idiom (which is universal for the region) with instruction in the local spoken dialects.

And yet the classical form of Arabic has been the preferred medium, in some ways the cultural signature, of the Islamic revival. The twenty-first century's Islamists and Jihadists use classical formulations and quote medieval sources and examples with great frequency. This goes well beyond the citation of the Koran and hadiths (the sayings and actions of the

Prophet Muhammad) to include medieval theologians, commentators, and historians. Academic Middle Eastern studies in the West was moving away from the classical idiom at the precise moment when the Arabs were returning to it.

The September 11 attacks reversed this trend by creating a new model for Middle Eastern studies, the institute or department of Islamic Studies. Increased public demand for knowledge on this now apparently important subject has been met with increased supply as both Muslim governments and Islamic groups in the United States have combined to support new university positions. This trend, when added to the slightly earlier expansion of Jewish studies, has further strengthened the identity-based nature of American university scholarship on the Middle East.

In the wake of September 11, American media, both popular and elite, are engaged in a debate about the nature of Islam and its role in the modern world. Is Islam a religion of peace? Or one that advocates holy war? Did the terrorists hijack a religion or merely express one of its options? Are those who criticize Islamic movements, institutions, or leadership echoing a long-held Western prejudice based on ignorance? Are fears of Muslims as potential terrorists in the United States prudence or prejudice? Would airport profiling or selective immigration rules be part of American racism? Are Arabs in America subject to discrimination as people of color? All these debates come back to the fundamental issue of Orientalism, as redefined by Said—a deeply held Western prejudice against the East, serving imperialist causes. In this way, the controversy over Orientalism continues, though the word itself has almost disappeared, victim of the political success of its critics.

See also Ethnocentrism; Eurocentrism; Occidentalism; Orientalism: African and Black Orientalism; Other, The, European Views of.

BIBLIOGRAPHY

- "After the Last Sky: The Humanism of Edward Said." *Intersections: The Near Eastern Center Newsletter of The G.E. Von Grunbaum Center for Near Eastern Studies, University of California, Los Angeles* XXIV, no. 2 (2004).
- Charnay, J. P. *Les Contre-Orients, ou, Comment penser l'Autre selon soi*. Paris: Sindbad, 1980.
- Fanon, Frantz. *Les damnés de la terre*. Paris: François Maspéro, 1961. Translated into English as *The Wretched of the Earth*.
- Foucault, Michel. *Les mots et les choses, une archéologie des sciences humaines*. Paris: Gallimard, 1966.
- . *Surveiller et punir: Naissance de la prison*. Paris: Gallimard, 1975.
- Lewis, Bernard, Edmund Leites, and Margaret Case, eds. *As Others See Us: Mutual Perceptions, East and West*. New York: International Society for the Comparative Study of Civilizations, 1985.
- "L'Orientalisme, Interrogations." Special issue. *Peuples Méditerranéens/Mediterranean Peoples* 50 (1990): entire issue.
- Malti-Douglas, Fedwa. "Dangerous Crossings: Gender and Criticism in Arabic Literary Studies." In *Borderwork: Feminist Engagements with Comparative Literature*, edited by Margaret R. Higonnet. Ithaca, N.Y.: Cornell University Press, 1994.
- . "Re-orienting Orientalism." *Virginia Quarterly Review* 55, no. 4 (1979): 724–733.

- Rodinson, Maxime. *La fascination de l'Islam*. Paris: F. Maspéro, 1980.
- Said, Edward W. *Covering Islam: How the Media and the Experts Determine How We See the Rest of the World*. New York: Pantheon, 1981.
- . *Orientalism*. New York: Pantheon, 1978.
- Shaheen, Jack G. *The TV Arab*. Bowling Green, Ohio: Bowling Green State University Popular Press, 1984.
- Tidrick, Kathryn. *Heart-Beguiling Araby*. Cambridge, U.K.: Cambridge University Press, 1981.

Allen Douglas
Fedwa Malti-Douglas

AFRICAN AND BLACK ORIENTALISM

Edward Said's 1978 book, *Orientalism*, is the harshest critique to date of Western scholarship on the Muslim orient. However, its focus is almost exclusively on the Near and Middle East. The policy statements of William Ponty, the French governor-general in Senegal (1907–1915), quoted below suggest a link between Orientalism, as understood by Edward Said, and colonial scholarship on Muslim societies in sub-Saharan Africa.

It is our duty to study the Muslim society of our colonies in the minutest details. . . . It presupposes special studies of Islam which the great Orientalists of France and of Europe have now virtually succeeded in establishing. . . . [The study] will seem very attractive to many because of the scientific interest attached to it. But above all it is interesting for political and administrative reasons. It is almost impossible to administer an Islamic people wisely, if one does not understand its religious faith, its judicial system and its social organization, which are all intimately connected and are strongly influenced by the Coran [*sic*] and the prophetic tradition. It is this understanding of native society which, alone, will enable a peaceful and profound action on the minds of the people. It is, therefore, in this study . . . that we will find the surest bases and the most suitable directions for our Muslim policy. (Harrison, p. 107)

Writings such as these have prompted scholars to explore the links between Orientalism and European-language scholarship on Africa, produced notably during the colonial period.

Africa and European Colonial Scholarship

European governments commissioned much of Western scholarship on African Muslim societies produced in the colonial period. The most influential writers on African Islam were scholar-administrators, or at least closely linked with colonial administrations. Britain, Germany, Holland, and France commissioned the most respected specialists on Islam to study the Muslim societies that were coming under their rule. The scholarship therefore studied Islam as a focus of resistance to colonial rule. Sometimes the scholars sought to justify the colonial undertaking.

For example, the writer of the apology of British occupation of Northern Nigeria, *A Tropical Dependency* (1905), was

Flora Shaw, the colonial correspondent for the London *Times*, who eventually married Lord Lugard, the first high commissioner of the British protectorate of Nigeria. Lady Lugard argued that African Islam had lost its initial grandeur and had betrayed its own ideals. Britain could, therefore, no longer ignore her historic responsibility to take over.

An anthology of works on African Islam by colonial-administrators would be encyclopedic. François Clozel, Maurice Delafosse, Jules Brévié and Paul Marty, Lady Lugard, Christiaan Snouck Hurgronje, and C.-H. Becker, to name a few, all adapted their writings for use by the colonial establishments that they served. Other scholars, such as Edward Wilmot Blyden, were missionaries, who by and large saw Islam either as an obstacle in their bid to Christianize Africa or else as a temporary and intermediary stage in the black African's journey from "paganism" to Christianity.

The image of African Islam that emerges from these writings is not consistent. Islam is revolutionary; it is fatalistic. It is misogynist; it elevates the status of the African woman. It is egalitarian; it allows a small clique of religious men (*marabouts*) to live at the expense of their gullible followers. All these perceptions and more had a lot to do with the concrete experiences of the scholars, the diversity of the societies studied, and the changing priorities and political landscapes of the colonizing countries. In consonance with the essentialism that Edward Said decries, writers tended to explain the behaviors of individuals and communities by evoking the single, universal, and unchanging reality of their being Islamic.

Not all of the images about African Muslim societies in colonial scholarship are, therefore, negative. Moreover, one has to acknowledge the great contributions made by some of the Orientalists to our knowledge of the societies they studied. For example, it was Octave Houdas, a French Orientalist, who studied and translated into French, over a hundred years ago, two of the most significant histories of West Africa, the *Tarikh el-Fettach* and the *Tarikh es-Soudan*. He was aided in this by Maurice Delafosse, a French linguist and ethnologist, who also a French colonial administrator. It is the view of some modern commentators that many of the Orientalist approaches to African Islam have been carried over into contemporary scholarship on Africa and African literature.

Orientalism, African Literature, and Criticism

George Lang is likely one of the first scholars to draw attention to Orientalist features in European-language African writing. Lang explores the effects of the reductions of Islam's complexity upon Africanist writing. The denial of the complexity of Islam impedes the understanding not just of Islam but of Africa. In the area of literary criticism, very frequently one or other dimension of Islam is either missed by Western critics or cast out of context. This also leads to significant misinterpretations of African novels of Islamic inspiration. Similar arguments are developed in Ahmed Bangura's book *Islam and the West African Novel: The Politics of Representation* (2000).

Edris Makward acknowledges a new shift in the African novel from a linguistic (English-French) to a religious polarity

based on writers' attitudes to Islam. The thought was impressed upon him by an address given in 1979 by Wole Soyinka in which Soyinka praises Sembène Ousmane, a Senegalese writer, for being critical of Islam in his work while denying Cheikh Hamidou Kane, another Senegalese writer, the merit of authenticity for depicting Islam as part of Senegal's heritage rather than as an alien religion that was imposed through violence and other coercive means.

Similarly, in the early 1990s Ali Mazrui and Wole Soyinka were locked in a debate pertaining partly to the question of African authenticity and the Islamic factor. Ali Mazrui wrote the article "Wole Soyinka as a Television Critic: A Parable of Deception" in response to Soyinka's negative critique in *Index to Censorship* of Ali Mazrui's television series, *The Africans: A Triple Heritage*. In his article, Soyinka accuses Mazrui of denigrating indigenous African culture in the series. Perhaps more significantly, he alludes to the fact that Mazrui is not only culturally Arabized, he is also by both blood and vocal identification part Arab. In both the address alluded to by Edris Makward and the debate between Soyinka and Mazrui, Soyinka repeats some of the negative opinions about Islam that one finds in colonial writings: Islam is a seductive superstition that was imposed on the Africans through the sword. Perhaps more significantly, Soyinka is ready to discredit an African scholar's interpretation of African history on the bases that the scholar is a Muslim and has allegedly Arab-Islamic sympathies.

Wole Soyinka's critique of Islam is part of an intellectual current that some commentators would consider to be Orientalist. It is related to the issue of Islam and African or black identity. Some African and black scholars assert that black Americans and black Africans who profess or advocate Islam are committing a form of cultural apostasy. They are critical of all "alien" ideologies such as Islam, which have allegedly brought havoc to Africa and the Black Diaspora.

Black America and Black Orientalism

Ali Mazrui was probably the first person to use the term *Black Orientalism* in his critique of the PBS documentary *Wonders of the African World*, produced by Henry Gates, an African-American professor. According to Mazrui, Gates is a Black Orientalist because he made condescending, paternalistic, ideologically selective, superficial, and uninformed depictions of Africa. He also suggests that Gate's emphasis on black Africans' participation in the Atlantic slave trade ends up exonerating the West. Just as Western Orientalist scholarship was used to justify and promote colonialism, Gate's work is an apology for European colonization and domination of the African continent.

Mazrui's use of Orientalism is very unconventional. He does not focus on Gate's attitudes toward Arabs, Muslims, and Islam, although Gate's documentary made what could be construed as negative and problematic portrayals of Arabs in the segments on Egypt and East Africa. Moreover, it is not clear why Mazrui calls Gate's alleged Orientalism "Black" and not African-American or just American.

Black Orientalism and "Immigrant" Islam

Sherman Jackson's article on "Black Orientalism" helps one to see Orientalism in the context of the African-American

experience. Jackson detected a major shift in black American responses to Islam and the immigrant Muslim community in America. Prior to the wave of Muslim immigration to America in the 1970s, Islam was by and large perceived in the black community as an authentic expression of African-American spirituality and identity. The gains of Islam that resulted from this perception constituted a loss to other African-American religious denominations and movements.

Then the new immigrants came with historical Islam from the Middle East and other parts of the Muslim world. The center of Islamic religious authority started shifting away from its erstwhile black core to new forms of orthodoxy that did not always manifest an understanding of African-American religious and ideological aspirations. "Real Islam" came to be perceived in segments of the African-American community as the religion of Arabs and foreigners, and black Americans who professed Islam increasingly faced the criticism of being cultural heretics, "self-hating 'wannabees' who had simply moved from the back of the bus to the back of the camel" (Jackson, p. 22).

Jackson makes a distinction between a critique of Islam, Arabs, and Muslim societies based on experience and sound knowledge and criticism based on imagination, ideology, and projection. It is the latter that can be called Orientalist. Black Orientalism seeks to undermine the popularity of Islam among African-Americans by highlighting the alleged race prejudice of the Muslim world. Jackson singles out for particular criticism the Afrocentric movement as it is best articulated in the writings of Professor Molefi Kete Asante, notably in *Afrocentricity* and *The Afrocentric Idea*. While Jackson reveals the problems in Black Orientalism, he also cautions immigrant Muslims to be sensitive to African-American Muslims' historical experience and to be active in building bridges with indigenous American Muslim communities. A failure to do so will alienate African-American Muslims and provide evidence to Black Orientalists, who are all too eager to portray Islam as a foreign and racist religion.

Jackson's study indicates that Black Orientalists are critical of Islam mainly on racial grounds. It would have been more helpful had it addressed the interlocking issue of Islam and the black American Muslim woman's experience. After all, Islam is more commonly perceived as holding women in subordination. This perception is, however, at odds with the enduring attractiveness of Islam to many accomplished black American women. The illustrious life of the late Betty Shabazz is worth citing, and so are the endeavors of other African-American Muslim women such as the professors Aminah McCloud and Carolyn Moxley Rouse, as well as many others, who are making their mark in different spheres of life.

Incidentally, Rouse's book *Engaged Surrender: African American Women and Islam* (2004) seeks precisely to clarify what Islam may mean to some black American women who have accepted it as their faith.

Conclusion

Based on the foregoing analysis, one can see that Orientalism, as it applies to Blacks and Africa, describes realities that are

not necessarily in consonance with Edward Said's original use of the term. In Said's usage, Orientalism is place-bound. It refers to scholarship on the Muslim orient. George Lang, Sherman Jackson, and other scholars have focused on the central targets of Orientalist discourse—Arabs, Islam, and Muslims—regardless of the geographical location.

See also *Ethnocentrism; Eurocentrism; Orientalism: Overview; Other, The, European Views of.*

BIBLIOGRAPHY

- Bangura, Ahmed. *Islam and the West African Novel: The Politics of Representation*. Boulder, Colo.: Lynne Rienner, 2000.
- Harrison, Christopher. *France and Islam in West Africa, 1860–1960*. Cambridge, U.K.: Cambridge University Press, 1988.
- Jackson, Sherman. "Black Orientalism: Its Genesis, Aims and Significance for American Islam." In *Muslims in the United States*, edited by Philippa Strum and Danielle Tarantolo. Washington, D.C.: Woodrow Wilson Center for Scholars, 2003.
- Lang, George. "Through a Prism Darkly: 'Orientalism' in European-Language African Writing." In *Faces of Islam in African Literature*, edited by Kenneth Harrow, 299–311. London and Portsmouth, N.H.: Heinemann, 1991.
- Makward, Edris. "Women, Tradition and Religion in Sembène Ousmane's Work." In *Faces of Islam in African Literature*, edited by Kenneth Harrow. London and Portsmouth, N.H.: Heinemann, 1991.
- Mazrui, Ali. "Black Orientalism." *West African Review* 1, no. 2 (2000).
- . "The Dual Memory: Genetic and Factual." *Transition* 57 (1992): 134–146.
- . "Wole Soyinka as a Television Critic: A Parable of Deception." *Transition* 54 (1991): 165–177.
- Rouse, Carolyn. *Engaged Surrender: African American Women and Islam*. Berkeley: University of California Press, 2004.
- Soyinka, Wole. "Footnote to a Satanic Trilogy." *Transition* 57 (1992): 148–149.
- . "Religion and Human Rights." *Index on Censorship* 17, no. 5 (1988): 82–85.
- . "Triple Tropes of Trickery." *Transition* 54 (1991): 178–183.

Ahmed S. Bangura

ORTHODOXY. The very suggestion of a unified tradition implicit in the idea of the word *orthodox* renders its meaning problematic for the simple reason that conceptions of any religion's traditions are notoriously pluralist. Moreover, the term is hardly universal, since it is seldom applied to indigenous traditions around the world, even though there are some beliefs and practices within each aboriginal group that might be regarded as orthodox to some practitioners—for example, the Plains peoples in North America regard the Sundance as an "orthodox" rite. Generally the articulation of a theological system is one requirement of an orthodox tradition, and indigenous traditions rarely have such a publicly acknowledged construction. Despite its problems, though, major religions continue to use the term, and believers, external observers, and sometimes scholars find it useful. In the contemporary period, it embraces notions of the

traditional, conservative, basic, and customary, all of which point to a normative idea about a religion's self-understanding. Because history, rituals, institutions, and doctrines all combine in manifold ways in each religion, orthodoxy really has to be understood from within each religion. Key notions will be drawn from diverse religious traditions.

Christianity

Christianity, for example, has a major group of churches whose links to each other in a single communion constitutes the Orthodox Church. Adherents look back to the great ecumenical councils and even to Jesus's apostles as the root of their identity, but the groups that make up national churches known as autocephalous (meaning that they are in full communion with each other, but independent of external, patriarchal authority) also acknowledge autonomous churches—that is, those that are not in full communion with them (usually because of some jurisdiction issue). Other issues related to identity also play a role; Orthodox Christianity makes much of its connection to the Greek fathers, has adopted the Julian calendar, affirms the validity of married parish priests, and gives an important place to monasticism, especially that of Mount Athos, from which the episcopacy is drawn.

Orthodox Christianity's central doctrinal difference with Western Christianity concerns the Trinity as developed by St. Augustine; Orthodoxy rejects the *filioque* affirmed by the Latin Church; the Latin idea was that the Holy Spirit proceeded from both the Father *and* the Son. Orthodoxy made the rejection of this doctrine a central fixture of its beliefs. Perhaps as a result, a different spirit is to be found in Orthodox liturgy, where the worshipper is encouraged to experience the presence of God in the sacraments, the icons, and the beauty of the rituals. This emphasis implies an engagement with God's mystical presence in many forms, whereas the Western Church emphasizes the person of Jesus Christ as the principal focus of that engagement.

Beyond this reference to particular institutional churches, however, one must acknowledge that Christianity in general holds certain notions to be orthodox: the idea of a sacred writing called the Scriptures, the role of the community of believers, the church, the central place of Jesus Christ in the understanding of revelation, and a firm commitment to the concept of God. While each of these doctrines is configured according to each group's theological instincts, all Christian groups insist on these conceptions as normative, and in some sense they all see them as existing from the beginning of the tradition. Feminist theologians have raised questions about the representativeness of such "orthodoxies," since, they hold, the orthodox theologians ignore the patriarchal substratum within which conventional theology was framed. The feminist claim is to a more authentic equality and inclusionary model before the official orthodoxy shaped the accepted discourse. Despite these claims, one point seems convincing: included in the term *orthodoxy* is the idea that it reflects a loyalty to the original or authentic content and expression of the religion.

Judaism

Religious orthodoxies are not necessarily historically ancient. Judaism's distinctive Orthodox tradition is fairly recent: 1791.

In this year, France recognized Judaism as a separate religion. This was partly in response to Moses Mendelssohn's influence, but also to Hasidism (established by Shem Tov [1700–1765]), which became an international movement emphasizing the return to the fundamentals of the tradition. By the beginning of the nineteenth century it had become clear to practicing Jews that the Orthodox way of life could be demarcated from those who affirmed a reforming vision of the tradition. Those who believed that the law, whether oral or written, was divine came to be known as Orthodox; for them, Torah could not be subject to modernization or cultural alteration, as the Reform Tradition insisted should be done.

For the Orthodox believers, however, the central ideas of their faith had nothing to do with Reform doctrine. Rather, Orthodoxy was based on limitations on the kinds of food that could be eaten under the laws of *kashrut*, proper observance of the Sabbath (i.e., restraint on activities on the day of rest), and a vigorous commitment to family purity. In effect, Orthodoxy was (and is) home-centered in ways other Judaic traditions were not, for the purity of the family arose out of relations between husband and wife and could not be observed by outsiders, while the laws of *kashrut* were principally practiced in the home. A life of training at home coupled with school-supported teachings and solid synagogue attendance constituted the main parameters of the Orthodox way of life; a corollary of this approach was (and is) a certain reluctance toward participation in modern life and even a trend towards isolation, especially in the face of contemporary secularism.

These beliefs have institutional impact; a central perception is that both non-Orthodox rabbis and converts to Judaism are beyond Orthodoxy and hence outside the community of those who practice the true Torah life. Consequently, community membership is hence strongly defined. In North America, Orthodox communities have steadily maintained their presence through an emphasis on the Hebrew language, *yeshivot* (day schools), and a trained rabbinate through Yeshiva University. Such an emphasis on a "true" Torah education also sets the Orthodox tradition apart from believers in the Conservative, Reform, and Reconstructionist branches of modern Judaism. The experience of the Orthodox in Judaism highlights the fact that orthodoxy is not always rooted in religion's antiquity.

Islam

Islam also reflects how difficult it is to define the term *orthodoxy*, even for a tradition that holds that the *umma* (the Islamic community) is theoretically united as one because God is one and He has given one divine Scripture, the Koran. There is, for example, no word in the Koran that is equivalent to the English word *orthodox*. Western writers often regard Sunnism, the tradition to whom the majority of Muslims belong, as orthodox, and many introductory texts define orthodoxy that way. But such a view is not valid, because Shiism, the other important group in Islam, does not regard Sunnism as defining Muslim orthodoxy for a variety of reasons, and even Sunnis would be reluctant to regard their beliefs as "normative," implying that others are not, because the Koran insists that one's true religion is to be judged by God, not by humans.

JEWISH ORTHODOXY

Of all the things you can teach, Gemara (explanations of the Mishna) is more important than anything else. Gemara is everything. It is *Torah sheh ba'al peh* (the Oral Law). It's the real stuff. Everything else will follow. In this world it is *Torah sheh ba'al peh*, which is the harder way, not the sweet way; it's demanding But we also give them what the guys call "bags of candy." We always laugh about it. They themselves call other studies bags of candy after a while. The rabbi calls it that, too. He says, "Okay. Give out bags of candy."

SOURCE: Murray Danzger, *Returning to Tradition: The Contemporary Revival of Orthodox Judaism*. (New Haven: Yale University Press, 1989), p. 118.

Moreover, contemporary Islam has been challenged by Islamism, or fundamentalism, which cuts across traditional distinctions between Sunni and Shii and embraces a neoconservative ideology that its practitioners regard as orthodox. Part of the doctrine of that stance involves an antipathy to all non-Muslim ideas and cultural expressions. Currently the West, in all its cultural diversity, is the object of that negative reading. This perception of Islamic orthodoxy is rejected by both mainstream Sunnis and Shiis.

Some scholars prefer to regard Sunnism as an orthopraxy, meaning that the way of life developed by most Muslims around the world reflects important common elements of belief and practice. The formation of a normative path for the believer to walk, particularly by means of the *shari'a* (Islamic law), became the preferred idea. Insisting on such a view accords with Sunni notions of their own tradition, because at a critical time in its development (c. 900 C.E.), Islamic doctrine moved away from Greek intellectual categories and the use of the mind to construct theologies. Such a movement reduced the input of the mind in constructing the true understanding of Islam. Still, even Shiis would accept that restriction with some modifications.

Despite these important qualifiers, orthodoxy does have a place in Islamic self-expression. For example, the Koran itself implores, "guide us in the *mustaqiam* [straight] path" (1:6), thereby implying that there is a singular way of being Muslim that all should follow. Moreover, Muslims have always valued the noun *salaam*, a word whose meanings include soundness of being, an attribute of God, as well as peace; in its verbal form it means "surrender" or "submit," and in another form it gives the name of the religion, Islam. Furthermore, submitting to God is held to bring a special perfection to the human

The method of final salvation that I have propounded is neither a sort of meditation, such has been practiced by many scholars in China or Japan, nor is it a repetition of the Buddha's name by those who have studied and understood the deep meaning of it. It is nothing but the mere repetition of the "Namu Amida Butsu," without a doubt of his mercy, whereby one may be born into the Land of Perfect Bliss. The mere repetition with firm faith includes all the practical details, such as the three-fold preparation of mind and the four primordial truths. If I as an individual had any doctrine more profound than this, I should . . . be left out of the Vow of the Amida Buddha.

SOURCE: Honen's *Pure Land Buddhism*. In Ryūsaku Tsunoda, Wm. Theodore de Bary, and Donald Keene, compilers, *Sources of Japanese Tradition*. (New York: Columbia University Press, 1958), p. 208.

being, a perfection called *salaam*. Finally, from the Koran, the verbal form *waqaa*, which means to protect, defend, or preserve, has a noun form *taqwa*, god-fearing or righteousness. This word takes on special meanings in pious circles, for it suggests someone who lives according to normative Islam.

Some contemporary Muslim women have argued that too much of traditional scholarship, and indeed, most of the tradition since the Prophet, has been crafted without proper regard to the principles of equality. They therefore maintain that the true orthodox position of Islam was essentially gender-neutral; male scholarship subsequently skewed the true orthodox position away from women's equal rights (see Ahmed). They contend that Islam must return to the true orthodox position on gender relations. All these interpretations delineate the idea of ethical and religious exemplariness involved in any definition of orthodoxy.

Hinduism

Hindu tradition has always privileged diversity, and at first blush, discovering any form of orthodoxy in Hinduism may seem to be impossible. Indeed, there is no institutional form that the majority of Hindus would consider the orthodox group. Nevertheless, there are ideas within Hinduism that fulfill the notion of orthodoxy, such as those designated by the word *astika*, or assenting to the authority of the Vedas. Almost all Hindus would acknowledge the singular importance and basic religious authority of the collection of texts known as the four Vedas. Moreover, the ordinary believer would probably insist that the most important marker of orthodoxy is the religious activity and interpretation approved by the local Brahman; he defines normativeness for the common folk.

Scholars acknowledge that some rituals are not propounded in the Vedas—rituals such as cremation, for example. Yet cremation acts are certainly *smriti* ("that which is remembered"); they are required acts that go beyond the Vedic record but are held to be essential for an acceptable Hindu life. Such requirements may be found in writings such as the *Laws of Manu*, a work that provides evidence that local custom can also be a

source of the true *dharma* (duty). Yet once again such teachings are likely to be defined for the faithful by the most respected local authority. Those of a more philosophical bent might insist that the system of belief known as Vedanta is likely the most orthodox "theology," even where some of the notions of the philosophical system pose serious problems.

Finally, in Hinduism, even if orthodoxy is not enshrined in any one particular sect or group, it does take a social form. An orthodox Hindu social form is represented most plainly by the caste system. Following one's designated caste in everything, from how and with whom one associates, to the minutia of life (i.e., what caste the person is who prepares lunch) indicates a marker of special gravity in Hindu tradition. Hindu women are deeply affected by the traditional stance of the dharma on caste, for it has defined women's roles almost completely within the role of marriage. The subordination of women to their husbands is most graphically expressed in the rite of suttee (from the Sanskrit *sati*, "faithful wife"), in which the widow immolated herself on her husband's funeral pyre. Modern Hindu women struggle with the implication of an identity tied to husbands and not to their own dharma. Still, for many Hindus, whether male or female, proper caste interaction is a true measure of one's orthodoxy.

Buddhism

The issue of orthodoxy in Buddhism has been a matter of no little disputation; the earliest form of the teachings of the Enlightened One (the Buddha) held sway for several centuries before the variety of Buddhist converts pushed the tradition to embrace doctrinal diversity. The "original" dharma, meaning the teachings or truth taught by the Buddha, was embodied in a *sangha*, or religious order, which encompassed both lay and ordained disciples. These "three jewels"—the Buddha, dharma, and sangha—constitute the fundamental building blocks upon which the worldwide Buddhist community rests. Yet the tradition became so diversified and those who pursued enlightenment so far removed from the milieu of ancient India, where the Buddha flourished, that three distinctive ways

or “vehicles” developed: the Theravada, the Mahayana, and the Vajrayana.

The Theravadans hold that they are loyal to the original Buddhist tradition, insisting, then, that they are orthodox in their teachings. They are often dubbed Hinayana (“Little Vehicle”) by rival Buddhists, implying that they have restricted the means of enlightenment to a single kind of experience. Both the other vehicles, however, hold that they are just as orthodox. They maintain that they accept other cultural frameworks for configuring the dharma and they notably give great significance to the Bodhisattva in the practice of Buddhism. For the ordinary believer, weighed down by the chores of life, the assistance of one who has completed the way is a magnificent boon: the Bodhisattva puts off entering into nirvana in order to assist those who are less endowed with good karma by transferring some of the merit obtained in the process of enlightenment to the less advanced searcher for enlightenment.

Debates about orthodoxy arose largely because of Buddhism’s swift successes across manifold cultural frontiers, and these debates pitted those committed to the earliest texts and most common social forms associated with earliest Indian Buddhism (termed the Way of the Elders) against more manifold expressions. Buddhist orthodoxy, then, rests upon claims of authentic connection to the ideas, doctrines, and social forms deemed consistent with those of this early period. Those committed to the Theravadan tradition believe that theirs most closely follows these normative dimensions of that early Buddhism. Others insist that their enlightenment truth is the same (i.e., is orthodox) but that the formulas for expressing it in human language must be diversified in order to appeal to humans in their rich cultural environment. Initially such groups designated themselves as Mahayanist or “Big Vehicle.”

In addition, Mahayanist tradition developed several philosophical schools as ways to comprehend the true impact of the Buddha’s teachings for all kinds of minds. One of the most important of these was begun by a Brahman convert called Nagarjuna. His position is referred to as the “Middle Way,” or *Madhyamika*. It is sometimes regarded as the most orthodox of the many schools in Mahayana Buddhism. Nagarjuna declined to debate whether or not one could talk about what is absolutely real. He insisted, rather, that anything that could be claimed to be real had to be “empty” of self-essence or absolute truth claims. This was because all the evidence around us in the world of phenomena points to the fact that nothing is permanent. Nagarjuna noted that everything appears to have an essence that abides forever, but in truth it does not. Thus what is true must be empty of such claims—it is truly “nothing” in its most authentic expression.

His orthodoxy of thought is often contrasted to orthodoxy of practice, such as that expressed in the great Yogacara school of meditation practice developed by a *bhikṣu*, or monk, named Maitreya (270–350 C.E.), who insisted on the momentariness of all conscious awareness. Once one had meditated to the point where the false nature of substance became apparent, one could then proceed to the point where consciousness itself would merge into ultimate reality. His sketch of the processes of meditation provided the foundation for subsequent meditational

developments and hence took on a kind of conservative orthodoxy. The citation of these schools as orthodox shows that the term relates to fundamental stances toward what is real or what exists.

Buddhist women in particular have no problem with the traditional religious understandings of the way, whichever of the three vehicles they belong to, but more and more they are objecting to the social restrictions imposed by the patriarchal structures of the Buddhist societies in which they live. Traditionally, monks were regarded as superior to nuns, and seldom were female practitioners of any Buddhism school accorded a leadership role. Monastic codes almost always insisted that females adopt a male stance in order to progress along the path. Currently women are insisting on the equality expressed by the Buddha’s original teachings, a notion of orthodoxy that differs considerably from the norm. In the final analysis, the case of Buddhist orthodoxy raises the issue of whether orthodoxy’s meaning can be limited to a single linguistic or cultural expression. Rather, it might well rest upon a core intuition which is then embodied in many cultural forms and languages, all of them ultimately unreal but all provisionally necessary for human knowledge.

This survey does not exhaust the religious environments in which the ideas of orthodoxy flourish, but what has been noted here should throw into relief some of the key ideas and affirm the multidimensionality of the term. Since the very use of the word implies exclusion, it runs counter to the more positive instincts of inclusion important today, especially in the West. Still, orthodoxy reminds us again of the immense power that religious affirmation and division have encapsulated in the human family.

See also *Buddhism; Christianity; Hinduism; Islam; Judaism; Orthopraxy; Religion.*

BIBLIOGRAPHY

- Ahmed, Leila. *Women and Gender in Islam: Historical Roots of a Modern Debate*. New Haven, Conn.: Yale University Press, 1992.
- Allen, Michael, and S. N. Mukherjee, eds. *Women in India and Nepal*. Canberra: Australian National University, 1982.
- Basham, A. L. *The Wonder that Was India: A Survey of the Culture of the Indian Sub-Continent before the Coming of the Muslims*. New York: Grove Press, 1959.
- Carmody, Denise Lardner. *Women and World Religions*. 2nd ed. Englewood Cliffs, N.J.: Prentice Hall, 1989.
- Carmody, Denise Lardner, and John Tully Carmody. *Roman Catholicism: An Introduction*. New York: Macmillan, 1990.
- Danzger, Murray Herbert. *Returning to Tradition: The Contemporary Revival of Orthodox Judaism*. New Haven, Conn.: Yale University Press, 1989.
- Eposito, John J. *Islam: The Straight Path*. New York: Oxford University Press, 1988.
- Gross, Rita M. *Buddhism after Patriarchy: A Feminist History, Analysis, and Reconstruction of Buddhism*. Albany: State University of New York Press, 1993.
- Klostermaier, Klaus K. *A Survey of Hinduism*. Albany: State University of New York Press, 1989.
- Meyendorff, John. *The Orthodox Church: Its Past and Its Role in the World Today*. Translated by John Chapin. New York: Pantheon, 1962.

- Robinson, Richard H., and Willard L. Johnson, assisted by Kathryn Tsai and Shinzen Young. *The Buddhist Religion: A Historical Introduction*. 3rd ed. Belmont, Calif.: Wadsworth, 1982.
- Ruether, Rosemary Radford, ed. *Religion and Sexism: Images of Women in the Jewish and Christian Tradition*. New York: Simon and Schuster, 1974.
- Sharma, Arvind, ed. *Today's Woman in World Religions*. Introduction by Katherine K. Young. Albany: State University of New York Press, 1994.
- Tsunoda, Ryūsaku, Wm. Theodore de Bary, and Donald Keene, compilers. *Sources of Japanese Tradition*. New York: Columbia University Press, 1958.
- Williams, Paul. *Mahāyāna Buddhism: The Doctrinal Foundations*. London and New York: Routledge, 1989.
- Ware, Timothy. *The Orthodox Church*. Baltimore, Md.: Penguin, 1964.

Earle H. Waugh

ORTHOPRAXY.

This entry includes two subentries:

Asia

Western Orthopraxy

ASIA

The term *orthopraxy* means “right practice,” and stands as a contrast term for *orthodoxy* “right belief.” It is often said of Asian traditions generally that—in contrast to most Western traditions—right practice is of more importance than right belief, and to a certain extent this is true. For instance, Confucianism is primarily concerned with the rituals and practices that constitute a properly ordered society, while Buddhism is ultimately concerned with the practices that bring about enlightenment. This emphasis should not be overstated, however, as particular beliefs often undergird the practices of Asian traditions (as in Confucian beliefs about the nature of cosmic order) and the practices themselves sometimes vary so widely as to call into question the very notion of right practice (as in Buddhism). As the following accounts will indicate, orthopraxy plays an important role in Asian traditions, but the definition of this role is always strewn with the challenges of diversity, consistency, and regulation within each of these traditions.

Hinduism

Orthopraxy is difficult to define for Hinduism, not because there is no mention of what constitutes right action, but rather because there is such diversity within Hinduism that it becomes difficult—if not impossible—to say anything definitive about the tradition as a whole. For any practice that might be considered “right practice” within Hinduism, there are usually a few traditions for which it is either irrelevant or even “wrong practice” (*heteropraxy*). Yet whatever diversity there is pertaining to practice, there is still more diversity pertaining to belief. For example, some Hindus believe in one god, others believe in many gods, and still others believe in no gods at all;

yet, within Hinduism, none of these beliefs necessarily renders a person unorthodox. Indeed, Hindus have at times demonstrated a remarkable pluralism with respect to belief (although variations in belief have often been seen as inferior alternatives), but have tended to identify themselves and their tradition with the rites and practices that underlie Hindu society.

Perhaps the most consistent trait of Hindus is that some relation to the Vedic texts plays an important role in their religious and cultural lives. Hindus tend to distinguish between two broad groups: the *astika* (those who accept the authority of the Vedas) and *nastika* (those who do not accept the authority of the Vedas). It should be noted that such acceptance says nothing about what beliefs a person or group holds, but rather whether they are participating in the preservation and enrichment of Hindu society as inaugurated in the Vedas. Thus, “orthoprax” Hindus are considered *astika*, while Buddhists, Jainas, and Carvakas (those who reject the tradition stemming out of the Vedas) are considered *nastika*. The Vedic tradition is ultimately a belief in the dharma revealed by the Vedas—the cosmic order of reality that, when embodied in the structure of Hindu society, leads to social and cosmic harmony.

The most basic exemplification of the dharma is proper observation of caste distinctions (although there are additional distinctions made according to age, social position, etc.). Within Hindu thought, caste distinctions are not artificial constructs, but natural designations: one is born into a particular caste because of karmic residue from past lives. Moreover, society functions well only when these distinctions are respected, because each caste was created with particular capacities that correspond to particular needs within society. Traditionally, *Brahmans*—typically seen as the highest caste—are priests and scholars, *kshatriyas* are warriors and rulers, *vaishyas* are merchants and artisans, and *shudras* are farmers and laborers (the so-called untouchables typically fall outside of the caste system, and are seen as even lower than the *shudras*). Right practice for a Hindu is thus a matter of living according to one’s caste and performing the duties and obligations of that caste (that is, living according to the dharma); however, because those duties and obligations are often different for each caste, what constitutes right practice for any Hindu is typically dependent on their caste (as well as a number of other related social considerations). Needless to say, caste intermarriage and attempts at social mobility have traditionally been censured within Hinduism.

Just as there are exceptions to the aforementioned adherence to the tradition stemming out of the Vedas, so there are other, less central practices that are widespread among Hindus (for example, reverence for the cow, refraining from harming other creatures, etc.). Furthermore, there are a number of *dharmashastras* (texts of religious laws) and other post-Vedic literature that further specify right action with respect to rituals, caste relations, and personal discipline (e.g., the *Manava Dharmashastra* or *Manusmṛti*, *Laws of Manu*). What all of these manifold specifications of practice have in common, however, is that they all exemplify the attempt to act in accordance with the dharma for one’s position in life and to do so while accruing as little negative karma as possible. Thus, while the

Vedas may not be in the forefront of every Hindu's understanding of "right action," they ultimately inform the traditions that make such action properly Hindu.

With the *Brahman* class at the head of the Hindu caste system, one would expect authority to reside with them for interpreting orthopraxy with respect to the dharma. Historically, *Brahman* scholars have in fact seen themselves as the protectors of the dharma and have argued in the courts of their rulers (typically *kshatriya*) for the preservation and enforcement of a social structure based on the Vedic rules and ritual practices. However, because there has traditionally been no prevailing institutional authority for Hinduism, such preservation and enforcement has typically been possible only at the level of broad social pressure. Moreover, any authority the *Brahmans* have for interpreting the dharma has been at least matched by the authority afforded to extraordinary devotees and saints of any caste for reinterpreting it. Perhaps the most prominent recent example of this is found in Mahatma Gandhi (1869–1948), who proposed a radical shift in the structure of Hindu society by renaming—and thus repositioning—the so-called untouchables (those who reside in India but fall outside of the caste system); he renamed them *harijan*, or "God's people," and gave them equal status among other Hindus in temples. As Gandhi's case illustrates, the authority for reinterpreting the dharma does not necessarily reside with social position (Gandhi was a member of the *vaishya* caste), but rather with the moral authority—usually understood in terms of devotion and service—to speak on behalf of the dharma.

In the end, orthopraxy is crucial to the understanding of Hinduism not because Hinduism entails no particular beliefs or because it makes no claims for orthodoxy; different traditions do espouse particular beliefs, and many will not hesitate to claim orthodoxy for those beliefs. Rather, orthopraxy is important for Hinduism because the commonality of practices among Hindus far exceeds the commonality of beliefs. Indeed, it is not merely religious scholars but also Hindus themselves who define Hindu identity in terms of practices more than beliefs. This emphasis on practice rather than belief runs counter to the typical Western model of religions, but it is an emphasis that proves characteristic not only of Hinduism but also of Asian religious and social traditions generally.

Buddhism

Strictly speaking, Buddhism is not interested in right action, as action itself is tied up in the ignorance and desire that Buddhism is intended to overcome. At least with respect to its ultimate aims, Buddhism is primarily interested in realizing the emptiness (*shunyata*) of action (as well as all other things, especially the self), and thus achieving enlightenment (nirvana). As Buddhists find themselves faced with a world that demands decisions in the midst of this quest for enlightenment, however, they have found it useful and appropriate to comment on what would constitute right practice in such a context. The most prominent example of this is found in the Eightfold Path for achieving enlightenment, as laid out in Gautama Buddha's (c. 563–c. 483 B.C.E.) first sermon. This path consists of right views, right intention, right speech, right action, right livelihood, right effort, right mindfulness, and right concentration

(*Samyutta-nikaya*, 420). From this account, at least two things become clear: The first is that Buddhism is not entirely antinomian—it is quite possible to follow the wrong path; the second is that, while right beliefs play an important role in Buddhist practice, greater emphasis is placed on right practice. At least at the origins of Buddhism, enlightenment was possible only when one's practices were consistent with the Eightfold Path.

Following the death of Gautama Buddha, however, Buddhism ceased to have any centralized religious authority and thus found it difficult to maintain any consistency with respect to its interpretation of the Buddha's message. It is notable that the early Buddhists held councils to determine right belief and practice, but—as evidenced by the various accounts of different schools—they proved less than effective at achieving any substantive degree of consistency. Rather, as Buddhism was interpreted by different persons in increasingly different contexts (in Tibet, China, and Japan), this diversity only compounded. Indeed, such diversity of practice is often considered a virtue: according to the doctrine of *upaya-kausalya* (skillful means), the Buddhist message is not seen as something static but rather something to be altered in such a way as to be effectively communicated to its intended audience. Thus, at least in theory, the diversity of forms that Buddhist practices can take is potentially limitless. These differences should not be overstated, because there is still an underlying consistency to Buddhism that affirms prevalence of illusion and the need for enlightenment; however, the practices that are pursued as a means to that end vary remarkably among the various schools of Buddhism.

Aside from the Eightfold Path, Buddhist orthopraxy is also exemplified in rituals and monastic orders. Rituals of one form or another are practiced by all Buddhists—monks and nuns, as well as laypersons—and pertain to actions whose merit can be applied toward achieving nirvana or a better position in the next reincarnation. This includes not only engaging in virtuous behavior and avoiding vicious behavior, but also participating in ceremonies, acts of devotion, and other symbolic acts. Significantly, whereas ritual is seen as secondary to meditation in most Buddhist traditions, it is given equal status and prominence in Tibetan Buddhism for the attainment of enlightenment. Monastic orders, in turn, offer a more disciplined approach, including an increased enforcement of orthopraxy in order to assist in aligning one's actions with the path to enlightenment (as the path is understood by that particular monastery). These practices differ from monastery to monastery, but they generally follow from the doctrinal commitments of each monastery. Like their monastic practices, Buddhist practices in general also vary markedly from context to context; what holds true in Buddhism across the board, however, is that these practices—whatever they are—are always designed to bring local Buddhists ever closer to nirvana.

Chinese Religion

From its very beginnings, Chinese society has placed a particular emphasis on the right performance of rituals. In the Shang dynasty (c. 1554–1045/1040 B.C.E.), this had to do primarily with performing rituals to appease the High God (Shangdi), one's ancestors, and other spiritual powers. It should be noted that the larger part of ritual activity was applied to the

Consider this doctrine as utilized some centuries later by Zhu Xi's (1130–1200) to (somewhat one-sidedly) compare Confucians and Buddhists on the question of ritual propriety.

[A student] asked how to tell the difference between Confucianism and Buddhism. The teacher said: just take the teaching 'what heaven has endowed is called the nature.' The Buddhists simply do not understand this and dogmatically say that the nature is empty consciousness. What we Confucians talk about is solid principles, and from our point of view they are wrong. . . .

Take the human mind-and-heart, for example. In it there must be the five moral relations between parent and child, ruler and minister, elder and younger, husband and wife, and friends. When the Buddhists are consistent in action, they show no affection in these relationships, whereas when we Confucians are consistent in action, there is affection between parent and child, rightness between ruler and minister, order between elder and younger, attention to their separate functions between husband and wife, and trust between friends." *Zhuzi quanshu* (*The Complete Works of Zhu Xi*) 60:14a. Translated by Wm. Theodore de Bary. In de Bary, p. 713.

reverence of ancestors, as it was generally felt that their approval was easier to attain than the more powerful but less reliable Shangdi. In all of this, the king bore a particular responsibility in performing the right rituals, since the success or failure of the state was seen to be a direct result of such performance. Indeed, proper performance of these rituals was seen to influence everything from harvests and weather patterns to illnesses and military campaigns. It should be noted, however, that this performance of ritual also served to legitimize the king's position, as it afforded him a special position as a mediator between spiritual forces and the welfare of the state.

In the Zhou dynasty (1045/1040–256 B.C.E.), this relationship became more formalized, largely in the attempt to legitimize the Zhou overthrow of the Shang. As recorded in the *Shujing* (Classic of documents), Shang rulers had once been virtuous and mindful of their ancestral obligations; toward the end of the dynasty, however, they became cruel and negligent. As a result, Heaven allowed the Zhou to rise up and overthrow the Shang, and thus to become the rightful rulers of China. As this account illustrates, the Zhou began to see the highest spiritual power as the impersonal Heaven (*tian*) rather than as the personal God, Shangdi; likewise, they saw the survival of the state as dependent on observance of a moral principle—the Mandate of Heaven (*tianming*)—rather than the allegiance of spiritual powers. Of course, this does not do away with the veneration of ancestors—a hallmark of Chinese practice—but begins to reinterpret it in terms of ritual responsibility rather than appeasement.

By the time of Confucius (Kong fuzi; 551–479 B.C.E.), the Zhou was in serious decline, such that there was military

upheaval, social unrest, and general devastation throughout the empire. Confucius's message, as found in the *Analects*, was that this devastation was the result of the fact that the order of Earth no longer reflected the order of Heaven and the order of Heaven could only be exemplified by reviving the classic virtues (most significantly, *ren*, or humaneness). These virtues, in turn, could only be realized by a revival of the rituals (*li*) that guide human relations. Confucianism brought ritual propriety to the fore by taking a term that had indicated guidelines for deference among the nobility and imbuing it with ethical implications for all people. In short, for Confucius, right practice is not a matter of mere politeness but is rather the very heart of a stable and prosperous society.

A good example of ritual propriety is found in the *Zhongyong* (*Doctrine of the Mean*), one of the central texts of the Confucian tradition. Among other things, it emphasizes acting in accordance with one's position: effectively, a person of lower position acts with deference without resentment, while a person of higher position acts with graciousness without disdain. Such ritual propriety applies on a diminishing scale as family relations become more distant and official positions less distinguished. Most importantly, the *Zhongyong* gives expression to the five relations taken to be the most important foci of right relation: "The five are those governing the relationship between ruler and minister, between father and son, between husband and wife, between elder and younger brothers, and those in the intercourse between friends. These five are universal paths in the world" (*The Doctrine of the Mean*, quoted in Chan, p. 105). It should be noted that, while Confucianism is often associated with patriarchy, not all of the relations

listed above are hierarchical. Thus, while many of its relations have historically been patriarchal, there is reason to believe that there is room in Confucian orthopraxy for more equitable relations.

While Confucianism is rightly seen as the dominant tradition informing social practices, it was only one of many approaches introduced during this tumultuous period; Mozi (fifth century B.C.E.), for example, argued for the eradication of all ritual (in that all people were equal before Heaven), while the so-called legalists argued for the strict enforcement of certain practices within the context of a system based on punishment and reward. Perhaps the most persistent counterpoint to the Confucian emphasis on ritual, however, was the Daoist tradition. Where the Confucians praised structured interactions, the Daoists prized spontaneity. To Daoists, the social constructs of the Confucians were unnatural at best, if not outright destructive. The opposition of these two schools of thought, however, should not be overstated, as each balanced the other and even borrowed from the other in its own development. Stated simply, even Daoists had their rituals, though they were less centralized than those of their Confucian counterparts (see, for example, Daoist liturgies, ordination rites).

Historically, however, it is the Confucians who have enjoyed the most government sponsorship, and have thus had the greatest influence on the nature and breadth of ritual practice in China. Consistent with the Confucian account, therefore, right practice was not enforced on any official level (as evidenced by its Daoist and Buddhist detractors), but it was upheld on an unofficial basis as a standard of social morality and decorum. Indeed, the prominence that ritual propriety still enjoys in Chinese society can be attributed in large part to the longstanding influence of the Confucian tradition on its history. Although the Confucian tradition is no longer officially sanctioned by the government in the early twenty-first century, the importance of ritual propriety continues to be very evident in Chinese social practices, and arguably will remain so for many generations to come.

See also *Buddhism; Confucianism; Daoism; Hinduism.*

BIBLIOGRAPHY

- Chan, Wing-tsit. *A Source Book in Chinese Philosophy*. Princeton, N.J.: Princeton University Press, 1963.
- De Bary, Wm. Theodore, and Irene Bloom, and comps. *Sources of Chinese Tradition: From Earliest Times to 1600*. 2nd ed. Introduction to Asian Civilizations Series. New York: Columbia University Press, 1999.
- Eno, Robert. *The Confucian Creation of Heaven: Philosophy and the Defense of Ritual Mastery*. Albany: State University of New York Press, 1990.
- Flood, Gavin D. *An Introduction to Hinduism*. New York: Cambridge University Press, 1996.
- Flood, Gavin D., ed. *The Blackwell Companion to Hinduism*. Malden, Mass.: Blackwell, 2003.
- Fowler, Merv. *Buddhism: Beliefs and Practices*. Portland, Ore.: Sussex Academic Press, 1999.
- Kinsley, David R. *Hinduism: A Cultural Perspective*. 2nd ed. Englewood Cliffs, N.J.: Prentice Hall, 1993.

- Klostermaier, Klaus K. *A Survey of Hinduism*. 2nd ed. Albany: State University of New York Press, 1994.
- Lagerwey, John. *Taoist Ritual in Chinese Society and History*. New York: Macmillan, 1987.
- Lopez, Donald S., Jr. *The Story of Buddhism: A Concise Guide to its History and Teachings*. San Francisco: HarperSanFrancisco, 2001.
- , ed. *Religions of China in Practice*. Princeton, N.J.: Princeton University Press, 1966.
- Michaels, Axel. *Hinduism: Past and Present*. Translated by Barbara Harshav. Princeton, N.J.: Princeton University Press, 2004.
- Miller, Jeanine. *The Vision of Cosmic Order in the Vedas*. Foreword by Raimunda Panikkar. London and Boston: Routledge and Kegan Paul, 1985.
- Radhakrishnan, S., and Charles Alexander Moore. *A Source Book in Indian Philosophy*. Princeton, N.J.: Princeton University Press, 1957.
- Reynolds, Frank E., and Jason A. Carbine, eds. *The Life of Buddhism*. Berkeley: University of California Press, 2000.
- Sharma, Arvind. *Classical Hindu Thought: An Introduction*. New York: Oxford University Press, 2000.
- Tu Wei-Ming. *Centrality and Commonality: An Essay on Confucian Religiousness*. Revised and enlarged edition of *Centrality and Commonality: An Essay on Chung-Yung*. Albany: State University of New York Press, 1989.
- . "Probing the 'Three Bonds' and 'Five Relationships' in Confucian Humanism." In *Confucianism and the Family*, edited by Wlater H Slote and George A. De Vos, 121–136. Albany: State University of New York Press, 1998.
- Walpola, Rāhula. *What the Buddha Taught*, rev. ed. New York: Grove Press, distributed by Random House, 1974.

Robert Smid

WESTERN ORTHOPRAXY

Orthopraxy or *orthopraxis* (from Greek *orthos*, "correct," and *praxis*, "action") denotes proper action, particularly in a religious context. It is contrasted with *orthodoxy* (*orthos* and *doxa*, "opinion"), which denotes proper belief. The word *orthopraxy* is of relatively recent invention and has been used above all in connection with Latin American "liberation theology." It does not otherwise have a significant history of its own in the West. Because of its pairing with *orthodoxy*, however, it is useful for a discussion of the conflict between action and belief, works and faith, obedience to law, and commitment to creed.

There has been some limited use of the term *orthopraxy* in connection with Islam. Malise Ruthven, for example, in his *Islam: A Very Short Introduction* (1997), speaks of Muslim fundamentalists (a term he disapproves of), commenting that for Muslims opposed to modern secularism, the emphasis is on action rather than belief. "Throughout history," he writes, "Islamic rectitude has tended to be defined in relation to practice rather than doctrine. Muslims who dissented from the majority on issues of leadership or theology were usually tolerated provided their social behaviour conformed to generally accepted standards. It is in enforcing behavioural conformity (*orthopraxy*) rather than doctrinal conformity (*orthodoxy*) that Muslim radicals or activists look to a 'restoration' of Islamic law backed by the power of the state."

But in the West, the dominant debates on orthopraxy and orthodoxy (whether or not these terms are used) take place in connection with Judaism and Christianity. This article will examine the conflict in those two religions.

Judaism

The Hebrew Bible is filled with statements that emphasize the importance of obedience to God's commandments. After his forty days and nights on Mount Sinai, Moses proclaims to his people, "So now, O Israel, what does the Lord your God require of you? Only to fear the Lord your God, to walk in all his ways, to love him, to serve the Lord your God with all your heart and with all your soul, and to keep the commandments of the Lord your God and his decrees that I am commanding you today, for your own well-being" (Deuteronomy 10:12–13). Elsewhere God directs Moses to say this to his people: "My ordinances you shall observe and my statutes you shall keep, following them: I am the Lord your God. You shall keep my statutes and my ordinances; by doing so one shall live: I am the Lord" (Leviticus 18:4–5).

In the twelfth century, Moses ben Maimon (Maimonides; 1135–1204) published his *Mishneh torah* (Repetition of the Torah, c. 1178), in which he gave definitive form to the list of 613 commandments (*mitsvot*) that pious Jews accept as binding on their daily conduct. Another milestone in the codification of Jewish practice is the *Shulchan 'arukh* (literally, "the set table"), written by the Spanish-born Joseph Karo (1488–1575) in the mid–sixteenth century. This work presents a legal code that many observant Jews continue to the present day to regard as definitive in the settlement of religious disputes. The emphasis that these works and Jewish tradition have placed on obedience has led many modern commentators, both Jewish and non-Jewish, to conclude that Judaism is a religion characterized primarily by its insistence on proper practice and obedience to God's law or, to put it in terms of this entry, a religion characterized by its insistence on orthopraxy over orthodoxy.

At the end of the eighteenth century, Immanuel Kant (1724–1804) declared Judaism to be a religion of "purely statutory laws" and therefore no religion at all. Georg Wilhelm Friedrich Hegel (1770–1831), in his early days, had followed Kant and (in "The Positivity of the Christian Religion") described Jews as struggling "under a burden of statutory commandments . . . that pedantically prescribe a rule for every casual action of everyday life." In their view of Judaism as a primarily legalistic religion, both men were following the German-Jewish philosopher Moses Mendelssohn (1729–1786), father of the modernizing Jewish *Haskalah* ("Enlightenment"). In *Jerusalem; or, On Religious Power and Judaism* (1783), Mendelssohn had stressed "divine legislation" (*göttliche Gesetzgebung*)—by contrast with "revealed religion" (*geoffenbarte Religion*) in the Christian sense—as an essential fact of Judaism.

A number of modern Jewish commentators agree that Judaism is a religion whose essence lies not in theory or belief but in practice. Samuel Belkin (1911–1976), president of Yeshiva University in New York and a respected Jewish leader, wrote, "Many attempts have been made to formulate a coherent and systematic approach to Jewish theology. All such attempts,

however, have proved unsuccessful, for Judaism was never overly concerned with logical doctrines. It desired rather to evolve a corpus of practices, a code of religious acts, which would establish a mode of religious living. . . . In Judaism, articles of faith and religious theories cannot be divorced from particular practices . . . the theology of Judaism is contained largely in the Halakha [Jewish law]—in the Jewish judicial system—which concerns itself not with theory but primarily with practice."

The issue arises with particular force in connection with the modern Orthodox movement. That movement arose in late-eighteenth- and early-nineteenth-century Germany, in response to various attempts to modernize Judaism, including the *Haskalah* and Reform Judaism. Orthodoxy's principal proponent, German rabbi Samson Raphael Hirsch (1808–1888), saw his movement as a means of accommodating traditional Judaism to the conditions of modern life. Still, Hirsch favored a strict interpretation of the practical duties of the Orthodox Jew. In his eyes, the fact of the revelation to the entire Jewish people at Mount Sinai obviated the need for faith or belief. The revelation is an established historical fact, and Judaism is thus a religion of law, not of belief. "Statutes of faith?" he asks in the fifteenth Letter. "Judaism knows 613 duties, but no commandments of faith." In light of such remarks, Jacob Katz, an historian of the movement, declared that *orthopraxy* would have been a more accurate term for the new movement than *orthodoxy*.

But Hirsch and modern commentators like Samuel Belkin by no means have the last word on this issue. There is a lively debate within rabbinic Judaism on the issue of whether belief should be considered a component of the religion alongside practice. After all, though Moses ben Maimon codified Jewish practice in his list of the *mitsvot* ("commandments"), he was also the author of the Thirteen Principles (*shloshah asar yesodot*) published in his commentary on Tractate *Sanhedrin* of the *Mishnah* (the codified oral law that forms the core of the Talmud). The Principles cover such matters as the existence (*metsi'ut*), unity (*yichud*), and incorporeality (*shlilat ha-gashmud*) of God, the divine revelation of Torah (*heyot hatorah min hashamayim*), and the resurrection of the dead (*techiyat hametim*). But the focus of the Principles is belief, so, for example, when Moses ben Maimon speaks of the existence of God, rather than simply declare it a fact, he tells us that we must believe (*leha'amin*) it. In the *Mishneh Torah*, he emphasizes the importance of *kavanah*, or intention, in prayer. *Kavanah* (from the verbal root *kun*, meaning "to be established" or "to be steadfast") had already appeared in the Talmud in roughly this sense, but Moses ben Maimon gives the word what is quite possibly its *locus classicus*, when he declares, "Any prayer that is not [said] with *kavanah* is not a prayer."

The history of Judaism is filled with challenges to what is perceived to be a rigid adherence to the letter of the law. *Kabbalah* (Hebrew *qabalah*, "tradition"), with its mystical emphasis on direct communication with the divinity, has roots that go back almost two thousand years. Some might regard this movement as representing a departure from legalism. The eighteenth century in eastern Europe brought a significant reaction to the aridity of Talmudic scholasticism, as practiced by then-powerful rabbis in Lithuania. The leader of the

opposition was Israel Ben Eliezer (c. 1700–1760), known popularly as the Ba'al Shem Tov ("master of the good name"), and his movement came to be known as Hassidism (from Hebrew *chasid*, "pious," "righteous"). The Ba'al Shem Tov emphasized a nonintellectual, spiritual communion with God (though he certainly did not advocate a rejection of Jewish law). The Paris Sanhedrin, the group of Jewish notables that Napoleon convened in 1806 to determine the legal position of Jews in France, helped establish as a principle in French law that Jews would be regarded as one religion among others, in other words, that, because religious duties must fall in place behind loyalty to the nation, Jewishness in France would henceforth be determined by one's faith, not by one's birth or one's actions. The Reform Movement started out in Germany with a quasi-Hegelian notion of the progressive, historically unfolding spirit of Judaism, something very different from traditional "orthopraxy." In the United States, the movement marked out its turf by expressly rejecting what it regarded as the religion's anachronistic legalism. The Pittsburgh Platform of 1885, which established the guiding principles of the American Reform Movement, contained this bold statement: "We hold that all such Mosaic and rabbinical laws as regulate diet, priestly purity and dress originated in ages and under the influence of ideas altogether foreign to our present mental and spiritual state." The contemporary world, especially in the United States, offers the Jew a varied menu of choices, from the strictly regulated life of the "ultra-Orthodox," to the secular humanism of Reconstructionism, to the mysticism of the modern Kabbalah movement.

While it might be tempting to claim that Judaism has traveled the path from orthopraxy to various forms of spirituality, one must not forget that many branches of Judaism in the modern world have emphasized praxis, but in the social and political rather than the personal, religious sphere. The Pittsburgh Platform, having affirmed the immortality of the human soul, concludes with this principle: "In full accordance with the spirit of Mosaic legislation, which strives to regulate the relation between the rich and poor, we deem it our duty to participate in the great task of modern times, to solve, on the basis of justice and righteousness, the problems presented by the contrasts and evils of the present organization of society." The Reform Movement is not the only branch of Judaism to have dedicated itself to this cause.

Christianity

The debate about proper belief and proper practice began almost at the moment Christians became conscious of themselves as members of a new religion distinct from Judaism. The debate was framed as faith (Greek *pistis*, Latin *fides*) versus works (Greek *erga, praxeis*, Latin *opera, facta*), and it attracted virtually every prominent figure in the history of Catholic theology, as well as the founding fathers of Protestantism.

The apostle Paul set the terms of the debate. In the decades following the death of Jesus, Paul's mission was to consolidate and universalize the new Christian church, to establish the principle that Gentiles need not pass through a conversion to Judaism in order to join the church, and finally to formulate an explanation of the position that Judaism and its laws were

to occupy in the church. The doctrine of justification by faith was perfect for Paul's purposes. It demonstrated that all were eligible to join the fledgling church since faith alone—no works or Pharisaic obedience to Jewish law—was necessary, and it assured new converts that obedience to the law and loyalty to the legacy of Abraham would follow naturally from a profession of faith in Christ. We find this doctrine in the Epistle to the Galatians (probably one of Paul's earlier letters, written between 52 and 55 C.E.). "We ourselves are Jews by birth and not Gentile sinners," he wrote, "yet we know that a person is justified not by the works of the law but through faith in Jesus Christ. And we have come to believe in Christ Jesus, so that we might be justified by faith in Christ, and not by doing the works of the law, because no one will be justified by the works of the law" (Galatians 2:15–16). Under this principle, the church becomes universal, as former distinctions among people disappear. At the same time, members of the church are implicitly incorporated into the traditions of Judaism: "There is no longer Jew or Greek, there is no longer slave or free, there is no longer male and female; for all of you are one in Christ Jesus. And if you belong to Christ, then you are Abraham's offspring, heirs according to the promise" (Galatians 3:28–29).

In his Epistle to the Romans, Paul reintroduces justification and once again links it with the principle of universality: "For we hold that a person is justified by faith apart from works prescribed by the law. Or is God the God of Jews only? Is he not the God of Gentiles also? Yes, of Gentiles also, since God is one; and he will justify the circumcised on the ground of faith and the uncircumcised through that same faith. Do we then overthrow the law by this faith? By no means! On the contrary, we uphold the law" (Romans 3:28–31). He also introduces two related principles that will guide discussions of faith and works for centuries to come: predestination (from Greek *proorizō*, "predetermine," Latin *praedestino*) and election by grace (Greek *eklogē kharitos*, Latin *electio gratiae*). "For those whom he foreknew he also predestined to be conformed to the image of his Son, in order that he might be the firstborn within a large family. And those whom he predestined he also called; and those whom he called he also justified; and those whom he justified he also glorified" (Romans 8:29–30). "So too at the present time there is a remnant [of the Jews], chosen by grace. But if it is by grace, it is no longer on the basis of works, otherwise grace would no longer be grace. What then? Israel failed to obtain what it was seeking. The elect obtained it, but the rest were hardened" (Romans 11:5–7).

What might well have begun as an effort to distinguish a new religious sect from Judaism quickly and lastingly came to be incorporated into the very core of Christian theology. The ultimate victory of Saint Augustine of Hippo (354–430 C.E.) in his long polemic with Pelagius, a theologian of the same era who had insisted that volition and action proceed from men themselves and not from Christ or God, established by the early fifth century C.E. the position that the Catholic Church would retain permanently: faith is a gift from God; our freedom of will both to believe and to act proceeds from God's grace; God predestines some, but not all, to faith; and the reasons for which some are elected while others are not is "inscrutable" (*On the*

Predestination of Saints, 428 or 429 C.E.). “Predestination is a preparation for grace; grace itself, however, is a gift [*donatio*].” When it comes to faith and works, Augustine is unequivocal: “faith is given first.” Faith takes precedence and is the sign of the new covenant: “As the law of works [*lex factorum*] is written on tablets of stone,” he says, “so the law of faith is written in hearts.” The rewards of the former are associated with the Old Testament, those of the latter with the New Testament (*On the Spirit and the Letter*, 412 C.E.).

In the writings of Saint Thomas Aquinas (c. 1225–1274), we find a shift in emphasis to the inwardness of the human will and the dominance of reason. But Thomas is careful to safeguard the divine origin of the human faculties that he exalted: “The movement of the will is from within, just like natural movement. . . . The cause of the will, however, can be nothing other than God, and for two reasons: first because the will is a power of the rational soul, which is caused by God through creation . . . and second because the will tends toward the universal good, from which it follows that nothing can be the cause of the will except God himself, who is the universal good” (*Summa Theologica*, 1265/1266–1273). To be sure, Thomas attributes to man a greater degree of autonomy than we find in Augustine and many other Christian theologians. For example, he distinguishes between two types of grace, under one of which, “operating grace” (*gratia per operantem*), God is our sole mover and under the other of which, “cooperating grace” (*gratia per cooperantem*), our actions stem from both God and our minds. But when it comes to judging actions, Thomas is quite clear: “our actions are meritorious in so far as they proceed from free choice, *moved by God through grace*” (emphasis added).

With the new emphasis on individual, subjective freedom that we find in Luther and the Protestant Reformation, we might expect to see man newly invested with the dignity of free choice in his actions. But for Martin Luther (1483–1546), John Calvin (1509–1564), and others, freedom meant freedom from the tyranny of the Catholic Church, not freedom in the sense of an autonomous volition that is the source of our actions. In Luther’s view, faith and grace once again precede actions, and righteous actions by themselves do nothing to render righteous the individual who commits those actions: “Not he who works much [*multum operatur*] is just but rather he who without works [*sine opere*] believes much in Christ” (*Heidelberg Disputation*, 1518). Luther wrote *The Bondage of the Will* (1525) expressly to refute the existence of free will, on the strength of the argument that original sin deprives us of the freedom to choose. “God foreknows and foreordains [*praescit et praeordinat*] all things,” he writes, thus only what God wills can take place, and “there can be no such thing as free choice [*liberum arbitrium*] in man or angel or any creature.” “The Gospel,” he writes in the preface to his German translation of the New Testament, “does not demand works of us, so that we might become devout and blessed [*frum und selig*] thereby; in fact, it condemns such works but demands only faith in Christ” (*Preface to the New Testament*, 1522).

By the end of Luther’s life, John Calvin had completed his *Institutes of the Christian Religion* (1536). To the modern reader, Calvin’s theology appears, as regards the issue of faith and

works, to differ very little from that of Augustine. But for a sixteenth-century reformer extending the work of Luther, the doctrine of justification by faith served as a repudiation of the temporal authority of the pope and thus had a resonance different from what it had had for the bishop of Hippo. Faith for Calvin is a gift of God, as it was for Augustine, Thomas Aquinas, and Luther, and righteousness arises not from works but from faith. Works are not the cause of holiness but are, rather, gifts of God (*Dei dona*), signs of his calling (*vocationis signa*; *Institutes of the Christian Religion*, 1536–1559). If Calvin’s thought represents a departure from that of his predecessors, it is largely owing to his attitude toward life. Contempt for our present life (*praesentis vitae contemptus*) and the practice of abstinence, sobriety, frugality, and modesty in that life are the guides to proper conduct.

With the age of Enlightenment and its increasing tendency to ground moral issues in nature and humankind, we see the emphasis in Christianity shift increasingly from faith to the human arena. The nineteenth century produced a spate of books, in a variety of European languages, under the title *The Life of Jesus*, most prominently *Das Leben Jesu* (1835–1836), by David Friedrich Strauss (1808–1874) and *La vie de Jésus* (1863), by Ernest Renan (1823–1892). The kenotic tradition in nineteenth-century German Protestant theology emphasized the human dimension of Jesus (“kenotic” refers to the process, described in Philippians 2:7, by which Christ “emptied himself” [*ekenosen*] and became a man). French socialist theory in the first half of the nineteenth century modeled its conceptions of social justice on a vision of the early Christian church and the teachings of Jesus. In *Le nouveau christianisme* (1825; English trans. *The New Christianity*, 1834) by Henri de Saint-Simon (1760–1825), the “new Christian” expresses what he sees as the “divine part” of Christianity: “men must conduct themselves as brothers with respect to one another. . . . They must make it their aim to ameliorate as promptly and as completely as possible the moral and physical existence of the most numerous class.”

The late nineteenth and early twentieth centuries produced a spate of socially conscious Christian thinkers and activists, especially in the United States. The Social Gospel movement, from roughly 1870 to 1920, encouraged followers to devote themselves to social justice, in imitation of Christ. Walter Rauschenbusch (1861–1918), one of its leaders, went so far as to embrace communism as a Christian principle in his *Christianity and the Social Crisis* (1907). Reinhold Niebuhr (1892–1971) helped define theological liberalism in the United States in the first half of the twentieth century.

In the second half of the twentieth century, two developments steered the Catholic Church (or some of its members) increasingly in the direction of praxis. In 1965, Pope Paul VI issued, as one of the sixteen decrees of Vatican II, *Gaudium et spes* (Joy and hope; titled in English “Pastoral Constitution On the Church in the Modern World”), which affirmed the church’s commitment to service in the human world: “What does the Church think of man? What needs to be recommended for the upbuilding of contemporary society? What is the ultimate significance of human activity throughout the world? People are waiting for an answer to these questions.

From the answers it will be increasingly clear that the People of God and the human race in whose midst it lives render service to each other. Thus the mission of the Church will show its religious, and by that very fact, its supremely human character." The Society of Jesus (the Jesuit order) today has an Office of Social and International Ministries, whose purpose is to serve the "Social Apostolate (ministries addressing domestic and international social problems)." One Jesuit priest, Philip J. Rosato, has suggested that Karl Barth (1886–1968), the great twentieth-century Protestant theologian who became increasingly committed to social justice during his long career, helped, through dialogue with Catholics, to steer the post-Vatican II church toward orthopraxy in social affairs.

In 1968, a Peruvian priest named Gustavo Gutiérrez published *Teología de la liberación* (English trans. *A Theology of Liberation*, 1973), which served as the central text for the Catholic "liberation theology" movement in Latin America. Gutiérrez is explicit about the orthopraxy/orthodoxy relationship. Human history, says Gutiérrez, is an "opening to the future" (*apertura al futuro*), and this means an emphasis on action, or "doing the truth" (*hacer la verdad*). "Only by doing this truth will our faith *veri-fy* itself, speaking literally," he says. "Hence the recent use of the term *orthopraxis*, which might shock certain sensibilities. Nor should this be understood as denying the meaning of *orthodoxy*, understood as a proclamation and reflection of affirmations considered to be true." Liberation theology represents an odd amalgamation of Marxist theory (the last of Marx's "Theses on Feuerbach," 1845, reads, "The philosophers have merely *interpreted* the world in various ways; the point is to *change* it.") and Christian theology.

It would probably be safe to say that many branches of Christianity in the twentieth century have placed an increasing emphasis on orthopraxy at least in addition to, if not to the detriment of, orthodoxy. The praxis that has come to be favored is of the sort that takes place in the social and political world and not just of the sort that is directly connected with the rituals of a particular institution. Waging a struggle against poverty and waging a struggle against abortion rights can both be expressions of religious principle, but they are different in kind from practices like taking communion and confessing.

See also *Christianity; Islam; Judaism; Orthodoxy; Religion*.

BIBLIOGRAPHY

- Augustine, Saint. *De praedestinatione sanctorum, De spiritu et littera*. In Vol. 43: *Patrologiae cursus completus, series latina*, edited by Jacques-Paul Migne. Paris: Migne, 1844–1891.
- . *Saint Augustin: Anti-Pelagian Writings*. In Vol. 5: *Select Writings of Nicene and Post-Nicene Fathers of the Christian Church*, edited by Philip Schaff. Peabody, Mass.: Hendricks, 1994.
- Belkin, Samuel. *In His Image: The Jewish Philosophy of Man as Expressed in Rabbinic Tradition*. New York: Abelard-Schuman, 1960.
- Calvin, John. *Institutes of the Christian Religion*. 1568. Modern edition, edited by John T. McNeill. Translated by Ford Lewis Battles. Philadelphia: Westminster, 1960.
- Gutiérrez, Gustavo. *A Theology of Liberation: History, Politics, and Salvation*. Translated and edited by Sister Caridad Inda and

- John Eagleson. Maryknoll, N.Y.: Orbis, 1988. First Spanish edition, 1968.
- Hegel, Georg Wilhelm Friedrich. "The Positivity of the Christian Religion." In *Early Theological Writings*, edited and translated by T. M. Knox. Chicago: University of Chicago Press, 1948.
- Hirsch, Samson Raphael. *The Nineteen Letters*. 1836. Translated by Karin Paritzky. Jerusalem and New York: Feldheim, 1995.
- Kant, Immanuel. *Religion within the Boundaries of Mere Reason and Other Writings*. Translated and edited by Allen Wood and George Di Giovanni. Cambridge, U.K., and New York: Cambridge University Press, 1998.
- Katz, Jacob. "Orthodoxy in Historical Perspective." In *Studies in Contemporary Jewry*. Vol. 2. Bloomington: Indiana University Press, 1986.
- Luther, Martin. *Martin Luther's Basic Theological Writings*, edited by Timothy F. Lull. Minneapolis: Fortress Press, 1989.
- Maimon, Moses ben. Commentary on Tractate *Sanhedrin* of the *Mishnah*, chap. 10.
- . "Helek: Sanhedrin, Chapter Ten." In *A Maimonides Reader*, edited by Isadore Twersky. New York: Behrman House, 1972.
- . *Mishneh torah. Hilkot tefilah*, IV, 15.
- Mendelssohn, Moses. *Jerusalem; or, On Religious Power and Judaismism*. Translated by Allan Arkush. Hanover, N.H.: University Press of New England, 1983.
- Montefiore, C. G., and H. Loewe, eds. "The Importance of Motive or Intention. *Kawwanah*, and *Lishmah*. The Love, the Fear, and the Praise of God." In *A Rabbinic Anthology*. New York: Schocken, 1974.
- Nessan, Craig L. *Orthopraxis or Heresy: The North American Theological Response to Latin American Liberation Theology*. Atlanta: Scholars Press, 1989.
- Paul VI, Pope. "Pastoral Constitution on the Church in the Modern World: *Gaudium et Spes*." Available at http://www.vatican.va/archive/hist_councils/ii_vatican_council/documents/vat-ii_cons_19651207_gaudium-et-spes_en.html.
- Privat, Edouard ed. *Le Grand Sanhédrin de Napoléon*. Toulouse: Edouard Privat, 1979.
- Rauschenbusch, Walter. *Christianity and the Social Crisis*. New York: Macmillan, 1907.
- Rosato, Philip J., S. J. "The Influence of Karl Barth on Catholic Theology." In *Gregorianum* 67 (1986): 659–678.
- Ruthven, Malise. *Islam: A Very Short Introduction*. New York and Oxford: Oxford University Press, 1997.
- Saint-Simon, Henri, comte de. *New Christianity*. Translated by J. E. Smith. London: B.D. Cousins, 1834.
- Senn, Frank C. "Orthodoxia, Orthopraxis, and Seekers." In *The Strange New Word of the Gospel: Re-Evangelizing in the Post-modern World*, edited by Carl E. Braaten and Robert W. Jenson. Grand Rapids, Mich.: William B. Eerdmans, 2002.
- Thomas Aquinas, Saint. *Basic Writings of Saint Thomas Aquinas*. Vol. 2. Edited by Anton C. Pegis. New York: Random House, 1945.

Steven Cassedy

OTHER, THE, EUROPEAN VIEWS OF. All epistemological and hermeneutical investigations are predicated on the observation that the human self, like all objects around a person, gains an understanding of its identity through the

binary opposition of self and other. No value can be established for any element in the material and abstract world without the differentiation from “the Other.” The famous linguist Ferdinand de Saussure described all essential components of language in terms of value units that develop their identity by being separate from all other elements surrounding them both in the syntagmatic and associative context. The same applies to the historical subject, man (here understood not in gender-specific terms), who discovers himself only when he realizes that he is different from all people around him. When a small child begins to recognize its environment, it also observes its own self. Hans-Georg Gadamer defines the phenomenon of selfhood versus otherness in the following way: “Whatever is being distinguished must be distinguished from something which, in turn, must be distinguished from it. Thus all distinguishing also makes visible that from which something is distinguished” (p. 272). All individuality is intimately connected with the recognition of the Other as a phenomenological entity outside of the self, and all cultures, religions, and peoples have relied on this fundamental truth in order to establish their own selfhood, legitimacy, culture, religion, and nationhood. The “I” discovers itself, as Martin Buber pointed out, through the separation from the “You,” which, in its ultimate manifestation, proves to be God. Once the individual realizes that there is the Other, expressed by the pronoun you, the process of speaking, dialogue, discourse, and epistemology, both in the mundane and spiritual dimensions, begins.

The phenomenon of “otherness,” as a subject of philosophical discourse led, in the 1980s, to the development of a new academic discipline, xenology, or the study of “alterity.” Xenology focuses on the Other as a critical component of cultural anthropology, and as a key issue in the history of mentality, of the Church, and also of everyday life (Sundermeier, Wierlacher, Hallson). Study of the Other cannot be limited to the history of the Western world—the same phenomena also determine cultures in all other parts of the world to a lesser or greater degree—but for pragmatic purposes this article concentrates on the Judeo-Christian tradition. Most military conflicts throughout time can be explained either by religious disputes or material greed, or the two combined. These sentiments, however, result from hostility against or disregard of the Other whose own identity is not acknowledged but instead is treated as a dangerous challenge, if not an actual threat, to the existence and social construct of the dominant culture.

Considering military conflicts since the mid-twentieth century, including the Kosovo War in 1999, the terrorist attack on the World Trade Center on September 11, 2001, and the Iraq War in 2003, hostility against the Other and xenophobia in global terms continues and represents a major source of discord in increasingly multicultural societies and among nations (Gioseffi).

Since the end of World War II, the number of legal and illegal immigrants to Western nations has grown steadily. Once these asylum seekers or economic refugees settle in the new home country, they often face prejudice, rejection, hatred, and physical violence. In fact the early-twenty-first-century world is undergoing a major paradigm shift because the ethnic

composition of Western societies is experiencing a transformation, bringing representatives of different religious, ethnic, and cultural groups into close proximity. The degree to which foreigners are integrated into a particular society undoubtedly represents a benchmark of its developmental stage as an enlightened, tolerant, and humanistic community. Earlier societies had to cope with similar phenomena, but throughout history the fundamental conflict between self and other has shaped most cultural, religious, military, and political developments. As Irvin Cemil Schick observed, identity is the result of a construction process, not simply a given, “and narrative is the medium through which that construction is realized” (Schick, p. 21).

Perspectives in the Ancient World

In ancient Greece, peoples of other ethnic backgrounds were identified as *barbarophonoi* (Homer, in the *Iliad* [c. 800 B.C.E.]), or as those who spoke nonunderstandable languages. However since the Greek world did not have the concept of a larger national unit, everyone outside the family or urban community was perceived as foreign, as other (*allos*, *alloadapos*, and *xenos*). Significantly the Greeks did not necessarily differentiate between members of a foreign polis (city-state) and non-Greeks. Nevertheless the Greeks espoused the ideal of hospitality, which extended especially to foreigners; in later centuries many cities appointed a *proxenos* whose task it was to serve as a host for foreigners, perhaps comparable to the modern diplomatic institutions. At the turn of the sixth century B.C.E., a more xenophobic concept of the barbarian developed in Greece, triggered by a feeling of cultural superiority and also by fear of the growing Persian threat. Both Euripides and Aristotle, for instance, identified the barbarian with subhuman creatures and argued that their sole function was to serve as slaves—an attitude that slowly changed only after Alexander the Great’s conquest of the Persian Empire (Stutzinger). Whereas the early Roman republic was built on a fairly strict division between Roman citizens and foreigners, during the time of the Roman Empire the Roman *civitas* was extended to additional population groups. The *Constitutio Antoniniana* (212 C.E.) awarded Roman citizenship to all free people living within the borders of the state. Nevertheless the entire ancient world accepted the idea of slavery and treated all defeated foreigners as objects that could be sold or killed at will. During the age of migration, Germanic tribes attacked the Roman Empire strengthening the notion of the barbaric others, especially since Romans regarded their nomadic opponents—in close parallel to the ideology espoused by modern colonialists, especially in the Americas and Africa—as primitive, lacking in culture and civilization.

During late antiquity the concept of monsters—teratology—living at the outskirts of the Roman world became popular; these monsters have populated literary and artistic imagination ever since. Pliny the Elder collected some of the most influential accounts about these monsters in his *Naturalis historia* (before 79 C.E.), followed by Caius Julius Solinus’s *Collectanea rerum memorabilium* (c. 250 C.E.), which medieval and early modern encyclopedists and naturalists eagerly copied. Solinus’s works became the source for scores of artists and writers who blithely integrated this “information” about strange beings on

the periphery of human civilization into their texts and images (Williams).

Medieval Perspectives

The ancient world primarily projected images of the Other as a matter of curiosity, with the specific purpose of populating worlds far from the eastern Mediterranean to satisfy general scientific interest. But in the early Middle Ages the contrast between self and other gained in intensity because of the sharp conflict between the Christian Church and pagan cultures, the constant threat of famine due to undeveloped agriculture and farming, and constant military threats from other places (Huns, Saracens [Arabs], Vikings, and later the Magyars). A remarkable expression of the fear of the Other can be found in the myriad monster images depicted in churches, on government buildings, on the facades of houses, in wall paintings, in sculptures, and in numerous manuscript illuminations (Benton, Camille). Some of the best medieval art focuses on these monstrous figures and elaborates on their fearful, hideous features, reflecting a highly ambivalent and contradictory attitude toward the Other. Whereas Christian theologians established rigid criteria to determine good versus evil, or self versus other, in accordance with biblical teaching, popular culture continued to be dominated by strong undercurrents of paganism that derived strength from its fascination with and abhorrence of the Other (Milis). In the Old English heroic epic *Beowulf* (early eighth century), for example, the protagonist's struggles, first against the monster Grendel, then against its mother, and finally against a dragon, represent the individual stages of interaction with a foreign world and establishment of an identity for a particular social group. Many other heroic epics in Old Norse and Old and middle-High German literature can be explained in terms of their treatment of the Other and their interest in offering a medium of self-identification for the reader/listener (Lionarons).

Religious Perspectives

All early-twenty-first-century world religions, especially Judaism, Christianity, and Islam, are predicated on the exclusivity and absoluteness of their own religion and the truth of their faith, since the monotheistic concept negatively determines the relationship with all other religions, rejecting them as other and hence as false. By contrast, people in ancient Greece and Rome recognized many different gods and easily tolerated representatives of other religions as long as they demonstrated loyalty to the secular authorities and obeyed the rules of public mores (Assmann).

Since the early Middle Ages, factions of all three major religions have demanded absolute adherence to their own faith and have not hesitated to persecute and execute members of the other religions, unless the latter voluntarily submitted to the dominant religion. The history of the Western world is deeply influenced by constant, bitter struggles among these three religions, whether in the form of Arab conquests in the seventh and eighth centuries, or Christian crusades between 1096 and 1291. In antiquity and the Middle Ages, these conflicts and tensions were often addressed with violence (crusades, pogroms, expulsions, imperialistic warfare, and hostile

persecutions), victimizing the Jewish population above all. There were a number of attempts by Christian philosophers and theologians from the thirteenth to the fifteenth centuries to enter into critical discourse with Jews (Paris Disputation [1240], Barcelona Disputation [1263], Tortosa Disputation [1413–1414]; Maccoby), but these were intellectual experiments and ultimately yielded no positive changes in the relationship between the religions; the situation for Jews became increasingly worse (expulsion from Spain in 1492). Although Augustine (354–430) had firmly argued for a tolerant attitude toward Jews, insisting that they were “living testimony to the antiquity of the Christian promise” (Cohen, p. 33), and although Bernard of Clairvaux (1090–1153) had emphasized that Jews were the “living letters of the law” (Cohen, p. 388), anti-Semitic attitudes grew in intensity throughout the late Middle Ages and were promulgated even by prominent theologians and philosophers including Thomas Aquinas (1225–1274), who argued that Jews willfully rejected the true faith and could be compared to recalcitrant heretics. In the early sixteenth century, the Christian convert Johannes Pfefferkorn, who had been a Jew, became one of the most vicious enemies of Jews and made highly controversial allegations against them, allegations that even some Christian thinkers, such as the Hebrew scholar Johannes Reuchlin (1455–1522), severely criticized (Kirn).

Legal Perspectives

The modern, post-Reformation world witnessed at least some attempts to establish principles of coexistence, toleration, and, especially, since the age of Enlightenment, tolerance. Nevertheless intolerance, xenophobia, religious tensions, and subsequent military conflicts have continued to torture humankind, and the contentious relationship between self and other, both in its philosophical and political contexts, remains highly fragile and subject to manipulation and distortion. Racism, sexual intolerance, marginalization of minority groups, misogyny, and numerous forms of violence against weaker members of society are results of this binary opposition in which the self sometimes desperately struggles against the Other in order to establish its identity.

The First Amendment to the U.S. Constitution, ratified in 1791, clearly specifies a modern, tolerant attitude toward the Other: “Congress shall make no law respecting an establishment of religion, or prohibiting the free exercise thereof; or abridging the freedom of speech, or of the press; or the right of the people peaceably to assemble, and to petition the government for a redress of grievances.” Although the meaning of this statement and its practical application have remained contested, the amendment continues to serve as the basis for intensive discussions about the relationship between the individual citizen and the state for the United States and many other Western societies in the early twenty-first century (Mittal and Rosset, Amar).

One of the most far-reaching and pragmatic expressions of the ideals of the Enlightenment was the legal code established under Napoléon, the *Code Napoléon* (1804), that stipulated the following: (a) equality of all in the eyes of the law; (b) no recognition of privileges due to the happenstance of birth; (c) freedom of religion; (d) separation of church and state; and

(e) freedom to work in an occupation of one's own choosing (Martin). Many of the principles in the *Code* decisively influenced legal systems developed in other countries in the Western world and continue to be cornerstones of modern societies.

Religious differences, even in the early-twenty-first-century West, are a major source of conflict and may always exist, as documented by numerous expressions of anti-Semitism, manifested most virulently in the Holocaust committed by the German Nazis. Each generation struggles with problems of cultural identity and differentiation from the Other, which is the basis for the exploration of the self. However when weakness on one's own part or ideological manipulation by authority figures are involved in the epistemological process, the Other can easily be abused for a wide range of political purposes. People are vulnerable to brainwashing, which relies on an underdeveloped sense of individuality and a high degree of insecurity in the face of ethnic, cultural, religious, linguistic, and political otherness. Fear, intolerance, and dogmatic thinking have always acted to strengthen the group identity and denounce the Others. This is evident in the centuries-old rejection of Sinti and Roma (formerly known as Gypsies), the persecution of Jews since late antiquity, the expulsion of the French Huguenots and the Amish and Mennonites in the sixteenth and seventeenth centuries, the abuse of blacks by colonialists and slaveholders worldwide, the genocide of North and South American Indians, the massive purge of alleged enemies of the Russian, Chinese, and Cambodian communist regimes, and the genocides in Armenia, Burundi, Kosovo, and elsewhere in the twentieth and early twenty-first centuries.

Mysticism, Demons, and the Other

Since the Middle Ages, belief in ghosts, demons, spirits, and other elements have represented a challenge to the Church, and philosophers and authorities struggle in vain against various forms of superstition and fear (Delumeau, Dinzelsbacher). During the high Middle Ages, supernatural phenomena were often associated with the divine, or regarded as emanations of the Godhead, leading to a widespread mysticism movement. Bernard of Clairvaux exerted great influence on his contemporaries and posterity not only due to his learnedness, but also because of his intensive examinations of mystical phenomena. His *super Cantica Cantorum* particularly developed a highly affective interpretation of the Song of Songs and its imagery of the Godhead as bridegroom and the soul as bride. Contemplation was the first stage in the quest for the religious other, followed by mediation, prayer, fasting, sleep deprivation, and grace, which ultimately allowed the mystic to experience revelations. Hildegard of Bingen (1098–1179), leader of a Benedictine convent, gained fame for her mystical visions, which were accepted as authentic by Church fathers (especially Bernard of Clairvaux and Pope Eugene III), who authorized her to go on preaching tours throughout Germany. Other famous mystics were Mechthild of Magdeburg (1208–1282), Mechthild of Hackeborn (1241–1299), Gertrud the Great (1256–c. 1301), Bonaventura (1217–1274), Henry Suso (1295–1366), Meister Eckhart (c. 1260–1327), Bridget of Sweden (1302–1373), and Catherine of Siena (1347–1380) (Szarmach). Although each mystic experienced individualized

visions, all mysticism commonly dealt with the ineffable quality of the Godhead and the absolute realization of the Other in the religious context (Classen, 2002a). Since there are no adequate words to explain the phenomenon of the soul's encounter with the divine, mystics commonly resorted to an apophatic discourse, or, as in the case of Meister Eckhart, to negative theology, which contended that man cannot really talk about God, the absolute Other, and emphasized the need to subjugate the self in the presence of the divine (Milem).

In the late Middle Ages and particularly from the sixteenth century, the Church intensified its control over individualized forms of religious experience and rejected those who claimed to have had visions or been privy to divine revelation (Caciola). As a consequence, women with prophetic abilities, visionaries, and ecstasies were increasingly regarded with suspicion and became victims of the Holy Inquisition.

Although attempts were made to reject magic and to oust different types of seers and sorcerers, such as *harioli*, *auspices*, *sortilegi*, and *incantatores*, these practitioners preserved their secret influence far into the modern age (Flint, 1991). Throughout Europe, both the rural population and intellectuals, even as late as the eighteenth and nineteenth centuries, subscribed to various forms of superstitions, including witchcraft, fear of the devil, and evil spirits (Ginzburg), not to mention a belief in astrology.

Surveying the eighteenth century, Theodor Adorno and Max Horkheimer identified the phenomena as the “dialectics of enlightenment.” But such beliefs continue in early-twenty-first-century society as well, allowing technocrats and bureaucrats to manipulate the Other for their own purposes without regard for the latter's nature, interests, and needs: “Enlightenment behaves toward things as a dictator toward men. He knows them in so far as he can manipulate them” (Adorno and Horkheimer, p. 9).

Even as rationality offers logical explanations of the world around us, people fall back to superstitions and irrational thinking, which permits ideologues to stereotype groups and blame them for a wide range of general ills. In the Middle Ages, the preferred object of this manipulative strategy was the Jews. In early modern Europe, women were accused of witchcraft and burned at the stake, serving as scapegoats for a heightened sense of religious insecurity, fear of the scientific paradigm shift occurring at the time, the growing pressure of the centralized power of the state, and a brewing conflict between popular culture and beliefs and intellectualism (Levack, Scholz Williams).

Ancient and medieval authors, chroniclers, and writers of travelogues projected images of a fabulous East, which was paradise-like in its luxuries and sophistication, but sometimes also populated by monsters. By contrast, early twenty-first-century authors, filmmakers, and artists have resorted to technological utopias, relying on a stereotypical fear of and fascination with extraterrestrial beings, but in anthropological and epistemological terms the differences are minimal. From the late Middle Ages, people imagined the East, especially India, as a sensuous paradise, just waiting for European colonization. This form of Orientalism, which Edward Said discussed

in his famous study (1978), continues to be a pervasive and manipulative concept of the Other both in its epistemological and social-literary dimensions in the early twenty-first century. Overcoming the monster, defeating extraterrestrial creatures, or colonizing their exotic worlds represent the triumph of the self over the Other and offer the chance to establish the self's identity. This phenomenon seems to have characterized all developmental stages of the Western world. Medieval monster lore was deeply influenced by ancient concepts developed by Herodotus (c. 484–between 430 and 420 B.C.E.), Ctesias (c. 400 B.C.E.), Pliny the Elder (23–79 C.E.), and Solinus (third century C.E.). Though Augustine, in his *City of God Against the Pagans* (BK. XVI, ch. 8) expressed doubts, he accepted the possibility that monsters might exist. He suggested that if these monstrous races were real, they should be treated as God's creatures: "He Himself knows where and when anything should be, or should have been, created; and He knows how to weave the beauty of the whole out of the similarity and diversity of its parts" (Augustine, p. 708). Decidedly excluding the idea that God might have erred when he created monsters, Augustine concludes that "just as some monsters occur within the various races of mankind, so there should be certain monstrous races within the human race as a whole" (Augustine, p. 710). One of the earliest examples of monster imagery in the Middle Ages can be found in the Anglo-Saxon *Wonders of the East* (c. 970–1150).

Throughout the Middle Ages, theologians and artists, writers and philosophers were deeply divided over the correct explanation of monsters, the absolute Other within human epistemology (Cohen, J. J., 1999). Jacques de Vitry (1160–1240) attempted to describe the European perspective of monsters: "And just as we consider Pygmies to be dwarfs, so they consider us giants. . . . We consider the black Ethiopians of bad character; among them, however, the one who is blackest is judged most beautiful" (Friedman, p. 164). The fascination that monsters exerted throughout the centuries was undeniable, as documented by numerous manuscript illustrations, sculptures, chronicle accounts, travelogues, textile images, and ivory, stone, and wood carvings (Bovey). Many bestiaries depict not only a wide variety of animals, but also a broad spectrum of monsters whose grotesque features were interpreted as signaling moral decrepitude or who were seen as symbols of imminent apocalypse. Often the treatment of monsters reflected a profoundly Manichean worldview that divided everything into good and evil. Late-medieval poets took a more diversified approach and developed accounts of basically good monsters, such as Melusine, half human and half snake (Classen, 1995, p. 141–162), who was eventually expelled from human society because of her human husband's failure to keep her true nature a secret (see the text versions by Walter Map, Gervasius of Tilbury, Jean d'Arras, Couldrette, and Thüring von Ringoltingen). Many medieval manuscripts, especially Psalters, contained images of hybrid creatures, grotesque beings, and monsters, which could have hardly served as deterrence from sinfulness; instead they represented a growing fascination with the Other and an emerging playfulness in the visual depiction of the world (Camille, Yamamoto). The encyclopedist Thomas of Cantimpré (1201–1272), relying on Augustine's ruminations, urged his readers to "consider the

forms of creatures and delight in the artificer who made them" (Friedman, p. 123). When explorers reached the shores of the New World in 1492, they used monster images to describe and depict the indigenous population, thereby casting them as other from the start (Flint, 1992, p. 53–54, 61, et seq.).

Tolerance and Toleration

The term "tolerance," reflecting a unique approach to the Other, requires a detailed explanation as to its meaning and manifestations during different cultural periods. While classical Greece and Rome generally tolerated people of different beliefs, it would be more correct to identify the openness toward Others as toleration. The persecutions of Jews, and later of Christians, was not the result of religious doctrines, but rather the consequence of claims by Jews and Christians as to the absolute truth of their respective beliefs. Augustine was the first to formulate a preliminary concept of tolerance toward those who embraced different religions (Jews) or were sinners in the eye of the Church, such as prostitutes (*Epistola ad Vincentium V* [1649]), as long as such open-mindedness contributed to the cohesiveness and stability of the Christian community. However, Augustine vehemently attacked those Christians who followed deviant teachings (Donatists), and approved of their persecution. In the Middle Ages, scholastic writers pursued the idea of tolerance in the light of sinful behavior that could be accepted as long as it did not affect the principles of Christian belief. Thomas specifically differentiated among heathens, Jews, and heretics, and argued for the toleration of various religious practices among Christians as long as they supported the truth of the New Testament. Moreover Thomas rejected forced conversion and baptism since such acts constituted a violation of natural law (Bejczy, p. 370).

A number of medieval writers explicitly advocated tentative models of tolerance. In his middle High German epic *Willhelam* (c. 1218), Wolfram von Eschenbach's female protagonist Gyburc pleads for humane treatment of the heathens, her own relatives who she had left behind when she fled to the Christian world with her lover and future husband Willhelam. In the pan-European love story *Floire et Blanchefleur* (Old French version, c. 1160), just as in *Aucassin et Nicolette* (Old French, early thirteenth century), the difference in religion of the young couple has no significance, whereas love is described as the dominant force that overcomes all social, ethnical, military, and political conflicts (Shutters, 2004). In the anonymous middle High German verse romance *Reinfried von Braunschweig* (c. 1280), the protagonist at first intends to force his opponent, the Prince of Persia, to convert to Christianity. But, upon the latter's plea, Reinfried allows the Persian to maintain his religion because he realizes that a forced conversion would never make the Prince into a true Christian. In fact the protagonist abandons all his religious goals and becomes a secular tourist who simply admires the wonders of the East. The Catalan mystic and poet Ramon Llull (c. 1232–1316) strongly advocated openness toward the Other in his *Book of the Gentile and the Three Wise Men* (c. 1275–1290). Similar to Peter Abelard's *Dialogue between a Philosopher, a Jew, and a Christian* (c. 1136–1139), Llull's treatise is built upon dialogues among representatives of the three world religions about their specific form of

belief. Although Lull, like Abelard, explicitly advocated Christianity, he accepted other religions as valid belief systems that he could not and did not want to condemn absolutely. On the contrary, both Abelard and Lull suggested that conversion to Christianity must be based on true conviction, which in turn was based on an intellectual, rational discourse in which the opponent was convinced of the falsity of his or her original belief and convinced by logical arguments and a newfound faith to accept Christianity (Nederman, Muldoon). Although in reality openness toward other religions was hardly ever practiced—as evidenced by the many persecutions and expulsions of and pogroms against Jews—many medieval and early modern philosophers can be credited with bold, farsighted exploration of the possibilities for various religions to exist side by side. Nicolaus of Cusa (1401–1464), in *De pace fidei* (1453), proposed embracing the concept of *concordia* (concordance) of the *religio una in ritum varietate* (one religion in a variety of rituals). Some humanists such as Thomas More (1485–1535) and Erasmus of Rotterdam (c. 1466–1536) advocated acceptance of religion as an individual worldview that should not be imposed on other people. Heretics should be persecuted, but only by the state and only when they represented a danger to the entire community (*De amabili ecclesiae concordia liber* [1533]). Conversely Martin Luther (1483–1546), although he had broken with the Catholic Church, strongly defended the persecution of Jews and members of various Protestant sects, and approved of the death penalty. John Calvin (1509–1564) defined tolerance as friendliness of the spirit (*mansuetudo animi*), but he did not raise any objections to imposing the death penalty on heretics, such as the Spanish theologian Miguel Serveto (c. 1511–1553).

On the opposite side of the debate was the French philosopher Jean Bodin (1530–1596) who defended the freedom of individual consciousness and tolerance (*Six Livres de la République* [1576]). In the tradition of Abelard and Lull, Bodin composed a dialogue text in which representatives of various religions discuss their theological differences (*Colloquium heptaplomeres* [c. 1593]).

Religious tolerance was an important issue in the wake of religious wars on the European continent and in England up to the end of the Thirty Years' War because the dominant religions persecuted minorities, which in turn led to military conflicts. Thomas Hobbes (1588–1679) was the first to define religious convictions as “private opinions” (*Leviathan* [1651]), which paved the way for John Locke's famous “Letter Concerning Toleration” (1689): “For no man can, if he would, conform his faith to the dictates of another” (Locke, see Zagorin). Nevertheless even Locke refused to accept atheists and charged them with refusing to abide by the basic rules of human society, which were predicated on the concepts of covenants, promises, and oaths.

Traditional scholarship argues that Locke's “Letter Concerning Toleration” represents the first attempt in the history of the Western world to establish philosophical principles of tolerance, followed by comparable statements by Wilhelm von Humboldt (1767–1835), Benjamin Constant (1767–1830), and John Stuart Mill (1806–1873). But even though the term

tolerance might not be fully applicable in other contexts, as early as late antiquity and the Middle Ages writers and philosophers embraced certain types of tolerance, or at least toleration, for example Augustine, John of Salisbury (c. 1115–1180), Marsiglio of Padua (1275–1342), Nicholas of Cusa (1401–1464), and Bartolomé De Las Casas (1484–1566) (Nederman, 2000). Francisco de Vitoria (1483–1546), insisting upon the inalienable rights of all peoples, formulated such astonishingly open-minded views regarding the North and South American Indians and their inhumane treatment at the hands of the Spanish conquistadors that his works were almost put on the papal index of forbidden books (Schmidinger, pp. 194–202). In particular, de Vitoria argued that conversion to Christianity can only be possible if the prospective convert has been convinced rationally. Infidels can never be forced to convert, since faith is also a matter of reason. This attitude resonated profoundly in John Locke's “Essay Concerning Human Understanding” (1690): “Such is the nature of the understanding that it cannot be compelled to the belief of any thing by outward force. Confiscation of estate, imprisonment, torments, nothing of that nature can have any such efficacy as to make men change the inward judgment that they have framed of things. . . . It is only light and evidence that can work a change in men's opinions; and that light can in no manner proceed from corporal sufferings, or any other outward penalties” (Vernon, p. 17). In other words, tolerance, or acceptance of the Other, in his inalienable character and nature, has been explored by philosophers throughout history, but has remained a fleeting concept regularly undermined and challenged by social, economic, political, and military realities.

Major breakthroughs in the history of modern tolerance did not occur until the late eighteenth century. Emperor Joseph II of Austria issued a law of tolerance for the various religious (Christian) communities in his inherited lands, giving members of non-Catholic communities recognition, as long as the dominance of the Catholic Church was not compromised. In letters that he exchanged with his mother Maria Theresa, he said that he remained an ardent defender of Catholicism, but wanted to give Protestants equal rights, at least in terms of their status as citizens, and to grant them the right to practice their religion. The Constitution of the United States was based on the principle of tolerance, best reflected in the Bill of Rights, as formulated by Thomas Jefferson (1743–1826), and Thomas Paine (1737–1809) in his enormously popular *Rights of Man* (1791).

The most influential and far-reaching public defense of tolerance, however, might well be that of the German Enlightenment writer Gotthold Ephraim Lessing (1729–1781) in *Nathan the Wise* (1779). Based on an episode from Boccaccio's *Decameron* (c. 1348–1350), the key component of the story is a parable that the Jew Nathan tells the Sultan Saladin. The Sultan, short of money, encourages Nathan to identify which of the three world religions is the only true one, hoping to extort money from Nathan who is sure to reveal his preference of Judaism. Nathan, however, does not provide a straightforward answer, and instead relates the parable of a man who owned a valuable ring that had the power to make its bearer loved by all people. The ring's owner leaves the ring to

the son who is dearest to him. The pattern of that legacy is continued for many generations, until one day a father has three sons whom he loves equally. When death approaches, the father has two perfect copies of the ring made and secretly gives one to each of his three sons, pretending that it is the only and true ring. After his death the sons go to a judge to determine who owns the authentic ring and hence who is heir to the father's estate. The judge refuses to decide and advises the three brothers to "Let each of you demonstrate his belief in the power of his ring by conducting his life in such a manner that he fully merits—as anciently promised—the love of God and man." The brothers are told to return to the ultimate judge, God, within a thousand years and to confirm before Him who had been the most loved because of his kindness and piety. Saladin understands Nathan's message and discharges him, accepting him as a friend. Saladin has learned that all three religions are equal in their basic essence and that believers of all faiths should tolerate each other, competing only in an attempt to be most worthy of the love of families and neighbors.

Assessment

Despite numerous efforts by lawmakers, philosophers, theologians, and poets, the deep gulf between self and the Other has continued to plague the modern world. Although Jews gained more freedoms after the early nineteenth century and were increasingly integrated into Christian society, by the 1890s anti-Semitism had reached new levels of intensity, making possible the atrocities committed by the Nazis during the Holocaust, and subsequent pogroms in Poland and Russia following World War II and continuing into the early twenty-first century. The world continues to struggle with the dialectics of self and other, in intellectual and popular culture, in economic and military terms, and in issues regarding the legal rights of immigrants, refugees, prisoners of war, criminals, and others who society at large does not accept or tolerate (Levinas, pp. 145–149). Ancient man regarded barbarians or even members of neighboring city-states as other. Medieval people used images of monsters to characterize believers of other religions as dangerous infidels or heretics. These as well as homosexuals, apostates, the possessed, and even women were considered to be the Other, both threatening and dangerous (Goodich). In the early twenty-first century, dominant societies have created a variety of new images of the Other, such as illegal immigrants, asylum seekers, political refugees, Muslim terrorists, and imagined creatures from outer space (Schreiner).

The content of the theoretical template of the Other has changed over the centuries but its fundamental binary opposition that the self always establishes barriers to the Other in order to create an identity—a process that is possible only through deliberate differentiations—remains. While not inherently hostile or dangerous, in most cases, throughout history people have tended to cast the Other in the worst possible light because the self usually chooses a path toward itself by rejecting the Other and establishing a close-knit community (family, village, church group, country, and people). Since the Middle Ages individual writers, poets, philosophers, and theologians have argued in defense of the Other and have made

serious attempts at breaking down the rigid barriers between it and the self, demonstrating that open-mindedness and tolerance are values that have long been important in human society. In other words, arguments for the humane, integrative treatment of the Other have been proposed throughout history, with the idea of tolerance arising in different contexts in different cultures and historical periods. Since the creation of the U.S. Constitution and the *Code Napoléon*, however, Western societies, particularly, have struggled, more or less successfully, to establish institutional frameworks and legal, social, economic, and religious conditions through which the constructive interaction between self and other have become increasingly possible (Wierlacher, 1993).

See also Anti-Semitism; Demonology; Enlightenment; Heresy and Apostasy; Humanity; Mysticism; Occidentalism; Orientalism; Toleration.

BIBLIOGRAPHY

- Adorno, Theodor W., and Max Horkheimer. *The Dialectics of Enlightenment*. Translated by John Cumming. New York: Continuum, 1972. Originally published in 1944.
- Bejczy, István. "Tolerantia: A Medieval Concept." *Journal of the History of Ideas* 58, no. 3 (1997): 365–384.
- Amar, Akhil Reed. *The Bill of Rights: Creation and Reconstruction*. New Haven, Conn.: Yale University Press, 1998.
- Assmann, Jan. "Praktiken des Übersetzens und Konzepte von Toleranz im Alten Orient und in der hellenistisch-römischen Antike." In *Kulturthema Toleranz: Zur Grundlegung einer interdisziplinären und interkulturellen Toleranzforschung*, edited by Alois Wierlacher, 283–306. Munich: Iudicium, 1996.
- Augustine. *The City of God against the Pagans*. Edited and translated by R. W. Dyson. Cambridge Texts in the History of Political Thought. Cambridge, U.K.: Cambridge University Press, 1998.
- Benton, Janetta Rebold. *Holy Terrors: Gargoyles on Medieval Buildings*. New York: Abbeville Press, 1997.
- Bovey, Alixe. *Monsters and Grotesques in Medieval Manuscripts*. Toronto: University of Toronto Press, 2002.
- Caciola, Nancy. *Discerning Spirits: Divine and Demonic Possession in the Middle Ages*. Ithaca, N.Y.: Cornell University Press, 2003.
- Camille, Michael. *Image on the Edge: the Margins of Medieval Art*. Cambridge, Mass.: Harvard University Press, 1992.
- Classen, Albrecht, ed. *The German Volkesbuch: A Critical History of a Late-Medieval Genre*. Lewiston, N.Y.: Edwin Mellen Press, 1995.
- . *Meeting the Foreign in the Middle Ages*. New York: Routledge, 2002.
- . "Die Suche nach dem Ich in der Gottheit. Mystische Literatur als epistemologisches Phänomen im Spätmittelalter: Zu Hildegard von Bingen, Mechthild von Magdeburg und Agnes Blannbekin." *Erudes Médiévales* 4 (2002): 21–34.
- Cohen, Jeffrey Jerome. *Of Giants: Sex, Monsters, and the Middle Ages*. Minneapolis: University of Minnesota Press, 1999.
- Cohen, Jeremy. *Living Letters of the Law: Ideas of the Jew in Medieval Christianity*. Berkeley: University of California Press, 1999.
- Delumeau, Jean. *Sin and Fear: the Emergence of a Western Guilt Culture: 13th–18th Centuries*. Translated by Eric Nicholson. New York: St. Martin's Press, 1990.

- Dinzelbacher, Peter. *Angst im Mittelalter: Teufels-, Todes- und Gotteserfahrung: Mentalitätsgeschichte und Ikonographie*. Paderborn, Germany: Schöningh, 1996.
- Flint, Valerie I. J. *The Imaginative Landscape of Christopher Columbus*. Princeton, N.J.: Princeton University Press, 1992.
- . *The Rise of Magic in Early Medieval Europe*. Princeton, N.J.: Princeton University Press, 1991.
- Friedman, John Block. *The Monstrous Races in Medieval Art and Thought*. Cambridge, Mass.: Harvard University Press, 1981.
- Gadamer, Hans-Georg. *The Hermeneutic Reader: Texts of the German Tradition from the Enlightenment to the Present*. Edited by Kurt Mueller-Vollmer. New York: Continuum, 1985.
- Ginzburg, Carlo. *The Night Battles: Witchcraft and Agrarian Cults in the Sixteenth and Seventeenth Centuries*. Translated by John Tedeschi and Anne Tedeschi. Baltimore: Johns Hopkins University Press, 1992.
- Gioseffi, Daniela. *On Prejudice: A Global Perspective*. New York: Anchor Books, 1993.
- Goodich, Michael, ed. *Other Middle Ages: Witnesses at the Margins of Medieval Society*. Philadelphia: University of Pennsylvania Press, 1998.
- Hallson, Fridrik. *Xenologie: Eine Begriffserläuterung*. Bielefeld, Germany: Universität Bielefeld, 1994.
- Kirn, Hans-Martin. *Das Bild vom Juden im Deutschland des frühen 16. Jahrhunderts*. Tübingen, Germany: Mohr, 1989.
- Levack, Brian P. *The Witch-Hunt in Early Modern Europe*. 2nd ed. London and New York: Longman, 1995.
- Levinas, Emmanuel. *Alterity and Transcendence*. Translated by Michael B. Smith. New York: Columbia University Press, 1999.
- Lionarons, Joyce Tally. "The Otherworld and its Inhabitants." In *A Companion to the Nibelungenlied*, edited by Winder McConnell, 153–171. Columbia, S.C.: Camden House, 1998.
- Locke, John. "A Letter Concerning Toleration." In *Two Treatises of Government and a Letter Concerning Toleration*, edited by Ian Shapiro. New Haven, Conn., and London: Yale University Press, 2003.
- Maccoby, Hyam, ed. and trans. *Judaism on Trial: Jewish-Christian Disputations in the Middle Ages*. London: Associated University Press, 1982.
- Martin, Xavier. *Nature humaine et révolution française: Du siècle des lumières au Code Napoléon*. Bouère, France: D. M. Morin, 1994.
- Milem, Bruce. *The Unspoken Word: Negative Theology in Meister Eckhart's German Sermons*. Washington, D.C.: Catholic University of America Press, 2002.
- Milis, Ludovicus, ed. *The Pagan Middle Ages*. Translated by Tanis Guest. Woodbridge, Suffolk, U.K., and Rochester, N.Y.: Boydell Press, 1998.
- Mittal, Anuradha, and Peter Rosset, eds. *America Needs Human Rights*. Oakland, Calif.: Food First Books, 1999.
- Muldoon, James, ed. *Varieties of Religious Conversion in the Middle Ages*. Gainesville: University Press of Florida, 1997.
- Nederman, Cary J. *Worlds of Difference: European Discourses of Toleration c. 1100–1550*. University Park: Pennsylvania State University Press, 2000.
- Said, Edward W. *Orientalism*. New York: Pantheon Books, 1978.
- Saussure, Ferdinand de. *Saussure's Third Course of Lectures on General Linguistics (1910–1911)*. Translated by Roy Harris. New York: Pergamon Press, 1993. Translation of *Troisième cours de linguistique générale (1910–1911)*. French text edited by Eisuke Komatsu.
- Schick, Irvin Cemil. *The Erotic Margin: Sexuality and Spatiality in Alteritist Discourse*. London, New York: Verso, 1999.
- Schmidinger, Heinrich, ed. *Wege zur Toleranz: Geschichte einer europäischen Idee in Quellen*. Darmstadt, Germany: Wissenschaftliche Buchgesellschaft, 2002.
- Scholz Williams, Gerhild. *Defining Dominion: The Discourses of Magic and Witchcraft in Early Modern France and Germany*. Ann Arbor: University of Michigan Press, 1995.
- Schreiner, Klaus. "Toleranz." In Vol. 6 of *Geschichtliche Grundbegriffe: Historisches Lexikon zur politisch-sozialen Sprache in Deutschland*, edited by Otto Brunner, Werner Conze, and Reinhart Koselleck, 445–605. Stuttgart, Germany: Klett-Cotta, 1990.
- Shutters, Lynn. "Christian Love or Pagan Transgression?: Marriage and Conversion in *Floire et Blancheflor*." In *Discourses on Love, Marriage, and Transgression in Medieval and Early Modern Literature*, edited by Albrecht Classen. Tempe, Ariz.: MRTS, 2004.
- Stutzinger, Dagmar. "Das Fremde und das Eigene: Antike." In *Europäische Mentalitätsgeschichte: Hauptthemen in Einzeldarstellungen*, edited by Peter Dinzelbacher, 400–415. Stuttgart, Germany: Kröner, 1993.
- Sundermeier, Theo. *Den Fremden wahrnehmen: Bausteine für eine Xenologie*. Gütersloh, Germany: G. Mohn, 1992.
- Szarmach, Paul E, ed. *An Introduction to the Medieval Mystics of Europe*. Albany: State University of New York Press, 1984.
- Vernon, Richard. *The Career of Toleration: John Locke, Jonas Proast, and After*. Montreal: McGill-Queen's University Press, 1997.
- Wierlacher, Alois, ed. *Kulturthema Fremdheit: Leitbegriffe und Problemfelder kulturwissenschaftlicher Fremdhheitsforschung*. Munich: Iudicium, 1993.
- Williams, David. *Deformed Discourse: The Function of the Monster in Medieval Thought and Literature*. Montreal: McGill-Queen's University Press, 1996.
- Yamamoto, Dorothy. *The Boundaries of the Human in Medieval English Literature*. Oxford: Oxford University Press, 2000.
- Zagorin, Perez. *How the Idea of Religious Toleration Came to the West*. Princeton, N.J.: Princeton University Press, 2003.

Albrecht Classen



P

PACIFISM. The issues summoned up by the term *pacifism* are complex and varied because different concepts, traditions, and definitions exist throughout the world, often creating misunderstanding and confusion—sometimes intentionally so. For example, the term may be used pejoratively in political debates by individuals seeking to portray opponents who refuse to support a specific military action, or by those who prefer nonviolent approaches to a problem or conflict while not being principled pacifists. The term underwent a bifurcation, redefinition, and narrower specification with the watershed years of the so-called Great War of 1914. The distinction between absolute pacifism and “pacific-ism”—the latter a term coined by the modern historian A. J. P. Taylor and used by his successors—or other less ethically rigid “pacifist” positions emerged then. Before 1915 the term *pacifist* was employed as a more general term to describe one who opposed war as an institution, rejecting violence in favor of turning “swords into plowshares.” But the earlier definition of *pacifist* did not necessarily exclude violence—still less all force—as a means to an end, for example, in opposing slavery.

This more general understanding of pacifism did not necessarily imply a refusal to support, or indeed fight in, a war once it broke out. The more rigid position became defined as “absolute” or “pure” pacifism, identifying those whose stance in 1914 or from 1915 to 1916 was based on consistent principles. The terms *pure* or *absolute* have been dropped from the political debate since then, and the term *pacifist* now tends to mean rejection of all and any war—especially since the 1960s, when some “pacifists” remained equivocal on violence in Indochina.

The Religious Concept of Pacifism

The individual moral concept of “turning the other cheek” is one that belongs to a number of religious traditions, though the position has perhaps arguably been most fully developed as an ethical position in Judaism and then Christianity and as a spiritual position in Buddhism—and, mainly through Mahatma Gandhi (1869–1948), as a revision of Hindu thought. The major religious tradition with the least apparent pacifist dimension seems to be Islam. Secular ethical pacifism emerged in the nineteenth century alongside other “isms” based on humanist and universalist ethics and overlaps with several ideological strands from liberalism to anarchism and, since the 1970s, feminism.

Pacifism and Resistance to War

The biblical commandment “thou shall not kill” does not specifically refer to organized war and can thus be taken as a prohibition of individual murder, perhaps not the “legitimate”

killing by soldiers in war—an ethical sleight of hand that has been convenient to states and rulers and allows the concept of just war, elaborated by the Christian Church when it became institutionalized in the West in the fifth century and continuing for a millennium. The injunction to turn the other cheek in the face of violent provocation has been seen not as a theory of nonviolence but as one of passivity, suffering, and stoicism. Pacifist idealism and ethics have evolved toward a more formal position of war refusal or war resistance. More generally, pacifism worldwide has evolved from an ethic of suffering and detachment to active engagement through nonviolence as an alternative to war. The invention of Gandhian nonviolence thus represented a critical moment in the evolution of pacifist ethics—though Gandhi was not an absolute pacifist in the strictest sense.

Conscientious Objection Based on Pacifist Principles

Since laws of universal military service—conscription or the draft—and claims of conscientious objection spread gradually during the nineteenth century, the issue of refusal to fight in war did not appear to be a universal issue of conscience. It had been possible to avoid the choice if faced with it. Pacifism as opposition to war as an institution did not mean refusal to participate in it until the drafts of 1914–1918, when those who accepted the call of country (so-called pacifists) divided themselves from the minority absolute pacifists who remained antiwar in practice as well as theory.

War Resistance versus Pacifism

Similar ethical divisions over war in general and specific (just) wars have continued. War resistance (often to specific wars) and pacifism are not the same; some have refused to participate in specific “unjust” wars or opposed an arms race or particular (for example, nuclear) weapons without being pacifists in regard to all war. For example, the peace movement was often partisan regarding whose weapons and wars it most actively opposed—divided over emancipatory or “progressive” war or violence (such as the defense of the Spanish Republic against fascism after 1936). Other ethical issues for pacifism have arisen over the moral duty to counsel others to refuse military service (under some laws “incitement to disaffection”)—or to take nonviolent action, even sabotage, to obstruct war or destroy weapons.

Further examples of this dilemma abound. Should continued religious teaching against war or military combat be interpreted as treasonable or subversive of a state in time of war? Certainly not all those who refuse to be involved in war on ethical grounds are advocates of nonviolence or turning the

other cheek in other situations. Equally those who accept a nonviolent discipline in domestic politics (such as Gandhi's) do not necessarily condemn all war. The grounds for opposing war and conscription are often not strictly ethical; they may be political or personal—ethics of justice, liberation, equality or “national liberation” may be more important than nonviolence in antiwar protests.

The Personal versus the Political in Pacifism

The term pacifism is usually used of an ideological position that is more than purely personal—the U.S. anarchist Paul Goodman (1911–1972) called himself a “fist-fighting pacifist.” For others personal nonviolence in life, or a meditative path, is more important than whether one dons a uniform or picks up a weapon or takes a position against a war or revolution. It is essentially retreatist. There are many variants of these positions.

The millennia of otherworldly retreat—monastic or utopian—from a world that appears lost repeats itself as communitarian pacifism and recurrently inherits recruits from failed or dissipated antiwar movements. There is an emphasis on child development, peace education, and the construction of a more peaceful culture, which has had an impact on modern pedagogy.

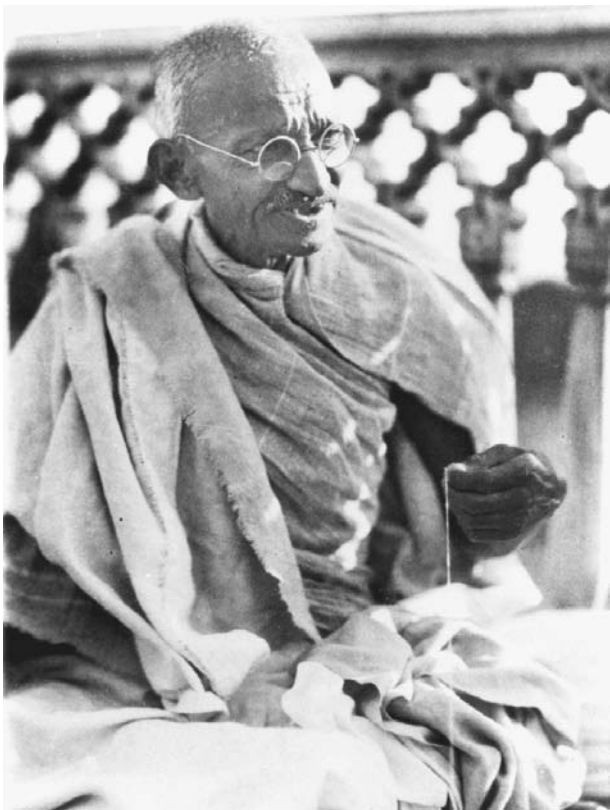

Mahatma Gandhi (1869–1948). Gandhi's policy of passive resistance—or, as he preferred to call it, *satyagraha* (truth and firmness)—was first manifested during his sojourn in South Africa in the late nineteenth century and continued upon his return to his homeland of India. AP/WIDE WORLD PHOTOS

Gandhi's own ambivalence on these dilemmas, expressed in his retreat after the mass 1920s campaigns became violent—again is symptomatic of this ambiguity in pacifist idealism; yet by the 1930s and 1940s he once again advocated mass nonviolent resistance to British colonial rule in India, even during wartime, while also urging such resistance to Hitlerism from the 1930s on—for those brave enough to do so. Violence in this view was the inferior weapon of the weak, preferable to cowardice, but a lesser evil at best. Gandhi's model was reproduced in Ghana to some extent, but more violent methods adopted by leftist or nationalist revolutionaries tended to dominate such struggles thereafter.

Gandhi was also a political pacifist, however, in seeking programs of social and institutional change, not merely personal transformation. He saw them as being linked—following the teachings of Leo Tolstoy—but went further than the Russian Christian anarchists in creating a political ethic of nonviolent collective action (drawing also from Thoreau's principles of civil disobedience). These ideas in turn inspired Dr. Martin Luther King Jr. (1929–1968) and other human rights leaders. In the early New Left of the 1960s and the women's movements of the 1970s and 1980s and since, the personal and the political came together again in a fusion of pacifism and antipatriarchal women's peace activism that sought to “take the toys from the boys” not least the Cruise missiles deployed in the United Kingdom by U.S. President Ronald Reagan in the 1980s. The Greenham Common Women's Peace Camp at the Greenham missile base in the United Kingdom was symptomatic of hundreds of such projects, militantly antimilitarist but linked to feminist and pacifist ideologies and predominantly nonviolent in methodology.

Twentieth-Century Developments

In the twentieth century new forms of pacifism emerged that were linked to political traditions: anarchist or socialist pacifism, nationalist pacifism (for example, in Wales), nuclear pacifism or the refusal to support or tolerate the stockpiling manufacture, use, or threatened deployment of weapons of mass destruction. Many pure pacifists were ambivalent about such a movement against only one form of war, while others took leadership roles in movements opposing the atomic bomb, in turning the movement to the use of Gandhian nonviolence. Feminism took an interest in pacifism from the first women's movements, burgeoning in the antinuclear women's peace movements of the 1980s and reflected in writers such as Barbara Deming.

Since 1918 the link between individual pacifist ethics and political pacifism has been shown to be most obvious; the sum of individual conscientious stances can create a social force based on ethics that can have an impact on policy. While more noticeable in liberal democratic contexts, even in authoritarian and repressive situations, such movements have had enormous effectiveness. Acting against the military draft, opposing the threat to engage in war, or the planned deployment of a new weapon (for example, to target civilians), or the invasion of another country—such movements have suffered many short-term setbacks but some long-term successes. Yet often pacifist and pacifist groups have remained marginal in their attempt to bring ethical stances into political life; the peace

churches and “prophetic minorities” have kept ethics alive and provided leadership but are at best pressure groups or lobbies for change, as was the attempt to stop the strategic bombing of cities in World War II (1943–1945). In retrospect this was, even from the mainstream, not considered treasonable behavior but a legitimate ethical position. At the time it was seen as disloyal and questionable and was therefore marginalized by the allied military-political elites.

The war in Vietnam is another instance where, in hindsight, the pacifist positions that were marginalized in 1965 seemed justifiable only a decade later. The draft resistance movement led by pacifist groups has gained a respectable if not heroic image. However, this opportunistic application of just war or pacifist theories is anathema to absolute pacifists for whom even World War II, the “good war,” remains ultimately an injustice—to the victims and those forced to fight in it.

Ethical pacifists who have emerged in the twentieth century with leading roles in social movements—Dr. Martin Luther King, Jr., Mahatma Gandhi, and many others—have, like some of the great pacifist religious prophets of the distant past, had an impact on social consciousness and cultural history far beyond their immediate actions. Yet pacifist ethics are in tension not only with the institution of war but even with the violent origins, foundations, and operations of the state and its penal and security systems. Despite the Gandhian model, pacifism often finds itself in tension with nationalist aspirations, or the urge toward armed emancipation from oppression. The “Balkan Gandhi,” Ibrahim Rugova (b. 1945), witnessed two decades of nonviolent struggle for the autonomy of Kosovo, but also saw his nonviolent movement overtaken by a violent reaction to Serb oppression in 1998–1999 and ultimately by military intervention by NATO.

The episode in Kosovo, like the Spanish Civil War of 1936, underlines the dilemmas of pacifist ethics in a highly militarized world, socialized toward violent solutions to conflict. Such events do not prove pacifism right or wrong; they do raise issues of immediate effectiveness in the last resort (especially where peoples are under threat, or as in Spain where the long-term consequences of inaction may be disastrous), as against aspirations for long-term cultural and political change, and the failure to break the cycle or self-sustaining character of violent action. The great social structural insight of pacifism (as opposed to its ethical probity) is that violent conflict and change begets violent institutions, authoritarianism, and further violence. Whether nonviolence as a method can slowly replace that structural dynamic remains open to question, yet it is surely one of the prime issues of all human politics.

See also Nonviolence; Peace; Resistance and Accommodation; War.

BIBLIOGRAPHY

Bondurant, Joan V. *The Conquest of Violence: The Gandhian Philosophy of Conflict*. Princeton: Princeton University Press, 1958. Still the classic academic work of political theory on the ideas and practice of nonviolence by political scientist.

Brock, Peter. *Pacifism in the United States: From the Colonial Era to the First World War*. Princeton: Princeton University Press, 1968. The foremost historian of pacifism.

———. *Pacifism since 1914 An Annotated Reading List*. 3rd ed. Toronto: P. Brock, 2000. Best bibliography on Modern pacifism

———. *Varieties of Pacifism: A Survey from Antiquity to the Outset of the Twentieth Century*. 4th ed. Syracuse, N.Y.: Syracuse University Press, 2000. Short essays.

Brock, Peter, and Nigel Young. *Pacifism in the Twentieth Century*. Syracuse, N.Y.: Syracuse University Press, 1999. Strongest on religious debates and useful as a comprehensive reference work.

Carter, April. *Peace Movements: International Protest and World Politics Since 1945*. London and New York: Longman, 1990. Sympathetic critical account of pacifist and nonpacifist movements by an academic once active in the movements.

Ceadel, Martin. *Pacifism in Britain 1914–1945: The Defining of a Faith*. Oxford: Clarendon, 1980. Written by a nonpacifist who has written several other works critically examining pacifism.

Cooney Robert, and Helen Michalowski. *The Power of the People: Nonviolent Action in the United States*. Philadelphia: New Society Press, 1988. Accessible, well-illustrated general accounts of pacifist campaigns mostly twentieth century.

Gandhi, Mahatma. *The Moral and Political Writings of Mahatma Gandhi*. Edited by Raghavan Iyer. 3 vols. Oxford and New York: Oxford University Press, 1986–1987. Contains “My Experiments with Truth” (Gandhi’s autobiography).

Nuttall, Geoffrey. *Christian Pacifism in History*. Oxford and New York: Blackwell, 1958. A summary of the religious standpoint.

Young, Nigel. “War Resistance and the Nation State.” Ph.D. diss., University of California, Berkeley, 1976. An academic political sociology of pacifist action written by an academic peace researcher, observer, and participant, who has written extensively on war resistance, peace, and radical movements.

———. “War Resistance in Britain.” In chap. 1, *Campaigns for Peace*, edited by Richard Taylor and Nigel Young. Manchester, U.K.: Manchester University Press, 1987. This collection contains several other useful and pertinent essays including on the women’s peace movement; the introduction has a useful tabulation of peace traditions following R. Overy and others.

Nigel Young

PAN-AFRICANISM. Because it refers neither to a single political ideology nor a clearly discernible philosophical tradition, *Pan-Africanism* is difficult to define. Many scholars avoid defining it, noting that black internationalism has varied drastically according to time and place. Indeed, various conceptions of Pan-Africanism have been aligned with disparate political and theoretical positions, from largely religious to communist to even, Paul Gilroy suggests, fascist forms. Yet, the concept can be said to signify a set of shared assumptions. Pan-Africanist intellectual, cultural, and political movements tend to view all Africans and descendants of Africans as belonging to a single “race” and sharing cultural unity. Pan-Africanism posits a sense of a shared historical fate for Africans in the Americas, West Indies, and, on the continent itself, has centered on the Atlantic trade in slaves, African slavery, and European imperialism.

Cultural and intellectual manifestations of Pan-Africanism have been devoted to recovering or preserving African “traditions” and emphasizing the contributions of Africans and those in the diaspora to the modern world. Pan-Africanists have invariably fought against racial discrimination and for the political rights of Africans and descendants of Africans, have tended to be anti-imperialist, and often espoused a metaphorical or symbolic (if not literal) “return” to Africa.

Origins and Development of Pan-Africanism

The modern conception of *Pan-Africanism*, if not the term itself, dates from at least the mid-nineteenth-century. The slogan, “Africa for the Africans,” popularized by Marcus Garvey’s (1887–1940) Declaration of Negro Rights in 1920, may have originated in West Africa, probably Sierra Leone, around this time. The African-American Martin Delany (1812–1885), who developed his own re-emigration scheme, reported in 1861 the slogan after an expedition to Nigeria during 1859–1860 and Edward Wilmot Blyden (1832–1912) adopted it when he arrived in West Africa in 1850. Blyden, originally from St. Thomas, played a significant role in the emergence of Pan-Africanist ideas around the Atlantic through his public speeches and writings in Africa, Britain, and the United States, and proposed the existence of an “African personality” resembling contemporary European cultural nationalisms. Blyden’s ideas informed the notion of race consciousness developed by W. E. B. DuBois (1868–1963) at the end of the nineteenth century.

The growth of Pan-African sentiments in the late nineteenth century can be seen as both a continuation of ethnic, or “pan-nationalist,” thinking and a reaction to the limits of emancipation for former slaves in the diaspora and European colonial expansion in Africa. There are a number of reasons why black internationalism had particular resonance during this period. African contact with Europeans, the slave trade from Africa, and the widespread use of African slaves in the New World colonies were the most salient factors, leading first those in dispersion and then many in Africa to envision the unity of the “race.” At the same time, as abolition spread gradually around the Atlantic during the nineteenth century, Europeans increasingly viewed race as a biological and, thus, inherent difference rather than a cultural one.

Back-to-Africa movements—particularly the establishment of Sierra Leone by the British in 1787 and Liberia by the American Colonization Society in 1816—also contributed to the emergence of Pan-Africanism, and were probably the original source of the phrase, “Africa for the Africans.” From 1808, English Evangelicals at the CMS Grammar School in Freetown taught their “liberated” students that there were other Africans around the globe, which instilled a sense of a common destiny. Many mission-educated Sierra Leoneans like Samuel Crowther (c. 1807–1891) and James Johnson (1836–1917) moved or, in some cases, moved back to Nigeria, primarily Lagos, beginning in the mid-nineteenth century, where they were joined by returning freed people from Brazil and the Caribbean. These groups quickly coalesced into the Christian, African upper class that produced the leaders of early Nigerian nationalism and Pan-Africanism. Pan-Africanism was the

product of extraordinary, European-educated Africans and African-Americans, in other words, those most exposed to metropolitan culture and the influences of the modern world.

Ethiopianism. Apart from the contributions of West Africans and African descendants in the New World, South Africa developed a distinctive form of race consciousness in the form of Ethiopianism. Up to the contemporary Rastafarian movement in Jamaica, the word *Ethiopian* has enjoyed a privileged position in the Pan-Africanist vocabulary as a term for all Africans and as one referring only to the inhabitants of a specific state (Abyssinia). The movement denoted by the term *Ethiopianism* draws on the former denotation and takes its name from the “Ethiopian Church” founded in 1892 by Mangena M. Mokone (1851–1931) who separated from the African Methodist Episcopal mission over discrimination in the church.

Ethiopianism emerged in response to European colonial settlement, the institutionalization of white supremacy, and rapid industrialization, particularly in mining areas like the Rand region near Johannesburg. Its leaders were largely graduates of missionary schools, but most in their audiences were illiterate. Thus, Ethiopianism became a significant means of spreading proto-nationalist ideas and a sense of Pan-African unity in southeastern and South Africa. Following the last Zulu uprising in 1906, white South Africans and the British associated the movement with the insurrection and became hypersensitive to any potential expressions of the “peril.” The notion of Ethiopianism, however, had spread to West Africa, notably the Gold Coast and Nigeria, by the end of the nineteenth century, where it blended with other Pan-Africanist currents.

Transnational Pan-Africanism

Although the exact origins are disputed, the term *Pan-African* first appeared in the 1890s. P. O. Esedebe maintains that the Chicago Congress on Africa held in 1893 marks both the transition of Pan-Africanism from an idea to a recognizable movement and the first usage of the word itself. In their collection on Pan-African history, however, Adi and Sherwood point to the creation of the African Association in 1898 and the convening of the first Pan-African conference in 1900 in London, both organized by the Trinidadian lawyer Henry Sylvester Williams (1869–1911), with the objective of “bringing into closer touch with each other the Peoples of African descent throughout the world,” as the beginning of the “organised Pan-African movement.” Despite these differences, scholars agree on the important role that the African American intellectual W. E. B. DuBois played in developing the idea of Pan-Africanism and marshalling a transnational political movement around it. Indeed, DuBois contributed significant speeches to the proceedings of the Chicago Congress and the Pan-African 1900 conference. In his “Address to the Nations of the World” at the latter, DuBois declared:

the problem of the twentieth century is the problem of the colour line, the question as to how far differences of race . . . are going to be made, hereafter, the basis of denying to over half the world the right of sharing to their utmost ability the opportunities and privileges of modern civilization. (1995, p. 11)

Although Williams was unable to bring plans for a second conference to fruition, DuBois soon initiated his own movement, resulting in five Pan-African Congresses during the first half of the twentieth century (1919, Paris; 1921, London, Brussels, Paris; 1923, London and Lisbon; 1927, New York; 1945, Manchester, England). During this period the nature and tenor of Pan-Africanist cultural and political activities changed drastically.

Pan-Africanism in the Early Twentieth Century

World War I brought thousands of African-Americans, Afro-Caribbeans, and Africans into contact with one another. The exigencies of war also led the imperial powers of Europe—Britain, France, and Germany—to train and employ colonial subjects in crucial industries while, as colonial combatants, many others saw firsthand the depravity that a supposedly superior European civilization had produced. Colonial soldiers also pointed to the racism implicit in being asked to fight to “make the world safe for democracy” when this world would not include them, a suspicion confirmed for many when the Allies refused to include a guarantee against racial discrimination in the League of Nations charter following the war. As a result, the interwar years witnessed an unprecedented growth in a sense of racial unity and the popularity of black internationalism.

Marcus Garvey. The most famous Pan-Africanist movement of the period was Garveyism. After struggling for some time to attract an audience in his native Jamaica, Marcus Garvey emigrated to Harlem in 1916, where he and a young, educated Jamaican woman, Amy Ashwood (who later married Garvey), relocated the Universal Negro Improvement Association (U.N.I.A.; founded 1914) on firmer footing. The U.N.I.A. quickly became the largest African-American organization in history due, in large part, to the diligent work of black women in the movement, especially West Indian emigrants like Ashwood and Marcus Garvey’s secretary and second wife, Amy Jacques (1896–1973).

The apogee of the U.N.I.A.’s success was probably its international convention in 1920, at which Garvey presented the Declaration of the Rights of the Negro Peoples of the World, demanding “self-determination for all peoples” and “the inherent right of the Negro to possess himself of Africa.” Garvey’s hubris—in declaring himself “the provisional president of Africa,” for instance—and autocratic leadership, however, cost him important friends and supporters, and his flair for ostentatious public spectacles and inflated expectations led many leading African-American writers and scholars, for example, Alain Locke (1885–1954) and DuBois, to decry him as a liability to the race. With most of his commercial enterprises like the Black Star shipping line failing or already bankrupt, in 1922 the U.S. government arrested and jailed Garvey for five years before deporting him in 1927, effectively ending the organizational life of the U.N.I.A. in the United States. Nevertheless, Garvey’s life and work left a powerful legacy around the African diaspora, and his ideas have reappeared in many guises, from the violent labor clashes in the Caribbean during the 1920s and 1930s to the more millenarian form of Garveyism that developed in South Africa.

Pan-Africanist literary and cultural movements. The interwar period also witnessed the flowering of a number of Pan-Africanist literary and cultural movements, especially in New York, London, and Paris, and the emergence of a trans-Atlantic periodical culture. In the United States, the New Negro movement of the 1920s, better known as the Harlem Renaissance, not only drew attention to the work of African American artists but also displayed distinct Pan-Africanist sensibilities. Writers like James Weldon Johnson (1871–1938) inspired others around the Atlantic, for example, the Nardal sisters from Martinique (Paulette, Jane, and Andrée, who ran a salon out of which came *La Revue de Monde Noir* [The Journal of the Black World] edited by Paulette Nardal and Léo Sajous) and Una Marson from Jamaica (1905–1965; the first major woman poet of the Caribbean and a playwright), to assert positive images of blackness while experimenting with stylistic innovations, often informed by black musical forms like the blues. Yet, the New Negro movement was not solely a literary or artistic movement: Pan-Africanist political organizations, including the explicitly communist African Blood Brotherhood, can also be seen as manifestations of it.

Pan-Africanists and communism. However, it was across the Atlantic in Britain—where by the mid-1930s a key group of West Indian and African radicals had assembled—that communism and, particularly, the recent success of the Bolshevik Revolution (1917) had its greatest impact on Pan-Africanist activists and intellectuals. The Trinidadians George Padmore (1902–1959) and C. R. L. James (1901–1989) were most significant in this regard. Padmore served as head of the International Trade Union Committee of Negro Workers and editor of its monthly newspaper, the *Negro Worker*, and James was an internationally known Trotskyite.

Growing awareness of Stalin’s abuses in the Soviet Union and, more importantly, the apathy with which the governments of Europe and the League of Nations greeted Mussolini’s invasion of Abyssinia (Ethiopia) and Haile Selassie’s pleas for intervention ultimately led them both to split from the Communist Party and foreground Pan-Africanism in their political and intellectual work. In 1938, James published two important books of Pan-African history, the *Black Jacobins* and *A History of Negro Revolt*. Both situated contemporary anti-imperialist struggles in Africa within a larger tradition of resistance stretching back to slave uprisings in the New World. As James explains in a revealing footnote that he later added to the *Black Jacobins*, “such observations, written in 1938, were intended to use the San Domingo revolution as a forecast of the future of colonial Africa.”

James formed the International African Friends of Abyssinia in 1935 along with Padmore, Amy Ashwood Garvey, the Trinidadian musician and journalist Sam Manning, Ras Makonnen (1892–1975) from British Guiana, the Sierra Leonean trade unionist I. T. A. Wallace-Johnson (1895–1965), and the future president of postcolonial Kenya, Jomo Kenyatta (1889–1978). The group soon became the International African Service Bureau and published a series of short-lived but important journals: *Africa and the World* (July–September 1937), *African Sentinel* (October 1937–April 1938), and *International African Opinion* (July 1938–March 1939).

Sojourners from Africa and the Caribbean created a number of other organizations in interwar Britain, most notably the West African Student Union (WASU) and the League of Coloured Peoples (LCP). Harold Moody (1882–1947), a West Indian doctor who was outspokenly anticommunist, founded the latter as an interracial association with the intention of fostering greater understanding and cooperation across racial boundaries. A small group of law students from West Africa, led by Ladipo Solanke (1884–1958), established the WASU to challenge racial discrimination and racist representations in Britain. However, they were also encouraged by the example of the National Congress of British West Africa under the leadership of J. E. Casely Hayford (1866–1930), which envisioned the creation of an independent “United States of West Africa.” The LCP and the WASU also published two significant mainstays of the black British press during the period, *The Keys* and *Wāsù* (Preach), respectively. Though initially neither was radical politically, by World War II both organizations had begun to call for an end to British colonial rule in Africa and the Caribbean, and the WASU’s local hostel in particular had become an important clearinghouse for Pan-Africanist ideas. In fact, several members of WASU went on to become prominent politicians in postcolonial Africa.

Pan-Africanism in France. Though they have received far less attention in the extant literature, students, writers, and activists from the Francophone Antilles and French West Africa also developed a distinct form of Pan-Africanism, or *internationalisme noir* (black internationalism), in Paris between the wars. After serving in World War I, the ambitious lawyer and philosopher Prince Kojouhar Tovalou-Houenou (1887–1925) from Dahomey founded the *Ligue Universelle pour la Défense de la Race Noire* (International League for the Defense of the Black Race), which published the first black newspaper in France, *Les Continents*, during the second half of 1924. The Martinican novelist René Maran (1887–1960) also played a major role in the paper as both an editor and writer.

However, the most well-known expression of black internationalism in interwar France was the literary and philosophical movement known as Negritude. The Martinican poet Aimé Césaire coined the term during 1936–1937. In addition to Césaire, the work of Léon-Gontran Damas (1912–1978) and Léopold Sédar Senghor (1906–2001) are usually credited with establishing and defining the movement. Yet, Negritude emerged within a broader spectrum of Pan-Africanist activities, from the Senegalese communist Lamine Senghor’s (1889–1927) Comité de Défense de la Race Nègre (Committee for the Defense of the Black Race), which was founded in 1926 and published the short-lived journal *La voix des nègres*.

Women’s contributions to Pan-Africanism. The essential contributions of women to the development of both Anglophone and Francophone forms of black internationalism were overshadowed by their male contemporaries and have fared little better in scholarship on Pan-Africanism. Recently, however, the feminist-inflected Pan-Africanism of Jamaican women—Amy Ashwood Garvey, Una Marson, and Claudia Jones (1915–1964)—and West African women such as Constance Cummings-John (1918–2000) and Stella Thomas

has received more attention. Likewise, the crucial role of the Martinican Nardal sisters in initiating and articulating *internationalisme noir* in Paris—as illustrated, for example, by *La revue du monde noir*—is only beginning to be acknowledged. Moreover, as Brent Hayes Edwards points out, historians have failed to recognize the ways in which various formulations of Pan-Africanism and, more specifically, the Negritude movement were implicitly gendered.

Pan-Africanism after World War II and Postcolonialism

Coming as it did immediately after the upheavals of World War II, the 1945 Pan-African Congress in Manchester marked a watershed in black internationalist activities around the Atlantic. Though ostensibly under DuBois’s guidance, it was organized primarily by socialist Pan-Africanists in Britain, especially George Padmore, and was the first Congress to include a significant number of Africans like Jomo Kenyatta and Kwame Nkrumah (1909–1972), who served as assistant secretary and joint secretary, respectively.

Following the Manchester Congress, the site of Pan-Africanist activities shifted from the United States and Europe to the colonies in the Caribbean and, particularly, Africa. In fact, many of the key figures in the movement—DuBois, Padmore, and Alphaeus Hunton—relocated to Africa during this period. In 1956, Padmore’s classic *Pan-Africanism or Communism?* appeared, and in 1958 Nkrumah hosted the first All-Africa People’s Conference at Accra in the wake of independence from British colonial rule in 1957 and the creation of an independent Ghana.

In the postcolonial era, the nature of Pan-Africanism and the problems facing Pan-Africanist projects changed dramatically. For the first time, Pan-Africanism became a broad-based mass movement in Africa and enjoyed its greatest successes as an international liberation movement in the first two decades after the war. Through his rhetoric and, most importantly, his example as president of independent Ghana, Nkrumah dominated this period in the history of Pan-Africanism. The context of the Cold War profoundly shaped the struggle for independence in Africa, as it did global politics in general, but in spite of his commitment to Marxism, Nkrumah avoided taking sides in the East-West Cold War and, instead, emphasized African unity. As some historians have noted, the All-Africa People’s Conference at Accra in 1957, attended by some 250 delegates, established the basic tenets of Pan-Africanism for decades to come: the attainment of political independence, assistance to national liberation movements, diplomatic unity between independent African states at the United Nations, and nonalignment. As Nkrumah asserts in *I Speak of Freedom*, “a Union of African states will project more effectively the African personality.”

In 1963, due primarily to the efforts of Nkrumah, President Sékou Touré (1922–1984) of Guinea, President Modibo Keita (1915–1977) of the Republic of Mali, and Haile Selassie, the emperor of Ethiopia, the Organization of African Unity (OAU) was founded in the midst of decolonization and the euphoria of independence in West Africa. However, economic neo-colonialism and the limits of political independence quickly

extinguished the optimism of the immediate postcolonial period, leading Pan-Africanist scholars like the Trinidadian historian Walter Rodney (1942–1980) to reevaluate the long-term repercussions of the Atlantic slave trade and European imperialism for Africa. The 1960s also witnessed a number of intra-African disputes between newly independent states, many of which were precipitated by border issues inherited from colonialism.

Pan-Arabism and Pan-Africanism. Another significant feature of the postwar period was the convergence of Pan-Africanism and Pan-Arabism, which had hitherto remained distinct movements in North Africa. Traditionally, Pan-Arabism focused on North Africa's historical links to the east, to the Arabian Peninsula and the Fertile Crescent, while sub-Saharan Pan-Africanism looks across the Atlantic to African descendants in the Americas. Moreover, religion (Islam) enjoys pride of place in Pan-Arabism as the basis of the perceived unity of the Arab world, but loosely defined cultural similarities and "racial" solidarity or, in Nkrumah's words, a distinctive "African personality" underlie Pan-Africanism.

The flowering of anti-imperialist, nationalist movements in North Africa after World War II, and especially the Egyptian revolution of 1952, however, signaled the emergence of a fusion of the two movements. Initially, this resulted principally from the political vision of Gamal Abdel Nasser (1918–1970), who succeeded Muhammad Naguib (1901–1984) as Egypt's leader. He maintained that his country had historically occupied the center of three concentric circles—the Arab world, the Muslim world, and Africa—and argued on this basis that Egypt should not remain indifferent to liberation struggles in sub-Saharan Africa. Despite his exaggeration of the importance of Egypt to Africa's future, the appearance in 1959 of his book, *The Philosophy of Revolution*, marked an important moment in the intersection of the Pan-Arab and Pan-African movements.

The triumphant resolution of the Suez Crisis in 1956 also enhanced Nasser's international standing, making him a source of inspiration and a symbol of the larger struggle to free Africa and the Arab world from European hegemony. The pioneering works of the Senegalese historian and politician Cheikh Anta Diop (1923–1986), such as *The Cultural Unity of Black Africa* (1963) and *The African Origin of Civilization: Myth or Reality* (1974), which resituated Egyptian history within its larger African context, represent another important intellectual manifestation of this moment in the history of Pan-Africanism.

The final, bloody years of the Algerian war of independence (1954–1962) also strengthened ties between Pan-Arabism and Pan-Africanism. The anticolonial war in Algeria had originally split intellectuals and politicians in Francophone Africa, due largely to the special status accorded the territory as a legal part of France. This began to change, however, after Ghana's independence in 1957 when Nkrumah, an outspoken proponent of the Algerian cause, became the new state's first president. In addition to Nkrumah's Ghana, Guinea and Mali joined the predominately Arab, pro-Algerian Casablanca Group, and Nkrumah became the first sub-Saharan African leader to support Arab nations in denouncing Israel as a "tool of

neocolonialism" in Palestine when he endorsed the Casablanca declaration.

After Algeria gained its independence in 1962, the Organization of African Unity (OAU) emerged as the primary agent of Arab-African cooperation after 1963. Many then interpreted the June War of 1967 between Arabs and Israel as an attack on a member of the OAU and an occupation of African territory by Israeli forces, which only served to strengthen the importance of anti-Israeli sentiment as a basis for Arab-African solidarity. By the time of the October War of 1973 between Arab nations and Israel, politics in the Middle East and Africa were more intertwined than ever due to the nearly unanimous severing of African states' diplomatic ties to Israel.

Pan-Africanism in the Late Twentieth Century

The mid-1970s saw the elaboration of a new philosophy and a new outline for long-term economic, technical, and financial cooperation between Africa and the Arab world. In some respects, oil and, particularly, the creation of the Organization of Petroleum Exporting Countries (OPEC) were important in this regard and transformed Nigeria into a crucial state in Arab-African relations. Oil profits and the institutional framework of OPEC enabled significant capital transfers from Arab to African states between 1973 and 1980. Yet, those funds fell well short of Africa's real needs for development capital, and these factors often proved to divide rather than promote unity. Ultimately, the dramatic downturn in oil prices beginning in the early 1980s not only hurt oil-producing countries but drastically reduced Arab aid to Africa.

At the end of the twentieth century, debates surrounding "globalization" and renewed interest in transnational communities and cultural networks sparked a number of attempts to "reconsider" the history of Pan-Africanism, particularly among scholars associated with the nascent fields of African diaspora studies and Atlantic history. The delegates at the Sixth and Seventh Pan-African Congresses—held in Dar es Salaam, Tanzania, and Kampala, Uganda, in 1974 and 1994, respectively—also revisited this history. They did so, however, in an attempt to emphasize the need for unity in confronting contemporary economic exploitation in Latin America and Africa as well as the revolutionary potential of Pan-Africanism for the future. Likewise, following the end of both the Cold War and apartheid in South Africa, the new African Union, founded at Sirte, Libya, in March 2001 to replace the OAU, was called on to address problems as diverse as the marginalization of Africa in international affairs, the global economy, and the AIDS pandemic on the continent.

The Future of Pan-Africanism

The career and rise to international prominence of Thabo Mbeki (b. 1942) as South Africa's second freely elected president exemplify the mixture of promise and immense difficulties facing Pan-Africanist projects and Africa in general in the twenty-first century. Like Nelson Mandela (b. 1918), Mbeki devoted his life to the fight against apartheid in South Africa, but, whereas Mandela was imprisoned for much of his adult life, Mbeki spent years in forced exile in Britain after 1962, earning a Master's degree in economics from Sussex

University in 1968 and working with Oliver Tambo (1967–1991), the effective leader of the African National Congress (ANC) in Mandela’s absence.

In 1969, like most ANC leaders, many of whom were also long-time members of the South African Communist Party (SACP), Mbeki went to the Lenin International School in Moscow for a year to receive military training. After serving as political secretary for Tambo, the ANC president in the late 1970s, he became the ANC’s chief diplomatic liaison, which increased the antiapartheid movement’s profile abroad as well as his own, and rose to the SACP’s central committee in the late 1980s. However, following F. W. de Klerk’s (b. 1936) lifting of the ban on dissident organizations like the ANC, SACP, and the Pan-Africanist Congress on February 2, 1990, Mbeki gradually distanced himself from the SACP, allowing his membership to lapse at the same time as he spearheaded attempts to transform the ANC from a prohibited liberation movement into a legal political party. Then, having served as Mandela’s deputy president from 1994 to 1999, Mbeki was inaugurated as his successor in June 1999.

Mbeki’s presidency became mired in a series of controversies, most famously concerning his flirtation with “dissident” views on the nature and treatment of HIV/AIDS, but his espousal of an “African Renaissance” made possible discussions over the relevance and potential of Pan-Africanism in the twenty-first century and, more specifically, the role of a free South Africa on the African continent. Mbeki’s notion of an “African Renaissance,” though deliberately vague, has a number of ideological roots. For one, it is situated within the long tradition of South African leaders who, regardless of their ideological or physical hue, have asserted the country as the driving force behind development on the continent in general. This is a position that, it is said, South Africa must reclaim and would otherwise already occupy had it not been for the artificial privileges accorded by race under apartheid.

The international stature of Nelson Mandela reaffirmed this assumption of the naturalness of South African leadership in both internal diplomatic relations in Africa and projecting Africa’s interests into the global market and international political organizations like the United Nations. Yet, as Peter Vale and Siphosiso Maseko observe, it was largely “the appeal of Mbeki’s lyrical imagery that turned the obvious . . . into a tryst with destiny.” It is clear that Mbeki’s thought rests on a social-contractual reading of the African Renaissance. It represents essentially a double-edged agreement that not only commits the South African state to a democratic concord with the people of South Africa but also to the cause of peace and democracy across the continent.

Unfortunately, the emancipatory potential of Mbeki’s message remained unrealized and, by and large, more promise than policy, limited changes like South Africa’s assumption of a peacekeeping role in Africa notwithstanding. Moreover, some have criticized the limitations of Mbeki’s approach: buoyed by the same modernization theory that inspired economic ambitions under apartheid, though directing attention backward to Africa’s past, it fetishizes new technologies, endowing the latter with the power to trigger profound social changes almost

single-handedly. Nevertheless, the ambiguity and potential weaknesses of Mbeki’s rhetoric have created a political space in which a multiplicity of competing interpretations of Africa’s future can be debated.

Vale and Maseko identified two distinct approaches to the idea of an “African Renaissance,” one “globalist,” the other “Africanist.” Based firmly in the modernist tradition, the former seems to assume that what is good for South Africa is also good for the rest of Africa, views the continent as principally an expanding market, and sees free markets, privatization, and cuts in public expenditure as prerequisites to curtailing the power of authoritarian governments. The latter, however, envisions an African Renaissance to promote a series of complex social constructions that turn on issues of identity and call for a reinterpretation of African history and culture outside of the analytical frameworks and narratives of European imperialism. Thus, representatives of the Africanist approach eschew the modernizing tendency toward Africa’s encounter with Europe, or “chasing of scientific glory and money,” and maintain that the globalist perspective will merely result in an externally driven consumerist movement in Africa. According to this view, Africans will continue to be valued solely for their capacity to absorb foreign goods if development on the continent continues to follow the globalist path. Despite advancing a powerful critique of globalist/modernist assumptions and encouraging alternative visions of Africa’s future, Africanist arguments rarely appear in mainstream political discussions of interstate relations in Africa. This is due in large measure to prevailing socioeconomic conditions on the continent in which states, suffocating under the burden of international debt, increasingly fail to provide their constituencies with basic amenities like water, electricity, and adequate housing.

One final development in black internationalism—the emergence of the concept of the “Black Atlantic”—figures in the future of Pan-Africanism. The idea was originally introduced by black British scholars, most famously Paul Gilroy, who emerged from the Cultural Studies group under the leadership of Stuart Hall at Birmingham University and whose work focuses heavily on African American and black British literature and popular culture. The notion of the Black Atlantic injected new life into attempts to examine the historical formations outside of the analytic framework of the nation-state by highlighting the singular importance of the legacy of the Middle Passage and African slavery around the Atlantic. In *Black Atlantic* (1993), Gilroy offered a compelling critique of the increasingly unproductive impasse between “essentialist” and “anti-essentialist” positions on racial and ethnic difference and what became known in the late twentieth century as “identity politics.” Many of the insights—as well as the potential pitfalls—of this approach have been picked up by academics in the Americas, and especially the United States. For example, Brent Hayes Edwards expands on this scholarship while also exposing the tendency of much work on the African diaspora to overemphasize similarities and obscure differences rather than recognizing the management of difference (cultural, economic, linguistic, etc.) as an inescapable and, indeed, constitutive aspect of the elaboration of any particular vision of diaspora.

See also *Africa, Idea of; Black Atlantic; Black Consciousness; Diasporas: African Diaspora; Nationalism: Africa; Nationalism: Cultural Nationalism; Negritude.*

BIBLIOGRAPHY

PRIMARY SOURCES

- Bowen, J. W. E., ed. *Africa and the American Negro: Addresses and Proceedings of the Congress on Africa 1895*. Atlanta, Ga.: Gammon Theological Seminary, 1896.
- Campbell, Horace. *Pan-Africanism: The Struggle against Imperialism and Neocolonialism, Documents of the Sixth Pan-African Congress*. Toronto: Afro Carib Publications, 1975.
- Cunard, Nancy, ed. *Negro: An Anthology*. 1934. Reprint, New York: F. Ungar, 1970.
- DuBois, W. E. B. *W. E. B. DuBois: A Reader*. Edited by David Levering Lewis. New York: Owl Books, 1995.
- James, C. L. R. *The Black Jacobins: Toussaint L'Ouverture and the San Domingo Revolution*. 1938. Reprint, New York: Vintage, 1963.
- . *A History of Pan-African Revolt*. Introduction by Robin D. G. Kelley. Chicago: C. H. Kerr, 1995. Originally published in 1938 as *A History of Negro Revolt*.
- Makonnen, Ras T. *Pan-Africanism from Within*. Recorded and edited by Kenneth King. London: Oxford University Press, 1973.
- Nasser, Gamal Abdel. *The Philosophy of the Revolution*. Buffalo, N.Y.: Smith, Keynes, and Marshall, 1959.
- Nkrumah, Kwame. *I Speak of Freedom: A Statement of African Ideology*. London: Heinemann, 1961.
- Padmore, George, ed. *History of the Pan-African Congress*. London: Hammersmith, 1947.
- . *Pan-Africanism or Communism? The Coming Struggle for Africa*. London: D. Dobson, 1956.
- Report of the Pan-African Conference held at the 23rd, 24th and 25th July, 1900 at Westminster S.W., London*. London: n.p., 1900.
- Rodney, Walter. *How Europe Underdeveloped Africa*. London: Bogle L'Ouverture, 1972.

SECONDARY SOURCES

- Adi, Hakim. "Bandeled Omoniyi—A Neglected Nigerian Nationalist." *African Affairs* 90 (1991): 581–605.
- Adi, Hakim, and Marika Sherwood. *Pan-African History: Political Figures from Africa and the Diaspora since 1787*. London: Routledge, 2003.
- Appiah, Kwame Anthony. *In My Father's House: Africa in the Philosophy of Culture*. New York: Oxford University Press, 1992.
- Cooper, Frederick. *Africa since 1940: The Past of the Present*. New York: Cambridge University Press, 2002.
- Decraene, Philippe. *Le Panafricanisme*. Paris: Presse universitaire de France, 1959.
- Edwards, Brent Hayes. *The Practice of Diaspora: Literature, Translation, and the Rise of Black Internationalism*. Cambridge, Mass.: Harvard University Press, 2003.
- Egonu, Iheanachor. "Les Continents and the Francophone Pan-Negro Movement." *Phylon* 42 (September 1981): 245–254.
- Esebebe, P. Olisanwuche. *Pan-Africanism: The Idea and Movement, 1776–1963*. Washington, D.C.: Howard University Press, 1994.
- Geiss, Imanuel. *The Pan-African Movement: A History of Pan-Africanism in America, Europe, and Africa*. Translated by Ann Keep. New York: Africana, 1974.

- Gilroy, Paul. *Between Camps: Nations, Cultures, and the Allure of Race*. London: Penguin, 2000.
- . *The Black Atlantic: Modernity and Double Consciousness*. Cambridge, Mass.: Harvard University Press, 1993.
- Hooker, James. *Black Revolutionary: George Padmore's Path from Communism to Pan-Africanism*. New York: Praeger, 1967.
- Jacobs, Sean, and Richard Callard, eds. *Thabo Mbeki's World: The Politics and Ideology of the South African President*. London: Zed, and Pietermaritzburg, South Africa: University of Natal Press, 2002.
- James, Winston. *Holding Aloft the Banner of Ethiopia: Caribbean Radicalism in Early Twentieth-Century America*. London: Verso, 1998.
- Jarrett-Macauley, Delia. *The Life of Una Marson, 1905–65*. Manchester, U.K.: Manchester University Press, 1998.
- Kodjo, Edem, and David Chanaiwa. "Pan-Africanism and Liberation." In *History of Africa*. Vol. 8: *Africa since 1935*, edited by Ali A. Mazrui. Oxford: Heinemann, Berkeley: University of California Press, and Paris: UNESCO, 1993.
- Langley, J. Ayodele. *Pan-Africanism and Nationalism in West Africa, 1900–1945: A Study in Ideology and Social Classes*. Oxford: Clarendon, 1973.
- Lemelle, Sidney J., and Robin D. G. Kelley, eds. *Imagining Home: Class, Culture, and Nationalism in the African Diaspora*. London: Verso, 1994.
- Sharpley-Whiting, T. Denean. *Negritude Women*. Minneapolis: University of Minnesota Press, 2002.
- Shepperson, George. "Pan-Africanism and 'Pan-Africanism': Some Historical Notes." *Phylon* 23 (1962): 346–358.
- Sherwood, Marika. *Kwame Nkrumah: The Years Abroad, 1935–1947*. Legon, Ghana: Freedom Publications, 1996.
- Vale, Peter, and Siphon Maseko. "South Africa and the African Renaissance." *International Affairs* (April 1998): 271–288.
- Zachernuk, Philip. *Colonial Subjects: An African Intelligentsia and Atlantic Ideas*. Charlottesville: University of Virginia Press, 2000.

Marc Matera

PAN-ARABISM. Pan-Arabism is the concept that all Arabs form one nation and should be politically united in one Arab state. The intellectual foundations of pan-Arabism were laid down in the early decades of the twentieth century, in the context first of Arab alienation from Ottoman rule and later in response to the imperialist partition of the Arab provinces of the Ottoman Empire after World War I. The doctrine became politically significant in the post-World War II era, when it produced the drive for integral Arab unity that culminated in the union of Egypt and Syria in the United Arab Republic (1958–1961). Since the 1960s pan-Arabism has receded as a meaningful political aspiration, giving way to the acceptance of the reality of the existing Arab state structure overlaid by a continuing sense of Arab cultural unity and political solidarity.

Both as theory and practice, pan-Arabism was a child of its times. Its roots lay in the linguistic unity of elite culture across the Arabic-speaking world, where classical Arabic provided a common means of communication transcending geographical barriers, and in Arab awareness of their historical importance as the people responsible for the spread of Islam. This latent Arab consciousness was politicized in the early twentieth

century, when educated Arabs in the Fertile Crescent provinces of the Ottoman Empire began to chafe at growing Ottoman centralization as well as at their partial exclusion from participation in Ottoman rule due to the growth of Turkish nationalism. With parallel aspirations for autonomy developing in the several Arabic-speaking provinces of the empire by the pre-World War I years, these first nationalist stirrings in the Fertile Crescent had an implicitly pan-Arab character. The proximate referent for an explicit pan-Arabist ideology was the Arab-run state that emerged in greater Syria by the close of World War I as a result of the wartime Arab Revolt. Although crushed by the French in 1920, Emir/King Faisal's short-lived Arab Kingdom was thereafter a constant reminder of the united Arab polity that might have been were it not for the machinations of imperialism.

An explicit ideology positing the existence of one Arab nation and calling for the unity of all Arabs emerged in the interwar years. Articulated particularly by ideologues from the new mini-states of Iraq, Syria, and Palestine, it was in large part a reaction to the externally imposed division of the Arab East. Its key spokesman was the Iraqi educator Sati' al-Husri (1880–1968), whose numerous essays hammered home the message that language and history were the main determinants of nationhood and consequently that the Arabs, united as they were by one language and a shared history, deserved a parallel political unity. Husri's message was reinforced and deepened by Arab pedagogues of the interwar era, whose histories of the Arab nation expounded on the concepts of linguistic unity and a glorious Arab history reaching into antiquity. By the 1940s the doctrine of the existential reality of the Arab nation had been internalized by much of the younger generation, generating new political movements dedicated to working for Arab political unification. The most important of these was the Ba'th or Renaissance Party formed in Syria in the 1940s, an organization that rapidly found adherents in other eastern Arab lands. Its slogan—"one Arab nation with an eternal mission"—encapsulated the pan-Arabist vision; its 1947 program—that "[t]his nation has the natural right to live in a single state and to be free to direct its own destiny"—set the pan-Arabist agenda.

Pan-Arabism became a major political force in the decades after World War II. The circumstances of the postwar era—the entry into political life of a younger generation imbued with pan-Arabist ideas; individual Arab countries obtaining a greater measure of independence from foreign domination, and with it a greater ability to pursue pan-Arabist goals; the existence of the common problems of Western imperialism and the new state of Israel, both of which were perceived as necessitating Arab cooperation to be successfully addressed—provided a receptive medium for the flourishing of political pan-Arabism. The new League of Arab States (formed 1945), although strictly a confederative arrangement in which the separate Arab states retained freedom of action, nonetheless indicated the new postwar mood envisaging greater inter-Arab cooperation in the future. The Ba'th and other pan-Arabist political parties grew in size and influence in states such as Syria, Iraq, and Jordan from the 1940s onward, occasionally succeeding in stimulating a measure of inter-Arab political cooperation and at least lip-service to the goal of Arab unity

from their governments. Most meaningful politically was the emergence of a new champion for pan-Arabism in the 1950s, in the person of Jamal 'Abd al-Nasir (Nasser) of Egypt. Although his own nationalist outlook was at base primarily Egyptian nationalist, Nasser nonetheless perceived the desirability of greater inter-Arab cooperation in order to attain the goal of complete independence for the Arab world. Nasser's successes in opposing Western imperialism in the mid-1950s made Nasser and Egypt the natural focus of pan-Arabist hopes.

The high point of pan-Arabism as a political movement came in 1958, when pan-Arabist activists in Syria approached Nasser to request the integral unity of Egypt and Syria. Not without reservations, but also snared by his own previous advocacy of Arab nationalism as a mobilizing slogan, Nasser assented. The result was the United Arab Republic (UAR), a new state uniting Egypt and Syria under Nasser's leadership. The creation of the UAR set off considerable agitation for unity with the UAR by pan-Arabist enthusiasts in other eastern Arab states such as Lebanon, Jordan, and Iraq, agitation resisted only with difficulty by more localist leaders and forces concerned about their own prospects in any unified Arab state.

In the end Nasser's reservations about the UAR were borne out. Frustrated by their marginalization within the counsels of the regime, and opposed to the socialist measures being introduced by the early 1960s, in September 1961 elements of the Syrian military revolted, expelled their Egyptian overlords, and effectively terminated the reality of the UAR (although Egypt retained the name until 1971). The breakup of the UAR was a crucial setback for the pan-Arabist goal of integral Arab unity. To be sure, the dream did not die; when Ba'thists seized power in Syria and (more briefly) in Iraq in 1963, both governments immediately entered into "unity talks" with Nasser. These collapsed (as did the subsequent but less substantial initiatives aimed at negotiating Arab federation initiated by Mu'ammarr Gadhafi of Libya in the early 1970s) on the rock of political power-sharing. A further and greater setback for pan-Arabism came in June 1967 with the stunning military defeat of Egypt, Jordan, and Syria by Israel, an Arab catastrophe in which the leading exponents of pan-Arabism, Nasser and the Syrian Ba'th, were indelibly discredited as potential leaders of the drive for Arab political unity.

As a political movement, pan-Arabism has receded since the 1960s. Just as the context of the post-World War II decades provided the necessary medium for its earlier flourishing, so changed conditions since the 1960s have contributed to pan-Arabism's fading. The gradual consolidation of the power and legitimacy of what were initially artificial Arab states; the end of overt imperialist domination, thereby undercutting much of the reason for inter-Arab solidarity; the growing acceptance of the reality of Israel; the increased clout of the Arab oil monarchies, regimes apprehensive about what Arab unity might mean for them; not least the growth of the rival transnational ideology of Islamism, many of whose spokesmen view Arab nationalism as an alien, Western-inspired concept designed to subvert Muslim unity: all these developments of the 1970s, 1980s, and 1990s have worked against significant movement toward Arab political unity.

Politically, pan-Arabism has stalled since the 1960s. Other than the union of Yemen and North Yemen in 1990, a local development with no broader nationalist implications, there have been no further mergers of separate Arab states since the formation of the UAR in 1958 (the forced “merger” of Kuwait with Iraq in 1990 was quickly reversed by international opposition, including that of most other Arab states). The post-1970 leaders of those states that had led the pan-Arabist movement in the 1950s and 1960s—Anwar al-Sadat and Husni Mubarak of Egypt; Hafiz al-Asad of Syria; intermittently Saddam Husayn of Iraq—all concentrated on promoting the interests of their respective states, rather than on pursuing integral Arab unity, during their long tenures in power. There have been various regional organizations of Arab states created since the 1970s, the Gulf Cooperation Council formed in 1981 by the six Arab monarchies bordering the Persian Gulf being the most durable and meaningful; but these have been confederative arrangements that guarantee the territorial integrity of their members.

If political pan-Arabism is in eclipse, what remains? The League of Arab States continues to exist, and through its various subsidiary organizations has fostered an impressive level of interstate Arab cooperation in the economic, social, and cultural fields. Inter-Arab migration for occupational or educational reasons boomed in the 1970s and 1980s, driven particularly by the demand for Arab labor in the Arab oil states. Literally millions of Arabs lived, worked, or studied in Arab countries other than their homelands in the 1970s and 1980s; this inter-Arab migration decreased from the mid-1980s onward. Perhaps most important in perpetuating and deepening a shared Arab consciousness in recent decades has been the mass media. First radio, then television, more recently the Internet and the emergence of Arab media outlets capable of reaching Arabs everywhere have spread a common Arab culture and kept “Arab” issues, Palestine being the most vital, at the forefront of Arab awareness. Political pan-Arabism may be stalled; but an abiding sense of the Arabs as one people with a common culture, similar problems, and shared aspirations has increased and penetrated more deeply into the fabric of Arab society.

The temporal trajectory of political pan-Arabism was thus significantly different from that of the cultural Arabism on which it was in part based. Whereas the former emerged, flourished, and then declined over the course of the twentieth century, the latter has steadily increased and disseminated more widely. Arabism is by no means an exclusive identity; it exists in tandem with affinal ties, a longstanding self-definition as part of the Muslim community (for most Arabs), and a more recent loyalty to the state in which Arabs live. But it remains part of the blend of referents that define collective identity, shape popular sentiment, and inspire political action.

See also *Anticolonialism: Middle East; Nationalism: Middle East; Pan-Islamism; Pan-Turkism.*

BIBLIOGRAPHY

Cleveland, William L. *The Making of an Arab Nationalist: Ottomanism and Arabism in the Life and Thought of Sati' al-Husri.*

- Princeton, N.J.: Princeton University Press, 1971. A careful biography of the seminal pan-Arabist ideologue.
- Dawisha, Aeed. *Arab Nationalism in the Twentieth Century: From Triumph to Despair.* Princeton, N.J.: Princeton University Press, 2003. A recent comprehensive survey.
- Dawn, C. Ernest. “The Formation of Pan-Arab Ideology in the Interwar Years.” *International Journal of Middle East Studies* 20 (1988): 67–91. Focuses on pan-Arabist histories.
- Devlin, John. *The Ba'ath Party: A History from Its Origins to 1966.* Stanford, Calif.: Hoover Institution Press, 1976. An account of the main pan-Arabist political party.
- Haim, Sylvia G., ed. *Arab Nationalism: An Anthology.* Berkeley: University of California Press, 1962. A useful anthology with an extended introductory essay.
- Hourani, Albert. *Arabic Thought in the Liberal Age, 1798–1939.* London: Oxford University Press, 1961. A magisterial survey of modern Arab thought including nationalism.
- Jankowski, James. *Nasser's Egypt, Arab Nationalism, and the United Arab Republic.* Boulder, Colo.: Lynne Rienner Publishers, 2002. A study of Nasser's and Egypt's pan-Arabist involvement.
- Jankowski, James, and Israel Gershoni, eds. *Rethinking Nationalism in the Arab Middle East.* New York: Columbia University Press, 1997. A collection of essays suggesting new perspectives on Arab nationalism.
- Nuseibeh, Hazem Zaki. *The Ideas of Arab Nationalism.* Ithaca, N.Y.: Cornell University Press, 1956. An articulation of the premises of Arab nationalism written at the height of the movement.

James Jankowski

PAN-ASIANISM. *Pan-Asianism* as a general term refers to a wide range of ideas and movements that called for the solidarity of Asian peoples to counter Western influences in the late nineteenth and early twentieth centuries. In Japan, where Pan-Asianism had a decisive influence on the course of its modern history and served as an ideological justification for its military expansionism through 1945, it is referred to as “Asianism” or “Greater Asianism.”

Origins and Development in Japan

In the late nineteenth century, when the leaders of the Meiji government pursued Western-style modernization, Pan-Asianists emphasized Japan's affinity with Asia. They felt that Japan's progress could not be secured without the liberation of Asian neighbors from poverty and backwardness and that the Japanese had a mission to lead Asians out of stagnation. Many of the early Pan-Asianists began their political activities in the Freedom and People's Rights movement, demanding democratic participation in the national government. Miyazaki Tōten (pen name of Miyazaki Torazō; 1871–1922) came from a family of rural samurai well known in their area for their devotion to the People's Rights movement. He was an outstanding example of romantic Pan-Asianism who devoted some thirty years of his life to the cause of Sun Yat-sen's republican revolution in China.

Anxiety over national security was at the root of Pan-Asianism. Tarui Tōkichi (1850–1922), who explored the coast of Korea in the early 1880s, wrote *Daitō gappōron* (Federated

states of great East), a proposal for a federation of Japan and Korea. His idea, that the only hope for survival for the small Asian nations was in joining forces, reflected a perception among the contemporary Japanese that the “white race” was superior in physical, intellectual, and financial power to the “yellow race.”

Defense of indigenous tradition was another issue at this time of rapid modernization. Miyake Setsurei (Yūjirō; 1860–1945) and other cultural nationalists formed in 1888 a political association, *Seikyōsha*, for the purpose of raising national pride in *kokusui* (cultural essence of the nation), and published a series of popular periodicals, *Nihonjin* (the Japanese), *Ajia* (Asia), and *Nihon oyobi Nihonjin* (Japan and the Japanese). Naitō Konan (Torajirō; 1866–1934), a prominent Sinologist, associated with this group in his early career as a journalist. He held China’s culture in high esteem but maintained that China had lost its vigor and needed Japan’s guidance for reform. Okakura Tenshin (Kakuzō; 1862–1913), a gifted art historian who studied with Ernest Fenollosa at Tokyo University, called for the resurgence of the East. He underscored the creative vitality of Chinese and Indian civilizations that had adapted to changing historical circumstances over millennia and attained high levels of maturity. “Asia is one,” stated at the opening of Okakura’s *Ideals of the East*, was frequently quoted and had enormous influence.

Pan-Asianist Organizations in Japan

To promote good will among Asian neighbors, the Japanese government encouraged Pan-Asianist organizations. *Kōakai* (Raise Asia society) was the earliest among them, organized in 1880 by Japanese literati and members of the Chinese legation. In 1898 Prince Konoe Atsumaro (1863–1904), the chairman of the House of Peers, formed the *Tōa dōbunkai* (East Asia common culture society). It played a major role in enhancing Japan’s cultural policies in China through 1945. Tōyama Mitsuru (1855–1944), of Fukuoka, the most influential Pan-Asianist outside the government, founded *Gen’yōsha* (Black ocean society), an expansionist association, in 1881 and named it after *Genkainada*, the sea between Fukuoka and Korea. Uchida Ryōhei (1874–1937), one of Tōyama’s followers, headed *Kokuryūkai* (Amur River [black dragon] society), organized in 1901. They cooperated with government authorities as unofficial handlers of visitors from Asia. Numerous Pan-Asianist groups were organized under their influence. Their followers served as freelance agents for the Japanese government, military, and commercial establishments in China.

Development in Twentieth-Century Japan

After Japan joined the ranks of colonial powers following its victories over China in 1895 and Russia in 1905, the Japanese government adopted a policy of cooperation with the Western powers. At the same time it asserted Japan’s special interest in China. Around World War I phrases like “Asia for Asians,” “Asian Monroe Doctrine,” and “White Peril” appeared in newspapers and popular periodicals. The earlier emphasis on solidarity with Asian neighbors was replaced by emphasis on Japan’s leadership and supremacy in Asia. The opinions of Tokutomi Sohō (Iichirō; 1863–1957), the long-lived influential publicist, reflected the changing mood in Japan. Kita Ikki (1884–1937),

who once joined the revolutionary activities in China, urged Japan’s aggressive expansion in Asia and called for a radical reform in Japan to establish a kind of state socialism under the emperor. Ōkawa Shūmei (1886–1957) believed that Japan had a mission to replace white men’s imperialism with a federation of all nations and to create a new world blending the civilizations of the East and the West. Ōyawa had close ties with ultranationalist army officers, including Ishiwara Kanji (1889–1949), the mastermind of Japan’s conquest of Manchuria in 1931. During the 1930s and early 1940s, when the Japanese government openly adopted military expansionism, Pan-Asianist ideas were expressed in official declarations proclaiming a “New Order in East Asia” and the “Greater East Asia Co-Prosperty Sphere.”

Asians and Pan-Asianism

Japan’s 1905 victory over Russia, a European power, was received as an exhilarating event throughout Asia. During the following decade, a large number of students and revolutionaries from China, Korea, Philippines, India, and other areas of Asia came to Japan hoping to find encouragement for their nationalistic causes. Sojourners in Tokyo developed a sense of community as Asians. In 1907 Zhang Binglin, Zhang Ji, Liu Shipai, and other revolutionaries from China organized a *Yazhou heqin hui* (Asiatic humanitarian brotherhood) with revolutionaries from India, Vietnam, Burma, Philippines, and Korea, as well as Japanese socialists, to help each other’s anti-imperialist activities. Among its members and their associates were Phan Boi Chau of Vietnam and Mariano Ponce of Philippines. This organization and other similar associations did not last long because Tokyo became a less hospitable place for expatriate revolutionaries. Other Asians increasingly criticized Japanese Pan-Asianism as mere rhetoric for Japanese imperialism. In 1919 Li Dazhao wrote that weak nations in Asia must unite themselves to form a “new Greater Asianism” to defeat Japan’s “Greater Asianism.” Sun Yat-sen gave a lecture on Pan-Asianism in Kobe in 1924 and tried to persuade the Japanese to join a truly pan-Asian movement instead of becoming a watchdog for Western imperialists. To the 1926 Japanese call for a Pan-Asian conference in Nagasaki, Chinese and Korean newspapers responded with strong protest against Japan’s “Twenty-one Demands” on China and imperialist oppression of Koreans.

In India, in the early decades of the twentieth century, Bengali intellectuals had lively debates on the civilizations of the East and the West. Rabindranath Tagore (1861–1941) eloquently advocated the revival of Asian culture and the unity of Asia, but was against political nationalism. Jawaharlal Nheru followed Tagore in spirit in promoting the ideal of united Asia giving peace to a troubled world.

See also *Colonialism: Southeast Asia; Empire and Imperialism: Asia; Pan-Africanism; Pan-Arabism; Pan-Islamism; Pan-Turkism.*

BIBLIOGRAPHY

- Hay, Stephen N. *Asian Ideas of East and West: Tagore and His Critics in Japan, China, and India.* Cambridge, Mass.: Harvard University Press, 1970.
- Jansen, Marius B. *The Japanese and Sun Yat-sen.* Cambridge, Mass.: Harvard University Press, 1954.

- Kuzuu, Yoshihisa. *Tōa senkaku shishi kiden*. 3 vols. Tokyo: Kokuryūyū, 1933–1936.
- Miyazaki, Tōten. *My Thirty-three Years' Dream: The Autobiography of Miyazaki Tōten*. Translated by Etō Shinkichi and Marius B. Jansen. Princeton, N.J.: Princeton University Press, 1982.
- Okakura, Kakuzō. *The Ideals of the East, with Special Reference to the Art of Japan*. 2nd ed. New York: Dutton, 1905.
- Tarui, Tōkichi. *Daitō gappōron*. In *Nihon shisōshi shiryō sōkan*, vol. 1. Tokyo: Chōryō Shorin, 1975.
- Yamamuro, Shin'ichi. *Shisō kadai to shite no Ajia*. Tokyo: Iwanami Shoten, 2001.

Noriko Kamachi

PAN-ISLAMISM. A term of European origin, *pan-Islamism* denotes the intellectual and institutional trends toward Islamic unity that emerged among Muslim peoples, starting in the mid-nineteenth century and continuing throughout the twentieth century. The need for a unified Islamic identity was a product of the challenges posed by Western intervention in and domination of Muslim societies during the colonialist period. Leaders throughout the Muslim world appealed to the Islamic tradition to solidify public opposition to foreign occupation and thereby gain political independence. Like its European namesakes pan-Hellenism and pan-Slavism, pan-Islamism used cultural ideas to achieve nationalist political ends. Unlike the ethnic identities emphasized in European nationalisms, however, pan-Islamism emphasized the religious heritage and symbols that both united all Muslims and set them apart from their Western Christian colonialist occupiers. The nationalist purposes to which pan-Islamism was primarily directed may seem at odds with the universal principles on which it rests, but this tension was largely resolved in the practical drive for political, economic, and social progress that enveloped Muslim societies. Nowhere is this resolution more clearly defined than in the life and work of Jamal al-Din al-Afghani (1839–1897), a Muslim reformer and key advocate of pan-Islamism.

Jamal al-Din al-Afghani

Born in Persia, not Afghanistan as his name suggests, al-Afghani led the life of an itinerant scholar and activist. After his initial education in Persia, he studied in India and then worked in Afghanistan, Istanbul, Egypt, and Paris. Al-Afghani's travels provided him with a unique insight into the modern condition affecting all Muslim peoples, a condition he believed was characterized by political weakness, social instability, and cultural ignorance. Contact with the West did not cause this condition, according to al-Afghani, but it did bring it into high relief; it also alerted Muslims to an essential but long-dormant element of their own tradition: rational thought. For al-Afghani, the power and success of the modern West rested on its rejection of the stultifying restrictions of Christianity and its turn toward reason; since Islam, by contrast, was rooted in rationalism, Muslims need only return to the essence of their faith to overcome the developmental asymmetry that had come to differentiate Western and Muslim societies.

Arguing for the rational nature of Islam was a common strategy among Muslim reformers, who wanted to facilitate change while maintaining cultural identity. It was a strategy that recognized the Western orientation of modern development and the threat this orientation posed to cultural authenticity in the Muslim world. Indeed al-Afghani believed that social and political change could only be brought about if Muslims had a firm sense of the civilization to which Islam had given birth. By *civilization*, al-Afghani meant the intellectual and moral achievements that contributed to the unity and greatness of a people—a notion he borrowed from the French statesman-historian François Guizot (1787–1874) and employed to foster a usable Islamic past. This past did not lead inexorably to the unification of the entire Muslim community (the *umma*) under a single Islamic state. Instead, al-Afghani viewed Islamic civilization, the foundation of pan-Islamism, as a common cultural stream that fed the national political aspirations of such distinct countries as India, Persia, and Egypt. Here the logical appeal of Islam as universal glue for all Muslim peoples was subordinated to the practical realities of a world where nation-states had become the political norm. Pan-Islamism, however, had served a very different political purpose under the Ottomans.

Late Ottoman Politics

If al-Afghani was the father of pan-Islamist thought, Ottoman sultans were the first to implement pan-Islamism as official state policy, a policy with imperialist, not nationalist, goals. As early as the 1860s, the then-sultan, Abdul Aziz (r. 1861–1876), tried to extend his political authority beyond the Ottoman Empire by casting himself as the caliph, the designated ruler of all Muslims and the defender of the faith. His successor, Abdul Hamid II (r. 1876–1909), adopted the same mantle of authority. This pan-Islamic appeal was tied to the growing Western influence in the Muslim world that the Ottomans themselves had facilitated through their efforts to reform. The need to reform had become apparent as European peoples began to win back territory in the seventeenth and eighteenth centuries that had been lost to the Ottoman expansion into Europe during the fifteenth and sixteenth centuries. The same rising tide of technological advancement that had allowed European nations to defeat the Ottomans in Europe also permitted them to project their power abroad. This new political reality was made clear to the Ottomans when, in 1798, one of their autonomous possessions, Egypt, was invaded and occupied by the French under Napoléon Bonaparte.

Conscious of their declining power, the Ottomans embarked on a series of military, educational, social, and governmental reforms throughout the first half of the nineteenth century, and they sought technical assistance and advice from the very European nations that threatened the empire's territorial sovereignty. While dramatic and far-reaching, the reforms came too late to prevent the Ottomans from becoming known as the Sick Man of Europe, an inefficient and weakened empire whose lands in the Middle East and Central Asia looked ripe for the picking. The competition to take control of Ottoman possessions was widespread in Europe in the late nineteenth century and early twentieth century, but it was

played out on a grand scale—referred to as the Great Game—by two imperialist powers bent on world domination, Great Britain and Russia. For the Ottomans, pan-Islamic propaganda seemed a viable means of reasserting its sway over Muslim subjects whose loyalty was being tested by new ideas like nationalism and undermining the progress of European influence among Muslim peoples in places such as India. Ultimately unsuccessful as an imperialist ideology, pan-Islamism did serve the nationalist desires of Muslim peoples trying to break free from both Ottoman and European rule. It failed, however, to take hold in modern Turkey, the nation that arose out of the heartland of the defeated and dismembered Ottoman Empire.

The Khilafat Movement

The first popular pan-Islamist political movement, the Khilafat movement (1919–1924), emerged in India after World War I, though support for the caliphate locally among Indian Muslims had been gaining momentum throughout the second half of the nineteenth century. Chafing under British occupation and mindful of the glory days of Mogul rule, Indian Muslims directed their spiritual and later political longings toward the remaining seat of independent Muslim rule: the Ottoman caliphate. With the Ottoman Empire in ruins after World War I and the office of the caliph, the caliphate, under threat of extinction, Indian Muslims organized to preserve what many viewed as the last vestige of Islamic unity and power. In 1919 activist groups like the Association of Servants of the Ka'ba and the Council of the All-India Muslim League convened a Khilafat Conference, during which the movement took official form as the All-India Central Khilafat Committee.

The politics of the Khilafat movement were clearly anti-imperialist and pro-independence, which accounts for the popular support it received across Muslim sectarian lines in India and across the Muslim world. Activists within the movement spread their message through publications at home and abroad. Delegations were sent to England, France, and Switzerland to shape public attitudes and government policy regarding the caliphate and the future of Muslim societies. In the end, however, it was not European leaders but the new leaders of Turkey who decided the fate of the movement by adopting a secular path for the nation based on a narrowly conceived ethnic identity—a path that mirrored European strains of nationalism—and then abolishing the office of the sultan in 1922 and that of the caliph in 1924. The Khilafat movement protested Turkey's actions, but with no power to impose its will and with its reason for existence eliminated, the movement had gradually faded from public view by the late 1920s. Pan-Islamism in India, however, continued to play a part in Muslim cultural and political life, especially the communal debates that resulted in the formation of Pakistan in 1947.

A World of Nation-States

The division of the Muslim world into nation-states has given rise to new strands of pan-Islamism. First, transnational organizations like the Organization of Islamic States (OIC) have been formed to express the collective sentiments and concerns of Muslim peoples. It remains to be seen whether the OIC or similar organizations can be effective in a world of nation-states, a

question made more serious in light of the events following September 11, 2001. Like the United Nations, the OIC depends on its integrity and moral authority to effect change unless it has the backing of a strong state. Second, Islamism, or Muslim fundamentalism, has laid claim to the pan-Islamic heritage in order to remake, if not undermine, the modern system of nation-states that divides Muslim societies. While pan-Islamism advocates Muslim unity and strength, it is not conducive to the totalizing agenda espoused by Islamists who wish to (re-)Islamize every aspect of society. Lastly, pan-Islamism remains a current of feeling and thought—typically associated with calls for justice and hope—that runs throughout Muslim societies and also minority Muslim communities in the West. Like religion itself, there is a certain ambiguity and ambivalence about the purposes to which it is put and the events that evoke it. The only certainty surrounding pan-Islamism is its perennial nature.

See also Cultural Revivals; Empire and Imperialism: Middle East; Ethnicity and Race: Islamic Views; Fundamentalism; Islam; Nationalism: Middle East; Pan-Africanism; Pan-Arabism; Pan-Asianism; Pan-Turkism; Westernization: Middle East.

BIBLIOGRAPHY

- Choudury, M. A. *Reforming the Muslim World*. London and New York: Kegan Paul, 1998.
- Eickelman, Dale F., and James Piscatori. *Muslim Politics*. Princeton, N.J.: Princeton University Press, 1996.
- Hourani, Albert. *Arabic Thought in the Liberal Age, 1798–1939*. Cambridge, U.K.: Cambridge University Press, 1983.
- Keddie, Nikki R. *An Islamic Response to Imperialism: Political and Religious Writings of Sayyid Jamāl ad-Dīn "al-Afghānī"*. Berkeley: University of California Press, 1968.
- Kramer, Martin S. *Islam Assembled: The Advent of the Muslim Congresses*. New York: Columbia University Press, 1986.
- Landau, Jacob M. *The Politics of Pan-Islam: Ideology and Organization*. Oxford: Clarendon, 1994.
- Lewis, Bernard. *The Emergence of Modern Turkey*. 2nd ed. London: Oxford University Press, 1968.
- Mandaville, Peter. *Transnational Muslim Politics: Reimagining the Umma*. London: Routledge, 2001.
- Piscatori, James P. *Islam in a World of Nation-States*. Cambridge, U.K.: Cambridge University Press, 1986.
- Sheikh, Naveed S. *The New Politics of Islam: Pan-Islamic Foreign Policy in a World of States*. London: RoutledgeCurzon, 2003.

Jeffrey T. Kenney

PAN-TURKISM. The term *Pan-Turkism* refers to an intellectual and political movement advocating the union of all Turkic peoples. Although some promoters of this ideology went as far as calling for a political union including all Turkic groups, many others envisioned only a cultural unity.

Intellectual Origins and the Impact of European Works

European works such as Joseph de Guignes's *Histoire générale des Huns, des Turcs, des Mogols, et des autres Tartares occidentaux*,

Éc. avant et depuis Jésus-Christ jusqu'à présent (Paris, 1756–1758) and Arthur Lumley David's *A Grammar of the Turkish Language with a Preliminary Discourse on the Language and Literature of the Turkish Nations* (London, 1832) paved the way for a debate on Turkish peoples living under different administrations and their common ethnic bonds. David rejected the lumping together of all Turkic tribes under the rubric of Tatars, and proposed the generic name Turk for all these peoples; this made many intellectuals in the Ottoman Empire and other Turkic states reevaluate their approach to their peoples' ethnic origins. A French translation of the work was submitted to the Ottoman Sultan Mahmud II in 1833, and was widely read by Ottoman intellectuals and linguists. A Polish convert, Mustafa Celâleddin Pasha (Constantine Borzecki), who had fled to the Ottoman Empire after the unsuccessful 1848 revolution, liberally used de Guignes's work in preparing his own study, *Les turcs anciens et modernes* (Constantinople, 1869). Mustafa Celâleddin Pasha maintained that Turks and Europeans were from the same "Touro-Aryan" race. Works of Arminius Vámbéry, who traveled widely in Central Asia and underscored the common racial "Turanian" characteristics of the Turkic peoples, and Léon Cahun's *Introduction à l'histoire de l'Asie* (Paris, 1896) presented the "Turanian" race as one that brought civilization to Europe; this strongly influenced many Turkish intellectuals. Vámbéry should be credited as the first non-Turkish savant who, in 1865, entertained the idea of a Turkic "empire extending from the shore of the Adriatic far into China." Many Ottoman intellectuals paid close attention to these new ideas. It is interesting to note that in the prefatory article of the Young Ottoman journal *Hürriyet* (established 1868), the Turks were portrayed as "a nation in whose medreses Farabis, Ibn Sinas, Ghazzalis, Zamakhsharis propagated knowledge." Another leading Young Ottoman, Ali Suavi, underscored the common ethnic origins of the Turkic groups in his journal *Mukhbir* (1878). In an essay on Khiva he criticized the Ottoman policy toward this Central Asian khanate and described its people as "Muslim Turks who belong to our religion, nation, and ethnic family." In 1876 Süleyman Pasha prepared the first volume of his "World History" to be used as a textbook at the Royal Military Academy; in it he underscored the common bond uniting the Turkic peoples by drawing heavily on de Guignes's work. Beginning in 1877 history textbooks referred to the Turkish ancestry of the Ottomans, and the Ottoman press developed a keen interest in Turks living in Central Asia and the Caucasus, publishing many articles on them.

First Pan-Turkist Ideas

Despite the emergence of a national consciousness among the Turks living in the Ottoman Empire and the Turkic peoples of the Caucasus, Central Asia, and Iran, and a strong focus on their common origins, no intellectual or politician openly promoted unification of the Turkic groups until 1904. In an essay published in 1881 Gaspıralı İsmail (İsmail Bey Gasprinskii) debated the reasons for the decadence of the great "Turco-Tatar nation scattered in Asia and parts of Europe." He argued that "Turks, Turcomans, Mongols, Tatars, Uzbeks, and Yakuts [were] all from the same family." He advocated similar theses in his journal *Tercüman*, published in Bakhchesaray in the Crimea. The importation of this influential newspaper was occasionally banned by the Ottoman authorities. Nevertheless,

it was widely read by Ottoman intellectuals and strongly influenced them.

In 1903 a Young Turk journal called *Türk* started publication in Cairo. This journal promoted a more developed Turkish nationalism and devoted its efforts toward "the moral and material progress of the Turkish world." In it Yusuf Akçura, a Young Turk intellectual and a former military officer of Tatar origin, published an essay entitled "Üç Tarz-ı Siyaset" (Three kinds of policy). He asserted that there were three alternatives before the Ottoman administration—Pan-Ottomanism, Pan-Islamism, and Pan-Turkism—and that the best choice would be "to pursue a Turkish nationalism based on race." This essay, which first appeared in 1904, might be considered the first clear-cut intellectual formulation of the Pan-Turkist idea. Following the Russian Revolution of 1905, Gaspıralı started using the motto "Unity in Language, Thought, and Work" under the masthead of his journal *Tercüman*. He presented his aim as an attempt to create a united front of Turks living under tsarist rule. He maintained that such unity would enable the Turks to defend their rights better. There is no doubt, however, that in reality he intended more than uniting Turks living in Russia. The Russian Revolution of 1905 and the increased cultural activities of the Turkic peoples under tsarist rule made the Ottoman press in the empire and in exile pay more attention to these groups and to relations between them and the Ottoman Empire. Many Turkic journals, mostly published by Azerbaijani and Tatar intellectuals, promoted closer cultural relations among Turkic peoples.

Another organization that developed an interest in such ideas was the Ottoman Committee of Union and Progress. Following its reorganization in 1905–1906, this committee established ties with Turkic intellectuals and provided finance to help some of them publish their journals. The committee supported the creation of a "Turkish Union in the regions from the Adriatic Sea to the Chinese Sea" and promised to extend a helping hand to these Turkic groups once it had toppled the regime of Sultan Abdülhamid II. Strident letters sent from Azerbaijani and Tatar organizations to this committee reveal that such an idea was also popular among the intellectuals of these peoples.

Pan-Turkism, 1908–1922

The Young Turk Revolution of 1908 brought the Committee of Union and Progress to power in the Ottoman Empire. Many Turkic intellectuals participated in its policy-making bodies along with Turkist intellectuals. The committee supported the establishment of various organizations such as the *Türk Ocağı* (Turkish Hearth) (established in 1912), and it published journals such as *Türk Yurdu* (Turkish homeland) promoting cultural or political Pan-Turkism and Pan-Turanism. It should be remembered, however, that despite their Turkist and Pan-Turkist proclivities, the leadership of the Committee of Union and Progress viewed these ideologies as tools with which to save the Ottoman Empire and employed them alongside the rival ideologies of Ottomanism and Pan-Islamism. The Ottoman entry into World War I against Russia gave a considerable edge to Pan-Turkism and a free

hand to the Committee of Union and Progress leaders in propagating it. The leading ideologues of Pan-Turkism and Pan-Turanism, such as Moiz Cohen (Tekin Alp), Ziya Gökalp, and Ömer Seyfeddin, further entertained the idea of a future Turanian state including all Turkic peoples. Ottoman war propaganda made much use of this idea. Despite this fact, the accomplishment of that goal had been envisioned by its major promoters as a gradual and long-drawn-out development. Even in 1918 Ziya Gökalp likened the accomplishment of this distant ideal to reaching a pure communist society. During the war, Ottoman agents worked in the Caucasus and Central Asia and were aided by the German government in their efforts to spread Pan-Turkist sentiments. In the final phases of the war, new governments promoting Pan-Turkism were set up in the Caucasus through Ottoman military incursions. Even after the war, the Young Turk leaders in exile made efforts aimed at arousing Pan-Turkish sentiment in an area stretching from the Caucasus to Central Asia and Afghanistan. During this period between 1918 and 1922, Pan-Turkish ideas were put to a test on the ground; however, the Soviet victories and the establishment of the Turkish Republic reduced Pan-Turkist activities to the publication of a few journals by various Turkic expatriate groups in France, Germany, Poland, and Romania.

Pan-Turkism from 1922 to the Present

Both the Soviets and the Turkish Republic, which was established in 1923, officially shunned Pan-Turkism and considered it a harmful form of adventurism. This view continued to be the official Soviet position on Pan-Turkism until the end of the Soviet Union. In Turkey, however, various Pan-Turkist groups were allowed to publish journals beginning in 1931. They were nevertheless closely scrutinized by the government. These groups were later backed by the Nazi government and tolerated by the Turkish administration, which wanted to avoid a confrontation with Germany; but with the waning of the German power in 1944, the leading Pan-Turkists were tried and sentenced to hard labor. The subsequent deterioration of Turco-Soviet relations, however, triggered a retrial in 1946 resulting in the dismissal of all charges against the leading Pan-Turkists. Later, Pan-Turkism was promoted by various cultural groups and political parties, the most important of which was the Nationalist Action Party under the leadership of Alparslan Türkeş.

The collapse of the Soviet Union and the emergence of new Turkic states gave fresh hope to many Pan-Turkists in Turkey, the Caucasus, and Central Asia. Developments to date, however, suggest that the most that they can hope for is a better cultural understanding between peoples living in nation-states with clearly molded identities and well-defined borders.

See also Ethnicity and Race; Pan-Africanism; Pan-Arabism; Pan-Islamism.

BIBLIOGRAPHY

- Akçuraoğlu, Yusuf. *Türk Yılı*, 1928. Istanbul: Yeni Matbaa, 1928.
 Ali Suavi. *Hive*. Paris: n.p., 1873.
 Arai, Masami. *Turkish Nationalism in the Young Turk Era*. Leiden: Brill, 1992.
 Cohen, M. *Türkismus und Panturkismus*. Weimar, Germany: G. Kiepenheuer, 1915.

- Hanioglu, M. Şükrü. *Preparation for a Revolution: The Young Turks, 1902–1908*. New York: Oxford University Press, 2001.
 Ismail Bey. *Gaspirinski, Russkoe musul'manstvo: mysli, zametki i nabliudeniia musul'manina*. Simferopol', Russia: Tipografia Spiro, 1881. Republished, Oxford: Oxford University Press, 1985.
 Kushner, David. *The Rise of Turkish Nationalism, 1876–1908*. London: Frank Cass, 1977.
 Landau, Jacob. *Pan-Turkism: From Irredentism to Cooperation*. Bloomington: Indiana University Press, 1992.
 ———. *Tekinalp, Turkish Patriot, 1883–1961*. Istanbul: Netherlands Historisch-Archaeologisch Institut, 1984.
 Ömer, Seyfeddin. *Yarınki Turan Devleti*. Istanbul: Kader Matbaası, 1914.
 Ziya, Gök Alp. *Yeni Hayat*. Istanbul: Yeni Mecmua, 1918.

M. Şükrü Hanioglu

PARADIGM. *Paradigm* is the key term in Thomas Kuhn's (1922–1996) very influential book, *The Structure of Scientific Revolutions* (1962). As is frequently the case when new ideas are presented, Kuhn took an existing term and gave it a specialized meaning. The term *paradigm* now occurs frequently in every kind of discourse, usually to mean something like “way of thinking” or “approach to a problem.” Kuhn has generally been given credit for introducing this usage, but the way that *paradigm* is popularly used misses a central aspect of his argument. Kuhn emphasizes that a paradigm cannot be reduced to a set of beliefs or to a list of rules and indeed that a paradigm cannot be put into words. Scientists have to learn by doing, both by thinking in terms of the concepts that are used in a particular science and by physically manipulating material to create phenomena.

Kuhn argues that the history of science is best understood as exhibiting stable periods, which he calls normal science, punctuated by revolutionary changes. *Paradigm* is the central concept that Kuhn uses to make his case, since a period of normal science is defined by its paradigm and a scientific revolution is, in Kuhn's terms, a change in paradigms. Typically a paradigm is first established by the publication of a groundbreaking book that sets out problems and solutions, then others adopt the aims and methods of the original, thus establishing a period of normal science. Contrary to the traditional view that science was founded in Renaissance Europe by “the scientific revolution,” Kuhn sees multiple revolutions in the history of science, that is, multiple cases of the overthrow of one scientific paradigm by another.

Paradigm is defined in the *Oxford English Dictionary* as a pattern, exemplar, or example. Kuhn acknowledges this meaning by giving the conjugation of a regular Latin verb as an example of a paradigm. Furthermore, since he believes that a normal science is typically established by an important book and often by a series of experiments, it is clear that Kuhn has the idea of a paradigm as a pattern that will be followed very much in mind when he is explaining his view. A key aspect of paradigms is that they set out problems and also show how to solve them. Newton's laws of motion and the force of gravity combine to explain planetary motion, for example. There is more to a

paradigm than a good model to follow, however. Kuhn also thinks that among scientists who are working under the same paradigm, the historian can find common methods, common standards, common aims, and fundamental agreement about the nature of the world and the nature of the processes in it. Periods of normal science are characterized by consensus, especially about fundamentals, and this agreement allows for specialization, or as Kuhn puts it, “professional and esoteric work” (1996, p. 23). The function of normal science is to extend the original work by applying its methods to new areas as well as to revisit old ground in order to refine the paradigm. Because normal science is based on agreement and has well-defined parameters, it can make progress and accumulate knowledge.

On Definition

Kuhn compresses his discussion of the centrality of the notion of paradigm into a single chapter entitled “The Priority of Paradigms.” Paradigms have priority because there is nothing more basic by which “paradigm” could be defined. In logical terminology, the word *paradigm* functions as a primitive term. Properties of paradigms can be given and examples of paradigms can be enumerated, but the word cannot be defined, any more than *number* can be defined in arithmetic. Kuhn justifies his introduction of the term *paradigm* by arguing that, for the historian, it is a better organizational concept than any other. By looking for paradigms and changes in paradigms, the historian can classify scientists and historical periods in ways that lead to productive research and a better understanding of the history of science. Turning to philosophers to justify the undefinability of paradigms, Kuhn invokes Michael Polanyi’s (1891–1976) idea of tacit knowledge and Ludwig Wittgenstein’s (1889–1951) idea that some human activities cannot be captured by a set of rules, arguing that while paradigms cannot be reduced to a set of methods and beliefs, they are recognizable to the historian as the organizing principle underlying a period of normal science.

The root definition of *paradigm* as both pattern and example exhibits both sides of a classical philosophical debate over the nature of definition. Plato (c. 428–348 or 347 B.C.E.) argued forcefully that providing examples is not adequate; the real definition of a term must specify what the examples have in common and thus explain why they all properly fall under the concept being defined. In the terminology of later philosophy, Plato argues that a definition must tell us the essence of a thing. For Plato, this is the *eidos*, the eternal form or idea to which all objects falling under a concept must conform. Kuhn sides with David Hume (1711–1776) and Wittgenstein in rejecting Plato’s requirement that the essence be given in the proper definition of a concept. Like Hume, Kuhn argues that it is enough to say that the objects falling under a concept resemble one another in various aspects that can be specified and to take that resemblance as a starting point. Kuhn claims that paradigms do not have an essence, since there is always some disagreement and some difference in emphasis among scientists who are working under the same paradigm. In Wittgenstein’s terminology, the historian can find a family resemblance among the views of these scientists rather than single common set of beliefs and methods.

Kuhn also defends his view that paradigms cannot be reduced to a set of beliefs and rules of method by pointing out that scientists learn by working through concrete examples of problems, not by learning rules. Thus learning a paradigm is more like learning a skill than like learning a body of knowledge, a point that Joseph Rouse has rightly emphasized. Kuhn is very close to using *paradigm* in its original meaning here, since the problems and solutions through which students learn are to be taken as patterns of scientific thought and work.

Criticism of Kuhn’s Paradigms

Kuhn’s use of the term *paradigm* was immediately criticized, especially by philosophers, for being too broad and vague. In the postscript to *Structure* (1962), Kuhn conceded that the term was perhaps too broad, saying that he would use *paradigm* to mean “exemplar,” that is, the founding book or experiment of a particular science, and that the rest of the elements that make up normal science will be called the “disciplinary matrix.” However, this change in terminology played no role in Kuhn’s later work, so it provides little gain in understanding his viewpoint.

Kuhn was also accused of circularity, since it seems that in order to determine the nature of the paradigm behind a particular period of normal science, the historian must first determine which scientists belong to that group and then study their work to discover their aims, methods, and assumptions. However, since normal science is defined in terms of a paradigm, it seems that the historian must also recognize a paradigm first in order to know which scientists are working under it. Kuhn acknowledged that this was indeed a problem, suggesting that scientists should be categorized first on purely sociological grounds, such as who works with whom, and then the paradigm that underlies these connections be can determined.

Revolutions

Kuhn argued that his use of the term *revolution* to describe changes in science is appropriate because, like political revolutions, scientific revolutions overturn existing rules and institutions in order to establish new ones. By definition, there can be no legal way to have a political revolution, since any changes that follow the processes of the old regime would merely be reform, not revolution. For Kuhn the key point of the analogy between political and scientific revolutions is that in both cases there are no rules that could help adjudicate between the two systems. The supporters of the old and the new paradigms will each follow their own methods, emphasize their own aims, and accept their own solutions to problems, without necessarily accepting any of the methods, aims, or standards of supporters of the other paradigm. In an influential paper that helped redirect criticism of Kuhn’s book, Gerald Doppelt emphasized the apparent relativism of Kuhn’s view, given that there is no right or wrong answer to the question of when an old paradigm should be abandoned and a new paradigm adopted. Antoine-Laurent Lavoisier (1743–1794) and Joseph Priestley (1733–1804) independently discovered oxygen, but while Lavoisier used this discovery as a basis for a new chemistry, Priestley never accepted Lavoisier’s revolution and maintained the old phlogiston paradigm instead. Kuhn argued that

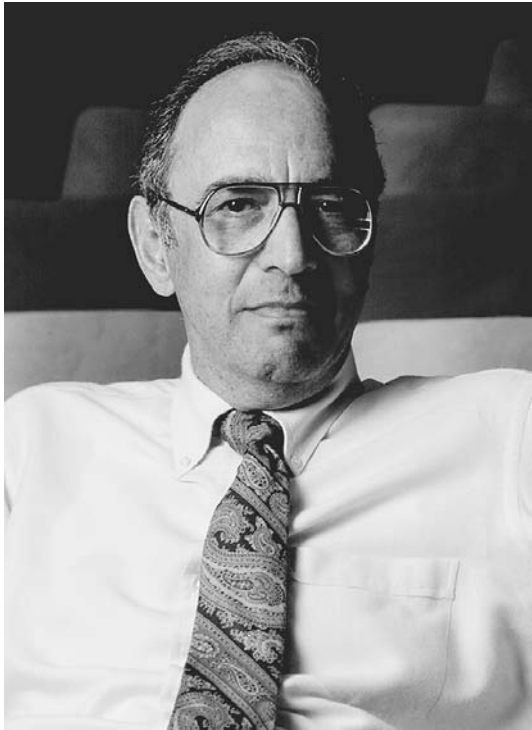

Thomas S. Kuhn. The Harvard-educated Kuhn first proposed his personalized theory of paradigm in his 1962 *Structure of Scientific Revolutions*. Kuhn posited that paradigms were conceived through thought and physical experimentation, rather than by representing established sets of beliefs. PHOTOGRAPH BY STANLEY BROWN. REPRODUCED BY PERMISSION OF THE ESTATE OF THOMAS S. KUHN

both of these famous scientists were acting reasonably. Nothing can force a scientist to change paradigms, according to Kuhn, because a scientist can always find a way either to incorporate new data into the existing paradigm or to show why the new data can be dismissed as unimportant from the point of view of the existing paradigm. It is important to note, however, that Kuhn is not saying that anyone can believe anything. Paradigms must be well developed and cover a wide range of phenomena. It is not easy to develop a new science that will justify the overthrow of an established paradigm.

Rather than promoting general relativism, Kuhn saw himself as rejecting particular philosophical accounts of science. He criticizes the idea of confirming scientific theories and comparing how well they are confirmed, a view of science associated with Rudolf Carnap (1891–1970), and he criticizes the idea of testing scientific theories to show that one theory is false, a view of science associated with Karl Popper (1902–1994). Both of these views require that a body of neutral evidence be available to scientists, a position that Kuhn disputes because, he claims, all evidence is acquired on the basis of a paradigm and therefore an element of it. He also points out that Popper's view that theories should be rejected when negative evidence is found is unrealistic, since there are always anomalies—problems that the paradigm cannot solve.

Leaps of Faith

Given that no new evidence or argument could overthrow a paradigm, Kuhn needs to explain “What causes the group [of professional scientists] to abandon one tradition of normal research in favor of another” (1996, p. 144). After pointing out that it is possible for a revolution to take place over generations without requiring individual scientists to change from one paradigm to another, Kuhn sets out four reasons that scientists may have for deciding to change paradigms. Two of these reasons, aesthetic considerations (including simplicity, unity, and so forth) and personal or political beliefs, are clearly subjective. We can understand how Lavoisier could have reasons to revolutionize chemistry that Priestley did not share, if the reasons given are personal and subjective. We do not expect others to have the same personal or subjective views or tastes that we do. Kuhn also says that a scientist may change from one paradigm to another if the new paradigm solves problems that the old one could not. New paradigms are successfully introduced when there is a crisis, that is, when scientists feel that the old paradigm is not working. To revolutionary scientists, what had been anomalies are now seen as refutations of the old paradigm. Although this reason for changing paradigms sounds objective, Kuhn argues that there is no objective way to know how seriously anomalies should be taken. Some, like Lavoisier, will feel that there is a crisis and a need for revolutionary change, while others, like Priestley, can look at the same situation and feel no need for change. To add to the sense that these two positions are subjective, Kuhn famously describes the change from one paradigm to another as a Gestalt shift, in which a picture of an old woman suddenly looks like a young woman or a duck suddenly looks like a rabbit. When they are seen from the perspective of the new paradigm, what had been minor anomalous puzzles suddenly show that the old paradigm was terribly wrong. Finally, Kuhn points out that in a revolutionary period, scientists must decide which paradigm is more promising for future success. Such forward-looking predictions are bound to be based on partial information and require belief in the promise of the paradigm. Kuhn calls this a matter of faith and argues that it too is subjective, like all of the reasons that scientists may have to change paradigms.

Criticism of Kuhn's Relativism

Kuhn was rather surprised at the reaction of many philosophers and scientists to his work. He did not see himself as claiming that science is irrational or subjective but rather as developing a philosophy of science that was true to the actual history of science. While this may be true, it is also clear that Kuhn was quite capable of using inflammatory rhetoric that was bound to offend many supporters of science. For example, when explaining the analogy with political revolution, he says that the defender of a new viewpoint must resort to “techniques of mass persuasion, including force” when political recourse fails (1996, p. 93). In the mythology of modern science, the church represents the Dark Ages, superstition, and jargon-filled Scholastic rationalizations, whereas science represents reason, knowledge, and the objective quest for the truth. Yet Kuhn says that science textbooks are as dogmatic as orthodox theology, and, in arguing that there is no objective criterion

THOMAS KUHN

Thomas Samuel Kuhn was born on 18 July 1922 in Cincinnati, Ohio. He graduated summa cum laude from Harvard in 1943 with a bachelor's degree in physics, and after some work in the government Office of Scientific Research and Development during World War II, he returned to Harvard for his master's and doctoral degrees in physics in 1946 and 1949. He remained at Harvard until 1956 teaching in the Department of the History of Science that had just been created by his mentor James Conant, who aided his transition from theoretical physics to the history and philosophy of science. Kuhn next joined the faculty of the University of California at Berkeley, where he developed the idea for his most influential book. In 1964 he moved to Princeton, where he was the M. Taylor Pyne Professor of

Philosophy and History of Science. Kuhn returned to Boston to complete his career at the Massachusetts Institute of Technology as professor of philosophy and history of science from 1979 to 1983 and the Laurence S. Rockefeller Professor of Philosophy from 1983 until 1991. Kuhn was the author or coauthor of five books and scores of articles on the philosophy and history of science. He was a Guggenheim Fellow in 1954–1955, the winner of the George Sarton Medal in the History of Science in 1982, and the holder of honorary degrees from many institutions, among them the University of Notre Dame, Columbia University, the University of Chicago, the University of Padua, and the University of Athens. Kuhn suffered from cancer during the last years of his life and died in 1996.

for deciding between paradigms, he says changing from one paradigm to another is a “conversion experience” (1996, p. 151). Explaining how the existence of multiple revolutions has been covered up by traditional histories of science, Kuhn compares these histories to those given to the population in George Orwell's (Eric Arthur Blair; 1903–1950) *1984* (1949), which is about as far from objective truth as can be imagined. Kuhn also compares science textbooks to tourist brochures.

Incommensurable Worlds

In order to justify his claim that there is no neutral set of observations or experiments that could help scientists determine which paradigm is true, Kuhn argues that the Gestalt experiments show how it is possible to think of a scientist as seeing the world very differently after a change of paradigm. Examples of scientists seeing different things after a change of paradigm include the following: The earth was seen as the center of the universe, then as a planet orbiting one of millions of stars. Light was seen first as a particle, then as a wave, and finally as a photon. Uranus was first seen as a star, then as a comet, then finally as a planet when William Herschel (1738–1822) “discovered” it. Dephlogisticated air was later seen as oxygen. Stones restrained from falling to their natural place were later seen as the repetitive motion of a pendulum. Kuhn argues that the revolutionary changes described in these examples are not simply changes in the name of something: Phlogiston is not anti-oxygen, the pendulum is not a falling stone, and so forth. Scientists working in different paradigms collect different data and work on different problems. Something that formerly needed to be explained may be seen as natural under a new paradigm, and what seemed natural before may now seem to need an explanation. Therefore “the historian of

science may be tempted to exclaim that when paradigms change, the world itself changes with them” (1996, p. 111).

Although he occasionally said contradictory things on this issue in *Structure*, Kuhn later insisted that the scientists working under different paradigms really do live in different worlds. Paradigms cannot be said to be different interpretations of a single objective world because “interpretation” only happens within a paradigm. We do not see the world as it really is but rather have to learn how to see, guided by the paradigm. Without a paradigm, there would be no science at all; rather there would only be confusion, a point that Kuhn makes with his reference to the experiments of Jerome S. Bruner and Leo Postman with anomalous playing cards and of George M. Stratton with inverted vision. Kuhn introduced the term *incommensurability* to describe the difficulty of comparing one paradigm to another. There is no way to test a paradigm as a whole or to compare the predictions that derive from paradigms against one another, as scientists do when they test theories. Kuhn argues that in cases where the same word is used in two different paradigms or when it seems that the same phenomenon can be described in both, the words in fact have different meanings in each paradigm and the phenomenon is not the same.

Revolutions have been covered up by textbooks, whose job it is to teach current science, not to teach history of science. Words are applied anachronistically, and the development of science is made to look linear and cumulative. As a historian, Kuhn discovered that there are radically different ways of doing science. He sought a way of expressing his discovery and of explaining the immersion into a historical text that is required for understanding. The concept of a paradigm is

central to Kuhn's expression of his discovery and to his attempt to correct philosophical misrepresentations of science.

See also *Knowledge; Relativism; Science*.

BIBLIOGRAPHY

- Barnes, Barry. *T. S. Kuhn and Social Science*. New York: Columbia University Press, 1983.
- Bird, Alexander. *Thomas Kuhn*. Princeton, N.J.: Princeton University Press, 2000.
- Doppelt, Gerald. "Kuhn's Epistemological Relativism: An Interpretation and Defense." *Inquiry* 21 (1978): 33–86.
- Fuller, Steve. *Thomas Kuhn: A Philosophical History for Our Times*. Chicago: University of Chicago Press, 2000.
- Gutting, Gary, ed. *Paradigms and Revolutions*. Notre Dame, Ind.: University of Notre Dame Press, 1985.
- Hacking, Ian, ed. *Scientific Revolutions*. Oxford Readings in Philosophy. New York: Oxford University Press, 1981.
- Horwich, Paul, ed. *World Changes: Thomas Kuhn and the Nature of Science*. Cambridge, Mass.: MIT Press, 1993.
- Kuhn, Thomas S. *Black-Body Theory and the Quantum Discontinuity, 1894–1912*. Chicago: University of Chicago Press, 1987.
- . *The Copernican Revolution: Planetary Astronomy in the Development of Western Thought*. Cambridge, Mass.: Harvard University Press, 1957.
- . *The Essential Tension: Selected Studies in Scientific Tradition and Change*. Chicago: University of Chicago Press, 1977.
- . *The Road since Structure: Philosophical Essays, 1970–1993, with an Autobiographical Interview*. Edited by James Conant and John Haugeland. Chicago: University of Chicago Press, 2000.
- . *The Structure of Scientific Revolutions*. Chicago: University of Chicago Press, 1996.
- Nickles, Thomas, ed. *Thomas Kuhn*. Cambridge, U.K., and New York: Cambridge University Press, 2003.
- Nola, Robert. *Rescuing Reason: A Critique of Anti-Rationalist Views of Science and Knowledge*. Dordrecht, Netherlands: Kluwer Academic, 2003.
- Nola, Robert, and Howard Sankey, eds. *After Popper, Kuhn, and Feyerabend: Recent Issues in Theories of Scientific Method*. Dordrecht, Netherlands: Kluwer Academic, 2002.
- Rouse, Joseph. "Kuhn's Philosophy of Scientific Practice." In *Thomas Kuhn*, edited by Thomas Nickles. Cambridge, U.K., and New York: Cambridge University Press, 2003.
- Sankey, Howard. *The Incommensurability Thesis*. Aldershot, U.K., and Brookfield, Vt.: Ashgate, 1994.
- Sardar, Ziauddin. *Thomas Kuhn and the Science Wars*. London: Icon, 2000.
- Von Dietze, Erich. *Paradigms Explained: Rethinking Thomas Kuhn's Philosophy of Science*. Westport, Conn.: Praeger, 2001.

David J. Stump

PARADISE ON EARTH. The word *paradise* develops in Western languages from the Greek word *paradeisos*, the old Persian word *pairidaeza*, and the modern Arabic and Persian *firdaus*, all of which originally denoted a walled garden. In the arid environment of the Near East, a garden must be carefully and laboriously constructed with watercourses for irrigation, and its precious flowers and fruits protected from theft by a surrounding wall. The conflation of this term for a type of gar-

den built and cultivated in the Near East with religious imagery of heaven, especially in Judaism, Christianity, and Islam, has given the term a far more complex set of meanings, which have come to permeate the cultures of the Christian West and the Islamic world, creating a metaphoric bridge between divine paradise and paradise on earth.

In these cultures the concept of paradise developed in two related levels. The first was scriptural and thus a part of religious belief: paradise is either a place for life after death—often serving as a more tangible and concrete substitute for the vaguer term *heaven*—or the setting for a primal, idealized epoch in human history: the Garden of Eden. The second way in which the concept developed was through the actual physical depiction or recreation of the religious image of paradise on earth, either in the form of actual gardens or through the use of certain types of garden imagery—with or without religious connotations—in music, literature, and the visual arts.

Religious Conceptions of Paradise

In the Jewish Torah, paradise first appears as the Garden of Eden in Genesis. It also is regarded as the abode of God, to which the righteous are welcome (Psalm 73:24–25):

Thou shalt guide me with thy counsel, and afterward receive me to glory. Whom have I in heaven but thee? And there is none upon earth that I desire besides thee.

In terms of concrete imagery, the most famous Old Testament vision of paradise is set forth in Psalm 23:2: "He maketh me to lie down in green pastures: he leadeth me beside the still waters." In Christianity paradise is the blessed afterlife promised by Christ in the Gospels—"And Jesus said unto him, Verily, I say unto thee, To-day shalt thou be with me in Paradise" (Luke 23:43)—or the more complex, mystical, and tangible paradise of the Book of Revelation (22:1–2):

And he showed me a pure river of water of life, clear as crystal, proceeding out of the throne of God and of the Lamb. In the midst of the street of it, and on either side of the river, was there the tree of life, which bare twelve manner of fruits, and yielded her fruit every month; and the leaves of the tree were for the healing of the nations.

In Islamic scripture the image of paradise (Ar. *janna*, garden) is far more concrete and descriptive, a garden with flowering trees, running streams, silken cushions, and chaste companions promised in so many passages in the Koran:

This is the picture of Paradise promised to those who fear God: it contains rivers of ever-fresh water, rivers of milk that never sours, rivers of wine that are a delight to those who drink, and rivers of pure honey; also for those who fear God are found every fruit, and their Lord's forgiveness. (47:15)

They will be attended by youths perpetually young, carrying chalices and ewers and cups filled from a flowing spring, neither giving a headache nor intoxication, and



The Adoration of the Lamb (c. 1425–1429) by Jan and Hubert van Eyck, from *The Ghent Altarpiece*, open-center panel. Christian interpretations of paradise in art were often drawn from passages in the Bible and other religious works, a practice discouraged by other faiths. The van Eyck brothers drew partly upon the Book of Revelations to create *The Ghent Altarpiece*. © ARCHIVO ICONOGRAFICO, S.A./CORBIS

such fruits as they wish, and the meat of birds as they wish. They will have as companions beautiful black-eyed maidens, pure as well-guarded pearls, a recompense for their righteousness. There will not be heard any vain or profane words, but only: “peace, peace, peace.” (56:10–25)

Although the concept of paradise as a religious afterlife is primarily found in the three monotheistic religions originating in the Near East, the association of a garden with religious repose is also found in Buddhism, where it ultimately influenced secular garden culture in China and Japan. Of course for those of a secular bent, the metaphor of a heavenly garden may ultimately derive from the ancient use of a garden as a place of earthly pleasure, rest, or contemplation, but in the world of metaphor the heavenly garden precedes and influences its earthly counterpart.

In an intermediate step from scriptural sources toward earthly recreation in the arts, paradise forms a part of various liturgies, especially those involving funerals. Thus paradise is invoked in the Jewish prayer for the dead, the Islamic *mawlid*, and the Roman Catholic requiem mass, where paradise is also seen as the heavenly Jerusalem, what St. Augustine of Hippo termed the City of God: “May the Angels lead you into paradise; may the martyrs receive you and lead you into the holy city of Jerusalem.”

Representations in Western Culture

From scriptures and liturgical texts the concept of paradise emerges as a dominant image in the religious art of Christianity

and Islam over the centuries and eventually develops what we might term quasi-secular cognates as well, in which theological paradise in effect loans part of its meaning to secular palaces, poetry, and visual arts. In the Christian tradition, images of an essentially scriptural paradise figure prominently in literature of the West. These range from the Neoplatonic vision of a multi-tiered heaven in the early-sixth-century *Celestial Hierarchy* of Dionysius the Areopagite through the paradise described by the ninth-century Beatus of Liebana in his *Commentaries on the Apocalypse* to the lofty poetic visions of Dante’s *Divine Comedy* in the early fourteenth century and Milton’s *Paradise Lost* in the seventeenth, finding echoes in the earthy twentieth-century representations of Roark Bradford and Marc Connelly, epitomized in the latter’s *The Green Pastures*.

These scriptural, liturgical, and literary images of paradise in turn had a profound influence on music and the visual arts, starting with illustrations to the texts in question. The medieval sculptural reliefs of the Last Judgment that so often grace the doorways of eleventh- and twelfth-century Romanesque churches traditionally depicted the rewards of paradise on the left (to the right of a central figure of Christ) and the torments of hell to the right or below, with details taken from Revelation and from the Beatus manuscripts. From Dante’s late medieval exegesis and expansion of biblical texts came a view of paradise that was to influence later generations of visual artists. From Genesis combined with Milton’s poetic text came Franz Joseph Haydn’s musical depiction of paradise in *The Creation* as well as a number of depictions in painting.



Court of the Lions in Casa Real Palace, Alhambra, Granada, Spain. The concept of paradise on earth developed partly through physical representation in gardens, palace courtyards, or the cloisters of medieval monasteries. © PATRICK WARD/CORBIS

The image of paradise on Earth in the Western tradition is not exclusively Christian in inspiration. An idyllic earthly paradise is also evoked in the rich tradition of poetry and art inspired by the Greek myths of Arcadia and given defining shape in the poetry of Virgil. The classical Arcadia is a land of shepherds and idyllic peace that returns again and again in the poetry, prose, and painting of the West, given perhaps its most characteristic form in the paintings of Claude Lorrain and Nicolas Poussin in seventeenth-century France.

In Western art of the Christian tradition, where the illustration of religious texts is encouraged rather than actively discouraged as in Judaism and Islam, depictions of paradise are as likely to recall the primal innocence of Eden as they are the reward awaiting Christians in the afterlife. Seen from a strictly narrative perspective, the artistic potential of Christian hell is rich in pictorial possibilities, full of emotion and activity, while that of heaven or paradise is, comparatively speaking, both formulaic and limited, with the exception of the high drama of the expulsion of Adam and Eve from Eden. The Western art tradition does not, however, possess the embedded cultural tradition of the walled garden, and so, to paraphrase Freud, in Western art a flower is often simply a flower.

Among the many depictions of paradise in Western art, two may serve to illustrate the gamut of imagery. In the famous Ghent altarpiece painted by the Van Eyck brothers between 1425 and 1432, a literal depiction of paradise in the lower central panel of the open altarpiece shows a green meadow populated by crowds of angels, apostles, clerics, martyrs, and other saints, adoring the Holy Lamb on a stone altar, while an octagonal basin in the foreground, recalling the baptismal font with its water of salvation, contains a playing fountain of life. The inspiration for the imagery comes in part from Revelation and probably in part from the liturgy of All Saints, and the imagery itself is Roman Catholic in conception and detail. By contrast, the various depictions of the *Peaceable Kingdom* by the American naive painter Edward Hicks recall the Old Testament prophecy of Isaiah 11:6, the peaceable kingdom that will

arrive on earth with the coming of the Messiah: “The wolf also shall dwell with the lamb, and the leopard shall lie down with the kid; and the calf and the young lion and the fatling together; and a little child shall lead them.”

Explicit physical recreations of paradise in Western landscape architecture are rare. The enclosed cloisters of medieval monasteries sometimes carried such an association, and the forecourts or enclosed gardenlike settings for some churches, referred to as *parvises*, carry the same connotation.

Islamic Art and Literature

In Islamic culture there is likewise a literary tradition of direct depiction of paradise, most typically represented by Mir Haydar’s *Miraj-nama* (Book of the ascension), a fourteenth-century poetic description of the Prophet’s mystical journey to heaven and hell, which takes much of its imagery of paradise directly from highly descriptive scriptural passages of the Koran. The most famous illustrated manuscript of the poem, created for the Timurid ruler Shah Rukh in Herat in about 1435, depicts a paradise with triple gates, four flowing rivers of water, milk, wine, and honey, and flowering trees, among which the houris engage in games and provide refreshments. In a *fal-nama* or “book of divination” manuscript created in Istanbul around 1600, a famous miniature depicts Adam and Eve expelled from paradise along with the serpent, as an astonished angel and a peacock look on.

In the complex metaphorical imagery of Persian poetry, the drinking of wine in the setting of a garden combines secular cultural praxis with the mystical notion of divine intoxication. For this reason, illustrations to the texts of poets such as Hafiz often show couples or individuals drinking wine in a garden, or even, in one famous example painted around 1529 by the Tabriz artist Sultan-Muhammad, a sort of half-earthly, half-heavenly saturnalia of elderly sheikhs and heaven-sent angels.

While paradisiacal imagery is found in many different Islamic arts, from ceramics and metalwork to miniature painting, some of the most memorable evocations of the heavenly garden are seen in textile arts. Many of the most famous Islamic carpets created under the Safavid dynasty in Iran in the sixteenth century are in the form of what one scholar has termed a “paradise park” format, in which an outer border symbolic of the surrounding wall encloses a lush vision of paradise that often includes depictions of the drinking of wine, the royal sport of hunting (itself often a metaphor of the soul’s search for paradise), and lovers enjoying the floral ambience of the garden. The same motifs grace many of the famous figural Safavid velvets, in which the images of lovers in a garden are conflated with the idea of the soul’s love of God. The two celebrated Ardebil carpets, probably woven in Kashan around 1537, depict the reflection of the sun’s medalion—a metaphor for God as the giver of light—in a dark blue formal pool filled with countless floating lotus flowers on scrolling stems. Other Islamic carpet forms, such as the *sajjadah* or prayer rug, often depict a gateway to a tree- and flower-filled paradise, while one carpet form, the garden carpet, actually depicts a traditional Islamic garden with its cruciform axial watercourses (often filled with fish) and rectangular plantings, in a woven form that conveniently remains in bloom throughout the year.



Detail from Edward Hicks's *Peaceable Kingdom* (c. 1833; oil on canvas). Many of Hicks's paintings were illustrations of scenes in the Bible, such as his famous *Peaceable Kingdom*, which was based on a prophecy from the Book of Isaiah in the Old Testament. © BURSTEIN COLLECTION/CORBIS

In the Islamic world, the combination of a pre-Islamic form of walled garden from Iran known as a *char bagh*—literally a “fourfold garden”—and the imagery of the Koranic texts combined to foster a long tradition of princely garden building in which religious ideas formed a sort of symbolic overlay. The four long pools arranged in cruciform fashion that divide the garden into four represent the four heavenly rivers; a pavilion set in the middle of the garden might then take on equally heavenly symbolism, as in the Hasht Bihisht (“eight heavens”) Safavid palace from seventeenth-century Isfahan. Among the countless Islamic attempts to create an earthly paradise, two gardens have achieved unusual historical prominence. The earlier of these, known today as the Court of the Lions, graces the fourteenth-century Nasrid Alhambra palace in Granada, Spain. Its four streams, fed by a central playing fountain in a basin borne on the backs of twelve sculpted lions, recall the heavenly rivers of the Koran, together with the fountain Salsabil that graces Islamic paradise (Koran 76:12). The other Islamic garden of special prominence is the great *char bagh* arrayed before the Mughal royal mausoleum known as the Taj Mahal, created in the mid-seventeenth century in Agra, India, by the Mughal emperor Shah Jahan. The inscriptions of the Taj Mahal itself stress the metaphor of an earthly depiction of heavenly paradise, in which the mausoleum itself is a symbol for the throne of God. The popularity of the *char bagh* in Islamic cultures from India to Iberia is a strong testament to its Islamic religious associations with paradise, as well as to the astonishing persistence of pre-Islamic forms in Islamic art.

East Asia

While the concept of an earthly paradise as a reflection of a heavenly paradise permeates much art in cultures under the influence of Christianity and Islam, a somewhat similar concept of a heavenly presence on earth—not specifically derived from the west Asian *firdaus*—can also be seen in other cultures, notably those influenced directly or indirectly by Buddhism. A final example of a constructed heaven on earth may

be seen in the succession of Chinese capital cities and royal palaces built in Beijing by the Jin, Yuan (Mongol), Ming, and Qing dynasties. The elevation of the emperor in China to semi-divine status encouraged the creation of a quasi-celestial abode for the emperor on earth. The hierarchical organization of the Forbidden City, with its succession of courts and gateways, each leading to a more rarified and exclusive precinct, also represents an attempt to create a heavenly city on earth, if not embodying direct metaphors for a scriptural paradise such as those found in the Christian and Islamic West. This in turn led to reflections of an earthly paradise in the palace architecture (and, in Japan especially, in the construction of palace gardens as places of aesthetic as well as religious contemplation) in other cultures of East Asia.

See also Garden; Heaven and Hell; Landscape in the Arts; Utopia.

BIBLIOGRAPHY

- Blair, Sheila S., and Jonathan M. Bloom, eds. *Images of Paradise in Islamic Art*. Hanover, N.H.: Hood Museum of Art, 1991.
- Gardet, L. “Djanna.” In *Encyclopedia of Islam*. Vol. 2. Leiden: Brill, 1965.
- Lehrmann, Jonas. *Earthly Paradise: Garden and Courtyard in Islam*. Berkeley: University of California Press, 1980.
- Moynihan, Elisabeth B. *Paradise as a Garden in Persia and Mughal India*. New York: Braziller, 1979.
- Psaki, Regina, and Charles Hindley, eds. *The Earthly Paradise: The Garden of Eden from Antiquity to Modernity*. Binghamton, N.Y.: Global Publications, Binghamton University, 2002.

Walter B. Denny

PARADOX. *See Logic.*

PATRIOTISM. Patriotism is one of a large class of words that are linked to the virtues of membership. To participate in relations of, for example, friendship, community, nationhood, citizenship, or marriage implies normative conventions. In other words, there are value expectations built into such membership. One important dimension of any membership relation is an expectation of loyalty. Fidelity or loyalty to a nation, community, friend, citizenship, marriage, or state is thus implied in the actual practice. To participate openly and self-consciously, therefore, in any of these membership practices involves adherence to loyalty-based virtue. In this context, the term *patriotism* usually denotes a specific loyalty virtue, consequent upon membership of a country or state. However, the term *loyalty* alone does not quite cover the range of values associated with patriotic membership. Patriotism also signifies a sense of personal identification with, and concern for, the well-being or welfare of that country or state. Further, it entails a readiness to make sacrifices for its defense or welfare. In addition, it provides (for some) the ground for all moral action—in the sense that morality, in itself, is seen to be, quite literally, premised on patriotic membership. Patriotism also indicates a

special affection, feeling, or emotive response. This emotive response is commonly designated as a “love of country.”

Origins

A distinction is often drawn between the terms *patriot* and *patriotism*. The former is seen as an older usage, traceable back to the ancient Roman republic, while the latter is viewed as an eighteenth-century neologism. Patriotism, as in most ideological “isms,” is therefore often considered a more recent word. However, the older term *patriot* still covers many of the conceptual aspects of patriotism. The term *patriotism* figured in European and North American political discussion (and poetry) over the nineteenth and early twentieth centuries. However, during the larger bulk of the twentieth century its academic usage diminished. Certainly up to the 1990s it was considered, in academic debate, to be an antiquated term—particularly in liberal and Marxist political theory. However, there has been, over the last decade, a rediscovery of patriotism (among other membership-related concepts) within political theory and related disciplines. This rediscovery began in the 1980s with communitarianism and then developed into a renewed academic interest in nationalism, multiculturalism, citizenship, and the like. Patriotism is one of the latecomers to this process. It should be stressed, though, that this academic interest, or lack of interest, has little bearing on the ordinary political usage of these terms. Patriotism, regardless of academic concerns, persisted in lay political vocabularies throughout the twentieth century.

The deep roots of the word *patriot* lie in Roman antiquity, particularly in terms such as *patria* and *patrius*, which indicate fatherland, city, native, or familiar place. *Familiar* has links with the word *family* (*familia*). This also has ties with the term *father* or *paternal* (*pater*, *père*, *Vater*, *padre*), or what is implied by the “role of the father” within a family. In terms of the “role of father,” *patria* and *patrius* have subtle connections with property, authority, and status. The word *patriarch* evolves from this dimension. The links between father, authority, family, property, and politics can be observed, for example, in the Roman patrician class, who possessed considerable wealth in land and were dominant in the older Roman political structure. Their property enabled wide-ranging political influence. This was also connected to the original use of the cognate terms *patron* and *patronage*. Early Roman political factions, as in later European monarchies, worked through powerful wealthy families. Loyalty to kin in politics was supremely important for survival and political success. Early Roman *pietas* was, therefore, originally loyalty to the family hearth. However, Roman republican writers, such as Cicero, also saw a wider patria in the *res publica* (the public thing). The later Roman legal *Digesta* and *Institutiones* referred to two patrias affecting citizens: the more local (*patria sua*) and the more abstract public Rome (*communis patria*). Under the later Roman Empire (and again under later European absolute monarchies), this second patria became increasingly more abstract and legalistic.

In effect, the highest patria (status and estate) became synonymous with the state. The state was, in a sense, paternal authority “writ large.” This idea can still be seen in seventeenth-century doctrines of political rule, such as patriarchalism, where

all authority is traced to the paternal role. The prince thus embodied the essence of the state. Traces of this can still be seen in eighteenth-century writings, such as Henry St. John, first viscount Bolingbroke’s (1678–1751) *Idea of a Patriot King* (1749). The opposition to this reading of the state also employed the language of patriotism. Yet it wanted to colonize the state with a different set of values. Thus, liberty under the law became a motif for a divergent set of arguments. Consequently, if republicans, dissenters, and revolutionaries absorbed the language of patriotism, they could claim to be struggling for the “real” rights and freedoms of the people, and consequently for the soul of the state. At this point in the argument, in the early nineteenth century, the language of patriotism began slowly to mutate into nationalist language.

In summary, the qualities of “local familial or community loyalty” and an “impersonal abstract legal loyalty” have remained part of the vocabulary of patriotism to the present day. Local communal identification implies a more visceral loyalty, an attachment and love for the “familiar.” This is why some contemporary commentators can still insist that patriotism is more of an emotion than an intelligible political idea. Yet at the same time, the loyalty to the remote authoritative legal abstraction of the state or city-state embodies another important formal aspect of the legacy of patriotism.

Objects of Patriotic Loyalty

First, in the medieval period, the patria could be identified with a locality, hamlet, clan, village, township, or city. The patriot was one who submitted to the village or city and was prepared to defend it. Second, in terms of the feudal structure, defending homelands could also entail defending the lands of a local lord or prince. In this sense, feudal and vassal relations became integral to patriotic argument. Third, in Augustinian Christian thought the significant patria was the “city of God,” which transcended all cities and states. During the later medieval period, Roman imperial thought was utilized by secularizing territorial states (initially city-states) in Europe. However, “abstract legal Rome” (*communis patria*) was a movable feast. It could apply equally to Venice, Florence, Paris, or London. Princes became, in effect, supreme lawmakers (sovereigns) and emperors in their own realms. The objects of patriotism thus became the new territorial states with their fatherly princes.

From the twelfth century, the notion of patria often arose in the context of defense of a state territory. Defense of patria was a key ground for “just war.” This identification with patria intensified with renewed study of writers such as Cicero (106–43 B.C.E.), and later, with the thirteenth-century rediscovery of Aristotle’s political writings. Thomas Aquinas (1225–1274) also touched on the issue of the religious duty of citizens to render themselves vulnerable to death for their patria—*pro patria mori*. Religious language was immensely important here. Death for patria and death for the Christian faith became virtually coeval by the late medieval and early modern period. The emotive religious memorials and formal recognition we still give to patriotic war dead are a testimony to how deeply this idea has permeated state theory. It is crucial to the understanding of patriotism to the present day. Finally, it is

important to underscore the point that patriotism is formally compatible with any political creed or “object of attachment.” Family, locality, city, tradition, land, absolute monarch, total state, and republic have all been objects of patriotic loyalty.

Forms of Patriotism

In contemporary discussion there have been a number of renderings of patriotism. These can be distinguished between two forms—strong and moderate patriotisms. The stronger version argues that patriotic loyalty is the sole source of any meaningful moral claims. The content of patriotism is therefore always particular or local. In this context, the loyalties demanded from the patriot are simply to whatever values are regarded as dominant within a state or community. The key critical opposition to this perspective comes from universalist forms of argument, such as universal human rights claims. However, the larger bulk of recent writings on patriotism have appeared within the moderate category. The moderate category tries to mediate between universalism and localism.

Strong patriotism. The strong variant of patriotism does not have as many proponents as the moderate form. One key example of this is strong communitarian patriotism. In his 1984 essay, “Is Patriotism a Virtue?,” Alasdair MacIntyre sees patriotism as one of a class of “loyalty-exhibiting virtues.” These virtues exhibit “action-generating regard” for particular persons or groups, and they are embedded in highly particular relationships. Morality is thus rooted within communal relations. For MacIntyre, morality is always learned from within a particular way of life. Goods are always the particular goods of communities. The morality of patriotism is therefore seen as perfectly natural to us as communal beings. MacIntyre’s citizen is basically a very mild-mannered political animal; however, it is important, nonetheless, to realize that the strong particularist arguments he deploys have been utilized by much more worrying forms of politics. Racial exclusivism or political authoritarianism could well be justified within this framework. The dangers implicit within this perspective are those of extreme exclusion and the lurking possibility of communal jingoism. In the twentieth century, strong variants of patriotism have been associated (rightly or wrongly) with the militaristic or bellicose stance of German national socialism and Italian fascism in the 1930s.

Moderate patriotism. The more recent moderate account of patriotism contains four subtle variants. First, for neo-classical republicans the distinctive character of patriotism is its focus on political liberty and civic virtue. Love of country is not love of a language or ethnicity, but rather of political liberty. This is not a love of a particular liberty, but a generic nonexclusive liberty as embedded in law. It is seen essentially as a universalizing force. A republic is seen to embody a powerful sense of local solidarity contained within a universal vessel of liberty under law. For its proponents, republican language is thus a viable alternative to current liberal foundationalism, ethnic nationalism, and strong patriotic arguments.

Second, for recent theorists such as Charles Taylor, moderate communitarian patriotism envisages a direct link between patriotism, republicanism (although some would categorize it

as civic humanism), and communitarian motifs. Communitarians are clearly not of one mind here. The distinction between strong and moderate patriotism has direct parallels with the distinction, made within communitarian theory, between strong and moderate senses of community. Whereas MacIntyre sees a direct synonymy between nationalism and patriotism and adopts a narrower, stronger, and more exclusive sense of community, Charles Taylor seeks some separation between patriotism and nationalism and adopts a more differentiated view of community (incorporating multicultural diversity). Further, whereas, for Taylor, moderate patriotism is a matter of self-conscious citizen identification with a polity, strong patriotism swims in murkier waters, usually envisaging patriotism as a prepolitical, nonintentional attachment. Moderate communitarian patriotism, for Taylor, has no “prepolitical” reference. It rather implies more intentional attachment to a country and its laws. Patriotism is therefore always “politically defined,” as in the American and French Revolutions. However, most moderate communitarian patriots admit that in the nineteenth and twentieth centuries the vocabularies of nationalism and patriotism became confusingly intermeshed.

Third, Stephen Nathanson, in constructing his moderate liberal patriotism, has contrasted it with both the “extreme patriotism” of MacIntyre and communitarian arguments. Moderate liberal patriotism basically sees certain liberal universalist, essentially neo-Kantian, moral constraints acting upon patriotic goals. Too much patriotism, or too much liberal universalism, is to be avoided. Patriotism therefore requires a middle way. Thus, liberal universalism can and should legitimately restrain local solidarities and membership loyalties. Nathanson’s position is at least a salutary reminder to republicans that liberal universalist language is not necessarily always antipatriotic.

The fourth, final strand is constitutional patriotism. This is associated with the writings of Jürgen Habermas on what he calls *Verfassungspatriotismus*. This is essentially, again, a neo-Kantian orientated loyalty to the universalistic principles of liberty and democracy embodied in a constitution. The emphasis is quite explicitly legalistic. Constitutional patriotism is an allegiance to a constitutional juristic tradition embodying certain fundamental rational values. The background to this is Habermas’s own deep sensitivity to the events of World War II in Germany, particularly in relation to nationalism. In Habermas’s case, constitutional patriotism is patriotic loyalty to the universalistic principles embodied in the German constitution. Citizens, in this scenario, are linked together by a formal common agreement on the shared values of the constitution. Habermas is insistent that constitutional patriotism has no connection with any prepolitical attachments, characteristic of nationalism or strong patriotism. This kind of general constitutional theme can be found, for some Habermasians, in the polity of the United States and, possibly, even the burgeoning European Union legal structures.

Nationalism and Patriotism

There are negative and positive arguments for both separating and fusing nationalism and patriotism. The positive statement for their fusion is contained in stronger views of communal identity. Both concepts embody powerful statements on the

moral priority of the community. The positive view therefore involves the direct normative assimilation of nationalism and patriotism to communitarianism. This can be termed the “positive assimilation model.” MacIntyre articulates this view, in which patriotism and nationalism become indistinguishable.

The negative reading of the “fusion” views patriotism and nationalism with equal contempt as blemishes on political and moral discourse. This can be termed the “mutually disagreeable model.” There are a number of background points to this model. First, patriotism is seen as a verbal “sleight of hand” to avoid the pejorative connotations of nationalism; however, basically they are the same. The separate use of patriotism therefore has a face-saving character. Second, it might well be the case that patriotism did have an older individual meaning, but since the nineteenth century that older sense has been totally lost. Patriotism is exactly the same appalling entity as nationalism. Patriotism should therefore share all the opprobrium heaped upon nationalism. The “mutually disagreeable model” was well formulated by Leo Tolstoy at the beginning of the twentieth century. Tolstoy found both ideas repellent. Despite great efforts by states to foster patriotism, it is the same doctrine as nationalism. In the final analysis, both entail the renunciation of all human dignity, common sense, and moral conscience.

The opposite thesis to the above is the separation of nationalism from patriotism. This again has positive and negative dimensions. The positive reading of the separation is most forcibly rendered by recent republican writers. Thus, true patriotism must be kept completely distinct from nationalism. For such republicans (as Maurizio Viroli), the language of patriotism invokes a specific love of the political institutions and laws that embody a nondominatory concept of liberty. It is therefore about sustaining a particular way of life in a republic. Nationalism, on the other hand, is seen as a highly exclusive, prepolitical, culturally oriented attachment that is antagonistic to liberty. It is therefore deeply pernicious to confuse patriotism and nationalism, since patriotism is the theoretical and practical antidote to nationalism.

The negative reading of their separation suggests that patriotism and nationalism should be kept distinct on negative grounds. The concepts are historically different. Each has a distinct historical trajectory. Patriotism, for example, is an older terminology that has a much more intimate connection with both the state and religious language, whereas nationalism has closer connections to modernity and secularism. However, both terms are to be mistrusted for different reasons. Both are equally objectionable as narrow, exclusive, tribal, and deleterious to human dignity. In this context, the separation between patriotism and nationalism is valid, but this redeems neither doctrine.

See also *Nation; Nationalism; State, The; Romanticism in Literature and Politics.*

BIBLIOGRAPHY

Dietz, Mary. “Patriotism.” In *Political Innovation and Conceptual Change*, edited by T. Ball, J. Farr, and R. L. Hanson. Cambridge, U.K.: Cambridge University Press, 1989.

Habermas, Jürgen. “Citizenship and National Identity: Some Reflections on the Future of Europe.” *Praxis International* 12 (1992): 1–19.

Ingram, Attracta. “Constitutional Patriotism.” *Philosophy and Social Criticism* 22 (1996): 1–18.

MacIntyre, Alasdair. *Is Patriotism a Virtue?* Lawrence: University of Kansas Press, 1984.

Nathanson, Stephen. *Patriotism, Morality, and Peace*. Lanham, Md.: Rowman and Littlefield, 1993.

Nussbaum, Martha Craven. *For Love of Country: Debating the Limits of Patriotism*. Edited by Joshua Cohen. Boston: Beacon, 1996.

Primoratz, Igor, ed. *Patriotism*. New York: Humanity Books, 2002.

Taylor, Charles. “Nationalism and Modernity.” In *The Morality of Nationalism*, edited by Robert McKim and Jeff McMahan, 31–55. Oxford: Oxford University Press, 1997.

Tolstoy, L. N. “Christianity and Patriotism.” In his *The Kingdom of God and Peace: Essays*. Translated by Aylmer Maude. London: Oxford University Press, 1935.

Vincent, Andrew. *Nationalism and Particularity*. Cambridge, U.K.: Cambridge University Press, 2002.

Viroli, Maurizio. *For Love of Country*. Oxford: Clarendon, 1995.

Andrew Vincent

PEACE. The peace concept has a long history both in the Western and Eastern intellectual traditions. While Greco-Roman and Judeo-Christian ideas regarding peace have expanded and changed over time, this is not so much the case in Muslim, Hindu, and Buddhist thought.

Ancient and Early Christian West

For the ancient Hebrews, *shalom* signified a state of prosperity and well-being as well as security. The Greek word, *eirēnē* from which we get the word *irenic*, also denotes the contentment and fruitfulness that comes from concord and harmony. Order (*tranquillitas ordinis*), quiet (*quies*), and repose (*otium*) inhere within the Latin word *pax*, which Romans sought and maintained as a higher good. Altars to peace were erected by both Greeks and Romans, and the Stoic view of the universe visualized an intrinsic natural harmony, which the virtuous endeavored to restore. In all of these ancient conceptualizations, there was a belief that an Eden-like time of peace had existed before war and disorder disrupted it. Peace, then, was understood mostly as a cessation of the chaos of the created disorder, including war. While it may have been the natural state of humankind at one time, in the early twenty-first century it is an idyll that can only be approximated by a good government that can ensure the security necessary for the achievement of concord and personal well-being.

The corresponding development of just-war ideas provided a program for realizing peace, or the restoration of order. Strict guidelines were erected in an attempt to prevent any behavior, especially by governments, that would be disruptive, unless it resulted in the ultimate acquisition of peace. While the earliest Christian writers eschewed war altogether, seeing it as contrary to the “way of love” taught by Christ, by the third century some Christians were fighting in Roman wars without compunction. Augustine of Hippo (354–430) did much

to establish the components of the just war that would affect subsequent attitudes toward war in the West; but he also more fully defined what peace meant in a Christian context. For this early church father, peace was largely a spiritual concept. In his famous *City of God*, as well as in other works, Augustine incorporated the earlier Greek, Roman, and Jewish elements and contended that peace is essentially a right relationship with God that, through the indwelling of the Holy Spirit, will advance love and concord among human beings. The earthly city is a fallen one and original sin will prevent temporal peace from being established fully; thus, only when Christ returns to judge humanity will true, lasting peace be possible. By removing true temporal peace from the realm of possibility, Augustine bequeathed to the European Middle Ages a concept that was relatively idealistic and millennialistic, even as he sought to mitigate the horrors of warfare with a rigorous just-war doctrine.

Western Middle Ages

The medieval period produced elaborations of Augustine's idea of peace within the context of crusade and feudal politics. The fall of Rome in the late fifth century led to the foundation of numerous bellicose Germanic kingdoms, which struggled to create a new basis for social and political order while adopting gradually much of the culture of antiquity, especially as the Germanic peoples converted to Christianity. The Western Church in the early Middle Ages required exacting penances for the shedding of blood, which were enhanced in early Carolingian laws (eighth century). In this context it was often difficult to distinguish between war and peace, and peace came to be viewed mostly in practical terms as simply a respite from fighting, sometimes even being depicted as the goddess of victory. The Peace of God (*pax Dei*) movement around the turn of the first millennium attempted to regulate warfare through strict papal restrictions on times of fighting and types of weaponry used, violations of which could lead to excommunication or interdict. As feudal relationships came to provide a new negotiated basis for order and peace by the twelfth century, the emerging chivalric code incorporated just-war theory, and set as one of its objectives the perpetuation of order or peace. The inclusion of the Augustinian motivation of love as necessary in any just war helped to ensure that the Christian spiritual ideal regarding peace would remain the goal even if in practical terms it would always remain elusive. The Crusades became the ultimate expression of the just war in continental Europe, but the barbarous actions of the knights who journeyed to the Holy Land compromised the church's credibility in fostering peace, since plenary indulgences seemed to excuse all kinds of violence and manslaughter in this supposedly sacred cause. This situation also created the intellectual climate for the first real investigation of peace as an idea, coming as it did on the heels of charges of corruption against the clergy.

While there were new investigations of peace in continental Europe—such as Dante's (1265–1321) vision of a Christian emperor in *Monarchia* (c. 1315), who established a one-world government that would provide true peace and order—the concept of peace itself underwent little change. Only in England during the Hundred Years' War (1337–1453) is there

found a protracted military enterprise provoking extensive criticism of warfare as an institution and, subsequently, suggesting a more complicated notion of what peace itself means. By the 1380s, writers such as John Gower (1330?–1408), Geoffrey Chaucer (c. 1342–1400), William Langland (c. 1330–c. 1400), Thomas Hoccleve (1368 or 1369–c. 1450), John Bromyard (d. c. 1390), John Lydgate (c. 1370–c. 1450), and John Wyclif (c. 1330–1384) all were attacking the justifications for wars, and the insincerity behind the putative goal of restoring order and peace. A new typology of peace emerged from this crucible of war and critique that would remain the basis for understanding peace right up until the modern period. First, the original Augustinian idea of personal, spiritual peace remained, along with its association with mercy, love, and patience. But for the critics of war, it was no longer enough to expect spiritual renewal to end the killing on a one-to-one basis. Relying on personal forbearance did not seem to reduce incidence of war at all. The other, older view of peace as order, including its affiliates—quiet, rest, concord, and law—now took on new resonance as writers excoriated the behavior of knights who supposedly followed a strict, peace-loving code of arms.

Two new elements of peace, however, which had been introduced by the early fifteenth century, proved to be more practical. First, Wyclif and the Lollards, who could easily be termed pacifists, emphasized the un-Christlikeness of war, and thus attempted to return to an early Christian ideal of peace as reflecting the image of Christ (*imago Christi*), demonstrated through acts of love. Unlike the Augustinian concept, here, to live like Christ is to work to stop war and to promote peace, not just in one's spiritual journey, but in society at large. The idea is that Christ believed that peace was possible, and in fact the Gospels say the angels proclaimed peace at his birth. Regardless of whether a cause seems just or not, war is always wrong and it must be a matter of conscience for all Christians to oppose it. By undercutting just-war arguments as inimical to God's way of peace, the concept for the first time emerged from the cloak of impossibility and became an obligatory pursuit. Issuing from this was the related idea that peace offered many practical benefits, thereby stressing its pragmatic nature. Lydgate, Hoccleve, and works such as *The Libelle of Englyshe Polycye* (c. 1436) equated temporal peace with economic well-being, personal security, and the growth of learning. From the late fifteenth century the value of peace was located increasingly in the language of political economy with its complex associations to the public good, which war was less likely now seen to promote.

Renaissance and Reformation

Renaissance humanists, especially those in northern Europe who had spent time in England, took the peace imperative and fashioned it into an ethic based on a dedication to the public good, or commonwealth. Desiderius Erasmus (1466?–1536), Thomas More (1478–1535), Juan Luis Vives (1492–1540), and John Colet (1466 or 1467–1519) all published works hostile to war, promoting all four meanings of peace elucidated above. Within the context of emerging nation-states in western Europe, Erasmus, in his *Complaint of Peace* (1517) and many other works, argued that spiritual peace, embodied in

the virtuous Christian prince, would be the foundation of a true and lasting temporal peace. His somewhat Stoic view of the kinship of humanity emphasized the *concordia* aspect of *pax*, which would lead to a personal closeness to God, Christ-like behavior, an absence of strife, and the practical rewards of greater happiness such as the promotion of learning and economic prosperity. While events tended to make humanist pacifists appear idealistic in their own day, their endeavors enshrined peace as an uncontested value and its advancement a virtuous pursuit.

The Protestant reformers, many of whom were also humanists, came to stress the obligations to pursue peace as well through their literal interpretation of the Bible, although they were less optimistic concerning the depraved nature of humankind. One group, however, the Anabaptists, took Christ's words literally when he said "blessed are the peacemakers," and their devotion to all forms of peace became one of their most distinctive characteristics. Not since the time of the early church had a Christian position been so unilaterally in favor of peace; and later groups, such as the Quakers, also came to adopt this position. For these "separatists" peace continued to be understood as both a spiritual condition and a way of life, in all of its practical applications leading to a harmonious and godly society.

The Modern West

The peace concept in the Western tradition from this point onward changed very little in meaning. In the modern period, however, a humanitarian ethos largely replaced the once Christian foundations for valuing peace, but the growing interdependency of nations also produced new concerns about the survival of human existence. By the eighteenth century, many intellectuals opposed the unreasonableness and barbarism of war, and as a result, construed peace as a rational pursuit by enlightened peoples. The philosopher Immanuel Kant (1724–1804), in his *Perpetual Peace* (1795), argued that a world order built upon reason and prudence, which is basically enlightened self-interest, will produce a peaceful society, and bring with it all that is good. The nineteenth century witnessed few large-scale wars in Europe, leading some to believe that Kant's admonition had become a cultural reality. Attempts at balances of power up through the early twentieth century seemed to prove that the West had found the practical solution to the problem of war, and that temporal peace could be realized and perpetuated by sophisticated diplomacy and the careful and humane study of international politics. This rather hegemonic view of peace recalls the ideas of Aristotle and of later officials of the Roman Empire, both of whom believed that empire—that is, rule by a presumably superior civilization—was best positioned to ensure peace. Peace took on the additional nuance then of a planned arrangement for cooperation among nations, even as its moral and practical elements remained prominent.

World War I, the rise of fascism, and the development of nuclear and atomic weapons, all in the twentieth century, left the West once again arguing for peace more from an ethical stance. Since diplomacy and international institutions devoted to peace (such as the United Nations) often fail to prevent wars, the survival of humanity may depend more on people

recognizing the moral necessity for keeping peace. This outlook tends to reduce the peace idea to its most basic meaning as the guarantor of continued human existence, a good for which there is universal agreement and support across cultures.

By the early twenty-first century, especially in Western societies, the concept of peace was most often linked to notions of justice and fairness. The modern ethical paradigm for peace espoused by most pacifists assumes that only when economic and political inequities are minimized or eliminated can we provide a basis for real and lasting peace and the consequent guarantee of prolonged human existence. Many contemporary intellectuals, such as Peter Brock, Peter Calvocoressi, Martin Ceadel, Michael Howard, and Charles Chatfield, have explored creatively the implications of this connection and have tried to offer specific and practical means for achieving true justice and, successively, peace.

Muslim, Hindu, and Buddhist Traditions

The Arabic word *salam*, a cognate of the Hebrew *shalom*, means "making peace." For Muslims, one comes to a purest state of peace by submitting to the will of Allah (*islam*), and anyone who has accomplished this is a *muslim*. *Salam* is even one of the ninety-nine names of Allah in the Islamic religion. In the Koran, anyone doing the will of God and giving all to exalt his sacred name, including the making of holy war (*jihad*), will receive the divine blessing of peace and eventually live with God in that perfect state. Peace also can become an earthly state, in that good Muslims desire temporal peace, not war, realizing that only through an Islamic polity, serving Allah faithfully, can people prosper and live in harmony with one another. Thus, in Islam, ultimate peace, both spiritual and temporal, harmonizes within a submission to the divine will.

In eastern intellectual traditions the spiritual and practical elements of peace have cohered much more intricately and consistently than they have in the west. The Chinese word for peace, *heping*, is comprised of two characters meaning harmony and level (or flat), which suggests equalizing and balancing. (This type of peace may be inherent in the famous Taoist cosmic principles of *yin* and *yang*, which when symmetrical restore order and oneness to the universe.) The Japanese cognate *hewa* means much the same.

In classical Sanskrit *shanti* is the word closest in meaning to peace, usually denoting tranquility, calm, bliss, eternal rest, and happiness, but usually in connection to destruction or death. The term is often synonymous with *sandi* (association, combination) and the opposite of *vigraha* (separation, isolation, hostility). Peace here is contrary to the "absence of isolation" (*vigrahabhava*) or the "absence of strife or war" (*yuddhabhava*). From earliest Hindu thought it became the goal of the individual to escape from the necessity of being reborn, which was accomplished through deep meditation and the avoidance of bad *karma*, thus bringing ultimate peace. Another Indian concept, *ahimsa*, which is found first in the sacred *Upanishads* (c. eighth century B.C.E.), means nonviolence to animals and humans, and is based on the assumption that harm to living creatures produces bad *karma* by endangering or killing the soul of another. All life is one, and any animal

could contain the soul of a relative who has been reincarnated, and so harming it is wrong, Mahatma Gandhi's (1869–1948) pacifism owed a great deal to this tradition of peace. By the time caste distinctions separated the ancient Indians, and led to warfare and strife, the famous meditation known as the *Bhagavad Gita* found in the epic classic Indian poem, the *Mahabharat* offered another means for achieving ultimate peace. *Krishna* tells the warrior Arjuna that in honoring the conditions of caste/race he brings honor to himself, and since souls return to new bodies after the old ones die, death does not matter. But one must reject all greed and anger, and therefore one can, even in the midst of battle, have peace within. Peace is ultimately an inner state that will beget positive ramifications as well for society as a whole.

Buddhist ideas of peace derived from these early Hindu notions that asserted self-denial was the key to contentment and ultimate peace with the universe of which we are all a part spiritually. Also centered in the idea of *ahimsa*, Buddhists have believed that true peace and happiness come from the eradication of all desire, including the desire for permanence that creates conflict and division. Through meditative practices, selfish desire can be gradually eliminated until absolute peace, in this case, *nirvana*, is reached when our state of being ends. Part of this process entails the gradual shutting down of all sensory awareness and feeling, in what is known as *sannavedayitanirodha*. Since one does not stay in this state of contemplation permanently, this does not provide a lasting peace. Buddha believed that peace (*shanti*), both internally and externally, can only be achieved truly when it becomes part of one's conception of the world and of those who live within it. Peace is conditional for Buddha as he taught that the insistence on any type of permanence led to inflexibility, and ultimately, to conflict. This recognition of "dependent arising" forms the path to enlightenment and brings freedom and peace within, but also peace without, since it allows for change and newness.

Conclusion

In summary, while the Eastern and Western intellectual traditions historically have construed peace differently, there are certain characteristics that appear to transcend culture and that are held in common, even if the emphasis varies. There persists a spiritual notion of peace that represents inner calm, wholeness, contentment, and selflessness. The internal condition tends to affect the external so that if individuals are not at peace with themselves, they are unlikely to engender temporal peace. On the contrary, they are more apt to participate in wars, since conflict among peoples usually comes from a dissatisfaction with the current state of being (or affairs) that needs redress, perhaps even violently. In most cultural traditions, peace is the natural state of the universe, and throughout history one of the most universal endeavors of humankind has been the quest to end strife and to restore a beneficial order and tranquility. In linking these various but complementary aspects of what it means to be at peace, peace scholar Gerald James Larson has concluded:

To be at peace with oneself is to accept what or who one is and to have stopped warring with oneself. To be

at peace in community is to make an agreement to end hostility, to live together in harmony, accepting the presence of one another. To be at peace in the cosmos is to accept, largely on faith, that the universe is benign, a more or less fitting habitat for the sorts of beings and forces that dwell or operate within it. (Rouner, p. 138)

See also *Buddhism; Christianity; International Order; Islam; War; Yin and Yang.*

BIBLIOGRAPHY

- Bainton, Roland H. *Christian Attitudes toward War and Peace: A Historical Survey and Critical Re-evaluation*. New York: Abingdon Press, 1960.
- Dyck, Harvey L., ed. *The Pacifist Impulse in Historical Perspective*. Toronto: University of Toronto Press, 1996. Includes many good essays, including Roy C. Amore's "Peace and Non-violence in Buddhism," Klaus K. Klostermaier's "Himsā and Ahimsā Traditions in Hinduism," and Charles Chatfield's "Thinking about Peace in History."
- Gallie, W. B. *Philosophers of Peace and War: Kant, Clausewitz, Marx, Engels, and Tolstoy*. Cambridge, U.K.: Cambridge University Press, 1978.
- Johnson, James Turner. *The Quest for Peace: Three Moral Traditions in Western Cultural History*. Princeton, N.J.: Princeton University Press, 1987.
- Kalupahana, David J. *The Buddha and the Concept of Peace*. Sri Lanka: Vishva Lekha Publishers, 1999.
- Kelsay, John, and James Turner Johnson, eds. *Just War and Jihad: Historical and Theoretical Perspectives on War and Peace in Western and Islamic Traditions*. New York: Greenwood, 1991.
- Lowe, Ben. *Imagining Peace: A History of Early English Pacifist Ideas, 1340–1560*. University Park: Pennsylvania State University Press, 1997.
- Rouner, Leroy S., ed. *Celebrating Peace*. Notre Dame, Ind.: University of Notre Dame Press, 1990. A number of excellent essays, including Sissela Bok's "Early Advocates of Lasting World Peace: Utopians or Realists?," Gerald James Larson's "The Rope of Violence and the Snake of Peace: Conflict and Harmony in Classical India," and Bhikhu Parekh's "Gandhi's Quest for a Nonviolent Political Philosophy."
- Zampaglione, Gerardo. *The Idea of Peace in Antiquity*. Translated by Richard Dunn. Notre Dame, Ind.: University of Notre Dame Press, 1973.

Ben Lowe

PEASANTS AND PEASANTRY. The words *peasants* and *peasantry* are generally associated with a way of life and mind-set that is the opposite of modernization. The terms referred, initially, to small-scale agricultural producers, also known as serfs, who comprised the majority of the populations of Western Europe from the fall of Rome in the fifth century C.E. and during the Middle Ages. Deriving their livelihood mainly, but not exclusively, from agriculture, medieval peasants depended heavily on landlords to whom they had sworn an oath of loyalty and on whose land they lived and farmed. They were expected to provide certain services and to meet specified obligations such as paying rent and taxes, in

cash or in kind, and providing free labor as well giving tithes to the church. Lords, on their part, were obligated to protect the peasants under their care. While most peasants lived directly off the land, some earned their living from nonagricultural activities, namely as blacksmiths, tavern owners, or millers. Dependence on small-scale agriculture, lack of ownership of land, and subservience to a dominant class to which they gave their surplus were, thus, early characteristics of peasant societies and influenced the manner in which scholars conceived of them. Hence, Eric Wolf defined peasants as “rural cultivators whose surpluses are transferred to a dominant group of rulers” (1966, pp. 3–4). Similarly, Douglas Kincaid maintained that peasants were “rural cultivators from whom an economic surplus is extracted, in one form or another, freely or coercively, by non-producing classes” (p. 145).

Defining the Modern Peasantry

Currently concentrated in Africa, Asia, and Latin America, the peasantry has been defined differently by various scholars, depending on the degree of emphasis placed on any one of several characteristics. Definitions of the peasantry embrace some of the following characteristics: ownership and use of land, production methods, subordination to other social sectors, and the degree of integration into the market. For some scholars, therefore, peasants are agriculturalists who control most of the land they work, produce for the market, and who have obligations to other social classes, while for others, they are farmers who lack control over the land, labor, and capital they need to produce crops. For yet others, peasants are farmers who control the land they work as tenants or smallholders and who produce for the market and have obligations to other social classes.

Generally, however, with the exception of the more well-to-do peasant classes who own land and exploit the labor of poorer peasants, most peasants are associated with poverty; primitive production methods using little if any modern technology; small-scale production, mostly for subsistence purposes; and economic exploitation by and political and social subservience to a dominant elite class such as landlords or urban elites. They also lack capital and other production resources and, often, do not have control over the land on which they live and work. Where they do own the land, they tend to regard it as family property and not a commodity. In peasant societies, the family tends to be the central economic unit of production, consumption, reproduction, socialization, and welfare, while socially and culturally, peasant communities tend to be isolated from mainstream society and to have a distinctly local culture, as opposed to the dominant wider or higher national culture. They also have a conservative, inward-looking worldview revolving around the household and the kin group and are suspicious of outsiders and new ideas. Peasant communities are sometimes looked down upon by other social sectors who regard them as not only poor, ignorant, and subservient, but also backward, parochial, and closed.

Scholars, however, sometimes make a distinction between closed and open peasant communities; describing closed societies as being highly exclusive, suspicious of outsiders and new ideas, separated from wider society, and determined to protect

their way of life by, among other things, discouraging the accumulation and display of wealth. Open societies, on the other hand, are characterized as being plugged into the modern capitalist economy and made up of individuals who own their own land, welcome change, and are largely integrated into the larger society. According to some scholars, therefore, open peasant societies are relatively independent actors who produce for the market and exercise considerable autonomy in deciding what to produce, depending on their analysis of inputs that have to be sourced outside the community and rent and tax requirements.

Clearly, while there are certain characteristics common to most peasant societies, there can be no simple all-embracing definition of peasants and peasantry, as scholars tend to highlight different aspects of what marks peasants as a class. Indeed, while the terms are widely used to describe rural communities all over the world, it is evident that they can no longer be regarded in their classical sense, since the groups that are now referred to as peasants in most countries no longer live exclusively by agriculture, as did most of the serfs in medieval times, but combine various survival strategies that often include wage labor, craft making, trading, and other off-farm activities. They can be part-time farmers, factory workers, small business people, traders, and workers on commercial agricultural establishments or seasonal workers in urban factories, all at the same time. Others maintain links with members of the family unit who are urban workers and who send money to supplement the rural family members' income. This leads to the conclusion that, although large populations who live in rural areas derive most of their livelihood from agriculture and regard themselves as peasants, it no longer really makes sense to identify rural society with the role of the peasant farmer.

Yet other scholars insist that the terms peasant and peasantry can only be appropriately applied to medieval or early modern Europe, as the African, Asian, and Latin American situations are so different as to make any comparisons meaningless. With respect to Africa, specifically, the question of whether small-scale agrarian communities on the continent can be regarded as peasants or not has been contentious, with some scholars arguing that Africa did not have distinct social classes, let alone a class that could be identified as peasants. Consequently, Africa only had primitive, rather than peasant, economies. According to this view, distinguishing features of peasant economies include production for the market by the majority of the people and access to resources such as land, labor, and tools, either for purchase or for rent. African rural dwellers, on the contrary, neither had access to nor produced for the market, being merely subsistence producers.

Thereafter, following a prolonged debate, the existence in Africa of a distinct class that could be called peasants was gradually and begrudgingly acknowledged, and discussion moved on to analyze the experiences and role of this class in recent history. By the 1980s, studies were recording peasants' lived experiences and analyzing peasant social structures, histories, inter- and intrapersonal relations, and relationships with the dominant social and economic structures and systems such as colonialism or the postcolonial state and elites. Peasants had, thus, become fully integrated into African studies.

Phases of Historical Study

Meanwhile, in world history in general, the peasantry long occupied the attention of economists, political scientists, sociologists, and anthropologists. The first phase of scholarly interest in the peasantry began with classical economists, such as Adam Smith (1723–1790), who recognized rural workers as a group, but one that was insignificant in the evolving division of labor that he was interested in. Later, Karl Marx also recognized the presence and importance of peasants, but he, too, dismissed them as an economically and politically backward and doomed class, destined to fall into one of the two antagonistic classes of capitalism, namely, the bourgeoisie or the proletariat. Where Smith and Marx had treated peasants as a homogenous mass, the Russian theorist and revolutionary Vladimir Lenin highlighted the existence of peasant class differentiation, identifying three layers, namely, rich, middle, and poor peasants, according to land area, capital accumulation, and wage or family labor and sought to analyze their role in the twin processes of industrialization and socialist revolution.

The second phase of scholarly attention to the peasantry began in the 1960s and 1970s, mainly due to peasant political activism and insurgence in Africa evident in the anticolonial struggles throughout the continent, and in Asia in the form of the Vietnam War and the Chinese Cultural Revolution following the Chinese Revolution of 1949. This second phase is characterized by revived and growing interest by Western anthropologists in the rituals, social structures, and belief systems of peasant societies and the place of poor agricultural areas at the periphery in the world capitalist system with its center in the developed countries. It was a time of peasant activism in the immediate aftermath of the Cuban Revolution in Latin America that led to agrarian reforms that undermined the latifundio agrarian structure in Chile, Peru, Ecuador, Colombia, and other countries. It was also the period characterized by scholarly debates on “articulation of modes of production,” of development economists and donor agencies promoting the green revolution and encouraging peasants to participate fully in the world market in the belief that this would modernize “smallholder” agriculture and make rural producers full participants in the world economy.

Meanwhile, the development economists’ optimism was countered by some scholars who pointed out that peasants would forever remain exploited because of the problems of declining terms of trade and “unequal exchange.” Faced with the failure of the peasantry in the developing world to rise to expectations by raising their food productivity despite the efforts of development specialists to diffuse modern production values to them, Western governments began to blame this on developing country governments’ flawed food pricing policies and inefficient marketing structures and to call for economic structural adjustment programs in order to correct these ills. These programs, sponsored by multilateral financial agencies, by ending government subsidies to the agricultural sector, worsened the plight of the peasantry at a time when the establishment of the World Trade Organization (WTO) had exposed peasants to the harsh environment of international market forces.

Historical Precedents

Although marginalized and oppressed by other social sectors, such as landlords and urbanites, and dismissed by Karl Marx and Friedrich Engels as lacking revolutionary consciousness, peasants have periodically asserted themselves politically throughout history either single-handedly as a class or in alliance with other deprived groups such as workers. Among some of the most known peasant political actions was the Peasants’ Revolt of June 1381 in England when peasants from the English counties of Kent, East Anglia, Somerset, and Yorkshire rose up in protest at their oppression. They were particularly unhappy with the labor demands placed on them by the church and the poll tax that King Richard II had imposed in 1380. Under the leadership of John Ball and Wat Tyler, they destroyed tax records and registers, and burned down buildings housing government records before capturing the Tower of London and compelling King Richard to negotiate with them at Mile End. By late 1381, however, the movement had fizzled out after its leaders were hanged.

Another important peasant uprising in Europe was the Peasants’ War in Germany from 1524, when the peasantry and the lower classes of the towns rose up against their feudal overlords protesting growing economic, religious, and judicial oppression under the nobles and clergy. The peasants’ demands included the right to choose their own ministers, the abolition of serfdom, the right to fish and kill wild game, the abolition of many kinds of feudal dues, and the guarantee of fair treatment in courts presided over by the feudal nobles. Peasants also played an important role in the French Revolution and in the Russian Revolution in 1917. In Russia, although nominally emancipated by Tsar Alexander I through the Emancipation Manifesto of 1861, which decreed an end to serfdom and permitted former serfs to rent or buy land from the landlords, most Russian peasants, numbering some twenty-three million, were still landless by the turn of the twentieth century, as most land remained in the hands of the rich landlords. Among the grievances that the 1917 Russian revolutionaries were able to exploit, therefore, was the peasants’ land hunger. The peasants’ reluctance to fully embrace the socialist goals of the Bolshevik Party, particularly under Joseph Stalin, made them targets of Stalin’s sustained campaign to destroy them during his collectivization drive of the 1930s, which resulted in the death and exile of thousands of peasants.

In Africa, peasants played a crucial role in resisting colonialism and its prescriptions, as evident in the 1905 Maji Maji uprising in Tanganyika (Tanzania), where German conquest and colonization between 1895 and 1900 provoked a massive uprising when African peasants objected to the taxes, forced labor, and harsh working conditions that came with German colonialism. Although it failed to dislodge German colonialism, the Maji Maji mass uprising forced the German colonial authorities to reform their administration and practices. Another example of armed peasant resistance is the 1896–1897 Chimurenga/Umvukela uprising in Zimbabwe (Southern Rhodesia) where, following British occupation in 1890, African peasants lost their land and cattle to colonial settlers and were subjected to forced labor and an array of taxes designed to force them into the labor market. Similarly, in

Namibia, German colonial rule also provoked armed resistance from the Herero and the Nama between 1904 and 1907. Here, too, colonialism brought with it massive land alienation, loss of sovereignty, loss of cattle to incoming German settlers, numerous taxes, openly racist policies and practices that marginalized Africans, corporal punishment, and other ills associated with European colonialism in Africa. In January 1904, the Herero rose up against German rule. In late 1904, the Nama began a three-year guerrilla campaign against German rule that was only crushed by German forces in 1907.

After the first wave of resistance, peasant protest continued throughout the interwar years and, thereafter, flowered into militant mass nationalism that finally led to the demise of colonialism. In Kenya, Zimbabwe, Angola, Mozambique, and Namibia, peasants participated in the armed struggle that brought about independence in those countries. Their contribution to the struggle for independence notwithstanding, most peasants benefited little from political independence, as post-colonial political and economic systems were dominated by the urban elite who promoted their interests at the expense of the peasant majority. Meanwhile, in Asia, peasants also participated in political movements, the most notable being the struggle of the Red Army organized by the Chinese Communist Party in the late 1920s, which ended with the setting up of the People's Republic of China in 1949.

In attempting to understand why peasants rebel, J. C. Scott contended that peasants tend to rebel when they perceive their traditional moral order or moral economy as being violated. The above examples seem to validate this claim, as they show that peasants have not been merely passive victims of other classes' machinations but have asserted and defended their rights and way of life when they felt that these were threatened.

See also **Anticolonialism; Capitalism; Colonialism; Feudalism, European; Poverty; Revolution; Work.**

BIBLIOGRAPHY

Bryceson, Deborah, Cristóbal Kay, and Jos Mooij, eds. *Disappearing Peasantries? Rural Labour in Africa, Asia, and Latin America*. London: Intermediate Technology Publications, 2000.

Bundy, Colin. *The Rise and Fall of the South African Peasantry*. London: Heinemann, 1979.

Dalton, George. "The Development of Subsistence and Peasant Economies in Africa." *International Social Science Journal* 16 (1964): 378–389.

———. "Economic Theory and Primitive Society." *American Anthropologist* 63 (1961): 1–25.

De Janvry, Alain. *The Agrarian Question and Reformism in Latin America*. Baltimore: Johns Hopkins University Press, 1981.

Emanuel, Arghiri. *Unequal Exchange: A Study of the Imperialism of Trade*. Translated by Brian Pearce. New York: Monthly Review Press, 1972.

Evans, David. "Unequal Exchange and Economic Policies: Some Implications of the New-Ricardian Critique of the Theory of Comparative Advantage." *IDS Bulletin* 6, no. 4 (1975).

Fallers, Lloyd. "Are African Cultivators To Be Called 'Peasants'?" *Current Anthropology* 2, no. 2 (1961): 108–110.

Frank, Andre Gunder. *Capitalism and Underdevelopment in Latin America: Historical Studies of Chile and Brazil*. Harmondsworth, U.K.: Penguin, 1969.

Isaacman, A. "Peasants and Rural Social Protest in Africa." *African Studies Review* 33 (1990): 1–120.

Kincaid, Douglas A. "Peasants into Rebels: Community and Class in Rural El Salvador." In *Constructing Culture and Power in Latin America*, edited by Daniel H. Levine. Ann Arbor: University of Michigan Press, 1993.

Klein, Martin, ed. *Peasants in Africa: Historical and Contemporary Perspectives*. Beverley Hills, Calif.: Sage, 1980.

Landsberger, Henry A. "The Role of Peasant Movements and Revolts in Development." In *Latin American Peasant Movements*, edited by H. A. Landsberger. Ithaca, N.Y.: Cornell University Press, 1969.

———. *Rural Protest: Peasant Movements and Social Change*. London and New York: Macmillan, 1974.

Mafeje, Archie. "Peasants in Sub-Saharan Africa." *African Development* 10, no. 3 (1977): 412–422.

Ranger, Terence. *Peasant Consciousness and Guerrilla War in Zimbabwe: A Comparative Study*. Berkeley: University of California Press, 1985.

Scott, James C. *The Moral Economy of the Peasant: Rebellion and Subsistence in Southeast Asia*. New Haven, Conn.: Yale University Press, 1976.

Shanin, Teodor, ed. *Peasants and Peasant Societies: Selected Readings*. 2nd ed. Oxford and New York: Blackwell, 1987.

Wolf, Eric R. *Peasants*. Englewood Cliffs, N.J.: Prentice-Hall, 1966.

———. *Peasant Wars of the Twentieth Century*. Reprint, Norman: University of Oklahoma, 1999.

Alois Mlambo

PERIODIZATION. Periodization, which became a branch of historical method and the philosophy of history in the twentieth century, has to do with the division of time's arrow—the theoretical timeline of the movement from past to present and future. In Western tradition this speculative aspect of history has its roots in myth and in the Bible—in Hesiod's succession of gold, silver, and bronze ages, for example, and in the periods and generations of the nation of Israel since Creation and the Fall, which long furnished the framework for the Judeo-Christian story of humanity, within which other cultural traditions were synchronized. To these, Christian theologians added ideas of particular ages (*aetates*), especially those before the law, under the law, and under grace, and later the ages of the Father, Son, and Holy Ghost, inspired by Joachim of Fiore (c. 1130 or 1135–1201 or 1202); and such messianic periodization passed also into eastern Europe, especially Poland. In ancient and medieval times, as in the work of St. Augustine of Hippo, Isidore of Seville, and the Venerable Bede, there was much speculation about the natural "ages of man"—three, four, six, or seven of them—which carried the analogy of the trajectory of human life (birth, youth, maturity, degeneration, and death) into the collective experience of nations or of humanity as a whole. Thus in the twentieth century Claude de Seyssel adapted Joachim's conceit of four ages to French history, marking infancy from the legendary Pharamond, youth to the end of the Merovingian dynasty, maturity under the Carolingians,

and old age under the Capetian. On the political level the commonest way of describing the structure of history was through the biblically inspired conceit of the succession of four world monarchies—Medes, Persians, Greeks, and Romans, which included the Carolingian refoundation, the “Holy Roman Empire of the German Nation,” down to its extinction by Napoleon in 1806. The notion of periods defined through political dominance was continued in the modern European tradition by recognition of Spain, France, England, Germany, and the United States (and the Soviet Union) as leading powers in their respective hours of glory.

For five or more centuries Western history has been dominated by the ancient-medieval-modern periodization, which arose from the conception of a “middle age” between ancient cultural splendor and its modern recovery by the humanists of the fourteenth and fifteenth centuries and by Protestant Reformers reacting to the intellectual “barbarism” of medieval scholasticism. As Petrarch (1304–1374) wrote in one of his sonnets (*Epistolae metricae* 3.33): “Long before my birth time smiled and may again, / for once there was, and yet will be, more joyful days. / But in this middle age time’s dregs / sweep around us. . . .” And “in order to forget my own time, I have constantly striven to place myself in spirit in other ages”—whence the conceit of a rebirth of antiquity and the aforementioned triad of periods. Similar to Petrarch’s perspective was the view of Christian humanists and reformers like Martin Bucer (1491–1551), who wrote of “the various periods of the church,” from the purity of the primitive church to the centuries of oppression under Antichrists to his own time of a return to the true gospel in the Kingdom of Christ. The seventeenth-century notion of “a middle time between ancient and modern,” fixed in the textbook tradition by Conrad Cellarius (1574–1636), and continued into the later period, when the “renaissance of letters” was essentialized and publicized as simply “the Renaissance” by Jules Michelet, Jacob Burckhardt, and their epigones, later became the subject of debate by twentieth-century scholars. In the nineteenth century his convention of three ages was applied by European historians also to India, China, and America.

Periodization focused first on literary and artistic change, but from the eighteenth century it attended also to the material base and, in the work of Adam Smith, Anne Turgot, and Y.-A. Goguet, developed a stadial conception of human history. “The four stages of society,” wrote Smith in 1762, “are hunting, pasturage, farming, and commerce.” He explained these stages and the “origins of government” with the help of the ancient theory of three constitutional forms: “In the age of hunters there can be very little government of any sort, but what there is will be of the democratical kind. . . . The age of shepherds is that where government properly commences, followed by agriculture, property, and rule by a few rich men, and then by the emergence of chieftains, marking a monarchical government.” Arts and manufactures are then cultivated, “as property arrangements and disputes are multiplied and civilized through writing” (pp. 201, 459). By the end of the century this thesis, promoted also by Lord Kames, James Dalrymple, John Millar, Lord James Barrett Monboddo, William Russell, Christoph Meiners, and others had become

commonplace in Britain as well as the continent, and it had a significant impact on the ideas of Karl Marx, Friedrich Engels, and later world historians and textbook writers.

This line of inquiry and interpretation were part of what Dugald Stewart called “conjectural history,” and there were many examples of efforts at periodization in this connection, beginning with the old biblical narrative, which Bishop Bossuet (1627–1704) divided into twelve “epochs” from Adam and the Flood down to Charlemagne’s empire. A more secular periodization was devised by Giambattista Vico, who posited a succession of three ages—poetic (barbaric), heroic (feudal), and human (civil). Perhaps the most famous system was that of Marie-Jean Caritat, Marquis de Condorcet (1743–1794), who, like Bossuet a century earlier, divided universal history into “epochs,” but ten instead of twelve and following not Biblical chronology but rather a “reasoned” sort of history, analogous to Lockean psychology but projected onto a collective tabula rasa. Condorcet followed the improvement of social skills, technology, and the advancement of learning—from tribal, pastoral, and agricultural society, through the ancient and medieval periods, down to the invention of printing, the rise of modern philosophy, the founding of the French Republic in the age of revolutions, and his own agenda—“reason, toleration, and humanity”—which he presented in the form of prophecy. So he made his transition from the ninth to the tenth epoch, which was devoted to “the future progress of the human mind” and which represented a secular version of the eschatological dimensions of Christian tradition. As humanity approaches perfection, so history becomes futurology, and this heritage was taken up by French Utopians, Socialists, Positivists, Marxists, and not a few historians in the next century, who offer a wide range of ideas of progress.

Marx continued the economic interpretation, making the primary mode of production and class conflict the criteria, and the result was the threefold division of history of (primitive) feudal, capitalist, and proletarian, which inspired research, speculation, and polemic for over a century. For Marx history begins in barbarism and its kinship relations and moves on to the higher form of feudalism, based on control of landed property and serfdom, and then, with the development of trade, commerce, and finance, to a capitalist mode of production and industrialization that, generating proletarian class consciousness, looks forward to a transition to communism. The materialist view of history, inherited by Marx from Enlightenment political economy, was taken up as well by prehistorians, who on the basis of archeological researches distinguished the ages of stone (old and new—paleolithic and neolithic), bronze, and iron, which replaced or gave solid reinforcement to the “four-stage” system of eighteenth-century conjectural history, by connecting it with more precise chronological—that is, stratigraphic—calibrations. In the twentieth century the *Annales* school shifted attention from events and periodization to structures of long duration, and historians of women have questioned the relevance of traditional periodization to the turning points in the history of women.

Systems of periodization continue to appear, but most are variations on these old themes, applying ideas of evolution and “modernization,” if not decadence and decline. Of course there

are lower levels of periodizing, that is designating periods, whether by centuries, decades, cultural styles (Romantic, Baroque, Gothic, fin de siècle), political domination (Elizabethan, Napoleonic, Victorian, Soviet, Nazi), or individual celebrities (the age of Shakespeare, Bach), and the like. As for the time line for the story of the human species the parallel columns started by Eusebius and filled in by later chroniclers has been vastly expanded by geographical, archaeological, and anthropological discoveries, and periodization in the old sense has been marginalized, although appending a “postmodern” age to a modern one suggests that the impulse still survives.

See also *Historiography; History, Idea of; Periodization of the Arts.*

BIBLIOGRAPHY

Burrow, J. A. *The Ages of Man: A Study in Medieval Writing and Thought.* Oxford: Clarendon, 1986.
 Ferguson, Wallace K. *The Renaissance in Historical Thought: Five Centuries of Interpretation.* Boston: Houghton Mifflin, 1948
 Koselleck, Reinhart. *Futures Past: On the Semantics of Historical Time.* Translated by Keith Tribe. Cambridge, Mass.: MIT Press, 1995
 Meek, Ronald L. *Social Science and the Ignoble Savage.* Cambridge, U.K., and New York: Cambridge University Press, 1976
 Smith, Adam. *Lectures on Jurisprudence,* edited by R. L. Meek, D. D. Raphael, and P. G. Stein. Oxford: Clarendon, 1978.
 Van der Pot, J. H. J. *De Periodisering der Geschiedenis.* The Hague: W. P. van Stockum, 1951.

Donald R. Kelley

PERIODIZATION OF THE ARTS. Notions of boundaries, categories, and periods frame discussions of art and visual culture. The desire to organize visual information and material into clearly defined, manageable units has provided an irresistible impetus for periodization since the emergence of art historical and critical studies in the Renaissance. The application of periods to art and visual culture was extended in the nineteenth and twentieth centuries, when philosophers, historians, and critics of the arts searched for objective ways to explore their world. Their search for objectivity resulted in their conceptualization of periods as a metalanguage rooted in empiricism through which to communicate ideas. Centuries of scholarship have produced a multiplicity of periods underscoring diverse perspectives and serving diverse ends. For some observers, the study of periodization is an exercise in disillusionment. The absence of any single, consistent system of periodization is construed as a symptom of the failure of the intellectual disciplines surrounding the arts. For other observers, the study of periodization is an affirmative endeavor. The existence of alternative schemas for periodization indicates that intellectual discourse about the arts is open to debate, reconsideration, reorganization, and reinterpretation.

What Is a Period?

Art historians and aesthetic philosophers employ a number of ways to group world arts into systems of classification, known

as *periods*. Periodization subdivides the continuous flow of artworks through time and space into groupings. Period groupings are defined by the perception that the artworks within them share a single quality or a set of qualities that are significant. Significant qualities can include the formal, stylistic, iconographic, thematic, or other aspects of art. Moreover, period groupings are further defined by the perception that the quality or qualities by which each grouping is defined is distinctive.

Rather than being neutral, periodization organizes art according to critical viewpoints and explanatory hypotheses. The definition of a period reflects judgments about the nature of meaningful connections between artworks and between art and its larger context. The divisions made between periods reveal judgments about the paths of artistic development or moments of artistic disjunction.

Periodization also influences the perception of the audience according to the quality or qualities that are used to group artworks. Qualities in individual artworks that are deemed significant to the period are more visible to viewers, while other qualities in the same artworks tend to be overlooked.

Is it necessary to periodize? Some theorists object to the concept of periods as a contradiction against the very nature of the art. According to this viewpoint, periodization merges the individuality of the artist and the uniqueness of artworks into homogeneity that is inherently the antithesis of creativity. Other theorists object to the utilization of periods as a distortion of the historical process. According to this viewpoint, periodization falsely divides the continuity of history. Critics of periodization argue that history should be written as a continuous chronicle of occurrences and their interrelations and that the principal purpose in writing art history should be to enhance our appreciation of the uniqueness of individual works of art.

One such critic was Roger Fry (1866–1934). While employing period names in his critical writings, Fry applied an overall approach that is essentially timeless. In his analysis of early-twentieth-century art, Fry denied that modern art was the next element in a cycle or sequence of periods. Artworks, in Fry’s view, should be construed as the fruitions of independent creative acts, and hence as fundamentally unhistorical. Instead, Fry postulated a great tradition whose representatives can belong to any age.

Despite objections, most art historians and critics have utilized systems of periodization. Heinrich Wölfflin (1864–1945) both recognized that time can be convincingly presented as an uninterrupted flow and asserted that systems of periodization were crucial apparatuses to intellectual understanding. While acknowledging that, at some level, the concept of periods is invented, Wölfflin felt that periodization was necessary for the self-preservation of the scholar. He pragmatically observed that the infinity of images and events was overwhelming unless structured in some way.

The pragmatic justification for periodization offered by Wölfflin has been extended beyond its utility on the personal level. Periodization is defended as a necessity in educational

enterprises, including community programs, college and university courses, and media programs. According to this viewpoint, periods offer institutions a useful way to package information into topics and courses; periods offer introductory students a reasonable way to absorb information; and periods offer professional teachers a commonly acknowledged way to define a special area of study by which to justify inclusion in the academy. When education is treated as a businesslike enterprise selling a commodity, the information must be packaged in a manner that meets the expectations of all its consumers to some extent.

There is a widespread consensus that periodization is a convenient and utilitarian schema. At the same time, debate persists over whether periodization is an arbitrary system that segments historical continuity or an embedded structure that reveals historical meaning. Proponents of the second viewpoint argue that, without periodization, observations about artworks would consist of little more than masses of unrelated visual observations and historical incidents. With periodization, it is suggested, not only is visual data collected and organized but relevant comparisons about artworks over time and space can be discerned; the past visual traditions can be described in a meaningful way; and the present imagery can be interpreted as a logical outcome of the past. Periodization is defended as being embedded in history because with it intentions, patterns, and purposes can be revealed, and without it some types of visual analysis and interpretation become impossible.

What types of periods are used? Both extrinsic and intrinsic periods are applied to the visual arts. Extrinsic models that are used to categorize and organize art rely on elements external to the artworks themselves, particularly chronological time and political history. Most extrinsic systems of classification are anchored by firm dates to mark beginning and end points. Therefore, extrinsic period names can be shared between various disciplines (the Neolithic period, for example).

Models of periodization that correspond to specific centuries and decades are among the most conventional and most deeply entrenched systems used to divide Western art into groups. These models result in familiar periods such as the medieval, Renaissance, and modern periods.

Additional factors extrinsic to the artworks themselves can also provide the frameworks through which periods may be defined. Some systems of periodization are determined by political figures and events. These models generate periods based on factors including the reign of particular rulers (as in the Georgian, Victorian, or Edwardian periods) or dynasties (Carolingian, Ottonian, Tudor), revolutions (such as the French and Bolshevik Revolutions), wars (such as World Wars I and II), and other public events. Still other extrinsic models of periodization are grounded in factors such as inventions (for example, the invention of writing as the endpoint of the "prehistoric period" or of metallurgy as the beginning of the "Bronze Age").

Extrinsic periods can become internal factors that influence artists and imbue artworks with particular qualities. Artists in

the last decades of the nineteenth century were conscious of their art as *fin de siècle*, just as artists in the last years of the twentieth century were aware that they were producing art at the end of a millennium. But passages of chronological time and even events in political history are rarely determinants of aesthetic changes or stylistic choices. Since extrinsic periodizations are usually extraneous to the arts, many systems of periodization group artworks on the basis of factors intrinsic to art. Differences in the appearance of artworks, changes in the production of artworks, shifts in the purposes of artworks, and other factors particular to the history of art are frequently cited as more significant bases for the definition of periods. Therefore, some systems of periodization are considered to be intrinsic, rather than extrinsic, in nature. Intrinsic periods can be determined by either single or combined qualities, including skills (such as the discovery of foreshortening, perspective, light and shade in painting), materials (oil painting, ferroconcrete), content (dada, surrealism), and formal choices (abstract expressionism, cubism). Changes in these qualities are often explained as the result of changes in the ideals, interests, beliefs, and/or lifestyles of artists and audiences. Thus intrinsic periods are correlated with sets of values that are distinctive to themselves and assumedly or demonstrably different from sets of values prevailing in previous or successive periods. The most common paradigm used to explain changes in the values considered normative for a period is a gradual process during which ideas are first proposed, then fully realized, later regarded ambivalently, and eventually replaced by newly formulated ideas.

In contrast to extrinsic period names that can be extended to many disciplines, intrinsic period names are usually appropriate to only a few areas or to a single field (such as abstract expressionism or pop art). Although they arise directly from the study of the artworks, intrinsic periods in art history can become complex. The complexity of intrinsic period names is exemplified by the term *Baroque*. *Baroque* initially was a pejorative label for shapes and designs that were regarded as bizarre or extravagant. It was applied as a negative characterization for the art of the seventeenth and first half of the eighteenth centuries that followed after and differed from Renaissance art. It later became identified with a period style admired for distinct values of its own. As a period, the Baroque takes on a spatial character defined by the spread of those characteristics to different regions. This spread is recognized as occurring earlier in some countries and later in others, resulting in chronological dates of the Baroque period that vary according to region. Moreover, the Baroque period is also differently regarded in terms of a period sequence. Sometimes it is regarded as the last major subdivision of the Renaissance and sometimes as reaction against the "classicism" of Renaissance art. But the Baroque also appears in geographical regions in which Renaissance art is absent and therefore is sometimes independent of the paradigmatic style by which it is defined. Finally, the Baroque is sometimes regarded as a set of values that infuses morphological unity into all artworks of the period. This viewpoint stresses putative shared values underlying the artworks of contemporaneous painters such as Georges de La Tour, Nicolas Poussin, and Pietro da Cortona, artists who were born within three years of each other. In contrast, the



Notre Dame Cathedral, c. 1900. Notre Dame was built during the intrinsic High Gothic period in architecture, which art historians note was marked by high, vaulted ceilings, a sense of flowing, uninterrupted space, and an abundance of light. © BETTMANN/CORBIS

Baroque is alternatively regarded as what James Ackerman described as one of several “confluent, overlapping, and intersecting” stylistic trends. This viewpoint stresses the evident dissimilarities in the visual qualities of the same artworks by the same painters.

The complexity of intrinsic period terms is further illustrated by other uses of the term *Baroque*. *Baroque* is used as a period concept either to imply that a set of ideals or values pervaded an age or to suggest a set of visual elements that were predominant in a given spatiotemporal context. At the same time, *Baroque* is used as a style name that imputes a certain visual quality independent of time and space. Thus the term *Baroque* can be applied to one of the visual arts to designate formal elements that were widespread in the seventeenth century. But it can also be applied to other cultural phenomena, such as the “Baroque” organ, that share a common temporal context but none of the formal elements by which the Baroque was originally characterized. And it can be applied to visual designs produced in distant regions at unrelated dates, such as contemporary Latin American Baroque art.

The complexity of periodization is compounded by the convergence in the practical usage of extrinsic and intrinsic periods. Some extrinsic periods become identified with distinctive cultural and intellectual attitudes (such as “the Roman Empire”), others with a set of shared myths and memories (the 1960s, “the Reagan years”), or still others with a specific aesthetic outlook (“the Victorian era”). Because they can assume attributes of intrinsic periodizations, extrinsic period terms can mistakenly imply that each period automatically had a distinctive and unified visual character and necessarily differed from its predecessor or successor.

Periodization is complicated by at least one more issue, the issue of whether every period is unique or whether periods can be analogous. Meyer Schapiro (1904–1996) argued that periodization must recognize the fixed and unrepeatable order of events. However, intrinsic definitions of periods are based on qualities that are potentially applicable to more than a single period. One strategy that is frequently used in order to preserve the uniqueness of a period employs a dual method of description. A period description can be defined principally in



The Annunciation (c. 1432) by Fra Angelico. Tempera on panel. Critic Henrich Wölfflin (1864–1945) composed an analytical study of art that divided the discipline into three phases based on conflicting visual concepts. He applied his model to European art during the Renaissance. PHOTO CREDIT: ERICH LESSING/ART RESOURCE, NY

terms of intrinsic qualities but can also claim that those qualities are fully realized only in the extrinsic context of a specific time and place. As a consequence, for example, many periods might contain art with baroque qualities, but the claim is sometimes made that only one period can be Baroque.

How do periods change? Because periods, with their beginning and ending moments, purportedly chart shifts in visual expression, the use of periodization poses questions about the nature of artistic change over long durations of history. The nature of these changes has been addressed by many writers, among them Alois Riegl (1858–1905). According to Riegl, art always develops under universal laws, and these laws dictate that art always moves in a forward, unremitting progression. Riegl saw the final phase of a period as a necessary stage because it formed the foundation upon which the next phase would rest. Period endings and beginnings, therefore, blurred together almost seamlessly.

The use of periodization also poses questions about the nature of change within shorter spans of time. Periods are

generally subdivided into shorter units of time that purport to track internal dynamics of stylistic development. Descriptions of the progression of art through sequential subperiods generally employ metaphors of either organic evolution or physical mechanics.

Metaphors of organic evolution describe change in terms of the biological processes of birth, florescence, decay, and death. An early, and highly influential, art critic who utilized such a metaphor was Giorgio Vasari (1511–1574). In his *Lives of the Artists* (1568), Vasari celebrated the accomplishments of fellow Renaissance artists in an anthology of biographies. While Vasari portrayed the lives of famous painters, sculptors, and architects in a roughly chronological order, he divided the corpus of biographies into three distinctive groups. In the prologues that introduce each section, Vasari reveals the purpose for his divisions.

According to Vasari, the quality of the artists' works paralleled the relative time period in which they worked. Vasari

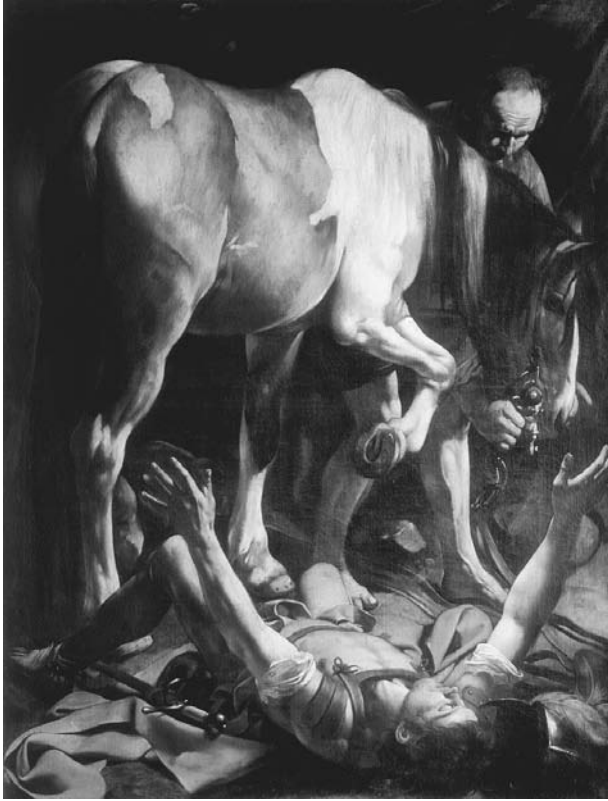

The Conversion of St. Paul (1600–1601) by Michelangelo Merisi da Caravaggio. Oil on canvas. During the Renaissance scholars and historians first began to divide works of art into specific units or periods. © ARALDO DE LUCA/CORBIS

placed the earliest Renaissance artists, such as Cimabue (Benvenuto di Pepo) and Giotto di Bondone, into his first group. The works of Piero della Francesca and Andrea Mantegna occupied the second category, while the third, and temporally latest, group included the works of Leonardo da Vinci, Raphael, and Michelangelo. Vasari's primary criterion for judging the quality of the artworks was based on the degree to which the art adhered to nature. Thus Vasari admired those artists, including Cimabue and Giotto, who initiated naturalistic styles of representation. He awarded high acclaim to Piero della Francesca and Mantegna for their increasing facility in accurately depicting nature, but Vasari bestowed the maximum degree of praise upon Leonardo, Michelangelo, and Raphael for not only masterfully portraying nature but also surpassing nature by perfecting its flaws.

Vasari's scheme established a biological model as a way both of dividing periods and of judging the quality of artworks. According to Vasari, internal cycles dictated the progression of art, and these perpetual cycles transcended any individual artist's talents. Vasari equated the artistic change to the human life cycle, a cycle governed by a clock beyond human control. To Vasari, art was born, grew to maturity, and eventually died. The artists who were described by Vasari as surpassing nature itself and as thereby attaining the highest level of artistic mastery were placed in the category of growth and florescence; they

represented the blossoming maturity that would eventually decline with subsequent artists of the seventeenth century.

The biological analogy utilized by Vasari has been adapted and applied to the arts for centuries. The twentieth-century literary critic Northrop Frye (1912–1991) also compared stylistic change to organic growth. Frye attributed the dynamics of change to the necessary process of technical mastery required of artists and craftsmen. He argued that, in any art form involving complex technical knowledge, each generation of practitioners must learn from its elders as it also struggles to introduce innovations. The phase of initial experimentation is followed by another of mature development and a final one of exhaustion and abandonment.

In counterpoint to metaphors of organic evolution, metaphors of physical mechanics have also been applied to periods. These metaphors describe change in terms such as cycles, oscillations, waves, and pendular swings. An influential critic who used a cyclical model was Heinrich Wölfflin. Wölfflin ushered in a phase of artistic inquiry in which formal qualities of art constituted primary data. Using this primary data, Wölfflin devised a new method of analysis that centered on comparing the observable formal qualities. According to Wölfflin, art follows cycles of three phases, early, classic, and baroque. In order to identify these phases, Wölfflin identified five pairs of opposed visual concepts by which art could be analyzed: linear versus painterly; plane versus recession; closed versus open; multiplicity versus unity; and absolute versus relative clarity. Wölfflin applied his comparative scheme of vision to European art of the fifteenth, sixteenth, and seventeenth centuries and associated the early Renaissance, or quattrocento, with the early phase of an artistic cycle, the High Renaissance, or cinquecento, with the classic phase of the cycle, and the Baroque with the late or baroque phase of the same cycle.

Some eighteenth-century aesthetic theorists, including Edmund Burke (1729–1797) and Johann Christoph Friedrich von Schiller (1759–1805), described period changes in terms of a series of pendular swings between polar opposites such as optic and haptic, additive and divisive. In the twentieth century, Martin Warnke (b. 1955) proposed a model of pulsation in which every age of classicism will be followed by an age of anticlassicism.

While pointing out the shortcomings in the pendular and pulsation metaphors, Ernst H. Gombrich (1909–2001) utilized the dialectic of the classical with the nonclassical. To Gombrich, every form of unity represented by classicism is followed by nonclassicism, that is, by disintegration. But Gombrich also consistently stressed the relevance of the changing functions of images in their social context and proposed an ecological metaphor for art. Similarly, Marxist and social historians of art have explained period dynamics in demographic and socioeconomic terms.

Critics have objected to analogies drawn from biology and physical mechanics. In the view of Horst W. Janson (1913–1982), such analogies result from the imposition of similar critical viewpoints rather than from an inherent organic unity.

According to Janson, these analogies amount to no more than pathetic fallacies in which living consciousness is attributed to historical accident. Other skeptics include James Ackerman (b. 1919) and George Kubler (1912–1996). Ackerman refuted the premise that change follows innate dynamics. He considered the process of change to be motivated by the constant incidence of probings into the unknown. Kubler cautioned that changes within a period often result from myriad randomly timed shifts rather than from a patterned progression.

Why should accepted periodizations be challenged? Periodization can be regarded as intellectually restrictive if it is accepted as the inevitable foundation of art history and theory rather than as a trigger for critical analysis and debate. Revisions to accepted periodizations often arise when researchers recover materials that have been ignored or dismissed. Reevaluations of the art corpus that are initiated to redress social injustices and to counter stereotypical imagery lead not only to the expansion of the visual record but also to the reconsideration of periodizations. Revisions to accepted periodizations also arise when new art theories are promulgated or when new visual styles are formulated. Challenges to existing periodizations can consist of modifications within an accepted structure or the proposal of an entirely different scheme. Rival periodizations do not necessarily diminish their utility or discredit the concept of periods. Instead, they may serve to underscore the dynamics of artistic complexity and to express the multiplicity of aesthetic creativeness.

Periodization and Globalization: Mesoamerica as a Case Study

When scholars encountered the artistic traditions outside of the Western world, they applied conventional systems of periodization that had initially been developed to organize the investigation of Western art. One non-Western region to which conventional, formalist periodization was applied was ancient Mesoamerica. Present-day Mexico, Guatemala, Belize, and Honduras constitute a region described as Mesoamerica, based on its position between North and South America and a number of cultural practices and characteristics shared among the many peoples who occupied this area between 1800 B.C.E. and the sixteenth century C.E. When the explorer Hernán Cortés arrived in the New World early in the sixteenth century, he immediately became interested in indigenous artworks fashioned of gold and precious stones. Cortés sent a sampling of Aztec-crafted gold objects back to Spain as evidence of the potential richness of the region, along with a few Aztec books and maps. Despite this early appreciation of indigenous artworks, within a few years of the Spanish arrival, Spanish governors and religious leaders ordered the mass burning of thousands of native books and the destruction of sculptures. Europeans entering the New World saw native artworks as dangerous purveyors of indigenous religious beliefs, as crafts, and as “idols,” which were far inferior in quality to known Western art.

It was not until the nineteenth century that scholars took an interest in analyzing the aesthetic qualities of the arts of the ancient Americas. An early system of periodization was designed by Wendell Bennett and Junius Bird to classify the great

variety of artifacts from the central Andean region of South America. Bennett and Bird consciously addressed theoretical issues involved with the creation and application of periods in artistic traditions outside Western, literate society. They noted that the choice of features by which a culture was identified was in some respects an arbitrary outcome of historical preservation and archaeological recovery. They further recognized that the problem of determining general periods was compounded by the absence of absolute dates and by the use of differing relative systems of dating employed in local regions. These relative systems included dating by the use of stratigraphy, surface collections of ceramics, sampling pits, and trade pieces. In addition, Bennett and Bird realized that a single system of periodization risked obscuring regional cultural variation within the central andean region.

Nonetheless, Bennett and Bird argued for the definition of overall cultural horizons as a means to permit the central Andes to be treated as a single unit and to be compared in its cultural developments and achievements with other parts of the world. The system designed by Bennett and Bird simplified relative chronologies of different regions named after

local sites into cultural horizons named by terms that cross-cut local terminology. Their system of periodization employed accessible period names, in part because period names were based on Western perceptions of indigenous economic and political organization. Those periods were termed Early Farmers (c. 2500–1200 B.C.E.), Cultist (c. 1200–400 B.C.E.), Experimenter (c. 400–1st C. B.C.E.), Master Craftsman (c. 1st c. C.E.–900), Expansionist (c. 900–1200), City Builder (c. 1200–1450), and Imperialist (after c. 1450–1532). The sequencing of periods in a linear progression suggested an evolutionary model of development.

The principles by which the Andean system of periodization was created were subsequently adapted for use in Mesoamerica. The occupation of the region was divided into Archaic (prior to 1500 B.C.E.), Formative (c. 1500 B.C.E.–250 C.E.), Classic (250–900), and Postclassic (after 900). While this periodization utilized less descriptive names, it was nonetheless based on the same Western perceptions of indigenous economic and political organization as the Andean scheme. Thus Archaic corresponded to Cultist, Formative to Experimenter, Classic to Master Craftsman, and Postclassic to Expansionist, City Builder, and Imperialist. Similarly to the Andean scheme, this periodization suggested an evolutionary model of developmental progression in its linear serialization while the subdivision of periods into phases echoed Vasari's organic model of biological cycles.

Still another Western model of periodization was also applied to Mesoamerica. The artworks created by the ancient Maya particularly interested Western scholars, and Maya artworks and style became a measuring stick against which all Mesoamerican artistic traditions were judged. The Maya occupied much of the eastern portions of Mesoamerica. Between 250 and 900 C.E. they constructed numerous large cities, with elaborate palace complexes, soaring temples, and vast plaza systems. They lavished their built environments with hieroglyphic inscriptions, paintings, and large-scale sculpture. The great architectural achievements evident in ancient Maya cities, combined with a style of sculpture that portrayed the human subject in an especially naturalistic manner, impressed Western viewers, who saw affinities between Classic Maya art and the celebrated Greek art of the Classic period (480–323 B.C.E.).

Like Greek sculpture during the Classic period, Maya art created between 250 and 900 seemed to exhibit the highest degree of naturalism and idealization, as though the indigenous artists looked to nature for their models and fused this observation with native ideals. Like the Classic period in Greece, the Classic period for the Maya was seen as the pinnacle of civilization—a time in which the Maya excelled in the realm of sciences, especially astronomy, and a time when Maya scribes recorded temporal and mythical histories using sophisticated calendrical systems. Western scholars also saw the Classic period as a moment in which theocratic rulers, guided by piety, religion, and logic, governed the activities of the Maya cities (an assumption that has subsequently been disproved in both the cases of Classic Greek and Classic Maya periods). With the term *classic* denoting a period of brilliance and the pinnacle of Greek cultural production, *classic* was similarly

employed to describe the apparent florescence of the Maya world between the years 250 and 900 C.E.

The periodization of Maya art thereby grafted Western perceptions of qualities described as “classical” or “less than classical” into a system of periods originally based on Western principles of economic and political organization. The resultant schema resembles the pendular models of periodization based on physical mechanics and parallels Gombrich's theory of periodization and style. In the literature on Maya art, the time period that chronologically preceded the Classic period frequently was termed the Preclassic rather than the Formative. The choice of this term suggested that the period represented a stage of infancy that would eventually mature and blossom into the splendor of the Classic. In examining the artworks created after the Classic period, scholars observed that artists no longer lavished monuments with lengthy hieroglyphic texts; artists no longer focused their attention on building large-scale architecture; and sculptors no longer placed priority in inscribing each monument with the most sophisticated systems of calendrical notation. In addition, Maya artists no longer imbued the human subject with the elements of naturalism and idealism that they had in the past. Thus the period known as the Postclassic was seen as a period of decline and decay.

Far-reaching consequences emerged as a result of the assumptions intrinsic to the system used for periodizing Mesoamerican art. These assumptions implicate the scholarly, economic, and social spheres that surround the artworks themselves. For decades, Maya art created during the Classic period received the most acclaim. Acclaim translated into importance, and Classic period art drew greater numbers of scholars than Preclassic and Postclassic art.

The desire to celebrate aesthetic qualities deemed Classical has promulgated a skewed picture of Mesoamerican art. Far greater financial support is directed, especially by North American and European institutions, toward the preservation, restoration, and exhibition of Classic period Maya art than to any other Mesoamerican artistic tradition. By extension, a distorted concept of Mesoamerican culture has also resulted. Far more archaeological investigations are proposed and funded for the purpose of studying Classic period Maya sites than any other set of Mesoamerican sites. As a result, both art historical and archaeological scholarship presents a lopsided view of Mesoamerica in which the importance of the Classic Maya period is overestimated.

By the turn of the twenty-first century scholars attempted to eliminate the attendant value judgment from conventional models of periodization by replacing value-laden terms with more neutral terms. The period named “Formative,” for example, gained popularity over the period name “Preclassic.” In addition, scholars strove to present the names of periods simply as temporal boundaries without attached notions of quality or sophistication.

Technology and periods in Mesoamerica. Technologies that had been unavailable in the formulation of early models of periodization now allow for the discussion of artworks based

solely on time. Radiocarbon dating, for example, provides a simple and reliable way to date ancient artifacts (if they contain organic matter), by measuring the residue of radiocarbon. Another useful dating method termed obsidian hydration is especially useful since Mesoamerican peoples frequently fashioned local obsidian into tools and artworks. Thermoluminescence, a more recently discovered dating technique, is employed to date rocks, minerals, and pottery. These recently developed methods allow investigators the option to remove artworks from previously codified systems of periodization, to reinterpret past models, and to define periods in new ways.

Western and indigenous traditions of time and periodization. Western-imposed modes of periodization often clash with indigenous traditions of dividing time and indigenous approaches to conceptualizing their material past. Among the ancient Maya, time was seen not as a single linear progression but as a series of unremitting cycles. Divided into sub-cycles and almanacs, native concepts of temporality dictate that time itself possesses distinctive qualities and purposes. Unlike some Western theories of time, which operate outside the boundaries of intrinsic nature, the Maya situated time as an entity that acts upon and shapes the content that it frames.

Feminism and Periodization

Voiced principally by women, radically new questions about artists and artistic canons emerged during the late 1960s and early 1970s. Feminist artists and writers, particularly Linda Nochlin (b. 1931), vigorously probed the history of art in order to understand why female artists were not celebrated in Western history and in contemporary culture. Deep within the internal structures of the discipline itself, feminist writers located inherently exclusionary foundations. One exclusionary strategy has been identified as the construction of definitions of art. Women traditionally created artworks that were often made, used, and exhibited within their homes. Media conventionally seen as “crafts,” such as embroidery, miniature painting, and ceramic production and decoration, constitute some examples of artistic production in which women historically participated. Conformist notions of “high art” and canons disregarded artworks created by women and subsequently excluded such art from the majority of periodization models (Alois Riegl is a notable exception who regarded crafts as equally important as figural arts). In the 1960s and 1970s women identified this exclusion and fought to unravel the system.

While designers of periodization paradigms ignored women, the trajectory of feminism itself gradually became divided into periods. Rather than hinging on factors external to feminism, feminist ideologies operated as the content around which periods were framed. Known as “waves,” these periods became incorporated into discussions of the differing interests within feminism, which loosely correlate with periods of time. Writers now place some of the earliest feminists in the first wave of feminism, which began in the late nineteenth and early twentieth centuries, when women fought for legal rights, including suffrage. Influential women such as Simone de Beauvoir and Susan B. Anthony have been placed within the first period or wave.

During the 1960s and 1970s, women concentrated on reviving the efforts and trajectories of issues explored by feminists during feminism’s first wave. This new movement, now known as second-wave feminism, strove to elevate the position of women, especially in professional contexts. Women of this period wanted to “have it all,” including equal access to privileges and positions along with equal compensation. Other paramount concerns for second-wave feminists included rights and control over their bodies. Other trajectories of feminism within the second wave focused on the difference between male and female in terms of sex and different reactions to gender. Cultural feminism and radical feminism, for example, held opposing views about the goal of feminism. The radical view argued for the cultural reconstruction of gender, reducing gender differences of males and females. Cultural feminism, on the other hand, emphasized the need to liberate, valorize, and preserve female difference as an absolute category.

The second wave of feminism bears particular relevance to periodization of the arts because it is within this period that Nochlin and others began to deconstruct the cultural paradigms that omitted women artists from the canon of masters. Second-wave feminist artists include Judy Chicago, Audrey Flack, and Miriam Schapiro, all of whom subverted notions of artistic canons by creating artworks that foreground the feminine through subjects and techniques that reference the artistic traditions of women and femininity itself.

Beginning in the 1980s and 1990s a new wave of feminism took shape and aimed at probing and revising some of the aspects of second-wave feminism. The third wave of feminism recognized exclusionary tendencies that characterized the interests of second-wave agendas and doctrine. Blurring the loose boundaries that separate the second and third waves, some feminists from the second wave shifted their interest and entered the third. Third-wave feminists recognized that the second wave had advocated social change primarily directed to the rights of white, straight, middle-class women. Third-wave feminism deemphasized the role played by sexual difference and explored the social structures, material and economic, that oppressed both women and men. As a result gender was framed in more neutral terms and as a product of enculturation rather than an innate quality.

Third-wave feminism’s multiplicity of foci and fluid boundaries oftentimes incite criticism. This strategy simultaneously generates power to sustain the movement. By their presence in popular media, participation in politics, and commitment to academic discourse and critique, proponents engage feminism with other discursive modes. Because they share the quality of persistent cultural subversiveness, second-wave artists such as Judy Chicago and Audrey Flack are embraced by new feminist artists. With its roots broadly anchored in cultural dialogues, third-wave feminism addresses immediate issues and influences that affect far-ranging audiences.

Conclusion

No single system of periodization has emerged. Some observers regard the existence of multiple systems based on varying criteria as a symptom of the arbitrariness and illogicality of

period schemes, while others interpret the same multiplicity as a positive result of the study of history. In this view, each periodization offers a possible strategy for the study of art, which encompasses widely diverse activities, including writing surveys, artistic biographies, catalogues raisonnés, iconographic analyses, or cross-cultural overviews. If the definition of periods and their temporal limits can be regarded as provisional strategies rather than objective reality, then the choice of periodization schema can be determined by the problem at hand. Different systems of periodization can be regarded as beneficial rather than chaotic when they permit the same masses of data to be organized by different principles and to yield different insights. Thus the ongoing debate about periodization contributes to the continuing vitality of the disciplines related to the visual arts.

See also *Aesthetics; Classicism; Communication of Ideas; Historiography; Impressionism; Mechanical Philosophy; Modernism; Organicism; Renaissance.*

BIBLIOGRAPHY

- Ackerman, James S. "Style." In *Problems in Aesthetics: An Introductory Book of Readings*, edited by Morris Weitz, 308–324. 2nd ed. New York: Macmillan, 1970.
- Bennett, Wendell C., and Junius B. Bird. *Andean Culture History*. New York: Natural History Press, 1964.
- Buszek, Maria Elena. "Waving not Drowning: Thinking about Third-Wave Feminism in the U.S." *Make: The Magazine of Women's Art*, no. 86 (December 1999–February 2000): 39–40.
- Davis, Whitney. "Periodization." In *The Dictionary of Art*, edited by Jane Turner. Vol. 24. London and New York: Grove's Dictionaries, 1996.
- Dolan, Jill. *The Feminist Spectator as Critic*. Ann Arbor: University of Michigan Press, 1988.
- Fernie, Eric, ed. *Art History and Its Methods*. London: Phaidon, 1995.
- Focillon, Henri. *The Life of Forms in Art*. Translated by George Kubler. New York: Zone Books, 1992.
- Fogle, French Rowe. *A Critical Study of William Drummond of Hawthornden*. New York: King's Crown Press, 1952.
- Fry, Roger. *Vision and Design*. London: Chatto and Windus, 1920. Reprint, London: Oxford University Press, 1947.
- Frye, Northrop. *Anatomy of Criticism: Four Essays*. Princeton, N.J.: Princeton University Press, 1957.
- Gallie, W. B. *Philosophy and the Historical Understanding*. 2nd ed. New York: Schocken, 1968.
- Gombrich, E. H. *Norm and Form: Studies in the Art of the Renaissance*. 4th ed. Oxford: Phaidon, 1985.
- . "Style." In *International Encyclopedia of the Social Sciences*, edited by David L. Sills. Vol. 15. New York: Macmillan and Free Press, 1968.
- Hart, Joan Goldhammer. *Heinrich Wölfflin: An Intellectual Biography*. Ph.D. diss., University of California at Berkeley, 1981.
- Kubler, George. *The Shape of Time: Remarks on the History of Things*. New Haven, Conn.: Yale University Press, 1962.
- . *Studies in Ancient American and European Art: The Collected Essays of George Kubler*. Edited by Thomas F. Reese. New Haven, Conn.: Yale University Press, 1985.
- Miller, Mary Ellen. *The Art of Mesoamerica*. 3rd ed. London and New York: Thames and Hudson, 2001.
- Minor, Vernon Hyde. *Art History's History*. 2nd ed. Upper Saddle River, N.J.: Prentice Hall, 2001.
- Nochlin, Linda. *Women, Art, and Power: And Other Essays*. New York: Harper and Row, 1988.
- Podro, Michael. *The Critical Historians of Art*. New Haven, Conn.: Yale University Press, 1982.
- Riegl, Alois. *Late Roman Art Industry*. Translated and annotated by Rolf Winkes. Rome: Giorgio Bretschneider, 1985.
- Schapiro, Meyer, H. W. Janson, and E. H. Gombrich. "Criteria of Periodization in the History of European Art." *New Literary History* 1, no. 2 (winter 1970): 113–125.
- Sparshott, F. E. "Notes on the Articulation of Time." *New Literary History* 1, no. 2 (winter 1970): 311–334.
- Vasari, Giorgio. *Lives of the Artists*. Translated by Julia Conaway Bondanella and Peter Bondanella. Oxford and New York: Oxford University Press, 1991.
- Warnke, Martin. *Political Landscape: The Art History of Nature*. Cambridge, Mass.: Harvard University Press, 1995.
- Wölfflin, Heinrich. *Principles of Art History: The Problem of the Development of Style in Later Art*. Translated by M. D. Hottinger. 7th ed. New York: Dover, 1940.
- . *Renaissance and Baroque*. Translated by Kathrin Simon. Ithaca, N.Y.: Cornell University Press, 1964.

Kaylee Spencer-Ahrens
Linnea Wren

PERSON, IDEA OF THE. Western European ideas about the person have long centered on the duality between body and soul (in religious discourse) or between body and mind (in the domains of philosophy and psychology). Consequently, early anthropological interest in non-European ideas of the person tended to mirror such deep-seated European conceptualizations, focusing on the origins of the concept of the soul.

The preoccupation of evolutionary Victorian anthropologists with religion focused on the question of its origins. By and large, these thinkers were apostles of secularism and science, committed to the notion that religion and its associated ideas (the soul included) were outdated, survivals from human prehistory. Religion was a repository of conceptions, which, while not entirely irrational in and of themselves, were fallacious or erroneous. In particular, Edward Tylor, in his book *Primitive Culture* (1871), saw in the idea of the soul the most ancient and fundamental of all religious beliefs, the key to understanding the subsequent development—but also the ultimate irrelevance—of religious ideas:

It seems as though thinking men, as yet at a low level of culture, were deeply impressed by two groups of biological problems. In the first place, what is it that makes the difference between a living body and a dead one; what causes waking, sleep, trance, disease, death: In the second place, what are those human shapes which appear in dreams and visions? Looking at these two groups of phenomena, the ancient savage philosophers probably made their first step by the obvious inference that every man has two things belonging to him, namely, a life and a phantom. These two are evidently in close connexion with the body, the life as enabling it to feel and think and act, the phantom as being its image or

second self; both, also, are perceived to be things separable from the body, the live as able to go away and leave it insensible or dead, the phantom as appearing to people at a distance from it. The second step would seem also easy for savages to make, seeing how extremely difficult civilized men have found it to unmake. It is merely to combine the life and the phantom. As both belong to the body, why should they not also belong to one another, and be manifestations of one and the same soul? (pp. 12–13)

In Tylor's scheme, the idea of the soul constituted the core of the most primitive form of religion, Animism, both in the form of the worship of the souls of departed ancestors and in the idea that inanimate objects—trees, rocks, bodies of water—also possessed souls and could be worshiped in their own right.

Durkheim's Critique

Émile Durkheim's (1858–1917) monumental treatise of *The Elementary Form of Religious Life* (1912) begins with the bold assertion that “a human institution cannot rest upon error and falsehood . . . when I approach the study of primitive religions, it is with the certainty that they are grounded in and express the real” (p. 2). Durkheim definitely had Tylor in mind when he wrote these lines, and devoted an entire chapter of the book to a refutation of Tylor's theories. Specifically, he argued that Tylor's account of the generation of ideas of the double and the soul from primitive explanations of dreams was radically circular. Rather, such notions presupposed the very ideas whose origins they were supposed to explain. For Durkheim, ideas such as the soul, ancestor spirits, totems, or gods could not be derived from the experience, much less the speculations, of individuals. Rather, they were intrinsically social phenomena.

Nonetheless, Durkheim concurred with Tylor that the idea of the soul was fundamental to religion: “Just as there is no known society without religion, there is no religion, however crudely organized, in which we do not find a system of collective representations dealing with the soul—its origin and destiny” (p. 242). Unlike Tylor, who drew for examples for his theories from around the globe and throughout history, Durkheim's examination of primitive religion focused on ethnographic accounts from Australia, and his discussion of the idea of the soul was correspondingly centered on Australian examples. According to native Australians, there exists a limited stock of souls. Each individual is a reincarnation of an ancestor, and all people are ultimately reincarnations of the original totemic *alcheringa* ancestors, powerful beings who existed in dreamtime and whose natures were merged with those of totemic species. For Durkheim, these representations addressed the critical problem of the relationship of society to the individual. The ancestral souls embodied the fundamental reality of society of which the individual was a particular manifestation.

Within the context of his discussion of the soul, Durkheim quietly introduced the idea of the person. The person, Durkheim suggested, represents the conjunction of an impersonal and personal principle, the soul and the body. The first, impersonal, derives from “the spiritual principle that serves as the soul of the collectivity . . . the very substance of which

individual souls are made” (p. 273), whereas the body, by situating this impersonal principle in a specific location in space and time, serves as the differentiating element. Hence, “individuation is not the essential characteristic of the person. A person is not only a singular subject that is distinguished from all the others. It is, in addition and most of all, a being to which a relative autonomy is imputed in relation to the milieu with which it interacts most directly” (p. 274).

The idea of the person, for Durkheim, squarely embodied the relationship between the individual and society at the very core of his approach to sociological theory. While it still reflected European dualistic thinking about body and soul, reading his own society's dichotomies into the thought of native Australians, it opened the way to new, less ethnocentric ways of understanding non-European conceptions of the person.

Mauss: The Person as “A Category of the Human Mind”

In a seminal lecture, which he delivered (in French) to a British audience in 1938, Durkheim's nephew, Marcel Mauss (1872–1950), was the first to bring the ideal of the person to center stage. Like Durkheim, he saw in the religious categories of so-called primitive societies a key to the understanding of modern European ideas. Citing examples from Australian societies as well as from Native Americans—Zuñi, Kwakiutl, Winnebago—he stressed the importance of names for the establishment of personhood. Names as such were not necessarily the hallmark of the individual, but rather of a persona, a fixed role or position within a society. Thus, a clan or other similar group might possess a finite stock of names. The name typically represented, not only membership in a group but also a specific position within it, and so individuals might change names within the course of their lives. Such names, Mauss suggested, were akin to masks—another phenomenon he related to ideas of personhood. The theatrical metaphor was intrinsic to Mauss's argument. In relatively “primitive” societies, there were a relatively fixed number of “roles.” Personhood in such instances reflected the individual's place within such a fixed scheme.

In his essay, Mauss contrasted this relatively fixed conception of personhood in non-European societies with a dynamic vision of the changing idea of personhood in Western Europe, through Greek philosophy, Roman law, Christian theology, and ultimately the Enlightenment. The end result of this evolution was a conception of personhood in terms of individual consciousness rather than as the embodiment of set social relationships. These ideas have been rejected by the overwhelming majority of anthropologists who reject any teleological dichotomy between European societies as essentially dynamic and non-European ones as static. However, if this part of Mauss's argument has fallen by the wayside, his insistence that conceptions of the person are culturally and historically constituted constantly subject to change provided the foundation for most subsequent anthropological writing on the subject.

The Anthropology of the Person since Mauss

While Mauss's essay provided inspiration to both French and British anthropologists, the implications of his work were

developed in substantially different ways by anthropologists belonging to different national schools. At the same time, American anthropologists were to approach the problem from a very different starting point. In all three cases, concepts of the person were explored in the context of extensive fieldwork in specific cultures. Rather than generalizing from the vantage point of European categories, taken as the end point of a process of evolution, anthropologists grappled with non-European conceptualizations firsthand.

Griaule and the French school. Marcel Griaule's work among the Dogon of modern Mali (then French Sudan) was to mark the French approach for at least a generation afterward. For Griaule, the complex esoteric cosmology of the Dogon, as revealed to him by his key informant, Ogotemmel, constituted an intricate and sophisticated philosophical system, an alternative way of thought in no way inferior to European equivalents. Dogon ideas of the person are consequently one element of this entire system. Crucial to these ideas is the principle of the ideal duality of all creatures. In the original acts of creation, only the Creator's firstborn—the jackal—was created single, and it is for this reason that the jackal is the quintessential trickster and embodiment of disorder, but also the agent through whom truth is revealed to the diviner. After the jackal, a couple, the Nommo, were born: demiurges who represent the ideal dual order. Twins consequently represent the ideal birth, and human twins become the object of a cult as soon as they are born. Even ordinary humans have double souls—*kinndou-kinndou*—one for each gender. The female principle resides in the man's foreskin, the male in the woman's clitoris; rites of circumcision and excision are consequently required at adolescence to transform ambivalently gendered children into fully male or female adults. In short, for Griaule, the Dogon myth of creation contained the key to their conceptions of personhood and of the world in general.

British social anthropology. The British school of social anthropology, also profoundly influenced by the work of Durkheim and Mauss, adopted a less abstract and more sociological approach to the study of ideas of the person. E. E. Evans-Pritchard's pioneering study of *Witchcraft, Oracles and Magic among the Azande* (1937), published a year before Mauss's lecture, did not explicitly mention the concept of the person, but his explanation of Azande notions of witchcraft nonetheless represented a landmark in the ethnographic exploration of personhood. Witchcraft is a common explanation of misfortune among the Azande, and is caused by a grudge or ill will on the part of a witch. However, not all people are witches. Witches are born with innate witchcraft substance, inherited by boys from their fathers and girls from their mothers. It operates through *mbisimu mangu*, the soul of witchcraft, which travels from the body of the witch to the body of the victim, although the witch himself may not be conscious of the harm he is perpetrating. However, Evans-Pritchard was not simply concerned with the ideology of witchcraft in itself, but in the way in which these ideas underpinned the everyday actions of Azande, so that they understood and reacted to the ordinary misfortunes of everyday life through consulting oracles, attempting to cool the anger of witches, and ultimately pursuing vengeance when witchcraft proved fatal.

In an essay titled "On the Concept of the Person among the Tallensi" (1973), Meyer Fortes explicitly developed Mauss's insights with specific reference to a particular West African culture:

observance of prohibitions and injunctions relating to the killing and eating of animals, to distinctions of dress, to speech and etiquette, to a wide range of ritual norms, to the jural regulations concerning marriage, property, office, inheritance and succession, play a key part in the identification of persons. Persons are kept aware of who they are and where they fit into society by criteria of age, sex, and descent, and by other indices of status, through acting in accordance with these norms. By these actions and forms of conduct they, at the same time, show to others who they are and where they fit into society. (p. 282)

Seen in this light, an individual's birth is merely the first step in the process of turning him or her into a full person, a process which only ends with death, when, as an ancestor, one may eventually become a full person. Tallensi personhood is thus not a feature of the individual per se, but of the individual's interaction with society as a whole. For Fortes as for Evans-Pritchard, this process of interaction was played out in the miniature crises of everyday life.

American anthropology and the problem of personality. During the first half of the twentieth century, anthropologists in the United States were far less influenced by the theories of Durkheim and Mauss than by the work of Sigmund Freud (1856–1939). Rather than evincing interest in "the person" as a category of thought, they focused on the formation of the individual personality in different cultures. Ruth Benedict's *Patterns of Culture* (1934) is the most famous example of this approach. For Benedict, each culture has its ethos, its style, which characterizes its art, its ritual, its ideology, the emotional tenor of social relationships, and so on. Individual children are raised in conformity with this ethos, internalizing patterns of feeling as well as of behaving. Those with little natural aptitude for the predominant ethos are deviants, though deviance in one culture can well be normality in another. Moreover, cultures may also have established deviant roles, such as the *berdache* in Native North America, a person who was born biologically male but who dressed as a woman, adopted women's occupations, and sometimes even married another man.

In the 1960s, Clifford Geertz attempted a synthesis between the American emphasis on personality and Mauss's conception of the person, most notably in his essay, "Person, Time, and Conduct in Bali" (1966). Geertz focused on those aspects of Balinese culture—names and titles—central to Mauss's formulation of the development of the idea of personhood. However, for Geertz, these component features of the Balinese conception of personhood were expressions of an overall Balinese ethos. Children are given a personal name, but this is generally a nonsense term and rarely used to address or refer to them. Children are more generally known by standard birth

order names, and adults (except for childless adults, who in some sense remain socially children themselves) by tekonyms—"father (or mother) of so-and-so (their first child)." Balinese status titles as well as names serve

to stress and strengthen the standardization, idealization, and generalization implicit in the relation between individuals whose main connection consists in the accident of their being alive at the same time and to mute or gloss over those implicit in the relation between consociates, men intimately involved in one another's biographies, or between predecessors and successors, men who stand to one another as blind testator and unwilling heir. (Geertz, pp. 389–390)

In short, the Balinese concept of the person, in keeping with the Balinese ethos, is depersonalizing, at least from a European point of view.

These different approaches to the study of the idea of the person, whether French, British, or American, have convincingly demonstrated that there is no single "primitive" conception of personhood, much less of "the soul." The different cultural constructions of "personhood" around the globe cannot be interpreted in terms of narratives of the progressive emergence, either of rationality or of individuality, in Europe as opposed to the rest of the world, as nineteenth and early twentieth century theorists attempted to argue.

See also Identity: Identity of Persons; Identity: Personal and Social Identity; Personhood in African Thought; Religion; Sociability in African Thought; Society.

BIBLIOGRAPHY

- Benedict, Ruth. *Patterns of Culture*. Boston: Houghton Mifflin Company, 1934.
- Carrithers, Michael, Steven Collins, and Steven Lukes, eds. *The Category of the Person: Anthropology, Philosophy, History*. Cambridge, U.K.: Cambridge University Press, 1985.
- Durkheim, Emile. *The Elementary Forms of Religious Life*, Translated by Karen Fields. New York: The Free Press, 1995.
- Evans-Pritchard, E. E. *Witchcraft, Oracles and Magic among the Azande*. London: Oxford University Press, 1937.
- Fortes, Meyer. "On the Concept of the Person among the Tallensi." In *La Notion de Personne en Afrique Noire*. Paris: Colloques Internationaux du Centre National de la Recherche Scientifique, No. 544, 1973. Reprinted in his *Religion, Morality and the Person: Essays on Tallensi Religion*, edited with an introduction by Jack Goody, 247–286. Cambridge, U.K.: Cambridge University Press, 1987.
- Geertz, Clifford. *Person, Time, and Conduct in Bali: An Essay in Cultural Analysis*. Yale Southeast Asia Program, Cultural Report Series 14, 1966. Reprinted in his *The Interpretation of Cultures*, 360–411. New York: Basic Books, 1973.
- Griaule, Marcel. *Conversations with Ogotemelli: An Introduction to Dogon Religious Ideas*. London and New York: Oxford University Press for International African Institute, 1970.
- Mauss, Marcel. "A Category of the Human Mind: The Notion of Person; the Notion of Self." Translated by W.D. Halls. In *The Category of the Person: Anthropology, Philosophy, History*, edited

by Michael Carrithers, Steven Collins, and Steven Lukes, 1–25. Cambridge, U.K.: Cambridge University Press, 1985.

Tylor, Sir Edward Burnett. *Primitive Culture*. London: John Murray, 1871. Reprinted in 2 vols. as *The Origins of Culture and Religion in Primitive Culture*. New York: Harper and Brothers, 1958.

Robert Launay

PERSONHOOD IN AFRICAN THOUGHT. What is a person? Two basic types of considerations are apparent in African answers to this question. The first is ontological, the second ethical. Ontologically a person is a combination of a physical constituent, namely the body and a set of two or in some cases three constituents of a rarefied character requiring careful elucidation.

The nonbodily constituent on which all the accounts of personhood seem agreed is what might be called the life principle. This is thought of as an entity whose presence in the body means life and its absence death. The Akans call it *okra*, the Yoruba *emi*, and the Nuer, roughly, *yiegh*. By common agreement it derives directly from God himself. Indeed the Akans are explicit that it is a speck of the divine substance. As metaphorically and often literally understood, this entity or an ontologically analogous one goes before God to take leave of him before coming to the world to be born of man and woman. It is at this meeting that God apportions the prospective person's destiny.

The Yoruba account of this meeting is the most dramatic of all. For them, unlike the Akans, it is not the life-giving constituent, like the Akan *okra* or Yoruba *emi*, but another nonbodily entity called the *ori-inu* that receives the apportioned destiny. It stands before God and proposes a destiny, which God either confirms or refashions. Or it kneels before God and has a destiny affixed to it. Either way, the apportionment is ultimately God's own. Moreover the destiny, which is the outline of one's earthly career, is doubly sealed, for on its way down to the world the individual encounters God's gatekeeper, who typically asks, "Where are you going? . . . What are you going to do?" To which the individual replies with a recitation of the destiny just assigned. The gatekeeper then says "*To*," which Bolaji Idowu translates as "It is sealed." Idowu comments, "And so the person passes into the world with his destiny doubly sealed" (p. 174).

This doctrine is widely received, though not universal, in Africa. Okot p'Bitek (chap. 9) argues that the Central Luo do not have a place in their worldview for a predetermined destiny. Wherever entertained, however, it is significant as indicating the moral uniqueness of every human individual, but it is also the source of some of the deepest problems at the intersection of morals and metaphysics. The African mind has been sorely challenged to fathom how an individual can be held responsible for his or her conduct if what he or she does is in fulfillment of a divine plan. Furthermore, even though it is generally supposed that the destiny assigned by God is unalterable, various African peoples are known to seek the help of "specialists" to rectify a dreary destiny.

Some writers on African thought, such as Idowu, content themselves with the observation that “the paradox involved in this two-sided conception is accepted by the Yoruba without question” (p. 183). Kofi Opoku writes similarly with regard to the Akans. It is, however, possible that the apparent inconsistency, euphemistically described by Idowu as a “two-sided conception,” is due to the fact that what one is dealing with is the confluence of a variety of unnamed sources amalgamated into a strand of the oral tradition. Kwame Gyekye (1995) and Kwasi Wiredu (1996) offer further suggestions. But the priority here is to elucidate the ontological character of the nonbodily components of personhood. In addition to those already noted, the Akans, for example, speak of *sunsum*, which may be rendered as that which is responsible for an individual’s personal presence. This seems to be thought of as a kind of entity. The *tali* of the Lugbara seems to be a similar conception.

In general the nonbodily constituents of personhood, as conceived by African peoples, number at least two. How do they compare, ontologically speaking, with the analysis of personhood best known in Western philosophy, namely that a person consists of body, mind, and soul, with the soul usually, as in René Descartes, identified with the mind? In both the African and the Western conceptions, all the items named are regarded as entities. But the similarity ends there. The elements of the African inventory of human personality are conceived as material, save only that they are supposed to be exempt from the ordinary laws of optics and dynamics. If such entities are, for convenience, called quasi-material, then the contrast might be expressed as follows. The nonbodily components are, as a rule, conceived as quasi-material in Africa, while among thinkers of a Cartesian predilection they are thought of as spiritual, in the sense of being immaterial, nonextended.

The quasi-material orientation of African thought is especially apparent in notions of the afterlife, which are often heavily laden with material imagery. On the present interpretation, this marks a fundamental difference between the many African and Western systems of ontology. Whereas the categories of material, quasi-material, and immaterial entities are widespread (though not universal) in Western ontologies, only the material and the quasi-material are admissible in the African counterparts (Wiredu, 1996, pp. 52, 55). This interpretation of African thought is not uncontested (see Gyekye, 1995, pp. 85, 89). Still it is interesting that, on the quasi-material interpretation of the nonbodily aspects of personhood, it is an ontological mistake to identify any of them with the Western concept of the soul.

According to the foregoing account, a person, in African thought, consists of a body combined with quasi-material entities that account for its animation and for its destiny and other marks of uniqueness. Nothing has been said of mind. But this is not a mindless omission. Africans do not appear to construe mind as a kind of entity. Certainly the Akans do not. For them, mind is the capacity to engage in various activities, such as perceiving, reasoning, feeling, talking, and dancing. (For more on this conception, see Wiredu, 1987; for a

contrary view, see Gyekye, 1995, chap. 6.) To the question as to what is the basis of this capacity, the answer is implicit but unmistakable. In Akan discourse it is the *amene* (the brain). The Yoruba too cite the *opolo* (the brain) as the seat of the human power of reasoning. They also, presumably metaphorically, invoke the *okan* (the heart) as the seat of will and emotion. In this, Bantu thought resembles closely that of the Yoruba. In his exhaustive study of the concept of personhood entertained by the Bantu peoples of Africa, Alexis Kagame, a Rwandan philosopher and linguist, found that the Bantu generally think of a human person as consisting of a body, an animating force (which he describes metaphorically as “shadow”), a principle of intelligence, and finally, the heart, which is not thought of as a pump. According to Kagame, the Bantu, exactly like the Yoruba, also speak of the heart as the seat of will and emotion.

In whatever way one looks at African conceptions of personhood then, mind, though not generally conceived as an entity, is accorded a high degree of importance. The topic of mind moreover brings up the second basic type of consideration discernible in African thought about personhood. Mind is crucial in a special way in the definition of personhood. In the normative part of the African conception, a person is not just an individual of human parentage. To ascend to the status of a person, an individual has to have attained a certain degree of moral maturity and social responsibility. This obviously is a matter of the quality of one’s mind.

Probably every conception of a person has the notion of a certain degree of moral competence annexed to it. This is certainly the case in English language discourse. But among many African peoples, such as the Akans and the Yoruba, such a notion is not additional to the concept of a person; it is an integral part of it. The comparison may be illustrated with the following anecdote. At the conclusion of the peace conference between the freedom fighters and the white settlers of present-day Zimbabwe that led to independence in 1980, Kenneth Kaunda, then president of Zambia, wishing to pay the highest compliment to Margaret Thatcher, then prime minister of Great Britain, for her contributions to the success of the negotiations said to her that she was very much a person. Not wishing to be considered (presumably by the Western press) as the author of the greatest understatement of the century, he hastened to explain that in his language to be said to be a person was praise indeed. Without this clarification, Western observers, he must have thought, would have had to be excused immeasurable puzzlement. On the other hand, any Akan journalists present would have been pleasantly surprised to discover that the concept of a person in the president’s language was, in this respect, exactly the same as their own.

But this linguistic clarification needs amplification. The word for a person in Akan, for example, is *onipa*. This carries an ambiguity. In one sense it means simply a human being; in another it refers to a human being of a certain moral and social status. Even the most elementary sense of context, however, suffices to disambiguate. An individual, for example, who is by reason of confirmed laziness or waywardness unable to hold down

a job long enough to make worthwhile contributions to the welfare of the family and community would be said not to be an *onipa* (person). But if one kills such an individual, one has killed an *onipa* (a human being), and there will be severe consequences. Any human being, according to the traditional understanding, contains an element of divinity and is, on that ground alone, entitled to life, liberty, and an ample dispensation of natural rights (Wiredu, 1996, chap. 12).

A similar circumspection is necessary regarding the status of children. In the normative conception, a child is not yet a person, not having reached the time of the requisite maturity in moral thinking and social action. But there is not here the criticism that would normally be intended of, say, a constitutionally wayward adult. The adult has taken the test of personhood and failed; the child is not yet due for the test and deserves the kindest solicitude. Even in the case of the adult, criticism is reformatory in intent and soon gives place to concerted efforts at helping the individual achieve or regain personhood.

The following propositions therefore should not seem paradoxical. Personhood, to the African, is not something one is born with. It is something one has to work for and something at which one can fail. Furthermore there are degrees of personhood, and its lower gradations can shade off into nonexistence in the life of a human individual. Life then, on the African conception, is a struggle for personhood.

One might now ask what accounts for this conception among Africans. The answer is quite simple. African societies are, famously, communalistic. The individual is brought up, from the beginning, with a sense of belonging and solidarity with an extensive circle of kith and kin. The basis of this solidarity is a system of reciprocity in which each individual has obligations to a large set of other individuals. These are matched by rights owed him or her by the same number of individuals. Living amid the reality of this reciprocity, one soon begins to see oneself as presupposing the group. This is the mainspring of the normative conception of a person.

In contemporary African philosophy the locus classicus of the normative conception of a person is Ifeanyi Menkiti's "Person and Community in African Traditional Thought" (1984). But the anthropologist Meyer Fortes had already in the 1940s noted the normative character of the concept of a person held, for example, by the Tallensi of northern Ghana. Wiredu's independent interpretation of the Akan concept of personhood as normative is in total agreement with Menkiti's main position on this matter. John S. Mbiti's now classic remark that the African individual "can only say 'I am, because we are'" may perhaps be called Africa's communalist answer to Descartes's *Cogito*; it is only one step away from the normative conception as outlined above. Gyekye's (1997) "moderate communitarianism" is, broadly speaking, an interpretation of normative personhood, and Gbadegesin is also sympathetic. These are some of the signs that the normative conception of a person, preached and practiced by the African ancestors, may perhaps become a source of insight and commitment for the larger community of contemporary African philosophers as well, possibly, as others.

See also Communitarianism in African Thought; Person, Idea of the.

BIBLIOGRAPHY

- Evans-Pritchard, E. E. *Nuer Religion*. Oxford: Clarendon, 1956.
- Fortes, Meyer. *Religion, Morality, and the Person: Essays on Tallensi Religion*. Edited with an introduction by Jack Goody. Cambridge, U.K., and New York: Cambridge University Press, 1987.
- Gbadegesin, Segun. *African Philosophy: Traditional Yoruba Philosophy and Contemporary African Realities*. New York: Peter Lang, 1991.
- Gyekye, Kwame. *An Essay on African Philosophical Thought: The Akan Conceptual Scheme*. Rev. ed. Philadelphia: Temple University Press, 1995.
- . *Tradition and Modernity: Philosophical Reflections on the African Experience*. New York: Oxford University Press, 1997.
- Idowu, Bolaji E. *Olódùmarè: God in Yoruba Belief*. London: Longmans, 1962.
- Kagame, Alexis. "The Problem of 'Man' in Bantu Philosophy." *African Mind: Journal of African Religion and Philosophy* 1, no. 1 (1989).
- Kaphagawani, Didier Njirayamanda. "African Conceptions of a Person: A Critical Survey." In *A Companion to African Philosophy*, edited by Kwasi Wiredu. Malden, Mass.: Blackwell, 2004.
- Little, Kenneth. "The Mende in Sierra Leone." In *African Worlds*, edited by Daryll Forde. New York and Oxford: Oxford University Press, 1954.
- Mbiti, John S. *African Religions and Philosophy*. 2nd ed. Oxford and Portsmouth, N.H.: Heinemann, 1990.
- Menkiti, Ifeanyi. "On the Normative Conception of a Person." In *A Companion to African Philosophy*, edited by Kwasi Wiredu. Malden, Mass.: Blackwell, 2004.
- . "Person and Community in African Traditional Thought." In *African Philosophy: An Introduction*, 3rd ed., edited by Richard A. Wright. Lanham, Md.: University Press of America, 1984.
- Middleton, John. *Lugbara Religion*. Oxford: Oxford University Press, 1960.
- Opoku, Kofi Asare. *West African Traditional Religion*. London: FEP International, 1978.
- p'Bitek, Okot. *Religion of the Central Luo*. Nairobi, Kenya: East African Literature Bureau, 1971.
- Wiredu, Kwasi. "The African Concept of Personhood." In *African-American Perspectives on Biomedical Ethics*, edited by Harley E. Flack and Edmund D. Pellegrino. Washington, D.C.: Georgetown University Press, 1992.
- . "The Concept of Mind with Particular Reference to the Language and Thought of the Akans." In *Contemporary Philosophy*, vol. 5: *African Philosophy*, edited by Guttorm Floistad. Boston: Kluwer, 1987.
- . *Cultural Universals and Particulars: An African Perspective*. Bloomington: Indiana University Press, 1996.
- . "Death and the Afterlife in African Culture." In *Person and Community: Ghanaian Philosophical Studies I*, edited by Kwasi Wiredu and Kwame Gyekye. Washington, D.C.: Council for Research in Values and Philosophy, 1992.
- . "Determinism and Human Destiny in an African Philosophy." *Hamline Review* 25 (spring 2001).

Kwasi Wiredu

PERSPECTIVE. In the visual arts, the English word *perspective* refers to the optical illusion whereby a picture on a flat, two-dimensional plane appears to be three-dimensional; as if the represented objects were actually in a deep space receding behind the picture surface (like looking at them through a window or in a mirror), and in some cases seeming even to project forward in front of the picture. The term itself derives from the Latin participle *perspectus* of the verb *perspicere*, meaning “to see through.” While artists in nearly every world culture since the beginning of the human race have sought to create some kind of illusion of visual reality in their image-making, none were so preoccupied with perspective mathematics as the painters of the Italian (and then pan-European) Renaissance.

Renaissance-Style Linear Perspective

Alternative means of creating the illusion of visual reality in other times and cultures will be discussed later, but this entry will begin with a review of what is generally taken for granted in our Western culture as the one “legitimate” construction, the method invented during the early Italian Renaissance (or rediscovered, if one believes the ancient Greeks and Romans already had discerned the basic geometric principles). Sometime in the late thirteenth century in central Italy, artists hired to paint frescoes on the walls of the new churches began to conceive of their pictures not as flat patterns in the traditional Romanesque manner, but as if they thought of their painted spaces as framed theatrical *proscenia* behind which the sacred scenes of the life of Christ and his saints were being acted out. Indeed, these artists may well have been inspired by the plethora of miracle plays performed on street corners, town squares, and even in the portals of churches in cities all over Europe during those intense years of religious uncertainty after the Crusades failed and the papacy fell into schism. Italian painters from Rome (who still remembered ancient wall-painting techniques) and from Florence—including the brilliant Giotto di Bondone (c. 1266/67–1337)—all working in the new basilica dedicated to the recently canonized Saint Francis in the Umbrian town of Assisi (Fig. 1), inadvertently began a revolution that was to radically change the style, and ultimately the content of Western art for the next six hundred years. No longer would artists simply repeat traditional medieval formulas for representing the sacred narratives. No longer would viewers sense these images only as abstracted iconic symbols. Rather, they should now feel as if they could reach beyond the frames right into the picture space and actually touch the holy beings represented on the other side—“seeing and believing” in the manner of St. Thomas, who, according to Scripture, put his finger into the very wounds of Christ in order to prove his Savior had really come back from the dead.

While these early perspective paintings did not depend on the old two-dimensional symbolic manner of representation, they also did not employ any systematic geometry for creating their exciting new optical illusions. The Italian artists were simply intent on depicting religious scenes as if they were being acted out before their eyes *de naturale*, or according to nature. They even introduced cast shadows and modeling as if the subjects they painted were illuminated on one side and in shade on the other, giving an effect of sculpture in relief. This nascent

perspective style is often called *empirical* to distinguish it from the more systematic mathematization of art that followed in the fifteenth century.

Art historians remain in some disagreement as to whether this early development of perspective from the thirteenth to the fifteenth century was an evolution within the painters’ profession itself, that is, isolated from the ideology and politics of contemporaneous Christian Europe, or whether it was nudged, so to speak, by a remarkable science, ancient to the Greeks and Arabs, but quite new to the Latin West when manuscripts of it were first discovered in Moorish Spain and Sicily after the Christian reconquest in the twelfth century. This science was called, in Greek, *optika*, that is, *optics*, which translated into Latin as *perspectiva*, but having no association yet to the art of painting, later termed *perspectiva artificialis* to distinguish it from the original *perspectiva naturalis*. In fact, the original *perspectiva* had only to do with explaining the nature of light rays, how they always travel in straight lines, how they are reflected in mirrors, refracted when entering a denser medium, and, especially, how they affect the way the human eye sees.

Perspectiva naturalis was regarded as the special handmaiden of Euclidean geometry, the latter also just revealed in the West in the twelfth century. Since light rays were understood by the ancient Greeks as always radiating from their source in the shape of a pyramid (a three-dimensional triangle), Euclid reasoned that the images framed by them must conform to his fundamental law of similar triangles; for instance, in Fig. 2, if A be the point of light source, and BCD the surface illuminated, then a consistent proportion always exists between the distance of AC from BCD and the relative size of BCD; in other words, AC:BCD as AF:EFG as AI:HIJ, etc. Greek and Arab commentators on Euclid were quick to realize the significance of this in explaining how the images of very large objects can penetrate the tiny pupil of the eye. Let A in Fig. 2 now stand for the human eye, and HIJ the object being observed (Arab commentators liked to use the camel as their example). As the distance AI between these points diminishes to AF and then to AC and so on, the illuminated “camel” will grow ever smaller in proportion until it is finally able to enter the eye and be “seen.”

Medieval Christian theologians were fascinated by these Greek and Arab revelations. The English bishop Robert Grosseteste (c. 1175–1253) noted that since God created light on the first day (Genesis), he intended to apply the absolute laws of geometry in the creation of the universe. Indeed, he must have formed its tiny shape a priori in his divine mind’s eye and then projected it full-scale into the void, creating the world’s three-dimensional space and volume according to the same Euclidean theorems. In other words, the science of optics seemed to be the very key to the mind of God.

Members of the young Franciscan order, headquartered in the Basilica of their founding saint in Assisi, were especially moved by these ideas, and none more so than his fellow Englishman, Roger Bacon (c. 1220–1292). Bacon’s famous treatise, the *Opus majus* (Great work), is replete with calls upon Christian leaders to study both Euclidean geometry and *perspectiva naturalis* as weapons against the Moors. Bacon was particularly intrigued by the way concave mirrors can convert light to heat, and so considered how they might be made to

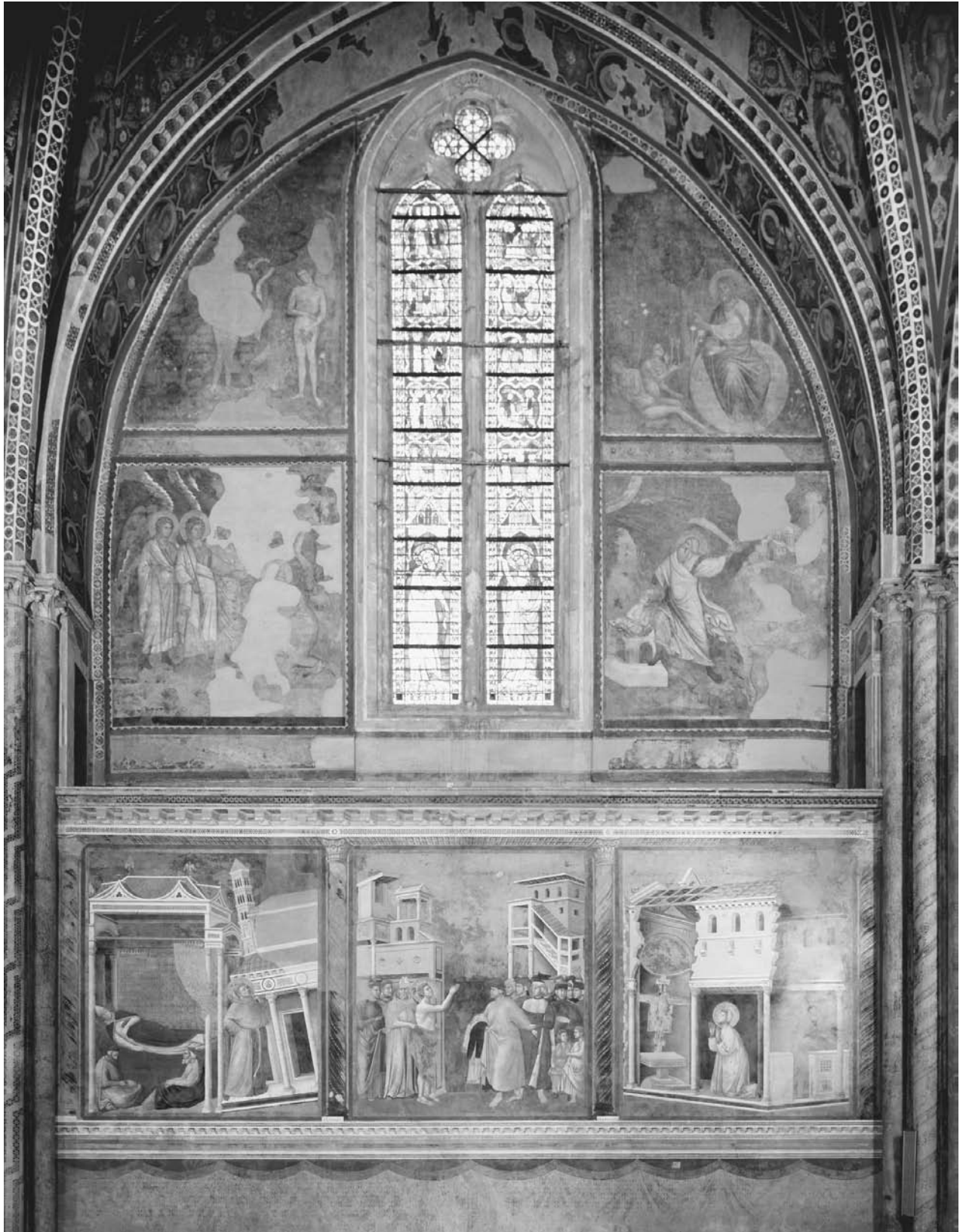

Figure 1. Mural by Giotto di Bondone; Bay B, right wall, upper church, Basilica of San Francesco, Assisi, Italy (late thirteenth century). SCALA/ART RESOURCE, NY

burn Moorish ships! Furthermore, he advised, geometry had application to the visual arts. If only religious pictures of, say, the Ark of Noah and other sacred objects mentioned in Scripture, were represented in the exact scale of their biblical description, Christians would be inspired as never before to renew the holy crusade and retake Jerusalem.

Speculum, Latin for mirror, became almost a synonym for divine revelation during the Middle Ages. Numbers of treatises with titles like *Speculum salvationis humanis* (Mirror of human salvation) were published everywhere in Christian Europe. Moreover, the technology of manufacturing mirrors was improving at this time, too, particularly in Venice where both flat and convex mirrors of glass began to be manufactured in convenient size, eventually becoming upper-class household items where their reflections might be compared, both actually and symbolically, with painted pictures.

According to medieval optical theory, the eye itself was nothing less than a mirror. The convex lens within the eye was understood (incorrectly, as we now know) to receive and display the minutely scaled image of whatever object is being seen,

just as if reflected in a mirror; the image then passed to the optic nerve for cognition in the brain. It should come as no surprise that the next critical development in the history of Renaissance perspective involved comparison to a mirror reflection. It is now generally agreed that the great Florentine architect, engineer, and impresario Filippo Brunelleschi (1377–1446) created the first picture ever to be constructed by adapting the geometric laws of *perspectiva naturalis*. The fact is that the optical pyramid explains both how a large image can be reduced to scale, and also how a small image might be similarly increased in reverse, in much the way that a modern film projector magnifies a small transparency that becomes enlarged to the same scale when it reaches the screen. Indeed, by this means, God must have formed the universe: first, it was a tiny shape in His divine mind’s eye, and then God projected it full-blown into the void. What Brunelleschi apparently realized is that the eye level of the person looking into a mirror sees not only his or her own eye reflected at that same level, but the edges of other reflected objects parallel to the ground on which the viewer stands, all appearing to converge to “vanishing points” on that same eye-level line. This is referred to as the “horizon” principle (Fig. 3).

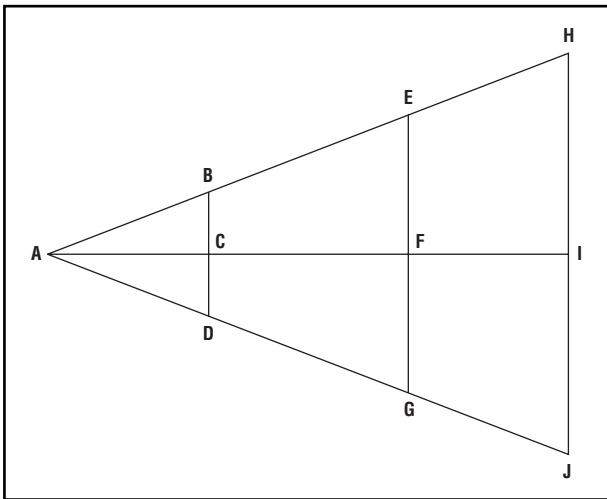

Figure 2. Euclid’s concept of *Perspectiva naturalis*.

In any event, sometime between 1413 and 1425, Brunelleschi did paint a small picture of the Baptistry of Florence as seen from the portal of the Duomo. Unfortunately, this historic painting is lost, but its composition was probably based on a geometric diagram combining mirror principles with certain other traditional measuring techniques employed by land surveyors, and possibly new projection methods inspired by cartography. We may presume the mirror connection because Brunelleschi’s biographer distinctly recalled that his hero demonstrated the first perspective picture by having the viewer hold its back side against one eye, the front side of the picture facing away, then peep through a small hole bored through the back side and see the painted image of the Baptistry on the obverse side reflected in a flat mirror held in the viewer’s other hand (Fig. 4). This was apparently the earliest acknowledgement of the true vanishing point in a perspective picture on line with the artist’s eye from which the depicted scene was imagined, and at which all receding perpendicular edges of objects represented in the picture appear illusionistically to converge.

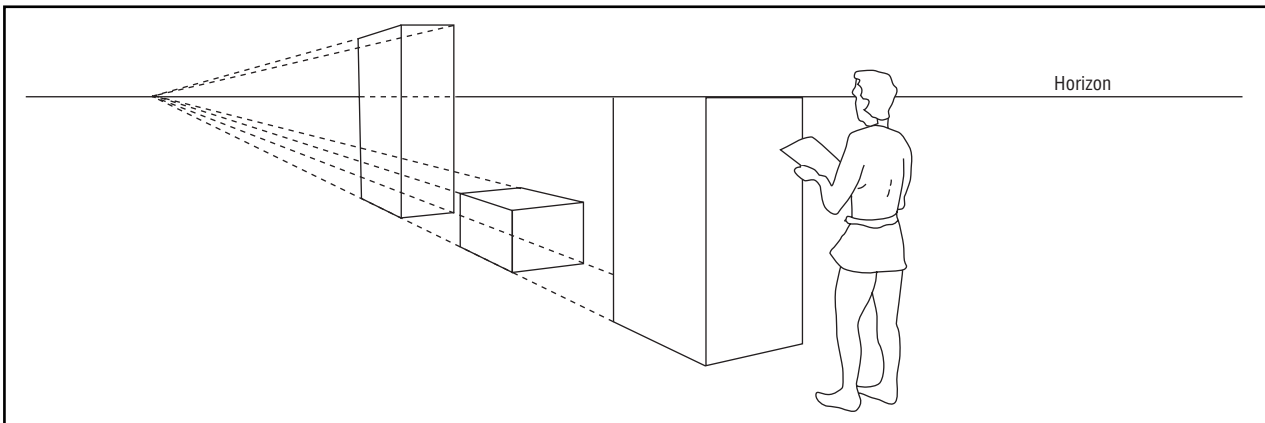

Figure 3. The horizon principle. COURTESY OF THE AUTHOR

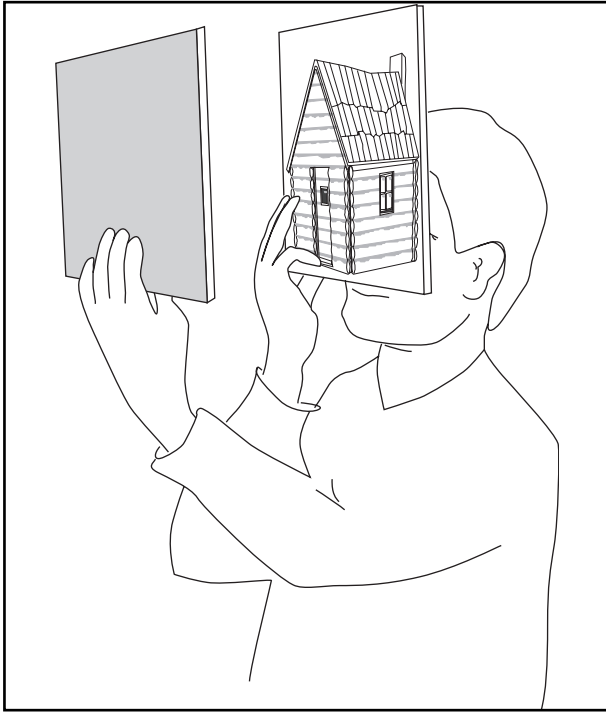

Figure 4. A demonstration of Brunelleschi's exercise with a mirror to establish perspective. COURTESY OF THE AUTHOR

In 1435 and 1436, the humanist Leon Battista Alberti (1404–1472), having just returned to Florence after a lifelong exile from the home of his forefathers, was so impressed by the city's fecund artistic activities that he wrote a treatise, *Della pittura* (On painting), dedicated to Brunelleschi and other contemporary artists. At the beginning of his book, Alberti advocated that painters must learn geometry if they are to be successful; he even spelled out the basic Euclidean definitions of point, line, and plane, and then proposed a simple geometric optical formula for laying out a perspective picture, perhaps a simplified codification of Brunelleschi's method. (See the sidebar for Alberti's textual explanation with accompanying illustrations.) Rather than comparing his system to a mirror, he likened it to looking through a window fixed with a gridwork of strings (Fig. 6). "Alberti's window" has since become the metaphor of Western civilization's concept of linear perspective, that is, perspective determined only by drawn lines signifying edges of things seen that converge or recede toward a single horizon.

Why was linear perspective so unique to Western civilization? As argued above, the advent of artificial linear perspective in the West had much to do with an idealized geometry that seemed to reveal the workings of God's mind, and thus, when applied to the making of holy pictures, should reenergize Christian faith. Perhaps it was no coincidence that the very first monumental painting to be constructed according to Brunelleschi's perspective had as its subject the *Holy Trinity* (Fig. 5), a large fresco depicting near-life-size figures on the nave wall of the Church of Santa Maria Novella painted c. 1425 by his friend Masaccio (1401–1428). This picture was certainly an attempt

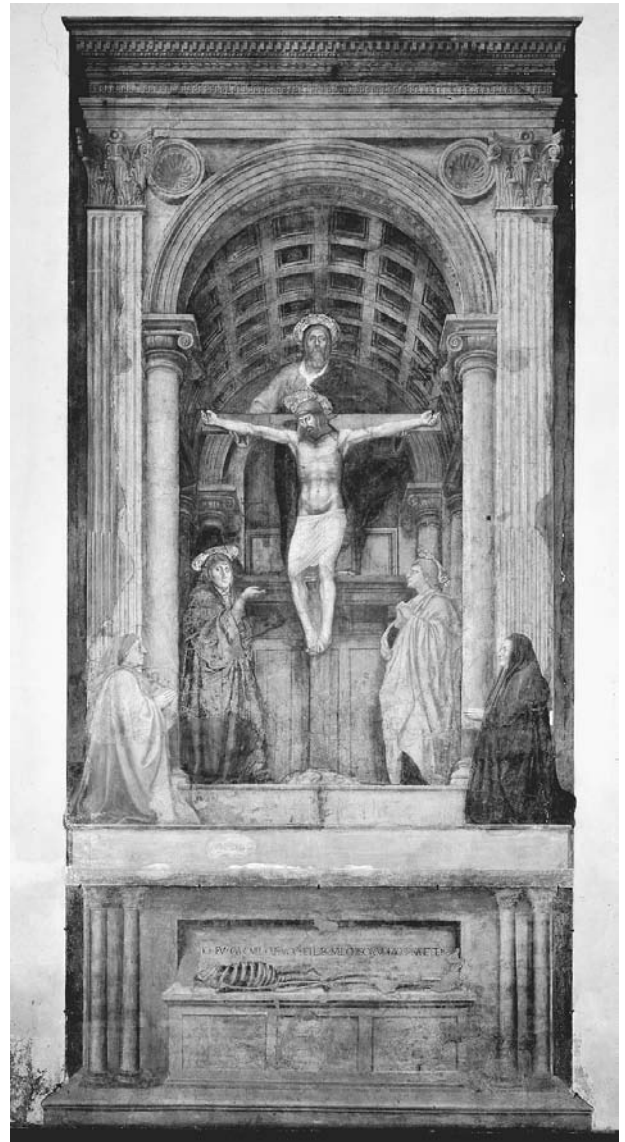

Figure 5. The fresco *Holy Trinity* (c. 1425) by Masaccio. Church of Santa Maria Novella, Florence, Italy. ERICH LESSING/ART RESOURCE, NY

to convince Christian viewers that the most metaphysical mystery in all Christian theology could actually be manifested in physical form before their very eyes.

Some present-day scholars, nonetheless, still maintain that Masaccio's *Trinity*, as well as Renaissance perspective from the very beginning, were secular reactions to medieval religiosity. Hubert Damisch, for example, thinks its advent is better explained ahistorically, by means of postmodern structuralism and Lacanian psychoanalysis (Damisch, 1994). In any case, by the sixteenth century, artists and their aristocratic patrons were showing less interest in applying perspective to uplifting religious pictures than to the revival of pagan antiquity. Indeed, instead of elevating human eyes to an intensified contemplation of the divine, Alberti's window had actually succeeded in

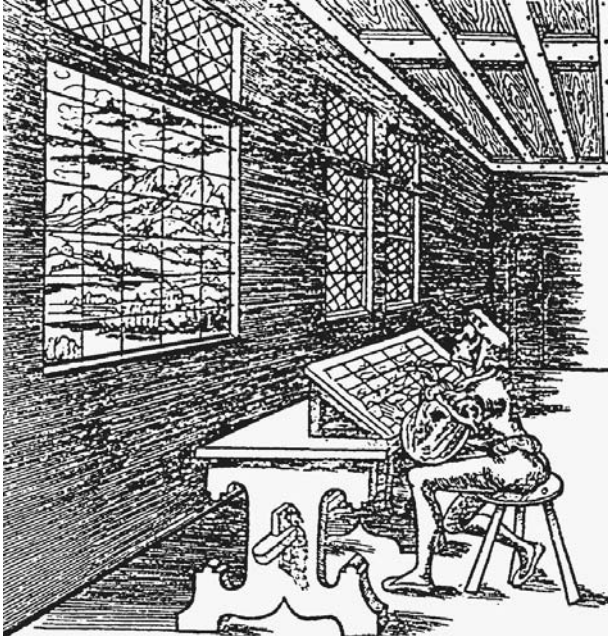

Figure 6. Leon Battista Alberti's method for laying out a perspective picture.

bringing heaven down to earth, revealing more materiality than spirituality in its ethereal essence. Even angels were henceforth transmogrified as secular solids, rigid Euclidean volumes that raised questions as to how they could convincingly appear to take flight. Galileo Galilei (1564–1642), beginning his career as a teacher of perspective at the Florentine Academy of Art, grew so expert that he built his own optical telescope in order to observe the moon. With an eye long nurtured by artificial perspective, especially from drawing shades and shadows of spherical solids, he was able to discern what no one in the world had ever understood before: that the lunar surface was covered not with mysterious supernatural blotches, but high mountains and low valleys catching sunlight and casting shadows—just like the Alpine region of northern Italy.

In the long run, linear perspective's most important contribution to Western art has been to its technology rather than its aesthetics. Even more importantly, it changed not just the way we draw pictures, but how we can actually see what we draw—but that's another story.

Other "Perspectives"

Although every human being (of whatever ethnicity) experiences the natural visual illusion of parallel edges—like

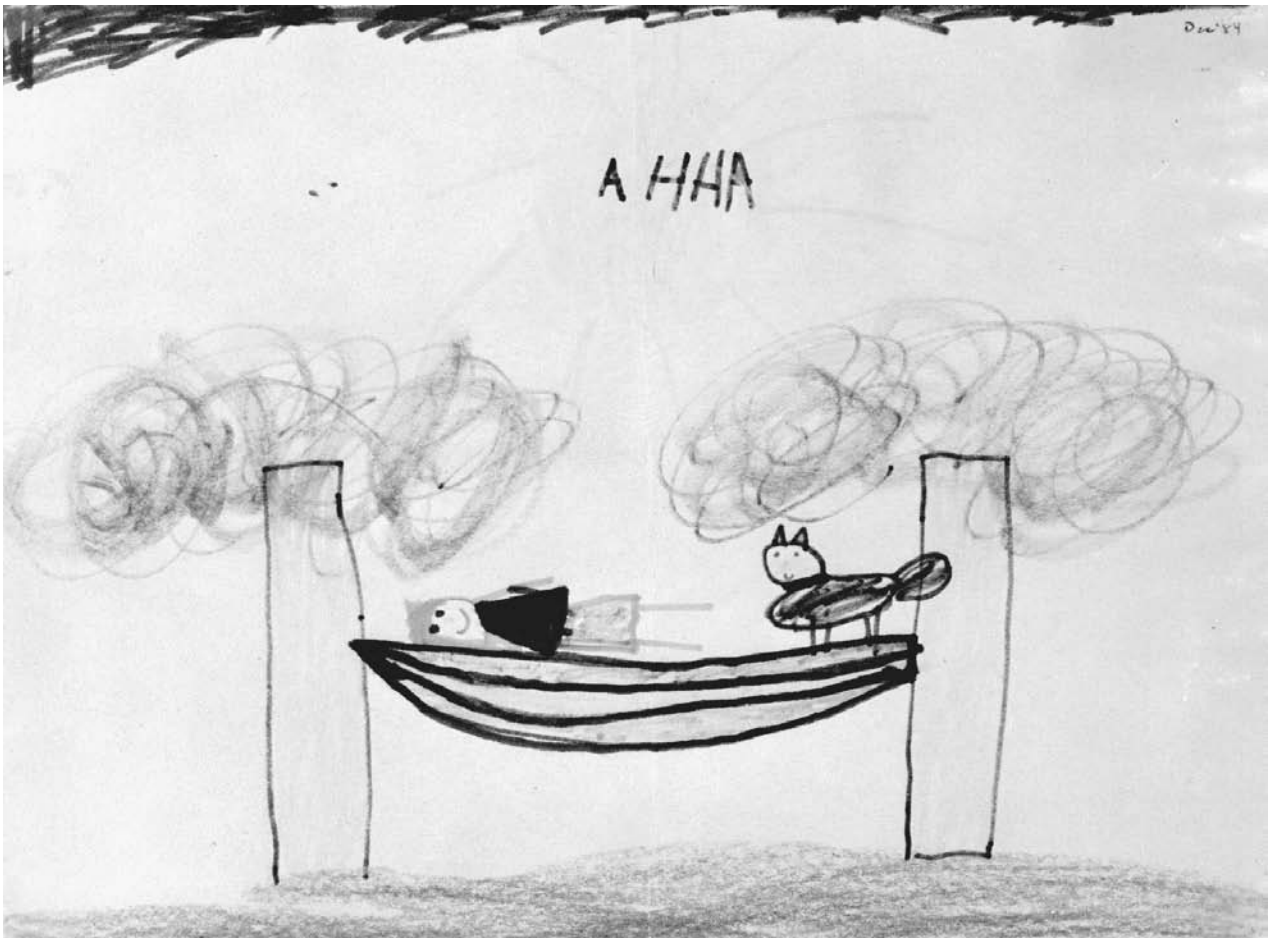

Figure 7. Drawing by five-year-old Anna Filipczak. Pen and crayon. COURTESY OF ANNA FILIPCZAK, WILLIAMSTOWN, MASS.

Anna, a five-year-old Ukrainian girl. Notice how she shows the trees and hammock in schematic side view but, because she wants to indicate her mother lying inside the hammock, depicts her posed as teetering on the edge; it is as if her mother is now imagined as being viewed from above. Until the infusion of Euclidean geometry and optics in the arts of western Europe during the early Renaissance, no artists anywhere had cultural need to have their pictures replicate the optics of single-viewpoint vision, and almost all the conventions they employed for signifying solid form and distant space—even in the most sophisticated art of the pre-Renaissance West and all other non-Western cultures—evolved from similar expressions found in the instinctive art of children.

This does not mean that non-perspectival pictures should be labeled “childlike” in the sense of being primitive (or inferior) to the Western style. Quite the contrary. Multiple viewpoints and other innate pictorial signifiers, such as placing nearby figures and objects at the bottom of the picture surface and those more distant at the top, have been refined into some of the most aesthetically beautiful and stylish painting in all art history. Manuscript illumination in medieval Persia is a fine example (Fig. 8). Interestingly, while medieval Islam possessed Greek optics, including Euclidean geometry, long before the West—with Muslim philosophers even adding their own commentary—Muslim painters never applied optics to art, and only used geometry for the creation of elaborate abstract designs in their magnificent architecture.

Artists in China and Japan, on the other hand, refined two perspective conventions that had naught to do with optical geometry. (Euclid was unknown in the Far East until the seventeenth century.) One method was a kind of axonometric projection whereby rectilinear objects were drawn as if their perpendicular sides were set at an angle, just as in Western perspective, but with their parallel edges remaining parallel and never converging (Fig. 9). The other convention, called aerial or atmospheric perspective, provided an effective illusion of distant landscape simply through the tonality of color. Far-off mountains, for instance, were painted in hazy gray or blue in contrast to the brighter colors of nearer foreground objects, thus creating an ideal complement to the Chinese predilection for philosophic contemplation. During the Renaissance, atmospheric perspective was also explored by Western artists, notably Leonardo da Vinci.

Another perspective convention, foreshortening, does not necessarily involve optical geometry and was also independently realized in other cultures. This is the pictorial illusion of an object appearing to extend forward or backward in space even though only one end of it can be observed, such as a body limb depicted as if thrust directly at the viewer. (Think of James Montgomery Flagg’s famous “I Want You” World War I recruiting poster.) Ancient Mayan artists in Central America, for ideological reasons peculiar to their culture, applied a similar foreshortening convention when representing their rulers seated with one leg bent sharply sideways (Fig. 10): note the twisted right foot of the seated male. This pose had special meaning because it signified the auto-sacrificial ritual in which Maya

roadsides or railroad tracks—appearing to converge toward a point as they approach the horizon, it is not natural to reproduce this illusion in pictures. In other words, while everybody sees the same phenomenon in reality, no one, no matter how artistically talented, is innately predisposed to picture it (except, remarkably, certain autistic prodigies). Perspective is a technique that generally must be learned. Therefore there is no reason to believe that nature rather than nurture had anything to do with why artists in other ages and cultures did not pursue the “realism” preferred in the West.

Young children do instinctively make pictures from a number of viewpoints simultaneously, as in Fig. 7, a drawing by

Let me tell you what I do when I am painting. First of all, on the surface of which I am going to paint, I draw a rectangle of whatever size I want, which I regard as an open window through which the subject to be painted is seen; and I decide how large I wish the human figures in the painting to be. I divide the height of a man into three parts, which will be proportional to the measure commonly called a *braccio* [.5836 meters]; for, as may be seen from the relationship of his limbs, three *braccia* is just about the average height of a man's body. With this measure I divide the bottom line of my rectangle into as many parts as it will hold; and this bottom line of the rectangle is for me proportional to the next transverse equidistant quantity seen on the pavement [Illus. A]. Then I establish a point in the rectangle wherever I wish; and as it occupies the place where the centric ray [from the painter's eye] strikes, I shall call this the centric [vanishing] point [Illus. B]. The suitable position for this centric point is no higher from the base line than the height of the man to be represented in the painting, for in this way both the viewers and objects in the painting will seem to be on the same

plane. Having placed the centric point, I draw straight lines from it to each of the divisions on the base line. These lines show me how successive transverse quantities visually change to an almost infinite distance [Illus. C]. . . .

I have [another] drawing surface on which I inscribe a straight line, and this I divide into parts

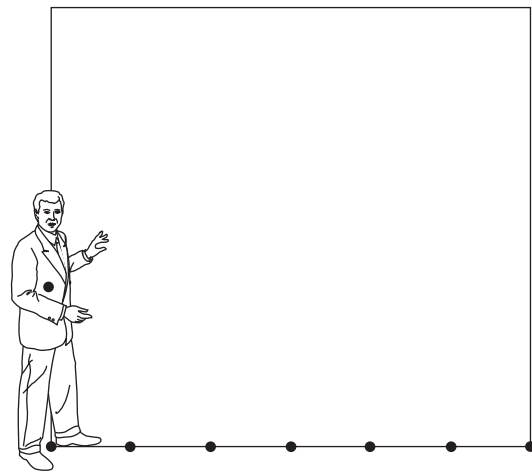

Illustration a. ILLUSTRATIONS A–G COURTESY OF THE AUTHOR
(continued on the next page)

(continued from previous page)

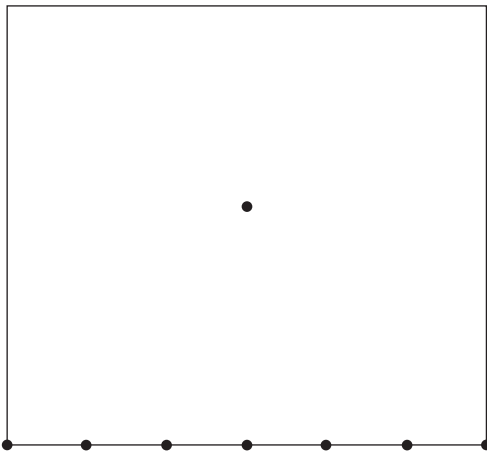

Illustration b.

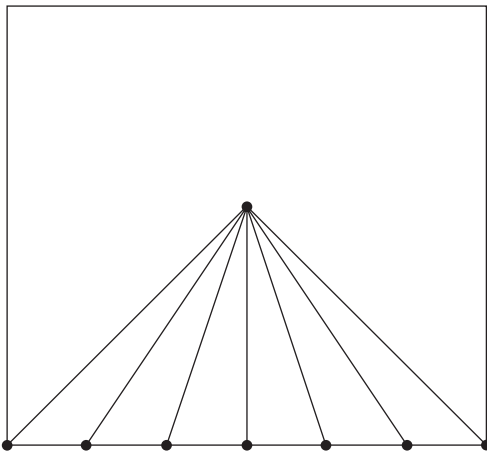
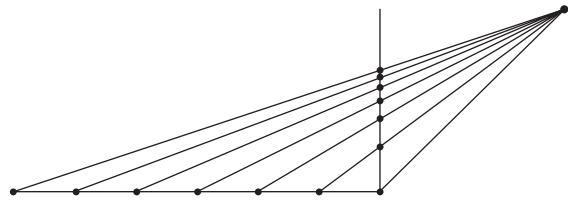

Illustration c.

like those into which the base line of the rectangle is divided. Then I place a point above this line, directly over one end of it, at the same height as the centric point is from the base line of the rectangle, and from this point I draw lines to each of the divisions of the line [Illus. D]. Then I determine the distance I want between the eye of the spectator and the painting, and, having established the position of the intersection at this distance, I effect the intersection with what mathematicians call a perpendicular. . . . This perpendicular will give me, at the places it cuts the other lines, the measure of what the distance



d.

Illustration d.

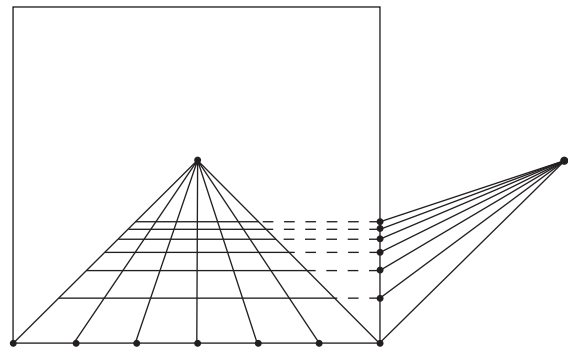

Illustration e.

should be in each case between the transverse equidistant lines of the pavement. In this way I have all the parallels of the pavement drawn [Illus. E]. . . . A proof of whether they are correctly drawn will be if a single straight line forms a diameter of connected quadrangles in the pavement [Illus. F]. When I have carefully done these things, I draw a line across, equidistant from the other lines below, which cuts the two upright sides of the large rectangle and passes through the centric point [Illus. G]. This line is for me a limit or boundary, which no quantity exceeds that is not higher than the eye of the spectator. As it passes through the centric point, this line may be called the centric [horizon] line. This is why men depicted standing in the parallel furthest away are a great deal smaller than those in nearer ones, a phenomenon which is clearly demonstrated by nature herself, for in churches we see the heads of men walking about, moving at more or less the same height, while the feet of those further away may correspond to the knee-level of those in front.

(continued on the next page)

(continued from previous page)

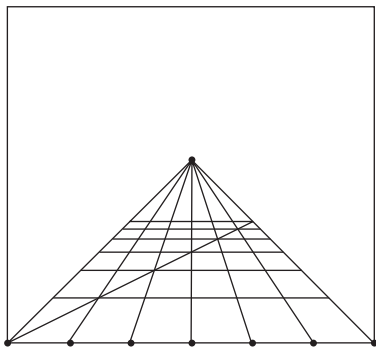

Illustration f.

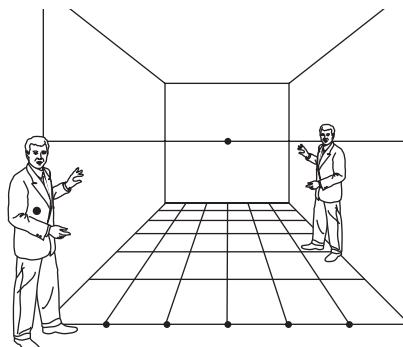

Illustration g.

SOURCE: Leon Battista Alberti, *On Painting and On Sculpture*. Translated by Cecil Grayson, 55–57. London: Phaidon, 1972.

BIBLIOGRAPHY

- Damisch, Hubert. *The Origin of Perspective*. Cambridge, Mass.: MIT Press, 1994.
- Edgerton, Samuel Y. *The Renaissance Rediscovery of Linear Perspective*. New York: BasicBooks, 1975.
- Kemp, Martin. *The Science of Art: Optical Themes in Western Art from Brunelleschi to Seurat*. New Haven: Yale University Press, 1990.
- Summers, David. *Real Spaces*. New York, Phaidon, 2003.
- White, John. *The Birth and Rebirth of Pictorial Space*. Cambridge, Mass.: Belknap, 1987.

Samuel Y. Edgerton

kings spread their legs apart in order to draw blood from the penis and offer it to the gods.

See also *Arts; Geometry; Landscape in the Arts; Realism; Visual Culture*.

PHENOMENOLOGY. Phenomenology is the study of experience, how things appear to us. The word comes from the Greek but was elaborated in the early nineteenth century on the basis of Immanuel Kant’s conception of the world as phenomenon, the world of our experience (as opposed to the world as noumenon, the world as it is “in itself”). Georg Wilhelm Friedrich Hegel famously employed the term in *Phänomenologie des Geistes* (1807; *The Phenomenology of Spirit*), suggesting that all knowledge was a matter of appearance with no world “in itself” other than the one we know. But phenomenology came of age with Edmund Husserl, who turned the Hegelian perspective into a rigorous philosophical method. Husserl in turn gave birth to a number of remarkable students, who together would set the tone for much of European philosophy in the twentieth century. Among them are Martin Heidegger, Max Scheler, Emmanuel Lévinas, Jean-Paul Sartre, and Maurice Merleau-Ponty.

Edmund Husserl

As a movement and a method, as a “first philosophy,” phenomenology owes its life to Edmund Husserl (1859–1938), a

German-Czech (Moravian) philosopher who started out as a mathematician in the late nineteenth century and wrote a book on the philosophy of mathematics, *Philosophie der Arithmetik* (1891; *The Philosophy of Arithmetic*). His view was that there was a strict empiricism, but on being shown (by the great German logician Gottlob Frege) that such an analysis could not possibly succeed, Husserl shifted his ground and started to defend the idea that the truths of arithmetic had a kind of necessity that could not be accounted for by empiricism. Thus, one of the main themes of his next book, *Logische Untersuchungen* (1913, 1921; *The Logical Investigations*), was a protracted argument against “psychologism,” the thesis that truth is dependent on the human mind. Rather, Husserl argues that necessary truths are not reducible to our psychology. Phenomenology was Husserl’s continuing and continuously revised effort to develop a method for grounding necessary truth.

Given Husserl’s beginnings in the rigorous field of mathematics, one must appreciate the temperament that he brought to his new discipline. By the end of the nineteenth century, a new perspectivism (or some would say a relativism) had come into philosophy. Friedrich Nietzsche, in particular, had argued that all knowledge is perspectival and that philosophy could not be reduced to a single perspective, that philosophy might be relative to a people, or to our particular species, or even to individual psychology. Husserl’s contemporary Wilhelm Dilthey defended a milder but similar thesis, and the “sociology of knowledge” was just beginning its ascension. Against any such relativism, Husserl insisted on philosophy as a singular, rigorous science, and his phenomenology was to provide the key.

It is often debated whether phenomenology is a philosophy or a method, but it is both. As a “first philosophy,” without presuppositions, it lays the basis for all further philosophical and scientific investigations. Husserl defines phenomenology as the scientific study of the essential structures of consciousness. By describing those structures, Husserl promises us, we can find certainty, which philosophy has always sought. To do that, Husserl describes a method—or rather, a series of continuously revised methods—for taking up a peculiarly phenomenological standpoint, “bracketing out” everything that is not essential, thereby understanding the basic rules or constitutive processes through which consciousness does its work of knowing the world.

The central doctrine of Husserl’s phenomenology is the thesis that consciousness is intentional, a doctrine that is borrowed from Franz Brentano. That is, every act of consciousness is directed at some object or other, perhaps a material object, perhaps an “ideal” object—as in mathematics. Thus, the phenomenologist can distinguish and describe the nature of the intentional acts of consciousness and the intentional objects of consciousness, which are defined through the content of consciousness. It is important to note that one can describe the content of consciousness and, accordingly, the object of consciousness without any particular commitment to the actuality or existence of that object. Thus, one can describe the content of a dream in much the same terms that one describes the view from a window or a scene from a novel.

In *Ideas: A General Introduction to Pure Phenomenology* (1931), Husserl distinguishes between the natural standpoint and the phenomenological standpoint. The former is our ordinary everyday viewpoint and the ordinary stance of the natural sciences, describing things and states-of-affairs. The latter is the special viewpoint achieved by the phenomenologist as he or she focuses not on things but on our consciousness of things. (This is sometimes confused by the fact that Husserl insists that the phenomenologist pay attention to “the things themselves,” by which he means the phenomena, or our conscious ideas of things, not natural objects.) One arrives at the phenomenological standpoint by way of a series of phenomenological “reductions,” which eliminate certain aspects of our experience from consideration. Husserl formulates several of these, and their nature shifts throughout his career, but two of them deserve special mention. The first and best-known is the *epoché* or “suspension” that he describes in *Ideas*, in which the phenomenologist “brackets” all questions of truth or reality and simply describes the contents of consciousness. (The word is borrowed from both the early Skeptics and René Descartes.) The second reduction (or set of reductions) eliminates the merely empirical content of consciousness and focuses instead on the essential features, the meanings of consciousness. Thus Husserl (like Kant) defends a notion of “intuition” that differs from and is more specialized than the ordinary notion of “experience.” We have intuitions that are eidetic, meaning that we recognize meanings and necessary truths in them, and not merely the contingent things of the natural world.

In his early work, including *Ideas*, Husserl defends a strong realist position—that is, the things that are perceived by consciousness are assumed to be not only objects of consciousness but also the things themselves. A decade or so later, Husserl made a shift in his emphasis from the intentionality of the objects to the nature of consciousness as such. His phenomenology became increasingly and self-consciously Cartesian, as his philosophy moved to the study of the ego and its essential structures. In 1931 Husserl was invited to lecture at the Sorbonne in Paris, and on the basis of those lectures published his *Cartesianische Meditationen* (1938; *Cartesian Meditations*, 1960). (The *Paris Lectures* were also published some years later.) He argues there that “the monadically concrete ego includes the whole of actual and potential conscious life” and “the phenomenology of this self-constitution coincides with phenomenology as a whole (including objects)” (*Cartesian Meditations*, 68, para. 33). These statements suggest the strong idealist tendency in his later philosophy.

As in the 1930s, Husserl again reinvented phenomenology, this time with a shift toward the practical, or what some might call the more “existential” dimension of human knowledge. Warning of a “crisis” in European civilization based on rampant relativism and irrationalism (an alarm that the logical positivists were raising about the same time in Vienna), Husserl published his *Krisis der Europäischen Wissenschaften* (1937; *Crisis of European Sciences and Transcendental Phenomenology*). In *Crisis*, the focus turned to the “lifeworld” and the nature of social existence, topics that played little role in his earlier investigations of the philosophy of arithmetic and the nature

of individual consciousness but would come to play a much greater role in the “existential” phenomenology that would follow. But it is much to Husserl’s credit that he continued to see the inadequacies of his own method and correct them, in ever-new efforts to get phenomenology right.

Martin Heidegger

Martin Heidegger (1889–1971) was a student of Husserl. Before that, he was a theology student, interested in much more concrete matters of human existence than his teacher, and his questions concerned how to live and how to live “authentically”—that is, with integrity, in a complex and confusing world. His use of phenomenology was subservient to this quest, although the quest itself soon transcended the phenomenological method. Heidegger’s phenomenology is most evident in his first (and greatest) book, *Sein und Zeit* (1927; English trans. *Being and Time*, 1962). Like his teacher Husserl, Heidegger insists that philosophical investigation begin without presuppositions. But Husserl, he says, still embraced Descartes’s basic picture of the world, assuming that consciousness, or “the mind,” was the arena in which phenomenological investigation took place. Such a philosophy could not possibly be presuppositionless. So Heidegger abandons the language of mind, consciousness, experience, and the like, but nevertheless pursues phenomenology with a new openness, a new receptivity, and a sense of oneness with the world.

Heidegger’s early work is defined by two themes: first, Heidegger displays a profound anti-Cartesianism, an uncompromising holism that rejects any dualism regarding mind and body, any distinction between subject and object, and the linguistic separation of “consciousness,” “experience,” and “mind.” This also demands a reconsideration of the Cartesian thesis that our primary relationship to the world is one of knowledge. Second, Heidegger’s early philosophy is largely a search for authenticity, or what might better be described as “own-ness” (*Eigentlichkeit*), which we can understand, with some qualification, as personal integrity. This search for authenticity will carry us into the now familiar but ever-renewed questions about the nature of the self and the meaning of human existence.

To ensure that we do not fall into Cartesian language, Heidegger suggests a new term (the first of many). *Dasein* (literally, “being-there”) is the name of this being from whose perspective the world is being described. *Dasein* is not a consciousness or a mind, nor is it a person. It is not distinguished from the world of which it is aware. It is inseparable from that world. *Dasein* is, simply, “Being-in-the-World,” which Heidegger insists is a “unitary phenomenon” (not being + the world). Thus, phenomenology becomes ontology (the nature of being) as well.

Being-in-the-World is not primarily a process of being conscious or knowing about the world. Science is not the primary concern of *Dasein*. *Dasein*’s immediate relation to the world is better captured in the image of the craftsman, who “knows his stuff,” to be sure, but might not be able to explain it to you nor even know how to show it to you. What he can do—what he does do—is engage in his craft. He shows you that

he knows how to do this and that by simply doing it. This knowing *how* is prior, Heidegger tells us, to knowing *that*. In effect, our world is essentially one extended craft shop, a world of “equipment” in which we carry out various tasks and only sometimes—often when something goes wrong—stop to reflect on what we are doing and look at our tools as objects, as things. They are, first of all, just tools and material to be used, and in that sense we take them for granted, relying on them without noticing them. Our concept of “things” and our knowledge of them is secondary and derivative.

Thus the notion of *Dasein* does not allow for the dualism of mind and body or the distinction between subject and object. All such distinctions presuppose the language of “consciousness.” But Heidegger defends an uncompromising holism in which the self cannot be, as it was for Descartes, “a thinking thing,” distinct from any bodily existence. But, then, what is the self? It is, at first, merely the roles that other people cast for me, as their son, their daughter, their student, their sullen playmate, their clever friend. That self, the *Das Man* self, is a social construction. There is nothing authentic, nothing that is my own, about it. The authentic self, by contrast, is discovered in profound moments of unique self-recognition—notably, when one faces one’s own death. And so Heidegger’s phenomenology opens up the profoundly personal arena of existentialist phenomenology.

Max Scheler and Emmanuel Lévinas

Max Scheler (1874–1928) was also a student of Husserl, but he, too, took phenomenology in a different direction, toward ethics (which had been ignored by both Husserl and Heidegger). Scheler was an intense man whose considerable contribution to philosophy was the introduction of emotion into the overly formal Kantian conception of ethics that still ruled the Continent. In *Wesen und Formen der Sympathy* (1913; English trans. *The Nature of Sympathy*, 1954), he resurrected moral sentiment theory and gave a central place in ethics to such emotions as love and hate. He argued that emotions have been understood by philosophers as merely “subjective” and argued a “cognitive” view, such that emotions could be construed as a source of knowledge. There is even, he argued, an emotional a priori, a universal and necessary status to the emotions that philosophers had neglected.

Scheler summed up the theme of the unfolding century between the wars in his book, *Ressentiment* (1961), in which he develops Nietzsche’s accusation that modern morality is a “slave morality,” a morality of resentment. But where Nietzsche blames Christianity, Scheler (a Catholic) exonerates his religion and shifts the blame instead to the bourgeoisie. Scheler’s phenomenology, unlike Husserl’s, was primarily concerned with value and, in particular, the source of values in feelings. What was becoming evident in phenomenology—and in European philosophy more generally—was a loosening up, a rejection of formality, an acceptance and an attempt to understand the less rational aspects of human existence. Worth mentioning here as well is Emmanuel Lévinas (1906–1995), who also elaborated a phenomenological ethics based on our felt relations with other people. “The face” is the focus of Lévinas’s phenomenology. It is an interpersonal phenomenology rather than an Ego- or

Dasein-based phenomenology, and interpersonal ethics, including love, plays a central role in it.

Jean-Paul Sartre

Jean-Paul Sartre (1905–1980) attended Husserl's lectures at the Sorbonne, and he became an enthusiast of phenomenology. He was first of all concerned with the nature of human freedom and the correlative sense of responsibility. Sartre's phenomenology is largely modeled on Heidegger's work, but in his *L'être et le néant* (1943; English trans. *Being and Nothingness*, 1956) he retreats from Heidegger's attack on the Cartesian view of consciousness, Sartre argues that consciousness (described as "being-for-itself") is such that it is an activity, not a thing or substance ("no-thing"), and it is always to be distinguished from the world it intends. Consciousness is free to choose and free to "negate" (or reject) the given features of the world. Thus, Heidegger's "being-in-the-world" phenomenon gives way to a conflicted portrait of human consciousness resisting and challenging the world.

As in Husserl, consciousness is essentially intentionality, but for Sartre it is nothing but intentionality, an activity directed at the world. Consciousness is active, essentially critical, and consists not just of perception, thoughts, and ideas but as much of desires, wishes, emotions, moods, impulses, and imaginings, negating the world as it is. Sartre celebrates our remarkable freedom to imagine the world other than it is. Our perceptions of the world, he argues, are always permeated by imagination, so that we are always aware of options and alternatives. Furthermore, there is no self or ego behind consciousness, no agent behind the activity. Thus, Sartre distinguishes consciousness from the self, and self, he insists, is "in the world, like the self of another [person]." The self is an ongoing project in the world.

Sartre defines his ontology in terms of the opposition of "being-in-itself" and "being-for-itself," manifested in the tension between the fact that we always find ourselves in a particular situation defined by a body of facts that we may not have chosen—our "facticity"—and our ability to transcend that facticity, to imagine, and choose—our transcendence. He tells us that consciousness "is what it is not, and is not what it is"—a playful paradox that refers to the fact that we are always in the process of "transcending" ourselves. He also defines a third ontological category, "being-for-others," which makes our lives with other people an essential part of our existence.

Maurice Merleau-Ponty

After the war, Sartre's younger colleague Maurice Merleau-Ponty (1908–1961) convinced him that he should modify his "absolute" insistence on freedom in his later works, although his insistence on freedom and responsibility remains. Merleau-Ponty went on to develop his own radical revision of the phenomenology of freedom and the essentially embodied nature of human consciousness. Following Sartre, Merleau-Ponty expanded the role of the body in phenomenology. Accordingly, Husserl's intentionality becomes motility, and instead of disembodied perception we have the body's orientation to the world. It is a radical move, and phenomenology could not

quite keep up with it. So when phenomenology was replaced in French thinking, by the new wave of poststructuralism, the body retained its now privileged position but phenomenology moved to the margins. It is still practiced by diehard Husserlians and Sartreans, and it has become a valuable tool—one among many—for researchers on all sorts of psychological topics, but as an exclusive approach to philosophy, a "first philosophy," it is now for the most part simply a part of history.

See also *Continental Philosophy; Existentialism; Kantianism; Structuralism and Poststructuralism.*

BIBLIOGRAPHY

- Brentano, Franz. *Psychology from an Empirical Standpoint*. Edited by Oskar Kraus and Linda L. McAlister. Translated by Antos C. Raucella et al. London: Routledge, Kegan and Paul, 1973.
- Heidegger, Martin. *Being and Time*. Translated by John Macquarrie and Edward Robinson. New York: Harper, 1962.
- Husserl, Edmund. *Cartesian Meditations*. Translated by Dorion Cairns. The Hague: Nijhoff, 1964.
- . *Ideas: General Introduction to Pure Phenomenology*. Translated by W. R. Boyce-Gibson. London: Macmillan, 1931.
- Sartre, Jean-Paul. *Being and Nothingness*. Translated by Hazel E. Barnes. New York: Philosophical Library, 1956.
- Scheler, Max. *Formalism in Ethics and Non-formal Ethics of Values*. 5th rev. ed. Translated by Manfred S. Frings and Roger L. Funk. Evanston, Ill.: Northwestern University Press, 1973.
- . *The Nature of Sympathy*. Translated by Peter Heath. New Haven, Conn.: Yale University Press, 1954.
- Solomon, Robert C. *From Hegel to Existentialism*. New York: Oxford University Press, 1987.
- . *From Rationalism to Existentialism: The Existentialists and Their Nineteenth-Century Backgrounds*. New York: Harper and Row, 1972.

Robert C. Solomon

PHILANTHROPY. Active in English usage by the seventeenth century, *philanthropy* has been shown more recently to have a long, complex, and controversial history displaying multiple meanings of the term. Now *philanthropy* is normally construed as love of mankind, a voluntary, practical benevolence toward others, or an effort to promote the welfare of humanity by gifts without self-benefit. However, philanthropy over the long span of its use in Western civilization has gained and shed a more diverse array of meanings. Historically, the dynamic succession of human ambitions and virtues associated with the term implicate philanthropy in the creation of cosmic and social hierarchies, the politics of city life, the proliferation of faiths, the making of laws, and the governance of states. Philanthropic behavior also helped to form economic systems like capitalism and has accelerated both the pursuit of knowledge and the pace of artistic innovation. To comprehend the significations of philanthropy over time requires a multidimensional perspective attentive to its many spatial, material, cultural, psychological, and ethical impacts over time.

For much of recorded history, charity and philanthropy are indistinguishable and must be analyzed together to understand

the evolution of the latter term. Historically, such giving has more often been construed as an imperative duty rather than as a choice of the fortunate toward the misfortunate. Only recently have forces of religious schism, liberalism, and individualism broken charity's traditional lien on property. Ancient service to the needy requires attention not only to the actual poor and their real needs, but also to the social imagination of the rich. Perceptions of dangerous want by the wealthy, accurate or not, more often determined the type and direction of their giving. The demand for and the supply of philanthropy rarely accord. Past disjunctures here, grown unbearable to new generations of aspiring benefactors, have caused epochal changes in the practice and meaning of philanthropy, religion, and politics.

Ancient Mediterranean Examples

The peoples of the ancient Mediterranean world made enduring contributions to the definitions and practices of philanthropy. In their law codes from the third millennium B.C.E., Babylonian kings decreed special punishments for the strong who abused the weak. These provisions made justice and clemency hallmarks of nobility. Babylonian epic poetry, exemplified by the *Gilgamesh* cycle (c. 2000 B.C.E.), reiterated this message. Verses retold the misfortunes of misanthropic kings while celebrating generosity and self-sacrifice as vital steps toward civilization. Contemporaneous Egyptian sacred writings such as *The Book of the Dead* make it clear that anyone's successful passage to the afterlife depended on a lifetime record of benevolent acts toward the suffering. Egyptian deities expected postulants for immortality to swear that they had never denied food to the starving, drink to the thirsty, and clothing to the ragged. Islam's many later commandments that the faithful must be charitable derive from philanthropy's sacred character among Semitic peoples in antiquity.

Judaism. Ancient Judaism went farther, postulating a single God as the epitome of generosity. All of creation belonged to Jehovah, but he gave the Israelites the promised land, sheltering them as refugees ("for the land is mine; for you are strangers and sojourners with me"; Lev. 25:23). Israel itself is defined in Jewish sacred writings as a foundling nation, rescued by the Lord. Repeated Mosaic descriptions of the deity as an avenger of the orphaned, the widowed, and the homeless compel Jews, in turn, to help the bereft ("Love the stranger therefore, for you were strangers in the land of Egypt"; Deut. 10:19). Here, misanthropy equals apostasy, and pious Jews are required to be givers. Charity becomes a mode of divine worship, and rituals of giving organize all Hebrew calendars. Days of celebration and atonement marking the lunar year must be accompanied by shared meals and presents. Seasonal harvests close with free gleanings in the fields accorded to the impoverished. Tithes to benefit the poor, priests, and slaves run at three-, seven-, and fifty-year cycles, perpetuating acts of charity among the tribes of Israel. Synagogues themselves embodied Judaism's charitable imperatives with spaces designed for the kindly deposit and distribution of alms. Donors left gifts secretly in one room of the temple. Beneficiaries collected the offerings in a second room unseen by contributors and thus immune to any shame in the transaction. Such philanthropic constructs prefigure the hierarchies of giving explained by

Jewish sages such as Moses ben Maimon (1135–1204 C.E.). Voluntary donors who act anonymously and who succeed in organizing others in durable networks of mutual aid get highest praise in this literature.

By the turn to the common era, gifts in Jewish communities had intensified as markers of social status and priestly privileges. More punctilious but also more debatable charitable acts invigorated Jewish sectarianism. Out of this controversy, disaffected Jews, like the Galilean, Jesus, sought for a more humble and true charity.

Greek models. Westerners owe the word *philanthropy* to the Greeks, who, since the fifth century B.C.E. ceaselessly elaborated on their idea of *philanthropia*. This concept they first embodied in the benevolent god Prometheus, who dared to share divine fire with mortals and suffered Zeus's wrath for his generosity. Greeks also revered their gods Hermes and Eros as especially philanthropic for the gifts of wisdom and desire they imparted to men. Greek fascination with knowledge as a gift freely communicated to mortals by other wise men registers in Plato's presentation of the philosopher Socrates stating the philanthropic nature of teaching (*Euthyphro*, c. 400 B.C.E.). The love of learning and discriminating art patronage employed by the Persian ruler Cyrus the Great induced his Greek biographer Xenophon to praise the monarch's supremely philanthropic soul (*Cyropaedia*, c. 380 B.C.E.). Here are the origins of the honorific by which Greek subjects addressed the emperors of Byzantium for centuries: "Your Philanthropy." This title was doubly appropriate since, by the sixth century C.E., a "philanthropy" in Greek also meant the tax exemption Byzantine emperors regularly gave to their favorite charities such as hospitals, orphanages, and schools. The tax-exempt condition of many modern philanthropies is ancient, and this type of privilege has long contributed to shaping various status hierarchies within Western societies.

In Greek cities, many forms of philanthropy combined to strengthen urban culture. Most important were the civic liturgies rich men assumed either voluntarily or under heavy peer pressure. These duties obligated wealthy citizens to subsidize personally the cost of temples, city walls, armories, granaries, and other municipal amenities promoting inhabitants' common identity and welfare. Prominent citizens vied with one another in the performance of these indiscriminate gifts to show the superiority of their own civic virtue. Personal vanity was a prime motive for donors, but rich citizens risked ostracism by peers and plebs if they failed to appreciate their wealth as a trust in which the community had a share. Greek philanthropists showed a genius for converting their gifts into potent symbols of communal strength and solidarity. Groups of wealthy men regularly paid for all the equipment necessary to stage the great Greek dramatic festivals. Such gifts of theaters, scripts commissioned from leading playwrights, costumes, and actors shaped the physical and cultural environments of Greek cities, gave audiences memorable lessons in civility, and enshrined drama as one of the greatest media of collective artistic expression in the West.

Roman philanthropia. As conquerors, heirs, and cautious emulators of the Greeks, the Romans assumed better regulation of what they called *philanthropia* to be among the greatest

obligations of their civilization. Influential authors like Cicero and Seneca composed manuals on the arts of proper gift giving and receipt. Seneca, tutor to the emperor Nero, emphasized that elite giving must generate gratitude between the vertical ranks of Roman society and argued that philanthropy rightly done formed the “glue” that held the Roman people together (*On Benefits*, composed c. 60 C.E.). Thus benefactors had to select appreciative beneficiaries carefully and choose presents capable of eliciting maximum acknowledgment from recipients. Heads must rule hearts in discriminate Roman philanthropy. Roman rulers took this advice with emperors asserting exclusive right to make choice gifts of baths, gymnasia, fountains, and gladiatorial games to the Roman population. The elaboration of Roman law aided less exalted philanthropists by giving legal status to trusts, charitable endowments, and mutual-aid societies. But the propensity of many donors to use such legal instruments for self-glorification, personally advantageous politicking, and the conservation of family wealth did little to help larger numbers of the destitute in growing Roman imperial cities. To Latins, philanthropy also meant the proper conduct of diplomacy, special respect for foreign ambassadors, fidelity to sworn treaties, and generous terms of alliance offered to defeated enemies. The propagandists of empire cited these philanthropies as justifications of Roman imperialism and the superiority of Roman civilization.

Christian Regimes of Philanthropy

The radical, roving holy man Jesus of Nazareth rebelled against all existing regimes of self-serving philanthropy in the ancient world simply by proclaiming: “Blessed are the poor” (Luke 6:20). The master commanded early apostles to abandon without recompense all material possessions by almsgiving and to strive for ever deeper humility through personal alms seeking, courting rejection and abuse at every door. The earliest Christian writings, the letters of Paul—composed c. 54–58 C.E.—advocate in part this radical social ethic demanding that all believers become tireless benefactors. Those formerly accustomed to being mere protégés of greater patrons must now aspire themselves to become protectors of their neighbors no matter how humble they all may be. Paul raised up new communities of donors to be inspired by Jesus’s manifest love and empowered spiritually and philanthropically through the church. New Testament evangelists amplified this charitable theme, emphasizing how Jesus immediately cared for the suffering even by doing good works on the Sabbath in contravention of Jewish worship protocols (Mark 3:4 and 6:2–5). Jesus personified as the Good Samaritan (Luke 10:29–37) emphasized that one’s obligation to help the stricken must extend to all and transcend ethnocentric notions of racial superiority, caste privilege, and self-interest. Fundamental tenets of Christianity formed as its exponents did battle with more ancient regimes of philanthropy.

Early Christian bishops, locked in vicious power struggles with old pagan elites for control of crumbling Roman imperial cities, could not be so generous. Anxious to portray themselves as potent “lovers of the poor,” they continually revised Christian doctrines on alms, riches, and the poor to gain disciplined blocks of loyal followers. Fidelity to Jesus’s more selfless teachings was sacrificed as bishops toned down earlier

rebukes of the wealthy, courted rich donors with preferred places in new congregations, and increasingly described almsgiving as a means by which the ordinary faithful could atone for their personal sins under reinforced church discipline. The crucial Christian linkage of philanthropy and penance enticed givers to look upon their alms as a form of spiritual capital accumulation and intensified self-centered motives for giving. Worldly charitable deposits would ultimately enable pious donors to boast in heaven about the purity of their own souls and to secure personal salvation.

Church efforts to monopolize regulation and distribution of alms, especially through fixed monastic offices, were continually challenged during the Middle Ages. Philanthropic insurrectionaries—like St. Francis of Assisi—embraced poverty in apostolic fashion and preferred direct care to the wretched within recovering European cities. Lay members of medieval civic confraternities, who pledged to help one another and to care for needy fellow citizens, thereby diminishing urban violence, also challenged ecclesiastical control of philanthropy. Voluntary brothers and sisters sought to convert their good works into better lives for fellow citizens, enhancing the social and spiritual capital of all.

Early Modern Refinements

Both the rise of the state and intensified religious conflict in early modern times contributed to critical redefinitions of philanthropy. This was especially true if kings meddled in religious affairs, as when King Henry VIII of England organized a new English Episcopal Church in the 1530s while systematically destroying Catholic institutions of worship and charity within his realm. These royal actions promoting the English Reformation first made it imperative for Tudor rulers to create a tax-supported poor-relief program to replace vanished Catholic charities. Then statesmen became determined to increase the efficiency of all remaining private philanthropic organizations so as to spare the state from unnecessary subventions of the needy. The result was the famous Elizabethan Statute of Charitable Uses (1601) that defined in passing legally acceptable charities. But this legislation far more amply encouraged private citizens and government officers to investigate and to sue surviving philanthropies and their private trustees for any suspected mismanagement of endowments now deemed vital to maintenance of public order.

The Reformations became a manifold gift crisis as Europeans questioned God’s bounty to man, what humans could offer the divine, and what they owed to one another. With Protestants facing off against Catholics, the integrity of Christian charity collapsed as giving became more sectarian. Surviving benevolent organizations competed fiercely for the smaller pools of total gift capital rival faiths could muster. Charity officials turned to perpetual fundraising campaigns and creatively diversified their funding sources, enhancing tactics of resource management vital to capitalism’s success. Churchmen on all sides complained that impetuous philanthropy would be not only wasteful, but also a boon to heresy if it wrongly benefited religious opponents. Agents of police, including clerics, denounced the poor as disruptively irreligious and denied them any legitimate right to aide from the rich.

These conditions sanctioned a reconceptualization of philanthropy as a riskier matter of choice and optional capital investment that should produce demonstrable returns in accord with the sacred and secular beliefs of donors. The current vogue for “entrepreneurial philanthropy” has ample precedents in early modern history.

Modern “Scientific” Philanthropy

Reformation-era debates over giving accelerated the secularization, rationalization, and nationalization of philanthropy. Disgusted with doctrinaire religious bickering and giving, statesmen-philosophers of the European Enlightenment sought to define and effect a “scientific philanthropy” that would efficiently benefit the truly needy and entire nations as well. Legislators in England, France, and central Europe simultaneously denounced private and religious endowed charitable foundations whose limited antique purposes or beneficiaries had been rendered obsolete by the passage of time. Parliamentarians enacted legislation to curb the creation of foundations via gifts of land to permanent endowments and they favored methods of ad hoc fundraising to meet any community’s pressing needs. Utilitarians of the nineteenth century, like John Stuart Mill, advocated closer national supervision of all charities and politically mandated investment of their liquid assets in state bonds to enhance their public benefit and economic partnership with government. Britain’s national Charity Commissioners, first deputized by Parliament in 1818 and made permanent in 1853, soon exercised authorization and annual inspection powers over all philanthropic organizations.

In America, colonial and then state constitutions differed widely in the encouragement and discouragement of private philanthropy leading to the failure of many interstate charitable bequests and organizations. This frustrating situation spurred many legal battles and multiple interventions by the U.S. Supreme Court, including the famous Dartmouth College case decision in 1819. Here, the justices quashed an attempt by the governor and state legislature of New Hampshire to take over Dartmouth College and change its curriculum to meet state needs. The court held that the state’s plan violated the school’s charter and grossly abused the law of contracts. That charter, obtained from the royal provincial governor by the college’s founders in colonial times, was itself a contract between the government that issued it and the trustees of the college. By the U.S. Constitution, such agreements could be altered only if all parties to the original contract, or their successors, concurred. This point of law reinforced the separation of church and state while also promoting the freedom of conscience and speech for the agents of philanthropic corporations.

Early Americans fought hard in the courts to compile a body of law stipulating the rights of incorporated philanthropies and protecting them against government spoliation. Boosters of charity organization societies in England and America campaigned successfully for greater coordination and professionalization of philanthropic work, castigating “mere charity” as wasteful, sentimental, and incapable of solving the modern socioeconomic problems caused by urbanization and industrialization. The rise of “social work” as an accredited, data-driven service vocation in modern times exemplifies the triumph of a

professionalized and scientific philanthropy. This trend strengthened when immensely wealthy and influential captains of U.S. industry, like Andrew Carnegie and John D. Rockefeller Sr., transferred their millions to personal philanthropic corporations organized and operated in accord with rigorous business principles. Foundation executives, confronted with the necessity of managing endowments now more often comprised of corporate stock, recruited highly skilled staffs to handle the accumulation and pay out of philanthropic capital.

Jewish benefactors contributed to these trends by subsidizing a wider array of causes and organizations, like loan funds, hospitals, and support networks for Eastern European immigrants, the aid being more practical and scientific than pious in nature. The advent of Zionism in the nineteenth century, the calamity of the Holocaust, and the creation of the state of Israel catalyzed modern Jewish philanthropy as a means of nation building and commemoration of historic events.

By contrast, ancient Islamic forms of philanthropy have remained very influential in Muslim communities throughout modern times, especially support of Koranic schools, mosques, public works, and poor relief. Vital here is the enduring medieval institution of the *waqf* (pl. *awqaf*), a transfer in perpetuity of real estate or productive property to support a religious or charitable institution forever. Islamic law stipulates the inviolability of such endowments, postulating Allah himself as their owner. This level of material security greatly appealed to elite Moslem property owners living under rapacious monarchs and without recourse to fixed laws of testation and property succession by heirs. They created many family *awqaf* with immediate kin and descendants richly rewarded as the direct beneficiaries or well-paid administrators of these endowments. Here, institutionalized philanthropy as protection of clan interests and as projection of political protest elicited the wrath of Muslim state rulers, ancient and modern. In the post-colonial Mid-East, secularizing Turkish and Arab nationalist governments (in Algeria, Egypt, Syria, and Tunisia) have resorted to confiscations of *waqf* properties, advancing state policies at the expense of traditional philanthropies and their prime beneficiaries, especially clerics. Such tactics underscore the fragility of civil society in the region and promote sectarian conflict.

In modern times, the rise of mass-circulation daily newspapers and muckraking exposés significantly reshaped Western philanthropy, as journalists produced stories decrying socioeconomic problems, the irrelevance of existing charities, and the need for better benevolent organizations. Learned societies and professional bodies—like bar associations, incorporated as nonprofit organizations, contributed their journals and specialized studies to a growing flood of information about the best means, measures, and objectives of effective philanthropy. Generalized contempt for charity’s dead hand made constant self-scrutiny and a capacity for self-renewal to meet new social problems prized attributes of modern philanthropic organizations. Many newer charitable foundations are even primed to spend themselves out of existence and self-destruct after a set period of time so as to prevent their social obsolescence. These achievements have often brought greater coherence between the demand and supply of philanthropy. The

remarkable dynamism of the nonprofit sector in the United States and abroad, signaled by the proliferation of private family foundations, grassroots community foundations, and donor-advised funds highly responsive to the fluid social awareness and giving interests of contributors, demonstrates broader public participation in historic debates over the real meaning of philanthropy. For the moment, this agitation confirms rather than subverts modern philanthropy's scientific pretensions.

See also *Christianity; Poverty; Property; Wealth*.

BIBLIOGRAPHY

- Andrew, Donna. *Philanthropy and Police: London Charity in the Eighteenth Century*. Princeton, N.J.: Princeton University Press, 1989.
- Brown, Peter. *Poverty and Leadership in the Later Roman Empire*. Hanover, N.H.: University Press of New England, 2002.
- Cavallo, Sandra. *Charity and Power in Early Modern Italy: Benefactors and Their Motives in Turin, 1541–1789*. Cambridge, U.K.: Cambridge University Press, 1995.
- Davis, Natalie. *The Gift in Sixteenth-Century France*. Madison: University of Wisconsin Press, 2000.
- Himmelfarb, Gertrude. *Poverty and Compassion: The Moral Imagination of the Late Victorians*. New York: Knopf, 1991.
- Jones, Gareth. *History of the Law of Charity, 1532–1827*. London: Cambridge University Press, 1969.
- Loewenberg, Frank M. *From Charity to Social Justice: The Emergence of Communal Institutions for the Support of the Poor in Ancient Judaism*. New Brunswick, N.J.: Transaction, 2001.
- McCarthy, Kathleen D. *American Creed: Philanthropy and the Rise of Civil Society, 1700–1865*. Chicago: University of Chicago Press, 2003.
- Miller, Howard S. *The Legal Foundations of American Philanthropy, 1776–1844*. Madison: State Historical Society of Wisconsin, 1961.
- Safely, Thomas M. *Charity and Economy in the Orphanages of Early Modern Augsburg*. Boston: Humanities Press, 1997.
- Veyne, Paul. *Bread and Circuses: Historical Sociology and Political Pluralism*. London: Penguin, 1992.
- Weissman, Ronald. *Ritual Brotherhood in Renaissance Florence*. New York: Academic Press, 1982.
- Winter, Bruce W. *Seek the Welfare of the City: Christians as Benefactors and Citizens*. Grand Rapids, Mich.: Eerdmans, 1994.

Kevin C. Robbins

PHILOSOPHIES.

This entry includes four subentries:

African
American
Feminist, Twentieth-Century
Islamic

AFRICAN

Ancient Egypt has been offered as a point of origin of African metaphysical speculation. According to the work of Senegalese historian Cheikh Anta Diop, Egypt is to Africa what the

Greco-Latin civilization is to the West, and texts such as *The Book of the Dead*, written more than 3,500 years ago, could play the role of a founding text for a tradition of philosophical thinking on the African continent. Most of Diop's work has been devoted to demonstrating that the history of ancient Egypt cannot be separated from the history of the rest of the continent. The cosmogony of the Dogon people, for example, described by the sage Ogotemméli and recorded by French ethnologist Marcel Griaule, is a testimony to the cultural and metaphysical continuity existing between the ancient Egyptians and the people living in the region of the Niger River's loop. Thus, the philosophy behind the practice of male and female circumcision is similar to what is found in ancient Egypt: that is, human beings have inherited from their divine origin an androgynous nature; at puberty, therefore, the right ontological order of things commands that the sexes be radically separated through circumcision and excision. Another important element of continuity is to be found in African languages, which, Diop claims, need to be studied in relation to the Egyptian language. In support of this, he presents in much of his work Egyptian philosophical concepts that survived in his native Wolof. Subsequently, Diop's disciple Theophile Obenga has emphasized the continuous presence in African tongues and cultures of the notion of *maat*, which is central in Egyptian philosophy and means "reality," "truth," "justice," "righteousness," "evenness," or "perfection." In Coptic and in other African languages spoken in Ethiopia, Congo, Gabon, Cameroon, Sudan, or Nigeria, recognizable derivatives from *maat* are indications of the permanence of this philosophical concept in the peoples' worldview as the expression of an African ideal of harmony in society. African philosophy could be characterized as a philosophy of *maat*.

Diop's views have provoked heated ideological debate, Egyptology being premised on the notion that ancient Egypt belongs to Asia rather than to the African continent, where it is and was situated. The German philosopher Georg Wilhelm Friedrich Hegel (1770–1831), in particular, insisted that Egypt and North Africa be culturally detached from Africa, the purpose being to erase any indication that what he called "Africa proper" could produce civilization, let alone philosophy, which for him uniquely represented the spirit of Europe.

The Islamic Past

To detach North Africa from the rest of the continent also meant to take out of it the chapters in the history of philosophy written in cities such as Alexandria, Carthage, or Hippo, where St. Augustine, "the most celebrated African thinker in history" as D. A. Masolo presents him, was a bishop in 396. It also meant ignoring the intellectual consequences of the penetration of Islam into Africa, starting in the eighth century, when the graphic rationality of the Muslim religion became part of African life. It is true that, by the end of the thirteenth century, the period of development of philosophy (*falsafā* in Arabic), which started in the ninth century, was coming to an end in the Sunni world. Still, Aristotelian logic was studied and philosophical thinking remained part of religious disciplines such as theology (*kalam*), commentary (*tafsir*), and mysticism (Sufism). In many learned centers in the Islamized regions of Africa, scholars in these

disciplines have created and developed an African written intellectual tradition, partly concerned with philosophical speculation. The legendary city of Timbuktu is the most famous of such centers. Ahmad Baba, who lived at the end of the sixteenth and in the early seventeenth century, was the best representative of the scholarly elite of Timbuktu. For Muslim scholars, the Saharan desert was not the wall Hegel supposed; they traveled in the Islamic world, North Africa, Egypt, and Arabia for intellectual purposes, often taking the opportunity of the pilgrimage to Mecca to do so. There is in the early twenty-first century a need to assess the importance of a written tradition of African philosophy in Arabic and in *Ajami*, that is, in African languages using Arabic script. This tradition is still widely unknown because many manuscripts kept in private family libraries are yet to be exhumed, restored, cataloged, and eventually published.

The Beginning of a Discipline

While Egyptian and Islamic components of African philosophy are now being researched, showing the historical depth of the intellectual tradition of speculation on the continent and questioning the received view that African cultures are naturally and essentially oral, the beginning of African philosophy as a discipline and an aspect of contemporary scholarship on Africa came after World War II. The publication in 1945 of Placide Tempels's *Bantu Philosophy* (in Dutch; it was translated into French in 1949 and English in 1959) was a crucial moment in this process, and so was the publication in 1948 of Griaule's *Conversations with Ogotemméli*.

Both works represented a break from the colonial negation of African cultures. Ethnologists such as Lucien Lévy-Bruhl had characterized the Africans' approach to reality as prelogical and magical, therefore foreign to any systematic view and organized philosophy; his concept of "primitive mentality" epitomized the face of anthropology as a science of the "other," which justified the "mission" of colonialism to bring civilization and rational thinking to people who were devoid of both. *Bantu Philosophy* showed a different face of anthropology as it affirmed, beyond the cultural traits, customs, and behaviors studied by ethnographers, the existence of a systematic "philosophy" that gives meaning and coherence to these cultural features. African philosophy as a discipline continuing, questioning, or criticizing the fundamental approach of *Bantu Philosophy* was born at that time, when Tempels's book was acclaimed by African and European scholars as doing justice to an African tradition of speculative thought.

Major Themes

The concept of *vital force* is considered characteristic of African philosophy. According to Tempels and to Alexis Kagame, it is a fundamental trait of African thought to hold that the force of life is the supreme value and to posit "being" and "force" as equivalent: such ontology is said to be dynamic. Although Tempels and Kagame limited their description of it to the Bantu peoples, this ontology has been considered valid for other African cultures and regions as well. It is central to the philosophy known as Negritude, defined by one of its heralds, Léopold S. Senghor, as the concept of a specific black identity founded on a core set of values shared throughout the black world.

African *religion* is an area in which the philosophy of vital force is visible. Contemporary African philosophers have established a general structure of religions other than Christianity and Islam and based on the following elements: a supreme being or force who created the world, which depends on him for its continuous existence; divinities or spirits or forces that are active in the world; ancestors who are the departed elders of the community and whose forces are still active (they have reached after their death the status of spirits, and the custom of pouring libation to them is still alive even in Christianized or Islamized groups); living creatures that are mineral, vegetal, animal, or human forces. All these beings or forces form together a field of interaction. This explains the conventional opinion that the Africans' worldview is essentially religious and indicates why this religiosity has been misunderstood as magical thinking (according to which a "force" can act on another "force" to increase or diminish it, apparently without an actual causal relationship).

African conceptions of *personhood and community* are to be understood within this cosmology. Many African philosophers hold that at the foundation of African socioethical thought is a communitarian philosophy. John Mbiti, in his *African Religions and Philosophy*, has thus summarized this notion of a priority of the community over the individual: "I am because we are; and since we are, therefore I am." *Nit, nitay garabam*, "the remedy for a human is another human," is a Wolof proverb that expresses this feature of African humanism and communalistic ethics. But a slightly different form of it—*nit niteey garabam*—is also often offered, meaning: "the remedy for a human is human behavior." This play on words is significant. The emphasis is now on the person and on the goal set for individuals to become what they have to be: accomplished humans. The community is ontologically rich in the individuals who compose it and who must realize through it their potential as accomplished persons. This dialectics of the community and the individual is considered by Kwame Gyekye as the basis for an African notion of human rights.

African cosmologies are also said to convey a specific African philosophical concept of *time*. One very controversial question is whether the future truly exists in African worldviews. After an examination of a few Bantu languages, John Mbiti has stated that, for African people, time is a composition of events and not a frame that remains when the events are taken out of it. The implication is that the past is the most important temporal dimension, while the future barely exists beyond the tiny span ahead, a mere continuation of today's events. Other African philosophers have brought forward counterexamples from other African cultures to argue that Mbiti's account was mistaken and tantamount to the prejudice against Africans as supposedly culturally unprepared to plan, manage time, or project themselves into the future.

African art is a major domain of investigation for African philosophy, as it is arguably in the arts that the greatest contributions of Africa to world culture in the twentieth century have been acknowledged. The use of stylization, the obvious symbolism of art objects that deliberately use disproportion, geometrical figures, and emphasis on certain parts of the body

have exercised influence on contemporary art worldwide and are regarded as expressive of an African metaphysics. This is also said of African music and drumming. The metaphysical significance of African dance as a way of participating in the life of the universe is central to Senghor's philosophy of African arts.

The Controversy about the Meaning of Philosophy

The radical rejection of the approach inaugurated by *Bantu Philosophy* came in the early 1970s from some African philosophers who characterized it as "ethno-philosophy," that is, a systematization of ethnological traits presented as philosophy. Paulin Hountondji and Marcien Towa are famous critics of the idea of a philosophy defined as the worldview of an ethnic group or a whole continent, arguing that philosophy is not the expression of a culture but the very possibility of stepping out of that culture and the unexamined collective opinions it carries in order to develop individual and critical thinking: folk wisdom expressed through proverbs cannot be considered the equivalent of philosophical argumentation, and one cannot speak of African philosophy in the absence of a written tradition because in oral cultures the function of memorizing is so demanding that it makes critical distance impossible. Hountondji also made the point that equating philosophy and culture would mean that everybody shares the same view in a society where unanimity would be a value; consequently, the political danger of legitimizing authoritarianism in the name of philosophical consensus could hardly be avoided. Thus traditionalism could be valued even when oppressive—to women, for example, when it comes to practices such as female circumcision.

The criticism of "ethno-philosophy" has been denounced as accepting an exclusivist Western notion of philosophy that fails to comprehend the challenge African and other speculative traditions present to this view.

For Odera Orika, beyond the controversy about philosophy lies the task of establishing a program of research in African sagacity. Individual sages—such as the Dogon Ogotemmêli—have always existed in the different African societies, and these sages can explain, question, and often criticize the elements of the culture, not simply regurgitate them. Such sages are also living today, and their thoughts must be acknowledged and recorded as part of the African philosophical library at large. Another way out of the debate about the meaning of philosophy is for contemporary African philosophers to call for a critical approach to African cultures, not to excavate their latent philosophical content but to illuminate the African context and experience and the task ahead: philosophizing in matters pertinent to the African peoples. Thus Kwasi Wiredu insists on an African orientation in philosophy that would mean conceptual decolonization. The simple test of using African languages to examine concepts such as reality, being, truth, justice, God, self, and reason would be a crucial step toward such a conceptual decolonization.

See also Negritude; Personhood in African Thought; Realism, Africa; Sage Philosophy.

BIBLIOGRAPHY

- Diop, Cheikh Anta. *Civilization or Barbarism, an Authentic Anthropology*. New York: Lawrence Hill, 1991. Translated from the French, this work was first published by Présence Africaine, Paris, in 1981. It is the last book by C. A. Diop, who died in 1986.
- Eze, Emmanuel. *African Philosophy: An Anthology*. Malden, Mass.: Blackwell, 1998.
- Griaule, Marcel. *Conversations with Ogotemmêli: An Introduction to Dogon Religious Ideas*. London and New York: Oxford University Press, 1965.
- Gyekye, Kwame, and Kwasi Wiredu eds. *Person and Community*. Ghanaian Philosophical Studies, I. Washington, D.C.: Council for Research in Values and Philosophy, 1992.
- Hountondji, Paulin. *The Struggle for Meaning: Reflections on Philosophy, Culture and Democracy in Africa*. Athens: Ohio University Center for International Studies, 2002. In this recent book the author presents his intellectual itinerary and softens some of the criticisms he leveled against "ethno-philosophy" in *African Philosophy: Myth and Reality* (London: Hutchinson, 1983).
- Kagame, Alexis. *La philosophie bantu-rwandaise de l'Être*. Brussels, Belgium: *Mémoires de l'Académie royale des Sciences coloniales*. Classe des sciences morales et politiques. Nouv. Série., t. 6, fasc. 1, 1956.
- Mbiti, John S. *African Religions and Philosophy*. 2nd ed. London: Heinemann, 1990 (1st ed. 1969).
- Mosley, Albert, ed. *African Philosophy: Selected Readings*. Englewood Cliffs, N. J.: Prentice-Hall, 1995. Contains Léopold S. Senghor's discussion of Negritude in an article titled "On Negrohood: Psychology of the African Negro."
- Oruka, H. Odera. *Sage Philosophy: Indigenous Thinkers and Modern Debate on African Philosophy*. Leiden, Netherlands, and New York: Brill, 1990.
- Tempels, Placide. *Bantu Philosophy*, 2nd edition. Paris: Présence africaine, 1969.
- Wiredu, Kwasi, ed. *Companion to African Philosophy*. Malden, Mass.: Blackwell, 2003. Theophile Obenga, who has published extensively on the Egyptian origin of African philosophy, has contributed an article titled "Egypt: Ancient History of African Philosophy." In the same volume are also: Souleymane Bachir Diagne, "Precolonial African Philosophy in Arabic" and D. A. Masolo's "African Philosophers in the Greco-Roman Era."

Souleymane Bachir Diagne

AMERICAN

American philosophies are as varied and diverse as the many backgrounds and cultures that collaborate to form American life. Even so, there are some similar emphases that cross these differences. Often, philosophies in America valorize action and the practical aspects of thought; American philosophers are regularly concerned with problems of race, class, gender, and other ethical and political forces that shape and undergird more abstract thought; and even the more religious and spiritual elements of American philosophies are characteristically addressed to matters of community and personal growth.

Native American Philosophy

Well prior to the arrival of European colonists, the Iroquois had developed sophisticated political thought and a government with a clear division of powers; Mississippian peoples

had constructed one of the largest cities in the Western hemisphere at Cahokia, spreading Mississippian religious and cultural influence throughout the region; and the Pueblo people had created intricate agricultural innovations, community structures, and economies. While it is impossible to tie together all the diverse traditions of thought and belief among the various cultures indigenous to the Americas, a few basic contrasts may be made between much of Native American thought and much of Western thought. There are clear differences in the treatment of individuality and community, in emphasis upon writing and oral communication, and in the separation, or lack thereof, between humanity and nature.

Such differences have, throughout the history of the Americas, led to misunderstandings between Native American peoples and European-Americans, as well as served as excuses to lie to, abuse, and kill indigenous people. Perhaps the most important of contemporary Native American thinkers, writers, historians, intellectuals, and activists is Vine Deloria, Jr. (1933–), whose works are extremely critical of much of U.S. culture and call for a reevaluation of the richness of Native American ways of life and thought. In 2003 the philosopher Anne Waters published an anthology, *American Indian Thought: Philosophical Essays*, a work key to understanding the breadth and depth of traditional and contemporary Native American thought.

Puritan Thought

Puritan philosophy arises out of sense of the separation and uniqueness that developed as the Puritans left England because of religious persecution and settled in the New World. The difficulty of such a journey and the problems of living in an unfamiliar land combined to add a kind of rigor and harshness to the Puritans' Christian theology and a strict ethical and social control over the members of their communities.

The first truly influential and famous of Puritan philosophers, Jonathan Edwards (1703–1758), came years after the Puritans settled in the New World, and is perhaps best known for his fiery sermons and his active role in the religious revivals of the Great Awakening. His endeavor to reconcile Calvinist theology and Congregationalist religious practices with Enlightenment philosophy and science put him squarely in the middle of the conflict between religious traditionalism and the increasing secularization of American society. Edwards's philosophy sought to discard neither religion nor science; rather, his systematic study of both brought him to espouse a naturalized religion in which religious affections and their effects on human conduct replace the supernatural as the primary objects of concern.

Transcendentalism

Transcendentalism, which blended philosophy, religious thought, social reform, and environmental concern, was most active during the first half of the nineteenth century, and most of its key figures lived in New England. These figures include Ralph Waldo Emerson (1803–1882), Henry David Thoreau (1817–1862), and Margaret Fuller (1810–1850). Through its major outlet for publications, the journal *The Dial*, transcendentalists focused on the individual as the source of moral authority and truth. Far from believing that this gave everyone the right to

do whatever he or she pleased, however, the transcendentalists described how, by looking within oneself, one can experience and reflect upon the universal that exists through all things. People all have a spark of the divine with them, according to the transcendentalists, and thus can transcend, or overcome, their limitations by turning toward the beauty and truth that lies within. Criticized for being overly optimistic about the nature of humanity and impractical for their eschewing of accepted social norms in their quest for more esoteric and ephemeral insights, nevertheless, the transcendentalists had a long-lasting and far-reaching influence on American philosophy, literature, and social thought.

Pragmatism

Pragmatism developed primarily out of the work of Charles Sanders Peirce (1839–1914), William James (1842–1910), and John Dewey (1859–1952). Peirce, a logician, semiotician, and philosopher, first developed the notion of pragmatism as a theory of meaning, a way of clarifying terms used in philosophical debate. Peirce claimed that when one understands “all the conceivable experimental phenomena which the affirmation or denial of a concept could imply,” one understands the definition of that concept. Peirce was attempting to force otherwise unending metaphysical speculation to come to terms with the effects and consequences of philosophic debate—to arrive at agreement as to the meaning of concepts by bringing those concepts into the shared realm of common experience.

While Peirce is normally heralded as the father of pragmatism, William James and John Dewey are usually credited with the popularization and refinement of this distinctly American philosophy. James, a psychologist, physician, and philosopher, emphasized the personal elements of pragmatic thought—focusing on what the adoption of pragmatic belief might mean for individuals confronted with difficult personal and philosophical dilemmas. James believed that by looking to consequences, and thus getting one's bearings through a consideration of the practical elements of a situation, one could resolve for oneself answers to otherwise endless difficulties. Dewey, also a psychologist and philosopher, and a key figure in the development of American educational theory, emphasized the social, political, and educational aspects of pragmatic thought. By looking to public and shared experience as the means of resolving philosophical debate, rather than antecedent arguments and abstract truths, Dewey's version of pragmatism focused on experimental inquiry and the refinement of practical, philosophic instruments of ongoing communication.

African-American Philosophy

African-American philosophy has historically struggled against the efforts of many European-Americans to marginalize and denigrate the importance of African-American experiences and reflections upon the unique situations of black Americans. For many centuries punished if they learned to read or write, black Americans communicated largely through the development of rich oral and religious traditions that cultivated unique and diverse philosophies of justice, morality, and human nature. As public participation and formal education among

African-Americans increased following the Abolitionist Movement of the nineteenth century and the American Civil War, African-American scholars and activists such as W. E. B. Du Bois (1868–1963), Alain Locke (1886–1954), and Martin Luther King Jr. (1929–1968) contributed to national and international debates on human rights and the nature of justice.

W. E. B. Du Bois is most famous for his explanation of the phenomenon of “double-consciousness,” by which he described the ambiguous ways in which African-Americans see themselves both from their own perspectives and from the perspectives of others. Du Bois, throughout his long career, argued that racism separates the human community, thus betraying its interdependent natures. From the founding of the National Association for the Advancement of Colored People (NAACP) early in his career to his later development as a communist, Du Bois worked continuously to embody and refine his social philosophy and reflections upon African-American experience.

Alain Locke, a Rhodes scholar and the first African-American to earn a doctorate from Harvard University, remains perhaps the most famous of African-American philosophers. During his time at Howard University, the school became the prime location for the education of African-American social thought and philosophy. Locke also published *The New Negro* in 1925, an anthology of work meant to encapsulate and present the Harlem Renaissance. According to Locke, this movement embodied and carried forward the notion of value pluralism, a rejection of absolutist philosophies and a positive construction of alternatives to the essentializing tendencies of Western philosophy.

From his inspirational sermons, to his elaboration of the philosophy of non-violence, to his leadership role in the American civil rights movement, the life and work of Martin Luther King Jr. is a testament to the American spirit of uniting philosophy with action, theory with practice. Steeped in both the tradition of the Southern black churches and the philosophy of personalism espoused by Borden Parker Bowne (1847–1910) and Edgar S. Brightman (1884–1953), King believed in a living, personal God whose struggle for justice is evidenced in the concrete actions of ethical human persons. King urged that people treat each other with respect for the presence of God in the growth of individuals and communities—that is, he urged that individuals treat each other as persons. King’s personalism and his encounter with the work of the Indian religious leader Mohandas Gandhi (1869–1948) led him to preach a philosophy of non-violent resistance toward social injustices, thus providing the grounds for one of the more momentous public movements in American history.

Feminist Philosophy

Women in American society have also been marginalized and their unique perspectives have been often overlooked and many times simply discarded. Despite this forced invisibility, American women have contributed to worldwide feminist movements, often in uniquely American ways far different from their counterparts in other nations and cultures.

Western civilization seems clear, orderly, obvious, and without possibility of reform primarily because it defines the world in certain rigid categories. The product of this clarity, however, is a certain kind of insanity that can survive only by renewed efforts to refine the definitions and that, ultimately, becomes totally self-destructive.

SOURCE: Vine Deloria Jr., *Spirit and Reason*, p. 4.

From childhood, Jane Addams (1860–1935) was deeply troubled by the blight of economic and social inequality. As a philosopher, social activist, and founder of Hull House, a settlement house for immigrants and the working poor in Chicago, her work focused on rehabilitating communities in theory and in practice, and rectifying inequalities not by philanthropic charity work, but by cultivating sympathetic understanding and mutual concern. Addams offered her principle of *reciprocity* as an important tool with which to approach the building of communities. Addams insisted that the interaction of otherwise separate social groups be treated as reciprocal, that is, as offering mutual benefit. Viewed in this way, what might otherwise become an impersonal philanthropic enterprise that serves to make more explicit the line between giver and taker becomes instead an opportunity for mutual enrichment and the sympathetic understanding necessary to create a community.

In the late twentieth century, feminist Carol Gilligan (1936–) wrote *In a Different Voice: Psychological Theory and Women’s Development* (1982), calling for recognizing the different and valuable ways that women think and evaluate moral situations. Having done extensive study on moral and psychological development, Gilligan found most research to be biased toward the male point of view. Focusing instead on care for others and responsibility toward relationships, feminine morality should be valued for its own merits and not treated as secondary to a more masculine emphasis on rules, rights, and laws, according to Gilligan.

Catharine MacKinnon (1946–), an attorney, social activist, and writer, successfully argued that sexual harassment is, legally, a form of sexual discrimination. Her books and other writings have had a powerful impact on American and international movements in the legal status of pornography, hate speech, and women’s rights. Other key contemporary American feminists are Sandra Harding (1935–), Nancy Fraser, Donna Haraway (1944–), and Alison Jaggar.

Anglo-American Philosophy

Anglo-American philosophy, also known as analytic philosophy, is largely an import from European thinkers who immigrated to the United States during the first half of the twentieth

century and their followers. Perhaps the most famous of these immigrants was Bertrand Russell (1872–1970), who was a serious academic philosopher and a great popularizer of both analytic philosophy and his own controversial ethical and political beliefs. Analytic philosophy focuses on rigorous argumentation, is typically quite amenable to scientific evidence and concerns, and tends to primarily address linguistic, logical, epistemological, and metaphysical issues. In some ways, analytic philosophy arose as a reaction to what was seen as a weakness in much of European philosophy—its increasing tendency toward vagueness, metaphor, and literary conceit. By the end of the twentieth century, Anglo-American philosophy and its methods had become the most influential force in most academic philosophy departments in the United States, as well as in the largest group of professional philosophers, the American Philosophical Association.

See also *Analytical Philosophy; Philosophies: Feminist, Twentieth-Century; Pragmatism.*

BIBLIOGRAPHY

- Addams, Jane. *Democracy and Social Ethics*. New York: Macmillan, 1902.
- Deloria, Vine, Jr. *Spirit and Reason: The Vine Deloria, Jr., Reader*. Golden, Colo.: Fulcrum, 1999.
- Flower, Elizabeth, and Murray Murphey. *A History of Philosophy in America*. 2 vols. New York: Putnam, 1977.
- Harris, Leonard, ed. *Philosophy Born of Struggle: Anthology of Afro-American Philosophy from 1917*. Dubuque, Iowa: Kendall/Hunt, 1983.
- Martinich, A.P., and David Sosa, eds. *Analytic Philosophy: An Anthology*. Malden, Mass.: Blackwell, 2001.
- Myerson, Joel, ed. *Transcendentalism: A Reader*. Oxford: Oxford University Press, 2000.
- Schneider, Herbert W. *A History of American Philosophy*. New York: Columbia University Press, 1946.
- Seigfried, Charlene Haddock. *Pragmatism and Feminism: Reweaving the Social Fabric*. Chicago: University of Chicago Press, 1996.
- Smith, John E., Harry S. Stout, and Kenneth P. Minkema, eds. *A Jonathan Edwards Reader*. New Haven, Conn.: Yale University Press, 1995.
- Stuhr, John J., ed. *Pragmatism and Classical American Philosophy: Essential Readings and Interpretive Essays*. Oxford: Oxford University Press, 1999.
- Waters, Anne, ed. *American Indian Thought: Philosophical Essays*. Malden, Mass.: Blackwell, 2003.

Stephen Barnes

FEMINIST, TWENTIETH-CENTURY

The term *feminism* is used both in reference to social movements, such as the late-nineteenth century women's rights movement or the mid-twentieth century women's movement in Europe and the United States, and to theories that identify and critique injustices against women, such as *A Vindication of the Rights of Woman* by Mary Wollstonecraft (1759–1797) or *The Book of the City of Ladies* by Christine de Pisan (c. 1364–1430). Although there are various uses of the term, a core connotation of *feminism* is the commitment to revealing and eliminating sexist oppression.

If one searches the discipline of twentieth century philosophy for philosophers who were feminists, few if any names surface prior to mid-century. It was only beginning in the last half of the twentieth century that philosophers systematically turned their attention to the issues of feminism and embraced the label of "feminist philosophy" to signify a method or focus of attention for doing philosophy. Although it would be a mistake to conclude from this that earlier philosophers were not concerned with the identification and elimination of gender injustice, it does reflect the fact that this was not a central concern of academic philosophy.

It could be argued that feminist philosophy in the late nineteenth and early twentieth centuries began outside the academy, birthed through the writings and radical activities of such feminists as Charlotte Perkins Gilman (1860–1935), Ida B. Wells-Barnett (1862–1931), Emma Goldman (1869–1940), Jane Addams (1860–1935), and Anna Julia Cooper (1858–1964). Indeed, one important tenet of feminist history of philosophy is an awareness of the fact that due to the systemic exclusion of most women from the dominant sites of philosophy—the academy and the seminary—one must look to those locations where women are doing philosophy at different historical periods, such as the salon, the convent, and the women's movement.

Many scholars have marked the genesis of contemporary feminist philosophy with *The Second Sex* by Simone de Beauvoir (1908–1986), and there is good reason for doing so. *The Second Sex* provides one of the first sustained analyses of the lived experience of "becoming woman." Beauvoir examines the institutions and practices that lead to women internalizing a sense of inferiority to men, that is, woman as Other. Beauvoir's philosophical insights are contained in her now famous phrase, "One is not born a woman: one becomes one." In this she presages feminist distinctions between sex and gender, and the ways in which women are "produced" through complex disciplinary practices such as marriage, motherhood, and sexuality.

Beauvoir's philosophy not only provided an important source of modern feminist philosophy, the reception of her work illustrates the very types of exclusions feminists have critiqued. Her writings were, until recently, often relegated to asides or footnotes, and typically treated as derivative of the philosophy of Jean-Paul Sartre (1905–1980). The 1967 *The Encyclopedia of Philosophy*, to cite just one telling example, only refers to Beauvoir in two entries, one on Sartre where she is described as one of the founders of the review *Les Temps Modernes*, and another on existentialism that asserts that she employed some of Sartre's analyses in her writings. Contemporary feminist philosophical scholarship on Beauvoir has transformed her position in the philosophical canon by demonstrating the significant impact of Beauvoir's ideas on Sartre's philosophy and by locating her work within the phenomenological tradition.

Social and Political Theory

Feminist philosophical work that emerged after Beauvoir's *Second Sex* was influenced by the women's movement and had

a strong focus on issues of justice and equality. Feminist philosophers began by paying attention to women, to their roles and locations. What are women doing? What social and political locations are they part of or excluded from? How do their activities compare to those of men? What do women's roles and locations allow or preclude? How have their roles been valued or devalued? Because of the centrality of questions such as these, feminist philosophers grappled with political theories that would be adequate to such concerns.

Alison Jaggar's 1983 *Feminist Politics and Human Nature* provided an influential discussion of the various political theories feminists employed in efforts to argue for women's liberation. Jaggar delineated four primary frameworks: liberal feminism, which focuses on rights and equal access, and argues that the primary cause of women's oppression is laws and rules that limit women's equal access to educational, economic, and political institutions; Marxist feminism, which argues that at the root of sexist oppression is class oppression; radical feminism, which identifies patriarchy and male control over women's bodies, including sexuality and reproduction, as the cause of sexual subordination; and socialist feminism, which views economic and social institutions as interdependent and thus attempts to incorporate the insights of the class analysis of Marxism with the radical feminist critique of patriarchal social organizations.

Ethics

Contemporary feminist philosophers have also enriched and arguably transformed the field of ethics. Through their attention to the concerns of women, feminist philosophers have introduced new issues to feminist ethics and social theory, such as affirmative action, sexual harassment, and comparable worth, and have brought new insights to more traditional issues, for example, discussions of abortion, and the institutions of marriage, sexuality, and love.

Some feminists who work in the field of ethics have argued that traditional ethical theories are inadequate in that they ignore the experiences and perspectives of women by overstressing rights or duties and neglecting issues of care and relationships. Virginia Held argues for an enriched moral theory that is based not on the ideal of the "autonomous man" but rather on the ideal of the "relational woman." Others, such as Sara Ruddick, have argued that traditional Western ethical theories have trivialized those virtues historically associated with women and in so doing have neglected the fact that the typical moral situation is not between two completely autonomous and equal individuals, but rather, more like the relationship between parent and child: that is, between individuals with different strengths and weaknesses. Ruddick claims that maternal practices, with their aims of preservation, growth, and acceptability of children, provide a particularly rich alternative to the "contract model" of liberal social theory.

Feminist philosophers have also argued that attention to gender cannot be done in isolation from other axes of oppression, such as sexuality, race, ability, or class. The work of feminist philosophers such as Linda Martín Alcoff, Claudia Card, Nancy Fraser, Marilyn Frye, Sarah Lucia Hoagland, Eva

Kittay, María Lugones, Anita Silvers, Elizabeth Spelman, Iris Marion Young, and Naomi Zack reveal the importance of analyses that identify the structure and consequences of the interaction between different forms of discrimination or subordination.

While ethics and political theory have been a focal point of contemporary feminist philosophers, feminist philosophical work has included all the core areas of philosophy and has made use of all the philosophical traditions. The "difference" of feminist philosophy does not have to do with philosophical traditions or themes—indeed, feminist philosophers work in all the traditions of philosophy including analytic, Continental, and classical American philosophy, and their thematic focus is often influenced by the topics and questions highlighted by these traditions.

History of Philosophy

Feminist work in the history of philosophy was initially concerned with analyzing canonical philosophers' accounts of women and their conceptions of femininity. Although there were exceptions, the philosophical canon is rife with conceptions of women as lesser or misbegotten men, a bias that has had a profound structuring impact on the history of philosophical and scientific conceptions of men as the true form and women as inferior. Luce Irigaray argues that woman has been defined not in terms of true difference from men, but in terms of lack according to an A (male) / -A (female) logic. Men are the true form; women the deviation. Men are rational animals; women less capable of reason.

But the "question of women" in feminist scholarship in the history of philosophy is far broader than canonical (male) philosophical views of women. Much feminist philosophical scholarship has been devoted to recovering the work of women philosophers who have been "forgotten" or, like Beauvoir, seen as too marginal to be included in the canon. Philosophers of history such as Mary Ellen Waite, Eileen O'Neill, Therese Dykeman, and John J. Conley, who have devoted their attention to recovering the work of women philosophers, argue that the lack of women philosophers in contemporary histories of philosophy is due neither to the absence of women philosophers nor to the significance and value of their work, but is the result of complex values that inform the narratives of philosophy and determine what questions and styles count as philosophical and whose voices are sufficiently influential to be chronicled.

Feminists working in the history of philosophy have further argued that gender leaves traces not only on canonization processes, but deeply inscribes the very concepts of philosophy. One common theme in feminist histories of philosophy is the contention that many of the central categories of philosophy are formed through the exclusion of the feminine. In a complex two-step process, concepts such as reason, morality, and agency are produced through the prioritizing of masculine characteristics and the forgetting of gender. The concepts so constructed are then posited as objective and universal rather than gendered and particular. As just one example, Genevieve Lloyd argues that "rationality has been

conceived as the transcendence of the feminine; and the ‘feminine’ itself has been partly constituted by its occurrence within this structure” (p. 104).

To the extent that the central categories of philosophy have been inscribed in this way, not only is philosophy *not* the objective, universal practice many philosophers have believed it to be, it is also complicit in a social organization that impoverishes the lives of women as well as men. The question of the maleness of reason, for example, may be what is behind common judgments of women as less capable of rational thought, but the question itself is far more complex. To investigate the maleness of reason, one must consider the extent to which conceptions of rationality have privileged traits historically associated with masculinity. In other words, one must consider the extent to which the attainment of rationality has been perceived as involving the control or transcendence of attributes historically identified as female—the body, the emotions, the passions, the appetites, the erotic. If it is the case that what Michèle Le Dœuff has called the “philosophical imagery of gender” (1989) is inscribed onto a philosopher’s conception of reason, then one can not simply ignore his (or her) sexism for it is at the core of the values from which this central category emerges.

Feminist philosophy’s attendance to the denigration of the feminine in the history of philosophy presents an important step, but one that must be seen as a first step of a much larger inquiry. Feminists delineate such bias not to simply reject a philosopher, but rather to participate in new ways of reading historical texts that identify resources for engendering the central concepts of philosophy in ways not predicated on the forgetting of gender. These reading strategies are diverse and reflect the different positions and training of feminists themselves. Some, such as Le Dœuff, Penelope Deutscher, Sarah Kofman, and Irigaray, bring deconstructive methods to bear on canonical texts. Others, such as Annette Baier, Barbara Herman, and Martha Nussbaum, read through the lens of contemporary feminist revaluing of the emotions.

Epistemology and Philosophy of Science

Feminist philosophers have also made significant contributions to epistemology and the philosophy of science. Lloyd’s insights about the gendering of reason led to substantive analysis of contemporary conceptions of rationality, the process of inquiry, and the knowing subject. Epistemologists and philosophers of science such as Lorraine Code, Sandra Harding, Helen Longino, Lynn Hankinson Nelson, Elizabeth Potter, and Naomi Scheman have critiqued traditional “S knows that P” models of knowledge. A common theme of feminist epistemology is that the traditional view of the knowing subject as distinct but not distinctive is inadequate in that it occludes the ways in which human knowledge practices emerge out of and are influenced by social structures, including those of gender. In other words, the goal of a generic knower is misguided in that subjectivity is always at least partially socially constituted. On this position, no one, regardless of gender, race, class, or ability, is a generic subject.

This conception of situated knowers is a key component of many feminist epistemologies and philosophies of science.

Harding develops a version of standpoint theory to account for the ways in which social location can impact knowledge practices, and argues that this theory supports a strengthened conception of objectivity, one that is less susceptible to the production of community-wide biases than research modeled on the “neutrality ideal.” Longino and Nelson have also critiqued the individualism of “S knows that P” accounts, arguing in the case of Longino that knowledge is held by persons who are part of complex social communities where both the knower and what is known are marked by that relationship. Nelson, building on a naturalized epistemology inspired by W. V. O. Quine’s emphasis on studying how humans in fact reason, argues that it is communities rather than individuals who know.

The commitment to situated knowers has led to an appreciation of the role of embodiment in knowledge practices (for example, in the work of Susan Bordo, Elizabeth Grosz, and Gail Weiss), as well as the role of emotion, imagination, empathy, and values (for example, in the work of Louise Antony, Susan Babbitt, Lorraine Code, Longino, and Alison Wylie).

Conclusion

Feminist philosophical work is making an impact in other areas of philosophy such as metaphysics (Charlotte Witt, Sally Haslanger, Marilyn Frye, Christine Battersby), aesthetics (Peg Brand, Cynthia Freeland), and the philosophy of religion (Pamela Sue Anderson, Ellen Armour, Gail Jantzen).

For those who would critique feminist philosophy as motivated by political concerns and thus not a pure philosophy, Alcoff provides a reminder that much work in the history of western philosophy emerged out of particular political motivations, including the work of René Descartes (1596–1650), Immanuel Kant (1724–1804), John Locke (1632–1704), and Bertrand Russell (1872–1970). As Alcoff explains, “like Kant, feminist philosophers are committed to using philosophical methods to clarify and disempower the current dogmatism that inhibit political advance” (p. 55).

See also Feminism; Gender; Gender Studies; Anthropology; Human Rights; Women’s Rights; Sexual Harassment; Womanism.

BIBLIOGRAPHY

- Addams, Jane. *Democracy and Social Ethics*. New York: Macmillan, 1902.
- Alcoff, Linda Martín. 2001. “On Judging Epistemic Credibility: Is Social Identity Relevant?” In *Engendering Rationalities*, edited by Nancy Tuana and Sandra Morgen. Albany: State University of New York Press, 2001.
- Anderson, Pamela Sue. *A Feminist Philosophy of Religion: The Rationality and Myths of Religious Belief*. Oxford: Blackwell, 1998.
- Antony, Louise M. “Quine as Feminist: The Radical Import of Naturalized Epistemology.” In *A Mind of One’s Own: Feminist Essays on Reason and Objectivity*, edited by Louise M. Antony and Charlotte Witt. Boulder, Colo.: Westview, 1993.
- Armour, Ellen T. *Deconstruction, Feminist Theology and the Problem of Difference: Subverting the Race/Gender Divide*. Chicago: University of Chicago Press, 1999.

- Babbitt, Susan E. *Impossible Dreams: Rationality, Integrity, and Moral Imagination*. Boulder, Colo.: Westview, 1996.
- Baier, Annette. *A Progress of Sentiments: Reflections on Hume's Treatise*. Cambridge, Mass.: Harvard University Press, 1991.
- Battersby, Christine. *The Phenomenal Woman: Feminist Metaphysics and the Patterns of Identity*. New York: Routledge, 1998.
- Beauvoir, Simone de. *The Second Sex*. Translated and edited by H. M. Parshley. New York: Knopf, 1953.
- Bordo, Susan. *Unbearable Weight: Feminism, Western Culture, and the Body*. Berkeley: University of California Press, 1993.
- Brand, Peg, and Mary Devereaux, eds. "Women, Art, and Aesthetics." Special issue of *Hypatia: A Journal of Feminist Philosophy* 18, no. 4 (2003), entire issue.
- Card, Claudia. *Lesbian Choices*. New York: Columbia University Press, 1995.
- Code, Lorraine. *What Can She Know? Feminist Theory and the Construction of Knowledge*. Ithaca, N.Y.: Cornell University Press, 1991.
- Cooper, Anna Julia. *A Voice from the South*. Xenia, Ohio: Aldine, 1892.
- Conley, John J. *The Suspicion of Virtue: Women Philosophers in Neoclassical France*. Ithaca, N.Y.: Cornell University Press, 2002.
- Deutscher, Penelope. *Yielding Gender: Feminism, Deconstructionism, and the History of Philosophy*. London: Routledge, 1997.
- Dykeman, Therese Boos, ed. *The Neglected Canon: Nine Women Philosophers First to the Twentieth Century*. Dordrecht, Netherlands: Kluwer Academic, 1999.
- Fraser, Nancy. *Unruly Practices: Power, Discourse, and Gender in Contemporary Social Theory*. Minneapolis: University of Minnesota Press, 1989.
- Freeland, Cynthia. *But Is It Art?: An Introduction to Art Theory*. Oxford: Oxford University Press, 2001.
- Frye, Marilyn. *The Politics of Reality: Essays in Feminist Theory*. Trumansburg, N.Y.: Crossing Press, 1983.
- Gilman, Charlotte Perkins. *Women and Economics: A Study of the Economic Relation between Men and Women as a Factor in Social Evolution*. Boston: Small, Maynard, 1898.
- Goldman, Emma. *The Traffic in Women and Other Essays in Feminism*. New York: Times Change Press, 1970.
- Grosz, Elizabeth A. *Volatile Bodies: Toward a Corporeal Feminism*. St. Leonards, Australia: Allen and Unwin, 1994.
- Harding, Sandra. *Whose Science? Whose Knowledge?: Thinking with Women's Lives*. Ithaca, N.Y.: Cornell University Press, 1991.
- Haslanger, Sally. "Feminism and Metaphysics: Negotiating the Natural." In *Cambridge Companion to Feminism in Philosophy*, edited by Miranda Fricker and Jennifer Hornsby. Cambridge, U.K.: Cambridge University Press, 2000.
- Held, Virginia. *Feminist Morality: Transforming Culture, Society, and Politics*. Chicago: University of Chicago Press, 1993.
- Herman, Barbara. *The Practice of Moral Judgment*. Cambridge, Mass.: Harvard University Press, 1993.
- Hoagland, Sarah Lucia. *Lesbian Ethics: Toward New Value*. Palo Alto, Calif.: Institute of Lesbian Studies, 1988.
- Irigaray, Luce. *Speculum of the Other Woman*. Translated by Gillian C. Gill. Ithaca, N.Y.: Cornell University Press, 1985.
- Jaggar, Alison. *Feminist Politics and Human Nature*. Totowa, N.J.: Rowman and Allanheld, 1983.
- Jantzen, Gail. *Becoming Divine: Towards a Feminist Philosophy of Religion*. Manchester, U.K.: Manchester University Press, 1998.
- Kittay, Eva. *Love's Labor: Essays on Women, Equality, and Dependency*. New York: Routledge, 1999.
- Kofman, Sarah. *The Enigma of Woman: Women in Freud's Writings*. Translated by Catherine Porter. Ithaca, N.Y.: Cornell University Press, 1985.
- . *Socrates: Fictions of a Philosopher*. Translated by Catherine Porter. Ithaca, N.Y.: Cornell University Press, 1998.
- Le Dœuff, Michèle. *The Philosophical Imaginary*. Translated by Colin Gordon. Stanford, Calif.: Stanford University Press, 1989.
- Lloyd, Genevieve. *The Man of Reason: "Male" and "Female" in Western Philosophy*. Minneapolis: University of Minnesota Press, 1984.
- Longino, Helen. *Science as Social Knowledge: Values and Objectivity in Scientific Inquiry*. Princeton, N.J.: Princeton University Press, 1990.
- Lugones, María. *Pilgrimages = Peregrinajes: Theorizing Coalition Against Multiple Oppressions*. Lanham, Md.: Rowman and Littlefield, 2003.
- Nelson, Lynn Hankinson. *Who Knows: From Quine to a Feminist Empiricism*. Philadelphia: Temple University Press, 1990.
- Nussbaum, Martha C. *Sex and Social Justice*. New York: Oxford University Press, 1999.
- O'Neill, Eileen. "Disappearing Ink: Early Modern Women Philosophers and Their Fate in History." In *Philosophy in a Feminist Voice: Critiques and Reconstructions*, edited by Janet A. Kourany. Princeton, N.J.: Princeton University Press, 1998.
- Pisan, Christine de. *The Book of the City of Ladies*. Translated by Rosalind Brown-Grant. London: Penguin, 1999.
- Potter, Elizabeth. *Gender and Boyle's Law of Gases*. Bloomington: Indiana University Press, 2001.
- Ruddick, Sara. *Maternal Thinking: Towards a Politics of Peace*. Boston: Beacon, 1989.
- Scheman, Naomi. *Engenderings: Constructions of Knowledge, Authority, and Privilege*. New York: Routledge, 1993.
- Silvers, Anita, David Wasserman, and Mary B. Mahowald, eds. *Disability, Difference, Discrimination: Perspectives on Justice in Bioethics and Public Policy*. Lanham, Md.: Rowman and Littlefield, 1998.
- Spelman, Elizabeth. *Inessential Woman: Problems of Exclusion in Feminist Thought*. Boston: Beacon, 1988.
- Tougas, Cecile T., and Sara Ebenrick, eds. *Presenting Women Philosophers*. Philadelphia: Temple University Press, 2000.
- Tuana, Nancy. 1993. *The Less Noble Sex: Scientific, Religious, and Philosophical Conceptions of Woman's Nature*. Bloomington: Indiana University Press, 1993.
- . *Woman and the History of Philosophy*. New York: Paragon House, 1992.
- Weiss, Gail. *Body Images: Embodiment as Intercorporeality*. New York: Routledge, 1999.
- Wells-Barnett, Ida B. *On Lynchings*. Amherst, Mass.: Humanity Books, 2002.
- Witt, Charlotte. "Feminist Metaphysics." In *A Mind Of One's Own*, edited by Louise Antony and Charlotte Witt. Boulder, Colo.: Westview, 1993.
- Wollstonecraft, Mary. *A Vindication of the Rights of Women*. London: J. Johnson, 1792.
- Wylie, Alison. *Thinking From Things: Essays in the Philosophy of Archaeology*. Berkeley: University of California Press, 2002.
- Young, Iris Marion. *Justice and the Politics of Difference*. Princeton, N.J.: Princeton University Press, 1990.
- Zack, Naomi. *Race and Mixed Race*. Philadelphia: Temple University Press, 1993.

Nancy Tuana

ISLAMIC

All Muslims hold the Koran as the very word of God, who provides guidance and understanding of creation and proper human conduct by divine wisdom (*hikma*). This wisdom is also reflected in the oral statements of the prophet Muhammad collected in the Traditions (hadith) and in the reports of the life and deeds (sunna) of the Prophet. The study of these in the traditional Islamic religious sciences of Koranic commentary (*tafsir*), Traditions, religious law (*al-fiqh*), Arabic grammar, and related religious studies is the human response to the command of the Koran to seek out knowledge and understanding (20:114; 39:9). That search for knowledge and understanding is not limited to studies strictly religious since the whole of creation manifests divine wisdom. Hence medicine, mathematics, and study of nature can be included in the divine command, though these are classified as foreign sciences and rational or intellectual sciences. Philosophy, which retains its reference to its non-Islamic origins in its transliterated form as *falsafah*, is located in this second group but nevertheless came to be identified by the philosophers of the Islamic milieu with the wisdom (*al-hikma*) mentioned in the Koran and Traditions of the Prophet. In the classical period (eighth to twelfth centuries) the major philosophers of the lands of Islam (*dar al-islam*) characterized philosophical understanding at the highest levels as concerned with principles ultimately founded in God and thereby claimed a rightful stake in knowledge of the divine and of God's creation for the rational sciences. The significance of this idea can hardly be overemphasized since this controversial assertion of the value of independent rationality was a hallmark of philosophy in the classical period and has had a deep and lasting influence not only among Muslim, Christian, and Jewish philosophical thinkers in Islamic lands but also in the medieval Latin West, where its effect was shocking and altogether new.

Philosophical Theology in Islam

Among the most important participants in *kalam* or Islamic theological dialectics were the Mu'tazilis whose name came from their reasoned disassociation from extremist views of moral purists (Kharijīs), who would exclude sinners from the community and from those more accepting of transgressors (Murji'īs). The name came to be associated with theologians asserting the value of human reason in the judging of religious issues, famously insisting on rational coherence in regard to divine attributes by denying scriptural literalism in favor of allegorical interpretation and the denial of attributes to divine unity, on the rational necessity of the restraint of divine justice by human freedom, and on the created nature of the Koran. Abu'l-Hasan al-Ash'ari (873–935), breaking away from his Mu'tazili teacher, al-Juba'i (d. 915), argued for the literal understanding of divine attributes recounted in God's revelation, for what is now characterized as divine command moral theory (that Justice is itself defined as whatever God decrees), and for the eternal speech of God and the uncreated Koran. This was so, he asserted, because on such matters the statements of the Koran must be accepted *bi-la kayf*, "without asking how." Insofar as all power belongs to God, all actions are dependent upon God and are merely "acquisitions" (*aksab*) by humans of states and actions created by God. This led to the

development of an occasionalist atomism in which transitory atoms having no persisting natures are renewed in existence only by divine power and apparent regularity of nature is fully dependent on divine will. The Ash'ari analysis receives its most powerful expression in the later thought of al-Ghazali, who attacked Aristotelian accounts of natural causality by famously arguing that there is no metaphysically necessary connection between what purport to be cause and effect.

Transmission and Development of Greek Science and Philosophy

The quantity of important works of science and philosophy translated into Arabic was unrivaled until modern times. Among the philosophical writings translated were the entire corpus of Aristotle's works (with the notable exception of his *Politics*), the dialogues of Plato as well as their *Summaries* by Galen, a vast array of medical works by Galen and others, substantial portions of the *Enneads* of Plotinus, the *Isagoge* and other works of Porphyry, and works by nearly all of the writers of the philosophical commentary tradition, such as Theophrastus, Alexander, Iamblichus, Themistius, Syrianus, Proclus, Ammonius, Simplicius, Philoponus, Olympiodorus, and others.

The extraordinary transference of philosophical and scientific knowledge from Greek into Arabic that took place during the long period of the Abbasid caliphate may be traced to a large array of factors: a desire to enhance Abbasid power by opening Islamic society to many different peoples; concerns of the ruling class for future success (thus the interest in Greek astrology) and for good health (thus the interest in Greek medical writings); the needs of a new, powerful, and growing empire for knowledge both practical and theoretical; and perhaps also a cultural ideology of valuing knowledge in all its forms as part of a Zoroastrian heritage. Whatever the precise reasons, it is clear that the translation, assimilation, and development of Greek thought was a broad cultural movement involving Christians, Muslims, and Jews working in concert both as translators and as philosophers teaching students and developing new approaches that, though founded on Greek thought, inevitably led to new doctrines argued not solely on the basis of tradition but on the basis of new scientific analyses and on the basis of reason itself.

Al-Kindi and the Assimilation of Greek Neoplatonic Metaphysics

Research on the thought of al-Kindi (d. c. 870) and an early phase of the translation movement at Baghdad has led to the conclusion that this Arab philosopher was part of a circle or group of thinkers with special interest in Greek metaphysical texts concerning God, the higher intellects moving the heavens, and the soul. Among the works translated wholly or partially and studied by this group were Aristotle's *Metaphysics* by Eustathius; selections from Plotinus's *Enneads*, books 4–5 (portions of which were revised, edited, prefaced by al-Kindi to be issued as the *Theology of Aristotle*); Plato's *Timaeus*; Aristotle's *On the Heavens*, *Meteorology*, *Prior Analytics*; works on animals by Yahya Ibn al-Bitriq; and selections or perhaps all of the *Elements of Theology* of Proclus as well as other selections by Proclus attributed to Alexander of Aphrodisias

by unknown translators (Endress). This group produced a paraphrase of the *De Anima*; the widely read and influential *Theology of Aristotle*; and the *Discourse on the Pure Good*, a creationist treatise based on the *Elements of Theology* of Proclus and the *Theology of Aristotle*. The *Discourse* was read in Arabic by a number of philosophers but had its greatest influence in the Latin West as the *Liber de causis*, where its highly influential discussion of the First Cause as being alone, devoid of form, was read as the completion of Aristotle's discussion of God in the *Metaphysics* (D'Ancona and Taylor). That metaphysical doctrine was borrowed from the Arabic Plotinus, which had already probably been "adapted" by the Christian translator Ibn Na'ima al-Himsi to monotheism and to an Aristotelian conception of God as the First Being and cause of all other beings (Adamson). In the pseudo-Aristotelian *Theology of Aristotle*, metaphysics ("what is after the physical") is presented as identical with divine sovereignty (*rububiyya*) and divine things (*ilahiyat*). Al-Kindi as editor and presumed author of the preface of this work set forth the view that the subject matter of metaphysics is the same as that of dialectical theology or *kalam*.

Arguing against those theologians of his day who would reject any role for the foreign science of philosophy, al-Kindi boldly asserted in what is extant from his *On First Philosophy* that the goal of the philosopher is the attainment of truth by causal knowledge of the True One, which is the cause of existence for all things. Identifying the religious study of divine unity (*tawhid*) as having the same end as the philosophical pursuit of the truth, al-Kindi not only argues for a major role for philosophy in defending against unbelievers of various sorts but also asserts that philosophical metaphysics has the God of revelation as its ultimate object of study. By an examination of the nature of unity or oneness (*wahda*), al-Kindi concludes that there is no true or essential unity in created things and that unity must be derived from the True One. Creation is also argued in another work to be the only True Agent insofar as it alone acts by a creative agency presupposing nothing, while all other agents are mere metaphorical agents insofar as their agency is not essentially their own but rather derived from their being and power, which are to be traced to God. These accounts of God as True Unity and as First and Primary Cause of all are also found in the *Discourse on the Pure Good* and contribute to the view that al-Kindi himself may have been the author or editor of that work as well as of the *Theology of Aristotle*. Al-Kindi's philosophical psychology is also based on a mixture of genuine Aristotelian teachings and adapted teachings of Plotinus, though other sources from the Greek tradition are detectable. His treatise *On the Intellect* with its assertion of intellect as of four kinds (intellect eternally in act, intellect as potency in the soul, intellect as an actualized disposition in the soul, and intellect as act in the soul) shows more immediate dependence on the school account of the Christian Alexandrian John Philoponus. He also employed the arguments of Philoponus to assert for philosophical reasons the temporal creation, a doctrine thought to be in accord with the apparent sense of Koranic revelation. And in his ethical treatise, *On the Art of Dispelling Sorrows*, he draws upon the Stoic argument for restraint regarding earthly desires and the cares they engender for the sake of a hoped-for lasting and

permanent intellectual fulfillment of the higher realm not further elaborated.

In his teachings al-Kindi clearly showed a degree of affinity with the rationalist goals of the Mu'tazili theologians of his day as well as a desire for conciliation of philosophy and Islam, though his commitment to Greek philosophy was foundational. That his followers used his works and those of his group for the understanding of Islamic teachings is particularly evident in the work of al-'Amiri (d. 992) who wrote *On the Afterlife*, drawing on Aristotelian and Neoplatonic sources for arguments for personal immortality promised in the Koran. He made use of a large array of materials from al-Kindi's group and was quite familiar with the Arabic Plotinus texts as well as with the *Discourse on the Pure Good*, which he paraphrased in *Chapters on Metaphysical Topics* (Rowson). The tradition of al-Kindi, however, was soon eclipsed by the work of Avicenna, who drew upon the thought of al-Farabi, a thinker who was less sanguine on the harmony of philosophy with Islam.

Hunayn ibn Ishaq and Baghdad Aristotelianism

Contemporaneous with the circle of al-Kindi, the Christian Hunayn ibn Ishaq (d. 873) initiated a tradition of sophisticated translation of Greek philosophical, medical, and scientific works into Syriac and Arabic. In contrast to the al-Kindi group, Hunayn's group of translators and their successors made extensive efforts to track down works for translation, exercised greater care in selecting and collating manuscripts, translated by consideration of whole phrases or sentences rather than individual words, and standardized much vocabulary. Translation, particularly of works by Galen and other physicians, was a lucrative business, and some of its practitioners were paid well by wealthy families for quality translations and the revision or retranslation of earlier versions. The enormous wealth of translations of this period recorded in the *Fihrist* or book catalogs of Ibn al-Nadim bears witness to the fertile ground for the rise of a new Aristotelianism in Baghdad fostered by Christian translators and philosophers of Syriac background, such as Abu Bashr Matta, Ishaq ibn Hunayn, and many others who were able to consult Syriac as well as Arabic translations. F. W. Zimmermann notes that "in the contemporary milieu of Baghdad the predominant language of Christian scholarship still was Syriac. Syriac Christianity, owing to its roots in the Greek church and a considerable tradition of Hellenic learning in Syriac, had a virtual monopoly of access to the Greek legacy" (al-Farabi, 1981, lxxvii). The tradition this movement inherited was that of late Aristotelianism of the Alexandrian School. And while he apparently did not know Syriac and depended on his teachers and colleagues for philosophical sources, the representative of this tradition most well-known today is al-Farabi.

Abu Nasr al-Farabi

Abu Nasr al-Farabi (c. 870–950) likely worked for the greater part of his eighty-year lifespan in Baghdad, where he was a student of logic with the Christian Yuhanna ibn Haylan and taught the Christian Yahya ibn 'Adi, who came to be a leading philosophical figure in Baghdad. Al-Farabi was thoroughly engaged in the great project of the establishment of a new

Alexandrian Aristotelianism in the Arabic philosophical context. His apparently enormous literary output, of which only a modest portion survives, includes sophisticated paraphrases and commentaries on Aristotle's logical works as well as lost commentaries on Aristotle's *On Generation and Corruption* and *Nicomachean Ethics*, innovative emanationist accounts of principles governing the universe and human societies (*The Principles of the Opinions of the People of the Virtuous City* and *The Political Regime or the Principles of Beings*), a set of works on Plato and Aristotle (*The Attainment of Happiness*, *The Philosophy of Plato*, *The Philosophy of Aristotle*, *The Harmony of Plato and Aristotle*), complex works on the nature of metaphysics, logic, and language (*On One and Unity*, *The Book of Letters*, and *The Purposes of Metaphysics*), and more.

Al-Farabi worked to build a coherent understanding of philosophy as a systematic discipline founded on Platonic insights and Aristotelian principles. At the foundation of this was his apparent correction of the view of al-Kindi and his group that the end of philosophy and religion is the same, namely the knowledge of divine unity and truth. In his *Intentions of Aristotle's Metaphysics*, al-Farabi argues for metaphysics to be understood not as a special science dealing primarily with God, as in al-Kindi, but as a general science dealing with the principles of being. On this understanding the study of God and higher causes (special metaphysics) is understood as encompassed within general metaphysics, which deals with all being and unity. Since metaphysics deals with the more universal causes of beings of the material world, al-Farabi does not neglect special metaphysics but rather sets out to explain that causality by way of an account of emanation following Ptolemaic astronomy in *The Principles of the Opinions of the People of the Virtuous City* and *The Political Regime or the Principles of Beings*. From the noetic activity of the First Cause, which in Aristotelian fashion is self-thinking thought, another emanates and from this there emanate both another intellect and the outermost celestial sphere, a process that continues giving rise to intellects and planetary spheres terminating with the final and lowest intellect, the agent intellect (*al-'aql al-fa'āl*), which oversees the sublunar realm, the matter for which comes from the celestial spheres. This last intellect in the emanative hierarchy al-Farabi identifies with the agent intellect that Aristotle posited in *De Anima* 3.5 to account for the understanding of intelligible universals in contrast with sensation and imagination, which apprehend only particulars. In his *Treatise on the Intellect* based on his study of Alexander of Aphrodisias rather than the *De Anima* directly (Geoffroy 2002), he explains that human happiness lies in the transcendence of the body and some degree of immaterial noetic identity with the agent intellect. The separate agent intellect enables abstraction and brings the potential intellect to act with intelligibles in actuality existing in individual minds. When the acquired intellect has been perfected by the understanding of universal principles, the philosopher no longer requires the body and is able to associate with the separate agent intellect. Although this doctrine of intellectual perfection plays an important role in al-Farabi's teachings, Averroës, Ibn Bajjah, and others report that he abandoned this view that a generated human knower could become immortal and eternal in his lost *Commentary on the Nicomachean Ethics* as an old wives' tale.

Al-Farabi's account of intellect and the knowledge of universal principles provides the noetic account essential for his understanding of human beings and society. Just as with Plato, who singled out the philosopher-king to rule because of his highest, most perfect knowledge in the ideal city-state of the *Republic*, so too according to al-Farabi the rightful place of rule belongs to the philosopher-king, who has exact scientific knowledge through philosophical demonstration and proof, not the mere dialectical accounts of poetry and rhetoric. While these are understood to be included in the *Organon* with Aristotle's logical works, they aim only at persuasion by the prompting of images in the hearer and not at the rigorous truth of demonstration. Ideally the images of religion conveyed by a prophet and taught by an imam work to prompt those receiving them into action in accord with the end of human beings, which is happiness in perfection of intellect. Yet few are intellectually capable of this, so rhetoric, poetry, dialectic—all of which are contained in religion and revelation—provide a way for the truth (which is known to the philosopher directly but to the others in the emotive movement of the soul's imagination) to be shared with the community. This allows for the prophet-imam-philosopher to guide the community toward its perfection, which is the perfection of individual human beings to the point that they ascend to the level of the agent intellect. In accord with this, al-Farabi says at the beginning of his *Book of Religion*, "religion is opinions and actions, determined and restricted with stipulations and prescribed for a community by their first ruler, who seeks to obtain through their practicing it a specific purpose with respect to them or by means of them" (al-Farabi, 2001, p. 93). Thus rather than being one with philosophical metaphysics as al-Kindi had it, religion is concerned with particular human responses to the general end of human intellectual perfection. For al-Farabi, metaphysics and philosophical theology concern the intellectual study of the essential matters of being, unity, and its causes, while religion is concerned with particular and varying ways for the establishment of the conditions for highest human intellectual fulfillment on the part of select individuals.

This was a period of great intellectual diversity and creativity at Baghdad and elsewhere. The renowned physician Muhammad Ibn Zakariyya al-Razi (d. 925) wrote a wide range of works in philosophy, theology, cosmology, medicine, and more; he gave an account of creation as the fall of soul infused with knowledge by God and permitted to fulfill its yearning to be in matter, space, and time. It is likely that at about this time at Basra the Brethren of Purity (Ikhawan al-Safa) crafted and assembled much of their collection of treatises drawing upon Aristotle and the Arabic Plotinus to weave a view of philosophy as an essential part of the religious goal of the saving of the soul. But much of the work of this era was dwarfed and nearly forgotten in the shadow of Islam's most influential philosopher, Avicenna.

Avicenna (Ibn Sina)

The brilliant Persian philosopher, physician, and vizier Avicenna (Ibn Sina; 980–1037) was born in the village of Afshanah near Bukhara in present-day Uzbekistan. A diligent and exceptionally insightful student according to his own autobiographical account, Avicenna mastered medical, legal, scientific,

and philosophical studies in short order and went on to develop his own philosophical teachings. The context in which he worked was that of the harmonization of the philosophies of Plato and Aristotle and the effort to bring about a complete and consistent teaching of the sort found in the late commentator Ammonius and pursued by al-Farabi, whose work guided Avicenna's understanding of Aristotle's *Metaphysics*. From this and his studies of Islamic theology, Avicenna crafted a new synthesis most evident in his broadly influential teachings on God as the Necessary Being and the human soul's separability from the body.

Avicenna's arguments for the Necessary Being appear in a number of important works. In the *Metaphysics* of his *Shifa'* (Healing), the argument that leads to the Necessary Being begins in book 1, chapter 5, which is on being (*mawjud*) and thing (*shay'*). There Avicenna writes that there are three first intentions that arise initially in the soul: being or existent, thing, and necessary. These are primary intentions that naturally arise as first principles grasped by the mind in the consideration of reality in any of its forms. But apprehended quiddity or essence has of its very nature an indeterminate openness to various sorts of existence determined by something outside the essence. The arguments for the existence of the Necessary Being then proceed by rejection of the impossibility that all beings are merely possible or contingent and the acceptance that there must be necessary being for the actual existence. Since there cannot be an infinite regress of beings necessary by another, Avicenna concludes that there must be a first, the unique Necessary Being that causes the existence of the dependent necessary and possible beings and is itself uncaused. This analysis leads to the Avicennian distinction of essence and existence so influential in Arabic philosophy and in the Latin West. The First is the True One that is existence alone, free of the limitation of form, while all other things are form and being received ultimately from God. Causality here is by way of emanation, as with al-Farabi, in a hierarchy of necessary beings, except that for Avicenna there is an emanation of an intellect, a celestial sphere, and a celestial soul associated with the celestial intellect as its mover. Holding firm to the principle "from one only one can arise," Avicenna asserted that there first was emanated an intellect and from that plurality arose. This emanation continues down to the level of the moon, at which point the agent intellect generated the world and all the forms in it.

This agent intellect is denominated the "giver of forms" because it gives forms both to human minds and to natural entities of the world. The human soul has a temporal origination and its individuation in being is the result of its association and joining with the body. But its nature as intellectual shows that it is not merely the form of a body. Rather, its nature as rational indicated to Avicenna that the soul is incorruptible and that it does not die with the death of the body. This is illustrated (not proved) by the famous "Flying Man" argument which holds that it can be imagined that even if a man is suspended in the air and in complete sensory deprivation as if bodiless, he would nonetheless affirm his existence as a rational soul. According to his *Letter to Kiya*, the key principle is found in Aristotle's discussion of the atomism of Democritus

in the *De Anima* and the notion that intelligibles can only exist in immaterial subjects. The common explanation that these intelligibles come to be in the soul by emanation when the soul is prepared for their reception and not by true abstraction has been challenged recently with texts suggesting a greater role for the activities of the soul itself. Still for Avicenna the soul of a prophet has special powers of imagination to receive intelligibles directly from the agent intellect and to communicate them to the people in religious discourse.

Avicenna's philosophy dominated the tradition that continued to develop after his death even after the harsh attacks of the Ash'ari theologian Abu Hamid Muhammad al-Ghazali (1058–1111). In the *Incoherence of the Philosophers*, al-Ghazali attacked the thought of the philosophers (al-Farabi and Avicenna) as insufficiently founded and also as contrary to Islam on the eternity of the world, God's knowledge of particulars, and the resurrection of the body. While the stated purpose of this work is to undermine the pronouncements and arguments of the philosophers, al-Ghazali's own Ash'ari occasionalism plays a role, for example, when he argues that there is no necessary connection but rather only habitual association between what are customarily called cause and effect. Such connections must be traced to divine will and power and are not found in the natures of things themselves.

Philosophy in Andalusia

While philosophical texts and ideas are present in the eclectic thinking of the Cordoba native and Sufi Ibn Masarra (883–931), who drew upon Mu'tazili theology and Neoplatonic and pseudo-Empedoclean texts, the beginnings of rigorous philosophical study are with Ibn Bajjah (d. 1138). This philosopher from Saragossa is most famous for his challenge to the understanding of motion in the natural philosophy of Aristotle with a theory of impetus and momentum, for his theory of intentional forms and intellect and for his political philosophy of solitude. His theory of intellect is based on the consideration of spiritual forms or intentions that are apprehended in sensation and must be traced to higher realities. Using arguments from Neoplatonic sources against Aristotle's rejection of Plato's transcendent forms, Ibn Bajjah holds in his *Treatise on Conjunction with the Intellect* that intelligibles in act or universals cannot be founded on abstraction from particulars but rather can only be grounded in forms located in the unique agent intellect. True knowledge is not tied in any way to the transitory world but rather is the grasp of the eternal and unchanging forms causative of things of this world. These are apprehended by an intellectual "conjoining" with the agent intellect that is a uniting in oneness without the destruction of the individual. In this the end is the perfection and happiness that consist in conjoining and uniting with a separate agent intellect, and the means is intellectual understanding. Those who are intellectual in nature either are in a society in which they can lead as philosopher-king or they are rejected by the ignorant masses and must live a solitary life. Most often they find themselves in an unreceptive society, as in Andalusia and elsewhere, where they are like weeds. A similar theme is found in Ibn Tufayl's tale *Hayy ibn Yaqzan*, in which the protagonists find it impossible to lead the people by religion and take refuge in a solitary life apart from society.

Averroës (Ibn Rushd)

The Cordoban jurist, physician, and philosopher Averroës (Ibn Rushd; 1126–1198), more influential in the history of philosophy by his commentaries on Aristotle translated into Latin in the thirteenth century than for his work extant in Arabic, is famous for his commitment to the proper interpretation of Aristotle's philosophy and the rejection of the innovations of Avicenna, for his detailed response to the theologian al-Ghazali's attack on the philosophers in his *Incoherence of the Incoherence* and his rationalist critique of *kalam*, and for his own creative completion of Aristotle's doctrine of human intellect with the theory of a single shared receptive and incorporeal intellect (called "material intellect" following Alexander of Aphrodisias). While Averroës thought philosophy had attained its highest achievement in the thought of Aristotle ("I believe that this man was a model in nature and the exemplar which nature found for showing ultimate human perfection" [Averroës, 1953, p. 433]), his *Short, Middle* and detailed *Long Commentaries* expounded the difficult texts of Aristotle and completed unfinished philosophical accounts. Although he followed emanationist views in some early works, in his own mature account he argued that God is "creator" as the ultimate final cause drawing generated things from potency into act, continuing the heavens in eternal motion, sustaining the separate intellects (angels in religious language), and generally attracting all things toward the perfection of which he is the exemplar. He rejected Avicenna's distinction of essence and existence as philosophically unwarranted insofar as it is founded on *kalam* and also Avicenna's theory of the soul as an immortal substrate for the reception of intelligibles by emanation from the agent intellect. While in his early works on psychology Averroës held that each person possesses a distinct receptive material intellect, his final position was that both the material intellect and the agent intellect are distinct immaterial substances in which human knowers share. He was prompted to this position by the need for there to be one set of intelligibles for intersubjective discourse and understanding and by the realization that intelligibles in act received into a plurality of particular minds would become particulars, not the universals needed for knowledge. As a consequence he held the eternity of the material and agent intellects and also of the human species that provides images for abstraction by the agent intellect to impress upon the receptive material intellect. Contrary to Ibn Bajjah, Averroës viewed conjoining with separate intellect not as the end itself but as the means to human happiness in intellectual understanding. These mature positions were expounded only after he had written several works critical of *Kalam* advocating for a central role for philosophy in the attainment of truth concerning God and his creation. Most famous of these is the *Decisive Treatise*, in which this jurist who served as chief judge (*qadi*) of Cordoba mounted a vigorous defense of the pursuit of philosophy on the basis of Islamic religious law. He argued that philosophy is not only permitted but is the surest method of the attainment of truth and philosophical demonstration and so is endorsed by the Koran. Holding that there can be no conflict between the truths of demonstration and religion, he declared, "Truth does not contradict truth but rather is consistent with it and bears witness to it"—without mention of his source in Aristotle's

Prior Analytics—thereby dispelling any concerns about the issue of a double truth, one for religion and one for philosophy. Where conflict between religion and reason arises, particularly concerning scriptural interpretation, reason's method of demonstration of truth is primary in determining the need for allegorical interpretation of otherwise conflicting explanations.

Condemned and exiled toward the end of his life, Averroës founded no school, and his influence in the subsequent development of philosophy in the Islamic milieu is hardly detectible until a revival of interest in the nineteenth century in the Arab world, where his thought was used to support various causes current then and later. His greatest influence was through Latin and Hebrew translations of his work that taught Latin and Jewish thinkers to read Aristotle and stirred great controversies among religious authorities wary of reason acting independently of the traditions of faith.

Before, during, and after the time of Averroës, Sufi mystical thought was a strong presence in Andalusia, and it is reported that the elderly Averroës met the very young Sufi Ibn al-'Arabi (1165–1240). Ibn al-'Arabi's notion of the unity of all being (*wahdat al-wujud*) and the perfect human being as the mirror of the divine brought to the fore the importance of imagination in apprehending the divine and contributed powerfully to the development of mystical philosophy in the East. Detailed work on the texts of philosophy is evidenced in the work of the pantheistic Sufi Ibn Sab'in (c. 1217–1270), whose broad knowledge of philosophy made him a suitable candidate for answering philosophical questions posed by the emperor Frederick II of Sicily. Ibn Khaldun (1332–1406) of Tunisia was an astute reader of philosophy, including the work of Averroës, and in his *Muqaddimah* he set forth a philosophy of history explaining political change in terms of social and structural changes.

In the East, philosophy continued to flourish with new developments in which the philosophy of Avicenna was the centerpiece, particularly his *Pointers and Reminders (al-Isharat wa'l-tanbihat)*, the last section of which was read literally as mystical and religious. The Ash'ari theologian Fakhr al-Razi (d. 1209) attacked Avicenna, as later did the mystic illuminationist Suhrawardi (d. 1191), for whom Avicenna's Peripatetic epistemology was to be replaced by the necessity of Platonic Forms for true knowing in a doctrine of knowledge by presence in the intellectual ability to apprehend essences. The illuminationism of Suhrawardi had a lasting impact on philosophy in the East, as did the continuing legacy of Avicenna in figures such as Nasir al-Din al-Tusi (d. 1274), who expounded Avicennian metaphysics and authored the widely influential *Nasirian Ethics*. The development of *isbraqi* or illuminationist philosophy was continued by Qutb al-Din al-Shirazi (d. 1311), who studied Avicenna and wrote a commentary on Suhrawardi's *Philosophy of Illumination*. By the time of the founding of the School of Isfahan by Mir Damad (d. 1631) and Sadr al-Din al-Shirazi or Mulla Sadra (d. 1641), the Safavid dynasty had long supported mystical thinking in Twelver Shiism. This new school systematically completed the synthesis of philosophical and Sufi mystical teachings from Ibn al-'Arabi and others in ways that continue to be reflected dominantly in Shiite thought. One notion of lasting philosophical

interest is that of knowledge by presence with a focus on the “I” as knowing subject in lieu of a role for Avicenna’s separate agent intellect. In the early twenty-first century the writings of Mulla Sadra and Suhrawardi play a powerful role in Iran, where philosophy is taught not only in religious schools but also in universities. Contemporary thinkers of the Shiite tradition of Iran, such as Mehdi Ha’iri Yazdi, who studied in the West and published *The Principles of Epistemology in Islamic Philosophy* in 1992, continue these traditions by placing the thought of Avicenna, Suhrawardi, and Mulla Sadra in dialogue with modern Western thought.

See also *Aristotelianism; Death and Afterlife, Islamic Understanding of; Islam; Philosophy and Religion in Western Thought; Sacred Texts: Koran.*

BIBLIOGRAPHY

- Adamson, Peter. *The Arabic Plotinus: A Philosophical Study of the Theology of Aristotle*. London: Duckworth, 2002.
- al-Farabi. *Alfarabi, the Political Writings: Selected Aphorisms and Other Texts*. Translated and annotated by Charles E. Butterworth. Ithaca, N.Y., and London: Cornell University Press, 2001.
- . *Al-Farabi’s Commentary and Short Treatise on Aristotle’s De Interpretatione*. Edited and translated by F. W. Zimmermann. Oxford: Oxford University Press, 1981.
- Averroës (Ibn Rushd). *Averroës Cordubensis Commentarium Magnum in Aristotelis De Anima Libros*. Edited by F. Stuart Crawford. Cambridge, Mass.: Medieval Academy of America 1953.
- . *Averroës: On the Harmony of Religions and Philosophy*. Translated by George F. Hourani. London: Luzac, 1961.
- . *Averroës’ Tahafut al-Tahafut (The Incoherence of the Incoherence)*. Translated by Simon Van Den Bergh. London: Luzac, 1969.
- Corbin, Henry. *En islam iranien, aspects spirituels et philosophiques*. 4 vols. Paris: Gallimard, 1971–1972.
- D’Ancona, Cristina, and Richard C. Taylor. “Le Liber de causis.” In *Dictionnaire de Philosophes Antiques. Supplément*. Edited by Richard Goulet et al. Paris: CNRS Edition, 2003.
- Davidson, Herbert A. *Alfarabi, Avicenna, and Averroës on Intellect: Their Cosmologies, Theories of the Active Intellect, and Theories of Human Intellect*. Oxford: Oxford University Press, 1992.
- Endress, Gerhard. “The Circle of Al-Kindi. Early Arabic Translations from the Greek and the Rise of Islamic Philosophy.” In *The Ancient Tradition in Christian and Islamic Hellenism: Studies on the Transmission of Greek Philosophy and Sciences*, edited by Gerhard Endress and Remke Kruk. Leiden, Netherlands: Research School CNWS, 1997.
- Fakhry, Majid. *Al-Farab, Founder of Islamic Neoplatonism: His Life, Works, and Influence*. Oxford: One World, 2002.
- Geoffroy, Marc. “La tradition arabe du Peri; nou d’Alexandre d’Aphrodise et les origines de la theorie farabienne des quatre degres de l’intellect.” In *Aristotele e Alessandro di Afrodizia nella Tradizione Araba*, edited by Cristina D’Ancona and Giuseppe Serra. Padua, Italy: Il Poligrafo, 2002.
- Gohlman, William E. *The Life of Ibn Sina: A Critical Edition and Annotated Translation*. Albany: State University of New York Press, 1974.
- Gutas, Dimitri. *Avicenna and the Aristotelian Tradition: Introduction to Reading Avicenna’s Philosophical Works*. Leiden, Netherlands: Brill, 1988.
- . *Greek Thought, Arabic Culture: The Graeco-Arabic Translation Movement in Baghdad and Early Abbâsîd Society (2nd–4th/8th–10th centuries)*. London and New York: Routledge, 1999.
- Hasse, Dag Nikolaus. “Avicenna on Abstraction.” In *Aspects of Avicenna*, edited by Robert Wisnovsky. Princeton, N.J.: Markus Wiener Publishers, 2001.
- Ha’iri Yazdi, Mehdi. *The Principles of Epistemology in Islamic Philosophy: Knowledge by Presence*. Albany: State University of New York Press, 1992.
- Harvey, Steven. “The Place of the Philosopher in the City according to Ibn Bâjjah.” In *The Political Aspects of Islamic Philosophy: Essays in Honor of Muhsin S. Mahdi*, edited by Charles E. Butterworth. Cambridge, Mass.: Harvard University Press, 1992.
- Hourani, George F. “Ibn Sina on Necessary and Possible Existence.” *Philosophical Forum* 4 (1972): 74–86.
- Ibn al-Nadim. *The Fihrist of al-Nadîm: A Tenth-Century Survey of Muslim Culture*. Edited and translated by Bayard Dodge. New York and London: Columbia University Press, 1970.
- Ibn Bajjah. *Treatise on Conjunction with the Intellect (Risâlat Itisâl al-fi Aql bi-l-Insân)*. Edited with introduction and Spanish translation, “Tratado de Ibn Bajja sobre al Union del Intelecto con el Hombre,” by Miguel Asin Palacios. *al-Andalus* 7 (1942): 1–47.
- Marmura, Michael. “Avicenna’s ‘Flying Man’ in Context.” *Monist* 69 (1986): 383–395.
- Rowson, Everett K. “An Unpublished Work by al-Âmirî and the Date of the Arabic De causis.” *Journal of the American Oriental Society* 104 (1984): 193–199.
- Taylor, Richard C. “‘Truth Does Not Contradict Truth’: Averroës and the Unity of Truth.” *Topoi* 19 (2000): 3–16.
- Von Kügelgen, Anke. *Averroës und die arabische Moderne: Ansätze zu einer Neubegründung des Rationalismus im Islam*. Leiden, Netherlands: Brill, 1994.
- Wisnovsky, Robert. *Avicenna’s Metaphysics in Context*. Ithaca, N.Y.: Cornell University Press, 2003.
- Zimmermann, F. W. “The Origins of the So-Called *Theology of Aristotle*.” In *Pseudo-Aristotle in the Middle Ages*, edited by Jill Kraye, W. F. Ryan, and Charles B. Schmitt. London: Warburg Institute, University of London, 1986.

Richard C. Taylor

PHILOSOPHIES, EASTERN. See *Chinese Thought; Japanese Philosophy, Japanese Thought.*

PHILOSOPHY.

This entry includes two subentries:

Historical Overview and Recent Developments
Relations to Other Intellectual Realms

HISTORICAL OVERVIEW AND RECENT DEVELOPMENTS

Philosophy is the noble art of thinking carefully, persistently, even obsessively, about the Big Questions of life—the meaning of life and with it the business of living, that is living well.

It is also, as Aristotle (384–322 B.C.E.) famously said, looking with wonder at ourselves and the world around us, being intrigued by both nature and the way we look and talk about nature, and the ways in which we think and talk about ourselves. But philosophy—and even the word *philosophy*—is shot through with contentiousness and is subject to endless debate. This was true in the days of Socrates, Plato, Aristotle (teachers and students, respectively) and it is certainly true today. The word itself is a Greek coinage, supposedly by Pythagoras (c. 580–c. 500 B.C.E.), who when asked if he was wise gave the modest answer “no, but I am a lover of wisdom.” Thus the words love (*philein*) and wisdom (*sophia*) were fused into “philosophy,” the love of wisdom. But the true nature of philosophy is perhaps better captured by Socrates, who showed quite clearly that philosophy is essentially the love of argument. Or, as Bertrand Russell cynically noted, “philosophy is an unusually ingenious attempt to think fallaciously.”

The prototype of philosophical disagreement was captured by Raphael Stanza in his well-known painting *The School of Athens*, where he depicts Plato (c. 428–348 or 347 B.C.E.) and Aristotle in animated conversation, elderly Plato pointing up to the heavens and a younger Aristotle, no longer just the pupil, making a down-to-earth gesture, palm toward the ground. Thus the history of Western philosophy displays profound disagreement between those philosophers who would appeal to the otherworldly and those who would remain unabashedly worldly. If the long history of medieval philosophy kept its eyes fixed on the heavens, the subsequent history of “modern” philosophy has tended to be resolutely worldly and secular, even when religion remained lurking in the background, in awe of science and often taking philosophy itself to be a science—or to be at least “scientific.” Since René Descartes (1596–1650) followed Galileo Galilei (1564–1642) and embraced the scientific revolution in the fifteenth century, philosophy has been primarily concerned about the objectivity of knowledge. Since the eighteenth-century Enlightenment, in particular, the philosophy of religion has been a marginal specialty and not the whole or at any rate the heart of philosophy, as it was from St. Augustine of Hippo (354–430) to St. Thomas Aquinas (c. 1224–1274), almost a millennium. But before that, Plato, writing in playful, witty dialogues, and Aristotle, whom we know only through his matter-of-fact lectures, exemplified a dramatic difference in philosophical style, already raising the question whether philosophy is a science or an art, the literal pursuit of truth or the metaphorical expression of deep inner longings. From Plato and Aristotle, two opposed but complementary threads of the history of philosophy continue to interweave.

Dialectic in Philosophy

The dialectic between religious and secular philosophy and the split between those who think of philosophy as akin to poetry and those who insist that it be exact and rigorous are not the only oppositions that rend modern philosophy. There is also the perennial tug-of-war between those philosophers who stubbornly hold onto the ancient paradigm of philosophy as the more or less practical search for the good life and those who insist on philosophy being “heavenly” in a different sense,

namely that philosophy is hopelessly impractical and esoteric and has nothing to do with the problems of real life. It is this opposition, perhaps, that best allows us to understand the current situation in philosophy. A good deal of contemporary philosophy has become quite technical, almost like mathematics. Philosophers are entranced by problems mainly of their own making and enraptured by the difficulty of solving them, with very little concern for others outside their academic circle, who have no interest anyway. Others have turned directly to real-life problems, in business and in medicine, for example, and “applied” the skills of philosophy to questions about fairness in the marketplace and to life and death issues in health care. Then, too, others have turned these skills at argument to an enhanced appreciation of the arts and aesthetics, to the improvement of psychology and the other social sciences, even to physics and evolutionary biology. For several decades, now, feminist philosophers have challenged the male archetypes of philosophy and argued that philosophy is in fact gender-defined and have elaborated in many directions, especially concerns with motherhood and “sisterhood,” just what this amounts to. Still other philosophers, steeped in cultures outside the West, have turned their eye to comparing ideas and cultures, drawing sometimes dramatic contrasts between both strains of philosophy since Plato and Aristotle in the West and dramatically different (but sometimes dramatically similar) traditions in other parts of the world.

If one were to paint a broad-brush history of Western philosophy from ancient times, it would begin with the origins of philosophy and science together in ancient ontology and cosmogony (the Pre-Socratic philosophers from Thales to Democritus, culminating in Aristotle) along with a heavy emphasis on the Good and living well (Socrates, Plato, and Aristotle through the Stoics and the Skeptics). After Aristotle, science is almost totally eclipsed as the philosophy of religion becomes virtually the whole of philosophy, culminating in the rich convergence of Judaic, Christian, and Muslim ideas and cultures in the thirteenth century. With the Renaissance, the classics come alive again, humanism becomes the reigning philosophy, science is again on the rise, Niccolò Machiavelli (1469–1527) and Thomas Hobbes (1588–1679) revolt against the supposedly gentlemanly art of politics of the ancients. Then comes Descartes and with him the pre-occupation with epistemology (“the theory of knowledge”) and skepticism. But whereas ancient Skepticism was always concerned with the best way to live, modern skepticism became narrowly epistemological, “absurd” even to its most illustrious defender, the Scot David Hume (1711–1776). Thus by the end of the nineteenth century, the German philosopher Friedrich Nietzsche (1844–1900) would complain, “Philosophy reduced to theory of knowledge—that is philosophy in its last throes.” Over the course of the nineteenth century, philosophers in both Europe and America tried to regain their cosmic reach, in the magnificent multiple *Critiques* of Immanuel Kant (1724–1804), by way of the cranky pessimism of Arthur Schopenhauer (1788–1860), through the all-bracing Spirit of Georg Wilhelm Friedrich Hegel’s (1770–1831) phenomenology, and in the German-inspired American “Transcendentalism” of Ralph Waldo Emerson (1803–1882), Henry David Thoreau (1817–1862), Amos Bronson Alcott (1799–1888), and Margaret

Fuller (1810–1850). This brings us to the border of the twentieth century and then philosophy today.

Philosophy West and East

If there is a single word that best captures the spirit of twentieth-century philosophy, it would be *relativism*. Nietzsche prefigured the new century in the 1880s with his doctrine of “perspectivism,” the idea that there is no singular truth and no “God’s eye” view of the world. Albert Einstein (1879–1955) defended relativity in physics at the same time that Pablo Picasso (1881–1973) was displaying it in the new art of “cubism.” Not that every thinker of the twentieth century was a relativist, of course. Some fought bitterly against relativism: Edmund Husserl (1859–1938) and Alfred North Whitehead (1861–1947), for instance. But if the perennial struggle had been primarily between the this-worldly and the otherworldly, the new tension in philosophy was between relativism and one or another form of absolutism, whether it was the residue absolutism of religion (as in contemporary America) or by way of fascism, which gained a frightening foothold in Europe mid-century. At the beginning of the twenty-first century, this struggle has by no means been resolved. If anything, it has intensified, as absolutism takes the form of religious fundamentalism and relativism finds new stylistic expression in the writings and sometimes the ravings of the postmodernists.

But this broad-brush sketch leaves out most of the world. As noble as the philosophical traditions of the West may be, they should be humble in comparison to the much longer-standing traditions of Asia. The first philosophical scriptures were the Vedas, produced in India some thirty-five hundred years ago. Indian philosophy progressed through scholarly commentary and argument by way of Vedanta and the great literature of the Mahabharata and through the breakaway philosophies of Buddhism and Jainism. Buddhism migrated north and east through Tibet and southeast Asia to China, where it joined with the indigenous Chinese philosophies of Daoism and Confucianism, and on to Japan where it transformed the local spirit-worship called Shintoism and gave rise to the dramatic philosophy of Zen, captivating the Samurai class who ruled the country. But the fate of philosophy in Asia displayed some dramatic differences from the fate of philosophy in the West. In Asia there was never so much of an opposition between philosophy and religion, nor for that matter were the various philosophy-religions so antagonistic. Buddhism, Daoism, Confucianism, and Hinduism had more of a mix-and-match relation to each other, and they were treated more as a spiritual smorgasbord than as competing occasions for a “leap of faith.” Beneath the Eastern emphasis on spirituality is that thread familiar to us from the ancient Greeks, the ultimate ideal of living a good life, philosophically. And, ironically, the Asians pursued this ideal in what is supposed to be the prototypical American fashion—pragmatically.

Contemporary Philosophy

Philosophy from its inception has always been all-embracing and thus lends itself to both a learned eclecticism as well as dilettantism. Ironically, then, philosophy has also always tended to encourage a certain sense of superiority as well as

schoolishness, even cultishness. The schools of the ancient world—Skeptics, Stoics, Cynics, and Academics—and the schools of medieval Scholasticism were paralleled (unknowingly) by the many competing schools of Confucianism, Daoism, Legalism, Buddhism, Zen, and neo-Confucianism in Asia. In the “professional” philosophy of the twentieth century, especially in American universities, the tendency to overspecialization can be partly explained by philosophers’ efforts to distinguish philosophy from all of those other disciplines that it originally spawned from its womb. But it is also the very nature of philosophy itself, which while striving for the all-embracing universal has always tended to be laughably parochial. Thus contemporary philosophy has predictably become Balkanized, not quite to say cult-like. In particular, there is the well-known opposition between “analytic” and “continental” philosophy, although it should be said from the first that the distinction itself is problematic as well as destructive. To begin with, the contrast is a false one. “Analysis” refers to a method that, superficially at least, concentrates on the use of language and is mainly concerned with logic and conceptual analysis. “Continental” refers to a place, namely, Continental Europe. Apart from the fact that “the Continent” so referred to usually includes only Germany and France and the fact that “analytic philosophy” includes a fair number of contrasting and competing methodologies, there are many twisted and interwoven schools, methods, and styles of philosophy that are not distinguished by such a narrow body of water as the English Channel.

Analytic philosophy is often defined in terms of its interest in logic and language, but that interest emerges first in Germany (with Gottlob Frege [1848–1925], in particular) and is fully shared by the progenitor of this century’s “Continental” movements, Edmund Husserl. The most influential philosopher of the century, Ludwig Wittgenstein (1889–1951), who was twice the definitive philosopher of the “analytic” tradition, came to England from Austria, never leaving his “Continental” roots behind him. He was particularly interested in the limits of language, but so are such contemporary poststructuralists as Jacques Derrida (1930–), the nemesis of most analytic philosophers. There are analytic philosophers who, like their peers on the Continent, talk and write about sex, gender, death, and the meaning of life. And despite the more polemical pronouncements of some of its practitioners, analytic philosophy is not just logic, devoid of concern for content. Though it still prides itself on being “scientific,” analytic philosophy is not wholly devoid of interest in history, context, empirical content, and etymology. If Bertrand Russell (1872–1970) misrepresented the analysts’ case against the Hegelians at Cambridge in his day, he was, nevertheless, the very model of an engaged and popular philosopher, with a great deal to say to ordinary people about immensely important issues. At the start of the twenty-first century, too, there are philosophers at the barricades, which means on television, talking about the vital issues of the day. One of the areas of contemporary interest in philosophy is “cognitive science,” which brings together the empirical research of neurologists, evolutionary biologists, computer specialists, psychologists, and linguists with the conceptual demands and arguments of the philosophers. At its best, contemporary philosophy breaks through its

traditional provincialism—as it always has in those golden epochs of the past—and synthesizes as well as analyzes the knowledge of the world. In this endeavor, analytic and continental philosophers work best when they work together, when they try to overcome their respective mind-numbing technical devices and jargon and grapple with what Husserl kept referring to as “the things themselves,” the distinctive content of human experience and the Big Questions of philosophy that get us all started down the philosophical road to begin with.

The ancient quest for the good life has all too often tended to get lost, or at any rate eclipsed, by the contemporary squabbling over the name “philosophy.” (Is philosophy, indeed, nothing but logic and conceptual analysis? Or is it worry about matters of “ultimate concern”? Or is it a bottomless spiral of self-reference that ultimately leads to nothing at all?) The perennial quest for the good life, shared by philosophers and non-philosophers alike, ensures that everyone is a philosopher, not just a few thousand university-trained specialists. (French philosopher Maurice Risseing has commented, “sooner or later, life makes philosophers of us all.”) This explains, in the face of increasingly specialized and inaccessible academic philosophy, why there continues to be widespread fascination with Eastern philosophy, often repackaged as “New Age” philosophy. If philosophy abandons what has always been its noble aim, to teach us how to live well, other alternatives will always be attractive. But this particular fascination with the East only began in the nineteenth century (Arthur Schopenhauer’s flirtation with Buddhism was particularly significant), when the first wave of professionalized academic philosophy swept over Germany in the wake of Immanuel Kant. (Before that, most of the great philosophers were “independent scholars,” except perhaps for Plato and Aristotle, who owned their own academies.) The importance of the East and cosmopolitan philosophy has only become more intense as the distortions of the Cold War on geopolitics came to an abrupt end, as global markets open up, and now that Islam has made a new forceful entrance into the world of ideas. But despite its disdained “popular” appeal and the intricacies of ideology and ideas, the fascination with non-Western and comparative philosophies is one of the most exciting late developments of the twentieth and now the twenty-first century.

To contrast “Eastern” with “Western” philosophy is not to suggest that false stereotype too long accepted among Western philosophers, namely, that Eastern philosophy is all religion and mysticism devoid of concern about knowledge and science. Buddhist philosophy, in particular, has a long rich history of logic and brilliant logicians. But the theme of living a good life is pervasive, and it is this, perhaps, that explains the appeal of the generic “East” in the West. There is also the obvious concern with spirituality that pervades so much of Eastern philosophy. Spirituality should not be confused with mysticism, nor should it be conflated with mindlessness. (It is instructive than one of the favorite terms in New Age philosophy today is “mindfulness.”) Spirituality is, as the present author has written, “the thoughtful love of life.” But in the pursuit of a rigorously “scientific” philosophy, Western philosophy since the Enlightenment has tended to dump all mention of spirituality as just so much “superstition” and

sentimentality. Thus it is often said that there is a widespread “spiritual hunger” that is not satisfied by either philosophy or traditional organized religion. But if scientific philosophy has thrown out the baby with the bath water, traditional organized religion has violated philosophy’s new insistence on pluralism (relativism), even if orthodox (absolutist) pretensions still remain. Much of Eastern philosophy, not burdened with the antagonism between philosophy and religion, has less trouble capturing both spirituality and truth in the same intellectual package, even where the main conclusion is that neither spirituality nor truth can be captured intellectually.

Conclusion

What is happening in philosophy at the start of the twenty-first century? Philosophy is as vibrant as ever, an opinion that is shared by the various Balkanized citizens of the philosophical profession, although from dramatically different perspectives on what that vibrancy consists of. Analytic philosophers will puff with pride about the technical abilities that are so much in evidence among the newly minted philosophers among them. Poststructuralist philosophers will point with pride to the number of art and literature departments, especially, that have been converted to their ways of thinking. Comparative philosophers with an eye on the East (and, to a lesser extent, on the southern hemisphere) will make sure to mention the number of courses and the extensive interest in ideas from beyond the ever more narrow borders of Anglo-American and European philosophy. Philosophers who do “cognitive science” will beam with satisfaction at the progress being made in understanding the human brain and its manifestations. And more practical (“applied”) philosophers will tell you about the number of philosophers employed by business schools, law schools, medical schools, and hospitals. But the truth is that philosophy continues as always, stimulating wonder and argument and spawning intelligent if not always loving attention to the world and to the myriad of human activities that, on reflection, become philosophical.

See also Analytical Philosophy; Continental Philosophy; Philosophy and Religion in Western Thought; Philosophy of Religion; Structuralism and Poststructuralism.

BIBLIOGRAPHY

- Copelston, Frederick. *The History of Philosophy*. 9 vols. Rev. ed. Westminster, Md.: Newman Bookshop, 1946–1975.
- Durant, Will. *The Story of Philosophy: The Lives and Opinions of the Great Philosophers of the Western World*. 9 vols. New York: Simon and Schuster, 1933. Reprint, 1983.
- Kenny, Anthony. *A Brief History of Western Philosophy*. Malden, Mass.: Blackwell, 1998.
- Russell, Bertrand. *A History of Western Philosophy*. Simon and Schuster, 1945.
- . *The Problems of Philosophy*. 2nd ed. Oxford and New York: Oxford University Press, 1998.
- Skorupski, John. *English-Language Philosophy 1750–1945*. Oxford and New York: Oxford University Press, 1992.
- Solomon, Robert C. *The Joy of Philosophy: Thinking Thin Versus the Passionate Life*. New York: Oxford University Press, 1999.
- . *Spirituality for the Skeptic: The Thoughtful Love of Life*. Oxford and New York: Oxford University Press, 2002.

- Solomon, Robert C., and Kathleen M. Higgins. *A Short History of Philosophy*. New York: Oxford University Press, 1996.
- Spiegelberg, Herbert. *The Phenomenological Movement: A Historical Introduction*. The Hague: Nijhoff, 1960.
- Weitz, Morris, ed. *Twentieth-Century Philosophy: The Analytic Tradition*. New York: Free Press, 1966.
- Whitehead, Alfred North. *Adventures of Ideas*. New York: Macmillan, 1933.

Robert C. Solomon

RELATIONS TO OTHER INTELLECTUAL REALMS

According to an ancient tradition deriving from Heraclides of Pontus (388–310 B.C.E.), a disciple of Plato (c. 428–348 or 347 B.C.E.), Pythagoras of Samos (c. 580–c. 500 B.C.E.) was the first to describe himself as a philosopher. Three types of person, he is alleged to have said, attend the festal games: those who seek fame by taking part in them; those who seek financial gain by selling their trade goods there; and those (“the best people”) who are content to be spectators (Diogenes Laertius, *De vita et moribus philosophorum*, I, XII). Philosophers or “lovers of wisdom” resemble persons of this third class: spurning both fame and profit, they seek to arrive at the truth by means of contemplation. Pythagoras distinguished the wisdom (*sophia*) sought by the philosopher—knowledge of the truth—from the mercantile skills of the merchant and the physical prowess of the athlete. Whether or not these distinctions derived from an actual utterance of Pythagoras, they can most certainly be found in the works of other ancient thinkers such as Plato, who was much preoccupied with the question of what philosophy is and how it differs from other forms of intellectual inquiry. Many of Plato’s contemporaries had thought his teacher Socrates (c. 470–399 B.C.E.) a sage; some considered him a Sophist, while others believed him to be a cosmologist. In Plato’s eyes and in the judgment of posterity, Socrates was none of these things; he was first and foremost a *philosopher*. But what made him different from a sage or Sophist? What made him recognizable as a seeker after wisdom and truth? In attempting to find answers to these questions, it is possible to learn something of the manner in which philosophers have traditionally characterized their métier, and how their different views on the scope and point of philosophical practice has led them to speculate on the relations between philosophy and other forms of intellectual labor.

Many ancient savants believed Socrates to be inimitable for the reason stated by Marcus Tullius Cicero (106–43 B.C.E.): he “first called philosophy down from the heavens” and thereby made the study of nature instrumental to human happiness (*Tusculan Disputations*, 5.X–XI; cf. Diogenes Laertius, *De vita et moribus philosophorum*, II, 16, 45). In other words, Socrates’ life as a philosopher was devoted not to the scientific description of the universe in the manner earlier advanced by Ionian cosmologists, but to the pursuit of wisdom in order to secure genuine human happiness. For this reason a philosopher, according to Socrates, could not devote himself simply to the study of the requisite arts and sciences, but had to have his mind attuned to the requirements of wisdom in the context of striving to live the best possible life. Such a life *had* to be

lived, even if it entailed the bitter fate of drinking a draft of hemlock.

For Plato, the first characteristic of philosophical wisdom is that it meet the needs of rational inquiry. As he suggests at *Apology* 22, this criterion precludes all types of quotidian knowledge and other homespun verities in favor of genuine philosophical insight. Neither the statesman, the artisan, nor the poet can explain *why* he is doing what he is doing, for none of them has formulated a clear, tractable, and explicit method of self-reflexive reasoning. That some members of humanity may act wisely on occasion does not prove that they possess genuine wisdom, for to be wise such persons must be able to offer explanatory and justificatory reasons for their deeds that will stand up to dispassionate scrutiny. The philosopher has this ability, and by means of dialectic, he can make progress in the quality of his self-understanding by criticizing received opinions. Philosophy thus liberates the space of reasons and never imposes itself upon the human mind by means of arbitrary techniques or conflated methods. Even mathematics, which for Plato is the most developed and admirable of the sciences, is subject to philosophical criticism. Philosophy is the highest form of speculative thought because it alone involves no presuppositions and is predicated on gratuitous reflection.

Unlike other branches of human learning and industry, philosophy has direct access to a “true reality” as distinct from the phenomenal world of ever-changing things. Having access to such a world, philosophy can offer pertinent and definitive criticisms of received opinions about the nature of meaning, beauty, and goodness. And since it concerns itself with the relationship between eternal and unchanging entities and verities, philosophy can validate its claim to possess certain knowledge of what actually exists rather than what seems to exist. At *Phaedo* 98–99, Plato suggests that the Ionian cosmologists did not possess true philosophical learning because they could not explain the purpose and nature of things. Being ignorant of the reality that upholds and sustains the universe and its objects, the cosmologists could not explain anything of real value concerning the nature of the world.

Lastly, and on account of a philosopher’s certain knowledge of an eternal and unchanging reality, he can know how people ought to live. For Plato, this entails that the speculative excellence of philosophical thought can be applied to the variable conditions of action, thereby reforming the moral quality of human life. Echoing the earlier pronouncements of Socrates, Plato readily castigated the proud claim of the Sophists to teach their charges the art of immediate worldly gain by means of quick wit and self-serving judgment. Such “fruits” of sophistical learning can never amount to genuine knowledge, since the mere exertion of intelligence is not comparable to the exercise of wisdom. Though the philosopher might look forlorn and foolish next to those who claim to teach the most efficacious route to fame and fortune, he is privileged by being in receipt of a form of understanding whose enduring qualities stand in stark contrast to the fleeting glories and superficialities of the world. For Plato, any attempt to explain and interpret the nature of the universe and human beings must involve philosophy. That is why the ideal ruler must be

a philosopher, and those who would claim to be wise must be imbued, like Socrates, with a spirit of critical reflection.

What can be learned from Plato's specification of the differences that separate philosophy from other branches of human learning is the idea that philosophy is quite unlike anything else. It is not reducible to another art or science, and its subject matter as well as its point and scope are not circumscribed by considerations that are external to its method of enquiry. Philosophy, then, belongs at the very summit of human knowledge. If prosecuted appropriately, it bequeaths to the individual mind a form of sagacity and judgment that will enable any human being to live well. Like Socrates, the philosopher stands apart from the world while seeking to make sense of it; philosophy is a *sui generis* activity.

After Plato

These ideas found repeated expression, albeit in different forms, throughout the course of ancient philosophy. Aristotle, although he made enduring contributions to most forms of human knowledge (especially the natural sciences), was mindful of the differences between more rarefied forms of intellectual speculation, such as metaphysics and theology, and prosaic methods of taxonomy and description that belonged to the sciences of physics and what we could now term biology. Aristotle can be said to preserve the spirit if not the letter of Platonic teaching, especially in his insistence that the goal of human life is gratuitous contemplation of the divine.

In the schools of the Hellenistic period and late antiquity, the writings of adherents to Stoicism, Epicureanism, Cynicism, and Skepticism demonstrate a similar commitment to preserve a conception of philosophy as an autonomous discipline that can authenticate a reflective way of life. While individual members of these schools all emphasized the need to preface philosophical study by securing a sound knowledge of other fields of human enquiry, they held firm to the belief that the study of subjects such as physics, mathematics, or rhetoric is but a preface to the more challenging regime of philosophy. Even in certain Neoplatonic schools, where the view that theology is the goal of any genuine intellectual quest had gained momentum, there is little evidence to suggest that philosophers were prepared to characterize their subject, or at least to specify its difference from other branches of intellectual enquiry, in a manner that radically departed from the views of Socrates and Plato. Seen thus, an important aspect of the intellectual legacy of the ancients was the idea that philosophy stands apart from all other abstract and cerebral pursuits. Philosophy is not a physical science concerned with the description of natural phenomena; it is not a form of poetical discourse or artistic endeavor; it is not civic religion; philosophy is about critical reflection on the nature and conditions of human life leading to the development and practice of wisdom.

Although the idea that philosophy enjoyed a unique position in the scheme of human knowledge and was thereby unanswerable to anything but itself did not go unchallenged in antiquity, when ancient philosophy came into contact with biblically-based monotheistic religions of the Judeo-Christian tradition, it met with a thorough reappraisal of its claim to

dominance. While Jewish and Christian thinkers such as the Alexandrians, Philo Judaeus (20 B.C.E.–45 C.E.), St. Clement of Alexandria (c. 150–between 211 and 215), and Origen of Alexandria (185?–?254), all endeavored to make sense of doctrinal issues by appropriating philosophical insights, a growing and increasingly vocal constituency, especially in Christian circles, argued that philosophy ought to be subservient to the claims of revealed religious teaching.

From the advent of the common era, a discussion was set in place that aimed to clarify the exact relations between philosophy and theology or sacred teaching (*sacra doctrina*). At its simplest, this debate sought to posit clear lines of demarcation that would distinguish the nature of philosophy and remit it from the province of theology. The debate sought to arrive at a view of how philosophy might or might not contribute to the path of individual salvation as that idea had been set down by Jewish, Christian, and from the seventh century onwards, Islamic teaching. The debate between “Athens and Jerusalem,” so famously instituted by Tertullian (c. 160–c. 220), was in part a discussion as to how ancient philosophy might or might not be arrogated by the theological doctrines of a biblically-grounded monotheism. A by-product of this discussion would be its detailed consideration of the relationship of philosophy to other fields of intellectual activity.

In their distinctive ways, Christian thinkers as dissimilar as the Cappadocian Fathers, St. Augustine of Hippo (354–430), Boethius (c. 480–c. 524), and Gregory I (c. 540–604); early medieval thinkers such as John Scotus Erigena (c. 810–c. 877), Peter Abelard (1079–?1144), and St. Anselm of Canterbury (1033 or 1034–1109); and the scholastics of the thirteenth and fourteenth centuries all attempted to clarify the relationship of philosophy to theology. For these thinkers, the subject of “philosophy” amounted to the scientific teaching and ethical wisdom of the ancients (specifically Aristotelian learning conjoined to aspects of the Neoplatonic tradition and trace elements of Stoicism), while prevailing ideas of “theology” were distilled from ongoing attempts to codify the requirements of revealed teaching by means of ideas of tradition and authority. In different guises and with very different exigencies, these efforts were replicated by thinkers in the Jewish and Islamic traditions. One of the more pressing questions confronted by all who attempted to gauge the relationship between philosophy and theology was the issue of *duplex veritatis* or “double truth,” a problem that was debated in earnest from the thirteenth century onwards following the reintroduction of the *corpus Aristotelicum* to the Latin West.

Medieval and Renaissance

Given the authority assigned to Aristotle's arguments on a wide variety of philosophical and scientific questions, it became apparent to many that what he had to say about such pressing topics as the origins of the world, the nature of the soul, and the final end of human life were at variance with the strictures of revealed biblical teaching. Some thirteenth-century theologians such as Albertus Magnus (c. 1200–1280), St. Thomas Aquinas (c. 1224–1274), and St. Bonaventure (1217–1274) advocated the use of aspects of Aristotelian philosophy, supplemented and corrected by the “higher truths” of revelation.

Other thinkers, though—especially members of the Arts Faculty of the University of Paris, the so-called Latin Averroists—attempted to balance Aristotelian philosophy in its own right over against Christian revelation by arguing that a distinction could be enunciated between philosophical teaching and theological truth. In short, they proposed a theory that looked to their opponents and generations of more impartial scholars as a theory of “double truth,” according to which something might be true in philosophy, such as Aristotle’s well-known cosmological theory of the eternity of the world, yet false in theology and vice versa.

As medieval scholarship has long pointed out, the Latin Averroists, most notably Siger de Brabant (1240–between 1281 and 1284) and Boethius, did not themselves argue for a theory of double truth; rather, they reserved the term *truth* in an ultimate sense for revealed doctrine and never claimed the possibility that there could ever be two equally true contradictory truths specific to the competing requirements of theological and philosophical discourse. Nonetheless, they did recognize that reason rightly used could reach conclusions that did not agree with revealed doctrine, or else placed the veracity of certain biblical statements in question. Such was the hostility to their views in theological circles that Bishop of Paris Stephen Tempier issued condemnations of propositions associated with their work in 1270 and 1277.

In the later Middle Ages, yet another element was added to the general debate about the relationship of philosophy to theology by the nominalists and Scotists, followers of John Duns Scotus (c. 1266–1308): they contended that rationally deducible concepts and theological systems do not necessarily stand in any pertinent relationship to one another. The issue here is not one of *duplex veritatis* but rather one of a radical diastasis between philosophical or, in a Scotist dispensation, specifically metaphysical argument and the claims and requirements of theology. Some scholars have argued that this late medieval perspective underlies a good deal of the early Reformers’ rejection of philosophy in their initial attempts to codify their emerging theological positions. The problem set in motion by late medieval Scotism was further complicated by a shared proclivity among many Lutheran and Reformed theologians to embrace an Augustinian view of how the effects of original sin corrupt and deprave an individual’s powers of reasoning and the exercise of will.

The issue of double truth also appears in sixteenth-century philosophy in the writings of the Renaissance thinker Pietro Pomponazzi (1462–1525). He turned the medieval discussion on its head by arguing for the superiority of philosophical over theological truth. As an Aristotelian philosopher whose principal work was the exposition and analysis of the pages of Aristotle for the sake of developing a modern Peripatetic philosophy, Pomponazzi addressed the issue of the immortality of the soul and argued that the question could only be clarified and resolved philosophically. His conclusion was that the soul was indeed capable of discovering knowledge of higher things, especially the eternal truths of the universe, but he also indicated that such knowledge was restricted temporally to the life of the individual. The mind cannot survive the death of

the body and cannot exist in a disembodied state. All of this Pomponazzi argued from the perspective of (Aristotelian) philosophy, while at the same time acknowledging that Scripture is without error and the doctrine of the immortality of the soul can be proved from it. More so than the much-maligned Siger de Brabant and Boethius of Dacia, Pomponazzi began to trespass into the territory of *duplex veritatis*, and can be said to have reasserted the traditional claim of philosophy to be the final tribunal in any dispute of reason.

One consequence of the protracted and sophisticated medieval debate on the relationship of philosophy to theology—a discussion that can be said to have continued in different guises, albeit with slightly altered terms of references, in the polemical disputations of the Renaissance and Reformation—was to initiate by the end of the sixteenth century a willingness on the part of philosophers to assert their independence from the theologians. In the time of the ancients, philosophers had enjoyed preeminence among the cognoscenti, yet with the advent of biblical monotheism and the rapid expansion of Islamic and Christian civilization, the place of philosophy had been relegated in importance next to theology. In addition to this, the developing system of university education that was established in Western Europe supported subjects such as medicine and law, each of which claimed their own unique intellectual status and professional structure. For the medieval tradition, philosophy (which included logic and the natural sciences) was at best the handmaid of theology, a valuable intellectual training that prepared the able minded for the dizzy heights of speculation on the truths of the bible and the mystery of the Godhead. While many of the most important and enduring achievements of high scholastic theology are framed within philosophical terms of reference (e.g., the use of the language of Aristotelian metaphysics to describe issues concerning the Trinity, the Incarnation, and the Eucharist), for the authors of these works these discussions were theological, pertaining to *sacra doctrina*, and not philosophy.

Early Modern

With the dissolution of the medieval outlook in the sixteenth and seventeenth centuries, philosophers set about the long enterprise of recasting their subject so as to ensure its independence from theology but also to align it with new developments in scientific thinking. These tendencies can be observed in the writings of influential figures in the history of early-modern thought ranging from Galileo Galilei (1564–1642), Francis Bacon (1561–1626), Thomas Hobbes (1588–1679), and René Descartes (1596–1650). That said, what in the early twenty-first century tends to be thought of as philosophy—a broad but relatively precise discipline distinct from the humanities, sciences, and religion and characterized by certain kinds of difficult and even irresolvable questions—would have struck an early modern thinker as a definition all too parsimonious in scope. The term *philosophy* in the seventeenth century included a great deal more than it does in the twenty-first, and this complicates any attempt to clarify the relationship of philosophy to other forms of human leaning in the early modern period. Philosophical learning would include the physical and biological sciences, as much as the logical structure of argument,

conceptions of the good life, as well as questions about being and the existence and nature of God. Thus, a natural scientist in the seventeenth century would consider himself a “natural philosopher,” and though preoccupied with issues in mathematics and physics, would attempt to relate his understanding of these questions to more general areas of philosophical concern. Here one thinks of the very different writings of Marin Mersenne (1588–1648), Pierre Gassendi (1592–1655), Johann Clauberg (1622–1665), Robert Boyle (1627–1691), and Sir Isaac Newton (1642–1727). Similarly, it would be wrong to detach figures who are believed to be purely “philosophical” (as that term is currently understood) from those who were “theologians,” “biblical exegetes,” “political theorists,” and “jurists.” Authors such as John Locke (1632–1704), Ralph Cudworth (1617–1688), Gottfried Wilhelm von Leibniz (1646–1716), Nicholas Malebranche (1638–1715), Antoine Arnauld (1616–1694), Baruch Spinoza (1632–1677), Blaise Pascal (1623–1662), and Hugo Grotius (1583–1645) all displayed expertise in these disciplines. The range and generality of so many seventeenth-century philosophical questions, and the continuing disputes concerning the appropriate characterization of the world of nature accompanied by several thorny theological problems concerning divine grace and predestination, provides evidence that philosophy was connected to most fields in the arts and sciences, and enjoyed a close association with theology. The synoptic enterprise of seventeenth century philosophy would have to include not only the well-known canonical figures but also confessional apologists, corpuscularian scientists, alchemists and chemists, Jansenist polemicists, Jesuit moralists, activists advancing toleration, country clergy, urban rabbis, city intellectuals, and a panorama of intellectually gifted royalty and nobles.

From the seventeenth century to the Enlightenment, a new intellectual entity known as “culture,” an enterprise that connoted more than simple custom but less than learning, began to occupy the middle ground between knowledge and ignorance. Most philosophes of the salons conceived their métier quite differently from the preceding generation of seventeenth-century thinkers who had attempted, with some optimism, to translate the fruits of scientific knowledge into an accessible idiom open to all educated persons. Not all the protagonists of the European Enlightenment upheld belief in the incremental democratization of human learning; rather, they held to the view that an encyclopedic understanding of all branches of knowledge would enhance the cause of civilization and harmony among nations.

Such ideas helped to facilitate a very different understanding of philosophy and its relationship to the arts and sciences. Enlightenment thinkers and their successors no longer embraced a model of the subject that was directly influenced by the ancients. Aristotle’s teaching was believed to have been made obsolete by the intellectual developments of the seventeenth century, and while the deeds and opinions of ancient thinkers like Socrates, Plato, the Stoics, and the Epicureans were widely respected and valorized, post-Enlightenment thinkers looked more to the “novelties of the moderns” than the “wisdom of the ancients” for essential instruction about the nature of the world and the purpose of human life. In

addition, the increasing secularization of European thought and the general advancement of science in society, industry, and learning became increasingly opposed to the earlier models of philosophical practice that had encouraged the gratuitous pursuit of wisdom or the importance of a metaphysics leading to theology. Such views of philosophy were deemed to be out of keeping with the intellectual, cultural, and mercantile needs of the age. Perhaps more than at any other time in its illustrious history, the proud boast of the ancients that philosophy should stand at the top of the hierarchy of knowledge was now forcefully challenged by thinkers who remained unconvinced that philosophy was any different than other reputable branches of learning.

Modern Times

What one might term the conversion of philosophy from the quest for wisdom to the more prosaic pursuit of conceptual analysis, or the abstract clarification of the claims of more important scientific theories, is a marked feature of the philosophical thought since the turn of the nineteenth century. Since Immanuel Kant (1724–1804), philosophers have become more limited in their intellectual ambitions and, at times, have dispensed with the pretensions of their subject to be a synoptic discipline, or else to propose something of enduring value or pertinence on the subjects of God, ethics, and beauty. For good or ill, modern philosophy has preferred to restrict its purview to those matters that can be demonstrated to be legitimate objects of discourse and has eschewed ways of talking about issues that are deemed to lie outside the boundaries of sense meaning.

The prominence of such views, especially in the English-speaking world, eventually led to a recasting of the relationship of philosophy to other subjects of intellectual concern. In those quarters where the influence of scientism has been unyielding, there has been widespread support for the view that philosophy can never pretend to emulate the accuracy, reliability, and verisimilitude of valid scientific theories. Going on from there, some thinkers have taken the further step and argued that there are no perennial philosophical questions, and that traditional philosophical puzzles concerning the nature of the mind, the structure of the world, and the moral qualities of human beings have either been resolved or else superceded by advancements in physics, biology, and psychology. For these thinkers, there is nothing special about philosophy, and there is nothing to privilege it over and above other branches of intellectual inquiry. A well-known position associated with the work of the American thinker Richard Rorty (b. 1931) has even suggested that philosophy has expired through exhaustion. Now that science has demystified the world and resolved the perennial mysteries, what else is there for philosophy to do? Given the end of philosophy, Rorty has suggested that scholars turn to subjects such as literature in order to make sense of the seeming intractabilities of human worldly existence.

Yet Rorty’s position, though it is based on a set of metaphysical commitments that are widely shared by contemporary philosophers, is by no means universal, and despite the blandishments of fashion and novelty, the daily grind of philosophical speculation still goes on. Few are persuaded that the

subject first commissioned by father Thales (c. 625–c. 547 B.C.E.) and so suggestively ameliorated by Socrates and his successors is really at an end. What is perhaps significant about this phenomenon is the fact that the very practice of philosophy, whether it be in dialogical or in written form, helps to ensure the impression among practitioners of the subject that the discipline is really quite different from every branch of the humanities, sciences, and theology. Why is this so? It really comes down to the type of question, the supporting framework of reference, and the variety of answer that it invites that identify and individuate a question as a *philosophical* question. Socrates understood this and the Sophists did not. That each generation of his successors has attempted to honor the special nature of the discipline he did so much to create stands as testimony to the fact that philosophy will always enjoy a vicarious relationship to other branches of human learning.

See also *Interdisciplinarity; Knowledge; Logic; Philosophy, History of; Truth.*

BIBLIOGRAPHY

- Boys-Stones, George. *Post-Hellenistic Philosophy: A Study of its Development from the Stoics to Origen*. Oxford: Oxford University Press, 2001.
- Copenhaver, Brian, and Charles Schmitt. *Renaissance Philosophy*. Oxford: Oxford University Press, 1992.
- Funkenstein, Amos. *Theology and the Scientific Imagination from the Middle Ages to the Seventeenth Century*. Princeton, N.J.: Princeton University Press, 1986.
- Grant, Edward. *God and Reason in the Middle Ages*. Cambridge, U.K.: Cambridge University Press, 2001.
- Hadot, Pierre. *Exercices Spirituels et Philosophie Antique*. 2nd ed. Paris: Études Augustiniennes, 1987.
- Jordan, William. *Ancient Concepts of Philosophy*. London: Routledge, 1990.
- Oberman, Heiko Augustinius. *The Harvest of Medieval Theology: Gabriel Biel and Late Medieval Nominalism*. Cambridge, Mass.: Harvard University Press, 1963.
- Rorty, Richard. *Philosophy and the Mirror of Nature*. Princeton, N.J.: Princeton University Press, 1980.
- Sorell, Tom, ed. *The Rise of Modern Philosophy: The Tension Between the New and Traditional Philosophies from Machiavelli to Leibniz*. Oxford: Clarendon, 1993.
- Stone, M.W.F. and Jonathan Wolf, eds. *The Proper Ambition of Science*. London: Routledge, 2000.

M. W. F. Stone

PHILOSOPHY, HISTORY OF. A respected Princeton philosopher keeps a sign on his office door forbidding the discussion therein of any philosophy more than ten years old. At this late stage in his career the restriction includes a good deal of his own work. This may well be the limit case of the anti-historical attitude that prevailed throughout much academic philosophy of the twentieth century, motivated by the view that philosophy, as an academic discipline, need have no more connection to its past than does any other positive domain of inquiry. A physicist, for example, may be interested to know how exactly Newton came upon his discovery of the laws of gravity.

But this interest is, as it were, extracurricular, not a necessary part of the specialized knowledge of a competent physicist. It will be enough that the physicist learn the relevant laws in a textbook; Newton's name need not appear at all, much less the details of his distinctly seventeenth-century concerns.

Can philosophy be understood in the same way? At the other end of the spectrum from our Princeton philosopher, we find some maintaining that philosophy is entirely constituted by its history, that the study of philosophy can never be anything but the study of the history of philosophy. Between these two extremes, there are a vast number of intermediate positions concerning the value of philosophy's history to its present practice. Among those who accept that this history is in some degree valuable, moreover, there are vastly different conceptions of the nature of this value. What follows is a review, with the help of some slightly cumbersome "-isms," of some of the possible perspectives on the history of philosophy from within philosophy at the beginning of the twenty-first century, with an eye toward the deeper understanding of the nature of philosophy itself that informs these perspectives.

Indifferentism

Indifferentism is plainly summed up in the message on the Princeton office door. But this label does not tell all, for indifferentism's vociferous defenders are anything but indifferent about what philosophy (as an ahistorical discipline) is, and about what philosophers ought to be doing. Most likely, the indifferentist would like to see philosophy come forward as a science, to adapt a phrase of Immanuel Kant's (1724–1804), and believes that it can do so by simply focusing on an appropriate, rather narrow set of questions. In the twentieth century, these were questions arising in the analysis of language and the methodology of science, and so it has been with some justice that indifferentism has commonly been associated with analytic philosophy.

Around the turn of the twenty-first century, though, most philosophers working in this tradition had come to recognize the usefulness to their own work of the history of philosophy, and particularly of the history of analytic philosophy itself. It has become rare that a philosopher of science or language who does not also have some competence in the history of these subdisciplines will find a job. Some of the best contemporary analytic philosophers choose to congregate at meetings of the History of the Philosophy of Science group to discuss, among other things, the revision of our understanding of the very notion of "analysis" as it was understood in early analytic philosophy by, for example, Rudolph Carnap (1891–1970) or Otto Neurath (1882–1945). What is sometimes described as "post-analytic philosophy," then, might better be thought of as analytic philosophy after its historical turn, and is in any case a sure sign that strict indifferentism is on its way out.

Indifferentists tend to believe that philosophy, like any other discipline, has seen some progress over the past few millennia. One standard example is the resolution of the paradoxes of Zeno of Citium (c. 335–c. 263 B.C.E.) with mathematical tools that had to wait until the nineteenth century to see the light of day. On another understanding, though, what happens

when a philosophical question is “solved” is that it ipso facto ceases to be a philosophical question at all and becomes a mathematical or scientific one. Thus, any philosophical question is by definition unanswerable, and the history of philosophy becomes but the prehistory of science, the initial recognition that a problem exists without any clue as to how to render it scientifically tractable. It may be impossible to say which perspective is right; but those who believe that the mathematization of Zeno’s paradoxes was an instance of philosophical progress will likely think that there is no reason to dwell too much in the past. Why waste our time on those who hadn’t yet figured out as much as we have? We may be grateful to past philosophers for having discerned the problem and taken some initial stabs at solving it, as a twenty-first century astronomer might appreciate Claudius Ptolemy (c. 100–c. 170), but there is no pressing need to figure out the details of their theories and how they came up with them.

Those who believe philosophy is cumulative and progressive, then, will likely incline toward indifferentism in some degree. Others, though, believe that what makes philosophy unique is that it never really gets anywhere. There may be personal progress that comes from studying it and learning how complex the problems it addresses are, but the discipline as a whole witnesses no real progress over the course of centuries. On this view, history will be of tremendous value, because it is only through the study of philosophy’s history, the way it keeps circling back around the same challenges, always coming up with solutions from within a limited range of options, that one can experience personal progress out of an adolescent optimism, or even arrogance, about these problems’ facile solvability.

Appropriationism

Appropriationism may describe any approach to the history of philosophy that seeks to take from it tools that may be of service to one’s ahistorical philosophical task. An appropriationist asks of the history of philosophy: What can it do for me? Representatives of different strains of appropriationism will have different answers to this question.

Reconstructionism. This breed of appropriationism searches philosophy’s past for arguments that have stood the test of time and can still be of service in defense of some philosophical position advocated by the appropriator. For instance, a reconstructionist who believes that no better account of personal identity has been offered since the late seventeenth century than that presented by John Locke (1632–1704)—who roots it in continuity of memory—will cite Locke’s argument for this theory in support of his or her own, similar one. The same reconstructionist, though, will not feel obligated to adopt, or even take an interest in, Locke’s support of, say, a cosmological argument for the existence of God. Reconstructionists take piecemeal from philosophy’s past what is useful for their own projects, and will generally not feel obligated to consider whether the argument borrowed from a past figure was *really* offered in response to concerns similar to theirs. As Jonathan Bennett approvingly describes this approach to history, dead philosophers should be approached as colleagues, with the one minor but not insurmountable difference that they are, well,

dead. In this spirit, twentieth-century scholars of the philosophy of René Descartes (1596–1650) have been able to portray him as engaged, to use Bernard Williams’ phrase, in a “project of pure enquiry,” without acknowledging that he was also engaged in a project of empirical physiology, and other areas of seventeenth-century philosophy that have since been outsourced to the appropriate science departments.

Neo-x-ism. An absolutely dogmatic Marxist would be an entirely uninteresting character, not because Karl Marx (1818–1883) was wrong, but because a follower who adheres utterly to every aspect of his predecessor’s thought is in essence only a relay station for that thought’s dissemination, not a thinker in his own right. Any noteworthy Marxist thinker, other than Marx himself, will be in his or her unique way a *neo-Marxist*, even if the prefix remains only implicit. Thus V. I. Lenin (1870–1924), a Marxist if there ever was one, nonetheless modified some of Marx’s central doctrines concerning the essential class-rootedness of conflict to account for the new phenomena of imperialism and the growing antagonism between the colonizing and the colonized parts of the world that at least the early Marx could not possibly have foreseen. Similarly, Jacques Lacan (1901–1981) adopts the basic categories developed by Sigmund Freud (1856–1939) for the analysis of the psyche but explicates them in terms of a poststructuralist philosophy of language. Lenin and Lacan are not reconstructionists; they do not pretend that Marx and Freud were concerned with the same problems they themselves face or even that their predecessors would approve of the way they are tackling these problems. But they are appropriationists of a different stripe, mastering and defending the ideas of a predecessor, while showing how these ideas can be of use in application to new and unforeseen problems.

Neo-x-ists will speak of working within a “broadly *x*-ian framework” while dealing with questions that admittedly did not concern *x*. Conversely, a reconstructionist will find and extract passages in which some predecessor *x* dealt with the same questions that interest him or her today, without, in performing this extraction, feeling obligated to confess to any broadly *x*-ian framework or world-view.

Contextualism

A contextualist will, to the extent possible, let philosophical predecessors speak for themselves through the texts they have left behind. If a great thinker from some bygone era turns out to have believed in ghosts or astrology, then so be it; these features of his or her thought need to be acknowledged and understood just as much as those that have stood the test of time. Facing up to these odd and sundry concerns of our predecessors, a contextualist thinks, has more than just the virtue of shocking our shockingly narrow colleagues. Contextualism, in its honesty about the distance between our concerns and those of our predecessors, reminds us that past philosophers were not just early models of ourselves, but were concerned with a largely different set of problems and saw their role and responsibility as thinkers very differently. In this way, contextualism can help overcome the tendency to see the past as a mere prelude to the present. And this benefit may be of more philosophical significance than it first appears.

Contextualism, understood as the “merely” historical study of the history of philosophy, helps history to be something more than history of the present, in the same way that the study of natural selection in now-extinct evolutionary lines can help to drive home the important point that evolution is not a teleological process that has as its end its crowning accomplishment, *homo sapiens*. The present state of philosophy is not the end toward which the past has been striving, just as human beings are not the end toward which evolution has been striving. Against this view, it might be pointed out that the tradition of philosophy has been a common project, whereas evolution has been a blind and stumbling affair. But the contextualist will remind us that, even if we might recruit the dead to help us with our philosophical tasks, this does not mean that they would recognize as much commonality with us as we claim with them if *per impossibile* they could have been given advance warning about their posthumous affiliations. Among the contextualists, we may mention, by way of example, the names of Dan Garber, Roger Ariew, Lloyd Gerson, and Michael Frede, each of whom seeks, to a greater or lesser extent, to reveal the circumstances of time and place that help to shine light on the philosophical thought of that time and place.

Constitutivism

A constitutivist tends to believe that philosophy just is a particular tradition, fundamentally rooted in history and comprehensible only synchronically. For the constitutivist, it is our primary task today to investigate how we came to inherit the philosophical concerns we have, rather than to continue to seek answers to questions as though they were timelessly meaningful. Thus for Marx, each era’s philosophy is one of the superstructural reflections, along with other outcroppings of culture, of the class relations that fundamentally define that era; for Michel Foucault (1926–1984), philosophy as the contemplation of timeless questions is in need of replacement by a genealogy of the concepts that came to predominate, mostly in only very recent history, in philosophical discourse. There is an air of subject-changing in these accounts of the history of philosophy: they want to reveal the true nature of philosophical discourse, rather than to continue to participate in it. For instance, when Frederic Jameson describes Daniel Dennett’s *Consciousness Explained* (1991) as an allegory of late capitalism—as outlined by Slavoj Žižek in the *London Review of Books* (“Bring Me My Phillips Mental Jacket,” 22 May 2003)—he is not engaging with Dennett’s arguments in a way that could even permit the author to respond. He is explaining Dennett’s concerns, his very conception of philosophy, as the product of a history of which Dennett need not be at all aware. Dennett may say this is unfair (though more likely he will not say anything at all); Jameson, for his part, could respond, true to his Marxist constitutivist convictions, that the deepest and most fundamental account of the philosophy of any era, including recent analytic philosophy, will be one that roots it in its time and place. Any account that does not do this will fail to grasp what the theory it is studying is really “all about.” And any constitutivist would insist that such a failure is a philosophical failure, perhaps the cardinal one.

Conclusion

Most scholars working in the history of philosophy will combine in varying degrees some or all of these various approaches. Many scholars believe that, qua *historian* of philosophy, one is required to accomplish some serious historical research, preferably involving archives and manuscripts, in order to claim any expertise on the subject studied. A real *historian* must know at least a few languages, understand the basics of historiographical method, and know at least a bit about the social and political background of the era in question. But, qua *philosopher*, at the end of the day one must also prove able to do what other philosophers demand of their colleagues: namely, offer some insight into the essences of things, or show that what was thought to have an essence lacks one, or show, as the American philosopher Wilrid Sellars says, how things hang together in the broadest sense. This may be done simply through the discussion of what some past thinker thought on these topics, but the crucial thing is that essences, hangings-together, and other such philosophical staples be tackled directly or through the mediation of one who has gone before, rather than resting content with, say, a tally of the dates and recipients of some seventeenth-century philosopher’s letters.

Some historians of philosophy might not be exactly sure what they’re doing. While many of us know of no other way to talk or write about the history of philosophy than by purporting to explain what the philosopher in question *actually meant*, we are too sophisticated to believe that this is what we are really doing. We claim to be setting the record straight, but sense that at least to some extent we are pushing our own agendas. These need not be mutually exclusive tasks, however. A feminist historian of philosophy may wish to push her worthy agenda, for example, by setting the record straight concerning the great number of largely ignored women active in the central philosophical debates of the seventeenth century, such as Anne Conway (1631–1679) and Damaris Masham (1658–1708). And yet, even after this correction to the record is made and women gain their rightful place in the canon, it would be naïve to think that the record has been set straight once and for all. A future generation will undoubtedly discover something else that has remained sub-rosa in earlier generations’ reception of our shared past. There are ever new and previously undetected angles from which to consider philosophy’s past. So long as it interests us, we will never cease to find new ones. The ones we find, moreover, will always be at least partially a reflection of our own interests, even if we hold out just letting the texts speak for themselves as the soundest methodology. We might worry that this is to allow rather too much “as if” to enter into our understanding of our own projects: know that you can never do more than reflect your time and place in your reception of the past, but approach the past as if you had the power of discernment to say once and for all what it was all about. This and similar worries, far from indicating professional incompetence, might be better understood as proof that the study of the history of philosophy is a quintessentially philosophical endeavor, and carries with it all the aggravation and perplexity one might expect from any endeavor deserving of this label.

See also *Historiography; Ideas, History of; Philosophy.*

BIBLIOGRAPHY

- Bennett, Jonathan. *Learning from Six Great Philosophers: Descartes, Spinoza, Leibniz, Locke, Berkeley, Hume*. 2 vols. New York: Oxford University Press, 2001.
- Collingwood, R. G. *The Idea of History*. Oxford: Clarendon, 1946. Reprint, edited by Jan Van Der Dussen, Oxford: Clarendon, 1993.
- Foucault, Michel. *The Order of Things: An Archaeology of the Human Sciences*. London: Tavistock, 1970.
- Gracia, Jorge J. E. *Philosophy and Its History: Issues in Philosophical Historiography*. Albany: State University of New York Press, 1992.
- Hutton, Sarah. *Anne Conway: A Woman Philosopher*. New York: Cambridge University Press, 2004.
- Rorty, Richard. *Philosophy and the Mirror of Nature*. Princeton, N.J.: Princeton University Press, 1979.
- Rorty, Richard, Jerome B. Schneewind, and Quentin Skinner, eds. *Philosophy in History: Essays in the Historiography of Philosophy*. Cambridge, U.K.: Cambridge University Press, 1984.
- Tully, James, ed. *Meaning and Context: Quentin Skinner and His Critics*. Princeton, N.J.: Princeton University Press, 1988.
- Williams, Bernard. *Descartes: The Project of Pure Enquiry*. Atlantic Highlands, N.J.: Humanities Press, 1978.

Justin E. H. Smith

PHILOSOPHY, MORAL.

This entry includes four subentries:

Africa
Ancient
Medieval and Renaissance
Modern

AFRICA

Morality consists of two parts: first, morality in the strict sense; and second, morality as custom or mores. The defining principle of the first is the golden rule, that of the second, local utility, idiosyncrasy, or even accident. The first is known to be universal to all human cultures. This has to be so of a necessity, in view of what the rule entails. The golden rule, to follow Harry Gensler, enjoins that one ought not to endeavor to do something to somebody without conceding that it would be acceptable for that person to do the same thing to one in an imagined, exactly reversed situation. From this, specific imperatives of honesty, fairness, and respect are derivable without which human community is inconceivable.

To take an example reminiscent of Immanuel Kant (1724–1804), suppose a particular individual's project is to make a promise to someone that he or she has not the slightest intention of keeping. If that person pauses for a moment to consider whether he or she is prepared grant that it would be all right for the other person, in an exactly reversed situation, to do the same, the person making the promise will see that this is not possible. Moreover, if one has basic intelligence, one will see that the general avowal among all people of the reverse of the injunction against false promises would bring human community to an end.

The working of the golden rule in the shape of specific rules, such as this last, is manifest in moral conduct and discourse all over the world, irrespective of differences of culture or even of individual thought habits. Thus, for example, if Christians are at least theoretically dedicated to the counsels of the golden rule, so also have Chinese Confucians have also been so since pre-Christian antiquity. Nor, similarly, is it difficult to find formulations of the golden rule in the repertoire of didactic epigrams in the oral traditions of Africa. The Yoruba say, "Whenever a person breaks a stick in the forest, let him consider what it would feel like if it were himself [who was thus broken]" (Idowu, p. 166). And defining the quintessence of moral insensitivity by way of the inverse of the golden rule, the Akans remonstrate, "Sticking into another person's flesh, it might just as well be sticking into a piece of wood" (Wiredu, 1992, p. 198). To be moral, accordingly, is to evince empathetic impartiality in one's actions on the model of the golden rule.

Notwithstanding this universality in the living of the moral life, the theorizing of it, that is, its philosophy, gives rise to great diversities of persuasion not only among cultures but also within them. Famously, Western philosophers, sharing basically the same moral values, have been in earnest conflict about the nature of moral ideas and the ultimate principles of moral judgment. So among other "isms," there are subjectivism and objectivism, on the first front, and consequentialism and deontology, on the second. In contemporary African philosophy, too, unanimity does not reign. But the bone of contention lies in the interpretation of the traditional communal philosophy of morals.

Morality Based on Religion in African Thought

By one account, African life and thought is religious through and through, and ethics is only a special case of this orientation: everything in morality, as regards both meaning and principle, comes from God. A most eloquent articulation of this view is found in Bolaji Idowu's *Odumare: God in Yoruba Belief*. After rejecting any suggestion that morality derives from society's need for self-preservation or that morality is "the product of commonsense" (Idowu, p. 144), he asserts "Our own view is that morality is basically the fruit of religion and that, to begin with, it was dependent upon it. Man's concept of deity has everything to do with what is taken to be the norm of morality" (p. 145). More specifically, "The sense of right and wrong, *by the decree of God*, has always been part of human nature" (p. 146, italics added). Again, "With the Yoruba, morality is the fruit of religion" (p. 146). See also, in support of this standpoint, M. Akin Makinde's *African Philosophy, Culture, and Traditional Medicine* (1988).

There is a general objection to a view of this sort that is well known in Western philosophy. If something is good irrespective of its intrinsic character simply because it is decreed by God, then if God were to decree something like slavery, it would have to be accepted it as moral. But surely, one might retort, God would never decree so radical an affront to human dignity as slavery! Exactly this is the point. One is inconsistently proceeding with a criterion of moral goodness that is logically antecedent to God's decrees, on the basis of which

one already esteems God as morally good (in the highest). Note further that if moral goodness were defined in terms of the decrees of God, then to say that God is good would amount to just saying that God decrees what he decrees. In African philosophy, however, it is not these objections but rather a consideration linked to a deep feature of African culture that has militated against any kind of divine-decree view of morals.

The feature in question is, actually, the lack of a feature familiar to students of the “world religions.” These religions—almost all of them—are *dogmatic* religions, and the dogma relevant here is that of revelation: God is supposed to reveal directly to a select few what the rules of right conduct are. This is necessary because if right conduct is by definition what is decreed by God, there is an urgent need to know what those decrees are. Obviously this is too important to be left to fallible individual speculation. On the other hand, in African traditional religions, as far as one can see from the literature and from one’s experience, direct revelation from God is unheard of. Alleged “specialists” do indeed claim direct knowledge from extrahuman sources, frequently hyperbolically described as “gods.” But these are mundane sources, and the information volunteered by them is empirical and open to falsification. In fact, in the traditional scheme of things, repeated falsification of the messages of such “gods” can lead to their demise by reason of the accumulated contempt of their erstwhile devotees.

It is of a piece with these last considerations that there are no prophets of God in African traditional religion and, in particular, none with any pretences to moral or any kind of revelation. J. B. Danquah, speaking of the Akans, has declared with good reason that “Never in the history of the Akan people, so far as we know, have we had what is known as a revealed religion, a revelation to, or by, a prophet, of duty to a Supreme or Lord” (p. 3). Naturally, therefore, the Akans and, it would seem, Africans south of the Sahara generally do not seek the rationale of morality in the decrees of God but in the exigencies of social existence (see Wiredu, 1991). The Akan philosopher Kwame Gyekye has argued to the same conclusion (Gyekye, 1995, chap. 8). Regarding the Yoruba, Segun Gbadegesin also maintains that they “are very pragmatic in their approach to morality, and although religion may serve them as a motivating force, it is not the ultimate appeal in moral matters” (p. 82).

The remaining impediment to a just conception of the African approach to the foundation of morals is the notion that African morality is determined by the decrees of the ancestors. Two things may be meant here. First, the suggestion may be that the conduct of Africans is decisively influenced by considerations as to the likes and dislikes of the ancestors. If so, some validity may be conceded to it. It is true that in “family” (or, more strictly, lineage) matters the ancestors are believed to reward rectitude on the part of the living and punish its opposite in their own extrahuman manner. But the principles supposed to be used in their evaluations are the moral and in some cases customary principles by which the ancestors themselves lived when they were alive in this world, and these, as suggested above, have a this-worldly rationale. Besides, those in African society who are moved to action or forbearance by the thought

of ancestral rewards or reprisals are those of a weak moral fiber. Those of a more solid moral aptitude adjust their conduct by a direct cognizance of the principles themselves. The same applies to moral action or inaction enforced by the “fear” of God or motivated by any sort of religious causes. Second, the notion under consideration may mean that for Africans, moral rightness or goodness is defined in terms of the will (or wills?) of the ancestors. If so, the considerations already adduced concerning the relativization of morality to the decrees of God should be more than enough to lay this to rest too.

What then, more specifically, is the foundation of morality in African thought? It is morality in the strict sense that is being considered here, that is, as defined by the golden rule. This rule, indeed, defines morality, but it does not motivate it. Why is this rule needed at all? It is because of the following. Human individuals have their own interests that they pursue or desire to pursue. But they live in society, and in that setting, the efforts of individuals in pursuit of their interests not infrequently threaten to conflict or actually conflict with varying degrees of severity, not excluding the deadly. Only the most basic ability to reflect is needed to see that in this situation it is in the interests of all concerned that a way be found for harmonizing those interests. Any principle for pursuing such a harmony of interests will inevitably involve the occasional pruning down of the interests of an individual in deference to the interests of others. But this restraint must apply to individuals impartially. The golden rule is exactly that principle.

These thoughts on the rationale of morality, strictly so called, are encapsulated in an Akan art motif depicting a freak crocodile with one stomach and two heads locked up in a fight over food. The profundity of this art construct is typical of the way in which art is used in Africa to express ethical and more generally philosophical conceptions. Its meaning will not be exhausted here, but it is crucial to note that the two heads symbolize the reality and diversity of the interests of individuals, while the common stomach represents the common interests of all and sundry. The teaching is that the conflict can be resolved only by the realization of this second-order commonality of interests. And the resolution will have to be one in which the targeted resource is shared in a manner impartially sensitive to the original interests of all the parties, that is, in accordance with the golden rule. This reflection also suggests a succinct characterization of the rationale or foundation of morals as the evenhanded pursuit of human interests, where the evenhandedness is thanks to the golden rule. The reader might like to note the rational bent of this conception of morality.

The golden rule had a similar centrality in the moral system of the seventeenth-century Ethiopian philosopher Zara Yacob (1592–1692). He was a contemporary of René Descartes who, independently of Descartes, developed a rationalistic philosophy that was if anything more radical in its insistence on reason than that of Descartes (see Sumner, p. 224 ff.). Although he laid much stress on the will of God, he self-consciously construed it as that which is in conformity with reason: “God does not order absurdities” (Sumner, 1994, p. 238).

Morality as Custom

The foregoing has been about morality as determined by the golden rule. But there are, as hinted in the opening paragraph, countless behavioral as well as institutional options that are neither prescribed nor proscribed by the golden rule. This brings us to the sphere of custom, broadly conceived. Customs are multifarious, both in nature and origin, in Africa and everywhere else. Some precipitate philosophical questions; others do not. It is in terms of custom that cultures are differentiated. And one of the most important criteria of differentiation lies in the contrast between individualism and communitarianism. It is a contrast that is also, philosophically, quite challenging.

There is a veritable consensus among students of African societies south of the Sahara that traditional African culture is communitarian. A communitarian society is one in which individuality is regarded as a construct out of community, and an individualistic society, one in which community is regarded as a construct out of individuality. The apparent sharpness of the contrast, however, is illusory. It is a matter of degree, for without individuals there is no community, and without a community there are no *human* individuals. Still, a lively concern in moral philosophy among contemporary African philosophers is to clarify and evaluate the claims of individuality in the context of African communitarianism. Kwame Gyekye, for example, stresses the importance of individuality and entitles his version of communitarianism “moderate communitarianism” (Gyekye 1997, chap. 2). Dismas Masolo (pp. 495f.) also suggests that African communitarianism, properly considered, is hospitable to individuality. The enterprise of reassessment naturally spills over into social and political philosophy (Gyekye 1995, chaps. 8, 10; Masolo).

See also *Communitarianism in African Thought; Personhood in African Thought; Philosophies: African*

BIBLIOGRAPHY

- Danquah, J. B. “Obligation in Akan Society.” *West African Affairs Series*, no. 8. London: Bureau of Current Affairs, 1952.
- Gbadegesin, Segun. *African Philosophy: Traditional Yoruba Philosophy and Contemporary African Realities*. New York: Peter Lang, 1991.
- Gensler, Harry J. *Symbolic Logic: Classical and Advanced Systems*. Englewood Cliffs, N.J.: Prentice-Hall, 1990.
- Gyekye, Kwame. *An Essay on African Philosophical Thought: The Akan Conceptual Scheme*. Rev. ed. Philadelphia: Temple University Press, 1995.
- . *Tradition and Modernity: Philosophical Reflections on the African Experience*. New York: Oxford University Press, 1997.
- Idowu, Bolaji E. *Olódùmarè: God in Yoruba Belief*. London: Longmans, 1962.
- Kant, Immanuel. *Foundations of the Metaphysics of Morals, and What is Enlightenment?* Translated with an introduction by Lewis White Beck. New York: Liberal Arts Press, 1959.
- Makinde, M. Akin. *African Philosophy, Culture, and Traditional Medicine*. Athens: Ohio University Center for International Studies, 1988.
- Masolo, Dismas. “African Communalism and Western Communitarianism: A Comparison.” In *A Companion to African Philosophy*, edited by Kwasi Wiredu. Malden, U.K.: Blackwell, 2004.

Sumner, Claude. *Classical Ethiopian Philosophy*. Los Angeles: Adey, 1994.

Wiredu, Kwasi. *Cultural Universals and Particulars: An African Perspective*. Bloomington: Indiana University Press, 1996.

———. “Moral Foundations of an African Culture.” In *Person and Community: Ghanaian Philosophical Studies*, edited by Kwasi Wiredu and Kwame Gyekye. Vol. 1. Washington, D.C.: Council for Research in Values and Philosophy, 1992.

———. “Morality and Religion in Akan Thought.” In *African-American Humanism: An Anthology*, edited by Norm R. Allen Jr. Buffalo, N.Y.: Prometheus Books, 1991.

Kwasi Wiredu

ANCIENT

Ancient Greek moral theories are concerned in the first instance with the good life for human beings, or, in a word, happiness—what it is and how we might attain it—and with the role of the virtues of character—for example, temperance, courage, and especially justice—in achieving it. Serious critical inquiry into these questions began in Athens in the fifth century B.C.E. with Socrates (469–399), peaked twice in the theories of Plato (427?–347) and Aristotle (384–322), and came to rest in the Hellenistic period (323–30) with the calmer and more austere theories of the Epicureans and Stoics.

Socrates

Our picture of Socrates derives mainly from several short, inconclusive dialogues by his disciple Plato. In these, Socrates, believing that “the unexamined life is not worth living,” typically challenges the conventional beliefs of his fellows, both ordinary people and more sophisticated thinkers, with questions about how human life should be lived. When his interlocutors prove unable to defend their opinions on such questions, Socrates offers his own, radical, positive agenda in their place. We are happy, he thought, when our souls are in the best condition—when, as he believed, we have the virtues of character, especially justice. Since we all want to be happy, we will inevitably do what is virtuous if we know what it is. Hence happiness is achieved by removing ignorance and vice from our souls and replacing them with knowledge and virtue. Socrates’ moral seriousness and courage, in discussion and in life, won favor not only with posterity but also with many of his contemporaries—but not all of them: in 399 he was tried and convicted on a charge of impiety, and put to death.

Plato

Socratic ethics insists that we will do what makes us happy if we know what that is. Often enough, however, when we (think we) know what will make us happy, we would rather do something else instead, and sometimes we do that something else. Also, Socratic ethics does not say enough about the soul to establish that justice and the other virtues bring the soul into its best condition or that we are happy when our souls are in their best condition.

In response to these concerns, Plato in the *Republic* (360 B.C.E.) distinguishes between the “rational,” “emotional,” and “appetitive” parts of the soul.

Each part is defined by desires: reason, by desires for what is best for us; emotion, by desires for honor, achievement, power, domination of others, and so on; and appetite, by desires for various kinds of physical pleasure. Plato also associates each part of the soul with goals: reason he associates with seeking after knowledge or understanding and emotion, and appetite with the various forms of emotional and physical gratification. Given these distinctions, Plato goes on to argue that our souls will be in better condition to the extent that our lives are structured and our practical activities are motivated by goals associated with reason, not goals associated with emotion and appetite.

Plato's metaphysics provides us with his account of the proper objects of understanding. According to his "theory of forms," the world that we are familiar with and the items populating it are merely "shadows" or "reflections" of a separate world of eternal and unchanging "forms," or "ideas," such as Number, Man, and Justice. By "sharing in" or "participating in" these most fundamental realities, ordinary objects are what they are and have the features they do. The desire to attain understanding of these entities should dominate our lives. Apprehending and appreciating formal reality, Plato thinks, makes us happy and makes our lives worth living.

It also makes us moral. Formal reality, Plato thinks, is so appealing—so riveting—as to cause us to lose interest altogether in emotional and physical forms of gratification. In consequence we will behave decently toward our fellows. Justice is thus the natural expression in the field of human relationships of a properly lived human life.

Aristotle

Aristotle in the *Nicomachean Ethics* (350 B.C.E.), like Plato in the *Republic*, makes knowledge or understanding central to his conception of what is good for us as human beings. He also sees the virtues as expressing knowledge or understanding in action and in a life. But the kind of knowledge he takes to be involved in the virtues and how exactly he sees the virtues give expression to them are very different from what Plato thought.

Happiness for Aristotle consists primarily in the contemplation of the eternal truths of mathematics, physics, and theology. But practical wisdom, which is deployed in living a life well, is a separate intellectual virtue for Aristotle, and the virtues of character are closely connected with it. In the case of justice, Plato thinks that I will not take what is yours because, given my compelling interest in intellectual activities, I am no longer interested in what is yours. Arguably, this is not to take you and your rights as a person seriously. Aristotle's account of justice is a useful corrective. To be just requires not that I am uninterested in what is yours, but that I am disinterested or impartial; I see what is yours as yours and what is mine as mine.

I can achieve this perspective in matters of justice, Aristotle thinks, if I assume the perspective of a judge who sees us as free and equal citizens, each with his own interests and entitlements, and decides matters between us accordingly. And if I achieve this perspective, I will behave justly toward you. Thus being just requires that I understand what it is to be a citizen on a par with other citizens and to act from that

perspective. So too with the other virtues: each involves correctly understanding the area of human reality appropriate to it and embodying that understanding in our actions and passions.

Hellenistic Theories

The most important ethical theories of the Hellenistic period are Epicureanism and Stoicism. According to the Epicureans, we are happy to the extent that we achieve a state of mind called "peace of mind" or "lack of disturbance." Disturbance is pain, and its absence is pleasure. To achieve peace of mind, we need to recognize that any fear of death or of the gods is baseless and that wronging others or pursuing physical pleasures beyond what is necessary will produce more pain than pleasure in the end. Thus knowledge as well as virtues such as justice and temperance do have value for the Epicureans, but they are valued only as means to peace of mind, not for themselves as they are for Socrates, Plato, and Aristotle.

The Stoics identified happiness with a state of mind called "absence of passion" or "spiritual peace." We can achieve this by coming to understand and identify with the impartial moral order of the universe and living "according to nature." This means living in ways that express our nature as rational beings. Crucial to such a life are the virtues, since they are all forms of knowledge; for example, justice is knowledge of what we owe to other people. Such knowledge is of a piece and is all or nothing; if we attain it, we will become calm and indifferent to such ills as poverty, pain, and even enslavement and death. Thus, although the Stoics' conception of happiness resembles that of the Epicureans, their view of virtue and its relation to happiness is closer to the views of Socrates, Plato, and Aristotle.

See also *Philosophy, Moral: Medieval and Renaissance; Philosophy, Moral: Modern; Virtue Ethics*.

BIBLIOGRAPHY

- Barnes, Jonathan, ed. *The Complete Works of Aristotle: The Revised Oxford Translation*. Princeton, N.J.: Princeton University Press, 1984. A two-volume revision of the Oxford Translation that includes all of Aristotle's works mentioned earlier, as well as a number of works attributed to Aristotle but of doubtful authenticity; various fragments, including parts of two poems; and Aristotle's will.
- Bekker, Immanuel, ed. *Aristotelis Opera*. 5 vols. Berlin: G. Reimerum, 1831–1870. The complete Greek text of Aristotle's writings but for the *Constitution of Athens*.
- Burnet, John, ed. *Platonis Opera*. 5 vols. Oxford: Clarendon, 1900–1907. A complete Greek text of Plato's writings.
- Cooper, J., ed. *Plato: Complete Works*. Indianapolis and Cambridge, U.K.: Hackett, 1997. A one-volume translation by various hands of all of Plato's writings, including works attributed to Plato that he may not have written.
- Hamilton, Edith, and Huntington Cairns, eds. *The Collected Dialogues of Plato, Including the Letters*. Translated by Lane Cooper and others. New York: Pantheon, 1961.
- Inwood, Brad, and L. P. Gerson, trans. *Hellenistic Philosophy: Introductory Readings*, 2nd ed. Indianapolis: Hackett, 1998. A one-volume selection of materials.

- Long, A. A., and D. N. Sedley, eds. *The Hellenistic Philosophers*. 2 vols. Cambridge, U.K., and New York: Cambridge University Press, 1987. Greek and Latin texts of the principal sources for Hellenistic philosophy, with notes, translations, and commentary.
- McKeon, Richard, ed. *The Basic Works of Aristotle*. New York: Random House, 1941. A one-volume abridgment of the Oxford Translation.
- Ross, W. D., and J. A. Smith, eds. *The Works of Aristotle Translated into English*. Oxford: Clarendon, 1910–1952. The standard English version of Aristotle's writings, referred to as the "Oxford Translation."

Charles M. Young

MEDIEVAL AND RENAISSANCE

Moral philosophy in the medieval West derived from two main sources: Christianity and classical ethics. The attempt to reconcile these different traditions and develop a viable synthesis of the two was a central concern of moral philosophy throughout the period.

Christianity and Classical Ethics in the Medieval West

Starting with the early church fathers, Christian thinkers took differing views of the proper relationship between their moral system and that of the pagan philosophers of antiquity. On the one hand, St. Ambrose (c. 340–397), in *De officiis ministrorum* (On the duties of the ministry), was prepared to adapt the Stoic-inspired account of virtue set out in Cicero's (106–43 B.C.E.) *De officiis* (On duties) to the needs of Christians seeking eternal bliss in the afterlife. On the other hand, St. Augustine (354–430), another doctor of the church, denied that Christians could learn anything from pagans about either virtue in the present life or happiness in the next, both of which were gifts of God's grace.

Ambrose's conviction that the ancient framework of ethical theory could be extended and modified to accommodate Christianity found wide resonance in thinkers from the Iberian bishop St. Martin of Braga (c. 520–580), who wrote influential moral tracts closely based on the writings of the Roman Stoic Seneca (4 B.C.E.–65 C.E.), to the Cistercian abbot Ailred of Rievaulx (1109–1166), whose treatise *De spiritali amicitia* (On spiritual friendship) is modeled on Cicero's *De amicitia* (On friendship).

The uncompromising position of Augustine was echoed by monastic moralists such as Abbot Rupert of Deutz (c. 1076–c. 1129), who rejected pagan philosophers out of hand on the ground that they had no knowledge of spiritual or heavenly values. The first medieval philosopher to put forward a serious challenge to Augustine's characterization of virtues as gifts of divine grace was Peter Abelard (1079–1142). Drawing on Cicero and on Boethius's (c. 480–c. 524) commentary on Aristotle's (384–322 B.C.E.) *Categories*, he defined natural virtues as fixed dispositions that were acquired by the exercise of human powers and that could be transformed into Christian virtues by being directed toward God. Abelard was nevertheless acutely aware that while Seneca, the pagan philosopher he most admired, held that virtue must be sought for its own

sake, Christians believed that virtue should be pursued in the hope of a greater reward: happiness in the future life.

It was precisely this issue that made Aristotelian ethics, with its this-worldly orientation, particularly problematic for medieval Christians. In the *Nicomachean Ethics*, which began to be available in Latin translation at the end of the twelfth century, Aristotle declared that humankind's supreme good was a happiness that consisted of philosophical contemplation in the present life—a view that was clearly incompatible with the Christian belief that humanity's highest and ultimate goal was everlasting bliss in the afterlife. A solution to the problem was found in the mid-thirteenth century by scholastic philosophers at the University of Paris. Building on a distinction originally made by the French theologian William of Auxerre (d. 1231), they maintained that the subject of Aristotle's treatise was imperfect happiness, a natural state attainable in the present life by human powers, while perfect happiness or beatitude, a supernatural state attainable in the next life through grace, was the subject of theological, not philosophical, inquiry.

This position was further developed by the Dominican theologian and philosopher Thomas Aquinas (c. 1225–1274), who carved out a legitimate area of investigation for moral philosophy: the examination of the limited happiness that can be achieved by man through the naturally acquired virtues described by Aristotle, whereas theology was concerned with the unlimited heavenly beatitude produced by divinely infused virtues. This formulation, which established that Aristotelian moral philosophy, though vastly inferior to Christian theology, was nonetheless fundamentally in agreement with it, made it possible for university professors from the late Middle Ages to the end of the Renaissance and beyond to base the teaching of ethics firmly on the doctrines of Aristotle.

Islam, Judaism, and Classical Ethics

As in the Christian West, medieval Islamic and Jewish moral philosophy devoted considerable effort to reconciling scriptural precepts and values with those deriving from the classical ethics inherited from Greece. Muslim moral philosophers, rather than drawing a clear distinction between the imperfect happiness of the present life and the perfect beatitude of the hereafter in the manner of their Christian counterparts, emphasized the harmony between religion and philosophy (or *falsafah* from the Greek term *philosophia*) by pointing out that both were based on a proper understanding of the universe and mankind's place within it. Ethics was linked to theoretical knowledge, acquired by rational means, which led individuals toward the ultimate goal of attaining happiness in this life or the next. The Spanish Muslim philosopher Ibn Rushd (1126–1198), who produced comprehensive commentaries on the Aristotelian corpus that circulated widely in the West under his Latinized name Averroës, held that the path to happiness was an intellectual ascent to the contemplation of ever higher beings, culminating in the contemplation of the first cause and temporary union with the source of intellectual understanding. This account of happiness, which had no need for divine revelation or life after death, apparently gained adherents among Latin Averroists at the University of Paris in the late thirteenth century, since the doctrine "that happiness

is to be had in this life and not in another” was among the 219 propositions condemned by the bishop of Paris in 1277.

Jewish moral philosophy was also concerned with establishing the proper relationship between religious and philosophical ethics. Moses Maimonides (1135–1204), the most influential of medieval Jewish philosophers, held that faith and reason were not in conflict and therefore, attempted to ground the basic principles of Aristotelian ethics in Jewish tradition, modifying them according to its needs. Maimonides, like Islamic moral philosophers, had a highly intellectualist conception of ethical perfection, in relation to which moral perfection played a merely subsidiary and preparatory role. A different trend in ethics, however, arose in conjunction with Kabbalah, a form of Jewish mysticism. Kabbalists such as Moses ben Jacob Cordovero (1522–1570) regarded moral perfection as the road to mystical union with aspects of the deity and believed that the moral behavior of individuals had an impact on the cosmic struggle between good and evil.

The Renaissance Recovery of Ancient Moral Philosophy

Although Aristotelianism dominated ethics in the West well into the seventeenth century, the Renaissance witnessed the recovery of other ancient traditions of moral philosophy. As had happened with Aristotle’s ethical thought in the Middle Ages, the acceptability of these revived philosophies was largely conditioned by their compatibility with Christianity. The Florentine priest and philosopher Marsilio Ficino (1433–1499), who played the key role in the fifteenth-century revival of Platonism, stressed the extent to which the doctrines of Plato, unlike those of his student Aristotle, were in accord with Christianity. Ficino demonstrated this agreement most successfully in relation to moral philosophy through his influential theory of Platonic love, in which Plato’s intellectual ascent from physical beauty to the realm of Ideas was interpreted as a spiritual journey whose final destination was God.

Stoic ethics inspired admiration from many Renaissance thinkers on account of its high-minded principle that virtue alone was sufficient for the good life. Yet its stern moral demands, which included a complete eradication of the emotions, provoked an equal amount of criticism for requiring a superhuman strength that surpassed even the powers of Christ, who had given way to both anger and sorrow. This ambivalent attitude toward Stoic moral philosophy was not overcome until the late sixteenth century, when a new brand of Stoicism, more accommodated to Christianity, was promoted by the Flemish humanist Justus Lipsius (1547–1606). The Spaniard Francisco de Quevedo (1580–1645) attempted to carry forward Lipsius’s program of Christianizing Stoicism by claiming that the ultimate source of the philosophy of patient resignation recommended by the Greek Stoic Epictetus (c. 55–135) was the Book of Job. The recovery of Stoic moral philosophy, with its belief that human beings through their reason can comprehend and participate in the rational order of nature, contributed to renewed interest in natural-law theory.

Compared to Platonism and Stoicism, Epicurean moral philosophy made very few inroads into Renaissance thought.

Epicurus’s doctrine that pleasure was the supreme good, misinterpreted since antiquity as an endorsement of sensual indulgence, combined with his rejection of divine providence and immortality, rendered his philosophy unacceptable to Christians. Not surprisingly, serious attempts to adapt Epicureanism to Christianity were rare. When the Italian humanist Lorenzo Valla (1407–1457) transferred the earthly pleasures of Epicurus to the heavenly ones enjoyed by the virtuous in the next life, his aim was less to rehabilitate the ancient philosophy than to reassess Christian theology. Similarly, the Dutch humanist Desiderius Erasmus (1466?–1536), by maintaining that Christ was the true Epicurean, since his disciples led the most pleasurable life, sought to highlight the ethical dimension of Christian piety.

The first Renaissance thinker to tap the ethical potential of Pyrrhonian skepticism, which held that it was impossible to attain certain knowledge, was the French essayist Michel de Montaigne (1533–1592). Adopting the motto *Que sais-je?* (What do I know?), he deployed skeptical arguments to undermine any claims to moral knowledge, in the hope of deflating human presumption, which he regarded as the root of all evil. The recovery of skepticism was part and parcel of the Renaissance movement to revive ancient philosophical traditions. Yet it presented epistemological challenges that in the following era would turn moral philosophy from a discipline based on classical and Christian authority to one founded on principles that had been rationally deduced from self-evident axioms.

See also *Aristotelianism; Natural Law; Neoplatonism; Skepticism; Stoicism.*

BIBLIOGRAPHY

PRIMARY SOURCES

- Abelard, Peter. *Peter Abelard’s Ethics*. Edited and translated by D. E. Luscombe. Oxford: Clarendon, 1971.
- Aquinas, Thomas. *Selected Writings*. Edited and translated by Ralph McInerney. London and New York: Penguin, 1998.
- Kraye, Jill, ed. *Cambridge Translations of Renaissance Philosophical Texts*. Vol. 1: *Moral Philosophy*. Cambridge, U.K., and New York: Cambridge University Press, 1997.
- Montaigne, Michel de. *The Complete Essays*. Edited and translated by M. A. Screech. London and New York: Penguin, 1993.

SECONDARY SOURCES

- Becker, Lawrence C., and Charlotte Becker, eds. *A History of Western Ethics*. 2nd ed. New York and London: Routledge, 2003. See especially chapters 5–7 for early medieval, late medieval, and Renaissance ethics.
- Butterworth, Charles E. “Ethics in Medieval Islamic Philosophy.” *Journal of Religious Ethics* 11 (1983): 224–239.
- Dan, Joseph. *Jewish Mysticism and Jewish Ethics*. Seattle: University of Washington Press, 1986.
- Hovannisian, Richard G., ed. *Ethics in Islam*. Malibu, Calif.: Undena Publications, 1985.
- Kraye, Jill. *Classical Traditions in Renaissance Philosophy*. Aldershot, U.K.: Ashgate, 2002. See especially the section “Classical Ethics in the Renaissance.”
- Lagerlund, Henrik, and Mikko Yrjönsuuri, eds. *Emotions and Choice from Boethius to Descartes*. Dordrecht, Netherlands, and Boston: Kluwer, 2002.

- Lines, David A. *Aristotle's "Ethics" in the Italian Renaissance (ca. 1300–1650): The Universities and the Problem of Moral Education*. Leiden, Netherlands, and Boston: Brill, 2002.
- McGrade, A. S., ed. *The Cambridge Companion to Medieval Philosophy*. Cambridge, U.K., and New York: Cambridge University Press, 2003. Chapters 10 and 11 deal with moral philosophy.
- Weiss, Raymond L. *Maimonides' Ethics: The Encounter of Philosophic and Religious Morality*. Chicago: University of Chicago Press, 1991.
- Wieland, Georg. "The Reception and Interpretation of Aristotle's *Ethics*" and "Happiness: The Perfection of Man." In *The Cambridge History of Later Medieval Philosophy: From the Rediscovery of Aristotle to the Disintegration of Scholasticism, 1100–1600*, edited by Norman Kretzmann, Anthony Kenny, and Jan Pinborg; associate editor, Eleonore Stump. Cambridge, U.K., and New York: Cambridge University Press, 1982.

Jill Kraye

MODERN

The moral philosophy of the modern period traditionally included ethics as well as natural-law theories of rights and the normative foundations of state authority. Nowadays, the term *moral philosophy* tends to be used mainly with reference to ethics proper, while modern natural-law theories and their history are often treated under the headings of political philosophy and philosophy of law. In keeping with this convention, the following summaries concentrate mainly on developments in ethics since 1600.

Seventeenth Century

Modern Western philosophy emerged in conjunction with the religious, political, and social upheavals that characterized the Reformation period and the first half of the seventeenth century. Early modern moral philosophy reflected the need to reassess the ways that European thinkers had viewed moral knowledge, the human good and the nature of moral value, and the relation between God's will and the principles of human conduct. The extent to which seventeenth-century moral thought represents a break with late medieval and Renaissance views is controversial. But by the early 1600s modern conceptions of the character and goals of the theory of morals differed significantly from their historical antecedents. Hugo Grotius (1583–1645) provided an alternative to Scholastic natural-law theory as well as a response to the skeptical views on moral knowledge put forward by sixteenth-century thinkers like Michel de Montaigne (1533–1592). Grotius took a broadly empirical approach to the question of universal natural law by considering the features of human nature that make law-governed cooperation between individuals both possible and necessary. When presenting the basic precepts of human conduct, Grotius tended to focus on the self-interested individual. While Grotius accepted that humans are naturally sociable, he did not ground his natural jurisprudence in a rich, substantive conception of the good life or the chief good for human beings. Rather, he offered key elements of a theory of natural rights. Grotius regarded natural rights as subjective qualities of the human individual that must be respected by morally viable forms of human association. Subsequent

modern natural-law theories were generally in keeping with Grotius's minimalist conception of the good as well as with the Grotian idea of rights.

Thomas Hobbes (1588–1679) combined a denial of natural sociability with an egoistic view of human motives. His works on moral philosophy were interpreted as providing a naturalistic account of obligation, an account based on the fundamental good (the self-preservation) of the separate agent. An important problem linked to Grotius's and Hobbes's moral thought was the relationship between the laws of nature and God. Samuel von Pufendorf (1632–1694) made the will of God the ultimate source of such laws, and made God's power to punish and reward the ultimate ground of our obligation to obey them. This voluntarist view of morality as obedience to the will of a superior generated the systematic theory of duties and rights found in Pufendorf's immensely influential works. A similar view underlies the treatment of moral ideas given by John Locke (1632–1704). Locke combined a hedonistic explanation of the origins of our ideas of moral good and evil with a voluntarist conception of the relationship between law and the sanctioning power of a superior.

The voluntarist view of morality was a primary target of early modern perfectionist philosophers. Baruch Spinoza (1632–1677) held that the world is not the separate creation of God but a natural whole completely determined by eternal truths and laws knowable by reason. The philosophically informed agent's moral task is not to *obey* God's commands. Rather, the task is to understand divine law as the expression of eternal truths and thus to grasp the object of law as the supreme good. The true knowledge and love of God represents the highest state of human perfection. Striving to know this good through reason, the agent transcends selfish motivation and narrow self-interest. Nicolas Malebranche (1638–1715) viewed the world as having causal order through continual divine intervention. According to Malebranche, we are wholly dependent on God, and morality is obedience to God. This obedience, however, does not involve blind or even self-interested acceptance of divine commandments. Obedience requires that we understand God's order, and our intellectual apprehension of this order moves us to act from love in accordance with God's will. Repudiating the central tenets of voluntarist morality, Gottfried Wilhelm von Leibniz (1646–1716) based his moral system on the supposition that all actions must have a sufficient reason, a supposition linked to the notions of divine omniscience and metaphysical perfection. While many possible worlds are conceivable, God's perfection and infallibility guarantee that he chose optimally, thus creating the best of all possible worlds. Humans act morally when they act from the habit of loving or willing the good; and they act in this way when they learn to act on their knowledge of the world's perfection. The ethics of Christian von Wolff (1679–1754) were generally in keeping with the Leibnizian perfectionist view, although Wolff modified Leibniz's metaphysical tenets in a variety of ways.

Eighteenth Century

A characteristic component of eighteenth-century sentimental ethics was the rejection of the rationalist accounts of

moral knowledge and motivation that supported theoretical views like those just summarized. Sentimentalist thinkers held that our awareness of moral good and evil, our ability to judge actions and character traits, and our motives for action depend on our capacity to be affected by feelings that are common to all human beings. The notion of a moral sense thus often figured prominently in the sentimentalists' portrayals of the source of our feelings of moral approval and disapproval. Contrary to the theorists of natural law discussed above, these theorists of moral sensibility tended not to regard concepts of law, obligation, and duty as primary ethical notions. Anthony Ashley Cooper, better known as the earl of Shaftesbury (1671–1713), understood virtue in terms of actions that give rise to feelings of approbation, actions that in turn show evidence of an agent's self-ordered affective harmony with respect to the feelings that move him to act. According to Francis Hutcheson (1694–1746), human moral sensibility is naturally structured in such a way that we approve of actions and character traits to the extent that they exhibit benevolent inclination as their motivating condition. Hutcheson formulated a theory of virtue in which universally benevolent inclination features as the morally best of motives. While David Hume (1711–1776) did not follow Hutcheson in maintaining that benevolent inclination supplied the only genuinely moral basis for action, he advanced a secular science of morality founded on the analysis of the moral sentiments and the human capacity for sympathy. Making use of the systematic superstructure of modern natural-law accounts of duties and rights, Hume constructed a comprehensive theory of the virtues revolving around the distinction between the "natural" virtues (such as compassion and generosity) and convention-dependent "artificial" virtues (such as justice). Jean-Jacques Rousseau (1712–1778) and Adam Smith (1723–1790) published highly influential treatises that further articulated the view that human morality has its grounds in the sensuous dimension of our nature.

A further type of approach was furnished by ethical theories that assumed egoistic explanations of moral motivation, typically in conjunction with hedonistic accounts of the good and proto-utilitarian principles requiring the maximal promotion of human happiness. These theories were often rooted in the Augustinian view of the sinfulness and corruption of human nature that was presupposed not only by Lutheran and Calvinist moral theology but also by French Jansenist ethical thought. Interweaving the Augustinian view with themes drawn from Hobbes's anthropology, Pierre Nicole (1625–1695) maintained that, although virtuous action is at bottom the result of self-interested passion, such selfish action has beneficial consequences for society as a whole. Bernard de Mandeville (1670–1733), writing in English, radicalized this line of thinking to the point of rupture with traditional religious conceptions of vice and sinfulness. While Mandeville's theory of morals scandalized his immediate contemporaries, the connection between selfish motivation and general utility came to be regarded with increasing favor during the eighteenth century. That connection provides a crucial element of the moral philosophies of Claude-Adrien Helvétius (1715–1771) and Paul-Henri-Dietrich d'Holbach (1723–1789), both of whom were important influences on the full-fledged utilitarian ethics of Jeremy Bentham (1748–1832). Bentham argued that the

general happiness, to be promoted through actions and governmental policies, must be understood quantitatively in terms of the favorable balance of pleasure over pain, as experienced by separate individuals in the pursuit of their particular ends.

Immanuel Kant (1724–1804) sought the grounds of morality in concepts and principles of practical reason that could be established independently of facts about the sensuous dimension of human nature. Kant's major works on moral philosophy aimed to give an account of the fundamental moral law as a supreme formal principle of duty, which he called the categorical imperative. Kant thought of the categorical imperative as an objectively valid principle by which an agent can determine the moral content of subjective practical principles called maxims. Maxims conforming to the universality requirements expressed by the categorical imperative supply laws of practical reason that specify particular duties. The categorical imperative, however, is much more than just an abstract and legalistic formal principle of duty. For it requires the individual agent to make it *her* maxim to act in such a way that the maxims of her actions can be willed as universal laws, thus making the principle of duty itself the sufficient incentive for action, independently of inclination and sentiment. The rationally legislating human agent gives laws of duty to herself in conformity with the idea that every human will *can* be a will that legislates universally through all its maxims. Such is the Kantian idea of rational self-legislation as autonomy of the will. In keeping with this idea, Kant asserted that morality is "the relation of actions to the autonomy of the will, that is, to a possible giving of universal law through its maxims."

Nineteenth Century

Kant's theory of autonomy and his treatments of the universal principles of rational willing were of determinative significance for the idealist philosophy of Georg Wilhelm Friedrich Hegel (1770–1831). Yet Hegel considered the Kantian method of grounding ethics strictly in the analysis of the formal aspects of rational self-legislation to be fundamentally incomplete. According to Hegel, that method could not overcome its "empty formalism" because it was unable to take proper account of the human agent's embeddedness in historically conditioned societal settings. Hegel's work on moral philosophy reflects the concern to understand both the form and the content of modern morality in its systematic connections with, on the one side, abstract principles of property law, contractual relations, and legal wrongdoing and, on the other side, the concrete norms governing the historically given institutional structures of the bourgeois family, civil society, and the political state.

An important characteristic of nineteenth-century British ethics is the opposition between utilitarian and intuitionist theories. Intuitionists maintained that we have the rational capacity to apprehend self-evident moral principles and that we can be moved to act by virtue of our intuitive grasp of these principles. Intuitionist accounts of morality were formulated on terrain already well prepared by thinkers like Samuel Clarke (1675–1729), Joseph Butler (1692–1752), Richard Price (1723–1791), and Thomas Reid (1710–1796). William Whewell (1794–1866) may be taken as the representative

figure for nineteenth-century intuitionism in Britain. John Stuart Mill (1806–1873) defended utilitarianism against its intuitionist detractors. His theory of happiness, however, rejects Bentham's purely quantitative version of hedonism. Mill emphasized the distinction between higher and lower pleasures, and he argued that higher pleasures are better than the lower ones. Henry Sidgwick (1838–1900) investigated egoism, intuitionism, and hedonistic utilitarianism in relation to the principles that underlie intuitive commonsense morality. While Sidgwick took a utilitarian position, he concluded that the standardly accepted antithesis between utilitarianism and intuitionism was spurious since self-evident moral principles are required in order to provide a rational foundation for utilitarian ethics.

Friedrich Nietzsche (1844–1900), who was to have a decisive impact above all on Continental European ethical thought during the twentieth century, devoted much of his writing to a frontal criticism of Western moral philosophy. Rejecting the universality claims of modern thinkers like Kant, Nietzsche focused on historically existing moralities and treated them naturalistically as the outcome of society's development. He was concerned to uncover the psychological underpinnings of our attributions of value and to articulate a "genealogy" of morals that supports a fundamental reevaluation of values. Nietzsche regarded modern morality as the result of the creation and imposition of value by the weak, by those who have always struggled against the "master" morality of the strong and noble. Nietzsche emphasized the necessity of overcoming the roots of modern morality, hence the life-affirming will to go "beyond good and evil."

Twentieth Century

Offering an alternative to neo-Kantian ethics and prevalent strains of utilitarian ethics, the emergence of systematic value theory represented an important trend in German and Austrian academic philosophy during the late nineteenth century and the early decades of the twentieth century. The pivotal thinkers in this regard, Franz Brentano (1838–1917) and Max Scheler (1874–1928), held that ethics must be based on the investigation of objective and intrinsic values that are apprehended through the emotions. Brentano's theory of the intrinsically good and bad focused on the implications of the analogical relationship between the intellectual operations of judgment and our emotive attitudes (such as love and hate) toward intentional objects. Stressing the objectivity of values as intentional objects of feeling, Scheler investigated the a priori structures of emotive experience. Scheler devoted much of his work to the detailed phenomenological description of particular emotions such as resentment, love, and sympathy, often in opposition to Nietzsche's moral psychological claims.

Influenced by Brentano, and disavowing the Kantian and neo-Hegelian proclivities of many of his contemporaries, George Edward Moore (1873–1958) held that the fundamental object of ethics was the "good," understood as an intuitively apprehensible, simple, and indefinable property. Moore criticized theories that conceive of the good as something specifiable in terms of natural properties (such as pleasure). Moore held that such theories commit the "naturalistic

fallacy," and his criticism of naturalism in ethics fed into the rise of an analytic tradition that was prevalent in Anglo-American philosophy throughout the twentieth century. Analytic ethical theorists characteristically concentrated on "metaethical" issues such as the meaning of moral terms and the justification of moral judgments. They generally kept these issues separate from the examination of substantive proposals concerning ethical values and the norms of conduct and character. Normative ethics, as distinguished from metaethics, was predominantly utilitarian until the later decades of the 1900s. This situation changed dramatically with John Rawls (1921–2002). Drawing on aspects of modern natural-law theory, but also on Kantian as well as on certain features of intuitionist ethics, Rawls's contractarian theory of justice furnished a clear alternative to the various types of utilitarian approach taken by twentieth-century thinkers. The publication of Rawls's theory of justice represents, in effect, the beginning of the international renaissance of normative ethics that has characterized moral philosophy since the 1970s.

The revival of virtue ethics has been an important factor in Anglo-American philosophy since the 1970s. Criticizing especially Kantian and utilitarian moral thought, virtue ethicists have often located the sources of their theoretical projects in Aristotle and Thomas Aquinas. But eighteenth-century sentimentalists thinkers have also had significant impact on recent virtue ethics. Reflecting the demand that ethics should have relevance beyond the confines of academia, the late twentieth century also witnessed the proliferation of fields in professional and applied ethics as philosophers became increasingly concerned with social and political issues such as the environment, war, medical and business practices, and questions of race and gender. Feminist ethics, which benefited from the expanded scope of practical ethical inquiry, has become a central area of contemporary research. Feminist philosophers have aimed to reconstruct traditional moral philosophy by insisting that ethics should finally take proper account of women's experience and the historically given structures of female subordination. The emancipatory impetus of North American feminist ethics has often been supported by the reception of Continental thought, especially by work stemming from the phenomenological and existentialist tradition, from broadly Marxist schools of social criticism, and from structuralist and poststructuralist philosophy.

See also Existentialism; Good; Law; Moral Sense; Natural Law; Utilitarianism.

BIBLIOGRAPHY

- Becker Lawrence C., and Charlotte B. Becker, eds. *Encyclopedia of Ethics*. 2nd ed. 3 vols. New York: Routledge, 2001.
- Darwall, Stephen, Allan Gibbard, and Peter Railton, eds. *Moral Discourse and Practice*. Oxford: Oxford University Press, 1997.
- Haakonssen, Knud. *Natural Law and Moral Philosophy: From Grotius to the Scottish Enlightenment*. Cambridge, U.K.: Cambridge University Press, 1996.
- Keohane, Nannerl O. *Philosophy and the State in France: The Renaissance to the Enlightenment*. Princeton, N.J.: Princeton University Press, 1980.
- Schneewind, J. B. *The Invention of Autonomy: A History of Modern Moral Philosophy*. Cambridge, U.K.: Cambridge University Press, 1998.

- . *Sidgwick's Ethics and Victorian Moral Philosophy*. Oxford: Oxford University Press, 2000.
- , ed. *Moral Philosophy from Montaigne to Kant*. Cambridge, U.K.: Cambridge University Press, 2003.
- Schneiders, Werner. *Naturrecht und Liebesethik*. Hildesheim: Georg Olms, 1971.
- Singer, Peter, ed. *A Companion to Ethics*. Oxford: Blackwell, 1991.
- Tuck, Richard. *Philosophy and Government, 1572–1651*. Cambridge, U.K.: Cambridge University Press, 1993.

Jeffrey Edwards
Michael Hughes

PHILOSOPHY AND RELIGION IN WESTERN THOUGHT.

Before Socrates, speculative thinkers addressed in several ways what would be identified as religious matters in the twenty-first century. Some of them criticized what they deemed to be implausible features of conventional religion: thus Xenophanes of Colophon (c. 560–c. 478 B.C.E.) attacked both the immorality and the anthropomorphism of the poets' depiction of the gods, while Democritus of Abdera (fifth century B.C.E.) provided explanations of the causes of events that were opposed to ideas of divine intention or arguments from design. Several early philosophers further advanced an understanding of the concept of divinity in terms that were opposed to ordinary religious experience. Their efforts were often caricatured by the public imagination as instances of impiety. It is revealing that Aristophanes (c. 450–c. 388 B.C.E.) in his play *The Clouds* depicted philosophers as promoters of irreligion, and Socrates (c. 470–399 B.C.E.) at his trial was accused of being “completely godless” (*to parapan atheos*).

With the work of Plato (c. 428–348 or 347 B.C.E.) and Aristotle (384–322 B.C.E.), these strategies for addressing the claims of religion were consolidated in ways that did much to determine future discussion. Plato's Socrates defends traditional mythology and participates in civic rituals. He recounts to Phaedrus the myth about Boreas and Orithyia and admonishes those who seek to explain its point naturalistically, and his famous last words to Crito request that a ritual sacrifice be made on his behalf. More formally, however, Plato's dialogues repeatedly turn on a rejection of doubts about the divine (see *Laws*, book 10), and he provides several arguments against those who deny the existence, nature, or providence of the gods. His most enduring representation of divine action is the account in the *Timaeus* of the Demiurge who creates the universe out of a benevolent motive.

In the works of Aristotle, criticisms of popular misconceptions of divinity and genuine moments of piety are combined. More important for later thinking about theology, however, are Aristotle's arguments for the existence of a divine prime mover of the universe and his account of that entity. At the end of *Physics* (book 8) and in *Metaphysics* (book 12), he argues that the impossibility of an infinite regress in motion requires that there be a fully actualized entity who causes all other motions by being the universal object of desire. In the *Metaphysics*, Aristotle describes the life of this being as one of “thinking of thinking” (*noesis noeseos*). Beyond this highly suggestive passage and

a few allusions elsewhere, the Aristotelian corpus affords researchers no explicit description of a divine agent.

After the deaths of Plato and Aristotle, their followers widely disseminated their theologies throughout the ancient world and engaged in dialogue with some of the teachings of Stoicism. The Stoic analysis of pain and misadventure was facilitated by a doctrine of divine providence. The Stoics were also very capable natural scientists, and this led to their promulgation of many theories about the origin of the universe. Such physical processes, however, were held to be orchestrated by a divine mind, a mind that could find expression in the civic gods of traditional religion. These three schools—the Platonic, the Aristotelian, and the Stoic—all disputed at great length with the Epicureans, for whom the gods' interventions in human affairs were nothing but a series of malicious fictions. What “gods” the Epicureans did permit were always characterized in terms that made them fully physical and natural, subject to the same laws of generation and corruption, pleasure and tranquility, that conditioned human life. An illustration of the dialectic between these competing views, as well as a resistance to Epicurean doctrines, can be found in Cicero's (106–43 B.C.E.) *On the Nature of the Gods* (book 1).

The Early Christian and Medieval Periods

The course of ancient speculation about divine matters was dramatically altered as early as the first century of the common era by the pagan world's contact with Judaism and subsequently Christianity. The intellectual directions of these faiths were also shaped as a result of coming into contact with ancient philosophy. In pagan thought, the contact produced a renewed interest in the representation of the divine nature. In Judaism and Christianity, it produced an energetic effort to present the claims of revelation in philosophically coherent ways. The renewed interest among the pagans is most evident in Neoplatonism, a school that included Plotinus (205–270), Porphyry (c. 234–c. 305), Iamblichus (c. 250–c. 330), and Proclus (410?–485). The new effort of speculation about divine matters can be seen, albeit in a different guise, in Jewish thinkers such as Philo Judaeus of Alexandria (first century C.E.) and among Christian thinkers such as Clement of Alexandria (150–between 211 and 215) and Origen (185?–254?). It led not only to philosophical explorations of Scripture but also to the development of a view within Christian circles that the “best” philosophy was to be found in Scripture.

After 400, philosophy became fully subsumed within the three monotheistic religions—Judaism, Christianity, and then Islam. Throughout the thousand years from the fifth to the fifteenth century, the largest part of speculative talent in the West was devoted to considering questions about the God of the Scriptures or revelation. Very few philosophers neglected the issues raised by the confrontation of ancient philosophy with the monotheistic religions, as can be observed in the writings of Arab thinkers such as al-Kindi (fl. ninth century), Avicenna (Ibn Sina; 980–1037), and Averroës (Ibn Rushd; 1126–1198).

In many Latin works the conversion or ascent of philosophy to faith is the central theme, as can be witnessed in the *Confessions* of St. Augustine of Hippo (354–430). For other

late antique and early medieval thinkers, philosophy served as a prolegomenon to faith grasped and expressed as sacred doctrine (*sacra doctrina*). In Boethius's (c. 480–524) *Consolation of Philosophy*, the figure of philosophy reminds Boethius of virtues without which his faith cannot be restored. One of the more enduring models of reflection on divine matters was presented by Anselm of Canterbury (1033 or 1034–1109) in his *Proslogion*. Building on the intellectual heritage of Augustine, he uses the phrase *fides quaerens intellectum*—faith seeking understanding. This strategy can clearly be seen at work in Anselm's so-called “ontological argument” in the *Proslogion* 2 and 54. It can be argued that one does much better justice to Anselm's intentions if one views the argument not as a demonstration of the existence of God but as a systematic investigation into God's mode of existence. As a person seeking understanding (*fidelis quaerens intellectum*), Anselm begins from a faith that provides the conceptual parameters of his philosophical reflection and then attempts to win his way through to a better understanding of the divine nature.

In terms loosely contiguous with Anselm's project, other medieval authors clarified the relation between philosophy and theology by insisting that philosophy must be studied thoroughly before proceeding to theology. Different examples of this tendency can be found in thinkers as diverse as the Christian Bonaventure (c. 1217–1274), in his *Itinerarium*, and the Jewish polymath Moses ben Maimon (Maimonides; 1135–1204). In a similar spirit, the Oxford philosopher and natural scientist Roger Bacon (c. 1220–1292) argued that nothing could be known about God without a prior study of languages, mathematics, optics, experiential science, and moral philosophy.

When arriving at the zenith of Scholastic speculation on God in the last quarter of the thirteenth and the first half of the fourteenth century, one finds a profound illustration of the range and diversity of the engagement of Christian theologians with the Aristotelian inheritance in the works of Thomas Aquinas (c. 1224–1274), John Duns Scotus (c. 1266–1308), and William of Ockham (c. 1285–?1349). For Aquinas, theology (*theologia*) employs, improves, and then perfects the best of ancient philosophy. He extended great deference to pagan philosophers, especially Aristotle, but whenever he spoke in his own voice he systematically transformed most of the Aristotelian doctrines he discussed, often in directions quite opposed to Aristotle's original intentions. Duns Scotus, on the other hand, began by candidly refusing to accommodate Aristotle, but what is called his “Augustinianism” is nothing but a mélange of the theological legacy from Augustine, the philosophical deposit of Neoplatonism, Scotus's reaction to the work of his contemporaries (in particular Henry of Ghent [c. 1217–1293]), and a model of Aristotelianism derived from reading Aristotle refracted through the glass of Latin Averroism. William of Ockham saw fit to repudiate some of the central features of the Aristotelianism espoused by his forebears, but he repeatedly sought to use Aristotle's work to support his own philosophical views and aspired to be perceived as a faithful Aristotelian.

The Early Modern Period

The medieval requirement of *fides quaerens intellectum* carried forward into the early modern period. Yet its legacy was

complicated in three distinct ways. First, the Christian reform movements of the Reformation were often sharply critical of the use of philosophy in any discussion of God and his creation. This criticism varied in intensity from one reforming group to another and often coexisted with humanist learning and philosophical erudition. For example, both Martin Luther (1483–1546) and John Calvin (1509–1564) frequently mocked Aristotle, and by implication much of the Scholastic tradition of philosophical theology. But more commonly, their criticisms of philosophy arose from claims about the opposition of philosophy to the Gospels, or from a vivid conviction of the impotence of “sinful” human reason, or from a confidence that God would teach what was needed in human affairs by “inspiration” and would do so not only for the prince, philosopher, and prelate but also for the common ploughboy. That said, it is telling that in the years immediately after the schism with Rome, the speculative theology of Lutheran and Reformed traditions is characterized by a return to the resources of the Aristotelian metaphysics and Scholastic argument in order to make sense of their distinctive theological claims. This can be observed in the writings of Philipp Melancthon (1497–1560) and Théodore de Bèze (1519–1605).

The second complication in the relations of philosophy to theological issues arose from fierce disputes over the conclusions of the *nova scientia*, or “new science.” The condemnation of Galileo Galilei (1564–1642) is one well-known example. Opposition to the metaphysical implications of the new science in certain religious quarters made many philosophers cautious in expressing their views. It thus becomes tricky to construe the exact nature of their theological allegiances. On the surface, the work of René Descartes (1596–1650), for example, appears to display a scrupulous Catholic orthodoxy accompanied by frequent protestations of obedience to the *magisterium* (or “teaching authority”) of the Roman Church. But Descartes was also extremely reticent and somewhat guarded about many of his cosmological views, and he continually did his very best to ensure that his publications would not provoke theological controversy. Likewise, Baruch Spinoza (1632–1677) littered his *Tractatus theologico-politicus* (anonymously published in 1670) with misdirections in order to increase the likelihood that the reader would miss his heterodox interpretation of Scripture.

The final complication arose from a more pronounced ambivalence concerning the status or even utility of advancing rational arguments for the existence of God. Thinkers such as Blaise Pascal (1623–1662) argued that the universe is characterized by a fundamental ambiguity and that arguments for the existence of God were inconclusive. On this basis, he argued that individuals ought instead to ground their religious practices in a volitional choice by which they would make themselves firmly assent to the teaching and doctrines of the church. Without such a decision, he argued, one's faith would be without foundation. This tendency, however, was opposed by a strong support for a posteriori arguments in support of “natural religion,” the claim being that it is only by means of impartial human reason that the truths of revelation can be authenticated and defended. The consequence of this move was to usher in the view that religious belief was irrational

unless buttressed by a prior philosophical justification. Of course, this left open the distinct possibility that reason might in the end disprove belief in God.

By themselves, these complications could not undo the ancient engagement of philosophy with speculation about divine matters, nor could they sever the ancient dependence of religious thought upon established modes of philosophical discourse. The overwhelming majority of early modern philosophers affirmed the existence and activity of a God, and most aligned themselves with one Christian denomination or another. John Locke (1632–1704) and George Berkeley (1685–1753) were both Anglicans. Nicolas Malebranche (1638–1715), Antoine Arnauld (1612–1694), and Pascal all published works that reflected their own distinctive brands of Roman Catholicism. Gottfried Wilhelm von Leibniz (1646–1716), while a Lutheran, distinguished himself in a period woefully characterized by religious conflict by advancing for ecumenicalism. Jonathan Edwards (1703–1758) forcefully expounded the Puritan notion of the utter dependence of all things on God. Of all the philosophers of the period, only Thomas Hobbes (1588–1679) appears a heterodox theist.

The Eighteenth and Nineteenth Centuries

If many of the central figures of the European Enlightenment were trenchant critics of established religion, they often enough professed views about a divine origin or general governance of the created order. This is true of Denis Diderot (1713–1784), Voltaire (1694–1778), and Jean-Jacques Rousseau (1712–1778). The most important works of this time regarding religion are David Hume's (1711–1776) *Natural History of Religion* (1757) and *Dialogues concerning Natural Religion* (1779, but first written in the 1750s). The former deals with the causes of religion, as it originates in human nature and society, while the latter examines the reasons or putative grounds for believing in a God or gods. The force of Hume's work resided in his claim that the culminative arguments of natural religion do not establish the existence of any deity that could be the proper object of religious belief. If revelation cannot be authenticated by reason, it might seem that the only answer that can be given to the question "Why does anyone believe in God or gods?" is that such practices have a natural origin. An investigation of these causes is the subject of the *Natural History of Religion*. Central to Hume's argument there is the provocative contention that the source of a belief in deities is to be found in numerous human pathologies that derive from a fear of the unknown.

It was not only Hume who fired a successful broadside at the theistic tradition of Western philosophy. Immanuel Kant (1724–1804) sought to refute the questionable metaphysical assumptions he believed inherent in the traditional "speculative proofs" for the existence of God, by demonstrating the incoherence of the ontological argument, the cosmological proof, and the argument from design. The effect of Kant's onslaught was to undermine not only the substance of these arguments but also trust in their philosophical efficacy. After him, philosophers such as Georg Wilhelm Friedrich Hegel (1770–1831) chose to construct a metaphysico-religious view of "Absolute Spirit," a highly suggestive concept that draws on pantheistic

ideas of the identity of the universe and God, together with theistic ideas concerning the necessary "self-consciousness" of God. The peculiarity of Hegel's view lies in his notion that the mind of God becomes actual only via the minds of his creatures.

While Kant and Hegel by no means excluded religious topics or even religious sentiments from their work, many of their subsequent readers appropriated only the negative conclusion that could be distilled from their critique of traditional theism. Thus it is unsurprising that they were followed either by fideistic thinkers such as Søren Kierkegaard (1813–1855) or else resolutely antitheistic thinkers, of whom Ludwig Feuerbach (1804–1872), Arthur Schopenhauer (1788–1860), Karl Marx (1818–1883), Friedrich Nietzsche (1844–1900), and Sigmund Freud (1856–1939) were the most influential. This atheistic legacy was prosecuted still further in the twentieth century by luminaries of the Continental tradition such as Martin Heidegger (1889–1976) and Jean-Paul Sartre (1905–1980), whose philosophical systems leave no room for God.

The Twentieth Century

Only in the twentieth century did it become commonplace for philosophers in the West to engage with the central concerns of their subject without so much as raising questions about God. A collective penchant for empiricism in both Britain and America prompted Rudolph Carnap (1891–1970) and A. J. Ayer (1910–1989) to argue that all religious claims are meaningless. Other influential philosophers such as Willard Van Orman Quine (1908–2000) essayed a metaphysics and epistemology that disqualified many of the assumptions on which a theistic philosophy could be based. It was only with the move away from strict verificationism and the development of a greater pluralism in so-called "analytic philosophy" that religious topics reappeared in philosophical thought. The work of Ludwig Wittgenstein (1889–1951), while by no means concordant with earlier traditions of metaphysics, was believed by many of his followers to have a broadly theological outlook whereby religious practices and belief could be shown to have dignity and purpose, as well as a discursive integrity that insulated them from the critiques of Hume and Kant.

In the final decades of the twentieth century, philosophers such as Alvin Plantinga in the United States and Richard Swinburne in Great Britain set about the task of applying the rigorous standards of analytic philosophy to the discussion of traditional theological subjects. The effect of their work was to increase the institutional profile of the subject known in the early 2000s as "the philosophy of religion" in professional philosophy. In many senses, this subdiscipline provides the main conceptual forum in which philosophers can debate the claims of the Western theistic tradition.

Notwithstanding the reemergence of the philosophy of religion, it is important to stress that philosophy has become a secular discipline in most Western countries. Yet the fact that it is practiced by philosophers with little or no faith or indeed historical understanding of religion does not negate the fact that throughout the ages philosophy has been closely connected to religion and speculative theology. While the impulse to philosophize and to reflect on ourselves and the world around us

may or may not have its origins in a protoreligious sentiment or disposition, the very nature of philosophical reflection will always dispose itself to intrude upon matters connected with religion and concepts of divinity. Even in this godless age, it is to be expected that the uneasy and, at times, vicarious relationship between philosophy and religion will continue.

See also **Aristotelianism; Christianity: Overview; Deism; Enlightenment; Epicureanism; Monism; Neoplatonism; Philosophy, History of; Philosophy: Relations to Other Intellectual Realms; Religion and Science; Scholasticism; Skepticism; Stoicism.**

BIBLIOGRAPHY

- Davidson, Herbert A. *Proofs for Eternity, Creation, and the Existence of God in Medieval Islamic and Jewish Philosophy*. New York: Oxford University Press, 1987.
- Frank, Günter. *Die Vernunft des Gottesgedankens: Religionsphilosophische Studien zur frühen Neuzeit*. Stuttgart, Germany: Frommann-Holzboog, 2003.
- Funkenstein, Amos. *Theology and the Scientific Imagination from the Middle Ages to the Seventeenth Century*. Princeton, N.J.: Princeton University Press, 1986.
- Gerson, Lloyd P. *God and Greek Philosophy*. London: Routledge, 1990.
- Grant, Edward. *God and Reason in the Middle Ages*. Cambridge, U.K.: Cambridge University Press, 2001.
- Israel, Jonathan I. *Radical Enlightenment: Philosophy and the Making of Modernity, 1650–1750*. Oxford: Oxford University Press, 2001.
- Marrone, Steven P. *The Light of Thy Countenance: Science and Knowledge of God in the Thirteenth Century*. 2 vols. Leiden, Netherlands: Brill, 2001.
- Oberman, Heiko. *The Harvest of Medieval Theology*. Rev. ed. Grand Rapids, Mich.: Baker, 2000.
- Popkin, Richard H., and Arjo Vanderjagt, eds. *Scepticism and Irreligion in the Seventeenth and Eighteenth Centuries*. Leiden, Netherlands: Brill, 1993.
- Webb, Clement C. J. *Studies in the History of Natural Theology*. Oxford: Clarendon, 1915.
- Wolfson, Harry A. *Philosophy of the Church Fathers*. 3rd rev. ed. Cambridge, Mass.: Harvard University Press, 1970.

M. W. F. Stone

PHILOSOPHY OF LANGUAGE. See **Language, Philosophy of.**

PHILOSOPHY OF MIND.

This entry includes two subentries:

Overview
Ancient and Medieval

OVERVIEW

Issues related to the mind are an important component in contemporary philosophy. While colleagues in psychology,

neuroscience, and cognitive ethology do empirical scientific studies of the mind, philosophers tend to focus on more general questions: What is the nature of mind, such as it may be found in *any* creature or thing? Philosophers tend to concentrate on questions such as: How is mind related to body? and How are we to understand the nature of such operations of mind as believing, knowing, perceiving, thinking, willing, understanding, and the like? Philosophers ask as well about the nature of self, of consciousness, and of the relation of these to the capacity for language.

Early Ideas

It is generally agreed that the question What is mind?—with all its modern connotations—is not found in ancient texts. The question first emerges clearly in the philosophical work of René Descartes (1596–1650). For centuries, psychological and philosophical inquiry proceeded together. The term *psychology* has its roots in the Greek term *psyche*, which has come to be translated as *soul*. In very early texts *psyche* is associated with breath, the loss of which is thought to result either in unconsciousness or death. In the work of Plato (c. 428–348 or 347 B.C.E.), the soul is taken to be simple and immortal. It is the soul—and in particular that rational part of soul, *nous*—that apprehends the Forms, and, in life, controls the body's passions. It is with Aristotle (384–322 B.C.E.) and his more biological orientation that the study of *psychology* is launched (although it is not until the late nineteenth century that the discipline is fully defined). In Aristotle we find the idea of the soul as the form of a living body, a form that has different aspects in plants, in nonrational animals, and in human animals.

Descartes's Legacy

The contemporary study of mind was given its shape by the seventeenth century philosopher René Descartes. In his *Meditations on First Philosophy*, Descartes begins with questions about what he can know. He carefully peels away from all that he has taken to be true anything that can be doubted. Descartes claims to reach the limits of doubt when he considers that, although he can doubt the existence of his body, he cannot doubt the existence of his mind. Descartes interestingly (and importantly) conducts the entire of his *Meditations* in the first person singular. He then presents the conclusion of his doubt thus: “*I am, I exist*, is necessarily true whenever it is put forward by me or conceived in my mind.” (In another of his works, he formulates the conclusion thus: “I think, therefore I am.”) This conclusion then launches him onto an examination of what he (this *I*) is. He considers, and rejects, the suggestion that he is a body (he can, after all, doubt the belief that his body exists). Thinking, however, is “inseparable from me.” Descartes concludes that he is a thinking thing, “a thing that doubts, understands, affirms, denies, is willing, is unwilling, and also imagines and has sense perception.” Descartes interestingly considers sense perception and points out that, although the objects of sight and sound may not exist, it is still indubitable that one has certain visual and auditory perceptions—that one *seems* to see and *seems* to hear. By the end of the *Meditations*, Descartes has set the stage in the philosophy of mind for the ensuing generations: Mind and body are distinct, each with a different essential nature. The world

can seem exactly as it is to a mind, while the bodies to which we take them to correspond may not exist; our world could be the result of the machinations of an evil demon. This is the metaphysical and epistemological position that Descartes bequeathed to future generations of philosophers.

This Cartesian philosophy of mind contains several key aspects. First, it establishes the position known as Cartesian, or substantial, dualism (mind and body are distinct substances). Second, it sets up the possibility of various kinds of skepticism concerning not only the external world, but also the existence of other minds. Third, it sets forth the mind as an arena that is private to the thinker, and—as far as what one *seems* to perceive—an arena whose contents are infallible and incorrigible. Fourth, it includes in the term *thought* (Latin *cogitatio*) not only understanding, willing, imagination, and the like, but also feeling. Fifth, it represents a deliberate rejection of the ancient way of thinking about the soul. Descartes holds that mind is not part of the soul but the “thinking soul in its entirety.” The result of this shift is significant. Whereas the ancients allowed souls to all living organisms, with mind restricted to human animals, Descartes holds that the soul or mind is to be found only in human animals. All nonhuman living creatures are, accordingly, mere mechanisms. Interestingly, Descartes views the human body as a mere machine, albeit one to which God has endowed a mind or soul.

Philosophy and Psychology

The study of mind, from these Cartesian roots, can be seen to take two identifiable paths (although these paths were not clearly distinguished for some considerable time). One path is through philosophy, where questions concerning mind remain closely connected with other philosophical issues such as the nature of the self, the mind’s knowledge of the world, and the nature of perception, belief, memory, and the emotions. The other path leads from philosophy to the development of psychology. The work of the British empiricists (John Locke [1632–1704], George Berkeley [1685–1753], David Hume [1711–1776])—in particular their sensationalism and associationism—was taken up in the eighteenth and nineteenth century and developed into a more empirical study of mind. This new study of mind gained momentum both in Great Britain (with associationalists such as David Hartley [1705–1757], James Mill [1773–1836] and John Stuart Mill [1806–1873], and Alexander Bain [1818–1903], as well as with the more Darwinian-inspired work of Sir Francis Galton [1822–1911], James Ward [1843–1925], and G. F. Stout [1806–1944]), in France (with the work of Etienne Bonnot de Condillac [1715–1780] and Claude-Adrien Helvétius [1715–1771]), and in Germany (with the work of Ernst Heinrich Weber [1795–1878], Gustav Theodor Fechner [1801–1887], Friedrich Beneke [1798–1854], Hermann von Helmholtz [1821–1894], Wilhelm Wundt [1832–1920], and others).

This study transferred to the United States in the very early twentieth century, where it gave rise (by way of revolt against associationalism) to the highly influential school of behaviorism under the direction of J. B. Watson (1878–1958) and B.F. Skinner (1904–1990). Behaviorism was a rejection of much of Descartes’s legacy—of his dualism, as well as of his

use of an introspective method in the study of mind. Behaviorists favored a physicalism rooted in the study of responses to stimuli in the environment. Behaviorist doctrines are to be found in both psychological and philosophical studies of the mind at this time. From around the middle of the twentieth century, behaviorist doctrine came under heavy attack. The American linguist Noam Chomsky published an influential review of Skinner’s work in which he pointed out that it is not possible to come up with a reduction of, say, a belief in terms of behavior without mentioning other mental states such as desire. The elements of the mind work *together* to produce behavior. The hope of finding a behaviorist reduction of mind seemed doomed.

With the demise of behaviorism came a renewed interest in mentalist causes and the rise of cognitive psychology. An interaction between philosophy and cognitive psychology emerged in the mid- to late twentieth century in the form of the philosophy of psychology, the study of conceptual issues in psychology using many of the methodological tools of the philosopher. The philosophy of psychology is firmly grounded in empirical studies of the mind. Questions concerning the nature of mental representation, mental imagery, what it is to have a concept, and whether there are innate ideas figure high on the agenda of these philosophers of psychology. Also around this time, there developed a multidisciplinary approach to the study of mind, *cognitive science*, encompassing philosophy, cognitive psychology, neuroscience, linguistics, and computer science. What these practitioners from different areas of study share is a belief that the workings of the mind can be modeled on the workings of a computer—that the mind is an information processing system and a representational device. Cognitive science incorporates work that stretches from artificial intelligence (AI) to parallel distributed processing (PDP or connectionist networks). It has been fueled by work such as Chomsky’s on generative grammar in linguistics, the work of the American philosopher Jerry Fodor on the language of thought in philosophy and psychology, and the work of the psychologist David Marr on visual processing. The American philosopher John Searle, with a thought experiment called “the Chinese Room,” has played the gadfly to much of the work in cognitive science. What Searle questions is the very idea that a computer program, a mere syntactic engine, can be identical to a mind, a semantic engine. In effect, we are back trying to understand the relationship of mind to body.

Identity Theory, Eliminativism, Functionalism, and Anomalous Monism

Attempts to get a grip on mind and to understand its relationship to body proliferated in the twentieth century. In the 1950s, J. J. C. Smart and U. T. Place advocated a form of identity theory. As these physicalists (or materialists) put it, consciousness is a brain process just as lightening is electrical discharge or water is H₂O. This identity was famously challenged by the American philosopher Saul Kripke who, with his “Cartesian intuitions,” argued that such an identity could only be maintained if it could be explained why it seemed to one that there could be a brain process in the absence of experience and experience in the absence of the brain process.

Alternative accounts of mind were proposed. One highly influential account, functionalism, took its cue from the development of information processing and computer technology, with its important distinction between the level of implemented software and that of implementing hardware. According to functionalism, mental states are the upshot of various causal impacts from the world, and they, in their turn, typically cause certain behavior as well as other mental states. Functionalism was hailed as an advance on both behaviorism and physicalism. Unlike behaviorism, functionalism is committed to internal, causal states. Unlike physicalism, functionalism is defined as a relation among states, thus leaving open the possibility that what realizes this function may vary from individual to individual. In the words of one early exponent, the American philosopher Hilary Putnam, our brains could be made up of gray matter or Swiss cheese; what matters is the functional organization of the system. Another important proposal for the understanding of mind came from the work of another American philosopher, Donald Davidson, who aimed to reconcile the irreducibility of mind with a commitment to monism. Davidson's anomalous monism draws a distinction between type and token identity theories. Earlier identity theorists—for example, Place and Smart—aimed to identify types of mental states with types of physical states (e.g., pain with c-fiber firing); Davidson insisted that only token mental states could be identified with token physical states (e.g., my pain at noon on 3 January 2004 with a state of my brain on that date at that time). Ontological monism (all that there is, is physical) can now be combined with conceptual dualism (mental concepts are distinct from, and cannot be reduced to, physical concepts). The principle of rationality governs the mental realm, but not the physical. With this distinction Davidson hoped to reconcile our culture of materialism/physicalism with an understanding of those characteristics of mind that make us free and moral agents.

By the turn of the twentieth century, it had become clear that talk of “the mind” is too broad and that there may be issues to do with experience and sensation that are distinct from those that arise in connection with such mental states as believing, desiring, and the like (the so-called propositional attitudes). It was thought that, while functionalism, for example, might provide a plausible account of belief, it encountered real difficulties when it came to accounting for experience. This thought was reinforced with the work of the American philosopher Thomas Nagel, who pointed out that human beings—as well as other animals such as bats—enjoy conscious experiences: there is something it is like to *be* that organism, something it is like *for* that organism. Nagel labels this the “subjective character of experience” and he argues that it is hard to see how this subjectivity could be captured in an objective science of the brain. Nagel, like Descartes before him, wants to understand just how the working of the grey matter that constitutes our brain could possibly explain the way the world seems to us—explain the dazzle of fireworks or the taste of chocolate. The philosopher Colin McGinn has argued that there is a very simple explanation here, but it is not one our human minds will ever be able to comprehend. Those working in the scientific study of mind have vigorously rejected this mysterianism. One empirically oriented American philosopher, Daniel

Dennett, claims to be able to reconcile our view of ourselves as rational, free, and conscious agents with a belief in the completeness of science by arguing that the former constitutes an ineliminable level of description of our behavior. Others, like the American philosophers Paul and Patricia Churchland, argue that psychological concepts such as belief, desires, and so on produce no definable brain activity and therefore these concepts should form no part of a completed science of mind.

The study of mind extends from philosophy to psychology and has expanded more recently to include neurophysiology, as well as cognitive ethology. The race is on to look ever more closely at the workings of the brain and at the behavior of all animals. On the one hand there is the age-old fascination with the idea of man as a machine, while on the other there is the hope that by understanding the fine-tuning of behavior we will find evidence that we share mentality with non-human animals.

Ludwig Wittgenstein

The Cartesian legacy is strong and everywhere apparent in discussions of the mind. It received a penetrating critique in the early part of the twentieth century, however, in the later work of Ludwig Wittgenstein (1889–1951), such as his *Philosophical Investigations*. Wittgenstein can be taken to have rejected the introspective method as well as the dualism of Cartesianism, and for this reason is sometimes said to be a behaviorist of sorts. It is, however, best to avoid this comparison. What Wittgenstein urges is that when we study the mind, we need to accept and understand the fact that the mind has both a first and a third person aspect; that is, each one of us knows the mind both from the “inside” as a subject and from the “outside” as the observer of other subjects. For Wittgenstein, the study of mind needs to be taken to be the study of the concept of mind, a concept that has application to oneself as well as to others. Wittgenstein's private language argument is interpreted as a critique of the very idea that one can make sense of the application of mental states to oneself in the absence of the acquisition of a concept—an acquisition that takes place through the use of language and in a social setting. Through the interaction with others, the child comes to understand that pain, for instance, is something that happens when, for example, one encounters sharp objects and reacts with a cry. The child's nature is such as to respond to its environment in certain ways; this nature and this response form the basis of the child's use of language and contribute to the development of the child's concepts. In this way the child develops concepts that have application both to the child and to others. With its constant reminder of the role that others play in the way we understand the mind, Wittgenstein's work offers a fundamental alternative to Cartesian individualism.

Conclusion

The study of mind in the early 2000s has been invigorated through the study of disorders of the mind. Appreciating the ways in which mind can break down can add to our understanding of what it is that we are studying. The mind is at once most intimately familiar to each of us and at the same time most mysterious and elusive to our understanding. While

the human mind retains its preeminence, it is a real question whether it represents something continuous or discontinuous with what we find in other animals, and in machines. While materialism is the dominant culture, we must not forget the observations of Descartes and others that make it difficult to understand just how a mere body can produce the various activities we associate with mind. The history of mind is the history of our attempt to explain how our experiences, perceptions, thoughts, emotions, and the like can be fully understood in relation to the world of flesh and blood.

See also *Behaviorism; Cartesianism; Consciousness; Mind; Psychoanalysis; Psychology and Psychiatry.*

BIBLIOGRAPHY

- Chomsky, Noam. "Review of B. F. Skinner's *Verbal Behavior*." In *Readings in Philosophy of Psychology*, edited by Ned Block. 2 vols. Cambridge, Mass.: Harvard University Press, 1980.
- Churchland, Paul. *Matter and Consciousness: A Contemporary Introduction to the Philosophy of Mind*. Cambridge, Mass.: M.I.T. Press, 1984.
- Davidson, Donald. *Essays on Actions and Events*. Oxford: Clarendon, 1980.
- Dennett, Daniel. *Consciousness Explained*. Boston: Little, Brown, 1991.
- Descartes, René. *The Philosophical Writings of Descartes*. Translated by John Cottingham, Robert Stoothoff, and Dugald Murdoch. 2 vols. Cambridge, U.K.: Cambridge University Press, 1984.
- Kripke, Saul. *Naming and Necessity*. Cambridge, Mass.: Harvard University Press, 1980.
- McGinn, Colin. *Problems in Philosophy: The Limits of Inquiry*. Oxford: Blackwell, 1993.
- Nagel, Thomas. *Mortal Questions*. Cambridge, U.K.: Cambridge University Press, 1979.
- Putnam, Hilary. *Mind, Language and Reality*. Cambridge, U.K.: Cambridge University Press, 1975.
- Wittgenstein, Ludwig. *Philosophical Investigations*. Translated by G. E. M. Anscombe. Oxford: Blackwell, 1953.

Anita Avramides

ANCIENT AND MEDIEVAL

The mind is a modern notion. But like many modern notions, it did not emerge from nowhere. What contemporary philosophers mean when they talk about the mind is part of a long tradition, stretching back through the Middle Ages to Greek and Roman antiquity.

The mind in its modern sense is best understood in opposition to the body, the extended, flesh-and-blood entity that it seems to inhabit and move at will. It was René Descartes (1596–1650) who popularized the idea that humans are two things, mind and body, and who argued further that the mind is a completely separable and immaterial substance capable of surviving the death of the body. The influence of Cartesian dualism can be seen in the fact that even in the twenty-first century, competing viewpoints tend to be defined in terms of it.

Although dualism in its strongest form originated with Descartes, there are some similarities with earlier accounts.

Descartes might even have been inspired by them. Unfortunately, this has proved to be a stumbling block for many modern scholars, who, because their thinking has been shaped by the Cartesian paradigm, cannot help but see earlier philosophers as proto-Cartesians or read their works as contributing to the solution of Cartesian problems. While this makes for interesting reading, it does a disservice to ancient and medieval authors because it refuses to understand what they were trying to do on its own terms. But Descartes's agenda differs from Plato's, which is different again from that of Aristotle, Epicurus, Chrysippus, Plotinus, Augustine, Thomas Aquinas, and John Buridan.

Ancient Greek and Roman Views

The main precursor of the modern concept of mind is the ancient Greek notion of soul (*psyche*), which was originally used to mark the difference between things that are alive and things that are dead. Conceptually, it was related to breath (*pneuma*), and was thought to come in degrees corresponding to different states of consciousness. Thus, a dead man was said to have lost his *psyche* entirely, whereas a sleeping or fainting man has lost enough of it to lose consciousness, though that too would bring him a step closer to death. The soul is composed of extremely light and tenuous matter, variously identified with pure and "breathable" elements such as air (as by the philosophers Thales [c. 625–c. 547 B.C.E.] and Anaximenes [570?–500? B.C.E.]) or fire (by Heraclitus [c. 540–480 B.C.E.]). Most pre-Socratic thinkers would have understood the expression "he breathed his last" literally, and seen the dying gasps of a Homeric warrior, say, as the exhalation of his soul. If *psyche* could exist in a disembodied state—and it is doubtful whether most early Greek philosophers thought that it could—it would have been as a shadowy or ephemeral form, like the denizens of Hades.

With Plato (c. 428–348 or 347 B.C.E.), philosophers began to ask more sophisticated questions about how one can feel, think, possess knowledge, and choose rightly. Plato's strategy here was to divide the soul in terms of its capacities, producing the first faculty psychology in the western tradition.

In his earlier writings, Plato came closer than any other ancient or medieval philosopher to advancing a dualist account like that of Descartes. In the *Phaedo*, he took immortality to be an essential feature of the soul, so that "mortal soul" is a contradiction in terms. Thus, "when death comes to a man, the mortal part of him dies, but the immortal part retires at the approach of death and escapes unharmed and indestructible" (106e). But a soul immortal by definition has more in common with what is cosmic and divine than with anything in the visible realm—such as its own body, for example—which is why Plato shows little interest in exploring its everyday operations. The soul's union with the body is not its natural state; in fact, the whole point of philosophy is to prepare the soul for its release from the "prison" of the body (80c–84b).

Plato is more forthcoming in his later works, where the concept of the soul plays a major role in his explanation of moral conflict and human action. From the fact that one can be affected by two or more desires simultaneously, he infers

that the soul cannot be unitary, since it is impossible for the same thing to act in opposite ways at the same time (there are obvious affinities here with the logical principle of non-contradiction, which Plato learned from Socrates [c. 470–399 B.C.E.]). Accordingly, in the *Republic* he identifies three distinct parts of the soul—reason (*nous*), passion (*thumos*), and appetite (*epithumia*)—and posits these as the source of conflicting desires (IV, 439d–e). Reason rules over the soul with wisdom, but opposed to it is appetite, the irrational part of the soul “with which it loves, hungers, thirsts, and feels the flutter and titillation of other desires” (439d). Reason and appetite would remain in unending combat but for the intervention of passion, the “spirited” part of the soul that helps reason subdue appetite. Plato has in mind here the experience of steeling our resolve, when we angrily force ourselves to do something we don’t want to do because reason has judged it to be the best course of action. What is important about this model, however, is the elevation of rationality to the dominant position in the soul, and conversely, the denigration of appetite as an irrational force that threatens to destroy our well-being. In the *Phaedrus*, Plato likens reason to a charioteer trying to control two horses: a good horse (passion), who “needs no whip” because he is driven by the command of reason alone, and a bad horse (appetite), who is hard to control and who would run the chariot into the ditch if left unchecked (253d–254e). Plato saw no redeeming value for the emotions in human moral life, though anger, at least, could sometimes be placed in the service of reason.

Aristotle (384–322 B.C.E.) took the study of the soul in a less speculative direction. He wrote an entire treatise on the soul—*Peri psyche*, or *De anima* in its Latin translation—that views the soul as a natural phenomenon. The soul is defined as “an actuality of the first kind of a natural organized body” (412b4): that which makes the body alive and capable of performing its characteristic functions. Aristotle divides these into vegetative powers, concerned with nutrition and growth; sensory powers (that is, vision, hearing, taste, smell, and touch, as well as the internal senses of imagination and memory); and intellectual powers (understanding, assertion, and discursive thinking). In his broader taxonomy of life forms, these correspond to the souls of plants, brute animals, and human beings, respectively, with the higher forms subsuming the powers of those lower in the hierarchy (so brute animals are capable of nutrition and sensation but not understanding, whereas human beings exhibit all three capacities). Only the third capacity is relevant to the modern conception of mind, though it should be noted that this is far from being a dualist conception. Aristotle’s intellect is a perfection of the organic unity of body and soul, and although he concedes that the activity of thinking is “separable, impassible, and unmixed” (430a17), thinking cannot occur without sensory images.

The Hellenistic period was a time of great philosophical activity, but unfortunately, most of the primary sources have been lost. Thankfully, scholars have managed to piece together some of what was said from fragments of texts and reports in the work of other philosophers. Three figures and their representative schools were especially important. Epicurus (341–270 B.C.E.) revitalized the materialist doctrine of earlier atomists such as

Democritus (470–360 B.C.E.), arguing that the soul is composed of extremely light and mobile atoms (thereby accounting for the spontaneity of sensation), whose unpredictable “swerves” are the source of human free choice. Particular features of living things result from the blending of soul atoms, of which there are four different types, each with its own psychological effect: fiery (bodily heat), air-like (rest), wind-like (movement), and a fourth, nameless atom responsible for sensation. The soul is also quickly dispersed at death, its atoms moving on to rain invisibly through the cosmos until joining together with other atoms to make new things. This led Epicurus to argue that “that most frightful of evils, death, is nothing to us, seeing that when we exist death is not present, and when death is present we do not exist” (*Letter to Menoceus*, 124–25; Long and Sedley, 24A). Death is literally nothing to an Epicurean, though whether this is sufficient to dispel the fear of death remains an open question.

The Stoics were another Hellenistic school with a materialistic conception of the soul, though their theory was highly nuanced and more teleologically sophisticated than even Aristotle’s. Rejecting the tripartite accounts of Plato and Aristotle, they held that the soul is unitary. As Chrysippus of Soli (c. 280–206 B.C.E.), one of the leading Stoics, explained, the soul is a mixture of air and fire (*pneuma*) whose “parts flow from their seat in the heart, as if from the source of a spring, and spread through the whole body. They continually fill all the limbs with vital breath, and rule and control them with countless different powers—nutrition, growth, locomotion, sensation, impulse to action” (Calcidius, *Commentary on Plato’s Timaeus*, 220; Long and Sedley, 53G). Because their *pneuma* exists in a certain tension, animal souls can register sense impressions and initiate impulses (*hormē*), or move towards what they desire. Humans are higher still because they are capable of assenting to (or rejecting) these impressions. Assent is just rational impulse, “a movement of thought towards something in the sphere of action” (Stobaeus, 2.86, 17–87, 6; Long and Sedley, 53Q). Thus, words are sounds arising through our vocal apparatus from impulses in the heart, so that on the Stoic view, “language is sent out imprinted, and stamped as it were, by the conceptions present in thought” (Galen, *On Hippocrates’ and Plato’s Doctrines*, 2.5, 9–13; Long and Sedley, 53U).

Plato’s teachings were refined throughout the Hellenistic period, culminating in the movement that later came to be known as Neoplatonism. Its foremost practitioner was Plotinus (205–270 C.E.), who offered an original synthesis of the Platonic and Aristotelian perspectives, advancing the former as the model of intelligible reality and the latter of sensible reality. There are three principles in his metaphysical system: the One, the utterly transcendent and unknowable source of everything in the universe; Intelligence or Mind (*nous*), which is where all eternal and necessary truths are actively thought; and Soul, which is the discursive manifestation of Mind’s activity in lesser beings throughout the cosmos. Intellectual thinking is a quasi-mystical act through which we move beyond ourselves and our particular bodily circumstances to grasp eternal principles: “We are not separated from the One, not distant from it, even though bodily nature has closed about us and drawn us to itself” (*Enneads*, VI, 9.ix). From the Stoics,

Plotinus borrows the concept of “seminal reasons,” or patterns implanted in Soul by Mind, which Soul then uses to produce the sensible world. This idea was later picked up by Christian thinkers such as St. Augustine of Hippo (354–430), who explains providence in terms of seminal reasons existing eternally in the mind of God.

Medieval Views

Two main factors shaped medieval thinking about the mind or soul. The first is religious doctrine. The idea that God freely created the world from nothing is absent from ancient Greek philosophy, but more or less definitive of medieval philosophy in all three monotheistic traditions: Christian, Islamic, and Jewish. In the Western or Christian tradition, it was expressed in terms of providence, the idea that creation is a product of God’s wisdom and goodness, and that this is manifested in the orderly structure of the universe all the way down to its smallest details. Needless to say, it would have struck an ancient Greek philosopher as absurd that something could be made from nothing, or that a divinity—especially an omnipotent divinity—would care what happens to beings less powerful than it. But such doctrines changed the way the mind was understood, granting pride of place to the human soul and human modes of cognition. Since humans are made in God’s image (Gen. 1:26), their own nature must in some way reflect the divine.

The second factor is simply physical access to ancient texts, which became more and more difficult in the West until direct knowledge of most Greek sources was lost for nearly six centuries. Philosophical psychology was especially hard hit, as none of the works mentioned above was available after the sixth century, and eventually only Aristotle’s *De anima* was recovered in a form that could have any direct influence. This meant that medieval thinkers had to learn about ancient theories indirectly, via textbook summaries and discussions by early Church fathers who were trained in or otherwise influenced by pagan schools of philosophy. Platonic, Epicurean, Stoic, and Neo-Platonist doctrines went underground, as it were, and sometimes came to be defended by philosophers who were unaware of their true origins.

Augustine is the most important medieval philosopher in the sense that his teachings set the agenda in Western thought for the next millennium, including the kinds of questions that were asked about the soul. For Augustine, the human mind is the foremost expression of the truth of *Genesis* 1:26, and the doctrine of the Trinity provides the mode of resemblance. Just as God is three persons (Father, Son, and Spirit) in one being, so the mind is three aspects or activities in one substance: “Since then these three, memory, understanding, will, are not three lives but one life, nor three minds but one mind, it follows certainly that neither are they three substances but one substance” (*De trinitate* X, 11.18). It is possible that Descartes was influenced by Augustine’s use of the Latin term *mens* or “mind” here (*anima* was used for the souls of living things more generally), except that Augustinian *mens* always has a dense layer of Neo-Platonic and Christian associations attached to it that would have certainly made Descartes cringe. Augustine also thought that because it is immediately present to

itself, the mind knows itself and that in knowing itself, it knows God as well. There are remarkable similarities between Augustine’s argument that a man who knows he is alive cannot be deceived about this fact (from *De trinitate* XV, 12.21), and Descartes’s more famous anti-skeptical argument, the “I think; therefore, I am,” of his *Meditations* II.

Some seven centuries after Augustine, philosophical psychology was transformed again by the reintroduction of Aristotle’s *De anima* and the commentary tradition that surrounded it. Philosophers and theologians struggled to assimilate this new authority with Christian teaching on the soul, which by now had acquired its own authority in Augustine. St. Thomas Aquinas (c. 1224–1274) was perhaps the most successful at synthesizing pagan and Christian philosophical learning, especially in his magisterial *Summa theologiae*, a beautifully ordered compendium of theological teachings prepared for Dominican novices. The first part contains a series of fifteen “Questions” on human nature in which he defends the Aristotelian account of the soul as the first principle of the human body, and explains the soul’s various powers and modes of operation. But he parts company with Aristotle on the question of the human soul’s immortality (recall that Aristotle was willing to treat only the active part of the capacity of thinking as immortal). To allow for disembodied existence, Aquinas argues that the soul is a special kind of form because it is also a substance, and that it can therefore continue to exist after the death of the body. In fact, he claims that “a separated soul is in a way more free to use the intellect, insofar as the weight and distraction of the body keeps it from the pure operation of intellect” (*Summa theologiae* Ia, q.89, a.3). Much of his account of disembodied thinking is indebted to Augustine and Christian Neoplatonism. But Aquinas also subscribed to the Christian doctrine of the resurrection, according to which everyone’s separated souls will be reunited with their (glorified and incorruptible) bodies at the Last Judgment. This forces him into the awkward position of arguing that despite its capacity to exist on its own in a purer and presumably higher state, it is somehow more natural for the soul to be united to the body.

After Aquinas, philosophers tended to be less optimistic about the prospects of uniting Athens and Jerusalem. Theories about the nature of the soul were trimmed almost to the vanishing point in favor of discussions of what the soul does, on the grounds that only the latter is naturally or empirically evident to us. Thus, John Buridan (1300–1358) argues that there is no philosophical knowledge of the soul, if by that one means the soul’s essential nature, although one can know its faculties and operations. The notion that the human soul, something that is by definition immaterial and unextended, could inhere in a divisible and extended body, amazed him—he declared it “a miracle” (*mirabile*) (*Questions on Aristotle’s De anima* II.9). That is, he believed it, but he did not regard it as knowledge. In this, of course, Buridan is well on the way to modernity, and to the modern distinction between faith and reason.

See also Aristotelianism; Neoplatonism; Person, Idea of the; Platonism.

BIBLIOGRAPHY

PRIMARY SOURCES

- Aristotle. *The Complete Works of Aristotle: The Revised Oxford Translation*. Edited by Jonathan Barnes. Princeton, N.J.: Princeton University Press, 1984.
- Augustine, St. *The Essential Augustine*. Edited by Vernon J. Bourke. New York: New American Publishing, 1964.
- Long, A. A., and D. N. Sedley. *The Hellenistic Philosophers*. 2 vols. New York: Cambridge University Press, 1987.
- Plato. *The Collected Dialogues of Plato*. Edited by Edith Hamilton and Huntington Cairns. New York: Pantheon, 1961.
- Plotinus. *The Enneads*. Translated by Stephen MacKenna and abridged by John Dillon. London: Penguin, 1991.

SECONDARY SOURCES

- Des Chene, Dennis. *Life's Form: Late Aristotelian Conceptions of the Soul*. Ithaca, N.Y.: Cornell University Press, 2000.
- Fitzgerald, Allan D., ed. *Augustine through the Ages: An Encyclopedia*. Grand Rapids, Mich.: Eerdmans, 1999.
- Pasnau, Robert. *Thomas Aquinas on Human Nature: A Philosophical Study of Summa theologiae Ia, 75-89*. Cambridge, U.K.: Cambridge University Press, 2002.
- Sorabji, Richard. *Emotion and Peace of Mind: From Stoic Agitation to Christian Temptation*. Oxford: Oxford University Press, 2000.
- Zupko, Jack. *John Buridan: Portrait of a Fourteenth-Century Arts Master*. Notre Dame, Ind.: University of Notre Dame Press, 2003.

Jack Zupko

PHILOSOPHY OF RELIGION. A well-established discipline in early-twenty-first-century Western philosophy, the subject known as “the philosophy of religion” has not always been easily demarcated with respect to its nature and scope. The reason for this is historical. The long engagement of philosophy with the claims of religion has manifested itself from antiquity to the early twenty-first century in a wide variety of intellectual enquiries. Thus, early-twenty-first-century philosophers of religion address topics and analyze arguments that were earlier conceived as belonging to very different areas of philosophical thought. These topics and arguments once fell under the heads of what ancient Greek philosophers simply called philosophy (*philosophia*), of what patristic and medieval thinkers referred to as revealed teaching or theology (*sacra doctrina* and *theologia*), and of what philosophers in the modern period characterized as natural theology or “natural religion.” Many of the questions of early-twenty-first-century philosophy of religion also fall within the traditional purview of subjects such as metaphysics and ethics. In themselves, these titles indicate very different views about how to address the questions that arise from the engagement of philosophy with religion and theology. For this reason it is difficult to sustain the idea that the “philosophy of religion” has always been a recognizable discipline with an unvarying subject matter that has spanned the course of Western philosophical history.

Changing Conceptions

The actual term “philosophy of religion” is itself a modern addition to the philosophical lexicon, being used sparingly in early modern times. One of the first occurrences in the

English language can be found in the work of the Cambridge Platonist Ralph Cudworth (1617–1688), while toward the end of the eighteenth century the term *Religionsphilosophie* became part of an accepted terminology used by German-speaking philosophers. At this time, many thinkers sought to replace the previous idea of a “natural religion” with a “philosophy of religion,” since the latter notion was deemed to bequeath a much more rigorous method of discovering truths about the nature and origin of religion. This conception of the subject received lucid exposition in Immanuel Kant’s (1724–1804) *Religion within the Limits of Reason Alone* (1793). Building on his earlier demolition of the traditional proofs for the existence of God in the *Critique of Pure Reason* (1781, revised in 1787), Kant argues in this work that religion is not a matter of theoretical cognition but of moral disposition. Hence religion is to be understood as a moral outlook to observe all duties as divine commands.

By the early decades of the nineteenth century, however, the term had already changed its meaning. In Georg Wilhelm Friedrich Hegel’s (1770–1831) famous *Lectures on the Philosophy of Religion* (1821–1831) the subject is defined as the study of the manner and ways in which God is represented in religious consciousness. What is interesting about the respective projects of Kant and Hegel is the gulf that separated their respective accounts of philosophical theology from more orthodox religious doctrines. Indeed such was the extent of these differences that, despite their very best intentions, many of their theories eventually lent themselves to forms of antitheistic skepticism. Given this, it is unsurprising that Kant and Hegel are followed by resolutely atheistic thinkers of whom Arthur Schopenhauer (1788–1860), Ludwig Feuerbach (1804–1872), Karl Marx (1818–1883), Friedrich Nietzsche (1844–1900), and Sigmund Freud (1856–1939) are the most prominent. Although the general drift toward atheism in Continental thought might be said to have been countered by the writings of thinkers such as Friedrich Schleiermacher (1768–1834) and Søren Kierkegaard (1813–1855), the inheritance of nontheistic philosophers who followed in the wake of Kant and Hegel was subsequently refined and extended in the twentieth century by figures such as Jean-Paul Sartre (1905–1980) and Martin Heidegger (1889–1976), whose own work yet further entrenched philosophical atheism in many areas of French- and German-speaking thought. In many ways, early-twenty-first-century philosophers of religion who look to these various traditions of so-called Continental philosophy can be said to explore and clarify questions about the nature and meaning of religion that go back to the very different legacies of Kant, Hegel, Nietzsche, and Freud.

Early-twenty-first-century English-speaking philosophers of religion, however, be they of theistic, agnostic, or atheistic orientation, can be said to adopt a quite different outlook on their subject. In opposition to Continental thought, they tend to characterize philosophy of religion as the critical analysis of certain concepts and issues deemed central to the study of monotheistic Western religions. An important stimulus to their work can be found in the trenchant critique of religion advanced by David Hume (1711–1776), specifically in his *Natural History of Religion* (1757) and *Dialogues Concerning*

Natural Religion (1779, but first written in the 1750s). For Hume the arguments of what he terms “natural religion” do not establish the existence of any deity that could be the proper object of religious belief. If revelation cannot be authenticated in any way conducive to reason, then religious beliefs can be deemed to have natural causes. Central to Hume’s argument in the *Natural History of Religion* is the contention that the very origin of religious belief is to be found in numerous human pathologies that derive from a fear of the unknown. Hume’s views have been typically regarded as providing a dialectical framework for modern English-speaking philosophy of religion. Accordingly, those who adhere to the claims of natural theology and traditional religion are supposed to address his intricate critique of their position, while those enamored of atheism invariably look to Hume’s works as providing a paradigm for how to demonstrate that the claims of the theistic tradition are but a set of philosophical fictions.

Modern Conceptions

The modern subject of “philosophy of religion” continues to debate the legacy of Hume’s broadside against theology. English-speaking philosophers of different persuasions still address a posteriori proofs for the existence of God such as cosmological arguments and arguments from design, while interest in the ontological argument—a specific object of Kant’s wrath—shows no signs of fading. For much of the twentieth century many forces conspired to thwart the progress of those enamored of the project of responding to Kant’s and Hume’s critique. Predominant among these was the influence and legacy of logical positivism in both Great Britain and North America. The strict empiricism that was the hallmark of positivism launched a wide-ranging critique of traditional metaphysics by insisting that the subject matter of philosophy ought to be addressed by scientifically conditioned methods of inquiry. The collective penchant for empiricism in both Britain and America prompted philosophers like Rudolph Carnap (1891–1970) and Sir Alfred Jules Ayer (1910–1989) to argue that all religious claims are meaningless. In keeping with these tendencies, many philosophers of religion either sought to apply the methods of logical empiricism to their own discipline with the consequence that the subject became almost solely preoccupied with the topic of meaning in religious language, or else to fight a rearguard action to expose the inadequacies of the positivist position. Both of these strategies met with paltry success, as they failed to bring the philosophy of religion back within the mainstream of English-speaking philosophy.

With the move away from verificationism and the development of a greater pluralism in Anglophone philosophy, however, philosophers like Alvin Plantinga in the United States and Richard Swinburne in Britain set about the task of applying the rigorous standards of analytic philosophy to the discussion of traditional theological subjects. The effect of their work, particularly when combined with the historical studies of Anthony Kenny and Norman Kretzmann, was to increase the institutional profile of the subject in professional philosophy. However, the tremendous growth of the philosophy of religion in the English-speaking world is a phenomenon of the late twentieth century and is due in part to the establishment

of new journals and confessionally minded societies dedicated to the study of the discipline.

Much of the best late-twentieth- and early-twenty-first-century work in philosophy of religion has taken place in the subdivision of the subject then specified as “philosophical theology” and “religious epistemology.” The first, which claims a distinguished ancestry in ancient and medieval philosophy, can be said to concern itself with issues focusing on the nature and coherence of our concept of God, and especially the manner in which God’s attributes (omnipotence, omniscience, simplicity, eternity, and the like), can be defined so as to escape confusion and paradox. The second is concerned with the nature and justification of religious belief. Topics here have to do with whether or not it is ever reasonable to conclude that religious belief must always be justified by external evidence, or whether it is best to argue that religious belief is *sui generis* and quite different in form and structure from our more prosaic beliefs about the world. In this sphere many philosophers, following the lead of Plantinga, have argued that religious belief need not be beholden to canons of external evidence and have thereby debunked Hume’s putative challenge to any rational justification of theistic belief. The effect of their writings has been to shift the focus of philosophy of religion away from natural theology, such as a strict attention to the a posteriori proofs for the existence of God, to a more general epistemological concern with the justification of religious belief. An important by-product of this change in emphasis has been the rehabilitation of the subject of religious experience as an area of pressing philosophical concern. The American philosopher William Alston, whose own approach to philosophy of religion can be said to steer a middle course between the work of Swinburne and Plantinga, can be credited with bringing this subject to the foreground of recent debate.

Alongside these important developments there has been a growing interest in religious pluralism and a greater philosophical attention to the claims of nonwestern religious traditions. As part of this general revival of the philosophy of religion, a number of philosophers whose main work lies in other areas have been attracted to the discipline. Thus, complex arguments about substance, space and time, free will, and determinism, which might be thought more properly at home in metaphysics, epistemology, philosophical logic, philosophy of mind, and philosophy of science, have all been explored with reference to the idea of God. At the turn of the twenty-first century, there are efforts to explore cross-cultural philosophies of religion, to articulate feminist challenges to traditional religions, and to consider many political, moral, and social problems from the standpoint of a religiously motivated ethics or political theory. Further to this, specific issues that are internal to religious traditions, such as monotheistic faiths like Judaism, Christianity, and Islam, are also receiving some coverage with increased philosophical effort being given to speculation on heaven, hell, atonement, the sacraments, and the meaning of prophesy and Scripture.

Philosophy of religion, then, might be said to have its place in English-speaking and Continental philosophy not only in the domain of the history of philosophy but also in areas of

genuine and earnest philosophical debate. It is for this reason that the subject presents to the individual already acquainted with the traditional core of Western philosophy, namely logic, metaphysics, epistemology, and ethics, an opportunity to apply their philosophical learning to a set of important questions. Since “philosophy of religion,” as its history testifies, is nothing more than a rich deposit of questions that have always belonged to the central core of subjects that have characterized the concerns of philosophers from antiquity onward, it could be said that to engage with it is to acquaint oneself with the basic questions of Western philosophy itself. In contrast with its dire fortunes at the outset of the twentieth century, philosophy of religion reveals itself, one hundred years later, to be a confident and sophisticated area of philosophy at ease with itself and its place within the philosophical curriculum.

See also *Continental Philosophy; Epistemology; Logic; Metaphysics; Philosophy and Religion in Western Thought; Philosophy of Mind; Religion.*

BIBLIOGRAPHY

- Alston, William P. *Perceiving God: The Epistemology of Religious Experience*. Ithaca, N.Y.: Cornell University Press, 1991. Seminal treatment of religious experience by a leading epistemologist.
- Kenny, Anthony. *The God of the Philosophers*. Oxford: Clarendon, 1979. A helpful guide to the medieval origins of many debates in contemporary philosophical theology.
- Kretzmann, Norman. *The Metaphysics of Theism: Aquinas's Natural Theology in Summa contra gentiles I*. Oxford: Clarendon, 1997. An influential statement of the power and force of natural theology based on the work of Thomas Aquinas.
- . *The Metaphysics of Creation: Aquinas's Natural Theology in Summa contra gentiles II*. Oxford: Oxford University Press, 1999. The second installment of a planned trilogy left incomplete at Kretzmann's death.
- Plantinga, Alvin. *Warranted Christian Belief*. New York and Oxford: Oxford University Press, 2000. Plantinga's definitive statement of his theory that theistic belief, specifically Christian belief, can enjoy warrant.
- Plantinga, Alvin, and Nicholas Wolterstorff, eds. *Faith and Rationality: Reason and Belief in God*. Notre Dame, Ind.: University of Notre Dame Press, 1983. Influential anthology that initiated a move away from natural theology to questions of religious epistemology.
- Swinburne, Richard. *The Coherence of Theism*. Oxford: Clarendon, 1977. The first installment of Swinburne's trilogy, which takes issue with the claim that religious discourse is meaningless.
- . *The Existence of God*. Oxford: Clarendon, 1979. The second volume, which uses the methods of Bayesian probability theory to advance a culminative case argument for the existence of God.
- . *Faith and Reason*. Oxford: Clarendon, 1981. The final volume of the trilogy that seeks to reinvigorate the traditional teaching about the compatibility of faith and reason by means of the arguments of analytic philosophy.
- Westphal, Merold. *Overcoming Onto-Theology: Toward a Post-modern Christian Faith*. New York: Fordham University Press, 2001. An accessible guide to recent developments in “continental” philosophy of religion.

Martin Stone

PHRENOLOGY. Phrenology, a science popular from the early to the mid-nineteenth century, was dedicated to the discernment of one's character or traits of personality from reading—that is, feeling the shape and size of—the bumps on one's skull. As formulated by the German physician and anatomist Franz Josef Gall (1758–1828) and as popularized by his student and follower Johann Gaspar Spurzheim (1776–1832), phrenology was based on five main tenets: (1) the brain is the organ of the mind—mental activity is produced by the structure and function of the brain, not through some spiritual or immaterial process; (2) the brain is not unitary but a congeries, or collection, of separate faculties; (3) these faculties are localized in different regions of the brain; (4) the activity of a mental faculty determines the size of the brain organ that represents it; and (5) the skull ossifies over the brain during infant development, so that an external examination of the size and shape of the bumps on the skull will reveal the size of the underlying brain organs. A staunchly materialistic doctrine, phrenology held that each mental faculty, envisioned by Gall as an innate instinct, produced a striking behavior or characteristic. Each innate mental faculty was in turn produced by its underlying brain organ, whose size depended on its activity and which could be revealed by its corresponding cranial bump.

Origins and Development

Gall was born in Baden, Germany, and studied medicine in Strasbourg and Vienna, where he established a successful medical practice and became renowned as a comparative anatomist. In the 1790s he began to develop the principles of phrenology out of his observations of his fellow students—those with protuberant eyes, he noted, had particularly good memories—and of animals, as well as from dissection of human and animal brains. He also amassed a large collection of skulls, both human and animal, and busts, to support his theory. His method, however, depended on anecdote and striking confirmation rather than rigorous experimental testing of his theory. In Vienna, Gall lectured on phrenology as a “craniologist,” but by 1805, joined by Spurzheim, he traveled around Europe to spread his ideas, eventually settling in Paris. There, between 1810 and 1819, he and Spurzheim published the four volumes and atlas of 100 engraved plates of *Anatomy and Physiology of the Nervous System . . . with Observations on the Possibility of Identifying Many Intellectual and Moral Dispositions of Men and Animals by the Configuration of Their Heads*. In addition to propounding the principles of phrenology, the work constituted a major contribution to cerebral anatomy.

Gall identified twenty-seven basic mental faculties, each correlated with a brain organ: faculties such as veneration, wonder, wit, tune, memory, language, cautiousness, secretiveness, and philoprogenitiveness (love of children). He rejected the notion that the mind was a tabula rasa—a blank slate—and emphasized that each of these mental faculties was inherited as an innate instinct. He and the phrenologists who followed him tended to be interested in differences between individuals as well as between groups. Men and women, for example, were thought to possess different types of faculties.

Spurzheim, however, parted ways with his mentor, changing the content and focus of Gall's science in several

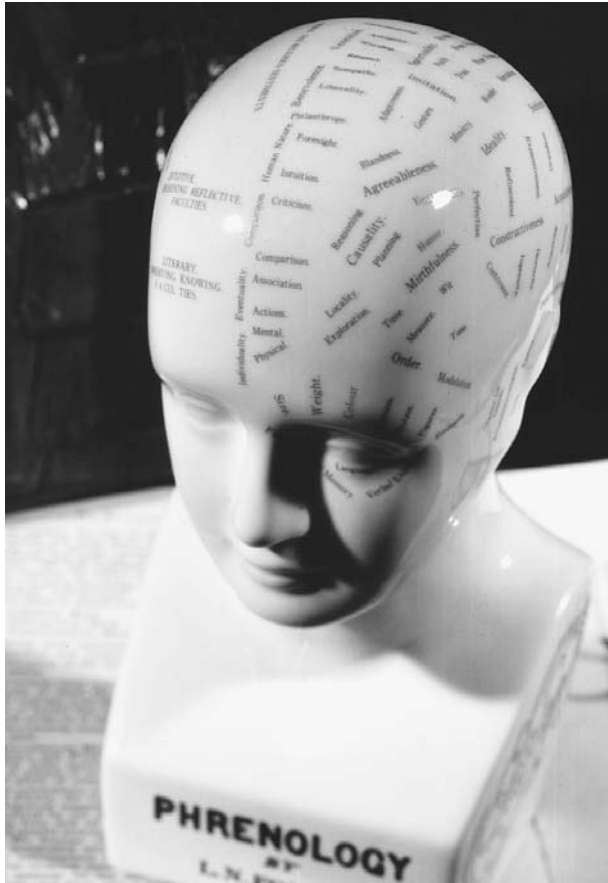

Phrenological bust for mapping areas of the skull. The science of phrenology reached its apex during the early 1830s and began its eventual decline approximately a decade later. Adherents were still numerous in the late nineteenth century, especially in the United States and Britain. PHOTO RESEARCHERS, INC.

important ways. First, Spurzheim actually coined the term *phrenology*, distinguishing it from physiognomy (reading character from the face) and craniology (measurement of the skull), thereby establishing its claim as a new science. Second, Spurzheim shifted the emphasis of phrenology from anatomy, which was Gall's main interest, to the religious, moral, and philosophical aspects of the science and to its political and social applications and consequences, a move that laid the groundwork for its popularity. He added new mental faculties to Gall's original twenty-seven and grouped the faculties into two major categories: feelings, including propensities and sentiments, and intellectual faculties, of perceptive and reflective kinds. Finally, Spurzheim abandoned Gall's emphasis on the innateness of the faculties and promulgated phrenology as a doctrine of self-help instead of determinism. In Spurzheim's formulation, education and exercise were the means to build up, train, or control the mental faculties and brain organs, and it was this more optimistic view that became part and parcel of popular phrenology. Leaving aside Gall's notion that human beings possessed such evil faculties as murder, Spurzheim promulgated the notion that people were intrinsically good and could be perfected through the practice

of phrenology, altering their mental faculties through exercise.

To spread phrenological doctrine, Spurzheim traveled to Britain, where he met George Combe (1788–1858), a lawyer and moral philosopher in Edinburgh. Spurzheim's teachings converted Combe to phrenology, and he helped to popularize the science in Britain and North America. In 1828 Combe published *The Constitution of Man Considered in Relation to External Objects*, a work that formed the basis for orthodox phrenology and that developed Spurzheim's connection between phrenology, self-help, and social reform. At the height of phrenology's popularity in the early 1830s, there were more than two dozen phrenological societies in Britain alone. Numerous books, lecture series, and journals were devoted to the science, including the *Phrenological Journal*, which Combe edited in Edinburgh from 1832 to 1847. Thousands of serious believers espoused the doctrine, from the eminent doctors and scientists of the day to famous literary and cultural figures. Phrenology became central to the sociology and psychology of Herbert Spencer, the evolutionary science of Robert Chambers and Alfred Russel Wallace, and the anthropology of James Hunt and Paul Broca. Because of its associations with social and political reform, phrenology surged in popularity among the less educated classes as well.

Decline

As it became increasingly popularized and vulgarized, phrenology fell into disrepute and by the 1840s was discredited by most physiologists. The increasing demand for phrenologists' services in assessment of character allowed charlatans to flourish as head readers, undermining the scientific integrity of the doctrine. Disunity and splits within the movement itself, antagonism from the religious establishment on account of its perceived materialism, and new discoveries about brain function in neuroanatomy and physiology all helped to push phrenology to the margins of science. In the second half of the nineteenth century, however, its popularity remained strong, especially in Britain and the United States. In America, for example, the entrepreneurial Fowler brothers, Lorenzo and Orson, established a successful business in character advice based on phrenological principles and sold china busts, models of the head marked with the divisions of the various phrenological faculties, that became popular among collectors. Phrenology also became associated with other popular psychological movements: in the combination of phrenology and mesmerism known as phreno-mesmerism, when the practitioner touched various parts of the subject's head, the subject evinced the traits supposedly connected to the underlying brain organs. Such continuing popular uses for phrenology show that it maintained its place in drawing room and parlor throughout the nineteenth century, even if it had lost scientific sanction.

Phrenology was relegated to the status of pseudoscience for political and social reasons as well as scientific ones. As medicine and the sciences of anatomy and physiology diversified and professionalized in the late nineteenth century, there was no longer any room in them for the kind of informally trained practitioner that many a popular phrenologist represented.

PHYLOGENY

Meanwhile, the work in localization of function in the brain, associated with Broca and with the German researchers Gustav Fritsch and Eduard Hitzig, while seemingly returning to Gall's principles, actually disputed them by localizing not complex mental faculties but much simpler sensory and motor functions. But debate over the extent and type of localization of brain function—a debate that phrenology can be understood to have started—continued throughout the twentieth century and is still not entirely settled.

See also *Anthropology; Philosophy of Mind; Pseudoscience.*

BIBLIOGRAPHY

- Combe, George. *The Constitution of Man Considered in Relation to External Objects*. Edinburgh: Anderson, 1828.
- Cooter, Roger. *The Cultural Meaning of Popular Science: Phrenology and the Organization of Consent in Nineteenth-Century Britain*. New York: Cambridge University Press, 1984.
- . *Phrenology in the British Isles: An Annotated Historical Bibliography and Index*. Metuchen, N.J.: Scarecrow Press, 1989.
- De Giustino, David. *Conquest of Mind: Phrenology and Victorian Social Thought*. London: Croom, Helm; and Totowa, N.J.: Rowman and Littlefield, 1975.
- Gall, Franz Josef. *On the Functions of the Brain and Each of Its Parts*. Translated by Winslow Lewis Jr. Boston: Marsh, Capen, and Lyon, 1835.
- Shapin, Steven. "Homo Phrenologicus: Anthropological Perspectives." In *Natural Order: Historical Studies of Scientific Culture*, edited by Barry Barnes and Steven Shapin. Beverly Hills, Calif.: Sage, 1979.
- Spurzheim, Johann Gaspar. *Phrenology, or the Doctrine of the Mental Phenomena*. Boston: Marsh, Capen, and Lyon, 1833.
- Young, Robert M. *Mind, Brain, and Adaptation in the Nineteenth Century: Cerebral Localization and Its Biological Context from Gall to Ferrier*. Oxford: Clarendon, 1970.

Nadine Weidman

new dictionary of the history of ideas

EDITORIAL BOARD

Editor in Chief

Maryanne Cline Horowitz, *Occidental College*
University of California, Los Angeles

Associate Editors

Jonathan Berkey, *Davidson College*
Zvi Ben-Dor Benite, *New York University*
Benjamin A. Elman, *Princeton University*
George Esenwein, *University of Florida, Gainesville*
Cary J. Nederman, *Texas A&M University*
Vassiliki Betty Smocovitis, *University of Florida, Gainesville*
Neferti Tadiar, *University of California, Santa Cruz*
Mary J. Weismantel, *Northwestern University*
Paul Tiyambe Zeleza, *Pennsylvania State University*

Advisors

Diane Apostolos-Cappadona, *Georgetown University*
Edwina Barvosa-Carter, *University of California, Santa Barbara*
Nupur Chaudhuri, *Texas Southern University*
Kostas Gavroglu, *University of Athens, Greece*
Donald R. Kelley, *Rutgers University*
Zine Magubane, *University of Illinois, Urbana-Champaign*
J. B. Schneewind, *Johns Hopkins University*
Blair Sullivan, *University of California, Los Angeles*
Reed Ueda, *Tufts University*

Librarian Advisory Board

Mary W. George, *Princeton University*
Suzy Szasz Palmer, *University of Louisville*

Editorial Assistant

Lisa Griffin

new dictionary of the history of ideas

maryanne cline horowitz, editor in chief

volume 5

Physics to Syncretism



CHARLES SCRIBNER'S SONS

An imprint of Thomson Gale, a part of The Thomson Corporation

THOMSON
—★—™
GALE



New Dictionary of the History of Ideas
Maryanne Cline Horowitz, Editor in Chief

©2005 Thomson Gale, a part of the Thomson Corporation.

Thomson and Star Logo are trademarks and Gale is a registered trademark used herein under license.

For more information, contact
Thomson Gale
27500 Drake Rd.
Farmington Hills, MI 48331-3535
Or you can visit our Internet site at
<http://www.gale.com>

ALL RIGHTS RESERVED
No part of this work covered by the copyright hereon may be reproduced or used in any form or by any means—graphic, electronic, or mechanical, including photocopying, recording, taping, Web distribution, or information storage retrieval systems—without the written permission of the publisher.

For permission to use material from this product, submit your request via Web at <http://www.gale-edit.com/permissions>, or you may download our Permissions Request form and submit your request by fax or mail to:

Permissions Department
Thomson Gale
27500 Drake Road
Farmington Hills, MI 48331-3535
Permissions Hotline:
248-699-8006 or 800-877-4253, ext. 8006
Fax: 248-699-8074 or 800-762-4058

Since this page cannot legibly accommodate all copyright notices, the acknowledgments constitute an extension of the copyright notice.

While every effort has been made to ensure the reliability of the information presented in this publication, Thomson Gale does not guarantee the accuracy of the data contained herein. Thomson Gale accepts no payment for listing; and inclusion in the publication of any organization, agency, institution, publication, service, or individual does not imply endorsement of the editors or publisher. Errors brought to the attention of the publisher and verified to the satisfaction of the publisher will be corrected in future editions.

LIBRARY OF CONGRESS CATALOGING-IN-PUBLICATION DATA

New dictionary of the history of ideas / edited by Maryanne Cline Horowitz.
p. cm.
Includes bibliographical references and index.
ISBN 0-684-31377-4 (set hardcover : alk. paper) — ISBN 0-684-31378-2 (v. 1) — ISBN 0-684-31379-0 (v. 2) — ISBN 0-684-31380-4 (v. 3) — ISBN 0-684-31381-2 (v. 4) — ISBN 0-684-31382-0 (v. 5) — ISBN 0-684-31383-9 (v. 6) — ISBN 0-684-31452-5 (e-book)
1. Civilization—History—Dictionaries. 2. Intellectual life—History—Dictionaries.
I. Horowitz, Maryanne Cline, 1945–
CB9.N49 2005
903—dc22
2004014731

This title is also available as an e-book.
ISBN 0-684-31452-5
Contact your Thomson Gale sales representative for ordering information.

Printed in the United States of America
10 9 8 7 6 5 4 3 2 1

CONTENTS

Volume 1

List of Articles

Preface

Historiography

Reader's Guide

NEW DICTIONARY OF THE HISTORY OF IDEAS

Abolitionism–Common Sense

Volume 2

Reader's Guide

Communication of Ideas–Futurology

Volume 3

Reader's Guide

Game Theory–Lysenkoism

Volume 4

Reader's Guide

Machiavellism–Phrenology

Volume 5

Reader's Guide

Physics–Syncretism

Volume 6

Reader's Guide

Taste–Zionism

List of Contributors

Index

EDITORIAL AND PRODUCTION STAFF

Project Editors

Mark LaFlaur, Scot Peacock, Jennifer Wisinski

Editorial Support

Kelly Baiseley, Andrew Claps, Alja Collar, Mark Drouillard,
Kenneth Mondschein, Sarah Turner, Ken Wachsberger,
Rachel Widawsky, Christopher Verdesi

Art Editor

Scot Peacock

Chief Manuscript Editor

Georgia S. Maas

Manuscript Editors

Jonathan G. Aretakis, John Barclay, Sylvia Cannizzaro,
Melissa A. Dobson, Ted Gilley, Gretchen Gordon,
Ellen Hawley, Archibald Hobson, Elizabeth B. Inserra,
Jean Fortune Kaplan, Christine Kelley, John Krol,
Julia Penelope, Richard Rothschild, David E. Salamie,
Linda Sanders, Alan Thwaites, Jane Marie Todd

Proofreaders

Beth Fhaner, Carol Holmes, Melodie Monahan,
Laura Specht Patchkofsky, Hilary White

Cartographer

XNR Productions, Madison, Wisconsin

Caption Writer

Shannon Kelly

Indexer

Cynthia Crippen, AEIOU, Inc.

Design

Jennifer Wahj

Imaging

Dean Dauphinais, Lezlie Light, Mary Grimes

Permissions

Margaret Abendroth, Peggie Ashlevitz, Lori Hines

Composer

GGIS Information Services, York, Pennsylvania

Manager, Composition

Mary Beth Trimper

Assistant Manager, Composition

Evi Seoud

Manufacturing

Wendy Blurton

Senior Development Editor

Nathalie Duval

Editorial Director

John Fitzpatrick

Publisher

Frank Menchaca

READER'S GUIDE

This Reader's Guide was compiled by the editors to provide a systematic outline of the contents of the New Dictionary of the History of Ideas, thereby offering teachers, scholars, and the general reader a way to organize their reading according to their preferences. The Reader's Guide is divided into four sections: Communication of Ideas, Geographical Areas, Chronological Periods, and Liberal Arts Disciplines and Professions, as indicated in the outline below.

COMMUNICATION OF IDEAS

Introduction to History of Communication of Ideas

Communication Media

GEOGRAPHICAL AREAS

Global Entries

Africa

Asia

Europe

Middle East

North America

Latin and South America

CHRONOLOGICAL PERIODS

Ancient

Dynastic (400 C.E.–1400 C.E.)

Early Modern (1400–1800 C.E.)

Modern (1800–1945)

Contemporary

LIBERAL ARTS DISCIPLINES AND PROFESSIONS

Fine Arts

Humanities

Social Sciences

Sciences

Professions

Multidisciplinary Practices

Especially Interdisciplinary Entries

COMMUNICATION OF IDEAS

This category is the newest aspect of the *New Dictionary of the History of Ideas*; cultural studies, communications studies, and cultural history are moving the disciplines in this direction.

Introduction to History of Communication of Ideas

The following entries focus on the media humans have used to communicate with one another.

Absolute Music
Aesthetics: Asia
Architecture: Overview
Architecture: Asia
Arts: Overview
Astronomy, Pre-Columbian and Latin American
Bilingualism and Multilingualism
Borders, Borderlands, and Frontiers, Global
Calendar
Cinema
City, The: The City as a Cultural Center
City, The: The City as Political Center
Communication of Ideas: Africa and Its Influence
Communication of Ideas: Asia and Its Influence
Communication of Ideas: Europe and Its Influence
Communication of Ideas: Middle East and Abroad
Communication of Ideas: Orality and Advent of Writing
Communication of Ideas: Southeast Asia
Communication of Ideas: The Americas and Their Influence
Consumerism
Cultural Revivals
Cultural Studies
Dance
Diffusion, Cultural
Dress
Dualism
Education: Asia, Traditional and Modern
Education: Global Education
Emotions
Experiment
Garden
Gesture
Humor
Iconography
Images, Icons, and Idols
Japanese Philosophy, Japanese Thought
Language and Linguistics
Language, Linguistics, and Literacy
Learning and Memory, Contemporary Views
Mathematics
Media, History of
Metaphor
Migration: United States
Modernity: Africa
Museums
Music, Anthropology of

READER'S GUIDE

Musical Performance and Audiences
Oral Traditions: Overview
Oral Traditions: Telling, Sharing
Political Protest, U.S.
Practices
Protest, Political
Reading
Realism: Africa
Reflexivity
Relativism
Representation: Mental Representation
Resistance
Resistance and Accommodation
Rhetoric: Overview
Rhetoric: Ancient and Medieval
Ritual: Public Ritual
Ritual: Religion
Sacred Places
Text/Textuality
Textiles and Fiber Arts as Catalysts for Ideas
Theater and Performance
Third Cinema
Totems
Tradition
Translation
Virtual Reality
Visual Culture
Visual Order to Organizing Collections

Communication Media

This is a listing of the types of historical evidence the author used in writing the entry. While entries in the original Dictionary of the History of Ideas were to a great extent the history of texts, the entries in the New Dictionary of the History of Ideas are generally the cultural history of ideas, making use of the records of oral communication, visual communication, and communication through practices, as well as the history of texts, in order to show the impact of the idea on a wide variety of people.

ORAL

The selective list below contains the entries that give the most coverage to historical examples of the oral transmission and transformation of ideas.

Civil Disobedience
Civil Society: Europe and the United States
Communication of Ideas: Orality and Advent of Writing
Cosmopolitanism
Cultural Capital
Determinism
Dialogue and Dialectics: Socratic
Dialogue and Dialectics: Talmudic
Dream
Emotions
Empire and Imperialism: Europe
Equality: Overview
Etiquette
Fascism
Harmony
Magic
Masks
Media, History of
Millenarianism: Latin America and Native North America

Music, Anthropology of
Musical Performance and Audiences
Musicology
Nomadism
Oral Traditions: Overview
Oral Traditions: Telling, Sharing
Populism: United States
Psychoanalysis
Public Sphere
Republicanism: Republic
Rhetoric: Overview
Ritual: Public Ritual
Ritual: Religion
Slavery
Theater and Performance
Tragedy and Comedy
Trope
Wisdom, Human
COMMUNICATION THROUGH HIGH TECHNOLOGY MEDIA (radio, television, film, computer, etc.)
Absolute Music
Africa, Idea of
Alienation
Americanization, U.S.
Anticolonialism: Africa
Anti-Semitism: Islamic Anti-Semitism
Architecture: Overview
Avant-Garde: Overview
Bilingualism and Multilingualism
Bioethics
Calculation and Computation
Capitalism: Overview
Capitalism: Africa
Censorship
Chicano Movement
Cinema
City, The: The City as a Cultural Center
City, The: The City as Political Center
Colonialism: Southeast Asia
Communication of Ideas: Africa and Its Influence
Communication of Ideas: Asia and Its Influence
Communication of Ideas: Europe and Its Influence
Communication of Ideas: Middle East and Abroad
Communication of Ideas: Orality and Advent of Writing
Communication of Ideas: Southeast Asia
Communism: Latin America
Composition, Musical
Computer Science
Consciousness: Overview
Consumerism
Cosmopolitanism
Creativity in the Arts and Sciences
Critical Theory
Cultural Studies
Death
Demography
Development
Dream
Dress
Dystopia
Empire and Imperialism: United States
Environmental History
Expressionism
Fascism
Fetishism: Fetishism in Literature and Cultural Studies

Field Theories
 Futurology
 Game Theory
 Gay Studies
 Gender: Gender in the Middle East
 Gender in Art
 Genetics: Contemporary
 Genetics: History of
 Genocide
 Genre
 Geography
 Globalization: General
 Harmony
 Hinduism
 History, Economic
 Human Capital
 Iconography
 Intelligentsia
 Jihad
 Jouissance
 Judaism: Modern Judaism
 Language and Linguistics
 Law
 Learning and Memory, Contemporary Views
 Life
 Life Cycle: Elders/Old Age
 Literary Criticism
 Literature: Overview
 Literature: African Literature
 Loyalties, Dual
 Lysenkoism
 Maps and the Ideas They Express
 Masks
 Mathematics
 Media, History of
 Medicine: Europe and the United States
 Medicine: Islamic Medicine
 Meme
 Memory
 Modernism: Overview
 Modernism: Latin America
 Modernity: East Asia
 Motherhood and Maternity
 Motif: Motif in Music
 Music, Anthropology of
 Musical Performance and Audiences
 Musicology
 Nuclear Age
 Occidentalism
 Pan-Arabism
 Parties, Political
 Physics
 Political Protest, U.S.
 Political Science
 Postmodernism
 Power
 Presentism
 Privacy
 Probability
 Progress, Idea of
 Propaganda
 Property
 Protest, Political
 Public Sphere
 Quantum

Reading
 Reform: Europe and the United States
 Reform: Islamic Reform
 Relativity
 Representation: Mental Representation
 Resistance
 Rhetoric: Overview
 Science Fiction
 Sexuality: Overview
 Social History, U.S.
 Society
 State, The: Overview
 Symbolism
 Taste
 Technology
 Third Cinema
 Third World
 Totalitarianism
 Victorianism
 Virtual Reality
 Visual Culture
 War and Peace in the Arts
 Westernization: Africa
 Westernization: Middle East
 Women and Femininity in U.S. Popular Culture
 Work
 World Systems Theory, Latin America

VISUAL

Each of the following entries in the *NDHI* either evocatively describes ideas, includes a visual image of an idea, or provides historical examples of societies visually transmitting and transforming ideas.

Abolitionism
 Aesthetics: Africa
 Aesthetics: Asia
 Aesthetics: Europe and the Americas
 Alienation
 Altruism
 Ambiguity
 Americanization, U.S.
 Ancestor Worship
 Animism
 Anti-Semitism: Overview
 Apartheid
 Architecture: Overview
 Architecture: Africa
 Architecture: Asia
 Arts: Overview
 Arts: Africa
 Asceticism: Hindu and Buddhist Asceticism
 Asceticism: Western Asceticism
 Asian-American Ideas (Cultural Migration)
 Assimilation
 Astrology: Overview
 Astronomy, Pre-Columbian and Latin American
 Authoritarianism: Latin America
 Autobiography
 Avant-Garde: Militancy
 Aztlán
 Barbarism and Civilization
 Beauty and Ugliness
 Behaviorism

READER'S GUIDE

Bioethics
 Black Atlantic
 Black Consciousness
 Body, The
 Bushido
 Calculation and Computation
 Calendar
 Cannibalism
 Capitalism: Overview
 Capitalism: Africa
 Causation
 Censorship
 Change
 Chemistry
 Childhood and Child Rearing
 Cinema
 City, The: Latin America
 City, The: The City as a Cultural Center
 City, The: The City as Political Center
 City, The: The Islamic and Byzantine City
 Civil Disobedience
 Classicism
 Classification of Arts and Sciences, Early Modern
 Colonialism: Southeast Asia
 Common Sense
 Communication of Ideas: The Americas and Their Influence
 Communication of Ideas: Asia and Its Influence
 Communication of Ideas: Europe and Its Influence
 Communication of Ideas: Orality and Advent of Writing
 Communication of Ideas: Southeast Asia
 Composition, Musical
 Computer Science
 Consciousness: Overview
 Consumerism
 Continental Philosophy
 Cosmology: Asia
 Cosmopolitanism
 Creativity in the Arts and Sciences
 Critical Race Theory
 Critical Theory
 Cultural Capital
 Cultural History
 Cultural Revivals
 Cultural Studies
 Cycles
 Cynicism
 Dada
 Dance
 Death
 Death and Afterlife, Islamic Understanding of
 Demography
 Demonology
 Determinism
 Development
 Diasporas: African Diaspora
 Diasporas: Jewish Diaspora
 Dictatorship in Latin America
 Discrimination
 Diversity
 Dream
 Dress
 Dystopia
 Ecology
 Education: Europe
 Education: Islamic Education
 Emotions
 Empire and Imperialism: Europe
 Empire and Imperialism: United States
 Empiricism
 Encyclopedism
 Enlightenment
 Environment
 Environmental History
 Epistemology: Ancient
 Epistemology: Early Modern
 Equality: Overview
 Equality: Racial Equality
 Essentialism
 Ethnicity and Race: Anthropology
 Ethnicity and Race: Islamic Views
 Ethnocentrism
 Etiquette
 Eugenics
 Europe, Idea of
 Everyday Life
 Evil
 Expressionism
 Extirpation
 Family Planning
 Fascism
 Fatalism
 Feminism: Overview
 Feminism: Chicana Feminisms
 Feminism: Third World U.S. Movement
 Fetishism: Overview
 Fetishism: Fetishism in Literature and Cultural Studies
 Feudalism, European
 Field Theories
 Form, Metaphysical, in Ancient and Medieval Thought
 Foundationalism
 Friendship
 Futurology
 Game Theory
 Garden
 Gender: Overview
 Gender: Gender in the Middle East
 Gender in Art
 Genetics: Contemporary
 Genetics: History of
 Genius
 Genocide
 Geography
 Geometry
 Gesture
 Ghetto
 Globalization: Asia
 Globalization: General
 Greek Science
 Harmony
 Hate
 Health and Disease
 Heaven and Hell
 Heaven and Hell (Asian Focus)
 Hedonism in European Thought
 Heresy and Apostasy
 Hinduism
 History, Economic
 History, Idea of

- Honor
 Honor, Middle Eastern Notions of
 Humanism: Chinese Conception of
 Humanity: African Thought
 Humanity: European Thought
 Humanity in the Arts
 Humor
 Hygiene
 Iconography
 Idealism
 Ideas, History of
 Identity: Identity of Persons
 Identity, Multiple: Overview
 Identity, Multiple: Jewish Multiple Identity
 Images, Icons, and Idols
 Imagination
 Impressionism
 Intentionality
 Interdisciplinarity
 Islam: Shii
 Islamic Science
 Jainism
 Jihad
 Jouissance
 Knowledge
 Landscape in the Arts
 Language, Linguistics, and Literacy
 Law, Islamic
 Leadership
 Learning and Memory, Contemporary Views
 Liberty
 Life Cycle: Overview
 Life Cycle: Elders/Old Age
 Literary History
 Love, Western Notions of
 Machismo
 Magic
 Maps and the Ideas They Express
 Masks
 Mathematics
 Matriarchy
 Mechanical Philosophy
 Media, History of
 Medicine: Europe and the United States
 Medicine: Islamic Medicine
 Memory
 Men and Masculinity
 Mestizaje
 Metaphor
 Microcosm and Macrocosm
 Migration: United States
 Millenarianism: Islamic
 Millenarianism: Latin America and Native North
 America
 Minority
 Miracles
 Modernism: Overview
 Modernism: Latin America
 Modernity: Overview
 Modernity: Africa
 Monarchy: Overview
 Monasticism
 Motherhood and Maternity
 Motif: Motif in Music
 Museums
 Musical Performance and Audiences
 Musicology
 Mysticism: Chinese Mysticism
 Mysticism: Christian Mysticism
 Myth
 Nation
 Nationalism: Overview
 Natural History
 Naturalism
 Naturalism in Art and Literature
 Naturphilosophie
 Negritude
 Newtonianism
 Nomadism
 Nuclear Age
 Nude, The
 Occidentalism
 Organicism
 Orthodoxy
 Pacifism
 Pan-Asianism
 Paradigm
 Paradise on Earth
 Periodization of the Arts
 Person, Idea of the
 Perspective
 Philosophies: American
 Philosophies: Feminist, Twentieth-Century
 Philosophy: Relations to Other Intellectual Realms
 Phrenology
 Physics
 Political Protest, U.S.
 Population
 Postmodernism
 Practices
 Pre-Columbian Civilization
 Prejudice
 Privacy
 Property
 Protest, Political
 Psychoanalysis
 Public Sphere
 Pythagoreanism
 Queer Theory
 Race and Racism: United States
 Reading
 Realism
 Relativism
 Religion: Indigenous Peoples' View, South America
 Religion and Science
 Religion and the State: Latin America
 Renaissance
 Representation: Mental Representation
 Representation: Political Representation
 Republicanism: Republic
 Resistance
 Resistance and Accommodation
 Responsibility
 Ritual: Public Ritual
 Ritual: Religion
 Romanticism in Literature and Politics
 Sacred and Profane
 Sacred Places
 Science, History of
 Science Fiction

READER'S GUIDE

Scientific Revolution
Sexuality: Overview
Sexuality: Sexual Orientation
Shinto
Slavery
Social History, U.S.
Sophists, The
Sport
Subjectivism
Superstition
Surrealism
Symbolism
Syncretism
Taste
Terror
Text/Textuality
Theater and Performance
Theodicy
Third Cinema
Third World Literature
Toleration
Totalitarianism
Totems
Trade
Tragedy and Comedy
Treaty
Untouchability: Menstrual Taboos
Utilitarianism
Utopia
Victorianism
Virtual Reality
Visual Culture
Visual Order to Organizing Collections
Volunteerism, U.S.
War
War and Peace in the Arts
Westernization: Southeast Asia
Witchcraft
Witchcraft, African Studies of
Women and Femininity in U.S. Popular Culture
Women's History: Africa
World Systems Theory, Latin America
Yin and Yang

PRACTICES

Most of the entries in the *NDHI* discuss how specific societies habituated people to specific ideas. This selective list includes the entries on schools of thought and practice, religions, and political movements, as well as the entries on distinctive practices.

Abolitionism
Afropessimism
Agnosticism
Alchemy: China
Alchemy: Europe and the Middle East
Anarchism
Ancestor Worship
Animism
Anticolonialism: Africa
Anticolonialism: Latin America
Anticolonialism: Middle East
Anticolonialism: Southeast Asia
Anticommunism: Latin America
Antifeminism

Anti-Semitism: Overview
Anti-Semitism: Islamic Anti-Semitism
Apartheid
Aristotelianism
Asceticism: Hindu and Buddhist Asceticism
Asceticism: Western Asceticism
Astrology: Overview
Astrology: China
Atheism
Avant-Garde: Militancy
Behaviorism
Black Consciousness
Buddhism
Bureaucracy
Bushido
Cannibalism
Capitalism: Overview
Capitalism: Africa
Cartesianism
Character
Chicano Movement
Chinese Thought
Christianity: Overview
Christianity: Asia
Cinema
Citizenship: Naturalization
Civil Disobedience
Classicism
Classification of Arts and Sciences, Early Modern
Colonialism: Africa
Colonialism: Latin America
Colonialism: Southeast Asia
Communication of Ideas: Orality and Advent of Writing
Communism: Europe
Communism: Latin America
Communitarianism in African Thought
Computer Science
Confucianism
Conservatism
Constitutionalism
Cosmopolitanism
Creationism
Critical Theory
Cultural Capital
Cultural Studies
Cynicism
Dance
Daoism
Deism
Dialogue and Dialectics: Socratic
Dialogue and Dialectics: Talmudic
Discrimination
Diversity
Eclecticism
Ecumenism
Empire and Imperialism: Overview
Empire and Imperialism: Americas
Empire and Imperialism: Asia
Empire and Imperialism: Europe
Empire and Imperialism: Middle East
Empire and Imperialism: United States
Empiricism
Epicureanism
Equality: Overview
Etiquette

- Eugenics
 Everyday Life
 Existentialism
 Extirpation
 Fascism
 Fatalism
 Feminism: Overview
 Feminism: Africa and African Diaspora
 Feminism: Chicana Feminisms
 Feminism: Islamic Feminism
 Feminism: Third World U.S. Movement
 Fetishism: Overview
 Feudalism, European
 Game Theory
 Genocide
 Ghetto
 Gift, The
 Gnosticism
 Health and Disease
 Hegelianism
 Hinduism
 Humanism: Renaissance
 Humanism: Secular Humanism in the United States
 Human Rights: Overview
 Human Rights: Women's Rights
 Interpretation
 Islam: Africa
 Islam: Shii
 Islam: Southeast Asia
 Islam: Sunni
 Jainism
 Japanese Philosophy, Japanese Thought
 Jihad
 Judaism: Judaism to 1800
 Judaism: Modern Judaism
 Kantianism
 Law
 Leadership
 Legalism, Ancient China
 Liberalism
 Liberation Theology
 Machiavellism
 Magic
 Manichaeism
 Maoism
 Marxism: Overview
 Marxism: Asia
 Marxism: Latin America
 Masks
 Mechanical Philosophy
 Medicine: China
 Medicine: Europe and the United States
 Medicine: India
 Medicine: Islamic Medicine
 Migration: Migration in World History
 Monarchy: Overview
 Monasticism
 Multiculturalism, Africa
 Museums
 Music, Anthropology of
 Musical Performance and Audiences
 Musicology
 Myth
 Nationalism: Overview
 Nationalism: Africa
 Nationalism: Cultural Nationalism
 Nationalism: Middle East
 Neoplatonism
 Nihilism
 Nomadism
 Nonviolence
 Orthodoxy
 Orthopraxy: Asia
 Orthopraxy: Western Orthopraxy
 Pacifism
 Pan-Africanism
 Pan-Arabism
 Pan-Asianism
 Pan-Islamism
 Pan-Turkism
 Paradigm
 Phrenology
 Physics
 Platonism
 Political Protest, U.S.
 Polytheism
 Population
 Populism: Latin America
 Positivism
 Practices
 Pragmatism
 Pseudoscience
 Psychoanalysis
 Psychology and Psychiatry
 Public Sphere
 Punishment
 Race and Racism: Asia
 Race and Racism: Europe
 Race and Racism: United States
 Radicals/Radicalism
 Rational Choice
 Reading
 Realism: Africa
 Reflexivity
 Reform: Europe and the United States
 Relativism
 Religion: Overview
 Religion: Africa
 Religion: African Diaspora
 Religion: East and Southeast Asia
 Religion: Indigenous Peoples' View, South America
 Religion: Latin America
 Religion: Middle East
 Republicanism: Latin America
 Republicanism: Republic
 Resistance
 Resistance and Accommodation
 Responsibility
 Revolution
 Ritual: Public Ritual
 Ritual: Religion
 Romanticism in Literature and Politics
 Sacred and Profane
 Scholasticism
 Science: Overview
 Scientific Revolution
 Secularization and Secularism
 Segregation
 Skepticism
 Slavery

READER'S GUIDE

Socialism
Socialisms, African
Sophists, The
Sport
Stoicism
Subjectivism
Suicide
Superstition
Symbolism
Syncretism
Temperance
Terror
Theater and Performance
Time: Traditional and Utilitarian
Totalitarianism
Totems
Trade
Tradition
Tragedy and Comedy
Tribalism, Middle East
Untouchability: Overview
Untouchability: Menstrual Taboos
Untouchability: Taboos
Utilitarianism
Visual Order to Organizing Collections
Volunteerism, U.S.
Westernization: Africa
Westernization: Middle East
Westernization: Southeast Asia
Witchcraft
Witchcraft, African Studies of
Work
Yoga
Zionism

TEXTUAL

Every entry in the *New Dictionary of the History of Ideas* used texts. The following is a list of entries that focused mainly on the history of a succession of texts. Each academic discipline has a succession of major authors with whom later practitioners of the discipline build upon and respond to creatively. The historian of a discipline—such as the history of political philosophy, literary history, or the history of science—considers the responses of thinkers and practitioners of a discipline to the major earlier texts in the discipline. In tracing the origin, development, and transformation of an idea, the historian of ideas considers thinkers' responses to texts from a variety of disciplines.

Agnosticism
Alchemy: Europe and the Middle East
Algebras
Altruism
America
Analytical Philosophy
Aristotelianism
Asceticism: Hindu and Buddhist Asceticism
Autobiography
Autonomy
Biography
Bureaucracy
Capitalism: Overview
Cartesianism
Casuistry

Causality
Censorship
Change
Chinese Thought
Civil Disobedience
Class
Communitarianism in African Thought
Conservatism
Continental Philosophy
Cosmology: Cosmology and Astronomy
Creolization, Caribbean
Crisis
Cycles
Death and Afterlife, Islamic Understanding of
Deism
Dialogue and Dialectics: Socratic
Dialogue and Dialectics: Talmudic
Eclecticism
Encyclopedism
Epistemology: Ancient
Epistemology: Early Modern
Equality: Gender Equality
Eschatology
Essentialism
Existentialism
Experiment
Falsifiability
Fatalism
Fetishism: Fetishism in Literature and Cultural Studies
Form, Metaphysical, in Ancient and Medieval Thought
Free Will, Determinism, and Predestination
General Will
Generation
Genius
Genre
Geometry
Gift, The
Globalization: Asia
Gnosticism
Good
Greek Science
Happiness and Pleasure in European Thought
Heaven and Hell
Hegelianism
Hermeneutics
Hierarchy and Order
Hinduism
Historical and Dialectical Materialism
Historicism
Historiography
History, Idea of
Humanism: Africa
Humanism: Chinese Conception of
Humanism: Renaissance
Humanity: Asian Thought
Human Rights: Overview
Idealism
Ideas, History of
Identity, Multiple: Overview
Identity: Identity of Persons
Imagination
Immortality and the Afterlife
Individualism
Intelligentsia
Jouissance

Judaism: Judaism to 1800
 Justice: Overview
 Justice: Justice in American Thought
 Justice: Justice in East Asian Thought
 Kantianism
 Knowledge
 Language, Philosophy of: Ancient and Medieval
 Language, Philosophy of: Modern
 Legalism, Ancient China
 Liberalism
 Liberty
 Literature: African Literature
 Materialism in Eighteenth-Century European Thought
 Mechanical Philosophy
 Medicine: China
 Metaphor
 Metaphysics: Ancient and Medieval
 Metaphysics: Renaissance to the Present
 Microcosm and Macrocosm
 Mind
 Modernity: East Asia
 Mohism
 Moral Sense
 Motif: Motif in Literature
 Mysticism: Chinese Mysticism
 Mysticism: Christian Mysticism
 Mysticism: Kabbalah
 Natural Law
 Natural Theology
 Naturalism
 Naturphilosophie
 Negritude
 Neocolonialism
 New Criticism
 Nihilism
 Organicism
 Orientalism: Overview
 Orthopraxy: Western Orthopraxy
 Paradigm
 Phenomenology
 Philosophies: African
 Philosophies: Islamic
 Philosophy: Historical Overview and Recent Developments
 Philosophy, History of
 Philosophy, Moral: Ancient
 Philosophy, Moral: Medieval and Renaissance
 Philosophy, Moral: Modern
 Philosophy and Religion in Western Thought
 Philosophy of Mind: Ancient and Medieval
 Philosophy of Religion
 Pietism
 Platonism
 Poetry and Poetics
 Political, The
 Postcolonial Theory and Literature
 Practices
 Pragmatism
 Prehistory, Rise of
 Progress, Idea of
 Psychoanalysis
 Queer Theory
 Race and Racism: Overview
 Rationalism
 Reading

Realism: Africa
 Reflexivity
 Relativity
 Religion: Overview
 Representation: Political Representation
 Republicanism: Republic
 Romanticism in Literature and Politics
 Sacred Texts: Asia
 Science: East Asia
 Science, History of
 Science Fiction
 Social Capital
 Social Contract
 State of Nature
 Stoicism
 Structuralism and Poststructuralism: Overview
 Structuralism and Poststructuralism: Anthropology
 Taste
 Text/Textuality
 Toleration
 Treaty
 Truth
 Universalism
 Utopia
 Virtue Ethics
 Wealth
 World Systems Theory, Latin America

GEOGRAPHICAL AREAS

Global Entries

EXEMPLARY GLOBAL ENTRIES

Anthropology
 Atheism
 Bilingualism and Multilingualism
 Black Atlantic
 Christianity: Overview
 Communication of Ideas: Orality and the Advent of Writing
 Constitutionalism
 Critical Theory
 Dance
 Environmental History
 Eurocentrism
 Feminism: Overview
 Fundamentalism
 Garden
 Historiography
 History, Economic
 Humanity in the Arts
 Identity, Multiple: Jewish Multiple Identity
 International Order
 Islam: Shii
 Islam: Sunni
 Life Cycle: Elders/Old Age
 Magic
 Maps and the Ideas They Express
 Marxism: Overview
 Mathematics
 Migration: Africa
 Migration: Migration in World History
 Migration: United States
 Monasticism
 Music, Anthropology of

READER'S GUIDE

- Musical Performance and Audiences
Nuclear Age
Pan-Africanism
Peasants and Peasantry
Person, Idea of the
Polytheism
Postcolonial Theory and Literature
Property
Protest, Political
Religion and the State: Africa
Resistance and Accommodation
Ritual: Religion
Sacred Places
Secularization and Secularism
Slavery
Sovereignty
Superstition
Syncretism
Temperance
Third Cinema
Third World Literature
Tradition
Treaty
Witchcraft
Women's Studies
- ENTRIES ON AT LEAST THREE GEOGRAPHIC
AREAS OR A GLOBAL TOPIC
- Abolitionism
Aesthetics: Africa
Africa, Idea of
Alchemy: China
Alienation
Animism
Anthropology
Anticolonialism: Africa
Anticolonialism: Latin America
Anticolonialism: Southeast Asia
Antifeminism
Architecture: Overview
Arts: Overview
Arts: Africa
Asceticism: Hindu and Buddhist Asceticism
Astrology: Overview
Atheism
Authoritarianism: Overview
Authority
Autobiography
Barbarism and Civilization
Bilingualism and Multilingualism
Bioethics
Biography
Black Atlantic
Body, The
Borders, Borderlands, and Frontiers, Global
Buddhism
Calculation and Computation
Calendar
Cannibalism
Capitalism: Overview
Capitalism: Africa
Censorship
Childhood and Child Rearing
Cinema
Citizenship: Overview
City, The: The City as a Cultural Center
Civil Disobedience
Civil Society: Europe and the United States
Colonialism: Africa
Colonialism: Southeast Asia
Communication of Ideas: Africa and Its Influence
Communication of Ideas: Middle East and Abroad
Communication of Ideas: Orality and the Advent of
Writing
Computer Science
Consciousness: Overview
Corruption in Developed and Developing Countries
Cosmology: Asia
Cosmopolitanism
Creativity in the Arts and Sciences
Creolization, Caribbean
Critical Theory
Cultural Capital
Cultural Studies
Dance
Death
Deism
Democracy
Demography
Demonology
Dependency
Diasporas: African Diaspora
Diasporas: Jewish Diaspora
Discrimination
Diversity
Dream
Dress
Dualism
Ecology
Economics
Ecumenism
Education: Global Education
Education: Islamic Education
Empire and Imperialism: Overview
Empire and Imperialism: Asia
Empire and Imperialism: Europe
Empire and Imperialism: Middle East
Empire and Imperialism: United States
Environment
Equality: Overview
Equality: Gender Equality
Equality: Racial Equality
Ethnicity and Race: Anthropology
Ethnocentrism
Ethnography
Evil
Family: Family in Anthropology since 1980
Family Planning
Fascism
Feminism: Africa and African Diaspora
Feminism: Islamic Feminism
Feminism: Third World U.S. Movement
Fetishism: Overview
Friendship
Futurology
Gay Studies
Gender: Overview
Gender: Gender in the Middle East
Gender in Art
Gender Studies: Anthropology
Generation

- Genius
 Genocide
 Geography
 Ghetto
 Globalization: General
 Hate
 Heaven and Hell
 Honor
 Human Capital
 Humanism: Chinese Conception of
 Humanity: African Thought
 Human Rights: Overview
 Human Rights: Women's Rights
 Iconography
 Identity, Multiple: Overview
 Images, Icons, and Idols
 Immortality and the Afterlife
 Intelligentsia
 Islam: Africa
 Islamic Science
 Jihad
 Judaism: Modern Judaism
 Justice: Overview
 Kinship
 Landscape in the Arts
 Language, Linguistics, and Literacy
 Law
 Liberation Theology
 Liberty
 Life Cycle: Overview
 Life Cycle: Adolescence
 Literature: Overview
 Machiavellism
 Masks
 Matriarchy
 Media, History of
 Medicine: China
 Meditation: Eastern Meditation
 Men and Masculinity
 Millenarianism: Overview
 Millenarianism: Latin America and Native North America
 Minority
 Miracles
 Modernism: Overview
 Modernism: Latin America
 Modernity: Overview
 Modernity: Africa
 Modernization Theory
 Monarchy: Overview
 Motif: Motif in Music
 Museums
 Musicology
 Mysticism: Chinese Mysticism
 Myth
 Nation
 Nationalism: Overview
 Nationalism: Africa
 Native Policy
 Negritude
 Neocolonialism
 Nihilism
 Nomadism
 Nonviolence
 Occidentalism
 Oral Traditions: Overview
 Organicism
 Orientalism: Overview
 Orientalism: African and Black Orientalism
 Orthodoxy
 Orthopraxy: Asia
 Other, The, European Views of
 Pacifism
 Paradise on Earth
 Peace
 Periodization
 Periodization of the Arts
 Perspective
 Philosophies: African
 Philosophy: Historical Overview and Recent Developments
 Philosophy: Relations to Other Intellectual Realms
 Philosophy, Moral: Africa
 Political Science
 Population
 Postcolonial Studies
 Practices
 Prehistory, Rise of
 Prejudice
 Presentism
 Privatization
 Pseudoscience
 Race and Racism: Overview
 Reading
 Reflexivity
 Religion: Overview
 Religion: East and Southeast Asia
 Religion: Latin America
 Religion and the State: United States
 Representation: Political Representation
 Republicanism: Republic
 Rhetoric: Overview
 Ritual: Public Ritual
 Sacred and Profane
 Scarcity and Abundance, Latin America
 Science: Overview
 Segregation
 Sexuality: Overview
 Social Capital
 Society
 Sport
 State, The: Overview
 Structuralism and Poststructuralism: Anthropology
 Symbolism
 Third World
 Time: China
 Toleration
 Totalitarianism
 Totems
 Trade
 Translation
 Travel: Travel from Europe and the Middle East
 University: Overview
 University: Postcolonial
 Untouchability: Overview
 Untouchability: Menstrual Taboos
 Untouchability: Taboos
 Victorianism
 Visual Order to Organizing Collections
 War

READER'S GUIDE

War and Peace in the Arts
Westernization: Africa
Westernization: Southeast Asia
Wisdom, Human
Work
World Systems Theory, Latin America

Africa

ENTRIES FOCUSING ON AFRICA

Aesthetics: Africa
Anticolonialism: Africa
Architecture: Africa
Arts: Africa
Authenticity: Africa
Black Atlantic
Capitalism: Africa
Colonialism: Africa
Communication of Ideas: Africa and Its Influence
Communitarianism in African Thought
Democracy, Africa
Diasporas: African Diaspora
Ethnicity and Race: Africa
Feminism: Africa and African Diaspora
Globalization: Africa
Humanism: Africa
Humanity: African Thought
Islam: Africa
Literature: African Literature
Migration: Africa
Modernity: Africa
Multiculturalism, Africa
Mysticism: Mysticism in African Thought
Nationalism: Africa
Pan-Africanism
Personhood in African Thought
Philosophies: African
Philosophy, Moral: Africa
Realism: Africa
Religion: Africa
Religion: African Diaspora
Religion and the State: Africa
Sociability in African Thought
Socialisms, African
Sufism
Westernization: Africa
Women's History: Africa
Witchcraft, African Studies of

ENTRIES THAT CONSIDER AFRICA

Abolitionism
Africa, Idea of
African-American Ideas
Afrocentricity
Afropessimism
Ancestor Worship
Anthropology
Apartheid
Arts: Overview
Bilingualism and Multilingualism
Black Consciousness
Buddhism
Christianity: Overview
Civil Disobedience
Civil Society: Responses in Africa and the Middle East
Communication of Ideas: Orality and Advent of Writing

Creolization, Caribbean
Critical Theory
Dance
Demography
Dependency
Diasporas: Jewish Diaspora
Discrimination
Dress
Ecology
Empire and Imperialism: Europe
Empire and Imperialism: Middle East
Environmental History
Equality: Racial Equality
Ethnography
Eurocentrism
Family: Modernist Anthropological Theory
Fascism
Feminism: Overview
Feminism: Islamic Feminism
Fetishism: Overview
Genocide
Globalization: General
Historiography
History, Economic
Humanity in the Arts
Identity, Multiple: Jewish Multiple Identity
International Order
Islam: Shii
Islam: Sunni
Jainism
Kinship
Law
Liberation Theology
Life Cycle: Elders/Old Age
Machiavellism
Magic
Maps and the Ideas They Express
Masks
Mathematics
Men and Masculinity
Migration: Migration in World History
Migration: United States
Minority
Modernism: Overview
Motherhood and Maternity
Museums
Music, Anthropology of
Negritude
Neocolonialism
Nomadism
Oral Traditions: Overview
Orientalism: African and Black Orientalism
Pacifism
Peasants and Peasantry
Person, Idea of the
Philosophies: Islamic
Polytheism
Postcolonial Studies
Postcolonial Theory and Literature
Property
Protest, Political
Race and Racism: Overview
Religion: Latin America
Religion and the State: United States
Resistance and Accommodation

Ritual: Religion
 Sacred and Profane
 Sage Philosophy
 Segregation
 Slavery
 State, The: The Postcolonial State
 Syncretism
 Temperance
 Third Cinema
 Third World
 Third World Literature
 Time: Traditional and Utilitarian
 Toleration
 Totems
 Treaty
 Tribalism, Middle East
 University: Postcolonial
 Untouchability: Menstrual Taboos
 Victorianism
 War
 Wisdom, Human
 Witchcraft
 Womanism
 Women's Studies
 Work
 World Systems Theory, Latin America

Asia

ENTRIES FOCUSING ON ASIA

Aesthetics: Asia
 Alchemy: China
 Anticolonialism: Southeast Asia
 Architecture: Asia
 Authoritarianism: East Asia
 Buddhism
 Causation in East Asian and Southeast Asian Philosophy
 Chinese Thought
 Chinese Warlordism
 Christianity: Asia
 Colonialism: Southeast Asia
 Communication of Ideas: Asia and Its Influence
 Communication of Ideas: Southeast Asia and Its Influence
 Confucianism
 Consciousness: Chinese Thought
 Consciousness: Indian Thought
 Cosmology: Asia
 Daoism
 Education: Asia, Traditional and Modern
 Education: China
 Education: India
 Education: Japan
 Empire and Imperialism: Asia
 Examination Systems, China
 Globalization: Asia
 Heaven and Hell (Asian Focus)
 Hinduism
 Humanism: Chinese Conception of
 Humanity: Asian Thought
 Islam: Southeast Asia
 Jainism
 Japanese Philosophy, Japanese Thought
 Justice: Justice in East Asian Thought
 Landscape in the Arts

Legalism, Ancient China
 Literature: Overview
 Maoism
 Marxism: Asia
 Medicine: China
 Medicine: India
 Meditation: Eastern Meditation
 Modernity: East Asia
 Mysticism: Chinese Mysticism
 Mysticism: Islamic Mysticism in Asia
 Orthopraxy: Asia
 Pan-Asianism
 Pan-Turkism
 Philosophy: Historical Overview and Recent Developments
 Race and Racism: Asia
 Religion: East and Southeast Asia
 Sacred Texts: Asia
 Science: East Asia
 Time: China
 Time: India
 Westernization: Southeast Asia
 Women's History: Asia

ENTRIES THAT CONSIDER ASIA

Algebras
 Ancestor Worship
 Anthropology
 Anticolonialism: Africa
 Architecture: Overview
 Arts: Overview
 Asceticism: Hindu and Buddhist Asceticism
 Asian-American Ideas (Cultural Migration)
 Astrology: China
 Astronomy, Pre-Columbian and Latin American
 Atheism
 Autobiography
 Barbarism and Civilization
 Beauty and Ugliness
 Bilingualism and Multilingualism
 Biography
 Body, The
 Borders, Borderlands, and Frontiers, Global
 Bushido
 Calculation and Computation
 Cannibalism
 Censorship
 Childhood and Child Rearing
 Christianity: Overview
 Cinema
 Civil Disobedience
 Civil Society: Responses in Africa and the Middle East
 Communication of Ideas: Middle East and Abroad
 Communication of Ideas: Orality and the Advent of Writing
 Constitutionalism
 Cosmopolitanism
 Creativity in the Arts and Sciences
 Critical Theory
 Cultural Revivals
 Cycles
 Dance
 Deism
 Demography
 Demonology
 Dependency

READER'S GUIDE

Diasporas: African Diaspora
Diffusion, Cultural
Dream
Dress
Dualism
Ecumenism
Education: Global Education
Education: Islamic Education
Empire and Imperialism: Europe
Empire and Imperialism: Middle East
Empire and Imperialism: United States
Environment
Environmental History
Ethnography
Eurocentrism
Evil
Family: Family in Anthropology since 1980
Family Planning
Fascism
Feminism: Overview
Field Theories
Friendship
Fundamentalism
Garden
Gay Studies
Gender Studies: Anthropology
Generation
Genetics: Contemporary
Genocide
Globalization: General
Health and Disease
Heaven and Hell
Historiography
History, Economic
Human Capital
Humanity in the Arts
Hygiene
Iconography
Identity, Multiple: Asian-Americans
Identity, Multiple: Jewish Multiple Identity
Images, Icons, and Idols
Imagination
Immortality and the Afterlife
Individualism
Intelligentsia
International Order
Islam: Shi'i
Islam: Sunni
Islamic Science
Kinship
Language, Linguistics, and Literacy
Liberty
Life Cycle: Overview
Life Cycle: Adolescence
Life Cycle: Elders/Old Age
Machiavellism
Magic
Maps and the Ideas They Express
Marxism: Overview
Masks
Mathematics
Matriarchy
Migration: Migration in World History
Migration: United States
Miracles
Modernism: Latin America
Modernity: Africa
Modernization Theory
Mohism
Monarchy: Overview
Monasticism
Monism
Motherhood and Maternity
Motif: Motif in Music
Museums
Musical Performance and Audiences
Musicology
Nation
Neoliberalism
Nomadism
Nonviolence
Nuclear Age
Nude, The
Occidentalism
Organicism
Orientalism: Overview
Orthodoxy
Pacifism
Paradise on Earth
Peace
Peasants and Peasantry
Periodization
Person, Idea of the
Perspective
Philosophy: Relations to Other Intellectual Realms
Political Science
Population
Postcolonial Studies
Postcolonial Theory and Literature
Practices
Prehistory, Rise of
Privacy
Property
Protest, Political
Race and Racism: United States
Reading
Religion: Overview
Religion and the State: United States
Resistance and Accommodation
Revolution
Rhetoric: Overview
Ritual: Public Ritual
Ritual: Religion
Sacred and Profane
Sacred Places
Secularization and Secularism
Sexual Harassment
Sexuality: Sexual Orientation
Shinto
Slavery
Society
Sovereignty
Sport
Suicide
Superstition
Syncretism
Taste
Temperance
Terror
Textiles and Fiber Arts as Catalysts for Ideas

Third Cinema
 Third World
 Third World Literature
 Toleration
 Totems
 Trade
 Translation
 Treaty
 University: Postcolonial
 Untouchability: Overview
 Untouchability: Menstrual Taboos
 Untouchability: Taboos
 Victorianism
 Virtue Ethics
 Visual Order to Organizing Collections
 War and Peace in the Arts
 Wisdom, Human
 Witchcraft
 Women's Studies
 Work
 World Systems Theory, Latin America
 Yin and Yang
 Yoga
 Zen

Europe

ENTRIES FOCUSING ON EUROPE

Architecture: Overview
 Capitalism: Overview
 Christianity: Overview
 Classification of Arts and Sciences, Early Modern
 Colonialism: Africa
 Colonialism: Latin America
 Colonialism: Southeast Asia
 Communication of Ideas: Europe and Its Influence
 Communism: Europe
 Consumerism
 Dada
 Democracy
 Dialogue and Dialectics: Socratic
 Dialogue and Dialectics: Talmudic
 Education: Europe
 Empire and Imperialism: Overview
 Empire and Imperialism: Europe
 Encyclopedism
 Enlightenment
 Epistemology: Ancient
 Epistemology: Early Modern
 Epistemology: Modern
 Eurocentrism
 Europe, Idea of
 Existentialism
 Expressionism
 Fascism
 Feudalism, European
 Greek Science
 Happiness and Pleasure in European Thought
 Hedonism in European Thought
 Historical and Dialectical Materialism
 Humanism: Europe and the Middle East
 Humanism: Renaissance
 Humanity: European Thought
 Judaism: Judaism to 1800
 Judaism: Modern Judaism
 Landscape in the Arts

Literature: Overview
 Love, Western Notions of
 Marxism: Overview
 Materialism in Eighteenth-Century European Thought
 Mechanical Philosophy
 Medicine: Europe and the United States
 Metaphysics: Ancient and Medieval
 Metaphysics: Renaissance to the Present
 Monarchy: Overview
 National History
 Orthopraxy: Western Orthopraxy
 Other, The, European Views of
 Pan-Turkism
 Philosophy: Historical Overview and Recent Developments
 Philosophy, Moral: Ancient
 Philosophy, Moral: Medieval and Renaissance
 Philosophy, Moral: Modern
 Philosophy and Religion in Western Thought
 Philosophy of Mind: Ancient and Medieval
 Pythagoreanism
 Race and Racism: Europe
 Regions and Regionalism, Eastern Europe
 Religion and the State: Europe
 Scientific Revolution
 Victorianism

ENTRIES THAT CONSIDER EUROPE

Abolitionism
 Absolute Music
 Aesthetics: Europe and the Americas
 Africa, Idea of
 Afrocentricity
 Agnosticism
 Alchemy: Europe and the Middle East
 Algebras
 Alienation
 Altruism
 Ambiguity
 America
 Americanization, U.S.
 Analytical Philosophy
 Anarchism
 Animism
 Anthropology
 Anticolonialism: Africa
 Anticolonialism: Latin America
 Anticolonialism: Middle East
 Anticolonialism: Southeast Asia
 Antifeminism
 Anti-Semitism: Overview
 Anti-Semitism: Islamic Anti-Semitism
 Apartheid
 Architecture: Africa
 Aristotelianism
 Arts: Overview
 Arts: Africa
 Asceticism: Western Asceticism
 Assimilation
 Astrology: Overview
 Atheism
 Authoritarianism: Overview
 Authority
 Autobiography
 Autonomy
 Avant-Garde: Overview

READER'S GUIDE

Avant-Garde: Militancy
Barbarism and Civilization
Beauty and Ugliness
Behaviorism
Bilingualism and Multilingualism
Biography
Biology
Black Atlantic
Body, The
Borders, Borderlands, and Frontiers, Global
Buddhism
Bureaucracy
Calculation and Computation
Calendar
Cannibalism
Cartesianism
Casuistry
Causality
Causation
Censorship
Change
Character
Chemistry
Childhood and Child Rearing
Christianity: Asia
Cinema
Citizenship: Overview
Citizenship: Naturalization
City, The: The City as a Cultural Center
City, The: The Islamic and Byzantine City
Civil Disobedience
Civil Society: Europe and the United States
Civil Society: Responses in Africa and the Middle East
Class
Classicism
Common Sense
Communication of Ideas: Africa and Its Influence
Communication of Ideas: Middle East and Abroad
Communication of Ideas: Orality and the Advent of Writing
Communication of Ideas: Southeast Asia
Composition, Musical
Computer Science
Consciousness: Overview
Conservatism
Consilience
Constitutionalism
Continental Philosophy
Corruption
Cosmology: Cosmology and Astronomy
Cosmopolitanism
Creationism
Creativity in the Arts and Sciences
Creolization, Caribbean
Crisis
Critical Theory
Cultural Capital
Cultural History
Cultural Revivals
Cultural Studies
Cycles
Cynicism
Dance
Deism
Demography
Demonology
Dependency
Determinism
Development
Diasporas: African Diaspora
Diasporas: Jewish Diaspora
Diversity
Dream
Dress
Dystopia
Eclecticism
Ecology
Economics
Ecumenism
Education: Global Education
Education: India
Education: Islamic Education
Emotions
Empire and Imperialism: Asia
Empire and Imperialism: Middle East
Empire and Imperialism: United States
Empiricism
Environment
Environmental Ethics
Environmental History
Epicureanism
Equality: Overview
Equality: Gender Equality
Equality: Racial Equality
Essentialism
Ethnicity and Race: Africa
Ethnicity and Race: Anthropology
Ethnocentrism
Etiquette
Eugenics
Everyday Life
Evil
Evolution
Experiment
Extirpation
Fallacy, Logical
Falsifiability
Family: Modernist Anthropological Theory
Family: Family in Anthropology since 1980
Family Planning
Fatalism
Feminism: Overview
Feminism: Africa and African Diaspora
Feminism: Islamic Feminism
Fetishism: Overview
Fetishism: Fetishism in Literature and Cultural Studies
Field Theories
Form, Metaphysical, in Ancient and Medieval Thought
Formalism
Foundationalism
Free Will, Determinism, and Predestination
Friendship
Fundamentalism
Garden
Gay Studies
Gender: Gender in the Middle East
Gender in Art
Gender Studies: Anthropology
General Will
Generation

- Genetics: Contemporary
 Genetics: History of
 Genius
 Genocide
 Geography
 Geometry
 Gesture
 Ghetto
 Gift, The
 Globalization: Africa
 Globalization: Asia
 Globalization: General
 Good
 Harmony
 Hate
 Health and Disease
 Heaven and Hell
 Hegelianism
 Hegemony
 Heresy and Apostasy
 Hermeneutics
 Hierarchy and Order
 Hinduism
 Historicism
 Historiography
 History, Economic
 History, Idea of
 Honor
 Human Capital
 Humanity in the Arts
 Human Rights: Overview
 Humor
 Hygiene
 Iconography
 Idealism
 Ideas, History of
 Identity: Identity of Persons
 Identity, Multiple: Overview
 Identity, Multiple: Jewish Multiple Identity
 Images, Icons, and Idols
 Immortality and the Afterlife
 Impressionism
 Individualism
 Intelligentsia
 Intentionality
 Interdisciplinarity
 International Order
 Interpretation
 Islam: Africa
 Islam: Shii
 Islam: Sunni
 Islamic Science
 Jainism
 Jouissance
 Justice: Overview
 Kantianism
 Kinship
 Knowledge
 Language and Linguistics
 Language, Linguistics, and Literacy
 Language, Philosophy of: Ancient and Medieval
 Language, Philosophy of: Modern
 Law
 Leadership
 Learning and Memory, Contemporary Views
 Liberalism
 Liberation Theology
 Liberty
 Life
 Life Cycle: Overview
 Life Cycle: Elders/Old Age
 Linguistic Turn
 Literary Criticism
 Literary History
 Logic
 Logic and Philosophy of Mathematics, Modern
 Loyalties, Dual
 Lysenkoism
 Machiavellism
 Magic
 Manichaeism
 Maoism
 Maps and the Ideas They Express
 Masks
 Mathematics
 Matriarchy
 Media, History of
 Medicine: Islamic Medicine
 Meme
 Memory
 Men and Masculinity
 Metaphor
 Microcosm and Macrocosm
 Migration: Africa
 Migration: Migration in World History
 Migration: United States
 Millenarianism: Overview
 Millenarianism: Islamic
 Millenarianism: Latin America and Native North America
 Mind
 Miracles
 Modernism: Overview
 Modernism: Latin America
 Modernity: Overview
 Modernity: Africa
 Modernity: East Asia
 Modernization
 Modernization Theory
 Monasticism
 Monism
 Moral Sense
 Motherhood and Maternity
 Motif: Motif in Literature
 Motif: Motif in Music
 Museums
 Music, Anthropology of
 Musical Performance and Audiences
 Musicology
 Mysticism: Christian Mysticism
 Mysticism: Kabbalah
 Mysticism: Mysticism in African Thought
 Myth
 Narrative
 Nation
 Nationalism: Overview
 Nationalism: Africa
 Nationalism: Cultural Nationalism
 Nationalism: Middle East
 Native Policy

READER'S GUIDE

Natural History
Natural Theology
Naturalism
Naturalism in Art and Literature
Nature
Naturphilosophie
Negritude
Neocolonialism
Neoliberalism
Neoplatonism
New Criticism
Newtonianism
Nihilism
Nonviolence
Nuclear Age
Nude, The
Objectivity
Obligation
Occidentalism
Organicism
Orientalism: Overview
Orthodoxy
Pacifism
Pan-Africanism
Pan-Asianism
Pan-Islamism
Paradigm
Paradise on Earth
Parties, Political
Patriotism
Peace
Peasants and Peasantry
Periodization
Periodization of the Arts
Person, Idea of the
Perspective
Phenomenology
Philosophies: African
Philosophies: Feminist, Twentieth-Century
Philosophies: Islamic
Philosophy: Relations to Other Intellectual Realms
Philosophy, History of
Philosophy, Moral: Africa
Philosophy of Mind: Overview
Phrenology
Physics
Platonism
Pluralism
Poetry and Poetics
Political, The
Political Science
Polytheism
Population
Positivism
Postcolonial Studies
Postcolonial Theory and Literature
Postmodernism
Poverty
Power
Practices
Pragmatism
Pre-Columbian Civilization
Prehistory, Rise of
Prejudice
Presentism
Privacy
Probability
Progress, Idea of
Propaganda
Property
Prophecy
Protest, Political
Pseudoscience
Psychology and Psychiatry
Public Sphere
Punishment
Puritanism
Quantum
Queer Theory
Radicals/Radicalism
Rational Choice
Rationalism
Reading
Realism
Realism: Africa
Reason, Practical and Theoretical
Reform: Europe and the United States
Reform: Islamic Reform
Reformation
Relativism
Relativity
Religion: Overview
Religion: East and Southeast Asia
Religion: Latin America
Religion: Middle East
Religion and Science
Religion and the State: Latin America
Religion and the State: United States
Renaissance
Representation: Mental Representation
Representation: Political Representation
Republicanism: Latin America
Republicanism: Republic
Resistance
Resistance and Accommodation
Responsibility
Revolution
Rhetoric: Overview
Rhetoric: Ancient and Medieval
Ritual: Public Ritual
Ritual: Religion
Romanticism in Literature and Politics
Sacred and Profane
Sacred Places
Sage Philosophy
Scarcity and Abundance, Latin America
Scholasticism
Science: Overview
Science, History of
Science Fiction
Secularization and Secularism
Sexuality: Overview
Skepticism
Slavery
Social Capital
Social Contract
Social Darwinism
Socialism
Socialisms, African
Society

Sophists, The
 Sovereignty
 Sport
 State, The: Overview
 Stoicism
 Structuralism and Poststructuralism: Overview
 Structuralism and Poststructuralism: Anthropology
 Subjectivism
 Suicide
 Superstition
 Surrealism
 Symbolism
 Taste
 Technology
 Temperance
 Terror
 Terrorism, Middle East
 Textiles and Fiber Arts as Catalysts for Ideas
 Theodicy
 Third Cinema
 Time: Traditional and Utilitarian
 Toleration
 Totalitarianism
 Trade
 Tragedy and Comedy
 Translation
 Travel: Travel from Europe and the Middle East
 Treaty
 Trope
 Truth
 Universalism
 University: Overview
 University: Postcolonial
 Untouchability: Overview
 Untouchability: Menstrual Taboos
 Untouchability: Taboos
 Utilitarianism
 Utopia
 Virtue Ethics
 Visual Order to Organizing Collections
 Volksgeist
 Volunteerism, U.S.
 War
 War and Peace in the Arts
 Wealth
 Westernization: Africa
 Westernization: Middle East
 Westernization: Southeast Asia
 Wildlife
 Wisdom, Human
 Witchcraft
 Witchcraft, African Studies of
 Women's History: Africa
 Women's Studies
 Work
 World Systems Theory, Latin America
 Zionism

Middle East

ENTRIES FOCUSING ON THE MIDDLE EAST

Alchemy: Europe and the Middle East
 Anticolonialism: Middle East
 Civil Society: Responses in Africa and the Middle East
 Communication of Ideas: Middle East and Abroad
 Death and Afterlife, Islamic Understanding of

Dialogue and Dialectics: Talmudic
 Education: Islamic Education
 Empire and Imperialism: Middle East
 Feminism: Islamic Feminism
 Gender: Gender in the Middle East
 Honor, Middle Eastern Notions of
 Humanism: Europe and the Middle East
 Intercession in Middle Eastern Society
 Islam: Shii
 Islam: Sunni
 Islamic Science
 Judaism: Judaism to 1800
 Judaism: Modern Judaism
 Law, Islamic
 Literature: Overview
 Medicine: Islamic Medicine
 Monarchy: Islamic Monarchy
 Nationalism: Middle East
 Pan-Arabism
 Pan-Islamism
 Pan-Turkism
 Philosophies: Islamic
 Religion: Middle East
 Religion and the State: Middle East
 Sufism
 Terrorism, Middle East
 Tribalism, Middle East
 Westernization: Middle East
 Zionism

ENTRIES THAT CONSIDER THE MIDDLE EAST

Africa, Idea of
 Algebras
 Anthropology
 Antifeminism
 Anti-Semitism: Overview
 Anti-Semitism: Islamic Anti-Semitism
 Architecture: Overview
 Architecture: Africa
 Aristotelianism
 Arts: Africa
 Astrology: Overview
 Astrology: China
 Atheism
 Authoritarianism: Overview
 Authority
 Barbarism and Civilization
 Bilingualism and Multilingualism
 Biography
 Calendar
 Childhood and Child Rearing
 Christianity: Overview
 City, The: The Islamic and Byzantine City
 Class
 Communication of Ideas: Africa and Its Influence
 Communication of Ideas: Europe and Its Influence
 Communication of Ideas: Orality and the Advent of Writing
 Computer Science
 Constitutionalism
 Cosmopolitanism
 Creativity in the Arts and Sciences
 Critical Theory
 Dance
 Deism
 Demography

READER'S GUIDE

Demonology
Dependency
Diasporas: African Diaspora
Diasporas: Jewish Diaspora
Dream
Dualism
Ecumenism
Empire and Imperialism: Europe
Environment
Ethnicity and Race: Islamic Views
Eurocentrism
Evil
Family Planning
Feminism: Overview
Feminism: Africa and African Diaspora
Free Will, Determinism, and Predestination
Friendship
Fundamentalism
Garden
Gay Studies
Gender in Art
Ghetto
Gift, The
Gnosticism
Hate
Health and Disease
Heaven and Hell
Heresy and Apostasy
Historiography
Humanity in the Arts
Iconography
Identity, Multiple: Jewish Multiple Identity
Images, Icons, and Idols
Imagination
Immortality and the Afterlife
Intelligentsia
International Order
Islam: Africa
Jihad
Language, Linguistics, and Literacy
Language, Philosophy of: Ancient and Medieval
Liberty
Life Cycle: Elders/Old Age
Literature: African Literature
Logic
Manichaeism
Maps and the Ideas They Express
Mathematics
Matriarchy
Microcosm and Macrocosm
Migration: Africa
Migration: Migration in World History
Millenarianism: Overview
Millenarianism: Islamic
Minority
Miracles
Monarchy: Overview
Motherhood and Maternity
Museums
Musicology
Mysticism: Islamic Mysticism
Mysticism: Islamic Mysticism in Asia
Mysticism: Kabbalah
Mysticism: Mysticism in African Thought
Nation
Nationalism: Cultural Nationalism
Nihilism
Nomadism
Nonviolence
Nuclear Age
Organicism
Orientalism: Overview
Orientalism: African and Black Orientalism
Orthodoxy
Orthopraxy: Western Orthopraxy
Pan-Africanism
Paradise on Earth
Peace
Perspective
Philosophies: African
Philosophy, Moral: Medieval and Renaissance
Philosophy of Mind: Ancient and Medieval
Political Science
Polytheism
Postcolonial Studies
Postcolonial Theory and Literature
Property
Prophecy
Protest, Political
Pythagoreanism
Reform: Islamic Reform
Religion: East and Southeast Asia
Religion and Science
Religion and the State: Africa
Religion and the State: Europe
Religion and the State: United States
Resistance and Accommodation
Rhetoric: Overview
Sacred Places
Sacred Texts: Koran
Science, History of
Scientific Revolution
Secularization and Secularism
Sexual Harassment
Sexuality: Islamic Views
Slavery
Sovereignty
Suicide
Superstition
Syncretism
Temperance
Textiles and Fiber Arts as Catalysts for Ideas
Theodicy
Third Cinema
Third World Literature
Toleration
Totalitarianism
Totems
Travel: Travel from Europe and the Middle East
Treaty
University: Overview
Untouchability: Menstrual Taboos
Untouchability: Taboos
Visual Order to Organizing Collections
Westernization: Africa
Westernization: Southeast Asia
Wisdom, Human
Women's History: Africa
Women's Studies
World Systems Theory, Latin America

North America

ENTRIES FOCUSING ON NORTH AMERICA

African-American Ideas
 America
 Asian-American Ideas (Cultural Migration)
 Black Atlantic
 Chicano Movement
 Christianity: Overview
 Civil Society: Europe and the United States
 Communication of Ideas: The Americas and Their Influence
 Consumerism
 Democracy
 Education: North America
 Empire and Imperialism: Americas
 Empire and Imperialism: United States
 Ethnohistory, U.S.
 Feminism: Chicana Feminisms
 Feminism: Third World U.S. Movement
 Humanism: Secular Humanism in the United States
 Identity, Multiple: Asian-Americans
 Judaism: Modern Judaism
 Justice: Justice in American Thought
 Landscape in the Arts
 Medicine: Europe and the United States
 Migration: United States
 Millenarianism: Latin America and Native North America
 Native Policy
 Philosophies: American
 Political Protest, U.S.
 Populism: United States
 Race and Racism: United States
 Reform: Europe and the United States
 Religion and the State: United States
 Volunteerism, U.S.

ENTRIES THAT CONSIDER NORTH AMERICA

Abolitionism
 Aesthetics: Europe and the Americas
 Africa, Idea of
 Afrocentricity
 Altruism
 Americanization, U.S.
 Analytical Philosophy
 Anthropology
 Anticolonialism: Latin America
 Anticolonialism: Southeast Asia
 Antifeminism
 Asceticism: Western Asceticism
 Assimilation
 Astronomy, Pre-Columbian and Latin American
 Atheism
 Authoritarianism: Latin America
 Authority
 Autobiography
 Aztlán
 Beauty and Ugliness
 Behaviorism
 Bilingualism and Multilingualism
 Bioethics
 Biology
 Body, The
 Borders, Borderlands, and Frontiers, Global
 Buddhism
 Calculation and Computation

Cannibalism
 Causation
 Censorship
 Childhood and Child Rearing
 Cinema
 Citizenship: Overview
 Citizenship: Cultural Citizenship
 Citizenship: Naturalization
 City, The: The City as a Cultural Center
 Civil Disobedience
 Colonialism: Latin America
 Communication of Ideas: Africa and Its Influence
 Communism: Latin America
 Computer Science
 Conservatism
 Consilience
 Constitutionalism
 Continental Philosophy
 Cosmopolitanism
 Creationism
 Critical Race Theory
 Critical Theory
 Cultural Capital
 Cultural Revivals
 Cultural Studies
 Dance
 Death
 Deism
 Demography
 Diasporas: African Diaspora
 Diasporas: Jewish Diaspora
 Discrimination
 Diversity
 Dream
 Dress
 Dualism
 Dystopia
 Ecology
 Economics
 Ecumenism
 Education: Global Education
 Emotions
 Empire and Imperialism: Asia
 Empiricism
 Enlightenment
 Environment
 Environmental Ethics
 Environmental History
 Equality: Overview
 Equality: Gender Equality
 Equality: Racial Equality
 Essentialism
 Ethnicity and Race: Anthropology
 Ethnocentrism
 Ethnography
 Eugenics
 Eurocentrism
 Everyday Life
 Evil
 Evolution
 Family: Modernist Anthropological Theory
 Family: Family in Anthropology since 1980
 Family Planning
 Feminism: Overview
 Feminism: Africa and African Diaspora

READER'S GUIDE

Feminism: Islamic Feminism
Fetishism: Overview
Fetishism: Fetishism in Literature and Cultural Studies
Field Theories
Foundationalism
Friendship
Fundamentalism
Game Theory
Garden
Gay Studies
Gender: Overview
Gender: Gender in the Middle East
Gender in Art
Gender Studies: Anthropology
Generation
Genetics: Contemporary
Genetics: History of
Genius
Genocide
Ghetto
Globalization: Asia
Globalization: General
Hate
Hegelianism
Historiography
History, Economic
Human Capital
Humanity: European Thought
Humanity in the Arts
Human Rights: Overview
Ideas, History of
Identity: Identity of Persons
Identity: Personal and Social Identity
Identity, Multiple: Overview
Identity, Multiple: Jewish Multiple Identity
Impressionism
Intentionality
Interdisciplinarity
Internal Colonialism
International Order
Interpretation
Islam: Shii
Jainism
Justice: Overview
Kantianism
Language and Linguistics
Language, Philosophy of: Modern
Law
Leadership
Learning and Memory, Contemporary Views
Liberation Theology
Life
Life Cycle: Adolescence
Life Cycle: Elders/Old Age
Linguistic Turn
Literary Criticism
Literary History
Loyalties, Dual
Machismo
Magic
Maps and the Ideas They Express
Marxism: Overview
Marxism: Latin America
Masks
Mathematics
Matriarchy
Media, History of
Meme
Men and Masculinity
Mestizaje
Migration: Africa
Migration: Migration in World History
Millenarianism: Overview
Mind
Minority
Modernism: Latin America
Modernity: Overview
Monasticism
Motif: Motif in Music
Museums
Music, Anthropology of
Musical Performance and Audiences
Myth
Narrative
Nation
Nationalism: Overview
Nationalism: Africa
Natural History
Natural Theology
Naturalism
Neocolonialism
Neoliberalism
New Criticism
Nihilism
Nuclear Age
Objectivity
Obligation
Occidentalism
Orientalism: African and Black Orientalism
Orthodoxy
Other, The, European Views of
Pacifism
Pan-Africanism
Paradigm
Parties, Political
Periodization
Person, Idea of the
Philosophies: Feminist, Twentieth-Century
Philosophy: Relations to Other Intellectual Realms
Philosophy of Mind: Overview
Pluralism
Political Science
Population
Positivism
Postcolonial Studies
Postcolonial Theory and Literature
Postmodernism
Practices
Pragmatism
Prehistory, Rise of
Prejudice
Presentism
Privacy
Probability
Progress, Idea of
Property
Protest, Political
Pseudoscience
Psychology and Psychiatry
Quantum

Queer Theory
 Race and Racism: Overview
 Rational Choice
 Reading
 Reflexivity
 Relativism
 Relativity
 Religion: Latin America
 Religion and Science
 Renaissance
 Representation: Mental Representation
 Representation: Political Representation
 Resistance
 Resistance and Accommodation
 Responsibility
 Rhetoric: Overview
 Ritual: Religion
 Scarcity and Abundance, Latin America
 Science, History of
 Science Fiction
 Secularization and Secularism
 Segregation
 Sexual Harassment
 Sexuality: Overview
 Sexuality: Sexual Orientation
 Slavery
 Social History, U.S.
 Sovereignty
 Sport
 State, The: Overview
 Subjectivism
 Suicide
 Superstition
 Syncretism
 Taste
 Technology
 Temperance
 Terrorism, Middle East
 Time: Traditional and Utilitarian
 Totems
 Trade
 Treaty
 Trope
 Truth
 University: Postcolonial
 Utilitarianism
 Victorianism
 Visual Culture
 Visual Order to Organizing Collections
 War
 War and Peace in the Arts
 Westernization: Southeast Asia
 Wildlife
 Witchcraft
 Womanism
 Women and Femininity in U.S. Popular Culture
 Women's Studies
 World Systems Theory, Latin America

Latin and South America

ENTRIES FOCUSING ON LATIN AND SOUTH AMERICA

Anticolonialism: Latin America
 Astronomy, Pre-Columbian and Latin American
 Authoritarianism: Latin America

Black Atlantic
 Colonialism: Latin America
 Communication of Ideas: The Americas and Their Influence
 Communism: Latin America
 Creolization, Caribbean
 Empire and Imperialism: Americas
 Marxism: Latin America
 Millenarianism: Latin America and Native North America
 Modernism: Latin America
 Native Policy
 Populism: Latin America
 Pre-Columbian Civilization
 Religion: Indigenous Peoples' View, South America
 Religion: Latin America
 Religion and the State: Latin America
 Republicanism: Latin America
 Scarcity and Abundance, Latin America
 World Systems Theory, Latin America

ENTRIES THAT CONSIDER LATIN AND SOUTH AMERICA

Abolitionism
 Aesthetics: Africa
 Africa, Idea of
 America
 Ancestor Worship
 Animism
 Anthropology
 Arts: Overview
 Atheism
 Authenticity: Africa
 Authoritarianism: Overview
 Autobiography
 Aztlán
 Bilingualism and Multilingualism
 Borders, Borderlands, and Frontiers, Global
 Calculation and Computation
 Cannibalism
 Chicano Movement
 Christianity: Overview
 Cinema
 Citizenship: Overview
 Citizenship: Cultural Citizenship
 Citizenship: Naturalization
 Critical Theory
 Cultural Capital
 Dance
 Demography
 Demonology
 Dependency
 Diasporas: African Diaspora
 Diffusion, Cultural
 Discrimination
 Diversity
 Empire and Imperialism: United States
 Environmental History
 Ethnohistory, U.S.
 Evil
 Extirpation
 Family Planning
 Fascism
 Feminism: Overview
 Feminism: Africa and African Diaspora
 Feminism: Chicana Feminisms

READER'S GUIDE

Fetishism: Overview
Friendship
Gender in Art
Genetics: Contemporary
Historiography
History, Economic
Honor
Humanity in the Arts
Identity, Multiple: Overview
Identity, Multiple: Jewish Multiple Identity
Indigenismo
Internal Colonialism
International Order
Liberation Theology
Life Cycle: Overview
Life Cycle: Elders/Old Age
Machiavellism
Machismo
Magic
Maps and the Ideas They Express
Masks
Mathematics
Matriarchy
Media, History of
Men and Masculinity
Mestizaje
Migration: Africa
Migration: Migration in World History
Migration: United States
Minority
Modernism: Overview
Modernization Theory
Motherhood and Maternity
Motif: Motif in Music
Museums
Music, Anthropology of
Nationalism: Africa
Negritude
Orthopraxy: Western Orthopraxy
Pan-Africanism
Peasants and Peasantry
Periodization of the Arts
Perspective
Phrenology
Political Protest, U.S.
Polytheism
Population
Postcolonial Studies
Postcolonial Theory and Literature
Practices
Prehistory, Rise of
Property
Protest, Political
Race and Racism: Overview
Religion: African Diaspora
Resistance and Accommodation
Revolution
Rhetoric: Overview
Ritual: Public Ritual
Ritual: Religion
Secularization and Secularism
Segregation
Slavery
Sport
State, The: Overview

Structuralism and Poststructuralism: Anthropology
Surrealism
Syncretism
Temperance
Third Cinema
Third World
Third World Literature
Trade
Treaty
University: Overview
University: Postcolonial
Visual Order to Organizing Collections
Witchcraft
Women's Studies
Work

CHRONOLOGICAL PERIODS

This section is divided according to five periods in world history: Ancient, Dynastic, Early Modern, Modern, and Contemporary. Use this section together with the section on Geographical Areas.

Ancient (before 400 C.E.)

ENTRIES FOCUSED ON THE PERIOD

Buddhism
Consciousness: Chinese Thought
Consciousness: Indian Thought
Democracy
Dialogue and Dialectics: Socratic
Epicureanism
Gnosticism
Greek Science
Hinduism
Justice: Justice in East Asian Thought
Language, Linguistics, and Literacy
Microcosm and Macrocosm
Orthopraxy: Asia
Orthopraxy: Western Orthopraxy
Poetry and Poetics
Sacred Places
Sacred Texts: Asia
Sophists, The
Textiles and Fiber Arts as Catalysts for Ideas
Time: China
Time: India
Yin and Yang

ENTRIES WITH EXAMPLES FROM BEFORE 400 C.E.

Generally the examples in this category are from the ancient Middle East, Europe, or Asia.

Aesthetics: Asia
Aesthetics: Europe and the Americas
Africa, Idea of
Alchemy: China
Alchemy: Europe and the Middle East
Algebras
Ambiguity
Anarchism
Anthropology
Anti-Semitism: Overview
Architecture: Overview

- Architecture: Africa
 Architecture: Asia
 Aristotelianism
 Arts: Overview
 Asceticism: Western Asceticism
 Astrology: Overview
 Astrology: China
 Atheism
 Authority
 Autobiography
 Barbarism and Civilization
 Beauty and Ugliness
 Biography
 Biology
 Body, The
 Borders, Borderlands, and Frontiers, Global
 Bureaucracy
 Calendar
 Casuistry
 Causality
 Causation
 Causation in East Asian and Southeast Asian Philosophy
 Censorship
 Change
 Character
 Childhood and Child Rearing
 Chinese Thought
 Christianity: Overview
 Christianity: Asia
 City, The: The City as a Cultural Center
 City, The: The City as Political Center
 City, The: The Islamic and Byzantine City
 Civil Society: Europe and the United States
 Class
 Classicism
 Classification of Arts and Sciences, Early Modern
 Communication of Ideas: Asia and Its Influence
 Communication of Ideas: Europe and Its Influence
 Communication of Ideas: Middle East and Abroad
 Communication of Ideas: Orality and Advent of Writing
 Communication of Ideas: Southeast Asia
 Communication of Ideas: The Americas and Their Influence
 Composition, Musical
 Confucianism
 Constitutionalism
 Corruption
 Cosmology: Asia
 Cosmology: Cosmology and Astronomy
 Cosmopolitanism
 Creationism
 Creativity in the Arts and Sciences
 Creolization, Caribbean
 Cycles
 Cynicism
 Dance
 Daoism
 Death
 Demonology
 Development
 Diasporas: Jewish Diaspora
 Dream
 Dress
 Dualism
 Eclecticism
 Ecumenism
 Education: Asia, Traditional and Modern
 Education: China
 Education: Europe
 Education: India
 Emotions
 Empire and Imperialism: Overview
 Empire and Imperialism: Asia
 Environment
 Epistemology: Ancient
 Equality: Overview
 Eschatology
 Essentialism
 Etiquette
 Eurocentrism
 Europe, Idea of
 Evil
 Evolution
 Experiment
 Fallacy, Logical
 Fatalism
 Form, Metaphysical, in Ancient and Medieval Thought
 Foundationalism
 Free Will, Determinism, and Predestination
 Friendship
 Fundamentalism
 Garden
 Gay Studies
 Gender in Art
 Generation
 Genre
 Geography
 Geometry
 Gesture
 Gift, The
 Good
 Happiness and Pleasure in European Thought
 Harmony
 Health and Disease
 Heaven and Hell
 Heaven and Hell (Asian Focus)
 Hedonism in European Thought
 Hegemony
 Heresy and Apostasy
 Hierarchy and Order
 Historiography
 History, Idea of
 Humanism: Chinese Conception of
 Humanism: Europe and the Middle East
 Humanity: African Thought
 Humanity: Asian Thought
 Humanity: European Thought
 Humanity in the Arts
 Human Rights: Overview
 Humor
 Hygiene
 Ideas, History of
 Identity, Multiple: Jewish Multiple Identity
 Images, Icons, and Idols
 Imagination
 Immortality and the Afterlife
 Individualism
 International Order
 Interpretation

READER'S GUIDE

Jainism
 Judaism: Judaism to 1800
 Justice: Overview
 Knowledge
 Landscape in the Arts
 Language, Philosophy of: Ancient and Medieval
 Leadership
 Legalism, Ancient China
 Liberty
 Life
 Literary History
 Literature: Overview
 Literature: African Literature
 Logic
 Love, Western Notions of
 Loyalties, Dual
 Machiavellism
 Manichaeism
 Maps and the Ideas They Express
 Marriage and Fertility, European Views
 Mathematics
 Matriarchy
 Mechanical Philosophy
 Media, History of
 Medicine: China
 Medicine: Europe and the United States
 Medicine: India
 Medicine: Islamic Medicine
 Meditation: Eastern Meditation
 Memory
 Men and Masculinity
 Metaphor
 Metaphysics: Ancient and Medieval
 Migration: Migration in World History
 Millenarianism: Overview
 Miracles
 Mohism
 Monarchy: Overview
 Monasticism
 Monism
 Motherhood and Maternity
 Museums
 Music, Anthropology of
 Musical Performance and Audiences
 Mysticism: Chinese Mysticism
 Mysticism: Christian Mysticism
 Narrative
 Nation
 Natural Law
 Nature
 Neoplatonism
 Nomadism
 Nonviolence
 Nude, The
 Organicism
 Orthodoxy
 Other, The, European Views of
 Pacifism
 Paradigm
 Paradise on Earth
 Patriotism
 Peace
 Periodization
 Periodization of the Arts
 Perspective
 Philanthropy
 Philosophies: African
 Philosophies: Islamic
 Philosophy: Historical Overview and Recent Developments
 Philosophy: Relations to Other Intellectual Realms
 Philosophy, Moral: Ancient
 Philosophy, Moral: Medieval and Renaissance
 Philosophy and Religion in Western Thought
 Philosophy of Mind: Ancient and Medieval
 Physics
 Platonism
 Pluralism
 Political, The
 Political Science
 Poverty
 Prehistory, Rise of
 Presentism
 Prophecy
 Punishment
 Pythagoreanism
 Rationalism
 Reading
 Reason, Practical and Theoretical
 Reform: Europe and the United States
 Reformation
 Religion: Overview
 Religion: Africa
 Religion: East and Southeast Asia
 Religion and the State: Europe
 Renaissance
 Representation: Political Representation
 Republicanism: Republic
 Resistance
 Responsibility
 Revolution
 Rhetoric: Overview
 Rhetoric: Ancient and Medieval
 Ritual: Public Ritual
 Science: East Asia
 Scientific Revolution
 Shinto
 Skepticism
 Slavery
 Society
 Sovereignty
 Sport
 State of Nature
 Stoicism
 Suicide
 Superstition
 Syncretism
 Taste
 Text/Textuality
 Toleration
 Totalitarianism
 Tragedy and Comedy
 Translation
 Travel: Travel from Europe and the Middle East
 Treaty
 Trope
 Truth
 University: Overview
 Untouchability: Overview
 Untouchability: Menstrual Taboos

Virtual Reality
 Virtue Ethics
 Visual Order to Organizing Collections
 War and Peace in the Arts
 Wealth
 Wildlife
 Witchcraft
 Work
 Yoga
 Zen

Dynastic (400 C.E.–1400 C.E.)

ENTRIES FOCUSED ON THE PERIOD

Astronomy, Pre-Columbian and Latin American
 Buddhism
 Death and Afterlife, Islamic Understanding of
 Dialogue and Dialectics: Talmudic
 Feudalism, European
 Heresy and Apostasy
 Motif: Motif in Literature
 Orthopraxy: Western Orthopraxy
 Sacred Places
 Sacred Texts: Asia
 Sacred Texts: Koran
 Scholasticism
 Textiles and Fiber Arts as Catalysts for Ideas

ENTRIES WITH EXAMPLES FROM THE PERIOD
 400 C.E.–1400 C.E.

Aesthetics: Asia
 Africa, Idea of
 Alchemy: China
 Alchemy: Europe and the Middle East
 Algebras
 America
 Anti-Semitism: Overview
 Anti-Semitism: Islamic Anti-Semitism
 Architecture: Overview
 Architecture: Africa
 Architecture: Asia
 Aristotelianism
 Arts: Overview
 Asceticism: Western Asceticism
 Astrology: Overview
 Astrology: China
 Authority
 Autobiography
 Aztlán
 Barbarism and Civilization
 Beauty and Ugliness
 Biography
 Biology
 Body, The
 Borders, Borderlands, and Frontiers, Global
 Bureaucracy
 Bushido
 Calculation and Computation
 Calendar
 Casuistry
 Causality
 Causation in East Asian and Southeast Asian Philosophy
 Change
 Childhood and Child Rearing
 Chinese Thought
 Christianity: Overview
 Christianity: Asia

City, The: The City as a Cultural Center
 City, The: The Islamic and Byzantine City
 Civil Disobedience
 Civil Society: Europe and the United States
 Class
 Classicism
 Classification of Arts and Sciences, Early Modern
 Communication of Ideas: Africa and Its Influence
 Communication of Ideas: Asia and Its Influence
 Communication of Ideas: Europe and Its Influence
 Communication of Ideas: Middle East and Abroad
 Communication of Ideas: Orality and Advent of Writing
 Communication of Ideas: Southeast Asia
 Communication of Ideas: The Americas and Their
 Influence
 Composition, Musical
 Confucianism
 Consciousness: Indian Thought
 Consilience
 Constitutionalism
 Corruption
 Cosmology: Asia
 Cosmopolitanism
 Creationism
 Creativity in the Arts and Sciences
 Daoism
 Death
 Democracy
 Demonology
 Diasporas: Jewish Diaspora
 Dream
 Dualism
 Eclecticism
 Ecumenism
 Education: Asia, Traditional and Modern
 Education: China
 Education: Europe
 Education: India
 Education: Islamic Education
 Education: Japan
 Empire and Imperialism: Overview
 Empire and Imperialism: Asia
 Encyclopedism
 Equality: Overview
 Eschatology
 Ethnicity and Race: Islamic Views
 Etiquette
 Eurocentrism
 Europe, Idea of
 Evil
 Examination Systems, China
 Experiment
 Fallacy, Logical
 Feminism: Islamic Feminism
 Form, Metaphysical, in Ancient and Medieval Thought
 Free Will, Determinism, and Predestination
 Friendship
 Garden
 Gay Studies
 Gender: Gender in the Middle East
 Gender in Art
 Gesture
 Gift, The
 Globalization: Asia
 Good

READER'S GUIDE

- Happiness and Pleasure in European Thought
 Harmony
 Health and Disease
 Heaven and Hell
 Hegemony
 Hierarchy and Order
 Hinduism
 Historiography
 History, Idea of
 Honor, Middle Eastern Notions of
 Humanism: Africa
 Humanism: Chinese Conception of
 Humanism: Europe and the Middle East
 Humanity: Asian Thought
 Humanity: European Thought
 Humanity in the Arts
 Human Rights: Overview
 Hygiene
 Iconography
 Identity, Multiple: Jewish Multiple Identity
 Images, Icons, and Idols
 Imagination
 Immortality and the Afterlife
 Individualism
 Intentionality
 International Order
 Interpretation
 Islam: Africa
 Islam: Shii
 Islam: Sunni
 Islamic Science
 Jainism
 Japanese Philosophy, Japanese Thought
 Jihad
 Judaism: Judaism to 1800
 Knowledge
 Landscape in the Arts
 Language, Philosophy of: Ancient and Medieval
 Law, Islamic
 Liberty
 Literary History
 Literature: Overview
 Logic
 Love, Western Notions of
 Loyalties, Dual
 Manichaeism
 Maps and the Ideas They Express
 Marriage and Fertility, European Views
 Mathematics
 Medicine: China
 Medicine: Europe and the United States
 Medicine: Islamic Medicine
 Metaphor
 Metaphysics: Ancient and Medieval
 Microcosm and Macrocosm
 Migration: Africa
 Migration: Migration in World History
 Millenarianism: Overview
 Millenarianism: Islamic
 Millenarianism: Latin America and Native North America
 Miracles
 Monarchy: Islamic Monarchy
 Monarchy: Overview
 Monasticism
 Monism
 Motif: Motif in Music
 Musical Performance and Audiences
 Mysticism: Chinese Mysticism
 Mysticism: Christian Mysticism
 Mysticism: Islamic Mysticism
 Mysticism: Islamic Mysticism in Asia
 Mysticism: Kabbalah
 Nation
 Natural Law
 Natural Theology
 Neoplatonism
 Nomadism
 Nude, The
 Objectivity
 Organicism
 Orthodoxy
 Other, The, European Views of
 Paradigm
 Paradise on Earth
 Patriotism
 Peace
 Peasants and Peasantry
 Periodization
 Periodization of the Arts
 Perspective
 Philanthropy
 Philosophies: African
 Philosophies: Islamic
 Philosophy: Historical Overview and Recent Developments
 Philosophy, Moral: Medieval and Renaissance
 Philosophy and Religion in Western Thought
 Philosophy of Mind: Ancient and Medieval
 Physics
 Platonism
 Poverty
 Pre-Columbian Civilization
 Prophecy
 Protest, Political
 Race and Racism: Asia
 Reform: Islamic Reform
 Religion: Africa
 Religion: East and Southeast Asia
 Religion: Middle East
 Religion and the State: Europe
 Religion and the State: Middle East
 Religion and the State: United States Renaissance
 Representation: Political Representation
 Republicanism: Republic
 Responsibility
 Revolution
 Rhetoric: Overview
 Rhetoric: Ancient and Medieval
 Ritual: Public Ritual
 Scientific Revolution
 Sexuality: Islamic Views
 Shinto
 Skepticism
 Sophists, The
 Sovereignty
 Stoicism
 Sufism
 Suicide
 Superstition

Syncretism
 Taste
 Terror
 Time: Traditional and Utilitarian
 Toleration
 Totalitarianism
 Tragedy and Comedy
 Translation
 Travel: Travel from Europe and the Middle East
 Tribalism, Middle East
 University: Overview
 Untouchability: Menstrual Taboos
 Virtual Reality
 Virtue Ethics
 Visual Order to Organizing Collections
 War
 War and Peace in the Arts
 Wealth
 Women's History: Asia
 Work
 Yoga
 Zen

Early Modern (1400–1800 C.E.)

ENTRIES FOCUSED ON THE PERIOD

Astronomy, Pre-Columbian and Latin American
 Cartesianism
 Casuistry
 Empiricism
 Humanism: Renaissance
 Idealism
 Identity: Identity of Persons
 Kantianism
 Materialism in Eighteenth-Century European Thought
 Mechanical Philosophy
 Moral Sense
 Naturphilosophie
 Newtonianism
 Phrenology
 Protest, Political
 Reformation
 Renaissance
 Scientific Revolution
 Theodicy
 Time: Traditional and Utilitarian
 Westernization: Middle East

ENTRIES WITH EXAMPLES FROM THE PERIOD

1400–1800 C.E.
 Abolitionism
 Aesthetics: Africa
 Aesthetics: Asia
 Aesthetics: Europe and the Americas
 Africa, Idea of
 African-American Ideas
 Agnosticism
 Alchemy: Europe and the Middle East
 Algebras
 Ambiguity
 America
 Ancestor Worship
 Anticolonialism: Latin America
 Antifeminism
 Anti-Semitism: Overview
 Apartheid
 Architecture: Overview

Architecture: Asia
 Aristotelianism
 Arts: Overview
 Arts: Africa
 Asceticism: Western Asceticism
 Astrology: Overview
 Atheism
 Authoritarianism: Latin America
 Authority
 Autobiography
 Autonomy
 Aztlán
 Barbarism and Civilization
 Beauty and Ugliness
 Biography
 Biology
 Body, The
 Borders, Borderlands, and Frontiers, Global
 Buddhism
 Bureaucracy
 Bushido
 Calculation and Computation
 Calendar
 Cannibalism
 Capitalism: Overview
 Capitalism: Africa
 Causality
 Causation
 Causation in East Asian and Southeast Asian Philosophy
 Censorship
 Change
 Character
 Chemistry
 Childhood and Child Rearing
 Chinese Thought
 Christianity: Asia
 Christianity: Overview
 City, The: The City as a Cultural Center
 City, The: Latin America
 Civil Disobedience
 Civil Society: Europe and the United States
 Civil Society: Responses in Africa and the Middle East
 Class
 Classicism
 Classification of Arts and Sciences, Early Modern
 Colonialism: Africa
 Colonialism: Latin America
 Colonialism: Southeast Asia
 Common Sense
 Communication of Ideas: Africa and Its Influence
 Communication of Ideas: The Americas and Their Influence
 Communication of Ideas: Asia and Its Influence
 Communication of Ideas: Europe and Its Influence
 Communication of Ideas: Middle East and Abroad
 Communication of Ideas: Orality and Advent of Writing
 Communication of Ideas: Southeast Asia
 Communism: Europe
 Composition, Musical
 Computer Science
 Confucianism
 Consciousness: Overview
 Conservatism
 Constitutionalism

READER'S GUIDE

Consumerism
 Context
 Continental Philosophy
 Corruption
 Cosmology: Asia
 Cosmology: Cosmology and Astronomy
 Cosmopolitanism
 Creationism
 Creativity in the Arts and Sciences
 Creolization, Caribbean
 Crisis
 Critical Theory
 Cultural History
 Cycles
 Death and Afterlife, Islamic Understanding of
 Deism
 Democracy
 Dependency
 Determinism
 Development
 Diasporas: African Diaspora
 Diasporas: Jewish Diaspora
 Dictatorship in Latin America
 Dream
 Dress
 Dualism
 Dystopia
 Eclecticism
 Ecology
 Economics
 Education: Asia, Traditional and Modern
 Education: China
 Education: Europe
 Education: India
 Education: Islamic Education
 Education: Japan
 Education: North America
 Empire and Imperialism: Americas
 Empire and Imperialism: Asia
 Empire and Imperialism: Middle East
 Encyclopedism
 Enlightenment
 Epistemology: Early Modern
 Equality: Overview
 Equality: Gender Equality
 Equality: Racial Equality
 Eschatology
 Essentialism
 Etiquette
 Eurocentrism
 Europe, Idea of
 Everyday Life
 Evil
 Evolution
 Examination Systems, China
 Experiment
 Extirpation
 Fascism
 Fetishism: Overview
 Field Theories
 Foundationalism
 Free Will, Determinism, and Predestination
 Friendship
 Garden
 Gay Studies
 Gender in Art
 General Will
 Genius
 Genre
 Geography
 Geometry
 Gesture
 Ghetto
 Gift, The
 Globalization: Africa
 Globalization: Asia
 Globalization: General
 Gnosticism
 Good
 Harmony
 Health and Disease
 Hedonism in European Thought
 Hierarchy and Order
 Historiography
 History, Idea of
 Honor
 Honor, Middle Eastern Notions of
 Human Capital
 Humanism: Africa
 Humanism: Chinese Conception of
 Humanism: Europe and the Middle East
 Humanism: Secular Humanism in the United States
 Humanity: African Thought
 Humanity: Asian Thought
 Humanity: European Thought
 Humanity in the Arts
 Human Rights: Overview
 Humor
 Hygiene
 Iconography
 Identity, Multiple: Overview
 Identity, Multiple: Jewish Multiple Identity
 Imagination
 Immortality and the Afterlife
 Indigenismo
 Individualism
 International Order
 Interpretation
 Islam: Africa
 Islam: Shii
 Islam: Southeast Asia
 Islam: Sunni
 Islamic Science
 Japanese Philosophy, Japanese Thought
 Judaism: Judaism to 1800
 Judaism: Modern Judaism
 Justice: Overview
 Justice: Justice in American Thought
 Knowledge
 Landscape in the Arts
 Language, Linguistics, and Literacy
 Leadership
 Liberalism
 Liberty
 Life
 Life Cycle: Overview
 Literary History
 Literature: Overview
 Logic
 Love, Western Notions of

- Loyalties, Dual
 Machiavellism
 Magic
 Maps and the Ideas They Express
 Marriage and Fertility, European Views
 Mathematics
 Medicine: Europe and the United States
 Medicine: Islamic Medicine
 Men and Masculinity
 Mestizaje
 Metaphor
 Metaphysics: Renaissance to the Present
 Microcosm and Macrocosm
 Migration: Africa
 Migration: Migration in World History
 Migration: United States
 Millenarianism: Overview
 Millenarianism: Islamic
 Millenarianism: Latin America and Native North America
 Mind
 Modernity: Africa
 Monarchy: Overview
 Monarchy: Islamic Monarchy
 Monasticism
 Monism
 Motif: Motif in Literature
 Motif: Motif in Music
 Museums
 Mysticism: Christian Mysticism
 Mysticism: Kabbalah
 Nation
 National History
 Native Policy
 Natural History
 Natural Law
 Natural Theology
 Nature
 Neoplatonism
 Nomadism
 Nude, The
 Objectivity
 Obligation
 Oral Traditions: Overview
 Organicism
 Orientalism: Overview
 Orthodoxy
 Orthopraxy: Western Orthopraxy
 Other, The, European Views of
 Paradigm
 Paradise on Earth
 Patriotism
 Peace
 Periodization
 Periodization of the Arts
 Perspective
 Philanthropy
 Philosophies: American
 Philosophies: Feminist, Twentieth-Century
 Philosophy: Historical Overview and Recent Developments
 Philosophy: Relations to Other Intellectual Realms
 Philosophy, History of
 Philosophy, Moral: Africa
 Philosophy, Moral: Medieval and Renaissance
 Philosophy, Moral: Modern
 Philosophy and Religion in Western Thought
 Philosophy of Mind: Overview
 Philosophy of Religion
 Physics
 Pietism
 Platonism
 Pluralism
 Poetry and Poetics
 Political Protest, U.S.
 Political Science
 Polytheism
 Poverty
 Power
 Pre-Columbian Civilization
 Prehistory, Rise of
 Presentism
 Probability
 Progress, Idea of
 Propaganda
 Property
 Prophecy
 Punishment
 Puritanism
 Pythagoreanism
 Race and Racism: Asia
 Race and Racism: Europe
 Radicals/Radicalism
 Rationalism
 Reason, Practical and Theoretical
 Reform: Europe and the United States
 Reform: Islamic Reform
 Relativity
 Religion: Africa
 Religion: African Diaspora
 Religion: East and Southeast Asia
 Religion: Indigenous Peoples' View, South America
 Religion: Latin America
 Religion and Science
 Religion and the State: Europe
 Religion and the State: Latin America
 Religion and the State: Middle East
 Religion and the State: United States
 Representation: Political Representation
 Republicanism: Latin America
 Republicanism: Republic
 Resistance
 Resistance and Accommodation
 Responsibility
 Revolution
 Rhetoric: Overview
 Ritual: Public Ritual
 Ritual: Religion
 Romanticism in Literature and Politics
 Scarcity and Abundance, Latin America
 Scholasticism
 Science: Overview
 Science, History of
 Secularization and Secularism
 Sexuality: Overview
 Sexuality: Islamic Views
 Shinto
 Skepticism
 Slavery
 Social Contract

READER'S GUIDE

Society
Sovereignty
Sport
State of Nature
Stoicism
Sufism
Suicide
Superstition
Syncretism
Taste
Temperance
Terror
Text/Textuality
Toleration
Totalitarianism
Tradition
Tragedy and Comedy
Translation
Travel: Travel from Europe and the Middle East
Treaty
Tribalism, Middle East
Trope
Truth
Universalism
University: Overview
Untouchability: Taboos
Utopia
Virtue Ethics
Visual Order to Organizing Collections
Volkgeist
Volunteerism, U.S.
War and Peace in the Arts
Wealth
Westernization: Middle East
Westernization: Southeast Asia
Witchcraft
Women's History: Africa
Work
World Systems Theory, Latin America

Modern (1800–1945)

ENTRIES FOCUSED ON THE PERIOD

Alienation
Altruism
Americanization, U.S.
Analytical Philosophy
Avant-Garde: Overview
Avant-Garde: Militancy
Black Atlantic
Bureaucracy
Chicano Movement
City, The: Latin America
Civil Disobedience
Consumerism
Continental Philosophy
Democracy
Empire and Imperialism: Europe
Eugenics
Evolution
Existentialism
Expressionism
Fascism
Field Theories
Fundamentalism
Futurology

Globalization: Africa
Globalization: Asia
Globalization: General
Hegelianism
Hegemony
Historicism
Humanism: Secular Humanism in the United States
Impressionism
Internal Colonialism
Kantianism
Life
Linguistic Turn
Literary History
Logic and Philosophy of Mathematics, Modern
Maoism
Marxism: Overview
Marxism: Asia
Marxism: Latin America
Media, History of
Modernism: Overview
Modernism: Latin America
Modernity: Overview
Modernity: Africa
Modernity: East Asia
Modernization
Modernization Theory
National History
Nationalism: Overview
Nationalism: Africa
Nationalism: Cultural Nationalism
Nationalism: Middle East
Naturalism
Naturalism in Art and Literature
Naturphilosophie
Neocolonialism
Neoliberalism
Orientalism: African and Black Orientalism
Pan-Africanism
Pan-Arabism
Pan-Asianism
Pan-Islamism
Pan-Turkism
Parties, Political
Phenomenology
Philosophies: Feminist, Twentieth-Century
Phrenology
Populism: Latin America
Populism: United States
Positivism
Pragmatism
Protest, Political
Psychoanalysis
Psychology and Psychiatry
Quantum
Realism
Realism: Africa
Relativism
Relativity
Science Fiction
Secularization and Secularism
Segregation
Sexuality: Sexual Orientation
Sociability in African Thought
Social Darwinism
Socialism

- Socialisms, African
- Structuralism and Poststructuralism: Overview
- Structuralism and Poststructuralism: Anthropology
- Subjectivism
- Surrealism
- Technology
- Third World
- Time: Traditional and Utilitarian
- Totalitarianism
- Utilitarianism
- Victorianism
- Westernization: Africa
- Westernization: Middle East
- Westernization: Southeast Asia
- Work
- Zionism
- ENTRIES WITH EXAMPLES FROM THE PERIOD
1800–1945
- Abolitionism
- Absolute Music
- Aesthetics: Africa
- Aesthetics: Asia
- Aesthetics: Europe and the Americas
- Africa, Idea of
- African-American Ideas
- Agnosticism
- Alchemy: China
- Alchemy: Europe and the Middle East
- Algebras
- Ambiguity
- America
- Anarchism
- Ancestor Worship
- Animism
- Anthropology
- Anticolonialism: Africa
- Anticolonialism: Latin America
- Anticolonialism: Middle East
- Anticolonialism: Southeast Asia
- Antifeminism
- Anti-Semitism: Overview
- Anti-Semitism: Islamic Anti-Semitism
- Apartheid
- Architecture: Overview
- Aristotelianism
- Arts: Overview
- Arts: Africa
- Asceticism: Western Asceticism
- Asian-American Ideas (Cultural Migration)
- Assimilation
- Atheism
- Authenticity: Africa
- Authoritarianism: Overview
- Authoritarianism: East Asia
- Authoritarianism: Latin America
- Authority
- Autobiography
- Barbarism and Civilization
- Beauty and Ugliness
- Behaviorism
- Bilingualism and Multilingualism
- Bioethics
- Biography
- Biology
- Body, The
- Borders, Borderlands, and Frontiers, Global
- Buddhism
- Bushido
- Calculation and Computation
- Capitalism: Overview
- Capitalism: Africa
- Cartesianism
- Casuistry
- Causality
- Censorship
- Change
- Character
- Chemistry
- Childhood and Child Rearing
- Chinese Warlordism
- Christianity: Overview
- Christianity: Asia
- Cinema
- Citizenship: Overview
- Citizenship: Naturalization
- City, The: The City as a Cultural Center
- City, The: The Islamic and Byzantine City
- Civil Society: Europe and the United States
- Civil Society: Responses in Africa and the Middle East
- Class
- Classicism
- Colonialism: Africa
- Colonialism: Latin America
- Colonialism: Southeast Asia
- Common Sense
- Communication of Ideas: Africa and Its Influence
- Communication of Ideas: The Americas and Their Influence
- Communication of Ideas: Asia and Its Influence
- Communication of Ideas: Europe and Its Influence
- Communication of Ideas: Middle East and Abroad
- Communication of Ideas: Orality and Advent of Writing
- Communication of Ideas: Southeast Asia
- Communism: Europe
- Communism: Latin America
- Composition, Musical
- Computer Science
- Confucianism
- Consciousness: Overview
- Conservatism
- Constitutionalism
- Context
- Corruption
- Corruption in Developed and Developing Countries
- Cosmology: Asia
- Cosmology: Cosmology and Astronomy
- Cosmopolitanism
- Creationism
- Creativity in the Arts and Sciences
- Creolization, Caribbean
- Crisis
- Critical Theory
- Cultural Capital
- Cultural History
- Cultural Revivals
- Cycles
- Dada
- Dance
- Death
- Death and Afterlife, Islamic Understanding of

READER'S GUIDE

Deism
 Democracy: Africa
 Dependency
 Determinism
 Development
 Diasporas: African Diaspora
 Diasporas: Jewish Diaspora
 Dictatorship in Latin America
 Diffusion, Cultural
 Discrimination
 Diversity
 Dream
 Dress
 Dystopia
 Ecology
 Economics
 Education: Asia, Traditional and Modern
 Education: China
 Education: Europe
 Education: Global Education
 Education: India
 Education: Islamic Education
 Education: Japan
 Education: North America
 Emotions
 Empire and Imperialism: Asia
 Empire and Imperialism: Middle East
 Empire and Imperialism: United States
 Empiricism
 Environmental Ethics
 Environmental History
 Epistemology: Modern
 Equality: Overview
 Equality: Gender Equality
 Equality: Racial Equality
 Eschatology
 Essentialism
 Ethnicity and Race: Africa
 Ethnicity and Race: Anthropology
 Ethnicity and Race: Islamic Views
 Ethnography
 Etiquette
 Eurocentrism
 Europe, Idea of
 Everyday Life
 Evil
 Examination Systems, China
 Experiment
 Falsifiability
 Family: Modernist Anthropological Theory
 Family Planning
 Feminism: Overview
 Feminism: Africa and African Diaspora
 Feminism: Chicana Feminisms
 Feminism: Third World U.S. Movement
 Fetishism: Overview
 Fetishism: Fetishism in Literature and Cultural Studies
 Formalism
 Foundationalism
 Friendship
 Game Theory
 Gay Studies
 Gender: Gender in the Middle East
 Gender in Art
 Gender Studies: Anthropology
 General Will
 Generation
 Genetics: Contemporary
 Genetics: History of
 Genius
 Genocide
 Genre
 Geography
 Geometry
 Gesture
 Ghetto
 Gift, The
 Gnosticism
 Good
 Happiness and Pleasure in European Thought
 Harmony
 Health and Disease
 Hermeneutics
 Historical and Dialectical Materialism
 Historiography
 History, Economic
 History, Idea of
 Honor, Middle Eastern Notions of
 Human Capital
 Humanism: Africa
 Humanism: Chinese Conception of
 Humanism: Europe and the Middle East
 Humanity: African Thought
 Humanity: Asian Thought
 Humanity: European Thought
 Humanity in the Arts
 Human Rights: Overview
 Humor
 Hygiene
 Iconography
 Idealism
 Ideas, History of
 Identity: Identity of Persons
 Identity, Multiple: Overview
 Identity, Multiple: Asian-Americans
 Identity, Multiple: Jewish Multiple Identity
 Imagination
 Immortality and the Afterlife
 Indigenismo
 Individualism
 Intelligentsia
 Intentionality
 Intercession in Middle Eastern Society
 International Order
 Interpretation
 Islam: Africa
 Islam: Shii
 Islam: Southeast Asia
 Islamic Science
 Japanese Philosophy, Japanese Thought
 Jihad
 Jouissance
 Judaism: Modern Judaism
 Justice: Overview
 Justice: Justice in American Thought
 Justice: Justice in East Asian Thought
 Kinship
 Knowledge
 Landscape in the Arts
 Language and Linguistics

- Language, Linguistics, and Literacy
 Language, Philosophy of: Modern
 Law
 Law, Islamic
 Leadership
 Learning and Memory, Contemporary Views
 Liberalism
 Liberty
 Life Cycle: Adolescence
 Life Cycle: Elders/Old Age
 Literary Criticism
 Literature: Overview
 Literature: African Literature
 Love, Western Notions of
 Loyalties, Dual
 Lysenkoism
 Magic
 Maps and the Ideas They Express
 Marriage and Fertility, European Views
 Masks
 Mathematics
 Matriarchy
 Medicine: Europe and the United States
 Medicine: India
 Medicine: Islamic Medicine
 Memory
 Men and Masculinity
 Mestizaje
 Metaphor
 Metaphysics: Renaissance to the Present
 Microcosm and Macrocosm
 Migration: Africa
 Migration: Migration in World History
 Migration: United States
 Millenarianism: Overview
 Millenarianism: Latin America and Native North America
 Mind
 Minority
 Monarchy: Overview
 Monarchy: Islamic Monarchy
 Monasticism
 Monism
 Motherhood and Maternity
 Motif: Motif in Literature
 Motif: Motif in Music
 Multiculturalism, Africa
 Museums
 Music, Anthropology of
 Musical Performance and Audiences
 Musicology
 Mysticism: Kabbalah
 Mysticism: Mysticism in African Thought
 Myth
 Narrative
 Nation
 Native Policy
 Natural History
 Natural Theology
 Nature
 Negritude
 New Criticism
 Nihilism
 Nonviolence
 Nude, The
 Objectivity
 Obligation
 Occidentalism
 Oral Traditions: Overview
 Organicism
 Orientalism: Overview
 Orthodoxy
 Orthopraxy: Western Orthopraxy
 Other, The, European Views of
 Pacifism
 Paradigm
 Patriotism
 Peace
 Peasants and Peasantry
 Periodization
 Periodization of the Arts
 Person, Idea of the
 Philanthropy
 Philosophies: African
 Philosophies: American
 Philosophy: Historical Overview and Recent Developments
 Philosophy: Relations to Other Intellectual Realms
 Philosophy, History of
 Philosophy, Moral: Africa
 Philosophy, Moral: Modern
 Philosophy and Religion in Western Thought
 Philosophy of Mind: Overview
 Philosophy of Religion
 Physics
 Platonism
 Pluralism
 Poetry and Poetics
 Political Protest, U.S.
 Political Science
 Political, The
 Polytheism
 Population
 Postcolonial Studies
 Poverty
 Power
 Practices
 Prehistory, Rise of
 Prejudice
 Presentism
 Privacy
 Probability
 Progress, Idea of
 Propaganda
 Property
 Pseudoscience
 Punishment
 Puritanism
 Queer Theory
 Race and Racism: Overview
 Race and Racism: Asia
 Race and Racism: Europe
 Race and Racism: United States
 Radicals/Radicalism
 Rational Choice
 Rationalism
 Reading
 Reason, Practical and Theoretical
 Reflexivity
 Reform: Europe and the United States

READER'S GUIDE

Reform: Islamic Reform
Regions and Regionalism, Eastern Europe
Religion: Overview
Religion: Africa
Religion: African Diaspora
Religion: East and Southeast Asia
Religion: Indigenous Peoples' View, South America
Religion: Latin America
Religion: Middle East Religion and the State: Africa
Religion and Science
Religion and the State: Europe
Religion and the State: Latin America
Religion and the State: Middle East
Religion and the State: United States
Renaissance
Republicanism: Latin America
Republicanism: Republic
Resistance
Resistance and Accommodation
Responsibility
Revolution
Rhetoric: Overview
Ritual: Public Ritual
Ritual: Religion
Romanticism in Literature and Politics
Sacred and Profane
Sacred Places
Sage Philosophy
Scarcity and Abundance, Latin America
Science: Overview
Science, History of
Sexuality: Overview
Sexuality: Islamic Views
Shinto
Skepticism
Slavery
Social Capital
Social History, U.S.
Society
Sophists, The
Sovereignty
Sport
State of Nature
State, The: Overview
Sufism
Suicide
Superstition
Symbolism
Syncretism
Temperance
Terror
Text/Textuality
Toleration
Totems
Trade
Tradition
Translation
Travel: Travel from Europe and the Middle East
Treaty
Trope
Truth
Universalism
University: Overview
Untouchability: Overview
Untouchability: Menstrual Taboos

Untouchability: Taboos
Utopia
Virtual Reality
Visual Culture
Visual Order to Organizing Collections
Volksggeist
Volunteerism, U.S.
War
War and Peace in the Arts
Wealth
Wildlife
Wisdom, Human
Witchcraft
Witchcraft, African Studies of
Women's History: Africa
Women's History: Asia
World Systems Theory, Latin America

Contemporary

ENTRIES FOCUSED ON THE PERIOD

African-American Ideas
Americanization, U.S.
Anticolonialism: Africa
Anticolonialism: Latin America
Anticolonialism: Middle East
Anticolonialism: Southeast Asia
Anti-Semitism: Islamic Anti-Semitism
Apartheid
Bioethics
Black Atlantic
Black Consciousness
Buddhism
Bureaucracy
Capitalism: Africa
Chicano Movement
Citizenship: Naturalization
Civil Disobedience
Communitarianism in African Thought
Consumerism
Continental Philosophy
Creationism
Critical Race Theory
Critical Theory
Cultural Studies
Democracy
Dress
Dystopia
Empire and Imperialism: Europe
Empiricism
Eugenics
Field Theories
Fundamentalism
Futurology
Gay Studies
Gender: Overview
Genetics: Contemporary
Globalization: Africa
Globalization: Asia
Globalization: General
Historicism
Humanity: African Thought
Human Rights: Overview
Human Rights: Women's Rights
Internal Colonialism
International Order

Jihad
 Liberation Theology
 Liberty
 Life
 Linguistic Turn
 Literary History
 Logic and Philosophy of Mathematics, Modern
 Maoism
 Marxism: Overview
 Marxism: Asia
 Marxism: Latin America
 Media, History of
 Modernization
 Modernization Theory
 Nationalism: Overview
 Nationalism: Africa
 Nationalism: Cultural Nationalism
 Nationalism: Middle East
 Neocolonialism
 Neoliberalism
 Nuclear Age
 Orientalism: African and Black Orientalism
 Pan-Africanism
 Pan-Arabism
 Pan-Asianism
 Pan-Islamism
 Pan-Turkism
 Paradigm
 Parties, Political
 Personhood in African Thought
 Phenomenology
 Philosophies: Feminist, Twentieth-Century
 Poetry and Poetics
 Populism: Latin America
 Populism: United States
 Positivism
 Postcolonial Studies
 Postcolonial Theory and Literature
 Postmodernism
 Pragmatism
 Presentism
 Privatization
 Protest, Political
 Psychoanalysis
 Psychology and Psychiatry
 Quantum
 Queer Theory
 Realism: Africa
 Relativism
 Relativity
 Science Fiction
 Segregation
 Sexual Harassment
 Sexuality: Sexual Orientation
 Sociability in African Thought
 Social Darwinism
 Socialisms, African
 Structuralism and Poststructuralism: Overview
 Structuralism and Poststructuralism: Anthropology
 Subjectivism
 Technology
 Terrorism, Middle East
 Text/Textuality
 Theater and Performance
 Third Cinema

Third World
 Totalitarianism
 Virtual Reality
 Virtue Ethics
 War
 Westernization: Africa
 Westernization: Southeast Asia
 Witchcraft
 Womanism
 Women and Femininity in U.S. Popular Culture
 Women's Studies
 Zionism

ENTRIES WITH EXAMPLES FROM THE PERIOD
 SINCE 1945 (especially since the 1970s)

Absolute Music
 Aesthetics: Africa
 Aesthetics: Asia
 Aesthetics: Europe and the Americas
 Africa, Idea of
 Afrocentricity
 Afropessimism
 Agnosticism
 Algebras
 Alienation
 Altruism
 Ambiguity
 America
 Analytical Philosophy
 Anarchism
 Animism
 Anthropology
 Antifeminism
 Anti-Semitism: Overview
 Architecture: Overview
 Architecture: Africa
 Arts: Overview
 Arts: Africa
 Asceticism: Western Asceticism
 Asian-American Ideas (Cultural Migration)
 Assimilation
 Atheism
 Authenticity: Africa
 Authoritarianism: Overview
 Authoritarianism: East Asia
 Authoritarianism: Latin America
 Authority
 Autobiography
 Autonomy
 Avant-Garde: Overview
 Aztlán
 Barbarism and Civilization
 Beauty and Ugliness
 Behaviorism
 Bilingualism and Multilingualism
 Biography
 Biology
 Body, The
 Bushido
 Calculation and Computation
 Cannibalism
 Capitalism: Overview
 Cartesianism
 Casuistry
 Causality
 Causation

READER'S GUIDE

Censorship
Change
Character
Childhood and Child Rearing
Christianity: Overview
Christianity: Asia
Cinema
Citizenship: Overview
Citizenship: Cultural Citizenship
City, The: The City as a Cultural Center
City, The: The City as Political Center
City, The: The Islamic and Byzantine City
Civil Society: Europe and the United States
Civil Society: Responses in Africa and the Middle East
Classicism
Colonialism: Africa
Colonialism: Southeast Asia
Communication of Ideas: Africa and Its Influence
Communication of Ideas: Asia and Its Influence
Communication of Ideas: Southeast Asia
Communism: Europe
Communism: Latin America
Composition, Musical
Computer Science
Confucianism
Consciousness: Overview
Conservatism
Consilience
Context
Corruption
Corruption in Developed and Developing Countries
Cosmopolitanism
Creolization, Caribbean
Crisis
Cultural Capital
Cultural History
Cultural Revivals
Cycles
Dada
Dance
Death
Death and Afterlife, Islamic Understanding of
Deism
Democracy: Africa
Demography
Demonology
Dependency
Determinism
Development
Diasporas: African Diaspora
Diasporas: Jewish Diaspora
Dictatorship in Latin America
Diffusion, Cultural
Discrimination
Diversity
Dream
Dualism
Ecology
Economics
Ecumenism
Education: Europe
Education: Global Education
Education: Islamic Education
Education: North America
Emotions
Empire and Imperialism: Middle East
Empire and Imperialism: United States
Enlightenment
Environment
Environmental Ethics
Environmental History
Epistemology: Modern
Equality: Overview
Equality: Gender Equality
Equality: Racial Equality
Essentialism
Ethnicity and Race: Africa
Ethnicity and Race: Anthropology
Ethnicity and Race: Islamic Views
Ethnocentrism
Ethnography
Ethnohistory, U.S.
Etiquette
Eurocentrism
Europe, Idea of
Evil
Existentialism
Experiment
Falsifiability
Family: Modernist Anthropological Theory
Family: Family in Anthropology since 1980
Family Planning
Fascism
Fatalism
Feminism: Overview
Feminism: Africa and African Diaspora
Feminism: Chicana Feminisms
Feminism: Islamic Feminism
Feminism: Third World U.S. Movement
Fetishism: Overview
Fetishism: Fetishism in Literature and Cultural Studies
Formalism
Foundationalism
Free Will, Determinism, and Predestination
Friendship
Game Theory
Gender: Gender in the Middle East
Gender in Art
Gender Studies: Anthropology
Generation
Genetics: History of
Genius
Genocide
Geography
Ghetto
Gift, The
Gnosticism
Good
Happiness and Pleasure in European Thought
Harmony
Hate
Health and Disease
Hegelianism
Hermeneutics
Hierarchy and Order
Hinduism
Historical and Dialectical Materialism
Historiography
History, Economic
History, Idea of

- Honor, Middle Eastern Notions of
 Human Capital
 Humanism: Africa
 Humanism: Europe and the Middle East
 Humanism: Secular Humanism in the United States
 Humanity: European Thought
 Humanity in the Arts
 Humor
 Ideas, History of
 Identity: Identity of Persons
 Identity: Personal and Social Identity
 Identity, Multiple: Overview
 Identity, Multiple: Asian-Americans
 Identity, Multiple: Jewish Multiple Identity
 Imagination
 Immortality and the Afterlife
 Impressionism
 Intelligentsia
 Intentionality
 Intercession in Middle Eastern Society
 Interdisciplinarity
 Islam: Shii
 Islam: Southeast Asia
 Jainism
 Japanese Philosophy, Japanese Thought
 Jouissance
 Judaism: Modern Judaism
 Justice: Overview
 Justice: Justice in American Thought
 Kantianism
 Kinship
 Knowledge
 Landscape in the Arts
 Language and Linguistics
 Language, Philosophy of: Modern
 Law
 Law, Islamic
 Leadership
 Learning and Memory, Contemporary Views
 Liberalism
 Life Cycle: Adolescence
 Life Cycle: Elders/Old Age
 Literary Criticism
 Literature: African Literature
 Lysenkoism
 Machiavellism
 Machismo
 Magic
 Maps and the Ideas They Express
 Marriage and Fertility, European Views
 Masks
 Mathematics
 Matriarchy
 Medicine: China
 Medicine: Europe and the United States
 Medicine: Islamic Medicine
 Meditation: Eastern Meditation
 Meme
 Memory
 Men and Masculinity
 Mestizaje
 Metaphor
 Metaphysics: Renaissance to the Present
 Migration: Africa
 Migration: Migration in World History
 Migration: United States
 Millenarianism: Overview
 Millenarianism: Islamic
 Millenarianism: Latin America and Native North America
 Mind
 Minority
 Modernism: Latin America
 Modernity: Overview
 Modernity: Africa
 Modernity: East Asia
 Monarchy: Overview
 Monasticism
 Monism
 Moral Sense
 Motherhood and Maternity
 Motif: Motif in Literature
 Motif: Motif in Music
 Multiculturalism, Africa
 Museums
 Music, Anthropology of
 Musical Performance and Audiences
 Musicology
 Mysticism: Mysticism in African Thought
 Narrative
 Nation
 Native Policy
 Natural Law
 Natural Theology
 Nature
 Negritude
 New Criticism
 Nihilism
 Nomadism
 Nonviolence
 Objectivity
 Obligation
 Occidentalism
 Oral Traditions: Overview
 Organicism
 Orientalism: Overview
 Orthodoxy
 Pacifism
 Patriotism
 Peace
 Peasants and Peasantry
 Periodization of the Arts
 Person, Idea of the
 Perspective
 Philanthropy
 Philosophies: American
 Philosophy, History of
 Philosophy, Moral: Africa
 Philosophy, Moral: Modern
 Philosophy and Religion in Western Thought
 Philosophy of Mind: Overview
 Philosophy of Religion
 Pluralism
 Political Protest, U.S.
 Political Science
 Population
 Poverty
 Power
 Practices
 Prejudice

READER'S GUIDE

Privacy
Probability
Progress, Idea of
Propaganda
Property
Pseudoscience
Public Sphere
Punishment
Race and Racism: Overview
Race and Racism: Asia
Race and Racism: Europe
Race and Racism: United States
Radicals/Radicalism
Rational Choice
Reading
Reason, Practical and Theoretical
Reflexivity
Reform: Europe and the United States
Reform: Islamic Reform
Regions and Regionalism, Eastern Europe
Religion: Africa
Religion: African Diaspora
Religion: Indigenous Peoples' View, South America
Religion: Latin America
Religion: Middle East
Religion and Science
Religion and the State: Africa
Religion and the State: Latin America
Religion and the State: Middle East
Religion and the State: United States
Renaissance
Representation: Mental Representation
Representation: Political Representation
Resistance
Resistance and Accommodation
Responsibility
Ritual: Public Ritual
Ritual: Religion
Sacred Places
Sacred Texts: Koran
Sage Philosophy
Science: Overview
Science: East Asia
Science, History of
Scientific Revolution
Secularization and Secularism
Sexuality: Overview
Sexuality: Islamic Views
Shinto
Skepticism
Slavery
Social Capital
Social Contract
Social History, U.S.
Society
Sophists, The
Sovereignty
Sport
State, The: Overview
State, The: The Postcolonial State
State of Nature
Superstition
Surrealism
Symbolism
Syncretism

Taste
Terror
Third World Literature
Toleration
Totems
Trade
Tradition
Translation
Treaty
Tribalism, Middle East
Trope
Truth
Universalism
University: Overview
University: Postcolonial
Untouchability: Overview
Untouchability: Menstrual Taboos
Untouchability: Taboos
Utilitarianism
Utopia
Visual Culture
Visual Order to Organizing Collections
War and Peace in the Arts
Wealth
Wildlife
Wisdom, Human
Witchcraft, African Studies of
Women's History: Africa
Women's History: Asia
Work
World Systems Theory, Latin America

LIBERAL ARTS DISCIPLINES AND PROFESSIONS

This section is in accord with the university divisions of the Liberal Arts into Fine Arts, Humanities, Social Sciences, and Sciences and the graduate programs of the professions of Law, Medicine, and Engineering. The sample of Interdisciplinary Programs are listed under their most common university grouping. For example, Fine Arts includes Performance Arts; Social Sciences includes Women's Studies and Gender Studies, as well as Ethnic Studies; Sciences includes Ecology and Geology, as well as Computer Sciences; Humanities includes programs of Communication, Language, and Linguistics. Meanwhile, the growth of interdisciplinary programs reflects the increasing overlap between studies listed under the labels of Fine Arts, Humanities, Social Sciences, and Sciences. A discipline or interdisciplinary program only appears once, but an entry may appear under the several disciplines and interdisciplinary programs that influenced the scholarship of the article. Titles that appear in bold indicate entries that are especially suited as an introduction to the discipline.

Under the category Multidisciplinary Practices, there are entries on the many methods, techniques, theories, and approaches that have spread across the disciplines. The Multidisciplinary Practices help explain the contemporary trend of interdisciplinarity for which the history of ideas has long been known. At the end of this Reader's Guide is a listing of a number of entries that overlap three of the four divisions and a listing of entries that overlap all four divisions.

Fine Arts

VISUAL STUDIES

Absolute Music
Aesthetics: Africa
Aesthetics: Asia
Aesthetics: Europe and the Americas
 Ambiguity
 Anthropology
 Architecture: Overview
 Architecture: Africa
 Architecture: Asia
 Arts: Overview
 Arts: Africa
 Asceticism: Hindu and Buddhist Asceticism
 Asceticism: Western Asceticism
 Avant-Garde: Overview
 Avant-Garde: Militancy
 Aztlán
 Beauty and Ugliness
 Body, The
 Buddhism
 Change
 Chinese Thought
 Cinema
 City, The: Latin America
 City, The: The City as a Cultural Center
 City, The: The Islamic and Byzantine City
 Classicism
 Classification of Arts and Sciences, Early Modern
 Communication of Ideas: Asia and Its Influence
 Composition, Musical
 Consumerism
 Context
 Cosmopolitanism
 Creativity in the Arts and Sciences
 Cultural History
 Dada
 Death
 Dream
 Dress
 Dystopia
 Environmental Ethics
 Environmental History
 Everyday Life
 Expressionism
 Extirpation
 Fascism
 Fetishism: Overview
 Garden
 Gay Studies
 Gender in Art
 Genre
 Geography
 Geometry
 Gesture
 Ghetto
 Globalization: Asia
 Heaven and Hell (Asian Focus)
 Hinduism
 History, Idea of
 Humanity: European Thought
 Humanity in the Arts
 Humor
 Iconography
 Ideas, History of

Images, Icons, and Idols
 Imagination
 Impressionism
 Islamic Science
 Kantianism
 Knowledge
 Landscape in the Arts
 Life Cycle: Overview
 Literary History
 Literature: Overview
 Maps and the Ideas They Express
 Masks
 Matriarchy
Media, History of
 Medicine: Europe and the United States
 Mestizaje
 Modernism: Overview
 Modernism: Latin America
 Modernity: Africa
 Modernity: East Asia
 Monarchy: Overview
 Motherhood and Maternity
 Museums
 Musical Performance and Audiences
 Musicology
 Mysticism: Chinese Mysticism
 Mysticism: Christian Mysticism
 Naturalism in Art and Literature
 Negritude
 Nude, The
 Occidentalism
 Organicism
 Pan-Africanism
 Paradise on Earth
Periodization of the Arts
 Perspective
 Philosophy: Historical Overview and Recent Developments
 Political Protest, U.S.
 Postmodernism
 Pre-Columbian Civilization
 Protest, Political
 Psychoanalysis
 Pythagoreanism
 Realism
 Realism: Africa
 Religion: Africa
 Renaissance
 Representation: Mental Representation
 Ritual: Public Ritual
 Sacred Places
 Sacred Texts: Asia
 Science: East Asia
 Science, History of
 Science Fiction
 Social History, U.S.
 Sport
 Surrealism
 Symbolism
 Syncretism
 Taste
 Text/Textuality
 Textiles and Fiber Arts as Catalysts for Ideas
 Third Cinema
 Victorianism

READER'S GUIDE

Virtual Reality
 Visual Culture
 Visual Order to Organizing Collections
 War and Peace in the Arts
 Westernization: Southeast Asia
 Women and Femininity in U.S. Popular Culture
 Yin and Yang

MUSIC

Absolute Music
 Aesthetics: Africa
 Aesthetics: Asia
 Authenticity: Africa
 Avant-Garde: Overview
 Cinema
 Classicism
 Classification of Arts and Sciences, Early Modern
 Communication of Ideas: Africa and Its Influence
 Composition, Musical
 Context
 Cosmopolitanism
 Dada
 Dance
 Empire and Imperialism: United States
 Formalism
 Generation
 Genre
 Harmony
 Hinduism
 Humanism: Africa
 Humanism: Chinese Conception of
 Humor
 Iconography
 Identity, Multiple: Jewish Multiple Identity
 Judaism: Judaism to 1800
 Knowledge
 Learning and Memory, Contemporary Views
 Love, Western Notions of
 Modernism: Overview
 Motif: Motif in Music
Music, Anthropology of
Musical Performance and Audiences
Musicology
 Mysticism: Chinese Mysticism
 Orientalism: Overview
 Pan-Asianism
 Pietism
 Political Protest, U.S.
 Postmodernism
 Protest, Political
 Pythagoreanism
 Realism: Africa
 Religion: Africa
 Religion: African Diaspora
 Resistance
 Resistance and Accommodation
 Society
 Sophists, The
 Symbolism
 Taste
 Text/Textuality
 Third Cinema
 Virtual Reality
 Visual Order to Organizing Collections
 Westernization: Africa

PERFORMANCE ARTS (includes drama, dance, oratory, ritual, and ceremony)

Absolute Music
 Aesthetics: Africa
 Aesthetics: Asia
 Alienation
 Americanization, U.S.
 Ancestor Worship
 Anthropology
 Arts: Overview
 Asceticism: Hindu and Buddhist Asceticism
 Asceticism: Western Asceticism
 Astronomy, Pre-Columbian and Latin American
 Authenticity: Africa
 Autobiography
 Avant-Garde: Overview
 Body, The
 Cannibalism
 Censorship
 Cinema
 Civil Disobedience
 Civil Society: Europe and the United States
 Communication of Ideas: Africa and Its Influence
 Communication of Ideas: Asia and Its Influence
 Communication of Ideas: Orality and Advent of Writing
 Communication of Ideas: Southeast Asia
 Composition, Musical
 Confucianism
 Context
 Cosmopolitanism
 Creolization, Caribbean
 Cultural Capital
 Cynicism
 Dada
Dance
 Determinism
 Dialogue and Dialectics: Socratic
 Dialogue and Dialectics: Talmudic
 Dictatorship in Latin America
 Dream
 Dress
 Emotions
 Empire and Imperialism: Europe
 Environment
 Equality: Overview
 Ethnicity and Race: Anthropology
 Etiquette
 Everyday Life
 Expressionism
 Extirpation
 Fascism
 Feminism: Chicana Feminisms
 Fetishism: Overview
 Fetishism: Fetishism in Literature and Cultural Studies
 Game Theory
 Gay Studies
 Gender: Overview
 Gender in Art
 Generation
 Genre
 Gesture
 Harmony
 Hinduism
 History, Economic

- History, Idea of
 Honor
 Humanism: Africa
 Humanism: Chinese Conception of
 Humanity: African Thought
 Humor
 Ideas, History of
 Identity, Multiple: Jewish Multiple Identity
 Images, Icons, and Idols
 Intelligentsia
 Islam: Shii
 Islam: Sunni
 Jouissance
 Judaism: Judaism to 1800
 Knowledge
 Language and Linguistics
 Language, Philosophy of: Modern
 Law, Islamic
 Leadership
 Learning and Memory, Contemporary Views
 Life Cycle: Overview
 Literary Criticism
 Literary History
 Literature: African Literature
 Love, Western Notions of
 Magic
 Manichaeism
 Masks
 Media, History of
 Medicine: China
 Medicine: Islamic Medicine
 Meditation: Eastern Meditation
 Men and Masculinity
 Metaphor
 Millenarianism: Islamic
 Millenarianism: Latin America and Native North America
 Modernism: Overview
 Modernity: Overview
 Modernity: Africa
 Motif: Motif in Music
 Music, Anthropology of
 Musical Performance and Audiences
 Musicology
 Mysticism: Chinese Mysticism
 Mysticism: Islamic Mysticism in Asia
 Mysticism: Kabbalah
 Myth
 Narrative
 Nation
 Nationalism: Middle East
 New Criticism
 Nomadism
 Nuclear Age
 Oral Traditions: Overview
 Orientalism: Overview
 Orthodoxy
 Orthopraxy: Asia
 Pan-Turkism
 Periodization of the Arts
 Person, Idea of the
 Philosophies: African
 Philosophies: American
 Philosophies: Feminist, Twentieth-Century
 Philosophies: Islamic
 Philosophy: Historical Overview and Recent Developments
 Philosophy, Moral: Ancient
 Philosophy of Mind: Ancient and Medieval
 Pietism
 Poetry and Poetics
 Political Protest, U.S.
 Populism: United States
 Postmodernism
 Practices
 Pre-Columbian Civilization
 Propaganda
 Protest, Political
 Psychoanalysis
 Punishment
 Queer Theory
 Reading
 Realism: Africa
 Reflexivity
 Reform: Europe and the United States
 Relativism
 Religion: Africa
 Religion: African Diaspora
 Religion: East and Southeast Asia
 Religion: Indigenous Peoples' View, South America
 Religion: Latin America
 Religion: Middle East
 Religion and the State: United States
 Republicanism: Republic
 Resistance
 Resistance and Accommodation
 Responsibility
Rhetoric: Overview
Rhetoric: Ancient and Medieval
 Ritual: Public Ritual
 Ritual: Religion
 Romanticism in Literature and Politics
 Sacred Places
 Sacred Texts: Asia
 Sexuality: Overview
 Shinto
 Slavery
 Society
 Sophists, The
 Sport
 Stoicism
 Subjectivism
 Superstition
 Surrealism
 Symbolism
 Syncretism
 Taste
 Temperance
 Text/Textuality
Theater and Performance
 Third Cinema
 Third World Literature
 Time: China
 Time: India
 Toleration
 Totalitarianism
 Totems
 Tragedy and Comedy
 Translation
 Trope

READER'S GUIDE

Untouchability: Menstrual Taboos
Utilitarianism
Victorianism
Virtual Reality
Volunteerism, U.S.
Westernization: Middle East
Westernization: Southeast Asia
Wisdom, Human
Witchcraft
Witchcraft, African Studies of
Yin and Yang
Yoga

Humanities

COMMUNICATION, LANGUAGE, AND LINGUISTICS

Aesthetics: Africa
Aesthetics: Asia
Africa, Idea of
Afrocentricity
Agnosticism
Algebras
Americanization, U.S.
Analytical Philosophy
Anthropology
Anticolonialism: Africa
Asceticism: Hindu and Buddhist Asceticism
Asceticism: Western Asceticism
Astronomy, Pre-Columbian and Latin American
Authenticity: Africa
Avant-Garde: Overview
Avant-Garde: Militancy
Aztlán
Barbarism and Civilization
Beauty and Ugliness
Behaviorism
Bilingualism and Multilingualism
Body, The
Borders, Borderlands, and Frontiers, Global
Buddhism
Calculation and Computation
Calendar
Cannibalism
Casuistry
Censorship
Chinese Thought
Cinema
Civil Disobedience
Classification of Arts and Sciences, Early Modern
Colonialism: Southeast Asia
Communication of Ideas: Africa and Its Influence
Communication of Ideas: The Americas and Their Influence
Communication of Ideas: Asia and Its Influence
Communication of Ideas: Europe and Its Influence
Communication of Ideas: Middle East and Abroad
Communication of Ideas: Orality and Advent of Writing
Communication of Ideas: Southeast Asia
Computer Science
Consumerism
Context
Continental Philosophy
Cosmopolitanism
Creolization, Caribbean
Critical Theory
Cultural Capital

Cultural History
Cultural Revivals
Cultural Studies
Cynicism
Dance
Democracy
Determinism
Dialogue and Dialectics: Socratic
Diasporas: Jewish Diaspora
Dictatorship in Latin America
Diffusion, Cultural
Discrimination
Diversity
Dream
Dress
Ecumenism
Education: Asia, Traditional and Modern
Empire and Imperialism: Asia
Empire and Imperialism: Europe
Empire and Imperialism: United States
Empiricism
Encyclopedism
Epistemology: Ancient
Epistemology: Early Modern
Epistemology: Modern
Ethnicity and Race: Africa
Ethnicity and Race: Anthropology
Ethnicity and Race: Islamic Views
Etiquette
Eurocentrism
Everyday Life
Examination Systems, China
Extirpation
Fallacy, Logical
Feminism: Overview
Feminism: Chicana Feminisms
Fetishism: Overview
Fetishism: Fetishism in Literature and Cultural Studies
Feudalism, European
Formalism
Gender: Gender in the Middle East
Gender in Art
Geometry
Gesture
Globalization: Asia
Globalization: General
Greek Science
Harmony
Hegemony
Hermeneutics
Hinduism
History, Economic
History, Idea of
Humanism: Africa
Humanism: Chinese Conception of
Humanism: Europe and the Middle East
Humanism: Renaissance
Humanity: African Thought
Human Rights: Overview
Idealism
Ideas, History of
Identity: Identity of Persons
Identity, Multiple: Overview
Identity, Multiple: Jewish Multiple Identity
Indigenismo

- Intelligentsia
 Interdisciplinarity
 Interpretation
 Islam: Africa
 Islam: Southeast Asia
 Islam: Sunni
 Islamic Science
 Japanese Philosophy, Japanese Thought
 Jihad
 Jouissance
 Judaism: Judaism to 1800
 Kantianism
 Kinship
 Knowledge
Language and Linguistics
Language, Linguistics, and Literacy
 Language, Philosophy of: Ancient and Medieval
 Language, Philosophy of: Modern
 Law
 Liberty
 Life Cycle: Overview
 Linguistic Turn
 Literary Criticism
 Literary History
 Literature: Overview
 Literature: African Literature
 Machismo
 Magic
 Maps and the Ideas They Express
 Masks
 Materialism in Eighteenth-Century European Thought
 Mathematics
 Matriarchy
 Media, History of
 Medicine: Europe and the United States
 Medicine: India
 Meme
 Mestizaje
 Metaphor
 Metaphysics: Renaissance to the Present
 Migration: Africa
 Migration: United States
 Millenarianism: Latin America and Native North America
 Mind
 Minority
Modernism: Overview
 Modernity: Overview
 Modernity: Africa
 Monarchy: Overview
 Motherhood and Maternity
 Motif: Motif in Literature
 Motif: Motif in Music
 Multiculturalism, Africa
 Music, Anthropology of
 Musical Performance and Audiences
 Musicology
 Mysticism: Chinese Mysticism
 Mysticism: Christian Mysticism
 Mysticism: Islamic Mysticism in Asia
 Mysticism: Kabbalah
 Mysticism: Mysticism in African Thought
 Narrative
 Nation
 Nationalism: Overview
 Nationalism: Middle East
 Native Policy
 Natural History
 New Criticism
 Nomadism
 Objectivity
 Occidentalism
Oral Traditions: Overview
 Organicism
 Orientalism: Overview
 Orthodoxy
 Pacifism
 Pan-Africanism
 Pan-Arabism
 Pan-Asianism
 Pan-Turkism
 Paradigm
 Patriotism
 Periodization of the Arts
 Person, Idea of the
 Personhood in African Thought
 Philosophies: African
 Philosophies: American
 Philosophies: Feminist, Twentieth-Century
 Philosophies: Islamic
 Philosophy: Historical Overview and Recent Developments
 Philosophy of Mind: Overview
 Philosophy of Mind: Ancient and Medieval
 Philosophy of Religion
 Poetry and Poetics
 Political Protest, U.S.
 Positivism
 Practices
 Pre-Columbian Civilization
 Prejudice
 Presentism
 Privacy
 Probability
 Progress, Idea of
 Propaganda
 Protest, Political
 Pseudoscience
 Psychology and Psychiatry
 Public Sphere
 Punishment
 Pythagoreanism
 Quantum
 Queer Theory
 Race and Racism: Asia
 Race and Racism: Europe
 Race and Racism: United States
 Reading
 Realism
 Realism: Africa
 Reflexivity
 Relativism
 Relativity
 Religion: Africa
 Religion: African Diaspora
 Religion: East and Southeast Asia
 Religion: Indigenous Peoples' View, South America
 Religion: Latin America
 Religion: Middle East
 Religion and the State: Latin America

READER'S GUIDE

Religion and the State: Middle East
Representation: Mental Representation
Republicanism: Republic
Resistance
Resistance and Accommodation
Responsibility
Rhetoric: Overview
Ritual: Public Ritual
Ritual: Religion
Romanticism in Literature and Politics
Sacred and Profane
Sacred Places
Sacred Texts: Asia
Sacred Texts: Koran
Sage Philosophy
Science: East Asia
Science, History of
Sexual Harassment
Sexuality: Overview
Sexuality: Sexual Orientation
Shinto
Slavery
Social History, U.S.
Society
Sophists, The
Sport
State, The: Overview
Stoicism
Structuralism and Poststructuralism: Overview
Structuralism and Poststructuralism: Anthropology
Subjectivism
Superstition
Surrealism
Symbolism
Syncretism
Technology
Temperance
Text/Textuality
Textiles and Fiber Arts as Catalysts for Ideas
Theater and Performance
Third Cinema
Third World Literature
Time: India
Time: Traditional and Utilitarian
Toleration
Totalitarianism
Totems
Trade
Tragedy and Comedy
Translation
Travel: Travel from Europe and the Middle East
Treaty
Trope
Truth
Untouchability: Taboos
Utilitarianism
Victorianism
Virtual Reality
Visual Culture
Visual Order to Organizing Collections
Westernization: Middle East
Westernization: Southeast Asia
Wisdom, Human
Witchcraft
Witchcraft, African Studies of

Womanism
Women and Femininity in U.S. Popular Culture
Yin and Yang
LITERATURE
Absolute Music
Aesthetics: Africa
Aesthetics: Asia
Aesthetics: Europe and the Americas
Africa, Idea of
African-American Ideas
Alienation
America
Anticolonialism: Africa
Anti-Semitism: Overview
Architecture: Asia
Asceticism: Hindu and Buddhist Asceticism
Authenticity: Africa
Autobiography
Avant-Garde: Overview
Aztlán
Biography
Buddhism
Bushido
Casuistry
Chinese Thought
Cinema
Classicism
Classification of Arts and Sciences, Early Modern
Colonialism: Africa
Communication of Ideas: Africa and Its Influence
Communication of Ideas: Asia and Its Influence
Communication of Ideas: Europe and Its Influence
Communication of Ideas: Middle East and Abroad
Communication of Ideas: Orality and Advent of Writing
Communication of Ideas: Southeast Asia
Consciousness: Overview
Continental Philosophy
Corruption
Cosmopolitanism
Creativity in the Arts and Sciences
Critical Race Theory
Critical Theory
Cultural Studies
Dada
Dialogue and Dialectics: Socratic
Dream
Dystopia
Education: Islamic Education
Empire and Imperialism: Europe
Enlightenment
Etiquette
Europe, Idea of
Evil
Examination Systems, China
Existentialism
Expressionism
Extirpation
Fascism
Feminism: Overview
Feminism: Chicana Feminisms
Feminism: Third World U.S. Movement
Fetishism: Fetishism in Literature and Cultural Studies
Formalism
Friendship
Futurology

- Game Theory
 Gay Studies
 Gender: Overview
 Gender: Gender in the Middle East
 Generation
 Genius
Genre
 Globalization: Asia
 Gnosticism
 Heaven and Hell
 Heaven and Hell (Asian Focus)
 Hedonism in European Thought
 Hermeneutics
 Hinduism
 Historiography
 History, Economic
 History, Idea of
 Honor, Middle Eastern Notions of
 Humanism: Africa
 Humanism: Chinese Conception of
 Humanism: Renaissance
 Humanity: African Thought
 Humor
 Ideas, History of
 Identity, Multiple: Jewish Multiple Identity
 Imagination
 Indigenismo
 Individualism
 Intelligentsia
 Interdisciplinarity
 Interpretation
 Islam: Africa
 Islam: Shii
 Islam: Sunni
 Islamic Science
 Japanese Philosophy, Japanese Thought
 Jouissance
 Judaism: Judaism to 1800
 Judaism: Modern Judaism
 Language and Linguistics
 Language, Philosophy of: Ancient and Medieval
 Language, Philosophy of: Modern
 Law, Islamic
 Leadership
 Life Cycle: Overview
 Linguistic Turn
 Literary Criticism
Literary History
 Literature: Overview
 Literature: African Literature
 Love, Western Notions of
 Magic
 Manichaeism
 Marxism: Overview
 Marxism: Latin America
 Masks
 Matriarchy
 Medicine: China
 Medicine: Islamic Medicine
 Memory
 Men and Masculinity
 Mestizaje
 Metaphor
 Metaphysics: Renaissance to the Present
 Microcosm and Macrocosm
 Millenarianism: Overview
 Millenarianism: Islamic
 Millenarianism: Latin America and Native North America
 Modernism: Overview
 Modernism: Latin America
 Modernity: Overview
 Modernity: East Asia
 Mohism
 Monarchy: Overview
 Motherhood and Maternity
 Motif: Motif in Literature
 Motif: Motif in Music
 Musicology
 Mysticism: Chinese Mysticism
 Mysticism: Christian Mysticism
 Myth
 Narrative
 Nation
 Nationalism: Africa
 Naturalism
 Naturalism in Art and Literature
 Nature
 Negritude
New Criticism
 Occidentalism
 Oral Traditions: Overview
 Organicism
 Orientalism: Overview
 Orientalism: African and Black Orientalism
 Pan-Africanism
 Pan-Asianism
 Person, Idea of the
 Phenomenology
 Philosophies: African
 Philosophies: American
 Philosophies: Feminist, Twentieth-Century
 Philosophies: Islamic
 Philosophy: Historical Overview and Recent Developments
 Philosophy, Moral: Ancient
 Philosophy, Moral: Medieval and Renaissance
 Pietism
 Platonism
Poetry and Poetics
 Political Protest, U.S.
 Postcolonial Studies
 Postcolonial Theory and Literature
 Postmodernism
 Practices
 Privacy
 Property
 Prophecy
 Protest, Political
 Psychoanalysis
 Queer Theory
 Race and Racism: Europe
 Reading
 Realism: Africa
 Religion: Africa
 Religion: African Diaspora
 Religion: East and Southeast Asia
 Religion: Indigenous Peoples' View, South America
 Religion: Latin America
 Religion: Middle East

READER'S GUIDE

- Religion and the State: United States
- Renaissance
- Republicanism: Republic
- Resistance and Accommodation
- Rhetoric: Overview
- Rhetoric: Ancient and Medieval
- Ritual: Public Ritual
- Romanticism in Literature and Politics
- Sacred Texts: Asia
- Sacred Texts: Koran
- Sage Philosophy
- Scholasticism
- Science Fiction
- Science: Overview
- Sexuality: Overview
- Slavery
- Social History, U.S.
- Society
- Sophists, The
- State of Nature
- Stoicism
- Structuralism and Poststructuralism: Overview
- Surrealism
- Symbolism
- Syncretism
- Text/Textuality
- Theater and Performance
- Third World Literature
- Toleration
- Totalitarianism
- Tragedy and Comedy
- Translation
- Travel: Travel from Europe and the Middle East
- Trope
- Utopia
- Victorianism
- Virtue Ethics
- Visual Order to Organizing Collections
- War and Peace in the Arts
- Wisdom, Human
- RELIGION
- Abolitionism
- Aesthetics: Africa
- Aesthetics: Asia
- Africa, Idea of
- Agnosticism
- Alchemy: China
- Alchemy: Europe and the Middle East
- Alienation
- Altruism
- Americanization, U.S.
- Ancestor Worship
- Animism
- Antifeminism
- Anti-Semitism: Overview
- Anti-Semitism: Islamic Anti-Semitism
- Architecture: Overview
- Architecture: Asia
- Aristotelianism
- Arts: Overview
- Arts: Africa
- Asceticism: Hindu and Buddhist Asceticism
- Asceticism: Western Asceticism
- Assimilation
- Astrology: Overview
- Astrology: China
- Astronomy, Pre-Columbian and Latin American
- Atheism
- Authority
- Autonomy
- Bioethics
- Body, The
- Buddhism
- Calendar
- Cannibalism
- Capitalism: Overview
- Cartesianism
- Casuistry
- Causality
- Causation in East Asian and Southeast Asian Philosophy
- Censorship
- Change
- Chinese Thought
- Christianity: Overview
- Christianity: Asia
- City, The: Latin America
- City, The: The Islamic and Byzantine City
- Civil Disobedience
- Civil Society: Europe and the United States
- Classification of Arts and Sciences, Early Modern
- Colonialism: Southeast Asia
- Communication of Ideas: Africa and Its Influence
- Communication of Ideas: Asia and Its Influence
- Communication of Ideas: Middle East and Abroad
- Communication of Ideas: Orality and Advent of Writing
- Communication of Ideas: Southeast Asia
- Composition, Musical
- Confucianism
- Consciousness: Indian Thought
- Conservatism
- Continental Philosophy
- Corruption
- Cosmology: Asia
- Cosmology: Cosmology and Astronomy
- Cosmopolitanism
- Creationism
- Cultural History
- Dance
- Daoism
- Death
- Death and Afterlife, Islamic Understanding of
- Deism
- Demonology
- Dialogue and Dialectics: Talmudic
- Diasporas: Jewish Diaspora
- Dictatorship in Latin America
- Diversity
- Dream
- Dress
- Dualism
- Ecology
- Ecumenism
- Education: Asia, Traditional and Modern
- Education: Europe
- Education: Islamic Education
- Education: Japan
- Empire and Imperialism: Overview
- Empire and Imperialism: Americas
- Empire and Imperialism: Europe
- Enlightenment

- Environment
 Environmental Ethics
 Environmental History
 Epicureanism
 Epistemology: Early Modern
 Epistemology: Modern
 Equality: Overview
 Eschatology
 Ethnicity and Race: Islamic Views
 Etiquette
 Europe, Idea of
 Everyday Life
 Evil
 Evolution
 Existentialism
 Expressionism
 Extirpation
 Family: Family in Anthropology since 1980
 Fascism
 Fatalism
 Feminism: Overview
 Feminism: Africa and African Diaspora
 Feminism: Chicana Feminisms
 Feminism: Islamic Feminism
 Fetishism: Overview
 Form, Metaphysical, in Ancient and Medieval Thought
 Free Will, Determinism, and Predestination
 Friendship
 Fundamentalism
 Gay Studies
 Gender: Gender in the Middle East
 Gender in Art
 General Will
 Genetics: Contemporary
 Genocide
 Ghetto
 Gift, The
 Globalization: Asia
 Gnosticism
 Good
 Harmony
 Health and Disease
 Heaven and Hell
 Heaven and Hell (Asian Focus)
 Hedonism in European Thought
 Heresy and Apostasy
 Hermeneutics
 Hierarchy and Order
 Hinduism
 Historicism
 Historiography
 History, Idea of
 Honor
 Honor, Middle Eastern Notions of
 Humanism: Africa
 Humanism: Chinese Conception of
 Humanism: Renaissance
 Humanism: Secular Humanism in the United States
 Humanity: African Thought
 Humanity: Asian Thought
 Humanity: European Thought
 Humanity in the Arts
 Human Rights: Overview
 Iconography
 Ideas, History of
 Identity: Identity of Persons
 Identity, Multiple: Jewish Multiple Identity
 Images, Icons, and Idols
 Imagination
 Immortality and the Afterlife
 Individualism
 Intelligentsia
 Intentionality
 Intercession in Middle Eastern Society
 Interdisciplinarity
 Islam: Africa
 Islam: Shii
 Islam: Southeast Asia
 Islam: Sunni
 Islamic Science
 Jainism
 Japanese Philosophy, Japanese Thought
 Jihad
 Jouissance
 Judaism: Judaism to 1800
 Judaism: Modern Judaism
 Kantianism
 Kinship
 Knowledge
 Language and Linguistics
 Language, Philosophy of: Ancient and Medieval
 Law, Islamic
 Liberation Theology
 Life
 Literary History
 Love, Western Notions of
 Magic
 Manichaeism
 Marriage and Fertility, European Views
 Marxism: Overview
 Marxism: Latin America
 Masks
 Materialism in Eighteenth-Century European Thought
 Matriarchy
 Medicine: Europe and the United States
 Medicine: Islamic Medicine
 Meditation: Eastern Meditation
 Men and Masculinity
 Metaphor
 Millenarianism: Overview
 Millenarianism: Islamic
 Millenarianism: Latin America and Native North America
 Minority
 Miracles
 Modernity: Overview
 Mohism
 Monarchy: Overview
 Monarchy: Islamic Monarchy
 Monasticism
 Monism
 Motherhood and Maternity
 Motif: Motif in Music
 Multiculturalism, Africa
 Museums
 Music, Anthropology of
 Musical Performance and Audiences
 Mysticism: Chinese Mysticism
 Mysticism: Christian Mysticism
 Mysticism: Islamic Mysticism

READER'S GUIDE

Mysticism: Islamic Mysticism in Asia
 Mysticism: Kabbalah
 Mysticism: Mysticism in African Thought
 Myth
 Nation
 Nationalism: Cultural Nationalism
 Nationalism: Middle East
 Naturalism
 Natural Law
 Natural Theology
 Newtonianism
 Nomadism
 Nonviolence
 Nude, The
 Obligation
 Organicism
 Orientalism: Overview
 Orientalism: African and Black Orientalism
 Orthodoxy
 Orthopraxy: Asia
 Orthopraxy: Western Orthopraxy
 Other, The, European Views of
 Pacifism
 Paradise on Earth
 Parties, Political
 Peace
 Periodization of the Arts
 Person, Idea of the
 Personhood in African Thought
 Perspective
 Philanthropy
 Philosophies: African
 Philosophies: American
 Philosophies: Feminist, Twentieth-Century
 Philosophies: Islamic
 Philosophy: Historical Overview and Recent Developments
 Philosophy: Relations to Other Intellectual Realms
 Philosophy, Moral: Africa
 Philosophy, Moral: Medieval and Renaissance
 Philosophy, Moral: Modern
 Philosophy and Religion in Western Thought
 Philosophy of Mind: Ancient and Medieval
 Philosophy of Religion
 Physics
 Pietism
 Platonism
 Political Protest, U.S.
 Polytheism
 Population
 Poverty
 Practices
 Pre-Columbian Civilization
 Privacy
 Propaganda
 Prophecy
 Protest, Political
 Pseudoscience
 Psychoanalysis
 Punishment
 Puritanism
 Pythagoreanism
 Race and Racism: Europe
 Rationalism
 Reading
 Reflexivity
 Reform: Islamic Reform
 Reformation
 Relativism
 Religion: Overview
 Religion: Africa
 Religion: African Diaspora
 Religion: East and Southeast Asia
 Religion: Latin America
 Religion: Middle East
 Religion and Science
 Religion and the State: Africa
 Religion and the State: Europe
 Religion and the State: Latin America
 Religion and the State: Middle East
 Religion and the State: United States
 Renaissance
 Representation: Political Representation
 Republicanism: Latin America
 Resistance and Accommodation
 Responsibility
 Rhetoric: Ancient and Medieval
 Ritual: Religion
 Romanticism in Literature and Politics
 Sacred and Profane
 Sacred Places
 Sacred Texts: Asia
 Sacred Texts: Koran
 Scholasticism
 Secularization and Secularism
 Sexuality: Islamic Views
 Shinto
 Skepticism
 Slavery
 Sophists, The
 Subjectivism
 Sufism
 Suicide
 Superstition
 Symbolism
 Syncretism
 Temperance
 Theodicy
 Time: China
 Time: India
 Time: Traditional and Utilitarian
 Toleration
 Totalitarianism
 Totems
 University: Overview
 Untouchability: Overview
 Untouchability: Menstrual Taboos
 Untouchability: Taboos
 Utilitarianism
 Victorianism
 Visual Order to Organizing Collections
 Volunteerism, U.S.
 War
 War and Peace in the Arts
 Westernization: Africa
 Westernization: Middle East
 Westernization: Southeast Asia
 Witchcraft
 Witchcraft, African Studies of
 Yin and Yang

- Yoga
 Zen
 Zionism
 PHILOSOPHY
 Absolute Music
 Aesthetics: Asia
 Aesthetics: Europe and the Americas
 Africa, Idea of
 African-American Ideas
 Afrocentricity
 Agnosticism
 Alchemy: China
 Algebras
 Alienation
 Altruism
 Ambiguity
 Analytical Philosophy
 Anticolonialism: Africa
 Antifeminism
 Architecture: Overview
 Architecture: Asia
 Aristotelianism
 Asceticism: Hindu and Buddhist Asceticism
 Asceticism: Western Asceticism
 Astronomy, Pre-Columbian and Latin American
 Atheism
 Authenticity: Africa
 Autonomy
 Avant-Garde: Militancy
 Bioethics
 Black Consciousness
 Body, The
 Buddhism
 Cartesianism
 Casuistry
 Causality
 Causation
 Causation in East Asian and Southeast Asian Philosophy
 Censorship
 Change
 Character
 Chemistry
 Chinese Thought
 Christianity: Overview
 Civil Disobedience
 Civil Society: Europe and the United States
 Civil Society: Responses in Africa and the Middle East
 Class
 Classification of Arts and Sciences, Early Modern
 Common Sense
 Communitarianism in African Thought
 Confucianism
 Consciousness: Overview
 Consciousness: Chinese Thought
 Consciousness: Indian Thought
 Conservatism
 Consilience
 Context
 Continental Philosophy
 Corruption
 Corruption in Developed and Developing Countries
 Cosmology: Asia
 Cosmopolitanism
 Creationism
 Critical Race Theory
 Critical Theory
 Cultural History
 Cycles
 Cynicism
 Dance
 Daoism
 Death
 Deism
 Democracy
 Democracy: Africa
 Determinism
 Dialogue and Dialectics: Socratic
 Dream
 Dress
 Dualism
 Dystopia
 Eclecticism
 Education: China
 Education: Global Education
 Education: Japan
 Emotions
 Empiricism
 Enlightenment
 Environment
 Environmental Ethics
 Environmental History
 Epicureanism
 Epistemology: Ancient
 Epistemology: Early Modern
 Epistemology: Modern
 Equality: Overview
 Equality: Gender Equality
 Equality: Racial Equality
 Essentialism
 Ethnocentrism
 Eugenics
 Everyday Life
 Evil
 Existentialism
 Expressionism
 Fallacy, Logical
 Falsifiability
 Family Planning
 Fascism
 Fatalism
 Feminism: Overview
 Feminism: Africa and African Diaspora
 Feminism: Chicana Feminisms
 Feminism: Islamic Feminism
 Field Theories
 Form, Metaphysical, in Ancient and Medieval Thought
 Foundationalism
 Free Will, Determinism, and Predestination
 Friendship
 Gender: Gender in the Middle East
 Gender in Art
 General Will
 Genetics: Contemporary
 Genetics: History of
 Geometry
 Gift, The
 Globalization: Asia
 Gnosticism
 Good
 Greek Science

READER'S GUIDE

- Happiness and Pleasure in European Thought
 Harmony
 Health and Disease
 Heaven and Hell (Asian Focus)
 Hedonism in European Thought
 Hegelianism
 Hegemony
 Hermeneutics
 Hierarchy and Order
 Hinduism
 Historical and Dialectical Materialism
 Historicism
 Historiography
 History, Idea of
 Humanism: Africa
 Humanism: Chinese Conception of
 Humanism: Europe and the Middle East
 Humanism: Secular Humanism in the United States
 Humanity: African Thought
 Humanity: Asian Thought
 Humanity: European Thought
 Human Rights: Overview
 Human Rights: Women's Rights
 Idealism
 Ideas, History of
 Identity: Identity of Persons
 Identity, Multiple: Overview
 Identity, Multiple: Jewish Multiple Identity
 Immortality and the Afterlife
 Impressionism
 Individualism
 Intelligentsia
 Intentionality
 Interdisciplinarity
 International Order
 Islam: Africa
 Islam: Sunni
 Islamic Science
 Jainism
 Japanese Philosophy, Japanese Thought
 Jouissance
 Judaism: Modern Judaism
 Justice: Overview
 Justice: Justice in American Thought
 Justice: Justice in East Asian Thought
 Kantianism
 Knowledge
 Language and Linguistics
 Language, Philosophy of: Ancient and Medieval
 Language, Philosophy of: Modern
 Law
 Liberalism
 Liberty
 Life
 Linguistic Turn
 Literary Criticism
 Literary History
 Logic
 Logic and Philosophy of Mathematics, Modern
 Magic
 Manichaeism
 Maoism
 Marxism: Overview
 Marxism: Latin America
 Materialism in Eighteenth-Century European Thought
 Mathematics
 Mechanical Philosophy
 Medicine: China
 Medicine: Europe and the United States
 Meditation: Eastern Meditation
 Memory
 Metaphor
 Metaphysics: Ancient and Medieval
 Metaphysics: Renaissance to the Present
 Microcosm and Macrocosm
 Mind
 Modernism: Latin America
 Modernity: Overview
 Mohism
 Monism
 Moral Sense
 Music, Anthropology of
 Musicology
 Mysticism: Chinese Mysticism
 Myth
 Narrative
 Natural History
 Natural Law
 Natural Theology
 Naturalism
 Nature
 Naturphilosophie
 Neoplatonism
 Newtonianism
 Nihilism
 Nonviolence
 Nuclear Age
 Objectivity
 Obligation
 Occidentalism
 Organicism
 Orientalism: Overview
 Orthopraxy: Asia
 Other, The, European Views of
 Pacifism
 Pan-Africanism
 Paradigm
 Parties, Political
 Peace
 Person, Idea of the
 Personhood in African Thought
 Phenomenology
 Philanthropy
 Philosophies: African
 Philosophies: American
 Philosophies: Feminist, Twentieth-Century
 Philosophies: Islamic
 Philosophy: Historical Overview and Recent Developments
Philosophy: Relations to Other Intellectual Realms
 Philosophy, History of
 Philosophy, Moral: Africa
 Philosophy, Moral: Ancient
 Philosophy, Moral: Medieval and Renaissance
 Philosophy, Moral: Modern
 Philosophy and Religion in Western Thought
 Philosophy of Mind: Overview
 Philosophy of Mind: Ancient and Medieval
 Philosophy of Religion
 Physics

- Pietism
 Platonism
 Pluralism
 Poetry and Poetics
 Political Protest, U.S.
 Political Science
 Population
 Populism: United States
 Positivism
 Postcolonial Studies
 Postmodernism
 Poverty
 Practices
 Pragmatism
 Presentism
 Privacy
 Probability
 Progress, Idea of
 Protest, Political
 Pseudoscience
 Punishment
 Pythagoreanism
 Quantum
 Queer Theory
 Race and Racism: Overview
 Radicals/Radicalism
 Rational Choice
 Rationalism
 Reading
 Realism: Africa
 Reason, Practical and Theoretical
 Reflexivity
 Reform: Europe and the United States
 Relativism
 Relativity
 Religion: Overview
 Religion: East and Southeast Asia
 Religion: Middle East
 Religion and Science
 Religion and the State: United States
 Renaissance
 Representation: Political Representation
 Resistance
 Responsibility
 Rhetoric: Overview
 Romanticism in Literature and Politics
 Sacred Texts: Asia
 Sage Philosophy
 Scholasticism
 Science: Overview
 Science: East Asia
 Science, History of
 Scientific Revolution
 Secularization and Secularism
 Sexual Harassment
 Sexuality: Overview
 Skepticism
 Sociability in African Thought
 Social Darwinism
 Socialisms, African
 Society
 Sophists, The
 State of Nature
 Stoicism
 Structuralism and Poststructuralism: Overview
- Subjectivism
 Suicide
 Surrealism
 Symbolism
 Taste
 Text/Textuality
 Theodicy
 Time: China
 Time: India
 Toleration
 Totalitarianism
 Translation
 Truth
 Universalism
 Utilitarianism
 Victorianism
 Virtue Ethics
 Visual Culture
 Visual Order to Organizing Collections
 Volksgeist
 Volunteerism, U.S.
 War
 Wildlife
 Wisdom, Human
 Witchcraft
 Witchcraft, African Studies of
 Womanism
 Yin and Yang
 Yoga
 Zen
- EDUCATION
 Abolitionism
 Aesthetics: Africa
 Aesthetics: Asia
 Afrocentricity
 Altruism
 Americanization, U.S.
 Anthropology
 Anticolonialism: Africa
 Anticolonialism: Southeast Asia
 Antifeminism
 Anti-Semitism: Overview
 Apartheid
 Architecture: Overview
 Aristotelianism
 Asceticism: Hindu and Buddhist Asceticism
 Authenticity: Africa
 Authoritarianism: Latin America
 Behaviorism
 Bilingualism and Multilingualism
 Biology
 Black Consciousness
 Body, The
 Buddhism
 Bushido
 Calculation and Computation
 Capitalism: Overview
 Capitalism: Africa
 Character
 Childhood and Child Rearing
 Chinese Thought
 Christianity: Asia
 Citizenship: Naturalization
 City, The: The City as a Cultural Center
 Civil Society: Europe and the United States

READER'S GUIDE

Classification of Arts and Sciences, Early Modern
Communication of Ideas: Africa and Its Influence
Communication of Ideas: Asia and Its Influence
Communication of Ideas: Europe and Its Influence
Communication of Ideas: Southeast Asia
Composition, Musical
Confucianism
Consciousness: Chinese Thought
Consciousness: Indian Thought
Cosmopolitanism
Creationism
Creolization, Caribbean
Cultural Capital
Cultural Revivals
Cultural Studies
Dance
Daoism
Death and Afterlife, Islamic Understanding of
Democracy: Africa
Dialogue and Dialectics: Socratic
Dialogue and Dialectics: Talmudic
Diasporas: Jewish Diaspora
Diffusion, Cultural
Discrimination
Diversity
Dress
Eclecticism
Education: Asia, Traditional and Modern
Education: China
Education: Europe
Education: Global Education
Education: India
Education: Islamic Education
Education: Japan
Education: North America
Emotion
Empire and Imperialism: Asia
Empire and Imperialism: Europe
Empire and Imperialism: United States
Enlightenment
Environmental Ethics
Environmental History
Epicureanism
Epistemology: Ancient
Epistemology: Early Modern
Epistemology: Modern
Equality: Overview
Ethnicity and Race: Anthropology
Etiquette
Examination Systems, China
Experiment
Extirpation
Family Planning
Fascism
Feminism: Overview
Feminism: Africa and African Diaspora
Feminism: Chicana Feminisms
Feminism: Islamic Feminism
Gender: Gender in the Middle East
Generation
Globalization: Asia
Good
Greek Science
Harmony
Health and Disease
Hermeneutics
Hinduism
Historical and Dialectical Materialism
Historiography
History, Economic
Human Capital
Humanism: Chinese Conception of
Humanism: Europe and the Middle East
Humanism: Renaissance
Humanity: Asian Thought
Hygiene
Ideas, History of
Identity, Multiple: Jewish Multiple Identity
Individualism
Interdisciplinarity
Interpretation
Islam: Africa
Islam: Southeast Asia
Islam: Sunni
Islamic Science
Japanese Philosophy, Japanese Thought
Jihad
Jouissance
Judaism: Judaism to 1800
Judaism: Modern Judaism
Justice: Justice in East Asian Thought
Kantianism
Kinship
Knowledge
Language and Linguistics
Language, Linguistics, and Literacy
Learning and Memory, Contemporary Views
Life Cycle: Overview
Life Cycle: Adolescence
Life Cycle: Elders/Old Age
Literary Criticism
Loyalties, Dual
Maoism
Maps and the Ideas They Express
Marxism: Overview
Masks
Matriarchy
Medicine: Europe and the United States
Men and Masculinity
Mestizaje
Metaphor
Minority
Modernity: Overview
Modernity: Africa
Modernity: East Asia
Modernization Theory
Mohism
Motherhood and Maternity
Multiculturalism, Africa
Museums
Music, Anthropology of
Musical Performance and Audiences
Musicology
Mysticism: Chinese Mysticism
Mysticism: Islamic Mysticism in Asia
Mysticism: Kabbalah
Nation
Nationalism: Africa
Natural History
Negritude

- Neoplatonism
- Newtonianism
- Nuclear Age
- Nude, The
- Objectivity
- Occidentalism
- Oral Traditions: Overview
- Organicism
- Orientalism: Overview
- Orthodoxy
- Pan-Arabism
- Pan-Asianism
- Paradigm
- Periodization of the Arts
- Philosophies: American
- Philosophies: Feminist, Twentieth-Century
- Philosophies: Islamic
- Philosophy: Historical Overview and Recent Developments
- Philosophy, History of
- Philosophy, Moral: Ancient
- Philosophy, Moral: Medieval and Renaissance
- Philosophy, Moral: Modern
- Philosophy of Mind: Ancient and Medieval
- Physics
- Platonism
- Political Protest, U.S.
- Population
- Populism: United States
- Practices
- Pragmatism
- Prejudice
- Privacy
- Propaganda
- Protest, Political
- Pseudoscience
- Psychoanalysis
- Punishment
- Queer Theory
- Reading
- Realism: Africa
- Reason, Practical and Theoretical
- Reflexivity
- Reform: Islamic Reform
- Reformation
- Relativism
- Religion: East and Southeast Asia
- Religion: Middle East
- Religion and the State: Europe
- Religion and the State: Latin America
- Religion and the State: Middle East
- Religion and the State: United States
- Renaissance
- Representation: Political Representation
- Republicanism: Republic
- Resistance
- Rhetoric: Overview
- Rhetoric: Ancient and Medieval
- Ritual: Public Ritual
- Sacred Places
- Sacred Texts: Asia
- Sage Philosophy
- Scholasticism
- Science: East Asia
- Segregation
- Sexuality: Overview
- Skepticism
- Slavery
- Sociability in African Thought
- Social Capital
- Social History, U.S.
- Sophists, The
- Sport
- State, The: Overview
- Stoicism
- Subjectivism
- Sufism
- Superstition
- Temperance
- Theater and Performance
- Third Cinema
- Third World Literature
- Time: China
- Totalitarianism
- Tragedy and Comedy
- University: Overview
- University: Postcolonial
- Untouchability: Menstrual Taboos
- Untouchability: Taboos
- Utilitarianism
- Utopia
- Victorianism
- Visual Order to Organizing Collections
- Volunteerism, U.S.
- War and Peace in the Arts
- Westernization: Africa
- Westernization: Middle East
- Westernization: Southeast Asia
- Wisdom, Human
- Women's History: Africa
- Women's Studies
- Yoga
- Zen

Social Sciences

WOMEN'S STUDIES AND GENDER STUDIES

- Abolitionism
- Aesthetics: Asia
- African-American Ideas
- Anarchism
- Anthropology
- Antifeminism
- Asceticism: Western Asceticism
- Autobiography
- Beauty and Ugliness
- Biography
- Black Atlantic
- Body, The
- Capitalism: Africa
- Censorship
- Chicano Movement
- Childhood and Child Rearing
- Christianity: Overview
- Cinema
- Class
- Colonialism: Africa
- Colonialism: Southeast Asia
- Communication of Ideas: Southeast Asia
- Composition, Musical
- Confucianism

READER'S GUIDE

Consumerism
Continental Philosophy
Creativity in the Arts and Sciences
Critical Race Theory
Critical Theory
Cultural Studies
Dance
Death
Death and Afterlife, Islamic Understanding of
Democracy: Africa
Demography
Diversity
Dress
Dystopia
Economics
Education: Asia, Traditional and Modern
Education: China
Education: Europe
Education: Islamic Education
Education: North America
Emotions
Environmental History
Equality: Overview
Equality: Gender Equality
Essentialism
Etiquette
Eugenics
Eurocentrism
Everyday Life
Existentialism
Family: Modernist Anthropological Theory
Family: Family in Anthropology since 1980
Family Planning
Fascism
Feminism: Overview
Feminism: Africa and African Diaspora
Feminism: Chicana Feminisms
Feminism: Third World U.S. Movement
Fetishism: Overview
Fetishism: Fetishism in Literature and Cultural Studies
Friendship
Gay Studies
Gender: Overview
Gender: Gender in the Middle East
Gender in Art
Gender Studies: Anthropology
Genius
Genre
Hate
Historiography
History, Economic
Honor
Honor, Middle Eastern Notions of
Human Capital
Humanism: Renaissance
Humanity: Asian Thought
Humanity: European Thought
Human Rights: Women's Rights
Humor
Iconography
Identity: Identity of Persons
Identity, Multiple: Overview
Impressionism
Intelligentsia
Interdisciplinarity
Internal Colonialism
Interpretation
Islam: Shii
Jouissance
Justice: Overview
Kinship
Knowledge
Law
Law, Islamic
Legalism, Ancient China
Liberalism
Liberation Theology
Life Cycle: Adolescence
Literary History
Literature: African Literature
Love, Western Notions of
Machismo
Marriage and Fertility, European Views
Masks
Matriarchy
Medicine: Europe and the United States
Men and Masculinity
Mestizaje
Minority
Modernism: Overview
Motherhood and Maternity
Music, Anthropology of
Musicology
Mysticism: Christian Mysticism
Narrative
Nude, The
Orientalism: African and Black Orientalism
Orthodoxy
Pan-Africanism
Periodization of the Arts
Philosophies: African
Philosophies: American
Philosophies: Feminist, Twentieth-Century
Philosophy: Historical Overview and Recent Developments
Poetry and Poetics
Political Protest, U.S.
Population
Postcolonial Studies
Postcolonial Theory and Literature
Postmodernism
Pre-Columbian Civilization
Privacy
Progress, Idea of
Propaganda
Prophecy
Protest, Political
Psychoanalysis
Public Sphere
Queer Theory
Radicals/Radicalism
Reading
Reflexivity
Relativism
Religion: Africa
Religion: African Diaspora
Renaissance
Republicanism: Latin America
Resistance and Accommodation
Rhetoric: Ancient and Medieval

- Ritual: Public Ritual
- Ritual: Religion
- Romanticism in Literature and Politics
- Science: Overview
- Science, History of
- Science Fiction
- Scientific Revolution
- Secularization and Secularism
- Sexual Harassment
- Sexuality: Overview**
- Sexuality: Islamic Views**
- Sexuality: Sexual Orientation**
- Shinto
- Slavery
- Social Contract
- Social History, U.S.
- Sport
- State, The: The Postcolonial State
- Structuralism and Poststructuralism: Overview
- Subjectivism
- Symbolism
- Universalism
- University: Overview
- Untouchability: Menstrual Taboos
- Utopia
- Victorianism
- Virtue Ethics
- Visual Culture
- Visual Order to Organizing Collections
- Volunteerism, U.S.
- War
- Witchcraft
- Witchcraft, African Studies of
- Womanism
- Women and Femininity in U.S. Popular Culture
- Women's History: Africa
- Women's History: Asia
- Women's Studies**
- Work
- ETHNIC STUDIES**
- Abolitionism
- Absolute Music
- Africa, Idea of
- African-American Ideas
- Afrocentricity
- America
- Americanization, U.S.
- Ancestor Worship
- Anthropology
- Anticolonialism: Africa
- Anticolonialism: Southeast Asia
- Anti-Semitism: Overview
- Anti-Semitism: Islamic Anti-Semitism
- Apartheid
- Architecture: Africa
- Arts: Overview
- Assimilation
- Astronomy, Pre-Columbian and Latin American
- Authenticity: Africa
- Autobiography
- Aztlán
- Barbarism and Civilization
- Bilingualism and Multilingualism
- Black Atlantic
- Black Consciousness
- Body, The
- Borders, Borderlands, and Frontiers, Global
- Cannibalism
- Capitalism: Overview
- Capitalism: Africa
- Chicano Movement
- Cinema
- Citizenship: Cultural Citizenship
- City, The: Latin America
- City, The: The City as a Cultural Center
- City, The: The City as Political Center
- Civil Disobedience
- Class
- Colonialism: Africa
- Colonialism: Latin America
- Colonialism: Southeast Asia
- Communication of Ideas: Southeast Asia
- Communitarianism in African Thought
- Composition, Musical
- Consumerism
- Context
- Cosmopolitanism
- Creolization, Caribbean
- Critical Race Theory
- Critical Theory
- Cultural Capital
- Cultural Revivals
- Cultural Studies
- Dance
- Death
- Demography
- Diasporas: African Diaspora
- Diasporas: Jewish Diaspora
- Diffusion, Cultural
- Discrimination
- Diversity
- Dress
- Education: North America
- Empire and Imperialism: Europe
- Empire and Imperialism: Middle East
- Environmental History
- Equality: Overview
- Equality: Racial Equality
- Essentialism
- Ethnicity and Race: Africa**
- Ethnicity and Race: Anthropology**
- Ethnicity and Race: Islamic Views**
- Ethnocentrism
- Ethnography**
- Ethnohistory, U.S.
- Eugenics
- Eurocentrism
- Extirpation
- Family Planning
- Fascism
- Feminism: Overview
- Feminism: Africa and African Diaspora
- Feminism: Chicana Feminisms
- Feminism: Third World U.S. Movement
- Fetishism: Overview
- Fetishism: Fetishism in Literature and Cultural Studies
- Gender Studies: Anthropology
- Generation
- Genetics: Contemporary
- Genocide

READER'S GUIDE

Gesture
 Ghetto
 Gift, The
 Hate
 Hinduism
 History, Economic
 Honor
 Humanity: European Thought
 Humor
 Hygiene
 Iconography
 Identity, Multiple: Overview
 Identity, Multiple: Asian-Americans
 Identity, Multiple: Jewish Multiple Identity
 Indigenismo
 Intelligentsia
 Interdisciplinarity
 Internal Colonialism
 Islam: Africa
 Jouissance
 Judaism: Modern Judaism
 Kinship
 Law
 Liberation Theology
 Life Cycle: Adolescence
 Literary History
 Literature: African Literature
 Loyalties, Dual
 Machismo
 Marxism: Latin America
 Mathematics
 Matriarchy
 Men and Masculinity
 Mestizaje
 Migration: Africa
 Migration: Migration in World History
 Migration: United States
 Minority
 Modernism: Overview
 Modernity: Africa
 Motherhood and Maternity
 Multiculturalism, Africa
 Music, Anthropology of
 Musical Performance and Audiences
 Mysticism: Kabbalah
 Nation
 Nationalism: Overview
 Nationalism: Africa
 Nationalism: Cultural Nationalism
 Nationalism: Middle East
 Native Policy
 Naturalism
 Negritude
 Nomadism
 Nuclear Age
 Occidentalism
 Orientalism: Overview
 Orientalism: African and Black Orientalism
 Orthodoxy
 Other, The, European Views of
 Pan-Africanism
 Pan-Asianism
 Pan-Islamism
 Pan-Turkism
 Patriotism
 Periodization of the Arts
 Person, Idea of the
 Philosophies: African
 Philosophies: American
 Political Protest, U.S.
 Population
 Populism: United States
 Postcolonial Studies
 Postcolonial Theory and Literature
 Postmodernism
 Practices
 Pre-Columbian Civilization
 Prehistory, Rise of
 Prejudice
 Privacy
 Protest, Political
 Psychoanalysis
 Queer Theory
 Race and Racism: Overview
 Race and Racism: Asia
 Race and Racism: Europe
 Race and Racism: United States
 Reading
 Realism: Africa
 Reflexivity
 Regions and Regionalism, Eastern Europe
 Relativism
 Religion: African Diaspora
 Religion: Indigenous Peoples' View, South America
 Religion: Latin America
 Religion: Middle East
 Republicanism: Latin America
 Resistance and Accommodation
 Ritual: Religion
 Sage Philosophy
 Scarcity and Abundance, Latin America
 Secularization and Secularism
 Segregation
 Sexuality: Overview
 Shinto
 Slavery
 Socialisms, African
 Sport
 State, The: The Postcolonial State
 Superstition
 Symbolism
 Syncretism
 Terror
 Third Cinema
 Third World
 Third World Literature
 Time: Traditional and Utilitarian
 Totalitarianism
 Totems
 Trade
 Translation
 Treaty
 Untouchability: Menstrual Taboos
 Untouchability: Taboos
 Utopia
 Victorianism
 Visual Culture
 Volksgeist
 Volunteerism, U.S.
 War

- Westernization: Africa
 Westernization: Southeast Asia
 Wisdom, Human
 Witchcraft, African Studies of
 Womanism
 Women and Femininity in U.S. Popular Culture
 Women's History: Africa
 Women's Studies
 Work
 World Systems Theory, Latin America
 Zionism
- HISTORY**
- Aesthetics: Europe and the Americas
 Afrocentricity
 Afro pessimism
 Altruism
 Americanization, U.S.
 Anthropology
 Anticolonialism: Latin America
 Anticolonialism: Southeast Asia
 Anti-Semitism: Overview
 Architecture: Overview
 Architecture: Africa
 Asceticism: Hindu and Buddhist Asceticism
 Authoritarianism: Latin America
 Autobiography
 Autonomy
 Aztlán
 Barbarism and Civilization
 Biography
 Buddhism
 Capitalism: Overview
 Change
 Childhood and Child Rearing
 Chinese Thought
 City, The: The City as a Cultural Center
 Classification of Arts and Sciences, Early Modern
 Colonialism: Africa
 Colonialism: Latin America
 Colonialism: Southeast Asia
 Consciousness: Overview
 Conservatism
 Context
 Continental Philosophy
 Cosmology: Asia
 Creolization, Caribbean
 Crisis
 Cultural History
 Cultural Revivals
 Cultural Studies
 Cycles
 Dance
 Determinism
 Diasporas: African Diaspora
 Diasporas: Jewish Diaspora
 Dictatorship in Latin America
 Diffusion, Cultural
 Dress
 Ecology
 Economics
 Education: Europe
 Empire and Imperialism: Overview
 Empire and Imperialism: United States
 Enlightenment
 Environmental History
- Ethnography
 Ethnohistory, U.S.
 Eurocentrism
 Everyday Life
 Evil
 Extirpation
 Fascism
 Fatalism
 Feminism: Overview
 Feminism: Third World U.S. Movement
 Feudalism, European
 Futurology
 Gender in Art
 Generation
 Genius
 Genre
 Geography
 Globalization: Asia
 Hegelianism
 Hermeneutics
 Historical and Dialectical Materialism
 Historicism
Historiography
 History, Economic
History, Idea of
 Honor
 Iconography
 Ideas, History of
 Identity, Multiple: Jewish Multiple Identity
 Intelligentsia
 Intentionality
 Interdisciplinarity
 Internal Colonialism
 International Order
 Interpretation
 Islamic Science
 Japanese Philosophy, Japanese Thought
 Jihad
 Judaism: Judaism to 1800
 Knowledge
 Language and Linguistics
 Leadership
 Learning and Memory, Contemporary Views
 Life Cycle: Elders/Old Age
 Linguistic Turn
 Literary Criticism
 Literary History
 Literature: African Literature
 Love, Western Notions of
 Machiavellism
 Maoism
 Marxism: Overview
 Marxism: Asia
 Marxism: Latin America
 Matriarchy
 Media, History of
 Memory
 Mestizaje
 Metaphor
 Migration: Africa
 Migration: Migration in World History
 Millenarianism: Overview
 Millenarianism: Islamic
 Millenarianism: Latin America and Native North America

READER'S GUIDE

Modernism: Latin America
Modernity: Overview
Modernity: Africa
Modernity: East Asia
Modernization
Modernization Theory
Motif: Motif in Literature
Music, Anthropology of
Musicology
Narrative
Nation
Nationalism: Overview
Nationalism: Africa
Native Policy
Negritude
Nomadism
Nuclear Age
Occidentalism
Oral Traditions: Overview
Pan-Asianism
Paradigm
Patriotism
Peasants and Peasantry
Periodization
Periodization of the Arts
Philosophies: Feminist, Twentieth-Century
Philosophy: Historical Overview and Recent Developments
Philosophy, History of
Philosophy of Religion
Poetry and Poetics
Political Protest, U.S.
Polytheism
Postcolonial Theory and Literature
Postmodernism
Power
Practices
Pragmatism
Pre-Columbian Civilization
Presentism
Privacy
Progress, Idea of
Protest, Political
Public Sphere
Queer Theory
Race and Racism: Asia
Reading
Realism: Africa
Reflexivity
Reform: Europe and the United States
Reformation
Regions and Regionalism, Eastern Europe
Relativism
Religion: East and Southeast Asia
Religion: Indigenous Peoples' View, South America
Religion: Middle East
Religion and the State: United States
Renaissance
Republicanism: Latin America
Republicanism: Republic
Resistance
Responsibility
Revolution
Ritual: Public Ritual
Sacred Texts: Asia
Scarcity and Abundance, Latin America
Science: Overview
Science, History of
Scientific Revolution
Sexuality: Overview
Skepticism
Slavery
Social Capital
Social Darwinism
Social History, U.S.
Society
Sophists, The
Sport
State of Nature
Structuralism and Poststructuralism: Overview
Subjectivism
Surrealism
Syncretism
Technology
Theater and Performance
Theodicy
Third World
Time: China
Time: India
Time: Traditional and Utilitarian
Toleration
Totalitarianism
Trade
Treaty
Trope
Utopia
Victorianism
Visual Order to Organizing Collections
Volkgeist
War
War and Peace in the Arts
Westernization: Middle East
Westernization: Southeast Asia
Witchcraft
Witchcraft, African Studies of
Women's History: Africa
Women's History: Asia
World Systems Theory, Latin America

ANTHROPOLOGY AND SOCIOLOGY

Aesthetics: Asia
Aesthetics: Europe and the Americas
Africa, Idea of
Alienation
Altruism
Americanization, U.S.
Ancestor Worship
Anthropology
Anti-Semitism: Overview
Architecture: Overview
Architecture: Africa
Asceticism: Hindu and Buddhist Asceticism
Asceticism: Western Asceticism
Astronomy, Pre-Columbian and Latin American
Aztlán
Barbarism and Civilization
Beauty and Ugliness
Bilingualism and Multilingualism
Body, The
Borders, Borderlands, and Frontiers, Global
Buddhism

- Calendar
 Cannibalism
 Capitalism: Overview
 Character
 Childhood and Child Rearing
 Chinese Thought
 Cinema
 Citizenship: Cultural Citizenship
 City, The: The City as a Cultural Center
 Civil Society: Europe and the United States
 Colonialism: Latin America
 Colonialism: Southeast Asia
 Communication of Ideas: Orality and Advent of Writing
 Communication of Ideas: Southeast Asia
 Communitarianism in African Thought
 Composition, Musical
 Context
 Continental Philosophy
 Cosmopolitanism
 Creativity in the Arts and Sciences
 Creolization, Caribbean
 Cultural Capital
 Cultural History
 Cultural Revivals
 Cultural Studies
 Dance
 Death
 Death and Afterlife, Islamic Understanding of
 Demography
 Demonology
 Development
 Diasporas: African Diaspora
 Diasporas: Jewish Diaspora
 Diffusion, Cultural
 Discrimination
 Diversity
 Dream
 Dress
 Ecology
 Environment
 Environmental Ethics
 Environmental History
 Ethnicity and Race: Africa
 Ethnicity and Race: Anthropology
 Ethnocentrism
Ethnography
 Ethnohistory, U.S.
 Etiquette
 Eugenics
 Eurocentrism
 Europe, Idea of
 Everyday Life
 Extirpation
 Family: Modernist Anthropological Theory
 Family: Family in Anthropology since 1980
 Family Planning
 Fascism
 Feminism: Overview
 Feminism: Third World U.S. Movement
 Fetishism: Overview
 Gender Studies: Anthropology
 Generation
 Genetics: Contemporary
 Genetics: History of
 Gesture
 Ghetto
 Gift, The
 Globalization: Asia
 Hinduism
 Historiography
 History, Economic
 History, Idea of
 Honor
 Honor, Middle Eastern Notions of
 Humanism: Chinese Conception of
 Humanity: African Thought
 Humanity: European Thought
 Humor
 Ideas, History of
 Identity: Personal and Social Identity
 Identity, Multiple: Asian-Americans
 Identity, Multiple: Jewish Multiple Identity
 Intelligentsia
 Intentionality
 Interdisciplinarity
 Interpretation
 Jouissance
 Judaism: Modern Judaism
 Kinship
 Knowledge
 Language and Linguistics
Life Cycle: Overview
Life Cycle: Adolescence
Life Cycle: Elders/Old Age
 Linguistic Turn
 Literary Criticism
 Machiavellism
 Magic
 Manichaeism
 Marriage and Fertility, European Views
 Marxism: Overview
 Masks
 Matriarchy
 Meditation: Eastern Meditation
 Memory
 Men and Masculinity
 Mestizaje
 Metaphor
 Migration: Migration in World History
 Migration: United States
 Minority
 Motherhood and Maternity
 Motif: Motif in Music
 Music, Anthropology of
 Musical Performance and Audiences
 Musicology
 Mysticism: Chinese Mysticism
 Myth
 Nation
 Native Policy
 Natural History
 Occidentalism
 Oral Traditions: Overview
 Organicism
 Orientalism: African and Black Orientalism
 Orthodoxy
 Orthopraxy: Asia
 Other, The, European Views of
 Peasants and Peasantry
 Person, Idea of the

READER'S GUIDE

- Philosophies: Feminist, Twentieth-Century
 Philosophy, Moral: Africa
 Phrenology
 Pluralism
 Polytheism
 Postcolonial Theory and Literature
 Postmodernism
 Power
 Practices
 Pre-Columbian Civilization
 Prehistory, Rise of
 Prejudice
 Presentism
 Privacy
 Psychoanalysis
 Public Sphere
 Queer Theory
 Race and Racism: Asia
 Reading
 Reflexivity
 Reform: Europe and the United States
 Relativism
 Religion: Overview
 Religion: Africa
 Religion: African Diaspora
 Religion: Latin America
 Religion: Middle East
 Representation: Mental Representation
 Resistance
 Resistance and Accommodation
 Ritual: Public Ritual
 Ritual: Religion
 Sacred and Profane
 Scarcity and Abundance, Latin America
 Sexuality: Overview
 Sexuality: Sexual Orientation
 Social Capital
 Social Darwinism
 Social History, U.S.
 Society
 Sport
 State of Nature
 Structuralism and Poststructuralism: Overview
 Structuralism and Poststructuralism: Anthropology
 Subjectivism
 Superstition
 Surrealism
 Symbolism
 Syncretism
 Textiles and Fiber Arts as Catalysts for Ideas
 Theater and Performance
 Time: Traditional and Utilitarian
 Toleration
 Totalitarianism
 Totems
 Trade
 Tradition
 Tragedy and Comedy
 Tribalism, Middle East
 Trope
 Untouchability: Menstrual Taboos
 Untouchability: Taboos
 Utilitarianism
 Victorianism
 Virtue Ethics
 War and Peace in the Arts
 Westernization: Southeast Asia
 Wisdom, Human
 Witchcraft
 Witchcraft, African Studies of
 Women's History: Africa
 Work
 World Systems Theory, Latin America
 Yin and Yang
POLITICAL SCIENCE (emphasizing political philosophy)
 Abolitionism
 Absolute Music
 Africa, Idea of
 African-American Ideas
 Afrocentricity
 Afropessimism
 Alienation
 Altruism
 America
 Americanization, U.S.
 Anarchism
 Anthropology
 Anticolonialism: Africa
 Anticolonialism: Latin America
 Anticolonialism: Middle East
 Anticolonialism: Southeast Asia
 Anti-Semitism: Overview
 Anti-Semitism: Islamic Anti-Semitism
 Apartheid
 Architecture: Overview
 Architecture: Africa
 Architecture: Asia
 Asceticism: Western Asceticism
 Asian-American Ideas (Cultural Migration)
 Assimilation
 Astronomy, Pre-Columbian and Latin American
 Authoritarianism: Overview
 Authoritarianism: East Asia
 Authoritarianism: Latin America
 Authority
 Autobiography
 Avant-Garde: Militancy
 Aztlán
 Barbarism and Civilization
 Bilingualism and Multilingualism
 Bioethics
 Black Atlantic
 Black Consciousness
 Borders, Borderlands, and Frontiers, Global
 Bureaucracy
 Bushido
 Calculation and Computation
 Cannibalism
 Capitalism: Overview
 Capitalism: Africa
 Casuistry
 Censorship
 Chicano Movement
 Childhood and Child Rearing
 Chinese Warlordism
 Christianity: Overview
 Christianity: Asia
 Citizenship: Overview
 Citizenship: Cultural Citizenship
 Citizenship: Naturalization

- City, The: Latin America
 City, The: The City as a Cultural Center
 City, The: The City as Political Center
 Civil Disobedience
 Civil Society: Europe and the United States
 Civil Society: Responses in Africa and the Middle East Class
 Colonialism: Africa
 Colonialism: Latin America
 Colonialism: Southeast Asia
 Common Sense
 Communication of Ideas: Europe and Its Influence
 Communication of Ideas: Middle East and Abroad
 Communication of Ideas: Southeast Asia
 Communication of Ideas: The Americas and Their Influence
 Communism: Latin America
 Communism: Europe
 Communitarianism in African Thought
 Composition, Musical
 Computer Science
 Confucianism
 Consciousness: Overview
 Consciousness: Chinese Thought
 Conservatism
 Constitutionalism
 Continental Philosophy
 Corruption
 Corruption in Developed and Developing Countries
 Cosmopolitanism
 Creolization, Caribbean
 Critical Race Theory
 Cultural Studies
 Cycles
 Cynicism
 Dada
 Dance
 Daoism
Democracy
 Democracy, Africa
 Demography
 Dependency
 Determinism
 Dialogue and Dialectics: Socratic
 Diasporas: African Diaspora
 Diasporas: Jewish Diaspora
 Dictatorship in Latin America
 Discrimination
 Diversity
 Dress
 Dystopia
 Ecology
 Economics
 Education: China
 Education: Global Education
 Education: India
 Education: Japan
 Education: North America
 Empire and Imperialism: Overview
 Empire and Imperialism: Americas
 Empire and Imperialism: Asia
 Empire and Imperialism: Europe
 Empire and Imperialism: Middle East
 Empire and Imperialism: United States
 Environmental Ethics
 Environmental History
 Equality: Overview
 Equality: Gender Equality
 Equality: Racial Equality
 Ethnicity and Race: Africa
 Ethnicity and Race: Anthropology
 Ethnicity and Race: Islamic Views
 Etiquette
 Eugenics
 Eurocentrism
 Europe, Idea of
 Evil
 Examination Systems, China
 Existentialism
 Expressionism
 Extirpation
 Fallacy, Logical
 Family Planning
 Fascism
 Feminism: Overview
 Feminism: Africa and African Diaspora
 Feminism: Chicana Feminisms
 Feminism: Islamic Feminism
 Feminism: Third World U.S. Movement
 Fetishism: Overview
 Feudalism, European
 Friendship
 Fundamentalism
 Futurology
 Game Theory
 Garden
 Gay Studies
 Gender: Gender in the Middle East
 Gender in Art
 General Will
 Generation
 Genetics: Contemporary
 Genocide
 Ghetto
 Globalization: Africa
 Globalization: Asia
 Globalization: General
 Good
 Happiness and Pleasure in European Thought
 Heaven and Hell
 Heaven and Hell (Asian Focus)
 Hegelianism
 Hegemony
 Hinduism
 Historical and Dialectical Materialism
 Historiography
 History, Economic
 History, Idea of
 Honor
 Honor, Middle Eastern Notions of
 Human Capital
 Humanism: Chinese Conception of
 Humanism: Europe and the Middle East
 Humanism: Renaissance
 Humanism: Secular Humanism in the United States
 Humanity: African Thought
 Human Rights: Overview
 Human Rights: Women's Rights
 Hygiene
 Ideas, History of

READER'S GUIDE

- Identity, Multiple: Overview
 Identity, Multiple: Asian-Americans
 Identity, Multiple: Jewish Multiple Identity
 Individualism
 Intelligentsia
 Intentionality
 Intercession in Middle Eastern Society
 Interdisciplinarity
 Internal Colonialism
 International Order
 Islam: Africa
 Islam: Shii
 Islam: Southeast Asia
 Islam: Sunni
 Islamic Science
 Japanese Philosophy, Japanese Thought
 Jihad
 Jouissance
 Justice: Overview
 Justice: Justice in American Thought
 Justice: Justice in East Asian Thought
 Kantianism
 Kinship
 Knowledge
 Language and Linguistics
 Law
 Law, Islamic
 Leadership
 Legalism, Ancient China
 Liberalism
 Liberation Theology
 Liberty
 Life Cycle: Elders/Old Age
 Literary Criticism
 Literary History
 Literature: Overview
 Literature: African Literature
 Lysenkoism
 Machiavellism
 Machismo
 Maoism
 Maps and the Ideas They Express
 Marriage and Fertility, European Views
 Marxism: Overview
 Marxism: Asia
 Marxism: Latin America
 Masks
 Mathematics
 Matriarchy
 Medicine: Europe and the United States
 Meme
 Men and Masculinity
 Mestizaje
 Migration: Migration in World History
 Migration: United States
 Millenarianism: Islamic
 Millenarianism: Latin America and Native North America
 Minority
 Modernism: Overview
 Modernism: Latin America
 Modernity: Overview
 Modernity: Africa
 Modernity: East Asia
 Modernization
 Modernization Theory
 Mohism
Monarchy: Overview
 Monarchy: Islamic Monarchy
 Motherhood and Maternity
 Motif: Motif in Literature
 Multiculturalism, Africa
 Music, Anthropology of
 Musical Performance and Audiences
 Musicology
 Mysticism: Chinese Mysticism
 Myth
 Narrative
 Nation
 Nationalism: Overview
 Nationalism: Africa
 Nationalism: Cultural Nationalism
 Nationalism: Middle East
 Native Policy
 Natural Law
 Naturalism
 Negritude
 Neocolonialism
 Neoliberalism
 New Criticism
 Newtonianism
 Nihilism
 Nomadism
 Nonviolence
 Nuclear Age
 Objectivity
 Obligation
 Occidentalism
 Organicism
 Orientalism: Overview
 Orientalism: African and Black Orientalism
 Orthodoxy
 Orthopraxy: Asia
 Pacifism
 Pan-Africanism
 Pan-Arabism
 Pan-Asianism
 Pan-Islamism
 Pan-Turkism
 Paradigm
 Parties, Political
 Patriotism
 Peace
 Periodization of the Arts
 Person, Idea of the
 Personhood in African Thought
 Philanthropy
 Philosophies: American
 Philosophies: Feminist, Twentieth-Century
 Philosophies: Islamic
 Philosophy: Historical Overview and Recent Developments
 Philosophy, History of
 Philosophy, Moral: Africa
 Philosophy, Moral: Ancient
 Philosophy, Moral: Modern
 Philosophy of Religion
 Phrenology
 Pluralism
 Political Protest, U.S.

Political Science

Political, The
 Population
 Populism: Latin America
 Populism: United States
 Postcolonial Studies
 Poverty
 Power
 Practices
 Pre-Columbian Civilization
 Prejudice
 Presentism
 Privacy
 Privatization
 Probability
 Progress, Idea of
 Propaganda
 Property
 Protest, Political
 Pseudoscience
 Psychoanalysis
 Public Sphere
 Punishment
 Puritanism
 Pythagoreanism
 Quantum
 Queer Theory
 Race and Racism: Overview
 Race and Racism: Asia
 Race and Racism: United States
 Radicals/Radicalism
 Rational Choice
 Reading
 Realism
 Realism: Africa
 Reason, Practical and Theoretical
 Reflexivity
 Reform: Europe and the United States
 Reform: Islamic Reform
 Regions and Regionalism, Eastern Europe
 Relativism
 Religion: Africa
 Religion: African Diaspora
 Religion: East and Southeast Asia
 Religion: Latin America
 Religion: Middle East
 Religion and the State: Africa
 Religion and the State: Europe
 Religion and the State: Latin America
 Religion and the State: Middle East
 Religion and the State: United States
 Renaissance
 Representation: Political Representation
 Republicanism: Latin America
 Republicanism: Republic
 Resistance
 Resistance and Accommodation
 Responsibility
 Revolution
 Rhetoric: Ancient and Medieval
 Ritual: Public Ritual
 Romanticism in Literature and Politics
 Sacred and Profane
 Scarcity and Abundance, Latin America
 Science, History of

Science Fiction
 Secularization and Secularism
 Segregation
 Sexual Harassment
 Sexuality: Overview
 Sexuality: Islamic Views
 Sexuality: Sexual Orientation
 Shinto
 Skepticism
 Slavery
 Sociability in African Thought
 Social Capital
 Social Contract
 Social History, U.S.
 Socialism
 Socialisms, African
 Society
 Sophists, The
 Sovereignty
 Sport
 State, The: Overview
 State, The: The Postcolonial State
 State of Nature
 Stoicism
 Subjectivism
 Sufism
 Suicide
 Superstition
 Surrealism
 Symbolism
 Syncretism
 Technology
 Temperance
 Terror
 Terrorism, Middle East
 Third Cinema
 Third World
 Third World Literature
 Time: China
 Time: Traditional and Utilitarian
 Toleration
 Totalitarianism
 Trade
 Translation
 Treaty
 Tribalism, Middle East
 University: Postcolonial
 Untouchability: Menstrual Taboos
 Untouchability: Taboos
 Utilitarianism
 Utopia
 Victorianism
 Virtue Ethics
 Visual Order to Organizing Collections
 Volksgeist
 Volunteerism, U.S.
 War
 War and Peace in the Arts
 Wealth
 Westernization: Africa
 Westernization: Middle East
 Westernization: Southeast Asia
 Wildlife
 Witchcraft
 Witchcraft, African Studies of

READER'S GUIDE

- Women's History: Africa
Work
World Systems Theory, Latin America
Zionism
- ECONOMICS**
Abolitionism
Africa, Idea of
African-American Ideas
Afropessimism
Alienation
Altruism
Anarchism
Anthropology
Anticolonialism: Africa
Anticolonialism: Latin America
Anticolonialism: Middle East
Anticolonialism: Southeast Asia
Anti-Semitism: Islamic Anti-Semitism
Apartheid
Architecture: Africa
Arts: Africa
Asceticism: Western Asceticism
Asian-American Ideas (Cultural Migration)
Assimilation
Astronomy, Pre-Columbian and Latin American
Authoritarianism: East Asia
Authoritarianism: Latin America
Avant-Garde: Militancy
Bioethics
Black Atlantic
Black Consciousness
Bureaucracy
Bushido
Calculation and Computation
Capitalism: Overview
Capitalism: Africa
Chicano Movement
Cinema
City, The: The City as a Cultural Center
City, The: The City as Political Center
City, The: The Islamic and Byzantine City
Civil Society: Europe and the United States
Civil Society: Responses in Africa and the Middle East
Class
Colonialism: Africa
Colonialism: Southeast Asia
Communication of Ideas: Africa and Its Influence
Communication of Ideas: Middle East and Abroad
Communication of Ideas: Southeast Asia
Communism: Europe
Communism: Latin America
Composition, Musical
Confucianism
Consumerism
Corruption in Developed and Developing Countries
Critical Race Theory
Cultural Capital
Cultural History
Cultural Studies
Democracy: Africa
Demography
Dependency
Diasporas: African Diaspora
Diasporas: Jewish Diaspora
Dictatorship in Latin America
Diffusion, Cultural
Discrimination
Diversity
Dress
Dystopia
Economics
Education: China
Education: Global Education
Empire and Imperialism: Americas
Empire and Imperialism: Asia
Empire and Imperialism: Europe
Empire and Imperialism: Middle East
Empire and Imperialism: United States
Environmental Ethics
Environmental History
Equality: Overview
Equality: Gender Equality
Equality: Racial Equality
Eugenics
Eurocentrism
Europe, Idea of
Everyday Life
Examination Systems, China
Family: Modernist Anthropological Theory
Family Planning
Fascism
Feminism: Overview
Feminism: Africa and African Diaspora
Feminism: Chicana Feminisms
Feminism: Islamic Feminism
Feminism: Third World U.S. Movement
Fetishism: Overview
Fetishism: Fetishism in Literature and Cultural Studies
Feudalism, European
Futurology
Game Theory
Generation
Genetics: Contemporary
Ghetto
Gift, The
Globalization: Africa
Globalization: Asia
Globalization: General
Good
Hegelianism
Hegemony
Hinduism
Historical and Dialectical Materialism
Historicism
Historiography
History, Economic
History, Idea of
Human Capital
Human Rights: Women's Rights
Ideas, History of
Identity, Multiple: Asian-Americans
Indigenismo
Individualism
Intelligentsia
Intentionality
Internal Colonialism
Interpretation
Islam: Africa
Islam: Sunni
Islamic Science

- Jainism
- Japanese Philosophy, Japanese Thought
- Jihad
- Justice: Overview
- Justice: Justice in American Thought
- Law, Islamic
- Leadership
- Liberalism
- Liberation Theology
- Life Cycle: Elders/Old Age
- Literary Criticism
- Maoism
- Maps and the Ideas They Express
- Marriage and Fertility, European Views
- Marxism: Overview
- Marxism: Asia
- Marxism: Latin America
- Mathematics
- Migration: Africa
- Migration: Migration in World History
- Migration: United States
- Minority
- Modernity: Africa
- Modernity: East Asia
- Modernization
- Modernization Theory
- Motherhood and Maternity
- Nationalism: Africa
- Native Policy
- Naturalism
- Neocolonialism
- Neoliberalism
- Nomadism
- Nuclear Age
- Occidentalism
- Orthopraxy: Asia
- Pan-Africanism
- Pan-Asianism
- Parties, Political
- Peasants and Peasantry
- Philanthropy
- Philosophies: American
- Philosophy, History of
- Political Protest, U.S.
- Political Science
- Population
- Populism: Latin America
- Populism: United States
- Postcolonial Studies
- Poverty
- Practices
- Pre-Columbian Civilization
- Presentism
- Privacy
- Privatization
- Probability
- Progress, Idea of
- Property
- Protest, Political
- Pseudoscience
- Public Sphere
- Punishment
- Puritanism
- Race and Racism: United States
- Radicals/Radicalism
- Reason, Practical and Theoretical
- Reform: Europe and the United States
- Religion and the State: Africa
- Religion and the State: Latin America
- Renaissance
- Representation: Political Representation
- Republicanism: Republic
- Resistance
- Resistance and Accommodation
- Responsibility
- Ritual: Public Ritual
- Ritual: Religion
- Scarcity and Abundance, Latin America
- Secularization and Secularism
- Segregation
- Sexual Harassment
- Sexuality: Islamic Views
- Slavery
- Social Capital
- Social Darwinism
- Social History, U.S.
- Socialism
- Sport
- State, The: Overview
- State, The: The Postcolonial State
- Technology
- Terrorism, Middle East
- Third Cinema
- Third World
- Third World Literature
- Time: China
- Time: Traditional and Utilitarian
- Totalitarianism
- Trade
- Translation
- Travel: Travel from Europe and the Middle East
- Treaty
- Untouchability: Taboos
- Utilitarianism
- Victorianism
- Visual Culture
- Volunteerism, U.S.
- War and Peace in the Arts
- Wealth
- Westernization: Africa
- Westernization: Middle East
- Westernization: Southeast Asia
- Women and Femininity in U.S. Popular Culture
- Women's History: Africa
- Work
- World Systems Theory, Latin America
- Zen
- Zionism
- GEOGRAPHY
- Africa, Idea of
- America
- Anthropology
- Architecture: Overview
- Barbarism and Civilization
- Borders, Borderlands, and Frontiers, Global
- Capitalism: Overview
- Chinese Warlordism
- Cultural Studies
- Diffusion, Cultural
- Economics

READER'S GUIDE

Environment
Environmental History
Ethnicity and Race: Anthropology
Ethnicity and Race: Islamic Views
Eurocentrism
Feudalism, European
Geography
Ghetto
Globalization: Asia
Globalization: General
History, Economic
History, Idea of
Identity, Multiple: Jewish Multiple Identity
Islamic Science
Maps and the Ideas They Express
Mathematics
Migration: Africa
Migration: Migration in World History
Migration: United States
Minority
Nation
Nationalism: Africa
Natural History
Nomadism
Occidentalism
Orientalism: Overview
Pan-Africanism
Pan-Asianism
Perspective
Population
Privacy
Race and Racism: Asia
Race and Racism: United States
Regions and Regionalism, Eastern Europe
Religion: Indigenous Peoples' View, South America
Sacred Places
Scarcity and Abundance, Latin America
Third Cinema
Third World
Travel: Travel from Europe and the Middle East
Victorianism
Westernization: Southeast Asia
World Systems Theory, Latin America

Sciences

HISTORY OF SCIENCE, EARLY (entries focused on early ideas about nature and the human relationship with nature)
Alchemy: China
Alchemy: Europe and the Middle East
Anthropology
Aristotelianism
Asceticism: Hindu and Buddhist Asceticism
Astrology: Overview
Astrology: China
Astronomy, Pre-Columbian and Latin American
Change
Confucianism
Consciousness: Chinese Thought
Cosmology: Asia
Daoism
Ethnicity and Race: Africa
Ethnicity and Race: Anthropology
Ethnicity and Race: Islamic Views
Greek Science

Harmony
Hierarchy and Order
Hinduism
Humanism: Chinese Conception of
Humanity: African Thought
Ideas, History of
Lysenkoism
Magic
Manichaeism
Medicine: China
Medicine: India
Metaphysics: Ancient and Medieval
Mysticism: Chinese Mysticism
Myth
Natural Theology
Naturphilosophie
Organicism
Paradigm
Person, Idea of the
Philosophies: Islamic
Philosophy: Historical Overview and Recent Developments
Philosophy of Religion
Phrenology
Pseudoscience
Race and Racism: Europe
Race and Racism: United States
Religion: Indigenous Peoples' View, South America
Religion and Science
Ritual: Religion
Sacred Places
Science: East Asia
Segregation
Sexuality: Sexual Orientation
Slavery
Superstition
Syncretism
Time: China
Time: India
Untouchability: Menstrual Taboos
Witchcraft
Yin and Yang
HISTORY OF SCIENCE, MODERN AND CONTEMPORARY (entries focused on the origins of modern or contemporary ideas in the physical, chemical, biological, mathematical, or earth sciences)
Agnosticism
Algebras
Behaviorism
Body, The
Calendar
Cartesianism
Causation
Causation in East Asian and Southeast Asian Philosophy
Chemistry
Communication of Ideas: Middle East and Abroad
Computer Science
Context
Continental Philosophy
Cosmology: Cosmology and Astronomy
Creationism
Creativity in the Arts and Sciences
Cultural History
Demonology
Determinism

- Development
 Ecology
 Education: Islamic Education
 Empiricism
 Enlightenment
 Environment
 Environmental History
 Epistemology: Early Modern
 Equality: Racial Equality
 Everyday Life
 Experiment
 Falsifiability
 Free Will, Determinism, and Predestination
 Health and Disease
 History, Economic
 Idealism
 Islamic Science
 Kantianism
 Knowledge
 Life
 Linguistic Turn
 Mathematics
 Mechanical Philosophy
 Medicine: Europe and the United States
 Medicine: Islamic Medicine
 Metaphor
 Museums
 Nature
 Newtonianism
 Nuclear Age
 Objectivity
 Philosophies: African
 Philosophies: Feminist, Twentieth-Century
 Philosophy, History of
 Philosophy of Mind: Overview
 Philosophy of Mind: Ancient and Medieval
 Physics
 Platonism
 Poetry and Poetics
 Positivism
 Prehistory, Rise of
 Probability
 Progress, Idea of
 Pythagoreanism
 Quantum
 Race and Racism: Asia
 Rationalism
 Reason, Practical and Theoretical
 Reflexivity
 Reform: Europe and the United States
 Relativity
 Renaissance
 Scholasticism
 Science: Overview
Science, History of
Scientific Revolution
 Sexuality: Overview
 Social Darwinism
 Social History, U.S.
 Technology
 Victorianism
 Visual Order to Organizing Collections
PSYCHOLOGY
 Absolute Music
 Aesthetics: Asia
 Aesthetics: Europe and the Americas
 Alchemy: Europe and the Middle East
 Alienation
 Altruism
 Ambiguity
 Ancestor Worship
 Animism
 Anthropology
 Anti-Semitism: Overview
 Asceticism: Hindu and Buddhist Asceticism
 Asceticism: Western Asceticism
 Authoritarianism: East Asia
 Beauty and Ugliness
 Behaviorism
 Bioethics
 Biography
 Biology
 Body, The
 Buddhism
 Cartesianism
 Character
 Cinema
 Communitarianism in African Thought
 Composition, Musical
 Computer Science
 Consciousness: Overview
 Consciousness: Chinese Thought
 Consciousness: Indian Thought
 Consumerism
 Context
 Continental Philosophy
 Creativity in the Arts and Sciences
 Cultural Studies
 Dada
 Dance
 Daoism
 Death
 Demonology
 Determinism
 Diffusion, Cultural
 Discrimination
 Dream
 Emotions
 Empiricism
 Epistemology: Early Modern
 Epistemology: Modern
 Ethnicity and Race: Africa
 Eugenics
 Everyday Life
 Existentialism
 Feminism: Overview
 Fetishism: Overview
 Fetishism: Fetishism in Literature and Cultural Studies
 Form, Metaphysical, in Ancient and Medieval Thought
 Foundationalism
 Friendship
 Gay Studies
 Gender: Overview
 Gender: Gender in the Middle East
 Gender in Art
 Gender Studies: Anthropology
 Gesture
 Harmony
 Hate
 Health and Disease

READER'S GUIDE

Heaven and Hell
Hinduism
Humanism: Secular Humanism in the United States
Humanity: African Thought
Humanity: European Thought
Identity: Identity of Persons
Identity: Personal and Social Identity
Identity, Multiple: Overview
Identity, Multiple: Asian-Americans
Images, Icons, and Idols
Imagination
Immortality and the Afterlife
Impressionism
Indigenismo
Intentionality
Jainism
Jouissance
Kinship
Knowledge
Language and Linguistics
Learning and Memory, Contemporary Views
Life
Life Cycle: Elders/Old Age
Literary Criticism
Love, Western Notions of
Machismo
Magic
Manichaeism
Masks
Medicine: China
Medicine: Europe and the United States
Meditation: Eastern Meditation
Memory
Men and Masculinity
Metaphor
Metaphysics: Renaissance to the Present
Mind
Modernism: Overview
Modernity: Overview
Modernity: Africa
Modernity: East Asia
Monarchy: Overview
Monism
Motherhood and Maternity
Musical Performance and Audiences
Mysticism: Chinese Mysticism
Mysticism: Islamic Mysticism in Asia
Myth
Narrative
National History
Nationalism: Overview
Naturphilosophie
Negritude
Objectivity
Person, Idea of the
Personhood in African Thought
Philosophies: Islamic
Philosophy, Moral: Modern
Philosophy of Mind: Overview
Philosophy of Mind: Ancient and Medieval
Philosophy of Religion
Phrenology
Political Science
Prejudice
Presentism
Privacy
Probability
Progress, Idea of
Protest, Political
Psychoanalysis
Psychology and Psychiatry
Punishment
Queer Theory
Realism: Africa
Reflexivity
Religion: Africa
Religion: African Diaspora
Religion: Indigenous Peoples' View, South America
Religion: Latin America
Religion and Science
Representation: Mental Representation
Resistance and Accommodation
Responsibility
Ritual: Public Ritual
Sexuality: Overview
Sexuality: Sexual Orientation
Slavery
State of Nature
Structuralism and Poststructuralism: Overview
Subjectivism
Superstition
Surrealism
Symbolism
Syncretism
Temperance
Text/Textuality
Third Cinema
Toleration
Totalitarianism
Tragedy and Comedy
Untouchability: Menstrual Taboos
Untouchability: Taboos
Utilitarianism
War and Peace in the Arts
Witchcraft
Witchcraft, African Studies of
Womanism
Women and Femininity in U.S. Popular Culture

BIOLOGICAL SCIENCES
Agnosticism
Altruism
Ancestor Worship
Anthropology
Antifeminism
Asceticism: Hindu and Buddhist Asceticism
Asceticism: Western Asceticism
Beauty and Ugliness
Behaviorism
Bioethics
Biology
Body, The
Buddhism
Cannibalism
Cartesianism
Casuistry
Classification of Arts and Sciences, Early Modern
Composition, Musical
Computer Science
Consciousness: Overview
Consilience

- Creationism
 Critical Race Theory
 Death
 Demography
 Determinism
 Development
 Dystopia
 Ecology
 Emotions
 Environmental Ethics
 Environmental History
 Epistemology: Early Modern
 Equality: Racial Equality
 Ethnohistory, U.S.
 Eugenics
Evolution
 Family: Modernist Anthropological Theory
 Family: Family in Anthropology since 1980
 Family Planning
 Feminism: Overview
 Game Theory
 Garden
 Gender: Overview
 Gender: Gender in the Middle East
 Gender in Art
 Gender Studies: Anthropology
Genetics: Contemporary
Genetics: History of
 Genocide
 Gesture
 Greek Science
 Health and Disease
 Heaven and Hell
 History, Idea of
 Humanism: Secular Humanism in the United States
 Humanity: African Thought
 Hygiene
 Identity: Identity of Persons
 Immortality and the Afterlife
 Intentionality
 Islamic Science
 Jainism
 Jouissance
 Kinship
 Learning and Memory, Contemporary Views
 Life
 Life Cycle: Adolescence
 Life Cycle: Elders/Old Age
 Lysenkoism
 Machiavellism
 Marriage and Fertility, European Views
 Masks
 Materialism in Eighteenth-Century European Thought
 Mechanical Philosophy
 Medicine: China
 Medicine: Europe and the United States
 Medicine: Islamic Medicine
 Meme
 Memory
 Men and Masculinity
 Mestizaje
 Monarchy: Overview
 Motherhood and Maternity
 Musical Performance and Audiences
 Natural History
 Naturalism
 Natural Theology
 Nature
 Naturphilosophie
 Negritude
 Organicism
 Other, The, European Views of
 Periodization of the Arts
 Person, Idea of the
 Perspective
 Philosophies: Islamic
 Philosophy of Mind: Ancient and Medieval
 Phrenology
 Population
 Prehistory, Rise of
 Probability
 Progress, Idea of
 Psychoanalysis
 Psychology and Psychiatry
 Punishment
 Queer Theory
 Religion: Indigenous Peoples' View, South America
 Representation: Mental Representation
 Science: East Asia
 Science, History of
 Sexuality: Overview
 Sexuality: Sexual Orientation
 Sociability in African Thought
 Social Darwinism
 Sport
 State of Nature
 Subjectivism
 Superstition
 Temperance
 Terror
 Text/Textuality
 Totems
 Untouchability: Menstrual Taboos
 Utilitarianism
 Victorianism
 Visual Order to Organizing Collections
 War and Peace in the Arts
 Wildlife
 Women and Femininity in U.S. Popular Culture
- PHYSICAL SCIENCES**
 Agnosticism
 Alchemy: China
 Astrology: China
 Astronomy, Pre-Columbian and Latin American
 Calculation and Computation
 Calendar
 Causality
 Causation
 Causation in East Asian and Southeast Asian Philosophy
 Change
 Chemistry
 Classification of Arts and Sciences, Early Modern
 Computer Science
 Consciousness: Overview
 Consilience
 Cosmology: Asia
 Cosmology: Cosmology and Astronomy
 Creationism
 Cycles

READER'S GUIDE

Ecology
 Empiricism
 Environmental Ethics
 Environmental History
 Epistemology: Early Modern
 Ethnohistory, U.S.
 Experiment
 Falsifiability
 Field Theories
 Form, Metaphysical, in Ancient and Medieval Thought
 Geography
 Geometry
 Greek Science
 Harmony
 Hinduism
 History, Economic
 Islam: Sunni
 Islamic Science
 Japanese Philosophy, Japanese Thought
 Knowledge
 Language, Philosophy of: Modern
 Life
 Literary History
 Logic and Philosophy of Mathematics, Modern
 Maps and the Ideas They Express
 Materialism in Eighteenth-Century European Thought
 Mathematics
 Mechanical Philosophy
 Metaphysics: Renaissance to the Present
 Microcosm and Macrocosm
 Monism
 Myth
 Natural Theology
 Naturalism
 Nature
 Naturphilosophie
 Newtonianism
 Nuclear Age
 Paradigm
 Periodization of the Arts
 Philosophies: Islamic
 Philosophy: Historical Overview and Recent Developments
 Philosophy, History of
Physics
 Positivism
 Power
 Pragmatism
 Probability
 Progress, Idea of
 Psychoanalysis
 Pythagoreanism
 Quantum
 Rationalism
 Realism: Africa
 Reason, Practical and Theoretical
 Relativity
 Religion: East and Southeast Asia
 Religion: Indigenous Peoples' View, South America
 Religion and Science
 Science: Overview
 Science: East Asia
 Science, History of
 Scientific Revolution
 Sophists, The

Stoicism
 Subjectivism
 Superstition
 Time: China
 Time: India
 Victorianism
ECOLOGY AND GEOLOGY
 Aesthetics: Asia
 Anthropology
 Architecture: Overview
 Architecture: Asia
 Astronomy, Pre-Columbian and Latin American
 Authoritarianism: Overview
 Bioethics
 Biology
 Borders, Borderlands, and Frontiers, Global
 Calendar
 Capitalism: Overview
 City, The: Latin America
 City, The: The City as a Cultural Center
 City, The: The Islamic and Byzantine City
 Creationism
 Death
 Dystopia
Ecology
 Education: Global Education
Environment
 Environmental Ethics
 Environmental History
 Evolution
 Feminism: Overview
 Garden
 Genetics: Contemporary
 Genetics: History of
 Genocide
 Geography
 History, Economic
 History, Idea of
 Hygiene
 Impressionism
 Landscape in the Arts
 Life
 Life Cycle: Elders/Old Age
 Lysenkoism
 Machiavellism
 Maps and the Ideas They Express
 Matriarchy
 Medicine: Islamic Medicine
 Memory
 Migration: Migration in World History
Natural History
 Nuclear Age
 Organicism
 Periodization of the Arts
 Political Protest, U.S.
 Prehistory, Rise of
 Presentism
 Protest, Political
 Religion: Latin America
 Ritual: Religion
 Scarcity and Abundance, Latin America
 Science, History of
 Social Darwinism
 Totems
 Untouchability: Menstrual Taboos

- Utopia
- Visual Order to Organizing Collections
- Wildlife
- Witchcraft
- Witchcraft, African Studies of
- World Systems Theory, Latin America
- CHEMISTRY**
- Alchemy: China
- Alchemy: Europe and the Middle East
- Biology
- Chemistry**
- Classification of Arts and Sciences, Early Modern
- Computer Science
- Consciousness: Overview
- Development
- Experiment
- Genetics: Contemporary
- Genetics: History of
- Health and Disease
- Islamic Science
- Life
- Materialism in Eighteenth-Century European Thought
- Mechanical Philosophy
- Medicine: Europe and the United States
- Mysticism: Chinese Mysticism
- Paradigm
- Philosophies: Islamic
- Physics
- Quantum
- Science: East Asia
- Science, History of
- MATHEMATICS**
- Absolute Music
- Aesthetics: Europe and the Americas
- Algebras**
- Analytical Philosophy
- Astronomy, Pre-Columbian and Latin American
- Beauty and Ugliness
- Calculation and Computation
- Causation
- Causation in East Asian and Southeast Asian Philosophy
- Chemistry
- Classification of Arts and Sciences, Early Modern
- Computer Science
- Cosmology: Cosmology and Astronomy
- Death
- Demography
- Economics
- Empiricism
- Environmental History
- Equality: Overview
- Experiment
- Fallacy, Logical
- Falsifiability
- Foundationalism
- Futurology
- Game Theory
- Generation
- Genetics: Contemporary
- Genetics: History of
- Genocide
- Geometry**
- Harmony
- History, Economic
- Humanism: Chinese Conception of
- Islamic Science
- Knowledge
- Language, Philosophy of: Ancient and Medieval
- Language, Philosophy of: Modern
- Language and Linguistics
- Logic and Philosophy of Mathematics, Modern
- Mathematics**
- Newtonianism
- Perspective
- Philosophies: Islamic
- Philosophy: Historical Overview and Recent Developments
- Physics
- Political Science
- Positivism
- Prejudice
- Probability
- Pythagoreanism
- Quantum
- Rationalism
- Reading
- Reason, Practical and Theoretical
- Relativism
- Relativity
- Representation: Mental Representation
- Scientific Revolution
- Social History, U.S.
- Sophists, The
- Truth
- COMPUTER SCIENCE**
- Calculation and Computation**
- Computer Science**
- Consciousness: Overview
- Futurology
- Game Theory
- Genetics: Contemporary
- Genetics: History of
- Geography
- History, Economic
- Interdisciplinarity
- Language and Linguistics
- Learning and Memory, Contemporary Views
- Maps and the Ideas They Express
- Mathematics
- Privacy
- Probability
- Social History, U.S.
- Virtual Reality
- Professions**
- MEDICINE**
- Alchemy: China
- Alchemy: Europe and the Middle East
- Americanization, U.S.
- Ancestor Worship
- Anthropology
- Asceticism: Hindu and Buddhist Asceticism
- Asceticism: Western Asceticism
- Astrology: China
- Bioethics
- Biology
- Body, The
- Casuistry
- Chemistry
- Childhood and Child Rearing

READER'S GUIDE

- Computer Science
 Creativity in the Arts and Sciences
 Death
 Demography
 Determinism
 Diversity
 Environment
 Environmental History
 Eugenics
 Feminism: Overview
 Feminism: Third World U.S. Movement
 Gay Studies
 Gender: Overview
 Gender Studies: Anthropology
 Genetics: Contemporary
 Genetics: History of
 Greek Science
Health and Disease
 Hinduism
 Humanity: African Thought
 Humor
 Hygiene
 Iconography
 Islam: Sunni
 Islamic Science
 Life
 Life Cycle: Elders/Old Age
 Literary Criticism
 Magic
 Mathematics
Medicine: China
Medicine: Europe and the United States
Medicine: India
Medicine: Islamic Medicine
 Meditation: Eastern Meditation
 Miracles
 Motherhood and Maternity
 Music, Anthropology of
 Mysticism: Chinese Mysticism
 Narrative
 Naturphilosophie
 Philosophies: Feminist, Twentieth-Century
 Philosophies: Islamic
 Phrenology
 Population
 Privacy
 Psychoanalysis
 Psychology and Psychiatry
 Pythagoreanism
 Queer Theory
 Religion: Africa
 Religion: African Diaspora
 Religion: East and Southeast Asia
 Religion: Indigenous Peoples' View, South America
 Ritual: Religion
 Science: East Asia
 Science, History of
 Sexuality: Overview
 Skepticism
 Superstition
 University: Overview
 Untouchability: Menstrual Taboos
 Utilitarianism
 Victorianism
 Visual Culture
 Visual Order to Organizing Collections
 Volunteerism, U.S.
 Westernization: Africa
 Witchcraft
 Women and Femininity in U.S. Popular Culture
 Yin and Yang
- LAW**
- Abolitionism
 African-American Ideas
 Altruism
 Anticolonialism: Africa
 Anticolonialism: Latin America
 Anticolonialism: Southeast Asia
 Antifeminism
 Anti-Semitism: Islamic Anti-Semitism
 Apartheid
 Asian-American Ideas (Cultural Migration)
 Assimilation
 Authoritarianism: Overview
 Authoritarianism: East Asia
 Barbarism and Civilization
 Bioethics
 Black Consciousness
 Cannibalism
 Capitalism: Overview
 Capitalism: Africa
 Casuistry
 Censorship
 Citizenship: Overview
 Citizenship: Cultural Citizenship
 Citizenship: Naturalization
 City, The: The Islamic and Byzantine City
 Civil Disobedience
 Civil Society: Europe and the United States
 Colonialism: Southeast Asia
 Consciousness: Chinese Thought
 Constitutionalism
 Context
 Corruption in Developed and Developing Countries
 Creationism
 Critical Race Theory
 Cultural History
 Cultural Revivals
 Deism
 Democracy
 Democracy: Africa
 Dialogue and Dialectics: Socratic
 Dialogue and Dialectics: Talmudic
 Dictatorship in Latin America
 Discrimination
 Diversity
 Education: Islamic Education
 Empire and Imperialism: Overview
 Empire and Imperialism: Europe
 Empire and Imperialism: United States
 Environmental History
 Equality: Overview
 Equality: Racial Equality
 Ethnicity and Race: Anthropology
 Ethnicity and Race: Islamic Views
 Europe, Idea of
 Extirpation
 Fallacy, Logical
 Falsifiability
 Family Planning

- Fascism
 Feminism: Overview
 Feminism: Africa and African Diaspora
 Feminism: Islamic Feminism
 Feudalism, European
 Gender: Gender in the Middle East
 General Will
 Genetics: Contemporary
 Genetics: History of
 Genocide
 Ghetto
 Globalization: Africa
 Good
 Hate
 Heresy and Apostasy
 Hinduism
 Honor, Middle Eastern Notions of
 Human Rights: Overview
 Humanism: Secular Humanism in the United States
 Iconography
 Identity, Multiple: Jewish Multiple Identity
 Indigenismo
 Individualism
 Intentionality
 Interdisciplinarity
 International Order
 Islam: Africa
 Islam: Shi'i
 Islam: Southeast Asia
 Islam: Sunni
 Jihad
 Judaism: Judaism to 1800
 Justice: Overview
 Justice: Justice in American Thought
 Justice: Justice in East Asian Thought
 Kinship
 Language and Linguistics
Law
Law, Islamic
 Learning and Memory, Contemporary Views
 Legalism, Ancient China
 Liberalism
 Liberty
 Life Cycle: Elders/Old Age
 Literary Criticism
 Loyalties, Dual
 Marriage and Fertility, European Views
 Masks
 Matriarchy
 Migration: United States
 Minority
 Modernity: Overview
 Monarchy: Overview
 Monarchy: Islamic Monarchy
 Motherhood and Maternity
 Mysticism: Islamic Mysticism
 Narrative
 Nation
 Nationalism: Cultural Nationalism
 Nationalism: Middle East
 Native Policy
 Natural Law
 Nonviolence
 Nuclear Age
 Obligation
 Person, Idea of the
 Philanthropy
 Philosophies: American
 Philosophies: Feminist, Twentieth-Century
 Philosophies: Islamic
 Philosophy: Historical Overview and Recent Developments
 Philosophy, Moral: Ancient
 Political Protest, U.S.
 Population
 Postcolonial Studies
 Power
 Privacy
 Progress, Idea of
 Property
 Protest, Political
 Punishment
 Queer Theory
 Race and Racism: United States
 Reason, Practical and Theoretical
 Reform: Europe and the United States
 Regions and Regionalism, Eastern Europe
 Relativism
 Religion: African Diaspora
 Religion: Middle East
 Religion and the State: Africa
 Religion and the State: Europe
 Religion and the State: Middle East
 Religion and the State: United States
 Representation: Political Representation
 Republicanism: Republic
 Resistance
 Responsibility
 Rhetoric: Ancient and Medieval
 Ritual: Public Ritual
 Sacred Texts: Koran
 Segregation
 Sexual Harassment
 Sexuality: Overview
 Sexuality: Islamic Views
 Sexuality: Sexual Orientation
 Skepticism
 Slavery
 Sociability in African Thought
 Social Contract
 Socialisms, African
 Society
 State, The: Overview
 State, The: The Postcolonial State
 State of Nature
 Stoicism
 Subjectivism
 Sufism
 Suicide
 Temperance
 Toleration
 Totalitarianism
 Treaty
 University: Overview
 Untouchability: Taboos
 Utilitarianism
 Victorianism
 Virtue Ethics
 Visual Order to Organizing Collections
 Volunteerism, U.S.
 War and Peace in the Arts

READER'S GUIDE

Westernization: Africa
Westernization: Middle East
Westernization: Southeast Asia
Wildlife
Witchcraft
ENGINEERING
Alchemy: China
Alchemy: Europe and the Middle East
Architecture: Overview
Architecture: Africa
Architecture: Asia
Beauty and Ugliness
Biology
Calculation and Computation
Capitalism: Overview
Capitalism: Africa
Cinema
City, The: Latin America
City, The: The City as a Cultural Center
City, The: The City as Political Center
City, The: The Islamic and Byzantine City
Communication of Ideas: Southeast Asia
Computer Science
Diffusion, Cultural
Dystopia
Ecology
Empire and Imperialism: Europe
Environmental History
Epistemology: Early Modern
Experiment
Futurology
Gender Studies: Anthropology
Genetics: Contemporary
Genetics: History of
Genocide
Geometry
Globalization: General
Greek Science
Harmony
Historical and Dialectical Materialism
History, Economic
Humanism: Secular Humanism in the United States
Interdisciplinarity
Japanese Philosophy, Japanese Thought
Knowledge
Literary Criticism
Maps and the Ideas They Express
Mathematics
Mechanical Philosophy
Meme
Modernity: Overview
Modernity: Africa
Modernity: East Asia
Modernization
Modernization Theory
Motherhood and Maternity
Music, Anthropology of
Musical Performance and Audiences
Mysticism: Chinese Mysticism
Newtonianism
Nomadism
Nuclear Age
Occidentalism
Perspective
Power

Presentism
Privacy
Progress, Idea of
Protest, Political
Reform: Europe and the United States
Relativity
Science, History of
Science Fiction
Technology
Textiles and Fiber Arts as Catalysts for Ideas
Totalitarianism
Victorianism
Virtual Reality
Visual Culture
War and Peace in the Arts
Westernization: Middle East
Westernization: Southeast Asia
World Systems Theory, Latin America

Multidisciplinary Practices

The *New Dictionary of the History of Ideas* has many entries that discuss the methods by which scholars and researchers pursue knowledge. The entries below discuss approaches, methods, and practices that have influenced many disciplines.

ENTRIES ON MULTIDISCIPLINARY PRACTICES THAT ORIGINATED IN ANCIENT TIMES

Aesthetics: Asia
Africa, Idea of
Algebras
Anthropology
Architecture: Overview
Architecture: Asia
Aristotelianism
Astrology: Overview
Biology
Body, The
Buddhism
Casuistry
Causality
Censorship
Classicism
Classification of Arts and Sciences, Early Modern
Composition, Musical
Cosmology: Asia
Creationism
Creativity in the Arts and Sciences
Daoism
Development
Dialogue and Dialectics: Socratic
Dualism
Eclecticism
Education: China
Education: Europe
Epistemology: Ancient
Equality: Overview
Essentialism
Eurocentrism
Experiment
Fallacy, Logical
Fetishism: Fetishism in Literature and Cultural Studies
Form, Metaphysical, in Ancient and Medieval Thought
Fundamentalism
Gender in Art
Genre

- Geometry
 Greek Science
 Harmony
 Health and Disease
 Hierarchy and Order
 Hinduism
 History, Idea of
 Humanism: Europe and the Middle East
 Humor
 Ideas, History of
 Imagination
 Interpretation
 Knowledge
 Language, Philosophy of: Ancient and Medieval
 Life
 Literary History
 Literature: African Literature
 Logic
 Maps and the Ideas They Express
 Mathematics
 Medicine: China
 Medicine: Europe and the United States
 Medicine: India
 Memory
 Metaphor
 Metaphysics: Ancient and Medieval
 Monism
 Museums
 Music, Anthropology of
 Musical Performance and Audiences
 Mysticism: Chinese Mysticism
 Narrative
 Nature
 Orthodoxy
 Orthopraxy: Asia
 Orthopraxy: Western Orthopraxy
 Paradigm
 Periodization
 Perspective
 Philosophies: African
 Philosophies: Islamic
 Philosophy: Historical Overview and Recent Developments
 Philosophy and Religion in Western Thought
 Physics
 Platonism
 Presentism
 Progress, Idea of
 Pythagoreanism
 Rationalism
 Reading
 Reason, Practical and Theoretical
 Religion: Overview
 Responsibility
 Rhetoric: Overview
 Rhetoric: Ancient and Medieval
 Sacred Places
 Sacred Texts: Asia
 Science: East Asia
 Scientific Revolution
 Skepticism
 Sophists, The
 Syncretism
 Taste
 Text/Textuality
 Toleration
 Translation
 Trope
 Truth
 Virtual Reality
 Wisdom, Human
 Yin and Yang
- ENTRIES ON MULTIDISCIPLINARY PRACTICES OF MORE RECENT ORIGIN
 Absolute Music
 Aesthetics: Africa
 African-American Ideas
 Afrocentricity
 Analytical Philosophy
 Astronomy, Pre-Columbian and Latin American
 Avant-Garde: Militancy
 Behaviorism
 Bilingualism and Multilingualism
 Bioethics
 Black Atlantic
 Calculation and Computation
 Class
 Conservatism
 Consilience
 Continental Philosophy
 Critical Race Theory
 Critical Theory
 Cultural Studies
 Dada
 Dialogue and Dialectics: Talmudic
 Dream
 Dystopia
 Economics
 Education: Global Education
 Education: Islamic Education
 Empiricism
 Encyclopedism
 Environmental Ethics
 Environmental History
 Epistemology: Early Modern
 Epistemology: Modern
 Ethnicity and Race: Anthropology
 Ethnocentrism
 Ethnography
 Ethnohistory, U.S.
 Examination Systems, China
 Expressionism
 Family: Modernist Anthropological Theory
 Feminism: Overview
 Fetishism: Overview
 Field Theories
 Formalism
 Futurology
 Game Theory
 Gender: Gender in the Middle East
 Generation
 Genetics: Contemporary
 Genetics: History of
 Geography
 Hegelianism
 Hermeneutics
 Historicism
 Humanism: Africa
 Humanism: Renaissance
 Iconography

Idealism
 Identity: Identity of Persons
 Intentionality
 Interdisciplinarity
 Japanese Philosophy, Japanese Thought
 Language, Philosophy of: Modern
 Language and Linguistics
 Law, Islamic
 Learning and Memory, Contemporary Views
 Linguistic Turn
 Literary Criticism
 Logic and Philosophy of Mathematics, Modern
 Masks
 Metaphysics: Renaissance to the Present
 Mind
 Modernism: Overview
 Modernism: Latin America
 Modernization
 Modernization Theory
 Motif: Motif in Literature
 Motif: Motif in Music
 Mysticism: Kabbalah
 Myth
 Naturalism
 Naturalism in Art and Literature
 Naturphilosophie
 Newtonianism
 Objectivity
 Oral Traditions: Overview
 Orientalism: Overview
 Philosophies: Feminist, Twentieth-Century
 Philosophy, Moral: Africa
 Philosophy of Religion
 Phrenology
 Poetry and Poetics
 Polytheism
 Positivism
 Postcolonial Studies
 Postmodernism
 Power
 Practices
 Pragmatism
 Prejudice
 Probability
 Pseudoscience
 Psychoanalysis
 Queer Theory
 Realism
 Realism: Africa
 Reflexivity
 Regions and Regionalism, Eastern Europe
 Relativism
 Relativity
 Religion: Indigenous Peoples' View, South America
 Religion and Science
 Representation: Mental Representation
 Romanticism in Literature and Politics
 Sacred Texts: Koran
 Sage Philosophy
 Scholasticism
 Science: Overview
 Science, History of
 Science Fiction
 Secularization and Secularism
 Social Capital

Social History, U.S.
 State, The: Overview
 Structuralism and Poststructuralism: Overview
 Structuralism and Poststructuralism: Anthropology
 Subjectivism
 Symbolism
 Third Cinema
 Totems
 Tradition
 Universalism
 Utilitarianism
 Visual Culture
 Volksgeist
 Women's Studies

Especially Interdisciplinary Entries

The most interdisciplinary entries synthesized knowledge by using the methods and focusing on the topics of practitioners of several disciplines. Very few entries listed below are in only one division. Common pairs for the history of ideas are social sciences and humanities, social sciences and sciences, and humanities and sciences. In the early twenty-first century there is generally a recognition of the common overlap of the social sciences with the humanities; social scientists may take ethical and literary factors into consideration and humanists may incorporate societal contexts into their work. The presence of psychology in the sciences, as well as the quantitative nature of some social sciences work, creates an overlap of social sciences with sciences. Another interesting overlap is between humanities and sciences—topics that in antiquity were treated as philosophy or religion are now investigated by those following scientific methods.

SOCIAL SCIENCES, SCIENCES, AND FINE ARTS

Architecture: Africa
 Geography
 Phrenology
 Virtual Reality

SCIENCES, FINE ARTS, AND HUMANITIES

Enlightenment
 Epistemology: Early Modern
 Feminism: Third World U.S. Movement
 Field Theories
 Geometry
 Globalization: Asia
 Text/Textuality

FINE ARTS, HUMANITIES, AND SOCIAL SCIENCES

Aesthetics: Africa
 Alienation
 Americanization, U.S.
 Anticolonialism: Africa
 Arts: Overview
 Arts: Africa
 Authenticity: Africa
 Autobiography
 Avant-Garde: Overview
 Aztlán
 Censorship
 Chinese Thought
 City, The: The Islamic and Byzantine City
 Civil Disobedience
 Civil Society: Europe and the United States
 Colonialism: Southeast Asia
 Communication of Ideas: Africa and Its Influence
 Communication of Ideas: The Americas and Their Influence

Communication of Ideas: Asia and Its Influence
 Communication of Ideas: Orality and Advent of Writing
 Cultural Capital
 Cultural History
 Cynicism
 Dialogue and Dialectics: Socratic
 Dialogue and Dialectics: Talmudic
 Diasporas: Jewish Diaspora
 Dictatorship in Latin America
 Etiquette
 Everyday Life
 Expressionism
 Extirpation
 Fascism
 Feminism: Chicana Feminisms
 Gay Studies
 Gender Studies: Anthropology
 Genre
 Ghetto
 Honor
 Humanity in the Arts
 Humor
 Identity, Multiple: Jewish Multiple Identity
 Images, Icons, and Idols
 Islam: Shii
 Landscape in the Arts
 Leadership
 Life Cycle: Overview
 Linguistic Turn
 Literature: African Literature
 Maoism
 Millenarianism: Islamic
 Millenarianism: Latin America and Native North America
 Minority
 Modernism: Latin America
 Musicology
 Mysticism: Christian Mysticism
 Mysticism: Islamic Mysticism in Asia
 Mysticism: Kabbalah
 Mysticism: Mysticism in African Thought
 Nation
 New Criticism
 Nude, The
 Oral Traditions: Overview
 Orientalism: Overview
 Orthodoxy
 Orthopraxy: Asia
 Pan-Africanism
 Pan-Asianism
 Pan-Turkism
 Philosophies: African
 Philosophies: American
 Philosophy, Moral: Ancient
 Populism: United States
 Postmodernism
 Practices
 Pre-Columbian Civilization
 Realism
 Religion: Africa
 Religion: Middle East
 Religion and the State: United States
 Renaissance
 Resistance

Romanticism in Literature and Politics
 Sage Philosophy
 Shinto
 Society
 Taste
 Theater and Performance
 Theodicy
 Third World Literature
 Wisdom, Human
HUMANITIES, SOCIAL SCIENCES, AND SCIENCES
 Afropessimism
 Alchemy: China
 Alchemy: Europe and the Middle East
 Altruism
 Antifeminism
 Asceticism: Hindu and Buddhist Asceticism
 Asceticism: Western Asceticism
 Astrology: China
 Astrology: Overview
 Borders, Borderlands, and Frontiers, Global
 Calculation and Computation
 Calendar
 Capitalism: Overview
 Capitalism: Africa
 Cartesianism
 Casuistry
 Causality
 Causation
 Causation in East Asian and Southeast Asian Philosophy
 Character
 Chicano Movement
 Childhood and Child Rearing
 Confucianism
 Consciousness: Chinese Thought
 Consciousness: Indian Thought
 Consilience
 Cosmology: Asia
 Cycles
 Daoism
 Demography
 Demonology
 Discrimination
 Dress
 Dualism
 Education: Islamic Education
 Empiricism
 Equality: Racial Equality
 Ethnicity and Race: Africa
 Ethnohistory, U.S.
 Fallacy, Logical
 Foundationalism
 Futurology
 Genetics: Contemporary
 Genetics: History of
 Genocide
 Health and Disease
 Hermeneutics
 Historical and Dialectical Materialism
 Hygiene
 Intelligentsia
 Internal Colonialism
 Islam: Africa
 Jainism
 Japanese Philosophy, Japanese Thought
 Kinship

READER'S GUIDE

- Law, Islamic
 Machiavellism
 Machismo
 Medicine: China
 Medicine: India
 Meme
 Memory
 Mestizaje
 Modernization Theory
 Motif: Motif in Music
 Museums
 Music, Anthropology of
 Nationalism: Africa
 Natural History
 Naturalism
 Negritude
 Objectivity
 Philosophy, History of
 Philosophy, Moral: Modern
 Philosophy of Religion
 Population
 Positivism
 Pragmatism
 Prejudice
 Presentism
 Privacy
 Probability
 Quantum
 Race and Racism: Overview
 Race and Racism: Asia
 Race and Racism: Europe
 Reason, Practical and Theoretical
 Religion: Overview
 Religion and Science
 Science: Overview
 Scientific Revolution
 Segregation
 Sexuality: Islamic Views
 Sexuality: Sexual Orientation
 Skepticism
 State of Nature
 Structuralism and Poststructuralism: Overview
 Time: China
 Time: India
 Truth
 Universalism
 University: Overview
 Wildlife
 World Systems Theory, Latin America
- FINE ARTS, HUMANITIES, SOCIAL SCIENCES, AND SCIENCES**
 Absolute Music
 Aesthetics: Asia
 Aesthetics: Europe and the Americas
 Ancestor Worship
 Anthropology
 Architecture: Overview
 Architecture: Asia
 Astronomy, Pre-Columbian and Latin American
 Beauty and Ugliness
 Bilingualism and Multilingualism
 Bioethics
 Body, The
 Cannibalism
 Change
 Chemistry
 Cinema
 City, The: The City as a Cultural Center
 City, The: The City as Political Center
 Classification of Arts and Sciences, Early Modern
 Communication of Ideas: Southeast Asia
 Composition, Musical
 Computer Science
 Consciousness: Overview
 Consumerism
 Context
 Continental Philosophy
 Cosmopolitanism
 Creationism
 Critical Theory
 Cultural Studies
 Dance
 Death
 Determinism
 Dream
 Dystopia
 Ecology
 Emotions
 Empire and Imperialism: Europe
 Environment
 Environmental Ethics
 Environmental History
 Equality: Overview
 Equality: Gender Equality
 Ethnicity and Race: Islamic Views
 Eugenics
 Examination Systems, China
 Feminism: Overview
 Fetishism: Overview
 Fetishism: Fetishism in Literature and Cultural Studies
 Friendship
 Game Theory
 Gender: Gender in the Middle East
 Gender in Art
 Generation
 Greek Science
 Harmony
 Heaven and Hell
 Hinduism
 History, Economic
 History, Idea of
 Humanity: African Thought
 Ideas, History of
 Identity, Multiple: Overview
 Intentionality
 Interdisciplinarity
 Islam: Sunni
 Islamic Science
 Kantianism
 Knowledge
 Language and Linguistics
 Learning and Memory, Contemporary Views
 Life
 Literary Criticism
 Literary History
 Love, Western Notions of
 Magic
 Manichaeism
 Maps and the Ideas They Express
 Masks

- Mathematics
 Matriarchy
 Medicine: Europe and the United States
 Medicine: Islamic Medicine
 Meditation: Eastern Meditation
 Men and Masculinity
 Metaphor
 Modernism: Overview
 Monarchy: Overview
 Modernity: Africa
 Modernity: East Asia
 Motherhood and Maternity
 Musical Performance and Audiences
 Mysticism: Chinese Mysticism
 Myth
 Narrative
 Newtonianism
 Nomadism
 Nuclear Age
 Occidentalism
 Organicism
 Paradigm
 Periodization of the Arts
 Person, Idea of the
 Philosophies: Feminist, Twentieth-Century
 Philosophies: Islamic
 Philosophy: Historical Overview and Recent Developments
 Poetry and Poetics
 Political Protest, U.S.
 Progress, Idea of
 Property
 Protest, Political
 Pseudoscience
 Psychoanalysis
 Punishment
 Pythagoreanism
 Queer Theory
 Reading
 Realism: Africa
 Reflexivity
 Reform: Europe and the United States
 Relativism
 Religion: East and Southeast Asia
 Religion: Indigenous Peoples' View, South America
 Religion: Latin America
 Representation: Mental Representation
 Resistance and Accommodation
 Responsibility
 Ritual: Public Ritual
 Ritual: Religion
 Sacred Places
 Science: East Asia
 Science, History of
 Science Fiction
 Sexuality: Overview
 Social History, U.S.
 Sophists, The
 Sport
 Stoicism
 Subjectivism
 Superstition
 Surrealism
 Symbolism
 Syncretism
 Temperance
 Third Cinema
 Toleration
 Totalitarianism
 Totems
 Tragedy and Comedy
 Untouchability: Menstrual Taboos
 Untouchability: Taboos
 Utilitarianism
 Utopia
 Victorianism
 Visual Culture
 Visual Order to Organizing Collections
 Volunteerism, U.S.
 War and Peace in the Arts
 Westernization: Middle East
 Westernization: Southeast Asia
 Witchcraft
 Witchcraft, African Studies of
 Yin and Yang



P

CONTINUED

PHYLOGENY. See **Development.**

PHYSICS. It should be understood that a full understanding of the history of physics would include consideration of its institutional, social, and cultural contexts. Physics became a scientific discipline during the nineteenth century, gaining a clear professional and cognitive identity as well as patronage from a number of institutions (especially those pertaining to education and the state). Before the nineteenth century, researchers who did work that we now refer to as *physics* identified themselves in more general terms—such as *natural philosopher* or *applied mathematician*—and discussion of their work often adopts a retrospective definition of physics.

For researchers of the nineteenth century, physics involved the development of quantifiable laws that could be tested by conducting experiments and taking precision measurements. The laws of physics focused on fundamental processes, often discovered in particular areas of research, such as mechanics, electricity and magnetism, optics, fluids, thermodynamics, and the kinetic theory of gases. The various specialists saw physics as a unified science, since they shared the same concepts and laws, with energy becoming the central unifying concept by the end of the century. In forming its cognitive and institutional identity, physics distinguished itself from other scientific and technical disciplines, including mathematics, engineering, chemistry, and astronomy. However, as we will see, the history of physics cannot be understood without considering developments in these other areas.

Middle Ages

The Middle Ages inherited a wealth of knowledge from antiquity, including the systematic philosophy of Aristotle (384–322 B.C.E.) and the synthesis of ancient astronomy in the work of the Hellenistic astronomer Ptolemy (fl. second century C.E.). In agreement with those before him, Aristotle maintained that the terrestrial and celestial realms, separated by the orbit of the Moon, featured entirely different physical behaviors. His terrestrial physics was founded on the existence of four elements (earth, water, air, and fire) and the idea that every motion requires the specification of a cause for that motion. Aristotle considered two broad classes of motion: natural motion, as an object returned to its natural place (as dictated by its elemental composition), and violent motion, as an object was removed forcibly from its natural place. Because the natural place of the element earth was at the center of the cos-

mos, Aristotle's physics necessitated a geocentric, or Earth-centered, model of the heavens.

Whereas the terrestrial realm featured constant change, the heavenly bodies moved in uniform circular orbits and were perfect and unchanging. Starting from an exhaustive tabulation of astronomical data, Ptolemy modeled the orbits of each heavenly body using a complex system of circular motions, including a fundamental deferent and one or more epicycles. Often, Ptolemy was forced to make additions, including the eccentric model (in which the center of rotation of the orbiting body was offset from Earth) and the equant model (in which a fictitious point, also not located at Earth, defined uniform motion).

Despite the great value of this work, the West lost a good portion of it with the erosion of the Roman Empire. Luckily, a number of Islamic scholars took an interest in the knowledge of the ancients. In addition to translating Aristotle and Ptolemy (among others) into Arabic, they commented on these works extensively and made a number of innovations in astronomy, optics, matter theory, and mathematics (including the use of “Arabic numerals,” with the zero as a placeholder). For example, al-Battani (c. 858–929) made improvements to Ptolemy's orbits of the Sun and Moon, compiled a revised catalog of stars, and worked on the construction of astronomical instruments. Avempace (Ibn Badja, c. 1095–1138 or 1139) developed a position first staked out by the Neoplatonist philosopher John Philoponus (fl. sixth century C.E.), arguing that Aristotle was wrong to claim that the time for the fall of a body was proportional to its weight. After the reconquest of Spain during the twelfth century, ancient knowledge became available once again in the Latin West. Arab commentators such as Averroes (Ibn Rushd, 1126–1198) became influential interpreters of an Aristotle that was closer to the original texts and quite different from the glosses and explanatory aids that the West had grown accustomed to.

During the late Middle Ages, there was a general revival of learning and science in the West. The mathematician Jordanus de Nemore (fl. thirteenth century C.E.) pioneered a series of influential studies of static bodies. In addition to studying levers, Jordanus analyzed the (lower) apparent weight of a mass resting on an inclined plane. Despite the church's condemnation of certain radical interpretations of Aristotelianism during the late thirteenth century, there followed a flowering of activity during the fourteenth century, particularly concerning the problem of motion. Two important centers of activity were Merton College (at Oxford), where a group of mathematicians

and logicians included Thomas Bradwardine (c. 1290–1349) and Richard Swineshead (d. 1355), and the University of Paris, which included John Buridan (c. 1295–1358) and Nicole Oresme (c. 1325–1382).

The scholars at Merton College adopted a distinction between dynamics (in which the causes of motion are specified) and kinematics (in which motion is only described). The dynamical problems implied by Aristotelian physics, especially the problem of projectile motion, occupied many medieval scholars (see sidebar, “Causes of Motion: Medieval Understandings”). In kinematics, the release from the search for causation encouraged a number of new developments. The Mertonians developed the concept of velocity in analogy with the medieval idea of the intensity of a quality (such as the redness of an apple), and distinguished between uniform (constant velocity) and nonuniform (accelerated) motion. They also gave the first statement of the mean velocity theorem, which offered a way of comparing constant-acceleration motion to uniform motion.

While the Mertonians presented their analyses of motion through the cumbersome medium of words, other scholars developed graphical techniques. The most influential presentation of the mean speed theorem was offered by Oresme, who recorded the duration of the motion along a horizontal line (or “subject line”) and indicated the intensity of the velocity as a sequence of vertical line segments of varying height. Figure 1 shows that an object undergoing constant acceleration travels the same distance as if it were traveling for the same period of time at its average velocity (the average of its initial and final velocity). Although this work remained entirely abstract and was not based on experiment, it helped later work in kinematics, most notably Galileo’s.

Following Aristotle’s physics, medieval scholars pictured the celestial realm as being of unchanging perfection. Each heavenly body (the Sun, the Moon, the planets, and the sphere of the fixed stars) rotated around Earth on its own celestial sphere. Ptolemy’s addition of epicycles on top of Aristotle’s concentric spheres led medieval astronomers to speak of “partial orbs” within the “total orb” of each heavenly body. The

orbs communicated rotational movement to one another without any resistive force and were made of a quintessence or ether, which was an ageless, transparent substance. Beyond the outermost sphere of the fixed stars was the “final cause” of the Unmoved Mover, which was usually equated with the Christian God. Buridan suggested that God impressed an impetus on each orb at the moment of creation and, in the absence of resistance, they had been rotating ever since. Both Buridan and Oresme considered the possibility of a rotating Earth as a way of explaining the diurnal motion of the fixed stars, and found their arguments to be promising but not sufficiently convincing.

Sixteenth and Seventeenth Centuries

The period of the scientific revolution can be taken to extend, simplistically but handily, from 1543, with the publication of Nicolaus Copernicus’s *De revolutionibus orbium coelestium*, to 1687, with the publication of Isaac Newton’s *Philosophiae naturalis principia mathematica*, often referred to simply as the *Principia*. The term “revolution” remains useful, despite the fact that scholars have suggested that the period shows significant continuities with what came before and after. Copernicus (1473–1543) was attracted to a heliocentric, or Sun-centered, model of the universe (already considered over one thousand years before by Aristarchus of Samos) because it eliminated a number of complexities from Ptolemy’s model (including the equant), provided a simple explanation for the diurnal motion of the stars, and agreed with certain theological ideas of his own regarding the Sun as a kind of mystical motive force of the heavens. Among the problems posed by Copernicus’s model of the heavens, the most serious was that it contradicted Aristotelian physics.

Heliocentrism was pursued again by the German mathematician Johannes Kepler (1571–1630). Motivated by a deep religious conviction that a mathematical interpretation of nature reflected the grand plan of the Creator and an equally deep commitment to Copernicanism, Kepler worked with the Danish astronomer Tycho Brahe (1546–1601) with the intention of calculating the orbits of the planets around the Sun. After Brahe’s death, Kepler gained control of his former associate’s data and worked long and hard on the orbit of Mars, eventually to conclude that it was elliptical. Kepler’s so-called “three laws” were identified later by other scholars (including Newton) from different parts of his work, with the elliptical orbits of the planets becoming the first law. The second and third laws were his findings that the area swept out by a line connecting the Sun and a particular planet is the same for any given period of time; and that the square of a planet’s period of revolution around the Sun is proportional to the cube of its distance from the Sun.

The career of Galileo Galilei (1564–1642) began in earnest with his work on improved telescopes and using them to make observations that lent strength to Copernicanism, including the imperfections of the Moon’s surface and the satellites of Jupiter. His public support of Copernicanism led to a struggle with the church, but his greater importance lies with his study of statics and kinematics, in his effort to formulate a new physics that would not conflict with the hypothesis of a moving Earth.

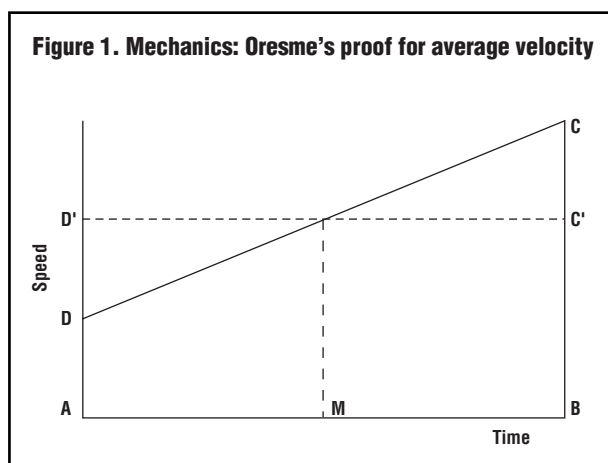

His work in statics was influenced by the Dutch engineer Simon Stevin (1548–1620), who made contributions to the analysis of the lever, to hydrostatics, and to arguments on the impossibility of perpetual motion. Galileo also repeated Stevin’s experiments on free fall, which disproved Aristotle’s contention that heavy bodies fall faster than light bodies, and wrote about them in *On Motion* (1590), which remained unpublished during his lifetime. There, he made use of a version of Buridan’s impetus theory (see sidebar, “Causes of Motion: Medieval Understandings”), but shifted attention from the total weight of the object to the weight per unit volume. By the time of *Two New Sciences* (1638), he generalized this idea by claiming that all bodies—of whatever size and composition—fell with equal speed through a vacuum.

Two New Sciences summarized most of Galileo’s work in statics and kinematics (the “two sciences” of the title). In order to better study the motion of bodies undergoing constant acceleration, Galileo used inclined planes pitched at very small angles in order to slow down the motion of a rolling ball. By taking careful distance and time measurements, and using the results of medieval scholars (including the mean speed theorem), he was able to show that the ball’s instantaneous velocity increased linearly with time and that its distance increased according to the square of the time. Furthermore, Galileo proposed a notion of inertial motion as a limiting case of a ball rolling along a perfectly horizontal plane. Because, in this limiting case, the motion of the ball would ultimately follow the circular shape of the earth, his idea is sometimes referred to as a “circular inertia.” Finally, Galileo presented his analysis of parabolic trajectories as a compound motion, made up of inertial motion in the horizontal direction and constant acceleration in the vertical.

The French philosopher René Descartes (1596–1650) and his contemporary Pierre Gassendi (1592–1655) independently came up with an improved conception of inertial motion. Both suggested that an object moving at constant speed and in a straight line (not Galileo’s circle) was conceptually equivalent to the object being at rest. Gassendi tested this idea by observing the path of falling weights on a moving carriage. In his *Principia philosophiae* (1644), Descartes presented a number of other influential ideas, including his view that the physical world was a kind of clockwork mechanism. In order to communicate cause and effect in his “mechanical philosophy,” all space was filled with matter, making a vacuum impossible. Descartes suggested, for example, that the planets moved in their orbits via a plenum of fine matter that communicated the influence of the Sun through the action of vortices.

Building on work in optics by Kepler, Descartes used the mechanical philosophy to derive the laws of reflection and refraction. In his *Dioptrics* (1631), he proposed that if light travels at different velocities in two different media, then the sine of the angle of incidence divided by the sine of the angle of refraction is a constant that is characteristic of a particular pair of media. This law of refraction had been discovered earlier, in 1621, by the Dutch scientist Willibrord Snel, though Descartes was probably unaware of this work. In 1662, the French mathematician Pierre de Fermat recast the law of refraction by showing that it follows from the principle that light

follows the path of least time (not necessarily the least distance) between two points.

The study of kinematics yielded various conservation laws for collisions and falling bodies. Descartes defined the “quantity of motion” as the mass times the velocity (what is now called “momentum”) and claimed that any closed system had a fixed total quantity of motion. In disagreement with Descartes, Gottfried Wilhelm von Leibniz (1646–1716) suggested instead the “living force” or *vis viva* as a measure of motion, equal to the mass times the square of the velocity (similar to what is now called “kinetic energy”). For a falling body, Leibniz asserted that the living force plus the “dead force,” the weight of the object times its distance off the ground (similar to “potential energy”), was a constant.

The culmination of the scientific revolution is the work of Isaac Newton. In the *Principia* (1687), Newton presented a new mechanics that encompassed not only terrestrial physics but also the motion of the planets. A short way into the first book (“Of the Motion of Bodies”), Newton listed his axioms or laws of motion:

1. Every body perseveres in its state of being at rest or of moving uniformly straight forward, except insofar as it is compelled to change its state by forces impressed . . .
2. A change in motion is proportional to the motive force impressed and takes place along the straight line in which that force is impressed . . .
3. To any action there is always an opposite and equal reaction; in other words, the actions of two bodies upon each other are always equal and always opposite in direction . . . (1999, pp. 416–417)

The first law restates Descartes’s concept of rectilinear, inertial motion. The second law introduces Newton’s concept of force, as an entity that *causes* an object to depart from inertial motion. Following Descartes, Newton defined motion as the mass times the velocity. Assuming that the mass is constant, the “change of motion” is the mass (m) times the acceleration (a); thus the net force (F) acting on an object is given by the equation $F = ma$. Analyzing the motion of the Moon

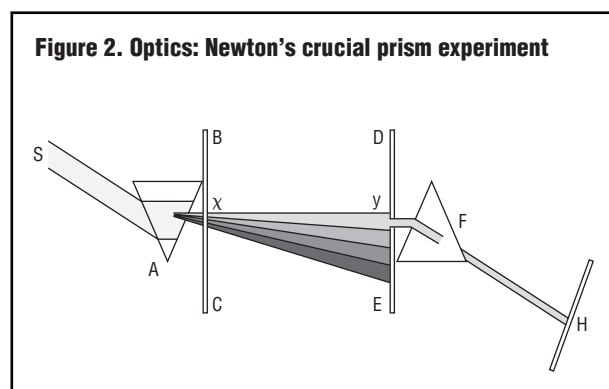

led Newton to the inverse-square law of universal gravitation. Partly as a result of a debate with the scientist Robert Hooke (1635–1703), Newton came to see the Moon as undergoing a compound motion, made up of a tangential, inertial motion and a motion toward the Sun due to the Sun’s gravitational attraction. The Dutch physicist Christiaan Huygens (1629–1695) had suggested that there was a centrifugal force acting *away* from the center of rotation, which was proportional to v^2/r , where v is the velocity and r is the distance from the center of rotation. Newton had derived this result before Huygens but later renamed it the centripetal force, the force that is required to keep the body in orbit and that points *toward* the center of rotation. Using this relation and Kepler’s finding that the square of the period was proportional to the cube of the distance (Kepler’s “third law”), Newton concluded that the gravitational force on the Moon was proportional to the inverse square of its distance from Earth.

Newton presented his law of universal gravitation in the third book of the *Principia* (“The System of the World”), and showed that it was consistent with Kepler’s findings and the orbits of the planets. Although he derived many of these results using a technique that he invented called the method of fluxions—differential calculus—Newton presented them in the *Principia* with the geometrical formalism familiar to readers of the time. He did not publish anything of his work on the calculus until *De Analysisi* (1711; On analysis) during a priority dispute with Leibniz, who invented it independently.

Eighteenth Century

It is helpful to identify two broad tendencies in eighteenth- and nineteenth-century physics, which had been noted by a number of contemporaries, including the German philosopher Immanuel Kant (1724–1804). On the one hand, a mechanical approach analyzed the physical universe as a great machine and built models relying on commonsense notions of cause and effect. This sometimes required the specification of ontological entities to communicate cause and effect, such as Descartes’s plenum. On the other hand, the dynamical approach avoided mechanical models and, instead, concentrated on the mathematical relationship between quantities that could be measured. However, in avoiding mechanical models, the dynamical approach often speculated on the existence of active powers that resided within matter but could not be observed directly. Although this distinction is helpful, many scientists straddled the divide. Newton’s physics, and the general Newtonian scientific culture of the eighteenth century, utilized elements of both approaches. It held true to a mechanical-world picture in analyzing macroscopic systems involving both contact, as in collisions, and action at a distance, as in the orbital motion. But it also contained a dynamical sensibility. Regarding gravity, Newton rejected Descartes’s plenum and speculated that gravity might be due to an all-pervasive ether, tantamount to God’s catholic presence. Such reflections appeared in Newton’s private notes and letters, but some of these became known during the 1740s.

The development of mechanics during the eighteenth century marks one place where the histories of physics and mathematics overlap strongly. Mathematicians with an interest in

physical problems recast Newtonian physics in an elegant formalism that took physics away from geometrical treatment and toward the reduction of physical problems to mathematical equations using calculus. Some of these developments were motivated by attempts to confirm Newton’s universal gravitation. The French mathematician Alexis-Claude Clairaut (1713–1765) used perturbation techniques to account for tiny gravitational forces affecting the orbits of heavenly bodies. In 1747 Clairaut published improved predictions for the Moon’s orbit, based on three-body calculations of the Moon, Earth, and Sun, and, in 1758, predictions of the orbit of Halley’s comet, which changed slightly each time that it passed a planet. Some years later, Pierre-Simon Laplace produced a five-volume study, *Celestial Mechanics* (1799–1825), which showed that changes in planetary orbits, which had previously appeared to be accumulative, were in fact self-correcting. His (perhaps apocryphal) response to Napoléon’s question regarding the place of God in his calculations has come to stand for eighteenth-century deism: “Sire, I had no need for that hypothesis.”

The most important mathematical work was the generalization of Newton’s mechanics using the calculus of variations. Starting from Fermat’s principle of least time, Louis Moreau de Maupertuis (1698–1759) proposed that, for a moving particle, nature always sought to minimize a certain quantity equal to the mass times the velocity times the distance that the particle moves. This “principle of least action” was motivated by the religious idea that the economy of nature gave evidence of God’s existence. The Swiss mathematician Leonhard Euler (1707–1783) recast this idea (but without Maupertuis’s religious motivations) by minimizing the integral over distance of the mass of a particle times its velocity. The Italian Joseph-Louis Lagrange (1736–1813) restated and clarified Euler’s idea, by focusing on minimizing the *vis viva* integrated over time. His *Mécanique analytique* (1787) summarized the whole of mechanics, for both solids and fluids and statics and dynamics.

In its high level of mathematical abstraction and its rejection of mechanical models, Lagrange’s formalism typified a dynamical approach. In addition to making a number of problems tractable that had been impossible in Newton’s original approach, the use of the calculus of variations removed from center stage the concept of force, a vector quantity (with magnitude and direction), and replaced it with scalar quantities (which had only magnitude). Lagrange was proud of the fact that *Mécanique analytique* did not contain a single diagram.

Newton’s physics could be applied to continuous media just as much as systems of masses. In his *Hydrodynamica* (1738), the Swiss mathematician Daniel Bernoulli used conservation of *vis viva* to analyze fluid flow. His most famous result was an equation describing the rate at which liquid flows from a hole in a filled vessel. Euler elaborated on Bernoulli’s analyses and developed additional formalism, including the general differential equations of fluid flow and fluid continuity (but restricted to the case of zero viscosity). Clairaut contributed to hydrostatics through his involvement with debates regarding the shape of the earth. In developing a Newtonian prediction, Clairaut analyzed the earth as a fluid mass. After defining an equilibrium condition, he showed that the earth

should have an oblate shape, which was confirmed by experiments with pendulums at the earth's equator and as far north as Lapland.

The study of optics inherited an ambivalence from the previous century, which considered two different mechanical explanations of light. In his *Opticks* (1704), Newton had advocated a corpuscular, atomistic theory of light. As an emission of particles, light interacted with matter by vibrating in different ways and was therefore either reflected or refracted. In contrast with this, Descartes and Huygens proposed a wave theory of light, arguing that space was full and that light was nothing more than the vibration of a medium.

During the eighteenth century, most scientists preferred Newton's model of light as an emission of particles. The most important wave theory of light was put forward by Euler, who hypothesized that, in analogy with sound waves, light propagated through a medium, but that the medium itself did not travel. Euler also associated certain wavelengths with certain colors. After Euler, considerable debate occurred between the particle and wave theories of light. This debate was resolved during the early nineteenth century in favor of the wave theory. Between 1801 and 1803, the English physician Thomas Young conducted a series of experiments, the most notable of which was his two-slit experiment, which demonstrated that two coherent light sources set up interference patterns, thus behaving like two wave sources. This work was largely ignored until 1826, when Augustin-Jean Fresnel presented a paper to the French Academy of Science that reproduced Young's experiments and presented a mathematical analysis of the results.

Electrical research was especially fruitful in the eighteenth century and attracted a large number of researchers. Electricity was likened to "fire," the most volatile element in Aristotle's system. Electrical fire was an imponderable fluid that could be made to flow from one body to another but could not be weighed (see sidebar, "Forms of Matter"). After systematic experimentation, the French soldier-scientist Charles-François Du Fay (1698–1739) developed a two-fluid theory of electricity, positing both a negative and a positive fluid. The American statesman and scientist Benjamin Franklin (1706–1790) proposed a competing, one-fluid model. Franklin suggested that electrical fire was positively charged, mutually repulsive, and contained in every object. When fire was added to a body, it showed a positive charge; when fire was removed, the body showed a negative charge. Franklin's theory was especially successful in explaining the behavior of the Leyden jar (an early version of the capacitor) invented by Ewald Georg von Kleist in 1745. The device was able to store electrical fire using inner and outer electrodes, with the surface of the glass jar in between. Franklin's interpretation was that the glass was impervious to electrical fire and that while one electrode took on fire, the other electrode expelled an equal amount (see Fig. 3).

After early efforts by John Robison and Henry Cavendish, the first published precision measurements of the electric force law were attributed to the French physicist and engineer Charles-Augustin de Coulomb (1736–1806). Coulomb used

Figure 3. Electricity: One of Franklin's experiments with the Leyden jar

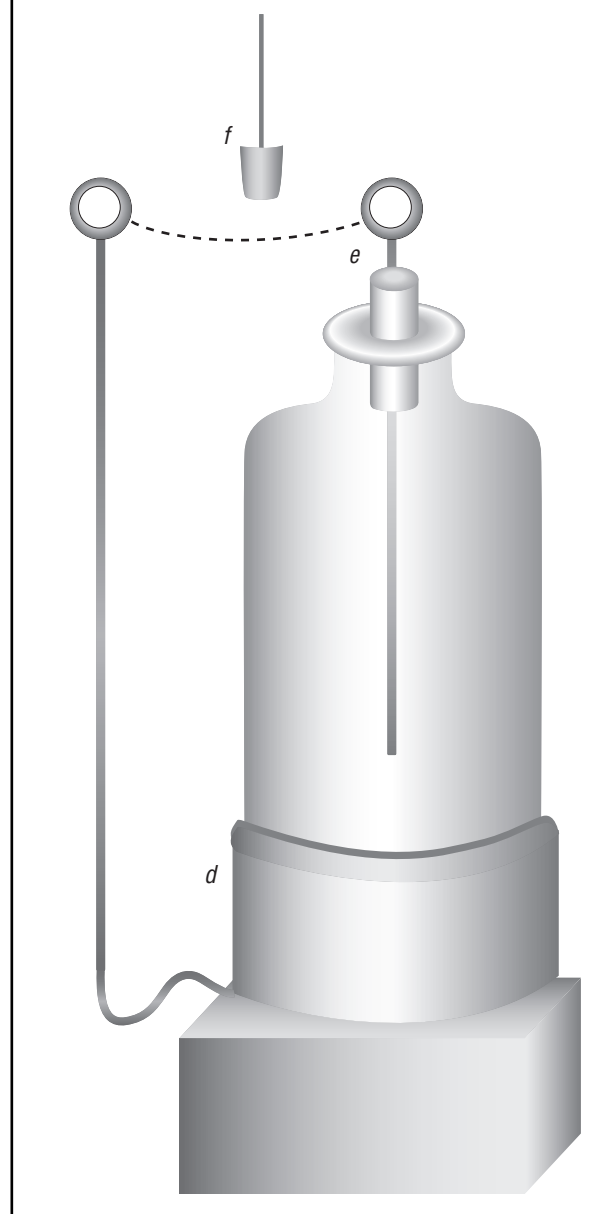

a torsion balance to measure the small electrostatic force on pairs of charged spheres and found that it was proportional to the inverse square of the distance between the spheres and to the amount of charge on each sphere. At the close of the century, Cavendish used a similar device to experimentally confirm Newton's universal law of gravitation, using relatively large masses.

Nineteenth Century

The development of physics during the nineteenth century can be seen as both a culmination of what went before and as

CAUSES OF MOTION: MEDIEVAL UNDERSTANDINGS

Medieval scholars put considerable effort into modifying Aristotelian dynamics and answering the problems posed by it. Because most terrestrial bodies were composed of many elements, their natural motion was explained by summing the total power of heavy and light elements. This led medieval scholars to consider the minority type of material as providing a kind of “internal resistance.” Using this idea, motion in a hypothetical void or vacuum could be explained by qualities of both motive force and resistance that inhered in the object itself.

Probably the greatest puzzle facing medieval interpreters of Aristotle was the violent motion of projectiles. If the motion of every object required the analyst to specify a mover or cause for that motion, then what caused projectiles to continue in their trajectories after they lost contact with their original projector? Aristotle suggested that a surrounding medium was pushed by the original mover and so continued to push the projectile. For medieval scholars who admitted the possibility of a vacuum, however, this explanation was not tenable. In addition, if the medium was slight compared to the projectile (such as the air compared to a stone), then it was difficult to see how a corporeal mover could continue to be the cause of violent motion. Motivated by such concerns, in the sixth century John Philoponus suggested that the continued motion of a projectile was due to an incorporeal force that was impressed on the projectile itself by the original mover. The projectile would finish its motion when this impressed force wore off.

Some eight hundred years later, in the fourteenth century at the University of Paris, Jean Buridan renamed Philoponus’s impressed force “impetus,” and used the concept to interpret the motion of projectiles and falling bodies. Once impressed on a projectile, the impetus could bring about virtually constant motion unless it was interrupted or dissipated by a resistive medium, a notion that bears some resemblance to the conceptions of inertia developed later. Buridan also attempted to quantify impetus, by saying it was proportional to the moving object’s speed and its quantity of matter. As an object engaged in free fall, the power of gravity imparted larger and larger amounts of impetus to the object, thereby increasing its velocity.

A number of scholars attempted to quantify a relation between the impressed force and the velocity of an object. Paramount among these was Thomas Bradwardine of Merton College. In comparison to a projectile, a falling object presented special problems. Aristotle suggested that the velocity of the object was proportional to the total impressed force (F) and inversely proportional to the resistance of an ambient medium (R). Bradwardine rejected this formulation and a number of other suggestions by Philoponus, Avempace, and Averroes that involved simple ratios or subtractions of F and R . Instead, he proposed a dynamics in which the velocity of a body increased arithmetically as the ratio F/R increased geometrically. This formulation proved to be influential well into the sixteenth century.

preparing the stage for the revolutions in relativity and quantum theory that were to follow. The work of the Irish mathematician and astronomer William Rowan Hamilton (1805–1865) built on Laplace’s revision of Newtonian dynamics to establish a thoroughly abstract and mathematical approach to physical problems. Originally motivated by his work in optics, Hamilton developed a new principle of least action. Instead of using Lagrange’s integral of kinetic energy, Hamilton chose to minimize the integral of the difference between the kinetic and the potential energies. In applying this principle in mechanics, Hamilton reproduced the results of Euler and Lagrange, and showed that it applied to a broader range of problems. After

his work was published, as two essays in 1833 and 1834, it was critiqued and improved upon by the German mathematician Carl Gustav Jacob Jacobi (1804–1851). The resulting Hamilton-Jacobi formalism was applied in many fields of physics, including hydrodynamics, optics, acoustics, the kinetic theory of gases, and electrodynamics. However, it did not achieve its full significance until the twentieth century, when it was used to buttress the foundations of quantum mechanics.

Work on magnetism was encouraged by Alessandro Volta’s (1745–1827) development, in 1800, of the voltaic pile (an early battery), which, unlike the Leyden jar, was able to pro-

THE NEWTONIAN SYNTHESIS

The Newtonian synthesis was, first and foremost, a unification of celestial and terrestrial physics. Newton's famous story of seeing an apple fall in his mother's garden does a good job in summarizing this achievement. According to the story, the falling apple made Newton consider that the gravitational force that influences the apple (a projectile in terrestrial motion) might also act on the moon (a satellite in celestial motion). He concluded that "the power of gravity . . . was not limited to a certain distance from the earth but that this power must extend much farther than was usually thought" (Westfall, 1980, p. 154). This idea is displayed in a famous diagram in the *Principia*, depicting a projectile being thrown from a mountain peak, which rests on a small planet; as the projectile is thrown with greater and greater speed, it eventually goes into orbit around the planet and becomes a satellite. Consideration of the moon's motion led Newton to the force law for universal gravitation. Simply by virtue of having mass, any two objects exert mutually attractive forces on each other (in accordance with the third law of motion). The inverse-square force law made the gravitational force quantified and calculable but regarding the cause of gravity itself, Newton famously claimed, "I feign no hypotheses."

As much as his specific scientific achievements, Newton's method of working became a touchstone for scientists of the eighteenth century and defined a general scientific culture of "Newtonianism." In this regard, the Newtonian synthesis can be seen as a combination of three broad

traditions: experiment, mathematics, and mechanism. Newton's *Opticks* (1704) exemplified the empirical, inductive approach recommended by Francis Bacon. There, Newton reports on careful experiments with light, including a series showing that when light passes through a prism, the prism does not modify the color of the light but rather separates it into its component colors (see Fig. 2). He also did experiments in which he shone monochromatic light on thin plates and films, to produce patterns of light and dark regions; these later became known as "Newton's rings."

The effort to describe physical events with mathematics, which was so evident in the work of Kepler, Galileo, and Descartes, reached its full expression in Newton's dynamics. The universal gravitation law, along with the three laws of motion and the calculus, presented a complete Newtonian approach to quantifying and calculating the motion of everything from the smallest atom to the largest planet. Closely related to this mathematical tendency is the mechanical philosophy pursued by Descartes, Gassendi, and Robert Boyle (1627–1691). Although Newton rejected Descartes's plenum, he retained a modified idea of mechanical causality. For Newton, gravity was an action at a distance; two masses acted on one another despite the fact that empty space lay between them. Defined as a change in motion, Newton's conception of force was a mechanical, causal agent that acted either through contact or through action at a distance.

duce a steady source of electric current. Inspired by the German philosophical movement of *Naturphilosophie*, which espoused that the forces of nature were all interrelated in a higher unity, the Danish physicist Hans Christian Ørsted (1777–1851) sought a magnetic effect from the electric current of Volta's battery. Ørsted's announcement of his success, in 1820, brought a flurry of activity, including the work of Jean-Baptiste Biot and Félix Savart, on the force law between a current and a magnet, and the work of André-Marie Ampère, on the force law between two currents. The magnetic force was found to depend on the inverse square of the distance but was more complex due to the subtle vector relations

between the currents and distances. For the analysis of inverse-square force laws, the German mathematician Carl Friedrich Gauss (1777–1855) introduced, in 1839, the concept of "potential," which could be applied with great generality to both electrostatics and magnetism. This work grew from Gauss's efforts in measuring and understanding the earth's magnetic field, which he undertook with his compatriot Wilhelm Eduard Weber (d. 1891).

The most significant work in magnetism was done by Michael Faraday (1791–1861) at the Royal Institution of London. By 1831, Faraday had characterized a kind of reverse

FORMS OF MATTER

The development of physics both contributed to and depended on ideas about the structure of matter. In this regard, the history of physics is tied to the history of chemistry. Both sciences inherited a debate that began with the ancients regarding atomism versus continuity. Combining the influences of, among others, Pythagoras and Democritus, Plato saw matter as being composed of atoms that had different geometrical shapes for each of the four elements. Against this, Aristotle developed a continuum theory of matter, in part because his theory of motion would be contradicted by the existence of a void. This debate was reawakened during the sixteenth and seventeenth centuries. On the one hand, Descartes embraced a continuum theory involving a plenum of fine matter and vortices, founded on the idea that motion is caused through contact. On the other hand, Robert Boyle proposed atomistic explanations of his finding that reducing the volume of a gas increased its pressure proportionately. Newton refined Boyle's ideas by interpreting pressure as being due to mutually repelling atoms, and recommended an atomistic stance for further research in chemistry and optics.

During the eighteenth and nineteenth centuries, many theorists and experimentalists posited the existence of a number of "imponderables," substances that could produce physical effects but could not be weighed. The first of these was proposed in 1703 by the German physician and chemist Georg Ernst Stahl in order to explain the processes of oxidation and respiration. Stahl's phlogiston theory, and the renewed interest in Newton's theories of an ether medium for gravity, encouraged further theories involving imponderables, most notably electrical fire (to describe the flow of static electricity) and caloric (to describe heat flow). Although the imponderables were eventually rejected, they served as useful heuristic devices in quantifying physical

laws. For example, the Scottish chemist Joseph Black (1728–1799) used the caloric theory to found the study of calorimetry and to measure specific heat (the heat required to raise the temperature of a substance one degree), and latent heat (the heat required for a substance to change its state).

Even after the work of John Dalton, few chemists and physicists before 1890 accepted the actual existence of atoms. Nevertheless, they found the atomic hypothesis to be useful in suggesting experiments and interpreting the results. In 1863, the Irish physical chemist Thomas Andrews experimentally characterized the "critical point" between the gas and liquid phases: at relatively low temperatures, as the pressure was increased, the change from gas to liquid was abrupt; however, at relatively high temperatures, the transition was continuous. In part to account for the behavior of the critical point, the Dutch physicist Johannes Diderik van der Waals (1837–1923) assumed that the forces between atoms were attractive at large range but repulsive at short range. The work of van der Waals represented the first successful theory of phase transitions and showed how an atomistic model could describe both phases.

In the mid-nineteenth century, Michael Faraday and Julius Plücker (1801–1868), among others, pioneered research on the discharge of electricity through partially evacuated glass tubes. The British chemist William Crookes made a number of improvements to these discharge tubes and called the glowing material that formed in them the "fourth state of matter" (which was later dubbed "plasma" by the American chemist Irving Langmuir). Work in this area eventually led to Joseph John Thomson's discovery of the electron and Philipp Lenard's characterization, in 1899, of the photoelectric effect.

Ørsted effect, in which a change in magnetism gave rise to a current. For example, he showed that this "electromagnetic induction" occurred between two electric circuits that communicated magnetism through a shared iron ring but, other-

wise, were electrically insulated from one another (an early version of the transformer). Faraday made the first measurements of magnetic materials, characterizing diamagnetic, paramagnetic, and ferromagnetic effects (though this terminology is

SECOND LAW OF THERMODYNAMICS

The development of the second law of thermodynamics was intimately tied to the kinetic theory of gases, and carried with it the rebirth of atomism and the founding of statistical mechanics. Despite the fact that Sadi Carnot believed that caloric was not lost when it traveled from the hot body to the cool body of an engine, he recognized that the work delivered depended on the temperature difference between the two bodies and that this difference constantly decreased. This observation was clarified by the German physicist Rudolf Clausius. In 1851, a few years after the acceptance of the first law of thermodynamics, Clausius recognized the need for a second law, to account for the fact that energy was often irrecoverably lost by a system. In a paper published in 1865, Clausius analyzed thermodynamic cycles with a quantity that he dubbed the “entropy” and found that it usually went up or at best (for a reversible process) was zero.

The Austrian Ludwig Boltzmann read Clausius’s paper and set about developing a mechanical interpretation of the second law. In a first attempt, published in 1866, he used Hamilton’s principle to analyze the development of a thermodynamic system made up of discrete particles. After Joseph Stefan (1835–1893) alerted Boltzmann to James Clerk Maxwell’s probabilistic approach, Boltzmann made refinements to Maxwell’s ideas and incorporated them into his mechanical interpretation. In 1872, he published a paper that made use of a transport equation (now called the “Boltzmann equation”) to describe the evolution of a probability distribution of particles. As the atoms of a gas collided and

eventually reached an equilibrium velocity distribution, the entropy was maximized.

Boltzmann’s ideas were met with a number of objections. One objection argued that because Newton’s laws were reversible, thermodynamic processes described by the motion of atoms could be reversed in time to yield processes that deterministically went to states of *lower* entropy, thus contradicting the second law. Boltzmann’s response highlighted the statistical nature of his interpretation, arguing that, given particular initial conditions, any thermodynamic system has a vastly greater number of final states available to it with relatively high entropy. An increase of entropy means that the system has become randomized as the available energy is spread around to its constituent atoms. In 1877 Boltzmann published a paper that incorporated this idea and defined the entropy as a log of a quantity measuring the number of states available to a system. In doing his calculations, Boltzmann used the device of counting energy in discrete increments, which he took to zero at the end of his calculation. This method, a harbinger of the quantization of energy, influenced Planck and Einstein, over twenty years later.

Boltzmann had less success answering a second set of objections regarding atomism. The British physicist William Thomson (1824–1907) and Scottish physicist Peter Tait (1831–1901) rejected atomism as a result of their adherence to the dynamical theory of matter, which rejected the existence of a void. Similarly, Ernst Mach put forward empiricist counterarguments, which rejected Boltzmann’s adherence to entities that could not be confirmed by direct observation.

due to the English mathematician William Whewell). Finally, Faraday pioneered the concept of the field, coining the term “magnetic field” in 1845. He saw the “lines of force” of magnetic or electric fields as being physically real and as filling space (in opposition to the idea of action at a distance).

One of the pinnacles of nineteenth-century physics is the theory of electromagnetism developed by the Scottish

physicist James Clerk Maxwell (1831–1879). Maxwell brought together the work of Coulomb, Ampère, and Faraday, and made the crucial addition of the “displacement current,” which acknowledged that a magnetic field can be produced not only by a current but also by a changing electric field. These efforts resulted in a set of four equations that Maxwell used to derive wave equations for the electric and magnetic fields. This led to the astonishing prediction that light was an electromagnetic wave. In developing and interpreting his results,

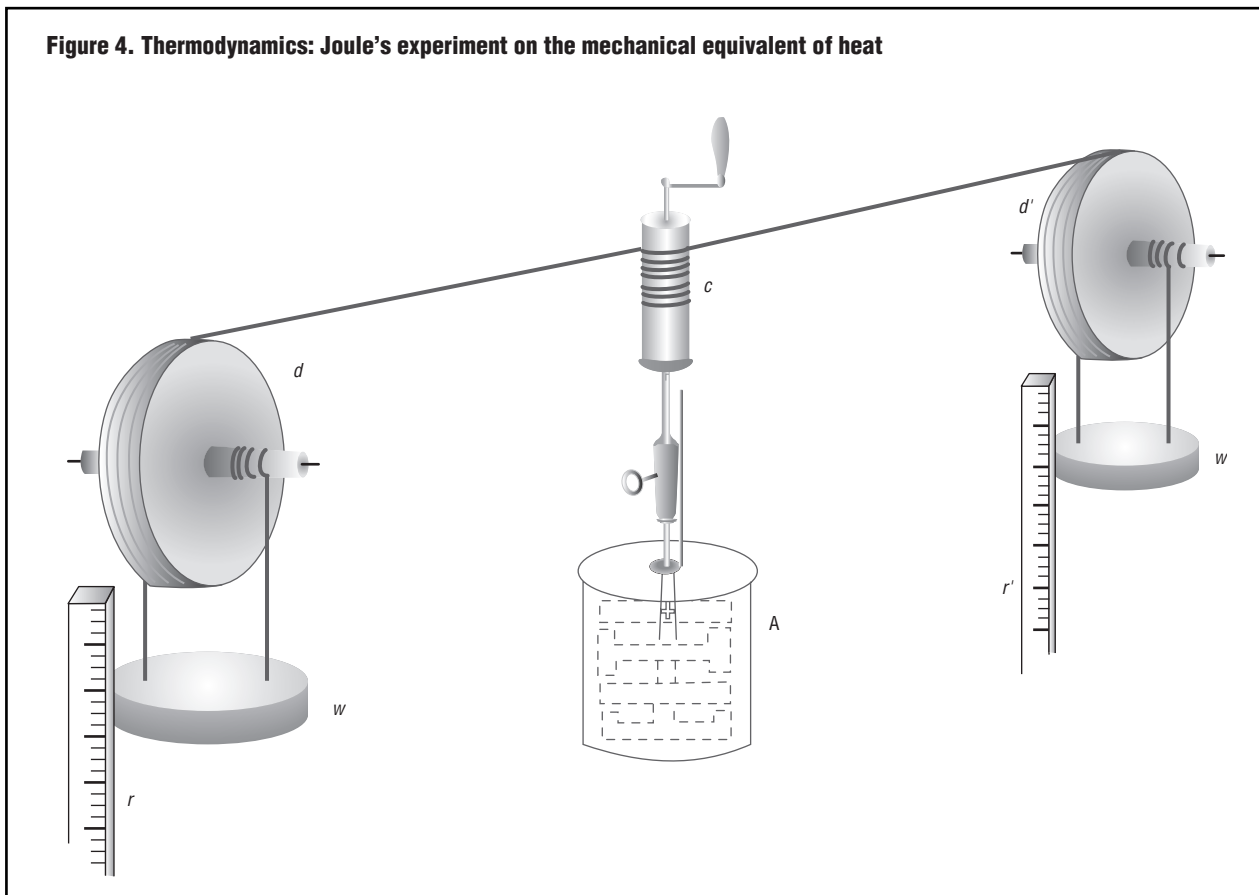
Figure 4. Thermodynamics: Joule's experiment on the mechanical equivalent of heat

Maxwell sought to build a mechanical model of electromagnetic radiation. Influenced by Faraday's rejection of action at a distance, Maxwell attempted to see electromagnetic waves as vortices in an ether medium, interspersed with small particles that acted as idle wheels to connect the vortices. Maxwell discarded this mechanical model in later years, in favor of a dynamical perspective. This latter attitude was taken by the German experimentalist Heinrich Rudolph Hertz (1857–1894), who, in 1886, first demonstrated the propagation of electromagnetic waves in the laboratory, using a spark-gap device as a transmitter.

During the eighteenth century, most researchers saw the flow of heat as the flow of the imponderable fluid caloric. Despite developments, such as Benjamin Thompson's cannon-boring experiments, which suggested that heat involved some sort of microscopic motion, caloric provided a heuristic model that aided in the quantification of experimental results and in the creation of mathematical models. For example, the French engineer Sadi Carnot (1791–1832) did empirical work on steam engines which led to the theory of the thermodynamic cycle, as reported in his *Reflections on the Motive Power of Fire* (1824). A purely mathematical approach was developed by Jean-Baptiste-Joseph Fourier, who analyzed heat conduction with the method of partial differential equations in his *Analytical Theory of Heat* (1822).

Carnot's opinion that caloric was conserved during the running of a steam engine was proved wrong by the development of the first law of thermodynamics. Similar conceptions of the conservation of energy (or "force," as energy was still referred to) were identified by at least three different people during the 1840s, including the German physician Julius Robert von Mayer (1814–1878), who was interested in the human body's ability to convert the chemical energy of food to other forms of energy, and the German theoretical physicist Hermann Ludwig Ferdinand von Helmholtz (1821–1894), who gave a mathematical treatment of different types of energy and showed that the different conservation laws could be traced back to the conservation of *vis viva* in mechanics. The British physicist James Prescott Joule (1818–1889) did an experiment that measured the mechanical equivalent of heat with a system of falling weights and a paddlewheel that stirred water within an insulated vessel (see Fig. 4).

In his *Hydrodynamica*, Bernoulli had proposed the first kinetic theory of gases, by suggesting that pressure was due to the motion and impact of atoms as they struck the sides of their containment vessel. The work of the chemists John Dalton (1766–1844) and Amedeo Avogadro (1776–1856) indirectly lent support to such a kinetic theory by casting doubt upon the Newtonian program of understanding chemistry in terms of force laws between atoms. After John Herapath's work on the kinetic theory, in 1820, was largely ignored, Rudolf

Clausius published two papers, in 1857 and 1858, in which he sought to derive the specific heats of a gas and introduced the concept of the mean free path between atomic collisions. James Clerk Maxwell added the idea that the atomic collisions would result in a range of velocities, not an average velocity as Clausius thought, and that this would necessitate the use of a statistical approach. In a number of papers published from 1860 to 1862, Maxwell completed the foundations of the kinetic theory and introduced the equipartition theorem, the idea that each degree of freedom (translational or rotational) contributed the same average energy, which was proportional to the temperature of the gas. Clausius and Maxwell's work in kinetic theory was tied to their crucial contributions to developing the second law of thermodynamics (see sidebar, "Second Law of Thermodynamics").

End of Classical Physics

By the close of the nineteenth century, many physicists felt that the accomplishments of the century had produced a mature and relatively complete science. Nevertheless, a number of problem areas were apparent to at least some of the community, four of which are closely related to developments mentioned above.

New rays and radiations were discovered near the end of the century, which helped establish (among other things) the modern model of the atom. These included the discovery (by William Crookes and others) of cathode rays within discharge tubes; Wilhelm Conrad Röntgen's finding, in 1895, of X rays emanating from discharge tubes; and Antoine-Henri Becquerel's discovery in 1896 that uranium salts were "radioactive" (as Marie Curie labeled the effect in 1898). Each of these led to further developments. In 1897, Joseph John Thomson identified the cathode rays as negatively charged particles called "electrons" and, a year later, was able to measure the charge directly. In 1898, Ernest Rutherford identified two different kinds of radiation from uranium, calling them alpha and beta. In 1902 and 1903, he and Frederick Soddy demonstrated that radioactive decay was due to the disintegration of heavy elements into slightly lighter elements. In 1911, he scattered alpha particles from thin gold foils and explained infrequent scattering to large angles by the presence of a concentrated, positively charged atomic nucleus.

The study of blackbody radiation (radiation from a heated object that is a good emitter) yielded results that are crucial to the early development of quantum mechanics. In 1893 Wilhelm Wien derived a promising "displacement law" that gave the wavelength at which a blackbody radiated at maximum intensity, but precision data failed to confirm it. Furthermore, classical theory proved unable to model the intensity curves, especially at lower wavelengths. In 1900 the German theoretical physicist Max Planck (1858–1947) derived the intensity curve using the statistical methods of the Austrian physicist Ludwig Eduard Boltzmann (1844–1906) and the device of counting the energy of the oscillators of the blackbody in increments of hf , where f is the frequency and h is a constant (now known as "Planck's constant"). Despite achieving excellent fits to data, Planck was hesitant to accept his own derivation, due to his aversion for statistical methods and atomism.

It is doubtful that Planck interpreted his use of energy increments to mean that the energy of the oscillators and radiation came in chunks (or "quanta"). However, this idea was clearly enunciated by Albert Einstein in his 1905 paper on the photoelectric effect. Einstein explained in this paper why the electrons that are ejected from a cathode by incident light do not increase in energy when the intensity of the light is increased. Instead, the fact that the electrons increase in energy when the frequency of the light is increased suggested that light comes in quantum units (later called "photons") and have an energy given by Planck's equation, hf .

Electromagnetic theory, though one of the most important results of nineteenth-century physical theory, contained a number of puzzles. On the one hand, electromagnetism sometimes gave the same result for all reference frames. For example, Faraday's induction law gave the same result for the current induced in a loop of wire for two situations: when the loop moves relative to a stationary magnet and when the magnet moves (with the same speed) relative to a stationary loop. On the other hand, if an ether medium were introduced for electromagnetic waves, then the predictions of electromagnetism should usually change for different reference frames. In a second paper from 1905, Einstein reinterpreted attempts by Henri Poincaré (1854–1912) and Hendrik Antoon Lorentz (1853–1928) to answer this puzzle, by insisting that the laws of physics should give the same results in all inertial reference frames. This, along with the principle of the constancy of the speed of light, formed the basis of Einstein's special theory of relativity.

See also Causality; Change; Chemistry; Experiment; Field Theories; Mathematics; Mechanical Philosophy; Quantum; Relativity; Science.

BIBLIOGRAPHY

PRIMARY SOURCES

- Brush, Stephen G. *The Kinetic Theory of Gases: An Anthology of Classic Papers with Historical Commentary*. Edited by Nancy S. Hall. London: Imperial College Press, 2003.
- Franklin, Benjamin. *Benjamin Franklin's Experiments: A New Edition of Franklin's Experiments and Observations on Electricity*. Edited by I. Bernard Cohen. Cambridge, Mass.: Harvard University Press, 1941.
- Galilei, Galileo. *Two New Sciences: Including Centers of Gravity and Force of Percussion*. Translated by Stillman Drake. Madison: University of Wisconsin Press, 1974.
- Newton, Isaac. *Opticks; or, a Treatise of the Reflections, Refractions, Inflections, and Colours of Light. Based on the 4th ed., London 1730*. New York: Dover, 1952.
- . *The Principia: Mathematical Principles of Natural Philosophy*. Translated by I. B. Cohen and Anne Whitman. Berkeley: University of California Press, 1999.
- Maxwell, James Clerk. *A Treatise on Electricity and Magnetism*. 2 vols. Unabridged 3rd ed. New York: Oxford University Press, 1998.
- Shamos, Morris H., ed. *Great Experiments in Physics*. 1959. Reprint, New York: Dover, 1987. Features brief introductions to each experiment, followed by passages from the original publications.

SECONDARY SOURCES

- Berry, Arthur. *A Short History of Astronomy: From Earliest Times through the Nineteenth Century*. New York: Dover, 1961.
- Brush, Stephen G. *Statistical Physics and the Atomic Theory of Matter: From Boyle and Newton to Landau and Onsager*. Princeton, N.J.: Princeton University Press, 1983.
- Buchwald, Jed Z. *The Creation of Scientific Effects: Heinrich Hertz and Electric Waves*. Chicago: University of Chicago Press, 1994. A detailed account for the advanced reader.
- . *The Rise of the Wave Theory of Light: Optical Theory and Experiment in the Early Nineteenth Century*. Chicago: University of Chicago Press, 1989.
- Cahan, David. *An Institute for an Empire: The Physikalisch-Technische Reichsanstalt, 1871–1918*. Cambridge, U.K., and New York: Cambridge University Press, 1989. An exemplary study of how physical science served state interests.
- Caneva, Kenneth L. *Robert Mayer and the Conservation of Energy*. Princeton, N.J.: Princeton University Press, 1993.
- Cannon, John T., and Sigalia Dostrovsky. *The Evolution of Dynamics: Vibration Theory from 1687 to 1742*. New York: Springer-Verlag, 1981. Detailed history for mathematically adept readers.
- Cercignani, Carlo. *Ludwig Boltzmann: The Man Who Trusted Atoms*. New York: Clarendon, 1998.
- Clagett, Marshall. *The Science of Mechanics in the Middle Ages*. Madison: University of Wisconsin Press, 1959.
- Cohen, H. Floris. *The Scientific Revolution: A Historiographical Inquiry*. Chicago: University of Chicago Press, 1994. A long but valuable historiographic survey.
- Cohen, I. Bernard. *The Birth of a New Physics*. Rev. ed. New York, W. W. Norton, 1985. An excellent place to start for the general reader, covering the period from Copernicus to Newton.
- . *The Newtonian Revolution*. Norwalk, Conn: Burndy Library, 1987.
- D'Agostino, Salvo. *A History of the Ideas of Theoretical Physics: Essays on the Nineteenth and Twentieth Century Physics*. Boston: Kluwer, 2000.
- Damerow, Peter, et al. *Exploring the Limits of Preclassical Mechanics: A Study of Conceptual Development in Early Modern Science*. New York: Springer-Verlag, 1992. Detailed treatments of the motion studies of Descartes, Galileo, and Beeckman.
- Dear, Peter. *Revolutionizing the Sciences: European Knowledge and Its Ambitions, 1500–1700*. Princeton, N.J.: Princeton University Press, 2001.
- Dobbs, Betty Jo Teeter, and Margaret C. Jacob. *Newton and the Culture of Newtonianism*. Atlantic Highlands, N.J.: Humanities Press, 1995.
- Dugas, René. *A History of Mechanics*. Translated by J. R. Maddox. New York: Dover, 1988. A useful survey from ancient to modern times, concentrating on the development of theory and often using long quotations from the original sources.
- Duhem, Pierre. *Essays in History and Philosophy of Science*. Edited by Roger Ariew and Peter Barker. Indianapolis: Hackett, 1996. Includes Duhem's excellent article on the history of physics, written for an encyclopedia.
- . *Medieval Cosmology: Theories of Infinity, Place, Time, Void, and the Plurality of Worlds*. Edited and translated by Roger Ariew. Chicago: University of Chicago Press, 1985.
- Elkana, Yehuda. *The Discovery of the Conservation of Energy*. Cambridge, Mass.: Harvard University, 1974.
- Fraser, Craig G. *Calculus and Analytical Mechanics in the Age of Enlightenment*. Aldershot, U.K., and Brookfield, Vt.: Variorum, 1997. Detailed history for mathematically adept readers.
- Gillmor, C. Stewart. *Coulomb and the Evolution of Physics and Engineering in Eighteenth-Century France*. Princeton, N.J.: Princeton University Press, 1971.
- Goldstine, Herman H. *A History of the Calculus of Variations from the Seventeenth through the Nineteenth Century*. New York: Springer-Verlag, 1980. Detailed history for mathematically adept readers.
- Grant, Edward. *The Foundations of Modern Science in the Middle Ages: Their Religious, Institutional, and Intellectual Contexts*. Cambridge, U.K., and New York: Cambridge University Press, 1996. A good place to start for the general reader.
- Hakfoort, Casper. *Optics in the Age of Euler: Conceptions of the Nature of Light, 1700–1795*. Cambridge, U.K., and New York: Cambridge University Press, 1995.
- Hankins, Thomas L. *Science and the Enlightenment*. Cambridge, U.K., and New York: Cambridge University Press, 1985. The best place to start for the general reader.
- Harman, P. M. *Energy, Force, and Matter: The Conceptual Development of Nineteenth-Century Physics*. Cambridge, U.K., and New York: Cambridge University Press, 1982. A useful book but compact and difficult for the beginner.
- . *The Natural Philosophy of James Clerk Maxwell*. Cambridge, U.K., and New York: Cambridge University Press, 1998.
- Heilbron, J. L. *Electricity in the Seventeenth and Eighteenth Centuries: A Study of Early Modern Physics*. Berkeley: University of California Press, 1979. A particularly good survey of both the conceptual and the institutional development of physics.
- Hendry, John. *James Clerk Maxwell and the Theory of the Electromagnetic Field*. Bristol, U.K., and Boston: A. Hilger, 1986. A superb scientific biography with a useful interpretive framework that has been used in the present essay.
- Hogendijk, Jan P., and Abdelhamid I. Sabra, eds. *The Enterprise of Science in Islam: New Perspectives*. Cambridge: MIT Press, 2003.
- Holton, Gerald, and Stephen G. Brush. *Physics, the Human Adventure: From Copernicus to Einstein and Beyond*. New Brunswick, N.J.: Rutgers University Press, 2001. A textbook for teaching physics with history.
- Jungnickel, Christa, and Russell McCormmach. *Cavendish: The Experimental Life*. Rev. ed. Cranbury, N.J.: Bucknell University Press, 1999.
- . *Intellectual Mastery of Nature: Theoretical Physics from Ohm to Einstein*. Chicago: University of Chicago Press, 1986. A detailed study of the conceptual and institutional development of theoretical physics as a subdiscipline.
- Kline, Morris. *Mathematical Thought from Ancient to Modern Times*. New York: Oxford University Press, 1972.
- Kuhn, Thomas S. *Black-body Theory and the Quantum Discontinuity, 1894–1912*. Chicago: University of Chicago Press, 1987.
- . *The Copernican Revolution: Planetary Astronomy in the Development of Western Thought*. Cambridge, Mass.: Harvard University Press, 1971.
- Leijenhorst, Cees, Christoph Luthy, Johannes M. M. H. Thijssen, eds. *The Dynamics of Aristotelian Natural Philosophy from Antiquity to the Seventeenth Century*. Leiden, Netherlands: Brill, 2002.
- Lindberg, David C. *The Beginnings of Western Science: The European Scientific Tradition in Philosophical, Religious, and Institutional Context, 600 B.C. to A.D. 1450*. Chicago: University of Chicago Press, 1992. A good place to start for the general reader.
- Lindberg, David C., ed. *Science in the Middle Ages*. Chicago: University of Chicago Press, 1978.
- Mach, Ernst. *The Principles of Physical Optics: An Historical and Philosophical Treatment*. Mineola, N.Y.: Dover, 2003.

- . *Principles of the Theory of Heat: Historically and Critically Elucidated*. Edited by Brian McGuinness. Boston: D. Reidel, 1986.
- . *The Science of Mechanics: A Critical and Historical Account of Its Development*. Translated by Thomas J. McCormack. 6th ed. LaSalle, Ill.: Open Court, 1960. Mach's books are guilty of "presentism," the tendency to judge past science in terms of current knowledge. Nevertheless, his work should be studied by the more advanced student.
- Maier, Anneliese. *On the Threshold of Exact Science: Selected Writings of Anneliese Maier on Late Medieval Natural Philosophy*. Edited and translated by Steven D. Sargent. Philadelphia: University of Pennsylvania Press, 1982.
- Merz, John Theodore. *A History of European Thought in the Nineteenth Century*. Vols. 1 and 2. New York: Dover, 1965. Reprint of edition appearing between 1904 and 1912.
- Olesko, Kathryn M. *Physics as a Calling: Discipline and Practice in the Königsberg Seminar for Physics*. Ithaca, N.Y.: Cornell University Press, 1991.
- Park, David. *The Fire Within the Eye: A Historical Essay on the Nature and Meaning of Light*. Princeton, N.J.: Princeton University Press, 1997. A good popularization.
- Pullman, Bernard. *The Atom in the History of Human Thought*. New York: Oxford University Press, 1998. Guilty of "presentism," but nevertheless a useful survey.
- Purinton, Robert D. *Physics in the Nineteenth Century*. New Brunswick, N.J.: Rutgers University Press, 1997. The best place to start for the general reader.
- Segrè, Emilio. *From Falling Bodies to Radio Waves: Classical Physicists and Their Discoveries*. New York: W. H. Freeman, 1984.
- . *From X-Rays to Quarks: Modern Physicists and Their Discoveries*. San Francisco: W. H. Freeman, 1980.
- Stephenson, Bruce. *Kepler's Physical Astronomy*. New York: Springer-Verlag, 1987.
- Tokaty, G.A. *A History and Philosophy of Fluid Mechanics*. 2nd ed. New York: Dover, 1994.
- Toulmin, Stephen, and June Goodfield. *The Architecture of Matter*. Chicago: University of Chicago Press, 1982. A history of theories of matter, from ancient to modern times.
- Truesdell, C., *The Tragicomical History of Thermodynamics, 1822–1854*. New York: Springer-Verlag, 1980. Detailed history for mathematically adept readers.
- Westfall, Richard S. *The Construction of Modern Science: Mechanisms and Mechanics*. Cambridge, U.K., and New York: Cambridge University Press, 1977.
- . *Force in Newton's Physics: The Science of Dynamics in the Seventeenth Century*. New York: Elsevier, 1971.
- . *Never at Rest: A Biography of Isaac Newton*. Cambridge, U.K., and New York: Cambridge University Press, 1980.
- Whittaker, Edmund. *A History of the Theories of Aether and Electricity*. New York: Humanities Press, 1973.
- Williams, L. Pearce. *The Origins of Field Theory*. Lanham, Md.: University Press of America, 1980. This classic study focuses on the work of Michael Faraday.

G. J. Weisel

PIETISM. Like the Enlightenment, Pietism has produced an extremely diverse body of historical scholarship, with opinions ranging from a denial of its existence to precise nationally,

geographically, or chronologically defined variants, as well as views that see Pietism essentially as identical with the history of modern Protestantism. Such divergent opinion has led to the introduction of categories such as reformed, classical, enthusiastic, and radical Pietism. The picture often becomes more complex when the scope of Pietism is expanded to include other religions such as Judaism, where Hasidism appears at least on the surface as a similar phenomenon. But even within Christianity, apparently similar movements such as French Jansenism or Spanish Quietism emerged almost at the same time.

The term *Pietist*, created during the seventeenth century, served initially as a derogatory term in reference to people who exhibited excessively spiritual and devout behavior. Most were followers of the German Lutheran reformer Philipp Jakob Spener (1635–1705), who organized Bible study gatherings, the so-called *collegia pietatis* (colleges of piety), in addition to the regular church services, which indicates how the term *Pietist* was often used interchangeably with the term *Spenerianer* (Spenerian). But in 1689 Joachim Feller (1628–1691), professor of poetry at the University of Leipzig, used the term in a positive way by including it in a funeral poem to stress the deceased person's interest in the study of the Bible, his saintly life, and his true devoutness.

History

Most historical treatments of Pietism start with Spener, then pastor and senior of the ministerium in Frankfurt, who is generally regarded as a founding figure of the movement. Spener believed that the state's Lutheran churches had failed to complete the Reformation and had instead descended into theological irrelevance and quarrels. In his work *Pia Desideria* (1675; Pious desires) Spener proposed six measures that could lead to a revival of the German churches. They included the organization of small conventicles (*ecclesiola*) for meditation and the joint study of the Bible, an emphasis on the priesthood of all believers, a stress on practical rather than theological and intellectual Christianity, the abandonment of religious argument with other churches, a reorganization of the training of future ministers at the universities, and an increased emphasis on preaching. Spener's most notable follower was August Hermann Francke (1663–1727), who in 1691 was appointed professor of Greek and Oriental Languages at the newly established University of Halle. Under Francke's direction, Halle quickly became a leading center of Pietist studies. Although Pietism initially encountered significant resistance, especially from adherents of Lutheran orthodoxy, some rulers, such as the elector Frederick I of Prussia, embraced it. In Prussia, where the nobility was closely tied to the Lutheran Church, the monarchy's support of Pietism helped it secure a new ally against the provincial estates. In other cases, however, Pietists were less fortunate and were forced to move to areas where they would find a benefactor.

In Saxony, Count Nicolaus Ludwig von Zinzendorf (1700–1760), strongly influenced by Pietism, granted refuge to a group of Moravians on his estate in 1722, where they were able to found the community Herrnhut (the Lord watches over). Under Zinzendorf's leadership the community spread quickly throughout Europe and to North America, where it inspired John Wesley (1703–1791), the founder of Methodism.

During the nineteenth and twentieth centuries, a variety of different movements emerged, which are all indebted to Pietism in varying degrees and even crossed the denominational line into Catholicism. Among these are Evangelicalism in England, the Réveil in France and Switzerland, and the Awakenings in Germany and the United States. Paradoxically this “neo-Pietism” was an offspring of the Enlightenment. In contrast to their seventeenth- and eighteenth-century predecessors, this new form of Pietism exhibited an unprecedented degree of optimism and an eagerness to establish societies and organizations such as youth groups.

Significance of Pietism

The diversification of Pietism is also emblematic for the intellectual sources it drew on, digested, and developed. Many concepts and characteristics such as the “universal priesthood of all believers,” the formation of conventicles, or mysticism stem from the teachings of Martin Luther (1483–1546), John Calvin (1509–1563), and Jakob Böhme (1575–1624). At the center of Pietism stood the idea of a spiritual rebirth. Although this involved a higher degree of individualism, the concept of *communitas* remains pivotal. A process of sanctification, which includes a strong emphasis on inward edification, would eventually lead to the formation of a community of the “children of the Lord.” This belief, in combination with chiliastic elements under the guidance of the Book of Revelation, led to an increased emphasis on charitable and missionary work, since this would quicken the Second Coming of Christ.

Pietism’s greatest contribution was certainly in the field of Protestant theology. Pietism produced a large body of edifying literature and song. Especially noteworthy is its contribution in the area of the spiritual song, which served as a compensation for Pietism’s otherwise strict admonition against secular forms of entertainment such as theater or dance. Most famous in this area is probably Johann Anastasius Freylinghausen’s (1670–1739) *Geistreiche Gesangbuch* (1704; Spiritual hymnal), whose first edition contained 683 hymns and 183 melodies. It possibly served as a source for the composer Johann Sebastian Bach (1685–1750), whose cantatas and passions may have been influenced by Pietism.

A major point of scholarly debate remains the complex relationship between Pietism and the Enlightenment. Both of these “movements” were brothers in arms (at least initially) against religious orthodoxy and doctrine, and both strongly emphasized charity, compassion, and pedagogical initiatives. Pietism’s contributions in education, such as Francke’s *Pädagogium*, founded in Halle in 1696, are as significant as those of the Enlightenment, such as the Philanthropinum, founded in Dessau/Saxony in 1774 by Johann Bernhard Basedow (1723–1790). Enlightenment figures such as Samuel von Pufendorf (1632–1694) and Christian Thomasius (1655–1728) embraced Pietism’s focus on the laity and works of charity.

Yet the substance of the program of both the Enlightenment and Pietism with regard to religion could not have been more different. Whereas the rationalism of the Enlightenment sought to demystify religion, Pietism emphasized the inward spirituality of a “religion of the heart” as well as the centrality

of Scripture. The historical-critical method of biblical criticism undertaken by proponents of the Enlightenment undermined scriptural authority completely, whereas for Pietists the Bible practically served as the main source of guidance and knowledge. Symbolic for this antagonism is the conflict between the German Enlightenment philosopher Christian von Wolff (1679–1754) and factions of the theological faculty of the University of Halle under the leadership of Joachim Lange (1670–1744) and Johann Franz Buddeus (1667–1729). Both attacked Wolff on the grounds that his rationalism would inevitably lead to atheism and Spinozism. Surprisingly, many early Spinozists and radical thinkers such as Gottfried Arnold (1666–1714) and Johann Christian Edelmann (1698–1767) were originally Pietists, who still held on to many original ideas of the Reformation, such as the universal priesthood of all believers and freedom of conscience.

The case of Gottfried Arnold is particularly noteworthy. His *Unpartheyische Kirchen- und Ketzer-Historie* (2 vols., 1699–1700; Nonpartisan history of the church and heresy) was a pioneering work in ecclesiastical historiography. Far from being an apologetic work for heretics and still heavily influenced by mysticism, Arnold’s work nonetheless rendered heresy a respectable subject of scholarly study. It revealed the historical role of laymen and women in the church, and by describing the interrelation of church and state in history Arnold exposed darker aspects of the Christian Church. Arnold also serves as an example of how Pietism influenced later philosophical and literary movements.

The literary movement of Sturm und Drang (storm and stress) adopted Pietism’s emphasis on sensibility and spirituality to counter the rationalism of the Enlightenment. Johann Wolfgang von Goethe (1749–1832) wrote in his *Dichtung und Wahrheit* (1811–1833; Poetry and truth) that he profited from reading Arnold’s work at a very young age. But figures like Johann Georg Hamann (1730–1788), Johann Gottfried von Herder (1744–1803), and Friedrich Schleiermacher (1768–1834) were also indebted to the Pietist concept of devoutness, and more recent scholarship suggests that Immanuel Kant (1724–1804) as well as Georg Wilhelm Friedrich Hegel (1770–1831) were more indebted to Pietism than previous studies assume. Most of these figures were educated or raised under Pietist influence and digested parts of this early encounter in their works. In fact, Schleiermacher’s Moravian roots become apparent in his theology, which combined the Pietist idea of religious experience with the Romantic ideal of sensibility as opposed to the rationalism of the Enlightenment.

Pietism is a highly complex and multifaceted phenomenon that goes beyond the denominational limits of Lutheranism. Extending beyond just a spiritual phenomenon and the field of theology, Pietism’s impact could be felt in politics and culture as well. The movement’s far-reaching impact and diversity often makes it difficult to describe precisely the avenues it took, and so it often seems more fitting to distinguish between different Pietisms rather than lumping these strands together under one single umbrella. This becomes especially important with regards to the different strands of radical and separatist movements that developed the *collegia pietatis* into independent

social communities but which are often overlooked in general surveys of Pietism. The unprecedented, avid participation of women also suggests that these movements transgressed gender and class boundaries.

See also *Christianity; Enlightenment; Religion*.

BIBLIOGRAPHY

PRIMARY SOURCES

- Erb, Peter C., ed. *Pietists: Selected Writings*. New York: Paulist Press, 1983.
- Francke, August Hermann. *Streitschriften*. Edited by Erhard Peschke. Berlin: de Gruyter, 1981.
- . *Werke in Auswahl*. Edited by Erhard Peschke. Berlin: Luther-Verlag, 1969.
- Spener, Philipp Jakob. *Pia Desideria*. Translated and edited with an introduction by Theodore G. Tappert. Philadelphia: Fortress Press, 1964.
- . *Die Werke Philipp Jakob Speners: Studienausgabe*. Edited by Kurt Aland. Giessen, Germany: Brunnen, 1996.
- Zinzendorf, Nicolaus Ludwig Graf von. *Nine Public Lectures on Important Subjects in Religion, Preached in Fetter Lane Chapel in London in the Year 1746*. Translated and edited by George W. Forell. Iowa City: University of Iowa Press, 1973.
- . *Kleines Brüdergesangbuch: Hirten-Lieder von Bethlehem*. Hildesheim, Germany, and New York: Olms Verlag, 1978.

SECONDARY SOURCES

- Beyreuther, Erich. *Geschichte des Pietismus*. Stuttgart, Germany: Steinkopf, 1978.
- Blaufuß, Dietrich, et al., eds. *Gottfried Arnold (1666–1714): Mit einer Bibliographie der Arnold-Literatur ab 1714*. Wiesbaden, Germany: Harrassowitz, 1995.
- Brecht, Martin, Ulrich Gäbler, and Hartmut Lehmann, eds. *Geschichte des Pietismus*. Vol. 1, *Der Pietismus vom siebzehnten bis zum frühen achtzehnten Jahrhundert*, edited by Martin Brecht. Vol. 2, *Der Pietismus im achtzehnten Jahrhundert*, edited by Martin Brecht. Vol. 3, *Der Pietismus im neunzehnten und zwanzigsten Jahrhundert*, edited by Ulrich Gäbler. Vol. 4, *Glaubenswelt und Lebenswelten des Pietismus*, edited by Hartmut Lehmann. Göttingen, Germany: Vandenhoeck & Ruprecht, 2000–2004.
- Fulbrook, Mary. *Piety and Politics: Religion and the Rise of Absolutism in England, Württemberg, and Prussia*. Cambridge, U.K., and New York: Cambridge University Press, 1983.
- Gawthrop, Richard L. *Pietism and the Making of Eighteenth-Century Prussia*. Cambridge, U.K., and New York: Cambridge University Press, 1993.
- Gierl, Martin. *Pietismus und Aufklärung: Theologische Polemik und die Kommunikationsreform der Wissenschaft am Ende des 17. Jahrhunderts*. Göttingen, Germany: Vandenhoeck and Ruprecht, 1997.
- Hinrichs, Carl. *Preußentum und Pietismus: Der Pietismus in Brandenburg-Preußen als religiös-soziale Reformbewegung*. Göttingen, Germany: Vandenhoeck and Ruprecht, 1971.
- Hoffmann, Barbara. *Radikalpietismus um 1700: Der Streit um das Recht auf eine neue Gesellschaft*. Frankfurt, Germany, and New York: Campus Verlag, 1996.
- Lehmann, Harmut, Hans-Jürgen Schrader, and Heinz Schilling, eds. *Jansenismus, Quietismus, Pietismus*. Göttingen, Germany: Vandenhoeck and Ruprecht, 2002.

- Miersemann, Wolfgang, and Gudrun Busch, eds. *Pietismus und Liedkultur*. Tübingen, Germany: Verlag der Franckeschen Stiftungen Halle im Max Niemeyer Verlag, 2002.
- Ritschl, Albrecht Benjamin. *Geschichte des Pietismus in der lutherischen Kirche des 17. und 18. Jahrhunderts*. 3 vols. Bonn, Germany: Marcus, 1880–1886. Reprint, Berlin: de Gruyter, 1966.
- Schicketanz, Peter. *Der Pietismus von 1675 bis 1800*. Leipzig, Germany: Evangelische Verlagsanstalt, 2001.
- Stoeffler, F. Ernest. *German Pietism during the Eighteenth Century*. Leiden: Brill, 1973.
- . *The Rise of Evangelical Pietism*. Leiden: Brill, 1965.
- Temme, Willi. *Krise der Leiblichkeit: Die Sozietät der Mutter Eva (Buttlarsche Rotte) und der radikale Pietismus um 1700*. Göttingen, Germany: Vandenhoeck and Ruprecht, 1998.
- Wallmann, Johannes. *Philipp Jakob Spener und die Anfänge des Pietismus*. Tübingen, Germany: J. C. B. Mohr, 1986.
- Wallmann, Johannes, and Udo Sträter, eds. *Halle und Osteuropa: Zur europäischen Ausstrahlung des halleischen Pietismus*. Halle, Germany: Verlag der Franckeschen Stiftungen Halle im Max Niemeyer Verlag, 1998.

Ulrich Groetsch

PIETY AND IMPIETY. See *Religion*.

PLATONISM. A principle feature of Platonism, which refers to the doctrines or philosophies influenced by Plato, is the belief in the existence of a distinction between the world that appears to the senses and a real realm that can be grasped only by the intellect. This latter realm contains the transcendental Ideas or Forms which, although existing independently of both the empirical world and human consciousness, may be apprehended through a human capacity of central import to Platonism, namely, that of reason. Reason, however, is not posited solely as a capacity possessed by humans, but is also understood more expansively as an ordering principle that extends throughout the entirety of the universe.

Platonism can be said to begin at Plato's death in 347 B.C.E. when his nephew Speusippus (c. 410–c. 339 B.C.E.) succeeded him as head of the Academy (founded by Plato in 386 B.C.E.). Under Speusippus, a Pythagorean metaphysics linking thought and numbers was drawn to the fore. The influence of the Epicurean and Stoic schools eventually superseded the preeminent role of the Academy, which turned toward the tradition of the Skeptics in its attempt to counter Stoicism. Confluent in many ways with the critical stance of Plato's teacher Socrates, the initial turn toward the Skeptic influence is generally associated with Arcesilaus (c. 316–c. 241 B.C.E.), while the further amplification of this tendency is associated with Carneades (213–129 B.C.E.).

With the decline of the Stoic influence, Neoplatonism, a new and highly significant strain of Platonism, emerged in the third century C.E. The influence of Pythagoreanism, already strongly imbued in Platonist thought, was here combined with features of Aristotelianism—although with Neoplatonism both the mathematical and quasi-religious features of Pythagorean

thought were greatly emphasized. Traceable to Ammonius Saccas (175?–c. 242), Neoplatonism was founded by his student Plotinus, the Egypto-Roman philosopher (205–270). In its broad fundamentals, Neoplatonism appears as an effort to articulate a relation between the two spheres that comprise the premier division in Platonism, that of the world of sense and that of the transcendent realm of Ideas. In Neoplatonism, the dichotomy between the two spheres emerged as a hierarchy of Being: in descending order, the One, Intellect or Mind, and the Soul, the Soul serving as the mediating functionary. Among those whose writings helped prepare the way for Neoplatonism was Philo (c. 20 B.C.E.–c. 50 C.E.), a notable member of the Egyptian Jewish diaspora whose writings on Hebrew scripture were based on Jewish religious revelation and highly influenced by the theory of Forms. Philo located the Forms within the Divine Mind; as preexisting features, these Forms serve as the pattern for the sensible world.

The significance exerted by Neoplatonist thought on Christian theology is traceable to Origen (185?–254? C.E.), who took from the Platonist tradition the doctrines of the preexistence of the soul and reincarnation and for whom, as for Philo, reason and revelation were not clearly distinguished. The relation between Neoplatonist philosophy and Christianity is most fully and richly pronounced, however, in the writings of St. Augustine (354–430). Augustine, a student of Neoplatonism before his conversion to Christianity, maintained the importance of this influence in his evolution toward the Christian faith. The Neoplatonist features of Augustine's thought emerge in his linking of human knowledge to an illumination by the Divine Mind and the positing of truth as existing in the mind of God. As with Philo and Origen, no absolute demarcation between reason and spiritual advancement exists in the writings of Augustine, for whom the highest level of philosophic knowledge is also at once a state of beatitude.

Neoplatonism exerted an influence not only upon Christianity, but also upon Islamic philosophy. Al-Kindi (c. 801–873) was the first of the Islamic philosophers influenced by Neoplatonism; he combined Neoplatonist thought with Aristotelian philosophy. Another significant figure was Avicenna (980–1037), who, like al-Kindi, is generally classified as an Aristotelian and was likewise influenced by Neoplatonism in his attempt to combine Platonist and Aristotelian traditions. The Neoplatonist proclivity for melding reason with spiritual insight emerged in the Middle Ages in the writings of St. Anselm (1033?–1109) and St. Bonaventure (1221–1274); the rationalist writings of the former were carried out under the Augustinian motto of *credo ut intelligam* (“I believe in order to understand”).

Despite the fact that by the thirteenth century Aristotle had largely supplanted Plato as the preeminent source of philosophic influence, a revival of Platonism occurred during the Renaissance. Inspired by Plato's Athenian Academy, the Florentine Academy was founded with the support of Cosimo de' Medici (1389–1464) in the mid-fifteenth century. Among the more influential figures populating the Academy were Marsilio Ficino (1433–1499) and Giovanni Pico della Mirandola (1463–1494); Ficino's rendering of Platonic love exerted

considerable influence on the literature of the sixteenth century and beyond. In the European literature of successive centuries, both the doctrine of Platonic love and the notion of an unchanging transcendent true world resonated strongly, as, for example, in the sixteenth-century writings of Edmund Spenser (1552–1599) and in the Romanticism of the nineteenth century as found in the writings of Percy Bysshe Shelley (1792–1822) and William Wordsworth (1770–1850).

In the latter portion of the seventeenth century, the Neoplatonist tendency toward religiosity and mysticism emerged again in a group referred to as the Cambridge Platonists, for whom divine authority asserted the transcendent existence of ethical ideas. The premier enemy of the Cambridge Platonists was materialism; particularly that variation articulated in the writings of Thomas Hobbes (1588–1679). Benjamin Whichcote (1609–1683) and Henry More (1614–1687) number among this group, although Ralph Cudworth (1617–1688) is generally considered to be the most significant figure. Platonism was utilized not only as a counter to materialism but as a means to rethink empiricist philosophy, as found in the response of Richard Price (1723–1791) to the philosophy of John Locke (1632–1704). Among the German idealists, a Platonic inflection is found in the writings of Immanuel Kant (1724–1804), while similar tendencies condition the work of Georg Wilhelm Friedrich Hegel (1770–1831). In the late nineteenth and early twentieth centuries, a strikingly Platonic metaphysics occurred in the work of the Hegelian John Ellis McTaggart (1866–1925), for whom reality is a system of spiritual substances that reveal the unreality of both matter and temporality.

The influence of the Platonist rejection of the immediacies of sensible existence is likewise found in the writings of G. E. Moore (1873–1958). A common-sense realist, Moore rejected both materialism and idealism in favor of a philosophic realism. Moore was among the more energetic critics of idealism at the turn of the century, and his realism maintained a separation between the mental act of knowing and the objects of knowledge, the latter existing as interconnected objects independent of thought. Finally, Alfred North Whitehead (1861–1947) has been called the last and greatest of the Cambridge Platonists. A critic of positivism who sought a unified scientific religion, Whitehead articulated universal absolutes as eternal objects—and it was Whitehead who famously commented that all philosophy was “a series of footnotes to Plato.”

See also Aristotelianism; Neoplatonism; Pythagoreanism; Stoicism.

BIBLIOGRAPHY

- Cherniss, Harold Fredrik. *The Riddle of the Early Academy*. Berkeley: University of California Press, 1945.
- Gersh, Stephen, and Charles Kannengiesser, eds. *Platonism in Late Antiquity*. Notre Dame, Ind.: University of Notre Dame Press, 1992.
- Pater, Walter. *Plato and Platonism: A Series of Lectures*. London: Cambridge Scholars Press, 2002.
- Shorey, Paul. *Platonism, Ancient and Modern*. Berkeley: University of California Press, 1938.

Kimberly Sims

PLURALISM. Pluralism derives from the Latin *plures*, meaning “several” or “many,” and it has formed the central concern of various intellectual traditions throughout the history of the West. Applied in philosophy, political theory, religion, and ethnic and racial relations, pluralism challenges the notion that a single authority or group must dominate all others. Rather than accepting the imposition of conformity to either a single standard of truth or a center of power, whether it is moral, political, cultural, or religious, pluralists have defended the right to diversity and difference. At its most promising, pluralism thus forms the basis of tolerance and the essential limitation of power and authority on behalf of human freedom.

Philosophical Pluralism

Philosophical pluralism’s core belief consists of the notion that humans do not simply discover and copy, through the use of reason, a unified reality that exists independently of them. Rather, our view of reality, or that which we take as truth, is always influenced by our cultural and historical context. Truth, accordingly, can never be absolute, static, strictly objective, and monolithic. On the contrary, it always contains elements of subjectivity and change, more of relativism than absolutism. In short, truth, and even reality itself, consist of the many rather than the one.

Absolutism, on the other hand, holds that the human mind acts ideally as a passive mirror that faithfully reflects an independently existing, unified reality without distortion. Universal agreement about the nature of that reality is therefore possible. This notion was most famously articulated by the ancient Greek philosopher Plato (c. 428–348 or 347 B.C.E.). In his allegory of the cave, Plato regarded the knowledge of ordinary people to be distorted by the conventions of culture and the flux of change typical of the empirical world of passing phenomena. Plato’s philosopher, on the other hand, abandoned the cave of culture and walked outside into the light. There he apprehended the eternal, the unchanging, the very essence of all being—the pure Idea. Thus Plato’s philosopher rose above myth, deception, and error, above the darkness of the empirical world typical of the cave of ordinary life. He transcended all limitations to achieve objective, transparent, and timeless truth through the exercise of unconditioned reason. With his mind thus unfettered, the philosopher should also assume the political authority of king in the ideal republic because he alone could rule on the basis of truth and reason. Plato thereby introduced the undemocratic view that only those with privileged consciousness should rule.

Aristotle

Future generations of pluralists would challenge absolutism in various ways, but it fell to Plato’s student Aristotle (384–322 B.C.E.) to criticize the overly abstract quality of the Platonic Idea of the Good, the True, and the Beautiful. In *The Nichomachean Ethics*, Aristotle pointed out that Plato’s disembodied categories of thought proved unhelpful and even irrelevant because they were too disconnected from reality to serve as a useful guide to experience. Even if the Platonic Idea of the Good, for example, could somehow be known by human reason (and Aristotle thought this impossible) “it is not easy to see

how knowing that same Ideal Good will help a weaver or carpenter in the practice of his own craft,” Aristotle argued, “or how anybody will be a better physician or general for having contemplated the absolute Idea” (p. 25). For Aristotle, reality consisted rather of the empirical facts as faced by humans in concrete situations. Not even the physician studies the Good in the abstract. Rather, “he studies the health of the human being—or rather of some particular human being, for it is the individual that he has to cure” (p. 25). Like Aristotle, future generations of pluralists would chafe against the arid abstractions of idealist philosophy; they, too, would favor the multiplicity of empirical facts encountered by historically situated subjects in search of truth capable of guiding action in the world shared by men and women. Their universe, unlike Aristotle’s, however, would be open-ended, changing; their truths would be plural rather than singular, monistic, and absolute. Nor would they come to expect universal agreement; for them, Socratic dialogue would be their guide.

German Historicism

Giambattista Vico (1668–1744) and Johann Gottfried von Herder (1744–1803), the founders of German historicism, deepened the rebellion against monism and absolutism. These critics of the great tradition of Western philosophy rejected that tradition’s key assumption that natural laws operated to maintain an independent, objective reality, knowledge of which would yield absolute, foundational truth. Attacking the Enlightenment claim that European culture best exemplified the triumph of reason and science, Vico and Herder surveyed the sweeping panorama of history and cultural variation with deep respect and tenderness. Rather than demanding conformity to some chimerical universal truth, these pluralists cherished a world made vibrant by difference. Each culture, each epoch did not represent a mistake, deviation, or lower stage of development. Like a colorful garden made up of many flowers, the plurality of cultures suggested beauty and completeness in each form, all wondrous manifestations of the creative force of humankind. Vico grounded his defense of pluralism in a rejection of the philosophes’ notion that mathematical laws corresponded to those of an independent reality. Far from offering a paradigm of certainty, mathematics, for Vico, provided at best knowledge of regularity but certainly not authentic understanding of the human world. The utility of mathematics lay in its origin as a human creation, not in its presumed correspondence with reality. And humans could understand mathematics because they had created it. Vico then applied this maker’s theory of knowledge to the realm of culture. We could come to understand other cultures by virtue of our shared humanity and capacities as cocreators of culture. For this to occur, however, we must abandon the fallacious doctrine of absolutism and approach other cultures on their own terms.

Herder too rejected the mechanical method of science and universalism for sympathetic understanding, which he termed *Verstehen*. In exercising this ability to understand others separated from us by time or cultural difference, we engage the other in a process of dialogue in an encounter between self and other. Through the use of subtlety and imaginative reconstruction, we attempt to understand the different on its own terms rather than attempting to force it into conformity

with nonexistent laws. For Herder then, authentic progress consisted not in uniformity but in the acknowledgment that “not a man, not a country, not a people, not a natural history, not a state are like one another. Hence the True, the Good, the Beautiful in man are not similar either” (Berlin, p. 210). Thus by Herder’s lights, “It is terrible arrogance to affirm that, to be happy, everyone should become European” (Berlin, pp. 210, 197). For these defenders of difference, the flowering of spontaneous, natural forms of human self-expression by men and women in cultural groups united by a common language and worldview provided humankind with a flesh-and-blood alternative to the abstract, lifeless citizen of the Enlightenment.

Pragmatism

At the dawn of the twentieth century, a new philosophical movement called pragmatism emerged, part of the modernist revolt against nineteenth-century orthodoxy. Influenced by the German philosopher Friedrich Nietzsche (1844–1900) and the French thinker Henri-Louis Bergson (1859–1941), the movement included such leading figures as Charles S. Peirce (1839–1914), William James (1842–1910), and John Dewey (1859–1952). Although differences existed within the movement, pragmatists were united in their search for empirical truths capable of guiding action in a changing world. Unlike absolutists therefore, pragmatists conceived of truth as relative and akin to scientific hypotheses verifiable through experience and subject to revision in the light of new conditions. William James captured the reigning view of truth in his critique of absolute theism. Like philosophical idealism, its more secular counterpart, absolute theism insisted that “truth exists per se and absolutely by God’s grace and decree, no matter who of us knows it or is ignorant, and it would continue to exist unaltered, even though we finite knowers were all annihilated” (1909, p. 28). However, the proliferation of contending scientific theories in the late nineteenth century, as well as the profound influence of Charles Darwin’s theory of evolution, called into question the entire notion that truth represents a mere mental copy of a static, independent reality. Pragmatists believed “that even the truest formula may be a human device and not a literal transcript” (James, 1955, p. 233). Indeed James regarded the “very notion of a world complete unto itself, to which thought comes as a passive mirror, adding nothing to fact” as “irrational” (1955, p. 233).

By situating truth and reason inside the empirical flux of experience rather than outside it in some abstract, static transcendental realm, pragmatists abandoned the unhelpful quest for certainty and instead offered reason as an instrument of adaptation and dynamic transformation of the world. “What really exists,” James held, “is not things made but things in the making” (1909, p. 263). Regarding truth as an encounter between subject and object, he looked to “living understanding of the movement of reality” as an alternative. Moreover that flux could only be seen as pluralistic rather than monistic. In the place of monism, James thus offered his pluralistic universe, which he regarded “more like a federal republic than like an empire or kingdom. However much may report itself as present at any effective center of consciousness or action,” he cautioned, “something else is self-governed and absent and unreduced to unity” (1909, pp. 264, 321–322).

Life can be seen through
many windows,
none of them necessarily
clear or opaque,
less or more distorting
than any of the others.

SOURCE: Sir Isaiah Berlin, “Winston Churchill in 1940,” in *Personal Impressions*, p. 4.

Cultural Pluralism

The pluralistic defense of cultural diversity typical of Vico, Herder, and James has grown more powerful in the modern world as ethnic and racial groups within multiethnic societies have increasingly sought to exercise political power and retain their cultural heritage in the face of demands for cultural conformity. In the United States the pragmatists Horace Meyer Kallen (1882–1974) and Randolph Silliman Bourne (1886–1918) supplied a spirited defense of diversity during World War I. Although the American political tradition of classical liberalism championed individual rights, it failed to extend those rights to include the right to be culturally different. Liberal rights had wrongly assumed “that men are men merely, as like as marbles and destined under uniformity of conditions to uniformity of spirit,” Kallen wrote in “Democracy versus the Melting Pot” (p. 193). The right to cultural identity was essential to selfhood, however, and Kallen called for a “Federal republic,” a “democracy of nationalities, cooperating voluntarily and autonomously in the enterprise of self-realization through the perfection of men according to their kind” (p. 220).

Similarly Bourne’s 1916 essay “Transnational America” reminded dominant Anglo-Saxons that even the early colonists “did not come to be assimilated in an American melting-pot. They did not come to adopt the culture of the American Indian” (p. 249). Bourne also called for a “cosmopolitan federation of national colonies” within which ethnic groups “merge but they do not fuse” (pp. 258, 255). Thus an immigrant would be both a Serb and an American, for example, as difference harmonized with common ground.

Although both men challenged what was taken by most Anglo-Saxons to be the absolute truth regarding what it meant to be an American, Bourne went well beyond Kallen’s demand for freedom defined simply as a private right to be different. Influenced by the Enlightenment, Kallen assigned ethnicity to private life while he placed the public world in the hands of technical experts. Bourne, on the other hand, urged a national collaboration in the construction of a new national culture by all racial and ethnic groups in terms reminiscent of Herder. Contrarily then, Bourne’s freedom meant “a democratic cooperation in determining the ideals and purposes and industrial and social institutions of a country” (p. 252). Thus while Kallen’s vision served to strengthen the dominance of experts in the public

sphere of work and politics, Bourne called for a “Beloved Community” that placed democratic participation and a discussion of values at the very center of public life (p. 264).

Animated by these somewhat contradictory ideals, cultural pluralism constituted a protean movement in the first half of the twentieth century in the United States. Particularly important achievements include the efforts of John Collier (1884–1968) as commissioner of Indian Affairs during the administration of Franklin Roosevelt to overturn the U.S. government’s policy of assimilation of the American Indian. Due to Collier’s efforts, Native Americans regained the right to their cultures, lands, and tribal political institutions after decades of denial. The Harlem Renaissance of the 1920s also reflected the principles of cultural pluralism. Alain Leroy Locke (1886–1954), America’s first African-American Rhodes scholar and a former student of William James, furnished the guiding vision of the Renaissance and helped to achieve Bourne’s “beloved community.” Finding beauty within himself, through a rebirth of black art, the “new Negro” would thereby achieve the moral dignity suited to a “collaborator and participant in American civilization” (Locke, 1925, p. 5). Langston Hughes, Zora Neale Hurston, Claude Mackay, Jean Toomer, and others awakened black pride and offered an aesthetically and spiritually barren industrial capitalist America African-American wisdom and beauty instead of the ashes of materialism.

During the second half of the twentieth century, cultural pluralist thought in the United States was increasingly eclipsed by the lingering commitment of liberal intellectuals to the Marxist notion of culture as mere superstructure or as determined by the more fundamental struggle for power. Nevertheless, minority groups continue to struggle to achieve cultural democracy in the early twenty-first century’s multicultural societies. As the Canadian philosopher Charles Taylor, following Herder, has argued, being true to oneself requires an acknowledgment by both self and other of the indispensable role of culture in the creation of identity. Because culture imparts those particular aspects—religion, language, traditions—that make an individual or group unique, the forced assimilation of minorities to the hegemonic standard of identity by a majority group constitutes a form of oppression and violence of the spirit. This recognition has led in turn to efforts to expand the political theory of liberalism to include not only a defense of identical universal rights but the right of groups to cultural differences as well. Cultural pluralists therefore seek to supplant cultural monism or absolutism with pluralism by reconciling community with diversity in the modern world.

Critics of cultural pluralism and multiculturalism worry, however, that the twenty-first century’s emphasis on racial, ethnic, and cultural diversity will go too far and erode the common ground necessary to national unity. Arthur M. Schlesinger Jr., for example, decried the collapse of shared values and traditions under the weight of a dangerous tribalism in *The Disuniting of America*. Assimilation within the crucible of the melting pot, America’s “brilliant solution for the inherent fragility of a multicultural society,” was being destroyed by the multiculturalists’ “search for roots” and the “cult of ethnicity” (Schlesinger, pp. 13, 15). Thus unity threatened to “give way to the Tower of Babel” (Schlesinger, p. 17).

Political thought is representative. I form an opinion by considering a given issue from different viewpoints, by making present to my mind the standpoints of those who are absent; that is, I represent them. . . . The more people’s standpoints I have present in my mind while I am pondering a given issue, and the better I can imagine how I would feel and think if I were in their place, the stronger will be my capacity for representative thinking and the more valid my final conclusions, my opinion.

SOURCE: Hannah Arendt, “Truth and Politics,” in *Between Past and Future*, p. 241.

David Hollinger has similarly pointed out the dangers of diversity. Unlike Schlesinger’s prescription for a conformist unity based on assimilation, however, Hollinger has called for a postethnic America founded upon cosmopolitanism. Drawing a helpful distinction between cosmopolitanism and conformist universalism, he argued that the former “shared with all varieties of universalism a profound suspicion of enclosures, but cosmopolitanism is defined by an additional element not essential to universalism itself: recognition, acceptance, and eager exploration of diversity” (p. 84). At their best, such critics remind us that the claims of diversity and community must be reconciled, a reconciliation achieved by the civil rights movement of the 1950s and 1960s.

Political Pluralism

In practice, the political variation on pluralist thought has attempted to disperse political power and authority in modern societies, with varying degrees of success. English political pluralists, for example, grappled with the problem of maintaining political diversity and liberty in the face of the growing power of the modern state in the early twentieth century. Influenced by the Whig tradition, which sought to safeguard the achievements of the Glorious Revolution of 1688 by limiting state power through a system of checks and balances, J. N. Figgis (1866–1919) and Harold J. Laski (1893–1950) feared this centralization of power and sought to disperse it among the various groups and associations within society. They thus opposed the idealist view of the state, typical of T. H. Green (1836–1882) and F. H. Bradley (1846–1924), as the highest expression of social unity. Contrarily, pluralists regarded the state as one group among many, the function of which consisted of maintaining individual liberty and the social order necessary to the pursuit of substantive goods by groups within a flourishing civil society. In their insistence that state power be limited, pluralists therefore followed the lead of Alexis de Tocqueville (1805–1859) and F. W. Maitland (1850–1906),

both of whom sought to strengthen those intermediate groups between the individual and the state as the most effective bulwark against tyranny. The works of Laski and Figgis influenced English guild socialists, such as G. D. H. Cole, S. G. Hobson, and A. R. Orage, who hoped to use the state to establish guilds that would abolish capitalism and reinstitute worker control of industry. That tradition, however, lost influence from 1920 to 1960 to the state socialism of the Labour Party.

Whereas their English counterparts were preoccupied with limiting state power, American pluralists, such as Arthur F. Bentley, Walter Lippmann, David Truman, and Robert Dahl, stressed a notion of pluralism as a system of indirect democracy characterized by interest-group competition and a balance of power. Purportedly open to all citizens and overseen by enlightened elites, these groups engaged in bargaining and compromise over rational, limited ends. With its roots in the works of Roberto Michels, Gaetano Mosca, and Vilfredo Pareto, American political pluralism, especially after World War II, emphasized the necessity of political and economic elites in maintaining democracy. As interpreted by liberal intellectuals during the Cold War, the masses could not be trusted to act rationally out of reasonable self-interest. Instead, they were seen as authoritarian, prone to conspiracy theories, and uncommitted to the values of liberal democracy. Only a system of interest-group competition within a stable, corporate capitalist system overseen by enlightened elites could prevent the mass activism that had led in Europe to the totalitarian regimes of Adolf Hitler and Joseph Stalin, it was believed. Thus democracy was redefined to mean not rule by the people but rather rule of the people by elites. Ethnic and racial groups were consequently redefined as organized interest groups vying with each other for a fair share of economic and political power within a responsive, expanding system of corporate capitalism and interest-group pluralism. Rule by the professional managerial class, experts, and intellectuals was therefore both rationalized and justified, a view for which pluralism has often been criticized. Nevertheless, Robert Dahl has called for the establishment of self-governing worker cooperatives in industry as a democratic antidote to the concentration of political power by America's corporate oligarchy. Likewise some neopluralist thinkers seek to revise conceptions of political power and better account for the political voice and engagement of the diverse groups pluralism aims to protect.

Conclusion

Reinhold Niebuhr captured the spirit of pluralism when he wrote: "Absolutism, in both religious and political idealism, is a splendid incentive to heroic action, but a dangerous guide in immediate concrete situations. In religion it permits absurdities and in politics . . . unbearable tyrannies and cruelties" (p. 199). As the horrific events of September 11, 2001, demonstrated, religious absolutism too is capable of "unbearable cruelties." In the aftermath of September 11, pluralism therefore increasingly became synonymous with religious and cultural diversity and secularism as well as the decentralization of political power typical of the modern West. Thus pluralism has come to signify the tolerance and liberalism of the Western tradition as opposed to the closed, totalitarian societies of

Islamic fundamentalists. Whatever the sources of absolutism may be, the works of Hannah Arendt (1906–1975) and Isaiah Berlin (1909–1997) as well as those of the earlier pluralists remain an important guide in troubled times.

See also Capitalism; Citizenship; Civil Society; Cultural Studies; Idealism; Identity: Personal and Social Identity; Liberalism; Marxism; Nation; Representation: Political Representation.

BIBLIOGRAPHY

PRIMARY SOURCES

- Arendt, Hannah. *Between Past and Future: Eight Exercises in Political Thought*. New York: Viking, 1968.
- Aristotle. *The Nichomachean Ethics*. Translated by H. Rackham. Cambridge, Mass.: Harvard University Press, 1939.
- Berlin, Isaiah. *Personal Impressions*. 2nd ed. Princeton, N.J.: Princeton University Press, 2001.
- Bourne, Randolph. "Transnational America." In his *The Radical Will: Selected Writings, 1911–1918*. Edited by Olaf Hansen. New York: Urizen Books, 1977.
- Dahl, Robert A. *A Preface to Economic Democracy*. Berkeley: University of California Press, 1985.
- Hirst, Paul Q., ed. *The Pluralist Theory of the State: Selected Writings of G. D. H. Cole, J. N. Figgis, and H. J. Laski*. London: Routledge, 1989.
- James, William. *A Pluralistic Universe: Hibbert Lectures to Manchester College on the Present Situation in Philosophy*. London: Longmans, Green, 1909.
- . *Pragmatism: And Four Essays from "The Meaning of Truth"*. Edited by Ralph Barton Perry. New York: Meridian, 1955.
- Kallen, Horace M. "Democracy versus the Melting Pot." *Nation* 100 (18/25 February, 1915): 190–194; 217–220.
- Locke, Alain. *The Critical Temper of Alain Locke: A Selection of His Essays on Art and Culture*. Edited by Jeffrey C. Stewart. New York: Garland, 1983.
- . "The New Negro." In *The New Negro: An Interpretation*, edited by Alain Locke. New York: A. and C. Boni, 1925.
- Niebuhr, Reinhold. *Moral Man and Immoral Society: A Study in Ethics and Politics*. New York: Scribners, 1932.
- Taylor, Charles. "The Politics of Recognition." In *Multiculturalism and "The Politics of Recognition": An Essay*. Edited by Amy Gutmann. Princeton, N.J.: Princeton University Press, 1992.

SECONDARY SOURCES

- Akam, Everett Helmut. *Transnational America: Cultural Pluralist Thought in the Twentieth Century*. Lanham, Md.: Rowman and Littlefield, 2002.
- Berlin, Isaiah. *Vico and Herder: Two Studies in the History of Ideas*. New York: Viking, 1976.
- Berman, Paul. *Terror and Liberalism*. New York: Norton, 2003. An example of the identification of the West with pluralism, in contrast to "totalitarian" Islamic fundamentalism.
- Hollinger, David A. *Postethnic America: Beyond Multiculturalism*. New York: BasicBooks, 1995.
- Isaac, Jeffrey C. *Arendt, Camus, and Modern Rebellion*. New Haven, Conn.: Yale University Press, 1992.

Runciman, David. *Pluralism and the Personality of the State*. Cambridge, U.K.: Cambridge University Press, 1997.

Schlesinger, Arthur M., Jr. *The Disuniting of America*. New York: Norton, 1992.

Everett Helmut Akam

POETRY AND POETICS. In the fourth century B.C.E. Aristotle (384–322) successfully founded the discipline of poetics both by accepting poetry as suitable for rational analysis and by setting up the main terms of debate that still define the field today. Issues of genre, representation, decorum, interpretation, aesthetic evaluation, and what might be considered the essence of literary language are all broached in Aristotle's remarkable treatise *On Poetics*. Moreover, since he described this art or skill (*technē*) as concerned with what *may happen* as opposed to what *has happened*—with possibility, probability, or necessity rather than mere actuality (1451b)—the topic has been consistently attractive to philosophical investigation. Unmarred by the contingencies or accidents that characterize historiography, poetry may serve as a privileged area for philosophical reflection. Long before the eighteenth century developed a rigorous theory of aesthetics, Aristotle outlined the conceptual space wherein poetry and philosophy could enter into a fruitful and mutually enlightening dialogue.

Genre

As a science of interpretation, poetics has consistently been concerned with delineating its proper field of study (“What is a poetic text?”) and then subdividing it into genres (“What kind of poetic text is under consideration and what interpretive approaches does it select?”).

Classical poetics. Although classical writers on the subject of literary types failed to formulate a comprehensive system of genres, they did fix certain distinctions that would continue to play a role—first prescriptive, then descriptive—in the Western poetic tradition. To begin with, the term *poetics* as Aristotle defined it exclusively pertains to literary works composed in verse. The verse form, however, is a less important criterion than the notion of *poiēsis*, which perhaps would be best understood as “fiction.” While it was common practice in antiquity to present scientific material in verse form, Aristotle decisively limited the term *poetry* to fictional representations. Homer is a poet; Empedocles is not (1447b). Prose, which was then restricted to oratory, historiography, and Aristotle's own manner of philosophical discourse, belongs instead to the realm of *rhetoric*. The fact that Aristotle neglected to account for the fictional use of prose, for example, in the fable, is already an indication of his general lack of comprehensiveness.

In a similarly broad move, Plato (c. 428–348 or 347 B.C.E.) had divided all literary genres into two primary categories: poetic representations by way of described action, as in epic poetry; and representations by way of impersonated action, as in drama. When Plato was faced with the fact that Homeric epic in fact employs both modes of representation, the philosopher added the “mixed mode,” where the related action alternates

between straight narrative and re-created dialogue (392–394). The existence of what we would call lyric poetry (for example, iambic poetry, elegy, melic poetry, or choral odes) is vaguely acknowledged by Plato in Book 10 of the *Republic*, but only to be condemned as beautifully contrived falsehoods passed off as truth. Aristotle, whose explicit intention at the beginning of *On Poetics* is to give an account of “poetry in itself and its kinds or forms [*eidē*]” (1447a), summarily abandons a discussion of lyric composition by reverting to Plato's fundamental division between narration and impersonated dialogue.

This persistent lacuna, however, hardly played a role in the development of European poetics. The crucial point rather is that both Plato and Aristotle insisted that poetry is an art of representation or imitation (*mimēsis*). Placed alongside a nascent theory of genre, the idea of mimesis introduces the important issue of *decorum* (what is appropriate for certain characters to say or do in certain situations). An ancient concern for genre thereby anticipated one of the fundamental tenets of later formalism, namely that representational content is inseparable from representational form. With the identification and accumulation of more poetic forms in Latin treatises such as Horace's *Ars poetica* and Quintilian's *Institutio oratoria*, classical genre theory could be further codified to serve as a system of prescriptive rules for composition as well as for the critic's evaluation.

Neoclassicism and its critics. The rediscovery of Aristotle's *On Poetics* in the sixteenth century gave rise to a fresh and impassioned interest in codifying a system of poetic forms. In addition to debates on the viability of particular “mixed forms,” for example, Giovanni Guarini's scandalous defense of his tragicomedy, *Il pastor fido* (1590; *The faithful shepherd*), this period established the doctrine of the three “unities” of time, place, and action, which would have a decisive influence on dramatic productions well into the eighteenth century. Lodovico Castelvetro's seminal commentary on Aristotle's *Poetics* (1570) is the key source of much of the normative poetics promulgated by European Neoclassicism. Another high point is Nicolas Boileau's elaborate typology, outlined in his *Art poétique* (1674), where the fundamental categories of epic and drama (both tragic and comic) are joined by the pastoral poem, the elegy, the ode, the epigram, and satire. As is generally the case with neoclassical movements, the rationale for such divisions as well as the demand that each genre remain distinct from the others are proffered as self-evident and entirely natural. Twentieth-century critics of ideology, for example, Fredric Jameson, will argue that it is precisely this naturalness that indicates that all genre theories reinforce the hegemonic order. The hierarchies of generic explication and their attendant ideals of decorum dictate the relations between the high, middle, and low spheres and thereby have deep implications for societal and political organization.

Although Romanticism rejected the authoritarian conventions prescribed by Neoclassicism, poets of the late eighteenth century, particularly in Germany, seem to have recognized the importance of literary form in relation to content. Genre is how poetry specifically transforms the actual into the possible. Friedrich Hölderlin (1770–1843), for example, developed an elaborate genre system to underwrite his experiments on the

long Pindaric ode. In his fragmentary essay, “Über die verschiedenen Arten, zu dichten” (c. 1800; On the different ways to compose poetry), he combines genre theory and a kind of ontological decorum by detecting a “proper” and “improper” tone in the constitution of the three major poetic modes: the natural, the heroic, and the ideal, which correspond respectively to lyric, epic, and drama. Literary genres became associated with the epistemological concerns opened up by the critical philosophy of Immanuel Kant (1724–1804). Here, traditional approaches to genre-criticism contributed to new models for explaining how we give form to the world around us.

Contemporary issues. Although the idea of using prescriptive norms for poetic composition had been entirely discredited by the close of the eighteenth century, this does not mean that theories of genre no longer contributed to discussions of poetics. Although Benedetto Croce (1866–1952) in his *Aesthetics* (1902) persuasively argued that all genre designations were mere abstractions disrespectful of the artwork’s uniqueness, there has been no lack of theoreticians who have recognized the benefits of generic descriptions for the study of literature. Accordingly, genre criticism has yielded to notions of intertextuality, where, as in the famous remark by T. S. Eliot (1888–1965), a poet’s individual voice is determined only in relation to the preceding tradition of forms or conventions. Northrop Frye, who outlines an altogether elaborate system of literary archetypes in his *Anatomy of Criticism* (1957), similarly approaches literary history with an eye toward broad, organizational patterns. Structuralist accounts, which in many respects respond to Frye’s archetypal criticism, essentially replace the term *genre* with *code*. The work of Roland Barthes, Tzvetan Todorov, and Gérard Genette, for example, demonstrates the continued usefulness of generic criticism, especially when the notion of genre assumes a more provisional and aspectual quality. Even postmodern theorists of *écriture féminine* (feminine writing), which explicitly claim to transgress all interpretive laws, as in the work of Hélène Cixous, should be regarded as perpetuating discussions of genre, however idiosyncratically. This is the case even when generic boundaries serve as the target of critique, as in theories of gender and sexuality, for example in the work of Judith Butler.

Interpretation

Since Aristotle, poetic theory has oscillated between two distance tendencies: the desire to formulate philosophical statement aimed at describing the essential elements of poetry; and the equally prevalent desire to make aesthetic judgments capable of evaluating a given poetic work. Both strands work together to define the basic project of interpretation.

Philosophy and aesthetic judgment. Evident throughout Aristotle’s *Poetics* is an oscillation between two distinct tendencies: the desire to formulate philosophical statements aimed at describing the essential elements of poetry; and the equally prevalent desire to make aesthetic judgments capable of evaluating a given poetic work. Aristotle assumes the twin roles of theorist and critic. Certainly the theoretical emphasis on mimesis establishes the criterion for critical evaluation. Once representation is posited as the defining term for poetry, the question that always arises is: How well has the artist portrayed

the real? If one accepts Plato’s ontological division between a realm of transcendent Forms and the physical reality that merely copies them, then poetic mimesis is a doubly weak version, being a mere copy of a copy, “two steps removed from Truth” (10.602c).

If, however, like Aristotle, one construes mimesis as something creative rather than passive, as something that represents human actions rather than physical objects, then one can judge how effectively the poet has presented a new reality—a *possible* world—albeit on the basis of the actual. Already, then, in this quarrel between Plato and Aristotle, one can see the divide, persistent throughout the centuries, between those who demand poetry’s adherence to a referent in the world and those who appreciate poetry’s capacity to be self-referential.

Kant’s *Critique of Judgment* (1790) is the first sustained attempt to reconcile the claims of philosophical description with the declarations of subjective evaluation. By grounding the judgment of the beautiful entirely in a nonutilitarian, “disinterested pleasure,” Kant arrives at his goal of a subjective universal, which solves the inevitable problem of any poetic theory: How can the unique qualities of a poem (*poiesis singularis*) withstand the abstracting, de-individualizing forces of conceptual understanding (*mathesis universalis*)? Kant’s aesthetics, which successfully delimits a space for a nonconceptual mode of philosophizing, thereby becomes a foundational text for Western poetics, first through Samuel Taylor Coleridge and Friedrich Schiller, and then in twentieth-century aesthetics devoted to the intricate relations between content and form.

Representation and expression. Whereas the experience of the beautiful is firmly based on notions of representation, Kant’s discussion of the sublime takes place precisely where representation breaks down. An increasing attention to the ancient treatise *On the Sublime*, falsely attributed to Longinus (fourth century C.E.), brought along a new understanding of literature not strictly as a mimesis of the external world but rather as an expression of something internal. The title of M. H. Abrams’s extensive study *The Mirror and the Lamp* (1953) concisely marks the transition from a classical poetics of representation to a Romantic theory of expression, where, in the words of William Wordsworth (1770–1850), poetry became “the spontaneous overflow of powerful feelings” (Preface to *Lyrical Ballads*, 1798). Accordingly, the trend at the beginning of the nineteenth century to emphasize expression over representation paralleled the privilege given to lyric poetry over epic. This new preference reflected the general turn to concerns about subjectivity, which had come to define the post-Kantian philosophical environment. As might be expected, the fresh subjectivism brought a rekindled interest in notions of affect, consciousness, and emotion, all of which acted as a corrective to what was now viewed as the excessively one-sided objectivism of the Aristotelian tradition.

Expressivist theories of literature extended well past Romantic schools and informed a good deal of twentieth-century poetics. Theories of the preverbal or nondiscursive origins of art belong to this tradition, be it in the psychoanalytic-semiotic investigations of Julia Kristeva or the nearly Heideggerian meditations of Maurice Blanchot, where the work of art is but the

finite expression of an otherwise inaccessible, original experience. In this respect, Orpheus is Blanchot's paradigmatic poet precisely because Eurydice disappears in his backward gaze: what is always missing from the work of art is its origin.

Poetic Function

The question of whether poetry is primarily representation or expression invariably hinges on the poetic function in language. What makes language literary? Is it possible to distinguish between a literary and a nonliterary use of language? Twentieth-century responses to these perennial questions differed from earlier discussions in that they tended to reformulate the matter by questioning the very tenability of a division between poetry and poetics. With an increased awareness of the rhetorical quality of all language—its “rhetoricity”—come fresh difficulties in discerning scientific from nonscientific discourse, concepts from metaphors, objectivity from subjectivity.

New criticism and formalism. Common sense would assert that the distinction between poetry and poetics is obvious. The poet provides what the interpreter must study, appreciate, and even evaluate. The New Critics, who during the middle decades of the twentieth century governed the reading practices of English-speaking academia, reinforced this commonsense premise by stressing the creative, literary qualities of the primary material (for example, the poem) and the scientific, essentially nonliterary qualities of the commentary devoted to it. This theoretical partitioning already determines what may and may not be considered a poem. As is so often the case, theory produces its own object of study. Whereas other interpretive traditions would regard poetry as representing reality mimetically, or as an expression of some internal state, or even as a vehicle for knowledge about the world or humankind in general, the New Critics were concerned exclusively with formal properties. And it is this decisive emphasis that invariably characterized the exegetical activity of the interpreter as an altogether distinct mode of discourse. The activities of the poet and the poetician rested on two entirely different functions of language. Even when a single person happened to publish both poetry and works of criticism, the difference was maintained by keeping an inventive treatment of language separate from more utilitarian intentions. The crafted, somewhat opaque quality of the poem, which featured any number of figurative and stylistic devices, from metaphors and imagery to alliteration and rhyme, distinguished itself from the critical tools of poetics, which on the whole abstained from figurative language and instead gave the appearance of being unambiguous and immediately transparent.

The paradigm for establishing this firm boundary between poetry and poetics is derived from the belief that the text should be approached by a reader who remains utterly detached from it. Cleanth Brooks's “well-wrought urn,” therefore, constituted an isolated and autonomous artifact, a tightly composed object wherein content is absolutely inseparable from form. Immanently coherent and dramatically structured by forces in tension, the poem presents itself as especially amenable to a highly professional explication. In a methodology that built on Kant's notion of aesthetic disinterestedness, the New Critical ideal prohibited any recourse to subjective opinion or impressionistic

feelings. Poetry and poetics had to be sharply delineated so as to preserve the formal purity of the artwork from personal contamination, not only from the reader, but from the author as well. Biographical details, sociocultural context, or other historical circumstances were all excluded from consideration by the New Critics, for whom art subsisted on intrinsic qualities alone free from all extrinsic forces.

Similarly, but with a greater attention to linguistic patterns, Russian formalists such as Victor Shklovsky, Boris Eichenbaum, and Roman Jakobson held that the distinction between the nonliterary and the literary was of primary importance. Again, their mode of investigation was concerned entirely with intrinsic elements. In his seminal essay “Linguistics and Poetics” (1960), Jakobson defines the “poetic function” of language as that which promotes “the palpability of signs,” which is to say that poetic language calls attention to its own medium. Whereas when one reads a nonliterary text it is necessary to *look through* the text, a literary experience is essentially an invitation to *look at* the text. The doctrine of the inseparability of form and content demands that the materiality of textual signs resist easy dissolution into immaterial sense. This adherence to the radically self-referential qualities of a poem was aimed at correcting the subjectivism of Romantic criticism, but thereby it also instigated denunciations from more politically motivated theorists, for example, from the Marxist Leon Trotsky (1879–1940), who attacked the formalists' neglect of the historical, social, and economic conditions of literature. For Trotsky—and this point would be championed by later Marxist critics—the formalist's act of sealing the poem off from life could be understood only as a grave shortcoming.

Structuralism. It was Jakobson's indebtedness to the work of the linguist Ferdinand de Saussure (1857–1913) that connected Russian formalism to various trends of literary and cultural analysis grouped under the name *structuralism*. The key methodological premise of structuralism is that theoretical investigation must attend to systems, as opposed to the manifestations of those systems. In Saussure's terms, analysis is concerned with *langue* (“the system of language,” analogous to grammar) as opposed to *parole* (“actual expressions in the language”). The autonomous work of art should be subjected to an examination that will yield information about the system's operation. It is easy to see how this theoretical disposition would appeal more readily to the Russian formalists than to the Anglo-American New Critics, who had difficulties abandoning the idea of the poet as individual crafter. In structuralism, the literary work of art is simply the creation of transpersonal or even impersonal systems wholly beyond the author's control. As a movement, it marked the deposing of the individual, which eventually developed into the antihumanist stance most popularly associated with Roland Barthes, who along with others announced the “death of the author.” Interestingly, it is precisely this decentering of the individual artist that reconciled formalism with the demands of Marxist criticism: no longer the product of a single author working essentially in isolation, literature for the structuralists came to be regarded as the result of cultural and social systems, which served as correlatives to the socioeconomic conditions scrutinized by Marxist theorists. The ideological criticism of writers such as Louis Althusser reinterpreted the author

more specifically as a *subject* whose particular historical position serves as a conduit for the forces that maintain the hegemonic order of the state.

The work of Northrop Frye, which gives a different critique of formalism, owes more to Freud than to Marx. Still, Frye upheld the formalist principle of the poem's autonomy by keeping poetics (criticism, interpretation, or commentary) qualitatively separate from poetry. At the beginning of his *Anatomy of Criticism*, for example, he asserts, "There is a totally intelligible structure of knowledge attainable about poetry which is not poetry itself, or the experience of it" (p. 14). This distinction corresponds specifically to the difference between science and art. Science, the science of poetics, for example, deals exclusively with concepts or with the essence of poetry, both of which necessarily transcend the particularity of the object under investigation. The structure that makes poetry comprehensible is explicitly not poetry. The practice is similar to the model of psychoanalytic theory in that the wakeful scientist-*cum*-interpreter stands apart from the various distortions of the dream-work, in order to render the incomprehensible comprehensible. Accordingly, the singular experience of art must find its truth outside itself in the abstract categories of understanding.

Poststructuralism. The weaknesses of a demarcation between poetics and poetry along the lines of science and art are acutely recognized by literary theorists working in the wake of formalist and structuralist methods. First and foremost, any systematic division between poetry and poetics is based on the presumption that the particularities of a poem must be subsumed under the general concepts of theory if they are to communicate intelligibly. This view holds that abstractions alone give meaning to the singular event of the text. Invariably, these approaches lead to either a naïve optimism or a barren skepticism: the interpreter is either applauded for discovering and transmitting some hidden significance of a poetic work of art or denounced for proffering illusory interpretations that are merely subjectively imposed structures whose actual existence in the text remains highly questionable. On a more fundamental level, the distinction between a scientific poetics and a nonscientific (artistic) poetry relies on the untenable belief that poetic language can readily be separated from nonpoetic usage. As Jacques Derrida has shown, throughout the history of Western metaphysics philosophy persistently has made every effort to deny its participation in a language that it shares uncomfortably with poetic and literary texts. Philosophy tries to disavow a metaphorical use of language that necessarily compromises its aspirations to conclusions that are purely scientific, not contingent on history or culture, and therefore universally applicable. Deconstruction works to reveal that all language is metaphorical, that all science is art, that every poetics is poetry.

The dissolution of these barriers is already recognizable in the Greek word *technē*, which ambiguously denotes both science and art. Insofar as it is a *technē*, poetics shares with poetry the capacity to produce. Aristotle thereby brought out the artistic element of poetics as well as the scientific element of poetry, by considering both as modes of production. Just as Sophocles was responsible for producing *Oedipus Tyrannus*, so

For the historian and the poet do not differ by speaking either in meters or without meters. . . . But they differ in this: the one speaks of what has come to be while the other speaks of what sort would come to be. Therefore *poiēsis* is more philosophic and of more stature than history. For poetry speaks rather of the general things while history speaks of the particular things.

SOURCE: Aristotle, *On Poetics*, 1451b.

Aristotle saw himself as producing statements or judgments about it. Even in granting the fundamental distinctions between the scientific, investigative approach of one and the inventive, creative intent of the other, Aristotle suggests it is necessary to maintain this essential similarity.

That said, it is important to remember that although Aristotle does not posit poetry and poetics as opposites, he does in fact oppose poetry to history. It is history and not poetry that should be understood as the presentation of the particular. Poetry, by contrast, is philosophical, more interested in universals. If it is true that poetics performs a creative role comparable to poetry, then it is also true that poetry participates in the philosophical, abstracting project of poetics. In other words, Aristotle does not so much turn the philosophical project of poetics into poetry as transform poetry itself, in all its uniqueness, into a kind of philosophy. On this basis it is simple to see how Aristotelianism came to underwrite centuries of normative poetics. Precisely because poetics is a *productive* science, it has been capable of serving as a guide for the poet. Poetics operates not only in the realm of theory but in that of practice as well.

Romanticism may offer an alternative conclusion, namely that *as production* poetics itself should be construed as poetry. As Walter Benjamin (1892–1940) demonstrates in his study on the concept of criticism in Friedrich von Schlegel (1772–1829), both the artwork and the attendant theory must exhibit a creative impulse. Contrary to the formalist conclusion, Romantic theoreticians would deny the nonpoetic access to the poetic. In Lyceum Fragment 117, Schlegel adheres to the broadest ramifications of the word *technē*; when he collapses any distinction between art and science: "A critical judgment which is not itself a work of art has no citizen's rights in the realm of art" (p. 319).

Hermeneutics, reception theory, and new readings. The poetic response to poetry established by Romantic theory underpins one of the greatest achievements of Romantic philosophy, namely hermeneutics as elaborated by Friedrich Schleiermacher (1768–1834). By emphasizing the role of the reader in the production of a text's meaning, Schleiermacher

prepared the way for later theoreticians of reading, particularly those associated with reader response. Reader-response theory identifies, describes, and gathers together a variety of reader types into a general theory of reception. Wolfgang Iser, for example, overrides the New Critical neglect of the reader's role—once branded the “affective fallacy” by William K. Wimsatt and Monroe C. Beardsley (1954)—when he grounds interpretation in the ever-shifting and inexhaustibly complicated experience of reading itself.

Deconstructive critics go even further. They radicalize the idea of the reader by voiding any promise of discovering a stable meaning within the text. Exposed to an apparently infinite universe of readerly forces, the poem or literary work puts into play textual energies impossible to foresee or control. At best, as Paul de Man has suggested, the literary critic may attend to the text's rhetorical properties: not what textual content might mean, but rather how meaning is produced. It is when such fresh and sophisticated investigations are focused on the construction of meaning that poetic theory becomes especially applicable to intellectual and political debates. Feminist criticism, queer studies, and postcolonial studies all build on rhetorical training in an essential way. The politically focused work of Susan Bordo and Judith Butler, Eve Kosofsky Sedgwick's advance in queer theory, and studies in postcolonialism sparked by theorists like Edward Said, Gayatri Spivak, and Homi Bhabha all provide crucial approaches and speculative models to culture with its variegated materials. The political ramifications of poetic theory are no more clearly revealed than in Aristotle's formulation that poetry liberates us from the actual by presenting us with the possible. No longer in thrall to “what has come to be,” we become open to “what *would* come to be.” At least potentially, every poetics speaks in the optative mood.

See also *Aesthetics; Literary Criticism; Literature; Rhetoric.*

BIBLIOGRAPHY

PRIMARY SOURCES

- Abrams, M. H. *The Mirror and the Lamp: Romantic Theory and the Critical Tradition*. New York: Oxford University Press, 1953.
- Aristotle. *On Poetics*. Translated by Seth Benardete and Michael Davis. South Bend, Ind.: St. Augustine's Press, 2002. An updated and accurate translation, with useful notes on details of Greek terminology and syntax.
- Benjamin, Walter. “The Concept of Criticism in German Romanticism.” In *Selected Writings, Volume 1: 1913–1926*, edited by Marcus Bullock and Michael W. Jennings, 116–200. Cambridge, Mass.: Belknap Press, Harvard University Press, 1996.
- Blanchot, Maurice. *The Gaze of Orpheus and Other Literary Essays*. Translated by Lydia Davis. Barrytown, N.Y.: Station Hill Press, 1981.
- Brooks, Cleanth. *The Well Wrought Urn: Studies in the Structure of Poetry*. New York: Reynal and Hitchcock, 1947.
- Frye, Northrop. *Anatomy of Criticism: Four Essays*. Princeton, N.J.: Princeton University Press, 1957.
- Iser, Wolfgang. *The Act of Reading: A Theory of Aesthetic Response*. Baltimore: Johns Hopkins University Press, 1978.
- Jakobson, Roman. “Linguistics and Poetics.” In *Style in Language*, edited by Thomas A. Sebeok, 350–377. Cambridge, Mass.: MIT Press, 1960.

- Plato. *Republic*. Translated by Robin Waterfield. Oxford: Oxford University Press, 1994.
- Schlegel, Friedrich. “Critical Fragments.” In *Theory as Practice: A Critical Anthology of Early German Romantic Writings*, edited by Jochen Schulte-Sasse. Minneapolis: University of Minnesota Press, 1997.
- Wimsatt, W. K. Jr. *The Verbal Icon: Studies in the Meaning of Poetry*. Lexington: University of Kentucky Press, 1954. Features two preliminary essays coauthored with M. C. Beardsley.

SECONDARY SOURCES

- Culler, Jonathan. *Structuralist Poetics: Structuralism, Linguistics, and the Study of Literature*. Ithaca, N.Y.: Cornell University Press, 1975. A critical survey of contemporary poetic theories.
- De Man, Paul. *Allegories of Reading: Figural Language in Rousseau, Nietzsche, Rilke, and Proust*. New Haven, Conn.: Yale University Press, 1979. Features exemplary deconstructive and rhetorical readings.
- Doležel, Lubomír. *Occidental Poetics: Tradition and Progress*. Lincoln: University of Nebraska Press, 1989. Discusses contemporary poetic theories in relation to the broader history of philosophy, linguistics, and semiotics.
- Leitch, Vincent et al. *The Norton Anthology of Theory and Criticism*. New York: Norton, 2001. A comprehensive selection of primary texts from antiquity to the modern day, with brief informative essays introducing each author.
- Preminger, Alex, and T. V. F. Brogan, eds. *The New Princeton Encyclopedia of Poetry and Poetics*. Princeton, N.J.: Princeton University Press, 1993. An excellent guide to key terms and topics throughout the history of the field, with good bibliographical references.
- Wellek, René, and Austin Warren. *Theory of Literature*. 3rd rev. ed. San Diego: Harcourt Brace Jovanovich, 1977. First published in 1949, this study remains a standard work.

John T. Hamilton

POLITICAL, THE. The word *political* derives from a Latin cognate (*politicus*) of the original Greek adjective *politikos*, which is also sometimes employed as a masculine noun to signify a public official or statesman.

Origins

The term thus originates in the ancient world, where it was typically applied to the features and qualities of a life based in the *polis*, delineating the uniquely civic existence led by its citizens from other modes of life. In Roman antiquity, Greek terminology for the polis disappeared in favor of *civitas* (which can refer to the city, but also to the condition of being a citizen) and related words derived from the Latin world of the Roman Republic. But under the influence of Aristotle, medieval Europe became reacquainted with the Greek vocabulary, employing it interchangeably with the Latin and, later, incorporating it into vernacular languages. Early modern authors referred repeatedly to “political society” and similar doctrines. Subsequently, social researchers have maintained that politics, like other human endeavors, should be the subject of scientific study, creating the modern discipline of “political science.”

Current Usage

Precisely understood, the nominalization of the adjective “political” to construct *the political*, an abstract noun that demarcates a unique realm of existential experience, reflects an entirely modern development along with the influence of German philosophy on the contemporary lexicon of political theory. While in the early twenty-first century it enjoys broad circulation conveying a range of meanings that traverse the spectrum of contemporary political theory, this usage can be traced to the controversial German legal scholar, Carl Schmitt (1888–1985), whose treatise on *The Concept of the Political* (*Der Begriff des Politischen*) appeared in 1932.

Schmitt contends that the concept of the political is integral to the idea—and therefore to the intelligibility as well as ultimately the viability—of the state. As he explains at the beginning of *The Concept of the Political*, “[t]he concept of the state presupposes the concept of the political” (p. 19), for the latter expresses the defining antithesis around which every genuine political order arises. To be precise, *the political* denotes a fundamental, existential category to which belongs the distinction between friend and enemy. It hence encompasses powers, actions, and institutions tied to the necessity of such a determination, distinguishing them from those that pertain to other elemental categories, such as the moral, the aesthetic, or the economic. Moreover, it necessarily exercises a certain priority over all other categories since it entails, as Schmitt puts it, “the right to demand from [members of the polity] the readiness to die and unhesitatingly to kill enemies” (p. 46). And by the same token, it conveys the essence of the idea of sovereignty, that is, the authority to make such demands from those claiming membership in the sovereign entity.

An enemy, for Schmitt, is one who threatens the way of life of another. Schmitt therefore represents the state as a collective body whose political character resides most definitively in its ability to identify those who threaten its way of life—its enemies. In Schmitt’s words, “the state as an organized political entity decides for itself the friend-enemy distinction” (p. 29). Schmitt does not, however, mean to imply that every state is perpetually faced with war and conflict or that political life consists only of military action. He argued, in fact, that war is neither the aim nor the substance of politics but simply “the leading presupposition which determines in a characteristic way human action and thinking, and thereby creates a specifically political behavior” (p. 34). That behavior, accordingly, always has the preservation and perpetuation of a certain existence or mode of life as its ultimate impetus and justification. Thus the practice of politics is always tethered to a situation in which war, acknowledged by Schmitt to be the “most extreme” possibility (p. 35), remains nevertheless wholly conceivable.

If the possibility of war should be finally eliminated and the distinction between friend and enemy rendered obsolete, politics too would disappear. A world in which no social entity any longer finds reason to employ the distinction between friend and enemy would, according to Schmitt, include “neither politics nor state,” even if “culture, civilization, economics, morality, law, art, entertainment, etc.” persist (p. 53). Moreover, because politics can never be cordoned off from the

possibility of conflict and violence, the attempt to liberate politics from the friend-enemy distinction, an endeavor that Schmitt identified with modern liberalism, leads to an illusory politics that eventually abandons the state to the play of private interests. Schmitt believed this condition to be in fact the state of affairs that characterized Germany during the Weimar Republic.

Recent Impact

Schmitt had a pronounced if sometimes unacknowledged impact on a number of important German social and political thinkers coming of age in the Weimar period, in particular on leading members of the Frankfurt School such as Walter Benjamin and Otto Kirchheimer. The often uneasy interest of radical left-wing thinkers is largely what enabled Schmitt to exercise a lasting influence on the contours and vocabulary of modern political thought. It is certainly not the case, however, that Schmitt’s influence has been limited to thinkers on the left. Among the last century’s most important thinkers for conservatives was Leo Strauss, another young student of political philosophy who came to maturity in the Weimar Republic. Strauss’s critique of modern liberalism might be said to take its cue from an acknowledgment of Schmitt’s achievement in reviving the political.

In more recent decades, both contemporary feminist political theory and select currents of democratic theory have been invigorated by a confrontation with the thought of Schmitt. Feminist champions of an “agonistic politics” have drawn inspiration from Schmitt’s treatment of the state, which arises in the first instance as a bulwark against enemies. Schmitt’s formulation of the political, moreover, implicitly rejects the liberal subordination of politics to material and economic relations, lending support to feminist assertions of the primacy of politics. Other theorists of contemporary democracy have found in Schmitt’s work a powerful critique of liberal democracy that can, however, usefully orient its defenders to the limitations and vulnerabilities of liberal-democratic theory and practice.

See also *Liberalism; Political Science; Public Sphere; Sovereignty; State, The.*

BIBLIOGRAPHY

PRIMARY SOURCES

- Schmitt, Carl. *The Concept of the Political* (with Leo Strauss’s Notes on Schmitt’s Essay). Translation, introduction, and notes by George Schwab; with Leo Strauss’s notes on Schmitt’s essay; translated by J. Harvey Lomax; forward by Tracy B. Strong. Chicago: University of Chicago Press, 1996.
- . *Crisis of Parliamentary Democracy*. Translated by Ellen Kennedy. Cambridge, Mass.: MIT Press, 1985.
- . *Political Theology: Four Chapters on the Concept of Sovereignty*. Translated by George Schwab. Cambridge, Mass.: MIT Press, 1985.

SECONDARY SOURCES

- Kelly, Duncan. *The State of the Political: Conceptions of Politics and the State in the Thought of Max Weber, Carl Schmitt, and Franz Neumann*. Oxford and New York: Published for the British Academy by Oxford University Press, 2003.

McCormick, John P. *Carl Schmitt's Critique of Liberalism: Against Politics as Technology*. Cambridge, U.K., and New York: Cambridge University Press, 1997.

Mouffe, Chantal, ed. *The Challenge of Carl Schmitt*. London: Verso Books, 1999.

———. *The Return of the Political*. London and New York: Verso Books, 1993.

Dwight D. Allman

POLITICAL PROTEST, U.S. Protests disrupt the peace, stop business as usual, and cause disquiet. Protesters in effect withdraw their consent to the way things are. Even if people are poor, unemployed, or seemingly without power, when organized together they can become a force that troubles the powerful. When the powerful are inconvenienced (or worse) by sit-ins, strikes, marches, and occupations, they will often negotiate to restore order and their own peace and privileges. In this way the powerless often wrestle concessions from the powerful.

The First Amendment to the U.S. Constitution explicitly protects citizens' rights to assemble (gather in groups), speak out, protest, and believe in and practice their chosen religion (or absence of religion). Closely linked to these freedoms are the guarantees of a free press. Protest is a time-honored tradition in the United States. American schoolchildren are taught the stories of the Boston Massacre, the Boston Tea Party, and other events leading up to the American Revolution, many of them subversive protests against the ruling regime.

Protest is often difficult, however, because oppressed people understand the harsh consequences their dissent draws from the powers-that-be. People put up with a lot of injustices out of a sense of hopelessness, futility, fear, intimidation, and internalized oppression. Government repression of protest and activism was seen in the American labor union movement, the antislavery movement, the women's suffrage movement, and the early years of the civil rights movement. Governments can damage themselves, however, if they brutally repress a non-violent, sympathetic protest movement, as the British learned in India from the nonviolent civil disobedience movement led by Mohandas (Mahatma) Gandhi.

Ideological hegemony, a form of internalized oppression, is one of the most powerful barriers to protest by oppressed and aggrieved people. "Inequalities in power have their most insidious effect when the dominant group has so much control over the ideas available to other members of society that the conceptual categories required to challenge the status quo hardly exist" (Mansbridge, p. 4). Marxist theory of "false consciousness" similarly asserts that the poor are indoctrinated to believe in the justice of a system that harms them.

The latent powers of the weak, however, are often manifest in their potential to protest and in their actual demonstrations of disobedience. People can take courage from observing protests, as demonstrations show potential supporters that they are not alone in their beliefs and desires. Challenging authority can have harsh, even deadly, consequences for people; noteworthy, then, are the numerous—in fact countless—times peo-



School desegregation protest, St. Louis, Missouri, 1933. The 1930s saw an increase in black demonstrations against discrimination. After the 1954 landmark ruling in *Brown v. Board of Education*, which stated that racially segregated educational facilities were a violation of the Constitution, opposition to integration rose swiftly, primarily in the South. NATIONAL ARCHIVES AND RECORDS ADMINISTRATION

ple, often without formal power, have challenged authority and protested. Within societies, repertoires of protest develop. These are learned conventions of political contention that become part of the public culture (Tarrow, p. 20). Examples of culturally familiar protest repertoires include the French barricades, consumer boycotts, labor strikes, silent vigils at the White House by women's suffragists, the sit-ins of the civil rights movement, and petitions, to name a few.

Protest and the Media

Media attention often follows protest. For environmental causes, television footage of small Greenpeace boats and rafts moving against giant factory whaling ships epitomizes the adage "a picture is worth a thousand words." Another notable protest was the highly photogenic occupation of Alcatraz Island in San Francisco by Native American rights activists from 1969 to 1971.

Media coverage can potentially expand the audience for a protest worldwide, thus embarrassing and pressuring dominant groups to explain themselves and account for the issues protesters are raising. In the early 1960s, images of peaceful civil rights protesters being set upon by police dogs, water cannon, and police with truncheons troubled the consciences of citizens observing this on television news programs. Highly placed U.S. government officials were also forced to explain the contradictions between their Cold War rhetoric about oppressive governments abroad and the images shown worldwide of brutal treatment of their own American citizens.

Media attention can be harmful to a protest movement if the images are negative. For example, the anti-legal abortion group Operation Rescue found that extensive media coverage of abortion clinic blockades partly backfired against their cause.

Even when the public's reaction to media coverage of protests is negative, the protesters have achieved something because they have publicized their cause. The group ACT UP (the AIDS Coalition to Unleash Power), for instance, engaged in wild and confrontational acts of protest about the spread of AIDS/HIV and the relatively weak governmental programs to address the disease. As a small group, ACT UP was able to broadcast its causes through media coverage of its flamboyant demonstrations, a sure success even though the television public was shocked and repelled by some of its performances. ACT UP's slogan, "Silence = Death," deftly epitomizes its approach.

Violent Protest

One threat that groups can use is violence. Violence can help topple dominant regimes, but it has dangerous potentials for protesters. Violent protest can frighten the public, scare away potential allies, and ricochet against causes of groups that adopt these tactics. It also gives authorities a perceived mandate for severe repression.

Regime Change and Revolutions

States can be toppled and replaced by sustained protest and contentious, rebellious movements. The most glaring instance of this in the United States is the American Revolution. The subtext of the Declaration of Independence is that governments can be legitimately, righteously replaced. Regime change is also evident in the aftermath of the American Civil War, with the defeat of the Confederacy and ratification of the Thirteenth, Fourteenth, and Fifteenth Amendments to the U.S. Constitution. Regime change was also arguably the result of the American civil rights movement and the transformation of the solid Democratic Party South into a two-party system or in some states a one-party (Republican) South. The realignments caused by the civil rights movement have done away with the official, *de jure* forms of racial segregation, something that the countermovements of the White Citizens Councils and the Ku Klux Klan tried to prevent.

Protests and Political Parties

In democratic systems, political parties need to respond and adjust to new political social movements. Parties that do not realign to incorporate new interests and respond to protests and challenges often "go the way of the Whigs," that is, become a historic political party. In the meantime, new parties can arise and grow in response to shifts in popular opinion sometimes manifest in contentious politics such as protests (Sundquist, 1983). In the American two-party system, some third parties are protest parties to which the two dominant parties often selectively adjust. The Progressive Party, for instance, with its agitation for more open and representative government, had its thunder stolen in part by the Democratic Party, which over time incorporated Progressive Party platforms and absorbed Progressive activists. The Mississippi Freedom Democratic Party, formed in protest to the all-white official Democratic Party of Mississippi, challenged the credentials of the official party at the 1964 Democratic National Convention and won only token reforms from the national Democratic Party. By the 1968 Democratic Convention, however, partly because of the protest efforts in 1964 and beyond,



Texas students demonstrating for equal rights march to the state capitol, Austin, Texas. In *Sweat vs. Painter* (1950), the United States Supreme Court ruled that Texas University had to allow minorities into its law school, sparking demonstrations, both pro and con. RARE BOOKS AND SPECIAL COLLECTIONS DIVISION, THE LIBRARY OF CONGRESS

states could no longer send all-white delegations chosen by procedures that excluded African-Americans.

La Raza: Latino and Latina Rights

Both major American political parties are currently vying for the Latino vote. Once a subjugated people, the Latino community in the United States has mobilized to assert the rights of Latinos and Latinas as full American citizens. In the 1960s and 1970s, for instance, the La Raza movement resonated positively with many Latinos. La Raza demonstrations for equal access to education, bilingual education, voting rights, and land tenure occurred throughout the Southwest. Often grassroots-organized, these protests had positive impacts on the political position of Latinos (Marquez; Montejano). As with all movements, however, while much was gained, much still needs to be achieved for Latinos and Latinas (as well as African-Americans, Native Americans, women, gay citizens, and others) to be fully incorporated into the body politic. Protest is one way this is achieved.

Abortion Protests

Notably, groups on both sides of an issue can use similar rights discourses to frame their protests. Pro-choice protests highlight the rights of women, the right of privacy, and the right of bodily integrity. Anti-choice/pro-life protests focus on the right to life of the fetus (they do not use the word *fetus* but rather *unborn*, *preborn*, *baby*, or *child*).

Protest and Religion

People organized in churches, synagogues, and mosques constitute existing networks that can often be mobilized into protest deriving from their religious beliefs and tenets. American antislavery activists were inspired by their Christian religious beliefs of equality and social obligations. When Britain abolished slavery and used its mighty navy to hinder



Thousands protest the Vietnam War outside the United Nations, New York City, 1967. By the late 1960s, opposition to the Vietnam War began to rise among Americans and protestors took to the streets in nationwide antiwar demonstrations. AP/WIDE WORLD PHOTOS

the slave trade, this gave added impetus to American antislavery societies and, indeed, to antislavery efforts worldwide. Their protests, then, were not seen by them as subversive or disrespectful but rather as respectful of the principals of the American political system and their religion. Religious activists often assert that it is the government, not them, in the wrong. Religious beliefs and organizations are also fluid across state borders. Believers in one state might be mobilized to pressure their own government on behalf of fellow religious members in another state who are being oppressed or persecuted. Protests of this type are transnational and evoke a sense of community and solidarity beyond the borders of any one state.

Protest via Irony, Satire, Performance, and Art

People can articulate new values through their dress, lifestyles, music, and consumption patterns. In the 1960s and 1970s, the way young people wore their hair made symbolic statements against the dominant value system. When African-American youth wore their hair naturally in “Afros,” they were asserting race pride and protesting the power of the dominant white culture to prescribe what was “good” or “pretty” hair (i.e., straightened). Men and women can perform gender in ways that protest dominant images. During the antiwar movement in the 1960s and 1970s, men wearing their hair long was in part a symbolic protest against corporate dress styles and the close-cropped heads of the military.

Political cartoons, some quite scatological, have often lampooned government officials and corporate tycoons. While often humorous, political cartoons also protest in line and ink the transgressions and foibles of the powerful. Making fun of powerful people in this way “brings them down to size,” so to speak, and helps citizens conceptualize that the people in power are just like them. Tyrannical regimes, then, expend a lot of energy trying to silence the free press, artists, and performers who dare to poke fun at them and thus make them seem simply human.

In addition to visual art, music has the potential for unobtrusive mobilization and dissent. For instance, some slave songs tolerated by slaveholders as innocent and benign were actually songs of pride, solidarity, and liberation. Drawing upon the Jewish people’s escape from slavery in Egypt as told in Exodus, one powerful slave song states, “When Israel was in Egypt’s land—Let my people go—Oppressed so hard they could not stand—Let my people go.” Here religious beliefs and subversive speech are intertwined within a song. One scholar explains, “Thus in the Christian as well as the Jewish tradition the embedded heritage of God’s implacable opposition to oppression gave subordinate groups a strong claim for rectification of wrongs rooted in the unjust power that one group could wield against another” (Mansbridge, p. 3). When regimes officially repress dissent, it often goes underground

into clandestine newspapers, songs, legends, art, jokes, and satire that skewer the powerful and build a community of dissent and networks for protest and political challenges when the opportunities arise.

Examples of songs with political messages include Woody Guthrie's "This Land Is Your Land"; Bob Dylan's "The Times They Are A-Changing"; James Brown's "Say It Loud, I'm Black and I'm Proud"; "Bread and Roses," written by James Oppenheim in 1912 and adopted by the labor movement; "We Shall Overcome," a gospel song adapted as a civil rights anthem; and "Jesus Loves the Little Children," an innocent indoctrination in human equality.

Symbols

Dissenters utilize symbols to promulgate their causes, sometimes under the very noses of their opposition. Use of flags, whistles, clothing, and jewelry (with symbols such as the "peace sign," for example) are illustrative. The wire clothes hanger, for instance, is a symbol and trope for the pro-choice movement that hearkens back to the days of illegal abortion when desperate women used implements such as coat hangers to self-abort.

The Internet

The pamphlets of Thomas Paine leading up to the American Revolution were protests in print, information for adherents, and indications to consumers that they belonged to a larger community of readers. Today the World Wide Web disseminates information quickly, cheaply, and without respect for political borders or the sensitivities of the powers-that-be. Dissenting communities on the Internet have organized to protest the Iraq War, environmental issues, and women's rights, to name just a few issues. Through print and literacy via pamphlets, e-mail, or Web sites, information is out of the control of the powerful. Bad news about rulers and regimes can be horizontally, democratically diffused throughout this invisible community of readers.

Intersectionality Simultaneously Expressed

People have often asserted their rights through protest. Citizens live within an interlocking context of their race, gender, social class, and sexuality. These variables are often simultaneously expressed (Weber). When people protest over racial equality, then, many of those attending the marches and sit-ins might also be thinking of the equality of gender and class. Questions of gender equality, privacy rights, and freedom of choice segue into mobilization and action around sexual diversity and legal rights. It is often when coalitions of groups mobilize around an issue that protesters have the highest chances of success. Ad hoc, issue-specific coalitions, however, can break apart if not prepared to address differences between people and groups as well as their commonalities (Woliver, 2002, 1993).

Ranging from large-scale mass actions to daily acts of resistance, people assert their beliefs through protests. Fluid social movements are not easily categorized as having won or lost politically, but they often leave "a residue of reform" (Tarrow, p. 175), changes in political cultures, and networks of people with common interests who survive after a particular protest is over.

See also **Abolitionism; Civil Disobedience; Democracy; Non-violence; Protest, Political.**

BIBLIOGRAPHY

- Carson, Rachel. *Silent Spring*. 25th anniversary ed. Boston, Mass.: Houghton Mifflin, 1987.
- Collins, Patricia Hill. *Black Feminist Thought: Knowledge, Consciousness, and the Politics of Empowerment*. Rev. 10th anniversary ed. New York: Routledge, 2000.
- Costain, Anne N. *Inviting Women's Rebellion: A Political Process Interpretation of the Women's Movement*. Baltimore, Md.: Johns Hopkins University Press, 1992.
- Freeman, Jo, and Victoria Johnson, eds. *Waves of Protest: Social Movements since the Sixties*. Lanham, Mass.: Rowman and Littlefield, 1999.
- Mansbridge, Jane, and Aldon Morris, eds. *Oppositional Consciousness: The Subjective Roots of Social Protest*. Chicago: University of Chicago Press, 2001.
- Marquez, Benjamin. *Constructing Identities in Mexican-American Political Organizations: Choosing Issues, Taking Sides*. Austin: University of Texas Press, 2003.
- McAdam, Doug. *Political Process and the Development of Black Insurgency, 1930–1970*. Chicago: University of Chicago Press, 1982.
- Montejano, David, ed. *Chicano Politics and Society in the Late Twentieth Century*. Austin: University of Texas Press, 1999.
- Piven, Frances Fox, and Richard A. Cloward. *Poor People's Movements: Why They Succeed, How They Fail*. New York: Pantheon Books, 1977.
- Shabecoff, Philip. *A Fierce Green Fire: The American Environmental Movement*. New York: Hill and Wang, 1993.
- Sundquist, James L. *Dynamics of the Party System: Alignment and Realignment of Political Parties in the United States*. Rev. ed. Washington, D.C.: Brookings Institution, 1983.
- Tarrow, Sidney. *Power in Movement: Social Movements and Contentious Politics*. 2nd ed. Cambridge, U.K., and New York: Cambridge University Press, 1998.
- Vélez-Ibáñez, Carlos G., and Anna Sampaio, with Manolo González-Estay, eds. *Transnational Latino/a Communities: Politics, Processes, and Cultures*. Lanham, Mass.: Rowman and Littlefield, 2002.
- Weber, Lynn. *Understanding Race, Class, Gender, and Sexuality: A Conceptual Framework*. Boston, Mass.: McGraw Hill, 2001.
- Woliver, Laura R. *From Outrage to Action: The Politics of Grass-Roots Dissent*. Urbana: University of Illinois Press, 1993.
- . *The Political Geographies of Pregnancy*. Urbana: University of Illinois Press, 2002.

Laura R. Woliver

POLITICAL SCIENCE. Political science, as currently conceived, is a relatively new concept that dates to the nineteenth-century United States. Prior to this time, the study of politics in the West remained a part of natural philosophy, and it tended to focus on philosophical, historical, and institutional approaches. The ancient Greek philosopher Aristotle is often named as the first "political scientist," but his approach differs markedly from what is currently understood to be "political science." Aristotle primarily occupied himself with addressing what sort of political system would best enable the

highest human life of *eudaimonia* (happiness). In the *Politics*, Aristotle surveys an array of constitutions, separating them into six categories based on how many rule the system and whether or not they rule well. This may be considered an empirical study of sorts and perhaps the first “typology,” but his method of study falls well short of what is currently considered to be scientific.

The ancient Indian approach exemplified in the treatise *Arthashastra* (written by Kautilya around 300 B.C.E.) similarly differs from the modern approach to studying politics. Kautilya, often compared to Thucydides, Thomas Hobbes, and Niccolò Machiavelli, discusses the importance of law, kingly conduct, foreign policy, and administrative practices in an attempt to explain that governments have the responsibility of tending to the well-being (broadly understood) of their people. While these ancient approaches to studying politics differ in important ways from the contemporary approach of political science, their emphasis on the pragmatics of political rule connect rather well with contemporary political practice in the West. The Islamic approach to political practice, however, contains some important differences. Notably, Islamic political practice is firmly grounded in religion in so far as it sees the purpose of the state to be the satisfaction of Allah’s wishes, namely, the eradication of evil. Thus, whereas political practice in the industrialized West has been able to evolve as ethical and moral codes have been altered or evaporated (for example, the Christian prohibition on usury no longer carries much weight in a capitalist framework), Islamic political practice has much more difficulty with such changes because Allah is considered the One who dictates moral and ethical codes.

Political scientists of the early twenty-first century are motivated far more by an interest in attaining political “knowledge” than Aristotle or Kautilya were. Aristotle sought less to be sure of what he knew than to assess the role of politics in the good life. Indeed, this was the motivating force behind almost all studies of politics (with the notable exceptions, perhaps, of Augustine of Hippo and Machiavelli) until the nineteenth century. In many areas of the world, such as Continental Europe, Asia, and the Middle East, the importance of studying politics for more metaphysical reasons, rather than for simply epistemological ones, continues into the twenty-first century. In these places, society still generally tends to take precedence over the individual as the focus of political study. In the United States and the United Kingdom, by contrast, the study of politics has adopted a strongly scientific stance, a stance that has embedded itself in empiricist epistemology and individualism.

The Importance of Knowledge

The reasons for the empiricism of political science multiply the more one investigates the topic, but the secularization of the Western world certainly played a prominent role. The changes that occurred during the sixteenth century called into doubt the traditional understanding of the place of humans in the world by undermining the existential authority of the church. Now humans were faced once again with the same metaphysical problem of antiquity (“why are we here?”), and the French essayist Michel de Montaigne (1533–1592) gave voice to the age-old skeptical response. Interestingly, the French philosopher René Descartes (1596–1650) followed

Montaigne in the seventeenth century by providing a very similar answer, though he couched it in philosophical terms. Montaigne had said that because human knowledge is in doubt and human existence correspondingly has no necessarily universal meaning, it is up to the individual to endow his or her own life with meaning based on his or her own beliefs. Descartes also believed that human knowledge was in doubt, and he too contended that the grounding point for knowledge and human existence was the individual human. Actually, the grounding point for him was reason but only insofar as individual human beings exercise reason. Descartes believed that the world was composed only of matter and mind. The mind accesses matter via the senses and reason, but the senses are faulty and therefore they give humans an imperfect understanding of matter. Reason, however, is much more trustworthy. It is more trustworthy because it focuses the mind on the eternal or universal characteristics of the things it encounters, whereas the senses focus on the mortal or particular characteristics of the things it encounters. The senses trick people into focusing on the things that change, whereas reason focuses the mind on what is universal, on the properties of the thing rather than on the thing itself.

So, one can see that even in the modern epoch philosophy focused (as did the ancients) on the relationship between the particular and the universal. Interestingly, though, in the modern epoch God dropped out of the picture. Descartes did not rely on God to provide the universalistic foundation for particularistic actions, beliefs, knowledges, and so on. Instead, for him, reason played this role. This “individualist” turn in philosophy led to some interesting problems with existence of God arguments, and some interesting solutions as well (for example, that of the eighteenth-century Irish philosopher George Berkeley [1685–1753]). Descartes, in other words, humanized philosophy, which opened up space for the individual. The individual’s exercise of reason allowed access to an understanding of the universal properties of the material world. All of modern philosophy extends from this basic principle. The eighteenth-century Scottish philosopher David Hume (1711–1776) dealt with it in his problem of induction. Berkeley approached it with his emphasis on perception. And the German philosopher Immanuel Kant (1724–1804) addressed it with the synthetic a priori and the categorical imperative. Modern philosophers showed themselves to be preoccupied with epistemology, with finding a universal grounding point for knowledge in the absence of God as a unifying force. Science, accompanied by the belief that knowledge could transcend the subjective viewpoints of individual humans, ultimately emerged as an organizing principle for knowledge and, then, for society.

The Universal and the Particular

The first applications of this particular understanding can be seen in the attempts by Kant, Georg Wilhelm Friedrich Hegel (1770–1831), and Karl Marx (1818–1883) to assess history in terms of how one might, through the proper understanding of historical trends and developments, actualize history’s end (or purpose). For each of these thinkers, the proper application of reason to history would enable humans to live together in peace and harmony. But these sorts of approaches to studying

politics were quickly displaced by narrower, more empirical approaches. Hegel had argued that the existential problem of human history had always been oriented toward an interplay, or dialectic, between the particular and the universal. Humans, in other words, have always sought to understand the nature of being, not only their existence in the world but also the existence of the world. The movement of history, then, can be seen in terms of the dialectic between developing understandings of the particular place of humans in the universe. For Hegel, the critical metaphysical question became not so much “why are we here?” but “who are we, here?” Hegel, in other words, sought to situate human beings within lived (or material) history and also within spiritual history. Hegel, that is, wanted to determine who people are or believe themselves to be (in spiritual history) at particular moments (in lived or material history). He understood who individuals are at particular moments in history to be simply the current synthesis of the historical dialectic between the particular and the universal. This approach, he believed, allowed human beings to ask not only what it means to be me (as a self or as an individual apart from others) but also what it means to be us (as individuals living together in a particular material and spiritual moment in history).

Empiricism

Hegel’s idealism, while quite popular during much of the nineteenth century, was nevertheless displaced (in the United States and the United Kingdom, at least) by empiricism. (Positivism and logical positivism are contained within the empiricist approach.) Empiricists define knowledge in terms of a separated subject or agent accessing the truth, or accurately representing the facts, of the objective world. This presupposes Descartes’s separation of mind from matter, taking as given the existence of both and their necessary division. In this view, the external objective world of matter simply is separate from the internal subjective world of the mind. The problem for humans, and indeed for empiricist epistemology, then becomes how minds gain knowledge, understood in the universal terms of certainty, of the material world. The modern empiricist view of knowledge, then, proceeds from a profoundly skeptical viewpoint, which is what Kant called, in his *Critique of Pure Reason*, the “scandal of philosophy.”

Indeed, Kant endeavored to answer the skepticism of Descartes. Kant’s fundamental concern was to determine if inner experience (that is, ideas, perceptions, and representations) provides humans with any true knowledge about outer experience (that is, the objects that humans believe exist in the external world). But Kant, of course, was much more concerned with developing a scientific metaphysics. Modern empirical scientists had different goals. In the modern scientific view, the object world has a logic all its own. This means that anything that is *actually* separate from a subject or that is *understood* to be separate from a subject can be known (i.e., accurately represented) by a subject who has an inclination to represent it. One might even go so far as to say that any such separate thing can be *understood* by a subject so inclined to understand it. This allows individuals to give understandable and accurate *representations* of the things they study, and it helps them explain how humans might behave given those representations. But any

deeper, more metaphysical understandings and explanations of human actions drop from view. Some, such as Martin Heidegger, Ludwig Wittgenstein, and Paul Feyerabend, have differed strongly from the empiricist approach, but they have not succeeded in dulling the effects of the empiricist approach on political science.

And so, whereas in the early history of modern political science one can still find many of the lingering foci of earlier political studies (for example, attempts to provide political solutions to the timeless questions of antiquity regarding the good life), by the twentieth century many of these foci had disappeared. Increasingly, political scientists oriented their inquiries into politics around analysis of the concepts raised by the classical questions. Political scientists, in other words, began to shy away from metaphysical questions and systemic solutions, preferring instead to suggest pragmatic and prudential political action in accord with the rules established by the current political system. They took this approach because they appeared to find the political questions and “answers” put forth by metaphysicians to be philosophically irresponsible (because they cannot be logically justified given deductive logic), and this philosophical irresponsibility would then give rise to social, political, and moral irresponsibility. The metaphysical commitments of the philosophical idealists must be authoritarian because they can only be contingent and perspectival rather than necessary and absolute. Therefore, the “responsible” thing to do was to, as Daniel Bell put it in *The End of Ideology*, give up “the dream of organizing society by complete blueprint.” The prudent action is to focus, “within a framework of liberal values, on problem solving as a means of remedying social ills and inadequacies” (Bell, p. 419). Political science, then, must echo President John F. Kennedy’s statements in his commencement address at Yale University in 1962. It must “research for sophisticated solutions to [the] complex and obstinate issues” associated with the practical management of modern society. Searches for meaning and morality in social action, then, must fall by the wayside. No matter what, then, the human value of political action ceases to be a viable consideration when politics is studied scientifically.

The Discipline of Political Science

The beginning of American political science as an organized discipline can be dated to December 30, 1903, when John Burgess, Frank Goodnow, Westel W. Willoughby, and others founded the American Political Science Association (APSA). The association’s journal, the *American Political Science Review* (APSR), followed in 1906. Even though most schools still lacked separate political science departments, the appearance of the APSA, and thereafter its journal, legitimated professional commitment to political science as a coherent area of study. The APSA gave political scientists, in and out of the university, a sense of common purpose, and the APSR offered an outlet for original research and scholarly exposure.

As the discipline was established, political scientists increasingly incorporated political knowledge as their peculiar domain. Political scientists, after “authorizing” themselves through the creation of a discipline, began cordoning off political research as their area of study. The study of politics

started to become a professional pursuit, sanctioned by a professional association. This trend toward professionalism in the field of political research became more clear during the behavioral revolution's move to "pure" science. With behavioralism, the discipline settled on a scientific identity, an identity that has changed little since its inception. Behavioralism, though, has its roots in the "science of politics movement," which began in the 1920s.

Political scientists believed that a scientific, disciplinary, and professional identity (that is, acceptance as "legitimate" producers of knowledge) depended on a common and useful methodology to separate trained "political scientists" from methodologically untrained amateurs. Scientific method would allow political scientists to arrive at objective, value-free truth (or truths) about a certain aspect of (usually) American politics in order to aid a modernizing polity in a purely technical way. There could be no normative goals in a value-free science. Political scientists, in other words, should not seek to express what ought to be done. Instead, their goal must be simply to explain the political world.

The roots of behavioralism. In the early 1900s, Arthur F. Bentley offered a tool for empirical, value-free social research in his work, *The Process of Government: A Study of Social Pressures*. Although Bentley was not an academic by trade, he did influence subsequent generations of political scientists, especially those within the behaviorist tradition. In *The Process of Government*, Bentley wanted to move away from the traditional notions of scientific explanation in society. He considered political science, with its nineteenth-century reliance on formalist studies of institutions, to be dead. The "barren formalism" of political science needed to be touched up with the "glow of humanity" by studying social actors themselves "for what they are" and "for what they represent" (Bentley, pp. 163–164). According to Bentley, the "raw material" for the scientific study of government cannot be found in one person. It must always be located in "something doing," in the activity of groups, in "the dispersal of one grouping of forces by another grouping." And while these groups do consist of thinking and feeling persons, the social scientist knows "nothing of 'ideas' and 'feelings' except through the medium of actions" (p. 175–176). Government is a process that is forever in flux, and, as such, it can never be described by law books, law, essays, addresses, or constitutional conventions.

Bentley argued that social science, then, should be empirical, measurable, progressive, and concerned with the interaction and activity of a complex and overlapping system of social, political, and economic groupings. Such a social science could, in Bentley's view, be objective and, as such, achieve "knowledge." Most of these aspects are evident again, in the science of politics movement of the 1920s and 1930s and in the behavioral political science that conquered the discipline by the late 1950s. The empirical, measurable, "progressive," and quantified behaviorist tradition gave political science the "scientific" identity it had sought since Bentley's era.

The science of politics movement. The new era in political science that followed World War I, like most new eras in the discipline, repudiated the previous era of political science.

Progressive political science was condemned as invalid and partisan, not scientific enough. The new era sought even more detached, scientific, methodical, and therapeutic reforms for what was perceived to be a democracy in crisis. According to post–World War I political scientists, the United States' "liberal democracy" emerged badly shaken from the war. Political scientists had supported the war "for the usual reasons—it was supposed to end European autocracy and thus end war" (Seideman and Harpham, p. 102). Instead, emboldened and effective fascist and communist governments in Europe strengthened their abilities to motivate their populaces to act in accordance with government interests. Post–World War I political scientists in America noticed a peculiar lack of any such motivational ability in the United States, and their wrath fell on their immediate predecessors. In their view, reform-minded progressive political scientists had not adequately and systematically located receptive reform publics, and their superficial and hasty analyses and proposals had consequently failed to be effective.

In light of this, political scientists of the new era saw the need for scholarly renovation. They renewed their dedication to establishing scientific inquiry in the hope that "scientific knowledge would emerge and contribute to improving the quality of public life in America" (Ricci, p. 77). The professional identity of the political scientist became that of political "healer," and political knowledge, implemented in the governmental system, was to be constructed toward this end. Political scientists such as Charles E. Merriam and Harold D. Lasswell saw themselves as social engineers whose purpose was the "rational" supervision of political actors tasked with ordering and controlling a logical and brave new political society. Merriam and Lasswell simply wanted to install a professional identity for political scientists based on a science that was organized to aid the liberal democratic state. As such, political knowledge was to be organized for the same purpose. This is part of the reason why such a formulation of science caught on in the discipline. It was constructed to correspond to the technical needs of society, and therefore it became the accepted identity for political scientists. But after World War II, this identity began to crumble. Behaviorists wanted to purify scientific political knowledge.

According to Albert Somit and Joseph Tanenhaus, numerous factors emerged to help establish behavioralism as a force in political science: Political scientists perceived that they were not considered legitimate scientists and consequently had problems securing research grants; they believed that the other social sciences (particularly psychology) were making broad advances while political science lagged behind; the reformist, normative nature of the discipline was generally considered speculative and unscientific; research technology (including survey techniques, statistical computations, and computers) became much more refined and available; and they pursued a "pure" science that operated on the presupposition that democracy is *the* best system of government because of its open and scientific qualities. In short, post–World War II political scientists sought to define the science of politics from the standpoint that science should be pure. The science of politics should be interested only in *explaining* the workings of American democracy in order to understand the American system better.

Behavioralism. Postwar political scientists believed that political crises remained because pre–World War II political scientists had allowed their reformist aims to occlude their understanding of politics. Many postwar political scientists wanted to embark on the pure scientific project of analyzing the workings of the American system without tainting the analysis with speculative notions of reform. These were the first self-conscious attempts to push normative political theory to the margins of the discipline. The assumption that American democracy is the best political system in the world expels the normative determination of value from the discipline’s activities. A pure science, after all, cannot consider such a claim. Rather, it must presuppose its end as it determines how best to reach or enhance it.

Somit and Tanenhaus have combined the various strands of behavioralism into what they term the “behavioral creed”:

1. Political science should search rigorously for regularities in political behavior in order to facilitate prediction and explanation.
2. Political science should concern itself with empirical political phenomena, that is, with the behavior of individuals and political groups.
3. Data should be quantifiable in order to aid predictive capabilities.
4. Research should be theory driven; in other words, research should begin with a theory that yields empirically testable hypotheses.
5. Political scientists should avoid applied (reform-minded) research in favor of pure scientific research.
6. Values such as democracy, equality, and freedom cannot be scientifically established and should thus be avoided unless they can somehow be made empirically testable.
7. Political science should become more interdisciplinary, at least at the behavioral level.
8. Political science should place more emphasis on methodology and make better use of multivariate analysis, sample surveys, mathematical models, and simulation.

Behavioralists were intent on building a scientific community that was centered on behavioral inquiry. They could do this by further institutionalizing political knowledge. Therefore, the research skills that behavioral inquiry required served to exclude those who did not possess the proper training and to solidify the scientific identity of political scientists.

One example of behavioral inquiry can be found in the work of David B. Truman, who is probably best known for his book *The Governmental Process*, first published in 1951, which revived Bentley’s group process theory of government. Truman’s argument, although less polemical, closely resembles Bentley’s and is offered in response to the expanding role of

interest groups in American politics and the public’s growing fear of their influence. *The Governmental Process*, by Truman’s own account, contributed to the “political behavior movement” in political science by increasing “the analytical strength and usefulness of the discipline” (pp. xix–xx). It also triggered the growth of the study of interest groups in the United States and abroad. Like Bentley’s work, *The Governmental Process* offers a tool for analysis: a theory to drive systematic behavioral research. It contains many “testable hypotheses” ranging from the political orientations of groups to the internal politics of the group process to the influence of groups on the legislature, the executive, the judiciary, and elections.

Truman’s basic argument revolves around the notion that because every individual attempts to become an accepted participant in a group or a set of groups, it makes sense to study political behavior in terms of groups and group interactions. He argues that “the patterns of action and attitude among individuals will differ from one another in large measure according to the clusters of group affiliations that the individuals have” (p. 16). Individuals define themselves based on the opportunities that groups afford. In Truman’s words, “It appears . . . that the group experiences and affiliations of an individual are the primary, though not the exclusive, means by which the individual knows, interprets, and reacts to the society in which he [sic] exists” (p. 21). Like Merriam, Truman believed that society had become sufficiently complex to necessitate an interdependent approach to the analysis of political behavior and government. In other words, any social or political action involves a complicated series of interactions, particularly at the group level, that affect individuals and the government. With this in mind, the purpose of Truman’s book was to analyze rigorously both the operations of representative government in the United States and the character of groups’ relationships with the governing process. He does not desire progressive reform; his research seeks “pure” explanation.

Another behavioralist, Heinz Eulau, openly criticized the reformist (“utopian”) political science of the pre–World War II era. In his 1969 book, *Behavioralism in Political Science*, Eulau argued that science can function only “in an environment that permits freedom of inquiry and freedom of speech” (p. 12). American liberal democracy allows such freedoms and thus is most suitable for scientific work. Political science can never undermine liberal democracy, as David M. Ricci reported that pre–World War II political scientists feared. Political scientists assumed, then, that American democracy must be alive and well as they pursued the new, nonreformist, scientific goal of analyzing and explaining the ways in which the American political system functioned.

The dominance of the behavioral approach to studying politics was seen in the field of international relations as well, which tended to personify states and study their “behavior.” This approach has been seen most clearly in realist and neorealist research in international politics. The field of comparative politics was also affected by the behavioral shift, as its practitioners abandoned the field’s legal-institutional approach in favor of a more quantitative analysis. Instead of simply explaining the similarities of and the differences between political institutions

across culture and context, behaviorally inclined comparative politics scholars sought to ground such institutional differences and similarities in “universal” terms of political behavior. The field of normative political theory was largely immune to the behavioral revolution and operated as a critic from without, which ultimately served to marginalize it from the accepted approach of the discipline. Postbehavioralism altered this situation in some important ways. All of the various subfields of study were opened to other methodological approaches, and political theory moved in a bit from the margins. Still, the scientific mood was not fundamentally altered.

Postbehavioralism. In 1967 the Caucus for a New Political Science was organized as a response to behavioral hegemony. Behavioral discourse, pro and con, dominated the discipline’s mainstream by the mid-1960s in terms of method, language, and research focus. Members of the caucus lamented the limited scope of behavioral inquiry. Behavioralism, they argued, neglected too many possible points of view; it was too “parochial.” The caucus desired a more open and expansive discipline. In 1969 David Easton responded to the aims of the caucus in his presidential address to the APSA. Easton coined the term *postbehavioralism* and made *relevance* and *action* its watchwords. Postbehavioralists, Easton argued, wanted to make political science more relevant to and active in society.

Ultimately, new areas of research were opened up within the discipline (for instance, the Vietnam War, race relations, poverty, and women’s rights), and the well-populated, university-centered discipline became specialized. Political scientists increasingly carved up special areas of the discipline for themselves, each area with a special language and technique that made intercommunication difficult and often without purpose. These subfields rapidly grew into self-contained entities within the field of political science.

During this era of fragmentation, antibehavioral forces found new voices. Research that was distinctly anti- or nonbehavioral found legitimacy as the discipline’s professional identity evolved away from its behavioral parochialism. The discipline became more tolerant of various perspectives on politics and political science during the postbehavioral era. The intellectual “community” that behavioralism constructed in the discipline of political science collapsed during the 1970s, the decade that witnessed the fragmentation of the discipline’s research agenda. This transpired for at least three reasons: (1) the Caucus for a New Political Science’s effectiveness at forcing the field to open up to more research interests; (2) the population explosion that occurred in the discipline following World War II, which increased the competition for recognition among political scientists; and (3) a related mood of openness that prevailed in the discipline following the closed and parochial behavioral era.

Because political scientists were generally required to publish in order to advance the accumulation of knowledge that “scientific communities” need, and because the range of suitable research topics was limited during the behavioral era while the population of the discipline was rapidly increasing, the discipline was quickly saturated. Political scientists sought new areas of expertise and the discipline opened up, allowing for

the creation of many new subfields. The topics covered by these new subfields were so diverse by 1977 that Nelson Polsby, the managing editor of the *APSR* at the time, “conceded that no editor could ‘judge the quality of manuscripts over the full range of concerns that political scientists write about’” (quoted in Ricci, pp. 222–223).

The discipline has become so complicated that even political scientists are unable to comprehend completely or become comfortable with its entire range of research. So much material is published in increasingly narrow fields that political scholars find it difficult to keep up with their own subfields, much less understand and integrate other subfields. Specialties and subspecialties continually emerge, and a broader base of expertise results. Each subfield churns out vast quantities of literature, and the literature from each subfield, taken together, is more than any one researcher can master. Nevertheless, one researcher can become an “expert” in the work of one subfield. Therefore, the discipline does not consist of “experts” in political knowledge (a central tenet of the APSA); it consists of “experts” in *certain aspects* of political knowledge. But while political scientists from different subfields find communication difficult, the notion of a common purpose (the construction of a body of political knowledge) remains.

In the early twenty-first century, however, the claim to this common purpose has come under some scrutiny by a new movement within the discipline called “Perestroika.” The Perestroika movement, begun anonymously in 2000, calls attention to two problems in the discipline: its lack of inclusiveness and its increasingly mathematical approach. In many ways, this movement revives the thinking behind the Caucus for a New Political Science movement in its concern for the apparent irrelevance of the discipline in the wider political context and its criticism of an increasingly quantitative orientation within the discipline. Those active in the Perestroika movement consistently point to the growing preponderance of rational choice approaches to studying politics, which, in their view, are becoming hegemonic within the discipline as departments repopulate themselves with scholars using rational choice methodologies in their research. While the Perestroika movement has witnessed some success (such as the founding of a new journal that promises to be more methodologically inclusive), it is not at all clear that it will succeed in altering the increasingly quantitative orientation of the discipline.

See also ***Democracy; Historical and Dialectical Materialism; Humanism; Machiavellism; Marxism; Power; Representation: Political Representation.***

BIBLIOGRAPHY

- Aristotle. *The Politics*. Edited by Stephen Everson and translated by Benjamin Jowett. Cambridge, U.K.: Cambridge University Press, 1988.
- Bell, Daniel. *The End of Ideology*. Rev. ed. 1962. Reprint, with a new afterword, Cambridge, Mass.: Harvard University Press, 2000.
- Bentley, Arthur F. *The Process of Government: A Study of Social Pressures*. Rev. ed. Evanston: Principia Press of Illinois, 1949.
- Easton, David. *A Framework for Political Analysis*. Englewood Cliffs, N.J.: Prentice-Hall, 1965.

- . “The New Revolution in Political Science.” *American Political Science Review* 63, no. 4 (1969): 1051–1061.
- Easton, David, John G. Gunnell, and Michael B. Stein, eds. *Regime and Discipline: Democracy and the Development of Political Science*. Ann Arbor: University of Michigan Press, 1995.
- Eulau, Heinz. *The Behavioral Persuasion in Politics*. New York: Random House, 1963.
- . *Behavioralism in Political Science*. New York: Atherton Press, 1969.
- . *Micro-Macro Political Analysis: Accents of Inquiry*. Chicago: Aldine Publishing, 1969.
- Eulau, Heinz, ed. *Crossroads of Social Science: The ICPSR 25th Anniversary Volume*. New York: Agathon Press, 1989.
- Farr, James, John S. Dryzek, and Stephen T. Leonard. *Political Science in History: Research Programs and Political Traditions*. Cambridge, U.K.: Cambridge University Press, 1995.
- Farr, James, and Raymond Seidelman, eds. *Discipline and History: Political Science in the United States*. Ann Arbor: University of Michigan Press, 1993.
- Feyerabend, Paul K. *Against Method*. 3rd ed. London: Verso, 1993.
- Graham, George J., Jr., and George W. Carey. *The Post-Behavioral Era: Perspectives on Political Science*. New York: David McKay, 1972.
- Gunnell, John G. *The Descent of Political Theory: The Genealogy of an American Vocation*. Chicago: University of Chicago Press, 1993.
- Haddow, Anna. *Political Science in American Colleges and Universities, 1636–1900*. New York: Octagon Books, 1969.
- Hegel, Georg Wilhelm Friedrich. *Phenomenology of Spirit*. 1807. Translated by A. V. Miller, with analysis of the text and foreword by J. N. Findlay. Oxford: Clarendon, 1977.
- Hempel, Carl G. *Aspects of Scientific Explanation*. New York: Free Press, 1965.
- Kant, Immanuel. *Critique of Pure Reason*. 1781. Translated by F. Max Müller. New York: Anchor Books, 1966.
- Kaplan, Abraham. *The Conduct of Inquiry: Methodology for Behavioral Science*. San Francisco: Chandler, 1964.
- Kress, Paul F. *Social Science and the Idea of Process: The Ambiguous Legacy of Arthur F. Bentley*. Urbana: University of Illinois Press, 1970.
- Kuhn, Thomas S. *The Structure of Scientific Revolutions*. 3rd ed. Chicago: University of Chicago Press, 1992.
- Lakatos, Imre, and Alan Musgrave, eds. *Criticism and the Growth of Knowledge*. Cambridge, U.K.: Cambridge University Press, 1970.
- Lasswell, Harold D. *Politics: Who Gets What, When, How*. New York: Peter Smith, 1950.
- . *Psychopathology and Politics*. 1930. Reprint, with a new introduction by Fred I. Greenstein. Chicago: University of Chicago Press, 1977.
- Laudan, Larry. *Progress and Its Problems: Toward a Theory of Scientific Growth*. Berkeley and Los Angeles: University of California Press, 1977.
- Locke, John. *An Essay Concerning Human Understanding*. 1690. Reprint, edited with a foreword by Peter H. Niddich. New York: Oxford University Press, 1979.
- Merriam, Charles E. *The Making of Citizens*. 1931. Reprint, with introduction and notes by George Z. F. Bereday, New York: Teachers College Press, 1966.
- Popper, Karl R. *Objective Knowledge: An Evolutionary Approach*. Oxford: Clarendon, 1972.
- . “Unity of Method in the Natural and Social Sciences.” In *Philosophical Problems of the Social Sciences*, edited by David Braybrooke, 32–41. New York: Macmillan, 1965.
- Ricci, David M. *The Tragedy of Political Science: Politics, Scholarship, and Democracy*. New Haven, Conn.: Yale University Press, 1984.
- Seidelman, Raymond, and Edward J. Harpham. *Disenchanted Realists: Political Science and the American Crisis, 1884–1984*. Albany: State University of New York Press, 1985.
- Somit, Albert, and Joseph Tanenhaus. *The Development of American Political Science: From Burgess to Behaviorism*. Boston: Allyn and Bacon, 1967.
- Truman, David B. *The Governmental Process: Political Interests and Public Opinion*. 2nd ed. New York: Knopf, 1971.
- Tucker, Robert C., ed. *The Marx-Engels Reader*. 2nd ed. New York: Norton, 1978.
- Wittgenstein, Ludwig. *Philosophical Investigations*. Translated by G. E. M. Anscombe. New York: Macmillan, 1953.
- . *Tractatus logico-philosophicus*. 1921. Translated by D. F. Pears and B. F. McGuinness. London: Routledge and Kegan Paul, 1961.

Tim Duvall

POLYTHEISM. The concept of polytheism was a creation of the Enlightenment. Before then, Europeans had characterized the religious universe in terms of Christianity, Judaism, paganism, and (eventually) Islam. As late as the sixteenth century, the Franciscan friar Bernardino de Sahagun, in his remarkably detailed and sensitive account of pre-Columbian Mexican religion and culture, equated various Aztec divinities with their putative Roman equivalents. The rubric of “paganism” embraced any and all religions with multiple divinities.

The very distinction between monotheism and polytheism, lumping together, as it did, Christianity with Judaism and Islam, was the product of secularizing intellectuals—deists if not agnostics or atheists—distancing themselves in this manner from any specific theology. These implications were most fully developed by David Hume in *The Natural History of Religion* (1755). Polytheism, he argued, was the earliest form of religion: “the first ideas of religion arose not from a contemplation of the works of nature, but from a concern with regard to the events of life, and from the incessant hopes and fears which actuate the human mind” (p. 139). Such hopes and fears—about childbirth, illness, a bad harvest, and so on—were multiple, and each was presided over by a separate divinity. Eventually such notions gave way to a far more rational understanding of the world in terms of a single ideal creator—in other words, monotheism. In this way, the difference between polytheism and monotheism embodied the conflict between reason and the passions, which for Hume, ever the pessimist, led not to the ultimate triumph of reason but rather to a perpetual “flux and reflux in the human mind” (p. 58) when the cold and abstract reason of monotheism left human hopes and fears unsatisfied. Worse yet, the emotions aroused by monotheism were “sacred zeal and rancour, the most furious of all human passions” (p. 161). Polytheism was more irrational but also more tolerant than monotheism.

Polytheism as an Evolutionary Stage

Nineteenth-century anthropological theorists adopted the perspective of their Enlightenment predecessors, not to mention their anticlerical biases, by categorizing types of religious beliefs as more or less rational. However, they did not share Hume's pessimism; instead they incorporated such ranking within an overall narrative of evolutionary progress. Sir Edward Burnett Tylor's *Primitive Culture* (1871) developed the most elaborate scheme of religious evolution. He categorized the most primitive religious beliefs as *animism*, the idea of a soul whose existence was separate from the body. The idea that human souls survived the death of the body engendered a belief in malevolent ghosts or the veneration of more benevolent ancestors. The notion that animals, plants, and even inanimate objects such as rocks or streams also possessed souls led to the worship of various nature spirits. Genuine polytheism emerged only at a higher stage of human development as distinctions of rank became increasingly important: "As chiefs and kings are among men, so are the great gods among the lesser spirits. They differ from the souls and minor spiritual beings which we have as yet chiefly considered, but the difference is rather of rank than of nature" (vol. 2, p. 334). If monotheism represented yet a higher stage of religious development, it was still characterized by survivals from the most primitive beliefs, not least of all in the soul. For Tylor, as for his contemporaries such as Herbert Spencer or James Frazer, science represented a development of human thought that made all religions, including monotheistic ones, obsolete.

Sigmund Freud's last book, *Moses and Monotheism* (1939), was the last major formulation of this kind of evolutionary scheme. For Freud, all religions were projections of unconscious facets of the human mind conceived and experienced as external forces. The gods of polytheism represented the multiple sexual urges of the Id, which had in some measure to be appeased if not gratified lest they wreak a terrible revenge, but which were by their very nature amoral at best. Monotheism, invented by the Egyptian Pharaoh Akhenaton and transmitted to the Jews by Moses, an Egyptian prince, represented a great advance in its worship of one God, a father figure and an externalization of the Superego, the arbiter of good and evil.

Polytheism in Modern Anthropology

In the twentieth century, anthropologists rejected the grand evolutionary schemes of their predecessors and pursued the study of religion through attempts to understand religious beliefs from the perspective of the cultures they studied firsthand. Anthropologists concerned themselves with the internal logic of a culture's beliefs, not with their rationality as compared to those of our own or of other cultures. The very idea of polytheism, to the extent that it amalgamated highly disparate systems of religious belief in different places and times, was largely irrelevant to this enterprise.

One notable exception that indeed proves the rule was E. E. Evans-Pritchard's *Nuer Religion* (1956). Evans-Pritchard was concerned with reconciling Nuer concepts of *kwoth* (God or Spirit) with ideas about a variety of different kinds of spirits of the above and below. Spirits of the above included Deng, associated with illness, Buk, his mother, and Col, associated

with rain; spirits of the below were mainly totemic spirits associated with different lineages. Evans-Pritchard's solution was to suggest that

Since God is kwoth in the sense of all Spirit and the oneness of Spirit, the other spirits . . . are all, being also kwoth, thought of as being of the same nature as God. Each of them . . . is God regarded in a particular way; and it may help us if we think of the particular spirits as figures or representations or refractions of God in relations to particular activities, events, persons, and groups. (p. 107)

In other words, as far as the Nuer were concerned, the distinction between monotheism and polytheism was not one of religious belief but rather a question of emphasis, either on the oneness of Spirit or of the plurality of its manifestations.

More recently, Robin Horton's analysis of conversion to Christianity and Islam in Africa attempted to identify a sociological dimension to polytheism and monotheism. African cosmologies, he argued, included ideas about a high god, a creator, as well as a multiplicity of lesser spirits associated with specific localities or kin groups. These lesser spirits governed local events and social relationships, whereas the creator god transcended specific localities. Small-scale societies whose members were relatively unconcerned by events outside their social microcosm emphasized the importance of local spirits in their religions. As the social horizons of groups and individuals expanded, religious emphasis shifted toward the creator, if not toward monotheism, as beliefs in local spirits were ill equipped to make sense of the social macrocosm. Horton's self-styled intellectualist approach shared with his Enlightenment predecessors an emphasis on religion as a means of understanding and manipulating the world; but rather than rating religions in terms of rationality, he suggested that different kinds of religious beliefs were appropriate for different types of societies.

Most anthropologists found Horton's scheme too general to account for the complex historical interactions that led (or did not lead) to conversion in specific cases, African or other. J. D. Y. Peel, initially a proponent of Horton's approach, wrote one such account of the encounter of the Yoruba people with Christianity. Indeed, rather than studying polytheism as such, anthropologists such as Andrew Apter and J. Lorand Matory wrote rich, historically contextualized ethnographies of the worship of various deities in the Yoruba pantheon, while Sandra Barnes, among others, studied the ways in which these gods made their way into New World religions such as Voudou in Haiti, Candomble in Brazil, and Santería in Cuba.

See also Animism; Religion.

BIBLIOGRAPHY

- Apter, Andrew. *Black Critics and Kings: The Hermeneutics of Power in Yoruba Society*. Chicago: University of Chicago Press, 1992.
- Barnes, Sandra, ed. *Africa's Ogun: Old World and New*. Bloomington: Indiana University Press, 1997.
- Evans-Pritchard, E. E. *Nuer Religion*. Oxford: Clarendon, 1956.

- Freud, Sigmund. *Moses and Monotheism*. Translated by Katherine Jones. New York: Knopf, 1939.
- Horton, Robin. "African Conversion." *Africa* 41, no. 2 (1971): 85–108.
- Hume, David. "The Natural History of Religion." In his *Four Dissertations*. London: A. Millar, 1757. Repr. as *The Natural History of Religion*, edited with an introduction By H. E. Root. Stanford, Calif.: Stanford University Press, 1956.
- Matory, J. Lorand. *Sex and the Empire That Is No More: Gender and the Politics of Metaphor in Oyo Yoruba Religion*. Minneapolis: University of Minnesota Press, 1994.
- Peel, J. D. Y. *Religious Encounter and the Making of the Yoruba*. Bloomington: Indiana University Press, 2000.
- Tylor, Sir Edward Burnett. *Primitive Culture: Researches into the Development of Mythology, Philosophy, Religion, Art, and Custom*. London: J. Murray, 1871. Repr. in 2 vols. as *The Origins of Culture and Religion in Primitive Culture*. New York: Harper and Brothers, 1958.

Robert Launay

POPULATION. Perceptions of the meaning, implications, and control of reproduction and sexuality, at both the individual and community levels, are among the most important, but also the most challenging, in the history of ideas. Changes in human population helped shape the twentieth century and are creating new tensions in the twenty-first, but, despite the profound significance of childbearing to individuals and the impact of population change on economics, politics, maternal and infant health, the environment, and national security, the intellectual history of population is oddly fractured and frequently uninformative. There are still divisions on the exact mix of factors, such as vaccination and socioeconomic change, driving the dramatic fall in death rates that pushed the global population from 1,650 million in 1900 to 6,071 million in 2000, and there is no consensus on the factors driving falling birth rates in recent decades. Many societies have made pragmatic decisions about their citizens' access to modern contraception and safe abortion, but bitter and painful differences on ethics persist. The two most important shifts in the intellectual history of population—the Papal encyclical *Humanae vitae* and the Chinese "one-child" policy—represent diametrically opposed responses to population change.

An understanding of population must draw on reproductive biology, anthropology, economics, political science, and demography, as well as knowledge of cultural and religious beliefs, but cross-disciplinary progress has been slow. As Charles Darwin (1809–1882) acknowledged, Thomas Robert Malthus's (1766–1834) *An Essay on the Principle of Population*, published in 1798, was the intellectual trigger for *The Origin of Species* (1851). In the second half of the twentieth century, biological perspectives began to influence ideas about population change. Anthropologists reconstructed the demographic history of preliterate communities, which have been characteristic of the hunter-gatherer way of life for more than 95 percent of the time *Homo sapiens* has been a distinct species. In such societies, women sometimes do not menstruate until they are eighteen or even twenty years old, and pregnancies are well

spaced by natural endocrine changes associated with breast-feeding. The average woman has six to eight pregnancies, half of which usually die, with the consequence that hunter-gatherer populations grow slowly.

The second half of the twentieth century saw unprecedented and unrepeatable changes in the growth of the global population. Rising potential fertility, as a result of changes in breast-feeding and the age of puberty, together with a rapid fall in death rates, pushed population growth rates up. The highest absolute growth in global population occurred in the mid-1980s, with more than 85 million more births than deaths per annum. During the same period, developed countries finally gained wide access to contraception and safe abortion, and in some regions average family size fell below two. In parts of Asia, which formerly had large families, the birth rate also fell to replacement level or below, although elsewhere in Asia and in Africa birth rates remain high. The implications for the health of women and children, for economic prosperity, social stability, and the environment of these changes are profound, yet some of the most important population changes were not predicted by most demographers.

The standard theory of the demographic transition was that a fall in the birth rate would lag behind any decline in the death rate and that birth and death rates would slowly stabilize as couples grew richer, became more educated, and made a rational decision to have smaller families. Frank Notestein, the distinguished American demographer, gave articulate expression to the theory. As the volume of empirical data on family planning has increased, so demographers have defined the proximal determinants of family size with increasing accuracy. These are the age at commencing intercourse, the prevalence of pathological causes of infertility, the suppression of ovulation associated with lactation, and use of contraception and abortion. However, the more distal determinants that make birth rates decline continue to be debated. The Office of Population Research at Princeton University explored the history of fertility decline in various parts of Europe and found that ideas about family planning spread by diffusion in homogeneous political and religious groups.

Clash of Ideas

The United States led the way in research that produced oral contraceptives and a new generation of intrauterine devices (IUDs) in the 1960s, although restrictive contraceptive laws remained in place in many states until the 1965 Supreme Court case *Griswald v. Connecticut*. Eastern Europe and parts of Scandinavia reformed their abortion laws in the 1960s and England followed in 1967. In 1972 the U.S. Supreme Court struck down state laws forbidding abortion in *Roe v. Wade*. Advocates for family planning were often led by physicians, such as Alan Guttmacher, president of the Planned Parenthood Federation of the United States, and Fernando Tamayo, leader of Profamilia in Colombia.

In the 1960s, demographers and economists warned of adverse effects of rapid population growth on development. Paul Erhlich captured public attention with *The Population Bomb* (1968). The Rockefeller and other foundations began to fund family planning. The Swedish government offered international

support for family planning, and in the United States General William Draper Jr. persuaded Congress to follow suit.

However, other demographers, such as Kingsley Davis, continued to emphasize socioeconomic development as a prerequisite for smaller families. Gary Becker and others framed decisions about family size as economic decisions based on a rational analysis of costs and benefits of having children. However, given the frequency of human intercourse in relation to conception, the issue is not to decide when to have a child, but how to turn off the possibility of conception, something that can only be done when a couple has ready access to contraception, backed up by safe abortion. Everywhere poor families had more children than rich ones, but the question remained: was this a choice, or did poor people find it more difficult to access contraception and safe abortion?

Those working in the front lines of family planning, led by Reimert T. Ravenholt, the principal administrator in the U.S. Agency for International Development (USAID), believed improving access to fertility-regulating choices was the key to smaller families. He began to implement large-scale programs offering oral contraceptives, IUDs, condoms, and voluntary sterilization as well as initiating surveys of the family planning knowledge, attitudes, and practices of women in developing countries. These surveys have been broadened into *Demographic and Health Surveys*, and they remain the largest social science surveys ever conducted. Virtually every survey has demonstrated that women are having more children than they intend, and everywhere that realistic family choices were made available, as in South Korea, Thailand, or Mexico, family size fell. Nevertheless, several schools of thought about population continue to compete for intellectual dominance. All are influential in discussions about population, although only those specifically concerned with family planning have put population center stage.

Economists. Economists have always played an important, although sometimes contradictory, role in establishing intellectual and public policy related to population. Macroeconomic concerns that the investment required to keep pace with rapid population growth would undermine the economic development of poor countries supported family planning policies in the 1960s and 1970s. In a much-quoted article, “The Tragedy of the Commons,” Garrett Hardin saw rapid population growth exceeding the carrying capacity of the land. But, accepting then-current ideas about the demographic transition, Hardin concluded that voluntary family planning would not ameliorate the threat. Other experts saw the relationship between population and the environment as so complex that they were reluctant to provide clear-cut conclusions. Julian Simon, Ben Wattenberg, and others argued that increasing population would drive technical ingenuity to substitute new materials for declining resources. In the 1980s, the Reagan administration free-market policies trumped any adverse effects of rapid growth. In the 1990s, the pendulum began to swing back when it was shown that countries that had undergone a rapid fall in birth rates had reaped a “demographic dividend” benefiting their economies.

Equity group. A politically influential group in population research has been those who argue that attention to population

takes attention away from the excessive consumption of the first world, reflecting economic inequity, which is the primary injustice needing remedy. This school of thought was influential at the Rio Conference on population and development (Rio de Janeiro, 1992) and in certain circumstances it is a valid conclusion. In other situations, however, there is little doubt that population growth per se is the key factor. For example, in 2000, 179 million people in Egypt, Sudan, and Ethiopia depended on the Nile, which is almost depleted by the time it reaches the Mediterranean. In 2050, 385 million people will compete for the same amount of water.

Women’s groups. Since the mid-1960s, women’s groups have played an increasingly important role in discussions of population. In Europe and North America, they were forceful advocates for access to family planning as essential to female equality and empowerment. However, a subgroup of feminists opposed hormonal contraceptives as unnatural and feminists in India have prevented the use of the popular injectable contraceptive, DepoProvera, and objected to the use of a low-cost, nonsurgical method of voluntary sterilization.

National security. Rapid population growth is associated with a high ratio of younger to older men, and analysts in both academia and the U.S. Central Intelligence Agency found a relationship between this ratio and civil disturbances, warfare, and terrorism. It is a theme that was taken up in a secret National Security Study Memorandum requested by President Nixon in 1974, which recommended additional support to international family planning. As can happen in a field permeated with emotions and religious beliefs, and thinking that has no evidential basis, lobbying by Catholic bishops successfully blocked implementation of this memorandum, which was only declassified in 1989.

The Vatican. The Judeo-Christian association of sex with sin goes back to the Adam and Eve myth, but it was St. Augustine’s assertion that coitus can be justified only for procreation that underlies Vatican teaching. In the 1960s, many leading theologians, including the commission the pope himself established, argued that sex had a dual purpose—to express love and to procreate—and that contraception could be used to separate the two. The Catholic physician John Rock, who had played a leading role in developing oral contraceptives, argued in *The Time Has Come* that the pill was morally acceptable because it imitated the natural suppression of ovulation during pregnancy and lactation. However, Pope Paul IV provided the most wrenching twist in the intellectual history of population of the second half of the twentieth century by reiterating the Augustinian interpretation of sexuality in his 1968 encyclical *Humanae vitae*. In its wake, priests and communicants left the Catholic Church, and those who remained adopted contraception and safe abortion at the same rate as non-Catholics. While the Holy See continues to oppose family planning on the international stage, Italy voted in two referenda for contraception and safe abortion.

Changing Paradigms and Uncertain Policies

The lack of consensus in intellectual thinking, the strength of faith-based assertions about human reproduction, and

competition over limited funds have all fed large and sometimes contradictory swings in domestic and international policies. The first of three landmark decennial international conferences on population in Bucharest in 1974 was summed up by the aphorism that “development is the best contraceptive.” Shortly afterward, however, China instituted a one-child policy and India passed (although it was never implemented) a compulsory sterilization law. By the 1984 conference in Mexico City, the developing countries were asking for main-line family support but the Reagan administration proclaimed that free markets trumped the population explosion.

The 1994 Cairo International Conference on Population and Development (ICPD) saw yet another policy change. Some in the women’s movement began to portray organized family planning as intrinsically coercive and sought to secure the transfer of international resources to broader aspects of women’s health. The ideological shift altered the vocabulary in revealing ways, as *gender* was substituted for *sex* and *reproductive health* replaced *family planning*. For many, Cairo was an intellectual turning point, but shortfalls in funding have stymied large-scale implementation of the Cairo Program of Action.

The ICPD occurred as the number of AIDS infections was growing exponentially, although calls for action in this area were buried in a plethora of less important issues. In the early twenty-first century AIDS has reached catastrophic levels in some countries, but it will not change the trajectory of global population by much. It has, however, taken priority away from family planning in foreign aid budgets and, as a result, in parts of Africa the trend toward lower birth rates stalled or has been reversed.

In the 1990s, as access to contraception and safe abortion increased in Europe, birth rates fell to below replacement level, while in the rest of the world increases in population fed internal and cross-border migrations, with more and more people crowding into big cities. In 1975, 40 percent of four billion people lived in cities (twenty-six cities had more than five million people); it is estimated that in 2025, of almost eight billion people, 60 percent will live in cities (seventy cities with more five million people). Migration between countries is driven by economic pressures, long exposed borders between high- and low-income regions in North America and Europe, and the relatively low cost of air travel. In Europe, the right of citizens from the British Commonwealth or former French colonies to enter the mother country broke down because of the scale of the populations seeking to migrate. In the United States, policy differences between employers and free-market economists, both endorsing a free flow of labor, and those concerned with the environment remain unresolved.

In the history of ideas about population, abortion has proved the single most divisive topic. Abortion is one way women can limit the number of children they have and an important variable in family size. Globally, it is estimated that, on average, every woman now alive will have one abortion in her reproductive lifetime. Intellectually, the abortion debate has been framed in two ways: either as fetal rights or the mother’s right to control her body—a dichotomy that preempts further debate—or as an ethical question of “when life begins.” The U.S. Supreme Court, however, concluded “that

the right of personal privacy includes the abortion decision, but that this right is not unqualified and must be considered against important state interest in regulation.” The abortion debate deeply divides the United States, both because of strongly held religious views and because the Supreme Court, Congress, and state legislators can all set policy. In 1973, Jesse Helms, a conservative U.S. senator from North Carolina, amended the Foreign Assistance Act to exclude any support of abortion, forcing U.S. international family-planning policies into a more conservative mode.

The two most important responses to population growth occurred far outside the Western intellectual tradition. The first was the Chinese one-child policy of 1979, which was driven by intellectual analysis of demographic projections, but the policy encountered much external criticism. Yet, however the policy is viewed, without it, the economic growth in China from the 1990s on could not have happened. The second occurred in the Islamic Republic of Iran, where the average number of children in a family fell from 5.5 in the late 1980s to 2.0, a decline equal to that of China’s, but without a one-child policy. The driving force in the Iranian transition was not socioeconomic change, but a national policy to make all methods of family planning widely available. Iran’s demographers noticed that their population was growing faster than the economy, and if average family size did not decline, poverty would increase. The country’s religious leadership, whose intellectual framework for policymaking in the 1990s was profoundly different from that of Chinese Communism in the 1980s, and totally unlike the Vatican in the 1970s, agreed to family planning if it was for the woman’s health.

On the whole, the intellectual history of population in North America and Europe has been disappointing. There has been increasing methodological sophistication combined with an inability to produce an acceptable paradigm of human reproductive behavior. At the end of the twentieth century, discussion of population growth was pushed off the debating table by competing schools of thought. Yet, serious problems remain. Despite well-publicized declines in birth rates, globally there are one million more births than deaths every 110 hours. India has one million more births than deaths every twenty-three days and China (even with its one-child policy) adds one million people every thirty days.

In the history of ideas, interpretations of population change, appreciation of the consequences, and evidence-based rational responses have a long way to go.

See also Antifeminism; Demography; Economics; Family Planning; Feminism; Motherhood and Maternity; Poverty; Religion and Science.

BIBLIOGRAPHY

- Asbell, Bernard. *The Pill: A Biography of the Drug that Changed the World*. New York: Random House, 1995.
- Becker, Gary S. “An Economic Analysis of Fertility.” In *Demographic and Economic Change in Developed Countries*, edited by National Bureau of Economic Research, 209–231. Princeton, N.J.: Princeton University Press, 1960.

- Campbell, Martha M. "Schools of Thought: An Analysis of Interest Groups Influential in International Population Policy." In *Population and Environment* 19 (1998): 487–512.
- Cincotta, Richard P., Robert Engleman, and Danielle Anastasion. *The Security Demographic: Population and Civil Conflict after the Cold War*. Washington, D.C.: Population Action International, 2003.
- Coale, Ansley J., and Susan C. Watkins, eds. *The Decline of Fertility in Europe*. Princeton, N.J.: Princeton University Press, 1986.
- Davis, Kingsley. "Population Policies: Will Current Programs Succeed?" *Science* 158 (1967): 730–739.
- Ehrlich, Paul R. *The Population Bomb*. New York: Ballantine, 1968.
- Finkle, Jason L. "Ideology and Politics at Mexico City: The United States at the 1984 International Conference on Population." *Population and Development Review* 11 (1985): 1–28.
- Finkle, Jason L., and Barbara B. Crane. "The Politics of Bucharest: Population, Development, and the New International Economic Order." *Population and Development Review* 1 (1975): 87–114.
- Hardin, Garrett. "The Tragedy of the Commons." *Science* 162 (1968): 1243–1248.
- Kohler, Hans-Peter, Francesco C. Billari, and Jose A. Ortega. "The Emergence of Lowest-Low Fertility in Europe during the 1990s." *Population and Development Review* 28 (2002): 641–680.
- McIntosh, C. Alison, and Jason L. Finkle. "The Cairo Conference on Population and Development." *Population and Development Review* 21 (1995): 223–260.
- Notestein, Frank W. "Demography in the United States: A Partial Account of the Development of the Field." *Population and Development Review* 8 (1982): 651–870.
- . "Population: The Long View." In *Food for the World*, edited by Theodore W. Schultz, 36–57. Chicago: University of Chicago Press, 1945.
- Potts, Malcolm. "Sex and the Birth Rate: Human Biology, Demographic Change, and Access to Fertility-Regulation Methods." *Population and Development Review* 23 (1997): 1–40.
- Ravenholt, Reimert T. "AID's Family Planning Program." *Science* 160 (1969): 541–543.
- Rock, John C. *The Time Has Come: A Catholic Doctor's Proposals to End the Battle over Birth Control*. New York: Knopf, 1963.
- Simon, Julian. *The Ultimate Resource*. Princeton, N.J.: Princeton University Press, 1981.

Malcolm Potts
Martha M. Campbell

POPULISM.

This entry includes two subentries:

Latin America
United States

LATIN AMERICA

If the term *populism* was initially borrowed from radical farmers' movements in the United States in the late nineteenth century to describe early-twentieth-century political developments

in Latin America, since then it has certainly acquired a special relevance for understanding this region's politics. The golden era for Latin American populism is usually cited as the 1930s to the 1960s and identified with such preeminent populists as Lázaro Cárdenas (1934–1940) in Mexico, Víctor Raúl Haya de la Torre in Peru (though never president), and Juan and Eva "Evita" Perón in Argentina (1946–1955). If populism had a transformative impact on the region's politics, it was assumed that the series of military dictatorships beginning in the 1960s ended the populist phase. But since the 1980s Latin America has unexpectedly witnessed a round of neopopulism, with an expansion of the possibilities for popular political practice. Populism, it is clear, is a more enduring feature of the region's political landscape than once imagined.

Political analysts, however, have had great difficulty precisely defining populism. A wide selection of political goings-on have been called "populist." These include radical farmers' movements (Pancho Villa in the Mexican Revolution), or movements of radical intellectuals who valorize the "peasantry" (Luis Valcarcel's "Indianism" in Peru), and also spontaneous grassroots peasant movements (the populist Mexican Revolution's Zapatistas, but not the Cuban Revolution), dictatorships (Argentina's Perón, and more recently, Alberto Fujimori in Peru and Hugo Chavez in Venezuela), as well as distinctly reactionary populisms (Rene Barrientos in Bolivia). Since the 1980s we can add neoliberal neopopulisms and the populist practices of the New Social Movements to more documented variations.

The Practice of Populism

If it is a distinctly Latin American way of conducting the people's business, what are the characteristics of populism as a political practice? Though diverse commentators emphasize different combinations of traits, generally populism has been associated with expansive electoral campaigning by a "charismatic" leader with special attributes (often a political outsider), the participation of the masses (that is, the "people," or the "popular" of populism), with strong appeals to nationalism or to cultural pride. Successful populist movements usually bypass traditional political institutions like the church, the oligarchy, political parties, newspapers, and elites. Given this, they are typically urban-centered and particularly court the working class but bring together a heterogeneous, if sometimes fleeting, coalition.

The career of Argentina's populist dictator Juan Perón is an oft cited archetypal instance of Latin American populism. Ideologically eclectic and personally charismatic, though a career army officer, Colonel Perón won the loyalty of most of the nation's working class by 1944, at once facilitating the desires of labor unions, long socially and politically isolated, while repressing the uncooperative. The bond between Perón and the nation's worker's movement (called the "shirtless ones") won him the 1946 election, after which he became a caudillo, or personalistic leader, even as he oversaw economic growth and continued to expand his political base among workers, improving health care, pension plans, and more. The great popularity of his wife, the actress Eva Perón, among the poorest classes, and her role as his personal intercessor to the people,

helped to cement Perón's image as a populist and to develop the political rituals of Peronism, which outlived the man himself.

To summarize, populism assumes a quasi-direct, emotionally charged relation between a personalistic leader and his devoted followers. If anything, "clientelism" is the experiential basis of populism. If populist leaders effectively redistribute material goods and other benefits among their loyal, poor constituency, the masses are incorporated into the political process only in a subordinated fashion, as the clients of a top-down, vertical process dependent on the patron's generosity. As prefigured in Antonio Gramsci's concept of the "national-popular," and reworked by populist theorist Ernesto Laclau, populism can obscure class rule and inequality by provisionally absorbing the contradictory interests of civil society within the orbit of the state. For this reason, populism has sometimes been treated as incompatible with democracy. An accompanying nation-building strategy of populist, clientelistic, regimes in Mexico, Bolivia, Peru, and Brazil has been to identify national identity with (racial, cultural, and class) mixture in the figure of the "mestizo," or what José Vasconcelos lyrically called the "cosmic race." Recent work of such cultural critics as Nestor García Canclini has given renewed attention to "cultural populism."

The wide application of the term *populism* begs the question: What might not be considered populist? Populism appears not in moments of stability, but as a condition of adjustment to periods of generalized political crisis. Historically it has been treated as a phase of political development in Latin America associated with the industrial period and the growth of cities, which made possible the political incorporation of the new urban masses. It has also been identified with the transition from oligarchic to modern politics, and with the condition of dependent capitalism. Populism is often located between the extremes of military dictatorship and political party democracy, though at times each has exhibited populist traits. Populism is also thought to spring up in the absence of both the gradual expansion of individual rights and self-governance. In contrast to liberalism or Marxism, populism conspicuously lacks an identifiable doctrine.

Features of Populism

It has been easier to cite examples of populist leaders than to clearly demarcate the features of populism. To begin with, as a macro-explanatory framework, populism is often applied in a too general, and therefore vague, fashion. Attempted definitions, such as the formula: Populism = leader √ charismatic bond + elections √ followers, are imprecise and explain little, obscuring most of what deserves debate. Part of the problem has to do with the conditions of most populist movements: specific in time and place, associated with crisis and with political transition. Another error directly equates populism with a "leadership style." This leads to a plethora of biographies of outstanding populists, where "charisma," another slippery term, becomes a sufficient explanation for the phenomenon of populism, not in the sociologist Max Weber's sense of an attributed social authority, but as an essentially psychic fact. This ignores the collective nature of all such populist movements.



Argentinean demonstration by supporters of Juan Perón, Vicente Lopez, Argentina, 1972. Populist dictator Juan Perón rose to power in 1946, riding a wave of popular opinion he had fostered among Argentina's working class and labor unions. CORBIS/BETTMANN

A further temptation when defining populism is the almost tautological appeal to the "popular," which at once makes a virtue of "the people" and mystifies what it should explain. Locating a given movement in "the people" (as a collective national-popular will) fails to differentiate between politics as social and cultural practice (the work of politicians) and a given constituency, particularly in terms of the idioms, exchanges, and representations that produce and maintain relationships between leaders and followers, along with their contingent relation to social and historical context. In fact, simplified moral narratives of "the people" typically characterize political (and some scholarly) backlashes against populist regimes, where the lack of a doctrine and the demagoguery of an irresponsible leader are assumed to ignite a disorganized explosion of the masses, thus destabilizing the state. These arguments justified military coups in Argentina in 1955, in Brazil in 1964, in Panama in 1968, in Peru in 1968, and in Bolivia in 1964, among others.

For the many reasons cited above, it is less constructive to insist upon populism as an identifiable political type, philosophy, doctrine, or style, in short, any "ism" succinctly defined. Rather, *populism*, the term, is itself implicated in the history and struggles of Latin America, a charged point of reference for diverse political relationships, practices, strategies, and sets of representations, in specific times and places, where new political constituencies are introduced. Called both "premodern" and "progressive," populism is a relational rather than categorical fact of Latin American politics.

Neopopulisms in Latin America since the 1980s, both in government and as effective opposition movements, have surprised many. Neopopulists like Argentina's Carlos Saúl Menem (1989–1999), Brazil's Fernando Collor (1990–1992), and Peru's Alberto Fujimori (1990–2000) all combined populist charisma and neoliberal structural adjustment policies to

address their nations' economic stagnation, demonstrating unexpected affinities between neopopulism and neoliberalism. Both rely on mass support of the poor, distance from intermediary organizations (like political parties), attacks on the "political class," strengthening of the state, winning of support through bold reform, and targeted benefit programs. Neoliberal neopopulism has been criticized, however, for confusing "consumer" with "citizen," where collective demands are articulated primarily through individual cost-benefit analyses, the market, voting, and the sale of labor.

Further populist developments deserving mention are the region's many New Social Movements, primarily in nations with significant indigenous populations such as Mexico, Ecuador, Bolivia, Guatemala, and Brazil, and for which Mexico's EZLN (1994–present)—also called the Zapatistas—has been a model. These movements often rely on grassroots agrarian unionism, frequently combine antineoliberalism (such as rejection of NAFTA, the North American Free Trade Agreement) with defense of national sovereignty, the call to expand citizenship rights, and the use of spectacular direct-action protests. Less preoccupied with charismatic leadership than with a new locus for "the people," these movements have switched the emphasis from "peasant" to "Indian" and from "class" to "culture," while embracing a plebiscite or assembly-style democracy to critique the exclusionary state. La Confederación de Nacionalidades Indígenas in Ecuador and MAS (Movement toward Socialism) in Bolivia are current examples. Venezuela's Hugo Chavez (1998–) is a hybrid exception, mixing an authoritarian caudillismo with effective use of the popular referendum. These movements demonstrate the symbolic power of populist tactics, as an opposition dedicated to the region's political renewal.

See also *Authoritarianism: Latin America; Capitalism; Communism: Latin America; Democracy; Dictatorship in Latin America; Nationalism.*

BIBLIOGRAPHY

- Auyero, Javier. *Peronist Survival Networks and the Legacy of Evita*. Durham, N.C.: Duke University Press, 2000.
- Conniff, Michael, ed. *Populism in Latin America*. 2nd ed. Tuscaloosa: University of Alabama Press, 1999.
- Dix, Robert. "Populism: Authoritarian and Democratic." *Latin American Research Review* 20, no. 2 (1985).
- Knight, Alan. "Populism and Neo-Populism in Latin America, Especially Mexico." *Journal of Latin American Studies* 30 (1998): 223–248.
- Torre, Carlos de la. *Populist Seduction in Latin America: The Ecuadorian Experience*. Athens: Ohio University's Center for International Studies, 2000.

Robert Albro

UNITED STATES

Populism (from the Latin term *populus*, usually translated as "the people") is the name of a group of ideologies that stresses the need for a more equitable distribution of economic, political, and cultural power. Populists argue that an elite of some form or another holds an unfair concentration of political and

I would be presumptuous, indeed, to present myself against the distinguished gentlemen to whom you have listened if this were but a measuring of ability; but this is not a contest among persons. The humblest citizen in all the land when clad in the armor of a righteous cause is stronger than all the whole hosts of error that they can bring. I come to speak to you in defense of a cause as holy as the cause of liberty—the cause of humanity.

SOURCE: William Jennings Bryan, "Cross of Gold" speech (1896).

economic power and typically that government intervention is required to counteract this injustice. Occasionally, this belief in the unfair concentration of power leads to complex theories about the subtle mechanisms by which many are oppressed and the belief that only the "common people" have the moral wherewithal to see through these manipulations. Nevertheless, such theories often penetrate the subterfuge of those in power and work to form a rallying point for those being unfairly treated.

Populists typically valorize the traditional over the contemporary, small-town and rural culture over cosmopolitan and urban culture, and basic or simple values over more complicated versions of morality and ethics. "The people" are seen as the exemplars of virtue and are marked off from the corrupting influence of large-scale government and grand economic powers. Often these beliefs lead populists to advocate the suppression of less traditional ways of life, cultural beliefs, and foreign influences. Because of this, populists are sometimes painted as culturally backward and suspicious of any form of diversity. At the very least, populists are usually seen as alarmists and often as merely reactionary. Such characterizations, however, are not always accurate but rather represent a means by which those who wish to maintain the status quo discredit their more radical adversaries.

In many cases, populists depend upon a mythological and often heavily nostalgic portrait of their own pasts and their own traditions. Rather than carefully critiquing their traditional ways of life alongside the problems of more contemporary movements, populists often eschew outside influences in a wholesale fashion, preferring a romanticized version of their accepted way of life. By offering such familiar notions of virtue, however, populism can serve as a call to action against oppressive forces that might otherwise obscure or erase the many achievements of the past and the lessons that can be culled from their study. Hence populism is not so much a political theory as it is a political strategy. While certainly not always a conscious tactic, populism may take the form merely of a rhetorical appeal to these notions of basic fairness, suspicion of a perceived class of elites, and a desire to return to a simpler life.

Populist movements often occur in reaction to perceived cultural changes brought about by technological and economic development that the populists find threatening. Populism is hence often a movement to shore up local and more traditional values over and against values deemed too new or from outside sources. Populism often takes the form of consolidating one's in-group, of working to ensure that one's way of life may continue, or of efforts to prevent further encroachment of the large-scale over the small. These movements work to halt or alter such changes, but often with unintended consequences that are themselves significant changes.

Populism may take a variety of forms; historically, powerful populist movements have arisen on both the left and the right. On the left, populists are usually concerned with hedging the power of big business. Left-leaning populists are suspicious of free-market capitalism, with its consequent growth and monopolization of power in the hands of an economic elite of the privileged few. Right-wing populists, by contrast, typically work to curtail the reach of government power, seeing the real threat to traditional ways of life in the form of bureaucracy, standardization, and intrusive legal power. In either case, what is usually advocated is some sort of regulation on the broad exercise of power by the suspected group in favor of more local or small-scale organizations. Populists on the left, for example, typically praise the virtues of smaller and locally owned businesses, whereas more conservative populists prefer a movement of government power away from the national or federal level and into local and regional sources.

Perhaps the best known and most influential populist movement is the rise of the People's Party in the late-nineteenth-century United States. Throughout the American South and West, an increasing level of discontent grew among farmers and other rural workers. It was felt that the more urban Northeast areas of the country harbored an increasing concentration of economic and political power and that the formation of political organizations such as the Farmers' Alliance and the People's Party was necessary to consolidate and give voice to these concerns. Added to this discontent was the position of black farm laborers, many of whom joined the Colored Farmers' Alliance, an organization formed in Houston County, Texas, in 1886 in response to the segregating practices of other populist organizations but which eventually spread throughout the South. These organizations were based in part upon the social and cultural ties made by the work of the Patrons of Husbandry, or National Grange, an older organization of farmers founded shortly after the end of the Civil War. Other predecessors include the Union Labor Party, the Knights of Labor, the National Labor Reform Party, and the Greenback Party.

By the end of the nineteenth century, the People's Party in the United States had elected governors, sent members to Congress, and had many successes with local elections. The party advocated women's suffrage, temperance, and various reforms in national and state policies involving land use. The People's Party was often at odds with the interests of railroad companies, banks, and other large business organizations and fought hard against the gold standard. Many of the issues important

to women, such as suffrage and temperance, however, were later taken out of the party's platform in the interest of gaining larger popular support. By 1896, the People's Party joined with the Democratic Party to support William Jennings Bryan's failed presidential campaign. Shortly thereafter, the party began declining as many of its members became Democrats or lost interest in large-scale national politics.

The history of the People's Party is only one example of populist organizations' activities. Populism, in fact, is not a unified theory or movement at all. There are as many populists as there are identifiable groups of people. Populism represents an attitude about the nature of a given social and political situation. It holds that there are those in power who hold that power unfairly, secretly, or in an unjust concentration. Regardless, this elite class wields such power at the expense of others—these others being “the people.” The populist claims to speak for these people, to represent their interests and their values. The populist wants to challenge, react to, and undermine the elite's claims to legitimacy and to fairness. The populist, instead, appeals to “common sense,” “common values,” and “basic fairness” in her or his attempts to reclaim a more traditional way of life, an exposure of the elite's secretive machinations and plots, or a more equitable distribution of cultural, economic, or political power.

See also *Democracy; Representation: Political Representation*.

BIBLIOGRAPHY

- Goodwyn, Lawrence. *Democratic Promise: The Populist Movement in America*. New York: Oxford University Press, 1976.
- Hofstadter, Richard. *The Age of Reform: From Bryan to F. D. R.* New York: Knopf, 1955.
- Kazin, Michael. *The Populist Persuasion: An American History*. New York: BasicBooks, 1995.
- McMath, Robert C., Jr. *American Populism: A Social History 1877–1898*. New York: Hill and Wang, 1993.
- Peffer, William Alfred. *Populism, Its Rise and Fall*, edited and with an introduction by Peter H. Argersinger. Lawrence: University Press of Kansas, 1992.
- Zinn, Howard. *A People's History of the United States: 1492–Present*. New York: HarperCollins, 2003.

Stephen Barnes

POSITIVISM. The history of positivism falls into two nearly independent stages: nineteenth-century French and twentieth-century Germanic, which became the logical positivism or logical empiricism of the Vienna Circle that, in turn, enjoyed an American phase. In the postmodern world, “positivist” is often a term of abuse, but historical research now contests the received characterization.

In a broad sense, positivism is the philosophical expression of scientism, the view that empirical science is the primary cultural institution, the only one that produces clear, objective, reliable knowledge claims about nature and society that accumulate over time and thereby the only enterprise that escapes the contingencies of history. For positivists, that reliability is

proportional to the proximity of claims to observed facts—the empirical basis of knowledge. Every substantive claim not tested by experience is sheer human fabrication. Positivists claim that they alone take fully into account the special nature and historical importance of science, with its actual and potential contribution to human life and culture. They reverse the traditional intellectual priority of science and philosophy (epistemology): philosophy is no longer prior to science but becomes the interpreter of and commentator on science. As W. V. Quine once quipped, “Philosophy of science is philosophy enough” (1976, p. 155).

Positivists aim to carry on the social mission of the scientific Enlightenment. The sciences, including the new human sciences, are to be unified under one method, usually with physics as the model. The positivists’ insistence that the hardheaded, allegedly value-free methods of the natural sciences (*Naturwissenschaften*) be extended to the human sciences or humanities (*Geisteswissenschaften*) has provoked charges of cultural imperialism from those defending historical, hermeneutical-interpretive, religious, or aesthetic modes of understanding (*Verstehen*).

In the broad sense, Karl Popper and even Quine are positivists, despite their trenchant critiques of the logical empiricists of the Vienna Circle (especially Rudolf Carnap), who achieved cultural authority in the twentieth century and with whom “positivism” in a narrow sense is now identified.

The Nineteenth Century: Comte to Mach

Although it owes something to the British empiricism of David Hume and to later radical empiricists such as John Stuart Mill and Alexander Bain, positivism as a movement developed on the Continent in France and later in central Europe, especially Vienna and Berlin. We can recognize positivist strains in the French Académie des Sciences around 1800, but it was the sociologist and philosopher August Comte who, in the 1830s, founded positivism as a distinctive movement, gave it its name, and also named the new science of social physics “sociology.” The conjunction was not accidental. For him, sociology was the final science, crowning the hierarchy of sciences, employing the same lawful methods as all positive sciences, and making possible a mature scientific philosophy. Comte is most famous for his law of three stages, which claims that civilization (and every field of knowledge) passes from a naïve, animistic, theological stage, through a more abstract, metaphysical-philosophical stage, to a final, scientific or “positive” stage. In the French tradition of Descartes and the *encyclopédistes* of the Enlightenment, Comtean positivism was an entire cultural system designed to fill the vacuum left by the French Revolution, which had swept away the religious and metaphysical *ancien régime*. Comtean positivism became an evangelical movement, with scientific humanism as the new religion and Comte himself as the high priest.

The law of three stages implied the need to demarcate science from other endeavors. Comte’s criterion was that scientific claims are predictive, which excluded not only metaphysics but also unstructured accumulations of singular facts. Positive science aims at lawful generalizations expressing invariable succession and resemblance, including laws of history and

society—previously considered the domain of free human action and thus outside the scope of science. Positive science is cumulative and hence progressive. For Comte, something is “positive” insofar as it is precise, certain, useful, an organic organizing tendency for society, and relational rather than absolute. This last contrast means that Comte’s science seeks lawful correlations among phenomena rather than essences or underlying causes (the postulation of which smacks of metaphysics). It sticks to the observable surface of the world. “No proposition that is not finally reducible to the enunciation of a fact, particular or general, can offer any real and intelligible meaning” (vol. 3, p. 358). For Comte, explanation has the same form as prediction, namely subsumption of a fact under a general regularity rather than as the effect of a cause. Yet Comte also embraced the newly popular method of hypothesis against the old empiricist requirement that laws be induced from prior facts. All of these tenets except the strange Comtean religion are characteristic of later forms of positivism, although rarely via Comte’s influence. The great French sociologist Emile Durkheim did acknowledge a large debt to him.

Positivist strains are also evident in German scientific thinking in the decades before and after 1900, but it was Ernst Mach, physicist, historian, and philosopher of science, who made Vienna a center of positivist thinking. Positivists typically minimize the gap between appearance and underlying reality, at least knowable reality. Mach rejected atomic theory as empirically meaningless metaphysical speculation, at best of heuristic value; and his emphasis on the economy of thought led him to view scientific laws as rationally organized summaries of facts. Unlike the later positivists, he worked seriously on history of science (especially mechanics) and wrote on the processes of problem solving and discovery.

Logical Positivism and the Vienna Circle

The most developed form of positivism was the logical positivism or logical empiricism (LE) of the Vienna Circle. LE developed in three main phases: the first Vienna Circle from about 1907; the second Vienna Circle (the Vienna Circle proper), from the mid-1920s until about 1933; and the predominantly American emigrant phase after Hitler came to power. In all three cases the logical empiricists (LEs) were scientists, mathematicians, and scientifically trained philosophers who met to discuss substantive and methodological problems of science and society. The first circle was influenced directly by Mach and other scientists such as Heinrich Hertz, Richard Avenarius, Wilhelm Ostwald, Henri Poincaré, and Pierre Duhem, and by scientific developments such as non-Euclidean geometry, David Hilbert’s axiomatization of Euclidean geometry, and Einstein’s relativity theories. The second circle was heavily influenced additionally by Bertrand Russell and Alfred North Whitehead’s attempted reduction of mathematics to the new symbolic logic in *Principia Mathematica* (1910–1913), Ludwig Wittgenstein’s *Tractatus* (1921), Hilbert’s metamathematics, the new quantum theory, behavioral psychology, and antivitalistic progress in biology.

All three phases were also shaped by their respective social contexts. The first circle experienced the events leading to World War I and the final days of the Habsburg Empire, while

the Weimar period framed the sociopolitical issues of the second circle. By contrast, the “end of ideology” characterized the American period, especially after World War II. Upon the emigration to America by members of the circle, the LE social program vanished. The American LEs presented their work as purely technical and hence politically neutral.

Many postmodern intellectuals, who think of the positivists as heavy-handed, dogmatic conservatives or as emotionless technical analysts disinterested in cultural affairs, are surprised to learn that the Vienna Circle assigned itself the urgent mission of reforming and transforming all of social and political culture by adapting to present conditions the program of the scientific Enlightenment. A major initiative was linguistic reform. The Viennese positivists’ animus against metaphysics was directed as much against obfuscatory and potentially totalitarian political discourse as it was against woolly philosophy. This is apparent at once in the manifesto of 1929, “The Scientific Conception of the World: The Vienna Circle,” by Hans Hahn, Carnap, and Otto Neurath in honor of their leader, Moritz Schlick. Modernist in outlook, the Vienna Circle celebrated the machine age and the transformative reconstruction (*Aufbau*) of Europe after World War I. It had close ties with a similar circle of scientific philosophers around Hans Reichenbach (Einstein’s colleague) in Berlin and with the Bauhaus school of design at Dessau, which in its own way emphasized clarity of structure shorn of all baroque, metaphysical adornment. Like the Bauhaus, the circle was international in outlook and pro-working class, and some members were politically active. Neurath was a neo-Marxist social scientist who radicalized the young Carnap, a logician. Schlick led a moderate wing.

When Schlick was assassinated in 1936, Neurath and Carnap became the leaders of the circle. It was in America that the indefatigable Neurath found a publisher for his dream project of a new, systematic encyclopedia of the sciences, but the overall project was a failure. Neurath died in 1945, and the University of Chicago Press published only twenty monographs of what was intended to be a long-term monthly subscription series. (These were later reissued as the two volumes of *Foundations of the Unity of Science* in 1955 and 1970.) One of the last contributions was Thomas Kuhn’s *Structure of Scientific Revolutions* (1962), commonly regarded as a refutation of logical empiricism. Meanwhile, Carnap, Herbert Feigl, Reichenbach, and Carl Hempel (a student of Reichenbach) headed the American phase of the movement. Ernest Nagel, although of a more Deweyan pragmatic cast, was a close associate. In America, unlike Europe, the aforementioned all had important academic positions, which they used to found the new specialty discipline of philosophy of science as well as to teach a new generation of philosophers, including Adolf Grünbaum, Wesley Salmon, and Hilary Putnam. With its rigorous formal methods, LE made the pragmatism of Charles Peirce, William James, and John Dewey seem quaintly dated and gradually displaced it as the official scientific philosophy. LE remained dominant until the 1960s and still casts a large shadow at the start of the twenty-first century.

The received view of the Vienna Circle is largely a post-Kuhnian construction that is now being contested. To be sure,

the LEs wanted to make philosophy (or their replacement for it) a collective, progressive enterprise like that of the sciences, but the manifesto announced a more iconoclastic unity than was actually present. Accordingly, it was easy for opponents to miss the internal discord and tar all LEs with the same brush. Although the LEs were vehemently antimetaphysical and rejected most philosophy as a meaningless, fruitless pursuit of solutions to “pseudoproblems,” they were liberal in refusing to dogmatize about empirical questions and they viewed their group as open to discussion of all views. Another source of misunderstanding was A. J. Ayer’s inflammatory *Language, Truth, and Logic* (1936), the book that brought German positivism to an English-speaking audience. Ayer’s “potboiler” (as it has been called) mislocated the positivists in the British empiricist tradition.

Archival research sensitive to the intellectual and cultural milieu of central Europe later provided a major reinterpretation of the Austro-German positivist movement from Mach to Hempel. The participants came from varying academic backgrounds and life experiences and they frequently disagreed over matters of philosophical content as well as strategy and politics. They were their own most trenchant critics. For example, Kurt Gödel defended a Platonist (and hence metaphysical) ontology of mathematics. Neurath was out of sympathy with Carnap’s project to reconstruct science within a formal logical system and with Schlick’s commitment to the correspondence theory of truth. Neurath rejected the foundational, linear empiricist theory of justification, from supposedly infallible basic statements up through ever-higher levels of theory, in favor of a holistic coherence position featuring mutual support, a stance that he famously articulated in his ship metaphor: “There is no tabula rasa. We are like sailors who have to rebuild their ship on the open sea, without ever being able to dismantle it in drydock and reconstruct it from the best components” (Giere and Richardson, p. 83).

The LEs also disagreed over labels. Several members attacked “positivism,” and Reichenbach sometimes denied that he was a “logical empiricist.” (By the beginning of the twenty-first century, however, the inclusive term “logical empiricism” was commonly applied to both the Vienna and Berlin groups as well as the American contingent and was preferred to “logical positivism.”) Also, the views of the leading figures developed significantly over their lifetimes. Accordingly, a summary that is both brief and accurate is impossible.

Contrary to Ayer, the LEs had too serious an engagement with Kant to be squarely in the British empiricist tradition. They were anti-Kantian up to a point, with the political goal of displacing the neo-Kantians of the Marburg school (which included Ernst Cassirer) as the dominant school of scientific philosophy in Europe. The central problem was to retain what was correct in Kant’s critique of crude, British empiricism without commitment to Kant’s permanent categories and forms of intuition, which licensed synthetic a priori judgments. The latter are necessary truths that are knowable a priori yet make substantive statements about the universe, for example, that physical space is Euclidean and the laws of mechanics, Newtonian. Without them, Kant had said, mathematics and natural science would be impossible.

Kant had realized that sensory inputs do not automatically sort themselves into intelligible perceptions about which we can make coherent judgments. Coherent perception and thought must be actively constituted by the human mind by means of its processing rules (the categories and forms of intuition). Upon analyzing relativity theory, Reichenbach and Schlick concluded that Kant was partly right: science does need constitutive framework principles that are neither logical truths nor empirical claims subject to testing and in that sense a priori. But how, then, to avoid Kant's commitment to a special, nonnatural intuition that yields synthetic a priori truths? Briefly, the LEs' solution, anticipating Kuhn's paradigms by several decades, was to disambiguate Kant's *necessary* a priori from the *constitutive* a priori of framework principles and to regard the latter as based on human convention rather than Kantian intuition. For example, Reichenbach's analysis of space-time theory bifurcated it into two components: a purely conventional component of "coordinating definitions" that define the meaning of measurement operations (and that we could change if it proved convenient to do so), plus a purely empirical component expressing the substantive content of the theory relative to the constitutive framework.

Stated in another way, the LEs' problem was how to wed empiricism to logic and mathematics. As Kant had emphasized, raw experience is not the sort of thing that can enter into logical relations with statements, providing justificatory reasons or evidence. And analytic claims need their own special warrant. Carnap, the most influential LE, later widened the above approach to include logic itself. The axioms of a logical system are not self-evident to reason, he said, for there is no such thing as a special faculty of rational intuition. It is not even a question of epistemic correctness; rather, it is a question of human linguistic convention—choice of language. The choice is pragmatic, not epistemic. We may freely choose any formal system we like and explore its consequences, keeping those systems that produce the most fruitful consequences for our purposes. Thus we arrive at the mature LE view that all and only empirical statements are synthetic and all and only a priori statements are analytic (in the pragmatically grounded sense). On this view, the a priori—a posteriori distinction coincides with the analytic-synthetic distinction. There is no synthetic a priori.

Where does philosophy fit into this scheme? For Carnap its task is purely analytic—*Wissenschaftslogik*, the logical analysis of the language of science using the tools of symbolic logic. Scientific philosophers clarify the logical structure of empirical science but do not *do* empirical science. Thus was born both mature analytic philosophy and philosophy of science as a specialty.

Logical Empiricist Themes—and Their Reception

What follows is a list of several interlocking theses and projects and their outcomes, several of which were controversial among the LEs themselves.

1. *The verifiability theory of meaning.* A sentence is empirically meaningful if and only if it is verifiable in principle and (roughly) its meaning is given by the method of its verification. The LEs quickly rejected full verifiability in favor of weaker forms

of testability. However, they were never able to formulate an adequate formal criterion of meaning or justify the equation of meaning with empirical evidence. It was this "verificationism" that backed the LEs' anthropomorphic claim that all genuine problems are empirical and therefore humanly solvable and their dismissal of all metaphysical problems as pseudoproblems. Since competing metaphysical positions, by definition, have no empirical consequences, they cannot differ in meaning; so there can be no meaningful problem of choosing between them.

2. *The attack on metaphysics as meaningless.* The LEs agreed that an enlightened society has no room for metaphysics; however, they sometimes disagreed over what counts as metaphysics.

3. *A sharp fact-value distinction and emotive ethics.* Ethical and aesthetic utterances are emotional reactions. Since they are not empirically testable, they have no cognitive meaning and cannot be true or false. Nonetheless, the early LEs took a strong normative stance on social and political issues.

4. *The observational-theoretical distinction.* The project to distinguish epistemically unproblematic observational terms and sentences from the theoretical ones and legitimize the latter in terms of their logical relations to the former ran into similar difficulties despite important progress such as Carnap's treatment of dispositional terms. N. R. Hanson, Popper, Kuhn, Paul Feyerabend, and Putnam noted that scientific observational language is "theory laden" and that there is no context-free, linear gradation of theoreticity.

5. *The analytic-synthetic distinction.* Quine's influential critique of this pillar of LE (and of much else), in "Two Dogmas of Empiricism" and other writings, and his return to a pragmatic naturalism were heavy blows. The second dogma was "radical reductionism," the idea that each sentence in isolation can be correlated with a range of experience.

6. *Application of the resources of the new symbolic logic and the third dogma.* The LEs (especially Carnap) developed and applied the new symbolic logic in ingenious ways, mainly in terms of purely syntactic rules; but later critiques by Quine, Hempel, Nelson Goodman, and others showed that semantic and pragmatic considerations are unavoidable, effectively dooming Carnap's project to produce objective, ahistorical, context-free languages of science. By the 1950s and 1960s, philosophers increasingly felt that the LEs had exhausted the resources of deductive logic without adequately capturing the richness of scientific reasoning. Static logical relations seemed especially incapable of modeling scientific theories and deep conceptual change, for example, scientific revolutions. Commitment to deductive logic by the LEs and Popper has been called the third dogma of empiricism. (Others, following Donald Davidson, give this label to the so-called scheme-content distinction.) Reichenbach all along had urged a probabilistic approach (a theme continued by his student, Salmon), although he and Carnap had developed probability theory in roughly opposite ways.

7. *Logical analysis of scientific confirmation, explanation, and theory structure.* The LEs admirably articulated

old and new ideas here in terms of detailed models. Their work set the standard for ongoing research in these areas. Hempel's extension of "covering law" explanation to history, psychology, and the social sciences was especially controversial since it challenged old ideas about human freedom and spontaneity and the need for sympathetic understanding. Yet it also failed to capture the force of causal explanation.

8. *The unity of science.* Pitting the sciences against the rest of culture, some LEs defended the unity of science on three fronts: conceptual, doctrinal, and methodological. Conceptual unity means that there is one universal language of science; doctrinal unity, that more complex disciplines such as biology are ultimately reducible to more basic disciplines such as chemistry and physics; methodological unity states that there is one general method of science, that all legitimate theories, all explanations, and so on possess the same logical structure. All of these projects produced interesting results, but have since been abandoned. In the antireductionist, more pragmatic atmosphere of the early twenty-first century, the emphasis is on diversity, on teasing out the differences among the various sciences rather than on trying to model all of them on physics; and physics itself turns out to be internally diverse. Most experts reject the existence of a unique scientific method as a fiction of textbooks and school administrators.

9. *The fall and rise of naturalistic epistemology.* Prominent LEs followed Gottlob Frege in sharply distinguishing logic and epistemology from psychology; "psychologism" was the fallacy of confusing them. It was on this point that the positivists differed most obviously from the American pragmatists. (As usual, the most important exception was Neurath, who promoted a naturalistic epistemology.) But the LEs' own critique of Kant's transcendental epistemology could be viewed as a step toward a naturalistic epistemology. Quine took the next step and urged a return to a naturalistic pragmatism, contending that epistemology should become a branch of behavioral psychology. Historical case studies by Kuhn, Feyerabend, and their followers showed that the failure of LE and Popperian methodologies to fit actual history was so great as to raise the question whether anything recognizable as science could fit the old rules of method. Since (as Kant said) "ought" implies "can," the critics thereby showed that empirical information is relevant to and can in a sense "refute" a methodology despite its normative character.

This surprising turn does fit Quine's pronouncement that "no statement is immune to revision," come what may—not a conventional or "analytic" statement or even a normative one. The critics increasingly perceived some problems in the philosophy of science as artifacts of the LE approach and hence as pseudoproblems with respect to real science. Kuhn famously distinguished normal science under a paradigm (a quasi-Kantian categorical scheme that made normal science possible and intelligible) from revolutionary science, neither of which fit the tenets of either LE or Popperianism. In "the battle of the big systems" (initially among the LEs, Popper, Kuhn, Feyerabend, Imre Lakatos, and Stephen Toulmin), many considered Kuhn the winner, although many philosophers severely criticized his work. And yet Carnap, who increasingly thought

in terms of free, pragmatic choices among available linguistic frameworks, welcomed Kuhn's contribution as making a similar point. The work of Kuhn and Feyerabend brought all the above-mentioned difficulties of LE to a focus, which hastened its demise as the generally accepted account of science. No similarly grand consensus has replaced it.

10. *The discovery-justification distinction.* This distinction was an LE bulwark against psychologism. The basic idea is that it does not matter how or why a theory or problem solution pops into someone's head; what matters is how the claim is tested. There is a psychology of discovery but no logic of discovery, only a logic of justification. Philosophy is concerned only with the logically reconstructed products and not the processes of science. The LEs' applications of the discovery-justification distinction drew philosophy of science closer to philosophical problems of logic and epistemology and away from the study of science as practiced by communities of scientists. Since the new historical case studies were precisely the study of the process of investigation, they challenged these applications.

11. *The emergence of science studies.* As scientific insiders, the original LEs relied on their own knowledge and intuitions about how science works (or should work) and, qua analytic philosophers, saw no need for careful empirical studies of the sciences themselves. The Kuhnian revolution changed that. Their sharpest critics noted the irony that the logical *empiricists* urged everyone else to be empiricists but themselves! But while post-Kuhnian philosophers began to take the history of science seriously, they did not study in detail the scientific practices of contemporary science. They thereby left an opening for the new empirical sociology of scientific knowledge that has since grown into a multidisciplinary "science studies," often defined to exclude philosophy.

12. *Realism versus social constructionism and "the science wars."* As strong empiricists, early LEs tended to advocate a minimalist stance toward theories and the entities that they appeared to postulate. Some regarded theories as instruments for calculation rather than as attempts truly to describe underlying reality. Carnap himself used Russell's maxim as a motto: "Wherever possible logical constructions are to be substituted for inferred entities." This is a *logical* constructionist position. Most science studies practitioners are also constructionists, but *social* constructionists. They deny that science is a special, epistemically privileged institution and regard its results as negotiated social constructions. In reaction, many philosophers now take a "realist" position that affirms objective, scientific progress toward truth and vigorously denies the cultural relativity of scientific results. As heirs of the Enlightenment, they reject the centrifugal tendencies of postmodernism and defend the special place of the sciences in human culture. This heated debate among philosophers, science studies practitioners, culture theorists, and scientists themselves is commonly known as "the science wars." If the postmodernist critics are right, Comte's law of three stages stopped at least one stage too soon!

13. *The linguistic turn and the rise and fall of narrowly analytic philosophy.* With G. E. Moore, Russell, and the early Wittgenstein as precursors, the LEs, and especially

Carnap, were the primary developers of analytic philosophy. After World War II, a wider sort of linguistic philosophy, “ordinary language philosophy,” flourished at Oxford. Both movements construed philosophy itself as a metadiscipline concerned to analyze language rather than to address substantive questions about the world and human activity. But since the 1960s, Anglo-American philosophy has become more liberal in its interests and methods. Philosophers once again vigorously discuss the metaphysical issues rejected by the LEs as pseudoproblems, and there is even something of a rapprochement with the so-called Continental philosophy of Heidegger and his successors. Carnap dominated the American phase and the received view of LE; but at the turn of the twenty-first century, many experts were examining Neurath’s position in greater detail and finding it more defensible.

See also Analytical Philosophy; Empiricism; Falsifiability; Linguistic Turn; Paradigm.

BIBLIOGRAPHY

- Ayer, A. J. *Language, Truth, and Logic*. New York: Oxford University Press, 1936.
- , ed. *Logical Positivism*. Glencoe, Ill.: Free Press, 1959.
- Cartwright, Nancy, et al., eds. *Otto Neurath: Philosophy between Science and Politics*. Cambridge, U.K.: Cambridge University Press, 1996.
- Comte, Auguste. *The Positive Philosophy of Auguste Comte*. Translated and condensed by Harriet Martineau. 3 vols. London: G. Bell, 1913.
- Feigl, Herbert, and May Brodbeck, eds. *Readings in the Philosophy of Science*. New York: Appleton-Century-Crofts, 1953.
- Friedman, Michael. *A Parting of the Ways: Carnap, Cassirer, and Heidegger*. Chicago: Open Court, 2000.
- Giere, Ronald N., and Alan W. Richardson, eds. *Origins of Logical Empiricism*. Minnesota Studies in the Philosophy of Science 16. Minneapolis: University of Minnesota Press, 1996.
- Hahn, Hans, Rudolf Carnap, and Otto Neurath. “The Scientific Conception of the World: The Vienna Circle.” In Otto Neurath, *Empiricism and Sociology*, 299–318. Dordrecht: Kluwer Academic Publishers, 1973. Originally published in German in 1929.
- Hardcastle, Gary L., and Alan W. Richardson, eds. *Logical Empiricism in North America*. Minnesota Studies in the Philosophy of Science 18. Minneapolis: University of Minnesota Press, 2003.
- Hempel, Carl G. *Aspects of Scientific Explanation, and Other Essays in the Philosophy of Science*. New York: Free Press, 1965.
- Kuhn, Thomas S. *The Structure of Scientific Revolutions*. 1962. 2nd ed., with postscript. Chicago: University of Chicago Press, 1970.
- Neurath, Otto, Rudolf Carnap, and Charles F. W. Morris. *Foundations of the Unity of Science: Toward an International Encyclopedia of Unified Science*. 2 vols. Chicago: University of Chicago Press, 1955, 1970.
- Parrini, Paolo, Wesley C. Salmon, and Merrilee H. Salmon, eds. *Logical Empiricism: Historical and Contemporary Perspectives*. Pittsburgh: University of Pittsburgh Press, 2003.
- Quine, Willard Van Orman. “Mr. Strawson on Logical Theory.” *The Ways of Paradox*. Rev. edition. Cambridge, Mass.: Harvard University Press, 1976.
- . “Two Dogmas of Empiricism.” In his *From a Logical Point of View: Logico-Philosophical Essays*, 20–46. Cambridge, Mass.: Harvard University Press, 1953.

Russell, Bertrand, and Alfred North Whitehead. *Principia Mathematica*. 3 vols. Cambridge, U.K.: Cambridge University Press, 1910–1913.

Sarkar, Sahotra, ed. and introductions. *The Legacy of the Vienna Circle: Modern Reappraisals*. New York: Garland, 1996.

Simon, Walter Michael. *European Positivism in the Nineteenth Century, an Essay in Intellectual History*. Ithaca, N.Y.: Cornell University Press, 1963.

Wittgenstein, Ludwig. *Tractatus Logico-Philosophicus*. Translated from the 1921 German edition by C. K. Ogden. London: Routledge and Kegan Paul, 1922.

Thomas Nickles

POSTCOLONIAL STUDIES. Postcolonial studies designates a broad, multidisciplinary field of study that includes practitioners from literary, cultural, and media studies, history, geography, art history, philosophy, anthropology, sociology, and political economy. Postcolonial studies is the analysis of the phenomenon of imperialism and its aftermath: slavery, colonialism, nationalism, independence, and migration. Its eclectic disciplinary and methodological range differentiates postcolonial studies from its subdivision field of “postcolonial theory,” which is dominated by practitioners of literary studies who conceptualize narrative structures, representations of cultural difference, and strategies of subject-formation in colonial and postcolonial texts.

Edward Said’s *Orientalism* (1978) initiated the entry of postcolonial studies into the metropolitan academies of Europe and the United States. Said’s study draws upon the ideas of Antonio Gramsci and Michel Foucault to explore constructions of “the Orient” by European and American politicians, scholars, and artists. The intellectual origins of postcolonial studies are more debatable. Deconstructionist or postmodernist practitioners (including Homi Bhabha and Gayatri Spivak) regard *Orientalism* as the inaugural text of postcolonial studies, while for Marxist or materialist practitioners (including Timothy Brennan, Benita Parry, and E. San Juan, Jr.), the field’s origins are much earlier, with the predominantly Marxist anticolonial writings of activist-intellectuals that include George Antonius, Edward Wilmot Blyden, Simon Bolivar, Amilcar Cabral, Aimé Césaire, Frantz Fanon, Marcus Garvey, C. L. R. James, Kwame Nkrumah, Julius Nyerere, George Padmore, Roberto Fernández Retamar, Walter Rodney, Jean-Paul Sartre, Léopold Senghor, and Eric Williams.

Many prominent contemporary practitioners originate from Asia (Aijaz Ahmad, Bhabha, Said, San Juan, Jr., Spivak); Africa (Chinua Achebe, Mahmoud Mamdani, Achille Mbembe, V. Y. Mudimbe, Ngugi wa Thiong’o, Wole Soyinka); and Latin America and the Caribbean (E. Kamau Brathwaite, Ariel Dorfman, Eduardo Galeano, Eduardo Glissant, Wilson Harris, Jamaica Kincaid). Of these, the majority have relocated to Europe or North America, where there is no intellectual monopoly on postcolonial intellectual practices but where practitioners enjoy the lion’s share of material resources to publish and distribute postcolonial academic materials.

Colonial Encounters

Materialist postcolonial scholars understand colonialism to be a territorial expression of political-economic expansionism. Its foundations in domination, appropriation, and exploitation place the colonizer and colonized populations in a fundamentally antagonistic relationship that Fanon famously described as “Manichean.” Deconstructionists tend instead to understand colonialism as a cultural, epistemological, or psychological condition, and they perceive its political dimension as a “will to power” that operates autonomously of material determinants. In general, deconstructionists regard Fanon’s Manicheanism as a binary opposition that requires breaking down. Accordingly, they interpret colonial dynamics as ambivalent, indeterminate, or negotiated.

All practitioners share an understanding that colonies played a constitutive role in the emergence and development of metropolitan Europe. These global dependencies have been studied in all spheres of human activity: cultural, economic, subject-formation. Ann Laura Stoler and others have developed Foucault’s ideas of power/knowledge, discourse, and governmentality. This Foucauldian wing analyzes the production and regulation of colonial identities through modes of government, sexuality and gender, and educational systems. Colonial discourse analysis is concerned with knowledge production by various agencies of empire about colonized “others” (travel writers, missionaries, administrators, merchants, ethnographers, and so forth). Some practitioners emphasize the “epistemic violence” performed by these discourses; others emphasize their self-deconstructive qualities. Marxist studies have instead used concepts of ideology to explore the relations between imperialist ideologies and material practices, and consider the ways in which imperialist activities have denied and distorted indigenous social, cognitive, and cultural structures. Deconstructionists reason in spatial terms: space confers a single homogeneous political, social, ideological, and cultural identity upon its occupants (the West, Europe, Africa). Materialists criticize this approach for being monolithic, and explore instead the dynamic social-economic processes and diverse human agencies that, for them, operate within certain spaces.

Nationalism

Benedict Anderson’s *Imagined Communities* (1983) has been influential in its suggestion that nationalism is constitutively paradoxical, the expression of a historical rupture that must assert itself as an historical continuity. This has encouraged studies of the temporality of nationalism and highlighted the function of print capitalism in the development of national identities. Divisions between materialism and deconstructionism feature in studies of nationalism as they do in debates over colonialism. Materialists analyze historical anticolonial nationalist resistance as a collective and liberatory struggle for self-determination; deconstructionists analyze it as a master narrative derived from and complicit with the West. The Western source is, for some deconstructionist thinkers, the Enlightenment, for others, humanism, for others, colonialism, and for others, European nationalism.

According to materialists, anticolonial nationalism has historically mobilized leaders and masses as a political unity that

represents the needs and desires of the entire colonized population. Materialist scholars apply class analysis to differentiate between socialist, populist nationalisms and bourgeois nationalisms. Their approach rests on a dialectical understanding of the reciprocal transformability of leaders and masses as political agents.

Deconstructionists, who see the concept of political unity as a ruse, question such an understanding. They contend that it is the interests of a male social elite that nationalism actually served (and serves) and that these interests conflict with the interests of women, the peasantry, workers, and the poor. The deconstructionist critique of nationalism rests on a categorical or structural (as opposed to a dialectical and historical) understanding, which posits that these heterogeneous groups are fixed in their autonomous, essentially cultural, differences. Any claim, or attempt, to unify them does violence to those differences; any attempt to politically represent, or “speak as” the entire dominated population is actually an exploitative act of “speaking for,” that is, another example of self-consolidation through others.

Resistance

Debates over nationalism have intensified studies of anticolonial resistance in general. The conventional historical distinction between primary resistance (physical opposition to initial colonial invasion) and secondary resistance (constitutionalist struggles against an established colonial administration) has been augmented and contested by a broad range of studies. These have examined spontaneous political uprisings, local insurgencies, and industrial action, and have tended to focus analysis on the consciousness of the resisters. The indirect, everyday, cultural, religious articulations of anticolonial resistance have also been energetically analyzed and theorized, as have women’s resistances. In this context, Bhabha’s notions of “sly civility” and “mimicry” have been widely circulated.

Some practitioners have been prompted by a postmodern politics of difference, while others have seen their work as an extension of Marxist and nationalist politics. Both tendencies, however, evaluate the material value of culture and debate the relationship between cultural and political expressions of resistance. Some have analyzed a dialectical relationship; others have seen culture as necessarily preceding political forms. Still others have seen culture as following from politics.

In general, recent critical studies of resistance have disputed developmental models that posit a qualitative linear progression of resistance and consciousness “from protest to challenge.” For some, this model denies the heterogeneity of resistant currents at work in any one historical movement or moment; others object to the teleological worldview, or belief in the idea of progress, to which this model subscribes.

Decolonization, Postindependence and Neocolonialism

The debate over nationalism extends to the nation-state and to nationalism’s legacy in postindependent societies. Deconstructionists argue that the state is an alien structure imposed by colonialism. By adopting it as their goal and means of

social liberation, anticolonial nationalists doomed themselves to cultural inauthenticity and to political failure. Against this, materialists have argued that the state, as a political structure, has its origins in precolonial, not colonial, polity. They suggest that in a world increasingly governed by global capitalism, the state potentially provides an important safeguard of human needs. As a structure it is uniquely accountable to, and transformable by, its populations; the nation-state remains a tool to oppose neocolonialism.

Both tendencies agree that there are serious difficulties besetting much of the postcolonial world. Materialists regard and study political corruption, ethnic and religious conflicts, patriarchal practices, gross socioeconomic inequality, and national debt as originating in colonialism and in contemporary global configurations of capitalism that follow a neocolonial dynamic. Postmodernists interpret these same phenomena as arising from the structural flaws of nationalism itself.

Historical and Regional Contexts

Academic postcolonial studies initially focused largely on the imperial metropolises, colonies, and former colonies of Britain and France. It has subsequently expanded to include critical analysis of other European imperialisms (Dutch, Spanish, Portuguese, German) and that of the United States. The field has additionally investigated transnationalism, race, ethnicity, diaspora, and globalization, which now operate as autonomous academic fields. The institutional relationship of postcolonial to ethnic studies and to area studies varies; in some instances, mergers of these previously discrete programs and departments have occurred.

Different regions are associated with different intellectual concerns and contributions. The study of race, for example, has been particularly pronounced in work from (and about) Africa and the Caribbean, challenging orthodox political economy by arguing that, historically, enslaved labor did not precede but was integral to the development of metropolitan capitalism. This work insists on the economic as well as the ideological significance of race.

Postcolonial intellectuals from these regions have also developed negritude and pan-Africanist scholarship that argues for the liberatory value of racial identification. At the same time the strikingly multicultural and multiracial qualities of Caribbean history have led to scholarly studies of cultural plurality and mixing: creolization, *metissage*, *mestizaje*, and syncretism are ideas that have been heavily debated in and regarding the Caribbean.

Postcolonial studies originating from (or about) Asia have arguably shown the heaviest imprint of poststructuralism applying Foucauldian, Derridean, and Lacanian psychoanalytic ideas. From India emerged Subaltern Studies, an influential collective of historians. Its original Gramscian-Marxist orientation produced studies of colonialism as “domination without hegemony” (Ranjit Guha), and studies of the resistance history and consciousness of subalterns (a term describing subordinated social agents). At the start of the twenty-first century, subaltern studies has moved towards deconstructionism.

See also Empire and Imperialism; Equality; Eurocentrism; Europe, Idea of; Interdisciplinarity; Nationalism; Postcolonial Theory and Literature; Postmodernism; Structuralism and Poststructuralism.

BIBLIOGRAPHY

- Ahmad, Aijaz. *In Theory: Classes, Nations, Literatures*. London and New York: Verso, 1992.
- Anderson, Benedict. *Imagined Communities: Reflections on the Origin and Spread of Nationalism*. London and New York: Verso, 1991.
- Bhabha, Homi K. *The Location of Culture*. London and New York: Routledge, 1994.
- Cabral, Amílcar. *Return to the Source: Selected Speeches*, edited by Africa Information Service. New York: Monthly Review Press, 1973.
- Césaire, Aimé. *Discourse on Colonialism*. Translated by Joan Pinkham. New York: Monthly Review Press, 2000.
- Chatterjee, Partha. *Nationalist Thought and the Colonial World: A Derivative Discourse?* Minneapolis: University of Minnesota Press, 1993.
- Fanon, Frantz. *The Wretched of the Earth*. Translated by Constance Farrington, preface by Jean-Paul Sartre. New York: Grove, 1968.
- Guha, Ranajit. *Dominance without Hegemony: History and Power in Colonial India*. Cambridge, Mass: Harvard University Press, 1997.
- Pratt, Mary Louise. “Transculturation and Autoethnography: Peru 1615/1980.” In *Colonial Discourse, Postcolonial Theory*, edited by Francis Barker, Peter Hulme, and Margaret Iversen. Manchester, U.K.: Manchester University Press, 1994.
- Retamar, Roberto Fernández. *Caliban and Other Essays*. Translated by Edward Baker. Foreword by Fredric Jameson. Minneapolis: University of Minnesota Press, 1989.
- Rodney, Walter. *How Europe Underdeveloped Africa*. Washington, D.C.: Howard University Press, 1974.
- Said, Edward. *Orientalism*. New York: Pantheon, 1978.
- Scott, James C. *Weapons of the Weak: Everyday Forms of Peasant Resistance*. New Haven, Conn.: Yale University Press, 1985.
- Spivak, Gayatri. *A Critique of Postcolonial Reason: Toward a History of the Vanishing Present*. Cambridge, Mass.: Harvard University Press, 1999.

Laura Chrisman

POSTCOLONIAL THEORY AND LITERATURE.

Postcolonial theory, often said to begin with the work of Edward W. Said, Gayatri Chakravorty Spivak, and Homi K. Bhabha, looks at literature and society from two broad angles: how the writer, artist, cultural worker, and his or her context reflects a colonial past, and how they survive and carve out a new way of creating and understanding the world. One of the earliest critical works to present this point of view is Robert J. C. Young’s *White Mythologies: Writing History and the West* (1990).

When Said published his path-breaking book *Orientalism* in 1978, it established a trend that was, for some years, loosely described as “colonial discourse studies” rather than “postcolonial theory.” Although Said ostensibly wrote about the Middle East being constructed as the “Orient” by French intellectuals of the eighteenth and nineteenth centuries, it was the Spanish

EDWARD W. SAID

Edward W. Said was born in Jerusalem in 1935 and raised in Jerusalem and Cairo. Said earned his B.A. from Princeton University in 1957, and his M.A. (1960) and Ph.D. (1964) from Harvard University.

Said began teaching at Columbia University in 1963, where he rose to be University Professor of English and Comparative Literature. He was the author of twenty-two books, translated into thirty-five languages; they include *Beginnings: Intention and Method* (1975); *Orientalism* (1978); *The Question of Palestine* (1979); *Covering Islam* (1981); *The World, The Text, and the Critic* (1983); *After the Last Sky* (1986); *Musical Elaborations* (1991); *Culture and Imperialism* (1993); *Representations of the Intellectual: The 1993 Reith Lectures* (1994); *Peace and Its Discontents: Essays on Palestine in the Middle East Peace Process* (1996); *Out of Place: A Memoir* (1999); *The End of the Peace Process: Oslo and After* (2000); *Reflections on Exile and Other Essays* (2001); *Power, Politics, and Culture* (2001); *Parallels and Paradoxes* (2002); and *Freud and the Non-European* (2003). *Humanism and Democratic Criticism* (2004) appeared posthumously.

Said experienced postcoloniality as exile when the state of Israel was established in Palestine in 1948. "Orientalism" created a new way of theorizing the last few centuries, when the imperialist West constructed the colonies as aberrant cultural and political objects, needing the civilizing efforts of the master races. This is postcolonial theory. As a public intellectual, Said spoke indefatigably against Israeli colonialism in occupied Palestine. We might call this postcolonial intellectual practice.

Said wrote a twice-monthly column for London-based pan-Arab daily *Al-Hayat* and the Cairo paper *Al-Abram*; he wrote regularly for newspapers in Europe, Asia, and the Middle East, and was the music critic for the magazine *The Nation*. Said lectured all over the world, protesting the violence in the Middle East, speaking "truth to power." A member of the American Academy of Arts and Sciences, the American Academy of Arts and Letters, the Royal Society of Literature, and the American Philosophical Society, Said was a member of the PEN Executive Board until 1998, and President of the Modern Language Association for 1999.

Said received twenty honorary doctorates, from the University of Chicago, Jawaharlal Nehru University (New Delhi), Haverford College, Bir Zeit University (Palestine), University of Michigan, University of Edinburgh, University of Warwick, University of Exeter, National University of Ireland, University of Paris 7 – Denis Diderot, Institute of Social Sciences (The Hague), American University of Beirut, and the University of Aberdeen, among others. In 1998, he was awarded the Sultan Owais Prize for general cultural achievement; in 1999, he received the first Spinoza Prize (Netherlands). Said's memoir *Out of Place* received the New Yorker Book Award for Non-Fiction (1999), the Anisfield-Wolf Book Award for Non-Fiction (2000), and the Morton Dauwen Zabel Award in Literature. In 2001, Said was awarded the Lannan Literary Award for Lifetime Achievement; in 2002, he received the Prince of Asturias Award for Concord. Professor Said died on 23 September 2003.

and British empires that formed the main fields of colonial discourse studies. Although Said's main thesis was that the West constructed something called the "Orient" as an object of investigation through varieties of cognitive, disciplinary, and administrative practice, colonial discourse studies was broader in its focus and conclusions.

Said, an Arab-American of Palestinian origin, continued to influence colonial and subsequently postcolonial studies and

its offshoots (cultural studies, women's studies, ethnic studies) with his writings and his political journalism. Important works are *Covering Islam* (1981), *The Question of Palestine* (1979), *The World, the Text, the Critic* (1983), and *Culture and Imperialism* (1993).

First Wave: Colonial Discourse

The influential practitioners of early colonial discourse studies were, on the Latin American front, Gordon Brotherston,

MAHASWETA DEVI

Mahasweta Devi was born 1926 in Dhaka, then in British India, to parents who were nationalist intellectuals. She was educated at a school and college established by anti-imperialist poet Rabindranath Tagore (1861–1941). Devi earned her M.A. in English from Calcutta University in 1963.

Exposing exploitation and domination in the postcolonial state, Devi's writings are different from the literature of diasporic nostalgia for the place left behind. Between 1956 and 1965, Devi published nineteen titles. Among these was *Jhansir Rani* (The Queen of Jhansi, 1956), a novel about young princess of a small princely state losing her life in the Mutiny of 1857 against the British, based on archival sources as well as oral history collected by Devi herself.

From 1966 to 1975, Devi published three historical novels. One explored a low-caste boy's struggle for human rights; another, the Maratha cavalry raids in the eighteenth century. *Hajar Churashir Ma* (Mother of 1084) provided a feminist and urban perspective on the Naxalite movement of the early 1970s that brought peasants and intellectuals together. This was Devi's first major book.

Between 1976 and 1985, Devi's work focused on the aboriginal and the (post)colonial state. Her fiction about the Indian "aboriginals" (remnants of ethnic groups already living on the Indian subcontinent when the pastoralist economies, speaking Indo-European languages, spread to the area between 6000 and 2000 B.C.E.) include the novel *Aranyer Adhikar* (1975; Right to the forest), on Birsa Munda and the anti-British Munda rebellion in the late nineteenth century; the short story collection *Agnigarbha* (1978; Womb of fire); and the novel *Chotti Munda Ebong Tar Tir* (1980; Chotti Munda and his arrow).

In 1980, Devi started the Bengali quarterly *Bortika* (Torch) as a forum for peasants, agricultural and factory workers, the urban subproletariat, middle-class activists, and conscientious government workers. It was the first significant alternative publication in Bengali. In 1980 and 1981, she initiated investigative and interventionist journalism against every social ill in the postcolonial state. In 1981, Devi became involved with bonded labor (rural landowners charging exorbitant interest for small, often imagined, and invariably undocumented, loans, so that generations give free labor in "exchange"). Active in national and state-level human rights, Devi masterminded the first public interest litigation against the state on behalf of the aboriginals in 1998.

Devi is a one-person resource center for people in distress, tenaciously holding the state to its accountability. Her activism is thus different from the international civil society—self-selected moral entrepreneurs, controlled by the dominant states of the world, who bypass the dominated states. She is "postcolonial" against this new and unacknowledged colonialism. Devi approaches administrative machinery at all levels. In her fiction, she presents the aboriginal in her otherness and singularity. In her activism, she is careful that those whose suffering she foregrounds should not suffer because of her intervention.

Devi was named Padmashree (distinguished citizen) by the government of India in 1986 for work among aboriginals. In 1996, she received the Jnanpith (a literary award presented by the government of India) and the Ramon Magsaysay award (for literature, given by the government of the Philippines). In 2003, Devi was named to the Légion d'honneur (second order, by the government of France).

José Rabasa, and Peter Hulme. Brotherston's book *The Book of the Fourth World* (1992) was particularly significant in suggesting major differences in the historiography of time and place if indigenous languages were studied in depth.

By far the most numerous studies were confined to the British Empire in India. An offshoot of this work was a thorough investigation of the cross-cultural elements of the British Renaissance period. This work has also been called the New

W. E. B. DU BOIS

W. E. B. Du Bois was born in 1868 in Great Barrington, Massachusetts. At fifteen, Du Bois was a race correspondent for the *New York Globe*. He encountered racism early, but gained a deeper knowledge of it teaching at a county school while an undergraduate at Fisk College in Nashville, Tennessee. Du Bois earned his B.A., M.A., and Ph.D. from Harvard University. His doctoral thesis, *The Suppression of the African Slave Trade to the United States of America, 1638–1870*, is the first volume of the Harvard Historical Series.

Du Bois initiated the scientific approach to social phenomena in 1896 with his work *The Philadelphia Negro*. He continued developing methodology while serving on the faculty of Atlanta University, presenting historical versions of African and African-American cultural development. Du Bois engaged in a growing ideological controversy with Booker T. Washington (1856–1915), who preferred industrial to liberal education and limited economic growth to political power. Du Bois proposed higher education of the “Talented Tenth.”

In 1903, Du Bois saw the publication of his landmark *The Souls of Black Folk*.

In 1906, Du Bois organized the “Niagara Movement,” leading on to the establishment of the National Association for the Advancement of Colored People (NAACP). In 1909, Du Bois began editing the chief organ of the NAACP, *Crisis* magazine; he continued as editor for twenty-five years. Du Bois’s scathing editorials often led to battles within the ranks of the association.

During World War I, Du Bois used *Crisis* to lead Congress to open black officer training schools, bring legal action against lynchers, and set up a federal work plan for returning veterans. *Crisis* subscription grew from 1,000 in 1909 to over 10,000 in 1919. Du Bois’s “Returning Soldier” editorial marked the climax of the period.

In 1919, Du Bois represented the NAACP at the Peace Conference in France, where he organized the abortive Pan-African conference. In 1921, Du Bois planned a second Pan-African meeting. That same year, Du Bois met the populist Jamaican

leader Marcus Garvey (1887–1940) and visited Africa for the first time. With the publication of “The Negro Mind Looks Out” (1925), Du Bois anticipated postcolonial criticism by fifty years.

In 1927, Du Bois visited the Soviet Union. He commented, “My day in Russia was the day of Communist beginnings.” Du Bois left the NAACP in 1933 and rejoined Atlanta University. His works on the black freedom struggle, *Black Reconstruction* and *Dusk of Dawn*, were published in 1935 and 1940, respectively.

As an associate consultant to the American delegation, Du Bois charged the fledgling United Nations with imperialism in 1945.

The Fifth Pan-African Congress, also in 1945, included Kwame Nkrumah (1909–1972), the first president of Ghana; George Padmore (1903–1959), the international revolutionary; and Jomo Kenyatta (c. 1890–1978), the first president of Kenya. Du Bois was elected International President, and was named “Father of Pan-Africanism.” His *The World and Africa* was published in 1947.

As a member of the American Labor Party, Du Bois asserted, “Drunk with power, we are leading the world to hell in a new colonialism with the same old human slavery, which once ruined us, to a third world war, which will ruin the world.”

Du Bois demanded the outlawing of atomic weapons as chairman of the Peace Information Center. He was indicted under Foreign Agents Registration Act, but was acquitted on insufficient evidence. In 1959, Du Bois told a large audience in Beijing: “In my own country for nearly a century I have been nothing but a NIGGER.” Du Bois left the United States permanently for Ghana in 1961. He directed the state-sponsored *Encyclopedia Africana* at Nkrumah’s request and became a Ghanaian citizen and member of the Communist party.

Du Bois died in Ghana in 1963.

SOURCE: Adapted from Gerald C. Hynes, “A Biographical Sketch of W. E. B. Du Bois.” Available from <http://www.duboislc.org/html/DuBoisBio.html>.

Historicism. The most important critic in this trend is Stephen J. Greenblatt. Greenblatt's most representative book is *Marginal Possessions: The Wonder of the New World* (1991).

As for colonial discourse studies proper, work by the British Indian scholar Homi K. Bhabha can be seen as groundbreaking in the early 1980s. In the essays collected as *The Location of Culture* (1994), Bhabha describes "mimicry" as "at once resemblance and menace," "hybridity" as "'denied' knowledges enter[ing] upon the dominant discourse and estrang[ing] the basis of its authority," and the "third space" as "the non-synchronous temporality of global and national cultures."

The importance of Bhabha's early work lay in his use of the discourse of psychoanalysis as revised by the French psychoanalyst Jacques Lacan (1901–1981), and developed by the British journal *Screen*, where some of Bhabha's earliest writings appeared. "DissemiNation," the influential introduction to his edited volume *Nation and Narration* (1990), considers how to conceptualize the nation under colonialism and, by default, in postcoloniality. Here he takes issue with the anthropologist Benedict Anderson's view of the relationship between imperialism and its resistance in *Imagined Communities* (1991). Anderson, a scholar of Southeast Asia, suggests that the narrative time of the novel is particularly suitable for the epistemic shift suffered by colonial populations. In his 1998 book *The Spectre of Comparisons*, Anderson provides a detailed analysis of the coming into being of a place called Southeast Asia. This is a postcolonial text that carries on the Saidian tradition of the construction of an object of investigation into the academic practice of the U.S. university.

Interdisciplinarity

Although the three founders of the movement are located in the discipline of literary criticism, the Saidian revolution has been felt in anthropology as well. In a landmark article published in 1989 and delivered earlier to the American Association of Anthropology, Said accused anthropology of being a tool of imperialism. From within the discipline, the response to this was not as hostile as might have been expected. Important texts are Johannes Fabian's *Time and the Other* (1983); Michael Taussig's *Devil and Commodity Fetishism in South America* (1980) and *Shamanism, Colonialism, and the Wild Man* (1987); and James Clifford's *Predicament of Culture* (1988). Arjun Appadurai cofounded the journal *Public Culture* in 1988, and it soon became a leading proponent of a postcolonial approach to global migration. Carol Breckenridge, its founding co-editor, is a feminist postcolonialist historian of South Asia. In the discipline of history, names to be mentioned are Ann Laura Stoler and Gauri Viswanathan, a star pupil of Edward Said, whose work combines historical scholarship with skills in literary reading.

Subaltern Studies

The connection between the discipline of history and colonial discourse/postcolonial studies can be traced also through the Subaltern Studies collective, established in the early 1980s at the University of Sussex under the leadership of Ranajit Guha. The term *subaltern* comes from the Italian political theorist

Antonio Gramsci (1891–1937). Guha had, however, published a monograph entitled *A Rule of Property for Bengal* in 1963, which anticipated colonial discourse studies by two decades. The collective initially concentrated on the study of peasant and tribal insurgency in South Asia. Their main thesis was that colonial, nationalist, and Marxist historiography of this region had ignored the importance of such insurgencies. In asserting this, they questioned the validity of the category of the "pre-political," as advanced by British historian Eric Hobsbawm. Dipesh Chakrabarty's *Rethinking Working-Class History* (1989) is a study that illustrates why a strict Marxist class analysis is not appropriate for the study of the subaltern in colonial discourse. Chakrabarty has moved to a more metropolitan approach in his later work *Provincializing Europe* (2000).

Indeed, by the turn of the twenty-first century, the entire Subaltern Studies group had moved to problems that are more specifically post-colonial. Important in this area are Partha Chatterjee's studies of nationalism and his idea of "political" rather than "civil" society in the postcolonial subaltern context.

Second Wave: Postcolonial

This entry will now consider second-wave postcolonial theory as applied to Latin America, Britain, the Caribbean, Africa, Australian, New Zealand, Hawai'i, and East and Southeast Asia, as well as from the perspective of feminism.

Latin America. It has already been mentioned that colonial discourse studies was strong in the Latin American area. Specifically postcolonialist work was undertaken by Jean Franco; Walter D'Amico, with his *Local Histories/Global Designs* (2000); Mary-Louise Pratt, with specific reference to migrant movements; and others. Franco's *Plotting Women* (1989) is an exemplary text of postcolonialist feminism. Her *Decline and Fall of the Lettered City* (2002) relates postcolonial theory to the thematics of the Cold War. In addition, John Beverley, Ileana Rodríguez, Alberto Moreiras, and others have started a Latin American Subaltern Studies group. Moreiras's work is strongly marked by poststructuralism.

The Latin American trend continues the tradition of José Enrique Rodó (1871–1917), with his work *Ariel* (1900); Roberto Fernández Retamar (b. 1930), with his "Caliban" (1974); and Angel Rama (1926–1983), with *The Lettered City* (1996), as these earlier writers considered the relationship of Latin America to the metropole. Behind them is the shadow of the Cuban writer José Martí (1853–1895) and his powerful work, especially his essay "Our America" (1891), which defines Latin America not only in terms of the European metropole, but also over against the United States.

British cultural studies. Bhabha's early affinities were with the Birmingham Cultural Studies group, established in the mid-sixties by Richard Hoggart and Stuart Hall. This group was specifically interested in Black Britain—the scene of the migrant—and was thus unconnected, in early stages, with colonial discourse as such. Hall was a member of the British New Left of the 1960s and later an editor of *Marxism Today*, the journal of British Labour. He followed and developed Louis Althusser's (1918–1990) theory of ideology. His loyalties were therefore more centrally connected to Marxism than many of

the postcolonialists. In “When Was Postcolonialism?” published in 1996, Hall clarifies his own relationship to postcolonialism.

Paul Gilroy was the leader of the Race and Politics Group that produced the celebrated Birmingham Cultural Studies collection *The Empire Strikes Back* (1982). Gilroy moved to the United States and published a book called *The Black Atlantic* (1993), which is more in the postcolonial stream. His work then shifted into the space occupied by Martin Bernal’s *The Black Athena* (1987), which claims “African” origin for Greek culture; or Ivan van Sertima’s book, with the self-explanatory title *They Came Before Columbus* (1976); or yet the work of Jack D. Forbes, the most interesting example being *Black Africans and Native Americans* (1988), where Forbes argues the heterogeneity of the color-coding of the Greater Caribbean, by which he means North America.

Under the influence of Henry Louis Gates, Jr., the eminent African-Americanist, Bhabha’s work now focuses on the great African-American historian W. E. B. Du Bois (1868–1963). In Britain, Robert J. C. Young’s *Postcolonialism: An Historical Introduction* (2001) has provided a compendious volume that should be read in conjunction with this essay. The other important figure is Rajeswari Sunder Rajan, who divides her time between India and Britain. Among her many books, *Real and Imagined Women: Gender, Culture, and Postcolonialism* (1993) and *The Scandal of the State: Women, Law, Citizenship in Postcolonial India* (2003) are most pertinent to postcolonial theory. Young and Sunder Rajan co-edit *Interventions*, an important journal of postcolonial studies.

Caribbean. This is also an extension of Bhabha’s earlier and continuing work on Frantz Fanon (1925–1961), the revolutionary psychiatrist from Martinique. The work of Aimé Césaire, also from Martinique and the author of *Discourse on Colonialism* (1970), should be mentioned here. With Léopold Sedar Senghor, Césaire founded the movement called “Négritude,” a critique of colonial discourse that looked forward to postcoloniality. Édouard Glissant’s concept of “créolité” or “creoleness” may be termed its postcolonial hybridization. Pertinent essays are to be found in *Caribbean Discourse* (1989).

With Guha’s *Rule of Property for Bengal*, C. L. R. James’s *The Black Jacobins: Toussaint L’Ouverture and the San Domingo Revolution* (1963) can be considered a source text of postcolonialism.

Africa. In 1974, the African novelist Chinua Achebe published an essay, “An Image of Africa: Racism in Conrad’s *Heart of Darkness*,” which may be called the first essay of postcolonial literary criticism. Like much postcolonial criticism, it is undertaken by a metropolitan migrant. The question—Can a work which represents Africans as near-animals be called “great”?—is a classic postcolonial question.

In the case of sub-Saharan Africa, there is also a text located on the continent that has become a classic. It is the Kenyan writer Ngũgĩ wa Thiong’o’s *Decolonising the Mind: Politics of Language in African Literature*, published in 1986. In it, Ngũgĩ makes the bold and controversial suggestion that, in postcoloniality, the indigenous languages of Africa should

be developed as interactive literary languages. Ngũgĩ writes in Kikuyu himself and translates the material into English. He also works to support Kikuyu-language publication among Kenyan-Americans.

Among other African postcolonialists, one should consider the Nigerian-American Nobel Laureate Wole Soyinka’s writings, among them *Open Sore of a Continent: A Personal Narrative of the Nigerian Crisis* (1996), and “Arms and the Arts,” given as a T. B. Davie memorial lecture at the University of Cape Town. In Cape Town, the work of Njabulo Ndebele (*South African Literature and Culture: Rediscovery of the Ordinary*, 1994) should be considered, and in the United States, the work of Anne McClintock and Rob Nixon in the context of South Africa. Shula Marks produced feminist postcolonial work in South Africa. Marks edited *Not Either an Experimental Doll: The Separate Worlds of Three South African Women* (1987), which outlines the race, class, and gender lines in postcolonial feminism with extraordinary poignancy.

The Congolese-American philosopher V.Y. Mudimbe has laid down the lines of postcolonial thinking in his book *The Invention of Africa* (1988). Abdul JanMohamed, a Kenyan Indian who burst upon the U.S. scene with his *Manichean Aesthetics: The Politics of Literature in Colonial Africa* in 1983, has combined Africa with African-America in his later work on the author Richard Wright. In this connection, it should be mentioned that Rodolfo Acuña (*Occupied America*, 1972) and Mario Barrera (*Race and Class in the Southwest*, 1979) had theorized “internal colonization” in the Chicano context.

Samir Amin, the eminent Egyptian sociologist, would not describe himself as a postcolonialist. His first monumental book, *Unequal Development: An Essay on the Social Formation of Peripheral Capitalism* (1975), is, however, a “postcolonial” re-thinking of the Marxian vision of the narrative history of the world in terms of the progression of the modes of production. In the field of anthropology, one should mention Ifi Amadiume, *Male Daughters, Female Husbands: Gender and Sex in African Society* (1987).

Australia, New Zealand, Hawai’i. The names to be mentioned in the Australian context are Simon During, editor of *The Cultural Studies Reader* (1993); Helen Tiffin and Bill Ashcroft, editors of the *Post-colonial Studies Reader* (1995); John Hutnyk, co-editor of *Travel Worlds: Journeys in Contemporary Cultural Politics* (1999); and Nikos Papastergiadis, long associated with the London-based postcolonialist art journal *Third Text* and author of *Turbulence of Migration: Globalization, Deterritorialization, and Hybridity* (2000). The specifically feminist postcolonialist here is Sneja Gunew, who indefatigably edited and co-edited multicultural and feminist Australian texts since 1982.

In New Zealand, postcolonial studies merge with Maori Studies. An important feminist whose work tends toward postcolonialist theory is Ngahuia Te Awakotuku, author of *Mana Wabine Maori: Selected Writings on Maori Women’s Art, Culture, and Politics* (1991). This tendency toward postcolonialism is also marked in Hawai’ian cultural theory, in the work of Jon Kamakawiwoole Osorio and Haunani-Kay Trask.

Post-Soviet. In post-Soviet Europe, postcolonial theory is undergoing a transformation, because the colonialism in question belongs to the old multicultural empires—Ottoman (c. 1300–1922), Hapsburg (1282–1918) and Russian—followed by the Soviet experiment. The Belgrade Circle has produced many interesting texts, among them *Balkan as Metaphor* (2002), edited by Savić and Dusan I. Bjelić. The “Tocka” group in Skopje, Macedonia regularly considers questions of postcoloniality. Translations of postcolonial texts are also being undertaken in Ukraine. Mark von Hagen has suggested that the postcolonial approach should be used to rethink the former Soviet Union as “Eurasia.” His essay “Empires, Borderlands, and Diasporas: Eurasia as Anti-Paradigm for the Post-Soviet Era” appeared in the *American Historical Review* in April 2004.

East and Southeast Asia. The adjective *postcolonial* is disputed among writers in China, Korea, and Japan. Among Chinese writers, one might mention Eileen Chang (1920–1995), who survived the Japanese occupation of China and moved to the United States, where she died. She wrote in English and Chinese. Xiao Hong (1911–1942), Xiao Jun (1907–1988), and Duanmu Hongliang (1912–1996) might also qualify. They published during the anti-Japanese war, criticizing both the colonizing power and a reactive patriotism.

The critic Ping-Hui Liao has claimed the Taiwan writer Wu Zhuoliu (1900–1976) as a postcolonial, again with reference to the Japanese occupation. And critics such as Kuei-fen Chiu have claimed that “when situated in the postcolonial historical context of Taiwan, the canon debate gets a further complicated twist that extends the issue beyond the scope of discussion found in Western feminist writing” (from a private communication with Tani Barlow, professor of Chinese literature at University of Washington). This relates to the view that Taiwanese literature cannot be considered part of the literature of China. It is not possible to entertain such broad issues here. The literature of the Southeast Asian Chinese diaspora is also an important consideration here, and it too is beyond the scope of this article. In Japan, the classic postcolonial writers are Yokomitsu Riichi (1898–1947) and Kenzaburo Oe. In his novel *Shanghai* (1929–32) and in his essay “China Sea” (1939), Riichi presents the hybrid modernity of Asia in Western colonialism. Kenzaburo Oe tackles the problem of America. His *Hiroshima Notes* (1963) perhaps confronts the problem most directly. “Literature must be written from the periphery towards the center, and we can criticize the center. Our credo, our theme, or our imagination is that of the peripheral human being. The man who is in the center does not have anything to write” (Kenzaburo Oe Internet site, available from <http://www.ou.edu/worldlit/authors/oe/oe.html>). His *Silent Cry* (1974) and *Dojidai Gemu* (The Game of Contemporaneity, 1979) are plangent novels of Japanese identity. The “Overcoming Modernity” debate of the 1940s presages in Japan a sort of postcolonial discussion that is distinctive: a regional colonial power coming to grips with the modernity of international colonialism. Harry Harootunian has written on this in his *Overcome by Modernity* (2000). This must be accommodated in a broad vision of postcoloniality. On the contemporary scene, one might consider the “resident Koreans” who write in Japanese and have created a flourishing and

much-prized tradition in fiction, drama, and other genres. Most famous perhaps is Yu Miri and Murakami Haruki. *Postcolonial* is also a problematic term in Korean literature, but three writers might be considered under that rubric: Sin Tongyop (1930–1969), Pak Wan-so, and Cho Chong-Rae. The first of these three, a poet, was associated with the Minjung Movement, giving a divided Korea a sense of being in the grip of U.S. colonialism, going back to the 1960s and early 1970s. Here again, we are facing a different picture of postcoloniality.

Feminists. Gayatri Chakravorty Spivak (b. 1942) is usually thought of as one of the three co-founders of postcolonial theory. Her *Critique of Postcolonial Reason: Toward a History of the Vanishing Present* (1999) is her definitive statement on postcolonial theory. Her work combines Marxism, feminism, and deconstruction. She introduced many to this type of postcolonial theory when she published three pieces in the 1980s: “Three Women’s Texts and a Critique of Imperialism,” “Can the Subaltern Speak?,” and “‘Draupadi’ by Mahasweta Devi.” Her translations of Mahasweta Devi, a fiction-writer in Bengali, have been influential in establishing the parameters of the literature of postcoloniality; these include *Imaginary Maps* (1995), *Breast Stories* (1997), *Old Women* (1999), and *Chotti Munda and His Arrow* (2002). Other feminist postcolonial theorists and their texts of note are Diane Bell, author of *Daughters of the Dreaming* (1983), a text on aboriginal women from Australia; Maxine Hong Kingston, *Woman Warrior: Memoirs of a Girlhood Among Ghosts* (1976); Trinh Ti Minh-ha, *Woman, Native, Other: Writing Postcoloniality and Feminism* (1989); and Chandra Talpade Mohanty, “Under Western Eyes,” (1984) and *Feminism Without Borders: Decolonizing Theory, Practicing Solidarity* (2003). Mohanty worked with U.S. feminists who thought of the older minorities as internally colonized, and women as doubly colonized within that pattern. A representative work would be *This Bridge Called My Back* (1981), edited by Gloria Anzaldúa and Cherrie Moraga. In 1999, Anzaldúa published *Borderlands*, a book on the new hybrid that has had an enormous impact on U.S. postcolonial thinking. A representative example of similar impulses within the African-American community would be the work of bell hooks. In the diasporic Asian context, Rey Chow’s *Writing Diaspora* (1993) occupies an important place.

Next Wave: Globalization

At the turn of the twenty-first century, postcolonial theory is merging with cultural theories of globalization, with the metropolitan emphasis coming frankly to the fore. A book riding the wave is Michael Hardt and Antonio Negri’s *Empire* (2000).

Literature: a reader’s guide. The literary production of postcoloniality has generally been in the languages of the metropole, sometimes creolized. This is such a prolific impulse that only a few names can be cited here. For purposes of efficiency, the list is confined to the areas of the world where postcolonial theory has developed and flourished. By and large, the main thematics of postcolonial literature divide themselves between the experience and legacy of colonialism and the experience of migrancy and exile.

Africa. Amos Tutuola, *The Palm-Wine Drinkard and His Dead Palm-Wine Tapster in the Dead’s Town* (1953); Nguigi

Mahfouz, *Palace Walk* (1956–1957); Chinua Achebe, *Things Fall Apart* (1958); Ousmane Sembène, *God's Bits of Wood* (1962); Bloke Modisane, *Blame Me on History* (1963); Tayeb Salih, *Season of Migration to the North* (1969); Wole Soyinka, *Death and the King's Horseman* (1975); Ngugi wa Thiong'o, *Petals of Blood* (1977); Mariama Bâ, *So Long A Letter* (1980); Nadine Gordimer, *July's People* (1981); Buchi Emecheta, *The Rape of Shavi* (1983); Nuruddin Farah, *Maps* (1986); Assia Djebar, *Fantasia: An Algerian Cavalcade* (1989); Abdelkebir Khatibi, *Love in Two Languages* (1990); J. M. Coetzee, *Disgrace* (1999); Tsitsi Dangarembga, *Nervous Conditions* (1988); Zoë Wycombe, *David's Story* (2001); and Tahar Ben Jelloun, *This Blinding Absence of Light* (2002), among many others.

Latin America. Alejo Carpentier, *The Lost Steps* (1956); Carlos Fuentes, *The Death of Artemio Cruz* (1964); Julio Cortázar, *Hopscotch* (1966); Mario Vargas Llosa, *The Green House* (1968); Gabriel García Márquez, *One Hundred Years of Solitude* (1970); Manuel Puig, *Betrayed by Rita Hayworth* (1971); Marta Traba, *Mothers and Shadows* (1983); Severo Sarduy, *Colibri* (1984); Isabel Allende, *House of the Spirits* (1985); Silviano Santiago, *Stella Manhattan* (1985); Diamela Eltit, *The Fourth World* (1995); João Gilberto Noll, *Hotel Atlântico* (1989); César Aira, *The Hare* (1998); Ricardo Piglia, *The Absent City* (2000); and Pedro Lemebel, *My Tender Matador* (2003), among many others.

East and Southeast Asia. Eileen Chang, *The Rouge of the North* (1967); Pramoedya Ananta Toer, *The Fugitive* (1975); John Okada, *No-No Boy* (1975); Theresa Hak Kyung Cha, *Dictee* (1982); Wendy Law-Yone, *The Coffin Tree* (1983); Amy Tan, *The Joy Luck Club* (1989); Jessica Tarahata Hagedorn, *Dogeaters* (1990); Pak Won-so, *The Naked Tree* (1995); Yu Miri, *Family Cinema* (1996); Lan Cao, *Monkey Bridge* (1997); Cho Chong-Rae, *Playing with Fire* (1997); Murakami Haruki, *The Wind-up Bird Chronicle* (1997); Wu Zhuoliu, *The Fig Tree: Memoirs of a Taiwanese Patriot* (2002); and Monique Truong, *The Book of Salt* (2003), among many others.

South Asia. R. K. Narayan, *Swami and Friends* (1944); Kamala Markandaya, *Nectar in a Sieve* (1954); Raja Rao, *Serpent and the Rope* (1960); Bharati Mukherjee, *The Tiger's Daughter* (1972); Salman Rushdie, *Midnight's Children* (1981); Hanif Kureishi, *The Buddha of Suburbia* (1990); Meena Alexander, *Fault Lines: A Memoir* (1993); Mahasweta Devi, *Imaginary Maps* (1994); Jhumpa Lahiri, *Interpreter of Maladies* (1999); Amitav Ghosh, *The Glass Palace* (2001); and Rohinton Mistry, *Family Matters* (2001), among many others.

Caribbean. George Lamming, *In the Castle of My Skin* (1953); V. S. Naipaul, *Mystic Masseur* (1959); Kamau Brathwaite, *Rights of Passage* (1967); Aimé Césaire, *Tempête* (1986); Maryse Condé, *Heremakhonon* (1976); Wilson Harris, *Guyana Quartet* (1985); Derek Walcott, *Omeros* (1990); Jamaica Kincaid, *Lucy* (1990); and Erna Brodber, *Louisiana* (1994), among many others.

Polynesia. Albert Wendt, *Sons for the Return Home* (1973); Keri Hulme, *The Bone People* (1985); Epeli Hau'ofa, *Tales of the Tikongs* (1983); Witi Tami Ihimaera, *Bulibasha: King of the Gypsies* (1994); Haunani-Kay Trask, *Light in the Crevice*

Never Seen (1994); Sia Figiel, *Where We Once Belonged* (1996); Patricia Grace, *Baby No-Eyes* (1998), among many others.

United States. Toni Morrison, *Beloved* (1987); Américo Paredes, *George Washington Gomez* (1990); Leslie Marmon Silko, *Almanac of the Dead* (1991); Sandra Cisneros, *Caramelo, or, Puro cuento* (2002), among many others.

See also **Literature; Occidentalism; Orientalism; Other, The, European Views of; Postcolonial Studies.**

BIBLIOGRAPHY

- Acuña, Rodolfo. *Occupied America: The Chicano's Struggle Toward Liberation*. San Francisco: Canfield Press, 1972.
- Anderson, Benedict. *Imagined Communities: Reflections on the Origin and Spread of Nationalism*. London: Verso, 1983.
- . *The Spectre of Comparisons: Nationalism, Southeast Asia, and the World*. London: Verso, 1998.
- Anzaldúa, Gloria. *Borderlands = La frontera*. San Francisco: Aunt Lute Books, 1999.
- Ashcroft, Bill, Gareth Griffiths, and Helen Tiffin, eds. *Post-colonial Studies Reader*. New York: Routledge, 1995.
- Barrera, Mario. *Race and Class in the Southwest: A Theory of Racial Inequality*. Notre Dame, Ind.: University of Notre Dame Press, 1979.
- Bernal, Martin. *Black Athena: The Afroasiatic Roots of Classical Civilization*. New Brunswick, N.J.: Rutgers University Press, 1987.
- Beverly, John. *Subalternity and Representation: Arguments in Cultural Theory*. Durham, N.C.: Duke University Press, 1999.
- Bhabha, Homi K. *The Location of Culture*. New York: Routledge, 1994.
- . *Nation and Narration*. New York: Routledge, 1990.
- Brotherston, Gordon. *Book of the Fourth World: Reading Native American Thoughts Through Their Literature*. Cambridge, U.K.: Cambridge University Press, 1992.
- Centre for Contemporary Cultural Studies. *The Empire Strikes Back: Race and Racism in 70s Britain*. London: Hutchinson in association with the Centre for Contemporary Cultural Studies, University of Birmingham, 1982.
- Chakrabarty, Dipesh. *Provincializing Europe: Postcolonial Thought and Historical Difference*. Princeton, N.J.: Princeton University Press, 2000.
- . *Rethinking Working-Class History: Bengal, 1890–1940*. Princeton, N.J.: Princeton University Press, 1989.
- Chatterjee, Partha. *Nationalist Thought and the Colonial World: A Derivative Discourse*. London: Zed Books for the United Nations University, 1986.
- . *A Possible India: Essays in Political Criticism*. Delhi: Oxford University Press, 1997.
- Chow, Rey. *Writing Diaspora: Tactics of Intervention in Contemporary Cultural Studies*. Bloomington: Indiana University Press, 1993.
- Clifford, James. *Predicament of Culture: Twentieth-Century Ethnography, Literature, and Art*. Cambridge, Mass.: Harvard University Press, 1988.
- Du Bois, W. E. B. "The Negro Mind Reaches Out." In *The New Negro*, edited by Alain LeRoy Locke. New York: A. and C. Boni, 1925. Reprint, New York: Arno, 1968.
- . *Souls of Black Folk: Authoritative Text, Contexts*. Edited by Henry Louis Gates, Jr., and Terri Hume Oliver. New York: Norton, 1999.

- Fabian, Johannes. *Time and the Other: How Anthropology Makes its Object*. New York: Columbia University Press, 1983.
- Fernández Retamar, Roberto. *Caliban and Other Essays*. Translated by Edward Baker. Minneapolis: University of Minnesota Press, 1989.
- Forbes, Jack D. *Black Africans and Native Americans: Color, Race, and Caste in the Evolution of Red-Black Peoples*. Oxford, U.K.: Blackwell, 1988.
- Franco, Jean. *Decline and Fall of the Lettered City: Latin America in the Cold War*. Cambridge, Mass.: Harvard University Press, 2002.
- . *Plotting Women: Gender and Representation in Mexico*. New York: Columbia University Press, 1989.
- Gilroy, Paul. *The Black Atlantic: Modernity and Double Consciousness*. Cambridge, Mass.: Harvard University Press, 1993.
- . "There Ain't No Black in the Union Jack": *The Cultural Politics of Race and Nation*. London: Hutchinson, 1987.
- Greenblatt, Stephen. *Marvelous Possessions: The Wonder of the New World*. Chicago: University of Chicago Press, 1991.
- Guha, Ranajit. *Rule of Property for Bengal: An Essay on the Idea of Permanent Settlement*. Paris: Mouton, 1963.
- Hall, Stuart. *Stuart Hall: Critical Dialogues in Cultural Studies*, edited by David Morley and Kuan-Hsing Chen. London: Routledge, 1996.
- Hardt, Michael, and Antonio Negri. *Empire*. Cambridge, Mass.: Harvard University Press, 2000.
- Hulme, Peter. *Colonial Encounters: Europe and the Native Caribbean, 1492–1797*. London: Methuen, 1986.
- Harootyan, Harry. *Overcome by Modernity: History, Culture, and Community in Interwar Japan*. Princeton, N.J.: Princeton University Press, 2000.
- Marks, Shula, ed. *Not Either an Experimental Doll: The Separate Worlds of Three South African Women*. Durban: University of Natal Press, 1987.
- Martí, José. *José Martí: Selected Writings*, edited and translated by Esther Allen. New York: Penguin Books, 2002.
- McClintock, Anne. *Imperial Leather: Race, Gender, and Sexuality in the Colonial Conquest*. New York: Routledge, 1995.
- Mignolo, Walter D. *Local Histories/Global Designs: Coloniality, Subaltern Knowledges, and Border Thinking*. Princeton, N.J.: Princeton University Press, 2000.
- Moreiras, Alberto. *The Exhaustion of Difference: The Politics of Latin American Cultural Studies*. Durham, N.C.: Duke University Press, 2001.
- Ndebele, Njabulo S. *South African Literature and Culture: Rediscovery of the Ordinary*. Manchester, U.K.: Manchester University Press, 1994.
- Ngugi wa Thiong'o. *Decolonising the Mind: The Politics of Language in African Literature*. London: J. Currey, 1986.
- Nixon, Rob. *Homelands, Harlem, and Hollywood: South African Culture and the World Beyond*. New York: Routledge, 1994.
- Pratt, Mary Louise. *Imperial Eyes: Travel Writing and Transculturation*. London: Routledge, 1992.
- Project for Transnational Cultural Studies. *Public Culture: Bulletin of the Project for Transnational Cultural Studies*. Philadelphia: University of Pennsylvania, 1988–.
- Rabasa, José. *Inventing America: Spanish Historiography and the Formation of Eurocentrism*. Norman: University of Oklahoma Press, 1993.
- Rama, Angel. *Lettered City*. Translated by John Charles Chasteen. Durham, N.C.: Duke University Press, 1996.
- Rodríguez, Ileana, ed. *Latin American Subaltern Studies Reader*. Durham, N.C.: Duke University Press, 2001.
- Said, Edward W. *Covering Islam: How the Media and the Experts Determine How We See the Rest of the World*. New York: Pantheon Books, 1981.
- . *Culture and Imperialism*. New York: Knopf, 1993.
- . *Orientalism*. New York: Pantheon, 1978.
- . "Representing the Colonized: Anthropology's Interlocutors." *Critical Inquiry* 15.2 (1989): 205–225.
- . *The Question of Palestine*. New York: Times Books, 1979.
- . *The World, the Text, the Critic*. Cambridge, Mass.: Harvard University Press, 1983.
- Schwarz, Henry, and Sangeeta Ray, eds. *A Companion to Postcolonial Studies*. Oxford: Blackwell, 2000.
- Soyinka, Wole. *Arms and the Arts: A Continent's Unequal Conversation*. Cape Town: University of Cape Town, 1999.
- . *The Open Sore of a Continent: A Personal Narrative of the Nigerian Crisis*. New York: Oxford University Press, 1996.
- Taussig, Michael T. *Devil and Commodity Fetishism in South America*. Chapel Hill, N.C.: University of North Carolina Press, 1980.
- . *Shamanism, Colonialism, and the Wild Man: A Study in Terror and Healing*. Chicago: University of Chicago Press, 1987.
- Van Sertima, Ivan. *They Came Before Columbus*. New York: Random House, 1976.
- Von Hagen, Mark L. "Empires, Borderlands, and Diasporas: Eurasia as Anti-Paradigm for the Post-Soviet Era." *American Historical Review* 109, no. 2 (April 2004).
- Young, Robert J. C. *Postcolonialism: An Historical Introduction*. Oxford, U.K.: Blackwell, 2001.
- . *White Mythology: Writing History and the West*. New York: Routledge, 1990.

Gayatri Chakravorty Spivak

POSTMODERNISM. Few terms in the contemporary critical lexicon have been as vociferously debated and as persistently unstable in meaning and use as *postmodernism* and its various avatars, such as *postmodernity*. In spite of this instability, postmodernity may be defined as a broad category designating the culture that historically extends from the late 1960s to the early twenty-first century, and that is economically determined by postindustrial capitalism. Postmodernism would refer, more narrowly, to the characteristic intellectual and aesthetic currents and practices of that era, reflected, for example, in certain philosophical ideas or works of literature and art.

The terms *postmodernity* and *postmodernism* also suggest a break, respectively, with *modernity*, determined economically by capitalism and culturally by humanism and the Enlightenment, and with *Modernism*, the literary and aesthetic movements of modernity in the late nineteenth and early-twentieth centuries. While the distinction between modernity and postmodernity can be made without much difficulty, the distinction between modernism and postmodernism is more complicated. Some early critics argued that postmodernism was not really "post" at all, but simply "late" modernism. It quickly became apparent, however, that, despite its continuities with modernism, postmodernism does represent a definitive break from its predecessor, as well as

The status of knowledge is altered as societies enter what is known as the postindustrial age and cultures enter what is known as the postmodern age. . . . Postmodern knowledge . . . refines our sensitivity to differences and reinforces our ability to tolerate the incommensurable.

SOURCE: Jean-François Lyotard, *The Postmodern Condition: A Report on Knowledge*.

a broader overall phenomenon, which includes in particular postmodernist theory.

Arguably the single most crucial conceptual determinate of the postmodern era and of postmodernism, defining this break, is an uncontainable and irreducibly de-centered multiplicity of coexisting cognitive and cultural paradigms, without any one of them being uniquely dominant or central. This postmodern de-centering, however, is defined not by the absence of all centrality, but by multicentering as the emergence of many centers and claims upon one or another centrality, including by previously marginalized fields and groups. Multiculturalism and related trends may be best seen as reflections of this situation, whose cultural and political implications, however, have a much greater scope.

Conceptual Postmodernism and Postmodernist Theory

The roots of conceptual postmodernism may be found in the ideas of some of the major figures of modernity and modernism, ideas that set in motion profound challenges to and changes in our thinking about the world and in the status of knowledge itself. Friedrich Nietzsche, in particular, initiated a radical critique of the Enlightenment ideals of absolute truth, universal morality, and transhistorical values, which he replaced with a radically multicentered or, in his terms, perspectival understanding of human knowledge, morality, and culture. It is primarily through Nietzsche and related figures, such as Sigmund Freud and Martin Heidegger, that the genealogy of postmodernist thinking is connected to *Poststructuralism*, one of the most important conceptual revolutions of postmodernism. Several parallel scientific revolutions took place throughout twentieth-century science, especially in physics (relativity and quantum theory) and biology, and in literature and art, and these revolutions also contributed to postmodernist conceptuality and epistemology.

These changes culminated in the postmodern crisis of, in Jean-François Lyotard's terms, legitimation of knowledge. "The postmodern condition" itself, responsible for this crisis, was famously defined by Lyotard as "an incredulity toward metanarratives," especially the "grand narratives" that seek to provide a single, all-encompassing or teleological framework for un-

derstanding the world. Lyotard's key example is the Enlightenment grand narrative of the progress of civilization through reason and science. He, however, extends this critique to other grand narratives of modernity, including Hegelianism, Marxism, and Freudianism. The collapse of the grand narratives has left us with no hope of a single conceptual system or discourse through which we might attempt to understand the totality of the world. Instead we have a plurality of frequently incommensurable *worlds* and often mutually incompatible *systems* of language and thought through which to comprehend them.

Cultural and Political Postmodernism

The cultural formations and aesthetic movements of postmodernism are intricately bound up with both the ideas of conceptual postmodernism and the economic, technological, and political transformations of postmodernity. A dramatic example of this entanglement is the relationship between "the disappearance of the real," which is an epistemological conception, and media culture. Jean Baudrillard observed that by the late twentieth century, media technologies in their roles as technologies of reproduction and representation, had become so advanced that images or copies have become "simulacra," reproductions sufficiently powerful that they first obscure, then displace, and ultimately replace and function as "the real." This instability in the distinction between reality and representation is an abiding theme and hallmark of postmodern culture and art.

Postmodern technologies are also transforming other fundamental concepts and categories through which people understand the world and themselves. As postmodern bioengineering and genomic technologies erode the distinction between human and machine, humans and their conceptions of themselves are being reshaped and reimagined to an unprecedented degree. Technologies of transportation and communication are creating the "spatialization of experience" and the concomitant disappearance of the temporal, which are linked to a postmodern subjectivity that is fragmented and contingent, an intersection of fluctuating "positions." This spatialization of experience and the loss of a sense of history accompanying it, Fredric Jameson argues, impair the ability of postmodern subjects to "cognitively map" their positions in relation to the increasingly complex political and economic systems of global capitalism.

For Lyotard, postmodernity potentially offers a new and better ground for the practice of democracy and justice. He argues, against Jürgen Habermas, that de-centered postmodern heterogeneity makes obsolete the Enlightenment ideal of consensus, which all too frequently required the suppression of minority dissent. Postmodernity, with its heterogeneous interests and worldviews, allows previously oppressed or marginalized groups to make claims upon justice, and upon a position of centrality, even in the absence of majority consensus concerning such claims.

By contrast, Jameson defines postmodernism as "the cultural logic of late capitalism," for him an inherently unjust formation. The material structures of postmodern technologies, local and international politics, and global capitalism, he argues, ultimately determine our experience of postmodernity

and the nature of postmodernist culture and art, and thus put justice in conflict with postmodernity.

Most current views of postmodernity and postmodernism may be positioned between these two visions, between the justice of the heterogeneous and the “cultural logic” and unbridled power of global capitalism. If, however, one combines the views of Lyotard and Jameson, cultural postmodernism embodies two competing and conflicting drives arising from capitalism and democracy defining postmodernity. Globalization, in its positive and negative aspects, comes with postmodernity, and together they give rise to conceptual, cultural, and political postmodernism across the geopolitical landscape of both hemispheres.

Postmodernism in Literature and Art

In considering postmodernist aesthetic practices in parallel with the postmodern lack of political consensus, Lyotard invokes “the lack of *consensus* of taste.” Instead these aesthetic practices are characterized by an affirmation of their multiplicity. None needs to be defined by any given form, however multiple or fragmented, as was the case in modernist aesthetics, and as would be demanded from art by the consensus of modernist taste. By contrast, postmodernist aesthetic practices may adopt any form, outlook, or agenda, new or old, and allow for other (than postmodernist) practices and alternative approaches. The postmodernist aesthetic is thus defined by the (political) sense of this multiplicity of practices.

Literature. Continuing the narrative experiments of the modernists, the first generation of postmodernists, American and British writers of the 1960s and 1970s “metafiction” (Kurt Vonnegut, John Barth, Thomas Pynchon, John Fowles, and Angela Carter), produced texts that simultaneously questioned and violated the conventions of traditional narrative. Similarly the postmodernist Language poets (Lyn Bernstein, Charles Hejninian, and Bob Perelman), inspired by the linguistic experiments of modernism and the new ideas of poststructuralism, deployed a fractured, systematically deranged language aimed at destabilizing the systems (intellectual, cultural, or political) constructed through language. The fragmentation, intertextuality, and discontinuity that characterize so much of experimental modernist and postmodernist literature find a kind of fulfillment in the inherently fragmented, intertextual, and discontinuous form of “hypertext,” a computer-generated Web text with multiple branching links.

Another hallmark of postmodern literature, and of postmodern art in general, is the erosion of the boundaries between “high,” elite, or serious art and “low,” popular art, or entertainment. Decidedly serious literary works now make use of genres long thought to belong only to popular work. A related phenomenon is the development of numerous hybrid genres that erode the distinctions, for instance, between literature and journalism, literature and (auto)biography, and literature and history.

The emergence and proliferation of feminist, multiethnic, multicultural, and postcolonial literature since the 1970s is, however, the most dramatic and significant manifestation of the de-centering and de-marginalization defining both postmodernity and postmodernism. In the 1970s and 1980s,

No doubt the logic of the simulacrum, with its transformation of older realities into television images, does more than merely replicate the logic of late capitalism; it reinforces and intensifies it.

SOURCE: Fredric Jameson, *Postmodernism, or, The Cultural Logic of Late Capitalism*.

American and European literature underwent an immense transformation as writers who had traditionally been excluded from literary canons—women and ethnic and racial minorities—moved from the margins to the centers of the literary world. There are counterparts to this phenomenon in history and anthropology, which have seen a proliferation of histories from below and outside—histories of women, of children, of the working class. Postmodernism has gone from History with a capital H, to histories, small h.

Visual art. With the institutionalization of “high modernism” in the mid-twentieth century and the increasing commercial appropriation and commodification of artworks, the modernist ideal of an artistic avant-garde, standing apart from mainstream culture, became increasingly obsolete. Postmodernist art has been, since its beginnings in the movements of the 1960s—Pop art, Fluxus, and feminist art—art that was inherently political and simultaneously engaged with and critical of commercial mass culture. All these movements are linked to the development of multimedia performance art and conceptual art, a term that designates art that is neither painting nor sculpture, art of the mind rather than art of the eye. The logical extension of this definition (following Marcel Duchamp) is that nearly anything, properly “framed” or designated as such, might be thought of as art. One of the most distinctive characteristics of postmodernist art is the dissolution of traditional categories of art and artworks, and the proliferation of new and hybrid forms that have broadened these categories to an unprecedented degree, even greater than encountered in literature.

The feminist art of the 1960s, 1970s, and 1980s challenged the institutionalized male bias and sexism of the art system in a wide-ranging critique that extended from the writing of art history and criticism, to museums and art galleries, to the predominance of the “male gaze” and the objectification of women in visual media throughout history, to definitions of art that excluded such traditionally female forms as quilts and weaving.

Other strains of postmodernist art (from the 1980s to the early twenty-first century), which one might call “the art of simulacra,” focus on the prevalence of the image (particularly the media image), technologies of reproduction, and strategies of appropriation of already existing works. It encompasses the work of a broad range of artists and movements, from the video and performance art of Nam June Paik, Laurie Anderson, and

Bruce Nauman, to the photography of Cindy Sherman and the graphic art of Barbara Kruger.

Architecture. While reflecting many general aspects of postmodernism, the phenomenon and concept of postmodernist architecture have a particular specificity and complexity, in part because the term postmodernist architecture was given a specific meaning very early in the postmodern period. What characterizes postmodernist architecture most, however, is its diversity in spirit and in style, and the ways it defines itself, in each movement and project, in relation to this diversity.

For some, the quintessential expression of postmodernist architecture is the shopping mall, an enclosed city in which spatial disorientation seems to have been a deliberate, structural intention. Elsewhere this disorientation also takes on a temporal, historical form, as architects combine disparate elements from previous architectural eras and styles in the same building, an incongruous mixing that initially gave rise to the term postmodernist architecture. Philip Johnson's AT&T headquarters in New York City, an austere, International-style skyscraper sporting a baroque Chippendale pediment, would be a postmodernist building in this earlier sense. For some architects, postmodernism was defined by the abandonment of modernist utopianism and a validation of vernacular architecture, as in Robert Venturi's celebration of the "decorated shed" of commercial architecture. New computer-assisted design and computer-assisted manufacturing (CAD/CAM) technologies and high-tech materials have made it possible to break from the traditional architectural forms and create more free-form and sculptural edifices, such as Frank Gehry's Guggenheim Museum in Bilbao, Spain.

Music and dance. Although not as widespread or influential as other art forms, postmodern music and dance have nevertheless developed many of the key traits of postmodernism, sometimes in their most radical aspects, both building upon and working against such modernist figures as Arnold Schönberg, Igor Stravinsky, and Pierre Boulez in music, and George Balanchine, Martha Graham, and Merce Cunningham in dance. Radically experimental postmodernist composers such as Karlheinz Stockhausen, Iannis Xenakis, and György Ligeti have gone beyond modernism in dislocating the classical harmonies and replacing them with ever more complex, nearly unmusical, sounds and noises.

The same formal experimentation can often be found in postmodernist dance. Postmodernist dance is, however, particularly characterized by the collapse of boundaries between "high" dance (classical ballet and modern dance) and "popular" dance (jazz dance, folk and tribal dance, ballroom dancing, break and line dancing, and Broadway musical choreography), as choreographers fused their various styles and movements. Among the most prominent representatives of the postmodern dance scene are Bill T. Jones, Twyla Tharp, and Mark Morris. Some choreographers have gone even farther afield, incorporating movements from the martial arts, sports, acrobatics, mime, games, and even the mundane physical activities of everyday life. These trends are found in postmodernist (classical) music as well, from the usage of elements of jazz and rock and roll to the incorporation of street or elevator noises.

Dance, however, became quite literally more a part of the world, as choreographers developed architecturally inspired, site-specific works. At the same time, dance increasingly became a part of the broader forms of performance art and multimedia art, as choreography was linked to political concerns and combined with video, text, and other media. One might say that the choreography of postmodern dance is the choreography of postmodernism itself, its aesthetics and its politics, including its politics of aesthetics defined by the lack of a single consensus of taste.

See also *Modernism; Structuralism and Poststructuralism*.

BIBLIOGRAPHY

- Amiran, Eyal, and John Unsworth, eds. *Essays in Postmodern Culture*. New York: Oxford University Press, 1993.
- Baudrillard, Jean. *Jean Baudrillard: Selected Writings*. Edited by Mark Poster. Stanford, Calif.: Stanford University Press, 1988. A defining treatment of the problematic of reality and representation in postmodernity.
- Geyh, Paula, Fred G. Leebron, and Andrew Levy, eds. *Postmodern American Fiction: A Norton Anthology*. New York: W. W. Norton, 1998.
- Harvey, David. *The Condition of Postmodernity: An Enquiry into the Origins of Cultural Change*. Oxford and Cambridge, Mass.: Blackwell, 1989. A comprehensive and authoritative study of modern and postmodern spatiality.
- Huyssen, Andreas. *After the Great Divide: Modernism, Mass Culture, Postmodernism*. Bloomington: Indiana University Press, 1986. An important treatment of the relations between elite and mass culture in modernism and postmodernism.
- Jameson, Fredric. *Postmodernism, or, the Cultural Logic of Late Capitalism*. Durham, N.C.: Duke University Press, 1991. The most influential Marxist treatment of postmodernism.
- Latour, Bruno. *We Have Never Been Modern*. Translated by Catherine Porter. Cambridge, Mass.: Harvard University Press, 1993. An important assessment of the state of culture after postmodernity.
- Liotard, Jean-Francois. *The Postmodern Condition: A Report on Knowledge*. Translated by Geoff Bennington, and Brian Massumi. Vol. 10 of *Theory and History of Literature*. Minneapolis: University of Minnesota Press, 1984. A seminal study defining the problematic of postmodernity.
- Phillips, Lisa. *The American Century: Art and Culture 1950–2000*. New York: Whitney Museum of American Art in association with W. W. Norton, 1999.

Paula E. Geyh

POSTSTRUCTURALISM. See *Structuralism and Poststructuralism*.

POVERTY. As an idea, poverty has had an eventful history. From roughly the eighteenth century onward, a change in moral sensibility caused a shift in the understanding of poverty as being an ideal state (for both individuals and communities) to being an execrable condition that societies should seek to ameliorate. In the twentieth and twenty-first centuries,

with the growth of social welfare programs, intense academic debate has focused on the meaning and definition of the term. These debates, though they now dominate the discussion of poverty, nevertheless echo earlier discussion surrounding poor laws and social administration. This article will chart the development in sensibilities and attendant evaluations and then consider how the “problem of poverty” was framed and how it has manifested itself in contemporary debates.

Poverty as an Ideal

There is a long-standing discourse within which poverty has a positive moral connotation. Facets of this discourse are delineated below.

Self-control. With respect to the idea of poverty as a voluntary condition, two emphases can be identified. The first of these is exemplified by Stoicism, in thinkers such as Seneca (4 B.C.E.–65 C.E.) and Epictetus (c. 55 C.E.–135 C.E.), but is equally manifest in the ascetic tradition in Christianity and other religions. Here, like its contextual close-relations, *simplicity*, *austerity*, and *severity*, *poverty* refers to the estimable practice of temperance and continence. To live the simple life of poverty in this sense is to be in control of oneself and thus of one’s actions; it is to know the true and proper value of things and to be in a position of forswearing temptations, that is, things of illusory value. The second emphasis is more civic and is embodied, though commonly retrospectively as some lost ideal, in Sparta or ancient Rome or the earliest Christian communities. One consequence, common to both emphases, of situating poverty in this lexicon is that it is a product of choice or will or reason. Thus understood it is possible to draw a conceptual distinction between poverty as a self-imposed voluntary state and being impoverished (or necessitous; that is, having no choice).

Accompanying this idealized or moralized use of poverty is a hierarchical division between reason and desire. The Greek philosopher Aristotle (384–322 B.C.E.) established the core principle when in *The Nicomachean Ethics* he distinguished those (the *enkratic*) who exhibit discipline and act from choice not from “desire” from those (the *akratic*) who lack discipline and who, as a result, pursue bodily pleasures excessively. The notion of “excess” is crucial. There is a natural norm that ought not to be transgressed. Hence, in line with this principle, the virtue of poverty is expressed by the individual who, in the light of a rational apprehension of the natural order, self-disciplines desires so that indulgence is forsworn. So the Stoic sage will drink but not get drunk and one informed with patristic teaching will forgo sex with (or as) a pregnant woman. Of course, the body has needs that must be satisfied but there is also a natural or rational limit to this satisfaction—hence only drink when thirsty and only have sex for the sake of conception. Similarly, in the civic emphasis, the virtuous citizens of Rome’s early years, for example, were portrayed as exhibiting personal poverty while dedicating their resources to public monuments.

This idea of self-control, of poverty as a voluntary state, played an important role in Christian teaching and practice. In part this was negative. As St. Thomas Aquinas (c. 1224–1274) expressed it in *Summa contra gentiles*, poverty is commendable

because it frees a man from “worldly solicitude.” The more positive aspect, as also articulated by Aquinas, was that those who embraced voluntary poverty did so to follow Christ and “be useful to their community.” While *community* here refers to society at large, perhaps, the most distinctive Christian contribution has been the establishment of institutions that explicitly identify poverty as their rationale.

Monasticism. Institutions embracing poverty, generically known as monasteries, took their inspiration from a view of the early life of the Christians, who, expecting an imminent Second Coming, withdrew from worldly contact and tried to live a simple Christ-like life. But the eventual establishment of Christianity as the legal religion of Rome by the Emperor Constantine in the Edict of Milan (313) led to a reaction and an attempt to re-create the ideal of poverty. This appeared first in Eastern (or Orthodox) Christianity as initially individuals, then communities, fled to the deserts of Egypt. The principles of life in such communities became codified and the most influential “code” was issued by St. Basil (c. 329–379 C.E.), the archbishop of Caesaria. His Rules established the goal of monastic life—jointly to practice the Christian virtues of chastity, poverty, and sharing the common goods of the monastery. These ideas spread into western (or Latin) Christianity through the medium of (among others) St. Ambrose (339–397), who had himself spent time in the Palestinian desert. The western equivalent to Basil was St. Benedict (480–547) who also laid down his Rule. This went into great detail about monastery life, not only specifying meal times but also how much can be consumed and the proper conduct while doing so. While not strenuously ascetic the monks are instructed to chastise the body, to love fasting and not become addicted to pleasures. They should also relieve the poor. This command seemingly acknowledges that for some, poverty was not a voluntary state.

Voluntary and involuntary poverty. The canon lawyer Huguccio of Pisa (d.1210) elaborated upon the distinction between voluntary and involuntary poverty. In his commentary (1188) on Gratian’s *Decretum* (c. 1140), the primary canon law text, Huguccio divided the poor into three categories. There were those who while born poor willingly endured this state as an expression of their love of God, and there were those who deliberately surrendered their possessions that they might live a virtuous Christian life. Both of these exemplified voluntary poverty. The third category, however, comprised those who were destitute and liable to be inhibited from achieving the higher moral values. This was involuntary poverty. However, the thrust here is on the involuntary poor being inhibited; as the first category demonstrates, the dominant sensibility was that poverty was not of itself an evil to be extirpated. Indeed, Stoic echoes can still be heard in Huguccio’s explicit identification of this category with those who are poor because they are filled with the “voracity of cupidity” (quoted in Tierney, p. 11).

Change and renewal. It is a notable characteristic of the ideal state of poverty that it represented a pristine condition from which any change was a deterioration. This resulted in a recurrent motif of regeneration or a return to “basics.” The Roman moralists treated the history of Rome in this manner. Livy (59 B.C.E.–17 C.E.) prefaced his *History* with the judg-

ment that no republic, in its origin, was greater or more virtuous, because then poverty and thrift were honored, but, now, it has been brought to ruin by the introduction of luxury and avarice. Since, for Livy, history is valuable because of the lessons it imparts then this judgment in this context makes his purpose clear. He was here following the lead of (among others) Sallust (86–35 or 34 B.C.E.), who, in his *The Conspiracy of Catiline* (43 B.C.E.), used polemically and not disinterestedly the corruption associated with that conspiracy (64 B.C.E.) to contrast the rampant love of luxury and riches with the original dedication of the Romans to the public good, as seen in their courage, their lavish treatment for the gods, and their domestic frugality. This motif was to recur. Niccolò Machiavelli (1469–1527), in what is ostensibly a commentary on Livy, declares that the way to renew a corrupt state of affairs is “to bring them back to their original principles.” And, as his version of the story of Cincinnatus makes plain, these principles were designed to keep the Roman citizens poor.

According to Machiavelli, religious, as well as political institutions, are liable to fall into corruption. It was certainly a feature of monasticism that it was continually being renewed. If one monastic order appeared to become lax, another more rigorous one was established. Given that a frequently identified source of this laxity was wealth, then these new (or renewed) orders laid emphasis on being truer to the founding ideals of poverty. Hence the Cistercian order, founded in 1098, though decisively developed by St. Bernard (1090–1153) in his *Apologia* (1127), was based on the original (ascetic) Rule of St. Benedict. But even the Cistercians accumulated wealth.

In the thirteenth century orders of mendicant friars were established, who being without ties to a particular institution were thought more likely to escape the accumulation and trappings of wealth. The Franciscan order, founded by St. Francis of Assisi (1181 or 1182–1226), was based on a re-created ideal of apostolic poverty (so begging was preferred to having money) and, the other great order, the Dominicans followed suit, if less wholeheartedly (always allowing for example the personal ownership of books). The adoption of these principles did not preclude, in due course, extensive intellectual debate between the two orders on the meaning of “property,” in which Aquinas (a Dominican) participated vigorously. At the end of the thirteenth and beginning of the fourteenth century, the so-called spiritual wing of the Franciscan order, under the influence of the writings of John Peter Olivi, insisted on an extreme interpretation of voluntary poverty. Their open conflict with the more moderate “conventuals” led to the suppression of the spiritual party by Pope John Paul XXII. These ideals and practices are not confined to Christianity. Most of the world’s religious and ethical systems adopt a similar range of attitudes. For example, one of the five great vows of Jainism is *aparigraha*, meaning nonpossession or nonattachment to material things (including people). Their monks (and nuns) follow this vow strictly and totally—they are permanently naked and eat only once a day—but even lay members try to follow the vow as far as they can, hence for example, they undergo prolonged fasts. Buddhism is less austere; only in the special cases of holy persons should poverty be deliberately cultivated. In Islam the emphasis is, perhaps, less on individ-

He, therefore, who keeps himself within the bounds of nature will not feel poverty; but he who exceeds the bounds of nature will be pursued by poverty even though he has unbounded wealth.

SOURCE: Seneca, *To Helvia on Consolation*.

ual self-control than on responsibility toward the poor. It is a recurrent injunction in the Koran that the poor rate should be paid, and it is a mark of the unrighteous that they do not feed the poor. Often too, here, there is the periodic call to abandon current corruptions and return to the purity of the original state and in Islam’s case this gathered political momentum in the later decades of the twentieth century.

Changing Conceptions of Poverty

The most far-reaching call for spiritual renewal was the Reformation, which characterized European Christendom in the sixteenth century. Martin Luther (1483–1546), himself a monk, inveighed against the corruption of Christian practice and advocated a return to a more austere theology. But, as argued in Max Weber’s (1864–1920) classic work *The Protestant Ethic and the Spirit of Capitalism* (1904), perhaps more strikingly, the Reformation fostered a view of salvation that associated it with industry or work in conjunction with a worldly asceticism. A corollary of this was to associate indolence with lack of virtue. While this applied to the “idle rich” it also encompassed “beggars and vagabonds,” whose poverty became presumptive evidence of their wickedness. Voluntary poverty now takes on a negative character, a “popish conceit,” as the English Puritan theologian William Perkins (1558–1602) called it. Nonetheless, Perkins also held that poverty should be seen as providential and even those whose “calling” requires the performance of “poore and base duties” will not be base in the sight of God, if they undertake those duties in obedient faith to the glory of God.

This idealization of poverty was undermined by the Scottish philosopher David Hume (1711–1776), who explicitly criticized those he called “severe moralists” (he named Sallust as an example). These individuals are those who uphold the virtue of poverty, which they typically contrast with the vice of luxury. Hume subverted this contrast. By understanding poverty not as virtuous austerity but as necessitousness then (and this is his main aim here) luxury can lose its negative (moralized) meaning. The effect of this is to associate “ages of refinement,” or luxury, with happiness and positively with virtue. Luxury nourishes commerce and this both reduces destitution and augments the resources available for amelioration.

This argument was influentially developed by the Scottish economist Adam Smith (1723–1790). By being “blessed” by opulence, the members of a commercial society are able to en-

joy a far better standard of living than those in earlier ages. In material terms their basic needs of food, shelter, and clothing are better and more adequately met. Beyond this, human relationships are more humane. This enhanced “quality of life” extends beyond “goods” or things to relationships. In the introduction to his text *An Inquiry into the Nature and Causes of the Wealth of Nations* (1776), Smith says that the inhabitants of “savage nations of hunters and fishers” are “miserably poor,” so that, as a consequence, “they are frequently reduced or, at least, think themselves reduced, to the necessity sometimes of directly destroying and sometimes abandoning their infants, their old people and those afflicted with lingering diseases, to perish with hunger or to be devoured by wild beasts.” This is a powerful and important argument. Contrary to Stoic “frugality” or Christian asceticism, or Algernon Sidney’s (1622–1683) characteristic neo-Stoic, or civic republican, view that poverty is “the mother and nurse of . . . virtue,” Smith is firmly repudiating any notion that poverty is ennobling or redemptive; a life of necessity now signifies not the austere life of poverty but an impoverished one, a life of misery. And since the abundance that commerce brings is precisely such an improvement, then Smith’s repudiation of the nobility of poverty is a key factor in his vindication of “modern” commercial society.

Smith is, perhaps, now best known for developing an economic theory that relied, in circumstances of “freedom and security,” on the “natural effort of every individual to better his own condition” in order to carry society to “wealth and prosperity.” This “effort,” moreover, was capable of “surmounting a hundred impertinent obstructions with which the folly of human laws too often incumbers its operations.” An example of such a folly is the English Poor Law, which, on Smith’s reading, by prohibiting the mobility of labor, inhibited the spread of commerce and thence of the affluence that was the most effective remedy for poverty. Smith similarly berates the mercantilist advocacy of “low wages.” In *Fable of the Bees*, the Dutch-born English essayist Bernard Mandeville (1670–1733)—admittedly an extreme case, a position he artfully cultivated—wrote that the poor are to be “well-managed,” so that while they should not starve yet they “should receive nothing worth saving.” This argument for what E. Furniss called the “utility of poverty” was rejected by Smith, who declared unambiguously in *The Wealth of Nations* that “no society can be flourishing and happy of which the greater part are poor and miserable,” (just as Hume had earlier stated, in “Of National Characters,” that “poverty and hard labour debase the minds of the common people.”

The change in sensibilities that the work of Hume and Smith represents comes to dominate. With the advent of the industrial revolution, the apparent confidence that Smith exhibited in the workings of commerce to improve the lot of the poor seemed increasingly complacent. The condition of the “working class” (as they became known) prompted a range of responses. What they shared was a moral revulsion at the dreadful circumstances in which the poor lived. Important work was done to document just how awful these conditions in fact were. Friedrich Engels’ (1820–1895) *Condition of the Working Class in England* (1845) was a pioneer study and the seventeenth-volume *Life and Labour of the People in London* (1891–1903)

Such poverty is therefore commendable when a man being freed thereby from worldly solicitude, is enabled more freely to occupy himself with divine and spiritual things yet so as to retain the possibility of lawfully supporting himself, for which purpose not many things are needful. And according as the manner of living in a state of poverty demands less solicitude, so much the more is poverty to be commended: but not according as the poverty is greater. . . .

For those who embrace voluntary poverty ought to hold temporal things in contempt . . . [and who] in order to follow Christ renounce all things precisely that they may be useful to the community since by their wisdom, learning and example they enlighten the people and sustain them by their prayers and intercession.

SOURCE: St. Thomas Aquinas, *Summa contra gentiles*.

of Charles Booth (1840–1916) and Seebohm Rowntree’s (1871–1954) study of York were prototype social surveys documenting the lives of the poor. Poverty gradually became in this way a topic of social science—something to be measured and statistically analyzed. But it never lost sight of its origins in moral disquiet. Rowntree, for all his deliberate attempt to “state facts,” declared the finding that a quarter of his survey lived below the poverty line, in a time of unexampled prosperity, may cause “great heart-searching” (p. 304). Hence, while emphases differed, this shared moral concern prompted a search for remedies. Karl Marx (1818–1883) is the best-known analysis of capitalism. He argued that the increasing (relative) misery of the proletariat was caused by capitalism. Marx is equally recognized (if only because of the subsequent revolutions that evoked his name) for his advocacy of communism as a solution. Poverty was thus for him symptomatic; for others it was more central. Some, like Pierre-Joseph Proudhon (1809–1865), while criticizing the destructive competitiveness of capitalism, even reinvoked the moral ideal of poverty. Marx was, however, scathing of the contemporary attempts to deal with the “problem of the poor,” which he alleged located the source of the problem in the poor themselves.

The Problem of the Poor

The “problem of the poor” was always one of a threat to social order and thus always had a political dimension. For example, in Aristotle’s classification of constitutions in *The Politics*, democ-

racy was identified as a perverse form, since it was rule by the “many” for the good of the many (not “all”). The many are immediately said to be the poor. This association between the poor and inferior political order endured. The “mob” was perceived as an ever present threat and European history has been marked by the recurrent eruptions of urban riots and peasant uprisings.

One of the striking things about the ideal of poverty was that very often in practice it served to underwrite a hierarchical status quo. For example, innumerable sumptuary laws were passed in the Roman republic and empire, and all European “states” followed suit throughout the early modern period. This legislation sought to preserve the extant social pecking-order, to attempt to confine the incidence of a good and prevent its diffusion. Luxury, “new” wealth, always threatened to overturn this hierarchy; Hume’s defense of luxury, as part of his reconfiguration of poverty from ideal to a state of necessity, was a critique of this rationale. From the “ideal” perspective, those in the lower ranks of these societies may well want some of those privileged goods but that “wanting” was a mark of their unworthiness; their lack of the requisite self-control, and if self-control is lost then the stability of the social order is under threat. Hume’s view contains a rebuttal of that disparagement. In so doing he was representing the “modern” view of human nature. Humans are motivated by their desires and the work of reason is not to control these but to steer them effectively. It is this same understanding of the effective springs of human motivation that underpins the shift in moral sensibilities that displaced the ideal view of poverty by one which conceived of it as state of material distress.

Poor laws. Sumptuary laws were only indirectly concerned with the question of the poor and poverty. More overt measures were undertaken. A petition to the English Parliament of 1376 linked poverty with idleness and criminality. This was before the English Peasants’ Revolt of 1381, which had been preceded by an uprising in France in 1358, and there were similar revolts in Florence in 1378 and the Low Countries in 1382. In early modern Europe, attempts were made to deal with poverty administratively. The Elizabethan Poor Law (1601), which Perkins, in *Treatise of the Vocations*, called an “excellent statute” and “in substance the very law of God,” charged each parish with the responsibility to support their own poor. Adam Smith put its origin down to Henry VIII’s dissolution of the monasteries, which had previously been the major source of charitable relief for the impoverished and destitute. This law was revisited over the years. The Act of Settlement of 1662 enabled parishes to eject immigrant paupers—ostensibly to counteract inequality of provision. The whole system was overhauled in 1834 after a royal commission into the Poor Laws. The new poor law nonetheless retained the basic distinction, made by Perkins and other advocates of the original poor law, between the deserving poor who worked (independent laborers) and the undeserving who were dependent on “public largesse” (paupers, sturdy beggars). The latter were less “eligible” for relief than the former; that is, the relief had to be less attractive than that available to even the poorest laborer (otherwise there would be no incentive to work). The tenability of the distinction was assailed from its origins, and a further commission in 1909 was divided in its

I am forced to admit that [my description] instead of being exaggerated . . . is far from black enough to convey a true impression of the filth, ruin and uninhabitableness . . . and such a district exists in the heart of second city of England [Manchester], the first manufacturing city of the world. . . . Everything which here arouses horror and indignation is of recent origin, belongs to the industrial epoch . . . [which] alone enables the owners of these cattlesheds to rent them for high prices, to plunder the poverty of the workers, to undermine the health of thousands in order that they alone may grow rich.

SOURCE: Friedrich Engels, *The Condition of the Working Class in England*, 1845.

recommendations. The majority view still distinguished between unwilling and willful incapacity and saw an important role for charity. The minority view, led by Beatrice Webb (1858–1943), an early leader of the Fabian Society, which published a cheap and best-selling version of her “view,” wanted a radical break with the past both administratively and with respect to the principle that the causes of poverty lay in individuals (in some moral defect) rather than having a social origin. With the emergence of explicitly welfare states in the second half of the twentieth century the basic thrust of the minority view was implemented.

Polizei. Because Britain was the most advanced industrial society, it is there that many of the issues surrounding the problem of poverty were articulated and why so many British sources and experience figure so prominently in its history. Britain, however, had no monopoly. The French, for example, had a system of *hospiteux* and the Dutch *spinhausen*, which functioned like English workhouses, although the parish-based localism of the English system was distinctive. While most of the associated literature dealt with practical issues, such as curbing the spread of begging, there were more theoretical treatments. Prominent among these is the systematic development by a group of theorists, known as the cameralists, of the notion of *Polizei* (police). The task of the *Polizei* was to care for the “order, security and welfare of subjects” (the German philosopher and administrator Johann Justi [1720–1771], quoted in Knemeyer). The Prussian code of 1794 institutionalized the idea, and the best-known theoretical appropriation of the term was by Georg Wilhelm Friedrich Hegel (1770–1831), who used the idea of *Polizei* to refer, in general, to the administration of the contingencies of “civil society” (*bürgerliche Gesellschaft*) and included, more particularly, therein an examination of the question of “modern poverty.” What is “modern” is not being

destitute but in having a “disposition” toward one’s plight, attributing it (say, a failed harvest) not to fate or God’s punishment but to a social cause. This attitude to poverty breeds what Hegel calls a “rabble” (*die Pöbel*) and he is, uncharacteristically, indeterminate when it comes to finding a solution. Marx, Hegel’s most famous critic, saw the solution (implicitly) in a cooperative society based on the common ownership of the means of production, where, it follows, there would be no exploitative relations, and where the organizing principle would be, in a famous—if unoriginal—phrase, “from each according to his ability, to each according to his needs.”

Relativism and Equality

The idea of needs, while always perhaps implicit in the notion of poverty, has come to the fore in contemporary debates. The crux of these debates is whether poverty is necessarily relative. At the root of Hume’s critique of the “severe” morality of poverty was his replacement of the categorical distinction between necessity and luxury to one where these are points on a scale. This then enabled him consistently to argue (as many others did likewise) that onetime luxuries could become necessities. Adam Smith defined “necessaries” as “not only commodities which are indispensably necessary for the support of life but whatever the customs of the country renders it indispensible for creditable, even of the lowest order, to be without.” Hence in Smith’s time, a day laborer would be ashamed to appear in public without a linen shirt (its nonpossession, indeed, would denote a “disgraceful degree of poverty”) when the Greeks and Romans of an earlier age lived very comfortably though they had no linen.

Relative or absolute? In modern debates, this fluidity in the meaning of *necessity* has been taken to be a vindication of the “relativity” of poverty. A major advocate of this position is the sociologist Peter Townsend, who declares that poverty can be defined “only in terms of the concept of relative deprivation” (p. 31). More precisely the standard of deprivation is socially relative and Townsend is critical of an “absolute concept” that would be based on some universal, extra-social, notion of “needs.” Townsend holds that needs must be defined as more than some biological minimum and, rather, as “the conditions of life which ordinarily define membership of society.” These conditions comprise “diets, amenities, standards and activities which are common or customary” (p. 915). The reference to “custom” is a deliberate echo of Smith’s argument. The poor are now identified as those who lack the resources to participate in those customary conditions definitive of social membership and who are as a consequence “excluded from ordinary living patterns” (p. 31).

To its critics, Townsend’s relativity approach leads to the absurd conclusion that someone could be called poor because they could buy only one Cadillac a day while others in the same community could buy two, or that more people can be “poor” in California than in, for example, Chad. It follows, further, that poverty cannot be eliminated, no antipoverty program can ever be entirely successful. To these critics there has to be an absolute core, since only from such a secure basis is it possible meaningfully to identify poverty and only then does it become possible to conceive of poverty’s elimination. Hence the num-

Poverty in itself does not reduce people to a rabble; a rabble is created only by the disposition associated with poverty, by inward rebellion against the rich, against society, the government etc. . . . The rabble do not have sufficient honour to gain their own livelihood through their own work yet claim they have a right to receive their livelihood. No one can assert a right against nature but within the conditions of society hardship at once assumes the form of a wrong inflicted on this or that class. The important question of how poverty can be reconciled is one which agitates and torments modern societies especially.

SOURCE: Georg Wilhelm Friedrich Hegel, *Elements of the Philosophy of Right*, 1821.

ber of people with inadequate sustenance, shelter, and life expectancy is greater in Chad than in California, and, thus, there are more in poverty in the former than in the latter location.

Whether poverty is regarded as a form of social exclusion or as the deprivation of basic needs, the shared assumption is that it is a morally pernicious state of affairs. It is bad in itself because suffering is bad in itself and not, as the “virtuous” view would claim, a condition of “indifference” or even sanctity. This is the modern sensibility and it is now dominant—in no way can poverty be an ideal. The corollary of this is that the existence of poverty is indefensible and there is a moral imperative to seek remediable action, which to be effective is now typically thought to require the activity or intervention of the state. Here the poverty debate enters into the mainstream of contemporary moral, social, and political theory.

Contemporary debate. On one side there are liberals (such as the Austrian economist F. A. Hayek [1899–1992]) who argue that the best remedy to poverty is to permit inequality in the form of wide income differentials so that the incentive to gain these high rewards produces the social wealth (and higher tax revenues) that enables the lot of the impoverished to be improved. Indeed, Hayek claims that in this way “poverty in the absolute sense has been abolished” (vol. 2, p. 139). This belongs in the Smithian tradition—Smith himself had said that universal poverty was conjoined with absolute equality in the earliest (hunter-gatherer) societies. The thrust of the argument here is that what matters morally is individuals having enough to sustain themselves, not that others might have more than enough. On the other side are welfare socialists, like Townsend, who (as previously noted) picks up a different aspect of Smith. Socialists are far less complacent about inequality. Townsend’s own

prescription is the abolition of “excessive” income and wealth and the establishment of a more egalitarian society. These two positions do not exhaust the field. There are welfare liberals (including John Rawls [1921–2002] in his *A Theory of Justice* [1971]) who think that inequalities in income and wealth are justified so long as the lot of the least-well-off is maximized. There are also more radical approaches that seek appropriately the root of the problem and locate this in a socially induced emphasis on production and consumption. The anthropologist Marshall Sahlins, for example and unwittingly echoing Thomas Paine in *Agrarian Justice* (1797) about the American Indians, argues that poverty is a problem created by the market-industrial system and when the lives of those assumed to be in dire poverty, such as the Bushmen of the Kalahari, are examined they can be discerned to live in “a kind of material plenty”—they are content with few possessions. This approach has affinities to environmental or “green” thought, which enjoins what one of its influential sources, E. F. Schumacher, in *Small Is Beautiful* (1973), has called “Buddhist economics.” Without ever expressing the point explicitly it is, from the perspective of the history of ideas, possible to see here a reprise of the ideal of poverty, understood as self-control. The Bushmen have (so to speak) heeded the wisdom of the Stoic sage and have no wants beyond what they need; they do not experience poverty.

Conclusion

Poverty is an idea with a history that is particularly instructive. In the twenty-first century, poverty as a state of material and social deprivation is regarded as the standard meaning. But when examined historically, it can be seen that this meaning has far from dominated. In the history of Western experience (with echoes elsewhere) poverty had for a long period been considered a preferred condition, one where humans demonstrated their control both of their own nature and of the circumstances in which they found themselves.

See also *Capitalism; Christianity; Liberalism; Monasticism; Property; Stoicism; Wealth.*

BIBLIOGRAPHY

PRIMARY SOURCES

- Aquinas, St. Thomas. *Summa contra gentiles*. 1259–1264. Vol. 3. Translated by the English Dominican Fathers. London: Burns, Oates, and Washbourne, 1928.
- Aristotle. *The Ethics of Aristotle: The Nicomachean Ethics*. Translated by J. A. K. Thompson. Harmondsworth, U.K., and New York: Penguin, 1976.
- . *Politics*. Translated by C. D. C. Reeve. Indianapolis: Hackett, 1998.
- Furniss, Edgar S. *The Position of the Laborer in a System of Nationalism: A Study in the Labor Theories of the Later English Mercantilists*. Boston: Houghton Mifflin, 1920.
- Hayek, F. A. *Law, Legislation and Liberty: A New Statement of the Liberal Principles of Justice and Political Economy*. 3 vols. in 1. London: Routledge and K. Paul, 1982.
- Hegel, G. *Philosophy of Right*. 1821. Translated by H. B. Nisbet. Cambridge, U.K.: Cambridge University Press, 1991.
- Hume, David. “Of National Characters” (1748) and “Of Refinement of Arts” (1752). In *Essays: Moral, Political, and*

- Literary*, edited by Eugene F. Miller. Rev. ed. Indianapolis: Liberty, 1987.
- Knemeyer, Franz-Ludwig. “Polizei.” *Economy and Society* 9 (1980): 172–196.
- Machiavelli, Niccolò. *Discourses on Livy*. 1531. Translated by L. Walker. Rev. by B. Richardson. Harmondsworth, U.K.: Penguin, 1974.
- Mandeville, Bernard. *The Fable of the Bees; or, Private Vices, Publick Benefits*. 1732. Edited by F. B. Kaye. Indianapolis: Liberty, 1988.
- Marx, Karl. “Critical Notes on ‘The King of Prussia and Social Reform.’” 1844. In *Early Writings*, translated by Rodney Livingstone and Gregor Benton. New York: Vintage, 1975.
- . “Critique of the Gotha Programme.” 1875. In *The Marx-Engels Reader*, edited by Robert C. Tucker. 2nd ed., New York: Norton, 1978.
- Perkins, Williams. *Three Books of Cases of Conscience*. In his *Works*. Cambridge: John Legate, 1612.
- . *Treatise of the Vocations* (1597-1601). In his *Works*. Cambridge: John Legate, 1612.
- Rowntree, B. Seebohm. *Poverty: A Study of Town Life*. 2nd ed. London: Macmillan, 1902.
- Sahlins, Marshall. *Stone Age Economics*. London: Tavistock, 1974.
- Sen, Amartya. “Poor: Relatively Speaking.” *Oxford Economic Papers* 35 (1983): 153–169.
- Sidney, A. *Discourses concerning Government*. 1698. Edited by T. West. Indianapolis: Liberty, 1988.
- Smith, Adam. *An Inquiry into the Nature and Causes of the Wealth of Nations*. 1776. Edited by R. H. Campbell and A. S. Skinner. Oxford and New York: Oxford University Press, 1976.
- Tierney, Brian. *Medieval Poor Law: A Sketch of Canonical Theory and Its Application in England*. Berkeley: University of California Press, 1959.
- Townsend, Peter. *Poverty in the United Kingdom: A Survey of Household Resources and Standards of Living*. Berkeley: University of California Press, 1979.
- Weber, Max. *The Protestant Ethic and the “Spirit” of Capitalism and Other Writings*. Translated and edited by Peter Baehr and Gordon C. Wells. New York: Penguin, 2002.

SECONDARY SOURCES

- Berry, Christopher J. *The Idea of Luxury: A Conceptual and Historical Investigation*. Cambridge, U.K., and New York: Cambridge University Press, 1994. Covers episodically issues and debates from the Greeks to the present day.
- Himmelfarb, Gertrude. *The Idea of Poverty: England in the Early Industrial Age*. New York: Knopf, 1984. Contentiously reviews orthodox interpretations.
- Sen, Amartya. *Poverty and Famines: An Essay on Entitlement and Deprivation*. Oxford and New York: Oxford University Press, 1981. A modern perspective by a Nobel prize winner in economics.
- Wood, Diana. *Medieval Economic Thought*. Cambridge, U.K., and New York: Cambridge University Press, 2002. A useful overview.

Christopher J. Berry

POWER. In its most general sense, *power* refers to the capacity to have an effect. A powerful hurricane comes ashore uprooting trees and destroying houses; the power of music stirs

our emotions; the power of love makes gentle the surly man or woman. We speak of electric or wind power, of powerful machines or human bodies. Many different phenomena with a very wide range of effects are said to be or to have power. The definition of the term therefore has led to a good deal of controversy.

Even more controversial has been the moral assessment of power: is power a good? Should one seek to acquire and to use power or is it the duty of morally conscientious persons to avoid power and the ability it implies of coercing others?

Personal Power

Much of the time, power is discussed only as it manifests itself in economic, social, and political life.

The power to get what one wants. Most generally, “The power of man is his present means to obtain some future apparent good” (Hobbes, p. 56). The ability to get what one wants because one believes it to be good is what the English philosopher Thomas Hobbes (1588–1679) calls “power.” Bertrand Russell (1872–1970), another English philosopher, defended a very similar conception of power. This is *power to get what one wants*.

The power to dominate. Much more common, however, is a more limited conception according to which power consists of getting what one wants from another person, particularly if it is ceded unwillingly. Thus Max Weber (1864–1920) defines power as “the probability that one actor in a social relationship will be in a position to carry out his own will despite resistance, regardless of the basis on which this probability rests” (Weber, p. 152). Power here concerns the relationship between individual actors or groups of individuals where some are able to do as they please in spite of the resistance by others. A similar definition was given by Robert A. Dahl (b. 1915): “A has power over B to the extent that he can get B to do something that B would not otherwise do” (1957, pp. 202–203). These formulations describe a form of power excessively familiar to children who are bullied by classmates or teachers; to their parents who feel oppressed by their employers; and to citizens who must unwillingly obey the dictates of the government, sometimes in the guise of the neighborhood policeman. This is the *power to dominate*.

The power to manipulate. However familiar, the preceding definition has encountered many criticisms and has had to defend itself against other concepts of power. Some theorists have pointed out that we do indeed exercise power when we overcome the resistance of others. But power can also shape situations and persons so that they will never think to resist. Instead, they submit willingly to a yoke, which later, perhaps, they may find onerous. The *power to manipulate* so that resistance does not arise is more impressive than the power to overcome resistance. Telling a child about to be inoculated that “it won’t hurt” sidesteps the child’s resistance and struggle. Official lies that persuade citizens that they have been attacked by a foreign power, when in fact it is their government that is the aggressor, have persuaded many who would not ordinarily consider becoming soldiers to flock to the flag of their country. The number of casualties in a war and the extent of destruction and suffering

imposed would produce strong criticism, but if no one knows about the damage done by the armies, opposition will not develop.

Hegemonic power, or ideology. Manipulation occurs between individuals and groups. But preemptive shaping of the agendas for discussion and action may be much more insidious and less deliberately deceptive. There are organizational structures that, although not intended for that purpose, function to lessen dissent and opposition. Electoral systems often function in that way, especially in a situation of severe economic and social stratification. The dissatisfied have a ready mechanism at hand for expressing their discontent, but unless they belong to the ruling elites, their efforts will consume a great deal of energy but bear little fruit. Such tamping down of discontent may be the unintended consequences of certain political arrangements. There exists no ready term for power in that sense. Terms sometimes used in this context such as *hegemonic power* or *ideology* are often understood in an excessively intellectual sense. At issue here is the power, inherent in existing institutions, of privileged strata of a society to avoid popular criticisms and demands.

These various forms of power, whether intentional or the side effect of certain political institutions, still deal with antagonists who are latent, if not actual, resisters. Were they not misinformed, or sidetracked by the complexities of electoral politics, they would certainly express their discontent quite vocally. These are all different variants of power that some one or some group has *over* another, individual or group. They are still variants of the power to dominate.

Influence and authority. But not all power is power to dominate. Influence is the most obvious example of a different kind of power. Frequently someone is only too glad to follow the wishes of another whom they love and who loves them. Their love is strong; there is no shadow of a threat to withdraw love if the other does not yield. But each is glad to do what is asked of them because it pleases them to please their lover. In similar ways parents and children often have influence over one another. Each person has power in relation to the other—a power freely given—which is power to influence the other. Influence does not dominate and neither does authority: one allows another to influence one’s thought and action because the other is an expert, or a revered spiritual teacher. Their power to give us orders or directions is, in some way, legitimate. (The word *authority* also has a different meaning. “The authorities”—not only legitimate authorities—are only too frequently able and willing to dominate by making us do what we do not want to do.)

Power with. Neither influence nor authority is the power to dominate—*power over*. Instead it is *power with* that arises out of the cooperation of several individuals or perhaps an entire people. We experience this in times of crisis, in a family or in a nation, when everyone ignores their own immediate needs and desires and pitches in to solve a shared problem or protect the entire group against imminent danger. Hannah Arendt (1906–1975) pointed out that a people gains strength from cooperation, from a shared sense of a common goal or mission: “Power corresponds to the human ability not just to

act, but to act in concert” (p. 44). The familiar slogan “United we stand; divided we fall” represents the popular understanding of this power that arises out of unity and cooperation. This power enhances the life of a nation and stiffens its resolve and ability to overcome difficult challenges. Only when it loses this *power with* does a government have to resort to violence. A nation subdued by violence may be tyrannized, but in order to govern it, one requires the support of the people. Only then can one have power.

Such *power with* exists not only in larger groups but is important in the relations between very few people. Couples find themselves better able to confront problems and to tackle difficult tasks because their shared values and understanding of the world increase their power. Power grows out of the mutual respect and recognition of two persons. Small groups, like families, grow better able to face demanding tasks when their mutual respect and understanding makes each stronger and wiser.

In the intellectual space of the West, *power with*, if recognized at all, is assigned a subsidiary role. But anthropologists report that among many of the indigenous inhabitants of the American continent, power was traditionally of this sort—*power with*. The chiefs of many tribes in North and South America did not have any power to dominate or to coerce. They provided leadership because they were respected. Many tribes had two chiefs; one led by authority and the voluntary compliance of the tribe’s members in peace time. The other, the war-time chief, had the more familiar kind of power—the *power to coerce*.

Comparisons between Western philosophy and Chinese thought are fraught with difficulties. Nonetheless, some experts recognize in Confucian classics distinctions very similar to the ones we draw between *power to dominate* and *power with*. Confucianism sought an ordered society through the education of a morally superior elite to lead the nation. For the purpose of forming such an elite, classical Confucian texts reject laws as means for developing this elite and, instead, recommend a civil, humane practice within communities resting on cooperation and mutuality. Laws threaten and coerce. The power to dominate wielded by laws is not acceptable to the Confucian educator who, instead, puts his faith in the *power with* of communal and reciprocal action.

Impersonal Power

The different forms of power discussed so far, whether variants of *power to dominate* or *power with*, are all intimately connected to specific and identifiable persons. One knows who the bully is in a group. One can identify the government functionaries who put out misleading propaganda. One can identify the persons who, through their solidarity and unity, give strength to their group, or even their nation. The power of ideology is more diffuse; it is less easy to identify the prominent contributors to dominant beliefs that reduce the possibility of resistance. But the ruling ideology is promulgated by and in the interest of the ruling strata of the society, and one knows who the members of these ruling strata are. One may not know all of them, but one knows that there are specific individuals and associations of individuals that yield the

powers that manipulate the majority of the population. All the variants of power discussed so far belong to specific human beings or groups who wield this power.

But the power individuals wield presupposes complex social arrangements. Thomas Wartenberg points out that a judge’s power to punish a convicted criminal depends on an intricate network of other institutions and the different roles these institutions contain. Judges can condemn the criminal only while seated on the bench in the courtroom; they must be within a prescribed context in order to exercise their official role. They cannot do it in their home while lounging in the bathtub. The court is not only a place; it is an institution, complete with court officers, stenographers, lawyers, prosecutors, and so forth. The entire power of the judge presupposes the law and the many different institutions that give rise to the law and legitimate it. The judge’s power does not belong to the judge unless there exists an extended set of institutions that function because everyone is doing his or her job and exercising the power that comes with that job.

It is important that the different participants in the drama of crime and punishment understand the significance of the places, the institutions, and the actions of functionaries. Everyone must understand what it means when the judge bangs her gavel and says “Twenty years.” Various persons understand that these two words instruct them to lead the criminal out of the courtroom and remand him to the prison authorities who, in their turn, must follow established bureaucratic procedures. In these two words the judge manifests her power and everyone must understand that. For power to function there must be a wealth of shared understanding of the significance of words and actions.

For this reason, Niklas Luhmann says that power is a “code”—a quasi language. This conception was first introduced by the American sociologist Talcott Parsons, who criticized the conception of power as belonging to individual persons, urging us, instead, to understand power as a “medium” analogous to money as the medium of the economy. An economic system, Parsons pointed out, consists of a large number of offers and demands for goods and services. These offers, and their acceptance or rejection, must be communicated, and money is the medium of this communication. (“Money” here does not refer to the dollar bills in your wallet but to the institution of the market and the banking institutions and other financial contrivances for communicating offers and demands within the economy.) Political institutions correspondingly are the medium in which in politics we pass on messages. Power is a form of “social knowledge.”

The importance of personal power. Power as medium or as code or as social knowledge is, indeed, social; it no longer belongs to specific individuals but inheres in the society. It is interesting to notice that, from the beginning of Western philosophy, the power inherent in societies to shape each of us has been familiar. In Plato’s dialogue *Crito*, Socrates, on the eve of his execution, receives his friend Crito in prison. Crito urges Socrates to escape with him; everything is prepared for him to flee. But Socrates refuses. The laws of Athens, he says, have made him who he is. He owes them obedience even if

they are, in his case, applied unjustly. Our culture shapes and constrains us and makes us who we are. While not a modern discovery, this social power has attracted a great deal of attention in modern times. Jean-Jacques Rousseau (1712–1778) complained about the conformity modern societies demand of their members, forcing them to pretend to be persons they are not rather than be themselves. Friedrich Nietzsche (1844–1900) echoes that understanding of the power of social structures. Karl Marx (1818–1883) is very clear that the injuries capitalism inflicts on workers are not to be laid at the door of individual capitalists because they, too, are under the compulsion of the laws of the capitalist marketplace. The power to exploit inheres in the capitalist system; it is not the fault of the capitalists.

Discussions of the impersonal power of social institutions, the “regime without a master” in the words of Joan Cocks (p. 187), have become even more frequent in the twentieth century. John Dewey complained about the standardization of human beings in modern society. Members of the Frankfurt School—Theodor Adorno, Max Horkheimer, Herbert Marcuse, and others—wrote about the power of mass entertainment to regiment members of modern societies and to make it impossible for critical voices to be raised, let alone be heard. The concept of a power not owned by anyone, implicit in these critiques, was then made explicit by the theorists of power, Talcott Parsons, Niklas Luhmann, and Barry Barnes.

Popular culture took up the worry of these theorists; the subservience of the individuals to their culture that seemed to Socrates a perfectly obvious and uncontroversial fact about each of us, has in our world become a matter of unease. In many cases this unease takes the form of a polemic against what the author labels “conformism” in such works as *The Organization Man* by William H. Whyte (1956), or Arthur Miller’s *Death of a Salesman* (1949), and in David Riesman’s *The Lonely Crowd* (1950) as well as the novel by Richard Yates, *Revolutionary Road* (1961). After World War II, talk about authenticity became very common—being oneself in the face of great social pressures to conform became a frequently heard moral demand. Films like *2001: A Space Odyssey*, and more recently *The Matrix*, had enormous appeal because, among other things, they expressed the anxiety felt by many that impersonal forces, unknown to us, hold us in their thrall.

It was left for the French philosopher Michel Foucault (1926–1984) to attempt an explanation of why we moderns are much more concerned about being subject to impersonal social power. The eighteenth century, he believes, brought many changes: the beginning of capitalism with its much more rational, carefully planned methods of production, the acceleration of urbanization, which brings many persons together in a small space, and the beginnings of the study of humans and their societies. These changes gave rise to many new techniques of surveillance, of controlling and keeping track of persons. The new social sciences developed a typology of persons; each of us exemplifies many different types, being men or women, parents or not, educated or not, belonging to a particular income bracket or not, practicing a particular religion or not, having children in the approved way (“in wedlock”), and so forth. The

typologies serve to “normalize,” to set standards by which we are measured from birth as being within normal range of variation or needing to be supervised, cured, corrected, counseled, tutored, or otherwise brought back to the norm.

All of these are forms of domination, Foucault argues. But the origins of the acts of domination are obscure. We are dominated by impersonal systems, much more often than by specific persons. “Power is no longer substantially identified with an individual . . . it becomes a machinery that no one owns” (Foucault, p. 156).

The Value of Power

There exists a range of different ideas in the different world traditions about the value of pursuing, having, and using power. Among the Old Testament Hebrews and in Islam, where temporal government and religion are very closely associated, the use and pursuit of power are accepted without question. Both the Old Testament Jews and the followers of Mohammed were quite content to use the temporal power in their possession for the purpose of extending the realm of the one true God. At the same time, the close association of governance and the deity imposed moral limitations on the uses of power. They were permitted only in the service of extending God’s realm.

Both Judaism and Islam, in their classical formations, were religions of this world. While Islam speaks of an afterlife, the work of the religious person was in this world to extend and fortify the rule of the divine. Some Eastern religions, by contrast, such as Hinduism and Buddhism, saw everyday life as full of suffering and a realm of mere appearance. The goal of the religious individual was to overcome suffering by detaching him- or herself from ordinary desires, from emotions, from attachment to the things of this world.

Nevertheless, dominant strands of Buddhism and Hinduism were willing to use secular and military power to extend the sway of their religions. But at the same time, Buddhist and Hindu thought made room for a radical rejection of the pursuit and use of power. Doing no harm to any human or animal is an important principle of Buddhism. The thought of Mahatma Gandhi illustrates one version of Hinduism that rejects all uses of power, other than the power of persuasion. It resolutely refuses to coerce anyone or to use power to dominate. In this context, the use of violence is definitely an inferior alternative to the use of nonviolence.

The Christian tradition is equally conflicted. Jesus’s saying that we should “render unto Caesar the things that are Caesar’s” (Matthew 22:21, Mark 12:17, and Luke 20:25) has encouraged Christian monarchs and popes to use violence and power to dominate in the Crusades, in the Inquisition, and in the conquest and devastation of the Americas. But there is another Christian tradition of nonviolence exemplified by the Christian injunction that we turn the other cheek to those who strike us (Matthew 5:39 and Luke 6:29). Martin Luther King Jr. (1929–1968) elaborated this reading of Christianity in his doctrine and practice of nonviolence, which substituted persuasion for coercion.

See also *Authority; Autonomy; Liberty.*

BIBLIOGRAPHY

- Arendt, Hannah. *On Violence*. New York: Harcourt Brace and World, 1970.
- Barnes, Barry. *The Nature of Power*. Urbana: University of Illinois Press, 1988.
- Clastres, Pierre. *Society against the State: The Leader as Servant and the Humane Uses of Power among the Indians of the Americas*. Translated by Robert Hurley, in collaboration with Abe Stein. New York: Urizen, 1977.
- Cocks, Joan. *The Oppositional Imagination—Feminism, Critique, and Political Theory*. London: Routledge, 1989.
- Dahl, Robert A. "On the Concept of Power." *Behavioral Science* 2 (1957): 201–215.
- De Bary, Wm. Theodore. *Asian Values and Human Rights: A Confucian Communitarian Perspective*. Cambridge, Mass.: Harvard University Press, 1998.
- Foucault, Michel. *Power/Knowledge: Selected Interviews and Other Writings, 1972–1977*. Edited and translated by Colin Gordon. New York: Pantheon, 1980.
- Hobbes, Thomas. *Leviathan*. Edited by Michael Oakshott. Oxford: Blackwell, n.d.
- Kelsay, John. *Islam and War: A Study in Comparative Ethics*. Louisville, Ky.: Westminster/John Knox, 1993.
- King, Martin Luther, Jr. *A Testament of Hope: The Essential Writings of Martin Luther King, Jr.* Edited by James Melvin Washington. San Francisco: Harper and Row, 1986.
- Luhmann, Niklas. *Trust and Power*. Translated by Howard Davis, John Raffran, and Kathryn Rooney. Chichester, U.K., and New York: John Wiley, 1979.
- Parsons, Talcott. *Sociological Theory and Modern Society*. New York: Free Press, 1967.
- Russell, Bertrand. *Power: A New Social Analysis*. New York: W.W. Norton, 1938.
- Schmitt, Richard. *Beyond Separateness: The Social Nature of Human Beings—Their Autonomy, Knowledge, and Power*. Boulder, Colo.: Westview, 1995.
- Wartenberg, Thomas E. *The Forms of Power: From Domination to Transformation*. Philadelphia: Temple University Press, 1990.
- Weber, Max. *The Theory of Social and Economic Organization*. Translated by A. R. Henderson and Talcott Parsons. Edited with an introduction by Talcott Parsons. New York: Oxford University Press, 1947.

Richard Schmitt

PRACTICES. Practices are actions or activities that are repeatable, regular, and recognizable in a given cultural context. In everyday language, *practice* is often contrasted with theory, ideas, or mental processes: what is done as opposed to what is thought, the pragmatic as opposed to the ideational. Practices may be *discursive* (practices that communicate meanings through language), *visual* (practices that communicate meaning through images), or *embodied* (practices accomplished through bodily movement and gesture). Julia Kristeva (b. 1941) has proposed using the term *signifying practices* to denote all types of practices that communicate meaning. It could be argued, however, that it is in the nature of *all* social practices to communicate

meaning. It has been argued, for example, that religions are not constituted solely or primarily by belief or doctrine, but by the inculcation of practices (through the actions of the powerful), both in terms of formal ritual and in terms of quotidian practices such as dress, diet, social interaction, and so forth.

Ritual practice is particularly important since, as Victor Turner (1920–1983) has argued, it links the natural, cosmological, and social levels of order through the manipulation of symbols. As such, it is an important legitimating device in the secular as well as religious spheres. As is true of religious beliefs, religious practices may be considered authorized and therefore legitimate (orthopraxy), or they may be practiced without formal legitimation (heteropraxy) and considered marginal, contestatory, or both.

Professions and disciplines, likewise, are defined and bounded as much by their practices as by their objects of investigation or intervention. Chemistry and alchemy, astronomy and astrology, for example, differ less in their objects of study (the combination of materials in the former, the stars and planets in the latter), than in the practices through which statements about the world may be considered true or false.

Practice Theory

In the 1970s and 1980s, practice and practices came to be seen as the object of theorization in certain branches of critical sociology and cultural anthropology. Practice theories, in general, seek to integrate objectivist theories of society (such as structuralism, functionalism, or Marxism) with theories that view social life as the contingent outcome of decisions, actions, and interpretations of competent (albeit not fully conscious) social actors. Prior to the 1970s, the dominant paradigms in both fields were objectivist, and shared a tendency to develop models of social life in which all social action could be seen as an outcome of underlying structures. Functionalist approaches derived from the sociology of Émile Durkheim viewed social behaviors as determined by the social structure, a set of interacting, mutually dependent institutions. Followers of the French anthropologist Claude Lévi-Strauss (1908–), on the other hand, understood social action to be the expression of conceptual structures. Structure, in Lévi-Strauss's sense, consists of cultural grammars, themselves the outcome of the structured categorizing activity that is a universal feature of the human mind. Materialist approaches (including Marxist and crypto-Marxist approaches such as U.S. cultural ecology) likewise saw social action as determined by a structure of social relations that are themselves determined by the exigencies of the natural and human environment.

In all three paradigms, then, some larger entity—a system or structure—is abstracted from the activities of social agents. The actions and intentions of social actors remain outside of the model in all three cases (with the partial exception of some varieties of Marxism). Finally, their coherence as paradigms depends on the suppression of the dimension of time (again, with the partial exception of Marxist paradigms). For example, functionalist approaches tend to be ahistorical. They portray society (or societies) as a set of relations among institutions as if they maintained a state of homeostasis. Likewise, for

Levi-Strauss and his followers, the object of analysis is always the relationship among and between conceptual elements that exist, as it were, outside of the flow of time. On the other hand, phenomenological approaches, such as Harold Garfinkel's (1917–) ethnomethodology or Erving Goffman's (1922–1982) symbolic interactionism took a processual view of society that accounted for both the temporal dimension of social life and the intentionality of subjects. Their account of society as the product of ongoing interactions could not, however, account for inequalities in power, status, or effective agency of those same subjects. The question raised by practice theorists in the 1970s, then, was how to reconcile objectivist and subjectivist accounts of society: to explain the reproduction of power and inequality as both ground and effect of quotidian interaction.

Practice theory (or action theory) has been associated primarily with four theorists: Michel Foucault (1926–1984), Pierre Bourdieu (1930–2002), Michel DeCerteau (1925–1986), and Anthony Giddens (1938–).

Practice and Discourse: Michel Foucault

Often described as a poststructuralist concerned with the analysis of power (although he himself rejected both labels), the philosopher/historian Michel Foucault's central project was developing “a history of the different modes by which, in our culture, human beings are made subjects” (1982, p. 208). In his analysis, the subject was not an a priori category, but, rather, an effect of power, of both objectification and subjection. His aim, however, was to move from state-centered models of power (which viewed power as a repressive force wielded by states) toward one that recognized power as diffused throughout societies, constitutive of social relations in general, and productive of distinct forms of subjectivity.

In the context of this larger project, practices (or “mechanisms”) served both a methodological and theoretical function. His interest was primarily in discursive practices, by which he meant *ways of constituting objects through their ostensible description*. His argument, in brief, was that the historical trajectory of the Enlightenment, conventionally understood as a progression toward more accurate descriptions of the natural world and more reasonable and humane forms of social organization, should be seen, instead, as a series of shifts in the ways in which power was exercised. For example, in *Discipline and Punish* (1975), his study of punishment in the West, he argues that the transition from the practice of public torture and execution to the practice of incarceration was not the result of an evolutionary trajectory from brutality to civilization, but part of a general shift toward an increasing investment of power in the surveillance and minute control of living bodies. This same change requires the surveillance and bodily ordering of children in schools, workers in factories, and soldiers in armies.

The key to understanding and historicizing the operations of power, according to Foucault, is to attend to the ways that specific *practices* of professional disciplines (and other social institutions)—surveillance, particular modes of categorization, particular bodily disciplines—surreptitiously undermine some forms of power and reorganize others. Practice thus produces

subjectivity (both in the sense of identity and the sense of subjection), simultaneously constituting and limiting social subjects.

Pierre Bourdieu and Anthony Giddens

The central problem in the work of the French sociologist/anthropologist Pierre Bourdieu and the British sociologist Anthony Giddens is the relationship between agency (the capacity of human subjects to engage in social action) and social structure. Both see social structure as including both patterns of distribution of material resources and systems of classification and meaning. In their works, *social structure* encompasses both the Marxian/Durkheimian and Lévi-Straussian senses of the phrase. Both share the insight that the social structure as such has no reality apart from its instantiation through the practices (Bourdieu) or actions (Giddens) of particular human beings. Those actions, in aggregate, create and reproduce the structure in which the actions are embedded.

The two theorists diverge, however, in their assessment of the importance of conscious intention in the reproduction of the social structure. Bourdieu labels the key concept for understanding the relationship between action and structure *habitus* (following Marcel Mauss [1872–1950]). The habitus consists of “systems of durable, transposable dispositions, structured structures predisposed to function as structuring structures” (1977, p. 72). Quotidian practices—of work and leisure, of the design and use of space—communicate basic assumptions about such social categories as gender, age, and social hierarchy. Through practice, actors are socialized to particular embodied dispositions (their habitus). Like Raymond Williams's (1921–1988) “structures of feeling,” the habitus does not determine particular actions, but orients actors to particular goals and strategies. Acting on their (socially determined) intentions, the improvised and contingent practices of social actors thus tend to reproduce the symbolic and material orderings of the social world. Since key aspects of the social order are naturalized through the discipline of the body, they are (or appear to be) beyond the social order itself, indeed becoming part of the taken-for-granted, “natural” order (in Bourdieu's system, *doxa*). Practices thus tend, regardless of the actor's intentions, to reinforce the claims of the powerful.

Although he prefers the term *action* to *practice* in his own work, Anthony Giddens is usually considered in discussions of practice theory. The key term in Giddens's work is *structuration*. Like Bourdieu, Giddens views social structure as encompassing both material and symbolic dimensions. Social structure, according to Giddens, is the product of action, “a stream of actual or contemplated causal interventions of corporeal beings in the ongoing process of events-in-the-world” (1979, p. 55). Agents (actors with the capacity to act and, moreover, the *capacity to have acted differently* in any given situation), thus, create structure. However, their agency is only meaningful insofar as they are constructed as subjects (in particular subject positions) in a given social structure. Structuration describes the essentially recursive quality of social process: the agent is produced by the structure, which is, in reality, no more than the objectification of past actions by agents.

The main difference between the accounts of Bourdieu and Giddens lies in the relative significance that each gives to the conscious intentions of social actors. For Giddens, actors are reflexive; they have the capacity to reflect on their actions and their identities, and to act according to their intentions. The reflexivity of actors is, indeed, an aspect of social action, and, thus, part of structuration. In the work of Bourdieu, conscious reflection on one's habitus is a possibility, but not a usual part of social process. For Giddens, in contrast, reflexivity is an essential and potentially transformative element of social process.

Practice as Resistance: Michel de Certeau

Influenced by the work of Foucault and Bourdieu, Michel de Certeau's main contribution to practice theory has been to posit practice as the ground of resistance to domination (in addition to the reproduction of power relations). De Certeau distinguishes between two types of practice: strategies and tactics. Strategies are only available to subjects of "will and power," so defined because of their access to a spatial or institutional location that allows them to objectify the rest of the social environment. "A strategy assumes a place that can be circumscribed as a proper (*propre*) and thus serve as a basis for generating relations with an exterior distinct from it (competitors, adversaries, "clienteles," "targets," or "objects of research)" (1984, p. xix). Strategies thus invoke and actualize a schematic and stratified ordering of social reality.

Other people, however, though lacking a space of their own from which to apply strategies, are not merely passive objects of such subjects. On the contrary, they are active agents, but their mode of practice is tactical rather than strategic. Everyday practices of consumption (including activities like walking or reading) are tactical in that they continuously resignify and disrupt the schematic ordering of reality produced through the strategic practices of the powerful. The possibility of contestation of the social order, which is created through multiple strategies, is always implicit in the tactical practices of everyday life.

Anthropology and Practice

The impact of practice theories, particularly those of Foucault and Bourdieu (who was trained in anthropology as well as sociology, and whose early work focused on the Berber-speaking Kabyle peasants of the Maghrib of North Africa), on cultural anthropology has been profound and far-reaching, sufficiently so that Sherry Ortner (1994) claimed it as the most important general paradigm of cultural anthropology of the 1980s as a whole. This should not be surprising; after all, participant-observation is a matter of observing and participating in practices. Theories that privilege practices—both as forms of communication and as the bases on which social relations are structured—provide a means of theorizing the connections between the "imponderabilia of daily life" and the larger questions about structures of power and social change.

Attention to processes of the transformability of social systems, indeed, distinguishes much practice-based ethnography from the practice theories of Bourdieu and Giddens. As Dirks, Eley, and Ortner point out, for Bourdieu, the habitus is a virtual mirror of the social order, thus the ethnographic project

is "largely a matter of decoding the public cultural forms within which people live their lives . . . that already encode the divisions, distinctions, and inequalities of the society as a whole. And the aim is to get as close as possible . . . to the practical ways in which, in enacting these forms, the subject/agent comes to embody them, assume them, take them so utterly for granted that 'it goes without saying because it comes without saying'" (1994, p. 16).

Indeed, practice theory can provide a framework for examining the reproduction of inequality in general. Works such as Paul Willis's *Learning to Labor* (1981) or Phillippe Bourgois's *In Search of Respect* (2003) are more closely aligned with neo-Gramscian theories of hegemony than practice theory as such. Nevertheless, these studies portray their disempowered subjects (working-class British teenagers and New York crack dealers, respectively) in a double bind: the social practices through which they express their resistance to their subjugated status (resistance to school or participation in the illegal economy) ultimately reproduce the set of social relations that binds them to those statuses. In general, however, practice-based ethnographies have been equally interested in the culturally situated practices that lead, intentionally or not, to social change.

Marshall Sahlins's (1930–) influential *Historical Metaphors and Mythical Realities* (1981) is a case in point. Using the episode of Captain Cook's death at the hands of the Hawaiians, Sahlins argued that the Hawaiians' complex response to Cook's arrival—ranging from exchanges of material goods and sexual relations up to and including Cook's murder—took place within the cultural logics of the Hawaiian prestige systems. These practices (seen, from the Hawaiian point of view in terms of circulation of *mana*, or "vital force"), however, applied to a novel context (from the English point of view, trade), ultimately undermined the bases of the indigenous prestige system by incorporating English trade (goods and relations) into that system. Social change, in Sahlins's model, happens as a result of "structures of conjuncture": changes in the systems of meaning, which are, in turn, the unintended consequences of the deployment of social practices, rooted in a traditional system of relations, to novel circumstances.

Sahlins's method—tracing out relationships between changes in practice, changes in systems of meaning, and changes in structures of power—has been applied to shed new light on processes of social change. In his study of the village of Gapun, New Guinea, for example, Don Kulick convincingly argues for the importance of attention to local practices in the process of "modernization." In his account of the disappearance of the local vernacular, Taiap, in favor of the Melanesian pidgin, Tok Pisin, he shows that changes in linguistic practice are motivated by traditional ideas linking gender, linguistic practices, and prestige. The conjunction of local systems of value with missionization and temporary wage labor led to a number of unrecognized effects. The incorporation of Christianized cosmological theories and the language Tok Pisin into indigenous categories, coupled with local ideas about first-language acquisition, led to the systematic suppression of Taiap competence among young children *and* changes in patterns of (adult and child) sociation. Gapuners came to devalue

Taiap not as a rejection of local symbolic practices in the face of outside forces, but of their resignification, the process of which, nevertheless, undermined the basis of reproduction of traditional forms of social action and authority.

Second, because practice provides the basis of the construction of categories of identity along with power, practice theories have been important (explicitly or implicitly) in anthropologies of gender. Roger Lancaster's 1994 study of Nicaraguan *machismo* as a discourse of embodied practices and Don Kulick's 1998 study of the construction of gendered identities through linguistic practices among Brazilian travestis are cases in point. Anna Tsing's 1993 analysis of discourses of power among the Meratus of Indonesia shows how gendered inequalities are constructed through practice, even where such inequality lacks an ideological basis. Sherry Ortner's (b. 1941) work (1989, 2001) shows the complex and sometimes contradictory character of the gendered projects of Sherpas in general, and Sherpa women in particular, in relation to their engagement with Western mountain climbers and Buddhist monasticism. Finally, practice theory has been important to the ethnography of science, the *doxa* of modern societies. The work of Bruno Latour (1947) and Steven Woolgar (1979) on the social construction of "facts" or Rayna Rapp's (2000) work on amniocentesis problematize the authorizing discourses of science through the examination of its practices.

Practice theory has, indeed, been of central importance in anthropology since the 1970s, because it links different levels of social analysis. In defining social structure as the outcome of the practices of (socially constructed and constrained) actors, it avoids the contradiction between objectivist and subjectivist, synchronic and diachronic accounts of society and culture.

See also Anthropology; Orthopraxy; Ritual; Society; Structuralism and Poststructuralism: Anthropology.

BIBLIOGRAPHY

- Bourdieu, Pierre. *Outline of a Theory of Practice*. Cambridge, U.K.: Cambridge University Press, 1977.
- Bourgois, Phillippe. *In Search of Respect: Selling Crack in El Barrio*. New York: Cambridge University Press, 1995.
- De Certeau, Michel. *The Practice of Everyday Life*. Translated by Steven Rendall. Berkeley: University of California Press, 1984.
- Dirks, Nicholas B., Geoff Eley, and Sherry B. Ortner, eds. "Introduction." In *Culture/Power/History: A Reader in Contemporary Social Theory*, 1–14. Princeton, N.J.: Princeton University Press, 1994.
- Foucault, Michel. "Afterword: The Subject and Power." In *Michel Foucault: Beyond Structuralism and Hermeneutics*, edited by Hubert Dreyfus and Paul Rabinow. Chicago: University of Chicago Press, 1983.
- . *Discipline and Punish: The Birth of the Prison*. New York: Pantheon, 1975.
- Giddens, Anthony. *Central Problems in Social Theory: Action, Structure, and Contradiction in Social Analysis*. Berkeley: University of California Press, 1979.
- Kulick, Don. *Language Shift and Cultural Reproduction: Socialization, Self, and Syncretism in a Papua New Guinean Village*. Cambridge, U.K.: Cambridge University Press, 1992.

- . *Travesti: Sex, Gender, and Culture among Brazilian Transgendered Prostitutes*. Chicago: University of Chicago Press, 1998.
- Lancaster, Roger N. *Life Is Hard: Machismo, Danger, and the Intimacy of Power in Nicaragua*. Berkeley: University of California Press, 1992.
- Latour, Bruno, and Steve Woolgar. *Laboratory Life: The Social Construction of Scientific Facts*. Beverly Hills, Calif.: Sage, 1979.
- Ortner, Sherry B. *High Religion: A Cultural and Political History of Sherpa Buddhism*. Princeton, N.J.: Princeton University Press, 1989.
- . *Life and Death on Mt. Everest: Sherpas and Himalayan Mountaineering*. Princeton, N.J.: Princeton University Press, 1999.
- . "Theory in Anthropology since the Sixties." In *Culture/Power/History: A Reader in Contemporary Social Theory*, edited by Nicholas Dirks, George Eley, and Sherry B. Ortner, 372–411. Princeton, N.J.: Princeton University Press, 1994.
- Rapp, Rayna. *Testing Women, Testing the Fetus: The Social Impact of Amniocentesis in America*. New York: Routledge, 1999.
- Sahlins, Marshall D. *Historical Metaphors and Mythical Realities: Structure in the Early History of the Sandwich Islands Kingdom*. Ann Arbor: University of Michigan Press, 1981.
- Tsing, Anna Lowenhaupt. *In the Realm of the Diamond Queen: Marginality in an Out-of-the-Way Place*. Princeton, N.J.: Princeton University Press, 1993.
- Willis, Paul E. *Learning to Labor: How Working-Class Kids Get Working-Class Jobs*. New York: Columbia University Press, 1981.

Heather Levi

PRAGMATISM. Pragmatism is the collective name for a family of theories emphasizing the practical consequences of holding a belief as a means to evaluating the truth of that belief. This focus on the practical was born of attempts to evade or escape many of the traditional metaphysical and epistemological puzzles and problems of traditional Western philosophy. Rather than continuing to deploy philosophical talents and energies in the service of seemingly endless debates about potentially irresolvable problems, pragmatists instead have addressed the specifics of actual, troubling difficulties felt by philosophers and non-philosophers alike.

Pragmatic theories of truth, for instance, seek to avoid the difficulties of traditional appeals to correspondence and coherence. A correspondence theory of truth typically claims that statements are true if and only if such statements correspond to actually existing and independent state of affairs in the world. Such a theory raises epistemological problems of knowing these relations among statements and the world, as well as the question of our ability to know any state of affairs independent of our ability to capture that state in language and description. A coherence theory of truth typically claims that a statement is true if and only if it coheres with the set of our other beliefs. Such a theory raises the immediate difficulty of possessing a large and coherent web of false beliefs—adding one more coherent belief to this web does nothing to make such a set any more true. Pragmatic theories of truth, instead,

Endeavoring, as a man of that type naturally would, to formulate what he so approved, he framed the theory that a *conception*, that is, the rational purport of a word or other expression, lies exclusively in its conceivable bearing upon the conduct of life; so that, since obviously nothing that might not result from the experiment can have any direct bearing upon conduct, if one can define accurately all the conceivable experimental phenomena which the affirmation or denial of a concept could imply, one will have therein a complete definition of the concept, and *there is absolutely nothing more in it*. For this doctrine he invented the name *pragmatism*.

SOURCE: Charles Sanders Peirce, "What Pragmatism Is" (1905)

It is astonishing to see how many philosophical disputes collapse into insignificance the moment you subject them to this simple test of tracing a concrete consequence. There can *be* no difference anywhere that doesn't *make* a difference elsewhere—no difference in abstract truth that doesn't express itself in a difference in concrete fact and in conduct consequent upon that fact, imposed on somebody, somehow, somewhere and some-when. The whole function of philosophy ought to be to find out what definite difference it will make to you and me, at definite instants of our life, if this world-formula or that world-formula be the true one.

SOURCE: William James, "What Pragmatism Means" (1907).

typically appeal to the practical consequences of holding a belief. A belief is true if it brings about a satisfactory result in a particular inquiry or investigation. Truth cannot be separated from the specific context of an investigation, nor can it be divorced from the interests of the inquirer, the history of such investigations, or the habits of the culture and persons involved. The specifics of such a theory—what constitutes a satisfactory outcome, how settled a situation must be in order to count as resolved, and the nature and influence of previous such inquiries, for instance—are the subject of much debate and form much of the history of pragmatism's development.

Charles Sanders Peirce

Charles Sanders Peirce (1839–1914) was a logician, mathematician, philosopher, and semiotician. He never published any books, nor did he hold an academic position for any significant period of his life. Nevertheless, Peirce is often credited with being the father of pragmatism. For Peirce, pragmatism was primarily a theory of meaning. He intended it to stand in opposition to various strands of idealism—to force mere theorizing to test the effects of beliefs in the "real" world.

His famous formulation set forth pragmatism as a method for testing the meaning of any belief, idea, or term by means of analyzing the effects of its adoption on future conduct and belief. For Peirce, beliefs were guides for action. Beliefs typically endure until some reason for calling them into doubt arises. Once one is confronted by doubt, he or she needs to once again arrive at some belief or beliefs as guides to future actions. Peirce explicated four methods of "fixing" such beliefs: tenacity, authority, an *a priori* method, and science, or experimentation. Tenacity and authority refer to the clinging to old beliefs in the face of present doubt due to, respectively, personal or institutional commitments. An *a priori* belief is

fixed solely by an appeal to some version of "reasonableness" or other already existing preferences. Experimentation, for Peirce, was the preferred method of fixing belief, entailing the testing of hypotheses against public and verifiable observations.

Although Peirce coined the term *pragmatism* in 1878, it was William James who later went on to popularize it. This led Peirce to introduce, in 1905, the term *pragmaticism*, thus distinguishing his theory from that of James. Peirce intended pragmatism to be a means to an objective and impersonal reality—William James's interests lay in a very different direction.

William James

William James (1842–1910), brother of novelist Henry James, was a psychologist, physician, and philosopher. For William James, pragmatism was personal and pluralistic. His attention to the affective elements of experience, such as feelings of volition, intention, and personal identity, mark the breaking point from Peirce's version of pragmatism. James was always more the psychologist, Peirce the logician and mathematician. Author of numerous influential books and essays, James's popularizing of pragmatism gained both him and the movement great notoriety.

James's landmark *The Principles of Psychology* (1890) described consciousness as an activity of selection. This selection occurs within a "stream of consciousness" (a term coined in *The Principles*). James worked to make psychology a natural science, using human physiology and employing the scientific method.

In "The Will to Believe" (1897), James advocated a freedom of choice or belief when empirical evidence does not provide sufficient warrant to commit us to one belief or another,

and when the situation presents us with a “forced, living, and momentous” decision. Here James employed the notion of selectivity he had earlier developed to describing the volitional function of consciousness.

In *Pragmatism* (1908) and *Essays in Radical Empiricism* (1912), James went on to develop a nondeterministic and nondualistic theory of knowledge. In these works, James advocated the notion of truth as the “cash value” of a proposition or belief. James called for a consideration of philosophical dilemmas in terms of the effects of their resolutions. If it benefits us to hold a particular belief, we should take those benefits into account when considering the advisability of adopting such a belief as true.

In addition to Peirce, James’s influences include Charles Bernard Renouvier (1815–1903) and F. C. S. Schiller (1864–1937). For example, James’s diary entry from April 30, 1870, addressed Renouvier’s definition of free will as “the sustaining of a thought *because I choose to when I might have other thoughts.*” James’s response was to write, “My first act of free will shall be to believe in free will...I will assume for the present—until next year—that it is no illusion.” And James worked with Schiller to establish pragmatism as a form of humanism.

Perhaps the most important philosopher to benefit directly from James’s work was American educator, psychologist, and public philosopher John Dewey.

John Dewey

John Dewey’s (1859–1952) life spanned nearly a full century, and his written work reflects a corresponding breadth of influences and interests. Dewey brought pragmatism to maturity by focusing on the pragmatic method of inquiry as an ever-ongoing, self-correcting, and social process. Dewey used the scientific method as a paradigm of controlled and reflective inquiry, and referred, in various works, to his version of pragmatism as “instrumentalism” and “experimentalism.” Dewey combined Peirce’s community-sense of inquiry with the affective elements of James’s work. Furthermore, Dewey added a historical consciousness he inherited from his study of G. W. F. Hegel (1770–1831). As a result, Dewey’s version of pragmatism deemphasized knowledge and belief as the sole ends of inquiry, and instead sought to combine intelligent reflection with intelligent action.

Dewey was born the same year as the publication of *On the Origin of Species* (1859), and Darwin’s evolutionary thought had a profound impact on Dewey’s contributions to pragmatism. Dewey’s instrumentalism is a theory of the process of the transformation of an inchoate, problematic situation into a coherent unified one where knowledge is the product of inquiry and the means, or instrument, by which further inquiries may be made. Dewey’s fallibilism, inherited from Peirce, holds that no belief, view, or claim to knowledge is immune to possible future revision. Whereas Peirce’s fallibilism emphasized the revisability of scientific theories, Dewey sought to advocate the ways in which ongoing communication among diverse persons and experiences may inform and refine each other. Knowledge, for Dewey, was the *product* of inquiry, built out of the raw materials of experience. Knowledge, or “warranted assertability,” is not a private

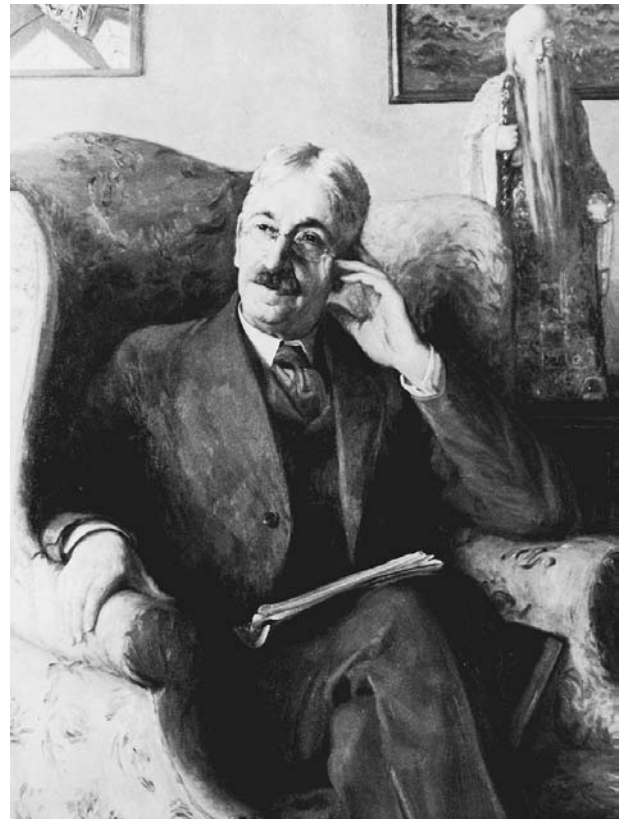

Portrait of John Dewey by Edwin B. Child. Dewey (1859–1952), an American philosopher, is considered by many to be one of the three most influential pragmatists. He believed that problems could be solved through the application of experience and inquiry. COLUMBIANA COLLECTION, COLUMBIA UNIVERSITY LIBRARIES

affair. Rather, it is the result of intelligent and public interaction between communicating inquirers and their world.

Other Key Figures in the History of Pragmatism

Ralph Waldo Emerson (1803–1882) was no pragmatist himself, but his provocative insistence upon the value of experience and the power of democracy provided the background for much of pragmatic thought. Other important figures in the history of pragmatism include: institutional economist Thorstein Veblen (1857–1929); philosopher, educational theorist, and social activist Jane Addams (1860–1935); sociologist and psychologist George Herbert Mead (1863–1931); critical race theorist, critic of capitalism, and social activist W. E. B. DuBois (1868–1963); philosopher William Ernest Hocking (1873–1966); philosopher and logician C. I. Lewis (1883–1964); philosopher Alain Locke (1885–1954); Marxist philosopher and Dewey’s student Sidney Hook (1902–1989); philosopher Justus Buchler (1914–1991); and sociologist C. Wright Mills (1916–1962).

Recent Developments in Pragmatism

Willard Van Orman Quine (1908–2000) wanted to naturalize epistemology, to make it a part of the physical sciences. In “Two

Dogmas of Empiricism" (1953), he rejected the analytic-synthetic distinction, and the strong distinction between math and logic, on the one hand, and the empirical sciences, on the other. Furthermore, he claimed that experience works on all of our beliefs holistically, and not as a piecemeal series of revisions.

Hilary Putnam (b. 1926) argues, by employing the writings of classical pragmatists, for various versions of realism. His use of figures like James and Dewey has not only served to revitalize interest in their work, but also to bring pragmatic points of view into conversation with many of the important contemporary debates in philosophy of mind.

Throughout his writings, Richard Rorty (b. 1931) argues for antifoundationalism and antiessentialism. According to Rorty, we know our experiences through "final vocabularies," which are always already products of social and historical contingencies. Philosophers do much of the work of clearing out dead vocabularies so that "strong poets" may develop the key terms of new ones.

The extremely prolific Cornel West (b. 1953) continues to develop a "prophetic pragmatism," emphasizing the religious and liberatory elements of pragmatic thought and social action. Through writings, audio recordings, and public presentations on television and radio, West has marked himself as an important advocate for the thoughtful exchange of ideas and the challenging of the political and social *status quo*.

The online "Pragmatism Cybrary" (www.pragmatism.org) is the chief Internet source of information and interest in the work of past and contemporary pragmatic thinkers. The leading print journals of pragmatism include *Transactions of the Charles Sanders Peirce Society* and the *Journal of Speculative Philosophy*.

See also *Epistemology: Modern; Truth*.

BIBLIOGRAPHY

- Dewey, John. *The Collected Works of John Dewey, 1882–1953*, edited by Jo Ann Boydston. 37 vols. Carbondale: Southern Illinois University Press, 1969–1991.
- Flower, Elizabeth and Murray Murphey. *A History of Philosophy in America*. 2 vols. New York: Putnam's, 1977.
- James, William. *The Works of William James*, edited by Frederick H. Burkhardt and Fredson Bowers. 19 vols. Cambridge, Mass.: Harvard University Press, 1975–1988.
- McDermott, John J. *Streams of Experience: Reflections on the History and Philosophy of American Culture*. Amherst, Mass.: University of Massachusetts Press, 1986.
- Peirce, Charles Sanders. *Collected Papers*, 8 vols., edited by Charles Hartshorne and Paul Weiss (vols. 1–6) and Arthur Burks (vols. 7–8). Cambridge, Mass.: Harvard University Press, 1931–1966.
- Quine, Willard Van Orman. *From a Logical Point of View*. New York: Harper and Row, 1953.
- Rorty, Richard. *Consequences of Pragmatism*. Minneapolis: University of Minnesota Press, 1982.
- Schneider, Herbert W. *A History of American Philosophy*. New York: Columbia University Press, 1946.
- Seigfried, Charlene Haddock. *Pragmatism and Feminism: Reweaving the Social Fabric*. Chicago: University of Chicago Press, 1996.

West, Cornel. *The American Evasion of Philosophy: A Genealogy of Pragmatism*. Madison, Wis.: University of Wisconsin Press, 1989.

Stephen Barnes

PRE-COLOMBIAN CIVILIZATION. Knowledge about pre-Columbian civilizations comes from two main sources: archaeological remains and the accounts written by European men. The latter include a first group of explorers who described the alien worlds they encountered (and destroyed), and a second group of priests, scholars, and administrators who interviewed the survivors who remembered the past, and later their descendants, who retold the tales they had heard in their youth. The first chroniclers viewed native societies through a self-confident, conservative, and unquestioning Catholic lens; fiercely religious themselves, they emphasized religion as the central force of native life. Although some, such as Bernal Diaz, express awe at the cultural, artistic, and technical achievements of Native Americans, for the most part these texts dismiss native societies as primitive and their religious ideas as confused and fundamentally wrong. Some use the term *pagan*; others assume that exotic practices such as polytheism and ancestor worship, common to many Native American societies, were synonymous with devil worship. Serious attempts at what in the early twenty-first century might be termed *ethnographic* and linguistic scholarship were nevertheless undertaken, mostly by religious writers. For the most part, as in the famous "Extirpation of Idolatries" texts, these were motivated by the need for more effective evangelization when, after years of conversion efforts, religious authorities realized that native understanding of Catholicism was spotty and shallow at best. Friars such as Bernardino de Sahagun of Mexico and Domingo de Santo Tomas of Peru began to study native languages and culture to facilitate intercultural communications and to explore native belief systems. Later, major extirpation campaigns yielded page after page of proceedings in which native witnesses tried to explain, usually through interpreters, the rationales for their persistent worship of their ancestral gods. The study of these records and the material record of these societies have led to the more relativistic prism through which most modern scholars have come to view these societies.

These early written sources are invaluable for understanding those civilizations that existed at the time of the encounter with the Europeans, most notably the Aztecs and Incas. The Aztecs, or Mexica, are believed to be migrants into central Mexico from the arid regions to the north, home to less settled tribes. As recent arrivals into an area that had for centuries been one of the great urban centers of art, architecture, religion, wealth, and political might, the Mexica at first served as mercenaries to some of the established city-states in the vicinity of Lake Texcoco. Their rapid rise to power appears to have been the result of a series of political intrigues, among other factors. But after the fact, the Aztecs, like other imperial peoples, came to see their own hegemony as foreordained by supernatural powers. According to their own origin myths, as recorded after the conquest, they had left their mythic home-

land of Aztlán, led by their priest-god Huiztlipochtli, and traveled until they settled where they saw a pre-ordained sign—an eagle with a snake in its mouth, resting on a rock. This rock happened to be in the middle of Lake Texcoco, so it was there that they began to construct their capital of Tenochtitlan. They later allied with two other city-states—Texcoco and Tlacopan—and, with their combined power, began their expansion. The Aztecs came to dominate the Triple Alliance and, at the time of contact with the Europeans, they occupied lands from the Gulf of Mexico to the Pacific, north toward the Rio Grande, and south through Tehuantepec.

The Aztecs worshiped a plethora of gods. They included creation gods such as Quetzalcoatl, the Feathered Serpent, who was also the wind god; Huehuateotl, the god of fire; Tezcatlipoca, the Smoking Mirror, the god of the night and darkness; Tlaloc, the rain god (one of the oldest and most widely worshiped Mesoamerican deities); and their own patron deity Huitzilopochtli, the god of war. Besides these gods, there were gods of certain social groups, like the *pochteca* (merchants) and lineage gods. For example, the *pochteca* chose Quetzalcoatl—god of creation and the bearer of culture, and often regarded as the maize god—as their patron and protector.

Their religious ideas provided the Aztecs and other Central Mexicans with an explanation of their origins, an expectation about life, and a method to influence the present and the future. Aztecs believed, as Friedrich Katz so ably states, that “a hard fate, filled with gloom and privation” awaited most of humankind (p. 161). They believed that life on earth was a short illusion. Only the warriors who fell in battle, the prisoners sacrificed to their deities, the women who died in childbirth, the persons who died in natural catastrophes, and children could hope for a more comfortable afterlife. Hope rested with the gods who could be placated through sacrifice. Human blood, for example, was shed to nourish the sun, which would be extinguished without such sustenance. Child sacrifices placated the rain god Tlaloc. Thus did ordinary individuals, some taken as prisoners in combat and others transferred to the state as tribute, contribute to the future of Aztec civilization. It is worth noting that in the twenty-first century, scholars such as Elizabeth Brumfiel have cautioned, however, that recorded Aztec religion is largely the religion of the male elite; its glorification of warfare and early death is probably not representative of the beliefs of the majority of the people, farmers, merchants, and artisans who may well have had a more pragmatic and life-affirming view of the cosmos.

The Aztecs adopted some of the gods and practices of their subject peoples. In Tenochtitlan a special temple housed the idols of vanquished peoples, but the Aztecs did not require subject peoples to worship their own deities; indeed, they reserved that right for the chosen few. They allowed the subject peoples to continue speaking their own language and practicing their own cults and culture. For these reasons, scholars have described the Aztec empire as a loose confederation of distinct peoples.

The Incas, like the Aztecs, were one of many relatively small polities in the Andean region of South America that rapidly expanded into an empire encompassing many peoples with

distinct traditions and identities. According to the histories told by Inca royalty to Spanish writers, the precipitating experience for expansion was the challenge from the leader of another polity, called the Chanca, for the claim of being the son of the sun. Once the Incas defeated these rivals, they began to expand, conquering the recalcitrant and allowing others to submit peacefully.

Inca imperial religion was built upon long-standing Andean beliefs and traditions, in which the worship of the ancestors and of sacred places played an important part. Each provincial people worshiped their forbearers, some of whom had been transformed into or identified with rocks or mountains. These ancestors, like the Sun, the apical ancestor of the Incas, were believed to have influence over daily life. In return for fertility, health, and success in battle, the natives sacrificed to and danced and sang for their gods. Sacrifices included corn beer and cakes, camelids, guinea pigs, and other foodstuffs. On special occasions, such as the death of an important ruler, humans were sacrificed. The paradigm can be summarized as “to feed and be fed.”

These lineage cults gave these agricultural and pastoral peoples their social and cultural identity at the local level. Expansive and ambitious polities such as the Inca state and its predecessors built larger political identities out of these localized traditions; the Inca constructed a complex state religion in which, out of the capital city of the Cuzco, radiated a set of sacred lines, called ceques, which were conceptualized as enveloping each of the local sacred places of lesser lineages into a single sacred landscape. This schema, at once religious and political, allowed individual peoples to retain their sense of cultural and religious autonomy and their distinctive deities, while still claiming a place within the larger imperial hierarchy. Within the capital city and other Inca centers, a highly stratified hierarchy of male priests and female *acllas* or “chosen women,” tended to the state religious cults, working in tandem with administrators and the military to fuel the imperial expansion.

The Andean civilization that built magnificent stone ceremonial cities, such as Cuzco and Huanuco Viejo, irrigated the hot desert coast; constructed footpaths linking what has become southern Columbia to the middle of Chile, and from the Pacific into the Andes mountains to Bolivia and southwestern Argentina, impressed the Spanish with its magnificence. Still, like the Aztecs, it was only the latest in a long line of impressive civilizations stretching back thousands of years, each of which contributed unique architectural, artistic, and intellectual legacies. The arrival of Europeans and Africans, and the vast, violent set of transformations that followed destroyed much of what had been, leaving only fragments and ruins. But archaeologists, ethnohistorians, and other scholars have reconstructed much of these lost social worlds, and the resurgent Native American political and cultural movements of recent decades have proudly reclaimed this history, serving as a reminder that if European culture has dominated in Latin America for the last five hundred years, the great Native American civilizations held sway for millennia before.

See also Astronomy, Pre-Columbian and Latin American; Empire and Imperialism: Americas.

BIBLIOGRAPHY

- Clendinnen, Inga. *Aztecs*. New York: Cambridge University Press, 1993.
- D'Altroy, Terence. *The Incas*. Malden, Mass.: Blackwell, 2002.
- Davies, Nigel. *The Ancient Kingdoms of Peru*. New York: Penguin Books, 1983.
- Katz, Friedrich. *The Ancient American Civilizations*. New York: Praeger Publishers, 1972.
- Ramirez, Susan Elizabeth. *To Feed and Be Fed: The Cosmological Bases of Authority and Legitimacy in the Andes*. Stanford, Calif.: Stanford University Press, 2004.
- Sahagun, Bernardino de. *Historia general de las cosas de Nueva Espana [Florentine Codex]*. Santa Fe, N. Mex.: School of American Research, 1950–1982.

Susan Elizabeth Ramirez

PREHISTORY, RISE OF. Historians have long distinguished between matters recent or of record and antiquities, which surpassed memory if not understanding, and which Thucydides (d. c. 401 B.C.E.) called “archaeology.” The prehistory of “prehistory” itself includes the collection of curiosities, remains, and relics underlying the emergent disciplines of mythology, philology, ethnography, and anthropology. The practice of prehistory was also apparent in the tradition of Eusebian world history (which was based on the model of Eusebius’s universal chronicle) and was set within the biblical framework until it was secularized in eighteenth-century conjectural history and shifted to the larger arena of natural history, as in the work of Johann Gottfried von Herder, Johannes von Müller, and C. A. Walkenaer. The pursuit of prehistory was especially evident in the work of Enlightenment philologists and mythologists such as Thomas Blackwell, C. G. Heyne, Georg Friedrich Creuzer, Friedrich Wilhelm Joseph von Schelling, and Karl Otfried Müller. As Heyne wrote, “In interpreting myth we must transport ourselves back into the manner of thought and expression which belonged to that remote period” (Müller, p. 256).

A major arena for the pursuit of prehistory *ante litteram* was the study of cultural history (*Kulturgeschichte*), especially in the work of authors like Herder, Gustav Klemm, Friedrich Hellwald, and Gustav Kolb. It was in the later nineteenth century, however, that such efforts produced the modern discipline of “prehistory,” a neologism self-consciously coined by Daniel Wilson in 1851. “Prehistory” (*Vorgeschichte, préhistoire, preistoria*) drew especially on two new disciplines with old names—that is, “anthropology” (the philosophical study of human nature) and “archaeology” (Thucydidean prehistory). Monuments, memorials, and material objects offered historians access to a deeper past than afforded by written records, private or public. Graves, sepulchral urns, runes, and stone implements uncovered beginning in the seventeenth century threw light on the life (as well as death) and migrations of “barbarian” peoples, while fossil remains forced Christian scholars to confront, and finally to acknowledge, the notion of a humanity older than Adam.

Science of Prehistory

In fact the materials for the “new science” of prehistory had been accumulating for three centuries and more, without the

accompaniment of a theoretical framework but with a substantial constituency in the republic of letters. The works of Georgius Agricola (Georg Bauer; 1494–1555) and Conrad Gesner (1516–1565) on fossils were followed in the seventeenth century by state-supported efforts, notably in Denmark and Sweden, the establishment of societies of antiquities (such as the Society of Antiquaries of London, 1717, and the Society of Dilettanti, 1732) and of journals (that of A. A. Rhode in 1719, and *Archaeologia*, London, 1770), and other signs of professionalization. Archaeological inspirations came from the discovery of Chilperich’s grave (1653), the study of the ruins of Pompeii, and the history of ancient art associated with Johann Joachim Winckelmann (1717–1768). In the view of Rhode writing on north German antiquities, material remains furnished a much better access to the ancient Germans than Cornelius Tacitus (c. 56–c. 120 C.E.) and all commentary and derivative historiography.

Throughout the century local evidence continued to accumulate. John Frere reported on evidence for the antiquity of man from a site in Suffolk in an archaeological journal in 1800, although its significance was not appreciated, or accepted, for another generation. In 1813 James Prichard had already held out the possibility of the nonbiblical principle of polygenesis. By 1846 Jacques Boucher de Crèvecœur de Perthes (1788–1868), acknowledged founder of “prehistory,” was publishing his findings about “antediluvian man.” In 1857 Neanderthal man was unearthed, and in the 1860s John Lubbock was celebrating Frere’s discoveries, adding his own and those of Boucher de Perthes. About the old biblical chronology he wrote, “The whole six thousand years, which were until lately looked on as the sum of the world’s existence, are to Perthes but one unit of measurement in the long succession of ages” (pp. 1–2).

Even before the English scholars, French, German, and especially Scandinavian archaeologists had appreciated the high “antiquity of man” (Charles Lyell’s phrase) for almost half a century. One pioneering archaeologist was Rasmus Nyerup, whose efforts led to the founding of a national museum in Copenhagen in 1819, whose first director, C. J. Thomsen, was one of the formulators of the three-age system, which was “archaeology’s first paradigm.” A variation on this scheme was offered by Sven Nilsson: savage, barbarian, agricultural, and (adopting the rubric of historians) civilized. Nilsson’s work on the early inhabitants of Scandinavia, published in 1834, was translated in 1868 by Lubbock, who drew on other Scandinavian researches and publications. In 1861 Lubbock painted a glowing picture of the progress of understanding prehistory and described the new periodization in this way: the ages of stone (which he divided into old and new—Paleolithic and Neolithic), bronze, and iron, which replaced or gave solid reinforcement to the “four-stage” system of eighteenth-century conjectural history, by connecting it with more precise chronological—that is, stratigraphic—calibrations.

A central figure in nineteenth-century prehistorical studies was Jens Jacob Asmussen Worsaae (1821–1885), who was both professor of archaeology at the University of Copenhagen and head of the Royal Museum of Northern Antiquities. For Worsaae the “progress of culture” was measured not by writing but “as indicated by the appearance of pile-dwellings and other

remains.” As for the “antiquity of man” he stopped short of Charles Lyell’s estimate of the age of the human race as about 100,000 years. “Yet this much is certain,” Worsaae added, “the more our glance is directed to that epoch-making point of time, when the Creator wakened man in all his nakedness into life, and therefore most probably under a warmer sun in some more genial clime, the more does that point recede into an endlessly distant undefinable past” (*The Prehistory of the North*, p. 2).

Evolutionary Contributions

The “antiquity of man” was confirmed by the evolutionary ideas that emerged and began to prevail in the nineteenth century. Darwinism, preceded by the naive evolutionism of Herbert Spencer (1820–1903), Robert Chambers, and Charles Darwin’s (1809–1882) own grandfather, Erasmus Darwin, gave systematic and scientific basis to age-old organic and biological analogies. It joined all human races, however defined, in one general process, and in this way extended the field of comparisons to the entire globe, which had been the scene of the ages of stone, bronze, and iron. With the emergence of written culture, however, the uses of archaeology diminish, so that, as Worsaae acknowledged, “monumental records and ancient relics become mere illustrations of the internal and external contemporary conditions of civilisation, the main features of which are already known in history” (*The Prehistory of the North*, p. 181). Later archaeologists, such as Gabriel de Mortillet (1821–1898), likewise insisted on the priority of cultural over narrowly paleontological criteria.

Evolutionism became commonplace in the wake of Darwin’s *Origin of Species* (1859) and the work of Ernst Haeckel (1834–1919) and Friedrich Ratzel (1844–1904) in Germany. The connection with prehistory became more direct in the work of Ratzel, who extended the views of Herder into the new discipline of “anthropogeography” and who published works on “the prehistory of European humanity.” A philosophical emphasis was added by Otto Caspari, who, investigating “the prehistory of humanity with a review of its natural development” followed the anti-Kantian critique of Herder by insisting on the growth of human reason rather than the structure of “pure” reason. By the later nineteenth century prehistory was not something that students of world history (or indeed national history) could ignore.

New World Discoveries

How did the New World fit into the prehistorical perspective that was emerging in the nineteenth century? The discoveries of Columbus and his followers and the imperial extensions of the conquistadores were incorporated without much difficulty into the “universal histories” of European tradition, though at first the political and cultural categories of the colonial intruders were imposed indiscriminately on the original inhabitants. The old theme of the four world monarchies was replaced by the modern succession of empires—Spanish, English, Dutch, French, and American—as a way of periodizing the grand narrative of Western history; and historians of all nationalities gave interpretations of the consequences of the opening of the new hemisphere. The old stereotypes of barbarism and civilization, too, were employed to distinguish not only the vanquished from the victors but also the primitive

stages of historical development from those of material and spiritual culture, whether governed by laws of providence or of secular progress.

Early ideas of pre-Columbian history were based on old rumors, prophecy, and poetic visions going back to Dante and Petrarch, and not until the seventeenth century did scholars begin to pass beyond myth and ungrounded speculation to ethnographic inquiries into the origins of the Indian populations of the Americas, such as arguments for the Israelite origins of the Indians and Hugo Grotius’s (Huigh de Groot; 1583–1645) choice of the Scandinavians. Indeed, wrote Justin Winsor, “there is not a race of eastern Asia—Siberian, Tartar, Chinese, Japanese, Malay, with the Polynesians—which has not been claimed as discoverers, intending or accidental, of American shores, or as progenitors, more or less perfect or remote, of American peoples” (p. 59)—and none of them, he went on to add, without some plausibility.

The Asiatic theory of American origins, upheld by Joseph-François Lafitau (1670–1740), Alexander von Humboldt (1769–1859), and Charles Lyell (1797–1875), was the most popular, although specific tall tales of Chinese discoveries were discredited; and it was reinforced by the fact of the narrowness of the Bering Strait and its frozen condition in winter. Long before the Norwegian author Thor Heyerdahl, ideas of Polynesian contacts were defended, and so were Welsh—even by Edward Burnett Tylor (1832–1917)—and Irish claims. In 1843 William H. Prescott, confronting the question in the context of Mexican civilization, surveyed the myths and theories deriving from discredited notions of the unity of the human race and in the end rejected Hebrew, Egyptian, Chinese, or Tartar origins for East Asia—but in a period “so remote, that this foreign influence has been too feeble to interfere with the growth of what may be regarded, in its essential features, as a peculiar and indigenous culture.” In other words, prehistory was largely a matter of speculation, and scholars should confine themselves to recorded and accessible periods.

Another question was that of the early contacts made by the Scandinavians and testified to by the Icelandic sagas written down by the thirteenth century and by later historical writings, including beginning with Olaus Magnus in the seventeenth century. Most controversial was the story of the voyages to Vinland, whether region or island, mentioned in the works of Adam of Bremen (d. 1081–1085) and Ordericus Vitalis (1075–?1142) as well as a number of other manuscripts. The problem was proving such claims, many of them arising from national pride, and the criteria for such proofs came to depend on increasingly strict and scientific standards of historical linkage. Arguments were supported by interpretations of myths, similarities of customs and rituals, intuitive etymologies, physical and cultural anthropology, comparative linguistics, and archaeology (later to be supplemented by radio-carbon and DNA testing); and though the standards and techniques change, the results are still coming in.

Archaeology and Related Fields

The idea of the “antiquity of man” overcame initial resistance, especially through the work of Tylor, Lubbock, Adolf Bastian,

and Theodor Waitz, based on studies of American Indians, and eventually shifted opinion within the scientific community; in 1896 Andrew Dickson White celebrated Darwin's victory over the obscurantist theological champions of the "fall of man." But prehistorical investigations were also pursued along more scientific lines. "Between 1780 and 1860," wrote Bruce Trigger, "archaeology in the central and eastern United States passed through an antiquarian phase which recapitulated the development of archaeology in England and Scandinavia between 1500 and 1800" (p. 105). As in Europe, the existence of human remains along with those of extinct mammals forced acceptance of the antiquity of man and, as C. C. Abbott concluded, following Scandinavian scholars, of his existence in Paleolithic times in America.

And proofs continued to accumulate, especially with the collective efforts reflected in the spread of archaeological museums and periodicals, beginning with the transactions of the American Philosophical Society (1769), whose president, Thomas Jefferson, was himself a pioneering archaeologist, the American Academy of Arts and Sciences (founded "to promote and encourage the knowledge of the antiquities of America"), the publications of the American Antiquarian Society (1812), the American Ethnological Society (founded by Albert Gallatin), the proceedings of the American Association for Advancement of Science (began in 1848), the publications of the American Geographical Society (1852), the *American Naturalist* (1867), the *American Antiquarian* (1878), the Archaeological Institute of America (1879), the *American Journal of Archaeology* (1881), the American Folk-Lore Society (1888), the Smithsonian Institution (1846), the Peabody Museum (1866), and others.

In Henri Berr's great series on "the evolution of humanity" the study of prehistory—"still in its infancy"—takes a place of honor with eleven volumes devoted to aspects of the subject, including Jacques de Morgan's *Prehistoric Man* (1925); and no survey of human civilization can omit consideration of this period before the appearance of historical "sources" properly speaking. Before spiritual advance came material endowment—before language came the tool; and the understanding of this link leads back to a modern sort of "conjectural history," which underlay the efforts of the post-World War I generation, scholars such as Jacques de Morgan and V. Gordon Childe (whose *Dawn of European Civilization* also appeared in 1925), to achieve a "new synthesis" for the study of humanity in its terrestrial home. "Aided by archeology," Childe wrote, "history with its prelude prehistory becomes a continuation of natural history." Yet there is still truth in the remark made by Morgan in the synthesis published three quarters of a century ago, that "What we know to-day is very little in comparison with what remains to be learned."

See also *Barbarism and Civilization; Evolution; History, Idea of*.

BIBLIOGRAPHY

Caspari, Otto. *Die Urgeschichte der Menschheit, mit Rücksicht auf die natürliche Entwicklung des frühesten Geisteslebens*. 2nd ed. Leipzig: Brockhaus, 1877.

- Childe, V. Gordon. *What Happened in History*. New York: Penguin, 1946.
- Daniel, Glyn, ed. *Towards a History of Archaeology*. New York: Thames and Hudson, 1981.
- Daniel, Glyn, and Colin Renfrew. *The Idea of Prehistory*. Edinburgh: Edinburgh University Press, 1988.
- De Morgan, Jacques. *Prehistoric Man: A General Outline of Prehistory*. Translated by J. H. Paxton and Vera C. C. Collum. New York: Knopf, 1925.
- Gamble, Clive. *Timewalkers: The Prehistory of Global Colonization*. Cambridge, Mass.: Harvard University Press, 1994.
- Grayson, Donald K. *The Establishment of Human Antiquity*. New York: Academic, 1983.
- Kelley, Donald R. *Faces of History: Historical Inquiry from Herodotus to Herder*. New Haven, Conn.: Yale University Press, 1998.
- . *Fortunes of History: Historical Inquiry from Herder to Huizinga*. New Haven, Conn.: Yale University Press, 2003.
- Lubbock, John. *Pre-Historic Times as Illustrated by Ancient Remains and the Manners and Customs of Modern Savages*. New York: Appleton, 1890.
- Malina, Jaroslav, and Zdenek Vasicek. *Archaeology Yesterday and Today: The Development of Archaeology in the Sciences and Humanities*. New York: Cambridge University Press, 1990.
- Müller, Karl Otfried. *Introduction to a Scientific System of Mythology*. Translated by John Leitsch. London: Longmans, 1844.
- Prescott, William H. *The Conquest of Mexico*. New York: Dutton, 1909.
- Schnapp, Alain. *The Discovery of the Past*. Translated by Ian Kinnes and Gillian Varndell. New York: Abrams, 1997.
- Trigger, Bruce G. *A History of Archaeological Thought*. New York: Cambridge University Press, 1989.
- Winsor, Justin. *Narrative and Critical History of America*. New York: Houghton Mifflin, 1889.
- Worsaae, J. J. A. *The Pre-History of the North Based on Contemporary Memorials*. Translated by H. F. Morland Simpson. London: Trübner, 1886.
- . *Primeval Antiquities of Denmark*. Translated by William J. Thoms. London: Parker, 1849.

Donald R. Kelley

PREJUDICE. The concept of prejudice emerged during the early twentieth century and soon became the most prominent social scientific and lay concept to describe antipathy for others based on their social group or category membership. Social scientists have typically defined prejudice as a negative intergroup attitude. Many, however, have added the rider that this negative intergroup attitude is bad or unjustified in some way, and it is this broader concept that has been entrenched in lay discourse. This conceptualization raises several issues. One is whether it is indeed possible to distinguish between negative intergroup attitudes that are prejudiced (that is, bad or unjustified) and those that are not. A second issue is that of the structure and dimensionality of these negative intergroup attitudes, a third is whether there are different types or kinds of prejudice, and a fourth is that of how prejudice has been explained and understood.

Prejudice: Social Problem, or Problem Concept

The perspective of prejudice as a “bad” or “unjustified” attitude arises out of the social-problems approach to the study of intergroup relations, which was prominent for much of the twentieth century. This perspective implied a distinction between those intergroup attitudes that were socially problematic and those that were not, and only the former qualified as prejudice per se. For example, George Simpson and J. Milton Yinger, in their influential handbook *Racial and Cultural Minorities: An Analysis of Prejudice and Discrimination* (1985), write that “for a democrat to be prejudiced against communists and fascists is different from his being prejudiced against Japanese—not entirely different, to be sure, but sufficiently so to require separation in vocabularies (for example, prejudice 1 and prejudice 2). It is the latter type that is the subject of this book” (p. 22).

But how do negative intergroup attitudes that are prejudiced differ from negative intergroup attitudes that are not prejudiced? A number of possible differences have been proposed. It has been suggested that prejudiced intergroup attitudes involve a faulty or incorrect generalization, that they involve rigid or inflexible attitudes, that they are overgeneralized attitudes, that they are irrational attitudes, that they justify discrimination, that they are attitudes that are not based on actual experience, that they are attitudes that are not based on objective evidence, and that they are unjust attitudes.

The problem with this pejorative concept of prejudice is that no evidence has ever shown that those negative intergroup attitudes viewed by social scientists as prejudiced are actually any more rigid, inflexible, irrational, any more based on faulty or incorrect generalizations, and any less based on real experience and objective evidence than negative intergroup attitudes not viewed as prejudiced. The distinction therefore has tended to reside purely in the belief, sometimes explicit but more commonly implicit, that these negative intergroup attitudes are “unjust” without any further specification in observable or measurable terms. The attribution “unjust” has therefore been purely a value judgment that is inevitably influenced by the beliefs, group membership, and biases of the person making it as well as the social and historical circumstances. For example, Simpson and Yinger’s suggestion that a democrat’s dislike of communists may be justified but not a dislike of Japanese may have seemed reasonable to American social scientists in the 1970s but might not have seemed as reasonable during World War II, when the Soviet Union and the United States were allies in the war against Japan.

Because the idea of prejudice as a bad or unjustified negative intergroup attitude has never had any empirical basis and therefore has not been empirically measurable, the body of knowledge that has emerged on the topic of “prejudice” actually consists of research on intergroup attitudes. Because of the social-problems perspective, social scientists have focused most of their attention on attitudes toward those social or ethnic groups, particularly minorities, which they have viewed as being the targets of unjustified negative attitudes and discrimination. Thus during the twentieth century first anti-Semitism and then antiblack racism were particular foci of attention.

There is no evidence, however, that the nature and dynamics of these “unjustified” negative intergroup attitudes toward minorities differ from negative attitudes that might be held by these minorities against majorities or indeed from any other negative intergroup attitudes, whether seen as “justified” or “unjustified.”

This problem with prejudice as a pejorative concept might be one reason why the term “prejudice” has been less used in the social-science literature on intergroup relations and attitudes since the last two decades of the twentieth century. When it has been used, it has also tended to be defined in an ostensibly neutral and nonpejorative manner, as simply referring to “negative intergroup attitudes” (Duckitt, 1992, pp. 15, 18), though the implication that these attitudes are “unjustified” has tended to remain, particularly in lay discourse. This shift toward defining prejudice in nonpejorative and ostensibly neutral terms has also paralleled a move away from the social-problems perspective of prejudice and the emergence of the cognitive approach to studying intergroup relations in psychology. This cognitive approach has viewed intergroup biases and stereotyping as being rooted in universal human cognitive processes rather than as pathological or abnormal phenomena.

The Structure of Intergroup Attitudes

Given that prejudice is conceptualized as a negative intergroup attitude, the issue of the structure and dimensionality of these negative intergroup attitudes arises. Social psychologists have distinguished three distinct components of prejudice or ways in which negative intergroup attitudes can be expressed or manifested. These are in the form of negative stereotypes (cognitive component) of the target group, negative feelings (affective component) toward the target group, and negative behavioral inclinations (behavioral component) toward the target group. Each of these components of negative intergroup attitudes will be briefly considered below.

Stereotypes and prejudice. Contemporary social scientists typically define stereotypes as beliefs about the personal characteristics of a group or category of people. In contrast to traditional approaches that saw stereotypes as necessarily incorrect, irrational, rigid, or faulty in some way, stereotypes in the early twenty-first century are seen as arising out of normal and adaptive cognitive processes, such as categorization, which function to reduce the complexity of social information processing. An important conclusion from research within this new approach has been that stereotypes function as generalized expectancies about social categories or groups, which bias the perception of and behavior toward individual members of those groups so as to maintain the stereotype and generate behavioral confirmation of it.

Stereotyping per se, however, does not necessarily involve prejudice. Out-group stereotypes can be evaluatively positive, neutral, or negative. Only evaluatively negative stereotypes are usually viewed as expressive of prejudiced attitudes. But how important are negative stereotypes as an expression of prejudice?

It has been widely assumed that negative stereotypes should be strongly associated with other expressions of prejudice, such as negative feelings or affect toward the target group or

discriminatory behavior toward and behavioral avoidance of the target group. The evidence, however, does not seem to support this. John Brigham's review of research on stereotyping concluded that negative stereotypes and prejudice were only weakly and inconsistently related. Later research has come to similar conclusions. A meta-analysis of thirty hypothesis tests from twelve different studies indicated that American whites' evaluative stereotypes of blacks correlated positively but only weakly with whites' overall racial attitudes and very weakly with indices of discriminatory behavior toward blacks (Dovidio et al.). These findings suggest therefore that negative stereotypes may not be as important a component of prejudice as has been frequently assumed.

Intergroup affect and prejudice. Although psychologists had originally believed that negative affect or feelings of dislike for out-groups were the central core of prejudice, in the 1970s their emphasis began to shift toward cognitive aspects of prejudice, such as categorization and stereotyping. However, during the 1990s several influential commentaries suggested a possible shift back to an emphasis on affect as central to intergroup attitudes, behavior, and relations. For example, Susan Fiske has suggested that prejudice should be conceptualized specifically as negative intergroup affect. Eliot R. Smith has also proposed a theory suggesting that when group identity is salient, the way in which people appraise intergroup contexts or relationships generates particular feelings about out-groups, and it is these "social emotions" that constitute prejudice and determine intergroup behavior.

Research has also suggested that affect toward out-groups may be the most critical component of prejudiced attitudes. Charles Stangor et al. found that affective responses to national, ethnic, and religious groups were clearly better predictors of general favorability toward and social distance from these groups than the stereotypes held about those groups. The aforementioned meta-analysis by John Dovidio et al. found that affective prejudice toward blacks correlated more strongly with discriminatory behavior toward blacks than did the stereotypes of blacks. Empirical research therefore seems to support those, such as Smith and Fiske, who have argued that the feeling or affective component of prejudice is its most central and critical aspect.

Behavioral expressions of prejudice: Social distance, discrimination, and violence. While social psychologists have primarily studied the cognitive, perceptual, and affective aspects of prejudice, sociologists have devoted more attention to its behavioral expressions, in the form of peoples' intentions and dispositions to behave negatively to out-group members. The most studied behavioral expressions of prejudice have probably been social distance preferences (behavioral avoidance) and discriminatory behavior. Interestingly, intentional acts of serious violence against individuals because of their group or category membership, or "hate crimes," have been much less studied.

Social distance is typically measured using variants of a questionnaire originally developed by Emory Bogardus in 1925, which asked about people's willingness to have personal contact of varying degrees of intimacy ("close kinship by marriage," "in my street as neighbors," "employment in my occupation," "citizenship in my country") with members of particular

ethnic groups. An important finding from social-distance research has been of the relatively consensual or normative nature of prejudice within societies. Numerous studies have documented a hierarchy of social-distance preferences in the United States that is widely accepted and has remained remarkably stable over much of the twentieth century. At the top of this hierarchy are fair-skinned North European peoples, followed by East and South Europeans, then Asian peoples, and finally African peoples at the bottom. Even low-ranking minorities accept the hierarchy, except for their own group, which they rank high.

Louk Hagendoorn's comparative research on the social-distance hierarchies within a number of West and East European societies confirmed that these hierarchies are highly consensual within social groups. They also tend to be consensual across groups within particular societies, except when there are sharp ideological or cultural cleavages within the society, in which case the conflicting groups might disagree on the hierarchy. This was the case, for example, for Islamic versus non-Islamic groups in several countries from the former Soviet Union.

The existence of pervasive discrimination against groups that are the targets of prejudice has been extensively documented. For example, Thomas F. Pettigrew has reviewed the substantial body of research on high levels of prejudice against and discrimination toward the new immigrant minorities of western Europe. Numerous studies have shown the existence of pervasive discrimination against blacks in the United States, despite apparent declines in overt prejudice.

It is interesting that at the group level there seems to be a strong tendency for those groups who are negatively stereotyped and the targets of prejudiced affect to be most discriminated against. This contrasts with the weak relationship obtained between discriminatory behavior and negative stereotypes and the moderate one between discriminatory behavior and intergroup affect at the individual difference level.

Aggression and violence toward out-group members constitute more extreme behavioral expressions of prejudice. Numerous studies have documented the long history of violence against blacks in the United States, and Pettigrew has described the late-twentieth-century and early twenty-first-century upsurge in anti-immigrant violence in western Europe. Much attention has therefore focused on the conditions that lead to prejudice being expressed in violence. Early findings suggesting a correlation between lynching of blacks in the American South and economic hardship have not been supported by subsequent reanalyses and new data. Nor has clear evidence emerged of a relationship between unemployment and hate crimes. Instead, ecological studies have suggested that xenophobic reactions might be particularly likely in situations where "established groups confront outsiders whose growing numbers and social practices challenge the preexisting hierarchy in which they occupied a favorable position" (Green et al., p. 430).

The Varieties of Prejudice

While prejudiced intergroup attitudes should always involve cognitive, affective, and behavioral expressions in the form of

unfavorable stereotypes, feelings of antipathy, and behavioral expressions of prejudice, a somewhat different issue is that of whether different kinds or forms of prejudice exist. This idea originated from research in the United States, which suggested that two different kinds of racism existed there, with one having a more traditional or overt form and the other a newer, more modern, or more subtle form.

Traditional racism and the new racisms. Several theories have proposed that a new more covert or subtle kind of racism emerged in the United States after the desegregation of the South—a form of racism that supplemented or supplanted an older more traditional form characterized by beliefs in black biological inferiority, white supremacy, and the desirability of segregation and formal discrimination. Some important empirical findings stimulated the emergence of these theories. First, findings indicated that despite survey evidence of sharp declines in whites' racial prejudice after the early 1960s, anti-black discrimination and racial inequality did not show corresponding decreases. Second, many ostensibly nonprejudiced whites expressed strong opposition to policies designed to reduce these inequalities. And third, research also indicated that whites' overtly friendly behavior to blacks or apparently nonprejudiced questionnaire responses could be accompanied by covert negative affect revealed by subtle indicators such as voice tone and seating distance or revealed when they were hooked up to a simulated lie detector (the bogus pipeline technique).

There have been four main approaches to this new racism: symbolic or modern racism, subtle versus blatant prejudice, ambivalent racism, and aversive racism. These four approaches have varied in their conceptualization of this new racism, but their essential features seem similar. The most important of these approaches is that termed symbolic or modern racism by David Sears. It has been described as a blending of antiblack affect with traditional Protestant ethic and conservative values. Thus blacks are disliked because they are seen as violating basic moral values, such as self-reliance, individual responsibility, and the work ethic. The modern racism scale was developed to measure this dimension and has tended to be highly correlated with measures of traditional racism yet factorially distinct from them. Numerous studies have found that the modern racism scale is a markedly more powerful predictor of whites' racial policy preferences and candidate preferences in racialized election campaigns than measures of traditional racism, political preference, or conservative ideology.

The second approach to the new racism was subsequently developed by Pettigrew and Roel Meertens, who constructed a set of scales to measure constructs very similar to symbolic and traditional racism that they have used extensively in European countries to measure prejudice against local minorities and outgroups. Their first component, "blatant prejudice," was assessed by subscales of "threat" and "rejection" and seems essentially equivalent to traditional racism. Their second component, "subtle prejudice," was assessed by three subscales of "defense of traditional values," "exaggeration of cultural differences," and "lack of positive affect," and is clearly similar to symbolic racism.

Third, Irwin Katz and R. Glen Hass took the new versus old racism distinction a step further by suggesting that white

Americans' racial attitudes could involve not just a new symbolic or subtle racism but also racial ambivalence. Their findings suggested that many whites could simultaneously hold antiblack and problack attitudes, and the resulting ambivalence could account for highly polarized responses to blacks, with "desirable" behavior by blacks eliciting particularly positive responses and "undesirable" behavior eliciting particularly negative and discriminatory responses.

The fourth approach, that of aversive racism, also emphasizes ambivalence in American whites' attitudes to blacks, though in a somewhat different form. It proposes that most whites acquire egalitarian beliefs and a nonprejudiced self-image at an overt and conscious level. At the same time, however, their exposure to a society characterized by black-white differentiation and inequality generates underlying covert negative feelings to blacks. This ambivalence results in whites generally behaving in an overtly nondiscriminatory manner toward blacks in order to preserve their nonprejudiced self-images while also behaving in a discriminatory manner in more ambiguous situations where the discrimination can be rationalized away or excused.

The concept of new racisms has not been without controversy. Critics have asserted that symbolic racism has been conceptualized and measured inconsistently over time and that the varying themes identified with it have not yet been coherently articulated or adequately measured. It has also been suggested that the "new" racisms are not really different at all but simply more subtle and socially acceptable expressions of the same old racism.

Implicit and explicit prejudice. During the 1990s the idea of the existence of new forms of prejudice was taken a step further. The distinction was now made between explicit prejudice, operating at a conscious level and therefore including both traditional and modern racisms, and implicit prejudice, which was assumed to be automatically activated by target persons and to operate largely unconsciously.

A variety of measures of implicit prejudice have been used. Some are indirect or covert behavioral indices of prejudice, such as linguistic biases, eye contact, or nonverbal behaviors, which could be subject to intentional control but typically would not be. Others are truly implicit measures of automatic cognitive or physiological responses that cannot readily be intentionally controlled. The most common have been "priming techniques," which measure how quickly positive or negative stereotypes can be activated after individuals are briefly exposed to a group or social category label, and variations of that procedure, such as the Implicit Association Test (IAT), which assesses how strong the temporal association is between a group or social category label and positively or negatively evaluative terms.

It was initially assumed that these implicit measures might provide more accurate information about peoples' real attitudes, but research findings have suggested a more complex picture. Generally whites have shown markedly greater negativity toward blacks on implicit measures of racism than on explicit measures, as would be expected. The difficulty with the concept of implicit prejudice, however, has been that dif-

ferent measures of implicit stereotyping and prejudice have tended to be only weakly correlated with each other, suggesting that they might not be measuring a single dimension at all, and they have also tended to be uncorrelated with explicit measures of prejudice or behavioral indices of discrimination.

One possible reason for the discrepancies between implicit and explicit measures is that they might reflect different response systems. Dovidio et al. have shown that automatically activated implicit evaluative stereotypes predict people's spontaneous interracial reactions (such as eye contact and rate of blinking) but not their more deliberative, controlled interracial judgments or behaviors (overtly expressed attitudes, interview evaluations, or judgments of guilt in simulated court cases). Explicit prejudice measures such as the modern racism scale on the other hand predicted deliberative responses but not spontaneous reactions.

Two theories of prejudice have been used to explain why there might be considerable discrepancies between individuals in their explicit and implicit prejudice against a particular group. Both suggest this discrepancy might arise from individuals acquiring values that motivate them to attempt to control prejudiced attitudes or stereotypes that were acquired earlier in socialization and that are therefore automatically activated by target persons. However, the nature of the values and motives proposed by the two theories differ in certain crucial respects. The theory of aversive racism suggests that many whites have underlying, covert racist attitudes but adopt and express egalitarian attitudes at an overt level in order to maintain a self-image of themselves as nonprejudiced and egalitarian. Because of their covert racism, they will act in discriminatory ways in situations in which they can rationalize or excuse it and will do so without guilt. Patricia Devine's theory suggests that whites acquire negative stereotypes of blacks during socialization. Later some whites come to internalize explicitly antiracist values, which are genuine and deeply held. As a result, their underlying and automatically activated prejudiced reactions engender guilt and are therefore inhibited whenever they are under conscious control.

These theories, and most of the research on implicit prejudice, have assumed that implicit prejudice and stereotypes are stable evaluative orientations that are automatically activated in response to stigmatized group members. Recent research, however, has shown that implicit prejudices seem to be malleable and fluid and to vary markedly in response to situational cues and motivational influences. Andrew Karpinski and James Hilton have therefore suggested that implicit attitudes reflect the evaluative associations with out-groups that people have been exposed to in their environment and not the degree to which they endorse these associations. One implication of this is that because these "implicit" associations have not been consciously articulated and organized in "explicit" form, the actual evaluative out-group associations elicited in any situation may be markedly influenced by the nature of the activating cues, procedures, and situation. This could explain the variability in implicit prejudice across situations and measuring techniques and the weak correlations between different implicit measures and between them and explicit measures of prejudice.

Explaining Prejudice

There have been a number of historical shifts in the dominant explanations of prejudice, and it is possible to identify six distinct periods in the way in which prejudice has been understood by social scientists. These paradigmatic shifts in explanation have been influenced by social and historical circumstances making particular questions or issues about the nature and causation of prejudice salient at the time as well as by empirical research findings. Different social-policy approaches to prejudice have therefore characterized each of these six periods. These six historical periods, their dominant theoretical and conceptual approaches to prejudice, and their social policy emphases are summarized in Table 1 and briefly described below.

Race theory: Up to the 1920s. During this period, racist attitudes were largely viewed as natural responses of "advanced" Western peoples to "inferior" or "backward" colonial peoples or "racially different" minorities. These attitudes had their logical social-policy expressions in justifying the political domination of these "backward" peoples, their segregation (formal or informal), and discrimination against them.

Race prejudice: The 1920s and 1930s. After World War I, however, as Western colonial rule was increasingly challenged and a black civil rights movement emerged in the United States, the idea of the inferiority of other "races" came to be rejected, at least by intellectual elites and social scientists. This stimulated a dramatic reversal in the way in which racist attitudes were conceptualized, from natural responses to the inferiority of other races to race prejudice—that is, as unjustified, unfair, and irrational negative intergroup attitudes.

The dominant explanation of prejudice that emerged during this period was the psychoanalytically derived frustration-displacement theory. This approach saw prejudice as an unconscious defense through which social stress and frustrations were displaced through the scapegoating of out-groups and minorities. This seemed to explain both the irrationality and unfairness of prejudice and its social pervasiveness.

This explanation of prejudice had its logical expression in the social policy of assimilation. The typical targets of prejudice and scapegoating were those viewed as different from and "less developed" (socioeconomically, culturally, ethnically) than the dominant majority. Thus assimilation of these minorities and colonial peoples would "civilize" or "uplift" them socially and economically, and with this, prejudice and discrimination against them should gradually erode.

Ideology and personality: The 1940s and 1950s. After World War II the dominant explanation of prejudice shifted, driven largely by the need to explain the Holocaust and anti-Semitism in Nazi Germany. It did not seem conceivable that these could be acts of normal persons, so prejudice came to be seen as the expression of disturbed or authoritarian personalities propagating antidemocratic and authoritarian ideologies. The social-policy implication of this approach was that both racial and political tolerance would arise out of the spread of liberal democratic values and institutions and the defeat of authoritarianism in all its variants.

Historical shifts in dominant theoretical and social-policy approaches to prejudice

Social and historical context and issues	Concept of prejudice and dominant theoretical approach	Dominant social policy orientation to prejudice and discrimination
Up to the 1920s: White domination and colonial rule of “backward peoples”	Prejudice as a natural response to the deficiencies of “backward” peoples: Race theories	Domination, discrimination, and segregation are natural and justified social policies
The 1920s and 1930s: The legitimacy of white domination and pervasive prejudice challenged	Prejudice as irrational and unjustified reaction to people who are different: Psychoanalytic and frustration theories	Assimilation as a gradual process as minorities and colonial peoples become westernized and “uplifted”
The 1940s and 1950s: Nazi racial ideology and the Holocaust	Prejudice rooted in anti-democratic ideology and pathological needs within authoritarian personalities	Democratic and anti-authoritarian social structures and values will erode intolerance and prejudice
The 1960s: The problem of institutionalized racism in the American South	Sociocultural explanations: Prejudice rooted in the social norms of discriminatory social structures	Desegregation and anti-discriminatory laws will lead to intergroup contact, which will erode prejudice
The 1970s: The problem of informal racism and discrimination in the North	Prejudice as an expression of dominant-group interests in maintaining intergroup inequality	Reducing intergroup inequality through affirmative action and minority empowerment
The 1980s to the 2000s: The stubborn persistence of stereotyping, prejudice, and discrimination	Prejudice as an expression of universal cognitive-motivational processes: social categorization and social identity	Multicultural policies to provide minorities with esteem and foster positive nonthreatened identities and tolerance for all groups

SOURCE: Courtesy of the author

Culture and society: The 1960s. At the end of the 1950s a new paradigm shift occurred, as public attention increasingly focused on the campaign for civil rights in the American South. It did not seem feasible to explain racism in the American South—where ordinary “good citizens” holding democratic values were racist and supported discrimination—in terms of disturbed or authoritarian personalities. The explanatory paradigm that emerged saw racial prejudice as rooted in social structures in which segregation and discrimination had been legally institutionalized and had become social norms that were taught to individuals during socialization and maintained by conformity pressures and lack of interracial contact.

The social policies necessary to reduce prejudice flowed logically from these assumptions. Segregation and discriminatory practices must be abolished. Schools and workplaces must be desegregated. The guiding principle was the “contact hypothesis”: that racial segregation and unfamiliarity would perpetuate racial prejudice, while desegregation and intergroup contact under the right conditions would reduce it.

Group interests and racial inequality: The 1970s. The optimistic assumption that racial integration would eliminate racism in American society rapidly faded in the late 1960s and the 1970s. As the institutionalized segregation and old-fashioned racism of the South disappeared, it was simply replaced by informal discrimination and segregation and the more subtle “modern” racism of the North. The paradigm that emerged saw racism and discrimination not just as a problem of the South but as being rooted in the power relations and inequality between white and black in American society as a whole.

The new paradigm of the 1970s therefore viewed racial prejudice as expressing the interests of the dominant white group in maintaining racial inequality and keeping blacks as a disadvantaged and powerless underclass. This was accompanied by a shift in the social policies most needed to reduce

prejudice. To eliminate racism, the social, economic, and political inequalities between black and white would have to be changed, most notably through affirmative action and the political empowerment of blacks in American society.

Group identity and multiculturalism: The 1980s and beyond. By the late 1970s the stubborn persistence of American racism and discrimination, albeit in subtle and modern rather than crude and traditional forms, had been powerfully documented. In addition research findings have shown that simply classifying individuals in completely arbitrary “minimal” groups results in them engaging in intergroup discrimination and in-group favoritism. During the 1980s it began to seem that more fundamental and perhaps universal cognitive and motivational human processes might underlie intergroup bias, discrimination, and even prejudice. The social-cognitive approach that emerged then and became the dominant approach to understanding intergroup relations and attitudes saw universal human cognitive processes functioning to simplify the social world through social categorization, that is, classifying people as group or category members and stereotyping them as members of their groups or categories. Categorization would also result in people identifying with their social groups and categories to form valued social identities, which they would then be motivated to try to differentiate positively from others generating intergroup competition and in-group favoritism.

The inevitability of group differentiation and its expression in distinct group identities challenged the explicit or implicit assimilationist assumptions underlying policies such as integration and even affirmative action. Multicultural policies emerged logically from this new paradigm. These policies rest on a view of cultural and social diversity as both inevitable and valuable in their own right and have the explicit objectives of accepting, recognizing, and supporting subcultural and minority identities and tolerance for them.

Conclusion

A number of different theoretical approaches to explaining prejudice dominated social scientific inquiry at different stages during the twentieth century with each having distinctive social policy implications. These different approaches seemed to emerge in response to specific historical circumstances that made particular questions about the nature or causation of prejudice salient for social scientists. The study of prejudice has therefore provided an interesting case study in how values and social milieu interact with and influence social scientific concepts and explanations.

See also *Apartheid; Discrimination; Diversity; Race and Racism; Segregation; Social History, U.S.*

BIBLIOGRAPHY

- Brigham, John. "Ethnic Stereotypes." *Psychological Bulletin* 76 (1971): 15–38.
- Crosby, Faye, and Susan Clayton. "Affirmative Action and the Issue of Expectancies." *Journal of Social Issues* 46 (1990): 61–79.
- Devine, Patricia. "Implicit Prejudice and Stereotyping: How Automatic Are They?" *Journal of Personality and Social Psychology* 81 (2001): 757–759.
- . "Stereotypes and Prejudice: Their Automatic and Controlled Components." *Journal of Personality and Social Psychology* 56 (1989): 5–18.
- Dovidio, John, and Samuel Gaertner. "Stereotypes and Evaluative Intergroup Bias." In *Affect, Cognition, and Stereotyping*, edited by Diane Mackie and David Hamilton, 167–193. San Diego, Calif.: Academic, 1993.
- Dovidio, John, et al. "Stereotyping, Prejudice, and Discrimination: Another Look." In *Stereotypes and Stereotyping*, edited by Neil Macrae, Charles Stangor, and Miles Hewstone, 276–319. New York: Guilford, 1996.
- Duckitt, John. "Reducing Prejudice: An Historical and Multi-Level Approach." In *Understanding Prejudice, Racism, and Social Conflict*, edited by Martha Augoustinos and Katherine Reynolds. London: Sage 2001.
- . *The Social Psychology of Prejudice*. New York: Praeger, 1992.
- Fiske, Susan T. "Stereotyping, Prejudice, and Discrimination." In *The Handbook of Social Psychology*, 4th ed., edited by Daniel Todd Gilbert, Susan T. Fiske, and Gardner Lindzey, vol. 2, 357–411. New York: McGraw-Hill, 1998.
- Gaertner, Samuel L., and John F. Dovidio. "The Aversive Form of Racism." In *Prejudice, Discrimination, and Racism*, edited by John F. Dovidio and Samuel L. Gaertner, 61–89. Orlando, Fla.: Academic, 1986.
- Green, Donald P., Robert P. Abelson, and Margaret Garnett. "The Distinctive Political Views of Hate-Crime Perpetrators and White Supremacists." In *Cultural Divides: Understanding and Overcoming Group Conflict*, edited by Deborah A. Prentice and Dale T. Miller, 429–464. New York: Russell Sage, 1999.
- Hagendoorn, Louk. "Intergroup Biases in Multiple Group Systems: The Perception of Ethnic Hierarchies." In *European Review of Social Psychology*, edited by Wolfgang Stroebe and Miles Hewstone, vol. 6, 199–228. Chichester, U.K.: Wiley, 1995.
- Karpinski, Andrew, and James Hilton. "Attitudes and the Implicit Association Test." *Journal of Personality and Social Psychology* 81 (2001): 744–788.
- Katz, Irwin, and R. Glen Hass. "Racial Ambivalence and American Value Conflict: Correlational and Priming Studies of Dual Cognitive Structures." *Journal of Personality and Social Psychology* 55 (1988): 893–905.
- Maass, Anne, Luigi Castelli, and Luciano Arcuri. "Measuring Prejudice: Implicit versus Explicit Techniques." In *Social Identity Processes: Trends in Theory and Research*, edited by Dora Capozza and Rupert Brown, 96–116. London: Sage, 2000.
- Owen, Carolyn, Howard Eisner, and Thomas McFaul. "A Half-Century of Social Distance Research: National Replication of the Bogardus Studies." *Sociology and Social Research* 66 (1981): 80–98.
- Pettigrew, Thomas F. "Reactions toward the New Minorities of Western Europe." *Annual Review of Sociology* 24 (1998): 77–103.
- Pettigrew, Thomas F., and Roel Meertens. "Subtle and Blatant Prejudice in Western Europe." *European Journal of Social Psychology* 25 (1995): 57–75.
- Sears, David O., et al. "Is It Really Racism? The Origins of White Americans' Opposition to Race-Targeted Policies." *Public Opinion Quarterly* 61 (1997): 16–53.
- Simpson, George, and J. Milton Yinger. *Racial and Cultural Minorities: An Analysis of Prejudice and Discrimination*. 5th ed. New York: Plenum, 1985.
- Smith, Eliot R. "Social Identity and Social Emotions: Toward New Conceptualizations of Prejudice." In *Affect, Cognition, and Stereotyping: Interactive Processes in Group Perception*, edited by Diane Mackie and David L. Hamilton, 297–315. San Diego, Calif.: Academic, 1993.
- Stangor, Charles, Linda Sullivan, and Thomas Ford. "Affective and Cognitive Determinants of Prejudice." *Social Cognition* 9 (1991): 59–80.

John Duckitt

PRESENTISM. *Presentism* is a neologism coined to identify today's preoccupation with the present age as the essential temporal referent in historical interpretation. (One notes that the term does not appear in the earlier edition of this *Dictionary*.) As a perspective on the meaning of historical time, it accords the present a privileged status. Presentism therefore stands as a counterpoint to the historicist idea of "progress," which dominated thinking about historical time during the modern age in its greater valuation of the future. As a stance on historical interpretation, moreover, presentism takes issue with the proposition that historical knowledge of the past should be pursued for its own sake, and offers instead the call for interpretations of the past that contribute to morally responsible critical perspectives on the present age.

Historical Time

In his classic essays on the time of history, the Enlightenment philosopher Immanuel Kant (1724–1804) proposed a unified narrative framework for recounting the way humankind over time had come to understand its own predicament, a saga with a conjectural beginning, middle, and end. Modern historical writing has for the most part played out this portrayal of history's script as a sustaining, all-encompassing "grand narrative." But presentism challenges the proposition that history

may be plotted on a single, continuous timeline. More and more, historians of our own day would prefer to divide the time of history into “regimes of historicity,” by which they refer to changing conceptions of historical time in different epochs of history.

Favoring the past. The regime of historicity in antiquity tended to favor beginnings. Thenceforth, at least until the age of the Renaissance, historians in the Western world presupposed a golden age shining forth as a guiding beacon out of humankind’s primordial past. As a lost Eden, it was a time to revere. The precedents of origins—ways of life as they were in *illo tempore*—served as models for emulation in the present. In interpreting the meaning of the past, this notion of a time of origins denotes a fullness of human experience then to which life now can never measure up. Humans may approach that past in their imaginative longings, the ancients argued, but only as a simulacrum of what it once was. Accordingly, they believed that historical time moves in circles in the repetitious search for a lost harmony, played out in the rise and fall of nations, the ebb and flow of human affairs. Implicit in such a notion of time is a fatalism about the future course of events, governed as they are by an all-knowing Providence. The classic formulation of this conception of time in the Western tradition was St. Augustine’s (354–430) speculation on the fortunes of the City of Man after the fall of humankind (*The City of God*, 427 C.E.). In modified versions, such a view of history had apologists as late as the mid-eighteenth century, notably Giambattista Vico (1668–1744), who formulated a philosophy of history based on the “course and recourse” of civilizations in his *New Science* (3rd ed., 1744). The notion of an archetypal golden age appears as well in a broad array of non-Western cultures.

Favoring the future. Historians of the modern age (i.e., from the Enlightenment well into the twentieth century), by contrast, assigned the future a favored status. Essential to such a notion of time is the proposition that humankind fashions its own destiny, and so has some measure of control over its own fortunes. Implicit in such a conception is the prospect of a better way of life to be attained over time. In its various depictions, such a vision of a more perfect society in the making incited rising expectations. In this view, historical time moves in a linear direction toward a transcendent future. Throughout the modern age, optimistic theories of progress (for example, Kant, Georg Wilhelm Friedrich Hegel, Jules Michelet, Karl Marx), and by the early twentieth century more disillusioned ones of decline (such as Oswald Spengler, Arnold Toynbee), became the fashion. On a timeline projected toward what was anticipated to be a transforming future, the present marked only a stage along the way. In early formulations of this conception of historical time, the process of historical change proceeds teleologically—toward the fulfillment of a process that was implied in its beginning. While the deterministic apparatus of metahistorical design was discarded by the late nineteenth century, the presumption of humankind’s advance into a better future, inspired by practical achievements in scientific technologies and rational reforms in social and political institutions, remained implicit in a great deal of historical writing about the course of Western civilization.

Favoring the present. But just as historical interpretation had been divested of its once profound reverence for past precedent, so it has been disabused of its more recent great expectations for the future. As a regime of historicity, the present age is distinctive for its preoccupation with its own predicament. The distinguishing trait of today’s historians of the present age is their newfound confidence that they can acquire a critical perspective on a present age in which they themselves are immersed. The early-twentieth-century pragmatism of American historians Charles Beard (1874–1948) and Carl Becker (1873–1945) prepared the way for this perspective by pointing out the subjectivity of the historians’ choices about questions to ask of the past. But the larger significance of presentism as a new historical perspective on time was signaled in the emerging distinction between a modern and a postmodern age as a basis for identifying an epochal change in the mid- to late twentieth century. Some philosophers of history have recently offered an alternative formulation of this reorientation in their notion of an “end” to history, conceived not as the eschatological end of time but as the end of the modern regime of historicity.

The philosopher who contributed most to this new way of historical thinking was Michel Foucault (1926–1984). Foucault rejected the historicist claim that the historians’ task is to return to the origins of the phenomenon under investigation to assess its meaning in light of its initial context, and then to trace modifications of its meaning in the ascent from that past into our present. Foucault reversed the interpretive process. Rather than search for the sources of language, he preferred to plot the genealogical descent of modes of discourse backward from the present age in order to appreciate the discontinuities revealed in disruptive and unexpected meanings encountered along the way. From this perspective, he explained, one recognizes that old forms of discourse are easily invested with new meanings, to be redeployed in unrelated ways. Linguistic forms are continually and often abruptly reinvented in the present to suit the needs of changing configurations of political and social power.

The present in historical interpretation. But the historians’ newfound attention to the present as the privileged temporal referent has come with a price, for it has destabilized the place of the present in historical interpretation. To privilege the past was to provide a solid ground for a world in which precedent was a reassuring guide to present action. To privilege the future was to provide a sense of direction for actions intended to hasten the coming of an unfulfilled destiny. But as past and future recede as horizons of transcendence, the historical meaning of the present becomes more elusive. Until very recently, historians were reluctant to approach the present age in their interpretations. Most of them ruled out historical assessments of the most recent fifty or sixty years (roughly the time of living memory) as a prudent hedge against missing patterns hidden in the flux of contemporary events, for unforeseen factors continually intrude to upset the most wisely conceived interpretive judgments about the historical meaning of the present age.

In light of the presentist perspective, therefore, the meaning of the present as a moment in historical time has come to

be characterized by its indeterminacy. The diminished faith of the present age in the past's precedents and the future's promise has dissolved the sense of continuity essential to the idea of a single timeline of history. History is no longer conceived as a grand narrative, but as a host of discrete, and not necessarily congruent, narratives that proceed from the particular topics historians choose to address in their random travels back in time. Such a perspective breaks up the sense of continuity that informed the understanding of historical time in the modern age. If the past is no longer perceived to exercise an inertial power, its uses in the present are understood to be more open-ended. The horizons of the present age are wider, even if expectations of the future are no longer as clear. The past is thereby revisited as a resource for re-visioning the future in terms of its infinite possibilities. As the future becomes less predictable, however, so too does the past. It becomes strange, a "foreign country" to be entered in more tentative ways.

Presentism, its apologists therefore contend, should not be charged with anachronism—that is, accused of interpreting the past as if it were just like the present. Rather, it underscores the differences between past and present, and the more discerning judgment needed to make sense of them in historical interpretation. It introduces as well the notion of the relativity of historical time. In other words, it not only discriminates among regimes of time, but also alters perception of the tempo at which time flows. The punctuation of time in historical periodization depends on the nature of the phenomenon addressed. While the plotting of political events lends itself to a perception of a rapid pace of change, that of social mores appears to proceed more slowly, whereas that of environmental change is rarely perceptible in living memory. In its geological depths, history becomes almost "immobile".

Concerns of History

As the dominant historical perspective on time in the contemporary age, presentism speaks to the urgency of the concerns of today's historians, notable among them:

A pessimism about the near past. The Holocaust and other egregious atrocities of the mid- to late twentieth century have rendered the idea of history as a continuous narrative problematic. The motives behind such acts have been so incomprehensible as to defy ready historical explanation. As historical assessment is postponed, gaping holes in previously accepted narratives begin to appear (as in the problem of assessing the place of the Third Reich in the history of modern Germany, or of the Soviet Union in the history of modern Russia). Nor has the wealth produced through capitalist economic expansion and the unprecedented affluence of Western society inspired unqualified optimism about the human prospect at the turn of the twenty-first century. Their benefits are measured against the deleterious effects of a seemingly insatiable consumerism, with its legacy of environmental destruction and overuse of natural resources critical for the future well-being of humankind. The outlook, moreover, is complicated by present-day problems that have proved intractable, among them: fulminating and unsustainable population growth; the pollution of the biosphere; and the pervasive tenor of violence in global politics, exacerbated by media-driven publicity. If the

techniques of enhancing the quality of life in the present age are vastly superior to any that have gone before, widespread human suffering remains persistent as the divide between rich and poor nations widens.

The eclipse of Eurocentrism. Given historical change whose dynamics are global in scope in the present age, the Eurocentric timeline of modern history has lost much of its meaning as a referent for interpreting today's problems. The time of history, previously conceived in light of the adaptation of the people of the world to a Western conception of civilization's advance, is now reconceived to consider the effects of encounters among diverse cultures, for good or ill. Such a vision of history reinterprets the past in terms of changing global patterns of equilibria and disequilibria. World historians showcase the assessment of political, cultural, and economic interchange, and so discard the once dominant model of history that focused on developments within the matrix of Western civilization.

The media revolution. The advent of media culture has given a new power to imagery as a mode of publicity. It has effaced continuities between past and present in its constant creation, re-creation, and recycling of images. It reveals the degree to which linear thinking about time was inextricably intertwined with the protocols of the print culture of the modern age. Therein images of the past were fixed securely in their places in time. Media, however, continually reinvents the images of human experience and mobilizes them in ways that intensify the public's desire for present-minded interpretations. These tend to dismiss the preoccupations of the past as extraneous to present concerns. A present-minded perspective serves the needs of a consumer-oriented mass culture, while obliterating the traditions of the past and thereby losing sight of the complex, richly layered textures of societies in times past.

The acceleration of time. The revolution in the technologies of communication has multiplied exponentially the publicizing of events, and so has reinforced present perceptions of the ever more discrete segmentation of time. The effect has been to create the impression that time is speeding up (a perception made manifest, for example, in the *Timetables of History* [3rd ed.; Bernard Grun, ed.], a popular reference of historical chronology since the beginning of recorded historical time but heavily weighted toward the events of the present age).

Symptomatic of presentism as a new regime of historical time is the historians' current obsession with history's relationship to collective memory, for memory displays all of the traits that betoken the sense of urgency about interpreting the meaning of the present age. Memory is present-minded. It is also protean, unreliable, easily and quickly remodeled. The shapes that collective memories assume reflect constellations of social or political power. In the process, the importance of some memories is exaggerated, others diminished. The study of the politics of memory has made historians more aware of the frequent misrepresentation of the past in what is officially remembered and what is thereby ignored and forgotten. It has also made manifest how commemorative monuments and rituals are used to further present-minded political ends. The historians' concern, therefore, is to tame memory—to expose its

distortions, repressions, and politics in more refined, comprehensive, and discriminating historical interpretations. At the same time, the interest in memory has made historians more sensitive to their own motives, presuppositions, and biases.

But historians have also come to understand that imagination is the reverse side of memory, and that they cannot evade moral responsibility in the choices they make about how the past should be rendered in the histories they write. In an age that has lost the consoling faith in a transcendent past or future, the responsibility of revisiting the past to make sense of the daunting problems of the present age has become more momentous. For this reason, the present vis-à-vis the past appears to today's historians as an expanding presence in their efforts to understand the nature of historical change. Historians are thus faced with a puzzle—the dilemma of how to reconcile the imposing demands of memory's immediacy with their own need for more deliberate and discerning judgment.

See also **Historiography; Memory; Narrative; Progress, Idea of**

BIBLIOGRAPHY

- Ariès, Philippe. *Le temps de l'histoire*. Paris: Editions du Seuil, 1986.
- Eliade, Mircea. *Cosmos and History: The Myth of the Eternal Return*. Translated by Willard R. Trask. New York: Harper and Brothers, 1959.
- Foucault, Michel. *The Archaeology of Knowledge*. Translated by A. M. Sheridan Smith. New York: Pantheon, 1972.
- Harlan, David. *The Degradation of American History*. Chicago: University of Chicago Press, 1997.
- Hartog, François. "Temps et histoire: 'Comment écrire l'histoire de France?'" *Annales HSS* (1995): 1219–1236.
- Kant, Immanuel. *On History*. Translated by Lewis White Beck, Robert E. Anchor, and Emil L. Fackenheim. Indianapolis: Bobbs-Merrill, 1963.
- Koselleck, Reinhart. *Futures Past: On the Semantics of Historical Time*. Translated by Keith Tribe. Cambridge, Mass.: MIT Press, 1985.
- Ladurie, Emmanuel Le Roy. *The Mind and Method of the Historian*. Translated by Siân Reynolds and Ben Reynolds. Chicago: University of Chicago Press, 1981.
- Lowenthal, David. *The Past Is a Foreign Country*. Cambridge, U.K.: Cambridge University Press, 1985.
- McNeill, William H. *Mythistory and Other Essays*. Chicago: University of Chicago Press, 1986.
- Niethammer, Lutz. *Posthistoire: Has History Come to an End?* In collaboration with Dirk van Laak. Translated by Patrick Camiller. London: Verso, 1992.
- Noiriel, Gérard. *Qu'est-ce que l'histoire contemporaine?* Paris: Hachette, 1998.
- Pomian, Krzysztof. *L'ordre du temps*. Paris: Gallimard, 1984.

Patrick H. Hutton

PRIMITIVISM. See Arts.

PRIVACY. The volume of studies on privacy has increased tremendously since the 1970s, especially in the United States, and their geographical spread has become wider. These studies

address new topics, including celebrity privacy for political and other public figures and privacy rights in international human rights law. Developments in advanced technology, such as electronic storage and DNA testing, have added increasing urgency to the debate, while overt and covert surveillance has become the major concern of Internet sites on privacy issues.

Debates on privacy are conducted on all levels. Personal, governmental, and commercial interests are all engaged, and academic arguments are informed by perspectives from almost every discipline in the humanities and social sciences, including philosophy, politics, geography, law, economics, sociology, social policy, anthropology, literature, language, and history. Journalists and the general public profess an intuitive understanding of what constitutes privacy, but decades of research suggest that there is a wide range of meanings even within a nation-state or common language. Within given communities, variations in attitudes can be related to age, gender, economic and social standing, and ethnic origin, but significant variations can also be found among individuals where these factors are roughly the same. Nevertheless, modern societies share an understanding that privacy is intelligible as a concept among the population at large and, as such, should be explicitly protected by law or custom as a valuable or even essential attribute of civilized life.

Privacy also appears in popular journalism and academic studies as a component of subjects that range across human experience, such as a sense of self; gender and body; private space and family life; intimacy and exclusion; and the impact of globalization on local and communal identity. Privacy studies tend to focus on one or more of the following aspects: (a) a sense of privacy, as experienced by people from different countries, times, and backgrounds; (b) distinctions between public and private realms; (c) rights of privacy in national and international law; (d) the role of advanced technology in privacy protection and intrusion; (e) the functions and values of privacy.

A Sense of Privacy

The existence of a sense of privacy across different cultures and times is frequently asserted or denied on little evidence. One of the most influential studies to encourage the belief that a sense of privacy is specific to the modern Western world was *The Civilizing Process: The History of Manners and State Formation and Civilization* (originally published as *Über den Prozess der Zivilisation* in 1939) by Norbert Elias (1897–1990). Elias did not take privacy as his subject, but his comments on shame, embarrassment, delicacy, and modesty are frequently quoted by writers on privacy. His work examines the process by which a code of polite manners was formulated and disseminated between the sixteenth and eighteenth centuries in Europe, starting with the publication of *De civilitate morum puerilium* (On civility in children) by Desiderius Erasmus (1466?–1536) in 1530. Erasmus dealt with the changing etiquette of familiar and social life, ranging from snot (how to handle a handkerchief before and after blowing one's nose) to urination (someone inadvertently seen urinating should not be greeted).

A large part of polite manners focused on how to accord personal space (physical or mental) to individuals (or groups of people) in which to carry out desirable or necessary activities

PRIVACY AND POPULAR FICTION

Habermasian concepts were so much part of British cultural life by the 1970s that readers of middle-brow fiction were deemed to be a knowledgeable audience for the novel *The History Man* (1975) by Malcolm Bradbury, whose protagonist Howard Kirk is writing a sociological treatise called *The Defeat of Privacy*. Throughout the novel, Kirk repeatedly attacks the notion of privacy as outmoded while in the last resort guarding his own privacy in his writing and sexual life. A hugely successful satire on academic sociology in contemporary Britain, *The History Man* was repeatedly re-issued throughout the 1970s and 1980s.

The academic sociologists and social psychologists who take part in one key scene in *The History Man*, a departmental meeting, are described by the author as “sophisticates of meetings, readers of Goffman.” Although the Canadian writer Erving Goffman restricts himself in works such as *The Presentation of Self in Everyday Life* (1956) to discussing “Anglo-American” behavior, his analysis of the psychological functions of privacy or “backstage behavior” are widely applicable.

without embarrassment to themselves or to onlookers. Elias did not assume that privacy as a goal of etiquette was unique to Europe; commenting on how meat is served and eaten, he notes that the concealment of carving behind the scenes was effected much earlier and more radically in ancient China than in the West.

Critics whose knowledge was largely confined to European and American history regarded a sense of privacy as peculiar to a specific Western economic and cultural environment. In a 1965 essay, “Literature and Post-History,” the American literary critic George Steiner (1929–) related the rise of the Western novel and its audience to the domestic privacy, leisure, and reading habits of the mercantile class of the eighteenth century, claiming that printed fiction and individual privacy were alike products of the typographical revolution. If typography is a measure of impersonality and privacy, then it would be reasonable to regard late imperial China, where moveable type was invented and where printed fiction flourished, and Korea, the first country in which moveable type passed into common use, as founders of the sense of privacy in the modern world. Historians of English literature nevertheless continued to site the development of a sense of privacy alongside long prose fiction in the eighteenth century. Works such as *Privacy and Print: Reading and Writing in Seventeenth-Century England* (1999) by Cecile M. Jagodzinski and *Privacy: Concealing the Eighteenth-Century Self* (2003) by Patricia Meyer Spacks also identified privacy as a special attribute of women, a theme that appears in many cultures under different guises, despite ample evidence to the contrary.

Anthropologists, on the other hand, produced evidence that privacy is a universal human condition whose expression is not necessarily verbal and is adaptable to specific circumstances.

Interest in the existence of universal traits in human behavior peaked in the early 1980s, when conventional assumptions on cultural differences that formed research methodology from the 1920s onwards were undermined by new research in the late 1960s and 1970s that showed the differences had been exaggerated and similarities had largely been ignored; new research in linguistics and in brain-mapping gave added support.

A summary of this debate and of traits that can be categorized as universal are contained in Donald L. Brown’s *Human Universals* (1991). Among the characteristics of what Brown calls “Universal People” (UP) are standards of sexual modesty, sex generally in private, and discreetness in elimination of body wastes. Universal people possess a concept of the person: “They distinguish self from others, and they can see the self both as subject and object. . . . They know that people have a private inner life, have memories, make plans, choose between alternatives, and otherwise make decisions” (p. 135). Most but not all of the lists of universal characteristics compiled by anthropologists since 1945 and summarized by Brown include privacy.

The anthropologists’ evidence became part of the background to discussions on privacy in the 1980s and 1990s. Still the belief persisted among non-anthropologists that a distinctively modern sense of privacy was an attribute of post-industrial societies. Even a philosopher as sensitive to ethnocentricity as Charles Taylor in 1981 and again in 1985 identified a sense of privacy as a defining characteristic of a specifically modern (and by assumption therefore Western) concept of self-identity. In premodern societies, according to Taylor, “One’s life was led before everyone else, and hence shame and its avoidance played a big role in people’s lives. There was no space, not just physically but psycho-socially, to

PRIVACY AND POPULAR FICTION

Rights to privacy in the United States have been heatedly debated in issues such as abortion, especially for minors, and the personal conduct of candidates for or persons elected to high political office. These concerns form the basis of two novels by the best-selling author Richard North Patterson: *No Safe Place* (1998) and *Protect and Defend* (2000). Underpinning a fast-paced narrative on electoral pressures, congressional trade-offs, abortion, adultery, domestic violence, and presidential privacy is thorough research on U.S. law and the advocacy of parties on all sides. Despite his even-handedness, the author comes down strongly against a bill requiring parental permission for the late termination of a minor's pregnancy in *Protect and Defend*. The fictional bill is defeated in the novel; three years later, President George W. Bush signed a similar bill into law.

withdraw into the privacy of one's own self-estimate, or the opinions of a circle based on affinity. . . . With the rise of the modern identity, this intensely public life withers. The community retreats, and the nuclear family achieves privacy" (pp. 261–262). In modern societies, Taylor concluded, privacy has become a requirement for the good life, a space for family affection and individual fulfillment.

Barrington Moore's *Privacy* (1984) was a unique contribution to the debate in examining four widely different types of premodern societies: primitive societies, classical Athens, Hebrew society as revealed in the Old Testament, and ancient China. Much of his discussion about ancient Greece and China is on the mutual obligations of government and the populace at large, and he records the Confucian distinction between the separate realms of the state (public) and the family (private), as well as information in early texts on courtship, the family, and friendship. Starting from a narrow definition of privacy, Moore found that rights to privacy in early Confucian China were weak in comparison those enjoyed in fourth-century B.C.E. Athens. He concluded that privacy of communication was possible only in a complex society with strong liberal traditions and that in the absence of democracy, private rights are either few or undeveloped.

The spread of globalization and the inclusion of privacy rights in international law has rendered almost irrelevant the argument about Western and non-Western or modern and premodern societies, as governments in all parts of the world strive to identify themselves as modern, democratic, and based on the rule of law. Although speculation in popular opinion, journalism, and conservative nationalism continues to dwell on which societies or ethnic groups do or do not enjoy a sense of privacy, the academic debate in the 1970s and 1980s shifted to distinctions between public and private realms.

Public and Private Realms

One of the earliest modern studies of privacy was by Hannah Arendt (1906–1975), who noted the blurring of the public

and private realms after Roman times. Jürgen Habermas (1929–) systematized and developed her concept of social and public life since Greek and Roman times in *Strukturwandel der Öffentlichkeit* (1962), which became the chief source for discussion of public and private realms from the 1960s on (the English translation, *The Structural Transformation of the Public Sphere*, appeared in 1989). Habermas was primarily interested in the public realm but found its vitality dependent on an organization of private life that enabled and encouraged citizens to rise above private identities and concerns. Drawing on literary evidence as well as philosophers and political writers, Habermas focused on the development of the modern European polity. His distinction between mutually interpenetrating public and private spheres within a general private realm (i.e., as opposed to the state) has led to considerable confusion, but his main thesis, that modern society has undergone a transformation in which the expansion of the public sphere within the private realm has taken place at the expense of the private sphere, became a dominant theme in Western culture in the late 1960s and 1970s. To his more radical followers, the apparent triumph of the public sphere represented a post-Marxian liberation from the petty concerns of private life.

The rise of communitarianism in the late 1980s further complicated the public versus private debate, aligning the public interest with conservative values rather than political reform. The American sociologist Amitai Etzioni's *The Limits of Privacy* (1999) depicted privacy in the United States as a highly privileged state that needed to be modified for the sake of common interests in public safety and public health. Paradoxically, his evidence showed that intrusions on privacy came chiefly from the private sector and that the privacy of individuals was best protected by granting more powers to governments.

The interface of public and private realms in modern Western societies is most strikingly evident in debates concerning abortion, domestic violence, and the private lives of public officials. Contrary to popular belief, no serious academic study has been able to draw a strict line between public and private realms, for

TERMINOLOGY

The English words *private* and *privacy* come from the Latin *privatus*, meaning “withdrawn from public life, deprived of office, peculiar to oneself,” and the generally negative sense is continued into the early understanding of the English word *private*, whose first recorded appearance goes back to 1380. The substantive *privacy* is not recorded until 1450, and its further meanings of “personal relationships,” and then “intimacy” and “confidential relationships” developed even later in succeeding centuries. By the end of the nineteenth century, *privacy* had begun to refer to legal and political rights, associated with modernity and advanced civilization, and attributed relatively or very high value. These associations were not transferred to *private* in its meanings of selfish interests or property rights or access. Near-synonyms for *private* as a descriptor in English in other contexts include *individual*, *personal*, *familiar*, *family*, *domestic*, *secret*, *confidential*, *secure*, *inner*, *interior*, and *intimate*; an Elizabethan

equivalent term for *privacy* *avant la lettre* is *contemplation*.

Many European languages do not have exact equivalents of the terms *private* and *privacy*. In Dutch, for example, the words *eigen* (cognate with “own”) and *openbaar* (cognate with “open”) are used with reference to property or access where English would use “private” and “public.” Swedish has a close equivalent for *private* (*privat*), but not for *privacy*. The Finnish words related to *privacy*, such as *yksityisasia* (“private or intimate affairs”), *yksityinen* (“private as opposed to public”) and *yksityisyydensuoja* (“private data protection”) are derived from the word *yksi* meaning “one” or “single.” Despite this etymological diversity, few English-speakers would wish to claim on linguistic grounds that concepts of privacy in the Netherlands, Sweden, or Finland are radically different from those held in the United Kingdom or United States.

reasons related to methodology and terminology. It is inherently unreasonable, for example, to expect that hard and fast borders are possible in such complex matters of political and social relationships. Studies in English, in particular, are typically confused by an ambiguity that is not necessarily present in other European languages (i.e., meanings of the attributive “private” that do not carry over into the substantive “privacy”). Attempts in the United States to incorporate a defense of privacy into law in the 1980s highlighted problems of terminology and definition.

Rights of Privacy in National and International Law

The principle of a right of privacy was traced back to ancient Jewish law in Samuel H. Hofstadter and George Horowitz’s influential *The Right of Privacy* (1964). Hofstadter, a justice of the New York Supreme Court, and Horowitz, a law professor, also cited case law from European and British Commonwealth countries to show the range of codified legal rights (or their absence) current at the beginning of the 1960s. This state of affairs gradually changed after the General Assembly of the United Nations “took cognizance” of the rights of privacy as formulated in English in Article 17 of the International Covenants on Human Rights in 1960. The text of Article 17 declared that “(1) No one shall be subjected to arbitrary or unlawful interference with his privacy, family, home or correspondence, nor to unlawful attacks on his honour or reputation;” and “(2) Everyone has the right to the protection of the law against such interference or attacks.”

Most works on privacy written after 1960 referred at least in passing to privacy as a universal human right, despite different legal systems. For practical reasons, however, discussions on legal aspects of privacy—as in Ruth Gavison’s often-quoted study in *The Yale Law Journal*, “Privacy and the Limits of the Law” (1980)—tend to be country-specific. Studies of rights to privacy in law also accepted nation-states as imposing significant boundaries; although to some extent common law in England corresponds to common law in the United States, the different legal systems of Scotland and continental Europe, not to mention other parts of the world, appear to be too remote for realistic comparison. Gavison’s methodology utilized a framework distinguishing *status* (privacy as a situation of an individual vis-à-vis others, rather than a claim, a psychological state, or a form of control) and *characteristics* (related to secrecy, anonymity, and solitude) to establish what she calls “a neutral concept of privacy” that might be used for cross-cultural comparison. This attempt at a legally acceptable definition has been criticized in principle and shown to be unworkable in practice.

Rights to privacy in law and their political and ethical implications in Britain and its colony Hong Kong have been exhaustively studied by Raymond Wacks, professor of law at the University of Hong Kong, in *The Protection of Privacy* (1980), *Personal Information: Privacy and the Law* (1989), and *Law, Morality, and the Private Domain* (2000). A collection of essays published as a special issue of the *European Human Rights*

DEFINITIONS

Producing an adequate definition of privacy is one of the most intractable problems in privacy studies. A University of Edinburgh Ph.D. dissertation by Katherine J. Day, "Perspectives on Privacy: A Sociological Analysis" (1985), listed more than a hundred examples. One of the oldest definitions remains influential: Samuel Warren and Louis Brandeis's 1890 declaration that privacy is the right of the individual to be left alone. However, its negativity and stress on the individual as the locus of privacy have had unfortunate consequences.

Alan F. Westin's 1967 definition of privacy is the most commonly cited, but strictly speaking his is not so much a definition as a two-tier description of privacy states and privacy functions. Julie Inness's 1992 attempt combines the aspects of control over access and the intimate nature of

privacy in a three-fold definition, but it requires further definition of what is meant by "intimate" and fails to cope with non-intimate instances of privacy.

Ruth Gavison highlighted the difficulty of legal definitions of privacy in 1980, and Raymond Wacks further explored the issue in 1989. Wacks concluded that the term was so overlaid with assumptions and ambiguous in terms of its use that conceptual coherence was an unreachable target. The proliferation of definitions and their unsuitability for legal purposes have therefore led some legal scholars to avoid the term *privacy* in formulating laws for its protection. It is highly unlikely, however, that the term will disappear from common use, since most people are content to muddle along with an imperfect but workable understanding.

Law Review in 2003, edited by Jonathan Cooper, raises cross-cultural issues such as transsexual marriage, policing, and the protection of privacy in the workplace as well as surveillance and constitutional rights. The most exhaustive global survey on rights under national and international laws is David Banisar's *Privacy and Human Rights 2000: An International Survey of Privacy Laws and Developments*, jointly published by the Electronic Privacy Information Center in Washington D.C. and Privacy International in London. Both organizations operate invaluable Web sites that include news, archives, and bibliographies. Inevitably, their emphasis is on ways in which advanced technology opens up new avenues for intrusions into privacy and for its protection.

Advanced Technology: Privacy Protection and Intrusions

Alan F. Westin's *Privacy and Freedom* (1967), a comprehensive work whose descriptions of privacy states and functions are cited and elaborated upon by most subsequent writers on privacy, was prompted by concern about new technologies for invading privacy in the hands of government and commercial agencies. As professor of public law and government at Columbia University, Westin occupied an influential position from which to propose changes in U.S. law. Calling for greater protection to the ordinary citizen, Westin pointed out that the tradition of limiting the surveillance powers of the authorities over the private activities of individuals and groups goes back to ancient Greece. He then dedicated over a decade's research to collecting data and investigating attitudes towards privacy in the United States.

In *Databanks in a Free Society* (1972), one of the first books linking data collection with privacy, Westin and his co-author Michael A. Baker found that the scope of information collection about individuals had not yet significantly expanded as a direct result of computerization, but a National Science Foundation conference in 1979 in which Westin was a key speaker concluded that this was no longer the case. A Harris survey directed by Westin in 1979 on attitudes towards privacy in the United States, which addressed the potential abuse or misuse of personal information by business or government, identified growing public concern about the perceived erosion of privacy in the early 1970s in the United States.

Inspired by Westin's advocacy to make the issue of data protection and privacy his life's work, David H. Flaherty produced two pioneering surveys, *Privacy and Data Protection: An International Bibliography* (1984) and *Protecting Privacy in Surveillance Societies: The Federal Republic of Germany, Sweden, France, Canada, and the United States* (1989). The former lists 1,862 Western-language works (books, articles, and government reports) published between 1978 and 1983 concerning Canada, the Federal Republic of Germany, France, Sweden, the United Kingdom, the United States, and the rest of the world. An impressive number of U.S. works on threats to information privacy followed, including *Managing Privacy: Information Technology and Corporate America* (1994) by H. Jeff Smith, *Privacy and Its Invasion* (1995) by Deckle McClean, *The Culture of Surveillance* (1997) by William G. Staples, *Technology and Privacy: The New Landscape* (1997) edited by Philip E. Agre and Marc Rotenberg, and *The Electronic*

CELEBRITY PRIVACY

The issue of celebrity privacy goes back at least to the nineteenth-century growth of newspapers, but came to dominate discourse on privacy at the end of the twentieth century and beginning of the new millennium. In the United Kingdom, the death of Diana, Princess of Wales, in 1997 was regarded by many as due in part to media intrusion, enabled by the use of new surveillance equipment, and also due in part to press refusal to observe conventions on personal privacy for public figures.

In the United States, President Bill Clinton's impeachment in 1999 for having denied on oath improper sexual relationships became unavoidable when DNA analysis was carried out on his semen. Responding to the constitutional crisis that then arose, Thomas Nagel, professor of philosophy and law at New York University, made a plea for the protection of presidential privacy. In what he called "the disastrous erosion of the precious but fragile conventions of personal privacy in the United States over the last ten or twenty years," Nagel lamented that "American society has lost its grip on a fundamental value, one which cannot be enforced by law alone but without which civilization would not survive. . . . The division of the self protects the limited public space from unmanageable encroachment and the unruly inner life from excessive inhibition. . . . The growth of tolerance does not make the collapse of

privacy significantly less damaging" (*London Review of Books*, 4 February 1999, p. 3–6). The support given to the president throughout the unsuccessful impeachment hearings in the spring of 1999 suggests that despite his admissions of wrongdoing, the U.S. electorate sympathized with Clinton's plea that even presidents have private lives.

A transatlantic case that came to trial under English law was the claim for damages by the film stars Catherine Zeta-Jones and Michael Douglas against *Hello!* magazine in 2003. The prosecution claimed that their right to privacy had been breached by the magazine's unauthorized publication of photographs from their wedding. Both sides claimed a vindication of sorts when Zeta-Jones and Douglas were granted the relatively small sum of £14,600 (US\$23,360), including £3,750 each for emotional hurt, in compensation for what the judge ruled was a breach of confidence, since the couple had granted publication rights to another publisher. The judge rejected the couple's complaint about invasion of privacy since there was no privacy law in England. Commenting on the verdict, many British newspapers described the issue as one of control rather than privacy, thus illustrating nicely the gap between popular understanding and academic research on privacy.

Privacy Papers (1998) edited by Bruce Schneier and David Baniser. Most of these works regarded surveillance and data collection as necessary evils in modern life against which the citizen should be warned and equipped with appropriate measures, including individual acts of resistance as well as pressure on corporate and stage agencies.

The most aggressive defense of privacy against intrusion from government and corporate interests was Gini Graham Scott's *Mind Your Own Business: The Battle for Personal Privacy* (1995). It contains detailed accounts of privacy cases in the United States since the 1960s, relating to employment, police surveillance, media intrusion, medical and health issues, and medical and insurance records. Scott is unequivocally opposed to court decisions that favor employers, the media, schools, the law courts, and the police. He alerts readers to grounds on which privacy may or may not be protected in law, provides an appendix listing computer privacy

bulletin boards, and gives his own address for further communication.

Compared to the United States, pressure groups in the United Kingdom were slow to react to privacy intrusions. Although one of the first works on the subject, *Private Lives and Public Surveillance* (1973) by James B. Rule, warned of the consequences, public safety concerns permitted the proliferation of surveillance technology, so that by the end of the twentieth century more closed-circuit television (CCTV) cameras were installed in shops and public places in the United Kingdom than anywhere else in the world. A guide to the new Data Protection Act of 1984 by Richard Sizer and Philip Newman noted that the act does not mention privacy as an issue, and that privacy was not a legal right under English law. Attempts to incorporate a bill of rights, including privacy rights, into law in the 1980s and 1990s were rebuffed with claims that English common law afforded greater protection. However,

works such as *The Governance of Privacy: Policy Instruments in Global Perspective* (2002) by Colin J. Bennett and Charles D. Raab show that by the beginning of the twenty-first century the mood had changed dramatically in the United Kingdom as well as in countries throughout the world.

New privacy issues arose in the 1990s with the adoption of DNA technology in preventive and forensic medicine. Mark A. Rothstein's *Genetic Secrets: Protecting Privacy and Confidentiality in the Genetic Era* (1997) and Graham Laurie's *Genetic Privacy: A Challenge to Medico-Legal Norms* (2002) are ground-breaking investigations on matters such as the disposal of body parts by hospitals for medical research and the status of the right to know—or not to know—one's individual medical records by the person concerned, by their families, by insurance companies, or by other interested agencies. Public outrage at intrusions into genetic privacy in the United States and United Kingdom demonstrates its close relation to questions of personal identity and the body, an area distinctly more emotional than intrusions via databases, surveillance devices, and Internet tracking. It is hardly surprising that the last three decades before the turn of the twenty-first century saw an unprecedented level of scrutiny of the nature, value, and functions of privacy.

The Psychological Functions and Philosophical Values of Privacy

According to the most prominent researcher on philosophical aspects of privacy, Ferdinand Schoeman, there was no major philosophical discussion on the value of privacy until the late 1960s. By 1968, another philosopher, Charles Fried, noted that the literature on privacy was "enormous," as psychologists and sociologists joined in the debate. Hannah Arendt's *The Human Condition* (1958) set out some of the basic functions of privacy: Privacy guarantees psychological and social depth, containing things that cannot withstand the constant presence of others on the public scene; it undergirds the public by establishing boundaries, which fix identity; and it preserves the sacred and mysterious spaces of life. Some phenomena are different if they are not private: confessions of shame or guilt made public become boastful; over-disclosure becomes false; terror, a guilty secret; love and goodness are destroyed.

Westin's *Privacy and Freedom* (1967) refined Arendt's analysis by introducing a two-tier definition of privacy, combining personal and social dimensions and consisting of four states (anonymity, reserve, solitude, and intimacy) plus four functions of privacy (personal autonomy, emotional release, self-evaluation, and limited and confidential communication). Westin is a firm universalist: Margaret Mead's famous proclamation that Samoans lacked a sense of privacy or shame is shown to be based on a restrictive understanding of the varied mechanisms of privacy, where speaking softly is as valid a mechanism as physical avoidance. Westin pointed out that that even animals seek periods of individual seclusion or small-group intimacy. He also acknowledged rights of privacy to organizations in areas such as medical and business confidentiality, jury deliberations, executive privilege, and the secrets of the confessional.

Writing in 1977, Carl D. Schneider related the sense of privacy to the sense of shame in his *Shame, Exposure, and*

Privacy. He listed phenomena where privacy is related to dignity: the use of nicknames or formal names; the names of relatives; things that carry the weight of the individual's identity or autonomy; faces and other body parts; things needed to care for the body such as soap, towels, and combs. The open display of bodily functions (defecating, great pain, the process of dying) threatens dignity, revealing an individual vulnerable to being reduced to bodily existence; the function of privacy and shame is to preserve wholeness and integrity. Bodily functions (sexual activities, sleep and excretion; illness, suffering, and eating) are rarely physiological processes alone. People invest all their activities with meanings, so that the physiological is invariably permeated with the human; the obscene is a deliberate violation of the sense of shame and privacy. Human relationships demand a pattern of mutual and measured self-disclosure. The private world is both a realm that is valued for oneself as a retreat, and one of which we are suspicious in other people; it is of lesser value than the public world. Totalitarian regimes are opposed to respect for persons, and thus deny privacy; when society does not provide for privacy, being apart will take the form of hiding.

The Private Me (1980), by June Noble and William Noble, anticipated the obsession with "me" that is said to characterize the 1980s. It is a crusading work, seeing privacy under threat from intrusions by family as well as government and society, and offering advice on ways to foster privacy through developmental programs including encounter groups and other forms of self-taught or group therapy. Among examples of modern devaluations in privacy, Noble and Noble noted that until the late twentieth century, diaries, letters and biographies were regarded as private legacy bequeathed by the deceased to family, and chart the growth of straight autobiography as distinct from the novel as fictionalized autobiography. They deplore compulsive self-disclosure (glamorized as candor) and over-disclosure, not only because it becomes boring, but also because it looks for sympathy as against creating intimacy or developing self-awareness. Reticence, on the other hand, encourages limited or protected communication, while privacy keeps emotions and acts from being trivialized: What is important is kept private (for example, lovemaking). Children develop a sense of privacy from the age of eight years on and need privacy to develop fulfilling sex lives.

Noble and Noble emphasized the link between privacy and power: Privacy allows or asserts power, and power confers privacy. Privacy in modern America has become a luxury, indicating status; lack of privacy among the poor and in the workplace leads to stress, and lack of assertiveness means that important boundaries cannot be established. Privacy is resisted by calling it "selfishness"; shyness in modern America is regarded as synonymous with worthlessness but can be seen instead as sensitivity and perceptiveness.

The most original attempt to provide a comprehensive account of privacy in the 1990s was *Privacy, Intimacy, and Isolation* (1992) by the philosopher Julie Inness. Inness constructed a definition of privacy from data on cases under tort and constitutional law in the United States, covering three areas: access to intimate information about the agent; access to

intimate aspects of the agent's person; and autonomy in the agent's decisions about intimate matters. Although it requires further definition of what is meant by "intimate" and fails to acknowledge nonintimate dimensions of privacy, the emphasis on control and access makes it one of the most useful definitions to date.

Inness is also unusually systematic on the question of values, stressing that privacy is rarely if ever given primary status in conflict with other values. Arendt and Westin both had previously pointed out limitations to privacy. According to Westin, "the individual's desire for privacy is never absolute, since participation in society is an equally powerful desire" (1967, p. 7). Inness adds a feminist perspective, pointing out that privacy protection may act as a mechanism for maintaining the dominance of groups or individuals in power and enforcing silence and helplessness on others.

With some outstanding exceptions, most researchers on privacy are located in the United States and focus on contemporary U.S. experience; relatively little has been produced about other modern societies, Western or otherwise. A countertrend may be starting with the publication of three books on privacy in China: *Private Life Under Socialism: Love, Intimacy, and Family Change in a Chinese Village, 1949–1999* (2003) by Yan Yunxiang; *Chinese Concepts of Privacy*, edited by Bonnie S. McDougall and Anders Hansson (2002); and *Love-Letters and Privacy in Modern China: The Intimate Lives of Lu Xun and Xu Guangping* (2002) by Bonnie S. McDougall. Among insights raised by these studies is the often-ignored fact that privacy is more frequently a condition shared by lovers, families, or friends than one experienced alone by a single individual. As concluded in the preface to *Chinese Concepts of Privacy*, "The apparent chaos in privacy studies is a reflection of real-life complexity and will not be resolved by including more cultures in the debate. But by taking Chinese and other non-Western cultures into account, a global understanding of privacy will help to clarify crucial issues such as universal awareness of privacy and universal privacy rights" (McDougall and Hansson, p. 24).

See also **Human Rights; Liberty; Public Sphere; Society.**

BIBLIOGRAPHY

- Agre, Philip, and Marc Rotenberg, eds. *Technology and Privacy: The New Landscape*. Cambridge, Mass.: MIT Press, 1997.
- Arendt, Hannah. *The Human Condition*. Chicago: University of Chicago Press, 1958.
- Banisar, David. *Privacy and Human Rights 2000: An International Survey of Privacy Laws and Developments*. Washington, D.C.: Electronic Privacy Information Center, and London: Privacy International, 2000.
- Bennett, Colin J., and Charles D. Raab. *The Governance of Privacy: Policy Instruments in Global Perspective*. Aldershot, U.K.: Ashgate, 2002.
- Brown, Donald L. *Human Universals*. Philadelphia: Temple University Press, 1991.
- Cooper, Jonathan, ed. *Privacy*. London: Sweet and Maxwell, 2003.
- Elias, Norbert. *The Civilizing Process: The History of Manners and State Formation and Civilization*. Translated by Edmund Jephcott. Oxford: Blackwell, 1994.
- Etzioni, Amitai. *The Limits of Privacy*. New York: Basic Books, 1999.
- Flaherty, David H., ed. *Privacy and Data Protection: An International Bibliography*. London: Mansell, 1984.
- . *Protecting Privacy in Surveillance Societies: The Federal Republic of Germany, Sweden, France, Canada, and the United States*. Chapel Hill: University of North Carolina Press, 1989.
- Goffman, Erving. *The Presentation of Self in Everyday Life*. London: Allen Lane, 1969.
- Habermas, Jürgen. *The Structural Transformation of the Public Sphere: An Inquiry into a Category of Bourgeois Society*. Translated by Thomas Burger. Cambridge, Mass.: MIT Press, 1989.
- Hofstadter, Samuel H., and George Horowitz. *The Right of Privacy*. New York: Central Book Co., 1964.
- Inness, Julie C. *Privacy, Intimacy, and Isolation*. New York: Oxford University Press, 1992.
- Jagodzinski, Cecile M. *Privacy and Print: Reading and Writing in Seventeenth-Century England*. Charlottesville: University Press of Virginia, 1999.
- Laurie, Graham T. *Genetic Privacy: A Challenge to Medico-Legal Norms*. Cambridge, U.K.: Cambridge University Press, 2002.
- McDougall, Bonnie S., and Anders Hansson, eds. *Chinese Concepts of Privacy*. Leiden, Netherlands: Brill, 2001.
- McLean, Decker. *Privacy and its Invasion*. Westport, Conn.: Praeger, 1995.
- Moore, Barrington, Jr. *Privacy: Studies in Social and Cultural History*. Armonk, N.Y.: M. E. Sharpe, 1984.
- Noble, June, and William Noble. *The Private Me*. New York: Delacorte Press, 1980.
- Norback, Craig T. *The Computer Invasion*. New York: Van Nostrand Reinhold, 1981.
- Rothstein, Mark A., ed. *Genetic Secrets: Protecting Privacy and Confidentiality in the Genetic Era*. New Haven, Conn.: Yale University Press, 1997.
- Rule, James B. *Private Lives and Public Surveillance*. London: Allen Lane, 1973.
- Schneider, Carl D. *Shame, Exposure, and Privacy*. Boston: Beacon, 1977. Reprint, New York: Norton, 1992.
- Schneier, Bruce, and David Banisar, eds. *The Electronic Privacy Papers: Documents on the Battle for Privacy in the Age of Surveillance*. New York: Wiley, 1997.
- Schoeman, Ferdinand David. *Privacy and Social Freedom*. Cambridge, U.K.: Cambridge University Press, 1992.
- , ed. *Philosophical Dimensions of Privacy: An Anthology*. Cambridge, U.K.: Cambridge University Press, 1984.
- Scott, Gini Graham. *Mind Your Own Business: The Battle for Personal Privacy*. New York: Plenum, 1995.
- Smith, H. Jeff. *Managing Privacy: Information Technology and Corporate America*. Chapel Hill: University of North Carolina Press, 1994.
- Spacks, Patricia Meyer. *Privacy: Concealing the Eighteenth-Century Self*. Chicago: Chicago University Press, 2003.
- Staples, William G. *The Culture of Surveillance: Discipline and Social Control in the United States*. New York: St. Martin's Press, 1997.
- Steiner, George. *Language and Silence, Essays 1958–1966*. London: Faber, 1967.
- Taylor, Charles. *Philosophy and the Human Sciences: Philosophical Papers 2*. Cambridge, U.K.: Cambridge University Press, 1985.
- Wacks, Raymond. *Law, Morality, and the Private Domain*. Hong Kong: Hong Kong University Press, 2000.
- . *Personal Information: Privacy and the Law*. Oxford: Clarendon, 1989.

- . *The Protection of Privacy*. London: Sweet and Maxwell, 1980.
- Weintraub, Jeff, and Krishan Kumar, eds. *Public and Private in Thought and Practice: Perspectives on a Grand Dichotomy*. Chicago: University of Chicago Press, 1997.
- Westin, Alan F. *Privacy and Freedom*. London: Bodley Head, 1967.
- Westin, Alan F., and Louis Harris, and Associates. *The Dimensions of Privacy: A National Opinion Research Survey of Attitudes Towards Privacy*. New York: Garland, 1981.

Bonnie McDougall

PRIVATIZATION. The American economist Steve Hanke defines privatization as “the transfer of assets and service functions from public to private hands. It includes, therefore, activities that range from selling state-owned enterprises to contracting out public services with private contractors” (p. 4). At one extreme, privatization might entail the wholesale transfer to the private sector of both ownership and management and service delivery functions formerly undertaken by the public sectors; at another it might entail the transfer of management and service delivery functions to the private sector while ownership remains with the public sector. Various intermediate arrangements can also be found whereby various degrees of government or public ownership are combined with different forms of management transfer to the private sector. In the early twenty-first century the term has been broadened to include normal administrative public sector functions as well.

Thus, the notion of privatization has resulted in a wholesale questioning of the role of the public sector in the economy, thereby raising a number of technical and philosophical issues pertaining to economic, social, and political organizations across countries and over time. For developing and transitional economies the commitment to privatization as a policy has become, in the eyes of developed market economies and prospective foreign investors, symbolic of a country’s commitment to an unfettered, free enterprise economy, which in its wake is expected to open doors to inflows of foreign investment and foreign aid.

World Trends in Privatization

Privatization has indeed become a core mantra of neoliberalism or market fundamentalism and received its strongest political support from British prime minister Margaret Thatcher (who served from 1979–1990), U.S. president Ronald Reagan (1980–1988), and Chilean president Augusto Pinochet (president from 1974–1990), who were all strong proponents of market fundamentalism. The collapse of the Soviet bloc strengthened the trend toward privatization as the state apparatus of the former socialist regime was systematically dismantled and privatized. Since 1990, privatization has been implemented to one degree or another in the developed economies of the West, the transitional economies of the former Soviet bloc, and in the developing countries of Africa, Asia, and Latin America. The enthusiasm by which privatization was embraced is illustrated by the following statement by M. Peter McPherson:

The development approaches of the past, based on large-scale government bureaucracies and centralized, government-controlled economies, have been discredited by their failure. Privatization is forging economic success and stability. Privatization works because it focuses on the entrepreneur, encourages individual initiative, and promotes market-oriented policies. More and more developing countries are discovering that privatization produces wealth for their economies and greater opportunities for a broader spectrum of their people. (Hanke, p. 20)

Toward the end of the twentieth century, it was apparent that the policy of privatization had mixed results and that in some countries it had generated significant opposition, apart from the fact that its theoretical premises were also being credibly challenged as well.

The Role of the State

Since privatization is aimed at reducing the role of the state, and by the same token expanding that of the private sector, it is useful to recall the various reasons why governments have taken on the functions that they do that are later targets for privatization. First, governments are expected to provide the necessary regulatory, legal, and security environment for the private sector to undertake its functions. Staunch neoliberals see this as the only major function that should be performed by the state. Crucial among these functions is the need to guarantee property rights, free disposal of property, and appropriation of the fruits arising from its use, and the facilitation and protection of contractual obligations. The second function relates to the provisions of pure public goods and services such as those related to security and defense, basic health, education, and sanitation and water. The third function concerns the provision of goods and services, such as the low level of development, market failures, missing markets or value chains, the small size of the local market, or excessive costs of production.

The fourth function has arisen as a result of strategic considerations, such as national security, the desire to be self-reliant, the need to develop infant industries, and the desire by some governments to influence the course of growth and development over time by seizing command of key industries or economic activities, especially at earlier levels of development and in order to effect rapid economic transformation and development as has been often the rationale for nationalization or government ownership. Finally, equity and welfare considerations, or the desire on the part of government to prevent a monopoly private sector outcome following privatization has led some governments to assume production of certain goods or provision of certain services.

Historically, governments have played an important role in the economy beyond the first function indicated above. The actual legacy of the nature of government participation has differed considerably between developed and developing nations and within each of these groupings. The increased adoption of Keynesianism and the growth of socialism had the effect of stimulating government participation in the economy especially after World War II, but even under these conditions,

there was an undercurrent of dissent in favor of privatization and a minimal role of the state which persisted and gained its prominence during the ascendancy of neo-liberalism following the recession of the 1970s. By the middle of the 1980s, L. Gray Cowan was able to observe the following:

Worldwide interest in reducing the role of the public sector in national economies is a phenomenon of the past four to six years. The growing movement to privatize industries, services, and agencies and the changed conception of government's role are products of pragmatism: the state-owned sector is not working, and enormous subsidies to maintain money-losing enterprises and services only get bigger. The conviction is growing that private entrepreneurs can manage industries more effectively and operate services more efficiently and at lower cost to the public than can government. Evidence supporting private enterprise over public ownership has emerged in areas of every continent. (Hanke, p. 8)

The collapse of the Soviet bloc and the wholesale privatization of public enterprises that followed in these countries leading to their being labeled "transition economies," the liberalization of economic activities in China, and initial bold privatization initiatives in the United Kingdom and Chile fueled the trend in support for privatization. By the mid-1990s, the call for privatization was no longer one of mere pragmatism. It had become a coherent ideological agenda and a major theoretical paradigm.

The Case for Privatization

The case for privatization has been based on a number of reasons. On a theoretical level economists in support of privatization have attempted to show that outside of the first function indicated above, the private sector is either a more efficient provider than the public sector or that the failures of the private sector are much lower than those of the public sector. This argument has increasingly been applied to justify the privatization of all of the functions listed above except the first one. At an empirical level, what Cowan refers to as "pragmatic" level attempts have been made to show the benefits and costs of public versus private ownership, management and service delivery of given activities under given circumstances. The evidence here has been mixed and areas of difference have related to methodological issues to philosophical ones as to the legitimacy of the criteria used to assess the relative performance of the two sectors. While at the microeconomic or enterprise level, analysis of costs and benefits of the production of goods and the provision of services by either sector has been straightforward enough and the analysis of net social benefits and costs in both dynamic and static terms has been inadequate to settle the issues at stake. The case for privatization has also been justified on the basis of the need to establish "sound" or "good" macroeconomic fundamentals conducive to the efficient and undistorted operation of domestic and global market forces related to capital, trade, and labor markets as demanded by global imperatives supported by neoliberalism. A final rationale for privatization has been an ideological or political one grounded

in the theoretical and macroeconomic rationales above. The political rationale sees privatization as a policy stance that sends the right message regarding a country's commitment to free enterprise to existing and prospective entrepreneurs and investors. It signals to domestic and international markets that the government is committed to protecting property rights and contractual obligations demanded by capitalism and the market.

Critics of Privatization

Nonetheless, at the start of the twenty-first century, privatization has been challenged on all fronts. On theoretical level, advances in the New Institutional Economics which have attempted to show that the ideal relationship between these two sectors cannot be settled a priori and universally for all time as its advocates are prone to imply, but very much depends on the specific social and economic circumstances prevailing in a given country. Similarly, Bruce Greenwald and Joseph Stiglitz have shown that the presumed efficiency of the market is highly compromised by the existence of externalities, imperfect information, and imperfect markets. At the empirical level there is now substantial evidence that the presumed efficiency and growth benefits of privatization have not been forthcoming, and that in general, privatization, more often than not, has tended to result in increasing unemployment and inequitable access to key assets and social services. With respect to the role of the state, various studies of the roles undertaken by government in a number of countries, particularly in East Asia, have shown that government involvement in the economy has yielded major long-term social and economic benefits in these countries. More generally, there is an emerging consensus that it is the quality of the state rather than the fact that assets are owned by the state that matters more, and that for developing countries with extensive market and information failures the state should play an important role in promoting equitable development over the long run. At the political level privatization has been challenged by workers affected by attendant retrenchments and the restructuring of internal and external labor markets consequent upon privatization that has resulted in increased worker vulnerability, and by consumers who have often been negatively affected by increased prices based on cost recovery pricing regimes instituted as a consequence of privatization, or by reduction in service provision arising from "efficiency enhancing" measures as a consequence of privatization.

In developing countries in particular, privatization appears to have resulted in the weakening of the state without the necessary substitute in form of a strengthened private sector emerging. This outcome has occurred while growth has become elusive, and while large segments of the population are being socially and economically marginalized and excluded. The euphoria over privatization, if there was ever one, outside of the Bretton Woods Institutions (the World Bank and the International Monetary Fund) and the prospective beneficiaries among a narrow circle of prospective domestic and foreign entrepreneurs, is diminishing as countries seek to find more creative ways of combining the activities of the private and public sectors in a manner that maximizes inclusive growth and generalized welfare gains in the long term. In addition, lessons from the past have been drawn upon to stipulate other conditions under which privatization is likely to succeed.

Some of these conditions relate to process, by requiring that stakeholder involvement be undertaken; the legal/regulatory environment, by requiring that an appropriate legal and regulatory environment needs to be in place prior to privatization to avoid abuse of the process and outcome by benefiting entrepreneurs; to the need for an overall development strategy within which privatization initiatives are undertaken is important especially for developing countries; to the need for social protection, by requiring that social safety nets be in place to protect the losers resulting from privatization; to the need for viable capital markets, by requiring that a country ensure that efficient capital markets are in existence before state assets are privatized.

See also *Capitalism; Economics; Neoliberalism*.

BIBLIOGRAPHY

- Greenwald, Bruce, and Joseph Stiglitz. "Externalities in Economies with Incomplete Information and Incomplete Markets." *American Economic Review* 45, no. 1 (1955): 1–25.
- Hanke, Steve H., ed. *Privatization and Development*. San Francisco: International Center for Economic Growth, 1987.
- Harris, John, Janet Hunter, and Colin Lewis, eds. *The New Institutional Economics and Third World Development*. New York: Routledge, 1995.
- Lindenberg, Marc, and Noel Ramirez, eds. *Managing Adjustment in Developing Countries*. San Francisco: International Center for Economic Growth, 1989.
- Stiglitz, Joseph. *Globalization and its Discontents*. New York: Penguin Books, 2002.
- Van der Hoeven, Rolph, and Gyorgy Sziraczki, eds. *Lessons from Privatization: Labour Issues in Developing and Transitional Countries*. Geneva: International Labour Office, 1997.
- World Bank. *Proceedings of the Annual Conference on Development Economics: Supplement to the World Bank Economic Review and The World Bank Research Observer*. Washington D.C.: World Bank, 1990.

Guy C. Z. Mhone

PROBABILITY. "Probability is the very guide of life," Bishop Butler wrote in 1736. Probability judgments of the efficacy and side effects of a pharmaceutical drug determine whether it is approved for release to the public. The outcome of a civil trial hinges on the jurors' opinions about the probabilistic weight of evidence. Geologists calculate the probability that an earthquake of a certain intensity will hit a given city, and engineers accordingly build skyscrapers with specified probabilities of withstanding such earthquakes. Probability undergirds even measurement itself, since the error bounds that accompany measurements are essentially probabilistic confidence intervals. We find probability wherever we find uncertainty—that is, almost everywhere in our lives.

It is surprising, then, that probability arrived comparatively late on the intellectual scene. To be sure, a notion of randomness was known to the ancients. Epicurus, and later Lucretius, believed that atoms occasionally underwent indeterministic swerves. The twelfth-century Arabic philosopher Averroës's

notion of "equipotency" might be regarded as a precursor to probabilistic notions. But probability theory was not conceived until the seventeenth century, in the correspondence between Pierre de Fermat and Blaise Pascal and in the Port-Royal Logic. Over the next three centuries, the theory was developed by such authors as Christian Huygens, Jacob Bernoulli, Thomas Bayes, Pierre Simon Laplace, the Marquis de Condorcet, Abraham de Moivre, John Venn, William Johnson, and John Maynard Keynes. Arguably, the crowning achievement was Andrei Kolmogorov's axiomatization in 1933, which put probability on a rigorous mathematical footing.

The Formal Theory of Probability

In Kolmogorov's theory, probabilities are numerical values that are assigned to "events." The numbers are non-negative; they have a maximum value of 1; and the probability that one of two mutually exclusive events occurs is the sum of their individual probabilities. Stated more formally, given a set Ω and a privileged set of subsets F of Ω , probability is a function P from F to the real numbers that obeys, for all X and Y in F , the following three axioms:

$$A1. \quad P(X) \geq 0 \quad (\text{Non-negativity})$$

$$A2. \quad P(\Omega) = 1 \quad (\text{Normalization})$$

$$A3. \quad P(X \cup Y) = P(X) + P(Y) \text{ if } X \cap Y = \emptyset \quad (\text{Additivity})$$

Kolmogorov goes on to give an infinite generalization of (A3), so-called countable additivity. He also defines the conditional probability of A given B by the formula:

$$P(A|B) = P(A \cap B) / P(B), \quad P(B) > 0$$

Thus, we can say that the probability that the toss of a fair die results in a 6 is $1/6$, but the probability that it results in a 6, given that it results in an even number, is $1/6$ divided by $1/2$ equals $1/3$.

Important consequences of these axioms include various forms of Bayes's theorem, notably:

$$P(H|E) = [P(H)/P(E)] P(E|H) = P(H)P(E|H) / [P(H)P(E|H) + P(\sim H)P(E|\sim H)]$$

This theorem provides the basis for Bayesian confirmation theory, which appeals to such probabilities in its account of the evidential support that a piece of evidence E provides a hypothesis H . $P(E|H)$ is called the "likelihood" (the probability that the hypothesis gives to the evidence) and $P(H)$ the "prior probability" of H (the probability of the hypothesis in the absence of any evidence whatsoever).

Events A and B are said to be independent if $P(A \cap B) = P(A)P(B)$. If $P(A)$ and $P(B) > 0$, this is equivalent to $P(A|B) = P(A)$ and to $P(B|A) = P(B)$. Intuitively, information about the occurrence of one of the events does not alter the probability of the other. Thus, the outcome of a particular coin toss is presumably independent of the result of the next presidential election. Independence plays a central role in probability theory. For example, it underpins the various important "laws

of large numbers,” whose content is roughly that certain well-behaved processes are very likely in the long run to yield frequencies that would be expected on the basis of their probabilities.

While the mathematics of Kolmogorov’s probability theory is well understood and thoroughly developed (a classic text is Feller), its interpretation remains controversial. We now turn to several rival accounts of what probabilities are and how they are to be determined (see Hájek for more detailed discussion).

Interpretations of Probability

The classical interpretation, historically the first, can be found in the works of Pascal, Huygens, Bernoulli, and Leibniz, and it was famously presented by Laplace (1814). It assigns probabilities in the absence of any evidence and in the presence of symmetrically balanced evidence. In such circumstances, probability is shared equally among all the possible outcomes—the so-called *principle of indifference*. Thus, according to the classical interpretation, the probability of an event is simply the fraction of the total number of possibilities in which the event occurs. This interpretation was inspired by, and typically applied to, games of chance that by their very design create such circumstances—for example, the classical probability of a fair die landing with an even number showing up is $3/6$. Notoriously, the interpretation falters when there are competing sets of possible outcomes. What is the probability that the die lands 6 when tossed? If we list the possible outcomes as $\{1, 2, 3, 4, 5, 6\}$, the answer appears to be $1/6$. But if we list them as $\{6, \text{not-}6\}$, the answer appears to be $1/2$.

The logical interpretation retains the classical interpretation’s idea that probabilities are determined a priori by the space of possibilities. But the logical interpretation is more general in two important ways: the possibilities may be assigned unequal weights, and probabilities can be computed whatever the evidence may be, symmetrically balanced or not. Indeed, the logical interpretation seeks to determine universally the degree of support or confirmation that a piece of evidence E confers upon a given hypothesis H . Rudolf Carnap (1950) thus hoped to offer an “inductive logic” that generalized deductive logic and its relation of “implication” (the strongest relation of support).

A central problem with Carnap’s program is that changing the language in which hypotheses and items of evidence are expressed will typically change the confirmation relations between them. Moreover, deductive logic can be characterized purely syntactically: one can determine whether E implies H , or whether H is a tautology, merely by inspecting their symbolic structure and ignoring their content. Nelson Goodman showed, however, that inductive logic must be sensitive to the meanings of words, for syntactically parallel inferences can differ wildly in their inductive strength. So inductive logic is apparently not of a piece with deductive logic after all.

Frequency interpretations date back to Venn (1876). Gamblers, actuaries, and scientists have long understood that relative frequencies are intimately related to probabilities. Frequency interpretations posit the most intimate relationship of all: identity. Thus, the probability of heads on a coin that

lands heads in 7 out of 10 tosses is $7/10$. In general, the probability of an outcome A in a reference class B is the proportion of occurrences of A within B .

Frequentism still has the ascendancy among scientists who seek to capture an objective notion of probability independent of individuals’ beliefs. It is also the philosophical position that lies in the background of the classical approach of Ronald A. Fisher, Jerzy Neyman, and Egon S. Pearson that is used in most statistics textbooks. Frequentism faces some major objections, however. For example, a coin that is tossed exactly once yields a relative frequency of heads of either 0 or 1, whatever its true bias—the infamous problem of the single case. Some frequentists (notably Hans Reichenbach and Richard von Mises) go on to consider infinite reference classes of hypothetical occurrences. Probabilities are then defined as limiting relative frequencies in infinite sequences of trials. If there are in fact only finitely many trials of the relevant type, this requires the actual sequence to be extended to a hypothetical or virtual infinite sequence. This creates new difficulties. For instance, there is apparently no fact of the matter of how the coin in my pocket would have landed if it had been tossed once, let alone an indefinitely large number of times. A well-known problem for any version of frequentism is that relative frequencies must be relativized to a reference class. Suppose that you are interested in the probability that you will live to age eighty. Which reference class should you consult? The class of all people? All people of your gender? All people who share your lifestyle? Only you have all these properties, but then the problem of the single case returns.

Propensity interpretations, like frequency interpretations, regard probability as an objective feature of the world. Probability is thought of as a physical propensity or disposition or tendency of a given type of physical situation to yield an outcome of a certain kind, or to yield a long-run (perhaps infinite) relative frequency of such an outcome. This view, which originated with Karl Popper (1959), was motivated by the desire to make sense of single-case probability attributions, particularly those found in quantum mechanics, on which frequentism apparently foundered (see Gillies for a useful survey).

A prevalent objection is that it is not informative to be told that probabilities are propensities. For example, what exactly is the property in virtue of which this coin, when suitably tossed, has a “propensity” of $1/2$ to land heads? Indeed, some authors regard it as mysterious whether propensities even obey the axioms of probability in the first place. To the extent that propensity theories are parasitic on long-run frequencies, they also seem to inherit some of the problems of frequentism.

Subjectivist interpretations, pioneered by Frank P. Ramsey (1926) and Bruno de Finetti (1937), regard probabilities as degrees of belief, or credences, of appropriate agents. These agents cannot be actual people, since, as psychologists have repeatedly shown, people typically violate probability theory in various ways, often spectacularly so. Instead, we have to imagine the agents to be ideally rational. Ramsey thus regarded probability theory to be the “logic of partial belief.” Underpinning subjectivism are so-called Dutch Book arguments. They begin by identifying agents’ degrees of belief with their

betting dispositions, and they then prove that anyone whose degrees of belief violate the axioms of probability is “incoherent”—susceptible to guaranteed losses at the hands of a cunning bettor. Equally important, but often neglected, is the converse theorem that adhering to the probability axioms protects one from such an ill fate. Subjectivism has proven to be influential, especially among social scientists, Bayesian statisticians, and philosophers.

A more general approach, again originating with Ramsey, begins with certain axioms on rational preferences—for example, if you prefer A to B and B to C , then you prefer A to C . It can be shown that if you obey these axioms, then you can be represented by a probability function (encapsulating your credences about various propositions) and a utility function (encapsulating the strengths of your desires that these propositions come about). This means that you will rate the choice worthiness of an action open to you according to its expected utility—a weighted average of the various utilities of possible outcomes associated with that action, with the corresponding probabilities providing the weights. This is the centerpiece of decision theory.

Radical subjectivists such as de Finetti recognize no constraints on initial (or “prior”) subjective probabilities beyond their conforming to axioms (A1) to (A3). But they typically advocate a learning rule for updating probabilities in the light of new evidence. Suppose that you initially have credences given by a probability function P_{initial} , and that you become certain of E (where E is the strongest such proposition). What should your new probability function P_{new} be? The favored updating rule among Bayesians is conditionalization, where P_{new} is related to P_{initial} as follows:

$$\text{(Conditionalization)} \quad P_{\text{new}}(X) = P_{\text{initial}}(X|E) \\ \text{(provided } P_{\text{initial}}(E) > 0)$$

Radical subjectivism has faced the charge of being too permissive. It apparently licenses credences that we would ordinarily regard as crazy. For example, you can assign without its censure a probability of 0.999 to your being the only thinking being in the universe—provided that you remain coherent (and update by conditionalization). It also seems to allow fallacious inference rules, such as the gambler’s fallacy (believing, for instance, that after a surprisingly long run of heads, a fair coin is more likely to land tails). A standard defense (e.g., Howson and Urbach) appeals to famous convergence-to-truth and merger-of-opinion results. Their upshot is that in the long run, the effect of choosing one prior rather than another is attenuated: successive conditionalizations on the evidence will, with probability 1, make a given agent eventually converge to the truth, and thus initially discrepant agents eventually come to agreement. Some authors object that these theorems tell us nothing about how quickly the convergence occurs; in particular, they do not explain the unanimity that we in fact often reach, and often rather rapidly.

Some Recent Developments

Since the late twentieth century, some subjectivists have canvassed further desiderata on credences. For example, we might evaluate credences according to how closely they match the

corresponding relative frequencies, according to how well “calibrated” they are. Also under consideration are “scoring rules” that refine calibration. Various subjectivists believe that rational credences are guided by objective chances (perhaps thought of as propensities), so that if a rational agent knows the objective chance of a given outcome, her degree of belief will be the same as the objective chance. There has been important research on the aggregation of opinions and the preferences of multiple agents. This problem is well known to readers of the risk-assessment literature. Moreover, in light of work in economics and psychology on bounded rationality, there have been various attempts to “humanize” Bayesianism, for example, in the study of “degrees of incoherence,” and of vague probability and decision theory (in which credences need not assume precise values).

Since the late twentieth century there have also been attempts to rehabilitate the classical and logical interpretations, and in particular the principle of indifference. Some objective Bayesians appeal to information theory, arguing that prior probabilities should maximize entropy (a measure of how flat a probability distribution is), subject to the constraints of a given problem. Probability theory has also been influenced by advances in theories of randomness and in complexity theory (see Fine; Li and Vitanyi), and by approaches to the “curve-fitting” problem—familiar in the computer science, artificial intelligence, and philosophy of science literature—that attempt to measure the simplicity of theories.

While Kolmogorov’s theory remains the orthodoxy, a host of alternative theories of probability have been developed (see Fine; Mückenheim et al.). For instance, there has been increased interest in nonadditive theories, and the status of countable additivity is a subject of lively debate. Some authors have proposed theories of primitive conditional-probability functions, in which conditional probability replaces unconditional probability as the fundamental concept. Fertile connections between probability and logic have been explored under the rubrics of “probabilistic semantics” and “probability logic.”

Some Applications of Probability

Probability theory thus continues to be a vigorous area of research. Moreover, its advances have myriad ramifications. Probability is explicitly used in many of our best scientific theories, for example, quantum mechanics and statistical mechanics. It is also implicit in much of our theorizing. A central notion in evolutionary biology is “fitness,” or expected number of offspring. Psychologists publish their conclusions with significance levels attached. Agricultural scientists perform analyses of variance on how effective fertilizers are in increasing crop yields. Economists model currency exchange rates over time as stochastic processes—that is, sequences of random variables. In cognitive science and philosophy, probability functions model states of opinion. Since probability theory is at the heart of decision theory, it has consequences for ethics and political philosophy. And assuming, as many authors do, that decision theory provides a good model of rational decision-making, it apparently has implications for even mundane aspects of our daily lives. In short, probability is ubiquitous. Bishop Butler’s dictum is truer today than ever.

See also *Game Theory; Logic and Philosophy of Mathematics, Modern; Mathematics.*

BIBLIOGRAPHY

- Butler, Joseph. *Analogy of Religion*. 1736. Reprint, New York: Frederick Ungar, 1961.
- Carnap, Rudolf. *Logical Foundations of Probability*. Chicago: University of Chicago Press, 1950.
- De Finetti, Bruno. "La Prévision: Ses Lois Logiques, Ses Sources Subjectives." *Annales de l'Institut Henri Poincaré* 7 (1937): 1–68. Translated as "Foresight: Its Logical Laws, Its Subjective Sources." In *Studies in Subjective Probability*, edited by H. E. Kyburg Jr. and H. E. Smokler. New York: Robert E. Krieger, 1980.
- Feller, William. *An Introduction to Probability Theory and Its Applications*. 3rd ed. New York: John Wiley and Sons, 1968.
- Fine, Terrence. *Theories of Probability*. New York: Academic Press, 1973.
- Gillies, Donald. "Varieties of Propensity." *British Journal for the Philosophy of Science* 51 (2000): 807–835.
- Hájek, Alan. "Probability, Interpretations of." In *The Stanford Encyclopedia of Philosophy*, edited by E. Zalta. Stanford, Calif.: Stanford University, 2002. Available at <http://plato.stanford.edu/entries/probability-interpret/>.
- Howson, Colin, and Peter Urbach. *Scientific Reasoning: The Bayesian Approach*. 2nd ed. Chicago: Open Court, 1993.
- Kolmogorov, Andrei N. *Grundbegriffe der Wahrscheinlichkeitrechnung, Ergebnisse der Mathematik*. 1933. Translated as *Foundations of Probability*. New York: Chelsea, 1950.
- Laplace, Pierre Simon. *Essai philosophique sur les probabilités*. 1814. Translated as *A Philosophical Essay on Probabilities*. New York: Dover, 1951.
- Li, Ming, and Paul Vitanyi. *An Introduction to Kolmogorov Complexity and Its Applications*. 2nd ed. New York: Springer-Verlag, 1997.
- Muckenheim, W., et al. "A Review of Extended Probability." *Physics Reports* 133 (1986): 337–401.
- Popper, Karl. *The Logic of Scientific Discovery*. London: Hutchinson, 1959.
- Ramsey, Frank P. "Truth and Probability." 1926. Reprinted in *Philosophical Papers*, edited by D. H. Mellor. Cambridge, U.K.: Cambridge University Press, 1990.
- Venn, John. *The Logic of Chance*. 2nd ed. London: Macmillan, 1876. Reprint, New York: Chelsea, 1962.
- Von Mises, Richard. *Wahrscheinlichkeit, Statistik und Wahrheit*. 1939. Translated as *Probability, Statistics, and Truth*. Rev. English ed. New York: Macmillan, 1957.

Alan Hájek

PROGRESS, IDEA OF. The idea of progress—the idea that human society can be made ever better by conscious effort, or that society is becoming ever better by spontaneous laws of history—is relatively new. The idea was virtually unknown in classical antiquity. In each of the three greatest books of that period, what we think of as progress is explicitly denied. In Plato's *Republic*, even the best possible political regime, based on the rule of the philosopher-king, is subject to inevitable decay and descent into tyranny. In the *Politics*, Aristotle argues that while frequent change is good in the arts and

sciences it is not good in matters of politics and law. And Thucydides' *History of the Peloponnesian War* begins with the famous "archaeology" meant to remind the reader of the oblivion into which even the mightiest human empires must inevitably fall. In the classical mind, the prevailing view was that the courses of time and the motions of the universe consist of endless cycles of rise and fall—creation is always followed by dissolution. It took the coming of the Bible for the courses of time to be understood as a story with a beginning, a middle, and an end. But with the Christian doctrine of sin and redemption in the heavens and not on this earth, it was many centuries before the biblical understanding of history was reinterpreted in the direction of human redemption on this earth and by secular means.

The First Prophet of Progress

Not even the coming of the Renaissance in Europe paved the way for the idea of progress. One could argue, in fact, that Renaissance humanism, with its focus on and reverence for classical antiquity, made it harder to conceive of progress, since the rebirth of learning in the Renaissance required looking backward from a condition of contemporary decay. This was certainly the view espoused by the first great thinker to broach the idea of progress as we know it: Francis Bacon (1561–1626). Bacon was, according to the biologist E. O. Wilson, the "grand architect" of the Enlightenment, the intellectual movement of the seventeenth and eighteenth centuries that gave birth to the idea of progress. According to Bacon, classical thought had infected Christian learning—especially in the form of Scholasticism—and had thus long retarded real progress of knowledge. The much revered "ancients" (in particular Plato and Aristotle) had, in Bacon's view, confused theology and natural science and as a result had spun out a teleological and speculative natural science that took nature to be a kind of God and revealed nothing of what nature really is. The humble and anonymous invention of the compass, said Bacon, did more to advance the human race than all the contemplative philosophy of the ancients, who prided themselves on respecting "theory" over mere "practice." Until the debilitating yoke of classical thought was removed from the human mind the real lesson of the Christian faith could not be followed up: the world is not a God and is but the object of divine art, wisdom, and power—and, ultimately, the object also of *human* art, wisdom, and power. Once the human mind was freed from the spell of the ancients, and once metaphysical speculation was replaced by knowledge based on experience and induction and organized by clear and regular methods, the real courses of nature could be revealed and nature could be conquered "for the relief of man's estate." In Bacon's view, when the harsh constraints of nature were removed from the human body, so too would be removed the vain illusions that disturb the soul and roil political life. On the foundation of modern science would rise the rational and secular state, whose business is progress.

The discovery of the humble compass, as Bacon pointed out, doubtless expanded massively the horizon of navigation, and advancements in shipbuilding must soon have followed. But there is an important difference between such facts of technical progress and the *idea* of progress—the idea that such inventions will necessarily lead to greater human happiness and

justice, or the idea that society can be ordered so as to produce such inventions and such happiness with ever increasing speed and to ever increasing good effects. The idea of progress as an organized and benevolent project was first broached by Bacon, who was revered by the figures of the later Enlightenment of the eighteenth century.

Although ideas may be the real queens of the world, they do not work their effects in immediate or in smooth and direct ways. So for a hundred years after Bacon's death in 1626 a literary and philosophical dispute called the quarrel between the ancients and moderns was waged in France and England over the issue of whether human thought and knowledge had degenerated from its height in classical antiquity, or whether modern times were more intellectually advanced, if only because of the accumulated wisdom of longer historical experience. In his 1688 pamphlet entitled *Digression on the Ancients and the Moderns*, the French philosopher Bernard Le Bovier de Fontenelle argued that indeed progress in the arts and sciences is both open-ended and necessary and proceeds according to laws of its own, having nothing to do with the efforts of particular thinkers. Fontenelle's argument added a significant new dimension to the idea of progress. Bacon's conception was voluntaristic, in the sense that a conscious reformation of the mind would produce the deliberate establishment of scientific and political institutions to produce material and moral progress. With Fontenelle we see the first appearance of the idea that progress is an historical process that moves as a force on its own, independently of human will, and that it can be traced in the record of human history and seen in one's own time.

Inevitable Progress

This new dimension introduced by Fontenelle was to become very important later on, but was often based more on faith than on clear evidence of the superiority of contemporary life. This dependence on faith sprang from a reason revealed by Fontenelle himself: the progress of knowledge and science, even if necessary and unending, did not in Fontenelle's mind lead necessarily to the amelioration of society and to increased human happiness. At the very least, it is not always obvious that progress in the arts and sciences leads to moral progress or to greater justice in society. Along with the compass, Bacon had mentioned the invention of gunpowder as among the most important discoveries in the practical arts. It is by no means clear that the invention of gunpowder was an unmitigated blessing. All the more reason, then, to see progress as inevitable but visible only retrospectively. It takes such faith to think that technological and social change, which are often violent and unsettling as we experience them, are necessarily for the better. At any rate, it was still some time before the Baconian theme of social transformation by science and reason became an active public project, enshrined in the famous *Encyclopédie*, published in France between 1751 and 1772. The *Encyclopédie* was edited by Denis Diderot and contained work by the dazzling group of thinkers called the philosophes, a group that included the likes of Voltaire, Charles-Louis de Secondat, baron de Montesquieu, Jean-Jacques Rousseau, Jean Le Rond d'Alembert, Georges-Louis Leclerc de Buffon, Anne-Robert-Jacques Turgot, and François Quesnay. Its purpose was to present a compendium of existing knowledge in popular

form, and it was meant as well to disclose the irrationality and defects of existing society and to trumpet the crucial-for-progress doctrine that human nature is sufficiently malleable to be reformed. With the publication of the *Encyclopédie*, the Enlightenment project for progress became a clarion call.

It was not long after that France and the whole of the West was convulsed by the French Revolution, the Reign of Terror, and the Napoleonic aftermath. In one of the great ironies of modern history, the first full-fledged work to broach explicitly the doctrine of progress was written by a victim of the revolution he supported. Marie-Jean Caritat, marquis de Condorcet—one of the brilliant minds of the French Enlightenment and a contributor to the *Encyclopédie*—wrote his famous *Sketch for a Historical Picture of the Progress of the Human Mind* while in desperate flight from the Jacobin radicals. Condorcet died in prison after having been discovered and beaten by an angry mob. Even so, Condorcet was convinced that the American Revolution and the spreading opposition to slavery were signs of moral progress visible in his time, and from this perspective he argued that the whole of human history is a connected series of stages in which the human mind has progressed, and as the mind progresses so too do the possibilities of material progress and moral and political reform. Human history is not a jumble of meaningless accidents, but moves and changes slowly for the better according to knowable laws. With Condorcet, the Baconian project, which linked scientific and moral progress, was derived from inexorable laws of history as much as from conscious human action and invention. Absent his "demonstration" of these laws, it might have been difficult for the suffering Condorcet to retain his optimistic spirit.

In the four or so decades after the publication of Condorcet's *Sketch* in 1795, the idea of progress was developed by two French thinkers into a school of thought known as positivism. The first, Claude-Henri de Rouvroy, Comte de Saint-Simon (1760–1825), was a founder of French socialism and a writer, pamphleteer, and journalist who worked out a theory that claimed to unearth the necessary laws of historical and social change. According to Saint-Simon, human history is characterized by alternating and advancing periods. Social and intellectual forms are first built and made to cohere, and this is followed by revolutionary criticism and change. Not the least of the critical periods was the Enlightenment and the subsequent French Revolution. For Saint-Simon, the alternating historical periods were stages of mental development. As the mind progresses to the present time, it becomes possible to grasp both the physical and social worlds in terms of scientific knowledge involving no speculation or metaphysical assumptions, and hence both nature and society can be illuminated by "positive" knowledge. Those who have such knowledge will organize those who do not, and in particular the wise in positive science will organize a socialist society that will benefit the working classes. Indeed, the wise in the positive sciences will become a new clergy for a new, positive age.

Saint-Simon's theory received its full exposition at the hands of Auguste Comte (1798–1857), the self-professed founder of positive sociology. Again, the history of the human race is occasioned by transformations in ideas, progressing

from the theological to the metaphysical, and then to the positive and scientific. With this conceptual scheme in mind, it is possible to divide human history into more specific periods marked by different religions and movements against them. In the present age the social world will be organized by sociologists according to the positive laws of sociology, and the eventual result will be a rational world without war and injustice.

Along with the rise of French positivism and sociology, the idea of progress grew as well, and in a different vein, in Germany. Even before Condorcet's *Sketch*, the philosopher Immanuel Kant published (in 1784) an essay entitled "Idea for a Universal History with a Cosmopolitan Purpose." A year later he published another essay entitled "Perpetual Peace." According to Kant, our practical reason impels us to postulate historical progress toward a point where happiness and morality coincide, and to look for signs that such progress has in fact occurred. Moreover, the means by which that progress takes place is antagonism and the "unsocial sociability" of men. Without the discordance between the selfish individual and society, humankind would have remained in an Arcadian sleep. The human powers and talents unleashed by antagonism are the means used by history to develop, over time, a form of civil society and a peaceful world order that will make universal justice possible. With Kant, we see an important new dimension of the idea of progress: the notion that history or nature uses human conflict for ultimately good ends. This notion came later to be expressed as the cunning of reason in the thought of Georg Wilhelm Friedrich Hegel (1770–1831), one of the most important figures in the history of the idea of progress.

According to Hegel, the history of the human race is produced by the dialectical contention among conflicting ideas of freedom and recognition. The movement is dialectical because each stage of history contains the conditions for its own demise and replacement by the next. Human history concerns the dialectical development of mind, and its stages proceed from the world in which it is thought that one man is free and all others are not, to one where it is thought that a few are free and all others are not, to a world where it is thought that all are free. In each case, what is thought is what is embodied in concrete institutions and social practices. The last stage has, in Hegel's mind, been reached and is embodied in the modern state characterized by equal rights, the rule of law, and the harmony among the separate spheres of expert political administration, economic and private life, and religion. With Hegel, we see another important dimension of the idea of progress: the end of history. For Hegel, human history is the story of progress, but that progress—and so history as we know it—not only comes to an end but has come to an end in his time. There will, therefore, be no new struggles between forms of moral, political, and social life.

Hegel is important in his own right, but also because his thinking influenced perhaps the single most important theorist of progress: Karl Marx (1818–1883). Hegel's followers divided between the Old Hegelians and the Young Hegelians. The issue concerned the extent to which Hegel's system did or did not reconcile reason and religion. Marx was influenced

by the Young Hegelians, who thought that the system required further critique of religion, but Marx rejected the idea of a dialectic of mind and replaced it with dialectical materialism. (And he accordingly derided the French socialism of Saint-Simon as utopian. Marx's associate Friedrich Engels, too, criticized Saint-Simon for trying to "evolve the solution to human problems out of the brain" rather than from material conditions.) According to Marx, the course of history is determined by the internal contradictions and class conflicts embedded in succeeding arrangements of the means of material production. As capitalism and the bourgeois monopoly of the means of production advance, traditional and rural forms of life are swept away. But as the productive power of revolutionary capitalism advances, so too does the impoverishment of the industrial proletariat, and inevitable crises of overproduction combine with that impoverishment to produce a revolution by the Communist Party that acts politically for the proletariat. With the coming of the revolution, the means of production are socialized, and with this oppression and inequality disappear, as does the coercive political state that will in time "wither away." Needless to say, Marxism was the most powerful political embodiment of the idea of inevitable progress in the twentieth century. Critics of the idea of progress might point out that more human beings perished at the hands of communism, which failed, than from any other idea or cause in the entire course of human history.

The Idea of Progress in the Anglo-American World

While the idea of progress was first announced by Francis Bacon in England, and while English philosophers (including Bacon, Thomas Hobbes, and especially John Locke) played an important role in the French and German Enlightenments, the idea of progress developed in more moderate and practical forms in England and America. There were English utopian thinkers in the nineteenth century, such as William Godwin (1756–1836) and Robert Owen (1771–1858), who broached theories of progress, human perfectibility, and socialism (Owen formed unsuccessful utopian communities in the United States). And in England by the end of the nineteenth century a strong socialist movement was in place. But socialism in England was far less revolutionary and utopian than its European counterparts, and in general the grand theories of historical progress were imported into England from the Continent. There is no doubt, however, that the idea of progress was important in the American political founding. Benjamin Franklin (1706–1790) and Thomas Jefferson (1743–1826) were zealous Baconians and, as is often noted, the Declaration of Independence owed much to the second treatise of Locke's optimistic *Two Treatises of Civil Government* (1690). But in America the idea of progress grew more from the Baconian idea that, given the right intellectual and political conditions, nature could be conquered "for the relief of man's estate." Progress was understood more as a real opportunity and fact of life than as some deep force at work in world history since the dawn of civilization. America represented a new world and a new hope and as such could stand as a light unto other less fortunate nations. Indeed, as Abraham Lincoln said in 1863 in the Gettysburg Address, and as he believed, the issue in the American Civil War was not just slavery, but whether democratic government

would be a real possibility in the world. For the most part, however, the new world was thought to have left the old one behind, mired in misery and oppression, and on its own and with little help to be expected from progress.

In America's first century, the dominant intellectual focus was, for the most part, on limited government and the expansion of liberty, more than it was concerned with social transformation and equality of conditions. By the 1890s, however, immigration and industrialization and the practice of laissez-faire economics gave birth to a movement that unabashedly adopted the idea of progress as its name: "progressivism." The Progressive Era spanned the period roughly between 1890 and 1914, but it made a lasting mark on American politics (including the New Deal and beyond) and American political thought. One of the most influential exponents of progressivism was Herbert Croly, a thinker and journalist (and cofounder and editor of the *New Republic*), whose two books, *The Promise of American Life* (1909) and *Progressive Democracy* (1914) were widely read and especially appreciated by Theodore Roosevelt. Croly was influenced by Hegel and by the American pragmatist thinkers, especially the American philosopher and educator John Dewey (who also appreciated Hegel). Croly's view of progress focused on the need to reform political institutions to cope with modern conditions—conditions that in his view were radically different from the world of the American constitutional framers. For Croly, the U.S. Constitution reflected a now outdated and "reactionary" legalism that stood in the way of social reform and the moral development of the American community. While the constraints of constitutional legalism were appropriate to the nation's childhood—when moral immaturity and impulsiveness require legal restraint—it is not appropriate for a more mature national community. As a consequence of this view, Croly and progressives in general disapproved of the Constitution and favored more direct forms of democracy tied to a more powerful and centralized government. And they favored as well the strong role of administrative and intellectual elites, including social scientists, in the formation of national policy and the fashioning of national character. In this they harked back to the views of the French positivists. The progressives' distinction between "progressive" and "conservative" is still acknowledged in the twenty-first century—as is the essential difference between them. The progressive position sees more democracy as the cure to problems of democracy, likes change for its own sake, and favors state action to promote increased equality. Progressives tend to think that the march of history is on their side. The conservative position is distrustful of direct democracy, fears change for its unintended consequences, and sees the increasing power of the state as a danger to liberty. Thus conservatives have little faith in the healing power of history.

Whither the Idea of Progress

The twentieth century was not kind to believers in the idea of inevitable progress. One could say without exaggeration that between World War I and the collapse of the Soviet Union and communism, the West, bosom of the Enlightenment and the idea of progress, was convulsed by sanguinary madness unparalleled in the whole of human experience. Baconian progress produced the rifled barrel and the machine gun, and

the latter were used by the Western "isms"—nationalism, colonialism, communism, and fascism—to transform Europe, Russia, and much of Asia into a charnel house. It is thus not surprising that in the twentieth century, intellectual currents began to challenge the idea of progress. The most fashionable of these currents included some forms of radical feminism and postmodernism. The two great thinkers of postmodernism were Friedrich Nietzsche (1844–1900) and Martin Heidegger (1889–1976), although their influence in America came more indirectly by way of the French thinkers, especially Jacques Derrida, influenced by Heidegger. According to postmodernism, the idea of the necessary progress of reason is incoherent because reason—especially modern positive science—cannot rationally justify the rule of reason over life. This fundamental limit of reason is itself a discovery made by reason. Reason learns that reason is itself but a way of life and projection of the will, and as such reason is one such projection (and a patriarchal one in the eyes of radical feminism) among many possibilities.

There is absolutely no doubt that science and technology now progress at geometrical speed. One need think only of genetic engineering and the computer to realize that the material world will be quite different very soon. As Benjamin Franklin predicted, some day humans will live three or four hundred years and old age will become a curable disease. But as the advent of postmodernism suggests, it will not be easy to predict what moral forms these long lives will adopt, or whether, if we could see into the future, we would see them as evidence of moral progress. In the United States, postmodernism is generally allied, perhaps paradoxically, with progressive or liberal movements such as multiculturalism and feminism. But postmodernism could just as easily be allied (as indeed it was in the case of Heidegger and the literary theorist Paul de Man) with illiberal political irrationalism, or even with a new age of faith. As Nietzsche argued, the demise of reason as an ideal takes place at the hands of reason. If Nietzsche is correct, then the terminus of progress is the end of the "idea" of progress.

See also Cycles; Enlightenment; Hegelianism; History, Idea of; Marxism; Postmodernism.

BIBLIOGRAPHY

- Alembert, Jean Le Rond d'. *Preliminary Discourse to the Encyclopedia of Diderot*. Translated by Richard N. Schwab. Indianapolis: Bobbs-Merrill, 1963.
- Bacon, Francis. *New Atlantis; and, The Great Instauration*. Edited by Jerry Weinberger. Rev. ed. Arlington Heights, Ill.: H. Davidson, 1989.
- Bury, J. B. *The Idea of Progress: An Inquiry into Its Origin and Growth*. New York: Dover, 1955.
- Comte, Auguste. *System of Positive Polity*. 4 vols. New York: B. Franklin, 1968.
- Condorcet, Marie-Jean-Antoine-Nicolas Caritat, Marquis de. *Sketch for a Historical Picture of the Progress of the Human Mind*. Translated by June Barraclough. New York: Noonday, 1955.
- Croly, Herbert. *Progressive Democracy*. New York: Macmillan, 1914.
- . *The Promise of American Life*. 1909. Reprint, New Brunswick, N.J.: Transaction, 1993.

- Fontenelle, M. de (Bernard Le Bovier). *The Achievement of Bernard le Bovier de Fontenelle*. Assembled with translations and introduction by Leonard M. Marsak. New York: Johnson Reprint, 1970.
- Hegel, Georg Wilhelm Friedrich. *Reason in History*. Translated by Robert S. Hartman. New York: Liberal Arts, 1953.
- . *Hegel's Philosophy of Right*. Translated by T. M. Knox. London and New York: Oxford University Press, 1967.
- Heidegger, Martin. *The Question Concerning Technology, and Other Essays*. Translated by William Lovitt. New York: Harper and Row, 1977.
- Kant, Immanuel. *Kant's Political Writings*, Edited by Hans Reiss. Translated by H. B. Nisbet. Cambridge, U.K.: Cambridge University Press, 1970.
- Marx, Karl. *The Marx-Engels Reader*. Edited by Robert C. Tucker. 2nd ed. New York: Norton, 1978.
- Melzer, Arthur M., Jerry Weinberger, and M. Richard Zinman, eds. *History and the Idea of Progress*. Ithaca, N.Y.: Cornell University Press, 1995.
- Nietzsche, Friedrich. *On the Genealogy of Morals*. Translated by Walter Kaufman and R. J. Hollingdale. New York: Vintage, 1967.
- Owen, Robert. *The Revolution in the Mind and Practice of the Human Race; or, The Coming Change from Irrationality to Rationality*. Clifton, N.J.: A. M. Kelley, 1973.
- Wilson, Edward O. *Consilience: The Unity of Knowledge*. New York: Knopf, 1998.

Jerry Weinberger

PROGRESSIVISM. See **Progress, Idea of.**

PROPAGANDA. Since the twentieth century, *propaganda* has largely had pejorative associations. The term continues to imply something sinister; synonyms for *propaganda* frequently include *lies*, *falsehood*, *deceit*, and *brainwashing*. In recent years unfavorable references have been made to “spin doctors” and the manner in which “propaganda” has devalued democratic politics. The psychologists Anthony Pratkanis and Elliot Aronson intended their book *Age of Propaganda* (1992) to inform Americans about the “sophisticated use of propaganda techniques” and how to “counteract” its “effectiveness.” A widely held belief is that propaganda is a cancer on the body politic, which manipulates our thoughts and actions and should be avoided at all costs.

If propaganda is to be a useful concept, it first has to be divested of its pejorative connotations. The ancient Greeks regarded persuasion as a form of rhetoric and recognized that logic and reason were necessary to communicate ideas successfully. Throughout history leaders have attempted to influence the way in which the governed viewed the world. Propaganda is not simply what the other side does, while one’s own side concentrates on “information” or “publicity.” Modern dictatorships have never felt the need to hide from the word in the way democracies have. Accordingly, the Nazis had their Ministry of Popular Enlightenment and Propaganda, the Soviets their Propaganda Committee of the Communist Party,

while the British had a Ministry of Information and the Americans an Office of War Information. The Allies in both world wars described the opinion-forming activity by the enemy as propaganda, while claiming that they themselves only disseminated the truth.

The origin of the word *propaganda* can be traced back to the Reformation, when the spiritual and ecclesiastic unity of Europe was shattered, and the medieval Roman Catholic Church lost its hold on the northern countries. During the ensuing struggle between forces of Protestantism and those of the Counter-Reformation, the church found itself faced with the problem of maintaining and strengthening its hold in the now non-Catholic countries. A commission of cardinals set up by Pope Gregory XIII (1572–1585) was charged with spreading Catholicism and regulating ecclesiastical affairs in heathen lands. A generation later, when the Thirty Years’ War (1618–1648) had broken out, Gregory XV in 1622 made the commission permanent, as the Sacra Congregatio de Propaganda Fide (Congregation for the Propagation of the Faith); it was charged with the management of foreign missions and financed by a “ring tax” assessed on each newly appointed cardinal. Finally, in 1627, Urban VII established the Collegium Urbanum or College of Propaganda to serve as a training ground for a new generation of Catholic propagandists and to educate young priests who were to undertake such missions. The first propaganda institute was therefore simply a body charged with improving the dissemination of a group of religious dogmas. The word *propaganda* soon came to be applied to any organization with the purpose of spreading a doctrine; subsequently it was applied to the doctrine itself, and lastly to the methods employed in undertaking the dissemination.

From the seventeenth to the twentieth century propaganda continued to be “modernized” in accordance with scientific and technological advances. During the English Civil War (1642–1646), propaganda by pamphlet and newsletter became a regular accessory to military action, Oliver Cromwell’s army being concerned nearly as much with the spread of religious and political doctrines as with victory in the field. The employment of propaganda increased steadily throughout the eighteenth and nineteenth centuries, particularly in times of ideological struggle, as in the American War of Independence and the French Revolutionary Wars. The Girondists, for example, distributed broadsheets among enemy troops offering them rewards for desertion, and American revolutionary propagandists were among the most eloquent in history, their appeal on behalf of the Rights of Man striking a chord in the minds of the people that resonates to this day. From the end of the Napoleonic Wars to the outbreak of World War I in 1914 there were no great wars of revolution, but the new visual “language” of political cartoons and satirical prints continued to feature prominently in propaganda campaigns. Historically, therefore, propaganda became associated with periods of stress and turmoil, in which violent controversy over doctrine accompanied the use of force.

It was, however, during World War I that the wholesale employment of propaganda as a weapon of modern warfare served to transform its meaning into something more sinister.



British World War I propaganda poster seeking to recruit women to the war effort, c. 1915. The first world war represented the advent of propaganda on a massive scale, as the participating countries realized the importance of public opinion and the need to keep morale high. © HULTON-DEUTSCH COLLECTION/CORBIS

Toward the end of the nineteenth century the introduction of new forms of communication had created a new phenomenon, the mass audience. The means now existed for governments to mobilize entire industrial societies for warfare by quickly disseminating information (or propaganda) to large groups of people. One of the most significant lessons to be learned from World War I was that public opinion could no longer be ignored as a determining factor in the formulation of government policies. The Great War was the first “total war,” in which whole nations, and not just professional armies, were locked in mortal combat. Propaganda was an essential part of this war effort, developing in all the belligerent countries as the war progressed.

The rival alliances anticipated a violent but short war. Instead, the relative parity of the opposing forces resulted in a military stalemate and a protracted war. With civilians required to participate in a “total war” effort, morale came to be recognized as a significant military factor, and propaganda began to emerge as the principal instrument of control over public opinion; both control of the mass media and propaganda were seen as essential in maintaining support for national war aims. The press, leaflets, posters, and the new medium of film were utilized, censored, and coordinated (arguably for the first time) in order to disseminate officially approved themes.

At the start of the war most of the belligerent states had only embryonic propaganda organizations. Such institutions developed piecemeal, with local initiatives later being centralized. In Britain, which is largely credited with disseminating the most successful propaganda, the Ministry of Information (MOI) was established in 1917 under Lord Beaverbrook, with a separate Enemy Propaganda Department under Lord Northcliffe. The basic British approach, known as “the propaganda of facts,” was for official propaganda to present events as accurately as possible, but with an interpretation favorable to British war aims. Upon entering the war in 1917, the United States copied the British policy of stressing facts whenever possible, establishing its own Committee on Public Information (CPI), known also as the Creel Committee after its director, George Creel (1876–1953). CPI activities were intended to “sell the war to the American people” and included poster campaigns and war bond drives. By comparison the German effort was controlled largely by the army. Contrary to received opinion, however, the German government had, from an early stage in the conflict, developed a sophisticated notion of propaganda and its reception by different publics and had established a national network of monitoring stations to provide feedback on the “pulse of the people.” But, having constructed the means to read the mood of the people, the German authorities failed to act accordingly. Moreover, as a result of the militarization of the society, German propaganda was too closely tied to military success. Austria-Hungary and Russia made little use of organized propaganda, although the Bolsheviks after 1917 regarded it as essential to their revolutionary effort.

All sides supplemented military engagement with propaganda aimed at stimulating national sentiment, maintaining home front morale, winning over neutrals, and spreading disenchantment among the enemy population. The British are credited with having carried out these objectives more suc-



U.S. Navy recruitment poster by Howard Chandler Christy, 1918. In the United States the Committee on Public Information was formed in 1917 as the official disseminating agency of propaganda. The committee sought to present the facts surrounding the war in a way that was favorable to the image of the country. © SWIM INK/CORBIS

cessfully than any other belligerent state. Britain’s wartime consensus is generally believed to have held under the exigencies of the conflict—despite major tensions. One explanation for this is the skillful use made by the government of propaganda and censorship. After the war, however, a deep mistrust developed on the part of ordinary citizens who realized that conditions at the front had been deliberately obscured by patriotic slogans and by “atrocious propaganda” that had fabricated obscene stereotypes of the enemy and their dastardly deeds. The population also felt cheated that their sacrifices had not resulted in the promised homes and a land “fit for heroes.” Propaganda was now associated with lies and falsehood, and the Ministry of Information was immediately disbanded. A similar reaction took root in the United States. In 1920 George Creel published an account of his achievements as director of the CPI, and in so doing contributed to the public’s growing suspicion of propaganda; this created a major obstacle for propagandists attempting to rally American support against Fascism in the late 1930s and 1940s.

Fledgling dictators in Europe, however, viewed war propaganda in a different light. The experience of Britain's propaganda campaign provided the defeated Germans with a fertile source of counterpropaganda aimed against the postwar peace treaties and the ignominy of the Weimar Republic. Writing in *Mein Kampf* (1925–1927), Adolf Hitler devoted two chapters to propaganda. By maintaining that the German army had not been defeated in battle but had been forced to submit due to disintegration of morale, accelerated by skillful British propaganda, Hitler (like other right-wing politicians and military groups) was providing historical legitimacy for the “stab-in-the-back” theory. Regardless of the actual role played by British propaganda in helping to bring Germany to its knees, it was generally accepted that Britain's wartime experiment was the ideal blueprint for other governments in subsequent propaganda efforts. Convinced of its essential role in any movement set on obtaining power, Hitler saw propaganda as a vehicle of political salesmanship in a mass market. It was no surprise that a Ministry of Popular Enlightenment and Propaganda was the first to be established when the Nazis assumed power in 1933.

The task of propaganda, Hitler argued, was to bring certain subjects to the attention of the masses. Propaganda should be simple, concentrating on a few essentials, which then had to be repeated many times, with emphasis on such emotional elements as love and hatred. Through the continuity and uniformity of its application, propaganda, Hitler concluded, would lead to results “that are almost beyond our understanding.” The Nazis though, unlike the Bolsheviks, did not make a distinction in their terminology between agitation and propaganda. In Soviet Russia, agitation was concerned with influencing the masses through ideas and slogans, while propaganda served to spread the communist ideology of Marxism-Leninism. The distinction dates back to Georgi Plekhanov's famous definition of 1892: “A propagandist presents many ideas to one or a few persons; an agitator presents only one or a few ideas, but presents them to a whole mass of people.” The Nazis, on the other hand, did not regard propaganda as merely an instrument for reaching the party elite, but rather as a means to the persuasion and indoctrination of all Germans.

If World War I had demonstrated the power of propaganda, the postwar period witnessed the widespread utilization of lessons drawn from the wartime experience within the overall context of a “communication revolution.” In the years between 1870 and 1939 the means of communication were transformed into mass media. In an age in which international affairs became the concern of peoples everywhere, governments could not afford to neglect the increasingly powerful press. But there was now more than just the press to contend with. Governments sought to come to terms with the mass media generally, to control them and to harness them, particularly in time of war, and to ensure that as often as possible they acted in the “national interest.” During the 1920s and 1930s the exploitation of the mass media—particularly film and radio—for political purposes became more common. Totalitarian states such as the Soviet Union, Fascist Italy, and Nazi Germany provide striking examples of media being conscripted for ideological purposes. These developments had grown to such proportions by the mid-1930s that, for example, the



Radio broadcast. With the rise in popularity of mass media in the late nineteenth and early twentieth centuries, new vehicles for the dissemination of propaganda were utilized, especially by the governments of totalitarian states. © H. ARMSTRONG ROBERTS/CORBIS

British government established (1934) the British Council and inaugurated (1938) British Broadcasting Corporation (BBC) foreign language broadcasts in an attempt to combat the perceived challenge to democracy.

World War II

According to Philip M. Taylor, World War II “witnessed the greatest propaganda battle in the history of warfare.” All the participants employed propaganda on a scale that dwarfed that of other conflicts, including World War I. Britain's principal propaganda structures were the MOI for home, Allied, and neutral territory and the Political Warfare Executive (PWE) for enemy territory. The programs of the BBC proved an asset long after the war had ended. When Sir John Reith (1889–1971), the former director general of the BBC, was appointed minister of information in 1940, he laid down two fundamental axioms, that “news is the shock troops of propaganda” and that propaganda should tell “the truth, nothing but the truth and, as near as possible, the whole truth.” Although Hitler believed implicitly in the “big lie,” Joseph Goebbels, the Nazi propaganda minister, claimed that propaganda should be as accurate as possible. Similarly, in the early part of the twentieth century Lenin had proclaimed that “in propaganda, truth pays off”; this dictum has largely been accepted by propagandists.

During what is known in Russia as “The Great Patriotic War,” propaganda played a central role in rallying the population to resist the Nazi invasion. Soviet propaganda was supervised by the Directorate of Propaganda and Agitation of the Central Committee under A. S. Shcherbakov and administered by the newly established Soviet Information Bureau. The story of American propaganda during World War II can be divided into two phases: a period of neutrality from September 1939 to December 1941, during which debate raged among the population at large, and the period of U.S. involvement in the war, when the government mobilized a major propaganda effort through the Office of War Information (OWI). The United States used propaganda to orient troops (most famously in the U.S. Army Signal Corps film series *Why We Fight*) and to motivate its civilian population. In all phases of war propaganda the commercial media played a key role.

The extraordinary level of government and commercial propaganda during the war continued during the period of economic and political hostility between communist and capitalist countries known as the Cold War (1945–1989). Propagandists on all sides utilized their own interpretations of the truth in order to sell an ideological point of view to their citizens and to the world at large. U.S. president Harry S. Truman described (1950) the conflict as a “struggle above all else, for the minds of men.” The Soviet leadership under Joseph Stalin (1879–1953), untroubled by the negative connotations of propaganda, viewed the role of the media as mobilizing and legitimizing support for expansionist policies. Stalin’s determination to control the countries “liberated” by Soviet armies led to a growth in arms production and strident anticapitalist propaganda, which contributed to growing tensions. The Department of Agitation and Propaganda (Agitprop) of the Central Committee of the Communist Party fed official propaganda to the media, closely scrutinized by the Soviet censors, while the Communist Information Bureau (Cominform) in September 1947 began a systematic campaign, masterminded by Agitprop, to marshal international support for Moscow against the West.

In the United States, the Smith-Mundt Act (1948) created the legal framework for a permanent overseas information effort, using the media, exchange programs, and exhibitions to counter the massive disinformation campaigns launched from Moscow to discredit the United States. From the mid-1950s, U.S. policy-makers believed that cultural diplomacy would successfully complement psychological warfare and that in the long term it might prove more effective. From the 1950s the export of American culture and the American way of life was heavily subsidized by the federal government and was coordinated by the United States Information Agency (USIA), which operated from 1953 to 1999. Cultural exchange programs, international trade fairs and exhibitions, and the distribution of Hollywood movies were some of the activities designed to extract propaganda value from the appeal of America’s way of life, particularly its popular culture and material success. From the 1960s the Voice of America (VOA) utilized the popularity of American rock music with audiences behind the Iron Curtain, using the music to boost the standing of the United States. While radio remained an important weapon in waging psychological warfare against the Soviets, broadcasting was also



Soviet poster, c. 1941–1945. During World War II, the use of propaganda reached a fever pitch amongst the warring countries. In the Soviet Union, the war was known as “The Great Patriotic War,” and the country’s propaganda was managed by the Directorate of Propaganda and Agitation of the Central Committee. © CORBIS

seen by American authorities as a means by which the United States could win hearts and minds throughout the world through a long-term process of cultural propaganda. Throughout the Cold War, the United States was also able to call upon the appeal of products of private and multinational concerns such as Coca-Cola, McDonald’s, and others. The universal popularity of such symbols of “Americanization” testified to the success of this approach. Such “cultural imperialism” was designed to convert the world into a “global village” dominated by American values.

The far-reaching impact of the Cold War led to new political and sociological theories on the nature of man and modern society—particularly in the light of the rise of totalitarian states. Individuals were viewed as undifferentiated and malleable while an apocalyptic vision of mass society emphasized the alienation of work, the collapse of religion and family ties, and a general decline in moral values. Culture had been reduced to the lowest common denominator and the masses were generally seen as politically apathetic, yet prone to ideological fanaticism, vulnerable to manipulation through the media—particularly the new medium of television—and through the



Poster celebrating China's Fifth National People's Congress, 1978. Propaganda seeks to evoke thoughts and actions that are desirable to those seeking sway over the public. The goal is to narrow viewpoints until they are in line with those of the propagandist. © BETTMANN/CORBIS

increasing sophistication of propagandists. Accordingly, propaganda was viewed as a “magic bullet” or “hypodermic needle” by means of which opinions and behavior could be controlled.

This view was challenged by a number of American social scientists, including Harold Lasswell (1902–1978)—a pioneer of propaganda studies—who argued that within the context of an atomized mass society, propaganda was a mechanism for engineering public opinion and consent and thus acted as a means of social control (what Lasswell referred to as the “new hammer and anvil of social solidarity”). In recent years the French sociologist Jacques Ellul (1912–1996) has taken this a stage further and suggested that the technological society has conditioned people to a “need for propaganda.” In Ellul's view propaganda is most effective when it reinforces already held opinions and beliefs. The “hypodermic” theory was largely replaced by a more complex “multistep” model that acknowledges the influence of the mass media yet also recognizes that individuals seek out opinion leaders from their own class and sex for confirmation of their ideas and in forming attitudes. Many early twenty-first-century writers agree that propaganda confirms rather than converts—or at least that it is more effective when the message is in line with the existing opinions and beliefs of its consumers.

The second wave of the feminist movement in the second half of the twentieth century is an example of this. Known as “women's liberation,” radical feminism developed in the United States and Britain in the 1960s among a group of women involved in a series of protest movements that challenged social norms and traditional values. Women began forming organizations to address their role and status, applying tactics of social agitation. In particular, they focused on employment and pay issues, child care, sex discrimination, and childbearing. Feminism became more mainstream during the 1970s and was addressed by a number of government-backed propaganda initiatives such as the International Women's Year (1975). As divisions within the movement appeared, a backlash of antifeminist propaganda from the media and right-wing politicians began in the 1980s, particularly in the United States.

The spread of television as a mass medium from the 1950s opened up the possibility of a radical new level of exposure of civilian populations to the “realities” of war. The term *media war* came into common usage during the Gulf War in 1991. In the Kosovo war (1999) both sides in the conflict understood the importance of manipulating real-time news to their own advantage. Moreover, the war witnessed the first systematic use of the Internet to disseminate propaganda, including

its use by nongovernmental players. Kosovo highlights the forces of change between the pre–Cold War era and the current globalized information environment. The centrality of propaganda was apparent once more in the terrorist attacks against the United States on September 11, 2001, which were planned for their media impact, as acts of propaganda by deed. Propaganda became a major feature of the “war against terrorism” that followed. The war to remove Saddam Hussein as leader of Iraq began on 19 March 2003 with an invasion by the United States and Great Britain. Officially, this was part of the campaign against international terrorism, but it also became a plan for the “liberation” of Iraq by “Coalition Forces,” the latter a propaganda device placing the U.S. and British military in a flattering light. Media coverage of this war and the war’s psychological dimension were of particular concern to the student of propaganda: it produced a number of innovations, particularly the decision to “embed” reporters and television journalists as members of the invasion forces, on the one hand allowing an immediacy never before possible, on the other introducing a new intensity of information overload.

Defining Propaganda

With rapidly changing technology, definitions of propaganda have also undergone changes. Propaganda has meant different things at different times, although clearly the scale on which it has been practiced has increased in the twentieth century. What are the characteristic features of propaganda, and how can it be defined? Propaganda (and deliberately excluded here are purely religious propaganda and the commercial propaganda we call advertising) is a distinct political activity, one that can be distinguished from cognate activities like information and education. The distinction lies in the purpose of the instigator. Put simply, propaganda is the dissemination of ideas or images intended to convince people to think and act in a particular way and for a particular purpose. Although propaganda can be unconscious, this entry is concerned with the conscious, deliberate attempts to employ the techniques of persuasion for specific goals. Propaganda can be defined as the deliberate attempt to influence public opinion through the transmission of ideas and values for reasons consciously thought out, and designed to serve the interest of the propagandist, either directly or indirectly. Whereas information presents its audience with a straightforward statement of facts, propaganda packages those facts in order to evoke a certain response. Whereas education (at least in the liberal notion of education) teaches the recipient how to think, so as to make up his or her own mind, propaganda tries to tell people what to think. Information and education aim to broaden the audience’s perspectives and to open their minds, but propaganda strives to narrow and preferably close them. The distinction lies in the purpose.

The importance of propaganda in the politics of the twentieth century should not be underestimated. When we speak of propaganda we think of the media as conventionally conceived—press, radio, cinema, television—but propaganda as an agent of reinforcement is not confined to these. Propaganda can manifest itself in the form of a building, a flag, a coin, a painting, even a government health warning on a cigarette pack. The role of commemoration in reinforcement propaganda is often overlooked; yet what better way of reinforcing

the present and determining the future than commemorating the past? It is no coincidence that London has its Waterloo Station and Paris its Gare d’Austerlitz!

Propaganda may be overt or covert, good or bad, truthful or mendacious, serious or humorous, rational or emotional. Propagandists assess the context and the audience and use whatever methods and whatever means they consider to be the most appropriate and most effective. We need, therefore, to think of propaganda in much wider terms: wherever public opinion is deemed important, there we shall find an attempt to influence it. The most obvious reason for the increasing attention given to propaganda and its assumed power over opinion is the broadening base that has dramatically transformed the nature of political participation. The means of communication have correspondingly broadened, and the growth of education and technological advances have proved contributory factors. The early twenty-first century is witnessing the proliferation of “information superhighways” and digital data networks, and legitimate concerns have been expressed about the nature of media proprietorship and access and the extent to which information flows freely (the question of what Noam Chomsky has referred to as the “manufacture of consent”). Propagandists have been forced to respond to these changes; they must, as before, assess their audience and use whatever methods they consider most effective. If we can widen our terms of reference and divest *propaganda* of its pejorative associations, the study of propaganda will reveal its significance as intrinsic to the political process in the twentieth and twenty-first centuries.

See also **Censorship; Communication of Ideas; Language and Linguistics; Media, History of; Nationalism; Patriotism; Totalitarianism; Truth; War; War and Peace in the Arts.**

BIBLIOGRAPHY

- Carr, Edward H. *The Twenty Years’ Crisis, 1919–1939: An Introduction to the Study of International Relations*. London: Macmillan, 1946.
- Connelly, M., and David Welch, eds. *The Management of Perception: Propaganda, the Media and Warfare, 1900–2002*. London: I. B. Tauris, 2003.
- Creel, George. *How We Advertised America*. New York and London: Harper, 1920.
- Cull, Nicholas J., David Culbert, and David Welch. *Propaganda and Mass Persuasion, 1500 to the Present*. Santa Barbara, Calif.: ABC-Clio, 2003.
- Ellul, Jacques. *Propaganda: The Formation of Men’s Attitudes*. New York: Knopf, 1965.
- Garnett, David. *The Secret History of PWE: The Political Warfare Executive, 1939–1945*. London: St Ermin’s Press, 2002.
- Held, David, Anthony G. McGrew, David Goldblatt, et al., eds. *Global Transformations: Politics, Economics, and Culture*. Stanford, Calif.: Stanford University Press, 1998.
- Herman, Edward S., and Noam Chomsky. *Manufacturing Consent: The Political Economy and the Mass Media*. New York: Pantheon, 1988.
- Hixson, Walter L. *Parting the Curtain: Propaganda, Culture, and the Cold War, 1945–1961*. New York: St. Martin’s, 1996.

- Horten, Gerd. *Radio Goes to War: The Cultural Politics of Propaganda during World War II*. Berkeley: University of California Press, 2002.
- Jowett, Garth S., and Victoria O'Donnell. *Propaganda and Persuasion*. 3rd ed. Thousand Oaks, Calif.: Sage, 1999.
- Kenez, Peter. *The Birth of the Propaganda State: Soviet Methods of Mass Mobilization, 1917–1929*. Cambridge, U.K., and New York: Cambridge University Press, 1985.
- Koppes, Clayton R., and Gregory D. Black. *Hollywood Goes to War: How Politics, Profits, and Propaganda Shaped World War II Movies*. Berkeley: University of California Press, 1990.
- Lasmar, Paul, and James Oliver. *Britain's Secret Propaganda War*. Stroud, U.K.: Sutton, 1998.
- Lasswell, Harold D., Daniel Lerner, and Hans Speier, eds. *Propaganda and Communication in World History. Vol. 1: The Symbolic Instrument in Early Times*. Honolulu: University Press of Hawaii, 1979.
- . *Propaganda and Communication in World History. Vol. 2: The Emergence of Public Opinion in the West*. Honolulu: University Press of Hawaii, 1980.
- Marlin, Randal. *Propaganda and the Ethics of Persuasion*. Peterborough, Ont. and Orchard Park, N.Y.: Broadview Press, 2002.
- Messinger, Gary S. *British Propaganda and the State in the First World War*. Manchester, U.K., and New York: Manchester University Press, 1992.
- Pratkanis, Anthony R., and Elliot Aronson. *Age of Propaganda: The Everyday Use and Abuse of Persuasion*. New York: W. H. Freeman, 1992.
- Reeves, Nicholas. *The Power of Film Propaganda: Myth or Reality?* London and New York: Cassell, 1999.
- Saunders, Frances S. *Who Paid the Piper? The CIA and the Cultural Cold War*. London: Granta, 1999.
- Taithe, B., and T. Thornton, eds. *Propaganda: Political Rhetoric and Identity 1300–2000*. Stroud, U.K.: Sutton, 1999.
- Taylor, Philip M. *The Munitions of the Mind: A History of Propaganda from the Ancient World to the Present Era*. 2nd ed. Manchester, U.K.: Manchester University Press, 2003.
- Thomson, Oliver. *Easily Led: A History of Propaganda*. Stroud, U.K.: Sutton, 1999.
- Welch, David. *Germany, Propaganda and Total War, 1914–18: The Sins of Omission*. New Brunswick, N.J.: Rutgers University Press, 2000.
- . *The Third Reich: Politics and Propaganda*. 2nd ed. London and New York: Routledge, 2002.
- Winston, Brian. *Media Technology and Society: A History: From the Telegraph to the Internet*. London and New York: Routledge, 1998.

David Welch

PROPERTY. “There is nothing which so generally strikes the imagination, and engages the affections of mankind, as the right of property; or that sole and despotic dominion which one man claims and exercises over the external things of the world, in total exclusion of the right of any other individual in the universe” (p. 2). So wrote Sir William Blackstone (1723–1780), the great English jurist, in his *Commentaries on the Laws of England*. Blackstone exaggerated: romantic love, sexual desire, and spiritual purity engage human creative attention as much as ownership of things. Yet Blackstone does not

overstate the importance of property among human institutions. Property joins the family, the state, and the church as the most basic and universal structures of human society; and among these four, it is likely the most indispensable. A society might persist without kinship, kings, or priests, but it will not survive without distributing to its members stable control over its resources.

The significance of property can be appreciated by considering whether there is anything around you that is not owned by someone. This book, certainly (although the owner of the paper and ink—or the computer screen—will not be the same person as the copyright holder). The chair in which you are sitting and all of the objects around you, the walls of the room, the surrounding building and the land on which it rests. Even the mineral deposits deep below and the airspace high above are owned by someone. Human beings themselves might be exceptions to this universal rule of ownership—although many think that there is a sense in which each person owns himself. And perhaps no one now owns the heavens. Yet if it is true that no one owns the planets and the stars, one feels that this is merely because humans have not reached them yet.

The Nature of Property

What is property? One will search in vain for its essence. Modern ideas of property are the product of millennia of change, their boundaries being stretched and cut to fit a long series of ideologies and social forms. One is left not with one definition of the term but rather with a variety of usages, some overlapping and some aloof. The sadistic boss uses the language of property when he says to the employee, “I own you,” as does the plaintive lover who cries, “You belong to me.”

The variety of meanings of the term may be demonstrated by considering cases in which it is not certain whether something is property or not. Is one's passport one's property? What of one's vote, one's entitlement to social security payments, or one's lungs? Do people own their appearance, or their reputation? People will disagree on these cases; most will say that there is a “sense in which” each is property. This is the point that is being emphasized here. There are many “senses” of property, each of them attracting us with its own gravitational pull.

The American legal theorist Thomas Grey has alleged that the dispersal of meanings has gone so far that it should be said that the concept of property has disintegrated completely. Not only are there a range of concepts in ordinary speech, but specialists such as lawyers and economists have defined their own discontinuous usages. Grey's thesis goes too far. There is a core of meaning to the idea of property, and at this core is found a prototype against which all other instances are measured.

The vital first insight into the nature of property distinguishes property from mere physical possession. Being in contact with an object is neither necessary nor sufficient for ownership. As the English jurist Jeremy Bentham (1748–1832) observed: “A piece of stuff which is actually in the Indies may belong to me while the dress I wear may not” (p. 133). The ownership relation is not a physical relation between a person and the property, but a moral or legal relation among persons

with respect to the property. Property is to possession as marriage is to mating.

As Bentham asserted, the relation of ownership is not material but metaphysical. What then is that relation? In all instances of ownership there are three variables: some *owner* has certain *rights* over the *property* that is owned.

Any number of entities can fill in the third, *property*, variable. Houses, steel factories, palaces, oil deposits, and interplanetary-exploration vehicles can all be property, as can taxi medallions, dividends, parts of the broadcast spectrum, works of fiction, and even forms of life themselves. The things that are property have almost infinite variety.

The types of *owners* of property sort themselves into familiar categories. The public owns public property, the government owns government property, and private persons—either individuals or “artificial” persons such as corporations—own private property. There are also sometimes special rules for certain kinds of owners: for example, couples share rights over joint property, and in some countries church property is exempt from tax. Since the past five hundred years have seen the torturous rise of private property to predominance, private property will be the particular focus here.

It is the *rights* that define the relation between owner and owned that distinguish the different senses of “property” from each other. The most basic rights that define most kinds of ownership are the rights of *exclusive use*. An owner has the right to use the property, and others may not use that property without the owner’s permission. Beyond these rights of exclusive use, there are other rights that define various senses of “property” related either to the owner’s control or to the property’s value. An owner may have the right to transfer the property (if so, the property is alienable). An owner may have the right to sell the property (if so, the property is a commodity). An owner may have the right to receive a stream of income from the property (if so, the property is an asset).

These categories nest or overlap. Not everything that an owner may exclusively use may be transferred: one may not legally transfer one’s prescription drugs to anyone else. Not everything that can be transferred may be sold: for example, United States law allows the transfer, but not the sale, of eagle feathers. Nor is everything with economic value something that the owner has the right to sell. Trust funds and tenured professorships are assets, but they are assets that cannot be sold.

The core meaning of property is that of a commodity: that is, of an object of salable rights of exclusive use. The commodity is the prototype of property, and sets the paradigm against which we measure less central senses of ownership. There is a “sense in which” one’s lungs are one’s property, since one has exclusive rights to use them. Yet there is also a sense in which they are not, since one cannot legally sell them to others. Similarly with one’s reputation. One’s reputation can be a financial asset, but there is little sense in saying that one has rights to exclusive use of it. Reputation can be considered a type of property, but its distance from the prototype makes it property of a particularly attenuated sort. The

commodity is at the core of current ideas about property, and, as will be seen, debates over what should be put into this crucial category have been some of the most heated.

There are also secondary rights and liabilities that accompany ownership in most of its senses. An owner has a right to compensation should another damage his property, and an owner is liable should her property cause harm to someone else. These secondary aspects of ownership tend to be taken for granted, yet they can be of the first importance for innovative approaches to property-related problems such as environmental protection.

Global Variation and Convergence

When people discuss global variations in property, they are usually speaking either about differences in how property is distributed, or about differences in how property rules are formulated.

Inequality. The question of the distribution of property is the question of inequality. There is no one factor that explains why some countries have more equal property distributions than others, as can be seen by taking income as the representative measure for all property. Some of the most egalitarian countries in the world (such as Hungary and Slovakia) have a tradition of equality that has persisted throughout large transformations in their political and economic systems. Other countries, for example those in Scandinavia, achieved greater equality through determined political reform. The most remarkable decline in inequality in the twentieth century was accomplished in socialist Cuba, which under Fidel Castro, who came to power in 1959, leveled its property holdings to a degree unparalleled in the Americas.

Among the major economic powers, Japan has the most equal distribution of income and the United States the most unequal. Inequality increased in the United States during the period of conservative ascendancy that began in the 1970s, and this growth of inequality appears to be related to a general strengthening of property laws. Latin America, dominated by entrenched landowning elites, is the most consistently unequal region of the world. Many African countries, struggling with failed governments, are also highly unequal in their distributions of property—as is South Africa, which in the early twenty-first century was only slowly recovering from decades of apartheid. Several nations in Southeast Asia are marked by inequality that runs along ethnic lines, with the greater riches of minority ethnic Chinese communities being a perennial source of social friction.

Finally, the world itself is a very unequal place. The level of inequality across the globe is greater even than the inequality within the most unequal large country (Brazil). According to the economist Branko Milanovic the richest 10 percent of individuals in the world control fifty times more of global income than do the poorest 10 percent of individuals, and the richest 1 percent of humankind receives more income in a year than does the poorest 50 percent. There are lively debates over whether this global inequality is increasing or decreasing, and over the impact of globalization on inequality. The only safe

conclusion to be drawn from these debates is that different conclusions about trends and impacts will be reached depending on the data that are used and the income brackets that are compared.

The distribution of property has a profound influence on almost all aspects of human life. One window into this conclusion is the robust causal connection between levels of inequality and human health. There are reliable data from within the wealthiest countries showing the influence of inequality on health outcomes. In all rich countries, the rich are much healthier than the poor. Moreover, the more unequal a country is in its property distribution, the more unequal it will be in the distribution of health. Interestingly, “middle” groups in rich countries with high inequality are less healthy than middle groups in rich countries with low inequality. Moreover, creating a more equal distribution of property makes the poor healthier without making the rich less healthy. When considering the global correlation between inequality and health, it is evident that the citizens of rich countries are on average much healthier than the citizens of poor countries. Further, as the medical anthropologist Paul Farmer has shown, poor individuals are much less healthy than rich individuals wherever they live. Regardless of where in the world they live, the poor tend to die younger from infectious diseases and violence, while the rich tend to die older from chronic conditions.

Property rules: capitalism. Beyond the question of the distribution of property is the question of global variations in how property rules are formulated. Looking at the world as a whole, by far the most important change in political economy since World War II is the transition to the near-universal acceptance of the legitimacy of private property in the means of production. This is a tremendous intellectual shift. The contrast between communist and capitalist countries, which defined half a century of world history, has vanished in most places and is vanishing in the rest. Even the Chinese constitution in the early 2000s requires that the right of private property be secured. The fates of the many millions of people who have made (and are making) the transition from a communist to a capitalist economy have been varied. On the one hand, the rapid privatization of state property in the former Soviet Union has been accompanied by a plunge in living standards to levels that are shocking within Europe. On the other hand, the gradual introduction of private property norms into the Chinese economy since the late 1970s has resulted in what is probably the greatest aggregate increase in well-being in human history.

The explanations for this remarkable global convergence on the legitimacy of private property in the means of production cluster around two poles: the political and the economic. Private property is associated with certain kinds of individual political freedom. One type of explanation for the transition to capitalism, emphasized by the historian Richard Pipes, is that the central control characteristic of communist states became intolerable to those wishing more individual control over the politics and less political intrusion into private life. The other cluster of explanations is economic. Communism is simply less efficient than is capitalism at generating the goods and services

that people want. The leading theorist of the inefficiency of communist economies was the Austrian economist F. A. Hayek (1899–1992). Hayek’s central insight was that the information about how and what an economy should produce is dispersed among millions of individuals, and that it is much less efficient to attempt to move this information to a central source of economic control (as state ownership systems do) than it is to disperse economic control to the individuals who have the information (as private property systems do).

Property rules: inheritance. Even though private property in the means of production has emerged as the global norm, there are still major variations among countries regarding more specific property rules. One of the most revealing dimensions of variation runs through the laws of inheritance. Inheritance laws are the site of several conflicting values. Parents tend to want to pass their property along to their children, either because this property is special to the family’s history or because the parents wish to increase their children’s economic security. Yet inheritance laws also permit or even require various forms of inequality to persist across generations, the most significant of these being inequalities between families and between genders. The way that a society frames its laws of inheritance reveals much about its social priorities.

The Islamic law of inheritance derives from the pronouncements of the Prophet in the Koran, which have spurred highly elaborated interpretations. All of the schools of interpretation agree that Islamic law requires a daughter to be given part of an inheritance (a very progressive rule in the Prophet’s day), but restricts her share to one-half of what a son receives (which does not satisfy liberals in the early twenty-first century). Also notable in Islamic law are the strict limitation of inheritance to blood relations, and the prohibition on Muslims either bequeathing to or inheriting from those outside the faith. In countries where Islamic law is the basis of national law, one interpretation or another of the Koranic injunctions is codified. In India, on the other hand, the Islamic law of inheritance applies within Muslim communities but not elsewhere. The inability of India to generate a uniform civil code that would bind both the Muslim minority and the Hindu majority (as well as Buddhists, Jains, and Sikhs) is a symptom of the deep social differences that continue to divide this vast and sometimes volatile nation.

Among the Tswana tribes of Botswana, the rules of inheritance perpetuate the prevailing economic, familial, and gender relations. Most of the tribes are patrilineal, meaning descent is traced through the males. In these tribes the wealth of the family (mostly cattle) is kept within the family by passing most of it to the eldest son. Interestingly, in some of these tribes the rule is that ownership of the family home passes to the youngest son, thereby ensuring that a widowed mother will be supported even if the eldest son moves away, and so that the traditional family homestead will be preserved. Other Tswana tribes are matrilineal. In these tribes it is still a male who inherits the cattle, but it is the oldest son of the oldest sister, not the son, who receives the main inheritance. Here again is seen the property rules sustaining, and even defining, the most basic social relationships over time.

Primogeniture (which vests ownership of land in the oldest son) is especially rewarding as a subject for investigation, because its presence correlates to important features in a society's economy. A Marxist thesis states that changes in political and economic rules will tend to follow developments in methods of production: as Karl Marx (1818–1883) himself said, the hand mill gives you society with a feudal lord, the steam mill, society with the industrial capitalist. The history of primogeniture tends to bear out this hypothesis. In the English feudal period arable land was the most productive asset, yet land was limited and required large estates to be worked effectively (to divide it was to ruin it, as the Scottish economist Adam Smith [1723–1790] remarked). Primogeniture ensured that an estate would remain intact, instead of dissipating the land into inefficient smaller parcels by dividing it among sons. These same economic facts also obtained in Japan during the period of domination by the samurai class, and again in Japan primogeniture defined the rules of inheritance. By contrast, primogeniture was never widely adopted in eighteenth- and nineteenth-century American law. This can be explained by the much greater availability of arable land in America (reducing the need to require a specific form of inheritance) and the increased importance there of industrial and financial capital (the ownership of which can be divided without similarly reducing productive efficiency).

The form of inheritance laws in a society are not only responsive to epochal trends in methods of production, they are also of first importance for explaining the specific character of that society at any time. For example, at the turn of the twenty-first century blacks in the United States faced far greater risks of poverty, unemployment, and imprisonment than did whites. The sociologist Thomas Shapiro argues in a 2004 book that the main explanation for this is that these blacks inherited much less wealth than did their white counterparts. Because blacks inherited less, their opportunities were fewer and they were less likely to be able to withstand the economic shocks that are a part of life in a modern economy. Moreover, this racial disparity in wealth can be expected to increase over time, as whites build up greater capital between generations at a much faster rate. Different rules of inheritance would produce different patterns of social inequalities between the races.

The Values of Property

As has been seen, the nature of property is complex. The values that bear on property are similarly complex. Indeed as the political theorist Alan Ryan has emphasized, the long history of the debate over the legitimacy of private property can be viewed as a succession of major theorists stressing the benefits or the burdens of this institution. The goods and the bads that these theorists have emphasized can be arranged along three dimensions: the values pertaining to individuals' relation to private property, the values arising from an owner's relation to other persons, and the values generated in a society where private property predominates.

Personal values. An owner has many advantages because of his relation to what he owns. As Bentham never tired of pointing out, owning property gives one a secure access to resources that may be essential to carrying out one's plans over

time. Ownership also allows one to enjoy and preserve items of personal value, such as a mother's wedding ring. A Hegelian point elaborated by the legal theorist Jeremy Waldron is that ownership also improves the owner. As an owner works on his property (for example, paints a picture) his self-awareness increases as he sees his personality reflected in the world, and he comes to develop prudence as he realizes that the changes he makes in his property on one day will determine what he starts work with on the next day.

The critics of private ownership have stressed the corresponding disadvantages. Marxist critics have worried that owners will fetishize what they own and come to believe that ownership of consumer goods can substitute for satisfying personal relationships or deserved self-regard. Nor do Marxists celebrate individuals' externalizing their personalities into the property on which they work, since in a capitalist system these individuals will have to sell the objects to others in order to make a living. Finally, nearly all critics of private property have made the mirror-image point to Bentham's concerning the owner's security. Those who do not own property, they note, can expect to be excluded from what they want and need, which makes their prospects predictably wretched.

Interpersonal values. The interpersonal benefits of private ownership are many. Property secures for an owner a protected sphere in which he is free to do as he likes. He may protect his privacy by keeping others out, and he may increase intimacy by allowing selected others to enter his private zone. Moreover, as Hegel saw, ownership brings with it social recognition: everyone must acknowledge that the owner's will is decisive over the disposition of the object of ownership. Aristotle also noticed that private ownership increases opportunities for generosity—it would be much harder to give gifts if no one owned anything that could be given.

Yet these benefits also have flip sides. The same rights that bring freedom and privacy can also foster disconnection, loneliness, lack of fellow-feeling, and antisociality. Further, as Jean-Jacques Rousseau (1712–1778) bemoaned, private property makes each person dependent on others for not only their material wants but for their very self-conception. In a capitalist system one depends for the satisfaction of one's needs on others who may have no concern for one's welfare, and one comes to evaluate one's self-worth mostly by reference to the property one has accumulated.

Societal values. Finally, the bitterest battles have been over the societal values attaching to a private property system. On the one hand, private ownership is often superior to common ownership for effective stewardship of resources. ("If everyone owns everything, then no one will take care of anything.") Private property economies encourage each person to work hard to satisfy the wants and needs of others, and so are likely to be more innovative and prosperous. Widespread property ownership is conducive to social stability, since those "with a stake in the society" are less likely to favor revolution or war. And private ownership, as the American economist Milton Friedman (b. 1912) argued, is the best bulwark against the overweening state power that the twentieth century gave so much cause to fear. On the other hand, the pathologies of

private ownership systems have been thoroughly documented. Private property economies foster competitive and exploitative relations, in which each sees the other as only a rival or a master, a servant or a dupe. Private property turns intimate relations into commercial relations (as one sees at weddings and Christmas). Markets multiply false needs and a blank consumerism, wasting resources and leading to uncontrolled environmental damage. Furthermore, a private property economy results in inequalities in almost every important aspect of human life, from political power to opportunities for meaningful work and leisure to life expectancy itself.

The complexity of the values surrounding private property has led all modern societies to frame commensurately complex property laws in an effort to capture the benefits of property while avoiding its burdens. For example, the law may allow the owner of a shopping mall to profit from renting space to popular stores but also forbid him to exclude protesters peacefully handing out political pamphlets. The law may allow a homeowner complete freedom of interior decoration but restrict her freedom to paint the exterior in garish colors so as to protect her neighbors' property values. Private property law in every legal system has become an intricate web of regulations, as each society has struggled to balance all of the countervailing values at stake.

Contemporary Debates

Within the framework presented here, private property rights are *instrumental* to achieving a *variety* of diverse values. This is by far the predominant framework among those who devise national and international property rules. Within the academy, however, the period since the early 1970s has seen two alternative paradigms emerge. Both of these paradigms tend toward libertarianism, which models politics as the interactions among private property owners and argues that property rights should be robustly resistant to state interference. Although these two paradigms converge on a libertarian political program, they reach it by quite different routes.

Academic debates: Nozick and law and economics. Robert Nozick's extraordinary *Anarchy, State, and Utopia* (1974) declared that property rights are not instrumental, but are rather morally fundamental. Respect for persons requires, Nozick claims, not only that one respect their rights to life and free movement, but that one respects their rights to their legitimately acquired property as well. A just social order will no more recognize an overall principle for distributing wealth than it will recognize an overall principle for distributing marriage partners. To tax someone's earnings and give these earnings to someone else is on a par with enslaving that person for someone else's benefit—it is a fundamental violation of the taxpayer's rights. The only justifiable state is a minimal one that protects people's property rights against encroachment; beyond this, individuals must remain free to use and sell their property (including themselves) as they choose.

Nozick here develops and radicalizes the theory of the English philosopher John Locke (1632–1704), who argued that private property rights are conceptually and historically prior to political institutions, and that political power cannot

legitimately be used to deprive individuals of the rights they have independently of the existence of the state.

The brilliance of Nozick's arguments stimulated an entire generation of philosophers to respond to the idea that property rights might be fundamental. Within the legal academy a second movement was also reaching consistently libertarian conclusions, albeit from a different set of assumptions. This movement, known as law and economics, holds that property rights are indeed instrumental, but that they are instrumental in achieving a single value: wealth. There are actually two separate law and economics theses: one is that the laws as they exist *do* generally work to maximize wealth, and the other is that the laws *should* work to maximize wealth. The maverick leader of the law and economics movement, Richard Posner, has advanced both theses.

The law is and should be framed, Posner argues, so as to maintain an efficient allocation of resources—meaning an allocation wherein those who are the most willing and able to pay for the various resources have control over those resources. For most resources, the law can achieve an efficient allocation by assigning strong property rights to owners. If someone besides an owner values a resource more than does the owner, they can then simply buy it from that owner. The main role of the state is again simply to enforce these strong property rights. However, there are some cases in which it is more efficient for the law to assign somewhat weaker property rights. For example, if a public use of a resource would bring more wealth than does a private use (building a highway through private ranches, for example), then the state may simply take the resource without entering into expensive negotiations with each private owner.

This wealth-maximizing paradigm has proved a powerful framework for explaining why the law is as it is within capitalist economies. Yet, clearly, even in capitalist economies not all laws work to maximize wealth, and legal economists have advocated a gamut of reforms that they believe would make these economies more efficient. They have generally argued that efficiency would be increased with stronger property rights, a less redistributive state, and, most notoriously, with a wider application of property rules. For example, legal economists have claimed that treating body parts, votes, and even babies as salable property would increase total social wealth. This last argument is one that leads this discussion out of the academy and into the more general public debate over commodification.

Commodification and progressive property-based arguments. The question of commodification is: What should be for sale? Disputes have focused on objects and activities that are particularly sensitive for human identity and contemporary morality: blood, organs, psychoactive drugs, sexual services (prostitution) and gestational labor (surrogate-motherhood contracts). The debates over whether these things should be commodities have had a certain structure. On the pro-commodification side, it is often said that commodification allows those who want something (sex or a baby) to get what they otherwise could not. Moreover, commodification tends to increase the supply of scarce goods (there would be few waiting

lists for organ transplants if there were a market for organs). Many pro-commodification arguments simply assert that restrictions on sales (of, for example, drugs) are insultingly paternalistic restrictions on harmless personal freedom. Some also argue that commodification allows the renegotiation of outdated cultural norms: for example, that legalizing surrogacy would show that women are in control of their own reproductive lives. Moreover, it is hard to limit anti-commodification arguments to their intended targets: Why is it wrong to sell one's services as a prostitute, but not as a nurse, a cellist, or a priest?

Anti-commodification arguments have revolved around harms to well-being, status, and community cohesiveness. It is said that allowing markets in, for example, organs would inevitably lead to exploitation of the poor and the desperate, and so exacerbate existing social inequalities. Moreover, legalized prostitution and surrogacy only reinforce the stereotypes of women as properly sexually subordinate or as baby factories. More subtly, it is argued that commodifying people's bodies, or their sexual or reproductive lives, would instill in them a degraded self-image as they came to view themselves as repositories of economic value instead of beings of dignity. Finally, as English social theorist Richard Titmuss found with blood donation, a society that gives gifts instead of making sales fosters the kind of altruism that is crucial for holding a community together.

Anti-commodification arguments have been one standard of the political Left during a period in which the political Right has eliminated everything from state ownership of industry to rent control. The collapse of Marxist ideology, and a new popular presumption against traditional taxation and redistribution schemes, has disrupted leftist politics. Only slowly is the Left learning to deploy property arguments toward progressive causes. One example is in environmental regulation, where it is argued that "dirty" industries should be held liable for the harms (pollution) that their property causes. The Peruvian economist Hernando de Soto, has launched a different kind of progressive-based argument from the Right by claiming that strengthening the property laws in developing countries would allow the many poor who work in the "shadow" economy to take advantage of the resources (houses, land) that they now control but cannot use as legal assets.

Intellectual Property

Intellectual property brings together many of the themes from the discussions above: conceptual complexity, global variation and convergence, and lively debates over values. Intellectual property rights are rights to control the use or transmission of intellectual creations. There are three basic categories. Copyright covers "expressive" works (such as books, musical compositions, films, paintings, computer programs) as well as performances, sound recordings, and broadcasts. Patents protect inventions. Trademarks and marks of geographical origin (for example, "Champagne") make distinctions among the goods and services that are brought to market. The wide historical variation in intellectual property law across the globe narrowed in the 1990s when intellectual property standards (such as that a copyright endures for fifty years after the death of the author, and patent protection lasts for twenty years)

were built into the treaties establishing the World Trade Organization.

The origins of copyright law lie in the desire of the English crown in the seventeenth and eighteenth centuries to censor publications by granting printing monopolies to selected publishers; patent monopolies over inventions emerged in Renaissance Italy. In the modern era the main justifications for intellectual property rights have been three. By far the dominant justification (enshrined, for example, in the U.S. Constitution) is that the prospect of exclusive control gives creators *incentives* to create works that will be pleasing and useful to others. A secondary justification, usually associated with continental Europe, is that intellectual property rights protect the *personality* interests of artists in the integrity of their expressions. A third justification, relating mostly to trademarks and geographical marks, is that these rights *assure* consumers by associating a product with known producers.

Global intellectual property law has become extraordinarily elaborate as its framers have tried to balance all of the values at stake. Many disputes remain. For example, many have argued for weakening the patent protection of pharmaceuticals so that sick people in poor countries can get the medicines they need. The pharmaceutical industry has countered that such weakening would lessen the incentives they have to create new life-saving drugs in the future. Another dispute has been over emerging technologies such as the Internet, whose potential, as legal theorist Lawrence Lessig maintains, is shackled by national regulations designed to favor powerful industries.

Given that the fates of millions of lives, the rate of global economic progress, and huge profits drive controversies such as these, it is not surprising that they have moved from the legal into the political arenas. On these issues, as with so many other issues concerning property, the most basic interests and values are at stake.

See also Capitalism; Class; Equality; Gift, The; Human Rights; Poverty; Wealth.

BIBLIOGRAPHY

- Bentham, Jeremy. *The Theory of Legislation*. New York: Oceana, 1976.
- Blackstone, William. *Commentaries on the Laws of England*. Vol. 2. Oxford: Clarendon, 1766.
- Farmer, Paul. *Infections and Inequalities: The Modern Plagues*. Berkeley: University of California Press, 1999.
- Friedman, Milton, with Rose D. Friedman. *Capitalism and Freedom*. Chicago: University of Chicago Press, 1962.
- Grey, Thomas. "The Disintegration of Property." In *Property*, edited by J. Roland Pennock and John W. Chapman. New York: New York University Press, 1980.
- Hayek, F. A. *The Essence of Hayek*. Edited by Chiaki Nishiyama and Kurt R. Leube. Stanford, Calif.: Hoover Institution Press, 1984.
- Hughes, Justin. "The Philosophy of Intellectual Property." *Georgetown Law Journal* 77 (1988): 287–366.
- Lessig, Lawrence. *The Future of Ideas: The Fate of the Commons in a Connected World*. New York: Random House, 2001.

- Marx, Karl. *The Poverty of Philosophy*. Translated by H. Quelch. Amherst, N.Y.: Prometheus, 1995.
- Marx, Karl, and Friedrich Engels. *The Communist Manifesto*. Edited by Frederic L. Bender. New York: Norton, 1988.
- Milanovic, Branko. "True World Income Distribution, 1988 and 1993: First Calculation Based on Household Surveys Alone." *Economic Journal* 112 (2002): 51–92.
- Nozick, Robert. *Anarchy, State, and Utopia*. New York: Basic, 1974.
- Paul, Jeffrey, ed. *Reading Nozick: Essays on Anarchy, State, and Utopia*. Totowa, N.J.: Rowman and Littlefield, 1981.
- Pipes, Richard. *Property and Freedom*. New York: Knopf, 1999.
- Posner, Richard A. *The Economics of Justice*. Cambridge, Mass.: Harvard University Press, 1981.
- Rousseau, Jean-Jacques. *A Discourse on Inequality*. Translated by Maurice Cranston. New York: Penguin, 1984.
- Ryan, Alan. *Property*. Minneapolis: University of Minnesota Press, 1987.
- Shapiro, Thomas M. *The Hidden Cost of Being African-American: How Wealth Perpetuates Inequality*. Oxford and New York: Oxford University Press, 2004.
- Soto, Hernando de. *The Mystery of Capital: Why Capitalism Triumphs in the West and Fails Everywhere Else*. New York: Basic, 2000.
- Titmuss, Richard M. *The Gift Relationship: From Human Blood to Social Policy*. Expanded and updated edition, edited by Ann Oakley and John Ashton. New York: New Press, 1997.
- Waldron, Jeremy. *The Right to Private Property*. Oxford and New York: Oxford University Press, 1988.

Leif Wenar

PROPHECY. The root of the English word *prophecy* is derived from the Greek *prophēteia*, Latin *prophetia*. The root of *prophēteia* is derived from *prophēmi*, which means to speak before or for someone or something. A cognate Greek word is *prophētazō*, which indicates the reception of the gift of interpreting the will of the gods—that is, the gift of prophecy. The gift of prophecy apparently is a universal attribute since many civilizations and their religions claim to have experienced divine revelation through those who have received the gift of prophecy.

Prophecy is one of the ways God communicates with humankind and may be a continuous process. God speaks but the human must hear and comprehend; only then can he or she speak for God as his messenger—that is, as God's prophet. A prophet reveals God's intention for the future but also for the present. Moses is a prototype of the prophet who speaks for God in regard to the present as well as to the future.

Hebrew Prophecy

The religion of the Hebrews was a prophetic religion from the beginning. The gift of prophecy was a distinctive mark of communion with the divine among the Semites. In the Old Testament theophanies and oracles were predominant in the earliest stages of God's revelation of himself. Before a war or the signing of a treaty, the Hebrew people would "consult" God through its seers and especially its priests. Gradually a

distinction emerged between dreams that truly revealed God's communication with prophets (Num. 12:6; Deut. 13:1–2) and those of professional seers (Jer. 23:25–32; Isa. 28:7–13).

The covenant revealed to Moses on Mt. Sinai became the apogee of God's revelations. Through this covenant God (Yahweh) became the head of the Hebrew people (Israel) and delivered them from Egypt. In return the people Israel promised fidelity to the Law (the Decalogue), which reveals the divine will. The prophets used the covenant in regard to events in their own time. The word of God spoken through his prophets summons Israel to have faith in the Decalogue and the covenant.

The Hebrew word for prophet (*nabhi*) implies that the subject is being acted upon and retains the character of that which has acted upon it. The verb *nibba* means "to make an announcement" and also "to display excessive excitement." *Nabhi* means one subject to the inspiration of a god or demon and designates the behavior associated with a prophet. Thus the word *prophet* could be applied to the prophets of the Bible and to the devotees of Baal. The dark aspects were surely present among the Hebrews, as witnessed by God's destruction of almost all of his creation because of humanity's sinfulness. Because of one man's devotion to God, however, humankind was given a second chance. Noah becomes symbolic of righteousness and of God's promise that he would not again destroy his creation by flood. Noah's story is a prophetic story that offers hope for humankind, who listens to God's voice and heeds it. While Noah himself was not considered a prophet in the strict sense, his faith in and obedience to God established the prophetic tradition among the Hebrews. Noah called upon his contemporaries to repent, hoping that their turning away from sin would secure their safety. Noah was called a righteous man because he obeyed God and served his fellow people. He brought aid to humankind by introducing plows, axes, sickles, and other implements that would lighten their labors, according to the Haggadah (folk legend, in distinction from law, in the Talmud). The Haggadah states that "wherever it says 'a righteous man' the meaning is of one who forewarns others." Therefore in the Haggadah Noah is regarded as a "prophet, a truthful man, a monitor of his generation, a herald persecuted for his rebukes and honesty."

In the last phase of Hebrew prophecy the word *nabhi* took on only the meaning of announcing. The Hebrews used another word in addition to *nabhi* when they spoke of prophets: "Now in time past, in Israel when a man went to consult God he spoke thus: 'Come, let us go to the seer [*ro'eb*]. For he that is now called a prophet [*nabhi*], in time past was called a seer" (1 Sam. 9:9). "Second sight" is a description of the ways in which prophets arrived at their forecasts of the future and appears to be a universal phenomenon. Seeing and hearing are the principal means by which the Hebrew prophets received commands from the invisible God. Whereas seeing God was an important part of God's revelation of himself, hearing God's word as revealed in history was of equal if not greater importance. The "second sight" of the prophet is seeing that which is unseen by others and hearing that which is unheard by others. The Greek word *oida* reflects this association. *Oida* means

literally “I have seen;” because “I have seen,” therefore “I know.” What the prophet has seen becomes for the prophet knowledge from God. A prophet has seen and consequently knows. An ordinary person has seen only.

The divine will might be manifested indirectly through the sights and sounds of physical nature, such as the rustling of trees (2 Sam. 5:24), the movements of clouds (Exod. 14:19–20), the power of the winds (Exod. 14:21–22), the consulting of lots, or even the movement of entrails of animals offered in sacrifice (Ezek. 21:19–21). God spoke directly through certain ministers chosen to be his prophets. Communication between God and humans was varied. Sometimes the prophet dreamed dreams (Numbers 12:6; 1 Sam. 28:6); sometimes the prophet’s inspiration came from music (2 Kings 3:15). Numbers 12:2–8 sets forth the distinctions God himself made about the types of prophecy and the reasons behind these types. When Miriam and Aaron spoke against Moses because of their jealousy, they complained, “‘Is it through Moses alone that the Lord speaks? Does he not speak through us also?’ And the Lord heard this.” God then summoned Moses, Aaron, and Miriam to come out to the meeting tent. All three obeyed. “Then the Lord came down in a column of cloud, and standing at the entrance of the tent, called Aaron and Miriam. When they both came forward, He said ‘Now listen to the words of the Lord: Should there be a prophet among you in visions, will I reveal myself to him, in dreams will I speak to him; not so with my servant Moses. Throughout my house he bears my trust; face to face I speak to him, plainly and not in riddles. The presence of the Lord he beholds.’” Since God chose Moses as the one to whom he would speak directly and face-to-face, Moses represented the highest order of prophecy, indeed the “prophet of prophets.” God had appeared to Moses in a burning bush in the land of Horeb and had bade Moses to lead the Hebrew people out of its bondage in Egypt. On Mount Sinai God spoke face-to-face. Moses towers above all in the Old Testament as a prophet and as a national leader, forging a captive people into a nation, Israel.

In *The Guide of the Perplexed*, Moses ben Maimon (*Maimonides*; 1135–1204) states that “the prophecy of Moses our Master is distinguished from the prophecy of those who came before and who came after him. . . . The same applies, in my opinion, to his miracles and to the miracles of others, for his miracles do not belong to the class of the miracles of the other prophets. The proof taken from the Law as to his prophecy being different from that of all who came before him is constituted by His saying: ‘And I appeared unto Abraham . . . but by My name, the Lord, I made Me not known to them.’”

Moses was the mediator between God and Israel in explaining the responsibilities of the covenant confirmed at Sinai. His significance as prophet, lawgiver, nation builder, and intermediary cannot be overemphasized. His wonders performed on behalf of Israel far exceeded those of any other prophet. Prevailing over the mightiest force of nature, he activated God’s power. He could speak with God at will, “mouth to mouth.” He is called God’s servant, his chosen; on occasion he is called “the man of God,” which is a prophetic epithet. In Deuteronomy (34:10–12) he is compared to other prophets: “Since then no prophet has arisen in Israel like Moses, whom

the Lord knew face to face. He had no equal in all the signs and wonders the Lord sent him to perform in the land of Egypt against Pharaoh and all his servants and against all his land, and for the might and the terrifying power that Moses exhibited in the sight of all Israel.”

Numbers (11:25–30) relates that God bestowed some of the spirit taken from Moses on the seventy elders in the meeting tent. Two men who had remained in the camp, Eldad and Medad, also received the spirit of the Lord, and they prophesied in the camp. An aide to Moses asked Moses to stop them from prophesying, but Moses replied: “Are you jealous for my sake? Would that all the people of the Lord were prophets! Would that the Lord might bestow his spirit on them all!” (Num. 11:29). From this passage it is clear that God bestows the gift of prophecy upon whomever he wills. It is also clear that Moses had all the qualities necessary to be “the man of God.” Therefore Moses can justly be called the archetype of a prophet.

The history of Israel could be said to demonstrate the significance of prophecy in the life of the nation. In Sirach (39:1) the sage sets forth for his contemporaries the essential nature of the Law and of prophecy. “How different the man who devotes himself to the study of the Law of the Most High! He explores the wisdom of the men of old and occupies himself with the prophecies.” The prophets who preceded the period of exile that began with the destruction of Jerusalem by the Babylonians in 587 B.C.E. conceived of themselves as defenders and guardians of the covenant. Amos, Hosea, Isaiah, Micah, Zephaniah, Nahum, Habakkuk, and Jeremiah called Israel to fidelity and service to God and his covenant; because of Israel’s frequent failure to observe the covenant, the prophets warned of divine punishments. Amos emphasized the role of prophet: “For the Lord God doth nothing without revealing his secret to his servants the prophets” (Amos 3:7). Prophets were not always well received by the people, however, and Amos was urged to go into the land of Judah and prophesy because he had proclaimed that Jeroboam, the king of Israel, would die by the sword and Israel would be carried away from its land (7:10–11). Amos steadfastly maintained that his words were God’s words. He also warned of a famine more severe than a famine of bread and water: the cessation of hearing God’s word.

The prophecies of Isaiah, the son of Amos, warn of the punishment of Judah, Israel, and Jerusalem, indeed of all the lands that had forgotten the Lord. The prophet’s language is beautiful, even as he enumerates the sins of the people. In spite of his reproofs against the people, he offers hope that Jerusalem will be restored: “And many people shall go, and say: Come and let us go up to the mountain of the Lord, and to the house of the God of Jacob, and he will teach us his ways, and we will walk in his paths: for the law shall come forth from Zion, and the word of the Lord from Jerusalem. And he shall judge the Gentiles, and rebuke many people: and they shall turn their swords into plowshares, and their spears into sickles: nation shall not lift up sword against nation” (Isa. 2:3–4). Isaiah often expresses optimism, emphasizing the peace that will follow true repentance and a turning to the words of the Lord.

Jeremiah occupies an important place among the prophets because it was he who tried to determine criteria by which the

word of God could be recognized: the authentic word of God would be known when the prophet's words were fulfilled (Jer. 28:9, 32:6–8); the prophecy would demonstrate faith in God and the traditional religion (23:13–32); and the heroic witness of the prophet himself would validate the prophecy (26:11–15). In contrast to Isaiah, who inferred that God needed his holy city and a people for his self-expression in the world, Jeremiah believed that God could establish his word among men with or without Israel (44:28). However, Jeremiah held that a remnant of Israel must survive to carry on the tradition and that Jerusalem, God's city and the seat of his worship, could not be allowed to be destroyed; but the deliverance of Israel would come from God himself, not from any human agent.

Whereas Jeremiah prophesied doom and Isaiah consoled, Ezekiel, whose name appears to mean "may God strengthen," began with doom and ended with consolation. He is perhaps the most colorful of the Hebrew prophets. The dramatic opening of Ezekiel's prophetic book sets the tone for the prophet's experiences. He writes that the heavens opened, and he saw visions of God: "And I saw and behold a whirlwind came out of the north, and a great cloud, and a fire infolding it, and brightness was about it: and out of the midst thereof, that is, out of the midst of the fire, as it were the resemblance of amber" (Ezek. 1:4). This divine chariot was borne by four creatures who had four faces with the likeness of humans, and all had four wings. After this awesome experience the Lord expressed the responsibility that he had placed upon the prophet: "Son of man, I have made thee a watchman to the house of Israel: and thou shalt hear the word out of my mouth, and shalt tell it them from me" (3:17). Ezekiel spoke for God in his denunciations against false prophets who follow their own spirit and see nothing, against the abominations of Jerusalem, against the ineffectiveness of the princes of Israel, and against the apostasies of Israel. Ezekiel's denunciations and his calls for repentance are based upon his insistence on the justice of God. Ezekiel was the only prophet since Moses to lay down a plan and law for the future. His plan envisioned true repentance and obedience to God as essential for a restored Israel. Then God in his justice would provide a permanent reconciliation with his people. Ezekiel followed the earlier prophetic view that God's special holiness, grace, and protection are reserved for Israel, although God rules over all the world.

Messianic expectations are also not missing in Ezekiel. Because of the wickedness and greed of the shepherds of Israel, who neglected their flock, the Lord will drive out the evil shepherds: "And I will set up one shepherd over them, and he shall feed them, even my servant David: he shall feed them, and he shall be their shepherd. And I the Lord will be their God" (34:23–24). This passage is extremely significant for the association of the shepherd with the house of David and its subsequent centrality in the messianic expectations concerning Jesus of Nazareth. In the Gospel of Matthew (1:1–17), the gospel writer traces the lineage of Jesus Christ, the son of David, the Lord's appointed shepherd, from Abraham to David and from David to Christ.

New Testament

Although the influence of prophecy declined after the time of the Hebrew prophets, the ancient belief in the word and

symbolic act maintained its efficacy because of humanity's need of God and of communion with him. The sacraments of the Christian Church exemplify the belief in this concept of the power of word and acts. When Hebrew prophecy was stilled for a long time, new prophets were inspired by the divine voice to proclaim the good news about a child, soon to be born to a virgin, who would be the savior of the people. The Lord appeared to Joseph in a dream, telling him that the Holy Spirit had touched his betrothed and that she would bring forth a son to be called Jesus, "for He shall save His people from their sins" (Matt. 1:18–25). John the Baptist called the people to repentance, for "the kingdom of heaven is at hand." He proclaimed Jesus as the one of whom Isaiah spoke.

Luke records the story of the angel who appeared to Zacharias, a priest, as he was burning incense in the temple. The priest's wife, Elizabeth, was barren, but the angel spoke to Zacharias with astonishing words: "Do not be afraid, Zacharias, for thy petition has been heard, and thy wife Elizabeth shall bear thee a son and thou shalt call his name John. . . . [He] shall be filled with the Holy Spirit even from his mother's womb." (Luke 1:13–15). When Zacharias asked the angel how this was possible, since he and his wife were elderly, the angel identified himself as Gabriel, "who stands in the presence of God; and I have been sent to speak to thee and to bring thee this good news. And behold, thou shalt be dumb and unable to speak until the day when these things come to pass, because thou hast not believed my words, which will be fulfilled in their proper time" (Luke 1:18–20). The prophecies of the angel Gabriel were fulfilled: Zacharias was dumb until the birth of the son, John, who was to be the forerunner of Jesus. Gabriel also appeared to Mary, a virgin, telling her that she had found favor with God and that she would bring forth a son from the Holy Spirit whose name was to be Jesus: "He shall be great, and shall be called the Son of the Most High; and the Lord God will give Him the throne of David his father, . . . and of His kingdom there shall be no end" (Luke 1:32–33). Prophecy clearly was the foundation of Christianity and continued the messianic expectations of the Hebrews who believed that the Messiah, accompanied by Elijah the prophet, would usher in a national regeneration. In Christian belief Jesus was the long-awaited Messiah who would both regenerate the nation and bring salvation to the whole world.

Isaiah is a favorite prophet among Christians because his prophecies are considered to proclaim a prince of peace who will be the Messiah. The prophet proclaimed that a virgin would conceive and bear a son whose name would be Emmanuel (Isa. 7:14). "For a child is born to us, and a son is given to us, and the government is upon his shoulder: and his name shall be called, Wonderful, Counselor, God the Mighty, the Father of the world to come, the Prince of Peace" (9:6). This prophecy is the heart of Christian belief in Jesus Christ as Prince of Peace and Messiah. The epithets of Jesus—prophet, priest, and king—also have their roots in Isaiah: "His empire shall be multiplied, and there shall be no end of peace: he shall sit upon the throne of David, and upon his kingdom; to establish it and strengthen it with judgment and with justice, from henceforth and forever: the zeal of the Lord of hosts will perform this" (9:7). The Servant Songs (Isaiah 42 and 49)

also proclaim a message of salvation and deliverance that can be associated with Israel and in Christianity with Jesus as the suffering servant. Isaiah and Christian prophecy both emphasize universalism.

One of the most significant examples of Christian prophecy was on the day of Pentecost, when after the Crucifixion the apostles were gathered together and were astonished when a sound like a strong wind came down from heaven; then “parted tongues of fire” settled on each of them, and all were filled with the Holy Spirit and began speaking in foreign tongues (Acts 2:1–4). The universality of the languages used represented the universality of the message of salvation and redemption. Peter’s discourse makes clear the point of the speaking in tongues: “this is what was spoken through the prophet Joel: ‘And it shall come to pass in the last days, says the Lord, that I will pour forth of my spirit upon all flesh; and your sons and your daughters shall prophesy, and your young men shall see visions, and your old men shall dream dreams. And moreover, upon my servants and upon my handmaids in those days will I pour forth of my Spirit, and they shall prophesy. . . . And it shall come to pass that whoever calls upon the name of the Lord shall be saved’” (Acts 2:16–21).

As the history of Israel was dependent upon the word of God as spoken through his prophets, Jesus Christ was the epitome of revelation and the fulfillment of the Law, according to the New Testament and Christian teaching. As Paul expressed it, “God, who at sundry times and in divers manners spoke in time past to the fathers by the prophets, last of all, in these days has spoken to us by His Son, whom he appointed heir of all things” (Heb. 1:1–3). Paul describes Jesus as a superior mediator, superior to the angels and to Moses. In Judaism and in Islam Jesus is considered a prophet; in Christianity he is superior to all prophets as the Son of God and Messiah, who by his death brought salvation to all who would live according to the will of God and accept his sacrifice as expiation of humanity’s sins.

In Christianity apocalyptic motifs are also strong, especially in the Gospel of Mark (13) and in the Book of Revelation (Apocalypse), which is “the revelation of Jesus Christ which God gave him to make known to his servants the things that must shortly come to pass and he sent and signified them through his angel to his servant John” (Apoc. 1:1). The apostles were witnesses and messengers of Christ and proclaimed what they had seen and received. To Paul revelation is “manifested now through the writings of the prophets, according to the precept of the eternal God, and made known to all Gentiles to bring about obedience to faith—to the only wise God, through Jesus Christ, be honor forever and ever” (Rom. 16:26–27). In the Gospel of John, Christ reveals God and is God revealed (John 1:18; 14:6–7).

Islam

Islam is also a prophetic religion, since the angel Gabriel revealed the divine message to the prophet Muhammad, who in turn communicated it to humankind. In the Koran every prophet of God is called a Muslim, and this is said to indicate that Islam is the true religion for the whole world. The prophet

Muhammad is the last and most perfect of the prophets who preached Islam among different nations at various times. Islam is said to contain within itself all religions that came before it, all of which have been revealed by God. Consequently, Islam believes not only in the prophet Muhammad but in all the other prophets. The Koran is said to be a combination of all the sacred scriptures of all religions. In Islam revelation is seen as a factor necessary in human evolution and is the universal experience of humanity; in prophetic revelation God has bestowed this gift on all nations of the world. According to the Koran, prophets were sent to all nations and peoples. The Koran expresses the paths of devotion and the forms of worship and the means by which humankind may attain communication with God. The relationship between human beings in all their experiences on earth is also defined in the Koran, which establishes rules for the progress of individuals and for society at large. The aim of Islam is to unify humankind in a universal brotherhood, and religion is the most efficacious force in accomplishing this unity. “All men are a single nation” (Koran 2:213). The Koran teaches that divine revelation has three forms: “And it is not vouchsafed to any mortal that Allah should speak to him, except by revelation or from behind a veil, or by sending a messenger and revealing by His permission what He pleases” (42:51). The third mode is the highest form of revelation, exemplified by Gabriel’s message to the prophet Muhammad, and is limited to the prophets of God.

Prophets also received the lower forms of divine revelation. Before Muhammad received the first revelation of the Koran, he had visions and heard voices. The details of the law were instilled in his mind as an “inner revelation.” Revelation is granted to righteous people who follow the Prophet and also to others. The highest form of revelation, which only the prophets enjoy, requires a passing from one world to the other while the prophet is fully awake. This revelation works a profound change in the prophet that is visible to those who see the prophet. The Koran was revealed to Muhammad by Gabriel in stages, and its arrangement is considered part of the divine plan; the word *Koran* indicates “he collected together things” and also means “he read or recited.” Islam teaches that God has sent to every nation prophets whose responsibility was to uplift the morals and regenerate the religion of each nation. In contrast, Muhammad was a prophet for the world.

According to Islam, a new age of prophecy was born with Muhammad. The Koran establishes the concept of world prophet when speaking of Muhammad: “We have not sent thee but as a bearer of good news and as a warner to all mankind” (48:9). (All scholars of Islam, however, are not in agreement about Muhammad as world prophet.) The Koran places prophecy as the greatest of all miracles and pronounces that Islam will be triumphant and spread to the farthest corners of the earth. Ultimately Islam would be supreme over all the religions of the world. In the tenets of Islam “prophethood” came to a close with Muhammad, but divine revelation continues as a gift of the righteous. The world does not need a new prophet, according to Islam, because there is the Koran, the perfect law. Still, in each century it is believed that a reformer will arise to remove any errors and to elucidate the religious truths of Islam in changing circumstances.

Greece and Rome

In ancient Greece and Rome oracles abounded. The primary meaning of the word *oracle* is “the response of a god to a question asked of him by a worshipper.” The word also indicates the college of priests who manage an oracular shrine or the shrine itself. Since there were many gods in the Greco-Roman world, there were many shrines, several of which were widely known. In each shrine the god was consulted in fixed procedures, and in the most primitive oracles the god revealed answers by means of the casting of lots, by observation of signs, the rustling of leaves in a sacred tree, the marking or entrails of victims sacrificed upon the altar of a god, or the movement of objects tossed into a spring. At healing oracles such as that of Asclepius at Epidaurus, the consultant slept in the shrine and received a vision after having performed preliminary sacred rites. At the most important oracles, the god spoke through a male or female intermediary who had spent hours in purification. At Delphi, for example, the Pythian priestess of Apollo drank from the sacred spring and chewed laurel leaves before taking her seat on the tripod in the temple, from which she in a trance heard the questions asked of her by the pilgrims to the shrine. Her responses were probably incoherent to the questioner, but a priest of the temple translated her utterances into understandable language. It was customary for the consultants to present questions in writing, and responses would be returned in written form. Many gods gave oracles at their shrines, but Apollo was the most famous and was considered an oracular god. He had important shrines at Delphi, Didyma, and Claros, as well as in Boeotia, Troas, and Lycia. Zeus was also an oracular god, with shrines at Dodona and Olympia.

For those seeking freedom from pain and disease, prophetic incubation was practiced among the Greeks and Romans, who believed that sleeping within the precincts of a temple would result in revelations, visions, and freedom from sickness. Speaking in dreams was common to all the gods, but only some were believed to be aroused by specific acts to give responses or perform certain functions. In the second century C.E. Pausanias described the emotional experience received by the devotees at the oracle of Trophonius as they descended into the earth and visited the god. Incubation was used especially at the temples for bringing about cures. At Epidaurus the cure was effected mainly by faith healing; however, in the *Orations* of Aelius Aristides (117–187 C.E.) and in later inscriptions, medical prescriptions were revealed. The great oracles were Greek, but there were also oracles in Syria, Egypt, and Italy. The oracle of Ammon at Siwa, although an Egyptian deity who was worshipped in Nubia, Syria, and Libya, was known to the Greeks in the seventh century B.C.E. and became so famous in the Greek world that it rivaled Delphi and Dodona. Ammon was portrayed on Greek coins with the head of Zeus and the curling horns of Ammon.

Prophets and prophetesses played a significant role in Greek literature from the time of Homer. The mythological blind prophet Tiresias was an infallible source of information for the Greeks and appears frequently in Greek tragedy. Most memorable is his warning in Sophocles' *Oedipus Rex* to Oedipus, king of Thebes, that he was the land's pollution. In this drama

the prophet Tiresias spoke the truth about Oedipus, who did not believe him. Yet the prophet's words—“God within, reckon that out, and if you find me mistaken, say I have no skill in prophecy”—provide the denouement of the tragedy, as the angry Oedipus begins his painful search for the truth about himself. The female prophetess Cassandra has a significant role in the *Agamemnon* of Aeschylus, when she, speaking with the chorus, predicts the death of Agamemnon at the hands of his wife, Clytemnestra. She also sees her own death, soon to come. Cassandra is an example of a prophet who was disbelieved, though she spoke the truth, because Apollo had placed this curse upon her, since she had refused his love. The significance of prophecy in Greece can be well documented from a study of Greek tragedy.

In Italy various prophetic sites provided the petitioner with numerous types of responses. The sibyl, a prophetess usually associated with Rome and Cumae, spoke from various localities and was known as early as the Greek philosopher Heraclitus (c. 540–c. 480 B.C.E.). At first she was a lone female prophet, but later her name, Sibylla, was made plural (Sibylle), and she flourished in various parts of the world. Ancient authors speak of different numbers of sibyls. Marcus Terentius Varro's naming of ten sibyls has been generally adopted. The ten sibyls resided in Persia, Libya, Delphi, Cumae in Italy, Erythrae, Samos, Cumae in Aeolia, Marpessa, Ankara, and Tiburtis. Of all the sibyls the Cumaean Sibyl in Italy is the most famous and was immortalized in Virgil's *Aeneid*. To learn of his fate in Italy, Aeneas was advised by Helenus to seek out the sibyl at Cumae: “When you have sailed here and have arrived at the city of Cumae and the divine lakes and Avernus resounding with its forests, you will see the frenzied prophet who sings the fates from the depths of the cliff and commits her signs and symbols to leaves. Whatever songs the maiden has written down, she arranges them in order and leaves them set apart in the cave.” (*Aeneid* 3:441–446).

Noted historians of the Roman republic reported that one of the sibyls offered nine volumes of her prophecies to Tarquin the Second, who refused the high price she asked. She then burned three of the books and asked the same price for the rest. Tarquin again refused but finally bought the last three, since the sibyl had burned all but these. The sibyl then disappeared, and her books were preserved and were called the Sibylline Verses. These prophetic books were revered by the Romans, and a college of priests was in charge of safeguarding them in the temple of Jupiter on the Capitoline Hill. When the Capitolium was burned in 83 B.C.E., the Sibylline Verses were destroyed. Verses were sought in Greece to replace those destroyed. Although eight books of Sibylline Verses remain, they were probably composed in the second century C.E. by Christians. The Renaissance humanist Guillaume Postel wrote a commentary on Virgil's fourth eclogue often referred to as the “Messianic Eclogue,” in the preface to which he indicated that if the eclogue were read as “Sibylline Enthusiasm,” which he equated to the most divine inspiration of the Holy Spirit, it would be worthy of the bishop of Clermont, to whom Postel dedicated the work. In his commentary he wrote that from the judgments of Janus, the sibyls, and the holy men of the Gentiles, among whom he included Job, prophecies developed

in a continuous tradition. He argued that the final age of the Cumaean song, which all antiquity awaited, depended upon the instauration of a golden age that also had been proclaimed by the sacred vow of the sons of Shem under Christ.

In both Greece and Rome ordinary people in the historical period were sometimes inspired to prophecy. In Greek those inspired people were called *chēsmōdoi* and in Latin *vates*. In *De divinatione* (Concerning divination) Cicero (106–43 B.C.E.) notes that Romulus did not establish the city of Rome until the auspices were taken and that Romulus, the parent of the city, was said to be the best augur. In Rome a college of augurs took the signs, usually from the flight of birds. Observations were taken before every public action. Cicero also indicated that the knowledge of augury came from the Etruscans. In *De divinatione* he identifies two methods by which “souls were aroused without reason and knowledge, by their own movement, spontaneous and free; one was raging, the other dreaming; the augurs believed that the divination of fury was contained especially in the Sibylline Verses.” They selected ten men from the state to interpret the Sibylline Verses. Virgil was considered a *vates* in subsequent centuries not only because of his so-called Messianic Eclogue but because of his *Aeneid*, the grand epic of Rome, which detailed the great glory that was to come to this small settlement on the Tiber. It seems worth noting that perhaps the greatest Roman authors, Cicero in prose and Virgil in poetry, understood the significance of prophecy in the lives of men and in the life of the state.

Among other significant oracles in Italy was the oracle of the dead at Avernus, a deep lake near Puteoli. Because of its great depth, the dark woods that surrounded it, and the offensive exhalations that Avernus spewed forth, this spot was considered by the ancients the entrance to the underworld. It was to Avernus that the Cumean Sibyl led Aeneas so that he might enter the underworld, meet his father, and learn his fate and that of his offspring. At Tibur there was an incubation oracle of Faunus. The goddess Fortuna had an oracular shine at Praeneste, where a boy would throw billets of oak wood (*sortes*) on which sentences had been inscribed. These randomly tossed billets might provide the consultant with advice for his own situation.

Middle Ages

Saint Augustine (354–430) considered the Psalms of David to be prophetic songs inspired by the Holy Spirit. He made reference to Christ’s command: “It is necessary that all things be fulfilled which have been written in the Law of Moses and in the Prophets and in the Psalms about me” (*Luke 24:44*). He also noted “The more open [the Psalm] seems, the more profound it is accustomed to be seen.” His belief that God spoke through his prophet David in the Psalms is quite clear in *De civitate dei* (The city of God). He accepted David’s authorship of all the Psalms “because the prophetic spirit was able to reveal even the names of future prophets to King David as he was prophesying, so that anything which could be appropriate to their person could be sung prophetically.” To Augustine the Psalms seemed to contain all the prophetic ideas found in the Law and Prophets individually. In a gloss on Psalm 18:15, when the psalmist wrote “the foundations of the world have

been revealed,” Augustine made clear the significance of prophets: “And the Prophets have been revealed, who were not being understood, upon whom the world, believing in God, would be built.” Tertullian and Jerome also ascribed prophetic mysteries to the Psalms.

As Rome waned and life in Europe became very difficult, prophecies began to abound. In fact, prophecy is often seen as a major, if not the major, theme in the literature of the Middle Ages. It is difficult to present even a small fraction of the “visions of the end,” as Bernard McGinn has aptly described them. A text called *The Tiburtine Sibyl* appeared in the fourth century and became an important prophetic voice that attempted to relate events of the Christian empire to a new apocalyptic vision. This work was renewed in the early eleventh century and had a continuing influence, since its universalism and the universalism of the Christian message transcended historical boundaries. Prophecies abounded about the antipope, who led the people of God away from his calling. The antipope would ultimately be replaced by an angelic pope, who would restore the church to its pristine purity and unity. The Great Schism and the Black Death were events that prompted prophetic utterances.

The influence of Joachim of Fiore (c. 1135–1202) was very significant in the Middle Ages and continued into the Renaissance. His prophetic admonitions for reform of the church were influential in the fifteenth and sixteenth centuries, especially in Venice. There was a tradition that Joachim had a small room in the upper section of the Basilica of San Marco, in which he designed the mosaics of the basilica. His prophecies were known from those designs and also from beautiful editions of his works, many of which were published in Venice. An important book of prophecies, *Expositio magni prophete Ioachim in librum beati Cirilli de magnis tribulationibus et statu Sancte Matris Ecclesie* (Exposition of the great prophet Joachim on the book of the blessed Cyril about the greatest tribulations and the state of the Holy Mother Church), was published in Venice in 1516. Although this work contains the prophecies of Telesphorus of Cosenza, John of Paris, Ubertino of Casale, and the author of the so-called Mestre prophecy, it is Abbot Joachim’s likeness that is seen on the title page. The heading “Abbas Ioachim magnus propheta” appears above a beautiful woodcut showing Joachim seated at his desk with head turned slightly and with his left hand held to this ear, while with his right hand he records the prophecies from God. In the *Expositio* Joachim expresses great expectations of an angelic pope, chosen by God for his sanctity. Joachim wrote that the patriarch of the Venetians would warn the flock about their sins and that the Venetians would be reformed from their iniquities. The reform would continue until the Day of Judgment, so much so that “not such good men among all nations of Christians will be found, as Merlin says in his own revelations.” Joachim also noted that before the Antichrist should come, a certain man, chosen by God, would come forth in Italy, though he was not an Italian, and would help to free Italy from her servitude to Lombardy. The prophecies of John of Paris contain the famous Mestre prophecy, which is filled with political overtones about France and Germany and the need to reform the church and follow in the train of Joachimite prophecy.

Renaissance

The diarist Marino Sanudo the Younger, in an entry for 30 May 1509, recounted the prophecies of Piero Nani, a Venetian patrician and a brother of the Order of Charity. Nani warned the patricians that Venice would lose all of its dominance because of sin, and the flagellation would last twelve years. He had a great supply of prophecies that predicted hunger and famine. Sanudo reports that Nani then remarked: "The people at present pay much attention to prophecies and go into the Church of San Marco, seeing the prophecies in mosaic which the Abbot Joachim made." In the Basilica of San Marco two unnamed figures in mosaics, designated only as *sancti*, were studied for their presumed messianic connotations. Under one figure were the words, no longer visible, "Fiet unum ovile, et unus Pastor." The figure, clothed *pontificalmente* in brown and carrying a bishop's staff, was believed to represent the angelic pope, according to Francesco Sansovino (1521–1586), the author of *Venetia città nobilissima*. Also influenced by the expectation of the angelic pope and "one sheepfold," Sansovino wrote a prophetic poem, still in manuscript, entitled *A principi Christiani*, in which he describes the evils of his day. After many troubles are endured, there will be a renovation of the church.

Francesco Sansovino has not been generally associated with prophecy, and prophecy has not usually been considered an important aspect of Renaissance thought after 1530. Research during the 1990s, however, demonstrated that prophecy was a continuing tradition throughout the sixteenth century, especially in Italy. The sack of Rome in 1527 by the forces of the Holy Roman Empire spawned prophets, and "inspired preaching" continued in spite of restrictions imposed by the Lateran Council and the Roman Inquisition after 1542. There were numerous preachers throughout Italy, and none more famous than Fra Girolamo Savonarola (1452–1498). Giovanni Nesi, one of the disciples of Marsilio Ficino, followed Savonarola's call for a *renovatio mundi* and glorified him as a prophet in the tradition of Hermes Trismegistus. Savonarola, however, denied any relation between the prophet and his prophecy, since prophecy was a gift from God, and humans had no power of prophecy without divine infusion. His prophetic preaching expressed his unfaltering belief in the necessity of reform on all levels of society and especially in the church, and his audiences were spellbound by his sermons, which often lasted for many hours.

Cardinal Egidio da Viterbo declared in his inaugural address to the Fifth Lateran Council of 1512 that he had preached for twenty years about the times prophesied in the Apocalypse. The strength of his convictions about prophetic preaching is all the more significant since the Lateran Council in 1517 prohibited "free and inspired preaching" and prophesying about the last days. One of the most influential books circulating in Italy during this period was the *Mirabilis liber* (1524; Wondrous book), a compilation of many prophecies from various ages that contained predictions about the reform of the church and the conversion of the enemies of Christianity. In the second decade of the sixteenth century, Father Zaccaria Ferreri wrote a devotional tract entitled *De reformatione ecclesiae* and sent it to Pope Adrian VI. On the

title page Father Ferreri includes the prophetic question "Are you the one who will come, or are we awaiting another?" The question reminds the pope that he should become the angelic pope who would reform the *Ecclesia militans*.

In European literature of the sixteenth century, visions of the Antichrist and the universal judgment were commonplace. In 1525, in the two nights preceding Pentecost, the painter Albrecht Dürer dreamed that the end of the world had arrived with a dire flood that encompassed the world; even the sky was obscured by a huge column of water. The dream made such an impression that next morning he painted his vision in watercolors and annotated various aspects of the dream in the margins.

Many prophets were women who proclaimed the need to practice works of charity and to aid in the reformation of the church. The messages of female prophets differed very little from their male counterparts. Francesco Zorzi (1466–1540), a Venetian friar and the author of *De harmonia mundi* and the *Problemata*, among other famous works, was deeply influenced by a mystical woman, Chiara Bugni, whose ecstasies, according to Zorzi, had revealed to her the mysterious secrets of divine will and endowed her with prophetic knowledge. Her renown in the monastery of San Sepolcro was so great that she was elected superior of the monastery. She accepted this responsibility only after God had revealed to her a "remarkable sign." Her fame was enhanced by Zorzi's confidence in her profound spirituality, which seemed to prepare the way for the ecstasies that engulfed her. Zorzi's belief in an angelic pope who would reform the church may have been influenced by Chiara Bugni. There are many accounts of the miracles, ecstasies, and visions that were attributed her.

Another important prophetess of Venice was called simply the Venetian Virgin because she did not choose to recall the name of her family. She said to the great French humanist Guillaume Postel that "no one knows from whence I am." The great sanctity of her life and her unceasing works of charity so inspired Postel when he first met her that he called her the Mother of the World. Her given name was Giovanna, and Postel said she was given this name more from divine will than from the will of her parents. The name Giovanna is the feminine form of Giovanni (John), who heralded the coming of the Messiah. Postel wrote often of her many miracles and her prophecies. She experienced a miraculous change in her person when she experienced the presence of Christ descending into her. She prophesied that the reformation of the world would begin in Venice; the Turks would soon be converted and would be the best Christians in the world; all who had faith in God and love for all would be blessed by Christ; ultimately all sinners would be restored as if the first parents had never sinned; and human nature would be led to such perfection that all men would be as Christ except for his divinity. The life and prophecies of the Venetian Virgin influenced Postel to the extent that they became for him a foundation for the restitution of humankind and for a universal monarchy under the rule of God. After his encounter with the Venetian Virgin, Postel proclaimed himself the Virgin's "little son," who would endeavor to set in motion the restitution of all things she foretold.

Postel was not the only humanist who turned to prophecy. Indeed, many humanists followed the same course, becoming reformers within or outside the Roman Church. Anabaptists following Jakob Hutter listened for the voice of prophecy that would proclaim the next installation of God's kingdom on earth. Erasmus wrote in 1526 in one of his *Colloquia* that the "Antichrist is awaited." The wars among Christian princes, popular uprisings, the collapse of Christian unity, and the threat of the Turks made it appear that the last days were at hand.

A French humanist who called himself Dionisio Gallo arrived in Venice on the feast of Pentecost in 1566. He was rector of the College of Lisieux until he experienced a mystical anointment by the Virgin Mary, who told him that he had been chosen by God to summon the princes to help him, God's servant and messenger, reform the church, society, and the universities. He was unsuccessful in gaining the help of the king of France, Charles IX, whose advisors claimed that the prophet was mad. Sometime in 1565 he left France for Italy, where he visited Duke Cosimo de' Medici of Florence. He composed a long work on prophecy while in the duke's household, as well as a work in which he laid out the program for the reformation of the church that the Virgin had given to him. He spent time in Ferrara as the guest of Francesco d'Este, marquis de Masse, and Duke Alfonso II, to whom he read his *Legatio*, the title that he gave to his program of prophetic reform. When he arrived in Venice, he lived in the home of a Venetian magistrate and was befriended by a Venetian patrician. Preaching for three days in the court of the Palazzo Ducale before his incarceration for preaching without a license, Dionisio urged the Venetians to assume the responsibilities bestowed upon them by God. He urged all three princes and the doge and Senate of Venice to aid him in his grand enterprise to help reform the church, since the pope and cardinals seemed unable or unwilling to accomplish this task, though it was ordained by divine decree. Dionisio remained in prison in Venice for about eighteen months and was finally released and put on a boat headed for Ferrara. Dionisio's prophetic message and his choice of "sacred space" in the ducal palace revealed his clear understanding of the connection between prophecy and politics in the sixteenth century.

See also *Christianity; Futurology; Islam; Judaism; Millenarianism; Miracles; Mysticism; Religion.*

BIBLIOGRAPHY

Ali, Muhammed Maulana. *The Religion of Islam*. 6th ed. Lahore, Pakistan: Ahmadiyya, 1990.

Barnes, Robin Bruce. *Prophecy and Gnosis: Apocalypticism in the Wake of the Lutheran Reformation*. Stanford, Calif.: Stanford University Press, 1988.

Gordis, Robert. *Poets, Prophets, and Sages: Essays in Biblical Interpretation*. Bloomington: Indiana University Press, 1971.

Greenstone, Julius H. *The Messiah Idea in Jewish History*. Philadelphia: Jewish Publication Society of America, 1906.

Guillaume, Alfred. *Prophecy and Divination among the Hebrews and Other Semites*. London: Hodder and Stoughton, 1938.

Kapellrud, Arvid S. *God and His Friends in the Old Testament*. Oslo, Norway: Universitetsforlaget, 1979.

Kuntz, Marion Leathers. *The Anointment of Dionisio: Prophecy and Politics in Renaissance Italy*. University Park: Penn State University Press, 2001.

———. *Guillaume Postel, Prophet of the Restitution of All Things*. The Hague, Netherlands: Martinus Nijhoff, 1981.

Maimonides, Moses. *The Guide of the Perplexed*. Translated with an introduction and notes by Shlomo Pines. 2 vols. Chicago: University of Chicago Press, 1969.

McBrien, Richard P. *Catholicism*. Rev. ed. San Francisco: Harper San Francisco, 1994.

McGinn, Bernard. *Visions of the End: Apocalyptic Traditions in the Middle Ages*. New York: Columbia University Press, 1979.

Niccoli, Ottavia. *Prophecy and People in Renaissance Italy*. Translated by Lydia G. Cochrane. Princeton, N.J.: Princeton University Press, 1990.

———. "Prophetie di Musaicho: Figure e scritture Gioachimite nella Venezia del Cinquecento." In *Forme e destinazione del messaggio religioso*, edited by Antonio Rotondò, 197–227. Florence: Olschki, 1991.

———. "Visioni e racconti di visioni nell'Italia del primo Cinquecento." *Società e Storia* 28 (1985): 253–273.

Noble, Thomas F. X., and Thomas Head, eds. *Soldiers of Christ: Saints and Saints' Lives from Late Antiquity and the Early Middle Ages*. University Park: Penn State University Press, 1995.

Patridges, C. A., and Joseph Wittreich, eds. *The Apocalypse in English Renaissance Thought and Literature*. Dover, N.H.: Manchester University Press, 1984.

Prosperi, Adriano. "Una cripto-ristampa dell'Epistola di Giorgia Siculo." *Bollettino della Società di Studi Valdesi* 134 (1973): 52–68.

Reeves, Majorie. *The Influence of Prophecy in the Later Middle Ages: A Study of Joachimism*. Oxford: Clarendon, 1969.

Robinson, Theodore H. *A History of Israel*. Vol. 1. Oxford: Clarendon, 1932.

Scholem, Gershom. *The Messianic Idea in Judaism*. New York: Schocken, 1971.

Vasoli, Cesare. *Profezia e ragione*. Naples: Morano, 1974.

Wade, G. W. *Old Testament History*. 13th ed. London: Methuen, 1951.

Williams, Ann, ed. *Prophecy and Millenarianism: Essays in Honour of Marjorie Reeves*. Harlow, U.K.: Longman, 1980.

Wuzgberger, Walter S. "Prophets and Prophecy." In *Encyclopaedia Judaica*. Vol. 13. Jerusalem: Keter, 1971.

Marion Leathers Kuntz

PROTEST, POLITICAL. *Protest*, in the context of this entry, is understood as more or less public visual dissent from an official governmental authority or from customs sanctioned socially by the dominant classes. The protesting voice may be that of a minority or a majority but is here defined, following historiographical and ethical norms, as being directed toward "good causes": democracy, civil rights, justice for all, equalization of resources within societies and between countries (e.g., North and South), halting ecological destruction, freedom from repression, and especially (in the twentieth century) a world without war or fear of war. The lack of these qualities has been most vigorously protested in the so-called Western democracies, where a certain freedom of speech is offset by governments' control of the major media of printed press

Passional Christi und



Antichristi.



Realistic cartoon. *Entry of Christ into Jerusalem/March to War of the Pope* (1521) by Lukas Cranach.

and television. The avenues of protest discussed in this entry include cartoon, comic strip, painting, mural, and especially poster; the latter are most conspicuously mobilized in mass demonstrations, such as those found worldwide in the early twenty-first century opposing the U.S. war in Iraq. This peaceful expression of public opinion, uniting literally millions of bodies in one place at one time, may be the most powerful manifestation of the lack of democratic access to the approved organs of power and information, that is, major communications media and government itself.

Those opposed to the goals of the iconography of protest, when they cannot ignore it, characterize it as the propaganda of the ignorant, and insofar as such iconography constitutes “art” (if not “Art”), critics set up false dichotomies between aesthetic merit and political message, between form and content, the former falling in value in inverse proportion to the strength or immediacy of the latter. The best “visual dissent” is remembered, indeed is immortalized as such, on aesthetic as well as moral grounds, the two aspects being inseparable. While visual protest is here being considered as a mass medium, that is, as imagery available to large numbers of people at one time and over time, new ideas generate new media. To the major public vehicles of visual protest cited, one may add such minor and individual political manifestations as graffiti, a banner unfurled over a freeway, the message chalked on walkways, lapel buttons, refrigerator magnets, bumper stickers, and, above all, T-shirts. Moreover, the poster fixed on an office wall

or a newspaper cartoon pinned to a bulletin board may have a social afterlife or ripple effect long after the event that occasioned it has been forgotten.

Cartoon and Caricature in Early Modern Europe

Before the invention of printing, nonmilitary expression of resistance to authority was limited. The evidence for visual protest before the sixteenth century is sparse and fragmentary. It may be, however, as recent scholarship has claimed, that the eleventh-century Bayeux tapestry contains in its margins and elsewhere, through representations of incidental cruelty to civilians, subversion of its overt purpose, which was to justify the Norman invasion of England. In the later European Middle Ages, alternative, critical, and satirical views were expressed in the marginalia of religious manuscripts and in the sculpted misericords and capitals of churches, which mocked aberrant ecclesiastical behavior and the abuse of sacred rituals, as well as human foibles. Absent a connection to wider currents of opposition, it is safer to see these as expressions of playfulness and mild irreverence toward the human, in the context of unwavering respect for the eternal verities of the divine and the fundamental structures of belief.

The invention of printing allowed for new modes of dissent and popular expression; henceforth, visual and literary protest marched hand in hand, the visual (readable by semi-literate and illiterate) acting as a means of popularization, a true international vernacular. The satirical engraving and



Polemical against Spanish domination. *The Duke of Alba, and the Three-Headed Beast of the Cardinals de Guise, Granvelle and Lorraine*, Dutch, c. 1570.



Allegorical cartoon. *The Donkey Pope of Rome* (1523) by Lukas Cranach.

woodcut, virtually coeval with the invention of printing from movable type in the middle of the fifteenth century, first came into its own as a polemical tool during the Reformation, fostered directly by Martin Luther (1483–1546) himself and executed in large numbers in separate single-leaf prints (broadsheets) and as illustrations to the Bible and other religious texts by the Saxon court artist Lucas Cranach (1472–1553). They were crude in style and rude in intent and probably as effective as any cartoon campaign has ever been. Two examples illustrate different modes of operation of the “cartoon” (the word itself did not come into use until the mid nineteenth century): realistic representations confronting the ideal and real (*Passional*), and the fantastic/grotesque, or allegorical (*Pope-Ass*). Since the propaganda was waged intensively on both (or all) sides, it is remarkable that the Lutheran cartoon enjoyed qualitatively and quantitatively complete supremacy against its Catholic counterpart. This is because the established church eschewed and despised woodcuts, which it considered vulgar and subversive, like as any uncontrollable means of expression generated from below.

Later in the sixteenth century the Dutch used allegorical-polemical engravings in their fight for religious and political

independence from Spain; their old habit of close visual and moralizing observation of social reality became a satirical reflex in the seventeenth-century Golden Age of Dutch painting and engraving, which abounded in political as well as social critique of all kinds. Meanwhile, in Germany, a great painting tradition had subsided in the course of the Thirty Years’ War (1618–1648) into pathetic complaint against war in word and graphic image, such as broadsheets complaining about the devastation of Germany by foreign armies. The best visual record of this period, however, is that of Jacques Callot (1592–1635), who protested the military abuses of his prince, the duke of Lorraine, in his *Miseries of War* (1633), and also military cruelty to civilians in general. His denunciation of war, artistically nonpareil at the time, was unequalled until *The Disasters of War* by Francisco José de Goya (1746–1828), also a great satirist of the mores, clerical and lay, of his country and age. A comparison of the two series illustrates how style is bound by time and country: Callot’s soldiers and peasants, in their sparkling elegance, add up to no less a heartfelt denunciation than the gritty, visceral etchings of Goya. Both were court artists secure enough to dissent, although Goya’s etchings denouncing the Napoleonic invasion were not published until 1863, and his work was censored.

People tend to honor the moral value of dissent by its willingness to confront censorship, but the definition of censorship is a difficult one, and dissent in the great democracies in the early twenty-first century is often stifled by internal censoring or self-censorship, apathy, and largely government-influenced or corporate major media of newspaper, television, and commercial advertising. In the early modern age, all European governments sought control of publication, but this occurred perhaps least of all in the Netherlands. Toward the end of the seventeenth century, antiwar art was best represented in the engravings of the Dutch artist Romeyn de Hooghe. The wars and massacres he opposed were those of Louis XIV of France, the national enemy, and he expressed his opposition in the spirit of Protestant and Dutch patriotism.

Rich as the eighteenth century was in satire of all kinds, a new technique, caricature, first nursed innocently in Italian art studios of the seventeenth century, gave new force and direction to visual protest. William Hogarth (1697–1764), painter and engraver, was certainly a key figure, but he was primarily a social rather than a political satirist, and he wanted to be thought of as the master of character, not caricature, which is constituted, properly and historically speaking, through exaggeration of the personal features of an individual. When the cartoonist attacks the individual (or the individual’s party) rather than the cause, it is often understood that by subverting or eliminating the peccant politician, something essential will change. This is especially the case when similar governments are constantly reshuffled, as in the two-party systems of the United Kingdom and United States.

Nineteenth Century

The extraordinarily prolific golden age of caricature (c. 1780–1820) was a peculiarly English phenomenon, arising out of a tradition of relatively free debate, party rivalries, imperial-industrial-economic growth, and the fear of the French

Abbildung des vnbarmerhertigen/ abschewlichen/ grausam, vnd gewulichen Thlers/
Welches in wenig Jahren/ den grössten Theil Deutsch-
 landes erbärm- vnd jämmerlichen verheeret/ außgezehret vnd verderbet. Veneben einem Bericht/
 woher dasselbe seinen Ursprung/ wer solches erzogen/ ernehret/ ic. Endlich durch was Mittel
 seiner wieder loß zu werden. Männiglich an Tag gegeben.



Einem Wolfe/ im Walde grühen/ vnd auff brei-
 tet / Erden /
 Der Mensch vnd Vieh / terreit in Ert um vnd
 die Schaf zerstreut/
 Ein Löwen / Einem wilden Hef / man sehr wenig trauet/
 Ingleichen einem Menschen / so mit böß / der sein Sün beraubt/
 Schlang / Endern / Natten vnd Kröten / man sehr fürcht / thut
 Bringen die Menschen oft in Nöthen / auch vmb Leib vnd Gut
 Ihrs gleichen ander schädlich Vieh / einem Himmel hoch/
 Welche den Menschen spaz vnd frue / zu Schadn schleichen
 nach/
 Willich seind diesen Bestien allen die Menschen feindlich gram/
 Keines man leben lassen soll sie / dem wo man kan/
 Aber abt solche liebten thut / außzueich vnd ernehret/
 Demselben ist an Leib vnd Gut / viel Anglück beschert
 Der Mensch so nun auf dieser Welt / sein Creutz vnd Anglück/
 Mit allem Rieser selber holt / vnd regiet auß dem Nüet/
 Ob er sich dessu kunn entschlagen / v' achers aber nit zuhumb/
 Wenn will er dann sein Schadn / laagn / den er blömbt darv/
 Solt man dan auch jeg in Teuschland / dergleichen Leute sindu?
 Ach Gott es ist zu sagen ein Schand / daß s' voll fern vnd hünd/
 Dann wie geschwind ist teinn herfür / in vnser liebe Teuschland/
 Von allen Quälten / ein Thier / der Bestien vorgnant.
 Dß Thier laufft außzerichs ember / mit zornigem Gesicht/
 Wie ein Löwe / Wolf vnd Bier / teins Menschen schoner
 nicht.
 Mit Furcht vnd Schrecken / in der Zeit / die armen Leute mit
 Hauffu
 Machn sich in der Flucht bereit / dem Thier zuentlauffu /

Was nun diß Thier ergriffen thut / Stab Dörf land vñ leut
 In die Menschen mit Leib vnd Gut / machet es ihm zur Deut/
 Dann es einen Wolfesraden hat / der nicht ist zufrühen
 Mit Gold vnd Geld frue vnd spaz / muß man sein Betz stillen.
 Zur Eert / hat es eine Menschen Hand / mit Feuer / Viech /
 Spiess / Degn /
 Verheeret ver derbet leut vnd land / was ihm kömbt erzeign.
 Des Löwenis Kunn zur lincken Seit / thut scharr vmb sich
 greiffu /
 Machet viel arm / in kurzer Zeit / mit durchzueich vñ Erzeiffu
 Wer sich ihm wiedersehen thut / muß es schwerlich büßu /
 Verleurt außleich Leib vnd Gut / wird vntzueit mit Füßu
 Die Truch / so kaum auß der Ert / in volk / Viecherlahn /
 Verderbt es wie ein wilds Pferd / das niemand halten kan.
 Et hat ein giftig Naturschwanz / mit viel Würmern vñ ein /
 Die im Abzug verderben ganz / was noch könn nützlich seyn.
 Ihm folgt auf dem Fuß geschwind / Hunger s' noch vnd die
 Pest /
 Die raumt weg diß auff den Grund / was sich noch finden
 leß /
 Wie nennet man dann dieses Thier? Es wird Arlez genant/
 Von wo man in sommer es dann her? Auß vnserm Bar' land/
 Der Mensch Sünde in gemein / diß böß Thier gebären/
 Welche selbst thut die Ert sein / vnbarbarerst verzeihn/
 Wer hat aber diß schrecklich Thier / biß daher außgezogen?
 Es hat / sag ich gewiß / all' her / vñ all' Drif / gelogen/
 Wer hat dich in Thier grausam / geboln auß die Wein/
 Thier vnd Thier weit außzerhan? wir all' groß vnd klein /

Aber weilt diß recht verheeren / das Gort Straff nit vñ?
 Die Welt dencket es thut geschick / obn' gelit was in / wunder.
 Weil die Menschen in Sünd verharnt sein / Weßlung zu
 spieren
 Daß auß' recht bleibt Gorts Arm / die Straff nit vñ
 Wird nun die Sünde nicht erkent / Gort vñ Gnad gebett u/
 Vnd besser sich ein jeder Stand / wie es hoch von nit u/
 Wird Gort / wie er g'han gar viel / dem Thier sein Willn
 labu /
 Mit vns den gar auß zufrühen / welche niemand hindra kan /
 Alleine wahre Dew vnd Duff / wer ein Müet gut /
 Daß Gort von seinem Born ablies / wänd von vns sein Nuth /
 So könn wir ein gnädig Gort / durch frem merdn erlangen
 Würden bald diß Thier leben tod / verderbu vnd vntzagan /
 Es würde sich mit seinem Schwert / selbst würgen vnd ledm /
 Also Teuschland geholn werden / aus diesen Jammer vñnd
 Nöthn
 Daru alle / was es verschlungen / heuffig wieder außspren /
 Drüber viel Arm verjagt vertrungen / sich würdn berglich
 freun
 Durch diß Mittel würden wir bald / von Gort Hilf er' r'bn /
 Wo nicht / müßn wir gleich Gestalt wie ander ganz verdrabn /
 Der ist nun weit vnd wegliebet / wird selig g' balm.
 Der sich an andr leut Schaden feyrt / habn g'f'at die hick /
 Atn.

E R D E.

1630

A graphic reaction to the Thirty Years' War (1618–1648). *The Monster of War*, German, c. 1630.

Revolution and Napoleon. Napoleon Bonaparte (1769–1821) became (with help from other countries) the single most satirized figure in history. The masters James Gillray (1756–1815) and Thomas Rowlandson (1756–1827) and, later, George Cruikshank (1792–1878), when not engaged in patriotic propaganda, took on a wide social range, scurrilously attacking individual political and social personalities. At this point, “protest” as embodied in caricature became a kind of social and political game played on shifting and not always honorable grounds. The broadsheet caricatures, often colored, were exhibited as conversation pieces in homes and became immediate collectibles whose seditious edge very occasionally landed artists and their publishers in jail. But to the degree to which the caricatures, some beautifully fashioned and labor-intensive (unlike the often rudimentary contemporary scribble), were entirely independent of the literary text, one may speak of a form of visual protest and satire sui generis, the equivalent of which in the early 2000s, in terms of its physical and moral independence, is the poster, not the newspaper cartoon, which, notoriously, is subject to being dropped or never being carried at all, if it might offend the newspaper’s owners or advertisers. The freedoms of the artists were in fact greater than those of the writers, and the attacks of Gillray and others on the British royal family were of a virulence approached (but not surpassed) only during the 1960s. In Gillray’s time the Royal family was embroiled in party politics, and attacked with a bias accordingly; and the Prince Regent, whose personal vices became a favorite butt, could only buy up copies of the caricatures against him, and hope to buy off the artist himself. Later, the anti-Royal cartoon was considered simply unpatriotic, and until the 1960s, in addition tasteless or cowardly in its attack upon a person or an institution not set up to respond in kind.

In terms of sheer recklessness, vulgarity, and, indeed, scatology, it may be that British caricature overreached itself, for the Victorian age demanded a quieter, more balanced, and less violent tone. Cruikshank is the transitional figure from Regency license to Victorian prudery, and Charles Dickens (1812–1870), whose literary art tried to subsume the pictoriality of the English satiric tradition, and who confessed himself a great admirer of Hogarth, could not afford his great predecessor’s sexual openness. The reform movements of the 1830s and Chartism were the last fling of pictorial satire, which by the 1830s was beginning to infiltrate newspapers and magazines. Henceforth, after early years in radical opposition, the weekly *Punch* (founded 1841), standard-bearer of the humorous cut and the political cartoon (the word derived from an Italian art term, *cartone*), settled into a cozy commentary of bourgeois mores and dignified allegories (by John Tenniel at their best) of current affairs, always “patriotic” when international. Like the *New Yorker* (founded in 1925) in the United States, *Punch* became a kind of “official” magazine of humor and critical commentary until it was superseded by the truly radical, muck-raking magazine *Private Eye* (founded 1961) in the United Kingdom.

Punch called itself “the London Charivari” after the Parisian magazine that spearheaded a great satiric movement of graphic opposition to King Louis-Philippe and his betrayal of the Rev-



Caricature of British King George IV. *A Voluptuary under the Horrors of Digestion* (1792) by James Gillray. PHOTO CREDIT: VICTORIA & ALBERT MUSEUM, LONDON / ART RESOURCE, NY. IMAGE REFERENCE: ART 113206

olution of 1830. As a form of virulent and hilarious visual dissent against politics and politicians, the French satirists, led by Honoré Daumier (1808–1879), Jean-Jacques Grandville (Jean Ignace Julien Gerard; 1803–1847), Edouard Traviès (1809–1865), and many others were stopped in their tracks by draconian press laws of 1835 and forced to confine their efforts to comment on the social scene. Not all their art was comic. It is ironic that the French demanded a freedom of the press modeled on that of the English at the very moment when the English were no longer exploiting it as they had earlier; so that French “caricature” for a long period (after 1835), while no longer personal-political, is much stronger, more socially dissident, and more broadly based than the English (such as the staid John Leech or George du Maurier in *Punch*), who became the amused “illustrators” of a status quo they condoned. The French were also more artistically ambitious, and the caricature magazines aimed to give “art prints” (usually lithographs) that were more supple in tone, striking and simply larger in format, than the modest woodcuts of the English. Muzzled under Napoleon III (r. 1852–1871), political fury returned in France with the Franco-Prussian War, the fall of the emperor, and the Paris Commune, the disaster of which excited both sympathy and revulsion.

By the end of the nineteenth century, the humorous illustrated magazine caricature, and its important offshoot, the comic strip, achieved status as distinct cultural phenomena,



Depiction of a government massacre. *Rue Transonain, 15 Avril 1834. A murdered family* (1834) by Honore Daumier. Lithograph. PHOTO CREDIT: ERICH LESSING/ART RESOURCE, NY

and was well established in Western European countries, Latin America, even Russia and the Slavic nations. One may ask whether the idea of actually changing political systems survived this social institutionalization. Did the cartoon aim merely to raise a chuckle over morning coffee? Was it a Band-Aid over social wounds, an anesthetic against social pains, like religion, an “opiate of the people”? Was it merely a safety valve permitted—even encouraged—by governments adept at co-opting social discontent? The advent of potentially revolutionary and actually revolutionary movements gave a new edge to graphics. Socialism and anarchism, then female suffragism, regenerated protest graphics and joined with a new art, larger than even the full-page cartoon of old—the posters. In the United States the cartoon achieved a moment of glory with Thomas Nast (1840–1902), the pro-Union, antislavery crusader who was credited by his political enemy William Marcy (“Boss”) Tweed (1823–1878) with having thoroughly exposed him in the eyes of the populace; it was through Nast’s cartoons that Tweed was identified and returned for trial from Spain to the United States on embezzlement and corruption charges. Second to Nast was Joseph Keppler (1838–1894), founder of *Puck* (in 1877), with *Judge* and *Harper’s Weekly* the leading U.S. critical magazine, which joined lustily in the strife caused by political rivalries, monopolies, and the emergent socialist and communist movements. “Dissent” during the whole era of democracy, when not truly radical (trying to uproot), may be defined as simply opposing the party in power from

the viewpoint of its rival (in a two-party system, like that of the United States and the United Kingdom). To be sure, there have always been outstanding syndicated newspaper cartoonists taking on the fundamental questions of the age, but one wonders whether the larger context in which they are allowed to work, as a kind of “licensed jester” at the court of Capital, does not weaken any impact they might otherwise have. The advent in the 1960s of Ron Cobb cartoons in the so-called underground press (“alternative” or “radical” would be a better word), such as the *Los Angeles Free Press* and many college papers, offered drastic, existential views of war and other ills, which have struck deeper into the historical record.

Twentieth Century

Whether the numerous cartoons and posters produced to celebrate and promote the Russian Revolution (1917) may be counted as “protest” is an open question insofar as they were produced in cooperation with the new government. But patriotic protest existed to counter threats to the Revolution from the Western democracies and the reactionary White armies. In the early 1920s many Russian artists important as formal innovators in the history of art, notably the constructivists such as Vladimir Mayakovsky, Alexander Rodchenko, and El Lissitzky, using a variety of styles, some abstract, some folk-derived, made posters demanding resistance to the enemy, the promotion of literacy, and the building of industry. The Stalin era crushed dissent and vanguard artistic styles, and it was only around 1990,

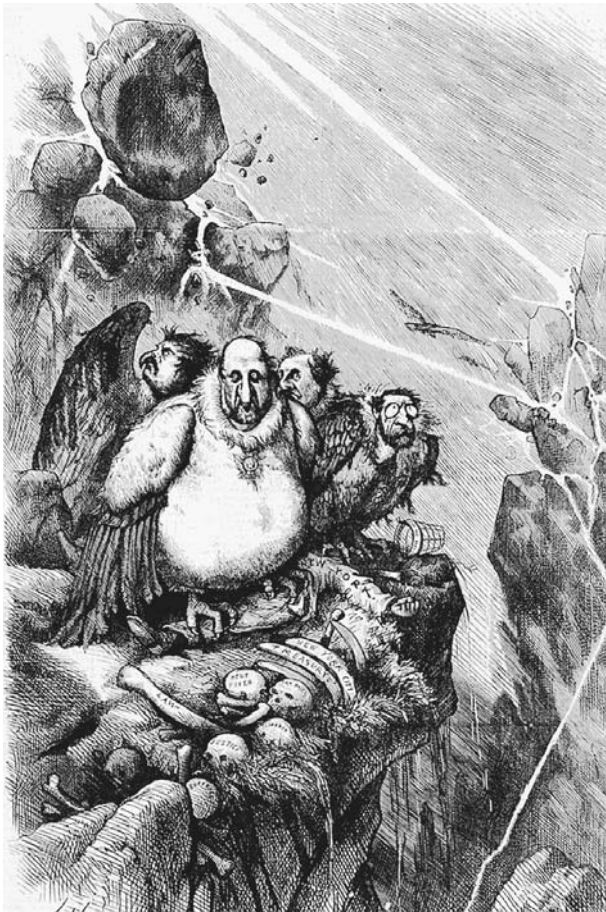

Exposing corruption. Cartoon of Boss Tweed and his associates as vultures (1871) by Thomas Nast. RARE BOOKS AND SPECIAL COLLECTIONS DIVISION. LIBRARY OF CONGRESS

following a period of *perestroika* (restructuring) and *glasnost* (openness), that posters resumed a socially critical (if still largely officialist) function. In the later Soviet era, clandestine art, like the famous clandestine (privately circulated samizdat) literature, flourished. In the generation before the fall of the Soviet Union, impressive posters for peace were officially sponsored by the government agency Plakat, in “protest” one might say against the silent (or actively war-mongering) propaganda of the so-called Free World governments, bent on nuclear supremacy. Here one may speak of “protest” officially sponsored by the militarily weaker of the superpowers, against the officially sponsored war-mongering propaganda of the other.

The posters from World War I produced by governments in the Western countries, in huge print runs and in innumerable different designs, were narrowly focused on winning the war, vilifying the enemy, and demanding sacrifice at home. They are hardly “protest” but become so in *You Back the Attack!* (2003), a book of “remixed” prowar posters from the two world wars, a classic example of using the enemy’s weapons against him. Here, a straight graphic of a heroic pilot stepping into the cockpit of his airplane, adds to the slogan “You Back the Attack! We’ll bomb who we want.” Thus the world of



Soviet poster advocating resistance to the enemy. *Against Gen. Wrangel’s White Guards* (c. 1920) by Vladimir Mayakovsky. PHOTO CREDIT: SNARK/ART RESOURCE, NY. IMAGE REFERENCE: ART172706

advertising, political and commercial, which has taken over entire public air and street spaces, not to speak of invading living rooms through newspaper and television, is subverted in its own language. “Billboard conversion” (or “correction”) is an illegal pastime of guerrilla artists who “improve” the slogans and images of billboard advertising. For instance, the addition to the egregiously sexist car ad saying “If this car was a lady, it would get its bottom pinched” of the words “if this lady was a car, it would run you down”; or the airline billboard “X airline flies every day to El Salvador” was changed by the substitution and addition of a few letters (fast, to avoid being caught by a passing police car) to read “Reagan lies every day about El Salvador.” It is only very occasionally that a peace group goes to the great expense of renting billboard space in the legal manner.

In the United States during World War I the real protest of the era came from the leftist periodical *The Masses*, which consistently opposed the war, unlike leftist sectors elsewhere in the United States and Europe. *The Masses* and *The New Masses* were dedicated to class struggle in the Marxian sense and used the (unpaid) graphics of brilliant artists such as John Sloan, Boardman Robinson, and George Bellows, who denounced the

prevalent social injustices, especially war and racism. *Masses* stalwart Robert Minor eventually turned from militant art to militant activism. Several painters during the first third of the twentieth century, dedicated to realistic styles and popular subjects, such as William Gropper, Philip Evergood, and Reginald March, are remembered perhaps more for their prints denouncing poverty and other social injustices, which eventually merged into opposition to rising fascism.

The other great foyer of anticapitalist and antiwar dissent came from Germany, where new caricatural and Expressionist styles lent force to the graphics of Johnny Heartfield and George Grosz in their exposés of the bitter conditions of living under the Weimar Republic and the rise of Adolf Hitler. Heartfield established a new medium of satire, photomontage, which in the Germany of the 1980s would undergo a potent revival with new editions of his work, and new photomontages by Klaus Staack and Jürgen Holtfreter. A Heartfield photomontage shows, for instance, Hermann Goering with his real face and body taken from a photograph, but with a butcher's arm around him and a bloody axe in his hand, while the Reichstag burns behind him. Heartfield and Grosz were satirists, using humor and the grotesque; Käthe Kollwitz (1867–1945), by contrast, from the turn of the century onward was always deadly earnest in her graphic manner, deploring the plight of the working classes and the poor. She has left one of the most enduring antiwar icons, the simple, anguished *Nur Wieder Krieg*, reactivated in recent decades.

Painting, Murals, Photography

Painting, traditionally commissioned and bought by the rich, generally supportive of the political and religious needs of established order, is by its nature less given to popular viewpoint and polemics, but certain figures stand out as exceptions: Hieronymus Bosch (c. 1450–c. 1516), whose paintings are certainly socially-critical of a gamut of personal vices, including those of corrupt lawyers, as seen in his *Tabletop of the Seven Deadly Sins* (under Avarice), or those of the clergy, male and female, as evident in his *Ship of Fools*. On the other hand, the fascination of this artist lies very much in his works' incomprehensibility to viewers of the early twenty-first century. Others are Hans Holbein's (1497?–1543) *Dance of Death* (1520s–1530s); exposing again the corruption of Law and Church; Pieter Brueghel (c. 1564–1638), whose paintings and engravings condemn the lusts of emergent capitalism and the warping of states; lesser Dutch and Flemish artists making small paintings depicting contemporary (sixteenth to seventeenth century) military abuses of civilians, unique in Europe and intended for an antiwar public; Hogarth, who raised the satirical genre to aesthetic heights, but depended financially on the sale of engravings after the paintings; Théodore Géricault (1791–1824), exposing a great contemporary scandal in *The Raft of the Medusa*; and Eugène Delacroix (1798–1863) celebrating the revolution of 1830 in *Liberty Leading the People*. From the middle of the nineteenth century Gustave Courbet (1819–1877) was pleading for the dignity of the common man, and paid for his real-life (pro-Commune) radical activism with a prison term and exile. These are, however, exceptions in the mainstream development of painting as defined by orthodox

art history, and sculpture hardly plays a role at all, apart from some small bronze busts by Daumier, ridiculing ministers and deputies, which remained, however, unknown at the time. The anarchism that informs the personal philosophy of the impressionist painter Camille Pissarro (1830–1903) is scarcely evident in his paintings, except as a vague sympathy for simple, rustic folk, equally present in the painting of the (earlier) Barbizon and other realist schools.

In the twentieth century the picture becomes wonderfully complicated. While the tendencies of certain late nineteenth- to early twentieth-century art in favor of the worker and the poor, heartfelt but unfashionable, such as the Ashcan School in the United States, seem to yield entirely to the stylistically and philosophically self-regarding—not to say self-indulgent and solipsistic—art that is now designated as avant-garde, this is a matter of ideologically driven historiographical bias. The Eurocentric, male-oriented, art-historical “canon” has been reluctant to admit the so-called “margins” (art of the Third World, minorities, women, lower classes). The caricature and “primitivism” that helped break the bonds of academic formalism also helped—partially or fragmentarily—to break the bonds of class prejudice. The bourgeoisie sought refuge for political revolution in artistic revolution, and drew on imagery from the (subjugated) Third World “primitive” to enrich rather than subvert. The artistic “revolution” of cubism is less socially conscious than those of dada and surrealism, which sought a kind of anarchistic destruction of social as well as artistic conventions. Surrealism particularly attracted communists and political radicals. The greatest artist of the age, Pablo Picasso (1881–1973), grew increasingly narcissistic in his work, except when it came to certain egregious military-political horrors; *Guernica* (1937) and *War and Peace* (1952) both, in different ways, try to universalize a particular incident or a particular war out of historical specificity.

All the great social movements of the century had their artistic responses. Racism, the civil rights movement, the degradation and pride of blacks in the United States are among the themes of Charles White and Jacob Lawrence. Ben Shahn was the great poster maker for human rights. While abstract expressionism in the Cold War 1950s tried to transcend the very idea of social engagement and celebrate the individual-in-isolation, U.S. pop art in the 1960s embraced ironically but not critically the world of rampant consumer imagery, of advertising, and of fashion. Among all the competing “-isms” arising later in the decade, conceptual art was formally most suited to social critique, since it aimed to represent and challenge current ideas and concepts rather than extend notions of art-as-form. Hans Haacke in New York used the language of corporate advertising to expose the sinister links between art and its patronage in industrial corporations. The new feminists, who used a variety of new visual media, conceptual, video, performance, and body art, directed attention to their hitherto unvalidated personal, social, and biological condition, and to the ongoing subordinations of women and women artists. The very idea of an exhibition of all-women artists became a form of protest against historic exclusions. In the world of postermaking, the work of the New York-based Guerrilla Girls gained notoriety, not least through their (illegal) fly-posting on random public

spaces, which was also the tactic of Robbie Conal, who has concentrated on large hostile portraits of politicians, and had many brushes with the law. The text-and-image art of Barbara Kruger, is close to the poster, and constitutes enigmatic and sardonic critique of life under capitalism.

In the postwar era there have been innumerable artists torn by the injustices of war, poverty, and racism; their efforts have been gathered into exhibitions, notably Lucy Lippard's *A Different War* (c. 1990), showing works about the Vietnam experience, by U.S. artists and veterans of the war. Artists have formed into short-lived groupings ("Artists Call Against Intervention in Central America" in the 1980s, led by Claes Oldenburg, a pop sculptor with truly satirical flashes); and the commercial illustrator like Tomi Ungerer was moved, by the Vietnam War, to do some of the most pungent posters of the era.

Murals. In Mexico following the revolution (1910–1920) the once-elite and almost forgotten art of wall-painting suddenly became populist, radical, and literally revolutionary: a major weapon in the struggle to preserve Emiliano Zapata's revolution. Diego Rivera (1886–1957) returned from his early and commercially promising phase as a cubist in Paris to dedicate himself entirely to utilitarian, didactic, exhortatory, and critical revolutionary themes. Rivera and his successors, José Clemente Orozco (1883–1949) and especially the politically hyper-activist David Alfaro Siqueiros (1896–1974)—the three are known as *Los Tres Grandes*—laid the basis of an entirely new, socially conscious artistic movement in the very old medium of fresco painting. They revived ancient precolonial art forms, denounced the Spanish invasion, celebrated the war of independence and Benito Juárez, and damned the tyranny of subsequent presidents and the betrayals of the revolution. Their example fomented a conviction in the United States during the Depression years that art should speak to popular needs and hopes; so that a number of artists in the United States (where the three great Mexicans also worked) filled the walls of public buildings with socially relevant themes in a variety of non-abstract, easily legible, more or less social-realist styles. Since they were largely sponsored by the U.S. government's Work Progress Administration (WPA), they could not raise their voices too loud, or communistically; and when Rivera dared to put Karl Marx and Vladimir Lenin into his great anti-capitalist "Man at the Crossroads" mural in New York, the sponsor, John D. Rockefeller, had it destroyed. Printmakers followed the lead: Leopoldo Méndez established a Taller de Gráfica Popular, which, like the murals, has resonated ever since.

The Great Depression also saw the rise of a new art form as a means of social agitation: photography. At the turn of the century, Jacob Riis (1849–1914) and Lewis Hine had turned their lens upon the miserable tenement housing and the plight of immigrants. In the Depression years Margaret Bourke-White (1906–1971), Dorothea Lange (1895–1965), and Walker Evans (1903–1975) registered images regarded as artistic masterpieces: the dignity and pathos of the migrant worker, the terrors of unemployment, and the hypocrisy of the United States touting itself as offering the highest standard of living in the world, above a line of miserable and ragged unemployed. In the international domain, photography-as-reportage was

waged by Robert Capa, recording the Spanish Civil War from the Republican side, condemning the Japanese in China, covering World War II, down to Vietnam, where he was killed when he stepped on a mine. Poster makers have made full use of press photographs and photomontage where reality seems to condemn itself.

After World War II: The Poster and the Mural

The years immediately following World War II were deceptively quiescent in the West. By the 1950s, the civil rights movement in the U.S. South and protests against nuclear weapons in Europe generated some oppositional graphics. These were overshadowed in the 1960s by the war in Vietnam, which was the catalyst for the greatest popular mobilization in the United States since the Civil War, and an unprecedented outpouring of first posters and then murals. It has been estimated that perhaps 100,000 different posters were produced during the height of the Vietnam War (1966–1973), by individuals and small groups, usually in association with one of the many antiwar organizations, large and small. The simple artless slogan and design "War is not healthy for children and other living things," conceived for Women Strike for Peace was repeated in every medium and endures. The posters may be regarded as a pictorial arm of the underground press, that alternative press made possible by cheaper printing; but many of the posters, produced in small quantities and silk-screen, testify to a crafts technology and the sacrifice of much



Vietnam War protest. *America Is Devouring Its Children*, poster by Jay Belloli, Berkeley, California, 1970. Silkscreen on paper. COURTESY OF JAY BELLOLI

time and personal money. Many of the more ambitious and professionally designed posters were sold from specialized stores catering to college students. Often unsigned, the posters used an array of styles enlarged by the simultaneous neo-art nouveau, psychedelic, and pop movements, with much reference to current commercial advertising, which it ipso facto subverted. The posters used national symbols such as the U.S. flag and the Statue of Liberty to expose the hypocrisy of the United States and its endeavor to suppress movements of national liberation; they condemned the suffering of civilians, the use of napalm and defoliants in Vietnam, and police brutality, the unfairness of the draft, and the corruption of the politicians at home. Posters took over the traditional role of the cartoon, which seems weak in comparison to the large, aggressive, and sometimes gaudy effects of the poster. Protest posters demanded an end to racism and the oppression of women, and moved ecology into public consciousness with awareness of destruction of the environment by industry.

The most bitter and pathetic of the designs condemn the cruelty perpetrated against Vietnamese civilians, and several of the concepts and photographs used have become classics. Live TV coverage (in color) and press photographs turned popular opinion and eventually opportunist politicians against the war. The photograph of a Vietcong suspect being shot in the head

in broad daylight in a crowded street by an officer of the U.S.-backed South Vietnamese army; that of a ten-year-old girl running screaming and naked down a road, her back on fire with napalm; the Goyaesque heaping of corpses of the My Lai massacre—these images were used again and again. The latter was made and distributed for free by the Art Workers Coalition, an alliance of New York artists. A small number of posters actually called for the victory of the Vietnamese under Ho Chi Minh. The condemnation of the U.S. war in Vietnam, like opposition to the war in Iraq forty years later, was a global protest, and there was hardly a country in the West that did not contribute its share. It is justly claimed that the antiwar movement, which had its own genius for publicity, played an essential role in ending the war by forcing U.S. withdrawal. In France, exasperation with the Vietnam War and the government of Charles de Gaulle led to a unique outpouring of posters in support of the student-worker strikes of May 1968. The “Affiches de Mai” are a stylistically homogeneous number of posters produced by the ad hoc group of students calling itself the Atelier Populaire, which functioned out of the École des Beaux-Arts in Paris. The designs were all based on very simple and drastic stencils silk-screened onto the cheapest paper; the style was imitated by students in the School of Environmental Design in Berkeley (1970), where a comparable surge of protest followed the invasion of Cambodia.

Cuba experienced a dramatic vitalization of poster art following the 1959 revolution that was out of all proportion to its size and resources. The production of one organization alone, the Organization of Solidarity with the Peoples of Africa, Asia and Latin America (OSPAAAL), which published the magazine *Tricontinental*, into which the posters were at first folded, ran into hundreds in the 1967–1987 period; the wit, ingenuity, and imaginative use of national symbols, in posters designed to support popular movements on three continents, had an impact far beyond the borders of the island nation, especially in the United States. The major dissident silk-screen artist-printmaker Rupert Garcia was much indebted to the Cuban style of posters, which acted on just about every sphere of Cuban life and revolutionary endeavor, consistently socialist, anticapitalist and anti-imperialist. Cuba’s is the best example of officially sponsored anti-imperialist protest art. Perhaps the most enduring icons that emerged from this context are the portraits of Ernesto “Che” Guevara, the immortal matrix for which is based on a photograph by the Cuban photographer Alberto Korda. This has been called the most famous photograph of all time, the Mona Lisa of photography. The image of the communist guerrilla in an apparent moment of serene vision appears with an astonishing ubiquity on T-shirts, buttons, banners, posters, and all manner of consumer objects. There has been a popular transformation of the historic Che (murdered by U.S.-backed Bolivian military in 1967) into a symbol of struggle for social justice, hope for a better world, and the spirit of personal sacrifice. Given the relative lack of native production, the number and variety of OSPAAAL posters for popular struggles of Africa emerging from European colonization and resisting the apartheid-supported wars of Jonas Savimbi, where Cuban soldiers were much involved, offers to North and West the most accessible iconography of African liberation. The Cubans were producing

posters for Nelson Mandela at a time when the United States was still branding him a terrorist; in terms of ubiquity, he stands beside Che Guevara.

The political poster, the graphics of protest, has become the subject of many books, conferences, exhibitions, and collections; political posters are also actively traded on the eBay Internet site and elsewhere. Like the mural movement, political poster-making is a worldwide phenomenon, and much of the subject matter is similar. More like a pamphlet than a book, posters are unattractive to libraries because of their fragility and are distributed in the most random fashion by organizations large and small at public street demonstrations and otherwise informally. The collection of the Los Angeles-based Center for the Study of Political Graphics consists of some fifty thousand works from some one hundred different countries, with many thousands of different items from (or about) Cuba, Nicaragua, and Chile. The “about” is important in such cases where the countries have endured assaults from the imperial power, for the poster is one of the most potent expressions of solidarity, and often uses text in more than one language (OSPAAAL used four). The extraordinary outpouring of posters made in Nicaragua to support the revolution there is matched by the numbers done with the same intent, and particularly to condemn the U.S.-sponsored Contra war, in Europe and the United States; the topics represented, literacy and health for all, the rights of women and children, the right to national sovereignty strike a common chord worldwide. The mural in Nicaragua, again quantitatively and qualitatively exceptional, has likewise been a means of establishing and calling for international solidarity, for about half of the three-hundred-plus murals done in that country between 1979 and 1990, and some of the very best, were done with the skills and materials brought by internationalists from twenty different countries, in cooperation with Nicaraguans. The destruction of many of the murals by the “liberal” post-Sandinista government represented not so much an attempt to wipe out dissidence as such (which was impossible), but rather a demonstration of the will to rewrite history in an anti-Sandinista light.

Murals in the United States appeared in the late 1960s and immediately became more strident and provocative than their Depression-era forbears. They have proliferated to an extraordinary degree, in every U.S. city and even small towns, and worldwide. Their function as “protest art” is harder to define than that of the posters, partly because they have relied on the sponsorship of businesses large and small, and local civic authorities, which tends to soften their subject-matter. Being location-bound, they tend to favor local issues. Some favorite topics, like drug-abuse and AIDS, may hardly be called countercultural. Murals have been more subject to censorship than have posters, and they may be termed ephemeral, liable to destruction by sun and rain and the wrecker’s ball. While it is virtually impossible to earn a living from making protest posters, there are many artists whose livelihood and reputation depends entirely on their skill as muralists.

Spray-can art, often mis-termed “graffiti” (which is something else), is the truly global, emphatically vernacular and irreducibly public mural style of the 1990s and early 2000s. Its explosively calligraphic style, which at its best attains to a

Book-of-Kells-like intricacy of design, is less overtly political than populist in location (abandoned walls, playgrounds, and railway sidings) and in process: a joyous protest against the commercialism of the world of high art, and the burned-and-bombed-out look of inner cities. With its multifarious references to pop culture (such as comic book, punk, hip-hop, and rap), it is both personal to the “writers,” as they are called (or “taggers”), and socially homogeneous in its anarchic, semi-legal, and often illegal way—this amid many attempts to co-opt and institutionalize it.

The poster of protest has been to a degree institutionalized by certain large organizations such as Amnesty International, Greenpeace, and the German Green Party. The international human rights organization Amnesty International has used the talents of artists everywhere for posters, which run the gamut of the beautiful and terrifying (often combining both qualities), and ring changes on the concept of bringing hope to those in jail and suffering torture. An example, sponsored by a major German corporation, testifies to corporate guilt over connivance with or exploitation of injustices, and to the desire to present a morally conscious face to the world. Greenpeace and Green parties have not only defended the environment against its destruction by governments and industry, but also condemned warmongering. Greenpeace activists have also engaged in direct action that branches, such as the Greenham Common protests of the 1980s and 1990s, into theater: in March 2004 two youths climbed the Big Ben clock tower in London with banners denouncing government lies. The government ignored the denunciation, but not the dramatic breach of security.

The Japanese Graphic Designers Association in 1983 launched a worldwide Hiroshima Appeal Poster competition, which resulted in a series of posters; a counterpart was started in the United States by Charles Helmken. In Britain in the late 1950s, the Campaign for Nuclear Disarmament (CND) gave the world the most universal peace or antiwar symbol, and has continued to produce and inspire posters, as have the Quakers and many other religious or spiritual organizations such as the World Council of Churches. Particular events, notably the stationing of U.S. Cruise and Pershing missiles in Europe and the apparent readiness of the United States to consider Europe as a theater of nuclear war, elicited an array of visual protests of various kinds. The encampment of women against the missiles placed on Greenham Common in Berkshire, England, aroused great media attention for their theatrical flair and dogged determination in harsh conditions; the perimeter fence became the stage for both actions and decorations that frustrated and ridiculed the authorities. The demonstrations in Beijing’s Tiananmen Square in 1989 combined a variety of visual effects: posters, banners, and a huge sculpture of the Goddess of Democracy

The German Greens stand at the center of the immense German production of the last decades. Their posters are very large and colorful and reach into all corners of German political and social life. Other major sources are the antifascist organizations (“anti-fa”) resisting fascist resurgence and racism, which is anti-Turkish and anti-foreigner generally. The range

of protest in Germany rivals that of the United States, touching U.S. missiles on German soil, the Berlin Wall, immigration (many posters are in Turkish as well as German and occasionally English), the plight of the homeless, housing, the right to legal abortion, and the rights of women, children, political prisoners, gays, and animals. Pollution, recycling, urban congestion, and every kind of environmental issue, as well as solidarity with popular struggles around the world, especially in Latin America, come under scrutiny. In the United States, Syracuse Cultural Workers have consistently produced designs, but the U.S. scene is more characterized by the sheer multiplicity of ad-hoc antiwar, pro-peace and solidarity organizations producing a design of the moment, often for an upcoming mass demonstration. Poster-making in Australia has also depended much on the consistency of small organizations, such as Tin Sheds (1972–1979), Redback Graphics, and the radical youth group Resistance (since 1967). All were inspired by the anti-Vietnam War movement but have also taken on local targets, especially the maltreatment of the Aborigines.

Asia

In Japan, emerging in 1952 from strict U.S. censorship, members of the Japanese Students Union (Zen Gakuren) opposed, in word and image, the Joint Security Pact of 1960 and the

continued U.S. occupation and re-militarization of their country. The first and foremost to condemn the destruction of the country by U.S. bombers was the painter Matsumoto Shunsuke. Much protest art has been created by women, dealing with more than “women’s issues”: disarmament, nuclear power, and U.S. bases. In Korea the underground woodblock prints emanating from the Minjung movement, composed of students, workers, and Christian churches, with their simultaneous reference to Western and Chinese traditions, especially the work of Käthe Kollwitz, protested the killings under the dictatorship and the rigging of elections and called for reunification of the peninsula. The artist Hong Song Dam used more traditional religious material.

In China a long tradition in the classical period of Chinese art, of subtle, personal forms of protest in calligraphy and painting, turned to open opposition against the nationalist armies and the Japanese occupation in the 1920s and 1930s. The stark and violent effects of German Expressionist and Russian vanguard graphics were turned to account, while Mao Zedong insisted, at the famous Yan’an forum of 1942, that all art be positive, supportive of the Chinese Revolution, and unambiguous, and so it was from 1949. There were two subsequent periods of protest: post-Mao, and post-Tiananmen. In the post-Mao era many artists exiled themselves to New York, Taiwan, and Hong Kong in order to express their opposition freely. Zhang Hongtu’s 1989 painting depicting Mao Zedong as Jesus along with his disciples, a travesty of Leonardo Da Vinci’s *Last Supper*, intended to mock the cult of Mao and Maoism itself, was completed and exhibited in exile. Since the Tiananmen protest and consequent repression, the openings for protest within China have wavered, with a modest policy of restrained censorship.

India inherited the lively British tradition of cartooning, promulgated in the 1920s and 1930s along with the Gandhian uprising. The cartoon was another form of English lingua franca that served to cut across the boundaries of the subcontinent, where a dozen or more different languages are spoken. Much protest, such as the Kaligat painting that caricatured the British, emanated from Bengal and denounced the ethnic and religious divisions. The high regard placed by leftist and Marxist collectives on the value of propaganda (by word and image), in tune with Gandhi’s insistence of nonviolence and his genius for self-presentation (as in the protest marches), ensured that visual protest in newspapers, posters, and on walls all over the country played a critical role in mobilizing masses against British rule. Since Indian independence, the cartoon has functioned much as it has in the West.

There has been a degree of international graphic solidarity with Palestine in its struggle with Israel. Resistance in the Occupied Territories is of course limited; even the use of the colors of the Palestinian flag has been banned. The work of the Palestinian poster artist Jihad Mansour (Marc Rudin) stands out, and among the many dissenting Israeli voices perhaps the most forceful has been that of the veteran Russian-Jewish Israeli David Tartakover.

Comic Strip and Graphic Novel

After a long period of sociopolitical quiescence—born of newspapers’ fears of offending subscribers and advertisers—the

comic strip resumed some of its original satiric purpose, which it had shown in the nineteenth century. Walt Kelly's *Pogo* in its innocent-looking, Disneyish, animal-fabulous garb, indicted Senator Joseph McCarthy in the early 1950s. The traditional taboo of the "controversial" was finally broken with Jules Feiffer, whose work was nevertheless confined to the progressive weekly magazine, unlike Garry Trudeau's syndicated *Doonesbury* (commencing in 1970, in the early 2000s the strip appears in four hundred newspapers worldwide). Highly topical and scathing of government lies and deceptions (the Watergate scandal was for Trudeau what McCarthy was for Kelly), and sympathetic to new social movements such as feminism, Trudeau has been called the most influential (and is probably the most regularly censored) cartoonist in the world; he won a Pulitzer Prize for cartooning in 1975. The drawing is stiff, but the dialogue perfectly tuned. His nearest British equivalent is Steve Bell, a principled, caustic, socialist critic of capitalist antics, whose daily "If" has appeared in the *Guardian* newspaper since 1981. His crude, chaotic linear style and composition derive from his background in children's comics. The child-like style, verging on bizarre abstractions, is best exemplified in the poster work of Berkeley artist Doug Minkler.

All kinds of long-established taboos, mainly in the social and sexual realm, were broken by the so-called Underground Comics (or comix) starting in the mid 1960s, led by Robert Crumb. These works heralded the sexual revolution that was also visualized by posters, and celebrated illegal drugs and the hippie lifestyle in a manner that is both hilarious and philosophical. Approaching the pornographic, such work endured brushes with law, and for a time it was easier to find these comics in Amsterdam than in their place of origin, the San Francisco Bay area.

The graphic novel emerged in the 1980s from the old comic book, which was typically a collection of short graphic sequences, related to and often reproducing newspaper strips. It has now become a major vehicle of social and political protest, gaining status from Art Spiegelman's autobiographical Holocaust account *Maus*, which won many prizes and is sold in mainstream bookstores. The genre has lent itself to autobiography laced with radical social critique, as in the feminist advocacy of Marisa Acocella's *Just Who the Hell Is SHE Anyway?* (1993). The comic strip and comic book format, much used everywhere for educational and didactic purposes, found essentially local critical forms in Latin America: the much-censored Rius (Eduardo del Rio) in Mexico, with his *Agachados* (The Downtrodden) and *Supermachos* (The Supermales), cutting a wide swath through the Mexican polis; Roberto Fontanarrosa, with his *Boogie el Aceitoso* (Boogie [from Humphrey Bogart] the Slippery), a crapulous, sadistic C.I.A. thug and U.S.-hired mercenary, whose laconic wit is his only virtue. Another Argentine, Hector Oesterheld, wrote for artist Alberto Breccia and his son Enrique a tragic life of Che Guevara (*Che*, 1968), which was burned and suppressed by the government, and Oesterheld was "disappeared" (murdered).

An example of socialist political comic, which has remained unique, emerged in Salvadore Allende's Chile (1970–1973), an exciting experiment that was aborted by the military coup

of Augusto Pinochet, which banned and burned it. Under the generic title *La Firme* (Steadfast) the series told amusing Chilean-dialectal and dialectical tales in quintessential Chilean working places and locales, serving to explain the need for the socialist transformation that was then in process and under threat. This was undertaken in tandem with the first radical, and enduring, critique of the Disney comic, which was especially hegemonic in Latin America: *How to Read Donald Duck* (1971), by Ariel Dorfman and Armand Mattelart, which was translated into a dozen foreign languages (the English edition, 1975, carried the subtitle *Imperialist Ideology in the Disney Comic*). After Chile's bloody counterrevolution of September 11, 1973, José Palomo, one of the *La Firme* artists, fled to Mexico where he created a tiny, Wizard-of-Id-like dictator, not at all innocuous like his Brant-Parker prototype, under the title *El Cuarto Reich*, published in *Uno mas Uno*. Contemporaneous and exploitative of the poverty and sufferings of his people, and backed by U.S.-trained thugs and death squads, he typifies the Third World dictator, especially in U.S.-dominated Latin America. This gag strip, hilarious as well as mordant, was little exported. Yet it is perhaps the only comic strip in the world about the life of truly immiserated majorities, although in the U.S. Aaron McGruder's *Boondocks* does deal with the impoverished and unemployed black youth, as well as issues of war and peace.

See also Arts; Avant-Garde; Feminism; Pacifism; War; War and Peace in the Arts.

BIBLIOGRAPHY

- Atelier Populaire. *Posters from the Revolution, Paris, May 1968, Texts and Posters*. Indianapolis: Bobbs-Merrill, 1969. There is also a collection of ninety-six posters in color published by Dobson in London in 1968. Eighty-seven posters were published in miniature by Usines Université Union, Paris, 1968.
- Blum, Paul von. *The Art of Social Conscience*. New York: Universe Books, 1976. Nineteenth and twentieth centuries.
- . *The Critical Vision. A History of Social and Political Art in the U.S.* Boston: South End Press, 1982.
- Bork, Angela, et al. *Die politische Lithographie im Kampf um die Pariser Kommune*. Cologne, Germany: Gahme, Henke, 1976.
- Commune de Paris 1871–1971. Exposition du Centenaire*. Saint Denis, Musé d'Art et d'Histoire, 1971.
- Craven, David. *Art and Revolution in Latin America, 1910–1990*. New Haven and London: Yale University Press, 2002. Covers Mexico (1910–1940), Cuba (1959–1989), and Nicaragua (1979–1990).
- Cushing, Lincoln. *Revolución! Cuban Poster Art*. San Francisco: Chronicle Books, 2003. Many OSPAAAL posters.
- Davidson, Steef. *Images de la révolte 1965–1975*. Paris: Musée de l'Affiche et de la Publicité, H. Veyrier, 1982. See introduction.
- Diederich, Reiner, and Richard Grübling. *Stark für die Freiheit: Die Bundesrepublik in Plakat*. Hamburg, Germany: Rasch und Röhrling, 1989. With 164 illustrations and commentary on all.
- . "Unter die Schere mit den Geiern." *Politische Fotomontage in der Bundesrepublik und Westberlin*. Berlin: Elefanten Press Galerie, 1977. Well-documented.
- Evans, David, and Sylvia Gohl. *Photomontage: A Political Weapon*. London: G. Frazer, 1968.
- Gaddi, Giuseppe. *Fascismo Mai. 100 Manifesti contro la Minaccia fascista in Europa*. Milan: La Pietra, 1972.

- Grupo Mira. *La Grafica del 68, Homenaje al Movimiento Estudiantil*. n.p.: Mexico D.F., 1981. Anthology of woodcuts about the repression of 1968.
- Heller, Steven. *Man Bites Man: Two Decades of Drawings and Cartoons*. New York: A and W Publishers, 1981.
- Jacobs, Karrie, and Steven Heller. *Angry Graphics: Protest Posters of the Reagan/Bush Era*. Salt Lake City: Peregrine Smith Books, 1992.
- Kunzle, David. *Posters of Protest: The Posters of Political Satire in the U.S., 1966–1970*. Santa Barbara: University of California, 1971. Exhibition catalog. A shorter version published by New School for Social Research, New York (Triple R. Press), 1971.
- . *Murals of Revolutionary Nicaragua, 1979–1992*. Berkeley: University of California Press, 1995. Includes reproductions of many posters.
- Langemeyer, Gerhard, et al. eds. *Bild als Waffe: Mittel und Motive der Karikatur in fünf Jahrhunderten*. Munich: Prestel-Verlag, 1984. Deals with various media from five centuries, very copiously illustrated.
- Lippard, Lucy R. *A Different War: Vietnam in Art*. Seattle: Real Comet Press, 1990. Works of “high art.”
- McQuiston, Liz. *Graphic Agitation: Social and Political Graphics since the Sixties*. London: Phaidon, 1993. Includes posters from countries around the world seldom regarded in poster history.
- Micheli, Mario de. *Manifesti Rivoluzionari: Europa 1900–1940*. Milan: Fratelli Fabbri, 1973. Many Soviet and Soviet-bloc posters.
- Philippe, Robert. *Political Graphics, Art as a Weapon*. Oxford: Phaidon; New York: Abbeville Press, 1982. Comprehensive.
- Poster Book Collective of the South African History Archive. *Images of Defiance: South African Resistance Posters of the 1980s*. Johannesburg: Raven Press, 1991.
- Ray, Violet. *Advertising the Contradictions*. Berkeley, Calif.: V. Ray, 1984. Collaging the real and fantasy worlds.
- Rickards, Maurice. *Posters of Protest and Revolution*. Bath, U.K.: Adams and Dart, 1970. Twenty-one countries represented in a very compact volume.
- Shikes, Ralph E. *The Indignant Eye: The Artist as Social Critic in Prints and Drawings from the Fifteenth Century to Picasso*. Boston: Beacon Press, 1969. Unsurpassed.
- Stermer, Dugald, and Susan Sontag. *The Art of Revolution: 96 Posters from Cuba*. New York: McGraw-Hill, 1970. Excellent texts with fine facsimiles.
- Thomas, C. David, ed. *As Seen by Both Sides: American and Vietnamese Artists Look at the War*. Boston: Indochina Arts Project, William Joiner Foundation, 1991.
- Track 16 Gallery/Center for the Study of Political Graphics. *Decade of Protest, Political Posters from the United States, Vietnam, Cuba 1965–1975*. Santa Monica, Calif.: Smart Art Press, 1996.
- Wright, Micah. *You Back the Attack! We'll Bomb Who We Want! Remixed War Propaganda Posters*. New York: Seven Stories Press, 2003. Preface urges readers to break book apart and make enlarged copies into posters.
- Yanker, Gary. *Prop Art: Over 1000 Contemporary Political Posters*. New York: Darien House, 1972. Mix of radical, historic, and straight election posters.

David Kunzle

PSEUDOSCIENCE. *Pseudoscience* is a term applied to a field of inquiry by critics claiming that it is a pretended or spurious science because it does not meet established standards.

The term *pseudoscience* is reserved for fields that claim to be a science, that make claims about the world and give explanations of natural processes. Statements of personal values or beliefs are neither scientific nor pseudoscientific, nor are works of art or literature. Religion is not a pseudoscience because it does not make scientific claims, but a faith-based alternative to Charles Darwin's evolutionary theory would be. Freudian psychology is an example of a theory considered pseudoscientific by some and defended as legitimate by others. Since the term *pseudoscience* is general, it is used to dismiss an entire field, rather than a specific study or the work of a particular individual. Alternative medicine might be dismissed, for example, when there are no double-blind controlled studies to support the claims of various treatments.

Criterion of Meaning

The prefix *pseudo* is taken directly from the ancient Greek, and it has been applied to a multitude of terms. While the labeling of various fields as pseudoscience is especially associated with the philosophers of science of the early twentieth century, the term predates them by eighty years or so. The members of the Vienna Circle and their collaborators, often called logical positivists, embarked on a campaign to rid philosophy, and culture in general, of metaphysical and pseudoscientific elements. The logical positivists focused on meaning, claiming that any word or sentence that did not ultimately connect to some possible sensory experience was meaningless. Thus Rudolph Carnap (1891–1970) would object to the use of pseudoconcepts and pseudosentences. Most famously, he attacked Martin Heidegger's obscurantism, which he felt hid the true social and political situation from the reader. In contrast to his attitude toward Heidegger, Carnap accepted Friedrich Nietzsche's works because of their literary, rather than pseudoscientific, form.

The verificationist theory of meaning was criticized within philosophy and was never found to be a successful way to distinguish science from pseudoscience. Carl Hempel's 1950 article summarizing the arguments surrounding the theory is usually taken to be its death knell. The project of ridding philosophy and culture in general of pseudoscientific elements continued, however, within the philosophy of science, but the focus shifted to what Karl Popper (1902–1994) called the demarcation problem—how to define science and pseudoscience so as to make a clear distinction between the two and show that all of the contemporary and historical cases of “good science” meet the standards of the definition. Although Popper claimed not to be very interested in the project of eliminating metaphysics and pseudoscience, he recognized that his project of characterizing science in general terms is equivalent to the project of demarcation. If science can be accurately characterized, it is easy to separate science and pseudoscience. Every mode of inquiry that fits the definition is science, while any mode of inquiry that makes claims about the nature of the world and the processes in it without fitting the definition is pseudoscience.

Scientific Method

Popper and other twentieth-century philosophers of science focused on method. They claimed that all of the sciences, as opposed to other fields of inquiry, shared a common methodology

that deserves the name of “the scientific method.” Philosophers disagreed about what this method was, but no one doubted that a single scientific method characterized all of science from the time of the scientific revolution, which they also saw as a single event. According to inductivists, scientists must find data that support a hypothesis or theory. Testing that provides positive results confirms a scientific theory and shows how it is grounded in reality. Thus, in the inductivist model of science, pseudoscience is a system of beliefs unconfirmed by experimental data. On the other hand, Popper and other supporters of the hypothetico-deductive method reject the idea of confirming theories, since there are always alternative hypotheses that can account for the same data and thus can be just as well confirmed. They argue instead that scientists formulate hypotheses and then test them by making predictions on the basis of the hypotheses and checking the validity of their predictions. If the predictions are inaccurate, the hypothesis must be rejected; if they are accurate, the hypothesis is accepted, but only tentatively as a hypothesis that has withstood the test and has not yet been falsified. According to Popper, the mark of a scientist is his or her willingness to subject a hypothesis to refutation. Scientific theories are those in which refuting instances can be specified. Pseudoscience, by contrast, is not refutable, since its practitioners construct an explanation for any data that seem to contradict their beliefs.

The notion that there is a single scientific method that defines science has been severely challenged, especially by historians and sociologists of science. Thomas Kuhn famously argued that each domain and period of science is defined by a “paradigm” that sets up problems to be solved and the methods for doing so. However, we find that the sciences are a diverse and disunified collection of practices and that there is no uniform scientific method common to all paradigms, which makes the task of finding a single definition that defines science and separates it from pseudoscience seem impossible.

Current Debates

While many philosophers may have convinced each other that the problem of demarcation is unsolvable, scientists feel that there are obvious differences between science and pseudosciences and many want to continue to use the distinction. The editors of the *Encyclopedia of Pseudoscience* (2000) reply to the problem by taking an ecumenical approach that presents differing views on the nature of pseudoscience and includes for discussion almost any scientific claim that has led to controversy. Instead of looking for an essence, it may be possible to show that there is a “family resemblance” among genuine sciences and clear differentiation between science and pseudoscience in many cases.

There are extremely strong practical reasons to make a general distinction between science and pseudoscience. First, we cannot investigate everything. Much of our knowledge is simply taken on authority. Scientists immediately dismiss certain kinds of claims in order to spend more time on what they hope will be more productive research. Stephen Braude complains that it seems almost impossible to conduct an open inquiry into psychic phenomena because most scientists insist that there is no good evidence for the existence of such

phenomena, without even looking at evidence that has been published. These dismissals of evidence seem more like close-minded prejudice than open-minded scientific inquiry, but they may be necessary to allow effective allocation of resources to projects that are considered more fruitful. The difficult issue is to know when to open an area for investigation and when to stop investigating and consider an issue settled. We inevitably take many majority opinions as fact, without question. As William James put it, “Our knowledge lives on the credit system.” Second, to settle some issues, we must make some principled distinction between science and pseudoscience. Given that the United States Constitution forbids government-established religion, attempts to require the teaching of creationism (an alternative to Darwin from which overt references to religion have been removed) force courts to decide whether creationism really is science or pseudoscience. Having politicians determine which scientific theories to teach in schools is problematic, but requiring the teaching of religion in disguise is unconstitutional.

See also **Creationism; Hermeneutics; Paradigm; Practices; Science.**

BIBLIOGRAPHY

- Braude, Stephen E. *The Limits of Influence: Psychokinesis and the Philosophy of Science*. Rev. ed. Lanham, Md.: University Press of America, 1997.
- Carnap, Rudolf. “The Elimination of Metaphysics through Logical Analysis of Language.” In *Logical Positivism*, edited by A. J. Ayer, 60–81. New York: Free Press, 1959.
- Hempel, Carl G. “Problems and Changes in the Empiricist Criterion of Meaning.” *Revue internationale de philosophie* 4, no. 11 (1950): 41–63.
- James, William. *Pragmatism*. Edited by Bruce Kuklick. Indianapolis: Hackett, 1981.
- . *Vaulting Ambition: Sociobiology and the Quest for Human Nature*. Cambridge, Mass.: MIT Press, 1985.
- Kuhn, Thomas S. *The Structure of Scientific Revolutions*. 3rd ed. Chicago: University of Chicago Press, 1996.
- Popper, Karl R. *Darwinism Defended: A Guide to the Evolution Controversies*. Reading, Mass.: Addison-Wesley Advanced Book Program/World Science Division, 1982.
- . *The Logic of Scientific Discovery*. London: Hutchinson, 1959.
- Williams, William F., ed. *Encyclopedia of Pseudoscience*. New York: Facts On File, 2000.

David J. Stump

PSYCHOANALYSIS. In a 1928 entry on the subject for the *Handwörterbuch der Sexualwissenschaft* (Concise dictionary of sexual research), Sigmund Freud (1856–1939) defined psychoanalysis as “the name (1) of a procedure for the investigation of mental processes which are almost inaccessible in any other way, (2) of a method (based upon that investigation) for the treatment of neurotic disorders and (3) of a collection of psychological information obtained along those lines, which is gradually being accumulated into a new scientific discipline” (Freud, vol. 18, p. 235). Freud’s description understates the

immense richness and complexity of his achievements in the study of the workings of the ungovernable impulses of the mind, which have had far-reaching and lasting impact on humanities thinking about itself, and whose many facets can only be hinted at here below.

Overview

Initially trained as a neurologist, Freud began working with hysterical and neurotic patients as an outgrowth of his private medical practice beginning around 1883. In 1895, in *Studies on Hysteria*, co-written with his mentor Josef Breuer, Freud first formulated the theories and method that would later become psychoanalysis. In 1899, after a decade of working with such patients amid ridicule and isolation from the Viennese medical establishment, Freud published *The Interpretation of Dreams*, his major work. Though it sold only six hundred copies during the five years following its release, by 1910 Freud had attracted a number of students, mostly physicians, from throughout Europe to the practice of psychoanalysis, and succeeded in establishing the International Psychoanalytic Association. Among the most prominent of these early psychoanalysts were Karl Abraham (1877–1925), Sándor Ferenczi (1873–1933), Ernest Jones (1879–1958), and Carl Jung (1875–1961). Jung, a Swiss psychiatrist, enjoyed a particularly close relationship with Freud, and was for a time his anointed successor to the leadership of the analytic movement, until their relationship dissolved in 1912–1913 over Jung’s denial of the centrality of sexuality in neurotic conflict. Jung went on to formulate his own ideas, including the notion of a collective unconscious governed by a universal symbolic order (“archetypes”), as “analytical psychology.”

Freud continued to work and publish right up until his death from cancer in September 1939, revising and significantly expanding his theories; increasing numbers of psychoanalysts throughout Europe joined him in this effort. Psychoanalysis continued to flourish, in Europe and the United States, until the outbreak of World War II forced many analysts to flee their homes in Europe. Following the war, analytic institutions continued to expand, and became especially vital in the United States, England, and France.

Psychoanalytic Theory of Mind

In *Studies on Hysteria*, Freud wrote that “hysterics suffer mainly from reminiscences,” and with those words summed up the fundamental insight of psychoanalysis. Through his work with his neurotic patients, and later, through his own self-analysis, Freud became convinced that the symptoms from which they suffered—which ranged from hysterical blindness to obsessive thoughts and behaviors, to near-catatonic states—were the result of conflicts in the mind between unacceptable ideas and wishes that sought expression, and forces in the mind opposing that expression. Unable to find an outlet in consciousness, these unacceptable, “repressed” wishes manifested themselves in other, compromised ways, in neurotic symptoms, slips of the tongue, and dreams. To explain how this came about, Freud devised a revolutionary concept of how the mind works.

Freud was influenced by the biological and physical sciences of his time, and his first theory of the mind was governed by

a principle of energy discharge. Conceiving of the mental apparatus as an organism, Freud postulated a system whose purpose, as in a biological nervous system, was to maintain its equilibrium by reducing energy (or tension) in it—an imperative Freud called the *pleasure principle*.

Later, based on this model, Freud distinguished two modes of thinking, which he termed the *primary* and *secondary* processes, which were identified respectively with *free* and *bound* energy (with energy ultimately coming to mean *libidinal*, or sexual energy), and the workings of the *pleasure* and *reality principles*. These antagonistic pairs were the starting point for the conflictual, dynamic perspective from which Freud consistently viewed mental processes.

Conscious, preconscious, and unconscious. To demonstrate his theory of mental functioning, Freud devised a topographical model made up of three connected systems—*conscious*, *preconscious*, and *unconscious*—which set up a stratified, differentiated relation among psychic contents, on a continuum from surface/conscious to depth/unconscious. The unconscious represents the largest set, comprising all sensory perceptions, both internal and external. The preconscious encompasses all those perceptions that have been perceived but not excluded from consciousness by repression. Finally, conscious perceptions are those that have come into awareness.

In this first model, the unconscious is identified with the primary process, whose purpose is the free discharge of energy; the *preconscious/conscious system* (the two agencies were often functionally united), on the other hand, is identified with the secondary processes, and with the binding of energy. Freud supposed that mental conflict was the result of antagonism between unconscious psychic contents pressing for discharge (according to the pleasure principle), and the censorship “guarding” the preconscious/conscious system (reality principle). When successfully kept out of consciousness, the repressed impulses continued to seek discharge, eventually succeeding through the “compromise formations” of dreams, slips of the tongue, and neurotic symptoms.

Repression. *Repression* was the name Freud gave to the *defensive* warding off of unacceptable thought contents from consciousness. This process was the result of the dynamic conflict within the mind between opposing forces of instinct and “reality,” and the agencies that housed them: the unconscious and the preconscious/conscious systems.

In *The Interpretation of Dreams*, Freud likened the agent of repression to a censor. The function of this censor—and of repression itself—is to keep from consciousness psychological contents that, though in their discharge (or expression) are pleasurable in themselves, must come into conflict with other exigencies, typically those that proceed from the external world, morality, or the person’s own wishes.

Freud came to regard neurotic illness as the result of conflicts between the drive of unconscious products toward expression and their repulsion by the defenses of censorship. He saw repression as the cornerstone of all these defensive processes, and considered other defensive processes to be derived from

it. It thus became the essential task of psychoanalysis to undo the effects of repression, to bring the unacceptable unconscious contents into awareness, and through this discharge to free up the psychical energy that was absorbed in the prevention of that discharge (in neurotic symptoms).

Fantasies. In his earliest work with the neuroses, Freud supposed them to originate either in constitutional factors or in the traumatic effect of actual sexual seduction. In 1897, however, Freud concluded that the majority of the accounts of seductions he had from his patients had little basis in reality. To account for this conclusion, to the existing two “predispositions” to neurosis Freud added a third cause: repressed wishes for instinctual gratifications, which manifested themselves in *fantasies*. These fantasies, typically sexual (and incestuous) in nature, which Freud initially took for real events, actually belonged to the province of psychical reality and had the traumatic force of “material” reality. Because of their unacceptable nature, these fantasies, originating in the unconscious, threw the psychic apparatus into turmoil when they came up against the censor and were repressed, able to assert themselves only in the compromise formations of dreams and neurotic symptoms. Freud came to believe that it was these fantasies of unacceptable wishes that were the determining factor in the majority of neuroses.

Infantile Sexuality and the Oedipus Complex

This was so because of infantile sexuality, the discovery of which Freud was led to by his abandonment of the *seduction theory*. Freud’s original theory of traumatic seduction as a two-phase process—in which the initial seduction was experienced passively, often without any traumatic significance, and registered only as traumatic and repressed as a result of a later event (often without sexual significance), typically during adolescence—prepared the way for Freud to understand the sexual desires (and autoerotic activities) of infants, which were themselves uninhibited until their repression at the time of the Oedipus crisis, and which were concealed behind the fantasies of seduction.

According to Freud, the establishment and eventual destruction of the *Oedipus complex* was the necessary, biologically determined culmination of the infant’s progress through the psychosexual phases of development, and his initiation into the object world (the social order). These phases—*oral*, *anal*, *genital*, and *phallic*—were characterized by the development of the child’s capacity for libidinal satisfaction (through the discharge of tension) from primitive autoerotism to object-(person-) oriented love, as well as the child’s increasing psychic complexity. Each of these phases was rooted in the infant’s physiological development, as well as in the development of the infant’s relation to the world. The *oral* phase was modeled on the importance of eating, and the infant’s relationship to its mother through the incorporation and refusal of her breast; the *anal* phase centered on the infant’s struggles for control over bodily functions, as well as for autonomy from his or her parents; and the *genital* and *phallic* phases involved the discovery first of genital satisfaction, then satisfaction through others, and later of symbolic satisfactions outside one’s own body.

Freud emphasized the psychological importance of the infant’s first tie from birth (or before) with its mother, a quasi-symbiotic unity that gave way in stages to differentiation and autonomy. This tie to the mother was primary irrespective of gender, but left the child of each gender with a different imperative. For the male child, in order to reproduce, and in obedience to the incest taboo, he needed to give up his tie to and desire for his mother in favor of other, female objects. For the female child, she must give up her attachment to female objects altogether.

Around three to five years of age, in consequence of his approach and attainment of genital sexuality (which is also to say, object-related sexuality), the child experiences sexual desire for his parents. In the *positive* Oedipal situation, the male child feels desire toward his mother, and jealously regards the father as a rival; Freud assumed that most children had direct knowledge of this rivalry through witness of the *primal scene* of intercourse, either between their parents, or from another source (such as the sight of animal copulation). Freud also assumed that the child had by this time become aware of the anatomical difference between the sexes, and from this discovery, inferred the threat (or in the case of the female, the fantasized “fact”) of *castration*—the loss of the penis as punishment for his incestuous wishes.

The conjoining in his mind of these factors, of his rivalry with his father for his mother’s love and the threat of castration, awakened in the male child an intense anxiety, and set in motion the repression of the child’s incestuous desires, and a subsequent switch in identification from the now dangerous mother to the powerful and punishing father. Significantly, the male child did not at the same time renounce his sexual desire for the opposite sex.

As a result of the dramatic repression of the Oedipus complex, the child unconsciously internalized the Oedipal situation, and especially the punitive idea of the father, as a way to ensure continued protection from castration. These new internalized others collectively became the new superego, which henceforth governed the child’s object-oriented actions, and superintended his sense of morality.

In the female child, the discovery of the “reality” of her castration led to *penis envy*, and with it a hatred of her mother, a sense of rageful betrayal at having been left unmade, unfinished. In her anger, Freud postulated that she would turn toward the father, and seek from him a penis—his penis—and later a baby.

Freud believed a girl’s sexuality was initially dominated by her clitoris, her “little penis.” Only with the move to vaginal sexuality was a woman’s sexual maturation complete. Freud himself, however, remained unconvinced as to the motives for this change.

The “phallogocentric” nature of the Oedipus complex had far-reaching consequences for female development. Without the threat of castration, the girl’s movement toward heterosexual object choice is not characterized by the same intensity of repression as the male’s, and consequently, Freud believed,

the superego development that was the legacy of the Oedipus complex was less developed.

Freud also suggested the presence in both genders of a *negative* Oedipus complex, involving the opposite series of identifications. In the male child, the father became the object of his (passive) sexual desire, fostering a sense of identification with his mother who was the father's sexual object. This constellation, too, required repression, and if this was insufficiently accomplished, Freud believed, it could serve as an important foundation for homosexual object choice.

Much of the rationale for the Oedipal struggle is rooted in the sexual, animal child's acceptance of the moral order of "civilized" culture, and it is often on this basis that it is criticized. Nevertheless, Freud believed that the Oedipus stage was central, not only because of its implications for the infant's psychosexual development, but also because it marked the infant's attainment of human subjectivity. With the Oedipus conflict the child also attained the capacity for "triadic relationships" (in which the child was able to regard others not simply from her own frame of reference, but as existing outside of and independent of her needs and wishes—and hence different from and at odds with her own) and with it the complex capacity for symbolism that was the precondition for language and for thought itself, as well as for the *free association* that was at the heart of analytic work.

In later years, many aspects of the Oedipus theory have received critical scrutiny. Emphasizing pre-Oedipal aspects of childhood development, female sexuality, and the degree to which the Oedipus complex was ever really abolished, many theorists have revised and extended the conception of the Oedipus complex and how it is used in clinical practice in the early twenty-first century.

Among the most vital of these contributions have been those of Hans W. Loewald, who came to regard the Oedipal conflict as an unending struggle perpetuated in the superego against the internalized *imagos* (unconscious representatives) of one's parents. Equally important are contributions from Karen Horney, Jessica Benjamin, and others, which emphasize the differences in female sexual development from those of the male, and question the central importance of the castration complex for girls. Other recent theorists, such as Arlene Kramer Richards, have emphasized the importance of female genital anxieties as a distinct influence on female psychosexual development, thereby further questioning the role of penis envy in the psychology of women.

Later Revisions: Mourning, Narcissism, and the Beginnings of Object Relations

In 1914 Freud began a series of major revisions of his theory with a discussion of the distinction between normal and pathological mourning, the latter of which he termed *melancholia*. The difference is this: In normal mourning, one gradually lets go of the love one has lost, piece by piece, and the *libido* (love) invested in them is taken back into oneself (into the ego) so that it can be used again, either for new love or for other creativity. In melancholia, the mourner holds on to the loved one's love like a phantom limb, refusing to let go, so that the libido never returns to its source, and is thus depleted,

leading to the familiar symptoms of depression: exhaustion, loss of appetite, and lack of interest in the world. (The refusal to let go happens, according to Freud, because a person turns the anger felt toward the lost one upon oneself.)

This discussion extended the idea, already present in *Three Essays on the Theory of Sexuality* (1905), of the role of the *object* in human psychic development and function. The theory of *object relations* was to have far-reaching impact on psychoanalytic theory, especially through the work of Melanie Klein.

In the *Three Essays*, Freud described two main aspects of sexual striving, the *aim* and *object* (*pressure* and *source* were additional, largely biological aspects of the instinct). *Aim* named the kind of gratification pressed for by the instinct, determined by the oral, anal, or genital desires of the infant that engendered it; this aim sought its satisfaction from an *object*.

Freud described objects (loved ones) as either *anaclitic* or *narcissistic*. Anaclitic objects took their model from an infant's parents or caregivers—those the infant relied on for survival. Narcissistic objects, on the other hand, were taken from the model of one's self and body, the original sources of satisfaction and pleasure.

Freud believed narcissism played a vital role in healthy development, and was the source of healthy striving and ambition, as well as camaraderie and nationalism. In pathological cases, however, the narcissist was unable to form or maintain relationships with others or with the outside world.

Freud thought narcissism originated in infancy, when the child took his own body as his first object (this he called *primary narcissism*). In normal development, narcissistic satisfactions were gradually replaced by anaclitic ones, as an infant became attached to, and then differentiated from, his caregivers. Far from disappearing however, narcissistic strivings were taken into the psyche as a vital component of a person's sense of self, eventually laying the foundation for the *ego ideal*, which was the individual's compass for his ambitions and strivings, for the self as he wished it to be, and which would reward him with new editions of the satisfactions he had taken in infancy from the pleasures of his own body. Later, as the child moved into the genital, adult phase of sexuality, it was the danger to the narcissistic object (the penis), that ushered in the castration complex, the Oedipus complex, and the whole order by which adult mental life is governed.

Narcissism, and the entire process of the formation of object relations in infancy, became increasingly important to psychoanalysis, as disturbances of these early processes came to be seen as the root of the most severe kinds of psychopathology—including (in current terminology) narcissistic personality disorder, borderline personality disorder, and the psychoses—which Freud had already termed the "narcissistic neuroses."

The Dual Instinct Theory/The Death Drive

In 1920 Freud opened *Beyond the Pleasure Principle* with a comparative discussion of the behavior of soldiers suffering from traumatic war neuroses (what would later be called post-traumatic stress disorder) and a child's game. In each of these

situations, Freud observed behavior, such as the dreams of soldiers that compulsively reprised the occasion of their injury, or an infant's repetitive tossing away and retrieval of an object in symbolic enactment of her parent's departure, which seemed to contradict the impulse to satisfy and reduce tension. From these observations of the workings of the *repetition compulsion*, Freud adduced the existence of a force in human nature that operated against the pleasure principle and its imperatives of human self-preservation and gratification. Freud called this counterforce the *Todestrieb*—the *death drive* (or *instinct*).

The death drive was an extension of Freud's earliest writings, having to do with conservation of energy in the organism, and was also the latest version of the dualism that was a constant in his work. In his earlier thinking, mental conflict had originated among *component instincts* of the libido—ego and object libido, self-preserved and erotic instincts. In the new conception, all these previous instincts were subsumed under the libido, or *Eros*, and opposed to the death instinct. According to the logic of the pleasure principle, energy was to be conserved at all costs. In view of the repetition compulsion, Freud amended his view: On the one hand, energy was to be conserved; on the other, according to the logic of the death drive, the reduction of tension demanded that energy be reduced to nothing, returned to a state of rest—a return to the inorganic stasis that Freud (borrowing from the science of his time) believed to be the original condition of all matter.

Freud saw evidence of the death drive in his observations of primary masochism and of hate, which he thought preceded any feeling of love. In these phenomena and others, Freud believed that the death drive was expressed as (or even synonymous with) aggression, and that it was frequently joined (*fused*) to libidinal energy. Though evidence of aggression and the death drive were readily observable in these "fused" forms, Freud was unable to isolate pure expressions of the death drive. And indeed the operation of the drive remained opaque, "mythical," in contrast to the workings of the libido, which Freud had observed and described in detail.

Because of its opacity and apparent remoteness from clinical practice (Freud himself acknowledged the "speculative" nature of its origins), the death drive became perhaps the most controversial aspect of Freud's theoretical corpus. A number of analytic theorists continued to explore its implications following Freud's death, especially Melanie Klein, in whose work the death drive figures prominently.

Later Revisions: The Structural Theory

In 1923, in the wake of his revisions of the theory of instincts on the one hand, and of object relations on the other, Freud published *The Ego and the Id*, and with it sharply revised his original theory of the mind. In his new model, commonly called the "structural theory," Freud introduced three new agencies—*ego* ("I"), *id* ("It"), and *superego* ("Over-I")—to represent intrapsychic mental functioning. The *ego* referred to the self, as the executive agency of the psychic system, governed by the secondary process, and responsible for conscious thought, fantasy, defense, and symptom formation. The *id* was the realm of the unconscious processes and thoughts, governed by the

instincts (libido and aggression) and the primary process. The *superego* represented the conscience, the critical (and also loving) internal representation of one's parents or caregivers that was the internalized legacy of the repression of the Oedipus complex. These new agencies reflected the increased prominence of object relations and the pervasive nature of conflict in the system, and a recognition that the essential goal of psychoanalysis was not merely to make the unconscious conscious, but to bring instinctual impulses under the sway of the ego.

Theory of Anxiety and Affects

Anxiety is at the core of the psychoanalytic theory of *affects* (feelings), and from the beginning of psychoanalytic thought has been recognized as central to an understanding of mental conflict (for it is through bad feelings that conflicts are felt and known). In his early work, Freud, in keeping with his early discharge model of mental function, considered anxiety to be a "toxic transformation" of undischarged libido. This failure of discharge could either be physiological ("realistic"), as in *coitus interruptus* or other incomplete or unsatisfactory sexual practices, resulting in "actual neuroses" or "anxiety neuroses"; or it could arise from repression (or its failure), as a symptom of the continued pressure of unacceptable desires, which led to the "psychoneuroses"—hysterias and obsessions.

In 1926 Freud radically revised his ideas about anxiety, abandoning the distinction between neurotic and realistic anxiety, and the claim that repression caused anxiety. In this new theory, Freud distinguished two types of anxiety, a traumatic, reality-oriented "automatic" anxiety in which the system was overwhelmed, and a secondary, "neurotic" anxiety in which reprisals of these situations were anticipated, thus setting in motion defensive processes. "Automatic anxiety" was an affective reaction to the helplessness experienced during a traumatic experience. The prototype for this experience lay in the helplessness of the infant during and after birth, in which the danger proceeded from outside, and flooded a psychic system essentially unmediated by the (as yet unformed) ego.

The second form of anxiety originated within the psychological system and was mediated by the ego. This "signal anxiety" presaged the emergence of a new "danger situation" that would be a repetition of one of several earlier, "traumatic states." These states, whose prototype lay in birth, corresponded to the central preoccupations of different developmental levels, as the infant's needs become progressively abstracted from the original situation of immediate sensory overload to more sophisticated forms of need regulation capable of synthesizing the many elements facing it (from the reality and pleasure principles and the object world). These moments—*loss of the object*, *loss of the object's love*, *the threat of castration*, and *the fear of punishment by the internalized objects of the superego*—which were experienced serially during the developmental process, could reemerge at any time in a person's subsequent adult life, typically brought on by some conflation of reality and intrapsychic conflict, as a new edition of anxiety.

This new way of conceptualizing anxiety was an outgrowth of Freud's late revisions of his theory (c. 1923) with the structural theory and his formulation of the mediating agency of

the ego, and it had the effect of shifting clinical work on anxiety into the realm of the ego. The correlation of the dangerous situations with developmental stages also suggested a diagnostic aspect to anxiety, with the earlier types of anxiety indicating earlier fixations. In the work of later theorists, the presence of the earliest anxieties in clinical work were thought to be indicative of pre-Oedipal disturbances in development, and of corresponding structural deficits in the ego.

Despite his later formulations, Freud never explicitly abandoned his first idea of anxiety, and the two theories continued to coexist uneasily in Freudian metapsychology long after Freud's death.

Melanie Klein and Object Relations

Probably the most influential analytic thinker after Freud, Melanie Klein (1882–1960) articulated a prehistory of childhood development, whose history in Freudian thought commenced with the Oedipus crisis. Following Freud, the sequence of events she outlined had as its main theme the integration of the chaotic desiring world of the infant with the real world.

According to Klein, the infant's world was threatened from the beginning by intolerable anxieties, whose source she believed to be the infant's own death instinct (whose central importance she forcefully affirmed, in opposition to many other contemporary theorists). These "persecutory" anxieties, which were felt in the infant's own bodily needs as well as from the external frustrations to those needs, were overwhelming to the infant, and in order to combat them the infant resorted to defenses whose aim was to isolate her from them. Through these primitive defenses—*projection, denial, splitting, withdrawal, and "omnipotent control"* of these objects—the infant put threatening, "bad" objects, outside herself and into the external world; simultaneously, she preserved the "good" objects, both within herself and externally, by splitting them off from their malevolent counterparts.

Perhaps the most fundamental of these processes were *projection* and *introjection*, which described the infant's first, primitive attempts to differentiate himself from the world, inside from outside, self from other, based on the prototype of oral *incorporation* (and spitting out) and the infant's relation to his first, nurturing/frustrating object, the mother's breast. The first objects were not the mature, "whole" objects of Oedipal development, but primitive "part" objects whose existence for the infant was determined solely by its function in the infant's world.

In the course of maturation, Klein believed that the infant introjected both "bad" and "good" objects, and that through processes of progressive internalization, these fragmentary objects were taken into the self, and became forerunners of the superego. Klein emphasized that this process (of introjection, projection, and re-introjection) was continuous and cyclical, leading to increasing synthesis as the infant gradually attained greater degrees of reality testing, differentiation, and control over her own psyche.

Klein divided *pre-Oedipal development* into the "paranoid/schizoid" and "depressive" positions. She located the

paranoid/schizoid position in the first months of an infant's life, a time in which the infant was in helpless thrall both to the outside world and to his own instincts. Deprivation, the experience of need, and frustration, even though emanating from the infant's own body, were perceived during this phase as persecutory, and the infant responded by putting them outside of himself, "projecting" or throwing them away.

The early objects—beginning with the breast—were experienced alternately as "good" or "bad" according to whether they were perceived as nurturing or destructive; and again partly on the model of the breast, the infant took in (introjected) or dispelled (projected) them according to their relative safety or danger. In this way, Klein believed, the infant took in and preserved those feelings in the external world that were felt as "good," while expelling from herself those destructive feelings directed "into" the object that threatened the relation with the object.

In the *depressive* position (roughly corresponding to the second six months of life), the trends established in the first months of life were extended. In this stage, the infant was able to bridge the gap between "good" and "bad" objects, and between his own experiences of love and hate, which created them. He became capable of ambivalence, and his awareness gradually grew to encompass the object world outside himself and his mother, who, in a crucial development, he now perceived as a discrete, whole object. The infant became aware of his own destructive impulses and, fearing the loss of his object's love (by his destructiveness), attempted to inhibit them, to preserve, protect, even resurrect the object that he continually destroyed in unconscious fantasy, or *phantasy*. His anxious awareness of his aggression toward the object/mother (which Klein called *guilt*), and subsequent efforts to contain his own anxieties by curtailing these impulses (efforts Klein termed *reparations*), led the child to an increasing tolerance for ambivalence, and acceptance of a position of mediation between the needed, loved object and his own instincts that threatened to destroy the object, preparing the way for stable object relations, first with the mother and then with other objects.

For Klein, both paranoid/schizoid and depressive positions represented normal developmental phases on the road to mature object relations; her use of the word *position* was indicative both of her view of this developmental scheme as normative and her conviction (derived from Freud) that "fixation" at such positions was the source of later psychopathology. The defenses of early infancy—including projection, splitting, withdrawal, and denial—became the prototype for the defenses of more severely disturbed patients, whose pathology Klein traced to disturbances in early development.

Klein saw the infant's efforts to bind and modify persecutory and depressive anxieties as the central struggle in the infant's development, and as the essential precursor to all subsequent mental development. Through this progressive process, the anxieties were modified, structuralization increased, and the anxieties and impulses that gave rise to them were themselves diminished. She saw all defense as directed against these anxieties, and regarded the earliest defenses, especially splitting, as

the foundation for repression, which she viewed as itself a restricted and refined form of splitting. She also saw forerunners of the Oedipal conflict and the superego in the very first months of life. Indeed, Klein's theory attributed to the infant from the first months of life a range of sophisticated, dyadic and triadic emotions—including greed, envy, and jealousy—that implied an acute sense of others and her relation to them, far earlier than was accepted in Freudian psychology.

The Evolution of Psychoanalytic Practice

In "On Beginning the Treatment" (1913), in explaining the method of free association, a hallmark of psychoanalytic technique, Freud likened it to a train journey. "Act as though, for instance, you were a traveler sitting next to the window of a railway carriage and describing to someone inside the carriage the changing views which you see outside" (Freud, vol. 12, p. 135). The "landscape" thus revealed was that of the patient's own inner world, its features psychic conflicts; at the heart of the psychoanalytic method is the proposition that *interpretation* of unconscious conflicts, and the subsequent *insight* gained by the patient, are themselves mutations of those conflicts. The patient's fantasies and unconscious desires are thrown upon the person of the analyst, through a phenomenon known as *transference*. Transference, literally the unconscious carrying over into the present of the meaningful relationships of the past, and of the fantasies and repressed wishes that shaped them, is at the core of all kinds of analytic therapy.

But in clinical work, especially with more disturbed patients, many therapists of the early twenty-first century embrace the value of a "therapeutic object," and indeed believe that this kind of work is essential to any kind of therapeutic progress with such patients. The idea of the therapeutic object is related to British analyst D. W. Winnicott's notion of the *holding environment* and to analytic *empathy*, an idea especially prominent in Heinz Kohut's work with narcissistic patients. Both these writers assumed that an infant's development is inescapably bound to her relations with her first caregivers, and that the emergence of the subjective, intrapsychic world coincides with the development of the infant's relations with these early objects. They presume, in different ways, that pathology, particularly more disturbed pathology, results from disturbances in this process, and that it is among the tasks of psychodynamic therapy to supplement the patient's earliest, often deforming, object relationships with newer healthy models, which can be internalized over time. According to this view, by revisiting and remodeling the earliest patterns of relating to the world (through internalization of new objects), lasting change may be effected both in the patient's internal world and in her relationships with new objects in the present.

This point of view is not shared by all contemporary analysts, least of all those "classical" analysts, who maintain that psychopathology is by and large derived from Oedipal and post-Oedipal development, that is, the point at which a patient begins to make symbolic sense of inner impulses and distorts them according to the repression. The classical view tends to play down or deny the importance of structural, ego "deficits" in early (pre-Oedipal) development resulting from inadequate nurture.

Psychoanalysis and Its Vicissitudes

The fate of psychoanalysis seems emblematic of the whole history of the Western world during the twentieth century. Psychoanalysis first flourished in the final days of the Austro-Hungarian Empire, at a time of unrivaled prosperity and intellectual ferment. World War I disrupted the progress of analytic institutions, but its barbarities may have played a role in Freud's revisiting some of his fundamental assumptions, most notably about the role of aggression in the human psyche, which led him ultimately to the death drive.

World War II forced the mass exile of psychoanalysts from Europe, many of whom, like Freud, were Jews from the occupied nations. Four of Freud's sisters perished in concentration camps, as did many of those analysts who remained in their home countries. Many of the émigrés resettled in England, the United States, and South America, and the field flourished in these areas as a result. Psychoanalysis in each of these regions is marked by its local influences, and the variety of psychoanalytic discourses in the early twenty-first century is such that one group may find the theories and practices of another unrecognizable.

Even within each region, the evolution of psychoanalytic theory and technique since the death of Freud has been marked by discord and schism, perhaps stamped by the Oedipal struggles whose mysteries psychoanalysts seek to plumb. This has been the case since the birth of the field, and the history of psychoanalysis is replete with examples of this: Alfred Adler (1870–1937), Wilhelm Stekel (1868–1940), Jung, Otto Rank (1884–1939), Ferenczi, Wilhelm Reich (1897–1957)—all were close members of Freud's circle, and all broke with Freud, in disputes fueled as much by personal as theoretical tensions.

Later fissures in the analytic community include the secession of Jacques Lacan (1901–1981) from the "classical" French establishment; in London, the intense conflict between adherents of Klein and Anna Freud; and in New York, the divisions that caused Karen Horney (1885–1952), Sandor Rado (1890–1972), Harry Stack Sullivan (1891–1949), and others to leave their places of training to found independent institutes. This discord has persisted into modern times, though the diminished influence of psychoanalysis and the proliferation of rival therapies and theories of mind have muted and submerged the original tensions, even as new voices constantly emerge to challenge their predecessors.

Though its impact has been felt most strongly in the West, analytic ideas have traveled around the world. By the early twenty-first century, analytic institutes had been founded in India, Korea, and Japan.

Impact on Other Disciplines

The influence of psychoanalytic theory upon contemporary thought is difficult to overstate, and equally difficult to quantify. Fundamental concepts of a dynamic unconscious, repression, ego, infantile sexuality, and the Oedipus complex have passed into popular discourse. Psychoanalysis is the root of all contemporary forms of psychotherapy, and as a clinical modality has had an enormous impact on the treatment of mental illness and on the fields of psychology and psychiatry,

though this influence has been challenged in recent years by the rise of biological psychiatry. Though the scientific validity of its methods and premises has been hotly disputed, neuroscientists, including Mark Solms, Antonio Damasio, Jaak Panksepp, and Joseph LeDoux, were actively conducting research in the early twenty-first century to correlate psychoanalytic ideas with the latest findings in brain science.

In the humanities, psychoanalytic theory has strongly influenced approaches to literary texts, biography, history, creativity, and sociology. Freud himself was the first to apply psychoanalytic principles to the arts, through readings of Wilhelm Jensen's novel *Gradiva* (1903), Ernst Theodor Amadeus Hoffmann's "The Sand-Man" (1817), and several of William Shakespeare's works; and through psychobiographical essays on Johann Wolfgang von Goethe, Shakespeare, Fyodor Dostoyevsky, and Leonardo da Vinci. Freud also explored the implications of his ideas upon anthropology, history, and, perhaps most famously, religion, which Freud considered a primitive, quasi-psychotic projection, and which he considered at length in *The Future of an Illusion* (1927) and *Moses and Monotheism* (1939). The poet Wallace Stevens characterized Freud's influence as "a whole climate of opinion," and the writings of Freud and other analysts, especially those of Jacques Lacan, have inspired countless artists and thinkers, including André Breton, André Gide, Benjamin, Thomas Mann, Rainer Maria Rilke, Jean Cocteau, Salvador Dalí, Jackson Pollock, Lionel Trilling, Edmund Wilson, Jacques Derrida, Gilles Deleuze, and Slavoj Žižek; and cultural movements such as surrealism, dada, existentialism, deconstruction, and postmodernism.

See also *Consciousness; Mind; Psychology and Psychiatry*.

BIBLIOGRAPHY

- Anzieu, Didier. *Freud's Self-Analysis*. Translated by Peter Graham. London: Hogarth Press and the Institute of Psycho-analysis, 1986.
- Deutsch, Helene. *The Psychology of Women: A Psychoanalytic Interpretation*. 2 vols. New York: Grune and Stratton, 1944–1945.
- Freud, Sigmund. *Standard Edition of the Complete Psychological Works of Sigmund Freud*. 24 vols. Edited and translated by James Strachey. London: Hogarth Press, 1953–1974.
- Gay, Peter. *Freud: A Life for Our Time*. New York: Norton, 1988.
- Grünbaum, Adolf. *The Foundations of Psychoanalysis: A Philosophical Critique*. Berkeley and Los Angeles: University of California Press, 1984.
- Hale, Nathan G., Jr. *The Beginnings of Psychoanalysis in the United States, 1876–1917*. New York: Oxford University Press, 1971.
- . *The Rise and Crisis of Psychoanalysis in the United States: Freud and the Americans, 1917–1985*. New York: Oxford University Press, 1995.
- Horney, Karen. *Feminine Psychology*. New York: Norton, 1967.
- Jones, Ernest. *The Life and Work of Sigmund Freud*. 3 vols. New York: Basic, 1953–1957.
- Kernberg, Otto F. *Borderline Conditions and Pathological Narcissism*. New York: Aronson, 1975.
- Klein, Melanie. *The Writings of Melanie Klein*. 4 vols. New York: Delacorte Press/Seymour Lawrence, 1975.
- Kohut, Heinz. *The Analysis of the Self: A Systematic Approach to the Psychoanalytic Treatment of Narcissistic Personality Disorders*. New York: International Universities Press, 1971.

- Kutter, Peter, ed. *Psychoanalysis International: A Guide to Psychoanalysis throughout the World*. 2 vols. Stuttgart-Bad Cannstatt, Germany: Frommann-Holzboog, 1995.
- Lacan, Jacques. *Écrits: A Selection*. Translated by Alan Sheridan. New York: Norton, 1977.
- . *The Four Fundamental Concepts of Psycho-analysis*. Edited by Jacques-Alain Miller and translated by Alan Sheridan. New York: Norton, 1978.
- Laplanche, Jean. *Life and Death in Psychoanalysis*. Translated by Jeffrey Mehlman. Baltimore: Johns Hopkins University Press, 1976.
- Laplanche, Jean, and J.-B. Pontalis. *The Language of Psychoanalysis*. Translated by Donald Nicholson-Smith. New York: Norton, 1973.
- Lear, Jonathan. *Love and Its Place in Nature: A Philosophical Interpretation of Freudian Psychoanalysis*. New York: Farrar, Straus and Giroux, 1990.
- Loewald, Hans W. *Papers on Psychoanalysis*. New Haven, Conn.: Yale University Press, 1980.
- Mahler, Margaret S., Fred Pine, and Anni Bergman. *The Psychological Birth of the Human Infant: Symbiosis and Individuation*. New York: Basic, 1975.
- Masson, Jeffrey Moussaieff, trans. and ed. *The Complete Letters of Sigmund Freud to Wilhelm Fliess, 1887–1904*. Cambridge, Mass.: Harvard University Press, Belknap Press, 1985.
- McWilliams, Nancy. *Psychoanalytic Diagnosis: Understanding Personality Structure in the Clinical Process*. New York: Guilford Press, 1994.
- Pine, Fred. *Drive, Ego, Object, and Self: A Synthesis for Clinical Work*. New York: Basic, 1990.
- Tyson, Phyllis, and Robert L. Tyson. *Psychoanalytic Theories of Development*. New Haven, Conn.: Yale University Press, 1990.
- Winnicott, D. W. *Collected Papers: Through Paediatrics to Psychoanalysis*. New York: Basic, 1958.

Matthew F. von Unwerth

PSYCHOLOGY AND PSYCHIATRY. Psychiatry in the United States has undergone a number of sweeping changes since the middle of the twentieth century. The settings in which psychiatrists practice, the range of diseases they seek to treat, their theoretical understandings of these diseases, and the treatments they apply are all radically different from those of their predecessors. These changes have had an impact not only on the psychiatric profession but on cultural understandings of the mind as well, altering how people make sense not only of mental illness but of their everyday feelings and behaviors.

What is remarkable is not that such changes occurred, for radical transformations in medical practice and understandings have come to be expected, but that they occurred in the way they did and for the reasons they did. Despite enormous changes, researchers have not identified the root cause of a single psychiatric disease or developed a single definitive cure. This is not to say that understandings and treatment of psychiatric illness have not improved, but simply to say that psychiatry's revolutions cannot be traced to the kinds of scientific breakthroughs that one might imagine, but rather to the interaction of a number of historical developments within psychiatry, medicine, and American culture as a whole.

This article traces the history of psychiatric theory, therapeutics, and clinical science since the mid-1900s, exploring the ways in which their interaction has shaped the course of psychiatry. This history covers three major transformations in psychiatry: an about-face in its theoretical orientation, characterized by the postwar rise and fall of psychoanalysis and the subsequent rise of biopsychiatry; the redefinition of the practice of psychiatry that followed the discovery of psychotropic drugs; and the changes in the clinical science of medicine as a whole that reinforced psychiatry's biological shift.

Psychiatric Diagnosis: From Psychosis to the "Psychopathology of Everyday Life"

The years following World War II were a time of unprecedented growth in the scope of psychiatry in the United States. In a transformation that reflected an increase in outpatient psychiatry rather than a decrease in state hospital treatment, the percentage of psychiatrists working in outpatient settings, a slim minority before the war, grew to more than half by 1947 and to an astounding 83 percent by 1957. Accompanying this shift was a similarly dramatic expansion in the kinds of ills that led patients to seek psychiatric care, inside or outside of the state hospital system. Psychiatrists began caring for an entirely new type of patient, one who suffered from "psychoneurotic" ills instead of severe mental illness.

Diagnostic expansion. Throughout the twentieth century, psychiatrists divided psychiatric illness into two main classes: "organic" and "functional." They classified organic illnesses as those in which there was an obvious cause (e.g., intoxication) or brain lesion (e.g., dementia), whereas the functional disorders, those most commonly associated with the practice of psychiatry, had no ascertainable biological cause. Toward the end of the twentieth century, psychiatrists increasingly criticized this division between functional and organic, arguing that all psychiatric illness is, at its root, biological. In 1994, the distinction was entirely dropped from the fourth edition of the American Psychiatric Association's (APA) *Diagnostic and Statistical Manual (DSM)*. However those disorders with known organic causes tend to fall under the domain of neurology, while psychiatry continues to tend primarily to disorders that fall under the traditionally functional category. These disorders are subdivided into two categories—psychotic disorders and nonpsychotic disorders—that are then further divided into specific diagnoses.

In 1952 the APA published the first edition of the *DSM (DSM-I)*, replacing the collection of diagnoses endorsed by the APA in 1933. *DSM-I* was heavily influenced by psychoanalytic theory and by Adolf Meyer's emphasis on individual failures of adaptation to biological or psychosocial stresses as the cause of psychiatric illness. The diagnoses enumerated in *DSM-I* indicate a major enlargement in the ways in which nonpsychotic illness could be experienced and named.

This change reflected not a simple recategorization of existing patients, but rather a redrawing of the line between "diseased" and "normal" distress that resulted in the creation of entirely new patients. The years following the war witnessed a staggering increase in the number of patients seeking psychiatric

care for their troubles in everyday living, either by voluntarily admitting themselves to state psychiatric hospitals or by hiring the services of a psychotherapist. This explosion of psychiatric concerns and practice is owed in large part to two related phenomena: the psychiatric profession's reaction to World War II, and the increasing dominance of psychoanalytic theory and practice.

World War II was the single most important factor in propelling psychodynamic psychiatry to the forefront of American psychiatry. Most fundamentally, the war reinforced the belief "that environmental stress contributed to mental maladjustment and that purposeful human interventions could alter psychological outcomes" (Grob, p. 427). Of the 18 million men screened for induction, nearly 2 million were deemed unfit for military service because of severe emotional difficulties. Despite flaws in the screening process (especially its cursory nature and the broad criteria used for rejection), this huge rejection rate highlighted the ubiquity of psychiatric disorder in the community.

The war provided a means for addressing this new concern by greatly increasing the number of physicians with experience treating psychiatric disorders. Between 1941 and 1945, the number of Army Medical Corps physicians working in psychiatry increased from 35 to 2,400. Psychoanalytic theory and therapy figured centrally in much of the training they received, and many of these physicians went on to practice psychiatry as well as psychoanalysis after the war. Moreover successfully treating wartime neuropsychiatric casualties with psychosocial interventions strengthened psychiatrists' convictions in the efficacy of psychotherapy based in psychodynamic principles.

The proportion of psychiatrists following psychodynamic tenets rose to a third by the late 1950s, and to half by the early 1970s. Psychoanalysis and psychodynamics dominated the curriculum of medical schools and residency programs, as well as the orientation of many academic departments, through the mid-1960s. The 1968 publication of the second edition of the *DSM (DSM-II)* reflected this. Like *DSM-I*, *DSM-II* presented a psychosocial view of psychiatric illness. Psychiatric illnesses were reactions to stresses of everyday living, not discrete disease entities that could easily be demarcated from one another or even from normal behavior or experience. From this perspective, naming a disease was of much less consequence than understanding the underlying psychic conflicts and reactions that gave rise to symptoms.

Diagnoses as disease entities. Diagnosis, relegated to the periphery of psychiatric concerns from the 1950s through 1970s, has since taken center stage. *DSM-III* (1980) and *DSM-IV* (1994), as well as *DSM-V* (planned for release in 2011), reflect American psychiatry's embrace of a biomedical model of disease, complete with discrete illness categories that are distinct both from one another and from that which qualifies as "normal." Unlike *DSM-I* and *DSM-II*, the subsequent revisions have been major undertakings of central scientific importance to the field. Whereas *DSM-II* had consisted of a paltry 119 pages, *DSM-III* was 494 pages long and listed 265 distinct subdisorders—a number that would grow to nearly 400 with the publication of *DSM-IV*. Many disorders came to

exist for the very first time when they made their appearance in print, the end product of six years' effort and of endless debate and compromise within committees assigned to each major disease category.

Unlike previous editions, *DSM-III* was intended to actively guide psychiatrists in assessing and diagnosing patients. The need for such a guide arose largely from psychiatry's place within larger contexts. The whole of medicine had experienced a cultural shift, one that was characterized by reliance on standardized knowledge rather than clinical expertise; statistical knowledge based on groups rather than individuals; and an increasingly reductionistic view of disease in which biology was paramount. This shift occurred within psychiatry as well: The availability of pharmacological treatments for psychiatric disorders, combined with a desire to remain part of an increasingly scientifically rigorous medical realm, led psychiatry to trade psychoanalytic theory for a new biopsychiatry that largely rejected a disease model rooted in individual biographies, psychological conflict, and psychosocial stressors. Shifting fiscal realities also contributed to psychiatry's need for greater diagnostic certainty and accountability for outcomes, as the percentage of outpatient psychiatric care paid by third-party payers (either private or public) in the United States rose from almost zero in the 1950s to nearly a quarter in the 1960s, and continued to rise steadily in the 1970s. The antipsychiatry movement of the 1960s, which critically viewed psychiatry's diagnostic categories as labels constructed by society in order to silence social deviance, created additional pressure on the discipline to define its targets in biological terms.

The diagnostic manual that grew out of this transition from psychodynamics to biopsychiatry was explicitly "atheoretical" with regard to etiology, but most of the diagnostic categories enumerated in the *DSM-III* were underpinned by an implicit assumption that biology and not psychological conflict was their primary cause. Symbolic of this was the excision of the word "reaction" from many diagnoses: thus a patient who would have been diagnosed with a "psychotic depressive reaction" prior to 1980 was now diagnosed with "major depression with psychotic features." Each diagnosis was thought of not only as stemming from a unique biological cause, but also as being made up of a unique (and determinant) set of symptoms—a marked departure from the psychodynamic view of disease, in which a given set of symptoms, depending as they did on the individual's life history and beliefs, could result from any number of underlying conflicts. *DSM-III* and *DSM-IV* have been heavily criticized for their approach to diagnosis, in which the presence of a minimum number of symptoms from a list determines the presence or absence of the disorder in question. However this approach is perhaps the best that can be expected from a field in which symptoms are generally thought to be direct reflections of an underlying disease of presumed, but as yet unknown, biological cause. As a means by which to increase diagnostic consensus, facilitate research into the efficacy of disease-specific cures, and justify insurance reimbursement, *DSM-III* and *DSM-IV* have been largely successful, and the *DSM* remains the dominant system of psychiatric classification in the United States and most other countries.

Implications. While psychoanalytic treatments have largely fallen from grace, psychoanalytic theory and language continue to influence American psychiatry and culture. Since the late-twentieth century, American psychiatry has traded this language for the language of biology and brain, but the expanded definition of psychiatric illness—one that includes problems formerly seen as inevitable parts of life—remains. Intriguingly while these problems originally were recast as psychiatric illnesses by virtue of their psychosocial etiology, beginning in the late twentieth century their status as disorders has them readily subject to purely biological interpretations and cures.

Therapeutics: From Behavioral Control to Biological Disease

The nature of psychiatric care has changed immensely since the early-twentieth century, shaped not only by prevailing psychiatric theory but also—and often more importantly—by practical realities such as setting, needs, and resources. State hospitalization and outpatient psychotherapy both largely have been replaced by a proliferation of psychotropic drugs, with considerable implications for how society views mental illness, as well as how people make sense of more everyday aspects of human feelings and behaviors.

Somatic therapies and behavioral control. In the early twentieth century, American psychiatry was almost exclusively institutionally based. Nineteenth-century asylum founders had created these institutions as a means of providing a psychologically therapeutic environment in combination with physical treatment regimens, but by the turn of the century their optimism had worn off, replaced by a biological fatalism regarding the patients' chances of improving. By the early twentieth century, state mental hospitals—a designation that had replaced that of asylum—were vastly overcrowded institutions for the care of severely ill patients, many of whom became permanent residents.

In such a setting, where a handful of psychiatrists often cared for thousands of patients, patients were categorized not by diagnosis but by behavior and prognosis, and were housed in wards with labels such as "acutely excited," "chronic quiet," "chronically disturbed," and "convalescing." Disordered behavior was the primary target of psychiatric interventions, which consisted almost exclusively of somatic therapies: hydrotherapy (e.g., continuous baths or wet-sheet body wraps), insulin-induced comas, electroconvulsive therapy, and lobotomy. These treatments were believed to be therapeutic by virtue of their success in subduing out-of-control (diseased) behavior; and behavior, not diagnosis, determined the need for a particular somatic cure.

Psychotherapy. As the overcrowding of state hospitals suggests, there was little place for psychotherapy in institutional psychiatry. It was not until the rise of psychoanalysis and outpatient psychiatry that psychotherapy became an important intervention within the field. Though psychoanalysis was largely a treatment sought by well-to-do and well-educated individuals suffering from everyday anxiety, unhappiness, or boredom, in the 1950s analysts began treating not only those suffering from neurotic ills but also traditional psychiatric patients with

severe psychotic disorders such as schizophrenia. These efforts led to significant controversy in the ensuing decades, contributing to psychiatry's abandonment of psychotherapy in favor of more biological approaches. For the most part, however, the demise of psychotherapy within psychiatry can be attributed to two causes: the advent of psychotropic drugs in the 1950s and competition from the growing fields of psychology and social work in the 1960s and 1970s. By the 1990s psychiatry had largely ceded matters of the mind to psychology, content to concern itself with matters of the brain.

Psychopharmacology and biological disease. Though psychiatrists have long had at their disposal a number of drugs capable of sedating patients (for example bromides, barbiturates, hyoscine, and chloral hydrate), these drugs were never seen as therapeutic but rather as “chemical straitjackets.” The age of psychopharmacology did not begin until the 1950s with the discovery of chlorpromazine, the first of what have come to be referred to as the antipsychotic drugs. Other classes of drugs followed, inducing a veritable therapeutic revolution in psychiatry. Since the last third of the twentieth century, the major classes of psychotropic drugs include antipsychotics, antidepressants, anxiolytics, mood stabilizers, and a miscellaneous assortment of other medications, and their use has largely displaced psychotherapeutic interventions as the mainstay of psychiatry practice.

Unlike the somatic therapies and psychotherapy, psychotropic drugs carry with them an implied diagnostic specificity: separate classes of drugs for psychosis, depression, anxiety, and bipolar disorder. Much as psychoanalytic theory and treatment went hand-in-hand (a psychodynamic cure for a psychodynamic ailment), the implied specificity of these drugs fits well with biopsychiatric thinking: a specific neurochemical cure for each neurochemical trouble. As with psychoanalysis, the language of biopsychiatry has heavily pervaded American culture, carrying with it both a scientific logic that links psychiatry to the rest of medicine and a compelling description of human experience that allows people to see themselves readily in biological terms, much as people in the twentieth century readily saw their present troubles as the product of their troubled personal pasts.

From “major tranquilizers” to antipsychotic drugs. The early stages of the psychopharmacologic revolution began in the 1930s and 1940s, when researchers began modifying phenothiazine compounds in an effort to develop synthetic antihistamines. Henri Laborit, a French military surgeon, was interested in these drugs for their analgesic, sedative, and hypothermic properties, believing that they might be of benefit in preventing shock associated with anesthesia. In 1949 he noted that promethazine—a phenothiazine derivative—produced a “euphoric quietude” in patients, prompting chemist Paul Charpentier, of the pharmaceutical company Rhône-Poulenc, to search for phenothiazine derivatives with even greater effects on the central nervous system. The result was chlorpromazine, a compound that would eventually become known as the first antipsychotic drug.

Initially Rhône-Poulenc believed that chlorpromazine might have a variety of applications, for conditions ranging

from nausea to itching, and they named it Largactil to emphasize its many uses. By 1951, however, physicians began recognizing its ability to calm agitated patients without overly sedating them. Smith, Kline & French bought the North American rights in 1952 and received U.S. Food and Drug Administration (FDA) approval to market it under the trade name Thorazine in May 1954. By 1956, 4 million patients in the United States had taken chlorpromazine—primarily for psychiatric applications—yielding \$75 million in profits in 1955 alone.

Psychiatrists began referring to these drugs as antipsychotics in the mid 1960s, but until that time they were generically referred to as the “major tranquilizers,” and psychiatrists considered them useful for most types of mental disorder. Smith, Kline & French recognized that state hospitals, housing more than half a million captive potential consumers, represented an enormous market. The introduction of chlorpromazine did away with the use of lobotomy almost overnight: The drug was easy to administer; rapidly and therapeutically eliminated recalcitrant, hostile, and violent behavior; and ostensibly produced relatively minor side effects. Perhaps more importantly for the course that psychiatry has taken since, physicians also prescribed it for the nonpsychotic patients who had so recently made their way into state hospitals and outpatient care, thus cementing the medical status of these new diagnoses. It was not until the mid-1960s—by which time the success of Thorazine had led to a proliferation of similar drugs—that psychiatrists winnowed down the application of these drugs primarily to the treatment of psychotic disorders, a fact reflected in the increasing use of the term antipsychotic. This transformation from tranquilizer to antipsychotic, implying the discovery of a biological cure for a specific psychiatric disease, reinforced the conviction that schizophrenia (and, by extension, most psychiatric illness) was at its root a biological disorder of the brain.

The discovery of a drug that seemed effective in treating a specific disorder—or at least in controlling its particular set of symptoms—provided researchers with a major opportunity to explore the workings of the disordered brain. Basic science research into the biological action of antipsychotic drugs laid the foundation for the remarkable progress that has taken place in the neurosciences since the mid-twentieth century. In the late 1950s, Arvid Carlsson discovered the neurotransmitter status of dopamine and demonstrated that antipsychotic drugs block dopamine receptors in the brain, research for which he was awarded the Nobel Prize in 2000. His discoveries also led researchers and psychiatrists to formulate the “dopamine hypothesis” of schizophrenia: since antipsychotic drugs work by blocking dopamine, the cause of schizophrenia must be an excess of dopamine. This bit of logic, compellingly simple and yet disturbingly circular, has been repeated with other classes of psychiatric drugs and the disorders that they seem to ameliorate. Research into the action of apparently effective drugs has been the source of many accepted models of psychiatric illness, largely because scientists lacked better ways of making sense of what goes on inside the living brain—an unfortunate reality that many hope to remedy thanks to the advent of high-quality brain imaging.

The basic nature of antipsychotic drugs changed little in the decades that followed, and the initial optimism that the drugs possessed antischizophrenic properties was increasingly tempered as the drugs' limitations became more apparent. By the late 1960s and 1970s, psychiatrists also began to notice that the drugs produced a number of untoward side effects, foremost among them being tardive dyskinesia, a late-appearing, difficult-to-reverse disorder characterized by involuntary movements of the tongue, jaw, limbs and/or trunk. Psychiatrists continued to prescribe the drugs widely, however, largely because they were simply the best available treatment for a terrible and incurable disease.

In the 1980s, a new era in antipsychotic drugs began, coupled with new hopes for better outcomes. Clozapine, a drug that was actually synthesized in the late 1950s and used briefly until clinicians discovered that it could cause a fatal blood disease called agranulocytosis, was "rediscovered" in the mid-1980s. A number of large, multicenter studies found clozapine to be highly effective in treating refractory patients—that is, patients whose condition responded poorly to other antipsychotic drugs. Clozapine was approved for use in 1989 under the trade name Clozaril and reintroduced alongside a system for carefully monitoring patients for any signs of agranulocytosis. Clozaril became the first of a number of "atypical" antipsychotic drugs, which cause markedly fewer motor side effects compared to the older drugs but, as is increasingly evident, produce a wide range of other problems, most notably severe weight gain and insulin-resistant diabetes. Because these new drugs—six of which are on the market in the United States as of 2004—do much more than simply block dopamine receptors, their success has led scientists to rethink the dopamine hypothesis of antipsychotic drug action and of schizophrenia, but also has reinforced broader claims for the biological basis of psychiatric illness and hopes for more successful cures to follow.

Psychopharmacology and the psychopathology of everyday life. Antipsychotic drugs are in many ways the most important class of psychotropic drugs, given their relative success in managing the most striking and debilitating psychiatric symptoms as well as their role in the early history of psychopharmacology. However they make up a relatively small share of the prescriptions written for psychiatric indications (though they are among the most profitable of all drugs, psychotropic or otherwise). The bulk of the psychotropic drug market, oddly enough, is devoted to the kinds of diagnoses that might never have made it onto the psychiatric landscape if not for the expansive territory staked out by psychodynamic psychiatrists in the mid-twentieth century.

Thanks to the widespread diagnosis and medical treatment of disorders like depression, anxiety, and attention deficit disorder, biopsychiatry has become as vital a part of American culture in the early twentieth century as psychoanalysis was a half-century earlier. As with antipsychotic drugs, the drugs used to treat these disorders were discovered to work only by accident, and the biological explanations for the disorders were gleaned from the actions of the drugs that seemed to treat them. When Prozac, the first of the selective serotonin reuptake inhibitors (SSRIs), was introduced in 1988, it was not

long until the SSRIs (a class of drugs that also includes Paxil, Zoloft, and Celexa) became the leading treatment for depression. Less than two decades later—thanks in no small part to direct-to-consumer drug advertising—the belief that depression is caused by a serotonin deficiency had become an established bit of cultural knowledge.

Polypharmacy and off-label use. Intriguingly, in spite of the apparent biological specificity of the drugs on the market, psychiatric practice does not adhere neatly to the categories for which drugs are named (and approved by the FDA). Psychiatrists often prescribe multiple drugs for a single patient with a single diagnosis, and this polypharmacy often combines drugs from different classes of drugs. It is not uncommon for a patient with a diagnosis of schizophrenia or bipolar disorder to be prescribed one or more antipsychotic drugs, a mood stabilizer, an antidepressant, and an anxiolytic, the combination of which is intended—in some unarticulated and scientifically unproven way—to improve the management of their disorder. Off-label prescribing—that is, the prescription of a drug for a condition other than that for which it is approved—is increasingly common. For example, psychiatrists routinely prescribe atypical antipsychotic drugs for patients with non-psychotic diagnoses, including children diagnosed with conduct disorders—a practice that is reminiscent of the widespread use of antipsychotic drugs in the state hospitals of the 1950s. It remains to be seen whether these practices will be validated by clinical research and, if so, what sort of biological explanations will be used to explain their effectiveness.

Importance. Since the mid-twentieth century, there has been a massive transformation in the understanding of how to treat psychiatric disease and, therefore, the understandings of its causes. For psychiatrists who cared for severely ill patients, antipsychotic drugs initially represented a different, albeit better and more efficient, means of treating behavioral symptoms, while for other psychiatrists the new drugs were merely adjuncts to the more important therapeutic task of psychological understanding and interpretation. As biological theory became more compelling, pharmaceutical marketing more effective, and cost-effectiveness a more essential determinant of therapeutic practice, drug therapy increasingly became the primary, and often only, means of psychiatric intervention. In a dramatic reversal of fortune, psychotherapy in the early-twentieth-first century is at best an adjunct to pharmacotherapy and at worst a wasteful use of scarce health care resources.

Science: From Clinical Expertise to Randomized Controlled Trials

Since the mid-twentieth century, American psychiatry has been characterized by increasing efforts to appear both medical and scientific, in terms of the reliability of its diagnostic criteria, the biological specificity of its treatments, and the methods by which these treatments are legitimated. Such efforts suggest the image of a laggard field attempting to play catch-up with its more scientific medical colleagues, but such a characterization ignores major transformations in the science of medicine as a whole over this time period. These transformations, most notable among them the development of the randomized controlled trial (RCT), coincided both with psychiatry's brief

psychoanalytic deviation from a biological approach to mental illness and with the advent of psychotropic drugs. Together these developments created the conditions and need for many of the changes that have characterized subsequent psychiatric history.

The RCT. Prior to the mid-twentieth century, physicians rarely resorted to experimental methods as a means to prove whether or not a treatment worked. Instead the determinant of legitimate therapeutic knowledge was expert clinical opinion, exercised through historical case controls, open trials, and clinical judgment. These means of evaluating treatments have since been replaced by the RCT.

The basic elements of the RCT—blinding, controls, randomization, and placebos—each have their separate histories. Research psychologists have actively employed experimental methods since the mid-nineteenth century, using randomization and controls much earlier than did the clinical sciences, psychiatry included. From the point of view of medical science, however, the formal birth of the RCT was in 1946, when these features were brought together in the streptomycin trials of the British Medical Research Council.

The design of the RCT is intended to ensure that perceived treatment outcomes are in fact due to the treatment under investigation, rather than to external factors or bias. Thus a basic RCT consists of two groups, an experimental group (given the treatment under investigation) and a control group (given another treatment or a placebo). Patients are randomly assigned to these groups to prevent their individual characteristics from biasing the results, and all participants—researchers, clinicians, and patients—are blinded as to which group a given patient is in, so that they do not bias the results of the experiment.

The RCT and psychiatry. Like all scientific methods, the RCT presupposes certain facts about the nature of the world, and thus circumscribes the questions that can be asked and the answers that can be extracted from nature. The RCT views treatment outcomes as data that are independent from the subjective opinions of both doctors and patients. Thus the RCT has arguably supported the turn toward a biological view of psychiatric illness and cure, including the development of discrete diagnostic categories and diagnostically specific treatments.

The influence of the RCT on psychiatry has been practical as well as philosophical. As much as any other medical professionals, psychiatrists wanted better methods of determining whether the methods they employed actually worked. Chlorpromazine was one of the first psychiatric interventions to undergo RCT evaluation, with successful outcomes. However subsequent evaluations of psychiatry's older somatic treatments ended in dismal failure, no doubt reinforcing psychiatrists' enthusiasm for the new pharmaceutical cures. Many other forms of psychotherapy have fared poorly as well when subjected to RCTs, though many psychiatrists have been more skeptical of these outcomes, given the ill fit between the reductionistic design of the RCT and the more context- and relationship-dependent nature of psychotherapeutic cures. In spite of these reservations, by the late 1960s and early 1970s, most

psychiatrists and clinical scientists had accepted the RCT as the best means of judging whether a treatment works.

Critiques of the RCT. Since the mid-1990s, the RCT has come under increasing scrutiny. A growing number of researchers have argued that the method favors biological treatments over psychological ones, and that it cannot assess the role that psychosocial factors (for instance, contexts and doctor-patient relationships) and individual factors (for example, the meanings a patient gives to a particular remedy) play in shaping how well the intervention works. Others contend that the clinical experiment is so unlike the unpredictable world of actual clinical practice that it may not provide a reliable gauge of whether a treatment will work in actual practice. Some critics have also challenged whether the RCT actually succeeds in eliminating bias. A number of literature surveys have found that the greatest predictor of an RCT's outcome is who funded it. Beginning in the late 1990s, a series of editorials and articles in major medical journals such as the *Journal of the American Medical Association* and the *New England Journal of Medicine* have wrestled with the problem of how financial interests shape, direct, and, at times, subvert the science of clinical evaluation, lamenting that the RCT, no matter how well it is executed, is vulnerable to the very biases it was designed to expunge.

Conclusion

Since the mid-twentieth century, psychiatry has undergone revolutionary changes in how psychiatrists diagnose patients, how they treat them, and how they evaluate whether a treatment works. These changes have brought with them major advances, especially in the neurosciences. But this history also suggests that psychiatry has lost something as it has narrowed its focus mainly to the brain and psychotropic drugs. Though psychiatrists are now trained to expertly manipulate a patient's drug regimen, they have become increasingly less able to situate a patient's suffering within a psychological and social context, and the doctor-patient interaction is often reduced to a querying and reporting of diagnostically sanctioned symptoms. Psychiatry, long charged with caring for those suffering from largely chronic conditions, has become focused on the diagnosis and cure of disease. This focus may someday bear therapeutic fruit, but until true cures are actually forthcoming it is important that the role of care not be lost. Like many of the shifts that psychiatry has undergone, these concerns are not unique to psychiatry, but are part of larger changes within medicine and the culture in which it is situated.

See also **Consciousness; Medicine; Mind; Psychoanalysis.**

BIBLIOGRAPHY

- American Psychiatric Association. *Diagnostic and Statistical Manual of Mental Disorders*. 1st ed. Washington, D.C.: American Psychiatric Association, 1952.
- . *Diagnostic and Statistical Manual of Mental Disorders*. 3rd ed. Washington, D.C.: American Psychiatric Association, 1980.
- Braslow, Joel. *Mental Ills and Bodily Cures: Psychiatric Treatment in the First Half of the Twentieth Century*. Berkeley: University of California Press, 1997.

- Carlsson, Arvid. "Does Dopamine have a Role in Schizophrenia?" *Biological Psychiatry* 13 (1978): 3–21.
- Gelman, Sheldon. *Medicating Schizophrenia: A History*. New Brunswick, N.J.: Rutgers University Press, 1999.
- Grob, Gerald N. "Origins of DSM-I: A Study in Appearance and Reality." *American Journal of Psychiatry* 148 (1991): 421–431.
- Hale, Nathan G., Jr. *The Rise and Crisis of Psychoanalysis in the United States: Freud and the Americans, 1917–1985*. New York: Oxford University Press, 1995.
- Healy, David. *The Antidepressant Era*. Cambridge, Mass.: Harvard University Press, 1997.
- . *The Creation of Psychopharmacology*. Cambridge, Mass.: Harvard University Press, 2002.
- Horwitz, Allan V. *Creating Mental Illness*. Chicago: University of Chicago Press, 2002.
- Kutchins, Herb, and Kirk Stuart. *Making Us Crazy: DSM: The Psychiatric Bible and the Creation of Mental Disorders*. New York: Free Press, 1997.
- Le Fanu, James. *The Rise and Fall of Modern Medicine*. New York: Carroll and Graf, 2000.
- Luhrmann, Tanya M. *Of Two Minds: The Growing Disorder in American Psychiatry*. New York: Knopf, 2000.
- Marks, Harry. *The Progress of Experiment: Science and Therapeutic Reform in the United States, 1900–1990*. New York: Cambridge University Press, 1997.
- Metzl, Jonathan. *Prozac on the Couch: Prescribing Gender in the Era of Wonder Drugs*. Durham, N.C.: Duke University Press, 2003.
- Porter, Roy. *Madness: A Brief History*. New York: Oxford University Press, 2002.
- Porter, Roy, and Mark Micale, eds. *Discovering the History of Psychiatry*. New York: Oxford University Press, 1994.
- Shorter, Edward. *A History of Psychiatry: From the Era of the Asylum to the Age of Prozac*. New York: John Wiley and Sons, 1997.
- Valenstein, Elliot S. *Blaming the Brain: The Truth about Drugs and Mental Health*. New York: Free Press, 1998.
- Wilson, Mitchell. "DSM-III and the Transformation of American Psychiatry: A History." *American Journal of Psychiatry* 150 (1993): 399–410.

Joel T. Braslow
Sarah Linsley Starks

PUBLIC SPHERE. The term *public sphere* is the English translation of the German term *Öffentlichkeit*. This term's significance in the late twentieth and early twenty-first century stems initially from its use in Jürgen Habermas's *Strukturwandel der Öffentlichkeit* (The structural transformation of the public sphere) in 1962. In spite of its foreign origin, the term *public sphere* actually represented an attempt to more adequately articulate those aspects of Anglo-American liberal culture associated with the formation of public opinion and popular sovereignty. The term *Öffentlichkeit*, which literally translates as "public-ness," can be taken to communicate two interconnected sets of meaning, one set involving the notion of "the public" as an actual physical entity, and a second set involving the concept of "publicity" or "openness." (This dual aspect is also found in the Russian *glasnost*.) Hence the term is meant to imply not merely the intellectual exchange present in the notion of a "marketplace of ideas" but also the embodied process of forming otherwise private people into a

public via various means of communication. Yet the term connotes not simply the physically existing public but rather the radically democratic openness implicit in public discourse. The ambiguity inherent in the term *public sphere* enables it to encompass both the rationality implied by open discourse and the sovereignty associated with an actual public.

The public sphere is neither merely the public nor simply the conditions of equality and universal access that permit the free exchange of ideas; it also encompasses the actual process through which private individuals come together to form public opinion. The notion that individuals are "private" is meant to indicate that rank or status should have no standing in the formation of public opinion. What makes an opinion "public" is not merely the accident of its popularity but also its accessibility and ability to withstand public scrutiny. The process through which private individuals come together as a public in the generation of public opinion involves achieving a critical distance from rank, status, or mere popularity in the assessment of opinion—in practice oftentimes accomplished through the private consumption of commodities (pamphlets, books, or programs) produced for the public market.

Controversies

Habermas's formulation of the concept of the public sphere was intended from the beginning to be controversial. The concept was conceived as a reproach to positivist social science and more specifically to the notion that scientific polling represented the last word in researching public opinion. Habermas sought through his conceptualization of the public sphere to reintroduce notions of reason and rational discourse into discussions of public opinion, in contrast to the pollster's practice of collecting unreflective responses. This approach has become an accepted criticism of public opinion polls, even while it has not appreciably lessened the reliance of marketing experts upon polls. This lack of impact can be attributed in part to a difference in aims between polling practitioners, who are simply looking for a current snapshot of public opinion, and social theorists, who seek to explain the differences between more or less legitimate examples of public opinion.

An important feature of Habermas's analysis was his claim that the public sphere did not represent a timeless aspect of society. Rather, the bourgeois public sphere had a history: it arose early in the eighteenth century and was subject to a "refeudalization" or transformation that commenced during the middle of the nineteenth century. The "liberal model" of the public sphere was to be sharply distinguished from the ancient publics of the Greek poleis, societies where the private realm was one of necessity and the public characterized by rhetorical competition for glory—not unlike an oral "Olympics" (Arendt). The feudal "representative public-ness" that preceded the liberal model was characterized by Habermas as a form of publicness that one encounters in a medieval court—publicness as a form of display, not as a subject of dispute. The "mediatized public" that followed the decline of the liberal model can likewise be understood as a form of mediated display, with the public as an audience reading, listening, watching—but in essence consuming—the mass media performance, whether it be in the form of print, radio, or television.

The German suffix *lich* is akin to the suffix “ly” in English insofar as it modifies the root word, rendering it an adjective (for example, *brüderlich* = brotherly). In a similar manner, the German suffix *keit* that follows *lich* can be thought of as analogous to “ness” in English, transforming the adjective into a noun that signifies the quality manifest in the adjective. *Brüderlichkeit* translates as “brotherliness” or “brotherly feeling or sentiment.” Another example is the triad *Ehre*, *ehrlich*, and *Ehrlichkeit*, which translate as “honor,” “honest,” (“honor-ly” being rather awkward) and “honesty.” This parallels the changes found in *offen*, *öffentlich*, and *Öffentlichkeit* (“open,” “public”—although one may discuss things “openly,” the English adjective is typically rendered “public”—and “publicity”/“the public”). As in the previous cases, the German suffix *keit* transformed the adjective form into a noun, but a noun with a different meaning from the

original root term (brotherliness vs. brother, honesty vs. honor, “publicness” vs. open). Unfortunately the English term *publicity*—which at first glance would seem the best noun form for translating “the quality of openness or being public”—is burdened by negative connotations through association with the advertising industry. The term *public sphere* avoids both the negativity of the term *publicity* and the narrow concreteness implied by “audience” (which in any case corresponds to *Publikum*). By encompassing both the quality of “public-ness” (“publicity” in the positive sense) and “the public,” the term *public sphere* also focuses attention on the nature and necessity of the relationship between the private consumption (of the audience) and the public market for production or performance (publicity). The existence of such a relationship is essential for the development of a critical public sphere.

The ideals of equality, inclusiveness, and rationality that lay at the heart of the liberal model rested upon the cultivation of a critical subjectivity that occurred within the intimate sphere (*Intimsphäre*) of the bourgeois conjugal family. The bourgeois family, which propagated an ideology of the family as a voluntary, loving community supportive of individual development, “raised bourgeois ideology above ideology itself” (Habermas, 1989, p. 48) by inculcating within its members the experience of humanity or “purely human” relations. The transference of the attitudes fostered within the private sphere to topics of public concern—first literary, then political—resulted in the rise of a critical public sphere. The subsequent collapse, beginning in the latter half of the nineteenth century, of the distinction between public and private—the “structural transformation” of Habermas’s title—exposed the fictive unity of the experience of humanity central to bourgeois ideology, thereby undermining the critical function of the public sphere.

The notion of “collapse” is meant to indicate the intervention of the state into what, under the liberal model of society, were previously considered “private” matters, for example, with regard to economic regulation and social programs, as well as the adoption of quasi-public powers—through the consolidation of market power—by powerful trusts and corporations. Notions of public and private did not disappear, but they changed. They no longer denoted completely independent spheres, one—the public—of coercion, and the other—the private—of mutual exchange. The “collapse” is not meant to imply the complete dissolution of the concepts of public and private, but rather the blurring of previous boundaries as regards appropriate spheres of action, as

manifest by the exercise of public power by private interests and concern over what were previously considered private economic circumstances on the part of the state. For example, the privacy of the family has become subject to regulation by child welfare services, and corporations have come to employ market power as a means of dictating public policy.

The dependence of this model of the public sphere upon the development of bourgeois civil society and in particular the bourgeois family was controversial. Although Habermas was well aware of the ideological nature of the rhetoric concerning the bourgeois family, his explanation of how the false synthesis of the abstract rights of *citoyen* (the citizen) and the economic necessities of *homme* (man, or the economic individual) “transcended” the temporal circumstances of bourgeois society by means of the concept of humanity left many unconvinced. Oskar Negt and Alexander Kluge made the questionable idealizations concerning the nature of the bourgeois public sphere—particularly with regard to class—the basis for their important contributions to the concept of the public sphere in their 1972 book *Öffentlichkeit und Erfahrung* (Public sphere and experience). Although Negt and Kluge essentially adopted many of the premises behind the bourgeois public sphere (for example with regard to origins, history, and gender), they did question the idealization of the bourgeois public sphere as the only public sphere. The term *counter public* (*Gegenöffentlichkeit*) illustrated their claim that the public sphere as posited by the bourgeois model had always existed in a state of tension with those excluded from it. According to Negt and Kluge, these exclusions were rendered ideologically invisible by the very abstract principles of universality that previously had been

idealized. Hence the growth of exclusions from public debate that Habermas depicted in the “refeudalization” of the bourgeois public sphere did not mark a departure from the underlying principles but rather an extension of their application. Rather than a singular, unified public sphere, there had always existed a variety of (counter) public spheres, each rooted in the experiences that as a whole make up the “context of living” (*Lebenszusammenhang*) of various individuals.

Feminist scholars also found the bourgeois model’s dependence upon a rigid division between public and private questionable. They held that the bourgeois model uncritically reproduced the very same emphasis upon the “intimate sphere as schoolhouse” that had been placed upon it during the eighteenth century by those who sought to disseminate an ideal of femininity that restricted women’s activities to the rearing of male citizens, thereby gendering the public as “masculine” and the private as “feminine.” According to this reading, the biases exhibited by the tendency of the literary sphere to be populated by women and the political sphere by men were not simply an accidental aspect of the bourgeois public sphere—such biases were fundamental elements in its construction and maintenance. The central role gender biases played in the maintenance of the bourgeois “masculinist” public sphere was further confirmed by the connection between its collapse and the collapse of the public-private distinction—a circumstance that Habermas would later term the “colonization of the lifeworld.” Observations such as these on the central role played by exclusions in the construction of the bourgeois public sphere have led feminist scholars such as Nancy Fraser to reject other aspects of the bourgeois public sphere: the notion that economic differences can ever be successfully bracketed; the assumption that the existence of multiple public spheres is regressive; the stricture that public discussions exclude expression of “private” interests; and the belief that a democratic public sphere requires a strict demarcation between civil society (weak publics) and public aspects of the state (strong publics).

Habermas has not been deaf to criticism and has creatively incorporated much of it into his later formulations concerning the public sphere. His work on universal pragmatics and discourse ethics during the late 1960s and 1970s prepared the ground for a less parochial model of the public sphere. Although never explicitly disavowed, the rather narrow foundations of bourgeois privacy were supplanted by the expansive, quasi-transcendental philosophical foundation of an always-already-presupposed ideal speech situation manifest within the everyday conversations that make up the lifeworld (*Lebenswelt*). This “conversational model” of public spheres, although subject to cooptation, was not extinguished with the passing of its bourgeois incarnation, but rather continued to reside in the communicative interstices of modern civil society. This conversational model was further modified through the attempt to integrate electronic media into the concept of the public sphere in a less negative, more productive fashion. Whereas previously the mass media was considered merely a “pseudo-public,” in later work the concept of the public sphere was acknowledged to include “abstract publics” composed of individuals only brought together by means of the mass media.

However, in seeking to project a more sociologically up-to-date depiction of the public sphere that fully incorporates electronic media, Habermas left himself open to accusations of alternately devaluing the normative prescriptions previously associated with the concept of the public sphere—in effect palming them off to civil society—or, in reaffirming the normative impulses that lay behind the initial formulation of the public sphere, rendering incoherent the description of the mass media as part of the public sphere.

These conceptual difficulties stem from the fact that the public sphere was initially conceived as an outgrowth of bourgeois civil society. The norms associated with the bourgeois public sphere or conversational public spheres were assumed to result from the conversations conducted within civil society. The normative status of such conversations derived from either the ideal of humanity, in the case of the bourgeois public sphere, or the ideal speech situation, in the case of conversational public spheres. In both cases, however, mass media were presumed to subvert the normative influence of such ideals by circumventing the medium of conversations in civil society through which such norms are presumed to be inculcated. As long as the conversational medium of civil society is considered the key factor in fostering the norms of the public sphere, the attempt to provide a sociologically accurate description of the public sphere that includes the mass media risks incoherence. One must either depict the public sphere as void of normative resources—contradicting thirty years of research on the subject—or exclude the mass media from the public sphere by definition. It can be argued that there are examples of both in Habermas’s *Between Facts and Norms* (1996).

The close link that is often presumed to exist between the public sphere and civil society lies at the root of the last controversy to be explored. Many social scientists and historians have found the concept of the public sphere to be useful and have sought to adapt it to their chosen field of study. Yet Habermas has argued that the public sphere has a specific historical origin and hence cannot be applied to earlier eras without doing violence to the very concept of the public sphere. The reasoning behind this position is fairly straightforward: if the public sphere represents the conversational matrix of (at least initially) bourgeois civil society, how could the public sphere possibly antedate civil society? A public sphere that predated civil society would by necessity differ conceptually from either the bourgeois or conversational models, both of which depend upon the conversations of civil society to inculcate the proper communicative ethics. Yet it is precisely this position that some have embraced: that the public sphere needs to be reconceptualized separately from civil society, in part in order to adequately account for prior developments in communications and the growth of the marketplace for textual commodities. A “mediated” concept of the public sphere would stress how mediated communications are capable of subverting hierarchy—thereby fostering autonomy of judgment and freedom of conscience—and emphasize the historical importance of literacy, commercial activity involving textual commodities, technological innovation, and the growth of textual (or imagined) communities.

Influence

The concept of the public sphere has had an important and lasting influence in virtually every social scientific field, as a brief perusal of the affiliations of the various contributors to Craig Calhoun's *Habermas and the Public Sphere* (1992) amply demonstrates. However, given the centrality of public opinion and the process of its formation to the legitimacy of modern democratic forms of government, the concept is most influential for debates involving the intersection of modern communications, opinion formation, and democracy. Such debates range over a wide variety of topics. Some fields are dominated by the conversational model; these include theoretical explorations of the concept of civil society (Cohen and Arato) and arguments concerning the value and feasibility of deliberative forms of democracy (Bohman and Rehg). Other fields of inquiry, such as historical examinations of the modern origins of the democratic ethos (Zaret), are more conducive to a mediated concept. Some have sought to apply the concept of the public sphere to different societies and social conditions—for example, in analyses of the public sphere in Chinese history—whereas others have sought to use the concept as an aid in assessing the future impact of the Internet. Every application of the concept of the public sphere involves a tension between sociological description and normative prescription. This productive tension—which spans the gap between actual and potential—is what has rendered the concept so fruitful and useful, and what promises that the concept will continue to provoke both interest and insight for many years to come.

See also *Civil Society; Equality; Media, History of; Privacy.*

BIBLIOGRAPHY

- Arendt, Hannah. *The Human Condition*. Chicago: University of Chicago Press, 1958.
- Bohman, James, and William Rehg, eds. *Deliberative Democracy: Essays on Reason and Politics*. Cambridge, Mass.: MIT Press, 1997.
- Calhoun, Craig, ed. *Habermas and the Public Sphere*. Cambridge, Mass.: MIT Press, 1992.
- Cohen, Jean L., and Andrew Arato. *Civil Society and Political Theory*. Cambridge, Mass.: MIT Press, 1992.
- Eisenstein, Elizabeth L. *The Printing Press As an Agent of Change: Communications and Cultural Transformations in Early Modern Europe*. Cambridge, U.K.: Cambridge University Press, 1979.
- Habermas, Jürgen. *Between Facts and Norms*. Translated by William Rehg. Cambridge, Mass.: MIT Press, 1996.
- . "The Public Sphere: An Encyclopedia Article." Translated by Sara Lennox and Frank Lennox. *New German Critique* 1, no. 3 (fall 1974): 49–55.
- . *The Structural Transformation of the Public Sphere: An Inquiry into a Category of Bourgeois Society*. Translated by Thomas Burger. Cambridge, Mass.: MIT Press, 1989.
- . *The Theory of Communicative Action: Lifeworld and System*. Translated by Thomas McCarthy. 2 vols. Boston: Beacon, 1987.
- Halasz, Alexandra. *The Marketplace of Print: Pamphlets and the Public Sphere in Early Modern England*. Cambridge, U.K.: Cambridge University Press, 1997.
- Landes, Joan B. *Women and the Public Sphere in the Age of the French Revolution*. Ithaca, N.Y.: Cornell University Press, 1988.

- Negt, Oskar, and Alexander Kluge. *The Public Sphere and Experience: Toward an Analysis of the Bourgeois and Proletarian Public Spheres*. Minneapolis: University of Minnesota Press, 1993.
- Zaret, David. *Origins of Democratic Culture: Printing, Petitions, and the Public Sphere in Early-Modern England*. Princeton, N.J.: Princeton University Press, 2000.

Thomas F. Murphy III

PUNISHMENT. Punishment is best defined as an authorized agent or institution intentionally inflicting pain on an offender or depriving the offender of something in response to an offense or crime the offender is said to have committed. But definitions, however broad, need to be approached with caution, since it is impossible to perfectly capture the myriad constellations of social practices labeled punishment over time and throughout the world. It is helpful to keep in mind Friedrich Nietzsche's (1844–1900) distinction between the forms of punishment (which have maintained a level of continuity) and the meanings of punishment (which have been numerous over time). Indeed, until Nietzsche, philosophical concern with punishment had been almost completely devoted to delineating the justifications of social sanctions. Although many philosophers, especially since the Enlightenment, have seen the great question as why anyone should be allowed to intentionally inflict harm at all, this need to justify the practice has been relatively recent. The more historically resonant need has not been to legitimate punishment itself but rather to distinguish punishment from revenge and justice from mere retribution.

Vengeance and Punishment

Because the figure of vengeance hovers behind punishment as a threat of lawlessness, some of the most common characteristics of punishment since classical Greece are most easily identified by contrasting them with revenge, as they are in Aeschylus' *Oresteia* trilogy. First, revenge is personal, an act of private justice taken by individuals for wrongs done to them or to those close to them, usually blood relatives. Punishment thus commits itself to impersonality, where the response to an offense is assumed by an authorized third party, typically the state. Second, revenge is based on a subjective sense of injury, which may arise out of something that is neither a crime nor even a tangible harm at all. Within a culture of honor, for example, a well-timed snub may be felt and treated as seriously as a physical assault. In contrast, punishment must be dispassionate and based on the commission of well- and previously defined crimes. Third, revenge is fueled by the desire for the offender to suffer as the victim has, and because of this element of passion it is impossible to ensure that the revenge will not greatly exceed the initial harm. Punishment must thus be proportionate, balancing the appropriate punishment and the severity of the crime. Fourth, revenge often spirals out of control, leading to blood feuds that implicate members of an extended family and continue for generations. Punishment commits itself to harming only the individual perpetrator of the initial harm. Fifth, revenge is not public nor is the avenger committed to requiring similar harms done to others.

Punishment must be a form of public policy, based in a violation of known laws, with consistent enforcement.

Retribution and Consequentialism

The philosophical justifications of punishment have tended to fall into two broad categories: retribution and consequentialism. Arguments based in retribution look backward toward the initial crime itself, justifying punishment as what the criminal deserves for his or her initial act. The earliest retributivist ideal, the *lex talionis* (literally, “law of the same kind”), is found in numerous ancient Near Eastern law codes, including the Code of Hammurabi (c. 18th century B.C.E.) and exemplified in the Old Testament formula of an “eye for eye, tooth for tooth, hand for hand, foot for foot” (*Deut.* 19:21; see also *Exod.* 21:24, *Lev.* 24:23). The principle of the *talionis* has often been compared to vengeance, and indeed the emotional satisfaction of the victim plays a large part in retributivist accounts, especially in the symbolic similarity of the punishment to the crime. However, retributive justice is meant to place a strict limitation on the extent of requital, disrupting potential blood feuds and ensuring both proportionality and a conclusion to strife. By offering an image of justice based in rebalancing a harmony that has been upset, retribution assumes the justness of the initial status quo and punishment invites a return to that initial stage.

The second common category of justification is consequentialism, which looks toward the future rather than backward toward the crime. For the consequentialist, retributivism is nothing more than a compromise with revenge, and no punishment can be legitimated without knowing that it will bring forth good effects. The good effects that are considered to derive from punishing the offender vary but have included (a) reducing the amount of crime by removing criminals from public circulation; (b) deterring others from committing crime through example and threat; and (c) reforming and rehabilitating the criminal.

In demanding that punishment have effects beyond harming an offender, the consequentialist theorist must often turn away from the criminal act itself and look toward the criminal or the socioeconomic environment, which leads to charges that consequentialism effaces the evil of the crime. Consequentialist theories are also often troubled by a lack of conformity between the guilt of the punished and the usefulness of the punishment. For example, punishing an innocent person may still serve as a deterrent, whereas punishing a truly remorseful criminal who committed an offence no one witnessed may be superfluous. Because punishment may serve goals that are often extraneous to the law, such as providing socially beneficial labor or edifying examples of redeemed guilt, or generating social cohesion, consequentialism often seems to be an affront to the strict rule of law.

Plato (428–389 B.C.E.) embodies the rehabilitationist aspirations of consequentialism. “The purpose of the penalty is not to cancel the crime—what is once done can never be made undone—but to bring the criminal and all who witness his punishment in the future to complete renunciation of such criminality, or at least to recovery in great part from the dreadful state” (p. 934). For Plato, it was important to redefine *dikē*

(punishment as justice) in a way that clearly distinguishes it from *timōria* (punishment as vengeance). Punishment is undertaken for the sake of the guilty party, as part of a cure for the injustice that diseases the criminal’s psyche. Since criminality harms the offender even more than the victim, and since one would never knowingly harm oneself, criminal acts cannot strictly be understood as voluntary. Plato nevertheless accepted many traditional forms of punishment involving suffering without clearly explaining how suffering is the best way to cure someone of injustice.

A secondary concern in justifying punishment has been the identity of those bodies authorized to punish. The primary solution, at least since early modernity, is for the sovereign state to claim exclusive authority, an assertion exemplified by Thomas Hobbes’ *Leviathan*. However, this claim has always been controversial, for religious organizations have often claimed the authority to punish parishioners for their sins. The medieval Catholic Church was often responsible for lessening the severity of punishments, especially in reducing the number of death sentences, since the Church primarily saw the criminal as a sinner in need of repentance. But this also meant that a number of acts of moral turpitude demanded punishment by religious authorities, regardless of civil law. This drawn-out conflict over penal sovereignty helped precipitated the critiques of the Enlightenment.

The Enlightenment

The Enlightenment’s contribution to both the philosophical justifications of punishment and to concrete penal reforms cannot be underestimated. Voltaire (1694–1778), Charles-Louis Secondat, baron de Montesquieu (1689–1755), Jeremy Bentham (1748–1832), and others challenged both the penal practices of the day and their justifications. These reformers were strongly consequentialist in orientation. “All punishment is mischief,” according to Bentham’s famous dictum, and could be admitted only on the basis of its future utility. The only just reason for punishment is to protect society lawfully by preventing future crime rather than to seek retribution or display the overwhelming power of the king. They argued that punishment must only result from violations of civil law, not of religious edicts, and that crime must be distinguished from sin. Voltaire condemned punishment for violations of religious ceremony or dogma, sarcastically calling them “local crimes” as opposed to acts universally condemned. They also criticized the lighter punishments meted out to the aristocracy and the arbitrary sentences handed out by judges with overly wide discretion. Violent but irregular punishments were not helpful and, as Montesquieu noted, witnesses to such ceremonies become inured to the sight. To be effective, they argued, punishment must be swift and must not be arbitrary. This requires that legislatures clearly define criminal law rather than allowing judges wide discretion—a point that was central to Bentham’s peneology.

Most of these reform proposals are collected in a slim, influential treatise by the Italian jurist Cesare Beccaria (1738–1794), *On Crimes and Punishments* (1764). Beccaria condemned the secrecy of criminal justice and demanded an end to the use of judicial torture. However, his most famous

proposal was to abolish the death penalty. He argued that not only is capital punishment ineffective as a deterrent but that it cannot have been agreed to as part of an original social contract. Thus, while the purpose of punishment may be the protection of the society, there are limits to how far that protection can extend.

Enlightened reformers moved away from corporal punishment, seeking to design a penal system that would make punishment more useful, edifying the prisoner while simultaneously repairing the damage the prisoner had inflicted upon society. Central to these plans were work and imprisonment. Work was a common corrective technique, and many reformers believed the regularity and discipline of labor would lead to the moral rejuvenation of the wrongdoer while serving social needs at the same time. During the late eighteenth and early nineteenth centuries, distinctions between the prison and the workhouse were cloudy, and prisons were often structured akin to factories. Other potential penalties could include transportation, sending convicts to work in overseas plantations as indentured servants for the duration of their sentence.

If retributivist theories did not disappear under the weight of the eighteenth century's legal reforms, neither were retributivists unaffected by the Enlightenment's powerful critique of traditional practices and justifications for punishment. Immanuel Kant (1724–1804), the Enlightenment's greatest retributivist, criticizes Beccaria as overly compassionate toward humanity. Punishment must relate only to the crime, he argued, and cannot be concerned with any other extraneous goals, such as reform or deterrence, for such utilitarian goals treat persons as mere things. Yet neither must punishment serve the emotional satisfaction of the injured; punishment must neither be passionate nor unpredictable, neither overly humane nor desirous of revenge. Kant did not justify his full embrace of the *lex talionis* as a controlled form of revenge but rather as a dispassionate principle of universality and equality. Thus his theory of punishment seeks fairness not only for the victim or for society but for the perpetrator of the crime as well.

For Kant, the *lex talionis* served not only to justify punishment but also as a guide to proper proportionality. The punishment must resemble the crime itself; not only retribution but similarity is required. For example, murder can only be punished through the death penalty and Kant dismissed Beccaria's critique of capital punishment as mere "sophistry and juristic trickery." Nevertheless, Kant still argued that a mother guilty of killing her illegitimate child should be excused from the death penalty on the grounds that the law has not recognized the birth and thus the mother stands in a "state of nature" in relation to her child. As this example suggests, Kant's theory of punishment is not simply the juridical translation of his moral theory. His complex reworking of the tradition of the *talionis* continues to have difficulties in separating from the ideal of revenge, yet despite these difficulties—or perhaps because of them—Kant's theory of just punishment featured strongly in the revival or redistribution in the United States and Britain during the 1980s.

Georg Wilhelm Friedrich Hegel (1770–1831), on the other hand, was a retributivist who rejected the *lex talionis* and

considered punishment a right of the criminal. Crime, he argued, is an affront to the very structure of legality and criminals have metaphorically torn the mask of legal personality from both their victims and themselves, revealing the naked contingency of the law. Punishment "annuls" the crime by reasserting the proper status of both parties as legal subjects. Thus punishment is a right of the criminal as much as of the victim (which does not mean that the criminal desires it). In a reflection of Plato, Hegel viewed punishment as a form of education, in which the criminal is taught how to behave in a manner worthy of his status as a person.

From Justification to Explanation

Implicit in Hegel's theory of punishment is the socially vital role of both the criminal and the act of punishing; far from being an unfortunate aberration, punishment is a constitutive force of social life and proves the law's force. This idea that crime and punishment play a necessary role was emphasized by a number of social thinkers at the beginning in the late nineteenth century. In the late nineteenth century, an alternative set of philosophical and historical speculations arose, which were more interested in explaining and examining the function of punishment within a social system than in justifying or legitimizing any particular set of practices.

This shift in philosophical attention came from multiple and not always reconcilable directions. Three key exemplars are the sociological analysis of Émile Durkheim (1858–1917), the Marxian tradition, and the genealogical method of Nietzsche and Michel Foucault (1926–1984). Despite their differences, these approaches have important similarities. First, these theorists did not see crime and punishment as aberrant, but as having the power to construct a larger social order. Thus, rather than intimately linking crime with punishment, they saw both within the context of a greater social and economic environment. Second, they were skeptical, if not outright dismissive, of the two conventional theories of penal justification. Third, all three showed an interest in the philosophical ramifications of taking seriously the historical changes in penal practices.

In *The Division of Labor in Society* (1893), Durkheim rejected the contention that punishment must break its ties with either vengeance or the emotional satisfaction it provides. For Durkheim, the social function of punishment is to give effect to the emotional outrage of a society whose norms have been breached by the criminal act. A criminal act is identified as that which shocks the social conscience; criminality functions as a way to clarify the moral boundaries of the social group. Punishment is the reciprocal effect of society's moral outrage, generating and maintaining a solidarity that society cannot readily do without.

Calls for restorative justice are one contemporary manifestation of Durkheim's theory of social solidarity. Rather than in placing either the crime or the criminal at center stage, this theory focuses on the injuries and needs of the victim and of the community as a whole. Offenders must be held accountable to these victims, and part of their penalty may involve direct restitution, apologies to the victims, and community

service. The goal is begin a process of restoring the trust and solidarity that is broken by a criminal act, and although restorative justice draws on both retributivism and therapeutic consequentialism, it offers a clear alternative to both theories by concentrating on the social relationships that are harmed in the wake of crime.

Marxist analysis of crime has often emphasized the political economy of penology and sought to strip the practices of punishment from their juridical justifications. Although he wrote infrequently on legal matters, Karl Marx (1818–1883) criticized the failure of penal theory to consider the social factors, especially economic inequality and poverty, that underlay criminal activity. Using this framework, Georg Rusche (1900–1950) and Otto Kirchheimer (1905–1965), in *Punishment and Social Structure* (1939), examined the development of various forms of punishment in the context of the labor market's fluctuating needs, from the Middle Ages through to the modern day. Imprisonment, for example, functions both as a useful source of cheap labor for the state and, during periods of high unemployment, as a useful way of clearing the streets of potentially dangerous subversives who have little to lose. Less deterministic in the way they linked the economy and penology were the works of British historians and sociologists led by E. P. Thompson (1924–1993), whose *Whigs and Hunters: The Origin of the Black Act* was published in 1975. In this important work, he used the relationship between capital punishment and property laws to examine how the law in general legitimates economic inequalities and mediates relationships between economic classes.

By looking at the social context of crime, skeptics inside and outside of the Marxist tradition have challenged the unequal distribution of punishment along racial lines, pointing to, for example, the disproportionate number of racial minorities filling prisons in the West and the statistical correlation between the severity of punishments (especially the death penalty) and the race of the victim. Criminologists studying the sociology of deviance have also examined the phenomenon of the “moral panic”—exaggerated responses to perceived outbreaks of deviance or criminal behavior.

In *On the Genealogy of Morals* (1887), Nietzsche sought to disrupt the ahistorical tendencies of utilitarian histories of punishment that conflated the current function of punishment with its origin, “just as one formerly thought of the hand as invented for the purpose of grasping” (Second Essay, Section 13, p. 79). He offered an alternative origin of penal practices in a primitive economic version of the *lex talionis*, in which the physical tortures associated with juridical punishment were associated not with a guilty subject but rather only with the pleasure a creditor took in harming a debtor with an outstanding bill.

The genealogical perspective has been most importantly taken up by the French historian Michel Foucault. In *Discipline and Punish: The Birth of the Prison* (1975), Foucault explains how imprisonment emerged out of a wide array of potential penalties in the late eighteenth and early nineteenth centuries to become almost the sole means of punishing criminals. He describes a shift away from sovereign authority acting publicly against those who transgressed its laws and

toward a complex and fractured form of power exercised through the techniques of discipline and centered in the controlled spaces of the prison, away from public sight. In describing this movement, Foucault challenges the Enlightenment's representation of itself. Whereas eighteenth century European penal reformers argued that they sought to humanize punishment by making its exercise equal, consistent, and beneficial to all of society, Foucault argues that they helped bring forth a new economy of power, one that shifted the emphasis away from the crime and onto the “moral” reform of the criminal. Bentham's Panopticon prison design is emblematic of this system of social knowledge gained through surveillance and a careful arrangement of the body in time and space. The prison, in Foucault's eyes, becomes not only the site of disciplinary mechanisms but also a sign of how the incarceration model of punishment has bled into many other social institutions, including schools and the workplace. Perhaps the most important ramification taken from Foucault's work is a radical reconceptualization of how power operates in society. Rather than modeling power on the top-down physical coercion of a sovereign, Foucault conceives of power relations as derived from the mutually reinforcing links between social practices such as punishment and systems of scientific knowledge such as penology. Ironically, this radical critique of the therapeutic model occurred at the same time that retributivist arguments favoring greater use of imprisonment gained a new lease on life, indicating a dearth of new justifications for prisons combined with a practical lack of penal alternatives.

No other penal issue has attracted such controversy since the mid-1970s as the death penalty. Abolitionists argue that morally it is inhuman and practically it is ineffective in deterring crime. Abolitionists also argue that it grants the state too much power, and is too often used as a tool of political terror, or used unequally upon minority communities. While some supporters of capital punishment argue from consequentialist principles that the death penalty is a deterrent to crime, most adopt a modern version of the *lex talionis*. By the end of the twentieth century many Western nations, especially throughout Europe, had banned this practice. The United States, along with many regimes in Africa, Asia, and the Middle East, continues to apply the death penalty. While the practice has been challenged as a violation of individual civil liberties, its popularity in the United States remains strong in the early twenty-first century.

See also *Natural Law; Society; Virtue Ethics*.

BIBLIOGRAPHY

- Beccaria, Cesare. *On Crimes and Punishments*. 1764. Reprint, translated by Henry Paolucci. Indianapolis: Bobbs-Merrill, 1963.
- Bentham, Jeremy. *An Introduction to the Principles of Morals and Legislation*. 1789. Reprint, edited by J. H. Burns and H. L. A. Hart. New York: Oxford University Press, 1996.
- Ezorsky, Gertrude, ed. *Philosophical Perspectives on Punishment*. Albany: State University of New York Press, 1972.
- Foucault, Michel. *Discipline and Punish: The Birth of the Prison*. Translated by Alan Sheridan. New York: Vintage, 1977.
- Garland, David. *Punishment and Modern Society: A Study in Social Theory*. Chicago: University of Chicago Press, 1993.

- Hart, H. L. A. *Punishment and Responsibility: Essays in the Philosophy of Law*. New York: Oxford University Press, 1968.
- Hegel, G. W. F. *Elements of the Philosophy of Right*. 1821. Reprint, edited by Allen W. Wood, translated by H. B. Nisbet. New York: Cambridge University Press, 1991.
- Kant, Immanuel. *The Metaphysics of Morals*. 1797. Reprint, translated by Mary Gregor. New York: Cambridge University Press, 1991.
- Mackenzie, Mary Margaret. *Plato on Punishment*. Berkeley: University of California Press, 1981.
- Nietzsche, Friedrich. *On the Genealogy of Morals*. 1887. Reprint, translated by Walter Kaufmann. New York: Vintage, 1967.
- Plato. *The Laws*. Translated by Trevor J. Saunders. New York: Penguin Books, 1970.
- Rushe, Georg, and Otto Kirchheimer. *Punishment and Social Structure*. 1939. Reprint, New York: Russell and Russell, 1967.
- Ten, C. L. *Crime, Guilt, and Punishment: A Philosophical Introduction*. New York: Oxford University Press, 1987.
- Tunick, Mark. *Punishment: Theory and Practice*. Berkeley: University of California Press, 1992.

Douglas C. Dow

PURITANISM. Puritanism is the set of religious beliefs and practices retroactively ascribed to Puritans by modern scholars. Since *Puritan* was originally a term of abuse toward people considered excessively, narrow-mindedly, or hypocritically religious, not an embraced identity, the definitions of both *Puritan* and *Puritanism* have been and remain inescapably vague. Roughly, we may take the term *Puritans* to refer to the fervently religious, “godly” fraction of the English nation who, dissatisfied with England’s imperfectly Reformed status quo, between the 1560s and the 1640s pushed for a further reformation of England as a corporate whole toward more fully Reformed ecclesiastical practice and for the infusion of their own ardent religiosity in the faith, worship, and daily life of all Englishmen. Puritanism, therefore, encompasses Puritans’ theology and practical divinity, the quite divergent religiopolitical goals of successive generations of Puritans, and, more loosely, the cultural, social, and economic habits scholars have since identified as corollaries of Puritan religiosity and belief.

Religious Practice

Puritanism began simply as a full-blooded articulation of Reformed theology, which strongly emphasized that the course of human events depended upon God’s omnipotent providence and that the soul’s salvation depended upon both human faith and God’s absolute and predestining power to save and to damn. Certain aspects of this belief were characteristically but not exclusively Puritan and were shared by most English Protestants. Many Puritans emphasized these more congenial aspects of Puritanism, seeking to unite the Protestant nation as much as possible. This soft-edged Puritanism promoted Reformed catechetical education, the support for a learned and godly ministry, the encouragement of ministerial preaching, the setting of psalms and hymns to popular song tunes, a unifying culture of providentialism among Englishmen that emphasized the possibility of saving grace, a fervent emphasis on anti-Catholicism rather than on the precise

details of Reformed theology, and the vision of England as an elect nation, collectively destined for salvation. This branch of Puritanism was essentially “hot Protestantism”—distinctive in its enthusiasm more than in its beliefs.

Other Puritans embraced a Puritanism that created a distinctive way of life alongside of distinctive religious beliefs. First, this Puritanism enjoined an ascetic variant of English culture that rejected as “ungodly entertainments” the songs, dances, and sports enjoyed by most Englishmen, and replaced them with sermon-going, Bible study, prayer, and (most unpopularity) the proselytization and coercive enforcement of this reformation of manners among their fellow Englishmen. Second, Puritanism faced squarely God’s predestining power to save and to damn, brought it into everyday religious practice and worship, and made this “experimental predestinarianism” central to their practical divinity and emotional connection with God; and so it focused on the search for ways to assure oneself of one’s soul’s salvation. Hence, Puritanism transformed Reformed providentialism into a search for this-worldly signs of God’s beneficial providence that would provide reasonably sure guarantees of other-worldly salvation and stressed the emotional, joyful assurance that came when one knew that God had predestined one’s soul for salvation. Third, since Puritans did not have the full coercive resources of the state at their command, Puritanism promoted “voluntary religion” that operated by persuasion rather than by compulsion. Puritan works of practical divinity therefore instructed ministers how to preach so as to bring listeners voluntarily to live a godly life, and instructed the Puritan laity how to order their own lives in a godly manner. Reformed manners, experimental predestinarianism, and the practical divinity of voluntary religion are the three most noteworthy characteristics of this branch of Puritanism.

Ecclesiology and Politics

Puritanism became a political issue around 1570, as Elizabeth began to resist demands for further reformation of the English Church. Political Puritanism at first denoted the party counseling Elizabeth to change her mind and resume the transformation of England toward the practices of more fully Reformed polities, such as Geneva and Scotland. These Puritans’ main desires were to eliminate England’s bishops and replace them in the Church’s governing structure with both a presbyterial-synodal church structure and a system of consistorial discipline, and to eliminate the vestments, liturgy, and church decoration that preserved aspects of England’s Catholic tradition. Puritan relations with Elizabeth became increasingly acrimonious, as by the end of the 1580s it was clear that her halt was meant to be permanent. Since first Elizabeth and then James remained adamant in their resistance to full national reformation, Puritanism from the 1590s to the 1610s chose two tactics by which to express their opposition. Most Puritans made the necessary obeisances to the forms of the English Church, but worked quietly to reform the church at the local level, while waiting for a chance to resume national reformation. A few radicals separated from the Church rather than acquiesce in its imperfect reformation; these ministers and laity, intermittently persecuted, generally abandoned the urge to create a national Church, and instead founded Congregationalist, Baptist, and other sects.

The onset of the Thirty Years War upset this political situation. As England's bellicose Reformed ministry urged intervention in the war, opposing James I's pacific policy, first James and then Charles I began to patronize more deferential "Arminian" bishops, who added to their respect for royal authority a shift from the traditional Reformed emphasis on faith and predestination toward an emphasis on tradition and ritual, and sought accordingly to move the Church even farther from the Reformed ideal. Puritanism therefore transformed itself in the 1620s and 1630s from an urge toward further reform to a defense of such reform as had already been achieved in the Church against Arminianizing changes. At the same time the actions of Charles and the Arminian bishops greatly radicalized Puritanism. Among those Puritans who still wished to take part in a national Church, the number of Puritans willing to tolerate episcopacy diminished drastically; and the sectarian impulse and the desire to emigrate to fully Reformed New England also rose sharply among Puritans in these decades. As his command of the nation broke down in the early 1640s, Charles confronted a radicalized Puritanism, which three generations of royal policy had made bitterly hostile to royal authority and extraordinarily receptive to radical political practice and thought.

Capitalism

In retrospect scholars have associated Puritanism with almost every "modernizing" development in early modern European history. At the heart of this mountain of theorizing is the thesis propounded by Max Weber that Protestantism transmuted the idea of a religious calling into this-worldly achievement in the service of God, Reformed theology especially emphasized this transmutation, and Puritanism in particular made possible England's pioneering transition to modern industrial capitalism and a pervasive, secularized Puritan work ethic. Studies of Puritanism in its classic development up to the 1640s therefore have often focused on attempts to prove or disprove Weber's thesis as it applies to the political, economic, and cultural aspects of Puritanism. At this point in time the latest scholarship hesitantly supports the idea that Puritanism did have a disproportionate appeal toward artisanal guild members and the literate, that Puritanism did help inspire middling Englishmen toward new, coercive policies of social control and welfare toward their poorer brethren, and that by focusing religious salvation upon individual faith and God's predestining power Puritanism did allow Puritans engaged in economic activity to act relatively unconstrained by the inhibitions of a traditional "moral economy." If this is so, Puritanism does correlate significantly with the prerequisites for the development of a modern economy and society; but this thesis is highly qualified, and remains strongly contested. This latest word ought not to be taken as the last word on the subject.

See also *Reformation; Religion; Religion and the State.*

BIBLIOGRAPHY

- Collinson, Patrick. *The Religion of Protestants: The Church in English Society, 1559–1625*. Oxford: Clarendon, 1982.
- Lake, Peter. *The Boxmaker's Revenge: "Orthodoxy," "Heterodoxy," and the Politics of the Parish in Early Stuart London*. Stanford, Calif.: Stanford University Press, 2001.

Underdown, David. *Revel, Riot, and Rebellion: Popular Politics and Culture in England, 1603–1660*. New York: Oxford University Press, 1985.

Walsham, Alexandra. *Providence in Early Modern England*. New York: Oxford University Press, 1999.

Weber, Max. *The Protestant Ethic and the Spirit of Capitalism*. Translated by Talcott Parsons. London and New York: Routledge, 2001.

David Randall

PYTHAGOREANISM. The most central teaching of the Pythagorean school—that there is an underlying mathematical structure to the universe—is a foundational idea of Western civilization, particularly in the sciences. Because of this, the entire history of Western scientific and cosmological thought has been intertwined with Pythagorean ideas. Certainly many of the greatest physicists and mathematicians have embodied a kind of Pythagorean worldview, especially those who have emphasized the elegant, mathematical harmonies of nature and the human mind's ability to grasp the underlying world order.

The first person to call himself a *philosopher* or "a lover of wisdom," the historical Pythagoras was born on the Greek island of Samos circa 570 B.C.E. According to his biographers, he traveled to Egypt and Babylonia before founding his philosophical school in Croton, in South Italy. The school included men and women, and was influenced by the Greek mystery religion of Orphism, which taught reincarnation and stressed the purification of the soul. Like the other Presocratics, for Pythagoras there was no differentiation between philosophy and natural science. The Pythagoreans conceived of philosophy as a total, integrative "way of life," and the purification of the soul was achieved through study and contemplation, rather than through religious ritual.

Number, Cosmos, and Harmony

While Pythagoras left no writings, the central focus of Pythagorean teachings remains clear. Number is a universal archetype, "the principle, source, and root of all things." More specifically, everything is composed of "the elements of number," which the Pythagoreans identified as the Limited and the Unlimited. The Pythagoreans engaged in the study of number theory or arithmetic (number in itself), geometry (number in space), harmonics or tuning theory (number in time), and astronomy (number in space and time). These descriptions correspond well with the modern definition of mathematics as "the study of patterns in space and time."

Since number and its qualities such as polarity, harmony, and proportion are archetypal principles that underlie physical manifestation, mathematics is discovered rather than invented, and possesses the power to reflect the essential nature of reality, rather than just modeling it or describing it. Moreover, in the Pythagorean view, because number is universal, it is also divine. While modern science is conceived in experimental terms, ancient Greek science was mathematical; and while mathematics has practical applications, Pythagoras's approach elevated mathematics to a study worth pursuing above any purely utilitarian ends for which it had previously been employed.

Pythagoras was the first person to call the universe a *kosmos*. The Greek term, which is the root of the word *cosmetic*, refers to an equal presence of order and beauty. The universe is a *kosmos* because the phenomena of nature embody geometrical form and proportion. These proportions allow things to unfold and function in the most elegant and efficient ways (which is a fact of nature), but also give rise to beauty (which is a value). In this way, the worlds of “fact” and “value” are not separate domains, but inherently related. In a larger sense, all things are related through whole–part and proportional relationships (*analogia*), as in an ecosystem. Because of this, the classical Pythagorean metaphor likens the universe to a living organism rather than an inanimate machine. Plato describes the Pythagorean view well when he describes the cosmos as “one Whole of wholes” and as “a single Living Creature which encompasses all of the living creatures that are within it” (*Timaeus* 33A and 30D).

The Pythagoreans (among whom Plato must be counted) perceived a fundamental relationship between proportion and the principle of justice, in which “each part of the whole receives its proper due.” They believed that the essential nature of justice could be understood through the study of continuous geometrical proportion (*analogia*) and through the study of the mathematical ratios of the musical scale, in which the two extremes of the musical scale are bridged through various types of mathematical proportion. Central to the Greek concept of proportion is the idea of finding “means” or types of mediation between extremes. In tuning theory, the Pythagoreans identified the arithmetic, geometric, and harmonic means which underlie the musical scale, as well as the perfect consonances of music, which are mathematical ratios: the octave (1:2), the perfect fifth (2:3), and the perfect fourth (3:4). The Pythagoreans likened a just and well-ordered society to a well-tuned lyre. While each note retains its individuality, all are proportionally linked together in a larger whole to form a musical scale, and all are interdependent in terms of their reliance on one another. (See Plato, *Republic* 443D–444). Justice is present in any well-functioning organism, society—and also the soul.

In Pythagorean thought, number gives rise to proportion, and proportion gives rise to harmony. The Greek word *harmonia* means “fitting together” or “joining together.” Harmony and justice is the result of good proportion made manifest, and the *kosmos* itself is a harmony in which all of the parts are proportionally bound together. While every organism—including the cosmos—is a unity, it is harmony that allows the parts to function together as an integrated whole. Harmony, justice, and proportion relate to Greek medical theory, because healthy organisms possess a type of dynamic balance in which the various elements work together; when lack of harmony prevails, illness will result.

Understanding the cosmos is essential for self-understanding, because humanity is a microcosm, a reflection of the entire world-order in miniature. To know the powers present in the greater cosmos—including the divine powers of order, beauty, and reason—allows humans to become aware of the divine, universal principles reflected within our own being. Science was thus envisioned as a spiritual undertaking, because contemplation of the cosmic pattern aids in the assimilation of the soul to the divine. Once again Plato makes the point clearly

when he writes that “a man should come to resemble that with which it delights him to associate. . . . Hence the philosopher through the association with what is divine and orderly (*kosmios*) becomes divine and orderly (*kosmios*) insofar as a man may” (*Republic* 500C).

Pythagoreanism, with its emphasis on attuning the soul to a vision of the deepest level of reality through the study of mathematics and proportion, lies at the heart of Plato’s educational program described in the *Republic*. Plato had personal contact with members of the Pythagorean school, including Archytas of Tarentum; the spirit of Pythagoreanism animated Plato’s works and was transmitted through the later Platonic tradition. Where Plato parted company with Pythagoras was in his overwhelming emphasis on the transcendent. For Pythagoras, the divine order is immanent in the cosmos, where it may be encountered; but Plato emphasized a transcendent metaphysics of forms or examples, only accessible to the purified intellect, divorced from the phenomena of nature. In either case, both Pythagoreanism and Platonism stressed an epistemology in which human beings can know the deep structure of the world because of the mind’s essential kinship with its archetypal structure.

Pythagoreanism remained active in medieval philosophical, scientific, and aesthetic thought, influencing the symbolism and architecture of the gothic cathedrals. It similarly influenced Islamic cosmological thought and architecture through the universal encyclopedia of the Brethren of Purity (*Ikhwan al-Safā*), compiled in the tenth century C.E. But it was with astronomer Johannes Kepler (1571–1630) that the Pythagorean tradition made its most spectacular triumph at the dawn of the modern era, in Kepler’s discovery of the three laws of planetary motion.

Motivated by a belief that divine harmonies animate the celestial order, Kepler finally proved Plato’s assumption that there was an elegant mathematical order underlying planetary motion despite the seeming, observed irregularities of retrograde motion. In this way, Kepler reconciled the mathematical science of the Greeks—and the Pythagorean spirit—with an absolutely rigorous empiricism that became the hallmark of modern physics.

See also **Geometry; Greek Science; Mathematics; Neoplatonism; Platonism.**

BIBLIOGRAPHY

- Guthrie, W. K. C. *A History of Greek Philosophy*. Vol. 1: *The Earlier Presocratics and the Pythagoreans*. Cambridge, U.K.: Cambridge University Press, 1962.
- Guthrie, Kenneth S., and David R. Fideler, eds. *The Pythagorean Sourcebook and Library: An Anthology of Ancient Writings which Relate to Pythagoras and Pythagorean Philosophy*. Grand Rapids, Mich.: Phanes Press, 1987.
- Navia, Luis E. *Pythagoras: An Annotated Bibliography*. New York: Garland, 1990.
- Vogel, Cornelia J. de. *Pythagoras and Early Pythagoreanism: An Interpretation of Neglected Evidence on the Philosopher Pythagoras*. Assen, Netherlands: Van Gorcum, 1966.

David Fideler



Q

QUANTUM. The German physicist Max Planck (1858–1947) introduced the quantum of action h (Planck's constant) into physics in his successful theory of blackbody radiation in 1900 and thus started quantum theory, one of several revolutionary discoveries that occurred in physics at the turn of the twentieth century. Others were Albert Einstein's (1879–1955) special theory of relativity, his theory of the light quantum, and the experimental proof of the existence of atoms and molecules, based on Einstein's theory of Brownian motion, all published in the single year 1905. These theories and the general theory of relativity distinguish modern physics from the classical physics that was dominant in 1900.

The desire to formulate physics in terms of observable quantities motivated Einstein's special theory of relativity, which eliminated the unobservable ether assumed by James Clerk Maxwell (1831–1879) and his followers. The "new quantum theory" of the 1920s was also supposed to be a theory of observables, as it eliminated the visualizable orbits of the "old quantum theory" that preceded it, but the new version introduced concepts such as Erwin Schrödinger's (1887–1961) wave function (ψ -function) that involves the imaginary number $i = \sqrt{-1}$. Quantum mechanics and quantum field theory employ other mathematical concepts that are far from the observable realm.

While other developments of modern physics, such as relativity, can be seen as generalizing classical physics, quantum mechanics makes a much stronger break with the past. Even the basic notion of measurement is problematic in quantum theory. One of its consequences is a fundamental indeterminacy that prevents, for example, the simultaneous determination of the position and momentum of a particle. That brings into question the entire epistemology on which classical physics is based. The ψ -function of an atom, for example, is the solution of a differential equation that is linear in the time variable, and once given, ψ is determined for all time. The ψ -function thus provides a deterministic description of the system, but from this complete description one can predict with certainty the outcome of only special "compatible" measurements; for most measurements, only the probability of a given result can be calculated.

The implications of quantum theory are so profound that even its creators, such as Planck and Einstein, found it difficult to accept and wrestled with its concepts all their lives. Skeptical physicists devised ways to avoid the apparent contradictions, and these proposals have led to experimental tests. All of the tests performed so far have confirmed the predic-

tions of quantum theory, although its laws are subject to differing physical interpretations.

Planck's Paper of 1900

As the nineteenth century drew to a close, many physicists felt that the fundamental laws of physics were well understood, and would be a permanent part of humanity's worldview. Although new experimental results, such as the recent discoveries of X-rays, radioactivity, and the electron, could modify the view of the microworld, it was felt that classical mechanics, electromagnetism, thermodynamics, and statistical mechanics, based on classical ideas, would sooner or later provide a satisfactory account of the new phenomena. When William Thomson (Lord Kelvin; 1824–1907) gave a talk at the Royal Institution in London in April 1900 concerning two clouds over the theories of heat and light, he referred not to the recent discoveries but to problems with the ether and the failure of the classical theorem that heat energy should be distributed uniformly among the various possible motions of molecules.

Einstein's relativity theory disposed of the ether (at least for the next century), while the more obscure problems of molecular motion would find their solution in a new mechanics that was born in 1900 from the revolutionary reasoning of a conservative middle-aged physicist, Max Planck. In 1860 Gustav Robert Kirchhoff (1824–1887) had shown that the relative amounts of energy emitted at different wavelengths from any surface was the same for any material and dependent only on the temperature. He also argued that the ratio of the emissive power to the absorptive power of any given material was constant. Kirchhoff conceived of an ideal blackbody that absorbed all the radiation that fell upon it, and he saw that this situation could be realized by an enclosure at constant temperature (such as the interior of a furnace). The radiation from a small hole in such an isothermal enclosure would not depend upon the size or shape of the enclosure or upon the material of the walls. Therefore it had a universal character that called for a fundamental explanation, one that was independent of theories regarding the structure of matter (which were essentially unknown). The spectrum, and hence the color, of the radiation depends only upon the temperature, whether the source be a furnace, the filament of an incandescent lamp, or a glowing star in the sky.

Planck found that explaining the spectrum of blackbody radiation was especially challenging, and hoped to understand its intensity as a function of wavelength λ or frequency ν (the two being related by $\lambda \nu = c$, c being the velocity of light in

vacuum). Born in 1858 in the Baltic city of Kiel to an academic family, he studied in Munich and Berlin, where one of his professors was Kirchhoff, to whose chair he succeeded in 1887 after receiving his Ph.D. in Munich in 1879. Planck lived a long and productive life, undergoing terrible personal losses in both world wars and also during the Nazi period. He died in 1947, after suffering the execution of his younger son for participating in a plot to kill Adolf Hitler.

Planck's Ph.D. thesis dealt with the second law of thermodynamics, which says that heat does not flow from a cooler body to a hotter body (one of several formulations). The first law of thermodynamics expresses the conservation of energy. Planck was attracted to the laws of thermodynamics because they were held to have a universal significance. From about 1897 on he devoted himself to understand the laws of blackbody radiation from the standpoint of thermodynamics. Another motivation for him was that experimental scientists at the *Physikalisch-Technische Reichsanstalt* (the German Bureau of Standards) in Berlin were making an accurate determination of the form of the blackbody spectrum. Using reasoning based first on thermodynamics and then on the statistical mechanics of the Austrian physicist Ludwig Boltzmann (1844–1906), Planck derived a formula that gave precise agreement with the latest experimental results, although even its author, who spent more than a decade afterward trying to improve it, later questioned its original derivation.

Planck's formula for u_ν , the energy per unit volume of radiation in a cavity at frequency ν , reads:

$$u_\nu = (8\pi h \nu^3 / c^3) (1 / \exp(h\nu / kT) - 1)$$

where T is the absolute temperature and k is called Boltzmann's constant. Plotted against ν , the curve for u_ν rises from zero at $\nu = 0$ to form a curved peak with its maximum near $h\nu = 3kT$, and then falls exponentially to zero for large ν , where the "1" in the denominator becomes negligible. The peak position that determines the color of the radiation thus increases linearly with the absolute temperature.

The important things to notice about Planck's formula, which he published in 1900, are that it gives the correct spectrum of blackbody radiation and that, aside from the variable quantities frequency and temperature, it contains only the fundamental physical constants h , c , and k . Boltzmann's constant k , which was first introduced by Planck, is the so-called gas constant per mole divided by the number of molecules in a mole (Avogadro's number) and its significance is that kT is a molecular energy. (A monatomic gas molecule has energy $(3/2) kT$.) The universal constant c is the velocity of light in vacuum. Planck's constant is $h = 6.626 \times 10^{-34}$ Joule-seconds. Its dimension of energy times time is called "action," and h is called the quantum of action. Evidently Planck's h is a very small quantity and, like k , its most important role is in atomic and molecular physics. The laws of motion of baseballs and planets do not depend upon h , but without it one cannot understand anything about the microworld; its size sets the scale for the elementary particles of which the world is built.

Einstein's Light Quantum

In deriving his blackbody formula Planck assumed the complete validity of classical electromagnetism and, not having any theory of atomic structure, used the fact that the radiation was independent of the material of the radiator to assume that it would be sufficient to consider the cavity walls as modeled by a collection of simple harmonic oscillators, each capable of absorbing and emitting a particular frequency. He then calculated the average energy of such an oscillator in equilibrium with the cavity radiation, using a method previously developed by Boltzmann for the statistical treatment of an ideal gas. As an aid to calculating the various possible "partitions" of the total energy among the gas molecules, Boltzmann had assumed each to have one of a discrete set of energy values, but afterward had let the separation of the values tend to zero, so that the molecules could have a continuous range of energy. However, Planck found good agreement with the experimental frequency distribution only when the oscillator energy values, separated by $h\nu$ in his theory, remained separated by that amount, with h retaining the finite value that we have given above.

Several physicists criticized Planck's derivation, claiming that he had misapplied Boltzmann's method to his problem, and pointing out that Boltzmann had treated his molecules as distinguishable from one another. Planck's treatment implied that oscillators of a given frequency were indistinguishable. Einstein's view was that the derivation was questionable, but the formula was undoubtedly correct and this brought into question certain aspects of Maxwell's electromagnetic theory. Einstein also had other grounds for questioning Maxwell's theory. In the photoelectric effect, radiation (e.g., ultraviolet light) falls on a metal plate and ejects electrons. Below a certain threshold frequency, dependent on the metal, no electrons are ejected. Above that threshold, electrons are ejected with kinetic energies that increase linearly with the difference of the light frequency from the threshold. At a fixed frequency, increasing the light intensity causes more electrons to be emitted, without increasing the energy per electron. This phenomenon is best explained by assuming that the light consists of concentrations of energy that can be transferred to individual electrons, as in a collision of particles. However, that picture is totally inconsistent with the smooth continuous wave picture of Maxwell's electromagnetic theory of light.

Einstein conjectured that the cavity radiation treated by Planck was like a gas consisting of "particles" called light quanta, each having energy $h\nu$. (In 1926 the American chemist Gilbert N. Lewis named these particles "photons.") Arguing this way, Einstein obtained Planck's formula without having to make any arbitrary assumption concerning the cavity walls, such as their being modeled by simple harmonic oscillators. Einstein also regarded that this particulate aspect belonged to radiation in general, whether in an enclosure or in free space. That amounted to a revolutionary modification of the existing theory of optics and electromagnetism. Planck and others found Einstein's proposal very difficult to accept. Although it explained phenomena that were otherwise mysterious, it was hard to see how such optical phenomena as refraction or diffraction (the spreading of light around a sharp edge) that since the early nineteenth century had been treated with a wave

theory of light, could be reconciled with almost Newtonian particles of light. For at least two decades, the quantum achievements of Planck and Einstein were regarded with suspicion. The Nobel Prize Committee recognized Planck's great discovery only in 1918; Einstein's in 1921 (but awarded the prize in 1922).

Neils Bohr and the "Old Quantum Theory"

In the same year (1922) in which Einstein was awarded the Nobel Prize, largely for his explanation of the photoelectric effect, the Danish physicist Niels Bohr (1885–1962) received the same recognition for his quantum theory of the structure of atoms and their radiations, first put forward in 1913. Before Bohr, the quantum of action had been associated with heat radiation and light. It had also dissipated (in the hands of Einstein and others) one of Kelvin's clouds hanging over physics, that of the specific heats. Bohr seized upon the quantum to make a durable model of the atom itself.

In 1909 the New Zealander Ernest Rutherford (1871–1937), a professor in Manchester, England who was famous for his work in radioactivity, asked one of his students to study the absorption of alpha particles in a thin foil of gold. As an atom was supposed to be a sphere of diffuse positive charge with electrons stuck in it, able to vibrate in response to light or to emit light when set into vibration, Rutherford expected the alpha particle, a high speed helium nucleus, about eight thousand times heavier than the electron, to pass through with only a small deviation. Instead, many alpha particles suffered deflections by large angles, and some were even reflected in the backward direction. After verifying this amazing result and analyzing it mathematically, in 1911 Rutherford announced that the atom, about 10^{-8} cm in radius, was almost entirely empty, that the positive charge was concentrated in a region no larger than 10^{-12} cm (the nucleus), and the electrons (79 in the case of gold) circled the nucleus as the planets circle the sun.

Niels Bohr came from a well-known academic family in Copenhagen, his father a professor of physiology and his mother belonging to a rich and cultivated Jewish family. Niels's brother Harald (1887–1951) became a famous mathematician and his son Aage (b. 1922) also won a Nobel Prize in physics. Born in 1885, Niels Bohr received his Ph.D. from the University of Copenhagen in 1911 and traveled for further study to England, first to Cambridge to work with Joseph John Thomson (1856–1940), who had discovered the electron in 1897. Thomson was responsible for the atomic model that was replaced by Rutherford's planetary picture. After a short time, Bohr moved to Manchester to work with Rutherford and began to think about atoms.

Comparing Rutherford's model of the simplest atom, hydrogen—one light electron circling a heavy positive nucleus—with a simplified solar system containing only the earth and the sun, the mechanical picture would seem to be nearly identical, with the inverse square electrostatic force in the atom replacing the inverse square gravitational force in the solar system. However, atoms that continuously interact and collide with other atoms (e.g., in a gas) remain remarkably stable, retaining their size and shape, which is not true of solar

systems. Moreover, according to classical electromagnetic theory even an isolated atom would be unstable, as the electron in its orbit accelerates toward the nucleus, it should radiate energy like a small antenna. Within a small fraction of a second, the electron should spiral in toward the nucleus and be absorbed. Yet atoms appear to be almost indestructible under ordinary conditions.

In 1913 Bohr published an atomic theory that solved these difficulties, but it required the acceptance of two very new principles. The electrons revolve around the nucleus, but only in certain well-separated orbits called "stationary states." In these allowed states, the electron does not radiate, but in passing from state of energy E to another of lower energy E' it emits a light quantum of energy $h\nu = E - E'$. Similarly it absorbs such a quantum (if present) in passing from the state of lower energy to the higher. In the case of hydrogen, the allowed energy states are circular orbits that are restricted by the condition $mvr = nh/2\pi$, where m and v are, respectively, the mass and speed of the electron and r is the radius of the circular orbit. The "quantum number" n is a positive integer. One can then show easily that the energies of the stationary states are given by $E_n = -(1/n^2) me^4/2(h/2\pi)^2 = -13.6/n^2$ electron volts. (The negative energy means that the electron is in a bound state. An electron with positive energy is outside of an atom.)

In 1860, Kirchhoff and Robert Bunsen (1811–1899) at the University of Heidelberg started systematic investigations of atomic spectra and showed that the frequencies of the spectral lines were characteristic of elements, even when those atoms formed part of a chemical compound. Any good theory of atomic structure would have to explain those frequencies. For the case of hydrogen, combining Bohr's two principles gave the result $h\nu = E - E' = -13.6(1/n^2 - 1/n'^2)$ electron volts. With $n' = 2$, Bohr's expression gave the Balmer formula for the hydrogen lines in the visible part of the spectrum, known since 1885. Other hydrogen lines predicted to be in the ultraviolet were found, as well as those of another "one-electron" atom, namely once-ionized helium. Another success was the prediction of X-ray lines arising from heavier elements, which gave an accurate determination of the element's atomic number and hence its correct place in the periodic table of the chemical elements. This showed that there was a "missing" element, with atomic number 43, still to be discovered.

The analysis of the spectra of heavier elements was not so simple, and even the observed hydrogen spectrum showed more structure than Bohr's first model allowed. Bohr himself attacked this problem, as did others, especially Arnold Sommerfeld (1868–1951) of the University of Munich. Besides Bohr's n , the "principle quantum number," Sommerfeld introduced an "angular momentum quantum number" l , which could take on the integer values from 0 to $n - 1$, and a "magnetic quantum number" with integer values from $-l$ to $+l$. With their help, Sommerfeld could account for many spectral lines, including the "splitting" into several components, an effect known as "fine structure." Even the hydrogen lines showed fine structure, and Sommerfeld was able to account for small relativistic effects.

Because the Bohr-Sommerfeld model had electrons following definite visualizable orbits, however restricted, including ellipses as well as circles, the model could be described as semiclassical. In the calculation of the probabilities of transitions between stationary states, which give the relative brightness of the various spectral lines, Bohr used another semiclassical idea, to which in 1923 he gave the name “correspondence principle.” According to this, the classical radiation theory is valid whenever the quantum numbers have large values, so that both the frequency and the intensity of light emission is that which would arise classically from the electron’s acceleration in its orbit.

The New Quantum Mechanics of Heisenberg, Schrödinger, and Dirac

From 1925 to 1927 three equivalent new versions of quantum mechanics were proposed that extended the Bohr-Sommerfeld theory, cured its main difficulties, and produced an entirely novel view of the microworld. These new theories were the matrix mechanics of Werner Heisenberg (1901–1976), the wave mechanics of Erwin Schrödinger (1887–1951), and the transformation theory of Paul A. M. Dirac (1902–1984), the last being a more general version that includes both of the other versions. The three physicists were awarded Nobel prizes in physics at a single award ceremony in Stockholm in 1933, Heisenberg receiving the prize for 1932 and Dirac and Schrödinger sharing the prize for 1933.

In his Nobel address, Heisenberg stated:

“Quantum mechanics . . . arose, in its formal content, from the endeavor to expand Bohr’s principle of correspondence to a complete mathematical scheme by refining his assertions. The physically new viewpoints that distinguish quantum mechanics from classical physics were prepared . . . in analyzing the difficulties posed in Bohr’s theory of atomic structure and in the radiation theory of light.” (*Nobel Lectures in Physics*, p. 290)

The difficulties were many, including that of calculating the intensities of spectral lines and their frequencies in most cases (hydrogen being an exception) and in deducing the speed of light in various materials. In classical theory an atomic electron would emit radiation of the same frequency with which it orbited a nucleus, but the frequencies of spectral lines are practically unrelated to that orbital frequency and depend equally upon the final and initial atomic states. Heisenberg argued that the electron orbiting the nucleus was not only “unobservable,” but also “unvisualizable,” and that perhaps such an orbit did not really exist! He resolved to reformulate the theory following Einstein’s procedure in formulating the theory of relativity, using only observable quantities. Heisenberg started, therefore, with the spectral lines themselves, not an atomic model, and introduced a transition “amplitude” A_{if} , depending on an initial state i and a final state f , such that the line intensity would be given by the square of A_{if} . That is analogous to the fact that light intensity in Maxwell’s optical theory is given by the square of the field intensity. (Actually, A_{if} is a complex number, involving the square root of -1 , so in

quantum mechanics we use the absolute square, which is a positive real number.)

In calculating the square to produce the light intensities, Heisenberg found it necessary to multiply amplitudes together, and he discovered that they did not behave like ordinary numbers, in that they failed to commute, meaning that in multiplying two different A ’s the result depended on the order in which they were multiplied. Heisenberg was working in Göttingen under the direction of Max Born, and when he communicated his new result, Born realized that the mathematics involving arrays of numbers such as A_{if} was a well-known subject known as matrix algebra. Born, together with his student Pascual Jordan (1902–1980) and Heisenberg, then worked out a complete theory of atoms and their transitions, known as matrix mechanics. Born also realized that the matrix A_{if} was a probability amplitude, whose absolute square was a transition probability. This meant that the law for combining probabilities in quantum mechanics was entirely different from that of classical probability theory.

Heisenberg was only twenty-four years old when he made his major discovery. The son of a professor of classics at the University of Munich, he received his Ph.D. under Sommerfeld at Munich in 1923, after which he went to work with Born and later with Bohr. He had an illustrious career, not unmarked by controversy. The author of wave mechanics, Erwin Schrödinger, on the other hand, was already in 1926 an established professor at the University of Zurich, holder of a chair once held by Einstein, and an expert on thermodynamics and statistical mechanics. He was born in Vienna to a wealthy and cultured family and received his Ph.D. at the University of Vienna in 1910.

Schrödinger’s theory was based on an idea that the French physicist Louis de Broglie (1875–1960) put forward in his Ph.D. thesis at the University of Paris in 1924. Einstein had advanced as further evidence of the particle character of the photon that it had not only an energy $h\nu$, but also a momentum $p = h\nu/c$. The American experimentalist Arthur Compton (1892–1962) showed in 1923 that X-rays striking electrons recoiled as if struck by particles of that momentum. Photons thus have wavelength $\lambda = c/\nu = h/p$. De Broglie conjectured that all particles have wave properties, their wavelengths being given by the same formula as photons, with p being given by the usual particle expressions ($p = mv$, nonrelativistically, or $p = mv\beta$ in relativity, with $\beta = (1 - v^2/c^2)^{-1/2}$). C. J. Davidson and L. H. Germer in America and G. P. Thomson in England in 1927 showed the existence of electron waves in experiments. An important application is the electron microscope.

Schrödinger’s theory merged the particle and wave aspects of electrons, stressing the wave property by introducing a “wave function,” often denoted by the Greek letter psi (ψ), which is a function of space and time and obeys a differential equation called Schrödinger’s equation. Psi has the property that its absolute square at a certain time and place represents the probability per unit volume of finding the electron there at that time. The stationary atomic states of Bohr are those whose probability density is independent of time; the electron in such

a state is spread out in a wavelike manner, and does not follow an orbit. The real and imaginary parts of the one-particle wave function are separately visualizable, but not for n particles, as it exists in a $3n$ -dimensional space.

Although the pictures of Heisenberg and Schrödinger are totally different, Schrödinger (and others) proved that their experimental consequences were identical. In 1926 the English physicist Paul Dirac showed that both pictures could be obtained from a more general version of quantum mechanics, called transformation theory, based on a generalization of classical mechanics. When he did this work, the basis of his doctoral thesis in 1926, he was the same age as Heisenberg. Dirac was born in Bristol, the son of an English mother and a Swiss father. The latter taught French language in the Merchant Venturers' School, where Dirac received his early education, going on to earn his Ph.D. at Cambridge. The influence of Dirac's treatise *The Principles of Quantum Mechanics*, published in 1930, has been compared by Helge Kragh to that of Newton's *Principia Mathematica*.

Uncertainty, Exclusion Principle, Spin, and Statistics

One of the striking consequences of the quantum theory is the noncommutation of pairs of "operators" representing physical quantities, such as position and momentum (whether regarded as matrices, derivatives acting upon the psi-function or, as Dirac would put it, abstract algebraic quantities). If p and q are two such operators, their commutation relations read: $p q - q p = \hbar/2\pi i$, where i is the square root of -1 . From this condition Heisenberg proved that q and p cannot be simultaneously measured with arbitrary accuracy, but that each must have an error, the product of the errors exceeding $\hbar/2\pi$. Since an exact knowledge of the initial conditions is necessary in order to make predictions of the future behavior of the system in question, and since such exactness is in principle impossible, physics is no longer a deterministic science. Even in classical physics, exact knowledge is not usually possible, but the important difference is that quantum mechanics forbids exactness "in principle." Heisenberg's uncertainty relations and other "acausal" predictions of quantum mechanics have given rise to an enormous amount of philosophical debate, and Einstein and other prominent older physicists never accepted the so-called Copenhagen interpretation, developed by the school of Bohr and Heisenberg. Bohr's principle of complementarity states that the world (or the part being studied) reveals itself to experimental probing in many different guises, but no one of these pictures is complete. Only the assembly of all possible pictures can reveal the truth.

One of the great aims of the Bohr-Sommerfeld quantum theory was to explain the periodic table of the chemical elements in terms of atomic structure, especially the periods 2, 8, 18, 32, and so on, having the general form $2n^2$, where n is an integer. Bohr and others made great progress in this direction, based on the quantum numbers of the allowed stationary states, except for the "2" in the formula. Wolfgang Pauli (1900–1958), who had worked with Born and Bohr and was studying the classification of atomic states in the presence of a strong magnetic field, suggested in 1925 that the electron

must possess a new nonclassical property, or quantum number, that could take on two values. With this assumption he could describe the atomic structures in terms of shells of electrons by requiring that no two electrons in the atom could have identical quantum numbers. This became known as Pauli's "exclusion principle."

A short time after this, two young Dutch physicists, Samuel Goudsmit and George Uhlenbeck, found Pauli's new property in the form of spin angular momentum. This is the analog for an elementary particle of the rotation of the earth on its axis as it revolves around the sun, except that elementary particles are pointlike and there is no axis. However, they do possess a property that behaves as and combines with orbital angular momentum and that can take on values of the form $s(\hbar/2\pi)$, where s can be zero, integer, or half-integer. That was a totally unexpected development, especially the half-integer quantum numbers. The electron is one of several elementary particles that has $1/2$ unit of spin, while the photon has spin of one unit.

The subject of quantum statistics, as opposed to classical statistical mechanics, is an important field. (Recall that \hbar entered physics through Planck's analysis of the statistics of radiation oscillators.) It is found that identical stable elementary particles of half-integer spin (electron, protons) form shells, obey the exclusion principle, and follow a kind of statistics called Fermi-Dirac, worked out by Dirac and the Italian-American physicist Enrico Fermi (1901–1954). Other Fermi-Dirac systems are the conduction electrons in a metal and the neutrons in a neutron star. On the other hand, identical elementary particles of integer spin, such as photons of the same frequency, tend to occupy the same state when possible, and obey Bose-Einstein statistics, worked out by the Indian physicist Satyendranath Bose (1894–1974) and by Einstein. This results in phenomena that characterize lasers, superfluid liquid helium at low temperature, and other Bose-Einstein condensates that have been studied recently.

Relativistic Quantum Theory and Antimatter

The effects of relativity are large when the speed of a particle approaches that of light or, equivalently, when its energy is an appreciable fraction of its rest energy mc^2 . This occurs in atomic physics only in the inner shells of heavier elements and plays a relatively minor role even in the physics of atomic nuclei. However, in treating such problems as the scattering of X-rays and gamma rays (the Compton effect), relativity and quantum theory are both important. In 1928 Dirac used his transformation theory to deduce for the electron a relativistic analog of the Schrödinger equation with remarkable properties. He found that it required four associated wave functions, where Schrödinger used only one. Dirac's equation automatically endowed the electron with its observed spin of $1/2$ ($\hbar/2\pi$), and gave it its observed magnetic moment and the relativistic fine structure of spectral lines. That accounted for one doubling of the number of wave functions. The second doubling resulted from the formalism of relativity and was very troubling, as it allowed electrons to have negative energy, which in relativity implies meaningless negative mass. After several years of pondering the problem, Dirac suggested an interpretation

of the theory that predicted the existence of a positive electron, capable of annihilating with a negative electron, the result being gamma rays, an example of the transmutation of mass into energy. A year later, in 1932, the positive electron (anti-electron or positron) was found in the cosmic rays and then was produced in the laboratory. All particles have been found to have antiparticles (some are their own antiparticles) and so there exists a world of antimatter.

Quantum Field Theory and Renormalization

Although the quantum theory began with the study of radiation, it took more than two decades before the electromagnetic field itself was quantized. The results obtained before 1928 used semiclassical approaches such as Bohr's correspondence principle. Dirac first made a fully quantum theory of electrons interacting with photons in 1927. Heisenberg, Pauli, and later Fermi, extended the theory, but although it produced valuable results not otherwise obtainable, it was found to be mathematically unsound at very high energy, and predicted infinite results for the obviously finite charge and mass of the electron. The problem was solved only in the late 1940s by the renormalization theories of the American theorists Richard Feynman, Julian Schwinger, Freeman Dyson, and the Japanese theorist Sin-itiro Tomonaga. Elementary particle physics in the twenty-first century is dominated by a so-called Standard Model, which is based entirely on the use of renormalized quantum fields.

See also *Physics; Relativity; Science*.

BIBLIOGRAPHY

- Bell, J. S. *Speakable and Unsayable in Quantum Mechanics: Collected Papers on Quantum Philosophy*. 2nd ed. Cambridge, U.K., and New York: Cambridge University Press, 1993. On hidden variables, the measurement problem, and so on.
- Cassidy, David C. *Uncertainty: The Life and Science of Werner Heisenberg*. New York: W. H. Freeman, 1991.
- Cushing, James T. *Quantum Mechanics: Historical Contingency and the Copenhagen Hegemony*. Chicago: University of Chicago Press, 1994.
- Feynman, Richard P., Robert P. Leighton, and Matthew Sands. *The Feynman Lectures on Physics*. Vol. 3. Reading, Mass.: Addison-Wesley, 1965.
- Fine, Arthur. *The Shaky Game: Einstein, Realism, and the Quantum Theory*. Chicago: University of Chicago Press, 1986.
- Heilbron, J. L. *The Dilemmas of an Upright Man, Max Planck as Spokesman for German Science*. Berkeley: University of California Press, 1986.
- Jammer, Max. *The Conceptual Development of Quantum Mechanics*. New York: McGraw-Hill, 1966.
- Kragh, Helge. *Dirac: A Scientific Biography*. Cambridge, U.K., and New York: Cambridge University Press, 1990.
- . *Quantum Generations, A History of Physics in the Twentieth Century*. Princeton, N.J.: Princeton University Press, 1999.
- Kuhn, Thomas S. *Black-Body Theory and the Quantum Discontinuity, 1894–1912*. Oxford: Oxford University Press, 1978. Reprint. Chicago: University of Chicago Press, with a new afterword. Kuhn's view that Planck did not introduce a quantum discontinuity until 1911 is controversial.

- Mehra, Jagdish, and Helmut Rechenberg. *The Historical Development of Quantum Theory*. 6 vols. New York: Springer-Verlag, 1982–2001. The most complete history available.
- Moore, Walter. *Schrödinger: Life and Thought*. Cambridge, U.K., and New York: Cambridge University Press, 1989.
- Nobel Lectures in Physics*. Vol. 2: 1922–1941. New York: Elsevier, 1965.
- Pais, Abraham. *Niels Bohr's Times: In Physics, Philosophy, and Polity*. Oxford: Clarendon 1991.
- . "Subtle Is the Lord—": *The Science and the Life of Albert Einstein*. Oxford, U.K., and New York: Oxford University Press, 1982.
- Schweber, Silvan S. *QED and the Men Who Made It: Dyson, Feynman, Schwinger, and Tomonaga*. Princeton, N.J.: Princeton University Press, 1994.
- van der Waerden, B. L., ed. *Sources of Quantum Mechanics*. Amsterdam: North-Holland Publishing, 1967. Reprint. New York: Dover Publications, 1968.
- Wheaton, Bruce R. *The Tiger and the Shark: Empirical Roots of Wave-Particle Dualism*. Cambridge, U.K., and New York: Cambridge University Press, 1983.

Laurie M. Brown

QUEER THEORY. Since the early 1990s, the term *queer* has been strategically taken up to signify a wide-ranging and unmethodical resistance to normative models of sex, gender, and sexuality. Although this use of queer marks a process of resignification as new meanings and values are associated with what was once a term of homophobic abuse, there is always an important sense in which queer maintains, even in changed illocutionary circumstances, its original charge of shame. Despite such a short history, the accelerated rise of queer as a critical term demonstrates the significant impact it has had on understandings of the cultural formations of gendered and sexual identities and practices, both in activist and academic circles.

The term *queer* is necessarily indeterminate, taking on different—and sometimes contradictory—meanings in different articulations. Sometimes queer is synonymous with *lesbian* and *gay*, for which it becomes a convenient shorthand. At other times, it refers to a generational or even fashion-led distinction between old-style lesbians and gays and new-style sexual outlaws. Yet again, it can signify a coalition of nonnormative sexual identities—most often conceptually rather than materially realized—which might include lesbian, gay, bisexual, and transgender people. In other deployments, queer denotes not an identity as such but the taking of a critical distance from the identity-based categories of modern sexuality—in particular a distance from the identity politics central to traditional understandings of the lesbian and gay communities: “instead of theorizing queer in terms of its opposition to identity politics, it is more accurate to represent it as ceaselessly interrogating both the preconditions of identity and its effects” (Jagose, pp. 131–132). This last sense is taken up by queer studies, which uses the term to draw attention to various incoherencies in the supposedly stable and causal relations between sex, gender, and sexual desire.

Origins of Queer Theory

Perhaps the most prominent—certainly the most respectable-sounding—use of queer can be seen in its frequent coupling with theory. Teresa de Lauretis, an academic and critical theorist, has been credited with coining the phrase *queer theory*. In 1991 she edited a special issue of the feminist cultural studies journal *differences* entitled “Queer Theory: Lesbian and Gay Sexualities.” In explaining her use of the term, de Lauretis indicates that she means it to indicate at least three interrelated critical projects: a refusal of heterosexuality as the benchmark for all sexual formations; an attentiveness to gender capable of interrogating the frequent assumption that lesbian and gay studies is a single, homogeneous object; and an insistence on the multiple ways in which race crucially shapes sexual subjectivities. De Lauretis suggests that the threefold critique she imagines might be drawn together under the rubric of queer theory makes it possible “to recast or reinvent the terms of our sexualities, to construct another discursive horizon, another way of thinking the sexual” (de Lauretis, p. iv).

It is important to remember the speculative framing of de Lauretis’s coining of the term, since the rapid institutionalization of queer theory has tended to conceal the fact that—insofar as it espouses no systematic set of principles, has no foundational logic or consistent character—queer theory is not really a theory at all. While it might seem paradoxical in a dictionary entry to insist on this resistance to definition, queer theory’s refusal to specify itself has been widely recognized as one of its tactical strengths. Resisting defining itself in relation to any specific material content, queer theory might be thought of less as a thing than a definitional field or network, “a zone of possibilities in which the embodiment of the subject might be experienced otherwise” (Edelman, p. 114). Since queer’s opposition to the normative is its one consistent characteristic, it has the potential to invent itself endlessly, reformulating whatever knowledges currently constitute prescribed understandings of sexuality.

It is not possible to trace a chronological history of queer theory without doing violence to its multiple origins and influences. Single, linearly organized narratives have difficulty capturing a sense of the sometimes inchoate energies of the various orders of political and scholarly work that made the rise of queer theory possible, necessary, perhaps even inevitable. The risk of telling the story of queer theory as if it were the latest critical turn in sexuality studies is that vital contributing forces to queer theory are written off as superceded, anachronistic, or irrelevant. It remains important to narrate the emergence of queer theory in terms of various critical and cultural contexts, including feminism, radical movements of color, the lesbian and gay movements, various sexual subcultural practices such as sadomasochism and butch-femme stylings, post-structuralism, postcolonialism, and AIDS activism.

AIDS and Queer Theory

For instance, strategies devised in relation to AIDS activism in the 1980s and 1990s reformulated many axiomatic understandings of sexuality in ways that were significant for the parallel development of queer theory. In the face of homophobic governmental responses to the health crisis (particularly in

North America), activists worked to contest dominant representations of HIV/AIDS as a gay disease and to develop and deliver safer-sex education programs to a dispersed population with no common sexual identity. In the context of AIDS activism, many commonsense understandings of knowledge, power, identity, and community were radically reworked in ways that coincided with queer theory’s denaturalization of sexuality. Advances in safer-sex education initiated a shift from thinking about risk populations to risk practices, reconceiving sexuality less in terms of sexual identities than sexual acts and allowing for meaningful discrepancies between sexual being and sexual doing. Likewise the ad hoc, direct-action, and decentralized character of much AIDS activism was marked by a coalitional rather than a separatist politics that enabled a consideration of identity in terms of affinity rather than essence. So, too, the urgent negotiations over epidemiology, public health, and scientific research implicit in contesting dominant representations of AIDS demonstrated that sexuality is an important nodal point in networks of power and its resistance.

Limits of Identity

Another way in which political activism has historically informed queer theory can be seen in the influential critiques of the identity politics that customarily underpin traditional leftist social movements. In this respect, the queer critique of lesbian and gay identity politics takes place in a wider frame that also includes, for example, postcolonial problematizations of “race” and problematizations of “gender” as feminism’s foundational category. One of the most substantial criticisms leveled at lesbian and gay politics relates to its insistence on sexual orientation as the most important index of personal identity and its consequent inability to register sexuality’s contextualization within a network of power relations productive of manifold and conflicted identity effects. Radical men and women of color, for example, pointed out that the identity politics model of the lesbian and gay movements ensured that any analysis of race and ethnicity in relation to sexuality would remain a secondary consideration. Exposing covert and overt racism in the mainstream lesbian and gay communities, they argued for the importance of thinking about the inextricable ways in which race inflects sexuality and vice versa, a perspective that continues to both inform and challenge queer theorizing in important ways.

Insofar as it assumed that sexuality was determined principally or solely by the gender of one’s sexual object choice, lesbian and gay identitarian politics naturalized the dominant system of sexual classification and its unexamined reliance on the reified categories of heterosexuality and homosexuality. This model was challenged in different ways from the perspective of various nonnormative sexual identities or practices that had been further pathologized by the legitimation of lesbian and gay paradigms. In arguing for the validity and significance of various marginalized sexual identities and practices, articulated around such things as bisexuality, transvestism, transsexuality, pornography, and sadomasochism, such critiques pushed for recognition of what Gayle Rubin describes as “a pluralistic sexual ethics” organized around “a concept of benign sexual variation” (Rubin, p. 15).

From the perspectives of racially marked and sexually non-normative subjects, it can be seen that the very processes of stabilization, consolidation, and mass recognition that enabled lesbians and gays to represent themselves as a relatively coherent and unified community generated disaffection among other populations newly disenfranchised from the struggle for sexual rights. The limitations or even failures of identity much debated across the 1980s largely hinge on the inevitable inadequacy of any single descriptive rubric to articulate the complex affective structures that constitute identity. Frequently enough, the initial demand for recognition of marginalized or plural identity categories was rearticulated as dissatisfaction with the categories of identification themselves. This questioning of the efficacy of identity categories for political intervention was a major inspiration for queer theory.

The self-evidence of identity has also been profoundly questioned in poststructural thought with its decentering of the Cartesian subject, the rational and autonomous individual, its emphasis on the plurality of interpretation, and its insistence that there is no outside to the discursive structures that produce cultural meaning. Destabilizing the commonsense assumption that identity is a natural and self-evident characteristic of any human subject, poststructuralism is a significant intellectual context for queer theory's anti-identitarian critiques.

Michel Foucault

Given his interest in the history of sexuality and his radical denaturalization of dominant understandings of sexual identity, Michel Foucault is a key poststructuralist influence on the development of queer theory. Foucault's understanding that sexuality is a discursive production, rather than an essential human attribute, is part of his larger conceptualization of power as less repressive and negative than productive and generative. That is, rather than characterize power's operation as suppressing our free sexual expression—this misrecognition of power's operation is so widespread that Foucault refers to it as “the repressive hypothesis” (p. 15)—Foucault instead argues that power operates through discourse to produce sexuality as a hidden truth that must be rooted out and specified in all its manifestations:

The society that emerged in the nineteenth century—bourgeois, capitalist, or industrial society, call it what you will—did not confront sex with a fundamental refusal of recognition. On the contrary, it put into operation an entire machinery for producing true discourses concerning it. Not only did it speak of sex and compel everyone to do so; it also set out to formulate the uniform truth of sex. (p. 69)

Identifying this conflation of sex and truth as key to the modern invention of sexuality, Foucault refuses the idea that sexuality can be authoritatively defined, focusing instead on the discursive production of sexuality within regimes of power and knowledge: what is said about it, what relations it generates, how it is experienced, what function it has historically played.

In arguing, first, that sexuality is not an essentially personal attribute but an available cultural category and, second, that it is the effect of power rather than its preexisting object, Foucault's work has been key to the development of queer theory, particularly its capacity to understand itself as a mode of analysis without a defined object.

Gayle Rubin

Foucault's constructivist understanding that sexuality is an effect of the discursive operations of power underwrites Gayle Rubin's important essay “Thinking Sex.” Often identified as one of queer theory's foundational texts, Rubin's essay follows Foucault's rejection of libidinal or biological explanations of sexuality in order to think about the way in which sexual identities and behaviors are hierarchically organized through systems of sexual stratification. Calling for the recognition of “the political dimensions of erotic life,” Rubin demonstrates the way in which certain forms of sexual expression are valorized over others, licensing the persecution of those who fall outside the narrow frame of what constitutes sexual legitimacy (p. 35). As part of her project of specifying the regulation and stratification of sexuality, Rubin argues against the feminist assumption that “sexuality is a derivation of gender” (p. 33). While she acknowledges that gender relations have been an important context for the articulation of the sexual system, she argues that sex and gender are not synonymous, and hence the rubric of gender cannot account for sexuality in its entirety. Rubin's critical interest in sexual variation that exceeds any hetero-homo differentiation demands “an autonomous theory and politics specific to sexuality” (p. 34).

Eve Kosofsky Sedgwick

Rubin's call for an analytic distinction to be made between gender and sexuality proved productive for Eve Kosofsky Sedgwick, whose groundbreaking *Epistemology of the Closet* combined feminist with antihomophobic methodologies: “In twentieth-century Western culture gender and sexuality represent two analytic axes that may productively be imagined as being as distinct from one another as, say, gender and class, or class and race. Distinct, that is to say, no more than minimally, but nonetheless usefully” (1990, p. 30).

Arguing for the absolute centrality of sexuality to understandings of modern culture—“an understanding of virtually any aspect of modern Western culture must be, not merely incomplete, but damaged in its central substance to the degree that it does not incorporate a critical analysis of modern homo/heterosexual definition” (1990, p. 1)—Sedgwick demonstrates that the homo-hetero distinction at the heart of modern sexual definition is fundamentally incoherent for two reasons. On the one hand, there is the persistent contradiction inherent in representing homosexuality as the property of a distinct minority population (Sedgwick refers to this as “a minoritizing view”) and a sexual desire that potentially marks everyone, including ostensibly heterosexual subjects (Sedgwick refers to this as “a universalizing view”). On the other hand, there is the abiding contradiction in thinking about the gendering of homosexual desire in both transitive and separatist terms, where a transitive understanding locates that desire as originating in

some threshold space between gender categories while a separatist understanding takes it as the purest expression of either masculinity or femininity.

Just as Foucault understands sexuality not as “a kind of natural given” but “a historical construct” (p. 105), so too Sedgwick understands that the critical task at hand is not to decide which of these contradictory modelings accurately describes homosexuality but to analyze instead the knowledge effects such contradiction puts into circulation. Assuming that “the most potent effects of modern homo/hetero sexual definition tend to spring precisely from the inexplicitness or denial of the gaps *between* long-coexisting minoritizing and universalizing, or gender-transitive and gender-intransitive, understandings of same-sex relations” (1990, p. 47), Sedgwick’s attention to the irresolvable inconsistencies of available models for thinking about homosexuality enables her to denaturalize current complacencies about what it is “to render less destructively presumable ‘homosexuality as we know it today’” (1990, pp. 47–48).

As part of her denaturalizing project, Sedgwick points up the historically circumstantial and conceptually unnuanced way in which modern definitions of sexuality depend fairly exclusively on the gender of object choice, assuming that one’s gender and the gender of those one is sexually attracted to mark the most significant facet of human sexuality. Noting that “sexuality extends along so many dimensions that aren’t well described in terms of the gender of object-choice at all” (1990, p. 35), Sedgwick argues for a closer attention to “the multiple, unstable ways in which people may be like or different from each other” (1990, p. 23). Rather than assume the monolithic differentiation effected by the homo/hetero distinction, Sedgwick focuses on the myriad of everyday differences that distinguish between people sexually but are not considered epistemologically significant:

For some people, the preference for a certain sexual object, act, role, zone, or scenario is so immemorial and durable that it can only be experienced as innate; for others, it appears to come late or to feel aleatory or discretionary.

For some people, the possibility of bad sex is aversive enough that their lives are strongly marked by its avoidance; for others, it isn’t.

For some people, sexuality provides a needed space of heightened discovery and cognitive hyperstimulation. For others, sexuality provides a needed space of routinized habituation and cognitive hiatus. (1990, p. 25)

Sedgwick’s insistence on the incoherence of current definitions of sexuality coupled with her fine-grained description of sexual variations that cannot be subsumed by the major axes of cultural differentiation (such as sex, class, and race) have been taken up in queer theoretical projects that work against the normalizing discourses of heterosexuality and homosexuality not only to consider sexual formations that fall outside this binary but also to emphasize the heterogeneous, unsystematizable elements of particular sex-gender identities.

Judith Butler

The theorist most prominently associated with analyzing the normative effects of dominant understandings of sex and gender is Judith Butler. Drawing explicitly on Foucault but with an attention to the workings of gender almost entirely absent from his work, Butler argues that gender, like sexuality, is not an essential truth derived from the body’s materiality but rather a regulatory fiction: “Gender is the repeated stylization of the body, a set of repeated acts within a highly rigid regulatory frame that congeal over time to produce the appearance of substance, of a natural sort of being” (1990, p. 33). Focusing on the discursive production of gender, Butler analyzes what cultural work is secured by the representation of gender as the natural expression of the sexed body, arguing ultimately that the status of heterosexuality as the default setting for sexuality generally depends on the intelligibility of gender:

The notion that there might a “truth” of sex, as Foucault ironically terms it, is produced precisely through the regulatory practices that generate coherent identities through the matrix of coherent gender norms. The heterosexualization of desire requires and institutes the production of discrete and asymmetrical oppositions between “feminine” and “masculine,” where these are understood as expressive attributes of “male” and “female.” (1990, p. 17)

As a performative effect of reiterative acts, the discursive production of gender naturalizes heterosexuality, insofar as heterosexuality is the proper outcome of normative relations between sex, gender, and sexual desire.

Following Foucault’s understanding that there is no utopian outside to power and consequently that resistance is possible only within the same discursive circuits through which power operates, Butler takes up the possibility of gender performativity as a strategy of resistance, citing as examples the parodic repetition of gender norms evident in the “cultural practices of drag, cross-dressing, and the sexual stylization of butch/femme identities” (1990, p. 137). For Butler, such practices contest the current conditions of cultural intelligibility for sexed-gendered subjects through a demonstration of “the utterly constructed status of the so-called heterosexual original” (1990, p. 31). In a later book, *Bodies That Matter*, Butler is careful to emphasize that performativity is not synonymous with performance. Far from being a playful or voluntarist enterprise, gender performativity is a reiterative process that constitutes the subject as a subject. “In this respect, performativity is the precondition of the subject” (Jagose, p. 86). Drawing attention to “new possibilities for gender that contest the rigid codes of hierarchical binarisms” (1990, p. 145), Butler’s work has been taken up, both enthusiastically and critically, in queer theoretical investigations of non-heteronormative subject positions.

Queer Theory and Difference

Although queer theory is prominently organized around sexuality, its critical pursuit of nonnormativity means that it is potentially attentive to any order of difference that participates

in the regimes of sexual normalization and deviance. Rather than separating sexuality from other axes of social difference—race, ethnicity, class, gender, nationality, and so on—queer theory has increasingly structured inquiry into the ways in which various categories of difference inflect and transform each other, an approach that considers “all the disparate factors comprised in the registration of various social identities and in their adjudication against the standard of social normativity” (Harper, p. 24). A vital strand of this discussion is concerned with the capacity of queer theoretical models to address substantive questions of race and ethnicity in the constitution of the queer subject.

Race-based critiques and activism have long been part of the feminist and lesbian-gay contexts crucial to the evolution of queer theory, particularly in their persistent challenge to the reification of allegedly foundational identities such as women or homosexuals. Recent work on the formation of sexuality alongside race, ethnicity, nationality, citizenship, and diasporic identities challenges queer theory not only to consider the significant ways in which sexual and racial identities are inextricable but also to abandon its self-representation as “the neutral ground on which the identities, cultures, and social movements of people are ‘explained’” (Quiroga, p. 135). Reciprocally, queer theoretical models have sometimes effected significant transformations in the traditional formations of academic fields organized by the rubric of racial or ethnic identities. Noting this mutually transformative relation, Jasbir K. Puar writes: “Envisioning and expanding on queer diasporas as a political and academic intervention not only speaks directly to the gaps around sexuality in ethnic studies, Asian American studies, and forms of postcolonial studies; it also points gay and lesbian studies, queer studies, and even women’s studies . . . toward the need to disrupt the disciplinary regimes that continually reinvent bodies of theory cohered by singular, modernist subjects” (pp. 405–406).

Thinking Transgender

The suspicion that normative models of identity will never be adequate to the representational work demanded of them provides the conditions of intelligibility not only for thinking about the emergence of queer theory from the identity-based models of the feminist and lesbian-gay movements but also for understanding twenty-first century and frequent announcements of the death of queer theory, most significantly from radical transgender perspectives that cast queer as complacently partisan, committed to notions of performativity that refuse cross-gender identifications in anything other than a parodic or figurative register.

Primarily through an extended reading of Butler but with reference to de Lauretis and Sedgwick among others, Jay Prosser notes that queer theory’s foundational texts have figuratively relied on the concept of transgender—an identification across genders—in order to destabilize received understandings of sexual and gendered identities. Queer theory’s annexation of transgender for its own critical project has, Prosser notes, tended to recuperate it “as the sign of homosexuality, homosexuality’s definitive *gender style*” (p. 30). Even when queer is understood not as a synonym for homosexual-

ity but as a term that denotes the performativity, nonreferentiality, and incoherence of the dominant sex-gender system, the queer theoretical valorization of transgender works against the legitimization of the specifically transsexual subject: “What gets dropped from transgender in its queer deployment to signify subversive gender performativity is the value of the matter that often most concerns the transsexual: the *narrative* of becoming a biological man or a biological woman (as opposed to the performative of effecting one)—in brief and simple the materiality of the sexed body” (p. 32). Noting that transgender negotiates its significance in delicate relation to both “transsexuality’s investment in the materiality of sex and a queer refiguration of gender into sexuality,” Prosser suggests that queer theory pay more attention to the lived differences of the constituencies it might be expected to represent (p. 176).

Similarly calling for a sensitivity toward the material practices of queer sex, not simply their allegorical formulation, Jacob Hale references the North American leatherdyke scene in order to argue that queer theory should complicate its own, less nuanced models of sex, gender, and sexuality by studying those elaborated within specific sexual subcultures:

Here’s the lesson, in a nutshell: if, minimally, you don’t understand the personals and other sexually explicit expressions of desire in queer and transgendered sex radical/leatherqueer publications (including homegrown ones), you don’t understand the margins, the edges, of our dominant cultural expressions of sex, gender, and sexuality. . . . if you don’t understand gendered life on the edge, you don’t understand gendered life at the center. (p. 118)

While these recent debates about the relevance of queer theory to marginalized sex-gender identities and practices are sometimes represented as territorial disputes, queer theory’s reluctance to specify its proper object means that its future directions might be productively determined by its present tense omissions or paradigmatic weaknesses.

Queer Futures

In organizing itself around the resurrected vitality of queer, queer theory has staked its paradoxical claim on something that is at once all future and no future. For every scholar who represents the critical impulse of queer as future-directed and open-ended, there is another who represents it as washed up and already exhausted: “In the short shelf-life American marketplace of images, maybe the queer moment, if it’s here today, will for that very reason be gone tomorrow”; “Queer may soon lose all affectivity as a word, a marker, or a threat (it may already have done so)”; “Queer politics may, by now, have outlived its political usefulness” (Sedgwick, 1993, p. xii; Halberstam, p. 256; Halperin, p. 112). This sense of queer theory’s built-in obsolescence might be read as evidence less of queer theory’s inevitable decline than its transitory and always transformational potential. Indeed suspicion about the ongoing usefulness of queer theory is a better measure of its viability than widespread institutionalization and normalization. The most valuable capacity of queer theory, after all, is not to

prove that it has been right all along but to hold open non-referentiality as a political strategy for thinking about a future that will be nonterritorial, demotic, and provisional but that remains for the present unimaginable.

See also *Gay Studies; Gender; Sexuality: Sexual Orientation; Structuralism and Poststructuralism*.

BIBLIOGRAPHY

- Berlant, Lauren, and Michael Warner. "What Does Queer Theory Teach Us about X?" *PMLA: Publications of the Modern Language Association of America* 110, no. 3 (May 1995): 343–349.
- Butler, Judith. *Bodies That Matter: On the Discursive Limits of "Sex."* New York: Routledge, 1993.
- . *Gender Trouble: Feminism and the Subversion of Identity*. New York: Routledge, 1990.
- De Lauretis, Teresa. "Queer Theory: Lesbian and Gay Sexualities." *differences: A Journal of Feminist Cultural Studies* 3, no. 3 (1991): iii–xviii.
- Edelman, Lee. *Homographesis: Essays in Gay Literary and Cultural Theory*. New York: Routledge, 1994.
- Foucault, Michel. *The History of Sexuality*. Vol. 1, *An Introduction*. Translated by Robert Hurley. London: Penguin, 1990.
- Halberstam, Judith. "Who's Afraid of Queer Theory?" In *Class Issues*, edited by Amitava Kumar, 256–275. New York: New York University Press, 1997.
- Hale, Jacob. "Are Lesbians Women?" *Hypatia* 11, no. 2 (spring 1996): 94–121.
- Halperin, David M. *Saint Foucault: Towards a Gay Hagiography*. New York: Oxford University Press, 1995.
- Harper, Phillip Brian. "Gay Male Identities, Personal Privacy, and Relations of Public Exchange: Notes on Directions for Queer Culture." *Social Text* 52–53 (fall/winter 1997): 5–29.
- Jagose, Annamarie. *Queer Theory: An Introduction*. New York: New York University Press, 1996.
- Prosser, Jay. *Second Skins: The Body Narratives of Transsexuality*. New York: Columbia University Press, 1998.
- Puar, J. K. "Transnational Sexualities: South Asian (Trans)national(alism)s and Queer Diasporas." In *Q & A: Queer in Asian America*, edited by David L. Eng and Alice Y. Hom, 405–422. Philadelphia: Temple University Press, 1998.
- Quiroga, Jose. "New Directions in Multiethnic, Racial, and Global Queer Studies." *GLQ: A Journal of Lesbian and Gay Studies* 10 (2003): 123–135.
- Rubin, Gayle S. "Thinking Sex." In *The Lesbian and Gay Studies Reader*, edited by Henry Abelove, Michele Aina Barale, and David M. Halperin, 3–44. New York: Routledge, 1993.
- Sedgwick, Eve Kosofsky. *Epistemology of the Closet*. Berkeley: University of California, 1990.
- . *Tendencies*. Durham, N.C.: Duke University Press, 1993.

Annamarie Jagose



R

RACE AND RACISM.

This entry includes four subentries:

Overview

Asia

Europe

Reception of Asians to the United States

OVERVIEW

The interrelated terms of race and racism should be examined separately before their connection is explored. This entry defines both terms and explores their meanings and new approaches to these concepts in the twenty-first century.

Defining Race

Race can be understood as a concept that signifies and symbolizes sociopolitical conflicts and interests in reference to different types of human bodies. Although the concept of race appeals to biologically based human characteristics (so-called phenotypes), selection of these particular human features for purposes of racial signification is always and necessarily a social and historical process. There is no biological basis for distinguishing human groups along the lines of “race,” and the categories employed to differentiate among these groups reveal themselves, upon serious examination, to be imprecise. Although they refer to corporeal characteristics like skin color, hair texture, and eye shape, these categories acquired their significance for sociohistorical reasons, not because they have any “natural” importance. For this reason the boundaries of racially defined groups are both uncertain and subject to change. Indeed whole groups can acquire or lose their racialized character as historical and social circumstances shift.

Dilemmas of Meaning: The Concept of Race

Few ideas have been so fraught with controversy, or have provided as much occasion for discussion and debate, as that of race. Race is a highly contradictory notion. Although deeply intertwined with the development of the modern world and intimately involved with the rise of Enlightenment-based rationalism, the idea of race also preserves fundamentally pre-modern and irrational characteristics. It is frequently dismissed today as an illusion (“There is no such thing as race”; “There is only one race: the human race”; etc.). Yet race continues to demarcate and stratify the world’s peoples in striking ways. Indeed, at the same time as it is dismissed, race is also taken for granted. While on the one hand constituting a fundamental aspect of human identity, something recognized across the

world, on the other hand race identity has very different meanings in particular societal and cultural settings, such that a person who is identified as belonging to one racial category (“white,” for example) in country A, may not be afforded that same racial status in country B.

From a logical point of view this situation is at the least very peculiar, since the wide variations just discussed do not in general undercut the near-universal acknowledgment of racial identity, racial hierarchy, and racially stratified status, such that lighter skin is perceived as “better” or “more attractive” than darker, for example. So how can these problems be explained? Is race an illusion or an objective reality? Is racial identity (or racial difference) a natural or sociohistorical attribute? Is race an atavistic holdover from an earlier epoch of conquest, colonialism, and African slavery—which were all organized along racial lines—or is it a more-or-less permanent means of organizing inequality and domination on both a local and global scale? What makes the racialized body so indispensable as a marker of socioeconomic difference? And why does race continue to operate so well at the crossroads of identity and social structure? After all, despite contemporary reluctance to recognize the continuing significance of race, race still operates as a social fact (in the Durkheimian sense of that term). It links the micro-social dimension of human existence (at which are located the personal, the experiential, the direct interactions by which we know ourselves and each other); and the macro-social dimension of human existence (at which institutions, markets, nation-states, and social stratification operate).

Defining Racism

In the wake of the civil rights movements of the 1950s and 1960s, racism has come to be seen as having three dimensions. *Prejudice* refers to unfounded and usually negative *beliefs and attitudes* about racially defined groups and individuals: stereotypes, ethnocentrism, xenophobia, and the like. *Discrimination* directs attention toward preferential or detrimental actions taken toward racially defined groups and individuals because of their race. Finally *institutional* (or *structural*) *racism* refers to the endemic character of racial injustice and inequality. As a social structure racism is understood to be a product of the systematic allocation of resources, privileges, and rights differentially by race: it is distributed across the whole range of social institutions both historically and in the present, and it does not require intention or agency to be perpetuated.

Dilemmas of Meaning: The Concept of Racism

As a world-historical phenomenon, racism is so large and so diverse that no definition can encompass all its varieties. The

term's origins are themselves quite modern: its earliest use, in the late 1930s, directed attention chiefly toward anti-Semitism. Of course, awareness of race prejudice and racial discrimination preceded that coinage.

The prejudice/discrimination/institutional racism trichotomy still effectively encompasses many aspects of the complex and varied phenomenon of racism. That synthetic view was without doubt an advance over previous conceptions, and embodied many of the hard-won understandings of the 1960s movements for racial justice and emancipation. Notably, its emphasis on the structural dimensions of racism allowed it to address the intransigence which racial injustice and inequality continued to exhibit, even after discrimination had supposedly been outlawed and bigoted expression stigmatized.

Yet, on closer examination the trichotomy also seems problematic. As Robert Miles has argued (1989), it tended to "inflate" the concept of racism to a point at which it lost precision. If the institutional component of racism is so pervasive and deeply rooted, this makes it difficult to recognize what accomplishments antiracist movements have achieved or what progress civil rights reforms concretely represent. How, under these conditions, could one validate the premises of political action aimed at racial justice and greater substantive social equality? If institutional racism is ubiquitous, it becomes difficult to affirm the existence of any democracy at all where race is concerned. The result is a leveling critique, which denies any distinction between the Jim Crow era (or even the whole *longue durée* of racism beginning with European conquest and leading through racial slavery, imperialism, "Jim Crow," apartheid, and the like), and the present. Similarly, if the prejudice component of racism is so deeply inbred, it becomes difficult to account for the apparent racial hybridity and cultural interpenetration that characterizes civil society both in the United States and across the globe; this is evidenced not only by the shaping of popular mores, values, language, and style, but also by the social practices of the millions of people, white and black (and neither white nor black) who occupy interstitial and ambiguous racial positions. The result of the "inflation" of the concept of racism is thus a deep pessimism about any efforts to overcome racial barriers: in the workplace, the community, or any other sphere of lived experience. An overly comprehensive view of racism, then, potentially serves as a self-fulfilling prophecy.

Yet the alternative view, which surfaced with a vengeance in the 1970s and urged a return to the conception of racism held before the movement's discovery of institutional racism, is equally inadequate. This is the neoconservative project (see, for example, Gerson 1997), which deliberately restricts its attention to injury done to the individual as opposed to the group, and to advocacy of a "color-blind" racial policy. Such an approach almost entirely neglects the continuing organization of social inequality and oppression along racial lines. It denies the continuity of racism in cultural and political life, particularly in the United States, but also in other societies in "cognate" forms such as racial "differentialism." Worse yet, such views tend to rationalize racial injustice as a supposedly natural outcome of group attributes in competition or of intractable national or cultural differences. Neoconservatism and parallel racial reactions have

thus rearticulated the demands for equality and justice made by antiracist and anticolonialist movements in a conservative discourse of individualism, competition, and laissez-faire. It is this "new right" discourse which is hegemonic in the early 2000s; in these terms racism is rendered invisible and marginalized. It is treated as largely an artifact of the past.

In the post-civil rights and postcolonial era the world has undergone a substantial modification of what were previously far more rigid lines of exclusion and segregation. The late twentieth and early twenty-first centuries have witnessed some real mobility for more favored sectors (that is, certain class-based segments) of racially defined minority groups. The entire post-World War II era also featured substantial demographic diversification as North America, Europe; other regions as well experienced new waves of immigration, notably from the global South and East. In the United States, for example, the 1965 reform of immigration laws (a civil rights measure in itself) occasioned large and continuing inflows from Asia and Latin America. In both the United States and Europe panethnic phenomena—the process by which new racial identities develop through alliance or convergence of previously distinct but socioculturally similar groups, such as Latinos/Hispanics or Asian Americans in the United States, or Muslims/Arabs/Turks in Europe—have increased throughout the global North (and elsewhere as well). This has reconfigured European and North American racial dynamics, moving them away from the former bipolar frameworks (white/black, European/ "native") and toward multipolar frameworks (multiculturalism, diversity, and the like). No longer is race a largely black-white issue in the United States; no longer is race in Europe a postcolonial confrontation between former settler and former native. Racial identity has also been problematized (at least somewhat) for whites—a fact which has its dangers but also reflects progress.

Yet at the same time, by almost every conceivable indicator researchers can bring forward, the same racial inequalities—or shall we say the same "structural racism"—that existed in the past continues in the early twenty-first century: modified here and there perhaps, but hardly eliminated and not even much reduced in scope, for example in terms of U.S. black-white disparities, or in terms of French-North African distinctions in contemporary France. This is not the place to inventory the data, but whether we look at wealth/income (in)equality, health, access to/returns to education, segregation by residence or occupation, rates of surveillance or punishment by the criminal "justice" system, or many other indicators that compare racial "life-chances," we find strikingly persistent patterns.

New Patterns

Given the thoroughgoing and persuasive empirical data available on the persistence of racial inequality, discrimination, and prejudice it is difficult to sustain claims that racism is a "thing of the past" or that racial identities and categories have become less salient at the turn of the twenty-first century than they were at the turn of the twentieth, whose problem, as W. E. B. Du Bois (1868–1963) famously proclaimed in the early twentieth century, would be that of the "color-line."

The great achievements of the movements that challenged racism in the twentieth century, and that largely overthrew

colonialism as well (a fundamentally racist system), were revealed to be partial and contradictory as the twenty-first century dawned. There is no gainsaying the transformations that have been wrought in the undoing of Jim Crow segregation in the United States or the apartheid system in South Africa, and in the restoration of some degree of self-rule in the global South and East. Yet the racial categories and racist social structures produced by centuries of white supremacism retain a great deal of force. It is more than ironic—it is a rather bitter truth—that racial rule has been strengthened in some ways by the reforms it has undergone. Racism has developed from domination to hegemony: to the extent that it incorporates its subjects it defuses their opposition. Thus in the United States, the European Union, South Africa, Brazil, and indeed in most of the world, racial repression and exclusion continue in practice while simultaneously being disavowed as doctrine (see Winant, 2001).

These racial conditions, however, are no more stable than those of the past. Injustice and inequality necessarily produce opposition. The movements of the early twenty-first century have learned the lessons of the twentieth century at least as well as the states and elites they are challenging. Once again “the wretched of the earth” assert their claims: as landless groups and workers; as women, gays, and students; as slum- and shantytown-dwellers, as prisoners and indigenous peoples. This time they have far more resources at their disposal, supporters in key positions, and indeed white allies (although far too few). All the old traditions of refusal, subversion, and racial solidarity remain available. The legacies of past cycles of resistance are never lost; they are reinterpreted, rearticulated, and put to use once again.

In the twenty-first century the task is no longer to recognize the problem of race, the problem is the color line. Rather, it is simultaneously to affirm and transcend the color line. To challenge racism is at last to be both citizen and subject.

See also *Apartheid; Discrimination; Ethnicity and Race; Multiculturalism, Africa; Prejudice.*

BIBLIOGRAPHY

- Allport, Gordon W. *The Nature of Prejudice*. Reading, Mass.: Addison-Wesley, 1979.
- Cordero-Guzmán, Héctor R., Robert C. Smith, and Ramón Grosfoguel, eds. *Migration, Transnationalization, and Race in a Changing New York*. Philadelphia: Temple University Press, 2001.
- Espiritu, Yen Le. *Asian American Panethnicity: Bridging Institutions and Identities*. Philadelphia: Temple University Press, 1992.
- Farley, Reynolds, ed. *State of the Union: America in the 1990s*. New York: Russell Sage Foundation, 1995.
- Feagin, Joe R. *Racist America: Roots, Current Realities, and Future Reparations*. New York: Routledge, 2001.
- Gerson, Mark. *The Neoconservative Vision: From the Cold War to the Culture Wars*. Lanham, Md.: Madison Books, 1997.
- Gilroy, Paul. “The End of Anti-Racism.” In *Racism*, edited by Martin Bulmer and John Solomos. New York: Oxford University Press, 1999.
- Gossett, Thomas F. *Race: The History of an Idea in America*. New York: Oxford University Press, 1997.

- Hirschfeld, Magnus. *Racism*. Translated by Eden and Cedar Paul. Port Washington, N.Y.: Kennikat Press, 1973.
- Jencks, Christopher, and Paul E. Peterson, eds. *The Urban Underclass*. Washington, D.C.: The Brookings Institution, 1991.
- Kinder, Donald R. and Lynn M. Sanders. *Divided by Color: Racial Politics and Democratic Ideals*. Chicago: University of Chicago Press, 1996.
- Mamdani, Mahmood. *Citizen and Subject: Contemporary Africa and the Legacy of Late Colonialism*. Princeton, N.J.: Princeton University Press, 1996.
- Massey, Douglas S., and Nancy A. Denton. *American Apartheid*. Cambridge, Mass.: Harvard University Press, 1993.
- Mauer, Marc. *Race to Incarcerate*. New York: New Press, 1999.
- Miles, Robert. *Racism*. London: Routledge, 1989.
- Montagu, Ashley. *Man’s Most Dangerous Myth: The Fallacy of Race*. New York: Oxford University Press, 1974.
- Noiriel, Gérard. *The French Melting Pot: Immigration, Citizenship, and National Identity*. Translated by Geoffroy de Laforcade. Minneapolis: University of Minnesota Press, 1996.
- Oliver, Melvin, and Thomas Shapiro. *Black Wealth, White Wealth: A New Perspective on Racial Inequality*. New York: Routledge, 1995.
- Olzak, Susan. *Dynamics of Ethnic Competition and Conflict*. Stanford, Calif.: Stanford University Press, 1994.
- Orfield, Gary. *The Growth of Segregation in American Schools: Changing Patterns of Separation and Poverty Since 1968*. Alexandria, Va.: National School Boards Association, 1993.
- Pettigrew, Thomas F., George M. Frederickson, and Reed Ueda. *Prejudice*. Cambridge, Mass.: Harvard University Press, 1982.
- Sowell, Thomas. *Ethnic America: A History*. New York: Basic Books, 1981.
- Taguieff, Pierre-André. *The Force of Prejudice: On Racism and Its Doubles*. Translated by Hassan Melehy. Minneapolis: University of Minnesota Press, 2001. Original French edition published in 1988.
- Ture, Kwame (Stokely Carmichael), and Charles V. Hamilton. *Black Power: The Politics of Liberation in America*. New York: Random House, 1992.
- U.S. Bureau of the Census. *Residential Segregation Detailed Tables*. Washington, D.C.: U.S. Bureau of the Census, 1994.
- Wieviorka, Michel. *The Arena of Racism*. Translated by Chris Turner. Thousand Oaks, Calif.: Sage, 1995.
- Winant, Howard. *The World Is a Ghetto: Race and Democracy after World War II*. New York: Basic Books, 2001.

Howard Winant

ASIA

To discuss race in Asia, race must first be defined. Changes in definitions of race over the centuries in the West make this difficult. The earliest uses of race in sixteenth-century Europe usually focused on differences arising from common ancestry, descent, or origin. These were perceived in kinship and lineage relationships, physiological differences, or even religious or mythical ancestors. The rise of science in the seventeenth and eighteenth centuries brought new methods for ascertaining these differences. Social Darwinism suggested that there were races that were more or less advanced. In the name of science, research pursued observational studies that sought to create taxonomies establishing the hierarchies and differences among races. This shifted again in the mid-twentieth century due to

the horrors of the Nazi Holocaust and developments in science. Although voices critical of biological definitions exist as early as the 1930s, in the 1960s and 1970s especially, scientific research undermined post-Darwinian, “scientific” notions of race. While genetics is involved in the perceived physical differences of people, research showed that many of these phenotypical differences that divide people along perceived racial lines are less significant than the greater genetic similarities and differences that suggested groupings altogether quite different from the commonly perceived racial groupings. This undermined definitions of race that presented the criteria as objective and natural. Although, for these reasons, some have argued that race no longer represents a useful analytical category, the historical consequences of these ways of viewing the world as well as the continuing efficacy of the term in contemporary discourse makes the word useful and necessary for analysis. Most scholars no longer accept the assumption that objective genetic and physical distinctions play a dominant role in defining different races. Increasingly, race is defined as a socially and culturally constructed concept of a common ancestry.

Discussions of racism in Asia must also first consider differing definitions of racism. Although there is a general sense of what racism or racialism is—belief, theories, or effects privileging one race over others—there is considerable debate over definitions that are salient for discussing racism in Asia. Some have defined racism narrowly as being inherently a “white” phenomena, intrinsically associated with “the West,” to which the history of Western slavery and colonialism attest. Such arguments can rightly emphasize historical, cultural, and institutional factors, and power relations, that should not be ignored when discussing European-American racism. Moreover, it is reasonable to consider—without falling into extreme nominalism—that there may be phenomena in other societies that do not neatly match Western conceptualizations. Such definitions, however, assume that there are no equivalents to Western racism, and force the coinage of new terms for every particular manifestation that could be seen as equivalent in a variety of ways. A more plausible variant defines racism as occurring only among dominant groups. This avoids some of the weaknesses of the position defined above and certainly has some merit, but it insufficiently describes situations when those usually considered minorities become the majority in a smaller context and embrace hateful attitudes and behavior. It also insufficiently describes instances when multiple parties act with similarly hateful intentions and behavior toward one another in a situation where power relations shift over time. In contrast, some definitions of racism have been expansive, sometimes describing as racist situations where such intentions were or are nonexistent. The following discussion defines racism, or racialism, as intentions of disregard, ill will, or hatred toward groups with presumed common ancestry, often closely associated with ideologies that assume that racial differences are fundamental to the fabric of reality and with effects that disadvantage particular racial groups.

Race and Racism in China

Common ancestry is a common theme in Chinese history. Recognized as having one of the world’s oldest civilizations, China’s

history shows the rise of a common sense of culture and identity early in its history. A common legend believed by many Chinese is that they (Han Chinese who form the dominant ethnic group in contemporary China) are descendants of the “Yellow Emperor” (Emperor Huang-ti), who is said to have ruled in the fifth millennium B.C.E. The focus on patrilineal descent—clearly discernible in the seventeenth century (late Ming, early Qing) but clearly existing before—has been another component of this racial focus. Indeed, Chinese descriptions of themselves as a “yellow” race predated European use of such terms. Evidence from Chinese scholars and common folk notions in the early Qing period suggest that the color harked back to their common descent from the “Yellow Emperor.” With connotations of purity and imperial grandeur, this was used to claim the superiority of the Chinese to other races in the early Qing period. Such definitions of the “yellow race” usually included the Manchu and did not threaten the legitimacy of their rule. Both Confucian and folk notions of patrilineal descent supported such racial aspects of Chinese identity.

This theme continued and became central to Chinese debates over identity in the modern era as evidenced by the thought and behavior of nineteenth-century elites. Ideas of some reformers such as Kang Youwei (1858–1927) in the late nineteenth century show the extent to which indigenous and Western notions of race shaped his view of domestic and global affairs. Kang selectively appropriated Western racial categories and created a taxonomy of hierarchical races according to “white,” “yellow,” “red,” and “black” skin colors, but presented the former two as superior to the latter two. The use of the same term for lineage and race (*zu*) aided the combination of both indigenous and foreign concepts. Others, while depending less on the language of scientific racism, conceived of fundamental issues nevertheless in racial terms. For example, Zhang Binglin (1868–1936), a more radical opponent of the Qing regime, understood the problem facing China as caused by the failure to protect the pure descent of the *Hanzu* (Han lineage-race) from the Yellow Emperor. In this view, the Manchu (Qing) were the culprits responsible for Han degeneration. While Zhang’s notion of race differed somewhat from the notions then dominant in Europe focusing on blood purity, it remains language firmly ensconced in the language of ancestry.

Racial discourse continued in republican China after the fall of the Qing in 1911. With the decline of Confucian discourse, science was seen as the new discourse that would establish the nature of things. Clearly imbibing from the scientific racism of the West, intellectuals turned to embryology and genetics to argue for the need to rejuvenate the yellow race. Myths were combined with so-called scientific studies such as craniology to bolster notions of Chinese superiority vis-à-vis their neighbors as well as darker-skinned races. Eugenics would become a dominant part of the discourse during this period.

In the early communist era (starting in 1949), the emphasis on class as a universal unifying concept and the notion of racial theory as a tool of Western imperialism, restrained racial discourse. Still, the state defined the minority groupings as organically connected to the Han race. While on the one hand

extolling the equality of groups, Maoist China still relied on the notion of a superior Han race, which would be the vanguard of the revolution and the embodiment of civilization that would lead the less advanced people. After the death of Mao in 1976, scientific discourse on race was granted more legitimacy, this time in the service of Chinese nationalism. Anthropology has sought to show that the earliest ancestors could be found in China competing with common assertions of the original hominid ancestor being in Africa. Serology has sought to show the intimate connections between the minority groups to the Han. Medicine has encouraged eugenics programs. Discrimination against the minority ethnic groups in contemporary China remains significant. While race is only one among many competing and complimentary discourses of nationalism and ethnicity, it remains a significant theme underlying Chinese identity in the modern era.

Race and Racism in Japan

The linguistic connections between Japanese and the Ural-Altaic language family have led many to suggest that the Japanese migrated from North Asia, though others have argued the possibility of migrations from Southeast Asia and the South Pacific. In any case, migrations of what constitute the majority of Japanese today over the centuries brought them into conflict with other ethnic groups already inhabiting the archipelago. For example, there is record of conflict against the Emishi of northeastern Honshu in the ninth century. Better known are the Ainu—a people ethnically distinct from the majority Japanese—whose culture had grown in the thirteenth and fourteenth centuries. The Japanese gradually pushed the Ainu north so that by the early Tokugawa period (early seventeenth century) they had either been eliminated or pushed to northern Hokkaido.

The existence of such ethnic groups and the history of their gradual territorial marginalization suggest the existence of racial identities, but they do not seem dominant among commoners. Lacking a strong central government for much of its medieval period, and probably because such contact existed mostly on the periphery, most of the commoner population were more concerned with the associations that governed daily life—relationships with kin, village, temple, and the regional lord. Indeed, there is some evidence of fluidity between ethnic groups where there was such contact: Under certain circumstances, some Japanese in Hokkaido identified themselves with “barbarians,” and some “barbarians” blended into mainstream society by becoming loyal imperial subjects.

During the Tokugawa period (1600–1868), however, there are indications that racial identities were recognized and nurtured at least among ruling elites and perhaps those living and working in close proximity to such ethnic groups. At least in Hokkaido, distinctly “Japanese” and “Ainu” identities formed during this period with clear discriminatory intentions. This was true also with the Ryukyans down south. Many in Tokugawa society also differentiated themselves from those classified as *eta* (outcaste) and *hinin* (nonpersons) who, though phenotypically no different from the majority population, were ostracized by society and forced to do menial or dirty work. Intermarriage was avoided, and the children born into these

groups were marked for life. Despite little “biological” difference, Tokugawa society perceived here a problem of ancestry and discriminated against them.

Japan’s modern era began with foreigners helping to open the country to a world dominated by Western influence. Western notions of race including Social Darwinism would deeply impact Japanese racial thought. The Meiji Constitutional order established the state based upon the notion that the Emperor was a direct descendant of the original Yamato clan, and that the Japanese people were in some way “organically” related to the emperor, thus creating the notion of a single, homogeneous racial identity. These ideas would provide a powerful foundation for nurturing an intense nationalism.

The speed of Japan’s development led leaders to envision an empire that would prove notions of Western superiority wrong. At the same time, many viewed Japanese civilization and race as having something to offer to the “less developed” peoples of Asia. This would lead to imperial expansion abroad and oppression at home. After the Meiji Restoration (1868), the government incorporated Ainu land and implemented assimilation policies. The Ryukyans, now Okinawans, were also expected to assimilate into mainstream culture. The term *burakumin* (hamlet people) replaced the terms *eta* and *hinin*, but such semantic changes did little to stop discriminatory practices. Japan’s extended empire also gave rise to a domestic Korean population who also experienced severe discrimination.

Prewar conceptions regarding the peculiar uniqueness of the Japanese race continued in postwar Japan. Likewise, racial discrimination continues to exist in the postwar era. Although the post–World War II constitution has granted equal rights, and Japan has participated in international agreements to respect minority rights, it was only in 1991 that the Ainu were recognized as a minority people with individual rights and 1997 that the government recognized them corporately as an indigenous group with rights to defend their distinctive culture. Laws have not addressed the history of discrimination, nor those living outside of Hokkaido. Discrimination against Koreans residing in Japan and against the Okinawans since the modern period as a result of Japan’s expansionism earlier in the century has also remained an issue throughout the twentieth century.

Race and Racism in India

Hints of the caste system can be seen in the *Rig Veda* written in the late second millennium B.C.E. It was clearly in place by the time of the later Vedic texts (c. 1000–500 B.C.E.). These Sanskrit texts are generally seen as products of an Aryan migration or invasion, and they teach a sacrificial religious system known as Brahmanism or Vedism, which would in later centuries develop into Hinduism. Deeply concerned with issues of purity and pollution, the Vedic texts divided people into different groupings called *varnas* (“colors”) at the top of which was a priestly caste called to set themselves apart from the others. In the early Hindu period (c. 300 B.C.E.–500 C.E.), the Sanskrit epics the *Ramayana* and the *Mahabharata* were incorporated into the tradition. These texts laid out four hierarchical *varna* classes (Brahman, Kshatriya, Vaishya, and

Shudra), which eventually became the larger groupings, which would encompass caste (*jati*) clusters. Although Hinduism does include elements of non-Vedic and non-Aryan sources, Vedic literature and Aryan civilization is seen as being at the core of the tradition.

Racial identities were fundamental to the development and continuation of this system. Those claiming Aryan heritage clearly stood to benefit. Orthodox scholarship interpreted the role of the Aryan in Indian society as the importer of high civilization, bringing Sanskrit, the Vedic Hindu texts, and the caste system. They constituted the Brahmanic class. The system was racial also in the sense that castes were based upon lineage. The family to which one was born usually determined one's social status for life with discriminatory social, political, and economical impact on the lower castes. It limited the range of occupations lower caste members could fill, kept them from gaining positions of power, and forced them to practice social rituals that demeaned and oppressed them.

The influx of Western notions of race further racialized the population. European discourse, however, held peculiar salience for India and had distinctive impact there. Since the late Renaissance, philologists had noted linguistic connections between Sanskrit and European languages. By the Enlightenment, such studies had been made a science, and in the nineteenth century, many Europeans believed in an Indo-European connection through a common, Aryan, ancestral race. Ideas of "the Aryan race" with its assumptions regarding, and potential for, high civilization captured the European imagination. Spurred by Orientalist fascination with the caste system, and the desire to standardize laws while yet respecting traditional Indian laws, the British established guidelines for caste employment and governance that ironically helped to solidify caste statuses where previously relations had been more fluid. The consequences of this process, in some cases, were tantamount to ethnogenesis, as groups maneuvered to protect their interests.

Notions of the Aryan race also pervaded nineteenth-century discussions among Indian reformers, suggesting how the concept could not be avoided when seeking any fundamental reshaping of Indian society. For example, Dayanand Saraswati (1824–1883), a radical reformer, criticized contemporary Hinduism and argued that it had distorted the virtues of Aryan civilization. While Dayanand defended the caste system as a system that worked out the complementary needs of society, he argued that these classes were to be attributed by merit and not by the hereditary status. Swami Vivekenanda (1863–1902) presented a different perspective. He argued that the revitalization of India could only occur if people returned to the Aryan virtues found in Vedic texts. Attributing Aryans with distinct physiological attributes, he strongly favored the maintenance of racial and caste divisions. The Aryan race language is central even among those championing the cause of the lower castes, such as B. R. Ambedkar (1892–1956). In sharp contrast to more orthodox reformers above, Ambedkar questioned the canonicity of the Vedic texts, and presented the Aryans as a race that brought moral decay to Indian society. He questioned the physiological characteristics that had long been attributed to the group.

In the postindependence era (1947–), the Indian Constitution has banned discrimination and ostracism of the scheduled castes, creating seats set aside only for them in parliament. But discrimination remains pervasive in Indian society. Gandhi, for example, chose to call them "*harijan*" (children of God), but they have seen this as paternalistic and many have preferred to go by the term *Dalit* (the oppressed).

Conclusion

Racial concepts, as well as racism, existed in Asia prior to the arrival of the West. Here, the temptation may be to assert that such an argument ignores the peculiarities of indigenous systems of conceptualization. But an overemphasis on the actual English words is misleading. These concepts need not be so static and narrowly defined that they cannot encompass commonalities across cultures. Nor does a focus on commonalities necessarily ignore the particularities of these societies. To argue that there were racial and racist elements in Indian, Chinese, or Japanese thought and behavior is not the same thing as reducing those concepts to only those qualities.

And yet, clearly, the arrival of the Western concepts did uniquely impact Asian thought and behavior. Some of this clearly victimized the Asians—who had to face Western racism and seek ways to counter it. Moreover, as in the example of the British in India, Western colonialism could exacerbate and solidify social divisions that had existed previously in more fluid form. In these cases, the agents were Westerners.

However, indigenous individuals also incorporated Western notions into their analysis and used them to construct arguments—against notions of Western superiority, as they nurtured nationalism, as they defended caste interests, or as they criticized the dominant system. A narrow definition of racism that pinpoints only the Western impact on the non-Western world would result in a skewed portrayal of "the West" as peculiarly imbued with a malady. It also denies non-Western individuals and societies agency and responsibility.

See also *Ethnicity and Race; Occidentalism; Orientalism; Prejudice; Social Darwinism.*

BIBLIOGRAPHY

- Anderson, Michael R., and Sumit Guha, eds. *Changing Concepts of Rights and Justice in South Asia*. Calcutta and New York: Oxford University Press, 1998. Covers broad chronological time span but usefully focuses on the theme of rights and justice.
- Bulmer, Marton, and John Solomos, eds. *Ethnic and Racial Studies Today*. London and New York: Routledge, 1999.
- Burkhardt, William R. "Institutional Barriers, Marginality, and Adaptation Among the American-Japanese Mixed Bloods in Japan." *The Journal of Asian Studies* 42, no. 3 (1983): 519–544.
- Dikotter, Frank. *The Discourse of Race in Modern China*. Stanford, Calif.: Stanford University Press, 1992.
- , ed. *The Construction of Racial Identities in China and Japan: Historical and Contemporary Perspectives*. Honolulu: University of Hawaii Press, 1997.
- Eberhard, Wolfram. *China's Minorities: Yesterday and Today*. Belmont, Calif.: Wadsworth, 1982.

- Figueira, Dorothy M. *Aryans, Jews, Brahmins: Theorizing Authority through Myths of Identity*. Albany: State University of New York, 2002. A fascinating comparison of the changing uses of the Vedic texts in both Europe and India.
- Garcia, Jose L. "Current Conceptions of Racism: A Critical Examination of Some Recent Social Philosophy." *Journal of Social Philosophy* 28, no. 2 (fall 1997): 5–42.
- . "The Heart of Racism." *Journal of Social Philosophy* 27, no. 1 (spring 1996): 5–45. Particularly helpful in comparing different definitions.
- Goldberg, David Theo, ed. *Anatomy of Racism*. Minneapolis: University of Minnesota Press, 1990. Useful for definitions of racism.
- Goldberg, David Theo, and John Solomos, eds. *A Companion to Racial and Ethnic Studies*. Malden, Mass.: Blackwell, 2002.
- Goodman, David G., and Masanori Miyazawa. *Jews in the Japanese Mind: The History and Uses of a Cultural Stereotype*. New York: The Free Press, 1995.
- Guha, Sumit. *Environment and Ethnicity in India, 1200–1991*. London: Cambridge University Press, 1999.
- Howell, David L. "Ainu Ethnicity and the Boundaries of the Early Modern Japanese State." *Past and Present* 142 (1994): 69–93.
- . "Ethnicity and Culture in Contemporary Japan." *Journal of Contemporary History* 31, no. 1 (1996): 171–190. For background to issues of ethnicity during the Tokugawa vis-à-vis the Ainu.
- Kotani, H., ed. *Caste System, Untouchability, and the Depressed*. New Delhi, India: Manohar, 1997. For a study of the caste system that conveniently gives brief snapshots looking at early India, under the British, and after independence.
- Kurien, Prema A. *Kaleidoscopic Ethnicity: International Migration and the Reconstruction of Community Identities in India*. New Brunswick, N.J.: Rutgers University Press, 2002. Chapter 3, "Colonialism and Ethnogenesis," looks at how British policies invited Indian responses that solidified caste relations.
- Miles, Robert, and Malcolm Brown. *Racism: Second Edition*. London and New York: Routledge, 2003. A useful introduction to the field.
- Neary, Ian. *Political Protest and Social Control in Pre-War Japan: The Origins of Buraku Liberation*. Atlantic Highlands, N.J.: Humanities Press International, 1989. For work on the treatment of the burakumin.
- Pusey, James Reeve. *China and Charles Darwin*. Cambridge, Mass.: Harvard University Press, 1983. Directly addresses the impact of Darwinism on China.
- Rao, R. Sangeetha. *Caste System in India: Myth and Reality*. New Delhi: India Publishers and Distributors, 1989.
- Red Sun Publishers. *China's Minority Nationalities: Selected Articles from Chinese Sources*. San Francisco: Red Sun Publishers, 1977. For an interesting glance at idealized PRC presentation of their views on the matter during the Maoist era.
- Sautman, Barry. "Anti-Black Racism in Post-Mao China." *The China Quarterly* 138 (June 1994): 413–437.
- Singh, Virendra Prakash, ed., *Caste System and Social Change*. New Delhi: Commonwealth Publishers, 1992.
- Sinha, Sachchidanand. *Caste System: Myths, Reality, Challenge*. New Delhi, India: Intellectual Publishing House, 1982.
- Sullivan, Michael. "The 1988–89 Nanjing Anti-African Protests: Racial Nationalism or National Racism?" *The China Quarterly* 138 (June 1994): 438–457.
- Thapar, Romila. *Cultural Pasts: Essays in Early Indian History*. New Delhi, India: Oxford University Press, 2000. For in-depth studies on various aspects of earlier Indian history.
- Weiner, Michael, ed. *Japan's Minorities: The Illusion of Homogeneity*. London and New York: Routledge, 1997. A helpful book that presents issues edited by a leading contributor in the field.
- . *The Origins of the Korean Community in Japan, 1910–1923*. Atlantic Highlands, N.J.: Humanities Press International, 1989.
- . *Race and Migration in Imperial Japan*. New York and London: Routledge, 1994.

Genzo Yamamoto

EUROPE

Of the ideas that have appeared in Europe over the centuries, race remains one of the most politically charged and difficult to define. Almost all scholars agree that race is a social construction, signifying no actual or important human difference. Yet, no one would argue that racism, or the process of viewing human groups as defined by inherited differences and acting in such a way as to reinforce and discriminate on the basis of these differences, is a quite tangible phenomenon. To best understand how the imagined and the real—the idea and the practice—come together, a historical view of the concept of race is instructive. The story of race and racism in Europe is at one time a study of the very origins of the idea itself and an example of the need to understand the application of racism in different contexts and across different time periods. Part of racism's malleability is rooted in the fact that race and racism have always emerged tethered to other important concepts—such as nation, class, and gender—that tended to reflect local tensions and prejudices. Yet, race, wherever it emerged, added biological weight to other forms of identity. Race was permanent, indelible, and inheritable. Race told of one's past, present, and future.

The Beginning

Linguists argue that the word *race* entered Europe in the twelfth century through the Arabic term for head or chief, *rās*. By the sixteenth century, French, German, Spanish, Italian, and English each had a similar sounding locution that connoted some kind of difference within species or breeds. Even though the arrival of the term seemed to coincide with European contact with wider areas of the world, recent scholarship has tended to dismiss the idea that the contact between Europeans and others prior to the 1400s produced any semblance of a racial concept. Instead, race is seen as emerging alongside the idea of the nation as a way of establishing cultural and social boundaries and political authority in medieval Europe. Ironically, racial thought appeared in Europe not when difference was so visible but rather when it disappeared.

This disappearance occurred most clearly in medieval Spain with the mass conversion of Jews (and others) into Spanish Christian society. Beginning in the 1300s, this conversion was the by-product of a burgeoning national consolidation of political authority in the Iberian Peninsula. The creation of a centralized bureaucracy, the sense of a cohesive territory that had been "reconquered" from eighth-century Arab invaders, and the attempt to forge religious and cultural homogeneity

signaled Spain's arrival as one of the first nation-states. Yet, the conversion of religious minorities to Catholicism placed increasing pressure on Spanish society to assimilate these "new" populations—the largest group, the Jewish *conversos*, alone surpassed 500,000 people—who were now free of legal proscriptions against "upward mobility." Converts had access to land and business ownership, to the university, and even employment within the powerful church—avenues that had long been closed to Jews. Attempts to regain some control over this group led to the passage of the blood-purity statutes (*estatutos de limpieza de sangre*), which barred those of "impure" blood from service in the church, from employment in public office, and from military service, especially in Spain's new colonies. The statutes presumed that converts were imbued with an inherent, immutable mark that rendered them all equally and unalterably different; conversion changed nothing.

Also, as legal statutes, the blood-purity conventions affected all of Spanish society. Thus, "old" Christians and converts alike were required to prove their lineage. Whether this system functioned as efficiently or monolithically as the statutes required has been a matter of continuing debate. But many scholars believe that the recourse of the Spanish state and church to blood was not merely a metaphor but reflected a new belief in intrinsic aspects of identity. Thus, the blood-purity laws have come to symbolize Europe's first foray into racial thinking. Yet, what scholars term "modern racism" depended on a number of other historical developments.

Making Race and Racism Modern

The Enlightenment, the Romantic movement, and the development of the modern nation-state in the nineteenth and twentieth centuries all played important roles in the unfolding of race and racism in Europe. The Enlightenment of the 1700s marked an intellectual shift defined primarily by an enthusiasm for organizing and understanding the world through secular reason. This shift coincided with a geopolitical expansion that made Europeans far more cognizant of human differences throughout the world. The Enlightenment impulse drove Europeans to categorize the diversity of life on Earth, especially in the arrangement of human difference. The first to use the term *race* to connote categories of people was François Bernier in 1684. For Bernier, race was entirely a physical distinction: people who looked different were clearly members of different races.

Others took up racial studies in an attempt to identify the exact number of races in the world. The most definitive efforts of the era were Carolus Linnaeus's 1735 four-part division of humanity ("White European, Red American, Dark Asiatic and Black Negro") and Johann Friedrich Blumenbach's 1776 division into five races ("Caucasians [a term he introduced], Mongolians, Ethiopians, Americans, and Malays"). Others countered that there were some thirty to eighty races. How thinkers distinguished between races mattered less than what united each of their approaches. Each definition used physical features as the primary measure of human difference. This physical basis relied on a hierarchical notion of proper development that was rooted in the Enlightenment's exaltation of the classical world as the epitome of beauty and ideal



Michelangelo's *David* (1501–1504). In the ancient art of Greece and Rome, gods and other notable figures were frequently depicted as possessing very pale or white features. This classical trend could also be found in art during the Enlightenment and the Renaissance. © SCALA/ART RESOURCE, NY

physical form. Thus, the statuary of ancient Greece and Rome was seen to depict the apex of humanity. The result was that the "milky whiteness of marble and the facial features of the Apollos and Venuses" created a standard against which most other people would be measured, and found deficient (Fredrickson, p. 59).

These early formulators of the concept of race did not actively ascribe the other important trope of racism—the correlation of talent, success, and value—to these physical differences. The qualitative differences between races arose when enlightened theorists sought to explain the source of human differences and the varieties of societies that Europeans were encountering. Most Enlightenment thinkers saw distinct races developing over time as a result of environmental influences, such as climate and soil, which ultimately determined the nature and success of different races.

Charles-Louis de Secondat, baron de Montesquieu, was one of the first, in his *Spirit of the Laws* (1748), to present human history as composed of stages, introducing the idea that races of people had developed their own legal and political systems

rooted in their climate and their temperament, or, as he called them, their race. Politics and race ran together; different races created the political systems only they were capable of creating. Other thinkers, like Immanuel Kant in his *On the Different Races of Man* (1775), aligned peoples' characters with their physical appearance. Now, behavior and appearance ran together; one could assess peoples' potential solely by looking at them. For the most part, however, Kant, like others at this time, used the term *race* loosely, without any real concern for scientific precision or exactness. Such systems provided a vocabulary for distinguishing between people based on (supposedly) natural differences that determined people's abilities and justified differing applications of rights and liberties. Yet, the rise of natural sciences and the modern nation-state gave racism its modern, more violent and dangerous character.

The French Revolution and the Nation

The ultimate lightning rod for racial hierarchies and the dividing of relative worth came after 1789 and the rise of modern nationalism in Europe. After the French Revolution, many European countries became nations, defined particularly by the fact that citizenship would now be based on birth, residency within national territory, and allegiance to law or a constitution. Nationalism, in a sense, was a great equalizer, placing all those living within the national territory on an equal footing as Englishman, Frenchman, Spaniard, Italian, German, Pole, Dane, and so on. Social and economic class, it was believed, would not matter; all citizens would be equal, based on their rights as human beings. Yet, defining inclusion in the nation was also invariably a process of exclusion. Nationalists of the 1800s, even deliberately nonracist ones like Johann Gottfried von Herder, worked very hard to define not only who belonged but, by default, who did not. Behaviors, attitude, language, dress, and appearance all played roles in assessing who was of the nation and who was not. This kind of cultural nationalism, and the rise of Romanticism that sought to explore the passionate, irrational side of humanity—not just the rational side that the Enlightenment promoted—worked together to fashion the ethnic nation. A state defined by ethnicity saw itself as a spiritual entity, with citizenship tied to a soul that one was born with and to an uncontrollable, indelible personal drive to act, think, and feel in a particular way. Even more important, this belonging was natural, transmitted down through the ages, so that one was connected inimitably to one's forebears. In the mid- to late nineteenth century, the *Rechtstaat* (state defined by rights) transformed into the *Volkstaat*, more an imagined ethnic community than an actual historical or territorial entity.

One of the first and most important thinkers of the nineteenth century to elaborate this view of society was Joseph Arthur de Gobineau, who began publishing his *L'essai sur l'inégalité des races humaines* (Essay on the inequality of the human races) in 1853. Gobineau's history presented human development for the first time as a contest of races. His book was heavily researched in an attempt to draw together the most up-to-date scholarship of the new realms of science, especially German archaeology and philology and French anthropology. He concluded that contemporary nations were the patrimony

of a racial past defined by the conquest of weaker races by stronger ones. He posited three great races, the white, the black, and the yellow, that engaged in constant battle. For Gobineau, the victor and true driving force of human history was the white, or European, race. Yet, this victory came always at a price. Lesser races never disappeared. Instead, they mixed into the conquering races, leaving a weaker whole. The mixture, in fact, elevated lower races, in which he included the yellow and the black and their lingering influence among European peasantry and urban working classes, while the white race was degraded.

Gobineau's racial vision also demonstrates how dependent racial thought was on historical context. Gobineau saw racial strength in social stability, the absence of class and political conflict that dominated his era, and especially in his own national context of France. Not surprisingly, therefore, the racial future that Gobineau foresaw was quite bleak. The history of human existence was a story of racial decay: even the Aryan, the most dominant among Europe's white races, lost something by intermixing with the rest. Later European thinkers would brighten Gobineau's pessimistic vision for human history. Further intellectual and scientific development, including the rise of Darwinism, positivist science, and more extreme nationalist movements, would give rise to a more optimistic belief that this degeneration could be reversed.

The rise of Social Darwinism and European imperialism in the late nineteenth and early twentieth centuries provided the impetus for more proactive racial thought. Although Darwin's theory of evolution did not offer a racial understanding of human development, some of his interpreters immediately began explaining aspects of Gobineau's view of human history as a conflict between the races, with Darwin's notion of conflict as the undercurrent of species survival. These interpretations fueled the Social Darwinism that underscored social thought in late-nineteenth-century Europe. These thinkers explained not only differences in national strength but also the differing levels of social, economic, and political success among individuals within those nations. New positivist sciences, such as physical anthropology, psychology, and ethnology, which relied on measurement and testing rather than speculation, all injected into the idea of race a sense of heredity and transcendence. Racial sciences now supposed a biological link across generations that subsumed other forms of national identity into a physical standard that others could never adopt. Head shapes, cranial capacity, and indices of different measurements all emerged as the telltale stigmata of racial identity. This explosion of measurements allowed scientists to perceive what they thought was an expanding number of races within Europe.

Georges Vacher de Lapouge, in his study of European skulls in 1888, saw three European races and ordered their quality and value: European Man, Alpine Man, and Homo Contractus. He argued that none of these races directly correlated with a specific nation, but his descriptions of their behaviors and religious ideas were clearly meant to correspond to Germany, Southern Europe, and the population of European Jews. The naturalized German citizen Houston Stewart Chamberlain wrote in 1899 that the German race struggled to maintain its

purity because of the Darwinian form of natural selection that caused Germans to feel a revulsion toward intermixing with lesser races. Overall, this putative science of race uncoupled nationalism from its liberal roots, implying that those who lived within a national community did not necessarily belong. One could act, speak, or feel German or French but never *be* German or French.

In a sense, the expansion of parliamentary democracies, the emancipation of minority groups like Jews, and continued social unrest in Europe all helped bring politics and race together in the form of political parties and movements in the late nineteenth and early twentieth centuries. These movements made race—and combating an internal enemy—a matter of public concern and state intervention. Edouard Drumont, much like Gobineau before him, saw his France as decadent because of the intermixture of external groups and the absorption of internal threats, like French Jews, through emancipation. The Dreyfus affair in France summarized this newly minted racial notion of national identity. Alfred Dreyfus, a captain in the French army and a Jew, was convicted of treason in 1894. That Dreyfus ultimately was acquitted in 1906 did not satisfy his opponents in France who had decided that, because he was Jewish, the fact of his French nationality did not matter. As Maurice Barrès wrote during the affair, he knew Dreyfus was “capable of treason . . . [simply] by knowing his race” (Mosse, p. 109–110).

The racist movements and political leagues that sprouted after the Dreyfus affair took hold throughout Europe. In Austria, Georg Ritter von Schönerer saw the Slavic races from the south and east as the greatest threat to recreating not merely a great Austrian nation but a greater ethnic German Empire. Wilhelm Marr, who coined the term “anti-Semitism,” wrote in 1879 that the greatest threats to the newly unified German state were the corrupt natures of internal elements, like the Jews, or intermixing with neighboring “races” such as the eastern Slavs. He, like others, ominously warned of a final racial conflict that would decide the fate of nations. Different interpretations of Darwinism, or even the denial of Darwinian evolution, did not necessarily leave nations free of racial thought. Environmental, or neo-Lamarckian (after French naturalist Jean-Baptiste-Pierre Lamarck) forms of racism saw race as slightly more mutable: race was not always a matter of visible differences, but of behaviors, practices, and ideas that were acquired in one lifetime and then passed on.

In newly unified Italy, northern Italians in Lombardy saw the threat of southern peoples, the Sicilians or Neapolitans, as racially enervating. They were thought to be different because of their hot-blooded, less rational characters—elements believed to emanate from their hotter climate and their proximity to Africa. Similar ideas existed in Spain toward those from the south, in particular Andalusia. In northern Spain, notions of racial purity became important adjuncts of the Basque nationalist movement that sprang up in the late nineteenth century. The presence of foreign guest workers, or *maketos*, from other parts of Spain, was perceived as a threat to Basque purity. Sabino Arana, an early founder of Basque nationalism, proposed miscegenation laws in 1901 to prohibit the marriage of Basques to Spaniards.

The rise of European imperialism further coarsened racial thought. Contact with and subjugation of different peoples in Asia, Africa, and the Pacific seemed to verify both the Enlightenment notion of human development as taking place in stages, and the Social Darwinist view that national success was predicated on conflict and conquest. This inequality of development came to justify any mistreatment of non-European peoples, especially in the “scramble” for Africa that placed almost the entire continent under European dominion by 1900.

Imperialism helped solidify a view of the world as a hierarchy of races with Europeans at the zenith and all others arrayed below. One ugly symbol of this worldview was the “human zoo” that appeared throughout fin de siècle Europe in international fairs and other public spectacles. This kind of menagerie, replete with dioramic portrayals of humans living in their “typical” habitat, produced wide-eyed amazement among Europeans of the late nineteenth century and established racial hierarchy not just as an elite, scientific view of history but also as a popular one. By the 1880s and 1890s, race existed as a concrete idea recognizable to any European. Race became an essential element of national strength—and required defense and protection.

The practical application of these racial ideas followed in the early twentieth century. The racial hierarchies so easily defended in imperialist language were also easily applied to European populations as well: if Europeans so easily conquered others, what made a European so dominant? How does society perpetuate this strength? What might threaten it? The eugenic policies developed in part by Francis Galton beginning in 1883 that defended sterilization, imprisonment, and marriage proscriptions, for example, relied on a basic biologicistic assumption that the social or national body could be weakened by the presence of debilitating agents. The “virus” in the eugenic model was certain kinds of people, and here race theories developed alongside other notions of difference, like class and gender, to locate the nation’s racial enemies. “Degenerative” forces like the poor, alcoholics, criminals, the handicapped, and prostitutes all were viewed as suffering from an internal weakness bred through the generations from a racial atavism. Research over the last few decades has demonstrated that eugenic policies took many forms in early-twentieth-century Europe, from the pro-natalist policies of France that encouraged population growth to the sterilization policies of Germany to the marriage restrictions and immigration quotas of England. Driving all of these policies was the same basic view: in the struggle for survival, the state had to engage in proactive social “medicine” to destroy or minimize “atavistic” or degenerative agents.

The Nazis, the Holocaust, and Others

Read in this context, the Nazis’ efforts to persecute and then to exterminate European Jewry and other supposedly threatening populations did not represent a radical departure from the ideas and practices that had long been evident in European history. What made the Nazis unique was the barbaric scale and geographical reach of their policies. Perhaps Michael Burleigh and Wolfgang Iyer said it best when they argued that the Nazis’ uniqueness rested in their desire to create

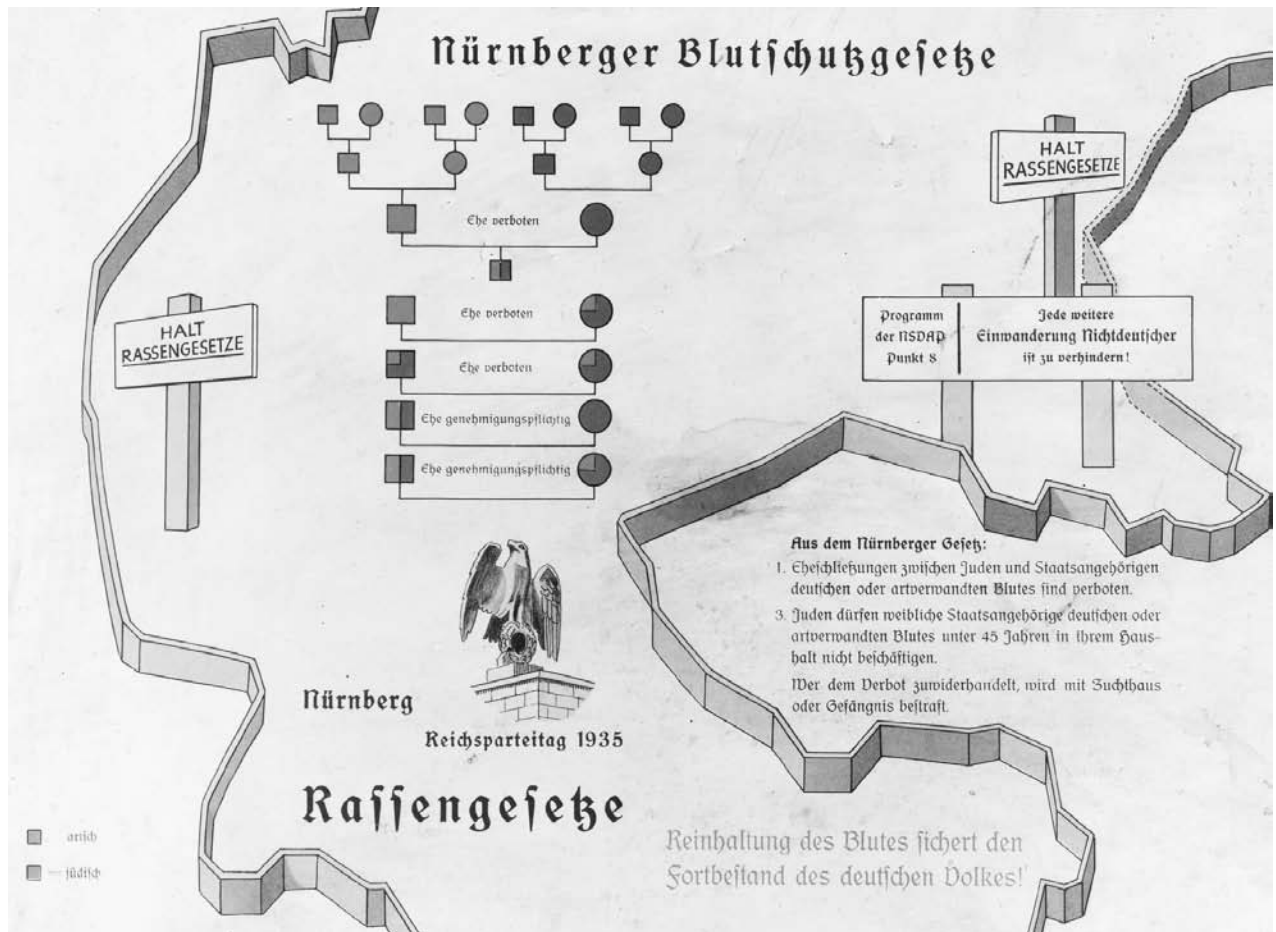

A poster titled “The Nuremberg Law for the Protection of Blood and German Honor” (c. 1935) with chart outlining which marriages were forbidden. The Nazi desire for a pure Aryan race placed many restrictions upon the German populace, as well as the citizens of the countries they invaded. In some cases, intercourse between Aryans and non-Aryans was outlawed. UNITED STATES HOLOCAUST MEMORIAL MUSEUM, COURTESY OF HANS PAULI

a racial state in which all facets of state policy, and the organization of society, were enacted with the promotion of racial purity in mind.

The Nuremberg Laws of 1935 codified German citizenship as the product of German blood, as defined by German anthropologists, biologists, and doctors. They also outlawed sexual intercourse between “pure” Germans and German Jews, and the employment of women under forty-five by Jews. In the Nazi mind and model, as in the eugenic one, procreation was the locus of racial protection. These laws affected German and foreigner alike. In fact, the list of racial threats expanded with the German Third Reich: Pole, Czech, and Slav all became racial threats as Germany entered Poland, Bohemia, southeastern Europe, and Russia. Suspect populations also lived among people who otherwise saw themselves as German. Political deviants, in particular, were seen as threats to the race and many ultimately followed paths to the concentration camp and gas chamber along with the Nazis’ Jewish victims. Socialists, communists, homosexuals, and Jehovah’s Witnesses all

came to represent biological threats to the pure Aryan, and their removal from society was justified along racial lines.

Yet, perhaps most importantly, the Nazis proved that race and racism were not merely products of the irrational, intemperate mind, but also dependent on a mind-set defined by respect for law and a rigidly organized view of the world. The horror of the Nazi regime arises from the fact that while the goals of German racial policies led to the Final Solution—extermination and mechanized killing in the death camps—their policies continued to be expressed in the seemingly rational language of problem-solving. In his essay “Deutschland und die Deutschen,” the German writer Thomas Mann described the Nazi mind-set as “highly technological Romanticism,” which encapsulates a sense of racial thought throughout Europe, a product of both passionate hatred and cold bureaucracy. Racism, in this reading, was the product of some of Europe’s greatest triumphs—the Enlightenment and the reverence for science and reason—and its darkest moments—the thirst for conquest, subjugation, and murder.

The opening stanza of Rudyard Kipling's
"White Man's Burden" (1899)

Take up the White Man's burden
Send for the best ye breed
Go bind your sons to exile
To serve your captives' need
To wait in heavy harness
On fluttered fold and wild
Your new-caught, sullen peoples
Half-devil and half-child

encapsulates the idea of proper inheritance and European supremacy over other races that drove the racist imagination of the late nineteenth century.

This view has allowed scholars to explore racial thought in areas where it was not previously believed to have existed. Some examples include the forced migration of populations in the Soviet Union, motivated by ethnic or racial concerns, and previously viewed as anathema to socialist policy. Spanish and Italian fascists have attracted attention for supposedly eugenic practices to weed out political opponents defined not just by intellectual differences, but by a genetic predisposition to certain political attitudes. The general reliance on biological metaphors in twentieth-century Europe has also widened the scope of racial studies, placing it within a larger nexus of social categories that include class and gender. For example, the focus on women's bodies as the template for racial production has expanded scholarly notions of what makes official policies racist. In an area not normally associated with racial thought, the Spanish Fascist policy of the forced adoption of children born to the wives of political opponents during the Spanish Civil War shared the same impetus as eugenic policies elsewhere and prove that race and racism were attractive ideas in a number of times and places.

Race and Racism Today

Since World War II, debates about race in Europe have remained rooted in the same tensions that drove European racism of the past. The incorporation of foreign-born immigrants emerged in the 1960s and 1970s as a result of the economic expansion that followed World War II and the decolonization of former European imperial holdings. Attacks on immigrant workers in most European countries have proved that the old conflict between liberal notions of the nation as one of rights of all citizens and ethnic notions of the nation as a community of similar-looking, similar-acting, and similar-sounding people still exists.

Yet, racism in Europe today also reflects some of the same tensions that define it elsewhere. Racism festers when the

economic future is cloudy or desperate, when more people seem to be vying for fewer social services, and when the state seems to struggle to meet its obligations. In fact, the harshest attacks against immigrants have taken place where social protections and guarantees are strongest. Race riots in Brixton and Nottinghill Gate in England in the 1970s and 1980s, or the attacks on Turkish workers in Rostock, Germany, in the 1990s and, most recently, on West African immigrants in El Ejido, Spain, all indicate that racism relies on a sense of threatened stability. Immigrant peoples are perceived as drains on the system; those who "don't belong" are more than an economic threat and are seen as enemies who weaken national strength from the inside. Hence, fights over cultural assimilation in France involving the wearing of headscarves in secular French public schools and the granting of citizenship to multigenerational families of Turkish guest workers in Germany maintain the racial component of the "outsider" as inherently different and dangerous. Yet, the real cause of concern is no longer the notion of physical differences signifying biological weakness in the national stock; the racial conflict remains a struggle over national identity and the basic definition of citizenship. In the words of Enoch Powell, a conservative member of Parliament in England who became infamous for racist diatribes against foreign guest workers in England in the 1960s and 1970s, "Racism is the basis of nationality."

In many ways, the particular historical experience of racial thought, especially as embodied in the Holocaust, has given an added weight and sense of foreboding to events that unfold today in Europe. Incidences of anti-Semitism and the rise of ultranationalist political parties that base national membership on an ethnic sense of nationalism, like Jean-Marie Le Pen's National Front Party in France, Jörg Haider's Freedom Party in Austria, or the Northern League of Italy, all have energized much public concern and debate. Yet, the most important lesson of European history is that race and racism are rooted in that continent's best traditions such as the Enlightenment, science, and social welfare, and its application in the most murderous and barbaric of ways both inside and outside the European continent.

See also Anti-Semitism; Discrimination; Enlightenment; Human Rights: Overview; Other, The, European Views of Race and Racism: Asia; Race and Racism: Overview.

BIBLIOGRAPHY

- Balibar, Etienne, and Immanuel Wallerstein. *Race, Nation, Class: Ambiguous Identities*. London: Verso, 1991.
- Bernasconi, Robert, and Tommy L. Lott, eds. *The Idea of Race*. Indianapolis: Hackett, 2000.
- Burleigh, Michael, and Wolfgang Wippermann. *The Racial State: Germany, 1933–1945*. Cambridge, U.K.: Cambridge University Press, 1991.
- Chamberlain, Houston Stewart. *Foundations of the Nineteenth Century*. New York: Fertig, 1968.
- Count, Earl W., ed. *This Is Race: An Anthology Selected from the International Literature on the Races of Man*. New York: Shuman, 1950.
- Dikötter, Frank. "Race Culture: Recent Perspectives on the History of Eugenics." *American Historical Review* 103, no. 2 (April 1998): 467–478.

- Fredrickson, George M. *Racism: A Short History*. Princeton, N.J.: Princeton University Press, 2002.
- Gobineau, Arthur. *The Inequality of Human Races*. New York: Fertig, 1999.
- Hannaford, Ivan. *Race: The History of an Idea in the West*. Washington, D.C.: Woodrow Wilson Center Press, 1996.
- Mosse, George. *Toward the Final Solution: A History of European Racism*. New York: Fertig, 1985.
- Pick, Daniel. *Faces of Degeneration: A European Disorder*. Cambridge, U.K.: Cambridge University Press, 1989.
- Stepan, Nancy. *The Hour of Eugenics: Race, Gender, and Nation in Latin America*. Ithaca, N.Y.: Cornell University Press, 1991.
- . *The Idea of Race in Science: Great Britain, 1800–1960*. Hamden, Conn.: Archon, 1982.
- Weitz, Eric D. “Racial Politics Without the Concept of Race: Reevaluating Soviet Ethnic and National Purges.” *Slavic Review* 61, no. 1 (spring 2002): 1–29.
- Yerushalmi, Yosef. *Assimilation and Racial Anti-Semitism: The Iberian and the German Models*. New York: Leo Baeck Institute, 1982. Lecture no. 26.

Joshua Goode

RECEPTION OF ASIANS TO THE UNITED STATES

Asian America is a meaningful social construct in understanding and analyzing Western colonialism in Asia, and immigration policy and racial hierarchy in American society. As a group identity, *Asian-American* is an externally imposed label because it is based on race rather than culture. The most misleading reference to Asians is the term *Oriental*. Derogatory in nature, the term refers to people anywhere east of the Suez Canal, blurs cultural differences within Asia, and defines many different peoples as one racial group. Beginning in the nineteenth century, Asian countries were subjected to the political and economical encroachment of Western imperialist powers. India became a colony under Britain after the 1813 Charter Act. China was almost dismembered after the Opium War in 1839–1842. Japan was opened up by the American commodore Matthew Perry in 1853. The Philippines became a U.S. territory after the Spanish-American War of 1898. Korea was annexed by Japan in 1910.

Asian Immigration

Asian migration to America was a result of colonialism in Asia and a response to the labor shortage in the American West. Global capitalism brought almost one million Asian immigrants to America. Asians became an “Oriental problem” when they arrived in American society. Racist rhetoric in California described Asian immigrants as “undesirable coolies” or as the “yellow peril” unable to assimilate into American culture. Perceived as “strangers from different shores” and denied equal protection under American law, Asians were often victims of racial harassment and violence. Regardless of their cultural differences, Asians’ experience in America is similar in nature. The Chinese Exclusion Act of 1882 prohibited Chinese labor migration. The Gentlemen’s Agreement of 1908 stopped the Japanese. The Barred Zone Act of 1917 banned Asian Indians. The Tydings-McDuffie Act of 1934 excluded Filipinos. Subject to exclusion and ineligible for citizenship, Asian immigrants lived under the shadow of institutionalized racism.

Chinese. Racial profiling of Asians began with the Chinese, as they were the first Asian group to arrive in the United States. During the peak of Chinese immigration in the late nineteenth century, union rallies, political election campaigns, and editorials in newspapers and journals all denounced the Chinese as a “degraded people with low civilization,” and as a “perpetual, unchanging, and unchangeable alien element.” Bret Harte’s poem “The Heathen Chinese” and its popularity best manifested the fear of Chinese in America. Travel accounts of American diplomats, missionaries, and merchants also described the Chinese as an inward-looking, superstitious, and devious race. In response to such anti-Chinese frenzy, the early Chinese community actively advocated their interest, engaged in lobbying and legal activities as a form of resistance, or appealed for better protection from the Chinese government. As early as 1852, a Chinese merchant named Norman Asing wrote a letter in smooth English rejecting Governor John Bigler’s description of the Chinese as “unassimilated and dishonest” and emphasizing the significant contribution the Chinese made to American society and their great cultural traditions. Mary Tape in 1885 made an angry protest when the San Francisco Board of Education banned her daughter from attending a public school. A Christian and an educated woman, she sued the board of education and the principal. When the superior court decided in the family’s favor, the board appealed to the California Supreme Court. The superintendent of schools then lobbied the legislature, which passed a law establishing separate schools for “children of Mongolian or Chinese descent.” This law was not repealed until 1947.

During the exclusion period (1882–1943), incoming Chinese immigrants were detained and interrogated at the Angel Island immigration station from several days to several months. Waiting in bitterness and frustration, Chinese immigrants inscribed hundreds of poems on the wall to express their resentment and to protest against racism. Chinese immigrants linked their suffering in America to a divided and weakened China. After Congress voted to bar Chinese immigration permanently in 1904, Chinese in America joined their countrymen in China to launch a vigorous boycott movement in 1905 against American imports to China. Interestingly, Harriet Beecher Stowe’s novel *Uncle Tom’s Cabin* was translated into Chinese in the same year and became an immediate hit as the Chinese related the African slaves’ misery to their own suffering. Though the boycott did not get the Chinese a better immigration policy, it forever linked the treatment of Chinese in America to Chinese nationalist consciousness.

Japanese. Arriving shortly after the Chinese were excluded, Japanese immigrants inherited much anti-Asian sentiment. Racial slurs in the American West were quickly switched from “chink” to “Yellow Jap.” However, the Japanese had better protection from their government than did the Chinese. When Japanese-American children were rejected from public schools in San Francisco after the 1906 earthquake destroyed “Little Tokyo,” Japan quickly protested and interfered. Writings from the missionary Sidney Gulick and the Japanese scholar Yamato Ichihashi, who was fluent in English, also assured the American public that Japanese immigrants were assimilating. Though the Gentlemen’s Agreement stopped labor immigrants, it

allowed Japanese women to enter America as “picture brides.” Allowed to develop family life, the Japanese-American community did not become a “bachelor society” like the Chinese and Filipino communities. Still, confronted with racial antagonism, Japanese immigrants pursued assimilation. Kyutaro Abiko, a wealthy labor contractor and publisher of a Japanese language newspaper, urged Japanese immigrants to consider permanent settlement and give up the *dekaseginin* (sojourner) mentality. Some Americanized Japanese immigrants like Takao Ozawa applied for citizenship. Ozawa argued that he was American by heart and that the Japanese belonged to a superior race, as they had absorbed many Caucasian qualities. Even his skin color appeared whiter than the dark-skinned Italians, Spanish, and Portuguese. However, in the case of *Ozawa v. the United States* of 1922, the U.S. Supreme Court ruled that “white person” means Caucasian—a race that the Japanese did not belong to. Congress later passed the 1924 Immigration Law, which totally stopped Japanese migration to America. Nationalistic mass rallies were held throughout Japan, and protesters called 1 July, the effective date of the law, “National Humiliation Day.” Japanese-American newspapers all criticized the law as racist.

Asian Indians. The racial identity of Asian Indians was perhaps more challenging to American racial discourse than that of any other Asian group (though only about eight thousand Indians arrived in America around the 1910s) because they were considered Caucasian. The San Francisco-based Asiatic Exclusion League argued that although Asian Indians shared similar ancestry with Europeans, they were eastern Aryans and “slaves of Creation.” The U.S. attorney general in 1907 declared that under no condition were those British nationals to be granted U.S. citizenship. After the Court denied Ozawa’s application for citizenship, the Indian immigrant Bhagat Singh Thind applied for his citizenship the following year. He cited many anthropological sources to prove the similarity of physical features between Indians, Englishmen, and Germans, and declared himself a member of the “pure Aryan race.” The Court replied that the definition of “white” had to be based on the “understanding of the common man.” Since the popular perception of the Caucasian race was based on skin color, the Court ruled that Asian Indians were Caucasians but not white. With this ruling, racial ideology placed Japanese and Asian Indians in the same racial category.

Filipinos. Filipino immigrants represent a different type of challenge to American racial ideology. Coming from a U.S. territory, Filipinos were American nationals who pledged allegiance to the American flag and could travel freely within the territories of the United States. Filipino men were also recruited into the American merchant marine and the U.S. Navy. As colonial subjects, however, they were treated as an inferior race. The English writer Rudyard Kipling described them as “half devil and half child” and called them “the White Man’s Burden,” which typically illustrates the racial image of Filipinos in the eyes of white Americans. The political, economic, and cultural relationship between the Philippines and the United States constituted the context in which the immigrants developed their identity. They spoke English, wore Western style clothes, and knew American culture. Many Filipino immigrants felt that they had already been somehow Americanized before their

arrival. The immigrant writer Carlos Bulason published his autobiographical novel entitled *America Is in the Heart*. Coming from a racially diverse society, Filipino men frequented dance halls and socialized with white women. Racial discourse on Filipinos often centered on “the threat of Filipinos to white racial purity.” A San Francisco municipal court judge wrote that it was “a dreadful thing when these Filipinos, scarcely more than savages, come to San Francisco, work for practically nothing, and obtain the society of these [white] girls” (cited in Takaki, p. 328). Dr. David P. Barrows, former president of the University of California, testified before Congress that social problems of Filipinos were based almost entirely on their sexual passion. An antimiscegenation law in California prohibited interracial marriage between whites and “Negroes, mulattoes, or Mongolians.” In 1933, Salvador Roldan and three other immigrants discovered a loophole in this law. Before the Los Angeles Superior Court, Roldan argued that Filipinos belonged to the Malay rather than the Mongolian race. Shortly after they obtained their marriage licenses, the California legislature amended the antimiscegenation law and added the Malay race to the restricted category. The following year, the Tydings-McDuffie Act granted the colony commonwealth status, permitted a ten-year transition period to independence, defined Filipinos as “aliens” though still owing allegiance to the United States, and allocated an annual immigration quota of fifty. Since the minimum quota for a country was usually one hundred, racial ideology degraded the Philippines as a semi-nation-state.

Koreans. Korean migration to America from 1902 to 1905 was a result of American missionary activities in Asia and the Japanese occupation of Korea. Fewer in number, Korean immigrants viewed themselves as exiled fighters for national liberation from Japan. While nationalism shaped Korean immigrants’ identity, Christian churches played a key role in community organization. The first Korean language church—the Korean Evangelical Society—was established in Hawaii in 1902. The Bible had already been translated into *hangul*, a script that replaced Chinese characters in late-nineteenth-century Korea. By 1918, there were thirty-three Korean Protestant churches in Hawaii that provided Sunday school and Korean language classes. Korean books and periodicals were imported as the immigrants maintained a distinct ethnic identity and resisted assimilation. In Hawaii, they organized *tong-hoe* (village councils) in each locality with more than ten Korean families. Their grass roots organizations later developed into the Korean National Association. Representing all Koreans in North America, the organization had 116 local branches and chapters in Manchuria and Siberia. In 1913, fifteen Korean farm workers were driven away by several hundred Caucasian workers in the small town of Hemet, California. When the Japanese ambassador in Washington, D.C., filed a protest on their behalf, the Korean National Association sent a telegram to the Department of State claiming that they were Koreans, not Japanese, and that the investigation made by Japanese diplomats was illegal. Preservation of Korean identity and culture became their patriotic duty.

Landmarks in Asian-American History

World War II was a watershed for Asian-American identity. Japan bombed Pearl Harbor on 7 December 1941. The next

day, the United States and China together declared war on Japan. The mainstream media began to portray the Chinese as honest and hardworking and the Japanese as treacherous and cruel. A *Time* magazine article on 22 December 1941 was intended to assist American society at large to physically distinguish the Chinese from the Japanese. According to the article, Japanese men were “broader hipped” than Chinese men; and the Chinese expression was likely to be “more placid, kindly, open while Japanese were arrogant, hesitant and nervous in conversation” (cited by Takaki, p. 370). In 1943, all Chinese exclusion acts were repealed; a quota of 105 was granted; and Chinese immigrants became eligible for citizenship. In 1946, Congress also extended the privilege of naturalization to Filipinos and Asian Indians with an annual quota of 100 respectively. The policy change was in fact a response to Japanese war propaganda, which often criticized racial discrimination against the Chinese in America. When the House delayed the repeal bill in June 1943, Japanese radio immediately challenged the sincerity of the American government in ending the racial disparity. During the war, magazines, journals, and newspapers defined Japanese-Americans as the “Fifth Column” and “potential spies or espionage agents” and called for mass internment. Shinto and Buddhist priests and Japanese-language teachers and newspaper editors were arrested as “enemy aliens.” Based on popular sentiment rather than on “military necessity,” Executive Order 9066 placed 120,000 Japanese Americans in ten internment camps without a legal procedure. In February 1943, the U.S. government required all internees to answer a loyalty questionnaire. Question No. 27 asked draft-age males about their willingness to serve in the U.S. armed forces while Question No. 28 required them to swear unqualified allegiance to America. Racial ideology embodied in the questionnaire implied that Japanese were not loyal. Minoru Yasui, Gordon Hirabayashi, and Frederic Korematsu challenged the constitutionality of the internment policy in court when they were ordered to go to the camps.

The 1965 Immigration Reform Act is another landmark in Asian-American history. Growing political consciousness among Asians in the late 1960s through participation in the civil rights movement, anti-Vietnam War protests, and student strikes demanding ethnic studies courses on university campuses laid the theoretical foundation for Asian-American identity. *Asian America* became a meaningful political term. Asian population in America also grew dramatically since the law removed racial criteria from immigration policy for the first time in American history. In 1965, Asian-Americans numbered about one million, or less than 1 percent of the U.S. population. In 2002, their numbers had increased 72 percent in a decade, and in 2004 they numbered almost 12 million, representing 4.2 percent of U.S. population. In December 1966, *U.S. News and World Report* published an article entitled “Success Story of One Minority in the United States.” This and many other articles on “Model Minority” myth commended the economical rise of Asian-Americans in spite of historical discrimination and accused African-Americans of making unreasonable demands for government assistance. Post-1965 racial rhetoric presents Asian-Americans as a minority with high educational attainment levels, high median family incomes, and low crime rates. Some Asian-American

scholars and leaders strongly disagree with this Model Minority theory, for it downplays historical racial discrimination against Asians and creates misunderstanding and conflicts between Asians and other groups. But there are many Asians who take a more nuanced view toward it. In any case, the “glass ceiling” is still a major obstacle to the career mobility of many professional Asian-Americans, and the “sweat shop” job is often the only option for working-class immigrant Asian women. More importantly, a high percentage of contemporary Asian-American families, especially the refugee immigrants from Vietnam, Cambodia, and Laos, still live below the poverty line, and the Model Minority theory has disqualified Asians as racial minorities from important social remedy programs in education and employment. Asian-Americans have a long way to go in their pursuit of racial equality.

See also Asian-American Ideas (Cultural Migration); Identity, Multiple: Asian-Americans.

BIBLIOGRAPHY

- Chan, Sucheng. *Asian Americans: An Interpretive History*. Boston: Twayne, 1991.
- Cheng, Lucie, and Edna Bonacich, eds. *Labor Immigration under Capitalism: Asian Workers in the United States before World War II*. Berkeley: University of California Press, 1984.
- Espiritu, Yen Le. *Asian American Panethnicity: Bridging Institutions and Identities*. Philadelphia: Temple University Press, 1992.
- Fong, P. Timothy. *The Contemporary Asian American Experience: Beyond the Model Minority*. 2nd edition. Upper Saddle River, N.J.: Prentice Hall, 2002.
- Hing, Bill Ong. *Making and Remaking Asian America through Immigration Policy, 1850–1990*. Stanford, Calif.: Stanford University Press, 1993.
- Kitano, Harry H. L., and Roger Daniels. *Asian Americans: Emerging Minorities*. 2nd edition. Englewood Cliffs, N.J.: Prentice Hall, 1995.
- Lee, Robert G. *Orientalism: Asian Americans in Popular Culture*. Philadelphia: Temple University Press, 1999.
- Takaki, Ronald T. *Strangers from the Different Shore: A History of Asian Americans*. Boston: Little, Brown, 1989.
- Wei, William. *The Asian American Movement*. Philadelphia: Temple University Press, 1993.
- Zhou, Min, and James V. Gatewood, eds. *Contemporary Asian America: A Multidisciplinary Reader*. New York: New York University Press, 2000.

Haiming Liu

RADICALS/RADICALISM. *Radix*, the Latin word for root, is the origin of the word *radical*. In contemporary political philosophy, the term describes activists who challenge established views and who operate outside the parameters of social convention to achieve political aims, sometimes employing extreme or violent methods in that pursuit.

The concept of political radicalism evolved out of the language and logic of the scientific revolution when educated intellectuals began to view the world in scientific, secular terms.

It gained popularity during the Enlightenment as social theorists employed the new method of critical thinking to challenge traditional religious and political dogma.

Radical Liberalism

Political liberalism emerged in the seventeenth century, most notably in the work of John Locke (1632–1704). It spread to colonial America and France and became part of political discourse by the early eighteenth century. Locke's theory of government—that is, that the governed are sovereign and have the right to replace a dysfunctional, tyrannical government when needed—provided the intellectual basis for the American Revolution of 1776 and was the motivating force behind the French Revolution of 1789. A child during the English Civil War, Locke was aware of the execution of England's King Charles I (1600–1649) and the subsequent establishment of the Commonwealth under Oliver Cromwell (1599–1658). Thirty years later, Locke himself participated in toppling the government of King James I (1566–1625) during the bloodless, Glorious Revolution of 1688.

The term *radical* took on political connotations in the years prior to the French Revolution when contemporary social thinkers attempted to apply scientific logic to political affairs. By 1792 the word was used to describe the extremist policies and zealous political activity of the revolutionary government, the most radical stage of which began on 10 August 1792 when the Parisian *sans-culottes* stormed the king's palace and toppled the throne of Louis XVI. A period of government-sanctioned mass executions followed, lasting from 1792 to 1794—a phase of the revolution known as the Terror.

The French and American Revolutions were an outgrowth of intellectual transformation that began during the Enlightenment. Many social thinkers who adopted the “scientific” perspective during this period embraced Locke's philosophy of self-determination. Two who proved crucial to future political developments were Thomas Paine (1737–1809), an Englishman of common birth, and Voltaire (1694–1778), a popular French playwright with a talent for political satire. In America, Paine became a primary figure in the struggle for American independence, publishing most notably *Common Sense* (1776), a radical if not treasonous tract that advocated American federalism and a permanent split with England. A penchant for political activism led Paine to France in 1792 where he became a member of the French National Convention. In 1793 the radical arm of the revolutionary government imprisoned Paine because of his relationship with a faction of liberal moderates. During his incarceration, Paine wrote *Age of Reason* (1795), a criticism of church theology, for which Americans later ostracized him.

In France, Locke's philosophy of individual freedom surfaced in intellectual circles via the work of Voltaire who had acquired knowledge of Locke's treatise on labor, government, and human knowledge while living in exile in England. Voltaire disseminated Locke's liberal philosophy in hilarious if subversive plays and novels that exposed corruption and misuse of power among the clergy. When Denis Diderot (1713–1784)—editor of the *Encyclopédie* (1751–1780), a thirty-five-volume

work with antiauthoritarian content—likewise undertook to change the common way of thinking, he found a number of like-minded liberals, Charles-Louis de Secondat, baron de Montesquieu (1689–1755), author of *De l'esprit des lois* (1748), among them, who were willing to criticize the old regime of France. Thereafter, liberalism, which called for toleration and liberty, became the new revolutionary creed.

Of all the philosophes to emerge from the French Enlightenment, Jean-Jacques Rousseau (1712–1778) was perhaps the most influential political thinker. By 1792, Rousseau's *Social Contract* (1763) had become the bible for radical revolutionaries. Maximilien Robespierre (1758–1794), a powerful leader in the Committee of Public Safety, embraced Rousseau's anti-Lockean model of direct democracy, which required the surrender of individual rights to the interest of the common good. Where Locke supported individual freedom, Rousseau argued for forcible imposition of the general will. Of all the eighteenth and early nineteenth-century revolutions—which began in America, spread to France, and subsequently to Italy, Spain, Greece, Prussia, the Caribbean, and Latin America—the French Revolution proved most radical because of the Terror, and the excesses aimed largely against French citizens. Robespierre based the use of terror on Rousseau's theory of just coercion. Since that time, liberal politics on the Continent has been associated with revolutionary radicalism.

The association of radicalism and the political left can also be traced to the layout of the French Revolutionary legislature, an arrangement that led to divisions of the left, right, and center—political designations that continue to this day. In 1789 when the Convention moved to the Tuileries, representatives (for reasons known only to them) grouped themselves according to political sympathies, sitting in semi-circular tiers facing a rostrum. To the speaker's left sat the radical contingency, or the *Montagnards*, who jokingly referred to themselves as the Mountain because of the height of their seats. To the right sat moderates *cum* conservatives, a loose association of men known as the *Girondins*. Between them both sat the vast majority, the Marsh or the Plain, who sided with neither party. The deputies came increasingly into conflict, first over the fate of the king and then over issues of war, property, rights, and the use of terror. In the spring of 1793 left-wing representatives in the Convention joined forces with the radicalized *sans-culottes* and staged an attack against the Girondins, the majority of which were arrested and later guillotined. With the opponents silenced, the Jacobins, as the new coalition was called, were free to enact any legislation they deemed fit. As the Terror intensified, in June 1794, these deputies dictated the Law of Prairial (10 June 1794). Its stated purpose was the extermination of the enemies of the republic. The Law of Prairial initiated a state of political radicalism known as the Great Terror in which crimes were defined as any word, deed, or appearance of guilt that threatened the revolution. In a space of six weeks more than 1,300 persons were beheaded under this law before the Terror was finally brought to an end with the execution of Robespierre on 10 Thermidor (28 July) 1794. The conservative reaction that followed ended terrorist legislation, but it also opened the way for retribution of a different sort as anti-Jacobins took revenge against their previous tormentors.

In England, meanwhile, liberals formed their own party and began to address social ills caused by the excesses of industrial capitalism. Poets William Blake (1757–1827) and William Wordsworth (1770–1850) condemned the modern factory culture in their writing while political philosopher Jeremy Bentham (1748–1832) and his so-called band of radical philosophers—David Ricardo (1772–1823), Thomas Malthus (1766–1834), and James Mill (1773–1836)—instigated reform via social theory based on modern economic philosophy. Bentham’s formula for addressing public ills was based on the utilitarian principle of “the greatest good for the greatest number” (Bentham, p. 505; Mill, p. 509).

Despite such efforts, working-class militancy in Great Britain increased in 1830 and 1845. Luddites staged attacks upon unprotected factories and machinery, destroying property and threatening bourgeois industrialists. That strategy changed with the Chartist movement of 1838 as workers employed petitions to demand universal male suffrage and better work conditions. While workers did not immediately realize their political objectives, such outbursts signaled class-consciousness in formation. Militant liberals, vanguards of this movement, helped bring about duty-free importation of wheat and limited suffrage in 1850. By 1884, with the Third Reform Bill, liberals could add male suffrage and labor laws to their list of accomplishments. As liberalism in England became less radical, with gradual reform replacing political extremism, socialists and militant nationalists branched off and formed more politically aggressive factions.

Radical Nationalism

Early advocates of nationalism drew from the French example and sought republican freedom and unification. Most were liberals in the Enlightenment tradition. The exceptions, however, East Central Europe and the German states, rejected the liberal-rational tradition, preferring a folk community where emotion trumped reason and where the needs of the individual merged nicely with those of the state. In Germany, Johann Gottfried von Herder (1744–1803), philosopher and close friend of Goethe, denied the universal nature of man and insisted upon the uniqueness of *Volk* or culture. Rationalism, he argued, ran counter to the German spirit.

Other Europeans with pro-nationalist sympathies shared similar desire to unite divided territory. Such sympathies led in 1815 to 1840 to nationalist revolts in Italy, Spain, and Greece. Only in Greece did the effort succeed, in 1830. Nevertheless, the demand for self-government did not die. In 1848 a workers’ revolution in France, which forced the abdication of King Louis-Philippe (r. 1830–1848), inflamed the imagination of nationalists everywhere, spurring a new round of insurrections. In Bonn, Carl Schurz (1829–1906), a student radical compelled to write from the safety of Switzerland, described reaction upon hearing the news. “We were dominated by a vague feeling as if a great outbreak of elemental force had begun,” he wrote (pp. 157–158). Indeed, it had. In 1848 revolution spread to nearly every state on the continent. In Italy, Giuseppe Mazzini (1805–1872) responded to the Paris uprising by writing subversive articles aimed at inciting the Italian

masses. “Every privilege which demands submission from you . . . is a usurpation and a tyranny which you are bound to resist and destroy,” he declared (p. 562). Mazzini’s radicalism manifested itself in his political activity; between 1844 and 1858, he plotted the overthrow of Austrian rule in Italy.

Revolution in Paris, Germany, and Italy failed and conservative forces regained control. Nationhood did not come for Italy until 1860 when another political subversive, Giuseppe Garibaldi (1807–1882), led a guerrilla army against Austria. The German Empire took shape in 1870, after a victorious war against France led to increased feelings of Teutonic greatness and superiority. Due to the farsighted vision of Otto von Bismarck (1815–1898), Germany adopted a federal constitution that included male suffrage. As a result, conservative nationalism subsequently replaced radical nationalism and the new state embraced the idea of German destiny.

Meanwhile, political radicalism emerged in Ireland between 1845 and 1849, the result of the potato famine and deliberate inaction on the part of the British government to feed the starving populace. In the summer of 1848, Irish republican nationalists attempted a revolution against England. The revolt failed, but the experience increased Irish radicalism, spawning the Fenian movement of 1858. In 1873 the Fenians became the Irish Republican Brotherhood, then the Irish Volunteer Force, and, in 1919, the Irish Republican Army (IRA), a paramilitary faction dedicated to the overthrow of British rule and the unification of Ireland. Beginning in 1970 the IRA, yet to achieve national independence, resorted to terrorist tactics while its political arm, Sinn Fein, made use of the ballot. In 1998 a splinter group, the “Real IRA” bombed the town of Omagh.

An inherent weakness in nationalist extremism was a tendency to divide the world into “them and us,” a process that postmodernists call Othering. After 1871 that predisposition caused governments to conflate national pride with militaristic goals, leading in June of 1914 to the assassination of Austria’s heir-apparent by militant Serbian nationalists. The murder of Archduke Francis Ferdinand and his wife Sophie was an act of political radicalism that provided the pretext for World War I.

The incredible cruelty of World War I—trench warfare, the horrendous effects of mustard gas, and sheer loss of life—caused intellectuals to lose faith in the idea of progress and to abandon their liberal ideals. Fascism and communism rose to fill the vacuum and a new sort of radicalism got underway. In Soviet Russia, that process began with Vladimir Ilyich Lenin (1870–1924) who established the first totalitarian dictatorship in 1917. In 1922 Benito Mussolini (1883–1945) seized power in Italy and formed the first fascist government. In Germany, militancy coupled with state-worship and the election of Adolph Hitler in 1933 gave rise to Nazism. In all three places, human rights, individual freedom, and social justice gave way to abuses, compulsory labor, and political terror. In terms of violence and challenge to conventional thinking, totalitarianism proved every bit as radical as any previous political movement. It peaked between 1927 and 1953, with the regime of Joseph Stalin (1879–1953).

Radical Socialism

Utopian socialism emerged as a rejoinder to liberal policies and practices during the Industrial Revolution and assumed different forms between 1816 and 1848. In England, Robert Owen (1771–1858) a civic-minded reformer experimented with planned communes in pursuit of the perfect socialist community. Owen's strong social consciousness and his belief in the power of science to create a better world led him in 1834 to found the Grand National Consolidated Trades Union, England's first national labor organization. Like Owen, the social theories of Count Henri de Saint-Simon (1760–1825), Charles Fourier (1772–1837), Auguste Comte (1798–1857), and Karl Marx (1818–1883) assumed the possibility of a perfect society. Such thinkers believed in progress and the ability of science to end scarcity and establish a better world, a perfect community supported by moral political institutions.

In France, utopian socialism grew out of the economic ideology of the revolutionary *sans-culottes* and the social criticisms of Saint-Simon and Fourier. A child of the revolution himself, Saint-Simon envisioned a world where parasites stepped aside and allowed doers to organize a planned community. In that same spirit of progress, Fourier championed sexual freedom and female emancipation. In 1830 he criticized arranged marriage, likening it to prostitution. Such a challenge to conventional thinking marked Fourier as dangerous if not subversive.

Utopian socialism appealed to the working classes primarily because of socialist opposition to laissez-faire capitalism. French workers adopted either a socialist political outlook or an egalitarian republican one. In June 1848 the two factions united against the French king Louis-Philippe, hoping to replace monarchy with a popular democratic government. Within days of accomplishing this goal, class warfare erupted in Paris (primarily over the issue of national workshops), and workers took to the streets. When the army quelled the riot, liberals returned with a constitution featuring a strong executive. Even so, working-class radicalism remained strong. In 1871 workers again stormed the capital (after national elections returned a majority of conservatives to the Assembly), set up the Paris Commune, and demanded the right to govern without interference. At the behest of Adolphe Thiers (1797–1877), the army smashed the rebels and destroyed the Commune. France was slowly stabilizing when in 1898 to 1899 an anti-Semitic controversy, the Dreyfus Affair, once again pitted the old and traditional—Catholics, racists, and the army—against democratic republicans. Under threat of yet another revolution, the government severed ties with the Catholic Church. The literary realist, Émile Zola (1840–1902) played an influential role in exposing the lie and reviving animosity against the church.

On the heels of the Dreyfus Affair came war with Germany. Brutalized by Germany's threat to "bleed France white" during World War I, survivors of the bloody conflict lost faith in reason and turned a curious eye toward totalitarian regimes. With the Great Depression of the 1930s, an innate weakness of capitalism lay exposed causing widespread panic to set in. As workers began to migrate toward fascism and communism,

socialists led by Léon Blum (1872–1950) responded, forming an alliance between radicals and communists in opposition to conservatives and fascists. The Popular Front, the result of this alliance, failed when rapid inflation curtailed Blum's efforts at reform. Blum resigned in 1937, leaving the French to choose between Stalinist Russia and Fascist Germany. The *Parti Républicain Radical et Radical Socialiste* shifted toward the moderate center.

Marxism

While a genuine socialist movement existed in France prior to the publication of the *Communist Manifesto* in 1848, the real founder of modern socialism is Karl Marx. Marx's contribution to economic-political theory—the theory of surplus labor—drew from French socialism and Hegelian philosophy and posited that profits were wages stolen from laborers by those who controlled the means of production. The solution to the problem of exploitation, Marx held, was a workers' revolution. A second concept in the *Communist Manifesto* was the idea of class struggle, which Marx maintained would end only when the proletariat united against the bourgeoisie. With this understanding, Marx penned the words that set socialism on a radical path: "Let the ruling classes tremble at a Communist revolution. The proletarians have nothing to lose but their chains. They have a world to win. Working men of all countries, unite!" (p. 179).

During the Soviet period in Russia, Marx's social theory became the ideological basis of the radical Bolshevik party. Only the anarchists proved more radical. Lenin, a staunch defender of violent revolution, introduced a changed form of radical socialism to Russia in 1917, altering the basic Marxian formula by bringing revolutionary peasants into the proletariat fight against capitalism and by creating a one-party system of communism. While undeniably radical, some historians deny that the Lenin-Stalinist regime was actually Marxian.

After Lenin's death, Trotskyites in the West rejected the notion of gradual social change, preferring the older concept of permanent revolution. In 1960 followers of Leon Trotsky (1879–1940) reinvigorated the social ideals of the Communist Party while other neo-Marxists such as György Lukács (1885–1971) and Antonio Gramsci (1891–1937) endeavored to revive the classical aspect of Hegelian Marxism. Gramsci's stress on the importance of intellectuals in the struggle against capitalist hegemony encouraged other intellectuals to take up the fight. One such scholar, Herbert Marcuse (1898–1979) of Frankfurt School fame, helped formulate popular political opinions using a Marxist interpretation of Freud—a theory of surplus repression and performance principle, which he used to criticize U.S. capitalism. Marcuse's preoccupation with the politics of emancipation made him an ideal spokesperson for the New Left during the politically explosive decade of the 1960s. Under his leadership, Students for a Democratic Society (SDS), the radicalized arm of the New Left, undertook a campaign of violence against American imperialism.

In London, meanwhile, the philosopher and political activist Bertrand Russell (1872–1970) linked forces with the New Left in 1960 after resigning as president of the *Campaign*

for *Nuclear Disarmament* (CND). Russell then launched the Committee of 100, a confrontational political organization that instigated political activism in Europe and the United States. The political reach of leftist politics spread, surfacing again in Paris in 1964 where Jean-Paul Sartre's (1905–1980) combination of Marxism and existentialism captured the imagination of French students. By 1968 radical violence engulfed France, Germany, Mexico, and Spain. Even Japan experienced student riots. Ostensibly, the New Left acted in the name of workers, fighting to overthrow capitalism and introduce socialism. In the 1970s, however, antiestablishment political factions, the Weathermen in the United States, the Red Brigade in Italy, the Red Army Faction (Baader-Meinhof) in Germany, the Angry Brigade in Great Britain, and the Action Directe in France, began a campaign of terror. In 1974 the Red Army Faction killed twenty-six and injured seventy-one unsuspecting travelers in Israel's Lod airport. In 1967 London's Angry Brigade attacked the U.S. Embassy, and in 1971 they bombed the home of U.K. minister of employment. Both groups cited militant liberation as motivating factors for these attacks. Marxian socialism was not the goal.

Radical Feminism

By definition all feminist movements are radical because they challenge established views. Nevertheless, most feminists would agree that modern radical feminism began with the women's movement in France and the United States during the 1970s and 1980s. The publication of Germaine Greer's (b. 1939) *The Female Eunuch* (1970) and Simone de Beauvoir's (1908–1986) release in 1949 of *The Second Sex* (*Le Deuxième Sexe*), led to the politicization of sexuality. Greer's book invited debate on issues of female sexuality and the role of patriarchal influence in shaping female destiny. Both Greer and de Beauvoir cited Freud's (1856–1939) study of female sexuality as a sample of male hegemony, which empowered men at the expense of women. The theory of universal patriarchal dominance over women, the primary issue upon which many feminists agree, is the intellectual foundation for radical feminist thought. In England, the feminist critique of Freud was not widely accepted. Juliet Mitchell (b. 1940), for example, argued in her 1974 publication of *Psychoanalysis and Feminism* that Freud had merely analyzed the biological relationship between mental life and sexuality and did not intend a misogynistic model of human development. In linking the unconscious to economic and political ideologies that oppress women, Mitchell, like Marcuse, offered a psychoanalytical reading of Marx. Her views influenced British feminists through the 1980s. In France, the *féministes révolutionnaires* shared the growing interest in the role of psychology in shaping attitudes, but they looked to the work of Jacques Lucan (b. 1947) and Jacques Derrida (b. 1930), who emphasize the role of language in shaping attitudes. Hélène Cixous (b. 1937) borrows from both traditions, employing Derrida's binary system to demonstrate ways in which male/female opposition in language is used to subordinate the female to the male and Lucan's theory of objectification through looking. Luce Irigaray (b. 1932) shares a similar conviction that language produces sexual difference at the psychic level. Irigaray holds that Freud contributed to the creation of a phallogocentric mind-set.

Radicalism in the Twenty-First Century

Since the 1990s, antiglobalization protestors have appeared throughout Europe and the United States. In June of 1999 demonstrators vandalized the city of Cologne, Germany, during the G8 Economic Summit and managed to disrupt business by staging a five-hour cyber attack upon computers. Financial districts were the target. Protestors repeated those tactics in November and December of 1999, at the meeting of the World Trade Organization in Seattle, and again in April of 2000 in Washington when student activists joined forces with environmentalists, labor leaders, and human rights advocates to strike against the International Monetary Fund. Protesters accused large corporations such as Nike, Gap Inc., and Starbucks of union-busting and unfair labor practice, and they indicted McDonald's, Monsanto, and Shell Oil for paying low wages and minimal health benefits, using unsafe pesticides, creating ecological damage, and "colluding with repressive regimes" (CSIS, p. 3). "Underlying the antiglobalization theme," according to the Canadian Security Intelligence Service, "is criticism of the capitalist philosophy." The largest of these, a group called *Third Position*, a European organization with both conservative and liberal members, has achieved notoriety for violence and destruction of property. This group and others communicate via Internet and, according to intelligence reports, are funded partially by organizations such as *Direct Action Network* and *Alliance for Global Justice* (CSIS, p. 9).

Terror is the extreme form of radicalism. On 11 September 2001, Islamic fundamentalists, who dreamed of restoring a religious caliphate, flew planes into the World Trade Center and the Pentagon, killing thousands of innocent civilians in pursuit of that aim. Meanwhile, in Spain, Basque separatists employed similar tactics in their fight for the creation of a single Basque nation. Both used terror to create and exploit a climate of fear—a means of advancing political goals. Whether conservative or extreme leftist, radicals of every generation have often been willing to employ unconventional methods to achieve political objectives.

See also *Anarchism; Conservatism; Fundamentalism; Liberalism; Revolution; Terrorism, Middle East.*

BIBLIOGRAPHY

- Bentham, Jeremy. "On the Principle of Utility." In *Main Currents of Western Thought: Readings in Western European Intellectual History from the Middle Ages to the Present*. 4th ed., edited by Franklin Le Van Baumer. New Haven, Conn., and London: Yale University Press, 1978.
- Canadian Security Intelligence Service (CSIS). "Anti-Globalization: A Spreading Phenomenon." Report 2000/08. 22 August 2000.
- Cixous, Hélène. "The Laugh of the Medusa." In *Feminist Theory: A Reader*, edited by Wendy Kolmar and Frances Bartkowski. London and Toronto: Mayfield, 2000.
- Comte, Auguste. *The Positive Philosophy*. In *Main Currents in Western Thought: Readings in Western European Intellectual History from the Middle Ages to the Present*. 4th ed., edited by Franklin Le Van Baumer. New Haven, Conn., and London: Yale University Press, 1978.
- Doyle, William. *Origins of the French Revolution*. 2nd ed. Oxford and New York: Oxford University Press, 1988.

Engels, Friedrich. *The Condition of the Working Class in England*. Translated and edited by W. O. Henderson and W. H. Chaloner. Stanford, Calif.: Stanford University Press, 1968.

Hegel, Georg F. W. *Philosophy of History*. In *Main Currents of Western Thought: Readings in Western European Intellectual History from the Middle Ages to the Present*. 4th ed., edited by Franklin Le Van Baumer. New Haven, Conn., and London: Yale University Press, 1978.

Herder, Johann Gottfried von. *Yet Another Philosophy of History*. In *Main Currents of Western Thought: Readings in Western European Intellectual History from the Middle Ages to the Present*. 4th ed., edited by Franklin Le Van Baumer. New Haven, Conn., and London: Yale University Press, 1978.

Langer, W. I. *Political and Social Upheaval, 1832–1852*. New York: Harper and Row, 1969.

Marx, Karl. *The Communist Manifesto*. In *Sources of the Western Tradition*. 4th ed., edited by Marvin Perry et al., vol. 2. Boston and New York: Houghton Mifflin, 1999.

Mazzini, Giuseppe. *Young Italy*. In *Sources of the Western Tradition*. 4th ed., edited by Marvin Perry et al., vol. 2. Boston and New York: Houghton Mifflin, 1999.

Mill, John Stuart. *Autobiography*. In *Main Currents of Western Thought: Readings in Western European Intellectual History from the Middle Ages to the Present*. 4th ed., edited by Franklin Le Van Baumer. New Haven, Conn., and London: Yale University Press, 1978.

Payne, Michael, ed. *A Dictionary of Cultural and Critical Theory*. Oxford: Blackwell, 1997.

Schurz, Carl. "Reminiscences." In *Sources of the Western Tradition*. 4th ed., edited by Marvin Perry et al., vol. 2. Boston and New York: Houghton Mifflin, 1999.

Thompson, Edward P. *The Making of the Working Class in England*. New York: Vintage Books, 1966.

Valerae M. Hurley

RASTAFARIANISM. See **Religion: African Diaspora.**

RATIONAL CHOICE. People constantly make choices or decisions in an uncertain world: should I buy life insurance, marry, change jobs? Rational decision making is an important topic in the social sciences, cognitive science, and philosophy, and for many years classical decision theory has dominated competing accounts of decision making.

Classical Decision Theory

Most of classical decision theory was developed over the first sixty years of the twentieth century. The theory focuses on instrumental rationality, that is, on reasoning about how agents can best achieve their desires in light of their beliefs. Decisions take place under three conditions: certainty (outcomes of actions are certain), risk (outcomes are not certain but their probabilities are known, as in some games of chance), and uncertainty (probabilities of outcomes are unknown). There are various ways of handling decision-making under uncertainty, but it is usually reduced to decision-making under risk by using the agent's subjective probabilities, and it will be the focus here.

Figure 1.

	Outbreak	No outbreak
Shot	No flu, sick one day	No flu, sick one day
No shot	Flu, sick for a week	No flu, not sick

SOURCE: Courtesy of the author

Building blocks of the classical theory. The following example is illustrative: Tom must decide whether to get a flu shot. Allergic to the vaccine, he realizes that getting the shot means he will be sick for a day. He also believes there may be an outbreak of flu that would make him very sick for a week.

Actions, conditions, and outcomes. Decision theory starts with three fundamental concepts:

1. **Actions.** These are the options an agent ponders (here getting a flu shot or not). Actions are often represented by rows in a table.
2. **Conditions.** These are how things turn out independently of actions (e.g., whether there is a flu outbreak or not). Conditions are represented by columns.
3. **Outcomes.** These are the states that result from actions under various conditions (e.g., getting sick for a day in the absence of a flu outbreak).

Desires and beliefs. Classical decision theory represents agents as having preferences over outcomes that capture their desires. For example, Tom prefers health to illness, and less illness to more. Preferences are mathematically represented by subjective utility functions, subject to certain constraints (e.g., the expected utility of one outcome is greater than that of a second only if the agent prefers the first to the second). $U(A,S)$ is the utility of the outcome of action A in condition S . Many sets of numbers can reflect the same preferences, as long as the intervals among them reflect analogous relationships among intensities of desires.

Classical decision theory also represents agents as having degrees of belief about conditions. For example, Tom might believe that a flu outbreak is less likely than not. Degrees of belief are mathematically represented by subjective probability func-

Figure 2.

	Outbreak	No outbreak
Shot	(.4)(1)	(.6)(-1)
No shot	(.4)(-6)	(.6)(3)

SOURCE: Courtesy of the author

tions that specify how likely the agent thinks various outcomes would be. $P(S|A)$ represents an agent's degree of belief that condition S will come about given that he performs action A . For example, Tom might surmise that $P(\text{flu outbreak} | \text{shot})$ is 0.4. Probabilities are represented by the first member of a pair of numbers in a cell, and utilities by the second number in Figure 2 (which has a hypothetical set of numerical values).

Expected utility. The subjective expected utility of each action is the sum of products in each cell in the action's row.

- Shot (row one): $(.4)(1) + (.6)(-1) = (.4) + (-.6) = -.2$
- No shot (row two): $(.4)(-6) + (.6)(3) = (-2.4) + (1.8) = -.6$

Here the first action has a higher expected utility than the second (in symbols): $EU(\text{shot}) > EU(\text{not shot})$, and decision theory reveals that getting a shot is the rational thing to do. There is often a compromise between beliefs and desires; for example, it is frequently often more rational to do something likely to lead to a moderate payoff than to pursue a higher payoff with less chance of success.

There can be more than two actions or situations, and the general formula is:

$$EU(A) = \sum_i P(S|A) \times U(A, S_i)$$

The fundamental claim of decision theory is that a rational decision is one with the highest subjective expected utility (there may be more than one due to ties). And the centerpiece is a representation theorem proving that any agent whose beliefs and desires conform to certain plausible constraints (e.g., whose preference ranking is transitive) behaves as if she were maximizing expected utility.

Interpretations of classical decision theory. Some see utility maximization as a descriptive claim; people in fact behave pretty much as the theory says they should. Others see it as a normative claim: a rational person should choose a utility maximizing action.

Descriptive Interpretations of Decision Theory

Descriptive interpretations of classical decision theory are supposed to provide (at least some) information about how people actually behave. These interpretations lie at the heart of modern economics and related social sciences.

Arguments for descriptive interpretations. Many arguments for descriptive interpretations of classical decision theory are based on the claim that the theory provides sound normative guidance, together with the view that human beings are pretty good at making decisions. Moreover, it is sometimes added, natural selection should favor creatures that are more rational than their dimmer conspecifics, so that bit by bit the human species has become more rational.

Objections and replies. One objection to empirical interpretations is that people simply cannot do what the classical

theory requires. People rarely have definite probabilities and utilities, and even if they did, their working memory and computational capacities are too limited to perform the required calculations (or even to run through processes that would allow them to behave as if they performed such calculations). Moreover, while natural selection may favor better reasoning over worse, there is little reason to suppose it could attune individuals to the subtleties of calculating expected utilities.

Another objection to empirical interpretations is that people behave in ways that are inconsistent with the classical theory. Every history book chronicles follies that are dreadful by the agents' own lights. Furthermore, decades of intense empirical investigation suggest that people simply do not act in the way descriptive decision theory says they do. For example, people's preferences are highly sensitive to how options are described, even where the theory says they should not be.

One response to these criticisms is that people sometimes have something close to definite utilities and probabilities and the relevant calculations are not always too demanding, so people are sometimes capable of maximizing utility. Another response is to scale back the claims made for decision theory. Many economists, for example, hold that it predicts well enough at the aggregate level, even if it only approximates individual behavior.

Normative Interpretations of Decision Theory

Normative interpretations of classical decision theory are supposed to show how people should behave. A rational person, in this view, will take the action with the highest expected probability.

Arguments for normative interpretations. Many arguments for the claim that decision theory is a good normative model for decision making portray irrationality as self-subversion. If an agent violates the theory, he will, over the long run, act in ways that undermine his very own desires. For example, if someone's subjective probabilities do not conform to probability theory, he will be susceptible to "Dutch book" (a series of bets he is guaranteed to lose, no matter how things turn out).

Objections and replies. It has been pointed out that Dutch book arguments and their kin rely on unrealistic assumptions and that there are other ways to avoid self-subversion besides conforming to classical decision theory. There is also a problem suggested by difficulties that beset empirical interpretations. Utility maximization cannot be an appropriate prescription if one lacks the cognitive capacities to follow it. One reply to these criticisms is that even if researchers fall short of classical decision theory's guidelines, rationality requires that is necessary to get as close to them as possible.

Another criticism is that some of the principles of the classical theory do not make sense as normative guidelines. For instance, they would enjoin people to prefer a chance at something with a high payoff to a smaller guaranteed payoff where the former had a higher expected utility, but it often seems quite rational to prefer the sure thing. Cases like this are intended to

show that rationality does not always require utility maximization. Advocates of the classical account counter that intuitive “violations” of the theory often result from simplistic (mis)applications of its principles. These issues remain a matter of controversy.

Extensions and Alternatives

There are various friendly amendments to classical decision theory; for example, there is now more focus on the role of causation in decision making and on plans and sequences of decisions. Other work involves larger departures. For example, some behavioral decision theorists argue that desires and beliefs are not captured by the classical account. Tversky’s and Kahneman’s prospect theory, the pioneer behavioral account, replaces utilities and probabilities with value functions and decision weights, both of which are constructed to capture the behavioral evidence. A competing approach, due to Gigerenzer and his coworkers, is based on “fast and frugal heuristics”; he holds that human behavior results from the application of a number of simple rules that are adapted to the situations people typically face and that this allows them to achieve good results with minimal use of computational resources. Alternative normative accounts of rationality have also been proposed, many of which demand less than do normative interpretations of the classical decision theory.

See also *Economics; Game Theory; Probability*.

BIBLIOGRAPHY

- Allais, Marice. “Le comportement d l’homme rationnel devant le risque: Critique des postulats et axiomes de l’ecole Americaine.” *Econometrica* 21 (1953): 503–546. Develops an early, influential empirical critique of classical utility theory.
- Archer, Margaret S., and Jonathon Q. Tritter, eds. *Rational Choice Theory: Resisting Colonization*. London and New York: Routledge, 2000. Essays by sociologists arguing that decision theory is a bad model or human behavior.
- Bernoulli, Daniel. “Exposition of a New Theory on the Measurement of Wealth.” *Econometrica* 22 (1954): 23–36. Earliest clear discussion of expected utility. Translated from the Latin, first published in 1738.
- Ellsberg, Daniel. “Classical and Current Notions of ‘Measurable Utility’.” *Economic Journal* 64 (1954): 528–556. Explains how von Neumann and Morgenstern cardinal utilities differ from both Marshallian cardinal utilities and Paretian ordinal utilities.
- . “Risk, Ambiguity and the Savage Axioms.” *Quarterly Journal of Economics* 75, no. 4 (1961): 643–669. Develops another influential empirical critique of subjective expected utility theory.
- Friedman, Milton. “The Methodology of Positive Economics.” In his *Essays in Positive Economics*. Chicago and London: Chicago University Press, 1953. Classic statement of economic irrationalism, arguing we should predict that people behave as if they were utility maximizers.
- Gigerenzer, Gerd, and Daniel G. Goldstein. “Reasoning the Fast and Frugal Way: Models of Bounded Rationality.” *Psychological Review* 103, no. 4 (1996): 650–669. Develops a model of bounded, ecological rationality based on fast and frugal heuristics.

Kahneman, Daniel, and Amos Tversky. “Prospect Theory: An Analysis of Decision Under Risk.” *Econometrica* 47 (1979): 263–291. Motivated by their earlier, very influential work in behavioral decision theory the authors develop prospect theory as a more accurate empirical account of human decision making.

Jeffrey, Richard C. *The Logic of Decision*. 2nd ed. Reprint, Cambridge, U.K.: Cambridge University Press, 1992. First published in 1983. State-of-the-art version of classical (“evidential”) decision theory.

Joyce, James M. *The Foundations of Causal Decision Theory*. Cambridge, U.K., and New York: Cambridge University Press, 1999. Lucid treatment of causal decision theory in a wider context that subsumes it and classical decision theory under a more general account.

Raiffa, Howard. *Decision Analysis*. Reading, Mass: Addison-Wesley, 1968. Provides an influential introduction to subjective probability and the application of Bayes theory to decision problems.

Richardson, Henry S. *Practical Reasoning about Final Ends*. Cambridge, U.K., and New York: Cambridge University Press, 1994. Urges that there is more to rationality than instrumental rationality, and presents an account about reasoning about what our more basic desires should be.

Savage, Leonard J. *The Foundations of Statistics*. New York: Wiley, 1954. The classical treatment of decision making with subjective probabilities.

Schick, Frederic. “Dutch Bookies and Money Pumps.” *Journal of Philosophy* 83 (1986): 112–119. Argues that self-subversion arguments for normative decision theory fail.

Simon, Herbert A. “Rational Choice and the Structure of the Environment.” *Psychological Review* 63 (1956): 129–138. Seminal defense of rationality as a bounded enterprise due to human cognitive limitations.

Tuchman, Barbara. *The March of Folly: From Troy to Vietnam*. New York: Knopf, 1984. Fascinating catalog of actions and policies that led to disaster even by the lights of those who proposed them.

Von Neumann, John, and Oskar Morgenstern. *Theory of Games and Economic Behavior*. 2nd ed. Princeton: Princeton University Press, 1947. The classical statement of mathematical utility theory.

Chris Swoyer
Stephen Ellis

RATIONALISM. In the final section of the *Critique of Pure Reason*, Immanuel Kant distinguishes empiricism and rationalism:

In respect of the origin of the modes of “knowledge through pure reason,” the question is as to whether they are derived from experience, or whether in independence of experience they have their origin in reason. Aristotle may be regarded as the chief of the empiricists, and Plato as the chief of the noologists [rationalists]. Locke, who in modern times followed Aristotle, and Leibniz, who followed Plato . . . have not been able to bring this conflict to any definitive conclusion. [Kemp Smith, trans.]



The School of Athens (1510–1511) by Raphael. In Raphael's fresco, Plato is pointing towards the heavens, indicating what he saw as the unchanging truths of knowledge, while Aristotle points downwards, symbolizing his belief that learning came from human experience. SCALA / ART RESOURCE, NY

Kant's vision of a conflict between empiricism and rationalism remains to this day the organizing principle for discussions of early modern metaphysics and epistemology. Kant may have overstated the extent to which there was a conflict between empiricists and rationalists: it has recently been suggested that both may be seen as pursuing the common project of defining the scope and limits of human knowledge. It has also been charged that the very distinction between empiricism and rationalism should be rejected. I believe that the distinction usefully captures certain defining features of early modern philosophy and that the terms *rationalism* and *empiricism* should be retained.

Rationalism Defined

Kant's characterization of rationalism is generally accurate. One addition must be made. Like most early modern philosophers, the rationalists conceived of the human cognitive faculties as distinguished into the pure intellect, the senses, and the imagination. The pure intellect was the faculty that enabled human beings to gain knowledge. Rationalism may be defined as the view that substantive truths about the nature of reality may be

derived from the pure intellect alone, operating independently of the imagination and the senses.

The Roots of Rationalism

It was by no means idiosyncratic for Kant to take Plato and Aristotle as prefiguring the opposition between rationalism and empiricism; this opposition is, for example, the organizing principle of Raphael's Vatican fresco *The School of Athens*. Plato points up, to the realm of Forms, the unchanging objects of the pure intellect; Aristotle points to the earth, thereby indicating the experiential origin of knowledge. Plato's commitment to the existence of unchanging truths, sharply contrasted with the variable images of the senses, marks him as the grandfather of early modern rationalism.

Approximately five hundred years later, Saint Augustine synthesized Plato's philosophy with the Christian religion in order to provide the latter a philosophical underpinning. Augustine found in Plato a remedy for the vagaries of sense experience that threatened the truth of Christianity; his work remained seminal for the early modern rationalists: Descartes, Leibniz, and Malebranche, believers all, explicitly hearkened

back to Augustine. Aristotle's work, however, held its importance for medieval philosophers. He became known as "the Philosopher," and his thought, especially as interpreted by Aquinas, became the official philosophy of Christianity.

René Descartes

Descartes formulated his conception of philosophy in explicit opposition to the Scholastic Aristotelians' emphasis on sense-based experience. The *Meditations* are best understood as a series of cognitive exercises that train the meditator to discover truths about the world by the use of pure intellect, independent of the senses. Beginning by purging the self of intellectual preconceptions, by doubting all knowledge hitherto received through the senses, the meditator rebuilds knowledge, achieving clear and distinct ideas of the nature of the soul, God, and body.

The *Meditations* was not a complete system of philosophy; it only laid the foundation for Descartes's broader philosophical project. Descartes explains in a letter to his friend Marin Mersenne that "my little book on metaphysics contains all the foundations of my physics." The point of the *Meditations* was to reconceptualize the physical world as a realm of extension, governed by laws of motion, and therefore amenable to mathematical investigation. Descartes envisioned his physics very broadly, extending his view from celestial bodies to terrestrial bodies, the operations of animals, and the nature of the human being. He meant for his scientific project to culminate in the *Principles of Philosophy*, which remained unfinished, although the broad lines of Cartesian science may be derived from other works.

Although Descartes turned to philosophy (metaphysics) in order to ground science and thought that the only genuine knowledge that human beings could achieve derived from the intellect operating independently of the senses, he nevertheless retained an important place in science for the senses. General truths about body only specify the possible range of explanations of physical phenomena; in order to determine the particular explanations, one must appeal to sense experience. Cartesian rationalism remains limited to the most general truths about the universe.

Benedict Spinoza

Spinoza is the only Jewish thinker among the rationalists. He was excommunicated from the Jewish community of Amsterdam, possibly on account of the heretical views that he held about the nature of God and the immortality of the soul, views later elaborated in his great systematic work, the *Ethics*. Spinoza's philosophical system is the purest example of rationalism.

Other rationalists remained committed to the truths of revealed religion; Spinoza maintains that the Bible does not contain the word of God, but is a work of men that serves the sociopolitical ends of establishing and securing the commonwealth. In his *Theological-Political Treatise*, Spinoza therefore argues that human beings should be free to hold whatever religious views they like, provided they do not upset the established civil order.

This work is a prolegomenon to the *Ethics*, where, on the basis of reason alone, Spinoza radically reconfigures traditional notions of God, nature, and morality. Rejecting all sensory inputs as mere "random experience" that do not reveal the nature of the world, he says there is only one substance, which he strikingly calls "God or nature." All existing things must be understood to be merely modifications of that single substance, not substances in their own right. One of the most provocative aspects of Spinoza's vision of the universe, which drew sustained criticism from his contemporaries, is his claim that all events are determined by God to occur. Indeed, he maintains, even God does not freely choose to create the world—this in sharp contrast to traditional views of God as creator—but is determined by his own nature to produce what exists in the world. This determinism renders the structure of nature intelligible to the human intellect.

By understanding the necessary and eternal order of the world, humans may come to understand both their place in the world and what they ought to do in the world. By achieving this understanding, they may achieve a kind of nontheological immortality. Their reason, which grasps the unchanging and eternal order of nature, enables them to achieve a kind of immortality as well.

Nicolás Malebranche

Malebranche's philosophical system is a synthesis of Cartesian philosophy and Augustinian theology. In *The Search after Truth*, Malebranche seeks to remedy human ignorance by presenting the nature of the human mind and showing that it is only by heeding the perceptions of the pure intellect that human beings may achieve knowledge. In the course of elaborating this view, Malebranche develops his two most distinctive doctrines: the vision in God and occasionalism.

The vision in God is Malebranche's account of human knowledge of truths about the world. He claims that human beings may cognize general truths because they have access to those truths in God's mind; they must have access to truths in God's mind because general truths are eternal and infinite and therefore could not be contained in the finite human mind. Occasionalism is a general account of causation, according to which no finite being (whether a mind or a body) is the real cause of any change in the world. Malebranche maintains that a real causal connection must be one that is necessary; however, there is a necessary connection only between God's will and some effect. Consequently, apparent causes are merely occasions for the exercise of God's causal power in accordance with the natural laws constitutive of nature.

In the *Treatise on Nature and on Grace*, Malebranche deploys these doctrines in order to explain God's action in the created world. He seeks to show that the seeming imperfection of the natural world manifest in natural disasters and the birth of monsters, and the apparent inequality in God's distribution of grace, are merely apparent defects. Because God acts in accordance with general laws, and does not intervene directly to produce particular events, his action in the realms of nature and grace is essentially limited. Malebranche believes that God must act in accordance with general laws because if he were to intervene at

every moment in the world, he would not act in accordance with his own nature. Moreover, the world would thereby cease to be intelligible to human beings. Occasionalism, consequently, guarantees the intelligible order of the universe.

Gottfried Wilhelm von Leibniz

Leibniz's philosophical system reflects an overarching commitment to the idea that there is a rational order to the universe that can be grasped by human minds. This commitment is manifest both in his more general epistemological and metaphysical views on display in works like the *Monadology* and in the philosophical theology contained in the *Theodicy*.

The foundation of Leibniz's philosophy is simple, soul-like substances, *monads*, which Leibniz believes are the only genuine substances in the universe. His argument rests on the claim that genuine substances must be simple, something he takes to be immediately evident to the human intellect. All other things—bodies, human beings, and animals—may be broken into their component parts; only minds are indivisible, and therefore only minds are substances.

Substantive metaphysical conclusions follow. Leibniz maintains that there may be no genuine causal interaction between substances, because genuine causal interaction would require that substances could be changed from without, thereby contravening their simplicity. Apparent changes are actually internal changes of substances. Because all changes are correlated with the states of all other monads, this "pre-established harmony" guarantees that apparent causal interactions will be grounded in actual changes in monads.

The idea of harmony lies at the heart of Leibniz's metaphysics. There is a preestablished harmony among the changes of substances; there is also a harmony between the order of nature and the order of grace, which ensures that the moral order will be realized. This point emerges clearly in Leibniz's claim that this is the best of all possible worlds. Here Leibniz seeks to defend God's goodness against the apparent visible evidence of all the evil in the world. According to Leibniz, this evil merely seems to tell against God's goodness. We know that God is a perfect being, and we know that a perfect being may act only in the best way. Consequently, the fact that God created this world reveals that it is the best of all possible worlds. The appearances that seem to tell against this are merely appearances, and we may therefore have confidence in the goodness and intelligibility of this world.

The Destiny of Rationalism

Kant's *Critique of Pure Reason* definitively limited the rationalists' pretensions to achieve knowledge of substantive truths by means of the intellect alone. Kant argues that knowledge is limited to the appearances presented to us by the senses; no extension of knowledge is possible to the "supersensible" or intelligible realm to which the rationalists, like Plato, purported to have access. Consequently, the rationalist belief in the capacity of the pure intellect to achieve knowledge of truths about the universe is revealed to be unfounded. Indeed, Kant's critique revealed that the rationalist commitment to pure intel-

lect that can operate independently of the senses was untenable. Moreover, recent developments in science further reveal that the rationalist conception of the world as an intelligible order was overstated. Nevertheless, the rationalist commitment to the power of reason remained alive for Kant, particularly in his practical philosophy. Rationalism encouraged women to use their own reason in philosophy: Princess Elizabeth of Bohemia and Damaris Masham directly engaged Descartes and Leibniz, respectively, in correspondence; Margaret Cavendish and Anne Conway worked out a rationalist paradigm. Finally, from a historical standpoint most significantly, rationalism inspired Enlightenment thinkers to trust in human abilities without reliance on divine illumination.

See also *Empiricism; Epistemology; Metaphysics*.

BIBLIOGRAPHY

PRIMARY SOURCES

- Descartes, René. *The Philosophical Writings of Descartes*. 3 vols. Edited and translated by John Cottingham, Dugald Murdoch, Robert Stoothoff, and Anthony Kenny. Cambridge, U.K., and New York: Cambridge University Press, 1984–1991. Most complete English edition of Descartes's writings.
- Kant, Immanuel. *Critique of Pure Reason*. Translated by Norman Kemp Smith. New York: St. Martin's, 1965. Classic, beautiful translation.
- Leibniz, G. W. *Philosophical Essays*. Edited and translated by Roger Ariew and Daniel Garber. Indianapolis: Hackett, 1989. Good selection of Leibniz's writings, spanning his entire philosophical career.
- . *Theodicy: Essays on the Goodness of God, the Freedom of Man, and the Origin of Evil*. Edited by Austin Farrer. Translated by E. M. Huggard. La Salle, Ill.: Open Court, 1985. The most readily available English translation.
- Malebranche, Nicolás. *The Search after Truth*. Edited and translated by Thomas Lennon and Robert Olscamp. Cambridge, U.K., and New York: Cambridge University Press, 1997. The most recent English translation.
- . *Treatise on Nature and on Grace*. Edited and translated by Patrick Riley. Oxford and New York: Oxford University Press, 1992. Fine edition; omits two of the *Elucidations* added by Malebranche.
- Spinoza, Benedict de. *The Collected Works of Spinoza*, Vol. I. Edited and translated by Edwin Curley. Princeton, N.J.: Princeton University Press, 1985. Magisterial edition of Spinoza's early writings. Volume II is in preparation.
- . *Theological-Political Treatise*. 2nd ed. Translated by Samuel Shirley. Indianapolis: Hackett, 2001. Best available English edition.

SECONDARY SOURCES

- Garrett, Don. *The Cambridge Companion to Spinoza*. Cambridge, U.K.: Cambridge University Press, 1989. Essays cover most aspects of Spinoza's work.
- Hatfield, Gary. "The Cognitive Faculties." In *The Cambridge History of Seventeenth-Century Philosophy*, edited by Daniel Garber and Michael Ayers. Cambridge, U.K.: Cambridge University Press, 1998. Seminal article; treats both rationalists and empiricists from the standpoint of the cognitive faculties.
- . *Routledge Philosophy Guidebook to Descartes and the Meditations*. London: Routledge, 2002. Sustained interpretation of

the *Meditations* as cognitive exercises; also considers alternative interpretations.

Nadler, Steven. *The Cambridge Companion to Malebranche*. Cambridge, U.K., and New York: Cambridge University Press, 2000. Essays cover most aspects of Malebranche's philosophical writings.

Rutherford, Donald. *Leibniz and the Rational Order of Nature*. Cambridge, U.K., and New York: Cambridge University Press, 1995. General interpretation of Leibniz's philosophy as motivated by the attempt to reveal the intelligible order of the universe.

Sean Greenberg

READING. The question “Who read what—and how?” is fundamental to intellectual history. No idea can have a history until someone reads it somewhere, and its impact on society will depend on the readings of individual readers. It was inevitable, then, that the historiography of ideas would turn toward the historiography of reading. That trend picked up momentum in the 1980s, when postmodern critics raised provocative theoretical questions about canon formation, the indeterminacy of texts, and the role of the reader in making meaning. Those critics, however, mostly failed to produce empirical studies of actual readers in history. That gap would be filled by scholars working in the emerging field of “book history,” taking their inspiration from Robert Darnton's 1986 manifesto “First Steps Toward a History of Reading.”

How Historians Study Reading

How can the historian recover something so private, so evanescent as the inner experience of the reader? Darnton conceded that documentary evidence was hard to come by, but he did not consider the problem insurmountable. In fact, since 1986 innovative historians of reading have located and used a broad range of primary sources, including memoirs, diaries, personal correspondence, library borrowing registers, wills (which often list books owned), booksellers' ledgers, reports filed by book peddlers and salesmen, minutes kept by literary societies, authors' fan mail, oral interviews, sociological surveys, marginalia, and iconography (the portrayal of readers in medieval manuscripts can be remarkably illuminating). Especially for the nineteenth century, when many newspapers were largely reader-written, one can look to published letters to the editor (and, more revealing, letters that were never published). Exceptionally valuable are the records of inquisitors and secret policemen, who obligingly asked precisely the questions that intellectual historians want to ask—questions about how individuals select, obtain, interpret, share, and discuss books. In *The Cheese and the Worms*, Carlo Ginzburg used the proceedings of the Inquisition to investigate the reading habits of Menocchio, a sixteenth-century Italian miller.

Menocchio was a strikingly idiosyncratic reader. Somehow he acquired a vernacular Bible, Giovanni Boccaccio's (1313–1375) *Decameron*, travel books, and perhaps the Koran. From these texts he drew highly independent conclusions about metaphysics, religion, the origins of the universe, social equality, and the economic basis of the Catholic Church. This is

what Roger Chartier has called *appropriation*: the tendency of readers to interpret and adapt texts to serve their own interests and uses. Other historians of reading, along similar lines, make use of Erving Goffman's “frame analysis,” where a frame is defined as a set of interpretive ground rules adopted by the reader. Either approach recognizes reading as a creative act rather than the passive absorption of the author's intended message. Thus the general thrust of the historiography of reading has been very different from Frankfurt School, Marxist, semiotic, and feminist criticism, which tended to treat the common reader as the passive victim of mass culture, capitalism, or patriarchal discourses.

Historians of reading inevitably take into account the influence of race, class, and gender, but often with unexpected results. Female readers are more likely than male readers to choose and identify with female authors: that appears to be a broad tendency, which cuts across time and culture. But beyond that, most recent studies have revealed that men and women read less differently than many researchers imagined. In Victorian Britain prison inmates devoured sentimental fiction, while Kate Flint found middle-class women who were tackling philosophy, politics, and the hard sciences. In the fan letters received by middlebrow Canadian novelists, Clarence Karr discovered that men as well as women were moved to tears, and women as well as men were inspired to rational critical analysis. After a generation of critics dismissed the traditional literary canon as elitist, Jonathan Rose revealed a large and passionate audience for the classics among the British working classes, and Elizabeth McHenry recovered a tradition of African-American literary clubs that discussed established white authors as well as new black authors. Priya Joshi found that readers in colonial India enthusiastically embraced the English novel, though the novel as a genre was not indigenous to the subcontinent. This was not a matter of the colonized slavishly mimicking the colonizer: Indian readers selectively read novelists that resonated with them, including some (notably G. W. M. Reynolds) that metropolitan critics considered hopelessly trashy.

Some historians of reading, such as Carlo Ginzburg, intensively study the experiences of a single reader. Others reconstruct the literary life of entire communities, as Christine Pawley did for Osage, Iowa, in the 1890s, or as William J. Gilmore did for a corner of rural Vermont in the early American republic. Still others show how print communicates the information needed to negotiate urban life (see David M. Henkin's *City Reading: Written Words and Public Spaces in Antebellum New York* and Peter Fritzsche's *Reading Berlin 1900*). Historians of literacy once merely measured whether people could read; more recently David Vincent has explored the actual uses of reading skills in nineteenth-century England. Ronald Zboray explained how reading habits in antebellum America were transformed by a vibrant market economy, which called into existence new methods of printing, illumination, transportation, marketing, book distribution, and literacy education. On the other hand, Stephen Lovell has described the very different impact of a command economy on reading choices in the Soviet Union, explaining why it created an extraordinary demand for classic literature.

“Reception histories” track the critical responses to individual texts or authors, a method particularly useful for historians of ideas. James Secord’s *Victorian Sensation* treated the controversy surrounding Robert Chambers’s *Vestiges of the Natural History of Creation*, a popular precursor of Charles Darwin’s *The Origin of Species*. John Rodden reconstructed the intellectual history of the Cold War through responses to George Orwell, showing how liberals, conservatives, neoconservatives, Marxists, social democrats, anarchists, New Leftists, Jews, Catholics, Germans, and Russians variously appropriated his work.

Some Models

Many historians have used Jürgen Habermas’s (1929–) model of the “public sphere” to explain the dissemination of ideas among eighteenth-century readers. The vast body of research on this subject has been synthesized by James Van Horn Melton in *The Rise of the Public in Enlightenment Europe*. The general assumption behind these studies is that only Western societies with mature printing industries could develop true public spheres, but C. A. Bayly questions that. In *Empire and Information*, Bayly argues that eighteenth-century North India nurtured what he calls an *ecumene*, similar to what Habermas observed in Europe, except that it arose in a preprint culture. Relying on circulated manuscripts and oral performances, Indian readers were able to follow and participate in public debates about politics, religion, law, society, literature, history, and aesthetics.

In addition to borrowing historical models, historians of reading have invented some of their own. In 1974 Rolf Engelsing argued that a “reading revolution” (*Leserevolution*) swept through the North Atlantic world around 1800. This involved a threefold shift: from reading aloud to private reading, from predominantly religious reading to predominantly secular reading, and from “intensive reading” (close and repeated study of a few canonical texts, such as the Bible or *Pilgrim’s Progress*) to “extensive reading” (rapid and continuous consumption of a large intake of ephemeral texts, mainly newspapers, magazines, and novels).

Engelsing’s hypothesis is still widely debated. Though the shift to private reading clearly did take place, it has come to appear much more drawn out than he suggested. Cecile Jagodzinski contends that in England reading became more private during (and as a result of) the religious conflicts of the seventeenth century, and reading aloud was still common in working-class households as late as 1900. Nevertheless, it may be that the “reading revolution” may be treated as researchers have learned to treat the Industrial Revolution: as a rough generalization about a ragged and uneven process, a concept that has some usefulness as long as it is borne in mind that reading habits (like industrialization) evolved along different paths in different societies.

But What Exactly Is Reading?

That question raises some intriguing anthropological issues. One could say that reading is retrieving information encoded by making marks on a material base, but that begs yet another question. As Germaine Warkentin has noted, some indigenous peoples of North America seem to have recorded

information on wampum belts, birch-bark scrolls, stone cliffs, and (among the Git’ksan of British Columbia) ceremonial cloaks. But linguists cannot read these texts (if indeed they are texts) as they might decipher and read Egyptian hieroglyphics, or the glyphs on a Mayan stela. In some cases they must be read—or, more accurately, performed—by an authorized member of the native nation. And different native “readers” may read different significances into the same inscription. One might conclude that a Git’ksan cloak is more like a work of abstract expressionist art than a document: it is supposed to be suggestive rather than precise. Yet a member of the Git’ksan nation will probably insist that the cloak is “written,” not “painted.” True, its meaning is radically indeterminate, but a generation of postmodern critics have argued that all texts are wide open to interpretation. Given all that, can one truly “read” a cloak?

One way of coping with this quandary is to go back to the original meaning of the word. Laurel Amtower makes the point that in Old English, *raedan* could refer to any kind of “interpretation and glossing of signs in a world in which all was text.” It might involve reading a *boc* (an Anglo-Saxon term that included all sorts of documents, not just books *per se*). But one could also read things that were not (strictly speaking) documents, for example “Ic raede swefn” (I read dreams) (Amtower, ch. 2). That wider meaning survives in colloquial English in the early twenty-first century, as in “How do you read this situation?” A new methodology, “audience history,” treats reading in that expansive sense, reconstructing (as far as possible) the entire cultural diet of a given group of individuals. Thus *The Intellectual Life of the British Working Classes* considers not only how workers read books, magazines, newspapers, and advertising bills, but also how they “read” films, radio programs, musical performances, and school lessons.

Broadly, then, the history of reading has become the history of interpretation. Historians have become all too aware of the epistemological questions they encounter whenever they try to make sense of texts, and some of them have concluded that the most fruitful approach to those questions is a historiography of reading, which asks how readers in the past made sense of texts. The importance of the subject is clear: wars have been fought over different readings of treaties, scriptures, and intelligence reports. If, as Erving Goffman put it, people are always “reading” the sensory data that showers in on them, always asking themselves “What is it that’s going on here?” then cultural historians must inevitably address “reading” widely defined.

See also Education; Language, Linguistics, and Literacy; Literature; Oral Traditions.

BIBLIOGRAPHY

- Amtower, Laurel. *Engaging Words: The Culture of Reading in the Later Middle Ages*. New York: Palgrave, 2000.
- Bayly, C. A. *Empire and Information: Intelligence Gathering and Social Communication in India, 1780–1870*. Cambridge, U.K.: Cambridge University Press, 1996.
- Cavallo, Guglielmo, and Roger Chartier, eds. *A History of Reading in the West*. Amherst: University of Massachusetts Press, 1999.

- Darnton, Robert. "First Steps Toward a History of Reading." In his *The Kiss of Lamourette: Reflections in Cultural History*. New York: W. W. Norton, 1990.
- Flint, Kate. *The Woman Reader 1837–1914*. Oxford: Clarendon, 1993.
- Fritzsche, Peter. *Reading Berlin 1900*. Cambridge, Mass.: Harvard University Press, 1996.
- Gilmore, William J. *Reading Becomes a Necessity of Life: Material and Cultural Life in Rural New England, 1780–1835*. Knoxville: University of Tennessee Press, 1989.
- Ginzburg, Carlo. *The Cheese and the Worms: The Cosmos of a Sixteenth Century Miller*. Translated by John and Anne Tedeschi. Harmondsworth: Penguin, 1982.
- Goffman, Erving. *Frame Analysis: An Essay on the Organization of Experience*. Cambridge, Mass.: Harvard University Press, 1974.
- Henkin, David M. *City Reading: Written Words and Public Spaces in Antebellum New York*. New York: Columbia University Press, 1998.
- Jagodzinski, Cecile M. *Privacy and Print: Reading and Writing in Seventeenth Century England*. Charlottesville: University Press of Virginia, 1999.
- Joshi, Priya. *In Another Country: Colonialism, Culture, and the English Novel in India*. New York: Columbia University Press, 2002.
- Karr, Clarence. *Authors and Audiences: Popular Canadian Fiction in the Early Twentieth Century*. Montreal: McGill-Queen's University Press, 2000.
- Lovell, Stephen. *The Russian Reading Revolution: Print Culture in the Soviet and Post-Soviet Eras*. New York: St. Martin's, 2000.
- McHenry, Elizabeth. *Forgotten Readers: Recovering the Lost History of African American Literary Societies*. Durham, N.C., and London: Duke University Press, 2002.
- Melton, James Van Horn. *The Rise of the Public in Enlightenment Europe*. Cambridge: Cambridge University Press, 2001.
- Pawley, Christine. *Reading on the Middle Border: The Culture of Print in Late Nineteenth-Century Osage, Iowa*. Amherst: University of Massachusetts Press, 2001.
- Rodden, John. *George Orwell: The Politics of Literary Reputation*. New Brunswick, N.J.: Transaction, 2002.
- Rose, Jonathan. *The Intellectual Life of the British Working Classes*. New Haven, Conn., and London: Yale University Press, 2001.
- Secord, James A. *Victorian Sensation: The Extraordinary Publication, Reception, and Secret Authorship of Vestiges of the Natural History of Creation*. Chicago: University of Chicago Press, 2000.
- Vincent, David. *Literacy and Popular Culture: England 1750–1914*. Cambridge, U.K.: Cambridge University Press, 1989.
- Warkentin, Germaine. "In Search of 'The Word of the Other': Aboriginal Sign Systems and the History of the Book in Canada." *Book History* (1999): 1–27.
- Zboray, Ronald J. *A Fictive People: Antebellum Economic Development and the American Reading Public*. New York: Oxford University Press, 1993.

Jonathan Rose

REALISM. Realism was a movement in nineteenth century Western culture that claimed to represent ordinary people and their everyday reality based on accurate observation. It challenged centuries of tradition when the highest art as-

pired to idealized pictorial forms and heroic subjects. Supporters considered its visual veracity to be an indication of an artist's "sincerity." Realism acquired a democratic political dimension from its inclusiveness and the accessibility of its imagery to ordinary people unversed in the classics but capable of recognizing "truth." Its moral appeal was informed by progressive attitudes and an empirical concept of knowledge. Social theory and scientific epistemology, as in the writings of Pierre-Joseph Proudhon (1809–1865) and Auguste Comte (1798–1857), converged in what was called Positivism. The leader of artistic Realism was the French painter, Gustave Courbet (1819–1877). Its advent revolutionized the history of art.

The artistic movement Realism must be distinguished from "realism"—the latter an aspect of most figurative art throughout time. In its general meaning, the word can refer to optical realism (in which forms or details are based on nature, as in Pre-Raphaelitism or Photo-Realism); psychological realism (in which sometimes distorted forms convey emotion, as in Expressionism); or illusionism (in which careful technique makes even imagined forms seem present, as in Surrealism). Realism paralleled the invention of photography in 1839, which introduced a new standard for optical realism while also being a technological response to the same conditions as artistic Realism. A later term, Naturalism, was developed as a more scientific-sounding, less politicized alternative by the novelist Emile Zola and the art critic Jules Castagnary.

Realism's most coherent artistic manifestation was in mid-nineteenth century France. It followed Romanticism, which encouraged artistic freedom and self-expression, looking to nature as their source. In his *Realist Manifesto*, Courbet stated his aim as: "to translate the customs, the ideas, the appearance of my epoch according to my own appreciation." Linking faithful portrayal of his times with artistic independence (from teachings based on imitations of classical art), he made both elements the basis for the movement of which he became the undisputed leader.

In the 1840s, Courbet's generation drew on two related artistic trends. First was the Barbizon School of landscape painters, who studied people and places from a recognizable countryside, usually near Paris. Second was the recent popularity in literature and art of provincial and rural life. As a contrast to urban materialism and its inequities, the virtues and innocence of country folk were extolled in novels by George Sand and stories by Courbet's friend Champfleury (Jules Husson). Painters such as the Leleux brothers and Jean-François Millet embodied this ethos in their representations of peasants. In addition, simple, often crude folk art and poetry were admired as naïve expressions of popular culture and the working class.

The difference between Courbet and these artists was that, beginning with his *Stonebreakers* (1849, Dresden, Kunstmuseum, destroyed, World War II), Courbet's people, places, and activities appeared specifically contemporary, devoid of anti-modern nostalgia, whereas his predecessors evoked a timelessness associated with Romantic innocence and virtue. Courbet's workers alluded to the harsh conditions of the 1840s, when



The Painter's Studio: A Real Allegory of Seven Years of the Artist's Life (1854–1855) by Gustave Courbet. Oil on canvas. Adherents of Realism, such as Courbet, stressed in their works the accurate representation of everyday reality as well as freedom from the constraints of classical art. MUSÉE D'ORSAY, PARIS. © THE ART ARCHIVE/DAGLI ORTI

failing harvests drove many off the land into day-wage labor. They were providing raw materials for modern infrastructure—roads, railroads, housing, and industry. Courbet's direction was encouraged by the left-wing Revolution of 1848, and thereafter his work was associated with Socialism.

A Burial at Ornans (Paris, Musée d'Orsay) painted in 1850, showed a ceremony outside Courbet's hometown in the region of Franche-Comté, near Switzerland. Against their rugged landscape, some thirty odd friends and neighbors gather at the open grave of a respected citizen. Courbet portrays death as a prosaic, literally "down-to-earth" event whose meaning goes no further than laying the body in the ground. Lacking the traditional apparatus of pictorial composition or religious interpretation, Courbet's picture would normally have been considered a genre painting—lower on the scale of values than academic history painting—rather than dramatically coherent, hence related to folk imagery. Yet the huge canvas with life-sized figures flaunted Courbet's challenge to assumptions about what was worthy of large-scale artistic representation, and his ostensibly coarse technique evoked a worker's handicraft. Both the *Stonebreakers* and the *Burial* earned Courbet heated criticism, making him a public figure and Realism a powerful force.

In 1855, Courbet challenged authority in a solo exhibition outside the grounds of the Universal Exposition of 1855. The

central painting in his "Realist Pavilion" was *The Painter's Studio* (Paris, Musée d'Orsay) in which he showed himself at the easel, supported by friends on the right and facing on the left a mix of figures embodying various ideas he considered outdated. The purpose of this much-interpreted painting was a declaration of artistic freedom, accompanied by the "Realist Manifesto," mentioned earlier.

Elsewhere, Courbet declared "Realism is the negation of the ideal" and that through it, he would "arrive at freedom." He saw Realism as a liberation of human consciousness from false ideology in order to take control of one's destiny. His ideas drew on the writings of his countryman and acquaintances, the radical philosopher Proudhon, who introduced materialist social thought to France in the 1840s, at the same time as Karl Marx's early writing.

Realism was associated with Impressionism when the latter first appeared, since Impressionism took up the commitment to modern life and contemporary surroundings. Edouard Manet was guided by these principles, although he looked to the example of Spanish realism and concentrated on urban leisure rather than rural labor. The young Claude Monet was friendly with and drew upon Courbet and his technique, as did several other Impressionists. But the greater legacy of Realism was to free artists to paint "sincerely,"—from their personal vision. Realism successfully undermined doctrinal academicism

by legitimizing images of modern life, heroic or anecdotal, rural or urban, and painted as the artist chose. Realism even entered sculpture, as in the work of Jules Dalou.

The response of establishment artists was to employ their labor toward a finished optical realism, as in Léon Bonnat, or to incorporate occasional free paint handling, as did Jules Bastien-Lepage. In other countries, Realism reinforced existing trends in genre painting, as in Holland (such as Jozef Israëls) and England. I Macchiaoli in Italy paralleled Realism and Impressionism, especially in outdoor scenes. Verismo in opera followed later. In Germany, where Courbet was popular, Realist images acquired a grander scale and avant-garde technique, as in William Leibl and Max Liebermann. The United States adopted Realism, as in Thomas Eakins, then Impressionism, as national styles, though usually without the avant-garde connotations. Later Realisms were often ostentatious, as in Richard Estes's displays of photograph-like technique, or Eric Fischl's Suburban Psycho-Realism.

Courbet's militancy during the Paris Commune led to exile in Switzerland, where he died. In an effort to rehabilitate him, writers even during his lifetime minimized Realism's politics in favor of an aesthetic of the sincere and natural eye. Around the mid-twentieth century, Meyer Schapiro and Linda Nochlin pointed out the historical origins of Realism, with its links to popular imagery and Dutch art implying its democratic cast. Nochlin's general book on Realism remains the standard. In the mid 1970s, Marxist art historian T. J. Clark's work on Courbet and his contemporaries faced the political issues directly, launching a revitalization in art history referred to as the Social History of Art. Since then, various noted scholars have sought to rehabilitate as Realists the many painters of contemporary life who were overshadowed by Courbet.

Whatever its manifestations, Realism continues to have a grip on consciousness thanks to its claim to represent "reality" more truthfully than other forms of art.

See also *Impressionism; Naturalism; Naturalism in Art and Literature; Periodization of the Arts.*

BIBLIOGRAPHY

- Clark, Timothy J. *Image of the People: Gustave Courbet and the Second French Republic, 1848–1851*. London: Thames and Hudson, 1982.
- Herding, Klaus. *Courbet: To Venture Independence*. Translated by John William Gabriel. New Haven, Conn.: Yale University Press, 1991.
- Nochlin, Linda. *Realism*. Harmondsworth, U.K.: Penguin, 1971.
- Rubin, James Henry. *Coubert*. London: Phaidon Press, 1997.
- Seigel, Jerrold E. *Bohemian Paris: Culture, Politics and the Boundaries of Bourgeois Life*. New York: Viking Press, 1986.
- Weisberg, Gabriel P., ed. *The Realist Tradition: French Painting and Drawing, 1830–1900*. Cleveland, Ohio: Cleveland Museum of Art; Bloomington: Indiana University Press, 1981.

James H. Rubin

REALISM, AFRICA. Realism in Africa is often expressed as a concern with the authentic and full representation of African cognitive, experiential, historical, and cultural reality, focusing on the fundamental nature of African identity as expressed in its thought, art and culture.

Realism in African Philosophy

In African philosophy, the very existence of such a discipline forms an important topic of discussion, as aptly captured in titles like Paulin Hountondji's *African Philosophy: Myth and Reality* (1983) and D. A. Masolo's *African Philosophy in Search of Identity* (1994). The central problem is whether there exists a separate discourse of philosophical reasoning that is specifically African. If at all it exists, what are its procedures? Can they be elaborated in a way that is distinctly African? Given that the term *philosophy* itself is a product of African cultural and historical contact with the West, does its adoption indicate the impossibility of such a discipline existing outside the symbolic order bequeathed to Africa by its colonial heritage? Various authors have taken different positions in the debate, with significant overlaps at times.

Some have challenged the very distinction between African and Western philosophy, contending that, since Egypt contributed substantially to the rise of Greek philosophy and, since Egypt—whatever the debate about the racial identity of its ancient inhabitants—is an African country, Africans should not be apologetic about the existence of an African philosophy—there has been an African philosophy for millennia. Others argue, that even without regard to the African origins of Western African philosophy, it can be amply demonstrated that there is a distinct African philosophy that is based on the elaboration of the traditional cosmology and belief systems of Africa. This is the position developed by John Mbiti, Alexis Kagame, and Placide Temple, for example. For V. Y Mudimbe in *The Invention of Africa* (1988), it is impossible to speak of Africa as if it were an unproblematic concept, since, as an idea it has been produced within the historical encounter with the West. Thus the very reality of Africa as a formation itself, let alone that of its philosophy, is under question or at least perceived as in need of clarification before being used as a secure ground for a pure and autonomous African reason.

Paulin Hountondji (b. 1942) considers Mbiti and others as practicing "ethnophilosophy" rather than professional philosophy. Hountondji argues that ethnophilosophy is characterized by the presupposition that the worldviews of African ethnic groups can be uncritically transposed into philosophical discourse. That is seen as a return to the colonial paternalistic view of African culture as separate and prelogical. He also maintains that such a transposition would be equivalent to Greek philosophers abstracting their philosophy from Greek cosmology, which is the very thing that the founding Greek philosophers deliberately refrained from in order to launch philosophy as a distinct secular, and for Hountondji, scientific discipline. (It should be noted that Louis Althusser [1918–1990] heavily influenced Hountondji's notion of science.) Henry Odera Oruka concedes that the kind of philosophy practiced by Mbiti and similar scholars is indeed a form of

ethno-philosophy. Oruka agrees with Hountondji and Kwasi Wiredu that African philosophy is what professional post-colonial African philosophers, or in his view, rationalist philosophers, who have been exposed to Western philosophy (such as they themselves) do, but he allows for the possibility of the existence of unlettered African sages in traditional society in the manner of Socrates in ancient Greece. In his view, ethnophilosophy presents traditional African society as one where individuality of outlook and thought is not only disallowed, but impossible, making the formation appear static rather than as dynamic and open to change as revealed by historical research. African society is shown as providing for the emergence and sustained presence of individual and critical consciousness rather as singularly engaged in promoting adherence to a consensual and collective view of reality. The African sage is thus capable of reflecting on the fundamental problems of philosophy such as the nature of reality. More radically, Oruka believes that philosophy does not need to be written down—it can be produced orally as in the case of the sages of Kenya he and his colleagues studied. Nevertheless, philosophical sagacity does not necessarily imply that African sages are the same breed as their Western-trained counterparts, but neither does it suggest that they are an utterly distinct species—they elaborate the first order of concepts whereas their university-trained counterparts grapple with both first and second order conceptualization. Like Oruka, Kwasi Wiredu accepts the validity of a traditional African philosophy, but he regards it as markedly distinct from postcolonial African philosophy. Wiredu observes, “There is a traditional African philosophy, and there is an emerging modern philosophy. A modern philosophy will appropriate whatever there is of value in [Western philosophy] and domesticate them and it will seek also to make contributions to them” (p. xi). Thus, Western problems of philosophy can still form the basis of African philosophical practice without compromising its capacity to promote the modernization of the continent as well as the advancement of philosophy as a global discipline, contributing simultaneously to the particular and the universal.

One general problem Wiredu investigates is the relationship between language and representation. Focusing on the Akan language group of Ghana, he examines the difference between logical and mystical statements and concludes that the two differ fundamentally in their adherence to the law of consistency. Whereas the former abide by the principle of non-contradiction, the latter follow that of contradiction. Nevertheless, the contrast between the two forms of statements does not correspond to the differences between African and Western society. Both societies have their fair share of the both logical and mystical statements. Wiredu shows how the Akan respect the law of noncontradiction in the domain of knowledge, but will accept its nonobservance in the sphere of mystical articulation. This leads him to conclude that fundamental structures of language are not necessarily a reflection of the culture of a given society, but of universal logical structures. It is with this in mind that Wiredu cautions against the argument for the uniqueness of African philosophy in terms of its focus, for in the end, its distinctiveness is less a matter of its object of knowledge, but more of the cultural and environmental location of the philosopher. Location may deflect the

philosopher’s view of universal problems of philosophy, but does not thereby consign his or her observations to the status of the mystical utterings of the sage of an ethnic group. Thus, the philosophical study of African languages reveals fundamental universal laws rather than those of a particular language, undermining the perception that language is simply a reflection of a given ethnic cosmology. For him what makes translation possible between languages is the universality of their underlying logical structures, observing, “unless different languages share basically the same logic, it would be impossible to translate one into another” (Oruka, *Trends*, 1990, pp. 149–148). More research on the general laws of African languages has been conducted by theoretical linguists, some of whom have used Noam Chomsky’s (b. 1928) notions of transformational generative grammar and universal language as well as H. P. Grice’s pragmatics to study African languages. While this research represents a serious advance on the early studies of African languages, especially in its examination of the general laws of meaning in the languages, its theoretical categories are borrowed from Western linguistics without much concern with the underlying compatibility between African culture and Western knowledge. This lack of concern exhibits the universalism of the rationalist school of African philosophy. Literary and cultural critics such as Ngugi wa Thiong’o (b. 1938), as shall be discussed later, are much more sensitive to the ethnocentricity of what passes off as objective universal philosophical categories and consequently emphasize the political character of language and its use.

The classic problem of appearance and reality has also been examined in African philosophy. Wiredu, for instance, locates it within a commonsense view that is modulated by his dual subject position within the Western philosophical tradition and the contemporary African experience, which is a hybrid of traditional African cosmology, such as the Akan worldview, and Western modernity. From this perspective, in the debate between, on the one hand, the idealists such as George Berkeley (1685–1753) and Immanuel Kant (1724–1804) who believe that reality is a function of perception, and, on the other, the empiricists or phenomenologists, such as John Stuart Mill (1806–1873), who believe that there is a reality that is independent of perception, Wiredu steers a middle course, formulated as “to be is to be apprehended,” rather than “to be perceived,” as Berkeley had asserted. Wiredu contends “it is the existence of an object not the object itself that consists in being known” (p. 132). He sees his reformulation of the old problem of the argument from illusion as restoring the “cognitive relation to [the perceiver’s] relation to reality.” That is what underpins Wiredu’s theory of knowledge, summarized as “truth is nothing but Opinion” (p. 123). Oruka has criticized its implicit relativism, proposing instead the restatement “Truth is nothing but belief” (*Trends*, 1990). Nevertheless, according to Wiredu, the principal strength of his theory is that it enables the grounding of the validity of African philosophy in philosophical logic rather than the politics of identity and anti-imperialism, since African philosophical opinion is now a matter of a general law of perception and epistemology.

What is equally noticeable is the proximity of Wiredu's view to the idea that "Existence precedes essence" propounded by existentialists such as Jean-Paul Sartre (1905–1980). Ironically, this also brings Wiredu to the more radical view of African philosophy advanced by the younger generation of African philosophers, especially those of the Marxist-existentialist persuasion who regard the study of "being in the world," the contingent African contemporary world, as the primary object of African philosophical practice. As Tsenay Serequeberhan argues, "African philosophy is a historically engaged and politically committed explorative reflection on the African situation aimed at the political empowerment of the African people" (1990, p. xxi). Here, African reality is transformed into a politicized space, whereby the concerns of philosophy are not only the pursuit of abstract truth, but also the transformation of that reality. African philosophers, as much as literary and cultural critics, have been profoundly influenced by Karl Marx's (1818–1883) view that philosophers have hitherto merely interpreted the world, but the aim must be to change it.

This strand of philosophy is part of a broad Marxist approach to African culture, history, politics, and literature. Its presence within African philosophy has enabled the discipline to extend its object of analysis to the work of politicians such as Kwame Nkrumah (1909–1972), Amílcar Cabral (1924–1973), Sekou Toure (1922–1984), and Julius Nyerere (1922–1999); and of cultural and political theorists such as Franz Fanon (1925–1961), as well as that of African writers and artists.

Reality in African Aesthetics and Literary Criticism

One of the concerns of aesthetics has been the refutation of the colonialist definition of African aesthetics. A particular area of debate has been the negative assessment of African art, such as the claim that the category of realism does not apply to African art. William Abraham argues, "When critics like Gombrich say that the African artists were incapable of realistic representation, they quite miss the point of African art. If they seek life-like representation, they should turn to secular art, the art which was produced for decorative purposes or the purposes of records, rather than moral art, the art whose inspiration is the intuition of a world force" (p. 113). Ernst Gombrich (1909–2001) had only looked at one particular African art form, and proceeded to make inferences about the general character of African art. Abraham observes, "The Ashanti wooden maidens, which epitomise epitomize the Ashanti ideal of female beauty . . . were reasonably life-like." (p. 111), thus demonstrating that African art is both realistic and figurative, depending on its specific social function. Abraham's broad concern is to show African culture, including African art, as expressions of an essential African cosmology. For that reason, despite being a pioneer of professional or rationalist African philosophy, he is nevertheless classified as an ethnophilosopher (Oruka, 1990, p. 151).

Yet, Abraham's position is typical of African aestheticians whose objective is mainly to elaborate the general aesthetic laws of African art. This effort has been significantly extended in what is known as Black Aesthetics, a movement rooted in the 1960s anticolonial movements in Africa and the civil rights

struggles in the United States. The work of diasporic scholars, such as Addison Gayle's *The Black Aesthetic* (1972), was vital to the process of defining African aesthetics, as it offered a set of clearly defined theoretical tools for the analysis of black arts for their distinctive aesthetic qualities. According to Oruka Black Aesthetics is bound up with the black person's awareness of a negating social reality and his/her attempt to negate that reality by means of a counter-reality, that of the values of black people. The operative assumption is that in a racialized world, literary and other artistic norms and values themselves bear the stamp of racial ideology and cannot be applied uncritically to works of art produced by a people who are denigrated within that social and political formation. Thus the aim is to found a set of aesthetic principles which will do justice to the quality of Black works, and then use such principles and artistic works to foster a collective Pan-African consciousness. It is in this instance that the slogan "Black is beautiful" emerges. The quest achieves its most prominent public emblematic form in the FESTAC festivals (Black and African Festival of African Arts and Culture). Marxist critics such as Onafume Onoge view this movement as flawed since all it does is substitute race for class analysis without addressing the complexity of the real power relations of postcolonial societies.

Largely, this quest for an essential Pan-African culture is what animates one of the earliest and most persistent cultural movements of the twentieth century. Negritude, begun in the 1930s in France by Léopold Sédar Senghor (1906–2001) and Aimé Césaire (b. 1913), among others, sought to define and represent the essential core of African values as embodied in African spirituality and experience. In Senghor's case, this took the form of a preoccupation with the representation of the ancestral presence in literature and a positive revalorization of black identity. Additionally, for Senghor, African art is conceived as inherently committed because it is intrinsically social and communal, as opposed to the individualism of European art. Senghor is also famously quoted as having proclaimed "Emotion is [Black], as reason is Greek." Clearly, Senghor's is an affective mimesis.

This view has not gone down well within the community of African scholars. As for the rationalist philosophers, with their commitment to the idea of reason as universal, negritude is seen as a fundamentally unphilosophical characterization of both African and Western reason. Oruka regards what he describes as "Negritude's mythological consciousness" as a phase in the development of a colonized consciousness toward a more liberated postcolonial consciousness of a different and better reality. Marxist critics too dismiss Senghor's negritude as staging a bourgeois reification of the real conditions of postcolonial existence, describing it as a mystical affirmation of African identity that transposes the real into a cultural collective that offers little possibility of fundamental change in the social and political order. Onoge contrasts Senghor with Aimé Césaire whom he commends for offering a more radical version of negritude, one that is predicated on a revolutionary affirmation that goes beyond the validation of the integrity of African culture. For Wole Soyinka (b. 1934), negritude's major weakness is that it articulates rather than enacts its radical identity. As Soyinka says, "A tiger does not pronounce its tigritude, it pounces" (Feuser, p. 559).

Its influence is evident in the whole ideology of Black Consciousness and in particular in some of the radical attempts to produce anticolonial African aesthetics such as that of the self-proclaimed Bolekaja critics, Chinweizu, Onwuchekwa Jemie, and Ihechukwu Madubuike. They are particularly concerned with the dominance of what they term Euro-Modernism in African writing and criticism. They cite what they call the Ibadan school of writing, Wole Soyinka and Christopher Okigbo included, as the arch progenitor of this tendency. Soyinka retorted by describing them as Neo-Tazarnists, that is, critics who are bent on disseminating neo-primitivist ideas about the nature of contemporary African reality. However, Soyinka's commitment to developing a distinct African aesthetic is one of the most ambitious among African writers. He produces a cosmological aesthetic from his reading of Yoruba culture mediated by Friedrich Nietzsche's conception of Greek mythology in *Birth of Tragedy*, fashioning his own theory of tragedy that is both hybrid and authentically African. According to Soyinka, Yoruba art is both mimetic and transformative of the structure of traditional Yoruba cosmology. Furthermore, he argues that African reality can be best understood as a simultaneous inhabitation of the world of the living and the dead as well as the present and the past. It is the tension between all these coordinates that is the primary object of mimesis for African art, but in a way that turns the artwork itself into an active formative agency of the very reality it imitates. Thus, Soyinka's theory of mimesis works with a more complex idea of reality than we are offered in the founding text of mimetic theory, Aristotle's *Poetics*. On the whole, though, he encapsulates both the ethnophilosophic and rationalist traditions of African philosophy.

Ngugi's *Decolonising the African Mind* (1986) is another major attempt at grounding African literature and culture in the historical worldview of Africa, in the belief that the only way this can be done effectively is by producing literature in African languages instead of the received colonial languages. Ngugi argues that language is bound up with a people's being; it "is a carrier of the history and culture of a [given community], . . . a collective memory bank of a people (1993, p. 15). Ngugi uses the reflectionist view of language, seeing it as a mirror of a people's belief system. In light of this, he can be placed squarely within the Afrocentric camp, but perhaps not so easily within that of the ethnophilosophers.

In literary criticism, indeed in cultural theory generally, the term *realism* is usually employed to describe a concern with the way in which literary and artistic representation reflects African reality. Here the fictional universe is judged in relation to its verisimilitude or *vraisemblance* to the actual world. Thus, the application of the concept is not dissimilar to the way it is understood and used in the European critical tradition. This is a result of the very particular history of African critical and cultural criticism. African criticism has, like post-colonial African philosophy, developed within the terms of Western theory. There have been calls for a distinctly African critical language and some serious attempts have been made in this regard, for instance, Wole Soyinka's cosmological aesthetic and Henry Louis Gate's African-American vernacular theory. However, for the most part, like their counterparts in

philosophy, African writers and critics see their primary task as that of using all available meta-languages to illuminate the fundamental character of African cultural and artistic production, but in a way that adapts these various conceptual tools to the particular conditions of African reality.

Chinua Achebe's fiction is regarded as the supreme example of African literary realism, especially his novel *Things Fall Apart* (1958). Achebe's fiction can also be described as historical realism, especially when he seeks to recover the African past from its suppression in colonial discourse. He describes himself as practicing "applied art," suggesting that realism is also a politically committed and transformative form as opposed to the tradition of "art for art's sake." For Abiola Irele, it is this concern with historical and sociological reality that makes African literature a more accurate and comprehensive account of contemporary African reality than sociological or political documents. However, some critics such as Dan Izevbaye see that as the very fault of contemporary African writing, with its emphasis on the social function of literature constricting its formal possibilities. Izevbaye hopes that "as the literature becomes less preoccupied with social or national problems and more concerned with the problems of men as individuals in an African society, the considerations which influence critical judgement will be more human and literary than social ones" (Haywood, p. 30) Izevbaye is perhaps the closest to a universalist Platonic idealism in African literary criticism and aesthetics. His concept of humanity seems to be based on a transcendence of the experiential and the contingent.

According to Onoge, realism in African literature can be further subdivided into critical realism and socialist realism. The first, which is evident in the work of Chinua Achebe, Wole Soyinka, and a host of other African writers, is principally characterized by an accurate description of the condition of modern Africa, but without proffering a clear solution to the problems identified. However, the latter takes the socialist transformation of the continent as a matter of historical and political necessity and as the only way in which the legacy of colonial and imperial capitalism and their neocolonial manifestations can be eradicated in order to create an alternative political and economic formation. Writers such as Sembene Ousmane, Ngugi wa Thiong'o, and Femi Osofisan are exemplars of socialist realism. Georg Gugelberger advises against using the term, given its negative connotations arising out of its association with the propagandist writing produced in the 1930s in the Soviet Union. He suggests that Amiri Baraka's more radical concept, populist modernism, be adopted instead to describe progressive African literature. In his view, the word *populist* has an additional advantage, for instance, unlike *socialist*, it cancels the artificial contradiction between Marxism and modernism that has beset mainstream Marxism. Deconstructive critics such as Kwame Appiah argue that realism is the artistic expression of African nationalist ideology and is thus complicit with nationalism's superficial resolution of the underlying difficulties facing Africa. It no longer functions subversively—for that, one should turn to what he defines as postrealist or postnativist writing such as Yambo Oueloguem's *Le Devoir de Violence*, texts that interrogate the nationalist's imaginary and portray it as merely a reversal of the very race-

centered European ideology it set out to dislodge. This kind of writing is similar to postmodernist writing, questioning established totalizing narratives and their regimes of truth.

What Appiah describes as postrealist is also part of the general trend referred to broadly as nonrealist modes of representation, but more specifically as magical realism, the best example of which is Ben Okri's *The Famished Road* (1990). This type of writing, like its Latin American counterpart, involves the deliberate violation of the conventions of realism, for instance the transgression of the boundary between the real and the fantastic. Some critics feel uncomfortable about this label as it suggests African writing imitating alien forms. Other argue that the worldview depicted in such texts is inherent in the contemporary African Weltanschauung in which the elements of traditional African culture coexist with those of modernity. It is as a way of emphasizing the indigeneity of the form that Harry Garuba substitutes it with the term animist realism.

As can be seen, the concept of realism is used diversely in African philosophical and cultural practice. It is used in its traditional sense as a concern with art as a mirror of reality, but also in relation to the requirement for epistemological, cultural, and representational authenticity. It is noteworthy that the term realism is applied to a variety of realities and to different methods of representing the real. Even deconstructionists ultimately cannot avoid employing the traditional meaning of the word, of connoting the degree of representativeness or accuracy of artistic as well as philosophical and critical practice. What is also significant is that the philosophical attempt to define the real and realism often overflows the rather rigid categories set up by the African rationalist philosophers, proving that their concepts, rigorously defined as they are, cannot themselves fully represent the diversity of intellectual reflections on realism in Africa in the early twenty-first century. Perhaps even universal philosophy is particular after all.

See also *Black Consciousness; Negritude; Pan-Africanism; Philosophies: African; Postmodernism; Sage Philosophy.*

BIBLIOGRAPHY

- Abraham, William. *The African Mind*. London: Weidenfeld and Nicolson, 1962. A classic text of African philosophy.
- Achebe, Chinua. *Morning Yet On Creation Day*. New York: Anchor Press, 1975. A lucid and representative coverage of the writer's abiding critical concerns.
- Chinweizu, Onwuchekwa Jemie, and Ihechukwu Madubuike. *Toward the Decolonisation of African Literature*. London: Routledge, 1980. A passionate call to the decolonization of African literature and criticism that has generated a lot of controversy.
- Cooper, Brenda. *Magical Realism in West African Fiction*. London: Routledge, 1998. A groundbreaking study of the concept in African literature.
- Feuser, Willfred. "Wole Soyinka: The Problem of Authenticity." *Black Literature Forum* 22, no. 3 (fall 1988): 555–575.
- Garuba, Harry. "Explorations in Animist Materialism: Notes on Reading/Writing African Literature, Culture, and Society." *Public Culture* 15, no. 2 (2003): 261–285. A work of profound originality on realism and the philosophy of African arts.

Gates, Henry Louis, Jr. *The Signifying Monkey: A Theory of African-American Literary Criticism*. New York: Oxford University Press, 1988. An important contribution to the study of African and African-American cultural theory.

Gugelberger, Georg. *Marxism and African Literature*. Trenton, N.J.: Africa World Press, 1986. An outstanding and representative text on trends in African Marxist literary criticism.

Heywood, Christopher, ed. *Perspectives on African Literature*. London: Heinemann, 1971. A good source on 1960s African literary criticism.

Irele, Abiola. *The African Experience in Literature and Ideology*. London: Heinemann, 1981. A rigorous sociological study of African literature.

Ngugi wa Thiong'o. *Decolonising the African Mind*. London: Heinemann, 1986. A radical Afrocentric and original reading of the terms of cultural colonization as well as liberation.

———. *Moving the Centre*. London: Heinemann, 1993. A more universalist account of cultural decolonization.

Orika, Henry Odera. *Sage Philosophy*. Leiden, Netherlands: E. J. Brill, 1990. A singularly original piece of African philosophy.

———. *Trends in Contemporary African Philosophy*. Nairobi, Kenya: n.p., 1990. A good overview of African philosophy by one of its leading practitioners.

Senghor, Léopold Sédar. *Prose and Poetry*. London: Heinemann, 1974. Carefully chosen representative texts.

Serequeberhan, Tsenay, ed. *African Philosophy*. New York: Paragon House, 1991. An extremely useful overview of historical and current trends in African philosophy.

Soyinka, Wole. *Myth, Literature and the African World*. Cambridge, U.K., and New York: Cambridge University Press, 1976. A major work of African philosophy and literary criticism.

Welsh-Asante, Kariamu, ed. *The African Aesthetic: Keeper of the Traditions*. Westport, Conn.: Greenwood, 1993. An excellent assembly of the tradition.

Wiredu, Kwasi. *Philosophy and an African Culture*. Cambridge, U.K.: Cambridge University Press, 1980. A classic from a man who might be rightly called the father of modern African philosophy.

Mpalive-Hangson Msiska

REASON, PRACTICAL AND THEORETICAL. Aristotle relates that Socrates brought philosophy down from the heavens and into the cities of humans. More prosaically, Socrates invented the problem of practical reason by asking whether reasoning could guide action, and, raising the stakes, whether a life devoted to reasoning could be the best way to live. Aristotle closes the *Ethics* by ridiculing a too-close connection between reasoning and virtuous action and character. He notes, as Socrates had done, that those who are regarded as virtuous do not teach virtue, and those who pretend to teach it, do not possess it. Can reasoning guide action?

Definitions and Relationships

Theoretical reason tries to assess the way things are. Practical reason decides how the world should be and what individuals should do. A theoretical proposition is good if it conforms to reality, while a practical proposition has more complicated and

debatable standards, (For the idea of “direction of fit” see John Searle’s 1983 *Intentionality*.) While practical reason decides what to do, it cannot remake reality any way it likes. The successful practical agent must take into account truths about the world. Some have inferred from this that practical reason consists largely (or entirely) in using such knowledge for practical purposes. Similarly, while theoretical reason tries to conform to the world, its proceedings are influenced by the practical needs of inquirers. Some have concluded from this that theoretical reason is the specification of the norms of practical reason to the practical project of theoretical inquiry. How individuals ought to believe is then a practical question.

Some of the interest in practical reason comes from trying to understand its failures. Theoretical irrationality is simply a mistake. But practical irrationality may invite more detailed explanations than theoretical irrationalities, because there is more to explain. (The most influential modern discussion of weakness of will is in Donald Davidson’s 1980 “How Is Weakness of the Will Possible?” For Aristotle on *akrasia*—literally “without power over oneself,” but often translated as weakness of will—see Dahl.)

Formally, there are four possible relations between theoretical and practical reason. Penetrating philosophers cannot always be so easily categorized, but these possibilities set the agenda for philosophers trying to understand the relation between theoretical and practical reason.

First, in Plato’s representation of Socrates, theoretical and practical reasoning are only superficially distinct. Truth and goodness are convertible, as are the modes of reasoning that lead to apprehension of truth and goodness. To know the good is to desire it. The good life is the philosophical life, characterized not by knowledge but by eros. Anyone who fully understands the good must try to achieve it; no one can know the better, yet choose the worse. Vice is a practical form of ignorance.

Second, theoretical reasoning is a form of practice, judged by practical standards of effectiveness, appropriateness, and productivity. This position has reappeared in history under different names—sophism among the Greeks, humanism in the Renaissance, and now pragmatism and anti-foundationalism. The myth of Prometheus that Protagoras recounts to Socrates in Plato’s *Protagoras* sees that the only difference between the knowledge of justice and piety and the knowledge embodied in the arts is that practical reason is universally distributed, while the arts are more specialized. Thomas Hobbes (1588–1679) and Giambattista Vico (1668–1744) stress, in different ways, that one can only know what one has made. Theory is a moment in practice, sometimes a means of avoiding action and sometimes a means of domination. Theoretical reasoning is what happens to practical reasoning when one temporarily abstracts from the usual conditions of practical decision—limited information, time constraints, a need to be responsive to desires and opinions, even those that are not well-grounded. Max Weber’s essay, “The Profession and Vocation of Politics,” can be taken as an exemplar of this version of theory and practice. Practical reasoning, for Weber, requires a distinction between an ethics of conviction—which too closely mirrors

theoretical reasoning—and an ethics of responsibility. If the virtuous do not teach virtue, maybe the fault lies in their teaching ability, not in their virtue. If reason does not always rule, maybe it shouldn’t—maybe the competing claims of tradition or emotion should prevail.

Third, practical reason is the application of theoretical reasoning and its conclusions to concrete, practical situations. Even theoretical reasoning needs practical judgment to reach definite conclusions. Practical reasoning is instrumental, calculating how to achieve an end that is not itself rationally determined. To be practically rational is intelligently to pursue one’s interest. “Reason is, and ought only to be, the slave of the passions” (Hume, p. 415), and it is not irrational to “prefer the destruction of the whole world to the scratching of my finger” (p. 416). If reason is a slave of the passions, then practical reasoning is simply the name for reasoning that concerns itself with desires and the means of satisfying them. Practical reasoning does not differ from theoretical reasoning except in content: it is reasoning that is about preferences, desires, obstacles, and resources. If good people do not teach virtue, it is simply because they choose not to pass on their cleverness; virtue is taught by conditioning or persuading people to desire and take pleasure in the right things. This conception of the relation of theoretical to practical reason can argue that it is only through progress in the sciences that the emergence of democracy and human freedom can take place. The more one can calculate, the less one has to argue. But there is a problem within this line of thought. Without objective ends, goals are not rationally justified. Therefore, only means are justified and rational. But only ends motivate. This leaves a gap between justification and motivation. Sensing that gap, Jean-Jacques Rousseau (1712–1778) sets a new problem for practical reason when he asks how a free act of will can create obligations: what motivation could a free being have for entering a world in which he must justify what he does?

Finally, practical and theoretical reasoning are distinct forms of reasoning. Science and practical wisdom are irreducible to each other, and each, in its own sphere, gives orders to the other. In Aristotle, politics decides which sciences are studied but metaphysics determines truths according to which practice operates. Political science “prescribes which of the sciences ought to be studied in cities” (*Ethics*, I.2). “Phronesis is not in authority over wisdom or the better part of the intellect, any more than medical science is in authority over health. Medical science does not control health, but studies how to procure it; hence it issues orders in the interests of health, but not to health” (*Ethics*, VI.13). Aristotle also takes up Socrates’ challenge that knowing the better yet choosing the worse is impossible, and provides (*Ethics*, VII) logical and physical explanations for *akrasia*.

Aristotle argues that practical reasoning infers in the opposite direction from both theoretical reasoning and the deliberation involved in productive activity. In the arts, barring chance, the inference from product to artist is secure: looking at a painting can tell the observer if it was skillfully produced, while courageous or just acts do not always indicate the presence of a virtuous agent. On the other hand, a virtuous per-

son can be counted on to act virtuously; the virtuous person, unlike the artist, cannot say, “I could have acted virtuously but I didn’t want to.” The virtues are not rational in that way.

Immanuel Kant (1724–1804), too, sees both theoretical and practical reason as supreme, each in their own way. He states that everything acts according to laws, but “only a rational being has the capacity of acting according to the conception of laws, that is, according to principles” (*Critique of Pure Reason*, G412). Practical reason understands laws of freedom. In Kant, theoretical reason has priority because it can have knowledge where practical reason merely has conviction and belief. At the same time, practical reason has priority because the knowledge of theoretical reason is only knowledge of phenomena—how things appear to us—while practical reason orients itself to things as they really are. Moreover, even theoretical reason depends on practical reason, since Kant insists that “reason has no dictatorial authority; its verdict is always simply the agreement of free citizens” (A738–9/B766–67).

Kant’s “critical philosophy” asks how both theoretical and practical reason are possible. It takes for granted the existence and successful operations of theoretical reason in the sciences, and thus the *Critique* asks for the conditions that could justify this use of reason. At the same time, the *Critique* exposes as empty the claims of theoretical reason to transcend the empirical conditions that make scientific knowledge possible. The situation for practical reason is different. It cannot take some existing practices of practical reason as data to be explained. It is only by transcending the empirical conditions that limit practical reason to an instrumental role that one discovers, in pure practical reason, the legitimate moral employment of rationality. It is known that desires cause actions. Kant asks whether reason can lead to action on its own, and not only concludes that it can, but argues that actions caused by reason alone are identical with morally good acts.

For a final example, John Stuart Mill begins *Utilitarianism* (1863) by noticing this difference between theoretical and practical reasoning: “Though in science the particular truths precede the general theory, the contrary might be expected to be the case with a practical art, such as morals or legislation. All action is for the sake of some end, and rules of action, it seems natural to suppose, must take their whole character and color from the end to which they are subservient. When we engage in a pursuit, a clear and precise conception of what we are pursuing would seem to be the first thing we need, instead of the last we are to look forward to” (Ch. 1, para. 2).

Investigations of the Types of Reason

In the early twenty-first century, there are three sets of problems concerning practical reason: one that mostly relies on Aristotelian resources, a second that bases its inquiries on Kantian problems and texts, and a final group that derives from Machiavelli and Hobbes. The Aristotelian branch of the problem seeks to revive notions of phronesis, prudence, or practical wisdom by showing how practical rationality is not reducible to theory or to instrumental reasoning. Aristotelian practical reason is concerned with the virtues of practical reason, and their rela-

tion to the virtues of character. It looks to knowledge of particulars, rationality that does not exclude emotion. It tries to interpret Aristotle’s enigmatic sentence: “Thought by itself moves nothing, but only thought directed to an end, and dealing with action” (*Ethics*, VI.2.1139b1). Practical reason here is substantive, and therefore the challenge is in seeing whether it is not confined to codifying what the supposedly virtuous person already embodies, and therefore whether it is not parochial. Much of the Aristotelian revival tries to use Aristotle to confront problems beyond the scope of his original concerns. It seeks to overturn the modern distinction between moral and prudential reasoning. It asks whether, and how, practical reason can maintain its autonomy in the face of the increased domination of scientific reasoning in our lives, and without the strong practical conditions Aristotle imputed to the polis, such as confidence that ordinary political judgments were reliable enough that moral reasoning can defer to the ultimate authority of the person of practical wisdom. (Seminal here is Alasdair MacIntyre’s 1984 *After Virtue: A Study in Moral Theory*. See also Eugene Garver’s *Aristotle’s Rhetoric: An Art of Character* [1994] and *For the Sake of Argument: Practical Reasoning, Character, and the Ethics of Belief* [2004].)

The different ways Kant poses the question of critical philosophy for theory and practice reflects the success of science. The scientific revolutions of the seventeenth century apparently made progress by changing the idea of theoretical reason from a substantive one, in which scientific reasoning succeeded by tracking or imitating the rational structure of the universe, to a procedural one, in which something new, called the “scientific method,” succeeded just because its neutrality and purity allowed it fairly to interrogate nature. After such progress, practical reason, too, was tempted to become procedural. Therefore, the Kantian side of the current investigation of practical reason instead asks how reasoning can transfer motivation from an initial desire along the chains of reasoning to a conclusion about what to do.

The Kantian investigation of practical reason asks not about virtues but capacities and possibilities. “A practically rational person is not merely capable of performing certain rational mental operations, but capable also of transmitting motive force, so to speak, along the paths laid out by those operations” (Korsgaard, p. 320). Corresponding to skepticism about theoretical reason, the Kantian inquiry asks whether all the motivating force of reasoning must come from an irrational source, or whether practical reasoning can itself be motivating. Practical reason here is procedural, and so from the beginning the challenge to Kantian practical reason is whether it can give specific guidance. The analogy to logic is clear. If logic is pure procedure, it can detect fallacies and justify inferences, but it cannot generate truths of its own. Can practical reason tell one anything one does not already know by desire or other sources of ends?

Even before the scientific revolutions of the seventeenth century, philosophers had to change the terms in which they thought about practical reason because of the earlier revolution, instituted most dramatically by Machiavelli and Hobbes, of separating ethics from politics and therefore the practical

reasoning of the individual moral agent and of the state or the politician. Unfortunately, the separation of ethics from politics has resulted in these three research programs concerning practical reason having little communication among them. The Kantian, and most of the Aristotelian, explorations of practical reason concentrate only on the practical reasoning of the individual moral agent. There is a rich but distinct literature concerned with how individuals can, or cannot, coordinate their choices and actions through such research programs as game theory. Finally, problems of “dirty hands” and the relation between political morality and “real” or individual morality form a research program of their own.

In Isaiah Berlin’s influential formulation, Machiavelli inaugurates a new era in practical reason by denying the existence of a single highest good, claiming instead that not all good things can coexist. Regardless of whether Berlin’s account accurately describes Machiavelli, it rings true as a description of the contemporary predicament of practical reason. Toleration and compromise head the agenda for practical reason. Stoics once wondered whether someone could be happy on the rack; the readers of modern philosophy ask instead whether happiness is possible in the face of abundance.

See also Aristotelianism; Language, Philosophy of; Modern; Moral Sense; Philosophy; Platonism.

BIBLIOGRAPHY

- Berlin, Isaiah. “The Originality of Machiavelli.” In *Studies on Machiavelli*, edited by Myron P. Gilmore. Florence: Sansoni, 1972.
- Dahl, Norman. *Practical Reason, Aristotle, and Weakness of the Will*. Minneapolis: University of Minnesota Press, 1984.
- Davidson, Donald. “How Is Weakness of the Will Possible?” In his *Essays on Actions and Events*, 21–42. Oxford: Clarendon, 1980.
- Garver, Eugene. *Aristotle’s Rhetoric: An Art of Character*. Chicago: University of Chicago Press, 1994.
- . *For the Sake of Argument: Practical Reasoning, Character, and the Ethics of Belief*. Chicago: University of Chicago Press, 2004.
- Hume, David. *A Treatise of Human Nature*. Edited by L. A. Selby-Bigge. Oxford: Clarendon, 1978.
- Korsgaard, Christine. *The Sources of Normativity*. Cambridge, U.K.: Cambridge University Press, 1996.
- MacIntyre, Alasdair. *After Virtue: A Study in Moral Theory*. 2nd ed. Notre Dame, Ind.: University of Notre Dame Press, 1984.
- Mill, John Stuart. *Utilitarianism*. London: Parker, Son, and Bourn, 1863. Text available at <http://www.utilitarianism.com/mill1.htm>.
- O’Neill, Onora. *Constructions of Reason: Explorations of Kant’s Practical Philosophy*. Cambridge, U.K.: Cambridge University Press, 1989.
- Searle, John. *Intentionality: An Essay in the Philosophy of Mind*. Cambridge, U.K.: Cambridge University Press, 1983.
- Weber, Max. “The Profession and Vocation of Politics.” Originally published as “Politik als Beruf.” Available in translation in *Weber: Political Writings*, edited by P. Lassman and R. Speirs. Cambridge, U.K.: Cambridge University Press, 1994.

Eugene Garver

REBELLION. *See Resistance.*

RECAPITULATION. *See Development.*

RECIPROCITY. *See Gift, The.*

REFLEXIVITY. Reflexivity first entered into anthropological discourse in the late 1970s in response to several problematics that had emerged in the previous decade, but its use in the humanities and in sociology has a longer history. In the words of Barbara Myerhoff and Jay Ruby, two of its advocates, reflexivity “describes the capacity of any system of signification to turn back on itself, to make itself its own object by referring to itself” (p. 2). In the fields of literature, theater, and film, the term is used to describe formal devices by which cultural artifacts call attention to their own production. In the early twentieth century, reflexivity (also known as self-reflexivity, metaliterature, or metatheater) was particularly associated with experimental attempts to undermine the realist conventions of mainstream productions by inserting films (or film production) within films, having literary characters address their readers, and so on. Important early examples would include the work of Samuel Beckett (1906–1989), Luigi Pirandello’s (1867–1936) *Six Characters in Search of an Author* (1921), or Dziga Vertov’s (1896–1954) film *The Man with a Movie Camera* (1929). While it is still associated primarily with experimental works, reflexivity is also found in mainstream cinema and theater.

Reflexivity in Sociology

The term’s history in the social sciences has been somewhat more complex, as it has been used by different theorists to refer to different phenomena according to what both the object and subject of reflection is understood to be. The concept of reflexivity has a longer history in sociology than in anthropology. As a sociological term, it first appears in the work of Talcott Parsons where it refers to the capacity of social actors in modern societies to be conscious and able to give accounts of their actions. This usage was further developed by Anthony Giddens, who argues that one of the main characteristics of late modernity is a heightened importance of reflexivity in this sense, both at the individual and the societal level. In late modernity, he argues, most aspects of social activity are subject to constant revision in the light of new information or knowledge (sociology itself is a major source of such reflexivity at the level of the society). Individual social actors likewise must constantly revise their identities in light of the changing social categories at hand. A second meaning of the term in sociology is traceable to the work of Harold Garfinkel who used the term to mean the process by which social order is created through ad hoc instances of conversational practice. A third sense of the term is in the context of “reflexive sociology.” The term was coined by Parsons’s student Alvin Gouldner, who called for a sociological examination of the discipline itself as

part of a liberatory “radical sociology.” The theorist most closely associated with reflexive sociology in this sense is Pierre Bourdieu. In his work, reflexivity is understood as a strategic agenda, that of utilizing the tools of the discipline in order to demystify sociology as a power saturated social practice.

Reflexivity in Anthropology

Although reflexivity appears somewhat later in anthropology than it does in sociology, its impact has been far greater. It became a central theoretical (and practical) concern during the mid-1980s in response to a distinctive conjunction of events both within and outside of the discipline, which problematized the production of ethnographic texts. Like sociological reflexivity, reflexivity in anthropology encompasses several distinct, identifiable but related styles.

The first of these, chronologically speaking, is associated with Victor Turner and his students, and focuses on the study of reflexive moments in social life. Turner was interested in the ways in which social action was accomplished through the manipulation of symbols. Reflexivity, in Turner’s sense, refers to moments in which social actors become conscious of and can reflect upon social life in ritual and other cultural performances which are “*reflexive in the sense of showing ourselves ourselves . . . arousing consciousness of ourselves as we see ourselves.*” (Myerhoff, p. 105; italics in original). Of greater influence within the discipline, however, have been styles of reflexivity, broadly associated post-modernism that reflect upon the disciplinary practices of anthropology.

The so-called reflexive turn in anthropology came as the outcome of three distinct disciplinary crises, beginning in the early 1970s. The first crisis came out of the recognition and subsequent critique of the discipline’s complicity with structures of inequality wrought by European colonial expansion and its aftermath. These concerns were articulated in two publications of the period, Dell Hymes’s collection *Reinventing Anthropology* in the United States and Talal Asad’s *Anthropology and the Colonial Encounter* in Britain. Bob Scholte’s contribution to the former (echoing Gouldner’s call for a reflexive sociology) called for anthropologists to analyze the practice of ethnography as an instantiation of colonial power relations.

The second crisis was produced by the intersection of the feminist movement with anthropology. The feminist critique of the discipline’s androcentric bias problematized the notion of the objective, neutral observer. The feminist intervention in particular led to an emphasis on positionality—that is, a reflexivity that is enacted through the explicit acknowledgment and theoreticization of the “situatedness and partiality of all claims to knowledge” (Marcus, p. 198) and the ethnographers position in relation to his or her interlocutors. This has been particularly important in the work of “halfie” anthropologists—anthropologists working in communities in which they have ambivalent claims of membership (or at least commonality).

The 1967 publication of Bronislaw Malinowski’s field diaries (*A Diary in the Strict Sense of the Term*) constituted a third disciplinary crisis insofar as they undermined the seeming transparency of the relationship between fieldwork practice and the

production of ethnographic texts. In this spirit, a strain of ethnography more directly concerned with experiments in rhetorical styles emerged by the end of the 1970s. Three ethnographies in particular, Paul Rabinow’s *Reflections on Fieldwork in Morocco*, Vincent Crapanzano’s *Tuhami* and Kevin Dwyer’s *Moroccan Dialogues* utilized writing strategies that challenged the conventional distinction between subjective and objective styles of writing. These were followed by two 1986 collections, Michael Fisher and George Marcus’s *Anthropology as Cultural Critique* and James Clifford and Marcus’s *Writing Culture: The Poetics and Politics of Ethnography*, which focused attention on rhetorical strategies by which ethnographies produce their effects and called for a re-thinking of, and reflexive experimentation with writing strategies such as dialogue, pastiche, and memoir.

Reactions to the reflexive turn varied, even among its advocates. Marcus and Clifford, for example, were critical of the lack of formal experimentation in writings by feminist anthropologists. Feminist anthropologists, such as Ruth Behar and Deborah Gordon, responded, accusing them of insufficient reflexivity regarding their positionality. Others in the discipline, such as Clifford Geertz and Nancy Scheper-Hughes, expressed the following concern: the fact that ethnographic authority is constructed through rhetorical strategies is, ultimately, of limited relevance to the anthropological project (Geertz), and too much attention to the politics of representation could lead to a sort of politico-ethical paralysis on the ground (Scheper-Hughes). By the 1990s, however, most elements of the reflexive critique had been incorporated into the mainstream of U.S. cultural anthropology. At minimum, this consisted of the convention of introducing ethnographic works with brief biographical statements, designed to lay out the ethnographer’s personal history and stakes in his or her problem or subject. Other works incorporated reflexive concerns or strategies to broader ends, using them to interrogate the relationship between writing and theory or to problematize the role of ethnography in the construction of ethnographic subjects.

See also Anthropology; Cinema; Ethnography; Theater and Performance.

BIBLIOGRAPHY

- Asad, Talal, ed. *Anthropology and the Colonial Encounter*. Amherst, N.Y.: Prometheus Books, 1973.
- Behar, Ruth, and Deborah Gordon, eds. *Women Writing Culture*. Berkeley: University of California Press, 1992.
- Clifford, James, and George E. Marcus, eds. *Writing Culture: The Poetics and Politics of Ethnography*. Berkeley: University of California Press, 1986.
- Crapanzano, Vincent. *Tuhami: Portrait of a Moroccan*. Chicago: University of Chicago Press, 1985.
- Dwyer, Kevin. *Moroccan Dialogues: Anthropology in Question*. Baltimore, Md.: Johns Hopkins Press, 1999.
- Fisher, Michael M. J., and George E. Marcus, eds. *Anthropology as Cultural Critique*. Chicago: University of Chicago Press, 1986.
- Geertz, Clifford. *Works and Lives: The Anthropologist as Author*. Stanford, Calif.: Stanford University Press, 1990.
- Hymes, Dell, ed. *Reinventing Anthropology*. Ann Arbor: University of Michigan Press, 1999.

- Marcus, George E. *Ethnography through Thick and Thin*. Princeton, N.J.: Princeton University Press, 1998.
- Myerhoff, Barbara. "Life History Among the Elderly." In *The Cracked Mirror: Reflexive Perspectives in Anthropology*. Philadelphia: University of Pennsylvania Press, 1982.
- Myerhoff, Barbara, and Jay Ruby, eds. *The Cracked Mirror: Reflexive Perspectives in Anthropology*. Philadelphia: University of Pennsylvania Press, 1982.
- Rabinow, Paul. *Reflections on Fieldwork in Morocco*. Berkeley: University of California Press, 1978.
- Scheper-Hughes, Nancy. "The Primacy of the Ethical: Propositions for a Militant Anthropology." *Current Anthropology* 36 (1995): 409–440.
- Scholte, Bob. "Toward a Reflexive and Critical Anthropology." In *Reinventing Anthropology*, edited by Dell Hymes. Ann Arbor: University of Michigan Press, 1999.

Heather Levi

REFORM.

This entry includes two subentries:

Europe and the United States
Islamic Reform

EUROPE AND THE UNITED STATES

Reform, from the Latin *reformare*, to recast or reshape, denotes the overhaul of an existing state or condition with a view to its improvement. Until the eighteenth century the terms *reform* and *revolution* were used interchangeably. In the wake of the French Revolution, however, they took on distinct meanings. *Reform* came to denote substantial change through an orderly and lawful process; *revolution* described a radical change through violent and illegal means. In modern usage, a reform executed with striking speed and success may be apostrophized as a revolution, as for example in Peter Jenkins's *Mrs. Thatcher's Revolution* (1987) or Martin Anderson's *Revolution: The Reagan Legacy* (1988). This "upgrading" of a lawful process to a "revolution" may be regarded as a figure of speech and serves the purpose of demarcating a historical period. In the twentieth century further nuances to the concept of reform were introduced through the use of the term "protest." The word denotes collective action aimed at reform (for example, strikes and sit-ins), which avoids the violence associated with a revolution, yet transgresses normally accepted limits of social behavior. In the late twentieth century scholars noticeably shied away from the use of the term "reform," favoring instead value-neutral descriptions of the process of change. According to the *Oxford English Dictionary*, reform is an alteration "for the better." Such normative labeling is now seen as problematic. Marxists, for example, would deny that a reform from within the prevailing power structure produces betterment and would argue that this type of reform is in fact counterproductive to the socialist revolution they envisage. In academic discourse, therefore, the term *reform* has been largely replaced by *change* or *shift*. *Reform* remains the term of choice, however, in popular literature and in the propaganda of special-interest groups lobbying for change.

Categories and Theories of Causation

Already in antiquity we find theories of a "natural" reform—that is, an ongoing reform process or cumulative historical development. In the fifth century B.C.E., the Greek historian Herodotus discussed constitutional change in terms of a natural, cyclical reform: when monarchy deteriorates into tyranny, it is replaced by aristocracy; when aristocracy becomes corrupt, it is replaced by democracy; when it turns into mob rule, it is replaced by a monarchy. Thus the cycle begins anew. The idea of a linear progression, from a flawed earthly to a perfect heavenly life, was central to medieval Christian thinking. In the fourth century the church father St. Augustine of Hippo (354–430) postulated that God had implanted in humanity the capacity for advancement. The idea of linear progress was also promoted by secular philosophers, although they differed from Christian writers in attributing the cause of advancement to human reason rather than a divine plan. Enlightenment philosophers spoke of a maturing of the human mind and a progressive improvement of the human condition through science and reason. Expanding on Enlightenment thought, philosophers from Georg Wilhelm Friedrich Hegel (1770–1831) to Karl Marx (1818–1883) embraced the idea of progressive historical change through the actualization of the human rational capacity. Marxists introduced the idea that social and economic conditions were instrumental in bringing about reform or revolution. Similarly, sociologists in the twentieth century spoke of a "technological imperative" driving social change.

More frequently, however, reform is seen not as "natural" or circumstantial but as prompted by human agency and deliberately advanced by groups or individuals for ideological reasons. In this category, we must distinguish institutional from personal reform. The latter is an aspect of religion or education and is more appropriately discussed under that heading. This article focuses on institutional reform—that is, social and political changes. The personal may of course become political, as for example in the sixteenth century, when both Martin Luther (1483–1546) and Desiderius Erasmus (c. 1466–1536) depicted the invading Ottoman Turks as "the scourge of God" and insisted that repentance and personal reform must precede successful political action. Similarly, Islamic jihad, meaning "struggle," combines the notion of self-purification or striving against one's evil inclinations with political-theocratic ideas and the struggle for the preservation and dissemination of Islam through military means. In modern Western history, however, reform movements have been and are largely secular and concerned less with the emancipation of the individual than with societal change.

Principles of Validation

In modern usage reform is linked to innovation, a concept that is also used to validate it. Throughout antiquity and the Middle Ages, however, the idea of innovation lacked the positive connotation it acquired later on. In classical Latin the expression *cupidus rerum novarum* (keen on new things) was an idiomatic expression for "rebellious" and was invariably used in a deprecatory sense. Innovation was seen as dangerous, an assessment that remained the norm even in the Renaissance. Niccolò Machiavelli (1469–1527), for example, emphasized the

dangers of changing the status quo and described the process of establishing a new order of things as risky and therefore to be avoided. In the premodern age, and as long as tradition remained a powerful validating principle, would-be reformers therefore shied away from associating their cause with innovation. Instead, they regularly claimed to revert to a preexisting condition and restore a corrupt state to its original pristine state. Innovation was openly advocated only in utopian literature. There, reform proposals were presented in a whimsical or paradoxical manner and given a deliberately eccentric or unrealistic setting. This device, employed by authors from Plato (c. 428–348 or 347 B.C.E.) to Jonathan Swift (1667–1745), was often used to circumvent censorship and to air ideas in closed societies, which offered no effective legal channel to bring about change. Incentives to resort to satire and utopian fiction were especially strong when stable political and institutional alignments protected the status quo.

The Reformation of the sixteenth century, epitomized by Martin Luther, evinces the typical characteristics of a successful reform movement: a well-developed ideology, a conscious intention of overthrowing the status quo, and, given the stigma attached to innovation in early modern Europe, an appeal to a preexisting condition and a promise to restore the corrupt church to its original state. The Reformation also exemplifies the political circumstances favoring success. It enjoyed broad popular support and benefited from an unstable political climate. This allowed Protestants in Germany and Huguenots in France to align themselves with dissenting secular authorities. In Germany, the reformers were supported by cities and principalities that opposed the centralizing tendencies of the Catholic emperor. In France, Huguenots benefited from the power struggle between court factions in the dying days of the Valois dynasty. Similar crisis conditions allowed reformers and reforming groups in the seventeenth century to realize their goals. A new idea, however, emerged at that time and came into its own in the eighteenth century: the idea that the common people had not only duties but also rights. This was the theory underlying the 1649 Leveller's Agreement of the People and was the basic assumption of the 1776 Declaration of Independence as well as the French charter of rights drawn up in 1789. Its slogan, "freedom, equality, brotherhood," associated reform/revolution with freedom from religious and secular hierarchical power.

Although the revolutions of the eighteenth century shared with the sixteenth-century Reformation the rejection of traditional authority and references to individual responsibility, philosophers in the seventeenth and eighteenth centuries appealed to reason rather than the divine will as the source of life-structuring norms. René Descartes (1596–1650) first presented the reductionist theory that dictated rejection of values based on tradition and experience unless they could be fitted into a rational context. His thought supplied the basic motivation for reform until Karl Marx and Friedrich Engels (1820–1895) substituted material and economic conditions as initiating factors. Even they, however, presented reform as a rational attempt to achieve change.

It was only in the eighteenth century, the Age of Enlightenment, that the negative connotation of innovation was over-

come. The French philosophes unabashedly offered new ideas, which were taken up by European rulers, especially in Prussia and Austria, and found their way into parliamentary debates.

Agencies of Reform

Popular support has always played an important role in successful reforms, but there is a noticeable shift in the nineteenth century in the structures that serve as a means of galvanizing popular support and promoting bonding. Until then collective action to further reform and the intellectual solidarity on which it is predicated were promoted by kinship groups, regional networks, and religious congregations. The goals were specific and parochial, with the action typically arising from particular circumstances and ceasing when the specific objectives had been achieved. From the nineteenth century on, the role of these groups was increasingly taken over by governments, political parties, firms, or unions and involved long-range, sometimes cosmopolitan, goals. Realizing such goals required a permanent organization and planned action and often involved either coercion or reward for the participants. Already in the eighteenth century, major social and economic reforms were introduced from above, through the agency of "enlightened despots" like Frederick the Great of Prussia (r. 1740–1786) and Joseph II of Germany (r. 1764–1790). The civil service they created to implement the reforms may be seen as a harbinger of the developments in the nineteenth century, which saw a large number of reforms passed through legal channels and mediated by politicians and political parties. Indeed, "reform" became the watchword of socialist parties and was generally associated with their platform. In England, for example, the Tories who were dominant between 1770–1830 were opposed to reform, whereas the Whigs promoted and enacted a succession of reforms (for example, the Reform Act of 1832, which expanded suffrage). In the twentieth century reform was associated in Britain with the Liberal government before 1914 and the Labour government after 1945. In the United States, administrative reforms were seen as the result of the Progressive movement in the nineteenth century and associated with the Democratic Party and more specifically with the presidency of Franklin Delano Roosevelt (1882–1945) in the twentieth century. In the USSR the term "reform" was applied to Mikhail Gorbachev's efforts to restructure key state institutions and to bring about a fundamental change in social values through glasnost.

In the second half of the twentieth century, however, reform movements began to transcend class and party lines as well as other traditional groupings and increasingly signified personal choice and self-identification (for example, as gay, disabled, or black). On a broader level, reformers appealed to the communal good and a global human fellowship (for example, environmental, disarmament, anticonglomerate, and civil rights movements). The move from adherence to a cause determined by incidental membership in a group (class, gender, nationality) to a cause that was personally meaningful and from reform initiated by political parties to nonaligned protest organizers or organizations (for example, Ralph Nader, Greenpeace) was accompanied by a shift of authority from "without" to "within." This shift may be seen as a consequence of two

recognized social trends in the twentieth century: the encouragement of individualism and the rejection of ritualization.

Academic Approaches to Reform: Methodology and Conceptualization

Reform ideas were traditionally regarded as the bailiwick of political philosophers and intellectual historians. In the twentieth century, however, reform became the object of study of a newly formed discipline: sociology. The shift from philosophy to sociology was accompanied by a shift in focus. Sociologists examining the concept of change were more interested in the origin and dynamics of reform, the conditions that facilitated or impeded change, and strategies of mobilization that brought about reform than in the content of the reform program or the outcome of the movement. They avoided the value judgment inherent in gauging the success of a movement and shied away from stating whether its outcome was the result of a reform movement or a matter of cultural milieu. An example of this development in methodology is the rise and decline of the theory of “modernization,” which was based on the idea of progressive historical change. “Modernization” was first advocated by social historians and sociologists in the 1950s. Proponents like Daniel Lerner and Alex Inkeles regarded the characteristics of the modern society as preferable to traditional societies, equating it with more political freedom, higher income, better health, better education, and the triumph of science and reason over superstition. Western societies were thought to furnish the template for the modern society and expected to become the standard of other societies. The modernizations introduced in Turkey by Kemal Atatürk (1881–1938) in the 1920s were seen as the prototype of such a development. By the 1980s, however, the concept of modernization was recognized as problematic and was eventually discredited. Objections were raised against its ethnocentricity, facile optimism, and attempt at leveling cultural differences. Although globalism remains a buzzword today, social and intellectual historians have found it difficult to accept the idea of globally common dynamics and have generally come to favor pluralism over theories emphasizing uniformity. In the context of pluralism, reform is seen as an initiative of special-interest groups, usually antiestablishment, whose goals range from specific concessions to a large-scale overhaul or even a reordering of society.

Sociologists studying reform have drawn up a schema or typology of reform movements: They are often associated with pragmatic goals (as opposed to revolutions, which are informed by radical ideologies). They may be regarded as the second stage of a revolution, with an overtly radical movement ebbing into a reformist movement. Revolutions and/or reforms are generally launched in crisis situations and as the result of political malaise. Conversely, protest movements are less likely to make headway when political, social, and economic conditions are reasonably good and the prevailing powers are therefore able to defuse resentment. Effective government and moderate prosperity will generate a reluctance to harm vested interests for fear of losing the benefits already enjoyed. Support for a change of the status quo is also less likely when the group in power has been successful in public relations, promoted an image of success through self-congratulatory rhetoric, and created a sense of common in-

terest. Such conditions generally impede a society’s ability to recognize the need for change or develop a desire for it.

In the 1980s, theories about reforms and their desirability were jolted by postmodernists like Jean-François Lyotard in the field of political philosophy and Michel Foucault (1926–1984) in the field of social studies and ethics. They promoted a skeptical attitude toward the traditional assumptions of Western thought, among them the belief in the inevitability of progress, the power of reason, and the value of originality/innovation. One might associate their critique with the move away from authority and toward individualism that characterizes modern reform movements. The fundamental thrust of the postmodernists, however, is antiauthoritarian. Overtly, at any rate, postmodernists do not advocate political stances or social causes. Indeed, Ernesto Laclau has rejected “foundational” reform movements, whose leadership would become the new authority and issue a blueprint for a society reorganized along rational principles. In other words, the radical social and cultural relativism of postmodernists renders the concept of reform problematic if not senseless. A reaction against postmodernism has set in, however. Indeed, Jürgen Habermas notes the tendency of the critical impulse consuming the movement itself.

See also History, Idea of; Modernity; Revolution; Secularization and Secularism.

BIBLIOGRAPHY

- Birnbaum, Pierre. *States and Collective Action: The European Experience*. Cambridge, U.K.: Cambridge University Press, 1988.
- Blickle, Peter, ed. *Resistance, Representation, and Community*. Oxford: Oxford University Press, 1997.
- Hanagan, Michael P., et al., eds. *Challenging Authority: The Historical Study of Contentious Politics*. Minneapolis: University of Minnesota Press, 1998.
- Heelas, P., et al., eds. *Detraditionalization: Critical Reflections on Authority and Identity*. Cambridge, Mass.: Blackwell, 1996.
- Keeler, John, ed. “The Politics of Reform in Comparative Perspective.” Special issue of *Comparative Political Studies* 25 (Jan. 1993).
- Laclau, Ernesto. *New Reflections on the Revolution of Our Time*. London: Verso, 1990.
- Mohnhaupt, Heinz, ed. *Revolution, Reform, Restauration: Formen der Veränderung von Recht und Gesellschaft*. Frankfurt: Klostermann, 1988.
- Oksenberg, M., and B. Dickson. “The Origins, Processes, and Outcomes of Great Political Reforms.” In *Comparative Political Dynamics: Global Research Perspectives*, edited by Dankwart A. Rustow and Kenneth Paul Erickson, 235–261. New York: HarperCollins, 1991.
- Rucht, Dieter et al., eds. *Acts of Dissent: New Developments in the Study of Protest*. Berlin: Sigma, 1998.
- Skelton, Tracy, and Tim Allen, eds. *Culture and Global Change*. London: Routledge, 1999.
- Tarrow, Sidney G. *Struggle, Politics, and Reform: Collective Action, Social Movements, and Cycles of Protest*. Ithaca, N.Y.: Center for International Studies, Cornell University, 1991.

Erika Rummel

ISLAMIC REFORM

Contemporary Islamic reform movements often trace their roots to the founding era of Islam. Several verses of the Koran encourage reform (*islah*), and a statement of the prophet Muhammad predicts that a renewer (*mujaddid*) will arise in each century to reform the community of Muslims. Among the scholars cited by various reform movements as fulfilling this prediction are Abu Hamid Muhammad al-Ghazali (Iran-Baghdad, 1058–1111), Taqī al-Din Ahmad Ibn Taymiyya (Anatolia-Damascus, 1263–1328), Shah Wali Allah al-Dihlawi (India, 1703–1762), Muhammad Ibn ‘Abd al-Wahhab (Arabia, 1703–1792), and ‘Uthman dan Fodio (West Africa, 1754–1817). These and other prominent reformers shared a scripturalist desire to return Islam to the tenets of the sacred texts, as well as a corresponding distaste for popular practices and contemporary religious hierarchies that they viewed as deviating from these tenets. These recurrent movements for reform had varying impacts on Islamic thought. Some reformers, such as al-Ghazali, were incorporated into the orthodoxy of Islamic scholarship; others, such as Ibn Taymiyya, were largely ignored for centuries.

During the nineteenth century, a new wave of reform movements emerged as part of the resistance to European imperial expansion, on the proposition that this domination was due to Muslims’ religious laxity. Prominent movements and individuals included Hajji Shariat Allah and the Fara’idi movement in Bengal, Ahmad Brelwi in India, Imam Shamil in the Caucasus, ‘Abd al-Qadir in Algeria, and Muhammad Ahmad in the Sudan.

The nineteenth century also witnessed the rise of a new strain of Islamic reform, one that appealed to European models. Like earlier reformers, these modernists called Muslims to return to the sacred texts of Islam; unlike other reformers, however, they identified a happy coincidence between the spirit of these texts and contemporary European values and institutions. This coincidence accounted for Europeans’ power, and the adoption of these ways would restore the glory of Islam. For example, Sayyid Jamal al-Din al-Afghani (Iran, c. 1838–1897), one of the most influential figures in this movement, famously wrote, “I cannot keep from hoping that Muhammadan society will succeed someday in breaking its bonds and marching resolutely in the path of civilization after the manner of Western society” (Kurzman, 2002, p. 108).

One aspect of contemporary Western civilization that modernist Islamic reformers particularly appreciated was the Protestant Reformation, which they interpreted as a move toward the ideals of Islam. Muhammad ‘Abduh (Egypt, 1849–1905), Afghani’s student and another major figure in the movement, described Protestantism as “calling for reform and a return to the simplicities of the faith—a reformation which included elements by no means unlike Islam” (Browsers and Kurzman, p. 3). Similarly, the most prominent South Asian Islamic modernist, Muhammad Iqbal (India, c. 1877–1938), suggested that Protestantism emancipated Europe from religious and political absolutism and embraced human goodness as opposed to original sin—“the basic propositions of Islam, as of modern European civilization” (Browsers and Kurzman, p. 3).

In the middle of the twentieth century, the analogy was reversed: instead of measuring the Reformation by the yardstick of Islamic ideals, Muslim reformers measured Islam by the yardstick of the Reformation. Iqbal came to feel that Muslims “are today passing through a period similar to that of the Protestant revolution in Europe” (Browsers and Kurzman, p. 5) Abduh’s influential disciple, Muhammad Rashid Rida (Syria-Egypt, 1865–1935), phrased the analogy in exhortatory terms, citing the need for Muslims to combine “religious renewal and earthly renewal, the same way Europe has done with religious reformation and modernization” (Kurzman, 2002, p. 80).

Also in the mid-twentieth century, Islamic reformism split into two strands: one that upheld the equation of certain Western and early Islamic ideals, and one that rejected Western precedents. The liberal Islamic movement defended Western values such as democracy, human rights, and gender equality, using Islamic justifications—either specific injunctions from sacred texts on behalf of these positions, or silences in the texts that leave these matters to human invention, or the necessity and desirability of reinterpreting the texts within changing social contexts. A leading representative of this final approach, ‘Abd al-Karim Soroush (Iran, b. 1945), has argued that religious interpretation must take account of intellectual developments outside of the sacred sources: “No reform can take place without re-shuffling the traditional suppositions, and no re-shuffling can emerge unless one is masterfully acquainted with both traditions and the newly developed ideas outside the sphere of revelation” (Kurzman, 1998, p. 250).

The second strand adopted certain modern values and practices but denounced their European provenance. For example, Hasan al-Banna (Egypt, 1906–1949), founder of the Muslim Brotherhood, the first and largest revivalist organization of the twentieth century, called for modern-style “social reform” including mass education, a war on poverty, and public health measures, yet his definition of reform associated all ills in Muslim societies with the rise of Western influence (al-Banna, pp. 14–17 and 126–129). More recently, Usama bin Ladin’s Advice and Reform Committee, the Saudi Arabian opposition group that he founded while in exile in the Sudan in the mid-1990s, railed against political oppression and espoused the doctrines of human equality, rule of law, freedom of the press, human rights, and economic development, using the latest technologies to spread its message—while rejecting the notion that anything positive could be learned from the West.

Both strands of contemporary Islamic reform emerged largely from modern state school systems—Soroush was trained in pharmacology and philosophy, al-Banna in modern education, bin Ladin in engineering. With the expansion of secular education, the traditional seminary (*madrasa*) scholarship has lost the near-monopoly over religious interpretation that it attempted to enforce in earlier eras.

Among the beneficiaries of educational expansion have been women, who were almost entirely excluded in earlier eras from advanced training in religious matters. As more Muslim women have gained secular education, small Islamic feminist movements have emerged in numerous countries. These move-

ments criticize patriarchal cultural practices that they consider to be foreign to the original message of Islam, as well as patriarchal interpretations of the message that they consider to be a product of ongoing efforts by men to monopolize religious scholarship.

One of the common themes of Islamic reform movements, in the early twenty-first century as in past centuries, remains the denunciation of the seminaries' obscurantism and subservience to state authorities. This subservience has only been enhanced by the seminary reform projects of numerous colonial and postcolonial states.

At the same time, the proliferation of Islamic authorities beyond the seminary has generated such a large variety of liberal and radical Islamic movements, all of them espousing "reform," that the word has been rendered almost meaningless. The term is so elastic, and so positively charged, that it is difficult in the early 2000s to find Muslim statements that reject reform in principle—even as criticisms of any particular reform are legion.

See also Anticolonialism: Middle East; Education: Islamic Education; Feminism: Islamic Feminism; Islam; Reformation; Sacred Texts: Koran; Westernization: Middle East.

BIBLIOGRAPHY

- al-Banna, Hasan. *Five Tracts of Hasan Al-Banna (1906–1949)*. Translated by Charles Wendell. Berkeley: University of California Press, 1978.
- Browsers, Michaëlle, and Charles Kurzman, eds. *An Islamic Reformation?* Lanham, Md.: Lexington Books, 2004.
- Kurzman, Charles, ed. *Liberal Islam: A Sourcebook*. Oxford and New York: Oxford University Press, 1998.
- . *Modernist Islam, 1840–1940: A Sourcebook*. Oxford and New York: Oxford University Press, 2002.
- Rahman, Fazlur. *Revival and Reform in Islam: A Study of Islamic Fundamentalism*, edited by Ebrahim Moosa. Oxford: One-world Publications, 2000.
- Samiuddin, Abida, and R. Khanam, eds. *Muslim Feminism and Feminist Movement*. 5 vols. Delhi, India: Global Vision, 2002.
- Voll, John O. "Renewal and Reform in Islamic History." In *Voices of Resurgent Islam*, edited by John L. Esposito, 32–47. New York: Oxford University Press, 1983.

Charles Kurzman

REFORMATION. The Reformation was a movement in Europe of the sixteenth and seventeenth centuries that broke the monopoly over religion held by the Roman Catholic Church since the later years of the Roman Empire and that created a new set of alternative Protestant churches that have henceforth helped supply the needs of Christians in Western Europe and in countries influenced by Europe. Each of these churches developed a set of ideas drawn from the common Christian tradition to justify its separate existence, and the Catholic Church restricted itself to yet another set of received ideas. Some of these new churches called themselves Evangelical. They looked to Martin Luther (1483–1546) for their pri-

mary inspiration. Others called themselves Reformed. Beginning in a second generation, they looked to John Calvin (1509–1564) for their primary inspiration. An independent Church of England created its own middle way. A variety of radical churches, many of them called by their opponents Anabaptist, had trouble gaining toleration. Meanwhile, the Roman Catholic Church responded to the challenge by reforming itself.

Lutherans

The Reformation began in 1517 when Martin Luther, an Augustinian friar and professor of biblical studies at the relatively new university of Wittenberg in Electoral Saxony, posted a set of ninety-five theses inviting anyone to debate a number of propositions about the promulgation of indulgences by the Roman Catholic Church. Indulgences were documents that promised to give a remission of temporal punishments for anyone who genuinely regretted a sin he or she had committed. They were for sale and were vigorously promoted by a number of peddlers, of whom the most notorious was a Dominican friar named Johann Tetzel. Luther argued that the sale of these indulgences made people think they could buy eternal salvation. The publication of his theses provoked a tremendous uproar. That argument quickly developed into a broader one about the ways in which Christians could gain salvation. Luther argued that salvation had to be by faith alone, without any reliance on good works, like indulgences. The Catholic Church insisted that faith had to be supported by works before one could gain salvation. Luther further argued that the only authority that could resolve this dispute was the Bible, while the Catholic Church insisted that the Bible had to be supplemented by tradition, of which the church held custody. Luther also insisted on the priesthood of all believers, arguing that believers could gain salvation by themselves, rather than relying on priests as intermediaries. Luther was excommunicated by the Catholic Church, and new churches were quickly established that followed his leadership and refused to recognize the traditional authority of the pope and his appointees. Luther continued teaching in Wittenberg. He prepared a fresh translation into German of the Bible and wrote an enormous number of works, ranging from learned biblical commentaries to inflammatory polemical pamphlets, developing further his theology. He became one of the most popular published scholars of all time.

The churches Luther had inspired were supported by local governments within the Holy Roman Empire of the German Nation, the political entity controlling most of what we would call Germany and more. Some of these governments were run by princes, including the government of Electoral Saxony, where Luther lived, and the government of Hesse in western Germany. Many of them were run by city councils, within imperial free cities that had received charters from the imperial government to run their own affairs. Luther also gained support in neighboring kingdoms, particularly in Scandinavia.

The Reformed

A few cities in southern Germany and Switzerland followed the somewhat different leadership of Huldrych Zwingli (1484–1531), the principal preacher in the most important church in Zurich, within the Swiss Confederation. So did some of the

principalities in that area, as well as people in other countries. One particularly zealous group of religious reformers developed within France. They followed Zwingli especially in his sacramental theology, in his insistence that in the central Christian sacrament of communion, Christ was present only in spirit. He rejected the notion that the body and blood of Jesus could be transubstantiated into the elements of bread and wine served in this sacrament, as Catholic theologians claimed, or could even exist “in, with, and under” the elements as Luther and his followers claimed. Either interpretation of what happened was to Zwingli a form of idolatry, an invitation to people to adore man-made objects like bread and wine as if they were gods. And idolatry, the Bible makes clear, is condemned by God himself. In 1534, posters attacking the Catholic Mass as a form of idolatry were posted throughout France, even on the door of the king’s own bedroom. That posting led to savage persecution, with substantial numbers of the Protestants who had supported this argument put to death as heretics or forced to leave the country.

One of those who left France was John Calvin, a highly educated French lawyer and humanist who had become a Protestant. He fled to Basel in Switzerland, where he taught himself theology and wrote a book summarizing the Protestant position, called the *Christianae religionis institutio* (1536; *Institutes of the Christian Religion*). That book won him a new job, after one false start, directing the Reformed Church of Geneva. Geneva had revolted from the government of a prince-bishop and had become an independent republic in alliance with the Swiss cantons. Calvin persuaded the Genevans to create a new form of church government and a new liturgy, and before long a new institution of higher education, an Academy, in which he became a leading teacher. Like Luther, he also became a best-selling author, writing learned biblical commentaries and inflammatory pamphlets, as well as expanding and revising his *Institutes*. Meanwhile Zwingli had died at a relatively young age, as a chaplain to troops belonging to Zurich engaged in a war with Swiss Catholics. Calvin became the most prominent spokesman for the Reformed branch of Protestantism.

Calvin is probably best known as a theologian for his commitment to predestination, the doctrine that God deserves the sole credit for choosing eternal salvation for every individual who gains it. He added to that relatively orthodox doctrine the idea that God also deserves the sole credit for choosing eternal damnation for every individual who receives it. In other words, he taught double predestination, predestination of the saved and of the damned. He also taught that God had made his decision on whether or not to save or damn each individual before the beginning of time, before these individuals were even created.

Calvin is also known as a church leader for his insistence on discipline, his belief that every individual Christian must not only adopt true belief but also behave in a truly Christian manner. To that end he insisted that Geneva create a new institution charged with maintaining discipline, called the Consistory. And he insisted that this new institution must have real powers, the power to excommunicate any sinner who misbehaved,

without any provision for appeal, and to recommend expulsion from the city of sinners who refused to repent and reconcile themselves with the Consistory. This insistence on discipline became a mark of the true church to many of Calvin’s followers. Lutherans and Zwinglians said that the only marks of a true church are the teaching of true doctrine and the correct observation of the sacraments. Many Calvinists insisted that there had to be a third mark, the mark of discipline. Calvinism became the most influential form of Protestant Christianity in much of Switzerland, parts of Germany, the Netherlands, Scotland, Hungary, and selected parts of France.

Other Confessions

The Church of England broke with Rome over an entirely different issue. King Henry VIII (r. 1509–1547) wanted Pope Clement VII to annul his marriage with Catherine of Aragon and leave him free to marry another woman, Anne Boleyn. Catherine had been his brother’s wife, and Henry felt that his marriage to her, which was against church law but permitted by an earlier pope, was the reason she had produced no male heirs. Clement refused to act on this request, so Henry’s government broke all connections with the papacy, and, with the 1534 Act of Supremacy, made the king head of the Church of England, which remained Catholic in other respects. The government of Henry’s son, Edward VI (r. 1547–1553), went a step further and made the Anglican Church truly Protestant, basically Zwinglian in theology. Edward was succeeded by his sister Mary (r. 1553–1558), whose government tried to return England to Roman Catholicism. Mary was succeeded by yet another sister, Elizabeth I (r. 1558–1603), whose government returned England to Protestantism, now basically Calvinist in theology, but retaining much of Catholic liturgy and also retaining ecclesiastical government by bishops, rather than creating government by representative church councils called presbyteries, or classes, or synods, which most of the Reformed preferred.

Another group of early Protestants called themselves names like “Brethren,” but were often called by their enemies “Anabaptists” and are generally called by modern scholars “radicals.” They insisted on using the Bible as the only guide to religious observance, and among the biblical customs they insisted on was the practice of baptizing people into the church as adults, as believers who understood what they were accepting, rather than as infants who were presented by their parents and godparents. Infant baptism had become customary through the Middle Ages, in part because of a growing belief that everyone is born with the taint of original sin, and that this taint must be washed away by baptism before there is any hope for salvation. Any person who remained unbaptized on death, therefore, ran the risk of damnation without any hope of salvation, or perhaps, in the minds of some theologians, to relegation to a place called Limbo that was neither heaven nor hell. Infant baptism also had the advantage of making all individuals immediate members of the community, without any period of probation. By insisting on believers’ baptism, Anabaptists changed both the theological and the social meaning of baptism, and that upset a good many people. Anabaptists were often savagely persecuted for their beliefs, beginning in

Zwingli's Zurich where an early group of them emerged. They seldom gained the protection of any government. Numbers of them also known as Mennonites, who became ardent pacifists, managed to survive in the Netherlands and neighboring parts of Germany, tolerated but not permitted to participate actively in society.

Meanwhile, Roman Catholics reacted to all these changes by digging themselves in and drawing the lines of permissible belief more strictly than ever before. That work was accomplished primarily in the Council of Trent, which met between 1545 and 1563, under close direction from a series of popes, and prepared a set of theological decrees and disciplinary canons. Most of the decrees adopted ways of defining Catholic beliefs originally developed by Thomas Aquinas, in preference to alternative views originally developed by William of Ockham, Duns Scotus, and other medieval theologians that been widely accepted before the Reformation. The canons required organizational reforms.

One doctrine of particularly wide practical consequence that Catholics refused to abandon was celibacy. They believed that it was a higher way of life for those who could manage it. They insisted that all secular priests remain celibate, and they also wished to continue communities of contemplative monks and nuns, as well as active friars and sisters, that devoted themselves entirely to the work of the church and did not establish families. Almost all Protestants found the lifestyle of celibacy both unnatural and unnecessary. They wanted their ministers to marry and lead normal family lives, to join society and no longer live in a legally separate caste. And Protestant governments confiscated monasteries and convents, turning them into schools or hospitals, or simply selling the properties. This reduced the range of lifestyle options open to the general population in Protestant lands, particularly for women, who now had little choice but to marry and become housewives. Protestants also changed the institution of marriage in several ways. It was no longer permanent, and could be dissolved in divorce, either for adultery or desertion, at the request of either the husband or wife. In practice, however, divorce remained relatively rare.

Confessionalism

By the end of the sixteenth century each of the surviving religious groups identified itself with a succinct statement of belief called a confession. For Lutherans it was the Augsburg Confession, first advanced in 1530 at a meeting of the Diet, the representative body governing the Holy Roman Empire. It was further expanded and refined late in the century in a statement promulgated in 1577, called the Formula of Concord. For the Calvinists there were a variety of national formulations, including the Heidelberg catechism of 1563 in Germany, and Confessions for the Swiss (1566), the French (1559), the Dutch (1561), and the Scottish (1560). For Anglicans it was the Thirty-Nine Articles adopted in 1563. For Anabaptists there were a variety of local doctrinal statements, for example the Schleithem Articles of 1527. For Catholics there were the decrees and canons of the Council of Trent, as promulgated by popes after 1563. The promulgation of

confessions and the insistence on their use to control the belief of government employees, clergymen, and teachers, became one of the distinguishing features of the religious landscape in the late sixteenth and early seventeenth centuries. It helped states to consolidate their power, both against their neighbors and against supranational institutions like the Holy Roman Empire and the papacy. It made of this period an era of confessionalism and confessionalization. The resulting tensions led to a number of religious wars, in France between 1562 and 1598, in the Netherlands between 1568 and 1648, and within the Holy Roman Empire between 1618 and 1648. Only when governments stopped making decisions on religious grounds and moved to making them on more secular grounds, by 1648 in most areas, did this age of confessionalism end. Pockets of confessionalism remained in parts of Europe, however, and some of them survive into the present. It can be argued that the Reformation has not as yet completely ended.

See also *Christianity; Religion; Religion and the State.*

BIBLIOGRAPHY

- Benedict, Philip. *Christ's Churches Purely Reformed*. New Haven, Conn.: Yale University Press, 2002.
- Brady, Thomas A., Jr., Heiko A. Oberman, and James D. Tracy, eds. *Handbook of European History, 1400–1600: Late Middle Ages, Renaissance, and Reformation*, 2 vols. Leiden and New York: Brill, 1994–1995.
- Brecht, Martin. *Martin Luther*, translated by James L. Shaaf, 3 vols. Minneapolis and Philadelphia: Fortress Press, 1985–1993.
- Cameron, Euan. *The European Reformation*. Oxford: Clarendon, 1991.
- Dickens, A. G. *The English Reformation*. New York: Schocken Books, 1964.
- Duffy, Eamon. *The Stripping of the Altars: Traditional Religion in England, c. 1400–c. 1580*. New Haven, Conn.: Yale University Press, 1992.
- Jedin, Hubert. *Geschichte des Konzils von Trient*, 4 vols. Freiburg: Herder, 1949–1975. The first two volumes have been translated into English as *A History of the Council of Trent*, translated by Ernest Graf. London: T. Nelson, 1957–1961.
- Kingdon, Robert M. *Adultery and Divorce in Calvin's Geneva*. Cambridge, Mass.: Harvard University Press, 1995.
- Oberman, Heiko A. *The Harvest of Medieval Theology: Gabriel Biel and the Late Medieval Nominalism*. Cambridge, Mass.: Harvard University Press, 1963.
- Potter, G. R. *Zwingli*. Cambridge, U.K.: Cambridge University Press, 1976.
- Schilling, Heinz. *Civic Calvinism in Northwestern Germany and the Netherlands: Sixteenth to Nineteenth Centuries*. Kirksville, Mo.: Sixteenth Century Journal Publishers, 1991.
- . *Religion, Political Culture and the Emergence of Early Modern Society: Essays in German and Dutch History*. Leiden and New York: E. J. Brill, 1992.
- Wiesner, Merry E. *Women and Gender in Early Modern Europe*. Cambridge, U.K., and New York: Cambridge University Press.
- Williams, George Huntston. *The Radical Reformation*, 3rd ed. Kirksville, Mo.: Sixteenth Century Journal Publishers, 1992.

Robert M. Kingdon

REGIONS AND REGIONALISM, EASTERN EUROPE.

It would be difficult to find two people today—even two historians or political scientists—who would completely agree on the meaning of the phrase *Eastern Europe*. Unlike such phrases as *Great Britain, the former Yugoslavia, or the Baltic states*, *Eastern Europe* varies widely in what it denotes. The variation occurs in part because what the phrase denotes has changed frequently over time, and in part because in any given era it has carried a multitude of different meanings depending on a host of factors, from the intellectual context to the political orientation or ethnic identity of the speaker. Finally, it occurs because Eastern Europe refers not to an accepted geopolitical reality (like the collection of territories, with recognized boundaries, that used to be included in an entity called “Yugoslavia”) but rather to a region. Regions, which enjoy no formally, legally recognized geopolitical status, are notoriously slippery in their definitions. Eastern Europe serves as an excellent illustration of the dynamics of the concepts of regions and regionalism.

During the Cold War period, the phrase *Eastern Europe* was commonly used in political discussions to refer specifically to Yugoslavia plus the Warsaw Pact countries (that is, Albania, Bulgaria, Czechoslovakia, East Germany, Hungary, Poland, and Romania), excluding the Soviet Union. But in the years since World War II, it has also been used variously to refer to all of Europe east of East Germany, excluding the Soviet Union, Scandinavia, and Greece; to all of Europe east of East Germany, including Russia but excluding Greece; and to a number of other collections of nations and territories. In Jewish studies, Eastern Europe can mean (among other things) Hungary and the primarily Slavic-speaking areas between, but not including, modern-day Germany and the former Soviet Union (roughly corresponding to what is today Poland, the Czech Republic, Slovakia, and Hungary); it can mean those same territories plus modern-day Russia; it can mean those same territories, modern-day Russia, and such territories of the former Soviet Union as once held significant Jewish populations (Latvia, Lithuania, Belarus, Ukraine, and Moldova); and it can mean various other combinations of territories without Russia.

The broadest definition of Eastern Europe may well be the one that the School of Slavonic and East European Studies at University College, London, uses to describe the region to which its activities are devoted. That institution’s Web site includes this definition: “all the countries of Central and Eastern Europe from Finland in the north to the Balkans in the south [inclusive], and from Germany and Austria in the west to Russia in the east [inclusive].”

Regions and Nations, Regionalism and Nationalism in Modern Europe

There are at least two histories of the concept of Eastern Europe, both holding important implications for the broader concepts of regions and regionalism. The first imposes on Europe a regional division that is modern in design but that attempts to describe a historical reality dating back many centuries. The other recounts the emergence and development of the consciousness of Eastern Europe as a region.

The first history was told originally by the Hungarian historian and social theorist István Bibó in an article titled “The Distress of East European Small States” (1946). More recently, in 1983, the historian Jenő Szűcs revised his compatriot’s ideas and wrote a revised account in “Three Historical Regions of Europe: An Outline.” Szűcs’s implicit view of regions is devoid of ethnic or national considerations, resting instead on an observation concerning attitudes toward political power and its application in Europe. Western Europe, in Szűcs’s view, has been characterized for almost a millennium by the “structural—and theoretical—separation of ‘society’ from the ‘state.’” Despite what we are commonly taught, the notions of natural law, the social contract, and popular sovereignty first appear some five centuries before Thomas Hobbes (1588–1679) and John Locke (1632–1704), and they derive, surprisingly, from western European feudalism and the Roman Catholic Church. By the twelfth century, a distinctive political and social culture had set apart a region known as *Europa Occidens*, whose eastern boundary runs from the lower Danube through the Eastern Carpathians and into the Baltics. West of this line, Szűcs says, society was subordinated to the secular state (that is, the secular state asserted power over society but left it with some measure of freedom); east of the line, society was nationalized (in the sense in which modern totalitarian regimes nationalized industries by incorporating them into the state). In this formulation, what makes a region is primarily the relationship between governing power and the governed, and though religion and social mores clearly have something to do with this relationship, Szűcs treats these factors as mere data and is reluctant to use them as a basis for broad judgments of ethnic or national groups.

The second history is far more complicated because it involves popular attitudes—at various educational and social strata—toward cultures and toward categories (ethnic, national, religious) of people. Larry Wolff’s *Inventing Eastern Europe: The Map of Civilization on the Mind of the Enlightenment* (1994) approaches the topic of regionalism in Europe from a postcolonial perspective heavily indebted to the work of such theorists as Antonio Gramsci, Michel Foucault, and Edward Said. Gramsci and Foucault gave Wolff his understanding of power hierarchies; Said (who drew heavily on the first two) gave him his understanding of the cultural myth called “Orientalism,” by which the West (in its broadest sense, not confined to Europe) has allegedly investigated, classified, and subjugated any number of regions—either inside or outside Europe and generally but not always lying literally to the east—that it regards as other.

Whatever one might think of the charge that the West’s attitude toward what it has regarded as the East has been founded on domination or a desire to dominate, Wolff offers a compelling account of the emergence and subsequent history of Eastern Europe as a regional concept. In his view, the emergence takes place in the Enlightenment. The north–south axis, separating Europe into a culturally superior West and a culturally inferior East, Wolff says, replaced the Renaissance’s east–west axis, which separated Europe into a culturally superior South and a culturally inferior North.

The “invention” of Eastern Europe may well have been the work of Voltaire (1694–1778). His *History of Charles XII* (1731) gives an account of the Swedish monarch’s wars with the Russian tsar Peter the Great in the early eighteenth century. As Wolff sees it, Voltaire’s contribution to regionalism was to emphasize Russia’s position astride Europe and Asia. It would become increasingly clear during the eighteenth and nineteenth centuries that Asia was primarily the source of Eastern Europe’s “easterness” and that the two poles of Asia in Europe were Russia and the Ottoman Empire (together, at any given moment in history, with the Ottoman Empire’s former and then-current territorial possessions in Europe). To the extent that Orientalism in Europe was associated with the Ottoman Empire, it gave rise to a fascination with Islam and with the exotica connected in the western European mind with that religion. Such fascination tended to focus on the Balkan Peninsula. The enormous complexity of the Balkans as a regional construct is the subject of Maria Todorova’s *Imagining the Balkans* (1997). Todorova places particular emphasis on the Ottoman Empire as a source of Eastern cultural elements that, in the minds of western Europeans, characterize the Balkan region. To the extent that Orientalism was associated with Russia, it gave rise to a fascination with things Slavic, encouraging some adventurous and moneyed western Europeans to travel to points east (and northeast) and other less adventurous souls (Voltaire, for example, and Jean-Jacques Rousseau [1712–1778]), who wrote an important book on the Polish constitution) to write about eastern lands without ever bothering to visit them.

In the early to mid-eighteenth century, a trend arose in European thought that would develop side by side with the trend toward regionalism. It began with the scientific classification of living things, developed into the concept of race, and culminated in the nineteenth-century geopolitical theory of nationalism. By 1735, Carolus Linnaeus (1707–1778) had recognized the existence of physical and mental variations within the human species, though he attributed such variations to environmental factors rather than to heredity. In midcentury, Georges-Louis Leclerc de Buffon (1707–1788) defined species as the smallest groups whose individual members could produce offspring and subdivided the human species into smaller groups to which he applied the word *race*.

It was Immanuel Kant (1724–1804) who introduced scientific rigor into the subclassification of species. In three articles published between 1775 and 1788, he provided a definition of race that recognized the principle of interfertility among members of various races, he offered a division of the human species into four original races, and he asserted that racial characteristics are hereditary, not acquired. Though Kant regarded skin color as the most reliable indicator of racial origin, he did not hesitate to describe the four races according to their moral characteristics.

Kant’s taxonomy was necessarily broad and classed all Europeans in a single race (the “whites”). Not until later in the nineteenth century, with the advent of Darwin’s theory of natural selection and a rudimentary theory of genetics, was racial thinking given the elaborate scientific (some would say pseudoscientific) basis that led to the detailed classification of groups

within Europe’s borders. But even as Kant was publishing the last of his three essays on race, his countryman Johann Gottfried von Herder (1744–1803), in *Ideas Toward a Philosophy of the History of Man* (1784–1791), was explicitly rejecting the category of race, proposing instead a classification of peoples (*Völker*) by nation, a concept based on spiritual rather than on physical heredity. In Herder’s eyes, the dominant factors in the formation of nationhood are “national formation” (*Nationalbildung*) and language (which he describes as “the peculiar means for the formation [*Bildung*] of man”).

All that remained was to link *nation* in this spiritual sense to *nation* in the political sense. This fell to Johann Gottlieb Fichte (1762–1814), who in 1807 and 1808 delivered his *Addresses to the German Nation* in French-occupied Berlin, describing to his beleaguered compatriots the nation as the ultimate expression of the character of a people (*Volk*) and pointing to the features of the German people that set it apart from—and above—the other peoples of Europe, particularly the French. These addresses firmly established the basis for European nationalism, defined by Ernest Gellner in 1983 as “a theory of political legitimacy, which requires that ethnic boundaries should not cut across political ones, and in particular, that ethnic boundaries within a given state . . . should not separate the power holders from the rest” (p. 1). It was not until much later in the century, of course, that this concept arose with such consequential force in lands to the east and south of where Fichte stood as he rallied his countrymen.

The eighteenth and early nineteenth centuries thus show an oddly split attitude on the classification of people and places in Europe. As Wolff shows, when western European writers turned their attention eastward in the eighteenth century, they had a marked tendency to see ethnic and even linguistic homogeneity spread out over broad areas where the more discriminating outlook of nineteenth-century nationalism would judge that such homogeneity did not exist—thus regions rather than nations. A case in point is the common use of the proper adjective *Slavic* (Sclavic, Slavonic, Sclavonic) to designate the people and languages in Russia and virtually all European territories east of present-day Germany and Austria, including the Balkans (but not Greece). Visitors to Poland, Bohemia, Russia, and even Hungary commonly referred indifferently to the languages spoken there as Slavic, as if they were all identical. At the same time, however, writers in the West had discovered two criteria, inherited physical traits and common language, that would increasingly encourage the division and narrower classification of people within broad regions—thus nations.

Central versus Eastern Europe

To confuse the regional issue further, the nineteenth and twentieth centuries presented the competing concept of Central Europe, itself almost as fluid and unstable as Eastern Europe. As is well known, the rise of nationalism and the corresponding ideal of the ethnically homogeneous nation-state gave rise to centripetal and centrifugal geopolitical forces in nineteenth-century Europe. The final unification of Italy in 1870 and of Germany in 1871 represented the culmination of a centripetal process of unification, while events in the Balkan Peninsula and the non-German territories of the Habsburg Empire led

to a centrifugal process of secession and fragmentation. One result was the broad regional configuration that would remain in existence until the end of World War I. From the time of the Congress of Vienna in 1815, “Central Europe” (Mitteleuropa in German) referred essentially to the German Confederation (created at the Congress of Vienna and corresponding in its borders very roughly to present-day Germany, Austria, the Czech Republic, and Slovenia). This was the Austrian prince Metternich’s dream of a Europe dominated by a central core of German-speaking territories. In 1915, in the middle of World War I, the German theologian and liberal democrat Friedrich Naumann published a work titled *Mitteleuropa*, in which he called for an economic federation to be established after the war. Naumann’s idea was that the federation would have at its center Germany and the Austro-Hungarian Empire but would also include all European nations outside the Anglo-French alliance, on one side, and Russia, on the other. This large territory would be Mitteleuropa.

Naturally the political settlement at the end of the war, in particular the division of Germany into two separate pieces divided by the Danzig Corridor, made Naumann’s plans unrealizable. But events in European intellectual life in the early 1980s revived the concept of Central Europe and the debate about its definition and its broader significance. The process began in 1984, with the publication of Milan Kundera’s “The Tragedy of Central Europe” (though Kundera had written some pieces on the topic as early as 1981). It culminated with the publication of two collections of writings, immediately before the downfall of Soviet Communism in 1991: *In Search of Central Europe* (edited by George Schöpflin and Nancy Wood) in 1989 and a special issue of *Daedalus*, titled “Eastern Europe . . . Central Europe . . . Europe,” in the winter of 1990. Curiously, the principal actors in the resurrection of Central Europe, Kundera, Václav Havel, and Czesław Miłosz, were not from Germany or Austria but from areas that might just as easily be classified as Eastern Europe: Czechoslovakia and Poland. But in his 1984 essay, Kundera seemed to have in mind territories that, with respect to the Mitteleuropa of Metternich and Naumann, were marginal (which is to say, non-German speaking): Central Europe, he thought, was a region “culturally in the West and politically in the East,” and the nations he referred to were Hungary, Czechoslovakia, and Poland.

There can be no doubt that this debate over Central Europe was largely motivated by the social and political consciousness of groups living between the two Germanys, on one side, and the Soviet Union, on the other—groups, in other words, mindful of their exclusion from the ranks of historically more prominent and powerful neighbors. As Patrick Hyder Patterson put it, “Mitteleuropa emerges as a means for a people worried about their own European credentials to retrieve a place at the heart of European politics and culture” (p. 128). The Hungarian historian Péter Hanák, in 1989, dealt with the regional/definitional issue by simply declaring Eastern Europe to be Russia and then comparing the historical progress of Central Europe with that of the West. In the same year, the Slovak political scientist Miroslav Kus’ got around the regionalism issue by speaking wryly of “Central-European East Europeans,” a group that included East Germans, Hungarians, Poles, Czechs, and Estonians.

Such reflections on Central Europe took on an entirely new meaning, of course, as soon as the Soviet Union collapsed. For many observers, they simply became irrelevant. But they serve as a good reminder of the considerable extent to which regional categories in Europe at any given moment are tied to power configurations.

The Future of Eastern Europe

The geopolitical conditions that have had such a profound impact on the regional concepts of Central Europe and Eastern Europe in the nineteenth and twentieth centuries—essentially the political fallout of the Napoleonic era and the two world wars—are now a thing of the past, and some specialists today think that *Eastern Europe* has outlived its usefulness as a phrase. The expansion of NATO in 1999 to include Hungary, the Czech Republic, and Poland, and in 2004 to include Bulgaria, Estonia, Latvia, Lithuania, Romania, Slovakia, and Slovenia has erased boundaries that appeared fixed before the collapse of the Soviet Union. The American-led invasion of Iraq in 2003 led to at least a temporary reconfiguration of relations between the United States and various European NATO members. The traditional Cold War Continental allies, France and Germany, found themselves brushed aside by the United States in favor of Eastern European nations more supportive of American foreign policy.

To put it very simply, Eastern Europe began in the eighteenth century as something defined by contrast with England, France, and, to a lesser extent, the German-speaking territories. It then came to be something defined by its position between these same Western powers, on the one side, and Russia (and subsequently the Soviet Union), on the other. With the collapse of the Soviet Union and the expansion of NATO, the Cold War dynamic that made it possible for Eastern Europe to denote “Warsaw Pact Countries plus Yugoslavia but not the Soviet Union” ceased to exist, and the concept lost the small measure of precision that, at least in certain contexts, it had enjoyed for a half century.

See also *Europe, Idea of; Maps and the Ideas They Express; Nationalism; Orientalism; Other, The.*

BIBLIOGRAPHY

- Bibó, István. “The Distress of the East European Small States.” In *Democracy, Revolution, Self-Determination: Selected Writings*, edited by Károly Nagy and translated by András Boros-Kazai, 18–86. Boulder, Colo.: Social Science Monographs, 1991.
- Gellner, Ernest. *Nations and Nationalism*. Ithaca, N.Y.: Cornell University Press, 1983.
- Graubard, Stephen R., ed. “Eastern Europe . . . Central Europe . . . Europe.” Special issue, *Daedalus* 119, no. 1 (winter 1990).
- Hanák, Péter. “Central Europe: A Historical Region in Modern Times: A Contribution to the Debate about the Regions of Europe.” In *In Search of Central Europe*, edited by George Schöpflin and Nancy Wood, 57–69. Cambridge, U.K.: Polity, 1989.
- Herder, Johann Gottfried. *Outlines of a Philosophy of the History of Man*. Translated by T. Churchill. 1800. Reprint, New York: Bergman, 1966.

- Kant, Immanuel. "Of the Different Human Races." In *The Idea of Race*, edited by Robert Bernasconi and Tommy L. Lott, 8–22. Indianapolis and Cambridge, U.K.: Hackett, 2000.
- Kundera, Milan. "The Tragedy of Central Europe." *The New York Review of Books* 31 (April 1984): 33–38.
- Kusý Miroslav. "We, Central-European East Europeans." In *In Search of Central Europe*, edited by George Schöpflin and Nancy Wood, 91–96. Cambridge, U.K.: Polity, 1989.
- Patterson, Patrick Hyder. "On the Edge of Reason: The Boundaries of Balkanism in Slovenian, Austrian, and Italian Discourse." *Slavic Review* 62 (2003): 110–141.
- Said, Edward W. *Orientalism*. New York: Vintage, 1979.
- Schöpflin, George, and Nancy Wood, eds. *In Search of Central Europe*. Cambridge, U.K.: Polity, 1989.
- Szűcs, Jenő. "Three Historical Regions of Europe." In *Civil Society and the State: New European Perspectives*, edited by John Keane, 291–331. London and New York: Verso, 1988.
- Todorova, Maria. *Imagining the Balkans*. New York and Oxford: Oxford University Press, 1997.
- Wolff, Larry. *Inventing Eastern Europe: The Map of Civilization on the Mind of the Enlightenment*. Stanford, Calif.: Stanford University Press, 1994.

Steven Cassedy

REINCARNATION. See *Immortality and the Afterlife*.

RELATIVISM. Although relativism is most often associated with ethics, one can find defenses of relativism in virtually any area of philosophy. The following article first discusses the general structure of relativist positions and arguments. It then examines several influential ideas concerning relativism in the late twentieth century. Finally, it ends by considering the rise of relativism in one area outside of ethics: epistemology.

What Is Relativism?

Relativism about some property *F* can be divided into a number of different theses. One relativist view is that there exists a plurality of standards of *Fness* associated with different places, people, cultures, or times. Call this *descriptive relativism*. A different relativist thesis is that there is no single universally valid standard of *Fness* for all places, people, cultures, or times. Call this *philosophical relativism*. In this view, a plurality of standards of *Fness* provides the only frames of reference against which the truth of claims that something is *F* can be evaluated. Such claims thus cannot be evaluated unless and until a framework is specified. A third and further relativist thesis is that we should be tolerant of those who, for some *F*, use standards of *Fness* different from our own; each standard is appropriate for its own culture or time. The claim that we ought not pass judgment on those deploying alternative frameworks is often dubbed *normative relativism*. Although these three relativist doctrines are distinguishable from one another and can be consistently held in various combinations, all three quite often go together.

Most people are and ought to be relativists about some things—etiquette, for instance. Is it rude to call one's colleagues by their first names? Yes and no; yes in Japan and no in the United States. The truth or justifiability of judgments of rudeness can be evaluated only relative to the prevailing standards of etiquette, and it would be absurd to insist that one's own standard is closer to the right way of doing it; it is just different, not better. There is no "universal" standard of etiquette against which each act of rudeness can or should be measured. Relativism about what is funny, edible, or delicious seems reasonable as well. One's own sense of humor or one's tastes are just different, not better, than those of others. Some may feel less confident saying that one's own standard of beauty is just different, not better, than others, but few would press the issue.

About some things, however, it is difficult to defend relativist positions. Few think that arithmetical truths such as $7 + 5 = 12$ are only true relative to some arithmetical framework to which there are alternatives that are just different, not worse. There are necessarily no acceptable alternative mathematical frameworks in which $7 + 5 = 12$ is false. The ordinary view of moral judgments is that they lie somewhere in between etiquette judgments on the one hand and arithmetical judgments on the other. Some think they are closer to etiquette, others to arithmetic.

It is important to hold agreement on non-*F* facts fixed to determine whether there is a genuine difference in standards of *Fness*, and whether a given philosophical view is truly relativist. *Parametric universalism* (so dubbed by T. M. Scanlon) allows that what is *F* in one place or time might not be *F* in another. However, it is not a relativist view, since it allows opposed judgments of whether a given action or activity is *F* to be generated from a single universal standard of *Fness* due to different circumstances. Diversity of judgments about *Fness*, according to the parametric universalist, are traceable to differences in non-*F* facts, rather than different standards of *Fness*. Only a view that allows different standards in a given area of concern to be in some sense equally valid is a genuinely relativist view.

Issues and Arguments Relating to Relativism

As obvious as it may seem that we ought to be relativists about some things, late-twentieth-century philosophical discussions of relativism spent a surprising amount of time simply trying to state the view coherently. The ethical relativist familiar to most of us, for instance, combines all three above relativist theses in a way that best illustrates the problem. He will begin with the innocent observation of a diversity in moral practices, infer that therefore there is no single universal moral standard, and then confidently wrap up with the conclusion that therefore no person should judge the actions of those from other cultures or times. As Bernard Williams points out, although this crude bit of reasoning is obviously self-contradictory (the conclusion asserts a universal moral requirement the existence of which the premises deny), avoiding this kind of incoherence has proved surprisingly difficult.

Second, philosophers have also been concerned with the extent of defensible tolerance. For any outlook, sincerely hold-

ing that outlook seems incompatible with regarding it as merely one among a number of outlooks, each different, but not better, than the others. How, for instance, could morality have the grip on us that it does if it does not lead us to condemn those who, however distant from us in time and place, radically violate its deepest tenets? The normative relativist requirement of tolerance apparently can only be taken seriously by those who have no sincere moral convictions. Thus the basic relativist dilemma is this: either the “ought” in the claim that we ought not to condemn standards radically at odds with our own is a relative “ought” from within our own standards or an “ought” tied to an absolute standard. The former is incompatible with sincerely embracing and living within a standard. The latter is incompatible with relativism.

Third, does relativism about a given F require skepticism? Skepticism about F holds that there are no good grounds for believing anything really is F. The question is whether relativism about Fness undermines any good grounds for believing that there really is such a thing as Fness. Size, for instance, is relative to some frame of reference, such that a given whale might be tiny while a mosquito huge; but this seems compatible with claiming that the tiny whale *really* is tiny and the huge mosquito *really* is huge. Suppose what we morally ought to do is relative to the culture or era in which we find ourselves; is this compatible with claiming that what we ought to do is what we *really* ought to do? Some, such as J. L. Mackie, have argued that it is not. Moral beliefs, in his view, are beliefs about an absolute standard of conduct. If what exists are multiple standards, each no better than the others for its context, then it follows that there really is nothing answering to our moral beliefs. Others, such as David Wong, argue that moral beliefs are not about absolute standards but about prevailing standards. Hence there is something answering to these beliefs in his view.

The most powerful consideration philosophers have mobilized in favor of the claim that there is a plurality of equally correct standards of Fness is that it provides the most satisfying explanation of existing differences over the question of whether something is F. If relativism explains existing differences—differences that persist even against the background of agreement on non-F facts—then we should be relativists about F. Consider the question whether, for instance, C’s “thumbs-up” to D was a rude gesture. Suppose A from one culture and B from another agree on all the nonetiquette facts: C gestured toward D with his fist out and thumb extended skyward. A thinks this was rude. B denies it. One explanation for the dispute is that they have yet to uncover some further fact about the gesture, its deeper etiquette nature. But there is a better one available: A is judging relative to standards from his culture according to which the thumbs-up is rude, while B is judging relative to a different standard according to which the thumbs-up is not rude. Indeed, A and B will likely conclude this quickly. B will say “In *my* culture, the thumbs-up is a sign of encouragement,” while A will say *in his* it is not.

Of course, it does not follow from the fact that different frameworks for judging Fness exist or have existed that no single correct universal standard of Fness exists. Different frameworks might be assessable as more or less close to some

all-encompassing universal standard. Perhaps because of its complexity, it is simply difficult to understand or know the correct universal standard of Fness. But it may be that the existence of different frameworks could be explained by the absence of a universal standard. It also does not follow from the fact that there appear to be different frameworks for judging Fness that there are in fact different frameworks. The parametric universalist in moral standards, for instance, holds that diversity is a result of the application of a very general but universally shared standard to locally diverse conditions. If that view is right, then the philosophical relativist position that there is no such universal standard—sometimes referred to as “metaethical” relativism—lacks its main support, as an explanation of moral diversity.

Shared Motivational Attitudes

Gilbert Harman has argued for philosophical relativism about what he calls “inner” moral judgments. These are moral judgments that imply that the agent has certain motivating reasons to do something, and the person making the judgment and his audience endorse those reasons. For instance, the claim that S ought to do some action is an inner moral judgment. Harman claimed that relativism about such judgments is a “soberly logical thesis” about “what makes sense” and what does not in our moral language (1975, p. 3). The motivating reasons implied, Harman argued, are those that derive from an implicit agreement reached by bargaining between people of differing powers and resources. Such moral judgments are thus relative to this agreement. This agreement, in turn, may differ from society to society, each being different but not better than the other agreements. In a society with slavery but no agreement that speaks against it, for instance, it is false that the slave owners ought to free their slaves. Even if we would condemn such a society, Harman’s view implies that it would be “inappropriate to say that it was morally wrong of the slave owners to own slaves” (1975, p. 18). The agents involved are not parties to an agreement that would give them the relevant motivations.

In fact, the claim that slave owners are doing something wrong ought to be a logical mistake, if Harman’s relativism is a “soberly logical thesis.” But it is hard to see how this could be so. Surely it makes sense to say of slaveholders in a slaveholding society of the sort Harman envisions that they are doing something wrong. Perhaps we should not blame someone for an act if she had no chance to avoid it, and a person brought up in a slaveholding society might have had no chance to see slaveholding as wrong. Perhaps we should not blame her, if saying that she did wrong is a form of blame. But that such judgments, at least under some circumstances, might be inappropriate does not make them contrary to a soberly logical thesis.

In later works, Harman has elaborated his view so that it combines four theses: (1) there is a plurality of moral frameworks, none more correct than any other; (2) moral judgments are elliptical for more complex judgments whose truth conditions include one of these frameworks; (3) morality should not be abandoned; and (4) even if relative, moral judgments can play a serious role in practical thought (Harman and Thomson, pp. 3–19). The second thesis is an important adjustment: Relativism

is, he argues, not a claim about “what makes sense” in our moral statements but a claim about their truth conditions. What we are saying when we say the slaveholder is doing something wrong makes sense. It is just that we are saying something false because the slaveholder is not party to an agreement giving him motivation to act accordingly. But the third thesis runs into the relativist dilemma. What sort of “should” would we be invoking in saying that morality should not be abandoned? Suppose “morality” refers to some moral framework: We “should” have some morality or other. Then either there is some absolute framework that makes this “should” true, or there is no standard at all that makes this true. From within the point of view of one morality, it is not true that some other morality should not be abandoned.

Real and Notional Confrontations

Bernard Williams was concerned to come up with some way of stating normative relativism such that it is coherent and does not fall victim to self-contradiction. Recall that the self-contradictory ethical relativist view is the claim that since there are no universal moral standards, no one ever ought to condemn the practices of other cultures. The main issue is whether philosophical relativism can coherently be grounds for normative relativism. Coherent normative relativism requires recognizing the absence of a vantage point from which one can make meaningful evaluative comparisons between alternative frames of reference for judging *Fness*. Such a vantage point would result in what Williams calls a “real confrontation” between systems of belief (1981, pp. 132–143).

The idea is this: the possibility of normative relativism arises only when some action or practice is the locus of disagreement between holders of two self-contained and exclusive systems. Two systems of belief, *S1* and *S2*, are exclusive of one another when they have consequences that disagree under some description but do not require either to abandon their side of the disagreement. When groups holding *S1* and *S2* encounter one another, this can result in a confrontation between their systems of belief. A real confrontation between *S1* and *S2* occurs when *S2* is a real option for the group living under *S1*. In a notional confrontation, *S2* is not a real option. *S2* would be a real option for a group living under *S1* if two conditions held. First, those in *S1* could “retain their hold on reality” living under *S2*, in the sense that they would not, for instance, need to engage in radical self-deception. Second, they could acknowledge their transition to *S2* in the light of a rational comparison to *S1*. If the conditions for a real confrontation are not met for holders of *S1*, however, then there is only a notional confrontation with *S2* and there is no “point or substance” to considerations of whether *S2* might be a better or worse system of belief than *S1*. If a member of *S1* does not regard the confrontation with *S2* as a real confrontation, then “the language of appraisal—good, bad, right, wrong and so on . . . is seen as inappropriate, and no judgments are made” (Williams, 1985, p. 161). The suspension of such judgments amounts to adopting normative relativism about *S1* and *S2*.

The language of appraisal is appropriate regarding *S2* only if those in *S1* could “go over” to *S2*. The *hoi polloi* who pursue the pleasures of so-called “low” culture may judge that

there is little of value in a life crowded with the elite activities of “high” culture. It is a real possibility that they could learn to love opera and lose their taste for country music, so they may evaluate doing so in their own terms. Those from the low culture judge high culture to be boring; those from high culture judge low culture to be tacky and lacking depth. However, Williams observes, “the life of a Bronze Age chief or a medieval samurai are not real options for us: there is no way of living them” (1985, p. 161). They are too alien to permit us to make the same judgments made between culture mavens.

In this respect, however, Williams’s account, like Harman’s, fails to deliver what it set out to—a coherent normative relativism. For it is not clear in what sense it would not be “appropriate” to appraise these moralities as less morally enlightened than our own. If appraisals of *S2* are inappropriate, then they must be inappropriate according to some *S*. Can *S1*, then, forbid appraising other *Ss*? It is difficult to see how it could, if, as we assume, a system of belief requires having a grip on the thinking of those within it that prevents taking an external view of it. Suppose Williams thinks that a “real option” is an option that would be as good or better from a point of view external both to *S1* and *S2*—say, the point of view of human well-being. This would be to abandon relativism. For according to the relativist, there is no *S* external to particular systems such as *S1* or *S2*, a universal standard from which one could judge that appraisal is inappropriate. To measure *S2* and *S1* by human well-being would be to hold human well-being up as a universal standard. Alternatively, suppose Williams is thinking, like Harman, that this is a “soberly logical thesis”; it is just nonsensical to judge medieval samurai morals to be better or worse than our own. Williams himself denies this claim, saying that the vocabulary of appraisal in such cases “can no doubt be applied without linguistic impropriety” (1981, p. 141). But if he were to accept that this was a logical or linguistic impropriety, then he, like Harman, would have to explain how this could be so, given it seems intelligible enough to say that their morals were worse in many respects than our own.

Pluralism

With respect to some areas of thought and discourse, unbridled relativism will be less attractive than a relativism that requires certain boundaries be respected. As we have seen, it is difficult to see how tolerance about alternative standards of *Fness* can be maintained unless we suppose there is some viewpoint independent of these alternative standards from which to evaluate them. Many philosophers have come to the conclusion that there is such a viewpoint, although it can only be a very broad standard imposing limits on the range of acceptable standards. Some such philosophers, such as David Wong and Michael Walzer, do not shun the label “relativists,” but they are perhaps better described as “pluralists.” Pluralism holds that a range of different standards of *Fness* exists and can be tolerated, but only within limits. One sort of pluralism might be based on a kind of indeterminacy among acceptable standards: Begin with a universally valid framework for any acceptable standard, including, for instance, demands such as that any valid standard must treat like cases alike. Such a framework alone is not itself a standard for *Fness* and so cannot

provide any kind of guidance. It is, rather, a second-order standard, or a standard for any acceptable first-order standard Fness. Suppose, further, this framework marks off a “range” property of standards, in the sense that no standard fits the framework any better than any other standard fits the framework (as when, for a given circle, no point within the circle is more within it than any other) (see Rawls, p. 508). As long as a given standard fits the framework, it is acceptable, but an indefinite number of different standards could meet it. This case offers no grounds for judging that any standard of Fness is “better” or “worse” than any other, based on the second-order framework, except to say that either a standard fits the framework or it does not. Limited tolerance, then, would amount to approving of those standards within the range that fit the framework and disapproving of those outside of that range, based on the second-order standard of acceptability provided by the framework.

A different sort of pluralism would be based simply on epistemic modesty (i.e., a justifiable reticence to assert claims that one does not know to be true). One can even combine this with parametric universalism: a single universally valid framework yields standards that deliver opposed conclusions in a given case depending on the circumstances. Modesty implies that even if there is a determinate answer to the question whether, for any given thing, it is F or not, it may not be possible to be confident enough of this in any case. Suppose, then, no one can be confident that he or she knows how that framework is to be put into practice in any particular culture or time. That is, she does not know which of the available standards that fit the framework is best given the circumstances. Then, where one is not confident, one should be tolerant.

Whether pluralism of either kind can meet the challenge of developing a coherent defense of tolerance is not clear. For one thing, pluralism based on epistemic modesty implies a kind of diffidence in the face of alternative standards that is sufficient to prevent the modest judge from condemning the alternative standards. Yet it must also leave one confident in the importance of one’s own standard. Moreover, although pluralism based on indeterminacy allows one to see one’s own standard as acceptable based on meeting a sort of minimum, this is hardly the sort of endorsement that can sustain its grip on us in the face of a variety of equally acceptable alternative standards.

Contextualism and Relativism in Epistemology

By far the most discussed form of relativism is ethical relativism. However, relativist issues arise quite frequently in almost every area of philosophical research. One of the most significant trends in late-twentieth-century epistemology has been the rise of views that are broadly either relativist or pluralist and are loosely collected under the banner “contextualism.” Contextualists hold that the truth of sentences attributing knowledge, such as “S knows that p,” like the truth of sentences attributing tallness, such as “S is tall,” depends on the contexts of their use. In particular, the speaker’s context determines which standards of epistemic justification are in play. Hence, A’s statement “Stella knows that Stanley loves her” may be true, while B’s seemingly contradictory statement “Nobody ever knows any-

thing at all” might also be true, since their contexts of utterance might invoke quite different standards of justification. A’s may be a conversational context; perhaps Stella has told A about Stanley’s having confessed his feelings to her, A knows that Stella is a good judge of dissembling, and so on, so A can rule out the possibility that she is ignorant. In A’s context, that possibility is not salient. B, on the other hand, has been studying Descartes and in that context the possibility that everyone is being tricked by an all-powerful evil demon is very salient. In A’s context, the demon hypothesis is out of place. That “Stella knows” is true relative to one context of A’s statement that she does, but not relative to B’s context.

In effect, contextualism amounts to a kind of speaker relativism, in which the standards in play are determined by the person making knowledge claims. Standards are relative to contexts, and the context is set by the speaker. A certain standard is appropriate for each context. A speaker then “picks out” the relevant standard when making knowledge claims that then determine the truth conditions of the claim. However, it may be better to classify contextualism as a kind of pluralism, because any contextualist will hold that there are standards of justification no lower than which can be gone in any circumstance. For instance, there are no contexts in which simply having a belief that something is so counts as knowledge. Thus a range of standards exists, each appropriate for some context, but all are subject to a certain baseline minimum of justification.

It also seems as if contextualism could be regarded as a parametric universalist view. For instance, evidentialism is the view that S knows p only when S’s belief fits the evidence. When someone says that S knows that p, the evidentialist who is a contextualist will say that this will be true only when, according to the speaker’s context, there is enough evidence and the belief fits it well enough. What varies here, then, is not the standard of justification; the standard is that a justified belief must fit the evidence. It is the degree of fit that varies according to context, and that is not a matter of standards varying.

Steven Stich, however, defends an unambiguously relativist view of knowledge. In his view, it doesn’t make sense to think that there are standards of rational belief formation independent of those that happen to be accepted in a given place and time. Standards of rationality in belief formation vary from locality to locality. And this, it seems, is grounds for holding there is no universal standard. But someone knows something only if her beliefs about it are rationally held—formed for good reasons. Since the standards vary, knowledge varies with it. Hence, according to the prevailing standards of rationality in one locality, a belief may be held for good reasons, while in another those selfsame reasons may not be good enough.

Stich’s statement of epistemological relativism appears to conform to Harman’s original model. In particular, it conforms to Harman’s view that “there is no sense attached to” judging dimly the practices of someone who conforms to standards other than our own. Because of this, it also inherits the difficulty of explaining why that kind of judgment seems to make sense. There is no apparent confusion about what someone is saying when she says that those people over there have no reason to believe what they believe, even though they think

they do. We may think it morally inappropriate to make such judgments, but it is not nonsensical. Indeed, we may even think our condemnation to be epistemically rash. But just as in the case of ethical relativism, if we do think it epistemically rash to condemn the epistemic practices of others, it must be based on some standard of rationality. If it is based on our own standards, however, it is not clear how we can maintain confidence in those standards when forming beliefs on their basis. If it is not based on our own standards, then we must be invoking some nonrelative standards. It seems that relativism in epistemology faces the same dilemma that ethical relativism faces.

Conclusion

Normative relativism in a given area counsels tolerance of practices that conform to alternative standards prevailing in the area. The paradigm of acceptable tolerance is clearly the case of etiquette. Here we have grounds for a defensible and thoroughgoing relativism. And here the relativist doctrines we have discussed fit: Clear-eyed judgments that the practices in a different culture conforming to standards of etiquette prevailing there are rude are, indeed, puzzling. What could such judgments mean? It is true both that such judgments make little sense and that we ought not to try to engage in them. But what distinguishes etiquette from other areas is its relative lack of importance in our thinking and behavior. We can maintain our manners even while taking an external view of them as simply one standard of etiquette among others. When we turn to claims about what is of value or what is rational, for example, the subject matter itself raises the stakes. Once the stakes are raised, we seem less able to take an external view, to maintain our views about what is morally worth doing, or what it is reasonable to believe. Future work on relativism will no doubt bring new ways of thinking about such difficulties.

See also *Philosophy: Historical Overview and Recent Developments*; *Philosophy, History of*; *Philosophy, Moral: Modern*; *Skepticism*.

BIBLIOGRAPHY

- Cohen, Stewart. "How To Be a Fallibilist." *Philosophical Perspectives* 2 (1988): 91–123.
- . "Knowledge and Context." *Journal of Philosophy* 83 (1986): 575–583.
- DeRose, Keith. "Solving the Skeptical Problem." *Philosophical Review* 104 (1995): 1–52.
- Feldman, Richard. *Epistemology*. Upper Saddle River, N.J.: Prentice-Hall, 2003.
- Gibbard, Alan. *Thinking How to Live*. Cambridge, Mass.: Harvard University Press, 2003.
- Harman, Gilbert. "Moral Relativism Defended." *Philosophical Review* 84, no. 1 (1975): 3–22.
- Harman, Gilbert, and J. J. Thomson. *Moral Relativism and Moral Objectivity*. New York: Blackwell, 1996.
- Lewis, David. "Elusive Knowledge." *Australasian Journal of Philosophy* 74 (1996): 549–567.
- Mackie, J. L. *Ethics: Inventing Right and Wrong*. New York: Penguin, 1977.
- Rawls, John. *A Theory of Justice*. Cambridge, Mass.: Harvard University Press, 1971.
- Scanlon, T. M. *What We Owe to Each Other*. Cambridge, Mass.: Harvard University Press, 1998.
- Stich, Steven P. "Epistemic Relativism." In *Routledge Encyclopedia of Philosophy*, edited by Edward Craig. Vol. 3. New York: Routledge, 1999.
- Waltzer, Michael. *Interpretation and Criticism*. Cambridge, Mass.: Harvard University Press, 1987.
- Williams, Bernard. *Ethics and the Limits of Philosophy*. Cambridge, Mass.: Harvard University Press, 1985.
- . *Morality: An Introduction*. New York: Harper and Row, 1972.
- . *Moral Luck*. Cambridge, U.K.: Cambridge University Press, 1981.
- Wong, David. *Moral Relativity*. Berkeley: University of California Press, 1984.

Robert N. Johnson

RELATIVITY. The first thing to note about the theory of relativity is that there are two different theories of relativity, the special theory put forward in Albert Einstein's (1879–1955) famous 1905 paper, "On the Electrodynamics of Moving Bodies," and the general theory, completed in November 1915 and first presented systematically in a review article published in March 1916.

Special relativity extends the principle of relativity for uniform motion, known in mechanics since the days of Galileo Galilei (1564–1642), to all of physics, in particular to electrodynamics, the field out of which the theory grew. Although the key contribution was Einstein's, several other scientists deserve credit for it as well, most importantly the Dutch physicist H. A. Lorentz (1853–1928), the French mathematician Henri Poincaré (1854–1912), and the German mathematician Hermann Minkowski (1864–1909).

General relativity, by contrast, was essentially the work of one man. It was the crowning achievement of Einstein's scientific career. Its name, however, is something of a misnomer. The theory does not extend the principle of relativity for uniform motion to nonuniform motion. It retains the notion of absolute acceleration—that is, acceleration with respect to space-time rather than with respect to other bodies. In this sense, general relativity is no different from Newtonian theory or special relativity. Absolute acceleration, however, is much more palatable in general relativity than in these earlier theories.

From the point of view of modern physics, the question to what extent general relativity fulfilled Einstein's original hopes of relativizing all motion is of secondary importance. What matters most is that general relativity is a powerful new theory of gravity, based on the insight, called the equivalence principle, that the effects of gravity and those of acceleration ought to be described by one and the same structure: curved space-time.

Special Relativity

Special relativity grew out of problems in electrodynamics. In 1862 James Clerk Maxwell (1831–1879) first published the set of equations named after him, providing a comprehensive

description of all electric and magnetic phenomena that had been studied up to that point. He also made a new prediction. The equations allow electromagnetic waves propagating at the speed of light. Maxwell famously concluded: “*light consists of the transverse undulations of the same medium which is the cause of electric and magnetic phenomena*” (Niven, vol. 1, p. 500; italics original).

The luminiferous ether. As the quotation above illustrates, it was taken for granted in the nineteenth century that both light waves and electric and magnetic fields need a medium to support them. This medium, which was thought to fill the entire universe, was called the *luminiferous* (light-carrying) *ether*. Most physicists believed that it was completely immobile (for discussion of the reasons for this belief, see Janssen and Stachel). Ordinary matter, they thought, would move through the ether without disturbing it in the least. Earth, for instance, would zip through the ether at a velocity in the order of 30 km/s, the velocity of Earth’s motion around the sun. On Earth there should therefore be a brisk ether wind blowing in the opposite direction. This *ether drift*, as it was called, could not be felt directly, but ever since the resurgence of the wave theory of light at the beginning of the nineteenth century, attempts had been made to detect its influence on light from terrestrial and celestial sources. To be sure, such effects were expected to be small. The velocity of light, after all, is ten thousand times greater than Earth’s velocity in its orbit around the Sun. Yet optical experiments were accurate enough to detect such effects. All attempts to detect the elusive ether drift failed, however, and optical theory had to be adjusted to account for these failures.

The combination of Maxwell’s theory and the concept of an immobile ether likewise faced the problem of how to explain the absence of any detectable ether drift. When Maxwell found that his equations predict electromagnetic waves propagating with the velocity of light, he quite naturally assumed that this would be their velocity *with respect to the ether*. As long as one accepts classical ideas about space and time as everyone before Einstein tacitly did, it trivially follows that their velocity *with respect to an observer on Earth* is the vector sum of the velocity of propagation in the ether and the velocity of the ether drift on Earth. This, in turn, meant that Maxwell’s equations could only hold in a frame of reference at rest in the ether: in a moving frame, electromagnetic waves would have different velocities in different directions. The frame of reference of Earth is such a moving frame. One is thus driven to the conclusion that Maxwell’s equations do not hold in the frame in and for which they were discovered. Experiments with electricity and magnetism were not accurate enough to detect any possible deviations from Maxwell’s equations, but experiments in optics were. The failure of such experiments to detect ether drift thus posed a problem for the theory.

Lorentz invariance. In the 1890s Lorentz set out to explain the absence of any signs of ether drift on the basis of Maxwell’s theory. Tacitly using classical notions of space and time, Lorentz first determined the laws that electric and magnetic fields obey in a frame moving through the ether, given that they obey Maxwell’s equations in a frame at rest in the ether. He then replaced the components (E_x, \dots, B_x, \dots) of

the real electric and magnetic fields \mathbf{E} and \mathbf{B} by the components $(E'_x, \dots, B'_x, \dots)$ of the auxiliary and, as far as Lorentz was concerned, purely fictitious fields \mathbf{E}' and \mathbf{B}' . The components of these auxiliary fields mix components of the real electric and magnetic fields (e.g., in a frame moving with velocity v in the x -direction, $E'_y \approx E_y - vB_z$). He did the same with the space and time coordinates. In particular, he replaced the real time t by a fictitious variable t' , which he gave the suggestive name “local time,” because it depends on position (in a frame moving with velocity v in the x -direction, $t' \approx t - (v/c^2)x$). Lorentz chose these quantities in such a way that in any frame moving through the ether with some constant velocity \mathbf{v} , the fictitious fields \mathbf{E}' and \mathbf{B}' as functions of the fictitious variables (\mathbf{x}', t') satisfy Maxwell’s equations, just as the real fields as functions of the real space and time variables in a frame at rest in the ether. Maxwell’s equations, in other words, are invariant under the transformation from the real fields \mathbf{E} and \mathbf{B} as functions of the space and time coordinates in a frame at rest in the ether to the fictitious fields \mathbf{E}' and \mathbf{B}' as functions of the fictitious space and time coordinates of a moving frame. This is the essence of what Lorentz called the *theorem of corresponding states*. The transformation is an example of what are now called *Lorentz transformations*. Maxwell’s equations are invariant under Lorentz transformations—or *Lorentz invariant* for short.

In 1895 Lorentz proved the first version of this theorem, valid to the first order in the small quantity $v/c \approx 10^{-4}$. In 1899 he developed an exact version of the theorem, which he continued to improve over the following years.

With the help of his theorem was able to show in 1895 that, to first order in v/c , many phenomena on Earth or in any other frame moving through the ether will be indistinguishable from the corresponding phenomena in a frame at rest in the ether. In particular, he could show that, at least to this degree of accuracy, motion through the ether would not affect the pattern of light and shadow obtained in any optical experiment. Since the vast majority of optical experiments eventually boil down to the observation of such patterns, this was a very powerful result.

Contraction hypothesis. In 1899—and more systematically in 1904—Lorentz extended his analysis to higher powers of v/c . He now found that there is a tiny difference between the pattern of light and shadow obtained in an experiment performed while moving through the ether and the pattern of light and shadow obtained in the corresponding experiment performed at rest in the ether. Compared to the latter, the former pattern is contracted by a factor $\sqrt{1-v^2/c^2}$ in the direction of motion. Lorentz had come across this contraction factor before. In 1887, the American scientists Albert A. Michelson and Edward W. Morley had tried to detect ether drift in an experiment accurate to order $(v/c)^2$. They had not found any. Independently of each other (in 1889 and 1892, respectively), the Irish physicist George Francis FitzGerald and Lorentz had suggested that this negative result could be accounted for by assuming that material bodies, such as the optical components in the experiment, contract by a factor $\sqrt{1-v^2/c^2}$ in the direction of motion. Lorentz’s analysis of

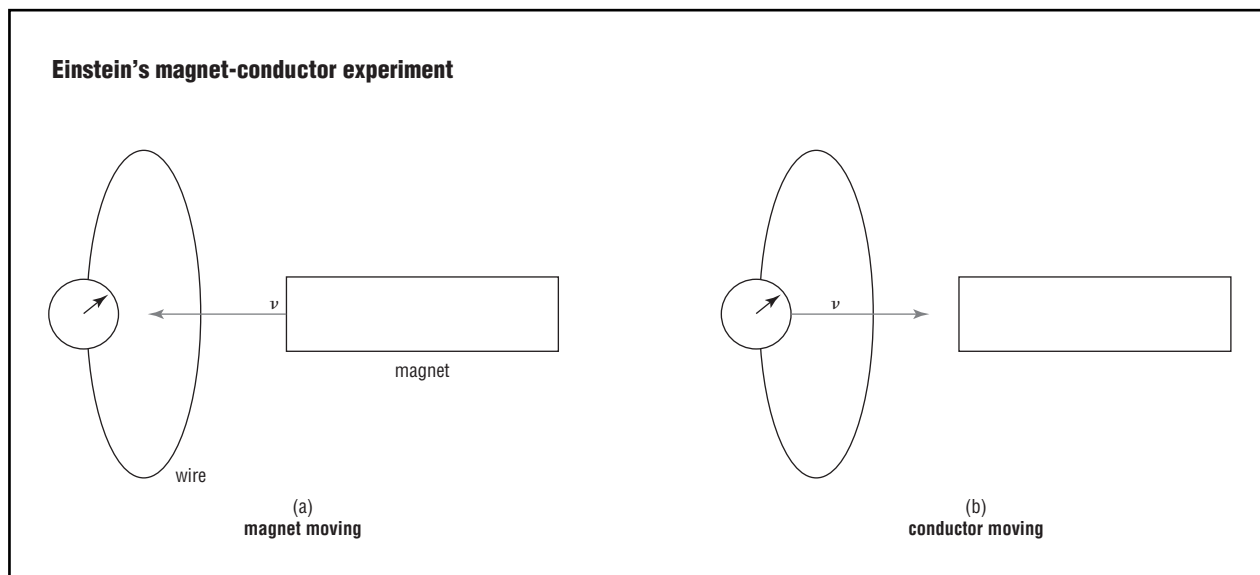

1899 and 1904 showed that this contraction hypothesis, as it came to be known, could be used not only to explain why the Michelson-Morley experiment had not detected any ether drift but also to explain much more generally why *no* observation of patterns of light and shadow ever would.

In modern terms, the hypothesis that Lorentz added to his theory in 1899 is that the laws governing matter, like Maxwell's equations, are Lorentz invariant. To this end, Lorentz had to amend the Newtonian laws that had jurisdiction over matter in his theory. As he had shown in the case of Maxwell's equations, it is a direct consequence of the Lorentz invariance of the laws governing a physical system that the system will undergo the Lorentz-FitzGerald contraction when moving with respect to the ether. From a purely mathematical point of view, Lorentz had thereby arrived at special relativity. To meet the demands of special relativity, all that needs to be done is to make sure that any proposed physical law is Lorentz invariant.

Concepts of space-time from Lorentz to Einstein. Conceptually, however, Lorentz's theory is very different from Einstein's. In Einstein's theory, the Lorentz invariance of all physical laws reflects a new space-time structure. Lorentz retained Newton's conception of space and time, the structure of which is reflected in the invariance of the laws of Newtonian physics under what are now called Galilean transformations. It is an unexplained coincidence in Lorentz's theory that all laws are invariant under Lorentz transformations, which have nothing to do with the Newtonian space-time structure posited by the theory.

This mismatch between the Newtonian concepts of space and time (and the invariance under the classical so-called Galilean transformations associated with it) and the Lorentz invariance of the laws governing matter and fields in space-time manifests itself in many other ways. Einstein hit upon a particularly telling example of this kind and used it in the very

first paragraph of his 1905 paper. The example is illustrated in Figure 1.

Consider a bar magnet and a conductor—a piece of wire hooked up to an ammeter—moving with respect to one another at relative velocity v . In Lorentz's theory it is necessary to distinguish two cases, (a) with the conductor and (b) with the magnet at rest in the ether. In case (a) the approaching magnet causes the magnetic field at the location of the wire to grow. According to Faraday's law of induction, this change in magnetic field induces an electric field, producing a current in the wire, which is registered by the ammeter. In case (b) the magnetic field is not changing and there is no induced electric field. The ammeter, however, still registers a current. This is because the electrons in the wire are moving in the magnetic field and experience a Lorentz force that makes them go around the wire.

It turns out that the currents in cases (a) and (b) are exactly the same. Yet, Lorentz's theoretical account of what produces these currents is very different for the two cases. This is, in Einstein's words, an example of theoretical "asymmetries that do not appear to be inherent in the phenomena" (Lorentz et al., 1952, p. 37). Einstein proposed to remove the asymmetry by insisting that cases (a) and (b) are just one and the same situation looked at from different perspectives. Even though this meant that he had to jettison the ether, Einstein took the relativity principle for uniform motion from mechanics and applied it to this situation in electrodynamics. He then proposed to extend the principle to all of physics.

In 1919, in an article intended for *Nature* but never actually submitted, Einstein explained the importance of the example of the magnet and the conductor for the genesis of special relativity:

The idea that we would be dealing here with two fundamentally different situations was unbearable to me . . .

The existence of the electric field was therefore a relative one, dependent on the coordinate system used, and only the electric and magnetic field taken *together* could be ascribed some kind of objective reality. This phenomenon of electromagnetic induction forced me to postulate the . . . relativity principle. (Stachel et al., Vol. 7, pp. 264–265)

The lack of documentary evidence for the period leading up to his creative outburst in his miracle year 1905 makes it very hard to reconstruct Einstein's path to special relativity (for a valiant attempt see Rynasiewicz). It seems clear, however, that Einstein hit upon the idea of "the relativity of electric and magnetic fields" expressed in the quotation above before he hit upon the new ideas about space and time for which special relativity is most famous. His reading of works of Lorentz and Poincaré probably helped him connect the dots from one to the other.

Once again, consider the example of the magnet and the conductor in Fig. 1. From the point of view of the magnet (b), the electromagnetic field only has a magnetic component. From the point of view of the conductor (a), this same field has both a magnetic and an electric component. Lorentz's work provides the mathematics needed to describe this state of affairs. Einstein came to recognize that the fictitious fields of Lorentz's theorem of corresponding states are in fact the fields measured by a moving observer. (He also recognized that the roles of Lorentz's two observers, one at rest and one moving in the ether, are completely interchangeable.) If the observer at rest with respect to the magnet measures a magnetic field with z -component B_z , then the observer at rest with respect to the conductor will not only measure a magnetic field but also an electric field with y -component E'_y . This is captured in Lorentz's formula $E'_y \approx E_y - vB_z$ for one of the components of his fictitious fields.

Maxwell's theory is compatible with the relativity principle if it can be shown that the observer measuring the Lorentz-transformed electric and magnetic fields \mathbf{E}' and \mathbf{B}' also measures the Lorentz-transformed space and time coordinates (\mathbf{x}', t') . Carefully analyzing how an observer moving through the ether would synchronize her clocks, Poincaré had already shown to first order in v/c that such clocks register Lorentz's local time. A direct consequence of this is that observers in relative motion to one another will disagree about whether two events occurring in different places happened simultaneously or not. Distant simultaneity is not absolute but depends on the state of motion of the observer making the call. This insight made everything fall into place for Einstein about six weeks before he published his famous 1905 paper.

The relativity postulate and the light postulate. Einstein modeled the presentation of his theory on thermodynamics (as he explained, for instance, in an article for *The London Times* in 1919; see Einstein 1954, p. 228). He started from two postulates, the analogues of the two laws of thermodynamics. The first is the relativity postulate, which extends the principle of the relativity of uniform motion from mechanics to all of physics; the other, known as the light postulate, is the key prediction

that Einstein needed from electrodynamics to develop his theory: "light is always propagated in empty space with a definite velocity c which is independent of the state of motion of the emitting body" (Lorentz et al., 1952 p. 37).

The combination of these two postulates appears to lead to a contradiction: two observers in relative motion will both claim that one and the same light beam has velocity c with respect to them. Einstein reassured the reader that the two postulates are "only apparently irreconcilable." Reconciling the two, however, requires giving up several commonsense notions about space and time and replacing them with unfamiliar new ones, such as the relativity of simultaneity, length contraction (moving objects are shorter than identical objects at rest), and time dilation (processes in moving systems take longer than identical processes in systems at rest). Einstein derived these effects from his two postulates and the plausible assumption that space and time are still homogeneous and isotropic in his new theory.

Following Poincaré's lead but without neglecting terms smaller than of order v/c , Einstein showed that the time and space coordinates of two observers in uniform relative motion are related to one another through a Lorentz transformation. Einstein thus introduced a new space-time structure. In the second part of his paper, he showed that this removes the incompatibility of Maxwell's equations with the relativity principle. He did this simply by proving that Maxwell's equations are Lorentz invariant. Since he was familiar with the early version of Lorentz's theorem of corresponding states (valid to order v/c), he would have had no trouble with this proof.

In 1908, Minkowski supplied the geometry of the Einstein's new space-time. The geometry of this Minkowski space-time is similar to Euclidean geometry. Frames of reference in different states of motion resemble Cartesian coordinate systems with different orientations of their axes. Lorentz transformations in Minkowski space-time are akin to rotations in Euclidean space. The demand that physical laws be Lorentz invariant thus acquired the same status as the demand that physical laws should be independent of the orientation of the axes of the coordinate system used to formulate them.

In a passage that echoes Einstein's comments about electric and magnetic fields quoted above, Minkowski wrote: "space by itself, and time by itself, are doomed to fade away into mere shadows, and only a kind of union of the two will preserve an independent reality" (Lorentz et al., 1952, p. 73). Different observers in Minkowski space-time will agree on the space-time distance between any two events, but disagree on how to break down that spatiotemporal distance into a spatial and a temporal component. It is this disagreement that lies behind relativity of simultaneity, length contraction, and time dilation, the effects Einstein had derived from his two postulates. In light of this analysis, Minkowski pointed out, the phrase *relativity postulate* seemed ill-chosen:

Since the postulate comes to mean that only the four-dimensional world in space and time is given . . . but that the projection in space and in time may still be un-

dertaken with a certain degree of freedom, I prefer to call it the *postulate of the absolute world*. (Lorentz et al., 1952, p. 83)

Einstein agreed with Minkowski on this point but felt that it was already too late to change the theory's name. However, he initially resisted Minkowski's geometrical reformulation of the theory, dismissing it as "superfluous learnedness" (Pais, p. 152). He only came to value Minkowski's contribution in his work on general relativity.

General Relativity

Einstein was not satisfied with special relativity for very long. He felt strongly that the principle of relativity for uniform motion ought to be generalized to arbitrary motion. In his popular book *Relativity: The Special and the General Theory* (1917) he used a charming analogy to explain what he found so objectionable about absolute motion. Consider two identical teakettles sitting on a stove. One is giving off steam, but the other is not. The observer is puzzled by this until realizing that the burner under the first kettle is turned on, but that the burner under the second is not. Compare this situation to that of two identical globes rotating with respect to one another around the line connecting their centers. Einstein discussed this situation in his first systematic exposition of general relativity in 1916. The situation of the two globes, like that of the two teakettles, at first seems to be completely symmetric. Observers on both globes will see the other globe rotating. Yet one globe bulges out at the equator, while the other does not. What is responsible for this difference? The Newtonian answer is: absolute space. What makes a globe bulge out is not its rotation with respect to the other globe, but its rotation with respect to absolute space. The special-relativistic answer is the same, except that Newton's absolute space needs to be replaced by Minkowski's absolute space-time. Einstein found this answer unsatisfactory, because neither Newton's absolute space nor Minkowski's absolute space-time can be directly observed. And without an observable cause for the difference between the two globes, we would have a violation of Gottfried Wilhelm von Leibniz's (1646–1716) Principle of Sufficient Reason. It would be as if the burners under both teakettles were turned on, but only one of them gave off steam.

There is a crucial difference, however, between the Newtonian and the special-relativistic answer as has been pointed out by Dorling). In special relativity, the situation of the two globes is not even symmetric at the purely descriptive level. Because of time dilation, one revolution of the other globe takes less time for an observer on the globe rotating in Minkowski space-time than it does for an observer on the other one. It therefore need not surprise us that the situation is not symmetric at the dynamic level either, that is, that only one globe bulges out. In terms of Einstein's analogy: if the two teakettles do not *look* the same, it need not surprise us that they do not *behave* the same. Absolute acceleration in special relativity thus does not violate the Principle of Sufficient Reason. Einstein failed to appreciate that special relativity had already solved what he himself identified as the problem of absolute motion.

Einstein's attempt to relativize acceleration. In 1907 Einstein set out on the road that would lead to general relativity. In the 1919 article quoted in the preceding section, he vividly recalls the initial flash of insight. Immediately following the passage quoted earlier, he writes:

Then came to me the best idea [*die glücklichste Gedanke*] of my life . . . Like the electric field generated by electromagnetic induction, the gravitational field only has a relative existence. *Because, for an observer freely falling from the roof of a house, no gravitational field exists while he is falling.* The experimental fact that the acceleration due to gravity does not depend on the material is thus a powerful argument for extending the relativity postulate to systems in non-uniform relative motion. (Pais, p. 178; see Janssen, "COI Stories" for further discussion of this argument)

This extended relativity postulate, it turns out, is highly problematic. What it boils down to is that two observers accelerating with respect to one another can both claim to be at rest if they agree to disagree about whether a gravitational field is present or not. This curious principle is best illustrated with a couple of examples.

First, consider the unfortunate observer falling from the roof in Einstein's example. For a fleeting moment this person will feel like a modern astronaut orbiting the earth in a space shuttle. Einstein, watching his observer accelerate downward from the safety of his room in the Berne Patent Office where he was working at the time, is at rest in the gravitational field of the earth. For the falling person, however, there seems to be no gravitational field. He can, if he wishes, maintain that he is at rest and that Einstein and the Patent Office are accelerating upward.

As a second example, imagine two astronauts in rocket ships hovering side by side somewhere in outer space where the effects of gravity are negligible. One of the astronauts fires up the engines of her rocket ship. According to the other astronaut she accelerates, but she can, if she were so inclined, maintain that she is at rest in the gravitational field that suddenly came into being when her engines were switched on and that the other rocket ship and its crew are in free fall in this gravitational field. Einstein produced an account of the twin paradox along these lines as late as 1919.

Notice that the "relativity of acceleration" in these two examples is very different from the relativity of uniform motion in special relativity. Two observers in uniform relative motion are physically fully equivalent to one another; two observers in nonuniform relative motion are not. This is clear in both examples. (1) Free fall in a gravitational field (a) *feels different* from resisting the pull of gravity (b). (2) Hovering in outer space (a) *feels different* from accelerating in outer space (b). In both cases, the "relativity of acceleration" is relativity in name only. In fact, the pair (1a)–(2a) and the pair (1b)–(2b) feel the same.

Equivalence principle. Einstein's excitement about "the best idea of his life" was nonetheless fully justified. Galileo's

principle that all matter falls with the same acceleration in a given gravitational field cries out for an explanation. Newton incorporated the principle by giving two very different concepts of mass the same numerical value. He set inertial mass, a measure of a body's resistance to acceleration, equal to gravitational mass, a measure of a body's susceptibility to gravity. In Newton's theory this is an unexplained coincidence. Einstein correctly surmised that this equality points to an intimate connection between acceleration and gravity. He called this connection the equivalence principle. It was not until after he finished his general theory of relativity, however, that he was able to articulate what exactly the connection is.

That did not stop him from relying heavily on the equivalence principle in constructing his theory. Since accelerating in Minkowski space-time feels the same as resisting the pull of gravity, Einstein was able to glean some features of gravitational fields in general by studying acceleration in Minkowski space-time. In particular, he examined the situation of an observer on a rotating disk or a merry-go-round in Minkowski space-time. Appealing to the embryonic equivalence principle, the man on the disk can claim to be at rest and attribute the centrifugal forces due to his centripetal acceleration to a centrifugal gravitational field. Suppose the man on the disk and a woman standing next to it are both asked to determine the ratio of the disk's circumference to its radius. The woman will find 2π , the answer given by Euclidean geometry. Because of length contraction, which affects the measuring rods placed along the circumference but not the ones along the radius, which move perpendicularly to their length, the man on the disk will find a value greater than 2π . This means that the spatial geometry for an observer rotating in Minkowski space-time is non-Euclidean. The equivalence principle says that the spatial geometry for an observer in a gravitational field will then, in general, also be non-Euclidean. This simple consideration, in all likelihood, gave Einstein the idea to represent gravity by the curvature of space-time (Stachel and Howard, pp. 48–82).

Recognizing that gravity is part of the fabric of space-time made it possible to give a more precise formulation of the equivalence principle. The mature form of the equivalence principle is brought out very nicely by the analogy that Einstein sets up but never quite finishes in the 1919 passage quoted above. Special relativity made it clear that electric and magnetic fields are part of one entity, the electromagnetic field, which breaks down differently into electric and magnetic components for different observers. General relativity similarly made it clear that the inertial structure of space-time and the gravitational field are not two separate entities but components of one entity, now called the *inertio-gravitational field*. Inertial structure determines the trajectories of free particles. Gravity makes all particles deviate from these trajectories in identical fashion, regardless of their mass. These are the only marching orders that *all* particles have to obey. In general relativity, they are all issued by one and the same authority, the inertio-gravitational field, represented by curved space-time. Which marching orders are credited to inertial structure and which ones to gravity depends on the state of motion of the observer. The connection between acceleration (or, equivalently, inertia) and

gravity is thus one of unification rather than one of reduction, as with the nominal “relativity of acceleration” discussed above, in which acceleration was being reduced to gravity.

How do the examples of nonuniform motion discussed above fit into the new scheme of things? Free fall in a gravitational field (1a) and hovering in outer space (2a) are both represented as motion along the straightest possible lines in what in general will be a curved space-time. Such lines are called *geodesics*. Resisting the pull of gravity (1b) and accelerating in outer space (2b) are both represented as motion along crooked lines, or *nongeodesics*. Since no change of perspective will transform a geodesic into a nongeodesic or vice versa, there is an absolute difference between (1a) and (1b) as well as between (2a) and (2b). Absolute acceleration survives in general relativity, as in special relativity, in the guise of an absolute distinction between geodesic and nongeodesic motion. This does not violate the Principle of Sufficient Reason, since geodesics and nongeodesics are already different at a purely descriptive or geometric level.

General covariance. Einstein did not give up his crusade against absolute motion so easily. Once he had realized that gravity is space-time curvature, he quickly came up with a new (though once again flawed) strategy for extending the principle of relativity from uniform to arbitrary motion. To describe curved space-time, Einstein had turned to the theory of curved surfaces of the great nineteenth-century German mathematician Carl Friedrich Gauss (1777–1855). To describe such surfaces (think of the surface of Earth for instance) one needs a map, a grid that assigns unique coordinates to every point of the surface, and sets of numbers to convert coordinate distances (i.e., distances on a map) to real distances (i.e., distances on the actual surface). These sets of numbers are called the components of the *metric tensor*. In general they are different for different points. The conversion from coordinate distances to real distances is thus given by a field, called the *metric field*, which assigns the appropriate metric tensor to every point.

A simple example may help to better understand the concept of a metric tensor field. On a standard map of the earth, countries close to the equator look smaller than countries close to the poles. The conversion factors from coordinate distances to real distances are therefore larger near the equator than they are near the poles. The metric tensor field thus varies from point to point, just like an electromagnetic field. Furthermore, at one and the same point, the conversion factor for north-south distances may differ from the conversion factor for east-west distances. The metric tensor at one point thus has different components for different directions.

Gauss's theory of curved surfaces was generalized to spaces of higher dimension by another German mathematician, Bernhard Riemann (1826–1866). This Riemannian geometry can handle curved space-time as well. In the case of four-dimensional space(-time), the metric tensor has ten independent components. In Einstein's theory, the metric tensor field does double duty: it describes both the geometry of space-time and the gravitational field. Mass—or its equivalent, energy—is the source of gravitational fields. Which field is produced

by a given source is determined by so-called *field equations*. To complete his theory Einstein thus had to find field equations for the metric field.

Einstein hoped to find field equations that would retain their form under arbitrary coordinate transformations. This property is called *general covariance*. The description of curved space-time outlined in the preceding paragraph clearly is generally covariant. One can choose any grid to assign coordinates to the points of space-time. Each choice will come with its own sets of conversion factors. In other words, the metric field encoding the geometry of space-time will be represented by different mathematical functions depending on which coordinates are used. Riemannian geometry is formulated in such a way that it works in arbitrary coordinates. It provides standard techniques for transforming the metric field from one coordinate system to another. If only Einstein could find field equations for the metric field that retain their form under arbitrary transformations, his whole theory would be generally covariant. In special relativity, Lorentz invariance expresses the relativity of uniform motion. Einstein—understandably perhaps, but mistakenly—thought that extending Lorentz invariance to invariance under arbitrary transformations would automatically extend the principle of relativity from uniform to arbitrary motion.

This line of thinking, however, conflates two completely different traditions in nineteenth-century geometry, as has been argued by John Norton. Minkowski's work with special relativity is in the tradition of projective geometry, associated with the so-called *Erlangen Program* of Felix Klein (1849–1925). Einstein's work with general relativity is in the tradition of differential geometry of Gauss and Riemann. The approaches of Klein and Riemann can be characterized as “subtractive” and “additive,” respectively.

In the subtractive approach one starts from an exhaustive description of space-time with all the bells and whistles and then strips this description down to its bare essentials. The recipe for doing that is to assign reality only to elements that are invariant under the group of transformations that relate different perspectives on the space-time. This group of transformations is thus directly related to some relativity principle. The most famous application of this strategy in physics is Minkowski's geometrical formulation of special relativity. The group of transformations in this case is the group of Lorentz transformations.

In the additive approach one starts with the set of space-time points stripped of all their properties and then adds the minimum geometrical structure needed to define straight(est) lines and distances in space-time. To guarantee that the added structure describes only intrinsic features of space-time, the demand is made that the description be generally covariant, that is, that it not depend on the coordinates used. This procedure can obviously be applied to any space-time. Only in certain special cases, however, will there be symmetries such as Lorentz invariance in Minkowski space-time reflecting the physical equivalence of different frames of reference and thereby some relativity principle. In the generic case there will be no symmetries whatsoever and hence no principle of rela-

tivity at all. This shows that general covariance has nothing to do with general relativity. Comparing Lorentz invariance in special relativity and general covariance in general relativity is like comparing apples and oranges.

The hole argument and the point-coincidence argument.

It was not until 1918 that a German high school teacher by the name of Erich Kretschmann (1887–1937) set Einstein straight on this score. This was a few years after Einstein had finally found generally covariant field equations. These equations, first published in November 1915, formed the capstone of his general theory of relativity. For more than two years prior to that, Einstein had used field equations that are not generally covariant. He had even found a fallacious but ultimately profound argument purporting to show that the field equations for the metric field cannot be generally covariant. For reasons that need not be of concern here the argument is known as the “hole argument.” The problem with generally covariant field equations, according to the hole argument, is that they allow one and the same source to produce what look like different metric fields, whereas the job of field equations is to determine uniquely what field is produced by a given source.

The escape from the hole argument is that on closer examination the different fields compatible with the same source turn out to be identical. The hole argument rests on the assumption that space-time points can be individuated and identified before any of their spatiotemporal properties are specified. Reject this assumption and the argument loses its force. The allegedly different metric fields only differ in that different featureless points take on the identity of the same space-time points. If space-time points cannot be individuated and identified independently of their spatiotemporal properties, this is no difference at all.

This comeback to the hole argument—a popular gloss on Einstein's so-called point-coincidence argument—amounts to a strong argument against the view that space-time is a substance, a container for the contents of space-time. The comeback shows that there are many ways to map spatiotemporal properties onto featureless points, all indistinguishable from one another. According to Leibniz's Principle of the Identity of Indiscernibles, all these indistinguishable ways must be physically identical. But then these points cannot be physically real, for that would make the indistinguishable ways of ascribing properties to them physically distinct.

The combination of the hole argument and the point-coincidence argument is thus seen to be a variant of an argument due to Leibniz himself against the Newtonian view that space is a substance. If space were a container, one version of the argument goes, God could have placed its contents a few feet to the left of where He actually placed it. But according to the Principle of the Identity of Indiscernibles, these two possible universes are identical and that leaves no room for the container, which could serve to distinguish the two. Einstein's fallacious argument against general covariance thus turned into an argument in support of a Leibnizian relational ontology of space-time.

Mach's principle. During the period that Einstein accepted that the field equations of his theory were not generally co-

variant, he explored yet another strategy for eliminating absolute motion. This strategy was inspired by his reading of Ernst Mach's (1838–1916) response to Newton's famous bucket experiment. Set a bucket filled with water spinning. It will take the water some time to catch up with the rotation of the bucket. Just after the bucket starts rotating, the water will still be at rest and its surface will be flat. Once the water starts rotating, the water will climb up the sides of the bucket and its surface will become concave. Newton pointed out that this effect cannot be due to the relative rotation of the water with respect to the bucket. After all, the effect increases as the relative rotation decreases and is at its maximum when there is no relative motion at all because the water is rotating with the same angular velocity as the bucket. Newton concluded that the water surface becomes concave because of the water's rotation with respect to absolute space. Mach pointed out that there is another possibility: the effect could be due to the relative rotation of the water with respect to all other matter in the universe. Picture the earth, the bucket, and the water at the center of a giant spherical shell representing all other matter in the universe. If Mach were right, it would make no difference whether the bucket or the shell is set rotating: in both cases the water surface should become concave. According to Newton's theory, however, the rotating shell will have no effect whatsoever on the shape of the water's surface.

In 1913–1914, Einstein was convinced for a while that this was a problem not for Mach's analysis but for Newton's theory and that his own theory vindicated Mach's account of the bucket experiment. It only takes a cursory look at Einstein's calculations in support of this claim to see that this attempt to relativize rotation is a nonstarter. When Einstein calculated the metric field of a rotating shell at its center, he considered a shell rotating in Minkowski space-time. The rotating shell does produce a tiny deviation from the metric field of Minkowski space-time, but nothing on the order needed to make the water surface concave. What Einstein would have had to show to vindicate Mach is that the metric field produced by the rotating shell near its center mimics Minkowski space-time as seen from a rotating frame of reference. In that case the situation of the bucket at rest in this metric field would have been identical to that of the bucket rotating in the opposite direction in Minkowski space-time. But in order to calculate the metric field of a rotating shell, one needs to make some assumption about boundary conditions, that is, the values of the metric field as we go to spatial infinity. Rotation with respect to space-time rather than other matter thus creeps back in.

Einstein's flawed Machian account of Newton's bucket experiment receded into the background when he finally found generally covariant field equations for the metric field in November 1915. As is clear from Einstein's first systematic exposition of the theory in 1916, he still believed at this point that general covariance guarantees the relativity of arbitrary motion. The Dutch astronomer Willem De Sitter disabused him of this illusion in the fall of 1916 (see Stachel et al, vol. 18, pp. 351–357, for a summary of the debate that ensued between Einstein and De Sitter). De Sitter pointed out that

Einstein used Minkowskian boundary conditions in his calculations of metric fields produced by various sources (such as the rotating shell discussed above) and thereby retained a remnant of absolute space-time. By early 1917, Einstein had worked out his response to De Sitter. He eliminated the need for boundary conditions at infinity simply by eliminating infinity. He proposed a model for the universe that is spatially closed. He chose the simplest model of this kind, which is static in addition to being closed. Such a static universe would collapse as a result of the gravitational attraction between its parts. Einstein therefore needed to add a term to his field equations that would provide the gravitational repulsion to neutralize this attraction. This term involved what has become known as the *cosmological constant*. In the late 1920s it became clear that the universe is expanding, in which case the gravitational attraction can be allowed to slow down the expansion and does not need to be compensated by a gravitational repulsion. In the wake of these developments, Einstein allegedly called the cosmological constant the biggest blunder of his life. In 1917, however, he felt he needed it to get rid of boundary conditions.

De Sitter quickly produced an alternative cosmological model that was allowed by Einstein's new field equations with the cosmological term. In this De Sitter world there is no matter at all. Absolute space-time thus returned with a vengeance. In reaction to De Sitter's model, Einstein formulated what came to be known as *Mach's principle*: the metric field is fully determined by matter and cannot exist without it. Einstein was convinced at this point that the addition of the cosmological term guaranteed that general relativity satisfies this principle, despite the apparent counterexample provided by the De Sitter solution.

Early in 1918, Einstein argued that the De Sitter world was not empty after all, but that hidden from view a vast amount of matter was tucked away in it. He concluded that general relativity satisfies Mach's principle and that this finally established complete relativity of arbitrary motion. All motion in general relativity is motion with respect to the metric field. But if the metric field can be reduced to matter, talk about such motion can be reinterpreted as a *façon de parler* about motion with respect to the matter generating the metric field. This certainly was a clever idea on Einstein's part, but by June 1918 it had become clear that the De Sitter world does not contain any hidden masses and is thus a genuine counterexample to Mach's principle. Another one of Einstein's attempts to relativize all motion had failed.

Einstein thereupon lost his enthusiasm for Mach's principle. He accepted that motion with respect to the metric field cannot always be translated into motion with respect to other matter. He also realized that motion with respect to the metric field or curved space-time is much more palatable than motion with respect to Newton's absolute space or Minkowski's absolute space-time anyway. The curved space-time of general relativity, unlike absolute space(-time), is a bona fide physical entity. It not only acts upon matter, like absolute space(-time), by telling matter how to move, but is also acted upon, as matter tells it how to curve (to

borrow two slogans from Misner et al., p. 5). In his lectures in Princeton in May 1921, Einstein reformulated his objection against absolute space(-time) accordingly: it is something that acts but is not acted upon.

Einstein had a deeper reason to abandon Mach's principle. It was predicated on an antiquated nineteenth-century billiard-ball ontology. Einstein thought of matter as consisting of electromagnetic fields, in combination perhaps with gravitational fields. Mach's principle would thus amount to reducing one field to another. As can be inferred from a lecture delivered in Leiden in October 1920 (Einstein, 1983, pp. 1–24), Einstein came to accept that the metric field exists on a par with the electromagnetic field. Just as he had unified the electric and the magnetic field in special relativity and space-time and gravity in general relativity, he now embarked on the quest for a theory unifying the electromagnetic and the inertio-gravitational field. He would spend the rest of his life looking for such a theory.

Conclusion

Einstein's struggle to relativize all motion, uniform and non-uniform, illustrates the old travelers' saying that the journey is more important than the destination. Although Einstein never reached the destination he originally had in mind, he found many valuable results along the way. For starters, he fulfilled many of his philosophical hopes, albeit in ways very different from what he originally envisioned. Absolute motion survives in general relativity, since there is an absolute difference between moving on a geodesic and moving on a nongeodesic. But motion with respect to curved space-time with a geometry described by a field interacting with matter (itself described by other fields) is a much more agreeable proposition than motion with respect to the absolute space(-time) of Newtonian theory and special relativity. The combination of the hole argument and the point-coincidence argument, moreover, had provided a strong argument against a Newtonian substantialist view of space-time and strong support for the rival Leibnizian relational view.

More importantly, Einstein had found a new theory of gravity, which does away with the artificial split between space-time and gravity of Newtonian theory. This theory opened up such exciting research areas as modern cosmology, black holes, singularities, gravitational waves, and gravitational lensing. Even some of the dead ends in Einstein's crusade against absolute motion led to interesting physics. In 2004, the National Aeronautics and Space Administration's (NASA) *Gravity Probe B* was trying to detect frame dragging, a phenomenon first investigated in the context of Einstein's misguided attempt to vindicate Mach's account of Newton's bucket experiment. The cosmological constant, originally introduced in the context of Einstein's ill-fated attempt to make general relativity satisfy Mach's principle, has made a spectacular comeback in modern cosmology as a straightforward phenomenological description of the repulsion driving the acceleration of the expansion of the universe discovered through Type Ia Supernovae observations. Einstein's quest for general relativity was a very rewarding journey indeed.

See also Cosmology: Cosmology and Astronomy; Geometry; Mathematics; Newtonianism; Physics; Science, History of; Science, Philosophy of.

BIBLIOGRAPHY

- Alexander, H. G., ed. *The Leibniz-Clarke Correspondence*. Manchester, U.K.: Manchester University Press, 1956.
- Barbour, Julian, and Herbert Pfister, eds. *Mach's Principle: From Newton's Bucket to Quantum Gravity*. Boston: Birkhäuser, 1995.
- Dorling, Jon. "Did Einstein Need General Relativity to Solve the Problem of Absolute Space? Or Had the Problem Already Been Solved by Special Relativity?" *British Journal for the Philosophy of Science* 29 (1978): 311–323.
- Earman, John. *World Enough and Space-Time: Absolute versus Relational Theories of Space and Time*. Cambridge, Mass.: MIT Press, 1989.
- Einstein, Albert. *Ideas and Opinions*. New York: Crown, 1954.
- . *The Meaning of Relativity*. Princeton, N.J.: Princeton University Press, 1956.
- . *Relativity: The Special and the General Theory*. New York: Bonanza, 1961.
- . *Sidelights on Relativity*. New York: Dover, 1983.
- Goenner, Hubert, et al., eds. *The Expanding Worlds of General Relativity*. Boston: Birkhäuser, 1999.
- Howard, Don, and John Stachel, eds. *Einstein and the History of General Relativity*. Boston: Birkhäuser, 1989.
- Janssen, Michel. "Reconsidering a Scientific Revolution: The Case of Einstein versus Lorentz." *Physics in Perspective* 4 (2002): 421–446.
- . "COI Stories: Explanation and Evidence in the History of Science." *Perspectives on Science* 10 (2002): 457–522.
- Janssen, Michel, and John Stachel. "Optics and Electrodynamics in Moving Bodies." In John Stachel's *Going Critical*. Dordrecht: Kluwer, forthcoming.
- Lorentz, Hendrik Antoon, et al. *The Principle of Relativity*. Translated by W. Perrett and G. B. Jeffery. New York: Dover, 1952.
- Misner, Charles W., Kip S. Thorne, and John Archibald Wheeler. *Gravitation*. San Francisco: Freeman, 1973.
- Niven, W. D., ed. *The Scientific Papers of James Clerk Maxwell*. 2 vols. Cambridge, U.K.: Cambridge University Press, 1890.
- Norton, John. "Geometries in Collision: Einstein, Klein, and Riemann." In *The Symbolic Universe: Geometry and Physics, 1890–1930*, edited by Jeremy Gray. Oxford: Oxford University Press, 1999.
- Pais, Abraham. *"Subtle Is the Lord . . .": The Science and the Life of Albert Einstein*. Oxford: Oxford University Press, 1982.
- Renn, Jürgen, et al. *General Relativity in the Making: Einstein's Zurich Notebook*. Vol. 1 of *The Genesis of General Relativity: Documents and Interpretation*. 2 vols. Dordrecht: Kluwer, in preparation.
- Rynasiewicz, Robert. "The Construction of the Special Theory: Some Queries and Considerations." In *Einstein: The Formative Years, 1879–1909*, edited by Don Howard and John Stachel. Boston: Birkhäuser, 2000.
- Stachel, John, ed. *Einstein's Miraculous Year: Five Papers That Changed the Face of Physics*. Princeton, N.J.: Princeton University Press, 1998.
- Stachel, John, et al., eds. *The Collected Papers of Albert Einstein*. 8 vols. Princeton, N.J.: Princeton University Press, 1987–2002.

Michel Janssen

RELIGION.

This entry includes seven subentries:

Overview

Africa

African Diaspora

East and Southeast Asia

Indigenous Peoples' View, South America

Latin America

Middle East

OVERVIEW

Like all items of culture, words have a history; meanings and usages change over time. So too, “religion,” and the assumption that the world is neatly separated between religious and nonreligious spheres (i.e., Church/State), is a product of historical development and not a brute fact of social life. In the early twenty-first century, long after the modern usage of the word was first coined, it is no longer obvious how it was understood or how it ought to be used. Therefore, contrary to other articles that employ the term *as if* it refers to a universal feature animating those social movements called “the world’s religions”—a term first coined in Europe in the nineteenth century (see Masuzawa)—this discussion will be concerned instead with the history of the idea of “religion.”

The Beginnings of “Religion”

The English “religion” has equivalents in other modern languages; for example, in Germany the academic study of religion is known as *Religionswissenschaft* (*Wissenschaft* = systematic study) and in France it is known as *les Sciences Religieuses* (in nineteenth-century Britain the academic study of religion was sometimes called Comparative Religion or the Science of Religion). A cursory comparison reveals that lexicons influenced by Latin and, later, European culture possess something equivalent to “religion.” This means that for pre-contact cultures, or those few that remain unaffected by Europe and North America, there was no necessary equivalent term.

Consider the case of modern India; although “religion” is not a traditional concept there (i.e., Sanskrit long predates the arrival of Latin-based languages), British colonialism ensures that contemporary English-speaking citizens of the Indian nation-state conceive what is called “Hinduism” as their “religion”—although, historically speaking, that which world religions textbooks now call “Hinduism” was understood by its practitioners as *sanatana dharma*: the cosmic system of obligations that impacted all aspects of *samsara* (the almost endless cycle of births and rebirths). Consider another case: even the New Testament is not much help since its language of composition—common, or koine Greek—also predated Latin; its authors therefore lacked the roots from which in the early 2000s are derived the word “religion.” So, although English translations routinely use “religion” or “godliness” to translate such Greek terms as *eusebia* (1 Timothy 3:16; 2 Timothy 3:5), or *threskia* (Acts 26:5; James 1:26, 27), these ancient Greek terms are much closer to the Sanskrit *dharma*, the Chinese *li*, and the Latin *pietas*—

all having something to do with the quality one is thought to possess as a result of properly fulfilling sets of social obligations, expectations, and ritual procedures, not only toward the gods or ancestors but also to one’s family, peers, superiors, servants, and so on. Despite “piety” currently meaning an inner sentiment or affection, to be pious in ancient Athens—what Socrates was accused of *not* being, as the story is told in Plato’s dialogue on defining piety, *Euthyphro* (c. 380 B.C.E.)—meant recognizing and publicly signaling differences in social status. This, of course, is the great irony of the *Euthyphro*: Socrates’ accuser is a young upstart, and Socrates’ teacher is an outright braggart; by their behavior the ancient reader would have known that neither can judge either *eusebia* or Socrates.

If by religion is meant a matter of belief, separable from forms of action and political organization, signified by one’s assent to a creed and enacted in certain ritual behaviors (i.e., worship), then even in Latin the modern term “religion” has no equivalent. For its precursors are thought to have meant, “to bind something tightly together,” “to re-read,” or “to pay close attention.” Recognizing that the term’s history holds no clue concerning how it ought to be used, scholars find a number of questions in need of investigation: If a culture does not have the concept, can “their religion” be studied? Should scholarship only employ concepts local to the group under study? Is the thing to which this word points shared by all people, regardless of their self-understandings (as Shakespeare wrote in *Romeo and Juliet*, “a rose by any other name would smell as sweet”)? Is using the local term as if it were a universal signifier an act of cultural imperialism?

These are important questions for those who attempt to develop a cross-culturally useful definition of this concept, distinguishable from its popular or folk definition. Just as chemists develop a technical vocabulary that enables them to talk about “H₂O” instead of “water,” so too scholars of religion attempt to develop technical categories capable of working with cross-cultural data. As with anthropologists who study “culture”—yet another Latin-based term—the challenge, then, is to take a contextually specific word and use it in diverse historical and geographic settings.

A religion is a unified system of beliefs and practices relative to sacred things, that is to say, things set apart and forbidden—beliefs and practices which unite into one single moral community called a Church all those who adhere to them. . . . In showing that the idea of religion is inseparable from the idea of a Church, it conveys the notion that religion must be an eminently collective thing. (Durkheim, p. 44)

The Essentials of Religion

A notable early attempt was that of Edmund Burnett Tylor (1832–1917) in his influential book, *Religion in Primitive Culture* (1871); religion, he argued, was to be defined as “belief in spiritual beings.” In this minimalist definition is seen the still common emphasis on an essentially private, intellectual component (religion = *believing* this or that) rather than on, for instance, the behavioral or the social components, as in Émile Durkheim’s (1858–1917) emphasis on public ritual and institution in his still influential study, *Les formes élémentaires de la vie religieuse* (1912). In Tylor’s onetime popular definition is therefore found the philosophically idealist remnants of an earlier era in European history, when one’s membership within certain groups was thought to be primarily dependent upon whether one believed in something (i.e., a creed). In fact, the presumption persists that “the cumulative tradition” is the deadened expression of a prior, dynamic affectation known as “faith” (e.g., W. C. Smith’s 1962 work, *The Meaning and End of Religion*). In contemporary popular culture, people who distinguish spirituality from the institution of religion are easily found.

With its emphasis on the intellectual component (along with Herbert Spencer [1820–1903] and James G. Frazer [1854–1941], Tylor is numbered among the Intellectualists, a nineteenth-century anthropological tradition), Tylor’s work offers an example of a classic definitional strategy: *essentialism*. Because religions struck such observers as obviously having a number of different characteristics, many of which were understood as mere accidents (i.e., the result of specific cultural, historical, or geographic context), they thought it unwise to define religion based on what they took to be its secondary, external aspects. Instead, Tylor reasoned, one ought to identify “the deeper motive which underlies them.” Belief in spiritual beings, he concluded, was therefore the “essential source” for all religions; accordingly, his naturalistic theory of religion sought to account for belief in spiritual beings. Tylor’s definition are therefore referred to as *essentialist* (also termed *substantivist*): identifying the one essential feature (or substance).

In other words, if, as the German Protestant theologian Rudolf Otto (1869–1937) once argued in *The Idea of the Holy* (1917), that which sets religions apart is the participant’s feeling of awe and fascination when in the presence of what Otto termed the *mysterium tremendum* (the compelling yet repelling mystery of it all), then without this sense of awe and fascination there is no religion. The feeling of awe (a complex combination of fear, trembling, fascination, and attraction) was, for Otto, the essence of religion. Although Tylor’s and Otto’s classic definitions are significantly different (i.e., the former is anthropological, interested only in the fact of a belief, rather than its truth, whereas the latter is theological, presuming the object of the belief to exist and to prompt an emotional response), both went about the task of definition in the same manner: the *inductive method* was used, whereby one compares a number of empirical examples, looking for their underlying similarity. Here is seen the common strategy of employing the comparative method to identify nonempirical commonality, such that difference is understood to be a nonessential feature of contingent history—an approach characteristic of a num-

While there is a staggering amount of data, phenomena, of human experiences and expressions that might be characterized in one culture or another, by one criterion or another, as religious—*there is no data for religion*. Religion is solely the creation of the scholar’s study. It is created for the scholar’s analytic purposes by his imaginative acts of comparison and generalization. Religion has no existence apart from the academy. For this reason, the student of religion . . . must be relentlessly self-conscious. Indeed, this self-consciousness constitutes his primary expertise, his foremost object of study. (Jonathan Z. Smith, p. xi)

ber of scholars, from Frazer’s multivolume *The Golden Bough: A Study in Magic and Religion* (first edition 1890) to Mircea Eliade’s (1907–1986) *Traité d’histoire des religions* (1949).

The Functions of Religion

With the *essentialist approach* in mind—an approach adopted by those who presume religions house a core experience that is set apart from all other human behaviors—it may be contrasted with the *functionalist approach*. Consider the thing that appears in many classrooms: a lectern behind which the professor stands while lecturing. What is the difference between a lectern and a pulpit, for the same physical object could easily be identified as both? For the functionalist scholar, there is no one essential feature that unites all things people call “lecterns”; instead, the context into which something is placed, the expectations placed upon it by its users, and the purpose it serves are what cause things to be defined as this and not that. For early twentieth-century scholars, it was this shift from speculating on universal, nonempirical qualities and affectations to observing the role of local, historical context and empirical effects that signified the development of a truly scientific (i.e., historical, documentable) study of religion, in distinction from a well-meaning but, nonetheless, theologically motivated study of religion’s enduring value or groundless speculations on its prehistoric origins and evolutionary development.

In the early twenty-first century, functionalists owe much to such writers as Karl Marx (1818–1883), whose materialist, political economy theorized religion as a social pacifier that both deadened the oppressed’s sense of pain and alienation while simultaneously preventing them from doing something about their lot in life since ultimate responsibility was thought to reside with a being who existed outside history; Durkheim, whose sociological study understood intertwined sets of beliefs and practices to enable individuals to form the idea of a common social identity; and, of course, Sigmund Freud (1856–1939), whose psychological studies led him to liken public ritual to private obsessive-compulsive disorders and myths to the

role dreams play in helping an individual to express symbolically antisocial anxieties in a manner that does not threaten their place within the group. Twenty-first-century scholarship is pressing such classic work in new directions—for example, drawing on materialist scholarship and semiotic theory to study myth (Lincoln); using a social theory to account for such things as the beginnings of Christianity (Mack); and developing a theory of religion based on the findings of cognitive psychology and evolutionary theory (Boyer).

Religion as an Item of Public Discourse

When it comes to defining religion, there are thus two common approaches: either one inductively browses through the group of things called religion, looking for an essentially shared feature or one sets about looking for the universal function it performs. If one takes the former route, then objects are defined by some feature that is internal to them, more often than not some nonempirical feature judged to be *sui generis* (i.e., self-caused, one of a kind). For instance, because there are innumerable observable differences among the members of the group known as, say, “U.S. citizens,” people often fall back on the assumption that what *really* unites the members of this group is an internal experience, a feeling, an attitude—all things that cannot be tasted, touched, smelled, or heard, but, instead, only felt by the participants themselves and approximated rather crudely by the uninitiated observer. Because for many people religion is assumed to refer to an invisible but all-too-real interior world that is fully experienced only by the believer (a point often associated with Otto’s work), this essentialist approach is still popular, within and outside the academy.

But, if “religion” is to be used in the human sciences as a classification to name an aspect of the observable, intersubjective world, then the essentialist approach is not helpful for it is premised on the priority of a subjective, private world of affectation and aesthetic appreciation. Because the functionalist approach focuses on the use to which something is put, it shifts attention to defining something in light of an observable group of people, their needs, their goals, and their interests (demonstrating the debt scholars of religion owe to such anthropological predecessors as Mary Douglas and her 1966 study of the sociology of classification, *Purity and Danger*). The functionalist approach therefore holds more promise for the academic study of religion practiced as part of a public discourse.

Resemblances among Religions

A final approach to consider is the one sometimes favored by those who wish to steer a middle path between essentialist and

To define “religion,” to say what it *is*, is not possible at the start of a presentation such as this. Definition can be attempted, if at all, only at the conclusion of the study. (Weber, p. 1)

To define is not to finish, but to start. To define is not to confine but to create something. . . . To define, finally, is not to destroy but to construct for the purpose of useful reflection. . . . In fact, we have definitions, hazy and inarticulate as they might be, for every object about which we know something. . . . Let us, then, define our concept of definition as a tentative classification of a phenomenon, which allows us to begin an analysis of the phenomenon so defined. (Brian K. Smith, pp. 4-5)

functionalist approaches. This is referred to as *the family resemblance approach*, credited to the philosopher Ludwig Wittgenstein (1889–1951), who asked people to stop and consider how it is that they actually go about classifying things. If they did this, he suggested, they would see that all members of the family called “game” *more or less* shared a series of traits or characteristics, just as no two members of a family are exactly alike but, instead, each *more or less* share a series of characteristics (such as name, hair color, temperament, height, favorite foods, blood type, and so on). Definition, for Wittgenstein, was therefore an activity of choice; it therefore falls to the users of classifications—such as those who seek to define religion—not only to have what an anthropologist, Benson Saler, has termed a prototypical definition, but also to be prepared to make judgmental calls when a cultural artifact meets so few of their prototype’s characteristics that it is questionable whether the artifact can productively be called a religion.

Contrary to both the essentialist and the functionalist scholar passively recognizing either some core feature or purpose served by a religion, Wittgensteinian scholars of religion actively constitute an artifact as religious inasmuch as it does or does not match their prototype. That the family resemblance definition widens in the case of more liberal scholars (either politically or theologically), and narrows in the case of those who are more conservative, should not go unnoticed.

Classification as a Scholarly Act

Keeping in mind this relationship between classifier, classification, and that which is classified, it may be seen why a number of contemporary scholars have found the essentialist approach to be unproductive inasmuch as its metaphysic presumes a common essence to underlie its varied manifestations—the presumption that motivated an earlier movement known as the Phenomenology of Religion (e.g., van der Leeuw’s 1933 work, *Religion in Essence and Manifestation*). Moreover, just as studies of the politics of scholarship have recently appeared throughout the human sciences, so too in the study of religion once this field was re-conceived as a site constituted by choice

and interests rather than one based on sympathetic spiritual insight (e.g., Fitzgerald, Wiebe). Due to the breadth of his own work and its international influence, the University of Chicago's Jonathan Z. Smith is, perhaps, the best representative of this recent development among scholars of religion who now take seriously that "religion" is their analytic tool and that it does not necessarily identify a universal affectation lurking deep within human nature.

Contrary to Max Weber (1864–1920), who famously opened his now classic *The Sociology of Religion* (1922) by stating that exhaustive description must precede definition, many scholars no longer see classification to be concerned with linking a historical word to an ahistorical trait identified only after all empirical cases have been considered. Instead, classification—like all human activities—is now understood as a tactical, provisional activity, directed by *deductive* scholarly theories and prior social interests in need of disclosure. Classification ensures that some generic thing stands out as an object worthy of describing; for without a prior definition of religion Weber would have had nothing to describe. To paraphrase Jonathan Z. Smith, classification therefore provides scholars with some elbowroom to get on with their work of disciplined inquiry.

See also Anthropology; Buddhism; Christianity; Free Will, Determinism, and Predestination; Heresy and Apostasy; Hinduism; Islam; Judaism; Mysticism; Orthodoxy; Orthopraxy; Phenomenology; Sufism; Shinto; Zen.

BIBLIOGRAPHY

- Arnal, William E. "Definition." In *Guide to the Study of Religion*. Edited by Willi Braun and Russell T. McCutcheon. London: Continuum, 2000.
- Boyer, Pascal. *Religion Explained*. New York: Basic Books, 2002.
- Douglas, Mary. *Purity and Danger: An Analysis of the Concepts of Pollution and Taboo*. London and New York: Routledge, 1991.
- Durkheim, Émile. *The Elementary Forms of Religious Life*. Translated by Karen Fields. New York: The Free Press, 1995.
- Fitzgerald, Tim. *The Ideology of Religious Studies*. New York: Oxford University Press, 1999.
- Lincoln, Bruce. *Theorizing Myth: Narrative, Ideology, and Scholarship*. Chicago: University of Chicago Press, 1999.
- Mack, Burton. *Christian Myth: Origins, Logic, and Legacy*. London: Continuum, 2001.
- Masuzawa, Tomoko. *The Invention of World Religions, or How the Idea of European Hegemony Came to be Expressed in the Language of Pluralism and Diversity*. Chicago: University of Chicago Press, 2005.
- McCutcheon, Russell T. *Manufacturing Religion: The Discourse on Sui Generis Religion and the Politics of Nostalgia*. New York: Oxford University Press, 1997.
- Morris, Brian. *Anthropological Studies of Religion: An Introductory Text*. Cambridge, U.K.: Cambridge University Press, 1988.
- Peterson, Derek, and Darren Walhof, eds. *The Invention of Religion: Rethinking Belief in Politics and History*. New Brunswick, N.J.: Rutgers University Press, 2001.
- Salter, Benson. *Conceptualizing Religion: Immanent Anthropologists, Transcendent Natives, and Unbounded Categories*. Leiden, Netherlands: E. J. Brill, 1993.
- Smith, Brian K. *Reflections and Resemblance, Ritual, and Religion*. New York: Oxford University Press, 1989.
- Smith, Jonathan Z. "Classification." In *Guide to the Study of Religion*. Edited by Willi Braun and Russell T. McCutcheon. London: Continuum, 2000.
- . *Imagining Religion: From Babylon to Jonestown*. Chicago: University of Chicago Press, 1982.
- Smith, Wilfred Cantwell. *The Meaning and End of Religion*. Minneapolis, Minn.: Fortress Press, 1991.
- van der Leeuw, Gerardus. *Religion in Essence and Manifestation*. 2 vols. Translated by J. E. Turner. New York: Harper and Row, 1963.
- Weber, Max. *The Sociology of Religion*. Introduction by Talcott Parsons and translated by Ephraim Fischoff. Boston: Beacon Press, 1993.
- Wiebe, Donald. *The Politics of Religious Studies*. New York: St. Martin's Press, 1999.

Russell T. McCutcheon

AFRICA

The modern academic study of indigenous African religions began with the publication of ethnographic, missionary, and travel monographs by Leo Frobenius, R. S. Rattray, H. A. Junod, W. C. Willoughby, Edwin Smith, E. E. Evans-Pritchard, John Middleton, Godfrey Lienhardt, Geoffrey Parrinder, and Marcel Griaule, among others. The African scholars Bolajiji Idowu, John Mbiti, and Gabriel Setiloane also published works on African religious life and practice. These studies explore religious life and the social history of specific communities. Studies that stress the historicity of African religions draw on oral traditions and archaeological records (Terrence Ranger, I. Kimambo, Wim M. J. van Binsbergen, Matthew Schoffeleers, Thomas Blakely, Walter E. A. van Beek, and Dennis L. Thompson).

The encounter with modernity and with other religions such as Christianity and Islam affected African religions in two ways. Positively, this encounter demonstrated that African religions share common features with other religions in the quest for ultimate and communal values. Negatively, the new religions dominated African religions through their massive social services, which they used for conversion. The messengers of the faiths introduced into Africa derided indigenous religions, competed with ritual experts, and were also impatient that changes they demanded in some aspects of African rituals did not take place soon enough. A good example is the case of circumcision among the Kikuyu. Conflicts arose in the Kikuyu area of Kenya because they practiced this rite, and escalated to the point where some mission organizations barred circumcised Kikuyu children from attending schools.

African religions were often seen as *preparatio evangelica* (preparation for the Gospel), and the encounter with modernity sharply curtailed and stunted the growth of African religions. In response, however, Africans continued to practice their religions. Africans converted to the new religions practiced a bricolage, combining elements of their religion with the new faiths. Africans also used their religious beliefs to confront newcomers. In East Africa, the Nyabingi cult of the nineteenth century, the Maji-Maji movement, the Mambo cult in Kenya, the Mwari

cult in Zimbabwe, and the Poro cult in Sierra Leone, all resisted colonial incursion into their territories.

African religions are local faiths and have no sacred book, although scholars have collected texts such as *Sixteen Cowries* and *Ifa Divination* (William Bascom) and *Texts on Zulu Religion* (Irving Hexham). Collections of prayers by John Mbiti and Alyward Shorter, and Marcel Griaule's *Conversations with Ogotemmel*, are also rudimentary religious texts. Although there is no uniformity of African religious thought, it is possible to summarize key components of African religious life and history.

Myth and Cosmology

African myths sketch a conceptual world presided over by a divinity that is responsible for the emergence of humanity and the development of a community. Myths provide the legitimacy of local authority, settlement, and social organization, and describe the moral universe of the people. Mythic narratives, which Paul Ricoeur describes as primary language, offer religious perspectives on the past and the present and provide an ethos upon which to construct the future. Zulu, Swazi, Xhosa, Tsonga, and some Sotho myths state that people came out of a bed of reeds. Yoruba myths state that the *orishas* Obatala and Oduduwa, representing Olodumare, the Supreme God, created the world and humanity. Elsewhere, Sotho myths hold that Kgobe the High God created the world and that his son Kgobeane created people.

Myths also account for the separation of humanity from divinity and place the responsibility for this separation on human beings. The Batammaliba people believe that Kuiye created the world and gave its people all they needed. Unfortunately, humans complained because God did everything for them. Their complaints forced the divinity to withdraw into the sky; as a result, suffering and death entered the human community. Kuiye was compassionate and provided the Batammaliba with rain and other things they needed to survive under their new circumstances. Batammaliba mythology informs the community's sociocultural practice as well as its architectural designs. In addition, mythology provides a religious view of human conflicts and the human family. According to Dogon myths, Amma the Supreme Deity created the world, but Ogo, one of the first primordial persons, rebelled and polluted the world. Amma rescued the creative process by killing Nommo, the twin brother of Ogo, to clean up the chaos caused by Ogo's act of rebellion.

Gods and Spirits

Belief in a High God is widespread in Africa. (Zulu: Unkulunkulu, the Great One, or Inkosi Yezulu, the Chief of the Sky; Yoruba: Olorun, King of the Sky, or Olodumare; Wimbun: Nyui; Igbo: Chukwu; Dogon: Amma.) The Zulus believe that in the beginning Unkulunkulu created people, male and female. He also created people of different colors and gave them their own dwelling places: the whites were to live in the water, and the black people in the land now occupied by the Zulu people. Beliefs about God indicate that God is a transcendent and immanent being who controls the universe and is responsible for all things and all human affairs. In some beliefs, God is an androgynous being. Kuiye of the Batammaliba has both male and female genitals and is called "The

Sun, Our Father and Our Mother." In Zimbabwe, Mwari, the god of fertility, also is androgynous. Theologians John Mbiti, E. Bolaji Idowu, and Gabriel Setiloane have articulated African perspectives on God using Christian theological categories.

In the divine hierarchy, divinities and spirits are ranked below God. Yoruba divinities are called *orishas*. God sent the divinities Obatala and Oduduwa to create the world and all things in it. Some of the *orishas* are divinized ancestors; the *orisha* Shango was the fourth king of Oyo. The *orisha* Esu is a trickster who opens the path to other *orishas*. Esu rewards devotees and also punishes them when they go astray. Orunmila is the *orisha* of wisdom and divination while Ogun is the *orisha* of iron and war. The female deity Oshun is the goddess of water and revered as a great mother. Her devotees hold festivals that have become important cultural manifestations in the Nigerian town of Oshogbo.

Evans-Pritchard argued that the Nuer god Kwoth was also a spirit. This theoretical move set up a complicated picture of the nature of gods and spirits. This remains a rich territory for further exploration because Nuer Kwoth is an entity that is both divine and a distinct spirit. Clan divinities among the Nuer and Dinka are believed to have the power to address moral issues and guide interpersonal relationships. These spirits and divinities are all subject to the authority of God and carry out God's will.

Ancestral spirits are also thought to interact with people. People offer sacrifice and pour libations to the spirits to ward off difficulties. Community leaders consult ancestral spirits for guidance; in Zimbabwe, *mhondoro* spirits helped determine succession to office. Chiefs and quarter heads of the Wimbun generally offer wine to the ancestors before they drink. In addition to ancestral spirits who may bless or punish people, there are hosts of other spirits, who may be mainly malicious. Among the Wimbun, some of these spirits are called *nyirr* and often bother people at night.

Religion and Possession

Spirit possession is a complex spiritual engagement that goes beyond psychological release for marginalized women and occurs in indigenous religions as well as in Islam and Christianity. Yoruba divinities such as Shango, Yemoja, Osun, and Obatala often possess people. In possession, a spirit takes control of an individual for a period of time. Such possession can be sudden and may be induced through music, drumming, or medicines. The possessed individual speaks for the spirit. Illness may indicate the presence of a spirit. Regardless of the duration, possession signifies a bond with the spirit; the possessed are called brides. Such bonds make possession an ecstatic and enjoyable experience. Despite the fact that possession is often described as a marriage between the spirit and the possessed individual, possession remains a symbolic act because there is no physical or genital activity involved, although the sense of pleasure or suffering is real. Possession can also be a violent event, especially possession by the god Shango, who is said to mount a person as a horse. Possession ends when the spirit departs, but the phenomenon of possession remains a constant feature of the spiritual life of the individual. Early lit-

erature on the Zar possession cult suggested that Somali women turned to spirit possession to address marginality. Janice Boddy has argued that possession involves several aspects of the human experience. Edwin Ardener argued that Bakwéri female cults expressed positive female values. And Michael Lambek has argued that possession should also be seen as a system of meaning that operates within a given culture.

Possession is important because the spirit that controls the devotee communicates messages to the community through that individual. Possession can also be part of what Jean Buxton described as a call to the healing profession and “a diagnostic technique” (p. 297). The possession experience can be a critical moment in creating self-understanding and personhood. It offers opportunities to resolve contradictions within the self and may be an incentive for people to pay attention to public morality. Spirit possession may also reflect disapproval and discontent with certain political agendas, or express a nationalist ideology—an activity noted in the Zimbabwean revolutionary struggle against the white minority rule of Ian Smith. Belief in spirit possession has not disappeared in the wake of Christian and Muslim attacks on it.

Religious Authorities

Religious authorities range from heads of households who perform family rituals to prophets, priests, and ritual experts. They serve as intermediaries between the spirits and the people, carry out divination to diagnose problems, and supervise the execution of rituals. Divination in Yoruba religion is carried out by a priest called *babalawo* (a father of secrets) who uses symbols to form a combination of numbers derived from the number 256 that points to a text which provides insights into the problem of the individual. When the diviner has arrived at a combination, he links it to the body of sacred oral verses called the Odu Ifa. The interpretation of a particular *odu* provides guidance for the solution to the problem.

Prophets speak on behalf of divinity and fight for a just society. Douglas Johnson argues that colonial authorities antagonized Nuer prophets and fostered a largely political interpretation of their prophetic role. However, prophets based their power on the spiritual and moral values of the community: neighborliness, generosity, and the peaceful resolution of disputes. People who practiced these virtues had the divinity in them and thus spoke on their behalf. “Evans-Pritchard identifies the *kuaar* as a priest who represents men to divinity by invoking the divinity of his flesh, contrasting with the prophet who, inspired by a divinity, represents divinity to men” (Johnson, p. 59). These individuals acquired special abilities to see and know things beforehand; the gift of prophecy made them spokespersons (*guk*) for divinity.

Ngundeng was one of these people. He was also called Dengkur and regarded as a prophet of the Nuer people. When he died, British colonial officials reported that people liked and feared him. He was just, helped the poor, rejected killing, and opposed colonial domination of the Nuer land in the Sudan. Prophet Kinjikitile led the Maji-Maji rebellion in Tanzania in 1905, inspired by sacred water (*maji*) that he believed would help his people withstand colonial

firearms. Past prophets worked on conflict resolution and promoted peace.

Worship Spaces

Worship takes place in a variety of sacred spaces and at shrines. A. I. Richards listed six types of shrines: personal huts, village shrines, places of deceased chiefs, natural-phenomena shrines, burial places of chiefs, and places containing the relics and paraphernalia of dead chiefs. Drawing on this, Van Binsbergen distinguished between shrines constructed by humans and natural shrines such as trees, hills, groves, pools, streams, falls, and rapids. Dominique Zahan calls these natural shrines of water, earth, air, and fire, “elementary cathedrals.” Sacred places associated with water include streams, rivers, lakes, and springs. Those associated with the earth include the ground itself, rocks, crossroads, hollows, hills, and mountains, and those associated with air include trees and groves. In the village of Ntumbaw, the burial groves of chiefs are considered sacred ground, and the current chief enters this sacred place only to communicate with the departed chiefs.

Religious activities also take place in the public square. In Nigeria, Oshun festivals take place in the courtyard of the *oba* (king) as well as in the sacred grove of Oshun. Worship also takes place in individual homes. Blier argues that the vertical houses of the Batammaliba (which they consider places of worship) are designed to emphasize their belief that God is the highest one and are oriented in an east-west path to face Kuyiekulie, the dwelling place of Kuyie. Other parts of the house point to their sacrificial relationship to Kuyie’s providence through human procreation, and to other deities in their religious system.

Rituals and Ceremonies

Recent interpretation of rituals supplements Émile Durkheim’s views that rituals are formalized and symbolic rites—controlled and repeated behavior in the presence of the sacred—which enact society’s separation of the sacred and the profane. In the work of Edmund Leach and Mary Douglas, rituals constitute a system of symbolic actions that communicate values about society. The Manchester School of Manchester University’s Department of Social Anthropology championed a *processual* view that interprets rituals as a symbolic mechanism in which form, content, meaning, and a dynamic process guides, confirms, and reorders individual as well social experience and practices. Victor Turner argued that in Ndembu rituals and rites of passage, symbols are employed to stabilize individuals and society, create new social locations, and anticipate transformation by establishing a *communitas*, or fellowship. Jean Comaroff has argued that rituals reenact the historical and social practices of a community.

Rituals give content and meaning to religious life. Life crisis and developmental rituals are transformative and stabilizing. Life cycle rituals such as funerals honor the dead and prepare them for transition into ancestors; ceremonies honoring dead chiefs take on cosmic proportions. The Wimbun people often suspend farm work for the duration of the celebrations. Rituals of affliction are performed to rebuff a spirit that causes illness, misfortune, failure, and barrenness. Certain afflictions may be a call for the afflicted to become a healer or assume an

important ritual office. In such a case, the afflicted receives ritual treatment from a specialist and is initiated into the practice. Rituals of rebellion offer opportunities for transformation and the creation of alternative social alliances. Religious rituals also involve propitiation of the ancestors and of gods who have the power to remove afflictions.

Personhood and Morality

Personhood and individuality are recognized in the context of a communitarian ethos. In Yoruba religion, Olodumare creates people and gives each person the opportunity to choose his or her destiny. Individuality is also spelled out in names and in the concept of *ori* (head), which indicates not only the physical head but also an important part of an individual's nature and character (*iwa*). The psychological aspect of the person is *inu*, and a sense of self is conveyed by the word *emi*. Yoruba thought stresses the need for individuals to carry out their obligations in order to fulfill their destiny. Such responsibility is not necessarily a set of rules, but entails living one's life in such a way that one's goals and destiny are accomplished. However, there are prescriptions. People are often advised to avoid witchcraft and shun polluting symbols. Evil is seen as any action that distorts interpersonal relations and brings about harmful social developments. Evildoers misuse magic and witchcraft and inflict violence on others, but that does not mean that witchcraft and other forms of powers are necessarily evil. Ritual specialists, such as diviners, help individuals to determine not only the course of their destiny, but also how to act in a way that will allow them to fulfill their destiny.

Religion and Art

Engelbert Mveng once described black art as "a cosmic liturgy and religious language." African art is primarily the expression of the artistic and aesthetic imagination of individual artists. However, some works of art carry religious meanings. Festivals often incorporate artistic celebrations because artistic work on materials such as musical instruments, regalia, and headdresses enhances these events. Art objects often point to spiritual and ancestral power. Works of art may be representations of gods and spirits. Art that has religious significance empowers people to live balanced lives and to fulfill their obligations to others. According to Robert Farris Thompson, Yoruba arts are avatars of *ashé* (divine energy) in ceremonial bowls, staffs, and iron sculptures. "A thing or a work of art that has *ashé* transcends ordinary questions about its make up and confinements: it is divine force incarnate" (p. 7). Furthermore, Suzanne Blier argues that *bocio* sculptures, which have been described as "fetishes, idols, *gris-gris*, devils, ill-formed monsters, villainous *maggot*, and *marmouset* (grotesque form) . . . function in conjunction with . . . *vodun* energies . . . they are . . . closely identified with *vodun* power, religious tenets, and philosophy" (1995, p. 4–5).

African art often depicts sacred kingship. Palace construction and royal regalia employ motifs of temple construction. Artworks often convey a sense of security in the community, which can be inferred from the masking tradition that uses reversal to hint at the presence of ancestors and spirits among people, demonstrating a power that can drive away evil. Blier

argues that the etymology of the word *vodun* "constitutes a philosophy which places a primacy on patience, calmness, respect, and order both in the context of acquiring life's basic necessities and in the pursuit of those extra benefits which make life at once full and pleasurable" (1995, p. 40). *Bocio* sculptures also provide protection from witches.

Art celebrates divine beauty and character. Batatunde Lawal argues that Yoruba aesthetics reveal outer and inner beauty of character and the joy of life, which endears an individual to others and to Olodumare. Artists thus possess *iwapele* (gentle character) in the manner of the *Orishanla*, divinities of creation and the primordial artist. Yoruba artists have depicted *aye*, the world of the living, and *orun*, the other world, in a spherical carved gourd. Divination trays are often elaborately carved to depict the wisdom of *Orunmila*, the divinity of divination. *Gèlèdè* headdresses often feature masks that represent "priests and priestesses to recognize publicly their contributions to the spiritual well-being of the community" (Lawal, p. 212). Rosalind Hackett argues that African art focuses on and shapes an individual's understanding of humanity, destiny, death, procreation, secrecy, power, divinity, spirits, and healing. Ritual art objects such as initiation stools, divination materials, staffs, and musical instruments express religious ideas and elevate spiritual life and experience.

Death and the Afterlife

Ancestor veneration suggests that, contrary to Mbiti's thesis, speculation about the afterlife is strong in African religions. Death rituals, offerings, and pouring of libations to ancestors all point to life beyond the grave. Yoruba proverbs state that life here on earth is transitory; the world is a marketplace and heaven is one's home. All people who die go before Olodumare and Obatala to be judged for their actions here on earth. In Manianga thought, moral and upright people go to Mpemba, the world of the ancestors. Evil people are prevented from entering Mpemba and are barred from meeting and staying with ancestors.

The Future of African Religions

African religions are alive in the early 2000s but often continue to be described, erroneously, as animism. Indigenous religions face prejudice from other religions—converts to Islam and Christianity still call African religions paganism. Hackett has argued that indigenous religions are being revitalized through the universalization, modernization, politicization, commercialization, and individualization of religious ideas and practices. African religions have a future for many reasons. First, these religions articulate worldviews that continue to provide a basis for morality, supporting what Laurenti Magesa has called "the moral traditions of abundant life." Second, African religions are linked to royal authority, influencing the selection and installation of royals and their system of governance. Third, celebrations and rituals will keep indigenous religions alive. Fourth, the need for healing will keep African religions alive. Fifth, the survival of African religions in the diaspora is testimony to their staying power. Sixth, the scholarly study of African religions could contribute to their survival. Growth depends upon how practitioners address issues in daily life. African religions

have always paid attention to individuals and the community; such attention in the twenty-first century could have a positive bearing on a contemporary society in need of revitalization.

See also Ancestor Worship; Animism; Arts: Africa; Humanity: African Thought; Immortality and the Afterlife; Masks; Oral Traditions: Overview; Personhood in African Thought; Philosophy, Moral: Africa; Ritual: Religion.

BIBLIOGRAPHY

- Abimbola, Wande. *Ifá: An Exposition of Ifá Literary Corpus*. Ibadan: Oxford University Press Nigeria, 1976.
- Bascom, William. *Ifa Divination: Communication Between Gods and Men in West Africa*. Bloomington: Indiana University Press, 1969. Reprint, 1991.
- Beattie, John, and John Middleton, eds. *Spirit Mediumship and Society in Africa*. London: Routledge and Kegan Paul, 1969.
- Blier, Suzanne Preston. *African Vodun: Art, Psychology, and Power*. Chicago: University of Chicago Press, 1995.
- . *The Anatomy of Architecture: Ontology and Metaphor in Batammaliba Architectural Expression*. Chicago: University of Chicago Press, 1994.
- Boddy, Janice. *Wombs and Alien Spirits: Women and Men in the Zar Cult in Northern Sudan*. Madison: University of Wisconsin Press, 1989.
- Buxton, Jean. *Religion and Healing in Mandari*. Oxford: Clarendon, 1973.
- Comaroff, Jean. *Body of Power, Spirit of Resistance: The Culture and History of a South African People*. Chicago: University of Chicago Press, 1985.
- Evans-Pritchard, E. E. *Nuer Religion*. Oxford: Clarendon, 1956.
- Fortes, Meyer. *Religion, Morality, and the Person: Essays on Tallensi Religion*. Cambridge, U.K.: Cambridge University Press, 1987.
- Griaule, Marcel. *Conversations with Ogotemmel: An Introduction to Dogon Religious Ideas*. London: Oxford University Press, 1965.
- Hackett, Rosalind I. J. *Art and Religion in Africa*. London: Cassell, 1996.
- Idowu, E. Bolaji. *African Traditional Religion: A Definition*. Maryknoll, N.Y.: Orbis, 1973.
- . *Olodumare: God in Yoruba Belief*. New York: Wazobia, 1994.
- Johnson, Douglas. *Nuer Prophets: A History of Prophecy from the Upper Nile in the Nineteenth and Twentieth Centuries*. Oxford: Clarendon, 1994.
- Lambek, Michael. *Human Spirits: A Cultural Account of Trance in Mayotte*. Cambridge, U.K.: Cambridge University Press, 1981.
- Lawal, Babatunde. *The Gèlèdè Spectacle: Art, Gender, and Social Harmony in an African Culture*. Seattle: University of Washington Press, 1996.
- Lienhardt, R. Godfrey. *Divinity and Experience: The Religion of the Dinka*. Oxford: Clarendon, 1961.
- Magesa, Laurenti. *African Religion: The Moral Traditions of Abundant Life*. Maryknoll, N.Y.: Orbis, 1997.
- Mbiti, John. *Introduction to African Religion*. Portsmouth, N.H.: Heinemann, 1991.
- Middleton, John. *Lugbara Religion: Ritual and Authority among an East African People*. Washington, D.C.: Smithsonian Institution Press, 1987.
- Ranger, Terence, and I. N. Kimambo, eds. *The Historical Study of African Religion*. Berkeley: University of California Press, 1972.
- Setiloane, Gabriel. *The Image of God among the Sotho-Tswana*. Rotterdam, Netherlands: Balkema, 1976.
- Smith, Edwin. *African Ideas of God*. London: Edinburgh House, 1950.
- Thompson, Robert Farris. *Flash of the Spirit: African and Afro-American Art and Philosophy*. New York: Vintage, 1984.
- Turner, Victor. *The Forest of Symbols: Aspects of Ndembu Ritual*. Ithaca, N.Y.: Cornell University Press, 1967.
- Van Binsbergen, Wim, and Matthew Schoffeleers, eds. *Theoretical Explorations in African Religion*. London: Kegan Paul, 1985.
- Zahan, Dominique. *The Religion, Spirituality, and Thought of Traditional Africa*. Translated by Kate Ezra Martin and Lawrence Martin. Chicago: University of Chicago Press, 1979.

Elias K. Bongmba

AFRICAN DIASPORA

The term *African-derived religions* (ADR) is used to identify various religions transplanted to the Americas with the enslavement of Africans. For simplicity, ADR will be used in this entry to denote Afro-Caribbean and Afro-Brazilian religions, whose traditions survived cultural and ideological assault and continued to provide spiritual resources for a civilization rooted in African cosmologies. Wide geographical distribution in the Americas reflects a similar distribution along the coast of West and Central Africa. African-derived religions are both an urban and a rural phenomenon, created in response to the existential realities of slavery and the derision of African spirituality. However, ADR inspired enslaved peoples in Haiti and provided inspiration for their revolution of 1791. ADR survived missionary attacks, ridicule, popular misunderstanding, and attempts to call into question their validity.

George Simpson grouped these religions into five types. First were the neo-African religions—Santería in Cuba, the Dominican Republic, and Puerto Rico; Vodun in Haiti; Shango in Trinidad and Grenada; and Candomblé in Brazil—drew from similar concepts and borrowed practices from Catholicism that reminded them of African realities. The second type were religions influenced by Protestant missionary activity in the region: Cumina and the Convince cult in Jamaica, The Big Drum Dance of Carriacou (Grenada), and Kele in St. Lucia. Third were groups influenced by Pentecostal groups from the United States. Religions that emphasize divination, healing, and spirit mediumship were the fourth type: Umbanda in Brazil, the Maria Lionza cult in Venezuela, and Espiritismo in Puerto Rico. The fifth type was Rastafarianism, a twentieth-century religion with a sociopolitical agenda.

Afro-Caribbean religions trace their origins to Africa.

- a. Santería, which is practiced in Cuba and in many parts of the United States, is perhaps the most well known of the African-derived religions. It is also called Regla de Ocha or Regla Lucumi.
- b. Regla de Palo, also called Palo Monte or Palo Mayombe, is linked to the religious traditions of

- Angola, Congo, and Gabon.
- c. Regla Arara, also called Gaga, derives from the Dogon people in Mali.
 - d. Nanigo, also called Abakuka, is associated by practitioners with African thought, beliefs, and rituals.
 - e. Vodú (Vodun) is practiced in Haiti and in parts of the United States.
 - f. Kunina is practiced in Jamaica.
 - g. Winti, practiced in Suriname, is a multinational and multicultural religion that incorporates African, Indian, and Christian traditions.
 - h. Shango religion, practiced in Trinidad and Grenada, started in 1849, when indentured African laborers brought in from Ijesha in Nigeria began to practice Yoruba beliefs.
 - i. Kele is practiced on St. Lucia.
 - j. Drum Dance of Carriacou in the Grenadines, where worshippers dance and communicate with ancestors.
 - k. The Venezuelan cult of Maria Lionza draws upon spiritism, Amerindian mythology, and shamanism, as well as the Afro-Cuban Catholic tradition.
 - l. Confa Obeah religion is practiced in Guayana.
 - m. The twentieth-century Rastafarian movement is not an African-derived religion in the strictest sense, but because it considers the Imperial Majesty of Ethiopia a divine personality, members of its community have strong ties to Africa.

The term *Afro-Brazilian religions* is used for religious traditions practiced in Brazil.

- a. Candomblé is a spirit-possession religion with strong ties to Africa and draws on Catholicism, Pentecostalism, Umbanda, and Brazilian mythology. It began when three women living in Bahia—Iyá Dêta, Iyá Kalá, and Iyá Nassô—started a house worship, which they called Engenho Velho. Disputes arose and led to the creation of Grantois and Axé Opó Afronjá. Roberto Motta has argued that Candomblé is being “churchified” through systematization and standardization at different levels and that this is reflected in several discourses and practices seeking to establish which community is authentic, who is the *pureza nagô*, who is the greatest *babalorixá*, which group offers the most social services in urban areas, and which theological literature stresses African roots and African memory and values.

- b. Umbanda grew out of a response to industrialization in Rio de Janeiro in the 1920s and spread to São Paulo. Members seek upward mobility, and their leaders are called *pai-de-santo* and *mae-de-santo*.
- c. Macumba, a syncretistic tradition, traces its roots to the Yoruba world. It is a ritual and dancing community led by priests (*babalorixá*) and priestesses (*iyalorixá*) who provide spiritual and psychological services to adherents.
- d. Scholars question the qualification of Batuque as an African-derived religion because it has few African traits and no strong slave tradition in the area of Belem, where the religion is practiced.
- e. Shango religions were created in honor of the *orisha* Shango.
- f. Tambor de Mina, also called Nago.
- g. Xango in Recife.

Originally, these nondoctrinaire and nontextual religions focused on a rich memory of African deities, rituals, morality, and practices that were passed on to younger generations. There is a wide range of scholarship on these religions, enabling broad descriptions of their spirituality.

Religious Symbioses

African-derived religions are symbioses of African religious and global culture. Their ceremonies provided social revolutionary inspiration in Jamaica and Haiti and inspired the mythologies behind the patron saint of Cuba, Virgen de la Caridad del Cobre (the Virgin of Charity of Cobre). ADRs maintain an orientation to Africa, but their ceremonies celebrate the rich diversity of the African community in the Americas. Even Rastafarianism lays claim to Ethiopia’s historical and genetic engagement with the biblical world mythologized in the Kebra Nagast. The faithful in ADR evoke a sense of belonging to their particular community similar to the Jamaican *yaad* (practice), and a sense of being at home.

Gatherings at Catholic churches provided a “clearing” for displaced Africans to occupy, enabling them to catch glimpses of African religiosity. Devotion to Catholicism was mandated by the *Code noir* of 1685, which required that slaves be initiated into Christianity. The early meetings of ADR were held in *cabildos*, later called *ile ocha* (house of *orisha*) or *casa templo* (house temple). Later devotees would point to spirits they served such as Santa Barbara, San Lázaro, and Yemayá.

The *patakis* (myths) of Africa provided the inspiration that diasporan Africans needed to create a dynamic life that would defy the realities of slave society. The gods of Africa energized lives, inspired celebrations that honored the *orishas*, and enabled participants to maintain balance and fulfill their purpose in life. Devotees of Candomblé maintained a constant relationship with Africa and organized pilgrimages to Africa. In the early 2000s, followers of African-derived religions serve the

spirits and honor their ancestors in colorful enactments of the ceremonies, dances, arts, and rituals of the African diaspora.

Divinity

African-derived religions worship a divine being and several divinities. The term *gadu* refers to Winti deities in Suriname. Religious traditions associated with the Yoruba religions call the supreme being Olodumare (Santería, Candomblé, and others). Olodumare is the creator and ruler of all things; he owns character and human destiny. He is also the source of *ashe*, or divine essence, and all other forces at work in the world. In Vodun devotees serve the Bondye (supreme being), who created the world and maintains balance. Divinity in the Rastafarian movement is called Jah Rastafaria.

Devotees serve the *orishas*, who manifest divine energy and are considered part of the community. The *orishas* themselves depend on the members of the community as much as the members of the community depend on them. Vodun devotees serve the *loas* (lesser deities), also called *les invisibles* and *les mysteres*. Among the *loas* (spirit intermediaries), Legba is important because he, like Esu, opens the door to divinity, and must receive a share of all offerings.

Ancestors

Ancestors are important in ADR because they link worshipers to the *loas*. Devotees affirm: "I believe in the power of ancestors who watch over us and serve us before the *loas*; that they must be remembered and served faithfully" (Desmangles, p. 63). A ceremony called *retirer d'en bas de l'eau*, performed for the dead, allows the soul of the deceased to find peace. This ceremony is considered a third birth for the individual (the first is physical, the second, spiritual) and gives the ancestor a new status and the power to influence life on earth. The ancestors are part of a hierarchy in the spiritual world, but are not considered to be gods.

Spiritual Assets: *Ase* and *Konesans*

Two central concepts in some African-derived religions are *ase* (or *axe*) and *konesans* (connaissance). *Ase* is the divine force, energy, and power incarnate in the world. Olodumare gives *ase* to everything, including inanimate objects. *Ashe* is the power behind all things in the universe. It enables people to find balance in life. The *orishas* are bearers of *ashe*. *Santeros* (Santería priests) use *ase* to provide blessing and healing to devotees. "*Ashe* is a current or flow, a groove that initiates can channel so that it carries them along their road in life. The prayers, rhythms, offerings, taboos of Santería tune initiates into this flow" (Murphy, 1993, p. 131). In Santería, herbs are impregnated with *ashe*. The color of the Obatala conducts *ashe*. Part of the Vodun initiation ceremonies gives the priest intuitive knowledge, or *konesans*, enabling him to understand people, diagnose problems, and perform healing.

Leadership

Priests and priestesses in ADR direct, guide, and organize ceremonies. These leaders are not as authoritative as in other religions because they are merely conduits of the spirits. Vodun

leaders are called *oungans* (male) and *mambos* (female) or *mães de santo* and *päis de santo*. A Candomblé leader is called *babalorixa* (male) or *iyalorixa* (female). Santería leaders are known as *santeros* (male) and *santeras* (female). The *orishas* select leaders; those chosen for office go through a three-year initiation that culminates in *asiento*, or *hacer santo*, when the *orisha* who called the neophyte is seated. The neophyte is called *iyawo* (bride). The newly initiated *iyawo* wears white during the first year. Some *santeros* may be initiated into the cult of *Ifá* and receive training from a leader, who imparts a mastery of the texts of divination. Initiation gives the neophyte a new personality as well as responsibility. The rites also link the leader with the first sixteen kings of the Yoruba people.

Divination and Spirit Possession

Devotees seek divine will and understanding through divination, which also serves as means of diagnosing illness and misfortune. A common divination system is the *dilloggun*, which draws on esoteric texts of the tradition that speak to the problem of the devotee. Guidance is also sought through the oracle.

Spirit possession is an important aspect of ADR. In possession, a spirit takes control of a devotee, provides direction, and imparts knowledge. When possessed, "the individual's executive faculties are temporarily placed in abeyance as the deity takes over . . . habitual functions. When the possession is ended the devotee is again himself with ordinarily no recollection of what has happened" (Walker, p. 36). The spirit would also possess devotees who surrender their lives to a deity or spirit. Thus, possession is a moment for submission to the suggestions of the spirit. In Candomblé, possession by the spirit is described as *incorporar* (to incorporate), *pegar* (to seize or grab), or *manifestar* (to manifest). In Winti religion, spirits control the conscience of an individual and reveal things to him. The spirit that possesses an individual might assume one aspect of that person's personality. Some spirits may appear only to certain people. In Trinidad, Ogun appears only to stout women, while Osian, the quiet god of the forest, appears only to slim men and women.

Songs and drum rhythms can invite possession. Possession can also take place during the initiation of a devotee. The drummer often releases the tension of monotony with breaks. Sometimes possession may come through hypnosis, periods of intense stress, pain, fear, or difficulties, which some interpret as a psychodrama or psychotherapeutic event through which the individual works out life's problems as they interact with other people. Possession may be a wild drama during which the possessed speaks on behalf of the deity, or it may end spontaneously, or when the community shifts emphasis to another deity. Possession establishes a spiritual bond, creating a *comunitas*. In possession, liminality replaces normalcy, making room for public excesses that express social desires, and may offer an opportunity for the spirit, who speaks through the voice of the possessed, to criticize unsocial behavior.

Rituals and Sacrifices

African-derived religious ceremonies are a service to the spirits. In the Bembé drum dance of the Santería community, the

ceremony is used to communicate with ancestors and summon spirits. Mederick Louis Moreau de St. Mery described Vodun religion as a dance of the Africans in Haiti that summoned the energies of Bondye and his spirits *lwas* and *les morts*. The Big Drum Dance of Carriacou celebrates ancestors through the *nacion* dance and songs. African-derived religious ceremonies also celebrate life, family, people, work, and provide occasion for practitioners to share food, time, and the presence of the spirit. Initiation ceremonies offer opportunities for the faithful to enter different stages of faith and leadership. Some ceremonies include classic ritual stages of separation, seclusion, and reintegration, signaling the birth or rebirth of the initiate into a new role.

Vodun ceremonies take place in the homes of the devotees or in the *oum'phor* (temple), an enclosed place. A significant ritual property is the *poteau mitan*, a supporting post that is a symbolic link and path to Ginen (Africa). Other ritual properties include images of *lwas*, flags, a machete of Ogou that is used for sacrifices, and a drum. Vodun employs four types of initiation rituals: head washing, which feeds the spirit and refreshes the individual; *kanzo*, a ritual of fire that strengthens the individual; *kouche sou pwen*, which strengthens the initiate's relationship with the spirit; and giving the *ason*, or sacred rattle, which qualifies the initiate to heal. Candomblé initiations are presided over by *iyalorixa* or *babalorixa* who help in preparing the shrine and the *otas* (sacred stones) that contain the powers of the *orixa*. The *abia* (initiate) is first isolated; then, during the second stage, learns about his or her spirit and the *atabaques* (drum) rhythms of the spirit. At the final stage, the *abia* is named and rejoins the community.

Devotees serve the spirits and the ancestors with *ebo* (offering or sacrifice). The *orishas* demand services such as feasts, initiations, and purifying baths. *Ebo* refers to offerings of animals, fruits, and vegetables given to the *orishas*. *Ebo* offerings are specific foods preferred by the *orishas*. Ogun, the divinity of iron, likes red and white roosters; Yemaya, the ocean divinity, likes duck, turtle, and goat. The *orishas* eat the *ashe* of the offerings; the rest is then shared among the members of the community. Animals are offered to the *orishas* because animal blood holds *ase*.

Religion and Healing

African-derived religious ceremonies double as healing sessions for physical and spiritual ailments, addressing concrete issues of the *serviteur* such as pain, disaster, loss, economic difficulties, problems in love, unemployment, and providing support to seek *chans* (luck) and to survive. "Life, in the Vodou view of things, is thus characterized by alternating cycles of suffering and the transient relief from suffering that is called having luck" (Brown, 1991, p. 344). Vodun devotees believe that although magical insects may cause illness, so can bad relationships. Santería devotees also believe that suffering and illness result from bad relationships among good and bad humans, divinities, ancestors, and the *orishas*. A devotee with difficulties consults a diviner to help determine the cause of his or her suffering and prescribe ways of dealing with the problem. The solution involves restoring

broken relationships and finding balance in the community. In Haiti, the *mambo* works with the people to seek healing. In Venezuela, the *curioso*, and the *lukuman* in Suriname practice divination to diagnose problems. Mediums, called *buyai*, practice healing in Belize, Honduras, Nicaragua, and Guatemala.

Herbalists provide remedies for illnesses. In colonial Brazil, people suffered from *banzo*, a condition that led to depression and physical deterioration. Its symptoms were alcoholism, use of narcotics, and the eating of dirt. Healers in the African diaspora were called root doctor, weed woman, magical doctor, or the bush doctor, who was also called *obeahman*. In Brazil, the *benzador* treated people with St. Mary's herb. In Candomblé, healers also use herbs and sacred leaves.

Rituals enable the *serviteur* to relate to a cosmic system, draw strength, and deal with evil. Because an inner miracle may take place in the individual, what happens may not be seen—nevertheless, a miracle strong enough to alter the circumstances of the *serviteur* is believed to occur. Priestesses may also diagnose a problem. Treatment may include, in the case of broken relationships, binding two dolls together. Other treatments involve preparing special food to calm a restive spirit, and giving healing baths using a mixture of herbs and perfumes. In Suriname, *meki wan sweri* is a healing technique in which a winti-man discovers the wishes of Winti and contracts to fulfill those desires and become well.

Religion and Gender

Women have been active in African-derived religions from the beginning; some of them are leaders. Women were at the forefront of the establishment of Candomblé and in the early twenty-first century women have great responsibility in the estimated 2,000 *terreiros* in Bahia. Members of the Sisterhood of Our Lady of the Good Death (a group in the Barroquinha church) and Iyalusso Danadana and Iyalusso Akala (a woman of Yoruba background) played key roles in the formation of the religion. Gender equality remains an issue where traditions still give men ritual privileges exclusively. For example, in Regla Conga the title *tata nganga* is reserved for men. Women can attain it only in the postmenstrual years. In Regla de Ocha, or Santería, women do not have access to the divination system of the *babalawo* (priest). Patriarchy exists in the Rastafarian movement: women do not participate in reasoning sessions. There are resources in some ADR that offer opportunity for a reconstruction of gender relations. Female deities such as Yemaja and Oxun, and the androgyny of Oxala, could be explored as a basis for more egalitarian relationships in African-derived religions.

Religion and the Arts

The arts are integral to the expression of African-derived religions and include chants, dance, rituals, ceremonies, feasts, altar construction, cloth work, beadwork (*collares de mazo*), ritual coverings (*bandeles*), carvings, paintings, and sculptures. The arts bring cosmology and ritual into the quotidian and the ceremonial without losing the profundity of their contextual (and contested) referential meanings. The visual arts come in a variety of media and colors; the drums and div-

ination tools are constructed from a variety of colorful materials. Artistic objects ground *ashe* in the individual and the community.

Artistic representations of the *orishas* depict their *ashe* as well as their *ewa* (beauty). *Orisha* art is *ohun oso* (adornment/ornament), attractive, and calls attention to the gods. *Ase* is often depicted as a bird. Carved ornaments depicting the *orishas* are often placed on the altar and fed with food and blood to give them *ashe*. Altars are constructed and decorated with the colors of a particular *orisha* to depict a divine throne of glory. Art objects also depict the priests and priestesses who go between the *orishas* and the community. The visual arts create a congenial atmosphere for worship. Vodun flags greet the deities—a sign of respect—and invoke the presence of the spirits. The *vévé* blazons drawn with powdered substances on the ground depict a cosmic connection with the gods and goddesses at the top. In Haiti, artistic representation depicts the virtues of self-restraint and steadfastness.

Conclusion

During their complex history, devotees of ADR have faced a number of challenges. First, Christian missionaries condemned their practices as heathen and demonic. Second, devotees of ADR faced legal challenges: legal restrictions were placed on meetings in Jamaica in 1781, 1784, and 1788. Further restrictions were placed on Obeah practices in 1808, 1816, and again in 1826 and 1827. Legislative acts restricted Africans from preaching and teaching in their assemblies. In Haiti, Catholic priests taught in catechism classes that Vodun was from the devil, the *houngan* a servant of Satan, and their sacrifices sinful. Laws were passed to restrict dancing by Winti devotees. In Paramaribo, the faithful could hold only four ceremonies per year. Rastafarians suffered persecutions on several occasions. In 1960, Claudius Henry was arrested and charged with treason. In 1966, the police destroyed the Back-O-Wall compound, one of the slum areas of Kingston where many Rastas lived on the pretext that the destruction was part of a cleanup campaign, and in 1978, police removed some Rastas from Heroes Park in Kingston, Jamaica.

African-derived religions continue to face difficulties because of their practice of sacrifice. In a recent case, however, the U.S. Supreme Court ruled that prohibiting the offering of sacrifices violates the religious freedoms of ADR devotees. African-derived religions continue to grow because they are the celebrations of a world in which the power and benevolence of the gods continuously employ *ashe* to create and shape human destiny. ADR celebrate family, community, and the blessings of life, and offer ways to understand the world and to deal with adversity. These religions offer hope to their devotees that the gods can and do transform, and help make this complex world beautiful.

See also Africa, Idea of; Ancestor Worship; Communication of Ideas: Africa and Its Influence; Communitarianism in African Thought; Immortality and the Afterlife; Personhood in African Thought; Religion: Africa; Ritual: Religion.

BIBLIOGRAPHY

- Barrett, Leonard E. *The Rastafarians*. Boston: Beacon, 1997.
- Bascom, William. *Sixteen Cowries: Yoruba Divination from Africa to the New World*. Bloomington: Indiana University Press, 1980.
- Bastide, Roger. *The African Religions of Brazil: Toward a Sociology of the Interpretation of Civilizations*. Baltimore: Johns Hopkins University Press, 1978.
- Brandon, George. *Santería from Africa to the New World: The Dead Sell Memories*. Bloomington: Indiana University Press, 1993.
- Brown, David. "Toward an Ethnoaesthetics of Santería Ritual Arts: The Practice of Altar Making and Gift Exchange." In *Santería Aesthetics in Contemporary Latin American Art*, edited by Arturo Lindsay, 77–146. Washington, D.C.: Smithsonian Institution Press, 1996.
- Brown, Karen McCarthy. *Mama Lola: A Vodou Priestess in Brooklyn*. Berkeley: University of California Press, 1991.
- Chevannes, Barry. *Rastafari: Roots and Ideology*. Syracuse, N.Y.: Syracuse University Press, 1994.
- Deren, Maya. *Divine Horsemen: The Living Gods of Haiti*. London: Thames and Hudson, 1953.
- Desmangles, Leslie G. *The Faces of the Gods: Vodou and Roman Catholicism in Haiti*. Chapel Hill: University of North Carolina Press, 1993.
- Harding, Rachel E. *A Refuge in Thunder: Candomblé and Alternative Spaces of Blackness*. Bloomington: Indiana University Press, 2000.
- Herskovits, M. J. "The World View of an Urban Community: Paramaribo, Dutch Guiana." In *The New World Negro*, edited by Frances Herskovits, 267–320. Bloomington: Indiana University Press, 1966.
- Johnson-Hill, Jack A. *I-Sight: The World of Rastafari: An Interpretive Sociological Account of Rastafarian Ethics*. Methuen, N.J.: Scarecrow, 1995.
- Lindsay, Arturo, ed. *Santería Aesthetics in Contemporary Latin American Art*. Washington, D.C.: Smithsonian Institution Press, 1996.
- Mason, Michael Atwood. *Living Santería: Rituals and Experiences in an Afro-Cuban Religion*. Washington, D.C.: Smithsonian Institution Press, 2002.
- McDaniel, Lorna. *The Big Drum Ritual of Carriacou: Praisesongs in Rememory of Flight*. Gainesville: University of Florida Press, 1998.
- Métraux, Alfred. *Voodoo in Haiti*. New York: Schocken, 1978.
- Murphy, Joseph. *Santería: African Spirits in America*. Boston: Beacon, 1993.
- . *Working the Spirit: Ceremonies of the African Diaspora*. Boston: Beacon, 1994.
- Murrell, Nathaniel, William Spencer, and Adrian McFarlane, eds. *Chanting Down Babylon: The Rastafari Reader*. Philadelphia: Temple University Press, 1998.
- Omari, Mikelle Smith. *Bahian Candomblé from the Inside to the Outside: The Art and Ritual of Bahian Candomblé*. Monograph Series of the Museum of Cultural History, 24. Los Angeles: University of California Press, 1984.
- Ramos, Miguel Willie. "Afro-Cuban Orisha Worship." In *Santería Aesthetics in Contemporary Latin American Art*, edited by Arturo Lindsay, 51–76. Washington, D.C.: Smithsonian Institution Press, 1996.
- Simpson, George Eaton. *Black Religions in the New World*. New York: Columbia University Press, 1978.

- Taylor, Patrick, ed. *Nation Dance: Religion, Identity, and Cultural Difference in the Caribbean*. Bloomington: Indiana University Press, 2001.
- Thompson, Robert Farris. *Flash of the Spirit: African and Afro-American Art and Philosophy*. New York: Vintage, 1984.
- Verger, Pierre. "Rôle joué par l'état d'hébétéude au cours de l'initiation des novices aux cultes de orisha et vodun." *Bulletin de l'Institut fondamental d'Afrique noire, série B*, no. 16 (1954): 322–340.
- Voeks, Robert A. *The Sacred Leaves of Candomblé: African Magic, Medicine, and Religion in Brazil*. Austin: University of Texas Press, 1997.
- Walker, Sheila. *Ceremonial Spirit Possession in Africa and Afro-America*. Leiden: Brill, 1972.
- Wittkower, E. D. "Spirit Possession in Haitian Vodun Ceremonies." *Acta Psychotherapeutica et Psychosomatica*, no. 12 (1964).

Elias K. Bongmba

EAST AND SOUTHEAST ASIA

When speaking of religion in East and Southeast Asia, a series of unique problems arises. What the West views as religion in Asia might well pass as philosophy and vice versa. *The Harper Collins Dictionary of Philosophy* views religion as oscillating between two extremes:

total reference to supernaturalism (religion is the belief in and worship of a divine transcendent reality that creates and controls all things without deviation from its will); *total reference to humanistic ideals* (religion is any attempt to construct ideals and values toward which one can enthusiastically strive and with which one can regulate one's conduct). (Angeles, p. 262)

Hence, the philosophy of religion studies a variety of topics from existence of "god" and moral thought to the relationships between church and state, science and religion, and philosophy and religion. Geddes MacGregor explains that the expression "philosophy of religion" arises from the eighteenth-century Enlightenment.

So religion, which Hegel tended to see as a sort of "baby philosophy" using picture-imagery rather than intellectual understanding, called for philosophical inspection along with everything else and was indeed peculiarly deserving of such philosophical scrutiny since it was to be regarded as a sort of kindergarten philosophy. (pp. 483–484)

Julia Ching also struggles with the fuzzy borders of philosophy and religion. She writes:

In discussing the continuum between the heavenly (or cosmic-natural) and the human orders, we are also discussing a theme common to both religion and philosophy. . . . This happens because the lines of demarcation between religion and philosophy are not so clear in the Chinese tradition—the situation resembles that in Europe before the eighteenth century, that is before a

parting of the ways between philosophy and its erstwhile mentor, theology. (p. 8)

Ching tries to resolve this dilemma by use of both a history of religions and history of ideas approach.

Ninian Smart takes religion to a civilizational level with "philosophical" and "doctrinal" dimensions. The ultimate meanings of life are examples of the philosophical dimensions, while daily rituals are part of the doctrinal dimensions (p. 17). Likewise, Willard G. Oxtoby asks the following questions: "Are there not philosophies that share with religion the contemplation of ultimate reality? Do not both enterprises seek to map out the good that people should seek in their conduct?" (p. 454). Oxtoby sees philosophy as an individual intellectual endeavor alongside religion as a collective ritualized force. The Western world invented the word *religion* to correspond to Christianity through the Latin word *religio* (religion), which carried with it the idea of "piety," "faith," and "action" (p. 449). He concludes that religion is

a sense of power beyond the human, apprehended rationally as well as emotionally, appreciated corporately as well as individually, celebrated ritually and symbolically as well as discursively, transmitted as a tradition in conventionalized forms and formulations that offer people an interpretation of experience, a view of life and death, a guide to conduct and an orientation to meaning and purpose in the world. (p. 454)

Rather than a hierarchy between philosophy and religion, the East sees co-constitutive relationships. The Chinese concept of *yin-yang* stood in for a complex crossing of experiences that encompassed rituals of everyday life, ethical behavior, heavens and hells, birth and death ceremonies, ancestors, cosmologies, and ideas about nature, health, and society. Collectively, *yin-yang* served the function of both religion and philosophy. Hence, there could be a religion of philosophy or a philosophy of religion.

The way that *yin* and *yang* are connected is unique to East Asia. Unlike a Hegelian-inspired conflictual world of culminations and overcomings of antipodes, the East embraces mutually conditioning linked opposites that are harmonious in both matter and spirit. The polarities of *yin* and *yang* are fundamental to the relationships within and between Eastern religions/philosophies such as Confucianism, Daoism, and Buddhism. Although Confucianism and Daoism are indigenous to China, they reach throughout Korea into Japan and south into Vietnam. Likewise, Indian Buddhism traversed the Silk Roads in the first century to pass throughout China and Thailand into the Far East.

The Daoist Yin-Yang

The principles of *yin* and *yang* were associated with both the *Yijing* of the twenty-third century B.C.E. and Laozi, the sixth century B.C.E. Daoist philosopher. *Yin* is dark, *yang* is light, *yin* is night, *yang* is day, *yin* is cold, *yang* is hot. One *yin* and one *yang* make the Dao (*yiyin yiyang zhiwei dao*). The Chinese characters tell the tale: *yin* represents the constitution

of the moon while yang represents the constitution of the sun. They are eternal partners in a cosmological relationship that governs every action and event in life. Yin-yang is the clearest expression of an ancient Chinese life of equilibrium. This polar coupling had a profound impact on Confucius and Confucianism, especially in terms of virtues and their coexistence.

Laozi believed that the yin-yang balance was key to the workings of the universe. To be mutable like water was the path to longevity. A single drop of water can go where no army can—through a crack in a mighty wall. In *Dao de jing* (*The Book of the Way and the Book of Virtue*), the philosophy of Dao shines forth. The best leader is the one who lags behind; the best teacher is the one who does not try to instruct anyone. Following his own philosophy, Laozi departed from an overly administered city life for the quiet confines of a mountain retreat far away from the Confucian bureaucracy.

Zhuangzi, a follower of Laozi, explicated many Daoist principles in terms of parables. He embraced Laozi's principle of *wuwei* (nonaction): the best action is no action. Recounting the ebb and tide of life, Zhuangzi tells the story of a trip to the mountains. One day, he sees a gigantic tree with plush foliage. When a woodcutter passed up the tree, Zhuangzi asked why. The reply was that the tree had no use. Zhuangzi concluded that because of its uselessness, the tree could live. Later on, Zhuangzi stopped by a friend's home in the valley. The friend had two geese, one that cackled and one that did not. The friend instructed his son to kill and prepare the goose that did not cackle. The following day, Zhuangzi's students asked of him: "Yesterday, there was a tree on the mountain that gets to live out the years Heaven gave it because of its worthlessness. Now there's our host's goose that gets killed because of its worthlessness. What position would you take in such a case, Master?" (Watson, p. 209). Zhuangzi answers that he might stand halfway between worth and worthlessness: "climb up on the Way and its Virtues and go drifting and wandering, neither praised nor damned, now a dragon, now a snake, shifting with the times, never willing to hold to one course only" (Watson, p. 209). Zhuangzi extols a middle path: "Now up, now down, taking harmony for your measure, drifting and wandering with the ancestor of the ten thousand things, treating things as things but not letting them treat you as a thing—then how could you get into any trouble?" (Watson, p. 210). Following from Laozi and Zhuangzi is a distinction between philosophical and religious Daoism. The study of the classical texts of Daoism caught the court's eye in the Han dynasty, where the term *daojia* (philosophical Daoism) was first introduced. As an exemplar for political rule, philosophical Daoism emphasized following the Dao through both meditation and the union of thought and action. Although Confucianism was proclaimed the official religion/philosophy of the Han, Daoism became popular while leading the path to the development of *daojiao* (religious Daoism) that revered a deified Laozi. Religious Daoism strove for immortality through various practices including meditation, alchemy, breathing, and sexual practices. The intermingling of official classical religions and popular versions is an important point of convergence. Endymion Wilkinson writes:

To the extent that historians are concerned with questions of value and belief, they cannot afford to ignore the history of Chinese religion in all its many forms—popular or elite, public or private, formal or informal, common or esoteric, home-grown or imported, secret or open. (pp. 570–571)

The impact that Daoism had on both Confucianism and Buddhism should not be overlooked. In the Wei (220–265 C.E.) and Jin (265–420 C.E.) dynasties, Daoism emerged again through a melding of Confucian ideas. Daoism may also have paved the way for Buddhism coming into China, especially with its emphasis on meditation. Buddhist monks, Daoist priests, and Confucian masters flourished at Lushan (Lu Mountain). Their interactions were reciprocal, especially in popular forms.

Three Teachings Are One

In coping with the diverse interweaving of religious and philosophical traditions of both popular and court forms, China originated an amalgamated version called the "three teachings" of Confucianism, Daoism, and Buddhism. This combination filtered through the rest of East and Southeast Asia. In a most general description, Confucianism represented social order and good daily conduct, Daoism represented an ambivalent response to this structure with a focus on longevity, and Buddhism represented a meditative bliss that looked beyond the material world. Although Buddhism is alien to China, it mediated Confucian virtuousness and Daoist cosmology. Stemming from the basic Chinese trinity of heaven (*tian*) earth (*di*) and humanity (*rendao*), three becomes a crucial number. Human beings represent the number three as they stand between heaven and earth (*tiandi zhijian*). Han philosophers saw the first three dynasties of Xia, Shang, and Zhou as aligning with loyalty, respect, and refinement. Although Confucianism was often the official state religion, *sanjiao heyi* (the three teachings are one) became a popular expression throughout Chinese history. Wolfram Eberhard writes: "Confucianism is the religion of filial piety (*xiao*); popular Taoism has to do with the individual's position in the community, with whose ceremonial purification it is charged; finally, Buddhism is a way of looking at death and at the meaning of life in general" (p. 289).

The creative interpolation of Confucianism, Daoism, and Buddhism in the third to the seventh century found an uncanny revival in the eighteenth-century Qing dynasty, where inquisitive Manchu rulers allowed many religions to exist together. While Buddhism stood between Confucianism and Daoism in the first century, it also disappeared at various times. During the Six Dynasties, especially from 386–587 C.E., Confucian texts were interpreted through Daoism. This is the same time that several Mahayana (Greater Vehicle) Buddhist texts were translated into Chinese. While Daoism was accepted during the late Ming, it was rejected in the Qing in favor of Confucianism and Buddhism. Stephen Little argues that the first Ming emperor, Zhu Yuanzhang (ruled 1368–1398), dissuaded organized religion while promoting the unity of the three teachings: "This concept, namely that Confucianism, Taoism,

and Buddhism were different paths to the same goal, attained increased popularity during the Song [960–1279] and Jin [1115–1234] dynasties, although its roots can be traced to the Six Dynasties period [222–589]" (p. 27).

Modern China

With the influx of Western colonialism in East and Southeast Asia in the modern era, many Asian countries began to reject religions of any sort. Embracing Marxism, Mao Zedong (1893–1976) saw religion in general as an opiate of the people. It was a dangerous ideology that concealed the true relations of power within society. Ironically some see Marxist-Leninism and Mao Zedong thought as a type of "religious worldview" with rituals and sacred scriptures. Smart sees Mao as creating a new religion that "harnessed some of the emotions and thoughts of Daoism (the anarchism of Laozi, the alchemy of right commitment) and of Buddhism (the Pure Land, but here and now, and Mao as a celestial Buddha but right here in Beijing)" (p. 448). In the early 2000s, hundreds of thousands of Daoist and Buddhist temples that were gutted during the Cultural Revolution of the 1960s were rebuilt in rural China, which still houses 70 percent of the population. With the recent resurrection of the Taishan (Tai Mountain) Daoist temple system that incorporates Confucian morality ledgers and Buddhist hells, China is recovering fundamental elements of its religious-philosophical heritage.

Korea

The impact of Chinese religion was felt with full force in both Korea and Japan. Korea was under direct Chinese rule from 193 to 37 B.C.E. with an influence that persisted for centuries. Monks such as Wonhyo (617–686) and Uisang (625–702) were crucial to the establishment of Buddhism in Korea. In particular, Uisang had a reciprocal relationship on the Chinese Huayan (Flower Garland) monk Fazang. Korean shamanism blended with both Confucianism and Buddhism. Smart writes:

Korean thinkers also made important contributions to the debates of the Neo-Confucian tradition, especially in the sixteenth century, through the writings of Yi T'ogyey and Yi Yulgok. The former developed the thinking of Zhuxi arguing that the priority of principle to material force as ethical rather than ontological. Yi Yulgok argued for the determining character of material force and he objected to the notion that *li* [principle] is always unchanging and pure, since it and material force are correlatives. (p. 133)

These strongly ingrained traditional Confucian positions of the classical world were juxtaposed to the modern world with the Japanese invasion and the onslaught of Christian missionaries. During the Choson dynasty (seventeenth and eighteenth centuries) Korean Confucianism forbade Buddhism from entering the capital city, while the Korean court frowned upon Catholicism. After the Korean-Japanese treaty of 1876, Japanese Pure Land Buddhism and Nichiren came to Korea. The Japanese occupation of Korea in 1910 greatly altered the sense of traditional religions. Smart sees a division between "indi-

vidualistic religions" such as *Son (Zen)* Buddhism and Protestantism on one hand and traditional Confucianism on the other. A resulting political split would follow: individual religions tended toward democracy and traditional religions tended toward military dictatorship. Smart also sees this as a way of understanding the fracture between North Korea (traditional) and South Korea (individualistic).

With the popularity of evangelical Protestantism, South Korea saw the rise of Sun Myung Moon in 1954. Smart writes of the Unification Church:

Its tenets involve a reinterpretation of the Bible; loyalty to Mr. Moon as possibly—that is, if he fulfills his destiny—the new Messiah; a new system of marriage designed to unite members in a large Family of which Mr. Moon and his wife are the True Parents; and the hope of unifying the world and the world's religions in a single harmony (in combat however with Communism, which is seen as the present chief manifestation of evil in the world). (pp. 453–454)

Japan

The long history of Japanese religion held to the anchor of Shinto as a primitive system based upon *kami* (spirits) that inhabited every thing, person, or place. Somewhere between 538 and 552 C.E., Buddhism came into Japan. Prince Shotoku Taishi (574–622) solidified Japan's hold on Buddhism by commissioning scholars to return from China with Mahayana texts including the *Lotus Sutra*. Shotoku combined Confucian court ranking with the Three Jewels of Buddhism (the Buddha, the Dharma, the Sangha) and belief in *kami*. Although Japan mediated political relations with various forms of Buddhism, monastic-level Buddhism also flourished at various times. In the Nara period (710–784), Emperor Shomu ordered the construction of a bronze Buddha at Todaiji Temple in Nara to embellish the imperial capital. With a growing number of Buddhist sects developing in Japan, Buddhist monks came under close government control. Relaxing these laws, Emperor Kammu shifted the capital to Heian. Monks were encouraged to bring new Buddhisms from China in order to bless the new capital. During the Heian period (794–1185), Saicho (767–822) brought Tendai (Celestial Platform) Buddhism from China. As a Mahayana (Greater Vehicle) School, it focused on the *Lotus Sutra* as a source for obtaining buddhahood for all of humanity. Likewise, Kukai (774–835) brought *Shingon* (True Word) Buddhism from China. Appealing to the aristocracy, it emphasized magic and incantations while including *mandalas* (sacred diagrams) and *mantras* (sacred syllables). In the Kamakura period (1192–1333) and beyond, Zen Buddhism appealed to the samurai because of its discipline and meditative search for *satori* (awakening), while Pure Land became the religion of the peasants.

During the *Kokugaku* (national learning) movement in the Tokugawa Shogunate, scholars such as Motoori Norinaga (1730–1801) saw three distinct periods of Japanese religion: a primordial period of purity, a period tainted by foreigners, and a period of the resurrection of the ancient world. After *Chushingura* (the treasury of loyal retainers) in 1703, the stage

was set for the reemergence of Shinto as a state religion and the future restoration of the Meiji emperor. The Ako *ronin* avenged their fallen Lord Asano by killing Lord Kira. In doing so, they upheld the duty of samurai honor that appeared secondary in their minds to Tokugawa's law. Although punished by death, the forty-seven *ronin* motivated townsfolk and onlookers to evaluate seriously the balance of Confucian virtues: property, righteousness, and benevolence. During imperial Japan of World War II, both Shinto and Buddhism were revived as a component of *Bushido* (the way of the warrior), the most notorious wartime manifestation being the kamikaze (divine wind) suicide bombers.

After 1945, Buddhism returned somewhat to a more classical stance, largely through the efforts of thinkers such as Daisetz Suzuki (1870–1966). Alongside this, *Nichiren Shoshu* (followers of Nichiren) reemerged (from the thirteenth-century tradition) with the supreme goal of happiness. Stemming from this, the *Soka Gakkai* (value-creation society) emphasized world peace achieved through chanting and devotion to the *Lotus Sutra*.

Impact on Southeast Asia

Charles F. Keyes describes mainland Southeast Asia (Burma, Thailand, Laos, Cambodia, and Vietnam) as the “crossroad of religions” whereby “a large diversity of autochthonous tribal religions are intermingled with Hinduism, Theravada and Mahayana Buddhism, Taoism, Confucianism, Islam, and Christianity, as well as the modern secular faith of Marxist-Leninism” (p. 512). The complex blending of early primitive religious practices and those influenced by China over several centuries were reshaped by political change in the twentieth century.

Because of the Han conquest between 124 B.C.E. and 43 C.E., Vietnam looked to China for religious guidance with the influx of Confucianism, Daoism, and Buddhism. This influence remained long after Vietnam's independence from China in the eleventh century. Vietnam, Cambodia, and Thailand were shaped by Indian Hinduism and Buddhism up to the fifteenth century. Traditional tribal societies that relied on archaic rituals and Sino-Indian religions were slowly changed by Christian missionaries. As new agricultural systems emerged, adherence to folk culture began to wane.

According to James J. Fox, island cultures of Southeast Asia (Malaysia, the Philippines, and Java) were similarly influenced by Chinese and Indian traditions alongside Islam. In the late twentieth century, about 90 percent of Indonesia's population was Muslim, while the Philippines still were predominantly Catholic. Even in the early 2000s, the eclectic blend of religions focuses on a type of animism with the predominance of life force in every creature. In collectively describing the spirit of Southeast Asia, Fox writes:

Equally, the same spiritual premises may promote notions of achievement. A recurrent image of life involves the metaphor of the “journey of achievement.” Myths recount the founding journeys of the ancestors, folk tales extol the attainments of heroic journeys, and dreams and séances can take the form of a spiritual journey. Furthermore, many societies encourage a period of jour-

neying in early adulthood as a means of gaining knowledge, wealth, fame, and experience. (p. 526)

In the twentieth century, various religious movements emerged in the island cultures of Southeast Asia to address the effects of globalization on ancient cultures. James J. Peacock categorizes these movements into three groups: Hindu-Buddhism, Muslim, and Christian movements. For example, Budi Utomo (high endeavor) in Java and Bali sought to reestablish religious beliefs against a growing Western technology and value system that replaced traditional beliefs of Javanist-Hindu-Buddhists. As Peacock relates: “Looking to India's Rabindranath Tagore and Mohandas Gandhi as inspirations in the revival of these traditions, Budi Utomo was controlled by the aristocracy and intelligentsia and never gained a broad popular following, although it had amassed some ten thousand members within a year of its founding [1908]” (p. 527). Much more widespread, the Muslim movements ranged from Indonesia to Singapore, Malaysia, and the Philippines.

Because of the completion of the Suez Canal in 1870, many Asian Muslims were able to travel easily to Mecca in the Middle East. The reciprocal influence of modern interpretations of Islam led to the founding of the Kaum Muda (new faction). With emphasis on textual exegesis, this movement spread from Singapore to Indonesia. With this entrenchment, Christianity gained a strong foothold in the Philippines. Summarizing the complex political interconnections of religious groups, Peacock writes of the early 2000s: “In Indonesia, the Muslims have generally acted as an oppositional force complementing the government, while the Hindu-Buddhist streams have either fed into the Javanist-oriented national culture and government or provided personal fulfillment outside the governmental arena” (p. 529).

See also Chinese Thought; Christianity: Asia; Confucianism; Daoism; Japanese Philosophy, Japanese Thought; Philosophy of Religion.

BIBLIOGRAPHY

- Angeles, Peter A. *The HarperCollins Dictionary of Philosophy*. 2nd ed. New York: HarperPerennial, 1992.
- Ching, Julia. *Chinese Religions*. Maryknoll, N.Y.: Orbis, 1993.
- Eberhard, Wolfram. *A Dictionary of Chinese Symbols: Hidden Symbols in Chinese Life and Thought*. Translated by G. L. Campbell. London: Routledge and Kegan Paul, 1986.
- Fox, James J. “Southeast Asian Religions: Insular Cultures.” In *The Encyclopedia of Religion*, edited by Mircea Eliade, vol. 13. New York: Macmillan, 1987.
- Goulding, Jay. “‘Three Teachings Are One’: The Ethical Intertwinings of Buddhism, Confucianism, and Daoism.” In *The Examined Life: Chinese Perspectives: Essays on Chinese Ethical Traditions*, edited by Xinyan Jiang. Binghamton, N.Y.: Global Publications, Binghamton University, 2002.
- Keyes, Charles F. “Southeast Asian Religions: Mainland Cultures.” In *The Encyclopedia of Religion*, edited by Mircea Eliade, vol. 13. New York: Macmillan, 1987.
- Little, Stephen. “Taoism and the Arts of China.” In *Taoism and the Arts of China*, with Shawn Eichman. Chicago and Berkeley: The Art Institute of Chicago in association with University of California Press, 2000.

- MacGregor, Geddes. *Dictionary of Religion and Philosophy*. New York: Paragon, 1989.
- Oxtoby, Willard G., ed. *World Religions: Eastern Traditions*. 2nd ed. Toronto: Oxford University Press, 2002.
- Peacock, James L. "Southeast Asian Religions: Modern Movements in Insular Cultures." In *The Encyclopedia of Religion*, edited by Mircea Eliade, vol. 13. New York: Macmillan, 1987.
- Smart, Ninian. *The World's Religions*. 2nd ed. Cambridge, U.K.: Cambridge University Press, 1998.
- Watson, Burton, trans. *The Complete Works of Chuang Tzu*. New York: Columbia University Press, 1968.
- Wilkinson, Endymion. *Chinese History: A Manual*. Revised and enlarged. Cambridge, Mass.: Harvard University Asia Center, 2000.

Jay Goulding

INDIGENOUS PEOPLES' VIEW, SOUTH AMERICA

Unlike Western systems of worship, religious thought and action from South American indigenous perspectives pervade every aspect of existence. As cultural systems, indigenous South American religions encompass quotidian life and become especially salient at times of life crises and during festival and protest activity. With more than three hundred languages grouped into a dozen or more macro families, cultural, and hence religious, diversity is enormous. Such complexity and diversity are compounded by the fact that South American indigenous numinous systems are understudied and the underpinnings of history and archaeology are informative and provocative but inadequate. The European conquest and subsequent colonial era violently introduced hegemonic Roman Catholic Christianity with highly variable affects on indigenous sacrality. Nevertheless, commonalities exist. This entry offers indigenous perspectives on pools of religious elements that adhere and cluster in a multitude of cultural systems ranging across vastly different topographical and ecological zones and boundaries. All elements are not found everywhere, but systems of religious adhesions that constitute native thought and culture expressing ineffable, reverential dimensions of life, death, afterlife, and the cosmos do exist.

Conceptualizing Space-Times

The cherished Western dichotomy of space (as in geography) and time (as in history) must be set aside in any understanding of native South American religions in favor of a relativistic conceptualization of space-times. Space-times are ancient, historical, modern, futuristic, local, regional, diasporic, and global. They may exist simultaneously, as when beginning-times-places encompass the present time and people seek movement between the two through ritual activity, song, dance, performative drama, fighting, or political protest. Mythic space-time has many phases, typically including an initial stage in which the inchoate actions of sentient entities bring the earth worlds, sky worlds, and underworlds into being, as seen in the Maya Popol Vuh. Such beginnings may be punctuated with catastrophic fire or flood, out of which all things transform radically. Culture heroes emerge and undergo violent deaths, only to reappear, until finally the beginnings of ancestral times-places emerge in different locations.

According to Lawrence Sullivan, all space-times are framed between the Primordium, which includes the prebeginnings and beginnings of everything, and the Eschaton, wherein lies the end of the world, the collapse of the cosmos, and the formation of a new universe of existence. Such a cosmic brink is often portrayed by people in periodic ritual performances, which underline the spatial sense of the Primordium unfolding in the Center of the universe and the Eschaton existing at its edge.

In the cosmic Primordium separations occur, one after another: the separation of earth and sky and then night and day, where night and the moon come to signal disorder as opposed to day and the sun's east-west order. Then comes the differentiation of all species, including humans, then the differentiation of sex, the functions of blood and semen in fertility, fecundity, and danger therein, which leads to a transformation from primordial incest to regulations of sexual relationships and rules of endogamy and exogamy. Eventually one people become differentiated from another people, specificity of territories emerges with centers and peripheries. Cultural coherence emerges in the origins of war, origins of marriage, origins of trade, and systems of marriage-war-trade wherein individual bodies and collective bodies both abuse and venerate one another. A theme running through all of these transformations is that of consumption: who and what may and may not be consumed by whom and what becomes a system of numinous ineffability.

The Axis Mundi

The axis mundi—an imagined and often represented up-down orientation that extends from earth straight up into the sky worlds and straight down into the underworlds—is framed by a strong east-to-west orientation that occurs when the sun emerges out of primordial water on the edge of the earth to begin its journey over land, moving first northward to cross the apex of the vertical axis at the center, and then back westward, where it goes underwater at the other edge and travels southward and then eastward at night. The spatial representation of the axis together with the cardinal points of reference that radiate from its center are motivated by the daytime sun's temporal movement and the disorderly nighttime movement of the moon. The axis mundi is the center of the universe, constituted by a peoples' territory, village, house, body, and even fighting sticks, all of which are represented aesthetically as a dynamic, living, structure of, and in, particular times-places. The axis mundi is often manifest as a world tree or a tree-of-life that grows and branches, creates diversity of fruits and other beings that, when violently cut down, peppers the earth with its variety of life-giving plants, animals, and diverse human beings that transform eventually into today's people and their living environs. It is also represented as a ladder or stairway coming out of deep earth from underwater, and extended up into sky worlds. Severing of this ladder sets in train more events that eventuate in contemporary people and cosmos.

Indigenous historicity—what people take to be salient in their pasts—is intricately and inextricably bound to the landscape, which is itself a sacred and cosmic phenomenon embodying everything by which people identify as us and other. Shamans travel the routes of landscape and mythopoetic history. There they "see" what others can only know by direct or

vicarious experience. The shaman is “one who knows.” Both male and female shamans exist, though males predominate. All fully human beings, and some focal animals, have something of shamanic power in them, represented as their very own life force that gives meaning to cosmos, landscape, kin, enemies, home, and self. In South America, such focal animals include the anaconda of the water domain, the jaguar or puma of the earth domain, and harpy eagle or condor of the sky domain. Great powers abide in the sky, earth, water, and underearth and are concentrated in special places and objects. Control of these powers lies in the ability of the shaman (and in some areas past and present, a priest)—and counterparts to the shaman, such as artists, speakers, dancers, and ritual specialists—to move in and out of the world of spirits; to cure body, soul, and psyche; and to “see” the everyday world and the cosmos in aesthetic patterns communicated to others through ritual, art, design, speech, drama, poetics, rhythm, and song.

Shamans and Ritual

Focal shamanic characteristics include the ability to “come and go” from the spirit world and to move in and out of trance states, an ability to “see” the quotidian invisibilities, abilities to cure afflictions and to send afflictions to others. Hallucinogens are often (but not always) used by shamans and others to enhance their powers of ecstatic travel, curative gnosis, and harmful malignity. Prominent among these are soul vine (*ayahuasca*, *yajé*—*Banisteriopsis*) of Upper Amazonia, *Datura* (*Brugmansia*) of Amazonia, Andes, and Southern Cone, Hekura snuff or Yopo (*ebené*—*Anadenanthera*) from Western Amazonas, Epená (*Virolá*) of Northwest and Western Amazonas, and tobacco from all of Amazonia in Mesoamerica and the continental United States as well, a panoply of vision-inducing drugs, including tobacco, as well as fasting and other techniques, were used to achieve spiritual and corporeal transformations.

Concepts of souls and spirits are fundamental to indigenous perspectives on religion in South America. Humans have souls, and so do spirits, animals, plants, and inanimate substances. Also significant and animate are sacred sites such as trees, mountains, caves, waterfalls, cataracts, springs, and underground rivers. All communication necessitates knowledge of soul and spirit essences and substances. Ritual—a system of stylized behavior only partially encoded in indigenous exegesis and performance but discernible through time in indigenous historicity, shamanism, and discourse—is the primary vehicle of religious instantiation. Music, rhythm, poetry, and aesthetic imagery are all part and parcel of shamanic performative dramatic art. During indigenous ritual enactment the cosmology and cosmogony open up to include all peoples of the universe, living and dead, together with animal spirits and souls. Humans take on the roles of other people and other beings, collectively portraying the diversity of life and humanity within their individualities. During ritual activity harmony and acrimony are both enacted on various stages of drama that signal both order and chaos. Lawrence Sullivan places ritual activity in a eschatological category that he calls “diversionary activity” (or “entertainment”) and vividly summarizes the dramas of such activity: “*By turning primordial realities off to one side and historical existence off to another, diversionary enter-*

tainment rends chaos asunder and stretches open the distance between clashing times” (p. 681; italics in original).

European Contact

Beginning in 1492, under the epitomizing banner of Roman Catholic Christianity and Western wealth-production through the forced and violent acquisition, sale, and exploitation of indigenous and African labor to acquire gold, pearls, and spices, indigenous people were confronted not only with unrelenting demands on their bodies and their souls, but also subject to the sustained indignities of an Inquisitorial system that placed their sacred concepts and objects in league with the Christian devil. By the late twentieth century the “globalization of monopoly finance capitalist culture” (Hopkins, p. 8) ushered in an era of sustained indigenous rejection of neoliberalism, privatization, and deregulation.

In the face of conquest, inquisition, terror, slavery, oppression, relocation, reduction, population collapse, and a myriad of violent indignities, indigenous religious change from the fifteenth century through the present times-places is characterized by the fusing of ultimate cosmogonic contexts of the Primordium and Eschaton with the proximate contexts of political, economic, and cultural transformations. Changes in indigenous perspectives on religious phenomena in South America stem from the radical hegemony of the hyper-globalization of Iberian Catholic Church policies and practices syncretized with the Western god Mammon. More recently, North American fundamentalist Protestantism has sustained a Manichean cosmic competition with Roman Catholicism with similar effects.

Indigenous religious systems historically and in contemporary times take on strongly millenarian dynamics as people endeavor to right the universe and re-create a place for themselves in their own times—ancient, past, present, and future—and demarcated in their contemporary and ancestral landscapes. Sullivan writes: “In all the millennial movements . . . the earth is a primordial instrument of change as well as a cosmic object affected by alteration. . . . Eschatological ordeals and stylized performance transform human beings by allowing them to assume the mythic stature and heroic destiny formerly achieved by only a few after death” (pp. 613–614). Examples of indigenous millenarianism include nineteenth-century chiliastic movements in Amazonia, post-conquest movements to transform emerging Spanish society to imagined Incan systems in the Andes, movements by native people to bring a giant anaconda (corporeal beings such as Tupac Amaru or Tupac Katari) to overwhelm the Spanish structures of the Andes, and the emergence and persistence of “dark shamanic” predation on modernity in the Guianas. Contemporary movements in the twenty-first century include, especially, indigenous and Afro-Latin American movements in Ecuador that have recently resulted in the bloodless expulsion of two elected presidents and created a new system of emergent space-times in national politics.

Conclusion

In summary, religious thought and practice of South American indigenous people are rich and varied, but contain common elements that adhere to one another in recognizable configurations. A common history of extraordinary oppression,

violence, terror, and death has led to an intensification of ineffable cosmological and cosmogonic systems within which indigenous people communicate with one another across vastly different language systems. Indigenous perspectives on South American religion are at the same time a critical metacommentary on history and territoriality and a mechanism of sustained millennial transformation. That which appears to be “political” from Western standpoints comes to be revealed in indigenous numinous thought and praxis as sacred and reverential.

See also *Calendar; Ritual; Religion; Time: Traditional and Utilitarian.*

BIBLIOGRAPHY

- Conklin, Beth A. *Consuming Grief: Compassionate Cannibalism in an Amazonian Society*. Austin: University of Texas Press, 2001.
- Hill, Jonathan D. *Keepers of the Sacred Chants: The Poetics of Ritual Power in an Amazonian Society*. Tucson: University of Arizona Press, 1993.
- Hopkins, Dwight N. *The Religion of Globalization*. In *Religions / Globalizations: Theories and Cases*, edited by Dwight N. Hopkins et al., 7–32. Durham, N.C.: Duke University Press, 2001.
- Lambek, Michael, ed. *A Reader in the Anthropology of Religion*. Malden, Mass., and Oxford: Blackwell, 2002.
- MacCormack, Sabine. *Religion in the Andes: Vision and Imagination in Early Colonial Peru*. Princeton, N.J.: Princeton University Press, 1991.
- Reichel-Dolmatoff, Gerardo. *Amazonian Cosmos: The Sexual and Religious Symbolism of the Tukano Indians*. Chicago: University of Chicago Press, 1971.
- . *The Forest Within: The World-View of the Tukano Amazonian Indians*. Tulsa, Okla.: Council Oak Books, 1996.
- Saler, Benson. *Conceptualizing Religion: Immanent Anthropologists, Transcendent Natives, and Unbounded Categories*. Leiden, Netherlands, and New York: E. J. Brill, 1993.
- Schultes, Richard Evans, and Albert Hofmann. *Plants of the Gods: Origins of Hallucinogenic Use*. New York: McGraw-Hill, 1979.
- Sullivan, Lawrence E. *Icanchu's Drum: An Orientation to Meaning in South American Religions*. New York: Macmillan, 1988.
- Taussig, Michael. *Shamanism, Colonialism, and the Wildman: A Study in Terror and Healing*. Chicago: University of Chicago Press, 1987.
- Viveiros de Castro, Eduardo. *From the Enemy's Point of View: Humanity and Divinity in an Amazonian Society*. Translated by Catherine V. Howard. Chicago: University of Chicago Press, 1992.
- Whitehead, Neil L. *Dark Shamans: Kanaimà and the Poetics of Violent Death*. Durham, N.C.: Duke University Press, 2002.
- Whitehead, Neil L., ed. *Histories and Historicity in Amazonia*. Lincoln: University of Nebraska Press, 2003.
- Whitten, Norman E., Jr. “Historical and Mythical Evocations of Chthonic Power in South America.” In *Rethinking History and Myth: Indigenous Perspectives on the Past*, edited by Jonathan D. Hill, 282–307. Urbana: University of Illinois Press, 1988.
- . *Sicuanaga Runa: The Other Side of Development in Amazonian Ecuador*. Urbana: University of Illinois Press, 1985.
- . “Ultimate and Proximate Contexts of Cosmology and History in Dark Shamanic Cultural Performances.” *Journal for the Anthropology of Consciousness*. Forthcoming in 2004.
- , ed. *Millennial Ecuador: Critical Essays on Cultural Transformations and Social Dynamics*. Iowa City: University of Iowa Press, 2003.
- Whitten, Norman E., Jr., and Arlene Torres, eds. *Blackness in Latin America and the Caribbean: Social Dynamics and Cultural Transformations*. Bloomington: Indiana University Press, 1998.
- Wilbert, Johannes. *Mystic Endowment: Religious Ethnography of the Warao Indians*. Cambridge, Mass.: Harvard University Press, 1993.
- . *Tobacco and Shamanism in South America*. New Haven, Conn.: Yale University Press, 1987.
- Wright, Robin. *Cosmos, Self, and History in Baniwa Religion: For Those Unborn*. Austin: University of Texas Press, 1998.
- Wright, Robin, and Jonathan D. Hill. “History, Ritual, and Myth: 19th Century Millenarian Movements in the Northwest Amazon.” *Ethnohistory* 33 (1986): 31–54.

Norman E. Whitten Jr.

LATIN AMERICA

Religion is a system of beliefs that explains what happens in the world, justifies order, and (usually) prescribes certain behaviors. In Latin America, the Spanish and Portuguese imported and spread Catholicism, the predominant religion, starting with the voyages of Columbus in 1492. The belief in and practice of Christianity gradually replaced the native belief systems; at the beginning of the twenty-first century, Catholicism itself faced challenges from a new wave of proselytizing and conversion by several Protestant missionary groups operating in the region.

Before the Spanish arrived, tremendous religious diversity marked the region, but animistic, polytheistic, and ancestor worship systems predominated. In tribal societies, every man and woman might feel themselves to have some level of shamanic ability; in large, imperial complexes, there were elaborate systems of priests, temples, and religious specialists, including cloistered women such as the *acllas* of the Inca. Tribal hunter-gatherers found spiritual life in every living thing, while agriculturists often worshiped their ancestors at special tombs belonging to specific lineages. In the Andes, some groups mummified or otherwise preserved the dead so that their remains (or the representation of their remains) might take an active role in ritual observance. The living believed it was their duty to care for and reverence their ancestors, sacrificing to them in return for fertility and health.

Andean religion also included many aspects of geomancy, or the recognition of sacred places; throughout the Americas, buried offerings and astronomical alignments marked important places, whether temples, palaces, or naturally occurring mountain peaks or streams. In central Mexico under the Mexica (Aztecs or Nahuas, following James Lockhart, a scholar dedicated to their study), individual lineages had patron deities. Professional groups such as the merchants also revered specific gods.

Before the rise of the Mexica, Mesoamericans worshipped many different gods, with the rain god as one of the most important. With their rise to power, the Mexica began to call



Painting of Our Lady of Guadalupe, artist unknown. Catholicism, with its pantheon of saints, is the predominant religion of Latin America. Our Lady of Guadalupe, the Mexican incarnation of Mary, mother of Jesus, is an important figure to Latin Americans and the patron saint of the Americas. © THE ART ARCHIVE/PINACOTECA VIRREINEL MEXICO CITY/DAGLI ORTI

themselves the people of the sun and to encourage the worship of their own totemic deity, Huitzilpochtli, or the humming-bird on the left, whom they believed had led them from obscurity to greatness. Similarly, the Inca claimed to be the sons of the sun and daughters of the moon, making the imperial religion a form of ancestor worship. They promised that service to the Inca would bring to the vanquished, and those who joined the empire peacefully, protection and subsistence, especially in times of natural disaster or crisis.

Belief in and participation in their cults explained the creation of the dominant group and justified the domination of the dominated. The relationship between humans and the gods was often portrayed as one of mutual nurturance that could take benign form, as when the ancestors brought fertility to their descendants in return for offerings, or more frightening forms in which hungry deities preyed upon hapless humans. In Mesoamerica, long traditions of blood sacrifice to the gods could take the minor form of a few drops of blood from a

pierced earlobe sprinkled on a piece of paper or could reach the horrific extremes of the Mexica, who sacrificed hundreds and perhaps thousands of war captives in public ceremonies. According to the claims of the priests and warriors, these sacrifices were necessary to nourish the sun, and without them, the sun would cease to exist and the world would end. Because brave warriors were the preferred sacrificial victims, the Mexica expanded the empire and fought ritualistic wars (of flowers) to secure prisoners for sacrifice, a belief system that turned humans into tribute. By the arrival of the Spanish, both Mexica and Incas believed that their ruler was a divine successor of the sun and his government a reflection of supernatural will.

Catholic priests accompanied the conquerors and explorers and began the task of conversion. Orders such as the Franciscans and Jesuits established missions on the frontiers. The acceptance of the new faith meant a repudiation of the native belief systems and identities. It involved learning a new language, moral code, religious pageantry, and folkways. Despite some sincere efforts to teach Christianity to the native population, progress was slow. Conversion became more complicated as large numbers of black slaves were imported to work in domestic service, on plantations, and in mining. They came from various African groups or tribes, each with its own language and religious traditions. Over the years, close interaction between natives and Africans and their offspring, all affected to a greater or lesser extent by Catholic doctrines, led to religious syncretism. The fusion of beliefs and rituals gave rise to distinct religions, such as Voudou, Santeria, and Rastafarianism, that continue to be practiced in the early twenty-first century.

The Catholic Church, however, played a large role in colonial life. Because the colonial administration was weak, the church became an important partner in governing. Its roles included educating the youth, especially males and sons of the native nobility; organizing charitable institutions such as hospitals; keeping vital statistics on baptisms, marriages, and deaths; communicating important messages to the populace from the crown and its representatives; and banking—lending capital to property owners for investment and conspicuous consumption. It became a rich and influential institution, despite intrachurch struggles between the secular clergy and the regular orders over mission fields and politics.

After independence was won from Spain, the creole elite split into conservatives and liberals. One of the issues of contention was the status of the Catholic Church. The liberals wanted religious toleration and secularization of some of the church's roles. The conservatives wanted Catholicism to be the official and—in some times, places, and among certain groups—the only religion. In Mexico, conflict over the issue resulted in war and, indirectly, foreign intervention. Tolerance eventually became the order, and new groups with other religions established themselves.

In the twentieth and twenty-first centuries, the dominance of the Catholic Church has been challenged. Starting in the second half of the twentieth century, liberation theology, an interpretation of the Bible meant to portray Christ as a social activist and empower the poor, threatened the conservative clerical power structure. A second, even greater threat was the

proliferating numbers of non-Catholic groups growing in size and importance. In the cities there were sizeable groups of Jews and Muslims. But Protestant evangelical groups such as the Pentecostals (which experts proclaimed the largest and fastest growing denomination) vastly outnumbered these. Membership of these groups grew from 200,000 in the 1920s to more than 50 million at the beginning of the twenty-first century.

By the year 2050, some predict, the majority of Latin Americans will be Protestants. In countries such as Guatemala and Brazil, the population was 30 percent Protestant in the early twenty-first century, with membership growing at more than 7 percent per year. Some of the reasons given for this phenomenal rate of growth are the use of radios and television to spread the word, the emphasis on family, and help in finding work and raising the standard of living.

See also Animism; Extirpation; Liberation Theology; Religion: Indigenous Peoples' View, South America.

BIBLIOGRAPHY

- Katz, Friedrich. *The Ancient American Civilizations*. Translated by K. M. Lois Simpson. New York: Praeger, 1972.
- Ricard, Robert. *The Spiritual Conquest of Mexico: An Essay on the Apostolate and the Evangelizing Methods of the Mendicant Orders in New Spain, 1523–1572*. Berkeley: University of California Press, 1966.
- Schwaller, John Frederick. *The Church and Clergy in Sixteenth-Century Mexico*. Albuquerque: University of New Mexico Press, 1987.

Susan Elizabeth Ramirez

MIDDLE EAST

This surveys the religious traditions of the Middle East from the seventh century C.E., with limited attention to earlier developments. By the seventh century the Middle East had largely accepted monotheism in its Jewish, Christian, or Iranian form. This involved the worship of one God, who has created and sustains the universe but is separate from it, and a more or less forceful rejection of other gods. This God is symbolized in male terms and is very much concerned with human moral activities, which he will reward or punish in the afterlife.

Islam: Beginnings and Basic Teachings

The Arabian peninsula was one of the last places to accept monotheism, and it did so in a distinctive form that was to dominate the Middle East thereafter. From about 610 until 632 Muhammad, a caravan merchant in Mecca, received verbal messages that he and his followers understood to come from God and that were collected together to form the Koran, the Muslim scripture. The Koran is considered to be the verbatim word of God, but only in the original Arabic language. Muhammad was rebuffed by the leaders of Mecca and, in 622, migrated with his followers to a nearby city thenceforth known as Medina. From here he conducted a campaign involving some fighting and much political maneuvering,

which led to his victorious return to Mecca in 630 and the acceptance of his religion and leadership by the Meccans. His immediate successors effectively moved forth to conquer the neighboring lands, establishing in the course of a century an empire extending from Spain in the west to central Asia in the north to the Indus River in the east. While they established their political rule quickly, it was several centuries in most places before the majority of the conquered peoples embraced their religion.

This religion is called Islam, meaning “submission to God,” and its adherents are Muslims, or submitters. Its key doctrines are summed up the words “No god but God (Allah); Muhammad is the Messenger of God.” The recognition of other divine beings alongside God is called *shirk* and is strongly rejected. Muhammad is understood to be the last of a series of prophets sent by God to humans, beginning with Adam and including biblical figures such as Nuh (Noah), Ibrahim (Abraham), Musa (Moses), and ‘Isa (Jesus). These prophets had missions limited in time and place, and their messages have been lost or altered. Muhammad’s mission, by contrast, is universal, and his message has been faithfully preserved. Jews and Christian are viewed as “people of the scripture” (that is, previous scriptures), having genuinely based but inferior religions. They were granted the status of *dhimmis* (“protected peoples”), having what might be called “second-class citizenship” in Muslim society. In practice, their situation varied with circumstances, and other groups, such as Zoroastrians, were also often granted similar status.

Islam: Sunnis, Kharijites, and Shiites

The main divisions among Muslims are based on differing views of the political succession to Muhammad. In the Sunni view the first four caliphs (successors) were legitimately chosen by the community and were the best rulers the community has ever had. With the coming of the Umayyad dynasty, the moral level declined and rulers were sometimes corrupt, but they were usually to be accepted since the dangers of revolt were a greater evil. The Umayyad (661–750) and Abbasid (750–1258) dynasties are generally recognized by Sunnis as true caliphs. In more recent centuries the Ottoman rulers up to 1924 gained wide recognition as caliphs.

The Kharijites held that major sins disqualified a ruler, often seeking to enforce this view by violent revolts. These revolts failed, but the Kharijites contributed to Muslim theological thinking, and small groups of them continue to the present. Modern Islamic radicals have similarities to the Kharijites and are often labeled as such by their opponents.

In the Shiite view Muhammad had chosen his son-in-law and cousin, ‘Ali, as his successor, but the majority passed him over three times. When he finally became caliph (fourth in the Sunni reckoning), he could not stem the moral decline and was soon murdered. After this, his rightful successors, all descendants of his, never ruled although they taught their followers. His second successor, Husayn, led a small army in revolt against the Umayyads and was killed at Karbala’, in Iraq. The commemoration of his martyrdom has come to include emotional and dramatic rituals, and he has become an effective model for revolutionary action since the 1970s, especially

in Iran. The largest group of Shiites, the Twelvers, recognize a line of twelve legitimate rulers, or imams, of whom the last disappeared about 874 and is expected to return in the future as the Imam Mahdi to bring just government to Earth. Sunnis also have the idea of the Mahdi as an ideal ruler, but not necessarily in the line of 'Ali, and conceptions vary considerably.

Another group of Shiites, the Seveners or Ismaili, accept a line of imams that diverges from that of the Twelvers at the seventh imam and continues with imams who are sometimes visible and sometimes hidden. Of the various subdivisions of the Ismailis, the best known in the early twenty-first century are the followers of the Aga Khan. The Ismailis constituted a significant revolutionary movement from the eleventh to the thirteenth centuries and became known to Westerners as the Assassins.

Another group of Shiites is the Zaydis, whose line of imams diverges with the fifth. Of all Shiites, the Zaydis are the closest to the Sunnis in their ideas and practices. A Zaydi imam ruled Yemen from 901 to 1961.

Islamic Law, Theology, and Philosophy

The primary concern of Muslim religious thinking has been the elaboration of the rules for living, including social and political life. The key concept here has been *shari'a*, the "path" God has laid out for believers to follow, involving the moral evaluation of actions as "obligatory," "recommended," "permitted," "discouraged," and "forbidden." The details of this are worked out in *fiqh* (literally "understanding") by qualified scholars, or ulema. The authoritative sources are the Koran and the sunna (the words and deeds of Muhammad, usually understood as protected from error; for Shiites the words and deeds of the imams are included), and the ulema engage in effort, *ijtihad*, to derive from these sources rules for particular situations. The Sunni view has generally been that whenever they come to a consensus on some issue, this is binding on future generations. Among Sunnis several traditions or "schools" of *fiqh* developed, of which four survive into the twenty-first century, the Hanafi, Maliki, Shafi'i, and Hanbali. Although there have been tensions among them in the past, they are now mutually recognized and in principle a Muslim should follow one of them. Twelver Shiites give less weight to consensus, and the currently dominant form of Twelver *fiqh* stresses the need to follow a living *mujtahid* (one qualified to practice *ijtihad*), or ayatollah. As a result, some ulema acquire a following and have considerable influence. While *fiqh* in principle covers all areas of life, in practice some areas have been more elaborated than others, and the degree to which *fiqh* is applied in practice has varied considerably with time and place.

Theology (kalam) in Islam arose, in a considerable measure, out of the challenge of Greek philosophy, which was still very much alive in a Christianized form in the areas the Muslims had conquered. The first major school of kalam was the Mu'tazila, who appear to have been influenced by disputations held with Jewish, Christian, and other scholars. Among their better-known views is the claim that the Koran is created and that humans have free will. Al-Ash'ari (873–935) used their ra-

tional methods to uphold the uncreated nature of the Koran and divine determination. Another school, that of al-Maturidi, was similar but somewhat less extreme on the last point. Over against all of these, the Hanbalis largely rejected the venture of kalam as an inappropriate probing into the divine. An attempt to impose Mu'tazilism as orthodoxy in the ninth century backfired and the Mu'tazila lost ground among Sunnis, though their ideas continued to be influential among Shiites.

Kalam sought to use reason to interpret revelation, but the philosophers sought to build on reason alone and saw themselves in the line of Plato and Aristotle. For them reason gave the purest knowledge but was only for an elite; revelation provided the same basic knowledge in symbolic and concrete form for ordinary people. The greatest of the philosophers was Avicenna (Ibn Sina; 980–1037), who developed a system designed to incorporate all experience and knowledge, from the physical to the psychological to the spiritual. For him reason at its highest level is a divine faculty that leads us to the vision of the divine. The more spiritual side of Avicenna was later developed in Iran into a kind of philosophical mysticism known as *irfan*, whose greatest proponent was Mulla Sadra (d. 1641), and which continues very much alive in the early 2000s. Conceptions drawn from philosophy are also central to the teachings of the Ismailis and most of the esoteric groups mentioned below.

More important than kalam or philosophy has been the Sufi movement. From the early centuries individuals such as Rabi'a al-Adawiya (d. 810), Abu Yazid Bistami (d. 874), and al-Hallaj (857/858–922) sought a more direct contact with God and expressed this in sometimes unconventional ways. From about the thirteenth century this developed into large-scale movements, *turuq* ("orders"), which provided spiritual and moral guidance and distinctive rituals (*dhikr*) designed to produce ecstasy. Later Sufi theoreticians made considerable use of philosophical concepts to express their views and experiences. The greatest of these was Ibn al-'Arabi (1165–1240), known for his doctrine of the "unity of being" (*wahdat al-wujud*) in which the Names of God correlate with the visible world in a kind of mutual dependence via a spiritual realm of prototypes.

Smaller Esoteric Groups Connected with Islam

There are a number of smaller groups, many derived from Shiism, whose teachings and practices are quite distinctive, whose full doctrines are often known only to an elite, and who are quite tightly organized and often do not accept converts. They are often considered non-Muslims by others and have often suffered persecution.

The Druze believe that God is beyond description and that the Ismaili ruler of Egypt, al-Hakim, who died or disappeared in 1021, was his final earthly manifestation. They also believe that human souls transmigrate. The Druze live primarily in Lebanon, where they have played a strong political role.

The 'Alawis (or Nusayris) in Syria and the Alevi in Turkey are quite distinct groups, but both recognize 'Ali as the highest manifestation of the divine. The 'Alawis follow the teachings of Ibn Nusayr (ninth century) and believe in transmigration. The Alevi in Turkey derive from the Shiite Safavid

movement in the sixteenth century and are closely connected to the Bektashi Sufi order. They suffered considerable persecution under the Ottomans.

The Yazidis, a Kurdish sect dating from the twelfth century, believe in a creator God who has delegated the running of the world to seven angels, of which the chief is Malak Ta'us (Peacock Angel), said to have once rebelled against God but repented. This may be the reason they are called "devil worshippers" by outsiders. They believe themselves to have been created in a manner different from other humans, and they believe in reincarnation.

The Ahl-i Haqq, also Kurdish, believe in seven manifestations of divinity, of whom 'Ali was the second and Sultan Sohak (fifteenth century?) was the last. They also believe in reincarnation, in which those souls capable of it will be purified.

The Baha'i movement developed out of Iranian Shiism in the nineteenth century. Baha' Ullah (1817–1892) claimed to be a new prophet for the present age and produced a scripture, *Kitab al-aqdas* (Most holy book), thus moving out of the Islamic orbit and presenting a new religion. Teaching that prophecy has not ended but that each age has its prophet, the movement has stressed its "ecumenical" dimension arising out of its recognition of all the previous prophets and has emphasized human unity. It has gained a considerable following worldwide, as well as still having a significant following in Iran, where it has suffered persecution, especially since the Islamic revolution.

Iranian Movements: Zoroastrianism and Manichaeism

Zoroastrianism looks back to the Iranian prophet Zarathushtra, who may have lived anywhere from 1500 to 500 B.C.E. Central to its view is a cosmic struggle between good and evil in which humans are called to participate. Ahura Mazda (later Ormazd), the creator of the universe, chose the good, while the evil spirit, Angra Mainyu (later Ahriman) chose the evil. These two are both primordial, but Ormazd will defeat Ahriman at the end of time. Its highly developed conceptions of spiritual beings and its eschatology probably influenced Jewish thinking in the later centuries B.C.E. It uses fire as its central symbol, so that the Muslims called the Zoroastrians "fire worshippers." In the third century C.E. Zoroastrianism was reorganized as the state religion of the Sassanian dynasty. After the Muslim conquest, most Iranians became Muslims, but Zoroastrian activity remained vigorous for some time. A small Zoroastrian community continues to exist in Iran and a larger one in India (the Parsis).

The Manichaean movement was founded by Mani (216–277?) and has an extremely dualistic view in which the material world is the realm of evil and darkness. Particles from the world of light have been captured and imprisoned in matter, and knowledge (gnosis) and highly ascetic practices are designed to free them and return them to their heavenly home. The movement spread widely and was strong for some centuries, being the official religion of the Uighur state in central

Asia from 763 to 840. It was severely persecuted by both Christians and Muslims and died out by about the twelfth century.

The Mandaeans, located mainly in southern Iraq, are an ancient Gnostic sect, claiming John the Baptist as their prophet at least since Islamic times. They practice frequent ritual immersions (baptism).

Judaism

By the seventh century most Jews lived outside the land of Israel, a situation experienced as *galut* (exile, alienation) and one that was to be ended only with the advent of the Messiah. In the meantime, they were to live by Torah, a term that in its narrowest sense refers to the first five books of the Bible but in its broadest sense to all authoritative teaching, and in particular by halakah, the practical part of Torah (similar to *shari'a* among Muslims). The main authority, apart from the Bible, was the Babylonian Talmud (completed about 700), a wide-ranging collection of laws, discussions, and commentary. The authority of the Talmud was rejected by the Karaites in the eighth century, and they became a minority sect, surviving in small numbers into modern times.

As *dhimmi*s under Islamic rule, Jews sometimes suffered but often prospered, and many of them participated significantly in the high culture of the Islamic world. This participation included a notable philosophical movement whose greatest representative was Moses ben Maimon (Maimonides; 1135–1204), who was also physician to the vizier of Saladin, then ruler of Egypt. An esoteric mystical movement, the Kabbalah, was very influential from the fourteenth to the eighteenth centuries. Outbursts of messianic fervor occurred from time to time, of which the most tragic was that of Shabbetai Zvi (1626–1676), whose messianic pretensions ended with his conversion to Islam. By this time the cultural and religious leadership of Judaism had largely shifted to Europe.

Christianity

By the seventh century much of the Middle East was ruled by the Christian Byzantine Empire, Armenia was Christian, and there were many Christians in Iran and central Asia. Most of these Christians came under Muslim rule in the seventh century, although the Byzantine Empire did not finally succumb until the fifteenth century. These areas eventually became predominantly Muslim, but Christian communities continued to exist down to the twenty-first century. Many Arab Christians are "Greek" Orthodox or Melchite, continuing the Byzantine tradition, accepting the Nicene and Chalcedonian Creeds and recognizing the seven ecumenical councils, of which the last was at Nicaea in 787. The last of the great Orthodox Fathers, John of Damascus (c. 675–749), lived under Muslim rule and wrote a treatise against Islam. There are four Orthodox patriarchates in the Middle East, those of Constantinople, which has precedence of honor, Alexandria, Antioch (now based in Damascus), and Jerusalem. The latter three are mainly Arabic speaking, and that of Antioch has the largest following.

Several Middle Eastern churches rejected the Chalcedonian formula of the “two natures” of Christ, speaking rather of one “divine-human nature,” and are often called Monophysite (“one nature”). These include the Armenian and the Syrian Orthodox (Jacobite) Churches, as well as the Coptic Church of Egypt and Ethiopia. The Syrians and the Egyptian Copts suffered considerable persecution under the Byzantines and at first welcomed Muslim rule. The Syrian Church continued quite strong through the fourteenth century. The Coptic Church enshrines a strong sense of Egyptian ethnic identity and is characterized by an ascetic and monastic spirituality as well as a veneration for its ancient martyrs. In the early twenty-first century about 10 percent of Egyptians are Copts.

The Nestorian Church, also non-Chalcedonian, was particularly strong in Iraq and eastward into central Asia beyond the Muslim empire. Nestorian scholars were among the main translators of Greek philosophy into Arabic. Many of the Mongols, who devastated much of the Middle East and sacked Baghdad in 1258, were Nestorians, but after the Mongols converted to Islam at the end of the thirteenth century, the Nestorian Church declined rapidly. In the twenty-first century the small Nestorian community in Iraq calls itself “Assyrian.”

Europeans attempted to impose their form of Christianity and their rule in the Crusades, ultimately unsuccessfully and with often disastrous results for local Christians. They received support, however, from the Maronite Church of Lebanon, which dates from about the seventh century and which eventually adhered to the Roman Catholic Church, while retaining many of its distinctive practices. In recent centuries groups from other Eastern churches, known as Uniates, have also adhered to Rome while retaining many of their distinctive practices. Since the nineteenth century, Protestant missionary efforts have resulted in the establishment of small Protestant communities in many Middle Eastern countries.

Modern Developments

European imperialism in the nineteenth and twentieth centuries has had a considerable effect on religion as on other aspects of life in the Middle East. For Muslims it has created a crisis that is at once spiritual and political. Muslims have tended to assume that since they had the true religion, God would grant their community material and moral success, and for a thousand years history largely supported this perception. The European success has challenged this perception, and the effort to meet this challenge has given rise to a series of reform efforts. Some seek to limit and control the influence of religion on society in order to clear the way for modernizing (effectively Westernizing) reforms, usually arguing that their reforms are consistent with a properly understood Islam. These reformers have usually adopted a nationalist ideology in which Islam may figure as a subordinate aspect. The best known of these was Atatürk, whose reforms in Turkey included an explicit rejection of *shari'a* law. Another radical nationalism is that of the Ba'ath Party in Syria and Iraq. This approach is called “secularism,” and many Middle Eastern governments are more or less secular. At the other extreme are those who insist on an

even more stringent application of the *shari'a* than was generally true in earlier times and who strongly reject Western culture and values while accepting Western material technology. This position is diversely called Islamic radicalism, Islamism, or Fundamentalism. The Islamic Republic of Iran and the Taliban regime in Afghanistan are prominent but quite different examples. Osama bin Laden and those like him are exceptionally extreme Islamists.

The situation of the Jews in the Middle East changed dramatically in the course of the twentieth century, largely as a result of events in Europe. European Zionists, many of them antireligious, sought to establish a national home in what was then Ottoman-ruled Palestine. The Nazi Holocaust confirmed in many minds the necessity of this. The State of Israel was established in 1948 by European Jews, but most Middle Eastern Jews soon moved there. This has in a large degree shifted the Jewish focus back to the Middle East and shifted the image of Jews from a weak and persecuted to a strong and self-reliant people. Unfortunately the displacement of Arab Palestinians has led to continual conflict and exacerbated tensions in the area. It has increased Muslim antagonism toward Jews generally.

The situation of the smaller groups has varied considerably. Christians often welcomed and sought to benefit from European imperialism or, at least, were quicker than Muslims to take advantage of the educational opportunities offered by the missionaries and others. Traditional church leaders, however, often saw a threat in the missionaries. Arab nationalism took hold first among Christians, and Marxism has appealed more to the Christians than to the Muslims. Helped by a French connection, the Maronites have had a strong position in Lebanese politics. The esoteric groups have fared variously. The Druze have formed an effective political bloc in Lebanon and have been inclined to identify ideologically with Arab nationalism. The Alawis have accepted the Ba'ath version of Arab nationalism and have effectively been in power in Syria since about 1970. The Alevis in Turkey supported Atatürk and have inclined toward secular left-wing politics. Since the 1980s, they have staged a considerable cultural revival. Whether among secularists or Islamists, modern conditions have tended to politicize religious divisions. Virtually all of the groups here considered have experienced considerable out-migration to Western countries, and these diasporas influence the home-country groups in various ways.

See also Christianity: Overview; Death and Afterlife, Islamic Understanding of; Islam; Judaism; Manichaeism; Millenarianism: Islamic; Mysticism: Islamic Mysticism; Mysticism: Kabbalah; Philosophies: Islamic; Religion and the State: Middle East.

BIBLIOGRAPHY

- Atiya, Aziz S. *A History of Eastern Christianity*. Enlarged and updated. Millwood, N.Y.: Kraus, 1980.
- Cook, Michael. *Muhammad*. Oxford: Oxford University Press, 1983.
- Denny, Frederick Mathewson. *An Introduction to Islam*. New York: Macmillan, 1985.

- Eliade, Mircea, ed. *The Encyclopedia of Religion*. 16 vols. New York: Macmillan, 1987–.
- Gibb, H. A. R., et al., eds. *Encyclopedia of Islam*. New ed. 11 vols. Leiden: Brill, 1960–.
- Hodgson, Marshall G. S. *The Venture of Islam*. 3 vols. Chicago: Chicago University Press, 1974.
- Lapidus, Ira M. *A History of Islamic Societies*. 2nd ed. Cambridge, U.K.: Cambridge University Press, 2002.
- Momen, Moojan. *An Introduction to Shi'i Islam*. New Haven, Conn.: Yale University Press, 1985.
- Neusner, Jacob. *The Way of Torah*. 6th ed. Belmont, Calif.: Wadsworth, 1997.
- Voll, John Obert. *Islam: Continuity and Change in the Modern World*. 2nd ed. Syracuse, N.Y.: Syracuse University Press, 1994.

William E. Shepard

RELIGION AND SCIENCE. Almost every culture in human history has had a religious framework. Almost every religion offers some form of cosmology, some account of the origin of the world and of humanity, and some sort of *scientia*, some wisdom about how to relate to the world.

The reason why the interaction of religion and science has been of such interest since the mid–nineteenth century is that modern Western sciences, as they have developed from the seventeenth century on, seem to have dispensed with the underlying religious basis out of which they grew (which was largely that of Christianity). So this article will concentrate on the interaction between modern Western sciences and theology, predominantly Christian theology, while acknowledging that there have been other very important interactions—for example, between the medieval sciences and Islam and Judaism, and between Chinese medicine and Daoism.

Historical Review: Galileo and Darwin

The history of the science-religion debate is often told by means of two famous test cases: the Italian mathematician Galileo Galilei (1564–1642) and his interaction with the Roman Catholic Church, and the English naturalist Charles Darwin (1809–1882), whose ideas led to controversies with various (mainly Protestant) theologians. Two cases do not make a history, and John Brooke's work has shown how diverse and particular are the interactions of different sciences with different patterns of religious thought. However, the two cases are highly significant.

Galileo made advances in many areas of mathematics, science, and technology. He is most famous for his adoption of a sun-centered model of the solar system at a time when the church taught that the Earth was the center of the universe. His defense of the sun-centered model, first developed by Copernicus (1473–1543), led ultimately to Galileo being placed under house arrest by the Catholic Church. It is important to recognize, however, that the church was not separate from science but a great sponsor of scientific exploration, and that Galileo was himself a believer and cared passionately about the interpretation of Scripture as well as about the truths of physics. Political and personal tensions played a large part in his denunciation.

The “Galileo affair,” then, was not a simple case of the church suppressing free enquiry by a devoted scientist. Galileo's significance is somewhat different. First, in retrospect religious authorities could see that prevailing theories of the cosmos might undergo gradual change and that this process was one they could not control. Second, Galileo's thought set the tone for the development of physical science from that point. He saw that science would be most effective if it concentrated on measurable quantities and reproducible effects; he also saw that observations of a ball sliding down a slope—a testable, quantifiable system—could be applied to more remote problems such as planetary orbits. Galileo's thought therefore anticipated the massively successful mechanics of Isaac Newton (1642–1727) and the impression Newton's work gave of a mechanical universe, resembling a giant clock. In such a picture of the cosmos, the role of a deity might be restricted (though Newton would not himself have accepted this) to that of the maker and initial winder of the clock.

The thought of Galileo therefore helped to shape not only the particular sciences he studied but the whole scientific method. Modern science has focused very effectively on the reproducible and measurable and on understanding complex systems through simple models. It has rigorously avoided explanations involving a creator with purposes for the creation. However, the sciences do rest on faith commitments. Particularly important is the belief that the universe is ordered and consistent, such that the same laws operate in complex systems remote in time or space from the experimenter—in the center, for example, of a distant star—as operate in model systems.

It has often been argued that the Christian thought-world was particularly propitious to the development of this faith commitment because that thought-world not only emphasized the cosmos as a rational place, created by God through rational commands, but also stressed the distinction between God and the world. A strong motivation among many of those who developed the natural sciences was the desire to investigate the world to see how the creator had designed it. This exploration of “natural theology” went hand in hand with the development of physics and chemistry, especially in England between 1650 and 1800. But the exploration was only made conceivable by the conviction that the world was not in itself sacred. The relationship between physical science and Christian theology (at least in England) in the second half of the seventeenth century has been described as “almost a rapturous love affair.” However, the success and reach of the sciences grew in parallel with developments in Enlightenment thought that enabled thinkers to question the authority of traditional religious teaching. Moreover, previously unexplained phenomena that had been considered “acts of God” turned out to obey scientific laws. Where God's activity had been inserted to plug a “gap” in scientific accounts, gap after gap tended to close, and those studying the clockworklike Newtonian universe found it easier and easier to dispense with talk of the clock maker. Those who resisted this mechanistic worldview, such as proponents of *Naturphilosophie* in Germany, tended to part company with mainstream scientific thought.

In a sense, the process by which theological explanations lost their authority and their partnership with scientific theories reached its climax in the disputes over the thought of Charles Darwin. Very careful observations of the natural world, coupled with consideration of artificial breeding methods and restrictions on population sizes, had led Darwin to his theory of evolution by natural selection: variations occurred at random in biological organisms, and environmental pressures and competition with other organisms “selected” the variants that survived to reproduce themselves. As in the case of Galileo, theologians and scientists alike were divided as to the correctness of these new proposals. Many theologians celebrated Darwin’s theory of “descent with modification” as a sign of God making a world that could make itself. Others resisted Darwinism on the grounds that it eliminated the need for a divine role in the design of individual creatures, and by implication also abolished the distinctiveness of human beings. Evolutionary theory seems to dispense with the need for any sort of “watchmaker,” any sort of rational designer to design the mechanisms of living things. These nineteenth-century Darwinian controversies shaped not only the course but also the nature of modern science because they aided the shift away from the “gentleman amateur” scientist (often a clergyman) to the professionalized model we know today.

Philosophical Considerations

Two branches of philosophy are central to the analysis of the relationship between religion and science. The first is ontology, the study of what reality is, and the second is epistemology, the study of how humans can know anything about reality. However, there is huge disagreement among religions as to the nature of ultimate reality; there is also much contention among philosophers of science as to the status of scientific explanations of the world. In one sense science and theology are both rational enterprises aimed at exploring the same world, based on motivated faith commitments; in another sense they are utterly different because they operate from such different assumptions. Science aims to make matter an object of study, whereas theology aims ultimately to learn from a self-communicating God.

Much of the epistemological debate in science and religion has centered around “critical realism.” This account of explanation within science and theology has been framed (slightly differently) by Ian Barbour, Arthur Peacocke, and John Polkinghorne. It claims that both science and theology offer accounts of reality that, though they may be partial and corrigible and depend on the use of models and metaphors, nevertheless, by a process of inference to the best explanation, draw progressively closer to a description of things as they really are. This is definitely what most practicing scientists think is the case, and some claim that theology also follows such a method (though encounter with a personal God must always imply a slightly different sort of enquiry). The problem with critical realism is that it is so difficult ever to imagine how we would *know* we were closer to an explanation corresponding to reality. Postmodernism insists that all our formulations are culturally laden and must be treated with suspicion, and the development of science often involves the radical overturning

of previous models (as with the Copernican revolution). Nancey Murphy, writing in Peters and Bennett, concludes that critical realism is not appropriate to a postmodern epistemology but that there still are methodological similarities between science and theology. Wentzel van Huyssteen makes a good case that the science-religion debate is postmodern thought at its most constructive and least corrosive, since it involves two rational communities in conversation about areas of genuine common concern.

Evolutionary Biology

Evolution remains a contentious subject among conservative Christians, particularly in the United States, and also among many Muslims. Belief in the literal truth of sacred texts, and in the surpassing sovereignty of the divine creator, has led many to reject the theory of evolution, an enormously powerful and generally coherent scientific explanation, in favor of some variety of “creationism.” This polarization of argument about evolution has restricted a very important area of theological exploration, namely how we can understand the activity of a God who seems to have created a system that contains very widespread suffering among animals, and in which over 90 percent of all the species that have ever lived are extinct. Evolutionary theory also raises other issues—in particular to do with the nature and distinctiveness of humanity. The Book of Genesis describes human beings as being uniquely made “in the image and likeness of God” (1:26). If we can explain a great deal about human beings in terms of our evolutionary inheritance, what becomes of these theological claims about humans?

The key phrase here is “a great deal.” Advances in evolutionary explanation have been greatly accelerated by the “modern synthesis” of evolutionary theory with classical genetics, and then by the discovery of the structure of DNA in 1953, enabling us to describe evolutionary patterns at the level of molecular genetics as well as anatomy. It is sometimes thought that understanding genes effectively allows us to account for every aspect of human behavior. This “sociobiological” account of humanity implies that higher-level descriptions of human beings as creatures who worship, who pray, who exhibit self-sacrificial love can all be dispensed with. This kind of dismissal is an example of “reductionism” taken too far. Understanding higher-level properties in terms of simpler systems is part of the power of science—it goes back in a sense to the insights of Galileo—but reductionism has often been used too sweepingly when science has interacted with other types of explanation, such as those given by theologians.

Psychology

One of the most intensively studied elements of the science-religion relationship is the relation of psychology to the theology of personhood and of agency. Here the theological language of *soul* and *spirit* has had to be clarified in the light of scientific descriptions of mental functioning. There have been claims, again simplistic and reductionistic, that religious experience merely reflects enhanced activity in a particular area of the brain. This claim overestimates our current understanding of the functioning of the brain and of consciousness

and ignores the possibility that brain function can reflect both a complex pattern of the firing of neurons and a human being relating to God. Key areas in this exploration are the question as to what happens to an individual's spiritual state in a case of profound damage to the brain, for example, through Alzheimer's disease, and the scientific evaluation of accounts of "near-death" experiences, in which individuals claim to have seen not only bright and gentle light but also things that could not be perceived by their ordinary senses.

Another contribution psychology has to make to theology is in our understanding of agency. The three great monotheisms, Judaism, Christianity, and Islam, all speak of the divine in personal terms; God is a personal agent who interacts with the world. Much energy has been devoted to trying to understand how such interaction relates to the law-governed descriptions of the world that science offers. So psychology can contribute to the theology of providence through the increase in our understanding of agency (as long as it is understood that human, embodied agency is at best a weak analogy with the relation of God to the universe); theology can contribute to psychology through its long study of divine and human freedom.

Physics

Theologians are much concerned with the relationship between God, time, and human freedom. The development in the twentieth century of first quantum theory and then chaos theory has emphasized the inadequacy of a clockwork model of the universe. In the usual interpretation of quantum mechanics, chance is a genuine and inalienable element in the unfolding of physical systems. Chaos theory, moreover, stresses our inability ever to predict precisely how complex systems will unfold. Theological models have emerged of the universe unfolding according to the interplay of chance with God-given laws, in a way that cannot be predicted by humans and may even not be known precisely by God. There have been various efforts, none of them very successful, to identify these "unclosable gaps" in determinacy and knowledge as loci at which God might act providentially but undetectably on physical systems, so keeping alive both the model of a God who intervenes in the world to effect purposes of divine love and healing and also the model of a God who is faithful to the laws with which God endowed creation.

One of the scientific developments of the twentieth century that seemed most consonant with the Christian tradition was big bang cosmology, with its description of the universe as arising out of an explosion that was extremely violent and yet seems precisely "tuned"—if any one of a number of key parameters had been even minutely different, no life could ever have arisen. There has been a great temptation to insert God into this causal gap at the beginning of time, to suggest that God must have been both fine-tuner and initiator of the big bang. Again this sort of theology has been shown to be inadequate, as cosmological physics has moved into a realm of speculation about the big bang as a random, uncaused frothing-up (perhaps one of many) of a preexisting quantum vacuum. The type of explanation Christian theology offers of the universe

is an ontological one—God as the answer to the question Why—is—there—something—and—not nothing?—rather than an account of God as the first cause in a series of temporal causes.

Astrophysics currently predicts the end of this universe as being its eventual expansion out to a low-temperature, low-density continuum from which all life and structure have disappeared. Here there is evident dissonance from those theological formulations that picture God as gathering up the whole creation into a pattern of new order and goodness. Again, the effect of exploring the dialogue with science is to cause theologians to be more precise about the type of explanation they are giving. Just as the resurrection of Jesus is postulated by Christians to involve a new state of matter, having some continuity with our present bodily state but also being different, incompletely recognizable, so the final state of matter is presumed to involve divine transformation, not a mere unfolding of the present creation.

Ecology and Ethics

The science-religion conversation as it has been conducted over the last forty years—very much under the influence of Ian Barbour in the United States and the priest-theologians John Polkinghorne and Arthur Peacocke in Britain—has tended to focus on physics in particular, not only as the source of vital data about the beginning and end of all things but also as the paradigm of rationality. Theologians have tended to be in awe of physics, and physicists in turn have sometimes developed an almost religious awe of their subject.

However, environmental science has had a very different conversation with theology. Ecological thinkers have often blamed religious formulas (such as the verse of Genesis cited above) as licensing human abuse of nature; they have also been critical of science as determined to dissect nature and as providing the technology used to accelerate ecological abuse. This criticism ignores the vital point that it is science that provides the diagnosis of our environmental state. However, the de-divinizing of nature by Christian theology that we noted above *was* a catalyst for Western scientific development, and science in turn *has* reinforced a sense that we are free to use nature as we want. It has been hard for humans to keep a sense both of God's distinctness from the world and of God's immanent presence in every aspect of that world. Here theology may need new imagery for the God-world relation; for example, Jay McDaniel offers the image of God as "heart" but also draws on Buddhist principles such as nonharming in order to derive a more sustainable environmental ethic.

Importantly, then, the science-religion conversation is not just about fine metaphysical distinctions between types of explanation of the origin of the universe; ultimately it is about the wisdom to relate appropriately to our world, and (if such is our belief) to our creator—to know how best to address our ever-growing power to influence that world, through the sheer extent of our technological life, and specifically through such advances as the new genetics. Science must inform our wisdom but cannot be its sole source.

See also *Creationism; Evolution; Monism; Natural Theology; Naturphilosophie; Newtonianism; Philosophy and Religion in Western Thought; Physics; Science, History of; Scientific Revolution.*

BIBLIOGRAPHY

- Barbour, Ian G. *Religion and Science: Historical and Contemporary Issues*. San Francisco: HarperSanFrancisco, 1997. Useful general introduction and classification of science-religion relationships.
- Brooke, John Hedley. *Science and Religion: Some Historical Perspectives*. Cambridge, U.K.: Cambridge University Press, 1991. Very important account of the diverse relationships between sciences and theology.
- Haight, John F. *God after Darwin: A Theology of Evolution*. Boulder, Colo.: Westview, 2000. Good exploration of the issues evolution raises for theology.
- Murphy, Nancey, and George F. R. Ellis. *On the Moral Nature of the Universe: Theology, Cosmology, and Ethics*. Minneapolis, Minn.: Fortress Press, 1996. Important coupling of this sort of theology with ethics.
- Peacocke, Arthur. *Paths from Science Towards God: The End of All Our Exploring*. Oxford: Oneworld, 2001. Summary of Peacocke's long investigation of this field and its implications for Christian theology.
- Peters, Ted, and Gaymon Bennett, eds. *Bridging Science and Religion*. London: SCM Press, 2002. Considers several key areas mentioned above and also Islam, Buddhism, and Hinduism.
- Polkinghorne, John. *The Faith of a Physicist: Reflections of a Bottom-Up Thinker*. Princeton, N.J.: Princeton University Press, 1994. Perhaps the clearest communicator on the relation of physical science to classical Christian faith.
- Richardson, W. Mark, and Gordy Slack, eds. *Faith in Science: Scientists Search for Truth*. New York and London: Routledge, 2001. Fascinating account by scientists from a variety of faith positions.
- Rolston, Holmes, III. *Genes, Genesis, and God*. Cambridge, U.K.: Cambridge University Press, 1999. Important critique of sociobiological understandings of human being.
- Russell, Robert J., William R. Stoeger, and George V. George, eds. *Physics, Philosophy and Theology: A Common Quest for Understanding*. Vatican City State: Vatican Observatory, 1988.
- Russell, Robert J., et al., eds. *Chaos and Complexity: Scientific Perspectives on Divine Action*. Vatican City State: Vatican Observatory and Berkeley, Ca.: Center for Theology and the Natural Sciences, 1995. See also other titles in the Scientific Perspectives on Divine Action series, edited by Robert J. Russell et al. An outstanding set of resources at advanced level for understanding divine action debate.
- Southgate, Christopher, ed. *God, Humanity, and the Cosmos: A Textbook in Science and Religion*. 2nd ed. Harrisburg, Pa.: Trinity Press International, 2003. See especially the foreword by van Huyssteen, chapter 7 on divine action, and chapter 9 on Islamic science.
- Van Huyssteen, J. Wentzel, ed. *Encyclopedia of Science and Religion*. 2 vols. New York: Macmillan, 2003. Key resource across the field.

Christopher Southgate

RELIGION AND THE STATE.

This entry includes five subentries:

Africa

Europe

Latin America

Middle East

United States

AFRICA

The modern African state system is a new political concept that came about from the struggle for independence. These states are organized in the matrix of the two great religious traditions: Islam and Christianity. The secular hegemonic nature of the founding of these states brings into play the political meaning of these religious traditions. Religion in Africa is projected as a part of a continuum in the debate about the "national question": Who shall rule, and how shall the state be governed? Several historical conjectures indicated that religion would have a say in addressing the question of governance. These historical conjunctures include:

1. The institution of apartheid in South Africa with the blessing of the Dutch Reformed Church of South Africa.
2. The Africanization of the leadership of the Christian Church at the same time that African nationalists were replacing the European colonial governors.
3. The rise of modern anxieties, culture of crime, and graft and corruption in the political arrangements of the new states, causing life in many of these states gradually to become vulgar, morally degraded, depraved, and spiritually vacuous.
4. The official formation of the Organization of Islamic Conference (OIC) in Rabat, Morocco, in 1969, the formation of the Islamic Development Bank in 1975, and the successful establishment of the Islamic Republic of Iran after the revolution in 1979 led by Ayatollah Khomeini, combined with subsequent influences of Wahhabi Islam originating from Saudi Arabia and the al-Qaeda factor, especially in East Africa, all increased the climate of Islamic zealotry.
5. Liberal democracy and economic prosperity, which African nationalists promised their masses in the 1960s and 1970s, were not achieved; rather, all the inescapable realities of lack of human dignity and economic assurances, with a deepening gap between rich and poor and rising ethnic frictions, broke down the social contract between the state and its citizens. African religious leaders with faith in their belief systems counter that religion should be the keystone in

both the personal life and the fulfilling of state obligations; that, measured against the majesty of God's work, the state is subsumed under that majesty.

African states, then, in their earlier stages were conflicted in the interaction with the two great religious traditions in their midst. There was initially a love-hate relationship between the state and the two great religious traditions. Sometimes the politicians cracked down on the religious leaders or their organizations; at other times they tried to appease them. Nasser and the Ikhwan al-Muslimin (Muslim Brotherhood) in Egypt, Gadhafi and the Sanusiyya brotherhood in Libya, Nimeiri and the National Islamic Front in Sudan, all experienced a love-hate relationship. There was a period of appeasement in the relationship between state and religion, but by the 1980s, powerful Islamic and Christian movements came to be seen as threat to the very existence of the state. In such situations, the confrontations between state and religion took a different turn.

South Africa, with its "state theology," came under serious scrutiny. The Muslim community and a counterreligious consciousness among Black liberation theologians initiated a powerful ideological attack on the ideology of apartheid. Liberation theologians came to see apartheid as a form of "structural sin" and sought to persuade the religious community (the South African Council of Churches, the World Lutheran Federation, the World Council of Churches, and, more important, the World Alliance of the Dutch Reformed Church) of this. The extraordinary role of the members of the religious community (both Christian and Muslim) in mobilization of the oppressed in South African and the international community—that finally came to see apartheid as heresy and apostasy—contributed immensely to the collapse of the apartheid system.

In other parts of Africa, Christian leadership produced Pastoral Letters—a rare, frank critique of African dictatorships in Idi Amin's Uganda, Hasting Banda's Malawi, Mengistu's Ethiopia, Abacha's Nigeria, and, more recently, Mugabi's Zimbabwe. On the other hand, African political leaders who were Christian did not shy away from proclaiming publicly their Christian faith; notice the born-again Christian president of Nigeria, Olusegun Obasanjo, and the building in 1989 of one of the largest Roman Catholic churches (the Basilica in Yamoussoukro, Ivory Coast) in modern Christianity in Côte d'Ivoire by its Christian president Felix Houphouët-Boigny.

African Muslims who see the state as a sacred entity under the rule of Allah exhorted the leadership of the secular states for an Islamic dispensation as the politicians go about creating new political formations. The various Islamic organizations in varying degrees encountered problems. In Morocco, the Islamic group Justice and Welfare was ordered to disband in 1990; Algerian "Salafists" who wanted to return to pristine Islamic ideals came under great pressure from the government. The Islamic Salvation Front (FIS) was legalized in 1989. It won the elections of that year, but the Algerian government canceled the second round of elections, jailed most of the FIS leaders, and in 1992 banned the organization. Tunisia never legalized the Ennahda (Renaissance) Party, repressed its mem-

bers, and closed down its newspaper. The Libyan government disrupted the Islamic movement in that country, and by the early twenty-first century the movement was unstructured, with many of its leaders imprisoned. The Islamic Party in Kenya was summarily denied official recognition during the presidency of Daniel arap Moi. But in states such as Tanzania and Uganda, Islamic organizations were encouraged to form and acquire government patronage. The Egyptian experience with the radical Islamic group "Jihad," which was implicated in the assassination of President Anwar Sadat in 1981, was very instructive to many African politicians.

The Islamic code of *shari'a*, which regulates the Islamic community, has received special attention in Africa. Strict Islamic laws—such as the imposition of amputation or death by stoning for transgressions such as theft, adultery, or fornication and the banning of prostitution, gambling, and consumption of alcohol—are elements embedded in the *shari'a*. These are elements of Islamic law that African secularists deemed too harsh.

Sudan introduced the *shari'a* in 1990 (although in 1983, Colonel Nimeiri had introduced the "September Laws," which recognized the *shari'a* as the basis of state law, it was alleged that he did so to serve his own political agenda, not as a sincere application of the *shari'a*). The civil war that raged in that state from 1957 pitched the north, which is Muslim, against the south, which is predominantly Christian and traditional religionists. With the introduction of the *shari'a* by the government, the south, under the leadership of the Sudan Peoples Liberation Army, began challenging the Islamization of the state and its extension to the south. But the Islamization program of the Hassan al-Turabi and Omar Hassan al-Bashir governments took root. Peace negotiations were in progress in 2004 to bring the north and south together, but the south was reluctant to accept the political control of an Islamic republic.

Nigeria, on the other hand, came out of the Nigeria-Biafra civil war in 1971 with the dictum "No victor, no vanquished" under the leadership of a Christian military leader, General Gowon. Yet from 1971 the southern and Middle Belt Christians were continuously victimized, and militant Muslims in Northern Nigeria killed thousands. This religious bloodletting was exacerbated with the introduction of the *shari'a*, first by the state of Zamfara but subsequently practiced in eleven northern states. The Amina Lawal court case, in which Amina Lawal was prosecuted for illegal sex and pregnancy out of wedlock, received national and international attention. International outrage, particularly the outrage of women's rights groups nationally and globally, and the intervention of the secular state of the Federation of Nigeria, along with a brilliant defense team saved Amina Lawal from the capital punishment authorized by the *shari'a*.

In addition, Muslim political leaders, in a secretive process, applied for Nigeria membership in the Organization of Islamic Conference. All these actions by the Muslim leadership led to the formation of the Christian Association of Nigeria, whose agenda aimed at putting a stop to further Islamization of the Nigerian state. The Nigerian state, however, presented itself as a mediator in Muslim/Christian relations. The state funded

the building of a Christian cathedral and mosque in the federal capital of Abuja, funded pilgrimages to Mecca and Jerusalem for Muslims and Christians, respectively, and also created a Ministry of Religious Affairs.

In both states, Nigeria and the Sudan, the tendency was for religious vigilante groups to form and keep an eye open for any transgressions of *shari'a* regulations. The Sudan People's Liberation Army and the Christian Association of Nigeria opposed such intrusion of religious oversights in the body politic of their respective states. Unlike the Sudan, where a real war was waged to settle the matter, in other parts of Africa, including Nigeria, a religious "cold war" operated in the context of a constitutional truce.

To anyone who has looked closely enough, the religious leaders of Africa and their beliefs and faith, plainly enjoy a strength. Arguably the greatest strength of all, something truly imposing, is their ability to threaten the state. Their positions and beliefs have broader historical roots than the African states. They are not only popular, wealthy, and global in the sense that they are well connected, they are also institutionally sophisticated. Their ideas appeal to many African citizens who are poised to challenge the state whenever possible. Christians and Muslims alike in Africa should see themselves as effective intermediate civil societies that lie between the *state* and the *household*. In this sense, then, they exist to protect and advance their religious interests and values in a plural society. African governments, on the other hand, should be encouraged to look at African religious leaders and their faith as autonomous intermediaries between the state and its citizens. The role that these religious leaders have played in dislodging African dictatorships, apartheid, corruption, and social justice and their implementation of compassionate charities to help bridge the deep gap between the rich and the poor on the African continent is highly commendable. The state governments, however, have in many instances cracked down on the religious leaders and their followers in the pursuance of the dictum of political realism when they felt that the state was threatened.

Three major concerns in the relationship between state and religion in Africa can be deciphered from historical occurrences of the late twentieth and early twenty-first centuries. First, in the genocidal activities that raged in Rwanda in 1994, certain Roman Catholic priests were said to have participated in the genocide of the Tutsis by the Hutus. The inability of the church to forestall this genocide is troublesome. Second, the recent linkages between al-Qaeda activities and some religious organizations in Africa have foreboding consequences. The intricate web of front companies and individuals in Africa who were associated with the al-Qaeda movement, allowing al-Qaeda operatives to trade in African gold, diamonds, and other gems—thus providing the economic resources and networks that led to the bombings in Nairobi, Kenya, and Dar es Salaam and the possible assistance given to those who shot down the U.S. Black Hawk helicopter in Mogadishu—and al-Qaeda's presence in Sudan are all indications of serious problems for African state/religious relations. Third, Christians and Muslims in Africa are gradually accepting the electoral system as

the moderating instruments to affect change in their states, but when the states are unable to accept the electoral victories of religious parties, political instability of the African states becomes inevitable.

In one sense, neither religion nor state may claim the high ground in any assessment of instability of African political culture. Yet both should strive to use their powerful influence to illuminate African lives in order to fulfill the promise of the majesty of God's/Allah's work. The genius of modern liberal education in Africa in the early twenty-first century is the pragmatic compromise that many African citizens are learning; religion has a place in pursuing the aim of social justice and freedom. Many Africans would love to have the freedom to choose for themselves how they ought to live. Their devotion to God's law and their devotion to the secular state are sometimes conflicted. But these should not be judged trivial when measured against the majesty of God's/Allah's work.

The recent use of the phrase "African Renaissance" by such leaders as President Mbeki of the Republic of South Africa once again reminds African citizens that the ideals and spirit of enlightenment that both the state and African religious leaders are exposed to could be helpful in promoting coexistence. In trying to define "African Renaissance," both the state and religious leaders in Africa should aim at reconciling God and freedom, political liberty, and pragmatic compromise. As the states in Africa mature, there is the hope that the deepest believers in Islam and Christianity will tone down their rhetoric and devise ways to coexist with the state rather than prepare for a possible showdown with the state. The African states, with all their failures, still provide the one political-legal framework that can transcend all the manifold differences between the religious traditions, can accommodate their various belief systems and ways of life, and can serve as a normative basis for their coexistence and cooperation.

See also Islam: Africa; Religion: Africa; State, The.

BIBLIOGRAPHY

- Ahanotu, Austin Metumara, ed. *Religion, State and Society in Contemporary Africa: Nigeria, Sudan, South Africa, Zaire, and Mozambique*. New York: Peter Lang, 1992.
- . "Religion and the Problem of Power: South Africa." In *The Terrible Meek: Essays on Religion and Revolution in Cross-Cultural Perspective*, edited by Lonnie O. Kliever, 217–250. New York: Paragon Publishers, 1987.
- Borer, Tristan Ann. *Challenging the State: Churches as Political Actors in South Africa, 1980–1994*. Notre Dame, Ind.: University of Notre Dame Press, 1998.
- El-Affendi, Abelwahab. *Turabi's Revolution: Islam and Power in Sudan*. London: Grey Seal, 1991.
- Falola, Toyin. *Violence in Nigeria: The Crises of Religious Politics and Secular Ideologies*. New York: University of Rochester, 1998.
- Gifford, Paul. *African Christianity: Its Public Role*. Bloomington: Indiana University Press, 1998.
- Levtzion, Nehemia, and Randall L. Pouwell, eds. *The History of Islam in Africa*. Athens: Ohio University Press, 2000.

- Ludwig, Frieder. *Church and State in Tanzania: Aspects of Changing Relationships, 1961–1994*. Leiden, Netherlands: Brill, 1999.
- Okulu, Henry. *Church and Politics in East Africa*. Nairobi: Uzima Press, 1982.
- . *Challenge to the Church: A Theological Comment on the Political Crisis in South Africa: The Kairos Document*. Braamfontein, Johannesburg, South Africa: Kairos Theologians, 1985.
- Shahin, Emad Eldin. *Political Ascent: Contemporary Islamic Movements in North Africa*. Boulder, Colo.: Westview Press, 1997.
- Usman, Yusufu Bala. *The Manipulation of Religion in Nigeria 1977–1987*. Kaduna, Nigeria: Vanguard, 1987.
- Word, Kevin. “The Arrival of the Lord’: Christianity, Rebels and the state in Northern Uganda 1986–1999.” *Journal of Religion in Africa* 31, no. 2 (2001): 187–221.

Austin M. Ahanotu

EUROPE

In order to discuss religion and the state, the demarcation between the two must be clear, which leads to the postulation of distinct and potentially conflicting purposes. For most of the world’s cultures at most times, a separation of political and religious goals was simply unimaginable. In social systems such as ancient Egypt’s and Japan’s, where the supreme leader was accorded the status of a deity, the fusion of the religious and the political was seamless. Obedience to the divine and to the ruler could not meaningfully be distinguished, and a heavenly mandate alone determined who should command. Likewise, in urbanized polities such as the classical Greek *polis* or the Roman Republic, performance of one’s public duties included a clearly religious dimension, and priestly offices were civil in origin and nature. When Socrates (469–399 B.C.E.) was tried and convicted by an Athenian jury in 399 B.C.E. on the charge of “not recognizing the gods that the city recognizes,” this was an overtly political crime inasmuch as disrespect to the local deities meant undermining the traditional arrangements that characterized Athenian civil order. To “invent new gods,” as Socrates was further accused of doing, violated the shared bases of citizenship.

The historical division between religion and politics that leads to the problem of their proper ordering and relation emerges only in coincidence with the phenomenon of divine revelation, and hence only with the so-called Abrahamic religions of Judaism, Christianity, and Islam. Religions that rest on a direct relationship between individual human beings and a deity effectively circumvent the monopoly of spiritual authority claimed by the state and its authorized priestly agents. Hence God’s revelation may contradict or contravene political commands, generating a conflict that requires resolution. One solution to the dilemma is for the state to adopt some form of tolerance for the revelation claimed by members of a religious group. An alternative is to engage in widespread persecution and repression of religious communities that assert the precedence of God’s word over earthly legal command. Another alternative might be the complete co-opting of the religion by the state, which then claims divine right.

Rome and Revelation.

Rome, during its history as an imperial power, adopted all three strategies in relation to revealed religion, depending on circumstance. In general, when Rome conquered a territory, it stipulated that the new provincials sacrifice to the approved Roman deities in addition to their own gods—a relatively unproblematic request to pantheist or pluralistic religions. In the case of Judaism, however, this approach was unacceptable. The Jews had a long history of living and thriving within non-Jewish civilizations in both the Eastern and Western worlds, while nonetheless maintaining their own religious and cultural identity. Rome accommodated the Jews by tolerating non-worship of its cult provided that the unbelievers were prepared to pray to their own God for the sake of the Roman *imperium*. Although the Roman establishment was by no means fond of the beliefs and rites of Judaism, the religion’s antiquity and venerability earned its adherents the respect and forbearance of authorities.

By contrast, the relation between Christianity and the Roman state was considerably more fraught. The early Christianity of Roman antiquity is commonly imagined to be a persecuted religion. This statement requires qualification, however. Although persecution of Christians occurred prior to the Christianization of the Roman Empire, it was seldom conducted on a systematic basis coordinated by imperial authorities (the Great Persecution of 303–312 was exceptional in this regard). Rather, persecution of Christians happened in a sporadic and localized manner, and was sometimes even discouraged by imperial officials who sympathized with persons accused of holding Christian beliefs. Perhaps the most troublesome aspect of Roman persecutions was the nature of the charge: merely to be Christian, rather than to commit some definite offense, was sufficient to be prosecuted for a capital crime. This harshness stemmed from the very odd character of Christian belief when judged by pantheistic Roman standards: it was universalistic and exclusivist. That is, Christians claimed the validity of their faith for all people at all times and in all places and were unwilling to accommodate other deities or the public rites associated with the Roman cults. Indeed, Roman society regarded Christianity to be atheistic in the sense that its adherents refused to “pay cult to the gods.”

The landscape changed dramatically during the fourth century, as Christianity moved rapidly from a proscribed faith to an officially protected and subsidized sect. In the wake of Emperor Constantine’s extension of support, the Christian church became an institutionalized wing of the Roman government and, with the exception of the reign of Julian the Apostate, at least nominal membership within the Christian community was expected of imperial magistrates. In turn, the emperor was transformed into the acknowledged head of the visible church (a doctrine known as Caesaropapism). This meant that the emperor enjoyed broad responsibilities for ensuring the unity of the faith and directing imperial resources toward essentially religious ends. A synthesis of state and religion resulted from the Christianization of Rome.

Yet the public privileging of the Christian religion did not lead to a state-sanctioned imposition of strict orthodoxy on

the lands under the control of the Roman Empire. Beyond the myriad practical problems involved with eliminating paganism and heretical Christian movements, Christianity's universalistic and exclusivist elements were tempered by biblical teachings about charity, patience, nonviolence, and the like. Jesus had advocated preaching and example as the appropriate techniques for disseminating his message. The employment of Church-endorsed state compulsion in order to enforce Christian conformity fit uncomfortably with scriptural lessons that advocated personal free choice and commended turning the other cheek in response to one's enemies. Thus, at the end of the fourth century, St. Augustine of Hippo (453–426) grappled with the issue of whether he should call upon the armies of the Roman state to suppress heresy. Although Augustine ultimately embraced persecution and intolerance as the only practicable solution, he did so only as a last resort, after nearly a decade of promoting less extreme measures. In his initial view, at least, the role of the state should be strictly limited to the protection of peaceful persons from religiously motivated attacks, a function essentially consistent with publicly approved toleration.

The Islamic Caliphate.

The relationship between religion and the state in the lands that came under Islamic control during the spread of the Muslim faith charted a somewhat different, although not entirely unfamiliar, path. Following the death of the Prophet Muhammad in 632, his successors (caliphs) took up the mantle both of the pure word of God contained in the Koran and of the creation of a common Arab civilization. Although the actual power of the caliphs declined during the eighth and ninth centuries, the ideal of a single imperial office maintaining the unity of religion and civilization remained strong throughout the Middle Ages.

The caliphate was not precisely a religious office in the sense of having a priestly status; although the caliph was understood to be a "shadow of Allah on earth," his ordained function was primarily a military one: he was to protect the faithful and spread the words recorded by the Prophet by means of conquest and conversion. Moreover, once *shari'a* (Islamic law) was compiled in the ninth and tenth centuries, the caliph and other Muslim rulers were deemed to be subject to it, just like any other member of the faithful community (*umma*). Strictly speaking, neither the Koran nor *shari'a* dictated or legitimated any political system whatsoever. If every Muslim were to follow the teachings of the Koran and the dictates of religious law, then no political authority would be necessary. Indeed, some medieval Islamic authors promoted a doctrine that modern scholars have labeled anarchism.

Muslim government was also relatively mild in its treatment of those who subscribed to the other Abrahamic religions. In the Muslim-dominated Iberian Peninsula and in parts of the Middle East where Christian and Jewish communities existed, the caliphs and their successors extended the status of protected persons to believers. Protection came at a cost: special taxes were due to Muslim rulers, and adherents to other confessions did not enjoy equal legal rights. But recognition

that Jews and Christians prayed to the same God as Muslims, even if their doctrines were misguided, yielded a climate of relative tolerance. This was to remain the case through the long period of the Ottoman Empire.

Christian Europe: The Middle Ages.

The collapse of the Roman Empire in the West left the Christian church as the major source of trans-European political, cultural, and social unity, and thus Christianity learned to persevere without a meaningful state to depend upon. Indeed, the institutional church, with its authority increasingly centralized in the papacy and the episcopal and diocesan systems, superseded the state entirely, using a combination of spiritual suasion and socio-economic power to control the fragmented and decentralized lordlings who amounted to local strongmen under the feudal structure. Despite attempts on the part of certain dynasties to revive the imperial ideal and extend centralized political control—Charlemagne and his successors are especially noteworthy—the church alone managed to bridge the chronological period between late imperial Rome and emergent Europe.

Thus, the Christian church was left in an unusually powerful position in relation to state authority when consolidation of the social bonds of the feudal nobility, and with it political centralization, recommenced after the year 1000. On the one hand, the church's legal, judicial, and administrative system provided a ready model for temporal governance, and the class of literate clergy that it trained afforded a pool of staff for aspiring monarchic states. Yet on the other hand, the church's monopoly over the state of souls, justified by its claim to have inherited from the Petrine commission the keys determining entrance into heaven, translated into assertions of universal supremacy in all affairs, earthly as well as spiritual. Advocates of the pope's superior station proposed a "plenitude of power" (*plenitudo potestatis*) inhering in the office of the Roman bishop that permitted him, at least in cases of emergency, to exercise "two swords," that is, both corporeal and otherworldly forms of authority. If not quite amounting to theocratic government, the Roman church sought for itself a wide jurisdiction in determining the arrangement of secular rule.

This situation was reflected in the political ideas typical of medieval Europe. Such mainstream thinkers as John of Salisbury (1115 or 1120–1180) and St. Thomas Aquinas (1224–1274) viewed secular government as directed toward two goals, one natural, the other supernatural. The former involved the promotion of virtue and justice among subjects; this could be attained by any political society, whether Christian or pagan. The latter demanded the promotion and diffusion of the true religion of Rome; only a Christian ruler could achieve this goal, and only when guided by and deferential to the Roman church and its leaders.

Christian Europe: The Reformation.

During the sixteenth century, Protestant reformers such as Martin Luther (1483–1546) and John Calvin (1509–1564) challenged the Roman Church's monopoly over the interpretation of Christian doctrine and its maintenance of clerical

obedience. The Reformation generated waves of violent persecution and the suppression of religious dissent as well as forceful resistance by the oppressed confessions. Catholic princes and cities burnt reformers of all stripes; Protestant rulers and communities did the same to Catholics as well as to members of other reforming sects. The state as an agent of confessional enforcement only reinforced the impression that effective use of coercion and violence (even if in the name of the salvation of souls) were the real qualifications for political leadership.

The controversial role of religion in public life in turn spawned major reappraisals of the relationship between religion and the state. Authors began to argue in favor of tolerating differences of conviction and rite. Sebastian Castellion (1515–1563) argued that coercion is an inappropriate tool for effecting a change of religious views since Christian belief must be held with sincere conviction; hence clerics and magistrates must refrain from persecution of convinced Christians who cling to doctrines that do not coincide with official teachings. Major figures in European philosophy weighed in on the side of religious toleration. Baruch Spinoza (1632–1677) claimed a broad application for the right to liberty of thought and belief without inference from a sovereign power's (or a church's) determination of the truth or falsity of one's ideas. Pierre Bayle (1647–1706) asserted that persecution of religious diversity encouraged hypocrisy and eroded social order and that an erring conscience, if it be held in good faith, deserves as much protection as a correct one—a principle he extended even to atheists. Perhaps the most famous, although by no means the most original, proponent of toleration, John Locke (1632–1704), advocated toleration for most Christian (and perhaps some non-Christian) rites in his *Epistola de Tolerantia* (1689). For Locke, the role of the state should be confined to the maintenance of public tranquility and the defense of individual rights rather than the care of the soul.

Locke's *Two Treatises of Government* (1690) also stood at the culmination of another important line of early modern thought concerning the rights of populations to refuse obedience to tyrannical rulers, especially in matters of religion. Reforming Christians of a Calvinist persuasion led the way in articulating a theory of resistance to illegitimate applications of power. Initially, John Knox (1505–1572) and other British exiles propounded the view that government has a responsibility to God to eliminate all forms of idolatry (by which he meant Catholicism). If the ruler refuses to act on this duty, then lesser magistrates and even the common people must step in to suppress idolaters and their sympathizers—that is, Catholic priests and their royal protectors. The Huguenot reformers of France transformed this basic insight into a general account of resistance. According to them, a regime that aids, abets, and even guides the violent persecution of religious minorities may be licitly resisted. Authors including François Hotman (1524–1590) and Theodore Beza (1519–1605) produced a sizeable literature combining traditional Christian prohibitions against popular rebellion with the view that so-called intermediary magistrates—officials in service to a prince—are obliged to repel and contravene commands by their superiors that require religious persecution.

Finally, some thinkers of an Erastian bent wished to place religion entirely under the command of secular rule precisely in order to eliminate the conflicts that it seemed perpetually to engender. Intimations of this idea can be discovered in medieval authors such as Marsiglio of Padua (c. 1280–c. 1343) and Christine de Pisan (1364–c. 1430), for whom the priesthood constituted nothing more than a branch of temporal society under the control of the ruler. But the most robust statement of the secular position may be found in the *Leviathan* (1651) by Thomas Hobbes (1588–1679). Hobbes, who identified the maintenance of peace and order as the sovereign state's principal function, singled out religion as an especially fertile source of political disruption. To remedy the divisiveness of religion, he offered a rather extreme solution in the second half of *Leviathan*: strictly limiting the autonomy of ecclesiastical officials and offices and reinterpreting Christian theology in a manner consonant with his conception of political sovereignty.

Later Developments.

The basic issues concerning religion and the state that emerged during late classical, medieval, and early modern times framed later debates in those parts of the world (such as the Americas, the Middle East, and Africa) where revealed religions enjoy a considerable following. Specifically, one sees recurrent concern with whether political power is a hindrance or a boon to the spread and maintenance of religion, as well as whether the state should remain neutral to competing confessions. The early history of these discussions demonstrates that the dual questions of the role of religion in politics and politics in religion have always been settled in many different ways. There is no grand narrative of human progress in matters of religion, no progression from persecution to toleration or from unity to plurality or from superstition to secularity.

See also *Secularization and Secularism; Toleration*.

BIBLIOGRAPHY

- Black, Antony. *The History of Islamic Political Thought: From the Prophet to the Present*. New York: Routledge, 2001.
- Morrison, Karl F. *Rome and the City of God: An Essay on the Constitutional Relationships of Empire and Church in the Fourth Century*. Transactions of the American Philosophical Society new series 54, pt. 1. Philadelphia: The American Philosophical Society, 1964.
- Nederman, Cary J. *Worlds of Difference: European Discourses of Religious Toleration, c.1100–c.1550*. University Park: Pennsylvania State University Press, 2000.
- O'Donovan, Oliver, and Joan Lockwood O'Donovan, eds. *From Irenaeus to Grotius: A Sourcebook in Christian Political Thought*. Grand Rapids, Mich.: Eerdmans, 1999.
- Southern, R. W. *The Making of the Middle Ages*. New York: Hutchinson's University Library, 1953.
- Walzer, Michael, Menachem Lorberbaum, and Noam J. Zohar, eds. *The Jewish Political Tradition*. 4 vols. New Haven, Conn.: Yale University Press, 2000.

Cary J. Nederman

LATIN AMERICA

Church-state relations in Latin America since the arrival of the Spanish in 1492 and then the Portuguese can be discussed in four periods: (1) evangelicization and orthodoxy, 1492–c.1750, (2) the secular state, c.1750–1892, (3) *Rerum Novarum*, 1892 to 1962, and (4) Vatican II, 1962 on. The Roman Catholic Church has been the dominant religious institution and Catholics remain a majority in the region. The events of each era resulted from the interplay between secular and religious authorities. Civil authorities initiated the first two periods, and clerical leaders the second two periods. Church-state relations have become more complex in the past 50 years with the rise of Protestantism, the growth of African-based religions such as Macumba, and the increase of faiths brought by immigrants, including Hindu and Islam. Jews arrived with the first European expeditions, although they were forced to conceal their faith throughout the colonial period.

The Evangelical and Orthodox Period, 1492–c.1750

Once Europeans discovered the Western Hemisphere and church leaders determined that its residents were indeed human beings, both Spanish and Portuguese monarchs justified their claims to colonies and commercial monopolies in terms of bringing Christianity to the heathens. The monarchs codified this rationalization in the 1494 Treaty of Tordesillas that divided the non-European world between them for commerce, colonization, and religious conversion. Pope Alexander VI confirmed the treaty. For roughly the next three centuries, evangelization dominated church activities and church-state relations. The monarchs provided financial and political assistance. Conversion, often no more than baptism and mandatory weekly masses, was largely the work of Franciscan, Dominican, and later the Company of Jesus (the Jesuits) missionaries. During colonization of the Caribbean, Bartolomé de Las Casas (1474?–1566), one-time conquistador turned missionary, became the blistering critic of Spanish practices. In his political tract *A Short Account of the Destruction of the Indies*, he described the conquest as the sadistic brutality, torture, enslavement, or murder of indigenous peoples. He called on the king to restrain the conquest, reverse Indian slavery, and regulate Spanish-Indian relations. Spain's colonial rivals (e.g., England) and rebellious dominions (e.g., the Dutch) widely reprinted the book, often with Albrecht Dürer's (1471–1528) fanciful and terrifying engravings to mobilize popular opinion against the Spaniards. As Protestant northern Europe gained ascendancy over the Catholic south in global geopolitics, the influence of this text continued to grow, and its negative portrait of Spaniards and the church still colors popular perceptions in the twenty-first century.

Religious leaders undertook efforts to restrain the conquistadors and colonists and to impose religious orthodoxy by instituting the Inquisition in Spain's possessions. Because they were felt to have an incomplete understanding of religious doctrine, Indians, except in cases of bigamy and cannibalism, were not subject to the Inquisition. In its efforts to evangelize the Indians, and the arriving African slaves, the church utilized its most powerful symbols, frequently announcing new martyrs,

saintly behavior, and miracles. The most famous of these, the 1531 apparition of the Virgin of Guadalupe in Mexico, created an indigenously Mexican mythology in which an Indian, Juan Diego, was chosen by the Virgin to carry her message to a Spanish bishop. Doubters saw in this tale a ploy by church leaders to assist the evangelization process. Albeit initially violent and only intermittently successful, these conversion strategies aimed at African and Indian populations, and the partially successful campaign for orthodoxy among the settlers did result in a continent that was, for the most part, fervently Catholic—although Catholicism itself was transformed in the process, as it integrated symbols, rituals, and imagery from pre-Columbian and African sources, and from New World ecologies.

Church-state relations in Latin America changed fundamentally under Spanish King Charles V (1516–1556), an enlightened monarchy who intended to establish a secular, efficient empire. The best-organized and funded challenge to his authority was led by members of the Jesuit order. In response, the king acted decisively to expel all Jesuits from Spain and its possessions in 1767. This provided a preview of the often-bitter anticlerical policies of government leaders influenced by the Enlightenment and the French Revolution over the next century. The Latin American colonies for the most part had achieved independence by 1824, and nearly all new regimes, whether republics or monarchies, attempted to restrict church influence in secular life by deamortizing church properties, limiting religious holidays, and abolishing clerical control of the civil registry, cemeteries, and separate courts. Until the last decade of the century, Popes especially Leo IX (1049–1054) urged Catholics to reject these secular campaigns as threats to the church. In each of the Latin American nations, efforts to separate church and state resulted in civil strife, and often civil war. In Mexico, it provoked the War of the Reform (1858–1861) won by Benito Juárez and the Liberals, but the clerics made a final effort by helping inspire the French intervention and the empire of Maximilian and Carlota. Warfare continued from 1862 to 1867, when Juárez's armies defeated the French, executed the emperor, and separated the church and state. Similar if less violent struggles took place throughout the region.

The Papal Degree *Rerum Novarum* in 1892 represents a reversal of the Roman Catholic Church position on the struggle with national governments and modern society. Pope Leo XIII decreed that the church should protect the local nature of religion, and support individuals against the social homogenization and economic exploitation of modern life that destroyed faith. This decree inspired a re-evangelization campaign, and initiated the organization of Catholic unions and political parties, many of which, such as the Christian Democrats in Chile, remain powerful in the twenty-first century. Priests and members of religious orders now tried to control the programs of civil government rather than trying to dominate government. At times, the social activism resulted in bitter struggles, for example the Cristero Rebellion in Mexico (1926–1929) over the role of religion in a revolutionary society. *Rerum Novarum* also inspired what became splits within the church itself. The Pope encouraged

social activism, but by the 1920s and 1930s the militancy among some priests had become a revolutionary fervor. Colombian Father Camilo Torres, for example, went into the highlands in the 1960s to join revolutionaries and was later killed by counterinsurgents.

Pope John XXIII called the bishops to meet in 1962 in Vatican II. Beset by challenges of the world's economic inequities, the rise of communism, and the increase of revolution, the church fathers initiated changes. One result was the rise of liberation theology, with local parish programs for social welfare called Christian Base Communities (CBCs). These community action programs confronted needs unmet or ignored by civil authorities. The CBCs constituted an indirect challenge to government officials, and often provoked direct confrontation with governments to obtain basic necessities for the poor. These CBCs became especially important in Brazil during the years of the military dictatorship and served as a form of grassroots organizing. In other countries, Guatemala, for example, the failure of both government and church leaders to assist the indigenous population provided an opening for Protestant and Mormon missionaries. Conversion to these faiths provided a new support network for rural Guatemalans. The church-state experience, of course, varies by country, from leadership in challenges to dictatorship in El Salvador, to organization of indigenous peoples in Chiapas, to struggle to survive in antireligious Cuba. The rise in conversion to Evangelical Protestantism is another complicating factor, with some governments reacting with hostility and suspicion to a movement led by foreigners, while in other cases— notable Guatemala—conservative Protestants have become heads of state. In the twenty-first century, the relationship between church and state remains in flux.

See also *Anticolonialism: Latin America; Authoritarianism: Latin America; Colonialism: Latin America; Religion: Latin America.*

BIBLIOGRAPHY

- Garrand-Burnett, Virginia, ed. *On Earth as It Is in Heaven: Religion in Modern Latin America*. Wilmington, Del.: SR Books, 2000.
- Gutiérrez, Gustavo. *A Theology of Liberation: History, Politics, and Salvation*. Maryknoll, N.Y.: The Maryknoll Press, 1973.
- Mecham, J. Lloyd. *Church and State in Latin America*. Chapel Hill: University of North Carolina Press, 1966.
- Schwaller, John F., ed. *The Church in Colonial Latin America*. Wilmington, Del.: SR Books, 2000.

William H. Beezley

MIDDLE EAST

The relationship between religious and political domains in Islam is extraordinarily complex and is rooted in a rich conceptual and a long (although conflicting) institutional tradition. Koranic verses clearly endorse the prophet Muhammad's spiritual and temporal authority. Muslims agree that he was the sole transmitter of the divine message, the most qualified person to decide the meaning and application of that message, and the ultimate authority in applying that message. Sev-

eral Koranic verses, for example 3:32, 3:132, 4:42, 4:80, and particularly 4:59, call Muslims to obey Muhammad and his appointees. The first Muslim commonwealth, the city-state of Yathrib, which was later called *Madinat al-Nabi* (the "City of the Prophet"), was established on the conceptual basis of this unified authority. The prophet led the Friday prayers, acted as a judge, was the supreme commander of the Muslim forces, and appointed governors and ambassadors. A sovereign exercising both temporal and spiritual authorities remained ideal to a number of Muslim medieval political theorists such as al-Farabi (d. 950), who at the same time recognized the difficulty of finding a legitimate contender for such a position.

The Shia-Sunni Controversy

While the sources for reconstructing the early history of Islam leave much room for contention, it appears that a crisis of authority took place immediately after Muhammad's death (632 C.E.). Faced with the task of finding a successor to the Prophet, Muslims (at least according to later views) were divided into two main camps. The first group—later referred to as the Sunnis—decided that a successor should be elected by the highest-ranking Muslim leaders. These Muslims elected Abu Bakr, an old ally of Muhammad and one of his fathers-in-law, as his successor or "caliph." A second group argued that the matter of succession had already been decided by God and revealed by the Koran and the Prophet. This group believed that the legitimate successor was Muhammad's cousin and son-in-law 'Ali. The members of this group were referred to as the *shia* (partisans) of 'Ali, or simply the *shia* (or *shii*). To them, 'Ali and certain of his offspring—to whom they refer as imams—have been designated by God to rule the Muslims. According to most Shia, including those in contemporary Iran, imams have access to knowledge not available to any other human being, and they are free from sin. Because of these extraordinary characteristics, they are qualified to succeed the Prophet as the holders of both religious and political authority. The majority of Shia in the early twenty-first century believe that the last of these imams (the twelfth imam, al-Mahdi) went into hiding to avoid persecution at the hands of the Sunnis in the late ninth century. He remains in occultation today, but at some point will return in order to bring peace and justice to the world.

The majority of Muslims refer to the first four caliphs after Muhammad's death, including 'Ali (who was widely regarded as the fourth caliph), as the "Righteous" or "Rightly Guided" caliphs. While there is no question of their having wielded prophetic authority, prophethood having come to an end with the death of Muhammad, they nonetheless hold both religious and political authority. Later caliphs, however, were not able to keep these authorities unified. Over the course of the early medieval period, the *ulema* (religious scholars, literally "those who have religious knowledge") gradually staked for themselves the claim to have inherited the Prophet's religious authority. Moreover, by the late ninth and early tenth centuries, even the caliph's secular authority was reduced substantially, as local princes (emirs or, later, sultans) successfully usurped the caliph's temporal power and effec-

tively reduced him to the position of figurehead of Sunni unity. Meanwhile, a sovereign exercising both temporal and spiritual authorities remained ideal to a number of Muslim medieval political theorists such as al-Farabi, who at the same time recognized the difficulty of finding a legitimate contender for such a position. During the early medieval period, a number of explicitly Shia states were also established, in several of which the leaders claimed to rule as imams or in the name of the imams. In these states (the Nizari state in Iran and the Fatimid state in Egypt, for example), the unity of authority was better preserved, as the rulers claimed direct or indirect link to 'Ali's family (and thus to Muhammad), and so exercised both spiritual and temporal powers.

The Early Modern Islamic States

The Mongol invasion and the fall of Baghdad (1258) put an effective end to the caliphal system. Religious authority was officially separated from and formally subjugated to the political authority. The underlying tension between religious and political authority has, however, remained a central problem of modern Islamic history. By the early modern period, the Ottoman state, which owed its legitimacy to engagement in jihad against the Byzantine Empire, effectively renewed the caliphal tradition. The Ottoman sovereign was referred to as both the sultan and the caliph, and while the term "caliph" was sometimes used simply as a generalized marker of supreme authority, the Ottoman sultan also staked a claim to a degree of religious as well as political power. However, by the mid-seventeenth century, the Sunni religious establishment (the ulema) had also established itself as a formidable temporal power, and was, for example, at the center of the alliance that removed Sultan Ibrahim from the Ottoman throne (1648). In the late nineteenth and early twentieth centuries, the Ottoman state remained a source of inspiration for Muslim political activists who wished the return of an Islamic empire similar to that which existed under the Righteous Caliphs. Among those who articulated such inspirations was Sayyid Jamal al-Din al-Afghani (c. 1838–1897), an early modern advocate of Pan-Islamism, who also engaged in political intrigues and propaganda in Egypt and India in the name of Islam.

Shortly after the establishment of the Ottoman Empire, the Safavids (1502–1736), claiming to be the offspring of 'Ali, established their Shia state in Iran. Safavid shahs (kings) initially declared themselves to be either the deputies of the last imam or, in the more extreme formulation of their claims, the imam himself, and therefore the legitimate holders of both the spiritual and temporal authorities. But in this case, too, a religious establishment with rapidly growing influence began to appear soon after the empire was established. Thus, toward the end of the Safavid period, the leading cleric of the early seventeenth century, Muhammad Baqir Majlisi (1627–1698), enjoyed a degree of authority in temporal affairs only second, if not equal, to that of the shah.

During the eighteenth century, a third modern Muslim state was formed on the Arabian Peninsula. This was the result of an alliance between a Sunni religious scholar, Muhammad ibn Abd al-Wahhab (1703–1792), and a local prince,

Muhammad ibn Sa'ud. Abd al-Wahhab considered his movement an attempt to return to pure and genuine Islamic society, arguing that Muslims other than his followers had abandoned the principles of Islam. The alliance between Abd al-Wahhab and ibn Sa'ud led to the creation of an army of zealous Muslims. Following this alliance, the Saudi princes claimed the title of imam in order to unify spiritual and temporal authority in the Arabian Peninsula. The Wahhabi-Saudi alliance proved to be resilient and successful in unifying the peninsula and in providing the Saudi monarchs with substantial legitimacy. But again, one must not discount the influence of the ulema, who demonstrated their power in the abdication of King Saud (1964).

From Secularization to Islamic Revivalism

Throughout the nineteenth and twentieth centuries, the Muslim world in the Middle East witnessed a general turn toward secularization. Ottoman reform movements in the nineteenth century (the *Tanzimat* and, later, that of the Young Turks) and the Iranian Constitutional Revolution (1905–1911) were examples of attempts to duplicate European models of building modern states, with separation of religious and secular authority adopted as at least an implicit principle. This trend reached its height with the rise to power of Kemal Atatürk (Turkey, 1923) and Reza Shah (Iran, 1925). They reduced the influence of the ulema significantly and made the separation principle an explicit cornerstone of their reforms.

Ironically, the early twentieth century also witnessed the birth of contemporary Islamic Revivalism, especially in Egypt, where the state failed to take radical reform initiatives similar to those of Turkey and Iran. In response to various national and international challenges and the failure of both traditional and liberal (*Wafd* party) establishments in meeting these challenges, the Egyptian schoolteacher Hasan al-Banna (1906–1949) established the first modern political party, the Muslim Brotherhood (founded 1928). The Muslim Brotherhood advocated an exclusively Islamic ideology and a radical platform not only to reeducate individual Egyptians in Islam, but also to transform Egypt into an explicitly Islamic society with a self-consciously Islamic state. Another relevant event during the first half of the twentieth century was the birth of what was eventually called the Islamic Republic of Pakistan, a state that from the beginning justified its existence based on Islam. Pakistan was also the birthplace of another important ideologue of contemporary Islamic Revivalism, Abu l-A'la' Maududi (1903–1979).

Al-Banna and Maududi opened the road for other, often more radical, advocates of reviving Islamic societies, which would be ruled by Islamic states and according to the Islamic laws. Sayyid Qutb (1906–1966) of Egypt and (in a very different context) Ayatollah Ruhollah Khomeini (1902–1989) of Iran are among such figures. Maududi and Qutb contributed significantly to a new shift in radical Islamic political thought by developing the concept of *jahaliyya*, according to which Muslims in the contemporary world find themselves living in a state of "ignorance" similar to that confronted by Muhammad and his earliest followers. The concept accused contem-

porary Muslims of being ignorant of Islam and its laws, or ignoring those laws as the sole legitimate guidance for action in both public and private domains. Al-Banna, Maududi, Qutb, and Khomeini challenged Muslims to re-create the genuine Islamic state, whose principal characteristics could be traced to the prophet Muhammad's experience in Medina.

In Pakistan, after General Zia al-Haq seized power in a military coup (July 1977), attempts were also made to revive an Islamic state, particularly through a program known as Nizam-i Islam. However, it was in Iran that the principal contemporary Islamic state was created in 1979. Coming to power by mass revolution, Ayatollah Khomeini and his associates articulated a new and radical interpretation of an older Shia doctrine, that of the "Guardianship of the Jurist of Islamic Law" (*velayat-e faqih*). According to their interpretation, during the continuing absence of the twelfth Shia imam (al-Mahdi), the only legitimate political authority is that exercised by the qualified jurists of Islamic laws. Consequently, the Iranian Constitution places supreme authority in the hands of a cleric (referred to as the "Supreme Guide" or "Leader of the Revolution"). Thus, in Iran spiritual and temporal authority have once again become unified, albeit in a very modern (and also explicitly Shia) form.

Soon after the revolution in Iran, attempts to build an Islamic state in the Sudan were initiated. Similarly, Afghanistan witnessed the creation of an Islamic state with the fall of the socialist government of President Najiballah (1992), and the establishment of the Taliban regime in 1996. The Taliban ("students" in Persian) movement took root among young Afghan refugees in Pakistan, trained in schools with Islamic curriculums during the Soviet occupation of Afghanistan. Upon coming to power, the Taliban government strictly enforced its version of Islamic law, in yet another attempt to create an Islamic State based on the principles of Prophet Muhammad's commonwealth in Medina.

See also *Islam; Religion: Middle East*.

BIBLIOGRAPHY

- Abu Rabi', Ibrahim M. *Intellectual Origins of Islamic Resurgence in the Modern Arab World*. Albany: SUNY Press, 1996.
- Al-Farabi, Abu Nasr. *On the Perfect State*. Translated by Richard Walzer. New York: Oxford University Press, 1985.
- Algar, Hamid. *Wahhabism: A Critical Essay*. Oneonta, N.Y.: Islamic Publications International, 2002.
- Black, Anthony. *The History of Islamic Political Thought: From the Prophet to the Present*. New York: Routledge, 2002.
- Brown, Carl L. *Religion and State: The Muslim Approach to Politics*. New York: Columbia University Press, 2000.
- Crone, Patricia, and Martin Hinds. *God's Caliph: Religious Authority in the First Centuries of Islam*. Cambridge, U.K., and New York: Cambridge University Press, 1986.
- Esposito, John L., and John O. Voll. *Islam and Democracy*. New York: Oxford University Press, 1996.
- Esposito, John. *Islam and Politics*. 3rd ed. Syracuse, N.Y.: Syracuse University Press, 1991.

- Imber, Colin. *Ebu's-Su'ud: The Islamic Legal Tradition*. Stanford, Calif.: Stanford University Press, 1997.
- Khomeini, Ruhollah. *Islam and Revolution: Writings and Declarations of Imam Khomeini*. Translated by Hamid Algar. Berkeley, Calif.: Mizan Press, 1981.
- Lewis, Bernard. *The Political Language of Islam*. Chicago: University of Chicago Press, 1991.
- Momen, Moojan. *An Introduction to Shi'i Islam: The History and Doctrines of Twelver Shi'ism*. New Haven, Conn.: Yale University Press, 1985.
- Nizām al-Mulk, Abu 'Ali al-Hasan. *The Book of Government; or, Rules for Kings: The Siyāsāt-nāma or Siyār al-Mulūk*. Translated by Hubert Darke. New Haven, Conn.: Yale University Press, 1960.
- Qutb, Sayyid. *Social Justice in Islam*. Oneonta, N.Y.: Islamic Publications International, 2000.
- Rubin, Barry, ed. *Revolutionaries and Reformers: Contemporary Islamist Movements in the Middle East: Essential Writings of Abdolkarim Soroush*. Albany: SUNY Press, 2003.
- Soroush, Abdolkarim. *Reason, Freedom, and Democracy in Islam*. Oxford, U.K.: Oxford University Press, 2000.
- Tamimi, Azzam, and John Esposito, eds. *Islam and Secularism in the Middle East*. New York: Yale University Press, 2000.
- Weiss, Anita M., ed. *Islamic Reassertion in Pakistan: The Application of Islamic Laws in a Modern State*. Syracuse, N.Y.: Syracuse University Press, 1986.

Cyrus Masroori

UNITED STATES

Citizens of the United States quite properly regard the ideas and practices relating religion to the state in their nation as being sharply distinguished from those that prevailed in Europe at the time of the national founding. The sources of these ideas were European as opposed to African, Asian, or Native American. They arrived in America through literary imports and in the minds of colonists chiefly from the British Isles between 1607, when settlers arrived in Virginia, and 1787, when the U.S. Constitution was written in Philadelphia. The specific forms these ideas took on American soil, however, differed significantly from patterns that originated east of the Atlantic Ocean.

The Ideas Behind a Liberal Polity

What emerged in the United States in connection with these ideas was a form of liberal polity and practice. Whatever else this style of liberalism includes, it depends on reason, which means that participants are expected to argue their political cases on rational grounds without privileging religious warrants. Second, such a liberal state encourages or at least allows for a considerable expression of individual freedom. A third feature is the recognition that such a state cannot thrive if the majority of its citizens do not practice considerable degrees of tolerance in respect to the religious and philosophical commitments of others.

In the longer history of the West, religion had been a force that in many ways militated against these three expressions. In almost all cases, the founders came with preconceptions that

related specifically to Christendom, which was the political realization of Christianity as a set of both ideas and institutions.

Judaism was the ancestor of such Christianity, and in respect to thought about the state, most Christian founders at the time when the Constitution was being written drew as much on the Hebrew Scriptures as they did on the New Testament. Their “Old Testament” included many provisions for government, including the Decalogue, which remained highly influential in official European Christianity. The New Testament texts, while they included celebrations of government in several instances, were much more colored by apocalyptic thinking. When these were written, the world was expected to end soon, so there were not many reasons for believers to be concerned with how to govern the state.

Religious Establishment

One cluster of ideas in the experience of Christendom colored everything done in its name. This was the establishment of Christianity as the official religion of the Roman Empire in the fourth century. The division of the Christian Church into Roman and Eastern factions by the eleventh century in no way led to legal disestablishment. For the most part the Reformation of the sixteenth century that issued in Anglicanism and various forms of European Continental Protestantism also did not change this significantly. There were, of course, small dissenting groups such as the Quakers and Anabaptists, just as there had been marginalized groups in medieval Catholic times, but these suffered harassment and persecution.

Establishment meant that only one form of religious faith was given legal status, privilege, and the mandate to support the state. Almost all colonists came from European nations and territories that authorized and depended upon the sanction of only one religious expression—for example, Roman Catholicism, Anglicanism, or Presbyterianism. Even most of the dissenters who arrived from the British Isles, notably Puritans, set up established churches when they arrived in New England after the beginnings of the Massachusetts Bay colony in 1630.

Establishment Christianity did not imply that Christians were enemies of reason. It did prescribe, however, that revealed religion was to be honored. Thus “the divine right of kings” was a typical element of the system that the colonists had to counter when they declared independence from England in 1776. In 1787, however, in nine of the thirteen colonies they still drew upon the Bible and church authority to undergird the state and determine much of their own political argument.

Similarly, while the Constitution assured religious freedom in all colonies as they became states, in the new nation the Christian majority could appeal to many strands of biblical and ecclesiastical thought to legitimate individualism. Yet most Christians assigned priority to community expression. Individualists like Roger Williams (1603?–1683), Anne Hutchinson (1591–1643), and others were dissenters who always had to struggle for their rights.

As for tolerance, establishment Christians were not always poised with the sword to punish dissent in the harshest of terms, yet it was expected that one set of ideas should have a monopoly or at least privilege. Dissent was recognized only grudgingly.

The National Period: Disestablishment Favoring Religion

Despite these establishment predilections, within a fifty-year period after 1787 the vast majority of Christians in the United States came to embrace government of the state based at least theoretically and legally in nothing but rational discourse. Religious institutions paradoxically prospered when their advocates had to bid for public attention among people, many of whom did not assent to their sacred dogmas.

Second, not only did the religious leaders accept the concepts of individual freedom that much of Christendom had long inhibited. They began to claim that they had possessed a patent on them and were the main custodians of citizen rights. And while the religiously serious did not all assent to doctrines that made room for or depended upon tolerance, through the many decades after 1787 most people found ways to combine personal conviction and institutional truth claims with at least practical support of toleration in the face of religious diversity.

The Enlightenment and Evangelicalism

One set of leaders who helped make possible the drastic changes were advocates of an American version of the Enlightenment. Another were the new-style religious evangelicals, who were “awakeners” or revivalists, who made direct intuitive appeal to the minds of the public. In the process, they began to undercut establishments. In contrast to the anticlericalism of much of the European Enlightenment, in America the celebrators of reason and rational religion tended to be friendly to faiths. Many of the advocates—George Washington (1732–1799), John Adams (1735–1826), and others—praised the contribution of religion to the morality and virtue on which the free state depended. Even those who were the most strenuous advocates for disestablishment and religious freedom, among them James Madison (1751–1836) and Thomas Jefferson (1743–1826), who could be quite critical of much religious authority in their day, did much to help assure freedom for formerly established as well as dissenting churches and, of course, with them, for individuals.

Before long the revivalists and evangelists attracted followings and these outpaced those in establishment Congregationalism and Anglicanism (Episcopalianism). Their appeal to citizens to make religious choices did much to enhance the concept of individualism.

While the U.S. Constitution in Article 6 demonstrated the influence of the advocates of religious freedom, it also reflected the practical situation of colonists who knew there could not be a national union if Congress arranged for an established church. So that article ruled out all religious tests for holders of office. In the First Amendment (1789) the drafters were more specific and sweeping: “Congress shall make no law respecting an establishment of religion, or prohibiting the free

exercise thereof.” The wording referred only to Congress; the drafters could not have gotten assent to the law had they insisted on disestablishment in the various colonies, now states. But by 1833 the last establishments fell and after 1941 the U.S. Supreme Court set the precedent for incorporating all the legal terms of religious freedom nationally into the judicial rulings of the states.

Separation of Church and State

The term most citizens, including their legislators, executives, and jurists, have favored for their polity is “separation of church and state,” a phrase used by Thomas Jefferson in a letter to Connecticut Baptists in 1802. This is accepted as constitutional dogma by many, though it is not mentioned in the Constitution and in practice it has not meant the drawing of a radical line between what James Madison called “religion and civil authority.” Thus the fact that religious institutions are ordinarily exempted from taxation, that legislatures pay chaplains, and the like, suggests that extreme and pure separation has never existed.

The terms in which the Constitution is interpreted by the U.S. Supreme Court and other courts and by the public change regularly in the light of changed circumstances and changing Court personnel. Persistently, American majorities have indicated that they prefer policies friendly to religious institutions and expressions. Most of them withhold consent, however, when such policies verge too explicitly toward establishing a religion, or religion in general, when privileging one religious group over another, or privileging religion over nonreligion.

While these majorities insist that they are free to advocate for specific political outcomes on the basis of their interpretations of sacred texts such as the Bible or church dogma, most know that to be effective they cannot expect the nonreligious citizens or members of other religious groups to be swayed by their own interpretations and claims. The Enlightenment ideas have endured alongside dissenting Christian expressions to counter too aggressive religious movements.

In the *Federalist Papers* No. 10, James Madison, when he was trying to win support for the ratification of the Constitution, contended that the security of the republic lay in the multiplicity of interests, including religious ones. There have always been and there remain controversies over policy contention based on explicit religious claims of some versus those of others who would appeal chiefly to rational argument. However, in general, American religionists have bought into and support the liberal state.

The favor most Americans show religion and religious groups has been returned in kind throughout most of American history. During the Civil War southern religious leadership provided warrants for the ideas and military acts of the Confederate States of America while the northern clerics and lay articulators supported the ideas of the Union. At the same time, what scholars call civil religion, public religion, or the religion of the republic has tended to draw support of the members of religious organizations. While the voice of dissent has never been completely stifled, for the most part religious voices have been

nationalistic, supportive of the military in the nation’s wars, and confident that the American state is “a nation under God,” even if there is no Constitutional base for the claim.

Non-Judeo-Christian Religions

While over eighty percent of the people of the United States identify themselves with what has come to be called the “Judeo-Christian” religion, there have always been inhabitants who did not belong to that tradition. Most notable have been Native Americans or American Indians, many of whom did convert to Christianity, but others, down to the present, have retained their own rituals and traditions. They have often represented anomalies to the courts. In one of the most celebrated instances, for example, the United States Supreme Court in *Employment Division v. Smith* (1990) ruled against two Native American drug rehabilitation counselors who were fired because they ingested peyote during ritual observances.

Some of the founders anticipated a day when citizens from a variety of religious heritages would test the boundary of the biblical tradition. Already during the debates over religious freedom in Virginia in the 1780s, Thomas Jefferson argued that the legislature was trying to protect, and should protect, “the Jew and Gentile, the Christian and Mahometan, the Hindoo, and infidel of every denomination.” Through the next two and a half centuries “Mahometans” and “Hindoos” were few in number. After the U.S. Congress changed the immigration laws in 1965, however, great numbers of immigrants came from Asia, Africa, and especially nations where Muslims predominated.

Some came from places where religious practices were proscribed, but others had the experience of polities in which religion and regime had never been separated, as is the case with most areas dominated by Muslims. Their views on “religion and the state” did not awaken much curiosity until a number of terrorist acts, especially the destruction of the World Trade Center in New York on September 11, 2001, and the increasing involvement in Middle Eastern conflicts, as between Arabs and Jews, led many non-Muslim citizens to be suspicious and to resist efforts by Muslim populations to have some of their controversial practices protected by law.

The presence of the varieties of immigrants from other than Europe and the increase in both pluralism and in the demands for personal freedom led to many testings of the conventional boundaries of “church and state” in law and in custom. Not all the tensions among citizen groups resulted in legal battles, but across the spectrum from neighborhoods surrounding mosques to high governmental administrators and strategists, Muslims found themselves having to demonstrate that they were full participants in the American complex.

Given the suddenness of the arrival of new immigrants and the global conflicts reflected among American citizens, one might have expected that confrontations would have become menacing and even bloody. Yet gross violations of citizen rights were few, and most of the new Americans, whether or not they felt themselves to belong to the longer tradition called “Judeo-Christian,” adapted to their new environment. As is often the

case with converts to a cause or new arrivals to a culture, most went out of their way to advertise their attachment to the United States, even when and perhaps because its legal tradition and culture worked to keep Madison's line of distinction between religion and civil authority clear. And, like so many before them, they came to affirm America's "civil religion," were ready to sing "God Bless America," and to recite the Pledge of Allegiance concerning "one nation, under God. . . ."

See also *Americanization, U.S.; Assimilation; State, The; Toleration.*

BIBLIOGRAPHY

Hamburger, Philip. *Separation of Church and State*. Cambridge, Mass.: Harvard University Press, 2002.

Miller, Robert T., and Ronald B. Flowers. *Toward Benevolent Neutrality: Church, State, and the Supreme Court*. 4th ed. Waco, Tex.: Baylor University Press, 1992.

Noll, Mark A. *America's God: From Jonathan Edwards to Abraham Lincoln*. New York: Oxford University Press, 2002.

Noonan, John T., Jr. *The Believer and the Powers that Are: Cases, History, and Other Data Bearing on the Relation of Religion and Government*. New York: Macmillan, 1987.

Wilson, John F., ed. *Church and State in America: A Bibliographical Guide*. Vol. 1: *The Colonial and Early National Periods*; Vol. 2: *The Civil War to the Present Day*. Westport, Conn.: Greenwood, 1986, 1987.

Martin E. Marty

RENAISSANCE. The term *Renaissance* (English, French, German; *rinascità* in Italian) refers to (1) "a rebirth of arts and letters" noticed by authors and artists living between the 1300s and the 1600s; (2) Italian cultural history from about 1300 to 1520 ("La Rinascimento"), as in the period concept of Jacob Burckhardt's *The Civilization of the Renaissance in Italy* (1860); or (3) a period of European history starting in Italy as early as the fourteenth century and extending into the seventeenth century in England. In the twentieth century, those studying other European nations sought to document outside Italy the presence of both a renaissance of arts and letters and the Burckhardtian characteristics of Renaissance civilization. The Renaissance, especially in American humanities courses on "Western" civilization and to members of the Renaissance Society of America (founded 1954), became a full period concept for European civilization from Petrarch to Milton, including trade routes and colonization.

Medievalists, led by Charles Homer Haskins, researched a succession of medieval renaissances (Carolingian, Ottonian, twelfth century), suggesting that the fourteenth- and fifteenth-century Renaissance may be viewed as an extension of late medieval culture. Nevertheless, Erwin Panofsky in *Renaissance and Resuscitations in Western Art* (1972) argued that the Italian Renaissance differed from the earlier ones in that the revived classical heritage became a permanent possession and ancient forms were reunified with ancient content; to experience Panofsky's point, visit in the renovated Galleria Borghese in

Rome the succession of rooms of pagan gods such as Venus or Hermaphrodite.

Comparison of Culture to Horticulture

Petrarch, who was a practical gardener, viewed the rebirth of culture as plants regrowing in the sunlight of spring. Petrarch's French disciple Nicolas de Clamanges refers to flowers together with the Latin term *renasci*, meaning "to grow again" or "to be reborn." Boccaccio praised Dante for inviting back the Muses and Giotto for restoring the art of painting. Borrowing from the ancient vegetative imagery, such as the older Cato's image of a broken clover regrowing and Pliny's examples of vegetative matter regrowing as sprouts, humanists praised the work of fourteenth-century Italian artists and writers. Northern humanists continued a strategy of nourishing, cultivating, and transplanting from classical texts and images the seeds of virtue and knowledge. In the circle of King Francis I of France, in flowery rhetoric humanists praised him for the rebirth (*renaître*) of letters, and in the architecture, decorative arts, and manuscript and book collections in the court at Fontainebleau, there was a "renaissance of arts and letters." Visual evidence for concepts of the rebirth of culture include Simone Martini's illumination that Petrarch commissioned for his copy of Virgil's *Georgics* and *Eclogues*, Da Vinci's image of a trunk resprouting (a botanical lesson from Virgil's *Georgics*), and Botticelli's *Primavera*.

The Influence of the Burckhardtian Renaissance

Burckhardt claimed "the Italian Renaissance must be called the mother of our modern age" and described its six major characteristics: the vision of the state as a work of art in both princedoms breeding egocentric leaders and republics breeding new independent individuals; the development of the individual—newly subjective, conscious of fame, and multifaceted; the revival of antiquity, especially ancient Latin culture; the discovery of the world and of humanity as evidenced by mapmaking, landscapes, natural science, poetry, biography, and social commentary; the equalization of society through festivals that expressed a common culture; and the advent of an immoral and irreligious age with revival of ancient pagan superstitions and an oscillation between religiosity and secularity. Medievalists sought to show that especially the first four Burckhardtian characteristics were already present in the medieval world, that in fact a rich Roman culture persisted more in the north than in the divided Italian peninsula. They documented individualism in Thomas Aquinas and Eleanor of Aquitaine and medieval advances in science and in naturalistic art. Scholars of the fifteenth to seventeenth centuries in England, France, Spain, the Low Countries, the German lands, Hungary, Poland, and elsewhere have likewise claimed Burckhardtian Renaissances, usually like the medievalists emphasizing the first four traits, although in French scholarship a secular, doubting French Renaissance had a vogue to which Lucien Febvre responded in *The Problem of Unbelief in the Sixteenth Century: The Religion of Rabelais* (1982). In the expansion by later Burckhardtians, the Italian city-states were a model in miniature for the development of the nation-states (see Garrett Mattingly on diplomacy, Hans Baron on civic hu-

REBIRTH OF CULTURE AS A REGROWTH OF PLANTS IN THE SPRING

Petrarch, *Secretum*, c. 1343: “When too many plants are sown in a narrow ground, namely that their growth is prevented by crowding, the same thing happens to you, so that no useful roots are put down in the soul that is too occupied and nothing fruitful grows.”

Pierre Belon, *Observation*, 1553: “The minds of men . . . have begun to wake up and to leave the darkness where for so long they have remained dormant and in leaving have put forth and put in evidence all kinds of good disciplines, which to their so happy and desirable renaissance, all as the new plants after a season of winter regain their vigor in the heat of the Sun and are consoled by the mildness of the spring.”

SOURCE: From Maryanne C. Horowitz, *Seeds of Virtue and Knowledge*, pp. 115, 297, n. 96; pp. 156, 309, n. 7.

manism in Florence as a precedent for the United States), and individualism emerged not only from political turmoil but from the development of capitalist, middle-class occupations (Alfred von Martin, E. P. Cheyney).

Today the Burckhardtian Renaissance is evident in textbooks, in films on Renaissance individuals, and in art exhibitions. The term “renaissance” meaning a flowering of culture is positive and optimistic, and thus it has been extrapolated to other contexts, such as the “Jewish Renaissance” of Hebrew with the rebirth of Zionism in nineteenth-century Europe, the “Harlem Renaissance” of African-American culture in the 1920s, and numerous discussions of urban renewal as a “renaissance.”

Burckhardtian scholarship continues to emphasize Burckhardt’s first four characteristics of the Renaissance, finding isolated precedents in the medieval period. As social and economic historians and women’s historians have made evident the hierarchies of rank and gender that marked the age, scholars have recognized that the fifth characteristic, “equalization,” was limited to the mingling and rising of burgher to noble status and that a few daughters tutored along with sons and women’s presence at courts did not add up to Burckhardt’s “footing of perfect equality with men.”

In claiming Burckhardtian Renaissances for other nations, generally scholars isolated the “immoral and irreligious age” to the Italians, although in some postcolonial interpretations (such as that of Walter D. Mignolo), point four—the discovery of the world and of humanity—provides the strongest evidence of point six—the immorality of the European colonialist, slave trader, and missionary.

Scholars of the Protestant Reformation have always emphasized the Christian characteristics of northern humanists. Criticizing Luther for authoritarianism and asceticism, Ernst

Troeltsch (1906) contrasted medieval traits of the reformation with modern traits of the Renaissance; admiring Luther for redirecting Christian freedom to vocations in this world, Wilhelm Dilthey (1923) interpreted the Renaissance and Reformation together as the foundation of the modern world. Especially in the United States, where scholars specializing in the Renaissance and the Reformation often interpret the Reformation as a culmination of the Renaissance and focus on the humanist’s inquiries into Christian antiquity, the term “Christian humanism” is applied to humanists of both the Italian and the northern Renaissance. Nevertheless, we must note that curious and daring humanists employed Jews and Greek Orthodox to explore texts in Greek, Hebrew, Aramaic, and Arabic, and openly read and commented upon works written by ancient pagans; Jewish humanists in Italy brought about a renaissance of ancient Hebrew genres (see Cecil Roth and Arthur Lesley in *Renaissance Rereadings*).

Historical Challenges from *Annales* School and from Early Modernists

Coincident with national movements of independence from colonization by European nations, historians in Paris developed a movement disparaging the historical studies focused on “What’s new?” The *Annales* school focused on structures of long duration, emphasizing land patterns, family structures, religious and political rituals, and popular customs that have changed slowly and not in accordance with the traditional dates of historical periodization. Funded as social science and utilizing increasingly computerized databases on demography and prices of material goods (whether wine, salt, or catechisms), scholars are accumulating more precise information on living conditions in the premodern world.

The work of scholars seeking out lives of lesser-known people (women and the marginalized) and seeking documents of public performances (confraternity events, religious and political rituals) has provided a fuller awareness of premodern cultures. To be inclusive of popular as well as elite cultures and to start afresh without the ideological implications of nineteenth-century interpretations of “Renaissance,” some scholars prefer the period term “early modern.” Such scholars tend not to be working on the Italian Renaissance of the 1300s and early 1400s but to start after 1450, when the invention of the printing press accelerated the spread of the renaissance of arts and letters throughout Europe. For those scholars, who view either the invention of the printing press or Martin Luther the protester as the turning point from the Middle Ages to the early modern period and who drop Renaissance as a period concept, the Renaissance in Europe becomes closer to its original definition as a movement in arts and letters—in the early modernist’s viewpoint, the first movement in a succession of overlapping movements of the early modern period.

A strain of scholarship has emerged to historicize the development of the concept of a Renaissance period. Scholars are fascinated by various versions of ideas of the Renaissance, such as those of Jules Michelet, Burckhardt, the Victorians, J. P. Morgan, and Virginia Woolf. Pascal Briost emphasizes that Michelet published his *Introduction à la Renaissance* in 1855, the year Burckhardt began writing his more famous work. Even though Michelet originated the phrase “the discovery of the world and the discovery of man,” the term “Burckhardtian” remains the common adjective for “Renaissance” with a capital R.

While “medievalisms” are also studied, the brunt of historicizing of the period concept of Renaissance suggests that the Burckhardtian Renaissance is a nineteenth-century historical fiction or a utopian vision. J. B. Bullen traces the development of the “myth” of the Renaissance between Voltaire (1756) and Walter Pater (1873). Burckhardtrians have responded to the undermining of the period concept by printing editions of his work with art illustrations, as art more than any other medium demarcates a distinctive period. The 1793 creation of the Louvre Museum, with its succession of rooms of great civilizations (Egypt, Greece, Rome, and the centrally placed Renaissance) set a pattern spread by Napoléon to Madrid, Naples, Milan, and Amsterdam, and imitated in New York, Boston, and Chicago (see Carol Duncan’s 1995 study, *Civilizing Rituals: Inside Public Art Museums*). Daniel Ménager in 1992 emphasized the aesthetic, in fact the religion, of beauty that distinguishes the creativity of the Renaissance. Paula Findlen, in a 1998 *American Historical Review* forum on “The Persistence of the Renaissance,” demarcated the period by its passion for collecting objects of antiquity and taking creative inspiration from that collecting. The general public, as well as the tourist industry, recognizes the innovation, distinctiveness, and sheer visual beauty of art from, say, the cardinal and Christian virtues and vices of Giotto’s Arena Chapel in Padua to the nude forms of Michelangelo’s Sistine Chapel ceiling and *Last Judgment*.

Humanists and Early Scientists

Meanwhile, neither humanist nor reformer ushered in the world of the post-Sputnik generation; government funding of the sciences, including the history of science, has taught historians that the major intellectual shift of modernity occurred in the development of the sciences, especially from Galileo to Newton. Dava Sobel’s *Galileo’s Daughter* (1999) illuminates the contrasting mentalities of this shift as represented by the scientist’s relationship (through correspondence) with his daughter Maria Celeste, a nun. The interpretation of Copernicus and Galileo as early scientists rather than as “Renaissance men,” as well as the seeking of the origins of science in the practices of apprenticeship, the work of artisan workshops, and in the inventions accompanying military battles and world navigation, rivals the outpouring of current scholarship documenting the humanist movement in countries throughout Europe.

In the second half of the twentieth century, the decrease in humanists educated in Greek and Latin letters, the rise in the status of scientists and those educated in “science” or “social science” curricula, and the funding of the history of science encouraged a search for the origins of modernity in the seventeenth-century innovations in science and technology. To create global and multicultural liberal arts curricula, colleges and universities have condensed posts across the disciplines for premodern Europe, making it sensible for those doing scholarship on topics from antiquity to the French Revolution to advocate their common interests in the creation of academic centers, funding of journals, and defending posts in premodern studies. For those in the historical profession, “early modern” is the category used globally by the American Historical Association.

Renaissance of the Renaissance Society of America

Together with practical on-line resources for accessing published books, such as *Early English Books, 1475–1700*, Elizabeth Eisenstein’s *Printing Press as an Agent of Historical Change* refocused attention on 1450 as a turning point. E-mail groups such as FICINO and conferences have discussed the rivalry of the term “Renaissance” and the term “early modern,” but “Renaissance” persists as a period label for books and articles in disciplinary histories such as art history, music history, and history of science, in national and comparative literatures, and in history. While the *Journal of Medieval and Renaissance Studies* appeared in 1997 with the new title *Journal of Medieval and Early Modern Studies*, expanding its reach to “European and Western Asian cultural forms from late antiquity to the seventeenth century,” its home base at Duke University remained the Center for Medieval and Renaissance Studies. Women’s studies scholars, delving into women’s writings and disregarding the stereotype “Renaissance woman,” created the Society for Study of Early Modern Women with a home base at the University of Maryland Center for Renaissance and Baroque Studies.

Encouraging regional and topical organizations, the Renaissance Society of America holds council meetings with affiliates. As of 2003, there was no early modern umbrella organization. From the 1985 national meeting of the Renaissance Society of America at Occidental College, the Huntington Library, and the J. Paul Getty Museum, which ushered in open calls for

papers on distinctive topics of the European Renaissance (collected in *Renaissance Rereadings: Intertext and Context*, a selective anthology commemorating the conference) to the RSA's international meetings in 2000 in Florence, Italy, and in 2005 in Cambridge, England, there has been an international renaissance of Renaissance studies.

See also *Cultural History; Humanism: Renaissance; Periodization; Periodization of the Arts; Reformation; Science, History of*.

BIBLIOGRAPHY

- Benson, Robert L., and Giles Constable, eds., with Carol D. Lanham. *Renaissance and Renewal in the Twelfth Century*. Toronto: University of Toronto Press, 1991.
- Briost, Pascal. *La Renaissance: 1470–1570*. Paris: Atlande, 2003.
- Bullen, J. B. *The Myth of the Renaissance in Nineteenth-Century Writing*. Oxford: Clarendon, 1994.
- Burckhardt, Jacob. *The Civilization of the Renaissance in Italy*. Translated by S. G. C. Middlemore. New York: Penguin, 1990. Illustrations aid in providing visual evidence that Burckhardt did not include.
- Ferguson, Wallace F. *The Renaissance in Historical Thought: Five Centuries of Interpretation*. Boston: Houghton Mifflin, 1948.
- Findlen, Paula, and Kenneth Gouwens. "AHR Forum: The Persistence of the Renaissance." *American Historical Review* 103 (1998): 51–114.
- Gentrup, William F., ed. *Reinventing the Middle Ages and the Renaissance: Constructions of the Medieval and Early Modern Periods*. Turnhout, Belgium: Brepols, 1998.
- Horowitz, Maryanne Cline. *Seeds of Virtue and Knowledge*. Princeton, N.J.: Princeton University Press, 1998.
- Horowitz, Maryanne Cline, Anne J. Cruz, and Wendy A. Furman, eds. *Renaissance Rereadings: Intertext and Context*. Urbana: University of Illinois Press, 1988.
- Journal of Medieval and Renaissance Studies* 22, no. 1 (winter 1992). Special issue: "The Idea of the Renaissance in France." See especially Jean Delumeau, "Une histoire totale de la Renaissance"; Gisèle Mathieu-Castellani, "Pour une renaissance de la Renaissance"; and Daniel Ménager, "La Renaissance et la religion de la beauté."
- Kerrigan, William, and Gordon Braden. *The Idea of the Renaissance*. Baltimore: Johns Hopkins University Press, 1989. Committed to vitality of the concept.
- Marcus, Leah S. "Renaissance/Early Modern Studies." In *Redrawing the Boundaries: The Transformation of English and American Literary Studies*. Edited by Stephen Greenblatt and Giles Gunn. New York: Modern Language Association, 1992.
- Mignolo, Walter D. *The Darker Side of the Renaissance: Literacy, Territoriality, and Colonization*. Ann Arbor: University of Michigan Press, 1995.

Maryanne Cline Horowitz

REPRESENTATION.

This entry includes two subentries:

Mental Representation
Political Representation

MENTAL REPRESENTATION

Humans are surrounded by representations. Some of these occur naturally—for example, tree rings and footprints—while others are artificial—for example, words and photographs. Whatever their origins, all share a fundamental feature: they *stand for* something. Tree rings stand for the age of the tree; footprints stand for the entity that made them; a photograph stands for that which it pictures; and a proper name stands for the person so named.

There is considerable evidence that representations are not confined to the external world; they figure in people's mental lives as well. Perceptual illusions provide intuitive motivation: a straight oar in water appears bent, amputees may experience "phantom" tactile sensations in a missing limb, and some series of tones sound as if they are continually rising in pitch. In each of these cases, it is natural to explain the phenomenon by positing mental representations (albeit incorrect ones).

History

The Western intellectual tradition has long recognized the importance of representation in thought. A dramatic example is provided by the philosopher René Descartes (1596–1650), who hypothesized the existence of an "evil demon" that deceived him in every way, causing *all* of his mental representations to be false. Descartes's emphasis on the role of mental representations in thought was influential, and subsequent thinkers—John Locke (1632–1704), David Hume (1711–1776), George Berkeley (1685–1753), and John Stuart Mill (1806–1873), to name a handful—expanded the discussion.

Contemporary work on mental representation owes as much to the theory of computation as it does to modern philosophy. In the mid-twentieth century, psychology was dominated by *behaviorism*, according to which mental entities, even if they exist, have no theoretical role in explanations of behavior. Instead, behavior was to be explained exclusively in terms of stimulus-response patterns. However, in the 1950s, opponents argued that this goal could not be achieved; one must posit internal representations. Moreover, these researchers came armed with a powerful new tool—the methods and concepts of the theory of computation.

The abstract principles of information processing upon which devices such as personal computers are based constitute the theory of computation. According to this theory, computation consists in the rule-governed manipulation of symbols. For example, consider doing long division using pencil and paper. A problem is written on the paper as a set of numerals, and solving it involves repeatedly applying a series of basic rules: division, multiplication, subtraction, writing additional symbols on the paper, and so forth. Analogously, an influential predecessor of today's computers—proposed in 1936 by the mathematician Alan Turing (1912–1954)—consists of a tape for storing symbols, a means for writing and reading symbols to and from the tape, and a controller encapsulating the rules for performing a calculation using those symbols.

Turing's machines are machines in name only; in actuality, they are abstract definitions, introduced to address a prob-

lem of mathematical logic. Regardless, he and others realized that variations on these machines could be physically realized. It was only a small step to infer that human cognitive processes are computational, involving the manipulation of mental representations according to “rules of thought.”

Wielding the conceptual tools of computation, opponents of behaviorism initiated a flurry of research on mental representation, as well as creating entirely new areas of research, such as artificial intelligence and computational linguistics.

Three questions receiving considerable attention in contemporary research are: How do mental representations come to have their contents? What conditions must an entity satisfy in order to be a mental representation? And, what is the format of mental representation?

Mental Content

Concerning mental content, one hypothesis is that the content of a representation is determined by the role it plays in a person’s overall system of mental representations. As an analogy, consider chess pieces: the difference between a knight and a bishop consists in the fact they have distinctive ways of moving—they play different roles in the game. Similarly, mental representations with distinct contents differ in the types of inferences they invite: believing that Tom is tall leads to different conclusions than does believing he is handsome, and each of these beliefs will be the result of different sets of prior beliefs. Perhaps, then, these differences in roles are constitutive of the content of those beliefs.

One difficulty such theories face is that, because it is unlikely that any two people will share precisely the same network of representations, no two people possess beliefs with the same contents—a counterintuitive result. Additionally, the relationship between playing a certain role and “standing for” something is unclear. How do representations come to relate to things in the external world?

An alternative theory makes more of the representation-world relationship, proposing that the content of a representation is determined by its *resemblance* to things in the world. Just a painting of Napoléon Bonaparte represents Napoléon (and not Abraham Lincoln) because it *looks* like Napoléon (and not Lincoln), a mental representation has the content it does because it resembles that which it represents. This proposal also faces challenges. For example, if for a representation to resemble something is to picture, how can abstract entities (e.g., “justice”) be represented?

A descendant of the resemblance theory hypothesizes that the causal relations a representation has with the environment fix the content of that mental representation. According to a simple version of this theory, content is determined by the things that normally cause that representation to occur. For example, the “eagle” concept has the content it has because eagles (as opposed to other types of animals) cause one to think about eagles, that is, to instantiate that representation.

Despite obvious flaws in this simple theory (e.g., if a duck causes someone to think about eagles, then ducks are part of

the content of the “eagle” representation), more elaborate causal theories of content remain popular.

The Nature of Mental Representation

All representations have content; but do they typically possess other features as well? One proposal is that, for an entity to be a representation, it must also be capable of standing for its object in the absence of that object. In this case, for instance, the level of mercury in a thermometer would not represent the temperature of a room because the mercury cannot stand for that temperature in its absence: if the temperature were different, the level would change.

Even when this constraint is satisfied, different types of mental representation are distinguishable. For example, throughout the day, the sunflower rotates to face the sun. Moreover, this rotation continues even when the sun is occluded. Consequently, it stands to reason that somewhere there is a physical process that represents the location of the sun and that guides the flower’s rotation during those instances when the sun is not present. However, there is very little a sunflower can do with this representation besides guide its rotation. Humans, in contrast, are not subject to this limitation. For instance, when seeing a cat, a person may represent its presence at that moment. Furthermore, the person may think about the cat in its absence. But, unlike the sunflower, that person can also think *arbitrary thoughts* about the cat: “That cat was fat”; “That cat belonged to Napoléon,” etc. It seems as if the “cat” representation can be used in the formation of larger—and completely novel—aggregate representations. So, while possessing content is a necessary feature of mental representation, there may be additional features as well.

Representational Format

Some representations play certain roles better than others. For example, a French sentence conveys information to a native French speaker more effectively than does the same sentence in Swahili, despite the two sentences having the same meaning. In this case, the two sentences have the same content yet differ in the way in which they represent it; that is, they utilize different *representational formats*. The problem of determining the correct representational format (or formats) for mental representation is a topic of ongoing interdisciplinary research in the cognitive sciences.

One hypothesis was mentioned above: human cognition consists in the manipulation of mental symbols according to “rules of thought.” According to Jerry Fodor’s influential version of this theory, cognition requires a “language of thought” operating according to computational principles. Individual concepts are the “words” of the language, and rules govern how concepts are assembled into complex thoughts—“sentences” in the language. For example, to think that the cat is on the mat is to take the required concepts (i.e., the “cat” concept, the “mat” concept, the relational concept of one thing being on top of another, etc.) and assemble them into a mental sentence expressing that thought.

The theory enjoys a number of benefits, not least that it can explain the human capacity to think arbitrary thoughts.

Just as the grammar for English allows the construction of an infinite number of sentences from a finite set of words, given the right set of rules, and a sufficient number of basic concepts, any number of complex thoughts can be assembled.

However, *artificial neural networks* may provide an alternative. Inspired by the structure and functioning of biological neural networks, artificial neural networks consist of networks of interconnected nodes, where each node in a network receives inputs from and sends outputs to other nodes in the network. Networks process information by propagating activation from one set of nodes (the input nodes) through intervening nodes (the hidden nodes) to a set of output nodes.

In the mid-1980s, important theoretical advances in neural network research heralded their emergence as an alternative to the language of thought. Where the latter theory holds that thinking a thought involves assembling some mental sentence from constituent concepts, the neural network account conceives of mental representations as patterns of activity across nodes in a network. Since a set of nodes can be considered as an ordered n -tuple, activity patterns can be understood as points in n -dimensional space. For example, if a network contained two nodes, then at any given moment their activations could be plotted on a two-dimensional plane. Thinking, then, consists in transitions between points in this space.

Artificial neural networks exhibit a number of features that agree with aspects of human cognition. For example, they are architecturally similar to biological networks, are capable of learning, can generalize to novel inputs, and are resistant to noise and damage. Neural network accounts of mental representation have been defended by thinkers in a variety of disciplines, including David Rumelhart (a psychologist) and Patricia Churchland (a philosopher). However, proponents of the language of thought continue to wield a powerful set of arguments against the viability of neural network accounts of cognition. One of these has already been encountered above: humans can think arbitrary thoughts. Detractors charge that networks are unable to account for this phenomenon—unless, of course, they realize a representational system that facilitates the construction of complex representations from primitive components, that is, unless they implement a language of thought.

Regardless, research on artificial neural networks continues, and it is possible that these objections will be met. Moreover, there exist other candidates.

One such hypothesis—extensively investigated by the psychologist Stephen Kosslyn—is that mental representations are *imagistic*, a kind of “mental picture.” For example, when asked how many windows are in their homes, people typically report that they answer by *imagining* walking through their home. Likewise, in one experiment, subjects are shown a map with objects scattered across it. The map is removed, and they are asked to decide, given two objects, which is closest to a third. The time it takes to decide varies with the distance between the objects.

A natural explanation is that people make use of *mental imagery*. In the first case, they form an image of their home

and mentally explore it; in the second, a mental image of the map is inspected, and the subject “travels” at a fixed speed from one object to another.

The results of the map experiment seem difficult to explain if, for example, the map were represented mentally as a set of sentences in a language of thought, for why would there then be differences in response times? That is, the differences in response times seemed to be obtained “for free” from the imagistic format of the mental representations. A recent elaboration on the theory of mental imagery proposes that cognition involves elaborate “scale models” that not only encode spatial relationships between objects but also implement a simulated physics, thereby providing predictions of causal interactions as well.

Despite the potential benefits, opponents argue that a non-imagistic account is available for every phenomenon in which mental imagery is invoked, and furthermore, purported neuroscientific evidence for the existence of images is inconclusive.

Perhaps the most radical proposal is that there is no such thing as mental representation, at least not as traditionally conceived. According to dynamic systems accounts, cognition cannot be successfully analyzed by positing discrete mental representations, such as those described above. Instead, mathematical equations should be used to describe the behavior of cognitive systems, analogous to the way they are used to describe the behavior of liquids, for example. Such descriptions do not posit contentful representations; instead, they track features of a system relevant to explaining and predicting its behavior. In favor of such a theory, some philosophers have argued that traditional analyses of cognition are insufficiently robust account for the subtleties of cognitive behavior, while dynamical equations are. That is, certain sorts of dynamical systems are *computationally more powerful* than traditional computational systems: they can do things (compute functions) that traditional systems cannot. Consequently, the question arises whether an adequate analysis of mental representations will require this additional power. At present the issue remains unresolved.

See also *Consciousness; Mind; Philosophy of Mind*.

BIBLIOGRAPHY

- Davis, Martin, ed. *The Undecidable: Basic Papers on Undecidable Propositions, Unsolvability Problems and Computable Functions*. Hewlett, N.Y.: Raven Press, 1965. This volume collects historically important papers on the logical foundations of computation.
- Fodor, Jerry A. *The Language of Thought*. Cambridge, Mass.: Harvard University Press, 1975.
- . *A Theory of Content and Other Essays*. Cambridge, Mass.: MIT Press, 1990.
- Haugeland, John, ed. *Mind Design II*. Cambridge, Mass.: MIT Press, 1997. A well-rounded collection of important philosophical essays on mental representation, ranging from classic papers in artificial intelligence to more recent developments such as artificial neural networks and dynamical systems.
- Hodges, Andrew. *Alan Turing: The Enigma*. New York: Simon and Schuster, 1983. This engrossing biography of Alan Turing offers, among many other insights, well-written informal accounts of Turing’s contributions to logic and computation, in-

- cluding his theories on the role of mental representation in cognition.
- Kosslyn, Stephen M. *Image and Brain: The Resolution of the Imagery Debate*. Cambridge, Mass.: MIT Press, 1994.
- McCartney, Scott. *Eniac: The Triumphs and Tragedies of the World's First Computer*. New York: Walker, 1999.
- McClelland, James L., David E. Rumelhart, and the PDP Research Group. *Parallel Distributed Processing: Explorations in the Microstructure of Cognition*. Cambridge, Mass.: MIT Press, 1986. Published in two volumes, these works played a major role in reintroducing artificial neural networks to cognitive science.
- Watson, John B. "Psychology as the Behaviorist Sees It." *Psychological Review* 101, no. 2 (1913/1994): 248–253. A classic statement of the behaviorist program in psychology by a pioneer of the field.
- Watson, Richard A. *Representational Ideas: From Plato to Patricia Churchland*. Dordrecht, Netherlands, and Boston: Kluwer, 1995.

Whit Schonbein

POLITICAL REPRESENTATION

Although in the early twenty-first century *representative government* is synonymous with *democracy*, the concept of political representation arose separately from the idea of the rule of the people. Broadly political representation refers to an arrangement whereby one is enabled to speak and act with authority in the behalf of some other.

There are two issues that must be addressed in any theory of representation: who or what is to be represented, and who or what is to be the representative. The first question revolves around the description of constituencies. The second concerns the method of selection by which the representative is determined. There are specific answers to these questions that make representation compatible with and complementary to democracy. Once such a constellation of ideas is in place, however, the drama with which the conjunction of representation and democracy is received—in 1820 James Mill (1773–1836) wrote that “in the grand discovery of modern times, the system of representation, the solution to all difficulties, both speculative and practical, will perhaps be found” (p. 21)—eclipses somewhat the predemocratic origins of the concept of representation.

Classical Consent

An institutional arrangement that looks quite similar to modern representative democracy was established in Athens in 501 B.C.E. when Cleisthenes established the Council of Five Hundred, whose members were appointed in equal numbers from the ten tribes. The principle of sortition (lot) came to be central to the representative offices in Athens. This mechanism protected against the advantage the oligarchic elements enjoyed in elections, and kept representation democratic. The primary rationale for the use of a system of representation was its usefulness for extending the reach of democracy over a community larger than could be governed through the direct participation of all. However this Athenian institution did not receive a contemporaneous theoretical advocacy to match its practical use. Among those theorists who did not simply dis-

parage democracy (Aristotle stands out) the ideal polity was limited in size precisely by the requirements of direct participation in deliberative proceedings. The Roman assemblies, also apportioned on a tribal basis, did gradually become representative in fact, in that most citizens did not attend. No conceptual or legal recognition of this arrangement was put forth however. From ancient Greece to the eighteenth century, democratic regimes were always conceived of in terms of the “Athenian model” of a small community whose citizens participate directly in the government of affairs.

Election is an ancient custom, and early statements of electoral principle, such as that by Pliny the Younger (62–111), seem to imply a representative relation, “The emperor of all the people should be chosen by all the people” (*imperator omnibus eligi debet ex omnibus*). The practice of obtaining the consent of the “better part” of the people is referred to by Pope Celestine I (422–432), who states that “a bishop should not be given to those unwilling [to receive him],” and Pope Leo I (440–461) affirms that “He who governs all should be elected by all.” Numerous instances of such electoral consent can be found throughout the first millennium, in ecclesiastical settings at least. In 1140 Gratian transmitted the Roman principle, which required such consent: “What touches all must be approved by all” (*quod omnes tangit ab omnibus tractari et approbari debet*). (A similar formulation, referring exclusively to private matters, is found as early as the Justinian Code of 531.)

Medieval Corporatism and the Origin of Political Representation

The medieval conception of representation moved beyond the idea of consent, based on the principles of the right of the majority to determine an issue and the *quod omnes tangit*. These principles alone, realized in the context of feudal and Germanic law, were inadequate to produce the concept of representation. This tradition of law contemplated only real individuals as persons with rights and interests, and consequently contained only the concept of a proctor: one real person acting on behalf of another real person, as an agent. Political representation only arose after 1150 C.E. when the concept of the proctor was conjoined to the concept of a corporation, a fictive person comprised of a group of individuals with similar interests which was itself considered the seat of rights and interests. The corporation introduced the idea of the conscious embodiment of a collective unity, a social community, for the sake of the defense and advancement of the common interests of the community as a whole. Such representative relations are referred to repeatedly by Thomas Aquinas, for example, in the *Summa Theologia* (1265–1273), where a temporal or ecclesiastical authority, prince, king, ruler, pope, bishop, or other, is said to “represent” their communities in the sense that they stand as allegorical images or symbols of the collective and disembodied whole. This symbolic representation functions specifically when magistrates, by virtue of their office, represent the image of the whole state, and generally when the weightier part (*sanior pars*) of any group is taken (both definitionally and procedurally) as the majority (*maior pars*).

The idea of a corporation, and the collectivist conception of the relation between representative and constituency, was soon challenged by William of Ockham with his conception of a constituency as the aggregation of real individuals. Ockham's nominalism, applied to the corporate theory of representation, rejects the attribution of rights to abstract fictions such as the collective entities, the church and the state. Only real individuals have rights and interests, and these cannot be alienated to a fictive corporate entity. The notion of a representative of the corporate whole does not take into account the fact that real individuals cannot delegate all their authority or alienate all their rights: Delegation is always subject to the reservation that the delegate do nothing contrary to the faith and to sound morals. In rejecting the corporate account of representation, and in insisting that delegates can only represent real individuals and groups of individuals, Ockham prevents the assimilation of the representative to the community it represents. This distinction between representative and constituency clears the path for the development of a theory of the representative's accountability and responsiveness to the constituency.

It was the medieval development of parliaments that accrued to themselves the powers of deliberation and decision, first in 1188 in the Spanish kingdom of Leon, that brought the concept of representation to a proper political setting. These parliaments were power-sharing arrangements, particularly regarding the levy of taxes and troops, among crown, bishops, nobles, and wise men. The authority that the consent of such parliaments conferred was bolstered as they came to be understood as representative in nature. The first explicit recognition of political representation is found on the occasion of the English Parliament of 1254, when knights of the shires were elected in county courts and empowered to speak for and bind the whole county. The authority that such direct consent conveyed was repeatedly affirmed in formulations such as that of the Chief Justice of England who, in 1365, proclaimed that "Parliament represents the body of all the realm." By the fourteenth century as well, members of Parliament were expected to convey the grievances of their constituencies to the king and his counselors, giving rise to the formula "Redress of grievances before supply." Thus the function of the representative was to serve as a two-way channel of communication, expressing grievances and popular opinion, while garnering popular support for the policies of rulers. This in turn gave rise to the affirmation that rulers, in so far as they are representative, must act in the interests of those they represent.

The political theorists of Renaissance Italy, while interested in republican and participatory theories of government, had no conception that legislatures might properly consist in representatives elected by the people rather than the people themselves. There was some development of a protodemocratic conception of representation among some Puritans, especially the Levelers in England. In their search for a practical expression of their demands for a broader franchise and a government responsive to a broad electorate, they merged the democratic idea of rule by the people with the idea of representation. Through the seventeenth century, the corporate conception of representation in which individuals were considered to be sub-

sumed into the political body and its image, the representative, dominated both theory and practice.

Representing the Rights and Interests of Individuals

Thomas Hobbes's *Leviathan* (1651) contains a theory of authorization and consent that produces a conception of representation that straddles the corporatist-individualist divide. Individuals, in becoming party to the social contract, authorize the sovereign, who then becomes their representative. It is only after they enter into the contract that individuals are merged into the body politic. Once constituted, the state is conceived of in the medieval corporatist fashion, with all political rights of individuals being alienated unto it, with the single exception of the right to life of the individual, which, not being properly political, cannot be alienated. The individualist elements of Hobbes's theory begin the process that results in the individualization of the theory of political representation, laying the way for the development of modern democratic representation.

John Locke makes representation central to his theory of government in *The Second Treatise of Government* (1690), stating that the consent of the majority (primarily to taxation) must be given "either by themselves or their representatives chosen by them" (p. 362). He also introduces a fairly robust conception of the accountability of the representative organ to the people. The government is entrusted with the "right of making laws . . . for the public good," that is, in the interest and for the benefit of those represented, and if it breaches that trust, the people may rescind their authority and place it in another government. The mechanism of election is only imperfectly integrated into this theory, and is inadequate to attain the required degree of accountability, however, so Locke must include the "appeal . . . to Heaven," namely, the force of arms, as an alternate mechanism for the selection of representatives (p. 427).

The idea of the representation of individuals, and not corporations, paved the way for the theory of governmental accountability. This in turn paved the way for a democratic conception of representation, as all that was left at this point was to extend the franchise to the whole people. Montesquieu, in his discussion of the constitution of England, praises the institution of representative legislatures in a clear foreshadowing of the democratic revolution in representative practice: "As, in a free state, every man, considered to have a free soul, should be governed by himself, the people as a body should have legislative power; but, as this is impossible in large states and is subject to many drawbacks in small ones, the people must have their representatives do all that they themselves cannot do" (p. 159). However the democratization of representation faced two challenges in the years preceding the advent of representative democracy.

In his attack on political representation in *Of the Social Contract* (1762), Rousseau equates it with the use of mercenary soldiers, and then asserts that it is literally impossible: "Sovereignty cannot be represented for the same reason that it cannot be alienated; it consists essentially in the general will, and the will does not admit of being represented" (p. 114). The essential moral capacity of persons, the very soul of pol-

itics for Rousseau, cannot be delegated. It requires the direct, unmediated participation of the individual. Against this background, it is clear that representative democracy itself symbolizes the triumph of the liberal view of the appropriate sphere of politics: that the state should be limited in its enforcement of comprehensive moral or religious doctrines. It also heralds the triumph of an instrumental view of politics, as opposed to the classical view that direct participation in politics is a distinct endeavor essential to or necessary for the fullest expression of human being.

While affirming the centrality of representation to legitimate government, Edmund Burke revives the corporatist view that the interests and rights of the community are “unattached” to any concrete entities such as population, territory, and tax contribution. His view of parliament is that it is “the express image of the feelings of the nation,” (*Thoughts*, p. 292) and as such is “not a congress of ambassadors from different and hostile interests . . . but parliament is a *deliberative* assembly of *one* nation, with *one* interest, that of the whole” (*Speech*, p. 69). For this reason, representatives need not be tied directly to the constituencies they represent. Constituencies need not have direct representation, as they still enjoyed “virtual representation” deriving from a “communion of interests and sympathy in feelings and desires between those who act in the name of any description of people and the people in whose name they act, though the trustees are not actually chosen by them” (*Letter*, p. 629). Rather than viewing the representative as a delegate, authorized to do only what the constituency wills, and limited by the expressed interests and preferences, Burke saw the representative as a trustee authorized to judge and act independently of the constituency’s “opinions.”

Representative Democracy and Electoral Engineering

In practice, however, these views failed to prevent those in the American colonies without actual representation in parliament to formulate the revolutionary slogan “taxation without representation is tyranny.” The constitutions of these colonies and the new American republic affirmed that only election by individuals produces real accountability, and guarantees that representatives will in fact act in the interest of their constituencies. James Madison, in part following Montesquieu, gave definitive expression to the rationales for representative democracy. First through representative institutions democracy can be extended over a much greater territory and population than had been thought possible until this time. This practice has several advantages, including the likelihood that the representatives would be superior to their constituencies in judgment, knowledge, and such skills as public speaking and negotiation.

Further Madison claims, in “The Federalist No. 10” (1787), the effect of a representative legislature would be to “refine and enlarge the public views by passing them through the medium of a chosen body of citizens, whose wisdom may best discern the true interest of their country and whose patriotism and love of justice will be least likely to sacrifice it to temporary or partial considerations” (p. 409). Representative, as opposed to directly participatory, institutions provide more continuity and stability, as representative bodies are less likely than the people to act on sudden changes of opinion. Through the new

science of electoral engineering a representative government can be made to aim more reliably at a general good that encompasses the interests and preferences of many, more reliably than if all individuals in the people were polled directly. In “The Federalist No. 51” (1788), Madison says a multiplicity of overlapping and opposed constituencies, resulting from divided government and federalism, would make majority domination less likely “by comprehending in the society so many separate descriptions of citizens as will render an unjust combination of a majority of the whole very improbable, if not impracticable” (p. 166). Madison hoped that such institutions would reduce the importance of personal, that is, patron-client, ties between electors and their representatives. Such corruption was endemic in early parliamentary politics, and broad programmatic policies often suffered as a result.

The triumph of this view was so complete in the minds of democratic theorists by the mid-nineteenth century that, in *Considerations on Representative Government* (1862), John Stuart Mill could simply state it as matter of course, that “the only government which can fully satisfy all the exigencies of the social state in one in which the whole people participate. . . . But since all cannot, in a community exceeding a small town, participate personally in any but very minor portions of the public business, it follows that the ideal type of a perfect government must be representative” (p. 350).

The effects of the highly complex set of representative institutions in democracies have come to light only through experience. There is a wealth of examples, however, as elections are the primary source of government legitimacy in the world of the early twenty-first century, so much so that even dictators and ruling parties in authoritarian and totalitarian regimes have used elections to fashion themselves as “representative.” While corporatist forms of representation without direct electoral connections survived into the twentieth century in places as varied as Germany in the 1930s to Sweden in the 1970s, direct election of representatives by individuals aggregated into constituencies formed on a territorial basis is now the primary connection between citizens and their governments.

The analysis of representative institutions has yielded real advances in the knowledge of democratic politics. In systems where voters chose from among individually named candidates, the personal relation between the candidate and constituents will matter a great deal more than in systems where voters choose from among parties and the lists of candidates associated with them. Maurice Duverger formulated a set of propositions that outline the effect of district size on the political system as a whole. A first-past-the-post electoral system, in which districts elect a single member by plurality vote, tends to produce a two-party system, while a system in which districts elect multiple members simultaneously tends to produce a multiparty system. While there are exceptions to these claims, a set of refined propositions has been developed to account for most cases. That there is ample, if only tacit, knowledge of the workings of representative institutions is also demonstrated by the various successful attempts to manipulate the electoral rules to achieving system-wide results. Possible manipulations, corrupt and salutary, include denying or

ensuring minority representation, unifying divergent political interests into a few parties, and providing proportional representation to a wide variety of political positions. Thomas Hare developed a system of proportional representation called the single transferable vote, which is widely viewed to be the fairest, in that every individual's vote will count toward the electoral outcome. One puzzle that appears to outrun the ability of political scientists to illuminate, however, is why individuals vote at all. The irony of representation is that it allows the expansion of democracies over such large numbers that the likelihood of any single individual's vote being the tie-breaker is so infinitesimal that there seems to be no instrumental reason to vote. With or without large voter turnouts, however, the representative structure continues to confer and confirm the legitimacy of most modern governments.

See also *Democracy; Political Science*.

BIBLIOGRAPHY

PRIMARY SOURCES

- Aquinas, Thomas. *Political Writings: Thomas Aquinas*. Edited and translated by R. W. Dyson. Cambridge, U.K.: Cambridge University Press, 2002.
- Burke, Edmund. "Letter to Sir Hercules Langrishe, 1792." In *The Writings and Speeches of Edmund Burke. Vol. IX, I: The Revolutionary War 1794–1797 II: Ireland*, edited by Paul Langford, 594–638. Oxford: Clarendon, 1989.
- . "Speech at the Conclusion on the Poll, 3 November 1774." In *The Writings and Speeches of Edmund Burke. Vol III: Party, Parliament, and the American War, 1774–1780*, edited by Paul Langford, 63–70. Oxford: Clarendon, 1989.
- . "Thoughts on the Cause of the Present Discontents." In *The Writings and Speeches of Edmund Burke. Vol II: Party, Parliament, and the American Crisis, 1766–1774*, edited by Paul Langford, 251–322. Oxford: Clarendon, 1989.
- Duverger, Maurice. *Political Parties: Their Organization and Activity in the Modern State*. Translated by Barbara and Robert North. New York: Wiley, 1954.
- Hare, Thomas. *A Treatise on the Election of Representatives, Parliamentary and Municipal*. London: Longman, Green, Longman, and Roberts, 1861.
- Hobbes, Thomas. *Leviathan*. Edited by Richard Tuck. Cambridge, U.K.: Cambridge University Press, 1991.
- Locke, John. *Two Treatises on Government*. Edited by Peter Laslett. Cambridge, U.K.: Cambridge University Press, 1960.
- Madison, James. "The Federalist No. 10." In *The Federalist with Letters of "Brutus,"* by Alexander Hamilton, James Madison, and John Jay, edited by Terence Ball, 40–46. Cambridge, U.K.: Cambridge University Press, 2003.
- . "The Federalist No. 51." In *The Federalist with Letters of "Brutus,"* by Alexander Hamilton, James Madison, John Jay, edited by Terence Ball, 251–255. Cambridge, U.K.: Cambridge University Press, 2003.
- Mill, James. "Government." In *Political Writings: James Mill*, edited by Terence Ball, 1–42. Cambridge, U.K.: Cambridge University Press, 1992.
- Mill, John Stuart. "Considerations on Representative Government." In *American State Papers/The Federalist by Alexander Hamilton, James Madison, John Jay/On Liberty: Representative Government/Utilitarianism by John Stuart Mill*, edited by

Robert Maynard Hutchins, 325–442. Great Books of the Western World 43. Chicago: Encyclopaedia Britannica, 1952.

Montesquieu, Charles de Secondat, baron de. *The Spirit of the Laws*. Translated and edited by Anne M. Cohler, Basia C. Miller, and Harold Samuel Stone. Cambridge, U.K.: Cambridge University Press, 1989.

Rousseau, Jean-Jacques. "Of the Social Contract." In *Rousseau: The Social Contract and Other Later Political Writings*, edited by Victor Gourevitch. Cambridge, U.K.: Cambridge University Press, 1997.

SECONDARY SOURCES

- Cox, Gary W. *Making Votes Count: Strategic Coordination in the World's Electoral Systems*. Cambridge, U.K.: Cambridge University Press, 1997. A useful introduction to both the scientific study and legislative practice of electoral engineering.
- Kateb, George. "The Moral Distinctiveness of Representative Democracy." *Ethics* 91 (1981): 357–374. A defense against authoritarianism on the one hand and direct democracy on the other.
- Manin, Bernard. *The Principles of Representative Government*. Cambridge, England: Cambridge University Press, 1997. A historical sketch, with particular attention to how representatives are distinguished from their constituents.
- Mansbridge, Jane. "Rethinking Representation," *American Political Science Review* 97, no. 4 (2003): 515–538. Reviews forms of "virtual representation" in modern practice.
- Monahan, Arthur P. *Consent, Coercion, and Limit: The Medieval Origins of Parliamentary Democracy*. Kingston, Ontario: McGill-Queen's University Press, 1987. A thorough synthesis of the historical scholarship.
- Pitkin, Hanna F. *The Concept of Representation*. Berkeley: University of California Press, 1967. A historically illuminating conceptual and linguistic analysis; the classic theoretical work.

Hans von Rautenfeld

REPRODUCTION. See **Biology**.

REPUBLICANISM.

This entry includes two subentries:

Latin America
Republic

LATIN AMERICA

Republicanism advocates a government headed by commoners rather than a hereditary monarchy. It is similar to democracy in that it favors a representative form of government that receives its legitimacy from the people it rules, but democracy in theory also champions political, social, and economic equality. All of the Latin American countries (as well as the United States) are established as republics, while in the Caribbean some former colonies retain the British and Dutch monarchs as their heads of state. Republicanism no longer has the rhetorical appeal that it did two centuries ago, but related key constitutional

issues relevant to the concept of republicanism, including the division of governmental power, political participation, distribution of wealth, and extension of civil and social rights, continue to be important.

During the colonial period, hereditary absolute monarchies in Europe ruled over Latin America. In the nineteenth century, growing resentment at centralized control designed to benefit Europe and leave people in the colonies with little economic or political power led many patriots in Latin America to reject monarchy in favor of a republican system. Republican rhetoric was sometimes more of an opportunistic positioning to remove the entrenched Habsburg and Bourbon rule, which brought little benefit to the colonies, rather than serious commitment to the ideology itself. Conservative leaders, particularly those associated with the Catholic Church and the military, believed that a strongly centralized system was necessary to retain order in the newly founded independent republics. Some conservatives advocated the retention of a monarchy as a way to prevent social disintegration.

Republicanism in Latin America is often, though somewhat mistakenly, associated with movements for independence from Iberian colonial control during the early nineteenth century. Political independence brought few significant changes to the region's social, economic, and cultural structures. Often the new governments were as authoritarian as, if not more so than, the absolute monarchies they replaced. One concrete republican change that did come with independence was the abolition of titles of nobility and *fueros* (privileges extended to members of the church and military). But while a flourishing of liberal ideals brought an end to formal racial discrimination, it did not necessarily end the institution of slavery nor result in an extension of rights to women, Indians, or peasants.

Although women were active participants in the struggles for independence, they still remained legally subjugated to male control. They could not vote or hold public office and could not work or enter into legal contracts without a husband's or father's approval. Without the crown's paternalistic protection, Indians found themselves to be worse off under new republican regimes as creole elites preyed on their communal landholdings, further narrowing the base of landholders. Republicanism witnessed the continued dominance of elite, aristocratic values—with few economic or social advances for subalterns. This resulted in a long struggle by Africans, Indians, women, and other marginalized populations for full and equal participation in affairs of the new republics.

The history of Haiti, Mexico, and Brazil underscores the difference between independence and republicanism in Latin America. In Haiti, Jean Jacques Dessalines and Henri Christophe briefly set themselves up as monarchs after gaining independence from France. In Mexico, Agustín de Iturbide was a royal general who combined forces with creole leaders in a conservative declaration of independence to free Mexico from a liberal-controlled Spanish government. For a brief period of time after independence in 1821, Iturbide ruled Mexico as an emperor (Agustín I) in a constitutional monarchy; it was not

until 1824 that Mexico became a republic. In the 1860s, Mexico once again returned to a monarchy when the French imposed archduke Ferdinand Maximilian of Habsburg as king after occupying the country. In 1867, Mexico once again became a republic after the liberal leader Benito Juárez defeated the French occupying forces and executed Maximilian.

The gap between independence and republicanism is even more dramatic in the case of Brazil. In 1808, Napoleon's occupation of Portugal had driven King João VI's royal court from Lisbon to Rio de Janeiro. In 1821, João returned to Lisbon, leaving his son Dom Pedro as regent of Brazil. When Portugal attempted to curtail Brazilian autonomy, Pedro refused to comply. In his famous September 1822 *fico*, he declared that he would stay in Brazil—bringing a bloodless independence to the colony. Nevertheless, under Pedro I and his successor Pedro II Brazil remained a monarchy, although they ruled in a rather enlightened manner. In 1889, the military overthrew the monarchy, finally bringing a republican form of government to Brazil.

According to Thomas Millington, the persistence of monarchic rule in Brazil undermined a commitment to republicanism in Latin America. Specifically, he argues that Simón Bolívar's refusal to challenge the monarchy in Brazil, something that was within his reach, translated into a wider failure to challenge European influences in the New World—including authoritarianism and elitism. This allowed Bolívar to replicate authoritarian aspects of the Brazilian system, including the goals of order and progress, in the Spanish-American republics. In a sense, Millington contends, the new republics lacked a functioning civil society that provided the consensus necessary for a functioning republican system. Ironically, the Brazilian monarchy implemented a more liberal and "enlightened" system than that existing in the Spanish republics.

Political historians have traditionally portrayed the emergence of republican ideologies at the end of the eighteenth and beginning of the nineteenth centuries as a revolution in political culture. Popular participation in government replaced a hereditary monarchy allied with clergy and military interests. Social historians, however, have demonstrated just how exclusive citizenship rights were, as creole elites consolidated economic and political power in their hands. Economically, independence represented a transfer of wealth from peninsular to creole elites. Politically, the republican constitutions established legal equality but provided for little change in power relations. Without a broadening of suffrage, a very small elite continued to rule over the rest of the population. Even with representative government, there was not more participation in power. Ideologically, republicanism drew on positivist ideologies with its emphasis on liberty, order, and progress. The dissolution of central authority with the elimination of the European crown left nothing in its place, leading to struggles to determine who had the right to rule.

Deep social, economic, and geographic divisions also led to political instability following independence. Large and diverse countries divided physically, culturally, ethnically, and

linguistically, in which people who lived in one area had little to do with those in another area, led to relatively small groups of powerful men using force to assert their will. Small, individual factions with differences in values and ideals fought for control, resulting in rapid changes in power and the appearance of extreme political instability. Stable centralized governments did not emerge until perceived national interests surmounted the economic interests of regional leaders.

Peter Guardino, Mark Thurner, Charles Walker, and others have stressed the importance of examining these transitions to republican forms of government from a peasant perspective. Walker, for example, examines the critical and often unacknowledged role the indigenous peasantry played in battles for independence. Far from employing mindless mob actions, these dissidents engaged in thoughtful political and legal actions and cultivated coalitions with sympathetic outsiders. Rather than being passive or disengaged, Indians were active agents who “imagined” an alternative vision of the nation that conflicted with that of the dominant culture. Walker criticizes historians who “have far too often accepted contemporary views that deemed Indians incapable of political consciousness and indifferent to the battles over the state.” Rather, he sees indigenous peoples as “key to understanding the turbulent transition from colony to republic” (p. 2).

While voicing republican rhetoric, creole elites feared a militant and mobilized indigenous population. Walker argues that despite significant indigenous participation in independence movements, elites intentionally denied them citizenship rights, with the result that republican rule did little to improve their lot in life. Guardino challenges histories of Mexico’s transition to a republican government told from the point of view of the palace, instead stressing the critical role peasants played in this process. Historians are also gaining an increasing appreciation for the previously understudied role that subalterns played in shaping emerging state structures, a role that was significant despite their marginalization within elite conceptualizations of those state structures.

As these examples illustrate, although theoretically informed by liberal ideologies that favored equality under the law, Latin American republicanism did not lead to universal citizenship by any means. Despite variations in constitutions throughout the hemisphere, almost all created exclusionary systems that limited political participation based on literacy, property, gender, and sometimes religious beliefs. Even though property and religious restrictions were generally relaxed during the nineteenth century, it was not until well into the twentieth century that some countries extended suffrage to women and Indians (who had generally been targeted with literacy restrictions). Thurner plays off this imagery in his book *From Two Republics to One Divided*. Colonial administration deliberately divided society into two “republics”: one for Spaniards and another for Indians. Creole elites terminated this bipartite division in the independent republics, but the goal was to abolish separate ethnic identities through assimilation of Indians into a mestizo culture rather than respecting or preserving indigenous peoples’ unique traditions. As Thurner notes, these colonial divisions “were more fictional and juridical than they were actual,” but

“these imagined constructs had real historical consequences” (p. 6). They resulted in wide gaps between the liberal ideals of universal citizenship and the cold reality of highly exclusionary republican governments.

The history of Latin America since independence can be written as a story of subalterns fighting for full citizenship rights that republicanism had promised but never delivered. Women, Africans, Indians, peasants, and others subverted the language of elite rhetoric in order to demand popular sovereignty, political rights, and active citizenship so that they would also have a say in how the government was structured. Theoretically, elections form the base of a republic, as they express the will of the populace. The gap between theory and reality reveals the failure of republican systems in Latin America, but it is a failure slowly being overturned thanks to the efforts of those originally excluded from the political system. Ongoing political activism on the part of Indians, blacks, women, and the poor demonstrates that the republican ideal is still being realized for many.

See also Anticolonialism: Latin America; Authoritarianism: Latin America; Pluralism; Populism: Latin America.

BIBLIOGRAPHY

- Guardino, Peter F. *Peasants, Politics, and the Formation of Mexico’s National State: Guerrero, 1800–1857*. Stanford, Calif.: Stanford University Press, 1996.
- Millington, Thomas. *Colombia’s Military and Brazil’s Monarchy: Undermining the Republican Foundations of South American Independence*. Contributions in Latin American Studies, No. 7. Westport, Conn.: Greenwood Press, 1996.
- Thurner, Mark. *From Two Republics to One Divided: Contradictions of Postcolonial Nationmaking in Andean Peru*. Durham, N.C., and London: Duke University Press, 1997.
- Walker, Charles F. *Smoldering Ashes: Cuzco and the Creation of Republican Peru, 1780–1840*. Durham, N.C.: Duke University Press, 1999.

Marc Becker

REPUBLIC

The term *republic* derives from the Latin phrase *res publica* (“matter” or “thing of the people”). Most generally, the word refers to any political regime in which no king or hereditary dynasty rules over subjects in a state of submission or servility. A republic is thus populated by “citizens” who enjoy some manner of political and legal rights to govern themselves through collective political mechanisms and processes. Because citizens are self-governing, liberty is associated with and regarded as emerging from republican regimes. Yet republicanism must also be distinguished from democracy: the idea of a republic entails the imposition of fixed and strict limits on the power of the people. Consequently, a republic involves a constitutional system that provides checks and balances or a mixture of authorizing agents. Stated simply, the liberty of the citizens must be weighed against the maintenance of a common public good that is best identified by leaders who are insulated from the unchecked passions of the people.

Historically, the language of republicanism has been recognized as one of the central modes of political discourse in the European and modern Atlantic worlds. The title of a synoptic collection of essays from 2002 labels republicanism a “shared European heritage,” and many scholars treat it as a European bequest to the New World. Certainly, republicanism seems to be a distinctively Western construction, although a plausible case may be constructed that the pre-kingship system of Judaic government depicted in the Old Testament constituted an embryonic system of “federated republic.” (Indeed, many later thinkers viewed the Israelite polity as an inspiration for their own vision of a self-governing constitution.)

Perhaps the most hotly debated issue in current scholarship is the relationship between the ancient or classical, the medieval, and the modern strains of republican thought. Some have traced the diffusion of classical republicanism from the Renaissance through to the founding of the American republic, arguing for an essential continuity, a “Machiavellian moment,” in the phrase of John Pocock. Others have sternly criticized the view that a uniform revival of classical republicanism may be attributed to the modern world, contending instead that “classical” republicanism must be distinguished from a “modern” variant and that, despite superficial resemblances, different thinkers may be sorted into one or the other category. Paul Rahe represents the outstanding proponent of this view. Still others posit a continuous and developing tradition of republican thought that commenced in the Roman era and persisted (in necessarily transformed fashion) through the Latin Middle Ages into the modern world.

Roman Republicanism

Republicanism in practice predated any attempt to define or articulate it conceptually. Rome became a self-proclaimed republic at the end of the sixth century B.C.E. as a result of a revolt against the Tarquin dynasty of kings who had ruled the region. Thereafter, the Latin word for king, *rex*, was anathema to Romans (even after the rise of the Caesars, who styled themselves *princeps*, “first man,” instead.). The basic constitution of the Roman Republic evolved slowly over the course of the succeeding four centuries, always shaped by a practice of diffusing power among a range of institutions: administrative officers, a body of noblemen (the senate), and various popular citizen assemblies. In the beginning, the concentration of authority rested with the senate and the executive magistrates (chief among whom were the two consuls). Over the course of the republic’s history, however, the lesser citizens demanded and received greater power via the addition of further magistracies and assemblies.

It is perhaps not too great an exaggeration to say that Marcus Tullius Cicero (106–43 B.C.E.) was the most influential republican thinker of the ancient world. Although many other classical authors contributed significantly to the understanding of the theory and practice of the republic—Polybius (c.200–118 B.C.E.), Sallust (86–35 or 34 B.C.E.), and Livy (59 B.C.E.–17 C.E.) were among the most important—Cicero produced the largest body of writings about the topic. Moreover, he enjoyed the widest audience and most loyal following of

any republican author, both in ancient times and later. Drawing on Hellenic and Hellenistic philosophies, as well as on his knowledge of Roman history and his personal experiences with the practical requirements of republican rule, Cicero in many ways represented the pinnacle of republican theory as well as statesmanship. Reflecting the inherent tension within republicanism between populism and elitism, his teachings endorse two distinguishable and potentially competing theoretical defenses of republican government: one highlighting eloquent speech, the other focusing on the faculty of reason.

Populism and public discourse. In Cicero’s writings on rhetoric and oratory, a premium is placed on public discourse—among both citizens and statesmen—as the basis for the republican regime. In writings such as *De inventione* and *De oratore*, Cicero maintains that the eloquent expression of the common welfare binds the republic together. On the one hand, the leaders of the commonwealth are charged with acquiring the oratorical skills necessary to persuade citizens to accept the laws and policies conducive to the well-being of public affairs. On the other hand, all human beings, regardless of their station, are deemed competent (on the basis of their natural faculties) to discern and judge the pronouncements of orators in public assemblies and proceedings.

Cicero grounds this discursive approach to republican rule on the claim that human nature can only be fully realized through articulate and intelligent speech. While his rhetorical writings do not deny the importance of rationality, they are explicitly critical of the philosophical tradition, which glorifies reason to the exclusion or detriment of language. Rather, human beings are both rational and linguistic creatures, simultaneously capable of reasoning and speaking. Speech is, however, accorded primacy in this formulation of human nature. It is not enough to possess reason, for rational powers require the faculty of language in order that their discoveries may be disseminated.

Cicero believes that the realization of the associative potentialities present within human speech may only be achieved with the aid of oratory. The orator discovers what is truly good for his fellow creatures and communicates it to them in the most forceful and convincing manner so that they may put it to use. The combination of eloquence and wisdom characteristic of the orator assures that he will speak on behalf of the interests of the entire community. Cicero invokes a direct contrast between oratory and philosophy. The philosopher may know the good but lack the skill or training to convey it to the multitude. Inherent in the subject matter of oratory, then, is a regard for fellow citizens, which imposes on the orator an overarching duty to act in the service of public welfare. The orator can only achieve this goal, in turn, by expressing himself in the popular idiom. Oratory is concerned in some measure with the common usage, custom, and speech of humankind, so that, whereas in all other arts that which is most excellent is farthest removed from the understanding and mental capacity of the untutored, in oratory the very cardinal sin is to depart from the language of everyday life and the usage approved by the sense of the community.

Cicero's account of the discursive foundations of public life ties the role of political leadership to a clear notion of citizenship and civic intercourse. The man of public affairs is called on to persuade his fellow citizens to follow the wisest course of action in order to achieve the common good. Eloquent speech must, therefore, be cultivated alongside wisdom as a prized asset for political life; the statesman requires these qualities in order to appeal to and convince an audience. Likewise, even though ordinary citizens may lack the talent and skill of the orator, they are deemed to be competent to judge between competing arguments within the public arena and to choose in accordance with the best and most persuasive (that is, the wisest) case that they hear. Thus, citizenship ought to be construed in an active sense: statesmen seek the approval of citizens, who, by virtue of their inherently rational and linguistic faculties, are all qualified to discern the public good. Public life is a kind of recapitulation of the initial entry of human beings into the social and political order. Hence, this discursive approach has overtly participatory implications; it encourages political actors to conceive of their roles in terms of open rational persuasion and debate leading toward the civic recognition of the public good.

Elites and natural reason. Cicero bolsters this view with an account of the foundations of republican government that emphasizes the centrality of reason alone as the source of public welfare, and concomitantly diminishes the active and discursive dimensions of citizenship. In this version of republicanism, natural reason forms the cornerstone of human social relations. The role of reason is to discover those precepts of natural law that maintain and strengthen the bonds of communal order, and to impose such dictates through law and rulership in a manner consonant with the public good. Of course, Cicero acknowledges that reason is unevenly distributed among human beings. While all people may be minimally rational, some exceed their fellows in the exercise of reason, a fact that qualifies the wise to ascend to positions of authority within the civic body. Indeed, in a well-ordered regime, those lacking fully developed powers of reason ought freely to accede to governance by their betters, on the grounds that wise rule is the strongest safeguard of the common good. The rational powers of statesmen guide the republic for the benefit of citizens, and the people are best governed when they defer to magistrates of superior wisdom. Cicero's philosophical writings, in particular, tend to highlight the Stoic-derived view that human beings are inherently rational creatures and that their natural powers of reason constitute the precondition for all social intercourse and political community.

Cicero maintains that society, and hence people's very capacity to conceive of a public welfare, depends on the cultivation of virtue. Virtue is directly dependent, in turn, on the cultivation of the rational faculties. Hence, the mark of a harmonious communal setting is the presence of virtue as an ingrained feature of its organization. Cicero singles out and concentrates on justice, identifying it as the virtue most crucial to the perpetuation of human association. The Ciceronian conception of justice is rooted in the doctrine of natural law. Cicero holds that nature imposes on individuals a

certain code or measure of conduct, constituted in particular by the requirement to promote the ends and interests of human society. In order to prevent perpetual endangerment to the bonds of society, the law of nature is afforded prescriptive force. To know what accords with the law of nature, and hence what behavior is required by justice, one reasons about the common good. One's duty on the basis of natural law is always to act in the general welfare when there exists a conflict between private benefit and the general interests of society. The Ciceronian doctrine of natural law codifies and authorizes the obligation stemming from justice to value social fellowship above all else.

Cicero believes that all human beings share in the faculty of reason, and therefore are equal in their capacity to grasp what is just and lawful. But it is obvious that all people are not equally rational, and therefore virtuous and law-abiding. Whatever equality human beings enjoy by birth is in effect eradicated by differences of circumstance, so that wisdom is ultimately achieved by a very few persons, and the multitude remain in a state of ignorance. The distinction between the wise and the foolish has important implications for the foundations of the republic. Since civil law, properly speaking, has a rational origin in "what is true and just," according to Cicero, only those statutes that are framed and approved by the wise should be counted as valid. Valid legislation, therefore, must be referred to reason in accordance with nature and justice. No enactment of the multitude, regardless of how overwhelming the popular support, deserves to be accorded respect and obedience unless it is consonant with natural law. And only the wise are qualified to make this determination.

Cicero therefore turns to the *optimates* (best men), in whose hands the security of government must reside. The well-ordered republic of Cicero's *De re publica*—the constitution most in conformity with nature—is the creation of individuals who apply wisdom to the art of politics. In turn, the ideal constitution is balanced and harmonious when the *optimates* (embodied by the senate of the republic) enjoy the influence appropriate to their superior learning. *De re publica* commends that stage in the growth of the republican system when "supreme authority was in the senate with the sufferance and obedience of the people"; and Cicero bemoans the popular grasping after power (in the name of liberty) that leads to the decline in the concord afforded by the republic.

Hence, the rational conception of the republic promotes a passive conception of citizenship as well as an exalted idea of statesmanship. While all human beings are deemed minimally rational, Cicero regards the powers of reason of most of them to be insufficient for sharing directly in the judgment of the common good. Rather, it is up to the statesman, with his wisdom and superior virtue, to serve the public welfare by pioneering and preserving just institutions. Given the distinction between the ignorance of the multitude and the wisdom of the virtuous few, a direct appeal by a statesman to the masses would almost certainly be an act of demagoguery or tyranny, an attempt to destabilize the order of the republic. There is a noticeable contrast between this idea of the rational statesman, who governs on behalf, not at the behest, of

citizens, and the oratorical model, in which the statesman can only lead the citizen body by the force of his eloquence and must accede to the popular will.

Medieval Republicanism

The tension between the populist and elitist dimensions in republican thought is recapitulated in later important contributions to republicanism. Italy, in particular, produced a number of exponents of republican doctrines, such as Brunetto Latini (1220–c. 1294) and Ptolemy of Lucca (c. 1236–1327). Perhaps the most famous medieval republican work was the *Defensor pacis* (1324), written by Marsilius of Padua (c. 1280–c. 1343). Marsilius stresses the linguistic foundations of the community, following Cicero's account of the formation of the human community as a consensual process in which the multitude is convinced to join into bonds of social and political cooperation by the "persuasion and exhortation" of oratorically gifted individuals. In turn, Marsilius ascribes to discourse a continuing role in the conduct of public affairs, as a sort of repetition of the original foundation of the community. The framing of legislation, for example, he regards as a function of public speech. He stipulates that draft statutes are to be framed by prudent persons (*prudentes*) who, by virtue of their leisure and superior experience, are best qualified to discover just and useful laws. Yet the wisdom of the few does not entitle them to enact legislation on behalf of the general mass of citizens. Rather, the whole body of citizens (which Marsilius terms the *legislator humanus*) must consent to draft statutes in order to give them the status of laws that the community is obligated to obey.

The *Defensor pacis* ascribes to oratory two pivotal functions in the process of a "bill becoming a law." First, it is assigned to the *prudentes*, when they present their legislative proposals to the citizen body, to "explain" publicly the measures they have recommended; and their fellow citizens are likewise bound to "listen attentively" to the arguments given. The *prudentes* in effect play the role created by the primordial orator: they must attempt to persuade the assembly of citizens that the draft statutes are consistent with justice and contribute to the common good, while it is left to the multitude, whose powers of reason are less well developed, to reflect on the justifications presented to them and to approve (or withhold approval from) laws. Second, Marsilius views the occurrence of legislative authorization as an occasion for general public discussion and debate among the members of the civic body. The whole citizen population must have an opportunity to speak about the matters of communal concern placed before it, and the words of the populace are ultimately binding. Lest "partiality" creep into the legislative process, the entire citizen body is to enjoy a say in the laws by which it will be governed.

Renaissance Italian Republicanism

Scholars often view the Renaissance, especially in Italy, as a decisive period in the development of republican thought. Many important authors of the Renaissance glorified civic-minded virtue—the ethos of sacrifice for the sake of one's fellow citi-

zens and city—shared by members of a community (the so-called civic humanism identified most influentially by Hans Baron). While a simple equation of Renaissance thought with the revival of classical republicanism has come under serious and deserved challenge, some of the greatest humanists of the fifteenth and sixteenth centuries embraced citizenship as the fullest expression of a virtuous human life, taking Cicero as their exemplar. Consequently, republican discourse became one of the primary forms of political expression during the period.

The tension within classical republicanism between discursive and rationalistic conceptions of governance thus also reemerged among Renaissance thinkers, perhaps most strikingly in the works of Niccolò Machiavelli (1469–1527). One of the central themes of Machiavelli's famed treatise on republican government, the *Discourses on the Ten Books of Titus Livy* (1517) is the defense of the view that the popular elements within the community form the best safeguard of civic liberty as well as the most reliable source of decision making about the public good. In particular, Machiavelli contrasts the constancy and trustworthiness of the people, who are often accused of fickleness and ineptitude, with the improbity of the nobility, who are commonly regarded to be the "natural" leaders of a republic. What permitted Rome to avoid public corruption and to extend its empire for so many centuries, Machiavelli believes, was precisely the fact that ordinary citizens demanded and were accorded such a large hand in public determinations. The people thus thwarted the use by patricians of public power to pursue private interests. The apparent "tumults" between the popular and elite segments of the Roman population were in fact the key to Rome's success. Machiavelli's praise for the role of the people in securing the republic is supported by his confidence in the generally illuminating effects of public speech upon the citizen body. Near the beginning of the first *Discourse*, he notes that some may object to the extensive freedom enjoyed by the Roman people to assemble, to protest, and to veto laws and policies. But he replies by referring to Cicero's view that "the people, although they may be ignorant, can grasp the truth, and yield easily when told what is true by a trustworthy man"; that is, the people are competent to respond to and support the words of the gifted orator when he speaks truly about the public welfare.

Machiavelli returns to this theme in a chapter of the *Discourses* intended to demonstrate the superiority of popular over princely government. He argues that the people are well ordered, and hence "prudent, stable and grateful," so long as room is made for public speech and deliberation within the community. Citing the formula *vox populi, vox dei*, Machiavelli insists that the people are competent to discern the best course of action when orators lay out competing plans, and in fact they are better qualified to make decisions, in Machiavelli's view, than are princes. The republic governed by words and persuasion—in sum, ruled by public speech—is almost sure to realize the common good of its citizens; and even should it err, recourse is always open to further discourse. Nonrepublican regimes, because they exclude or limit discursive practices, ultimately rest on coercive domination and can only be corrected by violent means.

English Republicanism

According to many scholars, James Harrington (1611–1677) walks directly in Machiavelli's footsteps, circulating classical republicanism beyond the confines of Italian (especially, Florentine) writers, into the English tradition, and eventually across the Atlantic. Yet Harrington's *The Commonwealth of Oceana* (1656) seems to have detoured around some of the more populist elements of Machiavelli's classical republicanism. In preferring the government of Venice to that of Rome, and to a lesser extent, Sparta to Athens, he manifests overt hostility to public speech. Rome and Athens, he asserts, were both ruined by the "storms" arising from the "debate of the people." Far preferable is Venice, which, like its alleged Lacedaemonian exemplar, Sparta, never sanctions public debate. Indeed, in his own ideal commonwealth of Oceana, popular discussion of political affairs is punishable by no less a penalty than death. Harrington's abhorrence of public speech is tied to the rationalistic side of classical republicanism: namely, that public decision making must be conducted in accordance with a strict principle of right reason, accessible only to the wise few, who therefore take it upon themselves to serve as guardians of the people for the sake of the common benefit.

Harrington expressly distinguishes three concepts of reason—as self-interest, as group interest, and as the interest of the whole—and contends that only the latter should be taken into consideration in the formation of laws and public policies. The problem is how the "common right" may safely be discovered and converted into the law of the land. In Harrington's view, this cannot be achieved by the people as a whole, since he observes that nature itself generates clear differences between human beings and, in particular, produces a "natural aristocracy" of the wise who are clearly more adept in their faculties of understanding. Harrington thinks that the foolish or ignorant will recognize that it is desirable to be led by the "excellent parts" in whom special "virtue or authority" resides.

Harrington institutionalizes this distinction between the wise few and the foolish multitude in his construction of the constitution of Oceana. The natural leaders form the body of the senate, whereas the foolish are represented in a popular assembly (or "prerogative tribe") composed of 1,050 delegates. The functions of these two groups differ markedly. The senate is charged with debating public affairs and with decreeing laws and policies; within its halls, discussion of proposals is to be open and unrestricted, and its members are deemed free to express disparate and conflicting opinions, until some conclusion is achieved. That this will not lead to disorder, Harrington believes, stems from the fact that the procedures of debate will occur strictly in accordance with the precepts of reason. The prerogative tribe, by contrast, performs a completely passive role: strictly enjoined from debating the senate's decrees, its members instead either affirm or reject the proposals presented to them. This has the effect of ensuring that the senators do not attempt to employ their authority to pass measures that reflect either private or group interest. The popular assembly thus has the primary purpose of checking potential abuses of power. But Harrington ascribes to the prerogative tribe no positive or active functions; it cannot air grievances, suggest issues or topics for legislation, make any sorts of

changes in proposals, nor even question the wisdom of the senatorial decrees. Starting with the principle that reason is a special competence of the few, Harrington's republicanism excludes popular speech from the well-ordered constitution.

Modern Republicanism

The modern period witnessed a number of important practical experiments in the implementation of republican ideas, including the Netherlands, France, and the United States. One of the important facets of these experiments was the introduction of novel features into the classical tradition in recognition of the de facto replacement of the city by the territorial state as the central unit of public life. Modern republicans recognized that the process of political debate could not realistically be modeled on a direct interaction between speakers and an audience. Hence, political representation rather than direct governance by the people emerged as a hallmark of republican regimes, even as the principle of popular sovereignty was retained and reinforced. Representation permitted discussion and dispute in an assembly setting that presumably mimicked the views and disagreements that were held by members of society at large. Moreover, republicans such as James Madison (1751–1836) in the United States sought ways to mitigate the consequence of the factionalism that Machiavelli had regarded to be the hallmark of a healthy republic by institutionalizing mixed government by means of a constitutionally designated system of checks and balances. Thus, no faction could entirely impose its will on its opponents.

Another modification to traditional republican conceptions came with the challenge posed by the commercialization of Atlantic economic relations and social values. For classical republicans, the private accumulation of liquid wealth had been widely viewed as incompatible with civic virtue, but early modern authors began to reevaluate this doctrine. Some thinkers contended that citizens should proudly acknowledge industriousness and self-acquired possessions as the foundation of morality and the greatness of their cities. The Dutch-born Bernard Mandeville (1670–1733) proposed in his *Fable of the Bees* (1714) the famous principle that private vices yield public goods, which is to say that the pursuit of personal gain, and indeed the desire for comfort and luxury, leads directly to the enrichment of society as a whole and the consequent benefit of all its members. Republics should thus orient their political institutions in order to promote commercial enterprise.

With the rise of liberalism, capitalism, and democracy during the course of the nineteenth and twentieth centuries, republican ideas entered a period of decline. Only in very recent times has this fortune been reversed. On the one hand, historical scholars such as Gordon S. Wood and John Pocock have offered reminders of how great was the debt of modern political institutions to the language and doctrines of republicanism. On the other hand, political philosophers critical of the excesses of liberalism have turned to the communitarian orientation of classical republicanism for inspiration. Among the best known of these "new republicans" are Hannah Arendt (1906–1975), Alasdair MacIntyre (b. 1929), Michael Sandel (b. 1953), and Philip Pettit (b. 1945). It seems clear that in the early twenty-first century the republican tradition is

enjoying a considerable revival that suggests its continuing vitality and the relevance of its fundamental tenets to modern life.

See also *Capitalism; Constitutionalism; Democracy; Liberalism.*

BIBLIOGRAPHY

PRIMARY SOURCES

- Cicero, Marcus Tullius. *De inventione*, edited by H. M. Hubbell. Cambridge, Mass.: Harvard University Press, 1949.
- . *De officiis*, edited by Walter Miller. Cambridge, Mass.: Harvard University Press, 1913.
- . *De oratore*. Edited by E. W. Sutton and H. Rackham. 2 vols. Cambridge, Mass.: Harvard University Press, 1942.
- . *De re publica and De legibus*. Edited by C. W. Keyes. Cambridge, Mass.: Harvard University Press, 1928.
- Harrington, James. *The Political Works of James Harrington*, edited by J. G. A. Pocock. Cambridge, U.K.: Cambridge University Press, 1977.
- Machiavelli, Niccolò. *The Chief Works and Others*. Translated by Allan Gilbert. Durham, N.C.: Duke University Press, 1965.
- Marsiglio of Padua. *The Defender of Peace*. Translated by Alan Gewirth. New York: Columbia University Press, 1956.

SECONDARY SOURCES

- Baron, Hans. *The Crisis of the Early Italian Renaissance*. 2 vols. Princeton, N.J.: Princeton University Press, 1955.
- . *In Search of Florentine Civic Humanism*. 2 vols. Princeton, N.J.: Princeton University Press, 1988.
- Blythe, James M. *Ideal Government and the Mixed Constitution in the Middle Ages*. Princeton, N.J.: Princeton University Press, 1992.
- Fink, Zera S. *The Classical Republicans: An Essay on the Recovery of a Pattern of Thought in Seventeenth-Century England*. Evanston, Ill.: Northwestern University Press, 1962.
- Hankins, James, ed. *Renaissance Civic Humanism*. Cambridge, U.K.: Cambridge University Press, 2000.
- Hullington, Mark. *Citizen Machiavelli*. Princeton, N.J.: Princeton University Press, 1983.
- Pettit, Philip. *Republicanism: A Theory of Freedom and Government*. Oxford: Clarendon, 1997.
- Pocock, J. G. A. *The Machiavellian Moment: Florentine Political Thought and the Atlantic Republican Tradition*. Princeton, N.J.: Princeton University Press, 1975.
- Rahe, Paul A. *Republics Ancient and Modern: Classical Republicanism and the American Revolution*. Chapel Hill: University of North Carolina Press, 1992.
- Skinner, Quentin. *The Foundations of Modern Political Thought*. Vol. 1: *The Renaissance*. Cambridge, U.K.: Cambridge University Press, 1978.
- van Gelderen, Martin, and Quentin Skinner, eds. *Republicanism: A Shared European Heritage*. 2 vols. Cambridge, U.K.: Cambridge University Press, 2002.
- Viroli, Maurizio. *Machiavelli*. Oxford: Oxford University Press, 1998.
- Wood, Gordon S. *The Creation of the American Republic*. Chapel Hill: University of North Carolina Press, 1969.
- Wood, Neal. *Cicero's Social and Political Thought*. Berkeley: University of California Press, 1988.

Cary J. Nederman

RESISTANCE. The path of *resistance* has been neither straight nor narrow. First adopted by the political right, and then crossing the aisle to the left, resistance is sometimes considered a means and other times an end. Its modern history traces the evolution of an idea and a transformation in politics.

The English word resistance is a derivation of “resist,” stemming from the Latin—via the French—meaning “to stand.” Resistance has a technical scientific meaning, the opposition offered by one body to the pressure or movement of another, as well as a later psychoanalytic one, the unconscious opposition to repressed memories or desires. But the *Oxford English Dictionary*’s primary definition: “To stop or hinder (a moving body); to succeed in standing against; to prevent (a weapon, etc.) from piercing or penetrating,” has a distinct political bent.

Conservative Roots

Edmund Burke (1729–1797), the great conservative thinker of the modern era, makes the case for resistance in *Reflections on the Revolution in France* (1790). Fondly remembering Marie Antoinette as a “morning star, full of life, and splendour, and joy” (p. 75), Burke criticizes the revolutionary overthrow of birthright authority. Horrified by the thought of the hairdresser who thinks himself the equal of his betters, he rails against the leveling of classes. But what really motivates Burke’s fear and loathing of the French Revolution is his belief that these radical and sudden changes fly in the face of time-tested tradition and are an “usurpation on the prerogatives of nature” (p. 49). Undermining the firm foundations of society, this can only lead to chaos. As such, Burke appeals to his English audience to resist such progress in their own country “with their lives and fortunes” (p. 16).

Nearly a century later, Burke’s countryman Matthew Arnold (1822–1888) takes up the call of conservative resistance. In *Dover Beach* (1867) he describes a faithless land that “Hath really neither joy, nor love, nor light. . . . Swept with confused alarms of struggle and flight/ Where ignorant armies clash by night.” Arnold’s mid-nineteenth century England was a world of storm and strife: urbanization, industrialization, and class warfare. The republican ideals of the French Revolution had triumphed over Burke’s beloved tradition, and “nature,” after Darwin, was harnessed to progress. A new principle of resistance was needed; for Arnold it was culture. As “the best which has been thought and said” (p. 6) as he defines it in *Culture and Anarchy* (1869), culture offered a means with which to rise above the politics, commerce, and machinery of the day and supply a universal standard upon which to base “a principle of authority, to counteract the tendency to anarchy which seems to be threatening us” (p. 82) Culture was a metaphysical realm where “*real* thought and *real* beauty; *real* sweetness and *real* light” (p. 69, author’s emphasis) could safely flourish, eventually returning to terra firma—if at all—in the form of an ideal State to guide society.

Anti-Colonial Resistance

Halfway around the world Mahatma Gandhi (1869–1948) was developing his own ideas of resistance. Arriving at conclusions similar to Burke and Arnold, he stood these conservative

notions on their head in opposing British colonial rule. Central to Gandhi's political philosophy was the idea of *satyagraha*. In Sanskrit this means "insistence on the truth"; Gandhi, however, also used the word to denote "civil resistance." This was a logical translation for him. Insisting on the truth in an India under foreign rule meant resisting the imposition of that rule, for as long as India labored under colonial guns and culture, she would have a false idea of herself. It was this false idea: that English culture comprised the "best that has ever been thought and said," that one needed to be violent like one's oppressors, that needed to be resisted more fiercely than even the British themselves. To be free of European bodies on Indian soil was one thing, to be free of their ideas, their prejudices, and their technology, was another. As Gandhi rhetorically asks in an early pamphlet *Hind Swaraj* (1910), "Why do you forget that our adoption of their civilization makes their presence at all possible?" (p. 75). As with Arnold, insistence on the truth meant cultivating a resistant culture that could rise above the world of the West and act as a guide to a truly home-ruled India. And like Burke, tradition offered a resource for this resistant culture. Gandhi counseled breaking India's economic dependence on Britain by *khaddar*, a return to the hand loomed cloth, and looked to non-Westernized, rural India for political and spiritual models.

Radical resistance, defined in part as the rejection of foreign cultures and the celebration of indigenous traditions, winds its way through the twentieth century, as European colonies in Africa and Asia were swept away by struggles of national liberation. This strain of resistance makes its way back to the metropole in the words of those finding parallels between their own struggles and anticolonialism. A key point of identification was the fight against internalized oppression, what the Algerian writer and activist Albert Memmi (b. 1920) referred to as the colonizer within (1965). In 1970 the American group, Radicalesbians, issued a manifesto calling for "The Woman-Identified Woman." "[W]hat is crucial" they write, "is that women begin disengaging themselves from male defined response patterns. . . . For irrespective of where our love and sexual energies flow, if we are male-identified in our heads, we cannot realize our autonomy as human beings." "Only women," they conclude, "can give to each other a new sense of self."

These final words were picked up and developed by the radical black women of the Combahee River Collective, who asserted in 1977, "We believe that the most profound and potentially radical politics come directly out of our identity," setting the stage for an "identity politics" that argued for resistance based within and upon the unique experiences of a person's ethnicity, gender, or sexual identity (p. 272).

Totality

La Résistance was the name adopted by the French citizens who fought against the Nazi occupation of France. But the specter of oppression didn't disappear with the defeat of Fascism in the postwar West. Instead, totalizing power was identified everywhere and resistance was redefined as an everyday battle with no end in sight.

This total resistance against totality finds its roots in existentialism. Existentialists argued that the fate of humanity is

to choose and to act; indeed, it is only in these actions that one defines who one is. "Man is nothing else but that which he makes of himself," Jean-Paul Sartre (1905–1980) writes in *Existentialism Is a Humanism* (1946; p. 349). If the importance of action (or resistance) was once judged on its efficacy in bringing about (or protecting) an ideal or country, Sartre was now arguing that it was the choice, and the action that follows, which matters. In the *Myth of Sisyphus* (1955), Albert Camus (1913–1960) retells the tale of Sisyphus, condemned for eternity by the gods to roll a rock up a hill only to watch it roll back down again. In this task Camus identifies the human condition as being condemned to an action that brings no certain result, but also finding definition—and happiness—in the absurd and ceaseless labor.

In 1961 Erving Goffman (1922–1982), an American sociologist influenced by the existentialists, wrote *Asylums* (1961), discussing "total institutions." Observing patients in a mental asylum, Goffman argued that the job of total institutions is to create—or recreate—their charge's identity in order to integrate them into the world. Individuals, however, don't always do what they should. The patients Goffman observed elided institutional demands and created an "underlife" where different values reigned. Indeed, it was in resisting the definitions pressed upon them that inmates of institutions developed their own sense of identity. *Asylums* was an implicit critique of the postwar "Free World" of big business and the welfare state, mass media, and compulsory education. But, Goffman argues, this institutionalization and homogenization of thought and behavior need not lead only to despair, for as Goffman's mental patients taught him, "It is *against something* that the self can emerge" (p. 320).

Meanwhile, youth cultures such as the beatniks, and later the hippies, were busy acting out identities of resistance, defining themselves by what they were not as much as what they were ("I'm gonna wave my freak flag high," sang Jimi Hendrix in 1968). The freak, mental patient, artist, native, and resurrecting an old ideal of nineteenth-century anarchism, the criminal, were celebrated (and idealized) in their "otherness"; their resistance—conscious or not—to the world of the white-collared conservative. In 1968 the world seemed to explode. Vietnamese nationalists were defeating the most powerful military in the world, U.S. college campuses and urban ghettos were in upheaval, young people stood up to dictatorships in Mexico City and Prague, and perhaps most dramatic of all, students and workers, together, took to the streets of Paris in May 1968. The world was rocked to its core, yet politically little seemed to change: the ruling powers in these countries continued to rule.

In Paris of the 1960s Michel Foucault (1926–1984), like Goffman, was examining total institutions such as prisons, asylums, and schools, but the French intellectual was interested in institutions of the mind as well, such as disciplinary boundaries and classification systems. The failures of the political resistance in 1968 confirmed what Foucault had already known: that power was not something out there—easy to identify and to overthrow. Instead it was everywhere, "the disciplinary grid of society," which was continuous, anonymous, intimate, and even

pleasurable (1980, p. 111). Whereas previous critics of totalitarianism, from the left and the right, elevated the ideal of the individual subject resisting against totalizing society, Foucault countered that the individual was itself problematic. This Enlightenment creature that made new ideals of personal freedom possible also opened up a new site of oppression: the individual's mind, body, and spirit. Because power is impressed upon and internalized into the subject, it raises the vexing problem of who resists and what exactly are they resisting. Can one resist the very subject thing doing the resisting?

Resistance remains a stated goal for Foucault, but it must be reconceptualized. The ideal of developing the pure subject in opposition to the corrupting object of society must be rejected. "Maybe the target nowadays," he suggests, "is not to discover what we are, but to refuse what we are" (1984, p. 22). Foucault's refusal to provide an answer, to spell out what the resistant subject is for or against, is characteristic, as it is the answer, the category, the truth which constrains us most of all.

In his essay, "The Masses: The Implosion of the Social in the Media" (1985) the playful postmodernist Jean Baudrillard (b. 1929) extends Foucault's ideas to their—perhaps illogical—conclusion. Baudrillard argues that strategies of resistance always change to reflect strategies of control. Against a system that excludes or represses the individual, the natural demand is one of inclusion: to become a subject. This, however, is not the modern world. In twenty-first century Western society people are bombarded with appeals for their participation: "Vote!" and "This Bud's for You," and yet they also know that their choice or vote matters little. Against a system that justifies and sustains its existence by the consent (or consumer purchases) of those it governs, the masses have devised their strategy of resistance: apathy—"a spontaneous, total resistance to the ultimatum of historical and political reason" (p. 588). Popular politics is "no longer a question of revolution but of massive *devolution* . . . a massive desisting from will" (p. 586). It is a resistance to resistance.

Cultural Resistance

While apathy may reign supreme in the voting booth, some scholars and activists have been looking for resistance elsewhere: on the street corner, in the living room, or at the club, that is, in cultural expression. Matthew Arnold first articulated cultural resistance, but the Italian Marxist Antonio Gramsci (1891–1937) framed the contemporary discussion.

Gramsci, writing from a Fascist jail in the 1920s and early 1930s, reflected on why the communist revolutions he labored for in the West had so far failed. Part of the reason, he concluded, was a serious underestimation of culture and civil society. Power does not just reside in institutions, but also in the ways people make sense of their world; hegemony is both a political and cultural process. Armed with culture instead of guns, one fights a different type of battle. Whereas traditional battles were "wars of maneuver," frontal assaults that seized the state, cultural battles were "wars of position," flanking maneuvers, commando raids, and infiltrations, staking out positions from which to attack and then reassemble civil society (pp. 229–239). Thus, part of the revolutionary project was to

create counterhegemonic culture behind enemy lines. But if this culture was to have real power, and communist integrity, it could not—contra Arnold—be imposed from above; it must come out of the experiences and consciousness of people. Thus, the job of the revolutionary is to discover the progressive potentialities that reside within popular consciousness and from this material fashion a culture of resistance.

It was this implicitly politico-cultural mission that guided the Centre for Contemporary Cultural Studies at the University of Birmingham in the 1970s. The CCCS is best known for its subcultural studies, and it was within these mainly working-class subcultures that researchers found an inchoate politics of resistance. Mods one-upped their bosses with their snappy dress. Punks performed the decline of Britain with lyrics that warned: "We're your future, no future." Skinheads recreated a cohesive white, masculine working-class world that no longer existed. And Rastafarians turned the world upside down by rereading Christianity into a condemnation of white Babylon. It was through culture that young people contested and rearranged the ideological constructions—the systems of meaning—handed down to them by the dominant powers of postwar Britain.

For Stuart Hall (the influential director of the CCCS) and his colleagues, cultural resistance was politically ambiguous. Subcultures opened up spaces where dominant ideology was contested and counter hegemonic culture was created, however, these contestations and symbolic victories often remained locked in culture. "There is no 'subcultural solution'" to structural inequality write Hall and his colleagues in *Resistance through Rituals* (1976), "They 'solve,' but in an imaginary way, problems which at the concrete material level remain unresolved" (pp. 47–48). As W. H. Auden (1907–1973) came to lament, "Poetry makes nothing happen"—at least not by itself.

Resistance Refuted and Reimagined

Is cultural resistance, resistance at all? Malcolm Cowley (1898–1989) raised this question in *Exile's Return* (1934), his memoir of Bohemian days in Greenwich Village. He pointed out that while the cultural conservatism of the Victorians may have served an era of capitalism predicated on hard work and savings, by the 1920s a new ethic was needed for what was becoming a mass consumer economy. Within the context of consumer capitalism the bohemian call to be freed from yesterday's conventions translates easily into freedom to buy tomorrow's products. More recently, Thomas Frank has taken up the refrain, writing in his journal *The Baffler* (1993):

Over the years the rebel has naturally become the central image of this culture of consumption, symbolizing endless, directionless change, an eternal restlessness with "the establishment"—or, more correctly, with the stuff "the establishment" convinced him to buy last year. (p. 12)

As a purely political strategy resistance also has its critics. Resistance only exists in relation to the dominant power—"bonds of rejection," are what Richard Sennett calls these in

his discussion of *Authority* (1980)—and without that dominant power, resistance has no coherence or purpose. This is not a difficulty if resistance is a tactic on the road to revolution (and thus the end of resistance), but once this goal is discarded resistance becomes problematic, for what is the point of resistance if the very thing being resisted must be maintained?

In the early twenty-first century, theorists and activists are rethinking and redefining resistance, approaching it less as a stand against the world and more as means with which to actualize a new one. This is a central theme of Michael Hardt and Antonio Negri's *Empire* (2000). Resistance, they argue, has two sides. Yes, it is opposing the current world, "but at the same time it is linked to a new world." This new world, however, unlike the revolutionary utopias of times past, "knows no outside. It knows only an inside, a vital and ineluctable participation in the set of social structures, with no possibility of transcending them" (p. 413). This is a strange resistance. What sort of opposition counsels participation inside the system? What sort of new world cannot transcend the old one? The answers lie in Hardt and Negri's analysis of empire. Within the social structures of the system of global capitalism they discover resistant elements: global interdependence, social networks, systems of communication, affective and immaterial labor, and the formation of cooperative consciousness. These ideas and practices are as useful to a new world as they are necessary to the old one. As such, these experiences lived by the multitude are *both* conformity and resistance, depending upon how one understands and mobilizes them.

Hakim Bey (also known as Peter Lamborn Wilson) shares Hardt and Negri's suspicion of a world "outside," but believes that through resistance one can catch a glimpse of an alternative. His model is the TAZ, or *Temporary Autonomous Zone* (1985), an immediate experience—a happening—that temporarily reverses the rules, laying bare the structures of the present and experimenting with a model for the future. The TAZ is necessarily limited in time and space. "But," Bey argues, "such moments of intensity give shape and meaning to the entirety of a life" (p. 100). Protest groups such as London-born Reclaim the Streets put this philosophy of resistance into practice in the 1990s: throwing large, illegal street parties that literally *demonstrated* to participants what the experience of a participatory public culture feels like. What is being created, through acts of resistance, is a revolutionary imagination. As the rebel-poet Subcommandante Marcos of the Zapatista army in Southern Mexico writes,

In our dreams we have seen another world. A sincere world, a world definitively more just than the one in which we now move. . . . That sincere world was not a dream of the past, it was not something that came from our ancestors. It came from ahead, it was from the next step that we had taken.

See also *Liberty; Resistance and Accommodation*.

BIBLIOGRAPHY

Arnold, Matthew. *Culture and Anarchy*, 1869. Reprint, Cambridge, U.K.: Cambridge University Press, 1990.

- . "Dover Beach." In *Poetical Works*, edited by C. B. Tinker and H. F. Lowry. Oxford: Oxford University Press, 1950. First published in 1867.
- Baudrillard, Jean. "The Masses: The Implosion of the Social in the Media." *New Literary History* 3 (1985): pp 577–89.
- Bey, Hakim. *TAZ: The Temporary Autonomous Zone*. New York: Autonomedia, 1985.
- Burke, Edmund. *Reflections on the Revolution in France*, 1790. Reprint, Oxford: Oxford University Press, 1993.
- Camus, Albert. *The Myth of Sisyphus and Other Essays*. New York: Knopf, 1955.
- The Combahee River Collective. "The Combahee River Collective Statement." In *Home Girls: A Black Feminist Anthology*, edited by Barbara Smith. New York: Kitchen Table/Women of Color Press, 1983. First published in 1977.
- Cowley, Malcolm. *Exile's Return*. 1934. Reprint, London: Penguin, 1976.
- Duncombe, Stephen, ed. *Cultural Resistance Reader*. New York: Verso, 2002.
- Foucault, Michel. *The Foucault Reader*. Edited by Paul Rabinow. New York: Pantheon, 1984.
- . *Power/Knowledge*. New York: Pantheon, 1980.
- Frank, Thomas. "Alternative to What?" *The Baffler* 5 (1993): 5–14; 119–128.
- Gandhi, Mahatma K. *Hind Swaraj or Indian Home Rule*, 1910. Reprint, Madras: Gansh and Co/Nationalist Press, 1919.
- Goffman, Erving. *Asylums*. New York: Anchor, 1961.
- Gramsci, Antonio. *Prison Notebooks*. Edited by Quintin Hoare and Geoffrey Nowell Smith. New York: International, 1971. Originally written between 1929–1935.
- Hall, Stuart and Tony Jefferson, eds. *Resistance through Rituals*. London: Unwin Hyman, 1976.
- Hardt, Michael, and Antonio Negri. *Empire*. Cambridge, Mass.: Harvard University Press, 2000.
- Marcos, Subcommandante. "A Thank-You to the NGO's." EZLN communiqué, 1 March 1994.
- Memmi, Albert. *Colonizer and the Colonized*, 1965. Reprint, New York: Beacon Press, 1991.
- Radicalesbians. *The Woman-Identified Woman*. Gay Flames pamphlet, New York, 1970.
- Sartre, Jean-Paul. "Existentialism Is a Humanism." 1946. In *Existentialism from Dostoevsky to Sartre*, edited by Walter Kauffman. New York: New American Library, 1975.
- Sennett, Richard. *Authority*. New York: Norton, 1980.

Stephen Duncombe

RESISTANCE AND ACCOMMODATION. To fight and quite possibly die? Or to acquiesce in one's fate as a slave or conquered person? This has been the classic choice presented by conventional definitions of resistance and accommodation. In Thucydides' (d. c. 401 B.C.E.) *Peloponnesian War*, the people of Melos face the certainty of an invasion by Athens. Two options, both unpalatable, confront their leaders. On one hand, the Melians could acknowledge the superior power of Athens and the coming reality of foreign rule. "And how, pray," they ask, "could it turn out as good for us to serve as for you to rule?" To this the Athenians have a ready answer: "Because you would have the advantage of submitting before suffering the worst, and we should gain by not

destroying you.” On the other hand, the Melians could reject Athenian aggression. “[T]o submit,” they argue, “is to give ourselves over to despair, while action still preserves for us a hope that we may stand erect.” In the end the Melians resist Athenian imperialism, are defeated in battle, and have many grown men put to death and children and women taken as slaves.

Until recently, definitions of accommodation and resistance, particularly in relation to slavery and colonialism, have reproduced the stark decisions that faced the Melians more than two thousand years ago. To accommodate was to agree, however tacitly, with the existing order of things—to compromise, to oblige, to be pliable. Accommodation entailed the avoidance of further conflict, as in a treaty or some other form of agreement that settled a dispute. Compliance with prevailing norms and practices—in short, “accommodation”—contrasted with active contestation of social structures and systems of domination, or “resistance.” Accommodation assumed the absence or ending of conflict, whereas conflict—the throwing up of an obstacle, the establishing of a confrontation—was at the very center of resistance. In some early usages resistance was a physical thing, a type of fortification to slow advancing armies. Accommodation, in contrast, sprang from the mind, and was a strategy by which the less powerful adjusted their lives to the realities of their domination.

Slavery and colonialism represent among the most extreme forms of domination. Slavery centers on “natal alienation”—slaves are divorced from their own community—and property rights, one person owning another human being. Colonialism entails the domination of one society by another that is geographically and culturally distinct from the society that is subjugated. Slavery invariably involves close interaction, even intimacy. A central characteristic of colonialism, on the other hand, is foreignness, rule by a remote society.

Throughout most of the twentieth century perspectives on slavery and colonialism stressed the totality of domination and the apparent passivity of slaves and colonized peoples, or, conversely, dramatic examples of resistance. Influenced by his understanding of Jews in Nazi concentration camps during World War II, the historian Stanley Elkins argued that certain behaviors of slaves showed their near total domination by white masters and the psychological consequences of accommodation. Elkins drew on the work of the German philosopher Georg Wilhelm Friedrich Hegel (1770–1831), particularly on Hegel’s “master-slave dialectic,” according to which the slave becomes an instrument of his master’s will. To the extent that the master’s consciousness and identity come to depend on the slave, so the slave’s capacity for an independent consciousness will decline and he will adopt a “slavish consciousness.” The absence of dramatic resistance such as rebellions seemed to suggest the pervasiveness in American history of accommodation and “slavish consciousness.”

Theorists of colonialism occasionally made similar arguments. The Tunisian Albert Memmi wrote of the entwined identities of colonizer and colonized and of the psychological consequences of accommodation. Frantz Fanon (1925–1961), trained as a psychiatrist, thought colonialism a form of dehu-

**STATEMENT OF FREDERICK LAW
OLMSTED, HAVING VISITED VIRGINIA,
UNITED STATES**

[T]hat everywhere on the plantations, the agrarian notion has become a fixed point of the negro system of ethics: that the result of labor belongs of right to the laborer. . . . They [slaves] almost universally pilfer from the household store when they have a safe opportunity.

SOURCE: Frederick Law Olmstead, *A Journey in the Seaboard Slave States*.

manization; some of the disorders he treated during his time in French Algeria he considered to have originated in the effects of accommodation. Fanon elaborated ideas about resistance and advocated participation in anticolonial violence as a way by which the colonized could cleanse themselves of the stain of subjugation and reassert their basic humanity.

Until the 1970s, writings on accommodation in slave and colonial societies proceeded from a number of assumptions about resistance. Accommodation and resistance were viewed as inversely proportional: the greater the resistance, the less the accommodation, and vice versa. Resistance was clearly identifiable as purposive organized action. In the Americas, the Haitian Revolution (1791–1803), in which slavery was overturned, represented the clearest example of resistance. Scholars looked elsewhere for other examples of slave rebellions and argued that the absence of organized resistance indicated greater levels of domination and accommodation.

Throughout the postcolonial world, discussions of resistance likewise centered on organized actions to resist or to overthrow colonialism. Scholars of South Asia concentrated on revolts such as the 1857 Indian Rebellion or on the nonviolence campaigns of Mahatma Gandhi that led up to the granting of Indian independence in 1947. China specialists analyzed events such as the Boxer Rebellion at the beginning of the twentieth century.

Africanist scholars distinguished “primary resistance” from “secondary resistance.” Active, organized protest against colonial encroachment and conquest, or against early colonial rule, represented primary resistance. The Maji Maji rebellion in German Tanganyika (1905–1906), the Herero rebellion in German South West Africa (1904–1907), and military engagements across the continent in the late nineteenth and early twentieth centuries were representative examples. In contrast, “secondary resistance” looked ahead to the ending of foreign rule and the creation of new nation-states; strikes and demands by trade

**STATEMENT OF HENDRIK WITBOOI (NAMA CHIEF) ON THE GERMAN
ADMINISTRATION, SOUTH WEST AFRICA [NAMIBIA]**

The German himself . . . is just what he described the other nations as . . . he makes no requests according to truth and justice and asks no permission of a chief. He introduces laws into the land . . . [which] are entirely impossible, untenable, unbelievable, unbearable, unmerciful and unfeeling. . . . He personally punishes our people at Windhoek and has already beaten people to death for debt. . . . it is not just and right to beat people to death for that. . . . He flogs people in a shameful and cruel manner. We stupid and unintelligent people, for so he thinks us to be, we have never yet punished a human being in such a cruel and improper way for he stretches people on their backs and flogs them on the stomach and even between the legs, be they male or female, so Your Honour can understand that no one can survive such a punishment.

SOURCE: Namibweb.com, "German Imperialism in South West Africa."

unions and, especially, the claims and actions of nationalist organizations were the clearest examples. Importantly, whereas primary resistance invariably entailed violence, this was not necessarily so with secondary resistance, which embraced peaceful protests as well as armed movements for national liberation.

The Effects of Culture and Consciousness

Definitions of resistance and accommodation, even in their earliest formulations, inevitably raised issues of culture and consciousness. As early as the 1960s, scholars began widening their definitions and complicating what once appeared to have been clear distinctions between accommodation and resistance. The absence of organized resistance, they said, did not necessarily imply accommodation, and certainly not acquiescence. All forms of critique could be seen to be examples of resistance. In the study of slavery in the Americas, scholars called attention to symbolic rather than directly confrontational forms of resistance. Songs might criticize the planter class. The preservation and reworking of African beliefs and practices pointed to the creation of identities and consciousness independent of the slave master. The accumulation of personal property offered some, albeit often very small, degree of economic autonomy and indicated the success slaves had in mitigating their condition. The existence and preservation of family networks were another way slaves created a world separate from their masters and, in so doing, brought into question the solidity of slavery as a system of domination.

Indeed, in this new way of looking at slavery, masters were discovered to have accommodated to the demands of their slaves in order to protect their economic investment and preserve a modicum of stability. Slavery came to be seen in less stark terms, slave societies as intensely negotiated worlds. At

the same time, as topics such as songs and rituals began being included within the more expansive definitions of resistance, so also did theft, slowdowns, and other actions that did not have as their immediate object the overthrow of slavery itself. Because slaves had access to the master's valuable economic resources, they could steal from planters, damage crops, livestock, and machinery, or simply work slowly or inefficiently. Behaviors that Elkins and others had viewed as examples of moral defeat and acquiescence came to be viewed far differently, as creative expressions of resistance.

In Africa and elsewhere in the colonial world scholars were making similar points, focusing increasingly on symbolic and "hidden" forms of resistance. The older dichotomies of resistance versus accommodation fell out of favor. Historians called attention to social banditry, theft, and myriad activities ranging from tax evasion to migration, whereby the colonized resisted domination. One important concept was "moral economy," the cultural and ideological logic by which people understood social and economic relationships. The dominated—whether slaves or the colonized—expected their superiors to abide by certain codes of conduct that created a kind of consensus about how the community should function. These norms and obligations might range from how hard people should work to the provisioning of food. This logic could at times be articulated in ways that helped to foment active resistance or to force masters or colonizers to somehow accommodate to the demands of slaves or colonized peoples.

Oral histories and the recording of songs and other cultural productions pointed to the elaboration of rich critiques of colonial power. They also revealed the important roles of gender and generation. Women contested colonialism in ways that were often very different than men, and younger adults did so

differently than their elders. In Mozambique, women complained of the burdens of forced cash-crop production of cotton and of sexual abuse by local colonial functionaries. Pounding grain into flour offered women an opportunity to converse and to compose songs about their condition as exploited people. "I suffer, I do," women lament in one song (see White and Vail),

I cultivate my cotton,
I suffer, my heart is weeping,
 Picking, picking a whole basketful,
I suffer, my heart is weeping,
 I've taken it to the Boma [market] there,
I suffer, my heart is weeping,
 They've given me five escudos
I suffer, my heart is weeping.

Other songs the women sang parodied colonial officials, using rich and ribald language; the critique of colonialism remained implicit, so as not to invite retribution.

In the 1980s, the beginning of a cultural turn in studies of accommodation and resistance shifted attention away from collective acts such as rebellions. Increasingly, scholars emphasized culture and what people believed and how they felt. The definition of both words shifted from the physical to the mental to embrace historical conditions that could be political, cultural, even psychological. Scholars demonstrated the ways in which the creation of meaning, the ways people imbued the world around them with significance, could be powerfully constitutive of new identities that stood in opposition to slavery or the colonial order. Compliance therefore did not automatically indicate an absence of resistance. Indeed, some forms of accommodation could mask resistance as long as actions somehow mitigated conditions.

Cultural as opposed to political definitions of resistance have emphasized concepts such as moral economy, ritual, hegemony, and hybridity. Scholars of the subaltern school of South Asian history have been especially important in expanding the definitions of resistance and accommodation. They have, for instance, argued that since colonial domination was never total—that is, hegemonic—the culture of the colonized remained autonomous; their behavior cannot be reduced to so many reactions to colonialism. The emphasis thus shifts from resistance or accommodation to the kinds of engagements people had with those who wielded power. The decision the Melians faced more than two thousand years ago was exceptionally stark. Since most forms of domination—including slavery and colonialism—entail some sort of negotiation, scholars in the early twenty-first century focus on the complex cultural borrowing that typically characterizes slave and colonial societies.

For example, rituals and what some have described as "invented traditions" incorporated parts of the slave master's or the colonizer's world, such as dress, ceremony, or even state procedures such as criminal trials. This mixture of artifacts and other facets, what is called syncretism, can be seen most clearly in religion. Slave religions and religious movements through-

out the colonial world have combined Christianity with earlier conceptions based on local gods and ancestor worship. The new beliefs have frequently critiqued the slave or colonial order as not simply unjust but immoral, even evil. They also have helped shape resistance movements such as the Mau Mau rebellion in Kenya (1954–1956) and the 1915 Chilembwe revolt in Nyasaland (Malawi).

Definitions of resistance and accommodation now embrace far more than treaties, formal acceptances of defeat, and in the alternative large-scale organized movements against slavery or colonialism. As Fanon suggested, even looking the colonizer in the eye could be a form of resistance. Extending the definitions beyond formal settlements and organized resistance has not only broadened the range of possible examples but ultimately blurred the lines separating words that once had clearly opposed meanings. Even conventional acts of resistance are becoming seen as more ambiguous, since resistance often entails some sort of recognition of and accommodation to the colonizer's world. But the understanding of culture and consciousness raises thorny questions. Can one resist without consciously doing so? Can resistance include at the same time accommodation? The central challenge now facing scholars of slave and colonial societies is how to understand meaning and action within highly unequal relationships and how to creatively rethink those moments when people actively reassert their humanity in the face of power.

See also Anticolonialism; Civil Disobedience; Colonialism; Empire and Imperialism; Slavery.

BIBLIOGRAPHY

- Comaroff, Jean. *Body of Power, Spirit of Resistance*. Chicago: University of Chicago Press, 1985.
- Crais, Clifton. *The Politics of Evil: Magic, State Power, and the Political Imagination in South Africa*. Cambridge, U. K. and New York: Cambridge University Press, 2002.
- Elkins, Stanley M. *Slavery: A Problem in American Institutional and Intellectual Life*. Chicago: University of Chicago Press, 1959.
- Genovese, Eugene D. *Roll, Jordan, Roll: The World the Slaves Made*. New York: Vintage, 1976.
- Guha, Ranajit, ed. *Subaltern Studies I: Writings on South Asian History and Society*. Delhi and New York: Oxford University Press, 1982.
- Hegel, Georg Wilhelm Friedrich. *Phenomenology of Spirit*. Translated by A. V. Miller. Oxford: Clarendon, 1977.
- Hobsbawm, Eric. *Primitive Rebels*. 2nd ed. New York: Praeger, 1963.
- Levine, Lawrence W. *Black Culture and Black Consciousness*. New York: Oxford University Press, 1977.
- NamibWeb.com—The Online Guide to Namibia. "German Imperialism in South West Africa." Available at <http://www.namibweb.com/germans.htm>.
- Olmstead, Frederick Law. *A Journey in the Seaboard Slave States: With Remarks on Their Economy*. New York: Dix and Edwards, 1856.
- Scott, James C. *Domination and the Arts of Resistance*. New Haven: Yale University Press, 1990.
- . *Weapons of the Weak*. New Haven: Yale University Press, 1985.
- Thucydides. *The Peloponnesian War*. Introduction by John H. Finley, Jr. New York: Modern Library, 1951.

White, Landing, and Leroy Vail. *Power and the Praise Poem: Southern African Voices in History*. Charlottesville: University of Virginia Press.

Clifton Crais

RESPONSIBILITY. The term *responsibility* has several related meanings.

First, there is causal responsibility. To say that the short circuit is responsible for the fire is simply to say that the short circuit caused the fire.

Second, there is personal responsibility. This comes in two forms, prospective and retrospective. To say that the lifeguard is responsible for the swimmers' safety is to say that the lifeguard has a responsibility (a duty or obligation) to see to it that the swimmers remain safe. This is a prospective matter, since it points toward the future. In contrast, to say that the lifeguard is responsible for the swimmers' deaths is to say that the lifeguard bears responsibility for something that has already happened; it is to attribute a sort of blameworthiness to the lifeguard for having failed to fulfill a duty. Attributions of retrospective responsibility need not always be negative, though. To say that the generous donor is responsible for the charity's success is to attribute a sort of praiseworthiness to the donor.

Third, there is collective responsibility. This may also be either prospective or retrospective. Sometimes collections of individuals (such as corporations or nations) are said to have duties or obligations, and on such occasions they may also be held to account for fulfilling or failing to fulfill these duties. It is controversial whether collective responsibility is reducible to personal responsibility (so that all statements about the former can be translated into statements about the latter) or rather constitutes a distinct type of responsibility.

Noncausal responsibility, whether personal or collective and whether prospective or retrospective, may be either moral or nonmoral (as when it is legal or professional) depending on whether the duties in question are moral or nonmoral. Furthermore, retrospective responsibility, whether positive or negative, constitutes a susceptibility to reactions that may vary in kind. The most basic kind of reaction consists simply in an evaluation of the person (or collection of individuals) to whom (or which) the attribution of responsibility is made. Thus, to hold the lifeguard responsible, in this basic way, for the swimmers' deaths is to make a negative evaluation of him or her in light of the deaths. A more robust kind of reaction involves treating the person (or group) in some way—for example, by handing out reward or punishment. It is frequently held that justification for the more robust kind of reaction presupposes justification for the basic kind (so that, for example, punishment is warranted only if the person punished warrants a negative evaluation), but this is not universally accepted.

This article will concentrate on responsibility that is personal, retrospective, moral, and basic. Philosophers have concerned themselves with what is needed and what suffices for

such responsibility. Aristotle (384–322 B.C.E.) suggested two distinct conditions, and his discussion has shaped all subsequent treatment of the matter.

The First Condition: Freedom

A common assumption is that, to be responsible (personally, retrospectively, morally, and basically) for something, one must enjoy freedom of will or action. Just what the relevant sort of freedom consists of is controversial, but the central idea is that one's behavior must be within one's control.

There is a venerable argument to the effect that this condition of responsibility is impossible to satisfy, and hence that responsibility is never incurred. The argument involves the thesis of determinism (roughly, the view that every event has a cause) and may be put as follows:

1. If determinism is true, no one is ever in control of what happens.
2. If determinism is false, no one is ever in control of what happens.
3. Determinism is either true or false.

Hence,

4. No one is ever in control of what happens.
5. One is responsible for what happens only if one is in control of it.

Hence,

6. No one is ever responsible for what happens.

Premise 5 states the precondition for responsibility that is at issue. Premise 3 is taken to be a logical truth. The rationale for premise 1 is this: if something is caused to happen, then it is, under the circumstances, inevitable; and if it is inevitable, then no one is in control of it. The rationale for premise 2 is this: if something occurs uncaused, then it occurs at random and if it occurs at random, then no one is in control of it.

Some philosophers have accepted this argument, but it is surely hard to do so. (Others, such as Immanuel Kant [1724–1804], have insisted that the idea that individuals never act freely is, practically speaking, impossible to accept.) Among those who have rejected the argument, some have done so by explicitly disputing one or another of its premises. So-called compatibilists deny the first premise; their number includes such major historical figures as Thomas Hobbes (1588–1679), John Locke (1632–1704), David Hume (1711–1776), and John Stuart Mill (1806–1873). So-called libertarians deny the second premise; among major historical figures, perhaps the most uncompromising proponent of this view was Thomas Reid (1710–1796), although both Aristotle and Kant also flirted with it at times.

More recently, premise 5 has been challenged. Robert Adams has argued that certain sins, for which one is to blame,

are involuntary and hence such that one is not free with respect to them. Examples include the vices of bigotry, cowardice, cruelty, and so on, where these are understood not as a matter of behaving in a certain way (something that may well be under one's control) but of being a certain way, that is, of having certain inclinations, desires, or beliefs (something that may well not be under one's control). Adams's point is that, whether or not these phenomena are under one's control, one is certainly to blame for them.

One way to resist Adams's conclusion is to deny that the phenomena in question are never under one's control. Aristotle took this tack, claiming that, even if individuals have now reached a point in their lives at which certain of their virtuous or vicious traits are beyond their control (not in terms of acting on them, but in terms of ridding ourselves of them or of acquiring them), still there was a time when they could have acted in such a way as to prevent their having them (if they are vices they now have) or to produce them in themselves (if they are virtues they now lack). Another way to resist Adams's conclusion is to acknowledge that individuals may be to praise or blame in some way for such traits, but to deny that such praise or blame constitutes an attribution of responsibility. (Peter Abelard [1079–1142] at times suggested this position.)

Another challenge to premise 5 involves granting the traditional idea that responsibility requires freedom but denying the traditional idea that freedom requires control. Harry Frankfurt has recently pressed this line of thought, urging that the inability to behave differently does not compromise the freedom required for responsibility when this inability does not serve to explain one's behavior. His discussion of this issue has generated a vigorous, subtle, and often complex debate.

An argument similar to, but also importantly different from, the argument concerning determinism has lately garnered considerable attention. The argument ends, as before, with the inference of 6 from premises 4 and 5. The difference lies in the beginning. Now the claim is that 4 (the proposition that no one is ever in control of what happens) is true, not because of any general considerations concerning determinism, but simply because of the fact that luck cannot be eliminated from people's lives. In support of this contention, cases of the following sort are commonly cited: Alf shoots at Bert and kills him. Charlie shoots in like fashion at Dave but, because a bird happens to get in the way of the bullet, fails even to wound him. This case serves to dramatize the fact that, in all one's actions, what one succeeds in doing is in large measure not up to the individual but, as it is often put, up to nature. Or again, it may be that what saves Dave is not a passing bird that intercepts Charlie's bullet but a sudden sneeze that prevents Charlie from even firing his gun. The more one thinks about it (independently of any question of determinism), the more one sees that luck permeates people's lives, eroding the control over, and thereby the responsibility for, their actions that they like to think they have.

The force of such considerations is keenly debated. In light of them, some philosophers appear willing to forgo attributions of responsibility. Others seek to preserve such attributions by rejecting (once again) the traditional idea that

responsibility requires control. Still others seek to preserve such attributions by pointing out that lack of complete control over what happens need not amount to lack of any control.

Finally, just what sort of freedom or control might be thought necessary for responsibility has been a subject of some controversy. Some philosophers propose a fairly thin account, involving one's being in some sense the source of one's actions. Others propose richer accounts, involving some form of autonomy or of responsiveness to reasons. Whatever the proper account may be, it is important to note a distinction between two types of freedom, each of which may initially appear necessary for responsibility. This distinction can best be drawn by means of a familiar example. Suppose that Emma goes into a bank, points a gun at Fiona, the teller, and orders her to hand over all the money in her till. Fiona complies. Two questions arise: did Fiona freely hand over the money and is she responsible for doing so? One's initial inclination may well be to answer "No" to both. One may be tempted to add that the negative response to the first question is the ground for the negative response to the second. But on reflection this may seem mistaken. Although there certainly seems to be a sense in which Fiona did not act freely (for she was strongly coerced to do what she did), there is also clearly a sense in which it seems she did act freely; she had a choice in the situation (albeit an unpleasant one) and, one may assume, she made the right choice. Indeed, in light of this, it may well be appropriate to praise her for acting as she did, and this would seem to imply that she is responsible for her conduct after all. It thus seems that the sort of freedom necessary for responsibility (if, indeed, any sort of freedom is necessary) is that which Fiona exemplified rather than that which she failed to exemplify.

The Second Condition: Mentality

Control over one's behavior is not all that is necessary for responsibility. Gwen, a young child, may have control over what she does (for example, she may freely choose to yank the tail of the family cat), but that is no reason to hold her morally responsible for her behavior.

What is it that Gwen lacks? The obvious answer is that she fails to understand the moral character of her action and is thus not to blame for it. This suggests that one is blameworthy (in a way that imputes responsibility for one's behavior) only if one is aware that one is doing wrong. At least three reasons may be given for rejecting this view, however.

First, ever since Plato (c. 428–348 or 347 B.C.E.), philosophers have claimed that it is not possible freely to act in the belief that one is doing wrong, since this requires that one willingly do wrong, which is impossible. (Of course, many philosophers have rejected this claim. Indeed some, such as St. Augustine of Hippo [354–430], have gone so far as to suggest that it is possible to have wrongdoing as one's ultimate objective.) Although this claim may seem at odds with common experience, its plausibility may grow on reflection. For example, many apparent instances of willing wrongdoing may reveal themselves on inspection to be better characterized as cases of doing something that one merely believes that others take to be wrong.

Second, to be aware that one is doing wrong implies that one is indeed doing wrong, but some philosophers have claimed that blameworthiness merely requires the belief, and not the fact, that one is doing wrong.

Third, blameworthiness seems often to be incurred through negligence, which in many cases involves the failure to be aware that one is doing wrong; indeed, it is this very failure that seems to ground the attribution of responsibility.

On these arguments, it is doubtful that awareness of wrongdoing is necessary for blameworthiness. Yet, as the case of Gwen indicates, it seems that one must satisfy some rather sophisticated mental condition to be blameworthy; just what this condition is, however, remains unclear. Similarly, presumably some other rather sophisticated mental condition must be satisfied if one is to be praiseworthy (in a way that imputes responsibility for one's behavior). Again, it is controversial just what this condition is. Some philosophers appear to think that simply having good intentions will do; others, such as Kant, insist that one must have doing one's duty as one's ultimate objective.

Finally, there is the question of the relevance of mental disorders to responsibility. It is commonly said that suffering from a mental disorder relieves one of responsibility for one's conduct. But this is far too sweeping. While kleptomania may provide an excuse for theft, it surely provides no excuse for assault; similarly, pyromania may furnish an excuse for arson but not for theft. There must be some close connection between disorder and offense for an excuse to be in the offing. Even then, whether an excuse is indeed available is debatable. Suppose that Holly is a kleptomaniac; why think she therefore has an excuse for theft? One answer is that she literally cannot help stealing. But this seems dubious. More accurate would seem to be the claim that she finds it abnormally difficult, rather than literally impossible, to resist the impulse to steal. But if there is the possibility of resistance, why excuse her for failing to resist? Perhaps she is not to be excused after all, if she recognizes that it is wrong to steal. Or perhaps the unusual strength of the impulse to steal makes it justifiable for her to succumb to it, so that she is indeed not to blame for doing so. Or perhaps she is not justified in succumbing to the impulse but is still not to blame for doing so because of some aspect of her mental state that has yet to be identified; for it is noteworthy that we tend rather to pity people such as Holly than to judge them wicked.

It is safe to say that the grounds for attribution of moral responsibility are complex and that, despite Aristotle's lasting contributions, the discussion that began with him remains unresolved.

See also *Determinism; Fatalism; Moral Sense*.

BIBLIOGRAPHY

- Abelard, Peter. *Ethical Writings*. Translated by Paul Vincent Spade. Indianapolis: Hackett, 1995.
- Adams, Robert M. "Involuntary Sins." *Philosophical Review* 94 (1985): 3–31.

Aristotle. *Nicomachean Ethics*. Translated with an introduction by David Ross; revised by J. L. Ackrill and J. O. Urmson. Oxford and New York: Oxford University Press, 1998.

Augustine, St. *The Confessions*. Translated with an introduction and notes by Henry Chadwick. Oxford and New York: Oxford University Press, 1992.

Frankfurt, Harry G. "Alternate Possibilities and Moral Responsibility." *Journal of Philosophy* 66 (1969): 829–839.

Hobbes, Thomas. *Leviathan*. Edited with an introduction by C. A. Gaskin. Oxford and New York: Oxford University Press, 1996.

Hume, David. *An Enquiry Concerning Human Understanding*, edited by Tom L. Beauchamp. Oxford and New York: Oxford University Press, 1999.

Kant, Immanuel. *Groundwork of the Metaphysics of Morals*. London and New York: Hutchinson's University Library, 1948.

Locke, John. *Essay Concerning Human Understanding*, edited by Peter H. Niddich. Oxford: Clarendon; New York: Oxford University Press, 1979.

Mill, John Stuart. *An Examination of Sir William Hamilton's Philosophy*. Edited by J. M. Robson. Buffalo, N.Y., and Toronto: University of Toronto Press, 1979.

Plato. *Meno*. Edited with translation and notes by R. W. Sharples. Chicago: Bolchazy-Carducci, 1985.

Reid, Thomas. *Essays on the Active Powers of Man*. 1788. Reprint, New York: Garland, 1977.

Michael J. Zimmerman

REVELATION. See *Religion; Sacred Texts*.

REVOLUTION. It is tempting to give a definition of revolution at the outset of an account such as this. This is a temptation to be resisted. The great sociologist Max Weber (1864–1920) was right to say that “definition can be attempted, if at all, only at the conclusion of the study.” Another great thinker, Friedrich Nietzsche (1844–1900), declared that “only that which has no history can be defined.” Both of these remarks are highly relevant to the concept of revolution. It is best to postpone any attempt to define it until one has inquired into its history. As a humanly made event, revolution cannot be seen as a timeless thing, lacking change and variety. Like all human artifacts it has a history, and that must mean change. Our understandings of revolution must be sensitive to those changes. There cannot be any “essentialist” definition of revolution, any account that assumes some permanent, unvarying meaning, stretching across space and time.

This does not mean, on the other hand, that revolution can mean just anything (except, that is, to advertisers and marketing people who announce every new model of a motor car as a revolution). The various European languages have naturalized the word revolution—*révolution*, *Revolution*, *rivoluzione*, *revolución*—to mean much the same thing. That is because Western societies have shared certain common legacies and certain common experiences. The concept of revolution has reflected that shared tradition. While we should not

therefore expect revolution to carry one unequivocal meaning everywhere, we should at least expect what Ludwig Wittgenstein (1889–1951) called “family resemblances” between the various uses and understandings.

Revolution, finally, is a European invention. The meaning that it has in the world today derives from European use and experience. As a particular species of change it had no equivalent in the non-European world. The theory and practice of revolution was carried, along with other European inventions such as industrialism and nationalism, by traders, missionaries, and colonizers along the paths laid out by the European empires, formal and informal. It was learned and studied by non-Western intellectuals in the cities and academies of the West. If, as is indeed the case, revolution has become a worldwide inheritance, that is because Western principles and patterns of politics have become the norm for much of the world.

That some of the meanings in the non-Western world differ from those in the West is only to be expected from a concept that has always, even in the West, been sensitive to particular contexts and particular histories. The Russian understanding of revolution has been different from that of the French, and that too from the English or American, which have in their turn differed from German or Spanish conceptions. So African, Asian, and Latin American ideas of revolution have shown characteristic variations reflecting their different cultures. Even here, however, it is possible to see the same family resemblances that are observable in the Western cases. The fact that revolution has a tradition of use and meaning explains its variability; but it also points to continuities and similarities. The Western origin of revolution has meant that, as an ideal and a practice, it carries a certain basic stamp that enables us to identify and study it as a coherent phenomenon wherever it appears. Not anything can be called a revolution, whatever the claims of either its adherents or detractors.

Classical and Christian Conceptions

Revolution is an invention of Western modernity. In its generally understood meaning today, it was unknown in the ancient world. Nor was it understood in our sense in the European Middle Ages, or in the early modern period. It was only in the eighteenth century, with the American and French Revolutions, that the word *revolution* acquired its modern connotation of fundamental and far-reaching change.

The ancient Greeks certainly had their fill of violent politics; but they had no word for revolution, nothing that truly corresponds to our modern understanding of it. The commonest terms, used by both Thucydides (d. c. 401 B.C.E.) and Aristotle (384–322 B.C.E.), were *metabole politeias* (“change of constitution”), and *metabole kai stasis* (“change with uprising, change due to factional strife”). Plato in the *Republic* uses plain *metabole* (“change”), or occasionally a phrase such as *neoterizein ten politeian*, usually translated as “to revolutionize (or renew) the state.” But this translation, with its connotation of purpose and novelty, is misleading. Plato (in book 8 of the *Republic*) is discussing the inevitable decline of the ideal state, first into a timocracy then, though a series of successively determined stages, into an oligarchy, a democracy, and so to tyranny.

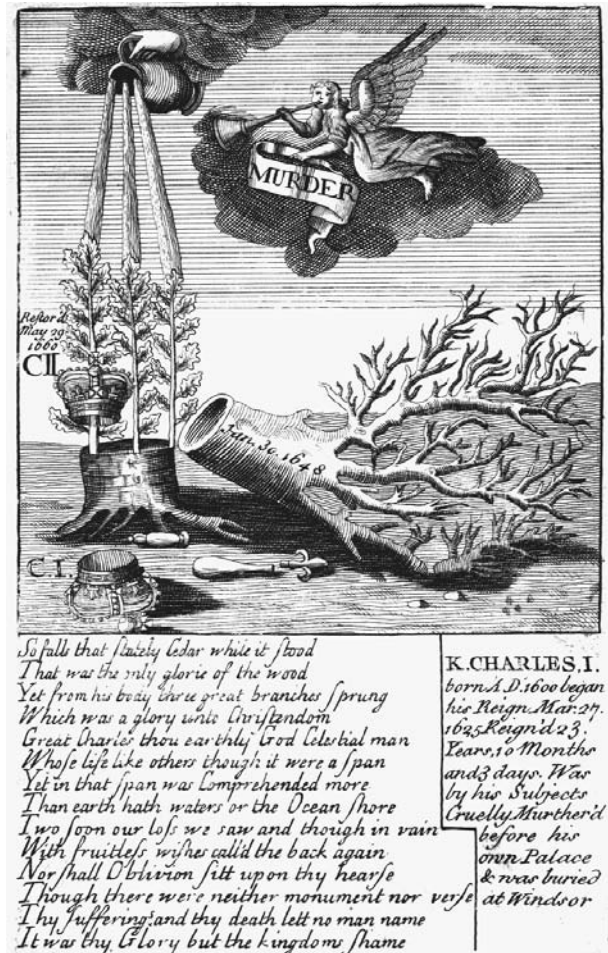

Political cartoon relating to the execution of Charles I during the English Civil War, c. 1660s. Many historians consider the English Civil War to be the first true large-scale revolution. The war led to substantial change in England’s government, including the execution of the ruling monarch and the establishment of a republic. © CORBIS

In this highly determinist pattern, there is no room for that consciously directed change that we associate with revolution.

The problem indeed is largely one of translation. *Stasis*, for instance, is regularly rendered by modern translators as “revolution.” Thus book 5 of Aristotle’s *Politics* is generally treated as a discussion of causes of revolution, while Thucydides, in various parts of *The Peloponnesian War*, is usually held to have given a brilliant account of the revolutionary condition of the Greek city-states at the time of the war (e.g., book 3, ch. 5: “Practically the whole of the Hellenic world was convulsed. . . . Revolution broke out in city after city.”).

The trouble is that, just as Plato is not speaking of revolution but of the predetermined turns of the political cycle, so Aristotle and Thucydides are not speaking of revolution but of faction or party, and the violent conflicts that spring from them. A condition of stasis is one of party warfare, one, moreover, where though there may be much noise and fury, there is little



The storming of the Bastille during the French Revolution, engraving after a painting by Francois Flamena, 1879–1881. The French Revolution is widely hailed as the epitome of revolutions, the revolution against which all others are measured. Afterwards, the concept of revolution became one of the triumph of human will against an unjust society. © CORBIS-BETTMANN

real change. *Stasis* derived from words meaning “standing still,” “stationariness,” “bring to a standstill,” and in contexts (e.g., Plato’s *Cratylus*) where it is said to be “denial of movement.” When applied to politics, it conjured up a picture of opponents locked in frenzied conflict, preventing, by the very violence and fanaticism of their mutual antagonism, any real change or any genuine resolution of political problems. In so far as revolution is concerned with fundamental change and the starting of new things, where there is *stasis* there cannot be revolution.

Similarly the widespread classical conception of revolution is of the turns of the political cycle, mirroring, or perhaps instancing, the cycles of growth and decay in nature. It excludes all ideas of true novelty, as well as of human agency. Plato had left the cycle incomplete. The degeneration of his ideal state ended with tyranny. It was left to the Greek writer Polybius, drawing explicitly on Plato, to complete the cycle, and to make tyranny pass back into the ideal state, when the cycle would begin all over again. What drove the cycle was Fate or Fortune (*tukhe*). Revolutions were the turns of For-

ture’s impassively revolving wheel—hence inevitable and irresistible, beyond human willing or control. “Such,” wrote Polybius (c. 200–118 B.C.E.), “is the course of political revolution (*politeion anakyklosis*), the course appointed by nature in which constitutions change, disappear, and finally return to the point from which they started.”

The importance of Polybius’s contribution was his influence on Roman writers, such as Cicero (106–43 B.C.E.), and through them the whole later classical and early Christian world. The standard terms—*metabole* and *stasis*—from the Greek political lexicon were glossed in Latin as *novae res, mutatio rerum*, and *commutatio rei publicae*. But when it came to fitting these phenomena into a philosophy of politics Roman writers were apt to fall back on the Platonic idea of the cycle, as amplified by Polybius. For Cicero, for example, the “revolution” whereby Julius Caesar attained power was an instance of the natural cyclical process described by the Greek philosophers. It marked the turn of the circle—*orbis*—that described political change generally.



Artist rendering of Bloody Sunday protest in Saint Petersburg, Russia. In 1905, some 200,000 Russian workers gathered outside the palace of the Tsar to demand better working conditions. The palace guards opened fire on the demonstrators, and the uprising of protest that followed eventually resulted in the first Russian Revolution. HULTON/ARCHIVE BY GETTY IMAGES

Christian writers of the Middle Ages were content to follow this respectable example, the more so as its Stoicism fitted in well with a cosmology that was even less inclined to allow freedom to merely human volition. By comparison with the cosmic “revolution” of Christ’s coming, and the end of human history that it portended, all secular changes among humans paled into insignificance. Platonic conceptions, which in any case tended to disparage the things of this world, were highly suited to this view. The political cycles of the earthly city could be seen as the secondary counterpart to the predominant rectilinear pattern of Providential history, which was preparing the way for the consummation in the heavenly city.

It was in fact from the heavens that the word *revolution* descended to enter the earthly domain of politics. Astrology provided the link. The word *revolutio*—from *revolvere*, “to roll back,” “to come back,” “to return in due course”—was a late Latin coinage. St. Augustine of Hippo (354–430) used it to refer to the migration of souls. It then came to be applied to the revolutions of the heavens, to the cyclical rotations of the planets and stars in their fixed orbits. The astronomical usage, as in Nicolaus Copernicus’s *De revolutionibus orbium coelestium* (1543), predominated until the late seventeenth century. But earlier it had already come to be applied to human society, through the widely shared astrological belief in the in-

fluence of the stars on human affairs. The revolutions of the heavens were the direct cause of revolutions among humans.

This confirmed rather than modified in any substantial way the concept of revolution as the turn of Fortune’s wheel. For not only were the movements of the stars as independent of human agency as the dispositions of Fortune (cf. Hamlet’s “Here’s fine Revolution,” as he muses on Yorick’s skull). They operated according to the same laws of motion as the political cycles of the Greeks. Each movement was preordained and predictable, a step or phase in the complete orbital cycle that returned the star or planet to its original starting point. The revolutions of the stars were therefore as bereft of novelty as the revolutions of the seasons. As Hannah Arendt has written of the astronomical *revolutio*, “if used for the affairs of men on earth, it could only signify that the few known forms of government revolve among the mortals in eternal recurrence and with the same irresistible force which makes the stars follow their pre-ordained paths in the skies” (p. 35). The astronomical conception of political change dominated the uses of the term *revolution* from the fourteenth to the sixteenth centuries. The *rivoluzioni* of the North Italian cities of the fourteenth century—when the term first entered the political vocabulary to denote violent political change—were seen in the perspective



Poster celebrating the Red Navy during the Russian Revolution, 1917. Two successive uprisings in 1917 by Russian peasants and the working class led to the overthrow of the monarchy and created the first Communist regime. © BETTMANN/CORBIS

of the cyclical conception derived from classical antiquity. Most commonly *revolution* was used in some sense of restoration, the return to a truer or purer or more original state of things. This was the meaning of its use in relation to the pro- and anti-Medicean revolts in Florence in 1494, 1512, and 1527. Widely called *rivoluzioni* by contemporary observers, the revolts were held by their supporters to bring back the better state of affairs displaced by their rivals. A similar meaning underlay the use of the term *révolution* to describe the conversion to Catholicism of the French king Henry IV in 1593. By so disarming his enemies, the Catholic League, and causing massive defections to his side, Henry was said both to have brought about an irresistible turn of the wheel of Fortune and at the same time to have restored the kingdom to an earlier condition of health (Griewank, p. 145). In this late sixteenth century usage one sees as clearly as anywhere the persistence of a concept of revolution in which the quality of novelty is conspicuously absent.

The Seventeenth Century

It has been common to see the seventeenth century as the source of the modern idea of revolution. Partly this is due to

the fact that seventeenth-century Europe was profoundly shaken by a great wave of rebellions and civil wars. There were revolts in the Netherlands against Spanish rule; major rebellions in France—the Fronde—and in several of the territories of the Spanish monarchy—Catalonia, Portugal, Naples, and Sicily; Scotland and Ireland rose against English domination. Above all there is the English Civil War of 1642–1649, seen by many, such as Karl Marx, as the first of the “great revolutions” of modern history.

Most historians agree that, however bloody the conflicts, most of these rebellions were just that—rebellions, not revolutions. These were traditional uprisings by traditional actors. There was no attempt to create anything new or different. Peasants, townsmen, and disaffected aristocrats appealed to “the ancient and fundamental laws of the kingdom,” to customs, traditions, and the “good old ways”—in other words, to the past—in their struggles with their rulers. The aim was to bring back or to confirm historic institutions—the French parliaments and Estates-General, the Spanish Cortes, the Catalan *diputació*, the English Parliament.

The English Civil War, however, has seemed to many a different kind of conflict, one deserving the name *revolution* in the modern sense. Did the English not execute their king, abolish the monarchy and the House of Lords, disestablish the Church of England, and proclaim a republic? In a more far-reaching way, did the English Civil War not clear the way for capitalist development, so launching England on the path that was to take it to the pinnacle of the world economy? Contemporaries called it “the Great Rebellion,” but should we not be prepared to call it, with Lawrence Stone, “the first ‘Great Revolution’ in the history of the world” (p. 147)?

One needs to attend to the language of contemporaries, and to beware of imposing our often anachronistic interpretations on past events. In relation to the events that occurred between 1640 and 1660, and even to those of 1688, contemporaries largely avoided the newly coined political term “revolution.” When they did use it, they gave it the meaning current in early modern political thought. That is, they employed it with the cyclical connotation derived from its astronomical usage. That is why it so often appeared in plural form, as when Robert Sanderson wrote in 1649 of “the confusions and revolutions of government,” or Matthew Wren in 1650 of “those strange revolutions we have seen.”

Most revealingly of all, what we call the “Restoration” of 1660 was widely hailed as a “revolution.” It was so termed by Lord Clarendon, the first historian of what he called, referring to the events of the past twenty years, the “Great Rebellion.” Thomas Hobbes, in his *Behemoth* (1668), was also clear that with the return of Charles II in 1660, a political cycle had been duly completed: “I have seen in this Revolution a circular motion of the Sovereign Power, through two Usurpers, from the late King to his Son.” Nor was it just monarchists and conservatives who remained wedded to the traditional concept of revolution. What was later to be sanctified as the “Glorious” or “Bloodless” Revolution of 1688 was also at the time understood to be a revolution in the tra-

ditional sense of the word. The parliamentary Whigs, taking their cue from John Locke, here turned the tables on Clarendon and the supporters of the Restoration by arguing that not 1660 but 1688 was the true restoration, hence the true, final revolution. Charles II, and even more James II, had flouted the fundamental laws and violated the original constitution of the kingdom every bit as much as Charles I and Oliver Cromwell. All had plunged the country into a cycle of violence and oppressive but unstable regimes. Only with the restoration of a truly constitutional monarchy in 1688 had the cycle run its course.

One is entitled, for certain purposes, to argue that the men and women of the seventeenth century knew not whereof they spoke, that when they spoke of “restoration,” we can quite properly speak of revolution in the modern sense. This claim has been especially made for the radicals of the English Civil War, the Levellers and Diggers, who are said to look forward to the socialist and communist revolutionaries of a later century. But why deny the reality to the radicals of the language that they used to describe their actions? When Levellers protested against “the Norman yoke,” this represented to them a real usurpation of traditional English rights and liberties by an alien ruling class. When the Diggers proclaimed communism, this was because, as their leader Gerard Winstanley said, they wished to restore “the pure law of righteousness before the Fall,” to make the earth “a common treasury again.” Along with such groups as the Fifth Monarchy men, the Diggers believed that Christ’s Second Coming, as foretold in the Book of Revelation, was imminent. With it would come “a new heaven and a new earth,” Christ’s millennial reign on earth. These were all convictions sincerely and powerfully held. On what grounds are we to say that they were deluded, that their actions really meant something else?

Millennial imagery and even doctrine are not foreign to modern concepts of revolution. It is even possible to argue, as Melvin Lasky does, that without this millenarian background, the idea of revolution is inconceivable. But revolution is no more religion than it is restoration—not, at least, in the senses that the term has come to hold for us. At some point revolution was stripped of its religious associations and launched on an independent career as a secular concept. This was the accomplishment of the American and French Revolutions of the eighteenth century. It is to them we must look for the birth of the modern concept of revolution.

Inventing Revolution: American and French Revolutions

The pull of the past is nowhere more evident than in the case of the American and French Revolutions. Repeatedly they made reference to the heroic deeds and figures of the past. Rome, the Rome of the Republic, was an inspiration to both revolutions. The revolutionaries frequently saw themselves in the guise of Gracchus or Brutus, opposing tyranny and striking a blow for the liberty of the people. Their painters and sculptors portrayed them in Roman costume. In their speeches they quoted the great Roman orators. They wished to revive the public spirit and civic virtue of the Roman Republic, to make citizens out of subjects.

The American and French Revolutions did in truth both begin with conservative intentions, or at least pretensions. The Americans wished, they said, to go back to the working arrangement that they had had with the British state since the seventeenth century, an arrangement upset by the “innovations” of the British Parliament; the French wished to restore power to the old institutions of the parlements and the Estates-General, in the face of a reforming and “modernizing” monarchy. In both cases the revolution rapidly went beyond these conservative premises, to the consternation of many who began the revolution. A new concept of revolution emerged in the course of these revolutions. Tom Paine, whose pamphlet *Common Sense* (1776) saluted the American Revolution as “the birth-day of a new world,” went on in *The Rights of Man* (1791–1792) to see the French and American Revolutions as jointly inaugurating a veritable “age of Revolutions, in which everything may be looked for.”

“What were formerly called Revolutions, were little more than a change of persons, or an alteration of local circumstances. They rose and fell like things, of course, and had nothing in their existence or their fate that could influence beyond the spot that produced them. But what we now see in the world, from the Revolutions of America and France, are a renovation of the natural order of things, a system of principles as universal as truth and the existence of man, and combining moral with political happiness and national prosperity.” (Paine, 1984 ed., p. 144)

Americans, increasingly dismayed by what many saw as the excesses of the French Revolution (though Thomas Jefferson was not one of them), progressively downplayed the significance of their own revolution, giving it a conservative interpretation that dominated all discussion until recently. In this they paid unconscious homage to the defining character of the French Revolution. Fairly or not, it is the French, not the American, Revolution that has come to be seen as the inventor of the modern concept of revolution.

The French Revolution is the model revolution, the archetype of all revolutions. It defines what revolution is. This is a matter of fact rather than of conceptual analysis—or rather, it is a matter of the concept being shaped by the historical experience. For not only was it during the French Revolution that the concept of revolution unmistakably acquired its modern meaning. The French Revolution also established the classic pattern of revolution. It named the revolutionary experience, and wrote the script of the revolutionary drama. It showed, by its own example as well as its attempt to export its revolution, by its ideas as well as its armies, what it is a society must do to undergo revolution. In this sense the French Revolution was not simply the first great revolution. It can seriously be argued to be the only revolution. All revolutions subsequently were indebted to it. It was from the French that they borrowed their concept; it was the French Revolution whose practice they attempted to imitate—even when they hoped to go beyond it.

With the French Revolution, the hesitations and ambiguities of earlier revolutions were swept aside. Revolution now acquired its distinctively modern meaning. It came to mean, not the turns of a recurrent cycle or the reversion to some earlier condition, but the creation of something radically new: something never before

seen in the world, a new system of society, a new civilization, a new world. Moreover it lost—though never entirely—its connotation of something natural, inevitable, and irresistible, something occurring beyond the province of human agency or the possibility of human intervention. Revolution was on the contrary now something quintessentially man-made. It was the action of human will and human reason upon an imperfect and unjust world, to bring into being the good society. This was for the philosopher Georg Wilhelm Friedrich Hegel the great discovery of the French Revolution: “Never since the sun had stood in the firmament and the planets revolved around him had it been perceived that man’s existence centres in his head, i.e. in Thought, inspired by which he build up the world of reality. . . . This was accordingly a glorious mental dawn. All thinking beings shared in the jubilation of this epoch” (Hegel, 1956 ed., p. 447).

With the example of the French Revolution before them, it became possible for contemporaries to see earlier events as comparable in several important respects, and retrospectively to baptize them as revolutions—often with a polemical purpose in mind. French revolutionaries such as the Marquis de Lafayette, who had fought with the Americans against the British, were quick to refer to “the American Revolution,” by analogy with what they saw as the similarly heroic enterprise embarked upon by the French in 1789. The French historian and liberal statesman François Guizot, in his *Histoire de la révolution d’Angleterre* (1826), was the first to call the English Civil War a revolution in the modern, that is, French, sense, in his case with the cautionary purpose of championing English moderation against French fanaticism. Dutch historians began to discover in the sixteenth-century “revolt of the Netherlands” rather a “Dutch Revolution.”

Nor did the comparisons remain solely in the political field. The technological and economic developments transforming England in the early nineteenth century were seen in the 1820s as “the industrial revolution.” Later scholars were to speak of “the revolution of the Baroque” and of “the scientific revolution” of the seventeenth century, to refer to the thoroughgoing changes in artistic practice and in scientific thought in that period. They would also speak of “revolutions of humanity,” such as the Paleolithic and Neolithic revolutions, or the “urban” or “agricultural” revolutions. Changes of an epoch-making kind routinely came to be called revolutions, as in “the Roman Revolution,” which produced the principate out of the republic in the first century of the common era.

In all cases what gave the term its meaning was the analogy with what increasingly came to be designated “the Great French Revolution” of 1789. In whatever sphere it was employed, political, economic, or cultural, revolution meant dramatic, fundamental change, change in a radically new direction, a complete change of “paradigm,” to use the term popularized by the philosopher of science Thomas Kuhn. Whether, especially in the political realm, the change had to be accompanied by violence, as in the French case, remained a matter of dispute. “Violence is the midwife of the old society pregnant with the new,” said Marx; but Vladimir Lenin, noting this, penciled in the laconic comment, “some births are difficult, others easy.” What mattered in the end was not so

much violence as the degree and intensity of the change. Revolution was a speeding up of evolution. It was an action by which men changed utterly the way they had traditionally done things. It looked to the future, not to the past.

In this respect, too, the future belonged to the French Revolution, as much as it inspired a renaming and reimagining of past episodes of change. Not the English or the American Revolution but the French Revolution became the inspiration of the revolutionary movement throughout Europe and the rest of the world. Marx called it “the lighthouse of all revolutionary epochs,” and he remained indebted to its example in his conception of the future socialist revolution. In the understanding of revolutionaries and revolutionary theorists everywhere, to undergo revolution was to imitate the French. The French Revolution displayed the universal “logic of revolution,” the stages or phases through which all revolutions must pass. There would be a “rule of the moderates” followed by “the rise of the radicals,” Girondists followed by Jacobins. Terror would give way to Thermidor, the point at which the revolution ceased its radicalization and tried to achieve a period of stability. As in the French case, this would often lead to a military dictatorship that claimed to safeguard the gains of the revolution. The symbolic dates of the French Revolution marked, for generations to come, the successive phases of the revolutionary process: the “Fourteenth of July” (capture of the Bastille and seizure of power), the “Ninth of Thermidor” (fall of Maximilien Robespierre and the beginning of the period of stabilization), the “Eighteenth of Brumaire” (Napoleon’s coup d’état and the inauguration of the dictatorship). If, as was claimed in the nineteenth century, *le nouveau Messie, c’est la Révolution* (“revolution is the new Messiah”), it was the French Revolution that had inspired these apocalyptic hopes.

The Revolutionary Idea in the Modern World

The idea of revolution, once invented by the French—Americans having for the most part disclaimed the patent—rapidly became the possession of the entire world. This was partly because the idea was carried on the bayonets of Napoleon’s armies in the French bid to revolutionize the whole of Europe. But the defeat of Napoleon was no barrier to the further spread of the idea. All attempts to repress it only seemed to lend it strength. It inspired a whole series of later revolutions in France, the land of its birth, in 1830, 1848, and 1871. In 1848 practically the whole of Europe—Britain and Russia were almost the sole exceptions—was convulsed by revolution. The idea had a particular appeal for intellectuals in Central and Eastern Europe, who embraced it with messianic fervor. In Russia in particular it found fertile soil, so much so that revolutionaries in Western Europe began to look to Russia to give the signal that would light the torch of revolution everywhere.

The idea of revolution as expressed by the French Revolution appealed because of its simplicity and universality. “Liberty, Equality, and Fraternity” could inspire populations from Brussels to Beijing, from Poland to Peru. Of course there remained the question of how to interpret and apply its terms. Here the main modification to the original idea consisted in seeking to realize liberty and equality in the social as well as the political realm. This was the contribution of the nineteenth-century socialists, supremely in the thinking of Karl

OLYMPE DE GOUGES (1748–1793)

Olympe de Gouges—the self-invented name of Marie Gouzes—was a playwright and pamphleteer who took an active part in the French Revolution. She agitated for the emancipation of slaves, divorce, and the rights of illegitimate children and unmarried mothers. After her own unhappy marriage she renounced marriage as such, proposing that the marriage contract be replaced by a “social contract” that specified the equal rights of the partners, including the right to end the union. Her best-known work is the *Declaration of the Rights of Woman and Citizen* (1791), a direct riposte and corrective to the more famous *Declaration of the Rights of Man and Citizen* of 1789. In it she strove to reconcile the abstract universality of that document, which she thought unreal and dangerous, with an acknowledgment of difference. Men and women were different, she argued, just as nature was variegated, but both were equally the bearer of rights, equally capable of agency and action. The Jacobins, like nearly all the leading French revolutionaries, were hostile to the claims of equality for women. They denounced Olympe’s activities as “unnatural,” and condemned her to death in 1793 for plastering the walls of Paris with posters opposing Jacobin centralization and in favor of the Girondist program of decentralized federalism.

Marx. For Marx, the French Revolution remained to be completed. It had freed the capitalists, the bourgeoisie, but at the cost of turning the mass of workers into exploited and propertyless proletarians. The liberal gains of the French Revolution—and Marx never denied that they were gains—had to be converted into the emancipation of the people as a whole. This would be accomplished by a socialist or communist revolution that would abolish private property and bring about the “free association of producers.” In the final condition of communism, following the transitional “dictatorship of the proletariat,” the state itself would “wither away,” having no necessary function. In this vision of the future, the Marxist concept of revolution fused with that of the anarchists, who had particularly strong followings, through the teachings of Pierre-Joseph Proudhon (1809–1865) and Mikhail Bakunin (1814–1875), in France, Russia, Spain, and Italy.

It is fair to say that, in one version or another, the Marxist concept of revolution came to dominate not just Europe but the world beyond in the later nineteenth and the twentieth centuries. This was perhaps inevitable, given the massive disruption and distress caused by the relentless march of capitalist industrialization across the globe. The Paris Commune of 1871, which Marx hailed as the first truly proletarian revolution, can perhaps be taken as marking the divide between the older, more purely political, concept of revolution, and the later one that made social and economic transformation the heart of the revolution. Symbolically, the old revolutionary hymn of the *Marseillaise* was replaced by the new socialist anthem, the *Internationale*; the red flag of the socialists replaced

the tricolor of the liberals. Not surprisingly, the Russian Revolutions of 1905 and 1917 gave a massive impetus to this socialist understanding of revolution, as did the later success of socialist revolutions in China (1948) and in Cuba (1958).

The Russian Revolution of 1917 became the type of twentieth century revolutions, especially in the non-Western world. It seemed to solve the difficult question of how to make a socialist revolution in conditions that, in a strictly Marxist understanding, were highly unpromising. Marx had expected the socialist revolution to begin in the advanced industrial societies, such as France, Germany, or Britain, where the industrial working class or proletariat made up the vast majority of society. Russia, like many other non-Western societies, was at the time of its revolution 80–90 percent peasant. It also had a relatively small and weak middle class. But in the main urban centers, such as St. Petersburg (Petrograd), it had a proletariat that, though small, was highly developed, well organized, and politically very conscious.

The Russian revolutionaries, especially Lenin and Trotsky, elaborated a theory of socialist revolution in which, under the guidance of the proletariat, the mass peasant population would be induced to rise in rebellion and to take over the land, at the same time as the proletariat took over the factories. Together the workers and peasants would coordinate the socialist revolution, after suppressing their common enemies among the bourgeoisie and the aristocracy. Throughout a significant role was marked out for the worker’s party—in this case the Bolshevik party—as the theoretical organ and directing force

of the revolution. But it was always stressed that rule by the party was in the nature of a temporary, bridging, operation, mainly concerned with mopping up the remaining pockets of resistance and in preparing the workers for direct rule.

Here then was a new model of revolution, though particularly appropriate for countries, such as Russia, that had not been through a “bourgeois revolution” and had not as a result enjoyed the benefits of liberal or constitutional rule. The proletariat, organized by the party, would in effect carry out a dual or two-fold revolution. It would overthrow autocratic or authoritarian rule, here accomplishing the aim of the classic bourgeois revolutions, such as the English and French revolutions; and it would also push through, in a single, uninterrupted sequence, to the proletarian or socialist revolution. Both political and social emancipation would be achieved by the self-same agency, in the same act of revolution. No wonder that, whatever the misgivings about the course of the revolution in Russia, such a model proved so compelling to those many non-Western countries that saw themselves as standing in the same semi-feudal and backward condition as Russia on the eve of 1917.

But it would be wrong to overstress the differences between the socialist and earlier conceptions of revolution. For Marx the French Revolution of 1789 was always the model revolution, the one that provided the essential terms of revolutionary conflict as a conflict of classes. If the French Revolution was a “bourgeois revolution,” the coming socialist one would be a proletarian revolution. It would differ in that the proletarian revolution would lead to general emancipation instead of the emancipation of only one class. But the form of the revolution, the conditions under which the proletariat would gather its strength and overthrow its oppressors were precisely modeled on the rise of the bourgeoisie in feudal society. Thus both in its form—class struggle—and its intention—liberty and equality, now understood in social and economic as well as political terms—the socialist revolution could plausibly be presented simply as the continuation and completion of the enterprise started by the French Revolution. This was the claim of many prominent socialist revolutionaries. “A Frenchman,” wrote Lenin to a French comrade in 1920, “has nothing to renounce in the Russian Revolution, which in its method and procedures recommences the French Revolution.” Fidel Castro, in his defense speech at the Moncada trial of 1953 (1968), saw the very existence of an independent Cuba as an inheritance of the European revolutionary tradition, and he looked back to the French Revolution to justify his actions and to proclaim the inevitability of revolution in Cuba.

Of course there had to be modifications even to the socialist idea of revolution, especially as it moved beyond its European base and encountered different conditions and different traditions in the non-Western world. The most important amendments were provided by Mao Zedong in China, Vo Nguyen Giap in Vietnam, and Castro and Che Guevara in Cuba—leaders and fighters as well as theoreticians. What especially concerned them was the role of the peasantry in what were overwhelmingly peasant societies. The predominantly urban tradition of revolution had to be rejected. “The city,” observed Castro of the Latin American experience, “is a cemetery of rev-

olutionaries and resources.” In place of the city and the urban workers they looked to the countryside and the organization of the peasants—in their traditional communities, if possible, in the form of mobile guerrilla bands if for whatever reasons this proved strategically dangerous (as for instance it appeared to do so in Cuba and Latin America generally). This was the revolutionary strategy that, often after decades of struggle, led to the success of the Chinese, the Cuban, and the Vietnamese revolutions. These in turn became the inspiration, the “model” revolutions, for other Third World societies. Socialist in form and rhetoric, they quite often—as in many African cases—embodied fundamentally nationalist aspirations in societies seeking to throw off colonial rule.

In the West too, changing conditions brought about modifications to the inherited concept of revolution. Revolution on the barricades began to appear increasingly unreal in societies where sophisticated firepower and counterinsurgency techniques gave states overwhelming power against potential insurgents. The fate of the Hungarian revolution of 1956 gave the clearest indication of this, as did, in a somewhat different way, the failure of the “Prague spring” of 1968. In the face of this, the student revolutionaries in Paris and elsewhere in 1968 turned away from direct confrontation with the state and invented subversive techniques based on ridicule and new forms of cultural opposition. “All power to the imagination”; “Be a realist: demand the impossible”; “I am a Marxist—Groucho style”—such were the slogans on the posters that the students plastered all over Paris in May 1968. Marx was still an influence, but it was Marx the philosopher of alienation rather than Marx the anatomist of the capitalist economy who continued to be an inspiration. In addition, and often taking over, were influences derived from the Dadaists and Surrealists, together with a radical reading of Sigmund Freud.

Revolution has not been a prominent feature of Western societies since World War I—not, that is, revolution as it has traditionally been understood in the libertarian, “left-wing,” versions inherited from the French Revolution. There have been some who have spoken of the Nazi or the fascist revolution, and have tried to offer a “right-wing” concept of revolution. This has to struggle with a whole tradition of meaning derived from the European experience of the past two hundred years. Inequality, authoritarianism, and racism—central elements of fascist ideology—simply have not been part of the revolutionary inheritance, whatever the practices of states, such as the Soviet Union, that claimed the revolutionary mantle. Condorcet’s statement of 1793, that “the word revolutionary can only be applied to revolutions which have liberty as their object,” aptly sums up the predominant and persistent meaning of the concept, as it has been elaborated by successive theorists since the French Revolution.

Nowhere was this demonstrated more forcibly than in the 1989 revolutions, the revolutions that overthrew communist rule throughout Central and Eastern Europe, eventually, in 1991, dissolving the Soviet Union itself. While in the same year the French and other Western Europeans, contemplating with a conspicuous lack of enthusiasm the bicentennial of the French Revolution, appeared disillusioned with the whole idea of rev-

olution, Eastern Europeans embraced it with fervor. Crowds occupied the squares of Prague, Warsaw, Budapest, and Bucharest, forcing, in almost classic demonstration of the power of the people, their rulers to depart. If the West had forgotten its revolutionary heritage, the same had not happened in the East. Moreover, it was not, for obvious reasons, the Marxist or socialist idea of revolution that inspired the East Europeans. In a remarkable reversal, what they looked back to, what was evident in almost every demand they made, was the tradition of the eighteenth-century American and French Revolutions. It was individual rights, a free civil society, and a liberal constitution that were the centerpieces of the programs of 1989.

Do the 1989 revolutions mark the end of revolution in the West, as many have claimed? Are they the final deposit of the revolutionary tradition? This may be too shortsighted a view, even for the West and certainly from the perspective of the world as a whole. In November 2003 the people of Georgia, one of the former republics of the Soviet Union, rose up against a corrupt ruler in a classic display of revolutionary action. Elsewhere in the world—in China, in Latin America, in the Middle East—there are intermittent but persistent revolutionary stirrings. Many of these are now mixed with religion, following the example of the Iranian Revolution of 1979. Revolution has always been a changing and many-sided thing. We can be sure there are many surprises in store for us still.

See also *Cycles; Evolution; Liberty; Marxism; Scientific Revolution.*

BIBLIOGRAPHY

Arendt, Hannah. *On Revolution*. London: Faber and Faber, 1963.

Blackey, Robert, ed. *Revolutions and Revolutionists: A Comprehensive Guide to the Literature.*, 2nd ed. Oxford and Santa Barbara, Calif.: Clio Press, 1982. A unique bibliography of over six thousand books, articles, and eyewitness accounts covering past and present revolutions.

Brinton, Crane. *The Anatomy of Revolution*. Rev. and expanded ed. New York: Vintage Books, 1965. Still a first-rate introduction to the comparative history of revolution.

Burke, Edmund. *Reflections on the Revolution in France* (1790). Harmondsworth, U.K.: Penguin Books, 1984. A classic statement on the significance of the French Revolution, even though couched in hostile terms.

Castro, Fidel. *History Will Absolve Me*. London: Jonathan Cape, 1968.

Donald, Moira, and Tim Rees, eds. *Reinterpreting Revolution in Twentieth-Century Europe*. London: Macmillan, 2001.

Draper, Hal. *Karl Marx's Theory of Revolution*. 2 vols. New York: Monthly Review Press, 1978. The fullest account of the most influential theory of the twentieth century.

Dunn, John. *Modern Revolutions: An Introduction to the Analysis of a Political Phenomenon*. 2nd ed. Cambridge, U.K., and New York: Cambridge University Press, 1989.

Fehér, Ferenc, ed. *The French Revolution and the Birth of Modernity*. Berkeley: University of California Press, 1990.

Goldstone, Jack, ed. *Revolutions: Theoretical, Comparative, and Historical Studies*. 3rd ed. Belmont, Calif.: Wadsworth/Thomson Learning, 2003.

Griewank, Karl. *Der Neuzeitliche Revolutionsbegriff*. 2nd ed. Frankfurt-am-Main: Europäische Verlagsanstalt, 1969. The

best account of the history of the concept. Nothing in English like it.

Halliday, Fred. *Revolution and World Politics: The Rise and Fall of the Sixth Great Power*. Durham, NC: Duke University Press, 1999.

Hegel, Georg Wilhelm Friedrich. *The Philosophy of History* (1830–1831). Translated by J. Sibree. New York: Dover, 1956.

Hobsbawm, E. J. *Echoes of the Marseillaise: Two Centuries Look Back on the French Revolution*. New Brunswick, N.J.: Rutgers University Press, 1990.

Keddie, Nikki R., ed. *Debating Revolutions*. New York: New York University Press, 1995.

Kuhn, Thomas S. *The Structure of Scientific Revolutions*. 2nd ed. Chicago: University of Chicago Press, 1970. An influential account that has important implications for the idea of revolution in general.

Kumar, Krishan, ed. *Revolution: The Theory and Practice of a European Idea*. London: Weidenfeld and Nicolson, 1971. Classic statements documenting the evolution of the idea of revolution.

Kumar, Krishan. *1989: Revolutionary Ideas and Ideals*. Minneapolis, Minn.: University of Minnesota Press, 2001.

Lasky, Melvin. *Utopia and Revolution*. Chicago: University of Chicago Press, 1985. Packed with fascinating, hard-to-find material on the ideology and imagery of revolution.

Lintott, Andrew. *Violence, Civil Strife and Revolution in the Classical City*. Baltimore: Johns Hopkins University Press, 1982.

Paine, Tom. *The Rights of Man* (1791–1792). Harmondsworth, U.K.: Penguin Books, 1984. The best riposte to Burke's attack on the French Revolution, and in general a stirring affirmation of the epochal significance of the French and American Revolutions.

Palmer, R. R. *The Age of the Democratic Revolutions*. 2 vols. Princeton, N.J.: Princeton University Press, 1970. Still the fullest and most stimulating account of the eighteenth-century revolutions, seen as having world-historical significance.

Parker, Noel. *Revolutions and History: An Essay in Interpretation*. Cambridge, U.K.: Polity Press, 2000.

Porter, Roy, and Mikulés Teich, eds. *Revolution in History*. Cambridge, U.K., and New York: Cambridge University Press, 1986.

Rice, E. E., ed. *Revolution and Counter-Revolution*. Oxford and Cambridge, Mass.: Blackwell, 1991.

Skocpol, Theda. *Social Revolutions in the Modern World*. Cambridge, U.K., and New York: Cambridge University Press, 1994.

Tilly, Charles. *European Revolutions, 1492–1992*. Oxford and Cambridge, Mass.: Blackwell, 1993.

Tocqueville, Alexis de, *The Old Régime and the French Revolution* (1856). Translated by Alan S. Kahan. Chicago: University of Chicago Press, 1998. The best book, not just on the French Revolution, but on revolution in general.

Wheatcroft, Andrew. *The World Atlas of Revolutions*. London: H. Hamilton, 1983. The best single source of detailed accounts, complete with maps, of the major revolutions from the eighteenth to the late twentieth centuries.

Zagorin, Perez. *Rebels and Rulers, 1500–1660*. 2 vols. Cambridge, U.K., and New York: Cambridge University Press, 1982. A comprehensive and invaluable survey of a controversial period in the development of the idea of revolution.

Krishan Kumar

RHETORIC.

This entry includes two subentries:

Overview

Ancient and Medieval

OVERVIEW

Rhetoric governs the effective use of verbal and nonverbal communication designed to influence an audience. Understood in its broadest sense, it is practiced more or less deliberately in all societies. Even the animal world seems to apply some of its principles. But in its original and historical form, rhetoric is associated with the use of human discourse to persuade and can be defined as the art of speaking, of speaking well, or of speaking effectively with the aim of persuading. Rhetoric is at once technical, practical, pedagogical, and analytical. It deals with opinions, rather than truths and certitudes, and as such, it can be abused as a means of manipulation.

Since originating in Sicily in the fifth century B.C.E., rhetoric has reflected a keen awareness of all the conditions that, taken together, influence an audience in one way or another. Rhetoric has established itself as a systematic and exhaustive synthesis of all the human sciences, as they are called, and of all practices from which it can draw a benefit, from philosophy to psychology, linguistics to literary theory, and anthropology to sociology. What is specific to rhetorical synthesis and what gives it its universal validity is its transdisciplinary dimension. Rhetoric is an art of synthesis that controls a series of approaches, which together—and only together—contribute toward bringing about the desired effect.

Universality

Although the most systematic formalization of rhetoric occurred in the West, first in Greece and then in Rome, its key practices and conceptions are universal. Ever since writing was invented in Mesopotamia and Egypt, people have recognized the power of professional writers. Examples of practices and precepts related to eloquence can be found in Egypt beginning with the second millennium B.C.E. and in the Book of Proverbs.

China, like Europe, wanted to separate the persuasive and expressive aspects of rhetoric, to distinguish between the rhetoric of public discourse and what is called literary or ornamental rhetoric. This can be seen throughout China's history in the many compilations of exemplary speeches, in the many treatises with a pedagogical aim, and in the long tradition of poetry and poetic commentary. India, which early on invented an argumentative epic literature, also had rhetorical competitions and later developed a practical and critical method for teaching rhetoric as well as a theory of poetry and drama.

Societies without writing sometimes recognize the authority of those gifted at speaking out. Hence we find the ethos of wisdom among Australian aborigines or that of venerable age and heroic deeds among Native Americans. European Americans recognized and appreciated the eloquence of Native Americans, who used irony or pathos. Thomas Jefferson, for example, com-

pared the Mingo chief Logan to the Roman orator Marcus Tullius Cicero. Specialists have studied the verbal formalism typical of Aztec ceremonies, evidence of which was passed down by the conquistadores. A society without rhetoric is hardly imaginable, since rhetoric is necessary to all communication. And it is impossible to imagine how anyone could utter words without seeking ways to make language more effective.

Fields of application. By definition, any human activity that explicitly or implicitly involves a quest for influence entails rhetoric in its broadest sense, whether or not that activity is grounded in verbal communication. Hence a multiplicity of rhetorics exists. Nothing prevents us from calling any field of interaction rhetoric, since it is precisely the field of interaction that defines the conditions for treating matters discursively, for arguing in one's own defense, or for choosing modes of expression. As a result, it is possible to speak of rhetorics of minorities and of majorities, rhetorics of sexuality, racism, and feminism, rhetorics of drugs, war, peace, exile, and so on. We may also speak of rhetoric in reference to nonverbal activities, assimilating them to one function or another of language to show their influence on the public. Every art form—music, painting, the figurative arts in general, architecture, and cinema—has its rhetoric, although it may lie at least as much in the manipulation of images as in the use of speech. There is, therefore, also a rhetoric of gestures, of mime, of public or religious gatherings, and of military parades, of all activities that are supposed to communicate a message or spread propaganda.

The Art of Persuasion

Because the Western world has offered the most systematic historical, methodological, and theoretical approach to rhetoric, this entry will focus on the Western concept of rhetoric, understood as the art of persuasion, essentially through speech.

Form and content. Rhetoric's persuasive efficacy depends on both thought and expression or style. Thought, which is the domain of philosophy, governs the art of dialectics. Expression, which is concerned with the speech act itself, governs how that thought is put into words and how it is delivered. That division between the philosophical realm of thought and the linguistic field of expression is problematic, and the history of rhetoric is in large part the history of their relationship. The tendency to separate them, to limit rhetoric to expression and reserve the dialectical realm of argument, evidence, and organization to philosophy is always present, as if thought were independent of its expression and, conversely, as if eloquence were independent of thought and truth. In rhetoric properly understood and as Cicero (106–43 B.C.E.) conceived it in *De oratore*, persuasion and expression are interdependent, organically connected. Meaning lies as much in form as in content.

Logos. Rhetoric thus defined deals with the everyday universe and the contingent aspects of human and social reality, which a certain kind of philosophy, practiced by Plato (c. 428–348 or 347 B.C.E.) and later by René Descartes (1596–1650), disdained and considered unworthy of interest. Philosophy in its traditional and classic sense is interested in eternal and universal certainties and truths. It intends to convince

by calling upon unassailable evidence and by invoking arguments that will make its demonstrations irrefutable. Rhetoric's philosophical method is dialectics, which relies on credible arguments, plausible evidence, or circumstantial events. Such arguments appeal to commonplaces and are based on received opinion; they allow for and may even demand refutation, or at least objections that appeal to competing opinions and the same sorts of evidence. Because rhetoric deals with opinions, it argues by applying what is called dialectical reasoning to the probable causes on which the opinion is based. In order to persuade, rhetoric relies on credible arguments, plausible evidence, or circumstantial events. Such arguments appeal to commonplaces and are based on received opinion, but at the same time, they must allow for and may even demand refutation, or at least objections that appeal to competing opinions and the same sorts of evidence.

Pathos and ethos. Although the first measures taken by the rhetoric of persuasion occur in the realm of thought (designated by the term *logos*), the order of verisimilitude to which thought belongs is not sufficient in itself to influence the audience decisively. Rhetoric moves beyond logical argument to consider indirect and circumstantial data (historical, political, social, religious, psychological, moral, and ethical, for example) as a way to increase its effectiveness. It also considers the audience's sensibility, passions, and emotions at least as much as its intellectual faculties. This appeal to the psychology of the audience is what traditional rhetoric calls pathos and it is directed primarily at the senses. Hence images, sounds, odors, and even tactile and gustatory sensations may serve to reinforce the influence sought. That is why the senses (especially sight but also hearing) seem to have become the target par excellence of modern methods of influence, as in advertising. The dominance of the visual in the twenty-first century means that image is often the determining factor; no one who is not at least minimally telegenic can expect to have much public or political success.

The final aspect of any rhetorical approach is ethos, which is linked to the orator's personality. It establishes authority and assures the audience's trust by presenting a view of the orator's character, moral qualities, and sincerity by projecting a moral and physical image. Hence venerable age, experience, social or religious position, or professional or media success may invest an individual with authority.

Description

The Greek philosopher Aristotle (384–322 B.C.E.) and the Roman Cicero provided what has become the standard description of rhetoric. In addition to the series of steps to be followed, they defined types of discourse according to the kind of public each type was meant to address.

Audience and types of discourse. The invention of Western rhetoric in Hellenic Sicily in the fifth century B.C.E. can be attributed to judicial, or forensic, discourse, which was developed to level accusations or mount defenses in the name of justice. In Greece, rhetoricians very quickly came to identify two other types of discourse as functions of the different audiences to which they were addressed. The deliberative, which

is supposed to inform, exhort, advise, or dissuade, coincides with the democratic political discourse and was initially addressed to the Senate to urge it to support the useful against the harmful. The epideictic, also called the demonstrative, whose purpose is to praise or blame, to commemorate or denounce, is addressed to a group of spectators to elicit their admiration or reprobation, often to hold something up as an example or as a value to them. These original distinctions are open to revision in the early twenty-first century, when more and more complex types of discourse seem to exist, ranging from the sciences to advertising, television to the Internet, drama to poetry, including treatises, theses, films, cartoons, and so on, and when these types of discourse seem to be more precisely defined and to have better-delimited audiences. Although the distinction between judicial and deliberative discourse still seems valid, we might have to concede, as some have suggested, that epideictic praise or blame has been reincarnated as advertising. In this new type of discourse, the audience is the consumer, the easily influenced viewer who is the potential customer for the items being extolled.

The parts of rhetoric. Since Aristotle's time, rhetoric has been divided into parts comprising the steps involved in producing a discourse and delivering it in person to the intended public. Each of these parts has in turn been subdivided, resulting in an extremely structured system wherein each phase in the production of a persuasive discourse is systematically and exhaustively represented. Rhetorical treatises are encyclopedias of discursive expertise on how to think, how to write, and how to deliver.

Latin writers, including Cicero in *De oratore*, definitively established the steps involved in elaborating an oral discourse. The first is *inventio* (invention), which consists of seeking and selecting the arguments and other resources necessary to one's cause as a function of the discourse chosen. These may include syllogisms, on which dialectical argument is based, or prototypical examples. Logos, pathos, and ethos are subdivisions of *inventio* and determine the type of argument selected, including the type of evidence, whether extrinsic or intrinsic.

Dispositio (arrangement or composition) defines the order and organization of these arguments. The discourse may have between two and seven parts, but usually has five: the introduction or exordium, the narration (exposition of facts), the confirmation (exposition of evidence), the refutation (denunciation of the opposing argument), and the conclusion or peroration.

Elocutio (elocution) has to do with style: the choice of words and figures and of their formal syntactical combination. These choices are adapted to fit the subject following the rules of decorum. Three styles have been identified. They are known in Latin as *grave* (noble), *tenue* (simple), and *medium* (agreeable); the choice of style is governed by the nature of the subject to be treated, the goal to be achieved, and the target audience. These styles determine the choice of vocabulary (unusual, common, or familiar), the complexity of syntax, and the use of relatively obscure versus transparent figures. A further distinction is made between figures that have to do with the words themselves and those that have to do with ideas. Individual words taken in a sense other than their

usual one are called tropes (metaphor and metonymy, for example). *Scheme* refers to the order in which the words are arranged. Rhetorical figures are often seen as the essence of *elocutio*; indeed, rhetoric as a whole is sometimes reduced to them. Such figures have regularly been seen as markers of a text's literariness.

Memoria (memory) designates the stage of memorizing a discourse and involves a complex mnemonics that places the parts of a discourse in an imaginary physical space such as, for example, a house or a human body. Finally, *actio* (delivery) is the art of public performance, the theatrical effects governing voice, accent, body language, mimicry, and so on. It names the moment when the orator comes into contact with the public, makes an entrance and becomes an actor. *Memoria* and *actio* apply only to oral discourse, whereas *inventio*, *dispositio*, and *elocutio* apply to both the written and the oral.

History

Rhetoric, which was first formalized in Greece, found a practical field for expansion in its service to the republic of Rome. Under the Roman Empire, Quintilian (c. 35–c. 100 C.E.) introduced the most systematic description of rhetoric. As a teacher, he saw the rhetorician as someone whose level of education entailed an ethical responsibility. The art of speaking well implied the art of speaking virtuously.

The Christian Middle Ages was wary of rhetoric, believing that revealed truth did not need the artifices of eloquence. But the Church also recognized its utility, since rhetoric made it possible to defend the new religion against its enemies. A moderate eloquence would soon be enlisted as an instrument of propaganda, a way of spreading the truth. Saint Augustine of Hippo (354–430), a rhetorician by profession, recognized the model for this eloquence in the Bible itself. In addition, medieval hermeneutics applied the rules of rhetorical analysis when it proposed that the books of the Old Testament be read allegorically.

From the twelfth century on, rhetoric survived in law studies, preaching, and poetry. Beginning in the fourteenth century, Francesco Petrarca (1304–1374) and the humanist Renaissance restored rhetoric's gleam, which had been tarnished by medieval suspicion. But this was also the age when the anti-Ciceronianism of Petrus Ramus (1515–1572) once again called into question the integrity of rhetoric, establishing a historical break between the fields of thought and expression that lasted for centuries. Rhetoric was confined to *elocutio*, whereas *inventio* and *dispositio* moved to the logico-philosophical realm of dialectics.

Although that revolution had no major consequences in the short term, Descartes and later John Locke (1632–1704) rejected the legitimacy of dialectics itself, believing that what is only probable and credible has no claim to truth, which lies in the realm of reason or experience. Rhetoric could no longer make use of dialectics but was confined to *elocutio*. That break was not universal: The Counter-Reformation viewed rhetoric as a useful instrument of propaganda, and thus rhetoric would have its moment of glory in Jesuit teachings.

Romanticism dealt rhetoric a nearly lethal blow, reacting to a rigid formalism that had gradually set in toward the end of the *ancien régime*. Johann Wolfgang von Goethe (1749–1832) and those who followed contrasted rhetoric to the freedom of a new sensibility that was in quest of a more personal and more sincere expression.

The art of rhetoric was resurrected many times in the twentieth century but always in the shadow of the Ramusian scission. On one side, philosophers such as Chaïm Perelman, in *The New Rhetoric*, took an interest in questions of argumentative logic and brought about a rhetorical revival in midcentury; on the other side, literary theorists and specialists in poetics confined their interest not just to *elocutio* but to rhetorical figures, and in the end to a few paradigmatic figures such as metaphor and metonymy. As Gérard Genette argued, the development of an increasingly limited rhetoric characterizes modern literary critical discourse.

Rhetoric and literature. Literature is one of the language arts most directly influenced by and dependent on rhetoric. Until the eighteenth century, even poetry, as any other oral or written discourse, was directly concerned with the three divisions of rhetoric applicable to written language (*inventio*, *dispositio*, and *elocutio*). It would be a serious anachronism to ignore this. But beginning in the nineteenth century, poetry considered only *elocutio* and gradually reduced even it to the question of figures, which became the chief subject of poetic treatises. Figures were now what defined the poetic quality of a text. No longer mere ornament and flowery language, they served to shore up a truly cognitive approach and became a privileged way of apprehending the world. Hence the formalist linguist Roman Jakobson defined the poetic function of a text as the display of its materiality, its "palpable" side, and as a figurative quality essential for expressing indirectly what is not accessible through "simple" speech.

Thus every age seems to have an emblematic figure. In the Middle Ages, allegory was conceived of as the tangible manifestation of the abstract and spiritual world through personification. In the nineteenth century, the symbol became an expression of the cosmic and universal correspondences that the romantics saw as the essence of their poetics. In the twentieth century, metaphor and metonymy became the exemplary figures for a conception of the world that was either poetic and founded on analogy, or prosaic and utilitarian and founded on contiguity. This was an extreme moment in the figurative character of literary rhetoric. Ultimately, an essential figurativeness was revealed at the core of all literary expression. The text, at odds with itself, was now seen as fundamentally incapable of representing the world. Only a return to philosophical reflection may be able to temper the rhetoric of figures and subordinate it to metalinguistic reflection.

General Assessment

From its birth in Sicily within the particular context of defending landowners' rights to twenty-first-century media globalization, rhetoric has evolved and adapted. It is interdisciplinary in its essence and has sometimes appropriated knowl-

edge from disciplines close to its own object; at other times, it has been appropriated by disciplines encroaching on its domain. A unique synthesis of philosophical and expressive approaches, rhetoric is constantly being born anew. It has at its disposal a set of prescriptive or analytical practices and theoretical reflections that even in the twenty-first century allows it to master all fields of human expression and communication designed to act on the world.

On the whole, the global conception of rhetoric as it appeared in Aristotle's Greece has changed little. Despite, or may because of, its desire for a somewhat utopian, if not ominous desire for control, its overall theoretical and practical understanding of persuasion is still valid.

What has changed are the resources available. One of the advantages its modern-day practitioners have over their ancestors is that they are able to benefit from advances in technology and from the knowledge acquired through research in the nearby branches of the human sciences. In these fields of research, the modern orator, whether a lawyer, a political candidate, or a car dealer, will find resources to better grasp the social, ideological, psychological, or emotional state characterizing the target audience and thus to better understand it so as to better influence, if not control it.

But what has changed even more deeply are the technological means of communication, which are now able to diffuse farther, more rapidly, and more effectively a larger number of messages to a greater number of targets in a greater number of places. The power of the message is directly affected by that new audience. The electronic revolution itself, which is at least as significant as the invention of the printing press, offers new means for more effective persuasion. It is easier to seduce, and hence to influence, through the use of audiovisual media and virtual reality. Virtual reconstitutions of crime scenes, for example, are admissible in court. Rhetoric can only seek to adapt to these technological media, which constitute the new field of *actio*. The television screen has replaced the forum, the actor has replaced the orator, and teleprompters have replaced memory.

Even more radically, control of the media and access to the means of communication are what now seem to determine the true efficacy of the message, rather than oratorical talent or the intellectual quality of an argument (with perhaps the exception of the lawyer in the courtroom). That revolution has altered the conditions governing access to an audience. The means of communication, when they are not controlled by the state, are increasingly placed in the hands of a few large institutions, which are often controlled by commercial or ideological interests.

The Internet as it exists in the early twenty-first century would seem to offer to each individual access to his or her own means of communication. It ends up, however, providing a virtual "audience" an anarchical plethora of mostly unreliable and inefficient information. Without access to the media, which are the chief if not the exclusive means for diffusing ideas, no opposing power and no perceptible dissension can exist. And dissension is an unavoidable marker for freedom of

speech, which is now reserved and limited to those who control access to the means of diffusion. Some speak of a "dictatorship of the media" linked to the power of the new technology, and of "formal democracy." Competition in the realm of opinion requires equal access to the forum.

Paradoxically, then, although nothing seems to have changed in terms of the general principles that govern the art of persuasion, the means available to rhetoric have shifted the essence of intellectual activity toward expression, whether that refers to *elocutio*, with the emphasis on seduction, or to *actio*, with the idea that the orator cannot be heard. It is somewhat as if the universe of communication were being transformed into an enormous literary fiction designed to entertain more than to inform or argue. This fiction is already embodied in our television screens and in our magazines as a new kind of discourse, the infomercial, whose very name captures its ambiguity.

Any rhetoric has two aspects: vacuity, if not manipulation and lies; and ethics and trust. We must ensure that such trust is not irremediably undermined by the distrust produced by the growing monopolization of increasingly effective means of communication. The public is now a captive audience, increasingly powerless in the face of that monopoly, and the very future of democratic societies is at stake. In addition to the tradition of reliance on the speaker's ethos, access to a multiplicity of opinions is the public's essential safeguard against possible abuse of rhetoric. Rooted in freedom of speech, rhetoric finds its justification in the equal opportunity of access to the means of communication.

See also Metaphor; Poetry and Poetics; Rhetoric: Ancient and Medieval.

BIBLIOGRAPHY

PRIMARY SOURCES

- Aristotle. *The Art of Rhetoric*. Translated by John Henry Freese. Cambridge, Mass: Harvard University Press, 1975.
- Augustine, Saint. *On Christian Doctrine*. In *The Confessions; The City of God; On Christian Doctrine*. Translated by J. F. Shaw. Chicago: Encyclopædia Britannica, 1990.
- Cicero, Marcus Tullius. *De oratore*. Translated by E. W. Sutton and H. Rackham. London: Loeb Classical Library, 1959.
- . *Orator*. Translated by H. M. Hubbell. London: Loeb Classical Library, 1952.
- Fontanier, Pierre. *Les figures du discours*. 1818. Reprint, Paris: Flammarion, 1968.
- Plato. *Phaedrus, Gorgias*. Translated by W. D. Woodhead. In *The Collected Dialogues of Plato, Including the Letters*, edited by Edith Hamilton and Huntington Cairns. New York: Pantheon, 1961.
- Quintilian. *Institutes of Oratory*. Translated by H. E. Butler. 4 vols. London: Loeb Classical Library, 1963.
- Ramus, Petrus. *The Logike of the Moste Excellent Philosopher P. Ramus, Martyr*. Translated by Roland MacIlmaine. 1574. Reprint, New York: Da Capo, 1969. Translation of *Dialecticae partitiones*.
- Rhetorica ad Herennium*. Translated by H. Caplan. London: Loeb Classical Library, 1954.

SECONDARY SOURCES

- Booth, Wayne. *The Rhetoric of Fiction*. Chicago: University of Chicago Press, 1961.
- Burke, Kenneth. *A Grammar of Motives*. New York: Prentice-Hall, 1945.
- De Man, Paul. *Allegories of Reading: Figural Language in Rousseau, Nietzsche, Rilke, and Proust*. New Haven, Conn.: Yale University Press, 1979.
- Fumaroli, Marc. *L'âge de l'éloquence: Rhétorique et "res literaria" de la Renaissance au seuil de l'époque classique*. Geneva: Droz, 1980.
- Jakobson, Roman, and Morris Halle. *Fundamentals of Language*. 4th ed. The Hague: Mouton, 1980.
- McKeon, Richard. *Rhetoric: Essays in Invention and Discovery*. Woodbridge, Conn.: Ox Bow Press, 1987.
- Murphy, James. *Rhetoric in the Middle Ages: A History of Rhetorical Theory from Saint Augustine to the Renaissance*. Berkeley: University of California Press, 1974.
- Ong, Walter. *Ramus: Method and the Decay of Dialogue*. Cambridge, U.K.: Cambridge University Press, 1958.
- Perelman, Chaïm, and Lucie Olbrechts-Tyteca. *The New Rhetoric: A Treatise on Argumentation*. Translated by John Wilkinson and Purcell Weaver. Notre Dame, Ind.: University of Notre Dame Press, 1969.
- Richards, I. A. *The Philosophy of Rhetoric*. New York: Oxford University Press, 1936.
- Ricoeur, Paul. *The Rule of Metaphor: Multi-disciplinary Studies of the Creation of Meaning in Language*. Translated by Robert Czerny, with Kathleen McLaughlin and John Costello. Toronto: University of Toronto Press, 1977.
- Sloane, Thomas O., ed. *Encyclopedia of Rhetoric*. New York: Oxford University Press, 2001. This is a rich source of references from specialists too numerous to name here.

Jean-Claude Carron

ANCIENT AND MEDIEVAL

Despite some recent controversy, *rhetoric* may be seen, from its ancient Greek-language origin, to be the systematic preceptive training that orators or public speakers have sought or received, from the fourth century B.C.E. onward. Signifying less a set of “ideas” than a preceptive practice, the Greek word *rhetoric*, later adopted into Latin (despite the equivalence of the phrase [*artificiosa*] *eloquentia*), always refers to the Graeco-Roman preceptive tradition, which remained foundational from the time of Aristotle (384–22 B.C.E.) to that of Hobbes (1588–1679), Vico (1668–1744) and even Nietzsche (1844–1900). It is only in recent times that the term has come to serve in a pejorative sense as a substitute for “truth.”

Graeco-Roman Origins

This Graeco-Roman tradition had its origins in certain specific situations that required extraordinary and popularized skills in public address. One such tradition of origin is associated with the names of Tisias and Corax (who may be one or two persons, or a figment of later theorizers and historiographers of rhetoric), who are supposed to have “invented” and “published” in now lost manuals, an art of legal pleading upon the fall of the “tyrants” who ruled in Sicily (until 467 B.C.E.) apparently enabling ordinary, propertied people to make court claims for

the restitution of lands confiscated under the preceding tyrannies. True or not, this judicial emphasis became progressively crucial and the earliest extant Latin manuals (Cicero’s *De inventione* and the pseudo-Ciceronian *Rhetorica ad Herennium*, both written in the Roman Republic during the first quarter of the last century B.C.E., have a courtroom context and background, and the training they offered, though apparently popular, was seen by some to be subversive of Roman ways. Although a perceived dependence upon Greek technical manuals stimulated this opposition, it was nevertheless such a dependence that produced the classic shape of Roman rhetoric.

Invention (*inventio*) is the devising of matter, true or plausible, that would make the (legal) case convincing. Arrangement (*dispositio*) is the ordering and distribution of the matter, making clear the place to which everything is to be assigned. Style (*elocutio*) is the adaptation of suitable words and sentences to the matter devised. Memory (*memoria*) is the firm retention in the mind of the matter, words, and arrangement. Delivery (*pronuntiatio*) is the graceful regulation of voice, countenance, and gesture.

The pseudo-Ciceronian *Rhetorica ad Herennium*—from which the above quotation comes, provides instruction in all these divisions of the art, though in a slightly different order to the enumeration here. This training, although it was later to be further adapted to Roman political and court contexts in the last century of the Roman Republic (principally by Marcus Tullius Cicero, 106–43 B.C.E., though others were similarly skilled, went back to the Greek preceptive texts of Aristotle (c. 330 B.C.E., his *On Rhetoric* being the earliest complete rhetorical “manual” to have survived the pseudo-Aristotelian *Rhetoric* [dedicated] to Alexander, the *Rhetorica ad Alexandrum*), Isocrates (436–338 B.C.E.), and above all Hermagoras of Temnos (middle of the second century B.C.E.), whose lost texts much influenced later developments.

Aristotle and His Successors

Aristotle set the tone of later ideas with his concept of the three major audiences (already found in Isocrates as three kinds of oratory, judicial, political / deliberative or “epideictic”—the audience is either a judge dealing with actions in the past [court cases] or the future [deliberative assemblies], or a spectator [listening to a speech in praise or blame of something/someone but not required to make a judgment]). Aristotle’s discussion of emotion and character—analyzing the feelings in an audience and the expectations the audience may have of the speaker (*pathos* and *ethos* respectively) and the strong links with argumentation (dialectic)—all in book II—were decisive for the future of the subject, as was book III on style, arrangement, and the parts of the speech. Thus “rhetoric” began its career by being forced into the straitjacket of the art or skill or preceptive system for finding what may be persuasive in any communications situation, as distinct from the direct “magic” of word power, stressed for example by Gorgias (fifth century B.C.E.), an early member of a group that came to be called “sophists,” that is, professional purveyors of “wisdom” and techniques that might lead to success in the world. A “stylistic” tendency had its outcome in the debate between protagonists of the “Asian” (“ornate”) and “At-

tic” (“restrained,” but originally assuming conscious imitation of Athenian writers of the fifth and fourth centuries B.C.E.) styles in Roman antiquity, in the emphasis upon style in the works of Dionysius of Halicarnassus (who lived at Rome in the last years of the era before Christ), Longinus (possibly Cassius Longinus, a rhetorician of the third century A.D.), and Hermogenes (second century C.E., known as perhaps the most important Greek rhetorician of the Roman Empire). Aristotle himself assumed that the user of rhetoric would be a “good person,” thus linking rhetoric with “virtue,” a link that had its origins, perhaps, in Isocrates’ emphasis upon the orator’s moral qualities and wide-ranging skills and knowledge. It was a link that remained strong, in Cicero, Augustine, and even in Alcuin’s *De rhetorica et virtutibus* (730–804 C.E.) Rhetoric (*copia dicendi ac summum eloquentiae studium*—“abundance of speech and the most elaborate study of eloquence” according to the terms used in Cicero’s *De inventione* 1.1) was capable of good or evil, and although the initial incentive toward civilized modes of living must have been implanted by a uniquely eloquent individual, there came a time when masters of eloquence paid insufficient attention to philosophy with the consequence that the state suffered (all this to be found in the proem to the *De inventione*). In later times the term “rhetores” was often reserved for those who used eloquence for shallow and selfish ends.

Roman Imperial Rhetoric

In the Roman Empire (31 B.C.E. to c. 476 C.E.), rhetoric reached its full development as a technical system useful for lawyers and advocates (most eloquently and grandly put in the twelve-book *Institutes of Oratory* by the Spanish orator Quintilian who lived in the first century C.E.) in court situations, especially the centumviral courts (concerned in the main with civil law, particularly inheritance), which spawned a set of manuals that formed a large part of what has come to be known as “the minor Latin rhetoricians.” Rhetoric was most eloquently and grandly described in the twelve-book *Institutes of Oratory* by the Spanish orator and advocate Quintilian who lived in the first century C.E. The art also served as a civilized code of shared behavior supposed to unite the elite court, curial (that is, related to the town councils of the Roman Empire), civil service, and rural aristocratic class of the empire with their rulers in pursuit of common cultural goals and parameters; as a code of ornate, ceremonial praise and blame in prose for the articulation of official values of the imperial autocracy (panegyric) and the proper celebration of important moments in elite life (see Menander Rhetor for the epideictic writings of Menander of Laodicea c.300 C.E.) and as a code of poetic and prose expression suited to the elaboration of elite perspectives on life, politics, and art. The best surviving late antique rhetor/orator is Libanius of Antioch (314–c.394), for whom some 51 declamations, 96 progymnasmata (see below), 64 orations, and 1600 letters have survived.

Christianity broke into this interlocking, mutually reinforcing complex in the course of the fourth century C.E. by stressing the dichotomy “truth versus ornate expression” and emphasizing new techniques of communication—sermons and homilies, together with a training in argumentation use-

ful for the doctrinal polemics that characterized early Christian history. Although ultimately destined to absorb and make over much of the classical rhetorical and hermeneutic tradition (Copeland), Christianity initially set itself against the elite preceptive communications system and (St.) Augustine himself (354–430) in his celebrated *Confessions* enshrined for later generations the difficult process of transition from this elite classical preceptive tradition to the new language of Christian discourse: “humble speech” (*sermo humilis*). Augustine focused on imitation of the supposed language of Christ speaking to ordinary people, and taking as a universal model biblical passages replete with moral and behavioral worth fitted to Christian doctrines and beliefs, and full of eloquence of an adapted sort.

Medieval Transitions

The Venerable Bede in England (672/73–735) brought this approach to a kind of fruition by pointing out in his treatise *De schematibus et tropibus* (“Concerning figures and tropes”) that the Bible revealed all the stylistic tricks inculcated by the Latin rhetorical preceptive tradition (under the heading of style or *elocution*, see Miller, Prosser, and Benson, pp. 96–122). However, although intellectual life in the western European Middle Ages (c. 500–1500) was committed rather more than that of pre-Christian antiquity to notions of revealed truth, it relied heavily upon the Graeco-Roman rhetorical preceptive tradition to organize its communicative needs and its perceptive grids. The Augustinian, imitative and the Ciceronian preceptive tradition were in balance until the twelfth century, when the habit of lecturing on the *De inventione* and *Ad Herennium* (begun, at least as far as the former treatise was concerned, in at least the third century C.E.) returned to favor and dominated communications systems, even invading theological discourse and ideas, where the distinction between “literal” and “allegorical” interpretations of a text permitted the carriage of multiple meanings, thus pluralizing “truth” in favor of what Abelard called the *multiloquium* (or “omnicompetent multifacetedness”) of language. From the period between c. 1020 and c. 1215 C.E. some twenty-two commentaries on the *De Inventione* and the *Rhetorica ad Herennium* have survived to the present in manuscripts, compiled usually as reportages of lecture series delivered in cities with teaching cathedrals or court and monastic schools. These texts, catering to situations that demanded intensified persuasive discourse (for example the so-called Investitures Controversy of the eleventh century or the intensified study of Roman law or the processes of argumentation in theology and university “arts-faculty” disputations / controversy), produced a series of new departures adapted to expanding government and church administrations and aspirations from c. 1000 onward. It is interesting, for example, that although neither Greek nor Roman antiquity produced any preceptive manuals devoted to letter and document composition, in the later period “formularies” have survived such as the model letter collection of the sixth-century Italian Cassiodorus, the late eleventh, twelfth, and thirteenth centuries spawned an important series of classically influenced treatises (on *dictamen* or “composition”) setting out the modes of address and persuasion between potential

letter writers and receivers in medieval diplomatic, administrative and intellectual contexts—where the letter was the major carrier of news, ideas, information, and polite discourse of a less-than-treatise worthy nature. In England at least these treatises expanded into regular “business courses” (Camargo, 1995), and the treatise-form was eventually adopted by a wide range of communication arts, including the arts of memory and public address.

The same can be said for the pressing need of the revivalist international (Latin-using) church of the thirteenth century felt to communicate its elaborate salvational doctrines against heresy, apostasy, witchcraft (*maleficium*), heathenism, Islam, Judaism, secularism, impiety and various forms of lay piety, particularly that of women. This emphasis produced a vast range of sermons and preaching manuals (the *ars predicandi* or “art of preaching” and the art of “praying” or *ars precandi*), which matched a somewhat smaller profusion of manuals (c.1175–1250) imitating the ancient *ars poetica* of Horace (a text commented upon with interest in the twelfth century) and designed to inculcate a maximum of prose and poetic flexibility in the ornate Latin discourse of the day.

Late Medieval Transformation

These perceptive packages continued to have an impact until the Renaissance of the fifteenth century and were joined from the time of Dante (1265–1321) onward by a less uniform but still extensive set of commentaries and notes on and from the *De Inventione* and *Ad Herennium*, in both Latin and, especially, in Italy, in the vernacular. This complex of texts had a profound influence on the shape of major literary works of the period (Jean de Meung’s *Romance of the Rose*, Dante’s *Divine Comedy*, the works of Chaucer) and on modes of elite historical writing, though the formal instruction of the universities (from the thirteenth century onward) concentrated only on the theoretical structure of the classical rhetorical system (using a text such as the early sixth-century Italian Boethius’s *On the different topics*), and on the provision of a training in *dictamen*, the *ars poetriae*, and the *ars predicandi*. Italian culture from the time of Petrarch on added force and precision to the classical rhetorical inheritance, enriching the texts favored by the Middle Ages with works less in vogue during the former period (the mature rhetorical texts of Cicero, and his letters—which became key texts in Renaissance rhetoric—together with the works of Hermogenes and the full text of Quintilian’s *Institutes of Oratory*), thus inculcating a more thorough-going recovery of classical Latin (and Greek) modes of expression and vocabulary, together with doctrines neglected—or practiced differently—in the Middle Ages (such as *numerus* or the system of prose rhythm discussed in many of Cicero’s mature rhetorical works). In this respect the medieval West finally drew nearer to the Byzantine world of Eastern Europe and western Asia, where classical Greek rhetorical influences maintained their hold and there was less of a parallel to the rupture caused in the west by the so-called fall of the (western) Roman Empire. In Byzantium, the emphasis evident in the “preliminary” compositional exercises or progymnasmata (Greek; in Latin *praexercitamina*) found among the works of

Hermogenes (this portion only translated into Latin and therefore available to the Latin Middle Ages) and Aphthonius of Antioch (fourth century C.E.—remained dominant. Judicial rhetoric was dominated by the classical emphasis upon *stasis*-theory (that is, a classification of the ‘issues’ an advocate might encounter in the law courts), whilst epideictic and deliberative rhetorical theory and practice gradually gained strength. The whole complex of Byzantine rhetoric proved influential even upon the Islamic world of the Arabs during the Middle Ages, and from the ninth-century onward, a commentary tradition emerged, based upon the so-called Athonian-Hermogenic corpus of rhetorical works. As in the West, a tension was evident between a striving for effect that might have struck some as “obscure” and an emphasis upon a simplicity open even to the ill-educated. The wide oral and theoretical range of Byzantine rhetorical studies and practice is illustrated by the works of Michael Psellus (1018–c. 1072). In contrast with the West, Byzantium emphasized rhetoric more than dialectic (argumentation) and made less of rhetorical techniques for scriptural exegesis or interpretation.

In both antique and medieval times, Greek and Latin rhetorical ideas, despite the patriarchal conventions that underlay contemporary gender ideas, spread to select women: in the medieval period (H)rotsvit of Gandersheim (tenth century), Heloise (twelfth century), and Christine de Pisan (writing in the French court vernacular but understanding and using Italian and Latin) made notable contributions to the literary genres of their day. Like the female mystics (for example Marguerite Porete, burnt in Paris for heresy in 1310), they did not contribute to the technographic rhetorical teaching literature, but they did absorb much of the contemporary rhetorical culture. Ancient examples include such figures as Aspasia, the mistress of Pericles of Athens (whose famous “funeral speech” in the later fifth century B.C.E. some suppose she wrote), and Hypatia of Alexandria (fourth century C.E.).

See also **Christianity; Logic; Power; Rhetoric; Overview.**

BIBLIOGRAPHY

- Briscoe, Marianne G., and Barbara H. Jaye. *Artes Praedicandi and Artes orandi*. Typologie des Sources du Moyen Age Occidental fasc. 61. Turnhout, Belgium: Brepols, 1992.
- Camargo, Martin. *Ars Dictaminis, Ars Dictandi*. Typologie des sources du moyen Age occidental fasc. 60. Turnhout, Belgium: Brepols 1991.
- . *Medieval Rhetorics of Prose Composition: Five English Artes Dictandi and Their Tradition*. Binghamton, N.Y.: Medieval and Renaissance Texts and Studies, 1995.
- Copeland, Rita. *Rhetoric, Hermeneutics, and Translation in the Middle Ages: Academic Traditions and Vernacular Texts*. Cambridge, U.K.: Cambridge University Press, 1991.
- Kelly, Douglas. *The Arts of Poetry and Prose*. Typologie des Sources du Moyen Age Occidental fasc. 59. Turnhout, Belgium: Brepols, 1991.
- Kennedy, George. *A New History of Classical Rhetoric: An Extensive Revision and Abridgement of The Art of Persuasion in Greece, The Art of Rhetoric in the Roman World and Greek Rhetoric under Christian Emperors, with Additional Discussion of Late Latin Rhetoric*. Princeton, N.J.: Princeton University Press, 1994.

- Mews, C. J., C. J. Nederman, and R. M. Thomson, ed. *Rhetoric and Renewal in the Latin West: Essays in Honor of John O. Ward*. Turnhout, Belgium: Brepols, 2003.
- Miller, Joseph M., Michael H. Prosser, and Thomas Benson, eds. *Readings in Medieval Rhetoric*. Bloomington: Indiana University Press, 1973.
- Murphy, J. *Rhetoric in the Middle Ages: A History of Rhetorical Theory from St. Augustine to the Renaissance*. Berkeley: University of California Press, 1974.
- Russell, D. A., and N. G. Wilson, eds. and trans. *Menander Rhetor*. Oxford: Clarendon, 1981.
- Ward, John O. *Ciceronian Rhetoric in Treatise, Scholion and Commentary*. Typologie des Sources du Moyen Age Occidental fasc. 58. Turnhout, Belgium: Brepols, 1995.

John Ward

RITUAL.

This entry includes two subentries:

Public Ritual
Religion

PUBLIC RITUAL

The study of ritual performed in communal life encompasses the wealth of world history and cosmology. Yet, few linguistic or conceptual categories of analysis address fully the diversity of ritual as an enactment of belief in the divine, inclusive of the mythologies of magic, associated with the liminal moments of human experience. For modern societies, the historical celebration of ritual as a dramatic enactment of the numinous (sacred) reveals a persistent trait among world communities to transform human existence in order to experience sacred presence. To this end, the stylized adaptation of religion, foremost for the Western world, is predicated on a richly variegated model of ceremonial systems that are centered on the formalized invocation of symbols, discourse, and gestures. Combined, the sensory experience innate in ritual performance extends to the history of communities, institutions, and the rise of the premodern and the modern state. The enactment of ritual, both political and religious, also touches on the history of law and the rise of modern theories of government predicated on precepts of moral obligation and the duty of obedience to ordained rulership that have historically been enjoined on individual members of civic communities.

Since the nineteenth century, the subject of ritual has been the focus of a considerable corpus of historical, philosophical, ecclesiastical, economic, and legal research. In the latter third of the twentieth century, significant contributions were also achieved through the application of models of social and cultural anthropology that link the transmission of oral, written, and visual texts. The discipline of art history, specifically the study of iconology, has further refined the implications of the sacred within the emerging loci of secular, national histories. Among the luminaries who have contributed to twentieth- and

twenty-first-century research on ritual are Émile Durkheim, Victor Turner, Clifford Geertz, Mircea Eliade, Natalie Zemon Davis, Catherine Bell, Michel Foucault, Marshall Sahlins, and Pierre Bourdieu. Each has approached the modern study of ritual with reference to the liminality of human experience; Foucault and Bourdieu have addressed concerns of communities to protect civic interests from nonconformist intrusion. A fourth contribution also informs the modern study of public ritual. The history of ritual violence, a trait of premodern communities, has effected the transformation in theories of resistance to authorized authority as well as the imposition of penal practices that now characterize the modern state. The ritualized forms of violence and murder that have been enacted against minorities in the twentieth century reveals the critical paradox of limning-out a theory of ritual as a codified form of social communication: ritual practices have promoted the consolidation of human resources without supporting a universal model of human rights predicated on notions of diversity and tolerance.

Historical Models in Premodern Europe

Basic to any study of ritual in Western culture is the understanding that its history is qualified through linguistic distinctions between ritual (derived from the study of liturgical rites, *ritus*) and ceremony (derived from the stages of the celebration, *caerimonia*). Thus, the modern etymological basis of ritual is rightly sited within the upheaval of the sixteenth century and the rise of Protestantism, yet its history from classical antiquity through modern culture is posited on the importance of public rituals enacted in early medieval communities. For example, the cultural performance of ritual at the close of the Roman Empire and the rise of the Christian West was predicated on the importance of liturgical rites that were performed by members of monastic communities in order to promote and to maintain the hierarchies of rulership that bound ecclesiastical and lay communities into a “body politic.” The embodied celebration of ritual was, in turn, founded on an ethos celebrating the omnipresence of the sacred. The elaboration of the *adventus novi episcopi* (the ceremonial entry honoring the appointment of new bishops) established the eternal model for the reception of royalty in Western kingdoms. The rituals of Visigothic kingship included the sacral elements of unction, the ecclesiastical ritual of coronation, and the swearing of a royal oath to protect property. By the tenth century, the most frequently enacted rituals were religious processions staged to honor the holy feast days and the solemn celebrations of the Church liturgy, which drew the attendance of dignitaries of the royal and Church courts. A more political use of early ritual enactment soon extended to the reconciliation of communities after a king’s subjects had suffered the trespass of war and violence. Both the frequency of war and the gravity of insurrection in the early Middle Ages influenced the protocol surrounding the presentation of royal regalia. Medieval rituals of lordship that were centered on restoring peace first incorporated the regalia of sword into the enactment of truce. Such ceremonies of peace then influenced the history of royal ritual. The incorporation of the sword of justice, spurs, and the enactment of the kiss of peace into the

royal coronation ritual are testimony that the divine providence of ordained authority that was increasingly celebrated in terms of “natural” realities.

If initially the celebration of royal ritual was performed to burnish regal authority, early commentators on such ceremonial enactments recognized how the symbolic enactment of the sacred promoted an ideology of power that ultimately lasted throughout the Middle Ages. Texts that recorded the liturgy of raising prayers and the celebration of Mass were central features in the corpus of historical scholarship that examined the liturgy of coronation rituals. In general, the records of such rites underscore the intrinsic association of *regnum* and *sacerdotium* based on the exaltation of Judeo-Christian models of kingship within a rapidly changing dynastic basis of medieval territories of power. In general, the multivalent history of the early medieval rituals of royal advent attests to the primacy of symbolic dramatization in the history of world culture. For anthropologist Clifford Geertz and modern scholars, the past dynamics of social order are linked to two sources, charisma and the authority vested in a ruler’s body. To this end, throughout the history of medieval and early modern Europe, religion provided a Christological basis that promoted ritual associations of the sacred and profane.

A parallel corollary, the consolidation of sovereign prerogative over civic resources, also requires the same cultural frame in order to define the rites of constitutive power and the (mystical) ceremonial attributes of bodily actions. Evidence supporting Geertz’s observations extend throughout the Middle Ages, when both royal and Church officials began to shape commentary on Church liturgy into a discourse that promoted the viability of a “political theology” predicated on ritual and the construction of holiness. The writings of men in orders, canon lawyers, and later royal publicists promoted the celebration of royal advent enacted through dramatic parallels drawn between the Majesty of Christological kingship and the *Dignitas* of the king’s body on display, vested with royal regalia and the insignia of spiritual authority. The annual rites commemorating Christ’s Birth and Passion were incorporated into the history of dynastic states. Failures derived from dynastic or territorial ambitions were atoned through recourse to rites of royal penance and the solemn display of relics in public processions. Imagery of coronation ceremonies was recorded in texts that enhanced the parallels of the lives of kings with the lives of the Biblical kings of the Old Testament. As contemporary culture articulated the spiritual basis of royal authority in terms of obligations and prerogatives of office, the resources of community life visualized the extended nature of this kingship with recourse to the sculpture that framed church portals. To summarize, members of civic communities who sought salvation through ritual enactment of Christ’s Majesty increasingly honored the thaumaturgical elements of royal Majesty as they crossed the liminal space of sanctity.

By the twelfth century, the history of royal advent had achieved an element of codification that proved essential to the emerging theory of political theology now associated with the celebration of late-medieval ritual and ceremonial traditions. First, the historical understanding of the sacred rites of

unction and coronation was articulated through the invocation of the *gravitas* of anointing medieval rulers. With recourse to historical texts, commentators grafted the legacy of eleventh- and twelfth-century Capetian ceremonial onto the stemma of the early-medieval royal dynasties of the Merovingian and Carolingian rulership. The transmission of one legend became the impetus of French ritual practice, and ultimately influenced the history of other national rituals of advent. The search for mystical provenance led to a premise of divine communication: the origins of Christian kingship were traced to the conversion of Constantine the Great and the baptism of the Frankish king, Clovis. The royal legend was familiarized in texts and the subsequent performance of the French ritual of consecration with holy oil increasingly celebrated the sacramental basis of political power achieved through hereditary rulership. Thus, the ritual elements of elevation and investiture that had once dramatized the elective principle of monarchy were effaced in the course of the High and Late Middle Ages in order to stress the primacy of royal power in a fully hereditary monarchy. The history of enthronement was addressed with recourse to ceremonial elevation, the display of royal insignia, and the incorporation of heraldic and dynastic emblems in the historical accounts of the Capetian dynasty. Jurists and publicists who wrote extensively on behalf of royal prerogative promoted royal authority over matters of church and state. Artists captured the primacy of such argument by depicting royal enthronement in manuscripts, liturgical texts, and coinage. In each medium, the representation of royalty was achieved through the dramatization of divine presence that extended to new participants, foremost the increasing large cadre of officials who promoted royal interests and the rise of civic communities that were steadily brought under an invigorated model of royal prerogative.

By the late thirteenth century, the articulation of the sacred in rituals enacted to dramatize obedience to ordained authority served to define communal practices inherent in the administration of law and justice. And, to exactly the opposite effect, the celebration of ceremonies and rituals that elevated the doctrine of political theology into a nascent form of constitutional thought were also enacted to manifest the “natural” realities of sacred rites and public ceremonies. Few scholars have influenced modern scholarship on the essence of ritual symbolism in the late medieval and early modern state as fully as Ernst H. Kantorowicz (1895–1963). In his seminal work, *The King’s Two Bodies: A Study in Mediaeval Political Theology*, Kantorowicz schematized the interplay of ritual, symbolism, politics, and law that flourished from the late Middle Ages well into the seventeenth century. Ultimately, Kantorowicz posited an integrated model of power that incorporated the full history of antiquity with that of Byzantium and the Western world. Central to the argument is the history of Roman law precepts addressing questions of majesty and authority; the development of laws of community, *ius commune*, were treated as empirical models of an ethos supporting civic authority within an integral community of divine providence. The model was antique and universal, but its application favored the northern monarchies of France, England, and the comital states of Burgundy.

As charted by Kantorowicz, in the course of the fourteenth century, as the Capetian royal house began to falter and the Valois dynasty was elevated to the throne, the drama of royal bodily metaphor achieved the status of public law pertaining to royal succession and the inalienability of royal domain. One effect of this emerging constitutionalism was to promote anew the fully hereditary title of the Valois to the crown of France. A second was to encourage representational models of kingship. The image of the sovereign as embodiment of both qualities of *Majestas* and *Dignitas* is one of the most striking features of late medieval kingship in both France and England. For France, modern scholars have elucidated how the pictorial traditions of representation were adapted to exceptional effect in the coronation book of Charles V of France and Jeanne of Bourbon. Executed at the king's request in 1364, the fully illuminated manuscript records the image of majesty with the presentation of the king and queen's authority during the royal ceremonial of coronation and their joint enthronement that concluded the ritual.

Although modern historians celebrate the articulation of Majesty through image, the constitutional implications of the subsequent ritual enactments staged during the reigns of Charles VI and Charles VII revived the drama of protecting the sempiternal basis of the crown of France within the context of war and trespass. Neither the French nor English monarchy exhibited the necessary vigor to assert dynastic preeminence and power. Yet, the effect on the French rite of royal coronation was to mark a liminal stage in articulating the abstract legal precepts of the early modern state. On the one hand, the rite of 1364 fully articulates the conscious and voluntary submission to the symbolic presentation of a king's body. Yet, the later inclusion of two oaths of office that bound successive kings to protect the full resources of the Church and the property of the royal domain produced the fictional ritual of royal marriage of the king to the kingdom. From this remarkable articulation of the duty of office, Kantorowicz was one of the first scholars to expand the constitutional meaning of ritual symbolism within the cognitive grammar of symbolic ritual. For both France and England, the subsequent elucidation of the legal fiction of the corporate soul influenced the tenor and protocol of ceremonial festivities, foremost by focusing on the presence of the "royal" body in politico-legal culture.

Following Kantorowicz's research, modern scholars have found considerable evidence attesting to a shared belief among contemporaries of late medieval Europe regarding the sempiternal nature of ordained rulership. The gravities of the Hundred Years War did little to efface belief in the mystical corpus of the realm, the body politic, and did much to promote the understanding of the king's authority as "living law," (*Vivat lex*). Royal piety attested to the sanctity of office and royal prerogative increasingly framed the duties and obligations imposed on subjects. The public display of the king's body was increasingly framed by extensive preparations that bound civic communities and the officials of the royal court who were charged with overseeing the enactment of power that was predicated on ideology and the control of social groups.

The symbols and rites associated with royal authority in the northern monarchies—foremost the crown, rite of unc-

tion, and the presentation of the scepter—were common attributes of other kingdoms. Variations in the rituals, however, reveal an issue innate in the classification of ritual. The development of a "functionalist" approach to celebrations of royal prerogative encourages the association of repetition with the emergence of new models of power. Yet, the English and French models cast a long shadow over the history of ritual celebrations of advent in other communities. Before the reign of Alfonso XI in 1312, Spanish kings rarely resorted to the full ritual of unction, coronation, and investiture. Yet, his dramatic gesture of self-coronation did not inspire subsequent kings who ruled over the regions of Spain and the Netherlands to repeat the gesture. Both Philip II and Philip IV were adamant promoters of royal prerogative and vigilant defenders of the primacy of Catholic ritual, yet the ritual of Habsburg advent is rarely celebrated within the model posited by Kantorowicz. Moreover, the perception that sites of power are defined through repeated enactment of ritual and secular ceremonies honoring the king's authority detracts from a full appreciation of the gravity of imperial authority in the late Middle Ages. For example, Emperor Charles IV of Bohemia established Prague as the center of empire but he remained a pivotal figure in the formation of French dynastic interests in the early fourteenth century. A second imperial figure, Frederick III, promoted a Christological depiction of Habsburg rule that marked the recovery of the vitality of German kingship. His magisterial enthronement in Rome in 1452 has not been studied as an *impresa* of ordained ritual; yet the liturgy, the drama of enactment by the presence of Pope Pius II as officiant and the vision of ordained rule shared with the Empress Eleanor of Portugal touch directly on the character of Renaissance rulership: the coronation accounts emphasize the imposition of a humanistic model of kingship that scholars now associate with the monarchies of Renaissance France and England.

Ritual and State-Building in Europe

Following the research of Kantorowicz, twenty-first-century scholars, foremost scholars of French ritual, have proposed a model of ritual that draws inspiration from antique sources. The effect of the scholarship on ceremonial has invigorated the association of classical and modern use of allegory and mythology in burnishing the royal prerogative of the heirs of Charles V of France. By the late fifteenth century, the history of royal presentations of majesty was predicated on the performance of four rituals associated with the king's advent: celebration of the royal coronation rite; the staging of an elaborate post-coronation entry ceremony into the city of Paris; the sporadic attendance of the kings of France within the chambers of judicial institutions (the *lits de justice*); and the orchestration of emotions associated with a king's death and the drama of the royal funeral ceremony. For each ritual, the medieval origins of the ceremony have been noted. The continuity in ritual enactment reveals a new tenor in kingship expressed through elaborate protocol, processional order, and the hierarchy of rulership; these qualities became defining characteristics of the modern, "absolute" ritual of Louis XIV's court that treated ritual as performance theater. The full resources of the crown of France were evoked through constitutional metaphor of the "king's two bodies," yet ritual performance

underlined the gravitas of the physical presence of a king's body amidst the collected members of the body politic. Both the festivities and participants increasingly eulogized the glory and prowess of hereditary monarchy at the juncture in history when ritual became a pejorative term for many communities who fought the resources of the crown and church in order to defend the Protestant faith.

Although the model of "state" ceremonial is grounded in study of Kantorowicz's seminal work and Geertz's research, the theory introduces critical elements of an antinomialism that limit the empirical and normative elements of ritual study. First, the public presentations of majesty in Renaissance and Reformation Europe also included adventitious ceremonies. For example, both civic and religious processions were staged throughout each realm to honor the presence of members of the royal family or the arrival of royal officials. The celebrations of royal births and marriages, as well as military and diplomatic victories, encouraged the invocation of ceremonial and rituals that paralleled the protocol of "state" ceremonial. The pageantry and orchestration of a processional order predicated on office and privilege reveals a vested interest in ceremonial robes and emblems of office. Yet, while the articulation of "state" ceremonial is defined through the pursuit of order among hierarchies of elites, the records of many of the adventitious celebrations demonstrate considerable dispute among contemporary office-holders regarding the past history of ritual, protocol, the privileges of office; even the history of gift-exchange was rigorously debated. Second, the model of "state" ceremonial is wholly royal and excludes the presence of royal women at critical moments of dynastic change. The result has been a celebration of royal prerogative that has been encoded in legal metaphors of power as a "canon of law" based on the promotion of misogyny. Yet, the full records of state and adventitious celebrations staged to honor the queens of France reveal a profuse culture of affective topoi based on the emotional elements of kinship and community evident in discourse and gesture that both acknowledged and celebrated the queens' authority within communities throughout the realm. Thus, if the model of "state" ceremonial is exclusively royal, the combined study of ritual and ceremonial suggests a fully gendered model that is at odds with social and political history of early modern monarchies and the rise of nation-states. The confluence of religion and political aspirations is especially striking in study of the acts of regicide enacted against Louis XVI of France and Charles I of England. The history of festivals during the French Revolution offers insight into the transformation of state-building based on the incorporation of republican models of citizenship that has transformed the process of government in Western communities.

Rituals Sacred and Profane

The contractual nature of public ritual in Western culture is critical to interpreting the symbolism of political rights within modern communities of world culture. For example, the gesture of gift-exchange is one measure of how rituals revitalize society by shared gestures of affection and devotion. A second example, the ritual invocation of violence touches directly on

the history of power. Feud and vengeance, combined with factional struggles in cities, territorial, and modern-nation states in Renaissance Italy, has supported the belief shared by scholars that the importance of ritual in political systems is its ability to foster the resolution of conflict. For the history of the Protestant Reformation, communities in the monarchies of northern Europe engaged in destructive elements of ritual and violence in order to discredit the authority of ordained rule predicated in the history of Catholic liturgy. The horrors of the Wars of Religion offer full testimony of the brutality inflicted throughout communities based on legitimate and historical practices that supported royal authority. Yet, the crisis of representation posed by a divided polity of Protestant and Catholic adherents ultimately produced rituals of reconciliation. In France, communities petitioned the queen regent of France, Catherine de Médicis (1519–1589), to uphold the sacred basis of royal authority. The shared language of devotion between the widowed queen and her subjects suggests that the sustained perception of transcendental experience ultimately supported the promulgation of the first modern notions of toleration. The subsequent promotion of Henri IV's authority as king in the late sixteenth century was achieved in two stages. First, the award of amnesty and gifts to the king's political rivals that took place in a ceremonial seating that captured the essence of the symbolism of the Last Supper; second, his conversion to Catholicism and the celebration of a royal rite of coronation enacted the drama of mystical revival of the royal body and the body politic. In Switzerland and Imperial German cities, the violence of the Reformation was addressed through the ritual of *stalling* (peace-bidding), which dramatized the connotations of the performance of Penance with the symbolism of the Last Judgment. Finally, in England, ritual use of royal healing, combined with elaborate pageantry and ceremonial associations between king, queen, and nobility, the ruler and the ruled, remained a potent force in royal courts of Sweden, Poland, and Russia in premodern Europe. The adaptation of rites of advent was a potent source of political renovation for Western Europe during the twentieth century. The confluence of ritual, pomp, and power as an ideology is also evident in the articulation of the doctrine of "manifest destiny" that has guided the diplomatic relations of both the United States and Britain.

Study of ritual also offers broader cultural implications throughout world communities. By the seventeenth century, ceremony was adapted by Spanish, English, and French inhabitants of colonial North America to legitimize claim to new lands and political power over native inhabitants. The ceremonial history of African and Caribbean communities, for example in Dahomey and Jamaica, reveals how political elites either created or usurped power over local communities and resources. The myths and symbols of ritual based on precepts of theology were also part of the politico-religious culture of the Incan rulers in premodern communities, Islamic communities in world culture, and the history of imperial authority in Japan and China into the twentieth- and twenty-first centuries. The modern use of ritual extends to the political drama of the Russian Revolution, the rise of ideologies of fascism, nazism, and communism. Rituals and the public display of symbols of authority in modern China underscores how fully aspects of political power based on

representation of human and divine decree have been adapted by communities to invent national and world mythologies of divine providence associated with the social construction of twentieth- and twenty-first century visions of hegemony. Of particular interest is the adaptation of ritual, foremost parades, to include the construction of national identity in Singapore, throughout communities in North America, as well as Sino-Soviet regimes of the late twentieth century. The general significance of parades as models of ritual and cultural anthropology has recently included study of both minority and gay and lesbian culture in world communities.

If the cumulative effect of this cycle of ritual performance was to promote a gradual secularization of society predicated on modern notions of state and conscience, one question remains open for the study of ritual within the political discourse of human rights: to what extent has the modern study of medieval ritual promoted a rebirth of violence associated with the rise of the modern state and the legal construct of racial slavery? Both events are predicated on the dichotomy of embodied rights and powers. Both systems of government have been historically grounded in royal legal fictions based on Christological notions of ordained authority. If, as scholars assert, the life of ritual and religion shifts continually between the two phases of maintaining and regenerating world systems of belief based on sacrifice, the model of cultural anthropology may need to question belief that the dynamic of ceremonial performance can be codified into a search for a universal system of just law necessary for the promulgation of human rights based on a model of theological ethics.

See also *Authority; Monarchy; Theater and Performance; Tradition.*

BIBLIOGRAPHY

- Bertelli, Sergio. *The King's Body: Sacred Rituals of Power in Medieval and Early Modern Europe*. Translated by R. Burr Litchfield. University Park: Pennsylvania State University Press, 2001.
- Buc, Philippe. *The Dangers of Ritual: Between Early Medieval Texts and Scientific Theory*. Princeton, N.J., and Oxford: Princeton University Press, 2001.
- Cannadine, David and Simon Price, eds. *Rituals of Royalty: Power and Ceremonial in Traditional Societies*. London and New York: Cambridge University Press, 1987.
- Davis, Natalie Zemon. *Society and Culture in Early-Modern France: Eight Essays*. Stanford, Calif.: Stanford University Press, 1975.
- Grachem, Malik W. "The Slave's Two Bodies: The Life of an American Legal Fiction." *The William and Mary Quarterly* Third Series LX (2003): 809–842.
- Hunt, Lynn, ed. *The New Cultural History*. Berkeley, Los Angeles, and London: University of California Press, 1989.
- Jackson, Richard A. *Vive le Roi!: A History of the French Coronation from Charles V to Charles X*. Chapel Hill and London: University of North Carolina Press, 1984.
- Kantorowicz, Ernst H. *The King's Two Bodies: A Study of Medieval Political Theology*. Princeton, N.J., and Oxford: Princeton University Press, 1997.
- Muir, Edward. *Ritual in Early Modern Europe*. Cambridge and New York: Cambridge University Press, 1997.

Pennington, Kenneth. *The Prince and the Law 1200-1600: Sovereignty and Rights in the Western Legal Tradition*. Berkeley, Los Angeles, and Oxford: University of California Press, 1993.

Seed, Patricia. *Ceremonies and Possession in Europe's Conquest of the New World, 1492-1640*. New York: Cambridge University Press, 1995.

Wilentz, Sean, ed. *Rites of Power: Symbolism, Ritual, and Politics since the Middle Ages*. Philadelphia: University of Pennsylvania Press, 1985.

Elizabeth McCartney

RELIGION

The comparative study of religion has generally focused on doctrine, on canonical texts and their interpretations. But what of religions without writing, much less canonical texts?

Evolutionary Anthropology

As E. B. Tylor noted in his seminal work, *Primitive Culture* (1871), "it is generally easier to obtain accurate accounts of ceremonies by eyewitnesses, than anything like trustworthy and intelligible statements of doctrine; so that very much of our knowledge of religion in the savage and barbaric world consists of acquaintance with its ceremonies" (1958 ed., vol. 2, p. 449). Such a division of religion into "doctrine" and "ceremony," into "belief" and "ritual," reflected an even more fundamental dualism in European thought between "mind" and "body." The unquestionably racist implications of the idea that, among "savages," ritual is more developed than doctrine is that their mental faculties are less developed than their physical ones.

Tylor and Frazer. Tylor was one of the key figures in the institutionalization of the modern discipline of anthropology; indeed, in 1884, he was appointed to the first university post in anthropology in Britain, at Oxford no less. Tylor and his contemporaries looked to so-called primitive societies for insights into the origins of modern institutions, such as marriage, the family, the state, and property. These scholars relied heavily on the accounts of European travelers, few of whom were conversant enough in the languages and cultures of the peoples they described to provide accurate and detailed accounts of religious belief. Consequently, Tylor depended upon descriptions of ritual in his attempt to infer a generalized idea of "primitive religion" that he argued was centered on "animism," the belief that humans, but also animals and even inanimate objects, have souls. To support his theory, he cited legions of examples from around the world of "water worship," of "tree worship," of the sacrifice of objects, animals, and humans at funerals so that their souls might assist the deceased, and other ritual practices. Tylor's ultimate aim was to demonstrate that religion as a whole was a holdover from primitive misconceptions about the world. Thus he also used ritual to demonstrate the existence of primitive "survivals" in contemporary religious practice: "throughout the rituals of Christendom stand an endless array of supplications unaltered in principle from savage times—that the weather may be adjusted to our local needs, that we may have the victory over all our enemies, that life and health and wealth and happiness may be ours" (p. 456).

Sir James Frazer shared Tylor's methods of argumentation as well as his opposition to Christianity. For Frazer, religions emerged from earlier forms of belief in magic, based on principles of analogy and imitation. *The Golden Bough* (1890) cited countless examples of rain-making and wind-making rites as illustrations of such principles of "sympathetic magic." Frazer's analysis revolved around the figure of the divine priest-king responsible for the rites ensuring the fertility and prosperity of the land, who had to be put to death once his powers gave signs of waning. For instance, he drew parallels between instances where divine kings in Japan or Mexico were prohibited from seeing the sun or touching the ground and similar interdictions in girls' puberty rites from around the world: "The uncleanness . . . of girls at puberty and the sanctity of holy men are only different manifestations of the same supernatural energy" (vol. 2, p. 242). For Frazer as well as for Tylor, primitive rituals provided a code with which to decipher imperfectly articulated systems of belief.

Robertson Smith. W. Robertson Smith's *The Religion of the Semites* (1889) aimed, like the work of Tylor and Frazer, to uncover the primitive roots of modern religion. However, he conceived of the relationship between ritual and belief in radically different terms. Premising that "the antique religions had for the most part no creed; they consisted entirely of institutions and practices" (1972 ed., p. 16), he concluded that ritual was prior not only to doctrine, but even to myth. Sacrifice, the most ancient of all rituals, addressed the relationship between the clan, its god, and its totem animal, all of whom were considered kin to one another. The god, as a member of the clan, was particularly concerned with maintaining harmony among fellow members. The original form of sacrifice was a holy meal for which the totem animal, whose flesh was otherwise strictly forbidden, was ritually killed and shared by the assembled clan and its god. The act simultaneously expressed and guaranteed the solidarity of the clan. If the theories of Tylor and Frazer were primarily intellectualist, attempts to use ritual as a key to primitive thought, Robertson Smith pioneered a more thoroughly sociological approach.

From Evolution to Sociology

Émile Durkheim acknowledged the influence of Robertson Smith in his magnum opus, *The Elementary Forms of Religious Life* (1912). However, unlike his evolutionist predecessors, his goals were not to uncover the original form of religion (which he rightly considered an impossible task) but rather the very essence of religion, its universal features. He accepted key evolutionary assumptions, notably that he could rank human societies unambiguously from simpler to more complex, and that the simplest society would have the simplest religion. Scholarly consensus at the time identified native Australian societies as the simplest in existence. Durkheim was able to rely on the work of pioneer Australian ethnographers Baldwin Spencer and F. J. Gillen, whose description of the Arunta in *The Native Tribes of Central Australia* (1899) contained a wealth of detail on religion and especially ritual. Durkheim intended his analysis of this "elementary" case to demonstrate the centrality of religion to human society in all of its forms, including modern Europe. For Durkheim, religion incarnated society's *conscience collective*, a

term that can be translated either as "collective consciousness" or as "collective conscience." If religious beliefs were expressions of this consciousness, then ritual imparted the conscience causing believers to internalize the deep-seated sentiments that made religious and moral ideas compelling. Rituals were, for Durkheim, sites of collective effervescence, moments when the very fact of congregating to perform set actions imparted special energy to the participants. These emotions generated by ritual gave credence to religious beliefs and moral dispositions. For example, mourning rituals were not simply expressions of an individual sense of loss; on the contrary, the rituals conditioned, if they did not create, the very sentiments they expressed. Last but not least, ritual was essential in maintaining the separation between the domains of the "sacred" and the "profane" that, for Durkheim, constituted the defining essence of religion.

Van Gennep. Arnold Van Gennep's *The Rites of Passage* (1909) considered rituals from an entirely different vantage point, neither in terms of the ideas they expressed nor the sentiments they instilled, but rather in terms of shared formal properties of ritual process. Specifically, he argued that a wide variety of rituals from very different types of society effected "passages" in a literal or metaphorical sense from one state to another. Literal passages included leaving or entering a specific territory or passing a threshold when entering or exiting a dwelling. Metaphorically, they denoted the passage from one social state to another, specifically rituals of pregnancy and childbirth, of initiation, of marriage and betrothal, and of death. Such ceremonies, he suggested, all involved the same sequence of phases—rites of separation, of transition, and of incorporation—so that the person or group could be separated from one initial state in order to pass into another. Van Gennep categorized the transitional phase in terms of the metaphor of the threshold (*limen* in Latin), as "liminal." His was undoubtedly the most fully "instrumental" of the early approaches to the study of ritual, an attempt to understand ritual in terms of what it accomplished instead of what it expressed.

From Theory to Ethnography

The development of anthropology as an academic discipline in the first half of the twentieth century effaced the distinction between ethnographic description and theorization that characterized the work of the evolutionists, as well as Durkheim and Van Gennep.

American approaches. In the United States, Franz Boas and his students were especially critical of the speculative nature of their predecessors' theories. Working for the most part among Native Americans, they provided richly detailed accounts of rituals while deliberately avoiding presenting their own interpretations. Paul Radin, in *The Winnebago Tribe* (1923), devoted a large portion of his text to descriptions of ceremonies, translated as literally as possible from informants' accounts. In his discussion of fasting and the vision quest, he juxtaposed a variety of individual accounts in order to demonstrate the importance of distinguishing between "the actions and testimony of the religious man from that of the intermittently religious and the nonreligious man" (1990 ed., p. 229). However, another of Boas's students, Ruth Benedict, was able

to find a means of interpreting ritual that avoided both intellectualist and sociological approaches. In *Patterns of Culture* (1934), she contrasted the Apollonian ethos of Pueblo culture with the Dionysian timbre of their neighbors, using examples largely drawn from ritual contexts. The vision quest and the Sun Dance among Plains cultures exemplified the extent to which they “valued all violent experience, all means by which human beings may break through the usual sensory routine” (p. 80). On the other hand, “There is nothing wild about [Pueblo dances]. It is the cumulative force of the rhythm, the perfection of forty men moving as one, that makes them effective” (p. 93). Rituals were an expression, not of individual ideas, but rather of the overall style of a culture, in the same way that Gothic architecture expressed the style of the later Middle Ages.

French approaches. Unlike their American counterparts, French and British anthropologists were self-conscious heirs to the Durkheimian tradition, though in very different ways. In France, an important school of thought developed around the work of Marcel Griaule among the Dogon in West Africa. In *Conversations with Ogotemelli* (1948), he related a series of interviews with a knowledgeable elder who gradually exposed an intricate, secret cosmology to the anthropologist, providing interpretations of major Dogon rituals in the process. For Griaule and his school, the true, deep meaning of rituals lay in esoteric traditions of exegesis, fully known only to a few initiates, the most knowledgeable of elders. If nineteenth-century theorists had argued that rituals were the key to understanding religious ideas which “natives” were incapable of articulating, Griaule suggested on the contrary that highly articulate native intellectuals held the key to understanding the inner significance of their culture’s rituals.

British approaches. Of the various national traditions, British anthropology was perhaps the most sociologically inclined. No doubt for this reason, early British ethnographic studies tended to focus on institutions—economy, law, politics, and especially kinship. The notable exception was Gregory Bateson’s *Naven* (1936), which centered on a transvestite ritual among the Iatmul of New Guinea; to honor a boy or a young man, his mother’s brother dressed in grotesque female attire and symbolically offered himself to his nephew, while his paternal aunt proudly donned male attire. The book was an extraordinary experiment in analysis, exploring the cogency and limits of four different approaches to explaining the ritual: a “structural” analysis in terms of the cultural logic of different kin relationships; a “sociological” analysis in terms of the contribution of the ritual to maintaining solidarity within the community; an “ethological” analysis examining the emotional component of Iatmul culture, especially in gendered terms; and an “eidological” analysis in terms of patterns of dualistic thought among the Iatmul.

In the 1950s, other British anthropologists turned increasingly to studies on religion and ritual. E. E. Evans-Pritchard’s experience of fieldwork among the Nuer of southern Sudan in the 1930s had led him to convert to Roman Catholicism. Years afterwards, in his study *Nuer Religion* (1956), he suggested that “Those who give assent to the religious beliefs of their own

people feel and think, and therefore also write, differently about the beliefs of other peoples from those who do not give assent to them” (p. vii). This attitude was evident in the rich and complex analysis of Nuer sacrifice that accounted for about one-third of the entire book. Sacrifice was a means of communication between the sacrificer and *kwoth*, “God” or “Spirit,” comprehensible only in terms of the complex Nuer representations of “Spirit” but also of “sin,” especially when the purpose of sacrifice was to restore the moral imbalance in the relationship between Spirit and the believer that the commission of a fault had occasioned. The sacrificer identified himself in the most intimate way with the spear with which he transfixed the victim, but equally with the ox, the victim, itself, so that sacrifice ultimately represented a gift of the self to God—a relationship that Evans-Pritchard refused to reduce to a sociological, psychological, or ideological explanation.

Audrey Richards’s *Chisungu: A Girl’s Initiation Ceremony among the Bemba of Zambia* (1956) was a pioneering study that focused centrally on women’s performance, ideas, and attitudes. She paid special attention to the explanations of different sorts of participants, ritual specialists as well as initiates or their mothers, and showed how the ritual simultaneously expressed dogmatic cultural values—the deference of juniors to elders and of females to males—and unconscious tensions connected with the ambivalent attitudes about sex and marriage.

The 1960s

The 1960s saw the emergence of sharply divergent currents in American anthropology, with some anthropologists focusing on the elaboration of cultural meanings while others stressed the relationship of behavior to ecology, with the interaction of humans with their environment.

Ritual and ecology. Marvin Harris was perhaps the most dogmatic of the latter, advocating a kind of analysis loosely inspired by Marx, which he labeled “cultural materialism.” For Harris, ritual and ideology were epiphenomena of modes of production, a mechanism for adapting to specific environments. His most famous example was the “sacred cow” in India; in his analysis, he maintained that ritual prohibitions on eating beef (which did not in any case apply to the least privileged classes, including Muslims) were not instances of the irrational sway of religious ideology, but rather a highly efficient strategy for managing scarce resources, including manure needed for fuel, milk, and animal traction for plows.

Roy Rappaport’s *Pigs for the Ancestors* (1968) analyzed the *kaiko*, a ritual cycle among the Maring of New Guinea, in terms of cultural ecology. The cycle began with the planting of a *rumbim* tree to signal a truce between warring groups. Some years later, the uprooting of the tree heralded the beginning of a year-long celebration whose climax involved a huge feast where most of the pig herd of the group was slaughtered and consumed, after which hostilities might resume. Rappaport included extensive discussions of the role of pork within the Maring diet, of the carrying capacity of the territory, of the balance between the human and the pig populations, and of warfare as a mechanism for controlling scarce

agricultural resources. He concluded by comparing the *kaiko* cycle to a thermostat, an on/off mechanism for adjusting the relationship between different variables: human and pig populations, but also trade, marriage, and relations of alliance and hostility. Unlike some of his colleagues, Rappaport never dismissed the importance of cultural meanings out of hand, but instead bracketed consideration of meanings for the specific analytical purpose of examining the pragmatic functions of ritual.

Geertz The 1960s also marked the heyday of “symbolic anthropology,” of a renewed interest in religion and symbolism, topics that for a long time, especially in the United States, had been marginalized in anthropology because they seemed intractable to scientific investigation. In an influential paper titled “Religion as a Cultural System” (1966), Clifford Geertz, the leading exponent of this approach, looked back to Durkheim when he postulated that “sacred symbols function to synthesize a people’s ethos—the tone, character, and quality of their life, its moral and aesthetic style and mood—and their actual world view—the picture they have of the way things in sheer actuality are, their most comprehensive ideas of order” (1973, p. 89). Ritual served to integrate ethos to worldview by rendering the ethos intellectually reasonable and the worldview emotionally compelling. In this way it supplied “models of” as well as “models for” reality—compelling representations of the way the world really is and the way it ought to be.

Geertz had already applied this perspective in his monograph on *The Religion of Java* (1960). Though the overwhelming majority of Javanese identified themselves as Muslims, Geertz identified three variants—*abangan*, *santri*, and *prijaji*—associated with three distinct strata of Javanese society: peasants, merchants, and bureaucrats. *Santri* were more preoccupied with doctrine than with ritual, whereas both *abangan* and *prijaji* variants were primarily associated with ritual expression. The core of *abangan* practice was the *slametan*, a communal feast shared with neighbors (not to mention local spirits), which “concentrates, organizes, and summarizes the general *abangan* ideas of order, their ‘design for living’ ” by stating “the values that animate traditional Javanese peasant culture: the mutual adjustment of interdependent wills, the self-restraint of emotional expression, and the careful regulation of outward behavior” (p. 29). Similarly, the mystical *prijaji* ethos and worldview were best expressed in shadow plays. Geertz went on to apply a similar approach to the politico-religious rituals of the Balinese theater state or, more prosaically, to cockfights.

Turner. The study of symbolism in ritual was already an important facet of British anthropology in the 1950s; in the 1960s, the next generation produced a dazzling array of detailed analytical studies of ritual, particularly in African societies, among which Victor Turner’s work with the Ndembu of Zambia stood out as particularly rich and multifaceted. Turner was deeply interested in theater, and used the analogy of “social drama” as an analytical device even before he focused specifically on ritual as a means of presenting case studies of village conflict. The analogy lent itself particularly well to ritual performance, especially healing rit-

uals, which simultaneously expressed and attempted to resolve specific conflicts generated by points of tension in Ndembu society. For the Ndembu, this tension revolved around conflicting principles of matrilineal descent and virilocal residence, whereby women were expected to live with their husbands; unstable communities were constantly being formed around men who would simultaneously strive to hold on to their wives and children while attracting their sisters and their sisters’ children as well. Turner suggested that such conflicting principles were not only acted out in the course of rituals, but also deeply embedded in ritual symbolism. Key symbols in rituals connoted multiple and often contradictory meanings. For example, the milk tree central to *Nkang’a*, the female rite of initiation, “stands for, *inter alia*, women’s breasts, motherhood, a novice at *Nkang’a*, the principle of matriliney, a specific matrilineage, learning, and the unity and persistence of Ndembu society” (1967, p. 28) Such meanings were clustered around two poles: an ideological pole, centered on the importance of group norms and values, such as matriliney; and a sensory pole, focused on emotional reactions to the body and bodily functions and fluids, such as milk. Loosely following Sigmund Freud, Turner suggested that such symbols were “a compromise between the need for social control, and certain innate and universal human drives whose complete gratification would result in a breakdown of that control” (p. 37).

Turner’s concern with process as well as with symbols in ritual led him to explore a specific aspect of Van Gennep’s scheme of rites of passage, the phase of “liminality.” Liminality in rites of initiation was associated with the temporary breakdown of social distinctions among novices, their assumption of a status that was simultaneously lowly and symbolically charged, even potent. Turner associated such a state with “*communitas*,” with the sentiment of common humanness, an antistructure in sharp contrast to the structured social relations before and after the ritual. If, for Turner, the dialectic between the ideological and sensory poles of symbolic meaning replicated the conflict between “self” and “society,” then the dialectic between structure and *communitas* embodied a countervailing conflict between “selflessness” and “society.”

Douglas. Like her colleagues, Mary Douglas was initiated into the ranks of British anthropology through fieldwork in Africa. However, in her most important work on ritual, she turned from the particulars of her field experience to the elaboration of a more general model. In *Purity and Danger* (1966), she focused on ritual concerns with purity and pollution. As a central case, she analyzed Hebrew dietary prohibitions as detailed in Leviticus, pointing out that the logic of the prohibitions rested on a scheme of classification that identified species as in one way or another typical or atypical. Anomalous animals, such as fish without scales, were deemed unclean. She argued that such preoccupations with cleanness (defined ideologically and not hygienically) corresponded with attempts to maintain group boundaries between insiders and outsiders as sharply as possible.

In *Natural Symbols* (1970) she pursued the relationship between ritual, ideology, and social organization. She proposed a two-dimensional scheme for classifying types of societies, with one axis representing “grid” and the other “group.” The “group” dimension referred to the extent of the emphasis placed on “insider” or “outsider” status; “grid” referred to the extent to which interpersonal relations were defined in terms of set, ascribed categories. Societies with high grid and high group had a firm commitment to ritual practice and place a higher priority on the group than the individual; societies that scored low on both counts (modern industrial societies among others) tended to devalue ritual in favor of personal expression. But it was possible to have one without the other. She furnished examples from Central African societies that placed high value on group membership but whose fluid role structure rated low in terms of “grid”; such societies, she suggested, were obsessed with their vulnerability to outside agencies of evil, notably witchcraft, and their ritual observances centered on the identification and expulsion of such threatening forces.

Practice and History

In France during the 1960s, anthropological concerns with symbolism, spearheaded by Claude Lévi-Strauss, were far more centrally concerned with myth than with ritual.

Bourdieu. Pierre Bourdieu’s *Outline of a Theory of Practice* (1972), a critique of French structuralist but also British functionalist approaches, proposed an alternative approach that devoted considerable attention to the analysis of ritual. As the title of the book suggests, Bourdieu stressed the importance of the domain of practical activity, understood in terms of “habitus,” taken-for-granted predispositions that were neither consistently verbalized nor unconscious in any deep sense. Such predispositions included, for example, bodily gestures, modes of interpersonal interaction, and the organization of space and time. “Rites, more than any other type of practice, serve to underline the mistake of enclosing in concept a logic made to dispense with concepts; of treating movements of the body and practical manipulations as purely logical operations; of speaking of analogies and homologies . . . when all that is involved is the practical transference of incorporated, quasi-postural schemes” (p. 116).

Ritual in historical time. In recent years, anthropologists have grown increasingly self-conscious about the historical contexts in which they conduct their research and correspondingly wary of abstracting cultures from particular places and times with specific antecedents. For example, Maurice Bloch’s analysis of circumcision ritual among the Merina of Madagascar paid particular attention to historical accounts to demonstrate how a family ritual was transformed into an expression of the central power of the state in the late eighteenth century and back again, in the twentieth century, into a family performance with increasingly anti-Christian and antielite overtones. While elements of the symbolism may have been invariant and placed constraints on the uses to which the ritual might be put, it was equally clear that the meanings of specific performances were highly subject to the agency of particular actors. Jean Comaroff’s

account of ritual in Zionist churches among the Tshidi of South Africa explicitly integrated a focus on practice with attention to historical context, arguing that the sometimes disjunctive synthesis of precolonial Tswana and of Protestant Christian imagery is a form of resistance to the social and cultural hegemonies that marginalize adherents.

Talal Asad has gone so far as to historicize the very concept of “ritual,” pointing out that in eighteenth and nineteenth century editions of the *Encyclopaedia Britannica* the term specifically referred to instructions for performing the divine service. It was precisely early anthropologists such as Tylor, Frazer, and Robertson Smith who introduced the concept of ritual as symbolic behavior, in other words as a form of practice that called for decoding, for interpretation, especially by an outsider. Using the *Rule* of St. Benedict as a paradigm, Asad advocated a return to the earlier meaning of ritual as a prescription for action: “Ritual is therefore directed at the apt performance of what is prescribed, something that depends on intellectual and practical disciplines but does not itself require decoding” (p. 62). While many anthropologists balk at so far-reaching a critique, contemporary accounts of ritual demonstrate a heightened sensitivity to issues of agency, gender, power, and the capacities of ritual performers to understand and interpret their own actions in modern contexts.

See also *Anthropology; Myth; Sacred and Profane; Theater and Performance.*

BIBLIOGRAPHY

- Asad, Talal. *Genealogies of Religion: Discipline and Reasons of Power in Christianity and Islam*. Baltimore and London: Johns Hopkins University Press, 1993.
- Bateson, Gregory. *Naven*. 2nd ed. Stanford, Calif.: Stanford University Press, 1958. Originally published in 1936.
- Benedict, Ruth. *Patterns of Culture*. Boston: Houghton Mifflin, 1934.
- Bloch, Maurice. *From Blessing to Violence: History and Ideology in the Circumcision Ritual of the Merina of Madagascar*. Cambridge, U.K., and New York: Cambridge University Press, 1986.
- Bourdieu, Pierre. *Outline of a Theory of Practice*. Translated by Richard Nice. Cambridge, U.K., and New York: Cambridge University Press, 1977. Originally published in 1972.
- Comaroff, Jean. *Body of Power, Spirit of Resistance: The Culture and History of a South African People*. Chicago and London: University of Chicago Press, 1985.
- Douglas, Mary. *Natural Symbols: Explorations in Cosmology*. London: Barrie Rockliff, the Cresset Press, 1970.
- . *Purity and Danger: An Analysis of Concepts of Pollution and Taboo*. London: Routledge and Kegan Paul, 1966.
- Durkheim, Émile. *The Elementary Forms of Religious Life*. Translated by Karen Fields. New York: Free Press, 1995. Originally published in 1912.
- Evans-Pritchard, E. E. *Nuer Religion*. Oxford, U.K., and New York: Clarendon Press, 1956.
- Frazer, Sir James. *The Golden Bough: A Study in Magic and Religion*. Reprint. New York: Gramercy Books, 1981. Originally published in 1890.
- Geertz, Clifford. *The Interpretation of Cultures: Selected Essays*. New York: Basic Books, 1973.

- . *The Religion of Java*. Glencoe, Ill.: Free Press, 1960.
- Griaule, Marcel. *Conversations with Ogotemelli: An Introduction to Dogon Religious Ideas*. London and New York: Oxford University Press for International African Institute, 1970. Originally published in French in 1948.
- Harris, Marvin. *Cows, Pigs, Wars & Witches: The Riddles of Culture*. New York, Random House, 1974
- Radin, Paul. *The Winnebago Tribe*. Reprint. Lincoln: University of Nebraska Press, 1990. Originally published in 1923.
- Rappaport, Roy A. *Pigs for the Ancestors: Ritual in the Ecology of a New Guinea People*. New Haven and London: Yale University Press, 1968.
- Richards, Audrey. *Chisungu: A Girl's Initiation Ceremony among the Bemba of Zambia*. Reprint. London and New York: Tavistock Publications, 1982. Originally published in 1956.
- Smith, William Robertson. *The Religion of the Semites: The Fundamental Institutions*. Reprint. New York: Schocken Books, 1972. Originally published in 1889.
- Spencer, Baldwin, and F. J. Gillen. *The Native Tribes of Central Australia*. Reprint. New York: Dover, 1968. Originally published in 1899.
- Turner, Victor. *The Forest of Symbols: Aspects of Ndembu Ritual*. Ithaca, NY and London: Cornell University Press, 1967.
- . *The Ritual Process: Structure and Anti-Structure*. Chicago: Aldine, 1969.
- Tylor, Sir Edward Burnett. *Primitive Culture: Researches into the Development of Mythology, Philosophy, Religion, Art, and Custom*. London: John Murray, 1871. Reprinted in 2 vols. as *The Origins of Culture and Religion in Primitive Culture*. New York: Harper and Brothers, 1958.
- Van Gennep, Arnold. *The Rites of Passage*. Translated by Monika Vizedom and Gabrielle Caffee. London: Routledge and Kegan Paul, 1960. Originally published in 1909.

Robert Launay

ROMANTICISM IN LITERATURE AND POLITICS.

Romanticism is perhaps the richest and certainly the most vexed of the "isms." At the most general level, the term denotes a set of common tendencies in European art and thought from about 1797 to 1848. Ultimately those tendencies influenced the arts, especially literature, in virtually every country from Spain to Russia, but their acknowledged origins and centers were Britain, France, and Germany. Until the late twentieth century, there was even wide critical and historical agreement on the canonical names and the succession of Romantic generations in these countries. In literature, criticism, and philosophy, it was standard to regard William Blake (1757–1827), William Wordsworth (1770–1850), and Samuel Taylor Coleridge (1772–1834) in England as constituting the first generation of major Romantic poets and Lord Byron (1788–1824), Percy Bysshe Shelley (1792–1822), and John Keats (1795–1821) the second, with Sir Walter Scott (1771–1832) the lone novelist; Thomas Carlyle (1795–1881) often figured as a later Romantic *sui generis*. In Germany, "early Romanticism" (*Frühromanti*) meant the Jena Circle of Friedrich Schlegel (1772–1829) and August Wilhelm Schlegel (1767–1845), Novalis (pseudonym for Georg Friedrich Philipp von Hardenburg [1772–1801]), and Ludwig Tieck (1773–1853)—the first self-conscious Romantic "movement,"

though without the name—along with Wilhelm Heinrich Wackenroder (1773–1798), Friedrich Hölderlin (1770–1843), the philosopher Friedrich Schelling (1775–1854), and the theologian Friedrich Schleiermacher (1768–1834). The younger writers of the second "War of Liberation" generation included the folklorists and writers Achim von Arnim (1781–1831), Clemens Brentano (1778–1842), the brothers Grimm (Jakob [1785–1863] and Wilhelm [1786–1859]), Jean Paul (1763–1825), and the more problematic Heinrich von Kleist (1777–1811). Romanticism in France arguably lasted longer, though it started a little later, and could be divided into four generations, both chronological and ideological—François René de Chateaubriand (1768–1848), Benjamin Constant (1767–1830), and Germaine de Staël (1766–1817) (the lone woman considered in her own right) in the revolutionary and Napoleonic periods; the *cénacles* around Victor Hugo (1802–1885) and Stendhal (pseudonym of Marie-Henri Beyle [1783–1842]) in the 1820s; the *Jeune France* (Young France) Romantics of the Revolution of 1830 and the following decade, including Théophile Gautier (1811–1872), Alfred Vigny (1811–1872), Alfred de Musset (1810–1857), and Gérard de Nerval (1808–1855); and finally the so-called Social Romantics led by the poet-politician Alphonse de Lamartine (1790–1869), whose ideas triumphed, then foundered in the failed Revolution of 1848, finally taking Romanticism with them.

The sheer number, diversity and chronological spread of these writers suggest the difficulty of generalization, and the list does not include all the putative Romantic writers and critics, let alone painters and composers. Nonetheless literary critics and historians through the 1960s did identify a number of characteristics that, even if not all shared by every Romantic, seemed to capture a distinctive Romantic style, indeed a whole ethos. Central to it was a validation of both unique human particularity or individuality and the human sense for the infinite, as well as the effort to reconcile the two. The Romantic idea of individuality involved a heightened awareness and legitimization of the emotions and the irrational, against what it took to be the arid rationalism and the narrow, destructive analytic spirit of the eighteenth century. The crucial faculty of the expanded Romantic self was the imagination, which through the emotions and the unconscious could grasp and unite with the infinite in its various characterizations, whether a virtually deified Nature, a more abstract Absolute, or a more traditionally theistic divinity. As to the origins of these new concerns, as early as the 1820s contemporaries had identified a number of instigating factors: the revival of ballads and of medieval and Elizabethan "romance," the rise of German Idealist philosophy, and the French Revolution.

M. H. Abrams's *Natural Supernaturalism: Tradition and Revolution in Romantic Literature* (1971) offered an elegant, powerful synthesis of British and German Romanticism whose range went beyond the narrowly literary implications of its title to include Johann Gottlieb Fichte and Georg Wilhelm Friedrich Hegel as well as such later figures as Karl Marx, Friedrich Nietzsche and D. H. Lawrence, whom Abrams also claimed for Romanticism. Abrams saw Romanticism as profoundly philosophical, a "metaphysics of integration" whose



The Death of Sardanapalus (1844) by Eugène Delacroix. Oil on canvas. As with Romanticism in the visual arts, written works in the Romantic style stressed emotions and intuition over rationalism and scientific analysis, and the imagination above all. © PHILADELPHIA MUSEUM OF ART/CORBIS

key was “the ‘reconciliation,’ or synthesis, of whatever is divided, opposed and conflicting.” Its central literary trope was the circuitous journey, in which the visionary writer, as prophetic representative of all humanity, falls from primal unity into individuated and conflicted existence but ultimately returns to a higher unity that restores the original harmony while preserving his fully separate identity. This trope was the secularized and naturalized transformation of Christian Neoplatonism, which posited a three-stage developmental history of Being as paradigmatic also for human development: primal cosmic unity and goodness, subsequent differentiation into multiplicity and particularity, equivalent to a fall into evil and suffering, and then a return to unity and goodness that yet retains individuation and differentiation.

Abrams explained the Romantic secularization of an originally religious metaphysics as the direct result of the French Revolution. The Revolution seemed to bring the prospect of

heaven down to earth, holding out a this-worldly hope for radical individual freedom and complete social harmony, only to betray that hope by its murderous course and ultimate failure. The Romantics, initially caught up in revolutionary fervor, transferred their quest for liberation and reconciliation from political actions and forms to the spheres of aesthetics and philosophy. As Abrams put it, external means for transforming the world were replaced by internal means; the millennial faith in an apocalypse by revolution gave way to faith in an apocalypse by imagination or cognition.

The depth, coherence, and comprehensiveness of Abrams’s synthesis meant that any new approach would inevitably, directly or implicitly, be directed against it. In the ensuing decades the “visionary” interpretation of Romanticism was subjected to three main sorts of criticism.

Even before *Natural Supernaturalism* was published, Geoffrey Hartmann’s groundbreaking work on William

Wordsworth had undermined one of Romanticism's fundamental premises: the idea of a Romantic reconciliation of individuality and infinity. The attack on reconciliation became the main thrust of deconstructionist criticism, drawing on the French philosopher Jacques Derrida and led by the critic Paul de Man, whose first essays also predated Abrams. As he and others argued, Romantic writing consistently "deconstructed" the hoped-for unity of the mind with the objective Absolute through literary tropes and rhetorical disclaimers that unintentionally revealed the supposedly objective Romantic absolute as a wishful linguistic artifact of mind itself. Ultimately there was nothing but the human imagination, looking for, but in the nature of things unable to find, an external cocreator of the human experience of infinite wholeness. Romantic literature, as one critic put it, was a constant "dialogue between illusion and its deconstruction."

A very different kind of criticism of the visionary approach implicated deconstruction as well: Both were radically unhistorical. Abrams's interpretation was ostensibly historically-minded in its claim that Romanticism was a continuation of the project of the French Revolution by other means. In the following decades, however, historicist criticism, partly building on an earlier Marxism but using new techniques of reading derived from the critic Stephen Greenblatt's application of Clifford Geertz's anthropology, the work of Michel Foucault, and deconstruction itself, insisted that this claim obscured the true relationship between politics and Romanticism. By shifting the arena of freedom and reconciliation to the imaginative and aesthetic, the Romantics were in fact either occluding politics or retreating from it altogether. Jerome McGann (1983), for example, asserted that the poetry of Romanticism was everywhere marked by an extreme form of displacement, through which the actual human issues of liberation from hierarchy, oppression, and poverty and the political struggle to achieve a just and egalitarian society were resituated in a variety of idealized locales such as nature, agrarian utopias, or the visionary imagination of art. Only a sociohistorical method of reading even such ostensibly unhistorical poems as Wordsworth's "Tintern Abbey" (1798) could demystify them by revealing the hidden conservative or outright antipolitics of a Romanticism that tried to transform concrete sociopolitical agenda into timeless ontological visions.

German historical criticism took a similar political tack, though it was less debunking in tone because there was never any doubt in the minds of critics that the original German Romantic impulse was inspired by the liberationist goals of the French Revolution or that the early Romantics themselves openly acknowledged this. As Frederick Beiser (1992) pointed out, what separated early from later German Romanticism was the distinction between the former's relatively egalitarian ideal of community and the latter's more authoritarian and paternalistic ideal of the state. The question for critics like him, therefore, was why the original radical thrust of German Romanticism, in which Friedrich Schlegel's demand for a "universal poetry" shaped only by the poet's sovereign will was initially linked with republican politics, not only dissipated but turned into its opposite.

The third line of dissent from the visionary hypothesis argued the limitations of an inherently masculine Romantic vision and its contemporary masculinist interpretation. Both, feminist critics claimed, entailed the ideological subordination of the feminine along with the simultaneous exclusion of real women from their purview. Feminist Romantic criticism undertook three distinct though connected initiatives. One worked at exposing the gendered character of the visionary synthesis. Ann Mellor (1988, 1993), for example, claimed that the Romantic poets endorsed a concept of the self as a power that gains control over and gives significance to nature, represented in their writings as female, thus legitimizing the continued repression of women. A second initiative focused on the women writers of the Romantic movement, both previously acknowledged if underestimated authors like de Staël and Mary Shelley, and those hitherto treated as little more than supernumeraries and handmaidens of the canonical Romantic writers, such as Dorothy Wordsworth, Dorothea Schlegel, and Caroline Schelling. A third approach, the one potentially most disruptive of the previous synthesis, tested the Romantic canon by resurrecting the work of a number of late-eighteenth- and early-nineteenth-century women writers such as Helen Maria Williams, Charlotte Smith, Mary Robinson, Felicia Hemans, and Maria Edgeworth, all well-known and well regarded in their own time but consigned by later critics to oblivion. Many of them could not be easily assimilated into the interpretive categories of visionary Romanticism.

In the face of the new diversity, there might be a temptation to return to Lovejoy's radical nominalism. But a more helpful approach, one faithful to the spirit of the times, revises the earlier synthesis in the light of its challengers, maintaining the meaningfulness of the term Romanticism, while acknowledging that not everything written during the "age of Romanticism"—for example, the novels of Jane Austen—was Romantic. Such revision, furthermore, is able to include more of the conclusions of the new methodologies, and more of the new work they examine, than might initially be expected. The indispensability of the historical context for understanding the emergence and development of Romanticism strongly suggests that synthesis must take the form of a narrative, however necessarily simplified in a short article.

The First Generation in Britain and Germany

Romanticism in Britain and Germany did indeed begin in the late 1790s as the young intellectual generation's response to the great hopes and correspondingly crushing disappointments of the French Revolution. The German Romantic poet Novalis wittily referred to the revolution, meaning his generation's reaction to it, as a puberty crisis. But if it was, the Romantics unwittingly revolutionized Western adolescence by inventing a new ideal of the self, which would become the maturational ideal of truly free and fully self-aware moderns. The first Romantics comprised an actual demographic generation; all were born within a few years of 1770, all came of age around the outbreak of the Revolution in 1789, all were its ardent partisans. They came to it out of personal motives of rebellion against hierarchical societies and paternalistic families on behalf of freedom of vocational choice and sexual self-expression.

Implicitly already political and social, their rebellion found in the Revolution the larger framework of socio-political analysis and universal ideals that enabled them to generalize it into an ideological worldview.

“Bliss was it in that dawn to be alive / But to be young was very heaven,” Wordsworth famously wrote of the Revolution. Heaven did not last long, but while it did, he and others pushed the Revolutionary ideal of freedom beyond anything the revolutionaries themselves had conceived, beyond freedom guided by reason to freedom that accepted no restraints from nature, history or any “general laws,” only the “light of circumstances / flashed / Upon an independent intellect.” In Germany the philosopher Fichte, explicitly generalizing from the political ideals of the Revolution, went beyond Kantian rational freedom to theorize the self as an infinitely striving subjectivity that in principle knows no boundaries except those of its own finitude, which it experiences as a goad to constant transcendence.

This vision of unbounded freedom could not survive either the dilemma of relativism that it generated or the perversions of tyranny and exploitation in both revolutionary politics and personal life that it seemed to produce. The first generation (with the exception of Hölderlin) turned away from radical politics while retaining the idea of infinite freedom in the sphere of the creative imagination. It was at this stage that August Wilhelm Schlegel, in *Athenaeum* Fragment 116, propounded his famous definition of romantic poetry. But even as an aesthetic doctrine, infinite freedom—Keats’s famous “egotistical sublime”—threatened anarchy and isolation. Recoiling from the imperial self, the young rebels created Romanticism by reconnecting the self with that which was greater than it, the infinite, embodied in an entity, whether nature, the beloved, or more abstractly, the Absolute, with which it could unite. As feminist critics noted, this entity was virtually always figured as feminine. But the Romantics’ relationship to the feminine infinite was not simply conquest and subordination, but a complex, and contradictory, mixture. On the one hand, the mind was dependent on the infinite, safely harbored in its sheltering matrix and, as in Wordsworth’s explicit metaphor of infant and mother, connected through its greater power to the rest of the world. On the other hand, nature was but mind’s partner and cocreator of the vision of the unity of all things, in Wordsworth’s words, the “genuine counterpart” of the “glorious faculty / Which higher minds bear with them as their own.” Thus the infinite was at once the mind’s external superior and mind’s own equal capacity; in Coleridge’s famous formulation, the poetic imagination was the repetition in the finite mind of the eternal act of creation in the infinite “I am.” Another version of the Romantic paradox, Schleiermacher’s description of the self’s two basic but opposite urges, presented a different face of contradiction. On the one hand, he wrote in *On Religion* (1799, 1806), the self “longs to expand . . . outwards into the world, and so to permeate everything with itself . . . to penetrate everything and fill everything with reason and freedom.” On the other hand, “the opposing drive is the dread fear of standing as a single individual alone against the whole; it is the longing to surrender and be completely absorbed in it, to feel taken hold of and determined

by it.” The Romantic self was driven at once by the desire for infinite self-assertion and the desire for complete subsumption into the infinite.

Before deconstruction, many Romantics were aware of the impossibility of this conjunction. Schlegel’s central concept of romantic irony was the expression of his insistence that every claim on the part of a Romantic work to totality was necessarily false because of the finitude of the self and of its creations. One strove to create knowing that one had to destroy the thing one loved in order to continue creating. And the German Romantic sense of infinite longing, *Sehnsucht*, epitomized in Novalis’s yearning poems of love *Hymns to the Night* (1800), testified to the awareness that haunted all of Romanticism, that the infinite was beyond human reach and could only be the achievement of wish-fulfilling dreams of eternal love.

The gendered contradictions in Romantic metaphysics between maternal symbiosis and partnership, and between surrender and penetrating mastery, parallel literary depictions of Romantic love as well as real relations among the Romantics. Friedrich Schlegel’s representative, quasi-autobiographical novel *Lucinde* (1799) describes a series of relationships with women that enable the male protagonist to mature into a centered, creative artist. His harmonious wholeness is achieved through the experience of being loved, and his unified personality in turn makes possible the organic form of his artistic work, which does not need to rely on classical rules for its unity. The relationship with Lucinde (a barely disguised if idealized version of the author’s lover and later wife, Dorothea Mendelsohn Veit) is described contradictorily both as reciprocal—“Only in the answer of its ‘you’ can every ‘I’ wholly feel its boundless unity”—and unequal: Lucinde, while an independent woman and an artist, is finally the mirror in which Julius sees his own unity and power reflected, the moon to his sun. Dorothy Wordsworth played an analogous role for William not only in life, but in poems like “Tintern Abbey,” where she serves as the guarantor for the poet’s vision of the unity of all things. While it was necessary for the feminine to be seen as independent, even omnipotent, to make possible the Romantic imagination of the unity of personality, it was precisely the exclusion of women from the public sphere, sparing them the conflicts and imperfections of striving, that made it plausible for the male Romantics to see the feminine as already achieved wholeness. The maternal role best symbolized feminine self-containment and selflessness, even as the male Romantics demanded that women be autonomous, indeed creative, intellectual companions.

The women of that first generation were, consciously at least, mostly content to fill the roles assigned them. Though Dorothy Wordsworth wrote poetry, she refused to think of herself as a poet, even referring to her poems as mere verses or rhymes. Conflicting assessments of her work suggest that it was either thwarted in its effort to follow her brother’s sense of the Romantic self by her felt exclusion from its masculine authority, or that it registered a different relation of self to community from that suggested by the visionary imagination, one in which the self had its place though not the privileged one of the male visionary. Her sense of community, however, was in fact no different from the ideal that William himself suggested in the chastened agrarian republicanism and later

increasingly Burkean traditionalism of his postrevolutionary social vision. Visionary imagination and the celebration of the common life were not mutually exclusive in the poetics of *Lyrical Ballads* (1798, 1800), but were rather in fact mutually entailed. Dorothea Schlegel, unlike Dorothy Wordsworth, published the work she wrote, the novel *Florentin* (1801), but its hero was the questing young male Romantic seeking the ideal woman who could complete him.

There is no critical consensus as yet, however, about the women poets of the time whose work critics are rediscovering in the early twenty-first century. Some critics like Mellor and Marlon Ross (1989) see in it a distinct feminine sensibility that offers a countertradition to that of the egotistical sublime, one that emphasizes local experience and sensibility rather than vision. Yet, as Isobel Armstrong argues, women's poetry shared with male Romantic writing the valorization of emotion and the language of the sense as well as the explicit self-consciousness about both long held to be one of Romanticism's chief characteristics. What does seem clearly to be the case, as Stuart Curran and Gary Kelly point out, is that in the first decade of the nineteenth century at the height of the Napoleonic wars women writers like Hemans and Edgeworth moved like their male counterparts away from radicalism to a celebration of domesticity which entailed the negative representation of "excessive selfhood." In this respect they participated in a consensual "discourse of Romanticism."

The Second Generation in Britain and Germany

Romanticism in Britain and Germany diverged in the second generation as a result of very different political experiences during and after the Napoleonic wars. Freed from the climate of oppressive wartime fear, though not from the continuing repressive policies of the British government, Byron and Shelley felt it was time to revive the original radical impulse of the first generation, and sharply criticized Wordsworth for his frightened apostasy from the cause of liberty. Both, however, understood the legitimate reasons for his fearfulness: Freedom had been perverted during the Revolution, and its champions knew that they had to explore and exorcise the inner temptations that a fledgling radical autonomy bred before it could be safely embraced. In his dramatic poems "Manfred" (1816) and "Cain" (1821), Byron wrestled with the problem of guilt over (possibly sexual) misuse of freedom and of the religious temptations of forgiveness and consolation at the cost of submission to authority, ultimately rejecting them for an affirmation of individual agency and moral responsibility. In *Prometheus Unbound* (1820), Shelley identified the tyrannical Zeus, who had punished the rebellious Prometheus, as an emblem of humanity's own worst potential, the corruption of freedom and love into self-love and the lust for domination. Only when freedom recognized its own temptations to omnipotence and controlled them was it capable of the mutuality on which both true love and a free polity were based. But in the end their Romantic visions were quite different. Shelley celebrated love, earthly and divine, as the symbol of the fusion of the individual and the whole. The relentless satire and irony of the late masterpiece *Don Juan* (1819–1824) have seemed to some later

critics un-Romantic, and certainly very different from the restless questing and world-weariness of the Byronic hero of the earlier *Childe Harold* (1812–1818), but they were in fact the other side of Romanticism, a display of the "mobility" Byron ascribed to his most positive character in the epic, the ability to respond spontaneously to every new stimulus without false sentimentality. In his own time, "Byronism" was second only to the cult of Napoleon—which Byron himself helped promote—in mythifying one Romantic life model: life as an experiment without bounds, the infinite conquest of experience.

The fiction of Scott showed, however, that the Romantic dialectic could produce yet another kind of synthesis. In the *Waverley* novels (first published in 1814) and in medieval romances like *Ivanhoe* (1819), Scott, a modernizer but an anti-Jacobin fearful of the radical effects of revolutionary individualism, in effect extended the ideal of individuality from person to nation. In the increasingly conservative and patriotic vein of the postrevolutionary Wordsworth, he established the genre of the historical novel as a vehicle for the creation of national identity through (mythic) national history. From a very different vantage point Mary Shelley also offered a critique of Romantic—and modern scientific—hubris in her novel *Frankenstein* (1816–1818), which, as she herself wrote in a preface to the third edition, was intended as the story of a "human endeavor to mock the stupendous mechanism of the Creator of the world." Contemporary feminist critics have pointed out that the creation of the "monster" was also a masculine attempt to usurp the feminine role in reproduction. The two interpretations are not mutually exclusive.

The transformation of individualism that Scott worked implicitly, the German Romantics of the second generation advanced programmatically. Most of the Jena Circle had by the late 1790s and early 1800s already become more conservative while striving to retain the forms of political freedom. In *Belief and Love* (1798), Novalis argued that the integration of monarchy and republic was the highest form of liberty. As inherently free egos, all men were in principle worthy of the throne. The legitimacy of the Prussian monarch derived from his being both incarnation of the Fichtean absolute ego—made possible, of course, only by the indispensable love of his queen; the purpose of his rule was to ultimately cancel out his own authority by preparing all men, through his example, for freedom in a polity of self-governing equals. The evolution of Friedrich Schlegel's politics, preceded by his conversion to Catholicism, brought him to an idealization of the Holy Roman Empire's universalism, whose unity under the aegis of the Roman Catholic Church had made safely possible the harmonious flourishing of plural national individualities.

Adding to the chaos produced by the French Revolution, the humiliations inflicted on Germany by Napoleon intensified German Romantic conservatism. Yet even when it seemed to elevate the nation or the state to dominance, it never wholly surrendered individualistic ideals. The second generation devised a putatively unique German version of individuality that displaced that idea from the person onto the collective entity. True individuality was thus not incompatible with social solidarity, as was merely "French" or self-interested individual-

ism; rather it was the salutary effect of identifying with the unique spirit of one's collectivity. Many Romantics embarked on the construction of a unique "personality" for Germany out of its history, language, and folk culture, for example, in the folk songs collected (and composed) by Arnim and Brentano in *The Boys Magic Horn* (1808), or the folk tales assembled (and revised) by the brothers Grimm (1812). These celebrants of folk culture recognized the "higher reality" of magic and the supernatural as vehicles of the collective unconscious, as did the tales of E. T. A. Hoffmann (1814, 1817), and thus as agencies of an expanded national individuality not constrained by the limits of universal rationality.

French Romanticism

Paradoxically, given the role of the Revolution in fostering Romanticism, French Romanticism began a few years later than British and German, in part because French writers could be more directly involved in the politics than their European counterparts. Perhaps for this reason too it took a somewhat different course in the first generation; two of its main protagonists, de Staël and Constant, remained liberal, if chastened, revolutionaries. It was de Staël, in her extraordinarily influential *Of Germany* (1810), who brought German Romanticism to French, and wider European, notice.

But it was the young aristocrat Chateaubriand who first dazzled France with an indigenous version of Romanticism. Initially a supporter of the Revolution, he had left, disillusioned by its violence, for the United States to investigate the pristine republican virtue of the native "noble savages," acclaimed by Jean-Jacques Rousseau and a generation of Enlightenment writers. It was in the wilderness, however, that he became aware of the dangers of *le vague des passions*, the passion for the indeterminate, which he came to believe had derailed revolutionary politics into self-deifying tyranny. In forced exile after a failed military venture in the royalist cause, he experienced a religious epiphany whose first fruits were the short stories "Atala" (1801) and "René," included in the enormously influential *Genius of Christianity* (1802). The stories are cautionary tales about the dangers of the quest of the infinite in its most exalted interpersonal form, sexual love. Only in religious yearning, expressed in such earthly creations as the Gothic cathedral and in the heavenly vision of the fulfillment of Christ's love in the afterlife, did passion have an adequate object that would never disappoint and the quest for which would never be destructive. Chateaubriand's Romantic religiosity, like that of his German Protestant counterpart Schleiermacher, was quite untraditional. The "genius" of religion lay not in its dogmatic claims but in its unique ability to fulfill secular yearnings for ecstasy and to inspire human creativity. The same powerful residue of revolutionary individuality can be found in Chateaubriand's later politics. A royalist out of reason, he said, he remained a republican by taste; only monarchy could preserve liberty because it was limited by divine law.

Unlike Chateaubriand, Constant's revolutionary liberalism weathered the Terror, though it was through it that he understood the dangers both of centralized political power and of "enthusiasm" in politics. But his attitude toward enthusi-

asm was necessarily ambiguous. A defender of the modern liberty of rights against both traditional authority and the classical republican priority of the common good, Constant was also deeply suspicious of self-interest for political as well as existential reasons. The self-interest of the private sphere not only endangered public-mindedness, it was a corrosive sentiment that drained life of meaning by drying up passion, above all the passion for the infinite. It was his onetime mistress and political mentor de Staël who had taught him its importance in politics and life. But, like Chateaubriand, Constant had learned that passion had to be directed at the proper object. Politicized in the abstractions of virtue and the common good, it could put tyrannical power in the hands of any group who claimed superior knowledge of them. It was ultimately in religion and the arts that absolute passion could most fully and safely express itself, though devotion to the transcendent ideal of liberty was its indispensably activist, public dimension.

Like Chateaubriand too, Constant believed that love was not passion's safest outlet, for love ran the same danger as politics of deifying the finite object of devotion. His novel *Adolphe* (1816) documented the insatiable need that continued to drive an erotic attachment that had outlived its initial frenzy, fully aware of the limitations of its object and of its own narcissistic tendency to exploit, yet unable to let go. Contemporaries and some later critics interpreted the novel as a roman à clef charting Constant's tortured relationship with de Staël (and other mistresses), but Germaine, a prolific and established novelist long before Constant, had her own Romantic agenda. More committed than Constant to the expression of enthusiasm as romantic passion, she also knew that passion was particularly problematic for women. Women love men for their individuality, but women's individuality is a hindrance to men's love. In her novels *Delphine* (1802) and *Corinne* (1807) talented women who aspire to creative achievement do not find the succor in men that men find in women; unable to hold a man's love, and no longer nurtured by it, they either die or lose their creativity.

Under Chateaubriand's influence, French Romanticism was predominantly royalist and Catholic during the Restoration, but there was a significant liberal coterie, under the leadership of Stendhal, that in the wake of aristocratic reaction in the late 1820s recruited former royalists like Hugo and Lamartine. In the preface to his play *Hernani* (1830), whose first production inspired an epoch-making riot in the theater between partisans of traditional neoclassical drama and the new Romantic ideas, Hugo called for a "July 14" of art and declared that liberty in art was the offspring of political liberty. Harmony, the goal of all art, could not be achieved by excluding the unique and the idiosyncratic or the ugly and grotesque. Rather the artistic challenge was to achieve formal unity and wholeness by including the infinite variety of life, and to do so not by following rigid rules but through the creative inspiration of the artist whose genius derived from being authentically him or herself. In his novels, particularly *The Red and the Black* (1830), Stendhal wittily explored the formidable obstacles to the Romantic ideals of authenticity and emotional sincerity in the way of an ambitious young man striving

to achieve both in the post-Napoleonic era of restored authoritarian hierarchy in society and church.

The Revolution of 1830 promised at first to realize liberal Romantic hopes for extending political as well as artistic freedom, but the younger generation was severely disappointed by the political and cultural dominance of a commercial oligarchy under the “Bourgeois Monarchy.” The writers of the Young France movement abandoned politics once again for art, now aiming it explicitly against the sordid materialism of bourgeois society. Proclaiming the aesthetic doctrine of “art for art’s sake,” they in fact posed ideals of sensuality and beauty as a counter-culture to the ugliness of everyday bourgeois life. In his novel *Mlle. de Maupin* (1835), Théophile Gautier extended the idea of the boundaryless Romantic personality in the first literary exploration of the realities and potentialities of human bisexuality and the need to integrate it into the personality that would be genuinely whole. Beyond art, Romanticism became a lifestyle whose declared purpose was to “shock the bourgeoisie” by flouting its norms and acting out the infinity of the self in theatrically eccentric and bizarre behavior. The “Bohemia” of the countercultural artist was a reality before it was a novel—though the novel by Henri Murger (1849) that gave it its name was an unsparingly unsentimental view of its less respectable underside.

In the final cycle of French Romanticism, the implicitly political critique of 1830s aestheticism reasserted itself directly in the 1840s as a growing protest against the selfish narrowness of the political class and the social oppression and misery that marked the beginnings of the industrial revolution in France. “Social Romanticism” idealized “the people” as the new Romantic hero, the repository of spontaneity, goodness, and unity, and demanded that their liberty be realized not only in more democratic politics but in providing the poor with the material means that were the prerequisite for full self-realization. The literature of Social Romanticism ranged from the Parisian novels of Georges Sand to the histories of Jules Michelet, the chronicler of the people’s struggle for liberty. But its great moment seemed to come when its most prominent spokesman, the poet-politician Lamartine, became leader of the provisional republican government of France in the Revolution of 1848. Lamartine was by far not the first Romantic politician—a number of his European predecessors had held offices high and low—but for the first time in history, a Romantic literary figure seemed to be in a position to legislate a version of Romanticism into reality. When, however, in the tragic denouement of the June Days, Lamartine found himself directing the army to shoot down “the people” on the barricades of Paris, the vision of Social Romanticism, and with it the era of Romanticism, came to an end. Its legacy nevertheless remained not only in the revived “late Romanticism” of

the fin-de-siècle but as a permanent dimension of contemporary art and of our understanding of the modern self.

See also *Enlightenment; Revolution; Romanticism.*

BIBLIOGRAPHY

- Abrams, Meyer H. *Natural Supernaturalism: Tradition and Revolution in Romantic Literature*. New York: Norton, 1971.
- Behler, Ernst. *Unendliche Perfektibilität: Europäische Romantik und Französische Revolution*. Paderborn, Germany: Schöningh, 1989.
- Beiser, Frederick C. *Enlightenment, Revolution and Romanticism: The Genesis of Modern German Political Thought, 1790–1800*. Cambridge, Mass.: Harvard University Press, 1992.
- Butler, Marilyn. *Romantics, Rebels and Reactionaries: English Literature and its Background, 1760–1830*. Oxford: Oxford University Press, 1982.
- Curran, Stuart, ed. *The Cambridge Companion to British Romanticism*. Cambridge, U.K.: Cambridge University Press, 1993.
- De Man, Paul. *The Rhetoric of Romanticism*. New York: Columbia University Press, 1984.
- Favret, Mary A., and Watson, Nicola J., eds. *At the Limits of Romanticism: Essays in Cultural, Feminist, and Materialist Criticism*. Bloomington: Indiana University Press, 1994.
- Feldman, Paula R., and Kelley, Theresa M., eds. *Romantic Women Writers: Voices and Controversies*. Hanover, N.H.: University Press of New England, 1995.
- Gutwirth, Madelyn, Avriel Goldberger, and Karyna Szmurlo, eds. *Germaine de Staël: Crossing the Borders*. New Brunswick, N.J.: Rutgers University Press, 1991.
- Izenberg, Gerald N. *Impossible Individuality: Romanticism, Revolution and the Origins of Modern Selfhood, 1787–1802*. Princeton, N.J.: Princeton University Press, 1992.
- McGann, Jerome J. *The Romantic Ideology: A Critical Investigation*. Chicago: University of Chicago Press, 1983.
- Mellor, Anne K., ed. *Romanticism and Feminism*. Bloomington: Indiana University Press, 1988.
- . *Romanticism and Gender*. New York: Routledge, 1993.
- Pipkin, James, ed. *English and German Romanticism: Cross-Currents and Controversies*. Heidelberg, Germany: C. Winter, 1985.
- Rajan, Tilottama. *Dark Interpreter: The Discourse of Romanticism*. Ithaca, N.Y.: Cornell University Press, 1980.
- Ross, Marlon B. *The Contours of Masculine Desire: Romanticism and the Rise of Women’s Poetry*. New York: Oxford University Press, 1989.
- Simpson, David. *Wordsworth’s Historical Imagination: The Poetry of Displacement*. New York: Methuen, 1987.

Gerald N. Izenberg



S

SACRED AND PROFANE. In order to define and explain the paired concepts of *sacred* and *profane*, it is important to look at these concepts as developed in the influential work of the French sociologist Émile Durkheim (1858–1917).

Durkheim's Definition of Religion

In his last great work, *The Elementary Forms of Religious Life* (1912), Durkheim set out “to study the simplest and most primitive religion that is known at present, to discover its principles and attempt an explanation of it” (p. 1) in order to uncover universal properties of religion. But first he needed to define religion, or else “run the risk of either calling a system of ideas and practices religion that are in no way religious, or of passing by religious phenomena without detecting their true nature” (p. 21). Rather than immediately proposing a definition of his own, he began by rejecting two existing definitions. Religion could not be defined, he argued, in terms of the “supernatural,” a category that made sense only in opposition to a modern European paradigm of scientific explanation for “natural” phenomena; for most of the world’s peoples, including premodern Europeans, religious phenomena were perfectly natural. Nor, he continued, could religion be reduced to ideas of “divinity” or even “spiritual beings.” For instance, salvation in Buddhism was not predicated on divine assistance, and many religious practices—Jewish dietary regulations, for example—were “wholly independent of any idea of gods or spiritual beings” (p. 32).

Instead, Durkheim formulated a radical proposition:

Whether simple or complex, all known religious beliefs display a common feature: They presuppose a classification of the real or ideal things that men conceive of into two classes—two opposite genera—that are widely designated by two distinct terms, which the words profane and sacred translate fairly well. The division of the world into two domains, one containing all that is sacred and the other all this is profane—such is the distinctive trait of religious thought. (p. 34)

Unlike definitions in terms of “supernatural,” “divinities,” or “spiritual beings,” Durkheim’s definition in no way predicated any specific kind of belief, much less belief in any particular kind of being. On the contrary, for Durkheim, the division into “sacred” and “profane” was a necessary precondition for religious beliefs, indeed their very foundation. “Religious beliefs are those representations that express the nature of sacred things and the relations they have with other sacred

things or with profane things . . . rites are rules of conduct that prescribe how man must conduct himself with sacred things” (p. 38).

Sacred versus Holy; Profane versus Secular

It is helpful to contrast Durkheim’s concept of the sacred to that of the holy in the contemporary work of the noted German theologian Rudolf Otto, in *The Idea of the Holy* (1917). The holy, for Otto, derived from a sense of the “numinous” (a word Otto coined): the experience of awe, of the transcendent majesty, energy, and mystery of the wholly other. For Otto, the holy was grounded in individual feeling, the apprehension of something outside the individual and infinitely greater. Durkheim hardly denied the existence, or for that matter the importance, of such an experience but held that it derived from the idea of the sacred rather than constituting its essence. For Durkheim, the concept of sacred was above all intrinsically social, the product of the social classification of all phenomena into the antithetical categories of sacred and profane. Unlike Otto’s “holy,” Durkheim’s sacred was literally unthinkable except in terms of the profane. The content of the category sacred was intrinsically fluid: anything might be classified as sacred. What mattered was the social act of separation from the profane.

At first sight, this dichotomy between sacred and profane seems identical to that between sacred and secular. While Durkheim did not explicitly argue against such assimilation, it is clear that he would have regarded it as analogous to that between natural and supernatural, a historically constituted distinction that made sense only in terms of relatively recent European history, with its emphasis on the separation of church and state. Most important, Durkheim very definitely refused to exempt the secular realm of the state from the domain of the sacred. One of his most powerful images—all the more so when one bears in mind that *The Elementary Forms of Religious Life* appeared only two years before the outbreak of World War I—was that of the flag: “The soldier who fall defending his flag certainly does not believe he has sacrificed himself to a piece of cloth” (p. 229); “A mere scrap of the flag represents the country as much as the flag itself; moreover, it is sacred in the same right and to the same degree” (p. 231).

Totems, Society, and the Sacred

Durkheim’s analysis centered on what he considered to be the simplest and most primitive known religion, namely Australian totemism, and rested on the consideration of what the Australians held sacred: “totemism places figurative representations

of the totem in the first rank of the things it considers sacred; then come the animals or plants whose name the clan bears, and finally the members of the clan” (p. 190). It is important to note that representations of totem animals were far more sacred than the animals themselves. Such designs were placed on ritual objects such as churinga (bullroarers), the very sight of which might be forbidden to profane noninitiates—foreigners, but also women and children—on pain of death. The relatively abstract nature of such representations made them particularly appropriate symbols, concrete manifestations of an abstract idea, just as the flag represented the nation; indeed, Durkheim noted, the “totem is the flag of the clan” (p. 222).

More generally, the totem represented a sacred force of energy that Durkheim (borrowing a term from other Melanesian and Polynesian peoples for lack of an appropriate Australian word) named *mana*. This force, external to the individual but in which he also participated, was nothing else but society itself, Durkheim argued. Ultimately, the sacred was not only social but also the very form in which society represented itself to its members.

The Ambiguity of the Sacred

The sacred was not in any simpleminded way reducible to “the good.” Mourning rituals pointed the way to another dimension of the sacred, connected with “[any] misfortune, anything that is ominous, and anything that motivates feelings of disquiet or fear” (p. 392). The domain of the sacred also included “evil and impure powers, bringers of disorder, causes of death and sickness, instigators of sacrilege” (p. 412). Just as the sacred and the profane could be defined only in terms of one another, so the pure and the impure constituted two inextricably linked modalities of sacredness. After all, both holy and polluting things need to be kept separate from the profane realm of everyday reality.

In some cases, Durkheim suggested that the same object could easily pass from one state to another. The impurely sacred, according to Durkheim, was necessary in order to represent inevitable negative facets of social reality. “[The] two poles of religious life correspond to the two opposite states through which all social life passes. There is the same contrast between the lucky and the unlucky sacred as between the states of collective euphoria and dysphoria” (p. 417).

Durkheim’s Critics

Despite the profound influence of Durkheim on the structural-functional school of British anthropology, many of its practitioners were highly critical of the pertinence of his antithesis between sacred and profane. E. E. Evans-Pritchard proposed “a test of this sort of formulation . . . : whether it can be broken down into problems which permit testing by observation in field research, or can at least aid in a classification of the observed facts. I have never found that the dichotomy of sacred and profane was of much use for either purpose” (p. 65). Specifically, British anthropologists challenged its applicability to the real-life situations they observed in the course of field research.

Evans-Pritchard argued that among the Azande of central Africa, sacredness might be situational. Shrines erected for the

purposes of ancestor worship in the middle of a compound might serve as a focus of ritual offerings on some occasions but on others, might be a convenient place for resting spears. W. E. H. Stanner found that the distinction was impossible to apply unambiguously in studying Australian religion, the very example on which it was ostensibly based. Jack Goody noted that many societies have no words that translate as sacred or profane and that ultimately, just like the distinction between natural and supernatural, it was very much a product of European religious thought rather than a universally applicable criterion.

Sacred and Profane since Durkheim

The American anthropologist W. Lloyd Warner, after conducting ethnographic research in Australia, turned in the 1930s to field work in a New England town that he called “Yankee City.” He published a series of monographs about American life through the lens of a small town, the last of which, *The Living and the Dead* (1959), focused on symbols and symbolism. The central chapter of the book, the one that most closely reflects the title of the book, was an analysis of Memorial Day rites, which “are a modern cult of the dead and conform to Durkheim’s definition of sacred collective representations” (p. 278). These rites transcended the division of the community in terms of class, ethnicity, and religion, uniting it around sacred symbols, including the cemetery, and national heroes—Lincoln, Washington, the Unknown Soldier. “The graves of the dead are the most powerful of the visible emblems which unify all the activities of the separate groups of the community,” whereas the celebration of the deaths of men who sacrificed their lives for their country “become powerful sacred symbols which organized, direct, and constantly revive the collective ideals of the community and the nation” (p. 279).

The sociologist Robert Bellah explicitly built on Warner’s analysis of Memorial Day rites to elaborate a concept of “American civil religion”—“a collection of beliefs, symbols, and rituals with respect to sacred things and institutionalized in a collectivity” (p. 10). Examining various presidential addresses on ceremonial occasions, from the founding father down to Lyndon Johnson, he notes the strategic invocation of “God” and the complete absence of mentions of “Christ,” which he argued signaled the transcendent, sacred nature of the nation while acknowledging the separation of church and state by avoiding references to any particular institutionalized religious faith. Ultimately, these analyses of American civil religion developed the analogies that Durkheim had suggested by stressing the identity of “flag” and “totem” and demonstrated the extent to which this conception of the sacred could not be opposed in any straightforward way to the secular.

More than any other contemporary anthropologists, Mary Douglas has made Durkheim’s distinction between sacred and profane a central focus of her work. In *Purity and Danger* (1966), she proposed a sweeping cross-cultural analysis of rules concerning purity and pollution that stressed Durkheim’s central thesis that religious ideas depended on the active separation of antithetical domains, a separation that in turn implied a system of classification. The central premise of her analysis

ÉMILE DURKHEIM

Émile Durkheim (1858–1917) was the founder of academic sociology in France and a thinker whose contribution to the social sciences, especially sociology and anthropology, continues to be fundamental. Born into a family of rabbis in Lorraine, he studied at the prestigious École Normale Supérieure in Paris, where his fellow students included the future philosopher Henri Bergson and Jean Jaurès, who was to become the leader of the Socialist Party. Philosophy was (and remains) a central focus of the humanities in France; Durkheim's first concern was to establish sociology as a legitimate branch. Consequently, his doctoral thesis and first major work, *The Division of Labor in Society*, published in 1893, sought to establish a "science of ethics."

The idea of looking for morality in the division of labor was startling, especially in light of the Marxist convictions of Durkheim's socialist friends. With equal daring, Durkheim suggested that such moral principles were reflected in the different types of law, repressive (criminal) and restitutive (civil). Repressive law rested on shared social understandings of "crime" morality, a domain Durkheim labeled the "conscience collective," which can be translated either as "collective consciousness" or "collective conscience." The moral underpinnings of such understandings amounted to "mechanical solidarity," the recognition of essential likeness between fellow members of a society. The increasing scope of the division of labor gave rise to a higher form of "organic" solidarity, reflecting complementarity rather than likeness. Ideally, organic solidarity was expressed by restitutive law stipulating reciprocal rights and obligations and redressing imbalances rather than punishing crimes. Durkheim was acutely aware of the gap between law and justice in modern society, a gap that he named "anomie," the absence of rules or norms. In his view, the economic aspects of the division of labor had temporarily outpaced the development of law and morality.

Two years later, in 1895, he published *The Rules of Sociological Method*, in which he insisted that

"social facts," "ways of acting, thinking, and feeling, external to the individuals, and endowed with a power of coercion, by which they control him" (p. 3), could be explained only in social terms and were not reducible to biological or psychological explanations. In 1897 he published *Suicide* as a dramatic demonstration of the power of his methods; after all, the decision to take one's own life seemed a matter of individual psychology. However, he persuasively argued that psychological, biological, or climatic theories could not explain differences in suicide rates. For example, Protestants were more suicide-prone than Catholics, recently widowed men more so than women; suicide rates climbed during economic depressions and dropped in periods of revolutionary upheaval. Different types of suicide could be classified with respect to two axes: one in terms of the individual's commitment to social norms and the other in terms of the extent to which such norms were available to guide the individual in particular situations.

In 1896 Durkheim founded a journal, the *Année Sociologique*, which served as a forum not only for his own ideas but also for those of a growing number of brilliant pupils, including his nephew, Marcel Mauss. In 1912 he published his last book, *The Elementary Forms of Religious Life*; in it, he used Australian totemism as his central case on the grounds that native Australians were the simplest society known to humanity and that their religion was consequently free from confusing accretions. In stark contrast to his predecessors, nineteenth-century theorists of social evolution such as E. B. Tylor, Lewis Henry Morgan, and James Frazer, Durkheim did not use the Australians to demonstrate how far European society had evolved but rather as a means of uncovering universal features of religion and society that we share with them.

As a native of Lorraine, which was annexed by Germany in 1871, Durkheim enthusiastically supported the cause of France in World War I, with tragic consequences. His only son and most of his students died at the front, and he died a broken man in 1917.

was that “dirt is essentially disorder” (p. 12). For this reason, anomalous persons or animals, those that did not fit neatly into preconceived, socially determined categories, were especially powerful or dangerous. Seen in this light, European-American preoccupations with hygiene were not qualitatively different from non-European anxieties about ritual pollution. Such preoccupations with the maintenance of order and the separation of antithetical categories were intimately related to the perpetuation of social boundaries between insiders and outsiders.

Most recently, Durkheim’s concepts have reappeared in a heated debate between anthropologists as to whether Captain James Cook, who arrived in the Hawaiian islands in 1778 and was killed by native Hawaiians in 1779, was really considered by his killers to be an avatar of the god Lono. Marshall Sahlins, in *Islands of History* (1985), asserted that Cook’s murder was a direct outgrowth of his deification. Sahlins’s analysis centered on the opposition between the god Lono, “associated with natural growth and human reproduction who annually returns to the islands with the fertilizing rains of winter” (p. 105) and the god Ku, associated with kingship, warfare, and human sacrifice.

Each year, the Makahiki festival celebrated the arrival of Lono along with the rains, his journey throughout the islands, and his departure/death, marked by the resumption of human sacrifice to the god Ku. The arrival of Cook in Hawaii, his journey around the island, and his departure all coincided with the ritual trajectory of the god Lono, with whom, Sahlins argued, Cook was literally identified, particularly by the priests of Lono. Disaster struck when, after his departure, Cook was obliged to return to Hawaii. The arrival of “Lono” at the wrong time and from the wrong direction was precisely a violation of rules of separation of antithetical categories, a direct threat to the god Ku and the king, who promptly had Cook killed. “Cook was transformed from the divine beneficiary of the sacrifice to its victim—a change never really radical in Polynesian thought, and in their royal combats always possible” (p. 106).

This analysis has been challenged by Gananath Obeyesekere, who has argued that such accounts of the deification of explorers like Cook were part of European imperial mythologizing rather than “native” thought. Advocating an approach derived from the sociology of Max Weber and emphasizing “practical rationality,” he has suggested that Cook’s death be interpreted more prosaically in terms of factional power struggles in Hawaii. Sahlins, it must be noted, carefully avoid the assertion that all Hawaiians accepted that Cook was a god. Rather, his point was that the historical events could be understood only in terms of the framework of Hawaiian ideas about the sacred, ideals that revolved around the classification of the social and the physical world in terms of one another, where the mixture of antithetical categories generated either great power or danger.

The debate shows clearly that Durkheim’s distinction between sacred and profane continues to inform anthropological analyses of religion (as well as of ostensibly secular ideologies) but also that such approaches continue to be challenged and

contested, and that the relevance of such distinctions is far from universally accepted.

See also Animism; Polytheism; Secularization and Secularism; Superstition; Untouchability; Taboos.

BIBLIOGRAPHY

- Bellah, Robert N. “Civil Religion in America.” In *Religion in America*, edited by William G. McLoughlin and Robert N. Bellah, 3–23. Boston: Houghton Mifflin Company, 1968.
- Douglas, Mary. *Purity and Danger: An Analysis of Concepts of Pollution and Taboo*. London: Routledge and Kegan Paul, 1966.
- Durkheim, Émile. *The Division of Labor in Society*. Translated by George Simpson. New York: Macmillan, 1933.
- . *The Elementary Forms of Religious Life*. Translated by Karen Fields. New York: Free Press, 1995.
- . *The Rules of Sociological Method*. Translated by Sarah A. Solovay and John H. Mueller; edited by George E. G. Catlin. Chicago: University of Chicago Press, 1938.
- . *Suicide: A Study in Sociology*. Translated by John A. Spaulding and George Simpson; edited, with an introduction, by George Simpson. Glencoe, Ill.: Free Press, 1951.
- Evans-Pritchard, E. E. *Theories of Primitive Religion*. Oxford: Clarendon, 1965.
- Goody, J. R. “Religion and Ritual: The Definitional Problem.” *British Journal of Sociology* 12, no. 2 (1961): 142–164.
- Lukes, Steven. *Emile Durkheim: His Life and Work, a Historical and Critical Study*. New York: Harper and Row, 1972.
- Obeyesekere, Gananath. *The Apotheosis of Captain Cook: European Mythmaking in the Pacific*. Princeton, N.J.: Princeton University Press, 1992.
- Otto, Rudolf. *The Idea of the Holy: An Inquiry into the Non-Rational Factor in the Idea of the Divine and Its Relation to the Rational*. Translated by John W. Harvey. Rev. ed. London: Oxford University Press, 1936.
- Sahlins, Marshall. *Islands of History*. Chicago: University of Chicago Press, 1985.
- Stanner, W. E. H. “Reflections of Durkheim and Aboriginal Religion.” In *Social Organization: Essays Presented to Raymond Firth*, edited by Maurice Freedman, 217–240. London: Cass, 1967.
- Warner, W. Lloyd. *The Living and the Dead: A Study of the Symbolic Life of Americans*. New Haven, Conn.: Yale University Press, 1959.

Robert Launay

SACRED PLACES. Every civilization has its share of sacred places, that is, geographical locations, buildings, monuments, or environmental features, such as mountains, lakes, rocks, waterfalls, and so on, that are believed to be endowed with intense spiritual qualities. Indeed, such places are frequently thought to possess a variety of supernatural powers that can heal, rejuvenate, or otherwise affect the human beings who visit them, often as devout pilgrims. They are also sometimes thought to be the focal points of creation, the places where deities first manifested themselves or performed some fundamental actions, and are thus typically steeped in mythology and theological dogmas.



Stonehenge. Wiltshire England. Constructed over a span of fifteen hundred years, Stonehenge is one of the oldest sacred places on the planet. The exact function of the stone circles remains unknown, although numerous theories exist. © BOB KRIST/CORBIS

In what follows, we shall consider eight well-known sacred places in several parts of the world, all of which have not only had a profound impact on the civilizations that venerate them, but also, in several cases, on a fair share of the human race. They are England's Stonehenge, the Great Pyramid of Egypt, the Greek oracle at Delphi, the Temple Mount and the Church of the Holy Sepulcher in Jerusalem, the Pyramid of the Sun at Teotihuacán, the great Islamic pilgrimage site of Mecca, and the Ise-Jingu, the most sacred of all Japanese Shinto shrines.

Stonehenge

We begin with one of the oldest—and best-known—sacred places on the planet, the great megalithic stone circle known as Stonehenge, the ruins of which still loom majestically above Salisbury Plain in southwestern England. Like Rome, Stonehenge was not built in a day, but rather over a span of about fifteen hundred years, from about 2900 to 1500 B.C.E. The earliest phase in its construction involved the excavation of a circular ditch some 360 feet (110 meters) in diameter and five feet (1.5 meters) deep. Inside the ditch was an embankment, composed of excavated material, and just inside the embankment was a circle of fifty-six holes, or pits, that have come to be known as “Aubrey Holes” after their seventeenth-century discoverer, John Aubrey. These holes may have held posts of some sort.

The second phase in Stonehenge's construction, which lasted from 2900 to about 2500 B.C.E., saw the erection of wooden structures and posts in the center of the site. It was during the third and final phase (2500–1600 B.C.E.), however, that the monument we know today was created. Two concentric circles of approximately eighty huge stone pillars, quarried in southwestern Wales and known as “bluestones,” from their bluish color, were erected in the center of the circle—only to be replaced several centuries later by a row of even bigger “sarsen” stones that were brought from Marlborough Downs,

some twenty-five miles (forty kilometers) to the north. The thirty sarsen stones, each of which stands approximately thirteen feet (four meters) high, form a circle about 108 feet (33 meters) in diameter. Originally, they were topped by a circle of lintels; however, today only a few remain intact, together with seventeen of the original sarsen pillars.

Inside the so-called Sarsen Circle the builders erected a horseshoe-shaped structure composed of five pairs of huge sarsen blocks, weighing approximately forty metric tons each, each topped by an equally massive lintel forming a series of trilithons, or three-stone gateways, the largest of which rises twenty-four feet (seven meters). Within the horseshoe, next to the central trilithon, lies the formerly erect Altar Stone. In addition, four “station stones” are located just inside the embankment, and several more sarsen blocks were originally placed near the entrance to the site. The two that survive are the Slaughter Stone and the Heel Stone, which were placed just outside the ditch. The latter stone appears to have played a crucial part in the rituals that took place (and still take place) during the summer solstice.

In any case, it is the ruins of this final phase in Stonehenge's evolution that impress visitors today. Although there are over one thousand stone circles in Britain, the massive remains on Salisbury Plain are by far the most impressive, despite the collapse of most of the lintels and over half of the original stones. That it was an intensely sacred place dating back into the mists of prehistory is undoubted, despite the fact that the closely related questions of who built Stonehenge and what went on there have long been hotly debated.

The earliest theory, advocated by the aforementioned James Aubrey, was that it was built by the ancient Celtic Druids. However, while these mysterious white-clad priests probably venerated Stonehenge and performed rituals there, it long predated their appearance in Britain around 600 B.C.E. Other theories range from wandering Mycenaean (on one of the sarsen



The Great Pyramid. Giza, Egypt (created c. 2525 B.C.E.; photographed c. 1880). The Great Pyramid, along with all of Egypt's sacred structures, was built on the western bank of the Nile River, facing the setting sun. The Egyptians believed that the land of the dead lay in this direction. © CORBIS

stones there are markings that some scholars have identified as a Mycenaean double-ax) to Egyptians and even ancient astronauts. However the most likely candidates were the Bronze Age (3000–1000 B.C.E.) inhabitants of southern Britain, including the “Wessex people,” whose precise linguistic affiliations are as yet unknown, although we do know that they shared a great many traits in common with the pre-Celtic populations of western Europe, including stone circles (compare Carnac in Brittany).

However, the questions of what it was used for can now be tentatively addressed, if not definitively answered. In the mid-1960s American astronomer Gerald S. Hawkins suggested that Stonehenge was an ancient astronomical observatory that was used to calculate a variety of celestial events, including both lunar and solar eclipses, as well as the summer and winter solstices. To this day, the sun rises over the Heel Stone on 21 June, the summer solstice, and thousands of pilgrims, including latter-day “Druids,” flock to Stonehenge every year on that date to watch this occur. If Hawkins is correct, the calendar, as well as the solar and lunar cycles, must have loomed large indeed in the beliefs systems of those who built the monument. However, this hypothesis is by no means universally accepted. Other scholars assert that, while it was clearly

a place where extremely important rituals took place, some of them perhaps involving animal and perhaps human sacrifices (hence the “Slaughter Stone”), it was not a primordial “computer” designed to facilitate the calculation of astronomical events. In short, a definitive interpretation of the fundamental meaning and purpose of this remarkable place remains elusive.

Nevertheless, anyone making the trek to Salisbury Plain for the first time cannot help but be awestruck at the sight of those mighty stones silhouetted against the sky. The enduring sacredness of Stonehenge is underscored by the fact that, unlike the other megalithic monuments of Britain, such as the great stone circle at Avebury, some thirty miles (forty-eight kilometers) to the north, it has never been intruded upon by a town or village.

The Great Pyramid

Our second example of a major sacred place, the Great Pyramid at Giza (near Cairo) in northern Egypt, dates from approximately the same time at which the prehistoric people of southern Britain were beginning the second phase in Stonehenge's construction, that is, c. 2500 B.C.E. In fact, the

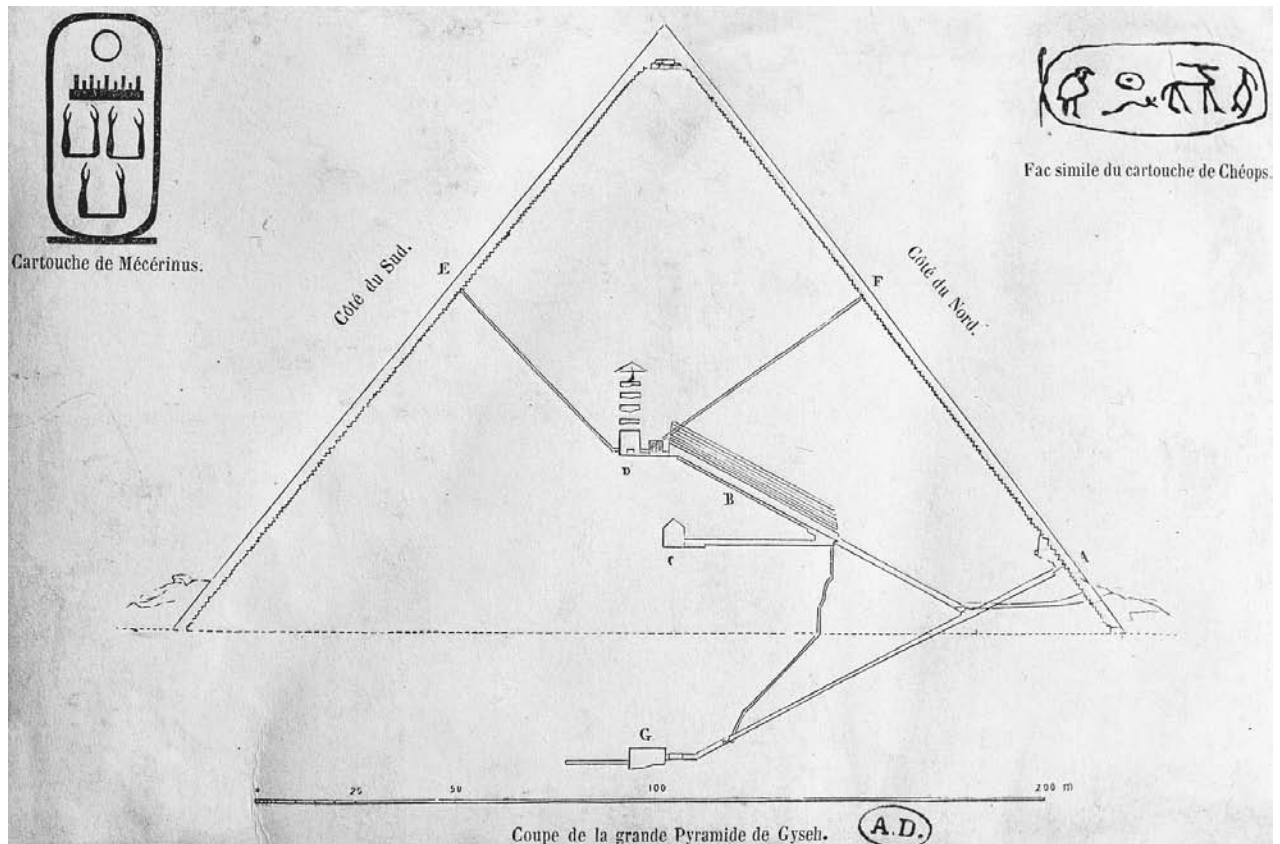

Cutaway diagram of the interior of the Great Pyramid at Giza. The incredibly precise geometric measurements of the Great Pyramid, along with the size and weight of the stones used, gave rise to many unusual theories about its construction. THE ART ARCHIVE / BIBLIOTHÈQUE DES ARTS DÉCORATIFS PARIS / DAGLI ORTI

Great Pyramid can be dated far more precisely. It was during the reign of the pharaoh Khufu (Cheops) (2551–2528), which marked the high point of what Egyptologists call the “Old Kingdom.” It was the first of the three major pyramids built at Giza, the other two being the pyramids of the pharaohs Khafre and Menkaure, respectively, Khufu’s son and grandson. However, it also represents the culmination of a long period of development that began in predynastic times with the construction of mastabas, or flat-topped tombs with sloping sides, and continuing through the famous Step Pyramid at Saqqâra (also near Cairo) that was designed by the brilliant Egyptian architect Imhotep for King Djoser (Third Dynasty), who reigned from 2630 to 2611, and the so-called Bent Pyramid built by Khufu’s father Sneferu (2575–2551).

Like those pyramids and mastabas that preceded it, the Great Pyramid, which originally rose 481.4 feet (146.73 meters) and is composed of approximately 2.3 million blocks, each of which weighs, on average, 2.5 metric tons, was a royal tomb. It was located on the west bank of the Nile. Indeed, all of the sacred places in Egypt that played host to the dead, from Giza and Saqqara to the Valley of the Kings opposite ancient Thebes (modern Luxor), were located on the west bank of the river because it was in the direction of the setting sun, that is,

the land of the dead, the place toward which the Sun God Re sailed each day as he navigated the Celestial Nile, which ran at right angles to the Earthly river.

In view of its mammoth proportions, the weight of the stone blocks, and the fact that it is almost perfectly aligned with the points of the compass, some researchers have suggested that the Great Pyramid, as well as the other two Giza pyramids and the Sphinx, traditionally attributed to Khufu’s son Khafre, must have been built by technologically sophisticated extraterrestrials, as no human technology, ancient or modern, could possibly have manipulated stones of this size and weight. However, recent archaeological research at Giza has clearly demonstrated that the pyramids were built by thousands of ordinary human beings, most of whom were peasants, rather than slaves, whose labor was conscripted during the fallow season, and who lived in nearby barracks. Moreover, the architects knew enough geometry to work out the remarkable alignments and, after several earlier failures, to determine the correct angle and slope. It is also clear that by using ramps, rollers, massive sleds, and sheer human muscle power, the builders were in fact able to wrestle the blocks into position without any extraterrestrial help.

Nevertheless, even though they were almost certainly not built by space aliens, from the beginning of Egyptian history,



King's Chamber of the Great Pyramid at Giza, photographed c. 1930. The mummified remains of the Pharaoh were placed in the King's Chamber, along with objects of wealth and a collection of figurines which were believed to serve the Pharaoh in the afterlife. HULTON ARCHIVE/GETTY IMAGES

the pyramids of Giza and Saqqara have had a special religious significance. They were thus fitting final resting places for the Pharaoh's soul—or souls, as the ancient Egyptians believed that each person had two souls: a *ka* and a *ba*. At death, the *ka* left the deceased's mortal remains and went to the afterworld; the *ba*, however, was destined to remain behind in the tomb, which was why pharaohs and other wealthy Egyptians were buried with such a plethora of grave goods: the *ba* needed these things to survive. Both souls needed as close a replica of the former living body as it was possible to produce, which accounts for the practice of mummification.

In any case, although the wealth interred with Khufu in the Great Pyramid has long since been looted, his *ba* must have been surrounded initially with a priceless horde of objects with which it could live in a princely style for what his heirs hoped would be eternity. In addition to physical objects, the needs of a deceased pharaoh were served by a retinue of figures called *ushabtis*, figurines would serve both his *ka* in the afterworld and his *ba* within the pyramid's burial chamber.

The interior of the Great Pyramid has two such chambers, the King's Chamber, which is reached by a steep gallery, and the Queen's Chamber, some distance below it. As just indicated, both chambers are now completely empty, and have been for several millennia. However, the King's Chamber, which is located close to the center of the pyramid, has long been considered to possess extraordinary spiritual power. The author of this article once spent the better part of an hour, between waves of tourists, sitting cross-legged in the center of the chamber in question, doing his best to absorb some of that supposed spiritual energy, or "pyramid power," as it is sometimes called. While he failed to notice any appreciable psychic changes, he did come away from the experience with a

profound sense of awe and wonder. The Great Pyramid is thus by any measure an extremely sacred place, and all who visit it, even casually, cannot help but be impressed not only by its sheer size, but also by its ineffable majesty and intense spiritual aura.

Delphi

Some five hundred-odd miles (805 kilometers) due north of Giza, on the slopes of Mount Parnassus, which looms above the north shore of the Gulf of Corinth in northwestern Greece, is another extremely sacred place: Delphi, site of the famous Oracle of Apollo. Like Stonehenge, the origins of Delphi are lost in the mists of mythology and prehistory; however, we do know that very early on the ancient Greeks came to consider it to be the center of the universe.

The central feature of Delphi is the Temple of Apollo, which commemorates the god's slaying of Python, a terrible she-dragon that lived on the slopes of Parnassus. According to ancient Greek mythology, the goddess Hera sent Python to harm her husband Zeus's paramour, Leto, while Leto was pregnant with Apollo and Artemis. But Leto was saved in the nick of time by Poseidon, who hid her in the waves. In any case, four days after he was born, Apollo set out to find a location where he could establish his sanctuary. When he wandered onto the slopes of Parnassus, he encountered Python, who immediately attempted to kill him, just as she had his mother. Apollo loosed one of the magical arrows the smith-god Hephaestus had forged for him and mortally wounded the monstrous reptile. However, one of Python's tasks had been to guard the region, which had been sacred to her mother, the primordial earth-goddess Gaia, and so Apollo needed to purify himself and placate the slain monster's spirit. He exiled himself to Thessaly, did his penance, and when he returned to what was to become Delphi, he established the oracle that bears his name. In memory of Python, he named the woman who spoke with his voice the Pythia.

The name Delphi comes from *delphin*, the Greek word for "dolphin." When Apollo realized that he needed priests to interpret his words, he changed himself into a dolphin and lured a boatload of Cretan sailors to the shore beneath Mount Parnassus and convinced them to serve him.

From the earliest period in Greek history, Delphi was an extremely sacred place. Both individuals and cities came to Delphi to hear Apollo's oracles. Indeed, each major Greek city maintained a treasury along the Sacred Way that led up to the Temple of Apollo. The region around Delphi was nominally a dependency of the city of Phocis, although the site was in effect international territory and, except on rare occasions, unaffected by the wars that constantly pitted city-state against city-state, the most famous of which was the Peloponnesian War (431–404 B.C.E.).

The mantic, or divinatory ritual, took place in a chamber deep within the temple called the *manteion*. The Pythia, who, in anthropological terms, was a shaman, that is, someone who goes into a trance and is either possessed by a divine being or is able to visit the spirit world, chewed a laurel leaf and then



Tholos of the Sanctuary of Athena at the Oracle at Delphi, Greece. Considered by the ancient Greeks to be the center of the universe and a place of great mystical power, the Oracle of Apollo at Delphi was constructed in the early 4th century B.C.E. and is located on Mount Parnassus. © BETTMANN/CORBIS

mounted a tripod that stood on top of the Omphalos Stone, which was believed to be the world's navel. According to several ancient eyewitnesses, including the second-century C.E. historian Plutarch, "noxious fumes" issued from a hole, about nine inches in diameter, directly beneath the tripod and surrounded the Pythia. Some modern scholars have suggested that the chewed laurel leaves might have been responsible for her altered state of consciousness, and that the fumes came from a natural source beneath the ground. However, we now know that no such source exists and that laurel is not a hallucinogen. The author of this article has suggested that the "noxious fumes" probably came from *Cannabis sativa* leaves burning in a secret furnace directly beneath the *manteion*, and that it was their hallucinogenic effect that put the Pythia into a trance. Unfortunately, all evidence of such a furnace has long since disappeared, and, until further research is done on the charring in the interior of the hole, this must remain a tentative hypothesis.

In any case, after the petitioner posed his question, the Pythia babbled incoherently. Her random utterances were then reshaped by the Delphic priests into coherent, albeit cryptic "responses," which frequently reflected current political

realities or the size of the gift the petitioner or his city had made to the oracle.

In addition to the Temple of Apollo, the surviving ruins of which date from the fourth century B.C.E., when the oracle was at the height of its importance, Delphi includes several other temples, a theater, and the aforementioned treasuries. Although it declined steadily during the Roman period (after 150 B.C.E.), and especially after the spread of Christianity in the fourth century, the oracle remained a sacred place in the eyes of both the Romans and the Greeks, and it survived until 390, when the Temple of Apollo was finally closed by the Roman emperor Theodosius I (347–395), along with other pagan sites in Greece, including the Parthenon.

The Temple Mount

Our next two sacred places, which still possess a profound spiritual aura, are in the city of Jerusalem, a city sacred to three world religions, Judaism, Christianity, and Islam, which, between them, command the devotion of well over two-thirds of the world's population. By the beginning of the Bronze Age (c. 3500 B.C.E.) what was to become Jerusalem had

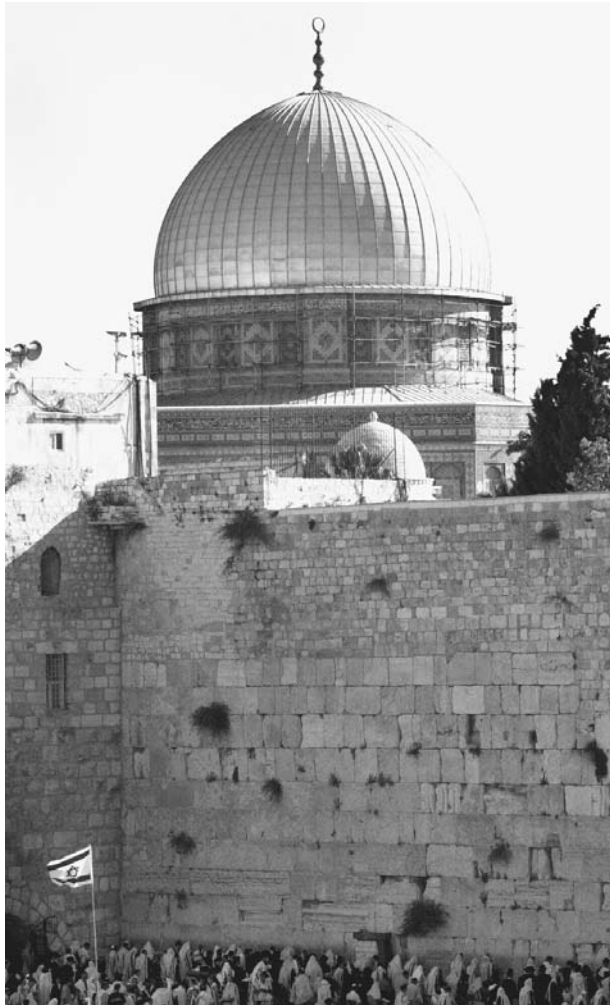

Jews at the Western Wall of the Temple Mount in Jerusalem. The Western Wall is all that remains of the Second Temple, which was destroyed in 70 B.C.E. It serves as a gathering place for Jews to lament the Temple's loss. AP/WIDE WORLD PHOTOS

been conquered by a Canaanitic people known as the Jebusites. By around 1400 Egyptian records indicate that the site was called *Urusalim* (Heb., *Yerushalayim*). However, the history of Jerusalem as we know it begins with the Hebrew conquest of the region around 1250. Around 1000 King David managed to capture the city from the Jebusites, brought the Ark of the Covenant from *Qiryat Ye'crim*, where it had been kept, and installed it in a tabernacle. He also began construction of a modest temple, which was vastly enlarged and completed by his son and successor, King Solomon.

Although Jerusalem is studded with monuments sacred to the three religious traditions that venerate the city, in what follows we shall focus on two locations that loom above the rest: the first is the Temple Mount, which today includes the Dome of the Rock, the al-Aqsa Mosque, and the Western Wall or "Wailing Wall," the last remnant of the Second Temple; the second is the Church of the Holy Sepulcher.



Church of the Holy Sepulcher, Jerusalem. The most well-known and popular Christian pilgrimage site, the Church of the Holy Sepulcher, was originally constructed in 330, but was destroyed some three hundred years later and rebuilt in the thirteenth century. © CARMEN REDONDO/CORBIS

The Temple Mount, also known as Mount Moriah and, to Muslims, as *Haram-esh-Sherif*, was initially the site of Solomon's Temple, completed in the early tenth century B.C.E., which was totally destroyed by the invading Babylonians in 586. The Second Temple was begun on the same site shortly after 539, when the Persians liberated the Jews from captivity. It was ravaged several times in the ensuing centuries, most notably by the Syrian king Antiochus IV in 168 B.C.E. In 4 B.C.E. the Second Temple was extensively restored by Herod the Great, only to be destroyed permanently by the Romans in 70 C.E. in the wake of the great Jewish Revolt of 69–70.

The dimensions and appearance of both temples were roughly similar. The First Temple reached the zenith of its development under King Hezekiah (c. 715–687 B.C.E.). By that time it had become a prime place of pilgrimage for Jews from both Israel and Judah. The most sacred part of the temple was the "Holy of Holies," where the Ark of the Covenant, a box, traditionally 2.5 cubits (3 feet, 9 inches) in length and 1.5 cubits (2 feet, 3 inches) in height, that contained the Tablets of the Law (the Ten Commandments) which Moses had received atop Mount Sinai, was kept. The Holy of Holies was located deep inside the principal building and could only be approached by the hereditary priests, that is, the descendants of Aaron, the first Jewish high priest and traditional founder of the Hebrew priesthood.

The Second Temple, especially as restored and enlarged by Herod the Great, was even larger and more impressive than Solomon's Temple, although it still served fundamentally to house the Ark and the Tablets of the Law. It was in the Second Temple that Jesus disputed with the Pharisees and later

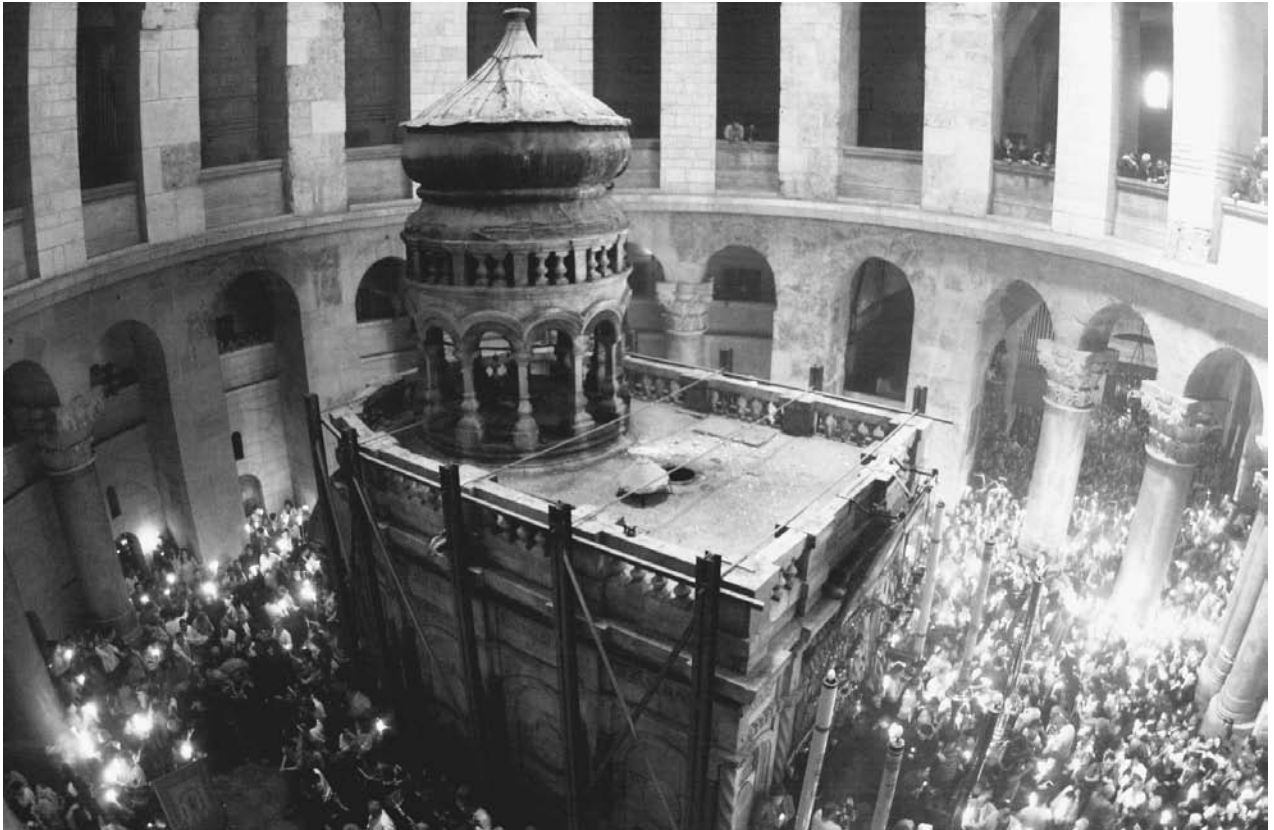

Worshippers around the tomb of Christ in the Church of the Holy Sepulcher. The Romans built the Church of the Holy Sepulcher on what they believed was Golgotha, the site of the crucifixion of Jesus. AP/WIDE WORLD PHOTOS

kicked over the tables of the money changers in the courtyard. However, save for a handful of artifacts looted by the Romans—a menorah, or sacred seven-branched candelabra, a shofar, or ritual horn, and some cups and other vessels, images of which were carved on the Arch of Titus in Rome—most of the Second Temple’s furnishings, including the Ark and its sacred contents, were lost forever when the building was razed in 70 C.E. (According to some legends, the Ark of the Covenant managed to survive the catastrophe, and several sites have been suggested as its ultimate resting place, including one in Ethiopia; this was the theme of the film *Raiders of the Lost Ark*.)

However, the Temple Mount remained, as did the aforementioned Western Wall, better known as the “Wailing Wall,” where Jews still come to pray and lament the temple’s loss. And the Temple Mount also came to occupy an extremely important position in Islam as well. Indeed, it is the third most important pilgrimage site, outranked only by Mecca and Medina. The reason is that when the prophet Muhammad died in 632 C.E. he ascended to heaven astride his horse, but not before stopping briefly at the Haram esh-Sherif, or Temple Mount, more specifically on the rock traditionally believed to be the one on which Abraham offered the sacrifice of his son Isaac to God. Indeed, devout Muslims believe that the imprint of one of Muhammad’s horse’s hooves can still be seen on this rock. A sanctuary, called the Dome of the Rock, was built

between 691 and 692 C.E. by the Umayyad caliph ‘Abd al-Malik to mark this sacred spot. Originally its domed roof was covered with gold leaf, although in 1962 the gold was replaced by gold-colored anodized aluminum. Nearby is the sacred al-Aqsa Mosque, which has also figured importantly in recent disputes between the Israelis and the Palestinians.

The Church of the Holy Sepulcher

The second sacred site in Jerusalem is the Church of the Holy Sepulcher, believed to have been constructed on the site of Jesus’ crucifixion and interment. In some respects, as the historian of religion Jonathan Z. Smith points out, the Church of the Holy Sepulcher, the original version of which was built by Helen, mother of the Roman emperor Constantine, in 330, can be regarded as the successor to the Second Temple. Indeed, it immediately became the single most important Christian pilgrimage site (the second was the equally ancient Church of the Nativity in Bethlehem) and thus carried on the tradition that Jerusalem was a supremely sacred place among adherents of the new religion.

The original church, built in the Byzantine style, was destroyed by the Persians in 614. It was rebuilt in the same style shortly thereafter and, although severely damaged by an earthquake in 808, managed to survive until the Fatimid caliph al-Hakim destroyed the building again in 1009 and along with it the cave that was the presumed tomb of Jesus. In 1244 the



Pyramid of the Sun at Teotihuacán, photographed c. 1931. The Aztec Pyramid of the Sun in the Valley of Mexico contains six man-made chambers beneath its base which were not discovered by archeologists until the twentieth century. HULTON ARCHIVE/GETTY IMAGES

Crusaders rebuilt the church, in the Romanesque style, and it has remained essentially intact ever since, despite several attempts at restoration.

In the interior, the site of Golgotha, the traditional location of Jesus' crucifixion is marked by a Greek Orthodox chapel, and his tomb, or Sepulcher, called in Greek the *Anastasis*, or "Place of Resurrection," is located beneath a rotunda surrounded by columns supporting an ornamented, domed roof. The Sepulcher itself is marked by a structure known as the Edicule, which is believed to be directly above the cave destroyed in 1009.

A unique—and not always happy—feature of the Church of the Holy Sepulcher is that it is jointly owned by three major Christian denominations: the Greek Orthodox, the Armenian Orthodox, and the Roman Catholic Churches. Other communities—the Egyptian Coptic, the Ethiopian Orthodox, and the Syrian Orthodox Churches—also possess certain rights and small properties in or near the building. For example, the Copts share a small area on the roof. The rights and privileges of all of these communities are protected by the Status Quo of the Holy Places (1852), as guaranteed in the Treaty of Berlin (1878), although the several communities jealously guard their spaces and rarely agree on even the smallest matters of basic maintenance. Indeed, at various times the secular authority, as of the early 2000s wielded by the State of Israel, has been

forced to intervene in these disputes and subsidize needed repairs and renovations.

Nevertheless, despite the recent political upheavals in the region and the ongoing squabbles among its owners, the Church of the Holy Sepulcher remains the foremost Christian pilgrimage site in the world and is indeed a worthy successor to its vanished neighbor, the ancient Hebrew Temple.

The Pyramid of the Sun at Teotihuacán

The Pyramid of the Sun at the great pre-Columbian site of Teotihuacán in the Valley of Mexico is an awe-inspiring sight. One of the largest man-made constructions in the Americas—a continent dotted with enormous pre-Columbian pyramids—the Sun Pyramid stands at 489 feet (149 meters) by 551 feet (168 meters) at its base, 148 feet (45 meters) in height. Its graceful volumetric construction echoes the shape of the mountain behind it, encouraging viewers to perceive the man-made shape as a metaphorical echo of the enormous natural form that dominates the valley.

The Pyramid of the Sun is one of a series of impressive pyramids, temples, and plazas that line the Avenue of the Dead, the main north-south axis of the central precinct of Teotihuacán, one of the largest cities of the world during the first millennium C.E., when it boasted a population of 100,000 to 150,000. The city began its rise to prominence around 1 C.E.; the pyramid began to be constructed around 150 C.E., and was repeatedly expanded through multiple construction phases. Abandoned rather suddenly after 600, the enormous ruins of this urban center nonetheless continued to influence Mexican life for centuries thereafter. The conquering Spanish learned of the site from the Aztec ruler Montezuma, who regularly visited there, considering it a holy place. Tourists, both Mexican and international, continue to be moved by its grandeur, and the U.S.-based artist Michael Heizer, son of an archaeologist, has gained international prominence for his abstract earthworks, which echo the majestic form of the pyramid he saw as a child.

The full significance of the Pyramid of the Sun only became clear to archaeologists in the early 1970s, when a tunnel was accidentally discovered at the foot of the main staircase. This tunnel leads directly toward the center of the pyramid's base, where six chambers or caves were discovered. Originally believed to be natural springs, these "caves" are now thought to be completely man-made, and to date back to the earliest date of the pyramid's construction.

In the religions of the ancient Americas, perhaps more so than in the other great religious traditions described here, sacred places loomed especially large in the spiritual imagination. Widespread traditions of ancestor worship invested the tombs of the dead with great power both as the sources of political and social legitimacy for the living, and as sites imbued with religious sanctity and powerful with the sources of life, fecundity, and health not only for human descendants, but for the ecosystem more generally. Features of the natural landscape, such as springs, caves, and mountain peaks, were likewise invested with great sacral significance, and were often



The Great Mosque at Mecca, Saudi Arabia, photographed 1973. Mecca, the birthplace of the Prophet Muhammad, is the most sacred place in Islam. © BETTMANN/CORBIS

believed to be original places from which the very first ancestors emerged. In Mesoamerica in particular, the idea of a hidden source of water inside a cave was closely associated with the birth of ancestors and with the control of rainfall, the circulation of water, the origins of time, and the source of life. This complex of ideas was one of the oldest and the most pervasive religious concepts, traceable far back in time, and shared across the many language and cultural groups of the region. The six secret caves under the Pyramid of the Sun may make specific reference to the origin myth of ruling lineages, but more importantly, in constructing their largest and most impressive temple-pyramid around a circle of secret caves containing canalized water, the builders of the Pyramid of the Sun tapped into this most primordial of ancient American ideas about sacred space.

Mecca

The most sacred place in Islam is the city of Mecca (or Makkah in Arabic), which is located in the western part of Saudi Arabia about seventy-five miles (121 kilometers) inland from the port city of Jidda in Hejaz province. Although it was clearly a sacred place for centuries before the time of Muhammad (c. 570–632 C.E.), and includes the famous Ka'ba, a cube-shaped building said to have been built by the Hebrew patriarch Abraham and in whose southeastern corner can be found the venerated "Black Stone," supposedly given to Abraham by the Angel Gabriel, the city's sacredness in Islam

derives primarily from the fact that it was the Prophet's birthplace.

Muhammad lived peacefully in Mecca, managing his wife's business affairs, until he was about forty years of age, when he began receiving revelations from God via the Angel Gabriel. He soon began to preach his new faith, supported by his devoted wife Khadijah and a growing number of followers. But after his wife died, he began to struggle against opposition from several quarters and, in the year 622, he was forced to flee to the nearby city of Medina one step ahead of a plot to assassinate him. This retreat, called in Arabic the *Hejira*, or "flight," later became the base-year for the Muslim calendar.

Eventually Muhammad returned to Mecca in triumph, and after his death in 632, his revelations were gathered together into the Muslim holy book, the Koran. These revelations included the "Five Pillars of Islam," one of which asserts that every Muslim should make a pilgrimage, called the hajj, to Mecca at least once in his or her lifetime. Thus the city annually plays host to two million Muslims from all over the world. Wearing a white robe called an *ihram*, the pilgrims are expected to circle the Ka'ba seven times, to run another seven times between two hills, Safa and Marwa, to spend from noon until sunset on a hill in the valley of Arafat, to throw stones at the devil in the valley of Mina, and to sacrifice sheep and goats. The hajj occurs only in the first two

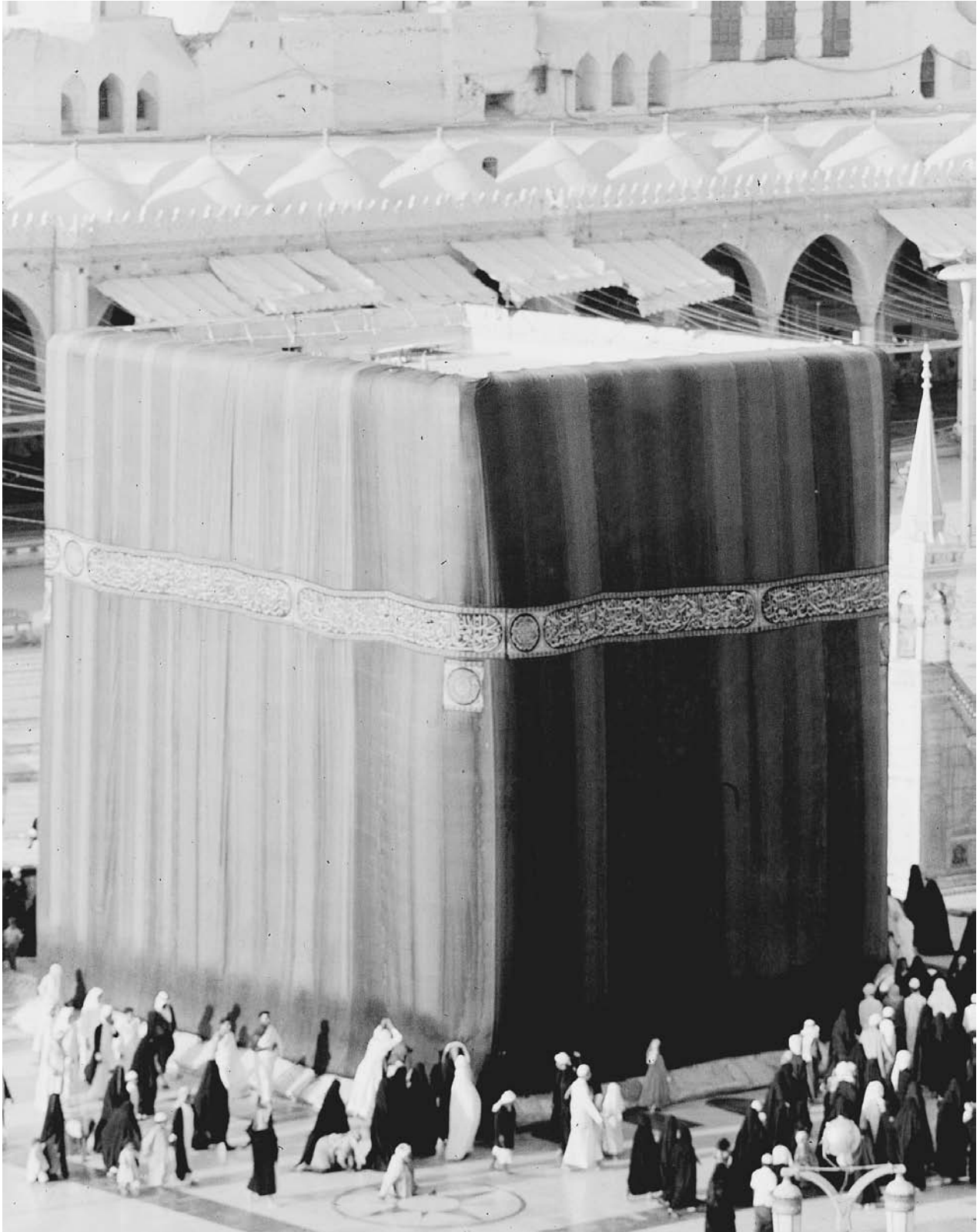

Moslems make the ritual circuit of the Ka'ba at Mecca. One of the sacred Five Pillars of Islam is the *hajj*, or pilgrimage to Mecca. More than two million Moslems make the journey to the city annually. THE ART ARCHIVE/HARPERCOLLINS PUBLISHERS

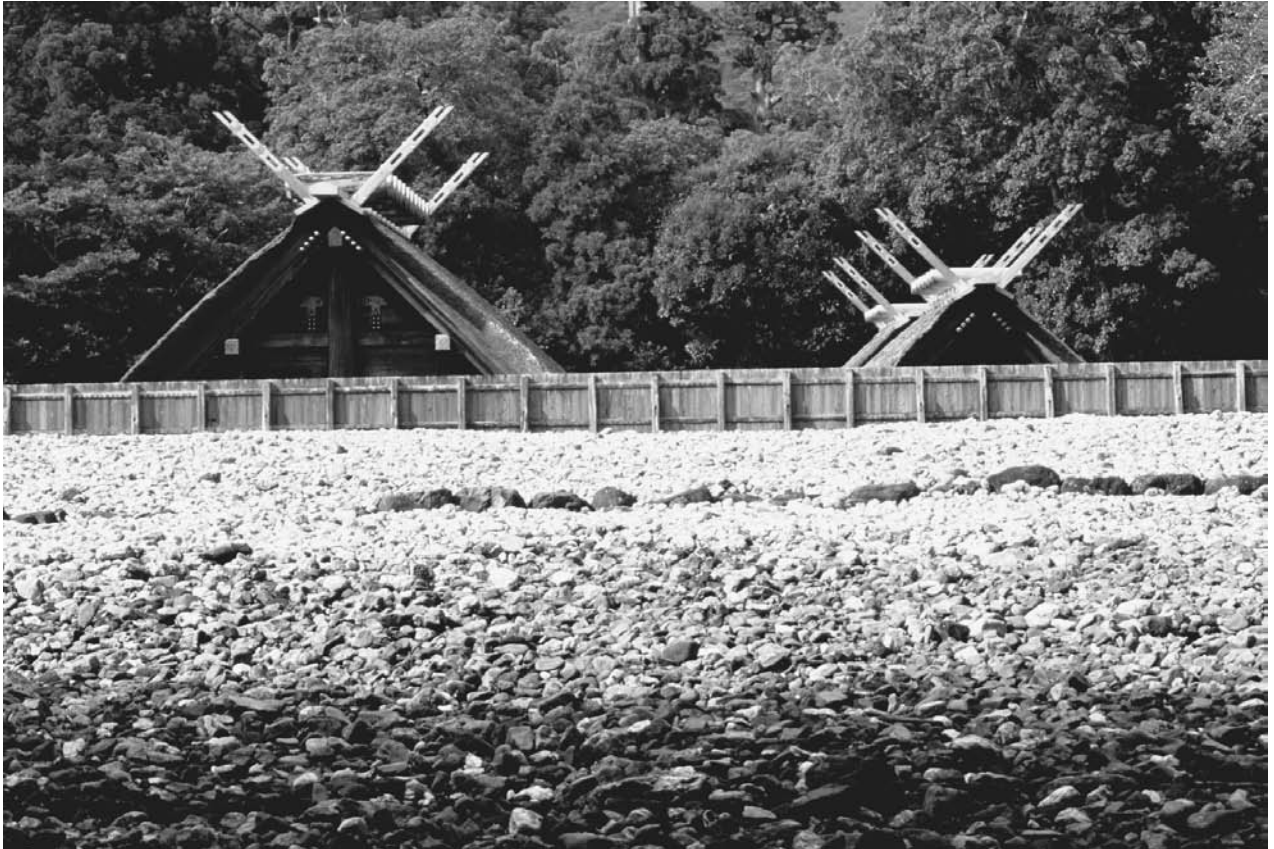

Naiku Shrine at Ise-Jingu, Japan. The inner shrine at Ise, the Naiku, is considered the final resting place of the Japanese Sun Goddess Amaterasu Omikami. Both the inner and outer shrines are destroyed and precisely rebuilt every twenty years. © MICHAEL S. YAMASHITA/CORBIS

weeks of Dhu al-Hijja, the last month of the Muslim lunar year, and during the time they are in Mecca and its environs the pilgrims are expected to observe some strict taboos, including abstinence from sexual activity. Those who make this pilgrimage are entitled to add the title *hajji* to their names.

Thus, like Jerusalem, Mecca has become a worldwide place of pilgrimage. It is clearly a place apart, a place brimming with spirituality and sacredness, despite the fact that only Muslims are permitted to visit it.

Ise

Our final example of an important sacred place is the Ise-Jingu, the most sacred shrine in Shinto, the indigenous belief system of Japan. Located in the city of Ise in Mie prefecture, about an hour's train ride south of Nagoya, it is dedicated to the Sun-Goddess Amaterasu Omikami, from whom the imperial family is traditionally believed to descend through her grandson, Honinigi, who, according to the *Kojiki* (712 C.E.), the most ancient Japanese mythological text, descended to Earth and extended his grandmother's sovereignty to the "Reed Plain," that is, the mortal realm. Actually, there are two major shrines at Ise. The Outer Shrine is dedicated to Toyouke, the *kami*, or god, of harvests and goods. But it is the Inner

Shrine, or Naiku, that is most important to the Japanese people, as it is there that Amaterasu is enshrined.

Traditionally, the Naiku is said to date from the third century C.E., and the extremely simple architecture reflects the wooden thatched-roof storehouses of the late prehistoric period. However, what sets the Ise complex apart not only from all other Shinto shrines, but from sacred places elsewhere in the world, is that all of the shrine buildings are torn down and rebuilt exactly as they were every twenty years (the most recent rebuilding was in 1993). Thus, the Ise shrines are at once extremely old—the rebuilding cycle began in the eighth century—and very new. And the same holds for Amaterasu and Toyouke, who are ritually rejuvenated with each rebuilding.

Each year, the emperor is expected to make a pilgrimage to Ise to honor his ancestor and report to her about what has happened to him and the realm since his last visit. But he is not the only pilgrim. A great many Japanese from all walks of life visit Ise annually to worship at its shrines and do honor to the Sun Goddess. Indeed, in the mid-nineteenth century, as Japan began to open up to the outside world, several Ise-related cults swept across the country and impelled thousands of Japanese peasants to leave their villages and head for the Ise-Jingu. While the current Ise pilgrimages are far less

frenziered, the shrine remains central not only to Shinto, but to Japanese culture per se.

Conclusion

These, then, are eight of our planet's premier sacred places. While they are very different from one another in a great many respects, all share at least one common quality: an intense spirituality that makes them special. Some paranormal researchers have suggested that they are inherent "power spots," located at the confluence of what have been called "ley lines," that is, energy-charged paths that presumably connect major ancient and prehistoric sites. While most orthodox scientists scoff at this notion, one cannot help but wonder whether these six locations and others like them do have an inherent spiritual power that sets them apart and renders them sacred, not only to those who built them, but to subsequent generations and cultures.

See also *Religion; Sacred Texts; Visual Order to Organizing Collections.*

BIBLIOGRAPHY

- Asali, Kamil J., ed. *Jerusalem in History: 3,000 B.C. to the Present Day*. Rev. ed. London and New York: Kegan Paul International, 1997.
- Ben-Dov, Meir. *In the Shadow of the Temple: The Discovery of Ancient Jerusalem*. New York: Harper and Row, 1985.
- Ben Ibrahim, Sliman, and Étienne Dinet. *The Life of Mohammad: Prophet of Allah*. Secaucus, N.J.: Chartwell Books, 1990. First published in 1918.
- Brooks, Miguel F., ed. and trans. *A Modern Translation of the Kebra Nagast: The Glory of Kings*. Lawrenceville, N.J.: Red Sea Press, 1996.
- Bruce, F. F. *Israel and the Nations, from the Exodus to the Fall of the Second Temple*. Grand Rapids, Mich.: Eerdmans, 1963.
- Budge, E. A. Wallis. *A History of Egypt from the End of the Neolithic Period to the Death of Cleopatra VII, B.C. 30*. London: Kegan Paul, Trench, Trübner, 1902.
- De La Coste-Messelière, Pierre. *The Treasures of Delphi*. Paris: Éditions du Chêne, 1950.
- Fontenrose, Joseph E. *The Delphic Oracle: Its Responses and Operations, with a Catalogue of Responses*. Berkeley, Calif.: University of California Press, 1978.
- . *Python: A Study of Delphic Myth and Its Origins*. Berkeley: University of California Press, 1959.
- Hawkins, Gerald S., and John B. White. *Stonehenge Decoded*. Garden City, N.Y.: Doubleday, 1965.
- Kojiki*. Translated by Donald L. Philippi. Tokyo: University of Tokyo Press, 1968.
- Littleton, C. Scott. "The *Pneuma Enthusiastikon*: On the Possibility of Hallucinogenic 'Vapors' at Delphi and Dodona." *Ethos* 14 (1986):76–91.
- Long, David Edwin. *The Hajj Today: A Survey of the Contemporary Makkah Pilgrimage*. Albany: State University of New York Press, 1979.
- Parrot, André. *Golgotha and the Church of the Holy Sepulchre*. Translated by Edwin Hudson. New York: Philosophical Library, 1957.
- Ritmeyer, Leen, and Kathleen Ritmeyer. *Secrets of Jerusalem's Temple Mount*. Washington, D.C.: Biblical Archaeology Society, 1998.
- Shah, Idries. *Destination Mecca*. London: Octagon, 1971.
- Smith, Jonathan Z. *To Take Place: Toward Theory in Ritual*. Chicago: University of Chicago Press, 1987.
- Tange, Kenzō, and Noboru Kawazoe. *Ise, Prototype of Japanese Architecture*. Cambridge, Mass.: M.I.T. Press, 1965.
- Tompkins, Peter. *Secrets of the Great Pyramid*. With an appendix by Livio Catullo Stecchini. New York: Harper and Row, 1971.
- Watanabe, Yasutada. *Shinto Art: Ise and Izumo Shrines*. Translated by Robert Ricketts. New York: Weatherhill/Heibonsha, 1974.

C. Scott Littleton

SACRED TEXTS.

This entry includes two subentries:

Asia

Koran

According to Buddhist tradition, questions regarding doctrinal authenticity first arose during the lifetime of the historical Buddha (c. fifth century B.C.E.). When asked how his followers should distinguish the true "word of the Buddha" (*buddha-vacana*) from false teachings, he is reported to have said, "whatever is well spoken is the word of the Buddha." Later commentators understood this to mean that if a doctrine or practice accords with the Buddhist goals of liberation from cyclic existence (*samsara*) and the alleviation of suffering (*dukkha*), and if it is concordant with the core doctrines of Buddhism, then it can be adopted and practiced by Buddhists, regardless of who originally taught it.

A more restrictive approach to questions of textual authority was presented in the Great Instruction Discourse (*Mahapadesa-sutta*, attributed to the Buddha but probably written after his death), in which he advises his followers to compare contested teachings with the corpus of discourses known to have been spoken by the Buddha. If a teaching or text accords with the oral instructions (*Pali, sutta*; Sanskrit, *sutra*) and the rules for monastic conduct (*vinaya*), then it can be accepted as authoritative. It should be noted, however, that the text assumes that only well-educated senior monks—not ordinary Buddhists who lack a thorough knowledge of the Buddha's teachings—will be able to make such determinations.

Shortly after the Buddha's death, a group of five hundred of his most advanced disciples convened to definitively settle the limits of Buddhist teaching. All were arhats, men who had eliminated mental afflictions and who would attain nirvana at the end of their lives. It was assumed that such people would not be hampered by faulty memories or sectarian biases. Ananda—who had been the Buddha's personal attendant and had been present at all of his discourses—was responsible for reciting the oral discourses, while Upali recounted the Buddha's instructions on monastic discipline. After the recitation was concluded, the canon was declared closed, and the assembled arhats agreed that no new teachings would be recognized as the "word of the Buddha."

Contemporary Western scholars have questioned the historicity of the “first council,” but the story is accepted as fact by the Theravada school, the dominant Buddhist tradition in Southeast Asia, which views it as an indication of the validity of its canon. This is written in an Indic language called Pali and is believed to have been definitively codified by the five hundred arhats. It is organized into three sections, called “baskets” (*pitaka*): Vinaya *pitaka*, which was concerned with rules for Buddhist monks and nuns; Sutta *pitaka*, the Buddha’s discourses on doctrine and practice; and Abhidhamma *pitaka*, containing scholastic treatises summarizing and explicating Buddhist doctrine.

Later Additions to the Buddhist Canon

Despite the confident pronouncement by the participants at the first council that the canon was closed, several centuries after the passing of the Buddha new texts began to appear in India that carried the title of “sutra,” purportedly spoken by the Buddha during his lifetime. These were part of a new movement that referred to itself as “Mahayana” (Greater vehicle) and that characterized its opponents as “Hinayana” (Lesser vehicle). Proponents of the Mahayana sutras claimed that their texts superseded those of their rivals and were of “definitive meaning” (*nitartha*), while those of the previous canons were relegated to the status of “interpretable meaning” (*neyartha*). The opponents of Mahayana, for their part, categorically rejected these new texts as forgeries, and pointed out that they differed significantly from those of the earlier canon and contained new doctrines and practices that were not attested in the earlier texts. The Mahayanists responded by claiming that their sutras had been taught by the Buddha but were only revealed to his most advanced disciples.

Some Mahayana sutras set out hermeneutical principles that could be used to differentiate which texts are definitive and which are interpretable. According to the Teaching of Aksayamati Sutra (Aksayamati-nirdesa-sutra), which became normative for the Middle Way (Madhyamaka) school, the differentiating factor is doctrinal content: those texts that discuss the final nature of phenomena are definitive, while all others are of interpretable meaning. The final nature of phenomena is said to be their emptiness (*sunyata*) of inherent existence (*svabhava*).

Another hermeneutical schema was propounded by the Sutra Explaining the Thought (Samdhinirmocana-sutra), which became the primary scriptural source for the Yogic Practice (*Yogacara*) school. In this text, the Buddha is presented as claiming that he taught his doctrines in three cycles, or “wheels of doctrine” (*dharmacakra*). The “first wheel” contains basic Buddhist doctrines that are contained in the early canon, which were taught for beginners and were not definitive. In the “second wheel” the literal interpretation of these doctrines was rendered problematic by the declaration that all phenomena—including Buddhist teachings and practices—are empty of inherent existence, and so the doctrines of the early canon lack the privileged truth status that conservative Buddhists had attributed to them. The “third wheel,” represented by the Sutra Explaining the Thought, differentiates interpretable and definitive teachings and provides hermeneutical guidelines by

which Buddhists (or at least those who accept them as normative) can differentiate the two.

The canonical situation of Indian Buddhism became even more confusing in later centuries when a new group of texts began to appear, again claiming to have been spoken by the Buddha. These were called “tantras” and contained significant innovations in doctrine and practice, although the basic path was that of the Mahayana. Like the Mahayana sutras before them, they claimed to supersede previous teachings and to represent the final “word of the Buddha” on doctrine and practice.

Regional Transmission

The profusion of canonical, protocanonical, and deutero-canonical literature in India presented significant difficulties for Buddhists in other Asian countries as the religion spread. Scholars of the tradition commonly identify three primary trajectories in the diffusion of Buddhism: Southeast Asian Buddhism, East Asian Buddhism, and Northern Buddhism.

According to tradition, Buddhism was first established in Southeast Asia by a mission led by Mahinda, a Buddhist monk who was the son of the Indian emperor Aśoka (ruled 272–236 B.C.E.). After arriving in Sri Lanka, Mahinda reportedly converted its king to Buddhism, and the two founded the Mahavihara, the first Buddhist monastery outside of India. It became the seat of Buddhist orthodoxy in Southeast Asia for millennia. The dominant Buddhist tradition in the region is Theravada (Teachings of the Elders), which prides itself on its conservatism and adheres to the Pali canon. According to mainstream Theravada, their canon contains the only true “word of the Buddha,” and all other purported teachings are spurious.

East Asian Buddhism mainly arrived via trade routes linking India to China and the rest of the region. Several of the oasis cities along these routes had established Buddhist centers, and these became a conduit by which texts, doctrines, and practices moved from India to China, and from there to Korea, Japan, and Vietnam.

The first outpost in the transmission process was a translation bureau established in the Chinese capital of Loyang in 148 C.E. by the Central Asian monk An Shigao. Together with a team of other Central Asian monks, he began rendering Indic texts into Chinese. The process of translation intensified in later centuries, and two primary techniques were adopted by Chinese translators: some coined new terminology for Indic technical terms that had no equivalents in Chinese, while others developed a system called “matching meanings” (*ke-yi*), in which they appropriated terms (mainly from Daoism) that approximated Indic originals.

Both of these approaches had inherent problems. Translators who opted for the creation of a new technical vocabulary often ended up with neologisms that sounded odd to Chinese readers and that had little resonance for them. While they might be technically accurate, literate Chinese often perceived them as evidence of the foreign (and inferior) origins of Buddhism and its unsuitability for Chinese. The practice of



Statue of Buddha with offerings, Munsusa Monastery, South Kyoongsang, South Korea. After the Buddha's death, a council of his disciples met to finalize and close the canon of his teachings. Several centuries later, however, new texts began to be presented as doctrines that Buddha had put forth during his lifetime. JOHN POWERS

“matching meanings,” on the other hand, produced texts with terms that were well known to Chinese and that appeared to contain familiar doctrines, but there was considerable slippage between the original Indic terms and their Chinese equivalents. For example, in some texts the Sanskrit term *nirvana*—liberation from the world and from rebirth, which is the result of the elimination of mental afflictions and the cultivation of wisdom and insight—was commonly rendered by the Daoist term “nonaction” (*wu wei*), which is the ideal way of life of the Daoist sage, who lives in accordance with the rhythms of the Dao and avoids micromanaging affairs.

Such terminological ambiguity was compounded by the problems of textual transmission to East Asia. Buddhism only gradually gained adherents, and for centuries texts flowed into China haphazardly, brought mainly by pilgrims or missionary monks. The difficult terrain of the deserts of Central Asia and the vast distances covered by the trade routes limited what individual travelers could carry with them. Missionaries would bring texts that were important to them and seldom attempted to carry a representative sampling of Indian Buddhist literature. As a result, commentaries sometimes arrived in China before the texts on which they commented, and polemical texts arrived before those they were attacking. The Chinese Buddhist canon contains a plethora of texts from

various regions of India, various schools and traditions, and from different periods of time. Many sutras exist in several variants, which are dated in the Chinese canon. These have provided scholars with evidence for when certain doctrines and practices developed in India, because later versions retrospectively added material as it became established in India. In addition, the Chinese canon contains portions of other Indian canons, which have revealed some of the doctrines and practices of schools that were influential at a certain point but later died out.

China was the conduit from which Buddhism was disseminated to the rest of East Asia. It first traveled to Korea, and from there it was exported to Japan and Vietnam. The Korean Buddhist canon is derived from the Chinese canon, and the canonical texts used in Japanese and Vietnamese Buddhism also derive from Chinese translations.

The transmission of Buddhism to Tibet and Mongolia was significantly different from that into East Asia. Like the Chinese, Tibetans adopted Mahayana Buddhism, but tantra was much more influential than in China. Also, while China had an advanced culture at the time when it first encountered Buddhism, Tibet was relatively backward culturally. Despite this, it was an expanding military power, and as it spread outward from the Tibetan plateau it encountered other civilizations that were

far more advanced in science, technology, and culture. One result of this was that the Tibetan kings of the Yarlung dynasty (so called because its headquarters were in the Yarlung Valley of central Tibet) decided to import elements of the civilizations beyond their borders.

Beginning in the seventh century, the Yarlung kings converted to Buddhism and began a process of transforming Tibetan society. According to tradition, the first of the “dharma kings” (*chos rgyal*) was Songtsen Gampo (Srong btsan sgam po; c. 618–850), who is said to have been a physical emanation of the Buddha Avalokitesvara, who embodies compassion and is the patron Buddha of Tibet. He married princesses from Nepal and China, both of whom are said by tradition to have been emanations of the Buddha Tara, and the three worked together to convert the Tibetans to Buddhism. Although this is the consensus of histories written centuries later by Buddhist clerics, there is little contemporary evidence that Songtsen Gampo had any real interest in Buddhism.

Some of his successors, however, were clearly devout Buddhists, and they allocated significant resources to the importation of Buddhism. Tibetan students were sent to the great seats of Buddhist learning at monastic universities like Nalanda and Vikramasila, and Indian masters were invited to Tibet to spread the faith. During the early period of transmission (*snga dar*), translation committees were established, often with government funding. Their task was to render the vast corpus of Indian Buddhist literature into Tibetan. Faced with the same translation issues that Chinese Buddhists had encountered earlier, the Tibetans opted for the development of a specialized vocabulary for Indian Buddhist technical terms. Many of these were Tibetan neologisms, such as the rendering of “passed beyond sorrow” (*nya ngan las ’das pa*) for the Sanskrit term *nirvana*.

During this early period, translation equivalents varied considerably, and when the Yarlung dynasty fell in 842, translation activity was largely suspended. It began again during the “second dissemination” (*phyi dar*), which was initiated by the arrival of Atisa (982–1054) in Tibet in 1042. During this period translation bureaus were reconstituted, and standard Sanskrit-Tibetan lexicons were created in order to standardize terminology. In the fourteenth century, the Tibetan scholar Bu-ston (Bu ston rin chen grub; 1290–1364) reportedly codified the Tibetan canon by poring through the various manuscripts of translations of Indian Buddhist texts and selecting those he deemed to be the most accurate. These were arranged into two groupings: Kangyur (bKa’ ’gyur, literally “translations of teachings”) and Tengyur (bsTan ’gyur, literally “translations of texts”). The first section contained Indian Mahayana sutras and tantras, as well as texts on monastic discipline. The “Translations of Texts” section includes Indian philosophical texts and commentaries on sutras, along with some indigenous Tibetan works and translations of Chinese treatises. Most of this literature was imported from the libraries of the great monasteries of northern India, but at the same time tantric teachings, both written and oral, came to Tibet, mostly transmitted by Indian masters and their students. These often

achieved a deuterocanonical status within tantric lineages, and many are still widely circulated and discussed.

During the early period of transmission of Buddhism, Tibetans mainly concentrated on translating Indic texts, but as they grew more confident in their understanding of the tradition, a vast corpus of indigenous works was composed. Over time, four main orders formed in Tibet: Nyingma (rNying ma), Kagyü (bKa’ rgyud), Sakya (Sa skya), and Geluk (dGe lugs). Each of these in turn produced deuterocanonical texts, and the Nyingma, Kagyü, and Sakya orders have compiled their own canons. The Gelukpa order mainly relies on the works of its founder Tsong Khapa (Tsong kha pa bLo sang grags pa; 1357–1419) and his disciples Kaydrup (mKhas grub rje) and Gyeltsap (rGyal tshab rje). All of these traditions continue to revere the Indic texts contained in the normative Buddhist canon, but in practice they are seldom studied today; instead, Buddhist students and scholars tend to rely on the works of their own traditions, supplemented by oral instructions by their teachers.

Questions regarding authenticity and interpretation remain important in Buddhism today. In most of Asia, the prime criterion for judging the validity of a given text is whether or not there is an Indian original. Given the vast size of the various Buddhist canons, however, this provides little help in deciding which texts or teachings should be regarded as definitive. Most Buddhist traditions base their decisions on what has been handed down to them by their respective lineages. Most of these privilege a particular text (or set of texts) and use it as the criterion for determining authoritativeness. Several East Asian lineages in particular have devised elaborate classification schemes that rank Buddhist teachings hierarchically, with those of their preferred text(s) on the top. It is rare for individual Buddhists to take the time to pore over the voluminous literature in their respective canons, and most interpret texts and doctrines in accordance with the traditions of their lineages.

See also Buddhism; Daoism; Zen.

BIBLIOGRAPHY

- Bond, George D. *The Word of the Buddha: The Tipitaka and Its Interpretation in Theravada Buddhism*. Colombo, Sri Lanka: Gunasena, 1982.
- Collins, Steven. *Nirvana and Other Buddhist Felicities*. Cambridge, U.K.: Cambridge University Press, 1998.
- Lancaster, Lewis. “The Oldest Mahayana Sutra.” *The Eastern Buddhist* 8 (1975): 30–41.
- Lopez, Donald S., Jr., ed. *Buddhist Hermeneutics*. Honolulu: University of Hawaii Press, 1988.
- Powers, John. *Hermeneutics and Tradition in the Samdhinirmocana-sutra*. Leiden, Netherlands: E. J. Brill, 1993.
- Ruegg, David Seyfort. “Purport, Implicature, and Presupposition: Sanskrit *Abhiprāya* and Tibetan *Dgons pa/Dgon gZi* as Hermeneutical Concepts.” *Journal of Indian Philosophy* 13 (1985): 309–325.
- Timm, Jeffrey R., ed. *Texts in Context: Traditional Hermeneutics in South Asia*. Albany: State University of New York Press, 1992.

John Powers

KORAN

The English word *Koran* comes from the Arabic *qur'an*, most likely meaning “recitation” or “reading,” although some Muslim commentators consider it simply the name of the scripture, while some others trace its etymology to a verb that means “to collect.” The word *qur'an* is probably related to the Syriac word *qaryānā*, which in pre-Islamic Christian usage meant a reading or a recitation from memory in the context of worship and prayer. The Koran is accepted by Muslims as the corpus of revelations given through Muhammad in the Arabian towns of Mecca and Medina between 610 C.E. and his death in 632 C.E. It is the revelations themselves that proclaim the Prophet's authority. At the same time, the revelations are accepted on the basis of his testimony.

The traditional biography of Muhammad portrays the first encounter of this forty-year-old merchant with God's messenger Gabriel in a mountain cave as a terrifying experience. He is commanded to recite, yet does not know how or what to recite. Indeed, for Muslims the illiteracy, or at least lack of education, on the part of the Prophet is a guarantee that the revelations were not composed by him, but have a divine origin. Over the ensuing twenty-two years, Gabriel teaches him the revelations that will eventually become the text at the heart of Muslim life and faith. It came initially not as a completed text but piecemeal, as the voice of God addressing the Prophet and his hearers according to the actual situation in which they found themselves.

Although it is common to think of the Koran as an elaborately calligraphed text, and in spite of the fact that it refers to itself as scripture (*kitab*), the name *qur'an* underlines in several senses the centrality of its oral character. It comes to the Prophet orally, dictated by the angel, who assures that it is committed to memory. It is delivered to the people orally as it is revealed piece by piece. Even after the text was transcribed on the basis of oral testimony and given standardized form probably some twenty years after the death of the Prophet, it continued to live principally in oral form, memorized and recited by the community. The oral tradition rather than ancient manuscripts formed the basis of the standard edition made in Egypt in 1924.

The Koran and Previous Scriptures

In its characteristically self-referential way, the Koran tells Muslims that they are to believe not only in what has been revealed through Muhammad, but also, and without distinction, in “what was revealed to Abraham, Ishmael, Isaac, Jacob, and the tribes, and what Moses and Jesus received, and what the prophets received from their Lord” (2:136). The Koran has a very clear idea of its place in the broader pattern of divine revelation: it contains essentially the same message as has been delivered by every prophet sent by God from the beginning of creation. Those who possess the earlier scriptures—the *ahl al-kitab*—recognize in the Koran the same truth (5:83). This was the first time the Arabs had been addressed by God in their own language, and Muslims consider the Koran the definitive and most complete version of the divine message currently available.

Even though in principle the other scriptures are to be believed, it is not clear whether or not the other communities are still in possession of the original message entrusted to them through their prophets. Charges of falsification and corruption of their scriptures, or at least of misinterpreting them, are often leveled against Christians and Jews.

The Koran addresses its hearers as though they are already familiar with the stories of the great biblical figures, commenting on them without retelling the narrative. In this the Koran sees itself acting as a reminder of the perennial revelation. It has often been noted that these figures are presented in the Koran with little of the detail and few of the distinguishing characteristics found in the biblical narratives. Early commentators of the Koran drew on the Bible and on other Jewish and Christian materials (referred to as *isra'iliyyat*) to explicate texts that were otherwise opaque.

History of the Koranic Text

There are several quite distinct senses in which one might speak of the history and prehistory of the text. For the believer, the Koran's prehistory is its preexistence in the heavenly realm: as God's speech, as part of the *umm al-kitab*, or “source of the scripture” (43:4) written on the heavenly *lahb mahfuz* (“Preserved Tablet”) (85:22). From the Preserved Tablet it descended as a whole to the lowest heaven on the Night of Destiny (97:1), whence it was transmitted to the Prophet as need and occasion required.

Non-Muslim scholarship, on the other hand, sifts the Koran in search of textual and conceptual parallels with the Bible, the Talmud, Christian apocrypha, and ancient near-eastern religions, hoping to discover there the prehistory of the text now known. However, this search for dependence has yielded little evidence to show that the Koran has relied on those texts, except to presuppose the broad lines of their narratives as background for its own teaching. For the believer, these echoes and similarities pose no difficulty, since the Koran makes no claim to novelty in its content, but rather asserts proudly the divine origin it shares with those earlier scriptures.

Historical setting. Another sense in which one might speak of the history of the text is in the attempt to determine the precise historical context that the text is addressing or, one might say, within which it is a player. Since the Koran itself has no narrative structure, and its chapters (*suras*) and verses (*ayat*, sing, *aa*) contain little or no indication of their historical context, various attempts have been made by Muslims and others to establish a chronological order for the revelations, and a context for each verse or group of verses. The basic division is between the revelations that took place in Mecca and those after the Emigration (*hijra*) to Medina. The Meccan verses are in their turn often divided into three subperiods. All this activity is at best speculative, though there does seem to be gradual development in style and thought that could be taken to mirror the changing circumstances of the Prophet's career. As the Koran came to be used as a source for the elaboration of law, it became increasingly important to establish context and chronology.

Most non-Muslim scholarship accepts along with Muslims that the Koran, whatever prehistory it might have, dates as a textual corpus to the time of Muhammad in Mecca and Medina. However, the years since the mid-1970s have seen a revisionist movement among historians of early Islam who take a radically critical approach to the historical evidence. These scholars, following the lead of John Wansbrough, suggest a later and more gradual process of canonization, taking place once the Arab conquerors had moved out of the Hejaz region of Arabia and encountered the sectarian milieu of Jewish and Christian Syria and Mesopotamia. Such a situation seems to them a much more probable setting for the Koran's particular range of concerns and styles. There is still considerable controversy over this question.

The written text. The history of the written text is also approached in various ways. Most Muslims would believe that the text currently available in print is precisely what was taught to the Prophet by Gabriel. Unexpectedly, perhaps, it is Muslim tradition itself rather than non-Muslim scholarship that throws most doubt on this simple approach. The tradition preserves accounts that assure the community that every word of the Koran was transcribed on whatever materials were to hand at the time of its revelation. However, it also contains accounts of disagreements about the content and pronunciation of the text even during the lifetime of the Prophet.

The official transcript of the text under the caliph 'Uthman (r. 644–656) seems to have been based on oral testimony. Even so it did not succeed in putting an end to variants, and the Koran has continued to be recited within a certain range of variation that came eventually to be agreed upon as canonically legitimate. The variant oral traditions themselves for the most part represent divergent ways of vowel-ing and so of pronouncing the original transcription, which contained only an incomplete consonantal skeleton. The script used in 'Uthman's transcription did not even distinguish all the consonants; one particular shape, for example, was used to represent five different consonants, a vowel, and a diphthong. Over the first three or four Islamic centuries a more complete script was gradually developed and came to be accepted.

No doubt the publication of the Egyptian standard edition has created the impression of uniformity and unanimity in the transmission of the text. Its wide circulation may indeed contribute to a real uniformity. However, ancient Koran manuscripts and fragments found in Yemen some years ago reveal that even the main written tradition took some centuries to achieve complete uniformity.

Themes and Styles

It comes as no surprise, either to Muslim or non-Muslim, to find that many of the central themes of the Koran are familiar from other scriptures. Prophetic denunciations of injustice and unbelief are characteristic of the revelations usually considered early. Mistreatment of the widow, the orphan, and the female child are condemned, the arrogant atheism of the rich deplored. These censures are accompanied by vivid images of the end-times, and the repeated announcement that all the

living will be raised by God to judgment, reward, and punish according to their deeds. God, who created all living things, can easily resurrect them.

The power, wisdom, and providence of God should be obvious to all who consider the signs (*ayat*) in nature and in human history (for example, 16:10–18; 30:20–25; 80:24–32). Many passages rehearse this theme and repeatedly call people to reflect on their world and on the history of nations that have gone before them. Each nation received prophetic guidance from God and was punished if it did not respond. Increasingly important as time goes on is the affirmation of God's unity, the center of Koranic thought and the basis of much of its polemic, not only against the pagan polytheists, but also against Jews and Christians. These latter groups, although having received the Scripture through Moses and Jesus, are considered to have abandoned the core Abrahamic belief in one God and to have given other figures a role alongside God as intercessors and protectors. The Koran consistently calls its hearers to faith in the one God (*iman, tawhid*), which consists in entrusting oneself to God alone (*islam*), and following the guidance God provides through the prophets.

A recurrent theme is the question of the Koran's own origin and authority, both of which are constantly questioned or denied by its hearers. This self-consciousness is a major feature of the Koran, and no other scripture observes and comments upon the processes of its own revelation and reception in such a sustained way. No other scripture argues with its hearers in order to proclaim and defend its authority and the bona fides of its prophet. The history of prophecy is rehearsed schematically to show that Muhammad's career conforms to a centuries-old pattern of rejection.

Particularly in the revelations of the Medinan period, the Koran provides regulations for the life of the new community of believers: for example, on the religious duties of prayer, fasting, almsgiving, and pilgrimage; on family matters of inheritance, marriage, and divorce; on communal obligations such as defense and propagation of the new faith and relations with other communities. Along with these, there are particular regulations for the Prophet and his family.

The Koran, like the Hebrew Bible, emerges in an environment of sometimes bloody conflict. However, unlike the Bible, it does not contain narratives of such bloodshed. Its regulation of religious conflict, even though sanctioning defensive and retaliatory violence, always carries conditions to provide for a cessation of hostilities (cf., 2:190–193; 9:5, 29).

Controversy over Whether the Koran Was Created

Any religion founded on the belief that God communicates with creatures must eventually consider the relationship between God and God's word or speech. Since Muslims consider God to be the "speaker" of the Koran, the text is therefore defined as God's speech (*kalaam Allah*). However, God's speech cannot be external to God or accidental, but belongs to God's essence. It is, therefore, uncreated and, according to some, eternal.

Beginning in the late eighth century much attention, and for a time an inquisition, came to be focused on the questions of whether, and if so in what sense, the Koran text itself is uncreated. Although one still hears echoes of the Mu'tazilite school of thought that denied the Koran is uncreated, the question of its uncreated nature has been resolved virtually unanimously in the positive. However, the question of in what sense the Koran is the uncreated speech of God was never firmly resolved and remains important even in the early twenty-first century.

There are several reasons for wanting to maintain a distance between the words of the Koran and the eternal speech of God. The first is to safeguard the otherness and immateriality of God and avoid the risk of anthropomorphism. Another is the logical need to recognize the historical particularity of many of the Koran's revelations. A third would be to avoid the idea that in the act of recitation the reciter of the Koran becomes completely identified with God (*hulul*).

At the same time, to distance the Koran too much from God risks undermining its authority and its value as "guidance for the God-fearing" (2:2). It risks reducing it to a merely human document, thus opening too much latitude for interpretation, and diminishing its value as a clear foundation for the law.

The Koran and Law

The Koran itself contains relatively little in the way of specific laws. What little there is, even the five crimes for which it fixes punishments (*hudud*), needs further specification. In one sense the Koran remains the foundation for all Islamic law, yet at the same time it must be read in the context of the Prophet's teaching and example (*sunna*). The intimate connection between Muhammad and the revelation makes it unthinkable that the sunna could conflict with the Koran. If there seems to be a contradiction, it is the sunna that indicates the true meaning of the Koran, makes it more precise, or renews it for changed circumstances. The idea that the Koran must share the place of authority with the sunna was elaborated by al-Shafi'i (d. 820), who argued that the Koran itself commanded obedience to the Prophet along with obedience to God (3:132; 4:180), and further that God had given Muhammad not only the Koran but also another form of revelation, the Wisdom (*al-hikma*, 2:151, 231; 62:2).

Koranic Interpretation

It is widely believed that Muslims cannot or will not interpret the Koran but insist on simple literalism. It is true that there is a strong preference for a plain reading that does not evade the claims the text makes on believer and unbeliever alike. However, the Koran itself says (3:7) that it contains some verses that are straightforward and others that need to be interpreted—either because they are metaphorical or because they can only be fully understood in relation to other verses. That verse itself is open to several interpretations, depending on how one divides the sentences within it, and on how one understands the key words translated here as "straightforward" and "metaphorical." Thus, the Koran itself, while denouncing the

kind of manipulation of the text that divides the community, recognizes the necessity of interpretation.

The tradition of commentary (*tafsir*) and analysis is rich and extensive, and draws on several principles and methods familiar in biblical studies: study of textual variants (*qira'at*); reconstruction of the historical context or "occasions of revelation" (*asbab al-nuzul*); distinguishing different literary forms; recourse to grammatical technicalities; and lexical studies of contemporary literature in order to understand unfamiliar vocabulary.

A major factor in interpretation is the doctrine of abrogation (*naskh*) based on the verses 2:106 and 16:101. It is effectively a recognition of the historicity of the text and of the developments this inevitably involves in the divine teaching and commands. As the situation of the Prophet and the community changes, so too does the guidance offered by God change or become more specific. As the faithful become more established in their religion, so too do the demands made upon them become more challenging: the prohibition of alcohol, for example, is introduced in stages.

The principle of abrogation is used by some Muslims, for example, to deny the continuing validity of verses that encourage patience under persecution, and good relations with Christians. Such counsel is considered appropriate only to the period in which the community is weak and unable to fight back. Others, however, would hold that such verses are still valid even where the community is strong.

Esoteric and mystical interpretations are often referred to as *ta'wil*. They rely on distinguishing between the surface meaning (*zahir*) and the deeper sense (*batin*) that should be developed from it on the basis of the teaching of the Shiite imam or the Sufi master.

Contemporary Controversies over Koranic Criticism

There has long been a distinction, if not a conflict, between interpretation based on traditions of the Prophet and his Companions (*tafsir bi-l-ma'thur*) and interpretation based on reason (*tafsir bi-l-ra'y*). Contemporary conflicts can to some extent be seen as a continuation of that classic dispute. The central question is what role the Prophet had in the process of revelation. Even without denying the divine origin of the Koran, some Muslim authors discuss the human, and therefore conditioned, aspect of the text. Though this has caused great consternation, particularly in the case of the Egyptian author Nasr Hamid Abu Zayd, in many respects it has its roots in classical discussions—about the nature of the prophetic access to the unseen realm, compared to that of poets and seers; and about the nature of the passage from the eternal divine word that has no letters, words, or sounds, to the actual Arabic words of the Koran. It is not new to suggest that what God revealed was the meaning (*ma'na*) and that the Prophet, or perhaps Gabriel, was responsible for the wording (*lafz*) that nonetheless faithfully conveyed that meaning.

Another approach came from the Sudanese author M. M. Taha, who suggested that, contrary to traditional approaches,

the earlier rather than the later revelations are the authoritative heart of the Koran. The Meccan verses contain the eternally valid principles of faith, justice, and equality. The Medinan verses, however, represent an application of the principles to a very particular historical circumstances and cannot respond to the changed circumstances of the early twenty-first century. Taha was executed for heresy in 1985. His approach has found echoes in the work of, among others, feminist writer Fatima Mernissi.

The controversy arises from calling into question the contemporary adequacy not of the Word of God itself, but of some of its traditional interpretations. This is seen to open the way to a reduction of the Koran to the same level as the much analyzed and thus diminished Bible. It is also an attack on the power of the guardians of traditional interpretations. Nonetheless, the quest for a new approach to the Koran continues, based on the confidence that the scripture need not remain locked in the seventh or the tenth century, but that it remains the Word of God valid for and relevant to this century.

See also *Islam; Law, Islamic; Religion*.

BIBLIOGRAPHY

- Abū Zayd, Nasr Hāmid. *Critique du discours religieux: Nasr Abou Zeid; essais traduits de l'arabe par Mohamed Chairet*. Arles: Actes Sud, 1999.
- Ahmed, Leila. *Women and Gender in Islam: Historical Roots of a Modern Debate*. New Haven, Conn.: Yale University Press, 1992.
- Al-Tabarī, Abū Ja'far Muhammad b. Jarīr. *The Commentary on the Qur'ān*. Vol. 1, edited by W. F. Madelung and A. Jones. Oxford and New York: Oxford University Press, 1987. A first volume of an abridged translation of the most famous classical commentary.
- Ayoub, Mahmoud. *The Qur'an and its Interpreters*. Albany: State University of New York Press, 1984-. Brings together the material of a dozen classical and modern commentaries. Only two volumes so far.
- Bell, Richard, and W. M. Watt. *Bell's Introduction to the Qur'ān*. New ed. Edinburgh: Edinburgh University Press, 1970. Classic Western introduction in English.
- Esack, Farid. *The Qur'ān: A Short Introduction*. Oxford: Oneworld, 2001.
- Hawting, G. R. *The Idea of Idolatry and the Emergence of Islam: From Polemic to History*. Cambridge, U.K., and New York: Cambridge University Press, 1999.
- Hawting, G. R., and Abdul-Kader Shareef, eds. *Approaches to the Qur'ān*. London: Routledge, 1993.
- Ibn Warraq, ed. *Origins of the Koran: Classic Essays on Islam's Holy Book*. Amherst, N.Y.: Prometheus Books, 1998. In spite of Ibn Warraq's polemical intent, these books are useful because they make available important scholarly articles on the Koran published in the last hundred years.
- . *What the Koran Really Says: Language, Text, and Commentary*. Amherst, N.Y.: Prometheus Books, 2002.
- Madigan, Daniel A. *The Qur'ān's Self-image: Writing and Authority in Islam's Scripture*. Princeton, N.J.: Princeton University Press, 2001.
- Martin, Richard C., ed. *Approaches to Islam in Religious Studies*. Oxford, U.K.: Oneworld, 2001.
- McAuliffe, Jane Dammen, ed. *Encyclopaedia of the Qur'ān*. Leiden: Brill, 2001-. A new project eventually to be five volumes.
- Mernissi, Fatima. *The Veil and the Male Elite: A Feminist Interpretation of Women's Rights in Islam*. Translated by Mary Jo Lakeland. Reading, Mass.: Addison-Wesley, 1991.
- Rippin, Andrew, ed. *Approaches to the History of the Interpretation of the Qur'ān*. Oxford: Oxford University Press, 1988.
- Robinson, Neal. *Discovering the Qur'ān: A Contemporary Approach to a Veiled Text*. London: SCM Press, 2003.
- Sells, Michael A. *Approaching the Qur'ān: The Early Revelations*. Ashland, Ore.: White Cloud Press, 1999.
- Soroush, Abdolkarim. *Reason, Freedom and Democracy in Islam: Essential Writings of 'Abdolkarim Soroush*. Translated and edited by Mahmoud Sadri and Ahmad Sadri. New York: Oxford University Press, 2000. Includes a critical introduction by the editors.
- Stowasser, Barbara Freyer. *Women in the Qur'an, Traditions, and Interpretation*. New York: Oxford University Press, 1994.
- Tāhā, Mahmūd Muhammad. *The Second Message of Islam*. Syracuse, N.Y.: Syracuse University Press, 1987.
- Wansbrough, John E. *Quranic Studies: Sources and Methods of Scriptural Interpretation*. Oxford: Oxford University Press, 1977.
- . *The Sectarian Milieu: Content and Composition of Islamic Salvation History*. Oxford and New York: Oxford University Press, 1978.
- Welch, Alford T. "Kur'ān." In *Encyclopaedia of Islam*, 2nd ed., vol. 5, edited by P. J. Bearman et al., 400–432. Leiden: Brill, 1960-.
- Wild, Stefan, ed. *The Qur'ān as Text*. Leiden: Brill, 1996.

Daniel A. Madigan

SAGE PHILOSOPHY. Sage philosophy is a body of knowledge attributed to wise men and women in communities and is regarded to be philosophically significant for both its content and its critical approach to the sustenance and growth of knowledge at the communal level. Although the term came into use rather recently in the course of African philosophers' appraisal of the nature and relation of philosophy to the indigenous traditions of their communities, questions that have emerged from debating the nature of sage philosophy are applicable beyond the postcolonial confines of African scholars' efforts to revise, redefine, and align disciplinary contents and practices to the recovery of their cultural values. For example, because sage philosophy raises such questions as the separation between critical thinking and popular belief, its discussion could resonate with analytical methods that rely on the analysis of popular conceptual assumptions and ideas as expressed either in ordinary language or in the language of professional communities. In these senses, analytic practices appear constantly to seek conceptual clarification by comparing and contrasting specific—and, therefore, sometimes specialized—uses of terms to their appearances in other domains. Discussions of sage philosophy might also be relevant to theories about the social underpinnings of scientific knowledge advanced by the American historian Thomas Kuhn

(1922–1996). He explains that a revolution occurs in scientific theory only when it is determined that a new explanation has made a complete break from a previous paradigm; this is, in a sense, a discussion of how radical critical thinking relates to a more popular—that is, communally held or communalized—mindset or framework from which it becomes disentangled by virtue of a critical engagement with it.

From a historical standpoint, sage philosophy connects with other voices and perspectives in the postcolonial discourse through its claim, however more implicit than it is an open expression, that Africans' creation of knowledge in the present moment of Africa's history cannot ignore those voices that give the present a sense of relevance and validity by bridging it with the past to form a continuum.

Historical Origins

Conceived, defined, advanced, and defended by the late Kenyan philosopher Henry Odera Oruka (1944–1995), the idea of sage philosophy has its historical origins in two separate but related colonial factors: first, the general disparaging colonial attitude that Africans were incapable of abstract thinking; and second, a vicious rivalry between different European religious denominations for control over Africans' minds and souls. On the one hand was a Protestant skepticism about Africans' capacity to philosophize, and on the other was the guarded Catholic belief, formed out of long years of training young Africans in ecclesiastic philosophy as part of their priestly education, that Africans could grasp some philosophy if it was appropriately tailored to have some resonance with their indigenous worldviews. Needless to say, Africans pursuing the study of philosophy as a secular and purely academic goal were rare in the colonial education system.

At the University of Nairobi, the Department of Religion and Philosophy (founded in 1970) was headed by Stephen Niell, an ultraconservative retired Anglican bishop. His deputy was Joseph Donders, a younger Catholic priest who doubled as a professor of philosophy at a local National Seminary. Convinced that Africans were not gifted for abstract or logical thinking, Niell had reluctantly offered Oruka employment as a special assistant, to ensure Oruka did not get a regular appointment despite his possession of a doctoral degree in philosophy from the University of Uppsala in Sweden. Specifically, Niell instructed Donders not to assign Oruka any logic classes—as Africans had no idea what that was, let alone being able to explain or teach it.

By the end of the 1960s and the beginning of the 1970s, anglophone Africa was still basking in the positive reception of John Mbiti's *African Religions and Philosophy* (1969) and of the slightly older translations of Marcel Griaule's *Conversations with Ogotemmêli* (1965) and Placide Tempels's *Bantu Philosophy* (1959). But as much as they were popular for a variety of reasons, these texts also clearly stated just what people like Niell would have liked to hear and to show in support of their skepticism regarding Africans' tuning to academic philosophy: that African modes of thought were deeply grounded in their mythical representations of reality. With this background, Oruka's project, simultaneously personal and professional, was

defined—to erase the two levels of myth surrounding and possibly even blocking the practice and growth of African philosophy. One level was established by the previously mentioned texts, by virtue of leaving many complex African myths and other representational forms unexamined and unexplained but presenting them intact as philosophical knowledge. The other, made possible by the first and created by people like Niell and their followers (both local and otherwise), was that Africans could not think philosophically.

Relation between Sage Philosophy and Popular Myths

Oruka's 1972 article "Mythologies as African Philosophy" marked the beginning of his project of dismantling the mythological constructs in African philosophy. Although others—such as Franz Crahay, Fabien Eboussi Boulaga, and Paulin Hountondji—shared similar concerns and produced similar arguments, these were veiled from Oruka by Africa's linguistic divide. Oruka argued that myths could not be substituted for philosophy for their lack of the subject and of the critical method. While Oruka recognized the universal presence and usefulness of myths at the cultural level, he claimed, like his contemporaries cited above, that the conflation of the two only in reference to Africa could lead to a harmful confusion. Like Crahay, he at least partially contended that philosophy builds on, even at the same time as it also "takes off" from, the cultural plain that for every thinker constitutes the sourcing field. At the same time, however, Oruka insisted that his separation of philosophy from mythology did not amount to the erroneous inference, once made by some critics of the essay, that philosophy was a monopoly of the academy in the narrow sense of a discipline practiced exclusively within the confines of its academic definition and control.

This double separation has not been easy. The key problem has been the contrast between the logical soundness of the argument and what is perceived to be the weakness of the examples accumulated as illustrations of the logical claim. For example, in contrast to Griaule's *Conversations with Ogotemmêli*, which, in Oruka's view, presents the commonly shared knowledge of Dogon worldview through the folk sage Ogotemmêli, the protagonists of Oruka's sage philosophy think as independent and critical-minded individuals. While folk sages know and teach the common wisdom of their communities as a way of both keeping traditions and group identity and protecting them from breach, philosophic sages, in a Socratic fashion, stir up this quiet in the interest of truth and inquiry. The philosophic sages are guided by their realization and admiration of the view that there are many aspects of culture that are neither rationally acceptable nor practically compelling for every member of the communities where these are operative. Thus, they share with others in the community only some selective customary practices and beliefs or some aspects of them. In the everyday negotiation—that is, explanations and determination of courses of action—over issues in the community, these independent-minded persons were a source of new knowledge and the change that issued therefrom.

According to the philosopher Kwasi Wiredu, such independent and critical thinking was available in varying forms in communities and was the basis of frequently protracted

disputations among elders, for example, in search of a consensus over different matters that required disputative negotiations. Thus, contrary to popular belief regarding knowledge at the communal level, it is precisely in regard to the importance of consensus on matters of common good that disputation and careful navigation through different opinions was crucial. Needless to say, such matters were not adjudicated without the input of those members of community who were well regarded for their excellent independent opinions. Africans often object to suggestions that some specific individual's opinion be sought on an issue under scrutiny: "Why seek so-and-so's opinion when he never has a personal view to anything? He only follows other people like sheep do." At the very least, such an observation about other people's character of mind suggests that independent thinking is not only accepted in African cultures, but it is also encouraged and admired as a virtue. Once in a while such independent-minded wise persons acquired some infamy and notoriety for stubbornness, especially in the eyes of those other persons whose opinions or justifications might have been the subject of the sage's criticism. History illustrates that outstandingly critical individuals in society only rarely enjoy comfort with those—usually in the majority—whose views stand in opposition to their own.

According to Oruka, for a person to be regarded a sage philosopher, one not only will be a catalyst to change within his or her community, one will also have to be a significant contributor to the growth and sustenance of the moral ideals of the community. In this context, the criterion for a moral ideal, according to the sage, is not that it match the historical belief of the community but that it satisfies an acceptable idea of right, fairness, and respectfulness toward all those who are involved or may be affected by its practical application. Imagine the conjunctural case where, for purposes of satisfying a local ritual requirement, custom dictates that a man and his baby son spend a night or two in an improvised structure outside his regular house. While the majority of the family group insists on the performance of the ritual according to custom, mindless of the weather uncertainties in the middle of the wet season, the sage among them steps in to object. According to her, custom provides guidance to desired behavior; it is not an end unto itself. Thus, she advises, calls for the performance of ritual need to take into consideration the view that because rituals are meant to give us a sense of reconciliation between a chain of ideas as we believe they relate to our practices; they are meaningful only if we do not cause harm to people in the course of performing them. In this case, she added, the performance of ritual as called for is likely to expose those involved, especially the baby son, to circumstances detrimental to their health. Hence the performance of the ritual would be counterproductive, and so unreasonable and unallowable. Such would be a circumstance where the sage would endeavor to subject a customary requirement to a rational appraisal and be committed to a view considered by her to be rationally superior to the traditional position. According to Oruka, the sage can sometimes have only a private disagreement with customary principles and that would be sufficient to define her as a person who relies on the dictates of rational appeal. Also, disagreement with commonly held knowledge is neither a condition nor a defining rational

character of the sage. Because she is a member of the community, she probably agrees with and abides by many of her community's maxims and ways. Thus her uniqueness emerges in those circumstances of need for exacting principles or reasons in matters requiring theoretical clarification and understanding. Faced with such a need, the sage can agree with custom but largely on the basis of independently concurring with the view expressed in a customary principle or the justification for one.

Worried that the ethnophilosophical texts of Tempels, Griaule, the Rwandan philosopher Alexis Kagame, and several others who merely baptized the anonymous traditional worldviews as philosophies may have justified the harsh but equally mythical criticisms like that of Niel, Oruka's endeavor was to separate the thoughts of individual thinkers at the traditional level from the collective traditional beliefs. The criterion set by Oruka for the qualification of the individual sages' views as philosophical thinking was not their mere variance from the communal beliefs of the sages' own groups but also a theoretical account provided by the sage as the foundation of his or her own view. Accordance or discordance with a group's views was, for Oruka, a factor that could not by itself satisfy the philosophical character of a sage's knowledge. The sage attends to the rationality of views rather than to the judgment of the group, although the sage always hopes that everyone sees and accepts the grounds that make his or her position the better one. This criterion, in Oruka's view, is precisely what qualifies Socrates (c. 470–399 B.C.E.) as a philosopher. And while the criterion favors the classification of both Socrates and Paul Mbuya as philosophers, for example, it disqualifies Griaule's Ogotemméli from being one (Oruka, 1991, p. 49–50).

In response to the question whether the one-time interviews with the sages was sufficient for the detection of their philosophical groundings, Oruka makes the following observation: "Some of the Greek sages are known and treated as philosophers for having made only one or two utterances. Thales, for example, is known to have said that 'everything is made of water,' and Heraclitus that 'strife is the truth of all life'" (1991, p. 2). Of course this is not correct. The selection of historical textual representation by historians of philosophy may have led to the impression that Oruka holds. But there are large collections of pre-Socratic texts that have been translated into modern languages and that show that there was much more than the specific topics historians have overwhelmingly focused on in order to create the image of a unilinear growth of the discipline generally and of specific topical issues. Hermann Diels's collection, *Fragmente der Vorsokratiker* (1903), is a good example of the contrast between what more there is—and could be if they were recovered in their complete forms—of the pre-Socratic period and what some historians have biasedly used. To be sure, Oruka uses the pre-Socratic example only as an explanatory tool, given that he too, like the ethnophilosophers that he partly wanted to correct, wrote largely for a European audience. As for their relevance to local societies, a case can be made that not only does Oruka's project aim at establishing the claim that the sages are philosophers in their own right, but it also teaches that there are many things to learn from careful consideration of the teachings of different experts in indigenous communities. In

other words, that a local philosophical tradition can ensue out of dialogues with the sages, especially with the sage philosophers, whether directly through dialogical interviews or indirectly by cogitating on the philosophical import of their assertions. This recognition of the philosophical worth of traditional thinkers is the basis of the work of Barry Hallen and John Olubi Sodipo, now in two volumes—one epistemological (*Knowledge, Belief, and Witchcraft: Analytic Experiments in African Philosophy*, 1997, by Hallen and Sodipo), the other ethical and aesthetic (*The Good, the Bad, and the Beautiful: Discourse about Values in Yoruba Culture*, 2000, by Hallen). In both, Hallen and Sodipo bring traditional thinkers, the *onisegun* or medical experts, into the enterprise of expounding and elucidating traditional thought of an African people, the Yoruba, as it relates to the conception or idea of knowledge in both cognitive and moral senses. Oruka counters Hallen and Sodipo that because the *onisegun* only expound and elucidate the traditional thought of the Yoruba, they are certainly very wise, but they are not philosophers. He thinks that the *onisegun*, who are deliberately kept anonymous by Hallen and Sodipo for reasons of privacy, are like Ogotemmêli, whose presentation, however complex and amazing in details, was exactly what every wise and well-trained Dogon person was expected to know (1990, pp. 9–10).

On the issue of literacy, Oruka is quite correct: literacy alone, in and of itself, does not constitute a measurement for philosophizing. Yet this is really not the point. Philosophy is characterized by some form of “tradition”: that is, by a sustained discursive inquiry rather than by just an expression of ideas, however scattered and unrelated among themselves, or however they may be at variance with some societal belief. Those who defend literacy (see, e.g., Goody; Popper; and Bodunrin) make the minimal claim that literacy contributes to the sustainability of a discourse by making it possible for all those who are or wish to be involved to critically engage in it with regard to a specific issue whose point of reference remains accessible. Thus, while the pre-Socratics may have offered little to regard as philosophy, the worth of the little they are alleged to have uttered lies in how reference to them by later thinkers made them the subject matter of wider and growing commentaries, interpretations, and, why not, even reaffirmations and re-elaborations. It is the possibility of a revisit of older texts that, for example, enables Martin Heidegger (1889–1976) to attempt to reestablish what he calls the proper understanding of Being.

As a discipline that aspires so much to clarify concepts and ideas as representations of reality, the task of philosophy includes conceptual analysis as a means to attain clarity and precision in understanding. So, in fact, the reason why the pre-Socratics have lost their worth is precisely that the scattered utterances in themselves do not lead to much, if anything, except via their re-interpretations by later philosophers. Thus reference to them may be crucial, but it is largely indirect.

It turns out, then, that Oruka was right in claiming that literacy per se does not constitute philosophy. Nor, conversely, would orality, in and of itself, be a hindrance to philosophizing. Critics of the attribution of philosophical thought to

Africans who were not formally schooled in the discipline held the generalizing view that oral cultures are incapable of producing or enhancing the growth in their individual members of the virtues of skepticism that these critics considered pivotal to philosophical thinking and inquiry. However, as argued by Oruka, Wiredu, Hallen, and Sodipo, philosophizing requires much more than the mere medium of its expression. For indeed, when considered together with other factors, each can be a medium by which ideas are made known and their defense elaborated. Nor does mere variance of opinion from some popular belief by itself constitute philosophy. But variance becomes an important characteristic of philosophy through a sustained critical inquiry that includes the testing of such an opinion against its real and possible rivals. Traditional palavers, negotiations, and other forums of public debates and deliberations provided the contexts for such testing. Such forums uncovered and enhanced the development of great communal orators as much as they did those individuals with succinct analytic mental skills. Analysis of the procedures of these forums could yield insight not only into how ideas were processed at the traditional level but also into the role and esteem accorded the personal skills of oration and debating.

But the rise of pluralism and the crisis of foundationalism in the late twentieth century introduced and require a fresh reading of sage philosophy. As one takes stock of what has happened in African philosophy from the 1980s through the turn of the twenty-first century through the aid of such compelling titles as Ngugi wa Thiong’o’s *Decolonising the Mind* (1986) and V. Y. Mudimbe’s *The Invention of Africa* (1988), there arises the possibility of reading Oruka’s idea of sage philosophy as part of the wider (postcolonial) critique and rejection of the Eurocentric idea of a comprehensive framework in which philosophical reflection must take place.

Out of the postcolonial discourse Oruka draws two implications. First, the irreducible plurality of values and cultures that issue into a plurality of forms of reflection makes it possible for him to call for an end to the unjustified Western monopoly of philosophy, and especially of the monopoly of the institutional mode of its production. Hence such plurality removes the monopoly of philosophy from the confines of the academy. But while he emphasizes this plurality, Oruka does not draw from it the view that informs the ethnophilosophical texts: that the nature of social organization within which African philosophy is produced distinguishes it from all others by making it a consensual or, as he calls it, a communalized commodity (1991, p. 8). Also, like Wiredu, Oruka did not believe that pluralism opened doors to relativism. Rather, again like Wiredu, he believed in the possibility of recasting the philosophical task as an invitation to a philosophical conversation both across cultures and between the professionals and the solid thinkers of the traditions.

In the wake of the emphasis of the plurality of forms of knowledge, the idea of sage philosophy becomes an interesting and important channel for identifying, understanding, and articulating the philosophical task through a comparative contrast of different epistemic fields. Hallen and Sodipo’s work does this, as does Wiredu in *Philosophy and an African*

Culture (1980) and in *Cultural Universals and Particulars* (1996), in the course of discussing the concepts of mind, the person, truth, democracy, human rights, and other matters pertinent to philosophical thought and practice. But above all, sage philosophy addresses the crucial question of who produces knowledge in the modern hierarchized social formations. In pursuit of the underpinning elements of an African epistemic field, Oruka originally classified Africans' practice of philosophy into four trends, listed as ethnophilosophy, nationalist-ideological philosophy, professional philosophy, and philosophic sagacity. In *Sage Philosophy* (1991), Oruka makes additions to this list to bring the number of the trends to six, including hermeneutic philosophy and artistic or literary philosophy. It is important to note that Oruka did not see these trends as separated in a strong sense. He thought of them as reconcilable by means of a comprehensive account. Such a comprehensive account, he thought, could be offered only by the professional philosophers. "No one thinks in a vacuum" is a tenet that appears to have been central to Oruka's view of this comprehensive account of the trends in African philosophy. The technical work of professional African philosophers, who are themselves also sages at a different level, should find its grounding and discursive context in the frameworks provided by the other three trends (Oruka, 1991, p. 2). He did not think of the trends as differentiated by value on a scale that runs from bad to best. Rather, they complement each other in constituting specific fields of knowledge.

Sometimes the proposed method for identifying a sage reads as problematic, as when Oruka says, for example, that "the best judge [of who qualifies as a sage] must be the community from which the person hails. The researcher [however,] must follow up the guidance of the community and be capable of assessing those alleged to be sages and dismissing others" (1991, p. 3). So, after all, it is the professional practitioner who produces the sage according to his or her institutionalized definitions of the categories of knowledge. Several other critics of the modes of executing the sage philosophy research have adequately covered other methodological problems (see, e.g., Keita; Bodunrin; and Oruka, 1991; several others are also reprinted in Oruka, 1991, and also noted by van Hook).

The significant merit of the idea of philosophic sagacity is to be found, at least in part, in a combination of what Mudimbe has called "the geography of a discourse" and the decentering implications of the Tanzanian politician Julius K. Nyerere's idea of *ujamaa* (the social and moral view that lasting good stems from recognition of the basic interdependency and ultimate unity of all human endeavors and goals). The idea of sage philosophy suggests that professional philosophers ought to take sufficiently into account the problems posed by the sages in the course of their conversations, not just once, but always. This engagement, Oruka believed, would erase the current division of African philosophical discourse into two opposed spaces of tradition and modernity. According to Mudimbe, the view of binary opposition between modernity and tradition can be justified only through the false representation of the latter as static and prehistoric. In his view, however, "tradition (*traditio*) means discontinuities through a dynamic continuation and possible conversion of *tradita*

(legacies). As such, it is part of a history in the making" (p. 189). Like Mudimbe, Oruka too postulates that an African tradition of philosophy will be hard to establish in an influential way "if it ignores the past and traditions. But the continent will equally be handicapped if it abandons science and logic, in the so-called Western sense, as things that are un-African" (1991, p. 26). It would be a tragedy, Oruka argued, as has happened in Great Britain, if the intellectual elite of society were to succeed in imposing its views on the masses.

By proposing to narrow the opposition between the academy as the institutionalized production center and the rest of society as the location of pure consumers at the periphery of the academy, Oruka strips the academy of its colonial definition and status. And he does not limit this stripping to the practice of philosophy. Rather, he sees it as a project to be expanded to all other disciplines and institutions whose processes find their justification and principles of procedure in colonial epistemological formulations and assumptions. His views as expert witness at the now-famous (or, for some, infamous) civil case over the Kenyan lawyer Silvano M. Otieno's body in 1987, and on several other related issues thereafter, clearly define Oruka's opposition to the naïvete with which many people, African and non-African, intellectual professionals and ordinary people, regard the idea and process of "modernization." Particularly relevant was his reply to the presiding judge's question as to whether he, Oruka, as a modern, well-educated (Western-educated) analytic philosopher and professor of philosophy, believed in the (assumedly traditional—by which was apparently implied "primitive") idea of ghosts and their vengeant powers. He responded thus: "there is no reason, your honor, for me to deny [or affirm] the existence of ghosts and their vengeant powers." The statement quickly acquired notoriety more for its perceived arrogance than for the analytic savvy that the judge had unwittingly evoked. In a 1989 article about the case, Oruka gave an analytic appraisal of the naïvete and contradictions of the accusations leveled at him following his testimony regarding belief in spirits.

According to Oruka, one of the most injurious blows colonialism dealt on Africa was to make Africans to think and believe that the label "traditional," applicable to their pre-colonial values, had the negative connotations of evil, brute, irrational, and so on, and hence were to be rejected (1989). Nowhere else, he observed, was "the distinction between tradition and modernity in any given culture [equitable with the] distinction between the *outdated* and the *novel*" (1989, p. 80). Why should Africans judge their participation in or practice of an antiquated European value or practice—such as reading Shakespeare or listening to Mozart's or Beethoven's music—as "modern," and some of their own people's still-valued musical traditions as "outdated"? Or why should Africans regard the reverence of Jesus, who died two millennia ago, as "modern," while tribute to an ancestor who died one year ago as "outmoded"? With these questions and considerations, Oruka appears to ask with surprise the criteria for defining the boundaries of reason with regard to cultural encounters. To be specific, listening to Mozart and reading Shakespeare had been cited in the Otieno case as legitimate indicators of Otieno's avowal of "modernity," and therefore repudiation of his own

local traditions, including the requirement that he be buried in his parents' still-standing homestead. In response to his own questions, Oruka observes: "In the naive sense of the term modern, such a person is [judged] modern just because the cultures associated with Shakespeare or Mozart are *European*. And to be European [or, when you are not one, to mimic anything European by origin], it is naively conceived, is to be civilized and modern" (1989, p. 81).

Conclusion

It is clear from this brief descriptive account of some of the things Oruka stood for that African philosophers are faced with crucial issues and pertinent questions as they critically appraise and define their participation in the wider global philosophical conversation. The influence of Oruka's work is to be seen in both the numbers and research interests of local, regional, and international scholars he inspired to work closely with him, whether or not they agreed with his positions. As a true scholar who believed in the historical spirit of philosophy, Oruka frequently supervised and directed dissertations that sometimes argued strongly against his positions.

See also *Philosophies: African; Wisdom, Human*.

BIBLIOGRAPHY

- Bodunrin, Peter. "The Question of African Philosophy." In *African Philosophy: An Introduction*, edited by Richard A. Wright. Lanham, Md.: University Press of America, 1984.
- Crahay, Franz. "Le 'Décollage' conceptuel: Conditions d'une philosophie bantoue." *Diogenes* 52 (1965): 61–84.
- Diels, Hermann. *Fragmente der Vorsokratiker*. 3 vols. Berlin: Weidmann, 1903. Reprint, Berlin: Weidmann, 1964.
- Eboussi Boulaga, Fabien. "Le Bantou problématique." *Présence Africaine* 66 (1968): 4–40.
- Goody, Jack. *The Domestication of the Savage Mind*. Cambridge, U.K.: Cambridge University Press, 1977.
- Granness, Anke, and Kai Kresse, eds. *Sagacious Reasoning: Henry Odera Oruka in Memoriam*. Frankfurt am Main, Germany: Lang, 1997. This is an excellent and exceptional text that carries Oruka's essays and interviews as well as essays on him and his work. Of particular importance are the essays by Oruka's former students who were his chief disciples and collaborators in the sage philosophy project.
- Griaule, Marcel. *Conversations with Ogotemmêli: An Introduction to Dogon Religious Ideas*. Oxford: Oxford University Press, 1965.
- Hountondji, Paulin. "Remarques sur la philosophie africaine." *Diogenes* 71 (1970): 120–140.
- Kalumba, Kibujjo M. "Sage Philosophy: Its Methodology, Results, Significance, and Future." In *A Companion to African Philosophy*, edited by Kwasi Wiredu. Malden, Mass.: Blackwell, 2004.
- Keita, Lansana. "Contemporary African Philosophy: The Search for a Method." *Praxis International* 5, no. 2 (1985): 145–161.
- Masolo, D. A. *African Philosophy in Search of Identity*. Bloomington: Indiana University Press, 1994.
- Mbiti, John S. *African Religions and Philosophy*. London: Heinemann, 1969.
- Mudimbe, V. Y. *The Invention of Africa: Gnosis, Philosophy, and the Order of Knowledge*. Bloomington: Indiana University Press, 1988.
- Ngugi wa Thiong'o. *Decolonising the Mind: The Politics of Language in African Literature*. London, Currey, 1981.

Oruka, Henry Odera. "Mythologies as African Philosophy." *East Africa Journal* 9, no. 10 (1972): 5–11.

———. *Sage Philosophy: Indigenous Thinkers and Modern Debate on African Philosophy*. Leiden, Netherlands: Brill, 1990.

———. "Traditionalism and Modernisation in Kenya—Customs, Spirits and Christianity." In *The S. M. Otiemo Case: Death and Burial in Modern Kenya*, edited by J. B. Ojwang and J. N. K. Mugambi. Nairobi, Kenya: Nairobi University Press, 1989.

———. "Truth and Belief." *Universitas* (Ghana) 5, no. 1 (1975).

Popper, Karl R. "On a Little Known Chapter of Mediterranean History." In *Transition to Modernity: Essays on Power, Wealth and Belief*, edited by John A. Hall and I. C. Jarvie. Cambridge, U.K.: Cambridge University Press, 1992.

Tempels, Placide. *Bantu Philosophy*. Paris: Présence Africaine, 1959.

Van Hook, Jay M. "Kenyan Sage Philosophy: A Review and Critique." *The Philosophical Forum* 27, no. 1 (1995): 54–65.

D. A. Masolo

SAINTS AND SAINTHOOD. See *Religion*.

SAMSARA. See *Consciousness: Indian Thought*

SATIRE. See *Genre*

SCARCITY AND ABUNDANCE, LATIN AMERICA.

Abundance and scarcity are crucial to Latin America because of the sharp disparities between the wealth produced in this region and the impoverishment of people and environment. Though ideas about causes differ sharply, Latin American social thought has revolved in substantial part around this axis. This entry begins with ideas from before the Spanish conquest, proceeds to key debates among the conquerors, moves then to ideas of progress and modernization, and finishes with recent, critical perspectives.

Pre- and Postconquest Thought

One risks overgeneralization in speaking of "pre-Hispanic" ideas as a unified entity since this covers so many cultures and geographic settings, but two themes stand out: to maintain abundance, communities engage in reciprocal exchanges with deities of particular places, set in broader spatial orders such as the four compass directions; and societies undergo great cycles of creation, destruction, and rebirth. Such visions once characterized official public thought but after conquest were submerged in the rituals of indigenous communities. The Spanish had a different set of concerns. They had conquered, with great self-confidence, a region of biological abundance and human wealth. Was this "natural" richness a sign of the backward state of the Americans compared to the rational, Christian Europeans? Or was it a paradise lost to pillage and enslavement by rapacious conquerors? The 1550 debate between Juan Ginés de Sepúlveda (taking the former position) and Bartolomé de Las Casas (taking the latter) carries into the present, in which the intellectual

descendants of Las Casas posit a romantic ecology and anthropology of profound indigenous cultures in lush but imperiled habitats and the inheritors of Sepúlveda see underutilized natural wealth needing rationality for its proper exploitation.

Modernization and the Ideology of Science

From the mid-nineteenth century until the early twentieth century, a broadly Sepúlvedan position held sway. After independence, political fragmentation and the decline of the colonial economy resulted in Latin America falling visibly behind industrializing western Europe and the United States. Capitalist pioneers from those areas after 1850 began to invest in Latin America in alliance with local landowners and businesspeople. Intellectual spokespeople for this process, the “*científicos*” (advocates of science and progress), saw Latin America as abundant and potentially wealth-producing but constrained by cultural and biological backwardness, especially on the part of darker-skinned lower orders. Scientific racism was in the air, making it easy to blame Latin America’s scarcity on Native Americans, African-Americans, and people of mixed European and non-European ancestry. One example of this kind of thought, though not as biologically racist as some, blamed Mexico’s underdevelopment on the nutritional deficiencies of corn tortillas, the millennia-old food of the Mexican people, and advocated instead the consumption of wheat bread, associated with Europe. There was little support for this seemingly “scientific” theory, and it ignored how inequality in resources led to nutritional shortfalls. But it seemed to explain Mexico’s poverty, offering a suitably progressive path forward.

There were dissenters, however. Two Peruvians, the social theorist José Carlos Mariátegui (1894–1930) and the novelist-anthropologist José María Arguedas (1911–1969), stand out for revaluing indigenous cultures. Mariátegui interpreted the indigenous people of the Andes as a revolutionary class in Marxist terms, while Arguedas deepened attention to highland Peruvian culture per se, noting the continuities of pre-Hispanic thought described above. Generally, though, notions that Latin America should follow external models of progress continued into the 1940s, 1950s, and early 1960s. The models had once been England and France, but in this period the economically and politically overwhelming United States provided the vision of power and abundance. Racist theories declined (though did not disappear), and the key idea was “modernization”: that Latin America could engineer progress by discarding its traditional social structures and cultures. A new nationalism crept in, with the central state and local capitalists seen as modernizers as well as, or in replacement of, foreigners. This opened the door for a major reversal in thought.

The Radical Critique of Modernization

In the 1960s and 1970s “dependency” theorists (including, among others, Teotonio Dos Santos, Fernando Henrique Cardoso, Anibal Quijano, and Andre Gunder Frank) argued that as Latin America entered into relationships with dominant economies like Spain and Portugal, and later Britain and the United States, it became poorer rather than richer. Various enterprises, from sugar plantations and silver mines to automo-

bile assembly plants and pharmaceutical factories, did not advance Latin America but rather removed its wealth and stunted its own, self-determining progress. Furthermore one could identify elite classes and dominant areas within Latin America not as modernizers but as doing the work of extraction and control for outsiders. Backwardness thus was imposed from outside on a potentially self-sufficient, abundant region.

Dependency theory at its most radical called for class revolutions in Latin America. It identified a carrier of change in the peasantry seen as a class (rather than as indigenous cultures) and, to a lesser extent, in the urban poor and workers in new industries. These classes were seen as the creators of abundance but the sufferers of scarcity because the surplus product of their labor was taken away in unequal exchange with the world centers of capitalism (a heterodox Marxism focusing on relations of exchange rather than production). In spite of this radical diagnosis, however, dependency theory overlapped in practice with nationalist-capitalist industrialization and urbanization guided by the central state, which envisioned scarcity and abundance in conventional economic terms.

The Return of Modernization (Neoliberalism) and Its Cultural-Ecological Critics

The nationalist-capitalist project collapsed in the 1980s due to corruption and inequity in which enormous debts to foreign (mostly U.S.) banks resulted in retrenchment, job loss, and impoverishment. Neoliberalism is the intellectual movement that corresponds to the dismal era of economic retrenchment and return of U.S. domination in the period from 1982 to the twenty-first century. As a set of ideas, neoliberalism differs little from those advocated by “*científicos*” and modernizers of past epochs except, perhaps, in its emphasis on the example of U.S. and East Asian business practices, such as private entrepreneurship. Again the assumption is that Latin America is characteristically backward and needs to import models for achieving abundance from more “successful” societies.

There are, however, two alternatives on the intellectual horizon. The Peruvian economist Hernando de Soto propounds the argument that Latin America has been hobbled by monopolies of economic and political power and that enduring prosperity will be created by the acts of millions of tiny entrepreneurs—street vendors, small businesspeople, and the like. This is clearly an idea of its time, related to neoliberalism and reflective of the retreat of the grand projects of the state and the proliferation of microscopic businesses among the unemployed, but it does touch on the persistent problem of stultifying monopolies of power in the region.

Meanwhile, welling up from innumerable social movements are the offshoots of dependency theory but with a new focus on indigenous cultures, women, and ecology. Like dependency theory, these diverse ideas (for which we do not yet have a name) locate abundance inside Latin America, in its forests and waters and in its pre-Hispanic and African-American legacies. They see globalization (economic and cultural) as threatening that abundance and thus form part of the international antiglobalization movement, centered on the World Social Forums held in Porto Alegre, Brazil. Unlike dependency theory, these ideas emphasize an encompassing cul-

tural vision of radical economy and ecology, drawing on 1960s forebears in liberation theology and Paulo Freire's "conscientization" approach to collective self-education. Fragmented as these tendencies are, there is no single intellectual spokesperson, but one might start with the Colombian anthropologist Arturo Escobar. We look hopefully for a synthesis of the penetrating critique of political-economic power characteristic of the 1960s and 1970s and the richer attention to culture and nature characteristic of recent Latin American thought.

See also *Capitalism; Communism: Latin America; Ecology; Globalization; Indigenismo; Marxism: Latin America; Modernization; Neoliberalism; World Systems Theory, Latin America.*

BIBLIOGRAPHY

- Alvarez, Sonia E., Evelina Dagnino, and Arturo Escobar, eds. *Cultures of Politics/Politics of Cultures: Re-Visioning Latin American Social Movements*. Boulder, Colo.: Westview Press, 1998. A compilation of work on modern Latin American radicalism.
- Arguedas, José María. *Yawar Fiesta*. Translated by Frances Horning Barraclough. Austin: University of Texas Press, 1985. A characteristic anthropological novel by Arguedas. Originally published in 1958.
- Bulnes, Francisco. *El porvenir de las naciones Hispano-Americanas ante las conquistas recientes de Europa y los Estados Unidos*. Mexico City: Imprenta de Mariano Nava, 1899. A representative work of the *científicos*.
- Cardoso, Fernando Henrique, and Enzo Faletto. *Dependency and Development in Latin America*. Berkeley: University of California Press, 1979. A nuanced statement of dependency theory.
- De Soto, Hernando. *The Other Path: The Invisible Revolution in the Third World*. Translated by June Abbott. New York: Harper and Row, 1989. An important work of neoliberalism.
- Frank, Andre Gunder. *Latin America: Underdevelopment or Revolution: Essays on the Development of Underdevelopment and the Immediate Enemy*. New York: Monthly Review Press, 1969. An emphatic statement of dependency theory.
- Freire, Paulo. *Pedagogy of the Oppressed*. Translated by Myra Bergman Ramos. New York: Herder and Herder, 1970. The classic statement of conscientization.
- Gossen, Gary H., and Miguel León Portilla, eds. *South and Meso-American Native Spirituality: From the Cult of the Feathered Serpent to the Theology of Liberation*. New York: Crossroad, 1993. A useful compilation of pre- and post-Columbian indigenous thought.
- Gutiérrez, Gustavo. *The Power of the Poor in History: Selected Writings*. Translated by Robert R. Barr. Maryknoll, N.Y.: Orbis Books, 1983. A valuable source for liberation theology.
- Mariátegui, José Carlos. *Seven Interpretive Essays on Peruvian Reality*. Translated by Marjory Uguindi. Austin: University of Texas Press, 1971. The key work by this radical Andean critic.
- Pagden, Anthony. *The Fall of Natural Man: The American Indian and the Origins of Comparative Ethnology*. Cambridge, U.K., and New York: Cambridge University Press, 1982. Covers the Sepúlveda–Las Casas debates, among other topics.
- Pilcher, Jeffrey M. *Que vivan los tamales! Food and the Making of Modern Mexican Identity*. Albuquerque: University of New Mexico Press, 1998. Discusses the tortilla debate in Mexico and offers a fascinating culinary angle on that nation's history.

Josiah McC. Heyman

SCHOLASTICISM. Scholasticism is best understood not as a set of doctrines, but as a method, or body of intellectual practices. In particular, Scholasticism developed as the method through which Christian thinkers of the patristic and medieval periods gradually transformed the narratives of Scripture into a theological system. Scholastic method, then, has its roots in the earliest Christian times. It reached its fullest development in the schools of the twelfth and thirteenth centuries. The disintegrating Scholasticism of the fourteenth and fifteenth centuries laid the foundations for modern forms of intellectual discourse.

Biblical and Patristic Roots

In Matthew 5:17 Jesus declares, "Do not think that I am come to destroy the law, or the prophets. I am not come to destroy but to fulfill (*plērōsai*)" (Douay-Rheims version). Christianity thus stands in a complex relationship of continuity and discontinuity with regard to its Jewish sources. The Christian faith views itself as preserving the Jewish heritage in its integrity, yet at a higher level. The precise definition of this "fulfillment"—that is to say, of the relationship between the Old and the New Testaments—was one of the central tasks of the first Christian thinkers, the church fathers. In addition, tensions that occur within the narratives and teachings of each of the two Testaments (in the four Gospels, for example) had to be explained and smoothed over as well. Some of the strategies that the church fathers used in order to harmonize the texts of Scripture were themselves scriptural, such as allegorization, which patristic thinkers widely employed to read the Old Testament in light of the New. Other techniques, however, were derived from non-scriptural sources; most importantly, the church fathers borrowed philosophical terminology of Greco-Roman provenance in order to articulate certain elements of the scriptural narrative in a systematic fashion, that is to say, as "doctrine." Thus, for example, occasional references to God the Father, the Son, and the Spirit came to be transformed into the doctrine of the Trinity, which was defined, in the Latin West, by means of the Greco-Roman philosophical terms of substance and person.

Unlike their Greek counterparts, the Latin church fathers did not produce a comprehensive account of the Christian faith in a complete theological system. Rather, they limited themselves to discussions of specific areas of theology, such as the Trinity or the relationship between grace and free will. And although they availed themselves of methods of textual synthesis and system-building, they rarely reflected upon these techniques in a detailed fashion. For many centuries, St. Augustine of Hippo's (354–430) treatise *On Christian Teaching* remained the standard text on Christian methodology.

The Early Middle Ages

The writings of the church fathers were soon subjected to the same synthesizing approach that they themselves had applied to Scripture. From the fifth century onward, Christian thinkers garnered *sententiae*—"sentences" or authoritative quotations—from the writings of their predecessors. The resulting sentence collections gave rise to two challenges that were crucial in honing the emerging Scholastic method: first, the task of reconciling the often divergent teachings of one or several church fathers on a given theological topic, and of doing so in light of the scriptural

texts upon which these teachings were built; and second, the task of arranging the theological topics in a meaningful order.

In subsequent centuries, the textual basis upon which this method was brought to bear became even broader; this increased breadth in turn called for improved strategies of structuring the material. Thus, the Carolingian era saw the introduction of Eastern theology into the Christian West, especially through the writings of John Scottus Eriugena (c. 810–c. 877). But around the same time, Christian thinkers also began an ambitious project of systematically elucidating the whole of Scripture with pertinent quotations lifted from authoritative writers of the tradition. In the *Glossa ordinaria*, or “Standard Gloss,” the text of the Bible was presented with interlinear notes to explain difficult words and phrases, while marginal annotations helped the reader understand the theological content of key passages. The *Glossa ordinaria* constituted a central step in the Scholastic project of translating the “stories” of Scripture into a theological system. It continued to be improved by successive generations of theologians, reaching its definitive shape only in the twelfth century.

The Twelfth and Thirteenth Centuries

In the twelfth century, the sentence collection became the central genre of theological writing, overshadowing the Scripture commentary and the treatise. A theologian now had to prove his competence by presenting a comprehensive synthesis of traditional doctrine. A number of factors flowed together to produce this situation, especially the inherent dynamics of the development of the Christian intellectual tradition and the increasing importance of urban schools as centers of education. In the monasteries—the paradigmatic institutional setting of earlier medieval writers—education and learning served a contemplative goal: the monks saw themselves as pursuing *salutaris scientia*, “salvific knowledge.” In the schools, on the other hand, knowledge came to be conceivable as an end in itself, dissociated from spirituality. The “master” teaching at the school was neither a monk nor a bishop entrusted with the care of souls, but an intellectual. He competed with masters at other schools for students, who judged his performance based not least upon how effectively he presented his subject matter.

The tradition of the sentence collections culminated in Peter Lombard’s (c. 1095–1160) *Sententiarum libri IV* (Book of sentences), which quickly became the standard theological textbook of the medieval schools—to the chagrin of more conservative thinkers, such as the English bishop Robert Grosseteste (c. 1168–1253), who believed that theology should remain centered on the study of Scripture. In the *Sentences*, Peter Lombard divides theology into four books, logically starting with God and the Trinity in book one, then moving on to Creation, the human being, and the Fall in book two, treating Christology in book three, and concluding with the sacraments in book four. The books were further broken down into chapters, with a table of contents placed at the beginning of the work to facilitate its consultation—a remarkable innovation at the time. Moreover, Lombard indicated the internal structure of each chapter by means of red subheadings, so-called rubrics. Within each chapter, a theological question is posed, then answered provisionally by means of scriptural and

patristic quotations that often remain discordant, therefore requiring reconciliation. This harmonization is effected through detailed examination of the texts, determination of each author’s precise meaning, and careful weighing up of arguments. Lombard usually attempts to formulate a consensus position in a short paragraph at the end of the chapter.

From the beginning of the thirteenth century until the early sixteenth, the history of Scholasticism can to a large extent be written as the history of commentaries upon the *Book of Sentences*. In the commentaries of the theologians of the thirteenth century, Scholastic method reached its most developed stage. Under the influence of newly available Aristotelian methodology, theology came to be defined rigorously as *scientia divina*, “divine science.” This *scientia divina* was conceived as being distinct both from philosophy (taught in a separate faculty at the recently founded universities) and from *sacra pagina*, that is to say, “sacred page” or Scripture commentary. Furthermore, in the commentaries upon the *Sentences*, the dialectical structure of Peter Lombard’s analyses was formalized, to yield the schema with which every reader of Thomas Aquinas’s (c. 1225–1274) *Summa theologiae* is familiar (the *Summa* is, in fact, a revised version of Aquinas’s own *Sentences* commentary): question; arguments con; arguments pro; solution by means of a distinction in which both sides are usually shown to have seen parts of the truth; response to the opening arguments. The “divine science” of the *Summa theologiae* leaves the narrative structure of Scripture behind completely, replacing it with a system that articulates all the elements of the Christian faith as parts of a coherent whole—a whole that represents the methodically generated sum total of all the authoritative voices of the tradition.

The Waning of Scholasticism

Already toward the beginning of the fourteenth century, however, the intellectual practices of high Scholasticism—such as the question schema just described—were disintegrating. The problems of Christian thought, together with its textual bases, had reached such a degree of complexity that a method designed to integrate discordant voices into a coherent tradition could no longer succeed. Authors now began to emphasize their originality, choosing a format for their presentation that allowed them greater independence. Thus, the “question” dissolved, and commentators on the *Sentences* used the genre for increasingly autonomous statements of doctrine.

See also *Aristotelianism; Christianity; Logic*.

BIBLIOGRAPHY

PRIMARY SOURCES

- Biblia latina cum Glossa ordinaria: Facsimile Reprint of the Editio Princeps, Adolph Rusch of Strassburg 1480/81.* Edited by Karlfried Froehlich and Margaret T. Gibson. Turnhout, Belgium: Brepols, 1992.
- Lombard, Peter. *Sententiae in IV libris distinctae.* Edited by Ignatius Brady. 2 vols. Grottaferrata, Italy: Editiones Collegii S. Bonaventurae Ad Claras Aquas, 1971/1981.
- St. Augustine of Hippo. *On Christian Teaching.* Edited and translated by R. P. H. Green. Oxford: Clarendon, 1995. Translation of *De doctrina christiana*.

Thomas Aquinas. *Summa theologiae*. 5 vols. Translated by Fathers of the English Dominican Province. Westminster, Md.: Christian Classics, 1981.

SECONDARY SOURCES

Froehlich, Karlfried, and Margaret T. Gibson. *Biblia latina cum Glossa ordinaria: Introduction to the Facsimile Reprint of the Editio Princeps, Adolph Rusch of Strassburg, 1480–81*. Turnhout, Belgium: Brepols, 1992.

Grabmann, Martin. *Die Geschichte der scholastischen Methode*. 2 vols. Freiburg im Breisgau: Herder, 1909–1911. Reprint, Berlin: Akademie-Verlag, 1988.

Rosemann, Philipp W. *Peter Lombard*. New York: Oxford University Press, 2004.

———. *Understanding Scholastic Thought with Foucault*. New York: St. Martin's, 1999.

Weijers, Olga. *Le maniement du savoir: Pratiques intellectuelles à l'époque des premières universités (XIIIe–XIVe siècles)*. Turnhout, Belgium: Brepols, 1996.

Philipp W. Rosemann

SCIENCE.

This entry includes two subentries:

Overview

East Asia

OVERVIEW

Science is a product, a particular kind of knowledge, as well as a process to obtain such knowledge. It is a social activity primarily aimed at obtaining objective and consensual knowledge about nature and to use this knowledge for socially desirable purposes. Scientists and philosophers disagree about whether scientific knowledge mirrors nature as it really is, or if it merely constitutes an instrument to describe and control natural processes and objects. Irrespective of the stance on this issue, scientists (and most philosophers) agree that objective and consensual knowledge can in fact be obtained, and that to a large extent the success of science derives from following certain rules and methods. Although there is no one scientific method that leads to true knowledge, there are rules and methods that are generally followed and in a loose way demarcate science methodologically from nonscience.

General

The methodological foundation of modern science was laid during the scientific revolution of the sixteenth and seventeenth centuries. Whereas one school of thought, going back to Francis Bacon, emphasized induction from particular observations and experiments, the followers of René Descartes favored a more hypothetical-deductivist approach. In the mid-nineteenth century, the two kinds of methodology were refined and developed by, among others, John Stuart Mill and William Whewell. It is commonly recognized that both methods are employed in real science and that they do not constitute two different ways of doing science. Moreover, the favored meth-

ods differ from one science to another. The methods of the astrophysicist are not the same as those of the botanist, yet they are not entirely different either.

Science is organized in a large number of disciplines and subdisciplines, including areas of research of a transdisciplinary nature. Although there have been many attempts to establish hierarchical, more or less natural classifications among the sciences, in the early twenty-first century these have largely been abandoned. All of the particular sciences have a limited area of validity, a domain of nature within which they are relevant and about which they can claim cognitive authority. Nevertheless, there is no one-to-one correspondence between domains and scientific disciplines, and many cases in which science has the “right” to speak about a certain domain is a matter of controversy. According to some positivistically minded thinkers, science as a whole covers all domains of nature, consciousness, and society in the sense that all meaningful questions can be answered scientifically, and they ought to be answered so. This point of view, which expresses a kind of scientific imperialism as it denies the legitimacy of, say, social, metaphysical, and religious explanations, is often referred to as scientism. Although few thinkers have endorsed scientism in a pure form, it is not unusual for scientists to believe that social and ethical questions can in the last resort be reduced to scientific questions. In his book *Consilience* (1998), the biologist Edward O. Wilson holds that the unification of the natural sciences with the social sciences and humanities can be achieved on terms dictated by science. It is a matter of debate how stringently a scientific theory should be restricted to its original domain. Nature does not tell what is the proper domain of a scientific theory or principle. According to “restrictionists” a theory can be legitimately applied only to its scientific context, whereas “expansionists” are willing to extrapolate it to very different areas, for instance by means of analogies. Scientism is typically more appealing to expansionists than to restrictionists.

It is a major aim of history and philosophy of science to establish how science develops over time. Science has been hugely successful, but how is it that scientists know so much more of nature, and so much more reliably, than their predecessors? How is cognitive progress achieved? The traditional view is that new scientific theories build on earlier theories, which are criticized and improved upon, typically because they fail to account for new phenomena. They are modified or rejected in order to give way to new theories, although most of the old experimental data will still be valid and have to form part of the new theories as well. According to this picture, science essentially evolves cumulatively, by adding knowledge to knowledge or replacing obsolete knowledge with better knowledge. Whereas the picture stresses the evolutionary and conservative aspects of science development, it pays little attention to major conceptual restructurings of knowledge.

In his *The Structure of Scientific Revolutions* (1962), Thomas S. Kuhn argued that cumulative progress occurs only in periods of “normal science” when the community of scientists within a given field agree upon the standards of science, its paradigm. During revolutionary changes a new paradigm

replaces the older one, and the two kinds of science are so different that they cannot be compared rationally. They are incommensurable in the sense that there is no neutral, trans-paradigmatic way to define progress across a revolution. According to the strong version of Kuhnian revolutionary changes, paradigms constitute separate worlds between which no communication is possible. Consequently Kuhn's theory opens up for relativism, with all its problems (as discussed further below). The strong Kuhnian picture, however, does not agree very well with the history of science, which includes many examples of scientists who have had no problems in maneuvering between competing paradigms. Although revolutions in the strong sense rarely or never occur, science often experiences major transformations that may involve drastic reinterpretations of past knowledge. Yet even in such cases—quantum mechanics may be an example—new theories are usually designed to account also for the successes of past science.

Recent Developments

In classical sociology of science, such as that developed by Robert K. Merton (1910–2003) in particular, ideological, political, and economic factors form the framework of science development, but they do not affect the epistemic content of science. From the 1970s onward, groups of sociologists and philosophers have gone beyond this position and argued that science is not epistemically privileged compared to other, non-scientific modes of obtaining knowledge. Partly inspired by Kuhn's book, scholars such as Paul Feyerabend, David Bloor, and Barry Barnes claimed that science is essentially ideological in nature and that its knowledge claims can be fully understood in terms of social mechanisms, hence by sociology. According to the so-called strong program of science studies, the distinction between science and nonscience cannot be upheld; furthermore, there is no intrinsic difference between true and false statements in science. A true theory is simply one that happens to be accepted by the relevant community of scientists.

Epistemic sociology of science, sociology of scientific knowledge (SSK), or social constructivism was a strong force in science studies during the last part of the twentieth century. It nevertheless left little mark on the scientists. Common to constructivists, of whatever inclination, is that they share to some degree a relativistic conception of science: A scientific theory is relative to social and cultural contexts, hence its truth value cannot be decided simply by comparing it with nature itself (that is, with observations and experiments, for these, too, are social constructs). Modern constructivists, such as Harry Collins, Andrew Pickering, Bruno Latour, and Karin Knorr Cetina, do not form a homogeneous group, but they all deny that science is a successful truth-seeking activity based upon an interplay between theories and experiments that reveal objective natural phenomena. In their arguments, they tend to emphasize controversies within the scientific communities, the contingent nature of scientific problems, and also the inescapable theory-ladenness of experiments. Naturally, the claim that accepted scientific knowledge is not derived from nature, but rather from local social and cultural contexts within and without the scientific community, has caused a great deal of controversy.

The “science wars” have principally been fought between scientists and academic analysts of science, but there have also been battles among scholars within the fields of sociology, history, and philosophy of science. In *Higher Superstition* (1994), the biologist Paul R. Gross and the mathematician Norman Levitt launched an attack on what they considered to be the antiscientific attitude of the “academic left.” It is probably true to say that in the early twenty-first century such battles are no longer as intense as they used to be, and that the radical relativism of the 1980s has only a few advocates left. As far as the scientists are concerned, the large majority continue their work unperturbed by the controversy and in many cases blissfully unaware of it.

Yet the turn toward contextualism and constructivism has clearly left its mark upon science studies and opened the way for a variety of new approaches to the historical, philosophical, and sociological study of science. Thus, with the development of SSK it became natural to investigate the role played by rhetoric in the construction of scientific arguments (whereas, traditionally, science and rhetoric have been seen as antithetical). Most scholars in this area of science studies are content to point out the importance of rhetorical strategies, but according to others, closer in spirit to social constructivism, science itself can be understood as a form of rhetoric. Whatever the differences, after about 1980 rhetorical and literary analysis became a legitimate and popular tool in the examination of science—although a tool unknown to most scientists. Among the rhetorical elements that have attracted much attention are metaphors in science.

Science is international, but of course it depends on national and other local contexts as far as funding, organization, and institutionalization are concerned. Since the late nineteenth century it has been argued that the national stamp also covers “styles” of doing science, which derive from either national characters or cultural traditions specific to a certain country. Although the notion of style is controversial, and that of national style even more so, the topic has been examined by several modern historians and philosophers of science. For example, Jonathan Harwood has used style as a historiographical category in studies of twentieth-century biology, and Alistair Crombie has provided an extensive treatment of style in science in his *Styles of Scientific Thinking in the European Tradition* (1994).

The gender aspect of science, although not a new one, has flourished only since the 1980s when Carolyn Merchant in *The Death of Nature* (1980) discussed the historical gendering of nature as female. Likewise, Evelyn Fox Keller argued in *Reflections on Gender and Science* (1985) that science, in its present form, is inherently masculine. One answer to the historically documented conflict between femininity and traditional science has involved attempts to develop a new “feminist science” that reflects what are supposedly feminine values, such as cooperation, tenderness, organicism, and reflexivity. This has resulted in a considerable amount of scholarship, but not any real changes in the practice and ethos of science. Social constructivists, radical feminists, multiculturalists, and postmodernist critics have been accused of fighting the case of antisience. Nevertheless, although they

oppose established science, they are not against science as such but rather seek to build up alternative modes of science in harmony with the social and cultural values they favor. Their endeavors have not been more successful, though, than the attempts of some Christian fundamentalists to establish an alternative “creationist science.” The norms, contents, and institutions of modern science have a remarkable degree of robustness. If there are alternative sciences, they are marginalized and have, at least so far, been unable to challenge established science.

Theory, and particularly mathematically formulated theory, has traditionally been the focus of philosophy of science, whereas experimental practice has been considered merely an appendix to theory. Experimental results have always been of interest, but only from the 1980s has attention been given to experiment and observation as a process. Experiment has become an important field of inquiry, irrespective of its connection to theory. Indeed, Ian Hacking, Allan Franklin, and others have questioned the notion that observations are always “infected” by the theory under test. They have urged scholars to study experiments and observations in their own right, including how instruments are built and used in measurements. Many constructivist scholars share this interest in the experimental workplace. Bruno Latour and Steve Woolgar’s *Laboratory Life* (1979) initiated a new kind of study, laboratory studies, in which scientists and other “actors” are followed in their daily work, much like anthropologists observe the habits of their subjects. Laboratory studies have in some cases been concerned with laboratories as buildings rather than workplaces of scientists. The architecture and physical arrangement of laboratories, observatories, museums, and botanical gardens is a field of growing concern, among other reasons because they are seen as expressions of the values associated with science at any given time and place.

See also *Experiment; Paradigm; Science, History of; Scientific Revolution.*

BIBLIOGRAPHY

- Cohen, I. Bernard. *Revolution in Science*. Cambridge, Mass.: Harvard University Press, Belknap Press, 1985.
- Golinski, Jan. *Making Natural Knowledge: Constructivism and the History of Science*. New York: Cambridge University Press, 1998.
- Gross, Paul R., and Norman Levitt. *Higher Superstition: The Academic Left and Its Quarrels with Science*. Baltimore: Johns Hopkins University Press, 1994.
- Holton, Gerald. *Science and Anti-science*. Cambridge, Mass.: Harvard University Press, 1993.
- Hoynigen-Huene, Paul. *Reconstructing Scientific Revolutions: Thomas S. Kuhn’s Philosophy of Science*. Chicago: University of Chicago Press, 1993.
- Jasanoff, Sheila, et al., eds. *Handbook of Science and Technology Studies*. London: Sage, 1995.
- Keller, Evelyn Fox. *A Feeling for the Organism: The Life and Work of Barbara McClintock*. San Francisco: Freeman, 1983.
- Kitcher, Philip. *The Advancement of Science: Science without Legend, Objectivity without Problems*. New York: Oxford University Press, 1993.
- Merchant, Carolyn. *The Death of Nature: Women, Ecology, and the Scientific Revolution*. San Francisco: Harper and Row, 1980.

Olby, R. C., et al., eds. *Companion to the History of Modern Science*. London: Routledge, 1990.

Pickering, Andrew, ed. *Science as Practice and Culture*. Chicago: University of Chicago Press, 1992.

Wilson, Edward O. *Consilience: The Unity of Knowledge*. New York: Knopf, 1998.

Helge Kragh

EAST ASIA

The most familiar characteristics of modern science—rigorously demonstrated relationships based on a combination of experimentation and exact measurement—did not exist anywhere in the world before the seventeenth century. Any definition of science that holds for earlier times or for places other than Europe must be more inclusive. More useful criteria are the attempt to find rational explanations, rather than those based on gods and analogues to human will, and the use of abstraction to generalize from concrete data.

One can speak of East Asian science because the educated elite of China, Japan, Korea, and Vietnam shared a classical written language. To a large extent, literacy in East Asia meant being educated in the same Chinese classics and writing in a language based on them, just as Europeans for centuries learned and communicated in Latin. China, because of its size, wealth, and bookish literati, tended to dominate its neighbors intellectually in science as in other fields, but East Asians elsewhere made notable contributions, some of which are noted below.

The Sciences

A peculiarity of Greek culture was that philosophy informed the basic educations of those who practiced mathematics and the natural sciences, and of many physicians whose writings became textbooks. In the Islamic world, and in the early European universities, curricula continued to put philosophy prior to science and medicine.

This was not the case in China. Information on natural phenomena first appeared in general writings devoted simultaneously to moral philosophy, political theory, and cosmology. Basic physical concepts and frameworks evolved in such works.

Beginning in the first century B.C.E., autonomous sciences separated from philosophy on the one hand and technical practice on the other. Their traditions, like those of earlier non-technical scholarship, were canonical. Confucius claimed that philosophy began with books that had survived from a golden antiquity into the degraded present. Analogously, almost every field of endeavor traced its beginnings to one or more classics revealed by an ancient sage-ruler. Education was based on the ritual transmission of such texts from master to disciple within each tradition.

Early monographic technical writings (many of which used the form and rhetoric of the classics) elaborated on their philosophic predecessors to meet their own needs. Practitioners did not, however, see themselves as supplementing philosophy, or engaged in an overarching intellectual enterprise. Rather, they were engaged in a common exploration of the Way (*dao*), an aim that encompassed aesthetic, literary, and visionary experi-

Some outstanding East Asian scientists

Name	Dates	Accomplishments
Zhang Heng	78-139	Polymath, astronomer, cosmologist, instrument designer
Zhang Ji	c. 160?–after 219	First formulary for febrile diseases
Sun Simo (or Simiao)	alive 673	Alchemist, physician
Yang Yunsong	9th century	Expert on siting, author of important manuals
Zan Ning	919–1002	Author of important sources for resonance studies
Shen Gua (or Kuo)	1031–1095	Polymath, astronomer, critical commentator on science
Guo Shoujing	1231–1316	Designer of astronomical instruments, expert on water control
Li Shizhen	1518–1593	Author of <i>Systematic Materia Medica</i>
Seki Kowa (or Takakazu)	d. 1708	Japanese innovator in calculus and other mathematical fields
Mei Wending	1633–1721	Mathematician, restorer of classic computational and astronomical traditions

SOURCE: Courtesy of the author

ence, in which cognition could play only a part. Because there was no science as a single, distinct activity, it is more accurate to speak of the Chinese sciences.

Scholars in East Asia in the early twenty-first century commonly enumerate the traditional sciences using modern categories (or rather those common in the 1950s). This positivistic approach often leads to a misperception. For instance, because there was no such field as biology in ancient classifications of knowledge, one must gather traditional notions about life and organisms from treatises on materia medica, handbooks for connoisseurs of goldfish and other creatures that people collected, travel accounts, textbooks on veterinary medicine, and so on. The result is inevitably a grab bag of incompatible notions, likely to give rise to the misconception that Asians did biology poorly. Nor was physics a discrete field. The physical disciplines that did exist, such as siting and resonance studies, had no counterpart in the West. This article follows current practice by discussing scientific ideas in the categories that practitioners used. It divides them into quantitative (*shushu*) and qualitative sciences.

Before addressing the individual sciences, it is necessary to discuss certain early concepts of the cosmos and its workings that affected every aspect of culture.

Qi, yin-yang, five phases. In the late Zhou period (722–256 B.C.E.), ritualists manipulated natural and social symbols in sets of costumes, implements, offerings, and so on, specifying the number in each set. As the notion evolved that the order of the good state reflected that of the cosmos, courtly discussions naturally adapted this idea of numbered sets to the social and natural worlds. Certain categories—especially those arising in twos, threes, fives, and sixes—turned out to be especially useful. As philosophers used them to group phenomena and analyze their interrelations, dependence on them grew. After the third century B.C.E. these categories, especially those of yin-yang and the five phases, became the first resort for systematic thought.

At the same time, thinkers trying to account for continuity and change refined the concept of *qi*, the stuff from which everything was formed, to deal with questions analogous to those that

Anaximenes' *aer* addressed. But unlike *aer* or Aristotle's *hyle*, *qi* was also the vitality of an organism' or thing,' responsible for its stability, growth, and change. *Qi* was predominantly a matter of cyclic processes, each a sequence of dynamic phases. It circulated through the body because it circulated through the universe and through the earth as part of the universe.

From the mid third century B.C.E., several philosophers explored the use of yin-yang and the five phases to discuss complementary aspects within temporal processes or spatial configurations. By the end of the first century B.C.E., the *Inner Canon of the Yellow Emperor (Huangdi nei jing)*, a collection of writings on medical doctrine, and *The Canon of Supreme Mystery (Tai xuan jing)*, a cosmological treatise, provided mature syntheses in which these twofold and fivefold concepts became ways of characterizing *qi*. In Chinese thought from then on, yin and yang were not activities or forces but phases of *qi* responsible for form, vitality, and change. This understanding became a foundation not only of philosophy but also of the autonomous sciences as they appeared. Each adapted this set of concepts to its own problems, and supplemented it with additional ones.

Quantitative sciences. The quantitative sciences in traditional China consisted of mathematics, mathematical astronomy, and mathematical harmonics.

Mathematics (*shu*, *suan*). The pattern for mathematics was largely formed by the *Mathematical Canon in Nine Chapters (Jiuzhang suan shu)* of the first century C.E. It brings together 246 problems, of which some reflect the practice of government accountants and surveyors and others the concerns of small private traders. For each it provides a step-by-step numerical solution. It is not concerned with proofs (these appeared at the end of the third century), but rather aims to show how one can solve a wide variety of problems using nine general computational methods. These methods, even for mensuration problems, remained algebraic, depending on computational devices (computing boards until around the fourteenth century, then the abacus).

Unlike earlier manuscripts, the book arranged its materials in standard and rather systematic form. The main mathematical

tradition remained focused on numerically stated practical problems. Over the last millennium even authors who explored more abstract realms—always tentatively until the introduction of European approaches—still stated their problems in concrete (and often impractical) form.

The texts gathered in the other early classic of mathematics, the *Zhou Gnomon* (*Zhou bi*, later called *Zhou bi suan jing*, between 50 B.C.E. and 100 C.E.), use the try square and compass to construct simple numerical models of the universe and its relation to a central earth. These texts apparently aim to demonstrate how one might go about building up a computational astronomy.

Mathematical astronomy (li). Chinese believed that Heaven gave the mandate to rule to the family best able to keep the cosmos and the state in harmony. Unpredicted celestial events were warnings to the current emperor that he was failing to carry out his responsibilities as he should. He therefore needed court astrologers to observe, report, and interpret these portents, and to find out what acts or omissions Heaven was warning him about. He also needed court astronomers to improve methods of prediction, so that there would be fewer omens to worry him. Thus both astrology and astronomy were state enterprises.

The Chinese began the day at midnight, the month at the new moon, and the year at the winter solstice. A system of computational astronomy (*li*) was a set of step-by-step procedures that officials could follow to generate a calendar for the coming year. It forecast actual new moons, solstices, eclipses, planetary phenomena, and much else.

Originators of systems generally claimed that they would yield highly accurate predictions forever. In practice, their slight errors accumulated and lead to failures sooner or later. Because unpredicted phenomena reflected on the emperor's virtue, there was endless pressure to design better systems. Some governments used them ritually to signal the cosmic aegis of a new dynasty or reign period, or even a renewal of virtue within a reign. Rulers over two millennia officially adopted roughly fifty systems. Other East Asian governments, generally relying on hereditary astronomy officials, tended to adopt or minimally adapt Chinese systems, and to use a very few of them for long periods of time.

The methods of computation were numerical, closer to modern computer algorithms than to the Greek geometric approach. Building a calendar was a matter of cycles, as a simple example illustrates.

Astronomers discovered early on that a year was on average 365 days long, and a month, a little over 29 days long. Since the units of a calendar must contain a whole number of days, the Chinese, roughly speaking, alternated months of 29 and 30 days. But 12 such months add up to only 354 or 355 days. It was therefore necessary to add an extra (that is, intercalary) month every so often to reach the correct long-term average. Specialists soon realized that adding 7 extra months at more or less equal intervals over 19 years, creating 7 years each 383 or 384 days long, would make the average year 365 days, so the calendar would roughly predict what people saw in the sky. By the end of the first century B.C.E., they extended

the scope of their systems to eclipses and planetary phenomena by incorporating many additional cycles.

This approach, based on average periods, could carry astronomers only so far. Later astronomy remained mainly cyclic in approach, but (from 223 C.E. on) gradually incorporated the varying, or apparent, motions of heavenly bodies, and (from the eleventh century on) evolved a trigonometric approach to spherical geometry. The high point of predictive power came with the *Season-Granting System* (*Shoushi li*), in use from 1281 to 1644 in China, and even later in Japan and Korea.

Mathematical harmonics (lü, lülü). Chinese thinkers were as fascinated by the quantitative relations between sounds and the physical arrangements that produced them as the Pythagoreans were. Harmonic intervals implied that a quantitative order underlay apparently qualitative and sensuous phenomena. In China such studies were concerned primarily with resonant pipes. These pitch pipes provided the standards for tuning ritual bells and stone chimes. Their lengths and volumes were also the basis—symbolically, at least—for metrological standards of length, volume, and (indirectly) weight. The ceremonial music of the court applied harmonics as an aspect of the imperial charisma.

Qualitative sciences. Among the qualitative sciences were astrology, medicine, materia medica, alchemy, siting, and resonance studies.

Astrology. Astrology (*tianwen*) complemented astronomy by dealing with unpredictable, and therefore ominous, phenomena. Its portents were mainly celestial, but also included freaks of weather and of animal or human birth, palace fires, and so on. These concerns led to assiduous observation and recording, and to archives maintained over many centuries. The second task of the astrologer was to correlate newly observed prodigies with recorded instances, and thus to direct the attention of the ruler and his advisors to what aspect of government needed reform. Practically speaking, such ritual (like economic forecasting in the early 2000s), although flawed as a technique of prediction, enabled a wider range of policy discussion than those in power might otherwise consider.

The registers of phenomena have been boons to modern science. They have provided richer collections of precisely dated observations than those from any other civilization—millennia not only of eclipses (used in studying, for instance, the gradual change in the moon's speed) and comets (used to establish changes in the orbital velocity of, for instance, Halley's comet), but also of earthquakes (which have given China a leading role in research on their prediction).

Medicine. Traditions of medicine (*yi*) based on abstract doctrines developed by elite practitioners and passed down in writing were only a small component of health care in East Asia, as elsewhere.

Those who treated the sick were mostly laymen, illiterate healers, and priests. In other East Asian societies, methods for healing the elite were very different from the culturally embedded practices available to the majority of those populations, and the practice of medicine was affected by different social cir-

A few important East Asian scientific books

Title	Author	Date	Contents
<i>Records of the Grand Historian (Shi ji)</i>	Sima Qian	c. 100 B.C.E.	First history to contain astronomical and astrological treatises
<i>Inner Canon of the Yellow Emperor (Huangdi nei jing)</i>	Anonymous	1st century B.C.E.?	Canonical collection of medical doctrines
<i>Mathematical Canon in Nine Chapters (Jiuzhang suan shu)</i>	Anonymous	1st century C.E.	Worked problems in practical form
<i>Kinship of the Three (Zhouyi cantong qi)</i>	Anonymous	c. 700	Early theoretical text of alchemy
<i>Formulas at the Heart of Medicine (Ishimpō)</i>	Tamba no Yasuyori	982	Compendious Japanese formulary from Chinese sources
<i>Season-Granting System (Shoushi li)</i>	Wang Xun et al.	1281	Most sophisticated system of astronomical computation
<i>Classified Collection of Medical Formulas (Ūibang yuchwi)</i>	Kim Yemong	1445	Korean collection of over 50,000 formulas
<i>Systematic Materia Medica (Bencao gangmu)</i>	Li Shizhen	1596	Wide range of data about nearly 2000 drug substances

There is no reliable, complete translation of any of these books into English.

SOURCE: Courtesy of the author

cumstances. For instance, classical Chinese medicine reached the Japanese court by the early ninth century, but was almost inaccessible outside aristocratic circles and a few Buddhist institutions. It became a mainstream tradition only between the mid sixteenth and mid seventeenth centuries, when its European counterpart was also first becoming known in Japan.

Materia medica. Materia medica (*bencao*) was the study of drugs of mineral, vegetable, and animal origin. But more than that, it was a trove of natural history. The earliest compilation (in the late first or second century C.E.) was as concerned with immortality as with the restoration of health. Later compilations described each medicinal substance in detail, with information ranging from habitat to adulterants to methods of processing. Charles Darwin drew on data from the *Systematic Materia Medica (Bencao gangmu, 1596)*, the most authoritative treatise on pharmacognosy, in his *Variation of Animals and Plants under Domestication* (1868).

Alchemy. The somewhat more than a hundred surviving treatises on alchemy (*liandan, lianjin, jindan*) vary greatly in their concepts, content, symbology, and rituals, and their interrelations remain far from clear. Research in the 1990s and 2000s places them tentatively on a spectrum ranging from external alchemy to internal alchemy. Adepts in external alchemy made elixirs much as mineral medicines were made, by treating chemical substances with fire and water. Elixirs, when ingested, could cure illness, restore youth, and bring about immortal life, for the alchemist or anyone who ingested them. Internal alchemists produced elixirs within the body by visualization, contemplation, and other meditative means. These were the same disciplines used in other modes of self-cultivation, but adepts of internal chemistry used the language of the external art—chemical ingredients, crucibles, furnaces, timed application of heat, and so on—to describe their own meditative experiences. On occasion, such experiences amounted to drug hallucinations. Between these two contrasting genres were theoretically inclined writings that explained alchemy (of the laboratory or of the body) as symbolic manipulation of time and space. Whether, in external prac-

tice, adepts were charging the furnace with timed sequences of carefully weighed fuel or, in internal alchemy, they were breathing in cycles regulated by depth and time, the aim was to reproduce on a compressed scale a great cycle of macrocosmic creation, growth, maturity, aging, death, and rebirth.

In this amalgam of theory and practice, witnessing in the laboratory the process that created the elixir of experiencing it within the body perfected the adept spiritually and, as a result, physically. It made him immortal. The chemical product was unimportant by comparison. Alchemy was as much concerned with religious transcendence as with chemical processes, but along the way alchemists accumulated a great deal of practical knowledge, including understanding of quantitative relations.

Siting. Siting (*dili, kanyu*, now called *fengshui*) was concerned with the placement of houses and tombs in relation to their environments. It was based on the idea that *qi* circulated regularly through the earth, channeled by high and low places, wet and dry places, and other topographic features. The ideal site was one on which a dynamic balance of *qi* converged. Great effort went into finding the right abode for a family or an ancestor—effort that intellectuals justified cosmically and that the less educated justified as bringing good fortune. Siting is historically interesting because the compass first appears in the early eleventh century in the hands of practitioners, a century before its use for navigation. Siting fascinates landscape architects because its systematic analyses of landforms generate consistently beautiful placements in the landscape.

Resonance studies. All the traditional sciences attempted to find the regularities underlying change. One widespread style of reasoning began with two assumptions. The first was that since things and events observably influence each other, such categories as yin-yang and the five phases can explain their interaction. The second was that things of the same category affect each other by resonance, the same resonance that causes interaction between certain musical strings or pitch pipes. The surviving literature consists of only a few books devoted to resonance studies (*ganying, wuli*) and a number of assertions in

the materia medica and other literatures, and these have been little studied. Some of the assertions about how one creature responds to or changes into another echo folklore. Still, the language of resonance made it possible to collect and set in order data on, for instance, a range of biological phenomena, such as grafting of trees.

Scholarship on East Asian Science

Historical studies of East Asian science grew out of two broader traditions: the rigorous philological scholarship (*kaozheng*) that evolved in China, Japan, and Korea, and the chronicling of positive progress (focused mainly on concepts) prevalent in early-twentieth-century Europe and America. The best-known philological scholars are Xi Zezong (b. 1931) in Beijing and Yabuuchi Kiyoshi (1906–2000) in Kyoto. And the best-known Western chronicler is Joseph Needham (1900–1995) in Cambridge, England. From around 1970 on, social history (drawing on sociology and anthropology) filled some of the gaps in the prevalent history of scientific ideas. In the 1980s, as the antagonism between “internalist” intellectual history and “externalist” social history drew to an end in the West, mainstream history of science took up the challenge of exploring phenomena as a whole, using the widest range of disciplinary tools. Nathan Sivin, using “cultural manifolds” that integrate every dimension of the problems investigated, has applied this approach to East Asian science and to cross-cultural comparisons.

New primary sources have led to fundamental reevaluations. From the 1950s on, archeological excavations have disinterred many troves of manuscripts, some earlier than any extant book, others that cast a fresh light on later technical developments. Many of these documents were not published until 1980 or later. And the excavations continue. The result is a quickly changing base of empirical knowledge, especially about the beginnings of science, that makes many earlier generalizations obsolete.

See also *Chinese Thought; Medicine: China*.

BIBLIOGRAPHY

- Cullen, Christopher. *Astronomy and Mathematics in Ancient China: The Zhou bi suan jing*. Cambridge, U.K.: Cambridge University Press, 1996. Includes an excellent introduction.
- Darwin, Charles. *Variation of Animals and Plants under Domestication*. 2 vols. London: Murray, 1868.
- Furth, Charlotte. *A Flourishing Yin: Gender in China's Medical History, 960–1665*. Berkeley: University of California Press, 1999. On medical care for women and childbirth, with a chapter on women as healers.
- Hsu, Elisabeth, ed. *Innovation in Chinese Medicine*. Cambridge, U.K.: Cambridge University Press, 2001. A good collection of conference papers.
- Jeon Sang-woon. *Science and Technology in Korea: Traditional Instruments and Techniques*. Cambridge, Mass.: MIT Press, 1974. Revised as *A History of Science in Korea*. Seoul: Jimoondang, 1998.
- Libbrecht, Ulrich. *Chinese Mathematics in the Thirteenth Century. The Shu-shu chiu-chang of Ch'in Chiu-shao*. Cambridge, Mass.: MIT Press, 1973.

Lloyd, G. E. R., and Nathan Sivin. *The Way and the Word: Science and Medicine in Early China and Greece*. New Haven: Yale University Press, 2002. Comparisons that use an integrative methodology.

Martizloff, Jean-Claude. *A History of Chinese Mathematics*. Translated by Stephen L. Wilson. Berlin: Springer-Verlag, 1997. Translation of *Histoire des mathématiques chinoises*. Paris: Masson, 1988.

Nakayama, Shigeru. *A History of Japanese Astronomy: Chinese Background and Western Impact*. Cambridge, Mass.: Harvard University Press, 1969. Offers many important insights into Chinese astronomy as well.

Needham, Joseph, et al. *Science and Civilisation in China*. 22 vols. to date. Cambridge: Cambridge University Press, 1954–. Magisterial survey, partly outdated.

Scheid, Volker. *Chinese Medicine in Contemporary China: Plurality and Synthesis*. Durham, N.C.: Duke University Press, 2002. Important, well-informed study.

Sivin, Nathan. *Science in Ancient China: Researches and Reflections*. Brookfield, Vt.: Variorum, 1995. Selected essays.

Sugimoto, Masayoshi, and David Swain. *Science and Culture in Traditional Japan: A.D. 600–1854*. Cambridge, Mass.: MIT Press, 1978.

Nathan Sivin

SCIENCE, HISTORY OF. The history of science as an academic discipline grew in the post-1945 era along with the development of higher education and the expansion of science and technology. In the United States, Vannevar Bush's seminal 1945 article, “Science, the Endless Frontier: A Report to the President,” called for a government-supported national research foundation. Bush's influence led to the creation of the National Science Foundation in 1950 and inaugurated an era in which science was a form of “politics by other means” for waging the Cold War. Science came to be combined with technology in ways that often made the two indistinguishable. The program to land men on the moon, the development of intercontinental ballistic missiles with nuclear warheads, the construction of supercomputers, and the war on cancer are just a few examples of technoscience during this era. As the role of science and scientists in society increased, so did the need to understand science and scientists in historical terms.

In the 1970s and 1980s, many universities established history of science programs or related science and technology studies programs, greatly increasing the number of professional scholars in the field. The annual edition of the *Isis Current Bibliography* is a good indicator of growth and decline in the history of science. *Isis* is the academic journal of the History of Science Society, the discipline's largest professional organization. According to the society's preface to the 2000 edition, “The *Isis Current Bibliography* is compiled by the systematic search of approximately 600 journals.” Throughout the 1970s, the *Isis Current Bibliography* typically listed fewer than 3,000 entries comprising books and journal articles. In 1983 the number of entries rose above 3,000, and in 1993 it first surpassed 4,000. After 1999, scholarship in the history of science seemed to decline rapidly in quantitative terms, and since 2000 the number of entries has hovered below 3,000.

Throughout most of the twentieth century, there were two generally opposed schools of thought in the history of science: internalist and externalist. Internalists believe that the history of science should be explained only through the growth and development of science as rational knowledge and methods. For the internalist, social or cultural factors merely hinder or accelerate this growth, but are not intrinsically part of science. Externalists believe that science is a part of culture and society. For the externalist, the explanation of scientific change necessarily must include non-scientific factors. Boris Hessen's book *The Social and Economic Roots of Newton's Principia* (1931) helped establish the boundaries of the externalist camp with its emphasis on the social, economic, and political forces that shaped Newton's science. Alexander Koyré's work *Études Galiléennes* (1939; Galileo studies) helped establish the boundaries of the internalist camp with its emphasis on intellectual content, growth of knowledge, metaphysical assumptions, and rational nature of Galileo's science. In principle this debate between internalist and externalist explanations in the history of science largely ended following the publication of Thomas Kuhn's *The Structure of Scientific Revolutions* in 1962. Though Kuhn had begun historical work as a disciple of Koyré, Kuhn's book emphasized the role of social factors in revolutionary periods when one paradigm replaces another. Subsequently, though non-historians often fall into the internalism versus externalism debate, historians tend to embrace both explanations as complementary ways of understanding scientific change through time. From the internalist versus externalist debates, the sociology of science emerged as a discipline closely allied to the history of science. Because the sociology of science may use a theoretical method that distinguishes it from history qua history, it is sometimes treated as a special subcategory of the history of science.

Most historians of science focus their work around some combination of chronological period, subject category, and cultural area. Chronological periods include classical antiquity (chiefly Greco-Roman to c. 500 C.E.), the Middle Ages (Latin culture and Europe in general from 500 to c. 1450), the Renaissance and Reformation (1450–1600), and century-by-century from the seventeenth to the twentieth. Subject categories include mathematics, earth sciences, biological sciences, social sciences, and medicine and medical sciences. These are further broken down into subcategories—for example, the physical sciences consist of astronomy, physics, and chemistry. Some historians use a biographical focus within the subject approach. Cultural areas include Islamic and related cultures (including Israel, Iran, and the Near East in general; chiefly from c. 500 to c. 1600), India (to c. 1600), and the Far East (to c. 1600). Presumably, global communication and unification in the sciences make these cultural categories unnecessary after 1600. The work of Joseph Needham seems to belie this point, and the history of modern science in non-Western cultures remains a fertile and largely unexplored academic terrain.

The following categories are by no means an exhaustive survey of new themes in the history of science. Rather, they are an effort to identify selected key developments—some in traditional areas such as the scientific revolution, and others in new areas such as feminist history of science—that will help

orient scholars who are new to the discipline. Also, in part because of space limitations, history of technology and history of the social sciences are excluded, and only the history of the natural sciences is covered here.

General Works

Specialization among historians of science and the sheer volume of publications make it difficult for a historian of science to publish a general overview of the field that pleases most colleagues and is sufficiently comprehensive. With this in mind, two generally successful efforts are Anthony Alioto's *A History of Western Science* (1987) and Daniel Boorstin's *The Discoverers* (1983). Alioto's book serves well as a general introduction for undergraduate students. It is broad and inclusive up through the end of the scientific revolution (c. 1700), and it makes some effort to survey developments in science to the late twentieth century. Alioto emphasizes that science is a way of seeing the world and a way of knowing, rather than a compilation of facts. He also acknowledges the role of metaphysics. Much like Koyré, Alioto regards metaphysics as a commitment to the inherent and knowable order of natural phenomena. Boorstin was a general social historian and not a historian of science per se, but his book is a pleasure to read and is an excellent introduction to the subject for lay readers. It portrays science as human discovery on the frontier of nature and as a progressive method for defeating ignorance. Boorstin is generally weak on the effect of the social and cultural milieu on science, but he is strong in explaining the role of instruments such as the printing press, the telescope, and the microscope. In addition to the general works by Alioto and Boorstin, W. W. Norton and Company has published a series of historical surveys of major disciplines such as chemistry, physics, and the human sciences. The volumes in the Norton series are highly recommended for scholars new to the history of science.

To understand the general scope of the history of science since 1970, two other introductory texts are necessary. One is a work about women in science, and the other is about science as socially constructed knowledge. Margaret Alic's *Hypatia's Heritage* (1992) surveys the role of women in science from antiquity through the nineteenth century. Through a series of chapter-length biographies, Alic helps students and general readers appreciate male biases that created both social hurdles to discourage women who wanted to become scientists and historical filters to render invisible those women who did become scientists. David Bloor's *Knowledge and Social Imagery* (1981) helped establish "the strong programme" for the social history of science. Bloor's method hinges on the belief that "knowledge for the sociologist is whatever people take to be knowledge." Thus, according to Bloor's symmetry principle, there should be no inherent difference between the explanations about what some might regard as true beliefs and what some might regard as false beliefs. Furthermore, Bloor is interested in the form and content of science as knowledge, and not in scientists per se. The strong programme is a theory supporting the social constructionist view and is not to be confused with the social history of science, which seeks merely to explain social influences on science. That said, the origins of the strong programme and social constructionist in the his-

tory of science can be traced to “The Merton Thesis.” Robert K. Merton’s *Science, Technology, and Society in Seventeenth Century England* (1938) argued for the linked origin of values in science, the English revolution, and the Anglican religion.

Preclassical Antiquity

Mott Greene’s *Natural Knowledge in Preclassical Antiquity* (1992) displays a time when people lived in an oral culture and were in close contact with their natural surroundings as a daily part of life. Greene argues that this firsthand experience of nature means that mythology should be understood in natural terms as well as through philology. For example, the enigma of the Cyclops might well be explained through the presence of volcanoes—gigantic one-eyed beasts that threatened humans with annihilation.

Ideas such as Greene’s have found their way into standard works of scholarship on human ecology and nature. In *The Idea of Wilderness: From Prehistory to the Age of Ecology* (1991), Max Oelschlaeger begins by trying to understand the worldview of Paleolithic humans. He writes, “Clearly, the mythology of the Great Hunt and totemism are not stupid responses to the world but mirror the same level of intelligence—albeit one directed to an unmistakably different view of the world—as modern science” (p. 15). Furthermore, in seeking to understand the meaning of wilderness for the modern world, Oelschlaeger considers the poetry of Robinson Jeffers or Gary Snyder to be on equal footing with the environmental science of Aldo Leopold. Understanding science as an integral part of culture rather than as an exceptional activity is characteristic of postmodernism, although this way of thinking is still disputed by many historians of science.

Middle Ages

The Middle Ages, from about 500 to about 1600, are in the early twenty-first century recognized as a fertile period marking a transition from the dominance of a handful of ancient authorities to a broad range of theory and experiment. These developments took place throughout Europe, North Africa, the Arabian Peninsula, and Asia. For the eventual rise of science in Renaissance Europe, developments in Islamic nations were especially important. For a comprehensive survey of this cultural transfer, see David Lindberg’s *The Beginnings of Western Science* (1992), which traces the development of ideas within cultures and their transfer from one culture to another as well as the cultural contexts that enframed these developments. As an historian who pioneered studies of the close relationship between science and Christianity in the West, Lindberg is especially good at laying the “religion versus science” myth to rest. He does this in a number of ways, including explanations of support for science and medicine in the medieval church and the transfer of Greek science from Islam to Europe through Christian scholars such as St. Thomas Aquinas.

Scientific Revolution

The “scientific revolution” embraces the period between 1500 and 1700. Major biographical figures such as Francis Bacon (1561–1626), Galileo Galilei (1564–1642), Robert Boyle

(1627–1691), Nicolaus Copernicus (1473–1543), Johannes Kepler (1571–1630), and Isaac Newton (1642–1727) dominate historiography for this period, although historians have done considerable work on figures such as Paracelsus (1493–1541) or Robert Fludd (1574–1637), whose ideas on occult sciences or mysticism influenced major figures, or those such as Marin Mersenne (1588–1648) or Christiaan Huygens (1629–1695), whose ideas on mechanism or metaphysics helped shape the work of others.

Historians of science long acknowledged the importance of published communication and authorship during this period. Yet until Elizabeth Eisenstein’s two-volume *The Printing Press as an Agent of Change: Communications and Cultural Transformation in Early Modern Europe* (1979), the importance of publication and authorship was a largely untested assumption with knowledge about these phenomena scattered throughout the literature. The second volume of Eisenstein’s work is mainly about communication and science and makes a strong case that, whereas print was not *the* agent of change in giving rise to the scientific revolution, it was a crucial one. The social power of scientists as authors and the development of print-based academic culture were seen in the importance of prestige and how it came to be defined as a system of social capital. This reward system did not guarantee that publications would bring acclaim from fellow scientists, but it did ensure that an otherwise original scientist who did not publish would not receive acclaim. As an important independent variable in the history of science, publishing helps explain Galileo’s popularity (and his political troubles with the Catholic Church), the obscurity of the Swedish chemist Carl Scheele (who made major chemical discoveries but did not publish in French or English, and hence was unknown to contemporaries), the importance of the priority dispute between Newton and Gottfried Wilhelm von Leibnitz (1646–1716), and the covert pleas by Charles Darwin’s (1809–1882) friends for him to publish his *On the Origin of Species by Means of Natural Selection* (1859).

Although the occasional social constructionist has doubted whether there was any such thing as the scientific revolution, most historians recognize its usefulness as a heuristic term to characterize this amazing era of change. Indeed, Kuhn’s work made revolution—the overthrow of one paradigm by another—the key event in explaining scientific change.

Instead of merely working with “revolution” as a historical tool, I. Bernard Cohen uses the historical method to investigate the very idea of revolution in science. By placing Kuhn’s work in historical context, Cohen explains how scientists used and shaped the idea of revolution from the early modern period, through the Enlightenment, and on to the late twentieth century. During the Enlightenment, revolution became a rhetorical instrument borrowed from politics and heavily laden with connotations of progress. Like Cohen’s earlier biographical histories, his investigation of revolution in science centered on key figures such as Copernicus and Newton.

Social constructionists have also focused on key biographical figures to explain the scientific revolution. By investigating

the work of the chemist Robert Boyle, Steven Shapin and Simon Schaffer sought to explain how faith in the mechanistic approach came to dominate scientific culture and how the mechanistic view came to be constructed as scientific reality. Although often criticized for its focus on Boyle's having established his legitimacy by emphasizing his own status as a gentleman, Shapin and Schaffer's work is more nuanced than that, and it does help explain Boyle's ascendancy over rival mechanists such as Thomas Hobbes (1588–1679). As a representative of the conservative traditional social order, Hobbes doubted the ability of experiments to yield knowledge and was a critic to be reckoned with. Boyle's ability to tie experimental demonstration to his mechanistic views was crucial in gaining public acceptance over Hobbes's skepticism. Shapin and Schaffer also effectively explain how the English Revolution and Anglican religion shaped the scientific revolution and hence modern science. Just as Hobbes had feared, scientists became the modern priesthood and science a major source of political authority.

In the history of science since the 1970s, Newton has continued to be a key biographical figure. In a series of books published between 1975 and 1995, Betty Jo Teeter Dobbs revealed Newton's passion for alchemy and explained the connections between this passion, Newton's theological beliefs, and his science. According to Dobbs, Newton's alchemical quest revolved around "Hunting the Green Lyon"—searching for the vegetable spirit that brought brute matter to life and revealed the divine origins of the world. Phenomena such as fermentation were examples of this vital spirit, which caused alchemical transformation as compared with mere chemical change. Newton also searched for essences through his religion and physics. Through his Bible studies, Newton sought a pure and uncorrupted reading of the Scriptures, a reading that would reveal the mind of God at work. In his physics research, Newton sought the essence of space, time, and physical matter—a research program that would reveal the "sensorium of God." Dobbs also demonstrated the effect of Newtonian science on industrial developments. Earlier scholars had pointed out Newton's search for ancient wisdom and alchemical investigation, but it was Dobbs who tied this to Newton's science in a convincing synthesis. Like Dobbs, Richard Westfall spent much of his life researching and writing about Newton. A paradigm for biographical studies, Westfall's book is more than 900 pages long, and the reader comes to Newton as a complete person in intellectual, social, and psychological terms. To accomplish this feat, Westfall deciphered Newton's boyhood journals, understood his private devotion to Bible studies, analyzed his private devotion to alchemy, and sympathized with his psychological challenges. Above all, Westfall explained the intellectual basis of Newton's science, with heavy emphasis on his mathematical and logical genius. Newton also emerges as a social force in his own right, from his work as warden and master of the mint to his leadership of the Royal Society (1703–1727).

Biological Sciences

Just as Newton endures as a primary biographical subject for the history of the scientific revolution, Charles Darwin endures

in the history of biology. As a biography, Adrian Desmond and James Moore's *Darwin* stands in stark contrast to Westfall's study of Newton. Desmond and Moore consider Darwin's life and science almost solely on their own terms. The book is about how Darwin comes to be Darwin and not about how Darwin's work comes to influence science. Throughout, the emphasis is on creating a narrative from primary sources, not on evaluating these sources through the lens of a century's worth of historiography. Desmond and Moore do explain the economic, political, and social factors that shaped Darwin, and they discuss the role of Thomas Malthus's (1766–1834) *An Essay on the Principle of Population* (1798) and other contemporary ideas. The leitmotif that binds this biography together is Darwin's frequent illnesses, but even this is treated strictly in terms of how the illnesses were understood by Darwin and his contemporaries with no allusion to the various later historical explanations for it.

As if to demonstrate the importance of Darwin to the history of biology and the attraction of such major figures for historians, Janet Browne's two-volume biography may prove to be the definitive work on Darwin. Both volumes, *Charles Darwin: A Biography: Voyaging* (volume 1, 1995) and *Power of Peace* (volume 2, 2002), successfully integrate the wealth of primary and secondary sources. Browne is especially adept at explaining the social context of Victorian England, where Darwin lived a privileged life as a member of the leisured class. The pivotal member within a network of actors including friends and family, Darwin was both taken care of by others and in a position to manipulate them. Browne's biography is by no means a one-dimensional sociological study, but also explains Darwin's involvement with and interest in the natural world.

Two other works are important for an understanding of Darwin's role in the history of biology: Ernst Mayr's *The Growth of Biological Thought: Diversity, Evolution, and Inheritance* (1982) for the significance of Darwin's work to later science, and Stephen Jan Gould's *Ontogeny and Phylogeny* (1977) for the clash of ideas (and their political significance) in Darwinian biology. The history of twentieth-century biology is of special interest because the discipline has been largely defined by historians who actively participated as scientists in the synthesis of fields such as cytology, genetics, and embryology. Ernst Mayr is a biologist who participated in the evolutionary synthesis and became a well-respected historian, and his 1982 book is a central text for understanding twentieth-century biology.

Like other historians who have written about the evolutionary synthesis, Mayr explains how diverse scientific streams converged to form the river of contemporary biology. He focuses mainly on the streams of taxonomy, evolution, and genetics and traces their origins to sources as diverse as Aristotle's classification, Jean-Baptiste Lamarck's (1744–1829) theory of adaptation, and the cell theory of Theodor Schwann (1810–1882) and Matthias Schleiden (1804–1881). Although Mayr's work is anything but social history, he does emphasize the cultural environment surrounding biologists and their ideas. And the emphasis on the role of individual biologists is so strong that one reviewer called Mayr's book "an intellectual biography in disguise."

Mayr is inclusive in considering the sources of modern evolutionary theory, but he also occasionally plays the role of historical judge in assessing the value of certain ideas to the history of biology. He is especially harsh regarding the “straight jacket of Plato’s essentialism,” which Mayr believes held back the development of biology for more than two thousand years. Mayr’s disdain for Platonism helps explain his appreciation for the Enlightenment-era naturalist Georges-Louis Leclerc de Buffon (1707–1788), who argued that there are no species but only individuals. Mayr also judged more contemporary aspects of history, as with his criticism of Gould’s work regarding punctuated equilibrium as a driving force in evolution and as an alternative to the gradual adaptation favored by Mayr.

Like Mayr, Stephen Jay Gould, in *Ontogeny and Phylogeny*, combines history with arguments regarding contemporary evolutionary theory. Instead of a historiography that looks for the synthesis of diverse ideas through time, Gould focuses more on history of science as a battle of ideas. Gould’s scientific roots were in paleontology as contrasted with Mayr’s roots in the systematics of extant species. Paleontologists must confront the enigma of sudden widespread extinctions and the dramatic rise of newly dominant taxa. Gould’s historiographic and scientific interests led him to examine different sources than those studied by Mayr and to interpret sources in alternate ways. Thus, Gould uses history to argue that an overemphasis on gradualism and “the evolutionary synthesis” unfairly obscured other historical developments such as the alteration of regulatory genes and the role of stochastic cataclysmic events. Moreover, as he did in numerous other publications, Gould critically examines science as a problem when it is taken as an “objective” frame for politics. For Gould, moral and humanistic concerns outweigh any easy tendency to reduce complex social problems to easy scientific solutions.

Historically, Gould’s fears regarding the political misuse of biological science were well founded. Although historians such as Robert Young have pointed out the implicit class prejudice inherent in Darwin’s science, it was not until after Darwin’s death that Darwinian biology began to shape politics in this way. Daniel J. Kevles in his *In the Name of Eugenics: Genetics and the Uses of Human Heredity* (1985) explains the origins of this desire to breed better humans. Starting with the work of Darwin’s cousin Francis Galton in the late nineteenth century, Kevles tracks this program through the twentieth century, explaining the success of eugenics legislation in the United States versus its failure in Britain. In Britain, legislation failed because of a deeper appreciation by politicians of the scientific complexity or heredity, resistance from the Labour party, and arguments for individual reproductive rights. Before World War II, the American genetics program sought to prevent inferior people from reproducing. After the war and the dark image created by the Nazis for human selective breeding, American scientists shifted their program to a “reform eugenics” based on genetic testing and counseling to screen out inherited disabilities. In Kevles’s historiography, science as a process for creating and developing ideas is replaced by a science that shapes law, feeds powerful political coalitions, gets tested in the courts, and becomes an economic commodity.

The American obsession with understanding and controlling genetics through inheritance has, in recent years, turned toward manipulating the genes themselves. Sheldon Krinsky was original in looking at an episode of contemporary history as a narrative about the politics of science and science policy. America’s war on cancer began in the late 1960s and helped generate interest in and funding for research on the viral causes of cancer. This led to the discovery of SV40, a monkey virus that transformed healthy cells into tumor cells and could also be used to insert new genes into cells. As scientists learned more about synthesizing and manipulating SV40, some of them—such as David Baltimore at MIT—raised ethical concerns over the creation of human health hazards. Although scientists tried to control such biohazards through voluntary agreements, their meetings and public communication attracted public scrutiny and political attention. When federal legislation threatened commercial prospects for recombinant DNA, scientists made every effort in their public communications to black box the issue and to emphasize its potential health benefits. As a black box, scientists could sell the public on the attractive applications of recombinant DNA applications without educating the public to understand either the scientific aspects or the potential disbenefits. This rhetorical strategy was largely successful, both in the 1970s and in more recent politics of genetic engineering.

Feminist History of Science

Since 1970, the feminist history of women in science has become an important field within the larger discipline. The term *feminist history* means more than simply the history of women in science. As an explicitly ideological perspective, feminist history seeks to explain the oppression of women and to offer strategies for overcoming that oppression. Unlike historians in other fields, who are frequently loath to consider themselves personally as agents of historical change, feminist historians of science often admit their personal biases and draw practical political implications from their work.

Carolyn Merchant in *The Death of Nature: Women, Ecology, and the Scientific Revolution* (1980) considers mechanistic natural science between 1500 and 1700 as an object of criticism. In defining the harm to women and ecology stemming from the scientific revolution, Merchant examines the controversy between mechanistic and organic views of nature, the social construction of a female-gendered nature, and the struggle of some women against dominant culture. For example, instead of dismissing the persecution of witches as a fundamentally irrational practice, Merchant sees it as an integral part of the mechanistic program of control over nature. Francis Bacon, René Descartes (1596–1650), and other architects of the scientific revolution promoted this program. Merchant’s criticism of the scientific revolution fits closely with the work of other postmodernists such as Albert Borgmann and Max Oelschlaeger, who identify historical developments such as Locke’s political and economic individualism, Descartes’s universal reductivism, and Bacon’s mechanistic control as key features of the modernist period.

Margaret Rossiter takes a very different yet equally original tack in *Women Scientists in America: Struggles and Strategies*

(1982). By collecting biographical information on thousands of women who earned a listing between 1906 and 1938 in the directory *American Men of Science*, Rossiter identified systemic barriers to women's advancement in science and common strategies by which women overcame or sidestepped these barriers. As factors to further explain these barriers and strategies, she examined more than a dozen variables such as education and marital status. Rossiter found clear patterns in the factors that were associated with professional success in science. This work deflated the myth of science as a meritocracy and also helped feminists develop strategies to promote inclusion in contemporary science. Furthermore, Rossiter's work encouraged historians to look more closely at the connections between gender and contemporary social institutions.

An exemplary scientific biography of a woman scientist is Evelyn Fox Keller's 1983 *A Feeling for the Organism: The Life and Work of Barbara McClintock*. McClintock won the Nobel Prize in Physiology or Medicine in 1983 for her research in corn genetics and her discovery of transposable genes. Keller focuses on McClintock's struggle against patriarchy, her perseverance in getting other scientists to examine her unorthodox research, and her way of knowing nature through connection and relationship rather than through abstract analytical power. By identifying particular masculine and feminine gender characteristics, Keller explains McClintock's scientific insight based on her sympathy for and involvement with the objects of her research. Thus Keller criticizes cultural limitations on scientific knowledge and also suggests ways in which those limitations might be transcended.

In identifying barriers to knowledge and imagining ways to overcome them, Donna Haraway is a distinctively original and inspirational thinker. Her *Primate Visions: Gender, Race, and Nature in the World of Modern Science* (1989) is a good example of her ability to build a historical narrative and use critical analysis to shift the reader's point of view. Haraway began this narrative by reading exhibits at the American Museum of Natural History in New York City as primary sources. These exhibits told a story of cultural politics and "a logic of appropriation and domination" by white male European culture in the postcolonial era. The book is in three parts, beginning with the pre-World War II emphasis on the balance of nature and the need for hierarchy, shifting after the war to a "man the Hunter" trope emphasizing cooperation and the integration of individuals into society, and ending with the "Politics of Being Female"—a new feminist primatology rooted in historical conditions. For Haraway, history of science matters because of the way it shapes society, defines our ideology, and limits our imagination. History matters because it can always be contested and revised, taking on a new narrative form to explore ontological possibilities.

Conclusion

In a brief entry such as this, it is necessary to emphasize a few popular themes at the expense of the great diversity comprising the field. Alas, much of the history of science since 1970 has revolved around telling and retelling narratives about the great men of physics and biology. It is a process that Mott Greene once called "toting bones from one graveyard to another." In his 1992 work on preclassical antiquity, Greene shows what interesting bones are yet to be discovered. In

Geology in the Nineteenth Century: Changing Views of a Changing World (1982), Greene demonstrates how a new way of looking at the world—the discovery of plate tectonics in the 1960s—could be a reason to rescue obscure geologists from historical oblivion. It is good history and also a good example of self-reflexivity in the post-Kuhnian age, where the historian becomes a self-conscious shaper of the social fabric, and not a mere narrator of historical truth.

Similarly—although it seems to have been a case of toting bones back and forth—the discovery of the importance of magic and mysticism to Newton, Bacon, and other major biographical figures of the scientific revolution helped open the door to another recovery project—this one centered around "wonders" and how scientists, physicians, and other adherents of natural philosophy experienced them. Lorraine Daston and Katharine Park researched accounts regarding objects of wonder such as monstrous births, extraordinary mushrooms, and urine stones that glowed in the dark. In addition to giving readers a richer sense of ontology from the twelfth to the eighteenth centuries, they also widened historical understanding of how empiricism related to society, morality, and aesthetics. Daston and Park argue that objects of wonder did not fall out of favor because empirical science excluded them as objects of popular fascination, but rather were driven to the pages of X-Men comics and supermarket tabloids by changing social fashions and etiquette.

Considered from a historiographic point of view, Greene, Dalton, and Park might have much to show about the future of the history of science. From Herodotus to Leopold von Ranke (1795–1886) to the postmodernist deconstructionists, the methods of researching, writing, and interpreting history have changed greatly. History is always subject to revision and reinterpretation based upon the questions one asks and how one seeks to answer them.

As a history of historiography, *Telling the Truth about History* by Joyce Appleby, Lynn Hunt, and Margaret Jacob is a comprehensive survey from the scientific revolution to the end of the twentieth century. By tracing history from the hagiography that made Newton into a cultural hero to the "crisis of modernity" that sees truth and objectivity as "dissimulations advanced by those who have power," Appleby et al. seek to fashion a reconstruction project. They argue that history is rooted in the human psychological experience of memory and the personal craving for meaning. This is an optimistic project. Although we must give up naïve notions of truth and objectivity, we may embrace a democratic truth that "celebrates a multiplicity of actors" (p. 283) and encourages "open-ended scholarly inquiry that can trample on cherished illusions" (p. 289).

See also *Biology; Chemistry; Historiography; Mechanical Philosophy; Medicine; Nature; Newtonianism; Paradigm; Physics; Scientific Revolution; Technology*.

BIBLIOGRAPHY

- Alic, Margaret. *Hypatia's Heritage: A History of Women in Science from Antiquity through the Nineteenth Century*. Boston: Beacon Press, 1986.
- Alioto, Anthony M. *A History of Western Science*. 2nd ed. Englewood Cliffs, N.J.: Prentice-Hall, 1993.

- Appleby, Joyce, Lynn Hunt, and Margaret Jacob. *Telling the Truth about History*. New York: Norton, 1994.
- Bloor, David. *Knowledge and Social Imagery*. 2nd ed. Chicago: University of Chicago Press, 1991.
- Boorstin, Daniel J. *The Discoverers: A History of Man's Search to Know His World and Himself*. New York: Random House, 1983.
- Borgmann, Albert. *Crossing the Postmodern Divide*. Chicago: University of Chicago Press, 1992.
- Browne, Janet. *Charles Darwin: A Biography*. Vol. 1, *Voyaging*. Vol. 2, *The Power of Place*. New York: Knopf, 1995–2002.
- Bush, Vannevar. "Science, the Endless Frontier: A Report to the President by Vannevar Bush, Director of the Office of Scientific Research and Development, July 1945." Washington, D.C.: United States Government Printing Office, 1945.
- Cohen, I. Bernard. *Revolution in Science*. Cambridge, Mass.: Harvard University Press, 1985.
- Daston, Lorraine, and Katharine Park. *Wonders and the Order of Nature, 1150–1750*. Cambridge, Mass.: Zone Books, 2001.
- Desmond, Adrian, and James Moore. *Darwin*. New York: Warner, 1991.
- Dobbs, Betty Jo Teeter, and Margaret C. Jacob. *Newton and the Culture of Newtonianism*. Atlantic Highlands, N.J.: Humanities Press, 1995.
- Eisenstein, Elizabeth. *The Printing Press as an Agent of Change: Communications and Cultural Transformation in Early Modern Europe*. Cambridge, U.K., and New York: Cambridge University Press, 1979.
- Gould, Stephen Jay. *Ontogeny and Phylogeny*. Cambridge, Mass.: Harvard University Press, 1977.
- Greene, Mott T. *Geology in the Nineteenth Century: Changing Views of a Changing World*. Ithaca, N.Y.: Cornell University Press, 1982.
- . *Natural Knowledge in Preclassical Antiquity*. Baltimore: Johns Hopkins University Press, 1992.
- Haraway, Donna. *Primate Visions: Gender, Race, and Nature in the World of Modern Science*. New York: Routledge, 1989.
- Hessen, Boris. "The Social and Economic Roots of Newton's *Principia*." [Soviet contributions to the International Congress for the History of Science and Technology, 1931.] Reprinted as *The Social and Economic Roots of Newton's Principia*. New York: Howard Fertig, 1971.
- Keller, Evelyn Fox. *A Feeling for the Organism: The Life and Work of Barbara McClintock*. San Francisco: W. H. Freeman, 1983.
- Kevles, Daniel J. *In the Name of Eugenics: Genetics and the Uses of Human Heredity*. New York: Knopf, 1985.
- Koyré, Alexander. *Galileo Studies*. Translated by John Mepham. Atlantic Highlands, N.J.: Humanities Press, 1978. Translation of *Études galiléennes*. Paris: Hermann and Cie, 1939.
- Krimsky, Sheldon. *Genetic Alchemy: The Social History of the Recombinant DNA Controversy*. Cambridge, Mass.: MIT Press, 1982.
- Kuhn, Thomas. *The Structure of Scientific Revolutions*. Chicago: University of Chicago Press, 1962.
- Lindberg, David C. *The Beginnings of Western Science: The European Scientific Tradition in Philosophical, Religious, and Institutional Context, 600 B.C. to A.D. 1450*. Chicago: University of Chicago Press, 1992.
- Mayr, Ernst. *The Growth of Biological Thought: Diversity, Evolution, and Inheritance*. Cambridge, Mass.: Harvard University Press, 1982.
- Merchant, Carolyn. *The Death of Nature: Women, Ecology, and the Scientific Revolution*. San Francisco: Harper and Row, 1980.
- Oelschlaeger, Max. *The Idea of Wilderness: From Prehistory to the Age of Ecology*. New Haven, Conn.: Yale University Press, 1991.
- Rossiter, Margaret. *Women Scientists in America: Struggles and Strategies to 1940*. Baltimore: Johns Hopkins University Press, 1982.
- Shapin, Steven, and Simon Schaffer. *Leviathan and the Air Pump: Hobbes, Boyle, and the Experimental Life, Including a Translation of Thomas Hobbes, Dialogus Physicus De Natura Aerus*. Princeton, N.J.: Princeton University Press, 1985.
- Westfall, Richard. *Never at Rest: A Biography of Isaac Newton*. Cambridge, U.K.: Cambridge University Press, 1980.

Pat Munday

SCIENCE FICTION. Like a rapacious and relentlessly predatory science fictional entity assimilating all it encounters (the *Star Trek* Borg come to mind), science fiction in the early twenty-first century is an unstoppable expansive force that is certainly not limited to one particular genre. Science fiction literature, once ghettoized and marginalized, is pervasive and ever more rapidly garnering respect.

PMLA, America's most distinguished literary criticism journal, published its first science fiction issue in May 2004. Stephen King received the 2003 National Book Foundation Medal for Distinguished Contribution to American Letters. Philip K. Dick once dismissed as a pulp science fiction writer—because of his works' emphasis upon paranoia regarding government, technology, and personal relationships and its attention to what constitutes reality itself—has been lauded as creating the most emblematic fiction of the turn of the twenty-first century. Jonathan Lethem's *The Fortress of Solitude* was applauded as one of the most important novels published in 2003, and *Star Trek* was recognized as the most enduring cultural mythology of the second half of the twentieth century.

The attention lavished upon King and Dick especially exemplifies why science fiction is pervasive and ever more rapidly gaining respect. The National Book Foundation's decision to recognize King's achievements signaled an end to the discrimination popular genre writers automatically suffered. Dick precisely envisioned the world of the early twenty-first century, a world that did not inherit flying cars, but which endures such Dickian devices and themes as implanted memories, commercialized personalities, dislocation, and disintegrating realities.

Literary theory reflects the newfound status science fiction garners. Carl Freedman, in *Critical Theory and Science Fiction* (2000), proclaims that science fiction, one of the most theoretically informed areas of the literary profession, is a privileged genre for critical theory:

I maintain that science fiction, like critical theory, insists upon historical mutability, material reducibility, and utopian possibility. Of all genres, science fiction is thus the one most devoted to the historical concreteness and rigorous self-reflectiveness of critical theory. The science-fictional world is not only one different in time

or place from our own, but one whose chief interest is precisely the difference that such difference makes. (p. xvi)

In a 1999 essay for the *New York Times* titled “Black to the Future,” Walter Mosley positions science as one of the most exciting emerging directions in contemporary American fiction; he explains that the newly free black imagination joins with science fiction to create a new force to counter racism. N. Katherine Hayles’ *How We Became Post Human: Virtual Bodies in Cybernetics, Literature and Informatics* (1999), in response to science fiction’s aforementioned pervasive presence within reality, declares that people are now more than simply human. Posthumans inhabit a brave new postmodern world in which science fiction infused reality ever more increasingly blurs the old comfortable distinctions between the real and the unreal. Via an overview of the development of science fiction literature and science fiction theory from the 1970s to the start of the twenty-first century, this entry will explore how we and our world became science fictionally post real.

Edward James’s *Science Fiction in the Twentieth Century* (1994) offers one of the best descriptions of science fiction’s historical progression; his ideas form the basis of the historical survey given here. The American New Wave influenced the most innovative science fiction writers of the 1970s (including John Crowley, Joe Haldeman, Ursula Le Guin, James Tiptree/Alice Sheldon, and John Varley). The New Wave can be defined as the 1960s generational shift away from the classic writers who began to write before World War II—such as Isaac Asimov, Alfred Bester, Ray Bradbury, Arthur Clarke, Robert Heinlein, and Theodore Sturgeon. The New Wave, an attempt to bring science fiction into the literary mainstream by emphasizing style rather than scientific accuracy, consisted of experimental works emphasizing psychology and soft sciences. New Wave writers shared the notion that the world is not improving, expressed a distrust of science and technology, and thought humans unworthy of valorization.

American New Wave writers (Robert Silverberg, Joanna Russ, Harlan Ellison, Roger Zelazny, and Samuel Delany, for example) wanted to improve upon rather than reject classic pulp science fiction. The word *pulp* refers to the inexpensive paper used to produce pulp magazines as well as to the characteristics of the fiction the magazines published. Action, romance, heroism, exotic settings, adventures, and positive endings characterize pulp science fiction stories. Pulp science fiction began with *The Argosy* in the 1890s and proliferated until the 1930s in such magazines as *Weird Tales*, *Amazing Stories* (created by Hugo Gernsback, the father of pulp science fiction and namesake of the Hugo Award), and *Astounding*. *Astounding* editor John W. Campbell insisted upon hard science as a basis for story acceptance; hence, classic pulp science fiction can be understood as a juxtaposition of science fiction, monster stories, and hero pulp stories. Such clichéd science fiction tropes as Bug-Eyed-Monsters and little green men emerging from the spaceship that lands on the White House lawn epitomize classic pulp science fiction.

During the 1970s, new subgenres arose from the combination of New Wave ideas engaging with the older traditions

classic pulp science fiction represents. Larry Niven, the exemplary writer of hard science fiction, emphasized technology, physics, and space exploration. Women writers (such as Ursula Le Guin, Joanna Russ, and James Tiptree/Alice Sheldon), in contrast, focused upon such soft sciences as psychology and sociology and produced pure literary experimentation. Much of the soft science fiction written during the 1970s was fantasy, not science fiction. (Critics have generated multitudinous arguments regarding the distinctions between science and fantasy. The rule of thumb is that texts about what can be realized are science fiction and those about what cannot be realized are fantasy. Future generations, for example, might travel in a *Star Trek* starship, which in the early twenty-first century exists only in science fiction; unlike the protagonists of the fantasy *Alice in Wonderland*, they will never experience close encounters with a watch-wearing white rabbit.) The rise of both women’s science fiction and fantasy rooted in the 1970s, two of the most important developments in the history of science fiction, continues into the twenty-first century. Feminist science fiction provides blueprints for social change, which enable us to rethink and reformulate patriarchal social domination.

Joanna Russ, the most important representative of the rise of 1970s feminist science fiction, is best known for *The Female Man* (1975), a startling, brilliant feminist novel which presents four female protagonists who inhabit four alternative worlds. Ursula Le Guin’s equally important *The Dispossessed: An Ambiguous Utopia* (1974) is more inspired by anarchism than by feminism. Delany’s *Triton: An Ambiguous Heterotopia* (1976) echoes Le Guin’s political emphasis and builds upon Russ’s feminist breakthroughs. Tiptree/Sheldon’s feminist short stories (such as “The Women Men Don’t See”—1973) are important contributions to the feminist and soft science fiction surge characterizing the 1970s. In international science fiction, the first English translations of the Polish writer Stanislaw Lem began to appear in the 1970s (for example, *Solaris* [1961, translated 1970] and *The Invincible* [1964, translated 1973]).

The new New Wave called cyberpunk dominated the 1980s. *Cyberpunk* is derived from the words *cybernetics* and the 1970s rock term *punk*. Cyberpunk arose in response to a discrepancy characteristic of the 1980s: the glaring difference between the gleaming pristine future cities traditional science fiction portrays and depressing real-world urban landscapes. Cyberpunk fiction, which portrays people dwarfed by machines in a technological world and alienated from nature, contributes a rethinking of the military-industrial complex’s hegemony. Pat Cadigan, best known for *Synners* (1991), has been called the “Queen of Cyberpunk.” William Gibson’s *Neuromancer* (1984) epitomizes cyberpunk in its portrayal of seedy and dark urban environments in which protagonists literally enter cyberspace.

In 1990, the U.S. president George H. W. Bush announced an intention to place people on Mars by 2019, inspiring some science fiction writers to focus upon Mars; such works as Kim Stanley Robinson’s *Red Mars* (1993), *Green Mars* (1994), *Blue Mars* (1996), and *The Martians* (1999) reflect this focus. Ben Bova’s *Mars* (1992) and Paul J. McAuley’s *Red Dust* (1993) are other noteworthy novels about Mars. In addition to Robinson,

Nicola Griffith and Gwyneth Jones were important writers who debuted during the 1990s. Attention to politics, ecology, feminism, and extraterrestrial soft science fiction dominate the science fiction written during this decade.

The surge in black science fiction, reflected in Walter Mosley's "Black to the Future" and Sheree R. Thomas's anthology *Dark Matter* (2000), was the most important development in science fiction at the beginning of the new millennium. Mosley's *Futureland* and work by Nalo Hopkinson, Tananarive Due, and Stephen Barnes build upon the tradition of black science fiction literature Delany and Octavia Butler pioneered. Darko Suvin's *Metamorphoses of Science Fiction: On the Poetics and History of a Literary Genre* (1979) is the most significant critical work about science fiction published since the 1970s. Suvin famously defines science fiction as

a literary genre whose necessary and sufficient conditions are the presence and interaction of estrangement and cognition, and whose main formal device is an imaginative framework alternative to the author's empirical environment. (pp. 7–8)

In concert with Suvin, Robert Scholes defines fabulation as "fiction that offers us a world clearly and radically discontinuous from the one we know, yet returns to confront that known world in some cognitive way." Marleen S. Barr, in *Feminist Fabulation: Space/Postmodern Fiction* (1992) defines feminist fabulation as feminist fiction that offers a world clearly and radically discontinuous from the patriarchal world we know, yet returns to confront that known patriarchal world in some feminist cognitive way. There is an intergenerational science fiction critical lineage between Suvin's and Scholes's corollary definitions and Barr's "feminist fabulation" that brings their influential definitions to bear upon feminism and postmodernism.

In the manner of their marked influence upon imaginative science fiction, feminism and postmodern are integral to science fiction criticism. Brian McHale in *Postmodernist Fiction* (1987) states that science fiction "is to postmodernism what detective fiction was to modernism: it is the ontological genre *par excellence* (as the detective story is the epistemological genre *par excellence*), and so serves as a source of materials and models for postmodernist writers." While McHale reads postmodernism in terms of science fiction, Larry McCaffery's *Storming the Reality Studio: A Casebook of Cyberpunk and Postmodern Science Fiction* (1991) reads science fiction in terms of postmodernism. Scott Bukatman's *Terminal Identity: The Virtual Subject in Postmodern Science Fiction* (1993), a compendious study of contemporary science fiction, positions techno-culture as the focus of the discussion about the relationship between postmodernism and science fiction. Donna J. Haraway's "A Cyborg Manifesto: Science, Technology, and Socialist Feminism in the Late Twentieth Century" (1985) links postmodernism and technoculture to the feminist analysis of science fiction.

Barr's *Future Females: A Critical Anthology* (1981) was the first essay collection devoted to feminism and science fiction. Sarah Lefanu's *In The Chinks of the World Machine: Feminism and Science Fiction* (1988), which followed Barr's *Alien to Fem-*

inity: Speculative Fiction and Feminist Theory (1987), asserts that

the plasticity of science fiction and its openness to other literary genres allow an apparent contradiction . . . it makes possible, and encourages (despite its colonization by male writers), the inscription of women as subjects free from the constraints of mundane fiction; and it also offers the possibilities of interrogating that very inscription, questioning the basis of gendered subjectivity.

The 1990s saw the appearance of Jenny Wolmark's *Aliens and Others: Science Fiction, Feminism and Postmodernism* (1994), which analyzes the "shared theoretical moments" between feminism and postmodernism; Russ's *To Write Like a Woman: Essays in Feminism and Science Fiction* (1995), which collects her most important essays; and Jane Donawerth's *Frankenstein's Daughters: Women Writing Science Fiction* (1997), which places Frankenstein as integral to science fiction written by women. In 2000, Barr, in *Future Females, the Next Generation: New Voices and Velocities in Feminist Science Fiction Criticism*, collected the work of young feminist science fiction theorists who analyze science fiction's relevance to disenfranchising patriarchal master narratives and social institutions. Brian Attebery's *Decoding Gender in Science Fiction* (2002) carries the torch of feminist science fiction criticism into the new century. Race and queer theory are discussed in Elizabeth Anne Leonard's edited collection *Into Darkness Peering: Race and Color in the Fantastic* (1997), Daniel Leonard Bernardi's *Star Trek and History: Race-ing toward a White Future* (1998), and Samuel Delany's *Shorter Views: Queer Thought and the Politics of the Paraliterary* (2000).

Two aforementioned scholars, Freedman and Hayles, respectively explain that science fiction is crucial to the entire enterprise of producing critical theory and that at the start of the twenty-first century human beings hold being posthuman in common with science fiction protagonists. As both the scholarly works about science fiction and science fiction literature itself indicate, the boundaries between literature and life drawn in terms of fixed definitions of what constitutes the real and the science fictional are becoming increasingly blurred. We might, sooner than we expect, find ourselves on the cusp of telling Scotty to beam us up.

See also **Dystopia; Futurology; Genre; Technology; Utopia.**

BIBLIOGRAPHY

- Attebery, Brian. *Decoding Gender in Science Fiction*. New York: Routledge, 2002.
- Barr Marleen S. *Alien to Femininity: Speculative Fiction and Feminist Theory*. New York: Greenwood Press, 1987.
- . *Feminist Fabulation: Space/Postmodern Fiction*. Iowa City: University of Iowa Press, 1992.
- . *Future Females: A Critical Anthology*. Bowling Green, Ohio: Bowling Green State University Press, 1981.
- . *Future Females, the Next Generation: New Voices and Velocities in Feminist Science Fiction Criticism*. Lanham, Md.: Rowman and Littlefield, 2000.

- Bernardi, Daniel. *Star Trek and History: Race-ing toward a White Future*. New Brunswick, N.J.: Rutgers University Press, 1998.
- Bukatman, Scott. *Terminal Identity: The Virtual Subject in Postmodern Science Fiction*. Durham, N.C.: Duke University Press, 1993.
- Delany, Samuel. *Shorter Views: Queer Thought and the Politics of the Paraliterary*. Hanover, N.H.: Wesleyan University Press, 2000.
- Donawerth, Jane. *Frankenstein's Daughters: Women Writing Science Fiction*. Syracuse, N.Y.: Syracuse University Press, 1997.
- Freedman, Carl. *Critical Theory and Science Fiction*. Hanover, N.H.: Wesleyan University Press, 2000.
- Haraway, Donna J. "A Cyborg Manifesto: Science, Technology, and Socialist-Feminism in the Late Twentieth Century." In her *Simians, Cyborgs, and Women: The Reinvention of Nature*. New York: Routledge, 1985.
- Hayles, N. Katherine. *How We Became Posthuman: Virtual Bodies in Cybernetics, Literature, and Informatics*. Chicago: University of Chicago Press, 1999.
- James, Edward. *Science Fiction in the Twentieth Century*. Oxford: Oxford University Press, 1994.
- Lefanu, Sarah. *In the Chinks of the World Machine: Feminism and Science Fiction*. London: Quartet Books, 1988.
- Leonard, Elizabeth. *Into Darkness Peering: Race and Color in the Fantastic*. Westport, Conn.: Greenwood Press, 1997.
- McCaffery, Larry. *Storming the Reality Studio: A Casebook of Cyberpunk and Postmodern Science Fiction*. Durham, N.C.: Duke University Press, 1991.
- McHale, Brian. *Postmodernist Fiction*. New York: Methuen, 1987.
- Mosley, Walter. "Black to the Future." *New York Times Magazine*, November 30, 1998, p. 32.
- Russ, Joanna. *To Write Like a Woman: Essays in Feminism and Science Fiction*. Bloomington: Indiana University Press, 1995.
- Scholes, Robert. "The Roots of Science Fiction." In *Twentieth Century Interpretations of Science Fiction: A Collection of Critical Essays*, edited by M. Rose. Englewood Cliffs, N.J.: Prentice-Hall, 1976.
- Suvin, Darko. *Metamorphoses of Science Fiction: On the Poetics and History of a Literary Genre*. New Haven, Conn.: Yale University Press, 1979.
- Wolmark, Jenny. *Aliens and Others: Science Fiction, Feminism, and Postmodernism*. Iowa City: University of Iowa Press, 1994.

Marleen S. Barr

SCIENTIFIC METHOD. See **Science**.

SCIENTIFIC REVOLUTION. As distinct from the centuries-old conception of scientific revolutions (plural), the concept of the one and only Scientific Revolution dates from the 1930s. What meaning, if any, to give the concept over and above its signifying the birth of modern science has been in lively, productive dispute ever since. This entry first outlines the historiographical vagaries of the term, then (from the heading "A Tentative, Synthetic Overview" onward) discusses the event itself in ways meant to do some justice to what historians' ongoing debates have yielded.

Historiographical Developments

The concept of the Scientific Revolution was introduced as part of a major historiographical overhaul that took place between the mid-1920s and the early 1950s. It was then meant to identify a period in European history, roughly between the second half of the sixteenth century and almost the full seventeenth century (that is, between Copernicus and Newton), when a unique, radical conceptual upheaval took place out of which modern science emerged essentially as we still know it. This view of a radical conceptual upheaval, first vaguely sensed in some earlier historiography, quickly began to be articulated in the budding field of the history of science in ways that turned the previously customary listing of one heroic scientific achievement after another into a careful reconstruction of the conceptual knots that those who brought about the Scientific Revolution actually had to disentangle.

A master narrative. Within this emerging concept-focused mode of history writing came a variety of path-breaking narratives minimally sharing a focus on how the once self-evident conception of our Earth at the center of the universe gave way to the core of the modern worldview of the Earth and the other planets placed in a solar system occupying a tiny portion of an infinite universe. What brought about this fundamental conceptual shift to a non-Earth-centered universe, as well as new conceptions of motion and of the creation of space as a void? Historians held that a major contributor was the quickly expanding process of the mathematization of nature, that is, the subjection of increasing ranges of empirical phenomena to mathematical treatment in ways generally suitable to experimental testing. Several people were seen as key figures in this process. Copernicus (1473–1543) computed, down to the required detail, planetary trajectories in a Sun-centered setting. Johannes Kepler (1571–1630) turned Copernicus's formulation into a previously inconceivable "celestial physics," and this led to his discovery of the planets' elliptical paths. Galileo (1564–1642) mathematized a significant terrestrial, as opposed to celestial, phenomenon—falling and projected bodies—in an effort to counter major objections to Copernicus's formulation. René Descartes (1596–1650) mathematically conceived space and particle interactions in space. Sir Isaac Newton (1642–1727) capped these developments by uniting terrestrial and celestial physics in his mathematically exact, empirically supported conception of universal gravitation. This is not to say that historians equated these scientists and their principal accomplishments with the Scientific Revolution. Still, for decades historians were inclined to treat most other noteworthy modern scientific attainments—such as William Harvey's (1578–1657) discovery of the circulation of the blood and others' refinements in chemical analysis—as somehow tangential to the main course of development.

New historiographical perspectives. Starting in the 1960s, historians introduced a range of perspectives to widen (or in some cases to replace) the historiographical master narrative just outlined and some of the insights gained thereby. In fairly random (certainly not chronological) order, these perspectives are listed below.

Historians have ceased identifying the present classification of scientific disciplines with their seventeenth century counterparts.

They are replacing it with a still increasing awareness that what we now call “mechanics,” for instance, scarcely had a counterpart in the early seventeenth century—so different, and differently aligned, was the intellectual context in which problems of motion used to be considered from the ancient Greeks onward. Some historians are even beginning to recognize that what we now call “science” developed at the time in several different modes, each with a distinct intellectual tradition, knowledge structure, mode of approach, and professional identity.

Historians are including in their narratives research subjects and/or people previously omitted or marginalized. Rediscovered research areas include ranges of (at the time) nonmathematical, chiefly descriptive subjects, like magnetism or illness, or subjects neglected because they are scarcely practiced any more today, like musical science, and/or are held under grave suspicion, like alchemy. Rediscovered contributors, though important, fall below the first rank. Examples are hosts of able Jesuit experimenters, numerous practitioners on the European Continent, as well as a small number of women (e.g., Margaret, duchess of Newcastle, who developed a speculative Cartesian yet creative theory of moving particles, or Elisabetha Hevelius, coworker with her better known astronomer-husband).

Perhaps most important of all, historians of science have strived to put the history of scientific ideas in institutional and other sociocultural contexts. Though history writing in the vein of “This thinker brought about this particular conceptual breakthrough; then that thinker that one” is still valuable for revealing the complex way in which conceptual innovation and continuity are intertwined, historians now feel that properly understanding scientific accomplishment requires a deep awareness of how it was situated in time and place. In this way historians have revealed, for example, the at times highly consequential dependence of practitioners on Europe’s patronage market, and the link between the controversy over the validity of instrument-aided experimentation, as articulated in Robert Boyle’s (1627–1691) and Thomas Hobbes’s (1588–1679) early 1660s dispute over the void, and the politics of the Stuart Restoration. As a result, historians have increasingly focused on the local particularity, over the universal validity, of the most seminal developments of the Scientific Revolution. Among genuine accomplishments of this contextualist approach must be counted a heightened concern for the day-to-day practice of experimental research and for the trustworthiness of results thus attained, a heightened sense that the course of discovery is at times fortuitous, and an awareness that discoverers had other motives than sheer backwardness and/or superstition. In the past contextualization has at times focused on this or that piece of pertinent microhistory. We face a wide-open opportunity to extend contextualization by taking the world-historical peculiarities of Europe as the context in which to make proper sense of large-scale scientific developments. Indeed, most writing on the history of science has been confined, if not just to the English speaking world, then at least to the Western tradition held to run from the Greeks, via the purported holding action of the Arabs, to medieval then Renaissance Europe, then to postrevolutionary science as it unfolded principally in the Western heartlands. Despite some inspiring, pioneering efforts in the 1930s to 1950s, a

cross-culturally comparative perspective on why modern science emerged where and when it did is still in its infancy.

Abandonment or new syntheses? The net effect of this plurality of novel viewpoints has been the perhaps predictable one of resignation. What numerous historians of science have given up is not the ongoing production of partly novel interpretations of events in the history of seventeenth-century science, but the very idea that, deeply below the surface of singular events, something identifiable holds so complex an event as the Scientific Revolution together. True, we can no longer accept the once enlightening yet too one-sided formula “Scientific Revolution = mathematization of nature.” But the message that historians’ resignation imparts to nonscholars is that one of the most decisive events in world history, one of the prime motors of our modern world, was due to little more than chance. We have ready to hand a great deal of material and hosts of penetrating yet partial interpretations to answer the question of how modern science emerged in seventeenth-century Europe, rather than in one of the other great pre-modern civilizations at that or some earlier time. Yet there has been no serious effort to come to grips with the question how modern science emerged in seventeenth-century Europe. Below is an inevitably idiosyncratic, highly schematic example of how we might grapple with the question.

A Tentative, Synthetic Overview

Of those civilizations where natural phenomena were subjected to scrutiny of a kind that went beyond their identification with the divine, only two did so against the background of an articulated worldview. In the Chinese tradition, which was uninterrupted until the Jesuits brought modern science along, practitioners were much inclined to an empiricist approach.

In contrast, two distinct Greek traditions—one mathematical, one philosophical—were quick to rationalize the empirically given. The Greeks also experienced a range of potentially fertile transplantations from other civilizations. In one tradition, called “Alexandrian” for short, Archimedes (c. 450–c. 388 B.C.E.), Ptolemy (2d c. C.E.), and others subjected a limited number of empirical phenomena (planetary positions, vibrating strings, and a few others) to mathematical treatment in highly abstract ways that left connections with reality minimal (i.e., the resulting science of music dealt with numbers, not with vibrations). In the other tradition, called “Athenian” for short, natural philosophers posited a limited number of first principles to explain the world at large (e.g., substantial forms in Aristotelianism, or indivisible particles and the void in atomism) and empirically shored up these principles by appeal to selected chunks of observable reality.

By means of three successive large-scale efforts at translation (second-/eighth-century Baghdad, twelfth-century Toledo, fifteenth-century Italy) these two modes of nature knowledge were transplanted, first to Islamic civilization wholesale, then (in a truncated manner) to medieval Europe, then (upon the fall of Byzantium) wholesale once again to Renaissance Europe. In each case the Greek legacy was received, then enriched in often creative ways that left the broad framework unscathed. As a result, the state that knowledge of nature attained in

Europe by 1600 was broadly similar to what it had once been like in Islamic civilization before (in the fifth to eleventh centuries) waves of invasions nipped a possible next stage of radical transformation in the bud. For the second time, in Renaissance Europe, careful reconstruction of the legacy of the Alexandrian geometers gave rise to incidental enrichment, the way Copernicus improved on Ptolemy in trusted Alexandrian fashion. Also, the incessant, inherently irresolvable debate between the four schools of Athenian natural philosophy and their skeptical nemesis raged once again.

Beside these essentially backward-looking modes of nature knowledge, Renaissance Europe also developed a third mode, which, unlike the other two, reflected in its forward-looking dynamism certain peculiarities of the civilization at large. This third mode of nature knowledge, bent upon accurate, magic-tinged description, developed an empiricism different from the Chinese variety in that it was marked by a drive toward domination or at least coercion of the natural environment.

Onset of the revolution. With this much as background, we can now conceptualize the onset of the Scientific Revolution very briefly as the near-simultaneous, revolutionary transformation of three traditions.

First, natural philosophers turned the Alexandrian tradition into the Alexandrian-plus tradition. In astronomy, Kepler and Galileo, in seeking to resolve major tensions in Copernicus's variety of heliocentrism, toned down the highly abstract approach of the Greek geometers with an infusion of physical reality. For terrestrial phenomena, other natural philosophers did this by means of experiments carefully designed to demonstrate the mathematically ideal phenomenon, and these served as an empirical check on theoretical outcomes. Central to such mathematization of nature was a new conception of motion as tending to persist and as relative, in ways tentatively worked out by Galileo and his disciples for a range of cases (like falling bodies and outflowing water).

Second, Isaac Beeckman (1588–1637), Descartes, and Pierre Gassendi (1592–1655) turned the Athenian tradition into the Athenian-plus tradition. Inside the atomist doctrine, which they adopted in its essentials, they shifted emphasis from the shapes and sizes of subvisible particles to their movements, and these movements, they held, were governed by general laws that conceived of motion as persisting and relative. Descartes gave systematic expression to this conception of a world fully explicable through the imagined motions of imagined particles. He found warrant for its truth in allegedly rigorous, pseudo-mathematical derivation from first principles and empirical backing in a wealth of examples taken, without experimental intervention, from real-life phenomena.

Third, in the uniquely European, coercive, and empirical third mode of knowledge of nature, setting up carefully designed fact-finding experiments was central. This contrasts with the Athenian-plus tradition, where experimentation was lacking, and the Alexandrian-plus tradition, where experimentation served as a means of a posteriori empirical support. This transformation occurred at the hands of, notably, Francis Bacon (1561–1626; who preached rather than practiced the

approach), William Gilbert (1544–1603; magnetic and electric phenomena), Jan Baptista van Helmont (1579–1644; the chemical composition of matter/spirit), and William Harvey (the circulation of blood).

Ongoing innovation and remaining continuities. In the hands of those who went along, the approaches of the traditions changed science drastically in each case. Natural philosophers mathematized an ever increasing range of phenomena, whether encountered in nature (like sound) or in contemporary craftsmanship (like gunnery), devised universal explanations through an endless variety of particle movements, and to a vast extent experimentally explored the unknown, whether encountered in nature (like wind) or in contemporary craftsmanship (like textile dyeing). What also changed was that the two first modes of explanation, which jointly defied common sense and conjured up the specter of a clockwork universe devoid of divine concern or human purpose, quickly became entangled in a battle of legitimacy of quite uncertain outcome. Meanwhile, what remained the same, at least up to the mid-seventeenth century, were the respective knowledge structures: in one case thinkers used first principles to attain at one stroke a definitive, comprehensive grasp of the world; in the other two cases, practitioners looked at phenomena to make piecemeal, step-by-step advances. Also, practitioners of each mode as a rule operated in insulation from one another. Even if an individual like Descartes or the English mathematician Thomas Harriot (1560–1621) did work in more than one mode, he made no effort to let results attained in one mode bear upon the other, let alone to reconcile (occasionally) incompatible outcomes (e.g., Descartes's Alexandrian derivation of his sine law of refraction required the assumption that light has finite velocity, whereas in his Athenian-plus philosophy its velocity is necessarily infinite).

A decisive, mid-century change of scenery. Starting in the early 1660s, after the stabilization of princely authority in the wake of the Peace of Westphalia and (in Britain) the Restoration, a mood of reconciliation descended upon Europe. That mood helped overcome the rapidly expanding crisis of legitimacy. Efforts in the 1630s to 1650s to enforce a return to the fold (the trial of Galileo, the tribulations of van Helmont and Descartes) and countless cases of ensuing self-censorship gave way to conditional, religiously sanctioned acceptance. A prerequisite for this transition was the well-known shift of Europe's political, commercial, cultural, and scientific center from the Mediterranean (Italy, Spain, Austria, and Southern Germany) to the Atlantic (France and Britain). The new science was carefully walled off from all that might smack of heresy, and its experimental, and hence philosophy-free, aspects were institutionally emphasized. As a result, its widely perceived material and ideological promise of improvement of daily life and of a decisive edge in warfare earned the new science official sustenance in two major associations that came to dominate ongoing innovation of knowledge of nature in the second half of the seventeenth century and beyond. These were the Royal Society in London and the Académie Royale des Sciences in Paris, both founded in the 1660s. As a result of breakthroughs in, for example, microscopy (Antony van Leeuwenhoek's discovery of bacteria and spermatozoa) and

telescopic measurement (large-scale revision of the size of the universe), the societies of London and Paris and the journals to emanate from both came to serve as rallying centers for intellectuals in Europe to contribute in a major way to ongoing innovation.

Even more revolutionary was a new mood of reconciliation in the sciences. The Dutch mathematician Christiaan Huygens (1629–1695) and the young Newton—in blending their prime allegiance to the Galilean approach with their acceptance of the doctrine of particles in ubiquitous motion not as comprehensive dogma but as a selectively applicable hypothesis—sought to resolve the tension between the Galilean and Cartesian conceptions of motion for a range of principal cases (impact, persisting motion, rotation, oscillation). At about the same time the British physicist and chemist Robert Boyle, the English scientist Robert Hooke (1635–1703), and again the young Newton, in blending their fact-finding experimentalism with the hypothesis of particles in ubiquitous motion, managed to anchor subtly particulate mechanisms in empirical evidence and by the same move to provide their fact finding with some badly needed coherence and direction. In the end, the mature Newton not only became aware of the limitations inherent in the two highly innovative approaches but even transcended these modes in ways codified in a book that rounded off the Scientific Revolution, his *Philosophiæ Naturalis Principia Mathematica* (Mathematical principles of natural philosophy), published in 1687.

The outcome. The major result of all this was that science became a distinct enterprise, placed more prominently in society than at any other time and place. Its prominence was due not only to the promise of practical results widely attributed to it but also to intellectuals' desire to make mathematical-experimental or fact-finding-experimental assertions about natural phenomena clinching rather than at best plausible (as in speculative natural philosophy). Indeed, up against the perennial human inclination to let our bias decide, it is in the capacity of the new science to produce conclusive outcomes that its uniqueness as a mode of knowledge resides. Herein lies the deepest reason for calling the highly conditioned emergence of science and its ensuing staying power a revolution if ever there was one.

See also *Classification of Arts and Sciences, Early Modern; Enlightenment; Historiography; Knowledge; Periodization; Science, History of.*

REFERENCES

Applebaum, Wilbur, ed. *Encyclopedia of the Scientific Revolution from Copernicus to Newton*. New York: Garland, 2000.
 Cohen, H. Floris. *The Scientific Revolution: A Historiographical Inquiry*. Chicago: University of Chicago Press, 1994. The major works on the history of science are here assembled and critically compared.
 Dear, Peter. *Revolutionizing the Sciences: European Knowledge and Its Ambitions, 1500–1700*. Princeton, N.J.: Princeton University Press, 2001.
 Henry, John. *The Scientific Revolution and the Origins of Modern Science*. 2nd ed. New York: Palgrave, 2002.

Westfall, Richard S. *The Construction of Modern Science: Mechanisms and Mechanics*. Cambridge, U.K.: Cambridge University Press, 1971.

H. Floris Cohen

SECULAR HUMANISM. See **Humanism**.

SECULARIZATION AND SECULARISM. The terms *secularization* and *secularism* have had a variety of meanings since they were coined; “secularization” in the mid-seventeenth century and “secularism” in the mid-nineteenth, both incorporating the word *secular*. “Secular,” from the Latin “saeculum,” a generation or age, originally referred to secular clergy who were not in a monastic order. It also came to refer to the worldly realm. *Secularism* is used here in two current senses—an emphasis on the this-worldly rather than the other-worldly, and what is called in the United States as the “separation of church and state.” In Latin countries terms based on *laic* imply stronger state controls, based on their history of struggles with the Catholic Church.

Secularization involves both increasing state control of spheres formerly controlled by religious institutions and the expansion and freedom from religious control of nonreligious institutions, both state and private, and comprising education, social welfare, law, publication and the media, and forums for the expression of belief and action. In some areas, notably Turkey and communist countries, there has been state control of religion, rather than separation of church and state, and it is unclear if such countries should be called secular. Every secular country has a different version of secularism, and none of them has an absolute separation of church and state. Secularism involves belief in the priority of this-worldly considerations, and an end to religious doctrinal influence on law, education, and welfare, and the need for equal treatment of various beliefs and believers. To its opponents secularism often implies unbelief, a sense also included in some dictionaries but denied by most secularists, whether or not they are believers.

Secularism has also involved egalitarian political and social treatment of religious minorities and unbelievers, which had not been true of either Protestant or Catholic majorities, while Islam had a place for minorities but an unequal one. The major Asian religions have traditionally been more religiously tolerant and have had fewer struggles over secularism.

Works about secularism and secularization have been scattered over time and region, with the greatest concentration covering the “secularization thesis,” most popular in Great Britain, which posited a steady progress of secularization, which has not since occurred outside Western Europe. India, where secularism is a central political issue, has seen more varied literature on the subject. Many works relevant to secularism and secularization are centered on different concepts.

History and Nature of Secularization and Secularism to 1914

Secularization originally meant the transfer of ecclesiastical property to civil or state ownership, and its first recorded use was apparently after the Thirty Years War in 1648 to mean the transfer of church lands to states. Christian Churches were huge landowners, and religious institutions in non-Christian countries also held or controlled very large properties, which states increasingly secularized. In England Henry VIII's dissolution of monasteries was a secularizing step. Secularization over time came rather to refer primarily to a process in which religious influence over government, institutions, ideas, and behavior is reduced and reliance on this-worldly bases for these spheres grows.

In premodern times religion and religious institutions had far greater power than they did later, though Confucianism, some kinds of Buddhism and Hinduism, and rationalist philosophies in ancient Greece, the Muslim world, and Europe had strong this-worldly elements. Secularization and secularism began in Western Europe, along with the rise of capitalism and stronger states. Other secularizing forces occurring first in the West, included the rise of science and the scientific outlook, over many centuries. The Copernican revolution in astronomy and the Darwinian evolutionary revolution contradicted the creation stories in Jewish, Christian, and Muslim scriptures, and cast doubt on these scriptures' literal infallibility, and spread of belief in this-worldly causation to ever-greater spheres, including history and social science, undermined ideas of divine intervention. In the eighteenth century, Enlightenment building on earlier science and philosophy, the idea of the Great Watchmaker who created the universe but did not afterward intervene became widespread among intellectuals, and was later refurbished to fit evolutionary theories. The Enlightenment had important proponents in most of Western Europe and the Americas, where Benjamin Franklin (1706–1790) and Thomas Jefferson (1743–1826) are the main names.

Protestantism is often considered a force for secularization, though it initially increased religiosity and religious loyalties, both among Protestants and among reformed and aroused Catholics. Ultimately, the proliferation of sects, including some liberal ones, and exhaustion in religious wars, helped lead to religious toleration by governments and recognition of various religious and irreligious beliefs—all elements of state secularism.

Several intellectuals encouraged secularism with writings advocating religious toleration, like John Locke's *A Letter Concerning Toleration* (1689) and John Stuart Mill's *On Liberty* (1859). Enlightenment writers often stressed anticlericalism and attacked the Catholic Church. Several, including Voltaire (1694–1778), said that religion was a good thing for the lower classes, to keep them honest, diligent, and peaceful, an idea that got support from the anti-church violence during the French Revolution. This idea had wide currency in the Muslim world until the Iranian Revolution (1979) showed again that popular religiosity did not always have such orderly effects.

The rise of nation-states and of nationalism encouraged secularism. Except in countries like Poland, Ireland, and former Yugoslavia where religious and nationalist boundaries coincide,

nationalism and nation-states have tended to undermine organized religion. Religious loyalties and ideologies were supranational, and religion supported hierarchical relations between genders, toward minorities, and in everyday life, which conflicted with the priorities of the nation. Nationalism provided an ideology for nonreligious loyalties. This accompanied socioeconomic modernization and industrialization, requiring similar workers, similar rules for treating people, and national markets. Nationalism was a secular force, and religion could play only a subordinate role in most nations. In many countries nation-states struggled with church control over schools, law, and social institutions, and generally nation-states won and expanded secular institutions.

Industrialization, urbanization, and the rising role of economic class groups helped undermine religious ties and promote secular ideologies, whether nationalist, liberal, or socialist. The rising socialist movement was often antireligious. The atheism of Karl Marx (1818–1883), who saw religion as unnecessary in a communist state, became widespread among workers and their supporters.

In mid-nineteenth century England, the terms *secularist* and *secularism* were coined by George Holyoake (1817–1906), who founded a secularist society that helped end religious discrimination in parliament and elsewhere. In the late nineteenth century elite ideas were increasingly secular and agnostic, including Charles Darwin (1809–1882) and his “bulldog” Thomas Huxley (1825–1895), the radical literary critics of Russia, and the new field of sociology, with Auguste Comte (1798–1857), Émile Durkheim (1858–1917), Max Weber (1864–1920), and others. Bible criticism, with Germans like Richard Strauss (1864–1949) and Frenchmen like Ernest Renan (1823–1892), undermined faith in established religion. Even an ideological trend that most people in the early twenty-first century find repellent—scientific racism—was predominantly secular. Women's rights movements have been secular in their effect, as all major religions endorsed male control of and superiority to women and denied women rights regarding property, work, political participation, and control of their bodies. In much of the world resistance to women's rights has been primarily based on religious, antiseccular, ideas.

Secularism usually endorses the idea found in nationalism, socialism, feminism, and some science, of progress. Darwinism, against the occasional caveats of Darwin, was seen as a story of progress, and was applied to Spencer's “survival of the fittest” in human society. Social Darwinism was intertwined with racism, one of whose offshoots was the eugenics movement, a supposed recipe for race amelioration. Socialism, nationalism, and feminism expected a better future, to be brought by human secular activity. By contrast, religions often saw history as a fall from a golden age, or as a period in which individual salvation was possible only through religion. A better world might only come via a sudden, millennial process. The contrast between traditional Jewish expectations of a messiah and the this-worldly efforts of modern (secular nationalist) Zionists exemplifies this difference.

The period 1848–1914 was the heyday of secularism and of belief in progress in the West, and saw their first rise in the

Global South. Several countries established secular states after major struggles. The papal territories were a major obstacle to Italian unification, which required their conquest and a break with the church, a break not healed until Mussolini's concordat. France experienced many struggles between clericals and anticlericals. French *laïcisme*, more militantly anticlerical than British and American secularism, won out decisively in the 1905 law disestablishing the Catholic Church. In England the Church of England remained established but, partly as a result of struggles by secularist groups, legal restrictions on non-conformists, Jews, and atheists ended, and the established church's power declined. The United States outlawed federal church establishment in the constitution, and the late nineteenth century saw the rise of new secular cultural trends and even the popularity of agnostics like Walt Whitman (1819–1892) and Robert Ingersoll (1833–1899). In all Western countries public education of children and young adults spread rapidly, and it was increasingly a secular education. In several Western countries, the fight against the Catholic Church was often the key issue in politics. Anticlericalism, with secular implications, became central to politics in several countries, partly because nineteenth-century popes ruled against modern socialist and liberal ideas.

Popular belief and state control over education and welfare became increasingly secular. In Eastern Europe and the Global South traditionalist religion remained strong and secularism made fewer inroads in governmental policy than in Western Europe, but secularism was rising, especially among intellectuals and the newly educated classes, and was often a component of nationalism. Many forces favoring secularism were similar in the West and the Global South, except (1) their time span was much shorter in the Global South, and (2) many secularizing forces entered with imperialism in the Global South, and some who resisted imperialism also resisted secularism and incorporated religion in resistance. The Indian National Congress, however, founded in 1885, was ideologically secular, secularism being the only way to unite different Hindu castes, Muslims, Sikhs, Christians, Buddhists, and others in a single national movement. In the Middle East the new ideologies of Turkish, Iranian, and Arab nationalism, which arose in the late nineteenth and early twentieth centuries, emphasized Islam less and secular and nationalist values more. Several Iranian and Turkish nationalists were hostile to Islam and constructed idealized pre-Islamic national pasts full of modern and secular virtues. Even Arab nationalists, who saw Islam as a great Arab achievement, mostly favored a more secular legal system with more equal treatment of minorities. While words like *secular* never became widely popular in Muslim countries, where adherence to Islam by political leaders, and also state churches, continued, there were strong secular trends.

Among Jews secular trends were strong in the West, especially in the middle classes, but less in Eastern Europe and in the Global South. Theodor Herzl (1860–1904) and most founders of political Zionism were secularists, but many Eastern European Zionists were not. Oriental Jewry was essentially untouched by secularism by 1914, while most Jews worldwide were either indifferent or hostile to Zionism until the 1930s. Among Jews secularism and nationalism were not congruent;

many Zionists were not secularists, and many secularists were not Zionists.

Secularism and Its Opponents since 1914

Since World War I there was at first a rise in secularism in the Global South, but then a rise in antiseccularist forces, both in the United States and in the Global South, along with a decline in optimism about the future. The biggest impetus to secular nationalism came after World War I, with Mustafa Kemal Atatürk (1881–1938) in Turkey, whose leaders wanted a strong secular national state to catch up with the West. Atatürk's secularizing measures included Romanization of the script, outlawing the use of Arabic, ending religious education and the *shari'a*, basing personal status law on the Swiss Civil Code, votes for women, and discouragement of veiling. His were the strongest measures outside the communist world, and after World War II, when political parties competed, some of his measures were eased. While in the early twenty-first century Turkey has seen Islamist or partially Islamist parties in power, there has been little change in secular laws and practices, which have been guarded by periodic interventions of the secularist army.

In Iran Reza Shah, (r. 1925–41) imitated Atatürk. He promoted the secular nationalist view of Iran earlier favored by oppositionists, glorifying pre-Islamic Iran and denigrating the Arabs and Islam. He forced men and later women to adopt Western dress, promoted a secular public school system, and so forth. His son, Muhammad Reza Shah (1941–1979), continued secularist measures. With secular opposition cowed, and secular nationalism partly associated with the status quo and subservience to the United States, support grew for a religious opposition that appealed to anti-Western and antityrannical feelings and triumphed in 1979. Since then, however, secular opposition and thought have revived.

In Egypt the secular nationalism of Gamal Abdel-Nasser was undermined by defeats by Israel, and his secular successors followed unpopular economic and political policies. A growing Islamist movement there has influenced policy. Islamism is strong in the Muslim world, though several governments have suppressed it. The association of secularism with Western dominance helps account for this growth of Islamism; even the strict rulers of Saudi Arabia are attacked as infidels dependent on the United States. When Muslims want to be free of Western interference, and associate the West with support for Israel, many do not want to imitate ideologically the secular West.

In Pakistan and Israel religious identity was the *raison d'être* of movements to create nations. The early Zionist leaders were, however, secularists, and much of the population is still secularist. Muhammad Ali Jinnah (1876–1948) of Pakistan was also a secularist. Reactions against secularism, organized into several parties have, however, taken advantage of both states' religious basis, and have grown. Both states incorporate significant bodies of religious law, including religious courts for some matters.

India, where there are several major religions, is more complex. While Hindu, Muslim, and Sikh movements have grown, the secular Indian National Congress represented the main

trend of the national liberation movement. Once the Muslim League adopted and agitated for the creation of Pakistan in the 1940s, communal-religious feelings were aroused, culminating in partition in 1947. A Hindu political party ruled for some years until the secular Congress Party ousted it in 2004. Religiously based political movements have caused a weakening of secularist commitments in the Global South, at the same time as most governments continue to follow secular policies in education, welfare, and economics.

The other major area where secularism has been on the defensive and religious politics on the rise is the United States. Although the United States is very different from the Global South, the rise of religious politics in both since around 1970 is to some degree a reaction to governmental secular measures. The Supreme Court, partly responding to cases brought by the American Civil Liberties Union, began rulings favoring church-state separation in the states only in the 1930s. After World War II there were several secularizing governmental measures, but antisecular opposition has focused on two Supreme Court decisions, the outlawing of school prayer in 1962 and the legalization of abortion in 1973. The earlier concern of the religious right with evolution has also continued, as well as focus on opposition to schools' teaching about homosexuality or even about sex. Many feel that after 2001 the U.S. government under President George W. Bush became less secular, endorsing federal funds for "faith-based" programs and acquiescing to religious objections to stem-cell research and to funding international programs that include mention of abortion.

In Eastern Europe and Central Asia, the end of communism unleashed some backlash and restatement of traditions, though secularism remains strong. Even among secularists, concern over contemporary behavior patterns has been added to antisecularist ideologies. Among worldwide trends decried by antisecularists are the rise of freer sexual habits and of sexually transmitted diseases, a rise in crime rates, and a decline in community action and spirit. Some find in revived religious ties and morality an answer to such problems. Many traditions have come to be romanticized and seen as belonging to religion. The religious right creates a picture of harmony that never existed, generally idealizing the past family situation and social relations. Antisecularists everywhere appeal to the past to create religious roadblocks to the liberation of, and equal rights for, women.

In the past, when secular ideologies like nationalism, socialism, free market capitalism, and others had not been widely tried they could be seen as panaceas, while religion in government existed widely, and its faults were obvious. In the early twenty-first century this situation has reversed, with secular ideologies having been tried and shown problems, and religious groups able to present alternative ideologies and create effective religio-political organizations.

Many of the changes instituted by governmental secularization have been retained or reinstated when religious parties come to power, as seen in Iran. The Islamic Republic adopted a largely secular constitution and its economy and schools are mainly secular, despite a religious overlay, which, as with the

U.S. religious right, concerns mainly questions of gender and sexuality. Secularist ideas are also popular and religious government unpopular.

The backlash to secularism can produce its own backlash, as is happening in the early twenty-first century in Iran and possibly in India. Taking the whole world, secularism is not in dramatic retreat, although antisecular ideologies are stronger than they were. Religious politics are not important in the large, secular Japan and China, nor are they in most of Europe. Secularism seems strongest in countries that are growing in prosperity and in those that have considerable resources devoted to social safety nets, like Western Europe and Canada. The presence of large Muslim populations in Western Europe discriminated against and sometimes following Islamist ideologies and gender practices that disfavor women has created problems for European secularism, however. The most dramatic expression of secularism in the face of such problems has been the controversial French outlawing of wearing religious symbols, including the headscarf, in the schools in 2003.

See also ***Atheism; Cultural Revivals; Nation; Nationalism; Religion and the State; Sacred and Profane; Toleration; Zionism.***

BIBLIOGRAPHY

- Berkes, Niyazi. *The Development of Secularism in Turkey*. Montreal: McGill University Press, 1964.
- Bhargava, Rajeev, ed. *Secularism and Its Critics*. New Delhi, India: Oxford University Press, 1998.
- Bruce, Steve, ed. *Religion and Modernization: Sociologists and Historians Debate the Secularization Thesis*. Oxford: Clarendon, 1992.
- Chadwick, Owen. *The Secularization of the European Mind in the Nineteenth Century*. Cambridge, U.K.: Cambridge University Press, 1976.
- Dobbelaere, Karel. "Secularization: A Multidimensional Concept." *Current Sociology* 29, no. 2 (1981): 3–213.
- Jacoby, Susan. *Freethinkers: A History of American Secularism*. New York: Henry Holt, 2004.
- Keddie, Nikki R. "Secularism and Its Discontents." *Daedalus* 132 (summer 2003): 14–30.
- . "Secularism and the State: Toward Clarity and Global Comparison." *New Left Review* 226 (1997): 21–40.
- Royle, Edward. *Radicals, Secularists and Republicans: Popular Freethought in Britain, 1866–1915*. Manchester, U.K.: Manchester University Press, 1980.
- . *Victorian Infidels: The Origins of the British Secularist Movement 1791–1866*. Manchester, U.K.: Manchester University Press, 1974.
- Ruedy, John. *Islamism and Secularism in North Africa*. New York: Palgrave Macmillan, 1994.
- Smith, Christian. *The Secular Revolution: Power, Interests, and Conflict in the Secularization of American Public Life*. Berkeley: University of California Press, 2003.
- Tamimi, Azzam, and John L. Esposito, eds. *Islam and Secularism in the Middle East*. London: Hurst, 2000.
- Yared, Nazik Saba. *Secularism and the Arab World: 1850–1939*. London: Saqi Books, 2002.

Nikki R. Keddie

SEGREGATION. The concept of segregation is usually based on race, gender, class, religion, or ethnicity, depending on the circumstances under which it is practiced. This entry will mainly address racial and ethnic segregation and when appropriate address how it spawned gender and class segregation in the Americas and Africa.

Segregation in the Americas

The concept of segregation in the United States was different from segregation in other parts of the Americas, although all practiced slavery that affected the indigenous population. Segregation, with the exception of the United States, was not codified into law. Throughout the colonial and slavery periods in Latin America, South America, and the Caribbean, people of European descent maintained a hierarchy based on race. They attended separate schools and churches, lived in separate neighborhoods, and used separate recreational facilities. In Brazil after slavery was abolished in 1888, segregation was not by law; however, blacks and the indigenous population were not integrated into society. The government wanted to “whiten” the population by encouraging European immigration and interracial marriages. People who were viewed as white or close to white accrued privileges from their skin color, therefore indigenous Brazilians and people of African descent remained excluded from whites. Under Brazil’s racial democracy project during the nineteenth and twentieth centuries, it was argued that Brazil did not have the same kind of racial problems as the United States because race was of little significance and people achieved social and economic mobility due to individual merit. If people of African descent were at the bottom of the socioeconomic ladder, it was due to poverty and past discrimination. Scholars such as Gilberto Freyre, Carl Degler, and Frank Tannenbaum contended that the Portuguese who colonized Brazil were used to black people because of their experience with the Moors. The Catholic Church encouraged slaveholders to treat the slaves with a certain amount of humanity, and miscegenation was encouraged. Critical race theorists such as Thales de Azevedo began to question the racial democracy myth during the 1970s and argued that blacks and indigenous Brazilians were segregated in society based on race and not class.

Segregation was also practiced in Canada, as illustrated by the experiences of people of African descent who fought on the side of the British during the American Revolutionary War and those who escaped through the Underground Railroad. They believed they would enjoy citizenship rights in Canada, but there were few economic and educational opportunities, and land for farming was scarce. Some blacks therefore opted for resettlement in Sierra Leone.

The concept of segregation in the United States has been defined in distinct ways, based on race and ethnicity. White Anglo-Saxon Protestant immigrants were the privileged group who wielded political, economic, and social power. Other European immigrant groups were excluded from various jobs, universities, residential neighborhoods, and recreational facilities. This segregation was not codified into law and ended as soon as these groups were considered “white” and granted citizenship.

The country was envisioned as a “white man’s” country regardless of the presence of American Indians. Beginning in the early seventeenth century, Africans were brought to work first as indentured servants and then (by the 1660s) as slaves, and thousands of people from Asia emigrated to the United States in search of jobs in the late nineteenth and early twentieth centuries. Residential segregation was evident with the establishment of reservations for American Indians in 1638. People of Mexican descent experienced economic, residential, and educational segregation following the end of the Mexican-American War in 1848. People of Asian descent were encouraged to immigrate to the United States for employment in the late nineteenth and early twentieth centuries. Nonwhite workers were relegated to unskilled jobs in factories and on sugar plantations, farms, and the railroads. They were forced to attend separate schools and live in separate neighborhoods.

Segregation in Africa

The concept of segregation in Africa will be discussed within the context of the colonial period. Segregation was defined as a hierarchy with Europeans on top; Indians, Arabs, other ethnic groups, and mixed-race people (depending on the colony) in the middle; and Africans on the bottom. In settler colonies such as South Africa, Namibia, and Zimbabwe, segregation was not solely defined in racial terms but also in ethnic, religious, and gender terms. Separate schools were maintained along religious and ethnic lines in Eritrea; Saint-Louis, Senegal, had segregated areas for Christians and Muslims; and reserves in South Africa were created along ethnic lines. Throughout southern Africa, rural areas were often disproportionately populated with women after men were forced into the urban labor market to earn wages, which left women segregated in the rural areas.

One of the most important forms of segregation found throughout Africa was residential, especially in urban areas. Cities in settler colonies were designed for Europeans and in some cases Asian and Arab merchants. The more developed parts of the city were designated for Europeans, while Africans (mostly male workers) were forced into reserves, prevented from owning freehold property, denied the franchise, and forced to carry passes. Thousands of Africans, Indians, and mixed-race people were forced out of cities in the 1950s and 1960s in South Africa and Namibia.

Ideas Surrounding Segregation

During the seventeenth century, when Europeans arrived in what later became the United States, the intellectual ideas that supported the segregation of people of European descent from the American Indians was predicated on the belief that Europeans were culturally superior. The idea that education and conversion to Christianity could civilize American Indians was abandoned because they were thought to be biologically different from whites. The segregation of American Indians must be understood in economic terms. The colonists were in competition with the American Indians for arable land in the North, and planters in the South needed large tracts of land to produce cash crops. The segregation of American Indians was justified in religious terms—God ordained whites to have

the land. John Winthrop and John Cotton contended that the diseases that killed many American Indians in New England were sent by God and that this cleared the way for the whites to possess the land. The political architects who ensured the segregation of American Indians were the “founding fathers” (Thomas Jefferson, James Madison, James Monroe). The segregation of American Indians was justified on cultural and legal grounds by the ideology of Thomas Jefferson and Andrew Jackson—both believed that American Indians were children and savages who could not survive in the larger society.

Before slavery was abolished in the United States, ideas among African-American intellectuals about segregation were mixed. Martin Delany and Edward Blyden believed that people of African descent would never be integrated into American society. Frederick Douglass believed that blacks should remain and fight for their full citizenship rights. Booker T. Washington, the most powerful African-American at the beginning of the twentieth century, endorsed social segregation. He argued that African-Americans should forego political and social equality until they achieved economic equality. At the same time, the most influential African-American intellectual, W. E. B. Du Bois, vehemently opposed Washington’s views on segregation. He argued that African-Americans should demand their full economic, political, and social rights and call for an end to all forms of segregation.

The emergence of the Ku Klux Klan following the Civil War illustrated how wedded some whites were to segregation. It was formed in 1866 by Nathan Bedford Forrest, who strongly believed that the South’s way of life was being undermined by the northern Republican government and the former slaves. The idea behind the Klan was to reestablish white rule in the South. The Klan was revived in 1915 by William J. Simmons, who espoused the ideas of patriotism, Protestantism, traditional American values, and American nativism. Simmons’s Klan was revived within the context of large influxes of immigrants who were not Protestant or Anglo-Saxon. The Klan was revived again in 1922 under Hiram Evans, who believed white American values needed to be preserved. Later figures associated with the Klan who espoused the values of nativism and white supremacy included Robert Shelton during the 1950s and David Duke in the 1980s and 1990s.

Ideas Surrounding Segregation in Africa

Africans, Asians, Arabs, and mixed-race people in Africa were viewed through the same cultural lens—Europeans were inherently superior, and Africans were the most inferior. They were uncivilized, lazy, and childlike in their behavior. They were prone to criminal activities and therefore had to be controlled and segregated for the protection of whites. During the nineteenth and twentieth centuries, biology spawned ideas about race that were used to justify racial segregation in the Americas and Africa. The belief developed that there were distinct races with different levels of intelligence, capacities, and abilities guided by the laws of nature. These ideas were given scientific and academic legitimacy through the writings of historians, anthropologists, and geographers. South Africa’s Howard Pim, Maurice S. Evans, Edgar H. Brookes, James Hertzog, Jan Christian Smuts, and Charles Loram advocated

racial segregation. Evans studied South Africa and the United States and concluded that segregation was a good policy because it would help to ensure the survival of European civilization. Loram supported the idea of separate vocational education along the lines of Booker T. Washington’s Tuskegee Institute. Africans and people of color were viewed as unhealthy, diseased, and contaminated, and they had to be segregated from whites. Segregation was also needed for economic reasons: the African communal economy was not compatible with the European capitalist economy, so a dual economy was needed. Finally, it was thought that African and European cultures were too different to coexist. African society was “primitive,” and its customs would not be able to survive contact with Europeans.

When the National Party came to power in South Africa in 1948, the ideas of apartheid, or separate development, were codified into law. The major supporters of these ideas included Daniel Malan, J. G. Strijdom, and Hendrik Verwoerd, whose campaign slogan was “the white man must remain master.” The cultural ideas that espoused a racial hierarchy throughout the Americas and Africa served as the foundation for religious, political, and economic ideas that embraced segregation. Segregation was supported both in the Americas and in Africa by Christian churches, especially in South Africa by the Dutch Reformed Church (until the 1990s) and in the American South by most of the predominantly white Christian denominations (until the 1960s). Religious leaders and church members argued that the Bible upheld segregation and that forced integration was against God’s will because God ordained people to live separately.

Social Movements to End Segregation

The ideas of the 1950s and 1960s that served as the catalyst to end Jim Crow segregation in the United States were not new. Intellectuals such as James Farmer, A. Philip Randolph, and Bayard Rustin supported and used the tactics of civil disobedience and mass resistance to end racial segregation. For example, James Farmer, who founded the Congress of Racial Equality, used Mahatma Gandhi’s philosophy of nonviolent civil disobedience in Chicago in the 1940s before Dr. Martin Luther King Jr. adopted them. King’s ideas of using the Christian faith, moral superiority, and moral persuasion as part of civil disobedience cannot be overlooked. King believed that unjust laws do not coincide with the law of God, therefore segregation laws, which were immoral and unjust, did not have to be obeyed. In addition, if people could not vote and did not have political representation, they were not obligated to obey unjust laws. These laws had to be overturned by just, moral means. In sum, King’s ideas of mass resistance, direct action, and civil disobedience were tied to Christianity, which instructed him to love his sisters and brothers and to have faith that morality and justice would prevail in overthrowing segregation. And through the abolition of segregation, whites could achieve salvation through living up to the American creed of democracy and liberty for all.

Segregation was opposed throughout Africa, but the fight to abolish apartheid in South Africa was waged both domestically and globally. At the turn of the twentieth century

Mahatma Gandhi developed nonviolent strategies to end segregation in South Africa, and he worked closely with the founders of the African National Congress (ANC), especially John Dube. Dube, along with Pixley Seme and Sol Plaatje, believed that African nationalism and unity would restore land and rights lost under European rule. Their beliefs were supported by the strategies of petitioning the British government and sending delegations to London to appeal for constitutional changes that would grant Africans their rights. Later leaders such as Walter Sisulu, Oliver Tambo, and Nelson Mandela committed themselves to the idea of mass resistance and established the ANC Youth League. They believed African nationalism would lead to African self-determination and that equality and the end of apartheid would only come through the efforts of Africans. Therefore, the ideology of the ANC shifted in the 1940s from a conservative to more a radical and militant approach that would involve the masses of people instead of a few educated members of the middle class. Mandela, Sisulu, and Tambo strongly believed in mass civil disobedience, boycotts, peasant revolts, and strikes, manifested in their support of the Campaign for the Defiance of Unjust Laws in 1952, when blacks, Indians, and coloreds refused to obey laws that they found unjust.

The ideas of the ANC's main leadership further shifted in the 1960s from attempting to abolish apartheid by disciplined and nonviolent means to violent forms of resistance with the establishment of a military wing, the Umkhonto we Sizwe (Spear of the Nation). This was established only after the South African state was ruling by force and violence and ANC leaders felt that all forms of peaceful protest had been exhausted. The ideas of black consciousness espoused by Steve Biko in the 1970s were based on building strong grassroots organizations to raise awareness of the plight of black South Africans. It was his belief that only blacks could liberate themselves through a reevaluation of African history, pride, religion, and culture: out of black consciousness, black liberation could be born. In turn blacks would gain respect from other groups in society, and the apartheid system would be abolished.

The abolition of apartheid in the 1990s was based on the political ideas of a multiracial democratic South Africa espoused by Nelson Mandela and F. W. de Klerk. The religious ideas to end apartheid came from church leaders such as Desmond Tutu and Allan Boesak, who both believed apartheid could be abolished through nonviolent means, resulting in a multiracial democratic society that granted full human rights to all citizens.

See also *Apartheid; Prejudice; Race and Racism.*

BIBLIOGRAPHY

- Cell, John W. *The Highest Stage of White Supremacy: The Origins of Segregation in South Africa and the American South.* Cambridge, U.K., and New York: Cambridge University Press, 1982.
- Fredrickson, George M. *The Comparative Imagination: On the History of Racism, Nationalism, and Social Movements.* Berkeley and Los Angeles: University of California Press, 1997.
- Hamilton, Charles V., et al., eds. *Beyond Racism: Race and Inequality in Brazil, South Africa, and the United States.* Boulder, Colo., and London: Lynne Rienner, 2001.

- Kirk, Joyce F. *Making a Voice: African Resistance to Segregation in South Africa.* Boulder, Colo.: Westview Press, 1998.
- Lapping, Brian. *Apartheid: A History.* New York: George Braziller, 1987.
- Marx, Anthony W. *Making Race and Nation: A Comparison of South Africa, the United States, and Brazil.* Cambridge, U.K., and New York: Cambridge University Press, 1998.
- Nascimento, Abdias do, and Elisa Larkin-Nascimento. *Africans in Brazil: A Pan-African Perspective.* Trenton, N.J.: Africa World Press, 1992.
- Smith, John David. *When Did Southern Segregation Begin?* New York: Bedford/St. Martin's, 2002.
- Vaughan, Alden T. *Roots of American Racism.* New York: Oxford University Press, 1995.
- Woodward, C. Vann. 1955. *The Strange Career of Jim Crow.* Reprint, Oxford: Oxford University Press, 2002.

Cassandra Rachel Veney

SEX AND GENDER. See **Gender; Gender Studies; Anthropology.**

SEXUAL HARASSMENT. Unwanted sexual attention was imposed on people in no position to refuse it long before *sexual harassment* was a recognized idea. Sexual harassment seems to be practiced wherever the sexes are materially unequal, which generally they are; its reality in paid work can be traced from the beginnings of industrialization and in unpaid work throughout slavery. Until the mid-1970s, it had no name.

The women's movement of that period brought many obscured and unnamed harms long inflicted on women to social consciousness, stimulating political intervention and legal action. In this context, unwanted sex began to be resisted in the United States within the framework of an analysis of sexual politics, conceptualized by Kate Millet as relations of power on the basis of sex. In this context, Working Women United Institute (first at Cornell University, then in New York City) and others organized against the coercive imposition of sexual demands with impunity on women in workplaces.

Building on this activism, sexual harassment of working women was theorized by Catharine MacKinnon as a form of sex inequality that drew its power from a gendered dominance that was sexual combined with a workplace hierarchy that was economic. Sexual harassment was argued to be a form of discrimination on the basis of sex under federal equal employment laws in the United States. Federal courts initially rejected this legal argument, then accepted it in 1977 in the breakthrough ruling of *Barnes v. Costle*. The Equal Employment Opportunity Commission's 1980 guidelines codified this ruling in an influential formulation of harassment on the basis of sex as a violation of federal antidiscrimination law when "unwelcome sexual advances, requests for sexual favors, and other verbal or physical conduct of a sexual nature [are made] a term or condition of . . . employment [or] submission or rejection of such conduct . . . is used as the basis for employment

decisions . . . [or] such conduct has the purpose or effect of unreasonably interfering with an individual's work performance or creating an intimidating, hostile, or offensive working environment." Sexual harassment became the first accepted legal concept to be defined by women based on their experience of victimization.

Framed as a civil right, the right not to be sexually harassed under United States law was extended from employment to education, from opposite sex patterns to same-sex situations to harassment on other grounds, and came to encompass sex- and race-based harassment combined. Through well-publicized claims against powerful men in public life, sexual harassment became a household word. By the turn of the twentieth century, legal systems around the world and international law had recognized that the human right to equality included not being sexually harassed.

The original debate centered on whether or not unwanted sex imposed under unequal conditions—whether as a *quid pro quo*, meaning in exchange for benefits, or as a hostile environment, meaning as a constant condition requiring tolerance or exit—should be subject to civil suits. What kind of violation was sexual harassment, if it was one at all? Advocates for survivors argued that it was imposed on women because they were women, thus was a form of sex-based discrimination, a status injury based on gender (the social form sex takes) of which unequal undesired sexual practices were a part. Courts that initially rejected this argument thought of sexual harassment as part of sexuality, hence personal, individual rather than gendered in the group-based sense, private, not properly regulable by public means, and biological, not social but natural and inevitable. As sexual, it was imagined inherently free and equal: nonexploitative, incapable of being socially stereotyped or scripted, intrinsically separate from social rank orderings. This sexual essentialism was authoritatively rejected when courts accepted the analysis that sexual harassment is sex-based discrimination: not personal, social; neither biological nor inevitable; the exploitative social imposition of inferiority on the group ground of sex, an injury of status as well as treatment.

The reasons the legal claim for sexual harassment was initially controversial continue, in ever-changing form, to operate as backlash and undertow in social and legal discussions of the subject. The debate over the place of sexuality in gender inequality, although authoritative resolved, has not gone away. It has continued to drive critical commentaries, to underlie public disputes, and to animate legal controversies, often taking the form of opposition to the hostile environment claim. Sexuality as such remains defended by some as inherently a sphere of freedom properly off limits to the law, while being scrutinized by others as a site of sex inequality, specifically of male dominance, propitious to abuse and in need of public exposure and redress.

Entrenched positions on these deeper questions shaped public conflicts and public dialogue through episodes that proved decisive in public consciousness. When Professor Anita Hill accused then-Judge Clarence Thomas in the fall of 1991 of what amounted to sexual harassment in his confirmation hearing for Justice of the Supreme Court of the United States,

many of the attacks on her and on the validity of the inquiry proceedings took the view that sexual goings-on did not belong in a Senate hearing or in a confirmation debate, or were not sufficiently severe to be worthy of concern. When Paula Jones accused then-President Bill Clinton in 1996 of having sexually harassed her when she was employed by the state of which he was governor, much of the hue and cry centered on the appropriateness or not of public airing of what were minimized as his sexual peccadilloes, as well as the fact that the allegations involved a single incident, which was minimized as not severe, although it was alleged to include unwanted sexual touching and indecent exposure. Trivializing sexual attacks because they are sexual remains an ideological feature of the discussion of such incidents. Far less public attention was visited on the U.S. Supreme Court decision in 1998 that public schools need not pay for the sexual injuries teachers inflicted on their students unless the abuse had been properly reported and the school had deliberately been indifferent to it—an exceedingly low standard of requisite institutional responsiveness. The Court's treatment of sexual use of young students by adult teachers reflected an ideology of sexuality as essentially private misbehavior for which public authorities were unaccountable unless put explicitly on notice.

If sexual harassment's conceptual resonance with women worldwide has propelled its acceptance, political organizing and legal acceptance has promoted its legitimacy, and the concept itself has proven adaptable to diverse legal cultures, each aspect of it has produced some debate somewhere. Some countries do not recognize it as sex inequality, as in France, where it is a crime, centering on the *quid pro quo* form. Israel's sexual harassment provision—the most explicit and far-reaching in the world in extending to all spheres of social life and expressly covering harassment based on sexuality and sexual tendencies as well as sex—is premised on values of dignity as well as equality. German law recognizes harassment only if women object to it, which can be problematic where unequal power exists. The European Community's approach has historically emphasized respect and dignity over equality, with European approaches generally tending to individualize the behavior, ignoring group hierarchies and obscuring the function of sexuality in gender-based discrimination.

In Japan, although the legal claim has been recognized, women continue to experience extraordinary difficulty being valued and believed when they claim they were sexually harassed—as, indeed, women do everywhere. Legal and social constraints on the form that the abuse must take that do not reflect the experience of victims is a globally shared problem, as is valuing the careers of perpetrators above the equality of victims. Perhaps the least legal debate has occurred in India, where the Supreme Court of India has embraced the concept and designed imaginative and aggressive relief for companies to institute. And the inclusion of the concept by interpretation under the Convention on the Elimination of All Forms of Discrimination Against Women has solidified its place in international law.

In the United States, some scholars have urged that unwelcomeness be assumed rather than be required to be proven, on

the view that it makes no sense to assume that women at work welcome sexual attention. Some academics have urged courts be more receptive to finding gender-based harassment that is not expressly sexual, a dimension of the legal claim that has always been a part of it, sometimes complaining that too much attention has been devoted to specifically sexual forms of abuse. To reduce controversy in legal decision-making over the hostile environment claim, some jurists have urged that a per se list of acts that constitute hostile environment sexual harassment be devised, typically including sexual assault, sexual threats, and pornography. Other advocates have argued that hostile environment sexual harassment, most of which is verbal or physical expressive behavior should not be legally actionable at all, because it is speech that should be constitutionally protected.

Whether or not the claim for sexual harassment should encompass sexual harassment of gay men and lesbians has produced considerable discussion in the United States. Proponents argue that sexual orientation should not deprive a person of a right from unwanted sexual attention on the basis of sex. Opponents argue that sexual abuse based on sexual orientation is not based on sex. Proponents reply that sexual orientation is itself sex-based, as is abuse based either on the sex or the sexual orientation of the victim, whether same-sex or not. There is also some concern on both sides that harassment claims premised on a same-sex sexual orientation, if permitted, could become a pretext for unfounded or bigoted claims.

Perhaps most significantly, the fact that the idea of sexual harassment is widely recognized as defining a violation does not mean that it no longer happens—far from it. It is also far from actionable wherever it occurs, including on the street and in the home. And for survivors, challenging the behavior is not yet safe or without cost. Although protections against retaliating against them proliferate, studies indicate that women are often better off not resisting the abuse than challenging it, which is no doubt the reason that reporting rates continue to be low. Perpetrators often protect one another. Institutions often elude responsibility. Victims seldom receive effective support and relief. Despite the strides toward eliminating this form of sex-based abuse, the history of the idea of sexual harassment continues to be a short chapter in the longer history of its practice.

See also *Equality: Gender Equality; Human Rights: Women's Rights; Power*.

BIBLIOGRAPHY

- General Recommendation 19*, Committee on the Elimination of Discrimination Against Women, U.N. GAOR, 47th Sess., Supp. No. 38, U.N. Doc. A/47/38.
- Hesson-McInnes, Matthew S., and Louise F. Fitzgerald. "Sexual Harassment: A Preliminary Test of an Integrative Model." *Journal of Applied Social Psychology* 27(1997): 877.
- MacKinnon, Catharine A. *Sexual Harassment of Working Women: A Case of Sex Discrimination*. New Haven, Conn.: Yale University Press, 1979.
- MacKinnon, Catharine A., and Reva B. Siegel, eds. *Directions in Sexual Harassment Law*. New Haven, Conn.: Yale University Press, 2003.
- Millett, Kate. *Sexual Politics*. New York: Doubleday, 1969.

Nomination of Judge Clarence Thomas to Be Associate Justice of the Supreme Court of the United States: Hearings Before the Senate Committee On the Judiciary (Pt. 4), 102d Cong. 36–41 (1991).

Catharine MacKinnon

SEXUALITY.

This entry includes three subentries:

- Overview*
- Islamic Views*
- Sexual Orientation*

OVERVIEW

When we think of sexuality, we think of many different things. We think of reproduction and the different bodies and reproductive capacities of men and women. We think of pleasure, the pleasures of the body, but also the pains, mental and physical, that can wrack the body. We think of love, and the joys of human involvement, but we might also remember the fear and hate that sexuality can evoke—through discrimination, prejudice, abuse, violence, rape. We think of potential diseases, of which HIV/AIDS has become the most potent symbol, and the possibility of death, which has always dogged sexual activity, from the perils of childbirth to the great artistic traditions that link love, sex, and death. Sexuality is about both pleasures and dangers, and that link gives it its ambiguity and its power.

This multiplicity of meanings can often confuse as much as clarify. At the most basic and popular level, *sexuality* refers to what most regard as one of the most basic features of human life, "our sexuality," the "most natural thing about us," the "truth of our being," in Michel Foucault's well-known phrase. When people say something like "this is my sexuality," they are referring to something that they see as essential to their needs, desire, identity, and social position. Yet even as we agree on its importance to individuals and cultures (at least in their Western, metropolitan forms) the term has become a highly contested one. Even those modern researchers who claim to have put our understanding of the body and its desires on a solidly scientific basis—like the sociobiologists or evolutionary psychologists who claim to be able to trace the roots of human sexuality to the first human steps on the African savannah tens of thousands of years ago—express puzzlement as to why sexuality should have evolved. For historians, anthropologists, and other social scientists alert to the different interpretations given to sexuality at different times in different cultures, the concept is a deeply problematic one.

The concept is so cloaked in historical myths and social ambivalence, and obscured by heterogeneous meanings and elaborate taboos, that sexuality often appears more a product of the mind than of the body. Perhaps, as the social anthropologist Carole Vance once suggested, the most important human sexual organ is located between the ears. Yet, of course, it is through the body that sexual desires are expressed, and the body is the site for marking gender differences, which

continue to shape culturally important differences and sexual beliefs and behaviors. The body, and its biology, cannot simply be ignored. So the safest way of putting it is that *sexuality* as a concept is perilously stretched between the biological, the social, and the psychic. Even Sigmund Freud, usually accused of putting sex into everything, confessed to the difficulty of agreeing on “any generally recognized criterion of the sexual nature of a process” (p. 323). Since then, despite our ever growing knowledge about the varieties of patterns, values, norms, lifestyles, and fantasies around the erotic, a certain ambiguity continues to cloak the meanings of sexuality.

Conceptualizing Sexuality

A brief history of the concept in English shows how meanings of sexuality continue to evolve. The earliest usage of the term *sex* in the sixteenth century referred to the division of humanity into the male section and the female section; and the quality of being male or female. The subsequent meaning, however, and one current since the early eighteenth century, refers to physical relations between the sexes, “to have sex.” What we know as masculinity and femininity, and what came to be labeled from the late nineteenth century as *heterosexuality*, with *homosexuality* as the aberrant “other,” are thus inscribed into the meanings of *sex* from the start. *Sexual*, a word that can be traced back to the mid-seventeenth century, carries similar connotations—pertaining to sex, or the attributes of being male or female, is one given meaning. *Sexuality* as a term meaning “the quality of being sexual” emerged early in the nineteenth century, and it is this meaning that is carried forward and developed by the sexologists, sexual theorists, and researchers who emerged as a distinct category of specialists in the late nineteenth century, and became increasingly influential in the twentieth century. Luminaries included not only Freud, who is now best remembered, but also the Austrian pioneer, Richard von Krafft-Ebing (1840–1902), who can lay claim to being the founding father of sexology; the Briton, Havelock Ellis (1859–1939), and the German, Magnus Hirschfeld (1868–1935), who was also a pioneer of homosexual rights, among many others.

Sexologists sought to discover the “laws of nature,” the true meaning of sexuality, by exploring its various guises and manifestations. They often disagreed with one another; they frequently contradicted themselves. But all concurred that sexuality was in some way a quality or essence that underlay a range of activities and psychic dispensations. Thus Krafft-Ebing became a pioneer in seeing sexuality as something that differentiated different categories of beings—so opening the way to theorizing sexual identities. Dozens of individuals wrote to him with their case histories, and in the process of studying them Krafft-Ebing came to understand that there were many types of sexualities that could not easily be reduced to the traditional assumption of heterosexual, reproductive sex. Freud went further. His *Three Essays on the Theory of Sexuality* (1905) began with a discussion of homosexuality, thus severing the expected connections between sexuality and heterosexual object choice, and continued with a discussion of the perversions, so breaking the expected link between pleasure and genital activity. In the psychoanalytic tradition,

sexuality was seen as central to the workings of the unconscious. More broadly, sexuality was becoming a distinct continent of knowledge, with its own specialist explorers. When people spoke of “my sexuality,” they increasingly meant those desires and behaviors that shaped their sexual (and social) identities, as male or female, heterosexual or homosexual, and so forth.

The result of all this classifying and definitional zeal was startling. The pioneering explorers of sexuality thought they were simply mapping and giving names to what was already there. It is to this generation that we owe concepts and terms such as *homosexuality* and *heterosexuality*, *transvestism* and *sadomasochism*, *coprophilia* and *necrophilia*, and a thousand more terms in the ever growing lexicon of the erotic. Later researchers such as Alfred Kinsey (1894–1956) and his colleagues sought to demonstrate that in biology there was little concept of what was right or wrong, normal and abnormal; and the sexual lives of our fellow citizens (or at least the twenty thousand or so American men and women from whom Kinsey obtained his information in the 1940s) displayed a spectrum of behaviors and desires that was far from the culture’s self-image of respectability. Whole armies, it has been well said, began to march out of the pages of the sexologists’ learned tomes and onto the stage of social history.

However, late-twentieth- and twenty-first-century theorists have questioned the naturalness and inevitability of the sexual categories and assumptions we have inherited. They suggest that the sexologists did not so much discover or map the world of sexuality as help create and constitute it. The concept of *sexuality*, they argue, unifies a host of activities that have no necessary or intrinsic connection: discourses, institutions, laws, regulations, administrative arrangements, scientific theories, medical practices, household organization, subcultural patterns, ethical and moral practices, the arrangements of everyday life. The idea of *sex*, which seems so foundational to the very notion of *sexuality*, is itself a product of the discourses. Nothing is sexual, as Ken Plummer (1975) suggests, but naming makes it so. So sexuality can be seen as a narrative, a complexity of the different stories we tell each other about the body; a series of scripts through which we enact erotic life; or an intricate set of performances through which the sexual is invented, ritualized, and embodied.

In other words, “sexuality” was a social construction, a “fictional unity” that once did not exist and that at some time in the future may cease to exist. John H. Gagnon and William Simon have discussed the need at an unspecified point in human history to *invent* an importance for sexuality. Michel Foucault queried the very category of “sexuality” itself: “It is the name that can be given to a historical construct (p. 105).” Foucault’s work particularly has had a huge impact on our thinking about the sexual. But he was building on new forms of sexual knowledge already in development. These were in turn being heavily influenced by radical social movements including second-wave feminism and the gay liberation movement, which emerged from the late 1960s.

The work of young scholars inspired by these movements began to develop critical social-scientific approaches to sexuality. Already by the mid-1970s feminists were questioning the

basic categories of sexuality, and a number of pioneering lesbian and gay historians were interrogating the fixity of the heterosexual-homosexual dichotomy to show that this apparently fundamental binary divide had a relatively recent history. If the homosexual identities we took for granted were indeed a historical construction, then so could the norm of heterosexuality be seen as something that was invented. In a similar way the sharp distinction that some of the pioneering writers on sexuality had drawn between “civilized” and “uncivilized” patterns of behavior could also be challenged, and instead could be seen as products of Western cultural—and racist—assumptions in the age of empire. In other words, sexuality, far from being the domain of the given, the natural, the biological, was preeminently historical and social, and moreover was shaped in relations of power. This has profound implications.

Questioning the Concept of Sexuality

In the first place, we need to question the concept of sexuality. We can no longer easily see sexuality as a given and constant nexus of instincts, drives, and desires with automatic effects on individual and social lives. Rather, we need to see the erotic as always and necessarily given meaning only through the social. That means inevitably that to find the sexual, we always need to look for its specific local manifestations and the forces that structure it. Instead of seeking the laws of nature that would explain sexuality as a universal phenomenon, we need to understand the social organizations of sexualities in all their diverse forms. We therefore need to speak not of sexuality but of sexualities, not of sex and society but of sexual cultures. To understand sexual cultures we need to understand the diverse contexts in which meanings are attributed to intimacy and eroticism, and the complex social interactions that shape the erotic cultures of different societies.

It is important, further, to recognize that sexualities are hierarchically organized—that is, some forms are dominant while others have been made subordinate and marginalized—and are shaped by complex relations of power. The most familiar of these relate to gender, class, age, race, and ethnicity. There has also been an increasing recognition that sexualities in the West at least have been organized into institutionalized forms of heterosexuality, leading to critiques of “compulsory heterosexuality,” “heterosexism,” the “heterosexual panorama,” the “heterosexual assumption,” and “heteronormativity”—the phrases vary, but the effort put into these concepts underlines the importance many people give to questioning our assumptions.

Gendering Sexualities

Gender is at the heart of our thinking about sexuality, though not necessarily in the ways traditionally believed. The complex ways in which gender is constructed, reinforced, and set in patterns of dominance and subordination through the institutionalization of heterosexuality, has become central to our developing understanding of sexualities and sexual cultures. Some feminist theorists have indeed argued that gender constitutes sexuality, and that female sexuality is shaped and organized through the mechanisms of male domination. Other theorists have argued for a significant distinction between the domains of sexuality and gender, regarding their relationship

as more complex and contingent than is often thought. But there can be little question that gender relations have been shaped asymmetrically, in patterns of domination and subordination.

But of course, the existence of a hierarchy does not determine gender relations in an absolute way. If that were the case, there could be no change. On the contrary, uneven power relations provide the necessary condition for resistance, and for sexual politics. The impact of feminism since the 1960s has simultaneously sharpened our awareness of the arbitrary nature of gender divisions and increased the possibility of changing them. Gender has increasingly been seen not simply as lived, but as “performed” through the constant iteration and reenactment of what are regarded as the essential characteristics of both sex (male and female) and gender. In such theorizations we seem to move ever further from any preexisting essence of femininity or masculinity.

New Subjectivities

We are also moving away from seeking an essence to our subjectivities and identities. The extent to which sexuality is central to people’s sense of self is increasingly seen as historically specific, as the first volume of Michel Foucault’s *History of Sexuality* powerfully suggested. This has been best explored in tracing the evolution of homosexual identities since the nineteenth century. In a culture in which a particular form of sexuality was either denied or punished, it was inevitable that people organized their sense of self around their sexuality in various forms of resistance—through what Foucault described as a “reverse discourse.” Historians have increasingly sought to understand the dynamics of push and pull, definition and self-definition that have shaped the emergence of nonorthodox sexual identities.

Identities have been the object of struggle, often against extremely forceful and imposed norms. The sexual movements of the 1970s were in some ways heirs of the modernist project, in which it was taken for granted that the historical distinction between heterosexuality and homosexuality would be reflected in homogeneous identities, of for example, heterosexuals, lesbians, and gays. This has met a dual challenge. The emergence from the late 1980s of “queer” political movements radically challenged the homogeneous nature of the identities that existed and constituted a self-conscious refusal of identity on the part of many younger people. An even more significant challenge has come from a growing recognition that the meanings developed around sexual identity in the West were of little relevance to many marginalized people from minority ethnic communities within the Western world, or to many people in other cultures.

Globalization

This is closely related to a recognition of the growing importance of globalization in relation to the organization of sexualities. A globalized world is one in which Western categorizations of sexuality increasingly interact and interpenetrate with those operating in other sexual cultures, and in which new categorizations emerging worldwide—whether being universalized or asserted in opposition to one another—are increasingly interconnected across cultures. The spread of the HIV/AIDS

epidemic since the 1980s to become a global pandemic is a vivid and tragic illustration of this. Sexual behavior has of course always been associated with risk: the risk of unwanted pregnancy, of disease, of exploitation, of prejudice and oppression. These risks did not disappear with the emergence of a new discourse of sexual rights over the last thirty years of the twentieth century. But the risks have changed their forms, giving rise to new forms of conflict—over, for example, the rights and roles of women in nonindustrialized societies, and the responsibility of the developed world to the Third World in relation to matters such as the population explosion. These often become central to political differences on a global scale, such as the postulated conflict between Western and Islamic values. Conflicts over sexuality have become integral to the emergence of fundamentalist politics both within Western societies and elsewhere around the world. The work of international campaigns for reproductive rights suggests that there is a double push in this global movement: for bodily integrity and the right of women to control their own body; but also for challenging wider social, economic, and cultural inequalities, without which rights may become meaningless.

This pinpoints the new dilemmas of “global sex.” If sexual cultures are varied and have specific historical formations, how do we distinguish those claims to right that have a universal resonance, and those that are highly culturally specific—and possibly distasteful to large numbers of citizens around the globe? One answer lies in the realization that human rights do not exist in nature. They are not there to be discovered written on tablets of stone. They have to be invented, in complex historical conjunctures and contestations, as part of the making of minimal common values. And in a divided, often violently polarized world, that is not an easy task.

Conflict of Values

This pluralistic, diverse world is subject to an unavoidable conflict of values that can neither be wished away nor easily resolved by a resort to absolute standards, science, history, or tradition. In a world that is simultaneously globalized and challenged by emergent differences and new fundamentalisms, questions of values and ethics inevitably come to the fore. Sexuality may always have been an arena of moral and cultural conflict, but in contemporary societies sexuality is becoming an increasingly central and explicitly debated issue in mainstream cultural conflicts and political debates over values and citizenship. Debates about who and what we are, what we need and desire, how we should live, are to a striking degree also debates about sexuality. It is not surprising therefore that debates over sexuality display anxiety and uncertainty. The fear aroused by the HIV/AIDS epidemic was more than simply concern about a new and possibly incurable disease; it also underlined our uncertainty about contemporary moral stances. The “culture wars” that have been so prominent a feature of United States politics since the 1980s revolve around abortion, sex education, same-sex marriage, and the family—keystone issues on which views seem irreconcilable because they speak of the sort of society we are, and want. As sexuality goes, so goes society.

Advances in science, far from resolving our dilemmas, only serve to compound the general air of uncertainty. How, for

example, should we react to the possibilities opened up by embryological research? What are the implications for sexual values and ethics of the Internet revolution? In a world where traditional sources of authority such as religion and the patriarchal family are under intense pressure, and heightened individualism is increasingly the norm, it is difficult to see how there can ever be agreement on a fixed set of values, or a categorical list of rights and responsibilities to which everyone can readily adhere.

It is perhaps for this reason that the language of human rights and of sexual or intimate citizenship has come to the fore. It provides at least one discursive form through which the necessary debates can be carried on in working out what is and is not possible. It provides an iterative framework through which we can try to agree to the minimum standards we need to attain to recognize simultaneously each other's differences and common humanity. This is a long way from the belief of the pioneering sexologists of the late nineteenth century and the sex researchers of the mid-twentieth century—that the truth of sexuality in nature could be discovered. It remains even further as a position from those prophets of the truth who would like us all to bend a knee to their insights, whether religious or moral. But it is in tune with a recognition that sexuality is a product of negotiation and choice as much as of revealed truth. And that, surely, is the only way forward that accords with the diversity of our sexual world.

See also *Body, The; Family Planning; Feminism; Gay Studies; Gender*.

BIBLIOGRAPHY

- Altman, Dennis. *Global Sex*. Chicago: University of Chicago Press, 2001.
- Butler, Judith. *Gender Trouble: Feminism and the Subversion of Identity*. New York and London: Routledge, 1990.
- Foucault, Michel. *The History of Sexuality*. Vol. 1: *An Introduction*. Translated by Robert Hurley. New York: Pantheon, 1978.
- Freud, Sigmund. “Introductory Lectures on Psychoanalysis,” lecture 21. In *The Standard Edition of the Complete Psychological Works of Sigmund Freud*, 24 volumes, edited by James Strachey, vol. 16. London: Hogarth Press and the Institute of Psychoanalysis, 1953–1974.
- Gagnon, John H., and William Simon. *Sexual Conduct: The Social Sources of Human Sexuality*. Chicago: Aldine, 1973.
- Plummer, Kenneth. *Sexual Stigma: An Interactionist Account*. London: Routledge and Kegan Paul, 1975.
- . *Telling Sexual Stories*. London and New York: Routledge, 1995.
- Vance, Carole S., ed. *Pleasure and Danger: Exploring Female Sexuality*. Boston and London: Routledge and Kegan Paul, 1984.
- Weeks, Jeffrey. *Invented Moralities: Sexual Values in an Age of Uncertainty*. Cambridge, U.K.: Polity; New York: Columbia University Press, 1995.
- . *Sexuality*. London and New York: Routledge, 2003.
- . *Sexuality and Its Discontents: Meanings, Myths, and Modern Sexualities*. London and Boston: Routledge, 1985.

Jeffrey Weeks

ISLAMIC VIEWS

Islam considers sexual pleasure to be a gift from God to humanity that should be enjoyed with gratitude. The religion has also always frowned on celibacy. The Prophet, who is an exemplar for all aspects of Islamic behavior, enjoyed his many wives, including his famous child-bride, 'A'isha. Hence, sexual regulation is concerned not so much with the potential for sexuality to distract the believer from God as with its capacity to disrupt social relations. Specifically, this means control over paternity, being sure that the father is really the father of his children. As a result, those forms of sexual behavior that do not threaten patriarchal transmission are either authorized or socially tolerated, while those behaviors that threaten to create a doubt over paternity are both condemned in Muslim law and aggressively repressed by Muslim societies.

Sexual segregation, rather than preaching, has always been seen as the most (if not the only) effective means to keep sex within licit channels. One of the most oft-repeated sayings of the Prophet is that when a man and a woman are together (alone is implied), the devil is the third. In premodern times one result, especially for the rich and powerful, was the use of eunuchs as guardians of women or domestic spaces generally. Even in the early twenty-first century, in most Muslim societies, women's domain is said to be the home and there is a reluctance, especially among revivalists, to permit women to go out into public nondomestic space more than the minimum necessary. Outside the home, and in the presence of all but a limited circle of male relatives, a Muslim woman should be covered by garments that range from a scarf covering the hair and neck, in the more lenient view, to the all-enveloping shrouds of *niqabs*, chadors, or burkas, for stricter interpretations. The need to avoid stimulating men and women through public contact has led to practices such as separate seating, or entrances, in public transportation, separate seating in public halls, and so on (mosques have separate seating and entrances). After a period when the imperialism of Western mores led to a reduction in segregation and covering, both practices have been on the increase since the late 1970s.

Licit sex includes sexual intercourse (whether genital, oral, or anal) within marriage. (A man may marry up to four wives if he has the means to support them; a woman may only have one husband). But a man may also have licit sex with concubines whose number is not limited. In premodern times there was a vigorous and legal trade in slave-girls for those with the means to own them. Some branches of Islam authorize temporary marriage. Since the period for this marriage may be as short as one hour, and since Islamic marriages are contracts in which property usually figures, the result can resemble prostitution, with the difference that the woman cannot remarry until she has had her menses, thus obviating any doubt over paternity.

Both male and female homosexuality are forbidden in Islamic law (though only male homosexuality is explicitly condemned in the Koran). In premodern Muslim societies homosexuality was widely tolerated, and even celebrated in literature. In discussions of lesbian practices, mutual masturbation (called rubbing) was even considered potentially positive as

it helps to prepare the woman for male sexual penetration. In most respects, attitudes to homosexuality in Muslim societies were a continuation of those that dominated in the ancient classical world in which any shame only attached to the passive partner. Modern revivalist movements, by contrast, have made the repression of homosexuality part of their neo-puritanical agenda.

Literature, both popular and elite, took a very free attitude to the varieties of sexual behavior in premodern Muslim societies. European imperialism, however, brought Victorian values that have been strengthened by the contemporary revivalist movements (at least in their public utterances). Hence, a great classic such as *The Thousand and One Nights* is only available in expurgated editions (or on the black market).

The sacralization of sexuality extends to the rewards promised to the just in Paradise. In addition to spiritual and other sensual pleasures, the elect male is given multiple (the most common figure is seventy) *houris*, beautiful maidens in paradise, for his sexual pleasure. He will also enjoy congress with all his legitimate wives (these last will have the enjoyment of their husbands).

The sacralization of sex coupled with the need to control behavior have historically led Muslim societies to potentially contradictory positions. On the one hand, the rich literature of sexual technique and description celebrates female pleasure. On the other hand, many Muslim societies (principally, though not exclusively, in Africa) continue to practice clitoridectomy, the removal of this part of the female genitalia before puberty in order to dampen female desire. The practice also exists in some non-Muslim African societies. Muslim jurists have labeled the practice as either recommended (hence optional) or permitted, but never required or forbidden.

The Koran specifically grants men authority over their wives, including the right to use corporal punishment on a rebellious wife. A wife's marital duties include the obligation to grant sex to her husband unless she is physically indisposed. However, contemporary revivalist women have argued either that the sexual obligation does not extend to anal sex, or that the husband's right to use corporal punishment does not apply to issues of sexual access. Disputes over anal sex also appear in premodern sources.

Adultery or any sex outside of licit relationships is condemned in Islam, though in practice enforcement has been made difficult, especially for men. A woman accused of sexual impropriety, or even the appearance of such, suffers the full brunt of social disapproval, extending to death by legal or extralegal means. The "honor killing" of females who have escaped the control of their male relatives or guardians is widespread in many Muslim societies. Though such homicide is clearly not consistent with Islamic law, its proponents claim the support of the religion and adduce the Koranic verse permitting corporal chastisement of rebellious women as justification.

See also Feminism: Islamic Feminism; Gender: Gender in the Middle East; Honor, Middle Eastern Notions of.

BIBLIOGRAPHY

- Ascha, Ghassan. *Du statut inférieur de la femme en Islam*. Paris: L'Harmattan, 1987.
- Bouhdiba, Abdelwahab. *Sexuality in Islam*. Translated by Alan Sheridan. London: Routledge and Kegan Paul, 1985.
- Malti-Douglas, Fedwa. *Woman's Body, Woman's Word: Gender and Discourse in Arabo-Islamic Writing*. Princeton, N.J.: Princeton University Press, 1991.

Fedwa Malti-Douglas

SEXUAL ORIENTATION

The phrase *sexual orientation* is used to describe different forms of erotic attraction: toward people of the same gender (homosexual), the opposite gender (heterosexual), or both (bisexual). Like any simplistic categorization, such definitions quickly become mired in contradictions and complications. For instance, is the label “heterosexual” to be reserved for people who only have sexual interactions with members of the other sex, so that those who deviate from this pattern are classed as homosexuals regardless of the number of same-sex relationships they have had, even if the opposite-sex relationships far outnumber them? When can an individual be labeled bisexual, homosexual, or heterosexual?

The influential study of Alfred Kinsey on American males in 1948 and his later study of females first pointed out the difficulties of such classification. To overcome it, he developed a 7-point scale with 0 representing individuals who only had heterosexual intercourse, and 6, those who only had same-sex activities. Unsurprisingly, Kinsey found that 37 percent of the males and 13 percent of the females in their sample had at least one homosexual encounter. The scale, however, did not establish numerical ranges for categorizing sexual orientation. Is a man who has sexual relations with females 70 percent of the time and with males 30 percent of the time a homosexual? Is a woman who has sex with males 30 percent of the time and with other women 70 percent a lesbian? Are they both bisexual? The issue is further complicated by the fact that many people do considerable experimentation before confining themselves to one sex. Others might originally have only partners of the opposite sex, but as they age they have increasing numbers of partners of the same sex and settle down with a same-sex partner. This pattern is even more marked in many non-Western societies, where same-sex sexual experimentation may be expected as a premarital phase; a highly institutionalized version of the age-specific structure was documented by Gil Herdt in parts of Melanesia, where before Christian missionizing changed sexual mores, every male was expected to progress through a series of alternating same-sex and heterosexual phases.

Some Factors to Be Considered

There are other factors to be considered, particularly the relation between actual practice, fantasy, and feelings. Anna Freud, for example, maintained that the crucial determination of homosexuality or heterosexuality was one's thoughts and images when masturbating or becoming sexually aroused. A woman who becomes sexually aroused by same-sex fantasies while having sex with her husband would be classed as homosexual even

though she never engaged in homosexual behavior. The opposite case with males would be equally true. The question of whether erotic attraction or sexual practice is the defining characteristic of sexual orientation continues to be debated by researchers.

Another approach taken by scholars attempting to discover the true “nature” of sexual orientation has been to look at nonhuman species. Frank Beach, for example, held that homosexual activity among animals was usually an expression of the dominant or submissive role of that particular individual animal vis-à-vis another. He cautioned, however, that the existence of homosexual behavior in some animals says little about homosexual relations in humans, that is, it could not prove that homosexuality is “biologically normal.” The empirical evidence from animals, he felt, was irrelevant.

Another knotty question has to do with the relationship between sexual orientation and gender. Whereas stereotypical images of the homosexual associate same-sex desire with male effeminacy and masculine-appearing women, in actuality the relationship between gender and sex is far less predictable.

Cross-cultural data further complicate the picture. Clellan Sterns Ford and Frank A. Beach (1951) examined 190 cultures for information about sexuality using what was then called the Human Relations Area Files, a collection of reports of a variety of cultures. The information was extracted from reports of observers in earlier periods, many of them missionaries or explorers, while later reports were more often made by trained anthropologists. They found that homosexual behavior was not a predominant sexual activity among adults in any of the societies but that in the majority of the seventy-six groups for which information on homosexuality was available, same-sex relations were considered to be normal and socially acceptable, at least for certain members of the society. In about one-third of these societies where homosexuality was reported, it was said to be rare, absent, or carried on only in secrecy. The fact that it was not mentioned in the reports of the majority of societies, however, should not be taken to say it was nonexistent since the observers might well not have been looking for it.

For example, Balinese society was classified by Ford and Beach among the 36 percent minority where homosexual activity was rare, absent, or carried on only in secret. Yet the crossing of sex roles is common among the Balinese, and their religious beliefs place a high valuation on the hermaphroditic figure of Syng Hyan Toengaal, also known as the Solitary or Tjinitja. Tjinitja existed before the division of the sexes and is regarded as both husband and wife. Are the transvestic ceremonies connected with god homosexuality? Other examples of gender and sexual variation in non-Western and tribal societies, such as the Native American *berdache* or “two-spirit person” or Polynesian *mahu*, have all been objects of fascination to European and U.S. homosexuals looking for evidence of sexual freedom, but in reality, it is very difficult to map Western notions about sexual orientation onto non-Western contexts. Even in closely related societies, such as those of Latin America, the United States, and Canada, ideas about male homosexuality have been shown to vary considerably, so that, for

example, the nature of the sexual activity (active versus passive) may be more important than the sex of the partner in determining sexual identity. Furthermore, within complex societies, distinct sexual subcultures with their own notions about sexual orientation flourish within different racial, class, ethnic, and regional groups. For instance, while upper-middle-class lesbians in the United States embraced a model of androgyny and equality between partners in the latter half of the twentieth century, working-class lesbians chose to be either “butch” or “femme,” a pattern that later came to influence their wealthier and better-educated sisters as well.

In the early twenty-first century, although some social and biological scientists continue to pursue other methods of identifying sexual orientation, most observers simply ask the person in question, leaving sexual orientation as a question of self-identity. Such an approach assumes a more tolerant attitude toward homosexuals and bisexuals than in the past, when such an identity was widely regarded as “sick” and their “illness” as illegal. It was not until 1974 that members of the American Psychiatric Association (APA) adopted a resolution that being “homosexual did not imply any impairment in judgment, stability, reliability or general social or vocational capabilities” (Bullough, 1994). Such a conclusion was based on research dating from at least the beginning of the twentieth century, but change in psychiatric opinion was slow and occurred only in response to activists in the gay and lesbian community, who confronted both the American Psychiatric Association and the legal system. Groups such as the American Civil Liberties Union (ACLU) and the American Law Institute began agitating for change in the 1950s and the early 1960s, as did a growing number of people in the gay community, an agitation culminating in the 2003 decision of the U.S. Supreme Court declaring sodomy laws unconstitutional.

Acquiring an Identity

As the barriers fell, increasing numbers of gays and lesbians came out of the closet, proclaiming their sexual orientations. Acquiring a public gay identity is extremely important but not always an easy process even though most gays and lesbians indicate they felt that somehow they were different in childhood and adolescence from others. Only gradually in their teens did they begin to identify themselves as homosexual. Those who do so tend to be culturally defined by society as a single homogeneous class.

In reality, of course, gays and lesbians, either as individuals or in groups, are a very mixed collectivity of individuals with a wide-ranging variety of behaviors, although most seem to be gender atypical in some traits. Attempts to identify the precise relationship between sexual orientation and gender by researchers have led only to contradictory and very tentative results, possibly because such relationships tend to change rapidly in response to changing social conditions.

Most theories fall into one of two categories: psychosocial dynamic or biological dynamic, sometimes simplified as nurture versus nature. Psychosocial dynamic theories attempt to explain development of a person’s sexual orientation in terms of internal mental processes and the interaction of these with

reward and punishment. Examples of these include the psychoanalytic theory of Sigmund Freud or socialization theory such as put forth by Ira Reiss, who held that the greater the rigidity of gender role in male-dominant societies, the higher the likelihood of male homosexual behavior. This was, he said, because the rigidity of the gender role could lead a male child who did not conform to find conformity with other nonconformists, that is, male homosexuals.

In the 1990s biological theories that explain sexual orientation in terms of biological phenomena, such as brain circuitry, hormones, genes, and evolution, became increasingly popular. Researchers have looked at such factors as prenatal hormones as well as other physiological and anatomical features, but all of these theories have limitations, some more serious than others. Since homosexuality is thought to run in families, there has been a search for genetic influence; but while some researchers have found what they think is evidence along these lines, there generally has been a failure to replicate the findings.

So far there are too many variables involved to come up with any definitive answers. At the moment, sexual orientation seems best left up to the individual to define for himself or herself.

See also Gender; Identity; Love, Western Notions of; Psychology and Psychiatry.

BIBLIOGRAPHY

- Beach, Frank A., ed. *Human Sexuality in Four Perspectives*. Baltimore, Md.: Johns Hopkins University Press, 1976.
- Bullough, Vern L. *Science in the Bedroom: A History of Sex Research*. New York: Basic Books, 1994.
- . *Sexual Variance in Society and History*. Chicago: University of Chicago Press, 1976.
- Ford, Clellan Sterns, and Frank A. Beach. *Patterns of Sexual Behavior*. New York: Harper, 1951.
- Freud, Anna. *The Ego and Mechanisms of Defense*. Translated by Cecil Barnes. Reprint, New York: International Universities Press, 1953.
- Herdt, Gilbert. *Guardian of the Flute: Idioms of Masculinity*. New York: Basic Books, 1994.
- Kinsey, Alfred C., Wardell Pomeroy, and Clyde E. Martin. *Sexual Behavior in the Human Male*. Philadelphia: W. B. Saunders, 1948.
- Kinsey, Alfred C., et al. *Sexual Behavior in the Human Female*. Philadelphia: W. B. Saunders, 1953.
- Lippa, Richard A. “Gender-Related Traits of Heterosexual and Homosexual Men and Women.” *Archives of Sexual Behavior* 31 (2002): 83–98.
- Reiss, Ira. *Journey into Sexuality: An Exploratory Voyage*. Englewood Cliffs, N.J.: Prentice Hall, 1986.

Vern L. Bullough

SHINTO. *Shinto*, composed of two ideographs, literally means the “way of the *kami*.” Although *kami* can be translated as gods or deities, it also refers more generally to spirit-beings, the supernatural, or to a sacred quality in which an individual can even participate. *Shinto* refers to what has become a

religious tradition indigenous to Japan that recognizes the existence of the *kami* governing various aspects of reality. There is no primary revelatory text from which doctrines emanate. Instead, doctrines have become established over time, with evidence showing conceptual interaction with Daoism, Buddhism, and Confucianism over the centuries.

The sacred as represented by the *kami*, in whom lie the constructive “way” of creation, harmony, and uprightness, plays a central role. These truths can be discerned through faith and ritual. While beneficial and malevolent forces are both recognized, they are not necessarily strictly separated, since good and evil are understood as closely related. In Shinto mythology, for example, it is not unusual for the effects of particular gods to change from one to the other depending on the *kami*’s circumstances.

Central to Shinto is the concept of purity and purification of one’s inner and outer selves. Purification of the inner self involves living before the *kami* in reverence and worship. Shinto recognizes that life lived with such reverence shapes attitudes of heart and mind, leading to *magokoro* (“heart of sincerity”). This, in turn, influences all of man’s relationships to himself, to others, and to the world leading to harmony and peace. In this way, man also partakes in the divine as he lives in accordance to the way of the *kami*. The purification of the outer self involves the observance of various rites—among which are included rites for different stages in an individual’s life, and festivals (*matsuri*) at various times of the year.

Contrary to common perceptions, for most of its past, Shinto did not exist as an independent religion. In this sense, presenting a summary of the “history of Shinto” may misleadingly reify its existence when it was not truly there as a distinctive religious tradition. The term as it is understood today did not become common parlance until the twentieth century. Still, since modern Shinto reflects the broader tendencies of folk religion in Japan’s history, and since the tradition claims historicity, the history of Shinto as it is often presented remains significant.

It is standard to present the origins of Shinto as being historically discernible as far back as the Yayoi period (roughly 300 B.C.E. to 300 C.E.) in which *uji*, or clans, worshipped the *ujigami*, its tutelary deity. While these *kami* were often ancestral, others represented various aspects of nature or ideas. As the Yamato clan, from which the imperial line is said to come, gradually grew powerful, the authority of its tutelary deity also expanded. During the seventh and eighth centuries, Daoist, Confucian, and Buddhist traditions deeply influenced Japanese folk belief. Efforts in the eighth century made Buddhist and Shinto philosophies compatible in a process called *shim-butsu shūgō* (unifying of gods and buddhas). Shinto *kami* became protectors of Buddhism, making it possible to have Shinto shrines within Buddhist temples. Such Buddhist-Shinto accommodation became more explicit during the Kamakura period (1192–1333): Ryobu (Dual) Shinto taught that the two realms of the universe in Shingon Buddhism corresponded with the two *kami* (Amaterasu and Toyouke) of the Ise Shrine; and, Sannō Shinto taught that the fundamental truth of the universe was equivalent to Amaterasu, the sun goddess, who

was the source of the universe. Buddhism, however, generally remained more politically powerful and much of what is referred to as Shinto during this time may, in fact, be more Buddhist.

Shinto as a more distinct religious tradition is said to become more recognizable in reactions to Buddhist dominance that occurred in the thirteenth and fifteenth centuries. In the thirteenth century, Watarai (or Ise) Shinto taught that *kami* were the basis of all beings including buddhas and bodhisattvas. In actuality, however, the Watarai tradition continued to assume compatibility with Buddhism. In the fifteenth century, hints of Shinto as a distinctive religion appear. Yoshida Shinto, established by Yoshida Kanetomo (1435–1511), taught that Buddhism and Confucianism were second-hand versions of Shinto, and that indigenous knowledge of truths had been handed down through generations through his lineage. Although Yoshida Shinto’s influence would be subdued during the Tokugawa period (1603–1867) when Neo-Confucian philosophy legitimized the state, it continued to inform Shinto beliefs leading to the development of Nativist Studies (Kokugaku) and the thinking of Motoori Norinaga (1730–1801). This would eventually coalesce in Fukko (Restoration) Shinto that called for the restoration of imperial rule, resulting in the Meiji Restoration and the start of Japan’s modern history.

Following the Meiji Restoration until the end of World War II, Shinto was made a state religion that taught the national ethic of reverence for and submission to the emperor. Kokka (State) Shinto, as this form is called, was very much a modern creation and was used aggressively by the state to nurture a loyal and nationalistic population. In the postwar period, though some traditionalist conservatives are known to seek revivals of this in some form, due to its disestablishment in the postwar constitution, Shinto no longer has such close connection with the state and is substantially weaker.

Still, Shinto belief and practice continue and exert their shaping influence upon attitudes and values of many Japanese. Shinto weddings, or festivals marking the calendar such as *obon* in the summer, the November festival for children, or New Year’s Day, all remain popular and have become deeply embedded in national life. This has invited a new generation of scholars to move beyond viewing Shinto only in its statist form, to seeing it as a rich and lively tradition that continues to flourish in modern Japanese society. Although its close association in both beliefs and practice with the people and politics of Japan has given Shinto a parochial sensibility not conducive to spreading overseas, its continuing vitality has raised questions regarding the place of folk religion in the modern era and has won scholarly interest.

See also Japanese Philosophy, Japanese Thought; Religion: East and Southeast Asia; Sacred Places.

BIBLIOGRAPHY

- Breen, John, and Mark Teeuwen, eds., *Shinto in History: Ways of the Kami*. Honolulu: University of Hawai’i Press, 2000. Provides a general overview covering various topics.
- Grapard, Allan G. “The Shinto of Yoshida Kanetomo.” *Monumenta Nipponica* 47, no. 1 (spring 1992).

- Hardacre, Helen. *Shinto and the State, 1868–1988*. Princeton, N.J.: Princeton University Press, 1988. A classic work explicating the construction and consequences of State Shinto in the modern era.
- Kuroda, Toshio. “Shinto in the History of Japanese Religion.” *Journal of Japanese Studies* 7, no. 1 (winter 1981): 1–21. An important critique of the normal historical genealogy presented for the ancient existence of Shinto.
- Littleton, C. Scott. *Shinto: Origins, Ritual, Festivals, Spirits, Sacred Places*. Oxford, U.K., and New York: Oxford University Press, 2002.
- Picken, Stuart D. B. *Essentials of Shinto: An Analytical Guide to Principal Teachings*. Westport, Conn.: Greenwood Press, 1994.
- . *Historical Dictionary of Shinto*. Lanham, Md.: Scarecrow Press, 2002.
- . *Shinto: Japan’s Spiritual Roots*. Tokyo and New York: Kodansha International, 1980. An accessible and beautiful visual introduction to various aspects of Shinto as practiced in Japan.
- Schnell, Scott. *The Rousing Drum: Ritual Practice in Japanese Culture*. Honolulu: University of Hawaii, 1999.
- Smyers, Karen A. *The Fox and the Jewel: Shared and Private Meanings in Contemporary Japanese Inari Worship*. Honolulu: University of Hawai’i Press, 1999.
- Teeuwen, Mark. “Attaining Union with the Gods.” *Monumenta Nipponica* 48, no. 2 (summer 1993).
- Teeuwen, Mark, and Fabio Rambelli, eds. *Buddhas and Kami in Japan: Honj Suijaku as a Combinatory Paradigm*. New York: Routledge, 2003.

Genzo Yamamoto

SKEPTICISM. Skepticism is both a generalized sense of doubt and disbelief as expressed in everyday language and an identifiable school of thought in the history of ideas. In its most general sense it refers to uncertainty, doubt, disbelief, suspension of judgment, and rejection of knowledge. It is characterized by its opposition to dogmatism, which claims to know reality and the truth.

As a philosophical tradition skepticism is best understood as the product of two movements in ancient Greek philosophy. Academic skepticism can be attributed to Socrates and to Plato’s successors at the Academy in Athens (fifth century to second century B.C.E.), and Pyrrhonism can be traced back to Pyrrho of Elis (c. 365–275 B.C.E.). Elements of skepticism can be found in many other schools of ancient Greek philosophy, from Heraclitus to the Cyrenaics and the Cynics. There are also analogies to ancient Greek and Roman skepticism in ancient Chinese, Persian, Arabic, and Indian philosophy, but they did not have the impact on modern thinking that the Mediterranean skepticisms did.

Academic Skepticism

The Roman philosopher and statesman Marcus Tullius Cicero (106–43 B.C.E.) is the chief source for Academic skepticism. His *Academica* (45 B.C.E.) reports on the teachings of Arcesilaus (315–240 B.C.E.) and Carneades (214–129 B.C.E.), both heads of the Academy, and he claims allegiance to the

Academic school. St. Augustine of Hippo’s earliest extant work, *Contra Academicos* (Against the Academics; 386 C.E.), is also an important source of knowledge about Academic skepticism.

Socrates can be placed at the origins of skepticism if it is understood that he only asked questions and did not teach positive doctrines. Plato and Aristotle strayed from his path when they claimed to know the truth. Arcesilaus gave renewed vigor to skepticism, arguing against the opinions of all men, as Cicero put it. But he also showed that skeptics could make choices in accordance with the *eulogon* (the reasonable) in the absence of truth. Carneades, also a master of arguing on both sides of every issue, refined this into the standard of the *pi-thanon* (the credible). Cicero translated this into Latin as *probabile*, setting the stage for the skeptics’ claim to live by the probable in the absence of truth.

Manuscripts of Cicero’s *Academica* were available in the Middle Ages to figures such as John of Salisbury (1115–1180), who used it to underpin defenses of liberty of thought and speech. The text was first printed at Rome in 1471, followed by numerous commentaries and annotations. By 1600 more than 100 editions had been published.

The Dutch humanist Desiderius Erasmus (1466?–1536) admired Academic skepticism in his *Praise of Folly* (1511), which provoked opposition from Christians like Philipp Melancthon (1487–1560). Gianfrancesco Pico della Mirandola’s *Examen Vanitatis* (1520) drew from both Cicero and Sextus Empiricus. Omer Talon emphasized the Academics’ philosophical freedom from dogmatism in his *Academia* of 1547, and Petrus Ramus praised their rhetoric and style in *Ciceronianus* of 1557. Giulio Castellani (1528–1586) defended Aristotelianism against Academic skepticism in *Adversus Marci Tullii Ciceronis* (1558), arguing that disagreement is not as widespread as the skeptics claimed. Johannes Rosa (1532–1571) brought out a substantial early commentary on the *Academica* in German in 1571, and Pedro de Valencia (1555–1620) refashioned Academic skepticism in his own *Academica* of 1596, published in Spain.

Publication of Sextus Empiricus’s works in the 1560s replaced Cicero as the chief source of information about ancient skepticism. After that point most authors drew their inspiration from both sources, so it is hard to speak of purely Academic skeptics from then on. One exception is David Hume (1711–1776), sometimes called an Academic skeptic, among other reasons because a character in his *Dialogues concerning Natural Religion* (1779) takes the role of an Academic. There has also been scholarly debate about whether other individual early modern figures were Academic skeptics or Pyrrhonians, but in this period the two traditions were often run together and few, if any, authors made a clear distinction.

Pyrrhonism

The chief source for ancient Pyrrhonism is the work of the Greek physician Sextus Empiricus (second century C.E.), including *Outlines of Pyrrhonism*, *Against the Dogmatists*, and *Against the Mathematicians*. Once thought of as a mere compiler, many recent studies have found philosophical originality

in his texts. As Sextus explained it, skepticism was not a philosophy but rather a way of life in which one opposed all claims to truth with equal opposite claims (equipollence). Standard tropes or formula arguments could be used against any certainty or truth. He attributed one set of these tropes to the Greek philosopher Aenesidemus and another to Agrippa (both first century B.C.E.). Diogenes Laertius's *Lives of the Philosophers* (early third century C.E.) is also a source for information about ancient skepticism, including the tropes.

In Sextus's account, the basic ten tropes or formula arguments show that the same thing appears differently (1) to different animals, (2) to different individuals, (3) to different senses, (4) to the same sense in different conditions, (5) in different positions or places, (6) in company with different things, (7) in different quantities, (8) in different relations, (9) if common or if rare, and (10) to people with different customs or ways of life. Thus, any claim about a thing could be matched with an equal counterclaim. Other tropes bring out the problem of the criterion (an infinite regress), unresolved disputes, problems with attributing causation, and more. The result of the skeptical tropes was that one would suspend judgment (*epochē*) and then find oneself in *ataraxia*, or tranquility, no longer disturbed by conflicting claims. One would live in accordance with the phenomena or appearances, without taking a stand on the truth or reality behind them. One would follow one's natural impulses as well as local customs and laws.

Even in ancient times, critics of the skeptics accused them of inconsistency, incoherence, immorality, and inability to live their skepticism. These arguments were more and less sophisticated, and ranged widely from the claim that skeptics cannot be fully skeptical because they believe their own positions are true to the claim that skeptics will not make reliable friends. As late as the 1980s, a number of scholars of ancient skepticism continued to maintain these claims, but opinion turned in the 1990s as a consensus emerged that skeptics could indeed live their skepticism, and that they would not necessarily be any more immoral than followers of other philosophies.

Much of Sextus's text consists of refutation of other dogmatic philosophies of the time. Since he quoted their ideas in order to refute them, his text has been an important source of information about ancient Stoicism, Epicureanism, and other philosophies.

Early Reception

Occasional references to the ancient Pyrrhonists can be found throughout the late Roman and early medieval periods. The oldest extant Greek manuscript of Sextus dates from the tenth century, and manuscripts of Latin translations existed in medieval collections by the fourteenth century. More manuscripts came into Italy from Byzantium in the mid-fifteenth century, when the Florentine religious leader Girolamo Savonarola (1452–1498) used Sextus to combat pagan philosophy, and the humanist scholar Pico della Mirandola drew on Sextus to fight other dogmatists. Knowledge of the materials eventually spread into France and other northern countries.

The printing press made for the most influential dissemination of these texts. Published Latin translations by Henri II

Estienne (Stephanus) (1562) and Gentian Hervet (1569) provided the stimulus for a widespread "skeptical crisis." Michel de Montaigne (1533–1592) was the most influential of the early European writers to draw on the writings of Sextus in his *Essais* (Essays; 1580–1595). In his longest essay, "Defense of Raymond Sebond," Montaigne retailed most of the skeptical tropes and all of the skeptical vocabulary from Sextus Empiricus. In this and other essays he demolished pretensions to human knowledge and argued both sides of nearly all issues. He was never pessimistic but showed people how to live a good life in spite of skepticism, which helps explain why his work was so popular.

Later thinkers often started from Montaigne. One who went beyond him in posing questions of skepticism was René Descartes (1596–1650). Without specific precedent in the ancient materials, he set out to answer the skeptical idea that there could be an all-powerful *malin genie* or evil demon that manipulates human perceptions and reasoning, fooling people about the world. His conclusion was that individuals know of their existence because they can think—the famous "I think therefore I am." Explaining why one's perceptions of thinking could not be a deception, Descartes asserts that God would not allow such deception. Religion is invoked to certify truth. Later skeptics would worry about a deceiving God.

Bishop Pierre-Daniel Huet (1630–1721) and the Huguenot refugee Pierre Bayle (1647–1706) have been described as the "master skeptics." Huet invoked Sextus Empiricus in great detail against Descartes and many other dogmatic philosophers in his *Traité philosophique de la faiblesse de l'esprit humaine* (1723; Philosophical tract on the weakness of the human mind). Bayle's massive works attacked all previous philosophy and historical scholarship but upheld moral rigorism.

Reception in and since the Enlightenment

The Scottish philosopher David Hume responded to the skeptical challenge in ways that made him central to philosophical discussion up to the twenty-first century. His *Treatise of Human Nature* (1739–1740) argued for skepticism about both facts and reason. His critique of causation reduces it to little more than a habit based on constant conjunction. And yet in typical skeptical fashion he showed people how to live with skepticism on the basis of probabilities and custom.

The Prussian philosopher Immanuel Kant (1724–1804) was called the "all-destroyer" because of his rejection of many other dogmatic philosophies. He adopted skeptical Greek vocabulary when he argued that one could have no knowledge of the noumena—the reality behind appearances—but only of the phenomena. He saved free will and morality from scientific determinism by reducing human knowledge of them to faith rather than knowledge. Other skeptics writing in German in his time included Salomon Maimon and Gottlob Ernst "Aenesidemus" Schulze. When Carl Friedrich Stäudlin's *Geschichte und Geist des Skepticismus* (History and spirit of skepticism) of 1794 showed Hume facing Kant on the title page, it was clear that these two thinkers had posed the skeptical challenge for the age. Stäudlin denounced unphilosophical skepticism even as he demonstrated that philosophical skepticism could not be refuted.

In the nineteenth century, the German philosopher Georg Wilhelm Friedrich Hegel (1770–1831) believed that ancient skepticism was of great philosophical importance while modern skepticism had little merit. The Danish philosopher Søren Kierkegaard (1813–1855) incorporated skepticism into his theology. One of the prize questions of the Royal Academy in Paris concerned the failure of all answers to skepticism. The Swiss philologist and philosopher Friedrich Nietzsche (1844–1900) made skepticism a significant part of his philosophy. Karl Marx (1818–1883) and Sigmund Freud (1856–1939) followed in a long-established tradition of using various skepticisms against their opponents but then claiming dogmatic truth for their own positions. Their practice reflected the important distinction between partial skepticism (e.g., of claims in one domain, such as religion, or the claims of an opposing political party) and global or universal skepticism, which suspends judgment about everything.

In the twentieth century Jean Grenier (1898–1971) translated Sextus into French. His student Albert Camus (1913–1960) drew on skepticism in his work as one of the founders of existentialism. In Germany, Odo Marquard (1928–) led a self-consciously skeptical charge against the dogmatism of thinkers such as Jürgen Habermas. Also in the same century, some analytical philosophers developed their own ahistorical definitions of skepticism and debated them with little if any reference to the traditions of skepticism. Revisionists such as Stephen Toulmin (1922–) then interpreted one of their heroes, Ludwig Wittgenstein (1889–1951), as following in the footsteps of the ancient skeptics.

Skepticism in Medicine and Science

Of all the fields that in the early twenty-first century are considered sciences, medicine has been especially intertwined with skepticism. Sextus Empiricus was a practicing physician whose work influenced his philosophy. The writings of the Greek physicians Hippocrates (c. 460–c. 377 B.C.E.) and Galen (c. 129–c. 200 C.E.) stressed the importance of skeptical observation and experience and the dangers of dogmatic theory in medicine. Their work was an important part of medical education in early modern Europe, introducing the student to both dogmatic medicine and the skeptical critique.

Several prominent early modern physicians developed the connections between skepticism and medicine. The Toulouse professor Francisco Sanches (c. 1550–1623) called himself “Carneades philosophus,” attacking Aristotelian science in his book *Quod Nihil Scitur* (That nothing is known; 1581). The English physician and philosopher John Locke (1632–1704) borrowed some of the skeptical elements in his philosophy from the skeptical physician Thomas Sydenham (1624–1689). Martín Martínez (1684–1734), royal physician and president of the Royal Medicine Academy of Medicine in Seville, published *Medicina Sceptica* (1722–1724), attacking dogmatic Galenism, and *Philosophia Sceptica* (1730), which introduced Descartes to Spain. The German physician Ernst Platner’s (1744–1818) skeptical writings were influential in Kant’s time.

The early natural scientist Francis Bacon (1561–1626) was convinced that the experimental method would produce

absolute certainty. Skeptics like François de La Mothe Le Vayer (1583–1672) used skeptical tropes to show that science could not produce certain knowledge. Other philosopher-scientists, such as Marin Mersenne (1588–1648) and Pierre Gassendi (1592–1655) in France, rejected the need for certainty and defended experimental science on the ground that it is enough that it produces useful knowledge. This attitude prevailed at the Royal Society in London. Skepticism could sweep away the pretensions of Aristotelians and other dogmatists while leaving scientists free to continue their experiments. In this spirit, Robert Boyle (1627–1691) named his spokesman “Carneades” in *The Sceptical Chymist* (1661), and Joseph Glanvill (1636–1680) titled one of his books *Scep̄sis Scientifica* (1665).

By the twentieth century, natural science had pretty much left the skeptical path, claiming something close to a monopoly on truth and knowledge. But avatars of the skeptical tradition still emerge here and there in connection with the sciences. The philosopher of science Karl Popper (1902–1994) contended that scientific claims could never be absolutely verified, only falsified. Paul Feyerabend (1924–1994) was described as a Pyrrhonian for his generally skeptical attitude toward all scientific claims.

Skepticism in Law, Historiography, and Political Thought

It is no accident that one of the chief sources for Academic skepticism was a lawyer. After all, Cicero spent much of his professional life making cases for clients, regardless of which side truth was on. Montaigne also studied law and served as a magistrate, and concluded both that judges can make the law come out any way they want, and that they are often wrong. Legal realists in the twentieth century endorsed these views, concluding that the law was more an expression of social power than of truth or certainty. Legal education encourages skepticism by teaching lawyers how to argue both sides of any case.

Especially in the seventeenth century, skepticism made its way into historiography, as writers began to question the received accounts of history. La Mothe Le Vayer’s *On the Small Amount of Certainty in History* (1668) and Pierre Bayle’s *Historical and Critical Dictionary* (1697–1702) brought numerous historical errors to public attention. The only lasting solution was to learn to live with the appearances and accept lower standards for practical purposes instead of absolute certainty.

Throughout the early modern era, skepticism was used to justify a wide variety of political stances, from radical reform to quietist conservatism. The implications of many of Montaigne’s political commentaries were quite subversive of the political arrangements of his time. But his contemporary, the Dutch thinker Justus Lipsius (1547–1606), claimed that skepticism justified repression of reformers on the ground that they could not know that they were right. The English political philosopher Thomas Hobbes (1588–1679) accepted much of the skeptical critique of knowledge and concluded that, for the sake of social order, the king should define the truth and punish deviations from it. Hume drew the different political

implication that people should be left alone in commercial society to define their own manners and opinions. Kant concluded that one can know what politics should be like (ethical and republican) but that one could never know if these standards are really instantiated in any concrete political arrangements.

Earlier figures from Montaigne to Kant were often aware of the genealogy of their ideas, but even later writers working in ignorance of the roots of their ideas have come up with a similarly wide range of political conclusions. Without indicating much awareness of the skeptical tradition, the British political philosophers Edmund Burke (1729–1797) and Michael Oakeshott (1901–1990), each in different ways, used skepticism to undermine dogmatic political activism. Post-modernists with generally radical or activist sympathies have also not usually been aware of how close some of their positions are to the skeptical tradition.

Skepticism and Religion

The historical scholarship of Isaac la Peyrère (1596–1676), Benedict de Spinoza (1632–1677), and Richard Simon (1638–1712) contributed to skepticism about the Bible. In response, it has been common to accuse skeptics of atheism, libertinism, and immorality. But skeptics were not necessarily atheists. One of the most common uses of skepticism was by the self-described orthodox against pagan claims to truth; by the Lutherans and Calvinists against Catholic claims to infallibility; and by Catholics against Protestant claims to truth. Many religionists believed that if all claims to truth can be demolished, one should accept traditional religion on faith. This position is known as fideism.

Various versions of fideism were widespread. Thinkers from Montaigne to Huet and Bayle wrote that skepticism cleared the way to faith by removing rationalist objections. Kant famously wrote that he had had to deny knowledge in order to make room for faith. Whether some of these figures were insincere atheists, using fideism as a defense against charges of heresy, has been the subject of debate ever since.

But there is little doubt about the sincerity of many fideists. The sixteenth-century translators of Sextus, Huet and Stephanus, were both Christians who believed that skepticism could help them in apologetics. Blaise Pascal (1623–1662) in France Christianized skepticism by showing that, properly understood, it set the scene for Christianity. Philosophers at the Prussian Academy who translated the Greek, Latin, and British skeptics into French and German, such as Jean-Henri-Samuel Formey (1711–1797), Jean-Bernard Mérian (1723–1807), and Jean de Castillon (1709–1791), tried to draw the teeth of skepticism by adding notes that made it consistent with Christianity. The Germans Johann Georg Hamann (1730–1788) and Friedrich Jacobi (1743–1819) adopted skepticism as a propaedeutic to Christian faith. Kierkegaard claimed that skepticism was the key to proper Christianity, which required a “leap of faith” after dogmatism had been destroyed by skepticism. The Russian theologian Lev Shestov (1866–1938) even rejected mathematics in order to achieve faith. Twentieth-century theologians were also compelled to either use skepticism or refute it.

In the twenty-first century it is safe to say that the challenges of the skeptical tradition to any claims to human truth and knowledge are alive and well. Many and perhaps most modern and postmodern thinkers have internalized much of skepticism, often without full awareness of the genealogy of their ideas. The chief elements of skepticism must be adopted, adapted, or refuted by any thinker. Since no one has succeeded fully at the last of these, variations on the former prevail.

See also Cynicism; Dialogue and Dialectics: Socratic; Epistemology; Philosophy, History of; Rhetoric.

BIBLIOGRAPHY

PRIMARY SOURCES

- Cicero, Marcus Tullius. *De natura deorum; Academica*. Translated by H. Rackham. Cambridge, Mass.: Harvard University Press, 1933.
- Hume, David. *A Treatise of Human Nature*. Edited by David Fate Norton and Mary J. Norton. Oxford: Oxford University Press, 2000.
- Montaigne, Michel de. *The Complete Essays*. Translated by Donald M. Frame. Stanford, Calif.: Stanford University Press, 1957.
- Oakeshott, Michael. *The Politics of Faith and the Politics of Scepticism*. Edited by Timothy Fuller. New Haven, Conn.: Yale University Press, 1996.
- Sextus Empiricus. *Against the Ethicists*. Translated by Richard Bett. Oxford: Oxford University Press, 1997.
- . *The Skeptic Way: Sextus Empiricus's Outlines of Pyrrhonism*. Translated by Benson Mates. Oxford: Oxford University Press, 1996.

SECONDARY SOURCES

- Bailey, Alan. *Sextus Empiricus and Pyrrhonian Scepticism*. Oxford: Oxford University Press, 2002.
- Bett, Richard. *Pyrrho, His Antecedents, and His Legacy*. Oxford: Oxford University Press, 2000.
- Floridi, Luciano. *Sextus Empiricus: The Transmission and Recovery of Pyrrhonism*. Oxford: Oxford University Press, 2002.
- Hankinson, R. J. *The Sceptics*. London: Routledge, 1995.
- Laursen, John Christian. *The Politics of Skepticism in the Ancients, Montaigne, Hume, and Kant*. New York: E. J. Brill, 1992.
- Paganini, Gianni, ed. *The Return of Skepticism: From Hobbes and Descartes to Bayle*. Dordrecht, Netherlands: Kluwer, 2003.
- Popkin, Richard H. *The History of Skepticism: From Savonarola to Bayle*. Rev. ed. Oxford: Oxford University Press, 2003.
- Popkin, Richard H., and José R. Maia Neto, eds. *Skepticism in Renaissance and Post-Renaissance Thought*. Amherst, N.Y.: Humanity, 2003.
- Van der Zande, Johan, and Richard H. Popkin, eds. *The Skeptical Tradition around 1800*. Dordrecht, Netherlands: Kluwer, 1998.

John Christian Laursen

SLAVERY. Slavery is possibly the most ubiquitous of all human institutions. It has existed in most times and most places, and few peoples have not, at various times, been either the enslaved or the enslavers. While slavery has generally been coerced, the result of war capture or kidnapping, in periods of



Slaves cutting sugar cane in Antigua, 1823 painting by William Clark. The majority of slave labor was used in crop production and the handling of livestock, but some slaves were retained as domestic servants and still others as concubines. COURTESY OF THE JOHN CARTER BROWN LIBRARY AT BROWN UNIVERSITY

low and variable levels of agricultural output slavery has been entered into voluntarily, people choosing survival ahead of freedom. Slavery has almost always been a status reserved to those, both males and females, considered outsiders to the enslaving society, but the definition of the outsider has varied over time and place. It has been based on nationality, ethnicity, religion, race, or membership in a different tribal or clan group. Individuals who are considered outsiders have a different legal status and can be subject to different treatment and punishments from those considered members of the enslaving society, who will not become slaves, whatever their treatment in other regards.

Slavery is regarded as one end of a spectrum that includes different forms of coerced labor, including serfdom, indentured labor, debt bondage, and “wage slavery,” in contrast with so-called free labor. Slavery is characterized legally as including the right to buy and sell the enslaved and to have control over where the slave will reside and the nature of his or her labor. As a legal system it is enforced by the government or the elites, and this enforcement is central to its continuity, since it precludes one individual bidding slaves away from their owner as well as ensuring that runaway slaves will be returned to their owners. These legal rights are given slave owners and create an unbalanced power relationship, with psychological

impacts upon the enslaved; these rights do not mean, however, that nominally free labor need be treated better or have a higher material standard of living than do slaves. If there are limited choices of work and residence due to poverty, the dramatic legal difference may seem more limited in its consequences in actuality.

The work performed by slave labor varied among slavery societies, and in several societies slave women served as concubines or objects for the sexual pleasure of the enslavers and not just as agricultural or industrial workers. In the extensive debate about the relative efficiency of free versus slave labor in agriculture, the expected benefits described for free labor included both the greater incentives of free labor compared to a slave system that presumably had no incentives and the greater need for free labor to work hard to avoid starvation, whereas slaves could be supported by their owners.

Abolition

Most religions generally considered that slaves be well treated and that, if possible, manumission into freedom was desirable. This did not mean, however, that the existence of the slave system was placed under attack. The first major attack on slavery as a system originated in England in the late eighteenth century, and this attack spread to other western European nations

Volume of transatlantic slave arrivals by region of arrival, 1519–1867

Region	Numbers (in thousands)	Percentage
British Mainland North America	361.1	3.8%
British Leewards	304.9	3.2%
British Windwards and Trinidad	362.0	3.8%
Jamaica	1077.1	11.2%
Barbados	494.2	5.1%
French Windwards	305.2	3.2%
St. Domingue	787.4	8.2%
Spanish American Mainland	430.3	4.5%
Spanish Caribbean	791.9	8.2%
Dutch Caribbean	129.7	1.4%
Brazil	3902.0	40.6%
Guianas	403.7	4.2%
Other Americas	118.7	1.2%
Africa	130.8	1.4%
All Regions	9599.0	100.0%

SOURCE: David Eltis, et al, eds. *Trans-Atlantic Slave Trade Database*

and to the United States in the nineteenth century. Although the attack was aimed at slavery on moral or economic grounds, most nations ended the foreign slave trade about a quarter-century before slaves were freed. Western European nations ended slavery in their American possessions at about the same time European nations ended serfdom, often with similar arguments about the nature and morality of coerced labor. In the cases of both slavery and serfdom, compensation was generally paid to slave owners and landowners in cash, bonds, or compelled labor time, with no compensation paid to the freed labor, reflecting the belief in the property rights of owners of labor, not the right of individuals to own themselves.

The antislavery argument stressed the immorality and the economic inefficiency of the slave system and argued that a devastating psychological impact resulted from the status of being a slave. Two arguments for this psychological effect dominated the slavery debates. To some, given the then-racial basis of slavery, it was due to the genetic basis of the African population. To most antislavery advocates, the destructive impact was due to the slave status and reflected environmental factors that would influence anyone, of any race, who had been enslaved. This distinction was not only important in the arguments about slavery but also was central to debates about whether emancipation should be immediate or gradual. Hence emancipation schemes that allowed for periods of apprenticeship were advocated not only because they helped masters obtain a financial return but also because such apprenticeship could serve to provide a necessary education to the freed people to deal with their freedom.

Modern Slavery in the Americas

Although slave societies have taken many different forms in terms of differences in the proportion of the population who

were slaves, in the labor undertaken by slave laborers, and whether they were located in rural or urban areas, most impressions of the meaning of slavery are based upon what Moses Finley (1980) describes as the five major slave societies in world history—Greece and Rome (each with about 30 percent of the population being slaves) and the three New World slave powers—the British and French Caribbean (90 percent slaves), the U.S. South, and Brazil (each with about 30 percent slaves).

The New World slave powers imported slaves purchased in Africa; about 10 million Africans were taken to the Americas from the start of the sixteenth century to the middle of the nineteenth century. Generally the number of males transported was greater than females (a proportion of about 60 to 40), due both to a New World desire for males and an internal African demand for females. There was also a large trade from southern Africa to North Africa and the Middle East, as well as a substantial internal slave trade within Africa. Most slaves in the transatlantic trade went to the Caribbean and to Brazil, with the United States receiving only a small part of this migration. The United States was unusual for a slave society because of its high fertility rate among slaves and rapid rate of natural increase, whereas the other areas suffered from a natural decrease, and the United States came to account for a large part of the New World slave population by the nineteenth century.

Slave labor was generally most important in producing crops, such as sugar, cotton, tobacco, rice, and coffee on plantations, for sale in European markets. Crops were grown on units larger than family farms—often, in the case of sugar, containing up to two hundred laborers—although most of the labor input on these plantations involved the growing of foodstuffs and the handling of livestock. Rising prices paid for slaves in Africa and in the Americas throughout this period are suggestive of the profits obtained from the use of slave labor. A few northern states in the United States ended slavery by the 1780s; with intellectual impetus from England and elsewhere in Europe, in the next century slavery was ended throughout the Americas due to slave rebellion in Haiti, legislated compensated emancipations by the British and French, the Civil War in the United States, and by legislation in Brazil in 1888.

The experience of all ages and nations, I believe, demonstrates that the work done by slaves, although it appears to cost only their maintenance, is in the end the dearest of any. A person who can acquire no property, can have no other interest but to eat as much, and to labour as little as possible.

SOURCE: Adam Smith, *The Wealth of Nations*.

There is no use for slaves, where all disagreeable work can be, and is performed by the weaker sex; Australian and Melanesian women supply the place of slaves. On the other hand, where the women hold a high position, and the men are desirous of relieving them of a part of their task, slavery is likely to arise sooner than otherwise would be the case.

SOURCE: H. J. Nieboer, *Slavery as an Industrial System*.

Despite the ending of slavery in the New World, it continued into the twentieth century in Africa and Asia, with the final legislated ending in the Arabian peninsula in the 1960s, although variant forms of slavery continue to exist in parts of North Africa and sex slaves continue to be held in Asia and Arabia. The term *slavery* remains applied to conditions of low income and of a loss of control by individuals over their own lives, not just to the existence of slaves as a form of legal property, so that it is still argued that slavery persists in the world of the twenty-first century.

See also ***Abolitionism; Black Atlantic; Liberty; Resistance and Accommodation.***

BIBLIOGRAPHY

Davis, David Brion. *Slavery and Human Progress*. New York: Oxford University Press, 1984.

Eltis, David, Stephen D. Behrendt, David Richardson, and Herbert S. Klein, eds. *The Trans-Atlantic Slave Trade: A Database on CD-ROM*. Cambridge, U.K.: Cambridge University Press, 1999.

Finley, M. I. *Ancient Slavery and Modern Ideology*. New York: Viking Press, 1980.

Fogel, Robert William. *Without Consent or Contract: The Rise and Fall of American Slavery*. New York: Norton, 1989.

Genovese, Eugene D. *Roll, Jordan, Roll: The World the Slaves Made*. New York: Pantheon Books, 1974.

Nieboer, H. J. *Slavery as an Industrial System: Ethnological Researches*. 2nd, rev. ed. The Hague: M. Nijhoff, 1910.

Patterson, Orlando. *Slavery and Social Death: A Comparative Study*. Cambridge, Mass.: Harvard University Press, 1982.

Stanley L. Engerman

SOCIABILITY IN AFRICAN THOUGHT. *Sociability* is a descriptive term that refers to the relational or interactive disposition and condition from which persons, as individuals, are said to derive their identity and status. According to this view, humans are regarded as beings whose defining characteristics, like reason, and its manifestation in cognitive, moral, and language

capacities, are said to arise from the social conditioning of human life. Although this communalistic principle underlies African philosophical endeavors as well as African people's practical orientations to social, moral, and political values generally, the concept has received only meager attention and treatment by African intellectuals and remains to be finely articulated and applied openly in metaphysical, epistemological, political, and ethical analyses of Africans' experiences. This lack of a robust presence of the relational view of the world in African theoretical culture is in spite of the vigorous claim by African political leaders like Léopold Sédar Senghor (1906–2001) and Julius Nyerere (1922–1999) in the early 1960s that "African socialism," an idea they claimed was based on traditional African communalism, was the moral flag of a distinctly African ideological framework and the key to a collective African socioeconomic growth. Benefiting from both the political (independence) and religious (post-Vatican II and ecumenical) fervors of the time, emerging African theologians and philosophers, like Vincent Mutilago (1924–) and John S. Mbiti (1931–), defended this view, arguing that the Christian Church had much to learn from the communalistic African cultures in its quest toward self-definition as a community or family of believers. More recently, African philosophers, especially Kwasi Wiredu and Kwame Gyekye, both of Ghanaian origin, have published works that crucially and compellingly place African communalism back at the center of a distinctly African point of view to philosophical visions.

The idea of human sociability is metaphysical, but it is founded on the observation of the biological human dependency of new members of the species on other and older members for their security, growth, and flourishing. The observation of this basic human condition leads to the idea that humans can attain the full development of the characteristics and properties that make them specifically human, or persons, only by depending on each. By education and imitation, humans learn from each other and acquire the capacity to competently function and behave as members of the species. Thus one is born biologically human but only socially does he or she become a person. It can be argued upon this view that although human nature is bestowed upon us by the biological constitution of the species, it is the communicative activity among us that sets in motion the development and flourishing of our cognitive and moral capacities. Thus our capacity to develop our basic human competencies is governed by our disposition to be sociable. It is in this sense that sociability becomes a metaphysical condition, because the distinguishing properties of the species depend on, and grow from, it.

While sociability is recognized in all cultures as a universal condition for the growth and flourishing of human capacities, some cultures go further by making such a condition the basis for advancing the belief that values that promote communal interests are superior to those that promote individual ones. Dominant ideas about individual selves, or persons, and about how they relate to others in society are the basis of vast differences in value systems of different societies and cultures as reflected in their respective sociopolitical and economic organizations, as well as in the principles upon which their moral systems and ethical theories are built. While cultural systems that give prominence to the rights and liberties of the

individual tend to define individuals in terms of their inherent personal attributes and capacities, those that put emphasis on the community tend to prefer relational models of personhood. In the latter, individuals are considered as links in genealogical chains within which they bear responsibility for the furtherance of their respective families and lineages. They are part of larger communal or social subjects that have rights just as individuals do. Cognitively and morally, individuals in relational models of society become part of the social quest toward ideal common goods such as truth and moral good. Because of this communalistic standpoint, one notices in these cultural systems or traditions a signification skepticism toward objectivist epistemological theories, as well as toward the idea, pivotal to the Kantian moral scheme in Western philosophy, of universal moral right that is knowable, directly and independently, by individual minds. By contrast, it is argued from the African communalistic view that epistemological truths and principles of moral right are ideals that we become aware of only in social contexts. Kwasi Wiredu, arguably the most senior and prominent African philosopher of the early twenty-first century, argues (1980, 1996) that epistemological truths are only opinions whereas the principles of moral right, while pursuing the golden rule, are arrived at by way of sympathetic impartiality. In other words, cognitive truths are neither part of the structural condition that makes experience possible nor are they the function of the mechanistic functioning of such structure. Truth is the idea, entailed in the nature of the assertions about our experience of the world, that it indeed be as we claim we perceive it. And it is hard, very hard, and perhaps impossible, for any one person to estimate such truth-value of their own assertions of their experiences without comparing them with those of other people, for every truth is always someone's truth. Truth, according to this view, is opinion. Similarly, as the estimation of the morally obligating nature of certain actions upon us, the idea of duty is not a structural property. Rather, it is a value that we know (become aware of) in social contexts as we attempt to harmonize our individual interests with the interests of others in society. Thus the communalistic view of morals provides the Kantian golden rule with a base, a social base. According to this view the construction of morals requires both the objective rationale and the subjective motivation.

African thought, whether traditional or more recent, does not view the idea of basic selfhood of all individuals as conflictual with what it upholds about community. In its constitution and realization, the self is enhanced and made possible by the communal condition of its flourishing, but it does not become inferior to the community by virtue of this dependency on it. Any view that sharply separates the two as mutually exclusive would be the result of the failure to see the pivotal mutual dependency between the two categories as logically, metaphysically, and practically related. Subjectivity is essentially intersubjective or relational, inasmuch as one can be empirically conscious of oneself only as one individual among many and must thus posit the freedoms and rights of self as commensurate with the freedoms and rights of others. Egoism and other principles of self-centeredness can thus develop only at the point where one loses sight of the superior common good that conditions and informs individual claims thereon, for common goods are, like human rights, those goods that are required equally by all as a means to leading life

worthy of human beings. For example, apart from abuses for which African leaders became notorious over the first four to five decades of Africa's independence from colonialism, traditional virtues are unequivocal on matters of human rights. Every person has a right to life irrespective of their age, gender, or their occupation in the community. Likewise, the traditional political and moral lores taught that every adult person has the right to those basic means, like land and their opinions, by which an adult is not completely one unless they can, respectively, fend for themselves and their dependents, as well as contribute to the growth of the community through the expression of their opinions. Because these rights are considered to be at the very foundation of what it means for everyone to be fully human, every individual has the right to demand these rights from their community as much as the latter has the duty to guarantee them for all its members. It will not escape the notice of many that this is one area in which African governments have made significant deference to traditional systems in matters of communal land use by limiting the jurisdiction of contemporary statutory law over some land tenure procedures. According to this view, the community protects the rights of the individual as much as the individual preserves the common good by respecting the rights of all other individuals with whom she shares basic equality in the eyes of the community.

African thought holds, therefore, that individual freedom must be externally limited if a community of free individuals with equal rights is to be possible, and demonstrates that a just political order is a demand of reason itself, since the principles of political and moral right are functions of generalizations made out of the practical experience of mutuality. The Ghanaian philosopher Kwame Gyekye uses Akan proverbs to illustrate the view that in African thought moral and political principles underscore the centrality of the idea of community while simultaneously upholding a relative status of individuality. According to him, "The view seems to represent a clear attempt to come to terms with the natural sociality as well as the individuality of the human person. It requires recognizing the claims of both communality and individuality and integrating individual desires and social ideals and demands" (1997, p. 41).

In their zeal to chart a sociopolitical path that was commensurate with their understanding of a full sense of post-colonial independence that included the recovery of cultural values deemed useful to the project, the first generation of African political leaders ideologized this communality into what they referred to as African socialism. It is significant to note that different brands of doctrinaire socialism were rife at the time African leaders were campaigning against colonial domination and therefore they may have been influenced in their choice of terminology (like the word *socialism*) to characterize this African virtue. However, the key texts in that generation of political thought, including the works of Léopold Sédar Senghor of Senegal and Julius Nyerere of Tanzania, both now deceased but renowned political and ideological leaders in the continent in their times, seem to indicate that their reference was to the communalism that Gyekye describes. In *On African Socialism*, Senghor says of the centrality of African idea of community: "Negro-African society puts more stress on the group than on the individual, more on solidarity than on the

activity and needs of the individual, more on the communion of persons than on their autonomy. Ours is a community society” (pp. 93–94). For Senghor, this communalistic “attitude” is an axiomatic foundation that clearly distinguishes Negro-Africans in their moral and sociopolitical value-systems from such others, like the European systems, for which society is an “assembly of individuals.” Thus for Senghor, as for the Martinican poet and political leader Aimé Césaire (1913–), with whom he jointly coined the term *negritude*, communalism was a major and distinctive characteristic of “being Negro-African.”

Like Senghor, Nyerere too believed that communalism was such a distinguishing mark of African cultures that it ought to be the guiding ideal of postcolonial politics. Nyerere gave it a new name, *Ujamaa*, a (Swahili) term recovered from the traditional social and moral systems to express the view that lasting good stems from recognition of the basic interdependency and ultimate unity of all human endeavors and goals. The distinguishing marks of *Ujamaa* were that it was communitarian rather than collective, democratic rather than totalitarian, homocentric rather than materialistic, and that it was founded on the primacy of law rather than on the dictatorship of class. In *Ujamaa: The Basis of African Socialism*, Nyerere says, “it is the attitude of mind, not the rigid adherence to a standard political pattern, which is needed to ensure that people care for each other’s welfare” (p. 1).

See also *Person, Idea of the; Personhood in African Thought; Society*.

BIBLIOGRAPHY

- Gyekye, Kwame. *An Essay on African Philosophical Thought: The Akan Conceptual Scheme*. 2nd rev. ed. Philadelphia: Temple University Press, 1995.
- . *Tradition and Modernity: Philosophical Reflections on the African Experience*. New York and Oxford: Oxford University Press, 1997.
- Masolo, D. A. “Western and African Communitarianism: A Comparison.” In *A Companion to African Philosophy*, edited by Kwasi Wiredu. Malden, Mass: Blackwell Publishers, 2004.
- Mbiti, John S. *African Religions and Philosophy*. 2nd ed. London: Heinemann Educational Publishers, 1990.
- Mulago, Vincent. “Christianisme et culture africaine: apport africain à la Théologie.” In *Christianity in Tropical Africa—Studies Presented and Discussed at the Seventh International African Seminar, University of Ghana, April 1965*, edited by C. G. Baeta. Oxford: Oxford University Press, 1968.
- . *La religion traditionnelle des Bantu et leur vision du monde*. Kinshasa: Presses Universitaires du Zaïre, 1973.
- Nyerere, Julius Kabarage. *Ujamaa: The Basis of African Socialism*. Dar es Salaam and Oxford: Oxford University Press, 1968.
- Senghor, Léopold S. *On African Socialism*. Translated with introduction by Mercer Cook. New York and London: Praeger, 1964.
- Wiredu, Kwasi. *Cultural Universals and Particulars: An African Perspective*. Bloomington and Indianapolis: Indiana University Press, 1996.
- . *Philosophy and an African Culture*. Cambridge, U.K.: Cambridge University Press, 1980.

D. A. Masolo

SOCIAL CAPITAL. The term *social capital* first began to be defined in the 1970s and remained largely restricted to the academic world of the social sciences until the 1990s, when it suddenly emerged as a central element in public discussions and policy debates about the quality of civic culture in Western nations, especially the United States of America. At the same time it also gained a place of prominence in discussions of political and economic “development” in the non-Western world by international agencies such as the World Bank. Despite this rapid ascent—becoming a key analytical concept used by academics (primarily sociologists, political scientists, and economists, but also anthropologists and historians), government policy planners, and international officials in development agencies within less than a generation—a firm definition of the term has not yet emerged, which is not surprising given that what it seeks to describe is largely intangible, diffuse, and elusive. As a result there has been a proliferation of usages, which has weakened the conceptual cogency of the term.

Broadly defined, what most authors mean in the early twenty-first century, when they write of social capital are social networks of cooperation in which people invest and from which they may ultimately derive benefits. According to most contemporary theorists of the concept, the three most important diagnostic features of such networks are social interaction, civic trust, and normative behavior.

Social capital is a theoretical concept rather than a clearly tangible phenomenon. Interaction, trust, and norms are observable and even measurable phenomena, whereas social capital is not itself perceptible, and hence difficult to define. Nevertheless, the first references to the term (as opposed to a defined concept) of social capital were observational rather than theoretical.

Most studies trace the first use of the term to a 1916 academic study by Lyda Judson Hanifan, a school supervisor, on the deterioration of civic culture in rural West Virginia. The next and perhaps most influential use of the idea came with Jane Jacobs’s 1961 study of the decline of American cities, a study that was based on her close observations of the changing nature of urban communities in New York City. Both authors called attention to the features and benefits of close social communities, and hence the need to preserve them.

It was not until the 1970s that the idea began to attract theoretical attention in the academic world; elements of the theory of social capital predate these attempts at definition, having been traced back to the idea of, among others, Jeremy Bentham (1748–1832), James Mill (1773–1836), Alexis de Tocqueville (1805–1859), Karl Marx (1818–1883), Max Weber (1864–1920), Georg Simmel (1858–1918), John Dewey (1859–1952), and Emile Durkheim (1858–1917). It is widely accepted that the three most important proponents of the concept of social capital have been the French social theorist Pierre Bourdieu (1930–2002) and two American social scientists, the sociologist James Coleman and the political scientist David Putnam. Their definitions of the concept, which vary considerably, usefully summarize a range of analytical and definitional perspectives.

Bourdieu's conceptualization of social capital, which owed nothing to the work of Hanifan and Jacobs, came out of his understanding of the workings of cultural capital among the upper classes of French society. He was interested in elucidating disguised or invisible forms of capital that were deployed by elites to maintain social inequality. He saw the nonmaterial exchanges inherent in social relationships as producing resources that members of elites drew upon to maintain their positions within the existing social structure. This view of social capital was very hierarchical and exclusive in its conceptualization, whereas Coleman's understanding of social capital was egalitarian and benign. His interest in social capital came out of his research on the importance of family and community in educational results. He found that familial and community resources, which he defined as social capital, were sufficiently powerful to compensate for economic disadvantages. For Coleman, whose definition of social capital drew on the concept of human capital that had been current in economics for over two decades, not only individuals benefited from social capital, but also society as a whole.

The highly influential definition of the social capital put forward by Putnam in the 1990s originated in his examination of the differences in civic engagement in northern and southern Italy; he used the concept to explain the more successful integration of civil society and the state in the north, which he traced back to medieval guilds. He went on to apply the concept of social capital to his study of civic culture in the United States; in an article published in 1995, which anticipated and summarized the argument of his book *Bowling Alone*, he brought the concept of social capital into the world of political debate and the popular media, first in the United States and then internationally.

Putnam looked at social capital primarily in terms of its benefits to society rather than the individual. He argued that there was a direct correlation between the quality of civic culture and levels of poverty, violence, and democracy. The diagnosis became popular in no small part because it suggested noneconomic solutions to social problems: increase social capital and solve a range of social problems. However, there was at least one major flaw in such reasoning: Putnam had failed to consider the role of economics adequately in the deterioration of civic culture in the first instance. Furthermore, as critics of Putnam, such as Alejandro Portes, have noted, social capital can itself lead to social problems, whether in the form of organized crime associations, prostitution and gambling rings, or youth gangs. These negative forms of social capital are much different than newspaper readership, voluntary associations, and political trust, which were the positive forms Putnam examined.

Social capital has been appealing to both conservatives, who use it to argue for the devolution of former governmental responsibilities onto society, as well as to liberals, who see it as a means for the state to deal directly with the causes of social problems rather than merely their symptoms.

Despite the divergent ideological lessons drawn from it, there is wide agreement about the importance of the concept in both academic and public policy circles today. However,

there is no consensus on how to measure it. Unlike conventional forms of capital, social capital is primarily relational rather than material. Some economists have been skeptical about the cogency of the concept as well as about the ability of proponents of social capital to arrive at quantifiable measures. Measuring social capital has been a particularly important task because of the prominent role the concept has assumed in discourses concerning economic development in the non-Western world, where the emphasis is not on civic culture but directly on amelioration of economic and political conditions.

By bringing the social to the forefront of discussions of economic and political conditions, social capital has had an important impact on the thinking of institutions such as the World Bank about development in the non-Western world. But the application of the concept beyond the West has raised a series of important questions, the central one of which is its relationship between society and the state. Some forms of social capital have been seen as inimical to economic and political development; where states have collapsed or become oppressive and economies deteriorated, and where accordingly survival strategies have heightened the importance of social capital, the symptoms have been read as a cause of continuing economic and political failure. Many forms of social capital that appear to be negative in the context of the West, must be understood within the much different historical origins and more problematic dynamics of the relationship between state and society in many parts of the non-Western world.

Both within the West and for the non-Western world, the idea of social capital offers new ways of thinking about social problems. In particular, it offers the possibility of integrating our understandings of the social and economic; however, if not properly integrated there is a real danger of the latter merely colonizing the former, thereby reducing social interactions to sets of instrumental strategies and rational calculations. Simply because it is a relatively recent concept, it requires further elaboration and refinement, which it is already beginning to attract. Even more nuanced insights will result.

See also Cultural Capital; Human Capital.

BIBLIOGRAPHY

- Bourdieu, Pierre. "Le capital social: notes provisoires." *Actes de la recherche en sciences sociales* (1980): 2–3.
- . "The Forms of Capital." In *Handbook of Theory and Research for the Sociology of Education*, edited by J. G. Richardson. New York: Greenwood Press, 1986.
- Coleman, James S. "Social Capital in the Creation of Human Capital." *American Journal of Sociology* 94 (1988): 95–120.
- Collier, Paul. *Foundations of Social Theory*. Cambridge, Mass.: Harvard University Press, 1990.
- . "Social Capital and Poverty: A Microeconomic Perspective." In *The Role of Social Capital in Development: An Empirical Assessment*, edited by Christiaan Grootaert and Thierry van Bastelaer. Cambridge, U.K.: Cambridge University Press, 2002.
- Dasgupta, Partha, and Ismail Serageldin, eds. *Social Capital: A Multifaceted Perspective*. Washington, D.C.: World Bank, 2000.

- Farr, James. "Social Capital: A Conceptual History." *Political Theory* 31, no. 10 (2003): 1–28.
- Field, John. *Social Capital*. London: Routledge, 2003.
- Hanifan, Lyda Judson. *The Community Center*. Boston: Silver Burdett, 1920.
- . "The Rural School Community Center." *Annals of the American Academy of Political and Social Sciences*, 67 (1916): 130–138.
- Jacobs, Jane. *The Death and Life of Great American Cities*. New York: Random House, 1961.
- Portes, Alejandro. "Social Capital: Its Origins and Applications in Modern Sociology." *Annual Review of Sociology* 24 (1998): 1–24.
- Putnam, Robert. *Bowling Alone: The Collapse and Revival of American Community*. New York: Simon and Schuster, 2000.
- . *Making Democracy Work: Civic Traditions in Modern Italy*. Princeton: Princeton University Press, 1993.
- Rotberg, Robert I. "Social Capital and Political Culture in Africa, America, Australasia, and Europe." *Journal of Interdisciplinary History*, 29, 3 (1999): 339–356. Introduction to two special issues of *JIH*: 29, no. 3 (1999), and 29, no. 4 (2000).
- Woolcock, Michael. "Social Capital and Economic Development: Toward a Theoretical Synthesis and Policy Framework." *Theory and Society* 27, no. 2 (1998): 151–208.

Sean Hawkins

SOCIAL CONTRACT. The "social contract" in the early twenty-first century is associated with the modern school of natural jurisprudence as crystallized in the seventeenth century (although earlier scholastics and humanists had also spoken of contracts, but differently, for example contracts between people and ruler rather than contracts that actually generate sovereignty). Yet there were preceding statements of central elements of social contract theory. The ancient Sophist Lycophron is sometimes credited with originating the idea of the social contract, and there are echoes of it in the teachings of Protagoras (c. 490–c. 421 B.C.E.) as well. The Roman author Cicero (106–43 B.C.E.) stated in his widely read treatise on rhetoric, *De inventione*, that social, legal, and political associations were the result of a primeval agreement to live together on the part of human beings who were previously in a wild and asocial condition. Likewise, St. Augustine (354–430) insisted that any true republic required agreement on the part of its citizens about the object of their love.

Modern Formulations

Modern theorists of the social contract school argued that political authority was artificial and conventional rather than divinely or naturally ordained. To sustain their argument, some—including Thomas Hobbes (1588–1679), John Locke (1632–1704), and Jean-Jacques Rousseau (1712–1778)—appealed to a social contract as a way of explaining the rational basis for and limits on political authority. But for most of these thinkers, the social contract was not the deepest basis of their arguments, which depended rather on new views about natural rights, sociability, passion, and reason. It was David Hume (1711–1776) in his "Of the Original Contract" of 1748, who, although agreeing that political authority was artificial and

conventional, attacked the use of the "social contract" by Locke and his followers and so retrospectively turned this image into the badge of a tradition.

By contrasting the social contract unfavorably with his own view of a duty to obey government grounded in utility, Hume established the debate between the social contract and utilitarianism that continued to structure Anglophone philosophy into the twenty-first century. (John Rawls's *A Theory of Justice*, 1971, is widely credited with reviving contractarianism, though others contributed to this revival before and since.) But Hume's classic criticisms of the contract approach—Were any governments actually founded by contract? When and how could people consent to such a contract, especially one founded before they were born? Why should the duty to keep contracts or promises be more fundamental than the duty to obey political authority?—apply principally to its Lockean interpretation.

Locke, in his *Second Treatise of Government* of 1689 (the year it was published anonymously), interpreted the social contract to require actual consent, whether explicit or "tacit." Most critics concur that he was unable to show convincingly when or how such consent is given, though he did powerfully develop the claim that however given, consent to a government that proves grossly incompetent or malicious can be rescinded. At the opposite extreme, Rousseau, in *Du contrat social* (1762; *On the social contract*), accepted only assemblies actually giving consent to laws as indicative of authentic social contracts. Yet the most interesting treatments of the idea of the social contract are those that treat it as a device for testing the rationality of obedience to political authority. Here, the justificatory force rests on not on visible consent or contract but rather on the rationality (broadly conceived) that such a contract exhibits. In different ways, Hobbes and Rawls both take this approach, as will be discussed below.

Political Authority versus Moral Principles

Hume's sometime-friend Rousseau can be seen as the initiator of a second fundamental question about the contract: that of its scope. Hobbes and Locke had both treated the contract in relation to the justification of political authority, although for Hobbes the contract also turned the precepts of a minimal morality (the "laws of nature") into binding civic law. Rousseau, however, saw the contract as creating simultaneously political legitimacy and genuine moral principles: in transforming asocial or antisocial "men" into civically minded "citizens," his social contract created justice and freedom along with the artifice of political authority. This role of the contract in constructing morality inspired Immanuel Kant (1724–1804), who, in addition to featuring the contract in his political theory, transformed its role in creating moral principles into his idea of the categorical imperative instructing every rational being to act only according to maxims that he or she could will to be a universal law.

Toward the end of the twentieth century, Rawls developed the role of the contract in justifying political authority, while its role in constructing and testing moral principles was developed primarily by David Gauthier, J. C. Harsanyi, and Thomas Scanlon. Scanlon extended a Rawlsian approach from

justice to morality, arguing that “contractualism” identifies principles that no one could reasonably reject. By contrast, Gauthier and Harsanyi both bridged the Humean distinction between contract and utility, using contractarian approaches to argue for utilitarian principles as simultaneously morally right and rational to pursue.

Hobbes and Rawls

This entry returns to the rational-justification approach to the contract’s role. Sometimes this is called the “hypothetical” approach, as it is often framed in terms of a contract to which one could or would agree. But since the question then arises of how a hypothetical contract can be regarded as morally binding, one is forced back upon its rationality. Rationality, however, can be divided (using Rawls’s terms) into a narrow conception of rationality on the one hand, and “reasonableness” on the other. The narrow conception of rationality, which the term bears in the remainder of this entry, is identical with prudence: assessing the best way to pursue one’s own goals and interests. “Reasonableness,” by contrast, involves assessing the fairness of the conditions under which all can pursue their goals and interests.

Using this distinction, it can be said that Hobbes, in his *Leviathan* of 1651, uses the contract to argue that it is rational to act reasonably—that is, it is rational and prudent to obey an effective sovereign and so to act fairly towards all the others who are also obeying rather than to try to evade obedience for personal advantage. Rawls, in contrast, uses the contract to argue that one must first establish reasonable conditions for reflection on what is rational and only then decide what one can rationally pursue. For Rawls, obedience is justified because what is obeyed is just, whereas for Hobbes, what is obeyed is just because this is what it is most prudent to obey.

So for Rawls, what is reasonable both structures the contracting position and shapes the analysis of what would be chosen within it. The role of the contract is to model the reasonable constraints of publicity and reciprocity: any principles of justice chosen must be mutually acknowledged by citizens, even though in the “original position” all are ignorant of their actual identities and so would reason the same way. Rawls insists on this ignorance because, like Kant in his moral theory, he wants to exclude special pleading and unfair existing advantages from the contracting or “original” position. Whereas for Hobbes, people have the same overriding interest in preserving their lives and can be shown that in a “state of nature” without government they will best do so by acting reasonably, for Rawls people should recognize the fairness of starting with the reasonable prior to any particular rational interest they might have.

Feminist Views

Some feminists have criticized the social contract approach as excessively individualistic, arguing that to treat contract as the fundamental moral and/or political relationship is to overlook the dependency on the care of others that characterizes infants, the elderly, the severely disabled, and everyone to the extent that they are vulnerable. Carole Pateman has noted the problematic relationship of women to contract in the seventeenth-century

heyday of natural jurisprudence, when married women could not own property or make contracts in English common law. But others have argued that the social contract approach can be turned to feminist ends. Susan Moller Okin argues that a consistent Rawlsian theory would include the family within the scope of the theory of justice, while Jean Hampton contends that contractarianism can be used to test and prevent the exploitation that may pervade intimate relationships between family and friends.

See also *Human Rights; Liberalism; Natural Law; Society; State of Nature.*

BIBLIOGRAPHY

- Hampton, Jean. “Feminist Contractarianism.” In *A Mind of One’s Own: Feminist Essays on Reason and Objectivity*, edited by Louise M. Anthony and Charlotte Witt. Boulder, Colo., and Oxford: Westview Press, 1993.
- Hobbes, Thomas. *Leviathan*. Edited by Richard Tuck. Rev. student ed. Cambridge, U.K., and New York: Cambridge University Press, 1996. Reprints the original frontispiece and has a valuable introduction.
- Hume, David. “Of the Original Contract.” In *Political Essays*. Edited by Knud Haakonssen. Cambridge, U.K., and New York: Cambridge University Press, 1994.
- Locke, John. *Two Treatises of Government*. Edited with an introduction and notes by Peter Laslett. Student ed. Cambridge, U.K., and New York: Cambridge University Press, 1988. Introduction summarizes Laslett’s influential view on when the *Treatises* were written.
- Rawls, John. *A Theory of Justice*. Rev. ed. Oxford: Oxford University Press, 1999.
- Rousseau, Jean-Jacques. *The Social Contract and Other Later Political Writings*. Edited and translated by Victor Gourevitch. Cambridge, U.K.: Cambridge University Press, 1997.

Melissa Lane

SOCIAL DARWINISM. Social Darwinism arose in the last quarter of the nineteenth century. It was an intellectual movement associated with the theory of evolution in general but was principally derived from the works of Charles Darwin (1809–1882), especially his *Origin of Species* (1859).

Five major questions are raised by the extension of Darwin’s theories to the human sphere.

1. To what extent was Darwin’s theory simply a reflection of the thinking and prejudices of his day?
2. What does “struggle” actually entail? And what exactly are these “human capacities”?
3. What have been the continuing effects of this movement?
4. What are the differences between the natural and social sciences and how do these disciplines relate to each other?
5. How can Social Darwinism be developed?

Darwinism: A Product of Society?

Darwin argued that biological laws affect all living beings. Population growth takes place within limited resources. This leads to a struggle for survival, with particular physical and mental capacities conferring advantages to some individuals and not others. These traits are selected for, reproduced, and inherited, resulting in new species emerging and others being eliminated.

Darwinism and Social Darwinism need to be placed in context for two reasons. First, many of the ideas that are conventionally linked to Darwinism were well established before *The Origin of Species* (1859). Herbert Spencer (1820–1903) was the dominant British philosopher of the late nineteenth century, and he, more than Darwin, made evolution the dominant discourse of that era. Similarly, Jean Baptiste Lamarck (1744–1829), who explained variation and diversification of life as a product of acquired characteristics, was expounding his ideas in the early decades of the nineteenth century. His views greatly influenced Spencer, and they were developed by Darwin, especially in *The Descent of Man* (1871).

Second, Darwinism as a science was itself influenced by its social context, specifically by British industrial capitalism at the heart of a global empire. The struggle for survival in the context of limited resources, with some organisms or species surviving and others not, mirrored mid-nineteenth-century society back on to the nonhuman world.

However, the fact that Darwinism was a product of its era does not make it useless for understanding how species have evolved. This point was well made by Karl Marx in his correspondence with Friedrich Engels.

Meanwhile, influential propagators of Social Darwinism made highly controversial parallels between the species of the natural world and different groups of humans. Nonwhites, women, and the working class apparently did not have the requisite physical and mental capacities to thrive in the modern world.

Human Nature and the Struggle for Survival

There are three connected issues here. What is human nature? How fixed and transmissible is it? How does human nature relate to modern society?

Commentators imbue “human nature” with the qualities that best fit their philosophical and political predilections. Writing in the early twentieth century, for example, the anarchist Pyotr Kropotkin (1842–1921) argued that all species are collectively oriented. The struggle for existence is actually composed of individuals collaborating. Indeed, the rise of capitalism had wrecked this essential human nature, a circumstance to be reversed by an anarchist society. In contrast, Fabian socialists, such as Sidney Webb (1859–1947) and Beatrice Webb (1858–1943), argued that people can easily be individualistic and competitive. They therefore envisaged a form of social engineering that would override these propensities. Individual actions “must sooner or later be checked by the whole, lest the whole perish through the error of its member” (cited in Hawkins, p. 165). Meanwhile, William Sumner (1840–1910)

MARX ON EVOLUTIONISM AS A SOCIAL CONSTRUCT

In a letter to Friedrich Engels, Karl Marx argued that the theory outlined in *The Origin of Species* is a construction of human society used to understand nature. “It is remarkable how Darwin recognises in beasts and plants his English society with its ‘inventions’ and the Malthusian ‘struggle for existence’” (Dickens, 2000, p. 29). But Marx had a great deal of respect for Darwin. Despite using metaphor, Darwin’s theory referred to real, important processes. It needed incorporating into Marx and Engels’s understanding of human society. “Although developed in the crude English fashion, this is the book which, in the field of natural history, provides the basis for our views.”

and others in the United States celebrated possessive individualism, arguing that “the progress of civilisation . . . depends on the selection process; and that depends upon the workings of unrestricted competition” (quoted in Hofstadter, p. 57).

Social Darwinism has relied heavily on the idea of “traits” or “characteristics” that are seen as determining whether an organism, a “race,” or even a nation survives and satisfactorily breeds. This issue is especially important when considering eugenics, the deliberate selection of people with particular traits and their discouragement from breeding through forms of social control. Darwin’s own writings, especially *The Descent*, express anxiety about biological decline stemming “the weak members of civilised society” not only propagating their kind but, as a result of medical and charitable intervention, leading to “the degeneration of a domestic race” (Darwin, 1901, p. 206).

The issue was to arise forcibly with Darwin’s cousin Francis Galton (1822–1911) and his colleague Karl Pearson (1857–1936). In *Hereditary Genius*, Galton studied family trees over a period of two hundred years and argued that a disproportionately large number of distinguished jurists, politicians, military commanders, scientists, poets, painters, and musicians were blood relatives. He concluded that it would be “quite practical to produce a highly gifted race of men by judicious marriages during several consecutive generations” (quoted in Kevles, p. 4). His young colleague Pearson attempted to measure mental capacities and claimed on a statistical basis, one appealing to scientific method, that these capacities were indeed passed on between generations.

But the influential Herbert Spencer envisaged “human nature” as flexible and transformed over time. “Primitive man”

was immoral, irrational, mendacious, and aggressive. A number of groups (including children, women, inferior social ranks, and tribal cultures) remain arrested in a prehistoric state, although they could be civilized during their individual lives. Social evolution, Spencer argued, is generally progressive. It has consisted of a steady improvement of a primitive state of affairs. Individualism, morality, and voluntary association (qualities Spencer approved of) had developed in modern society, one in which people could start caring for one another.

The idea of inborn characteristics generating success has remained influential since the days of Galton and Pearson. It was made prominent in the late twentieth century with the suggestion by Richard Herrnstein and Charles Murray that success in modern society depends on people's inbuilt ability to handle information. In modern society the successful are those with advanced mental capacities. Meanwhile unsuccessful people with low intelligence are interbreeding to produce a rapidly increasing underclass. Society is again envisaged as "natural," class structure being a product of inborn characteristics. Robert Plomin and others supporting the work of Herrnstein and Murray are searching for a genetic basis to intelligence.

The issue of a fixed, heritable, possibly genetically based human nature remains highly controversial. In contrast, there is a rapidly growing literature showing that early parenting and schooling are especially important in determining both mental and physical "fitness" (Dickens, 2004). Perhaps the most important defining "trait" of human beings is their flexibility, their capacity to adapt to many different circumstances.

As regards the relationship between human nature and modern society, a recurrent theme was established by Graham Wallas (1858–1932), another Fabian socialist. Writing in 1908, he asked, "Why should we expect a social organisation to endure, which has been formed in a moment of time by human beings, whose bodies and minds are the result of age-long selection under far different conditions?" (quoted in Hawkins, p. 64). The implication is that human nature was established during the earliest years of human evolution but is inappropriate for, or even destructive to, modern society.

This is a position developed later by "evolutionary psychology." Again using the idea of a genetically based human nature, the suggestion is that humanity's principle predispositions were established while the species evolved on the savannah. The modern mind remains a "neural computer," one "driven by goal states that served biological fitness in ancestral environments, such as food, sex, safety, parenthood, friendship, status and knowledge" (Pinker, p. 524). Male philandering, female coyness, and even aesthetic predispositions were genetically embedded in humanity during that era. These theories are also proving highly controversial (Rose and Rose).

Social Darwinism, Eugenics, and the Modern Era

Social Darwinism, and particularly its extension to eugenics, has had a continuing, often evil, impact on modern society. The Nazi Holocaust killed over 5 million Jews and sterilized at least 375,000 supposedly "inadequate" people. This was all

KARL PEARSON ON INHERITING OF MENTAL CAPACITIES

"We inherit our parents' tempers, our parents' conscientiousness, shyness and ability, even as we inherit their stature, forearm and span" (quoted in Kevles, p. 32).

in the name of a "science" of eugenics, one deeming Jews and others to be biologically inferior to the Aryan race. These programs were the horrific climax to an extreme eugenic movement that swept through much of the Western world during the first third of the twentieth century.

While Jews were the targets of eugenics in Europe, black people were made victims of this movement in the United States. Intelligence quotient (or IQ) tests purported to show that they were inherently inferior, a conclusion that greatly hindered the extension of educational opportunities beyond the white population. And it has become clear that in Sweden, a society often held up as a model of social democracy, thousands of misfits, deviants, gypsies, and others were sterilized as late as the 1960s. This was an attempt to make a pure, socially responsible breed of human being. Eugenics still finds echoes in the early twenty-first century. Yet eugenics has no serious credibility as a science. Not only are there no proven connections between innate biological characteristics and human behavior, but there is no such thing as a pure race—"Jewish," "black," "white," or otherwise. Migration and intermarriage have meant that biological characteristics have become fully combined.

Problems of Direction, Progress, and Teleology

Social Darwinism has often implied that evolution is developing in a linear and progressive way. Furthermore it may be fulfilling some long-term purpose. These themes have a long history. Georg Wilhelm Friedrich Hegel (1770–1831), writing in the early part of the nineteenth century, remains among the best-known advocates of the argument that history is marching toward a definite end, one in which human beings will finally recognize and fulfill themselves as human beings. A similar argument informed early evolutionary thought. In the mid-nineteenth century Robert Chambers (1802–1871) combined a notion of linearity and progress with one of teleology or underlying purpose. The fossil record shows, he argued, that invertebrates developed into fish, fish developed into reptiles, and the latter evolved into mammals. In due course the process culminated with "man." Furthermore these developments signify "progress," the transition from basic animals to humanity being seen as a generally beneficial development. Finally, Chambers argued that the advance toward humanity was the unfolding of a divine purpose. The law of progress was created by God.

Darwin resisted all three supposed tendencies. He saw evolution as open-ended and capable of diverging or branching

DARWIN AND WALLACE ON GENDER DIFFERENCES

Darwin wrote that “the chief distinction in the intellectual powers of the two sexes is shown by man’s attaining to a higher eminence in whatever he takes up, than can women—whether requiring deep thought, reason, or imagination, merely the use of the senses of the hands” (quoted in Richards, p. 119). Alfred Wallace (1823–1913), the codiscoverer of the theory of evolution, argued that if women were freed from financial dependence on men, their mental potentials would soon become fully realized. They would be “regenerators of the entire race” (quoted in Stack, p. 29).

in any number of directions. How, or whether, a species survives depends on the environment it encounters. Darwin certainly denied that it was directed toward some predetermined, God-given, goal. On the other hand, his understanding of “progress” was also colored by the dominant views of his day. Witness his assertion that the European white race represented a major advance over other “races” or that men are more capable of rational thought than women. Men, he argued, had developed this capacity when they had to hunt and protect their families in the earliest stages of evolution.

T. H. Huxley (1825–1895), Darwin’s contemporary and great publicist, offered a related analysis. He argued that women’s capacities excluded their full involvement in science. Their levels of intelligence rendered them largely unable to handle abstract ideas. Here again a supposed “science” is used to legitimate power relations. Social relations are envisaged as a product of nature, and nature is immutable.

As regards humanity as a whole, Darwin proposed a progressive model of evolution that conferred superiority on humans while remaining consistent with his general theory. In *The Descent of Man* he argued that humanity had separated itself from apes as a wholly unique way of adapting to life in the ancestral forests. Early human beings had adopted an upright posture in this kind of environment. Unlike the apes, who needed their hands for locomotion, early humans’ hands were freed up to hunt and make tools. This freeing up, Darwin argued, led to the development of advanced human intelligence and dominion over nature.

Nevertheless, the views of writers such as Chambers rather than Darwin were those that prevailed in the making of Social Darwinism, the idea of an open-ended, undirected form of evolution finding little or no support. Similarly, the idea of

a linear progression toward some kind of ideal solution was especially influential in evolutionary anthropology.

Notions of “progress” and direction remain important in early-twenty-first-century social and political science, albeit in muted and perhaps less-teleological forms. There often remains, for example, an implicit suggestion that there is just one way in which societies can evolve. It is toward liberal democracy, with individual fulfillment being obtained via democracy and the market. Pursuing such an end remains, for some, a divinely inspired mission. Such arguments are controversial since they do not recognize that societies, their politics, and religions may also branch off in their own, perhaps unique directions.

Evolution and Society: Ways Forward

Social Darwinism therefore has a distinctly checkered history. A “science” that concludes that nonwhites, working-class people, and women are biologically unable to succeed is nowadays likely to encounter ridicule and outright hostility. Sociobiology, the forerunner of evolutionary psychology, has run into similar controversy. It suggested that genes and the reproduction of genes into future generations is the primary mechanism informing the behavior of humans and other animals. Sexuality and gender inequalities are largely governed by genes, and there is little that can be done to change inherited nature (Wilson).

But there remains much potential value in alternative forms of Social Darwinism. One important contemporary application of evolutionary thought to human society is to use evolution primarily as a metaphor or analogy. Jürgen Habermas, for example, envisages society as similar to a natural organism, one with highly differentiated parts, one that is self-maintaining and capable of selecting alternative strategies. This has echoes in the analogies between society and nature made by, for example, Herbert Spencer. But Habermas uses the organic metaphor not as a means of developing laws supposedly applying to both humans and nonhumans. Rather, evolution and biology are being used as heuristic devices. They are deployed as a means of understanding how contemporary society develops and changes.

Evolutionary analogies are used in other fields. “Evolutionary economics,” for example, treats the competition of firms as analogous to the struggle for survival in the nonhuman world. And a popular understanding of technological change also uses evolutionary analogies, some technologies succeeding over others in a competitive process.

Analogies and metaphors of this kind are helpful in developing new insights. But they do not address the main difficulties of early Social Darwinism. Two central questions remain. In what sense is society “natural”? How are the insights of the social and natural sciences to be combined?

A useful first step in developing a modern “Social Darwinism” would be to recognize different levels of generality. Evolutionary processes and tendencies operate at a general level and over immense periods of time. Biological evolution has left human beings with developmental tendencies and needs stemming from their remarkably long periods of infancy. But precisely how these tendencies and needs are realized crucially depends on the contingent circumstances that they encounter.

Early parenting as well as experience at school and work deeply affect cognitive abilities and levels of health, and these are all highly variable over time and between different societies.

A rigorous dualism between “society” and “nature” was maintained by early Social Darwinism, women and nonwhites being allocated to the category of “nature,” for example, and European men being allocated to “culture.” This kind of dichotomy is full of dangerous implications but can be overcome if evolution and biology are envisaged as bequeathing potentials and tendencies that can be realized in different ways by the kinds of society encountered.

Social Darwinism attempted, often in crude, premature, and dangerous ways, to link insights from the social and natural sciences. But there remain exciting possibilities for developing new, more complex, nuanced, and transdisciplinary ways of linking the social and biological sciences. These are likely to throw important new light on the nature and well-being of humans as they interact with one another and their environment.

See also *Eugenics; Evolution*.

BIBLIOGRAPHY

- Darwin, Charles. *The Descent of Man and Selection in Relation to Sex*. 3rd ed. London: John Murray, 1901. Originally published in 1871.
- . *The Origin of Species*. London: John Murray, 1859.
- Dickens, Peter. *Social Darwinism: Linking Evolutionary Thought to Social Theory*. Buckingham, U.K., and Philadelphia: Open University Press, 2000.
- . *Society and Nature: Changing Our Environment, Changing Ourselves*. Cambridge, U.K.: Polity, 2004.
- Hawkins, Mike. *Social Darwinism in European and American Thought, 1860–1945: Nature as Model and Nature as Threat*. Cambridge, U.K.: Cambridge University Press, 1997.
- Herrnstein, Richard J., and Charles Murray. *The Bell Curve: Intelligence and Class Structure in American Life*. New York: Free Press, 1994.
- Hofstadter, Richard. *Social Darwinism in American Thought*. Boston: Beacon, 1983. First published in 1944.
- Kevles, Daniel J. *In the Name of Eugenics: Genetics and the Uses of Human Heredity*. Cambridge, Mass.: Harvard University Press, 1985.
- Kropotkin, Peter. *Mutual Aid: A Factor in Evolution*. London: Freedom Press, 1987. First published in 1902.
- Pinker, Steven. *How the Mind Works*. Harmondsworth, U.K.: Allen Land/Penguin, 1997.
- Plomin, Robert, John DeFries, and Ian Craig, eds. *Behavioral Genetics in the Postgenomic Era*. Washington, D.C.: American Psychological Association, 2002.
- Richards, Evellen. “Redrawing the Boundaries: Darwinian Science and Victorian Women Intellectuals.” In *Victorian Science in Context*, edited by Bernard Lightman. Chicago: University of Chicago Press, 1997.
- Rose, Hilary, and Steven Rose, eds. *Alas, Poor Darwin: Arguments against Evolutionary Psychology*. London: Jonathan Cape, 2000.
- Stack, David. *The First Darwinian Left: Socialism and Darwinism, 1859–1914*. Cheltenham, U.K.: New Clarion Press, 2003.
- Wilson, Edward. *Sociobiology: The Abridged Edition*. Cambridge, Mass.: Harvard University Press, 1980.

Peter Dickens

SOCIAL HISTORY, U.S. The “new” social history that emerged in the United States in the 1960s and came to dominate the profession by the 1980s, conjoined two scholarly agendas. The first was a program for reshaping history along the lines of the behavioral sciences—in particular economics, political science, and sociology—and employing quantitative methods and models in historical research. The second was the project of rewriting history from the “bottom up,” and providing a “usable past” for contemporary movements for social change. Although the advocates of social history might differ in their methodological or ideological commitments, they agreed on the need to displace “traditional” narratives of the American past—ones that privileged high politics, diplomacy, or intellectual life—and to replace them with “new” histories that emphasized social and economic processes and phenomena. Their efforts prompted extensive discussions about the means and ends of historical analysis, and produced a major reorientation within the profession.

Among the earliest, and most forceful, proponents of social science history were Lee Benson and Robert Fogel. Benson, and other practitioners of the “new” political history, urged historians to develop systematic methods and generate quantifiable data with which to verify hypotheses. In *The Concept of Jacksonian Democracy: New York as a Test Case* (1961), Benson used electoral returns and census data to suggest that ethnic and religious factors, rather than social class, best accounted for party affiliation and voting behavior. Fogel and his fellow “diometricians” developed a “new” economic history that adopted complex mathematical models and counterfactual questions from economics, and applied them in statistical analyses of serial data. In *Time on the Cross: The Economics of Negro Slavery* (1974), Fogel and Stanley Engerman drew upon a wide variety of sources in order to demonstrate that slavery was a profitable and efficient system of labor, and that in terms of material conditions, the lives of slaves could be compared to those of wage workers. The interdisciplinary interests and the collaborative activities of the new historians led to the establishment of such institutions as the Inter-University Consortium for Political and Social Research (1962), which served as an archive for machine-readable data and as a center for training in quantitative methods; the publication of such periodicals as *Historical Methods Newsletter* (1967), the *Journal of Social History* (1967), and the *Journal of Interdisciplinary History* (1970); and the organization of the Social Science History Association (1974).

For other scholars, the turn to quantitative methods was more a matter of pragmatic choice than professional manifesto. Stephan Thernstrom, in *Poverty and Progress: Social Mobility in a Nineteenth Century City* (1964), sampled city directories, and censuses in order to determine rates of occupational mobility in Newburyport, Massachusetts. Social mobility, he discovered, was a far less common phenomenon than was assumed by scholars or celebrated in popular culture. *Poverty and Progress* came to serve as a model for a number of social mobility studies, and as one of the key texts in the development of a “new” urban history. Thernstrom’s creative use of sources, in particular manuscript census returns, also generated significant interest among historians who wished to

examine the lives of a great majority of Americans, those whose experiences were missing from the pages of histories focusing on elites. Recovering the histories of workers, women, immigrants, and minorities—"anonymous Americans" as Tamara Hareven (1937–2002) characterized them—became a central concern for social historians. So, too, did the need to connect these histories to such contemporary issues as civil rights and feminism. To many aligned with the New Left, writing social history was both a professional and a political activity.

Both the historiographical critiques and the methodological prescriptions of the new social historians became matters of controversy. Scholars interested in such areas as foreign relations, finance, and the presidency rejected characterizations of their work as "top down" or "great man" history. Historians whose works were dismissed as being "impressionistic" rather than "rigorous" replied that not every past event or piece of evidence was suitable for quantification. Whether to count or not should be a matter of choice, not creed. The most extensive, and rancorous, exchanges over the implications of quantitative history came in the wake of the publication of *Time on the Cross*. In such works as Herbert Gutman's *Slavery and the Numbers Game* (1975), critics of Fogel and Engerman pointed to problems in their statistical analyses and the scope of their data sets. They raised moral objections as well. Should the suffering of slaves be reduced to a series of indices and equations? Could the complex system of chattel slavery be adequately represented with the tools of cliometrics?

Among those who identified themselves as social historians, there were also differences in approaches to materials and methods. While social science historians preferred to make their claims on the basis of "objective" sources—city directories, wills, estate inventories—historians of the marginalized and of social movements also continued to rely on "subjective" sources—letters, diaries, and newspapers—for evidence of consciousness or culture. Sean Wilentz and other "new" labor historians questioned the suitability of concepts imported from liberal social theory, such as modernization and social mobility, and the utility of elaborate statistical modeling. They preferred instead the style of social history done by such British Marxists as E. P. Thompson (1924–1993) and Eric Hobsbawm (1917–). In *Chants Democratic: New York City and the Rise of the American Working Class, 1788–1850* (1984), Wilentz examined the interaction of socio-economic transformation and political mobilization, in particular in the era of Andrew Jackson. Where Lee Benson had found cross-class alliances along "ethno-cultural" lines, however, Wilentz discovered class conflict and the development of an oppositional working class culture. Though not all social historians were Marxists, the revival of interest in modes of Marxist analysis, and the return of interpretations, which emphasized conflict instead of consensus, were among the most important changes that were wrought in the profession.

By the mid-1980s, much of what the first behavioralists and "bottom up" historians had envisioned was being realized. Major periods and problems in American history had been

reinterpreted and revised along social history's lines. New fields of study, such as women's history, had been opened up; and others, such as urban and labor history, had been renewed. A once-dominant political and diplomatic grand narrative of national development was being replaced by one that concentrated on questions of race, class, and gender, and that stressed conflict as the engine of social change. Scholars who wrote about members of the elite assumed defensive positions; prominent intellectual historians called for a new social history of ideas.

Yet a number of social historians, including Lee Benson, expressed doubts about the enterprise. The serious critiques of positivism gaining currency among social scientists could be directed toward social history as well. So, too, could questions about agency, and postmodern rejections of the possibility of objectivity. More than a few social historians turned away from the assumptions of behavioral economists and sociologists, and toward an engagement with methods of cultural anthropologists and literary critics. In these moves from statistics to symbols, and from verification to interpretation, the "new" social history began to give way to a "new" cultural history. Quantitative social science history did not disappear, however, and remains important in such areas as demographic history; yet when compared to cultural history, it is no longer as influential a force. To the extent that the new cultural historians employ American history in terms of oppression, resistance, and emancipation, they are carrying on the mission, if not always using the methods, of history "from the bottom up."

See also *Cultural History*.

BIBLIOGRAPHY

- Benson, Lee. *The Concept of Jacksonian Democracy: New York as a Test Case*. Princeton, N.J.: Princeton University Press, 1961.
- . *Toward the Scientific Study of History*. Philadelphia: Lippincott, 1972.
- Berkhofer, Robert. *A Behavioral Approach to Historical Analysis*. New York: Free Press, 1969.
- Fogel, Robert, and Stanley Engerman. *Time on the Cross: The Economics of Negro Slavery*. Boston: Little, Brown, 1974.
- Gutman, Herbert. *Slavery and the Numbers Game: A Critique of Time on the Cross*. Urbana: University of Illinois Press, 1975.
- Hareven, Tamara K., ed. *Anonymous Americans: Explorations in Nineteenth Century Social History*. Englewood Cliffs, N.J.: Prentice Hall, 1971.
- Lemisch, Jesse. "The American Revolution Seen from the Bottom Up." In *Towards a New Past: Dissenting Essays in American History*, edited by Barton J. Bernstein. New York: Pantheon Books, 1968.
- Tentler, Leslie Woodcock. *Wage-earning Women: Industrial Work and Family Life in the United States, 1900–1930*. New York: Oxford University Press, 1979.
- Thernstrom, Stephan A. *Poverty and Progress: Social Mobility in a Nineteenth Century City*. Cambridge, Mass.: Harvard University Press, 1964.
- Wilentz, Sean. *Chants Democratic: New York City and the Rise of the American Working Class, 1788–1850*. New York: Oxford University Press, 1984.

Martin J. Burke

SOCIALISM. The difficulty of defining socialism is apparent to anyone who attempts to study this protean doctrine, not least because what socialism is or is not is usually a matter of contentious debate. However, there is a general consensus that the various schools of socialism share some common features that can be summarized as follows. Socialism is above all concerned with the relationship between the individual, state, and society. For the socialist, the individual is never alone and thus must always define himself or herself in relation to others. Socialists believe that a well-ordered society cannot exist without a state apparatus, not least because the state is seen as the most effective vehicle for coordinating and administering to the needs of all.

Socialists' views on human nature distinguish them from their principal political rivals, the liberals and conservatives. While the latter two groups tend to hold that all humans are inherently self-interested and materialistic, socialists contend that these traits are products of social conditioning under capitalism. On this view, individuals act selfishly and competitively, not because it is in their nature to do so, but rather because they are encouraged and rewarded for such behavior. Socialists hold that the values and beliefs promoted in a socialist society would enhance our capacity for acting cooperatively and collectively in pursuit of mutually reinforcing material and spiritual goals.

Because they see material circumstances as being key to the well-being of individuals, socialists stress the importance of the economic system that operates in every society. It was their observations of the deleterious effects of industrial capitalism that caused socialist reformers to call for the development of new economic structures based on a completely different set of moral principles. The question of how the transition from capitalism to socialism would occur has been answered in different ways by different socialist theorists. Robert Owen (1771–1858), Charles Fourier (1772–1837), and other early socialist thinkers saw the need to reform rather than destroy capitalism, while followers of Karl Marx (1818–1883) and Friedrich Engels (1820–1895) insisted that capitalism had to be completely overturned in order for society to advance to a state of socialism. Contemporary socialists do not envisage the transition from capitalism to socialism as a sharp break, but as a process of economic reforms that takes into account the role of market forces.

So far as is known the terms *socialist* and *socialism* first appeared in print in Italian in 1803, but in a sense were entirely unconnected with any of their later meanings. No trace of the word *socialist* appears again until 1827, when it was used in the Owenite *Co-operative Magazine* to designate the followers of Robert Owen's cooperative doctrines. Across the English Channel, *socialisme* was adopted by the Saint-Simonians—followers of the French philosopher and social scientist Claude-Henri de Rouvroy (1760–1825), comte de Saint-Simon—during the 1830s to describe their theory, and thereafter it was increasingly used to refer to those groups aiming at some kind of new social order resting on an economic and social conception of human rights.

In these senses, socialism was used to distinguish the attitudes of those who laid stress on the social elements in human

relations from those who emphasized the claims of the individual. In fact, to be a socialist was to be someone who promoted a social system in direct opposition to the highly individualistic order being advocated by the proponents of *laissez faire* economics.

Industrial Revolution and the Rise of Socialism

As a political ideology, socialism arose largely in response to the economic and social consequences of the Industrial Revolution. There is an abundance of literature that attests to the dramatic way in which the industrialization of Europe affected the daily lives of individuals, particularly the working classes. The reformist trend in British politics during the 1830s brought some of these harsh realities to the public's attention. In 1832, for example, a parliamentary investigation into the conditions in the textile factories—later known as the Sadler Committee's Report—revealed the appalling toll on human life that had resulted from unregulated industrial growth. And, even if we discount certain embellishments or exaggerations, these accounts of the general working conditions in the factories were nonetheless all too illustrative of a social climate in which practices of the most callous inhumanity were accepted as a natural order of events and, most important, were at first not thought to be the general public's concern.

It deserves mention here that, in addition to the horrors wrought by an unregulated factory system, workers were also subjected to the changes brought on by the machine age. The introduction of new technologies in the workplace invariably meant the displacement of laborers. No less important was the fact that many of the changes wrought by rapid technological advances and the consequent restructuring of the workplace (e.g., the factory system) had an alienating effect on the worker. To the minds of some, however, these evils of industrialization were not inevitable outcomes. Such was the case with the so-called Utopian socialists who emerged in England and on the Continent around this time.

Utopian Socialists: Owen, Saint-Simon, Fourier

In the beginning there were basically three groups of socialists, although there were lesser groups representing broadly similar tendencies. The three principal groups were the Fourierists and Saint-Simonians in France and the Owenites in Great Britain. There were obvious similarities between them: (1) they regarded the social question as by far the most important of all; (2) insisted that it was the duty of all good men to promote the general happiness and welfare of everyone in society; (3) regarded this task as incompatible with the continuance of a social order that was maintained strictly on the basis of a competitive struggle between individuals for the means of living; and (4) were deeply distrustful of politics and politicians, believing that the future control of social affairs ought to lie not with parliaments or ministers or kings and queens but with the "producers." They held that, if the economic and social aspects of men's lives could be properly ordered, the traditional forms of government and political organization based on conflict and competitiveness would soon be superseded by a new world order of international peace and collaboration.

On the other hand, there were wide diversities separating these three groups. The Fourierists and Owenites were community-makers. They set out to establish a network of experimental communities based on their ideas that would become the foundation stones of a new social order. The Saint-Simonians differed from these two groups in that they were strong believers in the virtues of large-scale organizations and scientific planning. Their principal aim was to transform nations into great productive corporations dominated by a sort of “technocracy” composed of scientists and technicians. Unlike the Fourierists and Owenites, who eschewed political activity, the Saint-Simonians were not opposed to using the existing political channels as a means to bring about the transformations they were advocating.

Thus, at this juncture in its historical development, socialism meant collective regulation of the affairs of people on a cooperative basis, with the happiness and welfare of all as the ultimate goal, and with the main emphasis not on “politics” per se but on the production and distribution of wealth. Enemies of individualism, the socialists sought to strengthen the socializing influences that brought people together in a harmonious whole. They therefore emphasized education as an instrument for conditioning patterns of behavior, social attitudes, and beliefs.

It deserves mention that in this description of socialism nothing is said about the proletariat or the class struggle between it and the capitalist class. This is because the members of the aforementioned socialist schools did not think in these terms. They did not see capitalists and workers as rival classes, nor did they believe that a revolutionary struggle between the proletariat and bourgeoisie was necessary to put their social plans into effect.

“Scientific Socialism”

In following the historical analysis of socialism offered by Karl Marx and Friedrich Engels, the modern socialist movement dates from the publication of their *Communist Manifesto* in 1848. The term *communism*, which came into common usage in this same period, was often used in connection with the idea of socialism, though the former tended to have a more militant connotation. This is most likely why it was used by the Communist League, the group that commissioned Marx and Engels to write the *Communist Manifesto*. As Engels later explained, the word *communism* carried with it the idea of common ownership, and, above all, it helped to distinguish the ideas of Marx and Engels from those of the so-called utopian socialists in that it lent itself better to association with the idea of the class struggle and with the materialistic conception of history.

The publication of the *Communist Manifesto* coincided with the revolutionary tide that swept through Europe between 1848 and 1849. Marx and Engels were still correcting the proofs of their soon-to-be famous pamphlet when the first barricades of 1848 were being erected in Paris. But while it is true that the *Manifesto* was published during a period of political tumult, it did not have a profound impact on the revolutionaries of the period. Nevertheless, it was an important document in the

history of socialism, above all because it presented in outline form the theoretical basis for modern socialism.

Perhaps the boldest and most probing argument advanced by Marx and Engels was their critique of present and past societies. According to this, society’s political and cultural arrangements (superstructure) are shaped primarily by the forces of material production (base). When the productive modes and relations have developed as far as they can within the existing framework of political and economic structures of society, then the conditions arise for a thoroughgoing social revolution, a process that inevitably brings about a transmutation of these older forms into more progressive ones. In this way, societies are able to advance progressively from more primitive states (e.g., feudalism) to more sophisticated ones (e.g., capitalism).

In their discussion of the relationship between state and class, Marx and Engels identify further dimensions of their “stages” view of history that were to become cornerstones of “scientific” socialism. According to them, the state is essentially a class-based institution, expressing the will and exclusive interests of the dominant political and economic groups in society. The state and its apparatuses are thus seen as essential features of the superstructure that overlays the economic base (which itself corresponds to the stage reached in the development of the powers of production). Under capitalism, the authors go on to say, the bourgeoisie seek both to expand their base—which is too narrow to accommodate the wealth created by them—and to overcome the economic crises caused by the development of productive forces beyond the point compatible with capitalism. By so doing, they begin to dig their own graves, for the scramble for new markets inevitably creates new problems that cannot possibly be resolved within the framework of the one created by the bourgeoisie. At this point, the *Manifesto* explains that it is the ongoing and ceaseless dialectical struggle between the dominant and dominated classes that provides the impetus for breaking down the barriers for further social and economic development. With the advent of revolution, the control of the state and its forms passes into the hands of the new dominant class (the working classes), thus paving the way for the development of new forces of production.

Another distinguishing aspect of the doctrine outlined in the *Manifesto* has to do with the special historical mission that Marx and Engels assigns to the proletariat. Unlike previous insurgent classes, which developed their importance and strength within the preceding social order, Marx and Engels contend that the laboring class under capitalism is driven to revolt through its own increasing misery. Once they have wrested political power from the middle classes, the authors believe that the proletariat will be able to establish their own hegemony (construed more concretely in later writings as a dictatorship). Over time, during which the material conditions are created for the construction of socialism, their class rule would give way to a classless and stateless society, communism.

As regards the relationship between communists and the working classes, Marx and Engels assert that communists were the most advanced and politically resolute segment of the proletariat in every nation, not least because they had the

advantage of seeing more clearly than others the direction in which society is moving. As revolutionaries, their role was to assist the exploited workers in three ways: (1) to raise their class consciousness so that they can realize their role in history; (2) to overthrow the bourgeoisie; and (3) to establish working-class control of the state and its ruling apparatuses (i.e., a dictatorship).

Having said all of this it is important to keep in mind that the *Manifesto* cannot be regarded as a full exposition of Marxist doctrine. And while Marx sketches out many of the basic tenets of his communist viewpoint, at this point in his career he had not worked out his complete system of thought, which was carefully developed over many years, culminating with the publication of his magnum opus, *Das Kapital*, in 1867. Nonetheless, it is significant to note that both Marx and Engels continued to endorse the views of the *Manifesto* even after most of them were rendered irrelevant by the course of events. The continuing relevance of this important document, then, had less to do with its predictive powers than with its potency as a clarion call for revolution. The *Manifesto* is full of memorable and moving phrases such as, “Workers of the World unite. You have nothing to lose but your Chains.” The teleological understanding of history presented in the *Manifesto* was also compelling to successive generations of socialists. In their “scientific” critique of the bourgeois society with which they were acquainted, Marx and Engels managed to invest history with both a dramatic purpose and a desirable destination. History was, according to them, moving toward a higher goal that could only be obtained through class struggle and social revolution. It was thus the moral message embedded in their theory of historical materialism that made the *Communist Manifesto* a landmark publication in the history of modern socialism.

Socialism during its “Mature” Phase

The genesis and development of socialism paralleled the rise of liberalism in Europe. Over the course of the nineteenth century, liberalism had become the predominant ideology in Great Britain and on the Continent. However, from 1889 on, socialism increasingly challenged liberalism’s supremacy in the political arena. In Europe generally there were various schools of socialist thought that came to maturity during the second half of the nineteenth century: reformist socialism, Marxism, anarchism, and syndicalism. Of these currents, Marxism tended to be the dominant socialist theory, partly because of its conceptual cogency and partly because it was embraced by the most powerful and influential social democratic parties affiliated with the Second (Socialist) International, (1889–1914), a confederation of socialist parties and labor organizations that was created in order to continue the work of the First International Workingmen’s Association.

Why did socialism become so important at this time? One of the contributing factors was the growing influence of positivism on the general outlook of European thinkers. Following in the tradition of the French Enlightenment, intellectuals like Auguste Comte (1798–1857) and Herbert Spencer (1820–1903) promoted the idea that an understanding of both the natural and social worlds could be achieved through scientific

knowledge. It was this belief that inspired socialists like Saint-Simon and Marx to develop political cosmologies that they thought could be grounded on a sound empirical basis. Marx in particular asserted in the *Communist Manifesto* and other major writings that his brand of socialism was distinguished from all others by its “scientific” approach to the study of economics and society. This is not to say that Marxists were the only socialists who were convinced of the scientific validity of their theories. Anarchist social views, particularly those espoused by the Russian revolutionary Pyotr Kropotkin (1842–1921), also owed a great deal to the positivist tradition. And, finally, the evolutionary brand of socialism known as Fabianism that developed in Great Britain at the end of the nineteenth century was shaped by the positivist beliefs of its leading theorists.

A general shift in the attitude toward the role of the state in society also contributed to the growth of socialism. The failure of laissez-faire political and economic policies, which had been long favored by liberal governments as a way to respond effectively to the problems created by the periodic crises of capitalism, the second wave of industrialization, and the emergence of a mass society caused many to see the state in a more favorable light. For example, the unexpected and occasionally jolting economic fluctuations of the 1870s and 1880s not only drove a wedge between the workers and their liberal middle-class representatives, but also alarmed industrialists and other members of the economic elite. As a result, an increasing number of all these groups started turning to the government for protection. The growing popularity of imperialism in the closing decades of the century also made the average person less opposed to the growing powers of the state.

Among the many other factors that favored the rise of socialism at this time, the most notable can be summarized as follows. (1) The increase in the number of workers in the industrializing nations was one important factor. The concentration of industries during the so-called second industrial revolution that occurred during the last two decades of the nineteenth century brought together workers in unprecedented numbers. Rapid industrialization also accelerated the tendency of the general population to move from the countryside into urban centers. Cities proved to be favorable environments for socialist organizations—which demanded a fairly sophisticated social/cultural infrastructure in order to thrive. (2) The rise of literacy also redounded to the benefit of the socialists: as more and more workers learned to read they were able to imbibe socialist ideas in the form of pamphlets, books, and the press. (3) The “democratization” of the ballot box also helped the socialists in that the extension of the franchise brought more workers into the political arena thus making it possible to get socialist deputies elected to parliament. All of these factors created the basis for a “proletarian” mentality or consciousness. By the late 1880s workers were joining clubs and trade unions, electing their own representatives, and subscribing to their own publications. And though this is not to say that all workers were necessarily socialist, it did mean that the principal vehicles for propagating and sustaining socialism were now anchored in the framework of modern industrial society.

The Spread of Marxism during 1880s

Of all the varieties of socialism that existed during this period, Marxism proved to be the most popular doctrine among working-class parties that began to emerge in the 1870s in France, Germany, Belgium, and elsewhere where there was a large industrial proletariat. In countries where industrialization had yet to be firmly established, Marxism was a minority tendency. This was particularly evident in Spain, where anarchism was a major force among both the industrial workers and the peasantry. Anarchism also attracted a sizeable following among peasants and workers in Italy, though it never achieved the mass following it did in Spain. In Russia, Marxism became important only after the turn of the century and even then it did not represent the largest segment of the socialist movement as a whole.

Beginning in the 1880s a special effort was made by Friedrich Engels to popularize Marx's theories, particularly among the growing reading public of workers. As far as Marx's general theories were concerned, this was no easy task, for, apart from intellectuals, few people could easily grasp the meanings of his probing analysis of capitalist development. In order to make such views more accessible, Engels set himself the task of defending Marxian theories against Marx's would-be critics. In *Anti-Dühring* and several of his better known works, Engels attempted to expand upon the views of his lifelong collaborator by stressing that Marxism was not just a revolutionary theory but a scientific worldview that lay bare the complexities of society. By arguing in this way, Engels hoped not only to discredit rival views of socialism but also to demonstrate the continuing relevance of Marx's theories. From a doctrinal point of view, Engels's most enduring legacy to socialism, however, was his materialist conception of history. More so than Marx, Engels saw the march of socialism as an inexorable historical process that could be predicted with almost mathematical certainty by correctly reading the "objective laws" that governed the evolution of both the natural world and society. He therefore suggested a view of socialist development that linked it to a general process of change that could be measured and read by means of empirical investigations.

The certitude of the causal explanatory model sketched out in Engels' writings on historical materialism appealed especially to the generation of socialists who came of age during the closing years of the nineteenth century, a period when positivism was at its height. Karl Kautsky (1854–1938), Eduard Bernstein (1850–1932), Georgy Plekhanov (1857–1918), and V. I. Lenin (1870–1924) were all indebted to Engels's elaboration of Marxist doctrine. No less a testament to Engels's impact on the future development of socialism is the fact that his materialist conception of history became an article of faith in all the regimes that declared themselves to be Marxist in the twentieth century.

The Anarchist Alternative

The anarchists represented one of the strongest non-Marxian currents in the socialist movement and it was their ongoing rivalry with the Marxists that kept alive the doctrinal debates and organizational divisions that characterized both the First (1864–1876) and Second Internationals (1889–1914).

Anarchism was never a homogenous ideological movement. At one time or another in the course of the nineteenth and early twentieth centuries anarchists who belonged to the international socialist movement identified themselves as mutualists, collectivists, communists, and syndicalists. Yet, despite their theoretical differences, anarchists of all schools were united in their opposition to Marxism. Above all this was because of their diametrically opposed views of the role of the state. For the Marxists, the state was a necessary vehicle for governing society until full communism had been achieved. Once this stage of history had been reached, the state would, in the words of Engels, cease to be a useful instrument of rule and simply wither away. The anarchists completely rejected the notion that the state could serve any positive function. In sharp contrast to the Marxists, they believed that the working classes would overturn capitalism, not by wresting political power from the middle-classes, but by concentrating their energies in developing and organizing their own social institutions and by engaging continuously in an economic struggle against their oppressors.

Anarchists also opposed Marxism on the grounds that its communist principles were incompatible with the kind of libertarian society they envisaged. The Russian anarchist Mikhail Bakunin (1814–1876) famously declared that he detested communism because, "it is the negation of liberty." He further accused Marx of promoting an authoritarian form of communism that "concentrates and absorbs all the powers of society into the state."

Since the anarchists abstained from politics and thus rejected the ballot box as a means of advancing the workers' cause, they were forced to adopt a revolutionary strategy that also placed them at odds with Marxists and reformist socialists. For this reason there are two main features of the movement that need to be mentioned: direct action tactics and violence. The former included such things as sabotage, strikes, and public demonstrations—May Day celebrations, for example. The anarchists' reliance on a tactic known as "propaganda by the deed" gave rise to the stock image of them—popularized by writers and social scientists like Joseph Conrad (1857–1924), Henry James (1843–1916), and Cesare Lombroso (1835–1909)—as social deviants who were bent on destroying the foundations of civilization. This overblown stereotype was reinforced by several widely publicized anarchist outrages that punctuated the last years of the nineteenth century. Apart from launching small-scale attacks against symbols of class, state, and religious rule, anarchists were responsible for the political assassinations of several heads of state. Within a span of only six years, the presidents of France (1894) and the United States (1901), the empress of Austria (1898), the prime minister of Spain (1897), and the king of Italy (1900) were murdered by anarchists. The stigma that all anarchists were now saddled with obscured the fact that these were isolated acts committed by only a handful of individuals. Most rank-and-file anarchists were strongly opposed to terrorism, and most saw education and trade unions as the main vehicles for conducting their revolutionary activity.

At the turn of the century anarchism, which had nearly died out in most areas of Europe, was revitalized by the

development of yet another brand of socialism known as revolutionary syndicalism. When Arturo Labriola (1873–1959), Émile Pouget (1860–1931), José Prat (d. 1932), and other libertarian thinkers began to marry the new doctrine (which emphasized trade unionism and direct action tactics like the general strike) to old anarchist beliefs the result was anarchosyndicalism, a movement that was particularly important in France, Spain, and Italy. In fact, it was the introduction of syndicalism that brought about the phenomenal growth of anarchism in Spain. Over the course of the next two decades, anarchosyndicalism became a mass movement, with its membership peaking at over 1.5 million members during the Spanish Civil War (1936–1939).

Marxism Challenged

The anarchists were not the only ones to challenge the view that socialism was synonymous with Marxism. Toward the end of the nineteenth century there emerged several strands of “new” socialist thinking that developed outside the Marxist tradition. The most important of these was the brand of socialism known as Fabianism, which became an important movement in Great Britain after 1889. Originally comprised almost exclusively of upper-middle class intellectuals—notably, George Bernard Shaw (1856–1950), Annie Besant (1847–1933), and Beatrice Webb (1858–1943), and Sidney Webb (1859–1947)—the Fabian Society advocated a nonrevolutionary form of socialism that was shaped more by the ideas of Herbert Spencer (1820–1903), Jeremy Bentham (1748–1832), James Mill (1773–1836), and John Stuart Mill (1806–1873) than it was by those inspired by Karl Marx. Unlike the Marxists, who saw historical progress in terms of class conflict, the Fabians conceived of society as an organism that evolved gradually over time. Socialism was, in their eyes, a natural outcome of social development, but one that needed to be guided by enlightened thinkers like themselves. Drawing upon their faith in positivist principles, the Fabians were convinced that a “scientific” approach to the study of social phenomena would produce an effective strategy for constructing incrementally a socialist society. By insisting that socialism could be achieved in a peaceful way, the Fabians set themselves against the Marxian parties of the Second International who conceptualized social change in terms of a dialectical struggle.

Revisionist Controversy on the Continent

The greatest challenge to Marxism at this time, however, came not from without but from within the Marxian current of socialism. Beginning in the late 1890s a diverse group of so-called revisionist thinkers increasingly questioned the validity of a number of fundamental Marxist tenets. They particularly objected to how rigidly Marx’s doctrine was being interpreted by his epigones in the Second International. The foremost theoretical spokesman of the revisionist movement was Eduard Bernstein. Bernstein was a German social democrat whose views on socialism had been influenced by his extended sojourns in Switzerland and particularly in England, where he became familiar with the views of the early Fabian Society. While his own theory of socialism differed from theirs, Bernstein nevertheless shared many of the Fabian beliefs, including the notion that socialism could be achieved by

nonrevolutionary means. In a series of articles that first appeared in *Die Neue Zeit* between 1896 and 1899 and later published in the book *Evolutionary Socialism* (1899), Bernstein laid the foundation for a revisionist challenge to Marxist ideas that had long been regarded as sacrosanct. Above all, Bernstein’s writings were meant as a corrective to some of Marx’s fundamental economic suppositions—his theory of surplus value, for example—as well as to some of his a priori claims, such as his prophecy that, by virtue of its inherent contradictions, the cataclysmic end of capitalism was inevitable. From his own observations of general economic and political conditions at this time, for example, Bernstein concluded that class tensions were easing rather than intensifying. Instead of becoming increasingly poorer, Bernstein asserted that available statistical measures indicated that workers were generally enjoying higher living standards. By further arguing that the state should be used as a vehicle for abolishing all class privileges and promoting democratic rights, not just for workers, but for all groups in society, Bernstein also ran afoul of his colleagues in the Marxist-dominated sections of the German Social Democratic Party (known by the German acronym SPD) who maintained that the working classes alone should benefit from the advent of socialism.

Bernstein’s intellectual assault on the reigning orthodoxy of Marxist thinking set in motion a series of debates and discussions within the Second International that did not die down until the onset of the World War I (1914–1918). Leading the opposition to Bernstein’s revisionism were Karl Kautsky, the foremost interpreter of the writings of Marx and Engels at this time, and Georgy Plekhanov, the principal architect of the Russian Social Democratic movement. Both attempted to defend what they regarded as the core principles of Marxism by contending that Bernstein had failed to grasp Marx’s basic notions about the relationship between economics and politics and that the antirevolutionary policies implied by his revisionism rendered socialism completely unnecessary. In the former case, for example, Kautsky explained that socialism would come about, not as a result of the increasing pauperization of the working classes, but as a result of sharpening class divisions, which were inevitable and therefore unavoidable features of historical development.

In reaffirming their faith in the immutable principles of Marxism, Kautsky and other antirevisionists hoped that they could prevent socialism from deviating from its revolutionary path. Yet despite their commitment to this understanding of socialism, the fact is that the majority of groups affiliated with the Second International at this time were already pursuing reformist policies. In France, Spain, Italy, and even in Germany the social democratic parties preferred the ballot box to confrontational tactics as a means of advancing their cause. In most instances this entailed working in cooperation with rather than against the middle-class parties that dominated political activity in the various Western European countries where socialism had an important following. Thus, Jules Guesde (1845–1922), the leading figure in the Marxist branch of the French socialist movement, was so committed to the idea of achieving socialism through peaceful means that he advocated parliamentary collaborationism. Another key French socialist

in pre-World War I period, Jean Léon Jaurès (1859–1914), was equally convinced that theoretical concerns should be subordinated to the tactical needs of the movement. He therefore thought it possible to retain his commitment to revolutionary Marxism while at the same time promoting a democratic path to socialism.

There were other socialist thinkers around this time who did not necessarily draw reformist conclusions from their critique of Marxism. Georges Sorel (1847–1922) was a French socialist who had come to Marxism late in life. Within a few years of his conversion, however, Sorel was ready to reject the scientific pretensions of Marxist doctrine as well as the reformist policies of the French socialist movement in order to embrace a form of revolutionary syndicalism. In his most famous work, *Reflections on Violence* (1906–1908; English trans., 1912), Sorel set forth a philosophy of syndicalism that stressed the importance of violence (by which he meant rebellion against existing institutions) in the workers' moral and economic struggle against capitalism. According to Sorel, the revolutionary élan of the workers needs to be sustained by the "myth of the general strike" or poetic vision of the coming epic showdown between workers and their oppressors.

While Sorel himself was not directly involved in the working-class movement, his ideas contributed to the growing body of left-wing syndicalist theories that had been developing since the late 1890s in countries like Belgium, Holland, France, Italy, and Spain and that would continue to exercise a profound influence on trade union development in those countries until the outbreak of World War II (1939–1945).

Socialism versus Communism

The two events in the twentieth century that had the greatest impact on the course of international socialism were the World War I and the Russian Revolution (1917). The outbreak of hostilities in Europe in 1914 brought to an abrupt halt the numerous theoretical debates inside the socialist movement that had been raging up to that time. The war also dispelled the notion held by nearly all socialists that, irrespective of doctrinal differences, socialist parties everywhere were united by a common goal (the overthrow of capitalism) as well as by their internationalist outlook.

The Russian Revolution of 1917 that brought the Bolsheviks to power had even more far-reaching consequences for the development of socialism. First and foremost, it signaled an end to Marxism as it was generally understood by most socialists up to 1917. This was not least because the epicenter of Marxism was transferred from Western Europe to the east and would remain there for the greater part of the twentieth century. In its new surroundings, Marxism would be widely referred to as *communism*, a term that was adopted in 1919 by V. I. Lenin (1870–1924) and the Bolsheviks in order to distinguish their movement from the so-called infantile revisionist socialism that had come to characterize the Second International. With the founding of the Soviet Union in 1924, the division between socialism and communism was formalized and made permanent. From this point on, socialism moved along two very distinct paths. One was defined and

largely controlled by the Soviet communists and the other followed a course that was defined by the pluralistic socialist traditions of Western Europe. Because the story of communism occupies a distinct chapter in the history of socialism in the twentieth century, it is not our intention here to summarize the main features of that movement. Instead, we will proceed with our survey of European socialism after the advent of communism.

Socialism in the Interwar Period, 1919–1939

The trauma and physical destruction that resulted from the World War I created widespread political and economic instability in Europe. Established political traditions and practices were the first to be challenged in this uncertain environment, first by the communists who sought to build upon the revolutionary experiences of Russia, and then by radical right-wing factions and fascists, who set themselves against both liberal democrats and left-wing parties. In these circumstances, socialists of the social democratic variety fared poorly. In most countries, socialist parties had barely recovered from their setbacks during the war when they were met with crises caused by the aforementioned groups. On one level, the communists forced socialists to adopt either the Russian Revolution as their standard or the reformist model that still prevailed in most European social democratic movements. The result was disastrous in countries like Italy and Germany, where a divided left made the socialists and communists more vulnerable to their more unified opponents on the right. The fascists were particularly adroit at playing on the weaknesses of the socialists. By the mid-1930s socialists everywhere were either in retreat in the few democratic countries that had survived the aftershocks of the war or driven completely underground by the authoritarian and totalitarian one-party states that had come into existence across Continental Europe.

Socialist participation in the communist-inspired Popular Front was an electoral strategy during the mid-1930s that was meant to check the rapid advance of fascism and other antidemocratic movements that were gaining ground at this time. In both Spain and France, for example, socialists played a pivotal role in forging a political alliance that embraced a wide spectrum of left and liberal factions. However, in Spain the Popular Front government formed in February 1936 was short lived, as civil war broke out in July. In France, Léon Blum's (1872–1950) socialist-led Popular Front coalition also enjoyed only limited success between 1936 and 1938. In this brief period, Blum managed to push through a number of social reform measures, such as the implementation of the forty-hour work week, before his government succumbed to the pressures of its conservative and pro-appeasement rivals.

The outbreak of yet another general war in 1939 marked the beginning of a seven-year hiatus in the development of socialism. When the war ended in 1945, socialist parties found themselves struggling against a number of currents. On the one hand, they were confronted by the spread of communism throughout the greater part of East and Central Europe. The strangle-hold that Joseph Stalin (1879–1953) had secured over the postwar regimes that emerged in this region between 1946 and 1949 effectively smothered the development of any

independent socialist movement for the next few decades. Under immense pressure from Moscow, social democratic parties were forced to disband and amalgamate with the communist parties loyal to the Soviet Union.

Except in Great Britain and the Scandinavian countries—where social democratic parties were in the ascendant—circumstances in much of Western Europe also conspired against a general revival of socialism. The right-wing dictatorships in Portugal (Antonio de Oliveira Salazar) and Spain (Francisco Franco) survived the war and both governments maintained their ban on left-wing parties for the next few decades. The postwar difficulties socialism faced elsewhere in Europe were compounded by the onset of the Cold War. Because the political and economic stability of the pro-capitalist nations remained in doubt in the immediate aftermath of the war, socialism was generally viewed with suspicion by the electorate. This was partly because socialists in Italy and France tended to form alliances with the Moscow-oriented communists, and partly because of the growing dependency of many European nations on the economic and military support of the United States. In fact, the United States made it clear to the newly restored postwar regimes that, because Europe was now divided into mutually hostile ideological blocs, it would not tolerate the idea of socialists and communists forming government coalitions outside the Soviet umbrella.

There were further reasons why socialism failed to make inroads into the political arena at this time. One was connected with the cultural and ideological shifts on the liberal and conservative end of the political spectrum that had taken place in Europe since the Great Depression and World War II. The economic problems thrown up by the Depression had caused many liberals to revise their views regarding the state's role in the economy. The mixed economic model for capitalism promoted by the liberal economist John Maynard Keynes (1883–1946) gained currency at this time, and this trend in economic thinking was generally reinforced during the war, when the collectivist practices of the state were deemed both necessary and desirable by the majority of the population. At war's end, the consensus among liberals and conservatives was, at least for the time being, the state would have to play a major role not only in bringing about the political and economic recovery of war-torn Europe but also in sustaining the social welfare of the general population during this critical period of transition.

While the socialists stood to gain much from this development, they failed to win popular backing at the polls for policies with which they had long been identified. This was due in part to their own miscalculations—such as their insistence on forming alliances with the communists—and in part to the fact that the socialists' general political outlook was woefully out-of-date. With few exceptions, social democratic parties in Europe were reluctant to refashion the theoretical content of their political programs. For example, most still looked to the working classes (trade unions) as their main constituency and most retained a nostalgia and even reverence for the Marxist ideological underpinnings of their movement.

Despite these shortcomings, socialist parties continued to occupy an important place in the political arena. This was

especially true in countries like Sweden, where the social democrats (SAP) dominated politics for the greater part of the twentieth century, and in Great Britain, where the Fabian style of pragmatic reformism of the Labour Party has won out over other forms of socialism.

The cultural ferment associated with the 1960s and early 1970s helped to inject some new life into socialist doctrine. The left-wing radicals who spearheaded protest movements in this period turned a fresh eye to the historical and ideological roots of socialism. In doing so they helped to resurrect themes that had lain dormant for many years but that now appealed to the intellectually diverse postwar generation of leftists. Perhaps the most important of these was the question of women's role in the socialist movement. From its origins, socialist thinking had been concerned with the fate of both men and women. Yet, apart from Charles Fourier, August Bebel, Friedrich Engels, Edward Carpenter (1844–1929), and a handful of other theorists, socialists tended to ignore specific questions relating to sexuality and gender. Indeed, all of the classical socialists who addressed the woman question, such as Engels did in his *Origin of the Family, Private Property and the State* (1884), regarded women as proletarians in the household and thus did not, as twenty-first-century socialist feminists do, view gender as distinct from class. Fewer still thought it necessary to transform socialist practices so that they matched the profeminist rhetoric of their movement. It was against this background that a new generation of socialist thinkers began their campaign to infuse socialism with feminist values and beliefs. The research of socialist feminists like Sheila Rowbotham and other historians of gender revealed that women played a much greater role in the development of socialism than had hitherto been acknowledged. Up until this point, Flora Tristan (1803–1844), Vera Zasulich (1851–1919), Rosa Luxemburg (1871–1919), Alexandra Kollantai (1873–1952), Dolores Ibárruri (1895–1989), Clara Zetkin (1857–1933), Beatrice Webb, and other notable activists had rarely received the kind of historical attention that was commensurate with the contributions they had made to socialist theory and practice. For example, it was not until the late 1960s that the prominent role that Luxemburg played in the key debates and discussions within European socialism during the first decades of the twentieth century became widely recognized by the scholarly community. Beside making her mark as a theorist during the revisionist controversy in *Reform or Revolution* (1899), Luxemburg became famous during World War I for leading the socialist opposition to the war in Germany. By the time of her death in 1919, the year she helped spearhead an ill-fated coup against the provisional Weimar government, Luxemburg had also established a reputation as a critic of the authoritarian policies of the Leninist brand of revolutionary vanguard Marxism. While the theoretical differences between her and Bolsheviks such as Lenin and Trotsky should not be exaggerated, Luxemburg always stood for a more open and democratic interpretation of socialism than did her Russian counterparts. No less important was the light that gender-sensitive research cast on the role that anonymous women in the past and present played not only in building socialism through their participation in grass-roots associations but also in broadening female participation in the public sphere.

Besides seeking to revise the historical record, socialist academics, writers, and activists in the women's liberation movement were also interested in changing the attitudes and perceptions that the majority of socialist men held of women. Socialist feminists pointed out that, while most men endorsed pro-feminist principles, they nevertheless tended to see women in sexist terms. For example, few concerned themselves with issues—child care, birth control, sexual expression, among others—that directly affected their wives, sisters, mothers, and female friends. Nor were they alive to the second-class status to which women were consigned in the workplace, where gendered divisions of labor prevailed, and in society generally, where male dominance was both profound and pervasive. The degree to which socialist feminists were successful in their endeavors is hard to measure. There can be no question that their efforts to place the women's question high on the socialist agenda and their insistence that "the personal is political" contributed in a number of ways to the rejuvenation of the theory and practice of a doctrine that was increasingly out of step with the realities of late twentieth century society. Nonetheless, the legacy of socialist feminism is mixed. Though it failed to bring about the much sought after gender reorientation of a number of socialist parties, socialist feminism can be credited for greatly advancing the ongoing struggle for women's rights. Contemporary feminists are above all indebted to this movement for having raised society's awareness of the multiple ways in which gender relations affect the daily lives of everyone.

Socialism at the End of the Twentieth Century

In the closing years of the twentieth century, socialism experienced further transmutations. On a practical level, socialist parties tended to resemble each other more and more, though this was not necessarily due to a closer collaboration among the various socialist parties. Ever since the demise of the Second International in 1914, socialists had all but abandoned the idea of using an overarching body to coordinate the policies of the various national socialist parties. The largely inert bureau of the Labour and Socialist International (LSI) met for the last time in April 1940, and it was not replaced until 1946. The onset of the Cold War after 1948 forced changes within the LSI that resulted in the creation of a new organization, the Socialist International (SI), in 1951. Echoing the realities of the postwar era, the executive council of the SI made clear to all its members that it would "put an end to the equivocation of parties which want to belong to our socialist group while in fact obeying directives from Moscow." Apart from reaffirming the European socialist parties' commitment to democratic socialism, the SI provided intellectual and moral support to the socialist parties that had been forced underground in antidemocratic regimes of Western Europe or were threatened by communist influence in the non-aligned movement countries. It was particularly successful at assisting the resurrection of socialism in Portugal (1974) and Spain (1975) when democracy returned to those countries in the late 1970s. During the 1980s, the SI continued to expand its influence in Europe and in parts of the Third World, though, in an age when nationalist feelings greatly diminishes the spirit of internationalism, its relevance to the future development of socialism remains an open question.

Partly in response to the electoral successes of their ideological opponents on the right, during the mid-1980s socialists throughout Europe began questioning their longstanding commitment to socialization policies, such as social welfare and public ownership (nationalization). And though a small core of purists refused to abandon the transformative goals of their doctrine, the vast majority of socialists elected to office in this period believed that social justice and equality could best be achieved by adopting the principles and practices of neoliberalism. As a result, the notion of what it meant to be a socialist underwent significant revision, with some critics arguing that the pre-capitalist values of "credit card" socialists made them indistinguishable from their liberal and conservative rivals.

Those who belong to the generation of socialists alluded to here are widely known in the early twenty-first century as *social democrats*, a label that refers to their commitment both to parliamentary democracy as well as to the principles of market socialism. According to this model of a mixed economy, the government should play a role in overseeing the ownership of certain enterprises (e.g., utilities and public transportation) but would allow market forces to determine the allocation of their goods and services. While the social democrats insist that their policies are aimed at implementing the classic socialist ideals of social justice and economic equality for all, they do not subscribe to the age-old socialist belief that holds that the state should function as the sole vehicle for achieving these much-desired goals.

The theoretical and policy shift that were identified with the social democratic movements of the 1980s greatly contributed to a reversal of the political fortunes of socialist parties in several countries. In Spain and France, for example, the socialists dominated national politics throughout the 1980s. The ascendancy of the New Labour Party movement in Great Britain during the late 1990s and early years of the twenty-first century seems to have signaled a further shift of socialist doctrine away from its historic ideological foundations.

The rightward drift of socialism in the last decade of the twentieth century was given even greater emphasis following the collapse of communist regimes in East Central Europe in 1989 and the Soviet Union in 1991. With communist ideas largely discredited the socialists' doctrinal links with Marxism were completely severed. The intellectual preoccupations and foci of the post-Cold War era promise to erode further the core elements of socialist ideology.

It is evident from the foregoing account that socialism has been in a state of flux over the course of the past two centuries. Socialism in the twenty-first century cannot be located on the same ideological map that it occupied as a revolutionary theory in the nineteenth and greater part of the twentieth centuries. Whether it will continue to change or cease to exist as a distinct ideology remains to be seen. But whatever its fate as a doctrine, socialist ideas and values are so integral to Western political traditions that they will no doubt continue to find expression in an ever-changing political landscape.

See also Anarchism; Capitalism; Communism; Marxism.

BIBLIOGRAPHY

PRIMARY SOURCES

- Bebel, August. *Woman under Socialism*. New York: Socialist Literature, 1917.
- Bernstein, Eduard. *Evolutionary Socialism: A Criticism and Affirmation*. Translated by Edith C. Harvey. Introduction by Sidney Hook. New York: Schocken, 1961 Reprint, 1967.
- Engels, Friedrich. *Anti-Dühring*. London: Lawrence and Wishart, 1969.
- Kautsky, Karl. *The Class Struggle*. Translated by William E. Bohn. Introduction by Robert C. Tucker. New York: Norton, 1971.
- Kropotkin, Peter. *Revolutionary Pamphlets*. Edited by Roger N. Baldwin. New York: Dover, 1970.
- Manuel, Frank E., and Fritzie P. Manuel, eds. *French Utopias: An Anthology of Ideal Societies*. New York: Schocken, 1971.
- Marx, Karl. *Manifesto of the Communist Party*. Introduced by Harold J. Laski. London, 1948.
- Owen, Robert. *A New View of Society; and Report to the County of Lanark*. Edited by V. A. C. Gatrell. Harmondsworth, Middlesex, England: Penguin, 1970.
- Sorel, Georges. *Reflections on Violence*. Translated by T. E. Hulme and J. Roth. Edited by E. A. Shils. Glencoe, Ill.: Free Press, 1950.
- Webb, Sidney. *The Fabian Society: its Objects and Methods*. Notts., U.K.: Stafford, 1891.

SECONDARY SOURCES

- Berki, R. N. *Socialism*. London: Dent, 1975.
- Cole, G. D. H. *History of Socialist Thought*. 7 vols. New York/London: Macmillan, 1957–.
- Derfler, Leslie. *Socialism Since Marx: A Century of the European Left*. New York: St. Martin's, 1973.
- Eley, Geoff. *Forging Democracy: The History of the Left in Europe, 1850–2000*. Oxford and New York: Oxford University Press, 2002.
- Giddens, Anthony. *The Third Way: The Renewal of Social Democracy*. Cambridge, U.K., and Malden, Mass.: Polity Press, 1998.
- Kolakowski, Leszek. *Main Currents of Marxism: Its Rise, Growth, and Dissolution*. 3 vols. Translated by P. S. Falla. Oxford: Clarendon, 1978.
- Lichtheim, George. *A Short History of Socialism*. Glasgow: Fontana/Collins, 1975.
- Lindemann, Albert S. *A History of European Socialism*. New Haven/London: Yale University Press, 1983.
- McLellan, David. *Karl Marx: His Life and Thought*. London: Macmillan, 1973.
- Rowbotham, Sheila. *Hidden From History: 300 Years of Women's Oppression and the Fight Against It*. London: Pluto Press, 1973. Reprint, 1996.
- Sassoon, Donald. *One Hundred Years of Socialism: The West European Left in the Twentieth Century*. London: I. B. Taurus, 1996.
- Wright, Anthony. *Socialisms: Theories and Practices*. Oxford and New York: Oxford University Press, 1986.

George Esenwein

nineteenth century. African socialisms represent various combinations of African thinkers, politicians, and activists' absorption with and reconfiguring of nineteenth- and twentieth-century European socialist ideas and practice. The sources are multiple, from trades unions and contact with European workers, to affiliations with European political parties, and through contact with Pan-African (West Indian and African-American) radicals. Many African thinkers and movements have identified with various strands of social democratic and Marxian forms of socialism, seeking to indigenize them to Africa.

The rise of African socialisms as a movement coincides with the early phases of nationalism and national development, the high point of which was the non- nonaligned movement and Third Worldism. African socialism as practice began with the first self-proclaimed socialist-nationalist revolution in Africa, Gamal Abdel-Nasser's (1918–1970) 1952 Officers Coup in Egypt; and intended with globalization meeting South Africa's thwarted redistributive social democracy.

All African socialisms shared overlapping features that provided bases for nationalism and approaches to postcolonial development and nation building. First, was a combination of state ownership, an equitable distribution of wealth, and increasing citizen well-being; second, was the urgency of conquering underdevelopment, of "catching up"; third, was creating relevant noncapitalist institutions that would shape economic development; and fourth was creating well-balanced social relationships of citizenship that could establish cohesion between people and the state.

Prior to the 1917 Bolshevik Revolution in Russia, socialist ideas and practices were mooted among sections of the African middle and working classes. The *Sierra Leone Weekly News* in 1913 compared union-based socialism in industrial Europe with the supposed hallmark of an indigenous socialism, African "hospitality," auguring in sentiments (and myths) subsequently invoked by African Socialist-nationalists and political leaders. Striking laborers and clerks in Lagos in 1897 had neither socialist ideas nor organization to mobilize them against low wage labor policy for Africans, yet African socialist movements begin with the development of a modern work force.

Where industrial capitalism had penetrated more deeply in Africa, as in South Africa, Egypt, and Algeria, burgeoning workers and trade union movements would become subjects of communist and socialist ideas. Established primarily by settler, expatriate or European unionists and intellectuals, these movements learned their socialism in metropolitan-based parties. Striking white miners between 1906 and 1907 and from 1913 to 1914 in South Africa would beckon the call of (white) trade unionism and socialist organizing and practice, as would black workers in 1918. Socialism's claim to social justice would uniquely shape South Africa's national experience, where a class divided by race would force the national question to the center of discussions about the nature of socialism and independence in South Africa.

The first communist party in Africa (and in the Arab world) was formed in Egypt in 1921, where textile and transportation workers became the subject of communist attention after

SOCIALISMS, AFRICAN. Socialist ideas have been in Africa before the advent of colonialism at the turn of the

World War I. The general orientation of Egyptian Marxists and socialists was directed to the Arab world, which would persist into Nasserism. Egyptian communism remained small; having a large impact upon intellectual Marxism, debating many important questions about socialism in a backward country; it had little impact upon Egyptian politics and was unable to develop a mass following among a large indigenous working class, a well-developed trade union tradition, and millions of Egyptian peasants, or fellaheen. The party eventually disbanded in 1965 through in-fighting and Nasser's repression.

Until the formation of the 1970s Afro-Marxist regimes, movements espousing revolutionary Marxism were nonexistent. An exception was one the large metropolitan, European dominated, Algerian Communist Party, formed in 1936. By the 1950s it had disgraced itself by constantly placing the French interests above Algerians'. Two other exceptions were Sudan Communist Party and the South Africa Communist Party (SACP). In the early twenty-first century the SACP remains numerically strong, while the large Sudanese Communist movement, founded in 1946 under the influence of Egyptian Marxists, played a role in the nationalist movement, retaining significant influence in Sudanese politics before General Gafur Nimeri's murderous purges in the early 1970s.

Marxist influence would find homes within African socialism. Soviet and Chinese communism were benchmarks of socialism throughout colonialism, nationalism, and the formative years of national development. With few exceptions, like self-management in Algeria (1960–1965), alternative or academic socialisms had little foothold in Africa. If communist party formation was prohibited during colonialism, many independence parties (especially in Francophone Africa) were modelled on communist parties. Many African leaders, even when seeing communism as threatening, were impressed by the rapidity of its modernizing achievements through centralization, planning, and the one-party state. The Cold War also demanded positions on communism; most African states preferred charting unaligned vistas between it and Western capitalism.

North African, "Arab" Socialisms

Nasserite Egypt (1960–1974), Bourguiba's Tunisia (1954–1986), Algeria from Ahmed Ben Bella's and Boumediene's through the reforms of the mid-1980s Qaddafi's Libya (1969/1977–) represented the beginning and end of North African socialisms.

Like the Cold War, the Egyptian Young Officer's coup would prepare a template for much of the continent's independence with its one party, state capitalist socialism; it also demonstrated efficacy in achieving power through armed force. Originally hostile to socialism, Nasser eventually used "Arab" socialism to rationalize confiscating large landed estates, foreign nationalizations, and outlawing political and religious opposition, all identified with holding back national development. A trademark of African socialisms was invoking development in the "people's" name, and populist state capitalist socialism became a practice of legitimation. The imperative of rapid economic and social development through planning was put forward as guaranteeing modernization and equitable

redistribution that only the state could be charged with. Multiparty democracy was viewed as a disruptive extravagance the progress of the "people's" developmental state could ill afford, and trade unions, once a ground of radical support, were expected to have no role other than to support the aims of the state.

One finds similar rationalizations in all other North African socialisms, despite differences over, for instance, the extent to which there was a need for the state to own socialized property, rather than direct the redistribution of wealth. In Habib Bourguiba's modernist appeal to socialism at independence in 1956 through the Tunisian nationalist Neo-Destourisme; in Algeria's attempt to come to terms with the reconstructive aftermath of a brutal war of independence, in the response to the chaos of the early years under Ahmed Ben Bella's (1918–) chaotic self-management; and Houari Boumediene's (1965) coup, auguring in "Real Socialism," the rationalized normalizing of the revolution combing technocratic development through state-led industrialization; as well as Ghadafi's coup and eventual 1977 announcement of Jamahiriya (the "people's" state) socialism for Libya. In their different ways, each sought to balance national identity as Islamic, with the demands of modernizing under the quasi-secularist nationalizing, one-party state. Each feared fragmentation, and each sought centralized political and economic control to overcome it. Each restricted political parties, undertook a more or less centralized state for fear of unfettering dormant interests uniting around religion, class, and ethnicity. All claimed to have modern egalitarian and equitable ends, and all wanted to justify themes consistent with religion, while keeping the ulema and conservative classes allied with them under control, ensuring religion did not interfere with its national cohesion and national development.

Only Ghadafi clung to fictionalizing socialism's name as real; by the early twenty-first century Tunisia had abandoned all simulation, embarking on the most controlled secular march toward modernizing the society and the economy; while Algeria continued to live with the effects unleashed by the (1978–1991) economic and political liberalization, forces repressed by one-partyism. From the breakdown of the state from ethnic loyalties to the violence of Islamist backlash in the face of annulled elections in 1993, the facade of socialism was all but forsaken.

African Socialists

Nkrumah's Ghana (1957–1966), Ahmed Sékou Touré's Guiné (1958–1984), Modibo Keita's Mali (1960–1968), Julius Nyerere's Tanzania (1960–1985) Leopold Sédar Senghor's Senegal (1960–1981), and Kenneth Kaunda's Zambia (1964–1991) are the primary exemplars of "south of the Sahara" African socialisms.

African socialists were nationalist-politicians who believed the anthropologically problematic idea of a long-established ethos within the precolonial community's traditions of extended family networks of social mutualism, social egalitarianism, and a consensus system of political order. This order could be modernized but able to avoid conflicts inherent in European class

societies, as in Tanzania's Julius Nyerere's (1922–1999) vision of a policy of education for self-reliance that would enable a willing peasantry to accept collective decision-making in villages organized by the state. Ghana's Kwame Nkrumah (1909–1972) is often identified as the major figure, not because he was the most original; nor because of his execution of socialism when in power. It lies, rather, in his posthumous stature among Pan-Africanists and because he left a corpus of writing after his overthrow in 1966 that identified his credentials as a reborn radical. While in power, however, his political policies followed a familiar trajectory of one-party socialism—the imprisonment of the opposition, the banning of strikes by the same unions he would demand take up the cause of revolutionary socialism after his overthrow. There is little in his thought or, indeed, in much of his practice that to varying degrees, one cannot find in Mali's Modibo Keita (1915–1977) or in Guiné's Ahmed Sékou Touré (1922–1984), or for that matter much that is different in the North African socialist variants. In the case of Touré, he claimed that because prior to Guiné's independence in 1958, colonialism's inability to create class antagonisms was because extensive private ownership barely existed. The Africanization of Marxism could begin by building upon the supposed solidarity of a precapitalist caste-based society. His early, distinctly radical rule tried to create the cadres for a socialist revolution. As his policies failed, Touré responded with greater centralized rule and fiercer social oppression, which was mirrored in a collapse of the economy and livelihoods in Guiné.

Consistent with notions that the one-party state was best suited to carry out nation-building and development tasks, after independence Modibo Keita promptly moved to declare the Union Soudanaise Independence Party the single party of the Malian state, pursue a socialist policy based on extensive nationalization, and court both the Soviet Union and China. Malians were constructing socialisms through choosing the best from their Islamic past, where duties to the weakest and poorest in society were part of Afro-Islamic egalitarianism. Keita genuinely believed economic and financial decolonization from France and the establishment of socialist structures throughout the country. To this end, from 1961 before his overthrow in 1968, Keita's regime would maintain the necessity of structural sectorial reforms.

In contrast, Leopold Sédar Senghor (1906–2001) was a pragmatist for whom socialism was a cultural vision. Less interested in immediate structural transformations in the economy, he was more interested in an identification of the alleged mores of African societies, which, he claimed, were forms of social humanism. For Senghor, African socialism as culture never translated, except pragmatically, into much more than a cultural disposition that could modify some of the more corrosive values of western individualism. There were never the attempts at the large-scale socialization of production found among the more radical African socialists, in part because of the intimate economic and cultural relations Senegal had with France, and also because of the various conservative members of coalitions that supported the ruling Union Progressiste Sénégalaise (UPS), especially the Islamic Brotherhoods, who maintained some control over much of Senegal's main export commodity, groundnuts.

Political compromise rooted in production and key resources made political commitments appear rationalizations. So, Kenneth Kaunda's (1924–) eclectic African humanistic justification of state nationalization and state welfare through bringing together elements of Christian and Fabian socialisms allied with a selective liberalism was joined to a putative African collectivism. If it appeared well meaning, it could also appear a rationalization of state patronage through Zambia's major industry, copper: accumulation by political elites through nationalization. Profiting from soaring copper prices on world markets for over a decade after independence, many urban Zambians benefited from state subsidies and an expanded welfare system. Less than a decade later, however, these services shrunk under the burden of low world commodity prices and accumulated debt, revealing that the socialization means of production benefited a freeloading bureaucracy that contributed little but their vacancies.

Between 1965 and 1977, Nyerere's *ujamma* (familyhood) socialism was the highest profile African socialism and development. Initially meant to promote an egalitarian ethos, and a way of forestalling the development of classes and inequality, it failed because of a long price depression for its export commodities, costs sustained in removing Idi Amin from power, and the inability for the state to genuinely understand the needs of its peasantry. Peasants, the supposed source of *ujamma* modernization from below became subject to state-sanctioned bureaucratized replacement of traditional rural households with the forced displacement of nine million rural dwellers into planned resettlement “development” villages.

Nyerere said that villagization was not socialism but a technical decision concerned with the concentration of resources in settlements with little input from the peasantry; socialism and its full appreciation would come later. They never did. Very much reliant upon foreign aid for development programs, Tanzania was anything but self-reliant. After a decade of economic failure, and compelled by the demands of international financial institutions (IFIs) to adjust and stabilize its economy, by the time he left office in 1985 there was no more African socialists.

Afro-Marxism

Marxist socialisms grouped under the rubric of Afro-Marxist regimes, which came into and out of existence between 1963 and 1995, primarily coming to power through military coups. They include Congo's Masekela-Debat to Sassou Nguesso (1963–1991), Ethiopia under Mengistu Haile-Miriam (1974–1991), Somalia under Siad Barre (1969–1991), Mathieu Kérékou's Benin (1972–1991), and Didier Ratsiraka's Madagascar 1975–1993, 1997–). Also included is Zimbabwe's Robert Mugabe (1924–), who came to power through armed struggle and subsequent elections, and who also used Marxist-Leninist rhetoric. African “scientific socialisms” only real affinities to Marxism-Leninism and most practicing African socialism were one-partyism, the nationalization of industries, and authoritarianism. There were also Marxists, like the Cap Verdian Amílcar Cabral (1924–1973), the Angolan Augustinho Neto, and the Mozambiquans Eduardo Mondlane and Samora Machel, whose successors came to power inheriting very

unstable states in the violently uneven and unresolved Lusophone national liberation struggles. All regimes accepted some alliance with the Soviet Union. The one actual social revolution, which sought to socialize production and attempt to actually transform society, was the Ethiopian Revolution (1974), which was also the most bloody, killing thousands in its wake. Afro-Marxists also came into existence at a time when there was a revivification of Third Worldism, but also at a time when world markets were contracting, and debt was beginning to grow.

Afro-Marxism's rhetoric and practice were divorced from the realities they enforced themselves upon. Few understood, even cared to understand, both peasant life and the ethnic environments within which they inhabited. The exceptions were the assassinated leaders, Cabral and Eduardo Mondlane (1920–1969). For both Marxism had little utility unless it allowed activists and peasants alike to understand their worlds as ends to participation and well being, and both felt that understanding the materially cultural aspects of the populations that sought liberation was practically and normatively important. Striking about all of Afro-Marxist regimes is how easily they either collapsed or so easily altered themselves from Marxist-Leninist parties to liberalizing recipients of neoliberal adjustment policies. The regimes and leaders that did not collapse transformed themselves into devotees of the advice offered by (IFIs). Often leaving a bloody bequest of failure and death, these regimes' rhetoric was as deep as their commitment to actually revolutionize the relations and forces of production.

Conclusion

Whether Marxist, social democratic, or state-capitalist, African socialisms reflected diverse political economies and politics, covering theoretical intents, ideological perspectives, political movements, cultural and regional orientations, revolutionary struggles, and formerly actually existing socialist states. Over half of Africa's states have celebrated themselves as socialist or social democratic, have identified socialism in the pages of their liberation charters, and/or have retained "socialist," or socialism in their constitutions.

Like most other African political systems, African socialisms failed to meet people's aspirations and needs. They sometimes employed opportunistic and brutal ambition to thwart people's wishes for greater freedoms and choices over the nature and status of their needs. Equally, they frequently had their hopes aborted as casualties of Cold War realpolitik and vacillating economic desires of a world capitalist system.

African socialism's prospects look inauspicious. The wave of post-1970s, liberalization, and the collapse of the regimes, or death of many important leaders associated with African socialism's preeminence and disgrace, also saw many of these socialisms go with them. Increasing constraints of economic deprivation and debt, the imposition of adjustment and stabilization, and the demand, internally and externally, for greater pluralism and political choice, further limit prospects for renewal. African socialism became a consensus metaphor for failure—of the centralization, authoritarianism, and inefficiencies of state malfunction. The history of socialism in

Africa suggests much failure and a history of false promises; it also suggests, however, that those failures arise from development failure, a failure not generic to Africa and not to socialism alone. African socialism was a history of intent; as such it should also be remembered as past optimism for what it promised, even where it couldn't fulfill it.

See also **Socialism**.

BIBLIOGRAPHY

- Bénot, Yves. *Idéologies des indépendances africaines*. Paris: Maspero, 1969.
- Boele van Hensbroek, Pieter. *Political Discourses in African Thought: 1860 to the Present*. Westport, Conn: Praeger, 1999.
- Choueri, Youssef M. *Arab Nationalism—A History: Nation and State in the Arab World*. Oxford: Blackwell, 2000.
- Drew, Allison. *Discordant Comrades: Identities and Loyalties on the South African Left*. Aldershot, U.K.: Ashgate, 2000.
- Hughes, Arnold. "The Appeal of Marxism to Africans." *The Journal of Communist Studies* 2, no. 8 (1992): 145-159.
- Idahosa, P. L. E. *The Populist Dimension to African Political Thought: Critical Essays in Reconstruction and Retrieval*. Trenton, N.J.: Africa World Press, 2004.
- Young, Crawford. *Ideology and Development in Africa*. New Haven: Yale University Press, 1982.

Pablo L. E. Idahosa

SOCIETY. The concept of society is in transition due to globalization and the knowledge associated with it. Today's views of society are not altogether new, however. Rather, they are engaged with the rediscovery of the worlds of antiquity. Since the 1970s, scholars have reached to the past to explain mainstay concepts such as society. In this manner, ancient Eastern ideas flood into the current Western perspectives on society. The turn to the archaic East also heightens awareness of the West's own archaic past. Thus the concept of society metamorphoses while it embraces a living past.

Ancient Views of Society: East and West

Until the modern era, China did not have a word for society. The current term *shehui* means an organized assembly. In the ancient world, China utilized the idea of *wenming* (civilization), which literally meant the brightness of culture or the clarity of writing. It also had the idea of *zhongguo* (Middle Kingdom), denoting the middle of the world on a geographical plane and the middle of the universe (between heaven and earth) on a cosmological plane. During the pre-Qin era (third century B.C.E.), Chinese society was a living matrix of ideas and events, of spirituality and materiality. James Sellmann describes this world as "hylozoistic—a living world empowered with *qi* [life force]" (p. 5). As a "foci-field model" or "field cosmology," the pre-Qin society was conceived as an organic complex that changed as the seasons changed.

The Chinese philosophical coupling of yin-yang was an organizing principle that connected the heavens to earth and established all worldly changes. Political decision making relied on proper timing: the right season, the right pitch of the pipes,

the right state of mind. The balance of space and time was the key to harmony in the Chinese dynasties to come.

In highly stratified and patriarchal societies such as the West and Middle East, women might constitute a society within a society. While similar situations existed in the Far East, the harmonizing balance of Chinese philosophy accommodated women throughout history to occupy prominent roles ranging from calligrapher to empress.

In the Roman world, *socius* was a word that meant friend—hence the English word *society* as a modern word related to a community of friends. In the ancient world, one could not get by without friends who shared common values, common work, and common lands. Thus the Roman word *communitas* as applied to society symbolized the collectivity of physical and spiritual relations that bound together a people, as in the slogan *senatus populusque Romanus*—the Senate and the People of Rome. Roman community was bound together by a sense of *civitas* or citizenship as defined by the civil virtues of Rome. The English word *civilization* derives from the Latin and carries the sense of a social, political, cultural, religious, and philosophical whole. The Middle Ages in Europe saw the splintering of Roman civilization into church and state, or into religious and political spheres of influence. As towns began to develop and the world split more visibly into city and country, social philosophers' views on society also bifurcated.

Early Modern Views of Society

When the Jesuits brought knowledge of their explorations into China back to Europe, an organic view of society as a compendium of functioning interdependent parts started to take shape. Although this was a bare shadow of China's sophisticated civilization, it led to a Western idea of a body politic, with the state as the head, the church as the heart, and economy and other social systems as the limbs and organs of society. This organic view had far-reaching implications well into the twentieth century, especially in structural functionalist views of society. Karl Marx (1818–1883), however, regarded these developments as a definitive conflict between the generation of civil society and political community. Civil society developed conflicting classes within it that were regulated by the political community. The contradictions of everyday life were monitored by a state that favored the ruling class, and the state wore a political lion skin for the dominant class. Hence, political relations were often mediated by class relations. Hence, society began to manifest simultaneously both conflictual and consensual components. Society was forever in a state of flux.

With the division of labor, industrialization, and the quest for the development of the nation-state, a new philosophical challenge emerged in the form of one question: What comes first, society or the individual? In the ancient Western world of Greece and Rome, the individual was not so much a factor. Rather, a person made commitments to the virtues of various institutions and traditions such as the family. But with the struggle for the creation of the European nation, especially in France, the concept of the individual greatly challenged definitions of society. On the one hand, the more conservative view of kings retained the idea of society as a given, as a complete whole functioning in accord with the will

of God; individuals would simply obey the laws of society and work to maintain this equilibrium. On the other hand, the more radical views of French revolutionaries saw the individual as the center of the universe with a variety of inalienable rights; society would serve the individual while maintaining the supremacy of that individual through *liberté, égalité, fraternité*—liberty, equality, fraternity—a battle cry of the French Revolution.

Society: Consensus and Conflict

Views of modern Western society tend to fall into two camps: consensus and conflict. Consensus views beginning with the economist Max Weber (1864–1920) and continuing into the structural functionalism of the American sociologist Talcott Parsons (1902–1979) describe society as a complex combination of static and dynamic systems. Weber identified society as a system of potential harmonization, with rational actors choosing the best means to the end of ensuring the smooth operation of society; Parsons discussed the functional and dysfunctional aspects of society as it strives for a dynamic equilibrium through complementary institutional structures.

Marx is still the main proponent of the conflict theory of society, among a plethora of thinkers up to Louis Althusser (1918–1990) and beyond. Marx conceived of society as a kind of shape shifter, culminating in and overcoming moments of conflict through a sequence of class struggles: slavery giving way to feudalism, feudalism giving way to capitalism, capitalism giving way to socialism, socialism giving way to communism. Althusser divided society into repressive and ideological apparatuses. He had a rather pessimistic view of society's transformations because of its ingrained structures of dominance, especially in the overwhelming powers of the modern state.

The philosopher Jürgen Habermas (b. 1929) combined both consensus and conflict theories while exploring a legitimation crisis of modern society struggling for a communicative competence among both institutions and individual actors. These five thinkers—Weber, Parsons, Marx, Althusser, Habermas—still stand as the most prominent models of social scientific thinking regarding society today. What is attractive about their approaches seems to be an ability to connect abstract macro-level ideas about society with more concrete micro-level ideas about individual social actors within the framework of these umbrella systems.

The New Ancient World: Leibniz, Vico, and China

Given the present trend toward global communications, more attention has focused on the origins of concepts of society, especially in the works of pioneering scholars in the relations between East and West. The philosopher Gottfried Wilhelm Leibniz (1646–1716) did not simply rehearse Christian views of Chinese society. Like Giambattista Vico (1668–1744), Leibniz was impressed with the Confucian view of benevolence and the harmonious society that it spawned. Like Vico, he distrusted René Descartes's and Isaac Newton's image of a mechanical universe. Leibniz was indebted to the Jesuit Matteo Ricci (1552–1610), who was similarly open-minded about Chinese philosophical and religious life. Leibniz embraced a Chinese notion of society as a living organism and

popularized this image in Europe. His description of matter applies to society as well: “Thus every portion of matter can be conceived as a garden full of plants or a pond full of fish. But every branch of the plant, every limb of the animal, every drop of its humors, is again such a garden or such a pond” (1965, p. 159). For Leibniz, society was a thoroughly interdependent living entity whose every fiber was connected. Every societal institution was dependent on each other and necessary for a harmonious balance. Since every entity was composed of matter, then matter itself was infinitely interconnected. His idea of monadology was clearly linked to the Confucian idea of *li* (principle, form, pattern) as a primary substance that generated *qi* (primordial vapor or life-energy force), both of which acted upon every aspect of the life-world. He correctly perceived Chinese society as holding to a cosmology that ensured harmonious relations: “Indeed, it is difficult to describe how beautifully all the laws of the Chinese, in contrast to those of other peoples, are directed to the achievement of public tranquility and the establishment of social order” (1994, p. 47). Leibniz so much admired China’s “public morality” and “natural theology” that he referred to it as an “Oriental Europe.”

Whereas Leibniz was influenced by Matteo Ricci, Vico was influenced by another religious friend, Father Matteo Ripa (1692–1746). Ripa had lived for many years at the court of Kangxi, the emperor of China’s Qing dynasty. When Ripa returned to Italy, he brought with him copper engravings of world maps and garden vistas complete with Chinese poetry. Ripa introduced many Chinese scholars along with an abundance of knowledge to Naples, where he established the Collegio dei Cinesi (The Chinese institute). This cross-cultural milieu greatly influenced Vico’s formulation of *Scienza Nuova* (The new science) and his image of society that aimed to give birth to the ancient past in the present.

Vico was interested in myth and language, especially in tracing etymologies of words to their ancient roots and then awakening them in modern contexts. In other words, language was a conduit for the past to become the present. It is language that gives life its poetic character. Hence Vico characterized society in terms of a “poetic cosmography,” a mapping of the world of gods, heroes, and humans. As a humanist, Vico did not believe in the dominance of rationalism through physical and mathematical sciences to the exclusion of the arts of philosophy and history. Through each of these vehicles, humans could attempt to recover the essence of society. This fundamental societal essence is what Vico called “conatus,” a primordial beginning or striving “proper to the human will” (p. 101). Vico endeavored to discover this beginning through various stages of history: the age of gods, the age of heroes, and the age of men. Each held its own nature or birth: divine imagination, heroic nobility, and modest conscience. Likewise, each represented a kind of government: theocratic, aristocratic, and human. Finally, each offered a language: divine poetic, heroic blazoning, and articulate speech. In his linguistic configurations, Vico is clearly indebted to both ancient Chinese and Greco-Roman thought. Divine written characters (hieroglyphs) were used “by all nations in their beginnings” (p. 341). These “poetic universals” were followed by heroic “imaginative universals” that spoke of noble events and then by human words.

The Chinese, for example, retained the number of pictographs in circulation for daily use from the large lexicon of classical and literary characters. Like the Egyptians, the Chinese maintained “the vanity of their imagined remote antiquity” (p. 21). This included the elevated speech of heroic singing reflected in the tones of the Chinese language and the recording of their first histories in verse. In many ways, Vico tried to emulate this style in his own works. He describes the Greek use of the dragon Draco, probably one of Gorgon’s serpents attached to Perseus’s shield (later Athena’s shield) and eventually the writer of Athenian law in blood, as that which “signifies the rule of the laws” (p. 228) in the time of heroic aristocracies. He then compares this with the Chinese dragon used as a royal emblem and a symbol of civil rule, while marveling at the poetic convergence of East and West.

Phenomenology and Society

John O’Neill, who has made a significant impact on social sciences and humanities since the 1970s, develops Vico’s ideas into a new phenomenological view of society. O’Neill recognizes Vico’s call to enter language and thereby “renew” society through every word: “Thus etymology is the music of Vico’s wild sociology inviting us to hear our beginnings in the birth of language” (1974, p. 37). Vico’s Chinese-inspired metaphor of the body politic replaces a mechanical scientific one. In attempting to recreate the “public functions of rhetoric,” O’Neill revises Vico’s project by identifying three levels of body politic in modern society: bio-body, productive body, libidinal body. The first refers to the institution of the family through the discourse of well-being; the second refers to work through the discourse of expression; the third refers to personality through the discourse of happiness. In addition, O’Neill maintains that “on the one hand, we have the bodies we have because they have been inscribed by our mythologies, religions, philosophies, sciences, and ideologies. But, on the other hand, we can also say that we have our philosophies, mythologies, arts, and sciences because we have the body we have—namely, a communicative body” (1989, p. 3). Influenced by Maurice Merleau-Ponty, O’Neill’s idea of society takes shape by way of a communicative body as a reciprocal crossing of experience somewhere between idea and flesh. It is the visceral grounding that is the heart of a society in constant flux. O’Neill is not afraid to cross spatial and temporal borders in his embrace of global thought, both East and West. His influence is wide, reaching into political theory and philosophy.

Building upon a similar understanding, Fred Dallmayr invites scholars to move “beyond orientalism” in discarding the Eurocentric views of society. Dallmayr is concerned with the recognition of non-Western cultures in the current shaping of a “global village.” Phenomenology helps shape “cross-cultural ‘co-being’ in a shared world—where the issue is neither to distance the other into the indifference of externality nor to absorb or appropriate otherness in an imperialist gesture” (p. 52). A strategy for understanding a global society necessitates a comparative political theory. Hwa Yol Jung’s *Comparative Political Culture in the Age of Globalization* (2002) follows Dallmayr and O’Neill in evoking phenomenology to explain a cultural hybridization of East-West views of society. Inspired by Merleau-

Ponty and Martin Heidegger, Jung promotes an idea of “planetary thinking” whereby a “global citizen” (*homo globatus*) engages in a world beyond the nation-state. Jung writes, “For the transversalist, globalization means to decenter Western hegemony and disclaim Western superiority thereby empowering the non-West to participate fully in the new worldmaking as an act of hybridization or imbrication” (Jung, p. 14). The writings of O’Neill, Dallmayr, and Jung go a long way to providing a new global understanding of the concept of society.

See also *Chinese Thought; Civil Society; Communism; Globalization; Marxism.*

BIBLIOGRAPHY

- Coser, Lewis. *Masters of Sociological Thought: Ideas in Historical and Social Context*. 2nd ed. New York: Harcourt, Brace Jovanovich, 1977.
- Dallmayr, Fred R. *Beyond Orientalism: Essays on Cross-Cultural Encounter*. Albany: State University of New York Press, 1996.
- Jung, Hwa Yol, ed. *Comparative Political Culture in the Age of Globalization: An Introductory Anthology*. Lanham, Md.: Lexington Books, 2002.
- Leibniz, Gottfried Wilhelm von. *Monadology and Other Philosophical Essays*. Translated by Paul Schrecker and Anne Martin Schrecker. New York: Macmillan, 1965.
- . *Writings on China*. Translated by Daniel J. Cook and Henry Rosemont Jr. Chicago and LaSalle, Canada: Open Court, 1994.
- Martindale, Don. *The Nature and Types of Sociological Theory*. 2nd ed. Boston: Houghton Mifflin, 1981.
- Nisbet, Robert. *The Social Philosophers: Community and Conflict in Western Thought*. New York: Thomas Y. Crowell, 1973.
- O’Neill, John. *The Communicative Body: Studies in Communicative Philosophy, Politics, and Sociology*. Evanston, Ill.: Northwestern University Press, 1989.
- . *Critical Conventions: Interpretations in the Literary Arts and Sciences*. Norman: Oklahoma University Press, 1992.
- . *Making Sense Together: An Introduction to Wild Sociology*. New York: Harper and Row, 1974.
- Parsons, Talcott. *The Social System*. Glencoe, Ill.: Free Press, 1951.
- Sellmann, James D. *Timing and Rulership in Master Lü’s Spring and Autumn Annals*. Albany: State University of New York Press, 2002.
- Stone, Harold S. *Vico’s Cultural History: The Production and Transmission of Ideas in Naples, 1685–1750*. New York: E. J. Brill, 1997.
- Vico, Giambattista. *The New Science*. Translated by Thomas Goddard Bergin and Max Harold Fisch. 3rd ed. Ithaca, N.Y.: Cornell University Press, 1984.

Jay Goulding

SOCRATIC METHOD. See *Dialogue and Dialectics: Socratic.*

SOPHISTS, THE. The word *sophist* (Greek: *ho sophistês*) can be traced as far back as the early fifth century B.C.E. and

means literally someone who engages in or teaches wisdom (*sophia*). Thus Homer, Hesiod, the Seven Sages, Pythagoras, and other preeminent poets, musicians, philosophers, and statesmen are referred to as “sophists” by ancient writers. However, the word acquired a technical meaning by the middle of the fifth century B.C.E. to describe a number of itinerant teacher-intellectuals who, visiting Athens from time to time, displayed their wisdom in virtuosic speeches (*epideixeis*) and claimed to be able to teach human excellence or virtue (*aretê*) for large fees.

The principal source of information about the Sophists is Plato (427?–347 B.C.E.), whose dialogues portray them as occasional interlocutors of Socrates. Since their own works exist only in fragmentary form, there is uncertainty about their philosophical views and the precise impact of their thought on the history of rhetoric, philosophy, political theory, and pedagogy. If we follow Plato, the list of major fifth-century Sophists should include Protagoras of Abdera (c. 490–c. 421 B.C.E.), Prodicus of Ceos (c. 465–after 399 B.C.E.), Hippias of Elis (fl. after 460 B.C.E.), and the brothers Euthydemus and Dionysodorus from Chios (fifth century B.C.E.), all of whom teach virtue for pay. It is customary, however, to include a number of other figures on the list, such as Gorgias (c. 485–c. 380 B.C.E.), Polus (fifth century B.C.E.), and Thrasymachus (fifth century B.C.E.), who appear in Plato’s dialogues as teachers of rhetoric but not of virtue; as well as Xenocrates (fifth century B.C.E.), Lycophron (late fifth or possibly early fourth century B.C.E.), Critias (c. 460–403), and Antiphon (c. 479–411), whom we know of from other sources.

Sophistic Speeches

Sophistic speeches were famous in antiquity for their rhetorical style and their moral and philosophical content. Prodicus’ “Hercules at the Crossroads,” (see Xenophon, *Memorabilia*, II.i.21–34) depicts a young Hercules at the brink of manhood choosing between a life of virtue and one of vice. Though the life of vice appears easy at first and the life of virtue difficult, virtue is said to produce genuine happiness (*eudaimonia*), while vice produces shame and distress.

Another important speech is the “Great Speech” of Protagoras in Plato’s dialogue by that name (302c–328d), which details the process of moral education from childhood through adulthood and celebrates the virtues of justice (*dikê*) and respect for others (*aidôs*) as prerequisites for civil life. In a different vein are the speeches of Gorgias, which showcase the power of certain rhetorical techniques to defend positions of dubious morality and truth. Thus his “Encomium of Helen” and his “Defense of Palamedes” make two classical villains appear blameless, while his speech “On the Non-Existent,” argues that nothing exists, that even if it exists it is inapprehensible to man, and that even if it is apprehensible, it cannot be expressed.

Pedagogy

Surprisingly little is known of the virtues that Sophists taught in private when they took students under their wing for long periods (a pedagogical method referred to as “association,” *suneimi*). Certainly skill in legal and political argument was a

large part of these virtues, since the Sophists were all talented statesmen, and their students were aspiring members of the political class. Evidence suggests that the major Sophists imparted a fairly wide set of moral and intellectual virtues. Not only respect for others and justice, but *euboulia*, or sound political judgment, was evidently part of Protagoras' program; while Hippias taught students advanced arithmetic, astronomy, geometry, and music before arriving at anything immediately political.

An exception to this rule (besides Gorgias and other rhetoricians who eschewed the teaching of virtue) is the nefarious pair of Sophists, Euthydemus and Dionysodorus, who in Plato's dialogue *Euthydemus* present their crash course in "eristic" as a complete schooling in virtue. Eristic, which derives from the Greek word for strife, is a form of rapid verbal combat in which opponents are drawn into well-rehearsed philosophical paradoxes in order to be refuted or confounded. It is doubtful whether these Sophists' spurious arguments were ever taken seriously as "virtue," but they were at least philosophically interesting enough to attract the attention of Aristotle (384–322 B.C.E.), whose *On Sophistical Refutations* responds to them directly.

Doctrines

In addition to their activities as teachers and statesmen, the Sophists wrote treatises on a staggering array of subjects, including rhetoric, debate, poetry, music, natural science, geometry, theology, and government. The surviving fragments of these treatises suggest that the Sophists' philosophical interests and doctrines varied widely. (One of the most common mistakes has been to treat the Sophists as a unified movement or school.) Protagoras is best known for the opening (and only surviving) lines of two works. His book *On Truth* began: "Man is the measure of all things, of things that are that they are, and of things that are not that they are not." Debate has centered on whether this fragment represents some form of secular humanism (i.e., man, as opposed to the gods, measures the truth of all things), or a type of subjectivist relativism (i.e., each man measures what is true for himself). The latter interpretation is most plausible, though the former is sometimes supported by reference to the famous fragment from Protagoras's work, *On the Gods*: "Concerning the gods I cannot know either that they exist or that they do not exist, or what form they might have, for there is much to prevent one's knowing: the obscurity of the subject and the shortness of man's life."

The Sophist Prodicus also wrote on the gods, arguing anthropologically that what are called gods are "things useful for human life." Whether his theory was meant to support atheism or rather to bolster belief in the gods by relating them to human needs is not clear. Prodicus was more famous in antiquity for his art of defining words (called "synonymic" by German scholars), which enabled his students to untangle vexing paradoxes by distinguishing precisely between terms and concepts.

The fragments of Hippias of Elis testify to the breath of learning of the Sophists. If his work, *The Collection* (*Synagogê*), was an encyclopedia of some kind, which is likely, it would help explain why he is cited well into the Middle Ages on a

host of diverse topics—from the etymology of particular words, to the biographical details of famous personages, to questions of astronomy and geometry. Perhaps the most familiar Sophistic doctrine today is the one put forth by Thrasymachus in book one of Plato's *Republic*, namely that "justice is the advantage of the stronger." It is not certain that Thrasymachus should be grouped among the Sophists (Plato himself does not do so), but his oft-quoted maxim has been used to give the Sophists a bad name. It is interesting to compare Thrasymachus' views to those of the *Anonymous Iamblich*, a short treatise thought to be composed by a Sophist of the late fifth-century B.C.E., in which laws are similarly understood as merely conventional and yet defended as the source of political stability.

Historiography

The Sophists have always been controversial figures. They were vilified in Aristophanes' play *The Clouds* for teaching students to evade moral responsibility through argument. In Plato they are criticized chiefly for accepting pay when they have failed to think deeply and rigorously about the virtues they teach. Since the nineteenth century, however, the Sophists have been evaluated more favorably, beginning especially with George Grote's *History of Greece* (1850), which casts them as effective teachers of invaluable political skills. Grote's view that the Sophists contributed substantially to democratic theory, practice, and education was developed in the twentieth century by Werner Jaeger, Eric Havelock, Karl Popper, and Cynthia Farrar.

Other scholars, beginning with Hegel, have emphasized the Sophists' importance in the history of philosophy. This is usually described as a rejection of both Ionian and Eleatic accounts of reality for a greater emphasis upon sensory experience, where the Ionians had stressed a single causal substance at work in the universe (for example, fire or air), and the Eleatics (particularly Parmenides) had described being as one, the Sophists are said to have emphasized the phenomenal world with all its variety and contradictions. Though this philosophical-historical approach to the study of the Sophists has led to masterful studies by W. K. C. Guthrie and G. B. Kerferd, it often involves speculation beyond what the fragments can bear, as it did in Hegel's *Philosophy of History* and Mario Untersteiner's *The Sophists*. Most recently, the Sophists have been studied for their seminal role in the history of rhetoric. In this context the so-called "second Sophistic" movement is also important; this was a vast movement of the second century C.E. that attempted to recover and to develop the rhetorical techniques of the classical age.

See also *Aristotelianism; Democracy; Platonism; Rhetoric; Ancient and Medieval*.

BIBLIOGRAPHY

PRIMARY SOURCES

- Diels, Herman, and Walther Kranz, eds. *Die Fragmente der Vorsokratiker, griechisch und deutsch*. Berlin: Weidmann, 1951–1952.
- Sprague, Rosamond Kent, ed. *The Older Sophists: A Complete Translation by Several Hands of the Fragments in Die Fragmente der Vorsokratiker, edited by Diels-Kranz. With a New Edition of Antiphon and Euthydemus*. Columbia: University of South Carolina Press, 1972.

SECONDARY SOURCES

- Farrar, Cynthia. *The Origins of Democratic Thinking: The Invention of Politics in Classical Athens*. Cambridge, U.K., and New York: Cambridge University Press, 1988.
- Grote, George. *History of Greece*. Vol. 8. London: J. Murray, 1846–1856.
- Guthrie, W. K. C. *The Sophists*. Cambridge, U.K.: Cambridge University Press, 1971.
- Havelock, Eric Alfred. *The Liberal Temper in Greek Politics*. New Haven, Conn.: Yale University Press, 1957.
- Hegel, Georg Wilhelm Friedrich. *The Philosophy of History*. Translated by J. Sibree. New York: Dover, 1956.
- Jaeger, Werner. *Paideia: The Ideals of Greek Culture*. Vol. 1. Translated by Gilbert Highet. 2nd ed. New York: Oxford University Press, 1945.
- Jarratt, Susan C. *Rereading the Sophists: Classical Rhetoric Refigured*. Carbondale: Southern Illinois University Press, 1991.
- Kerferd, G. B. *The Sophistic Movement*. Cambridge, U.K., and New York: Cambridge University Press, 1981.
- Popper, Karl Raimund. *The Open Society and Its Enemies*. Vol. 1, *The Spell of Plato*. 4th ed.; rev. ed. Princeton, N.J.: Princeton University Press, 1963.
- Romilly, Jacqueline de. *The Great Sophists in Periclean Athens*. Translated by Janet Lloyd. Oxford: Clarendon; New York: Oxford University Press, 1992. Less scholarly, but helpful for understanding the Sophists' political significance.
- Untersteiner, Mario. *The Sophists*. Translated by Kathleen Freeman. Oxford: Basil Blackwell, 1954.

David D. Corey

SOVEREIGNTY. *Sovereignty* refers to the supreme and ultimate source of authority that exists within any political unit or association. A sovereign power is deemed independent of all other authorities and it possesses no rivals within its jurisdiction. Thus, sovereignty has internal and external dimensions. Internally, it connotes the superior and final power to determine who shall rule and how rule shall occur. Externally, it involves an exclusive right to exercise power within fixed geographical boundaries without interference from or intervention by other authorities. Although the terminology of sovereignty is sometimes employed metaphorically, it is fundamentally a concept related to matters of governance. For instance, when the sixteenth-century Protestant Reformer John Calvin (1509–1564) referred to “God’s sovereignty,” he was seeking to explain the relationship between the divine and His worldly creation in a way that characterized the governmental dimension of heavenly rule over the earth and its inhabitants.

Early Concepts

As an intellectual construct, sovereignty has often been assimilated to the rise of the nation-state in Europe during the early modern period. It is true that sovereignty as a theoretical or a practical precept is incompatible with tribal or feudal societies, where power is decentralized or parceled out into the hands of numerous lordlings, all of whom exercise governmental functions in overlapping and semi-autonomous forms. Yet societies that deified their supreme rulers, such as ancient Egypt or Japan, thereby sought at least implicitly to capture a salient el-

ement of sovereignty: that a unitary source existed from which flowed the validity of all lesser forms of command and rule.

Perhaps the political and legal system that most cogently expressed the aspiration to sovereign authority before the rise of the modern state system was the Roman Empire. (Of course, Roman ideas, especially those contained in its civil law, in turn exercised considerable influence on early modern thought.) The Roman doctrine of imperium, meaning the concentration of powers over the territories of the Empire in the hands of its Emperor, conveyed the unrivaled and unchallengeable supremacy invested in the ruler. To affront this imperium by word or deed constituted a grave crime against the Roman majesty, punishable by execution. When imperium is coupled with the legal doctrine that the Emperor is *legibus solutus*—a law unto himself answerable to no one—one arrives at a concept very nearly identical to that of sovereignty.

Although Roman law was widely disseminated in Europe during the postclassical period, and concepts such as imperium and *legibus solutus* were widely discussed, the conjunction of a feudal social structure with religious and ecclesiastical constraints on power rendered sovereignty functionally inapplicable to temporal government. The ecclesiological doctrine of the pope’s “plenitude of power” (*plenitudo potestatis*), according to which the papacy possesses final authority over the determination of matters of orthodox, however, does involve elements of a theory of sovereignty. Yet not even extreme papalists would claim that the pope is beyond error or “infallible” (in the meaning of that term as, in effect, spiritually sovereign, which was eventually proclaimed by the First Vatican Council in the nineteenth century).

Only near the end of the Middle Ages does the word *sovereignty* appear in the major vernacular languages of Europe, and its meaning during this time remains ambiguous. A particularly clear example of this ambiguity is afforded by the French law book *Coutumes de Beauvaisis*, compiled by Philippe de Beaumanoir (c. 1250–1296) during the later thirteenth century. Beaumanoir declared that “the king is sovereign (*souverains*) above all others and by his rights has the general protection of the whole realm, because he can make all statutes for the common benefit and what he decrees must be followed.” The assertion of binding legal authority sounds very familiar to modern ears. Yet Beaumanoir also blunts some of the impact of this sovereignty by insisting that “every baron is sovereign (*souverains*) in his barony,” meaning that each noble prince can do for his immediate territorial subjects precisely what the king does for the entire realm. Hence, an exclusive franchise is lacking from Beaumanoir’s doctrine, which remains consonant with the multiple and overlapping jurisdictions typical of European feudalism. The key idea of “complete” sovereignty stemming from a unitary wellspring is absent.

The Western world was not alone in struggling with the meaning behind sovereignty. In the Persian-language treatise of political advice *Mau'izah-i Jahangiri* (1612–1613), written in Muslim-controlled India by Muhammad Baqir Najm-i Sani (d. 1637), the ruler is counseled to exercise his “sovereignty [*dawlat*] according to the injunctions of Islamic law.” The word *dawlat* has a general meaning of “bliss” or “felicity” in Persian,

as well as the more concrete connotation of supreme political authority. Given the intertwined personal, religious, and political overtones, it becomes difficult to specify with precision whether Baqir intended to conceive of the Emperor as fully sovereign or whether instead the ruler must subject himself to religious precepts that constrain his authority.

Early Modern Views: Absolutism

The real crystallization of the doctrine of sovereignty occurred in sixteenth-century Europe and, like so much else, in the context of the religious turmoil that accompanied the Reformation. In France, Germany, England, and the Low Countries, the salient issue driving affairs of state in external relations with their neighbors and internal dealings with their populations concerned the determination of religious confession. Regardless of whether toleration or establishmentarianism prevailed, it came to be recognized—theoretically as well as practically—that a single authority must be ceded the right to determine how inhabitants might worship. And this ultimate and supreme authority enjoyed sovereignty.

The classic statement of this position is ordinarily ascribed to the *Six livres de la république* (1576) by the French lawyer and humanist Jean Bodin (1530–1596). Bodin proposed a definition of sovereignty as absolute and indivisible, so that the ruling power possessed sole final authority over the legislative, judicial, administrative, and military functions associated with the state. In formulating this conception of sovereignty, Bodin explicitly challenged many of the central tenets of Aristotle's political science, such as the distinction between the governance of the family and the rulership of the state. Moreover, Bodin ridiculed as incoherent the idea that sovereignty could be shared between or mixed among different groups or institutions. The sovereign is answerable to no earthly authority and, while he is cautioned by Bodin to subject himself to divine and natural law, there is no temporal compulsion that he do so. Hence, Bodin's doctrine is generally described as "absolutism," since it posits the absolute and unchecked sovereignty of the monarch.

Another important advocate of absolutism was Thomas Hobbes (1588–1679), especially in his masterpiece, the *Leviathan* (1651). Like Bodin, Hobbes insisted that the only justifiable form of sovereign authority is absolute and indivisible. Hobbes ascribed to human beings natural liberty and equality, which licenses them to undertake any actions necessary in order to preserve themselves and to avoid pain. He believed that the pursuit of self-preservation by free and equal creatures left to their own devices (the "state of nature") logically leads to unceasing conflict and unremitting fear. Frustrated in their realization of their basic desires, human beings voluntarily exchange their chaotic natural freedom for peace and order by means of a social contract, the terms of which call upon the parties to renounce all liberties and rights they possess by nature (with the exception of self-preservation itself). Any contract that permits the retention of some rights, and thus a limitation on the sovereign's absolute authority, will fail to achieve the peace sought and will eventually slip its members back into the state of nature. In contrast with Bodin, Hobbes did not insist that the constitutional form of sovereign rule *must*

be monarchy, although it is evident that he preferred royal government. Rather, Hobbes held that *any* type of regime—aristocracy (rule of the few) and democracy (the rule of the many) as well as kingship (the rule of one)—might meet the standard for sovereign authority so long as it commanded with an undivided and single voice.

Hobbes recognized that religion constituted an especially fertile source of political conflict and thus a particular threat to the maintenance of sovereign authority. To remedy the divisive consequences of religion, he offered a rather extreme solution in the second half of *Leviathan*, of strictly limiting the autonomy of ecclesiastical officials and offices and reinterpreting Christian theology in a manner consonant with his conceptions of human nature and sovereignty. While Hobbes's Erastian proposals were highly unusual, his comments about religion and public order demonstrate clearly how the emergence of the idea of sovereignty reflected deep concern about the corrosive effects of confessional dispute.

A further strand of absolutism may be associated with "patriarchal" ideas, such as were proposed by Sir Robert Filmer (c. 1586–1653). In his *Patriarcha*, Filmer drew a direct analogy between Adam, to whom God had entrusted the whole of the earth, and the kings who followed after him. Since Adam enjoyed unchecked sovereignty over both natural resources and over his family, so should his heir, the king, possess fatherly authority to dispose of his subjects and their goods as he saw fit, without the approval of a superior authority.

Early Modern Views: Popular Sovereignty

Alongside the view that absolute power was vested in a single governor (or group of governors) emerged the competing doctrine that the sole legitimate source of authority sprang from the people as a collectivity or joint body. Intimations of this idea can be discovered in medieval authors such as Marsilius of Padua (c. 1280–c. 1343), for whom all forms of legislative and executive power pertained in the first instance to the whole body of citizens. But Marsilius's theory possessed the same deference to the fragmented condition of authority in the Middle Ages that characterized Beaumanoir. Instead, the modern principle of popular sovereignty arose in response to the perceived excesses of absolutistic theories.

Writing in explicit opposition to Filmer (and perhaps also indirectly against Hobbes), John Locke (1732–1804) insisted that sovereignty is the creation of the people who contract with one another to form civil society and who only entrust executive authority to a government conditionally. In contrast with Filmer, Locke held that the natural condition of mankind was individual freedom, and no person—not even a man's own offspring—was entirely subject to arbitrary rule. Against Hobbes, Locke maintained the impossibility of renouncing one's natural rights of subjects to life, liberty, and estate in the process of creating sovereign power. Instead, a ruler who systematically violates human rights breaches the bond of trust that authorizes his office. Locke thus insists that no one is obligated to obey the commands of an illegitimate government. If the magistrate attempts to coerce their obedience, members of civil society may legitimately use force against him, just as

they would in the case of robbery or assault, since they retain control of their rights individually and together.

Jean-Jacques Rousseau (1712–1778) extended the idea of popular sovereignty by means of an innovative marriage between Lockean and Hobbesian insights. Sovereignty for Rousseau cannot be exercised legitimately by any authority external to the body of citizens. The citizens alone are competent to renounce their natural liberty and bind themselves jointly and individually to laws and rulers. Hence, no matter what constitutional form of government is appointed—and Rousseau contends that kingship, aristocracy, and democracy may each be appropriate, depending on the scale of the territory to be governed—it remains only the executive of the general will of the community. Freedom reposes strictly and exclusively in the communal order in which the moral liberty of each person assumes the equal moral liberty of every person, guaranteed under the terms of the law and protected by the magistrates. Hence, Rousseau’s free state is guided by the collective determinations of the people about how they wish to live—a clear statement of a system of popular sovereignty. Nor can the general will be judged errant or mistaken. Whatever the people decide is right and must be treated as obligatory.

Later Developments

The dispute between absolutistic and popular conceptions of sovereignty might seem highly polarized and irresolvable. Certainly, the violent upheavals of the French Revolution between the ancien régime and the advocates of popular rule seemed to presage a cataclysmic clash between two profoundly opposed visions of the location of supreme authority. But at times, efforts were made to find a common ground or bridge between the apparently incommensurable points of view.

The framers of the United States federal Constitution, ratified in 1789, afforded one strategy for resolving the conflict. The Constitution proclaimed in its preamble the sovereignty of the people as the source of the authorization of government and the execution of public duties. Toward this end, some officials were to be directly elected on the democratic principle of one vote assigned to each citizen. At the same time, other magistrates such as the President and Vice-President and senators were to be selected by intermediary bodies (the Electoral College and state legislatures, respectively, although the ratification of the Seventeenth Amendment in 1913 provided for senators to be directly elected), while still others (such as the judiciary) were appointed by essentially non-democratic means. The result was to create a system of checks and balances to diffuse the potential domination of any portion of the populace—especially, the poor and least educated (but numerically greater) segment of the people. The supporters of this vision articulated a set of theoretical principles supporting the constitutional design in the collection of occasional essays collected together under the title of *The Federalist Papers* (1788).

From a more philosophical perspective, the German thinker Georg Wilhelm Friedrich Hegel (1770–1831) in his *Philosophy of Right* (1821) endorsed a conception of the state that also sought to redress the divide between absolutism and populism. Hegel evinced considerable skepticism concerning the

viability—let alone coherence—of unmitigated popular sovereignty such as that endorsed by Rousseau. Hegel instead posited a realm of civil society the members of which concerned themselves with their own narrow and partial interests. In order to ensure that these interests did not come into conflict, they received representation at the level of a legislative body and enforcement by a professionalized and disinterested civil service. But Hegel also insisted that an independent hereditary monarchy, unencumbered by any external constraints, was necessary to ensure that the laws governing the nation arose from an undivided and unimpeachable act of will. Hence, Hegel’s king lacks constitutional restraints, in the sense that he is not obligated to defer to the popular determinations of the legislature, but his absolute power is limited to the ability to affirm or deny the statutes with which he is presented.

Obsolescence of Sovereignty?

Given the condition of the political map in the aftermath of the Treaty of Westphalia (1648), with its checkerboard of nation-states, sovereignty might seem to be a doctrine with global purchase, taken as universally efficacious and valid. Yet in many places the idea of sovereignty never really took hold, and in many contexts there may be good reason to declare its erosion or increasing irrelevance.

In certain cases, the spread of European political and legal values in the wake of colonialism often was received with indifference, if not hostility. New Zealand’s early colonial history is instructive. When the British arrived to settle Aotearoa in the mid-nineteenth century, they entered into an agreement, the Treaty of Waitangi (1840), with some of the tribal elders of the Polynesian (Maori) population that ceded—or so the colonizers thought—“absolutely and without reservation all the rights and powers of Sovereignty” to the English Crown. The Treaty, set down in both English and Maori languages (of which the latter is the official version), takes as the equivalent for *sovereignty* the word *kwanatanga*, a term that means something like “trusteeship” in Maori. Indeed, it remains unclear whether the Maori had any vocabulary at the time that could plausibly be translated as “sovereignty,” simply because their worldview, not to mention political and legal language, was so differently constituted than that of the Pakeha (Europeans). The consequences of this crucial failure on the part of the British to recognize the cultural specificity of “sovereignty” resonate into the twenty-first century, as the Maori and Pakeha populations of the country struggle to accommodate the tribal social, economic, and legal system that was never actually surrendered in the context of a representative democracy that claims the status of a sovereign state.

Another illustration of the breakdown of sovereignty derives from the appearance, especially since World War II, of transnational regimes in both the public and private spheres. Economic globalization, free trade zones, and the easy flow of capital across national borders obviously threaten the ability of sovereign states to make crucial decisions about the welfare of their citizens. Moreover, quasi-governmental and non-governmental agencies and institutions such as the United Nations, the World Trade Organization, the International Monetary Fund, and the European Union have been granted

(some say, usurped) many of the rights and powers customarily associated with sovereignty, whether in a legal, economic, military, or cultural sense. Little wonder that in a 1999 appraisal of the topic, Stephen Krasner refers to the very idea of sovereignty—in our own times, and perhaps even in the past—as “organized hypocrisy.” The interdependence that ties together the international state system seems increasingly likely to relegate sovereignty to the dustbin of obsolete concepts.

At the same time, sovereignty throughout the world has come under direct challenge from subnational groupings as well. The rise of regional independence movements, often built around ethno-nationalist agendas, sets in question the basic principle that public power must derive from a single autonomous and supreme source. One encounters the demand for autonomy and sometimes secession even in highly developed nation-states with strong traditions of sovereign authority, such as the United Kingdom, Spain, and Canada. It is little wonder that some scholars during the last several decades of the twentieth century spoke about the “re-feudalization” or “re-tribalization” of the political scene globally.

See also *Authority; Monarchy; Nation; Power; State, The.*

BIBLIOGRAPHY

- Anderson, Perry. *Lineages of the Absolutist State*. London: NLB, 1974.
- . *Passages from Antiquity to Feudalism*. London: NLB, 1979.
- Baqir Najm-i Sāni, Muhammad. *Advice on the Art of Governance: An Indo-Islamic Mirror for Princes: Mau'izah-i Jabāngiri*. Translated by Sajida Sultana Alvi. Albany: State University of New York Press, 1989.
- Beaumanoir, Philippe de. *Coutumes de Beauvaisis*. Trans. F. R. P. Akehurst. Philadelphia: University of Pennsylvania Press, 1992.
- Bodin, Jean. *On Sovereignty*. Edited by Julian H. Franklin. Cambridge, U.K.: Cambridge University Press, 1992.
- Filmer, Sir Robert. *Patriarcha and Other Writings*. Edited by Johann P. Sommerville. Cambridge, U.K.: Cambridge University Press, 1991.
- Hobbes, Thomas. *Leviathan*. Edited by Richard Tuck. Cambridge, U.K.: Cambridge University Press, 1991.
- Kawharu, I. H., ed. *Waitangi: Maori and Pakeha Perspectives on the Treaty of Waitangi*. Auckland, New Zealand: Oxford University Press, 1989.
- Krasner, Stephen D. *Sovereignty: Organized Hypocrisy*. Princeton, N.J.: Princeton University Press, 1999.
- Rousseau, Jean-Jacques. *The Social Contract and Other Later Political Writings*. Edited and translated by Victor Gourevitch. Cambridge, U.K.: Cambridge University Press, 1997.
- Sim, Stuart, and David Walker. *The Discourse of Sovereignty, Hobbes to Fielding: The State of Nature and the Nature of State*. Aldershot, U.K.: Ashgate, 2003.
- Skinner, Quentin. *The Foundations of Modern Political Thought*. 2 vols. Cambridge, U.K.: Cambridge University Press, 1978.
- Weston, Corinne Comstock, and Janelle Renfrow Greenberg. *Subjects and Sovereigns: The Grand Controversy over Legal Sovereignty in Stuart England*. Cambridge, U.K.: Cambridge University Press, 1981.

Cary J. Nederman

SPACE. See *Field Theories; Physics; Relativity.*

SPECIES. See *Life.*

SPONTANEOUS GENERATION. See *Development.*

SPORT. “What do they know of cricket who only cricket know?” queried the historian and political reformer C. L. R. James in the preface of *Beyond a Boundary* (1963), his lyrical exploration of political, social, and racial relations in the twentieth-century West Indies and British Empire. He answered throughout the book that those who only know sport really know nothing of value. Sport, he insisted, was an essential part of the fabric of modern cultures, the democratic art of the globe’s common folk, the stage on which a myriad of social issues were contested. Intellectuals who dismissed sport as mere games or mass opiates misunderstood the fundamental power of sport for shaping modern culture, James insisted. James wrapped his arguments for West Indian political independence and the equality of people of color in the British Empire in discourses on cricket and the ideals of fair play. “It isn’t cricket,” James insisted, whether he was decrying poor sportsmanship within the boundaries or denouncing racism on the cricket pitch or in any other human endeavor.

In the course of his meditation on sport, James also claimed that ideas about sport were interwoven with ideas about identity, citizenship, gender, and every other facet of human culture in ancient as well as modern societies. Following the lead of James, scholars since the 1960s have contended that ideas about sport are inextricably linked to ideas about politics, economics, and other facets of culture. The vast majority of investigations about the power of sport in shaping and revealing cultural mentalities have concentrated on modern history, especially on modern Western societies. A smaller contingent has excavated the athletic ideologies of classical Western antiquity. The sporting lives and ideas of non-Western and non-modern peoples remain mostly unexplored. Regardless of the time period or culture studied, however, recent scholarship insists that those who know only the details of sporting practices and nothing about the larger cultures which shape and are shaped by those practices really know nothing of value.

Sport and Traditional Cultures

Modern conceptions of the contrasts between tradition and modernity frame contemporary studies of the history of ideas about sport, physical education, and body culture. Perhaps the most influential work in shaping contemporary paradigms, Allen Guttman’s *From Ritual to Record* (1978), grounds the history of athletic competition firmly in the modernity versus tradition dialectic. While contemporary scholars certainly bring differing theoretical perspectives to the study of ideas about sport, they rarely question the notion that traditional and modern physical cultures are essentially different entities.

Even though a few historians argue that traditional physical activities are so different from modern athletics that sport can only be understood as a product of modernity, a range of evidence indicates an ancient lineage for sport. Sport, in various forms, has been a part of cultural life since the origins of the human species. As most anthropologists contend, the hunters and gatherers of early human history lived in societies with abundant leisure. Their sports played a critical role in teaching the skills and teamwork necessary for hunting and warfare. Athletic contests served as sites for the demonstration of physical prowess—particularly male prowess. Sports were also embedded in the religious rituals of hunters and gatherers, as they are enmeshed today in the sacred practices of the world's few remaining traditional cultures.

The archaeological evidence for sport among hunters and gatherers, or among the early farmers in the new agricultural societies that began to emerge in various places around the world circa 7000 B.C.E., is limited and sketchy. Carvings and inscriptions related to sport appear occasionally in ancient Western, American, and Asian civilizations. The first compelling written evidence regarding ancient ideas about sport appears in Homer's *Iliad* (c. 750 B.C.E.) and *Odyssey* (c. 725 B.C.E.). Homer's work reveals Greek aristocrats who used competitive sport as a vehicle for demonstrating prowess. Significantly the ancient Greeks used the same word, *agon*, to refer to athletic contests and combat. Winning honor and glory in war or sport marked the zenith of Greek masculine achievement.

Ancient Greeks formalized and rationalized competitive athletics, moving from funeral games and irregular contests to well-organized sporting extravaganzas held at a variety of sites, and especially in sacred places to honor Greek gods. The most important Greek athletic festival, celebrated every four years beginning in 776 B.C.E., was the Olympic Games. The Olympics evolved into a vital celebration of pan-Hellenic identity for the balkanized Greek city-states. Greek citizens felt compelled to make a pilgrimage to Olympia at least once in a lifetime. Homages to and exposés of the Olympics appeared frequently in Greek literature, philosophy, and drama. Greek city-states sponsored athletic programs to develop stars to win fame for their hometowns in the games, especially at Olympia.

The Olympics reveal much about Greek culture. Participation and spectatorship were limited to males. Only freeborn Greek citizens could compete in the Olympics. Victors won olive-wreath crowns symbolizing their accomplishments. Early twenty-first century scholarship indicates that the Greeks had no conception of what moderns label amateurism. While Olympic champions received only symbolic garlands from the sponsors of the festival, their city-states subsidized their training and bestowed enormous riches on those who brought glory to their polis.

The Greeks also sponsored sporting contests in which athletes competed directly for lucrative prizes such as the Panathenaic Games. Athletes earned fame and fortune in ancient Greece. Public acclaim translated their athletic prowess into political clout. Male athletes served as icons of physical beauty and objects of erotic desire. The athlete embodied Greek notions of physical perfection and inspired artistic re-creations of

the human form. By the 500s B.C.E., a class of professional athletes appeared in Greece. The time, effort, and attention lavished on athletics earned condemnation from Greek intellectuals such as Socrates, Plato, and Aristotle, who did not object to athletic competition in principle but disparaged the narrow focus on bodily prowess to the exclusion of all other characteristics of good citizenship required of elite athletes. These thinkers argued that athletics should be one of many components in the general training of good citizens. Such arguments sparked a debate about the meaning and purpose of sport that has raged in Western societies ever since, raising issues regarding whether sport should serve the general education of the common citizen or whether sport should serve exclusively to test the extremes of human capability.

Traditionally scholars have argued that, with a few exceptions such as an athletic festival for women hosted at Olympia in honor of the goddess Hera or odes to the athletic prowess of Spartan maidens, Greek athletics were relentlessly patriarchal. In the 1990s, a debate over the level of participation by Greek women in athletics began. Some revisionists posit a much more substantial role for women in Greek sport, noting that female names appear on lists of Olympic victors. In one famous case, a woman who owned a chariot team won an Olympic race. Other revisionists argue that contextual readings of the evidence reinforces rather than revises the patriarchal nature of Greek sport, contending that an accurate interpretation reveals that the Spartan female chariot owner was in fact a surrogate put forward by her male relatives to further embarrass the defeated chariot teams and demonstrate that wealth rather than masculine skill won equestrian competitions.

Greek athletics spread throughout the ancient world during the Hellenistic era. Greek stadia, gymnasia, and hippodromes appeared in cities throughout the ancient West. Even after the conquest of Greece by Rome, Greek athletics remained the normative conception in ancient Western cultures. The Romans, like other cultures influenced by the Greeks, both adopted and resisted Greek ideas. Some Roman patricians patronized the Olympic and other Greek games and propagated Greek notions of the importance of physical education in the general development of the citizenry. Other Roman elites, with the support of many plebeians, rejected Greek athletics as too hedonistic and effete for Roman tastes. The Greek custom of competing in the nude offended Romans such as the philosopher Cicero, who condemned Greek sport as undermining family, duty, and state.

Still, like the Greeks, the Romans promoted chariot racing and built huge monuments for sporting contests. The Romans practiced a different set of spectacles that emerged from a different history. The *ludi Romani* represent the first appearance of mass spectator sport in history. The Roman games comprised three basic disciplines. The circuses, by far the most popular and common of the three spectacles, devoted themselves to chariot racing. The *munera* presented gladiatorial combats to the masses. The *naumachia*, the rarest of the Roman games, were elaborate reconstructions of famous naval battles. Each of the Roman games was deeply intertwined in the political conflicts of Roman society. Chariot teams at

circuses promoted political factions. Gladiators fighting to the death reminded both Roman citizens and barbarians that the empire had been built on violence. Significantly very few of the gladiators were Roman citizens. The vast majority were war captives, criminals, or political or religious dissenters sentenced to the arena for the amusement of the masses. Opposition to gladiatorial games from both Roman and non-Roman sources highlighted the cruelty of the *munera*. Foes of Roman games also condemned them as part of a “bread and circuses” policy practiced by imperial governments to buy the consent of the masses with the dole and sporting delights. These condemnations of sport as an agent of statecraft bent on diverting the people from social problems have remained staples of sporting critiques into the contemporary era.

Greek and Roman sports were exceptional in their imperial reach and sophisticated organization but traditional in most other aspects. Traditional sports were frequently part of sacred rites and were generally martial exercises for training warriors. Traditional sporting practices were almost invariably local and loosely organized. Traditional games varied from place to place and from time to time, and were based on custom rather than formal rules. Traditional sports were incredibly durable, lasting in similar form for thousands of years. Finally traditional sports were, like traditional social relations, structured around social inequalities. Hierarchy, kinship, ethnicity, and gender habitually shaped participation. Women were generally excluded from the sports of traditional societies, especially as participants and sometimes as spectators.

Sport and Modern Cultures

Histories of sport reveal that modern cultures conceptualize physical activity differently than traditional societies. Modern sport tends toward the secular rather than the sacred. A focus on equality, both in the conditions of competition and in opportunities to compete, consumes modern sport. Modern sport replicates modern social structures in other ways as well, manifesting the peculiar modern manias for specialization, bureaucratization, rationalization, and quantification in unique ways. In modern history, sport is embedded in the major trends of modernity itself, industrialization, urbanization, and nationalism. Most significantly, at least from modern perspectives, has been a new conceptualization of sport as a useful tool for solving social problems that has replaced an understanding of sport as part of the steady rhythms of traditional life. The idea of sport as a social utility certainly has roots in older traditions, as Greek and Roman concepts about athletics as training for citizenship testify. However in the modern period the idea of sport as a useful tool grew to grand historic dimensions.

In early modern Europe, sports served the emerging centralized monarchies by symbolizing power and cultivating popular support. Monarchs commandeered the older sporting practices of the aristocracy in order to celebrate regal prowess and wealth. To gain popular support as they moved to usurp the power of the nobility and clergy, European monarchs transformed popular peasant pastimes into political rights to win over the masses. At the same time sport became a central element in the education of European elites. The Renaissance

witnessed the excavation of classical notions of sound minds in sound bodies. Renaissance thinkers insisted that a complete education developed physical as well as intellectual faculties. Utilitarian notions of sport also developed in unexpected places. Early-twenty-first-century scholarship has revealed that Protestant reformers, far from the sport-hating puritans of stereotype, in fact endorsed a variety of athletic endeavors as long as they were undertaken to make people better workers, better citizens, better soldiers, and better Christians.

Purposeful sport that served specific social ends was firmly established in Western societies in the early modern period. During the same epoch, the sports of non-Western cultures moved rapidly toward extinction. The “Columbian Exchange” in sport was initially a one-way street. Indigenous sports, such as the elaborate ritual of the Mesoamerican ball game, were destroyed by Western conquest. Modern sports developed almost exclusively in Western cultures. Western cultures sometimes appropriated pastimes such as lacrosse, a game with heritages in both Europe and the Americas, but they relentlessly modernized them. A survey of sports including the largest global athletic event, the modern Olympic Games, reveals that, with one exception, all developed from Western sources. That one exception, judo, was invented by pro-Western innovators in Japan who sought to modernize their own nation through the introduction of Western-style sports. The global sporting culture that has emerged since the mid-1800s is a product of the West.

The rise of the modern nation-state, beginning in Europe and North America in the eighteenth century, fueled rapid growth of the idea of sport as a useful social tool. In sport many nationalists thought that they had discovered an elemental force for making the French Revolution’s three criteria for modern nationhood—liberty, equality, fraternity—into social realities. Through modern sport they proclaimed the end of the old sporting order of *ancien regimes* and the rise of new national pastimes, from cricket to prize fighting to varieties of football to baseball. They recognized, as C. L. R. James later noted, that when the modern masses had the liberty to choose their leisure they gravitated to sport. Sport also became a testing ground for modern notions of equality. Class, ethnicity, race, and gender boundaries increasingly came under attack on playing fields in the nineteenth and twentieth centuries. The ideal, if not always the reality, of equality, played to mass audiences in sporting dramas through “great experiments” in racial integration such as the tales of Jackie Robinson in U.S. baseball, Edson Arantes do Nascimento (better known as Pelé) in Brazilian soccer, and Learie Constantine in British cricket.

It was, however, the third element of the French Revolution’s prescription for modern nationalism where sport found the most fertile loam. More than any other modern institution with the exception of war, sport provides the necessary conditions for the blossoming of fraternity, the patriotic bonds that bind citizen to citizen. Sport and physical education as agents of fraternal bonding first developed during the 1700s and 1800s in the English-speaking world and in Germany. In Germany, which was occupied by France and not yet unified as a modern state, a powerful national movement known as

the Turners arose. The Turners were devoted explicitly to promoting physical fitness and implicitly to creating a nation of soldier-athletes to win independence for the fatherland. The movement married exercise to patriotism. Turners formed the core of the German revolution against French hegemony and fought for a unified German nation. The Turner movement spread to German communities in Europe and the Americas, and sparked imitations in Denmark and Sweden. The inherent Germanness of the physical education system, however, ultimately prevented global diffusion of the Turners.

At the same time, in the heartland of the industrial revolution, modern competitive sports developed in Great Britain, its colonies, and its former colonies. National games such as cricket, soccer football, and rugby football emerged. Promoters sold these games as the fraternal foundation of Greater British identity. Resistance to British national games from sections of the English-speaking world sparked the modernization of Gaelic football and hurling in Ireland and the invention of baseball and American football in the United States. Through these games, and the massive literature that grew to support them such as the classic English sporting novel, *Tom Brown's Schooldays* (1857), Anglo-American cultures crafted the idea that participation in sport taught modern peoples the basic tenets of citizenship. In Anglo-American ideology sport promoted moral virtue, balanced individual and communal needs, and fostered fair competition in every social endeavor. Sports, as Anglo-American promoters ceaselessly preached, were essential tools in the construction of modern nationhood.

While the gymnastic exercises of German Turners failed to find a receptive global audience, Anglo-American sports soon became a worldwide phenomenon. As the world's major imperial power, Great Britain's games spread throughout the world. As a rising imperial power, the sports of the United States also spread. With the birth of the modern Olympic Games in 1896, an event midwived by the baron Pierre de Coubertin, a French Anglophile who fervently believed in Anglo-American sporting ideology, modern Western sport moved toward global hegemony. During the twentieth century, the Olympic Games and the World Cup soccer tournament—a 1930 spin-off from the Olympics—became the world's most popular spectacles. Soccer football, originally a British pastime, became “the world's game,” spreading from the West to the rest of the world through emulation and diffusion rather than at imperial gunpoint. Non-Western cultures clearly chose to adopt this European import.

Encased in rhetorical claims that sport promoted peaceful internationalism, the global spread of sport during the world's bloodiest century (the 1900s) revealed that most of the world's cultures had converted to the Anglo-American faith that sport was a crucial element for fueling patriotism rather than athletic pacifism. As sport became the common language of global culture, it represented a dialect that forged national rather than global identities and was spoken with equal fluency by dictatorships as well as democracies. Sport represented an essential bonding agent in the “imagined communities” of many modern nations. Initially national sporting cultures embraced men but discouraged or excluded women from serving as patriotic

athletes or fans. As ideas of gender equity altered social relations in modern nations, the homosocial boundaries of sport came under assault. By the end of the nineteenth century, women had begun to participate as both spectators and players in increasing numbers. The emergence of women in sport was frequently equated to women's emancipation and suffrage. When U.S. swimmer Gertrude Ederle became the first woman to conquer the English Channel in 1926, beating the times of all the men who had previously navigated those waters, her feat was hailed as a triumph that rivaled the acquisition of women's voting rights.

In spite of the feats of Ederle and other women, male performances remained normative in modern sport. Women athletes were frequently prized as much for their sexual appeal as for their athletic prowess, a consumer culture trend since the early twentieth century that perhaps explains the early-twenty-first-century global fascination with tennis player Anna Kournikova. Fans in many nations both cheered and leered when women Olympians stoked the fraternal furnaces of athletic nationalism. In cultures where women athletes raised direct challenges to gender orders, such as in some modern Islamic states, female champions such as the Algerian runner Hassiba Boulmerka aroused violent reactions.

Sporting conflicts over ideas about gender reveal that in the early-twenty-first century sport remains a powerful site for debating social concepts and practices. The history of ideas about sport indicates that the question that began C. L. R. James's meditation on cricket and West Indian culture should be expanded. What do they know of sport who only sport know? Insights into human societies develop at the intersection of sport with the myriad other facets of culture, from politics to religion to gender to economic interchange. In the history of ideas, sport represents a popular common pursuit for many societies at many times that can reveal much about the dynamic complexities of human cultures.

See also *Body, The*.

BIBLIOGRAPHY

- Baker, William J. *Sports in the Western World*. Rev. ed. Urbana: University of Illinois Press, 1988.
- Cahn, Susan K. *Coming on Strong: Gender and Sexuality in Twentieth-Century Women's Sport*. New York: Free Press, 1994.
- Dyreson, Mark. *Making the American Team: Sport, Culture, and the Olympic Experience*. Urbana: University of Illinois Press, 1998.
- Guttman, Allen. *From Ritual to Record: The Nature of Modern Sport*. New York: Columbia University Press, 1978.
- . *Games and Empires: Modern Sports and Cultural Imperialism*. New York: Columbia University Press, 1994.
- Holt, Richard. *Sport and the British: A Modern History*. New York: Oxford University Press, 1989.
- Howell, Colin. *Blood, Sweat and Cheers: Sport and the Making of Modern Canada*. Toronto: Toronto University Press, 2001.
- Hughes, Thomas. *Tom Brown's Schooldays*. Edited with an introduction by Andrew Sanders. New York: Oxford University Press, 1989. First published in 1857.
- James, C. L. R. *Beyond a Boundary*. Durham, N.C.: Duke University Press, 1993. Originally published in 1963.

- Kyle, Donald G. *Spectacles of Death in Ancient Rome*. London: Routledge, 1998.
- LaFeber, Walter. *Michael Jordan and the New Global Capitalism*. New York: W. W. Norton, 1999.
- Murray, Bill. *The World's Game: A History of Soccer*. Urbana: University of Illinois Press, 1996.
- Oriard, Michael. *King Football: Sport and Spectacle in the Golden Age of Radio and Newsreels, Movies and Magazines, the Weekly and the Daily Press*. Chapel Hill: University of North Carolina Press, 2001.
- Young, David C. *The Olympic Myth of Greek Amateur Athletics*. Chicago: Ares, 1984.

Mark Dyreson

STATE, THE.

This entry includes two subentries:

Overview

The Postcolonial State

OVERVIEW

The concept of the state was central to the social sciences until temporarily displaced in the 1950s by a concept of the “political system” that is mainly associated with Talcott Parsons’s (1902–1979) systems analysis. Parsons’s sociology identified the political system with behaviors and institutions that provide a center of integration for all aspects of the social system. David Easton echoed Parsons by declaring that “neither the state nor power is a concept that serves to bring together political research” and instead defined the political system as “those interactions through which values are authoritatively allocated for a society” (p. 106). Systems analysis was tied closely to various theories of decision making, but most notably to pluralist theory, which viewed decision making as the outcome of peaceful bargaining between interest groups in society. Pluralist theory implicitly assumed that key sources of power such as wealth, force, status, and knowledge, if not equally distributed, are at least widely diffused among a plurality of competing groups in society.

Return to the State

A return to the state in political science, sociology, and history was launched by the publication of Nicos Poulantzas’s *Pouvoir politique et classes sociales* (1968; Political power and social classes) and Ralph Miliband’s *The State in Capitalist Society* (1969), which directly challenged pluralist theory and systems analysis. The worldwide political rebellions of 1968 called into question the dominant assumptions of an academic social science that presumed the existence of pluralism and system equilibrium as the basis of the political system. Miliband and Poulantzas both drew on a radical tradition identified with the writings of Karl Marx (1818–1883), Friedrich Engels (1820–1895), V. I. Lenin (Vladimir Ilich Ulyanov; 1870–1924), and Antonio Gramsci (1891–1937) and considered a theory of the state anchored in this tradition to be the main alternative to the dominant social science. Their works were highly

influential. At the height of his popularity in the mid-1970s, Miliband was one of the leading political scientists in the English-speaking world. Nicos Poulantzas was arguably the most influential political theorist in the world, with works that influenced scholars in Europe, North America, and Latin America.

Instrumentalism and Structuralism

Miliband’s writings are most notable for reestablishing an instrumentalist theory of the state, which was subsequently adopted by many scholars conducting research on political institutions and public policy. Prior to Miliband, the instrumentalist theory of the state had been articulated cryptically by Paul Sweezy, who asserted the state is “an instrument in the hands of the ruling class for enforcing and guaranteeing the stability of the class structure itself” (p. 243). Miliband identifies the ruling class of a capitalist society as “that class which owns and controls the means of production and which is able, by virtue of the economic power thus conferred upon it, to use the state as its instrument for the domination of society” (p. 23). Both authors trace this concept of the state to Marx’s famous dictum in *The Communist Manifesto* that “the executive of the modern state is but a committee for managing the affairs of the whole bourgeoisie.” Miliband identified the chief deficiency of Marxist political theory as the fact that nearly all Marxists had been content to assert this general thesis as more or less self-evident, but without proving it. Thus, Miliband’s main objective in renewing state theory was “to confront the question of the state in the light of the concrete socio-economic and political and cultural reality of actual capitalist societies” (p. 6). Miliband suggests that Marx provided a conceptual foundation for the socioeconomic analysis of capitalist societies, Lenin provided guidance for a political analysis, and Gramsci supplied the conceptual apparatus for a cultural and ideological analysis of capitalist societies. Miliband was convinced that the central thesis and conceptual structure of Marxist political theory was effectively in place and therefore what Marxist political theory needed was more empirical and historical analysis to give concrete content to this thesis and its associated concepts.

The state, as Miliband conceives it, does not exist as such, but is a conceptual reference point that “stands for . . . a number of particular institutions which, together, constitute its reality, and which interact as parts of what may be called the state system” (p. 49). This state system is actually composed of five elements that are each identified with a cluster of particular institutions, including:

1. The governmental apparatus, which consists of elected legislative and executive authorities at the national level, which make state policy;
2. The administrative apparatus, consisting of the civil service bureaucracy, public corporations, central banks, and regulatory commissions, which regulate economic, social, cultural, and other activities;
3. The coercive apparatus, consisting of the military, paramilitary, police, and intelligence

agencies, which together are concerned with the deployment and management of violence;

4. The judicial apparatus, which includes courts, the legal profession, jails and prisons, and other components of the criminal justice system;
5. The subcentral governments, such as states, provinces, or departments, counties, municipal governments, and special districts.

One of the most direct indicators of ruling-class domination of the state is the degree to which members of the capitalist class control the state apparatus through interlocking positions in the governmental, administrative, coercive, and other apparatuses. Miliband emphasizes that: "It is these institutions in which 'state power' lies, and it is through them that this power is wielded in its different manifestations by the people who occupy the leading positions in each of these institutions" (p. 54). A similar concept of the state was also adopted by many non-Marxists, such as G. William Domhoff, who proposed a power structure theory of how "the owners and managers of large banks and corporations dominate the United States" (p. xi). Although indebted to Marx's writings, Miliband was also aware that Marx "never attempted a systematic study of the state" (p. 5) comparable to the one conducted by Miliband, but instead left a collection of political writings that are unsystematic, fragmentary, and sometimes self-contradictory.

This ambiguity in Marx's work quickly led to a disagreement with Nicos Poulantzas, who became the leading spokesperson for a structuralist theory of the state. Poulantzas claims that the basic structure of the capitalist mode of production generates contradictory class practices and crisis tendencies that inexorably disrupt the capitalist system at the economic, political, and ideological levels. These crisis tendencies and contradictions necessitate a separate structure to specifically maintain and restore its equilibrium as a system. Although Poulantzas modified systems analysis by introducing class conflict as a disequilibrating mechanism, he was nevertheless clearly indebted to the American functionalists and systems theorists in arguing that the general function of the state in the capitalist mode of production is its function as "the regulating factor of its global equilibrium as a system" (p. 45).

Whereas Miliband articulates an institutionalist conception of power, Poulantzas articulates a functionalist conception of power anchored by the methodological assumptions of structural functionalism. In direct contrast to Miliband, Poulantzas draws a sharp analytic distinction between the concepts of state power and the state apparatus. Poulantzas defines the state apparatus as: "(a) The place of the state in the ensemble of the structures of a social formation," that is, the state's functions and "(b) The personnel of the state, the ranks of the administration, bureaucracy, army, etc." (p. 116). The state apparatus is a unity of the effects of state power (i.e., policies) and the network of institutions and personnel through which the state function is executed. Poulantzas emphasizes the functional unity between state power and the state apparatus with the observation "that structure is not the simple principle of

organization which is exterior to the institution: the structure is present in an allusive and inverted form in the institution itself" (p. 115, fn. 24).

Poulantzas defines state power as the capacity of a social class to realize its objective interests through the state apparatus. Bob Jessop observes that within this framework "state power is capitalist to the extent that it creates, maintains, or restores the conditions required for capital accumulation in a given situation and it is non-capitalist to the extent these conditions are not realised" (p. 221). In structuralist theory, the objective effects of state policies on capital accumulation and the class structure are the main objective indicators of state power.

Poulantzas's well-publicized methodological differences with Miliband were deeply influenced by the French structuralist philosopher Louis Althusser, but like Miliband, he also claims to draw on the work of Marx, Engels, Lenin, and Gramsci and "to provide a systematic political theory by elucidating implicit ideas and axioms in their practical writings" (pp. 1, 42). Yet, while Miliband placed Marx and Engels's *Communist Manifesto* at the center of his political theory, Poulantzas identifies *Capital* as "the major theoretical work of Marxism" (p. 20). The chief difficulty in designating *Capital* as Marx's central theoretical treatise is that it is an unfinished work with no theory of social class and no theory of the state, but a text that is rife with lacunae, omissions, and stated intentions never fulfilled in fact, particularly in its latter volumes.

These disputes were aired in the *New Left Review* in a series of widely heralded polemical exchanges that became known as the Miliband-Poulantzas debate. The debate itself was symptomatic of unresolved epistemological issues within Marxism that had far-reaching methodological repercussions beyond state theory and even beyond Marxism. Their public debate set off a wide-ranging discussion among scholars throughout the world that stimulated renewed interest among social scientists in the nature of the state. The debate mainly revolved around Poulantzas's claim that Miliband's empirical and institutional analysis of the state in capitalist society constantly gives the impression that "social classes or 'groups' are in some way reducible to inter-personal relations . . . and the State is itself reducible to inter-personal relations of 'individuals' composing social groups and 'individuals' composing the State apparatus." Poulantzas insisted that this method of analysis failed to comprehend "social classes and the State as objective structures, and their relations as an objective system of regular connections, a structure and a system whose agents, 'men', are in the words of Marx, 'bearers' of it" (pp. 70–71).

Instrumentalists and structuralists were quickly divided into competing schools of thought symbolized by the fractiousness of the Miliband-Poulantzas debate. As the polemic between them and their supporters became redundant, state theorists began looking for ways to move beyond the methodological stalemate. Moreover, despite the ongoing methodological controversy, both theories of the state shared a common analytical postulate that the state successfully implements the long-term interests of the capitalist class by maintaining the equilibrium of the capitalist mode of production. This postulate was increasingly called into question in the later 1970s as a result of

slow economic growth, high unemployment, high inflation, and the crisis of the welfare state. The growing disequilibrium of the welfare state was dramatically symbolized by the expenditure rollbacks of Prime Minister Margaret Thatcher in Great Britain and President Ronald Reagan in the United States.

Derivationism

The Miliband-Poulantzas stalemate and the crisis of the welfare state defined the intellectual and political context in which the journal *Kapitalistate* first introduced derivationism—also known as the capital logic school—to Anglo-American scholars. Derivationism emerged from the West German student movement in 1969, but it did not have an impact outside Germany until the translation and publication in 1978 of several essays by John Holloway and Sol Picciotto. The central axiom of the derivationist approach is that the analysis of the relation between state and society must be deduced from contradictions inherent in the capitalist mode of production. The rationale for this claim is that if capitalism were in fact a spontaneous and self-regulating economic system as stipulated by neoclassical economics, there would be no logical rationale for state action in relation to capital accumulation. Yet, the state routinely intervenes in economic relations in all capitalist societies. Therefore, derivationists posit the state as a logically necessary instance of capitalist society that must perform for the capitalist class those tasks that it inherently cannot perform for itself. These tasks, whatever their nature at any given historical period, define the general interests of the capitalist class.

Derivationism was viewed briefly as a way to transcend the methodological antinomies of the Miliband-Poulantzas debate because it focused state theory on the limitations imposed on state policies by its relation to the process of capital accumulation. Derivationism seemed to offer a more dynamic approach to the state that would explain the relationship between the state's historical political development and the underlying contradictions of the capitalist mode of production in contrast to the static models proposed by Miliband and Poulantzas. Paradoxically, the major objection to derivationism was that it tended to remain ahistorical and nonempirical in its approach to the state and thus provided little guidance to scholars who were interested in studying the historical political development of actually existing states.

The derivationists' main contribution was to call attention to the possibility that systematic and insurmountable limitations on state policy may be imposed by the developing contradictions of the capital accumulation process. It could no longer be assumed that the state would automatically succeed in maintaining the equilibrium of the capitalist system or resolve the underlying political conflicts generated by that process. Thus, state theorists increasingly searched for a theory of the state that could identify the limits of its policy-making capacities and that could conceptualize, anticipate, and explain the crisis tendencies of late capitalist societies, rather than describe its maintenance and stabilization mechanisms.

Systems Analysis

A new systems-analytic approach sought to identify these limits by identifying specific examples of policy breakdown,

particularly instances where state policy either fails to maintain capital accumulation or to restabilize social order among disaffected subordinate classes. The systems-analytic theory of the state is largely identified with the "post-Marxist" works of Jürgen Habermas and Claus Offe, who were influenced by the derivationists conceptually, but whose methodology draws heavily on the radical systems theory of Niklas Luhmann. Offe is largely credited with advancing state theory beyond instrumentalism and structuralism by introducing the dependency principle. The dependency principle asserts that the decision-making power and policy capabilities of the state in capitalist society are dependent upon the continuity of the capital accumulation process, primarily because of the modern state's dependence on tax revenues. Therefore, state elites in a capitalist economy must adopt policies that enhance business confidence in the short-run and that promote a favorable business climate over the long-run. Where state elites promote a favorable business climate with public policy, they will be rewarded with high rates of private investment, economic growth, and employment stability. Where state policies undermine business confidence, business people will refuse to invest, which generates an investment strike throughout the economy, while many business people may even redeploy their capital toward economies in which they have greater political and economic confidence.

The modern state's dependence on substantial and growing tax revenues means that every interest state personnel have "in their own stability and development can only be pursued if it is in accordance with the imperative of maintaining accumulation" (Offe, p. 126). According to Offe, "this fundamental dependency upon accumulation also functions as a selective principle upon state policies," because violating this logic of accumulation would simultaneously weaken or undermine all state capacities. Thus, a concern for the continuity of private accumulation is "incorporated in the pursuit of interests and policies that, considered by themselves, may have little or nothing to do with accumulation" (p. 126).

However, in a political democracy, the capitalist state must also be legitimate. A capitalist state that sustains an exploitative accumulation process can only achieve legitimacy by deploying concealment and ideological mechanisms. Concealment mechanisms, such as administrative secrecy, facilitate the adoption and implementation of maintenance policies outside the sphere of class struggle and special-interest competition. The state's ideological mechanisms convey the image that its power is organized to pursue the general interests of society as a whole, even though it functions in a specific relationship to capitalist accumulation. Consequently, a capitalist state must sustain and yet conceal a structural disjuncture between its democratic form and its capitalist functions.

The capitalist state must respond to contradictions in the capitalist mode of production with social policies, but an important feature distinguishing post-Marxist systems analysis from similar structuralist analyses is the assertion that welfare states actually fail to function at precisely those moments when most needed and these system failures result in contradictory outcomes that produce a variety of cumulative crisis tendencies

in capitalist societies. Jürgen Habermas and James O'Connor suggest that the political contradictions and policy failures of modern states cumulatively generate an economic crisis, a fiscal crisis, crises of state rationality and legitimation, and a motivation crisis in the underlying population and workforce.

Organizational Realism

During the 1980s and 1990s, state theorists influenced by the new institutionalism in political science and sociology elucidated yet another post-Marxist approach to the state called organizational realism. Organizational realists define the state as an organization that attempts to extend coercive control and political authority over particular territories and the people residing within them. A fundamental thesis of organizational realism is that in pursuing this political objective state elites are self-interested maximizers whose main interest is to enhance their own institutional power, prestige, and wealth. Consequently, Theda Skocpol has suggested that during exceptional periods of domestic or international crisis state elites may be impelled to implement social policies, economic reforms, and institutional changes that concede subordinate class demands while violating the interests of those classes that benefit from the existing economic arrangements within a state's jurisdiction. Under certain circumstances, Skocpol argues that state elites might deploy state power to act against the long-run interests of a dominant class or even act to create a new mode of production. However, Skocpol cautions that the extent to which states actually are autonomous, and to what effect, varies from case to case, which means "the actual extent and consequences of state autonomy can only be analyzed and explained in terms specific to particular types of sociopolitical systems and to particular sets of historical international relations" (p. 30). Therefore, the aim of this research strategy has been to focus on the theoretically limited task of constructing empirical generalizations by using comparative historical case studies of policy formation and state institutional development.

Economics and the State

The new institutionalism in state theory has been embraced by some economists, such as Douglass C. North, who observes that "the whole development of the new institutional economics must be not only a theory of property rights and their evolution but a theory of the political process, a theory of the state, and of the way in which the institutional structure of the state and its individuals specify and enforce property rights" (p. 233). There have been few significant efforts to follow through on this observation. Joseph Stiglitz also suggests that because most state activities involve questions of resource allocation, state theory falls within the purview of the economics discipline, but economists have largely neglected the state despite their agreement that there are only two ways of coordinating the economic activities of large populations: (1) central direction involving the use of coercion (that is, the state) and (2) the voluntary cooperation of individuals (the market).

Economists have devoted little attention to the theory of the state because most assume that markets provide optimal resource allocations in contrast to the state's supposed inefficiency. From this perspective, state intervention in the economy

is only justified in cases of market failure, but since market failures are considered exceptions to the rule that markets optimize resource allocations, the analysis of the state and its role in society is considered marginal to the main focus of neoclassical economics. At its most extreme, libertarian philosophers and economists not only accept this proposition, but draw on well-accepted definitions of the state as a coercive institution to argue that the state is inherently parasitic. Murray Rothbard claims that regardless of its form, the state is inherently illegitimate since it is dependent on "coerced levies" (i.e., taxes) that make it essentially no different from "a criminal band" beyond the fact that it is the "best organized aggressor against the persons and property of the mass of the public" (pp. 46–47). In contrast to Marxist theory, which views the state as a mechanism for subordinating subaltern classes by a dominant class, libertarian theory views the state itself as a political class that exploits the entire society of economic producers.

Stiglitz has proposed an economic model that reverses the main assumption of neoclassical economics with the argument that markets are always imperfect because information is imperfect and this makes all markets incomplete without state intervention. In Stiglitz's model, the issue for economists is not to identify market failures, since "these are pervasive in the economy, but of identifying large market failures where there is scope for welfare-enhancing government interventions" (pp. 38–39). This model incorporates the normative assumption that the state will (or should) pursue welfare-enhancing policies and, therefore, challenges the normative claims raised by most other theories of the state, which view it as an exploitative organization.

Globalization and the State

The main contours of "the state debate" were fixed by the early 1990s, and there were few new developments in state theory as many scholars lost interest in the topic. The proliferation of state theories from 1968 onward resulted in an intellectual stalemate, where scholars retreated into their favored theoretical approach to conduct empirical and institutional research on political development and public policy. Postmodernist and poststructuralist theories of power claimed that power was not centered in the state, but diffused in a variety of everyday relationships and identities such as language, gender, race, ethnicity, mass media, medicine, family, work, and play. Many scholars shifted their attention to the analysis of these diffused forms of "micropower." Finally, the process of economic globalization, which became so evident in the 1990s, led others to conclude that the state was in crisis, retreat, or decline as its sovereign functions were lost or ceded to global markets and transnational corporations.

However, the latter trend also witnessed the emergence of new supranational institutions (for example, the European Union and the World Trade Organization) and the strengthening of preexisting international organizations (for example, the United Nations, the North Atlantic Treaty Organization, the World Bank, and the International Monetary Fund). This development stimulated renewed interest in state theory at the turn of the century, while shifting its analytic focus toward the new forms of global governance and their relation to the

nation-state. A variety of theoretical positions quickly appeared, which are distinguished mainly by their analysis of the American state within this global system and their claims about the role of the nation-state within the world economy.

The proponents of the American superstate thesis argue that the collapse of the Soviet Union has left the United States with no serious rivals in the economic, political, or military realms, and thus economic globalization and its auxiliary institutions are viewed as a projection of the American state's power on a global scale. Thus, globalization is not viewed as a development external to the nation-state, because it is nation-states, particularly the United States and its allies, that have played the leading role in creating a new global economy, while remaining the primary actors within the new supranational institutions.

A major theoretical challenge to this thesis is Martin Shaw's argument that an internationally legitimate "global-Western state" has integrated its member nation-state's functions as an organizer of legitimate violence and authoritative rule maker into larger bloc structures. While the United States played a leading role in constructing the Western state's supranational military and economic organizations, Shaw insists that "the idea of American hegemony is too simple to characterize relations within the Western state." Instead, Shaw claims that the global-Western state is "an integrated authoritative organization of violence" that should be considered "a new type of state, rather than an alliance or a complex set of alliances of states" (pp. 240–242).

Finally, a thesis proposed by Michael Hardt and Antonio Negri seems to mark a new phase in the abandonment of the state concept. Hardt and Negri seek to replace the state with a concept of empire. Their main hypothesis is that globalization is transforming governance to such an extent that "sovereignty has taken a new form, composed of a series of national and supranational organisms united under a single logic of rule" (p. xii). The global form of sovereignty is called empire. Hardt and Negri argue that "Empire establishes no territorial center of power and does not rely on fixed boundaries or barriers. It is a decentered and deterritorializing apparatus of rule that progressively incorporates the entire global realm within its open expanding frontiers" (p. xii). Hardt and Negri concede that the United States enjoys a privileged position in empire, and they attribute the origins of its logic to the United States Constitution, but they view empire as a supranational logic "that effectively encompasses the spatial totality . . . that rules over the entire 'civilized' world." Empire is an "order that effectively suspends history and thereby fixes the existing state of affairs for eternity" and thus marks the end of history or the final phase of world political development (p. xiv).

See also *Empire and Imperialism; Marxism; Political Science; Sovereignty*.

BIBLIOGRAPHY

Barrow, Clyde W. *Critical Theories of the State: Marxist, Neo-Marxist, Post-Marxist*. Madison: University of Wisconsin Press, 1993.

- Domhoff, G. William. *The Powers That Be: Processes of Ruling-Class Domination in America*. New York: Random House, 1978.
- Easton, David. *The Political System: An Inquiry into the State of Political Science*. New York: Knopf, 1953.
- Habermas, Jürgen. *Legitimation Crisis*. Boston: Beacon, 1975.
- Hardt, Michael, and Antonio Negri. *Empire*. Cambridge, Mass.: Harvard University Press, 2000.
- Holloway, John, and Sol Picciotto, eds. *State and Capital: A Marxist Debate*. Austin: University of Texas Press, 1978.
- Jessop, Bob. *The Capitalist State*. New York: New York University Press, 1982.
- Luhmann, Niklas. *Social Systems*. Stanford, Calif.: Stanford University Press, 1995.
- Miliband, Ralph. *The State in Capitalist Society*. New York: Basic, 1969.
- North, Douglass C. "The New Institutional Economics." *Journal of Institutional and Theoretical Economics* 142 (1986): 230–237.
- O'Connor, James. *The Meaning of Crisis: A Theoretical Introduction*. New York: Blackwell, 1987.
- Offe, Claus. *Contradictions of the Welfare State*, edited by John Keene. Cambridge, Mass.: MIT Press, 1984.
- Poulantzas, Nicos. "The Problem of the Capitalist State." *New Left Review* 58 (1969): 67–78.
- . *Political Power and Social Classes*. London: Verso, 1978.
- Rothbard, Murray. *For a New Liberty: The Libertarian Manifesto*. Rev. ed. New York: Collier Macmillan, 1978.
- Shaw, Martin. *Theory of the Global State: Globality as an Unfinished Revolution*. Cambridge, U.K.: Cambridge University Press, 2000.
- Skocpol, Theda. *States and Social Revolutions: A Comparative Analysis of France, Russia, and China*. Cambridge, U.K.: Cambridge University Press, 1979.
- Stiglitz, Joseph. *The Economic Role of the State*. Edited by Arnold Heertje. Cambridge, Mass.: Blackwell, 1989.
- Strange, Susan. *The Retreat of the State: The Diffusion of Power in the World Economy*. New York: Cambridge University Press, 1996.
- Sweezy, Paul. *The Theory of Capitalist Development: Principles of Marxian Political Economy*. New York: Monthly Review, 1942.

Clyde W. Barrow

THE POSTCOLONIAL STATE

The scope of coverage of the term *postcolonial* varies across disciplinary fields and authors, being broader in literary studies, for example, than in political science. Some authors include former settler colonies as referents alongside non-settler colonies. Other analysts, such as Amina Mama, distinguish the term *postcolonial*, used to refer specifically to former colonies, from the term *post-imperial*, preferring this term to refer to former imperial powers. In temporal terms, *postcolonial* does not refer simply to the period after colonialism but assumes continuity, in terms of the continued effects of processes initiated during colonialism, as well as discontinuity, in terms of new processes unfolding subsequently. The term *postcolonial* is used here to refer to the study of the attempted transformation, successful and otherwise, of former colonies in the context of changing imperial conditions.

From Structural Functionalism to Marxist Structuralism

In the early days of independence, the individualistic approach of authors who singled out the performance of those in positions of power earned them the label of “leadership theorists.” Leadership was essentially viewed as a means for achieving “order.” Such writers shared much in common with the “nation-building” school of American structural functionalism, where “nation” was very often equated with “state.” This literature was more concerned with the possibilities of statehood and the development of political institutions in the new states than with the constraints on institutional development, the latter being of greater interest to Marxists. The chief merit of leadership approaches is the emphasis on the created aspects of state formation and the efforts of individuals with a degree of control over their political life and environment. Critics (see Stark) point out, however, that the analysis tends to foster philosophical idealism and does not take enough account of the relationship between ideology and social action.

During the 1960s and 1970s, the underdevelopment paradigm became very influential in efforts to explain the economies and modes of rule that decolonizing nations were constructing. Underdevelopment theorists were concerned with the economic dependency of postcolonial states in the context of international capitalism as well as the relative autonomy of the postcolonial state from social classes. The theoretical model drew on the dichotomy between base and superstructure that characterized Marxist structuralism, but the focus was on trade rather than production. Several authors (see Ollawa) have pointed out that the developmental experiences of decolonizing countries highlight the centrality of the postcolonial state in structuring the necessary conditions for continued capital accumulation and regulating the allocation of surplus among different social categories.

In an influential essay on Pakistan and Bangladesh, “The State in Post-Colonial Societies—Pakistan and Bangladesh” (1972), Hamza Alavi posited that the postcolonial state was “over-developed” due to its foreign creation. It was consequently particularly powerful compared to the leading agrarian and industrial classes, the latter being “under-developed.” The idea of the relative autonomy of the state was proposed because of the independent material base of the bureaucratic-military oligarchy and its relative autonomy from the other propertied classes. Critics of Alavi’s position point to the idea of the state being reduced to a handful of bureaucrats and military officers in his analysis. Understanding the limitations placed on the state’s responses to pressures from hegemonic interests requires a closer examination of the state, in relation to its constituent parts and in relation to the international environment, and a more comprehensive view of classes.

Alavi’s 1972 essay sparked off considerable debate amongst Marxist Africanists. This included John Saul’s emphasis on ideology, which he said was neglected in Alavi’s analysis, but was necessary for the state’s function of holding together the capitalist system. Colin Leys responded by reasserting the importance of class as the basis of analysis of the state, and others responded in a similar vein. Many Marxists are of the view

that patterns of belief can bind the state together and, drawing on the ideas of Antonio Gramsci (1891–1937), have attempted to conceptualize anew the role of elites and their ideologies, in the complex economic relationships of the post-colonial state.

Interweaving History, Politics, and Culture

Jean-Francois Bayart points out that the notion that the state was an external structure does not recognize the ways in which Africans quickly re-appropriated the new state forms and the accompanying colonial political culture. Similar perspectives (e.g., Mbembe) point to the re-appropriation taking place not only in the institutional sphere but also in the material and cultural spheres. State power creates its own world of meanings through administrative and bureaucratic practices. It also attempts to institutionalize this world and turn it into people’s everyday understanding as well as the consciousness of the period.

The historicity of the postcolonial state is at the center of Bayart’s analysis. His focus is on the genesis of the state, the strategies of the actors, the procedures of accumulation and the world of political make-believe, all of which contribute to social inequality. Bayart’s evocative phrase, “the politics of the belly,” refers to desires and practices associated with interrelated themes: poverty and food scarcity; accumulation, corruption, and sexual excess. These are all understood as changing patterns of historical action, that are located in a network of tensions and interdependence, and that act upon one another. Bayart highlights the ways in which authoritarian regimes have managed to retain control over security forces and economic rents whilst maintaining the support of Western powers and international financial institutions. African postcolonial states rested on indigenous social bases whilst simultaneously being connected to the international system. Bayart’s approach counters the conception of African states and societies as lacking history, and of African politics as absent or inexplicable. These prevailed in colonial historiography, in philosophy, and continue today in mainstream Western sociology and political science.

From the 1980s onward, considerable scholarly attention across the social sciences has been paid to the “crisis” of the African state. The literature has also examined the shifting orientations of international financial institutions, from initially increasing the interventionist powers of the state to reversing that position by the mid-1980s. In an ideological climate defined by neoliberalism and marked by structural adjustment programs, scholars of diverse ideological orientations are united in their fierce criticism of international financial institutions, their appropriation of the concept of the “overdeveloped state” and the effects of their policy impositions on diverse categories of people. The literature has characterized the activities of international financial institutions as “rolling back the state” and bypassing the autonomy of the state in several critical ways through policy prescriptions and financing patterns.

Achille Mbembe’s poststructural analysis of the “post-colony” draws attention not just to the historical strength and purpose of the state but also to questions of power—its manifestations and the different techniques of enhancing its value to either ensure abundance or scarcity. Before and after

colonization, state power in Africa magnified its value by establishing specific relations of subjection that were informed by the distribution of wealth and tribute, and that shaped modes of constituting the postcolonial subject. Postcolonial states were strongly influenced by the modalities of their integration into world trade, such as reliance on one or more key resources for export, and whether they were financed through the peasantry, aid, or debt. Their modalities of integration shaped the forms taken by postcolonial states; the ways in which their ruling elites were inserted into international networks; and the structuring of relations among state, market, and society. Mbembe highlights the significance of the links that the postcolonial state in Africa forged among inter-related arenas. These were the production of violence, the allocation of privileges and livelihoods, and systems of transfer, such as the reciprocities and obligations comprising the communal social tie. The state's systems of allocations and transfers were significant in underpinning social and political cohesion and, thereby, the state's legitimacy.

Mbembe also draws attention to the present erosion of state legitimacy since the concentration of the means of coercion by the postcolonial state is difficult to achieve given the acute lack of material resources. Instead, autonomous power centers proliferate within what used to be a system. This is a consequence of the growing indebtedness of local rulers and trading elites, thus leading African polities to lose external power and exposing them to the risk of internal dissolution. The violence and predation required by the new form of integration into the international economy has led not only to the militarization of power and trade, and to increased extortion, but also to serious destabilization of the trade-offs that had previously governed the relationship between holding state power and pursuing private gain. The idea of the state as a general mechanism of rule and as the best instrument for making possible the exercise of citizenship is thus being seriously threatened.

Feminist Analyses of the Postcolonial State

In contrast to the above approaches, a key debate among feminist analysts of the postcolonial state concerns the extent to which the state is able to act as a vehicle for social change aimed at increasing gender equality. For example, in Morocco in the early 1990s, the modernizing state drew women into the public arena through law and education. The other side of the debate concerns the state as a mechanism for male social control and the convergence between the state and patriarchal forces. Where politics becomes deeply communalized, particularly when it is supported by state-sponsored religious fundamentalism, the traditional control over women that rested with particular male individuals—such as fathers, brothers, husbands—soon shifts to all men. Sonia Alvarez argues that there is nothing essential about the state's ability to act in either direction—social change or social control—but that its trajectory is more likely to be determined by political regime and historical conjuncture.

The feminist analyst Shirin Rai conceptualizes the state as a network of power relations that are located in economic, political, legal, and cultural forms interacting with and against each other. This allows her to examine the state in the context

of social relations shaped by systems of power, which are themselves affected by struggles against these systems. Rai points out that the state may take different forms in different historical, social, and economic contexts, as in the case of postcolonial states emerging from struggles against imperialism and colonial rule. The nationalist opposition to colonialism was itself located within the modernizing framework favored by colonialists. The prioritization of goals, first by the nationalist movement and then by the postcolonial state, erased issues that potentially challenged the modernist developmental conceptions of the new nation-state, such as women's interests and rights.

Rai highlights three features of postcolonial states that are significant for women's strategizing for social change. The first concerns the transformative role of the state: most nationalist elites saw themselves as agents for social and economic transformation, and state institutions were also relatively autonomous from dominant social classes. This allows space for institutional and political struggles. Second, the infrastructural capacity of the state is uneven, resulting in the possibility of activists targeting sympathetic institutions and individuals within the state. Third, the existing level of corruption is an important determinant of whether negotiation within the state is possible or not. Rai points out that one of the important implications of the poststructuralist conception of power as dispersed is the recognition that power takes diverse forms and can be used in varied ways. Simply taking an adversarial position against the state may be positively dangerous for women, given the deeply masculinist character of society, including civil society.

The gendered character of state formation, state practices, and militarism are analyzed by Amina Mama. In an earlier paper, Mama had argued that, in an international context highly influenced by women's movements, the military regimes of Generals Ibrahim Babangida (1985–1993) and Sani Abacha (1993–1998) were appropriating Nigerian women and their struggles whilst seeking legitimacy for their continued rule. Later, she refined this position by pointing out that the situation was more complex than this. This complexity included the fact that the politics of transition, and hence its gender politics, was more improvised than planned and took several turns in different and contradictory directions. Moreover, Nigerian women, in diverse and competing ways, were not passive pawns but actively engaged in the political maneuvers involved.

Drawing on Michel Foucault's theorization of power as dispersed, Mama theorizes power as dispersed across micropolitical, existential states of being as well as more macropolitical formations such as the nation-state. This allows her to consider ways in which these different levels of social reality come together to produce resonance and, potentially, dissonance. Mama also draws on the feminist philosopher Judith Butler's development of Foucault's theorization of power, arguing that being implicated or enabled by relations of power does not rule out the possibility of subversion. Mama examines the gender discourses articulated by the Heads of State and their wives in successive regimes, the programs and political practices articulated by these discourses, and the different structural changes made in efforts to institutionalize them. In the process, she highlights the interplay among power, knowledge, and

practice that facilitated the manufacture of consent to the military regimes dominating the workings of the state.

Rajeswari Sunder Rajan delineates the changing, heterogeneous character of the postcolonial state in India in her exploration of the state's contradictory positions toward female citizens. In a feminist analysis of social realities textured by divisions of age, ethnicity, religion, and class, Sunder Rajan examines women's lives, needs, and struggles around issues such as child marriage, compulsory sterilization, female infanticide, and prostitution. She shows how the state is critical to an understanding of women's individual and group identities at the same time as women and their struggles affect the operations of the state.

Conclusion

Three major conceptual fields are identifiable in the above literature. The first is that of structuralism, spanning ideas from structural functionalism to Marxism and with concomitant emphases on individualism and class. This field was in the ascendant in the 1960s and 1970s, its influence waning since then. The second field, emerging in the late 1980s, highlights the agency of actors in and around the state, located in inter-related historical, material, and cultural contexts. Although highly innovative in its syntheses of literature in history, politics, and cultural studies, the ideological orientation of this work in relation to social action is less clear. Finally, there is the field of feminist thought. This field shares common features with that highlighting agency, such as poststructural approaches to the analysis of power and the recognition of nonunitary, contradictory interests surrounding the postcolonial state. Unlike either of the other two fields, feminist scholarship is distinguished by its analysis of gendered state processes, the implications for women, and strategies for realizing gender justice.

See also *Anticolonialism; Colonialism; Postcolonial Studies*.

BIBLIOGRAPHY

- Alavi, Hamza. "The State in Post-Colonial Societies—Pakistan and Bangladesh." *New Left Review* 74 (1972): 59–80.
- Alvarez, Sonia E. *Engendering Democracy in Brazil: Women's Movements in Transition Politics*. Princeton, N.J.: Princeton University Press, 1990.
- Baker, C. "Colonial Rule and the Internal Economy in Twentieth-Century Madras." *Modern Asian Studies* 15, no. 3 (1981): 575–602.
- Bayart, Jean-Francois. *The State in Africa: The Politics of the Belly*. London and New York: Longman, 1993.
- Butler, Judith. "Gender Is Burning: Questions of Appropriation and Subversion." In *Dangerous Liaisons: Gender, Nation and Postcolonial Perspectives*, edited by A. McClintock, A. Muftic, and E. Shohat. Minneapolis: University of Minnesota Press, 1997.
- Kandiyoti, D., ed. *Women, Islam and the State*. London: Macmillan, 1991.
- Leys, Colin. "The 'Overdeveloped' Post Colonial State: A Re-evaluation." *Review of African Political Economy* 5 (1976): 39–48.
- Mama, Amina. "Changes of State: Gender Politics and Transition in Nigeria." Inaugural Lecture, September 15, 1999, New

Series no. 213, University of Cape Town, Department of Communication.

- Mbembe, Achille. *On the Postcolony*. Berkeley: University of California Press, 2001.
- Ollawa, P. "The Political Economy of Development: A Theoretical Reconsideration of Some Unresolved Issues." *African Studies Review* 26, no. 1 (1983): 125–155.
- Rai, Shirin. "Women and the State in the Third World: Some Issues for Debate." In *Women and the State: International Perspectives*, edited by S. Rai and G. Lievesley. London: Taylor and Francis, 1996.
- Saul, John. "The State in Post-Colonial Societies: Tanzania." In *The Socialist Register*, edited by R. Miliband and J. Savage. London: Merlin Press, 1974.
- Stark, F. "Theories of Contemporary State Formation in Africa: A Reassessment." *Journal of Modern African Studies* 24, no. 2 (1986): 335–347.
- Sunder Rajan, Rajeswari. *The Scandal of the State: Women, Law and Citizenship in Postcolonial India*. Durham, N.C.: Duke University Press, 2003.

Charmaine Pereira

STATE OF NATURE. The state of nature is a situation without government, employed in social contract theory in order to justify political authority. The device is most important in the works of the great contract theorists of the seventeenth and eighteenth centuries, mainly Thomas Hobbes (1588–1679), John Locke (1632–1704), and Jean-Jacques Rousseau (1712–1778). But it has a long history and was used by many other theorists. In the latter half of the twentieth century, variants of the state of nature were revived by John Rawls and other theorists who attempted to establish particular moral or political principles on the grounds that they would be selected in artificially constructed choice situations.

Accounts of humanity's purported natural condition differ in important ways, for example, whether circumstances are peaceful or riddled with conflict, whether there is an absence of society as well as the state, and the extent to which the people depicted resemble those in existing societies. These variations and others lead to justifications of different forms of governments—and moral principles.

Early History

Mythical accounts of a pre-social and/or pre-political Golden Age abound in classical literature. Familiar variants are found in Hesiod's *Works and Days* (lines 108–21) and in Plato's *Statesman*. In Plato's *Protagoras*, the title character describes the original human condition as one of isolation and peril from wild beasts and the elements. Divine intervention provided fire and the crafts, which allowed humans to defend themselves, and moral qualities of justice and respect, which allowed them to live together peaceably. A roughly similar account was presented by Cicero, in *De inventione* (On invention, I.2.2), and an especially vivid account in Book V of Lucretius' *De rerum natura* (On the nature of things). A variant of these themes is that people originally enjoyed a condition of peace and plenty, until some intervening event gave rise to conflict, which made

the state necessary. The Stoic Posidonius attributed humankind's fall to the origin of property (Seneca, *Epistle* 90), while according to Ovid, the change occurred as people began to eat meat (*Metamorphoses*, XV.96–111).

Connections between an original condition and the origin of justices are presented in Book II of Plato's *Republic*. Plato's spokesman, Glaucon, argues that justice arose from a general compromise: people agreed not to take advantage of others, in exchange for not being taken advantage of themselves (358e–59b). This was perhaps the first “social contract” argument in the Western tradition.

Classical arguments blended well with Judaeo-Christian accounts of the Garden of Eden and subsequent fall, to support the important medieval notion that the state arose as a remedy for sin. But other theorists, influenced by Aristotle, argued against the state of nature and contract traditions, claiming that the human is naturally a political animal, and so there could not have been a primordial pre-social (or pre-political) condition. St. Thomas Aquinas and subsequent Scholastic theorists argued that even in the Garden of Eden, authority was necessary to coordinate people's activity to achieve the common good.

Hobbes, Locke, and Rousseau

During the late medieval and early modern periods, claims according to which political power originated from a pre-political, natural condition generally supported limitations on political power—which people would have required for renouncing their natural liberty. The great originality of Hobbes was to use a contract argument to establish absolute government. He accomplished this by depicting the state of nature in horrific terms, as a war of all against all, in which life is “solitary, poore, nasty, brutish, and short” (*Leviathan*, chap. 13). Hobbes argued that, in order to escape such horrors, people would consent to absolute political authority—and that only absolute authority could ward off the state of nature.

Although Hobbes employed the device of the state of nature for largely analytical purposes, he also believed in its historical accuracy. Evidence he provided is people's defensive behavior in society, the “savage people” in America, whom he saw as living in a “brutish manner,” and how states confront one another in the international arena, “in the state and posture of Gladiators,” with their “Forts, Garrisons, and Guns” pointed at one another (*Lev.* chap. 13).

In the state of nature described by Locke in his “Second Treatise of Government,” people live under the law of nature, which, in the absence of government, they enforce themselves (Secs. 6–9). People also establish property rights, use money, and have something of a developed economy. But conflict arises because people are self-interested and so not impartial in their own disputes. Recognizing the need for an impartial umpire, Lockean individuals leave the state of nature, in two stages, forming first a community and then government. When government violates the agreement according to which it was established, people revert to a pre-political but not pre-social state. The state of nature returns only with complete destruction of society, through foreign invasion or similar catastrophes (Sec. 211).

In his “Discourse on the Origin of Inequality,” Rousseau criticized other theorists for attributing to natural man qualities they found in their own societies. Influenced by anthropological and zoological discoveries, Rousseau depicted natural man as little different than an ape: solitary, without language, and with limited reasoning capacity. But because his purely physical needs are satisfied relatively easily, he is content and, above all, morally innocent. Man becomes corrupt only through a gradual process of moving into society, and Rousseau depicted the contract through which government originates as a clever fraud perpetrated by the rich upon the poor. Rousseau's political theory aspired to recapture as much primordial natural purity as possible, through the new contract described in *The Social Contract*.

Contemporary Developments

By the end of the eighteenth century, the social contract was widely criticized on historical grounds. The idea fell into general disuse, and with it, the state of nature. Contract theory was revived by John Rawls, in *A Theory of Justice* (1971), although Rawls used his contract to justify moral principles rather than a form of government. Rawls's principles of justice are those that would be agreed upon under appropriately fair conditions. The state of nature reappears in his theory as the “original position.” In order to prevent people from choosing principles that would advantage themselves, they are placed behind a “veil of ignorance” and so deprived of knowledge of their personal attributes, e.g., age, religion, race, and wealth. The two principles selected under these conditions are highly egalitarian, guaranteeing equal liberty and that economic inequalities benefit the least-advantaged members of society. With Rawls, the state of nature (original position) loses all historical pretense. It is simply an analytical device to help identify appropriate moral principles.

Other theorists employ contractual devices to justify moral principles rather than government. In David Gauthier's *Morals by Agreement*, appropriate principles are those that would be agreed upon by parties motivated by self-interest. Gauthier's “initial bargaining position” differs from Rawls's original position in that the parties have full knowledge of their circumstances and interests. The principles agreed upon represent the parties' least possible concession to others' demands, the “maximum relative concession.”

A different, highly influential alternative to Rawls's contract theory is Robert Nozick's “invisible hand” explanation of the origin of the state, in *Anarchy, State, and Utopia*. According to Nozick, individuals situated in a Lockean state of nature join together in “mutual protective associations,” which are then moved by market forces to combine in ever-larger associations, eventually giving rise to an “ultraminimal state,” and finally a minimal state. Nozick argues that a state can arise through such a process without violating anyone's rights, and that only a minimal state can meet this condition.

See also *Human Rights; Philosophy, Moral; Social Contract*.

BIBLIOGRAPHY

Gauthier, David. *Morals by Agreement*. Oxford: Oxford University Press, 1986.

- Hobbes, Thomas. *Leviathan*. Edited by R. Tuck. Cambridge, U.K.: Cambridge University Press, 1991.
- Locke, John. "Second Treatise of Government." In *Two Treatises of Government*, edited by Peter Laslett. Cambridge, U.K., and New York: Cambridge University Press, 1988.
- Nozick, Robert. *Anarchy, State, and Utopia*. New York: Basic Books, 1974.
- Rawls, John. *A Theory of Justice*. Cambridge, Mass.: Harvard University Press, 1971; rev. ed., 1999.
- Rousseau, Jean-Jacques. "Discourse on the Origin of Inequality." In *Basic Political Writings of Jean-Jacques Rousseau*, edited by Peter Gay. Indianapolis: Hackett, 1987.

George Klosko

STOICISM. Stoicism, from its foundation, has been most famous for its ethical ideas. Even now, *stoical* suggests a particular ethical stance, endurance of pain or misfortune without complaint. But in antiquity Stoicism was notable also for its unified view of the scope of philosophy and of the nature of reality.

The Stoic School in Antiquity

Stoicism, alongside Epicureanism, was one of the two most important philosophical movements in ancient Greece in the Hellenistic period (after the transformation of the Greek world by Alexander the Great). Both schools were founded in Athens at the end of the fourth century B.C.E.; both offered a distinctive way of life and an integrated theory and worldview. Ancient philosophical schools were not formal institutions but rather groups of intellectuals and students centered on a leading figure (the head of the school). Stoicism was founded by Zeno of Citium (c. 335–c. 263 B.C.E.), and developed by a series of subsequent heads, particularly Chrysippus (c. 280–c. 206 B.C.E.) in the late third century, who systematized the teachings of Zeno and made special contributions in logic. From the first century B.C.E. onward, the school was not based at Athens or centered on a specific head, but became a more diffuse movement, with Stoic teachers and adherents throughout the Greco-Roman world. Stoic teachings were transmitted by an extensive body of treatises, especially by Chrysippus, supplemented by summaries of doctrines and more popular writings especially in practical ethics. Stoicism was a powerful philosophical force throughout the Hellenistic period (until the late first century B.C.E.) and in the first two centuries C.E. under the Roman Empire. It died out as a creative movement in the third century C.E., though its influence remained important in later antiquity.

Main Doctrines

In ethics, Stoics saw themselves as perpetuating the key ideas of Socrates (c. 470–399 B.C.E.), especially as presented in Plato's (c. 428–348 or 347 B.C.E.) dialogues. These ideas were combined with the view of philosophy as an integrated system of branches of knowledge and a picture of reality as an intelligible and unified whole. For the Stoics, complete wisdom consisted in a synthesis of ethics, physics (study of nature), and logic.

The Stoic ethical ideas drawn from Socrates were that virtue was unified, a type of knowledge, and the only thing that was good in itself. Also Socratic were the ideas that virtue was the sole basis for happiness and that all human beings were capable of achieving full virtue. The Stoics developed these ideas into a systematic theory of value linked with a normative picture of human development. Apart from virtue, the other so-called good things in human life, such as one's own health or prosperity and that of one's family or friends, were "matters of indifference," not goods, though they were naturally "preferable." In a complete process of ethical development, human beings would progress from valuing "preferable" things to recognizing that virtue (conceived as order and rationality) was the only good. Failure to develop an understanding of what was really good produced emotions, such as anger and grief, that were defective and misguided reactions. One of the main objectives of Stoic practical ethics was to cure people of the misconceptions that produced these emotions and to promote the development toward full wisdom that alone brought true peace of mind. Sociability and the desire to benefit others was also seen as a natural instinct in human beings, which should develop toward a sense of kinship with all other human beings as rational animals. The realization of the brotherhood of humankind (which was also seen as the expression of "natural law") was the ultimate ideal and desired objective of Stoic political thinking. Stoics did not favor any specific type of conventional constitution such as democracy or monarchy.

In Stoic physics, the natural universe was seen as unified and coherent. Reality, including god and the human mind, was conceived in wholly material terms. The universe was a total fusion of active and passive principles; the active principle could be understood as fiery air or animate breath (*pneuma*), and also as immanent god, reason, or fate. The universe was also seen as a seamless web of interconnected causes with no random events. This nexus of events, and the universe as a whole, was understood in teleological terms, as expressing underlying providential purpose or rationality and as being, in that sense, good.

For the Stoics the scope of logic included the philosophy of language and epistemology as well as the systematization of arguments. Chrysippus in particular developed formal logic to a very high level, especially the logic of propositions; Stoics also partly anticipated Gottlob Frege's (1848–1925) distinction between sense and reference. In epistemology, they maintained the empiricist claim that certain kinds of sensory "appearances" form the basis of an infallible grasp of reality. However, they also held that complete knowledge, or wisdom, involves a systematic, theoretically based understanding of reality as a whole.

The goal of philosophical enquiry was an integrated grasp of these three areas. For instance, the Stoic theory of determinism embraces a conception of universal causation (derived from physics), a logical analysis of possibility and necessity, and an ethical account of human responsibility, based on the idea of humans as both rational agents and an integral part of the causal chain. The modern stereotype of the stoical person as one who accepts life's vicissitudes as the work of fate derives from this conceptually powerful set of theories. The seemingly idealized

picture of natural human development adopted in Stoic ethics was seen as consistent with the idea, fundamental to Stoic physics, that nature forms an organic and providential whole. The Stoic conception of the good was, in essence, that of structure, order, and rationality, manifested as virtue in the sphere of ethics, as the order of the universe in physics, and as a system of argumentation and knowledge in logic.

The Medieval and Modern Reception of Stoicism

From the third century C.E., Stoicism was eclipsed as a creative force by Neoplatonism and Christianity. Both those movements replaced the Stoic holistic worldview with transcendent ideals, but they also absorbed and transformed key Stoic themes. The Stoic idea of *logos* (reason) as a bridge between the divine and the human, and as a fundamental principle of reality, was embraced in different ways by both Neoplatonists and Christians in late antiquity and the Middle Ages. One possible response was to draw on Stoic writings for their moral rigor but to ignore or revise their larger philosophical framework. This approach was applied to Epictetus's (c. 55–c. 135 C.E.) *Handbook*, a pithy statement of Stoic practical ethics; by the Neoplatonist commentator Simplicius (fl. c. 530 C.E.); and by medieval Christian ascetics, who used the text as a guide for monastic self-scrutiny. Christian philosophers such as St. Thomas Aquinas (1225–1274) and Francisco Suárez (1548–1617) similarly drew on Stoic ideas to define the idea of virtue as a natural property. In the Enlightenment period, engagement with Stoicism was more full-hearted, and the Neo-Stoic Justus Lipsius (1547–1606) argued for the fundamental equivalence of Stoic and Christian ethics and theology. In the nineteenth century, Hellenistic thought was often regarded as an inferior phase of ancient thought by philosophers (notably Georg Wilhelm Friedrich Hegel) and scholars. But in the twentieth century, especially its last thirty years, Stoicism was an object of intensive scholarly study. The modern revival of virtue-ethics and cognitive approaches to emotion, and current interest in nonreligious practical ethics, have given Stoic ideas renewed appeal. In the twenty-first century, we may expect to find Stoicism also valued for its holistic approach to the universe and the mind-body relationship and the attempt to integrate ethics, science, and logic.

See also *Christianity; Epicureanism; Epistemology; Language, Philosophy of; Ancient and Medieval; Logic; Neoplatonism.*

BIBLIOGRAPHY

- Algra, Keimpe, et al., eds. *The Cambridge History of Hellenistic Philosophy*. New York: Cambridge University Press, 1999.
- Bobzien, Susanne. *Determinism and Freedom in Stoic Philosophy*. Oxford: Oxford University Press, 1998.
- Inwood, Brad. *Ethics and Human Action in Early Stoicism*. Oxford: Oxford University Press, 1985.
- Inwood, Brad, ed. *The Cambridge Companion to the Stoics*. New York: Cambridge University Press, 2003.
- Long, Anthony. *Stoic Studies*. New York: Cambridge University Press, 1996.
- Long, Anthony, and David Sedley. *The Hellenistic Philosophers*. 2 vols. New York: Cambridge University Press, 1987.

Christopher Gill

STRUCTURALISM AND POSTSTRUCTURALISM.

This entry includes two subentries:

Overview

Anthropology

OVERVIEW

Structuralism was both an intellectual movement with wide ramifications in the twentieth century and an attempt to provide scientific status to the knowledge of language, culture, and society.

Structuralism originated in the work of Ferdinand de Saussure (1857–1913), a Swiss linguist whose lectures, when published by his students in 1916 (*Course in General Linguistics*), launched the new school of thought. Initially, the influence of Saussure's ideas was limited to linguistics and to the linguistics-based study of literature that the Russian formalists carried out in the early decades of the twentieth century. When one of the leaders of the formalist movement, Roman Jakobson, emigrated to the United States during World War II, he met the French anthropologist Claude Lévi-Strauss and introduced him to Saussure's work. When Lévi-Strauss returned to France after the war, he launched structural anthropology and initiated French structuralism. His work in the late 1940s and 1950s inspired congruent and related work in psychoanalysis, sociology, history, and literary and cultural studies that culminated in the mid-1960s in the writings of literary scholars Roland Barthes, Tzvetan Todorov, and Julia Kristeva, historian Michel Foucault, and psychoanalyst Jacques Lacan. Structuralism dominated French thought through the early 1960s. In 1967, a new movement that questioned and extended the insights of structuralism arose. Poststructuralism, as it came to be called, is best known in the work of philosophers Jacques Derrida, Luce Irigaray, and Jean Francois Lyotard; sociologist Jean Baudrillard; and literary critic Hélène Cixous.

Saussure and Structuralism

The Saussurean legacy in structuralism assumes two forms. The first is the study of the latent system that generates surface events such as speech in language. The second is the study of culture, language, and society as systems of signs that facilitate communication and the creation of meaning in human culture.

Saussure revolutionized the study of language. He shifted attention away from surface utterances, the everyday speech practices that make up spoken language, and focused it instead on the underlying system that allows those utterances to come into being. He distinguished between *langue* (language system) and *parole* (speech). Each speech utterance presupposes the simultaneous existence of the entire language system from which it arises, much as a leaf, when cut transversally, to use Saussure's example, reveals its entire invisible structure. Saussure also compared language to a game of chess, in which each move has meaning and is made possible by the rules of the game, all of which are implied in each move. In language, similarly, utterances can function as bearers of ideas or as names of things only if the entire system of language is implied in each utterance.

Saussure's most innovative contention was that words are signs that consist of a palpable sound image (signifier) and a mental concept (signified). All signs exist in chains that connect them to all other signs in the language. Language works through the interrelationship and interaction of linguistic signs, not as the naming of objects by words. The relation between words and things, Saussure contended, is entirely arbitrary. *Cat* names a particular animal not because the sound image or signifier "cat" has a real connection or resemblance to the creature but because the signifier "cat" is different from other adjacent signifiers such as "rat" or "hat" in the particular chain of signifiers in which it exists. The slight difference in sound and spelling creates a difference of meaning. Those signifiers in turn function to name things or have meaning because they sound different and are spelled differently from other words. This is known as the diacritical principle. The identity of signifiers is determined by their differences from other signifiers. In language, according to Saussure, there are no identities, only differences. It is the relation between terms that allows signifiers to appear to possess an identity of their own. Language, in other words, is entirely conventional, a matter of form, not natural substance.

Each signifier has a value, a function within the system of language understood as a set of relations between differentially connected terms. A signifier has value as a noun or a verb or as the designator of a particular thing or as performing a particular grammatical function—that is, as a qualifier or pronoun. Saussure notes, for example, that the French *mouton* functions to name both the animal and the food; it has a double value, while English uses two different words with two different values to carry out this function—*sheep* and *mutton*. Each language assigns different values to signifiers, and it is the relation between signifiers that determines value.

Saussure also distinguished between the syntagmatic and the paradigmatic dimensions of language. The syntagmatic names the linking together of parts of language in temporal chains such as a sentence. The paradigmatic is the spatial dimension of language that comprises the possible options that might fill any one space in a syntagmatic chain. For example, in an utterance requiring a verb in a particular position, the slot for "verb" might be filled by any number of possible actions from that particular paradigmatic set.

Influence of Saussure. Saussure made the study of language more scientific by dividing the field into its component parts. He also specified the linguistic field as being concerned with the way language worked as a sign system with a particular structure and with specific rules of operation.

Two of Saussure's ideas proved of great use to thinkers in other fields such as philosophy, history, and sociology. The first was that language is a self-sufficient system of interconnected terms whose value derives entirely from their functions within the system, not from their relation to objects or ideas outside it. This insight allowed other thinkers to argue that *human knowledge and human consciousness in social life occurs within language or discourse*. Knowledge of reality is frequently more a matter of the interconnections among terms in the particular discourse (of economics, politics, or science, for example) than of the connection between the terms of the discourse and

objects in the extra-discursive world. The second influential idea was that *difference makes identity possible*. There is no substance in language apart from the differential relations among the terms, none of which otherwise have an identity of their "own." All traditional notions of a natural substance in philosophy, social thinking, political theory, and other fields could now be rethought as effects of differential relations.

Saussure's discoveries influenced work in other fields directly and by analogy. In the structural anthropology of Lévi-Strauss, both kinds of influence are evident. Lévi-Strauss noted, for example, that numerous different myths, when studied together, reveal a common structure. Myths are sign systems in which terms have different values in relation to one another. Those values often consist of oppositions between terms such as the *raw* and the *cooked* or *nature* and *culture*. Myths functioned to resolve contradictions in human culture by constructing stories in which opposed and contradictory possibilities are mediated and their opposition resolved in a way that provides a solution to some conceptual problem or conflict of values in that particular culture. The myth of Oedipus, for example, resolves the dilemma of human origins by positing a mediation between the supposed earthly origins of human life and the fact that all humans are the product of human sexual relations. The tale is a version of the opposition between nature and culture.

Many mythic stories revolve around the incest taboo, which forbids marriage between members of the same family. In his famous study of human kinship systems (*The Elementary Structures of Kinship*, 1949), Lévi-Strauss noted that all human societies enjoin incest. If one studies kinship structurally as a system of relations between terms in which one element has meaning through its relation to all the other terms, then the incest taboo must be understood as a function of the larger kinship system. Kinship is like language in two respects. It is a system of communication among different tribal groups, and it is a language, in which value is determined by function. The value of the incest taboo is that it forbids marriage within a clan or family, but as a result, it has the function of obliging marriage between members of different clans, tribes, and family groups. The result is a form of communication through marriage that binds different people together. The larger function of this language-like kinship system is to work to prevent conflict; strife is less likely between groups connected by marriage.

Lévi-Strauss's work had an impact on literary and cultural studies, psychoanalysis, and historiography. Roland Barthes argues in *Mythologies* (1957) that culture (in the form of movies, advertisements, commodities, books of photography, wrestling matches, travel guides, and so on) resembles language in that it operates through signs that create meaning. Barthes distinguishes between signifiers such as the photo of a black French colonial soldier on the cover of a magazine saluting the French flag and the signifieds such an image generates. Such signifieds have several levels, from the elementary—the image signifies the loyalty of the colonial subject—to the more complex and abstract—the idea of imperialness that is sanctioned and communicated by the image. In his later work in literary criticism, Barthes studies literature in a similar manner, noting how

writers operate within systems of meaning that rely on the differences between terms to make signification possible.

The impact of Saussure is also evident in the work of literary critics Julia Kristeva and Tzvetan Todorov. Todorov argues in *The Poetics of Prose* (1971) that fictional narratives can be understood in structuralist terms. A diverse set of short stories by the same writer can be interpreted as having a similar internal structure. The tales of Henry James, for example, all deal with an absence at the center of the tale. Kristeva in *Semanalysis* (1967) uses structural linguistics to argue that works of literature have different levels—the phenotext and the genotext—that resemble Saussure’s distinction between *langue* and *parole*.

Jacques Lacan, Michel Foucault, and Gilles Deleuze

One of the most ingenious and influential uses of structuralism occurred in psychoanalysis. In *Écrits* (1966), Jacques Lacan gathered together three decades worth of work, much of which owed a debt to Lévi-Strauss and to Saussure. For Lacan, the psyche is immersed in signification, and psychic content exists in the form of signifiers. The unconscious, as he famously put it, “is structured as a language.” Symptoms of psychic dysfunction are signifiers, but because the psyche is semiotic in the same way that language is, one never moves from psychic signifiers to a content or a mental object. Instead, signifying reference moves along a chain of signifiers, each of which is linked to other signifiers. All one can do in the process of psychoanalysis, then, is trace the signifying links. One can never reach the “real” that would deliver up a knowable object or thing or reality signified by psychic language.

The other major work of mid-1960s structuralism was Michel Foucault’s *Words and Things* (1966; *Les mots et les choses*, translated 1970 as *The Order of Things*). A historian, Foucault argues that our knowledge of the world is always mediated by signifiers. Over time, systems of signification change, and with each new system, a different picture of the world emerges. Each *episteme*, or system of knowledge, portrays (or signifies) the world differently depending on what kind of signification is used.

Like a number of structuralists, Foucault pointed the way toward poststructuralism’s critique of rationalism. His *Madness and Civilization* (1961; *Folie et déraison*) reflected the influence of the philosopher Martin Heidegger, who shifted attention away from the post-Enlightenment philosophic concern with rational knowledge and focused instead on fundamental metaphysical issues that he felt withstood rationalization. A similar influence came from philosopher Friedrich Nietzsche, whose recently translated work was critical of the idea that one could know the world clearly through reason. Nietzsche noted that knowledge reduces the complexity of the world to false identities. His influence is evident in the work of the French philosopher Gilles Deleuze, especially in his *Nietzsche and Philosophy* (1961). Deleuze, in his work in the 1960s such as *The Logic of Sense* (1969), tries to expose the irrational and allogical elements of human knowledge.

What these thinkers share is a sense, derived from Saussure, that the identities of knowledge arise from and are made

possible by differential relations between terms that have no identities of their own apart from those relations. Reason, inasmuch as it operates through clear distinctions that demarcate separate identities (of categories, of things), cannot, by definition “know” or grasp this realm of difference. Difference makes knowledge possible, yet it is ungraspable using only the categories of knowledge. Difference by definition does not lend itself to identity, but knowledge consists of identification.

Jacques Derrida and Deconstruction

This antirational implication of Saussure’s thinking is most fully exploited beginning in 1967 in the work of Jacques Derrida (*Writing and Difference*, *Of Grammatology*, and *Speech and Phenomenon*, all published that year). Derrida contends that if difference makes knowledge possible, it also renders it impossible on its own terms. If the world is differential in the same way language is, then knowledge of that world which operates according to rationalist imperatives and seeks to identify “what is” will necessarily miss the mark. We have to think more complexly about how we know, and we have to rethink what the known world looks like.

Derrida’s most interesting advance on Saussure consists of formulating a new concept, which he calls *différance*. He argues that philosophy has traditionally based concepts of truth on presence—the presence of the thing or of the idea to the mind. Yet when one examines presence, one finds that it is not a simple identity. Presence must exist both in time and in space. In time, it must be distinguished from past moments and from future moments. In space, the presence of a thing can only be isolated and identified by distinguishing it from other objects. In both a temporal and a spatial sense, then, presence arises out of difference. Derrida combines spatial and temporal difference into one process—difference spelled with an *a*, or *différance*. This neologism is significant because in French one cannot hear the *a* when one pronounces the word. The *a*, in other words, cannot be made present. It thus resembles the way difference in time and space gives rise to presence (of the present moment, of the thing in its presence) without itself assuming the form of presence.

Derrida contends that all being and all thought is made possible by *différance*. In order for difference to be operative in language, there must, he argues, be at work in being a more primordial process that distinguishes one thing from another in time and space. It has no identity of its own, but it makes all identity possible. All things thus bear the mark or trace of other things from which they differ and to which they relate or are connected in their very constitution. Because this primordial process can never assume the form of presence or of identity, one finds its imprint, when one reviews the philosophic tradition, in the very concepts and categories that would seem to deny its priority. Because all philosophic concepts operate through identification and the naming of presence, they obscure the process of *différance*. Yet because it is prior and because it constitutes all presence and all identity, its effects are evident in the text of philosophy.

Derrida’s method of analysis, called “deconstruction,” seeks to locate the fuzzy, anti-identitarian process of *différance* at work

in philosophic and literary texts. He notices places in texts where thinkers lay claim to an ideal of natural substance or of full and self-identical presence that allows them to order their conceptual world. Usually, such ordering consists of a hierarchy in which the ideal of natural substance or of presence is thought to be prior, foundational, or axiomatic, and something else is declared to be derivative, secondary, and lesser in relation to that norm. Such differentiations, Derrida finds, characterize most if not all philosophical thinking. Many thinkers, for example, locate value and truth in what is declared to be more natural in relation to something else that is declared to be artificial, external, additive, or merely supplementary in relation to an internal or prior essence. Even Saussure, Derrida argues, is guilty of this “metaphysical” maneuver. He argues that speech is more central and internal to language because it is more natural, while writing is more artificial, a matter of external notation and convention rather than of natural substance. Yet, Derrida notes, Saussure’s own concept of difference should instruct him that what he calls nature is itself differential. Indeed, in order to delineate the natural as a concept, Saussure must differentiate between an inside and an outside. The supposed natural substance of speech is declared to be inside language, while the technical artifice of writing is declared to be an external addition. Saussure’s description of language never takes this particular distinction into account, but on it his entire argument rests. Saussure merely assumes it is the case that speech is closer to the natural “inside” of language while writing is an “external” form. If he tried to take the initial distinction between “inside” and “outside” into account, he would be obliged to notice that difference must precede and determine what he calls “nature.” And what this means is that nature is not foundational; it derives from and is produced by difference.

What Derrida calls *différance* thus obliges philosophic knowledge to relinquish its traditional concern with identification and to instead adopt a looser style that makes weaker, less absolutist claims. American philosophers like Richard Rorty (*Philosophy and The Mirror of Nature*, 1979) notice that Derrida’s position recalls arguments made by proponents of Pragmatism, which also favored a less absolutist epistemology and an approach to knowledge tailored to circumstances that would be more experimental in character. Knowledge, for Pragmatism, is what works in a particular historical situation, not what is absolutely and unequivocally true in nature.

Poststructuralism

Derrida’s work launched a new intellectual movement called poststructuralism. If structuralism searched for the invariant structures of language and culture, poststructuralism was more concerned with criticizing the rationalist impulse that animated the structuralist undertaking. The impact of his work was immediate and profound. Structuralists like Barthes and Kristeva shifted their focus to the alogical and prerational dimension of literary texts. In *S/Z* (1970), Barthes examines a tale by Honoré de Balzac from the perspective of the multiple codes that go into its making; in *Revolution in Poetic Language* (1974), Kristeva notices the conflict in texts between a symbolic level associated with logic and meaning and a semiological level that is prerational.

Derrida’s contention that the world is itself differential led many thinkers to apply his ideas to such social issues as feminism. The two most noteworthy practitioners of deconstructive feminism were Hélène Cixous and Luce Irigaray.

In *The Newly Born Woman* (1975), Cixous examines the traditional way in which men and women are characterized in Western culture. She suggests that men are associated with reason, identity, truth, and logic and women with unreason, difference, falsity, and hysteria. Cixous argues that this social and philosophical system is deconstructed by certain kinds of avant-garde writers such as James Joyce and Virginia Woolf who write in a way that undermines traditional rationalist assumptions. Their writing is deliberately alogical and semantically generative. It works through horizontal linkages along a differential chain of semiotic connections that obey no rationalist logic. Cixous calls this “feminine writing” because it accords with the traditional negative way of characterizing women. Following Derrida, she argues that a deconstructive strategy in regard to the patriarchal tradition would deliberately inhabit its terms and reveal their subversion from within. If *différance* does inhabit and make possible the categorical identities of patriarchy, then its undoing consists of revealing that *différance* and undermining the authority of those categories.

Luce Irigaray argues in *Speculum of the Other Woman* (1974) and *This Sex Which Is Not One* (1977) that in Western philosophy woman have been portrayed as matter, body, fluidity, boundarylessness, irrationality, artificiality, and the like. Women are the opposite or mirror image (hence *speculum*) of men, who are assigned reason, truth, and authenticity. Male philosophic speculation abstracts from concrete particularity and bodily materiality when it resorts to metaphysical concepts and categories such as “being,” “becoming,” “truth,” and “infinity.” The attempt to transcend matter is quintessentially male. In pursuing such speculative philosophy, men have sought to separate themselves from matter and from *mater*, that is, from their own links through their mothers to physical life and to material fluidity. Men must separate from their bloody origin in the mother’s body and elevate themselves above such matter if they are to attain a psychic identity predicated on masculine principles and ideals. The subordination of women is thus both a psychic and a philosophical necessity and process. Men take matter as an object of speculative knowledge and thereby gain control over physical processes that threaten to overwhelm and overpower male identity. Those processes must remain outside male reason and never accommodate themselves to its categories. Irigaray thus ends up arguing for female separatism.

Jean François Lyotard pursues the poststructuralist argument in books such as *The Postmodern Condition* (1979) and *The Differend* (1983). Lyotard argues that knowledge and discourse are inseparable. The traditional stories or narratives about the world have been transformed in what he calls the postmodern era. The classic narratives of the Enlightenment such as liberal humanism and Marxism no longer provide a convincing or accurate account of the world. They have been replaced by a proliferation of micro-narratives. In a world dominated by corporations, especially, what counts as true is increasingly determined by the

financial and technical requirements of those with economic power. Lyotard sees society as consisting of contending stories about the world, no one of which is in itself more true than another. Each person or group must work rhetorically to convince others of the truth of their own particular discourse. Social life is an ongoing discussion in which people seek to make their perspective and their story dominant. Totalitarianism consists of abolishing this free play of discussion by establishing a consensus that silences further discussion.

One of the most innovative French poststructuralists, Jean Baudrillard, began as a structuralist sociologist interested in the way the semiotic regimes of advertising shape and categorize reality. Baudrillard has since that early work on “consumer society” been preoccupied with the power of cultural representations to become lived reality. Initially, this meant for him the power of advertising images to shape social identities and to impose modes of behavior. By “being a Marlboro man,” one adopted a cultural sign and adapted one’s behavior to the code it implied and imposed. In that code, to become the bearer of certain signs (smoking cigarettes, for example) is tantamount to assuming a particular social identity. The code shapes and determines reality through the operation of both cultural and behavioral signs. Baudrillard’s understanding of this process becomes more pronouncedly pessimistic over time. From *Symbolic Exchange and Death* (1976) to “Simulacra and Simulations” (1981), he argues that the media have become so powerful that simulated realities have now replaced actual reality. This hyperreality is a perfect imitation of reality, much as Disneyland aspires to be a totally enclosed universe of its own, created through the manipulation of signs. At his most provocative, Baudrillard argues that something like the first Gulf War “did not take place.” Its “reality” was so mediated and constructed by images that in effect it occurred in hyperreality. The real, in other words, can be shaped to be whatever those with economic, political, and cultural power want it to be.

While there are significant differences between structuralism and poststructuralism, the two movements share a concern with signs and with the power of sign systems both in the field of human knowledge and in the field of culture and society. The structuralists moved from examining the operations of sign systems to understanding their role in human society. The poststructuralists furthered that undertaking by studying the way signs operate to misrepresent the world and to underwrite social power.

See also *Postmodernism; Structuralism and Poststructuralism; Anthropology; Text/Textuality.*

BIBLIOGRAPHY

Barthes, Roland. *Mythologies*. Translated by Annette Lavers. New York: Hill and Wang, 1972. Originally published in French, 1957.

———. *S/Z*. Translated by Richard Miller. New York: Hill and Wang, 1974. Originally published in French, 1970.

Baudrillard, Jean. *Selected Writings*. Edited by Mark Poster. Stanford, Calif: Stanford University Press, 1988. Contains “Simulacra and Simulations” (1981).

- . *Symbolic Exchange and Death*. Translated by Iain Hamilton Grant. London: Sage Publications, 1993. Originally published in French, 1976.
- Deleuze, Gilles. *The Logic of Sense*. Translated by Mark Lester with Charles Stivale. New York: Columbia University Press, 1990. Originally published in French, 1969.
- . *Nietzsche and Philosophy*. Translated by Hugh Tomlinson. New York: Columbia University Press, 1983. Originally published in French, 1961.
- Derrida, Jacques. *Of Grammatology*. Translated by Gayatri Chakravorty Spivak. Baltimore: Johns Hopkins University Press, 1976. Originally published in French, 1967.
- . *Speech and Phenomena, and Other Essays on Husserl’s Theory of Signs*. Translated by David B. Allison. Evanston, Ill.: Northwestern University Press, 1973. Originally published in French, 1967.
- . *Writing and Difference*. Translated by Alan Bass. Chicago: University of Chicago Press, 1978. Originally published in French, 1967.
- Foucault, Michel. *Madness and Civilization: A History of Insanity in the Age of Reason*. Translated by Richard Howard. New York: Pantheon, 1965. Originally published in French, 1964.
- . *The Order of Things: An Archaeology of the Human Sciences*. New York: Pantheon, 1971. Translation of *Les mots et les choses*, 1966.
- Irigaray, Luce. *Speculum of the Other Woman*. Translated by Gillian C. Gill. Ithaca, N.Y.: Cornell University Press, 1985. Originally published in French, 1974.
- . *This Sex Which Is Not One*. Translated by Catharine Porter. N.Y.: Cornell University Press, 1985. Originally published in French, 1977.
- Kristeva, Julia. *Revolution in Poetic Language*. Translated by Margaret Waller. New York: Columbia University Press, 1984. Originally published in French, 1974.
- . *Semiotike: Recherches pour une sémanalyse*. Paris: Éditions du Seuil, 1969.
- Lacan, Jacques. *Écrits: A Selection*. Translated by Alan Sheridan. New York: Norton, 1977. Originally published in French, 1966.
- Lévi-Strauss, Claude. *The Elementary Structures of Kinship*. Translated by James Harle Bell, John Richard von Sturmer, and Rodney Needham. Boston: Beacon, 1969. Originally published in French, 1949.
- Lyotard, Jean François. *The Differend: Phases in Dispute*. Translated by Georges Van Den Abbeele. Minneapolis: University of Minnesota Press, 1988. Originally published in French, 1983.
- . *The Postmodern Condition: A Report on Knowledge*. Translated by Geoff Bennington and Brian Massumi. Minneapolis: University of Minnesota Press, 1984. Originally published in French, 1979.
- Rorty, Richard. *Philosophy and The Mirror of Nature*. Princeton: Princeton University Press, 1979.
- Saussure, Ferdinand de. *Course in General Linguistics*. Translated by Wade Baskin. New York: Philosophical Library, 1959. Originally published 1916.
- Todorov, Tzvetan. *The Poetics of Prose*. Translated by Richard Howard. Ithaca, N.Y.: Cornell University Press, 1977. Originally published in French, 1971.

Michael Ryan

ANTHROPOLOGY

Structuralism in anthropology is inextricably linked with its founder, Claude Lévi-Strauss. His principal contributions have been in the field of kinship and in the analysis of symbolism, particularly of myths. The characteristic approach of structuralist analysis is to categorize systems, not in terms of the composition or content of their component elements, but in terms of the structure of relationships between these elements.

Lévi-Strauss's first major work, *The Elementary Structures of Kinship* (1949), begins with the premise that exogamy, the obligation to marry outside one's own group, is a corollary of the incest taboo, a defining criterion of "culture" as opposed to "nature." If complex kinship structures are characterized by negative rules—prohibitions on marrying certain categories of relatives—then elementary structures are defined by positive rules that indicate marriage with specific kinds of relatives. Bilateral cross-cousin marriage, in which a man marries either a father's sister's or a mother's brother's daughter, can be conceived of as a system of symmetrical exchange of women between two groups. Matrilineal cross-cousin marriage, where a man marries his mother's brother's daughter but never his father's sister's daughter, involves asymmetrical exchange, whereby a man takes a wife from one group and marries off his sister to another.

In 1962, Lévi-Strauss published *The Savage Mind*, a work on symbolism that characterized primitive thought as *bricolage*, a term that translates roughly as "handy work," working with whatever is readily available rather than using a specific tool adapted to a certain task. The primary tool of such thought is metaphor, grounded in analogical reasoning. In other words, if the members of one clan are "bears" and their neighbors "foxes," this has nothing to do with intrinsic resemblances; rather, the difference between human groups is considered to be analogous to the difference between species of animals.

Lévi-Strauss applied this approach in his magnum opus, a four-volume series on mythology: *The Raw and the Cooked* (1964), *From Honey to Ashes* (1966), *The Origin of Table Manners* (1968), and *The Naked Man* (1971). The aim of his analysis is "to show how empirical categories—such as the categories of the raw and the cooked, the fresh and the decayed, the moistened and the burned, etc., which can only be accurately defined by ethnographic observation and, in each instance, by adopting the standpoint of a particular culture—can nonetheless be used as conceptual tools with which to elaborate abstract ideas and combine them in the form of propositions."

Lévi-Strauss begins with a myth from the Bororo culture in Brazil, initially comparing it to other Bororo myths, then to myths from neighboring populations, until by the end of the fourth volume, he discusses no fewer than 813 myths from across North as well as South America. The mythology of the Americas is depicted as a single vast system in which individual myths can be interpreted as transformations of other myths and where relationships between elements from different codes—social categories, animal and plant species, modes of food preparation, parts of the body, celestial and meteorological phenomena, among others—can always be expressed as analogical to other codes.

Followers and Critics

Lévi-Strauss's work on kinship gave rise in Britain to "alliance theory," whose leading practitioners were Edmund Leach and Rodney Needham. They challenged the prevalent classification of kinship systems in terms of matrilineal and patrilineal descent and suggested instead a classification based on patterns of marriage. Needham attempted to distinguish between "preferred" and "prescriptive" cousin, but Lévi-Strauss himself refused to admit the pertinence of such a distinction, and Needham encouraged one of his students, Francis Korn, to publish a case-by-case refutation of *Elementary Structures of Kinship*. The work of Abraham Rosman and Paula Rubel in the United States and of Françoise Héritier in France represents other applications of structuralism to kinship theory.

Lévi-Strauss's influence has been even more pervasive, if more diffuse, in the study of symbolism. Edmund Leach and Dan Sperber have published important general works on the subject. Numerous ethnographies have incorporated structural approaches in their analyses of the symbolic systems of specific cultures, including Stephen Hugh-Jones's discussion of Amazonian cosmology, Sherry Ortner's analyses of Sherpa rituals, Louis Dumont's account of caste and pollution in India, and Luc de Heusch's comparative study of Central African myths of kingship. Although Mary Douglas has remained persistently critical of Lévi-Strauss's work, her work on purity and pollution shows definite affinities with structuralist approaches.

Certain Marxists and materialists such as Claude Meillassoux and Marvin Harris criticized Lévi-Strauss for his radical idealism, his interest in mental structures rather than in the material circumstances underpinning them; other Marxists, however, notably Maurice Godelier, sought to reconcile Marxism and structuralism. In addition, critics such as Pierre Bourdieu have pointed out that Lévi-Strauss's concern with abstract thought rather than with the process of thinking leaves no room for human agency.

Poststructuralism and Anthropology: Foucault and his Impact

Poststructuralism is a term loosely applied to members of the next generation of French thinkers after Lévi-Strauss who also concerned themselves with texts and discourses. Of these, Michel Foucault had the greatest impact on anthropology. Foucault's work is specifically concerned with the relationship between knowledge and power. Knowledge, for Foucault, is not primarily a collection of facts or even ideas, but only takes on significance within what he calls an *episteme*, an overarching framework situated in time, within which such ideas emerge as relevant and indeed possible. Though Foucault avoids Marxist terminology, one might characterize his epistemes as "modes of thinking" as opposed to "modes of production." In a similar manner, he situates "power" within a framework of possibilities determined by an overall system rather than as a property of individual actors. In *Discipline and Punish* (1975), he uses the modern prison system as a central example of how these two systems, of knowledge and of power, are fused in contemporary society. Discipline is, he argues, a central feature of modern institutions—prison, army, school—inscribing power relations on the bodies of subjects who must

conform but must also be constantly monitored; this monitoring of subjects is the intellectual task of modern “disciplines”—psychology, sociology, anthropology, and others.

Edward Said’s *Orientalism* (1978) argued in a similar vein that European and American expert knowledge of the “Orient” and particularly the Middle East was inextricably connected with the exercise of Western hegemony over the region. Such critiques have made anthropologists much more self-conscious about the implications of their own representations of “other,” non-European peoples. James Clifford and George Marcus have been concerned with the ways in which such representations are constructed through writing, and the rhetorical means by which anthropologists lay claim to “authority.” Talal Asad has suggested that anthropologists’ attempts to arrive at ahistoricized definitions of such phenomena as religion serve to naturalize (that is, make cultural concepts and thought systems appear timeless, natural, and universal) post-Enlightenment systems of European thought while simultaneously problematizing other systems of practice, even in European history. Paul Rabinow has been perhaps the most adamant disciple of Foucault within the discipline, both as an exegete and as an ethnographer of modern France.

Derrida and Deconstruction

At first sight, Jacques Derrida’s *Of Grammatology* (1967), which makes the provocative claim for the logical priority of writing (or at least “*archè*-writing”) over speech, might not seem a likely candidate for a work that would influence anthropological thinking. Derrida’s point is, first of all, that writing reveals the spaces, silences, and erasures that speech conceals; second, that there is an apparent gap in time and space, a *différance*, between the enunciation and reception of a written text, whereas speech gives the illusion of immediacy. Derrida’s purpose is to radically call into question the relevance of authorial intention and the possibility of any fixed meaning. Texts, written or spoken, must be interpreted not only in terms of what they “say” but of what they keep silent, and with respect to other texts before and after. Derrida’s approach to texts, “deconstruction,” lays bare the internal contradictions of any text, precluding the attribution of definitive meaning, intentional or otherwise.

The term *deconstruction* has been used so loosely by many anthropologists that it has lost any clear referent—an ironic fate for a concept intended to challenge the fixity of meaning. More specifically, Derrida’s skepticism about intentionality in the interpretation of texts has fueled “postmodern” critiques of anthropological representations of the “other.” Derrida’s wordplay and elliptical style have inspired new forms of anthropological writing, best exemplified by the work of Michael Taussig.

Ultimately, both structuralism and poststructuralism have contributed to tendencies on the part of many (but by no means all) anthropologists to call into question the characterization of their discipline as “science” and to reposition themselves more centrally in the humanities—structuralism through its emphasis on the decoding of symbols, a domain often considered antithetical to strictly “scientific” approaches; and

poststructuralism by forcing anthropologists to call into question their own practices of representation. Critics from within the humanist camp, however, have pointed out that both structuralism and poststructuralism are theoretically de-humanizing (that is, ignoring or minimizing the impact and importance of human agency), most obviously in Derrida’s critique of human intentionality but also, at least implicitly, in the work of Lévi-Strauss and Foucault. At best, such theories make any consideration of human agency problematic; at worst, they leave no place for it at all.

See also Anthropology; Cultural Studies; Postmodernism; Text/Textuality.

BIBLIOGRAPHY

- Asad, Talal. *Genealogies of Religion: Discipline and Reasons of Power in Christianity and Islam*. Baltimore: Johns Hopkins University Press, 1993.
- Clifford, James. *The Predicament of Culture: Twentieth-Century Ethnography, Literature, and Art*. Cambridge, Mass.: Harvard University Press, 1988.
- Clifford, James, and George E. Marcus, eds. *Writing Culture: The Poetics and Politics of Ethnography*. Berkeley: University of California Press, 1986.
- Derrida, Jacques. *Of Grammatology*. Translated by Gayatri Chakravorty Spivak. Baltimore: Johns Hopkins University Press, 1976.
- Douglas, Mary. *Purity and Danger: An Analysis of Concepts of Pollution and Taboo*. New York: Praeger, 1966.
- Dreyfus, Hubert L., and Paul Rabinow. *Michel Foucault, beyond Structuralism and Hermeneutics*. Chicago: University of Chicago Press, 1982.
- Dumont, Louis. *Homo Hierarchicus: An Essay on the Caste System*. Translated by Mark Sainsbury. Chicago: University of Chicago Press, 1970.
- Foucault, Michel. *The Archaeology of Knowledge*. Translated by A. M. Sheridan Smith. London: Tavistock, 1972.
- . *Discipline and Punish: The Birth of the Prison*. Translated from the French by Alan Sheridan. New York: Pantheon, 1977.
- . *Power/Knowledge: Selected Interviews and Other Writings, 1972–1977*. Translated and edited by Colin Gordon. New York: Pantheon, 1980.
- Héritier, Françoise. *Two Sisters and Their Mother: The Anthropology of Incest*. Translated by Jeanine Herman. New York: Zone Books, 1999.
- Heusch, Luc de. *The Drunken King, or, The Origin of the State*. Translated and annotated by Roy Willis. Bloomington: Indiana University Press, 1982.
- Hugh-Jones, Stephen. *The Palm and the Pleiades: Initiation and Cosmology in Northwest Amazonia*. Cambridge, U.K., and New York: Cambridge University Press, 1979.
- Leach, Edmund. *Claude Lévi-Strauss*. Revised edition. New York: Viking, 1974.
- . *Culture and Communication: The Logic by Which Symbols Are Connected*. Cambridge, U.K., and New York: Cambridge University Press, 1976.
- . *Rethinking Anthropology*. London: Athlone Press; New York: Humanities Press, 1961.
- Lévi-Strauss, Claude. *The Elementary Structures of Kinship*. Translated by James Harle Bell, John Richard von Sturmer, and Rodney Needham. Boston: Beacon, 1969.

- . *From Honey to Ashes*. Translated by John and Doreen Weightman. London: J. Cape, 1973.
- . *The Naked Man*. Translated by John and Doreen Weightman. London: J. Cape, 1981.
- . *The Origin of Table Manners*. Translated by John and Doreen Weightman. London: J. Cape, 1978.
- . *The Raw and the Cooked*. Translated by John and Doreen Weightman. New York: Harper and Row, 1969.
- . *The Savage Mind*. Chicago: University of Chicago Press, 1966.
- Manganaro, Marc, ed. *Modernist Anthropology: From Fieldwork to Text*. Princeton, N.J.: Princeton University Press, 1990.
- Ortner, Sherry. *Sherpas through their Rituals*. Cambridge, U.K., and New York: Cambridge University Press, 1978.
- Rabinow, Paul. *French Modern: Norms and Forms of the Social Environment*. Cambridge, Mass.: MIT Press, 1989.
- Said, Edward. *Orientalism*. New York: Pantheon, 1978.
- Taussig, Michael T. *Defacement: Public Secrecy and the Labor of the Negative*. Stanford, Calif.: Stanford University Press, 1999.
- . *Mimesis and Alterity: A Particular History of the Senses*. New York: Routledge, 1993.

Robert Launay

SUBJECTIVISM. *Subjectivism's* natural antonym is *objectivism*, and various species of subjectivism have been developed as alternatives to objectivism of various sorts. One can be a subjectivist about a variety of things—ethics, aesthetics, even science. Many of these topics are covered in related entries, however, and the emphasis here will be on subjectivism with respect to ethics in modern and contemporary thought.

Philosophers often distinguish normative ethics, which deals with specific questions about rights or duties or ideals (e.g., “is infanticide wrong?”) and metaethics, which deals with questions about the status of ordinary moral claims (such as, “can moral judgments be true or false?”). Subjectivism and objectivism are positions in metaethics.

Ethics and Values

The moral or ethical realm is extremely complex. Our moral lives involve practices, principles, convictions, commitments, duties, ideals, and more, and one can be a subjectivist about some of these without being a subjectivist about others.

Many versions of moral subjectivism are motivated by a combination of two views. In the first, different cultures, societies, subcultures, and the like often have strikingly different conceptions of morality; thus, many cultures have practiced human sacrifice, infanticide, and slavery. In the second, we are indelibly shaped by the culture and historical period in which we live; we cannot step outside our modes of evaluation and thought to some neutral Archimedean point from which we can impartially adjudicate the conflicting claims of alternative moral codes. Indeed, many subjectivists go one step further, urging that the notion that there is one true story about morality is empty.

Our moral beliefs and claims exhibit several fundamental features that any viable position in metaethics must either explain

or explain away. First, ethical discourse often appears to describe, quite literally, facts in the moral realm. The theory that endorses the claim to objectivity is known as cognitivism; moral judgments make cognitive or descriptive claims, rather than simply expressing emotions or making recommendations. Second, when we give arguments that something is right or wrong, we often marshal reasons for thinking certain moral claims to be true or false. Third, moral judgments often provide motivation to act in accordance with them. Fourth, morality is a social institution that involves shared practices and beliefs.

Objectivity

According to the metaphors often used to characterize objectivism, the world (or some subdomain of it, like ethics) is “out there,” beyond our language and thought. If we are fortunate, we may discover something about this mind-independent realm, but in no sense do we create or construct it. Thus, to objectivists, there is a fact about whether abortion is ever acceptable that obtains quite independently of anyone’s opinions on the matter.

Varieties of Subjectivism

When people say that morality is subjective, they often mean simply that there really aren’t any objective moral truths. But philosophers who defend versions of subjectivism frequently go on to offer us a new account of the moral dimension to compensate for the loss of objectivity.

Individual subjectivism: existential choice. If alternative moral codes and ideals are possible, can each person simply choose which ones to adopt? According to many existentialists, most notably Jean-Paul Sartre (1905–1980), there are no objective moral values or meanings. Each person, thrown into an indifferent, often cruel world, must create individual values through making choices and living life. Indeed, it is added, no values can be binding unless chosen personally. On this view a person’s claim that abortion is wrong represents a moral judgment, but one that is motivated by (and only by) subjective, existential choices. Views like Sartre’s are subjectivist in the sense that people create their own values for themselves, and different people (even within the same culture) may choose quite different values.

On accounts like Sartre’s, disagreements about very important things (like the death penalty or forced clitoridectomy) boil down to simple differences in the values people have decided (often tacitly, and for no objective moral reasons) to adopt. But people who disagree about things like the morality of abortion rarely feel that their claims are merely expressions of their subjective commitments; indeed, most of them would see this as trivializing their view. Finally, views like Sartre’s fail to do justice to the social nature of morality.

Individual subjectivism: noncognitivist views about ethics. Noncognitivism is the view that moral claims do not (despite appearances) function to describe a moral realm and that they instead play a very different role. The most common versions of noncognitivism are species of expressionism, according to which moral claims serve to express a speaker’s attitudes, feelings, or emotions.

In the 1930s the British philosopher A. J. Ayer (1910–1989) defended one of the earliest and most influential versions of expressionism. In the late twentieth and early twenty-first centuries, thanks to philosophers such as Allan Gibbard and Simon Blackburn, noncognitivism has enjoyed a resurgence, though the current versions are far more nuanced than Ayer's.

Noncognitivism avoids problems that threaten objectivism. It also explains the link between moral judgments and moral motivations, since such judgments are seen to be based on attitudes and feelings, which often have a powerful motivational force. On this view the claim that abortion is wrong serves to express the speaker's disapproval of, or horror at, abortion.

Objective versions of noncognitivism are possible, but noncognitivism has a strong tendency toward subjectivism. Most versions of noncognitivist subjectivism treat moral claims as expressions of a person's (subjective) attitudes or emotions and recognize that people (even within the same culture) may differ about these. Like most forms of individual subjectivism, this view is vulnerable to the difficulties, noted above, that threaten views such as Sartre's.

Group subjectivism. There are several different types of group subjectivism.

Different human groups. Human beings are social animals who acquire most of their values and attitudes in the process of socialization; these acquisitions become part of a shared social heritage. Hence, it is often argued, there can be widespread agreement about right and wrong and what makes for a meaningful life within a group (such as a culture). But groups with different cultures, languages, or religions may share values that are quite alien to other groups.

This view allows a good deal of agreement and intersubjectivity within a culture, and morality does not boil down to simply what any particular individual thinks or feels or decides. Furthermore, it enables us to explain how moral arguments within a culture are possible; the partisans share enough values and beliefs that disagreement here and there is possible, and issues can often be evaluated within a shared framework of values and standards for moral justification. On this view the claim that abortion is wrong amounts to the claim that all or most members of the culture believe that it is or, more plausibly, that they subscribe to more general principles that entail this.

This view is subjectivist in the sense that moral facts and values are not based on any objective moral realm, but instead derive from (shared) attitudes and outlooks that may vary from group to group. Although ethical debate within a relevant group (such as a culture) is possible, there are no non-question begging methods to adjudicate disagreements between different cultures or the like. Moreover, it is extremely difficult to view some moral differences (as about the Holocaust) as mere differences in group opinions.

Species subjectivism. Species subjectivism is the view that ethical matters rest on subjective aspects (like emotions) of human beings. Humans are similar enough, however, that specieswide values are possible. David Hume's (1711–1776)

mid-eighteenth-century account of morality is the prototype for such views.

On Hume's view, morality is a matter of feeling rather than reason and is based on human sentiments that are ultimately grounded in human sympathy. Because Hume believed human nature to be constant, he concluded that many of the basic aspects of morality would be similar for all human beings. Still, in a letter to Francis Hutcheson Hume regretted the limitations of his view, stating that it "regards only human nature and human life." Recent "sensibility theories" are more sophisticated than Hume's but are recognizably inspired by it.

Species subjectivism underwrites a specieswide intersubjectivity that allows genuine moral argument and debate among humans. Hume went on to argue that we often "project" our feelings and attitudes onto the world, so they seem (wrongly) to characterize something objective ("out there"). This enabled Hume to explain the appearance that moral discourse and argument involve literal description.

Different versions of species subjectivism would offer different accounts of the claim that abortion is wrong, but all rest on views about human nature and human sensibility. Views like Hume's are subjective in the sense that, although all human beings have roughly the same moral sentiments, this is a completely contingent fact about us.

Many philosophers have argued that morality is based on things like reason that run deeper than emotions like human sympathy. In fact, as Hume himself lamented, his account may make morality seem uncomfortably contingent, resting on subjective (such as emotional) aspects of human life. Indeed, it is nowadays natural to view these aspects as the product of an evolutionary history shot through with randomness and chance.

Conclusion

In the late twentieth and early twenty-first centuries there has been a great deal of work on objectivism and subjectivism. As such views become more subtle and sophisticated, it becomes more difficult for an outsider to tell them apart. But they remain important, involving as they do very basic questions about the human condition and our place in the world.

See also *Empiricism; Knowledge; Objectivity; Truth.*

BIBLIOGRAPHY

- Ayer, A. J. *Language, Truth, and Logic*. New York: Oxford University Press, 1950. The most famous early account (originally published in 1936) of noncognitivism; oversimplified by today's standards, but vividly written, very accessible, and still worth the read.
- Blackburn, Simon. *Essays in Quasi-Realism*. New York: Oxford University Press, 1993. A sophisticated account of projectivism which is a central component of Hume's moral philosophy.
- Gibbard, Allan. *Wise Choices, Apt Feelings*. Cambridge, Mass.: Harvard University Press, 1990. By far the most sophisticated development of noncognitivism.
- Harman, Gilbert. *The Nature of Morality*. New York: Oxford University Press, 1977. An influential argument against moral objectivity; very accessible.

- Hume, David. *Treatise of Human Nature: Being an Attempt to Introduce the Experimental Method of Reasoning into Moral Subjects*. Oxford: Oxford University Press, 2000. Originally published in 1739–1740. Book III contains Hume's views on ethics, including his seminal defense of subjectivism; accessible.
- Nagel, Thomas. *The Last Word*. New York: Oxford University Press, 1996. State-of-the-art defense of objective standards for many sorts of reasoning, including moral reasoning.
- Sartre, Jean-Paul. *Being and Nothingness: An Essay of Phenomenological Ontology*. Translated by Hazel E. Barnes. New York: Philosophical Library, 1956. Sartre's magnum opus, originally published in French in 1943. Difficult.
- Williams, Bernard. *Ethics and the Limits of Philosophy*. Cambridge, Mass.: Harvard University Press, 1985. A sustained and subtle argument against various forms of objectivism—particularly those inspired by Aristotle and Kant—in ethics. Difficult in spots, but repays the effort.

Chris Swoyer

SUFISM. Sufism is the English rendering of the Arabic word *tasawwuf*, which derives from *suf*, meaning “wool.” *Tasawwuf* in early Islamic history refers to the attitude of people who used to wear a white woolen garment as a sign of renunciation of worldly possessions. To be properly understood, the emergence of Sufism must be situated in the context of Islamic expansion. During the first and second centuries of Islamic expansion, Muslims conquered vast tracts of land that were part of the Byzantine or Persian Empires. They acquired huge amounts of wealth. Many of them became obsessed with mundane things. At that moment, a few believers, haunted by the Prophet's model of perfection and remembering the description of the hereafter in the Koran and the punishment reserved to those who went astray, did not only content themselves to follow the commandments of God and abandon his prohibitions. They devoted much of their time to praying, fasting, and nightly vigils. These are the first people who practiced what has come to be known as *tasawwuf* or Sufism. Sufism became one of two dominant paradigms in Islamic theology as to how Muslims might interpret the teachings of the prophet Muhammad.

The other paradigm is based on the premise that the prophet Muhammad was sent to deliver the Koranic message to the whole of humanity. In addition to the Koran, the deeds and sayings of the prophet Muhammad (known as the *sunna*) would provide guidance to Muslims who lived during his lifetime as well as to subsequent generations of Muslims until the day of the Last Judgment. But, according to this paradigm, no communication with the Prophet was possible after his death. This understanding led to a perspective labeled legalistic, fundamentalist, or scriptural based on the dual premise of the immediate readability of religious texts, which govern their rights and duties, and of the conceptual equality of all Muslims. This perspective also developed an individual approach to salvation.

Conversely, the Sufi paradigm is based on the belief that, after the passing of the prophet Muhammad, communication with his soul remains possible. As Islam spread and Islamic

theology became more and more elaborated, Sufis developed very complex sets of doctrines and worldviews, some of which bore a similarity to other forms of mysticism. One of the most fundamental Sufi ideas is that the Koran, in addition to an apparent meaning (Ar., *zahir*) that is accessible to all, has a hidden meaning (Ar., *batin*). To have access to the latter, one must follow a path (Ar., *tariqa*; pl., *turuq*) that leads to spiritual fulfillment. This was the justification for the creation of Sufi orders, which quickly became and still remain a dominant form of spirituality in the entire Muslim world.

Another fundamental Sufi idea is that there exists a conceptual inequality among believers, some of whom are closer to God by virtue of enjoying a higher rank in His eyes in relation to others. The Arabic word *wali*, “friend of God,” which suggests the idea of proximity and friendship, renders the notion of proximity to God. It occurs several times in the Koran either in the singular (*wali*) or in the plural (*awliya*) but is interpreted differently within each of the two above-mentioned paradigms. For legalist Muslims, every pious believer is close to God, whereas in the Sufi tradition, the status of *wali* is accorded exclusively by divine grace to certain individuals. Sufis believe that the *awliya* have extraordinary powers, because they are close to God. For example, they have the power to secure happiness in this world and in the next for their disciples and their descendants by blessing them. They have retaliatory powers over their enemies, whom they can curse and punish. They have the mystical power to heal the ill, and so on. These desires for happiness and healing constitute the basis of the veneration of Sufi *awliya* in the Muslim world. Sufis have successfully established themselves as mediators between God and believers throughout the Muslim world.

The commitment to Sufi Islam is marked by a formal introduction in the course of which a disciple is initiated by a master. The master was himself initiated by another master through a chain of initiation (Ar., *silsila*) going back to the founder of a Sufi order, who usually claims to have started his order subsequent to prophetic revelation. Once initiated, the disciple is expected to obey the master. Moreover, on his or her way to spiritual fulfillment, the disciple is believed to be in the hands of the master as a cadaver is in the hands of a mortician. In other words, there is an assumed relationship of utter dependence of the disciple on the master.

Islam in Africa was greatly influenced by Sufi ideas and understanding of salvation. The majority of African Muslims practice Sufi Islam. Historically, the two orders of the Tijaniyya and Qadiriyya spread in the whole Islamized part of the African continent during the nineteenth and twentieth centuries. These orders provided a paradigm of salvation based on the belief that certain persons have supernatural powers. But there are also orders that were founded locally, such as the Muridiyya established by the Senegalese Shaykh Ahmadu Bamba (1853 or 1854–1927).

The book *Rimah hizb al-rahim 'ala nubur hizb al-rajim* (1863), written by 'Umar B. Sa'id Tall (1797–1864), is one of the most elaborate expositions of the doctrine of the Tijaniyya Sufi order. It is a good illustration of the special privileges that God bestows on followers of Sufi orders. According

to the *Rimah*, all disciples of the Tijaniyya will be spared from the agonies of death, they will not be persecuted in their graves by angels, and they will be safe from all tortures in the grave from the day of their death until the day they enter Paradise. God will forgive all their sins and they will not have to account at the Day of Judgment. They will be among the first group of believers to enter Paradise together with the prophet Muhammad and his Companions. They will die as *awliya* (friends of God) because of their love for the founder of the Tijaniyya, Shaykh Ahmad al-Tijani (1737–1815). Finally, because, they are members of the Tijaniyya, not only will they go to Paradise, but members of their family will also go to Paradise.

More than just religious fraternities, Sufi orders have often been vital economic, political, and social organizations that perform many social functions. They are organized around *zawiyas* (lodges), which are centers of religious learning, initiation places for disciples in search of spiritual realization, shelters for fugitives, and locations of saintly shrines where disciples go to seek healing and blessing.

In Africa, there were times when some Sufi sanctuaries were virtual states within states, for example the Senusiyya in Cyrenaica (modern Libya) and the Tijaniyya in Algeria, and the Mourides in Senegal. Since the tenth century, Sufi orders have constantly risen, declined, regenerated, and split. Sufi orders exist in all Muslim countries.

Sufism provides ingredients through which many Muslims—educated and uneducated, “modern” and “traditional,” men, women, and children—understand their universe.

See also *Asceticism; Islam; Mysticism; Religion*.

BIBLIOGRAPHY

- Bousbina, Said. “Les mérites de la Tijaniyya d’après ‘Rimah’ d’al Hajj Umar.” *Islam et sociétés au sud du Sahara* 3 (1989): 253–259. A brief discussion of Tijaniyya doctrines related to salvation as exposed in the *Rimah hizb al-rahim* of ‘Umar Tall.
- De Jong, Frederick, and Bernd Radtke, eds. *Islamic Mysticism Contested: Thirteen Centuries of Controversies and Polemics*. Leiden, Netherlands, and Boston: Brill, 1999. The most comprehensive and recent survey of Islamic mysticism and its opponents.
- Robinson, David. *Paths of Accommodation: Muslim Societies and French Colonial Authorities in Senegal and Mauritania, 1880–1920*. Athens: Ohio University Press, 2000. A study of the emerging pattern of cooperation between Muslim societies and French colonial authorities in Senegal and Mauritania.
- Robinson, David, and Jean-Louis Triaud, eds. *Le temps des marabouts: Itinéraires et stratégies islamiques en Afrique occidentale française v. 1880–1960*. Paris: Karthala, 1997. Rise of Sufi orders in West Africa in the context of French colonial rule.
- Triaud, Jean-Louis, and David Robinson, eds. *La Tijaniyya. Une confrérie musulmane à la conquête de l’Afrique*. Paris: Karthala, 2000. A survey of the most widespread Sufi order in sub-Saharan Africa.

Ousmane Kane

SUPPLY AND DEMAND. See *Capitalism*.

SUICIDE. The word *suicide* is a seventeenth-century English invention put together from Latin elements and meaning literally “self-slaughter,” and from English the word spread to other European languages. An isolated scholar around 1130 had in fact coined a Latin word *suicida*, but it had not gained currency, and that fact highlights the question why so ancient an act should have had to wait so long for a name.

Taboo

One reason was taboo. People did not want to talk about suicide and, when they had to, used composite expressions like the medieval lawyers’ “homicide (or felony) of oneself,” or others, tinged with euphemism, like “to hasten death,” “to die by one’s own hand” (to quote from over a dozen expressions in classical Latin). A second reason, linked with the first, was an enduring difficulty in understanding the character of suicide. This is best seen in the history of a much older word, the Greek *biaiothanatos*. It literally meant “violent death” and included suicide along with deaths we would classify as accidents, like falling from a bridge, all of which were thought polluting, and had consequences for burial and for the dead person’s status as a ghost. Although the Latinized successor-word, *biothanatos*, came increasingly to be confined to suicide, it still carried the old ambiguity as late as the twelfth century. The slowness of that discovery is confirmed by early legal texts, where rabbis, Christian canon lawyers, and commentators on the Koran all, in their turn, insist that it is intention that distinguishes suicide—as if people did not know.

So the mere linguistic history of suicide already reveals a lot about how it was conceived. It suggests, further, that the taboo extended beyond the topic to the act of suicide, however vaguely distinguished. Religion absorbed the taboo, and in time gave it force and rationale. Already in Greek antiquity we find indignities attached to the burial of suicides, so understood. Similarly, as ideas of hell became better defined, we find suicides assigned to it, first (this time) in India.

Rationale

As for rationale, it drew on two kinds of source, divine and social. Around the sixth century B.C.E., Pythagoreans taught that we mortals are on sentry duty and bound to stay at our watch until relieved, an image that clearly implied man’s obligation to superior powers, sovereign beyond death. The image would be absorbed by Plato and his innumerable readers, who in the later Roman Empire included Neoplatonists and Christians, both of whom used it, with other borrowings, to fortify their faintly equivocal traditions. For the Christian tradition had until then itself been uncertain. In the Bible, keen eyesight is needed to find suicide expressly forbidden (as perhaps in Gen. 9:5 or Exod. 20:13). And although most suicides in the Bible—Judas the most notorious—are manifest villains, a “suicide guerilla” had slipped in among biblical heroes around the tenth century B.C.E., in the person of Samson (Judg. 16:18–30), and was joined around 70 B.C.E. by another hero, Razias, who had killed himself after military defeat, in the Roman manner (2 Macc. 14:43–46). The early church furthermore revered as saints certain women who had killed themselves to avoid rape. In the fourth century C.E., Christ-

ian opinion formers set about closing these loopholes, notably Pachomius (in respect of burial ritual) and Augustine (in argument). A few centuries later, Muslim commentators would do the same for the Koran, whose deficiencies in this particular were amply supplied by the Hadith (tradition).

A second main source for an antisuicide rationale was social. Aristotle had explained the Athenians' mutilation of suicides' corpses on the ground that a suicide had injured his polis (an argument to be seized on gratefully by Christian theologians in the later Middle Ages, when Aristotle became available in Latin). The Jews, for their part, told sympathetically (in *Tobit*, c. 200 B.C.E.) of a woman restrained from suicide by the thought that it would hurt her father. Even suicide-prone Roman Stoics could be restrained by consideration for their friends. Illiterates meanwhile expressed their social feelings on the subject by ideas about pollution of the community cemetery and bad weather. Finally, social considerations could express themselves on the vertical plane, from master to dependent. A Roman slave who killed himself robbed his owner, who might make him an example by maltreating the corpse. In early medieval Europe—when nearly everyone was someone else's dependent—lords would punish an underling's suicide by confiscating the property. That prerogative gradually passed to monarchs. That suicide was in England classed as a felony until 1961 probably owed its origin to the defiance it had represented, in the early Middle Ages, to the king qua lord.

Justifications of Suicide

Condemnation of suicide, though widespread, has been far from universal. In all kinds of society, including preliterate kinds in Africa and America, communities with a suicide taboo can sometimes be found alongside others without. At least in more advanced cultures, two kinds of milieu have bred acceptance of suicide. One is military. In 1897 Émile Durkheim's classic, *Suicide*, recorded abnormally high rates among military officers. Durkheim ascribed this to the military ethos, on grounds that soldiers are familiar with weapons and death and set a high premium on honor. The same factors have operated throughout history. Greek and Roman warrior-heroes like Ajax or Brutus—not to mention their opposite numbers among Germanic opponents of Rome—were remembered honorably as falling on their swords after defeat. Off the battlefield, in a political climate similarly based on honor, members of the same class might kill themselves to vindicate their honor, as Lucretia and Cato did, winning posthumous glory as martyrs, respectively to chastity and republicanism. In the most intensely militarized cultures, suicide can become an institution, as with the *hara-kiri* ("belly-cutting") ritualized by samurai in twelfth-century Japan, and the kamikaze of their twentieth-century successors, who piloted torpedoes and bombs. A more complex case is that of warriors fighting for Semitic monotheisms, which frown on suicide. That Jewish warrior-suicide Razias would set a dilemma for Christian commentators, while Muhammad's condemnation of suicide came to sit uneasily with the martial ethos of early Islam, which could at its most extreme produce an offshoot like the Shurat ("sellers of their lives for God"), who plunged into battle against patently overwhelming odds.



***Suicide of Lucretia* (c. late 16th-mid 17th century) by Guido Reni.** Lucretia, a Roman noblewoman who was raped by Sextus, son of the tyrant Tarquin the Proud, sought to restore her honor by committing suicide. © ARALDO DE LUCA/CORBIS

The second tolerant milieu has been philosophy. The classical Greek kind of philosophy, still thriving, tends to resist taboos unjustified by reason; and reason alone cannot easily justify the taboo on suicide, as Hamlet found. It may indeed resent it, since, lacking unquestionable evidence of sensation beyond death, reason suggests that an unhappy life with no prospects is best ended. This train of thought was formally inaugurated by the Cynic Diogenes in the fourth century B.C.E. and survived under the capacious blanket of Roman Stoicism, whose philosophers argued that, just as we may quit a banquet if it becomes tedious, so, under the same condition, we may—indeed must, to be rational—quit the banquet of life; what we do is in any case up to us and no cause for disgrace or punishment. Among lasting effects of this view was the systematic erasure from classical Roman law of any stigma on suicide as such. Around the fourth century C.E. came a change of mood, of which Augustine's arguments were less a cause than a symptom. The philosophical current only began reemerging in the Renaissance, and more fully in the eighteenth-century Enlightenment, when it targeted, in particular, ancient rituals that aimed to disgrace a suicide's memory, usually to the prejudice of his family. After a series of skirmishes—including a pan-European scandal at the romanticization of suicide in Goethe's novel *Die Leiden des jungen Werthers* (1774; The sufferings of young Werther)—philosophical tolerance completed its conquest of European law during the twentieth century.

Quite a different philosophical tradition has meanwhile recommended suicide of a very strictly defined type. The same ancient Sanskrit texts that condemned suicide done through passion have allowed those ascetics who have overcome passion to sever its last roots by parting from their bodies, by the least passionate method available (say, by drowning in a sacred river or by starvation). Traces of this view have been present in Mediterranean history, and condemnation of suicide by the Semitic religions may owe some of its force to a defensive reaction, against the doctrine of what one early Koran commentator calls the “Indian fools.”

While suicides form a minute proportion of the population (0.03 percent per annum is a fairly high figure), a study of their circumstances, as Durkheim and his successors have demonstrated, throws otherwise inaccessible light on the lives of everyone else. In the same way, while suicide commands only a small proportion of moral and legal theory, it raises inexhaustible questions, both of the casuistical kind about suicide as such and also, through those, about life itself.

See also *Christianity; Cynicism; Judaism; Stoicism.*

BIBLIOGRAPHY

- Bohannon, Paul, ed. *African Homicide and Suicide*. Princeton, N.J.: Princeton University Press, 1960.
- Durkheim, Émile. *Suicide: A Study in Sociology*. Translated by John A. Spaulding and George Simpson. 1952. Reprint, New York: Free Press, 1989.
- Halbwachs, Maurice. *The Causes of Suicide*. Translated by Harold Goldblatt. London: Routledge and Kegan Paul, 1978.
- McManners, John. *Death and the Enlightenment: Changing Attitudes to Death among Christians and Unbelievers in Eighteenth-Century France*. Oxford: Oxford University Press, 1981.
- Murray, Alexander. *Suicide in the Middle Ages*. 2 vols. Oxford: Oxford University Press, 1998, 2000.
- Stack, Steven. “Suicide: A Decade Review of the Sociological Literature.” *Deviant Behaviour* 4 (1982): 41–66.
- Thakur, Upendra. *A History of Suicide in India*. Delhi: Munshi Ram Manoharlal, 1963.

Alexander Murray

SUPERSTITION. Superstition has had different meanings in different cultures and epochs. One thing binding these meanings together is that they are usually negative—superstition is a concept defined principally by its self-declared opponents. A second is that superstition is defined as the opposite of something praiseworthy—usually true religion or true science.

The ancient Greeks referred to superstition as *deisidaimonia*—fear of the spirits or daimons. This term was originally used positively, in the sense of “God-fearing.” The first known negative use occurred around the fourth century B.C.E. in Theophrastus’s *Characters*. His character of the superstitious man shows a person so obsessed with carrying out rituals to ward off the gods’ anger that he could not lead a normal life. After Theophrastus, negative uses of *deisidaimonia* became much more common, although positive uses never entirely

ceased. Plutarch (c. 46–after 119 C.E.), in his essay on superstition in the *Moralia*, used the Aristotelian doctrine of virtue as a means to distinguish between atheism and *deisidaimonia*, opposite vices in the field of religion. He argued that atheism was in every way superior to superstition, as it was a lesser insult to the gods to assert that they did not exist than to assert that they were cruel. The atheist was insensitive, but the superstitious person lived in constant terror. Plutarch included a wider range of religious behavior in the category of superstition than had Theophrastus, including human sacrifice, Jewish observance of the Sabbath, fear of punishment in the afterlife, and belief in the literal truth of Greek myth. Unlike Theophrastus and many other ancient writers, Plutarch emphasized the grim rather than the comic aspects of superstition. The consequences of superstition could be disastrous not only for the superstitious person but for everyone—Plutarch’s life of the Athenian general Nicias ascribes the Athenian disaster at Syracuse in large part to Nicias’s timorous fear of a lunar eclipse.

The word *superstition* itself originates with the ancient Romans, who used the term *superstitio* mainly as a pejorative for those religions and religious practices they found barbarous, including Judaism and Christianity. Superstition was the opposite of religion, the decorous and pious worship of the gods. The antiquary Varro distinguished between the superstitious man, who feared the gods as his enemies, and the religious man, who was devoted to them as his parents.

Christians countered accusations of superstition by accusing their pagan opponents of both superstition and *deisidaimonia*. Christian polemicists particularly emphasized the superstitious nature of pagan “idolatry.” Saint Augustine (354–430), in a particularly influential passage of *On Christian Doctrine*, explicitly linked idolatry with divination as superstitious practices, essentially reducing all of pagan religion to superstition. The conversion of the Roman Empire to Christianity in the fourth century and the growing Christianization of Roman institutions led by the fifth century to Roman laws referring to all non-Christian religions as “superstition.” Christian authorities for a long time ascribed the superstitious practices of Christians themselves to lingering paganism.

Superstition and the Medieval and Early Modern Catholic Church

Thomas Aquinas (1225–1274) provided a meticulous and influential definition of superstition in the *Summa Theologica*. Aquinas followed Plutarch in claiming that superstition was a vice of excess of religion, as impiety was a vice of deficiency of religion. Varieties of superstition included erroneous worship of the true God (Aquinas gives the example of someone in the Christian era who worships according to the old Law, i.e., a Jew) or unsanctioned by the church. Another variety of superstition was idolatry, worship directed to inappropriate objects—that is, anything other than God. Divination and other magical practices, which Aquinas claimed involved an implicit or explicit agreement with demons, were also superstitious in violating the religious precept that man should learn from and trust in God. Even practices outwardly pious, such as wearing the relic of a saint, were superstitious if they relied

on practices having nothing to do with piety, such as the particular shape of the reliquary.

The Catholic campaign against superstition in the Middle Ages and early modern periods were not merely theoretical. Church reformers preached and campaigned against what they identified as superstitious religious practices, the wearing of charms and talismans and other non-Church sanctioned activities. Catholic authorities defined superstitious practices as those that did not rely either on nature or on divine power for their effectiveness. Superstition was not only a threat to the laity. Parish priests were often seen as tolerating superstition or even practicing it themselves, and many of the leading campaigners against it were friars operating outside the diocesan hierarchy of the church.

Early modern Spain produced a particularly rich literature on superstition from the pens of Catholic priests, ranging from the vernacular works of the sixteenth-century friars Pedro Ciruelo (1470–1548) and Martin de Castanega to the Scholastic Latin writings of the eminent Jesuit theology professor Francisco Suarez (1548–1617). Ciruelo's influential *Treatise Reproving All Superstitions*, aimed at ordinary Spaniards whose souls were threatened by superstition, identified it almost completely with magic. All superstition, Ciruelo claimed, was based either on the desire for illicit knowledge or material gain. Superstitions aimed at gaining knowledge were necromancy and divination; those aimed at gain were enchantment and witchcraft. Like much of the early modern Catholic literature, Ciruelo's work focused on questions of causation, claiming that events could be caused either by direct divine intervention, as in the case of miracles, the actions of good or evil angels, or natural causes. Ascribing outcomes to other causes was superstitious. The general tendency of the Spanish literature on superstition from the sixteenth to the eighteenth century was to circumscribe the area of direct divine action and ascribe more and more events to natural causes.

Superstition and Its Foes in the Islamic World

Campaigns against “superstitious” practices emerged independently in the Islamic world. Muslims who venerated shrines of deceased holy men or celebrated “mawlid”—the birthday of Muhammad—were condemned for practices that were non-Koranic and directed worship to persons other than God, the crime of “shirk” or idolatry. Among the most important medieval Muslim intellectuals to campaign against superstitious practices was the brilliant and uncompromising Syrian jurist of the Hanbali school of Sunni legal interpretation, Taqi al-Din Ibn Taymiyya (1263–1328), and his disciple Ibn Qayyim al-Jawziyya (1292–1350). Ibn Taymiyya and Ibn Jawziyya saw the first three centuries of Islam as free from superstitious practices but the Muslims of their own time as corrupted by them, linking prayer at graves with the practices of pre-Islamic Arab polytheists and contemporary Christians. Despite Ibn Taymiyya's influence, however, his opposition to shrine visits and other “superstitions” did not become the mainstream position in the Sunni ulama.

The Wahhabi movement of Islamic reform, which emerged in eighteenth-century Arabia, recognized Ibn Taymiyya as a

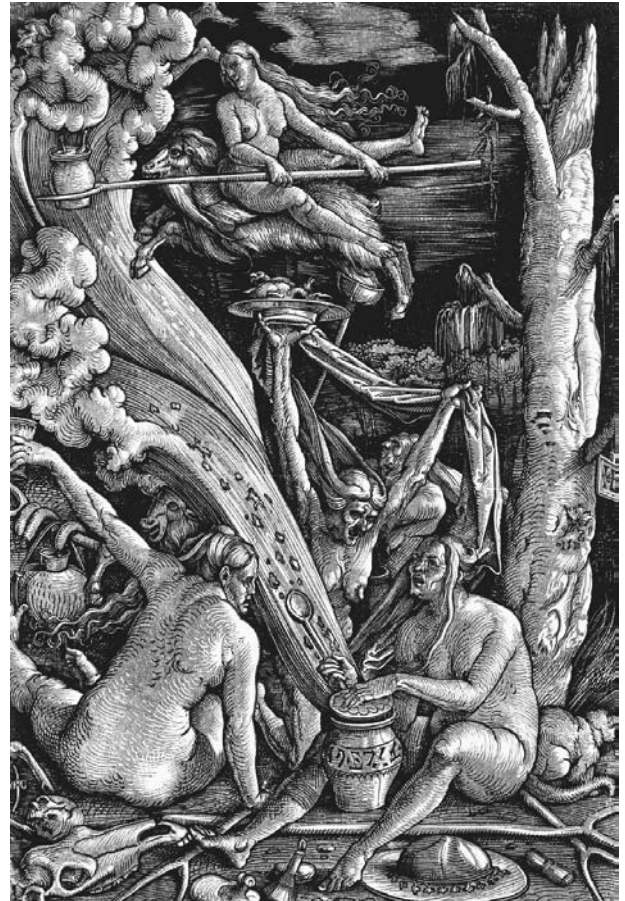

Sixteenth-century woodcut of witches by Hans Baldung Grien (1484–1545). During the medieval period, the Catholic Church labeled several different practices as superstitious, among them idolatry, incorrect worship of God, and magical practices such as witchcraft. PHOTO CREDIT: RÉUNION DES MUSÉES NATIONAUX / ART RESOURCE, NY

precursor and carried on a vigorous struggle against the “superstitious” veneration of tombs and shrines, destroying many of them. Similar Islamic reform movements, such as the Indian movement founded by Sayyid Ahmad Barelwi (1786–1831), would also denounce superstition. Indian Islamic reformers often linked “idolatry” to the influence of Hinduism.

Superstition in the Protestant and Catholic Reformations

The concept of superstition as a religious error was very influential during the Reformation, when Protestants defined many aspects of traditional Catholic worship, including pilgrimages, prayers for the dead, the cult of the saints, and the veneration of the consecrated host, as superstitious. Francis Bacon (1561–1626) in his essay on superstition quoted Plutarch and followed him in believing atheism preferable to superstition, a position he particularly emphasized by placing the essay on superstition immediately after the one on atheism. Bacon listed as superstitions “pleasing and sensual rites

THE *SPECTATOR* ON SUPERSTITION AND ENTHUSIASM

In an issue of the *Spectator* dated 20 October 1711, Joseph Addison distinguished between superstition and enthusiasm, linking superstition with Catholicism, enthusiasm with Protestant Dissent, and “masculine piety” with the group he himself was a member of, the Church of England.

An Enthusiast in Religion is like an obstinate Clown, a Superstitious Man like an insipid Courtier. Enthusiasm has something in it of Madness, Superstition of Folly. Most of the Sects that fall short of the Church of *England* have in them strong Tinctures of Enthusiasm, as the *Roman* Catholick Religion is one huge overgrown Body of childish and idle Superstitions.

The *Roman* Catholick Church seems indeed irrecoverably lost in this Particular. If an absurd Dress or Behaviour be introduced in the World, it will soon be found out and discarded: On the contrary, a Habit or Ceremony, tho’ never so ridiculous, which has taken Sanctuary in the Church, sticks in it for ever. A *Gothic* Bishop perhaps, thought it proper to repeat such a Form in such particular Shoes or Slippers. Another fancied it would be very decent if such a Part of publick Devotions were performed with a Mitre on his Head,

and a Crosier in his Hand. To this a Brother *Vandal*, as wise as the others, adds an antick Dress, which he conceived would allude very aptly to such and such Mysteries, till by Degrees the whole Office has Degenerated Into an empty Show.

Their Successors see the Vanity and Inconvenience of these Ceremonies; but instead of reforming, perhaps add others, which they think more significant, and which take Possession in the same manner, and are never to be driven out after they have been once admitted. I have seen the Pope officiate at St. *Peter’s* where, for two Hours together, he was busied in putting on or off his different Accoutrements, according to the different Parts he was to act in them.

Nothing is so glorious in the Eyes of Mankind, and ornamental to Human Nature, setting aside the infinite Advantages which arise from it, as a strong, steady masculine Piety; but Enthusiasm and Superstition are the Weaknesses of human Reason, that expose us to the Scorn and Derision of Infidels, and sink us even below the Beasts that perish.

SOURCE: Donald F. Bond, ed., *Spectator*, 2:289–290.

and ceremonies; excess of outward and pharisaical holiness; [and] overgreat reverence of traditions,” recapitulating common Protestant anti-Catholic rhetoric. The charge of superstition was also a polemical weapon in intra-Protestant battles. Bacon also hinted that there was a “superstition in avoiding superstition, when men think to do best, if they go furthest from the superstition, formerly received” a veiled thrust at the extreme Protestants of his day (Bacon, p. 40).

Catholic accusations of superstition against Protestants were less common, as the principal charge they made was heresy. Heresy differed from superstition in that it resulted from willful error rather than ignorance. In common usage, superstition also differed from heresy in that it was focused more on practices than beliefs. The early modern period also saw more secular analyses of superstition in Sir Thomas Browne’s (1605–1682) *Pseudodoxia Epidemica* (1646) and the works of other

collectors and denouncers of “vulgar errors” who preceded and followed him. These writers included superstitions among other false beliefs. Although in many places endorsing the theory that superstitions had been handed down from ancient pagans, Browne and his successors had more interest in cataloging and analyzing individual superstitions than did the theologians and religious polemicists. Their work contributed to the later development of the anthropological study of superstition.

Superstition in the Enlightenment and Romantic Periods

Enlightenment thinkers like David Hume (1711–1776) and Joseph Addison (1672–1719) adapted the “virtue of the mean” model of superstition by defining the opposite extreme not as atheism or irreligion but as enthusiasm or fanaticism. Hume considered the different social consequences of the two

extremes. Hume claimed that superstition originated in the fear of the unknown and that people undertook superstitious activities to propitiate unknown forces and thus protect themselves. Superstition sprang from excessive fear, enthusiasm from excessive confidence. However, Hume claimed that superstition was far more dangerous to society than enthusiasm. Superstitious people, afraid to approach the divine directly, handed over authority to priests, whereas enthusiasts refused to admit any intermediary between themselves and God. Superstition encouraged timorousness, and enthusiasm encouraged fearlessness—therefore despotic government and political passivity naturally accompanied superstition. Socially, eighteenth-century thinkers identified superstition with marginalized groups—peoples outside Europe, the European masses, and women, particularly old women.

Some radical Enlightenment philosophers broadened the concept of superstition until it described all organized religions. The entry on superstition in Voltaire's *Philosophical Dictionary* recounted how various Christian and non-Christian sects have accused each other of "superstition." By pointing out that there is no religion that has not been denounced by another as superstition, Voltaire discredited organized religion generally. Both Voltaire and Hume hinted that the inevitable superstition of the masses might not be altogether a bad thing, if it kept them quiescent.

The Romantic era saw a more positive valuation of superstition, part of the reaction against Enlightenment rationalism and the growing interest in "folk" culture. The English poet John Clare (1793–1864) viewed superstition in his country as a remnant of the culture of the Anglo-Saxons and Normans and spoke of it almost rhapsodically. "Superstition lives longer than books; it is engrafted on the human mind till it becomes a part of its existence; and is carried from generation to generation on the stream of eternity, with the proudest of fames, untroubled with the insect encroachments of oblivion which books are infested with" (Clare, p. 301). The human sciences that emerged in the nineteenth century considered superstition and particular superstitions part of their subject matter, and anthropologists and folklorists collected and analyzed them while psychologists sought the root of superstition in the human mind.

Superstition in the Modern World

Superstition in the modern era is less likely to be contrasted with true religion and more likely to be viewed as the opposite of science, reason, or modernity. Campaigns to abolish superstition have continued but have not usually been motivated by interest in purifying religion. The early twentieth-century Chinese government in its efforts to modernize Chinese culture employed a new concept, *mixin*, usually translated as "superstition," to denote many aspects of popular religion previously called *xie*, "heterodoxy." This linguistic change accompanied a shift from the Neo-Confucian strategy of incorporating popular religion as a support for the established order to one of actively suppressing many aspects of it. The Chinese nationalist government's 1928 decree "Standards for Preserving and Abandoning Gods and Shrines," attacked superstition as opposed to science and progress. The decree distinguished between cults, which remained permissible, mostly those of deified humans

such as Confucius and the Buddha, and "superstitious" cults, which were outlawed, mostly those of nature deities such as the god of rain. It was followed by several other antisuperstition edicts attacking divination and other magical practices.

Even when lacking the coercive power of a state or church, rationalist and scientific polemicists continue to describe the beliefs of their opponents as superstitious. Psychologists have investigated the human propensity for superstitious beliefs, attempting to identify those populations most and least likely to adopt superstitions. The causes for superstition they have put forth include the human propensity to ascribe meaning to coincidence or to assert control over uncontrollable events. Much of this work has been placed in a context hostile to superstition, seeing the identification of superstition's causes as essential to fighting it and defending rational thought. The idea of "superstition" has even been broadened beyond human beings; B. F. Skinner (1904–1990), in his 1947 paper on "Superstition in the Pigeon," gave a behaviorist interpretation of superstition. Skinner claimed to have produced in pigeons a tendency to repeat behavior associated with food getting, even when there was no real causal connection between the behavior and the appearance of food. He suggested that superstitious beliefs in humans could originate in the same way.

Anthropologists and folklorists have continued their studies of superstition, producing a myriad of studies of superstitions in particular geographical areas, among particular subcultures such as actors or baseball players, and concerning particular subjects, such as cats or fertility.

See also *Demonology; Magic; Miracles; Religion; Witchcraft.*

BIBLIOGRAPHY

- Bacon, Francis. *The Essays or Counsels Civil and Moral*. Edited with an introduction and notes by Brian Vickers. Oxford: Oxford University Press, 1999.
- Bond, Donald F., ed. *The Spectator*. 5 vols. Oxford: Clarendon, 1965.
- Campagne, Fabian Alejandro. "Witchcraft and the Sense-of-the-Impossible in Early Modern Spain: Some Reflections Based on the Literature of Superstition (ca. 1500–1800)." *Harvard Theological Review* 96 (2003): 25–62.
- Ciruelo, Pedro. *Pedro Ciruelo's A Treatise Proving All Superstitions and Forms of Witchcraft, Very Necessary and Useful for all Good Christians Zealous for Their Salvation*. Translated by Eugene A. Maio and D'Orsay W. Pearson. Rutherford, N.J.: Fairleigh Dickinson University Press, 1977.
- Clare, John. "Popularity in Authorship." *European Magazine*, n.s., 1, no. 3 (November 1825): 300–303.
- Duara, Prasenjit. "Knowledge and Power in the Discourse of Modernity: The Campaigns against Popular Religion in Early Twentieth-Century China." *Journal of Asian Studies* 50 (1991): 67–83.
- Moellering, H. Arnim. *Plutarch on Superstition: Plutarch's De Superstitione, Its Place in the Changing Meaning of Deisidaimonia and in the Context of His Theological Writings*. Rev. ed. Boston: Christopher, 1963.
- Parish, Helen, and William G. Naphy, eds. *Religion and Superstition in Reformation Europe*. Manchester, U.K., and New York: Manchester University Press, 2002.

Taylor, Christopher S. *In the Vicinity of the Righteous: Ziyra and the Veneration of Muslim Saints in Late Medieval Egypt*. Leiden, Netherlands: Brill, 1999.

Vyse, Stuart M. *Believing in Magic: The Psychology of Superstition*. New York: Oxford University Press, 1997.

William E. Burns

SURREALISM. In view of its global impact, as Anna Balakian has persuasively argued, Surrealism constituted the major poetic and artistic current of the twentieth century. Of the dozens of movements that vied for this honor, Surrealism proved to be the most influential and the most persistent. Although abstraction enjoyed a huge success, it was limited almost entirely to art. Surrealism's most serious rival was probably Cubism, since it had an important impact on both literature and painting. Another leading contender was Expressionism, however one chooses to define it, which influenced a broad spectrum of aesthetic creations. Nevertheless, Surrealism was the only movement to span the greater part of the century and to enjoy widespread popularity.

In the Beginning

The term "surrealism" was coined by Guillaume Apollinaire in 1917 to describe Jean Cocteau's ballet *Parade* and his own play *The Mammaries of Tiresias*. After Apollinaire died the following year, André Breton appropriated the term in homage to the fallen poet. In contrast to Apollinaire's surrealism, which was basically analogical, Breton's Surrealism (with a capital S) was preoccupied with the Freudian unconscious. Breton, a former medical student who served as a psychiatric orderly during the war, sought to probe the secret recesses of the mind. In particular, since he was a practicing poet, he wondered what aesthetic discoveries they might hold.

Although Surrealist art and film were destined to achieve greater popular success, Surrealism was originally conceived as a literary movement. The Surrealists proposed exploring the unconscious via the written and/or spoken word. By systematically violating linguistic rules, they attempted to increase our ability to describe irrational experiences and illogical events. By pushing language to the edge of intelligibility—and beyond—the Surrealists created a powerful instrument for exploring the unconscious. Like the Dada movement, from which it originally sprang, Surrealism strove not only to revolutionize language but also to renew its primary function. Surrealist practitioners no longer regarded words as passive objects but rather as autonomous entities. "Words . . . have finished playing silly games," Breton proclaimed; "Words have discovered how to make love" (p. 286).

Surrealism's basic principles were not all promulgated at the same moment nor adopted by everyone with the same measure of enthusiasm. The first *Manifesto of Surrealism* (1924) focused on the role of psychic automatism:

SURREALISM, n. Pure psychic automatism by which we propose to express—either verbally or in writing or

in some other manner—the true functioning of thought. The dictation of thought, in the absence of all control exercised by reason, outside all aesthetic and moral preoccupations.

ENCYCL. Philos. Surrealism rests on a belief in the superior reality of certain forms of association neglected until now, in the omnipotence of dream, in the disinterested play of thought. Ultimately it tends to destroy all other psychic mechanisms and to take their place in resolving the principal problems of life.

Despite the excitement evident in these and similar proclamations, psychic automatism assumed a limited role in Surrealism. Most, if not all, of the Surrealists exercised a certain amount of conscious control over their works. Breton himself distinguished between Surrealist texts, which were entirely automatic, and Surrealist poems, in which unconscious desires were encompassed by a broader design.

Marvelous Encounters

The concept of the marvelous also played a crucial role in Surrealist works. Differing from one era to the next, the marvelous was defined basically as exacerbated beauty. Provoking an involuntary shudder in the reader or viewer, the marvelous mirrored the perpetual anxiety underlying human experience. In Surrealist works, it often assumes the form of eerie images and enigmatic adventures. The concept of objective chance played an equally important role. According to Surrealist theory, the most powerful imagery was that which caused the greatest surprise. In order to create marvelous images, Surrealist poets juxtaposed two terms that appeared to conflict with each other but were secretly related. The power of the resulting imagery was directly proportional to their apparent dissimilarity.

Surrealist artists performed a similar operation by juxtaposing incongruous or contradictory images on the canvas. Psychic automatism provided one means of achieving this goal. Artists and writers also resorted to chance operations like those governing an exercise called "the exquisite cadaver," in which several individuals contributed different words to create a nonsensical utterance. The name derived from their first attempt, which produced the following phrase: "The exquisite cadaver will drink the new wine."

Later Developments

With the publication of the *Second Manifesto* six years later, the Surrealist program acquired additional principles. These principles applied to every official member of the Surrealist movement. One of these, which Breton called "the supreme point" (or sometimes "the sublime point"), attempted to revive the medieval concept of *coincidentia oppositorum*. "According to all indications," he declared, "a certain point exists in the mind where life and death, the real and the imaginary, the past and the future, the communicable and the incommunicable, the high and the low cease to be perceived as contradictions." The Surrealists sought to eliminate traditional binary oppositions, including the distinction between beauty and ugliness, truth and falsehood, and good and evil, because

they appeared to be arbitrary. In their opinion, these and other cultural constructions merely restricted the imagination.

Since the Surrealists strove to revolutionize life as well as art, they also, almost without exception, became ardent Marxists. How could one liberate humanity, they reasoned, without correcting widespread social abuses? Psychological freedom clearly depended on the achievement of political and economic freedom. Although the French Communist Party refused to take Breton and his colleagues seriously, they continued to subscribe to Marxist goals.

A final principle to be enshrined in the Surrealist pantheon was delirious love. Officially adopted in 1937, when Breton published a book of the same name, it was already well established. Hence the *Second Manifesto* (1930) celebrated love as the “only [idea] capable of reconciling every individual, momentarily or not, with the idea of *life*” (Breton, p. 823). In keeping with Surrealism’s objectives, passionate commitment was portrayed as a liberating force.

As much as anything, Breton and his colleagues insisted, Surrealism sought to improve the quality of everyday life. Although the movement’s accomplishments were largely aesthetic, it strove to revolutionize our view of the world around us. Among other things, Surrealism offered potential solutions to a number of problematic situations. One of the problems it addressed was the relation between the individual and his or her unconscious. By inventing strategies to glimpse this hidden realm, it conferred a new significance on the ancient Greek motto “Know thyself.” In addition, Surrealism explored the relation between individuals and the natural world. While the concept of the supreme point stressed the unity of life, the principles of objective chance and the marvelous emphasized its extraordinary beauty. In addition, the Surrealists aimed to redefine the relation between the individual and society and between man and woman. Reflecting the movement’s eclectic origins, they succeeded in reconciling Freud with the alchemist Fulcanelli and Eros with Marx. Ultimately, they attempted to modify the process of seeing, thinking, and feeling in order to achieve total liberation.

The Movement’s Reception

Originating in France, Surrealism soon spread to every corner of the globe. Painters and poets all over the world were attracted to the Surrealist endeavor, especially those living in Spain and Latin America. At least two of the latter artists, Salvador Dalí and Joan Miró, were destined to play a major part in the movement. An analogous role was reserved for Luis Buñuel, who founded the Surrealist cinema. In addition, Surrealism attracted three poets who would eventually receive the Nobel prize for literature: Vicente Aleixandre, Pablo Neruda, and Octavio Paz. In retrospect, Surrealism cast a long, indelible shadow over most of the twentieth century. Artists and writers who were not affiliated with the movement also benefited—and continue to benefit—from the Surrealist enterprise. Surrealism led to the creation of a new language, a new vision, and a vast body of exciting, innovative works. It revolutionized not only the way we perceive ourselves and the world around us but the way in which we translate this perception into words and images.

See also Arts: Overview; Avant-Garde; Dada; Dream; Periodization of the Arts.

BIBLIOGRAPHY

- Balakian, Anna. *Surrealism: The Road to the Absolute*. 3rd ed. Chicago: University of Chicago Press, 1986. A classic study.
- Bohn, Willard. *The Rise of Surrealism: Cubism, Dada, and the Pursuit of the Marvelous*. Albany: State University of New York Press, 2002.
- Breton, Andre. *Oeuvres complètes*. Edited by Marguerite Bonnet et al. Vol. 1. Paris: Gallimard/Pléiade, 1988.
- Caws, Mary Ann. *The Poetry of Dada and Surrealism: Aragon, Breton, Tzara, Eluard, and Desnos*. Princeton, N.J.: Princeton University Press, 1970.
- , ed. *Surrealist Poets and Painters: An Anthology*. Cambridge, Mass: MIT, 2001. A valuable collection of essays, manifestos, and illustrations.
- Chadwick, Whitney. *Women Artists and the Surrealist Movement*. Boston: Little, Brown, 1985. The basic text on women and Surrealism.
- Chénieux-Gendron, Jacqueline. *Surrealism*. Translated by Vivian Folkenflik. New York: Columbia University Press, 1990.
- Gale, Matthew. *Dada and Surrealism*. London: Phaidon, 1997. Primarily devoted to art.
- Ilie, Paul. *The Surrealist Mode in Spanish Literature: An Interpretation of Basic Trends from Post-Romanticism to the Spanish Vanguard*. Ann Arbor: University of Michigan Press, 1968. A basic text on Spanish Surrealism.
- Matthews, J. H. *Toward the Poetics of Surrealism*. Syracuse, N.Y.: Syracuse University Press, 1976. One of many books on Surrealism by a prolific author.
- Morris, C. B. *Surrealism and Spain, 1920–1936*. Cambridge, U.K.: Cambridge University Press, 1972. A basic text on Spanish Surrealism.

Willard Bohn

SYMBIOSIS. *See Environment.*

SYMBOLISM. The symbolist movement began in France in the 1880s as a literary phenomenon. The term *symbolism*, however, quickly came to encompass a range of arts, from painting and sculpture to theater and music. While the movement is often said to have spanned the years 1885–1895, the ideas and aesthetic interests of symbolism are often traced back to the middle of the nineteenth century, and many early twentieth-century artists and writers continued to be influenced by its ideas. Symbolism was first and foremost a movement in French literature centered in Paris, and many of its central participants were French (Stéphane Mallarmé, Paul Verlaine, Arthur Rimbaud). Yet many artists and writers from elsewhere were also central to French symbolism: Maurice Maeterlinck, Émile Verhaeren, and Albrecht Rodenbach were Belgian, Jean Moréas was Greek, Téodor de Wyzewa was Polish, and Stuart Merrill was American. In addition, there were symbolist movements in Germany, Italy, Russia, and Belgium. Many scholars also see mid-nineteenth-century British aestheticism as a form of symbolism.

Each manifestation of symbolism had its own distinct characteristics. For example, most Belgian symbolists were more socially and politically engaged with working-class issues than their French counterparts, while Russian symbolism linked spiritual, social, and national concerns. Many artists and writers who never would have called themselves symbolists are considered under the rubric of symbolism because their work shares at least some of the same interests as that produced by self-proclaimed symbolist artists.

Proponents of symbolist aesthetics rejected the notion that the purpose of the arts is to represent the world as it appears to one's senses. They proposed instead to create works that would use suggestive (and often abstract) forms, images, or sounds to embody transcendent (and sometimes spiritual) ideas and would thus offer their readers, viewers, or listeners an experience of truth, beauty, or the idea beyond the material realm. Symbolism—be it in literature, music, or the visual arts—is thus characterized by a paradox: It relies on an emphasis on material form (decorative patterns in painting, repeated sounds, or arrangements of words on the page in the literary arts) as the vehicle for transcending the material or empirical world. This foregrounding of form links symbolism to the emergence of modernist abstraction in art and literature.

For a long time, scholars saw the symbolist refusal to depict the empirical world as a reaction against naturalistic artistic and literary movements such as realism and Impressionism. Later scholarship suggested that, rather than seeing symbolism mainly as a rejection of naturalist aesthetics, it should be acknowledged that symbolism was embedded in wider cultural and political anxieties of the late nineteenth century. The dominant philosophies of positivism and Darwinism threatened to substitute empirical facts for the traditional religious explanations of the great mysteries of the world. Human activity was increasingly explained in mechanistic psychophysiological terms and human beings appeared to be less and less in control of their thoughts and behaviors. The development of capitalist economies led to an increasing commodification of daily life and an increasingly materialistic culture. Rather than situating symbolism in the rarified world of the aesthetic, scholars came to see the symbolist alternative to materialism—evocative abstraction, suggestion, mysticism, and dreamlike imagery—as an attempt to oppose the effects of materialism and capitalism.

Symbolism in French Literature

The symbolist movement was formally launched in 1886, when the poet Jean Moréas (1856–1910) published a manifesto in the major Parisian newspaper *Le Figaro*. Moréas described symbolism as the

enemy of teaching, of declamation, of false sensitivity, of objective description, Symbolic poetry seeks to clothe the Idea in a perceptible form that nevertheless will not be the ultimate goal in itself, but, which, even as it serves to express the Idea, remains subject to it. The Idea, for its part, must not allow itself to be deprived of the sumptuous robes of external analogies; for the essential character of symbolic art is never to reach the Idea itself. Accordingly, in this art, the depictions of nature, the

actions of human beings, all the concrete phenomena would not manifest themselves; these are but appearances perceptible to the senses destined to represent their esoteric affinities with primordial ideas. (p. 60)

Moréas' version of symbolism rejects all attempts to represent the perceptible world directly or instruct the reader straightforwardly. Instead, Moréas advocates allusive language that will allow the idea to be intuited by readers through a series of analogies. Moréas makes clear that for symbolism the important subject matter lies beyond the perceptible world. In addition, in the manifesto, Moréas advocates new kinds of verse no longer bound by traditional rules of poetic composition.

Moréas' manifesto served many purposes. On one hand, it was a declaration of the direction modern poetry should take and thus part of a wider attempt on the part of young writers to find cultural legitimacy while declaring themselves outside the traditional French academy. This general trend toward establishing an independent literary milieu is perhaps most clearly evidenced in the plethora of literary magazines that emerged in the mid-1880s: *Le Symboliste*, *La vogue*, *Le scapin*, *La Décadence*, and *Le Décadent*. Some, such as *La vogue*, sought legitimacy as serious journals by publishing new work by young poets such as Gustave Kahn, Jean Moréas, René Ghil, and Édouard Dujardin alongside the work of already established symbolist heroes such as Mallarmé and Rimbaud. These small journals also published articles further formulating and often arguing the points of symbolist theory. Many journals founded in the 1880s and early 1890s were short-lived, some lasting less than a year. Some journals, however, such as *La revue indépendante*, *La plume*, and *Entretiens politiques et littéraires* had more successful runs, and one, *Le mercure de France*, still exists, though its aims have been considerably broadened since the original publication.

While in some sense declaring his independence from tradition, Moréas also wanted to distinguish what he called "Symbolism" from the approach of other nontraditional writers and artists he designated as "Decadent." In 1883, Paul Bourget had expounded a "theory of decadence" when discussing Charles Baudelaire (1821–1867) in his *Essai de psychologie contemporaine* (Essay on contemporary psychology). Baudelaire's figure of the hypersensitive dandy aesthete became the model for the decadent artist, and Joris-Karl Huysmans's novel *À rebours* (1884; *Against nature*) became a veritable handbook: The main character, Des Esseintes, became a fictional cult hero and model for aspiring decadent artists and writers.

There is a great deal of overlap between decadence and symbolism. Both reject the value of empirical descriptions of the natural world and look to the artist's heightened sensitivity and imagination for the source of creativity. The aim of decadence, however, more often seems to be the rejection of bourgeois values and everyday morality in favor of detailed explorations of socially marginal and exotic subject matter: the occult, the femme fatale, sexual debauchery, extreme artifice, and aestheticism.

Conversely, symbolism, while sometimes overlapping in subject matter, is more seriously concerned with the search for a new approach to poetic, literary, or artistic form drawing on

the experimentations of an older generation of writers such as Baudelaire, Edgar Allan Poe, Mallarmé, Rimbaud, and Verlaine. Moréas' description of symbolism refers most directly to Baudelaire's poem "Correspondences" from his volume *Les fleurs du mal* (1857, expanded 1861; *The flowers of evil*)—a work that became a touchstone for symbolist artists and writers:

La nature est un temple où de vivants pilliers
 Laissent parfois sortir de confuses paroles;
 L'homme passe à travers des forêts de symboles
 Qui l'observent avec des regards familiers.
 Comme de longs échos qui de loin se confondent
 Dans une ténébreuse et profonde unité,
 Vaste comme la nuit et comme la clarté,
 Les parfums, les couleurs et les sons se répondent.
 Nature is a temple whose living pillars
 Sometimes emit confusing messages
 Man passes through forests of symbols
 That observe him with familiar glances.
 Like extended echoes that blend in the distance
 In a shadowy and deep unity,
 Vast as the night and as the light,
 The perfumes, the colors and the sounds are answered.
 (translation author's)

Baudelaire's poem suggests that humans inhabit a world where the mundane can serve as a "forest of symbols" to which the poet is especially attuned. Everyday objects and experiences offer secret correspondences between sounds, scents, and colors in which the poet deciphers a higher meaning. The poem evokes two ideas that will be central to symbolism: first, the role of the artist or poet as a gifted seer capable of identifying connections that point beyond the perceptible world; and second, the importance of formal echoes in sensory data where scents, colors, and sounds "se répondent" (respond to one another) in synesthesia—the connection between different sensory realms.

Baudelaire had been strongly influenced by the work of the U.S. writer Edgar Allan Poe (1809–1849), whose prose writings he had translated in the 1850s. Mallarmé and others were especially influenced by Baudelaire's 1859 translation of Poe's essay "Philosophy of Composition." Whereas Mallarmé was influenced by Poe's allusive figures and economy of means, others looked to Poe's status as *poète maudit* (damned poet), whose subject matter delved into mystery, the occult, and madness. In his work, Arthur Rimbaud (1854–1891) followed this interpretation of Poe, taking on the mantle of damned poet for himself. For Rimbaud poetry was not a controlled process of self-expression in the tradition of romanticism but instead a vehicle for the unraveling and disorganization of self—"a long, boundless, and systematized disorganization of *all the senses*"—that allows the exploration of those elements of human subjectivity associated with madness. As Rimbaud famously put it: "I is an *other*. . . . I am the spectator at the flowering of my thought: I watch it, I listen to it: I draw a bow across a string: a symphony stirs in the depths, or surges onto the stage" (p. 102). Rimbaud published *Un saison en enfer* (*A season in hell*) in 1873 and abandoned writing before the age of twenty. Other volumes of his work, *Illuminations*

(1886) and *Poésies complètes* (1895), were published at the instigation of others long after they had initially been written.

Whereas Rimbaud's questioning of the boundaries of poetry and of the self ultimately led him to abandon poetry, Stéphane Mallarmé (1842–1898) repeatedly wrote poems about the impossibility of embodying the Idea in poetic form. This is most famously thematized in the poetic symbol of *l'azur*, a term evoking both the color blue and the sky and alluding to the impossible ideal that the poet seeks to grasp and express. In an 1891 response to Jules Huret's *Enquête sur l'évolution littéraire* (*Survey of literary development*), Mallarmé, attempting to describe his approach to poetry, expanded on Baudelaire's notion of correspondences and turned it into the *modus operandi* of creation. According to Mallarmé,

to name an object is to suppress three quarters of the pleasure of the poem which is meant to be deciphered little by little: suggestion, that is the dream. This is the perfect use of mystery which constitutes the symbol: to evoke an object little by little in order to show a state of the soul or, conversely, to choose an object and glean from it an emotional state by a series of decipherments. (1891 response to Jules Huret, *Enquête sur l'évolution littéraire*)

As this passage suggests, the purpose of a poem is not to put forth a clearly decipherable message about the exterior world or the intentions of the writer, but to set in motion a process of reading. The word on the page always points beyond itself or its obvious referents to an unknown that cannot be fixed. Mallarmé's works place the emphasis on language's material unfolding through the poem, and the reader's unending act of decipherment is not a sign of the poem's failure but of its success.

Symbolism and Music

Many symbolists share the notion that all art should aspire to the condition of music, which was thought to be the most emotionally direct aesthetic medium. In "Art poétique" (1884), Paul Verlaine (1844–1896) famously instructed poets on the importance of "music before all else." This musicality was achieved in much symbolist poetry through rhyming, alliteration, assonance, and other rhetorical flourishes.

Mallarmé's famous late poem *Un coup de dés* (1897; *A die-throw*) takes the relationship between poetry and music even further than Verlaine. In this poem, Mallarmé radically experimented with type size and placement, leaving many blank areas, which themselves seem to carry meaning. The poem has been compared to a musical score with blanks that prescribe rests and with phrases that evanesce in much the same way as the music of Mallarmé's contemporary, the composer Claude Debussy. Indeed, Mallarmé's conception of his poems as a kind of music is brought out in an anecdote. When Debussy asked permission to set Mallarmé's "Afternoon of a Faun" (1876) to music, Mallarmé responded: "But I thought I had already done that!" (Sieburth, in Hollier, p. 796).

No composer is more closely aligned with symbolism than Claude Debussy (1862–1918). Debussy is famous for setting

many symbolist writings to music, including several poems by Baudelaire and Mallarmé. Most famously, he wrote “Prelude to the Afternoon of the Faun,” meant to complement and extend Mallarmé’s poem. Perhaps more important, Debussy approached musical composition with aims parallel to those of many symbolists. As Debussy wrote in an article of *La revue blanche* in 1902, music should not be “confined to producing Nature more or less exactly, but rather to producing the mysterious correspondences which link Nature with Imagination” (quoted in Lloyd, p. 266).

Like the symbolists, Debussy experimented radically with the conventions of rhythm, abandoning artificial demarcations within musical time in a move analogous to the symbolists’ rejection of the classic meters of poetry. Debussy compared his desire to minimize symbol and ornament in music to Mallarmé’s carefully wrought economy of language. Debussy also rejected any notion that music should tell an easily decipherable narrative: “There are those who want music to tell base anecdotes! As if the newspapers didn’t perform this task wonderfully well already” (quoted in Lloyd, p. 263). Both Debussy and Mallarmé imagined that their work, because of its rejection of anecdotal references and formulas, required active participation by its audience and asked them to transcend the mundanity of everyday experience. Debussy emphasized not only sound but silence as an element of meaning in his music, and this has been described as analogous to Mallarmé’s emphasis on the pauses and blank areas of the page in his late poem “Dice Thrown.” Finally, both Debussy and Mallarmé composed works that circle around the theme of desire.

Many poets associated with symbolism were extremely interested in the German composer Richard Wagner (1813–1883). The French interest in Wagner went back to the 1860s, when Baudelaire had admired and written about him and Auguste de Villiers de l’Isle-Adam, Judith Gautier, and Catulle Mendès had all visited him. Wagner imagined his music-dramas as *Gesamtkunstwerke* (total works of art) in which all the arts would be combined in a single work to transcend the possibilities of individual media. While some critics emphasized the naturalist tendencies of Wagner’s music, French interpreters of Wagner imagined the orchestrator of the total work of art as a secular priest and the work itself as a means to provide a transcendent experience. Baudelaire described his experience of Wagner’s music-drama *Lohengrin* (1848) as ecstatic, instigating an involuntary dreamlike state. Furthermore, in a transformation of Wagner that would be seized on by the symbolists, Baudelaire relates this experience to the synesthetic ideal he had described in “Correspondences,” saying that music by its very nature suggests synaesthetic analogies. In the aftermath of the Franco-Prussian War of 1870, the performance of Wagner’s operas had been banned in France. Many French literary figures, however, visited the festivals at Bayreuth, and by the mid-1880s there was a veritable cult of Wagner in France. From 1885 to 1888 one of Mallarmé’s disciples, Édouard Dujardin, published a symbolist journal, *La revue wagnérienne*, devoted to Wagnerism.

Les Vingt and Belgian Symbolism

In Belgium, the avant-garde group Les Vingt (The twenty) held exhibitions, musical events, and readings from 1884 to 1893.

Its founders, Edmond Picard and Octave Maus, aimed to promote avant-garde culture using the Wagnerian theory of the unification of the arts. The exhibition galleries of Les Vingt displayed works by avant-garde artists from Belgium and elsewhere. Performances of the work of contemporary composers (including Debussy) were held in the galleries. The elite of the literary world were invited to speak on literature, and readings of avant-garde poetry were regularly held. Belgium had long been fertile ground for the development of literature and the arts and the influence of France had always been strong. As a French-speaking nation close to France’s border, Belgium had hosted many exiled French artists and writers, including Baudelaire, and often works by French writers that could not be published in France were published in Belgium. Journals such as *La jeune Belgique*, *L’élan littéraire*, and *La Wallonie* contributed to the development of Belgian symbolism and also had a great influence in France. Many on the staff of *La Wallonie*, for example, were important players in the French symbolist movement. The Belgian symbolist writers Verhaeren, Maeterlinck, and Rodenbach participated in the literary events of Les Vingt. They were influential in the literary worlds of both Belgium and France. The journal *L’art moderne* championed Les Vingt and published many articles explaining its aesthetic platform, which was broadly antiacademic (and thus embraced Impressionism and Neoimpressionism alongside symbolism). Like the organization itself, the journal was devoted to a range of media—painting, sculpture, engraving, and furniture and costume design were discussed alongside literature and music. Significantly, *L’art moderne* also promoted a socialist political agenda and rejected the bourgeois public, the press, and the official exhibiting space of the Salon as its enemies.

Russian Symbolism

The symbolist movement in Russia is known as the Russian Silver Age (1892–1917). Although it was a widespread cosmopolitan movement encompassing often contradictory elements, certain general outlines can be drawn. In the 1890s a young generation of Russian writers was strongly influenced by Arthur Schopenhauer (1788–1860), Friedrich Nietzsche (1844–1900), Poe, Baudelaire, Mallarmé, Rimbaud, and Verlaine. The writer Valeri Briusov was instrumental in introducing Western work to the Russian audience through his translations of Baudelaire and Poe as well as his editorship of the important symbolist journal *Vesy* (The scales), which was modeled on *Le mercure de France* and published the works of Russian writers alongside European symbolists, including Moréas, Verhaeren, and Rémy de Gourmont. In 1892 three collections of verse were published under the title *The Russian Symbolists*. Rejecting positivism and materialism as well as the classic approach to literature, these writers followed the example of their Western counterparts. Writers such as Briusov, Konstantin Balmont, Fyodor Sologub, Zinaida Gippius, and Dmitry Merezhkovsky experimented with literary form and valued suggestion, intuition, and musicality in their work. The poet, mystic, and theologian Vladimir Solovyev described “life’s reverberating noise” as an “altered echo of transcendent harmonies.” Like their French and Belgian counterparts, Russian symbolists rejected the didactic depiction of the empirical world

and conceived of a truer reality hidden by phenomenal experience. They believed that intuition was more important than objective knowledge. This borrowing of ideas from further west was accompanied by an aesthetics of art for art's sake.

At the turn of the century Russian symbolism began to develop a much stronger character of its own, emphasizing a particularly Russian spiritual content. In 1901 Gippius and Merezhkovsky opened their Saint Petersburg Salon to contributors to Sergey Diaghilev's journal *World of Art* and in 1902 Merezhkovsky founded the Religious Philosophical Society. This led to a cross-fertilization of the literary, visual, and philosophical components of the movement in a forum focused on cosmic consciousness and the particular role of Russia as an intermediary between Eastern and Western spirituality, and on various forms of occult theorizing. The writers Vyacheslav Ivanov, Aleksandr Blok, and Andrey Bely were important participants in this later phase of the symbolist movement. Andrey Bely (1880–1934) described the new Russian poetry as apocalyptic and poets as prophets of the end of European civilization who foreshadow in their work a new, more highly evolved form of human consciousness. Solovyev described the poet as a possessor of secret knowledge. Aleksandr Blok (1880–1921) wrote poems drawn from mystic experiences and based on dreams. Bely is perhaps best known for his symbolist novels, the most famous of which is *Saint Petersburg* (1913). The novel, composed of experimental suggestive prose, combines descriptive narrative with mystical symbolism and can be read on many levels.

British Aestheticism

In Britain a movement known as aestheticism is often seen as part of the wider symbolist movement. From the mid-nineteenth century until the early twentieth century, the artists and writers associated with British aestheticism experimented with the idea that art is a realm separate from the everyday world and the artist's role is to cultivate and express beauty for its own sake. British aestheticists most often used very refined evocations of women from myth and legend as a means for exploring their own highly cultivated sensibilities. They rejected classic approaches to art and literature and disputed the notion that art should educate its audience about moral values. The retreat into the realm of highly refined art and the refusal to address contemporary issues are often regarded as an oblique attack on bourgeois morality and the growing commodity culture of nineteenth-century Britain.

The writers of the aesthetic movement drew on the work of British romantic poets such as William Blake (1757–1827). Some were also influenced by Baudelaire and the French symbolists. One of the precursors to the aesthetic movement was the Pre-Raphaelite Brotherhood, which was formed by a group of young painters and writers in the mid-nineteenth century. This movement rejected the classic aesthetic of the British academy and looked to other sources for its inspiration and subject matter. Many of their early works had Christian subjects. Often they tried to re-create the forms and methods of Gothic art and looked back to stories of knights and ladies. Pre-Raphaelite journals such as *The Germ* combined literary endeavors with explorations of the visual arts. Initially, the Pre-Raphaelite aesthetic involved taking a detailed approach and for this reason

it is often linked to realism. Nevertheless, many of the poems and paintings of artists such as James McNeill Whistler, Edward Burne-Jones, and Dante Gabriel Rossetti are rather vague and suggestive and these are commonly seen as part of the aesthetic movement. Writers associated with the aesthetic movement include John Ruskin, Alfred Lord Tennyson, Christina Rossetti, Charles Swinburne, Walter Pater, and Oscar Wilde. Many participants in British aestheticism embraced the notion of synesthesia and looked for correspondences between poetry, painting, and music. Dante Rossetti often based his paintings on his own poems, especially those evoking stories from the writings of Dante Alighieri (1265–1321), author of the *Divine Comedy*. Claude Debussy set Dante Rossetti's poem "The Blessed Damozel" (1850) to music in 1887–1888. Rossetti had completed his own painting of this poem in 1881, and the painting, which had the poem inscribed on the frame, is thought to have inspired Debussy's composition. James McNeill Whistler (1834–1903) was a close friend of Mallarmé and symbolist critics described him as a "painter-poet." Whistler embraced the connection between art and music by giving his works musical titles such as "symphony" or "nocturne," with subtitles designating colors or subject matter.

Symbolist Theater

Symbolist theater relied on the Wagnerian idea of the total work of art, while also emphasizing the importance of using suggestion to reach metaphysical concepts of "the enigma of life" (Villiers de l'Isle Adam). The symbolists aimed to eliminate all traces of naturalistic or imitative acting, and all romance and melodrama. In theory, the actor was to be a depersonalized symbol pointing to a meaning beyond what was visible on the stage. In France, the Théâtre d'Art and the Théâtre de l'Oeuvre put on plays by symbolist writers and held experimental poetry stagings. In addition to the plays of French writers, they produced adaptations of works by Edgar Allan Poe, which had recently been translated by Mallarmé, and of *Salomé*, the play Oscar Wilde had written in French during his exile from Britain. Plays by the Belgian symbolists Maeterlinck and Rodenbach were also produced. Often the plays featured stage sets created by Paul Sérusier and other artists from the symbolist group the Nabis. In "On the Absolute Lack of Utility of Exact Staging," the playwright and theorist Pierre Quillard wrote that "the set should be a pure ornamental fiction which completes the illusion through analogies of colors and lines with the play. . . . Theater will be what it should be: a pretext for dream" (quoted in Deak, p. 145). Significantly, the sets were meant not to echo the visible shapes or forms of the characters, but, in a kind of synesthesia, to analogize the essence of the play itself.

Plays by the Scandinavian writers Henrik Ibsen (1828–1906) and August Strindberg (1849–1912) also became important parts of the French symbolist repertoire. In a manifesto accompanying the opening of Aurélian-Marie Lugné-Poe's Théâtre de l'Oeuvre, the symbolist critic Camille Mauclair identified Ibsen with the symbolist struggle to express "libertarian ideas or taste for aestheticism" and "modern beauty." Ibsen's plays *Ghosts*, *The Wild Duck*, *Hedda Gabler*, *A Doll's House*, *The Lady from the Sea*, *Rosmersholm*, and *An Enemy of the People*

the *People* were all staged in the early 1890s. Part of the reason Ibsen was appropriated as a symbolist had to do with the staging. The Danish actor, director, and novelist Hermann Bang described Lugné-Poe's staging of *Rosmersholm* as "without any firm contours. The actors wander restlessly over the stage, resembling shadows drifting continuously on the wall. They like to move with their arms spread out, . . . like the apostles in old paintings who look as if they've been surprised during worship" (quoted in Deak, p. 189). Bang's description of actors resembling apostles and shadows on a wall gives us a sense of how the staging of the play used vagueness and suggestiveness to reach higher spiritual meanings. As Frantisek Deak points out in his study of symbolist theater, however, Bang saw these initial attempts by Lugné-Poe as a misappropriation of Ibsen and attempted to persuade Lugné-Poe to emphasize psychological elements in his staging. Many Scandinavian critics, who believed Ibsen's play was realist, objected to the staging. Several of August Strindberg's psychological dramas (including *The Father* and *The Creditors*) were also staged at the Théâtre de l'Oeuvre, despite the fact that he too had previously been understood to be a naturalist.

Symbolism in the Visual Arts

In the 1880s and 1890s, many European artists experimented with work that had similarities to symbolist literature. When applied to the visual arts, symbolism designates less a recognizable style than a general approach to art that rejects direct representation of the material world in favor of allusion and suggestion. While artists such as Paul Gauguin and the Nabis or Ferdinand Knopff consciously pursued an aesthetic agenda analogous to the project of literary symbolism, others, such as Pierre Puvis de Chavannes and Gustave Moreau or Auguste Rodin were annexed to the symbolist movement by a younger generation of artists in much the same way that Ibsen and Strindberg had been.

The aim of searching for more authentic ideas than those offered by material reality was in some sense similar to the traditional goal of idealization long pursued by academic art. The technical means by which symbolists pursued the idea was often quite innovative, however. In 1886, the symbolist critic Gustave Kahn offered a description of symbolism that lent itself to translation into visual media. Rather than portraying "the quotidian, the near at hand," as realist and Impressionist artists had done, symbolists "wish to be able to place the development of the symbol in any period whatsoever, and even in outright dreams (the dream being indistinguishable from life)." With this reference to Schopenhauer's theorization of the world as representation, Kahn proposed that symbolist artists or writers look inward for their subject matter: "The essential aim of our art is to objectify the subjective (the externalization of the Idea) instead of subjectifying the objective (nature seen through a temperament)." (*L'Événement*, 28 September 1886). Kahn negated the naturalist writer Émile Zola's championing of the expression of individual temperaments and called for the externalization of the transcendent Idea.

Symbolism and modernism. The symbolist artists imagined that their privileged subjective states were best expressed through allusive, nonnaturalistic arrangements of line and

color. *The Talisman* (1888), a painting by Paul Sérusier (1865–1927), is often said to be the first attempt by French symbolist artists to practice this aesthetic. In a story recounted by Maurice Denis, Sérusier is said to have painted the work following Gauguin's instruction: "How do you see this tree, Gauguin asked in front of a corner of the Bois d'Amour: is it green? Then paint it green, the most beautiful green on your palette; and that shadow, rather blue? Don't be afraid to paint it as blue as possible" (p. 50). In this way, bold and simplified color patterns were extracted from the natural landscape. In 1891 Albert Aurier wrote "Symbolism in Painting: Paul Gauguin," in which he defined the characteristics of symbolist painting and suggested by Gauguin's work embodied them. Like Moréas he emphasized the primacy of "the Idea" and necessity of clothing it in a synthetic form that would work by allusion. He stressed that the work should be *subjective*, because an object would not be considered as an object, but as a sign of an idea perceived by the subject.

Denis's painting *April* (1892) demonstrates his own experimentation with this aesthetic. In 1890, Denis wrote in his manifesto "Definition of Neo-Traditionism": "Before it is a battle horse, a nude woman, or an anecdote, a painting is a flat surface, covered with colors arranged in a certain order" (p. 1). Thus Denis, like the symbolist poets, foregrounded the abstract qualities of his medium and like them explicitly defined symbolism as a kind of modernism. The title of his manifesto points to the paradoxical nature of his symbolist project. Denis wished to turn to tradition in order to found a new (neo) kind of art. He argued that artists should look to aesthetic examples such as the Italian primitives and Pierre Puvis de Chavannes (1824–1898). That artist, who was France's greatest painter of murals on national themes, interested the symbolists because his large, boldly patterned compositions in muted colors, such as *Poor Fisherman* (1881), seemed to suggest rather than define their subjects. His compositions were often described as dreamlike. The critic Téodor de Wyzewa, for example, explained the unanimous praise for the artist as being a result of "a thirst for dream, emotion and poetry."

The artist as prophet. The notion that the artist was a seer or prophet who, in the words of the symbolist critic Camille Mauclair, "painfully saved our sickened souls from the excremental muck of materialism" (quoted in Matthews, p. 15), was explicitly embraced by many artists in France who wished to be associated with symbolism. Paul Gauguin as well as the artists who formed the avant-garde group the Nabis (*Nabis* is the Hebrew word for *prophets*)—Maurice Denis, Paul Sérusier, Paul Ranson, Édouard Vuillard, and Émile Bernard—are good examples of this. Art, they believed, had the potential to offer the kind of salvation that had previously been the terrain of traditional religions. Some, such as Denis, were part of a wider, extremely conservative neo-Catholic movement.

Others were looking for less traditional forms of spiritual meaning beyond everyday existence. Artists such as Paul Gauguin, Paul Ranson, and Odilon Redon in France, the Blue Rose group led by Pavel Kuznetsov as well as Mikhail Vrubel' in Russia, and the Czech artist František Kupka embraced the occult mysticism that was in vogue during the late nineteenth

century. Some artists employed principles of “sacred geometry” according to which basic shapes or harmonic ratios shared by plants, animals, or other natural objects were thought to demonstrate a universal continuum of form understandable to all. Such ideas were derived from the theosophy of Madame Blavatsky and Édouard Schuré and from the study of earlier illustrated treatises on the occult, which aimed to find unifying principles in disparate religions. These theories of the occult also shared an interest in dualistic principles of male-female, heaven-earth, and a three-part godhead of matter-mind-spirit, which were often represented using geometric diagrams. This emphasis on abstract geometry thus links the spiritualist emphasis of some symbolists to the more widespread modernism of the movement.

One of the main international exhibition forums for mystical symbolist art was the Order of the Rose + Cross of the Temple and the Grail, whose Salons were held in Paris from 1892 to 1897. The order had been founded by the self-anointed “Sâr” Joséphin Péladan (1859–1918; *Sâr* was the title designating Assyrian royalty), a prolific art critic, the author of *Androgyne* and *Vice suprême*, and a high priest of the occult. He described the artist as the “supreme priest” who should represent “dreams instead of reality.” The flamboyant Péladan viewed himself and all his public activities as a work of art. He even coined the term *kaloprosopia* to describe this art of personality in which the externalization of an aesthetic idea in dress, gesture, and demeanor would ultimately lead to the internalization of this aesthetic as a personality trait, and visa versa. Péladan himself dressed in archaic silk robes and affected the pose of a quasi-Byzantine mystic.

Péladan and other symbolist artist-prophets expected to be rejected by the mass audience, thought to be incapable of interpreting the truths embodied in their art. Thus symbolism often brought with it a form of elitism that was sometimes used to support a conservative social agenda. The symbolist rejection of a wider bourgeois audience has also been interpreted as a protest against the degraded mass culture that resulted from industrial capitalism and the related effects of capitalism’s materialist values on human subjectivity. However much the symbolists themselves may have understood their elitism as a form of protest, their emphasis on the creative genius unwittingly reinforced the notions of individualism on which the growing art market traded.

Symbolist primitivism: the retreat from Western civilization. Like Kahn, the symbolist art critic Albert Aurier described the artist as a visionary who, by looking inward, achieved access to the absolute. According to Aurier, this ability to communicate more directly with basic truths was shared by others whose “uncivilized” natures brought them closer to an originary state of being in which the senses were not yet dulled by daily exposure to decadent European culture: children, non-Europeans, peasants, madmen, and hysterical women. Symbolist artists who embraced the primitive wished to return their own consciousnesses to equivalent states of innocence and instinctiveness. In France, the symbolist interest in the primitive was related to the opening of markets between East and West, and to the expansion of colonialism that gave

artists exposure to what were viewed as more primitive peoples and their art. Many artists borrowed from non-Western sources. The Dutch artist Vincent van Gogh, Paul Gauguin, and many other late-nineteenth-century artists looked to the bold patterns and lack of traditional Western perspective of Japanese prints for a seemingly primitive source of artistic ideas.

Paul Gauguin (1848–1903) retreated to Brittany in the 1880s in what he imagined was an escape to a more primitive region of France, where he hoped to set up an artists’ colony. There he painted several images of the natives, including the famous *Vision after the Sermon* (1888). This painting used bold patterns and generalized shapes to picture the mystical vision of “primitive” peasants. Vincent van Gogh (1853–1890) moved from Paris to Arles at about the same time and invited Gauguin to join him in a similar attempt to escape the metropolis. Ultimately, seeking a retreat to a primitive paradise, Gauguin fled Paris for Tahiti in the 1890s. He continued to paint boldly patterned works of primitive subjects—especially native women—until his death.

On one hand, many of the symbolists sincerely valued what they believed to be positive characteristics of so-called primitive peoples. On the other, they also believed that though women, children, and savages were closer to the absolute, they lacked the intellectual ability to recognize and identify universal ideas. Neither did such primitives possess the artistic ability to communicate the absolute through art. Only the artist-seer had both access to the absolute and the means to recognize and communicate it. Thus, while symbolism encouraged artists and poets to explore marginalized realms—to “become” momentarily feminine, mad, or primitive in the act of creativity—it also denied the possibility that traditionally “primitive” people could themselves be artists. It therefore shored up the elite status of already privileged European male artists. In addition, in the process of celebrating the people they saw as primitive, these artists reinforced the stereotypes that allowed the wider culture to marginalize them, or, in the case of colonialism, they justified imperial expansion as a needed civilizing force.

Artifice against nature. In Joris-Karl Huysmans’s 1884 novel, *À rebours* (*Against the grain*, or *Against nature*), the decadent aesthete Des Esseintes withdraws into an elaborate world of his own construction in an effort fully to control his “reality.” Within the confines of his abode, the differences between nature and artifice, reality and imagination are effaced and the whims of his highly refined sensibility are indulged to such an extent that nothing natural remains. This transformation of the natural world into a product of the Des Esseintes artifice is well illustrated when the protagonist decorates his home with a live turtle encrusted with gold and jewels. (The turtle, not surprisingly, dies.) Des Esseintes’s walls are hung with the works of Odilon Redon and Gustave Moreau. Each artist pictures worlds that work “against nature.” Their works overtly claim status as products of the imagination rather than replications of the real.

Gustave Moreau (1826–1898) belonged to an earlier generation of artists and had little respect for the symbolist movement. He refused to exhibit with them at Sâr Péladan’s Salon



***Vision after the Sermon: Jacob Wrestling with the Angel* (1888) by Paul Gauguin. Oil on canvas.** Gauguin frequently imbued his boldly patterned paintings with spiritual meaning. He believed that art had the same power of salvation as religion. © ARCHIVO ICONOGRAFICO, S.A./CORBIS

of the Rose + Croix and described the “enthusiasm for the invisible . . . exclusive need of dreams, mystery mysticism, Symbolism and the undefined” as so much snobbery and posing (quoted in Cooke, 124). By the time Huysmans wrote about Moreau’s paintings *Salomé* (1874) and *The Apparition* (1876) in his novel, Moreau had been exhibiting scenes from the Old Testament and Ovid’s *Metamorphoses* in the Salon for nearly three decades. Despite this, Moreau did share some aims with the works of artists aligned with symbolism, though his aesthetic approach is quite different from artists such as Gauguin and the Nabis. His works embody the principle that one must move beyond the description of the everyday and against any sense of the replication of nature. Moreau’s paintings combine imagery and symbols from a wide range of sources (including Old Masters, Egyptian art, the Byzantine empire, and Asian culture). All these are incorporated into highly detailed paintings whose disparate symbols are held together by a distinctive painterly style. Elaborate and often minute patterns, sometimes painted, some-

times scratched into the paint, form a unifying armature or screen over the canvas. The effect is a disconcerting jewel-like surface and dreamlike treatment of the familiar that now appears to be wholly a product of the artist’s artifice.

Like Moreau, the printmaker and painter Odilon Redon (1840–1916) was chosen by Huysmans as an artist favored by his fictional decadent hero Des Esseintes. Redon’s small-scale works on paper differ greatly from Moreau’s intricately wrought history paintings. Redon’s imagery, however, like Moreau’s, draws on a range of sources, from ancient myth to Christian subjects to natural imagery to contemporary literature, and often combines sources in impossible and surprising ways that evoke formal or conceptual correspondences between seemingly disparate objects. This combination, reminiscent of dreams in which one thing metamorphoses into another, was sometimes further enhanced by the captions or evocative titles that accompanied the works. Like symbolist poetry, Redon’s prints push the reader into a process of interpretation where

echoes between elements suggest meanings but resist any ultimate decipherment or closure. In Redon's work, as in symbolist poetry, the viewer's engagement with the process of interpretation seems to be the most important element.

In many works, Redon specifically thematizes the transformation of nature into imagination by transmuting natural forms into highly evocative dreamlike visions. In *There Was Perhaps a First Vision Attempted in the Flower*, a plate from the lithograph series *Les origines* (1883; *Origins*), the orb at flower's center becomes an eye and the lashes give it the look of a carnivorous plant. In other works, flowers, spiders, or planetary orbs have human faces. Redon studied anatomy and natural history. His hybrid creatures cross categories of the natural world to become evocatively unnatural. Their hybridity also speaks to the possibility of a primeval continuum tying together different categories of being.

A similar hybridization of natural categories is seen in the works of the Norwegian artist Edvard Munch (1863–1944). In the series of paintings *The Frieze of Life*, the forms in background landscapes seem to be based on contemporary studies of the physiology of the human body. Furthermore, Munch described the landscape itself through physiological metaphors, sometimes of pulsing or breathing. In Munch, as in Redon, the metaphorical correspondences link disparate realms of being to point to basic structures or primeval truths beyond the immediately visible.

Symbolism, Gender, and Sexuality

Woman is a ubiquitous subject in symbolist art and literature. Sometimes, as in Denis's *April* or the early work of Piet Mondrian, she is a positive symbol of innocence and possibility—desexualized and dematerialized. In paintings by D. G. Rossetti or Whistler, woman is a highly aestheticized and unattainable love object. In his early work, the Russian artist Kazimir Malevich (1878–1935) used the motifs of women and embryos to express the notion that woman could be the incarnation of a higher, purer, more spontaneous realm. At other times, woman is turned into a sexualized femme fatale, as in Jean Delville's *Idol of Perversity* or in the works of the Belgian graphic artist Félicien Rops or the German artist Franz von Stuck. Thus, much symbolist visual art reinforces and amplifies a long-standing dichotomy between woman as virgin and woman as whore.

Significantly, each of these stereotypes aligns woman closely with nature. Such images reinforce the idea that woman, imprisoned within her biology—as the innocent vessel of the life-bearing force or as bearer of uncontrollable and instinctive sexual desire—is incapable of transcending her bodily functions and desires. Woman is a subcategory of nature and is linked to the primitivism that was such an important subtext of the symbolist project. The Belgian symbolist Ferdinand Khnopff's *Art (Caresses of the Sphinx)*, 1896) combines many of these elements. The Dutch symbolist Jan Toorop, with his flat linear vision, and Munch painted renditions of woman as femme fatale. Moreau's images of Salomé and other female figures also fit this description.

Significantly, these works were produced at a time when feminist movements were experiencing a resurgence across Eu-

rope and when women were beginning to work in a number of male professions. This imagery may be seen partly as a cultural reaction to the emergence of a well-defined social type—"the New Woman"—a bourgeois woman who sought financial independence, education, and a professional life. To counteract this threat to traditional values, the mainstream definitions of femininity in late-nineteenth-century European culture denied woman the possibility of "genius." And individual women who pursued intellectual or professional activities were described as "masculine." Artistic representations of woman's proximity to nature counteracted women's demands for intellectual pursuits by reinforcing the boundaries between intellectually endowed virile masculinity and body-bound femininity. Patricia Matthews argues that the masculinity of the intuitive artist-seer was ultimately protected by the exclusion of women from the category of genius. Like the primitives, women might experience intuition, spirituality, or a loss of the boundaries of self, but because they lacked genius, they would never be able to transform those experiences into an understanding of higher truths; nor could they communicate those truths through art. One rare exception to this general belief was the sculptor Camille Claudel, whose works were praised by several symbolist critics. Nevertheless, many of them still related the power of Claudel's works to her instinctual femininity. Other successful women artists and writers were said to have lost some of their femininity in expressing their genius.

The relationship between symbolism and sexuality was not always degrading to women. For some Russian symbolists, including the woman writer Zinaida Gippius and the male writers Ivanov and Merezhkovsky, sex was a source of liberation with the potential to unite humanity with God. Furthermore, many male symbolists conceived of their own projects in feminized terms. Intuition, spirituality, emotionalism, loss of intellectual control—all these were characteristics commonly aligned with the feminine. Many symbolists (Sâr Péladan is the most obvious example) enacted the role of feminized aesthete in their public lives, constructing personae that rejected bourgeois norms of masculinity. The British aesthete and writer Oscar Wilde (1854–1900) also assumed the role of the unconventional dandy (though in a less extreme form than Péladan). In the early twentieth century, many lesbians, including Romaine Brooks and Claude Cahun, would take the image of the male dandy as a model for their alternative visions of female sexuality.

Because it challenged normative values and offered alternative cultural forms, symbolism and the aestheticism that often accompanied it opened new avenues for imagining sexuality, which sometimes offered positive ways of conceptualizing the marginal subject position of the homosexual male. Rimbaud is famous for writing in a symbolist vein about his relationship with Verlaine. André Gide, who would openly theorize male homosexuality in dialogue form in *Corydon* (1911–1924), began his literary career in the symbolist milieu. Péladan described the androgyne as a symbol of creative possibility—an innocent creature prior to the corruption of sexuality who still embodied the intuitive possibilities of femininity without its negative aspects.



Laus Veneris (1873–1875) by Edward Burne-Jones. Oil on canvas. British artist Burne-Jones frequently depicted androgynous figures in his works, which certain critics believed to partially symbolize the homosexual subculture in the country. © ARCHIVO ICONOGRAFICO, S.A./CORBIS

Wilde seems to have found something enabling in the images of the femme fatale (his version of Salomé clearly differs from the overtly misogynist versions produced by many late-nineteenth-century artists). Swinburne attacked normative sexual morality in his poems by incorporating perverse sexuality into his images of beauty. British artists such as Aubrey Beardsley, Simeon Solomon, and Edward Burne-Jones, and writers such as Pater and Swinburne, often represented androgynous figures. Richard Dellamora and Thais Morgan connect these androgynous figures to the construction of a homosexual subcultural identity in Britain. Morgan suggests that images of the androgyne and of the hermaphrodite were meant to be read both as symbols of the perfect art object (by the mainstream audience) and as specific objects of homosexual desire.

Symbolism and the Unconscious

Symbolism was part of a wider cultural trend in which the order, clarity, and hierarchy that had long been associated with traditional academic art were replaced by modes of representation that focused instead on experimentation with representational form and an emphasis on individual sensibility. In this sense, symbolism is connected to Impressionism in painting and naturalism in literature. In fact, many symbolist artists

emerged from this naturalist milieu. Unlike naturalism, however, symbolism emphasizes the sensuous suggestiveness of language and form and the tendency of this suggestiveness to solicit individual interpretations from viewers and readers. Because symbolism suggested rather than instructing or describing, and because its subjects were so often themselves dreamlike, it seemed to open the door to a proliferation of fantasies in its audience. Thus the symbolist project was part of broader challenges to the notion of the autonomous human subject—a male subject for whom thought and representation had the potential to be transparent. When the boundaries of this traditional male subject position were opened up, many consequences, both aesthetic and political, followed.

The symbolist movement was one element in a general reconceptualization of human subjectivity that took place just as the existence of the unconscious mind was being imagined by psychologists and sociologists. One salient example of this theorization of the unconscious and the consequent questioning of the nature of subjectivity is to be found in the popular fascination with hysteria, hypnosis, and “suggestion.” The power of suggestion was thought to be especially strong when the subject had a weak or nervous personality (for example, children, primitives, and women). There was much debate over whether “normal” men with strong personalities were also

subject to the suggestion of others. In 1891, Alfred Fouillee summed up the consequences of recent psychological discoveries, saying “contemporary psychology has wrested from us the illusion of a bounded, impenetrable, and absolutely autonomous ego (p. 811). The discovery of the unconscious led to the possibility that human beings were not truly in control of their thoughts and actions. Works of art were deemed to have the potential to open their audiences to a suggestibility analogous to the state of hypnosis. Thus, paradoxically, the symbolist rejection of material reality in favor of the world of dream took shape at approximately the same time empirical science was confirming the importance of fantasy in daily life.

Conservative critics such as Ferdinand Brunetière in France or Max Nordau in Germany worried that symbolist work, with its incantatory echoing sounds and forms and its refusal to point readers or viewers to clear edifying messages, might encourage a loss of control not only in the artists who produced it but in the audiences who experienced it. Brunetière believed the aesthetic experience should serve as an edifying point of focus for the reasoning mind. He charged that the “empty forms” and “hollow rattling words” of symbolism would “dissolve the unity of the self in a diversity of successive states . . . give it over to the wandering voluptuousness of dream,” which would lead to “the glorification of egoism” rather than the betterment of society (Shaw, p. 192). Nordau’s book *Degeneration* described symbolism as a symptom of a general decline in Western civilization. Yet the very qualities that critics such as Nordau abhorred were the things that made symbolism a turning point in the arts. Symbolism opened new aesthetic possibilities of experimentation and abstraction and created space for alternative subject positions. It created the possibility, that is to say, for many of the wide range of avant-garde movements that followed in the early twentieth century.

See also **Arts; Modernism; Periodization of the Arts; Poetry and Poetics; Theater and Performance.**

BIBLIOGRAPHY

PRIMARY SOURCES

- Baudelaire, Charles. *Les Fleurs du Mal*. Edited by James McGowan. Oxford: Oxford University Press, 1993.
- . *Les Fleurs du Mal: The Complete Text of The Flowers of Evil*. Translated by Richard Howard. Brighton, U.K.: Harvester; Boston: D. R. Godine, 1982.
- Brunetière, Ferdinand. “Le Symbolisme Contemporain.” *Revue des deux mondes* (1 April 1891): 685–686.
- Denis, Maurice. *Theories, 1890–1910: Du symbolisme et de Gauguin vers un nouvel ordre classique*. Paris: L. Rouart and J. Watelin, 1920.
- Dorra, Henri, ed. *Symbolist Art Theories: A Critical Anthology*. Berkeley: University of California Press, 1993.
- Fouillee, Alfred. “Les grandes conclusions de la psychologie contemporaine: la conscience et ses transformations.” *Revue des deux mondes* 107, 1891.
- Harrison, Charles, Paul Wood, and Jason Gaiger, eds. *Art in Theory, 1815–1900: An Anthology of Changing Ideas*. Malden, Mass.: Blackwell, 1998.
- Huret, Jules. *Enquête sur l'évolution littéraire*. Paris: G. Charpentier and E. Fasquelle, 1984.
- Hustvelt, Asti. *The Decadent Reader: Fiction, Fantasy, and Perversion from Fin-de Siècle France*. New York: Zone, 1998.
- Huysmans, Joris-Karl. *Against Nature*. Translated by Margaret Mauldon. Oxford: Oxford University Press, 1998.
- Kahn, Gustave. “Response des Symbolistes.” *L'évenement* (28 September 1886).
- Mallarmé, Stéphane. *Selected Poetry and Prose*. Edited by Mary Ann Caws. New York: New Directions, 1982.
- Mangravitte, Andrew, ed. *An Anthology of French Symbolist and Decadent Writing Based upon The Book of Masks by Rémy de Gourmont*. London: Atlas, 1995.
- Moréas, Jean. “Le Symbolisme. Manifeste de Jean Moréas.” In *Les premières armes du Symbolisme*. Paris: Leon Varnier, 1889.
- Nordau, Max. *Degeneration*. Lincoln: University of Nebraska Press, 1993. Translation of *Entartung* (1892).
- Rimbaud, Arthur. *Complete Work*. Translated by Paul Schmidt. New York: Harper and Row, 1976.
- Verlaine, Paul. *One Hundred and One Poems by Paul Verlaine: A Bilingual Edition*. Translated by Norman R. Shapiro. Chicago: University of Chicago Press, 1999.

SECONDARY SOURCES

- Block, Jane. *Les XX and Belgian Avant-Gardism, 1868–1894*. Ann Arbor: UMI Research Press, 1984.
- Bowlit, John E. *The Silver Age: Russian Art of the Early Twentieth Century and the “World of Art” Group*. Newtonville, Mass.: Oriental Research Partners, 1979.
- Cooke, Peter. “French and European Perspectives.” In *Symbolism, Decadence, and the Fin de Siècle*, edited by Patrick McGuinness, 122–143. Exeter, U.K.: University of Exeter Press, 2000.
- Cordulack, Shelley Wood. *Edvard Munch and the Physiology of Symbolism*. London: Associated University Press, 2002.
- Deak, Frantisek. *Symbolist Theater: The Formation of an Avant-Garde*. Baltimore: Johns Hopkins University Press, 1993.
- Debussy, Claude. *Monsieur Croche et autres écrits*. Edited by François Lesure. Paris: Gallimard, 1971.
- Dellamora, Richard. *Masculine Desire: The Sexual Politics of Victorian Aestheticism*. Chapel Hill: University of North Carolina Press, 1990.
- Druick, Douglas W. et al. *Odilon Redon: Prince of Dreams, 1840–1916*. New York: Harry N. Abrams/Chicago: Art Institute of Chicago, 1994.
- Eisenman, Stephen F. *Gauguin's Skirt*. New York: Thames and Hudson, 1997.
- Fulcher, Jane F., ed. *Debussy and His World*. Princeton, N.J.: Princeton University Press, 2001.
- Hollier, Denis, ed. *A New History of French Literature*. Cambridge, Mass.: Harvard University Press, 1994. See especially pages 723–819.
- Kearns, James. *Symbolist Landscapes: The Place of Painting in the Poetry and Criticism of Mallarmé and His Circle*. London: Modern Humanities Research Association, 1989.
- Lacambre, Geneviève. *Gustave Moreau: Between Epic and Dream*. Chicago: Art Institute of Chicago, 1999.
- Marlais, Michael. *Conservative Echoes in Fin-de-Siècle Parisian Art Criticism*. University Park: Pennsylvania State University Press, 1992.
- Mathieu, Pierre-Louis. *The Symbolist Generation, 1870–1910*. New York: Rizzoli, 1990.
- Matthews, Patricia. *Passionate Discontent: Creativity, Gender, and French Symbolist Art*. Chicago: University of Chicago Press, 1999.

- Peterson, Ronald E. *A History of Russian Symbolism*. Philadelphia: John Benjamins, 1993.
- Prettejohn, Elizabeth, ed. *After the Pre-Raphaelites: Art and Aestheticism in Victorian England*. New Brunswick, N.J.: Rutgers University Press, 1999.
- Psomiades, Kathy Alexis. *Beauty's Body: Femininity and Representation in British Aestheticism*. Stanford, Calif.: Stanford University Press, 1997.
- Pyman, Avril. *A History of Russian Symbolism*. Cambridge, U.K.: Cambridge University Press, 1994.
- Shaw, Jennifer L. *Dream States: Puvis de Chavannes, Modernism, and the Fantasy of France*. New Haven, Conn.: Yale University Press, 2002.
- Smith, Richard Cándida. *Mallarmé's Children: Symbolism and the Renewal of Experience*. Berkeley: University of California Press, 1999.
- Weisenberger, Edward, ed. *The Spiritual in Art: Abstract Painting 1890–1985*. New York: Abbeville, 1986.

Jennifer L. Shaw

SYNCRETISM. Syncretism—the process whereby two or more independent cultural systems, or elements thereof, conjoin to form a new and distinct system—is among the most important factors in the evolution of culture in general, but especially in the history of religion. Indeed, *all* of the so-called world religions, that is, Christianity, Judaism, Islam, Hinduism, Buddhism, and Confucianism, are to a fair extent syncretistic. But the process occurs whenever previously independent belief systems come into sustained contact, no matter what their respective levels of sophistication may be. This article briefly surveys examples of syncretism drawn from several traditions, including the aforementioned world religions and Japanese Shinto, as well as three syncretistic belief systems that emerged as a result of Western colonial expansion, slavery, and/or proselytizing: Santeria, Voodoo (or Vodou), and the Ghost Dance, which twice swept across large areas of Native North America in the late nineteenth century.

Syncretism in the World Religions

Of all the world religions, Christianity is probably the most syncretistic. Although rooted in Judaism, Christianity quickly came to absorb elements of Zoroastrianism (the ancient dualistic religion of Iran), some important features of pharaonic Egyptian religion, the religions of ancient Mesopotamia, and a number of Greco-Roman cults, which were themselves highly syncretistic. The Zoroastrian impact, which was already present in postexilic Judaism, was profound indeed. The prime example here is the intense Christian (and late Judaic) emphasis on a constant struggle between good and evil, which was the essence of the religion found by the Iranian prophet Zoroaster (or Zarathustra, c. 630–550 B.C.E.). The fully evolved figure of Satan is a classic example of syncretism: a fusion of the Hebrew concept of Lucifer, the “fallen angel,” and the Zoroastrian figure Angra Mainyu (Ahriman), who is the evil opponent of Ahura Mazda (Ormazd), the “wise lord” and the embodiment of light, truth, and goodness. Moreover, the late Zoroastrian texts tell of a final conflict between Ahura

Mazda and Angra Mainyu, during which a messiah-like figure will appear and lead the forces of Good. This, of course, is dramatically reflected in a number of Judeo-Christian apocalyptic texts, from the Book of Daniel to the Book of Revelation. The important thing here is that neither Angra Mainyu nor Lucifer is identical to Satan. Rather, the Judeo-Christian figure is a syncretism of the two otherwise distinct evil entities.

Precursors to the importance of the resurrection of Jesus for Christianity were the resurrected Egyptian god Osiris, as well as the Mesopotamian deity Dummuzi, who was rescued from the land of the dead by his divine lover Inanna. The Egyptian cult of the goddess Isis, sister-wife of Osiris and mother of the god Horus, who, together with Astarte and other Near Eastern goddesses, influenced the rise of the medieval cult of the Virgin Mary. The Isis cult also affected Christian ritual. The *sistrum*, a tinkling rattle that was shaken during ceremonies honoring the goddess, is the source of the bell that is rung several points in a Roman Catholic mass.

Several Greco-Roman religious cults also impacted the new religion. For example, the dove, a widespread symbol of the goddess Aphrodite and her Roman counterpart, Venus, became a symbol of the Holy Ghost, and the god Apollo was sometimes equated with Christ.

Islam also drew extensively on older religions, including Christianity and Zoroastrianism, especially after the Muslim conquest of Iran in 641 C.E. The chief Muslim demon, Iblis, is markedly similar to Angra Mainyu, and Islam also holds that there will be a final, Armageddon-like battle between the forces of good and evil.

Classical and modern Hinduism can be characterized as a grand syncretism between the indigenous Dravidian belief systems of northern India, as reflected in the artifacts of the Indus Valley civilization, and those carried into India in the middle of the second millennium B.C.E. by the Aryans, whose beliefs were a variant of those carried by Indo-European speakers across Eurasia from India to Western Europe. One of the best examples is the major Hindu god Shiva, the third member of the trinity that includes Brahma and Vishnu. Shiva is often called “the Lord of Beasts,” and an Indus Valley stamp seal found at Mohenjo Daro dating from about 1800 B.C.E. shows a god seated in the lotus position and surrounded by animals. This figure’s connection with the later iconography of Shiva is clear, and thus strongly suggests that the god in question reflects a syncretism of the ancient Dravidian and Aryan religions. Even the fully evolved Hindu caste system involves an amalgamation of the Aryan tripartite social class system, which they shared with other ancient Indo-European-speaking communities, and the indigenous emphasis on occupation groups, which is clearly evident in the physical layout of the chief Indus Valley cities: Mohenjo Daro and Harappa.

Buddhism too has evolved its fair share of syncretistic beliefs and practices, especially as it spread to countries outside of India. In what is now northwest Pakistan (ancient Gandhara), where the Mahayana, or bodhisattva-centered, evangelical form of Buddhism crystallized in the centuries immediately preceding the beginning of the Common Era, the

religion's iconography (sacred images) was heavily influenced by Greek artistic ideals, as the region in question was conquered by Alexander the Great in 326 B.C.E. These Hellenized images of the Buddha and other sacred figures were later carried into China, beginning in the first century C.E., where they blended with the indigenous artistic tradition. Moreover, by the time Buddhism arrived in Korea and Japan in the late fifth to mid-sixth centuries C.E. it had heavily syncretized with Confucianism, a development that is clearly exemplified in Shōtoku Taishi's (574–622 C.E.) famous "Seventeen-Article Constitution" (604 C.E.), which seamlessly blended the idea of filial piety and the other primary Confucian relationships with the Buddhist concept of *dharma*, which is itself deeply rooted in the Hindu tradition.

Syncretism in Japanese Shinto

Shinto, the indigenous belief system of Japan, has coexisted with Buddhism for the past fifteen hundred years (the traditional date of the first appearance of Buddhism is 552 C.E., when the ruler of the Korean kingdom of Paekche sent a contingent of priests to the court of the Yamato emperor as a goodwill gesture), and Shōtoku Taishi's constitution is by no means the only example of syncretism between the two faiths. The form of Buddhism (Mahayana) that penetrated East Asia places great emphasis on bodhisattvas, or "enlightened," Buddha-like deities that intercede with the divine on behalf of human beings. Many of these figures were syncretized with the myriad Shinto *kami*, or deities. A good example is Hachiman, who became a Shinto war god, but whose origin, as Byron Earhart (p. 44) points out, "may be Chinese, Buddhist, or both."

Indeed, Shinto and Buddhism have become so intertwined in Japan that it is sometimes hard to know where one ends and the other begins. Most large Buddhist temples play host to one or more Shinto shrines, and, like Hachiman, Shinto *kami* are often conceived as guardians of the enshrined *bosatsu* (bodhisattva). Moreover, the latter are often worshiped in the same fashion as the *kami*, that is, he or she will be asked for the same sort of favors: good health, success in business or in passing examinations, and the like. Many Japanese assert that they "live" as Shintoists, but "die" as Buddhists, and this underscores a major distinction between the two faiths: the former emphasizes this world, while the latter tends to focus on the afterlife. But for practical purposes Shinto and Buddhism are, with a few exceptions, what amounts to a single faith in Japan, a complex syncretism that meets the religious needs of most Japanese.

Santeria and Voodoo

Yet another important example of syncretism can be found in the Caribbean. As a result of the slave trade, a host of West African religious beliefs were transplanted to Cuba, Haiti, and other Caribbean islands, as well as to Brazil, in the seventeenth and eighteenth centuries. There, they intermingled with the Roman Catholicism of the slave masters and plantation owners. The result was a set of syncretistic religions, the most important of which are Santeria and Voodoo (or Vodou).

Santeria took shape primarily in Cuba and reflects for the most part the beliefs of the Yoruba people, who live in what is now Nigeria. The focus of the Yoruba (and other West African

belief systems) is upon a pantheon of deities called *orishas*. However, in Santeria, these figures are often identified—that is, syncretized—with Catholic saints. A good example is Changó, a male god of thunder, lightning, and fire, who is nevertheless identified with St. Barbara, a devout young woman who lived in the fourth century C.E. and who was beheaded by her father for refusing to give up her Christian faith and marry according to his wishes. At the moment of her beheading her father was struck by lightning, and this gave rise to a legend that St. Barbara had power over lightning bolts. Although Changó is a masculine *orisha*, the similarities between this legend and the Yoruba traditions about him led to the syncretism in question.

Haitian Voodoo (more properly Vodou or Vodun) is similar to Santeria in a great many ways, both in its African heritage and when it comes to syncretism. Here, the West African deities, primarily from Benin and Dahomey, are called *loa* and are also usually identified with Roman Catholic saints. For example, the serpent *loa*, Damballah, is often identified with St. Patrick, drawing on the legend that the latter drove the snakes out of Ireland. *Houngan*, or Voodoo priests, have long since adopted elements of Roman Catholicism in Voodoo rituals, including the use of candles, bells, crosses, the practices of baptism, and making the sign of the cross. These Christian elements are intertwined with such African religious practices as drumming, dancing, ancestor worship, and spirit possession.

The Ghost Dance

The final example of syncretism involves what anthropologists call a "nativistic movement," that is, a religious reaction to the appearance of a more powerful and hegemonic culture. Although such movements have occurred in areas as diverse as Siberia and Melanesia in the late nineteenth and early twentieth centuries, the most intensely studied nativistic movement is the Ghost Dance, which began in northern Nevada among the Paiutes in 1870. In that year, a shaman named Tavibo had a vision in which he learned that if his people danced in a certain fashion, their ancestors, or "ghosts," would return, and the white men would be swallowed up by a great earthquake. Soon other tribes heard of this dance, and by 1871 it had spread widely among Native American tribes in the Great Basin and parts of California. However, the ghosts never materialized, and the religious fervor soon died down.

A generation later, Tavibo's possible descendant, another Paiute shaman named Wovoka (c. 1856–1932), revived the dance, but this time it was heavily syncretistic. As a youth Wovoka spent several years working for a white family that was extremely religious and gave him the name "Jack Wilson." In 1889, during a severe illness, Wilson had a vision in which God told him that not only would his ancestors return, but that a Native American incarnation of Jesus would return to help them, and that the whites, who were the spawn of Satan, would be swallowed by the earthquake that failed to occur in 1870. By the middle of 1890 the second Ghost Dance had spread widely east of the Rocky Mountains and eventually included among its converts the famous Sioux shaman Sitting Bull. However, on December 29, 1890, the Ghost Dance movement also led to one of the great tragedies in Native American history: the Wounded Knee massacre on the Pine

Ridge Reservation in South Dakota, in which several hundred people—including women, children, and elderly men—were killed simply because they refused to stop performing the Ghost Dance. Afterward, belief in the power of the dance diminished rapidly.

In sum, these are but a few examples of syncretism, a process that has played an enormous role in human religious history, from antiquity to modern times and in almost every corner of the globe.

See also *Communication of Ideas; Diffusion, Cultural; Religion.*

BIBLIOGRAPHY

- Brown, Karen McCarthy. "Voodoo." In *Magic, Witchcraft, and Religion: An Anthropological Study of the Supernatural*, edited by Arthur C. Lehmann and James E. Myers. Mountain View, Calif: Mayfield, 1993.
- Dauphin, C. "From Apollo and Aesclepius to Christ: Pilgrimage and Healing at the Temple and Episcopal Basilica at Dor." *Liber Anuus* 49 (1999): 397–430.
- Earhart, H. Byron. *Japanese Religion: Unity and Diversity*. Belmont, Calif: Wadsworth, 1982.
- González-Wippler, Migene. *Santeria: African Magic in Latin America*. New York: Anchor Books, 1975.
- Grant, Frederick C. *Hellenistic Religion: The Age of Syncretism*. New York: Liberal Arts Press, 1953.
- Kamstra, Jacques H. *Encounter or Syncretism: The Initial Growth of Japanese Buddhism*. Leiden, Netherlands: E. J. Brill, 1967.
- La Barre, Weston. *The Ghost Dance: The Origins of Religion*. New York: Dell, 1972. See especially chapter 7.
- Littleton, C. Scott. *Shinto: Origins, Rituals, Festivals, Spirits, Sacred Places*. New York: Oxford University Press, 2002.
- Mettinger, Tryggve N. D. *The Riddle of Resurrection: "Dying and Rising Gods" in the Ancient Near East*. Stockholm, Sweden: Almqvist and Wiksell, 2001.
- Organ, Troy Wilson. *Hinduism: Its Historical Development*. Woodbury, N.Y.: Barron's Educational Series, 1974.
- Wheeler, Sir Mortimer. *Civilizations of the Indus Valley and Beyond*. London: Thames and Hudson, 1966.
- Will, R. E. *Isis in the Ancient World*. Baltimore, Md.: Johns Hopkins University Press, 1971.

C. Scott Littleton

new dictionary of the history of ideas



maryanne dline horowitz, editor in chief

ideas

volume 6



new dictionary of the history of ideas

EDITORIAL BOARD

Editor in Chief

Maryanne Cline Horowitz, *Occidental College*
University of California, Los Angeles

Associate Editors

Jonathan Berkey, *Davidson College*

Zvi Ben-Dor Benite, *New York University*

Benjamin A. Elman, *Princeton University*

George Esenwein, *University of Florida, Gainesville*

Cary J. Nederman, *Texas A&M University*

Vassiliki Betty Smocovitis, *University of Florida, Gainesville*

Neferti Tadiar, *University of California, Santa Cruz*

Mary J. Weismantel, *Northwestern University*

Paul Tiyambe Zeleza, *Pennsylvania State University*

Advisors

Diane Apostolos-Cappadona, *Georgetown University*

Edwina Barvosa-Carter, *University of California, Santa Barbara*

Nupur Chaudhuri, *Texas Southern University*

Kostas Gavroglu, *University of Athens, Greece*

Donald R. Kelley, *Rutgers University*

Zine Magubane, *University of Illinois, Urbana-Champaign*

J. B. Schneewind, *Johns Hopkins University*

Blair Sullivan, *University of California, Los Angeles*

Reed Ueda, *Tufts University*

Librarian Advisory Board

Mary W. George, *Princeton University*

Suzy Szasz Palmer, *University of Louisville*

Editorial Assistant

Lisa Griffin

new dictionary of the history of ideas

maryanne cline horowitz, editor in chief

volume 6

Taste to Zionism, Index



CHARLES SCRIBNER'S SONS

An imprint of Thomson Gale, a part of The Thomson Corporation

THOMSON
—★—™
GALE



New Dictionary of the History of Ideas
Maryanne Cline Horowitz, Editor in Chief

©2005 Thomson Gale, a part of the Thomson Corporation.

Thomson and Star Logo are trademarks and Gale is a registered trademark used herein under license.

For more information, contact
Thomson Gale
27500 Drake Rd.
Farmington Hills, MI 48331-3535
Or you can visit our Internet site at
<http://www.gale.com>

ALL RIGHTS RESERVED

No part of this work covered by the copyright hereon may be reproduced or used in any form or by any means—graphic, electronic, or mechanical, including photocopying, recording, taping, Web distribution, or information storage retrieval systems—without the written permission of the publisher.

For permission to use material from this product, submit your request via Web at <http://www.gale-edit.com/permissions>, or you may download our Permissions Request form and submit your request by fax or mail to:

Permissions Department
Thomson Gale
27500 Drake Road
Farmington Hills, MI 48331-3535
Permissions Hotline:
248-699-8006 or 800-877-4253, ext. 8006
Fax: 248-699-8074 or 800-762-4058

Since this page cannot legibly accommodate all copyright notices, the acknowledgments constitute an extension of the copyright notice.

While every effort has been made to ensure the reliability of the information presented in this publication, Thomson Gale does not guarantee the accuracy of the data contained herein. Thomson Gale accepts no payment for listing; and inclusion in the publication of any organization, agency, institution, publication, service, or individual does not imply endorsement of the editors or publisher. Errors brought to the attention of the publisher and verified to the satisfaction of the publisher will be corrected in future editions.

LIBRARY OF CONGRESS CATALOGING-IN-PUBLICATION DATA

New dictionary of the history of ideas / edited by Maryanne Cline Horowitz.

p. cm.

Includes bibliographical references and index.

ISBN 0-684-31377-4 (set hardcover : alk. paper) — ISBN 0-684-31378-2 (v. 1) — ISBN 0-684-31379-0 (v. 2) — ISBN 0-684-31380-4 (v. 3) — ISBN 0-684-31381-2 (v. 4) — ISBN 0-684-31382-0 (v. 5) — ISBN 0-684-31383-9 (v. 6) — ISBN 0-684-31452-5 (e-book)

1. Civilization—History—Dictionaries. 2. Intellectual life—History—Dictionaries.

I. Horowitz, Maryanne Cline, 1945–

CB9.N49 2005
903—dc22

2004014731

This title is also available as an e-book.

ISBN 0-684-31452-5

Contact your Thomson Gale sales representative for ordering information.

Printed in the United States of America

10 9 8 7 6 5 4 3 2 1

CONTENTS

Volume 1

List of Articles

Preface

Historiography

Reader's Guide

NEW DICTIONARY OF THE HISTORY OF IDEAS

Abolitionism–Common Sense

Volume 2

Reader's Guide

Communication of Ideas–Futurology

Volume 3

Reader's Guide

Game Theory–Lysenkoism

Volume 4

Reader's Guide

Machiavellism–Phrenology

Volume 5

Reader's Guide

Physics–Syncretism

Volume 6

Reader's Guide

Taste–Zionism

List of Contributors

Index

EDITORIAL AND PRODUCTION STAFF

Project Editors

Mark LaFlaur, Scot Peacock, Jennifer Wisinski

Editorial Support

Kelly Baiseley, Andrew Claps, Alja Collar, Mark Drouillard,
Kenneth Mondschein, Sarah Turner, Ken Wachsberger,
Rachel Widawsky, Christopher Verdesi

Art Editor

Scot Peacock

Chief Manuscript Editor

Georgia S. Maas

Manuscript Editors

Jonathan G. Aretakis, John Barclay, Sylvia Cannizzaro,
Melissa A. Dobson, Ted Gilley, Gretchen Gordon,
Ellen Hawley, Archibald Hobson, Elizabeth B. Inserra,
Jean Fortune Kaplan, Christine Kelley, John Krol,
Julia Penelope, Richard Rothschild, David E. Salamie,
Linda Sanders, Alan Thwaites, Jane Marie Todd

Proofreaders

Beth Phaner, Carol Holmes, Melodie Monahan,
Laura Specht Patchkofsky, Hilary White

Cartographer

XNR Productions, Madison, Wisconsin

Caption Writer

Shannon Kelly

Indexer

Cynthia Crippen, AEIOU, Inc.

Design

Jennifer Wahj

Imaging

Dean Dauphinais, Lezlie Light, Mary Grimes

Permissions

Margaret Abendroth, Peggie Ashlevitz, Lori Hines

Composer

GGIS Information Services, York, Pennsylvania

Manager, Composition

Mary Beth Trimper

Assistant Manager, Composition

Evi Seoud

Manufacturing

Wendy Blurton

Senior Development Editor

Nathalie Duval

Editorial Director

John Fitzpatrick

Publisher

Frank Menchaca

READER'S GUIDE

This Reader's Guide was compiled by the editors to provide a systematic outline of the contents of the New Dictionary of the History of Ideas, thereby offering teachers, scholars, and the general reader a way to organize their reading according to their preferences. The Reader's Guide is divided into four sections: Communication of Ideas, Geographical Areas, Chronological Periods, and Liberal Arts Disciplines and Professions, as indicated in the outline below.

COMMUNICATION OF IDEAS

Introduction to History of Communication of Ideas

Communication Media

GEOGRAPHICAL AREAS

Global Entries

Africa

Asia

Europe

Middle East

North America

Latin and South America

CHRONOLOGICAL PERIODS

Ancient

Dynastic (400 C.E.–1400 C.E.)

Early Modern (1400–1800 C.E.)

Modern (1800–1945)

Contemporary

LIBERAL ARTS DISCIPLINES AND PROFESSIONS

Fine Arts

Humanities

Social Sciences

Sciences

Professions

Multidisciplinary Practices

Especially Interdisciplinary Entries

COMMUNICATION OF IDEAS

This category is the newest aspect of the *New Dictionary of the History of Ideas*; cultural studies, communications studies, and cultural history are moving the disciplines in this direction.

Introduction to History of Communication of Ideas

The following entries focus on the media humans have used to communicate with one another.

Absolute Music
Aesthetics: Asia
Architecture: Overview
Architecture: Asia
Arts: Overview
Astronomy, Pre-Columbian and Latin American
Bilingualism and Multilingualism
Borders, Borderlands, and Frontiers, Global
Calendar
Cinema
City, The: The City as a Cultural Center
City, The: The City as Political Center
Communication of Ideas: Africa and Its Influence
Communication of Ideas: Asia and Its Influence
Communication of Ideas: Europe and Its Influence
Communication of Ideas: Middle East and Abroad
Communication of Ideas: Orality and Advent of Writing
Communication of Ideas: Southeast Asia
Communication of Ideas: The Americas and Their Influence
Consumerism
Cultural Revivals
Cultural Studies
Dance
Diffusion, Cultural
Dress
Dualism
Education: Asia, Traditional and Modern
Education: Global Education
Emotions
Experiment
Garden
Gesture
Humor
Iconography
Images, Icons, and Idols
Japanese Philosophy, Japanese Thought
Language and Linguistics
Language, Linguistics, and Literacy
Learning and Memory, Contemporary Views
Mathematics
Media, History of
Metaphor
Migration: United States
Modernity: Africa
Museums
Music, Anthropology of

READER'S GUIDE

Musical Performance and Audiences
Oral Traditions: Overview
Oral Traditions: Telling, Sharing
Political Protest, U.S.
Practices
Protest, Political
Reading
Realism: Africa
Reflexivity
Relativism
Representation: Mental Representation
Resistance
Resistance and Accommodation
Rhetoric: Overview
Rhetoric: Ancient and Medieval
Ritual: Public Ritual
Ritual: Religion
Sacred Places
Text/Textuality
Textiles and Fiber Arts as Catalysts for Ideas
Theater and Performance
Third Cinema
Totems
Tradition
Translation
Virtual Reality
Visual Culture
Visual Order to Organizing Collections

Communication Media

This is a listing of the types of historical evidence the author used in writing the entry. While entries in the original Dictionary of the History of Ideas were to a great extent the history of texts, the entries in the New Dictionary of the History of Ideas are generally the cultural history of ideas, making use of the records of oral communication, visual communication, and communication through practices, as well as the history of texts, in order to show the impact of the idea on a wide variety of people.

ORAL

The selective list below contains the entries that give the most coverage to historical examples of the oral transmission and transformation of ideas.

Civil Disobedience
Civil Society: Europe and the United States
Communication of Ideas: Orality and Advent of Writing
Cosmopolitanism
Cultural Capital
Determinism
Dialogue and Dialectics: Socratic
Dialogue and Dialectics: Talmudic
Dream
Emotions
Empire and Imperialism: Europe
Equality: Overview
Etiquette
Fascism
Harmony
Magic
Masks
Media, History of
Millenarianism: Latin America and Native North America

Music, Anthropology of
Musical Performance and Audiences
Musicology
Nomadism
Oral Traditions: Overview
Oral Traditions: Telling, Sharing
Populism: United States
Psychoanalysis
Public Sphere
Republicanism: Republic
Rhetoric: Overview
Ritual: Public Ritual
Ritual: Religion
Slavery
Theater and Performance
Tragedy and Comedy
Trope
Wisdom, Human
COMMUNICATION THROUGH HIGH TECHNOLOGY MEDIA (radio, television, film, computer, etc.)
Absolute Music
Africa, Idea of
Alienation
Americanization, U.S.
Anticolonialism: Africa
Anti-Semitism: Islamic Anti-Semitism
Architecture: Overview
Avant-Garde: Overview
Bilingualism and Multilingualism
Bioethics
Calculation and Computation
Capitalism: Overview
Capitalism: Africa
Censorship
Chicano Movement
Cinema
City, The: The City as a Cultural Center
City, The: The City as Political Center
Colonialism: Southeast Asia
Communication of Ideas: Africa and Its Influence
Communication of Ideas: Asia and Its Influence
Communication of Ideas: Europe and Its Influence
Communication of Ideas: Middle East and Abroad
Communication of Ideas: Orality and Advent of Writing
Communication of Ideas: Southeast Asia
Communism: Latin America
Composition, Musical
Computer Science
Consciousness: Overview
Consumerism
Cosmopolitanism
Creativity in the Arts and Sciences
Critical Theory
Cultural Studies
Death
Demography
Development
Dream
Dress
Dystopia
Empire and Imperialism: United States
Environmental History
Expressionism
Fascism
Fetishism: Fetishism in Literature and Cultural Studies

Field Theories
 Futurology
 Game Theory
 Gay Studies
 Gender: Gender in the Middle East
 Gender in Art
 Genetics: Contemporary
 Genetics: History of
 Genocide
 Genre
 Geography
 Globalization: General
 Harmony
 Hinduism
 History, Economic
 Human Capital
 Iconography
 Intelligentsia
 Jihad
 Jouissance
 Judaism: Modern Judaism
 Language and Linguistics
 Law
 Learning and Memory, Contemporary Views
 Life
 Life Cycle: Elders/Old Age
 Literary Criticism
 Literature: Overview
 Literature: African Literature
 Loyalties, Dual
 Lysenkoism
 Maps and the Ideas They Express
 Masks
 Mathematics
 Media, History of
 Medicine: Europe and the United States
 Medicine: Islamic Medicine
 Meme
 Memory
 Modernism: Overview
 Modernism: Latin America
 Modernity: East Asia
 Motherhood and Maternity
 Motif: Motif in Music
 Music, Anthropology of
 Musical Performance and Audiences
 Musicology
 Nuclear Age
 Occidentalism
 Pan-Arabism
 Parties, Political
 Physics
 Political Protest, U.S.
 Political Science
 Postmodernism
 Power
 Presentism
 Privacy
 Probability
 Progress, Idea of
 Propaganda
 Property
 Protest, Political
 Public Sphere
 Quantum

Reading
 Reform: Europe and the United States
 Reform: Islamic Reform
 Relativity
 Representation: Mental Representation
 Resistance
 Rhetoric: Overview
 Science Fiction
 Sexuality: Overview
 Social History, U.S.
 Society
 State, The: Overview
 Symbolism
 Taste
 Technology
 Third Cinema
 Third World
 Totalitarianism
 Victorianism
 Virtual Reality
 Visual Culture
 War and Peace in the Arts
 Westernization: Africa
 Westernization: Middle East
 Women and Femininity in U.S. Popular Culture
 Work
 World Systems Theory, Latin America

VISUAL

Each of the following entries in the *NDHI* either evocatively describes ideas, includes a visual image of an idea, or provides historical examples of societies visually transmitting and transforming ideas.

Abolitionism
 Aesthetics: Africa
 Aesthetics: Asia
 Aesthetics: Europe and the Americas
 Alienation
 Altruism
 Ambiguity
 Americanization, U.S.
 Ancestor Worship
 Animism
 Anti-Semitism: Overview
 Apartheid
 Architecture: Overview
 Architecture: Africa
 Architecture: Asia
 Arts: Overview
 Arts: Africa
 Asceticism: Hindu and Buddhist Asceticism
 Asceticism: Western Asceticism
 Asian-American Ideas (Cultural Migration)
 Assimilation
 Astrology: Overview
 Astronomy, Pre-Columbian and Latin American
 Authoritarianism: Latin America
 Autobiography
 Avant-Garde: Militancy
 Aztlán
 Barbarism and Civilization
 Beauty and Ugliness
 Behaviorism

READER'S GUIDE

- Bioethics
- Black Atlantic
- Black Consciousness
- Body, The
- Bushido
- Calculation and Computation
- Calendar
- Cannibalism
- Capitalism: Overview
- Capitalism: Africa
- Causation
- Censorship
- Change
- Chemistry
- Childhood and Child Rearing
- Cinema
- City, The: Latin America
- City, The: The City as a Cultural Center
- City, The: The City as Political Center
- City, The: The Islamic and Byzantine City
- Civil Disobedience
- Classicism
- Classification of Arts and Sciences, Early Modern
- Colonialism: Southeast Asia
- Common Sense
- Communication of Ideas: The Americas and Their Influence
- Communication of Ideas: Asia and Its Influence
- Communication of Ideas: Europe and Its Influence
- Communication of Ideas: Orality and Advent of Writing
- Communication of Ideas: Southeast Asia
- Composition, Musical
- Computer Science
- Consciousness: Overview
- Consumerism
- Continental Philosophy
- Cosmology: Asia
- Cosmopolitanism
- Creativity in the Arts and Sciences
- Critical Race Theory
- Critical Theory
- Cultural Capital
- Cultural History
- Cultural Revivals
- Cultural Studies
- Cycles
- Cynicism
- Dada
- Dance
- Death
- Death and Afterlife, Islamic Understanding of
- Demography
- Demonology
- Determinism
- Development
- Diasporas: African Diaspora
- Diasporas: Jewish Diaspora
- Dictatorship in Latin America
- Discrimination
- Diversity
- Dream
- Dress
- Dystopia
- Ecology
- Education: Europe
- Education: Islamic Education
- Emotions
- Empire and Imperialism: Europe
- Empire and Imperialism: United States
- Empiricism
- Encyclopedism
- Enlightenment
- Environment
- Environmental History
- Epistemology: Ancient
- Epistemology: Early Modern
- Equality: Overview
- Equality: Racial Equality
- Essentialism
- Ethnicity and Race: Anthropology
- Ethnicity and Race: Islamic Views
- Ethnocentrism
- Etiquette
- Eugenics
- Europe, Idea of
- Everyday Life
- Evil
- Expressionism
- Extirpation
- Family Planning
- Fascism
- Fatalism
- Feminism: Overview
- Feminism: Chicana Feminisms
- Feminism: Third World U.S. Movement
- Fetishism: Overview
- Fetishism: Fetishism in Literature and Cultural Studies
- Feudalism, European
- Field Theories
- Form, Metaphysical, in Ancient and Medieval Thought
- Foundationalism
- Friendship
- Futurology
- Game Theory
- Garden
- Gender: Overview
- Gender: Gender in the Middle East
- Gender in Art
- Genetics: Contemporary
- Genetics: History of
- Genius
- Genocide
- Geography
- Geometry
- Gesture
- Ghetto
- Globalization: Asia
- Globalization: General
- Greek Science
- Harmony
- Hate
- Health and Disease
- Heaven and Hell
- Heaven and Hell (Asian Focus)
- Hedonism in European Thought
- Heresy and Apostasy
- Hinduism
- History, Economic
- History, Idea of

- Honor
 Honor, Middle Eastern Notions of
 Humanism: Chinese Conception of
 Humanity: African Thought
 Humanity: European Thought
 Humanity in the Arts
 Humor
 Hygiene
 Iconography
 Idealism
 Ideas, History of
 Identity: Identity of Persons
 Identity, Multiple: Overview
 Identity, Multiple: Jewish Multiple Identity
 Images, Icons, and Idols
 Imagination
 Impressionism
 Intentionality
 Interdisciplinarity
 Islam: Shi'i
 Islamic Science
 Jainism
 Jihad
 Jouissance
 Knowledge
 Landscape in the Arts
 Language, Linguistics, and Literacy
 Law, Islamic
 Leadership
 Learning and Memory, Contemporary Views
 Liberty
 Life Cycle: Overview
 Life Cycle: Elders/Old Age
 Literary History
 Love, Western Notions of
 Machismo
 Magic
 Maps and the Ideas They Express
 Masks
 Mathematics
 Matriarchy
 Mechanical Philosophy
 Media, History of
 Medicine: Europe and the United States
 Medicine: Islamic Medicine
 Memory
 Men and Masculinity
 Mestizaje
 Metaphor
 Microcosm and Macrocosm
 Migration: United States
 Millenarianism: Islamic
 Millenarianism: Latin America and Native North
 America
 Minority
 Miracles
 Modernism: Overview
 Modernism: Latin America
 Modernity: Overview
 Modernity: Africa
 Monarchy: Overview
 Monasticism
 Motherhood and Maternity
 Motif: Motif in Music
 Museums
 Musical Performance and Audiences
 Musicology
 Mysticism: Chinese Mysticism
 Mysticism: Christian Mysticism
 Myth
 Nation
 Nationalism: Overview
 Natural History
 Naturalism
 Naturalism in Art and Literature
 Naturphilosophie
 Negritude
 Newtonianism
 Nomadism
 Nuclear Age
 Nude, The
 Occidentalism
 Organicism
 Orthodoxy
 Pacifism
 Pan-Asianism
 Paradigm
 Paradise on Earth
 Periodization of the Arts
 Person, Idea of the
 Perspective
 Philosophies: American
 Philosophies: Feminist, Twentieth-Century
 Philosophy: Relations to Other Intellectual Realms
 Phrenology
 Physics
 Political Protest, U.S.
 Population
 Postmodernism
 Practices
 Pre-Columbian Civilization
 Prejudice
 Privacy
 Property
 Protest, Political
 Psychoanalysis
 Public Sphere
 Pythagoreanism
 Queer Theory
 Race and Racism: United States
 Reading
 Realism
 Relativism
 Religion: Indigenous Peoples' View, South America
 Religion and Science
 Religion and the State: Latin America
 Renaissance
 Representation: Mental Representation
 Representation: Political Representation
 Republicanism: Republic
 Resistance
 Resistance and Accommodation
 Responsibility
 Ritual: Public Ritual
 Ritual: Religion
 Romanticism in Literature and Politics
 Sacred and Profane
 Sacred Places
 Science, History of
 Science Fiction

READER'S GUIDE

Scientific Revolution
Sexuality: Overview
Sexuality: Sexual Orientation
Shinto
Slavery
Social History, U.S.
Sophists, The
Sport
Subjectivism
Superstition
Surrealism
Symbolism
Syncretism
Taste
Terror
Text/Textuality
Theater and Performance
Theodicy
Third Cinema
Third World Literature
Toleration
Totalitarianism
Totems
Trade
Tragedy and Comedy
Treaty
Untouchability: Menstrual Taboos
Utilitarianism
Utopia
Victorianism
Virtual Reality
Visual Culture
Visual Order to Organizing Collections
Volunteerism, U.S.
War
War and Peace in the Arts
Westernization: Southeast Asia
Witchcraft
Witchcraft, African Studies of
Women and Femininity in U.S. Popular Culture
Women's History: Africa
World Systems Theory, Latin America
Yin and Yang

PRACTICES

Most of the entries in the *NDHI* discuss how specific societies habituated people to specific ideas. This selective list includes the entries on schools of thought and practice, religions, and political movements, as well as the entries on distinctive practices.

Abolitionism
Afropessimism
Agnosticism
Alchemy: China
Alchemy: Europe and the Middle East
Anarchism
Ancestor Worship
Animism
Anticolonialism: Africa
Anticolonialism: Latin America
Anticolonialism: Middle East
Anticolonialism: Southeast Asia
Anticommunism: Latin America
Antifeminism

Anti-Semitism: Overview
Anti-Semitism: Islamic Anti-Semitism
Apartheid
Aristotelianism
Asceticism: Hindu and Buddhist Asceticism
Asceticism: Western Asceticism
Astrology: Overview
Astrology: China
Atheism
Avant-Garde: Militancy
Behaviorism
Black Consciousness
Buddhism
Bureaucracy
Bushido
Cannibalism
Capitalism: Overview
Capitalism: Africa
Cartesianism
Character
Chicano Movement
Chinese Thought
Christianity: Overview
Christianity: Asia
Cinema
Citizenship: Naturalization
Civil Disobedience
Classicism
Classification of Arts and Sciences, Early Modern
Colonialism: Africa
Colonialism: Latin America
Colonialism: Southeast Asia
Communication of Ideas: Orality and Advent of Writing
Communism: Europe
Communism: Latin America
Communitarianism in African Thought
Computer Science
Confucianism
Conservatism
Constitutionalism
Cosmopolitanism
Creationism
Critical Theory
Cultural Capital
Cultural Studies
Cynicism
Dance
Daoism
Deism
Dialogue and Dialectics: Socratic
Dialogue and Dialectics: Talmudic
Discrimination
Diversity
Eclecticism
Ecumenism
Empire and Imperialism: Overview
Empire and Imperialism: Americas
Empire and Imperialism: Asia
Empire and Imperialism: Europe
Empire and Imperialism: Middle East
Empire and Imperialism: United States
Empiricism
Epicureanism
Equality: Overview
Etiquette

- Eugenics
 Everyday Life
 Existentialism
 Extirpation
 Fascism
 Fatalism
 Feminism: Overview
 Feminism: Africa and African Diaspora
 Feminism: Chicana Feminisms
 Feminism: Islamic Feminism
 Feminism: Third World U.S. Movement
 Fetishism: Overview
 Feudalism, European
 Game Theory
 Genocide
 Ghetto
 Gift, The
 Gnosticism
 Health and Disease
 Hegelianism
 Hinduism
 Humanism: Renaissance
 Humanism: Secular Humanism in the United States
 Human Rights: Overview
 Human Rights: Women's Rights
 Interpretation
 Islam: Africa
 Islam: Shi
 Islam: Southeast Asia
 Islam: Sunni
 Jainism
 Japanese Philosophy, Japanese Thought
 Jihad
 Judaism: Judaism to 1800
 Judaism: Modern Judaism
 Kantianism
 Law
 Leadership
 Legalism, Ancient China
 Liberalism
 Liberation Theology
 Machiavellism
 Magic
 Manichaeism
 Maoism
 Marxism: Overview
 Marxism: Asia
 Marxism: Latin America
 Masks
 Mechanical Philosophy
 Medicine: China
 Medicine: Europe and the United States
 Medicine: India
 Medicine: Islamic Medicine
 Migration: Migration in World History
 Monarchy: Overview
 Monasticism
 Multiculturalism, Africa
 Museums
 Music, Anthropology of
 Musical Performance and Audiences
 Musicology
 Myth
 Nationalism: Overview
 Nationalism: Africa
 Nationalism: Cultural Nationalism
 Nationalism: Middle East
 Neoplatonism
 Nihilism
 Nomadism
 Nonviolence
 Orthodoxy
 Orthopraxy: Asia
 Orthopraxy: Western Orthopraxy
 Pacifism
 Pan-Africanism
 Pan-Arabism
 Pan-Asianism
 Pan-Islamism
 Pan-Turkism
 Paradigm
 Phrenology
 Physics
 Platonism
 Political Protest, U.S.
 Polytheism
 Population
 Populism: Latin America
 Positivism
 Practices
 Pragmatism
 Pseudoscience
 Psychoanalysis
 Psychology and Psychiatry
 Public Sphere
 Punishment
 Race and Racism: Asia
 Race and Racism: Europe
 Race and Racism: United States
 Radicals/Radicalism
 Rational Choice
 Reading
 Realism: Africa
 Reflexivity
 Reform: Europe and the United States
 Relativism
 Religion: Overview
 Religion: Africa
 Religion: African Diaspora
 Religion: East and Southeast Asia
 Religion: Indigenous Peoples' View, South America
 Religion: Latin America
 Religion: Middle East
 Republicanism: Latin America
 Republicanism: Republic
 Resistance
 Resistance and Accommodation
 Responsibility
 Revolution
 Ritual: Public Ritual
 Ritual: Religion
 Romanticism in Literature and Politics
 Sacred and Profane
 Scholasticism
 Science: Overview
 Scientific Revolution
 Secularization and Secularism
 Segregation
 Skepticism
 Slavery

READER'S GUIDE

Socialism
 Socialisms, African
 Sophists, The
 Sport
 Stoicism
 Subjectivism
 Suicide
 Superstition
 Symbolism
 Syncretism
 Temperance
 Terror
 Theater and Performance
 Time: Traditional and Utilitarian
 Totalitarianism
 Totems
 Trade
 Tradition
 Tragedy and Comedy
 Tribalism, Middle East
 Untouchability: Overview
 Untouchability: Menstrual Taboos
 Untouchability: Taboos
 Utilitarianism
 Visual Order to Organizing Collections
 Volunteerism, U.S.
 Westernization: Africa
 Westernization: Middle East
 Westernization: Southeast Asia
 Witchcraft
 Witchcraft, African Studies of
 Work
 Yoga
 Zionism

TEXTUAL

Every entry in the *New Dictionary of the History of Ideas* used texts. The following is a list of entries that focused mainly on the history of a succession of texts. Each academic discipline has a succession of major authors with whom later practitioners of the discipline build upon and respond to creatively. The historian of a discipline—such as the history of political philosophy, literary history, or the history of science—considers the responses of thinkers and practitioners of a discipline to the major earlier texts in the discipline. In tracing the origin, development, and transformation of an idea, the historian of ideas considers thinkers' responses to texts from a variety of disciplines.

Agnosticism
 Alchemy: Europe and the Middle East
 Algebras
 Altruism
 America
 Analytical Philosophy
 Aristotelianism
 Asceticism: Hindu and Buddhist Asceticism
 Autobiography
 Autonomy
 Biography
 Bureaucracy
 Capitalism: Overview
 Cartesianism
 Casuistry

Causality
 Censorship
 Change
 Chinese Thought
 Civil Disobedience
 Class
 Communitarianism in African Thought
 Conservatism
 Continental Philosophy
 Cosmology: Cosmology and Astronomy
 Creolization, Caribbean
 Crisis
 Cycles
 Death and Afterlife, Islamic Understanding of
 Deism
 Dialogue and Dialectics: Socratic
 Dialogue and Dialectics: Talmudic
 Eclecticism
 Encyclopedism
 Epistemology: Ancient
 Epistemology: Early Modern
 Equality: Gender Equality
 Eschatology
 Essentialism
 Existentialism
 Experiment
 Falsifiability
 Fatalism
 Fetishism: Fetishism in Literature and Cultural Studies
 Form, Metaphysical, in Ancient and Medieval Thought
 Free Will, Determinism, and Predestination
 General Will
 Generation
 Genius
 Genre
 Geometry
 Gift, The
 Globalization: Asia
 Gnosticism
 Good
 Greek Science
 Happiness and Pleasure in European Thought
 Heaven and Hell
 Hegelianism
 Hermeneutics
 Hierarchy and Order
 Hinduism
 Historical and Dialectical Materialism
 Historicism
 Historiography
 History, Idea of
 Humanism: Africa
 Humanism: Chinese Conception of
 Humanism: Renaissance
 Humanity: Asian Thought
 Human Rights: Overview
 Idealism
 Ideas, History of
 Identity, Multiple: Overview
 Identity: Identity of Persons
 Imagination
 Immortality and the Afterlife
 Individualism
 Intelligentsia
 Jouissance

- Judaism: Judaism to 1800
- Justice: Overview
- Justice: Justice in American Thought
- Justice: Justice in East Asian Thought
- Kantianism
- Knowledge
- Language, Philosophy of: Ancient and Medieval
- Language, Philosophy of: Modern
- Legalism, Ancient China
- Liberalism
- Liberty
- Literature: African Literature
- Materialism in Eighteenth-Century European Thought
- Mechanical Philosophy
- Medicine: China
- Metaphor
- Metaphysics: Ancient and Medieval
- Metaphysics: Renaissance to the Present
- Microcosm and Macrocosm
- Mind
- Modernity: East Asia
- Mohism
- Moral Sense
- Motif: Motif in Literature
- Mysticism: Chinese Mysticism
- Mysticism: Christian Mysticism
- Mysticism: Kabbalah
- Natural Law
- Natural Theology
- Naturalism
- Naturphilosophie
- Negritude
- Neocolonialism
- New Criticism
- Nihilism
- Organicism
- Orientalism: Overview
- Orthopraxy: Western Orthopraxy
- Paradigm
- Phenomenology
- Philosophies: African
- Philosophies: Islamic
- Philosophy: Historical Overview and Recent Developments
- Philosophy, History of
- Philosophy, Moral: Ancient
- Philosophy, Moral: Medieval and Renaissance
- Philosophy, Moral: Modern
- Philosophy and Religion in Western Thought
- Philosophy of Mind: Ancient and Medieval
- Philosophy of Religion
- Pietism
- Platonism
- Poetry and Poetics
- Political, The
- Postcolonial Theory and Literature
- Practices
- Pragmatism
- Prehistory, Rise of
- Progress, Idea of
- Psychoanalysis
- Queer Theory
- Race and Racism: Overview
- Rationalism
- Reading
- Realism: Africa
- Reflexivity
- Relativity
- Religion: Overview
- Representation: Political Representation
- Republicanism: Republic
- Romanticism in Literature and Politics
- Sacred Texts: Asia
- Science: East Asia
- Science, History of
- Science Fiction
- Social Capital
- Social Contract
- State of Nature
- Stoicism
- Structuralism and Poststructuralism: Overview
- Structuralism and Poststructuralism: Anthropology
- Taste
- Text/Textuality
- Tolerance
- Treaty
- Truth
- Universalism
- Utopia
- Virtue Ethics
- Wealth
- World Systems Theory, Latin America

GEOGRAPHICAL AREAS

Global Entries

EXEMPLARY GLOBAL ENTRIES

- Anthropology
- Atheism
- Bilingualism and Multilingualism
- Black Atlantic
- Christianity: Overview
- Communication of Ideas: Orality and the Advent of Writing
- Constitutionalism
- Critical Theory
- Dance
- Environmental History
- Eurocentrism
- Feminism: Overview
- Fundamentalism
- Garden
- Historiography
- History, Economic
- Humanity in the Arts
- Identity, Multiple: Jewish Multiple Identity
- International Order
- Islam: Shii
- Islam: Sunni
- Life Cycle: Elders/Old Age
- Magic
- Maps and the Ideas They Express
- Marxism: Overview
- Mathematics
- Migration: Africa
- Migration: Migration in World History
- Migration: United States
- Monasticism
- Music, Anthropology of

READER'S GUIDE

- Musical Performance and Audiences
 Nuclear Age
 Pan-Africanism
 Peasants and Peasantry
 Person, Idea of the
 Polytheism
 Postcolonial Theory and Literature
 Property
 Protest, Political
 Religion and the State: Africa
 Resistance and Accommodation
 Ritual: Religion
 Sacred Places
 Secularization and Secularism
 Slavery
 Sovereignty
 Superstition
 Syncretism
 Temperance
 Third Cinema
 Third World Literature
 Tradition
 Treaty
 Witchcraft
 Women's Studies
- ENTRIES ON AT LEAST THREE GEOGRAPHIC
 AREAS OR A GLOBAL TOPIC**
- Abolitionism
 Aesthetics: Africa
 Africa, Idea of
 Alchemy: China
 Alienation
 Animism
 Anthropology
 Anticolonialism: Africa
 Anticolonialism: Latin America
 Anticolonialism: Southeast Asia
 Antifeminism
 Architecture: Overview
 Arts: Overview
 Arts: Africa
 Asceticism: Hindu and Buddhist Asceticism
 Astrology: Overview
 Atheism
 Authoritarianism: Overview
 Authority
 Autobiography
 Barbarism and Civilization
 Bilingualism and Multilingualism
 Bioethics
 Biography
 Black Atlantic
 Body, The
 Borders, Borderlands, and Frontiers, Global
 Buddhism
 Calculation and Computation
 Calendar
 Cannibalism
 Capitalism: Overview
 Capitalism: Africa
 Censorship
 Childhood and Child Rearing
 Cinema
 Citizenship: Overview
 City, The: The City as a Cultural Center
 Civil Disobedience
 Civil Society: Europe and the United States
 Colonialism: Africa
 Colonialism: Southeast Asia
 Communication of Ideas: Africa and Its Influence
 Communication of Ideas: Middle East and Abroad
 Communication of Ideas: Orality and the Advent of
 Writing
 Computer Science
 Consciousness: Overview
 Corruption in Developed and Developing Countries
 Cosmology: Asia
 Cosmopolitanism
 Creativity in the Arts and Sciences
 Creolization, Caribbean
 Critical Theory
 Cultural Capital
 Cultural Studies
 Dance
 Death
 Deism
 Democracy
 Demography
 Demonology
 Dependency
 Diasporas: African Diaspora
 Diasporas: Jewish Diaspora
 Discrimination
 Diversity
 Dream
 Dress
 Dualism
 Ecology
 Economics
 Ecumenism
 Education: Global Education
 Education: Islamic Education
 Empire and Imperialism: Overview
 Empire and Imperialism: Asia
 Empire and Imperialism: Europe
 Empire and Imperialism: Middle East
 Empire and Imperialism: United States
 Environment
 Equality: Overview
 Equality: Gender Equality
 Equality: Racial Equality
 Ethnicity and Race: Anthropology
 Ethnocentrism
 Ethnography
 Evil
 Family: Family in Anthropology since 1980
 Family Planning
 Fascism
 Feminism: Africa and African Diaspora
 Feminism: Islamic Feminism
 Feminism: Third World U.S. Movement
 Fetishism: Overview
 Friendship
 Futurology
 Gay Studies
 Gender: Overview
 Gender: Gender in the Middle East
 Gender in Art
 Gender Studies: Anthropology
 Generation

- Genius
 Genocide
 Geography
 Ghetto
 Globalization: General
 Hate
 Heaven and Hell
 Honor
 Human Capital
 Humanism: Chinese Conception of
 Humanity: African Thought
 Human Rights: Overview
 Human Rights: Women's Rights
 Iconography
 Identity, Multiple: Overview
 Images, Icons, and Idols
 Immortality and the Afterlife
 Intelligentsia
 Islam: Africa
 Islamic Science
 Jihad
 Judaism: Modern Judaism
 Justice: Overview
 Kinship
 Landscape in the Arts
 Language, Linguistics, and Literacy
 Law
 Liberation Theology
 Liberty
 Life Cycle: Overview
 Life Cycle: Adolescence
 Literature: Overview
 Machiavellism
 Masks
 Matriarchy
 Media, History of
 Medicine: China
 Meditation: Eastern Meditation
 Men and Masculinity
 Millenarianism: Overview
 Millenarianism: Latin America and Native North America
 Minority
 Miracles
 Modernism: Overview
 Modernism: Latin America
 Modernity: Overview
 Modernity: Africa
 Modernization Theory
 Monarchy: Overview
 Motif: Motif in Music
 Museums
 Musicology
 Mysticism: Chinese Mysticism
 Myth
 Nation
 Nationalism: Overview
 Nationalism: Africa
 Native Policy
 Negritude
 Neocolonialism
 Nihilism
 Nomadism
 Nonviolence
 Occidentalism
 Oral Traditions: Overview
 Organicism
 Orientalism: Overview
 Orientalism: African and Black Orientalism
 Orthodoxy
 Orthopraxy: Asia
 Other, The, European Views of
 Pacifism
 Paradise on Earth
 Peace
 Periodization
 Periodization of the Arts
 Perspective
 Philosophies: African
 Philosophy: Historical Overview and Recent Developments
 Philosophy: Relations to Other Intellectual Realms
 Philosophy, Moral: Africa
 Political Science
 Population
 Postcolonial Studies
 Practices
 Prehistory, Rise of
 Prejudice
 Presentism
 Privatization
 Pseudoscience
 Race and Racism: Overview
 Reading
 Reflexivity
 Religion: Overview
 Religion: East and Southeast Asia
 Religion: Latin America
 Religion and the State: United States
 Representation: Political Representation
 Republicanism: Republic
 Rhetoric: Overview
 Ritual: Public Ritual
 Sacred and Profane
 Scarcity and Abundance, Latin America
 Science: Overview
 Segregation
 Sexuality: Overview
 Social Capital
 Society
 Sport
 State, The: Overview
 Structuralism and Poststructuralism: Anthropology
 Symbolism
 Third World
 Time: China
 Toleration
 Totalitarianism
 Totems
 Trade
 Translation
 Travel: Travel from Europe and the Middle East
 University: Overview
 University: Postcolonial
 Untouchability: Overview
 Untouchability: Menstrual Taboos
 Untouchability: Taboos
 Victorianism
 Visual Order to Organizing Collections
 War

READER'S GUIDE

War and Peace in the Arts
Westernization: Africa
Westernization: Southeast Asia
Wisdom, Human
Work
World Systems Theory, Latin America

Africa

ENTRIES FOCUSING ON AFRICA

Aesthetics: Africa
Anticolonialism: Africa
Architecture: Africa
Arts: Africa
Authenticity: Africa
Black Atlantic
Capitalism: Africa
Colonialism: Africa
Communication of Ideas: Africa and Its Influence
Communitarianism in African Thought
Democracy, Africa
Diasporas: African Diaspora
Ethnicity and Race: Africa
Feminism: Africa and African Diaspora
Globalization: Africa
Humanism: Africa
Humanity: African Thought
Islam: Africa
Literature: African Literature
Migration: Africa
Modernity: Africa
Multiculturalism, Africa
Mysticism: Mysticism in African Thought
Nationalism: Africa
Pan-Africanism
Personhood in African Thought
Philosophies: African
Philosophy, Moral: Africa
Realism: Africa
Religion: Africa
Religion: African Diaspora
Religion and the State: Africa
Sociability in African Thought
Socialisms, African
Sufism
Westernization: Africa
Women's History: Africa
Witchcraft, African Studies of

ENTRIES THAT CONSIDER AFRICA

Abolitionism
Africa, Idea of
African-American Ideas
Afrocentricity
Afropessimism
Ancestor Worship
Anthropology
Apartheid
Arts: Overview
Bilingualism and Multilingualism
Black Consciousness
Buddhism
Christianity: Overview
Civil Disobedience
Civil Society: Responses in Africa and the Middle East
Communication of Ideas: Orality and Advent of Writing

Creolization, Caribbean
Critical Theory
Dance
Demography
Dependency
Diasporas: Jewish Diaspora
Discrimination
Dress
Ecology
Empire and Imperialism: Europe
Empire and Imperialism: Middle East
Environmental History
Equality: Racial Equality
Ethnography
Eurocentrism
Family: Modernist Anthropological Theory
Fascism
Feminism: Overview
Feminism: Islamic Feminism
Fetishism: Overview
Genocide
Globalization: General
Historiography
History, Economic
Humanity in the Arts
Identity, Multiple: Jewish Multiple Identity
International Order
Islam: Shii
Islam: Sunni
Jainism
Kinship
Law
Liberation Theology
Life Cycle: Elders/Old Age
Machiavellism
Magic
Maps and the Ideas They Express
Masks
Mathematics
Men and Masculinity
Migration: Migration in World History
Migration: United States
Minority
Modernism: Overview
Motherhood and Maternity
Museums
Music, Anthropology of
Negritude
Neocolonialism
Nomadism
Oral Traditions: Overview
Orientalism: African and Black Orientalism
Pacifism
Peasants and Peasantry
Person, Idea of the
Philosophies: Islamic
Polytheism
Postcolonial Studies
Postcolonial Theory and Literature
Property
Protest, Political
Race and Racism: Overview
Religion: Latin America
Religion and the State: United States
Resistance and Accommodation

Ritual: Religion
 Sacred and Profane
 Sage Philosophy
 Segregation
 Slavery
 State, The: The Postcolonial State
 Syncretism
 Temperance
 Third Cinema
 Third World
 Third World Literature
 Time: Traditional and Utilitarian
 Toleration
 Totems
 Treaty
 Tribalism, Middle East
 University: Postcolonial
 Untouchability: Menstrual Taboos
 Victorianism
 War
 Wisdom, Human
 Witchcraft
 Womanism
 Women's Studies
 Work
 World Systems Theory, Latin America

Asia

ENTRIES FOCUSING ON ASIA

Aesthetics: Asia
 Alchemy: China
 Anticolonialism: Southeast Asia
 Architecture: Asia
 Authoritarianism: East Asia
 Buddhism
 Causation in East Asian and Southeast Asian Philosophy
 Chinese Thought
 Chinese Warlordism
 Christianity: Asia
 Colonialism: Southeast Asia
 Communication of Ideas: Asia and Its Influence
 Communication of Ideas: Southeast Asia and Its Influence
 Confucianism
 Consciousness: Chinese Thought
 Consciousness: Indian Thought
 Cosmology: Asia
 Daoism
 Education: Asia, Traditional and Modern
 Education: China
 Education: India
 Education: Japan
 Empire and Imperialism: Asia
 Examination Systems, China
 Globalization: Asia
 Heaven and Hell (Asian Focus)
 Hinduism
 Humanism: Chinese Conception of
 Humanity: Asian Thought
 Islam: Southeast Asia
 Jainism
 Japanese Philosophy, Japanese Thought
 Justice: Justice in East Asian Thought
 Landscape in the Arts

Legalism, Ancient China
 Literature: Overview
 Maoism
 Marxism: Asia
 Medicine: China
 Medicine: India
 Meditation: Eastern Meditation
 Modernity: East Asia
 Mysticism: Chinese Mysticism
 Mysticism: Islamic Mysticism in Asia
 Orthopraxy: Asia
 Pan-Asianism
 Pan-Turkism
 Philosophy: Historical Overview and Recent Developments
 Race and Racism: Asia
 Religion: East and Southeast Asia
 Sacred Texts: Asia
 Science: East Asia
 Time: China
 Time: India
 Westernization: Southeast Asia
 Women's History: Asia

ENTRIES THAT CONSIDER ASIA

Algebras
 Ancestor Worship
 Anthropology
 Anticolonialism: Africa
 Architecture: Overview
 Arts: Overview
 Asceticism: Hindu and Buddhist Asceticism
 Asian-American Ideas (Cultural Migration)
 Astrology: China
 Astronomy, Pre-Columbian and Latin American
 Atheism
 Autobiography
 Barbarism and Civilization
 Beauty and Ugliness
 Bilingualism and Multilingualism
 Biography
 Body, The
 Borders, Borderlands, and Frontiers, Global
 Bushido
 Calculation and Computation
 Cannibalism
 Censorship
 Childhood and Child Rearing
 Christianity: Overview
 Cinema
 Civil Disobedience
 Civil Society: Responses in Africa and the Middle East
 Communication of Ideas: Middle East and Abroad
 Communication of Ideas: Orality and the Advent of Writing
 Constitutionalism
 Cosmopolitanism
 Creativity in the Arts and Sciences
 Critical Theory
 Cultural Revivals
 Cycles
 Dance
 Deism
 Demography
 Demonology
 Dependency

READER'S GUIDE

Diasporas: African Diaspora
Diffusion, Cultural
Dream
Dress
Dualism
Ecumenism
Education: Global Education
Education: Islamic Education
Empire and Imperialism: Europe
Empire and Imperialism: Middle East
Empire and Imperialism: United States
Environment
Environmental History
Ethnography
Eurocentrism
Evil
Family: Family in Anthropology since 1980
Family Planning
Fascism
Feminism: Overview
Field Theories
Friendship
Fundamentalism
Garden
Gay Studies
Gender Studies: Anthropology
Generation
Genetics: Contemporary
Genocide
Globalization: General
Health and Disease
Heaven and Hell
Historiography
History, Economic
Human Capital
Humanity in the Arts
Hygiene
Iconography
Identity, Multiple: Asian-Americans
Identity, Multiple: Jewish Multiple Identity
Images, Icons, and Idols
Imagination
Immortality and the Afterlife
Individualism
Intelligentsia
International Order
Islam: Shi'i
Islam: Sunni
Islamic Science
Kinship
Language, Linguistics, and Literacy
Liberty
Life Cycle: Overview
Life Cycle: Adolescence
Life Cycle: Elders/Old Age
Machiavellism
Magic
Maps and the Ideas They Express
Marxism: Overview
Masks
Mathematics
Matriarchy
Migration: Migration in World History
Migration: United States
Miracles
Modernism: Latin America
Modernity: Africa
Modernization Theory
Mohism
Monarchy: Overview
Monasticism
Monism
Motherhood and Maternity
Motif: Motif in Music
Museums
Musical Performance and Audiences
Musicology
Nation
Neoliberalism
Nomadism
Nonviolence
Nuclear Age
Nude, The
Occidentalism
Organicism
Orientalism: Overview
Orthodoxy
Pacifism
Paradise on Earth
Peace
Peasants and Peasantry
Periodization
Person, Idea of the
Perspective
Philosophy: Relations to Other Intellectual Realms
Political Science
Population
Postcolonial Studies
Postcolonial Theory and Literature
Practices
Prehistory, Rise of
Privacy
Property
Protest, Political
Race and Racism: United States
Reading
Religion: Overview
Religion and the State: United States
Resistance and Accommodation
Revolution
Rhetoric: Overview
Ritual: Public Ritual
Ritual: Religion
Sacred and Profane
Sacred Places
Secularization and Secularism
Sexual Harassment
Sexuality: Sexual Orientation
Shinto
Slavery
Society
Sovereignty
Sport
Suicide
Superstition
Syncretism
Taste
Temperance
Terror
Textiles and Fiber Arts as Catalysts for Ideas

Third Cinema
 Third World
 Third World Literature
 Toleration
 Totems
 Trade
 Translation
 Treaty
 University: Postcolonial
 Untouchability: Overview
 Untouchability: Menstrual Taboos
 Untouchability: Taboos
 Victorianism
 Virtue Ethics
 Visual Order to Organizing Collections
 War and Peace in the Arts
 Wisdom, Human
 Witchcraft
 Women's Studies
 Work
 World Systems Theory, Latin America
 Yin and Yang
 Yoga
 Zen

Europe

ENTRIES FOCUSING ON EUROPE

Architecture: Overview
 Capitalism: Overview
 Christianity: Overview
 Classification of Arts and Sciences, Early Modern
 Colonialism: Africa
 Colonialism: Latin America
 Colonialism: Southeast Asia
 Communication of Ideas: Europe and Its Influence
 Communism: Europe
 Consumerism
 Dada
 Democracy
 Dialogue and Dialectics: Socratic
 Dialogue and Dialectics: Talmudic
 Education: Europe
 Empire and Imperialism: Overview
 Empire and Imperialism: Europe
 Encyclopedism
 Enlightenment
 Epistemology: Ancient
 Epistemology: Early Modern
 Epistemology: Modern
 Eurocentrism
 Europe, Idea of
 Existentialism
 Expressionism
 Fascism
 Feudalism, European
 Greek Science
 Happiness and Pleasure in European Thought
 Hedonism in European Thought
 Historical and Dialectical Materialism
 Humanism: Europe and the Middle East
 Humanism: Renaissance
 Humanity: European Thought
 Judaism: Judaism to 1800
 Judaism: Modern Judaism
 Landscape in the Arts

Literature: Overview
 Love, Western Notions of
 Marxism: Overview
 Materialism in Eighteenth-Century European Thought
 Mechanical Philosophy
 Medicine: Europe and the United States
 Metaphysics: Ancient and Medieval
 Metaphysics: Renaissance to the Present
 Monarchy: Overview
 National History
 Orthopraxy: Western Orthopraxy
 Other, The, European Views of
 Pan-Turkism
 Philosophy: Historical Overview and Recent Developments
 Philosophy, Moral: Ancient
 Philosophy, Moral: Medieval and Renaissance
 Philosophy, Moral: Modern
 Philosophy and Religion in Western Thought
 Philosophy of Mind: Ancient and Medieval
 Pythagoreanism
 Race and Racism: Europe
 Regions and Regionalism, Eastern Europe
 Religion and the State: Europe
 Scientific Revolution
 Victorianism

ENTRIES THAT CONSIDER EUROPE

Abolitionism
 Absolute Music
 Aesthetics: Europe and the Americas
 Africa, Idea of
 Afrocentricity
 Agnosticism
 Alchemy: Europe and the Middle East
 Algebras
 Alienation
 Altruism
 Ambiguity
 America
 Americanization, U.S.
 Analytical Philosophy
 Anarchism
 Animism
 Anthropology
 Anticolonialism: Africa
 Anticolonialism: Latin America
 Anticolonialism: Middle East
 Anticolonialism: Southeast Asia
 Antifeminism
 Anti-Semitism: Overview
 Anti-Semitism: Islamic Anti-Semitism
 Apartheid
 Architecture: Africa
 Aristotelianism
 Arts: Overview
 Arts: Africa
 Asceticism: Western Asceticism
 Assimilation
 Astrology: Overview
 Atheism
 Authoritarianism: Overview
 Authority
 Autobiography
 Autonomy
 Avant-Garde: Overview

READER'S GUIDE

Avant-Garde: Militancy
 Barbarism and Civilization
 Beauty and Ugliness
 Behaviorism
 Bilingualism and Multilingualism
 Biography
 Biology
 Black Atlantic
 Body, The
 Borders, Borderlands, and Frontiers, Global
 Buddhism
 Bureaucracy
 Calculation and Computation
 Calendar
 Cannibalism
 Cartesianism
 Casuistry
 Causality
 Causation
 Censorship
 Change
 Character
 Chemistry
 Childhood and Child Rearing
 Christianity: Asia
 Cinema
 Citizenship: Overview
 Citizenship: Naturalization
 City, The: The City as a Cultural Center
 City, The: The Islamic and Byzantine City
 Civil Disobedience
 Civil Society: Europe and the United States
 Civil Society: Responses in Africa and the Middle East
 Class
 Classicism
 Common Sense
 Communication of Ideas: Africa and Its Influence
 Communication of Ideas: Middle East and Abroad
 Communication of Ideas: Orality and the Advent of Writing
 Communication of Ideas: Southeast Asia
 Composition, Musical
 Computer Science
 Consciousness: Overview
 Conservatism
 Consilience
 Constitutionalism
 Continental Philosophy
 Corruption
 Cosmology: Cosmology and Astronomy
 Cosmopolitanism
 Creationism
 Creativity in the Arts and Sciences
 Creolization, Caribbean
 Crisis
 Critical Theory
 Cultural Capital
 Cultural History
 Cultural Revivals
 Cultural Studies
 Cycles
 Cynicism
 Dance
 Deism
 Demography
 Demonology
 Dependency
 Determinism
 Development
 Diasporas: African Diaspora
 Diasporas: Jewish Diaspora
 Diversity
 Dream
 Dress
 Dystopia
 Eclecticism
 Ecology
 Economics
 Ecumenism
 Education: Global Education
 Education: India
 Education: Islamic Education
 Emotions
 Empire and Imperialism: Asia
 Empire and Imperialism: Middle East
 Empire and Imperialism: United States
 Empiricism
 Environment
 Environmental Ethics
 Environmental History
 Epicureanism
 Equality: Overview
 Equality: Gender Equality
 Equality: Racial Equality
 Essentialism
 Ethnicity and Race: Africa
 Ethnicity and Race: Anthropology
 Ethnocentrism
 Etiquette
 Eugenics
 Everyday Life
 Evil
 Evolution
 Experiment
 Extirpation
 Fallacy, Logical
 Falsifiability
 Family: Modernist Anthropological Theory
 Family: Family in Anthropology since 1980
 Family Planning
 Fatalism
 Feminism: Overview
 Feminism: Africa and African Diaspora
 Feminism: Islamic Feminism
 Fetishism: Overview
 Fetishism: Fetishism in Literature and Cultural Studies
 Field Theories
 Form, Metaphysical, in Ancient and Medieval Thought
 Formalism
 Foundationalism
 Free Will, Determinism, and Predestination
 Friendship
 Fundamentalism
 Garden
 Gay Studies
 Gender: Gender in the Middle East
 Gender in Art
 Gender Studies: Anthropology
 General Will
 Generation

- Genetics: Contemporary
 Genetics: History of
 Genius
 Genocide
 Geography
 Geometry
 Gesture
 Ghetto
 Gift, The
 Globalization: Africa
 Globalization: Asia
 Globalization: General
 Good
 Harmony
 Hate
 Health and Disease
 Heaven and Hell
 Hegelianism
 Hegemony
 Heresy and Apostasy
 Hermeneutics
 Hierarchy and Order
 Hinduism
 Historicism
 Historiography
 History, Economic
 History, Idea of
 Honor
 Human Capital
 Humanity in the Arts
 Human Rights: Overview
 Humor
 Hygiene
 Iconography
 Idealism
 Ideas, History of
 Identity: Identity of Persons
 Identity, Multiple: Overview
 Identity, Multiple: Jewish Multiple Identity
 Images, Icons, and Idols
 Immortality and the Afterlife
 Impressionism
 Individualism
 Intelligentsia
 Intentionality
 Interdisciplinarity
 International Order
 Interpretation
 Islam: Africa
 Islam: Shii
 Islam: Sunni
 Islamic Science
 Jainism
 Jouissance
 Justice: Overview
 Kantianism
 Kinship
 Knowledge
 Language and Linguistics
 Language, Linguistics, and Literacy
 Language, Philosophy of: Ancient and Medieval
 Language, Philosophy of: Modern
 Law
 Leadership
 Learning and Memory, Contemporary Views
 Liberalism
 Liberation Theology
 Liberty
 Life
 Life Cycle: Overview
 Life Cycle: Elders/Old Age
 Linguistic Turn
 Literary Criticism
 Literary History
 Logic
 Logic and Philosophy of Mathematics, Modern
 Loyalties, Dual
 Lysenkoism
 Machiavellism
 Magic
 Manichaeism
 Maoism
 Maps and the Ideas They Express
 Masks
 Mathematics
 Matriarchy
 Media, History of
 Medicine: Islamic Medicine
 Meme
 Memory
 Men and Masculinity
 Metaphor
 Microcosm and Macrocosm
 Migration: Africa
 Migration: Migration in World History
 Migration: United States
 Millenarianism: Overview
 Millenarianism: Islamic
 Millenarianism: Latin America and Native North America
 Mind
 Miracles
 Modernism: Overview
 Modernism: Latin America
 Modernity: Overview
 Modernity: Africa
 Modernity: East Asia
 Modernization
 Modernization Theory
 Monasticism
 Monism
 Moral Sense
 Motherhood and Maternity
 Motif: Motif in Literature
 Motif: Motif in Music
 Museums
 Music, Anthropology of
 Musical Performance and Audiences
 Musicology
 Mysticism: Christian Mysticism
 Mysticism: Kabbalah
 Mysticism: Mysticism in African Thought
 Myth
 Narrative
 Nation
 Nationalism: Overview
 Nationalism: Africa
 Nationalism: Cultural Nationalism
 Nationalism: Middle East
 Native Policy

READER'S GUIDE

Natural History
 Natural Theology
 Naturalism
 Naturalism in Art and Literature
 Nature
 Naturphilosophie
 Negritude
 Neocolonialism
 Neoliberalism
 Neoplatonism
 New Criticism
 Newtonianism
 Nihilism
 Nonviolence
 Nuclear Age
 Nude, The
 Objectivity
 Obligation
 Occidentalism
 Organicism
 Orientalism: Overview
 Orthodoxy
 Pacifism
 Pan-Africanism
 Pan-Asianism
 Pan-Islamism
 Paradigm
 Paradise on Earth
 Parties, Political
 Patriotism
 Peace
 Peasants and Peasantry
 Periodization
 Periodization of the Arts
 Person, Idea of the
 Perspective
 Phenomenology
 Philosophies: African
 Philosophies: Feminist, Twentieth-Century
 Philosophies: Islamic
 Philosophy: Relations to Other Intellectual Realms
 Philosophy, History of
 Philosophy, Moral: Africa
 Philosophy of Mind: Overview
 Phrenology
 Physics
 Platonism
 Pluralism
 Poetry and Poetics
 Political, The
 Political Science
 Polytheism
 Population
 Positivism
 Postcolonial Studies
 Postcolonial Theory and Literature
 Postmodernism
 Poverty
 Power
 Practices
 Pragmatism
 Pre-Columbian Civilization
 Prehistory, Rise of
 Prejudice
 Presentism
 Privacy
 Probability
 Progress, Idea of
 Propaganda
 Property
 Prophecy
 Protest, Political
 Pseudoscience
 Psychology and Psychiatry
 Public Sphere
 Punishment
 Puritanism
 Quantum
 Queer Theory
 Radicals/Radicalism
 Rational Choice
 Rationalism
 Reading
 Realism
 Realism: Africa
 Reason, Practical and Theoretical
 Reform: Europe and the United States
 Reform: Islamic Reform
 Reformation
 Relativism
 Relativity
 Religion: Overview
 Religion: East and Southeast Asia
 Religion: Latin America
 Religion: Middle East
 Religion and Science
 Religion and the State: Latin America
 Religion and the State: United States
 Renaissance
 Representation: Mental Representation
 Representation: Political Representation
 Republicanism: Latin America
 Republicanism: Republic
 Resistance
 Resistance and Accommodation
 Responsibility
 Revolution
 Rhetoric: Overview
 Rhetoric: Ancient and Medieval
 Ritual: Public Ritual
 Ritual: Religion
 Romanticism in Literature and Politics
 Sacred and Profane
 Sacred Places
 Sage Philosophy
 Scarcity and Abundance, Latin America
 Scholasticism
 Science: Overview
 Science, History of
 Science Fiction
 Secularization and Secularism
 Sexuality: Overview
 Skepticism
 Slavery
 Social Capital
 Social Contract
 Social Darwinism
 Socialism
 Socialisms, African
 Society

Sophists, The
 Sovereignty
 Sport
 State, The: Overview
 Stoicism
 Structuralism and Poststructuralism: Overview
 Structuralism and Poststructuralism: Anthropology
 Subjectivism
 Suicide
 Superstition
 Surrealism
 Symbolism
 Taste
 Technology
 Temperance
 Terror
 Terrorism, Middle East
 Textiles and Fiber Arts as Catalysts for Ideas
 Theodicy
 Third Cinema
 Time: Traditional and Utilitarian
 Toleration
 Totalitarianism
 Trade
 Tragedy and Comedy
 Translation
 Travel: Travel from Europe and the Middle East
 Treaty
 Trope
 Truth
 Universalism
 University: Overview
 University: Postcolonial
 Untouchability: Overview
 Untouchability: Menstrual Taboos
 Untouchability: Taboos
 Utilitarianism
 Utopia
 Virtue Ethics
 Visual Order to Organizing Collections
 Volksgeist
 Volunteerism, U.S.
 War
 War and Peace in the Arts
 Wealth
 Westernization: Africa
 Westernization: Middle East
 Westernization: Southeast Asia
 Wildlife
 Wisdom, Human
 Witchcraft
 Witchcraft, African Studies of
 Women's History: Africa
 Women's Studies
 Work
 World Systems Theory, Latin America
 Zionism

Dialogue and Dialectics: Talmudic
 Education: Islamic Education
 Empire and Imperialism: Middle East
 Feminism: Islamic Feminism
 Gender: Gender in the Middle East
 Honor, Middle Eastern Notions of
 Humanism: Europe and the Middle East
 Intercession in Middle Eastern Society
 Islam: Shii
 Islam: Sunni
 Islamic Science
 Judaism: Judaism to 1800
 Judaism: Modern Judaism
 Law, Islamic
 Literature: Overview
 Medicine: Islamic Medicine
 Monarchy: Islamic Monarchy
 Nationalism: Middle East
 Pan-Arabism
 Pan-Islamism
 Pan-Turkism
 Philosophies: Islamic
 Religion: Middle East
 Religion and the State: Middle East
 Sufism
 Terrorism, Middle East
 Tribalism, Middle East
 Westernization: Middle East
 Zionism

ENTRIES THAT CONSIDER THE MIDDLE EAST

Africa, Idea of
 Algebras
 Anthropology
 Antifeminism
 Anti-Semitism: Overview
 Anti-Semitism: Islamic Anti-Semitism
 Architecture: Overview
 Architecture: Africa
 Aristotelianism
 Arts: Africa
 Astrology: Overview
 Astrology: China
 Atheism
 Authoritarianism: Overview
 Authority
 Barbarism and Civilization
 Bilingualism and Multilingualism
 Biography
 Calendar
 Childhood and Child Rearing
 Christianity: Overview
 City, The: The Islamic and Byzantine City
 Class
 Communication of Ideas: Africa and Its Influence
 Communication of Ideas: Europe and Its Influence
 Communication of Ideas: Orality and the Advent of Writing
 Computer Science
 Constitutionalism
 Cosmopolitanism
 Creativity in the Arts and Sciences
 Critical Theory
 Dance
 Deism
 Demography

Middle East

ENTRIES FOCUSING ON THE MIDDLE EAST

Alchemy: Europe and the Middle East
 Anticolonialism: Middle East
 Civil Society: Responses in Africa and the Middle East
 Communication of Ideas: Middle East and Abroad
 Death and Afterlife, Islamic Understanding of

READER'S GUIDE

Demonology
 Dependency
 Diasporas: African Diaspora
 Diasporas: Jewish Diaspora
 Dream
 Dualism
 Ecumenism
 Empire and Imperialism: Europe
 Environment
 Ethnicity and Race: Islamic Views
 Eurocentrism
 Evil
 Family Planning
 Feminism: Overview
 Feminism: Africa and African Diaspora
 Free Will, Determinism, and Predestination
 Friendship
 Fundamentalism
 Garden
 Gay Studies
 Gender in Art
 Ghetto
 Gift, The
 Gnosticism
 Hate
 Health and Disease
 Heaven and Hell
 Heresy and Apostasy
 Historiography
 Humanity in the Arts
 Iconography
 Identity, Multiple: Jewish Multiple Identity
 Images, Icons, and Idols
 Imagination
 Immortality and the Afterlife
 Intelligentsia
 International Order
 Islam: Africa
 Jihad
 Language, Linguistics, and Literacy
 Language, Philosophy of: Ancient and Medieval
 Liberty
 Life Cycle: Elders/Old Age
 Literature: African Literature
 Logic
 Manichaeism
 Maps and the Ideas They Express
 Mathematics
 Matriarchy
 Microcosm and Macrocosm
 Migration: Africa
 Migration: Migration in World History
 Millenarianism: Overview
 Millenarianism: Islamic
 Minority
 Miracles
 Monarchy: Overview
 Motherhood and Maternity
 Museums
 Musicology
 Mysticism: Islamic Mysticism
 Mysticism: Islamic Mysticism in Asia
 Mysticism: Kabbalah
 Mysticism: Mysticism in African Thought
 Nation
 Nationalism: Cultural Nationalism
 Nihilism
 Nomadism
 Nonviolence
 Nuclear Age
 Organicism
 Orientalism: Overview
 Orientalism: African and Black Orientalism
 Orthodoxy
 Orthopraxy: Western Orthopraxy
 Pan-Africanism
 Paradise on Earth
 Peace
 Perspective
 Philosophies: African
 Philosophy, Moral: Medieval and Renaissance
 Philosophy of Mind: Ancient and Medieval
 Political Science
 Polytheism
 Postcolonial Studies
 Postcolonial Theory and Literature
 Property
 Prophecy
 Protest, Political
 Pythagoreanism
 Reform: Islamic Reform
 Religion: East and Southeast Asia
 Religion and Science
 Religion and the State: Africa
 Religion and the State: Europe
 Religion and the State: United States
 Resistance and Accommodation
 Rhetoric: Overview
 Sacred Places
 Sacred Texts: Koran
 Science, History of
 Scientific Revolution
 Secularization and Secularism
 Sexual Harassment
 Sexuality: Islamic Views
 Slavery
 Sovereignty
 Suicide
 Superstition
 Syncretism
 Temperance
 Textiles and Fiber Arts as Catalysts for Ideas
 Theodicy
 Third Cinema
 Third World Literature
 Toleration
 Totalitarianism
 Totems
 Travel: Travel from Europe and the Middle East
 Treaty
 University: Overview
 Untouchability: Menstrual Taboos
 Untouchability: Taboos
 Visual Order to Organizing Collections
 Westernization: Africa
 Westernization: Southeast Asia
 Wisdom, Human
 Women's History: Africa
 Women's Studies
 World Systems Theory, Latin America

North America

ENTRIES FOCUSING ON NORTH AMERICA

African-American Ideas
 America
 Asian-American Ideas (Cultural Migration)
 Black Atlantic
 Chicano Movement
 Christianity: Overview
 Civil Society: Europe and the United States
 Communication of Ideas: The Americas and Their Influence
 Consumerism
 Democracy
 Education: North America
 Empire and Imperialism: Americas
 Empire and Imperialism: United States
 Ethnohistory, U.S.
 Feminism: Chicana Feminisms
 Feminism: Third World U.S. Movement
 Humanism: Secular Humanism in the United States
 Identity, Multiple: Asian-Americans
 Judaism: Modern Judaism
 Justice: Justice in American Thought
 Landscape in the Arts
 Medicine: Europe and the United States
 Migration: United States
 Millenarianism: Latin America and Native North America
 Native Policy
 Philosophies: American
 Political Protest, U.S.
 Populism: United States
 Race and Racism: United States
 Reform: Europe and the United States
 Religion and the State: United States
 Volunteerism, U.S.

ENTRIES THAT CONSIDER NORTH AMERICA

Abolitionism
 Aesthetics: Europe and the Americas
 Africa, Idea of
 Afrocentricity
 Altruism
 Americanization, U.S.
 Analytical Philosophy
 Anthropology
 Anticolonialism: Latin America
 Anticolonialism: Southeast Asia
 Antifeminism
 Asceticism: Western Asceticism
 Assimilation
 Astronomy, Pre-Columbian and Latin American
 Atheism
 Authoritarianism: Latin America
 Authority
 Autobiography
 Aztlán
 Beauty and Ugliness
 Behaviorism
 Bilingualism and Multilingualism
 Bioethics
 Biology
 Body, The
 Borders, Borderlands, and Frontiers, Global
 Buddhism
 Calculation and Computation

Cannibalism
 Causation
 Censorship
 Childhood and Child Rearing
 Cinema
 Citizenship: Overview
 Citizenship: Cultural Citizenship
 Citizenship: Naturalization
 City, The: The City as a Cultural Center
 Civil Disobedience
 Colonialism: Latin America
 Communication of Ideas: Africa and Its Influence
 Communism: Latin America
 Computer Science
 Conservatism
 Consilience
 Constitutionalism
 Continental Philosophy
 Cosmopolitanism
 Creationism
 Critical Race Theory
 Critical Theory
 Cultural Capital
 Cultural Revivals
 Cultural Studies
 Dance
 Death
 Deism
 Demography
 Diasporas: African Diaspora
 Diasporas: Jewish Diaspora
 Discrimination
 Diversity
 Dream
 Dress
 Dualism
 Dystopia
 Ecology
 Economics
 Ecumenism
 Education: Global Education
 Emotions
 Empire and Imperialism: Asia
 Empiricism
 Enlightenment
 Environment
 Environmental Ethics
 Environmental History
 Equality: Overview
 Equality: Gender Equality
 Equality: Racial Equality
 Essentialism
 Ethnicity and Race: Anthropology
 Ethnocentrism
 Ethnography
 Eugenics
 Eurocentrism
 Everyday Life
 Evil
 Evolution
 Family: Modernist Anthropological Theory
 Family: Family in Anthropology since 1980
 Family Planning
 Feminism: Overview
 Feminism: Africa and African Diaspora

READER'S GUIDE

Feminism: Islamic Feminism
Fetishism: Overview
Fetishism: Fetishism in Literature and Cultural Studies
Field Theories
Foundationalism
Friendship
Fundamentalism
Game Theory
Garden
Gay Studies
Gender: Overview
Gender: Gender in the Middle East
Gender in Art
Gender Studies: Anthropology
Generation
Genetics: Contemporary
Genetics: History of
Genius
Genocide
Ghetto
Globalization: Asia
Globalization: General
Hate
Hegelianism
Historiography
History, Economic
Human Capital
Humanity: European Thought
Humanity in the Arts
Human Rights: Overview
Ideas, History of
Identity: Identity of Persons
Identity: Personal and Social Identity
Identity, Multiple: Overview
Identity, Multiple: Jewish Multiple Identity
Impressionism
Intentionality
Interdisciplinarity
Internal Colonialism
International Order
Interpretation
Islam: Shii
Jainism
Justice: Overview
Kantianism
Language and Linguistics
Language, Philosophy of: Modern
Law
Leadership
Learning and Memory, Contemporary Views
Liberation Theology
Life
Life Cycle: Adolescence
Life Cycle: Elders/Old Age
Linguistic Turn
Literary Criticism
Literary History
Loyalties, Dual
Machismo
Magic
Maps and the Ideas They Express
Marxism: Overview
Marxism: Latin America
Masks
Mathematics
Matriarchy
Media, History of
Meme
Men and Masculinity
Mestizaje
Migration: Africa
Migration: Migration in World History
Millenarianism: Overview
Mind
Minority
Modernism: Latin America
Modernity: Overview
Monasticism
Motif: Motif in Music
Museums
Music, Anthropology of
Musical Performance and Audiences
Myth
Narrative
Nation
Nationalism: Overview
Nationalism: Africa
Natural History
Natural Theology
Naturalism
Neocolonialism
Neoliberalism
New Criticism
Nihilism
Nuclear Age
Objectivity
Obligation
Occidentalism
Orientalism: African and Black Orientalism
Orthodoxy
Other, The, European Views of
Pacifism
Pan-Africanism
Paradigm
Parties, Political
Periodization
Person, Idea of the
Philosophies: Feminist, Twentieth-Century
Philosophy: Relations to Other Intellectual Realms
Philosophy of Mind: Overview
Pluralism
Political Science
Population
Positivism
Postcolonial Studies
Postcolonial Theory and Literature
Postmodernism
Practices
Pragmatism
Prehistory, Rise of
Prejudice
Presentism
Privacy
Probability
Progress, Idea of
Property
Protest, Political
Pseudoscience
Psychology and Psychiatry
Quantum

Queer Theory
 Race and Racism: Overview
 Rational Choice
 Reading
 Reflexivity
 Relativism
 Relativity
 Religion: Latin America
 Religion and Science
 Renaissance
 Representation: Mental Representation
 Representation: Political Representation
 Resistance
 Resistance and Accommodation
 Responsibility
 Rhetoric: Overview
 Ritual: Religion
 Scarcity and Abundance, Latin America
 Science, History of
 Science Fiction
 Secularization and Secularism
 Segregation
 Sexual Harassment
 Sexuality: Overview
 Sexuality: Sexual Orientation
 Slavery
 Social History, U.S.
 Sovereignty
 Sport
 State, The: Overview
 Subjectivism
 Suicide
 Superstition
 Syncretism
 Taste
 Technology
 Temperance
 Terrorism, Middle East
 Time: Traditional and Utilitarian
 Totems
 Trade
 Treaty
 Trope
 Truth
 University: Postcolonial
 Utilitarianism
 Victorianism
 Visual Culture
 Visual Order to Organizing Collections
 War
 War and Peace in the Arts
 Westernization: Southeast Asia
 Wildlife
 Witchcraft
 Womanism
 Women and Femininity in U.S. Popular Culture
 Women's Studies
 World Systems Theory, Latin America

Latin and South America

ENTRIES FOCUSING ON LATIN AND SOUTH AMERICA

Anticolonialism: Latin America
 Astronomy, Pre-Columbian and Latin American
 Authoritarianism: Latin America

Black Atlantic
 Colonialism: Latin America
 Communication of Ideas: The Americas and Their Influence
 Communism: Latin America
 Creolization, Caribbean
 Empire and Imperialism: Americas
 Marxism: Latin America
 Millenarianism: Latin America and Native North America
 Modernism: Latin America
 Native Policy
 Populism: Latin America
 Pre-Columbian Civilization
 Religion: Indigenous Peoples' View, South America
 Religion: Latin America
 Religion and the State: Latin America
 Republicanism: Latin America
 Scarcity and Abundance, Latin America
 World Systems Theory, Latin America

ENTRIES THAT CONSIDER LATIN AND SOUTH AMERICA

Abolitionism
 Aesthetics: Africa
 Africa, Idea of
 America
 Ancestor Worship
 Animism
 Anthropology
 Arts: Overview
 Atheism
 Authenticity: Africa
 Authoritarianism: Overview
 Autobiography
 Aztlán
 Bilingualism and Multilingualism
 Borders, Borderlands, and Frontiers, Global
 Calculation and Computation
 Cannibalism
 Chicano Movement
 Christianity: Overview
 Cinema
 Citizenship: Overview
 Citizenship: Cultural Citizenship
 Citizenship: Naturalization
 Critical Theory
 Cultural Capital
 Dance
 Demography
 Demonology
 Dependency
 Diasporas: African Diaspora
 Diffusion, Cultural
 Discrimination
 Diversity
 Empire and Imperialism: United States
 Environmental History
 Ethnohistory, U.S.
 Evil
 Extirpation
 Family Planning
 Fascism
 Feminism: Overview
 Feminism: Africa and African Diaspora
 Feminism: Chicana Feminisms

READER'S GUIDE

Fetishism: Overview
Friendship
Gender in Art
Genetics: Contemporary
Historiography
History, Economic
Honor
Humanity in the Arts
Identity, Multiple: Overview
Identity, Multiple: Jewish Multiple Identity
Indigenismo
Internal Colonialism
International Order
Liberation Theology
Life Cycle: Overview
Life Cycle: Elders/Old Age
Machiavellism
Machismo
Magic
Maps and the Ideas They Express
Masks
Mathematics
Matriarchy
Media, History of
Men and Masculinity
Mestizaje
Migration: Africa
Migration: Migration in World History
Migration: United States
Minority
Modernism: Overview
Modernization Theory
Motherhood and Maternity
Motif: Motif in Music
Museums
Music, Anthropology of
Nationalism: Africa
Negritude
Orthopraxy: Western Orthopraxy
Pan-Africanism
Peasants and Peasantry
Periodization of the Arts
Perspective
Phrenology
Political Protest, U.S.
Polytheism
Population
Postcolonial Studies
Postcolonial Theory and Literature
Practices
Prehistory, Rise of
Property
Protest, Political
Race and Racism: Overview
Religion: African Diaspora
Resistance and Accommodation
Revolution
Rhetoric: Overview
Ritual: Public Ritual
Ritual: Religion
Secularization and Secularism
Segregation
Slavery
Sport
State, The: Overview

Structuralism and Poststructuralism: Anthropology
Surrealism
Syncretism
Temperance
Third Cinema
Third World
Third World Literature
Trade
Treaty
University: Overview
University: Postcolonial
Visual Order to Organizing Collections
Witchcraft
Women's Studies
Work

CHRONOLOGICAL PERIODS

This section is divided according to five periods in world history: Ancient, Dynastic, Early Modern, Modern, and Contemporary. Use this section together with the section on Geographical Areas.

Ancient (before 400 C.E.)

ENTRIES FOCUSED ON THE PERIOD

Buddhism
Consciousness: Chinese Thought
Consciousness: Indian Thought
Democracy
Dialogue and Dialectics: Socratic
Epicureanism
Gnosticism
Greek Science
Hinduism
Justice: Justice in East Asian Thought
Language, Linguistics, and Literacy
Microcosm and Macrocosm
Orthopraxy: Asia
Orthopraxy: Western Orthopraxy
Poetry and Poetics
Sacred Places
Sacred Texts: Asia
Sophists, The
Textiles and Fiber Arts as Catalysts for Ideas
Time: China
Time: India
Yin and Yang

ENTRIES WITH EXAMPLES FROM BEFORE 400 C.E.

Generally the examples in this category are from the ancient Middle East, Europe, or Asia.

Aesthetics: Asia
Aesthetics: Europe and the Americas
Africa, Idea of
Alchemy: China
Alchemy: Europe and the Middle East
Algebras
Ambiguity
Anarchism
Anthropology
Anti-Semitism: Overview
Architecture: Overview

- Architecture: Africa
 Architecture: Asia
 Aristotelianism
 Arts: Overview
 Asceticism: Western Asceticism
 Astrology: Overview
 Astrology: China
 Atheism
 Authority
 Autobiography
 Barbarism and Civilization
 Beauty and Ugliness
 Biography
 Biology
 Body, The
 Borders, Borderlands, and Frontiers, Global
 Bureaucracy
 Calendar
 Casuistry
 Causality
 Causation
 Causation in East Asian and Southeast Asian Philosophy
 Censorship
 Change
 Character
 Childhood and Child Rearing
 Chinese Thought
 Christianity: Overview
 Christianity: Asia
 City, The: The City as a Cultural Center
 City, The: The City as Political Center
 City, The: The Islamic and Byzantine City
 Civil Society: Europe and the United States
 Class
 Classicism
 Classification of Arts and Sciences, Early Modern
 Communication of Ideas: Asia and Its Influence
 Communication of Ideas: Europe and Its Influence
 Communication of Ideas: Middle East and Abroad
 Communication of Ideas: Orality and Advent of Writing
 Communication of Ideas: Southeast Asia
 Communication of Ideas: The Americas and Their Influence
 Composition, Musical
 Confucianism
 Constitutionalism
 Corruption
 Cosmology: Asia
 Cosmology: Cosmology and Astronomy
 Cosmopolitanism
 Creationism
 Creativity in the Arts and Sciences
 Creolization, Caribbean
 Cycles
 Cynicism
 Dance
 Daoism
 Death
 Demonology
 Development
 Diasporas: Jewish Diaspora
 Dream
 Dress
 Dualism
 Eclecticism
 Ecumenism
 Education: Asia, Traditional and Modern
 Education: China
 Education: Europe
 Education: India
 Emotions
 Empire and Imperialism: Overview
 Empire and Imperialism: Asia
 Environment
 Epistemology: Ancient
 Equality: Overview
 Eschatology
 Essentialism
 Etiquette
 Eurocentrism
 Europe, Idea of
 Evil
 Evolution
 Experiment
 Fallacy, Logical
 Fatalism
 Form, Metaphysical, in Ancient and Medieval Thought
 Foundationalism
 Free Will, Determinism, and Predestination
 Friendship
 Fundamentalism
 Garden
 Gay Studies
 Gender in Art
 Generation
 Genre
 Geography
 Geometry
 Gesture
 Gift, The
 Good
 Happiness and Pleasure in European Thought
 Harmony
 Health and Disease
 Heaven and Hell
 Heaven and Hell (Asian Focus)
 Hedonism in European Thought
 Hegemony
 Heresy and Apostasy
 Hierarchy and Order
 Historiography
 History, Idea of
 Humanism: Chinese Conception of
 Humanism: Europe and the Middle East
 Humanity: African Thought
 Humanity: Asian Thought
 Humanity: European Thought
 Humanity in the Arts
 Human Rights: Overview
 Humor
 Hygiene
 Ideas, History of
 Identity, Multiple: Jewish Multiple Identity
 Images, Icons, and Idols
 Imagination
 Immortality and the Afterlife
 Individualism
 International Order
 Interpretation

READER'S GUIDE

Jainism
 Judaism: Judaism to 1800
 Justice: Overview
 Knowledge
 Landscape in the Arts
 Language, Philosophy of: Ancient and Medieval
 Leadership
 Legalism, Ancient China
 Liberty
 Life
 Literary History
 Literature: Overview
 Literature: African Literature
 Logic
 Love, Western Notions of
 Loyalties, Dual
 Machiavellism
 Manichaeism
 Maps and the Ideas They Express
 Marriage and Fertility, European Views
 Mathematics
 Matriarchy
 Mechanical Philosophy
 Media, History of
 Medicine: China
 Medicine: Europe and the United States
 Medicine: India
 Medicine: Islamic Medicine
 Meditation: Eastern Meditation
 Memory
 Men and Masculinity
 Metaphor
 Metaphysics: Ancient and Medieval
 Migration: Migration in World History
 Millenarianism: Overview
 Miracles
 Mohism
 Monarchy: Overview
 Monasticism
 Monism
 Motherhood and Maternity
 Museums
 Music, Anthropology of
 Musical Performance and Audiences
 Mysticism: Chinese Mysticism
 Mysticism: Christian Mysticism
 Narrative
 Nation
 Natural Law
 Nature
 Neoplatonism
 Nomadism
 Nonviolence
 Nude, The
 Organicism
 Orthodoxy
 Other, The, European Views of
 Pacifism
 Paradigm
 Paradise on Earth
 Patriotism
 Peace
 Periodization
 Periodization of the Arts
 Perspective
 Philanthropy
 Philosophies: African
 Philosophies: Islamic
 Philosophy: Historical Overview and Recent Developments
 Philosophy: Relations to Other Intellectual Realms
 Philosophy, Moral: Ancient
 Philosophy, Moral: Medieval and Renaissance
 Philosophy and Religion in Western Thought
 Philosophy of Mind: Ancient and Medieval
 Physics
 Platonism
 Pluralism
 Political, The
 Political Science
 Poverty
 Prehistory, Rise of
 Presentism
 Prophecy
 Punishment
 Pythagoreanism
 Rationalism
 Reading
 Reason, Practical and Theoretical
 Reform: Europe and the United States
 Reformation
 Religion: Overview
 Religion: Africa
 Religion: East and Southeast Asia
 Religion and the State: Europe
 Renaissance
 Representation: Political Representation
 Republicanism: Republic
 Resistance
 Responsibility
 Revolution
 Rhetoric: Overview
 Rhetoric: Ancient and Medieval
 Ritual: Public Ritual
 Science: East Asia
 Scientific Revolution
 Shinto
 Skepticism
 Slavery
 Society
 Sovereignty
 Sport
 State of Nature
 Stoicism
 Suicide
 Superstition
 Syncretism
 Taste
 Text/Textuality
 Toleration
 Totalitarianism
 Tragedy and Comedy
 Translation
 Travel: Travel from Europe and the Middle East
 Treaty
 Trope
 Truth
 University: Overview
 Untouchability: Overview
 Untouchability: Menstrual Taboos

Virtual Reality
 Virtue Ethics
 Visual Order to Organizing Collections
 War and Peace in the Arts
 Wealth
 Wildlife
 Witchcraft
 Work
 Yoga
 Zen

Dynastic (400 C.E.–1400 C.E.)

ENTRIES FOCUSED ON THE PERIOD

Astronomy, Pre-Columbian and Latin American
 Buddhism
 Death and Afterlife, Islamic Understanding of
 Dialogue and Dialectics: Talmudic
 Feudalism, European
 Heresy and Apostasy
 Motif: Motif in Literature
 Orthopraxy: Western Orthopraxy
 Sacred Places
 Sacred Texts: Asia
 Sacred Texts: Koran
 Scholasticism
 Textiles and Fiber Arts as Catalysts for Ideas

ENTRIES WITH EXAMPLES FROM THE PERIOD

400 C.E.–1400 C.E.

Aesthetics: Asia
 Africa, Idea of
 Alchemy: China
 Alchemy: Europe and the Middle East
 Algebras
 America
 Anti-Semitism: Overview
 Anti-Semitism: Islamic Anti-Semitism
 Architecture: Overview
 Architecture: Africa
 Architecture: Asia
 Aristotelianism
 Arts: Overview
 Asceticism: Western Asceticism
 Astrology: Overview
 Astrology: China
 Authority
 Autobiography
 Aztlán
 Barbarism and Civilization
 Beauty and Ugliness
 Biography
 Biology
 Body, The
 Borders, Borderlands, and Frontiers, Global
 Bureaucracy
 Bushido
 Calculation and Computation
 Calendar
 Casuistry
 Causality
 Causation in East Asian and Southeast Asian Philosophy
 Change
 Childhood and Child Rearing
 Chinese Thought
 Christianity: Overview
 Christianity: Asia

City, The: The City as a Cultural Center
 City, The: The Islamic and Byzantine City
 Civil Disobedience
 Civil Society: Europe and the United States
 Class
 Classicism
 Classification of Arts and Sciences, Early Modern
 Communication of Ideas: Africa and Its Influence
 Communication of Ideas: Asia and Its Influence
 Communication of Ideas: Europe and Its Influence
 Communication of Ideas: Middle East and Abroad
 Communication of Ideas: Orality and Advent of Writing
 Communication of Ideas: Southeast Asia
 Communication of Ideas: The Americas and Their Influence
 Composition, Musical
 Confucianism
 Consciousness: Indian Thought
 Consilience
 Constitutionalism
 Corruption
 Cosmology: Asia
 Cosmopolitanism
 Creationism
 Creativity in the Arts and Sciences
 Daoism
 Death
 Democracy
 Demonology
 Diasporas: Jewish Diaspora
 Dream
 Dualism
 Eclecticism
 Ecumenism
 Education: Asia, Traditional and Modern
 Education: China
 Education: Europe
 Education: India
 Education: Islamic Education
 Education: Japan
 Empire and Imperialism: Overview
 Empire and Imperialism: Asia
 Encyclopedism
 Equality: Overview
 Eschatology
 Ethnicity and Race: Islamic Views
 Etiquette
 Eurocentrism
 Europe, Idea of
 Evil
 Examination Systems, China
 Experiment
 Fallacy, Logical
 Feminism: Islamic Feminism
 Form, Metaphysical, in Ancient and Medieval Thought
 Free Will, Determinism, and Predestination
 Friendship
 Garden
 Gay Studies
 Gender: Gender in the Middle East
 Gender in Art
 Gesture
 Gift, The
 Globalization: Asia
 Good

READER'S GUIDE

Happiness and Pleasure in European Thought
 Harmony
 Health and Disease
 Heaven and Hell
 Hegemony
 Hierarchy and Order
 Hinduism
 Historiography
 History, Idea of
 Honor, Middle Eastern Notions of
 Humanism: Africa
 Humanism: Chinese Conception of
 Humanism: Europe and the Middle East
 Humanity: Asian Thought
 Humanity: European Thought
 Humanity in the Arts
 Human Rights: Overview
 Hygiene
 Iconography
 Identity, Multiple: Jewish Multiple Identity
 Images, Icons, and Idols
 Imagination
 Immortality and the Afterlife
 Individualism
 Intentionality
 International Order
 Interpretation
 Islam: Africa
 Islam: Shii
 Islam: Sunni
 Islamic Science
 Jainism
 Japanese Philosophy, Japanese Thought
 Jihad
 Judaism: Judaism to 1800
 Knowledge
 Landscape in the Arts
 Language, Philosophy of: Ancient and Medieval
 Law, Islamic
 Liberty
 Literary History
 Literature: Overview
 Logic
 Love, Western Notions of
 Loyalties, Dual
 Manichaeism
 Maps and the Ideas They Express
 Marriage and Fertility, European Views
 Mathematics
 Medicine: China
 Medicine: Europe and the United States
 Medicine: Islamic Medicine
 Metaphor
 Metaphysics: Ancient and Medieval
 Microcosm and Macrocosm
 Migration: Africa
 Migration: Migration in World History
 Millenarianism: Overview
 Millenarianism: Islamic
 Millenarianism: Latin America and Native North America
 Miracles
 Monarchy: Islamic Monarchy
 Monarchy: Overview
 Monasticism
 Monism
 Motif: Motif in Music
 Musical Performance and Audiences
 Mysticism: Chinese Mysticism
 Mysticism: Christian Mysticism
 Mysticism: Islamic Mysticism
 Mysticism: Islamic Mysticism in Asia
 Mysticism: Kabbalah
 Nation
 Natural Law
 Natural Theology
 Neoplatonism
 Nomadism
 Nude, The
 Objectivity
 Organicism
 Orthodoxy
 Other, The, European Views of
 Paradigm
 Paradise on Earth
 Patriotism
 Peace
 Peasants and Peasantry
 Periodization
 Periodization of the Arts
 Perspective
 Philanthropy
 Philosophies: African
 Philosophies: Islamic
 Philosophy: Historical Overview and Recent Developments
 Philosophy, Moral: Medieval and Renaissance
 Philosophy and Religion in Western Thought
 Philosophy of Mind: Ancient and Medieval
 Physics
 Platonism
 Poverty
 Pre-Columbian Civilization
 Prophecy
 Protest, Political
 Race and Racism: Asia
 Reform: Islamic Reform
 Religion: Africa
 Religion: East and Southeast Asia
 Religion: Middle East
 Religion and the State: Europe
 Religion and the State: Middle East
 Religion and the State: United States Renaissance
 Representation: Political Representation
 Republicanism: Republic
 Responsibility
 Revolution
 Rhetoric: Overview
 Rhetoric: Ancient and Medieval
 Ritual: Public Ritual
 Scientific Revolution
 Sexuality: Islamic Views
 Shinto
 Skepticism
 Sophists, The
 Sovereignty
 Stoicism
 Sufism
 Suicide
 Superstition

Syncretism
 Taste
 Terror
 Time: Traditional and Utilitarian
 Toleration
 Totalitarianism
 Tragedy and Comedy
 Translation
 Travel: Travel from Europe and the Middle East
 Tribalism, Middle East
 University: Overview
 Untouchability: Menstrual Taboos
 Virtual Reality
 Virtue Ethics
 Visual Order to Organizing Collections
 War
 War and Peace in the Arts
 Wealth
 Women's History: Asia
 Work
 Yoga
 Zen

Early Modern (1400–1800 C.E.)

ENTRIES FOCUSED ON THE PERIOD

Astronomy, Pre-Columbian and Latin American
 Cartesianism
 Casuistry
 Empiricism
 Humanism: Renaissance
 Idealism
 Identity: Identity of Persons
 Kantianism
 Materialism in Eighteenth-Century European Thought
 Mechanical Philosophy
 Moral Sense
 Naturphilosophie
 Newtonianism
 Phrenology
 Protest, Political
 Reformation
 Renaissance
 Scientific Revolution
 Theodicy
 Time: Traditional and Utilitarian
 Westernization: Middle East

ENTRIES WITH EXAMPLES FROM THE PERIOD

1400–1800 C.E.
 Abolitionism
 Aesthetics: Africa
 Aesthetics: Asia
 Aesthetics: Europe and the Americas
 Africa, Idea of
 African-American Ideas
 Agnosticism
 Alchemy: Europe and the Middle East
 Algebras
 Ambiguity
 America
 Ancestor Worship
 Anticolonialism: Latin America
 Antifeminism
 Anti-Semitism: Overview
 Apartheid
 Architecture: Overview

Architecture: Asia
 Aristotelianism
 Arts: Overview
 Arts: Africa
 Asceticism: Western Asceticism
 Astrology: Overview
 Atheism
 Authoritarianism: Latin America
 Authority
 Autobiography
 Autonomy
 Aztlán
 Barbarism and Civilization
 Beauty and Ugliness
 Biography
 Biology
 Body, The
 Borders, Borderlands, and Frontiers, Global
 Buddhism
 Bureaucracy
 Bushido
 Calculation and Computation
 Calendar
 Cannibalism
 Capitalism: Overview
 Capitalism: Africa
 Causality
 Causation
 Causation in East Asian and Southeast Asian Philosophy
 Censorship
 Change
 Character
 Chemistry
 Childhood and Child Rearing
 Chinese Thought
 Christianity: Asia
 Christianity: Overview
 City, The: The City as a Cultural Center
 City, The: Latin America
 Civil Disobedience
 Civil Society: Europe and the United States
 Civil Society: Responses in Africa and the Middle East
 Class
 Classicism
 Classification of Arts and Sciences, Early Modern
 Colonialism: Africa
 Colonialism: Latin America
 Colonialism: Southeast Asia
 Common Sense
 Communication of Ideas: Africa and Its Influence
 Communication of Ideas: The Americas and Their Influence
 Communication of Ideas: Asia and Its Influence
 Communication of Ideas: Europe and Its Influence
 Communication of Ideas: Middle East and Abroad
 Communication of Ideas: Orality and Advent of Writing
 Communication of Ideas: Southeast Asia
 Communism: Europe
 Composition, Musical
 Computer Science
 Confucianism
 Consciousness: Overview
 Conservatism
 Constitutionalism

READER'S GUIDE

Consumerism
 Context
 Continental Philosophy
 Corruption
 Cosmology: Asia
 Cosmology: Cosmology and Astronomy
 Cosmopolitanism
 Creationism
 Creativity in the Arts and Sciences
 Creolization, Caribbean
 Crisis
 Critical Theory
 Cultural History
 Cycles
 Death and Afterlife, Islamic Understanding of
 Deism
 Democracy
 Dependency
 Determinism
 Development
 Diasporas: African Diaspora
 Diasporas: Jewish Diaspora
 Dictatorship in Latin America
 Dream
 Dress
 Dualism
 Dystopia
 Eclecticism
 Ecology
 Economics
 Education: Asia, Traditional and Modern
 Education: China
 Education: Europe
 Education: India
 Education: Islamic Education
 Education: Japan
 Education: North America
 Empire and Imperialism: Americas
 Empire and Imperialism: Asia
 Empire and Imperialism: Middle East
 Encyclopedism
 Enlightenment
 Epistemology: Early Modern
 Equality: Overview
 Equality: Gender Equality
 Equality: Racial Equality
 Eschatology
 Essentialism
 Etiquette
 Eurocentrism
 Europe, Idea of
 Everyday Life
 Evil
 Evolution
 Examination Systems, China
 Experiment
 Extirpation
 Fascism
 Fetishism: Overview
 Field Theories
 Foundationalism
 Free Will, Determinism, and Predestination
 Friendship
 Garden
 Gay Studies
 Gender in Art
 General Will
 Genius
 Genre
 Geography
 Geometry
 Gesture
 Ghetto
 Gift, The
 Globalization: Africa
 Globalization: Asia
 Globalization: General
 Gnosticism
 Good
 Harmony
 Health and Disease
 Hedonism in European Thought
 Hierarchy and Order
 Historiography
 History, Idea of
 Honor
 Honor, Middle Eastern Notions of
 Human Capital
 Humanism: Africa
 Humanism: Chinese Conception of
 Humanism: Europe and the Middle East
 Humanism: Secular Humanism in the United States
 Humanity: African Thought
 Humanity: Asian Thought
 Humanity: European Thought
 Humanity in the Arts
 Human Rights: Overview
 Humor
 Hygiene
 Iconography
 Identity, Multiple: Overview
 Identity, Multiple: Jewish Multiple Identity
 Imagination
 Immortality and the Afterlife
 Indigenismo
 Individualism
 International Order
 Interpretation
 Islam: Africa
 Islam: Shi'i
 Islam: Southeast Asia
 Islam: Sunni
 Islamic Science
 Japanese Philosophy, Japanese Thought
 Judaism: Judaism to 1800
 Judaism: Modern Judaism
 Justice: Overview
 Justice: Justice in American Thought
 Knowledge
 Landscape in the Arts
 Language, Linguistics, and Literacy
 Leadership
 Liberalism
 Liberty
 Life
 Life Cycle: Overview
 Literary History
 Literature: Overview
 Logic
 Love, Western Notions of

- Loyalties, Dual
 Machiavellism
 Magic
 Maps and the Ideas They Express
 Marriage and Fertility, European Views
 Mathematics
 Medicine: Europe and the United States
 Medicine: Islamic Medicine
 Men and Masculinity
 Mestizaje
 Metaphor
 Metaphysics: Renaissance to the Present
 Microcosm and Macrocosm
 Migration: Africa
 Migration: Migration in World History
 Migration: United States
 Millenarianism: Overview
 Millenarianism: Islamic
 Millenarianism: Latin America and Native North America
 Mind
 Modernity: Africa
 Monarchy: Overview
 Monarchy: Islamic Monarchy
 Monasticism
 Monism
 Motif: Motif in Literature
 Motif: Motif in Music
 Museums
 Mysticism: Christian Mysticism
 Mysticism: Kabbalah
 Nation
 National History
 Native Policy
 Natural History
 Natural Law
 Natural Theology
 Nature
 Neoplatonism
 Nomadism
 Nude, The
 Objectivity
 Obligation
 Oral Traditions: Overview
 Organicism
 Orientalism: Overview
 Orthodoxy
 Orthopraxy: Western Orthopraxy
 Other, The, European Views of
 Paradigm
 Paradise on Earth
 Patriotism
 Peace
 Periodization
 Periodization of the Arts
 Perspective
 Philanthropy
 Philosophies: American
 Philosophies: Feminist, Twentieth-Century
 Philosophy: Historical Overview and Recent Developments
 Philosophy: Relations to Other Intellectual Realms
 Philosophy, History of
 Philosophy, Moral: Africa
 Philosophy, Moral: Medieval and Renaissance
 Philosophy, Moral: Modern
 Philosophy and Religion in Western Thought
 Philosophy of Mind: Overview
 Philosophy of Religion
 Physics
 Pietism
 Platonism
 Pluralism
 Poetry and Poetics
 Political Protest, U.S.
 Political Science
 Polytheism
 Poverty
 Power
 Pre-Columbian Civilization
 Prehistory, Rise of
 Presentism
 Probability
 Progress, Idea of
 Propaganda
 Property
 Prophecy
 Punishment
 Puritanism
 Pythagoreanism
 Race and Racism: Asia
 Race and Racism: Europe
 Radicals/Radicalism
 Rationalism
 Reason, Practical and Theoretical
 Reform: Europe and the United States
 Reform: Islamic Reform
 Relativity
 Religion: Africa
 Religion: African Diaspora
 Religion: East and Southeast Asia
 Religion: Indigenous Peoples' View, South America
 Religion: Latin America
 Religion and Science
 Religion and the State: Europe
 Religion and the State: Latin America
 Religion and the State: Middle East
 Religion and the State: United States
 Representation: Political Representation
 Republicanism: Latin America
 Republicanism: Republic
 Resistance
 Resistance and Accommodation
 Responsibility
 Revolution
 Rhetoric: Overview
 Ritual: Public Ritual
 Ritual: Religion
 Romanticism in Literature and Politics
 Scarcity and Abundance, Latin America
 Scholasticism
 Science: Overview
 Science, History of
 Secularization and Secularism
 Sexuality: Overview
 Sexuality: Islamic Views
 Shinto
 Skepticism
 Slavery
 Social Contract

READER'S GUIDE

Society
Sovereignty
Sport
State of Nature
Stoicism
Sufism
Suicide
Superstition
Syncretism
Taste
Temperance
Terror
Text/Textuality
Toleration
Totalitarianism
Tradition
Tragedy and Comedy
Translation
Travel: Travel from Europe and the Middle East
Treaty
Tribalism, Middle East
Trope
Truth
Universalism
University: Overview
Untouchability: Taboos
Utopia
Virtue Ethics
Visual Order to Organizing Collections
Volksgeist
Volunteerism, U.S.
War and Peace in the Arts
Wealth
Westernization: Middle East
Westernization: Southeast Asia
Witchcraft
Women's History: Africa
Work
World Systems Theory, Latin America

Modern (1800–1945)

ENTRIES FOCUSED ON THE PERIOD

Alienation
Altruism
Americanization, U.S.
Analytical Philosophy
Avant-Garde: Overview
Avant-Garde: Militancy
Black Atlantic
Bureaucracy
Chicano Movement
City, The: Latin America
Civil Disobedience
Consumerism
Continental Philosophy
Democracy
Empire and Imperialism: Europe
Eugenics
Evolution
Existentialism
Expressionism
Fascism
Field Theories
Fundamentalism
Futurology

Globalization: Africa
Globalization: Asia
Globalization: General
Hegelianism
Hegemony
Historicism
Humanism: Secular Humanism in the United States
Impressionism
Internal Colonialism
Kantianism
Life
Linguistic Turn
Literary History
Logic and Philosophy of Mathematics, Modern
Maoism
Marxism: Overview
Marxism: Asia
Marxism: Latin America
Media, History of
Modernism: Overview
Modernism: Latin America
Modernity: Overview
Modernity: Africa
Modernity: East Asia
Modernization
Modernization Theory
National History
Nationalism: Overview
Nationalism: Africa
Nationalism: Cultural Nationalism
Nationalism: Middle East
Naturalism
Naturalism in Art and Literature
Naturphilosophie
Neocolonialism
Neoliberalism
Orientalism: African and Black Orientalism
Pan-Africanism
Pan-Arabism
Pan-Asianism
Pan-Islamism
Pan-Turkism
Parties, Political
Phenomenology
Philosophies: Feminist, Twentieth-Century
Phrenology
Populism: Latin America
Populism: United States
Positivism
Pragmatism
Protest, Political
Psychoanalysis
Psychology and Psychiatry
Quantum
Realism
Realism: Africa
Relativism
Relativity
Science Fiction
Secularization and Secularism
Segregation
Sexuality: Sexual Orientation
Sociability in African Thought
Social Darwinism
Socialism

- Socialisms, African
 Structuralism and Poststructuralism: Overview
 Structuralism and Poststructuralism: Anthropology
 Subjectivism
 Surrealism
 Technology
 Third World
 Time: Traditional and Utilitarian
 Totalitarianism
 Utilitarianism
 Victorianism
 Westernization: Africa
 Westernization: Middle East
 Westernization: Southeast Asia
 Work
 Zionism
- ENTRIES WITH EXAMPLES FROM THE PERIOD
1800–1945
- Abolitionism
 Absolute Music
 Aesthetics: Africa
 Aesthetics: Asia
 Aesthetics: Europe and the Americas
 Africa, Idea of
 African-American Ideas
 Agnosticism
 Alchemy: China
 Alchemy: Europe and the Middle East
 Algebras
 Ambiguity
 America
 Anarchism
 Ancestor Worship
 Animism
 Anthropology
 Anticolonialism: Africa
 Anticolonialism: Latin America
 Anticolonialism: Middle East
 Anticolonialism: Southeast Asia
 Antifeminism
 Anti-Semitism: Overview
 Anti-Semitism: Islamic Anti-Semitism
 Apartheid
 Architecture: Overview
 Aristotelianism
 Arts: Overview
 Arts: Africa
 Asceticism: Western Asceticism
 Asian-American Ideas (Cultural Migration)
 Assimilation
 Atheism
 Authenticity: Africa
 Authoritarianism: Overview
 Authoritarianism: East Asia
 Authoritarianism: Latin America
 Authority
 Autobiography
 Barbarism and Civilization
 Beauty and Ugliness
 Behaviorism
 Bilingualism and Multilingualism
 Bioethics
 Biography
 Biology
 Body, The
 Borders, Borderlands, and Frontiers, Global
 Buddhism
 Bushido
 Calculation and Computation
 Capitalism: Overview
 Capitalism: Africa
 Cartesianism
 Casuistry
 Causality
 Censorship
 Change
 Character
 Chemistry
 Childhood and Child Rearing
 Chinese Warlordism
 Christianity: Overview
 Christianity: Asia
 Cinema
 Citizenship: Overview
 Citizenship: Naturalization
 City, The: The City as a Cultural Center
 City, The: The Islamic and Byzantine City
 Civil Society: Europe and the United States
 Civil Society: Responses in Africa and the Middle East
 Class
 Classicism
 Colonialism: Africa
 Colonialism: Latin America
 Colonialism: Southeast Asia
 Common Sense
 Communication of Ideas: Africa and Its Influence
 Communication of Ideas: The Americas and Their Influence
 Communication of Ideas: Asia and Its Influence
 Communication of Ideas: Europe and Its Influence
 Communication of Ideas: Middle East and Abroad
 Communication of Ideas: Orality and Advent of Writing
 Communication of Ideas: Southeast Asia
 Communism: Europe
 Communism: Latin America
 Composition, Musical
 Computer Science
 Confucianism
 Consciousness: Overview
 Conservatism
 Constitutionalism
 Context
 Corruption
 Corruption in Developed and Developing Countries
 Cosmology: Asia
 Cosmology: Cosmology and Astronomy
 Cosmopolitanism
 Creationism
 Creativity in the Arts and Sciences
 Creolization, Caribbean
 Crisis
 Critical Theory
 Cultural Capital
 Cultural History
 Cultural Revivals
 Cycles
 Dada
 Dance
 Death
 Death and Afterlife, Islamic Understanding of

READER'S GUIDE

Deism
 Democracy: Africa
 Dependency
 Determinism
 Development
 Diasporas: African Diaspora
 Diasporas: Jewish Diaspora
 Dictatorship in Latin America
 Diffusion, Cultural
 Discrimination
 Diversity
 Dream
 Dress
 Dystopia
 Ecology
 Economics
 Education: Asia, Traditional and Modern
 Education: China
 Education: Europe
 Education: Global Education
 Education: India
 Education: Islamic Education
 Education: Japan
 Education: North America
 Emotions
 Empire and Imperialism: Asia
 Empire and Imperialism: Middle East
 Empire and Imperialism: United States
 Empiricism
 Environmental Ethics
 Environmental History
 Epistemology: Modern
 Equality: Overview
 Equality: Gender Equality
 Equality: Racial Equality
 Eschatology
 Essentialism
 Ethnicity and Race: Africa
 Ethnicity and Race: Anthropology
 Ethnicity and Race: Islamic Views
 Ethnography
 Etiquette
 Eurocentrism
 Europe, Idea of
 Everyday Life
 Evil
 Examination Systems, China
 Experiment
 Falsifiability
 Family: Modernist Anthropological Theory
 Family Planning
 Feminism: Overview
 Feminism: Africa and African Diaspora
 Feminism: Chicana Feminisms
 Feminism: Third World U.S. Movement
 Fetishism: Overview
 Fetishism: Fetishism in Literature and Cultural Studies
 Formalism
 Foundationalism
 Friendship
 Game Theory
 Gay Studies
 Gender: Gender in the Middle East
 Gender in Art
 Gender Studies: Anthropology
 General Will
 Generation
 Genetics: Contemporary
 Genetics: History of
 Genius
 Genocide
 Genre
 Geography
 Geometry
 Gesture
 Ghetto
 Gift, The
 Gnosticism
 Good
 Happiness and Pleasure in European Thought
 Harmony
 Health and Disease
 Hermeneutics
 Historical and Dialectical Materialism
 Historiography
 History, Economic
 History, Idea of
 Honor, Middle Eastern Notions of
 Human Capital
 Humanism: Africa
 Humanism: Chinese Conception of
 Humanism: Europe and the Middle East
 Humanity: African Thought
 Humanity: Asian Thought
 Humanity: European Thought
 Humanity in the Arts
 Human Rights: Overview
 Humor
 Hygiene
 Iconography
 Idealism
 Ideas, History of
 Identity: Identity of Persons
 Identity, Multiple: Overview
 Identity, Multiple: Asian-Americans
 Identity, Multiple: Jewish Multiple Identity
 Imagination
 Immortality and the Afterlife
 Indigenismo
 Individualism
 Intelligentsia
 Intentionality
 Intercession in Middle Eastern Society
 International Order
 Interpretation
 Islam: Africa
 Islam: Shii
 Islam: Southeast Asia
 Islamic Science
 Japanese Philosophy, Japanese Thought
 Jihad
 Jouissance
 Judaism: Modern Judaism
 Justice: Overview
 Justice: Justice in American Thought
 Justice: Justice in East Asian Thought
 Kinship
 Knowledge
 Landscape in the Arts
 Language and Linguistics

- Language, Linguistics, and Literacy
 Language, Philosophy of: Modern
 Law
 Law, Islamic
 Leadership
 Learning and Memory, Contemporary Views
 Liberalism
 Liberty
 Life Cycle: Adolescence
 Life Cycle: Elders/Old Age
 Literary Criticism
 Literature: Overview
 Literature: African Literature
 Love, Western Notions of
 Loyalties, Dual
 Lysenkoism
 Magic
 Maps and the Ideas They Express
 Marriage and Fertility, European Views
 Masks
 Mathematics
 Matriarchy
 Medicine: Europe and the United States
 Medicine: India
 Medicine: Islamic Medicine
 Memory
 Men and Masculinity
 Mestizaje
 Metaphor
 Metaphysics: Renaissance to the Present
 Microcosm and Macrocosm
 Migration: Africa
 Migration: Migration in World History
 Migration: United States
 Millenarianism: Overview
 Millenarianism: Latin America and Native North America
 Mind
 Minority
 Monarchy: Overview
 Monarchy: Islamic Monarchy
 Monasticism
 Monism
 Motherhood and Maternity
 Motif: Motif in Literature
 Motif: Motif in Music
 Multiculturalism, Africa
 Museums
 Music, Anthropology of
 Musical Performance and Audiences
 Musicology
 Mysticism: Kabbalah
 Mysticism: Mysticism in African Thought
 Myth
 Narrative
 Nation
 Native Policy
 Natural History
 Natural Theology
 Nature
 Negritude
 New Criticism
 Nihilism
 Nonviolence
 Nude, The
 Objectivity
 Obligation
 Occidentalism
 Oral Traditions: Overview
 Organicism
 Orientalism: Overview
 Orthodoxy
 Orthopraxy: Western Orthopraxy
 Other, The, European Views of
 Pacifism
 Paradigm
 Patriotism
 Peace
 Peasants and Peasantry
 Periodization
 Periodization of the Arts
 Person, Idea of the
 Philanthropy
 Philosophies: African
 Philosophies: American
 Philosophy: Historical Overview and Recent Developments
 Philosophy: Relations to Other Intellectual Realms
 Philosophy, History of
 Philosophy, Moral: Africa
 Philosophy, Moral: Modern
 Philosophy and Religion in Western Thought
 Philosophy of Mind: Overview
 Philosophy of Religion
 Physics
 Platonism
 Pluralism
 Poetry and Poetics
 Political Protest, U.S.
 Political Science
 Political, The
 Polytheism
 Population
 Postcolonial Studies
 Poverty
 Power
 Practices
 Prehistory, Rise of
 Prejudice
 Presentism
 Privacy
 Probability
 Progress, Idea of
 Propaganda
 Property
 Pseudoscience
 Punishment
 Puritanism
 Queer Theory
 Race and Racism: Overview
 Race and Racism: Asia
 Race and Racism: Europe
 Race and Racism: United States
 Radicals/Radicalism
 Rational Choice
 Rationalism
 Reading
 Reason, Practical and Theoretical
 Reflexivity
 Reform: Europe and the United States

READER'S GUIDE

Reform: Islamic Reform
Regions and Regionalism, Eastern Europe
Religion: Overview
Religion: Africa
Religion: African Diaspora
Religion: East and Southeast Asia
Religion: Indigenous Peoples' View, South America
Religion: Latin America
Religion: Middle East Religion and the State: Africa
Religion and Science
Religion and the State: Europe
Religion and the State: Latin America
Religion and the State: Middle East
Religion and the State: United States
Renaissance
Republicanism: Latin America
Republicanism: Republic
Resistance
Resistance and Accommodation
Responsibility
Revolution
Rhetoric: Overview
Ritual: Public Ritual
Ritual: Religion
Romanticism in Literature and Politics
Sacred and Profane
Sacred Places
Sage Philosophy
Scarcity and Abundance, Latin America
Science: Overview
Science, History of
Sexuality: Overview
Sexuality: Islamic Views
Shinto
Skepticism
Slavery
Social Capital
Social History, U.S.
Society
Sophists, The
Sovereignty
Sport
State of Nature
State, The: Overview
Sufism
Suicide
Superstition
Symbolism
Syncretism
Temperance
Terror
Text/Textuality
Toleration
Totems
Trade
Tradition
Translation
Travel: Travel from Europe and the Middle East
Treaty
Trope
Truth
Universalism
University: Overview
Untouchability: Overview
Untouchability: Menstrual Taboos

Untouchability: Taboos
Utopia
Virtual Reality
Visual Culture
Visual Order to Organizing Collections
Volkgeist
Volunteerism, U.S.
War
War and Peace in the Arts
Wealth
Wildlife
Wisdom, Human
Witchcraft
Witchcraft, African Studies of
Women's History: Africa
Women's History: Asia
World Systems Theory, Latin America

Contemporary

ENTRIES FOCUSED ON THE PERIOD

African-American Ideas
Americanization, U.S.
Anticolonialism: Africa
Anticolonialism: Latin America
Anticolonialism: Middle East
Anticolonialism: Southeast Asia
Anti-Semitism: Islamic Anti-Semitism
Apartheid
Bioethics
Black Atlantic
Black Consciousness
Buddhism
Bureaucracy
Capitalism: Africa
Chicano Movement
Citizenship: Naturalization
Civil Disobedience
Communitarianism in African Thought
Consumerism
Continental Philosophy
Creationism
Critical Race Theory
Critical Theory
Cultural Studies
Democracy
Dress
Dystopia
Empire and Imperialism: Europe
Empiricism
Eugenics
Field Theories
Fundamentalism
Futurology
Gay Studies
Gender: Overview
Genetics: Contemporary
Globalization: Africa
Globalization: Asia
Globalization: General
Historicism
Humanity: African Thought
Human Rights: Overview
Human Rights: Women's Rights
Internal Colonialism
International Order

Jihad
 Liberation Theology
 Liberty
 Life
 Linguistic Turn
 Literary History
 Logic and Philosophy of Mathematics, Modern
 Maoism
 Marxism: Overview
 Marxism: Asia
 Marxism: Latin America
 Media, History of
 Modernization
 Modernization Theory
 Nationalism: Overview
 Nationalism: Africa
 Nationalism: Cultural Nationalism
 Nationalism: Middle East
 Neocolonialism
 Neoliberalism
 Nuclear Age
 Orientalism: African and Black Orientalism
 Pan-Africanism
 Pan-Arabism
 Pan-Asianism
 Pan-Islamism
 Pan-Turkism
 Paradigm
 Parties, Political
 Personhood in African Thought
 Phenomenology
 Philosophies: Feminist, Twentieth-Century
 Poetry and Poetics
 Populism: Latin America
 Populism: United States
 Positivism
 Postcolonial Studies
 Postcolonial Theory and Literature
 Postmodernism
 Pragmatism
 Presentism
 Privatization
 Protest, Political
 Psychoanalysis
 Psychology and Psychiatry
 Quantum
 Queer Theory
 Realism: Africa
 Relativism
 Relativity
 Science Fiction
 Segregation
 Sexual Harassment
 Sexuality: Sexual Orientation
 Sociability in African Thought
 Social Darwinism
 Socialisms, African
 Structuralism and Poststructuralism: Overview
 Structuralism and Poststructuralism: Anthropology
 Subjectivism
 Technology
 Terrorism, Middle East
 Text/Textuality
 Theater and Performance
 Third Cinema

Third World
 Totalitarianism
 Virtual Reality
 Virtue Ethics
 War
 Westernization: Africa
 Westernization: Southeast Asia
 Witchcraft
 Womanism
 Women and Femininity in U.S. Popular Culture
 Women's Studies
 Zionism

ENTRIES WITH EXAMPLES FROM THE PERIOD
 SINCE 1945 (especially since the 1970s)

Absolute Music
 Aesthetics: Africa
 Aesthetics: Asia
 Aesthetics: Europe and the Americas
 Africa, Idea of
 Afrocentricity
 Afropessimism
 Agnosticism
 Algebras
 Alienation
 Altruism
 Ambiguity
 America
 Analytical Philosophy
 Anarchism
 Animism
 Anthropology
 Antifeminism
 Anti-Semitism: Overview
 Architecture: Overview
 Architecture: Africa
 Arts: Overview
 Arts: Africa
 Asceticism: Western Asceticism
 Asian-American Ideas (Cultural Migration)
 Assimilation
 Atheism
 Authenticity: Africa
 Authoritarianism: Overview
 Authoritarianism: East Asia
 Authoritarianism: Latin America
 Authority
 Autobiography
 Autonomy
 Avant-Garde: Overview
 Aztlán
 Barbarism and Civilization
 Beauty and Ugliness
 Behaviorism
 Bilingualism and Multilingualism
 Biography
 Biology
 Body, The
 Bushido
 Calculation and Computation
 Cannibalism
 Capitalism: Overview
 Cartesianism
 Casuistry
 Causality
 Causation

READER'S GUIDE

Censorship
Change
Character
Childhood and Child Rearing
Christianity: Overview
Christianity: Asia
Cinema
Citizenship: Overview
Citizenship: Cultural Citizenship
City, The: The City as a Cultural Center
City, The: The City as Political Center
City, The: The Islamic and Byzantine City
Civil Society: Europe and the United States
Civil Society: Responses in Africa and the Middle East
Classicism
Colonialism: Africa
Colonialism: Southeast Asia
Communication of Ideas: Africa and Its Influence
Communication of Ideas: Asia and Its Influence
Communication of Ideas: Southeast Asia
Communism: Europe
Communism: Latin America
Composition, Musical
Computer Science
Confucianism
Consciousness: Overview
Conservatism
Consilience
Context
Corruption
Corruption in Developed and Developing Countries
Cosmopolitanism
Creolization, Caribbean
Crisis
Cultural Capital
Cultural History
Cultural Revivals
Cycles
Dada
Dance
Death
Death and Afterlife, Islamic Understanding of
Deism
Democracy: Africa
Demography
Demonology
Dependency
Determinism
Development
Diasporas: African Diaspora
Diasporas: Jewish Diaspora
Dictatorship in Latin America
Diffusion, Cultural
Discrimination
Diversity
Dream
Dualism
Ecology
Economics
Ecumenism
Education: Europe
Education: Global Education
Education: Islamic Education
Education: North America
Emotions
Empire and Imperialism: Middle East
Empire and Imperialism: United States
Enlightenment
Environment
Environmental Ethics
Environmental History
Epistemology: Modern
Equality: Overview
Equality: Gender Equality
Equality: Racial Equality
Essentialism
Ethnicity and Race: Africa
Ethnicity and Race: Anthropology
Ethnicity and Race: Islamic Views
Ethnocentrism
Ethnography
Ethnohistory, U.S.
Etiquette
Eurocentrism
Europe, Idea of
Evil
Existentialism
Experiment
Falsifiability
Family: Modernist Anthropological Theory
Family: Family in Anthropology since 1980
Family Planning
Fascism
Fatalism
Feminism: Overview
Feminism: Africa and African Diaspora
Feminism: Chicana Feminisms
Feminism: Islamic Feminism
Feminism: Third World U.S. Movement
Fetishism: Overview
Fetishism: Fetishism in Literature and Cultural Studies
Formalism
Foundationalism
Free Will, Determinism, and Predestination
Friendship
Game Theory
Gender: Gender in the Middle East
Gender in Art
Gender Studies: Anthropology
Generation
Genetics: History of
Genius
Genocide
Geography
Ghetto
Gift, The
Gnosticisim
Good
Happiness and Pleasure in European Thought
Harmony
Hate
Health and Disease
Hegelianism
Hermeneutics
Hierarchy and Order
Hinduism
Historical and Dialectical Materialism
Historiography
History, Economic
History, Idea of

- Honor, Middle Eastern Notions of
 Human Capital
 Humanism: Africa
 Humanism: Europe and the Middle East
 Humanism: Secular Humanism in the United States
 Humanity: European Thought
 Humanity in the Arts
 Humor
 Ideas, History of
 Identity: Identity of Persons
 Identity: Personal and Social Identity
 Identity, Multiple: Overview
 Identity, Multiple: Asian-Americans
 Identity, Multiple: Jewish Multiple Identity
 Imagination
 Immortality and the Afterlife
 Impressionism
 Intelligentsia
 Intentionality
 Intercession in Middle Eastern Society
 Interdisciplinarity
 Islam: Shii
 Islam: Southeast Asia
 Jainism
 Japanese Philosophy, Japanese Thought
 Jouissance
 Judaism: Modern Judaism
 Justice: Overview
 Justice: Justice in American Thought
 Kantianism
 Kinship
 Knowledge
 Landscape in the Arts
 Language and Linguistics
 Language, Philosophy of: Modern
 Law
 Law, Islamic
 Leadership
 Learning and Memory, Contemporary Views
 Liberalism
 Life Cycle: Adolescence
 Life Cycle: Elders/Old Age
 Literary Criticism
 Literature: African Literature
 Lysenkoism
 Machiavellism
 Machismo
 Magic
 Maps and the Ideas They Express
 Marriage and Fertility, European Views
 Masks
 Mathematics
 Matriarchy
 Medicine: China
 Medicine: Europe and the United States
 Medicine: Islamic Medicine
 Meditation: Eastern Meditation
 Meme
 Memory
 Men and Masculinity
 Mestizaje
 Metaphor
 Metaphysics: Renaissance to the Present
 Migration: Africa
 Migration: Migration in World History
 Migration: United States
 Millenarianism: Overview
 Millenarianism: Islamic
 Millenarianism: Latin America and Native North America
 Mind
 Minority
 Modernism: Latin America
 Modernity: Overview
 Modernity: Africa
 Modernity: East Asia
 Monarchy: Overview
 Monasticism
 Monism
 Moral Sense
 Motherhood and Maternity
 Motif: Motif in Literature
 Motif: Motif in Music
 Multiculturalism, Africa
 Museums
 Music, Anthropology of
 Musical Performance and Audiences
 Musicology
 Mysticism: Mysticism in African Thought
 Narrative
 Nation
 Native Policy
 Natural Law
 Natural Theology
 Nature
 Negritude
 New Criticism
 Nihilism
 Nomadism
 Nonviolence
 Objectivity
 Obligation
 Occidentalism
 Oral Traditions: Overview
 Organicism
 Orientalism: Overview
 Orthodoxy
 Pacifism
 Patriotism
 Peace
 Peasants and Peasantry
 Periodization of the Arts
 Person, Idea of the
 Perspective
 Philanthropy
 Philosophies: American
 Philosophy, History of
 Philosophy, Moral: Africa
 Philosophy, Moral: Modern
 Philosophy and Religion in Western Thought
 Philosophy of Mind: Overview
 Philosophy of Religion
 Pluralism
 Political Protest, U.S.
 Political Science
 Population
 Poverty
 Power
 Practices
 Prejudice

READER'S GUIDE

Privacy
Probability
Progress, Idea of
Propaganda
Property
Pseudoscience
Public Sphere
Punishment
Race and Racism: Overview
Race and Racism: Asia
Race and Racism: Europe
Race and Racism: United States
Radicals/Radicalism
Rational Choice
Reading
Reason, Practical and Theoretical
Reflexivity
Reform: Europe and the United States
Reform: Islamic Reform
Regions and Regionalism, Eastern Europe
Religion: Africa
Religion: African Diaspora
Religion: Indigenous Peoples' View, South America
Religion: Latin America
Religion: Middle East
Religion and Science
Religion and the State: Africa
Religion and the State: Latin America
Religion and the State: Middle East
Religion and the State: United States
Renaissance
Representation: Mental Representation
Representation: Political Representation
Resistance
Resistance and Accommodation
Responsibility
Ritual: Public Ritual
Ritual: Religion
Sacred Places
Sacred Texts: Koran
Sage Philosophy
Science: Overview
Science: East Asia
Science, History of
Scientific Revolution
Secularization and Secularism
Sexuality: Overview
Sexuality: Islamic Views
Shinto
Skepticism
Slavery
Social Capital
Social Contract
Social History, U.S.
Society
Sophists, The
Sovereignty
Sport
State, The: Overview
State, The: The Postcolonial State
State of Nature
Superstition
Surrealism
Symbolism
Syncretism

Taste
Terror
Third World Literature
Toleration
Totems
Trade
Tradition
Translation
Treaty
Tribalism, Middle East
Trope
Truth
Universalism
University: Overview
University: Postcolonial
Untouchability: Overview
Untouchability: Menstrual Taboos
Untouchability: Taboos
Utilitarianism
Utopia
Visual Culture
Visual Order to Organizing Collections
War and Peace in the Arts
Wealth
Wildlife
Wisdom, Human
Witchcraft, African Studies of
Women's History: Africa
Women's History: Asia
Work
World Systems Theory, Latin America

LIBERAL ARTS DISCIPLINES AND PROFESSIONS

This section is in accord with the university divisions of the Liberal Arts into Fine Arts, Humanities, Social Sciences, and Sciences and the graduate programs of the professions of Law, Medicine, and Engineering. The sample of Interdisciplinary Programs are listed under their most common university grouping. For example, Fine Arts includes Performance Arts; Social Sciences includes Women's Studies and Gender Studies, as well as Ethnic Studies; Sciences includes Ecology and Geology, as well as Computer Sciences; Humanities includes programs of Communication, Language, and Linguistics. Meanwhile, the growth of interdisciplinary programs reflects the increasing overlap between studies listed under the labels of Fine Arts, Humanities, Social Sciences, and Sciences. A discipline or interdisciplinary program only appears once, but an entry may appear under the several disciplines and interdisciplinary programs that influenced the scholarship of the article. Titles that appear in bold indicate entries that are especially suited as an introduction to the discipline.

Under the category Multidisciplinary Practices, there are entries on the many methods, techniques, theories, and approaches that have spread across the disciplines. The Multidisciplinary Practices help explain the contemporary trend of interdisciplinarity for which the history of ideas has long been known. At the end of this Reader's Guide is a listing of a number of entries that overlap three of the four divisions and a listing of entries that overlap all four divisions.

Fine Arts

VISUAL STUDIES

Absolute Music
Aesthetics: Africa
Aesthetics: Asia
Aesthetics: Europe and the Americas
 Ambiguity
 Anthropology
 Architecture: Overview
 Architecture: Africa
 Architecture: Asia
 Arts: Overview
 Arts: Africa
 Asceticism: Hindu and Buddhist Asceticism
 Asceticism: Western Asceticism
 Avant-Garde: Overview
 Avant-Garde: Militancy
 Aztlán
 Beauty and Ugliness
 Body, The
 Buddhism
 Change
 Chinese Thought
 Cinema
 City, The: Latin America
 City, The: The City as a Cultural Center
 City, The: The Islamic and Byzantine City
 Classicism
 Classification of Arts and Sciences, Early Modern
 Communication of Ideas: Asia and Its Influence
 Composition, Musical
 Consumerism
 Context
 Cosmopolitanism
 Creativity in the Arts and Sciences
 Cultural History
 Dada
 Death
 Dream
 Dress
 Dystopia
 Environmental Ethics
 Environmental History
 Everyday Life
 Expressionism
 Extirpation
 Fascism
 Fetishism: Overview
 Garden
 Gay Studies
 Gender in Art
 Genre
 Geography
 Geometry
 Gesture
 Ghetto
 Globalization: Asia
 Heaven and Hell (Asian Focus)
 Hinduism
 History, Idea of
 Humanity: European Thought
 Humanity in the Arts
 Humor
 Iconography
 Ideas, History of

Images, Icons, and Idols
 Imagination
 Impressionism
 Islamic Science
 Kantianism
 Knowledge
 Landscape in the Arts
 Life Cycle: Overview
 Literary History
 Literature: Overview
 Maps and the Ideas They Express
 Masks
 Matriarchy
Media, History of
 Medicine: Europe and the United States
 Mestizaje
 Modernism: Overview
 Modernism: Latin America
 Modernity: Africa
 Modernity: East Asia
 Monarchy: Overview
 Motherhood and Maternity
 Museums
 Musical Performance and Audiences
 Musicology
 Mysticism: Chinese Mysticism
 Mysticism: Christian Mysticism
 Naturalism in Art and Literature
 Negritude
 Nude, The
 Occidentalism
 Organicism
 Pan-Africanism
 Paradise on Earth
Periodization of the Arts
 Perspective
 Philosophy: Historical Overview and Recent Developments
 Political Protest, U.S.
 Postmodernism
 Pre-Columbian Civilization
 Protest, Political
 Psychoanalysis
 Pythagoreanism
 Realism
 Realism: Africa
 Religion: Africa
 Renaissance
 Representation: Mental Representation
 Ritual: Public Ritual
 Sacred Places
 Sacred Texts: Asia
 Science: East Asia
 Science, History of
 Science Fiction
 Social History, U.S.
 Sport
 Surrealism
 Symbolism
 Syncretism
 Taste
 Text/Textuality
 Textiles and Fiber Arts as Catalysts for Ideas
 Third Cinema
 Victorianism

READER'S GUIDE

Virtual Reality
 Visual Culture
 Visual Order to Organizing Collections
 War and Peace in the Arts
 Westernization: Southeast Asia
 Women and Femininity in U.S. Popular Culture
 Yin and Yang

MUSIC

Absolute Music
 Aesthetics: Africa
 Aesthetics: Asia
 Authenticity: Africa
 Avant-Garde: Overview
 Cinema
 Classicism
 Classification of Arts and Sciences, Early Modern
 Communication of Ideas: Africa and Its Influence
 Composition, Musical
 Context
 Cosmopolitanism
 Dada
 Dance
 Empire and Imperialism: United States
 Formalism
 Generation
 Genre
 Harmony
 Hinduism
 Humanism: Africa
 Humanism: Chinese Conception of
 Humor
 Iconography
 Identity, Multiple: Jewish Multiple Identity
 Judaism: Judaism to 1800
 Knowledge
 Learning and Memory, Contemporary Views
 Love, Western Notions of
 Modernism: Overview
 Motif: Motif in Music
Music, Anthropology of
Musical Performance and Audiences
Musicology
 Mysticism: Chinese Mysticism
 Orientalism: Overview
 Pan-Asianism
 Pietism
 Political Protest, U.S.
 Postmodernism
 Protest, Political
 Pythagoreanism
 Realism: Africa
 Religion: Africa
 Religion: African Diaspora
 Resistance
 Resistance and Accommodation
 Society
 Sophists, The
 Symbolism
 Taste
 Text/Textuality
 Third Cinema
 Virtual Reality
 Visual Order to Organizing Collections
 Westernization: Africa

PERFORMANCE ARTS (includes drama, dance, oratory, ritual, and ceremony)

Absolute Music
 Aesthetics: Africa
 Aesthetics: Asia
 Alienation
 Americanization, U.S.
 Ancestor Worship
 Anthropology
 Arts: Overview
 Asceticism: Hindu and Buddhist Asceticism
 Asceticism: Western Asceticism
 Astronomy, Pre-Columbian and Latin American
 Authenticity: Africa
 Autobiography
 Avant-Garde: Overview
 Body, The
 Cannibalism
 Censorship
 Cinema
 Civil Disobedience
 Civil Society: Europe and the United States
 Communication of Ideas: Africa and Its Influence
 Communication of Ideas: Asia and Its Influence
 Communication of Ideas: Orality and Advent of Writing
 Communication of Ideas: Southeast Asia
 Composition, Musical
 Confucianism
 Context
 Cosmopolitanism
 Creolization, Caribbean
 Cultural Capital
 Cynicism
 Dada
Dance
 Determinism
 Dialogue and Dialectics: Socratic
 Dialogue and Dialectics: Talmudic
 Dictatorship in Latin America
 Dream
 Dress
 Emotions
 Empire and Imperialism: Europe
 Environment
 Equality: Overview
 Ethnicity and Race: Anthropology
 Etiquette
 Everyday Life
 Expressionism
 Extirpation
 Fascism
 Feminism: Chicana Feminisms
 Fetishism: Overview
 Fetishism: Fetishism in Literature and Cultural Studies
 Game Theory
 Gay Studies
 Gender: Overview
 Gender in Art
 Generation
 Genre
 Gesture
 Harmony
 Hinduism
 History, Economic

- History, Idea of
 Honor
 Humanism: Africa
 Humanism: Chinese Conception of
 Humanity: African Thought
 Humor
 Ideas, History of
 Identity, Multiple: Jewish Multiple Identity
 Images, Icons, and Idols
 Intelligentsia
 Islam: Shii
 Islam: Sunni
 Jouissance
 Judaism: Judaism to 1800
 Knowledge
 Language and Linguistics
 Language, Philosophy of: Modern
 Law, Islamic
 Leadership
 Learning and Memory, Contemporary Views
 Life Cycle: Overview
 Literary Criticism
 Literary History
 Literature: African Literature
 Love, Western Notions of
 Magic
 Manichaeism
 Masks
 Media, History of
 Medicine: China
 Medicine: Islamic Medicine
 Meditation: Eastern Meditation
 Men and Masculinity
 Metaphor
 Millenarianism: Islamic
 Millenarianism: Latin America and Native North America
 Modernism: Overview
 Modernity: Overview
 Modernity: Africa
 Motif: Motif in Music
 Music, Anthropology of
 Musical Performance and Audiences
 Musicology
 Mysticism: Chinese Mysticism
 Mysticism: Islamic Mysticism in Asia
 Mysticism: Kabbalah
 Myth
 Narrative
 Nation
 Nationalism: Middle East
 New Criticism
 Nomadism
 Nuclear Age
 Oral Traditions: Overview
 Orientalism: Overview
 Orthodoxy
 Orthopraxy: Asia
 Pan-Turkism
 Periodization of the Arts
 Person, Idea of the
 Philosophies: African
 Philosophies: American
 Philosophies: Feminist, Twentieth-Century
 Philosophies: Islamic
 Philosophy: Historical Overview and Recent Developments
 Philosophy, Moral: Ancient
 Philosophy of Mind: Ancient and Medieval
 Pietism
 Poetry and Poetics
 Political Protest, U.S.
 Populism: United States
 Postmodernism
 Practices
 Pre-Columbian Civilization
 Propaganda
 Protest, Political
 Psychoanalysis
 Punishment
 Queer Theory
 Reading
 Realism: Africa
 Reflexivity
 Reform: Europe and the United States
 Relativism
 Religion: Africa
 Religion: African Diaspora
 Religion: East and Southeast Asia
 Religion: Indigenous Peoples' View, South America
 Religion: Latin America
 Religion: Middle East
 Religion and the State: United States
 Republicanism: Republic
 Resistance
 Resistance and Accommodation
 Responsibility
Rhetoric: Overview
Rhetoric: Ancient and Medieval
 Ritual: Public Ritual
 Ritual: Religion
 Romanticism in Literature and Politics
 Sacred Places
 Sacred Texts: Asia
 Sexuality: Overview
 Shinto
 Slavery
 Society
 Sophists, The
 Sport
 Stoicism
 Subjectivism
 Superstition
 Surrealism
 Symbolism
 Syncretism
 Taste
 Temperance
 Text/Textuality
Theater and Performance
 Third Cinema
 Third World Literature
 Time: China
 Time: India
 Toleration
 Totalitarianism
 Totems
 Tragedy and Comedy
 Translation
 Trope

READER'S GUIDE

Untouchability: Menstrual Taboos
Utilitarianism
Victorianism
Virtual Reality
Volunteerism, U.S.
Westernization: Middle East
Westernization: Southeast Asia
Wisdom, Human
Witchcraft
Witchcraft, African Studies of
Yin and Yang
Yoga

Humanities

COMMUNICATION, LANGUAGE, AND LINGUISTICS

Aesthetics: Africa
Aesthetics: Asia
Africa, Idea of
Afrocentricity
Agnosticism
Algebras
Americanization, U.S.
Analytical Philosophy
Anthropology
Anticolonialism: Africa
Asceticism: Hindu and Buddhist Asceticism
Asceticism: Western Asceticism
Astronomy, Pre-Columbian and Latin American
Authenticity: Africa
Avant-Garde: Overview
Avant-Garde: Militancy
Aztlán
Barbarism and Civilization
Beauty and Ugliness
Behaviorism
Bilingualism and Multilingualism
Body, The
Borders, Borderlands, and Frontiers, Global
Buddhism
Calculation and Computation
Calendar
Cannibalism
Casuistry
Censorship
Chinese Thought
Cinema
Civil Disobedience
Classification of Arts and Sciences, Early Modern
Colonialism: Southeast Asia
Communication of Ideas: Africa and Its Influence
Communication of Ideas: The Americas and Their Influence
Communication of Ideas: Asia and Its Influence
Communication of Ideas: Europe and Its Influence
Communication of Ideas: Middle East and Abroad
Communication of Ideas: Orality and Advent of Writing
Communication of Ideas: Southeast Asia
Computer Science
Consumerism
Context
Continental Philosophy
Cosmopolitanism
Creolization, Caribbean
Critical Theory
Cultural Capital

Cultural History
Cultural Revivals
Cultural Studies
Cynicism
Dance
Democracy
Determinism
Dialogue and Dialectics: Socratic
Diasporas: Jewish Diaspora
Dictatorship in Latin America
Diffusion, Cultural
Discrimination
Diversity
Dream
Dress
Ecumenism
Education: Asia, Traditional and Modern
Empire and Imperialism: Asia
Empire and Imperialism: Europe
Empire and Imperialism: United States
Empiricism
Encyclopedism
Epistemology: Ancient
Epistemology: Early Modern
Epistemology: Modern
Ethnicity and Race: Africa
Ethnicity and Race: Anthropology
Ethnicity and Race: Islamic Views
Etiquette
Eurocentrism
Everyday Life
Examination Systems, China
Extirpation
Fallacy, Logical
Feminism: Overview
Feminism: Chicana Feminisms
Fetishism: Overview
Fetishism: Fetishism in Literature and Cultural Studies
Feudalism, European
Formalism
Gender: Gender in the Middle East
Gender in Art
Geometry
Gesture
Globalization: Asia
Globalization: General
Greek Science
Harmony
Hegemony
Hermeneutics
Hinduism
History, Economic
History, Idea of
Humanism: Africa
Humanism: Chinese Conception of
Humanism: Europe and the Middle East
Humanism: Renaissance
Humanity: African Thought
Human Rights: Overview
Idealism
Ideas, History of
Identity: Identity of Persons
Identity, Multiple: Overview
Identity, Multiple: Jewish Multiple Identity
Indigenismo

- Intelligentsia
 Interdisciplinarity
 Interpretation
 Islam: Africa
 Islam: Southeast Asia
 Islam: Sunni
 Islamic Science
 Japanese Philosophy, Japanese Thought
 Jihad
 Jouissance
 Judaism: Judaism to 1800
 Kantianism
 Kinship
 Knowledge
Language and Linguistics
Language, Linguistics, and Literacy
 Language, Philosophy of: Ancient and Medieval
 Language, Philosophy of: Modern
 Law
 Liberty
 Life Cycle: Overview
 Linguistic Turn
 Literary Criticism
 Literary History
 Literature: Overview
 Literature: African Literature
 Machismo
 Magic
 Maps and the Ideas They Express
 Masks
 Materialism in Eighteenth-Century European Thought
 Mathematics
 Matriarchy
 Media, History of
 Medicine: Europe and the United States
 Medicine: India
 Meme
 Mestizaje
 Metaphor
 Metaphysics: Renaissance to the Present
 Migration: Africa
 Migration: United States
 Millenarianism: Latin America and Native North America
 Mind
 Minority
Modernism: Overview
 Modernity: Overview
 Modernity: Africa
 Monarchy: Overview
 Motherhood and Maternity
 Motif: Motif in Literature
 Motif: Motif in Music
 Multiculturalism, Africa
 Music, Anthropology of
 Musical Performance and Audiences
 Musicology
 Mysticism: Chinese Mysticism
 Mysticism: Christian Mysticism
 Mysticism: Islamic Mysticism in Asia
 Mysticism: Kabbalah
 Mysticism: Mysticism in African Thought
 Narrative
 Nation
 Nationalism: Overview
 Nationalism: Middle East
 Native Policy
 Natural History
 New Criticism
 Nomadism
 Objectivity
 Occidentalism
Oral Traditions: Overview
 Organicism
 Orientalism: Overview
 Orthodoxy
 Pacifism
 Pan-Africanism
 Pan-Arabism
 Pan-Asianism
 Pan-Turkism
 Paradigm
 Patriotism
 Periodization of the Arts
 Person, Idea of the
 Personhood in African Thought
 Philosophies: African
 Philosophies: American
 Philosophies: Feminist, Twentieth-Century
 Philosophies: Islamic
 Philosophy: Historical Overview and Recent Developments
 Philosophy of Mind: Overview
 Philosophy of Mind: Ancient and Medieval
 Philosophy of Religion
 Poetry and Poetics
 Political Protest, U.S.
 Positivism
 Practices
 Pre-Columbian Civilization
 Prejudice
 Presentism
 Privacy
 Probability
 Progress, Idea of
 Propaganda
 Protest, Political
 Pseudoscience
 Psychology and Psychiatry
 Public Sphere
 Punishment
 Pythagoreanism
 Quantum
 Queer Theory
 Race and Racism: Asia
 Race and Racism: Europe
 Race and Racism: United States
 Reading
 Realism
 Realism: Africa
 Reflexivity
 Relativism
 Relativity
 Religion: Africa
 Religion: African Diaspora
 Religion: East and Southeast Asia
 Religion: Indigenous Peoples' View, South America
 Religion: Latin America
 Religion: Middle East
 Religion and the State: Latin America

READER'S GUIDE

Religion and the State: Middle East
Representation: Mental Representation
Republicanism: Republic
Resistance
Resistance and Accommodation
Responsibility
Rhetoric: Overview
Ritual: Public Ritual
Ritual: Religion
Romanticism in Literature and Politics
Sacred and Profane
Sacred Places
Sacred Texts: Asia
Sacred Texts: Koran
Sage Philosophy
Science: East Asia
Science, History of
Sexual Harassment
Sexuality: Overview
Sexuality: Sexual Orientation
Shinto
Slavery
Social History, U.S.
Society
Sophists, The
Sport
State, The: Overview
Stoicism
Structuralism and Poststructuralism: Overview
Structuralism and Poststructuralism: Anthropology
Subjectivism
Superstition
Surrealism
Symbolism
Syncretism
Technology
Temperance
Text/Textuality
Textiles and Fiber Arts as Catalysts for Ideas
Theater and Performance
Third Cinema
Third World Literature
Time: India
Time: Traditional and Utilitarian
Toleration
Totalitarianism
Totems
Trade
Tragedy and Comedy
Translation
Travel: Travel from Europe and the Middle East
Treaty
Trope
Truth
Untouchability: Taboos
Utilitarianism
Victorianism
Virtual Reality
Visual Culture
Visual Order to Organizing Collections
Westernization: Middle East
Westernization: Southeast Asia
Wisdom, Human
Witchcraft
Witchcraft, African Studies of

Womanism
Women and Femininity in U.S. Popular Culture
Yin and Yang

LITERATURE

Absolute Music
Aesthetics: Africa
Aesthetics: Asia
Aesthetics: Europe and the Americas
Africa, Idea of
African-American Ideas
Alienation
America
Anticolonialism: Africa
Anti-Semitism: Overview
Architecture: Asia
Asceticism: Hindu and Buddhist Asceticism
Authenticity: Africa
Autobiography
Avant-Garde: Overview
Aztlán
Biography
Buddhism
Bushido
Casuistry
Chinese Thought
Cinema
Classicism
Classification of Arts and Sciences, Early Modern
Colonialism: Africa
Communication of Ideas: Africa and Its Influence
Communication of Ideas: Asia and Its Influence
Communication of Ideas: Europe and Its Influence
Communication of Ideas: Middle East and Abroad
Communication of Ideas: Orality and Advent of Writing
Communication of Ideas: Southeast Asia
Consciousness: Overview
Continental Philosophy
Corruption
Cosmopolitanism
Creativity in the Arts and Sciences
Critical Race Theory
Critical Theory
Cultural Studies
Dada
Dialogue and Dialectics: Socratic
Dream
Dystopia
Education: Islamic Education
Empire and Imperialism: Europe
Enlightenment
Etiquette
Europe, Idea of
Evil
Examination Systems, China
Existentialism
Expressionism
Extirpation
Fascism
Feminism: Overview
Feminism: Chicana Feminisms
Feminism: Third World U.S. Movement
Fetishism: Fetishism in Literature and Cultural Studies
Formalism
Friendship
Futurology

- Game Theory
 Gay Studies
 Gender: Overview
 Gender: Gender in the Middle East
 Generation
 Genius
Genre
 Globalization: Asia
 Gnosticism
 Heaven and Hell
 Heaven and Hell (Asian Focus)
 Hedonism in European Thought
 Hermeneutics
 Hinduism
 Historiography
 History, Economic
 History, Idea of
 Honor, Middle Eastern Notions of
 Humanism: Africa
 Humanism: Chinese Conception of
 Humanism: Renaissance
 Humanity: African Thought
 Humor
 Ideas, History of
 Identity, Multiple: Jewish Multiple Identity
 Imagination
 Indigenismo
 Individualism
 Intelligentsia
 Interdisciplinarity
 Interpretation
 Islam: Africa
 Islam: Shii
 Islam: Sunni
 Islamic Science
 Japanese Philosophy, Japanese Thought
 Jouissance
 Judaism: Judaism to 1800
 Judaism: Modern Judaism
 Language and Linguistics
 Language, Philosophy of: Ancient and Medieval
 Language, Philosophy of: Modern
 Law, Islamic
 Leadership
 Life Cycle: Overview
 Linguistic Turn
 Literary Criticism
Literary History
 Literature: Overview
 Literature: African Literature
 Love, Western Notions of
 Magic
 Manichaeism
 Marxism: Overview
 Marxism: Latin America
 Masks
 Matriarchy
 Medicine: China
 Medicine: Islamic Medicine
 Memory
 Men and Masculinity
 Mestizaje
 Metaphor
 Metaphysics: Renaissance to the Present
 Microcosm and Macrocosm
 Millenarianism: Overview
 Millenarianism: Islamic
 Millenarianism: Latin America and Native North America
 Modernism: Overview
 Modernism: Latin America
 Modernity: Overview
 Modernity: East Asia
 Mohism
 Monarchy: Overview
 Motherhood and Maternity
 Motif: Motif in Literature
 Motif: Motif in Music
 Musicology
 Mysticism: Chinese Mysticism
 Mysticism: Christian Mysticism
 Myth
 Narrative
 Nation
 Nationalism: Africa
 Naturalism
 Naturalism in Art and Literature
 Nature
 Negritude
New Criticism
 Occidentalism
 Oral Traditions: Overview
 Organicism
 Orientalism: Overview
 Orientalism: African and Black Orientalism
 Pan-Africanism
 Pan-Asianism
 Person, Idea of the
 Phenomenology
 Philosophies: African
 Philosophies: American
 Philosophies: Feminist, Twentieth-Century
 Philosophies: Islamic
 Philosophy: Historical Overview and Recent Developments
 Philosophy, Moral: Ancient
 Philosophy, Moral: Medieval and Renaissance
 Pietism
 Platonism
Poetry and Poetics
 Political Protest, U.S.
 Postcolonial Studies
 Postcolonial Theory and Literature
 Postmodernism
 Practices
 Privacy
 Property
 Prophecy
 Protest, Political
 Psychoanalysis
 Queer Theory
 Race and Racism: Europe
 Reading
 Realism: Africa
 Religion: Africa
 Religion: African Diaspora
 Religion: East and Southeast Asia
 Religion: Indigenous Peoples' View, South America
 Religion: Latin America
 Religion: Middle East

READER'S GUIDE

- Religion and the State: United States
- Renaissance
- Republicanism: Republic
- Resistance and Accommodation
- Rhetoric: Overview
- Rhetoric: Ancient and Medieval
- Ritual: Public Ritual
- Romanticism in Literature and Politics
- Sacred Texts: Asia
- Sacred Texts: Koran
- Sage Philosophy
- Scholasticism
- Science Fiction
- Science: Overview
- Sexuality: Overview
- Slavery
- Social History, U.S.
- Society
- Sophists, The
- State of Nature
- Stoicism
- Structuralism and Poststructuralism: Overview
- Surrealism
- Symbolism
- Syncretism
- Text/Textuality
- Theater and Performance
- Third World Literature
- Toleration
- Totalitarianism
- Tragedy and Comedy
- Translation
- Travel: Travel from Europe and the Middle East
- Trope
- Utopia
- Victorianism
- Virtue Ethics
- Visual Order to Organizing Collections
- War and Peace in the Arts
- Wisdom, Human
- RELIGION
- Abolitionism
- Aesthetics: Africa
- Aesthetics: Asia
- Africa, Idea of
- Agnosticism
- Alchemy: China
- Alchemy: Europe and the Middle East
- Alienation
- Altruism
- Americanization, U.S.
- Ancestor Worship
- Animism
- Antifeminism
- Anti-Semitism: Overview
- Anti-Semitism: Islamic Anti-Semitism
- Architecture: Overview
- Architecture: Asia
- Aristotelianism
- Arts: Overview
- Arts: Africa
- Asceticism: Hindu and Buddhist Asceticism
- Asceticism: Western Asceticism
- Assimilation
- Astrology: Overview
- Astrology: China
- Astronomy, Pre-Columbian and Latin American
- Atheism
- Authority
- Autonomy
- Bioethics
- Body, The
- Buddhism
- Calendar
- Cannibalism
- Capitalism: Overview
- Cartesianism
- Casuistry
- Causality
- Causation in East Asian and Southeast Asian Philosophy
- Censorship
- Change
- Chinese Thought
- Christianity: Overview
- Christianity: Asia
- City, The: Latin America
- City, The: The Islamic and Byzantine City
- Civil Disobedience
- Civil Society: Europe and the United States
- Classification of Arts and Sciences, Early Modern
- Colonialism: Southeast Asia
- Communication of Ideas: Africa and Its Influence
- Communication of Ideas: Asia and Its Influence
- Communication of Ideas: Middle East and Abroad
- Communication of Ideas: Orality and Advent of Writing
- Communication of Ideas: Southeast Asia
- Composition, Musical
- Confucianism
- Consciousness: Indian Thought
- Conservatism
- Continental Philosophy
- Corruption
- Cosmology: Asia
- Cosmology: Cosmology and Astronomy
- Cosmopolitanism
- Creationism
- Cultural History
- Dance
- Daoism
- Death
- Death and Afterlife, Islamic Understanding of
- Deism
- Demonology
- Dialogue and Dialectics: Talmudic
- Diasporas: Jewish Diaspora
- Dictatorship in Latin America
- Diversity
- Dream
- Dress
- Dualism
- Ecology
- Ecumenism
- Education: Asia, Traditional and Modern
- Education: Europe
- Education: Islamic Education
- Education: Japan
- Empire and Imperialism: Overview
- Empire and Imperialism: Americas
- Empire and Imperialism: Europe
- Enlightenment

- Environment
 Environmental Ethics
 Environmental History
 Epicureanism
 Epistemology: Early Modern
 Epistemology: Modern
 Equality: Overview
 Eschatology
 Ethnicity and Race: Islamic Views
 Etiquette
 Europe, Idea of
 Everyday Life
 Evil
 Evolution
 Existentialism
 Expressionism
 Extirpation
 Family: Family in Anthropology since 1980
 Fascism
 Fatalism
 Feminism: Overview
 Feminism: Africa and African Diaspora
 Feminism: Chicana Feminisms
 Feminism: Islamic Feminism
 Fetishism: Overview
 Form, Metaphysical, in Ancient and Medieval Thought
 Free Will, Determinism, and Predestination
 Friendship
 Fundamentalism
 Gay Studies
 Gender: Gender in the Middle East
 Gender in Art
 General Will
 Genetics: Contemporary
 Genocide
 Ghetto
 Gift, The
 Globalization: Asia
 Gnosticism
 Good
 Harmony
 Health and Disease
 Heaven and Hell
 Heaven and Hell (Asian Focus)
 Hedonism in European Thought
 Heresy and Apostasy
 Hermeneutics
 Hierarchy and Order
 Hinduism
 Historicism
 Historiography
 History, Idea of
 Honor
 Honor, Middle Eastern Notions of
 Humanism: Africa
 Humanism: Chinese Conception of
 Humanism: Renaissance
 Humanism: Secular Humanism in the United States
 Humanity: African Thought
 Humanity: Asian Thought
 Humanity: European Thought
 Humanity in the Arts
 Human Rights: Overview
 Iconography
 Ideas, History of
 Identity: Identity of Persons
 Identity, Multiple: Jewish Multiple Identity
 Images, Icons, and Idols
 Imagination
 Immortality and the Afterlife
 Individualism
 Intelligentsia
 Intentionality
 Intercession in Middle Eastern Society
 Interdisciplinarity
 Islam: Africa
 Islam: Shii
 Islam: Southeast Asia
 Islam: Sunni
 Islamic Science
 Jainism
 Japanese Philosophy, Japanese Thought
 Jihad
 Jouissance
 Judaism: Judaism to 1800
 Judaism: Modern Judaism
 Kantianism
 Kinship
 Knowledge
 Language and Linguistics
 Language, Philosophy of: Ancient and Medieval
 Law, Islamic
 Liberation Theology
 Life
 Literary History
 Love, Western Notions of
 Magic
 Manichaeism
 Marriage and Fertility, European Views
 Marxism: Overview
 Marxism: Latin America
 Masks
 Materialism in Eighteenth-Century European Thought
 Matriarchy
 Medicine: Europe and the United States
 Medicine: Islamic Medicine
 Meditation: Eastern Meditation
 Men and Masculinity
 Metaphor
 Millenarianism: Overview
 Millenarianism: Islamic
 Millenarianism: Latin America and Native North America
 Minority
 Miracles
 Modernity: Overview
 Mohism
 Monarchy: Overview
 Monarchy: Islamic Monarchy
 Monasticism
 Monism
 Motherhood and Maternity
 Motif: Motif in Music
 Multiculturalism, Africa
 Museums
 Music, Anthropology of
 Musical Performance and Audiences
 Mysticism: Chinese Mysticism
 Mysticism: Christian Mysticism
 Mysticism: Islamic Mysticism

READER'S GUIDE

- Mysticism: Islamic Mysticism in Asia
 Mysticism: Kabbalah
 Mysticism: Mysticism in African Thought
 Myth
 Nation
 Nationalism: Cultural Nationalism
 Nationalism: Middle East
 Naturalism
 Natural Law
 Natural Theology
 Newtonianism
 Nomadism
 Nonviolence
 Nude, The
 Obligation
 Organicism
 Orientalism: Overview
 Orientalism: African and Black Orientalism
 Orthodoxy
 Orthopraxy: Asia
 Orthopraxy: Western Orthopraxy
 Other, The, European Views of
 Pacifism
 Paradise on Earth
 Parties, Political
 Peace
 Periodization of the Arts
 Person, Idea of the
 Personhood in African Thought
 Perspective
 Philanthropy
 Philosophies: African
 Philosophies: American
 Philosophies: Feminist, Twentieth-Century
 Philosophies: Islamic
 Philosophy: Historical Overview and Recent Developments
 Philosophy: Relations to Other Intellectual Realms
 Philosophy, Moral: Africa
 Philosophy, Moral: Medieval and Renaissance
 Philosophy, Moral: Modern
 Philosophy and Religion in Western Thought
 Philosophy of Mind: Ancient and Medieval
 Philosophy of Religion
 Physics
 Pietism
 Platonism
 Political Protest, U.S.
 Polytheism
 Population
 Poverty
 Practices
 Pre-Columbian Civilization
 Privacy
 Propaganda
 Prophecy
 Protest, Political
 Pseudoscience
 Psychoanalysis
 Punishment
 Puritanism
 Pythagoreanism
 Race and Racism: Europe
 Rationalism
 Reading
 Reflexivity
 Reform: Islamic Reform
 Reformation
 Relativism
 Religion: Overview
 Religion: Africa
 Religion: African Diaspora
 Religion: East and Southeast Asia
 Religion: Latin America
 Religion: Middle East
 Religion and Science
 Religion and the State: Africa
 Religion and the State: Europe
 Religion and the State: Latin America
 Religion and the State: Middle East
 Religion and the State: United States
 Renaissance
 Representation: Political Representation
 Republicanism: Latin America
 Resistance and Accommodation
 Responsibility
 Rhetoric: Ancient and Medieval
 Ritual: Religion
 Romanticism in Literature and Politics
 Sacred and Profane
 Sacred Places
 Sacred Texts: Asia
 Sacred Texts: Koran
 Scholasticism
 Secularization and Secularism
 Sexuality: Islamic Views
 Shinto
 Skepticism
 Slavery
 Sophists, The
 Subjectivism
 Sufism
 Suicide
 Superstition
 Symbolism
 Syncretism
 Temperance
 Theodicy
 Time: China
 Time: India
 Time: Traditional and Utilitarian
 Toleration
 Totalitarianism
 Totems
 University: Overview
 Untouchability: Overview
 Untouchability: Menstrual Taboos
 Untouchability: Taboos
 Utilitarianism
 Victorianism
 Visual Order to Organizing Collections
 Volunteerism, U.S.
 War
 War and Peace in the Arts
 Westernization: Africa
 Westernization: Middle East
 Westernization: Southeast Asia
 Witchcraft
 Witchcraft, African Studies of
 Yin and Yang

- Yoga
 Zen
 Zionism
 PHILOSOPHY
 Absolute Music
 Aesthetics: Asia
 Aesthetics: Europe and the Americas
 Africa, Idea of
 African-American Ideas
 Afrocentricity
 Agnosticism
 Alchemy: China
 Algebras
 Alienation
 Altruism
 Ambiguity
 Analytical Philosophy
 Anticolonialism: Africa
 Antifeminism
 Architecture: Overview
 Architecture: Asia
 Aristotelianism
 Asceticism: Hindu and Buddhist Asceticism
 Asceticism: Western Asceticism
 Astronomy, Pre-Columbian and Latin American
 Atheism
 Authenticity: Africa
 Autonomy
 Avant-Garde: Militancy
 Bioethics
 Black Consciousness
 Body, The
 Buddhism
 Cartesianism
 Casuistry
 Causality
 Causation
 Causation in East Asian and Southeast Asian Philosophy
 Censorship
 Change
 Character
 Chemistry
 Chinese Thought
 Christianity: Overview
 Civil Disobedience
 Civil Society: Europe and the United States
 Civil Society: Responses in Africa and the Middle East
 Class
 Classification of Arts and Sciences, Early Modern
 Common Sense
 Communitarianism in African Thought
 Confucianism
 Consciousness: Overview
 Consciousness: Chinese Thought
 Consciousness: Indian Thought
 Conservatism
 Consilience
 Context
 Continental Philosophy
 Corruption
 Corruption in Developed and Developing Countries
 Cosmology: Asia
 Cosmopolitanism
 Creationism
 Critical Race Theory
 Critical Theory
 Cultural History
 Cycles
 Cynicism
 Dance
 Daoism
 Death
 Deism
 Democracy
 Democracy: Africa
 Determinism
 Dialogue and Dialectics: Socratic
 Dream
 Dress
 Dualism
 Dystopia
 Eclecticism
 Education: China
 Education: Global Education
 Education: Japan
 Emotions
 Empiricism
 Enlightenment
 Environment
 Environmental Ethics
 Environmental History
 Epicureanism
 Epistemology: Ancient
 Epistemology: Early Modern
 Epistemology: Modern
 Equality: Overview
 Equality: Gender Equality
 Equality: Racial Equality
 Essentialism
 Ethnocentrism
 Eugenics
 Everyday Life
 Evil
 Existentialism
 Expressionism
 Fallacy, Logical
 Falsifiability
 Family Planning
 Fascism
 Fatalism
 Feminism: Overview
 Feminism: Africa and African Diaspora
 Feminism: Chicana Feminisms
 Feminism: Islamic Feminism
 Field Theories
 Form, Metaphysical, in Ancient and Medieval Thought
 Foundationalism
 Free Will, Determinism, and Predestination
 Friendship
 Gender: Gender in the Middle East
 Gender in Art
 General Will
 Genetics: Contemporary
 Genetics: History of
 Geometry
 Gift, The
 Globalization: Asia
 Gnosticism
 Good
 Greek Science

READER'S GUIDE

- Happiness and Pleasure in European Thought
 Harmony
 Health and Disease
 Heaven and Hell (Asian Focus)
 Hedonism in European Thought
 Hegelianism
 Hegemony
 Hermeneutics
 Hierarchy and Order
 Hinduism
 Historical and Dialectical Materialism
 Historicism
 Historiography
 History, Idea of
 Humanism: Africa
 Humanism: Chinese Conception of
 Humanism: Europe and the Middle East
 Humanism: Secular Humanism in the United States
 Humanity: African Thought
 Humanity: Asian Thought
 Humanity: European Thought
 Human Rights: Overview
 Human Rights: Women's Rights
 Idealism
 Ideas, History of
 Identity: Identity of Persons
 Identity, Multiple: Overview
 Identity, Multiple: Jewish Multiple Identity
 Immortality and the Afterlife
 Impressionism
 Individualism
 Intelligentsia
 Intentionality
 Interdisciplinarity
 International Order
 Islam: Africa
 Islam: Sunni
 Islamic Science
 Jainism
 Japanese Philosophy, Japanese Thought
 Jouissance
 Judaism: Modern Judaism
 Justice: Overview
 Justice: Justice in American Thought
 Justice: Justice in East Asian Thought
 Kantianism
 Knowledge
 Language and Linguistics
 Language, Philosophy of: Ancient and Medieval
 Language, Philosophy of: Modern
 Law
 Liberalism
 Liberty
 Life
 Linguistic Turn
 Literary Criticism
 Literary History
 Logic
 Logic and Philosophy of Mathematics, Modern
 Magic
 Manichaeism
 Maoism
 Marxism: Overview
 Marxism: Latin America
 Materialism in Eighteenth-Century European Thought
 Mathematics
 Mechanical Philosophy
 Medicine: China
 Medicine: Europe and the United States
 Meditation: Eastern Meditation
 Memory
 Metaphor
 Metaphysics: Ancient and Medieval
 Metaphysics: Renaissance to the Present
 Microcosm and Macrocosm
 Mind
 Modernism: Latin America
 Modernity: Overview
 Mohism
 Monism
 Moral Sense
 Music, Anthropology of
 Musicology
 Mysticism: Chinese Mysticism
 Myth
 Narrative
 Natural History
 Natural Law
 Natural Theology
 Naturalism
 Nature
 Naturphilosophie
 Neoplatonism
 Newtonianism
 Nihilism
 Nonviolence
 Nuclear Age
 Objectivity
 Obligation
 Occidentalism
 Organicism
 Orientalism: Overview
 Orthopraxy: Asia
 Other, The, European Views of
 Pacifism
 Pan-Africanism
 Paradigm
 Parties, Political
 Peace
 Person, Idea of the
 Personhood in African Thought
 Phenomenology
 Philanthropy
 Philosophies: African
 Philosophies: American
 Philosophies: Feminist, Twentieth-Century
 Philosophies: Islamic
 Philosophy: Historical Overview and Recent Developments
Philosophy: Relations to Other Intellectual Realms
 Philosophy, History of
 Philosophy, Moral: Africa
 Philosophy, Moral: Ancient
 Philosophy, Moral: Medieval and Renaissance
 Philosophy, Moral: Modern
 Philosophy and Religion in Western Thought
 Philosophy of Mind: Overview
 Philosophy of Mind: Ancient and Medieval
 Philosophy of Religion
 Physics

- Pietism
 Platonism
 Pluralism
 Poetry and Poetics
 Political Protest, U.S.
 Political Science
 Population
 Populism: United States
 Positivism
 Postcolonial Studies
 Postmodernism
 Poverty
 Practices
 Pragmatism
 Presentism
 Privacy
 Probability
 Progress, Idea of
 Protest, Political
 Pseudoscience
 Punishment
 Pythagoreanism
 Quantum
 Queer Theory
 Race and Racism: Overview
 Radicals/Radicalism
 Rational Choice
 Rationalism
 Reading
 Realism: Africa
 Reason, Practical and Theoretical
 Reflexivity
 Reform: Europe and the United States
 Relativism
 Relativity
 Religion: Overview
 Religion: East and Southeast Asia
 Religion: Middle East
 Religion and Science
 Religion and the State: United States
 Renaissance
 Representation: Political Representation
 Resistance
 Responsibility
 Rhetoric: Overview
 Romanticism in Literature and Politics
 Sacred Texts: Asia
 Sage Philosophy
 Scholasticism
 Science: Overview
 Science: East Asia
 Science, History of
 Scientific Revolution
 Secularization and Secularism
 Sexual Harassment
 Sexuality: Overview
 Skepticism
 Sociability in African Thought
 Social Darwinism
 Socialisms, African
 Society
 Sophists, The
 State of Nature
 Stoicism
 Structuralism and Poststructuralism: Overview
 Subjectivism
 Suicide
 Surrealism
 Symbolism
 Taste
 Text/Textuality
 Theodicy
 Time: China
 Time: India
 Toleration
 Totalitarianism
 Translation
 Truth
 Universalism
 Utilitarianism
 Victorianism
 Virtue Ethics
 Visual Culture
 Visual Order to Organizing Collections
 Volksgeist
 Volunteerism, U.S.
 War
 Wildlife
 Wisdom, Human
 Witchcraft
 Witchcraft, African Studies of
 Womanism
 Yin and Yang
 Yoga
 Zen
- EDUCATION
 Abolitionism
 Aesthetics: Africa
 Aesthetics: Asia
 Afrocentricity
 Altruism
 Americanization, U.S.
 Anthropology
 Anticolonialism: Africa
 Anticolonialism: Southeast Asia
 Antifeminism
 Anti-Semitism: Overview
 Apartheid
 Architecture: Overview
 Aristotelianism
 Asceticism: Hindu and Buddhist Asceticism
 Authenticity: Africa
 Authoritarianism: Latin America
 Behaviorism
 Bilingualism and Multilingualism
 Biology
 Black Consciousness
 Body, The
 Buddhism
 Bushido
 Calculation and Computation
 Capitalism: Overview
 Capitalism: Africa
 Character
 Childhood and Child Rearing
 Chinese Thought
 Christianity: Asia
 Citizenship: Naturalization
 City, The: The City as a Cultural Center
 Civil Society: Europe and the United States

READER'S GUIDE

- Classification of Arts and Sciences, Early Modern
 Communication of Ideas: Africa and Its Influence
 Communication of Ideas: Asia and Its Influence
 Communication of Ideas: Europe and Its Influence
 Communication of Ideas: Southeast Asia
 Composition, Musical
 Confucianism
 Consciousness: Chinese Thought
 Consciousness: Indian Thought
 Cosmopolitanism
 Creationism
 Creolization, Caribbean
 Cultural Capital
 Cultural Revivals
 Cultural Studies
 Dance
 Daoism
 Death and Afterlife, Islamic Understanding of
 Democracy: Africa
 Dialogue and Dialectics: Socratic
 Dialogue and Dialectics: Talmudic
 Diasporas: Jewish Diaspora
 Diffusion, Cultural
 Discrimination
 Diversity
 Dress
 Eclecticism
Education: Asia, Traditional and Modern
Education: China
Education: Europe
Education: Global Education
Education: India
Education: Islamic Education
Education: Japan
Education: North America
 Emotion
 Empire and Imperialism: Asia
 Empire and Imperialism: Europe
 Empire and Imperialism: United States
 Enlightenment
 Environmental Ethics
 Environmental History
 Epicureanism
 Epistemology: Ancient
 Epistemology: Early Modern
 Epistemology: Modern
 Equality: Overview
 Ethnicity and Race: Anthropology
 Etiquette
 Examination Systems, China
 Experiment
 Extirpation
 Family Planning
 Fascism
 Feminism: Overview
 Feminism: Africa and African Diaspora
 Feminism: Chicana Feminisms
 Feminism: Islamic Feminism
 Gender: Gender in the Middle East
 Generation
 Globalization: Asia
 Good
 Greek Science
 Harmony
 Health and Disease
 Hermeneutics
 Hinduism
 Historical and Dialectical Materialism
 Historiography
 History, Economic
 Human Capital
 Humanism: Chinese Conception of
 Humanism: Europe and the Middle East
 Humanism: Renaissance
 Humanity: Asian Thought
 Hygiene
 Ideas, History of
 Identity, Multiple: Jewish Multiple Identity
 Individualism
 Interdisciplinarity
 Interpretation
 Islam: Africa
 Islam: Southeast Asia
 Islam: Sunni
 Islamic Science
 Japanese Philosophy, Japanese Thought
 Jihad
 Jouissance
 Judaism: Judaism to 1800
 Judaism: Modern Judaism
 Justice: Justice in East Asian Thought
 Kantianism
 Kinship
 Knowledge
 Language and Linguistics
 Language, Linguistics, and Literacy
 Learning and Memory, Contemporary Views
 Life Cycle: Overview
 Life Cycle: Adolescence
 Life Cycle: Elders/Old Age
 Literary Criticism
 Loyalties, Dual
 Maoism
 Maps and the Ideas They Express
 Marxism: Overview
 Masks
 Matriarchy
 Medicine: Europe and the United States
 Men and Masculinity
 Mestizaje
 Metaphor
 Minority
 Modernity: Overview
 Modernity: Africa
 Modernity: East Asia
 Modernization Theory
 Mohism
 Motherhood and Maternity
 Multiculturalism, Africa
 Museums
 Music, Anthropology of
 Musical Performance and Audiences
 Musicology
 Mysticism: Chinese Mysticism
 Mysticism: Islamic Mysticism in Asia
 Mysticism: Kabbalah
 Nation
 Nationalism: Africa
 Natural History
 Negritude

- Neoplatonism
- Newtonianism
- Nuclear Age
- Nude, The
- Objectivity
- Occidentalism
- Oral Traditions: Overview
- Organicism
- Orientalism: Overview
- Orthodoxy
- Pan-Arabism
- Pan-Asianism
- Paradigm
- Periodization of the Arts
- Philosophies: American
- Philosophies: Feminist, Twentieth-Century
- Philosophies: Islamic
- Philosophy: Historical Overview and Recent Developments
- Philosophy, History of
- Philosophy, Moral: Ancient
- Philosophy, Moral: Medieval and Renaissance
- Philosophy, Moral: Modern
- Philosophy of Mind: Ancient and Medieval
- Physics
- Platonism
- Political Protest, U.S.
- Population
- Populism: United States
- Practices
- Pragmatism
- Prejudice
- Privacy
- Propaganda
- Protest, Political
- Pseudoscience
- Psychoanalysis
- Punishment
- Queer Theory
- Reading
- Realism: Africa
- Reason, Practical and Theoretical
- Reflexivity
- Reform: Islamic Reform
- Reformation
- Relativism
- Religion: East and Southeast Asia
- Religion: Middle East
- Religion and the State: Europe
- Religion and the State: Latin America
- Religion and the State: Middle East
- Religion and the State: United States
- Renaissance
- Representation: Political Representation
- Republicanism: Republic
- Resistance
- Rhetoric: Overview
- Rhetoric: Ancient and Medieval
- Ritual: Public Ritual
- Sacred Places
- Sacred Texts: Asia
- Sage Philosophy
- Scholasticism
- Science: East Asia
- Segregation
- Sexuality: Overview
- Skepticism
- Slavery
- Sociability in African Thought
- Social Capital
- Social History, U.S.
- Sophists, The
- Sport
- State, The: Overview
- Stoicism
- Subjectivism
- Sufism
- Superstition
- Temperance
- Theater and Performance
- Third Cinema
- Third World Literature
- Time: China
- Totalitarianism
- Tragedy and Comedy
- University: Overview
- University: Postcolonial
- Untouchability: Menstrual Taboos
- Untouchability: Taboos
- Utilitarianism
- Utopia
- Victorianism
- Visual Order to Organizing Collections
- Volunteerism, U.S.
- War and Peace in the Arts
- Westernization: Africa
- Westernization: Middle East
- Westernization: Southeast Asia
- Wisdom, Human
- Women's History: Africa
- Women's Studies
- Yoga
- Zen

Social Sciences

WOMEN'S STUDIES AND GENDER STUDIES

- Abolitionism
- Aesthetics: Asia
- African-American Ideas
- Anarchism
- Anthropology
- Antifeminism
- Asceticism: Western Asceticism
- Autobiography
- Beauty and Ugliness
- Biography
- Black Atlantic
- Body, The
- Capitalism: Africa
- Censorship
- Chicano Movement
- Childhood and Child Rearing
- Christianity: Overview
- Cinema
- Class
- Colonialism: Africa
- Colonialism: Southeast Asia
- Communication of Ideas: Southeast Asia
- Composition, Musical
- Confucianism

READER'S GUIDE

Consumerism
Continental Philosophy
Creativity in the Arts and Sciences
Critical Race Theory
Critical Theory
Cultural Studies
Dance
Death
Death and Afterlife, Islamic Understanding of
Democracy: Africa
Demography
Diversity
Dress
Dystopia
Economics
Education: Asia, Traditional and Modern
Education: China
Education: Europe
Education: Islamic Education
Education: North America
Emotions
Environmental History
Equality: Overview
Equality: Gender Equality
Essentialism
Etiquette
Eugenics
Eurocentrism
Everyday Life
Existentialism
Family: Modernist Anthropological Theory
Family: Family in Anthropology since 1980
Family Planning
Fascism
Feminism: Overview
Feminism: Africa and African Diaspora
Feminism: Chicana Feminisms
Feminism: Third World U.S. Movement
Fetishism: Overview
Fetishism: Fetishism in Literature and Cultural Studies
Friendship
Gay Studies
Gender: Overview
Gender: Gender in the Middle East
Gender in Art
Gender Studies: Anthropology
Genius
Genre
Hate
Historiography
History, Economic
Honor
Honor, Middle Eastern Notions of
Human Capital
Humanism: Renaissance
Humanity: Asian Thought
Humanity: European Thought
Human Rights: Women's Rights
Humor
Iconography
Identity: Identity of Persons
Identity, Multiple: Overview
Impressionism
Intelligentsia
Interdisciplinarity
Internal Colonialism
Interpretation
Islam: Shii
Jouissance
Justice: Overview
Kinship
Knowledge
Law
Law, Islamic
Legalism, Ancient China
Liberalism
Liberation Theology
Life Cycle: Adolescence
Literary History
Literature: African Literature
Love, Western Notions of
Machismo
Marriage and Fertility, European Views
Masks
Matriarchy
Medicine: Europe and the United States
Men and Masculinity
Mestizaje
Minority
Modernism: Overview
Motherhood and Maternity
Music, Anthropology of
Musicology
Mysticism: Christian Mysticism
Narrative
Nude, The
Orientalism: African and Black Orientalism
Orthodoxy
Pan-Africanism
Periodization of the Arts
Philosophies: African
Philosophies: American
Philosophies: Feminist, Twentieth-Century
Philosophy: Historical Overview and Recent Developments
Poetry and Poetics
Political Protest, U.S.
Population
Postcolonial Studies
Postcolonial Theory and Literature
Postmodernism
Pre-Columbian Civilization
Privacy
Progress, Idea of
Propaganda
Prophecy
Protest, Political
Psychoanalysis
Public Sphere
Queer Theory
Radicals/Radicalism
Reading
Reflexivity
Relativism
Religion: Africa
Religion: African Diaspora
Renaissance
Republicanism: Latin America
Resistance and Accommodation
Rhetoric: Ancient and Medieval

- Ritual: Public Ritual
- Ritual: Religion
- Romanticism in Literature and Politics
- Science: Overview
- Science, History of
- Science Fiction
- Scientific Revolution
- Secularization and Secularism
- Sexual Harassment
- Sexuality: Overview**
- Sexuality: Islamic Views**
- Sexuality: Sexual Orientation**
- Shinto
- Slavery
- Social Contract
- Social History, U.S.
- Sport
- State, The: The Postcolonial State
- Structuralism and Poststructuralism: Overview
- Subjectivism
- Symbolism
- Universalism
- University: Overview
- Untouchability: Menstrual Taboos
- Utopia
- Victorianism
- Virtue Ethics
- Visual Culture
- Visual Order to Organizing Collections
- Volunteerism, U.S.
- War
- Witchcraft
- Witchcraft, African Studies of
- Womanism
- Women and Femininity in U.S. Popular Culture
- Women's History: Africa
- Women's History: Asia
- Women's Studies**
- Work
- ETHNIC STUDIES**
- Abolitionism
- Absolute Music
- Africa, Idea of
- African-American Ideas
- Afrocentricity
- America
- Americanization, U.S.
- Ancestor Worship
- Anthropology
- Anticolonialism: Africa
- Anticolonialism: Southeast Asia
- Anti-Semitism: Overview
- Anti-Semitism: Islamic Anti-Semitism
- Apartheid
- Architecture: Africa
- Arts: Overview
- Assimilation
- Astronomy, Pre-Columbian and Latin American
- Authenticity: Africa
- Autobiography
- Aztlán
- Barbarism and Civilization
- Bilingualism and Multilingualism
- Black Atlantic
- Black Consciousness
- Body, The
- Borders, Borderlands, and Frontiers, Global
- Cannibalism
- Capitalism: Overview
- Capitalism: Africa
- Chicano Movement
- Cinema
- Citizenship: Cultural Citizenship
- City, The: Latin America
- City, The: The City as a Cultural Center
- City, The: The City as Political Center
- Civil Disobedience
- Class
- Colonialism: Africa
- Colonialism: Latin America
- Colonialism: Southeast Asia
- Communication of Ideas: Southeast Asia
- Communitarianism in African Thought
- Composition, Musical
- Consumerism
- Context
- Cosmopolitanism
- Creolization, Caribbean
- Critical Race Theory
- Critical Theory
- Cultural Capital
- Cultural Revivals
- Cultural Studies
- Dance
- Death
- Demography
- Diasporas: African Diaspora
- Diasporas: Jewish Diaspora
- Diffusion, Cultural
- Discrimination
- Diversity
- Dress
- Education: North America
- Empire and Imperialism: Europe
- Empire and Imperialism: Middle East
- Environmental History
- Equality: Overview
- Equality: Racial Equality
- Essentialism
- Ethnicity and Race: Africa**
- Ethnicity and Race: Anthropology**
- Ethnicity and Race: Islamic Views**
- Ethnocentrism
- Ethnography**
- Ethnohistory, U.S.
- Eugenics
- Eurocentrism
- Extirpation
- Family Planning
- Fascism
- Feminism: Overview
- Feminism: Africa and African Diaspora
- Feminism: Chicana Feminisms
- Feminism: Third World U.S. Movement
- Fetishism: Overview
- Fetishism: Fetishism in Literature and Cultural Studies
- Gender Studies: Anthropology
- Generation
- Genetics: Contemporary
- Genocide

READER'S GUIDE

Gesture
 Ghetto
 Gift, The
 Hate
 Hinduism
 History, Economic
 Honor
 Humanity: European Thought
 Humor
 Hygiene
 Iconography
 Identity, Multiple: Overview
 Identity, Multiple: Asian-Americans
 Identity, Multiple: Jewish Multiple Identity
 Indigenismo
 Intelligentsia
 Interdisciplinarity
 Internal Colonialism
 Islam: Africa
 Jouissance
 Judaism: Modern Judaism
 Kinship
 Law
 Liberation Theology
 Life Cycle: Adolescence
 Literary History
 Literature: African Literature
 Loyalties, Dual
 Machismo
 Marxism: Latin America
 Mathematics
 Matriarchy
 Men and Masculinity
 Mestizaje
 Migration: Africa
 Migration: Migration in World History
 Migration: United States
 Minority
 Modernism: Overview
 Modernity: Africa
 Motherhood and Maternity
 Multiculturalism, Africa
 Music, Anthropology of
 Musical Performance and Audiences
 Mysticism: Kabbalah
 Nation
 Nationalism: Overview
 Nationalism: Africa
 Nationalism: Cultural Nationalism
 Nationalism: Middle East
 Native Policy
 Naturalism
 Negritude
 Nomadism
 Nuclear Age
 Occidentalism
 Orientalism: Overview
 Orientalism: African and Black Orientalism
 Orthodoxy
 Other, The, European Views of
 Pan-Africanism
 Pan-Asianism
 Pan-Islamism
 Pan-Turkism
 Patriotism
 Periodization of the Arts
 Person, Idea of the
 Philosophies: African
 Philosophies: American
 Political Protest, U.S.
 Population
 Populism: United States
 Postcolonial Studies
 Postcolonial Theory and Literature
 Postmodernism
 Practices
 Pre-Columbian Civilization
 Prehistory, Rise of
 Prejudice
 Privacy
 Protest, Political
 Psychoanalysis
 Queer Theory
 Race and Racism: Overview
 Race and Racism: Asia
 Race and Racism: Europe
 Race and Racism: United States
 Reading
 Realism: Africa
 Reflexivity
 Regions and Regionalism, Eastern Europe
 Relativism
 Religion: African Diaspora
 Religion: Indigenous Peoples' View, South America
 Religion: Latin America
 Religion: Middle East
 Republicanism: Latin America
 Resistance and Accommodation
 Ritual: Religion
 Sage Philosophy
 Scarcity and Abundance, Latin America
 Secularization and Secularism
 Segregation
 Sexuality: Overview
 Shinto
 Slavery
 Socialisms, African
 Sport
 State, The: The Postcolonial State
 Superstition
 Symbolism
 Syncretism
 Terror
 Third Cinema
 Third World
 Third World Literature
 Time: Traditional and Utilitarian
 Totalitarianism
 Totems
 Trade
 Translation
 Treaty
 Untouchability: Menstrual Taboos
 Untouchability: Taboos
 Utopia
 Victorianism
 Visual Culture
 Volksgeist
 Volunteerism, U.S.
 War

- Westernization: Africa
 Westernization: Southeast Asia
 Wisdom, Human
 Witchcraft, African Studies of
 Womanism
 Women and Femininity in U.S. Popular Culture
 Women's History: Africa
 Women's Studies
 Work
 World Systems Theory, Latin America
 Zionism
- HISTORY**
- Aesthetics: Europe and the Americas
 Afrocentricity
 Afropessimism
 Altruism
 Americanization, U.S.
 Anthropology
 Anticolonialism: Latin America
 Anticolonialism: Southeast Asia
 Anti-Semitism: Overview
 Architecture: Overview
 Architecture: Africa
 Asceticism: Hindu and Buddhist Asceticism
 Authoritarianism: Latin America
 Autobiography
 Autonomy
 Aztlán
 Barbarism and Civilization
 Biography
 Buddhism
 Capitalism: Overview
 Change
 Childhood and Child Rearing
 Chinese Thought
 City, The: The City as a Cultural Center
 Classification of Arts and Sciences, Early Modern
 Colonialism: Africa
 Colonialism: Latin America
 Colonialism: Southeast Asia
 Consciousness: Overview
 Conservatism
 Context
 Continental Philosophy
 Cosmology: Asia
 Creolization, Caribbean
 Crisis
 Cultural History
 Cultural Revivals
 Cultural Studies
 Cycles
 Dance
 Determinism
 Diasporas: African Diaspora
 Diasporas: Jewish Diaspora
 Dictatorship in Latin America
 Diffusion, Cultural
 Dress
 Ecology
 Economics
 Education: Europe
 Empire and Imperialism: Overview
 Empire and Imperialism: United States
 Enlightenment
 Environmental History
- Ethnography
 Ethnohistory, U.S.
 Eurocentrism
 Everyday Life
 Evil
 Extirpation
 Fascism
 Fatalism
 Feminism: Overview
 Feminism: Third World U.S. Movement
 Feudalism, European
 Futurology
 Gender in Art
 Generation
 Genius
 Genre
 Geography
 Globalization: Asia
 Hegelianism
 Hermeneutics
 Historical and Dialectical Materialism
 Historicism
Historiography
 History, Economic
History, Idea of
 Honor
 Iconography
 Ideas, History of
 Identity, Multiple: Jewish Multiple Identity
 Intelligentsia
 Intentionality
 Interdisciplinarity
 Internal Colonialism
 International Order
 Interpretation
 Islamic Science
 Japanese Philosophy, Japanese Thought
 Jihad
 Judaism: Judaism to 1800
 Knowledge
 Language and Linguistics
 Leadership
 Learning and Memory, Contemporary Views
 Life Cycle: Elders/Old Age
 Linguistic Turn
 Literary Criticism
 Literary History
 Literature: African Literature
 Love, Western Notions of
 Machiavellism
 Maoism
 Marxism: Overview
 Marxism: Asia
 Marxism: Latin America
 Matriarchy
 Media, History of
 Memory
 Mestizaje
 Metaphor
 Migration: Africa
 Migration: Migration in World History
 Millenarianism: Overview
 Millenarianism: Islamic
 Millenarianism: Latin America and Native North America

READER'S GUIDE

- Modernism: Latin America
 Modernity: Overview
 Modernity: Africa
 Modernity: East Asia
 Modernization
 Modernization Theory
 Motif: Motif in Literature
 Music, Anthropology of
 Musicology
 Narrative
 Nation
 Nationalism: Overview
 Nationalism: Africa
 Native Policy
 Negritude
 Nomadism
 Nuclear Age
 Occidentalism
 Oral Traditions: Overview
 Pan-Asianism
 Paradigm
 Patriotism
 Peasants and Peasantry
 Periodization
 Periodization of the Arts
 Philosophies: Feminist, Twentieth-Century
 Philosophy: Historical Overview and Recent Developments
 Philosophy, History of
 Philosophy of Religion
 Poetry and Poetics
 Political Protest, U.S.
 Polytheism
 Postcolonial Theory and Literature
 Postmodernism
 Power
 Practices
 Pragmatism
 Pre-Columbian Civilization
 Presentism
 Privacy
 Progress, Idea of
 Protest, Political
 Public Sphere
 Queer Theory
 Race and Racism: Asia
 Reading
 Realism: Africa
 Reflexivity
 Reform: Europe and the United States
 Reformation
 Regions and Regionalism, Eastern Europe
 Relativism
 Religion: East and Southeast Asia
 Religion: Indigenous Peoples' View, South America
 Religion: Middle East
 Religion and the State: United States
 Renaissance
 Republicanism: Latin America
 Republicanism: Republic
 Resistance
 Responsibility
 Revolution
 Ritual: Public Ritual
 Sacred Texts: Asia
 Scarcity and Abundance, Latin America
 Science: Overview
 Science, History of
 Scientific Revolution
 Sexuality: Overview
 Skepticism
 Slavery
 Social Capital
 Social Darwinism
 Social History, U.S.
 Society
 Sophists, The
 Sport
 State of Nature
 Structuralism and Poststructuralism: Overview
 Subjectivism
 Surrealism
 Syncretism
 Technology
 Theater and Performance
 Theodicy
 Third World
 Time: China
 Time: India
 Time: Traditional and Utilitarian
 Toleration
 Totalitarianism
 Trade
 Treaty
 Trope
 Utopia
 Victorianism
 Visual Order to Organizing Collections
 Volkgeist
 War
 War and Peace in the Arts
 Westernization: Middle East
 Westernization: Southeast Asia
 Witchcraft
 Witchcraft, African Studies of
 Women's History: Africa
 Women's History: Asia
 World Systems Theory, Latin America
- ### ANTHROPOLOGY AND SOCIOLOGY
- Aesthetics: Asia
 Aesthetics: Europe and the Americas
 Africa, Idea of
 Alienation
 Altruism
 Americanization, U.S.
 Ancestor Worship
Anthropology
 Anti-Semitism: Overview
 Architecture: Overview
 Architecture: Africa
 Asceticism: Hindu and Buddhist Asceticism
 Asceticism: Western Asceticism
 Astronomy, Pre-Columbian and Latin American
 Aztlán
 Barbarism and Civilization
 Beauty and Ugliness
 Bilingualism and Multilingualism
 Body, The
 Borders, Borderlands, and Frontiers, Global
 Buddhism

- Calendar
 Cannibalism
 Capitalism: Overview
 Character
 Childhood and Child Rearing
 Chinese Thought
 Cinema
 Citizenship: Cultural Citizenship
 City, The: The City as a Cultural Center
 Civil Society: Europe and the United States
 Colonialism: Latin America
 Colonialism: Southeast Asia
 Communication of Ideas: Orality and Advent of Writing
 Communication of Ideas: Southeast Asia
 Communitarianism in African Thought
 Composition, Musical
 Context
 Continental Philosophy
 Cosmopolitanism
 Creativity in the Arts and Sciences
 Creolization, Caribbean
 Cultural Capital
 Cultural History
 Cultural Revivals
 Cultural Studies
 Dance
 Death
 Death and Afterlife, Islamic Understanding of
 Demography
 Demonology
 Development
 Diasporas: African Diaspora
 Diasporas: Jewish Diaspora
 Diffusion, Cultural
 Discrimination
 Diversity
 Dream
 Dress
 Ecology
 Environment
 Environmental Ethics
 Environmental History
 Ethnicity and Race: Africa
 Ethnicity and Race: Anthropology
 Ethnocentrism
Ethnography
 Ethnohistory, U.S.
 Etiquette
 Eugenics
 Eurocentrism
 Europe, Idea of
 Everyday Life
 Extirpation
 Family: Modernist Anthropological Theory
 Family: Family in Anthropology since 1980
 Family Planning
 Fascism
 Feminism: Overview
 Feminism: Third World U.S. Movement
 Fetishism: Overview
 Gender Studies: Anthropology
 Generation
 Genetics: Contemporary
 Genetics: History of
 Gesture
 Ghetto
 Gift, The
 Globalization: Asia
 Hinduism
 Historiography
 History, Economic
 History, Idea of
 Honor
 Honor, Middle Eastern Notions of
 Humanism: Chinese Conception of
 Humanity: African Thought
 Humanity: European Thought
 Humor
 Ideas, History of
 Identity: Personal and Social Identity
 Identity, Multiple: Asian-Americans
 Identity, Multiple: Jewish Multiple Identity
 Intelligentsia
 Intentionality
 Interdisciplinarity
 Interpretation
 Jouissance
 Judaism: Modern Judaism
 Kinship
 Knowledge
 Language and Linguistics
Life Cycle: Overview
Life Cycle: Adolescence
Life Cycle: Elders/Old Age
 Linguistic Turn
 Literary Criticism
 Machiavellism
 Magic
 Manichaeism
 Marriage and Fertility, European Views
 Marxism: Overview
 Masks
 Matriarchy
 Meditation: Eastern Meditation
 Memory
 Men and Masculinity
 Mestizaje
 Metaphor
 Migration: Migration in World History
 Migration: United States
 Minority
 Motherhood and Maternity
 Motif: Motif in Music
 Music, Anthropology of
 Musical Performance and Audiences
 Musicology
 Mysticism: Chinese Mysticism
 Myth
 Nation
 Native Policy
 Natural History
 Occidentalism
 Oral Traditions: Overview
 Organicism
 Orientalism: African and Black Orientalism
 Orthodoxy
 Orthopraxy: Asia
 Other, The, European Views of
 Peasants and Peasantry
 Person, Idea of the

READER'S GUIDE

- Philosophies: Feminist, Twentieth-Century
 Philosophy, Moral: Africa
 Phrenology
 Pluralism
 Polytheism
 Postcolonial Theory and Literature
 Postmodernism
 Power
 Practices
 Pre-Columbian Civilization
 Prehistory, Rise of
 Prejudice
 Presentism
 Privacy
 Psychoanalysis
 Public Sphere
 Queer Theory
 Race and Racism: Asia
 Reading
 Reflexivity
 Reform: Europe and the United States
 Relativism
 Religion: Overview
 Religion: Africa
 Religion: African Diaspora
 Religion: Latin America
 Religion: Middle East
 Representation: Mental Representation
 Resistance
 Resistance and Accommodation
 Ritual: Public Ritual
 Ritual: Religion
 Sacred and Profane
 Scarcity and Abundance, Latin America
 Sexuality: Overview
 Sexuality: Sexual Orientation
 Social Capital
 Social Darwinism
 Social History, U.S.
 Society
 Sport
 State of Nature
 Structuralism and Poststructuralism: Overview
 Structuralism and Poststructuralism: Anthropology
 Subjectivism
 Superstition
 Surrealism
 Symbolism
 Syncretism
 Textiles and Fiber Arts as Catalysts for Ideas
 Theater and Performance
 Time: Traditional and Utilitarian
 Toleration
 Totalitarianism
 Totems
 Trade
 Tradition
 Tragedy and Comedy
 Tribalism, Middle East
 Trope
 Untouchability: Menstrual Taboos
 Untouchability: Taboos
 Utilitarianism
 Victorianism
 Virtue Ethics
 War and Peace in the Arts
 Westernization: Southeast Asia
 Wisdom, Human
 Witchcraft
 Witchcraft, African Studies of
 Women's History: Africa
 Work
 World Systems Theory, Latin America
 Yin and Yang
POLITICAL SCIENCE (emphasizing political philosophy)
 Abolitionism
 Absolute Music
 Africa, Idea of
 African-American Ideas
 Afrocentricity
 Afropessimism
 Alienation
 Altruism
 America
 Americanization, U.S.
 Anarchism
 Anthropology
 Anticolonialism: Africa
 Anticolonialism: Latin America
 Anticolonialism: Middle East
 Anticolonialism: Southeast Asia
 Anti-Semitism: Overview
 Anti-Semitism: Islamic Anti-Semitism
 Apartheid
 Architecture: Overview
 Architecture: Africa
 Architecture: Asia
 Asceticism: Western Asceticism
 Asian-American Ideas (Cultural Migration)
 Assimilation
 Astronomy, Pre-Columbian and Latin American
 Authoritarianism: Overview
 Authoritarianism: East Asia
 Authoritarianism: Latin America
 Authority
 Autobiography
 Avant-Garde: Militancy
 Aztlán
 Barbarism and Civilization
 Bilingualism and Multilingualism
 Bioethics
 Black Atlantic
 Black Consciousness
 Borders, Borderlands, and Frontiers, Global
 Bureaucracy
 Bushido
 Calculation and Computation
 Cannibalism
 Capitalism: Overview
 Capitalism: Africa
 Casuistry
 Censorship
 Chicano Movement
 Childhood and Child Rearing
 Chinese Warlordism
 Christianity: Overview
 Christianity: Asia
 Citizenship: Overview
 Citizenship: Cultural Citizenship
 Citizenship: Naturalization

- City, The: Latin America
 City, The: The City as a Cultural Center
 City, The: The City as Political Center
 Civil Disobedience
 Civil Society: Europe and the United States
 Civil Society: Responses in Africa and the Middle East
 Class
 Colonialism: Africa
 Colonialism: Latin America
 Colonialism: Southeast Asia
 Common Sense
 Communication of Ideas: Europe and Its Influence
 Communication of Ideas: Middle East and Abroad
 Communication of Ideas: Southeast Asia
 Communication of Ideas: The Americas and Their Influence
 Communism: Latin America
 Communism: Europe
 Communitarianism in African Thought
 Composition, Musical
 Computer Science
 Confucianism
 Consciousness: Overview
 Consciousness: Chinese Thought
 Conservatism
 Constitutionalism
 Continental Philosophy
 Corruption
 Corruption in Developed and Developing Countries
 Cosmopolitanism
 Creolization, Caribbean
 Critical Race Theory
 Cultural Studies
 Cycles
 Cynicism
 Dada
 Dance
 Daoism
Democracy
 Democracy, Africa
 Demography
 Dependency
 Determinism
 Dialogue and Dialectics: Socratic
 Diasporas: African Diaspora
 Diasporas: Jewish Diaspora
 Dictatorship in Latin America
 Discrimination
 Diversity
 Dress
 Dystopia
 Ecology
 Economics
 Education: China
 Education: Global Education
 Education: India
 Education: Japan
 Education: North America
 Empire and Imperialism: Overview
 Empire and Imperialism: Americas
 Empire and Imperialism: Asia
 Empire and Imperialism: Europe
 Empire and Imperialism: Middle East
 Empire and Imperialism: United States
 Environmental Ethics
 Environmental History
 Equality: Overview
 Equality: Gender Equality
 Equality: Racial Equality
 Ethnicity and Race: Africa
 Ethnicity and Race: Anthropology
 Ethnicity and Race: Islamic Views
 Etiquette
 Eugenics
 Eurocentrism
 Europe, Idea of
 Evil
 Examination Systems, China
 Existentialism
 Expressionism
 Extirpation
 Fallacy, Logical
 Family Planning
 Fascism
 Feminism: Overview
 Feminism: Africa and African Diaspora
 Feminism: Chicana Feminisms
 Feminism: Islamic Feminism
 Feminism: Third World U.S. Movement
 Fetishism: Overview
 Feudalism, European
 Friendship
 Fundamentalism
 Futurology
 Game Theory
 Garden
 Gay Studies
 Gender: Gender in the Middle East
 Gender in Art
 General Will
 Generation
 Genetics: Contemporary
 Genocide
 Ghetto
 Globalization: Africa
 Globalization: Asia
 Globalization: General
 Good
 Happiness and Pleasure in European Thought
 Heaven and Hell
 Heaven and Hell (Asian Focus)
 Hegelianism
 Hegemony
 Hinduism
 Historical and Dialectical Materialism
 Historiography
 History, Economic
 History, Idea of
 Honor
 Honor, Middle Eastern Notions of
 Human Capital
 Humanism: Chinese Conception of
 Humanism: Europe and the Middle East
 Humanism: Renaissance
 Humanism: Secular Humanism in the United States
 Humanity: African Thought
 Human Rights: Overview
 Human Rights: Women's Rights
 Hygiene
 Ideas, History of

READER'S GUIDE

Identity, Multiple: Overview
 Identity, Multiple: Asian-Americans
 Identity, Multiple: Jewish Multiple Identity
 Individualism
 Intelligentsia
 Intentionality
 Intercession in Middle Eastern Society
 Interdisciplinarity
 Internal Colonialism
 International Order
 Islam: Africa
 Islam: Shii
 Islam: Southeast Asia
 Islam: Sunni
 Islamic Science
 Japanese Philosophy, Japanese Thought
 Jihad
 Jouissance
 Justice: Overview
 Justice: Justice in American Thought
 Justice: Justice in East Asian Thought
 Kantianism
 Kinship
 Knowledge
 Language and Linguistics
 Law
 Law, Islamic
 Leadership
 Legalism, Ancient China
 Liberalism
 Liberation Theology
 Liberty
 Life Cycle: Elders/Old Age
 Literary Criticism
 Literary History
 Literature: Overview
 Literature: African Literature
 Lysenkoism
 Machiavellism
 Machismo
 Maoism
 Maps and the Ideas They Express
 Marriage and Fertility, European Views
 Marxism: Overview
 Marxism: Asia
 Marxism: Latin America
 Masks
 Mathematics
 Matriarchy
 Medicine: Europe and the United States
 Meme
 Men and Masculinity
 Mestizaje
 Migration: Migration in World History
 Migration: United States
 Millenarianism: Islamic
 Millenarianism: Latin America and Native North America
 Minority
 Modernism: Overview
 Modernism: Latin America
 Modernity: Overview
 Modernity: Africa
 Modernity: East Asia
 Modernization
 Modernization Theory
 Mohism
Monarchy: Overview
 Monarchy: Islamic Monarchy
 Motherhood and Maternity
 Motif: Motif in Literature
 Multiculturalism, Africa
 Music, Anthropology of
 Musical Performance and Audiences
 Musicology
 Mysticism: Chinese Mysticism
 Myth
 Narrative
 Nation
 Nationalism: Overview
 Nationalism: Africa
 Nationalism: Cultural Nationalism
 Nationalism: Middle East
 Native Policy
 Natural Law
 Naturalism
 Negritude
 Neocolonialism
 Neoliberalism
 New Criticism
 Newtonianism
 Nihilism
 Nomadism
 Nonviolence
 Nuclear Age
 Objectivity
 Obligation
 Occidentalism
 Organicism
 Orientalism: Overview
 Orientalism: African and Black Orientalism
 Orthodoxy
 Orthopraxy: Asia
 Pacifism
 Pan-Africanism
 Pan-Arabism
 Pan-Asianism
 Pan-Islamism
 Pan-Turkism
 Paradigm
 Parties, Political
 Patriotism
 Peace
 Periodization of the Arts
 Person, Idea of the
 Personhood in African Thought
 Philanthropy
 Philosophies: American
 Philosophies: Feminist, Twentieth-Century
 Philosophies: Islamic
 Philosophy: Historical Overview and Recent Developments
 Philosophy, History of
 Philosophy, Moral: Africa
 Philosophy, Moral: Ancient
 Philosophy, Moral: Modern
 Philosophy of Religion
 Phrenology
 Pluralism
 Political Protest, U.S.

- Political Science**
 Political, The
 Population
 Populism: Latin America
 Populism: United States
 Postcolonial Studies
 Poverty
 Power
 Practices
 Pre-Columbian Civilization
 Prejudice
 Presentism
 Privacy
 Privatization
 Probability
 Progress, Idea of
 Propaganda
 Property
 Protest, Political
 Pseudoscience
 Psychoanalysis
 Public Sphere
 Punishment
 Puritanism
 Pythagoreanism
 Quantum
 Queer Theory
 Race and Racism: Overview
 Race and Racism: Asia
 Race and Racism: United States
 Radicals/Radicalism
 Rational Choice
 Reading
 Realism
 Realism: Africa
 Reason, Practical and Theoretical
 Reflexivity
 Reform: Europe and the United States
 Reform: Islamic Reform
 Regions and Regionalism, Eastern Europe
 Relativism
 Religion: Africa
 Religion: African Diaspora
 Religion: East and Southeast Asia
 Religion: Latin America
 Religion: Middle East
 Religion and the State: Africa
 Religion and the State: Europe
 Religion and the State: Latin America
 Religion and the State: Middle East
 Religion and the State: United States
 Renaissance
 Representation: Political Representation
 Republicanism: Latin America
 Republicanism: Republic
 Resistance
 Resistance and Accommodation
 Responsibility
 Revolution
 Rhetoric: Ancient and Medieval
 Ritual: Public Ritual
 Romanticism in Literature and Politics
 Sacred and Profane
 Scarcity and Abundance, Latin America
 Science, History of
 Science Fiction
 Secularization and Secularism
 Segregation
 Sexual Harassment
 Sexuality: Overview
 Sexuality: Islamic Views
 Sexuality: Sexual Orientation
 Shinto
 Skepticism
 Slavery
 Sociability in African Thought
 Social Capital
 Social Contract
 Social History, U.S.
 Socialism
 Socialisms, African
 Society
 Sophists, The
 Sovereignty
 Sport
 State, The: Overview
 State, The: The Postcolonial State
 State of Nature
 Stoicism
 Subjectivism
 Sufism
 Suicide
 Superstition
 Surrealism
 Symbolism
 Syncretism
 Technology
 Temperance
 Terror
 Terrorism, Middle East
 Third Cinema
 Third World
 Third World Literature
 Time: China
 Time: Traditional and Utilitarian
 Toleration
 Totalitarianism
 Trade
 Translation
 Treaty
 Tribalism, Middle East
 University: Postcolonial
 Untouchability: Menstrual Taboos
 Untouchability: Taboos
 Utilitarianism
 Utopia
 Victorianism
 Virtue Ethics
 Visual Order to Organizing Collections
 Volksgeist
 Volunteerism, U.S.
 War
 War and Peace in the Arts
 Wealth
 Westernization: Africa
 Westernization: Middle East
 Westernization: Southeast Asia
 Wildlife
 Witchcraft
 Witchcraft, African Studies of

READER'S GUIDE

- Women's History: Africa
 Work
 World Systems Theory, Latin America
 Zionism
ECONOMICS
 Abolitionism
 Africa, Idea of
 African-American Ideas
 Afropessimism
 Alienation
 Altruism
 Anarchism
 Anthropology
 Anticolonialism: Africa
 Anticolonialism: Latin America
 Anticolonialism: Middle East
 Anticolonialism: Southeast Asia
 Anti-Semitism: Islamic Anti-Semitism
 Apartheid
 Architecture: Africa
 Arts: Africa
 Asceticism: Western Asceticism
 Asian-American Ideas (Cultural Migration)
 Assimilation
 Astronomy, Pre-Columbian and Latin American
 Authoritarianism: East Asia
 Authoritarianism: Latin America
 Avant-Garde: Militancy
 Bioethics
 Black Atlantic
 Black Consciousness
 Bureaucracy
 Bushido
 Calculation and Computation
 Capitalism: Overview
 Capitalism: Africa
 Chicano Movement
 Cinema
 City, The: The City as a Cultural Center
 City, The: The City as Political Center
 City, The: The Islamic and Byzantine City
 Civil Society: Europe and the United States
 Civil Society: Responses in Africa and the Middle East
 Class
 Colonialism: Africa
 Colonialism: Southeast Asia
 Communication of Ideas: Africa and Its Influence
 Communication of Ideas: Middle East and Abroad
 Communication of Ideas: Southeast Asia
 Communism: Europe
 Communism: Latin America
 Composition, Musical
 Confucianism
 Consumerism
 Corruption in Developed and Developing Countries
 Critical Race Theory
 Cultural Capital
 Cultural History
 Cultural Studies
 Democracy: Africa
Demography
 Dependency
 Diasporas: African Diaspora
 Diasporas: Jewish Diaspora
 Dictatorship in Latin America
 Diffusion, Cultural
 Discrimination
 Diversity
 Dress
 Dystopia
Economics
 Education: China
 Education: Global Education
 Empire and Imperialism: Americas
 Empire and Imperialism: Asia
 Empire and Imperialism: Europe
 Empire and Imperialism: Middle East
 Empire and Imperialism: United States
 Environmental Ethics
 Environmental History
 Equality: Overview
 Equality: Gender Equality
 Equality: Racial Equality
 Eugenics
 Eurocentrism
 Europe, Idea of
 Everyday Life
 Examination Systems, China
 Family: Modernist Anthropological Theory
 Family Planning
 Fascism
 Feminism: Overview
 Feminism: Africa and African Diaspora
 Feminism: Chicana Feminisms
 Feminism: Islamic Feminism
 Feminism: Third World U.S. Movement
 Fetishism: Overview
 Fetishism: Fetishism in Literature and Cultural Studies
 Feudalism, European
 Futurology
 Game Theory
 Generation
 Genetics: Contemporary
 Ghetto
 Gift, The
Globalization: Africa
Globalization: Asia
Globalization: General
 Good
 Hegelianism
 Hegemony
 Hinduism
 Historical and Dialectical Materialism
 Historicism
 Historiography
 History, Economic
 History, Idea of
 Human Capital
 Human Rights: Women's Rights
 Ideas, History of
 Identity, Multiple: Asian-Americans
 Indigenismo
 Individualism
 Intelligentsia
 Intentionality
 Internal Colonialism
 Interpretation
 Islam: Africa
 Islam: Sunni
 Islamic Science

- Jainism
 Japanese Philosophy, Japanese Thought
 Jihad
 Justice: Overview
 Justice: Justice in American Thought
 Law, Islamic
 Leadership
 Liberalism
 Liberation Theology
 Life Cycle: Elders/Old Age
 Literary Criticism
 Maoism
 Maps and the Ideas They Express
 Marriage and Fertility, European Views
 Marxism: Overview
 Marxism: Asia
 Marxism: Latin America
 Mathematics
 Migration: Africa
 Migration: Migration in World History
 Migration: United States
 Minority
 Modernity: Africa
 Modernity: East Asia
 Modernization
 Modernization Theory
 Motherhood and Maternity
 Nationalism: Africa
 Native Policy
 Naturalism
 Neocolonialism
 Neoliberalism
 Nomadism
 Nuclear Age
 Occidentalism
 Orthopraxy: Asia
 Pan-Africanism
 Pan-Asianism
 Parties, Political
 Peasants and Peasantry
 Philanthropy
 Philosophies: American
 Philosophy, History of
 Political Protest, U.S.
 Political Science
 Population
 Populism: Latin America
 Populism: United States
 Postcolonial Studies
 Poverty
 Practices
 Pre-Columbian Civilization
 Presentism
 Privacy
 Privatization
 Probability
 Progress, Idea of
 Property
 Protest, Political
 Pseudoscience
 Public Sphere
 Punishment
 Puritanism
 Race and Racism: United States
 Radicals/Radicalism
 Reason, Practical and Theoretical
 Reform: Europe and the United States
 Religion and the State: Africa
 Religion and the State: Latin America
 Renaissance
 Representation: Political Representation
 Republicanism: Republic
 Resistance
 Resistance and Accommodation
 Responsibility
 Ritual: Public Ritual
 Ritual: Religion
 Scarcity and Abundance, Latin America
 Secularization and Secularism
 Segregation
 Sexual Harassment
 Sexuality: Islamic Views
 Slavery
 Social Capital
 Social Darwinism
 Social History, U.S.
 Socialism
 Sport
 State, The: Overview
 State, The: The Postcolonial State
 Technology
 Terrorism, Middle East
 Third Cinema
 Third World
 Third World Literature
 Time: China
 Time: Traditional and Utilitarian
 Totalitarianism
 Trade
 Translation
 Travel: Travel from Europe and the Middle East
 Treaty
 Untouchability: Taboos
 Utilitarianism
 Victorianism
 Visual Culture
 Volunteerism, U.S.
 War and Peace in the Arts
 Wealth
 Westernization: Africa
 Westernization: Middle East
 Westernization: Southeast Asia
 Women and Femininity in U.S. Popular Culture
 Women's History: Africa
 Work
 World Systems Theory, Latin America
 Zen
 Zionism
- GEOGRAPHY**
 Africa, Idea of
 America
 Anthropology
 Architecture: Overview
 Barbarism and Civilization
 Borders, Borderlands, and Frontiers, Global
 Capitalism: Overview
 Chinese Warlordism
 Cultural Studies
 Diffusion, Cultural
 Economics

READER'S GUIDE

Environment
Environmental History
Ethnicity and Race: Anthropology
Ethnicity and Race: Islamic Views
Eurocentrism
Feudalism, European
Geography
Ghetto
Globalization: Asia
Globalization: General
History, Economic
History, Idea of
Identity, Multiple: Jewish Multiple Identity
Islamic Science
Maps and the Ideas They Express
Mathematics
Migration: Africa
Migration: Migration in World History
Migration: United States
Minority
Nation
Nationalism: Africa
Natural History
Nomadism
Occidentalism
Orientalism: Overview
Pan-Africanism
Pan-Asianism
Perspective
Population
Privacy
Race and Racism: Asia
Race and Racism: United States
Regions and Regionalism, Eastern Europe
Religion: Indigenous Peoples' View, South America
Sacred Places
Scarcity and Abundance, Latin America
Third Cinema
Third World
Travel: Travel from Europe and the Middle East
Victorianism
Westernization: Southeast Asia
World Systems Theory, Latin America

Sciences

HISTORY OF SCIENCE, EARLY (entries focused on early ideas about nature and the human relationship with nature)

Alchemy: China
Alchemy: Europe and the Middle East
Anthropology
Aristotelianism
Asceticism: Hindu and Buddhist Asceticism
Astrology: Overview
Astrology: China
Astronomy, Pre-Columbian and Latin American
Change
Confucianism
Consciousness: Chinese Thought
Cosmology: Asia
Daoism
Ethnicity and Race: Africa
Ethnicity and Race: Anthropology
Ethnicity and Race: Islamic Views
Greek Science

Harmony
Hierarchy and Order
Hinduism
Humanism: Chinese Conception of
Humanity: African Thought
Ideas, History of
Lysenkoism
Magic
Manichaeism
Medicine: China
Medicine: India
Metaphysics: Ancient and Medieval
Mysticism: Chinese Mysticism
Myth
Natural Theology
Naturphilosophie
Organicism
Paradigm
Person, Idea of the
Philosophies: Islamic
Philosophy: Historical Overview and Recent Developments
Philosophy of Religion
Phrenology
Pseudoscience
Race and Racism: Europe
Race and Racism: United States
Religion: Indigenous Peoples' View, South America
Religion and Science
Ritual: Religion
Sacred Places
Science: East Asia
Segregation
Sexuality: Sexual Orientation
Slavery
Superstition
Syncretism
Time: China
Time: India
Untouchability: Menstrual Taboos
Witchcraft
Yin and Yang

HISTORY OF SCIENCE, MODERN AND CONTEMPORARY (entries focused on the origins of modern or contemporary ideas in the physical, chemical, biological, mathematical, or earth sciences)

Agnosticism
Algebras
Behaviorism
Body, The
Calendar
Cartesianism
Causation
Causation in East Asian and Southeast Asian Philosophy
Chemistry
Communication of Ideas: Middle East and Abroad
Computer Science
Context
Continental Philosophy
Cosmology: Cosmology and Astronomy
Creationism
Creativity in the Arts and Sciences
Cultural History
Demonology
Determinism

- Development
 Ecology
 Education: Islamic Education
 Empiricism
 Enlightenment
 Environment
 Environmental History
 Epistemology: Early Modern
 Equality: Racial Equality
 Everyday Life
 Experiment
 Falsifiability
 Free Will, Determinism, and Predestination
 Health and Disease
 History, Economic
 Idealism
 Islamic Science
 Kantianism
 Knowledge
 Life
 Linguistic Turn
 Mathematics
 Mechanical Philosophy
 Medicine: Europe and the United States
 Medicine: Islamic Medicine
 Metaphor
 Museums
 Nature
 Newtonianism
 Nuclear Age
 Objectivity
 Philosophies: African
 Philosophies: Feminist, Twentieth-Century
 Philosophy, History of
 Philosophy of Mind: Overview
 Philosophy of Mind: Ancient and Medieval
 Physics
 Platonism
 Poetry and Poetics
 Positivism
 Prehistory, Rise of
 Probability
 Progress, Idea of
 Pythagoreanism
 Quantum
 Race and Racism: Asia
 Rationalism
 Reason, Practical and Theoretical
 Reflexivity
 Reform: Europe and the United States
 Relativity
 Renaissance
 Scholasticism
 Science: Overview
Science, History of
Scientific Revolution
 Sexuality: Overview
 Social Darwinism
 Social History, U.S.
 Technology
 Victorianism
 Visual Order to Organizing Collections
PSYCHOLOGY
 Absolute Music
 Aesthetics: Asia
 Aesthetics: Europe and the Americas
 Alchemy: Europe and the Middle East
 Alienation
 Altruism
 Ambiguity
 Ancestor Worship
 Animism
 Anthropology
 Anti-Semitism: Overview
 Asceticism: Hindu and Buddhist Asceticism
 Asceticism: Western Asceticism
 Authoritarianism: East Asia
 Beauty and Ugliness
 Behaviorism
 Bioethics
 Biography
 Biology
 Body, The
 Buddhism
 Cartesianism
 Character
 Cinema
 Communitarianism in African Thought
 Composition, Musical
 Computer Science
 Consciousness: Overview
 Consciousness: Chinese Thought
 Consciousness: Indian Thought
 Consumerism
 Context
 Continental Philosophy
 Creativity in the Arts and Sciences
 Cultural Studies
 Dada
 Dance
 Daoism
 Death
 Demonology
 Determinism
 Diffusion, Cultural
 Discrimination
 Dream
 Emotions
 Empiricism
 Epistemology: Early Modern
 Epistemology: Modern
 Ethnicity and Race: Africa
 Eugenics
 Everyday Life
 Existentialism
 Feminism: Overview
 Fetishism: Overview
 Fetishism: Fetishism in Literature and Cultural Studies
 Form, Metaphysical, in Ancient and Medieval Thought
 Foundationalism
 Friendship
 Gay Studies
 Gender: Overview
 Gender: Gender in the Middle East
 Gender in Art
 Gender Studies: Anthropology
 Gesture
 Harmony
 Hate
 Health and Disease

READER'S GUIDE

Heaven and Hell
Hinduism
Humanism: Secular Humanism in the United States
Humanity: African Thought
Humanity: European Thought
Identity: Identity of Persons
Identity: Personal and Social Identity
Identity, Multiple: Overview
Identity, Multiple: Asian-Americans
Images, Icons, and Idols
Imagination
Immortality and the Afterlife
Impressionism
Indigenismo
Intentionality
Jainism
Jouissance
Kinship
Knowledge
Language and Linguistics
Learning and Memory, Contemporary Views
Life
Life Cycle: Elders/Old Age
Literary Criticism
Love, Western Notions of
Machismo
Magic
Manichaeism
Masks
Medicine: China
Medicine: Europe and the United States
Meditation: Eastern Meditation
Memory
Men and Masculinity
Metaphor
Metaphysics: Renaissance to the Present
Mind
Modernism: Overview
Modernity: Overview
Modernity: Africa
Modernity: East Asia
Monarchy: Overview
Monism
Motherhood and Maternity
Musical Performance and Audiences
Mysticism: Chinese Mysticism
Mysticism: Islamic Mysticism in Asia
Myth
Narrative
National History
Nationalism: Overview
Naturphilosophie
Negritude
Objectivity
Person, Idea of the
Personhood in African Thought
Philosophies: Islamic
Philosophy, Moral: Modern
Philosophy of Mind: Overview
Philosophy of Mind: Ancient and Medieval
Philosophy of Religion
Phrenology
Political Science
Prejudice
Presentism

Privacy
Probability
Progress, Idea of
Protest, Political
Psychoanalysis
Psychology and Psychiatry
Punishment
Queer Theory
Realism: Africa
Reflexivity
Religion: Africa
Religion: African Diaspora
Religion: Indigenous Peoples' View, South America
Religion: Latin America
Religion and Science
Representation: Mental Representation
Resistance and Accommodation
Responsibility
Ritual: Public Ritual
Sexuality: Overview
Sexuality: Sexual Orientation
Slavery
State of Nature
Structuralism and Poststructuralism: Overview
Subjectivism
Superstition
Surrealism
Symbolism
Syncretism
Temperance
Text/Textuality
Third Cinema
Toleration
Totalitarianism
Tragedy and Comedy
Untouchability: Menstrual Taboos
Untouchability: Taboos
Utilitarianism
War and Peace in the Arts
Witchcraft
Witchcraft, African Studies of
Womanism
Women and Femininity in U.S. Popular Culture
BIOLOGICAL SCIENCES
Agnosticism
Altruism
Ancestor Worship
Anthropology
Antifeminism
Asceticism: Hindu and Buddhist Asceticism
Asceticism: Western Asceticism
Beauty and Ugliness
Behaviorism
Bioethics
Biology
Body, The
Buddhism
Cannibalism
Cartesianism
Casuistry
Classification of Arts and Sciences, Early Modern
Composition, Musical
Computer Science
Consciousness: Overview
Consilience

- Creationism
 Critical Race Theory
 Death
 Demography
 Determinism
 Development
 Dystopia
 Ecology
 Emotions
 Environmental Ethics
 Environmental History
 Epistemology: Early Modern
 Equality: Racial Equality
 Ethnohistory, U.S.
 Eugenics
Evolution
 Family: Modernist Anthropological Theory
 Family: Family in Anthropology since 1980
 Family Planning
 Feminism: Overview
 Game Theory
 Garden
 Gender: Overview
 Gender: Gender in the Middle East
 Gender in Art
 Gender Studies: Anthropology
Genetics: Contemporary
Genetics: History of
 Genocide
 Gesture
 Greek Science
 Health and Disease
 Heaven and Hell
 History, Idea of
 Humanism: Secular Humanism in the United States
 Humanity: African Thought
 Hygiene
 Identity: Identity of Persons
 Immortality and the Afterlife
 Intentionality
 Islamic Science
 Jainism
 Jouissance
 Kinship
 Learning and Memory, Contemporary Views
 Life
 Life Cycle: Adolescence
 Life Cycle: Elders/Old Age
 Lysenkoism
 Machiavellism
 Marriage and Fertility, European Views
 Masks
 Materialism in Eighteenth-Century European Thought
 Mechanical Philosophy
 Medicine: China
 Medicine: Europe and the United States
 Medicine: Islamic Medicine
 Meme
 Memory
 Men and Masculinity
 Mestizaje
 Monarchy: Overview
 Motherhood and Maternity
 Musical Performance and Audiences
 Natural History
 Naturalism
 Natural Theology
 Nature
 Naturphilosophie
 Negritude
 Organicism
 Other, The, European Views of
 Periodization of the Arts
 Person, Idea of the
 Perspective
 Philosophies: Islamic
 Philosophy of Mind: Ancient and Medieval
 Phrenology
 Population
 Prehistory, Rise of
 Probability
 Progress, Idea of
 Psychoanalysis
 Psychology and Psychiatry
 Punishment
 Queer Theory
 Religion: Indigenous Peoples' View, South America
 Representation: Mental Representation
 Science: East Asia
 Science, History of
 Sexuality: Overview
 Sexuality: Sexual Orientation
 Sociability in African Thought
 Social Darwinism
 Sport
 State of Nature
 Subjectivism
 Superstition
 Temperance
 Terror
 Text/Textuality
 Totems
 Untouchability: Menstrual Taboos
 Utilitarianism
 Victorianism
 Visual Order to Organizing Collections
 War and Peace in the Arts
 Wildlife
 Women and Femininity in U.S. Popular Culture
PHYSICAL SCIENCES
 Agnosticism
 Alchemy: China
 Astrology: China
 Astronomy, Pre-Columbian and Latin American
 Calculation and Computation
 Calendar
 Causality
 Causation
 Causation in East Asian and Southeast Asian Philosophy
 Change
 Chemistry
 Classification of Arts and Sciences, Early Modern
 Computer Science
 Consciousness: Overview
 Consilience
 Cosmology: Asia
 Cosmology: Cosmology and Astronomy
 Creationism
 Cycles

READER'S GUIDE

Ecology
 Empiricism
 Environmental Ethics
 Environmental History
 Epistemology: Early Modern
 Ethnohistory, U.S.
 Experiment
 Falsifiability
 Field Theories
 Form, Metaphysical, in Ancient and Medieval Thought
 Geography
 Geometry
 Greek Science
 Harmony
 Hinduism
 History, Economic
 Islam: Sunni
 Islamic Science
 Japanese Philosophy, Japanese Thought
 Knowledge
 Language, Philosophy of: Modern
 Life
 Literary History
 Logic and Philosophy of Mathematics, Modern
 Maps and the Ideas They Express
 Materialism in Eighteenth-Century European Thought
 Mathematics
 Mechanical Philosophy
 Metaphysics: Renaissance to the Present
 Microcosm and Macrocosm
 Monism
 Myth
 Natural Theology
 Naturalism
 Nature
 Naturphilosophie
 Newtonianism
 Nuclear Age
 Paradigm
 Periodization of the Arts
 Philosophies: Islamic
 Philosophy: Historical Overview and Recent Developments
 Philosophy, History of
Physics
 Positivism
 Power
 Pragmatism
 Probability
 Progress, Idea of
 Psychoanalysis
 Pythagoreanism
 Quantum
 Rationalism
 Realism: Africa
 Reason, Practical and Theoretical
 Relativity
 Religion: East and Southeast Asia
 Religion: Indigenous Peoples' View, South America
 Religion and Science
 Science: Overview
 Science: East Asia
 Science, History of
 Scientific Revolution
 Sophists, The

Stoicism
 Subjectivism
 Superstition
 Time: China
 Time: India
 Victorianism
ECOLOGY AND GEOLOGY
 Aesthetics: Asia
 Anthropology
 Architecture: Overview
 Architecture: Asia
 Astronomy, Pre-Columbian and Latin American
 Authoritarianism: Overview
 Bioethics
 Biology
 Borders, Borderlands, and Frontiers, Global
 Calendar
 Capitalism: Overview
 City, The: Latin America
 City, The: The City as a Cultural Center
 City, The: The Islamic and Byzantine City
 Creationism
 Death
 Dystopia
Ecology
 Education: Global Education
Environment
 Environmental Ethics
 Environmental History
 Evolution
 Feminism: Overview
 Garden
 Genetics: Contemporary
 Genetics: History of
 Genocide
 Geography
 History, Economic
 History, Idea of
 Hygiene
 Impressionism
 Landscape in the Arts
 Life
 Life Cycle: Elders/Old Age
 Lysenkoism
 Machiavellism
 Maps and the Ideas They Express
 Matriarchy
 Medicine: Islamic Medicine
 Memory
 Migration: Migration in World History
Natural History
 Nuclear Age
 Organicism
 Periodization of the Arts
 Political Protest, U.S.
 Prehistory, Rise of
 Presentism
 Protest, Political
 Religion: Latin America
 Ritual: Religion
 Scarcity and Abundance, Latin America
 Science, History of
 Social Darwinism
 Totems
 Untouchability: Menstrual Taboos

- Utopia
- Visual Order to Organizing Collections
- Wildlife
- Witchcraft
- Witchcraft, African Studies of
- World Systems Theory, Latin America
- CHEMISTRY**
 - Alchemy: China
 - Alchemy: Europe and the Middle East
 - Biology
 - Chemistry**
 - Classification of Arts and Sciences, Early Modern
 - Computer Science
 - Consciousness: Overview
 - Development
 - Experiment
 - Genetics: Contemporary
 - Genetics: History of
 - Health and Disease
 - Islamic Science
 - Life
 - Materialism in Eighteenth-Century European Thought
 - Mechanical Philosophy
 - Medicine: Europe and the United States
 - Mysticism: Chinese Mysticism
 - Paradigm
 - Philosophies: Islamic
 - Physics
 - Quantum
 - Science: East Asia
 - Science, History of
- MATHEMATICS**
 - Absolute Music
 - Aesthetics: Europe and the Americas
 - Algebras**
 - Analytical Philosophy
 - Astronomy, Pre-Columbian and Latin American
 - Beauty and Ugliness
 - Calculation and Computation
 - Causation
 - Causation in East Asian and Southeast Asian Philosophy
 - Chemistry
 - Classification of Arts and Sciences, Early Modern
 - Computer Science
 - Cosmology: Cosmology and Astronomy
 - Death
 - Demography
 - Economics
 - Empiricism
 - Environmental History
 - Equality: Overview
 - Experiment
 - Fallacy, Logical
 - Falsifiability
 - Foundationalism
 - Futurology
 - Game Theory
 - Generation
 - Genetics: Contemporary
 - Genetics: History of
 - Genocide
 - Geometry**
 - Harmony
 - History, Economic
 - Humanism: Chinese Conception of
 - Islamic Science
 - Knowledge
 - Language, Philosophy of: Ancient and Medieval
 - Language, Philosophy of: Modern
 - Language and Linguistics
 - Logic and Philosophy of Mathematics, Modern
 - Mathematics**
 - Newtonianism
 - Perspective
 - Philosophies: Islamic
 - Philosophy: Historical Overview and Recent Developments
 - Physics
 - Political Science
 - Positivism
 - Prejudice
 - Probability
 - Pythagoreanism
 - Quantum
 - Rationalism
 - Reading
 - Reason, Practical and Theoretical
 - Relativism
 - Relativity
 - Representation: Mental Representation
 - Scientific Revolution
 - Social History, U.S.
 - Sophists, The
 - Truth
- COMPUTER SCIENCE**
 - Calculation and Computation**
 - Computer Science**
 - Consciousness: Overview
 - Futurology
 - Game Theory
 - Genetics: Contemporary
 - Genetics: History of
 - Geography
 - History, Economic
 - Interdisciplinarity
 - Language and Linguistics
 - Learning and Memory, Contemporary Views
 - Maps and the Ideas They Express
 - Mathematics
 - Privacy
 - Probability
 - Social History, U.S.
 - Virtual Reality
- Professions**
- MEDICINE**
 - Alchemy: China
 - Alchemy: Europe and the Middle East
 - Americanization, U.S.
 - Ancestor Worship
 - Anthropology
 - Asceticism: Hindu and Buddhist Asceticism
 - Asceticism: Western Asceticism
 - Astrology: China
 - Bioethics
 - Biology
 - Body, The
 - Casuistry
 - Chemistry
 - Childhood and Child Rearing

READER'S GUIDE

Computer Science
Creativity in the Arts and Sciences
Death
Demography
Determinism
Diversity
Environment
Environmental History
Eugenics
Feminism: Overview
Feminism: Third World U.S. Movement
Gay Studies
Gender: Overview
Gender Studies: Anthropology
Genetics: Contemporary
Genetics: History of
Greek Science
Health and Disease
Hinduism
Humanity: African Thought
Humor
Hygiene
Iconography
Islam: Sunni
Islamic Science
Life
Life Cycle: Elders/Old Age
Literary Criticism
Magic
Mathematics
Medicine: China
Medicine: Europe and the United States
Medicine: India
Medicine: Islamic Medicine
Meditation: Eastern Meditation
Miracles
Motherhood and Maternity
Music, Anthropology of
Mysticism: Chinese Mysticism
Narrative
Naturphilosophie
Philosophies: Feminist, Twentieth-Century
Philosophies: Islamic
Phrenology
Population
Privacy
Psychoanalysis
Psychology and Psychiatry
Pythagoreanism
Queer Theory
Religion: Africa
Religion: African Diaspora
Religion: East and Southeast Asia
Religion: Indigenous Peoples' View, South America
Ritual: Religion
Science: East Asia
Science, History of
Sexuality: Overview
Skepticism
Superstition
University: Overview
Untouchability: Menstrual Taboos
Utilitarianism
Victorianism
Visual Culture
Visual Order to Organizing Collections
Volunteerism, U.S.
Westernization: Africa
Witchcraft
Women and Femininity in U.S. Popular Culture
Yin and Yang

LAW

Abolitionism
African-American Ideas
Altruism
Anticolonialism: Africa
Anticolonialism: Latin America
Anticolonialism: Southeast Asia
Antifeminism
Anti-Semitism: Islamic Anti-Semitism
Apartheid
Asian-American Ideas (Cultural Migration)
Assimilation
Authoritarianism: Overview
Authoritarianism: East Asia
Barbarism and Civilization
Bioethics
Black Consciousness
Cannibalism
Capitalism: Overview
Capitalism: Africa
Casuistry
Censorship
Citizenship: Overview
Citizenship: Cultural Citizenship
Citizenship: Naturalization
City, The: The Islamic and Byzantine City
Civil Disobedience
Civil Society: Europe and the United States
Colonialism: Southeast Asia
Consciousness: Chinese Thought
Constitutionalism
Context
Corruption in Developed and Developing Countries
Creationism
Critical Race Theory
Cultural History
Cultural Revivals
Deism
Democracy
Democracy: Africa
Dialogue and Dialectics: Socratic
Dialogue and Dialectics: Talmudic
Dictatorship in Latin America
Discrimination
Diversity
Education: Islamic Education
Empire and Imperialism: Overview
Empire and Imperialism: Europe
Empire and Imperialism: United States
Environmental History
Equality: Overview
Equality: Racial Equality
Ethnicity and Race: Anthropology
Ethnicity and Race: Islamic Views
Europe, Idea of
Extirpation
Fallacy, Logical
Falsifiability
Family Planning

- Fascism
 Feminism: Overview
 Feminism: Africa and African Diaspora
 Feminism: Islamic Feminism
 Feudalism, European
 Gender: Gender in the Middle East
 General Will
 Genetics: Contemporary
 Genetics: History of
 Genocide
 Ghetto
 Globalization: Africa
 Good
 Hate
 Heresy and Apostasy
 Hinduism
 Honor, Middle Eastern Notions of
 Human Rights: Overview
 Humanism: Secular Humanism in the United States
 Iconography
 Identity, Multiple: Jewish Multiple Identity
 Indigenismo
 Individualism
 Intentionality
 Interdisciplinarity
 International Order
 Islam: Africa
 Islam: Shi
 Islam: Southeast Asia
 Islam: Sunni
 Jihad
 Judaism: Judaism to 1800
 Justice: Overview
 Justice: Justice in American Thought
 Justice: Justice in East Asian Thought
 Kinship
 Language and Linguistics
Law
Law, Islamic
 Learning and Memory, Contemporary Views
 Legalism, Ancient China
 Liberalism
 Liberty
 Life Cycle: Elders/Old Age
 Literary Criticism
 Loyalties, Dual
 Marriage and Fertility, European Views
 Masks
 Matriarchy
 Migration: United States
 Minority
 Modernity: Overview
 Monarchy: Overview
 Monarchy: Islamic Monarchy
 Motherhood and Maternity
 Mysticism: Islamic Mysticism
 Narrative
 Nation
 Nationalism: Cultural Nationalism
 Nationalism: Middle East
 Native Policy
 Natural Law
 Nonviolence
 Nuclear Age
 Obligation
 Person, Idea of the
 Philanthropy
 Philosophies: American
 Philosophies: Feminist, Twentieth-Century
 Philosophies: Islamic
 Philosophy: Historical Overview and Recent Developments
 Philosophy, Moral: Ancient
 Political Protest, U.S.
 Population
 Postcolonial Studies
 Power
 Privacy
 Progress, Idea of
 Property
 Protest, Political
 Punishment
 Queer Theory
 Race and Racism: United States
 Reason, Practical and Theoretical
 Reform: Europe and the United States
 Regions and Regionalism, Eastern Europe
 Relativism
 Religion: African Diaspora
 Religion: Middle East
 Religion and the State: Africa
 Religion and the State: Europe
 Religion and the State: Middle East
 Religion and the State: United States
 Representation: Political Representation
 Republicanism: Republic
 Resistance
 Responsibility
 Rhetoric: Ancient and Medieval
 Ritual: Public Ritual
 Sacred Texts: Koran
 Segregation
 Sexual Harassment
 Sexuality: Overview
 Sexuality: Islamic Views
 Sexuality: Sexual Orientation
 Skepticism
 Slavery
 Sociability in African Thought
 Social Contract
 Socialisms, African
 Society
 State, The: Overview
 State, The: The Postcolonial State
 State of Nature
 Stoicism
 Subjectivism
 Sufism
 Suicide
 Temperance
 Toleration
 Totalitarianism
 Treaty
 University: Overview
 Untouchability: Taboos
 Utilitarianism
 Victorianism
 Virtue Ethics
 Visual Order to Organizing Collections
 Volunteerism, U.S.
 War and Peace in the Arts

READER'S GUIDE

Westernization: Africa
Westernization: Middle East
Westernization: Southeast Asia
Wildlife
Witchcraft
ENGINEERING
Alchemy: China
Alchemy: Europe and the Middle East
Architecture: Overview
Architecture: Africa
Architecture: Asia
Beauty and Ugliness
Biology
Calculation and Computation
Capitalism: Overview
Capitalism: Africa
Cinema
City, The: Latin America
City, The: The City as a Cultural Center
City, The: The City as Political Center
City, The: The Islamic and Byzantine City
Communication of Ideas: Southeast Asia
Computer Science
Diffusion, Cultural
Dystopia
Ecology
Empire and Imperialism: Europe
Environmental History
Epistemology: Early Modern
Experiment
Futurology
Gender Studies: Anthropology
Genetics: Contemporary
Genetics: History of
Genocide
Geometry
Globalization: General
Greek Science
Harmony
Historical and Dialectical Materialism
History, Economic
Humanism: Secular Humanism in the United States
Interdisciplinarity
Japanese Philosophy, Japanese Thought
Knowledge
Literary Criticism
Maps and the Ideas They Express
Mathematics
Mechanical Philosophy
Meme
Modernity: Overview
Modernity: Africa
Modernity: East Asia
Modernization
Modernization Theory
Motherhood and Maternity
Music, Anthropology of
Musical Performance and Audiences
Mysticism: Chinese Mysticism
Newtonianism
Nomadism
Nuclear Age
Occidentalism
Perspective
Power

Presentism
Privacy
Progress, Idea of
Protest, Political
Reform: Europe and the United States
Relativity
Science, History of
Science Fiction
Technology
Textiles and Fiber Arts as Catalysts for Ideas
Totalitarianism
Victorianism
Virtual Reality
Visual Culture
War and Peace in the Arts
Westernization: Middle East
Westernization: Southeast Asia
World Systems Theory, Latin America

Multidisciplinary Practices

The *New Dictionary of the History of Ideas* has many entries that discuss the methods by which scholars and researchers pursue knowledge. The entries below discuss approaches, methods, and practices that have influenced many disciplines.

ENTRIES ON MULTIDISCIPLINARY PRACTICES THAT ORIGINATED IN ANCIENT TIMES

Aesthetics: Asia
Africa, Idea of
Algebras
Anthropology
Architecture: Overview
Architecture: Asia
Aristotelianism
Astrology: Overview
Biology
Body, The
Buddhism
Casuistry
Causality
Censorship
Classicism
Classification of Arts and Sciences, Early Modern
Composition, Musical
Cosmology: Asia
Creationism
Creativity in the Arts and Sciences
Daoism
Development
Dialogue and Dialectics: Socratic
Dualism
Eclecticism
Education: China
Education: Europe
Epistemology: Ancient
Equality: Overview
Essentialism
Eurocentrism
Experiment
Fallacy, Logical
Fetishism: Fetishism in Literature and Cultural Studies
Form, Metaphysical, in Ancient and Medieval Thought
Fundamentalism
Gender in Art
Genre

- Geometry
 Greek Science
 Harmony
 Health and Disease
 Hierarchy and Order
 Hinduism
 History, Idea of
 Humanism: Europe and the Middle East
 Humor
 Ideas, History of
 Imagination
 Interpretation
 Knowledge
 Language, Philosophy of: Ancient and Medieval
 Life
 Literary History
 Literature: African Literature
 Logic
 Maps and the Ideas They Express
 Mathematics
 Medicine: China
 Medicine: Europe and the United States
 Medicine: India
 Memory
 Metaphor
 Metaphysics: Ancient and Medieval
 Monism
 Museums
 Music, Anthropology of
 Musical Performance and Audiences
 Mysticism: Chinese Mysticism
 Narrative
 Nature
 Orthodoxy
 Orthopraxy: Asia
 Orthopraxy: Western Orthopraxy
 Paradigm
 Periodization
 Perspective
 Philosophies: African
 Philosophies: Islamic
 Philosophy: Historical Overview and Recent Developments
 Philosophy and Religion in Western Thought
 Physics
 Platonism
 Presentism
 Progress, Idea of
 Pythagoreanism
 Rationalism
 Reading
 Reason, Practical and Theoretical
 Religion: Overview
 Responsibility
 Rhetoric: Overview
 Rhetoric: Ancient and Medieval
 Sacred Places
 Sacred Texts: Asia
 Science: East Asia
 Scientific Revolution
 Skepticism
 Sophists, The
 Syncretism
 Taste
 Text/Textuality
 Toleration
 Translation
 Trope
 Truth
 Virtual Reality
 Wisdom, Human
 Yin and Yang
- ENTRIES ON MULTIDISCIPLINARY PRACTICES OF
 MORE RECENT ORIGIN
 Absolute Music
 Aesthetics: Africa
 African-American Ideas
 Afrocentricity
 Analytical Philosophy
 Astronomy, Pre-Columbian and Latin American
 Avant-Garde: Militancy
 Behaviorism
 Bilingualism and Multilingualism
 Bioethics
 Black Atlantic
 Calculation and Computation
 Class
 Conservatism
 Consilience
 Continental Philosophy
 Critical Race Theory
 Critical Theory
 Cultural Studies
 Dada
 Dialogue and Dialectics: Talmudic
 Dream
 Dystopia
 Economics
 Education: Global Education
 Education: Islamic Education
 Empiricism
 Encyclopedism
 Environmental Ethics
 Environmental History
 Epistemology: Early Modern
 Epistemology: Modern
 Ethnicity and Race: Anthropology
 Ethnocentrism
 Ethnography
 Ethnohistory, U.S.
 Examination Systems, China
 Expressionism
 Family: Modernist Anthropological Theory
 Feminism: Overview
 Fetishism: Overview
 Field Theories
 Formalism
 Futurology
 Game Theory
 Gender: Gender in the Middle East
 Generation
 Genetics: Contemporary
 Genetics: History of
 Geography
 Hegelianism
 Hermeneutics
 Historicism
 Humanism: Africa
 Humanism: Renaissance
 Iconography

Idealism
 Identity: Identity of Persons
 Intentionality
 Interdisciplinarity
 Japanese Philosophy, Japanese Thought
 Language, Philosophy of: Modern
 Language and Linguistics
 Law, Islamic
 Learning and Memory, Contemporary Views
 Linguistic Turn
 Literary Criticism
 Logic and Philosophy of Mathematics, Modern
 Masks
 Metaphysics: Renaissance to the Present
 Mind
 Modernism: Overview
 Modernism: Latin America
 Modernization
 Modernization Theory
 Motif: Motif in Literature
 Motif: Motif in Music
 Mysticism: Kabbalah
 Myth
 Naturalism
 Naturalism in Art and Literature
 Naturphilosophie
 Newtonianism
 Objectivity
 Oral Traditions: Overview
 Orientalism: Overview
 Philosophies: Feminist, Twentieth-Century
 Philosophy, Moral: Africa
 Philosophy of Religion
 Phrenology
 Poetry and Poetics
 Polytheism
 Positivism
 Postcolonial Studies
 Postmodernism
 Power
 Practices
 Pragmatism
 Prejudice
 Probability
 Pseudoscience
 Psychoanalysis
 Queer Theory
 Realism
 Realism: Africa
 Reflexivity
 Regions and Regionalism, Eastern Europe
 Relativism
 Relativity
 Religion: Indigenous Peoples' View, South America
 Religion and Science
 Representation: Mental Representation
 Romanticism in Literature and Politics
 Sacred Texts: Koran
 Sage Philosophy
 Scholasticism
 Science: Overview
 Science, History of
 Science Fiction
 Secularization and Secularism
 Social Capital

Social History, U.S.
 State, The: Overview
 Structuralism and Poststructuralism: Overview
 Structuralism and Poststructuralism: Anthropology
 Subjectivism
 Symbolism
 Third Cinema
 Totems
 Tradition
 Universalism
 Utilitarianism
 Visual Culture
 Volksgeist
 Women's Studies

Especially Interdisciplinary Entries

The most interdisciplinary entries synthesized knowledge by using the methods and focusing on the topics of practitioners of several disciplines. Very few entries listed below are in only one division. Common pairs for the history of ideas are social sciences and humanities, social sciences and sciences, and humanities and sciences. In the early twenty-first century there is generally a recognition of the common overlap of the social sciences with the humanities; social scientists may take ethical and literary factors into consideration and humanists may incorporate societal contexts into their work. The presence of psychology in the sciences, as well as the quantitative nature of some social sciences work, creates an overlap of social sciences with sciences. Another interesting overlap is between humanities and sciences—topics that in antiquity were treated as philosophy or religion are now investigated by those following scientific methods.

SOCIAL SCIENCES, SCIENCES, AND FINE ARTS

Architecture: Africa
 Geography
 Phrenology
 Virtual Reality

SCIENCES, FINE ARTS, AND HUMANITIES

Enlightenment
 Epistemology: Early Modern
 Feminism: Third World U.S. Movement
 Field Theories
 Geometry
 Globalization: Asia
 Text/Textuality

FINE ARTS, HUMANITIES, AND SOCIAL SCIENCES

Aesthetics: Africa
 Alienation
 Americanization, U.S.
 Anticolonialism: Africa
 Arts: Overview
 Arts: Africa
 Authenticity: Africa
 Autobiography
 Avant-Garde: Overview
 Aztlán
 Censorship
 Chinese Thought
 City, The: The Islamic and Byzantine City
 Civil Disobedience
 Civil Society: Europe and the United States
 Colonialism: Southeast Asia
 Communication of Ideas: Africa and Its Influence
 Communication of Ideas: The Americas and Their Influence

- Communication of Ideas: Asia and Its Influence
 Communication of Ideas: Orality and Advent of Writing
 Cultural Capital
 Cultural History
 Cynicism
 Dialogue and Dialectics: Socratic
 Dialogue and Dialectics: Talmudic
 Diasporas: Jewish Diaspora
 Dictatorship in Latin America
 Etiquette
 Everyday Life
 Expressionism
 Extirpation
 Fascism
 Feminism: Chicana Feminisms
 Gay Studies
 Gender Studies: Anthropology
 Genre
 Ghetto
 Honor
 Humanity in the Arts
 Humor
 Identity, Multiple: Jewish Multiple Identity
 Images, Icons, and Idols
 Islam: Shii
 Landscape in the Arts
 Leadership
 Life Cycle: Overview
 Linguistic Turn
 Literature: African Literature
 Maoism
 Millenarianism: Islamic
 Millenarianism: Latin America and Native North America
 Minority
 Modernism: Latin America
 Musicology
 Mysticism: Christian Mysticism
 Mysticism: Islamic Mysticism in Asia
 Mysticism: Kabbalah
 Mysticism: Mysticism in African Thought
 Nation
 New Criticism
 Nude, The
 Oral Traditions: Overview
 Orientalism: Overview
 Orthodoxy
 Orthopraxy: Asia
 Pan-Africanism
 Pan-Asianism
 Pan-Turkism
 Philosophies: African
 Philosophies: American
 Philosophy, Moral: Ancient
 Populism: United States
 Postmodernism
 Practices
 Pre-Columbian Civilization
 Realism
 Religion: Africa
 Religion: Middle East
 Religion and the State: United States
 Renaissance
 Resistance
 Romanticism in Literature and Politics
 Sage Philosophy
 Shinto
 Society
 Taste
 Theater and Performance
 Theodicy
 Third World Literature
 Wisdom, Human
HUMANITIES, SOCIAL SCIENCES, AND SCIENCES
 Afropessimism
 Alchemy: China
 Alchemy: Europe and the Middle East
 Altruism
 Antifeminism
 Asceticism: Hindu and Buddhist Asceticism
 Asceticism: Western Asceticism
 Astrology: China
 Astrology: Overview
 Borders, Borderlands, and Frontiers, Global
 Calculation and Computation
 Calendar
 Capitalism: Overview
 Capitalism: Africa
 Cartesianism
 Casuistry
 Causality
 Causation
 Causation in East Asian and Southeast Asian Philosophy
 Character
 Chicano Movement
 Childhood and Child Rearing
 Confucianism
 Consciousness: Chinese Thought
 Consciousness: Indian Thought
 Consilience
 Cosmology: Asia
 Cycles
 Daoism
 Demography
 Demonology
 Discrimination
 Dress
 Dualism
 Education: Islamic Education
 Empiricism
 Equality: Racial Equality
 Ethnicity and Race: Africa
 Ethnohistory, U.S.
 Fallacy, Logical
 Foundationalism
 Futurology
 Genetics: Contemporary
 Genetics: History of
 Genocide
 Health and Disease
 Hermeneutics
 Historical and Dialectical Materialism
 Hygiene
 Intelligentsia
 Internal Colonialism
 Islam: Africa
 Jainism
 Japanese Philosophy, Japanese Thought
 Kinship

READER'S GUIDE

- Law, Islamic
 Machiavellism
 Machismo
 Medicine: China
 Medicine: India
 Meme
 Memory
 Mestizaje
 Modernization Theory
 Motif: Motif in Music
 Museums
 Music, Anthropology of
 Nationalism: Africa
 Natural History
 Naturalism
 Negritude
 Objectivity
 Philosophy, History of
 Philosophy, Moral: Modern
 Philosophy of Religion
 Population
 Positivism
 Pragmatism
 Prejudice
 Presentism
 Privacy
 Probability
 Quantum
 Race and Racism: Overview
 Race and Racism: Asia
 Race and Racism: Europe
 Reason, Practical and Theoretical
 Religion: Overview
 Religion and Science
 Science: Overview
 Scientific Revolution
 Segregation
 Sexuality: Islamic Views
 Sexuality: Sexual Orientation
 Skepticism
 State of Nature
 Structuralism and Poststructuralism: Overview
 Time: China
 Time: India
 Truth
 Universalism
 University: Overview
 Wildlife
 World Systems Theory, Latin America
- FINE ARTS, HUMANITIES, SOCIAL SCIENCES, AND SCIENCES**
 Absolute Music
 Aesthetics: Asia
 Aesthetics: Europe and the Americas
 Ancestor Worship
 Anthropology
 Architecture: Overview
 Architecture: Asia
 Astronomy, Pre-Columbian and Latin American
 Beauty and Ugliness
 Bilingualism and Multilingualism
 Bioethics
 Body, The
 Cannibalism
 Change
 Chemistry
 Cinema
 City, The: The City as a Cultural Center
 City, The: The City as Political Center
 Classification of Arts and Sciences, Early Modern
 Communication of Ideas: Southeast Asia
 Composition, Musical
 Computer Science
 Consciousness: Overview
 Consumerism
 Context
 Continental Philosophy
 Cosmopolitanism
 Creationism
 Critical Theory
 Cultural Studies
 Dance
 Death
 Determinism
 Dream
 Dystopia
 Ecology
 Emotions
 Empire and Imperialism: Europe
 Environment
 Environmental Ethics
 Environmental History
 Equality: Overview
 Equality: Gender Equality
 Ethnicity and Race: Islamic Views
 Eugenics
 Examination Systems, China
 Feminism: Overview
 Fetishism: Overview
 Fetishism: Fetishism in Literature and Cultural Studies
 Friendship
 Game Theory
 Gender: Gender in the Middle East
 Gender in Art
 Generation
 Greek Science
 Harmony
 Heaven and Hell
 Hinduism
 History, Economic
 History, Idea of
 Humanity: African Thought
 Ideas, History of
 Identity, Multiple: Overview
 Intentionality
 Interdisciplinarity
 Islam: Sunni
 Islamic Science
 Kantianism
 Knowledge
 Language and Linguistics
 Learning and Memory, Contemporary Views
 Life
 Literary Criticism
 Literary History
 Love, Western Notions of
 Magic
 Manichaeism
 Maps and the Ideas They Express
 Masks

- Mathematics
 Matriarchy
 Medicine: Europe and the United States
 Medicine: Islamic Medicine
 Meditation: Eastern Meditation
 Men and Masculinity
 Metaphor
 Modernism: Overview
 Monarchy: Overview
 Modernity: Africa
 Modernity: East Asia
 Motherhood and Maternity
 Musical Performance and Audiences
 Mysticism: Chinese Mysticism
 Myth
 Narrative
 Newtonianism
 Nomadism
 Nuclear Age
 Occidentalism
 Organicism
 Paradigm
 Periodization of the Arts
 Person, Idea of the
 Philosophies: Feminist, Twentieth-Century
 Philosophies: Islamic
 Philosophy: Historical Overview and Recent Developments
 Poetry and Poetics
 Political Protest, U.S.
 Progress, Idea of
 Property
 Protest, Political
 Pseudoscience
 Psychoanalysis
 Punishment
 Pythagoreanism
 Queer Theory
 Reading
 Realism: Africa
 Reflexivity
 Reform: Europe and the United States
 Relativism
 Religion: East and Southeast Asia
 Religion: Indigenous Peoples' View, South America
 Religion: Latin America
 Representation: Mental Representation
 Resistance and Accommodation
 Responsibility
 Ritual: Public Ritual
 Ritual: Religion
 Sacred Places
 Science: East Asia
 Science, History of
 Science Fiction
 Sexuality: Overview
 Social History, U.S.
 Sophists, The
 Sport
 Stoicism
 Subjectivism
 Superstition
 Surrealism
 Symbolism
 Syncretism
 Temperance
 Third Cinema
 Toleration
 Totalitarianism
 Totems
 Tragedy and Comedy
 Untouchability: Menstrual Taboos
 Untouchability: Taboos
 Utilitarianism
 Utopia
 Victorianism
 Visual Culture
 Visual Order to Organizing Collections
 Volunteerism, U.S.
 War and Peace in the Arts
 Westernization: Middle East
 Westernization: Southeast Asia
 Witchcraft
 Witchcraft, African Studies of
 Yin and Yang



T

TASTE. We tend to use the word *taste* in two different ways. First, to refer to the ability to judge a thing correctly, usually (but not always) a work of art from an aesthetic point of view. Second, we use the word to refer to a particular set of aesthetic preferences, and given the most popular sense of this second usage, we understand that one person's set of preferences may differ from another person's set. In this article, *taste* refers to taste in the first sense, and *personal taste* refers to it in the second. "Personal taste" does not imply that one person's set of aesthetic preferences cannot be shared by others.

Taste

Taste in this first sense, by which we mean the ability to correctly judge aesthetic objects and events, has a long history, but happily that history is fairly easy to trace and fairly easy to contextualize. We will start in ancient Greece. In those philosophic traditions that begin with Greece, Aristotle (384–322 B.C.E.) is the first person who offers us a formula for beauty. If a thing possesses a certain set of properties—objective properties that anyone with working senses and a passing familiarity with those properties can easily pick out—then that thing is beautiful. Aristotle said that an object is beautiful if it is ordered, symmetrical, and definite, and if it demonstrates each of these virtues to a high degree. This analysis we call "formal," because it focuses on the presence in the object of certain aesthetic properties that have to do with the form (as distinguished from the content) of the object. If a set of criteria can be discovered, the presence of which will ensure that an object is beautiful, and the absence of which will ensure that it is not, then through this the correctness of aesthetic judgments can be established.

Formalism, as an objective approach to aesthetic judgment, has been very popular. We find in St. Augustine of Hippo (354–430) a formalist account of beauty: for an object to be beautiful is for it to exhibit unity, number, equality, proportion, and order, with unity as the most basic notion. And in the work of St. Thomas Aquinas (1224–1274), we find a formal account of beauty, which rests on three conditions: integrity or perfection, due proportion or harmony, and brightness or clarity. We find examples of formalists in eighteenth-century Britain. The third earl of Shaftesbury (Anthony Ashley Cooper, 1671–1713) believed that so long as one was disinterested in attitude, one's judgment that an object was beautiful was correct as long as the object exhibits "unity in multiplicity." Francis Hutcheson (1694–1746) believed that, given a disinterested attitude, if an object exhibits "uniformity amongst variety," that object is beautiful. The essayist and statesman Joseph Addison (1672–1719) believed that an

object was worthy of positive aesthetic judgment if it exhibited greatness and uncommonness. And jumping to the twentieth century, we find formalist accounts of aesthetic merit (though not explicitly about beauty per se) in the work of G. E. Moore (1873–1958) ("organic unity") and Clive Bell (1881–1964) ("significant form").

While theorists such as Shaftesbury and Hutcheson include clear formalist elements in their theories of aesthetic merit, they also stand at the beginning of a tradition of philosophers of aesthetics sometimes referred to as "taste theorists." The taste theorists are found, generally, in eighteenth-century Britain, and they begin as a bridge between objective formalist and subjective accounts of beauty. Although individual subjectivity now begins to appear in accounts of aesthetic judgment, it is important to note that these accounts were not antirealist (antirealism being the position that judgments about aesthetic objects are neither true nor false). Quite to the contrary, theorists like Shaftesbury and Hutcheson were still aesthetic realists (realism being the position that there are real answers to questions of aesthetic merit, that judgments about aesthetic objects really are true or false). In order to access the formal conditions of beauty, Shaftesbury and Hutcheson said that the attender must put himself or herself into a proper frame of mind. From this proper perspective—from the proper exercise of one's faculty of taste—one could judge correctly whether a thing is beautiful or not. The inclusion in their theories of the formal elements of "unity in multiplicity" and "uniformity amongst variety" were meant as explanations for why the exercise of one's taste would result in aesthetic enjoyment and correct judgment, but it is the exercise of taste that, in their theories, is logically prior: one exercises taste; one enjoys and judges positively; and notes subsequently that this enjoyment and positive judgment are occasioned by the presence of certain objective, formal features. Shaftesbury and Hutcheson are joined in their theories—which mix objective features of objects with subjective features of judgment—by others, most notably Joseph Addison (1672–1719), Archibald Alison (1757–1839), Lord Kames (Henry Home, 1696–1782), and Alexander Gerard (1728–1795).

The eighteenth-century British taste theorists are, in some sense, a product of their times. There are three items that motivate them. First, they rejected as insufficient pure formalist, objectivist theories of beauty. Second, they were inspired by empiricism, and they sought to connect knowledge with the focus on the senses as the medium through which reality was taken in. In aesthetic theory, this can be seen in the move from the Platonism apparent in theories like Shaftesbury's to



Les Femmes d'Alger (1907) by Pablo Picasso. Oil on canvas. Theories of taste have had a long history. In ancient Greece Aristotle claimed that order and proportion contributed to beauty. Twentieth-century theorists found distinctly asymmetrical works such as those of Picasso to have visual merit as well. AP/WIDE WORLD PHOTOS

the almost physiological tone of theories such as those of Hutcheson and Edmund Burke (1729–1797). Third, with political theorists in Britain like Thomas Hobbes (1588–1679) and John Locke (1632–1704) came a new focus on the authority and autonomy of the individual. This celebration of the individual, his rights, and the dominion and prerogative of his judgments, can be seen in the fundamental premises

upon which David Hume (1711–1776) and Immanuel Kant (1724–1804) build their theories of aesthetic judgment.

Although formalist accounts persist into the twentieth century, they reach a point of diminished popularity at the end of the eighteenth century when mixed objective-subjective accounts, such as those offered by Shaftesbury and Hutcheson,

are replaced in popularity by more purely subjective accounts offered by, to name the two most influential, Hume and Kant. Instead of focusing on the aesthetic object, both of these theorists focus on the aesthetic attender. Instead of offering objective-criteria formulae for what makes an object aesthetically good or beautiful, they focus exclusively on the qualities of the attender that make him or her a good judge.

Hume believed in the indisputability of particular taste and the sovereignty of the individual judge, but he also believed that “amidst all the variety and caprice of tastes, there are certain general principles of approbation and blame.” For Hume, an object is beautiful if and only if it provokes aesthetic sentiment in appropriately disposed competent critics, which he calls “true judges.” True judges have the following traits: (1) serenity of mind (mentioned earlier than the other five), (2) delicacy of taste, (3) they are well practiced, (4) they are versed in comparison between objects, (5) they are free from prejudice, and (6) they have good sense (i.e., their senses work very well).

Kant’s focus was similar, although the theoretical details are rather different. Kant’s means of establishing the worthiness of aesthetic judgment focuses somewhat less on the individual than Hume’s, and more on what is common about judgment. It is from the dual vantage point of the authority of the subject’s judgment and the call to universality of judgment—that we expect and even demand commonality in judgment—that Kant develops his view. Kant thought that the key to securing this universality was twofold: first, we recognize that each person has basically the same “common sense” for recognizing beauty in objects, and that aesthetic judgment is not merely a matter of sentiment but a matter of free play between the understanding and the imagination. Second, it is important for the judge to be properly disposed to making a correct judgment, and the proper disposition is for the judge to be disinterested—to consider the object/event for its own sake alone, without regard for any relation it bears to anything else, including personal interests. Given disinterest on the part of the judge, and given that we all have similar faculties for understanding the world—particularly, the formal structures and purposefulness of the phenomenal world—we would all judge similarly, at least with regard to individual, particular aesthetic judgments.

Hume and Kant opened the door for other subjective accounts of aesthetic goodness, but the real investment in subjective accounts came in the twentieth century and was provided by an assortment of aestheticians, Frank Sibley (1923–1996) being perhaps the most famous, who argue that reductions of evaluative aesthetic claims will never result in arrangements of objective properties. Sibley first identified aesthetic concepts and aesthetic terms as ones that necessarily include taste in their application. In justifying the use of aesthetic terms, however, we naturally seek out a basis that does not refer to taste. We look for the objective basis for our use of such terms, and we commonly expect to find such bases. Unfortunately, this only flows in one direction. While we may naturally look to non-aesthetic features to ground our ascriptions of aesthetic ones,

we cannot, no matter how full an account we offer, ever say that, due to the presence of given nonaesthetic features an aesthetic feature must certainly be present. We would, says Sibley, be suspicious of anyone who says that we can create a rule that states that a certain aesthetic feature can be created by inserting certain nonaesthetic ones. We would say that such a person is not exercising taste and, moreover, did not really understand the aesthetic term at issue unless he could correctly apply it in instances where citing the rule was not an option.

This movement, first begun in the latter eighteenth century, but really brought to bloom in the twentieth—twentieth-century formalists notwithstanding—through the work of Sibley and others, is a movement from objective accounts of beauty to subjective ones. The subjective accounts focus on taste, on the attenders or audience members (1) exercising their ability to judge correctly from an aesthetic point of view and (2) finding enjoyment in attending to those aesthetic qualities that properly should ground such enjoyment.

Personal Taste

The second sense in which the word *taste* is used, what we are calling “personal taste,” focuses on particular sets of aesthetic preferences. There is certainly a relationship between taste and personal taste, and we want to explore that a bit later on. For now, consider the nature of the preference that one may exhibit for vanilla ice cream over chocolate, for chicken over fish, for saturated colors over muted ones, and for action-adventure films over romantic comedies. In these matters, it is the rare observer who will assert that there is clearly a correct decision to be made, that one of each pair is clearly to be preferred over the other. Most observers are content to say that these are all simply matters of personal preference. Moreover, there are now many who say that all aesthetic judgments are on a continuum with such exemplars of personal preference. As mentioned earlier, antirealism is the position that there is nothing right or wrong about an aesthetic judgment that refers to anything beyond that judge’s preference—that all aesthetic judgment is a matter of personal preference. If one takes such phrases as “beauty is in the eye of the beholder” and “there’s no disputing individual taste” out of the realist contexts that the taste theorists had originally envisioned for them, one may understand taste as merely a set of personal preferences, over which external adjudication—or perhaps any adjudication—is inappropriate.

One challenge to this move toward antirealism as a theoretical platform for talking about personal taste is the widespread agreement in judgment forthcoming from certain aesthetic comparisons. Almost no one, on a “blind hearing,” prefers Salieri to Mozart, and it is easy to develop a list of such comparisons, each instance of agreement serving as one more bit of inductive evidence in support of aesthetic realism. There is an explanation for this, and it turns on the fact that there are purposes to our aesthetic choices. We mean to invest our attention in those aesthetic experiences that we predict we will find more enjoyable, satisfying, rich, and rewarding. There are few museum or gallery patrons who will spend minutes upon minutes staring at Andy Warhol’s *Campbell’s Soup Can*

or a Marcel Duchamp ready-made. These conceptual works can be taken in quickly, and perhaps fully so. But it is not uncommon to see patrons spend a good deal of time in front of a mature Joseph Mallord William Turner, Paul Cézanne, or Henri Matisse. If the experience one seeks is deep visual satisfaction, one will tend to invest attention in objects that most likely will provide this.

One's personal taste can be understood, then, as a series of past choices and resulting experiences that provide a basis upon which one will make future investment predictions and choices. If one has a rewarding experience listening to a Billie Holiday song, one will most likely seek out more Billie Holiday songs, and it is likely that one will also seek out blues in general. If one has a less than rewarding experience looking at a Jackson Pollock work, then one will probably avoid Pollock in the future, and it may be expected that one may avoid modern art altogether. If one has a good experience with works by Mark Rothko, one may reasonably expect to enjoy the work of Agnes Martin. All of this is based on induction. We find patterns in the world that serve us, that promote survival, flourishing, or simple enjoyment. It is only reasonable that we will follow those patterns and that, to some degree, groups of people who are similar will find similar patterns.

A second challenge, perhaps more intriguing than the first, is the regular phenomenon that with exposure, time, and information, aesthetic preferences tend to grow and develop in fairly predictable ways. The film preferences of freshman students tend to be for very recent works that provide immediate, easy reward. The preferences of students who have taken a few film courses tend to be informed by a much broader temporal span of the film world and tend to focus on films that require some subject-initiated investment of attention, both cognitive and psychological. The preferences of senior level film studies majors (and perhaps their professors) may be seen as bizarre by the aforementioned freshmen, as such preferences may well include silent films, nonnarrative films, and directors like Sergei Eisenstein, Ingmar Bergman, and Federico Fellini. College students commonly move in their musical preferences from rock to jazz and classical, if not giving up the former, at least adding to it the latter. The best explanation for this is that taste grows in regular ways, and once these regularities are identified, taste can be educated: personal taste can grow in sophistication.

We need to be careful here to distinguish between the effects of education as a tool for social or cultural indoctrination and education as a means of facilitating experience, furthering horizons, and encouraging genuine aesthetic enjoyment. It would be a shame and a loss to move a student, through the education of taste, to less aesthetic enjoyment, and there is a danger in declaring that a person's aesthetic preferences are wrong if they do not match some standard or other. This returns us to the authority and autonomy of individual judgment with which the taste theorists wrestled.

One bit of support for the appropriate plurality of personal taste comes from the diversity of aesthetic preferences that follows geographical, ethnic, and even gender identities. The patterns of bright, colorful dress that one may see in the Maya,

the Masai, and the Mongolians are very different from the patterns one sees in mainstream Europe and mainstream North America. Visually, traditional Asian artwork is easily separated from mainstream European and American artwork. One can take this to an even more basic level: the traditional Asian conception (or definition) of the aesthetic property of balance appears to be different from the mainstream European or American definition. If our very definitions of aesthetic properties diverge, yet in both contexts there is a general valuing of, in this case, balance, then the preferences that follow from this will diverge, as well.

Similar sorts of cases of diversity will manifest themselves in comparisons among ethnicities even within a geographical region. Public-space ambient music tends to follow these preferences; the music one hears in shopping centers in one part of the country may differ radically from the music one hears in another part. This is most likely more than simply the management's preferences. The choice in ambient music more likely follows the management's best judgments concerning the sort of music that the likely clientele will enjoy and that will keep them shopping. This is partly a geographical phenomenon, but in many places, can involve ethnic and subcultural considerations, as well.

The Relationship between Taste and Personal Taste

The recent understanding of taste (as closer to personal taste and away from the more traditional, realist sense of the word) can still be seen as pointing toward greater authority of the judgment of the individual that was one of the motivators of the original taste theorists. If there is ultimately no way to reasonably, authoritatively, or meaningfully adjudicate among divergent particular judgments or among divergent personal tastes as sets of matters of choice, then the eighteenth-century move toward a fuller respect for individual autonomy in aesthetic judgment has brought us to a point where taste gives way to personal taste. If one believes that Hume failed in his attempt to render consistent the authority of the individual with the call to commonality in judgment, and if one rejects Kant's attempt to solve the antinomy of taste ("taste is at the same time subjective and individual yet also universal") and save aesthetic realism where perhaps Hume was unable to, one may believe that, in these failures, the realist version of a singular, correct definition of taste is rightly abandoned. We may see as continuous with the decision between vanilla and chocolate ice cream a preference for Pink Floyd over Beethoven, Albee over Shakespeare, and Pollock over Rembrandt. Still, the recognition of this continuity is not a cause for surrender to the philosophy of "anything goes." As individuals may reasonably be expected to pursue those experiences that they find rewarding, and to make their investments of aesthetic attention based on predictions derived from patterns of past reward, we will continue to see some degree of commonality in personal judgment. The degree to which we see this—however modestly or subtly—will continue to advance culture positively.

See also Aesthetics; Arts; Beauty and Ugliness; Cultural Studies; Objectivity; Subjectivism.

BIBLIOGRAPHY

- Addison, Joseph, and Richard Steele. "On the Pleasures of the Imagination." In *Selections from The Tatler and The Spectator*. Edited by Robert Allen. New York: Holt, Rinehart and Winston, 1957.
- Dickie, George. *Evaluating Art*. Philadelphia: Temple University Press, 1988.
- Goldman, Alan. "The Education of Taste." *British Journal of Aesthetics* 30 (1990): 105–116.
- Hume, David. *Of the Standard of Taste and Other Essays*. Edited by J. W. Lenz. New York: Bobbs-Merrill, 1965.
- Hutcheson, Francis. *An Inquiry into the Original of Our Ideas of Beauty and Virtue*. New York: Garland, 1971.
- Kant, Immanuel. *Critique of Judgment*. Translated by Werner S. Pluhar. Foreword by Mary J. Gregor. Indianapolis: Hackett, 1987.
- Kivy, Peter. "Recent Scholarship and the British Tradition: A Logic of Taste, The First Fifty Years." In *Aesthetics: A Critical Anthology*, edited by G. Dickie, R. Sclafani, and R. Roblin. 2nd ed. New York: St. Martin's, 1989.
- Shaftesbury, Anthony Ashley Cooper. *Characteristics of Men, Manners, Opinions, Times*. New York: Bobbs-Merrill, 1964.
- Sibley, Frank. "Aesthetic Concepts." *Philosophical Review* 68 (Oct. 1959): 421–450.

David E. W. Fenner

TECHNOLOGY. Introduced in the first decades of the nineteenth century, the word *technology* signified the pursuit of a science to encompass all the *industrial arts*. *Mechanical arts*, a term used in medieval and early modern Europe, indicated something different because it included, for example, painting and sculpture. The introduction of the term *technology* corresponded somewhat contemporaneously with the introduction of other key terms for modernity, including *scientist*, *class*, *capitalism*, and *socialism*. They all come from a time troubled by the "machinery question," a fundamental topic for both political economists and Romantic authors during the same period. This question was posed as a response to the installation of an endless series of novel machines in newly built textile factories, which seemed to have nurtured a class differentiation between those who were amassing fortunes by owning the machines and those who were barely paid at subsistence level to work in them. Having won a decisive battle against those who defended the old order by crediting land rather than labor as being the source of value, classical political economists were unprepared to challenge the popular assumption of machinery being the source of value. The dramatic change similarly confused the best of the future critics of these economists. A young Karl Marx (1818–1883) assumed that the new machinery, despite the hardships that it imposed on many, inevitably paved the way to a better future society.

The denaturalization of the landscape ensuing from the spread of steam engines overwhelmed the Romantics, who lamented the loss of a better (past) society. Despite their unheard objections, for decades England had used previous "atmospheric" engines for draining mines, with pistons that moved up by the pressure of the steam and down by the

pressure of the atmosphere, in the pattern of the engine that Thomas Newcomen introduced early in the eighteenth century. By the last two decades of the same century, following James Watt's series of modifications, there were also engines with pistons moving in both directions only by the pressure of the steam. Like the electronic computer of the last decades of the twentieth century and the electric generator of the last decades of the nineteenth, Watt's steam engine was heralded as a universal (global, general purpose) machine, that is, a machine that could be automatically used in all places and at all times.

A technological progressive in comparison to Newcomen, Watt turned out to be conservative next to those who configured the successor models to his engine, namely, high-pressure steam engines versus his low-pressure model. A myriad of local reconfigurations were needed before the supposedly global steam engine could produce mechanical motion, first, strong enough to pull a train or propel a ship, and second, uniform enough to spin a fine textile or generate electricity. The need for reconfiguring a universal machine was repeated in the history of the supposedly universal electric generator and, more recently, regarding the supposedly universal electronic computer. The safety of low-pressure versus the efficiency of high-pressure engines has also been a perpetual issue, reproduced in the "battle of the currents" (direct versus alternating) between Thomas Edison and George Westinghouse during the 1880s and 1890s and the analog versus digital battle between engineers and mathematicians during the 1950s and 1960s. A symbol of progress in the 1880s, Edison in more recent times is viewed as exhibiting a puzzling conservatism. Biographers of the Massachusetts Institute of Technology electrical engineering professor Vannevar Bush are equally puzzled by how the preferences of this champion of mechanized analysis of the interwar period appear to be so incompatible with the prevalent post-World War II computing orientation.

Technocracy

The work of a generation of historians sensitive to the symmetrical study of technological success and failure suggests that animated debates concerning choice between competing technologies have been the rule, not the exception. In the case of the automobile—another technology assumed to be globally preeminent—early-twentieth-century battery-run and internal-combustion-powered vehicles competed hard in various local contexts against each other (as well as against those moved by steam pressure). Now a technical hope of the future, the electric car did not lose in the past because of an internal technical inferiority; the gasoline-driven internal combustion engine prevailed because of an abstracted over a socially situated conception of technical efficiency. Unsurprisingly, the term *technology* became widely used only after the early-twentieth-century rise of "technocracy," a movement that promoted an abstracted conception of technical superiority by seeking to replace the acknowledged subjectivity of politics by the assumed objectivity of engineering.

The technocracy movement was propelled by the establishment of Fordism, a mode of mass production of automobiles with internal combustion engines. The technical

efficiency of the automobile assembly line of the factories of Henry Ford was unquestionable in the 1910s. Things changed in the following decade when competitors chose production flexibility over efficiency by challenging the Fordist reliance on a combination of increasingly specialized machines and degraded skills; rather than producing a more affordable car but one offered only in a single model—the infamous black Model T—Ford’s competitors elected the option of producing a variety of car models.

Taylorism was the other side of Fordism because it started from changes in labor efficiency that were to match changes in machine efficiency. Interested in increasing the efficiency of low-skill work and then returning a portion of the extra value to be produced to the workers in the form of better wages, Frederick W. Taylor, through what became known as “scientific management,” proposed a scheme for a decisive advance in industrialization regardless of the availability and the wills of skilled workers, by relying on the unskilled labor of destitute urbanite and/or peasant masses. Varying mixes of the Taylorist-Fordist combination appealed to societies as different as that of the Germany and the USSR of the interwar period. Organic components of Stalinism, Taylorism, and Fordism also puzzled the most critical spirits of interwar Europe, including Antonio Gramsci, the imprisoned leader of the Italian Communist Party. In the pursuit of a worker who ought to abandon all preindustrial attitudes that were incompatible with the uniformity expected by the Taylorist-Fordist mode of production, Gramsci saw the potential for moral and material improvement of the working class, which he considered prerequisite to its emancipation.

Ford was not the only one concerned with creating a massive demand for his product to match its mass supply by his factories. Samuel Insull—who had started as Edison’s secretary before he controlled, through dubious financial schemes, an empire of electrical utilities—had clearly realized the need for around-the-clock demand for electricity to take advantage of mass-production-capacity installations. Whatever technology might have been, it has been shaped both in production and in consumption, by invention and in use. The study of the history of the experience of technology vis-à-vis consumption, such as in a First World household or a Third World farmstead, has managed a decisive blow for the commonplace assumption of technology’s universalism. It has shown that technology’s easy mix with time-honored ideologies such as sexism or racism has increased the household work of a First World woman and decreased the resources of a Third World habitant.

Unregulated overproduction across the whole of industry accumulated the forces that were unleashed with the 1929 stock market crash. Herbert Hoover, the engineer-president was replaced by the iron politics of Franklin D. Roosevelt. The state-driven civilian rural electrification of the 1930s, which matched demand to supply, the Manhattan Project, and the rest of the state-driven military-technological projects of World War II shaped the emergence of “technology policy” as a key issue for the post-World War II state. Success in what is now called technology policy has in fact been a prerequisite for the

constitution of the modern state as such on both sides of the Atlantic. The end of the *ancien régime* in France and of the democracy of artisans, farmers, and merchants in the United States was marked by the state’s pursuit of a technology for the mass manufacturing of guns with as uniform (or “interchangeable”) parts as possible. The transfer of this technology to the rest of U.S. manufacturing over the course of the nineteenth century resulted in the so-called American system of manufactures, which took the millions visiting the world’s fairs by surprise.

Technological Determinism

A visit to a world’s fair after the mid-nineteenth century proved that the “machinery question” had been practically answered by the tremendous increase in the number and kinds of new machines. With the interconnection of machines into networks (of transportation, energy, communication, and so on), the term *technology* started to obtain a new meaning. In doubt by then about machinery inexorably dictating a better society, Marx liked the new term enough to correct his earlier editions of *Das Kapital* by carefully distinguishing between the “technical” and the “technological,” according to whether the same process was experienced as an objective, product-making process or a subjective, value-forming one, respectively. Unlike the technical, the technological was subjective in that the revelation of the surplus value produced depended on political prerequisites. Technology, like surplus value, was a concept that pointed to an unspecified agency. Technology has since been recognized by its effects, whereas the issue of agency has remained conveniently abstract. In surveying the subsequent history of the use of the concept, Leo Marx, a distinguished historian of technology, finds that its abstractness has sustained the hegemony of the ideology of “technological determinism,” the assumption that technology is autonomous from society.

Technological determinism matches well with the canonical presentation of the archetypal engine of Watt as being self-regulated because of the inclusion of a mechanism known as the “governor” (the foundational circuit of “cybernetics”). It was this ideological canon that was displayed at world’s fairs, not, for instance, a diorama of the lethal steam boiler explosions that killed thousands. Historians have found that the dominance of technological determinism explains the many waves of technological utopianism and technological enthusiasm of the recent centuries. It explains why the late-nineteenth-century crash of the utopian hope that the telegraph would bring world peace was not taken into account in the enthusiasm that surrounded the initial emergence of the telephone, the radio, the television, and, more recently, the Internet. It also explains why the dramatic revelation of the destructive power of the atomic energy in Hiroshima was quickly followed by the hope that a nuclear reactor to run everybody’s automobile was just around the corner. It finally explains why Leo Marx finds that technology has emerged as a “hazardous concept.”

See also Computer Science; Nuclear Age; Science; Science, History of.

BIBLIOGRAPHY

- Adler, Ken. *Engineering the Revolution: Arms and Enlightenment in France, 1763–1815*. Princeton, N.J.: Princeton University Press, 1997.
- Berg, Maxine. *The Machinery Question and the Making of Political Economy, 1815–1848*. Cambridge, U.K.: Cambridge University Press, 1980.
- Corn, Joseph J., ed. *Imagining Tomorrow: History, Technology, and the American Future*. Cambridge, Mass.: MIT Press, 1986.
- Cowan, Ruth Schwartz. *More Work for Mother: The Ironies of Household Technology from the Open Hearth to the Microwave*. New York: Basic, 1983.
- Frison, Guido. "Some German and Austrian Ideas on *Technologie* and *Technik* between the End of the Eighteenth Century and the Beginning of the Twentieth." *History of Economic Ideas* 6, no. 1 (1998): 107–133.
- Hounshell, David A. *From the American System to Mass Production, 1800–1932: The Development of Manufacturing Technology in the United States*. Baltimore: Johns Hopkins University Press, 1984.
- Kline, Ronald. "Construing 'Technology' as 'Applied Science': Public Rhetoric of Scientists and Engineers in the United States, 1880–1945." *Isis* 86, no. 2 (1995): 194–221.
- Marx, Leo. "Technology: The Emergence of a Hazardous Concept." *Social Research* 64, no. 3 (1997): 965–988.
- Sinclair, Bruce, ed. *Technology and the African-American Experience: Needs and Opportunities for Study*. Cambridge, Mass.: MIT Press, 2004.
- Smith, Merritt Roe, and Leo Marx, eds. *Does Technology Drive History? The Dilemma of Technological Determinism*. Cambridge, Mass.: MIT Press, 1994.

Aristotle Tympas

TEMPERANCE. In classical and medieval thought, temperance, or *sōphrosynē*, could signify one or more of a congeries of traits, such as moderation, self-knowledge, self-restraint, or independence. These virtues were to be cultivated by the individual. In modern history, however, the meaning of temperance has become narrowed to refer only to limits on the consumption of alcoholic beverages, whether those restrictions are placed by an individual upon his or her personal consumption or by the state upon the habits of those subject to its jurisdiction. The principal agency in accomplishing this change in meaning has been a set of social movements whose origins lie in the sixteenth-century Protestant Reformation, but whose full flowering occurred in the nineteenth and twentieth centuries. Temperance movements have appeared in many societies, drawn upon diverse sources of support, pursued a variety of goals, and enjoyed widely varying degrees of success. In general, however, the temperance impulse in the modern world has been successful, whether its progress is measured by average levels of consumption or by preferences for less intoxicating forms of alcohol.

Temperance as Ideal and Issue

Most of the world's religions embrace temperance from alcoholic beverages as a virtue. For Hindu Brahmins, Buddhists,

Jews, Roman Catholic Christians, and especially for Muslims and Protestant Christians, temperance and, for some, abstinence is valued. Tantra Hinduism, Daoism, and Roman Catholicism incorporate alcohol into ritual, among others, but only a few mystical sects, such as Islamic Sufism, celebrate intoxication. As a result, the worth of temperance itself has rarely been at issue in any society, even when social conflict over drinking has been most bitter. Nearly all drinkers regard their own behavior as temperate. Rather, discord over temperance typically arises when one segment of society attempts to impose restrictions upon another's drinking—that is, when interpretations of the meaning of temperance clash. Temperance can also become involved in a struggle over other issues.

Colonial regimes, for example, have often imposed controls on the drinking of indigenous peoples, even when the introduction of alcohol into native cultures has undermined traditional ways and left native societies vulnerable to imperial domination. The European colonial powers in central Africa sought to compartmentalize the drinking of native laborers in space and time so as to safeguard productivity, and mine owners in South Africa went even further in the same direction when they forced prohibition on their workforces.

As early as the dawn of the nineteenth century, the United States federal government mandated prohibition for Native Americans. But embattled indigenous peoples have also sought to use temperance for their own purposes, as a buttress of anticolonial resistance, as was the case for South African kings, leaders of Native American revitalization movements such as the Seneca Handsome Lake and the Shawnee Tenskwatawa (1775–1836), and the Indian nationalist movement led by M. K. Gandhi (1869–1948). In such cases, the hypocrisy of colonial authorities in preaching temperance while allowing, or even fostering, alcohol consumption has given a weapon to those seeking to overthrow or reject their dominion.

In industrial societies, employers have often found it expedient to support controls on workers' alcohol consumption in the hope of habituating their workforce to the discipline of machine production. But militant workers' movements, such as the English Chartists, the Knights of Labor in the United States and Canada, Austrian Socialists, and Spanish anarchists, have realized the value of temperance in mobilizing sober opposition to capital or to capitalist governments. Furthermore, successful revolutionary movements have sometimes included liquor control among their tools for reshaping society, as was the case for the Mexican government in the 1930s and the early Soviet regime.

Temperance has been a subtler instrument in inter-group struggles when classes or professions have deployed it as a means of self-definition or as a vehicle for claims of expertise. In many industrializing English-speaking societies, middle classes have adopted sobriety as a badge of respectability, distinguishing themselves at least rhetorically from allegedly profligate elites on one hand and from purportedly dissolute workers on the other. Among professionalizing groups, physicians in particular have often taken leadership roles in temperance advocacy in societies as diverse as the United States,

Britain, Denmark, France, Australia, Imperial Russia, and the Soviet Union. In such cases, as sociologist Joseph Gusfield shows, temperance serves both as a badge of personal rectitude and as an assertion of the fitness of a class or profession to set society's direction.

Temperance Movements

The first temperance campaign in modern history was mounted by Martin Luther (1483–1546) and his followers as part of the Protestant Reformation, and was directed at the episodic drunkenness of traditional German drinking bouts. It failed, however, and German intellectuals instead came to view unconstrained drinking as a positive, indeed defining, Germanic trait.

Organized temperance societies next appeared in Britain and the United States in the early nineteenth century. Although the appearance of such societies derived critical impetus from evangelical Protestantism in both countries, temperance advocacy was by no means limited to evangelicals or to Protestants. By the 1870s, the Church of England had created its own temperance society, and during the same decade in the United States the founding of the Catholic Total Abstinence Union (CTAU) demonstrated Roman Catholic concern with the issue. The CTAU's definition of "temperance" as total abstinence also indicated how far temperance reform had traveled during its first half-century, since early American temperance reformers had first defined only moderation in the use of alcoholic beverages and later abstinence only from distilled spirits as their goal. Many reformers, however, soon moved to appeals for abstinence from all intoxicating beverages and then to a demand for state action to stop liquor sales, or prohibition. By the early twentieth century, movements for prohibition had appeared as well in Britain, in other British settler societies—Canada, Australia, and New Zealand—and in Nordic countries. The prohibition cause peaked during the 1910s and 1920s, when various forms of large-scale prohibition were adopted in Iceland (1915–1922), Finland (1919–1932), Norway (1916–1927), Russia and the Soviet Union (1914–1925), Canadian provinces (varying periods between 1901 and 1948) and by the Canadian federal government (1918–1919), and in the United States (1918–1933). In addition, a majority of voters in New Zealand twice supported prohibition (in 1911 and 1919), but the measure was never enacted. For those nations involved, World War I furnished a crucial stimulus for new restrictions on alcohol sales, such as the Carlisle system, a British scheme for government ownership and management of the liquor industry, and the French government's ban on absinthe.

Although temperance reform is commonly thought to have declined following the death of prohibition, new movements have simply taken on novel guises. American National Prohibition had been repealed only two years when a new self-help movement for habitual drunkards, Alcoholics Anonymous (AA), grew from the chance meeting of two drunks in Akron, Ohio. AA has since become a worldwide movement, with popular manifestations or imitations in countries such as Mexico and Japan, and its twelve-step method has found application to a variety of habits and afflictions. Since the 1940s,

academics following in the footsteps of E. M. Jellinek at the former Yale (University) Center of Alcohol Studies have taken a leading part in alcohol research and policy advice. Employers have continued to offer intervention in their workers' personal habits through "employee assistance programs." Both government policies and new organizations such as Mothers against Drunk Driving and Students against Destructive Decisions have focused on preventing or punishing drunken driving.

Women have often played key roles in temperance reform. In the United States, although women made up a large proportion of the membership of early temperance societies, they generally worked under male leadership. This began to change during the 1850s with the founding of the Independent Order of Good Templars, which soon became an international organization in which women in theory, and sometimes in practice, held equal status with male members. Women definitely seized the initiative in American temperance reform, however, in 1873–1874, when tens of thousands of women undertook nonviolent direct action against retail liquor dealers, using mass marches and public prayer and song. In the aftermath of the Women's Temperance Crusade, the national Woman's Christian Temperance Union (WCTU) was founded, and it soon became the largest organization of American women. Through the visit of an American activist from the Crusade the British Women's Temperance Association, Britain's first national women's temperance society, was established in 1876.

American and British women temperance activists soon began to extend their movement across the world, leading to the establishment in 1884 of the World's Woman's Christian Temperance Union (WWCTU). Although it was always controlled by American and British women, the WWCTU made temperance for the first time an international movement. Through this vehicle advocacy of other issues, such as peace and women's enfranchisement, was also spread.

Despite the common belief that failure of the various national prohibition schemes ended its impact, in fact temperance reform has exerted far-reaching influence upon consumption patterns, in large part because of its protean character and ability to adapt to diverse national cultures. Examples of its adaptability include AA in Roman Catholic Mexico, which in 1997 held the world's second largest number of local chapters; the Pioneer Total Abstinence Association of the Sacred Heart, an Irish Catholic society that at its peak in 1960 enrolled one-sixth of the Irish population and also attracted members in other countries; and the Danshukai societies in Japan, which have altered AA practices to fit Japanese culture. In the older industrialized countries at the outset of the twenty-first century, overall per capita consumption of alcohol was declining from peaks reached during the late twentieth century, and spirits and sometimes wine were being replaced in public preference by less potent beers, even in societies with long traditions of wine drinking. Nevertheless, rising consumption in the developing world, especially in China and India, presents new challenges to one of the world's historically most influential social movements.

See also *Religion and the State*.

BIBLIOGRAPHY

- Barrows, Susanna, and Robin Room, eds. *Drinking: Behavior and Belief in Modern History*. Berkeley: University of California Press, 1991.
- Blocker, Jack S., Jr. *American Temperance Movements: Cycles of Reform*. Boston: Twayne, 1989.
- Blocker, Jack S., Jr., David M. Fahey, and Ian R. Tyrrell, eds. *Alcohol and Temperance in Modern History: An International Encyclopedia*. 2 vols. Santa Barbara, Calif.: ABC-CLIO, 2003.
- Blocker, Jack S., Jr., and Cheryl Krasnick Warsh, eds. *The Changing Face of Drink: Substance, Imagery, and Behaviour*. Ottawa, Canada: Histoire sociale/Social History, 1997.
- Gusfield, Joseph R. *Symbolic Crusade: Status Politics and the American Temperance Movement*. Rev. ed. Urbana: University of Illinois Press, 1986.
- Heron, Craig. *Booze: A Distilled History*. Toronto: Between the Lines, 2003.
- Kurtz, Ernest. *Nor-God: A History of Alcoholics Anonymous*. Rev. ed. Center City, Minn.: Hazelden, 1991.
- Tyrrell, Ian R. *Woman's World/Woman's Empire: The Woman's Christian Temperance Union in International Perspective*. Chapel Hill: University of North Carolina Press, 1991.

Jack S. Blocker Jr.

TERROR. An apprehension of danger or impending violence, terror is akin to fear in an accentuated or distilled form and is often accompanied by trembling. It underpins many aspects of existence, especially the cut-and-thrust of the evolutionary drive and the predatory nature of the food chain. Lacking the “blood and sawdust” element associated with “horror,” it has nevertheless become allied with atrocities and outrages, from the emperors of Rome down to the massacring armies of Genghis Khan, Attila the Hun, and the later purges of dictators such as Stalin, Hitler, and Pol Pot.

The Politics of Oppression

In Europe, terror was employed as a tool by the church and state, often to suppress dissent and maintain the status quo. Campaigns like the Albigensian Crusade, in which the soldiers of Pope Innocent tortured, burned, and butchered the heretical sect of the Cathars, are examples of the extremes to which a religious body was prepared to go in order to maintain its authority, and the same might be said of the witch trials and the Spanish Inquisition. Many philosophers and statesmen have viewed such brutalities in terms of the degeneration of a cause. The German philosopher Georg Wilhelm Friedrich Hegel (1770–1794) considered the “Reign of Terror” of the French Revolution (April 1793 to July 1794) as a crisis of the human spirit: a vast abstract notion of freedom had arisen that annulled all moral and humanitarian considerations. Others saw it as a brutal mob avenging themselves on their enemies. During this period around seventeen thousand people were put to death, and the republican leader Maximilien de Robespierre (1758–1794) observed “in times of peace the springs

of popular government are in virtue, but in times of revolution, they are both in virtue and terror.”

Under ruthless regimes, people tend to adopt a docile attitude toward those in authority. It is not uncommon for families, neighbors, and friends to betray each other. Trust and the communal patterns of daily life inevitably suffer—during Stalin’s pogroms, for instance, hundreds of thousands of children were orphaned and left to roam the country, living rough, often starving, and many of these eventually became soldiers who were notably brutal and insensitive. In order to pursue his policies—particularly the collectivization of Soviet agriculture and the removal of all rival left-wing factions—Stalin institutionalized terror, creating government mechanisms that were extensions of his will, oiled by bureaucrats and fueled by propaganda. So many thousands were put to death on a daily basis that the appalling became indistinguishable from the ordinary.

From a despot’s point of view, the advantage gained from terror tactics is that he has under him a cowed, servile population; the disadvantage is that, having dispatched so many to camps or firing squads, he may start to anticipate revenge from every quarter and extend his field of killing until his situation becomes more isolated and absurd.

The Culture of Terror

But terror need not imply persecution or a life-threatening situation. It has another strand, a religious, aesthetic aspect that implies awe or reverence before a universe whose many mysteries—including those of religion—have never been fully grasped. William Wordsworth (1770–1850), in his poem *The Prelude* (published 1850), spoke of the “ministry of fear” and evoked the brooding silence of a huge mountain peak hemming him in as he rowed across Esthwaite Lake. The British



The Nightmare, engraving after 1790 painting by Henry Fuseli. The popularity of horror-themed books, films, and works of art suggests that on some level people are drawn to the concept of terror—or at least that of fabricated terror that can be easily banished. © HENRY FUSELI/FORTEAN PICTURE LIBRARY

GODS OF TERROR

The black Hindu goddess Kali was depicted with three eyes and four arms, bloated with the blood of her victims; Seth, the dark god of Egypt, as a monster or crocodile; and Satan, the adversary of Jehovah, as a scaly dragon devouring the souls of the dead. The Russians envisaged a figure of legendary dread in the “Pest Maiden,” whose billowing skirts unloosed plague and famine.

In ancient Greece, Pan the goat-god was associated with surges of panic and terror, such as a flocks bursting into a stampede or men overcome with fear and trembling in the depths of the forest. Apart from being a musician and flock-keeper, Pan was a god of the hunt. Undoubtedly a primal terror is that of the hunted creature pursued by an avenging pack. The phrase “thrill of the chase” may be counterbalanced by “terror of the quarry.” Frightened cries or pleas for clemency may have featured in the early articulation of speech.

NICCOLÒ MACHIAVELLI

Niccolò Machiavelli’s (1469–1527) manual of Renaissance statesmanship, *The Prince*, is a classic treatise on leadership utilizing terror or fear. It urges the ideal prince not to put “the reproach of cruelty” before such overwhelming issues as political unity and that “it is much safer to be feared than to be loved when one of the two must be lacking.” While seldom quoting or approving Machiavelli—unjustly his name became synonymous with conspiracy and deceit—many subsequent leaders and dictators have taken his strictures to heart.

politician and thinker Edmund Burke (1729–1797), in his *Philosophical Enquiry into the Origin of Our Ideas of the Sublime and Beautiful* (1757), saw terror as an elevating, thrilling sensation deriving from the “sublime” and accompanying the observation of soaring, stupendous scenery. In the *Duino Elegies* (1923), the Austrian poet Rainer Maria Rilke (1875–1926) perceived “beauty” as “nothing but the beginning of terror,” implying that, in the act of emotional surrender or identification, man lays himself open to a force over which he can exercise little control. Buildings, too, can produce such an effect. There are churches whose massive, solemn architecture, like those of the London architect Nicholas Hawksmoor (c. 1661–1736), induce a dread concomitant with an all-powerful deity.

Contemporary evangelists emphasize the “love of God,” but men like Martin Luther feared God just as much. The latter

was literally a “terrible” power capable of visiting plague, famine, and earthquake. During the Middle Ages and the early modern period, numerous “panic” and “God-fearing” cults sprang up—from the flagellants to the Anabaptists—that exploited mass credulity, drawing upon the end of the world or “day of judgment” theme and the glorious, terrifying visions of the Book of Revelation—a favorite text, significantly, of the deranged, self-appointed messiah David Koresh (1959–1993), who died amid the blood and flames of his apocalyptic vision at Waco, Texas, taking his followers with him.

During the early Romantic period, the classic terror image *The Nightmare* (1782) was painted by Henry Fuseli (1741–1825), showing a young woman sprawled out sleeping and the head of a phantom horse rising above the bed. Perched on the woman’s breast is a small hairy incubus. The popularity of such works gives rise to the question: Do people enjoy being terrified? The answer is that, in comfortable surroundings, they may enjoy the vicarious thrill of a mental journey through terrains littered with ruined castles, skulls, vampires, and apparitions: hence the enduring appeal of Gothic novels like *The Castle of Otranto*, *Dracula*, *Frankenstein*, and, more recently, the horror film and works of popular authors like Stephen King. Furthermore, the terrors banished at the climaxes of books and films are reassuring compared with the spectacular diseases and potential nuclear catastrophes filling much contemporary reality. Ghosts and ghouls, for all their menacing antics, hint at a startling extension of existence rather than the terminal facts of modern warfare. The effect of such works is to reassure more than terrify, for usually the fears are objectified and framed in the neutral environment of the page or screen.

The Amygdala

Since the 1990s, terror has been localized in tiny pathways between nerve cells in a small, almond-shaped clump of tissue called the amygdala. Joseph LeDoux—an authority on

the emotional brain—observed, “We have shown that the amygdala is like the hub in the centre of a wheel of fear. If we understand the pathways of fear, it will ultimately lead to better control.” Part of the primitive brain, the amygdala seems to have developed early, steering organisms away from poisons and predators. Some researchers associate it with conditions like depression and autism. Specific fears can be “burned” into it and stimulate a trigger reaction or recurrent terror. Through research into the amygdala and neurocircuitry, some hope that terror, man’s oldest adversary, will be conquered, provoking the question: Will there be such a thing as a hero in the future?

See also *Heresy and Apostasy; Machiavellism; Mind; Terrorism, Middle East; War.*

BIBLIOGRAPHY

- Burke, Edmund. *Philosophical Enquiry into the Origin of Our Ideas of the Sublime and Beautiful*. Edited by David P. Womersley. New York: Penguin, 1999. Primary source dealing with “terror” as an incarnation of what is sublime in nature.
- Carter, Rita. *Mapping the Mind*. London: Weidenfeld and Nicolson, 1998. Cogent, popular study of how the brain works, with sections on the amygdala or “fear center.”
- Cohn, Norman Rufus Colin. *The Pursuit of the Millennium*. London: Secker and Warburg, 1957. An authoritative look at the “panic cults” and apocalyptic terrors of the Middle Ages and early modern periods.
- Conquest, Robert. *The Great Terror: Stalin’s Purge of the Thirties*. New York: Macmillan, 1968. A gripping account of Stalin’s purges.
- Fumagalli, Vito. *Landscapes of Fear: Perceptions of Nature and the City in the Middle Ages*. Translated by Shayne Mitchell. Cambridge, U.K.: Polity, 1994. Enlightening psycho-geography of the medieval world.
- Machiavelli, Niccolò. *The Prince*. Translated by Peter Bondanella and Mark Musa. Oxford: Oxford University Press, 1998. Treatise on realpolitik in the sixteenth century.
- Newman, Paul. *A History of Terror*. Stroud, U.K.: Sutton, 2001. Accessible survey of the various manifestations of terror and panic against a historical backdrop.
- Schmitt, Jean-Claude. *Ghosts of the Middle Ages*. Chicago: University Press of Chicago, 1998. Shows how “ghosts” were harnessed to the chariot of religion.

Paul Newman

TERRORISM, MIDDLE EAST. While terrorism has arisen in a variety of cultures and historical periods, much of the world’s attention on this phenomenon in the late twentieth and early twenty-first centuries has centered on the Middle East. Middle Eastern terrorism emerged in Western consciousness during the 1970s, primarily through the rise of secular leftist and nationalist groups among Palestinian exiles, which targeted Israelis and their supporters both within and outside of Israel. Some (such as Yasir Arafat’s Fatah movement and George Habash’s Popular Front for the Liberation of Palestine) were part of broader political movements within the umbrella of the Palestine Liberation Organization, while others (such as Abu Nidal’s Fatah faction) operated outside the

PLO. Palestinian nationalists were inspired in part by the success of the Algerian revolution, which used terror as a tactic to free that North African nation from French colonialism in 1962, and by the case of Israel, which won independence from Britain in 1948 in part through the efforts of terrorist groups led by future prime ministers Menachem Begin and Yitzhak Shamir. Without a recognized government or territory, terrorism appeared to many Palestinians to be a more realistic option than conventional or guerrilla warfare.

The rise of Palestinian terrorism was concomitant with the rise of Palestinian nationalism, where successive betrayals and defeats by Arab governments had led Palestinians to take leadership in their own national struggle. The use of such high-profile tactics as airline hijackings and embassy takeovers helped call attention to the plight of the Palestinian people, most of whom were living under Israeli military occupation or in forced exile in refugee camps in neighboring Arab states. Though such tactics led the West to belatedly recognize the Palestinians as a distinct people with national aspirations, it also gave Israel and the United States the excuse to thwart these goals on the grounds that the nationalist movement was led by terrorists.

The fratricidal Lebanese civil war (1975–1990) brought to the fore a number of ethnic-based militias that utilized terror, including the right-wing Phalangists, based in the Maronite Christian community, and—following the 1982 Israeli invasion and subsequent U.S. intervention—Shiite Islamic groups, some of which coalesced into the Hizbollah movement.

Turkey has been subjected to widespread terrorism by extreme leftist and extreme rightist groups, particularly during the late 1970s and early 1980s. Also during this period, Armenian terrorists would periodically assassinate Turkish diplomats in retaliation for the 1915 genocide and the refusal of Turkey’s government to acknowledge their culpability. Kurdish nationalists, under the leadership of the Kurdish Workers Party (PKK), engaged in a series of terrorist attacks in Turkey through the 1990s in an effort to secure greater autonomy.

Leftist and Islamic groups used terror on a limited scale against the shah’s repressive regime in Iran during the 1970s. During the early 1980s, following the shah’s ouster in a largely nonviolent revolution and the subsequent consolidation of power by hardline Islamists, there was an upswing in terrorism that included assassinations of top officials of the revolutionary government.

In recent decades, the failure of secular nationalist and leftist movements in the Middle East has given rise to Islamic groupings, some of which have engaged in terrorism. Many were Arab veterans of U.S.- and Pakistani-backed mujahideen groups fighting the Communist Afghan government and its Soviet backers during the 1980s. This period saw the beginning of a tactic (which had previously been utilized primarily by Hindu Sri Lankan Tamils) where assailants, carrying explosives in a vehicle or strapped to themselves, would blow themselves up along with their targets, a phenomenon that became known as suicide bombings.

Several autocratic Arab regimes, long accused of corruption and abandonment of Islamic values, have become targets of Islamic radicals. Egypt was a hotbed of such movements throughout the 1980s and into the 1990s, with terrorists targeting government officials (including President Anwar Sadat), wealthy Egyptian elites, and foreign tourists. Conservative monarchies in Saudi Arabia, Kuwait, and Bahrain, along with their Western supporters, became targets of radical Islamists during this period as well. Algeria became the site of the most deadly acts of terrorism in the region beginning in the early 1990s, when the radical Armed Islamic Group (GIA) arose following a military coup that short-circuited scheduled national elections. During the 1990s, when the PLO's renunciation of terrorism and peace talks with Israel failed to end the occupation, Palestinian Islamic groups such as Hamas and Islamic Jihad, later joined by a renegade Fatah faction known as the Al-Aqsa Martyrs Brigade, commenced a suicide bombing campaign against Israel.

The ouster of Saddam Hussein's regime by invading U.S. forces in 2003 has resulted in Iraq's becoming a major center of terrorism. Though most of the Iraqi resistance to the U.S. occupation has targeted occupation forces, there has also been a series of bombings against civilians by both Iraqi and foreign terrorists.

The late 1990s saw the emergence of the Islamist Al Qaeda network, led primarily by Saudi exiles such as Osama bin Laden, who have targeted a number of Arab and Western targets, particularly the United States. Chief among their grievances have been U.S. support for Arab dictatorships; the American-led sanctions, bombings, and invasion of Iraq; U.S. support for Israel; and the ongoing U.S. military presence in the heart of the Islamic world. Al Qaeda's financial resources and sophisticated organization has taken terrorism to unprecedented levels, most dramatically illustrated by the devastating September 11, 2001, terrorist attacks on the United States that killed over three thousand people.

State-Sponsored Terrorism

Most governments and peoples of the Middle East categorically oppose terrorism. The taking of innocent human life is proscribed under Islam just as it is under Christianity and Judaism. However, a number of radical Middle Eastern states—such as the Islamist military government in Sudan, the Libyan regime of Muammar Qaddafi, the Baathist government of Syria, the former Taliban regime in Afghanistan, the Islamic Republic of Iran, and Saddam Hussein's former regime in Iraq—have provided or continue to provide funding and logistical support for terrorist groups.

Such activities have contributed to these governments' international isolation, although the United States has at times exaggerated the extent of support these regimes have provided terrorists in order to further advance other policy goals. U.S. forces bombed Libya in 1985, Iraq in 1993, and Sudan and Afghanistan in 1998 because of their governments' alleged support for terrorism, although some of these air strikes resulted in widespread civilian casualties themselves. In 2001, the U.S.-led air strikes played a decisive role in the ouster of the Taliban



Poster celebrating Palestinian suicide bomber, Jenin, 2002. Palestinian desire for Israeli withdrawal from occupied territories such as the West Bank has led to the formation of several terrorist organizations who utilize violent methods of coercion such as kidnapping, hijackings, and bombings. AP/WIDE WORLD PHOTOS

government in Afghanistan, which had provided sanctuary for Al Qaeda. Some intelligence and military officers and other officials in Saudi Arabia and Pakistan are believed to have quietly supported Islamist terrorists, although top government leaders largely support antiterrorism efforts.

Far more consequential, however, both politically and in terms of civilian lives, have been acts of state terror stemming directly from armed forces of governments themselves. For example, the Kurdish minorities in Iraq (particularly during the 1980s) and in Turkey (particularly during the 1990s) were subjected to widespread massacres, destruction of villages, and forced relocation, with civilian death tolls in the tens of thousands. In the former case, the United Nations Security Council set up a safe haven for Kurds in the northern part of Iraq following a devastating 1991 Iraqi offensive, the first time the UN had restricted the right of the armed forces of a sovereign country to operate within its internationally recognized borders on human rights grounds. During the Turkish invasion of Cyprus in 1974, hundreds of ethnic Greek civilians were killed, and ethnic cleansing uprooted the majority of the population in the northern one-third of the island; killings and forced relocations on a lesser scale occurred in other parts of Cyprus during this period against ethnic Turks. Successive Arab-dominated Sudanese governments contributed to the deaths of hundreds of thousands of Christian and animist blacks in the southern part of the country through massacre and forced starvation, more recently targeting black Muslims in the Dafur region in the west. Algerian forces killed thousands of civilians in counterinsurgency operations in the early to mid-1990s. In southern Iraq, Saddam Hussein's armed forces were responsible for the deaths of thousands of civilians following an uprising by Shiite Arabs in 1991. In Iran, too, under both the U.S.-backed shah and the Islamic regime that replaced it, thousands of Iranians have been killed by secret police and other government forces. The U.S. bombing of Afghanistan during the fall of 2001 ap-

pears to have killed more civilians than the September 11, 2001, attacks against the United States that prompted it.

Decades of Israeli bombing and shelling of civilian areas in Lebanon are believed to have resulted in the deaths of more than twenty thousand people. The number of Palestinian civilians killed in Israeli assaults in the occupied West Bank and Gaza Strip far surpasses the number of Israeli deaths from Palestinian terrorists. Israeli maltreatment of Palestinians under occupation, which has included widespread violations of the Fourth Geneva Convention, has been the subject of a series of UN Security Council resolutions demanding that such practices be halted, although the United States has blocked their enforcement and vetoed dozens of similar resolutions. Reports from reputable human rights organizations have also accused Moroccan occupation forces in Western Sahara of widespread abuses, particularly during the initial conquest of the former Spanish colony in 1975.

The Function of Terrorist Groups

In general, terrorism by non-state actors arises from those who are too weak to engage in more conventional forms of armed struggle or are motivated by the sheer frustration of their situation. Some individuals who enlist with radical Islamist groups may also be promoted in part by the perceived glory of martyrdom. Supporters of such terrorism justify such actions as a means of inflicting damage on political entities and societies as a whole that are seen as carrying out mass violence through government forces too strong to confront directly.

For example, Israel's occupation and colonization of Palestinian territory seized in the Six-Day War in 1967, the ongoing repression, and rejection of demands for a full withdrawal in return for security guarantees—combined with Israel's overwhelming military power and the large-scale military, financial, and diplomatic support from the world's only remaining superpower—have led some Palestinians to support suicide bombing as a means of convincing Israel that the costs of holding on to the occupied West Bank and Gaza Strip are higher than withdrawal. Such violence has actually hardened the attitudes of Israelis and their American backers, as it appears to reinforce their assumption that the Palestinians' actual goal is not just ending the Israeli occupation of the West Bank and Gaza Strip, but the destruction of Israel itself.

The terrorism of previous decades in the Middle East, like terrorism practiced by leftist and nationalist movements elsewhere, was based upon the idea of “propaganda of the deed”—inspiring popular struggle and demoralizing their opponents. In this regard, it was almost uniformly unsuccessful, particularly as enhanced security measures made successful terrorist operations more difficult.

Suicide bombing not only was easier to carry out, since the terrorists were willing to kill themselves in the process, but Islamist groups were able—despite Islamic prohibitions against suicide and killing innocent people—to take advantage of the exalted role of martyrdom among Muslims to gain recruits and popular support. Such terrorist operations, with their poten-

tial for inflicting enormous casualties, appear to also be designed to provoke a disproportionate reaction from governments with superior armed forces, resulting in large-scale civilian casualties and thereby increasing support for their extreme anti-Western ideology. A number of strategic analysts have argued that the U.S. response to September 11, particularly the invasion of Iraq, have actually strengthened Al Qaeda by leading increasing numbers of alienated young Muslims to adopt bin Laden's view of a holy war between Islam and the West.

Some groups, such as Al Qaeda, function primarily to promote their causes through terrorism. Others, like Hamas, carry out civilian functions—such as running health clinics and schools and providing social services—as well as supporting an armed wing involved in terrorism. Some have evolved into political parties: for example, since the mid-1990s, Hizbollah has refrained from attacks against civilians, has largely restricted its armed activities to Israeli occupation forces, and has competed in Lebanese parliamentary elections.

Most contemporary Middle Eastern terrorist groups have emerged out of situations where there has been widespread social dislocation through war or uneven economic development. Virtually all have emerged in situations where legal nonviolent means of political change have been suppressed. The disproportionate level of terrorism in the Middle East appears to be less a result of anything inherent within Arab culture or within Islam than a consequence of the systematic denial by governments to allow for the manifestation of basic rights, including the right of self-determination. Given that the primary supporters and arms providers of most of these repressive Middle Eastern governments are Western powers such as the United States, the threat from terrorism is unlikely to be suppressed through military means alone.

See also Jihad; Terror; War.

BIBLIOGRAPHY

- Esposito, John L. *Unholy War: Terror in the Name of Islam*. New York: Oxford University Press, 2002.
- Fisk, Robert. *Pity the Nation: The Abduction of Lebanon*. New York: Nation Books, 2002.
- Halliday, Fred. *Two Hours That Shook the World—September 11, 2001: Causes and Consequences*. London: Saqi Books, 2002.
- Sayagh, Yezid. *Armed Struggle and the Search for State: The Palestinian National Movement, 1949–1993*. New York: Oxford University Press, 1997.
- Telhami, Shibley. *The Stakes: America and the Middle East*. Boulder, Colo.: Westview Press, 2002.
- Zunes, Stephen. *Tinderbox: U.S. Middle East Policy and the Roots of Terrorism*. Monroe, Maine: Common Courage Press, 2003.

Stephen Zunes

TEXT/TEXTUALITY. This is not a definition. Well, of course it is—after all, it is appearing in a dictionary—and yet, in a certain and actually rather important way, it is not. Or, put differently, precisely to the extent that the text is not an

idea, this is not a definition. Of course, the text can be treated as an idea, perhaps even one whose time has come, but doing so misses something important about what the text is. In fact, what one misses in treating the text as an idea is its resistance to both idealism and the history of ideas, a resistance marked—however obliquely—by the necessarily digressive form of this definition that is not one.

Etymology

Text derives from the Latin *textus* (a tissue), which is in turn derived from *texere* (to weave). It belongs to a field of associated linguistic values that includes weaving, that which is woven, spinning, and that which is spun, indeed even web and webbing. *Textus* entered European vernaculars through Old French, where it appears as *texte* and where it assumes its important relation with *tissu* (a tissue or fabric) and *tisser* (to weave). All of these resonant associations are relevant to understanding how “the text” is used in contemporary scholarship, especially the interplay between its nominal and verbal forms, an interplay that registers the quality of what Julia Kristeva has called the text’s “productivity,” that is, its capacity to enable and exceed the producing, the materialization, of products.

The emergence of the text as an important concept in humanistic scholarship has taken many twists and turns. When Walter Benjamin, in his essay “The Image in Proust,” described Proust’s writing as a *textum*, a weaving not unlike the raveling and unraveling carried out by Penelope in the *Odyssey*, he was bringing to closure a tradition that dates back at least to Quintilian (c. 35–100 C.E.), a tradition of associating the literary work with a tissue woven of many threads. If it makes sense to associate Benjamin with the closure of this tradition, it is because in his insistence on the dialectic of raveling and unraveling, he foregrounds a key preoccupation of what came to be known as textual criticism. Textual criticism—a distinctive fusion of the practices of biblical exegesis, paleography, and philology linked now with the figure of the German philologist Karl Lachmann (1793–1851)—was an institutionally and largely theologically organized emphasis on the text as an empirical object. This expressed itself during the fourteenth century in the works of William Langland, Geoffrey Chaucer, and John Wycliffe (among others) as a concern for the original and therefore true words contained in any writing—in effect, what God actually said. The text was defined either in opposition to commentary and annotation or in opposition to all that is supplemental: introductions, appendices, etc. This was a text understood as a thing, as a specific and precise configuration of words toward which one was then authorized to turn his or her hermeneutical attentions.

Text and Semiological Text

When in 1972 Oswald Ducrot and Tzvetan Todorov published *The Encyclopedic Dictionary of the Sciences of Language*, it was the text as thing, the text of textual criticism, that oriented the first of their two entries on “the text,” which focused on the way the text fills a gap in linguistics, rhetoric, and stylistics by providing them with a concept of the autonomous and closed unit that arises through the individuated use of a language sys-

tem. In effect, “the text” answers the question: what thing is produced when a linguistic code is used to generate a message? In this it substitutes for either discourse or speech act. Significantly, though the *Encyclopedic Dictionary* contains a second entry on the text, it appears in an appendix, the very sort of supplementary material typically distinguished from the text of textual criticism. This text is dubbed “semiological” by the authors, a characterization meant to note the rather different way this second text engages the traditions and practices of humanistic scholarship.

In his contribution to the *Encyclopaedia Universalis* of the following year, Roland Barthes repeats this division of the concept of the text, suggesting that—despite the centrality of his contribution to the theorization of the semiological text—he found the division, if not compelling, then certainly useful. Framing his discussion in terms of the “crisis of the sign,” Barthes reminds us that the second text has a rather different genealogy than the text of textual criticism. For one thing, its emergence is considerably more recent. Although many of the writers who mattered to the theorists of the semiological text—Stéphane Mallarmé, Honoré de Balzac, Edgar Allan Poe, the Comte de Lautréamont, and others—wrote during the nineteenth century, the theorization of the text their work enabled unfolded during the postwar period in France. Nineteen-sixty is the date typically given for the emergence of the second text, and this is because it was in 1960 that the first issue of the influential journal *Tel Quel* appeared. While it is certainly the case that the text and *Tel Quel* are intimately related, the intellectual insights that converged in the concept of the text are discernible already in the 1940s. This becomes evident if one compares Maurice Blanchot’s 1948 essay “Literature and the Right to Death” with his “Reflections on Nihilism” from part two of *The Infinite Conversation* (1969). In “Reflections” Blanchot makes explicit how his earlier meditation on literature, the book, the work, and death—framed largely in terms of the Hegelian principle of negativity—converts almost effortlessly into the properly textual concerns of Barthes and Jacques Derrida. Indeed, Blanchot appears to trace here precisely the movement from work to text that was to be thematized so fruitfully by Barthes in 1971. Perhaps because Derrida has made his debt to Blanchot explicit, it is difficult not to read in the title of the opening section of *Of Grammatology* (1966), “The End of the Book and the Beginning of Writing,” the palimpsestic presence of Blanchot’s conception of the disappearance of literature and the absence of the book. While it is true that Blanchot holds the very term “text” in abeyance (systematically preferring “work”), it is clear that his profoundly philosophical engagement with the literary object opened what Barthes was later to call the “methodological field” of the semiological text.

Tel Quel

While it might be argued that the appearance of Michel Foucault’s “Language to Infinity” (an essay openly in dialogue with Blanchot) in an early issue of *Tel Quel* is what destined the encounter between the journal and the concept of the text, this presupposes rather than establishes the relevance of Blanchot. What clearly makes *Tel Quel* so pertinent to the

emergence of the text is the fact that its longtime senior editor, Philippe Sollers, sought explicitly to devote the resources of the journal to the dissemination of the concept. Indeed, it is largely through the intellectual debates stirred by the journal that the text and textuality came to belong together. Although it ceased publication in the 1980s (morphing into *L'infini* in 1982), the journal not only brought together all of the major theorists of the text—Barthes, Derrida, Kristeva, and Sollers—but, by virtue of its role in the French institutions of intellectual power, it allowed the text both to materialize and to do so in a manner that left it marked by the conditions of its emergence. Despite its heady and deeply theoretical character, the text was always in some ways a “pop” phenomenon. With the creation of the *Tel Quel* series at Editions du Seuil in 1962 (which eventually included major works by Barthes, Derrida, and Kristeva), not only was the text being widely disseminated (many titles in the series were translated), it became the topic of discussion at seminars, colloquia, and, thanks to Bernard Pivot’s *Apostrophes*, nationally televised debates. Those eager to dismiss the importance of the text typically point to this as evidence of its degraded character, but in thereby hiding the commodity character of virtually all academic concepts they overlook the distinctly textual character of the text. The heterogeneous threads woven into the concept always included unruly, indeed compromising, material elements; indeed, this was part of its purchase on the concept of materialism, a purchase that might be said to culminate in the displacement of context (whether social or historical) by contextuality.

Jacques Derrida: Writing

Philosophically, the semiological or second text was given its earliest and perhaps most enduring formulation in the work of Jacques Derrida. Although it is true that Barthes had a longer, much more intimate, affiliation with *Tel Quel* (first publishing there in 1961), he would have been the first to admit that most of the heavy theoretical lifting was done by those around him, certainly by Derrida (and earlier Roman Jakobson, Claude Lévi-Strauss, and Jacques Lacan), but also by his protégée, and later master, Julia Kristeva. Certainly, *Tel Quel*’s tenacious defense of the politics of writing (both phonetic and grammatological or *arché*) is unthinkable in the absence of Derrida. Indeed, Derrida’s attack on idealism provided Sollers and others affiliated with the journal with rigorous means by which to link their early commitment to literature with a post-engagement leftism. Derrida’s first sustained presentation of the concept of the text appears in *Of Grammatology*, although one finds important strands of the insight it crystallizes in his earlier reading of Edmund Husserl. There, the text is used in a way consistent with its use in textual criticism, except that it is linked to a meditation on the relation between what makes science scientific and writing, a link forged by making consistent appeal to Maurice Merleau-Ponty’s use of the Husserlian concept of “interweaving” in the former’s lectures on “The Origins of Geometry” from the 1950s. Invoked both by Husserl and by Merleau-Ponty to designate the encounter between language and thought, interweaving is taken up by Derrida as a way to introduce the rhetoric of textuality within a theorization of writing and its place in the dispute between science and philosophy. For example, in “Form and Meaning”

(another early essay on Husserl) Derrida explicitly translates interweaving (given in German as *Verwebung*) as the Latin *texere*, and does so in anticipation of a formulation in which linguistic and prelinguistic strata are shown to interact in accord with “the controlled system of a sort of text.” “Sort of” here marks the advent of the semiological text—that is, the concept through which Derrida seeks to challenge phenomenology’s account of the being of meaning.

The Text as Philosophical Paradigm

Of Grammatology draws out the relation between this text and a critique of the philosophical ethnocentrism expressed in the subordination of writing to speech. Although Derrida frames the issue in terms of a critique of Ferdinand de Saussure’s account of the linguistic sign, it is clear that the problems raised regarding Husserl’s figure of interweaving are not far away. Indeed, Saussure’s subordination of writing to speech is read as an expression of his tacit agreement with Husserl’s phenomenological construal of language. To challenge this subordination and the ethnocentrism sustaining it, Derrida uses the logic of the text, that is, the argument that the interweaving that confounds the distinction between different levels of consciousness and dimensions of reality also confounds not just the distinction between speech and writing but the distinction between thought and signs. Here, the semiological text comes to designate the unstable process whereby experience and representation (whether linguistic or not) engage one another in a radically undecidable manner. The oft-cited formulation “there is nothing outside the text,” which appears in the discussion of Jean-Jacques Rousseau, thus asks, at one level, to be taken this way: there is no experience that can be absolutely separated from the systems of representations developed for its expression. The text then is less a thing than a philosophical paradigm, that is, a way of representing—within the protocols and procedures of a certain discourse—the undecidable limits and procedures of representation. It is not that there is nothing but representation. Rather, if there is nothing outside the text, it is because there is nothing but the enduring missed encounter between experience and representation.

Because of the intimacy that defines the relation between *Of Grammatology* and *Writing and Difference* (from the same year), it is important here to acknowledge the way Derrida mobilizes Sigmund Freud to extend his critique of experience, a critique that might otherwise appear to leave both the personal and the ineffable unthematized. In “Freud and the Scene of Writing” Derrida, by tracing Freud’s ambivalent relation to the metaphors of writing as they appear in various discourses, shows how a textual logic is at work both in Freud’s account of neurophysiology (the thematics of *Bahnung*, “pathmaking”) and in his account of the psychical interaction of memory and perception, whether in waking life or in the dream. Thus, the semiological text, by representing the undecidable interweaving at work in the different operations of the psychical apparatus, is shown to have yet another relation to the systemic mediation of experience. If, as Derrida argues, the signifier and the signified are interwoven—in effect, structured by the differing deferral of *différance* (Derrida’s well-known neologism)—then, strictly speaking, there are no ideas. Idealism is then thrown into cri-

sis, and while Derrida's materialism has consistently defied philosophical categorization, it is clear that the text paradigm, in foregrounding the interminable labor of differentiation, exhibits an unmistakable materiality.

Julia Kristeva: Textual Productivity and Intertextuality

Perhaps because Julia Kristeva's earliest articulations of the theory of textuality are framed within the context of a more intimate dialogue with Marxism than Derrida's, the text's materiality receives more direct attention. Specifically, in several of the essays that comprise *Séméiotiké* (1969) Kristeva links the text with the concept of productivity. This term derives from her effort to rethink Marx's concept of the "mode of production" from the vantage points of linguistics and psychoanalysis, with the aim of capturing both how values (economic, linguistic, etc.) are effects of a system of relations, and how this system is defined by a heterogeneity of relations (social, psychic, etc.) that sustain themselves in a permanent state of crisis. In the essay "The Productivity Called the Text," Kristeva shows how the text, again as paradigm rather than as thing, allows one to think about how language is deployed in ways that undercut its communicative function, at once revealing and confounding the codes that organize the production of linguistic messages. Although it is impossible to designate the product of the productivity called the text, it is clear that what is at stake here is the subject in process/on trial (Kristeva's original formulation invites both). The text provides one with the conceptual means by which to theorize and thus analyze the formation and deformation of the human being that takes place in the circuits of symbolic exchange.

Crucial to her point about the systemic articulation of heterogeneous relations is the conceptual innovation of intertextuality. Derived from the semiological concept of substance (used by Louis Hjelmslev to track the plane of content from one sign system to another), intertextuality describes the transpositions that allow different semiological registers to engage one another. Kristeva's earliest characterizations of intertextuality—for example, "in the space of a text several utterances, taken from other texts, intersect and neutralize each other"—associate it with the process of literary allusion. In *Revolution of Poetic Language* (1974), however, a much stronger accent falls on the dynamics of transposition—that is, the unstable process whereby differently realized texts collide in, say, a novel—and she goes out of her way to disassociate intertextuality from the "study of sources." Because intertextuality is identified in *Revolution* as a third primary process (primary processes were Freud's list of psychic activities that effect the form and content of dreams), it is equally clear that transposition is designed to give the analyst access to the permutation of subject positions undergone in the production of a work. Kristeva's emphasis on textual interactivity underscores the interdisciplinary character of the text paradigm. No doubt because her mentor, Barthes, drew heavily on Hjelmslev's substance in his influential studies of fashion, where clothing is photographed, written about, and worn, Kristeva's use of intertextuality deliberately engages the forms of textuality that arise both in different sign systems and in different disciplines. Not

surprisingly, therefore, music and painting have mattered deeply to Kristeva's thinking about literature.

A final conceptual innovation must be mentioned. Throughout the late 1960s and early 1970s Kristeva appealed to a distinction between the "pheno-text" and the "geno-text." Obviously modeled on the discourse of genetics (such as phenotype and genotype), this distinction was not about restoring the work's "organic" character. Instead, it sought to stress the continuum of effects that passed between the formation of the speaking subject and the works produced by him or her. In *Revolution*, this distinction is tied to one between the semiotic and the symbolic, and Kristeva uses it to analyze how the subject's relation to the maternal body and the social order manifests itself in the form and content of a poem. In designating different levels of the text, the pheno-text and geno-text serve to give the textual paradigm access to a field of literary production that reaches well beyond the poem without, however, renouncing any claim on its formal detail. In providing the analyst with the conceptual means by which to track the transposition of the semiotic into the symbolic, the pheno-text/geno-text distinction gives intertextuality its deep structure. In doing so it makes the process of transposition central to Kristeva's theory of the text, a theory that, among other things, calls the concept of the literary tradition deeply into question.

Roland Barthes: Pleasure of the Text

As *Tel Quel's* "spiritual advisor," Roland Barthes (1915–1980) had enormous influence on the fate of the text. Although he often deferred to the theoretical rigor of others, he was unquestionably the text's most articulate and tenacious cultural ambassador. Like Kristeva he was keen to extrapolate the literary implications of the semiological text, and for this reason—not to mention the largely literary cast of the American reception of textuality—his studies *S/Z* and *The Pleasure of the Text* still define for many in the Anglophone world what the second text is. This reputation is by no means undeserved. It does, however, tend to obscure the permutations undergone by Barthes's text. In *S/Z* (a textual analysis of Balzac's *Sarrazine* [1830]), for example, Barthes deploys a straightforwardly etymological notion of the text by identifying five codes that, in his account of the story, are "woven together" in its narration. Although the strong suggestion made by the study is that this approach is warranted by its pedagogical value (and Barthes's skills here are legendary), it is clear that Barthes is reading the narrative in a deliberately textual manner. That is, he is constructing the means by which the story produces the possibility of its meanings, including, it should be added, the intensely queer motif of the sexual undecidability around which the narration winds and unwinds. This approach, also exemplified in numerous essays of the period, does at a certain point succumb to the affective charge it channels, resulting in the publication of *The Pleasure of the Text* (1973), where the figure of weaving, while not giving way entirely, recedes in importance. In its place appears a theme first programmatically identified in his groundbreaking essay from 1971, "From Work to Text": the theme of pleasure, later set off against its more strictly Lacanian double, *jouissance*.

As part of Barthes's professional trajectory from semiotics to semioclassicism ("sign breaking" or the defiling of the sacred status of signs), this shift clearly registers the impact of Kristeva (and to a lesser extent, Derrida) on his writing. Indeed, in engaging the theme of pleasure Barthes openly weaves into his text the problem of the body and its drives. Although struck by Kristeva's semiotics, Barthes rechannels pleasure toward the practice of the reader, that is, the highly mediated encounter between the absent body of the writer and the present, indeed attentive, body of the critic/theorist. Drawing on Blanchot's neutered account of literary space, Barthes reframes this encounter in the distinctly queer mood of promiscuous anonymity, making the textual paradigm accommodate a distinctly sexual, indeed homo-textual, relationality.

This attention to the reader's body and its practices (what the body does when it reads) finds perhaps its highest expression in Barthes's critique of the literary object, the work. Not content to stress the existential aspect of one's practice, Barthes links such practice to the social reproduction of the literary institution, arguing that its organizing conceit, the concept of a commodity laden with values deposited there by a genius, in short the literary work, is not only an ideological confection of that institution, but one being deployed in a rear-guard action against challenges being mounted against it from within a heterogeneous field of writings. Here, the methodological field of the text serves both to frame the literary institution, to account for its reproductivity, while also establishing how one might read from the inside out, that is, with an eye toward grasping how reading is also always an engagement with its social and psychic conditions. In thus calling for a paradigm shift from the work to the text, Barthes is not only echoing Derrida's call for the end of the book in historical terms, but is situating the text itself as the context for a transformation of intellectual power in the West, one that in demythologizing some of its most cherished ideas, challenges the West's ability to define and thereby legitimate its cultural values. In this sense the text is not itself an idea.

Textual Analysis outside Literary Studies

The specific terms in which the integrity of the literary object was questioned by the semiological text helped to catalyze discussion about objects in other disciplines. Kristeva's interest in painting and music has already been remarked. The most concerted effort to make the textual paradigm matter outside literary studies, however, was in cinema studies, where in the course of the 1970s "textual analysis" came to be synonymous with a rigorous psychoanalytically and/or philosophically inflected neo-formalism. This development had strong immediate repercussions outside France, notably in Britain, where many of the writers affiliated with the journal *Screen* saw themselves as contributing to the "textual analysis" initiative. In France, the figures typically associated with elaborating the cinematic text would include Christian Metz, Marie-Claire Ropars-Wuilleumier, Raymond Bellour, Michel Marie, and Thierry Kuntzel. That each is quite distinctive does not deny that, taken as a whole, they represent a concerted effort to displace the filmographic or humanistic object of cinema studies by bringing to bear upon the institutional consensus sustaining it all the questions animated in the works of Derrida, Kristeva, and Barthes.

Because the sound track figured centrally as one of the "codes" to weave into the textual analysis of film, music (one of several components of the sound track), and more specifically musicology, also became a site for the elaboration of the semiological text. Pitched against musicological structuralism (of the sort embodied in the work of Jean-Jacques Nattiez), the textual analysis of music sought to push away from the concerns of compositional syntax, and toward music's performativity, especially its interaction with the array of practices legitimated by post-Cagean aesthetics, notably of course dance and experimental theater. While it is certainly true that the textual analysis of music has never had the sort of impact enjoyed by cinema studies, the writings of Daniel Charles and Ivanka Stoianova have had influence. Moreover, precisely because of its emergence in musicology the textual paradigm has in significant ways secured its status as a uniquely powerful model of interdisciplinary and inter-media critical analysis. Indeed, textuality as a quality attributable to a wide variety of cultural practices derives its analytical force from the disciplinary dissemination both latent within the paradigm and materialized in its historical development.

The Global Social Text

Derrida, Kristeva, and Sollers were all still writing. Barthes died in 1980. Of the "textual survivors," none has assumed Barthes's ambassadorial responsibilities. In that sense the hour of the text may have passed. However, precisely because the semiological text posed the question of the literary, indeed the cultural, institution, thereby challenging the very logic of disciplinary reason and the ethnocentrism supporting it, the text retains what Benjamin called a "weak Messianic charge." This utopian and necessarily metacritical residue is nowhere more evident than in Gayatri Spivak's concept of "text-ility." Deftly picking up the etymological thread of the semiological text as a weaving, Spivak, in the controversial *A Critique of Post-Colonial Reason* (1999), deploys "text-ility" as the conceptual means by which to think the making and unmaking of the global social text. Specifically, she attempts to articulate the geopolitics of textile production in "the South," the multicultural fashion system supported in sectors of postcolonialism, and the "traveling theories" (a term derived from Edward Said's essay by that name) of largely Western academic intellectuals. Unashamed of her debts to Barthes and especially Derrida, Spivak makes it clear that in important ways the theory of the text, especially as it supplements itself, remains unfinished. At the very least she reminds us emphatically of what the text has always asked that we make of it: the theoretical and practical loom of the not there, the not yet—perhaps even the undefinable.

See also *Literary Criticism*; *Literary History*; *Literature*.

BIBLIOGRAPHY

- Barthes, Roland. *Image, Music, Text*. Edited and translated by Stephen Heath. New York: Hill and Wang, 1977.
- . *The Pleasure of the Text*. Translated by Richard Miller. New York: Hill and Wang, 1975. Originally published in French, 1973.
- . *S/Z*. Translated by Richard Miller. New York: Hill and Wang, 1974. Originally published in French, 1970.

- Benjamin, Walter. "On the Image of Proust." In *Walter Benjamin: Selected Writings*, 4 vols., edited by Marcus Bullock et al. Cambridge, Mass.: Harvard University Press (Belknap), 1996–2003. Vol 2 (1999), 237–247. Originally published in German, 1929.
- Blanchot, Maurice. *The Book To Come*. Translated by Charlotte Mendell. Stanford, Calif.: Stanford University Press, 2003. Originally published in French, 1959.
- Charles, Daniel. "La musique et l'écriture." *Musique en jeu* 13 (1973): 3–13.
- Derrida, Jacques. *Of Grammatology*. Translated by Gayatri Chakravorty Spivak. Baltimore: Johns Hopkins University Press, 1976. Originally published in French, 1967.
- . *Writing and Difference*. Translated by Alan Bass. Chicago: University of Chicago Press, 1978. Originally published in French, 1967.
- Ducrot, Oswald and Tzvetan Todorov. *Encyclopedic Dictionary of the Sciences of Language*. Translated by Carolyn Porter. Baltimore: Johns Hopkins University Press, 1979. Originally published in French, 1972.
- Jameson, Fredric. "The Ideology of the Text." In *The Ideologies of Theory: Essays 1971–86*. Minneapolis: University of Minnesota Press, 1988. Vol. 1, 17–71.
- Kristeva, Julia. *Desire in Language: A Semiotic Approach to Literature and Art*. Edited by Leon Roudiez. New York: Columbia University Press, 1980. Originally published in French, 1969–1979.
- . *Revolution in Poetic Language*. Translated by Margaret Waller. New York: Columbia University Press, 1984. Originally published in French, 1974.
- Metz, Christian. *Language and Cinema*. Translated by Donna Jean Umiker-Sebeok. The Hague: Mouton, 1974. Originally published in French, 1971.
- Mowitt, John. *Text: The Genealogy of an Antidisciplinary Object*. Durham, N.C.: Duke University Press, 1992.
- Ropars-Wuilleumier, Marie-Claire. *Le texte divisée*. Paris: Presses Universitaires de France, 1981.
- Said, Edward. "The Problem of Textuality: Two Exemplary Positions." *Critical Inquiry* 4, no. 4 (summer 1978): 673–714.
- Sollers, Philippe. *Logiques*. Paris: Editions du Seuil, 1968.
- Spivak, Gayatri Chakravorty. *A Critique of Postcolonial Reason: Toward a History of the Vanishing Present*. Cambridge, Mass.: Harvard University Press, 1999.
- Stoianova, Ivanka. *Geste, Texte, Musique*. Paris: Union Générale d'Éditions, 1978.
- The Tel Quel Reader*. Edited by Patrick French and Roland-François Lack. London: Routledge, 1998.

John Mowitt

TEXTILES AND FIBER ARTS AS CATALYSTS FOR IDEAS. Working with fiber has generated many seminal ideas in the course of human history, including the first notions of rotary motion, machines, and computers. The fiber arts also have provided an important means of expression of the human condition.

String

At some unknown time before 25,000 B.C.E. (when we get our first direct evidence), humans figured out that you could make long, strong flexible strings by twisting together thin, easily bro-

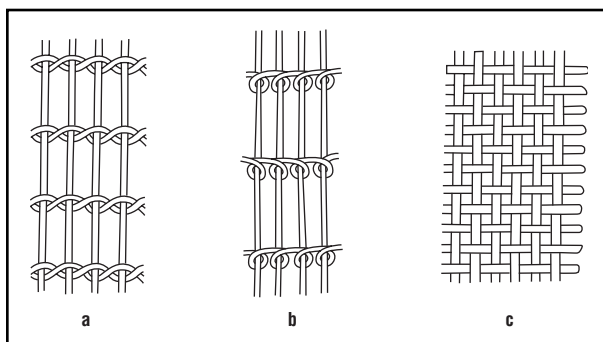

Figure 1. Earliest weaves: (a) twining with paired wefts; (b) warp-wrap twining; (c) plain-weave. COURTESY OF THE AUTHOR

ken plant fibers. Twist adds great strength, as one learns by twisting together a handful of fibers from a dead vine after the winter weather has rotted away (retted) the woody parts. The resulting string can be used in numerous ways to make life easier and more convenient: for tying things together (increasing one's power to carry, to store, and to make compound tools) or tying things down, and for crafting snares and nets (making hunting and fishing far more efficient). String is probably the special tool—almost unseen in the material record—that allowed the human race to move, during the Upper Paleolithic, into many ecological niches they otherwise could not have handled. All human cultures have string. Actual impressions of twisted plant fiber string and twined netting were found at Pavlov, Czech Republic, from 25,000 B.C.E., the middle of the Upper Paleolithic (Fig. 1a). These remains are already so sophisticated that string- and net-making must have been practiced for some time, possibly since the start of the era of cave art, c. 40,000 B.C.E. Other evidence of Paleolithic string and its uses has been found across Europe from 20,000 B.C.E., including increasing numbers of bone needles and fine-holed beads.

Once the domestication of plants and animals began in the Near East at the beginning of the Neolithic, c. 9000 B.C.E., evidence for fiber arts increases dramatically (partly because the newly permanent settlements make it easier to find human artifacts at all), allowing us to see new ideas in fiber and string technology.

Flax, still today an important fiber plant, was one of the first plants domesticated, and one of the first animals domesticated was the sheep (specifically *Ovis orientalis*). But sheep were domesticated for meat, not wool, as most people assume. Their coats were not soft and woolly, but coarse and bristly like a deer's, and it evidently took some four thousand years of inbreeding and selection to develop useably woolly sheep. Before that, domestic sheep and cattle were raised to be killed for food, but around 4000 B.C.E. people conceived the radical idea that they did better by keeping the sheep alive. Instead of providing one feast and one hide, each animal could provide a continuing supply of wool for clothing and of milk for food (preservable as yogurt and cheese). This change, as revolutionary as domestication itself, came to be known as the "secondary products revolution." Wool, from ever woollier sheep, is still one of the most important fibers worldwide.



Figure 2. Women weighing and preparing wool, spinning with drop-spindle, weaving on warp-weighted loom. From Greek wedding vase, 560 B.C.E. THE METROPOLITAN MUSEUM OF ART, FLETCHER FUND, 1931 (31.11.10) PHOTOGRAPH, ALL RIGHTS RESERVED, THE METROPOLITAN MUSEUM OF ART

Another key Neolithic invention was the spindle. Plant fibers are often long, making them easy to twist by hand into a single length of string. But for longer pieces, or if the fibers are short, one encounters a problem, for the string, once twisted, becomes quite ornery the moment you let go of one end to add more fiber to the other. It either untwists or gnarls up in a tangle, both effects being counterproductive. The solution is to wind it up on something, say a stick, which both stores it and keeps it from tangling or untwisting. But then the easiest way to twist more fiber onto the free end is to turn the stick itself. That's what a spindle is: a rod for holding the finished thread while adding twist to the newly forming part. The spindle can be twirled in the hand (hand-held), or with one end in a dish (supported), or hanging in the air from the newly forming thread (dropped) (Figs. 2 and 10). The speed and steady inertia of its spin can be increased by adding a little flywheel to the rod: an apple or potato will do, but we start finding small clay disks or wheels for the purpose, called spindle whorls, early in the Neolithic, by 6000 B.C.E. Spinning with a whorl-weighted spindle is many times faster (and easier) than twisting without a spindle.

So from the notion of twist to the notion of twirling a stick to the addition of the spindle whorl, humans came up with their first ideas of rotary motion, translated only much later, c. 3000 B.C.E., to the idea of the load-bearing wheel—a key idea that seems now to have been thought up only once, and in the area where spindles were invented.

Spindle technology was so easy, efficient, and portable that it remained essentially unchanged for seven thousand years, until the invention of the foot-powered spinning wheel in the Middle Ages, a design that quadrupled the speed of spinning and that was apparently jump-started by ideas from China, and finally, the spinning jenny—a hand-powered multiple spinning machine—during the industrial revolution. Hand spindles are still used in rural areas, however, where women make thread from fiber while doing other chores.

Textiles

Toward the end of the Paleolithic, people developed the idea of interlacing string or other long thin elements in a regular way to form a broad fabric: impressions of twined net or cloth

were found at Pavlov (see above) from 25,000 B.C.E., and fragments of mats and baskets are often found in the Near East from 7000 B.C.E. onwards. In a sense, the idea of interlacing is far older, since other large primates, such as chimps, will loosely “weave” together a few branches in a treetop to make a comfortable place to nap. (One can still see pleached [plaited] fences woven of the live branches of hedge plants in rural Wales [Fig. 3], and house walls woven of dead branches [wattle] were common in earlier times.) But interlacing in a *regular* way to make a *portable* object was a much newer idea.

Cloth differs from mats and baskets in one important respect. Mats and baskets, which hold their shape, are made principally from stiff materials, whereas cloth (whose prime quality is floppiness) is made entirely from pliable string or thread. A little experimentation will convince the reader that one cannot compactly interlace several pieces of string that are simply lying about: one set of string must be held under tension—a substitute for stiffness. This “foundation” set of threads is called the warp, and the frame that holds it is the loom (Fig. 4). Then it's easy to lace in crossways a second set—the weft or woof (both from the same ancient linguistic root as *weave*). There are also ways of holding several sets of material taut, as in braiding and other forms of plaiting and netting; but tension is basic to all of these.

Heddles

Most cloth today is true weave, in which the weft simply goes over and under successive warp threads (Fig. 1c; possibly in a pattern) rather than twisting around the warp or around other weft (twining; Fig. 1a–b). Because of the twist, twined fabrics are inherently more stable than those in true weave (consider how easily a torn edge of modern cloth frays out). Early cloth-like fabrics were therefore twined, as at Pavlov and in the earliest known cloth in the Western Hemisphere (from at least 8000 B.C.E.). The only advantage to true weave is that, unlike twining, the weaving process is mechanizable, making the production of true-weave cloth many times faster than that of twined cloth. When you can make so much so fast, the problem of unraveling becomes less important (and one can prevent raveling by binding the raw edges). Our first proof of true weaving occurs at Çatal Höyük, in central Turkey, around 6000 B.C.E., where we find a large amount of plain-weave



Figure 3. Freshly “pleached” hedge: thin, live branches have been bent obliquely to the right and woven across upright stakes. Powys, Wales, 1989. E. J. W. BARBER



Figure 4. Earliest extant depiction of loom. At bottom: horizontal ground loom with warp stretched between two beams pegged to the ground. At top: either weft-preparation or a mat loom. Painted dish, Badari, Egypt, c. 4200 B.C.E. © PETRIE MUSEUM OF ARCHAEOLOGY, UNIVERSITY COLLEGE LONDON

linen—coarse and fine; tight and open; hemmed, fringed, and with reinforced woven selvages of three sorts—and a very small amount of twined linen. The sheer statistics, as well as the fine and even weaving, tell us that these people knew and used the heddle—the invention that mechanized the loom.

Heddles are difficult to explain abstractly (although easy to use) and must have been very difficult to think up. The evidence suggests that the heddle was invented only once in human history and spread across the world from there. In 1900,

when extensive ethnographic work was being done in remote parts of the earth, it was clear that many human cultures had never got the idea of weaving with heddles, or even, in a few cases, of any kind of weaving.

Let’s imagine a loom in which the warp lies horizontally. The problem is to separate the warp threads so that one half—every second thread—is lifted. When the weft passes through the resulting “tunnel” (called the shed, from an old word for “divide”), it leaves its trail under one (lifted) thread, over the next (unlifted) thread, under the next, and so on. This can be accomplished easily by shoving a rod, called a shed bar, through the warp in exactly this way: then lift the rod, and you open the shed.

But the problem of lifting the other half of the warp, for what is called the countershed, is not so easy. You could stick a second rod into the opposite shed, but you will find your two rods interfere with each other hopelessly: one prevents the other from being raised. What you need is a discontinuous rod. Impossible.

The solution is to lay the second rod on *top* of the warp (not the obvious place), where it won’t interfere with the shed rod, then make a series of string nooses (heddles), each of which is attached to this rod (the heddle bar) and to one warp thread. Among them, they catch up all the intervening warp threads that still need to be raised. Now raise the heddle bar, and you open the countershed.

The solution of this difficult three-dimensional problem produced the world’s first complex machine, one with multiple moving parts, before 7000 B.C.E., more than a millennium

before the invention of fired pottery and nearly four thousand years before the hot-working of metals.

Looms

Once heddles were invented, loom weaving spread rapidly, spawning different types of looms. Narrow band-looms must have come first, then wider ones, with the warp stretched horizontally (as in Mesopotamia, Egypt, China, and Southeast Asia), vertically (Syria), or aslant (Europe and Central and South America), and tensioned with twin beams (Mesopotamia, Egypt, and Syria), weights (Europe), or the body (China, Southeast Asia, and Central and South America) (see Figs. 2, 4, 5, and 10). On all these early looms, the heddle bars—of which there might be several, for patterning—had to be shifted by hand to change the sheds.

The next conceptual development was to rig up pulley-linked treadles to use the feet for changing sheds, thereby freeing the hands to manipulate the weft more efficiently. Our first evidence for treadled looms comes in a manuscript of 1200. It shows the weft carried in a true shuttle (Fig. 6) rather than on a simple stick bobbin (as in Figs. 2 and 10). With the flick of one hand, this boat-shaped device can be shot rapidly through the wide-open shed—lightly supported on the horizontal warp as it passes across—and caught with the other hand, ready for the return shot a moment later when the stomp of one foot changes the shed. Again the new ideas, possibly inspired by information about Chinese practices, helped speed the work enormously.

To produce the elaborate silk brocades Chinese customers wanted, weavers eventually developed a system of pulling (“drawing”) the pattern heddles up by means of strings attached to special heddle bars that caught up the requisite threads for each row of the pattern. Called the draw-loom, this extremely complicated

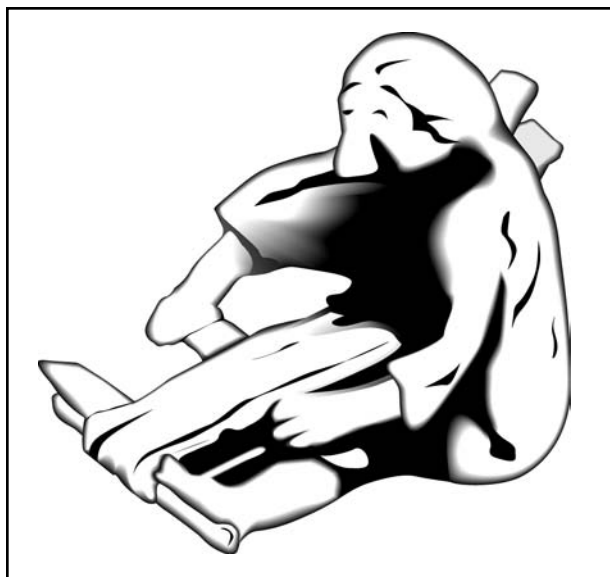

Figure 5. Woman weaving on a foot-tensioned backstrap loom. From a figurine on top of bronze Chinese vessel, Han Dynasty (206 B.C.E.–220 C.E.).

device required both a weaver to insert the variously colored wefts and a “draw-boy” (or -girl) perched above the loom to pull the strings. At the beginning of the nineteenth century, with fancy brocades in high demand in Europe, a French inventor from Lyon (center of the European silk industry), J. M. Jacquard, figured out how to mechanize the draw-loom process by punching onto cards the information about which heddles to raise for each successive row of the pattern (Fig. 7). The information was picked up mechanically, since the needles that slid through holes in a given card caused iron bars to lift hooks attached to the heddles. This idea of punch-hole patterns to encode and store information, already used in Lyon for simpler textile mechanization by 1730, facilitated the development of data storage and control mechanisms in the later nineteenth century, leading ultimately to the twentieth-century computer.

Clothing

Why was textile production such a catalyst for new ideas? Presumably because textiles had such important uses that people were pushed hard to improve the technology. But what were these uses, and how did we become so dependent on them?

Cloth is so perishable that until the advent of writing we have very little direct evidence of how textiles were used in early eras. (Writing began in the Near East shortly before 3000 B.C.E., by which time humans had been speaking for more than 100,000 years.) But we have a few interesting hints.

As already discussed, string alone enabled people to catch and hold more; nets did likewise. But cloth enabled people to cover and wrap things, and especially, because of its extreme flexibility, things of odd or lumpy shape—like the human body.

Already at 20,000 B.C.E., still in the Upper Paleolithic, we have a few representations of people wearing clothing clearly made from twisted fiber string. For example, a carved “Venus” (or fertility) figure from Lespugue, France, depicts a plump



Figure 7. Jacquard loom. © BETTMANN/CORBIS

woman wearing a so-called string skirt, a belt-band supporting a row of strings that hang down like a skirt or apron (Fig. 8b). (The carver marked not only the twists on the strings but even how the strings are coming untwisted at the bottom.) Other Venuses of the same era from Russia (Figs. 8a and c) are shown wearing string skirts or twisted bands worn across the chest, while the Venus of Willendorf (Austria) wears a spirally worked cap on her head.

All this clothing, clearly, was fashioned from string. Yet none is of any use for either warmth or what we would call modesty. So why did Paleolithic people trouble to make such clothing?

Apparently to communicate messages. String skirts continue to appear on European figurines through the Neolithic and Bronze Ages, by which time we begin to find actual string skirts preserved on buried women (in Denmark, where woolen garments often survive), and we see them occasionally in Iron Age Greece (in literature, and on figurines and vases). These women—both those buried and those represented and talked about—are clearly not children, but full-grown. In recent centuries such skirts still turn up as a key part of women’s folk costumes (rural dress) throughout eastern Europe, from the Adriatic to the Urals and from southern Greece to Latvia.

Wherever we find representations or physical remains, the woman has reached child-bearing age; wherever we find direct information about the skirt’s meaning, from Homer to the

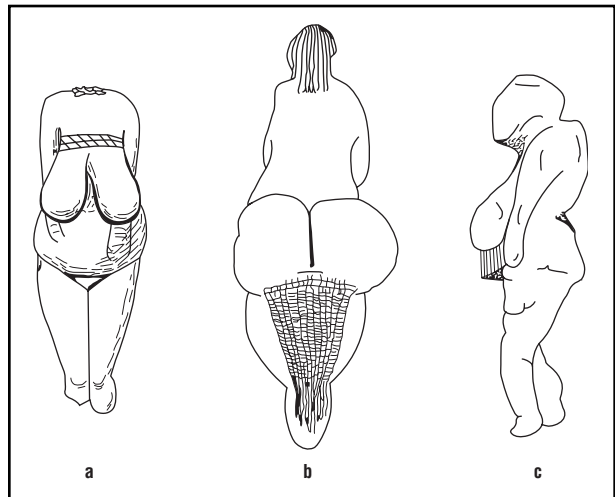

Figure 8. Paleolithic “Venus” figures of c. 20,000 B.C.E. wearing string clothing: (a) cords across chest (Kostenki, Russia); (b) string skirt in rear (Lespugue, France); (c) string skirt in front (Gagarino, Russia). The string skirt apparently signaled child-bearing status. COURTESY OF THE AUTHOR

modern ethnographers, it invariably indicates something about the ability or willingness to bear children. In eastern Europe, in fact, we learn that girls are not *allowed* to wear them until they reach puberty, at which point they *must* do so. In short, the string skirt (or its surrogate) gives the viewer crucial biosocial information about both the females who wear it and those who do not.

A quite different piece of clothing, in these societies, signals that the woman is also married and therefore no longer available: a headdress completely covering the hair. (It was, and in some places still is, widely believed that a woman’s fertility resides in her hair.) In modern Western societies, this message is conveyed by a piece of jewelry, the wedding ring.

What we see, then, is that humans started to devise clothing as a means of communication, and not, as is generally supposed, for warmth. We tend to forget that prolonged exposure to less-than-extreme cold inures the body to frigid weather (and, in fact, the humans in most depictions prior to the Bronze Age, which begins about 3000 B.C.E. in the Near East, are naked). Although not so flexible as language, clothing signals have the advantage that they do not die away instantly, but rather persist over time. If a woman wears a wedding ring, she doesn’t have to keep saying “I’m taken” every time a man looks at her. The earliest signals sent by clothing that we can detect thus concern marital status. Such signals gradually formed a vital communication system parallel to but independent of language.

Although harder to pin down, early uses also include marking special events, particularly religious rites, and along with this, marking people central to those events. For instance, Upper Paleolithic cave art includes a depiction of what appears to be a dancing man clad in what look like a deerskin and antlers (Trois Frères, France), presumably involved in a ritual.

One of the earliest clear depictions we have of a religious scene is on a tall alabaster vase from the great Mesopotamian

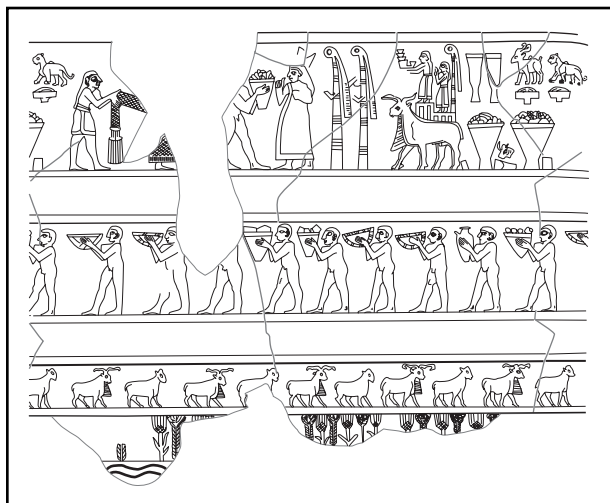

Figure 9. Naked workers (middle) and clothed elite (above) involved in agricultural ritual. Adapted from stone vase, Uruk (Warka), c. 3200 B.C.E.

city of Uruk, shortly before 3000 B.C.E. (Fig. 9). The bottom registers depict the key domestic plants and animals (wheat and sheep); above them, lines of naked workmen carry baskets laden with agricultural produce. In the top register we see people wearing kilts or long robes presenting some of this produce to a long-robed woman who, judging from the banners hung next to her, is either the goddess Inanna or her priestess. So people already “dressed up” for religious ceremonies, and the textiles sometimes marked the religious space itself.

We still tend to dress more specially for church, synagogue, mosque, or temple; special shawls, robes, or hats usually mark key participants; and the place of worship is generally set off or “dressed” with special textiles, from altar cloths to prayer rugs to screens and pavilions. In fact, in many cultures (for example, Indonesia or classical Greece), the laying out or hanging of special textiles serves to make that space sacred for the moment, in order to carry out a wedding, funeral, judgment, or other rite. Anyone of that culture, seeing that textile, recognizes its significance, although others probably will not.

The Uruk vase shows us something beyond religious status, however. While the peasants are naked, the elite are coming to be distinguished by their clothing. This idea of social status as economic and political, rather than solely marital or religious, seems to begin with the concentration of masses of people into cities in the fourth millennium B.C.E. and to spread with the quest for metals that ensued.

Metals were the first important commodity that people could neither grow nor find in their backyards; obtaining them required organizing resources to support expeditions to mine ore or to trade for finished metal. This meant increasingly permanent stratification into leaders and followers (instead of temporary stratification for local warfare) and quickly led to the differentiation between those who had power—and easy access to imported goods—and those who did not. The ancient

monuments show us that soon everyone in “civilized” areas took up clothing. Wearing clothes even came to be viewed as a mark of being civilized, to the Chinese and to many other cultures.

Clothing Design

Belts, cloaks, kilts—the earliest garments depicted—are mere wraparounds. The Egyptians are the first on record to think of sewing up cloth into a permanently formed dress, in their case a tube for the torso, held up by a strap over one or both shoulders and forming a sort of jumper (Figs. 10 and 11a). The earliest preserved body garment we possess is a First Dynasty linen shirt (c. 3100 B.C.E.) in which the idea of tubes has already been taken further to include sleeves (Figs. 11b and 12). Where one would expect the narrow supporting straps, two long rectangles of cloth were added, sewn up along the edges to form tube sleeves.

In the Near East, on the other hand, people seem to have worked from the concept of a garment hung from the shoulders. When they began sewing up clothes, rather than draping them anew with each wearing, they cut a neck hole in the middle of the cloth and sewed up the sides, eventually adding two tubes for sleeves (Fig. 11c). Our first extant example of this garment type was found in Tutankhamen’s (c. 1370–1352 B.C.E.) tomb (though details show it to be a Syrian import). This general design, improved by opening the front for easy donning (Fig. 11d), was destined to survive till today as our basic upper garment. Our oldest examples of this construction occur on magnificently preserved Caucasoid mummies from the deserts of central Asia from 1000 B.C.E.

These same immigrants also preserve our first examples of another clever use of cloth tubes: trousers, invented shortly before 1000 B.C.E. by Eurasian horsemen for protection while riding horseback (Fig. 13). Again, this clothing design has come down to us as one of our basic garments.

As textile technology progressed, who wore what often became strictly codified. In Egypt, only the pharaoh folded his kilt with the left lappet on top; in Rome, only the emperor could wear a garment entirely of purple, and only noble citizens a purple stripe. This meant the viewer could read rank and station from another’s costume, even, in some cases, down to the last degree. In China, for example, officials of all types sewed onto their robes fair-sized rectangular emblem-patches, known as rank badges, that specified their exact rank and position in the governmental hierarchy. (The highest emblem was the dragon, which only the emperor could wear.) Aztec warriors, for their part, displayed their degree of prowess in battle as special emblems on their cloaks. Less formally, but just as rigidly, European folk dress evolved in such a way that the knowledgeable viewer could look at a village woman’s garb and determine that, for example, the wearer had reached puberty, was a Christian rather than Muslim or Jewish, was not particularly wealthy, came from a certain village or locality, and was a skilled and diligent worker. The elements that conveyed this information accrued one by one over twenty thousand years, to the point that the costume represents multiple layers of walking history.

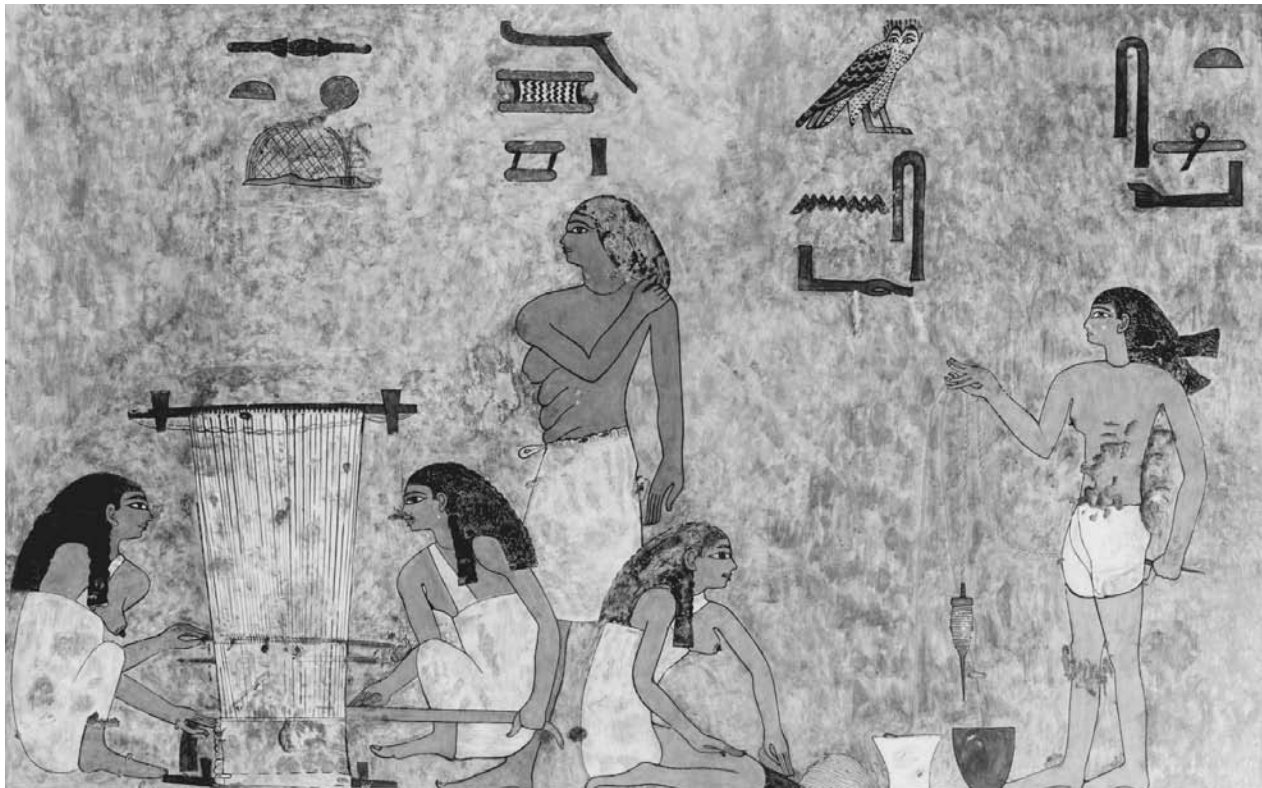

Figure 10. Egyptian textile workers (right to left: spinner, flax-splicer, overseer, two weavers squatting beside horizontal ground loom). Mural in tomb of Khnumhotep, Beni Hassan; Twelfth Dynasty (early 2nd millennium B.C.E.). THE METROPOLITAN MUSEUM OF ART, ROGERS FUND, 1933 (33.8.16) PHOTOGRAPH, ALL RIGHTS RESERVED, THE METROPOLITAN MUSEUM OF ART

Although much of this kind of information could be read from nineteenth-century traditional dress throughout Eurasia, the same could not be said in England, for an interesting reason. There the nobility habitually gave its cast-off clothing to the servants and tenant farmers, a practice that increasingly obscured an observer's ability to determine someone's standing by clothing alone, although poor fit, fraying edges, and outmoded fashion would give clues. Consequently there is no English "peasant costume" as in other parts of Europe. In this way, although court dress at the top of the scale was highly controlled, dress in the lower classes became more democratic, a trait that, to some extent, moved to North America with the colonists. In the early twenty-first century, the farther west you go across the United States, the less dress and its potential signals of status matter to many people. On West Coast college campuses it can be hard to tell students from professors, and at the Los Angeles Opera you may see everything from tuxedos and jeweled evening gowns to blue jeans—and running shoes on both sexes. For the middle class, at least, what you wear during leisure time is more a function of how you feel that day than of how you wish others to perceive you. If anything, the Bronze Age idea of telling people your social rank through dress has been emphatically rejected, and westerners will complain about easterners' "class consciousness."

The same people, however, still send messages through the textiles they choose to wear by selecting them according to

their personalities—within, of course, the general mores of their culture. Pluck them out of Los Angeles and drop them into, say, Ankara or Turfan, and their clothing readily signals their cultural origin.

Handmade textiles, too, have always had a personal element. Those who wove, embroidered, or knotted pile for home use are repeatedly documented as taking the attitude, "If I'm going to put this much work in, and use it all my life, I want it to look the way *I* want it to look." Hence no two rugs or aprons or blouses looked alike: the traditional was simultaneously personal.

Furnishings

Since about the third millennium, messages similar to those given by clothing have been transmitted by the textiles we use to dress our surroundings. We mentioned using cloth to set apart and adorn religious or sacred space, but textiles also adorned the home, as bedcovers, curtains, cushions, and so forth. Evidence from Çatal Höyük, Turkey, whence some of our earliest textile fragments (6000 B.C.E.), indicates that people slept and sat on low clay platforms covered with padding (dried grass? rushes?) topped with mats or textiles. The ancient Egyptians manufactured only plain white linen for normal household use—sheets, bedspreads, towels, and clothing—but from at least 2000 B.C.E., they were importing fancily patterned woolen cloth from the Aegean to make into

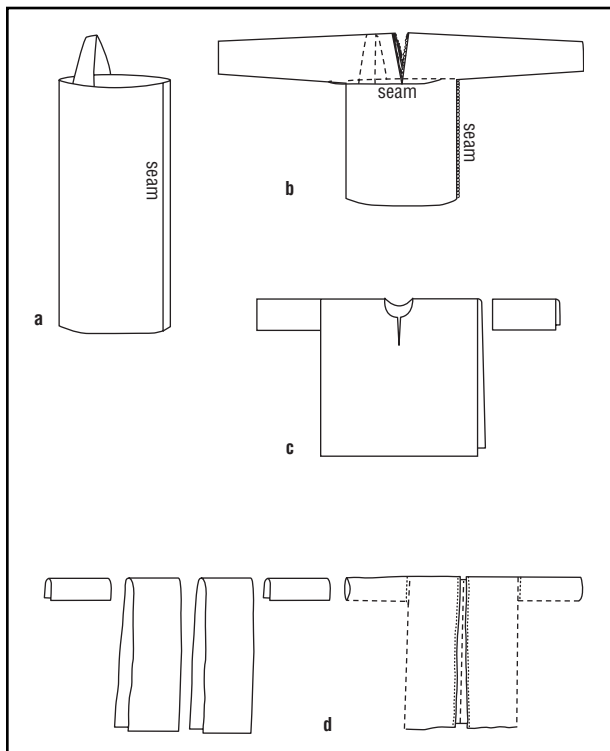

Figure 11. Construction of early clothing types: (a) Egyptian dress made of tube with shoulder strap; (b) Egyptian shirt, in which shoulder-straps were elongated into sleeves; (c) Syrian shirt with neck-hole in cloth hung from shoulders; (d) Eurasian nomad shirt, hung from shoulders but with front opening. COURTESY OF THE AUTHOR

ostentatiously colorful canopies, apparently to advertise their social status. Around 1370 B.C.E. we also glimpse colorful rugs and cushions, again probably of imported fabric.

We read in classical Greek literature that cloth tents were set up temporarily on temple grounds for celebrations. These pavilions were constructed from textiles decorated with elaborately woven scenes—rare and expensive textiles dedicated to the deities as votive gifts and stored in temple storehouses. Temples served as the treasuries, and indeed, museums, of the ancient world, just as cathedrals did in medieval times, and the rarer the gift, the higher the giver in people’s estimation.

Among nomadic peoples of Eurasia, cloth furnishings were even more important than among their sedentary neighbors, since cloth was highly utilitarian yet portable. They made their houses out of collapsible wicker frames covered with felt (densely matted wool) and fastened with colorful woven straps that signaled to visitors whose yurt (felt tent) it was (Fig. 14). Their possessions were stored in chests covered with brightly patterned felt padding, and their precious china teacups were carried in padded felt pouches. Pile carpets formed the (movable) floors, and colorful interior hangings further insulated and adorned the walls. Even the plates for dry foods were often made of felt. Because textiles were so central, they were an



Figure 12. Earliest preserved body-garment: linen shirt with sleeves finely pleated for trim fit. Tarkhan, Egypt, First Dynasty, c. 3000 B.C.E. COPYRIGHT: PETRIE MUSEUM OF ARCHAEOLOGY, UNIVERSITY COLLEGE LONDON

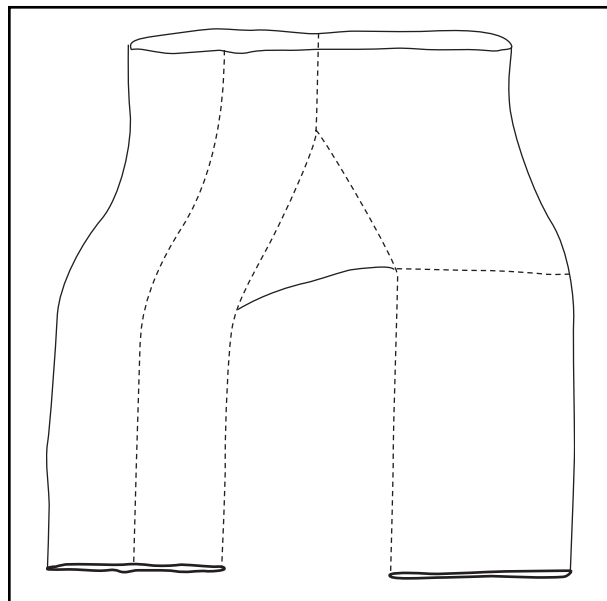

Figure 13. Construction of a pair of woolen trousers found with the mummies at Cherchen, 1000 B.C.E. COURTESY OF THE AUTHOR



Figure 14. Nomadic Kazakh family setting up yurt (portable felt house), Nan Shan, Uyghur Autonomous Region, 1995. E. J. W. BARBER

important form of gift exchange: in frozen burial sites of the fourth century B.C.E., in the Altai Mountains, excavators found saddle cloths of Chinese embroidered silk from far to the east, and of Persian woolen tapestry from far to the west, as well as of local polychrome felt cutwork.

As the world became more interconnected, trade in textiles became increasingly important. We hear of such trade already between Mesopotamia and Syria before 2000 B.C.E. and between Assyria and Anatolia (roughly modern Turkey) in 1800 B.C.E.; between China and India in the second century B.C.E., and between China and Rome in the early centuries C.E. (along the newly opened, so-called Silk Road). Long voyages of discovery were undertaken by Europeans in the fifteenth and sixteenth centuries to open up more trade with the Orient in textiles, as well as in spices and other commodities, leading to the accidental opening of routes to the New World. As such trade became serious international business, textile wars also broke out—the struggles among the Spanish, British, and Dutch over the wool trade among them—for, as the middle class rose after the breakdown of feudalism, more and more people wanted to display their status by means of elegant textiles for the furnishings of their parlors as well as their clothing. Imported fabrics spelled luxury, and their display announced those ever-crucial social messages.

See also Class; Communication of Ideas; Dress; Life Cycle; Trade.

BIBLIOGRAPHY

- Adovasio, J. M., Olga Soffer, and B. Klima. "Palaeolithic Fibre Technology: Interlaced Woven Finds from Pavlov I, Czech Republic, c. 26,000 year, B.P." *Antiquity* 70 (1996): 526–534. Earliest preserved textile remains yet found.
- Anawalt, Patricia Reiff. "A Comparative Analysis of the Costumes and Accoutrements of the Codex Mendoza." In *The Codex Mendoza*, edited by Frances Berdan and Patricia Anawalt, vol. 1, 103–150. Berkeley: University of California Press, 1992. Aztec clothing described and analyzed.
- Barber, E. J. W. *The Mummies of Ürümchi*. New York: Norton, 1999. Superbly preserved textile finds from prehistoric Central Asia.
- . "On the Antiquity of East European Bridal Clothing." In *Folk Dress in Europe and Anatolia: Beliefs about Protection and Fertility*, edited by Linda Welters, 13–31. Oxford: Berg, 1999. History of the string skirt and its relatives.
- . *Prehistoric Textiles: The Development of Cloth in the Neolithic and Bronze Ages*. Princeton: Princeton University Press, 1991. The majority of the data in this entry is documented in this compendium of archaeological textile data from 20,000 B.C.E. to about 400 B.C.E., from Iran to Britain. Includes massive bibliography and index.

- . *Women's Work: The First 20,000 Years: Women, Cloth, and Society in Early Times*. New York: Norton, 1994.
- Broudy, Eric. *The Book of Looms*. New York: Van Nostrand Reinhold, 1979. Lavishly illustrated, with well-selected bibliography.
- Emery, Irene. *The Primary Structures of Fabrics: An Illustrated Classification*. Washington, D.C.: Textile Museum, 1966.
- Geijer, Agnes. *A History of Textile Art*. Translated by R. Tanner. London: Pasold Research Fund, 1979. Classic general history of textiles.
- Rudenko, S. I. *Frozen Tombs of Siberia: The Pazyryk Burials of Iron Age Horsemen*. Translated by M. W. Thompson. Berkeley: University of California Press, 1970. Superbly preserved textiles from prehistoric Siberia.
- Sherratt, Andrew. "Plough and Pastoralism: Aspects of the Secondary Products Revolution." In *Patterns of the Past: Studies in Honour of David Clark*, edited by I. Hodder, G. Isaac, and N. Hammond, 261–305. Cambridge, U.K.: Cambridge University Press, 1981.

E. J. W. Barber

THEATER AND PERFORMANCE. "Performance" is an influential theoretical paradigm in the arts and humanities, with adherents in disciplines as diverse as anthropology, linguistic philosophy, and theater. Since the early 1980s, thinking about performance has been fostered in "performance studies" programs, disciplinary hybrids with widely variant intellectual genealogies, united by their commitment to performance as their central object and method of research.

Performance Studies' Interdisciplinary Genealogy

Histories of performance studies most frequently cite its formation in the convergence of experimental theater and structuralist anthropology in the late 1960s. Avant-garde theater practitioners in the United States such as Richard Schechner were exploring cultural traditions of performance that fell outside entrenched disciplinary traditions of Western theatrical practice and theater studies. Their work drew on research into archaic ritual and non-Western performance forms, unsettling representational conventions of illusionism and distinctions between artistic disciplines, exploring the significance of neglected parts of the performance process, such as audience response, rehearsal, and training, and blurring the boundaries between art and everyday life. Their investigations coincided with the structural anthropologist Victor Turner's interest in ritual, festival, and other forms of symbolic, collective action. Turner's dramatically inflected analysis of public culture and social events saw performance as the site of a given culture's fullest and most self-conscious expression of its unique values and categories, and the engine of its perpetuation and transformation. Schechner and Turner's research collaboration spurred the formation of New York University's Performance Studies Department in 1980.

The contemporary field of performance studies as a whole owes its genesis to a still broader range of disciplinary interests.

The Department of Performance Studies at Northwestern University, for example, grew from the tradition of oral interpretation of literature dating back to the late nineteenth century. Attuned to the rhetorical power of acts of verbal and embodied performance, the Northwestern school's interest is still primarily in performance as a mode of human communication that is "creative, constructed, collaborative, and contingent." Influential currents in the sociology and psychology of the 1960s and 1970s also informed the development of performance studies. These included the theorization of play, social dramaturgy, and the presentation of self in everyday life developed in the work of Johan Huizinga, Roger Caillois, Erving Goffman, and others, and the interpretive or symbolic anthropology of Clifford Geertz. At its broadest level, performance studies probably owes most to the linguistic turn in the arts and humanities, and its development has been closely aligned with poststructuralist or postmodernist innovation in philosophy, linguistics, anthropology, feminism, area studies, cultural studies, folklore, postcolonial studies, and queer studies.

Performance as Object

As an "interdiscipline," performance studies prides itself on its open, multivocal, and fluid character, refusing to dictate either a core methodology or canonical body of knowledge and resisting a fixed or exclusive definition of performance itself. That said, scholarship that goes under the banner of performance studies has in common a focus on process, action, events, and behaviors, be they physical, verbal, artistic, or technological, and claims performance—the execution or carrying out of things—as both its object and its method of study. This focus entails abandoning static, object-oriented, or textual approaches to cultural analysis, inclining instead toward processual, interactional, and experiential perspectives. An art historian or archaeologist working in performance studies, for example, might examine how a given object has functioned or been understood over time and in particular material and social contexts; a performance historian might concentrate on situating a historical document in the contexts and moments of its enunciation; an idea or political principle would not be approached in the abstract but through an analysis of its embodied enactment in ceremony, debate, or communal events. In the words of one of its more famous exponents, Dwight Conquergood, performance studies means understanding "culture" as a verb rather than a noun.

Among the basic premises shared by scholars in performance studies is the conviction that performance is one of the most powerful means that humans have for constructing reality, forging and sustaining collectivities, social relationships, and individual identities, and for questioning or imagining them otherwise. Performance is also a means for accomplishing agendas and forwarding arguments, for learning and persuading through the agency of narrative, semiotic communication, corporeal style and training, pleasure, and participation. While performance studies retains close ties to the study of Western theatrical practice, it regards illusionistic, representational theater as but one category in a broad spectrum of performance



Outdoor performance of Euripides' *Iphigenia in Taurus*, Bradfield College, Berkshire, England, 1912. The field of performance studies has its roots in the mid-nineteenth century, when experimental and avant-garde theater met structuralist anthropology. Performance was seen as a means to build new realities and stimulate the mind. © HULTON-DEUTSCH COLLECTION/CORBIS

practices, the majority of which are more concerned with *poesis* than mimesis, with making (of realities and meanings) rather than faking. Performance studies resists drawing hard and fast lines between aesthetic modes of performance and deliberative or habitual forms of action, arguing instead that analytical models used for either can be productively applied to both. However, the bulk of performance studies scholarship is still drawn to those actions along what Richard Schechner has called the “performance continuum” between everyday enactments and the performing arts, actions that are framed or designated in specific social contexts as performance.

Performance as Method

While performance studies scholars espouse a range of often innovative methodologies, the ephemeral, subjective nature of performance as its subject matter poses unique challenges. For a majority of those in the field, understanding performance as a way of knowing entails a commitment to participant-observer ethnography as the principal research methodology. Dwight Conquergood, who has written extensively on this issue, sees the performance ethnographer and her “informant” (or the teacher and student, performer and audience) as engaged in reciprocal, collaborative performances. Studying performance in this way foregrounds cultural knowledge as contingent, socially located, embodied, and contested, and implies that the ethnographer is directly implicated in and responsible to the community in which he or she studies. Following from this assumption, performance studies scholars frequently vaunt an open, politicized commitment to a position within their field and understand their performance scholarship as a mode of advocacy as much as analysis. Furthermore, they are frequently practitioners or artists themselves, confusing traditional anthropological distinctions between the subject and object of research.

Performance, Performativity, and Theatricality

The performance concept has since the late 1980s enjoyed a reach beyond this interdisciplinary constellation of performance studies through the elaboration of theories of performativity. Judith Butler’s famous formulation draws on continental philosophy and the work of the linguist J. L. Austin to argue that, through processes of forcible iteration, discourse has the power to enact or materialize (to “perform”) that which it names. Adherents of performativity use these theories, in the place of earlier theories of “representation,” to explain the ways in which norms of gender and sexuality are produced, reproduced, and modulated in cultural production. Thanks to this work, the performance concept has a life throughout the arts and humanities, even as current debates in performance studies seek to reconcile their field’s orientation around acts of performance (the tactical and interpretive agency of the performer and audience, and the subversive or deconstructive nature of theatrical traditions) with performativity’s emphasis on the power of textual systems.

The State of the Field

Performance studies has been most notable for work that examines the politics and poetics of identity (gender, race, ethnicity, and sexuality) in ways that are both responsive to the claims of human creativity and criticality and cognizant of the normative forces that constrain such expressions. This work avoids the Enlightenment distinctions between mind and body that have proved an obstacle to similar critique from other disciplines. Significant areas of interest in the field in the early twenty-first century include tourism, urban festivity, historical ethnography, pedagogy, and the performance of space and place. True to the origins of performance studies, much work examines contemporary performance art and experimental theater from a perspective that provocatively mixes criticism and practice. In a field that has historically privileged the localized study of live, embodied action and interaction, interest in globalization, diaspora, cyber-communities, and virtual, technological, and “mediatized” performance has proved theoretically fertile. Some prominent scholars have made broad claims that performance is the predominant paradigm of a globalized age, comparable to the colonial era’s orientation around models of “discipline.”

Performance studies is flourishing both within and outside the United States. Its flagship journals, *The Drama Review* (TDR) and *Text and Performance Quarterly* have been joined by publications such as *Performance Research*; performance research centers have been established in Cardiff, Wales, and Christchurch, New Zealand; and conferences have been held in Japan, Germany, and Singapore. The doctoral programs at New York University and Northwestern University, and the performance studies focus areas of numerous communications programs, have been joined by a world theater and dance program at UCLA, and formerly traditional theater programs (at the University of California at Berkeley, for example) are adopting the performance studies moniker as they increasingly embrace research interests and theoretical paradigms from outside the bounds of Western institutionalized theater.

Whether performance studies can sustain itself as an “interdisciplinary” formation, given the claims made on the performance concept by a range of disciplinary competitors, has been a matter for debate since the earliest inception of performance studies institutions. As a powerful tool for thinking about cultural process from the point of view of human action and expression, however, the performance concept will doubtless be a significant feature in the landscape of cultural criticism for some time to come.

See also *Avant-Garde; Musical Performance and Audiences; Structuralism and Poststructuralism*.

BIBLIOGRAPHY

- Butler, Judith. *Bodies That Matter: On the Discursive Limits of “Sex.”* New York and London: Routledge, 1993.
- Carlson, Marvin. *Performance: A Critical Introduction*. 2nd ed. New York: Routledge, 2004.
- Conquergood, Dwight. “Performance Studies: Interventions and Radical Research.” *TDR: The Drama Review* 46, no. 2 (2002): 145–156.
- Dailey, Sheron J., ed. *The Future of Performance Studies: Visions and Revisions*. Annandale, Va.: National Communication Association, 1998.
- McKenzie, Jon. *Perform or Else: From Discipline to Performance*. London and New York: Routledge, 2001.
- Schechner, Richard. *Performance Studies: An Introduction*. New York and London: Routledge, 2002.

Margaret Werry

THEODICY. Gottfried Wilhelm Leibniz’s (1646–1716) neologism *théodicée* (from Greek *theos*, God + *dike*, justice) means divine justice, but the term has long been conflated with John Milton’s (1608–1674) promise to “justify the ways of God to men.” In 1791 Immanuel Kant (1724–1804) defined theodicy as “the defense of the highest wisdom of the creator against the charge which reason brings against it for whatever is counterpurposive in the world” (p. 24).

Many intellectual historians see theodicy as a specifically modern, perhaps even a more specifically eighteenth-century phenomenon, but the term has come to have broader meanings. Auguste Comte (1798–1857) described all natural and philosophical theology as theodicy. Scholars of religion call all efforts to answer a problem of evil thought to be universal theodicies. The Book of Job, the Indian doctrine of karma, and even capitalist faith in the market have all been seen as theodicies.

There is good reason to restrict the meaning of the term, however, if not to post-Leibnizian thought then at least to philosophical discussions of a certain sort. Works like the Book of Job do not offer philosophical justifications of God, or even accounts of his justice; slamming the door in the face of human demands for intelligibility simply cuts the knot. Much can be learned from examining the presuppositions that make the door-slam inadmissible in the modern age.

Early Modern Theodicy

Pierre Bayle (1647–1706) forced the problem of evil in his 1697 *Dictionnaire historique et critique*. He may have been inspired by Nicolas de Malebranche’s (1638–1715) insistence on the world’s imperfections—albeit in the context of an argument for the supremacy of God. For Malebranche, evils prove that God sought not to create the best of all possible worlds but only the most perfect in relation to God’s ways. He could have created a better world, but this world, the work of “general” rather than “particular volition,” better expresses his nature.

Leibniz’s *Essais de théodicée* (1710) responded to Bayle’s challenge, but offers little that was really new. Leibniz himself traced its most famous claim—that this is “the best of all possible worlds”—back to Plato. The related idea that a perfect world is not possible because not all possible things are “compossible” with each other has a Stoic pedigree. Both claims had come close to the surface of Martin Luther’s polemic with Desiderius Erasmus and were explicitly made by Spanish Jesuits and by the Cambridge Platonists.

While Leibniz thought that we would do well to be more attentive to the good in our lives, his argument was a priori. A God infinite in goodness, power, and wisdom would not create a world unless it were good, and, if several worlds were possible, would create none but the best. “It is true that one may imagine possible worlds without sin and without unhappiness,” Leibniz conceded. Yet, “these same worlds again would be very inferior to ours in goodness. I cannot show you this in detail. For can I know and can I present infinities to you and compare them together? But you must judge with me *ab effectu*, since God has chosen this world as it is” (*Theodicy* §10).

Optimism. Christian Freiherr von Wolff (1679–1754), Leibniz’s most influential disciple, thought that Leibniz had unnecessarily abandoned the best argument against atheism—the argument from design, known in Germany as teleology or physico-theology. Much early-eighteenth-century thought offered teleological arguments that this was the best possible world. The word *optimism* (from *optimum*, the best), coined in the 1730s, lumped together decidedly different arguments. Wolff’s Leibnizian arguments are quite different from Alexander Pope’s assertion, in his best-selling *Essay on Man* (1733), that “Whatever IS, is RIGHT.”

The hollowness of optimistic claims was shown by Samuel Johnson’s *Rasselas* (1759), Voltaire’s *Candide* (1759), and most decisively by David Hume’s posthumously published *Dialogues Concerning Natural Religion* (1779). Hume’s character Philo declares “Epicurus’ old questions” concerning the compatibility of belief in God with evil “yet unanswered.” Immanuel Kant tried to show that they could never be answered.

Kant. Although he was originally a defender of optimism and remained impressed by the evidences of physico-theology, Kant pulled the rug out from under the project of theodicy. As an endeavor fusing theoretical and practical reason, philosophical theodicy for Kant represented a particularly dangerous form of pretension: it threatened to blunt the sense that

THEODICIES OF SUFFERING AND GOOD FORTUNE

Max Weber thought that the problem of theodicy was the stimulus for the “rationalization of religious ideas” in all—not just monotheistic—religious traditions. Alongside “theodicies of suffering,” accounts of the nature and distribution of misfortune in the world that console those who suffer, Weber discerned another kind of view that reassures those who do not suffer that it is just and right that they be spared. He deems this the “theodicy of good fortune” (ch. 6).

The idea seems to have roots in Marx, but Weber adds the idea that those theodicies that last are those that speak both to the fortunate and to the unfortunate. He thought only three have ever done so: Zoroastrian dualism, the Calvinist understanding of the hidden God (*deus absconditus*), and the Indian doctrine of karma, “the most complete formal solution of the problem of theodicy (ch. 8).

Weber’s is the most impressive effort to expand the meaning of theodicy beyond its monotheistic origins. No longer a problem only for theists, theodicy arises in response to the general problem of the “the incongruity between destiny and merit” (a Kantian problematic), which challenges all human efforts at making theoretical and practical sense of the world. Weber’s understanding of theodicy as a species of the problem of meaning has shaped important theories of religion by Clifford Geertz and Peter Berger.

defined the human ethical vocation—that the world of our experience is not as it ought to be. In his mature philosophy of religion, Kant was particularly attentive to insincerity and saw philosophical theodicies as a key example.

In his essay “On the Failure of All Philosophical Efforts in Theodicy” (1791), Kant likened theodacists to Job’s comforters. By contrast, Job, whose faith in God was firmly rooted in the moral law rather than in the claim to be able to understand God’s ways, was able to stand fast in his piety despite his “counterpurposive” experiences. In the place of the hypocrisy of “doctrinal” theodicy Kant recommended Job’s “authentic theodicy”: “honesty in openly admitting one’s doubts; repugnance to pretending conviction where one feels none” (p. 33).

Progress and Pessimism

Theodicy was not yet dead, however. Georg Wilhelm Friedrich Hegel (1770–1831) thought philosophical efforts at theodicy had failed only because they did not see history philosophically. Properly understood, history is “the true theodicy.” Like other nineteenth-century accounts of necessary progress, he did not deny the reality of evil. Evil qua evil is a necessary moment in the unfolding of spirit. For Karl Marx (1818–1883) and Friedrich Engels (1820–1895) feudalism was a necessary stage in human history. For Herbert Spencer (1820–1903) the competition that led to the “survival of the fittest” was the best promise for a bright future.

In response, Arthur Schopenhauer (1788–1860) developed his philosophical “pessimism,” a deliberate reversal of optimism. This is not the best of all possible worlds, but the worst, a mindless machine of self-inflicted suffering, among whose cleverest devices are precisely the philosophical theories of teleology and progress. All efforts to make life bearable only make things worse. The only hope is to deny the will to live. Schopenhauer claimed that his pessimism made it like Buddhism, a mistaken equation that persists to this day.

In turn, thinkers as varied as Friedrich Nietzsche, William James, and Karl Barth argued for views that acknowledged the impossibility of canceling out the evils of the world and yet affirmed the world. But these views are no longer theodicies—or at least do not claim to be. What makes it possible for us to resist pessimism is not reflection on the experienced order of the world but will (Nietzsche), temperament (James), or grace (Barth).

Contemporary debates. Debate on theodicy has come to be dominated by two very different tendencies. There has been a revival of philosophical theodicy among analytic philosophers of religion, who have moved from attention to the “logical problem of evil” to the “evidential problem of evil.” Alvin Plantinga has revived the important distinction between the “defense” of a view against objections and the far more demanding philosophical establishment of that view, which he calls “theodicy,” and which he thinks we can do without. On

the other hand, the very desire to do theodicy has been condemned as irreligious or ideological. “The disproportion between suffering and every theodicy was shown at Auschwitz with a glaring, obvious clarity,” wrote Emmanuel Levinas (p. 162).

See also *Evil; Philosophy of Religion*.

BIBLIOGRAPHY

- Adams, Marilyn McCord, and Robert Merrihew Adams, eds. *The Problem of Evil*. Oxford and New York: Oxford University Press, 1990.
- Bayle, Pierre. “Manichees.” In *Historical and Critical Dictionary: Selections*. Translated by Richard H. Popkin, 144–153. Indianapolis: Hackett, 1991.
- Kant, Immanuel. “On the Miscarriage of All Philosophical Trials in Theodicy.” Translated by George di Giovanni. In *Religion and Rational Theology*, edited by Allen W. Wood and George di Giovanni, 19–37. Cambridge, U.K.: Cambridge University Press, 1996.
- Leibniz, Gottfried W. *Theodicy: Essays on the Goodness of God, the Freedom of Man, and the Origin of Evil*. Translated by E. M. Huggard. La Salle, Ill.: Open Court, 1985.
- Levinas, Emmanuel. “Useless Suffering.” Translated by Richard Cohen. In *The Provocation of Levinas: Rethinking the Other*, edited by Robert Bernasconi and David Wood, 156–167. London and New York: Routledge, 1988.
- Weber, Max. “The Sociology of Religion.” Translated by Ephraim Fischhoff. In *Economy, and Society: An Outline of Interpretive Sociology*, edited by Guenther Roth and Claus Wittich. Berkeley: University of California Press, 1978.

Mark Larrimore

THEOLOGY. See *Religion*.

THIRD CINEMA. “The anti-imperialist struggle of the peoples of the Third World and of their equivalents inside the imperialist countries constitutes today the axis of the world revolution. Third cinema is, in our opinion, the cinema that recognizes in that struggle the most gigantic cultural, scientific and artistic manifestation of our time, the great possibility of constructing a liberated personality with each people as the starting point—in a word, the decolonization of culture.” These sentences were penned in 1969 by the revolutionary Argentine filmmakers Fernando Solanas and Octavio Getino in an essay titled “Towards a Third Cinema: Notes and Experiences for the Development of a Cinema of Liberation in the Third World.”

This essay, along with several other manifestos, including the Brazilian Glauber Rocha’s “Aesthetics of Hunger” and the Cuban Julio Garcia Espinosa’s “For an Imperfect Cinema,” placed questions regarding the interpenetration of political struggle, cultural struggle, and mass media squarely at the center of a global struggle against the intensification of Western imperialism. Other such proclamations, including Fernando

Birri’s “Cinema and Underdevelopment” and Tomás Gutierrez Alea’s “The Viewer’s Dialectic,” underscored and elaborated the concerns of Latin American revolutionaries with media and mass movements. What Solanas and Getino called “third cinema” was imagined, in short, as a cinema of liberation. Third cinema was to be filmmaking that would aid nationalist movements in creating a new sociocultural solidarity in the struggle against Western imperialism and for national self-determination.

Third Cinema and the Third World

Roy Armes, in his important work *Third World Film Making and the West*, suggests that during the 1960s “the steady development of industrialization combined with growing national awareness led almost imperceptibly to a belief, which came to be widely held, that an era of socialist revolution was dawning throughout the Third World.” This belief was based in part upon Cuban resistance during an invasion orchestrated by the U.S. Central Intelligence Agency at the Bay of Pigs in 1961, and the success of Algerian nationalists after eight years of armed struggle against French rule in 1962. Armes notes that there gradually emerged what Gérard Chaliand called “a sort of third world euphoria” over the potential for genuine political change. This euphoria was connected to a host of factors including widespread “anti-colonial struggle, opposition to the Vietnam war, student revolt, a new consciousness on the part of American blacks, the emergence of armed guerilla groups in Latin America,” and a reconceptualization of revolutionary strategies from the ferment of China and the Soviet Union. From so many uprisings and changes of consciousness there emerged the distinct possibility of what was to be a tri-continental revolution imagined via figures such as Frantz Fanon, Che Guevara, and Ho Chi Minh.

This possibility of a tricontinental revolution informed the work of many third world revolutionaries and filmmakers. The people aided by their leaders and artists would reinvent the terms of a new social order free from domination by outsiders, or indeed by anyone. To put an end to the systematic, violent, and continuous exploitation of the third world by first world economies, militaries, and persons, it was necessary to invent revolutionary strategy on several levels and, moreover, revolutionary culture. Filmmakers from Africa, Asia, Latin America, and even Europe bent themselves to this task. The ideas of strategy and culture are important here because the category of “thirdness,” as it turns out for many theorists of third cinema, was to be assigned *according to a film’s aesthetic and political strategy* as much as by either its geographical provenance or its thematic content. In many cases, the operative question both for film commentators and filmmakers was, What can a cinema of liberation accomplish in bringing about the overthrow of Western imperialist domination and creating revolutionary culture? Given the ways in which colonized nations are dominated by their colonizers at economic, geographical, cultural, intellectual, and psychological levels, this cinema of liberation was understood to be, necessarily then, a cinema of subversion. Revolutionary cultural politics needed to subvert the dominant paradigms of social organization and interpersonal relations. As the filmmaker Glauber Rocha, whose

masterfully subversive works including *Deus e o diabo na terra do sol* (1963; *Black God, White Devil*) and *Antonio das Mortes* (1969) remain staples of film-history courses, put it, “When one talks of cinema, one talks of American cinema. The influence of the cinema is the influence of *American cinema*, which is the most aggressive and widespread aspect of American culture throughout the world. . . . For this reason, every discussion of cinema made outside Hollywood must begin with Hollywood” (cited in Armes, p. 35).

Formal Dimensions

The inception of third cinema brought together participants in a variety of anticolonial revolutions during a period in which the world was understood to be fundamentally polarized along lines of nation and class. Beginning in the late 1950s and early 1960s, many third world writers and filmmakers saw themselves working in their own national contexts but connected intimately to a global uprising against worldwide racist and capitalist colonization. These uprisings extended from the Cuban and Algerian revolutions to political upheavals in Brazil, Argentina, Chile, Senegal, and Vietnam. Many of these films appear crude and characterized by low production values but revolutionary filmmakers found it necessary to work on very small budgets with whatever materials were available. Most of the films are black and white and made with few takes. However, Espinosa’s idea of “imperfect cinema” is central here because the practical and economic challenges to film production have formal consequences that speak to and of the problems faced by emergent nations.

Third cinema often uses a realistic style associated with cinema verité or sometimes with Italian neorealism. At times it uses nonprofessional actors or even workers and ordinary people doing their everyday tasks (as in the Chilean director Patricio Guzmán’s three-part documentary *The Battle of Chile* [1975–1978]). Some of the films are forms of social realism that take a typical figure or situation and create an archetypical narrative that shows how the prevailing social order limits and often destroys individual possibilities. Filmmakers such as Lino Brocka (Philippines), Hector Babenco (Brazil), and Dariush Mehrjui (Iran) have worked in this manner. At the same time, figures such as Rocha, Djibril Diop Mambety (Senegal), and Gutierrez Alea (Cuba) use mythic elements and modernist devices of fragmentation. In almost every case, films that are considered to be part of the third cinema corpus make difficult demands on their viewers, who are addressed such that they must not only understand the films’ nontraditional portrayals of the world but act upon that portrayal in order to change the world.

Periodizing Third Cinema

The third cinema movement, which emerged as a corollary to the worldwide decolonization movement, exploded in the late 1960s and thereafter went through several incarnations. In particular, one could discern three breaks. The inaugural moment of third cinema, which carried the movement through the 1970s, was followed by an academic and institutional revitalization during the mid-1980s that focused on reception and interpretation as well as the practice of filmmaking. This

mid-1980s resurgence of interest in third cinema occurred in part because it was felt that both national and perhaps more pointedly festival audiences did not easily fit into a standard differentiation between colonizer and colonized.

The uneasy fit of spectators into opposing first and third worlds, colonizers and colonized, which were formerly imagined as polar opposites, was exacerbated by the relative failure of revolutionary uprisings in the colonies to bring about the liberation of colonized peoples despite the fact that the colonies themselves had achieved nominal independence. It was further complicated by the growing numbers of third-world diasporic populations who faced difficult and vexing questions of existence and identity in the Western metropolises. Claiming that the unequal economic exchange between the first and the third world had its analogue in the unequal symbolic exchange between the first and the third world, Teshome Gabriel suggested that one of the effects of third cinema was to displace the Western(ized) viewer from his accustomed position of the privileged interpreter of the image. In assigning the category of thirdness to cinema, the spectators’ reception became part of that assignment and Gabriel proposed that it was also possible to read “first” or “second” cinema (cinema which registered the malaise or alienation of third world subjects but was not in itself revolutionary) in a third cinema way. However, despite the blurring of some polar distinctions between oppressive colonizer and oppressed colonial subject, many if not most of the intellectuals, organizers, and filmmakers involved with what was still, if with some reservations, called third cinema, worked in solidarity with ongoing revolutionary activity in places like Nicaragua, El Salvador, and the Philippines. Finally, in the opening years of the twenty-first century, there was a growing reassessment of third cinema practices, which took account of postcolonial theories, globalization, and the emergence of what might be called a world media system.

Ideology: Racism and Identification

Third cinema set out to destroy various aspects of what has been called the colonial mentality and to replace it with various forms of cultural affirmation. Summing up the situation of the third world and its peoples in 1969, Solanas and Getino wrote, “Just as they are not masters of the land upon which they walk, the neo-colonized people are not masters of the ideas in their heads” (p. 48). In a situation in which colonial control was maintained not only by economic and police violence but by mind control, third cinema was given the status of a weapon in a war that was not only for land and for laboring bodies, but also for minds. Quoting from their landmark film *La Hora de los Hornos* (*The Hour of the Furnaces*, 1968), a scathing analysis of the structure of Argentine society that sought to at once explain the violence foisted upon Argentina by Western capitalism and to offer a revolutionary solution, Solanas and Getino write, “In order to impose itself, neo-colonialism needs to convince the people of a dependent country of their own inferiority. Sooner or later the inferior man recognizes Man with a capital M; this recognition meant the destruction of his defenses. If you want to be a man, says the oppressor, you have to be like me, speak my language, deny your own being, transform yourself into me.”

The situation of colonial identification with the oppressor was forcefully formulated fifteen years earlier by one of the clear influences on this manifesto, Frantz Fanon, the philosopher, psychoanalyst, and expositor of negritude from Martinique. Fanon, after completing his education in Paris and painfully discovering that in spite of his colonial French education he was not seen to be French by the French colonizers of Martinique, lived and worked in Algeria. In *Black Skin, White Masks* (1952), Fanon wrote, "To speak a language is to take on a world, a culture. The Antilles Negro who wants to be white will be the whiter as he gains greater mastery of the cultural tool that language is. . . . Historically, it must be remembered that the Negro wants to speak French because it is the key that can open doors which were still barred to him fifty years ago." Thus in a film like *La noire de . . .* (*Black Girl*, 1966) by the Senegalese writer and director Ousmane Sembene, an impoverished Senegalese woman who works as a maid for a white expatriate French couple is persuaded to return with them to France to work in their home. Audiences see how her need to leave a life with no promising future in a Senegal recoiling under the destruction of colonization is coupled to her aspiration for the wealth and power of the Western metropole. Her desire for a better life in France becomes part of her oppression and eventual destruction. Although motivated by dreams of a better life in the colonial center, she finds instead utter isolation and virtual enslavement. Her tragedy, which Sembene handles with a devastating economy of means that requires from audiences an intense engagement with the experience of the Senegalese protagonist, is, at the end of the film, shown as reported by a French newspaper in two column inches. The contrast between what she has undergone in the house of the French and the official story told in the "objective" language of the press raises her tragedy to the level of outrage while showing how inadequate dominant media are to understand the colonial condition.

Mass Communications as Weaponry

What Fanon identified as the cultural and psychological dimensions of a racist—that is, white supremacist, imperialistic—capitalism, Solanas and Getino saw as being extended and intensified through mass communications:

As early as the 17th Century, Jesuit missionaries proclaimed the aptitude of the [South American] native for copying European works of art. Copyists, translator, interpreter, at best a spectator, the neocolonized intellectual will always be encouraged to refuse to assume his creative possibilities. Inhibitions, uprootedness, escapism, cultural cosmopolitanism, artistic imitation, metaphysical exhaustion, betrayal of country all find fertile soil in which to grow. (p. 47)

In seeking an alternative to mass communication's co-optation and colonization of spectators, all of the cultural conditions noted above become themes for various third cinema filmmakers: The culture, politics, psychology, and metaphysics of colonialism are analyzed at great length. For example,

another of Sembene's films, *Xala* (1973), depicts a postcolonial high government official of Senegal replicating the same patterns of domination practiced by the colonial masters: he steals the people's rice and fills the radiator of his Mercedes Benz with imported Evian water—but eventually he pays the price for his betrayal. In Gutierrez Alea's *Memories of Underdevelopment* (1968), the bourgeois protagonist, unable to identify with the project of the Cuban revolution despite his nationalist inclinations, cannot tap his creative powers and wastes away into "metaphysical exhaustion" and irrelevance. In Filipino filmmaker Lino Brocka's great *Manila in the Claws of Light* (1975), a provincial couple is lured by the glitz of Manila to the metropole in search of a better life, only to meet with betrayal and destruction.

The three films mentioned above along with myriad others foreground the pitfalls of what has been referred to in shorthand as a colonial mentality. Solanas and Getino bring the question of colonial culture to the question of neocolonial media as follows: "Mass communications tend to complete the destruction of a national awareness and of a collective subjectivity on the way to enlightenment, a destruction which begins as soon as the child has access to these media, the educational culture of the ruling classes. . . . Mass communications are more effective for neocolonialism than napalm" (pp. 48–49). They are more effective than napalm, for Solanas and Getino, because first world, capitalist mass communication's industries structure the imagination and organize the desire of viewers in terms or patterns that run counter to their own individual and collective/nationalist best interests. In this view, aside from seducing viewing subjects away from the immediate materiality of their own problems and the potential, collective solutions that may be at hand, "mass communications" as they stand under capitalism effect the ongoing normalization of, in Solanas and Getino's words, "Violence, Crime and Destruction . . . [as] Peace, Order and Normality." For this reason, "*Truth then amounts to subversion. Any form of expression or communication that tries to show national reality is subversion*" (p. 49).

First, Second, and Third Cinema and the Lie of Neutrality

To equate the "showing of reality" with "subversion" does not necessarily lead to a naive theory about a medium that can transparently represent reality. Rather, what passes for reality is inexorably tied to the forms by which it is rendered. It was understood that representational forms, from news formats to standard Hollywood narratives of individual heroism, were and are part of the functioning of institutions, as well as the functioning of cultural and economic power. Therefore, it was also understood that control of the spectator is central to the maintenance of power. Opposed to such hegemonic functionality, third cinema creates an activist relation to knowledge making; third cinema makers work with "a camera in one hand and a rock in the other." They tried to show that because all representation is shot through with power relations, the most pernicious representations are generally those in which the process—that is, the mode of representing—is naturalized and/ or made invisible. If representation appears larger than

I make the revolution; therefore I exist. This is the starting point for the disappearance of fantasy and phantom to make way for living human beings. The cinema of the revolution is at the same time one of destruction and construction: destruction of the image that neocolonialism has created of itself and of us, and construction of a throbbing, living reality which recaptures truth in any of its expressions.

SOURCE: Fernando Solanas and Octavio Getino, "Towards a Third Cinema."

life, as something like a second nature, human beings are simultaneously persuaded of their powerlessness. Third cinema endeavors, in one way or another, to show the world as being constructed in and through social relations.

In bourgeois cinema, write Solanas and Getino, "Man is accepted only as a passive and consuming object; rather than having his ability to make history recognized, he is only permitted to read history, contemplate it, listen to it, undergo it" (p. 51). This leads to another important set of distinctions impacting the term *third cinema*, for "thirdness" is to be distinguished from a "firstness" and "secondness" in the cinema. First cinema is the dominant Hollywood product, a "spectacle aimed at a digesting object." "The world, experience and historic process are enclosed within the frame of a painting, the same stage of a theater, and the movie screen; man is viewed as a consumer of ideology, not as the creator of ideology" (p. 51). Auteurist cinema, including the French new wave and Brazilian Cinema Novo, constitute second cinema. Here the filmmaker seeks a new film language and endeavors to challenge social constraints, but ultimately finds him or herself "trapped inside the fortress" as [Jean Luc] Godard put it (Solanas and Getino, p. 52). The second cinema often thematizes the situation of disaffected colonial subjects but can neither posit nor effect a social basis of transformation, caught up as it is in the ideology of bourgeois individualism. It thus remains closer to forms of existentialism but is not yet revolutionary. Third cinema sets out to fight "the system," and sees itself as a weapon in a collective struggle against racist, capitalist domination. It is defined as a cinema of liberation. It understands the collective character not only of history making but of historically individuated subjects.

Significance of Art

It is important to draw out the implications of third cinema as a practical critique of third world populations within the first and second worlds. Third cinema is put forward by Solanas and Getino as "above all, a new conception of filmmaking and the significance of art in our times" (p. 54).

Their phrase "*I make the revolution; therefore I exist*," echoes Rocha's important formulation in his essay from the same period, "The Aesthetics of Hunger": "The moment of violence is the moment when the colonizer becomes aware of the colonized." In other words, within the regime of institutionalized violence, any claim to existence, any assertion of will by the colonized, is taken as an act of violence or revolution by the colonial regime—for it is the working conceit of colonial regimes that colonial populations do not have will, do not suffer pain, humiliation, starvation, torture, and death, have no legitimate claims on the placid, beneficent world of colonial domination; and indeed, do not exist.

From such claims regarding revolution and violence emerges a theory of knowledge: "There is no knowledge of a reality as long as that reality is not acted upon, as long as its transformation is not begun on all fronts of struggle." To emphasize this point, Solanas and Getino invoke Marx's eleventh thesis on Ludwig Feuerbach: "The philosophers have only *interpreted* the world in various ways; the point, however, is to *change* it." Connecting third cinema to Marxism indicates that the historical development of class consciousness must be linked to developments of race consciousness and nationalist consciousness in the process of knowledge making. The world is not given merely in its representations. Representations present an interested picture of the world; in short, a worldview. This point connects the decolonization movements with the history and theory of Marxist revolution, and these thematics as well as those that arose with the negritude movement inform to varying degrees the work of many third cinema filmmakers.

Authors of History

According to Solanas and Getino, the connection of third cinema to revolutionary practice led to the discovery of "a new facet of cinema: the participation of people who . . . were [formerly] considered spectators" (p. 61). Thus, unlike in first and second cinema, film is seen not as a spectacle but as a "detonator or a pre-text." Third cinema is experimental, and impels its audience toward social change: spectators become actors, the authors of history. "The film act means an open-ended film; it is essentially a way of learning" (p. 62). Thus, as opposed to traditional cinema, third cinema is "*cinema fit for a new kind of human being, for what each one of us has the possibility of becoming*" (p. 63). The third cinema movement therefore represents a consciousness of the history-making and knowledge-making aspects of film and understands the historical role of cinema as creating a liberated society. The function of third cinema, while centrally concerned with the objective transformation of society, is not only extrinsic to viewing subjects but intrinsic as well. For all of the debates that have occurred over the tenability and fate of third cinema, the urgent call of Solanas and Getino may yet be heard: "The decolonization of the filmmaker and of films will be simultaneous acts to the extent that each contributes to collective decolonization. The battle begins without, against the enemy who attacks us, but also within, *against the ideas and models of the enemy to be found inside each one of us*" (p. 63).

See also *Anticolonialism: Latin America; Marxism; Nationalism: Cultural Nationalism; Negritude; Neocolonialism; Third World.*

BIBLIOGRAPHY

- Armes, Roy. *Third World Film Making and the West*. Berkeley: University of California Press, 1987.
- Beller, Jonathan. *Acquiring Eyes: Philippine Visuality, Nationalism and the World-Media-System*. Manila, Philippines: Ateneo de Manila University Press, 2004.
- Birri, Fernando. "Cinema and Underdevelopment." In *New Latin American Cinema*, edited by Michael T. Martin. Detroit: Wayne State University Press, 1997.
- Chaliand, Gérard. *Revolution in the Third World*. Translated by Diana Johnstone. Harmondsworth, U.K., and New York: Penguin; 1978.
- Espinosa, Julio Garcia. "For an Imperfect Cinema." In *New Latin American Cinema*, edited by Michael T. Martin. Detroit: Wayne State University Press, 1997.
- Fanon, Frantz. *Black Skin, White Masks*. Translated by Charles Lam Markmann. 1952. New York: Grove, 1967.
- Gabriel, Teshome H. "Towards a Critical Theory of Third World Films." In *Questions of Third Cinema*, edited by Jim Pines and Paul Willemen. London: BFI, 1989.
- Gutierrez Alea, Tomás. "The Viewer's Dialectic." In *New Latin American Cinema*, edited by Michael T. Martin. Detroit: Wayne State University Press, 1997.
- Pines, Jim, and Paul Willemen, eds. *Questions of Third Cinema*. London: BFI, 1989.
- Rocha, Glauber. "Aesthetics of Hunger." In *New Latin American Cinema*, edited by Michael T. Martin. Detroit: Wayne State University Press, 1997.
- Solanas, Fernando, and Octavio Getino. "Towards a Third Cinema: Notes and Experiences for the Development of a Cinema of Liberation in the Third World." In *Movies and Methods: An Anthology*, edited by Bill Nichols. Vol. 1. Berkeley: University of California Press, 1976.
- Wayne, Michael. "The Critical Practice and Dialectics of Third Cinema." In *The Third Text Reader: On Art, Culture, and Theory*, edited by Rasheed Araeen, Sean Cubitt, and Ziauddin Sardar. London and New York: Continuum, 2002.

Jonathan Beller

THIRD WORLD. The term *Third World* has long served to describe countries of Africa, Asia, and Latin America that have been seen to share relatively low per-capita incomes, high rates of illiteracy, limited development of industry, agriculture-based economies, short life expectancies, low degrees of social mobility, and unstable political structures. The 120 countries of the Third World also share a history of unequal encounters with the West, mostly through colonialism and globalization.

During the Cold War (1945–1991), *Third World* referred to countries that were relatively minor players on the international stage, strategic though they sometimes were to the United States and the Soviet Union as these superpowers sought to maintain their balance of terror. The tendency was to essentialize, oversimplify, and homogenize complex identities and diversities in the political systems of the Third World

by focusing too narrowly on the politics of bipolarity. Yet the so-called Third World countries always had many more divergences than similarities in their histories, cultures, demographics, climates, and geographies, and a great variation in capacities, attitudes, customs, living standards, and levels of underdevelopment or modernization.

Unilinear assumptions of modernization also encouraged pejorative connotations of the Third World as cultures and peoples trapped in tradition and custom, with a progressive few desperately seeking a "civilizing mission" in order to graduate into the rights and freedoms that capitalism and its modernity promise individuals and communities. Deaf to the diversities in the history, politics, and economics of the countries in question, and to the cultural and intersubjective rationalities that give contextual meanings to development, the concept has failed to inspire a meaningful comparative analysis of development.

Origins

The term *Third World* is European in origin, but analysts have yet to agree on its genesis. Some believe it came about through the search for an explanatory "third way" to the dualism of capitalism and socialism as analytical frameworks among European political scientists in the 1920s. This challenge became even more urgent in the 1950s as colonies increasingly gained independence and sought legitimacy as states and international actors in their own right. Others situate its birth with the classification of the world by the industrialized West into First (Western Europe and Japan), Second (the Soviet Bloc and its satellites), and Third (the rest) worlds. Still others have traced the term to 1940s and 1950s France, linking it with the "Third Estate" in French politics—the rising but underrepresented bourgeoisie in the French Revolution of 1789—who capitalized on the quarrel between nobility and clergy. Similarly, the Cold War provided the political opportunity for the "third way" in international politics, under the guidance of the newly independent developing countries. Whatever its origin, the idea of the Third World rapidly became embedded in the discourse and diplomacy of international relations, and those claiming or claimed by it were able to make the concept synonymous with radical agendas in liberation struggles and the clamor for more participatory and just international relations through new world orders.

Historical, intellectual, and ideological context. Despite various appropriations or attempts at domesticating the concept, Third World has always been an uneasy, controversial, and polemical concept, especially to the increasingly sensitive, critical, and rights-hungry intellectuals and elites of the post-colonies. Over the years, there have been efforts to coin new terms to replace "Third World." From a communist revolutionary perspective, Mao Zedong formulated a theory of three worlds in which the First World consisted of the then-superpowers (Soviet Union and United States), whose imperialistic policies, as he felt, posed the greatest threat to world peace. Mao placed the middle powers (Japan, Canada, and Europe) in the Second World. Africa, Latin America, and Asia (including China) formed the Third World. Others have dismissed the notion of three worlds as inadequate, and have asked

for four or more worlds. To some, the Fourth World should comprise currently underrecognized and underrepresented minorities, especially the indigenous “first” peoples of various states and continents. Still to others, only bipolar divisions along lines of physical geography and locality make sense, regardless of the differences and inequalities that may unite people across physical boundaries or divide those within the same borders.

To others, the whole notion of worlds is misleading for various reasons. First, it implies an essential degree of separation between different parts of the globe that is simply not realistic in a globalizing world marked by multiple encounters and influences. Second, despite the efforts to stimulate and sustain Third World unity in the struggles against various forms of subjection, current obsession with belonging and boundaries have fueled the conflicts undermining Third World solidarity and action. Third, the increased degree of polarization within a global economic geography, along with the collapse of state socialism, and the insertion of capitalist social relations even among the communist giants of the world (Russia and China), suggest not a reduction but a multiplication of worlds, including the production of material conditions characteristic of the Third World even within First World societies. Fourth, the emergence of newly industrializing countries represents a form of dependent development and a further differentiation of the global economic geography. If globalization is producing Third World realities in First World contexts, it is at the same time producing First World consumers in Third World societies. In certain contexts, globalization has generated levels of poverty and victimhood that best justify the qualification as Fourth World.

Movements associated with the Third World. During the Cold War, the term *Third World* or *Thirdism* inspired what came to be known as the “non-aligned movement” (NAM) a counterweight to the two rival Cold War blocs, and a kind of international pressure group for the Third World. NAM was founded on five basic principles—peace and disarmament; self-determination, particularly for colonial peoples; economic equality; cultural equality; and multilateralism exercised through a strong support for the United Nations. From the 1960s through the 1980s the movement used its majority voting power within the United Nations to redirect the global political agenda away from East-West wrangles over the needs of the Third World. However, in practice, with the exception of NAM’s anticolonialism, about which there could be strong agreement, the aim of creating an independent force in world politics quickly succumbed to the pressure of Cold War alliances. By the 1970s, NAM had largely become an advocate of Third World demands for a New International Economic Order (NIEO), a role it shared with the Group of 77, the caucusing group of Third World states within the United Nations. Through NIEO, the Third World argued in favor of a complete restructuring of the prevailing world order, which they perceived to be unjust, as the only enduring solution to the economic problems facing them. At the level of UNESCO, Third World scholars waged a war against unequal cultural exchange through calls for a New World Information and Communication Order (NWICO). In general, the Third World wanted a new order based on equity, sovereignty,

interdependence, common interest, and cooperation among all states. Given the economic weakness of the Soviet Union, these demands were essentially directed at the West.

Theories of “Third World” Development

In their quest for a new world order, Third World governments found measured support among radical academics who elaborated and drew from dependency and center-periphery frameworks to critique the basic tenets of modernization paradigms of development and underdevelopment. To these scholars, largely inspired by Marxism, the price of the development of the First World was the subjection to exploitation and dependency (or underdevelopment) that First World states and actors had brought to bear on the Third World through imperialism, colonialism, and globalization. Under the global capitalist system, the Third World can only play second fiddle to the real global decision-makers. This perspective explains both Third World economic underdevelopment and stalling democracy essentially in terms of the assimilation and exclusion logic of global capitalism, according to which only the handful of powerful economic elites in the Third World stand to benefit from its internalization and reproduction.

The Future of the Third World

Because the idea of the Third World was partly created and largely sustained by the logic of bipolarity that governed the Cold War era, some argue that in a unipolar world, in which the United States is the only global gendarme, to claim the same degree of existence for the Third World as in the past would be tantamount to a “fantasy” with little conceptual and analytical utility. Still, some factors persist to make the Third World still relevant as a concept. In analytical terms, the Third World idea identifies a group of states whose common history of colonialism has left them in a position of economic and political weakness in the global system. In this sense, the recent alignment in global politics neither undermines the coherence of the idea nor justifies its abandonment. The Third World may continue to exist in this sense, but the changing context confronts it with new challenges and opportunities.

See also Capitalism; Development; Economics; Empire and Imperialism; Globalization; International Order.

BIBLIOGRAPHY

- Amin, Samir. *Delinking: Towards a Polycentric World*. London: Zed, 1990.
- . “Reflections on the International System.” In *Beyond Cultural Imperialism: Globalization, Communication, and the New International Order*, edited by Peter Golding and Phil Harris, 10–24. London: Sage, 1997.
- Denoon, Donald. “Third World” In *The Social Science Encyclopedia*. Edited by Adam Kuper and Jessica Kuper. London and New York: Routledge, 1985.
- Frank, G. *Dependent Capitalism and Development*. New York: Monthly Review, 1978.
- Haynes, Jeffrey. *Third World Politics: A Concise Introduction*. Oxford: Blackwell, 1996.
- Independent Commission of the South on Development Issues. *The Challenge to the South*. Oxford: Oxford University Press, 1990.

- McGrew, A. "The "Third World" in the New Global Order." In *Poverty and Development in the 1990s*, edited by Tim Allen and Alan Thomas. Oxford: Oxford University Press in association with The Open University, 1992.
- Merriam, Allen H. "What Does 'Third World' Mean?" In *The Third World: States of Mind and Being*, edited by Jim Norwine and Alfonso Gonzalez. Boston: Unwin Hyman, 1988.
- Parkins, Colin. "North-South Relations and Globalization after the Cold War." In *Global Politics: An Introduction*, edited by Charlotte Bretherton and Geoffrey Ponton. Oxford: Blackwell, 1996.
- Rangel, Charles. *"Third World" Ideology and Western Reality: Manufacturing Political Myth*. New Brunswick, N.J., and Oxford: Transaction, 1986.
- Rodney, Walter. *How Europe Underdeveloped Africa*. Washington, D.C.: Howard University Press, 1981.
- Roy, Ash Narain. *The "Third World" in the Age of Globalisation: Requiem or New Agenda?* London and New York: Zed, 1999.
- Toye, J. F. J. *Dilemmas of Development*. Oxford: Blackwell, 1987.
- Tussie, Diana. "Introduction." In her *Latin America in the World Economy: New Perspectives*. Aldershot, U.K.: Gower, 1983.
- Wallerstein, Immanuel. *The Politics of the World-Economy*. Cambridge, U.K.: Cambridge University Press, 1984.
- Wells, Clark. *The UN, UNESCO, and the Politics of Knowledge*. New York: St. Martin's, 1987.

Francis B. Nyamnjoh

THIRD WORLD LITERATURE. As a term of standard usage, though still minus "literature," *Third World* dates from the 1950s. (The *Oxford English Dictionary's* first listing for it—still in its French form of *Tiers Monde*—is dated 1956.) Supposedly coined by the French sociologist Alfred Sauvy (1898–1990) in 1952, it initially referred to the independent and soon-to-be-independent nations of Africa and Asia that claimed to maintain a militarily nonaligned stance vis-à-vis both "First" and "Second" worlds—for instance, respectively, the United States, and its allies in NATO and SEATO, and the Soviet Union together with the nations of the Warsaw Pact, with the People's Republic of China a kind of wild card. But as this exact historical point of origin fades more and more into an unremembered past, *Third World* nevertheless continues to evoke the defining moments of a still iridescent lineage of the present: the era of anticolonial and national liberation mass movements and wars, from India to Algeria to Vietnam, that produced the contemporary grid of national boundaries in most of Africa and in large parts of Asia. Hence, the unmistakably radical overtone that is still audible in the term itself. And hence, given the eventual disappointment of that radical aspiration to become a "third"—that is, still another *new world*—there often appears an impulse to shrug it off in favor of more neutral-sounding terms such as "postcolonial."

Following Aijaz Ahmad, this "pre-history of the present" can be more precisely identified as the "Bandung Era," stretching from the meeting of nonaligned heads of Asian and African states in Bandung, Indonesia, in 1955—with statesmen such as Jawaharlal Nehru (1918–1970), Gamel Abdel Nasser (1889–1964), and Chou En-lai (1898–1976) presiding—to

the Iranian Revolution of 1979 and its embrace of an openly antiseccularist path to national emancipation. Though events in the world since the attacks of September 11, 2001, and the launching of a second war in the Persian Gulf in 2003 may at times seem to have set the historical clock back to a "Third World" moment—prospective or real Vietnam-style defeat for the United States in Iraq—the sense of repetition is finally possible only from the perspective of a newly humbled U.S. imperial hubris. Outside the metropolitan world, the struggles to resist or even just simply withstand what is now—relative to, say, 1968—the enormously worsened global crisis of capital seem to evoke only the terrible suffering and martyrdom of the successful war of national liberation eventually won, on the ground, by Vietnam in 1975. Long past is the historical conjuncture that saw in Vietnam the emblem, along with Cuba, of what Robert J. C. Young rechristens, in 2001, as "tri-continentalism": the uniting, within a "third" world forcibly triangulated by Cold War dualisms, of Asia and Africa, joined now by a Latin America obliged by modern imperialism to accept that, like the former regions, but unlike the settler colony to its north, it was also far "south" of the West.

For these reasons, "Third World literature" is not the name for a well-defined literary corpus—the way, say, "South African" literature, or even "Southern African" or "Latin American" can or could be. This is not just because, as Ahmad has noted, "it is in the metropolitan country . . . that a literary text is first designated a Third World text" (p. 44). It is also because Third World literature names a historical aspiration to objectivity, rather than an object per se. *Cahiers du retour au pays natal* could not belong to a Third World literature had its author, Aimé Césaire (b. 1913), not been Martinican, and probably had he not been a black Martinican. But just being Martinican does not itself make this work Third World in any meaningful sense either. It sounds more plausible to call *Martín Fierro*, the best known of the Argentina's nineteenth-century gaucho sagas, Third World than it does to call Argentine Jorge Luis Borges's (1899–1986) short story collection *Ficciones* by that name, even though only the latter (first published in 1944) falls within the appropriate, historically demarcated zone.

One might define Third World literature as composing the literatures of Asia, Africa, and Latin America—perhaps together with their respective metropolitan diasporas. But this could only work if the category was effectively restricted to works written after the end of World War II. And that still leaves the question of whether Third World literature continues to be written, or whether in fact it extends only as far as the various ideological slippage points for embattled national-liberationist energies: as early as the 1970s in West and South Asia and as late as the 1980s and 1990s in South Africa and Central America. Perhaps even so severely qualified a categorization remains technically defensible, since it does, after all, provide a means, however contentious, to refer collectively to the literature of a transnational but sub-global entity. As recently as the shutting down of the World Trade Organization meetings in Cancún in 2003 by an Indian-Chinese-Brazilian-led "Third World" alliance, this entity, in its political form, made its real presence known.

But, of course, what the notion of a third conveys—especially after the disappearance of a second—is essentially the fact that it is *not* first. Third World literature is that literature that is most emphatically *not* of the First—that is, *not* of the European, the Europeanized American, and perhaps simply *not* of the white man's world. In this sense it is Third World literature that inherited, if anything can be said to have done so, the revolutionary, utopian aspiration once claimed by a class, rather than a racial or ethnic "other": Third World literature appears, at times, to replace but also to act as a kind of relay for the lost promise of a "proletarian" literature. It is the non- or antibourgeois literature of a world for which literature itself has seemed to become irredeemably bourgeois. So, for example, not only in the militancy of a Ngugi wa Thiong'o or the epic gravity of a Pramoedya Anta Toer but even in the largely parodic structure of Latin American "magical realism," the direct mediation of class by "oppressed nation," theorized by Fanon, is arguably at work.

It is, ironically, just this absence of any positive, precisely determined empirical reference, this aspiration to "other" worldliness, however mystified, that has made of Third World literature what is still a key, if somewhat devalued, term in literary and cultural theory. Although it cannot refer to just any literary work, when it does refer to actually existing literature there is always embedded in the term itself a reference to the falsely claimed universality of the "Western canon." Thus whatever it is that, say, Tomás Gutiérrez Alea's film *Memorias del subdesarrollo* (Memories of underdevelopment, 1968), means on a literary and narrative plane, its meaning, as "Third World literature," is understood to be one that could not have been produced "in" the "First World."

In this register, one critical work above all has stamped our way of speaking and thinking of Third World literature: Fredric Jameson's 1986 essay "Third World Literature in the Era of Multi-national Capitalism." "As western readers, whose tastes (and much else) have been formed by our own modernisms," wrote Jameson, "a popular or socially realistic third-world novel tends to come before us, not immediately, but as though already-read. We sense, between ourselves and this alien text, the presence of another reader, of the Other reader, for whom a narrative, which strikes us as conventional or naïve, has a freshness of information and a social interest we cannot share" (p. 66). Jameson's reference to a habitual impression of the "conventional or naïve" in Third World literature has now itself come to seem naïve, and the sense of the "already-read" may now be replaced by a sense of an (always already) "unread." But the relation that Jameson captures here of reader to "Other reader" in and through Third World literature could not be more actual.

The tendency, since about 1990, to substitute the term *post-colonial* for Third World, reflects, of course, the rise of post-colonial theory in the metropolitan academy, and, if nothing else, the sense of embarrassment, within that academy, at making even the most remotely uncritical allusion to supposedly obsolete doctrines of national liberation. But, *mutatis mutandis*, the strange logical slippages bequeathed by history to Third World literature resurface in the newer jargon. Meanwhile, to

be sure, the literature itself—Third World, postcolonial, or however it is to be framed—occupies a central position in the metropolitan canons that once excluded it even as the presence of its Other reader, in ethical as much as in literary form, is felt just as strongly, if not more urgently than ever before.

See also Literature; Postcolonial Theory and Literature; Third Cinema; Third World.

BIBLIOGRAPHY

- Ahmad, Aijaz. *In Theory: Classes, Nations, Literatures*. London: Verso, 1992.
- Jameson, Fredric. "Third-World Literature in the Era of Multi-national Capitalism." *Social Text* 15 (1986): 65–88.
- Young, Robert J. C. *Postcolonialism: An Historical Introduction*. Oxford and Malden, Mass.: Blackwell, 2001.

Neil Larsen

THOMISM. *See Aristotelianism; Humanity; European Thought.*

TIME.

This entry includes three subentries:

China
India
Traditional and Utilitarian

CHINA

As in other civilizations, China has delved into both the sensible and the abstract, analytical aspects of time. Social-political time traditionally used sixty-day and sixty-year cycles, and a ten-day "week" framed plans, or divinations, about the near future (these schemata are seen in 1200 B.C.E. oracle records and remained ubiquitous). Usually, Chinese days were broken into twelve "hours" and 100 subunits ("minutes"). Archaeology provides examples of early imperial (c. 250–100 B.C.E.) clocks used by officialdom: one type was a gnomon chronometer—a small disk notched for diurnal shadows, in one case with sixty-nine subunits. Cosmic boards of the Han period (206 B.C.E. to 220 C.E.) mechanically aligned an inner wheel indicating segmented slices of time (seasons and hours) with cosmological categories and ecliptic constellations appearing on a square background. Third-century B.C.E. texts preserved in the western deserts refer to regulations for local functionaries in assigning times for signaling, delivering documents, and scheduling projects. Finally, in all time periods court experts performed time-related functions: calendar ritualists assigned dates for sacrifices and ceremonies; astrologers interpreted astral and meteorological portents, often drawing on computations for eclipses; and scholar-officials not only interpreted and debated the findings of such experts but also worked on genealogies and on philological research to correct primordial calendars, both of which played a role in political legitimacy.

Chinese thinkers did not devise philosophies, pedagogies, or keys of the sort developed in the West concerning time, and the context was chiefly driven by the state's need for cosmological and ritual correctness, and in some cases by cosmological and apocalyptic notions conveyed in Buddhist and Daoist scriptures. Yet China also produced its own sophisticated metaphysics of time—more accurately, sociocosmic “timing.” The 3,000-year tradition known as “the Changes,” or *Yi jing* (Book of changes), employed a set of arrayed lines, classically three or six per set, which was called a *gua*. The lines were associated with numbers; they could change in character (yin and yang) and concomitantly in numeric value; and they moved in and through other, associated, *gua* by means of permutations. Like dates and times of birth in Western astrology, they were used to predict career and health and to establish an individual's place in a local social or political network. The *Yi jing* achieved a high place in China's pedagogical, scholarly, and even political life, as influential in its way as the West's Bible. We should approach the *gua* system as an essential part of Chinese natural philosophy, a locus of scholarly work that linked broad areas of inquiry like cosmic patterns and regularity, divination, alchemy, chronology, medicine, and numerical principles.

Gua Time

China's most ancient, and deeply imprinted, conceptions of time developed through divination. Beginning around 1400 B.C.E., diviners at the Shang courts made auguries based on linelike cracks created by heating plastrons and bones, a practice that involved complex skills in recording and tracking time by means of astral, calendric, and proto-*gua* devices. *Yi jing* provided a way to examine individual and cosmic time frames, as well as the metaphysics of time. Its oldest textual layers (the *gua* line matrices and various divination formulas), which stemmed in some ways from the line cracking of the Shang era, date to 800–700 B.C.E.; the “Judgment” and “Images” commentaries date from about 500–350 B.C.E. Later commentaries (“Great Treatise” and “Words”; roughly 350–200 B.C.E.) connected these time matrices with unifying metaphysical concepts. The “Judgment” and “Image” layers refer often to time (*shi*) in the sense of “timeliness within a development,” or “season(s).” A strong metaphysical sense is found, for example, in the Judgment commentary's section on “Gen” (*Yi jing* hexagram no. 52): “*Gen* means stopping. When the timeliness [of this specific *gua*] comes to a stop, then one stops; when it goes, then one goes.” This is not about duration of motion or transitional states of being, but one's own “timeliness” in being part of the *gua*'s field of influence.

The “Great Treatise” expanded the notional sense of time. Several words there, taken as a set, explicate “change” and, indirectly, “time”: *bian* (“alternation,” movement from state to state in a matrix); *hua* (“transformation” as growth, maturation, influence); *tong* (“projection, development,” inferring an entire system from one of its aspects); *fan* (“reversion,” a deduced return point, or node, in a cycle).

By about 100 B.C.E., the most concrete sense of time (qua timing) in *Yi jing* was the notion carried in the fourth term, *fan*: astronomic reversal and return of solstices and diurnal and sidereal cycles. But, like all other concepts of time and change, this



Page showing the *Yi jing* system, from a Qing-era printing of the works of Jiao Xun. Conceived some three thousand years ago, the *Yi jing* is a sociocosmic system of lines with numeric values. The interactions of the lines were studied by the Chinese in order to predict the future.

is analogized as yin-yang dualism; even in twelfth-century B.C.E. inscriptions, diviners had used the interplay of even and odd numbers in a *gua* and observed the way one *gua* reached out to a “changed” correspondent and functioned to bridge time in situations of prediction. During the Han dynasty, brilliant metaphysician-ritualists like Jing Fang and Yang Xiong worked to unify mathematics, musical theory, calendrics, and *gua* systematics. Beginning around 300 C.E., diviners increasingly used astral position timing and integrated various numerate techniques, spurring technical elaborations in personal astrology (death and important career-date predictions). The culture at large became attuned to the numerate and mechanized aspects of time as they sought to establish personal “timing.”

Finally in the *Yi jing* system, “position” is a key component of time. The term *wei* refers not only to the situation surrounding a specific one of the six stacked lines of a *gua* but also to the line's interrelations. For example, a *gua*'s *wei* at the second line, traditionally a time of deference in a career, takes cues from its concurrent, yet future, partner *wei* at line five (career apogee, or seat of power). *Gua* time developed around the social appropriateness of one's *wei*, how much help one received from all entities acting in the matrix (the *wan-wu*), and, hermetically, the correctness of one's own union with the *gua* system.

Manipulable Time and Social Time: Progress, Alchemy, Salvation

Some observers of China have thought that Chinese time was entirely cyclical. It is true that political life traditionally was based on dynastic rise and fall and the attendant appeals to astral cycles, and religious ideas and movements frequently were founded upon era cycles. But China was not much different from other civilizations. Linear chronology, unique cosmic moment, and social progress can be seen in various, albeit not always culturally dominant, contexts concerning time.

The pathbreaking historian Sima Qian (d. c. 90 B.C.E.), for example, honed the use of tables (time-linear in concept) to demonstrate the role of genealogies and blood lines in political history. Moreover, his remarks often suggest that a dynasty should not be a passive recipient of judgments derived from divination but should also be headed toward something—a socio-cosmic correctness and unity. Joseph Needham considered, perhaps too emphatically, that the technical and intellectual work of court experts to achieve that unity was scientific “progress,” a way to understand linearity in Chinese time. But his observation prompts fruitful speculation. Chinese scholarship and bureaucratic institutions always recognized previous toilers and their goals. Scholar-officials occasionally sought to restore antique knowledge, in order to explain via commentaries rather technical matters or confront the influence of outside (foreign, in the case of Muslim and then Jesuit) court-appointed experts. Modern historians of Chinese sciences have fleshed out particular cases, and in them we see that “progress” often was ad hoc and piecemeal, or thwarted politically. Moreover, such “progress” was actually quite backward-looking, like sixteenth- and seventeenth-century European humanists who sought truths lodged in the biblical past—terms and keys to natural knowledge whose meanings had become obscured.

Another way to view Chinese ideas of time is through the cosmologies implied in computational astronomy. Early astronomers recognized what we term Metonic periods and Saros cycles, yet they were also attempting to reconcile the regularities of such cycles with all-important numerological constants. Unwieldy greatest common denominators resulted from factoring lunar, solar, and sidereal conjunctions, and such large numbers would represent a primordial cycle that could evidence new, or reformed, dynasties. Concomitantly, predictive astronomy often failed because of the need to fudge aesthetically desirable numerologies with data from incomplete, ad hoc observations of solstitial moments and tropical year lengths. Besides dyadic, “five phases,” and other cycles, Chinese experts undertook to grasp enormous reaches of cosmic time and the way human society and politics fit into it.

Daoist cult scriptures applied similar sorts of calculated eras to their propaganda during dynastic strife—for instance, calculations that claimed when a judgment of the corrupt by the sage-god Laozi or the Dao itself would occur. One example is the fourth-century C.E. *Purple Texts Inscribed by the Spirits*, which influenced ideas of dynastic and millennial time, affecting legitimization ideologies as late as the reunification of China in the sixth and seventh centuries. Scriptures of this sort

utilized calendrical arts to provide yet other numerological bases for arguing the existence of ending-nodes in the large conjunction cycles. Daoist scriptural time-concepts frequently meshed with Buddhist ones. In the Buddhō-Daoist mélange of scriptures and cult aims, tantric materials offered protection against apocalypse, as in the spells carried in the *Lotus Sutra*, which reached broad popular consumption from about 400 to 800 C.E. Such theologies reflect the cyclical nature of Chinese time but also furnish extremely important examples of unique (nonlinear, noncyclical) divine intervention into social time. Daoist scriptures speak of “seed people” planted by the Dao in order to renew the postapocalyptic world.

Chinese alchemy engaged in measurement and analysis. Although that in itself might imply notions of time, alchemy focused not on time but on the effort to “construct a model of the *Tao*, to reproduce in a limited space on a shortened time scale the cyclical energetics of the cosmos” (Sivin, 1976, p. 523). The early alchemical tradition known as *Zhouyi can tong qi* (originating in the second century and elaborated in Tang and Song times) was concerned with the progress of cosmogonic time and for that purpose used Han-era *gua* calendars. Ultimately, such approaches to “timing” and “timeliness” carry with them elements of the timeless, namely, the Dao principle of numero-cosmogony as found in *Laozi*, *Huainanzi*, and *Zhuangzi*, and as made precise by the *Yi jing* system. Time as quantifiable durations of states and qualifiable modes of change was not a primary concern.

Metaphysical Time: Terms and Philosophies

From about 500 to 200 B.C.E. several Chinese thinkers conceived time abstractly and without reference to *gua* systematics. Passages in *Zhuangzi*, *Huainanzi*, and *Shuowen jiezi* (a second-century C.E. lexicon) drew upon extant terms connoting “time,” linking them with categories for space and motion: these terms included *shi* (season, historical moment), *yu* (spatial expanse, first delineated as the area of a roof’s perimeter, later “the four directions plus up,” and, for *Zhuangzi*, “reality without anything in it [the void-expanse]”), and *zhou* (the cyclic, expected return of any moving thing; for *Zhuangzi*, “what goes on extensively but has no beginning or end”); hence the binome *yuzhou*—limitless expanse conjoined with cyclical return. The oldest terms were not intentionally abstract, but pointed to social time, timeliness of action, and spatiality as products of motion and change.

When the oldest *Zhuangzi* passages were created (probably c. 300 B.C.E.), logico-analytic debates were popular, and we find statements of a certain Hui Shi, who states the paradox, “One sets out for Yue today, but arrives in the past.” The authorial voice, *Zhuangzi*, ridicules Hui Shi’s mode of knowledge, yet the much later (fourth century C.E.) commentary takes it seriously, arguing that the “setting out” and the “arriving” (abstractly analogized as “knowing” and its known “entity”) are like facing mirrors, which make a continuum of reflection: thus the “knowing” about “setting out for Yue” engages simultaneously with its dyadic partner, the “arriving.”

Equally striking was the Mohists’ approach to time. Early Mohists (roughly 400–350 B.C.E.) were an influential

community dedicated to knowledge, ethics, and supplying political-military services to regional courts. Their writings were poorly transmitted and taken up only rarely by later Chinese scholars. The brilliant reconstruction of the jumbled extant version of the Mohist *Canon* by A. C. Graham has shown that time was articulated with brief declarations of such notions as light, weight, speed, and geometric axioms. One logical premise concerns “Duration: what fills out different times. Extension: what fills different locations.” The later Mohists (about 300 B.C.E.) blended their own thoughts into the *Canon* and distinguished between times with and without duration: “Of times in a movement some have duration, others do not have duration. The beginning does not have duration.”

Demands of Ritual Precision and the Impact of Western Learning

Since at least about 150 B.C.E. Chinese scholars, in the relatively rarefied contexts of court rites and projects, had perceived that space and time were quantifiable through measurement and notation of positions. But with the impact of Western learning after 1600, not only did the royal court become increasingly chronometric, so did urban and mercantile culture. In 1644 an important Jesuit, Adam Schall von Bell, proposed to the court that the one hundred minutes of the day be changed to ninety-six for purposes of meshing with the European twenty-four-hour clock. Gear-driven clocks introduced by Jesuits and other westerners made an enormous impact, and through much of the 1700s the court employed Jesuit clock technicians. Throughout urban China clock makers found a niche, and we even have writings on their arts that contain thoughts about time in a new, ontologically self-contained way, not part of traditional, relatively indirect, approaches to “time.”

Many Chinese, familiar with Jesuit ideas, consciously isolated Western challenges to Chinese notions of time from the accompanying cosmological and theological arguments. Some, however, engaged the new theology. Zhuang Qiyuan (1559–1633), who was influenced by Jesuits, pondered integrating the Christian “god” into Confucianism: “People of our age all know there is a Heaven, but they do not all know the reason why Heaven is Heaven. If Heaven had no ruler, then there would only be the present moment, motionless and stagnant, dreamlike without the mysterious spirit.” His descendant Zhuang Cunyu (1719–1788), not Jesuit-influenced in the same way, wrote that the “Great Ultimate” (an *Yi jing* schema for cosmic unity) is “Heaven. Nothing is prior to the beginning of Heaven.” The latter Zhuang was arguing that Confucian (*Yi jing*) cosmology was temporally prior to all things, implicitly positing the Chinese view as favorable to a Christian heaven. The Zhuangs were influential in fostering the Han Learning movement. From about 1600 to 1825 quite a few leading scholars reconstructed Han-era masters of *Yi jing* systematics (like the aforementioned Jing Fang), purged their product of any Buddhist and Daoist taint, and reexamined China’s own early mathematics. The movement developed tools for potentially taking astronomy and math back from the Jesuit grip. Yet the Western worldview would dominate, and after the 1949 Communist revolution, with its assaults on intellectual culture,

Chinese tradition—which had once accommodated a fine variety, including hermetic *gua* time, Daoist eschatology, and ad hoc technical progress in time-related arts like math, computational astronomy, and music—was replaced by modern science and physics and by reductionist interpretations of Western philosophy.

False dichotomies like “China the cyclical” versus “the West as progressive” do not work. Arnaldo Momigliano once demolished such caricatures about Jewish versus Greek “time,” noting that even within one culture we must not automatically compare a historian’s ideas about time with a philosopher’s (given the latter’s unbounded room for natural and metaphysical speculation). The same caveat applies to Chinese ideas of time. Educated officials, who wrote history, had to address the demands of political cycles, yet their classicist work could be “regressive”—seeking a perfect, primordial age of unity. Court ritualists perceived a certain progress in their arts, and alchemical writers and metaphysical philosophers used time-related ideas to pursue ontology and epistemology. The *gua* time presented here is just one possible, if important, way to approach a Chinese “concept” of time. The history of Chinese alchemy and medicine will in the future present other models, as will studies of scholar-ritualists.

See also Alchemy: China; Astrology: China; Calendar; Chinese Thought; Cosmology: Asia; Daoism; Mohism.

BIBLIOGRAPHY

- Bokenkamp, Stephen R. “Time after Time: Daoist Apocalyptic History and the Founding of the T’ang Dynasty.” *Asia Major*, 3rd ser., 7 (1994): 59–88.
- Libbrecht, Ulrich. “Chinese Concepts of Time: *Yü-chou* as Space-Time.” In *Time and Temporality in Intercultural Perspective*, edited by Douwe Tiemersma and H. A. F. Oosterling. Amsterdam: Rodopi, 1996. The first part is a critical review of Needham’s piece.
- Loewe, Michael. “The Cycle of Cathay: Concepts of Time in Han China and Their Problems.” In *Time and Space in Chinese Culture*, edited by Chun-chieh Huang and Erik Zürcher. Leiden and New York: Brill, 1995.
- Needham, Joseph. “Time and Knowledge in China and the West.” In *The Voices of Time: A Cooperative Survey of Man’s Views of Time as Expressed by the Sciences and by the Humanities*, edited by J. T. Fraser. 2nd ed. Amherst: University of Massachusetts Press, 1981. Nathan Sivin has convincingly demonstrated the unfeasibility of Needham’s take on the “scientific” nature of Chinese Daoism.
- Pregadio, Fabrizio. “The Representation of Time in the *Zhouyi cantong qi*.” *Cahiers d’Extrême-Asie* 8 (1995): 155–173.
- Sivin, Nathan. “Chinese Alchemy and the Manipulation of Time.” *Isis* 67 (1976): 512–526. Closer analysis of Daoist-alchemical “time,” to which Needham alluded briefly.
- . “Chinese Concepts of Time.” *The Earleham Review* 1 (1966): 82–92.
- . “Cosmos and Computation in Early Chinese Mathematical Astronomy.” in *T’oung Pao*, 2nd ser., 55 (1969): 1–73. A pathbreaking study of the historical and political implications of early seekers after precision in eclipse ephemerides, and their abilities (and failures) to perceive and apply cumulative achievements in mathematical astronomy.

Swanson, Gerald. "The Concept of Change in the *Great Treatise*." In *Explorations in Early Chinese Cosmology*, edited by Henry Rosemont Jr. Chico, Calif.: Scholars, 1984.

Howard L. Goodman

INDIA

In general, the conceptualization of time in Indian religious and philosophical thought is framed by a dichotomy between the phenomenal world and absolute transcendence—that is, the realms of time and the timeless. The former, the sphere of contingent temporality, is usually understood to be the world of suffering, of change and impermanence, of what is known in Sanskrit as *samsara*. The latter is the realm of God or the divine, the transcendental realm of changelessness and release from suffering (*moksha* or *nirvana*). While the Indian tradition does not, as was once thought by Westerners, entirely devalue the this-worldly (concerned with things in this world, as opposed to a future existence after death), the ultimate goal of all of the religious traditions that have sprung forth in India is indeed to overcome and transcend time and the death it entails.

As opposed to modern notions of the progressive nature of time, traditionally in Indian texts time is envisioned as degenerative and entropic. Such a viewpoint on the nature of cosmic time goes all the way back to the early Vedic cosmogonies where the universe is said to have been created by a god (Purusha, the Cosmic Man, or Prajapati, the "Lord of Creatures"). The work of creation, however, was defective. The creator "emits" from himself the creation, but in this cosmogonic move from primordial unity to multiplicity and diversity the product is characterized by disconnection, confusion, and disarray. The very parts of time are, in their original state, created in a "disjointed" manner: "When Prajapati had emitted the creatures, his joints became disjointed. Now Prajapati is the year, and his joints are the two junctures of day and night, of the waxing and waning lunar half-months, and of the beginnings of the seasons. He was unable to rise with his joints disjointed" (Shatapatha Brahmana 1.6.3.35).

The "natural state" of time is here mythically represented as discontinuous and chaotic. The point of such Vedic myths of origins is to represent God's cosmogonic activity as faulty—creation here is not cosmos. The universe, as it was in the beginning, is in need of repair. Vedic ritual activity was performed to continually "heal" a world that was created defective and perpetually tends toward its natural state of disjuncture. The ritual was conceived as a connective, reparative activity.

With the Agnihotra [the twice-daily sacrifice performed at dawn and dusk] they healed that joint [which is] the two junctures of night and day, and joined it together. With the new and full moon sacrifices, they healed that joint [which is] between the waxing and waning lunar half-months, and joined it together. And with the Caturmasyas [performed quarterly at the beginning of the seasons] they healed that joint [which is] the beginning of the seasons, and joined it together. (Shatapatha Brahmana 1.6.3.36)

Such is the power of human ritual activity, but the natural tendency to entropy, to return to the "natural" state of discontinuity, requires that human's continually reinvigorate time through ritual.

This vision of time as perpetually degenerating, encoded in the earliest texts of the Indian tradition, continues in one form or another to the present. By more or less the turn of the Common Era, Hindu, Buddhist, and Jain traditions had all accepted the notion that time, now measured in incomprehensibly long cycles, is constantly replicating, at the macrocosmic level, the process of birth, aging, and death that characterize the life of humans. Furthermore, time (and everything in it) was also seen as indefinitely recycled. The conceptualization of the cyclical nature of time, together with the idea of entropy, characterizes the basic understanding of temporality in the Indian context.

The assumption of transmigration and rebirth, already appearing in the middle centuries of the first millennium B.C.E., had both micro- and macrocosmic applications. Just as souls were perpetually reborn, so was the universe and time itself. The Sanskrit name for this theory is *samsara*, a word that literally means, "to wander or pass through a series of states or conditions." *Samsara* describes the beginningless and endless cycle of cosmic or universal death and rebirth; all of phenomenal existence is thought to be transient, ever changing, and cyclical.

Cosmological time in the classical texts of Hinduism is measured in units ranging from the infinitesimally short (the "particle" or atom of time called the *truti*, the "moment" or *kshana*, and the "eye blink" or *nimesha*) to the unimaginably long (the life span of the god Brahma, reckoned at 4,320,000,000 human years, according to one method of calculation). Within this framework are large units of time called the "eons" or *yugas* (which further combined into even greater periods called "great eons" or *mahayugas*). The first of these is the "Golden Age" or *krita-yuga*, which lasts for about 4,000 divine years (each divine year is the equivalent of 360 human years), a period of happiness and great virtue. The next two eons, the *trreta* and *dvapara*, are both shorter (3,000 and 2,000 divine years, respectively) and increasingly worse as all things, including life spans and the human's capacity for spirituality, decrease. The process culminates in the last and "dark" or *kali yuga*, which is identified always in these texts as the present age of utter degeneration. At the end of this final eon (which lasts 1,000 divine years), the world will end in a cataclysmic apocalypse. After a period of dormancy, the universe will be recreated and the process will begin again . . . endlessly.

In mythological terms, the cycle is said to involve the fall from a Golden Age of happiness and righteousness. Such a fall is sometimes attributed to the arising of greed and desire, which, together with hatred and ignorance, form the fundamental roots of negative karma, which keeps souls entrapped, and constantly circling in *samsara*. But it is, according to some theories, the simple "power of time" itself that results in the fall from grace in the "Golden Age":

In the beginning, people lived in perfect happiness, without class distinctions or property; all their needs were

supplied by magic wishing-trees. Then because of the great power of time and the changes it wrought upon them, they were overcome by passion and greed. It was from the influence of time, and no other cause, that their perfection vanished. Because of their greed, the wishing-trees disappeared; the people suffered from heat and cold, built houses and wore clothes. (*Vayu Purana* 1.8.77)

The cyclical nature of time entails not just an inevitable degeneration of time, with the resulting decrepitude of moral sensibility and the increase in evil and suffering; it also implies an equally inevitable return to the Golden Age as the wheel of time turns once again. The righteous will survive as the seeds for a new and better cosmic era:

In the Kali Age, men will be afflicted by old age, disease, and hunger and from sorrow there will arise depression, indifference, deep thought, enlightenment, and virtuous behavior. Then the Age will change, deluding their minds like a dream, by the force of fate, and when the Golden Age begins, those left over from the Kali Age will be the progenitors of the Golden Age. All four classes will survive as a seed, together with those born in the Golden Age, and the seven sages will teach them all dharma. Thus there is eternal continuity from Age to Age. (*Linga Purana* 1.40.72–83)

It is here the simple “force of fate” that impels the ever-changing world of samsara, characterized by an “eternal continuity” that links the circle of time. Evil and suffering are, from this point of view, the inexorable consequences of the eternal processes that guide the phenomenal universe.

Within this very large framework of ever-declining and infinitely repeated eons is found the divisions of calendrical time: the day (and its parts), fortnight, month, season, and year. The lunar calendar is divided into 360 days, each day divided into 30 units of 48 minutes called the *muhurtas*. The next unit traditionally was the fortnights of the waxing and waning moon. Together the two fortnights formed a month. The lunar year consists of twelve months divided into three four-month periods (the *caturmasyas*) or six seasons: spring, summer or the hot season, the rainy season, autumn, winter, and the cool season. The new year was reckoned to begin either with the full moon in the month of Tapasya (February–March) or with that of the month of Caitra (a.k.a. Madhu, March–April).

Also introduced already by the middle centuries B.C.E. in India and henceforth continuing in all Hindu, Buddhist, and Jain traditions was the notion that the world of *samsara* was fundamentally illusory. This doctrine, known as *maya* (“illusion”), held that it is because of our own ignorance that we perceive a world of differentiation and change; and it is through our own ignorance that we suffer and produce karma and thus circle through the cycle of perpetual rebirth. *Samsara* is contrasted to an unconditioned, eternal, and transcendent state that is equated with “freedom” or “liberation” from such transience, suffering, and rebirth, and the ultimate goal of all Indian religions is to attain such a state.

Whereas the monastic strains of Buddhism and Jainism tended to emphasize renunciation from the world of ordinary, worldly time and the suffering that accompanies it as soon as one had the inclination, in Hinduism a system of gradual withdrawal was recommended. At the level of the individual, a “life-time” is ideally divided according to the Hindu theory of *ashramas* or “stages of life,” each with its own set of necessary and important religious duties. The first of these is the stage of the student who is charged with learning the sacred texts and rituals and serving the teacher. This is followed by the stage of life of the married householder who is to pursue worldly life (including pleasure and material gain) within the boundaries of proper religion or *dharma*. When the householder “sees his son’s son,” he should begin the process of retiring from worldly concerns and take up the life of the “forest-dweller.” The final stage of life is that of the world-renouncer, the *sannyasi* who has given up worldly duties altogether and seeks the mystical knowledge whereby temporality itself is transcended and the eternal dimension of reality is fully realized. Such a person—and there are Buddhist and Jain equivalents—is thought to be permanently “released” from the bonds of time and forever is identified with the Absolute.

See also *Buddhism; Calendar; Hinduism; Jainism; Time; China; Time: Traditional and Utilitarian.*

BIBLIOGRAPHY

- Gonda, Jan. *Prajapati and the Year*. Amsterdam and New York: North-Holland, 1984.
- Lingat, Robert. “Time and the Dharma.” *Contributions to Indian Sociology* 6 (1962): 7–16.
- O’Flaherty, Wendy D. *Origins of Evil in Hindu Mythology*. Berkeley: University of California, 1976.
- Panikkar, Raimon. “Toward a Typology of Time and Temporality in the Ancient Indian Tradition.” *Quarterly of Asian and Contemporary Thought* 24, no. 2 (1974).
- Reimann, Luis Gonzalez. *Tiempo Ciclico y eras del Mundo en la India*. Mexico City: El Colegio de México, 1988.
- Samartha, Stanley J. *The Hindu View of History*. Bangalore: Christian Institute for the Study of Religion and Society, 1959.
- Underhill, M. M. *The Hindu Religious Year*. London: Oxford University Press, 1921.

Brian Smith

TRADITIONAL AND UTILITARIAN

A primary distinction separates sequential (or utilitarian) time, which has to do with the relations of before and after, from traditional time, which has to do with the relation of the present to both the past and the future. For Émile Durkheim (1858–1917), traditional societies were based on solidarities in traditional time, and they relegated to the margins of social life practical concerns emanating from sequential time, such as whether to do A before doing B. These latter (utilitarian) concerns typify, in Durkheim’s view, magic on the peripheries of traditional societies and utilitarian thinking about means and ends, or causes and effects, central to the ordering of modern societies. For Max Weber (1864–1920), charismatic leaders introduced radical disruptions in social orders based on

traditional times, but in order to survive, these movements had to become preoccupied with sequential or utilitarian time, with lines of success, and with logical or practical forms of thinking and action. Thus for Weber, charismatic authority, which is initially disdainful of practical concerns, defeats itself by its own successes, which dictate concern with means and ends, and causes and effects. Durkheim remains critical of such utilitarian concerns, even when they dominate the social order, because they are inadequate as bases for authority and social control. Thus in the disagreements between Weber and Durkheim one can find the roots of contemporary conflict in the field over whether utilitarian time is derived from, a side effect of, or opposed to traditional time and whether utilitarianism in various forms is typical of all social orders or primarily of modernity alone.

The Origins of Utilitarian Modernity

Various attempts have been made to explain how the sense of time in modern societies has come to be dominated by the concerns of rationality, which relegates to the peripheries of social life such other sources of social order and allegiance as loyalty to kinship and ethnic groups, or commitment to mythical versions of the past and of the future. The move toward utilitarian time in Europe may be due to the marginalization of traditional time, in which the present is both embedded in the past and mortgaged to the future, from the social life of the nation. The causes of this development have been variously attributed to a number of sources, notably: the legacy of the church as a source of rational social control; the tendency of the Protestant Reformation to displace traditional time, in which the departed were still intimately linked with the ongoing life of the community and were a source of authority for kinship and ethnic groups; and the early dissolution of the feudal system and the resultant ordering of production and of relationships between employers and employees, even in late medieval agricultural communities, along rational lines.

Some scholars have focused on the monastic, highly rational ordering of temporal sequences as the source and model for the increasing regulation of the temporal sequences of public life in the Western city from the twelfth century onward. Others, following this line of argument, have traced the concern for the rational ordering of everyday life and the self-perfection of the individual to the attempt to turn Purgatory into a this-worldly state of mind, in which individuals have to take on a rational self-discipline in their use of time for the purpose of spiritual perfection. Max Weber credited the church in the Western city with breaking open the communities based on familial or ethnic ties and replacing them with the more inclusive ties among coreligionists. It is also widely understood that utilitarian time was advanced by the administrative rationality and control of the Christian Church in Europe as it took on a wide range of functions after the collapse of the Roman Empire from the fifth century onward.

When Latin was replaced, the newer vernaculars took on the function of providing the extended present for nations and a sense of sharing in a common time as well as space. They provided a common language that was exclusive of the dialects and other traditional sources of loyalty and solidarity. The

vernacular, carried by the media and especially by the broadsheets, established a present and defined "the times" in which people were living, while relegating Latin to the past, to an old world that was passing away.

This strategy for relativizing and marginalizing is easily seen as utilitarian when it occurs under the auspices of the modern nation-state, as in the case of England under Henry VIII and Elizabeth, who replaced traditional religion with a more abstract or generalized form of ascetic belief and practice: from Scholasticism and systematic theology to science and public affairs. Here again, the broadsheet became the sacrament of a secular society.

If utilitarianism relegates traditional sources of solidarity, which rely on traditional time and its mediation of the past and the future to the present, utilitarian time construes an extended present, in which the various pasts of ethnic and kinship, racial or national groups are irrelevant to a discourse on precedents, conditions, and consequences of effective and legitimate action. Social processes are thus ordered in terms of sequences that link means to ends, causes to effects, and precedents to procedures: not in terms of priorities based on a wide range of collective memories and aspirations for the future. A major gulf thus opens up between discussions of social policy and the unsatisfied longings of minority or subordinate groups and communities, along with their aspirations for a redress of grievances in the future.

Modern Societies

In modern societies, however, those who control public discourse have arrogated to themselves the kind of time that Durkheim regards as merely utilitarian, "temporal," and thus lacking in the bases of traditional solidarity that would have been available in more primitive societies, where temporal sequence was a matter of peripheral concern for individuals and those practicing magic: not for those on whom the duration of the society itself depended.

Thus, for Durkheim, modern societies represent an inversion of the traditional: a change in which type of time dominates public discourse, and a change in the sort of elites that control public discourse. Because of his antipathy to utilitarianism, Durkheim took as his preferred model traditional social systems that considered themselves to be part of time that runs from the past through the present into the future; thus the sort of time that is concerned with the logical and practical relation of means to ends and of causes to effects was relegated, in his view, to the social periphery. In modern societies, however, these oppositions were reversed, with the utilitarian engagement with time preoccupying the political and cultural center, and communities with their own traditional bases of solidarity (and their views of the present as being linked with the past and the future) being relegated to the periphery.

Sociologists and historians remain divided as to whether the new elites and their utilitarian view of time can provide the bases for solidarity and for personal identity, which had been mediated by powerful myths and rituals linking the self to the duration of the society from the past into the present and the future. Some regard this conflict as a contest for the

“soul” of a nation such as America, while others regard the contest in more comparative terms as a problem faced by a wide variety of nations coping with indigenous and external sources of both threats and opportunities. Whether or not Durkheim is right about the inversion of time-sense between modern and traditional societies, a question remains as to whether any society, by its very formation, divides the flow of time into two separate streams, the one sequential or utilitarian, temporal and temporary, the other concerned with the long duration of peoples over many generations, and with the impact of both the past and the future upon the social present.

The question also remains whether, as Talal Asad argues, what is needed is an alternative to utilitarianism: a view of the world that “is not divided into significant binary features” (p. 15). In modern societies, of course, those opposites have been, at least since the Enlightenment, the modern and the premodern, and sometimes these oppositions have been arrayed in ideological discourse along lines separating the West from the East, or within the West between Europe and the United States. Other forms of binary opposition have arrayed the relatively educated, who have adapted well to living in a complex, highly differentiated society, in opposition to those who are looking for simpler formulations and more primitive forms of solidarity. For modern commentators working from within Weberian assumptions, utilitarianism has been accompanied by the emergence of a self with political rights and the freedom to make a variety of choices in the economy and the political system, as well as in the more intimate spheres of the family and local community. This freedom comes from the individuating consequences of complex societies, which keep individuals from being embedded in particular and highly limiting social contexts.

Conclusion

It may well be that, as Durkheim argued, the division of the world into binary opposites begins with the formation of any social system, which pits its own times against those of other forms of social solidarity. Thus the tendency to divide time between the utilitarian and the traditional, between concern with means-ends or cause-effect relationships and the long extension of the present into the past and the future is typical of any social system. Pierre Bourdieu argues in this vein, and separates the two kinds of time into “field” and “habitus,” their differences providing a potential source of tension within any social system.

Others, however, like Niklas Luhmann, argue that a binary opposition is typical of any social system. Luhmann uses the cybernetic model as an analogy for understanding the fluidity and complexity of relationships and practices in modern societies. On this view, the utilitarian tendency to divide time into two separate streams is not restricted to modern societies but is endemic to the formation of any social system.

See also *Enlightenment; Globalization; Modernity; Secularization and Secularism.*

BIBLIOGRAPHY

Anderson, Benedict P. O'G. *Imagined Communities: Reflections on the Origin and Spread of Nationalism.* London: Verso, 1991.

- Asad, Talal. *Formations of the Secular: Christianity, Islam, Modernity.* Stanford, Calif.: Stanford University Press, 2003.
- Bourdieu, Pierre. *Outline of a Theory of Practice.* Translated by Richard Nice. New York: Cambridge University Press, 1977.
- Bruce, Steve. *Politics and Religion.* Cambridge, U.K.: Polity, 2003.
- Demerath, N. J. *Crossing the Gods: World Religions and Worldly Politics.* New Brunswick, N.J.: Rutgers University Press, 2001.
- Durkheim, Émile. *The Elementary Forms of the Religious Life.* 1915. Translated by Joseph Ward Swain. New York: Free Press, 1965.
- Fenn, Richard K. *Beyond Idols: The Shape of a Secular Society.* New York and Oxford: Oxford University Press, 2001.
- Le Goff, Jacques. *The Birth of Purgatory.* Translated by Arthur Goldhammer. Chicago: University of Chicago Press, 1984.
- Luhmann, Niklas. *The Differentiation of Society.* New York: Columbia University Press, 1982.
- Martin, David. *Pentecostalism: The World Their Parish.* Oxford: Blackwell, 2002.
- Norman, Edward. *Secularisation.* London: Continuum, 2002.
- Sommerville, C. John. *The Secularization of Early Modern England: From Religious Culture to Religious Faith.* New York: Oxford University Press, 1992.
- Weber, Max. *On Charisma and Institution Building: Selected Papers.* Edited and with an Introduction by S. N. Eisenstadt. Chicago: University of Chicago Press, 1968.
- Wilson, Bryan R. *Religion in Sociological Perspective.* Oxford and New York: Oxford University Press, 1982.
- Wuthnow, Robert. *The Struggle for America's Soul: Evangelicals, Liberals, and Secularism.* Grand Rapids, Mich.: Eerdmans, 1989.

Richard K. Fenn

TOLERATION. Toleration is a policy or attitude toward something that is not approved and yet is not actively rejected. The word comes from the Latin *tolerare* (to bear or endure), suggesting a root meaning of putting up with something. There is no single and widely accepted definition of the term, and it is hardly an exaggeration to say that every author uses it in his or her own way. Therefore it may be best to understand the many uses of the word in terms of family resemblances.

It should be clear that each of the languages that uses a variant of the Latin term (German, *Toleranz*; Dutch, *tolerantie*; French, *tolérance*; Spanish, *tolerancia*; Italian, *tolleranza*; etc.) adds its own slightly different connotations to the word, based on historical experiences. Languages that do not derive the word from Latin have synonyms, each with some overlap and some difference in usage.

Throughout much of the history of the concept, *toleration* referred largely to a policy or attitude toward different religions. Intolerance could mean burning at the stake of heretics or apostates and forced conversions of adherents to different religions, and tolerance could mean anything short of that. By the late twentieth century, demands for toleration could also refer to other disputed behaviors such as sexual orientations, clothing and dress, drug use, vegetarianism versus meat-eating, and more (although religion was often not far behind these disputes). Ethnic and cultural behaviors and language usage

could be the subject of tolerance and intolerance as well. In medicine, toleration refers to an organism's capacity to absorb or endure something without untoward consequences.

Conceptual Nuances

Most uses of the word understand it as referring to a middle ground on a spectrum between rejection, intolerance, hate, and persecution on one end, and acceptance, approval, love, and respect on the other. They distinguish it from indifference because it only comes into play when something is disliked or disapproved and matters.

Who is doing the tolerating, who or what is being tolerated, and exactly what such toleration entails can vary enormously. Individuals can be said to tolerate their own personal foibles, not to tolerate fools, or to tolerate whole groups. Groups can be said to tolerate individuals within or without, or other groups. States and other political authorities can be said to tolerate individuals, groups, or other states. That which is tolerated can range from the very existence to the appearance, ideas, or activities of the tolerated entity. Toleration can range from providing only limited encouragement, to doing nothing, to applying limited sanctions short of persecution.

Some authors have tried to distinguish "toleration" from "tolerance," with the former referring to official policies and the latter to a personal attribute, but ordinary language does not seem to distinguish the two. For example, we can say that the behavior of tolerant persons shows that they tolerate others, or that all we are asking for from another person is toleration. We can also say that a government policy reflects tolerance of some activity.

Some authors have thought that toleration is only a second-best, half-way measure, and that we ought to go beyond toleration to embrace and respect others. This is certainly the right thing to do where whatever is being tolerated actually deserves to be embraced. But one can wonder if all human beings really are always doing things that deserve respect. What would the world be like if all people and all of their activities were worthy of embrace? Certainly unlike anything we have seen so far. Then, perhaps, there would be no need for a concept like toleration. But until that moment arrives, this is the term for the response to things that merit neither active persecution nor full acceptance.

Toleration may look weak and thin from the perspective of a possible acceptance and embrace, but it can look very good from the perspective of someone who is undergoing persecution. Many a victim of intolerance would just like to be left alone, and that is one of the modes of toleration. One of the paradoxes of toleration is that if one is tolerant of everything, then one is also tolerant of the intolerant. This may mean complicity with persecution, or at least failure to prevent it.

Related Concepts

A large vocabulary of related concepts has been used to define and promote toleration. If, as mentioned above, religion created many of the disputes that lead to persecution, it also produced many concepts that can lead toward toleration. Irenicism

(the seeking of peace), the pursuit of concord, comprehension, latitudinarianism, and basic agreement on fundamentals have been policies of many theologians and churchmen. Where these policies recognize that we may never approve of everything the other thinks or does, they promote toleration. Where they imply that someday we will all agree, they go beyond it.

Other terms that have both religious and secular meanings are relevant. Mercy and charity may inspire one to tolerate. Patience is close to the root meaning of the Latin word, helping one endure what one disapproves. Humility, modesty, and skepticism about one's own knowledge of what is right may incline one to tolerate others even when one disagrees with them. Indulgence can mean allowing something that one could prevent. Compromise may mean conceding some points in order to gain others, tolerating the loss of the conceded points.

High-minded philosophical principles can lead toward toleration. Belief in the autonomy and independence of other people can justify leaving them alone even when one does not like what they are doing. Principles of impartiality and neutrality may make a state stay out of religious or other quarrels. Of course, not just any principle will do: most persecution is justified by principle as well.

Toleration has not always been the result of principle. It can come about for purely practical reasons because of exhaustion, impotence, or impasse. It can be the result of political calculation that hostility does not pay. Swiss physician and theologian Thomas Erastus (1524–1583) gave his name to Erastianism, a term for state supremacy and policies that enforce toleration in order to maintain political stability and prevent religious fighting. Gag orders and decrees prohibiting further debate have often been used to silence contending parties in the hopes of reaching a modicum of mutual toleration.

Liberty of conscience and freedom of religion are policies that sometimes overlap with toleration and sometimes go beyond it. Liberty of conscience usually means that everyone may think what they like, and no one will inquire into what they think. But this is compatible with suppressing public expression of what one thinks. On the one hand, this may be better than regimes in which "thought police" are constantly monitoring people's ideas; on the other, it is not as free as forms of toleration that permit expression. Freedom of religion often means that one can choose among two or more established religions, but it sometimes also implies that one must choose one of the available religions. It may not tolerate rejection of all religion.

Valence

In modern times and in liberal ideology, toleration has a positive valence, associated with open-mindedness and egalitarianism. It can be a valued character trait or a beneficial attribute of a group or state.

But toleration has also been considered a negative trait or attribute. It can be associated with laziness, carelessness, and slacking. While many moderns do not consider it lazy or careless to tolerate other religions, we can capture some of the force that this charge once had if we consider that doing nothing

about cruelty or murder could be characterized as tolerating it. Then the tolerators would be tolerating something they should not, perhaps out of cowardice or carelessness.

Another negative valence of toleration can be found in the Marxist tradition, where tolerating something can be considered part of an oppressive regime. “Repressive tolerance” can include tolerating evil and oppressive people or activities. It can also mean tolerating a protesting group and thus depriving it of the importance it would have if it were taken seriously. In effect, this theory holds that in conditions of class inequality, both tolerance and intolerance are repressive.

Other modern groups have considered toleration condescending and ultimately affirmative of conditions of injustice. For example, T. S. Eliot (1888–1965) wrote that in the conditions of modern secularism “The Christian does not want to be tolerated” (Cranston, p. 101); rather, she wants to be respected. Similarly, spokespeople for ethnic groups, women, gays, and others have objected that simply being in a position of having to be tolerated is already unfair, reflecting power inequalities.

Perhaps because of its middle-way position, toleration is rarely likely to be stable over a long period. Rather, persons or states can become more or less tolerant or more or less tolerated as time goes by and opinions or conditions change. Since intolerance is often a response to a perceived threat, when the perception of threat increases or decreases, toleration may become less or more of an option. Individuals or groups that were once persecuted out of fear but are now perceived as harmless can become tolerated and eventually embraced. Vice versa, if people who were once considered innocuous become perceived as more of a threat, intolerance of them may increase.

Toleration in the Ancient World

Cyrus the Great of Persia (r. c. 558–529 B.C.E.) is a key figure at the foundation of two traditions of toleration. He is praised in the Hebrew Bible for allowing the Jews to return to Jerusalem after Babylonian captivity. And Xenophon (c. 431–c. 352 B.C.E.) lauded him in *The Education of Cyrus* (after 394 B.C.E.) for his policy of religious toleration, placing him in the Greek tradition. Scholars have speculated that his toleration of Medes, Hyrcanians, and other religious and ethnic groups was largely an imperial political strategy. He needed to draw on the manpower of conquered kingdoms and knew it would be easier to defeat kings whose peoples believed they could thrive under his rule.

Aspects of Buddhist religious thought, which originated in India, also justified peacefulness and toleration. Ashoka (r. c. 273–232 B.C.E.), the last emperor of the Mauryan dynasty in India, renounced war and promoted Buddhism while remaining tolerant of other religions.

Throughout much of history, the ancient Chinese were tolerant of a variety of religions ranging from Confucianism to Buddhism and Taoism to animism. Manichaeans and Jews thrived at times. Scholars have speculated that it was precisely because they were tolerated and not persecuted that Jews in ancient China seem to have shed their identity and blended into the rest of the population.

The Koran contains passages about living in peace with peoples of other religions, especially “peoples of the book” (Jews and Christians). Therefore, Islamic cultures such as medieval Spain tolerated flourishing Christian and Jewish communities in what was known as *convivencia*, or living together in peace. The Ottoman Empire developed regimes of toleration of those religions that included the “millet” system, in which each religion had its own legal system and paid its own tax rate, even though only Muslims could hold higher offices.

The ancient Romans were generally tolerant of the existence of many cults because of polytheism, which implied that every hearth, city, and people could have its own gods. When they became an imperial power, they tolerated any religion that would also show signs of respect for Roman deities. They conceived of the Jewish War not as wars against that religion but against a rebellious subject people. Christians were persecuted for their refusal to take part in the imperial cult and for their disrespect for Roman rule, not merely for their religion.

The Rise of Christian Persecution

Throughout world history, local practices of toleration have been interspersed with pogroms and persecution. Sometimes practices of toleration have come before ideas about it, and sometimes ideas have come before practices. Wherever toleration is practiced as a norm, there is not much need to think or write about it. By far the most elaborate discussion of the issue took place in the Christian West in the period from 1500 to 1800, precisely because a great deal of persecution was going on. To fully understand it, we must go back to the origins of Christian persecution.

The situation in the Roman Empire changed when the emperor Constantine (r. 306–337) legalized Christianity in 313 and promoted it as the public religion. Now it was implicated in state power and had to decide whether to tolerate or persecute others. In the following millennium there were wars against Muslims and persecution of pagans and Jews, as well as contentions within Christianity. With respect to the latter, one could justify intolerance if the people one disagreed with could be labeled as heretics or blasphemers.

The word *heresy* originally meant “choice,” as in a choice of beliefs or sects, with no negative connotations. But various passages in the New Testament used it to mean sinful divisiveness. Early church fathers such as St. Irenaeus (c. 120 to 140–c. 200 to 203), Tertullian (c. 155 or 160–after 220), and Eusebius of Caesaria (c. 260–c. 339) refuted the chief early heresies. In 325 Constantine convened the Council of Nicaea to settle church doctrine and then issued an edict banning heresies. In 385 a Spanish bishop, Priscillian (c. 340–385), became the first person to be executed for heresy.

St. Augustine of Hippo (354–430) was the most influential theorist of persecution. After belonging to the Manichaean heresy in his youth, he joined the Catholic Church in 387 and eventually became a bishop. Facing Manichaean, Pelagian, and Donatist heresies, at first he advocated peaceful methods but by about 400 he began to endorse coercion. He interpreted the parable of the tares (Matt. 13:24–30) and the parable of

the feast (Luke 14:21–23) to justify coercion of heretics. The latter was a particularly long stretch, because the parable merely has a rich man prepare a banquet and send his servant out into the streets to find people and “compel them to come in.” Later, both Catholics and Protestants justified forced conversions on the basis of this invitation to a feast.

Further developments in the justification of persecution include the definitions of heresy in Gratian of Bologna’s (d. before 1159) *Decretum* (c. 1140) and many further decrees. The persecution of heretics became the object of armed warfare in the bloody Albigensian Crusade (1209–1229). In 1233 Pope Gregory IX (ruled 1227–1241) assigned the persecution of heresy to the Dominican order, establishing the Inquisition.

Medieval voices for tolerance. However, not everyone went along with the violent treatment of religious difference. The *Dialogue of a Philosopher with a Jew and a Christian* of Peter Abelard (1079–?1144) demonstrated that the pursuit of knowledge could not be detached from the inclusion of diverse standpoints. John of Salisbury (c. 1115–1180) and Marsilius of Padua (c. 1280–c. 1343) combined defenses of personal liberty with functionalist accounts of the organic unity of the political community to maintain that the health of the body politic requires freedom of thought, speech, and even action. John Wycliffe (1330–1384) developed a theory of toleration that derived from his theology of grace and his political theory of the king’s responsibility to protect the welfare of both the graced and the ungraced.

Medieval times also included voices for toleration from the disempowered. Menachem Ha-Me’iri (1249–1316) developed a uniquely Jewish theory of toleration to justify cooperation with gentiles. Christine de Pisan (1364–1430) stressed the interdependence of the various parts of the body politic to justify tolerant treatment of differences of gender, class, and nationality.

In the late medieval or early Renaissance period, Nicholas of Cusa’s *The Peace of the Faith* (1453) recognized that mankind was inherently and inescapably diverse in language, culture, and politics. If there will always be different customs and rites, toleration is justified because persecution is futile. Giovanni Pico della Mirandola (1463–1494) and others from this period also developed toleration for non-Christians from their interests in the Jewish Kabbalah and pagan philosophy.

Early Modern Period

The Protestant Reformation created the most serious challenge to toleration in early modern Europe. Martin Luther (1483–1546), John Calvin (1509–1564), and Huldrych Zwingli (1484–1531) were the three most influential leaders of this movement, which permanently divided Christian Europe. Each demanded toleration for their own movement, but could be intolerant of other religions. Early Catholic responses included violent repression of the Protestants, but Humanists like Desiderius Erasmus (1466?–1536) called for a more irenic response of continuing dialogue and peaceful admonition.

Early Protestants soon justified being left alone based on their interpretations of the Bible. Spiritualists like Hans Denck

(c. 1495–1527) and Sebastian Franck (c. 1499–c. 1542) and mystics like Jakob Böhme (1575–1624) felt that God is within every man, and religious individualism is God’s purpose. Persecuted Anabaptists from Balthasar Hubmaier (1485–1528) and David Joris (c. 1501–1556) to Thomas Helwys (c. 1550–c. 1616) and Leonard Busher (dates unknown) argued that religious persecution is against the spirit of Jesus Christ and that judgment about matters of faith should be left to God. Menno Simons (1496–1561), founder of the Mennonites, argued for Christian pacifism, and Italian Protestants like Bernardino Ochino (1487–1564) and Celio Secondo Curione (1503–1569) defended their right to religious toleration on such grounds as faith is a gift from God, it is tyranny to punish an error of the soul, and God’s church has room for great variety.

At first the Protestants could claim the high moral ground because they did not use violence like their Catholic opponents. Then, in 1553, Michael Servetus (1511–1553) was burned for antitrinitarian heresy in Calvin’s Geneva. This provoked Sébastien Castellio (1515–1563) to write some of the first sustained defenses of toleration. *De haereticis* (1554; Concerning heretics) collected the irenic opinions of several writers and essays by the author under false names. “Heretic” is just the word we use to describe those with whom we disagree, he asserts. The suffering of persecution is actually the sign of a true Christian, and persecution of people who are acting in accord with their consciences promotes hypocrisy and is harmful to everybody. In later works Castellio drew on the ancient skeptics for their rejection of pretended certainty and argued for the separation of church and state. Other writers including Jacobus Acontius (1492–1566) and Mino Celsi (d. c. 1575) followed up on Castellio’s thinking. Among these, Dutchman Dirck Coornhert (1522–1590) insisted that civil unity was more important than religious unity; he was one of the first to argue in favor of tolerating atheists.

Throughout the early modern period, the ideal of the primitive church as voluntary and nonviolent appealed to many people. It could be carried to the point where Pietist Gottfried Arnold’s *Impartial History of Churches and Heretics* (1699–1700) redescribed most alleged heretics as pious, and most of the orthodox as the real heretics.

Catholic toleration. In the Anglophone world there has long been a tendency to claim that most theories of toleration came from the Protestant side. But Father Joseph Lecler found a Catholic writer in favor of toleration for almost every Protestant toleration theorist. For example, Cardinal Reginald Pole (1500–1558) developed the thought that “Heretics be not in all Things Heretics” into a defense of toleration. In the France of the religious civil wars of the sixteenth century, Chancellor Michel de l’Hôpital (1505–1573) strove for compromise and toleration between the Calvinists and Catholics, partly on the basis of his own Catholic religious convictions. The great author Michel de Montaigne (1533–1592) never renounced Catholicism even as his *Essays* (1580–1595) contained many reasons for toleration drawn from individualism, skepticism, and a deep sense of the bodily nature of human beings. Such thinkers were sometimes called “politiques” because of their arguments for toleration on practical political grounds.

Jean Bodin (1530–1596) is an intriguing figure, ostensibly Catholic, but he could have been a Judaizer. In several works including *Colloquium of the Seven about the Secrets of the Sublime* (c. 1588) he argued for nonviolence, neutrality, and mutual agreement not to discuss differences that might lead to fighting.

The Spanish conquest of Latin America led to much abuse of the natives, partly on the ground that they were not good Christians. Writers like the bishop of Chiapas, Bartolomé de Las Casas (1474–1566), wrote in their defense. Half-Spanish half-natives like Felipe Guaman Poma (1532–1614) wrote to reconcile the two cultures, to little effect. Garcilaso de la Vega, known as “the Inca” (1539–1616), also spoke up for tolerance from the native side.

By the mid-eighteenth century active persecution of Protestants in France had died down, but in 1762 Jean Calas, a Protestant, was the victim of a judicial murder. The famous writer Voltaire (1694–1778) took up the cause, publishing *A Treatise on Toleration* (1763), which received European-wide circulation and discredited such persecution in public opinion. It may have been the last major *cri de coeur* against religious violence, because even contemporary and later Catholic treatments of heresy such as François Adrien Pluquet’s *Dictionary of Heresies* of 1762 and Nicolas-Sylvestre Bergier’s *Methodical Encyclopedia* of 1788–1832 took for granted that heresy did not justify violence.

Antitrinitarianism (Socinianism). Antitrinitarianism or unitarianism—the theory that Jesus and the Holy Spirit did not share God’s nature—was a heresy considered as bad as atheism and persecuted all over Europe. But conditions close to anarchy have often been good for toleration. The absence of centralized power in Poland in the later sixteenth century meant that it became a haven for Lelio (1525–1562) and Fausto (1539–1604) Sozzini, founders of the antitrinitarian Socinians, and followers such as Samuel Przytkowski (1592–1670). They developed a battery of reasons why they should not be persecuted, most of them rooted in Scripture. Their much-anathematized writings were published in the Netherlands, which had one of the freest presses of the day. Later, many thinkers such as Isaac Newton (1642–1727) were clandestine sympathizers with antitrinitarianism under another of its variants, Arianism.

The Netherlands out front. The Dutch published a great deal of toleration theory and practiced toleration to a substantial degree from the later sixteenth to the eighteenth centuries. During early decades of the Revolt of the Netherlands (1568–1648) almost anything could be published because of the exhaustion of the political authorities, the myriad of decentralized jurisdictions, and appreciation of the economic value of the book market. William the Silent (1533–1584), leader of the Dutch Revolt, wrote that repression of worship leads to hypocrisy and that no false religion would last.

In the early seventeenth century a theological dispute in the Netherlands between Gomarists and Arminians led to suppression of the Arminians, but also to many writings against that suppression. Simon Episcopius (1583–1643) and Jan Uytenbogaert (1557–1644) wrote that Christian charity and reciprocity requires

freedom of conscience, even for Catholics. Hugo Grotius (Huigh de Groot; 1583–1645) defended a limited tolerance as part of his theory of natural law, which was developed by later natural-law theorists like the German Samuel von Pufendorf (1632–1694). Pufendorf’s *Of the Nature and Qualification of Religion* (1687) claimed that the genius of the Christian religion was nonviolence, that people’s thoughts were not punishable, and that the civil authorities should control religion.

Benedict Baruch Spinoza (1632–1677), an excommunicated Jew, wrote one of the most robust defenses of freedom of thought while living in the Netherlands. In his *Theological-Political Treatise* (1670) he argued for arming the state for security against the mob, and then for reining in the state in matters of religion. Pierre Bayle (1647–1706), a Huguenot refugee in the Netherlands, developed the most sophisticated and most tolerant theory of the century. In *Letters on the Comet* (1682) he showed how atheists could indeed live in civil peace, and in *Philosophical Commentary on the Words “Compel Them to Come In”* (1685) he developed a wide-ranging theory of toleration based on the rights of conscience, even erring conscience, that would protect not only Protestant sects, but Catholics and virtually all others as well. In his last writings, he asserted that he would rather live under an atheist king because that king would have one less reason to persecute.

The English Civil War and its aftermath. The anarchy of the English Civil War was also fertile ground for toleration writings. John Dury (1595–1680), Samuel Hartlib (c. 1600–1662), and Johann Comenius (1592–1670) drew on millenarian hopes to justify reunion and peace among Protestants. Merchant and Leveller William Walwyn (1600–1680) wrote in favor of complete religious toleration on religious grounds. Leveller Richard Overton (fl. 1642–1663) argued for toleration of Jews and Catholics and made free use of humor to take down over-serious persecuting pride, a method recommended in Anthony Ashley Cooper, Third Earl of Shaftesbury’s *Characteristics* (1711). John Milton (1608–1674) made an impassioned case for toleration of divorce in several pamphlets, and then wrote the first major defense of that aspect of toleration known as freedom of the press in *Areopagitica* (1644). His work was followed up in the first substantial French and German defenses of freedom of the press by Elie Luzac (1749) and Karl Friedrich Bahrtdt (1787).

Roger Williams (1603?–1683) founded the English colony of Rhode Island as a haven of freedom of religion, and published *The Bloody Tenent of Persecution* (1644) in favor of separation of church and state and freedom of religion on Christian grounds. William Penn (1644–1718) founded the colony of Pennsylvania as a haven for persecuted Quakers and published *The Great Case of Liberty of Conscience* (1671).

Thomas Hobbes (1588–1679) wrote *Leviathan* (1651), one of the most influential theories of absolute power in the history of political philosophy, but he has also been credited with a theory of toleration in the ruler’s own self-interest. Trying to control people’s thoughts may provoke too much opposition and squanders power that can best be used elsewhere.

The English philosopher John Locke’s (1632–1704) first work on toleration opposed it (1667). But after living for some

years in the Netherlands, becoming friends with Dutch toleration theorist Philip van Limborch (1633–1712), and reading Pierre Bayle and Adriaan Paets (1631–1686) he developed a theory of toleration, which he published in *A Letter Concerning Toleration* (1689). He relied on the Calvinist point that everyone is responsible for his own salvation, skepticism about who really knew the truth, and the political benefits of toleration. Like Milton, however, he was unable to conceive of toleration of Catholics and atheists because of their alleged political unreliability, but later wrote for legal endenization of Muslims and against licensing of the press.

Economic interests, travel writings, and belles lettres. Beyond religious and philosophical ideas, one source of toleration in theory and practice was economics. The Dutch found that wide toleration paid off in economic growth and provided a demonstration effect for the rest of Europe. Henry Robinson's (c. 1605–c. 1664) pamphlets of the 1640s and Daniel Defoe's (1660–1731) many writings of the beginning of the eighteenth century pointed out the commercial benefits of toleration of merchants and customers of differing religions.

Another source of tolerationist ideas was travel literature, which introduced Europeans to different customs and religions from around the world. This could include actual travel accounts; somewhat fanciful travel literature such as Fernão Mendes Pinto's *Travels* (1614); and imaginative works like Denis Veiras's *History of the Sevarites* (1675–1679), Defoe's *Robinson Crusoe* (1719), and Jonathan Swift's *Gulliver's Travels* (1726).

Other genres of literature could be important, too. Aphra Behn's play *Oroonoko* (1688) taught English audiences to tolerate Africans, Gotthold Ephraim Lessing's *Nathan the Wise* (1779) expressed the values of toleration for late-eighteenth-century Germany, and Karl Friedrich Bahrdt's play *The Edict of Religion* (1787) ridiculed Frederick William II's attempt to legislate religious conformity.

Despite all of the foregoing defenses of toleration, open admission of Socinianism or atheism remained dangerous throughout the early modern period. One recourse for Socinians, atheists, and libertines was the circulation of manuscripts and even clandestine printed works in the large underground literature of the time. Much of this literature, which included many pleas for toleration, has been explored in the French annual *La lettre clandestine* (1992–).

Toleration of Jews. Jews and heretics were often subjects of popular and clerical intolerance in medieval and early modern Europe, but writers could counteract some of that sentiment. Millenarians favored toleration of Judaism because they believed that the Jews must voluntarily convert before the restoration of Christ. Histories such as Jacques Basnage's *History of the Jews* (1707–1716) and Ludvig Holberg's *History of the Jews* (1742) helped place this much-maligned people in a more favorable light. The Jewish writer Moses Mendelssohn's *Jerusalem* (1783) was an eloquent plea for religious tolerance.

Nineteenth and Twentieth Centuries

It seems safe to say that although toleration of differing religions remains a political issue even into the twenty-first

century, there have been few or no substantial novelties concerning the idea of toleration since the eighteenth century. Wilhelm von Humboldt's *The Limits of State Action* of 1852, his follower John Stuart Mill's *On Liberty* of 1859, and twentieth-century pleas for tolerance have largely debated, restated, and updated the theoretical ideas already in place from earlier times.

Legal Acts and Declarations

In addition to political pamphlets and philosophical arguments, from the sixteenth century on toleration can be tracked by study of the legal provisions that were decreed to grant it. One form of toleration was settled by the Peace of Augsburg of 1555, which ended some of the wars between Lutherans and Catholics. Under the formula *cuius regio eius religio* (the ruler determines the religion) it held that each prince could decide which of the two religions would be established in his territories and permitted adherents to the other religion to emigrate. Although not much, this was an entering wedge for wider forms of toleration. The principle was reaffirmed, this time including Catholicism, Lutheranism, and Calvinism, in the Peace of Westphalia of 1648.

The Revolt of the Netherlands against Spain after 1560 eventually gave the once-persecuted victorious Protestants the dilemma of deciding how to deal with the large number of Catholics in their territories. Pacts of tolerance were published as early as the 1570s, and in some localities Catholics were forbidden to proselytize or engage in public processions but were allowed to worship in private homes.

In 1568 the Diet of Torda in Transylvania consolidated religious enactments of the previous decades into a decree that “no one should be abused by anyone for his religion” and further similar provisions. In the following decades Anabaptists, Unitarians, Jews, and Orthodox Christians were protected by various laws and patents. In 1573 the king of Poland was forced to accede to the Confederation of Warsaw, which granted Catholics, Lutherans, Calvinists, and even antitrinitarians some protection from persecution, leading to a golden age for Socinians there that lasted for several decades until Catholicism regained the ascendancy.

After decades of civil war between Calvinist Huguenots and Catholics in France, Henry IV enacted the Edict of Nantes in 1598, which guaranteed Protestant rights to worship in their churches and even to certain fortified cities. Several other edicts of the sixteenth century attempted to settle continuing religious rivalry, but Louis XIV ended efforts to make coexistence possible by his Revocation of the Edict of Nantes in 1685. As many as a hundred thousand Calvinists fled France.

Taking advantage of the outflow of these talented and hard-working Huguenots, Frederick William I, the Calvinist great elector of Lutheran Brandenburg, issued the Decree of Potsdam in 1685, announcing that he would provide refuge to them and respect their religion. Many came and settled in Berlin, helping the city prosper.

The Toleration Act of 1689 demonstrates what the word could mean in England in that period. It suspended penal laws

against Protestants who refused to conform to the Church of England. It did not lift penalties against antitrinitarians and Catholics, who were only given equal rights in 1813 and 1829, respectively. It maintained privileges such as exclusive qualification for political office for members of the Church of England. Nevertheless, this could be considered toleration because it allowed some dissenting sects that had not previously been permitted to worship in public to do so. Its perhaps unintended consequence was to keep alive the idea that other sects could eventually be tolerated, too.

Many who emigrated to the English colonies in North America did so in pursuit of religious freedom. Maryland's Act Concerning Religion of 1649 was the first to spell out religious freedom. As mentioned above, Roger Williams founded the colony of Rhode Island in order to institute religious liberty. By the later eighteenth century, the ideal of religious toleration was often institutionalized by declarations of rights. The Virginia Declaration of Rights of 1776, several other state declarations, and the First Amendment to the United States Constitution (1791) provided for religious freedom. In France, the "Declaration of the Rights of Man and of the Citizen" of the National Assembly in 1789 provided that "No one shall be disquieted on account of his opinions, including his religious views, provided their manifestation does not disturb the public order established by law" (Article 10). The United States and France served as models for such ideals and declarations in many countries throughout the next century.

Twentieth-century declarations. In the twentieth century, the United Nations internationalized the tradition of declarations of rights to toleration. In 1948 the General Assembly adopted the Universal Declaration of Human Rights, providing that "everyone has the right to freedom of thought, conscience and religion; this right includes freedom to change his religion or belief, and freedom, either alone or in community with others and in public or private, to manifest his religion or belief in teaching, practice, worship and observance" (Article 18).

In 1996 the United Nations Educational, Social, and Cultural Organization (UNESCO) issued a "Declaration of Principles of Tolerance." Ignoring the ordinary usage of *tolerance* as referring to the middle of the spectrum between persecution and warm embrace, UNESCO redefined it by fiat as "respect, acceptance and appreciation of the rich diversity of our world's cultures" (Article 1.1). This was surely well-intended as an effort to move people who are unjustifiably opposed to diversity toward more open-mindedness. But if warm embrace becomes the exclusive meaning of *toleration*, we will surely need another term for our attitude or policy toward the things we may justifiably not respect, accept, or appreciate, but also do not persecute.

See also **Christianity; Heresy and Apostasy; Liberalism; Liberty; Orthodoxy; Orthopraxy.**

BIBLIOGRAPHY

PRIMARY SOURCES

Bahrdr, Karl Friedrich. *The Edict of Religion: A Comedy; and The Story and Diary of My Imprisonment*. 1789. Translated and

edited by John Christian Laursen and Johan van der Zande. Lanham, Md.: Lexington, 2000.

Bayle, Pierre. *Pierre Bayle's Philosophical Commentary: A Modern Translation and Critical Interpretation*. 1685. Translated by Amie G. Tannenbaum. New York: Lang, 1987.

Castellion, Sébastien. *Concerning Heretics*. 1554. Translated by Roland H. Bainton. New York: Columbia University Press, 1935.

Locke, John. *A Letter Concerning Toleration, in Focus*. 1689. Edited by John Horton and Susan Mendus. London: Routledge, 1991.

Luzac, Elie. *Essay on Freedom of Expression*. 1749. In *Early French and German Defenses of Freedom of the Press*, edited by John Christian Laursen and Johan van der Zande. Leiden: Brill, 2003.

Milton, John. *Areopagitica*. 1643. In *Areopagitica and Other Political Writings by John Milton*, edited by John Alvis. Indianapolis: Liberty Fund, 1999.

Penn, William. *The Great Case for Liberty of Conscience*. 1670. In *The Political Writings of William Penn*, edited by Andrew R. Murphy. Indianapolis: Liberty Fund, 2002.

Pufendorf, Samuel. *Of the Nature and Qualification of Religion in Reference to Civil Society*. 1687. Edited by Simone Zurbuchen. Indianapolis: Liberty Fund, 2002.

Robinson, Henry. *Liberty of Conscience*. 1644. San Francisco: California State Library, 1940.

Spinoza, Benedictus de. *Theological-Political Treatise*. 1670. Translated by Samuel Shirley. Indianapolis: Hackett, 2001.

Williams, Roger. *The Bloody Tenent of Persecution*. London: n.p., 1644.

SECONDARY SOURCES

Berkvens-Stevelinck, Christiane, Jonathan Israel, and G. H. M. Posthumus Meyjes, eds. *The Emergence of Tolerance in the Dutch Republic*. Leiden, Netherlands: Brill, 1997.

Cranston, Maurice. "John Locke and the Case for Toleration." In *On Toleration*, edited by Susan Mendus and David Edwards. Oxford: Clarendon, 1987.

Eijnatten, Joris van. *Liberty and Concord in the United Provinces: Religious Toleration and the Public in the Eighteenth-Century Netherlands*. Leiden, Netherlands: Brill, 2003.

Guggisberg, Hans R. *Sebastian Castellio, 1515–1563: Humanist and Defender of Religious Toleration in a Confessional Age*. Göttingen, Germany: Vandenhoeck and Ruprecht, 1997.

Jordan, W. K. *The Development of Religious Toleration in England*. 4 vols. London: Allen and Unwin, 1932.

Laursen, John Christian, ed. *Histories of Heresy in Early Modern Europe: For, against, and beyond Persecution and Toleration*. New York: Palgrave Macmillan, 2002.

———, ed. *Religious Toleration: "The Variety of Rites" from Cyrus to Defoe*. New York: St. Martin's, 1999.

Laursen, John Christian, and Cary J. Nederman, eds. *Beyond the Persecuting Society: Religious Toleration before the Enlightenment*. Philadelphia: University of Pennsylvania Press, 1998.

Lecler, Joseph. *Toleration and the Reformation*. 2 vols. London: Longmans, 1960.

Levine, Alan. *Sensual Philosophy: Toleration, Skepticism, and Montaigne's Politics of the Self*. Lanham, Md.: Lexington, 2001.

Murphy, Andrew R. *Conscience and Community: Revisiting Toleration and Religious Dissent in Early Modern England and America*. University Park: Pennsylvania State University Press, 2001.

Nederman, Cary J. *Worlds of Difference: European Discourses of Toleration, c. 1100–c. 1550*. University Park: Pennsylvania State University Press, 2000.

Nederman, Cary J., and John Christian Laursen, eds. *Difference and Dissent: Theories of Toleration in Medieval and Early Modern Europe*. Lanham, Md.: Rowman and Littlefield, 1996.

John Christian Laursen

TOTALITARIANISM. Totalitarianism is a concept rooted in the horror of modern war, revolution, terror, genocide, and, since 1945, the threat of nuclear annihilation. It is also among the most versatile and contested terms in the political lexicon. At its simplest, the idea suggests that despite Fascist/Nazi “particularism” (the centrality of the nation or the master race) and Bolshevik “universalism” (the aspiration toward a classless, international brotherhood of man), both regimes were basically alike—which, as Carl Friedrich noted early on, is not to claim that they were wholly alike. Extreme in its denial of liberty, totalitarianism conveys a regime type with truly radical ambitions. Its chief objectives are to rule unimpeded by legal restraint, civic pluralism, and party competition, and to refashion human nature itself.

Coined in May 1923 by Giovanni Amendola, *totalitarianism* began life as a condemnation of Fascist ambitions to monopolize power and to transform Italian society through the creation of a new political religion. The word then quickly mutated to encompass National Socialism, especially after the Nazi “seizure of power” in 1933. By the mid-1930s, invidious comparisons among the German, Italian, and Soviet systems as totalitarian were becoming common; they increased considerably once the Nazi-Soviet pact was signed in 1939. Meanwhile, recipients of the totalitarian label took different views of it. Although, in the mid 1920s, Benito Mussolini and his ideologues briefly embraced the expression as an apt characterization of their revolutionary élan, Nazi politicians and propagandists saw a disconcerting implication. Granted, Adolf Hitler and Joseph Goebbels, during the early 1930s, had a penchant for cognate expressions such as “total state”; so, too, did sympathetic writers such as Ernst Forsthoff and Carl Schmitt. At around the same time, Ernst Jünger was busy expounding his idea of “total mobilization.” But “totalitarianism” was treated with greater circumspection. The *Volksgemeinschaft* (national community), Nazi spokesmen insisted, was unique: the vehicle of an inimitable German destiny based on a national, racially based, rebirth. *Totalitarianism* suggested that German aspirations were a mere variant on a theme; worse, a theme that current usage extrapolated to the Bolshevik foe.

Once Fascism and Nazism were defeated, a new global conflict soon emerged, and with it a reinvigorated role for “totalitarianism.” Anxiety over Soviet ambitions in Europe prompted Churchill’s use of the term twice in his “Iron Curtain” speech on March 5, 1946, at Fulton, Missouri. A year later, the Truman Doctrine entrenched the word in American foreign policy and security jargon. Then the Cold War took its course, punctuated by the Berlin Airlift, the building of the Berlin Wall, the Sino-Soviet treaties, the Korean War, the Cuban

Missile Crisis, and the Hungarian, Czech, and Polish uprisings. At each turn, the language of totalitarianism received a further boost, though there were significant national variations in the credence it received. In the United States, the language of totalitarianism, despite dissenting voices, had wide appeal across the political spectrum. In France, by contrast, it had practically none until the decay of existentialism and the appearance of Solzhenitsyn’s work on the Soviet Gulag triggered a major attitudinal shift. Postwar Germany represents an intermediate case: officially sanctioned by the Federal Republic, *totalitarianism* became the focus of major intellectual controversy from the late 1960s onward.

Even periods of engagement with the Soviet Union— notably détente and the Ronald Reagan–Mikhail Gorbachev dialogue—stimulated debate over totalitarianism. Some commentators optimistically announced its softening and demise, while others deplored collaborating with the totalitarian enemy. During the Soviet Union’s last decade, Western academics and foreign policy experts argued over the distinction between two kinds of regime. Authoritarian regimes (sometimes also called “traditional” or “autocratic”) typified the apartheid state in South Africa, Iran under the Pahlavis, and the South American military juntas. Though hierarchical, vicious, and unjust, they had limited goals, and they left large parts of society (religious practice, family, and work relations) untouched. Conceivably, they were capable of reformist evolution toward representative government. In contrast, totalitarian regimes were depicted as utopian, inherently expansionist, and indelibly tyrannical, an evil empire. Treating them as normal states was folly. Meanwhile, in central Europe, embattled oppositionists during the late 1970s and 1980s were coining terms that suggested novel permutations on the classical model. “Posttotalitarian” regimes, suggested Václav Havel in *The Power of the Powerless* (1978), retained a brutal apparatus of coercion but were no longer able to enthuse their populations with faith. Resistance required puncturing a hollow, mechanically recited ideology by everyday acts of noncompliance and by “living in truth” (that is, by speaking and acting honestly).

Following the collapse of the Soviet Union, twenty-first-century Islamism and the “war against terror” continued to keep the idea of totalitarianism salient. Yet if all these experiences are inseparable from the discourse of totalitarianism, its longevity has also been promoted by three rather different factors. One factor is the term’s elasticity. It can be applied either to institutions or to ideologies, to governments or to movements, or to some combination of all of these. Additionally, it can be invoked to delineate an extant reality or a desire, myth, aim, tendency, experiment, and project. *Total* and its cognates (*totality*, *total war*, etc.) are commonplaces of the current age, so it is unsurprising that *totalitarianism* is also one. A second factor, more important still, is the role played by journalists, novelists, poets, playwrights, and filmmakers in publicly disseminating the images of totalitarian domination. Their role was to ensure that totalitarianism never became a recondite, academic term but one central to the vernacular of educated people. Totalitarianism was a buzzword of political journalism before it received, in the late 1940s and 1950s, searching treatment by social science and political theory. Its

first literary masterpiece was Arthur Koestler's *Darkness at Noon* (1941) with its sinister portrayal of the Communist confessional. Many great works on a similar theme followed, making totalitarianism vivid and unforgettable to readers electrified by the pathos and terror such writing evoked.

Still, no novelist is more responsible for the notion that totalitarianism penetrates the entire human personality, dominating it from within, than George Orwell (Eric Arthur Blair, 1903–1950). That view appeared nothing less than prescient when stories later circulated in the 1950s about “brainwashing” of captured prisoners of war (POWs) during the Korean War. Orwell deserves a special place in any historical audit of totalitarianism for another reason. *Nineteen Eighty Four* (1949) introduced terms—“Thought Police,” “Big Brother,” “Doublethink”—that have since entered the English language as unobtrusively as those of Shakespeare and the King James Bible. So long as his work appears in the secondary school and university curricula, totalitarianism as an idea will survive. In a similar way, no one is more responsible for informing a general public about the Soviet Gulag than Aleksandr Solzhenitsyn (b. 1918). To his extraordinary novels, memoirs, and what he called “experiments in literary investigation,” one may add the work of Osip Mandelstam, Nadezhda Mandelstam, Anna Akhmatova, Boris Souvarine, and Boris Pasternak. Each bequeathed a searing portrait of the depravity and recklessness of “totalitarian” systems.

Finally, totalitarianism's endurance as a term owes much to its capacity for provocative and counterintuitive application. It was not only heterodox Marxists such as Herbert Marcuse who indicted modern pluralist regimes for a systemically imbecilic, one-dimensional, and totalitarian mass culture. Liberals such as Friedrich Hayek also warned in 1944 of totalitarian developmental tendencies—particularly the fetish with state planning and intervention—that were paving the “road to serfdom.” Many critics of the New Deal took a similar view; Herbert Hoover notoriously called Franklin Delano Roosevelt a “totalitarian liberal.” Also disquieting was the sociologist Erving Goffman's contention in *Asylums* (1961) that Nazi death camps were broadly comparable to widely accepted “total institutions” such as the asylum, prison, barracks, and orphanage. The implication was that totalitarianism was not an exotic species of regime “over there” but a legitimized institution or trend deeply embedded within modernity as a whole.

Origins, Trajectory, Causation

Theorists of totalitarianism take very different views of its origins. For some, Hannah Arendt foremost among them, totalitarianism is radically new, an unprecedented development that attended Europe's economic, political, and moral ruination during and after World War I. From this perspective, attempts to locate a long-established lineage of totalitarianism are fundamentally mistaken. So, too, are analogies of totalitarianism with Caesarist, Bonapartist, and other dictatorial regimes. Totalitarianism is conjunctural or unique, not an extreme version of something previously known. The point of using the term is precisely to show the novelty of the regime type and the crisis it denotes. Other writers, conversely, believe that totalitarianism has deeper roots. Hence it might be said that totalitarianism is

a perverted outgrowth of the Martin Luther–sanctioned authoritarian state, or an exaggerated legacy of tsarist intolerance. Or it might be argued that “totalitarian dictatorship” is ancient, prefigured in the Spartan state or the Roman imperial regime of Diocletian (r. 284–305). That was the judgment of Franz Neumann, who in addition claimed that National Socialism had revived the “fascist dictatorship” methods of the fourteenth-century Roman demagogue Cola di Rienzo. Nor, according to still others, should totalitarianism be understood as an exclusively occidental institution. Karl Wittfogel in *Oriental Despotism* (1957) found “total power” in the hydraulic governance of ancient China. And while sinologists have major reservations about describing Maoism as totalitarian, victims such as Harry Wu, imprisoned for nineteen years in the Chinese Laogai, exhibit no such compunction. Totalitarianism has also been located in Africa, for instance, in the rule of Shaka Zulu, while the Soviet Union itself was often depicted as a hybrid entity, more “Asian” than Western.

The search for the roots of totalitarian ideas, as distinct from institutions, has generated yet another fertile literature. Karl Popper found protototalitarianism in Plato. Max Horkheimer and Theodor Adorno spied a totalitarian dialectic evolving out of an “Enlightenment” fixation on mathematical formalization, instrumental reason, and the love of the machine. J. L. Talmon discovered a creedal, “totalitarian democracy” arising from one tendency among eighteenth-century philosophies. Enunciated by Jean-Jacques Rousseau (1712–1778), Morelly (fl. mid-eighteenth century), and Gabriel Bonnot de Mably (1709–1785); radicalized by the French Revolution, especially during its Jacobin phase; reincarnated in the Babouvist conspiracy, “totalitarian democracy” amounted to a leftist “political messianism” that preached the arrival of a new order: homogenous, egalitarian, yet supervised by a virtuous revolutionary vanguard able to divine the general will. This reminds one of Alexis de Tocqueville's observation, in *The Ancien Regime and the French Revolution* (1856), that the Revolution's “ideal” was nothing less than “a regeneration of the whole human race. It created an atmosphere of missionary fervor and, indeed, assumed all the aspects of a religious revival.” That “strange religion,” he continued, “has, like Islam, overrun the whole world with its apostles, militants, and martyrs” (p. 44).

Tocqueville's reference to Islam was deliberately discomfiting. It reminded his audience of what a modern “enlightened” European revolution shared with a declining Oriental civilization. Less than a century later, Bertrand Russell augmented that idea when he suggested that Bolshevism was like Islam, while John Maynard Keynes, in lapidary mood, remarked that “Lenin [was] a Mahomet, and not a Bismarck.” Yet since Al Qaeda's suicide attack on the World Trade Center and the Pentagon on September 11, 2001, a growing number of commentators have contended that it is *modern* Islam, or at least the current of Islamism associated with the legacy of the Egyptian Muslim Brotherhood and the Saudi Wahabite movement, with which previous European revolutions are best compared. On this account, twenty-first century Islamist (and perhaps Ba'athi) ideology, practice, and organization bear many disquieting parallels with National Socialism and Bolshevism.

Modern Islamism is a radical movement in which pluralism is anathema, and in which politics itself is derided as a sphere of venality. To that extent it mirrors Islamic doctrine more generally since the suras of the Koran make no categorical or principled distinction between public and private spheres: every duty emanates from God alone. The state has no independent authority. Among Islamist militants, the substitute for political institutions is, above all, the fellow-feeling and camaraderie bestowed by membership of a secret society and the existential tests that confront the believer. “Muslim totalitarianism” reconfigures the capillary, decentralized organization of its Western precursors. Islamist militants combine the conspiratorial anti-Semitism of the Nazis (for whom they entertain a nostalgic admiration) with the pan-territorial ambitions of Bolshevik universalism. Islamist language is also replete with millenarian images of struggle, merciless destruction, and “sacred terror.” Bent on purifying the world of Zionism, liberalism, feminism, and Crusader (U.S.) hegemony, Islamist ideology articulates a mausoleum culture of submission, nihilism, suicidal martyrdom for the cause, and mythological appeal to a world about to be reborn. That archaic demands for the reestablishment of the hallowed caliphate are pursued with all the means modern technology affords is consistent with the “reactionary modernism” of earlier totalitarian movements.

Such totalitarian parallels or intellectual lineages do not satisfy those who insist that family resemblance is no substitute for attributable historical causation. And since the early 1950s it has frequently been acknowledged that theorists of totalitarianism are much more adept at constructing morphologies than they are at establishing the precise relationship of totalitarian regimes to one another. François Furet argued this point eloquently, claiming too that Arendt’s hodgepodge reconstruction of totalitarianism’s career had failed to explain the “very different origins” of fascism and communism. Like Ernst Nolte, Furet was convinced that a “historico-genetic” approach to these movements was required to supplement the standard typological one. Like Nolte, as well, he believed that Bolshevism and National Socialism were historically linked, still a taboo contention among many leftists. Yet Furet disagreed with Nolte’s contention that, essentially, National Socialism was a reaction to Bolshevism, a defensive if evil posture that gained credibility owing to the disproportionate influence of Jews in Marxist and socialist parties. According to Furet, the genealogical relationship between Bolshevism and National Socialism was not principally cause and effect. Each had its own endogenous history. The two movements’ affinity derived instead from the fact that both of them (and Italian Fascism too—Mussolini was once a revolutionary socialist) emerged from the same “cultural” atmosphere: a late-nineteenth-, early-twentieth-century milieu suffused with “hatred of the bourgeois world.” Deep and bitter loathing of that world was well established before World War I and thus also before the October Revolution. Equally, German anti-Semitism did not require Jews to be major spokesmen and leaders of the left to be an object of detestation. Anti-Semitism was already firmly established before Bolshevism erupted, because Jews were seen as a vanguard of democracy itself. Bourgeois democracy was the common enemy of totalitarian movements: the “communist sees it as the

breeding ground of fascism, while the fascist sees it as the antechamber of Bolshevism (Furet and Nolte, p. 33).”

Totalitarian Characteristics

A conventional way of describing totalitarianism is to present a list of characteristics common to Italian Fascism, German National Socialism, and Soviet Bolshevism. (Other regimes may also be included—notably, Chinese Communism under the rule of Mao, the Democratic People’s Republic of Korea (North Korea), and Pol Pot’s “Democratic Cambodia.”) But how capacious should that portmanteau be? In *Totalitarianism*, published in 1954, Carl Friedrich itemized five elements, which, in a subsequent collaboration with Zbigniew Brzezinski, he increased to six. Yet, before that, Arthur M. Hill concocted fifteen points that Norman Davies, in *Europe: A History* (1997), expanded to seventeen. Recurrently mentioned features of totalitarianism include the following:

- A revolutionary, exclusive, and apocalyptic ideology that announces the destruction of the old order—corrupt and compromised—and the birth of a radically new, purified, and muscular age. Antiliberal, anticonservative, and antipluralist, totalitarian ideology creates myths, catechisms, cults, festivities, and rituals designed to commemorate the destiny of the elect.
- A cellular, fluid, and hydra-like political party structure that, particularly before the conquest of state power, devolves authority to local militants. As it gains recruits and fellow believers, the party takes on a mass character with a charismatic leader at its head claiming omniscience and infallibility, and demanding the unconditional personal devotion of the people.
- A regime in which offices are deliberately duplicated and personnel are continually shuffled, so as to ensure chronic collegial rivalry and dependence on the adjudication of the one true leader. To the extent that legal instruments function at all, they do so as a legitimizing sham rather than a real brake on the untrammelled use of executive power. Indeed, the very notion of “the executive” is redundant since it presupposes a separation of powers anathema to a totalitarian regime.
- Economic-bureaucratic collectivism (capitalist or state socialist) intended to orchestrate productive forces to the regime’s predatory, autarchic, and militaristic goals.
- Monopolistic control of the mass media, “professional” organizations, and public art, and with it the formulation of a cliché-ridden language whose formulaic utterances are designed to impede ambivalence, nuance, and complexity.
- A culture of martial solidarity in which violence and danger (of the trenches, the street fight, etc.) are ritually celebrated in party uniforms, metaphors

(“storm troopers,” “labor brigades”), and modes of address (“comrade”). Youth are a special audience for such a culture, but are expected to admire and emulate the “old fighters” of the revolution.

- The pursuit and elimination not simply of active oppositionists but, and more distinctively, “objective enemies” or “enemies of the people”—that is, categories of people deemed guilty of wickedness in virtue of some ascribed quality such as race or descent. Crimes against the state need not have actually been committed by the person accused of them. Hence the “hereditary principle” in North Korea where punishment is extended to three generations (the original miscreants, their children, and their grandchildren). Under totalitarianism, it is what people are, more than what they do that marks them for punishment. As Stéphane Courtois observes, “the techniques of segregation and exclusion employed in a ‘class-based’ totalitarianism closely resemble the techniques of ‘race-based’ totalitarianism” (p. 16). Soviet and Chinese Marxism may have claimed to represent humanity as a whole, but only a humanity divested first of millions—classes, categories—who were beyond the pale of Marxist doctrine. Its universalism was thus always, like National Socialism, an exclusive affair.
- Continual mobilization of the whole population through war, ceaseless campaigns, “struggles,” or purges. Moreover, and notwithstanding ideological obeisance to ineluctable laws of history and race, totalitarian domination insists on febrile activity. The mercurial will of the leader and the people as a whole must constantly be exercised to produce miracles, combat backsliding, and accelerate the direction of the world toward its cataclysmic culmination.
- The pervasive use of terror to isolate, intimidate, and regiment all whom the regime deems menacing. Charged with this task are the secret police rather than the army, which typically possesses significantly fewer powers and less status than it does under a non-totalitarian dictatorship or “authoritarian” regime.
- The laboratory of totalitarian domination is the concentration camp. The experiment it conducts aims to discover the conditions under which human subjects become fully docile and pliable. In addition, a slave labor system exists side by side with a racial and/or class-oriented policy of genocide. In Nazi Germany, Jews were the principal objective enemy—over six million were murdered—but there were others such as Slavs and Gypsies. In the Soviet Union, key targets of annihilation or mass deportation were Cossacks (from 1920), kulaks (especially between 1930–1932), Crimean Tartars (1943), Chechens, and Ingush (both in 1944). The Great Purge of 1937–1938 is estimated to have killed close to 690,000 people, but this is dwarfed by the systematically induced famine in Ukraine in 1932–1933,

thought to have killed around six million. Pol Pot’s Cambodian Communist Party had a similar penchant for mass extermination, as did the Chinese Communist Party (CCP) under Mao: the Chairman boasted that 700,000 perished in the 1950–1952 campaign against “counterrevolutionaries.” The CCP targeted landlords and intellectuals, and through a policy of accelerated modernization created the famine of the Great Leap Forward that claimed around 30 million victims.

It should be noted that there is widespread disagreement among commentators about whether Italian Fascism is properly classified as a totalitarian system. Hannah Arendt and George Kennan thought otherwise. Mussolini’s regime, on such accounts, is best comprehended as an extreme form of dictatorship or, according to Juan Linz, a species of “authoritarianism.” Though preeminent, it shared power with other collective actors such as the monarchy, the military, and the Catholic Church in a way that was utterly alien to National Socialism and Bolshevism. Official anti-Semitism was less intense and less vigorously policed. And Mussolini was domestically ousted in a way that indicates a far more precarious grip on power than either Hitler or Stalin evinced.

The Coherence of Totalitarianism

Since the 1950s, the majority of academic commentators who favor the term have acknowledged that totalitarianism was never fully successful in its quest for complete domination. (Critics of the concept of totalitarianism are considered in the final section of this entry.) This was the key intuition of David Riesman in his correspondence with Hannah Arendt (he read in manuscript the last part of *The Origins of Totalitarianism* [1951]). It was also a theme of the Harvard Project on the Soviet Social System and its literary offspring—notably, Alex Inkeles and Raymond Bauer’s *The Soviet Citizen: Daily Life in a Totalitarian Society* (1961). To that extent, as Daniel Bell remarked, totalitarianism was always a concept in search of reality. Unlike political philosophers, moreover, social scientists tend to see totalitarianism as an ideal-type, a one-sided model constructed for research purposes, which also suggests that totalitarianism in the flesh can be of greater or lesser virulence. Studies of inmate camp “culture” lend further credence to the oxymoronic concession that totalitarianism had its limits. Tsvetan Todorov and Anne Applebaum show that even under conditions expressly designed to expunge all traces of solidarity, acts of “ordinary virtue” persisted. Hence there were always people who maintained their dignity (by keeping as clean as they could), who cared for others (sharing food, tending the sick), and who exercised the life of the mind (by reciting poetry, playing music, or committing to memory camp life so as to allow the possibility of its being fully documented later). Michel Mazor’s luminous, yet astonishingly objective, autobiographical account of the Warsaw Ghetto (*The Vanished City*, 1955) expresses a similar message of hope. Survivors of death camps and Gulags have typically conveyed a different message, however. Crushed by a merciless regime determined to exterminate not only an individual’s life, but the concept of humanity itself, inmates endured a vertiginous “gray zone” of collaboration and compromise.

Any list of totalitarian features, such as the one itemized above, raises an obvious question: What gives the typology its coherence? Or, to put the matter differently, is there some property that furnishes the whole with its master logic or integral animation? Two frequently rehearsed, and related, answers are discernible. The first takes up the pronounced totalitarian attachment to the will, dynamism, and movement. As early as 1925, Amendola was struck by the “wild radicalism” and “possessed will” of the Italian Fascists. Mussolini himself spoke proudly of “la nostra feroce volonta totalitaria” (“our fierce totalitarian will”). And the virtue of “fanaticism,” “will,” and “the movement” for the nation’s well-being was tirelessly rehearsed by Hitler and Goebbels, as it was later by Mao. *Yundong* (movement, campaign) was among the most salient ideas of the Chairman, who specifically emphasized the importance of chaos. Sinologist Michael Schoenhals observes that in its original Maoist sense (since disavowed by Deng Xiaoping and his successors, who prefer to speak of an incremental *fazhan* or “development”), *yundong* entails the deliberate “shattering of all regular standards,” the suspension of all stabilizing rules, norms, and standards that may apply in ordinary times. The goals of this regularized suspension—there were sixteen major national “movements” between 1950 and 1976—were to orchestrate hatred against the Party’s latest enemy (often previously hallowed figures within the Party), to arouse superhuman efforts in support of economic targets, and incessantly to combat “revisionism” and the emergence of new elites. The Soviet Union during the heyday of Stalinism exhibited similar characteristics, as Boris Pasternak’s Dr. Zhivago explains:

The point is, Larissa Fyodorovna, that there are limits to everything. In all this time something definite should have been achieved. But it turns out that those who inspired the revolution aren’t at home in anything except change and turmoil: that’s their native element; they aren’t happy with anything that’s less than on a world scale. For them, transitional periods, worlds in the making, are an end in themselves.

The centrality of flux and activism to the idea of totalitarianism is integral to classical academic accounts of the phenomenon. It prompted Franz Neumann, in *Behemoth: The Structure and Practice of National Socialism* (1942), to call the Third Reich a “movement state,” and Ernst Fraenkel to describe it as a “dual state” in which the “normal” functions of the legal and administrative apparatus were constantly undermined by Party “prerogative”—Fraenkel’s term for the maelstrom of feverish Nazi initiatives that unleashed bedlam without respite. Similarly, Sigmund Neumann entitled his comparative study of the Nazi, Fascist, and Bolshevik hurricanes *Permanent Revolution: The Total State in a World at War* (1942).

Still, the most influential account along these lines was that proffered by Hannah Arendt. Totalitarianism, she argued, was a mode of domination characterized far less by centralized coordination than by unceasing turbulence. To confuse totalitarianism with dictatorship or to see it as a type of dictatorship (or even state) was to miss a fundamental distinction. Once consolidated, dictatorships—for instance, military juntas—typically

become routinized and predictable, domesticating and detaching themselves from the movements that were their original social basis. Totalitarian regimes, in contrast, rise to power on movements that, once installed in office, employ motion as their constitutive “principle” of domination. The volcanic will of the leader whose next decision could nullify all previous ones; rule by decree rather than law; the continual manufacture of new enemies; police institutions, Gulags, and death camps whose only purposes are to transform citizens into foes and transform individuals into an identical species and then into corpses: All these features characterize a regime-type of eternal transgression. “Terror,” remarks Arendt, is itself “the realization of the law of movement; its chief aim is to make it possible for the force of nature or of history to race freely through mankind, unhindered by any spontaneous human action” (p. 465). Indeed, it is the grotesque destructiveness and futility of totalitarian systems, their attack on every norm that might anchor human life in something stable, that makes them so resistant to methodical analysis.

A second thread that runs through discussions about totalitarianism is the pagan ardor that Fascism, National Socialism, and Bolshevism were capable of generating. Once more, Amendola was a pioneer in this line of interpretation, calling Fascism a “war of religion” that demands total devotion. More sympathetically, the philosopher Giovanni Gentile, ghost-writer of Mussolini’s “The Doctrine of Fascism” (1932), stressed the new movement’s penetrative spirit. Of special significance was the myth of rebirth: the creation of a new nation or a world without classes, and the formation of a selfless New Man or Woman, untainted by decrepit habits. Fascism, Mussolini avowed, was the author of the Third Italian Civilization (the previous two being the Roman Empire and the Renaissance). Nazi ideology was also replete with notions of national redemption, the spirit of a rejuvenated people, and even the divine mission of the SS. World War I, and the community of front-line soldiers (*Frontsgemeinschaft*) or “trenchocracy” it witnessed, was typically identified as the crucible of this steely resurrection. Coup d’état strategizing, the battles to defeat the Whites during the civil war, and the perennial trumpeting of the class struggle, promoted a similar mentality among the Bolshevik leaders.

Commentators who stress the mythological component of totalitarianism—writing of “ersatz religions,” “political religions,” the “myth of the state,” the “sacralization of politics,” and “palingenesis”—include Raymond Aron, Albert Camus, Ernst Cassirer, Norman Cohn, Waldemar Gurian, Jacob Talmon, and Eric Voegelin. Worthy successors are Michael Burleigh, Roger Griffin, and Emilio Gentile. Gentile, while desisting from the view that political religion is the most important element of totalitarianism, nonetheless affirms that it is “the most dangerous and deadly weapon” in its ideological arsenal (p. 49). Civic religions, such as those found in the United States and France, are different from political religions because they celebrate a republican concept of freedom and law. Church and state are separated, but each has its legitimate sphere of activity. In contrast, the sacralization of politics under totalitarian rule, together with its liturgies, festivals, and cults, is marked by the deification of the leader; idolatrous worship of the state,

which arrogates to itself the exclusive right to determine Good and Evil; marginalization or destruction of traditional religion; orgiastic mass rallies; immortalization of the party fallen; the appeal to sacrifice; and the cult of death. Interpretations of totalitarianism that emphasize political religion have one notable implication. They suggest that totalitarianism is best understood not as a singular event, or a unique set of institutions, but as a recurrent possibility of the modern world shorn of its customary restraints.

Criticisms and Responses

At the risk of simplification, criticisms of the concept of totalitarianism may be divided into two main, though overlapping, types: moral-political and scientific. The first type of criticism takes different forms but often hinges on the argument that *totalitarianism* was employed during the Cold War as an ideological weapon of a particularly Manichean, self-serving, and self-righteous kind. Starkly dividing the world into liberal democratic white-hats and communist black-hats, Abbott Gleason remarks, conveniently omitted the extent to which Western governments supported military and other regimes with bleak and bloody human-rights records. Describing military juntas as authoritarian rather than totalitarian made no difference to the people they murdered. A twist on this criticism, found among American disciples of the Frankfurt School, is that liberal democracy itself is not in principle the antithesis of totalitarianism, because both are disastrous permutations of “Enlightenment modernity.” A rather different objection is that totalitarianism is an opportune way for former collaborators of Nazism, Bolshevism, and so forth, to dodge responsibility for their actions. Its exculpatory value turns on the claim that “resistance was impossible” or that “we were all brainwashed.” Yet the charge of double standards is also made by those, such as Martin Malia, who vehemently defend the pertinence of *totalitarianism* as a label. Disavowing that term all too often means denying the evil symmetry of Nazism and Bolshevism. By recapitulating earlier leftist dogmas—that genuine antifascism required support for the Soviet Union, that comparisons with Nazi Germany are unacceptable because they play into the hands of U.S. imperialism—such denials can become an expedient means of rescuing Marxism from its real, sanguinary history. In a similar way, loose talk of the “dialectic of Enlightenment” is less a challenge to common sense than it is a meretricious affront to its very existence. In any case, the term *totalitarianism* preceded the Cold War by more than two decades.

Scientific objections to totalitarianism as an idea typically focus on a diverse set of issues. Critics argue that the notion is mistaken because:

- Totalitarianism is a fictive Orwellian dystopia instead of an empirical reality. The Soviet system, for instance, “did not exercise effective ‘thought control,’ let alone ensure ‘thought conversion,’ but in fact depoliticized the citizenry to an astonishing degree” (Hobsbawm, p. 394). Official Marxism was unspeakably dull and irrelevant to the lives of most people.
- *Totalitarianism* is a misnomer because in neither the Soviet Union nor Nazi Germany was terror total.

Instead it was always focused on particular groups. In the Soviet Union, terror formed a radius in which danger was greatest the nearer one was to power and purge. In Germany, once active domestic opposition to the Nazis was defeated, and Jews were deported to the camps, most citizens existed at peace with a regime they deemed legitimate. The majority would never have considered themselves as terrorized by it. Distinguishing between seasoned adversaries and pesky grumblers, the undermanned Gestapo rarely intruded into normal life. Denunciation by citizens of one another was a more effective means of garnering information than the prying eye of the security state.

- The theory of totalitarianism fails to specify a mechanism to explain the internal transition of the Soviet Union and China to nontotalitarian phases. Indeed, the very evolution of such regimes toward humdrum routinization flies in the face of the idea that totalitarianism is above all a movement that cannot be pacified, and is the antithesis of all forms of political normality.
- Totalitarian regimes are too heterogeneous for them to be classified under a single rubric. Under Mao, for instance, the People’s Liberation Army was a more powerful organ of control than the security forces, while Mao’s prestige was periodically checked, and occasionally deflated, by other CCP leaders. The contrasts between Hitler and Joseph Stalin are, Ian Kershaw suggests, even more telling. While Stalin was a committee man who ascended to rule within a recently established system, Hitler was a rank outsider, strongly averse to bureaucratic work of all kinds. Similarly, while Stalin was an interventionist micromanager, Hitler had little to do with the actual functioning of government. People did not so much directly follow his detailed orders, of which there were few, as second guess what he wanted them to achieve, thereby “working toward the Führer.” Then again, Hitler was a spectacular and mesmerizing orator; Stalin’s words were leaden by comparison. Mass party purges characterize one system, but not the other (the liquidation of the Röhm faction in 1934 was a singular event). And finally the systems over which the men prevailed had a different impetus. Stalin’s goal of rapid modernization was, some say, a humanly understandable, if cruelly executed, objective; that the end justifies the means is a standard belief of all tyrants. Conversely, the mass slaughter of the Jews and others was, for Hitler, an end in itself, unquestionably irrational if not insane.

All these objections are themselves the targets of rebuttal. Modernization at the expense of the nation it is intended to benefit seems hardly rational. Its victims rarely thought so. And did not Hitler, too, think in terms of instrumental means and ends? The goal was a purified Aryan civilization, regenerate,

marital, manly, and beautiful. To achieve it, putative nonhumans had to vanish from the face of the earth. Moreover, the transitions that Soviet and Chinese Communism witnessed by no means nullify the totalitarian model. They only appear to do so, Victor Zaslavsky argues, because of failure to distinguish between “system building” and “system maintenance” phases; the latter represents a more stable development, but one still mired in the militarization of society and mass surveillance. Where previous thinkers have erred is in identifying the “system building” stage with totalitarianism *tout court*. Finally, critics of the totalitarian model often object to it on spurious grounds. For to argue that totalitarianism was never systematic in its rule, never fully synchronized, but rather “chaotic,” “wasteful,” and “anarchic” is hardly a criticism of those such as Arendt who made such attributes pivotal to their theory. In good measure, her emphasis on movement is vindicated even by those who employ a different terminology. Examples include “regimes of continuous revolution” (enunciated by Michael Mann) and “cumulative radicalization” (preferred by Hans Mommsen).

Conclusion

As a vehicle for condemnation as well as analysis, *totalitarianism* is likely to remain a vibrant idea long into the twenty-first century. Its extension to radical Islam is already evident. And as a potent reminder of the terrible deeds of which humans are capable, the concept has few conceptual rivals. Principled disagreements as well as polemics about its value continue to mark its career. Present dangers, and anxious debates about how they should best be characterized, suggest that the age of totalitarianism is not yet over.

See also **Authoritarianism; Communism; Fascism; Nationalism.**

BIBLIOGRAPHY

- Applebaum, Anne. *Gulag: A History*. New York: Doubleday, 2003.
- Arendt, Hannah. *The Origins of Totalitarianism*. 1951. Reprint, New York: Harcourt Brace, 1968. Rich, acute, idiosyncratic, puzzling, seminal.
- Baehr, Peter, and Melvin Richter, eds. *Dictatorship in History and Theory: Bonapartism, Caesarism, and Totalitarianism*. Cambridge, U.K.: Cambridge University Press, 2004.
- Berman, Paul. *Terror and Liberalism*. New York: Norton, 2003. On “Muslim totalitarianism.”
- Burleigh, Michael. *The Third Reich: A New History*. New York: Hill and Wang, 2001.
- Canovan, Margaret. *Hannah Arendt: A Reinterpretation of Her Political Thought*. Cambridge, U.K.: Cambridge University Press, 1992. Unsurpassed analysis of Arendt’s multilayered theory of totalitarianism.
- Chandler, David. *Voices from S-21: Terror and History in Pol Pot’s Secret Prison*. Berkeley: University of California Press, 1999.
- Courtois, Stéphane, et al. *The Black Book of Communism: Crimes, Terror, Repression*. 1997. Reprint, Cambridge, Mass.: Harvard University Press, 1999. Foreword by Martin Malia. Contains chapters devoted to the Soviet Union, China, Cambodia, North Korea, Vietnam, Afghanistan, Central and Southeastern Europe, Latin America, and Africa.
- Friedrich, Carl J., ed. *Totalitarianism: Proceedings of a Conference Held at the American Academy of Arts and Sciences, March 1953*.

- Cambridge, Mass.: Harvard University Press, 1954. Contributors include Karl W. Deutsch, Erik H. Erikson, Waldemar Gurian, Alex Inkeles, George F. Kennan, Harold D. Lasswell, and Bertram D. Wolfe.
- Friedrich, Carl J., and Zbigniew K. Brzezinski. *Totalitarian Dictatorship and Autocracy*. 2nd rev. ed. Cambridge, Mass.: Harvard University Press, 1965. Lucid and influential.
- Furet, François, and Ernst Nolte. *Fascism and Communism*. Translated by Katherine Golsan. 1998. Reprint, Lincoln: University of Nebraska Press, 2001. A model of civilized debate by two of the twentieth century’s foremost historians.
- Gentile, Emilio. “The Sacralization of Politics: Definitions, Interpretations, and Reflections on the Question of Secular Religion and Totalitarianism.” Translated by Robert Mallett. *Totalitarian Movements and Political Religions* 1, no. 1 (2000): 18–55.
- Gleason, Abbott. *Totalitarianism: The Inner History of the Cold War*. New York: Oxford University Press, 1995. Excellent overall account which, despite its title, actually starts in the 1920s. My references to Giovanni Amendola come from this source.
- Griffin, Roger, ed. *Fascism*. Oxford: Oxford University Press, 1995. Ably edited collection that stresses Fascism’s ideological core in “palingenesis”—the myth of rebirth.
- Hobsbawm, Eric. *Age of Extremes*. New York: Pantheon, 1994.
- Kershaw, Ian, and Moshe Lewin, eds. *Stalinism and Nazism: Dictatorships in Comparison*. Cambridge, U.K.: Cambridge University Press, 1997. Includes essays by Michael Mann and Hans Mommsen.
- Kirkpatrick, Jeane. *Dictatorships and Double Standards: Rationalism and Reason in Politics*. New York: Simon and Schuster, 1982.
- Lifka, Thomas E. *The Concept “Totalitarianism” and American Foreign Policy, 1933–1949*. New York: Garland, 1988.
- Lifton, Robert Jay. *Thought Reform and the Psychology of Totalism*. New York: Norton, 1961. Rich empirical study of Chinese Communist “brainwashing.”
- Linz, Juan J. *Totalitarian and Authoritarian Regimes*. Boulder, Colo.: Rienner, 2000. A rigorous analysis that distinguishes among a variety of authoritarian regimes.
- Menze, Ernest A., ed. *Totalitarianism Reconsidered*. Port Washington, N.Y.: Kennikat, 1981. Contains two essays by Karl Dietrich Bracher.
- Nathan, Andrew. *China’s Transition*. New York: Columbia University Press, 1997.
- Schapiro, Leonard. *Totalitarianism*. New York: Praeger, 1972.
- Schoenhals, Michael, ed. *China’s Cultural Revolution, 1966–1969: Not a Dinner Party*. Armonk, N.Y.: Sharpe, 1996.
- Talmon, Jacob L. *The Origins of Totalitarian Democracy*. 1952. Reprint, Boulder, Colo.: Westview, 1985. A classic within the genre concerned with “political religion.”
- Todorov, Tsvetan. *Facing the Extreme: Moral Life in the Concentration Camps*. Translated by Arthur Denner and Abigail Pollak. New York: Owl, 1997.
- Zaslavsky, Victor. “The Katyn Massacre: ‘Class Cleansing’ as Totalitarian Praxis.” Translated by Joseph Cardinale. *Telos* 114 (1999): 67–107. Robust critique of the Frankfurt School’s “dialectic of Enlightenment” approach; argues for two phases of totalitarian development.

Peter Baehr

TOTEMS. The word *totem* is an anglicized rendering of the Ojibwa word *ninto:tem*. It refers to an animal or plant species emblematic of a specific group, notably a clan. While the term was originally applied only to practices of natives of northeastern North America, it was soon extended to refer to superficially similar phenomena around the globe, whose observances came to be known as “totemism.”

Evolutionary Theories

The concept of *totemism* as a form of religion was first formulated by John McLennan, one of the most prominent Victorian anthropologists, in an article entitled “The Worship of Animals and Plants” (1869–1870). McLennan based his concept on similarities between the beliefs and practices of native Australians on one hand, and native North Americans, especially from the northeastern United States, on the other. McLennan summarized his conclusions:

There are tribes of men (called primitive) now existing on the earth in the totem stage, each named after some animal or plant, which is its symbol or ensign, and which by the tribesmen is religiously regarded; having kinship through mothers only, and exogamy as their marriage law. In several cases, we have seen, the tribesmen believe themselves to be descended from the totem, and in every case to be, nominally at least, of its breed or species. We have seen a relation existing between the tribesmen and their totem . . . that might well grow into that of worshipper and god, leading to the establishment of religious ceremonials to allay the totem’s just anger, or secure his continued protection. (p. 518)

McLennan had earlier theorized that the earliest stages of human kinship and marriage, once humanity had evolved out of primeval hordes, were characterized by matrilineal descent and by exogamy—a term he coined and that was arguably his most lasting contribution to anthropology—the rule that states that one must marry outside one’s own kin group. Totemism, he suggested, was the earliest stage of religion, the logical companion to matrilineal descent and exogamy. The rest of his essay attempted to demonstrate that the Greek and Roman deities were anthropomorphized versions of earlier totemic animal and plant spirits.

The thesis that the worship of animals and plants was the earliest form of religion was not original to McLennan. It had been formulated over one hundred years earlier in 1760 by the French Enlightenment thinker Charles de Brosses, in a book entitled *Du culte des dieux fétiches* (Of the cult of the fetish gods), in which he attempted to establish parallels between ancient Egyptian religion and the contemporary religious practices of sub-Saharan Africans. However, McLennan considered fetishism to be a more general concept than totemism, which he argued was its most primitive form.

From Robertson Smith to Spencer and Gillen. In 1889 William Robertson Smith constructed a more elaborate scenario for the origin of religion around the idea of totemism. In *The Religion of the Semites*, he theorized that the original

form of Semitic religion (and by implication all religions) revolved around the notion of kinship between a human community, its totem species, and its god. Under normal circumstances, precisely because of such conceptions of kinship, men were forbidden to eat their totems. However, on specific ritual occasions, the totem animals were sacrificed and shared among members of the community and with their god, in an act where commensality—eating together—was literally a form of communion.

Robertson Smith’s theories were a direct inspiration to those of Émile Durkheim and Sigmund Freud, but they were based on no concrete evidence and were entirely speculative. However, ten years later, the detailed ethnographic research of Baldwin Spencer and F. J. Gillen in *The Native Tribes of Central Australia* appeared to lend credence to his hypothesis. Spencer and Gillen described important ceremonies called *Intichiuma*, which members of the clan performed in order to ensure the natural increase of particular species of animal or plant. At the end of the ceremony, initiates (women and children were rigorously excluded) consumed small portions of the sacred species. Spencer and Gillen’s work also included elaborate descriptions of initiation ceremonies and of the *churinga*—the sacred paraphernalia of totemic groups. They also contradicted McLennan’s hypothesis that totems were associated with matrilineal descent. In fact, a child did not derive his totem directly from either his mother or father, but from the spot where his mother believed him to have been conceived.

Frazer. Sir James Frazer’s *Totemism and Exogamy* (1910) was a massive, four-volume compendium of instances of totemism throughout the world. Frazer rejected McLennan’s contention that totemism was the earliest form of religion: “If religion implies, as it seems to do, an acknowledgment of the part of the worshipper that the object of his worship is superior to himself, then pure totemism cannot properly be called a religion at all, since a man looks upon his totem as his equal and friend, not at all as his superior, still less as his god” (vol. 4, p. 5). Rather, he considered totemic practices to be a form of magic, historically prior to the emergence of religion *per se*. The title of his book notwithstanding, Frazer also disagreed with McLennan’s contention that totemism was necessarily associated with exogamy. Although Frazer conceded that this was frequently the case, he correctly noted that later ethnographers had amassed ample cases of cultures where totemism existed without exogamy, or vice versa, and he provided different speculative explanations for the origins of both phenomena.

Durkheim and Freud

Émile Durkheim, in *The Elementary Forms of Religious Life* (1912), emphatically rejected Frazer’s claim that totemism did not constitute a religion. On the contrary, he used totemism as a case of “the simplest and most primitive religion that observation can make known to us” (1995 ed., p. 21), basing his assertion on Australian ethnography (especially Spencer and Gillen) but resorting to examples from North America and elsewhere at critical junctures of his argument. Durkheim used his analysis of totemism to demonstrate the social origins of knowledge and the underlying unity of religious, philosophical, and

scientific thought. Australian social organization was quite complicated, with tribes divided and subdivided into exogamous moieties (“halves”), classes, and clans, each associated with different species, in a system that incorporated all natural phenomena. “[These] facts illuminate the manner in which the idea of genus or class took form among humans. . . . It was the phratries [i.e., moieties] that served as genera and the clans as species. It is because men formed groups that they were able to group things” (p. 145).

Totemism was not just a way of thinking but also of acting and feeling, organized around the separation of the domains of “sacred” and “profane” that, for Durkheim, constituted the essence of religion itself. More sacred than the totem animals themselves were the *churinga*, bull roarers of wood or stone with schematic representations of the totemic ancestors painted upon them. Uninitiated women and children were forbidden to see them on pain of death, and loss or destruction of one of them was considered catastrophic. But totemism was no more the literal worship of *churinga* than of animals and plants; rather, these were merely the symbolic representations of a force, which Durkheim called *mana*, that was simultaneously external and internal to the worshiper. For Durkheim, the totem was the flag of the clan, a concrete object on which the individual’s allegiance was projected: ultimately, it was nothing other than society’s representation of itself to its members. In this sense, religion in general and totemism in particular did not “rest upon error and falsehood” but was indeed “grounded in and express[ed] the real” (p. 2). Unlike his predecessors, Durkheim stressed the fundamental comparability of “primitive” and “modern” religious thought rather than their essential dissimilarity.

Totem and Taboo. A year later, Sigmund Freud was to suggest in *Totem and Taboo* (1913) that totemism was the expression of a psychological, rather than social, reality. His theory was predicated on the link between totemism and exogamy, which Freud took to be a manifestation of the horror of incest. He was also profoundly inspired by Robertson Smith’s hypothesis of the ritual sacrifice and consumption of the totem animal. However, he incorporated these ideas into an original scenario of his own. Humanity, he suggested, once lived in primal hordes where the father monopolized all the women and exerted tyrannical authority over his children. His sons eventually conspired to kill him, eat him, and take his place. However, the guilt that they experienced not only prevented them from mating with their mother and sisters but ultimately caused them to institute a prohibition on incest.

Psychoanalysis has revealed to us that the totem animal is really a substitute for the father, and this really explains the contradiction that it is usually forbidden to kill the totem animal, that the killing of it results in a holiday and that the animal is killed and yet mourned. The ambivalent emotional attitude which to-day still marks the father complex in our children and so often continues into adult life also extended to the father substitute of the totem animal. (p. 182)

For Freud, parallels between the behavior of “primitives” and “neurotics” led him to seek explanations of both phenomena in

terms of his understanding of universal unconscious emotional processes.

Critique and Elaboration

By the time Durkheim and Freud were writing, the very concept of totemism had already come under attack in a long article by American anthropologist A. A. Goldenweiser, "Totemism: An Analytical Study" (1910). Goldenweiser began by listing the main features believed to be symptomatic of totemism:

1. An exogamous clan.
2. A clan name derived from the totem.
3. A religious attitude towards the totem; as a "friend," "brother," "protector," etc.
4. Taboos, or restrictions against the killing, eating (sometimes touching and seeing), of the totem.
5. A belief in descent from the totem (pp. 182–183).

In a comparison of cases from around the world, he arrived at the devastating conclusion that "Each of these traits . . . displays more or less striking independence in its distribution; and most of them can be shown to be widely-spread ethnic phenomena, diverse in origin, not necessarily coordinated in development, and displaying a rich variability of psychological make-up" (p. 266). Goldenweiser was not quite prepared to give up the concept altogether and proposed a definition of the phenomenon in terms of the association between "definite social units" and "objects and symbols of emotional value" (p. 275). Arguably, such a definition was far too vague and general to be of any use. A few years later, in a highly influential synthesis of cultural anthropology, Robert Lowie was to summarize Goldenweiser's findings and draw an even more radical conclusion: "Why not abandon the vain effort to thrust into one Procrustean bed a system of naming, a system of heraldry, and a system of religious or magical observances?" (p. 143). In other words, he suggested that there was no such thing as totemism, that it was for all intents and purposes an invention of anthropologists.

British functionalism and structural-functionalism.

British anthropologists were less ready to give up the concept of totemism than their American colleagues. Bronislaw Malinowski is often credited with an excessively utilitarian explanation of totemism: "The road from the wilderness to the savage's belly and consequently to his mind is very short, and for him the world is an indiscriminate background against which there stand out the useful, primarily the edible, species of animals or plants" (p. 44). Actually, Malinowski's position was slightly more complex, and he conceded that the "primitive" interest in nature, selective as it might be, was not limited to the edible, but included sentiments of admiration or fear. One way or the other, "the desire to control the species, dangerous, useful, or edible . . . must lead to a belief in special power over the species, affinity with it, a common essence between man and beast or plant" (p. 45).

A. R. Radcliffe-Brown, Malinowski's rival and contemporary, had a more sophisticated approach to the problem,

seeing it as part of "a much wider group of phenomena, namely the general relation between man and natural species in mythology and ritual. It may well be asked if 'totemism' as a technical term has not outlived its usefulness" (p. 117). More specifically, he suggested that totemism was a product of segmentary forms of social organization, the division of society into moieties, clans, or other similar institutions. He proposed a tentative analogy with sainthood in Roman Catholicism: saints are, at one level, universally recognized within the church, but also have particular relationships with specific congregations. In a similar manner, totem species do not simply stand for the clan, as Durkheim suggested, but also for the clan's place in a broader social scheme that includes all totemic species.

The students of Malinowski and Radcliffe-Brown tended to eschew general pronouncements on the nature of totemism. Instead, Raymond Firth, Meyer Fortes, and E. E. Evans-Pritchard, among others, wrote sophisticated ethnographic analyses of religion and social organization in specific societies, discussing totemism among the Tikopia, the Tallensi, or the Nuer in terms that could not readily be generalized. For example, Evans-Pritchard sought to understand totemism in terms of broader Nuer beliefs about *kwoth*, "God" or "Spirit." There were both higher and lower manifestations of "spirit," with totemic spirits definitely belonging to the realm of "spirits of the below." Nuer totems, he noted, were not symbols of lineages, since some lineages had none and other lineages shared the same totem but did not otherwise acknowledge kinship with one another. Nor did totems symbolize Spirit as such, but rather the relationship between God and a particular lineage. In short, such an analysis embedded totemism within the religious beliefs and practices of a particular society.

The Structural Study of Totemism

Paradoxically, Claude Lévi-Strauss began his short book *Totemism* (1962) with the contention that totemism as such did not really exist, comparing it to the concept of hysteria that emerged in psychology at about the same period: "once we are persuaded to doubt that it is possible arbitrarily to isolate certain phenomena and to group them together as diagnostic signs of an illness, or of an objective institution, the symptoms themselves vanish or appear refractory to any unifying interpretation" (1963 ed., p. 1). Even more damning than Goldenweiser, he suggested that the very concept of "totemism" served as a mechanism for establishing a gulf between "primitive" and "civilized" humanity. Ostensibly, totemistic primitives were those who confused the boundaries between "nature" and "culture," if not worshiping animals and plants at least positing bonds of kinship between humans and nonhuman species.

In one sense, the book was an obituary, the history of an illusion. However, it ironically recouped the value of the very concept it pretended to dismiss, as can be seen in the book's most oft-cited phrase, a rejoinder to functionalist approaches: "natural species are chosen [as "totems"] not because they are 'good to eat' but because they are 'good to think'" (p. 89). Examples of so-called totemism were really instances of universal features of human thought, a theme to which Lévi-Strauss returned in *The Savage Mind* (1962), several chapters of which were also devoted to totems and totemism. Seen in this light,

“totemism” was simply a variety of metaphorical thought—with the proviso that metaphor was an indispensable feature of human thought in general. What is more, the metaphor rested, not on the perception of intrinsic similarities, but rather on the recognition of systematic differences. In other words, if there were a Kangaroo clan and an Emu clan, this was not because members of the first clan considered themselves like kangaroos and the second clan like emus. Rather, the difference between species served as a metaphor for the difference between human groups, Nature as a metaphor for Culture.

Animal symbolism and classificatory schemes. In a radical way, Lévi-Strauss changed the terms in which problems were phrased. (To the extent that his book sealed the death knell of the concept of “totemism,” there ceased to be a single problem.) Whereas Lévi-Strauss’s particular concerns were with uncovering the abstract properties of human thought lurking behind concrete instances of its application, British anthropologists were able to combine his approach with an enduring preoccupation with the dynamics of specific societies. In particular, they examined the social implications of the ways in which different cultures classified animals.

Undoubtedly the best-known example is Mary Douglas’s analysis of the dietary prohibitions detailed in Leviticus. Robertson Smith had suggested that the pig, along with the dog, the horse, the mouse, the dove, and some varieties of fish were offered as totemic sacrifices in early Semitic religion. Douglas suggested instead that the distinction between clean and unclean (and forbidden) animals was an artifact of a system of classification made very clear in the text, and that distinguished between the normal and the anomalous. Mammals that had cloven hooves and that chewed their cud were the typical food of pastoralists like the ancient Hebrews, a criterion that excluded the pig, just as the notion that creatures who live in the water should typically possess scales and fins excluded eels, sharks, or shrimp. But such concerns with alimentary purity accompanied a preoccupation with social purity, and especially with the maintenance of a clear boundary between Jews and Gentiles, expressed in terms of separation of the clean from the unclean.

Ralph Bulmer’s analysis of the classification of the cassowary by the Karam of New Guinea took a similar approach. The cassowary, a relative of the ostrich and the emu, was not classed as a bird by the Karam. There were special rules for hunting cassowaries, who could not be shot with spear or arrow but had to be snared and bludgeoned. Live cassowaries had to be kept away from the village and fields, and usually they were cooked and eaten in the forest. Indeed, a person who killed a cassowary was ritually dangerous, and had to avoid the taro crops for a month. This attitude toward the cassowary simultaneously assimilated cassowaries to quasi-human status while highlighting the symbolic separation of the domains of the forest and the cultivated fields, a separation that in turn paralleled ambivalent relations between brother and sister. Sisters left the home village at marriage, but their children held residual rights in land; however, the brother’s sons tended to view these rights ambivalently at best. This attitude was captured by the symbolism of the cassowary, which was equated with the father’s sister’s children.

Other work along similar lines included S. J. Tambiah’s analysis of food prohibitions in Thailand and Edmund Leach’s comparison of the sexual commutations of animal names in English and in highland Burma. Ultimately, such analyses represent the very antithesis of the aims of the early writing on totemism, which sought to demonstrate the illogical nature of “primitive” as opposed to modern European thought. Instead, modern anthropologists have insisted, not only on the logical nature of non-European thought, but on its deep affinities with our own modes of thinking and speaking.

See also Myth; Religion; Symbolism; Untouchability; Taboos.

BIBLIOGRAPHY

- Bulmer, Ralph. “Why Is the Cassowary Not a Bird? A Problem of Zoological Taxonomy among the Karam of the New Guinea Highlands.” *Man*, n.s., 2 (1967): 5–25.
- Douglas, Mary. *Purity and Danger: An Analysis of Concepts of Pollution and Taboo*. London: Routledge and Kegan Paul, 1966.
- Durkheim, Émile. *The Elementary Forms of Religious Life*. Translated by Karen E. Fields. New York: Free Press, 1995. Originally published in 1912.
- Evans-Pritchard, E. E. *Nuer Religion*. Oxford: Clarendon, 1956.
- Frazer, J. G. *Totemism and Exogamy: A Treatise on Certain Early Forms of Superstition and Society*. 4 vols. London: Macmillan, 1910.
- Freud, Sigmund. *Totem and Taboo: Resemblances between the Psychic Lives of Savages and Neurotics*. Translated by A. A. Brill. New York: Vintage, 1946. Originally published in 1913.
- Goldenweiser, A. A. “Totemism: An Analytical Study.” *Journal of American Folk-lore* 23 (1910): 179–293.
- Leach, Edmund R. “Anthropological Aspects of Language: Animal Categories and Verbal Abuse.” In his *New Directions in the Study of Language*, edited by Eric H. Lenneberg. Cambridge, Mass.: MIT Press, 1964.
- Lévi-Strauss, Claude. *The Savage Mind*. Chicago: University of Chicago Press, 1966.
- . *Totemism*. Translated by Rodney Needham. Boston: Beacon Press, 1963.
- Lowie, Robert. *Primitive Society*. New York: Boni and Liveright, 1920.
- Malinowski, Bronislaw. *Magic, Science and Religion and Other Essays*. Boston: Beacon Press, 1948.
- McLennan, John. “The Worship of Animals and Plants.” Reprinted in his *Studies in Ancient History. The Second Series: Comprising an Inquiry into the Origin of Exogamy*. London and New York: Macmillan, 1896. Originally published in 1869–1870.
- Radcliffe-Brown, A. R. *Structure and Function in Primitive Society*. Glencoe, Ill.: Free Press, 1952.
- Smith, W. Robertson. *The Religion of the Semites: The Fundamental Institutions*. Reprint, New York: Schocken Books, 1972. Originally published in 1889.
- Spencer, Baldwin, and F. J. Gillen. *The Native Tribes of Central Australia*. Reprint, New York: Dover, 1968. Originally published in 1899.
- Tambiah, S. J. “Animals Are Good to Think and Good to Prohibit.” *Ethnology* 8 (1969): 424–459.

Robert Launay

TRADE. Trade is one of the basic processes that link individuals and groups. Trade binds people to one another through the expectations of reciprocal giving, through the formal calculus of wages and markets, and through the desires or needs to obtain items not locally available. In this way, trade is a fundamental element of human culture.

Trade and exchange are often used synonymously, but there is a basic difference. Trade refers to the movement of goods between individuals or groups where there is a general expectation of reciprocity and where the purpose is basically utilitarian. Exchange has a broader meaning, encompassing all movements of goods. The general expectation of reciprocity need not be a part of exchange, nor does exchange have to be utilitarian in nature. In contrast, both are central to trade.

Approaches to the Study of Trade

Various perspectives can be applied to understanding trade. Here it is discussed as reciprocity, exploitation, and adaptation, and in the context of globalization.

Trade as reciprocity. The earliest anthropological approaches to trade focused on reciprocity and how the expectations of reciprocity shaped social relations. In the classic ethnography *Argonauts of the Western Pacific* (1922), for example, Bronislaw Malinowski described and interpreted a complex system of reciprocal trade in the Trobriand Islands known as the *kula*. The items traded in the *kula* were of two kinds: shell beads and armbands. The value of these items was determined by their age and renown—some were heirloom pieces and even had names. The goal of participants in the *kula* was to gain prestige by obtaining, and then giving away, large amounts of *kula* goods and particularly highly valued heirloom pieces. Participants could lose prestige if they gave away valued items but did not receive equivalents in return. Malinowski described individuals carefully planning *kula* expeditions to other islands and scheming ways to bring particular *kula* goods into their possession. In this way, *kula* was a system of reciprocal trade through which the Trobrianders created and maintained social status.

But what about less formal systems of reciprocal trade, like the giving of Christmas presents? If we give a Christmas present to our neighbors, we generally expect one in return. And, if we give a nice present, we expect a similarly nice one in return. There is no formal system like the *kula* in place, so how is reciprocity maintained? These more sophisticated questions about trade were asked by anthropologists after Malinowski, and many significant contributions were made. Among the most influential was the work of Marcel Mauss, whose essay *The Gift* (1954) posited a universal reciprocal structure for gift giving. Mauss argued that gifts symbolize the giver, and the act of giving symbolizes the relationship between the giver and the receiver. The act of giving a gift necessitates a reciprocal gift if a social relationship is to be maintained. If a reciprocal gift is not given, it signals the end of the relationship. Gift giving, then, often takes on a cyclical form (as is the case with Christmas presents) and is a fundamental way that humans maintain social relationships.

Anthropological work on trade as reciprocity was pulled together in a concise form by Marshall Sahlins. In *Stone Age*

Economics (1972), Sahlins defined three forms of reciprocal trade: balanced reciprocity, generalized reciprocity, and negative reciprocity. Balanced reciprocity describes the forms of trade examined by Malinowski and Mauss, where there is an expected balance between what is given and what is received through trade. Generalized reciprocity is a less structured form of trade and takes place mainly within families and kin groups. For example, families often share an evening meal. Parents provide and prepare the food, and both parents and children share it. Children are expected to reciprocate by clearing the dishes, taking out the garbage, and loving and obeying their parents. Through these actions children maintain a general balance in the trade between family members, but no formal accounting is kept and no expectation of formal balance is ever made. This is the basic nature of generalized reciprocity. Negative reciprocity essentially refers to forms of cheating or stealing. Negative reciprocity occurs when one party in a trade relationship receives less than they give. Sahlins posited that negative reciprocity is most common when dealing with people from other societies for, as both Malinowski and Mauss imply, negative reciprocity within one's own society would seriously disrupt social relationships.

Trade as exploitation. Sahlins's definition of negative reciprocity illustrates the idea that not all trade takes place on an even footing. Some forms of trade are unequal, even exploitive. In the 1970s and 1980s a number of anthropologists began examining trade as an element of larger systems of production and consumption, often employing Marxist modes of production models. Eric Wolf's *Europe and the People without History* (1982) is illustrative of this type of research. Wolf explored three "modes of production": kin-based, which is characterized by generalized and balanced reciprocity; tributary, where tribute or taxes are provided to a centralized political authority that manages and maintains the society; and capitalist. For Wolf (and many others), the capitalist mode of production is rooted in exploitation. Workers sell their labor for wages but they must, by the very nature of capitalism, be paid less than their labor is actually worth—if not, then no profit would be possible. Wolf explains that capitalists in Europe were able to find a way around this problem by obtaining raw materials (and even labor in the form of slaves) for next to nothing by taking them from colonial areas. In the process, they actively exploited and essentially dehumanized the people living in those regions by creating a formal structure of negative reciprocity—one in which social relations cannot be maintained.

Trade as adaptation. The idea that trade is generally utilitarian in nature was seemingly ignored by anthropologists until the 1960s. At this time, theories of human behavior based on ecology began to be employed by anthropologists, and trade came to be seen as fundamental to the creation and maintenance of an ecosystem. Trade provided a mechanism through which matter, energy, and information moved through human-dominated ecosystems. For example, Stuart Piddocke (1965) argued that a reciprocal trade system known as the potlatch (and similar in nature to the *kula*) was essential to the survival of the Kwakiutl peoples of British Columbia. Piddocke demonstrated that the environment in which the Kwakiutl lived was subject to fluctuations that, in the same year, would

THE FORMALIST/SUBSTANTIVIST DEBATE

In the 1950s a group of social scientists, the most prominent among them being Karl Polanyi, proposed that trade was a social construction like the rest of culture and could not be usefully examined outside of its unique social setting. This perspective came to be known as “substantivism.” The substantivists argued that economic analyses of noncapitalist trade employing concepts like supply and demand, rational choice, profit, and other ideas linked to capitalist market economics was misguided, because these concepts were either meaningless or had different meanings in noncapitalist social settings. Other scholars, and archaeologists in particular, countered that markets and market-like economies were present for millennia before capitalism, and that many noncapitalist economies appear to be usefully analyzed with concepts and methods drawn from the study of capitalism. This perspective came to be known as “formalism.” The “formalist/substantivist” debate consumed economic anthropology throughout much of the 1960s, with no clear winner emerging. In the early twenty-first century, most anthropologists see the benefits of both perspectives in understanding trade.

cause some populations to lack resources while others had excess resources. The potlatch, Piddocke argued, was a formal system in which populations redistributed resources from areas with excess to areas of scarcity. For the Kwakiutl, then, trade was part of their adaptation to a highly variable and unstable environment.

Trade, globalization, and meaning. With increasingly global markets and the introduction of Western capitalism into all corners of the world, anthropologists have become increasingly concerned with the effects of trade on the cultures they study. As Wolf pointed out, initial trade relations in many of these areas were highly exploitive, and they essentially prevented the formation of social relationships between indigenous populations and Western capitalists. In most ways, the situation did not change much in the twentieth century, and many anthropologists are working at the turn of the twenty-first with indigenous populations to help them gain equity in trade relationships.

As Western products enter non-Western cultures, anthropologists have also become increasingly interested in the meanings people attach to things. How are new products integrated into society? What is the effect of the loss of indigenous products? Arjun Appadurai (1986) suggested that objects themselves are socially created, that their circulation through a society gives them meaning and purpose, and that they are recontextualized as they move through different social contexts. In this sense, the distinction between foreign and local goods becomes blurred, as “foreignness” and “localness” are attributes that are socially assigned and that can change as the context of their use changes, just as attributes such as “desirability,” “utility,” and “value” change in different contexts.

Trade not only brings Western products into non-Western cultures, but also many aspects of Western culture. Many anthropologists think that the adoption of capitalist modes of trade also promotes Western ideas such as profit, modernization, and individualism, pushing aside indigenous ideas of tradition and responsibility for the care of social relations. This process of Western ideas pushing out non-Western ones is called “Westernization,” and is seen by many anthropologists as a major problem facing the non-Western cultures of the world. In a larger sense, Westernization is part of “globalization,” the process through which international trade is increasingly binding the nations of the world together into a single, global economy. Again, many anthropologists view globalization as a major force acting to eliminate non-Western ideas and cultures from the global economy.

While Westernization and globalization may be forcing contemporary non-Western cultures to become more Western and global in their orientation, capitalist trade has had a much more profound effect on many historic non-Western cultures. In North America, for example, colonization by Europeans and the introduction of the fur trade in the 1600s led to competition between local groups, an increase in warfare, and dramatic population movements that transformed the social landscape of the Great Lakes and Plains regions. Trade brought with it not only Western goods (including guns, one of the items that fostered increased warfare), but also Western biota. European diseases such as smallpox and measles may have killed 80 percent of the indigenous peoples of North America. European plants and animals have dramatically changed ecosystems throughout the Americas. The point here is that trade brings with it many things in addition to the items

WORLD SYSTEMS THEORY

Immanuel Wallerstein developed world systems theory in the early 1970s as a new way of looking at the rapid expansion of capitalism. Wallerstein posited that in capitalism a clear geographical hierarchy of trade evolved. Europe was the core, the area where raw materials were converted into finished products. The rest of the world was the periphery, the area where raw materials were obtained and finished products consumed. Capitalism expanded rapidly because it needed raw materials to create goods and markets to consume them. Nineteenth-century colonialism was the political actualization of these capitalist needs. However, finished products always cost more than the value of the raw materials needed to make them, so the periphery, in providing raw materials and consuming finished products, was actively exploited by the core, a process world systems theorists came to refer to as “underdevelopment.” World systems theory provided social scientists a means to understand why and how the “developing” world was never able to actually “develop” despite many attempts to aid them in doing so—because they were being actively “underdeveloped” by the capitalist core. World systems theory continues to be one of the primary means that anthropologists and other social scientists use to examine and understand trade relations and their effects.

being traded—ideas, diseases, plants and animals—and all these have an effect on the people involved in trade.

Trade and the Development of Civilization

With trade being such an important concept for anthropologists and other social scientists attempting to understand the historic and contemporary cultures of the world, it is not surprising that trade has been an important concept to scholars attempting to understand the evolution of cultures and, in particular, the development of civilization.

Trade as redistribution. Elman Service (1962) saw trade as a basic element in the evolution of chiefdoms out of tribal societies. Chiefs, Service argued, functioned as the operators of centralized redistribution networks, which took in surplus goods from all populations in a society and redistributed them back to those populations, but spread them evenly so that no single population lacked goods they needed, and no single population could acquire an ongoing surplus. This system of redistribution only evolved among sedentary agriculturalists, because it was among these societies that redistribution was needed. Redistribution allowed regional fluctuations in agricultural production (due to variation in rainfall, for example) to be evened out. More importantly, however, Service argued that redistribution both required and fostered the centralization of political authority, and thus was essential to the evolution of chiefs. It was only with the creation of a formal position of redistributor—a chief—that the smooth functioning of a system of redistribution could be ensured. And once the position had evolved, chiefs quickly learned to use their authority to provide or withhold goods to increase their authority in other areas of social life.

Trade as legitimation. But there are problems with Service’s ideas. Not all chiefs function as redistributors, and not all societies with chiefs have resource bases that vary significantly. It is clear, however, that trade seems to be important in the evolution of many chiefdoms, and Mary Helms (1979) suggested that one reason might be that trade can serve as a mechanism for legitimating power. Helms studied the late prehistoric and early historic chiefdoms of Panama, where chiefs actively participated in and controlled trade in exotic goods such as gold ornaments, but had little to do with trade in basic, utilitarian goods of daily life. Helms argued that Panamanian chiefs used trade as a symbol of their ties to distant people and places and, through those ties, to exotic and even supernatural knowledge. Trade was not used as a means of controlling resources, but rather, of controlling knowledge and, through that control, of legitimating the chief’s authority. The chief was the legitimate leader because, through trade, he had formed social relationships with neighboring and distant chiefs. He also gained knowledge of distant people and things through these relationships, and, in some cases, even knowledge of supernatural powers unknown to the society he governed but well understood by distant people with whom he was in contact through trade.

Trade as finance. One of the key aspects of the evolution of civilization is the creation of surpluses to finance the support of individuals who are removed from production to become political leaders, priests, artisans, soldiers, and the like. Elizabeth Brumfiel and Timothy Earle (1987) suggested that trade, in the form of mobilization of surpluses, is a process through which this key aspect of civilization is played out.

They argue that political leaders evolve as individuals who are able to mobilize surpluses in order to finance their own support and, later, support for other political personnel. Over time, mobilization increases, and political leaders are able to finance support for larger numbers of people. Brumfiel and Earle suggest that this form of “staple finance” is often transformed into “wealth finance” as politics become larger and more complex. Political leaders employing wealth finance use trade to mobilize wealth, often in the form of exotic goods from distant locales, to finance support for political personnel. Wealth finance is less cumbersome than staple finance, as bulk goods such as food are not involved, and often provides political leaders with new avenues for social control. For example, complex administrative structures may be needed to maintain access to and control over trade in wealth items, and a market system may be required in order to provide political personnel a means to transform wealth items into staples. In this way, the mobilization of wealth through trade is seen as a driving force in the evolution of civilization.

Conclusions

Trade is the movement of goods between individuals or groups where there is a general expectation of reciprocity and where the purpose is basically utilitarian. Anthropologists have long been interested in trade because it is an important factor in shaping social relations. The earliest anthropological approaches to trade focused on reciprocity and how the expectations of reciprocity shaped social relations. But it was soon recognized that many forms of trade are unequal, even exploitive. Capitalism seems particularly exploitive, and with increasingly global markets and the introduction of Western capitalism into all corners of the world, anthropologists have become more and more concerned with the effects of trade on the cultures they study. Trade not only introduces Western products but also many aspects of Western culture, both good and bad, as well as Western plants, animals, and diseases. These have had a devastating effect on non-Western cultures and have profoundly impacted world history. Trade has also been important prehistorically and is an important concept to scholars attempting to understand the evolution of civilization. Trade has been seen as essential to the evolution of centralized polities, as trade provides means to both legitimate and finance positions of authority. With trade being such an important concept for understanding both contemporary and past cultures of the world, it is likely that research on trade will remain a central concern in anthropology and the other social sciences.

See also *Capitalism; Gift, The; Globalization; World Systems Theory, Latin America.*

BIBLIOGRAPHY

- Appadurai, Arjun, ed. *The Social Life of Things: Commodities in Cultural Perspective*. Cambridge, U.K., and New York: Cambridge University Press, 1986.
- Belshaw, Cyril S. *Traditional Exchange and Modern Markets*. Englewood Cliffs, N.J.: Prentice Hall, 1965.
- Brumfiel, Elizabeth M., and Timothy E. Earle. “Specialization, Exchange, and Complex Societies: An Introduction.” In

- Specialization, Exchange, and Complex Societies*, edited by Elizabeth M. Brumfiel and Timothy E. Earle. Cambridge, U.K., and New York: Cambridge University Press, 1987.
- Curtin, Philip D. *Cross-Cultural Trade in World History*. Cambridge, U.K., and New York: Cambridge University Press, 1984.
- Hall, Thomas, ed. *A World-Systems Reader: New Perspectives on Gender, Urbanism, Indigenous Peoples, and Ecology*. Lanham, Md.: Rowman and Littlefield, 2000.
- Helms, Mary W. *Ancient Panama: Chiefs in Search of Power*. Austin: University of Texas Press, 1979.
- Humphrey, Caroline, and Stephen Hugh-Jones, eds. *Barter, Exchange, and Value: An Anthropological Approach*. Cambridge, U.K., and New York: Cambridge University Press, 1992.
- Malinowski, Bronislaw. *Argonauts of the Western Pacific*. London: G. Routledge and Sons, 1922.
- Mauss, Marcel. *The Gift: Forms and Functions of Exchange in Archaic Societies*. Glencoe, Ill.: Free Press, 1954.
- Piddocke, Stuart. “The Potlatch System of the Southern Kwakiutl: A New Perspective.” *Southwestern Journal of Anthropology* 21, no. 2 (1965): 244–264.
- Plattner, Stuart, ed. *Economic Anthropology*. Stanford, Calif.: Stanford University Press, 1989.
- Polanyi, Karl K., Conrad Arensberg, and Harry Pearson, eds. *Trade and Markets in the Early Empires*. New York: Free Press, 1957.
- Sahlins, Marshall. *Stone Age Economics*. New York: Aldine, 1972. Reprint, London and New York: Routledge, 2004.
- Service, Elman. *Primitive Social Organization*. New York: Random House, 1962.
- Wallerstein, Immanuel. *The Modern World System*. New York: Academic Press, 1974.
- Wolf, Eric. *Europe and the People without History*. Berkeley: University of California Press, 1982.

Peter N. Peregrine

TRADITION. The basic sense of the term *tradition* remains quite close to its etymological roots. The Latin noun *traditio* describes the handing over of an item or an idea, while the English *tradition* refers to a social or cultural institution that is handed down from the past. This much seems straightforward. Sacrificing cattle, singing at graduation, celebrating the New Year with fireworks: all these appear quite plainly to be traditions for their practitioners. For all its seeming simplicity, though, *tradition* is indeed the “particularly difficult word” that Raymond Williams called it in his account of its changing meanings over the centuries. Its intellectual usage is especially fraught with argument, and since the 1970s, the term has been subjected to so many debates and revisions that few scholars use it nowadays with any confidence in its transparency.

Let us first consider how tradition has acquired its specific ideological and academic meanings. Often these formal uses have expanded on, intensified, and arguably distorted the minimal sense of traditions as institutions passed on through historical eras.

For a start, the idea that tradition derives from the past has often involved a subtle shift in emphasis, from the process of

transmission to the fact of repetition. In this view, deeming a cultural form a tradition implies that all its instances are identical, that it does not change over time. This is not necessarily the case, however. Think of how we refer to traditions like Greco-Roman sculpture or Renaissance painting. No one assumes these styles remained the same throughout the time they endured, only that their later manifestations were in some way shaped by precedents. Nor does derivation from the past exclude the idea that traditions embody active historical processes. A dynamic view of traditions as developing and changing continuities is intrinsic to the way we trace, say, a line from the Romanesque to the Gothic in the tradition of medieval European architecture. Nonetheless, the trend is to equate tradition with replication, to judge institutions traditions insofar as they reiterate past performance. Consider how we tend to think inauthentic any tradition that has been altered by contemporary practice. In this view we cannot adapt or reinvigorate real traditions, let alone create them. At best, we preserve them.

A closely related extension of the idea of tradition opposes it to modernity. If modernity is a state of ceaseless change, tradition, as unchanging repetition, is its antithesis. This notion is so well established it seems self-evident now, but it also subtly inflates the basic sense of the term. Its origins lie in the ideological conflicts surrounding the intellectual, political, and economic revolutions, starting in eighteenth-century Europe, that shaped what we now regard as modern society. On the one hand, the proponents of Enlightenment and their heirs have called for a world based on reason, not on what they regard as baseless custom. On the other hand, various strands of conservative and Romantic thought have celebrated tradition as the treasure chest of accumulated experience, collective cultural genius, and authentic human sentiment, all threatened by the totalitarian visions of social reformers. But the most important point here is that both camps see modern developments, like democracy or mechanization, as absolute departures from the past. The premodern or traditional past is not just what precedes these particular changes, then; instead, it becomes the opposite of historical change itself.

Once tradition acquires this extended sense as the opposite of modernity, it assumes quite a curious temporality too. It comes to be identified with the past from which it is passively handed down and not with the expanse of time through which it is transmitted, up to and including the present. But even while we insist that traditions are part of the past, we also thereby deny that they have real historical lives (except insofar as history has diluted them) precisely because we think they are unchanging. We think traditions persist across the passing of time, but we only think they are *in* it when we talk about their destruction. Modernity, on the other hand, exists in time inasmuch as it is constant change but precisely because it is change it has no past.

Another important effect of turning tradition into the opposite of modernity is that these problems with the concept seem to intensify the farther its objects lie from what we take to be modernity. Within societies felt to be mainly modern, for instance, an emphasis on static rather than changing continuity is much more pronounced in talk about folk art and

custom than it is in high cultural criticism. An electronic composer can move the classical chamber music tradition forward, but a hip-hop artist who samples the blues is untrue to its authentic agrarian roots. Elite traditions can change and still be traditions, but folk traditions cannot.

The greatest confusions come, though, from describing non-Western peoples and their societies as traditional in contrast to a West conceived as modern. This idea has global reach now, and non-Western intellectuals use it if anything more often than their Western peers at present. But it first appeared in the West, and it found its strongest expression there in the theories of specialist anthropological disciplines and discourses (Kuper; Stocking, 1968, 1996).

Anthropology began life as the study of non-Western peoples, and it kept this orientation until the late twentieth century because of the idea that these peoples' communities somehow embodied the human past. In the nineteenth through to the early twentieth centuries, this idea informed evolutionary theories that pictured human communities climbing a ladder of cultural progress. Topmost was the industrial West, with its bureaucratic states, nuclear families, and monotheistic faiths; at the bottom were stateless foragers with extensive notions of kinship and beliefs in natural spirits. Anthropology was tasked, then, with discovering where in this evolutionary hierarchy to place the many communities known to the ethnological record. But it was largely taken for granted that all peoples evolved in one and the same direction. And if some were less advanced at present than others, this had to be because they had developed more slowly. Some communities ambled along the course of human historical development, whereas others raced ahead. Traditional peoples were still living in the same evolutionary past that modern societies had already left behind them.

The catastrophes of the first half of the twentieth century made it hard to sustain such sanguine faith that Western history represented the course of progress for all humanity. Also, by the 1940s, the claim that Western societies were more advanced than others suffered the taint of associations with discredited racist and fascist thought. Anthropology turned away from evolutionary comparisons in this period, instead cultivating a relativist attention to the differences among cultural systems in terms of their *internal* patterns. This did not weaken the tendency to contrast types of societies as traditional or modern, however. If anything, ironically, it strengthened it. This is because the idea that some communities changed more slowly than others was now understood as a function, not of their place on the ladder of progress, but of their own internal resistance to change. Instead of being considered still traditional inasmuch as they were not yet modern, communities like these were now imagined to be traditional by nature. The structuralists of the 1960s thus distinguished "hot" from "cold" societies: those that changed dynamically from those that tried to conserve old institutions. While some peoples therefore had histories proper, others experienced change as an entropic force in the face of which traditions only survived if they imposed their older structures on new events. Insofar as they succeeded at this, traditions actually swallowed up all trace of the fact that change had ever happened (Levi-Strauss).

In other words, anthropology gave a cultural cast to the schisms of time already implied in the contrast of tradition with modernity. Traditional peoples derived their ways from the past but had no histories. They lived across time but not in it. Modern people had histories, but the burden of the past was far behind them. They lived in time but did not straddle its passing.

Despite this confusion, the notion that some communities are traditional, and therefore the antithesis of the dynamic, changing West, has proven very resilient and influential. Advocates of modernization often assert how peoples need to leave traditional ways behind them—not just because traditions are part of the past in this view but also because they are held to be antithetical to change. The model of a contrast between the West and the Rest is also used quite widely to explain social inequalities and differences *within* the so-called developing nations that used to be grouped as the Third World. In this view developing nations have both modern and traditional sectors inside them, as if time ran on unrelated tracks not just for the world as a whole but even within some societies. Nor are such beliefs only held by self-described opponents of tradition. Multiculturalists and cultural conservatives often cherish traditions because they see them as islands of stability, in a modern world they judge to be unmoored and inauthentic. These sentiments usually add a mid-twentieth century anthropological perspective to the doubts about modernity and nostalgia for the past derived from older forms of anti-Enlightenment thinking.

Ironically, however, anthropology itself has mostly abandoned these ideas. In part this shift is due to a growing awareness of the conceptual problems presented by older anthropological usages. But the impetus to question older usage in the academy has itself arisen from broader intellectual and political developments in the decades after World War II.

By far the most important of these developments is the wave of European decolonization that took place in the 1950s and 1960s, creating a host of new independent nations out of the formerly colonized territories of Africa and Asia. Once these nations' political representatives took their places on the international stage, it became increasingly difficult to describe them in terms that made them seem less modern or developed than their peers from the states of the West. And even amidst the divisions of the Cold War era, the rise of a set of global institutions like the United Nations fostered a new sense of planetary civilization. The notion of a shared human fate, demanding respectful dialogue, became more widespread than ever during these decades.

In this changed political climate, many intellectuals became concerned with what it meant to call non-Western peoples traditional. Since tradition was so strongly imbued with the sense of being the antithesis of modernity, it seemed less and less appropriate to apply the idea to societies that now had the very same sets of institutions and ambitions that were identified with modernity in the West. In fact, as many thinkers came to insist, the use of terms like *tradition* did much more than impose anachronistic mistakes about the contemporary social lives and institutions of peoples outside the West. For in so doing it also demeaned and diminished them. In the first place it belittled their modern achievements, such as their struggles for liberation

and their quests to achieve economic and political equality with European and other Western nations. In this way it, if anything, distorted these societies' actual histories. This seemed all the more discordant in the context of the 1960s and 1970s, when the former colonies witnessed new waves of social and cultural dynamism while Western nations mostly seemed to stagnate. But secondly and even more insidiously, to call these peoples traditional seemed to deny that they possessed even the capacities to have such histories at all. The strong distinction this usage drew between those who were tradition-bound on the one hand and the dynamic West on the other now seemed offensive to the new international ethos of equality among peoples. Most important, it also echoed the sorts of colonial stereotypes about non-Western peoples that anticolonial movements had resisted in their struggles for freedom from Western domination. To say that people were ruled by the past began to sound suspiciously like an excuse for ruling over them in the present.

In the postcolonial era, therefore, many politically minded intellectuals found ideas about tradition versus modernity inseparable from the history of colonial rule over non-European societies. By the early 1970s, this judgment had also penetrated critical discussions within universities. Inspired by the radical social movements of the 1960s, a young generation of scholars had already started questioning the idea that the academy and its products were politically disinterested. Instead, they argued, the mainstream human or social sciences had tended toward complicity in modern structures of power (Foucault and Gordon). In the case of anthropology, its relationship with European colonialism was the form of guilt provoking most critiques it faced (Asad; Mafeje). In their harshest forms, these discussions even saw anthropology mocked for having been the willing "handmaiden" of colonialism. And if anthropology found itself accused of being the intellectual servant of the West's colonial projects, this criticism was largely due to the images of non-Western peoples the discipline had developed under the rubric of tradition.

To critical scholars who sympathized with anticolonial movements, then, the use of the term *tradition* became problematic. Influenced by critiques of colonial discourse in the humanities, such as Edward Said's *Orientalism* (1979), some began to see anthropology's emphasis on traditions as part of a broader set of misrepresentations of non-Western peoples in Western thought. In this view, the portrayal of people in terms of their traditions made them appear to be mysterious, accepting of authority, immersed in collective cultural and spiritual life—in other words, not at all like the rational, pragmatic individuals who had earned the rights and freedoms of modernity. In one such commentary, Johannes Fabian (1983) showed how many anthropologists had exoticized the peoples whom they studied. Even though they shared so much time with their subjects during field research, he pointed out, their writing tended to represent these people as if they lived in other epochs. Not only did this make them look as if they lived in the past, but it also made it possible to overlook the conditions of colonial domination they faced in the present.

Critiques like these are widely accepted by scholars now, and few would think it tenable to assert today that some

peoples have traditions while others have histories. But this was not the only effect of the conversations that took place in this vein in the 1970s. By showing that there was a politics to the concept of tradition, these commentaries also opened up another kind of critical discussion about tradition in the 1980s and afterward. This second wave of studies has focused less on the ideological meanings implicit in the idea of tradition and more on the contested social contexts in which various parties refer to traditions in order to advance their own agendas.

The most important step in this direction was Eric Hobsbawm and Terence Ranger's collection of historical essays that showed how several institutions generally thought traditional, from chieftaincy in Africa to tartan-wearing in Scotland, were actually of recent historical vintage. In each case, these historians argued, an institution was made to seem as if it came from the age-old past, in order to grant legitimacy to a social group and its projects in the present. The real task of scholarship, then, was to study not the transmission or replication but the *invention* of traditions.

This argument is radically unsettling, of course. Traditions are supposed to be the stable, enduring antitheses of invention, not its new, ephemeral products. So the claim that they are the latter has inspired an enormous body of literature by way of response in the late twentieth and early twenty-first centuries.

Some have used this concept of invented traditions in order to revisit the relationship of ideas about tradition to colonialism. Instead of seeing tradition as a figment of the Western colonial mind alone, this kind of work examines the use of terms like *tradition* or *custom* by a range of social actors in colonial and postcolonial settings: by colonizers and colonized, urban elites and peasant villagers, nationalists and compradors, conservatives and modernizers, and even the scholars who study them all (Briggs; Foster; Jolly and Thomas; Keesing; Keesing and Tonkinson; Spiegel and Boonzaier). As these studies show, while Westerners may have used the idea of tradition to make non-Western peoples appear exotic and backward, non-Western peoples have used this concept to portray themselves as special communities, worthy of distinctive rights, entitlements, and identities. From this perspective tradition is less like an argument, true or false, about the lack of change in society and more like a language or idiom in which ever-changing arguments about social life are conducted. This treatment mitigates some of the most odious associations that critics of colonial discourse attached to the concept. It does not rescue the term itself for renewed academic use, however. Instead it demotes tradition to the status of a folk category—an excellent object of study just like any idea one finds in such wide social circulation, but hardly a viable tool of social analysis.

The convergence of the postcolonial moment with the critical turn in scholarship has thus made it very difficult for scholars to speak of traditions without embarrassment. One quite common response to this situation is to use the term as if in its naive sense, while hedging it in heavy layers of irony. While true to the uncertainties that now surround the label, this is a less than helpful strategy for conceptual clarification. Another more considered and productive response is to bite the bullet and try to understand the relations among society, culture, and

history with more rigor, self-reflection, and complexity than contrasts between tradition and modernity allow (Axel; Bauman and Briggs; Comaroff and Comaroff; Sahlins; Trouillot). But here there is also an irony of sorts. Although it may not use the term *tradition* with any innocence, what all such work affirms is that there are few more worthy tasks for the humanities and social sciences than helping us appreciate and understand the changing continuities in our social lives: the institutions that all of us keep handing down through time.

See also Anthropology; Cultural Revivals; Ritual.

BIBLIOGRAPHY

- Asad, Talal, ed. *Anthropology and the Colonial Encounter*. London: Ithaca Press, 1973.
- Axel, Brian Keith. *From the Margins: Historical Anthropology and Its Futures*. Durham, N.C.: Duke University Press, 2002.
- Bauman, Richard, and Charles L. Briggs. *Voices of Modernity: Language Ideologies and the Politics of Inequality*. Cambridge, U.K., and New York: Cambridge University Press, 2003.
- Briggs, Charles L. "The Politics of Discursive Authority in Research on the 'Invention of Tradition.'" *Cultural Anthropology* 11, no. 4 (1996): 435–469.
- Comaroff, John Lionel, and Jean Comaroff. *Ethnography and the Historical Imagination*. Boulder, Colo.: Westview Press, 1992.
- Fabian, Johannes. *Time and the Other: How Anthropology Makes Its Object*. New York: Columbia University Press, 1983.
- Foster, Robert John. *Nation Making: Emergent Identities in Postcolonial Melanesia*. Ann Arbor: University of Michigan Press, 1995.
- Foucault, Michel, and Colin Gordon. *Power/Knowledge: Selected Interviews and Other Writings, 1972–1977*. New York: Pantheon Books, 1980.
- Hobsbawm, Eric, and Terence Ranger, eds. *The Invention of Tradition*. Cambridge, U.K., and New York: Cambridge University Press, 1983.
- Jolly, Margaret, and Nicholas Thomas, eds. "The Politics of Tradition in the Pacific." Special issue of *Oceania* 62, no. 4 (1992).
- Keesing, Roger M. *Custom and Confrontation: The Kwaio Struggle for Cultural Autonomy*. Chicago: University of Chicago Press, 1992.
- Keesing, Roger M., and Robert Tonkinson, eds. "Reinventing Traditional Culture: The Politics of Kastom in Island Melanesia." Special issue of *Mankind* 13, no. 4 (1982).
- Kuper, Adam. *Anthropology and Anthropologists: The Modern British School*. London and Boston: Routledge and Kegan Paul, 1983.
- Levi-Strauss, Claude. *The Savage Mind*. Chicago: University of Chicago Press, 1966.
- Mafeje, Archie. "The Ideology of Tribalism." *Journal of Modern African Studies* 9 (1971): 253–262.
- Sahlins, Marshall David. *Islands of History*. Chicago: University of Chicago Press, 1985.
- Said, Edward. *Orientalism*. New York: Vintage Books, 1979.
- Spiegel, Andrew, and Emile Boonzaier. "Promoting Tradition: Images of the South African Past." In *South African Keywords: The Uses and Abuses of Political Concepts*, edited by Emile Boonzaier and John Sharp. Cape Town and Johannesburg, South Africa: David Philip, 1988.
- Stocking, George W. *Race, Culture, and Evolution: Essays in the History of Anthropology*. New York: Free Press, 1968.

———. *Volksgeist as Method and Ethic: Essays on Boasian Ethnography and the German Anthropological Tradition*. Madison: University of Wisconsin Press, 1996.

Trouillot, Michel-Rolph. *Silencing the Past: Power and the Production of History*. Boston: Beacon Press, 1995.

Williams, Raymond. *Keywords: A Vocabulary of Culture and Society*. New York: Oxford University Press, 1983.

Hylton White

TRAGEDY AND COMEDY. Various ideas have been associated with the term *tragedy* and the term *comedy* over the centuries, including tragedy that is not tragic, in the sense of “sad” or “disastrous,” and comedy that is not comic, in the modern prevalent meaning of “amusing.” The modern English meaning of comedy as a synonym for *humor* is largely a twentieth-century development.

Greek Origins

Tragedies are first heard of, as stage plays, in the Dionysiac celebrations in Athens at the turn of the fifth century B.C.E., and comedies appear as a contrasting type of play a century later. Aristotle (384–322 B.C.E.) said that tragedies dealt with *spoudaia* (serious matters) and comedies with *phaulika* (trivial subjects). Tragedies aimed at arousing and then purging emotions such as pity and fear. Effective tragedies need not end in disaster; he gives highest praise to the happily resolved *Iphigenia among the Taurians* of Sophocles, and, among narrative poems (since staging is not essential to tragedy), he considers the *Odyssey* to have a tragic story as well as the *Iliad*, though he notes at one point that the effects of such a double-plotted story (good end for the good, bad for the bad) are more appropriate to comedy.

Aristotle’s treatment of comedy has not survived, and his analysis of tragedy was not cited in antiquity. His chief disciple, Theophrastus (c. 372–c. 287 B.C.E.) also dealt with tragedy and comedy, and his definitions were cited by the Latin grammarian Diomedes (4th century C.E.). They can be rendered as follows: “Tragedy deals with the fortunes of heroes in adversity,” and “Comedy treats of private deeds with no threat to life.” Diomedes adds that tragedies usually move from joy to sadness, comedies the opposite.

Meanwhile, Horace (65–8 B.C.E.) had discussed the genres in his *Ars poetica*. He explains the meaning of “tragedy” as “goat-song,” so called because the winning players were rewarded with a cheap goat. He does not define the forms and deals mainly with questions of style, that is, tone and diction. The complaints of tragedy should not readily be mixed with the *privata carmina* (domestic verse) of comedy. Ovid (43 B.C.E.–17 C.E.), too, has style in mind when he says that tragedy is the gravest form of writing (*Tristia* 2.381). It consists of sublime verse, as opposed to the lighter forms of elegy (used for love poems) (*Amores* 3.1.39–42).

Another influential grammarian of the fourth century, Aelius Donatus, considers Homer the father of tragedy in the *Iliad* and the father of comedy in the *Odyssey*. He attributes

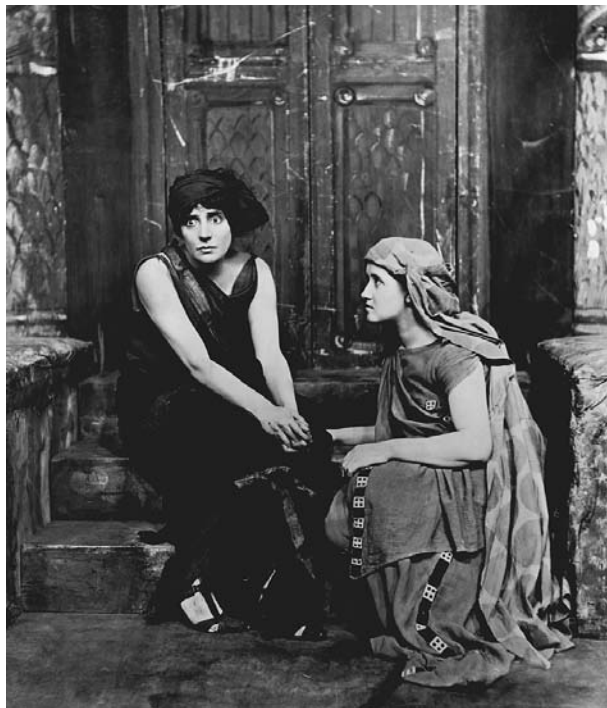

Scene from *Electra* by Sophocles, 1908. Sophocles was one of the three most important authors of tragedies in ancient Greece. He wrote more than one hundred plays, but only seven have survived in their entirety. © HULTON-DEUTSCH COLLECTION/CORBIS

to Cicero (106–43 B.C.E.) a definition of comedy as “the imitation of life, the mirror of custom, the image of truth,” which is later reflected in Hamlet’s discourse to the players.

The chief Greek authors of tragedies were Aeschylus (525–456 B.C.E.), Sophocles (c. 496–406 B.C.E.), and Euripides (c. 484–406 B.C.E.). Comedy was divided into old, middle, and new. Aristophanes (c. 450–c. 388 B.C.E.) straddled the old and the middle periods, while Menander (342–292 B.C.E.) represented the new. The Latin playwrights Plautus (c. 254–184 B.C.E.) and Terence (186 or 185–?159 B.C.E.) specialized in adapting Greek comedies from Menander’s period. As for tragedy, Lucius Annaeus Seneca (c. 4 B.C.E.–65 C.E.) is the only known playwright whose works are extant. Plautus claimed that one of his plays, the *Amphitruo*, was a combination of comedy and tragedy, not because it used an elevated style, but rather because it introduced characters proper to both genres, kings and gods on the one hand and slaves on the other.

The Latin World

By Seneca’s time, plays may have largely or entirely ceased to be performed by actors and, at most, been presented only by public recitations. The term *tragedy* was also used for pantomime productions, *tragoediae saltatae*, and also for *citharoediae*, in which a tragic protagonist sang and accompanied himself on the lyre.

The most important treatment of tragedy and comedy in the early Middle Ages was that of St. Isidore of Seville (c. 560–636).

In book 8 of his *Etymologies*, he cites Horace's etymology for tragedy, taking it to mean that the poets were originally held in low esteem, but that later they became highly regarded for the skill of their very realistic stories. Tragic poets deal with public affairs, the histories of kings, and sorrowful matters, whereas comic poets recite the deeds of private persons and emphasize joyful things. However, the new comic poets, like Persius (34–62 C.E.) and Juvenal (c. 55 or 60—in or after 127 C.E.), are called satirists, and they expose vice. Both tragic and comic poems consist entirely of the dialogue of characters.

In book 18 of his encyclopedia, Isidore takes up tragedy and comedy again, this time as theatrical pieces. Comic and tragic (or comedic and tragic) poets sang their poems on the stage, while actors and mines danced and made gestures. Thanks largely to this account, classical dramas were regarded in the Middle Ages and early Renaissance as having been recited by the poet himself, that is, Seneca, Plautus, or Terence (except that in Terence's case a stand-in was used); while he declaimed the lines of all of the characters himself, actors would mime their words and actions.

In addition to "theatricizing" tragedy and comedy in book 18, Isidore now gives a darker account of the subject matter of the two forms (there was some hint of this with regard to comedies in the account of the satirists in book 8). Here he says that the comedians sang not only of private men, but specifically of "the defilements of virgins and the loves of whores," and tragedians sang of the "sorrowful crimes of wicked kings" (18.45–46).

Just as influential as Isidore's accounts was a passage written a century before him by Boethius (c. 480–c. 524). In the *Consolation of Philosophy*, he portrays Lady Philosophy as inviting Lady Fortune to give an account of herself, and at one point she says, "What does the cry of tragedies bewail but Fortune's overthrow of happy kingdoms with a sudden blow?" (2 pr. 2). Subsequent commentators on the *Consolation* offered definitions of both tragedy and comedy. Notably, William of Conches, writing around the year 1125, says that tragedy begins in prosperity and ends in adversity, whereas in comedy the situations are reversed.

Medieval Contributions

The most important medieval writer of comedy was Dante (1265–1321), and Geoffrey Chaucer (c. 1342–1400) was the most important author of tragedy. Dante does not seem to have known either the comedies of Terence and Plautus or the tragedies of Seneca. The latter had recently been discovered and were being studied in Padua during Dante's time, notably by Albertino Mussato, who considered tragedy to be a genre of elevated subject matter, consisting of two subgenres: those dealing with disasters (like Seneca's works and his own *Ecerinis*) used iambic verse, and those dealing with triumphs, like the works of Virgil (70–19 B.C.E.) and Publius Papinius Statius (c. 45–96 C.E.), used dactylic hexameters.

Dante's own definitions of comedy and tragedy in *De vulgari eloquentia* are not connected to ideas of misery or felicity. He agrees with Mussato in considering tragedy to use elevated subjects. It also uses the best syntax, verse forms, and diction.

Comedy on the other hand is a style inferior to that of tragedy, using both middling and humble forms. He cites lyric poems, including some of his own, as examples of tragedy. In *Inferno* (20.113) he has Virgil refer to the *Aeneid* as "my high tragedy." He may have based his ideas on Papias's definition of comedy in his *Elementarium* (c. 1045), repeated in the *Catholicon* of John Balbus of Genoa (1286): comedy deals with the affairs of common and humble men, not in the high style of tragedy, but rather in a middling and sweet style, and it also often deals with historical facts and important persons.

Dante's commentators did not know of the *De vulgari eloquentia*, and most of them, including Guido da Pisa and the author of the *Epistle to Cangrande* (which purports to be by Dante himself), follow definitions similar to those of the Boethian commentators; thus they explain Dante's choice of title by the fact that the work begins in misery (hell) and ends in felicity (heaven). They hold that Terence's comedies follow the same pattern, and that Seneca's tragedies trace the reverse movement (hardly true in either case). Some readers, like Dante's son Piero, followed the rubrical tradition that designated *Inferno*, *Purgatorio*, and *Paradiso* as three comedies, and found an upbeat conclusion to all of them: each ends with a reference to the stars.

Chaucer, for his part, like Dante's commentators, was influenced by the Boethian tradition. He translated the *Consolation* and used glosses derived from the commentary of Nicholas Trivet (1258?–?1328). But whereas Trivet repeated Conches's definition of tragedy and added to its iniquitous subject by repeating Isidore's statement about the crimes of the wicked kings, the gloss that Chaucer received and translated removed all such reference: "Tragedy is to say a dite [literary composition] of a prosperity for a time that endeth in wretchedness" (pp. 409–410). He thus restored the concept to its Boethian context by removing the suggestion that all tragic falls are deserved and punitive. Chaucer wrote tragedies of this sort himself, on the model of the narratives of Giovanni Boccaccio's (1313–1375) *De casibus virorum illustrium* (Boccaccio himself did not consider these stories to be tragedies) and later assigned them to the Monk in the *Canterbury Tales*. In the meantime, he wrote an extended tragedy, *Troilus and Criseyde*. John Lydgate (c. 1370–c. 1450) subsequently applied Chaucer's idea of tragedy to *The Fall of Princes*, his translation of the *De casibus*, and it was adopted in its sixteenth-century continuation, *A Mirror for Magistrates*. Thus Chaucerian tragedy was transmitted to the age of Shakespeare.

The Renaissance

Shakespeare (1564–1616) himself does not say what he means by comedy and tragedy, but one can deduce from his characters that comedy has the general meaning of a pleasant or mirthful play, and that tragedy more often refers to an event than to a play, and more often concerns the downfall of an innocent than a guilty person. This is in contrast to formal discussions—like Sir Philip Sidney's (1554–1586) *Apology for Poetry*—that tend to restrict the subject of tragedy to bad men coming to bad ends, thereby "making kings fear to be tyrants." This is a kind of plot that received very low marks from Aristotle.



Scene from Shakespeare's *As You Like It*, starring Cloris Leachman (left) and Katherine Hepburn (right). Shakespeare, arguably the most famous dramatist in history, wrote numerous comedic plays, although he did not specifically explain what his criteria was for a play to be considered a comedy. © JOHN SPRINGER COLLECTION/CORBIS

By Sidney's time, Aristotle's *Poetics* was available in an accurate form (before the sixteenth century it was chiefly known from the commentary of Averroës [1126–1198], who understood comedy to refer to poems reprehending vice and tragedy to poems praising virtue). But it was mainly cited on minor points, or distorted through assimilation to Horatian concerns. Aristotle's insistence on unity of action was made equal to the newly invented unities of time and space.

Tragedy became an elite genre, in which only the best tragedies were thought worthy of the name of tragedy. In England this concept can be seen in Thomas Rymer's *Short View of Tragedy* (1692), when he speaks of "the sacred name of tragedy." Such an understanding is widely accepted and practiced in modern times, allegedly with the backing of Aristotle: the criterion that Aristotle gives for the most effective tragedy (the fall of a good man through a flaw) has been smuggled into the definition of and made a sine qua non for tragedy. Now there is no such thing as a bad or mediocre tragedy. For Aristotle, on the contrary, everything that was called a tragedy

or fitted general criteria was a tragedy, but some were better than others.

Problems of Definition

There have been dozens of attempts to define tragedy, understood as supreme tragedy, radical tragedy, pure tragedy, and the like. Most of these understandings are intuitive and personal to the definers and are based on a favorite example of tragedy (or a small cluster of favorite tragedies). To give a recent example, George Steiner defines tragedy as "the dramatic testing of a view of reality in which man is taken to be an unwelcome guest in the world"; and the plays that communicate "this metaphysic of desperation" are very few, "and would include *The Seven against Thebes*, *King Oedipus*, *Antigone*, the *Hippolytus*, and, supremely, the *Bacchae*" (1980 Foreword to *The Death of Tragedy*, 1961).

Because of the elevated status of the idea of tragedy, actual tragedies have become a thing of the past, represented by the classical plays, Shakespeare and his contemporary English

dramatists and, in France, Jean Racine and Pierre Corneille sometimes extending to Lope de Vega in Spain. The only more recent work that is named a tragedy by its author and acknowledged to be a great work is Johann Wolfgang von Goethe's (1749–1832) *Faust: A Tragedy* (1808), but it is not usually considered to be a great tragedy or even a tragedy at all. (Whether Goethe himself meant to call Part 2 a tragedy is not clear; but it was published as such, posthumously, in 1832.)

Comedy, in contrast to tragedy, remained a general and amorphous genre, encompassing ineffective as well as effective examples. No comic masterpieces have been singled out as supreme comedies (though Shakespeare's plays are given high ranking), and plays that do not measure up to some classical standard have not in general been drummed out of the genre, though occasionally this sort of qualifying spirit can be seen when a dud is denigrated as "mere farce."

In England in Shakespeare's time, when the action of a play was not amusing but simply avoided the usual final disasters of tragedy, it was given the name of "tragicomedy," which Sidney referred to as a mongrel form. When Plautus invented the term to describe his *Amphitruo*, it was for a different reason: because it had the characters proper to tragedy (kings and gods) as well as those proper to comedy (slaves, etc.). The term was revived in Spain for yet another reason, by what might well be called a comedy of errors. When Fernando de Rojas (c. 1465–1541) adapted the twelfth-century Latin "comedy" *Pamphilus* and published it under the title of *The Comedy of Calisto and Melibea* (1500), readers complained that its action was not that of comedy but rather of tragedy, and he thought to satisfy them by calling it a tragicomedy. This work, usually called *Celestina*, gave rise to several sequels, among them *Segunda Comedia de Celestina* (1534), *Tragicomedia de Lisandro y Roselia* (1542), *Tragedia Policiana* (1547), *Comedia Florinea* (1554), and *Comedia Selvagia* (1554). During this time, *comedy* came to mean "any stage play," and the most celebrated adaptation of the *Celestina* was Lope de Vega's (1562–1635) great tragedy, *El Caballero de Olmedo*, which appeared in Part 24 of Vega's *Comedias* (1641). *Comedia* also became the general name for theater, a practice found in France, as in the *Comédie Française* in Paris.

In Italy in the sixteenth century, Dante's *Comedy* was given the title of *The Divine Comedy*, seemingly to make the point that it has nothing to do with any of the usual senses of comedy. In France in the 1840s Honoré de Balzac (1799–1850) gave to his collected works the retrospective title of *The Human Comedy*, not because of any theory of comedy, but to contrast the mundane world of his novels with the otherworldly actions and interests of Dante's work. The designation of "art comedy," *commedia dell'arte*, was given to plays performed by professional actors on stereotyped plots with much improvisation. In the eighteenth century in both France and Italy sentimental or "tearful" comedy and "musical" comedy came into vogue.

In the late twentieth century "musical comedy" was shortened to "musical," which was contrasted with "comedy," both being contrasted with "drama" (as in the Golden Globe Awards). The latter category includes all revived tragedies and also modern plays or films that are perceived to have a sense of the tragic.

See also *Theater and Performance*.

BIBLIOGRAPHY

- Aristotle. *Poetics*. Edited and translated by Stephen Halliwell. Loeb Classical Library 199. Cambridge, Mass.: Harvard University Press, 1995.
- Bayley, John. *Shakespeare and Tragedy*. London: Routledge and Kegan Paul, 1981.
- Boethius. *The Theological Tractates*. Edited and translated by S. J. Tester. Loeb Classical Library 74. Cambridge, Mass.: Harvard University Press, 1973.
- Bradley, A. C. *Shakespearean Tragedy: Lectures on Hamlet, Othello, King Lear, Macbeth*. London: Macmillan 1904. The second edition appeared in 1905, with uncounted reprintings since.
- Chaucer, Geoffrey. *The Riverside Chaucer*. Edited by Larry D. Benson. Boston: Houghton Mifflin, 1987.
- Eagleton, Terry. *Sweet Violence: The Idea of the Tragic*. Malden, Mass.: Blackwell, 2003.
- Isidore of Seville. *Etymologiae*. 1911. 2 vols. Edited by W. M. Lindsay. Reprint, Oxford: Clarendon, 1985. For English translations of pertinent passages, see Kelly, *Ideas and Forms*, chap. 3, sec. 1, 36–50.
- Janko, Richard. *Aristotle on Comedy: Towards a Reconstruction of Poetics II*. Berkeley: University of California Press, 1984.
- Kelly, Henry Ansgar. *Ideas and Forms of Tragedy from Aristotle to the Middle Ages*. Cambridge, U.K.: Cambridge University Press, 1993.
- . *Tragedy and Comedy from Dante to Pseudo-Dante*. Berkeley: University of California Press, 1989.
- Nelson, T. G. A. *Comedy: An Introduction to the Theory of Comedy in Literature, Drama, and Cinema*. New York: Oxford University Press, 1990.
- Segal, Erich. *The Death of Comedy*. Cambridge, Mass.: Harvard University Press, 2001.
- Steiner, George. *The Death of Tragedy*. New York: Knopf, 1961. Reprint, with new foreword, New York: Oxford University Press, 1980.
- Williams, Raymond. *Modern Tragedy*. London: Chatto and Windus, 1966. Reprint, with new afterword, London: Verso, 1979.

Henry Ansgar Kelly

TRANSLATION. What may summarily be called *translation* has been practiced in many parts of the world for centuries and even millennia. The rendering of Buddhist texts into literary Chinese and the Latinization of the Bible in the first millennium are two instances of celebrated achievements in the long history of translation. There are countless cases where translations are known to have played a decisive role in the development of literary cultures, pedagogical institutions, ecclesiastic reformations, and the global spread of the nation-state and capitalism, particularly since the Renaissance and the European conquest of the Americas. Yet, until the 1970s or 1980s, translation did not attract much academic attention and consequently had not been studied systematically, though such diverse writers as John Dryden (1631–1700), Motoori Norinaga (1730–1801), and Walter Benjamin (1892–1940) offered insightful speculations on their own practice of translation.

In the early twenty-first century a number of scholars became aware of both the conceptual complexity and the politico-ethical significance of translation. Simultaneously, they came to realize that translations not only in the fields of literature and religion must be problematized but also those in the spheres of commercial advertisement, popular entertainment, public administration, international diplomacy, scientific research and publication, judiciary procedure, immigration, education, and family livelihood.

The conceptual complexity of the term *translation* and the difficulty in any attempt to define it make it necessary to historicize the particular ways translation has been understood and practiced in modern societies. The politico-ethical significance of translation is always complicit with the construction, transformation, or disruption of power relations. Translation involves moral imperatives on the part of both the addresser and the addressee and can always be viewed, to a greater or lesser degree, as a political maneuver of social antagonism. In addition, the representation of translation produces sociopolitical effects and serves as a technology by which individuals imagine their relation to the national or ethnic community.

The particular way translation is represented is conditioned by the essentially “modern” *schema of co-figuration*—most typically, the communication model according to which translation is represented as a transfer of signification between two clearly demarcated unities of ethnic or national languages—by means of which one comprehends natural language as an ethno-linguistic unity. In other words, the commonsensical notion of translation is delimited by the schematism of the world (that is, by the act of representing the world according to the schema of co-figuration). Conversely, the modern image of the world as “inter-national” (that is, as consisting of basic units called *nations*) is prescribed by a representation of translation as a communicative and international transfer of a message between a pair of ethno-linguistic unities.

The Concept of Translation and Its Complexity

The network of connotations associated with the term *translation* leads to notions of transferring, conveying, or moving from one place to another, of linking one word, phrase, or text to another. These connotations are shared among the words for translation in many modern languages: *fanyi* in Chinese, *translation* in English, *traduction* in French, *honyaku* in Japanese, *Übersetzung* in German, and so forth. It may therefore appear justified to postulate the following definition: “Translation is a transfer of the message from one language to another.” Even before one specifies what sort of transfer this may be, it is hard to refrain from asking about the message. Is not the message in this definition a product or consequence of the transfer called translation rather than an entity that precedes the action of transfer, something that remains invariant in the process of translation? Is the message supposedly transferred in this process determinable in and of itself before it has been operated on? And what is the status of the language from which or into which the message is transferred? Is it justifiable to assume that the source language in which the original text makes sense is different and distinct from the target language into which the translator renders the text as faithfully as possible?

Are these languages countable? In other words, is it possible to isolate and juxtapose them as individual units, such as apples, for example, and unlike water? By what measures is it possible to distinguish one from the other and endow each with a unity? But for the sake of facilitating the representation of translation, however, is it not necessary to posit the organic unity of language rather than see it as a random assemblage of words, phrases, and utterances if one is to speak of translation in accordance with the definition?

Accordingly, the presumed invariance of the message transmitted through translation is confirmed only retroactively, after it has been translated. What kind of definition is it, then, that includes the term in need of explanation in the definition itself? Is it not a circular definition? Similarly, the unity of the source language and of the target language is also a supposition in whose absence the definition would make little sense. What might translation be if it were supposed that a language is not countable or that one language cannot be easily distinguished from another?

It is difficult to evade this problem when attempting to comprehend the terms *meaning* and *language*. At the least, it may be said that, logically, translation is not derivative or secondary to meaning or language; it is just as fundamental or foundational in any attempt to elucidate those concepts. Translation suggests contact with the incomprehensible, the unknowable, or the unfamiliar—that is, with the foreign—and there is no awareness of language until the foreign is encountered. The problematic of translation is concerned in the first place with the allocation of the foreign.

If the foreign is unambiguously incomprehensible, unknowable, and unfamiliar, then translation simply cannot be done. If, conversely, the foreign is comprehensible, knowable, and familiar, translation is unnecessary. Thus, the status of the foreign is ambiguous in translation. The foreign is incomprehensible and comprehensible, unknowable and knowable, unfamiliar and familiar at the same time. This foundational ambiguity of translation is derived from the position occupied by the translator. The translator is summoned only when two kinds of audiences are postulated with regard to the source text, one for whom the text is comprehensible at least to some degree, and the other for whom it is incomprehensible. The translator’s work consists in dealing with difference between the two audiences. The translator encroaches on both and stands in the midst of this difference. In other words, for the first audience the source language is comprehensible while for the second it is incomprehensible. It is important to note that the term *language* in this instance is figurative: it need not refer to the natural language of an ethnic or national community—German or Tagalog, for example. It is equally possible to have two kinds of audiences when the source text is a technical document or an avant-garde work of art. In such cases *language* may well refer to a vocabulary or set of expressions associated with a professional field or discipline—for example, law; it may imply a style of graphic inscription or an unusual setting in which an artwork is displayed. This loose use of the term *language* invariably renders the task of determining the meaning of the term *translation* difficult, because all the acts of projecting, exchanging, linking, matching, and mapping could then be

considered kinds of translation, even if not a single word is involved. Here the discernability of the linguistic and the nonlinguistic is at stake.

Roman Jakobson's famous taxonomy of translation attempts to restrict the instability inherent in the figurative use of the word *language*. Jakobson divides translation into three classes: "1) Intralingual translation or *rewording* is an interpretation of verbal signs by means of other signs of the same language. 2) Interlingual translation or *translation proper* is an interpretation of verbal signs by means of some other language. 3) Intersemiotic translation or *transmutation* is an interpretation of verbal signs by means of signs of nonverbal sign systems" (p. 261). According to the Jakobsonian taxonomy, one who translates "legal language" into common parlance would be performing an intralingual translation, while one who offers a commentary on an obscure artwork would be engaged in an intersemiotic translation. Neither can be said to be a translator strictly speaking. Only someone who translates a text from one language to another would be doing translation proper.

Jakobson's taxonomy neither elucidates nor responds to the supposition concerning the countability and organic unity of the source and target languages. It does not empirically validate the supposition; it merely repeats and confirms it. Nevertheless, it discloses that "translation proper" depends on a supposed discernibility between the interlingual and the intralingual, between a translation from one language to another and a rewording within the same language. It thereby prescribes and demarcates the locus of difference between two presumably ethnic or national language communities by virtue of the fact that Jakobson presupposes that translation proper can take place only between two unequivocally circumscribed languages. It therefore eradicates the various differences within such a linguistic community and locates the foreign exclusively outside the unity of a language.

No doubt this conception of translation is a schematization of the globally shared and abstractly idealized commonsensical vision of the *international* world as basic units—nations—segmented by national borders into territories. It is not simply Jakobson's idiosyncratic view. In this schematization, "translation proper" not only claims to be a description or representation of what happens in the process of translation; that description also prescribes and directs how to represent and apprehend what one does when one translates. In this respect, "translation proper" is a *discursive* construct: it is part of what may be called the regime of translation, an institutionalized assemblage of protocols, rules of conduct, canons of accuracy, and ways of viewing. The *discursive* regime of translation is *poietic*, or productive, in that it foregrounds what speech acts theorists call the "perlocutionary" effect. Just as a perlocutionary act of persuading might well happen in a speech act of arguing but persuasion does not always result from argument, "translation proper" need not be postulated whenever one acts to translate. Yet, in the regime of translation, it is as if there were a causal relationship between the co-figurative schematization of translation and the process of translation. Collapsing the process of translation onto its co-figurative schematization, the representation of translation repeatedly discerns the domestic language co-figuratively—one unity is

figured out, represented, and comprehended as a spatial figure, in contrast to another—as if the two unities were already present in actuality.

As long as one remains captive to the regime of translation, one can construe the ambiguity inherent in the translator's positionality only as the dual position a translator occupies between a native language and a foreign tongue. Hence the presumption persists that one either speaks one's mother tongue or a foreigner's. The translator's task would be to discern the differences between the two languages. And the difference one deals with in translation is always determined as that between two linguistic communities. Despite countless potential differences within one linguistic community, the regime of translation obliges one to speak from within a binary opposition, either to the same or to the other. Thus, in the regime of translation the translator becomes invisible. This attitude in which one is constantly solicited to identify oneself may be called "monolingual address," whereby the addresser adopts the position representative of a putatively homogeneous language community and enunciates to addressees who are also representative of a homogeneous language community. The term *monolingual address*, however, does not imply a social situation in which both the addresser and the addressee in a conversation belong to the same language; they believe they belong to different languages yet can still address each other monolingually.

Translator: The Subject in Transit

Is it possible to understand the act of translation outside monolingual address? To respond to this question, it may be helpful to consider the translator's position of address. When engaged in the task of translation, can she perform a speech act such as making a promise? Is the translator responsible for what she says while translating? Because of the translator's unavoidably ambiguous position, the answer too is ambiguous. Yes, she can make a promise, but only on behalf of someone else. She "herself" cannot make a promise. The translator is responsible for her translation but she cannot be held responsible for the pledges expressed in it, because she is not allowed to say what she means; she is required to say what she says without meaning it. In essence, the translator is someone who cannot say "I." Here the problem of the invariant message returns as the question of meaning, of what the translator "means" to say.

In relation to the source text, the translator seems to occupy the position of the addressee. She listens or reads what the original addresser enunciates. At the same time, however, there is no supposition that the addresser is speaking or writing to her. The addressee of the enunciation is not located where the translator is; in translation, the addressee is always located elsewhere. Here again the translator's positionality is inherently ambiguous: she is both an addressee and not an addressee. She cannot be the "you" to whom the addresser refers.

A similar disjunction can be observed in the enunciation of the target text—that is, in the translation. In relation to the audience of the target text, the translator seems to occupy the position of the addresser. The translator speaks or writes to the audience. But it is seemingly not the translator herself who speaks or writes to the addressee. The *I* uttered by the

translator does not designate the translator herself but rather the subject of the original enunciation. And if the translator does indicate the subject of the translated enunciation by saying *I*—in a “translator’s note,” for example—she will then have to designate the original addresser as *he* or *she*.

In other words, in translation, the subject of the enunciation and the subject of the enunciated—the speaking *I* and the *I* that is signified—are not expected to coincide. The translator’s desire is at least displaced, if not entirely dissipated, in the translated enunciation, if by *desire* one understands that what is signified by *I* in “my” utterance, ought to coincide with the supposedly concrete and unique—but imagined—existence of “me” (the desire expressed as “I want to be myself”). This is why the translator cannot be designated straightforwardly either as *I* or *you*: she disrupts the attempt to appropriate the relation of addresser and addressee as a *personal* relation between the first person and the second person. According to Émile Benveniste, only those directly addressing and those directly addressed can be called persons, whereas *he*, *she*, and *they* cannot be so designated (Benveniste, p. 224). Hence, the addresser, the translator, and the addressee cannot be persons simultaneously. The translator cannot be the first or second person, or even the third “person” undisruptively. Ineluctably, translation introduces an instability into the putatively *personal* relations among the agents of speech, writing, listening, and reading. The translator is internally split and multiple, devoid of a stable position. At best, she is *a subject in transit*.

In the first place, this is because the translator cannot be an “individual” in the sense of *individuum*, the undividable unit. In the second, it is because she is a *singular* that marks an elusive point of discontinuity in the social, even though translation is the practice of creating continuity from discontinuity. Translation is a *poietic* social practice that institutes a relation at the site of incommensurability. This is why the discontinuity inherent in translation would be completely repressed if one were to determine translation as the communication of information; the *ambiguity inherent in the translator’s positionality* would have to be entirely overlooked as translation is grasped as the transfer of information.

The internal split within the translator demonstrates how the subject constitutes itself. In a sense, this internal split is homologous to what is known as the “fractured *I*.” The temporality of “I speak” necessarily introduces an irreparable distance between the speaking *I* and the *I* signified, between the subject of the enunciation and the subject of the enunciated. The subject in the sense that *I* am here and now speaking designates the subject of the enunciation, but it does not signify it because every signifier of the subject of the enunciation may be lacking in the enunciated or the statement. In the case of translation, however, an ambiguity in the translator’s personality marks the instability of the *we* as subject rather than the *I*, since the translator cannot be a unified and coherent personality in translation. This suggests a different attitude of address, namely, “heterolingual address” (Sakai, pp. i–xii)—that is, a situation in which one addresses oneself as a foreigner to another foreigner. Held captive in the regime of translation, however, the translator is supposed to assume the role of the

transcendent arbitrator, not only between the addresser and the addressee but also between their linguistic communities. As monolingual address, translation, as a process of creating continuity in discontinuity, is often replaced by the representation of translation in which translation is schematized according to the co-figurative communication model.

Modernity and the Schema of Co-Figuration: A Genealogy of the Modern

Consider how translation is displaced by its representation and how collective subjectivity, such as national and ethnic subjectivity, is constituted in the representation of translation. Through the translator’s labor, the incommensurable differences that call for the translator’s service in the first place are negotiated. In other words, the work of translation is a practice by which the initial discontinuity between the addresser and the addressee is made continuous. In this respect translation is like other social practices; translation makes something representable out of an unrepresentable difference. Only retrospectively, therefore, can one recognize the initial incommensurability as a gap, crevice, or border between fully constituted entities, spheres, or domains. But when so represented, it is no longer an incommensurability. It is mapped onto a striated space, which may be segmented by national borders and other markers of collective (national, ethnic, racial, or “cultural”) identification.

Incommensurable difference is more like a feeling prior to the explanation of how incommensurability occurred, and cannot be represented as a specific difference (in schemas of genera and species, for example) between two terms or entities. What makes it possible to represent the initial difference between one language unity and another as already determined is the work of translation itself. Hence the untranslatable, or what appears to be so, cannot exist prior to the enunciation of translation. It is translation that gives birth to the untranslatable. The untranslatable is as much a testimony to the sociality of the translator, whose elusive positionality reveals the presence of an aggregate community of foreigners between the addresser and the addressee, as the translatable itself. We fail to communicate because we are in common with one another. Community itself does not mean we share common ground. On the contrary, we are in community precisely because we are exposed to a forum where our differences and failure in communication can be manifest. Nevertheless, the translator’s essential sociality with respect to the untranslatable is disregarded in monolingual address, and with the repression of this insight, monolingual address equates translation with the representation of translation.

When the temporality of translation by which the translator’s disjunctive positionality manifests itself is erased, translation is displaced by the representation of translation. Because the disruptive and dynamic processes of translation are leveled out, the representation of translation makes possible the representation of ethnic or national subjects and, despite the presence of the translator, who is always ambiguous and disjunctive, translation as representation posits one language unity against another and one “cultural” unity against another. In this sense, the representation of translation transforms *difference in repetition* (Deleuze) into a *specific difference* between two particularities and serves to constitute the putative unities

of national languages, thereby reinscribing the initial difference and incommensurability as a specific, or commensurate and conceptual, difference between two particular languages within the continuity of languages. As a result of this displacement, translation is represented as a form of communication between two fully circumscribed, different but comparable, language communities in which social antagonism and the various loci of difference are expunged.

The particular representation of translation as communication between two particular languages is no doubt a historical construct. Given the politico-social significance of translation, it is no accident that, historically, the regime of translation became widely accepted in many regions of the world, after the feudal order and its passive vassal subject gave way to the disciplinary order of the active citizen subject in the modern nation-state, to an order consisting of disciplinary regiments that Michel Foucault describes brilliantly. The regime of translation serves to reify national sovereignty. As Michael Hardt and Antonio Negri have argued, it makes “the *relation* of sovereignty into a *thing* (often by naturalizing it) and thus weed out every residue of social antagonism. The nation is a kind of ideological shortcut that attempts to free the concepts of sovereignty and modernity from the antagonism and crisis that define them” (Hardt and Negri, p. 95, italics in the original).

Kant thought of the schema as a “third thing” heterogeneous to either sensibility or understanding, in which an intuition (in sensibility) is subsumed under a concept (in understanding), and attributed it to the general faculty of imagination, a faculty to give a concept its figure or *Bild*. He called this operation of schema *schematism*. Following the Kantian schematism, the *poietic* technology embedded in the regime of translation that renders translation representable may be called “the schema of co-figuration.” Since the practice of translation remains radically heterogeneous to the representation of translation, translation cannot always be represented as a communication between two clearly delineated ethno-linguistic unities. Rather, it was this particular representation of translation that gave rise to the possibility of figuring out the unity of ethnic or national language together with another language unity. Thanks to this co-figurative schematism, there emerges an ethno-linguistic unity as if it were a sensuous and unified thing hidden and dormant behind the surface of extensive variety. In other words, the schema of co-figuration is a technology by means of which an ethno-linguistic community is rendered representable, thereby constituting itself as a substratum upon which national sovereignty can be built. “People” is nothing but an idealization of this substratum.

This self-constitution of the nation does not proceed unitarily, but on the contrary, its figure constitutes itself only by making visible the figure of an other with which it engages in a relationship of translation. Precisely because the two nations are represented as equivalent and alike, however, it is possible to determine them as *conceptually different*, and their difference is construed as a *specific difference* (*daiphora*) between separate identities. Nevertheless, cultural difference, which calls for the work of a translator, is not a conceptual difference but an incommensurability. The relationship of the two terms as

equivalent and alike gives rise to the possibility of extracting an infinite number of distinctions between the two. Just as in the co-figuration of “the West and the Rest” by which the West represents itself, constituting itself by positing everything else as “the Rest,” conceptual difference allows one term to be evaluated as superior to the other. This co-figurative comparison enables typical binary oppositions—such as the presence of scientific rationality versus its absence, the future-oriented spirit of progress versus the tradition-bound sense of social obligation, and internalization of religious faith and its accompanying secularism versus the inseparableness of the private and the public—to characterize the West and the Rest.

The “modern” is marked by the introduction of the schema of co-figuration, without which it is difficult to imagine a nation or ethnicity as a homogeneous sphere. The economy of the foreign—that is, how the foreign must be allocated in the production of the domestic and non-universal language—has played a decisive role in the *poietic*—and poetic—identification of national languages (Berman). Most conspicuously in eighteenth-century movements such as Romanticism in western Europe and *Kokugaku* (National Studies) in Japan, intellectual and literary maneuvers to invent, mythically and poetically, a national language were closely associated with a spiritual construction of a new identity that later naturalized national sovereignty. This substratum for the legitimization of national and popular sovereignty was put forward as a “natural” language specific to the “people,” supposedly spoken by them in their everyday lives. Literary historians generally call this historical development “the emergence of the vernacular.” With the irruption of the sphere of nearness—extensive obsessions with things of everydayness and experimental immediacy—in which the ordinary and the colloquial were celebrated, the status of “universal” languages such as Latin, literary Chinese, and Sanskrit was drastically and decisively altered. In their stead, languages emerged whose markers were ethnic and national—English, German, Japanese, Spanish and so forth—and the ancient canons were translated into these languages. For this reason, Martin Luther’s German translation of the Bible and Motoori’s Japanese phonetic translation of the *Kojiki* (Records of ancient matters) can be said to mark crucial steps in modernity. This emphasis on ordinary and colloquial languages was correlated with the reconception of translation and the schema of co-figuration.

Historically, how one represents translation does not only prescribe how we collectively imagine national communities and ethnic identities and how we relate individually to national sovereignty. It is also complicit with the discourse of the West and the Rest through which the colonial power relationship is continually fantasized and reproduced.

See also *Interpretation; Language and Linguistics; Language, Linguistics, and Literacy; Other, The, European Views of; Representation*.

BIBLIOGRAPHY

Benjamin, Walter. “The Task of The Translator.” Translated by Harry Zohn, with a note by Steven Rendall. In *The Translation Studies Reader*, edited by Lawrence Venuti, 15–24. London: Routledge, 2000.

- Benveniste, Émile. *Problems in General Linguistics*. Translated by Mary Elizabeth Meck. Coral Gables: University of Miami Press, 1971.
- Berman, Antoine. *The Experience of the Foreign: Culture and Translation in Romantic Germany*. Translated by S. Heyvaert. Albany: State University of New York Press, 1992.
- Deleuze, Gilles. *Difference and Repetition*. Translated by Paul Patton. New York: Columbia University Press, 1994.
- Foucault, Michel. *Discipline and Punish*. Translated by Aln Sheridan. New York: Vintage Books, 1979.
- Hardt, Michael, and Antonio Negri. *Empire*. Cambridge, Mass.: Harvard University Press, 2000.
- Jakobson, Roman. "On Linguistic Aspects of Translation." In his *Selected Writings*. Vol. 2, 260–66. The Hague: Mouton, 1971.
- Laca, Jacques. *Écritis*. Translated by Alan Sheridan. New York: W. W. Norton and Company, 1977.
- Motoori, Norinaga. *The Kojiki-den*. Book 1. Translated by Ann Wehmeyer. Ithaca, N.Y.: East Asia Program, Cornell University, 1997.
- Sakai, Naoki. *Translation and Subjectivity: On "Japan" and Cultural Nationalism*. Minneapolis: University of Minnesota Press, 1997.
- . *Voices of the Past: The Status of Language in Eighteenth-century Japanese Discourse*. Ithaca, N.Y.: Cornell University Press, 1992.
- Venuti, Lawrence. *The Translator's Invisibility: A History of Translation*. London: Routledge, 1995.

Naoki Sakai

TRANSNATIONALISM. See Globalization.

TRAVEL FROM EUROPE AND THE MIDDLE EAST. Travel, as a human activity, predates language. It should be no surprise, then, that some of the first ancient literary expressions from the European and African continents should use travel as a motif. Certainly the ancient Hebrew biblical narratives of Abraham, Isaac, Jacob, and Moses structure the lives of their subjects through travel. Greek and Roman epics—*The Odyssey* and *The Aeneid*—as well as the history of Thucydides, use travel as an important thematic element, connecting it with various aspects of conflict. Similarly, Herodotus (c. 484–c. 424 B.C.E.), in his historical, ethnographic, and geographic compendium, uses travel in part as his method of research. The Islamic tradition begins with epic travel—flight and return—continuing with pilgrimage, educational, and diplomatic travel. In the millennium and a half since, the motif of travel has attracted a number of images that structure our view of this basic human activity, images that appear in both fiction and nonfiction.

Ancient and Medieval Travel: Epic Heroes, Pilgrims, and Merchants

The genre of epic structures the oldest European travel narratives extant, from the voyages of Ulysses to that of Beowulf. The epic as a form connects travel to conflict and cultural threat, as well as to the landscape of fantasy and to the epic hero. Just as the epic hero is larger and more marvelous than

life, so the epic landscape is both marvelous and dangerous. The epic hero and those who accompany him are often engaged in activities that either preserve or extend the culture of which he is the ideal. Such an image of travel has little room for reflection or satiric treatment; the mood is one of high seriousness. The epic form is modified in the oldest Hebrew writings; there, the culture-creating protagonists become sometimes the focal point of narrative but always the recipients of divine directives regarding travel. Biblical travel is conceived in three ways: first, as travel toward a land of divine promise; second, as wandering to or in the land; and third, as exodus or flight. In the Islamic tradition, the travel of the prophet Muhammad contains the same elements of divine directive, flight, and return.

The rise of Christianity and Islam activates a second image associated with travel, that of pilgrimage. One could classify the ancient Hebrew narratives as pilgrimage, but the concept, which gains importance in the period from 800 to 1400 C.E. in Europe and Africa, involves other elements. Pilgrimage is conceived as reenactment; the pilgrim undertakes a sacred journey, the significance of which is primarily spiritual, as he or she visits sites important to sacred history. In the Christian and Islamic traditions, this sacred journey is conditioned by devotion and obedience. Medieval Christian tradition adds the element of veneration and indulgence: the idea that acts of veneration for holy relics and places could provide spiritual benefit can be traced back to the late classical period. But the explicit linking of acts of devotion with the remission of temporal punishment for sin only began with the First Crusade in 1095, when Pope Urban II announced the granting of indulgences to those who fought to regain the Christian holy shrines. Such a view, conditioned by conflict, both renders ambiguous the spiritual aspects of the journey and historically allows the symbolizing of acts of devotion. The act of pilgrimage also allows travelers to escape being accused of the sin of curiosity; travel for sightseeing is problematic in the Middle Ages, but travel for at least ostensibly spiritual reasons can sometimes escape this censure.

In medieval Europe, a mode of pilgrimage writing develops, in which certain items of information and structures of narration become standardized. This tradition approaches landscape and the journey in the following ways: first, the journey is conceived as outgoing; narratives focus on the hardships of the journey out and the travels between the holy places, instead of on the journey out and back. Second, the journey within the holy destination is organized in terms of "stations" or stopping places, often connected with specifically significant sites. These significant sites usually become connected allegorically with a variety of biblical significances. The twelfth-century pilgrimage guide writer Fetellus, for example, localizes a number of biblical references in one spot. When he describes the traditional hill of Christ's crucifixion in his narrative, he names this spot as the site on which Abraham sacrificed Isaac and as the place where Adam was buried (and resurrected by Christ's blood falling upon him). Furthermore, this site has significance for the future, being the place upon which Christ will return at the end of history. Specific physical characteristics of the site are used to bolster these allegorical accretions: the crack running through the rocks

of the crucifixion hill is there because of the earth-rending strain of holding the cross. Other sites, from the city of Hebron to the Dead Sea, gain a number of allegorical significances based on their associations with the biblical narrative.

The third important type of travel, for the purposes of trade, had almost certainly been occurring concurrently with other forms of travel since the earliest human cultures. In Europe, commercial travel was seldom documented until well into the Middle Ages. By far the most important Continental writing about commercial travel was the narrative of Marco Polo, a Venetian who traveled to China and back during a twenty-four-year period, between 1271 and 1295. His writings were both widely publicized and widely ridiculed, as his European readers refused to believe the apparently miraculous accounts of the wealth, geographical wonders, and population of the Far East, as well as his account of offices he had held while in China. His ultimate nickname, *Il Milione* (The million), reflected the European public's sense that he had exaggerated the information that he brought back. The reaction to Marco Polo's narrative also points to the general reaction that hearers and readers in the Middle Ages expected from information derived through travel: generally they wanted to react with a sense of wonder and calculated disbelief to the tales brought back by far-flung narrators. This appetite for wonders can also be seen by the popularity of the information in the compendia of geographical and other lore compiled by such people as Vincent of Beauvais, the medieval encyclopedist (c. 1190–c. 1264).

Renaissance Travel: Exploration and Empire

With the beginning of the early modern period, the primary image of travel gradually transforms from the traditional images of epic and pilgrimage into something new—exploration. There is a sense in which exploration retains the heroic character of epic travel: it often highlights conflict, whether conflict with the elements and a hostile landscape or conflict with the other cultures encountered. But explorers, while at some level imperialists, are, during the early period of exploration at least, not really larger-than-life figures. The curiosity about geographic features and other cultures ceases to be a minor sin and becomes the animating reason for travel. The explorer travels expressly to find new lands and peoples, desiring to trade with other cultures or to exploit the riches of new lands. In the initial European encounter with America, Christopher Columbus was very much the medieval man, looking during his voyage for the lost earthly paradise, said to be located in the west. The Spanish conquistadors saw themselves as feudal overlords of subject peoples, and conducted their conquests accordingly. Narrators of their voyages over the ocean and over land contributed to a perspective on the native civilizations they found there, a perspective that inherited the sense of wonder found in medieval travel narratives but also a less benign questioning of the humanity of the others who were encountered. Seeing the native civilizations as strange and wondrous tended to dehumanize the people encountered. But the New World yielded another, more tangible, reward to the explorers—the gold and silver of the Americas. Ultimately all the European exploratory ventures took part in a quest for resources, either precious metals or the natural resources of the lands discovered.

Exploration narratives were writings in search of a genre. It was important, for the first time, that each explorer “answer for himself, justify his own reports, and stand accountable for his own doings,” according to England's greatest Renaissance collector and travel narrative editor, Richard Hakluyt, because these reports were becoming the guidebooks for colonists and pioneers. Curiosity about people, languages, and geography became a virtue, and truthfulness became important.

Fact and Fiction in Travel Narratives

Travel narratives allowed ancient and medieval audiences to escape through literary fantasy and compare their culture to different ones. But the wondrous living denizens of these narratives—people whose heads grew beneath their shoulders, people who lived on odors, tribes of Amazon women—would be proven nonexistent. In their place, exploration narratives would put the actual wonders of spices, gold, silver, canoes, and differing customs. Before the early modern period, the veracity of travel narratives was not a serious issue because travel was a rare event and large-scale cross-cultural contacts relatively few. The few medieval narratives that realistically recounted diplomatic missions to the invading Mongol hordes during the thirteenth and fourteenth centuries were not widely known.

Thus, though medieval travelers were not generally believed, veracity was trivial. The situation changed in the fifteenth century with the first seaborne expeditions around the African continent and to the Americas. Though the earliest sea voyagers carried medieval descriptions of the places for which they searched, it soon became apparent that these descriptions were untrustworthy. Columbus carried on his first American voyage a copy of the fourteenth-century *Travels of Sir John Mandeville*, one of the most popular pilgrimage and travel narratives of the time, hoping to use its description to find the scriptural earthly paradise. Richard Hakluyt reprinted a Latin version of Mandeville's *Travels* in the first edition of his collection *The Principall Navigations* (1589). He most probably dropped it from the second edition of the collection because of its falsehoods.

Travel as exploration demanded a different set of criteria; instead of wonder and the imaginative, the requirements of the new travel narratives involved reliability and exactness of detail. This demand for descriptive exactness contributed to an extension of the exploratory image in travel writing into the twentieth century. Though exploration as an image of travel connotes objectivity and exactness, it is clear that this image is affected by the historical concomitants of conquest and imperialism. Certainly the information the explorers recount is conditioned by their Eurocentric perspective.

As representatives of the ascendant European culture and its political hegemony spread out across the globe, the amount of travel writing greatly expanded. Women undertook journeys in support of spouses or independently and related their experiences exploring and encountering other cultures, often in epistolary form. Lady Mary Wortley Montagu traveled to Turkey with her husband, a diplomat, between 1716 and 1718. Her letters closely observe the cultures through which she passed. It is clear, as well, that she is familiar with the male

ISLAMIC TRAVELERS

Islamic travelers voyaged through Africa and into the Far East using established overland and sea routes from northern Africa and the Mideast. Routes were established in the Mediterranean to Spain and indirectly to the rest of Europe; overland, the great Silk Road reached into China; by sea, Arab traders reached India.

Of two important early Muslim travelers, Ibn Fadlan (Ahmad ibn Fadlan ibn al-'Abbas ibn Rashid ibn Hammad) and Ibn Jubayr (Abu al-Husayn Muhammad ibn Ahmad Jubayr), little is known. Ibn Fadlan includes little description of himself in his *risala*, or epistle, describing a diplomatic mission from the caliph of Baghdad in 921 to the Bulgarians of the Volga. Ibn Jubayr, a Spanish Arab traveler during the twelfth century, voyaged around the Mediterranean basin and through Mecca and Medina on a journey that he recorded in *rihla* form; it is the only journey for which he wrote a narrative of three that he made. What is known of his second journey is that he composed a poem celebrating Saladin's victory at Hittin.

The *rihla*, a genre of travel description in Arabic developed by various Islamic authors, encompassed various sorts of journey: pilgrimage, travel for learning, or travel for discovery. One of the greatest of the travelers of the Middle Ages, Shams al-Din ibn Battuta (1304–c. 1368), composed a *rihla* called *Tuhfat al-nuzzar fi ghara'ib al-amsar wa 'aja'ib al-asfar* (A feast for the eyes [presenting] exotic places and marvelous travels). This work so epitomized the genre of *rihla* that Ibn Battuta's work is often simply known by that name—the *Rihla*. Like Marco Polo, Ibn Battuta

and his account were greeted with skepticism by his contemporaries, including the great Islamic historian Ibn Khaldun. Also like Marco Polo, contemporary scholarship indicates that he was essentially truthful in most of his account. All in all, Ibn Battuta's account is a compendious store of information about the Muslim world of his day.

Leo Africanus (al-Hasan ibn Muhammad al-Wassan az-Zayyati), born in Islamic Spain, is one of the most important European writers about Africa between 1500 and 1800. His description of sub-Saharan and northern Africa, *Descrittione dell'Africa* (Description of Africa), was completed in 1529, after he had been captured by pirates and had converted to Christianity. His writing falls into the Arabic tradition of geography rather than into the tradition of the *rihla* account. Since, as a stranger in a different culture, he had no access to the traditional works of Arabic geography, he needed primarily to rely upon his memory to write his work. This necessity has led many readers to identify his *Description* more with genres of travel writing than geography.

One of the masters of *rihla* writing was the seventeenth-century Sufi scholar and poet Abu Salim Abd Allah ibn Muhammad al-Ayyashi, who left a detailed account of a journey that includes elements of pilgrimage and exploration. After a journey overland from his native Morocco to Cairo, al-Ayyashi continued his pilgrimage to Mecca and Medina. He was as interested in the people and customs that he saw as he was in the holy sites that he visited. His narrative makes clear the interconnected world of North African Islam and that of the Mideast.

tradition of travel writing, because she often provides a contrasting female perspective on her travel experiences, as do many female travel authors of the fifteenth through the eighteenth centuries. Mary Wollstonecraft's epistolary journal of her travels to Scandinavia in 1795, in the company of only her maid and infant daughter, was influenced (like Lady Wortley Montagu's) by the earlier letters of the French Madame de Sévigné. In general, the specifically female mode of travel writing has much in common with the parallel tradition of women's autobiography.

Men, meanwhile, continued the exploratory movement, this time under the aegis of scientific and sociological investigation. The narrative of David Livingstone in Africa in the mid-nineteenth century was constructed as an exploratory and imperialistic epic, while Mungo Park's narratives of Africa in the 1790s and Alexander von Humboldt's narratives of scientific discovery on the American continent from 1799 to 1804 combine both epic hardships and reports of important scientific investigations. Sir Richard Burton, one of the Victorian era's most intrepid travelers, hazarded his life in journeys

EARLY MODERN EUROPEAN TRAVEL COLLECTIONS

The early modern period in Europe (roughly 1450–1700) was not only a time of intense exploratory activity but also a time in which a number of editors and collectors strove to collect, organize, and distribute overviews of nonfictional writing about travel. Nationalistic impulses as well as the need for information drove a number of editors between 1550 and 1650 to collect narratives.

Giovanni Ramusio (1485–1557) collected and translated the works in *Delle navigationi et viaggi* (On navigations and travels) between 1550 and 1559. In this work, he intended to produce a new kind of compendium, an overall survey of important geographical treatises, organized by global region. It contains writing by Leo Africanus, Antonio Pigafetta (who took part in Magellan's circumnavigation), and Amerigo Vespucci, among others.

Richard Hakluyt (c. 1552–1616) compiled, edited, and translated *The Principal Navigations, Voyages, Traffiques, and Discoveries of the English Nation* in two editions: 1589 and 1598–1600. Though both editions concentrated on English discoveries, the second edition especially had a larger scope, to provide information for English

explorers and traders about all the areas in which they might have interest. Organized both chronologically and regionally, the collection provides a comprehensive look at the history of exploration and trade to the point of publication, insofar as Hakluyt was able to obtain information.

Samuel Purchas, a clergyman originally interested in a universal history of religions told through travel narratives, purchased Richard Hakluyt's literary effects around 1620. From it and his own collecting, Purchas compiled a collection called *Hakluytus Posthumous, or Purchas his Pilgrimes*, in 1625. Though organized in much the same way as Hakluyt's collection, Purchas's editorial methods and aims are quite different. He is interested as much in the edification and educational benefits of travel as he is in accurate information about exotic locations.

The *Collectiones peregrinationum in Indiam orientalem et Indiam occidentalem*, produced by the de Bry family at Frankfurt (begun by Théodor de Bry, but brought to conclusion by his sons; 1590–1634), enhanced narratives of travel with high-quality engravings.

through the Islamic world, including making a disguised pilgrimage to Mecca, bringing back the first eyewitness European description of that great journey (*Personal Narrative of a Pilgrimage to El-Medinah and Meccah*; 1855–1856). Travel writing of the exploratory type thus takes on a more personal and literary character as time goes on.

Modern Images of Travel: Tourist or Ironist

Tourism began in the early modern period as travel for education. At this time, travel was seen as an important pedagogical capstone. In England, such important social and literary figures as Sir Philip Sidney (1554–1586) took the “grand tour” (an extended visit to important cities and courts of continental Europe) as an appropriate way to conclude their education in the arts of politics and culture. Ideally, the grand tour introduced its practitioner to the languages and polite societies of the Continent; practically, a number of English critics of this type of travel complained that it led to students coming back with French affectations and fashions, German manners, and Italian diseases. The playwright Thomas Nashe penned an ingenious satiric journey for his picaresque traveler Jack Wilton in *The Unfortunate Traveller* (1594). In the realm of nonfiction, the Oxford-educated

eccentric Thomas Coryate penned his voluminous *Crudities* (1611), in which he paints himself as the innocent abroad, coming into contact with various kinds of picaresque adventures while undertaking a perhaps not-so-grand tour through the Continent. That Coryate had elements of the explorer in himself as well is evident from his death in India while on a more far-flung journey. George Sandys's *Relation of a Journey Begun Anno Domini 1610* combines the structures of pilgrimage narrative with the motivations of the practitioner of the grand tour.

During the eighteenth and early nineteenth centuries, travel became more consciously literary. Such figures as Samuel Johnson and James Boswell melded the tour of the countryside with autobiography, biography, and the essay, while Romantic period authors in Britain and on the Continent celebrated the imaginative potential of journeys through the natural world. This sort of travel often allied itself to the emerging genre of the novel, in which the physical journeys of various protagonists were paralleled by their interior development, sometimes with comic results.

However, travel could never fully become tourism until the level of danger inherent in the activity had diminished. One

could say that tourism was born in Europe with the guides of Baedeker during the Victorian period and in America with the closing of the frontier in the late 1800s. But there had always been a sense of conflict between the “true” traveler and the mob of others; as early as the fourteenth century, Margery Kempe, the English mystic and pilgrim, lamented the motivations (curiosity and good fellowship) of her fellow pilgrims, to the point that her traveling companions attempted to strand her in Rome because of her constant moral hectoring. But with the advent of technology, one of the cachets of travel, its attendant dangers, had been removed. Thus, with the rise of tourism, a new tension arose in the image of travel: that between the true traveler and the tourist. While tourists stick to the instructions of Baedeker and travel in herds, the true traveler takes the road untraveled (at least by Europeans).

For literary travelers, this tension between tourism and other forms of travel produced much fruit. It would probably be a mistake to count various tourist guides as literary productions, but traveling authors have gained much ironic material by their appropriation of and resistance to the activities and material of tourism. During the early to mid-twentieth century, as well, there were still substantial portions of the globe generally off limits to tourists for political or other reasons. Modern authors tended to seek out just those sorts of marginal journeys.

Between the world wars, literary travelers often took the pose of ironists or reporters, sometimes espousing specific ideological points of view and sometimes using the profits gained by writing travel volumes to finance more “serious” literary pursuits. The English authors Graham Greene and Evelyn Waugh traveled extensively: Waugh used his journeys in the Mediterranean and South America as well as his stint as a reporter in Africa to provide material for some of his satiric novels. André Gide’s travels in Africa and the Mideast animated his sense of the ideal artistic life: to construct a careful equilibrium between the exotic and the familiar.

The contemporary literary traveler becomes a complexly folded narrator, taking an ironic stance, not just toward other cultures but often toward other travelers and even to him- or herself. Contemporary travel writing partakes of many genres and modes: novelistic, picaresque, satiric, and contemplative. Even the ancient motif of flight and return is explored as a means of self-discovery. For postmodernity, travel becomes a means of self-discovery or self-exploration.

See also *Empire and Imperialism; Eurocentrism; Orientalism; Other, The, European Views of.*

BIBLIOGRAPHY

PRIMARY SOURCES

- Casas, Bartolomé de las. *De unico vocationis*. Edited by Helen R. Parish and translated by Francis Sullivan. New York: Paulist Press, 1992.
- Cortés, Hernán. *Letters from Mexico*. Edited and translated by A. R. Pagden. New York: Grossman, 1971.
- Gide, André. *Amyntas*. Translated by Richard Howard. New York: Ecco, 1988.

Ibn Battuta. *Ibn Battuta in Black Africa*. Edited and translated by Said Hamdun and Noël King. 2nd ed. Princeton, N.J.: M. Weiner, 1994.

Ibn Jubayr. *The Travels of Ibn Jubayr*. Translated by R. J. C. Broadhurst. London: J. Cape, 1952.

Montagu, Mary Wortley. *Embassy to Constantinople: The Travels of Lady Mary Wortley Montagu*. Edited by Christopher Pick, with an introduction by Dervla Murphy. London: Century, 1988.

Polo, Marco. *The Travels of Marco Polo*. Edited by Ronald Latham. New York: Viking, 1958.

Pratt, Mary Louise. *Imperial Eyes: Travel Writing and Transculturation*. London and New York: Routledge, 1992.

Waugh, Evelyn. *When the Going Was Good*. Boston: Little, Brown, 1947.

Wollstonecraft, Mary. *Letters Written during a Short Residence in Sweden, Norway, and Denmark*. Edited by Carol H. Poston. Lincoln: University of Nebraska Press, 1976.

SECONDARY SOURCES

Campbell, Mary B. *The Witness and the Other World: Exotic European Travel Writing, 400–1600*. Ithaca, N.Y.: Cornell University Press, 1988.

Fussell, Paul. *Abroad: British Literary Traveling between the Wars*. Oxford: Oxford University Press, 1980.

Howard, Donald R. *Writers and Pilgrims: Medieval Pilgrimage Narratives and their Posterity*. Berkeley: University of California Press, 1980.

Speake, Jennifer, ed. *Literature of Travel and Exploration: An Encyclopedia*. 3 vols. New York: Fitzroy Dearborn, 2003.

James P. Helfers

TREATY. In modern diplomatic practice, a treaty is a formal written agreement between states (though recently also designating agreements with and between international organizations), which is legally binding under international law. Treaties differ from a variety of other international agreements like declarations, memorandums of understanding, and gentlemen’s agreements, which only create moral and political obligations, nonbinding commitments, or what has been branded as “soft law.” The Helsinki Final Act of the Conference on Security and Cooperation in Europe (1975) is an example of an important international agreement that was deliberately drafted in a way that was legally nonbinding to the parties at the time, circulated at the United Nations but deliberately not registered with the Secretariat. In legal jargon, and as codified in the preamble as well as Article 26 of the Vienna Convention on the Law of Treaties (1969), a treaty, unlike other international agreements, comes under “the fundamental principle” of *pacta sunt servanda*. This Latin phrase means that “agreements must be observed,” unless forced upon or concluded in bad faith. *Pacta sunt servanda* is a Ciceronian principle that has been selectively and problematically appropriated by modern treaty law. In *De officiis* (3.24), Cicero (106–43 B.C.E.) speaks extensively of ethical conduct and makes no distinction between agreements and promises (*pacta et promissa*) in his meditation on the matter. By contrast, international legal discourse allows for agreements that do not

follow the *pacta sunt servanta* rule, in turn providing for diplomatic flexibility and a bypassing of ethics. This makes it possible to daily exchange agreements and promises that have shades of legality, publicly simulating commitment, but in practice retaining opt-outs and remaining legally unenforceable.

Linguistic Issues

Although the word *treaty* can be etymologically traced back to the Latin *tractus*, meaning treatment, handling, discussion, and management, there was no Latin word with that root having the notion of an (international) agreement. If anything, *tractus* sometimes had the sense of a disagreement, of a violent handling of affairs, such as the dragging by the hair of the priestess of Apollo. A common Latin word for treaty is *foedus*—interestingly a word that also meant the unseemly, horrible, and detestable, probably depicting in the mind of the users the forced circumstances and unholy power deals that led to the conclusion of some. Another Latin word for treaty is *conventio*, from which the English word *convention* derives, a term currently used as a synonym for *treaty*, especially when following long multilateral negotiations. *Conventio* has in addition the meaning of an assembly and is a word that literally translates *sumbais*, an ancient Greek word for treaty. *Sumbainō* had the meaning of coming to an agreement but also of walking together, just like in the Latin *convenio*. Walking together along the same path or in the same direction is a good metaphor for agreement, though in practice it was also meant literally, like the walking together of comrades to the assembly, battlefield, or exile. There were other words for treaty in ancient Greek, such as *sumphōnia*, the harmony of speaking with a “common voice” about an issue, depicting people in great solidarity and symphony, or *sunthēkē*, which meant literally the composition of words, emphasizing the textual or synthetic sense of an agreement. But the most formal and solemn treaty was called *spondē*, meaning literally “libation,” which included the calling of the gods to witness the treaty and the taking of the oaths that sanctified it. Unlike other agreements, the breaking of a *spondē* was not just an illegal or immoral act, but a sacrilege.

The move to the term *treaty* signifies a change from the usual metaphors of agreement but also a turn toward secularization in international relations and law. In the sense of a contract between states the first recorded use of *treete* is in 1430. But as a technical term of international law the word is commonly employed from the end of the seventeenth century onward (*Oxford English Dictionary*). Interestingly, the introduction of the term follows the end of the Thirty Years’ War and the conclusion of the Treaty of Westphalia (1648), which is supposed to have secularized international norms and practice and provided the foundation of the modern (European) interstate system.

Typically, the only state that made and still makes the point of not using the name *treaty* for its legally binding international agreements is the Holy See. In diplomatic practice, bilateral treaties signed with the Vatican are called *concordats*, and canonists have gone to great pains to show that the “nature of concordats” bears practical similarities—but is not identical—to

that of treaties. A concordat refers to a cordial agreement, a union of wills, the successful meeting of hearts and minds in Christian harmony. The concordat is supposed to pass its provisions spiritually, requires no diplomatic “handling,” and its conclusion is avoided by the Holy See if it foresees complications in the ratification process from the other side. It is a euphemism through which papal treaty practice is rendered sui generis, supposed always to operate in concord, thus rhetorically separating itself from the worldly bargaining and crude pursuit of national interest associated with conventional treaty-making. Note also that in concordat practice, the Holy See emulates the discourse of the new covenant, which in Christian cosmology constitutes “the treaty of treaties,” rendering all other sacred or secular agreements false or insignificant by comparison. It was the messianic advent of Jesus Christ that brought forth the “new covenant,” bypassing and superceding the collective oath of the faithful to keep the “old covenant.” As taken up in the Epistle to the Hebrews—which is precisely a call to reject the old and accept the new covenant—the old covenant requires command ethics and rabbinic enforcement, whereas the new one inscribes the divine laws in the minds and hearts of the people in concordat style (see sidebar).

The story of rendering the old covenant obsolete following the declaration of a momentous happening or new revelation has ironically established a pattern in secular treaty law, and specifically in the employment of the principle of *clausula rebus sic stantibus*, the “clause of things standing thus.” This clause renders a treaty obsolete if there is a significant change in the conditions under which it was first concluded. The principle is a late-sixteenth-century invention coined by Alberico Gentili (1552–1608), a Protestant theologian and international jurist, in *De iure belli libri tres*. By mixing religious and legal discourse, oath-taking and treaty (*foedus*) ratification, Gentili suggests that there is in every treaty a silent assumption, an understanding (*intelligitur*) or mental reservation (*subintelligi*) of a *clausula rebus sic stantibus* (pp. 244–245, 599). This is only the case among Christian rulers, for Gentili doubts the legal durability of treaties concluded with untrustworthy infidel rulers (*nec fidere infidelibus potes*) on scriptural qua moral grounds: “For although the impious oath of an infidel may be accepted, yet what trust can be put in an unbeliever” (p. 660). That a tacit understanding of termination exists when circumstances fundamentally change reinforces the privilege of “mortal gods,” but highly complicates the binding status of treaties between them. Not surprisingly, in actual diplomatic practice, statesmen from Otto von Bismarck (1815–1898) to Woodrow Wilson (1856–1924) considered the denouncement of or abrogation from a treaty as the solemn and inalienable right of state sovereignty. Taken to its logical conclusion, *clausula rebus sic stantibus* poses a fundamental challenge to the principle of *pacta sunt servanta*, the treaty’s defining characteristic. Still, the *rebus sic stantibus* principle became part of customary international law and was codified—albeit in a more restrictive form because of its common abuse—in the Vienna Convention on the Law of Treaties (Article 62).

Contexts

Examining how the concept of treaty developed as a basic form of inter- and cross-cultural handling requires consideration of

COVENANTS OLD AND NEW

Had that first covenant been faultless, there would have been no occasion to look for a second to replace it. But God finds fault with his people when he says, "The time is coming, says the Lord, when I shall conclude a new covenant with the house of Israel and the house of Judah. It will not be like the covenant I made with their forefathers when I took them by the hand to lead them out of Egypt; because they did not abide by the terms of that covenant, and so I abandoned them, says the Lord. For this is the covenant I shall make with Israel after those days, says the Lord: I shall set my laws in their understanding and write them on their hearts; I shall be their God, and they will be my people. They will not teach one another, each saying to his fellow-citizen and his brother, "Know the Lord!" For all of them will know me, high and low alike; I shall pardon their wicked deeds, and their sins I shall remember no more." By speaking of a new covenant, he has pronounced the first one obsolete; and anything that is becoming obsolete and growing old will shortly disappear.

SOURCE: Hebrews 8:7–13, in *The Revised English Bible with the Apocrypha*.

its ideological affinities to the concept of trade. These affinities are lexically quite striking, more so in the French words for treaty and trade, *traité* and *traite*, respectively. This is not surprising when one recalls how the conclusion of treaties was an important means through which Western trade expanded, initially in the East and then globally. During this period we saw the development of the terms "treaty port" and "treaty national." Treaty ports were established all over the coasts of East Asia and along navigable waterways too, through treaties between Western nations and the rulers of China, Japan, Korea, and Siam. The treaty ports regime allowed for the establishment of self-administered foreign settlements for the purposes of trade, settlements that enjoyed varying degrees of autonomy. The main provision was that foreign or treaty nationals enjoyed extraterritoriality and were therefore deemed to be outside the jurisdiction of the country they actually resided in, thus being legally accountable only to their respective consular courts. Though treaty ports and nationals were not limited to the east coast of Asia, and could be found also in the Ottoman Empire and Morocco, it was in China that they reached unparalleled proportions to the bitterness of the local elite that was forced to capitulate. There was a time that up to eighteen countries, not only Western powers but also Mexico, Brazil, and Peru, signed such treaties with China, in the first instance for the promotion of trade, but in the longer term infiltrating the region culturally and politically through missionaries and consuls.

In the sense of "worldly handling," treaties were also used as an instrument for colonial expansion. Note, parenthetically, that formal treaties were not always employed, especially with regard to the colonization of Africa, or the Spanish conquests

of America, which were "legalized" through the Papal Bull *Inter caetera* (1493). The latter gave the "illustrious sovereigns" of Castile the exclusive right to acquire all the land they had discovered or might discover in the future one hundred leagues west of the Azores and Cape Verde islands. In terms of local instruments, the Spanish morally and practically dispossessed indigenous peoples through a legal caricature, the *Requerimiento*, a Eurocentric and Christocentric document on the history and state of the world, read to the natives and asking them to accept it by submitting to Spanish sovereignty or be made to submit. Nonetheless, treaties with the natives were often employed by colonial powers when commercial, political, or military interests so demanded. Such treaties were textually very basic, written in paternalistic discourse, and indirectly legitimated colonial occupation and governance in exchange for vague promises of protection of native life, possession, and culture. Their current "anomalous" status in terms of legal claims and retrospective enforcement has become a hotly contested issue in, among other places, North America, Australia, and New Zealand.

Perhaps a paradigmatic treaty between a colonial power and an indigenous community is the Treaty of Waitangi (1840), concluded between Britain and the Maori chiefs of New Zealand (see sidebar). This treaty is interesting because it has been retrospectively enforced, albeit reluctantly and selectively, through a 1975 New Zealand Act of Parliament and currently forms the basis of a number of claims by Maori groups for partial restitution and nondiscrimination. Still, the treaty's terms and processes expose the catachrestic political environment within which colonial treaty-making was taking place. For a start, there are significant differences between the English and

THE TREATY OF WAITANGI, 1840

Victoria, the Queen of England, in her concern to protect the chiefs and subtribes of New Zealand and in her desire to preserve their chieftainship and their lands to them and to maintain peace and good order considers it just to appoint an administrator one who will negotiate with the people of New Zealand to the end that their chiefs will agree to the Queen's Government being established over all parts of this land and (adjoining) islands and also because there are many of her subjects already living on this land and others yet to come. So the Queen desires to establish a government so that no evil will come to Maori and European living in a state of lawlessness. So the Queen has appointed me, William Hobson, a captain in the Royal Navy to be Governor for all parts of New Zealand (both those) shortly to be received by the Queen and (those) to be received hereafter and presents to the chiefs of the Confederation chiefs of the subtribes of New Zealand and other chiefs these laws set out here.

The First

The chiefs of the Confederation and all the chiefs who have not joined that Confederation give absolutely to the Queen of England for ever the complete government over their land.

The Second

The Queen of England agrees to protect the chiefs, the subtribes and all the people of New

Zealand in the unqualified exercise of their chieftainship over their lands, villages and all their treasures. But on the other hand the Chiefs of the Confederation and all the Chiefs will sell land to the Queen at a price agreed to by the person owning it and by the person buying it (the latter being) appointed by the Queen as her purchase agent.

The Third

For this agreed arrangement therefore concerning the Government of the Queen, the Queen of England will protect all the ordinary people of New Zealand and will give them the same rights and duties of citizenship as the people of England.

(Signed) W. HOBSON

Consul and Lieutenant-Governor

So we, the chiefs of the Confederation and of the subtribes of New Zealand meeting here at Waitangi having seen the shape of these words which we accept and agree to record our names and our marks thus.

Was done at Waitangi on the sixth of February in the year of our Lord 1840.

SOURCE: Literal translation of the Maori text of the Treaty as proposed by Sir Hugh Kawharu; quoted from Ian Brownlie, *Treaties and Indigenous Peoples*, pp. 6–7.

the Maori texts of the treaty as well as differences in the understanding of the concepts used within. The English text included a provision that the Maori chiefs were “claiming authority over the Tribes and Territories which are specified after our respective names,” a passage that is missing from the Maori text. The Maori translations for “government” (*kawanatanga*) did not have the Western conception of the exercise of sovereignty, nor did “rights and duties” (*tikanga*) have the notion of the pursuit of individual claims and obligations outside the remit of local custom (see www.archives.govt.nz/holdings/treaty_frame.html). There are also variations between the original Maori text and the eight copies in Maori opened for signature. The more than five hundred signatures to the treaty were a “cumulative process,” added by different chiefs on different copies at different locations in New Zealand. In

addition, not all copies bear a government seal. Some chiefs signed on unknown dates and without any witnesses. Some signatories have not been identified. Others signed without any clarification on the text of what representative authority they had, if any. The “Confederation of the Chiefs” referred to in the treaty was instigated by the British Resident in 1835 and only covered the north of the country. What is more, some important chiefs and tribes rejected the treaty and refused to sign, yet found themselves bound by it. As a leading legal authority implies, even using the most “generous” and “creative” interpretation of the provisions of the treaty, the Maori people cannot overcome the biases of the initial colonial policy through which they were “legally” dispossessed of their lands and polities (Brownlie). Ironically, recent human rights treaties of which they are not a party may provide a better basis for recognition

of their claims than the treaty they signed as “independent” and “sovereign” people. In practice, of course, indigenous groups use a combination of the original bilateral and recent multilateral treaties to support their claims.

Jurisprudence

Such cases illustrate that the modern idea of treaty developed within but also beyond the parameters of international legal history. In global practice, and from a non-Western perspective, treaties of particular historical periods could be seen as instruments for the aggressive promotion of commercial and imperial interests. In this sense, their primary aim was less the creation of legally binding commitments and more the economic and political infiltration of territories whose population status was legally defined through the treaty in ways that made this possible. As unequal devices and cover-ups through which Western global hierarchy was legitimated and reinforced, such historical treaties provide an antinomy to their conventional legal purpose as currently understood. Yet there are specific conceptual and practical limitations that need to—and perhaps cannot—be overcome in transforming a treaty into a politically neutral instrument. For example, as the Vienna Convention on the Law of Treaties (Article 2.1a) and treaty specialists outline, the designation of an agreement as a “treaty” does not in itself render it into a treaty, if written in contrary spirit and terminology. Similarly, the designation of an agreement by a nontreaty name (including memorandum of understanding) does not mean that it is automatically not a treaty, if parties textually display intention to be bound, yet decide not to go through the usual legal motions. In short, almost anything is technically possible given that the status of international agreements, in the final analysis, always depends on the definition whims of sovereign agents. That is why legal attempts to progressively develop the concept of treaty by extending it to all kinds of agreements that create binding obligations, and thus challenging the devious uses of “soft law,” may be important but can only go so far. Soft law is an expedient diplomatic practice that is likely to continue, exploiting the space between the “hard” obligations of treaty making and the dubious legality of nontreaty commitments, “creatively” mixing the two when politically necessary, establishing concomitant duties of varying degrees. This is not to belittle the usefulness and importance of treaties in creating contractual obligations that can be recognized if parties to a treaty agree (a current prerequisite under international law) to take disputes over validity and interpretation before an international tribunal or the International Court of Justice. It should be remembered, however, that treaties, like the one done in Waitangi, have also been an instrument to obliterate an international legal personality and deny an international *locus standi*, by creating internal rather than external treaty obligations, which can always be bypassed by new domestic law. From this perspective, as a means of both constituting and erasing international legal subjectivity, treaties have been essential in reproducing state sovereignty, through which humans invariably benefit or suffer.

See also *International Order; Peace; War*.

BIBLIOGRAPHY

- Aust, Anthony. *Modern Treaty Law and Practice*. Cambridge, U.K.: Cambridge University Press, 2000.
- Brownlie, Ian. *Treaties and Indigenous Peoples*. Oxford: Clarendon, 1992.
- Cicero. *De officiis*. Translated by Walter Miller. London: Heinemann, 1913.
- Deloria, Vine, and David E. Wilkins. *Tribes, Treaties, and Constitutional Tribulations*. Austin: University of Texas Press, 1999.
- Fairbank, John King. *Trade and Diplomacy on the China Coast: The Opening of Treaty Ports, 1842–1854*. Cambridge, Mass.: Harvard University Press, 1964.
- Gentili, Alberico. *De iure belli libri tres*. Translated by John C. Rolfe. Oxford: Clarendon, 1933.
- Herodotus. *Histories*. Rev. ed. Translated by Alfred Denis Godley. Cambridge, Mass.: Harvard University Press, 1938.
- Hillgenberg, Hartmut. “A Fresh Look at Soft Law.” *European Journal of International Law* 10, no. 3 (1999): 499–516.
- Klabbers, Jan. *The Concept of Treaty in International Law*. Boston: Kluwer, 1996.
- Ovid. *Metamorphoses*. Rev. ed. Translated by Frank Justus Miller. Cambridge, Mass.: Harvard University Press, 1984.
- The Revised English Bible with the Apocrypha*, Oxford: Oxford University Press, 1989.
- Satow, Ernest. *A Guide to Diplomatic Practice*. London: Longmans, 1957.
- Sinclair, I. M. *Vienna Convention on the Law of Treaties*. Manchester, U.K.: Manchester University Press, 1984.

Costas M. Constantinou

TRIBALISM, MIDDLE EAST. The term *tribe*, derived from the Latin *tribus*, refers to a group of persons forming a community and claiming descent from a common ancestor. In the Middle East and North Africa, unlike many other parts of the world, claiming tribal affiliation often positively affirms community, identity, and belonging. In the mid- to late twentieth century, nationalist leaders in some regions rejected claims to tribal identity as “primitive” or potentially divisive to national unity. In the early twenty-first century in Morocco, Yemen, and Jordan, tribal affiliations figure implicitly in electoral politics in many regions, although other aspects of personal and collective identity also come into play. In the Iraq ruled by Saddam Hussein (1979–2003), the mention in public of one’s tribal identity, outlawed in the 1980s in an effort to forge national identity, crept back into common usage and regime practice by the mid-1990s. Tribal identities remain important in many regions of the Middle East. They provide the basis for many forms of communal and political solidarity, although never exclusive ones, in many parts of the Arabian peninsula, Iraq, Jordan, Syria, among Arabs in Israel, and in the Palestinian areas.

Tribes in Seventh-Century Arabia

Tribal identities in the Middle East are best seen in the context of the wider social and economic networks in which they have played a part, from ancient empires to the present. Tribal, kinship, and genealogical identities also profoundly influenced

religious and political formations in earlier periods of the Middle East. For example, studies of ancient Judaism now also take tribal relations more into account than did earlier accounts that relied primarily on textual exegesis. In all these cases, however, alternative forms of social and political identity were never entirely absent.

For example, in the Arabian peninsula at the time of the advent of Islam in 622 C.E., social position in both oasis towns and their hinterlands depended foremost on overlapping ties of family, kinship, and tribe. In this context, Islam offered a new form of belonging, the “firmest tie” in the language of the Koran (2: 256), binding believers to God and giving them a sense of individual responsibility. The Koran morally sanctions ties to family, kin, and tribe but the community of Muslims (Ar., *umma*), united in submission to the one God, takes precedence.

The sense of belonging as individuals to the community of Muslims as the principal social and religious identity broke with the primary loyalties of the pre-Islamic era, but in practice tribal structure and claimed descent remained essential to understanding political, social, and economic action from later historical periods to the present. Thus there are many early references to the prophet Muhammad as an arbitrator among feuding tribes, a role traditionally played by members of his descent group, the Quraysh, prior to the advent of Islam. Many tribal groups decided that their adherence to the community of Muslims ceased with Muhammad’s death in 632 C.E., leaving them open to forge new alliances.

Tribal Identity and Political Metaphor

Tribal genealogies and identities often employ metaphors such as the parts of the human body and the branches of a tree to symbolize stability, obligation, and belonging, but tribal and lineage identities in the Middle East are social constructs that change and are manipulated with shifting political and economic circumstances. Ibn Khaldun (1332–1406), the medieval North African historian and advisor to kings, recognized the flexible shape of tribal identities.

For Ibn Khaldun, “group feeling” (Ar., *‘asabiyya*) exists when groups act cohesively, as if compelling ties of obligation hold them together to achieve common interests over extended periods of time. Thus belonging to a tribe does not depend on kinship or descent alone. In certain circumstances, individuals can change tribal, lineage, and clan affiliations. Dynasties and political domination were hard to sustain without such cohesiveness, especially present in tribal contexts. Group feeling is expressed in terms of presumed “blood” relationships, but in tribal contexts these are strong and compelling social metaphors for bonds of solidarity that take precedence over all other bonds of association. In Jordan, Iraq, Egypt, and elsewhere, tribal codes of responsibility and justice based on such cohesion often parallel the civil and criminal codes of state justice, and those of Islamic law, the *shari‘a*.

The Multiple Meanings of *Tribe*

The fact that one word, *tribe*, describes a range of ideas about society and social forms throughout the Middle East, as

elsewhere in the world, does not make these meanings intrinsically related. For example, take the notion of tribe, still prevalent in many archaeological discussions, as an organizational level between “band” and “state.” This formulation implies that tribes are on an evolutionary ladder and independent of states. Yet in earlier historical periods and in the present, tribes and states coexist and overlap. The problem of misrecognizing tribal identities is further compounded by the views of some Middle Eastern urban intellectuals who have adopted nineteenth-century evolutionary views and assume that tribes exist only at the fringes of states or are residues of pre-state formations. Both now and in the past, however, ideas of tribe share “family resemblances,” possessing partial and overlapping similarities and a shared cultural logic. Far from being a relic of the past, “tribe” in the Arabian peninsula and the modern Middle East can even sustain modern national identity.

Tribal identity, like other bases of social cohesion, including kinship, citizenship, and nationalism, is something that people (and sometimes ethnographers and state officials) create, and it changes with historical and political context. The first form that the notion of tribe can take is the elaboration and use of explicit ethnopolitical ideologies by people themselves to explain their social and political organization. These locally held ideologies of tribal belonging in the Middle East are generally based on a concept of political identity formed through common patrilineal descent. A major exception is the Tuareg of the Sahara, where tribal identity is based on matrilineal descent—descent traced through the mother.

People in such tribes sometimes hold that how groups align themselves in time of dispute is explained by tribal and lineage identities alone, but other grounds for political action coexist and overlap. In precolonial Morocco as elsewhere, coalitions did not necessarily occur along the lines of tribe or lineage. This is demonstrated by the patterns of resistance in which people from various sections and tribes aligned themselves against the French in the early twentieth century. Precolonial accounts of disputes in western Morocco also suggest that alliances followed more flexible lines than those predicted by formal classification.

In general, tribal names and chains of patrilineal genealogies provide a range of potential identities rather than a basis for sustained collective action in itself. Often there is strong resistance to efforts to write down genealogies or claims to tribal descent because writing, by fixing the relationships among groups, distorts the ongoing process by which groups rework alliances and obligations and “re-imagine” the past in order to legitimate actions in the present.

For example, when Moroccan tribespeople discuss *tribe* (Ar., *qabila*), they elaborate the notion in different ways depending on their generation and social status. Socially and politically dominant individuals use ideas of tribe and lineage to fix political alliances with members of other tribal groups and to enhance their own position vis-à-vis state authorities and their followers. Ethnographers working in tribal societies have frequently based their accounts of kinship relations and tribal organization on information provided by such socially and

politically dominant individuals. In contrast, the notions of tribal identity maintained by ordinary tribesmen, not to mention tribeswomen, often differ significantly from such formal ideologies of politically dominant tribal leaders.

A second notion of *tribe* is based on its use as an administrative device in contexts as varied as the Ottoman Empire, Morocco, Iran, and other countries prior to, during, and after colonial rule. Administrative assumptions concerning the nature of tribes are generally based, to some degree, on locally maintained conceptions modified for political purposes. Thus administrative concepts of tribe frequently assume a corporate identity and fixed territorial boundaries that many “tribes” do not possess and give privileges and authority to tribal leaders that are dependent on the existence of a state organization and not derived from leadership as understood by tribal people themselves. In cases such as Morocco and the Sudan, colonial authorities formally promoted “tribal” identities and developed tribal administration to a fine art in an attempt to retard nationalist movements. In reaction, the postcolonial governments of these and other countries signaled an ideological break with the colonial past by formally abolishing tribes as an administrative device, although such identities remain politically significant.

A third meaning of *tribe* refers to the practical notions that tribal people implicitly hold as a guide to everyday conduct in relating to their own and other social groups. These notions emerge primarily through social action. Tribal people do not always articulate such notions in ordinary situations because they are so taken for granted and because the social alignments based on these notions frequently shift. Practical notions of tribe and related concepts of social identity implicitly govern crucial areas of activity, including factional alignments over land rights, pastures, and other political claims, marriage strategies (themselves a form of political activity), and many aspects of patronage. In Jordan and among Palestinians in the occupied West Bank and in Israel, for example, Arabic newspapers are filled with announcements indicating the settlement of disputes among lineage and tribal groups precipitated by disputes or even automobile accidents resulting in personal injury in which tribal leaders mediate a settlement that is then publicly announced.

A fourth meaning of *tribe* relates to the analytical conceptions of the term held by anthropologists. Anthropological conceptions are intended primarily to make sociological sense of tribal social relations and often parallel those held by tribal people themselves. They are not more real than tribal people’s conceptions of tribe or superior to them; they are a more explicit form of knowledge intended to explain how societies work. The anthropologist’s objective is to achieve as adequate an understanding as possible of how people in a given society conceive of social forms, use this knowledge as a basis for social action, and modify these conceptions in practice and over time.

See also *City, The: The Islamic and Byzantine City; Identity: Personal and Social Identity; Nationalism: Middle East; Pan-Islamism.*

BIBLIOGRAPHY

- Eickelman, Dale F. *The Middle East and Central Asia: An Anthropological Approach*. 4th ed. Upper Saddle River, N.J.: Prentice Hall, 2002. See chap. 5, “What is a Tribe?”
- Khoury, Phillip S., and Joseph Kostiner, eds. *Tribes and State Formation in the Middle East*. Berkeley and Los Angeles: University of California Press, 1990. An indispensable review of the topic.
- Peters, Emrys L. *The Bedouin of Cyrenaica: Studies in Personal and Corporate Power*. Edited by Jack Goody and Emanuel Marx. Cambridge, U.K., and New York: Cambridge University Press, 1990. A classic reference.
- Shryock, Andrew. *Nationalism and the Genealogical Imagination: Oral History and Textual Authority in Tribal Jordan*. Berkeley and Los Angeles: University of California Press, 1997.
- Varisco, Daniel Martin. “Metaphors and Sacred History: The Genealogy of Muhammad and the Arab ‘Tribe.’” *Anthropological Quarterly* 68, no. 3 (July 1995): 139–156.

Dale F. Eickelman

TROPE. The trope concept, which is used increasingly in the social sciences to conceptualize the dynamics of definitions (and redefinitions) of social situations involved in communicative interaction, is derived from the Greek *tropos* (a turning), *tropē* (a turn), or *trepein* (to turn). It has long been used as a technical term in rhetoric to designate the use of a word or expression in a different sense than that which properly belongs to it in order to give liveliness, emphasis, perspective, coloration, or some other quality to an idea. The figures of speech (metaphor, metonym, synecdoche, and irony) are the four main categories of tropes, although tropes have been multitudinously identified in treatises on rhetoric.

The Tropes in Classical Rhetoric

At issue here is the very human tendency when thinking about some difficult, banal, or obscure subject to think about something else that can enliven, offer perspective on, or cast light on the subject. Although a tropologist is anyone interested in the role figures of speech play in discourse, in the social sciences tropology is an interest in how such figurative expression can be used persuasively to affect the understanding of social situations and consequently effect social interaction. A basic question is what role figures of speech play in the figuring out and playing out of human life in society as, mainly, a playing out of categories of social belonging and social differentiation. As can be seen in the Greek root of the word, the use of tropes, these turnings of thought, raises the question of mutability in society and its susceptibility to persuasion and change of direction. Contemporary tropologists are particularly interested in the plotting of this dynamic.

The trope concept, and the rhetorical disciplines in general, have long been opposed by the exponents of clearly reasoned argument and of explicit syllogistic logic whose truth can be ascertained. These exponents dislike the volatility and obscurity that figures of speech bring into any argument. They have misgivings about the enthymemic quality—that is, the truncated syllogisms of rhetorical argument—caused by the use of the tropes. These objections were first raised by Plato

(c. 428–348 or 347 B.C.E.) in various dialogues with the Sophists, the professional rhetoricians of his time. Socrates (c. 470–399 B.C.E.) questioned the Sophists' practice of the arts of persuasion, in which belief and opinion were manipulated but what he considered true knowledge, obtained through the dialectic, was neglected. Nevertheless, Aristotle (384–322 B.C.E.), in both the *Poetics* and the *Rhetoric*, considers rhetoric the counterpart of logic and an offshoot of the dialectic, although he focuses on metaphor and not on the overarching concept of the trope as a whole. He holds rhetoric to be worthy of attention and study, particularly in the education of the young. Indeed, in the classical world, training in the rhetorical arts of speaking, persuading, and debating was the hallmark of elite education. This is seen both in Marcus Tullius Cicero (106–43 B.C.E.; *De Oratore*) and in the massive rhetorical treatise (essentially a schoolbook) *De Institutione Oratoria* or *On the Education of the Orator*, by Marcus Fabius Quintilian (c. 35–c. 100 C.E.). By “the orator,” Quintilian meant scions of the patrician classes destined by birth to become persuasive in public affairs and naturally endowed to give shape and order to society. Important sections of this massive work are devoted to the various tropes and to the associated figures of speech that lie at the heart of rhetorical power and persuasion.

The idea of the trope and of studying the trope as affective and effective in public argument—that is, the idea of a science of tropology—was both appreciated and disliked by the ancients. The negative view of employing tropes in argument, which is that they confuse more than they enlighten, continues into the early modern period and is found in René Descartes (1596–1650), Thomas Hobbes (1588–1679), and John Locke (1632–1704), and can still be found in the present. Whereas the Cartesian, Hobbesian, and Lockian views first articulate early modern misgivings about the obfuscating role of the tropes and figures of speech in reasoned argument, other early moderns, such as Giambattista Vico (1668–1744) in the *New Science* (1725), argued that it was the tropes that enabled human understanding, or at least the escape from misunderstanding. Vico argued that a poetic logic existed in the creation and conduct of human life as it has evolved through the stages of civilization, and that studying the use and effect of the various tropes in discourse was central to understanding that logic and that evolution.

Vico devised an etymological method for discovering the tropes that were the source of our understanding of the world and of ourselves and whose evolutionary dynamic accounted for the cycle of civilization. His method is similar to the “genealogical method” developed by Friedrich Nietzsche (1844–1900) in *The Genealogy of Morals* (1897), through which he sought to discover the metaphors that lie behind the mummified concepts that we take as objective and direct representations of the world. For Nietzsche, all conceptualizing is willfully metaphoric, and it would follow that tropology is the only method through which to understand the springs of our thinking and its dynamic of power in human relations over time. His stark observations on the metaphoric basis of any supposedly secure metaphysical belief have become classics:

What then is truth? A movable host of metaphors, metonymies, and anthropomorphisms: in short, a sum

of human relations which have been poetically and rhetorically intensified, transferred, and embellished, and which, after long usage, seem to a people to be fixed, canonical, and binding. (1979, p. 23)

The Tropes in Contemporary Thought

Nietzsche's tropological approach to human understanding is echoed in subsequent thought, and especially in such postmodern thinkers as Jacques Derrida and Michel Foucault and in postmodern deconstructionism. This late-twentieth-century work is co-occurrent with the revival of interest in Vico and his tropology in the 1960s and 1970s. The tropological theories of the historian Hayden White are notable here. White echoes Nietzsche's assertion in *The Use and Abuse of History* (1957) that historical writing is not a window enabling us to directly perceive historical reality but rather a perspectival screen always obstructing our view of the past in its particular way, according to the persona and preferences of the historian. In *Metahistory* (1973), White examines the great historians of the eighteenth and nineteenth centuries, Edward Gibbon (1737–1794), Alexis de Tocqueville (1805–1859), Thomas Babington Macaulay (1800–1859), Jules Michelet (1798–1874), Jacob Burckhardt (1818–1897), and Leopold von Ranke (1795–1886), showing how each had a particularly powerful poetic grasp of the part of the past that interested him and how this grasp was a function of the particular poetic tropes that he found evocative and helpful in organizing his thoughts. These tropological screens, or “governing metaphors,” of historical writing acted in the particular historian to more or less self-consciously include or eliminate data from consideration. Historical understanding is thus anchored in the constraints exercised by the tropes the historian chooses.

White's work was accompanied in the seventies and eighties by tropological approaches to both anthropology and cognitive linguistics. Beginning in the collection *The Social Use of Metaphor* (1977) edited by David Sapir and Christopher Crocker, anthropologists gradually worked toward analyzing the role of the various tropes as they played off or interacted with each other in social life and culture. This interactive tropology, the authors in this collection argued, was useful in developing a more sensitive anthropological ethnography—that is, the study of the dynamics of “communicative interaction” in society and culture. Cognitive linguists, working over a twenty-year period that began in 1980, developed a linguistic theory of the logic behind the figuration of human understanding as anchored in bodily experience and projected out on the world. This is a theory sharply contesting the objectivist and rationalist paradigms in philosophy and in its way an actualization in cognitivist terms of Vico's efforts to identify the poetic logic of life in civilization. Cognitivists pay particular attention to the effect this logic has on the categorization processes in cognition, an emphasis that is congenial to anthropologists interested in the social categorization processes in culture and social relations.

The trope concept is an integral part of an enduring debate about the role of the figurative both in human communication and in bringing about social and cultural change. Cultures may vary in their stability over time, but all cultures are dynamic to one degree or another and can be persuaded

to change the structure of their social relationships and turn in a new direction. The degree to which the tropes—themselves micro-turnings of thought—are influential in these macro-level social turnings has been a central question of tropology.

See also *Iconography; Ideas, History of; Postmodernism; Rhetoric*.

BIBLIOGRAPHY

PRIMARY SOURCES

- Nietzsche, Friedrich Wilhelm. *A Genealogy of Morals*. Translated by William A. Haussmann. New York: Macmillan, 1897.
- . *Philosophy and Truth: Selections from Nietzsche's Notebooks of the Early 1870's*. Translated by Daniel Breazeale. Atlantic Highlands, N.J.: Humanities, 1979.
- . *The Use and Abuse of History*. Translated by Adrian Collins. New York: Liberal Arts, 1957.
- Quintilian, Marcus Fabius. *Quintilian's Institutes of Oratory; or, Education of an Orator*. 12 vols. Translated by John Selby Watson. London: H. G. Bohn, 1856.
- Vico, Giambattista. *The New Science of Giambattista Vico*. 1744. Translated by Thomas Bergin and Max Fisch. Reprint, Ithaca, N.Y.: Cornell University Press, 1948.

SECONDARY SOURCES

- Fernandez, James W., ed. *Beyond Metaphor: The Theory of Tropes in Anthropology*. Stanford, Calif.: Stanford University Press, 1991.
- Fernandez, James W. *Persuasions and Performances: The Play of Tropes in Culture*. Bloomington: Indiana University Press, 1986.
- Lakoff, George, and Mark Johnson. *Metaphors We Live By*. Chicago: University of Chicago Press, 1980.
- . *Philosophy in the Flesh. The Embodied Mind and Its Challenge to Western Thought*. New York: Basic, 1999.
- Lakoff, George. *Women, Fires, and Dangerous Things: What Categories Reveal About the Mind*. Chicago: University of Chicago Press, 1987.
- Sapir David, and Christopher Crocker, eds. *The Social Use of Metaphor: Essays on the Anthropology of Rhetoric*. Philadelphia: University of Pennsylvania Press, 1977.
- White, Hayden V. "The Burden of History." In his *Tropics of Discourse: Essays in Cultural Criticism*. Baltimore, Md.: Johns Hopkins University Press, 1978.
- . *Metahistory: The Historical Imagination in Nineteenth-Century Europe*. Baltimore, Md.: Johns Hopkins University Press, 1973.

James W. Fernandez

TRUTH. The concept of truth is central to Western philosophical thought, especially to such branches of philosophy as metaphysics, epistemology, and the philosophy of language. In particular, the correspondence theory of truth has long been associated with a realist metaphysics, according to which objects exist independently of cognition by the human mind. Alternatives to the correspondence theory have, by contrast, been associated with antirealist metaphysics.

The Correspondence Theory: Ancient and Modern

The correspondence theory of truth holds that a belief or proposition is true when it corresponds to the way the world is. The theory originated with Plato (c. 428–348 or 347 B.C.E.) and held the stage in Western theories of truth through the eighteenth century. At *Theaetetus* 188c–189b, Plato considered what is sometimes called the "existence" theory of truth: true opinion is thinking what is, while false opinion is thinking what is not (pp. 893–895). Plato dismissed this view of false opinion on the ground that to think what is not is to think nothing, and this is no more possible than to see nothing. At *Sophist* 240d–241a and 260c–263d, Plato proposed an alternative theory of truth designed to circumvent this difficulty: a thought resembles a sentence in consisting of a noun and a verb, and one's thought can be about something even though it is false because the noun refers to an object while the verb misdescribes this object (pp. 984, 1007–1011). This is a correspondence theory in the sense that truth requires that the truth bearer concatenate a noun and verb just as the object to which the noun refers has the property expressed by the verb.

At *De Interpretatione* 16a10–19, Aristotle (384–322 B.C.E.) endorsed Plato's *Sophist* point against the existence theory when he proposed that truth and falsity require names and verbs in combination or separation (p. 25). His definition of truth at *Metaphysics* Γ 7, 1011b26ff is committed to complex truth bearers: "To say of what is that it is not, or of what is not that it is, is false, while to say of what is that it is, and of what is not that it is not, is true . . ." (pp. 1597–1598).

The Stoics also offered a correspondence theory: "They [the Stoics] say that a true proposition [*axioma*] is that which is and is contradictory to something" (Sextus Empiricus, p. 203). However, the Stoics parted with Aristotle in defending the principle of bivalence, that there are only two truth values, true and false. St. Thomas Aquinas (c. 1224–1274) said that "truth is primarily in intellect; and secondarily in things, by virtue of a relation to intellect as to their origin" (p. 63).

Philosophers of the seventeenth and eighteenth centuries also accepted the correspondence definition of truth, but they differed from their ancient and medieval predecessors in emphasizing that the definition has no utility as a criterion of truth, that is, as a means to judge whether given propositions are true. René Descartes (1596–1650) conceded that "the word *truth*, in the strict sense, denotes the conformity of thought with its object" (p. 65). But he denied that this definition is useful for clarifying or explaining the concept: "it seems a notion so transcendently clear that nobody can be ignorant of it" (p. 65); a definition can only cause confusion. He offered clear and distinct perception as a criterion of truth.

Baruch Spinoza (1632–1677) expressly applied *true* to ideas in *Ethics*: "A true idea must agree with its object" (p. 410). The axiom is used to show that reason regards things as necessary.

John Locke (1632–1704) endorsed the Platonic-Aristotelian view that *true* applies strictly to truth bearers of subject-predicate form—to propositions, in particular. He did not, however, formulate a correspondence definition of true proposition. Instead, he offered an account of the conditions in

which truth is ascribed to ideas. Though ideas do not have a subject-predicate form and are thus not strictly true, one nevertheless ascribes truth to them in a manner that derives from one's "tacit supposition of their conformity to" their object (p. 514). When I ascribe truth to an idea belonging to another individual, I say that the idea is true when I suppose it conforms to my idea; and when I ascribe truth to my own idea, I suppose it is "conformable to some real existence" (Locke, p. 515). David Hume (1711–1776) loosely follows Locke in his account of the kinds of truth in the *Treatise*. "Truth is of two kinds, consisting either in the discovery of the proportions of ideas, consider'd as such, or in the conformity of our ideas of objects to their real existence" (p. 448). The second kind of truth, concerning matters of fact, echoes Locke's account of the ascription of truth to my own ideas and defines truth for matters of fact as conformity to the real existence of objects. Note that Hume endorses a correspondence theory only for matters of fact, not for matters of reason (or the discovery of proportions of ideas).

In the *Critique of Pure Reason*, Immanuel Kant (1724–1804) defined truth as correspondence: "The nominal definition of truth, namely that it is the agreement of cognition with its object, is here granted and presupposed; but one demands to know what is the general and certain criterion of the truth of any cognition" (p. 197). However, Kant denied that there is a universal material criterion of truth and observed that a universal formal criterion of truth, being nothing but logic, is sufficient only for consistency, not truth. Georg Wilhelm Friedrich Hegel (1770–1831) too accepted a correspondence definition of truth in his *Science of Logic*: "Objective truth is no doubt the Idea itself as the reality that corresponds to the Notion" (p. 784). But he did not see this as helping us with subjective truth.

Pragmatist and Coherence Theories

In *Logic*, Kant noted that to judge whether a cognition is true, one must compare it with its object, and this requires another cognition of the object, which may be fallible—hence the judgment of truth is not sufficient for truth. Kant took this to show that the correspondence definition is useless as a criterion of truth. By contrast, followers of Kant took it to show that correspondence truth is unknowable or even unthinkable, since it requires comparing a cognition with its uncognized object, which is uncognizable. One can compare a cognition only with other cognitions. Moreover, a cognition cannot copy or resemble an object. This difficulty led many philosophers in the nineteenth century to seek an alternative to the correspondence definition, and they naturally sought to define truth in terms of the criterion of truth.

In "How to Make Our Ideas Clear," the American pragmatist Charles Sanders Peirce (1839–1914) proposed a method of clarifying our everyday conceptions: a conception is to be identified with the conception of the practical effects of its object. For example, "To say that a body is heavy means simply that, in the absence of opposing force, it will fall" (1992b, p. 48). Applying this to truth, to say that a belief is true is to say that it would permanently survive sustained inquiry conducted in a proper way. This is an epistemic definition of truth, since it

defines truth in terms of proper inquiry. An epistemic definition runs into circularity if proper inquiry is in turn defined in terms of the aim of true belief. In "The Fixation of Belief," Peirce answered this threat of circularity by characterizing proper inquiry without employing the notion of truth—as inquiry that fixes belief by eliminating doubt.

Like Peirce, William James (1842–1910) applied a pragmatist theory of meaning to *true* and identified the notion of true belief with that of the consequences for experience of the belief's being true—"truth's cash-value in experiential terms" (p. 200). James differed from Peirce in characterizing a true belief as one that is eventually verifiable, rather than one that would be permanently fixed in sustained inquiry. This allows the possibility that a true belief will be permanently retracted after its eventual verification in sustained inquiry. James was more pragmatist than Peirce in attempting to use his pragmatist theory of true belief to explain the practical, and not merely cognitive, utility of true belief. A true belief is one that would fit my experience in a counterfactual circumstance. Because my true belief that the cowpath leads to a house would fit my experience were I to go down the path, it enables me to select the more useful course of action—going down the path that leads to food, as opposed to one that does not. Moreover, James, unlike Peirce, was guided in his choice of a definition of truth by the aim of finding a definition that explains the practical utility of true belief.

British idealists developed coherence theories of truth in the late nineteenth century. One motivation for these theories was epistemological: knowledge of whether a given judgment is true cannot result from comparing the target judgment with its object, as the correspondence theory requires; it must result from comparing judgments with other judgments. The available criterion here is coherence of the judgments with one another. This motivation for the coherence theory received its most extensive expression in the twentieth century in the American idealist Brand Blanshard (1892–1987) (pp. 225–237, 268). An alternative metaphysical motivation, to be found in the work of Francis Herbert Bradley (1846–1924) and Harold H. Joachim (1868–1938), appeals to the doctrine of internal relations. According to this doctrine, every relation is grounded in the natures of the relata. This is said by Bertrand Russell (1872–1970) to be equivalent to the monistic theory of truth, that judgments are not true one by one, but only abstracted from a concrete known whole (1906–1907, p. 37). From monism, it is supposed to follow that the truth of a judgment consists in its coherence with the whole, rather than in correspondence. Russell objects to the coherence theory on the ground that it does not rule out contrary propositions both being true: "coherence as the definition of truth fails because there is no proof that there can be only one coherent system" (1912, p. 122).

The Correspondence Theory: Twentieth Century

The correspondence theory was revived at the beginning of the twentieth century by the founders of analytic philosophy, G. E. Moore (1873–1958) and Russell, in reaction to James, Bradley, and Joachim. The new correspondence theories addressed the worries of idealists and pragmatists about just what the correspondence relation is, if not the discredited copying relation, and what the terms of the relation are.

In lectures delivered in 1910 and 1911, Moore posed a problem like the one Plato urged against the existence theory of truth. On the one hand, if one believes that God exists, and this is true, one believes a fact (that God exists), and this fact is. On the other hand, one believes the same thing whether the belief is true or false; so there must be a fact even if one believes falsely that God exists; yet in this case there is no such fact (pp. 250–251). In “Beliefs and Propositions,” Moore resolved this dilemma by denying that what one believes in a true or false belief is a fact. The clause “that p ” in the description “the belief that p ” does not name any fact or indeed anything at all. A belief, whether true or false, is not a relation between a believer and a fact, or even between a believer and a proposition. So one can believe the same thing in a false belief as in a true belief, even though for the false belief there is no fact. Moore nevertheless found it convenient to speak of beliefs as referring to facts: “To say that a belief is true is to say that the *fact to which it refers is* or has being; while to say that a belief is false is to say that the fact to which it refers is not—that there is no such fact” (p. 267). Moore was unable to analyze what is involved in referring (which amounts to correspondence when the fact referred to has being), but he was quite clear that, although “the belief that p is true” is equivalent to “ p ” on the assumption that the belief p exists, this is not a definition of truth precisely because “ p ” says nothing about the belief p or a correspondence relation.

Russell tried to say what correspondence is in his work between 1906 and 1912. Othello’s belief that Desdemona loves Cassio is a four-term relation between Othello, Desdemona, the relation of loving, and Cassio, while the corresponding fact (if there is one) is a two-term relation of loving between Desdemona and Cassio. Correspondence is then a certain match between the terms in the belief relation and the fact (1912, pp. 124–130). Later, Russell abandoned the idea that a false proposition is one that does not correspond to a fact, in favor of the view that it is one that bears a different correspondence relation to a pertinent fact (1956, p. 187). The latter view avoids a commitment to the idea that the clause “that p ” in the description of a false belief names a fact, but it is encumbered with the burden of defining the two correspondence relations so that they cannot both obtain, on pain of allowing a proposition to be both true and false.

The British ordinary language philosopher John Langshaw Austin (1911–1960) proposed a correspondence theory in his article “Truth” (1950). His theory takes statements as truth bearers and states of affairs as truth makers, and it defines correspondence as a correlation that relies on conventions of two kinds: “demonstrative” conventions relating token states of affairs to statements, and “descriptive” conventions relating types of states of affairs to sentence types expressing those statements. A statement is true when the state of affairs to which it is correlated by demonstrative conventions is of a type with which the sentence used in making the statement is correlated by descriptive conventions. The British philosopher P. F. Strawson (b.1919) attacked Austin’s theory, and correspondence theories more generally, on the ground that there are no bearers of truth values, there are no entities in the world amounting to facts, and there is no relation of correspondence (1950). Strawson

endorsed the opposing view that an assertion made by uttering “It is true that p ” makes no assertion beyond one made by uttering “ p ,” although it may be used to do things other than make this assertion (for example, confirm or grant the assertion that p).

The Polish-American logician Alfred Tarski (c. 1902–1983) offered a “semantic” conception of the truth of sentences in a given interpreted and unambiguous formalized language L . His account was intended to capture an Aristotelian notion of truth. Tarski set as a material adequacy condition on a theory of truth-in- L what is called Convention T: that the theory entails all sentences of the form “ X is a true sentence if and only if p ,” where X is a name of some sentence of L , and p is the translation of this sentence into the metalanguage of the theory. Tarski then demonstrated that a recursive truth definition satisfies Convention T.

The basic idea of the truth definition is that a sentence such as “ a is F ” (for a name “ a ” and a predicate “ F ”) is true just in case F applies to the object denoted by a , where application is defined case by case for each name in the language L . Now let us give a Tarski-like truth definition for a simple language L with two names, “ a ” and “ b ,” and one predicate “ F .” We may begin by defining truth separately for each atomic sentence of L in semantic terms like “applies” and “denotes.” (Tarski made central a notion of satisfaction related to application.) The basis clause is: “ a is F ” is true just in case “ F ” applies to the object denoted by “ a ”; and similarly for “ b is F .” We then define “denotes” for each name: “ a ” denotes x just in case $x = a$; and similarly for “ b .” We define “applies”: “ F ” applies to y just in case ($y = a$ and a is F) or ($y = b$ and b is F). This has been called a disquotational definition of the semantic terms. Finally, we define truth for nonatomic sentences by exploiting the truth-functional properties of logical connectives like “or” and “not.” Treating truth as involving subject-predicate form is mandated by the need to satisfy Convention T.

Tarski’s theory formulated in terms of “denotes” and “applies” is plausibly regarded as a correspondence theory. However, Harry H. Field (b. 1946) charged that Tarski’s definition of truth does not reduce truth to a physicalistically acceptable property, as Tarski desired (1972). For Tarski’s disquotational definitions of semantic terms do not provide an explanatory reduction of those terms to any general physical properties. This is shown by the fact that if we augment L by adding a new name or predicate to form a language L' , the definition of truth-in- L gives no hint of what truth-in- L' amounts to. Field proposed that we remedy such difficulties by fitting Tarski’s theory in terms of semantic concepts with a physicalistically acceptable causal theory of denotation and application, rather than a disquotational definition of these concepts.

Deflationary Theories

Deflationary theories treat the truth predicate as having only a logical or grammatical function, rather than as ascribing a property or relation to a truth bearer, as on correspondence, pragmatist, and coherence theories. Frank Plumpton Ramsey (1903–1930) proposed, contrary to Moore, that *true* generally makes no substantive contribution to what is asserted in a

statement: “‘it is true that Caesar was murdered’ means no more than that Caesar was murdered” (p. 157). “Whatever he says is true” comes out “For all p , if he says that p , then p .” This is called the redundancy theory of truth. It is deflationary in denying that *true* expresses a property of truth bearers or a relation of correspondence between truth bearers and the way the world is.

In *Philosophical Investigations* (1958), Ludwig Wittgenstein (1889–1951) rejected his idea presented in the *Tractatus* (1961, originally published in 1922) that “This is how things are” expresses the general form of a proposition. This form of words does express a proposition, but “To say that this proposition agrees or does not agree with reality would be obvious nonsense.” Rather, it is a propositional variable the value of which is fixed by an earlier statement, in the way the referent of a pronoun is fixed by an earlier use of a name. This proposal, known as the “prosentential” theory of truth because it treats “That is true” as a “prosentence,” was subsequently developed by Dorothy Grover, Joseph L. Camp, Jr., and Nuel D. Belnap, Jr. (1975).

Willard Van Orman Quine (1908–2000) proposed that the truth predicate is used for semantic ascent, which in certain cases is indispensable for expressive purposes: “If we want to affirm some infinite lot of sentences that we can demarcate only by talking about sentences, then the truth predicate has its use” (p. 11). If we wish to say only that Tom is mortal, we can say “‘Tom is mortal’ is true,” but we need not do so. But if we wish to affirm each of the sentences of Euclidean geometry, we have no option but to say “All the sentences of Euclidean geometry are true.” We are saying no more than we would say by uttering each of the sentences, but since there are infinitely many of them, we cannot utter them all. For this reason, the truth predicate is practically indispensable. This suggests a disquotational theory of truth on which the content of *true* for a language is given by all the equivalences: “ p ” is true just in case p (for all sentences “ p ” of the language). Presumably, occurrences of *true* in contexts like “What he said is true” or “That is true” would be either spelled out in the manner of Ramsey or implicitly defined by the T-equivalences in virtue of the fact that the subject of the sentence refers to a particular sentence. Paul Horwich developed a related minimalist theory of truth by taking as the axioms of the theory all the equivalences: the proposition that p is true if and only if p (1990). These deflationary theories have, in common with Moore’s and Russell’s correspondence theories, the disadvantage of entailing the principle of bivalence, which prohibits “truth-value gaps,” as in borderline vague sentences or sentences with presuppositions that fail. A correspondence theory such as Field’s can be formulated in a way that avoids bivalence (1972). Deflationary theories also differ from correspondence theories in making it impossible to ascribe truth to sentences in a language we can’t understand. Field argued in a 1986 article that a deflationary notion of truth cannot be employed to account for how our tendency to believe truths explains our practical success in action.

Some have denied that truth is definable. Gottlob Frege (1848–1925) argued that if truth is definable as a property, then any judgment of whether an idea is true would involve judging whether the idea has the property, and the question

would then arise whether it is true that the idea has the property, generating a circle (1956). The early Moore (1953, p. 262) and Donald Davidson (1917–2003) also denied that truth is definable. Since 1980, philosophers (e.g., Huw Price) have shown an interest in functionalist accounts of truth, which characterize truth in terms of its cognitive or social function, rather than define the concept in other terms.

See also **Logic; Philosophy; Platonism; Pragmatism.**

BIBLIOGRAPHY

- Aquinas, St. Thomas. *Summa Theologiae*. 2 vols. Edited by Thomas Gilby. Garden City, N.Y.: Image Books, 1969.
- Aristotle. *The Complete Works of Aristotle: The Revised Oxford Translation*. 2 vols. Edited by Jonathan Barnes. Princeton, N.J.: Princeton University Press, 1984.
- Austin, J. L. “Truth.” *Proceedings of the Aristotelian Society* 24 (1950): 111–128.
- Blanshard, Brand. *The Nature of Thought*. 2 vols. New York: Allen and Unwin, 1939.
- Bradley, F. H. *Essays on Truth and Reality*. Oxford: Clarendon, 1914.
- Davidson, Donald. “The Folly of Trying to Define Truth.” *Journal of Philosophy* 93 (1996): 263–278.
- Descartes, René. “Letter to Marin Mersenne, 16 October 1639.” In *Descartes: Philosophical Letters*. Translated and edited by Anthony Kenny. Minneapolis: University of Minnesota Press, 1970.
- Field, Harry. “The Deflationary Conception of Truth.” In *Fact, Science, and Morality: Essays on A. J. Ayer’s Language, Truth, and Logic*, edited by Graham Macdonald and Crispin Wright. Oxford: Blackwell, 1986.
- . “Tarski’s Theory of Truth.” *Journal of Philosophy* 69 (1972): 347–375.
- Frege, Gottlob. “The Thought: A Logical Inquiry.” Translated by A. M. Quinton and Marcelle Quinton. *Mind* 65 (1956): 289–311.
- Grover, Dorothy, Joseph L. Camp, Jr., and Nuel D. Belnap, Jr. “A Prosentential Theory of Truth.” *Philosophical Studies* 27 (1975): 73–125.
- Hegel, Georg Wilhelm Friedrich. *Hegel’s Science of Logic*. Translated by A. V. Miller. Atlantic Highlands, N.J.: Humanities Press, 1989.
- Horwich, Paul. *Truth*. Oxford: Blackwell, 1990.
- Hume, David. *A Treatise of Human Nature*. 2nd ed., edited by L. A. Selby-Bigge. Oxford: Clarendon, 1978.
- James, William. *Pragmatism: A New Name for Some Old Ways of Thinking, Together with Four Related Essays Selected from The Meaning of Truth*. New York: Longmans, Green, and Co., 1947.
- Joachim, Harold H. *The Nature of Truth*. Oxford: Clarendon, 1906.
- Kant, Immanuel. *Critique of Pure Reason*. Translated and edited by Paul Guyer and Allen W. Wood. Cambridge, U.K.: Cambridge University Press, 1997.
- . *Logic*. Translated by Robert S. Hartman and Wolfgang Schwarz. Indianapolis: Bobbs-Merrill, 1974.
- Locke, John. *An Essay Concerning Human Understanding*. 2 vols. Edited by A. C. Fraser. New York: Dover Publications, 1959.
- Moore, G. E. *Some Main Problems of Philosophy*. London: Allen and Unwin, 1953.
- Peirce, Charles Sanders. *The Essential Peirce: Selected Philosophical Writings*. 2 vols. Edited by Nathan Houser and

TRUTH

- Christian Kloesel. Bloomington: Indiana University Press, 1992–1998.
- Plato. *The Collected Dialogues of Plato*. Edited by Edith Hamilton and Huntington Cairns. New York: Pantheon, 1961.
- Price, Huw. *Facts and the Function of Truth*. Oxford: Blackwell, 1988.
- Quine, W. V. *Philosophy of Logic*. Englewood Cliffs, N.J.: Prentice-Hall, 1970.
- Ramsey, Frank P. "Facts and Propositions." *Proceedings of the Aristotelian Society* 7 (1927): 153–170.
- Russell, Bertrand. *An Inquiry into Meaning and Truth*. London: Allen and Unwin, 1921.
- . *Logic and Knowledge, Essays 1901–1950*. Edited by R. C. Marsh. London: Allen and Unwin, 1956.
- . "On the Nature of Truth." *Proceedings of the Aristotelian Society* 7 (1906–1907): 28–49.
- . *The Problems of Philosophy*. New York: H. Holt, 1912.
- Sextus Empiricus. *Against the Professors* 8.85–6. In *The Hellenistic Philosophers*. 2 vols. Edited and translated by A. A. Long and D. N. Sedley. Cambridge, U.K.: Cambridge University Press, 1987.
- Spinoza, Baruch. *Ethics*. In *The Collected Works of Spinoza*, volume 1. Translated and edited by Edwin Curley. Princeton, N.J.: Princeton University Press, 1985.
- Strawson, P. F. "Truth." *Proceedings of the Aristotelian Society* 24 (1950): 129–156.
- Tarski, Alfred. "The Semantic Conception of Truth and the Foundations of Semantics." *Philosophy and Phenomenological Research* 4 (1944): 341–375.
- Wittgenstein, Ludwig. *Philosophical Investigations*. Translated by G. E. M. Anscombe. New York: Macmillan, 1953.
- . *Tractatus Logico-Philosophicus*. Translated by D. F. Pears and B. F. McGuinness. London: Routledge and Paul, 1961.

Frederick F. Schmitt



U

UNIVERSALISM. Since the late nineteenth century, the debate around issues concerning universalism and universalizability has intensified. Against the claims to universal knowledge made on behalf of Christianity, the West, rationality, and mankind, feminist, critical race, and postcolonial scholars and activists have shown that the issues are more complicated. Notwithstanding the validity of their criticism, universalism is not only compatible with the approaches that have condemned it, but is importantly in a sense presupposed by them.

First, we need to distinguish between different kinds of universalism. Universalism, in its most sophisticated form as it appears in the philosophy of science, defends the idea that thinking about any problem in science always leads to reasoning and that this reasoning will always seek the outermost limits through attempts to be universally valid, and to discover nonrelative truth. There are two forms of this simple and elegant idea about reason. One argues that this submission to an order of reason is a demand of reason itself. The other disagrees with the idea that we are ultimately submitting ourselves to an order of reason that is there for us to discover. Following Charles Peirce, this view argues that even as we try to think of this order of nature and of rationality, we are always doing so through a community of inquirers, so that this convergence of opinion about universally valid scientific laws always retains its ideal aspect. Here, Peirce sought to update Immanuel Kant's transcendental idealism, and show its relevance to the philosophy of science. For Kant, our scientific laws are valid for rational creatures such as us, and we can show their validity through transcendental deduction. But we cannot ultimately reach beyond the synthetic imagination and the categories of space and time that shape our world to reach into the world of things themselves. Convergence, for Peirce, means that divergent opinions can actually come to agreement on specific scientific laws and that unless there is a significant challenge to that agreement it will remain valid as true. But it is precisely because it is an agreement of a community of inquirers that also makes it open-ended, since such agreements can, at least in principle, always be challenged or re-elaborated by new paradigms of scientific truth. In some sense then, we are creating the order of reasons through the articulation of scientific laws. Simply put, there is always more to know, and as we know more, scientific laws that we previously thought of as unshakeable can either be criticized, extended, or in some cases, downright rejected. Peirce further argues that how well we think is ultimately dependent on the ethics of the scientific community to which we belong. Ethics then, as critiques of a community of knowledge, including scientific knowledge, can be foregrounded without necessarily losing the appeal to scientific laws as justifiable and as universally valid.

Feminists writing in the philosophy of science, such as Evelyn Fox Keller and Sandra Harding, have made important contributions in critiquing claims of universality for scientific law from at least two vantage points. The first and most important is that the community of knowledge is corrupt at the deepest level. It has adopted an ethics of scientific inquiry that, for the most part, has excluded women. Moreover, by so excluding women, it has in fact adopted notions of instrumental rationality that fail to achieve true objectivity because they relate to nature from a masculine or patriarchal viewpoint in which nature is reduced to something only valuable for its use to us. There is a rich and important literature in feminist epistemology and it is obviously impossible for me to be fair to the extent of the varieties of critique offered there. But even when such a feminist critique is allied with the searing analysis of the destructiveness of instrumental rationality as it takes over what we can even think of as reason—an analysis put forth by thinkers of the Frankfurt school such as Theodor Adorno and Max Horkheimer—it does not in itself necessarily lead to the rejection of a universality understood as always taking reason to its limit. This is true even if one allows, following Peirce, that that limit might always recede under the changing principles of scientific knowledge. Again, for Peirce, as for many feminists and other critical theorists, convergence remains always and still an ideal.

Indeed, we could argue that Peirce, following Kant, offers us a powerful critique of the pretensions of reason. This critique forces us to see how a thoroughgoing rationalism always is thrown back on the finitude of any actually given community of inquirers, humbled before their own historical position, even as they aspire to the scientific grandeur of ultimately trying to grasp the meaning of the universe. If Kant is right, we will never be able to think God's thoughts. But if Albert Einstein is also right, and the basic argument about reason is compelling, then any given community of inquirers will never stop trying.

Another central question in the debates surrounding universalism has been raised in ethics; precisely, the question is whether we need to rationalize ethical reasons into something more than a circular procedure for moral reasoning. In the famous case of John Rawls's proceduralism, he defends the hypothetical experiment of putting ourselves behind the veil of ignorance to imagine what Kant would have called our noumenal selves unbounded at least as imagined by the contingencies of our own history. Unlike Jürgen Habermas, Rawls does not want to defend his theory of justice or his own political liberalism through an overarching philosophical conception of reason and history that explains ethical and moral principles by an appeal to something outside of them.

Famously, Habermas argued against his predecessors, and indeed Kant himself, by trying to show us that reason can ground itself in universal principles of communicative action when combined with an empirically validated notion of evolutionary learning processes. This attempt to rationalize moral reason has been criticized extensively by theorists of language and of communication who have argued that first of all, no presuppositions can be found. Further, even if they could be found, they would not be strong enough to ground a normative theory, let alone an overarching normative conception of modernity and of human moral learning leading to the one-way street of modern Europe. Habermas is adding an empirical dimension to the general and comprehensive worldview of strong universalism advocated by Hegel. For Hegel, the universal ideal of humanity unfolds in all its greatness and, despite its floundering, finally culminates in a grand unity of our particular historical expression and our universal moral selves in what some may have seen as a rather limited embodiment, i.e. the German state. Habermas, in other words, attempts a general and comprehensive theory, to use John Rawls's expression that justifies universalism through a connection of reason and an overarching concept of rationality. But, as mentioned earlier, Rawls himself rejects this as the basis of the universalizable ideals of what he calls political liberalism. Rawls, one of the greatest voices of this vision, argued that at least hypothetically, we should be able to imagine ourselves as noumenal beings that could idealize themselves so as to articulate and defend as reasonable certain universal principles of justice. Rawls certainly defends the universality of the principles of justice. But he refuses universalism understood as the attempt to ground moral reason in an order of reason outside of the procedure, such as in the case of Habermas, who seeks to ground morality and ethics in the presuppositions of language.

In her own work in moral philosophy, Martha Nussbaum has tried to defend universalism in the sense of defending an Aristotelian notion of a moral view of human nature. Her view too should be considered universalism in the sense that she argues that we can know what our nature is and derive from that knowledge a strong commitment to values, universalizable because they are true to the substance of our human nature. By universalizable, I mean to indicate ideals that purport to include all of humanity and therefore can be accepted by all of us. This way of thinking about what is universalizable emphasizes the idea of the scope of who should be included in the ideal of humanity, and the rights that are accorded to those so included. But universalism as defended by either Nussbaum or Habermas ultimately denies the central importance of the insight of the Kantian proceduralism of Rawls. That insight is for a norm to be truly universalizable, it cannot be based on a notion of the human that generalizes out of a particular experience. Again, the feminist critiques of man were not arguing against the aspiration to universalizability of the rights of man, but claiming instead that those rights were indeed only for men, in many instances being granted to men only, and thus fail the test of universalizability that they purported to meet. Feminists, of course, have been joined by postcolonial theorists who have reminded us that the identification of humanity as an ideal, including as a moral ideal, with European modernity, not only risks reducing the universal to the particular, but has also justified the worst forms of colonial cruelty.

A critique then, of European modernity as other than a particular form of history is crucial for the unmooring of the ideal of universality and even the ideal of humanity itself from its implications in a brutal imperialist history. Universalizable norms, in this sense, carry with them a specific kind of self-reflexivity in which universality as an ideal must always lead to critical analysis. The danger is not only of confusing generality with universality, but also of proclaiming a particular form of being human as if this were the last word on who and what we could be. Universality, in other words, as a claim to cover the scope even of rights to be protected is always open to the moral contest it protects.

When Hegel is removed from his presumptuous philosophy of history, the lingering truth of Hegel's insight is that the re-articulation of universality and universalizable norms always takes place through a struggle. Karl Marx saw that struggle, or at least the struggle that could ultimately bring us to our truest humanity, as the battle between classes. History in other words, had not stopped with the bourgeois German state, but would only reach its culmination when humanity realized itself in communism. The lingering importance of German idealism is that it teaches us that at the end of the day we are left with a struggle—the struggle to see that taking reason to its limit also takes us back to the limit of reason itself, as Kant so powerfully taught us. Therefore, Kant's critique itself is integral to what is understood as an ideal in which the procedures by which we seek to universalize a norm or an ideal are always themselves open to question and re-articulation.

This notion of universality, as an ideal whose meaning can be reinterpreted in order for it to be able to live up to its own claims, should not be confused with relativism. Relativism, which argues that norms, values, and ideals are always relative to culture, actually turns on a strong substantive claim about the nature of moral reality. Relativists have to become the strongest kinds of rationalists in order to defend their position. To defend relativism as a substantive truth about moral reality clearly has to appeal to a form of universal knowledge. After all, if the claim is that principles are always inevitably relative to culture, then that claim is one that must defend itself as a universal truth. In our globalized world, the remembrance and the commitment to universality demands nothing less of us than a commitment to the critique and the corresponding imaginative openness to the re-articulations of the ideal.

See also *Essentialism; Feminism; Human Rights; Humanity*.

BIBLIOGRAPHY

- Adorno, Theodor, and Max Horkheimer. *Dialectic of Enlightenment*. New York: Continuum, 1999.
- Appadurai, Arjun. *Modernity at Large: Cultural Dimensions of Globalization*. Minneapolis: University of Minnesota Press, 1996.
- Butler, Judith. "Contingent Foundations." In *Feminist Contentions: A Philosophical Exchange*, edited by Seyla Benhabib et al. New York: Routledge, 1995.
- Chakrabarty, Dipesh. *Provincializing Europe: Postcolonial Thought and Historical Difference*. Princeton, N.J.: Princeton University Press, 2000.
- Habermas, Jürgen. *On the Pragmatics of Communication*. Cambridge: MIT Press, 1998.

- . *The Theory of Communicative Action*. Boston: Beacon Press, 1984.
- Harding, Sandra. *Is Science Multicultural?: Postcolonialisms, Feminisms, and Epistemologies*. Bloomington: Indiana University, 1998.
- Hegel, G. W. F. *Elements of the Philosophy of Right*. Cambridge, U.K.: Cambridge University Press, 1991.
- . *Phenomenology of Spirit*. Oxford: Oxford University Press, 1977.
- Kant, Immanuel. *Critique of Pure Reason*. Cambridge, U.K.: Cambridge University Press, 1998.
- Keller, Evelyn Fox, ed. *Feminism and Science*. Oxford: Oxford University Press, 1996.
- Matustik, Martin Beck. *Jürgen Habermas: A Philosophical-Political Profile*. Oxford: Rowman and Littlefield, 2001.
- Nagel, Thomas. *The Last Word*. New York: Oxford University Press, 1997.
- Nussbaum, Martha. *Sex and Social Justice*. Oxford: Oxford University Press, 1999.
- Peirce, Charles. *The Essential Peirce: Selected Philosophical Writings*. Bloomington: Indiana University Press, 1992.
- Rawls, John. *Political Liberalism*. New York: Columbia University Press, 1993.
- . *A Theory of Justice*. Cambridge: Belknap Press, 1999.
- Ruddick, Sara. *Maternal Thinking: Toward a Politics of Peace*. Boston: Beacon Press, 1995.
- Spivak, Gayatri. *Critique of Postcolonial Reason: Toward a History of the Vanishing Present*. Cambridge, Mass.: Harvard University Press, 1999.
- Williams, Patricia. *The Alchemy of Race and Rights*. Cambridge, Mass.: Harvard University Press, 1991.

Drucilla Cornell

UNIVERSE, THEORIES OF. See *Cosmology*.

UNIVERSITY.

This entry includes two subentries:

Overview
Postcolonial

OVERVIEW

The university is a legal corporation empowered by civil or ecclesiastical authorities to award degrees certifying that the recipients have achieved significant levels of expertise in various disciplines. Teachers instruct students of various ages and preparation in higher learning in several subjects. Many, but not all, teachers are scholars who carry on original research in order to add to the body of knowledge available to all. The world outside the university expects it to contribute to society by creating new knowledge, by training learned professionals at an advanced level, and helping all students to develop intellectually and culturally. This is the idea of the university. It has not changed in substance in nine hundred years, even though ideas about how universities should fulfill their missions have changed and expanded.

Precedents in the Ancient World and Islam

The ancient world did not have universities. But it did have several centers for research and study at an advanced level that provided the opportunity for a limited amount of informal education. Plato (427–348 B.C.E.) after 388 B.C.E. founded an Academy in Athens in which men gathered to discuss broad philosophical issues through interrogation and dialogue. The Academy lasted until 529 C.E., albeit with many changes. Aristotle (384–322 B.C.E.) had a circle of friends and pupils who gathered just outside Athens. After his death, Theophrastus (c. 372–c. 287 B.C.E. made it into a center, usually known as the Peripatetic School, for the study of the subjects that interested Aristotle, which meant practically everything from natural science to poetry, but especially philosophy. Neither the Academy nor the Peripatetic School, which lasted until the third century C.E., offered structured education or awarded degrees.

The museum and its library in Alexandria, Egypt, was the most important center for advanced learning in the Greco-Roman world. *Museum* meant a place where learned men cultivated the muses, not a collection of artifacts. Founded in

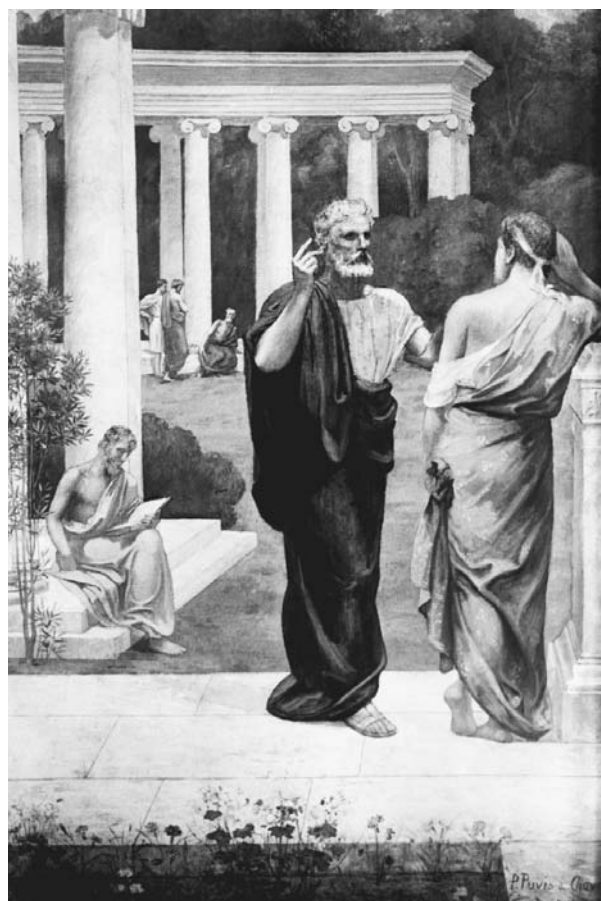

A student consults with Plato. Mural painting by Puvis de Chavannes. While the ancient world did not have accredited universities, it did offer informal centers for education, such as the one founded in Athens, Greece, by Plato in the third century B.C.E. © BETTMANN/CORBIS

the third century B.C.E. by Ptolemy I Soter (r. 305–283 B.C.E.), the museum provided support for writers but soon attracted scholars in many other fields, especially astronomy, mathematics, and philosophy. Ptolemy I added a library that attempted to obtain, or make copies of, the works of all known Greek authors. Scholars corrected and edited the texts, an important form of advanced academic scholarship. The museum of Alexandria had numerous scholars, some of whom attracted followers, but it did not offer formal education or confer degrees. The persecutions of Ptolemy VIII (r. 145–116 B.C.E.) drove some scholars away and ended the museum's greatest days, although it lasted until 651. The idea motivating Plato's Academy, Aristotle's Peripatetic School, and the museum and library of Alexandria was the advancement of high-level scholarship in many fields through the gathering of scholars and texts.

Between the eighth and eleventh centuries the Islamic world created the college, called *masjid khan* and later *madrasa*, a place where mature scholars taught law based on the Koran to younger men. Teachers, advanced students who assisted the master in teaching, and beginning students lived together for several years in inns attached to important mosques. But Islamic law colleges did not develop the corporate structure and legal identity of the

university, and they did not influence the Christian West. Nor did Islam have organized institutions for medical and philosophical higher education. Distinguished Islamic scholars such as the medical scholar Ibn Sina (or Avicenna, 980–1037) and the philosopher and commentator on Aristotle, Ibn Rusd (Averroës, 1126–1198), did not hold teaching positions but were court physicians most of their adult lives. In similar fashion, Jewish students came to learn from eminent Jewish interpreters of the Talmud, the basic source for Jewish law, in German and northern French towns, especially in the twelfth century. But the Talmudic schools did not evolve into universities.

The Creation of the University

The Western European Middle Ages created the university, its most significant and enduring achievement after the Roman Catholic Church. No clear idea or plan lay behind the beginning of the university. Rather, the two original universities of Bologna and Paris arose spontaneously as practical responses to circumstances, desires, and needs. In the late eleventh century, law students began to gather in Bologna at the feet of senior jurists who looked to ancient Roman law as the guide for creating legal principles to sort out the conflicting claims

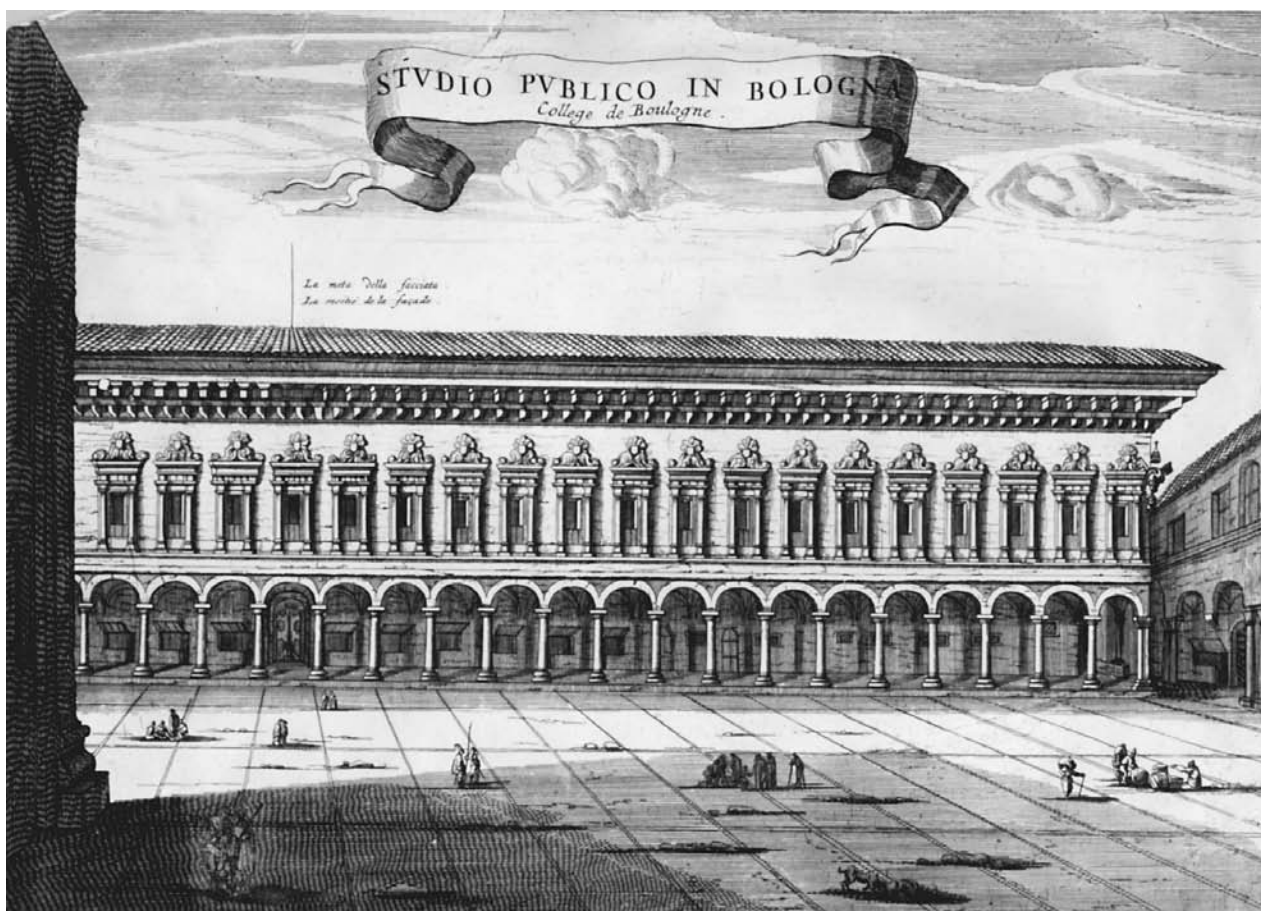

Engraving of Bologna University, c. 1790. Bologna University, established in the early thirteenth century, is considered one of the first two official universities. An important advancement in the history of the university occurred in Bologna in the 1220s when the government began taking responsibility for the teacher's salaries. HULTON GETTY/LIAISON AGENCY

and rights of empire, church, kingdoms, princedoms, towns, and individuals. In similar fashion students came to Paris to study arts, philosophy, and especially theology. In both cities enough teaching and organization regulating the teaching and the rights and obligations of teachers and students was in place by about 1150 that it could be said that universities were born.

Recognition that universities were new and unique institutions came after the fact. In the twelfth century *universitas* meant a group of people legally recognized as a collectivity. The corporation of masters and students at Paris first called itself a *universitas* in 1221. Hence, universities came into existence when society recognized that teachers and students as a collectivity had certain legal rights. Another term was *studium generale* (universal school), meaning an institution of higher learning that attracted students from a wide area and had the right to grant degrees authorizing the holder to teach anywhere in the world. A key event occurred in Bologna in the 1220s when the city government began to pay the salaries of teachers. This meant that professors would stay in one place and guaranteed the stability and continuity of the university. While pope and emperor played no role in their creation, civil governments, teachers, and students accepted that it was useful and orderly that popes and emperors should issue charters authorizing universities to award degrees recognized throughout Christendom.

These and other measures gave the university the basic shape that continues in the twenty-first century. The medieval university consisted of a corps of professors teaching arts (including logic, Latin literature, and mathematics), philosophy, medicine, surgery, science, canon law, civil law, and theology at an advanced level. Students of varying ages, from the early teens through men in their mid-twenties, heard lectures, studied texts required by university statutes, and participated in academic exercises for several years, sometimes for more than a decade. They submitted themselves to examinations for bachelor's, master's, and doctoral degrees. Upon obtaining degrees, they practiced or taught the disciplines that they had mastered. While sharing a basic structure, universities in northern and southern Europe differed. Many northern universities, including Paris and Oxford, taught mostly arts and theology to students studying for bachelor's degrees. Bologna and other Italian universities concentrated on law and medicine and awarded doctoral degrees.

European monarchs, princes, and towns founded and staffed at considerable expense a very large number of universities in the fourteenth, fifteenth, and sixteenth centuries. Historians frequently state that monarchs and cities founded universities in order to train civil servants to fill the expanding ranks of government offices, and certainly many law graduates did so. But contemporary documents do not mention this rationale for founding universities. Instead, university foundation charters offered as reasons the universal thirst for knowledge and the benefits to society of men learned in different subjects and full of mature counsel. There is no reason to doubt the sincerity of these lofty concepts. And reference to mature advice meant that university training would give those who later served ruler or town the scholarly perspective with which to approach complex issues.

The University in the Renaissance and Reformation

In the Middle Ages and the Renaissance, universities enjoyed a nearly complete monopoly as educators of Europe's scholarly, civic, and ecclesiastical elites. Although no author or treatise articulated the idea that universities should train the intellectual and sometimes the political and ecclesiastical leaders of Europe, they did. In the sixteenth century European universities probably exerted the greatest influence on learning and society in their history. Professors at Italian universities made extraordinary, original, scholarly contributions in medicine, philosophy, mathematics, and astronomy. The original anatomical research of Andreas Vesalius (1514–1564) while at the University of Padua from 1537 to 1543 and the mathematical and scientific research of Galileo Galilei (1564–1642), who taught at the University of Pisa from 1589 to 1592 and the University of Padua from 1592 to 1610, were just the best known of many examples of innovative research with enduring consequences. Martin Luther (1483–1546) created a new theology while teaching at the University of Wittenberg from 1513 on. He and many other professors of theology led the Protestant Reformation through their teaching, writing, and advice to princes. The Reformation, in turn, changed Europe religiously, politically, and culturally.

As a result of the Protestant and Catholic Reformations, many European universities became closely allied with religious groups in ways that they never had been in the past. The Society of Jesus in particular dominated some older universities or played major roles in newly founded ones from the middle of the sixteenth century onward. On the other side of the religious divide, some universities became closely identified with Protestant churches, such as the University of Wittenberg with the Lutheran Church and several universities with Calvinism, especially in the Netherlands. The University of Leiden (founded in 1575) was the most important among the latter.

Universities beyond Europe

When Europeans took their civilization to new continents, they quickly founded universities modeled on those of Europe. Catholic religious orders and Protestant churches founded most of the overseas universities, which trained indigenous clergy and produce educated lay leaders. The first universities founded in the New World were Santo Domingo (after 1538), Mexico (1551), and Lima (1571). A Catholic bishop of the Dominican Order founded the University of Santo Tomas in Manila, the Philippines, in 1611. The Congregational Church founded Harvard College in Cambridge, Massachusetts, in 1636 and named it for a minister who bestowed a considerable gift on the new college. These and many other universities across the world were based on European models. They were small in enrollment, faculty, and instruction at first, but grew over the centuries.

Universities in Decline

By 1600 European universities were beginning a period of decline in accomplishments and influence that lasted about 250 years. Many new schools arose in both Catholic and Protestant Europe to take students away from universities and to offer employment for scholars. In the Catholic world the Society of Jesus or Jesuits and other new religious orders developed schools that taught part of the university curriculum. The Je-

suits began by teaching Latin grammar, humanities, and rhetoric to boys aged ten to sixteen, then added a three-year program of logic, natural philosophy, and metaphysics at a higher level, as well as mathematics and occasionally other subjects. These were university subjects. The Jesuits had 578 schools, many with university-level instruction, across Europe in 1679. In Protestant Europe academies competed with universities. These were small schools offering higher instruction in a limited number of disciplines, especially arts and theology, without necessarily conferring degrees. The prototype was the Geneva Academy, founded by John Calvin in 1559. Academies hired excellent teachers and took students away from universities.

Learned societies, such as the Royal Society of London for the Advancement of Natural Knowledge, founded in 1662, offered more competition to universities by supporting scholars without requiring them to teach. Most learned societies on the Continent received funding from governments, which enabled them to offer salaries to members who carried on research in mathematics, astronomy, chemistry, and other subjects without teaching.

Enlightenment philosophes of the eighteenth century strongly criticized universities for not being useful to society because they held on to a traditional curriculum, a criticism often repeated in the next two centuries. The philosophes persuaded rulers to create nonuniversity institutions of higher learning to teach specialized practical subjects, such as agricultural technology, engineering, military science, surgery, even painting. They thought that such institutions would produce citizens capable of contributing useful knowledge to society and the state. Napoléon Bonaparte (who ruled France and much of Europe from 1799 to 1815) agreed. He abolished many universities in France and Germany and created technical schools in their place.

The Nineteenth and Twentieth Centuries

Nineteenth-century German educational reformers revived and gave new meaning to the idea of the university. Karl Wilhelm, baron von Humboldt (1767–1835), minister for education in Prussia, believed that universities should support *Wissenschaft*, faculty research and discovery in all fields, and should foster *Bildung*, or cultivation, meaning broad intellectual development and humanistic culture, in students. The new University of Berlin, founded in 1810, embodied Humboldt's vision. The renewed emphasis on research echoed the importance of innovative scholarship in theology, philosophy, law, and medicine by professors at medieval and Renaissance universities. The German research university of the second half of the nineteenth century realized the first goal and was widely copied by North American universities in the twentieth century. Many universities, especially those focusing on undergraduate education, in England, North America, and parts of the world influenced by England, emphasized a version of *Bildung* and called it *liberal education* in English and *culture générale* in French.

Beginning in the nineteenth century, governments assumed a greater role in higher education in Western Europe and the

United States. National governments in France, Germany, Italy, and elsewhere founded new state universities and closed or took control of church-sponsored institutions. Governments provided funding for universities, but also brought them under the control of ministries of education and made professors into civil servants. This process continued in the twentieth century, especially in the former Soviet Union (1917–1991). In the United States, state governments founded land-grant colleges in the nineteenth century that often became the largest and most important universities in the state. Although the United States still has a large number of colleges and universities affiliated with religious denominations, the ties between churches and universities have weakened and sometimes been dissolved. Church-affiliated universities have become less insistent that professors be members of the affiliated church, and they increasingly attract students of many faiths or none at all.

Since World War II (1939–1945) the dominant ideas shaping the university are that it should create new learning, teach skills in all fields and especially science and medicine, help the economy create wealth, and support a knowledge-driven society. While not ignored, humanistic research and teaching are less central. The multi-university, as it is sometimes called, offers an astonishing range of institutes, centers, and schools to teach all manner of knowledge, much of it practical. Emblematic of the new conception of the university is the addition of business schools preparing students to be successful in the many areas of national and international commerce and finance.

The idea that universities should provide higher education for a much larger proportion of the population has also won wide support from the public and governments. Hence, beginning in the 1960s governments increased the number and enrollments of universities and eased or broadened admission requirements. In addition, many more older students attended universities than in the past. As a result, the number of university students in Europe, North America, and other parts of the world greatly increased in the last thirty years of the twentieth century. One or two percent, at most, of the university-age population (eighteen through twenty-four) attended European universities in the first half of the twentieth century. By contrast, about half of the university-age population received some university education in the United States at the end of the twentieth century. In Europe as well, an increasing number of young people are attending university. Also, the European Union is slowly moving toward cooperation between universities in different countries and greater mobility of professors and students.

Women Students and Professors

Women were neither students nor professors in universities for many centuries. This was probably not the result of a conscious decision to exclude them, but the logical consequence of the view that universities prepared students for public careers and professions that women traditionally did not enter or from which they were barred. The path toward acceptance of women in universities was long and slow. The first woman to obtain a university degree was Elena Lucrezia Cornaro Piscopia (1646–1684), a Venetian noblewoman, who received a doctorate of philosophy from the University of Padua on 25 June 1678.

She did not attend lectures but obtained the degree through examination, an accepted practice in Italian universities. The second was Laura Bassi (1711–1778), a highborn Bolognese woman who obtained a doctorate of philosophy, again through examination, from the University of Bologna on 12 May 1732. She was the first female professor, as she taught experimental science at the University of Bologna from 1732 to 1738. The third was Maria Pellegrina Amoretti, who earned a doctorate in law from the University of Pavia on 25 June 1777.

From 1800 through 1945 more women, although still a small minority, attended university and earned degrees. Because many universities did not accept women as students, undergraduate colleges for women were founded, as well as new colleges and universities that admitted both men and women, especially in the United States. This changed greatly in the last thirty years of the twentieth century. Nearly all male-only colleges and universities in the United States accepted women as students, and a majority of women-only institutions enrolled men. But except for traditional female-dominated professions, such as nursing, only a few women were university professors in Europe and North America as late as the 1960s. Then, in response to larger societal moves to provide equal rights and opportunities for women, the barriers became lower or disappeared. By the twenty-first century women constituted the majority of undergraduates in American universities and about half of the students in law and medical schools. The number of women professors has increased greatly, although their distribution by fields varies. European universities also saw an expansion in the number of female students and professors, although the number of female faculty members varies considerably from country to country.

The idea of a university that offers education to students and supports advanced research by professors has proven to be one of the most enduring and influential ideas in Western civilization.

See also *Education*.

BIBLIOGRAPHY

- Addy, George M. *The Enlightenment in the University of Salamanca*. Durham, N.C.: Duke University Press, 1966.
- Bendall, Sarah, Christopher Brooke, and Patrick Collinson. *A History of Emmanuel College Cambridge*. Woodbridge, U. K.: Boydell Press, 1999. Has interesting intellectual, personal, and social detail.
- Brockliss, L. W. B. *French Higher Education in the Seventeenth and Eighteenth Centuries: A Cultural History*. Oxford: Clarendon, 1987.
- Clark, Burton R., and Gary R. Neave, eds. *The Encyclopedia of Higher Education*. 4 vols. Oxford and New York: Pergamon Press, 1992. Provides information on higher education in all parts of the world with a contemporary emphasis.
- Grendler, Paul F. *The Universities of the Italian Renaissance*. Baltimore and London: Johns Hopkins University Press, 2002.
- History of Oxford University*. 8 vols. in 9 parts. Oxford: Oxford University Press, 1984–2000. Comprehensive history beginning with the earliest schools at Oxford through the twentieth century.
- History of Universities*. Avebury and Oxford, U.K.: Avebury Publishing Co. and Oxford University Press, 1981–. Annual

volume covering universities in all centuries. Includes articles, comprehensive bibliography, and reviews.

- Jarusch, Konrad H., ed. *The Transformation of Higher Learning 1860–1930: Expansion, Diversification, Social Opening, and Professionalization in England, Germany, Russia, and the United States*. Chicago: University of Chicago Press, 1983.
- Jílek, Lubor, ed. *Historical Compendium of European Universities/Répertoire historique des universités européennes*. Geneva: CRE, 1984. Useful list with short historical summaries of European and overseas universities based on European models founded before 1800.
- McClelland, Charles E. *State, Society, and University in Germany, 1700–1914*. Cambridge, U.K.: Cambridge University Press, 1980.
- Ridder-Symoens, Hilde de, ed. *A History of the University in Europe*. Vol. 1, *Universities in the Middle Ages*. Cambridge, U.K.: Cambridge University Press, 1992. Vol. 2, *Universities in Early Modern Europe (1500–1800)*. Cambridge, U.K.: Cambridge University Press, 1996.
- Rothblatt, Sheldon, and Björn Wittrock, eds. *The European and American University since 1800: Historical and Sociological Essays*. Cambridge, U.K.: Cambridge University Press, 1993.
- Seabury, Paul, ed. *Universities in the Western World*. New York and London: Free Press and Collier Macmillan, 1975.

Paul F. Grendler

POSTCOLONIAL

The late twentieth century saw a renewed interest in the postcolonial development of higher education systems within broader literature on globalization and education policies. Particularly, efforts by international institutions, such as the World Bank, to prevent the global and local effects of the so-called knowledge divide, led to a number of policy documents and initiatives aimed at leveling the pace of changes and development in higher-education landscapes of rich and poor countries. Policy in this domain seemed largely influenced by studies that presented the gradual domination of managerialism in the organization of both teaching and research, the commercialization of research, and the outsourcing of many services to create leaner structures as inevitable consequences of globalization and the “knowledge explosion.” As a result, most developing countries were restructuring their already inherited systems of higher education along similar patterns to those observed in the West and the Pacific Rim. How this process—sometimes described as the “recolonization” of education—translates into actual higher education landscapes around the world seems to depend on a number of contextual variables.

A Contrasted Picture

A closer look at local and regional situations reveals persistent differences, in terms of institutional management, relations to the state, enrollments, and patterns of participation and academic careers. Beyond similar policy agendas, these realities signal contrasted histories and unequal states of development of higher education.

The fortune of universities and university education in countries that regained independence from waning European

INDIAN HIGHER EDUCATION SYSTEM: THE CRIPPLED GIANT

When India achieved independence in 1947, only a few thousand students were enrolled in higher education. In 2004, with 250 universities and approximately 8 million students, India had the world's second-largest system of higher education and produced more Ph.D.s per capita than anywhere in the world. However, the gross enrollment ratio in tertiary education stagnated at 11 percent. This figure, although higher than the average of 4 percent in Africa, remained low as compared to the countries of North America (60 to 70 percent) and Europe (40 to 60 percent), or the recently developed Asian Tigers (33 to 55 percent).

colonial "empires" (e.g., France, Britain) in the mid-twentieth century have differed, following routes largely influenced by their regional environment. If university education in Jamaica, Malaysia, Nigeria, and India still bears the mark of a common colonial origin, the universities of the West Indies in Mona, of Ibadan, of Malaya, and the Jawaharlal Nehru University of Delhi have, by will or by happenstance, been permeable and responsive to the realities and needs of postcolonial societies they had, to a large extent, not been designed to serve.

With a few exceptions, these countries are located in low-income regions where university education was reluctantly established in the agonizing days of the colonial era. As part of the colonial educational edifice, universities contributed to the spreading of a knowledge base rooted in the Western episteme. But as training centers of a mid-ranked indigenous bureaucracy, they also turned out to be the breeding ground of two generations of postcolonial political elite who led their countries as politicians, public servants, professionals, and businessmen. Following independence, the mission of universities established under colonial rule or with Western universities as their models was everywhere challenged and replaced by much more ambitious agendas for the development of genuine post-colonial university education systems.

At the beginning of the twenty-first century, universities throughout the postcolonial world were still criticized for underachievement. The criticisms remained the same: it was said that the universities produced graduates who were unemployable; they inculcated alien values; they failed to serve the interests of the vast majority of the population through appropriate courses and research dealing with the problems of the common man; they engaged in pure research that adds little value to the economy; they lacked in innovation and perpetually copied in-

novations in the developed world that may not be suitable for local circumstances. Despite these criticisms, enrollment in higher education grew steadily over the period, and universities gradually emerged as protected spaces, promoting a unique gender- and minority-inclusive culture. From the 1980s, female enrollment grew considerably in the poorest countries while it remained fairly flat in Europe and America. However, in the case of sub-Saharan Africa, while significant progress was made, the troubles of history since the mid-twentieth century (unstable governments, supra- and international pressures, civil strife, pandemics) made it extremely difficult for universities to develop appropriate curricula or to adjust their research agendas to local needs and realities. Once the euphoria of the 1960s waned, universities fell victim to distrust from growing authoritarian regimes and were among the first victims in the 1980s of the structural

Gross enrollment ratios (GER) in tertiary education, 2000–2001

Country	GER M & F	GER Male	GER Female	Gender Parity Index for GER. Tertiary
Australia	63	57	70	1.24
Bangladesh	7	8	5	0.55
Belgium	58	54	62	1.16
Botswana	5	5	4	0.89
Brazil	17	14	19	1.29
Burundi	1	2	1	0.36
Cambodia	3	4	2	0.38
Canada	59	51	68	1.34
Chile	38	39	36	0.92
Czech Republic	30	29	31	1.05
Eritrea	2	3	-	0.15
Estonia	58	45	70	1.55
France	54	48	59	1.23
Ghana	3	5	2	0.4
Hong Kong	25	24	25	1.06
Hungary	40	35	45	1.27
Indonesia	15	16	13	0.77
Iran	10	10	10	0.93
Jamaica	16	(**) 11	(**) 22	1.89
Japan	48	51	44	0.85
Kenya	3	3	3	0.77
Lao	3	4	2	0.59
Lebanon	42	40	44	1.09
Lesotho	3	2	3	1.76
Libya	(**) 49	(**) 50	(**) 48	0.96
Madagascar	2	2	2	0.84
Malaysia	28	27	29	1.08
Mauritania	4	6	1	0.2
Mexico	21	21	20	0.96
Morocco	10	11	9	0.8
Netherlands	55	53	57	1.07
Niger	1	2	1	0.34
Portugal	50	43	58	1.37
Russia	64	56	72	1.29
Rwanda	2	2	1	0.5
South Africa	15	14	17	1.23
Thailand	35	33	37	1.11
Trinidad and Tobago	6	5	8	1.53
Uganda	3	4	2	0.52
United Kingdom	60	53	67	1.27
United States	73	63	83	1.32
Vietnam	10	11	8	0.74

SOURCE: UNESCO. 2003

THE EUPHORIA OF THE 1960s: UNIVERSITIES AND POSTCOLONIAL DEVELOPMENT IN AFRICA

In 1962, UNESCO and the Economic Commission for Africa organized a conference on the Development of Higher Education in Africa in Tananarive, Madagascar, which highlighted many of the challenges of the African universities. The conference focused on problems related to staffing, financing, and content of higher education, with particular attention to the Africanization of staff and curriculum. The participants at Tananarive concluded that in addition to the role of teaching and of research, higher education was to contribute to the social, cultural, and economic development of Africa. Higher education was to do so by promoting national unity, prioritizing teaching and research on African concerns, and training human resources to meet “manpower” demand, while simultaneously maintaining international standards of academic quality. This focus on the role of universities in national development, marked the rise of the notion of the “developmental university.”

adjustment policies imposed by the International Monetary Fund (IMF) and the World Bank on almost all African countries that qualified for loans.

Drastic cutbacks in research and infrastructure grants, along with the withdrawal of state support to student services and the rapid downfall of the standard of living of staff threw most developing world universities into a state of dereliction. The situation was condemned in the following terms by a task force convened by the World Bank in cooperation with UNESCO in 1999:

Since the 1980s, many national governments and international donors have assigned higher education a relatively low priority. Narrow—and, in our view, misleading—economic analysis has contributed to the view that public investment in universities and colleges brings meager returns compared to investment in primary and secondary schools, and that higher education magnifies income inequality. As a result, higher education systems in developing countries are under great strain. They are chronically under-funded, but face escalating demand. (The Task Force on Higher Education and Society, 2000, p. 10)

A Peripheral World of Learning

The dilemma facing higher education worsened through the 1980s and 1990s due to a massive south-north intellectual migration flow. The movement illustrates in itself the role higher education plays in keeping up the tight and imbalanced links initiated in the colonial era.

Alongside the development of local elitist systems of higher education, and in reaction to the growing attractiveness of North American institutions among local “educated elites,” colonial powers were keen to encourage the most promising graduates of secondary schools to further develop their training in the home institutions. This fact, added to the flow of students migrating as

a result of the higher education Malthusianism applied in the colonies, constituted the basis of a steady south-north study migration flow, which in many cases resulted in a “brain drain.” Leaning on family networks or supported by external donors, and fostered by the ever-increasing economic gap between industrialized and developing countries, the flow was barely affected by the development of university education in newly independent countries. On the contrary, with local curricula largely untouched, postcolonial higher education offered excellent basic training to candidates for postgraduate programs in the developed world. This diversion of funding opportunities affected in return the quality of higher education in the developing countries. The earlier perspective of encouraging students from abroad to study in the United Kingdom or France as a form of colonial or postcolonial aid and encouragement of trade (in goods or ideas) was transformed; education came to be seen more as a directly saleable commodity. The concomitant abandonment of scholarship policies, which primarily affected students from low-income countries, impacted markedly on the origin of international students in host countries. However, as shown in Table 2, postcolonial study migration routes continued to reflect strong economic, cultural, and linguistic ties with the former home institutions, except where the United States and Australia (notably in Asia) took over leadership in the provision of higher education services.

Mediating the Global and the Local

The postcolonial era is marked in most countries by attempts to combine the quality of teaching inherited from highly elitist higher education systems and the necessity to widen access to higher education to “bridge the development gap” and to strengthen democratic institutions. However, political developments since the 1960s, economic choices, and global pressures show that higher education cannot be developed to the exclusion of broader policy initiatives, leaving out the sociocultural context. The unequal distribution of colonial universities generated con-

The postcolonial routes to study abroad: main destinations in 2001

	Australia	Belgium	France	Germany	Japan	Netherlands	UK	USA
Algeria (F)	36	613	24,040	346	32	38	586	381
Cambodia (F)	254	43	1,151	45	245	0	34	324
Côte d'Ivoire (F)	6	203	5,079	252	22	8	142	1,104
D.R. Congo (B)	2	3,482	1,516	206	0	38	39	0
Djibouti (F)	0	10	2,144	1	0	0	6	13
Ghana (UK)	90	51	118	374	112	82	2,015	4,282
Hong Kong (UK)	15,842	4	0	14	0	0	16,244	13,230
India (UK)	12,390	238	462	1,413	395	98	8,441	94,822
Indonesia (NL)	21,452	159	365	2,128	2,420	1,058	2,070	20,165
Jamaica (UK)	12	1	22	12	8	2	715	7,328
Kenya (UK)	1,054	113	228	202	105	34	4,788	10,805
Madagascar (F)	0	74	4,620	125	20	0	27	199
Malaysia (UK)	25,858	10	214	197	3,241	24	18,183	13,521
Nigeria (UK)	126	278	34	667	70	132	4,598	6,626
Pakistan (UK)	1,912	42	237	681	210	84	3,781	12,052
Rwanda (B)	8	574	36	100	2	29	93	452
Senegal (F)	6	202	243	247	48	4	52	1,269
Singapore (UK)	21,430	10	96	73	259	20	9,075	7,226
Suriname (NL)	4	34	22	2	0	1,737	12	209
Trin. & Tob. (UK)	20	0	48	13	4	2	883	5,032
Vietnam (F)	3,260	305	2,801	1,458	1,229	67	331	3,507
Zambia (UK)	164	18	10	35	26	10	799	1,063

Former colonial authorities in parentheses.

SOURCE: OECD statistics, 2001

trasting expectations from populations. National policies on education then endured enormous tensions from the multiple pressures of ever more exigent demands from an educated minority; of ever more dramatic educational, social, and regional discrepancies; and of ever more restrictive recommendations and conditions set by international organizations. The landscape of higher education that emerged from these contradictory tensions reflected both the peculiarities of national trajectories and the inequalities of the postcolonial world order.

See also *Colonialism; Education; Global Education; Education: India; Empire and Imperialism.*

BIBLIOGRAPHY

- Ajayi, J. F. A., Lameck K. H. Goma, and G. Ampah Johnson. *The African Experience with Higher Education*. Athens: Ohio University Press, 1996.
- Altbach, Philip G., and Suma Chitnis, eds. *Higher Education Reform in India: Experience and Perspectives*. New Delhi: Sage Publications, 1993.
- Dunne, Mairead, and Yusuf Sayed. "Transformation and Equity: Women and Higher Education in Sub-Saharan Africa." *International Studies in Educational Administration* 30, no. 1 (2002): 50–66.
- Federici, Silvia, George Caffentzis, and Ousseina Alidou, eds. *A Thousand Flowers: Social Struggles against Structural Adjustment in African Universities*. Trenton, N.J.: African World Press, 2000.
- Hoogvelt, Ankie. *Globalisation and the Postcolonial World: The New Political Economy of Development*. Basingstoke, U.K.: Macmillan, 1997. 2nd ed., Baltimore: Johns Hopkins University Press, 2001.
- Howe, Glenford D., ed. *Higher Education in the Caribbean: Past, Present and Future Directions*. Kingston, Jamaica: University of the West Indies Press, 2000.

Lebeau, Yann, and Mobolaji Ogunsanya, eds. *The Dilemma of Post-Colonial Universities: Elite Formation and the Restructuring of Higher Education in Sub-Saharan Africa*. Ibadan: IFRA/ABB, 2000.

Lee, W. O., and Mark Bray, eds. *Education and Political Transition: Perspectives and Dimensions in East Asia*. Hong Kong: CERC, University of Hong Kong, 1997.

Task Force on Higher Education and Society. *Higher Education in Developing Countries: Peril and Promise*. Washington, D.C.: World Bank, 2000.

Tikly, L. "Globalisation and Education in the Postcolonial World: Towards a Conceptual Framework." *Comparative Education* 37, no. 2 (2001): 151–171.

World Bank. *Constructing Knowledge Societies: New Challenges for Tertiary Education*. Washington, D.C.: World Bank, 2002.

Yann Lebeau

UNTOUCHABILITY.

This entry includes three subentries:

- Overview*
- Menstrual Taboos*
- Taboos*

OVERVIEW

A basic idea of social grouping emerged in one of the late poems in the earliest of the Hindu scriptures, the Rig Veda. In this mythic account, probably composed about three thousand years ago, the primeval man was sacrificed to make the *varnas* (castes): the Brahmans emerged from his head, the Kshatriyas from his arms, the Vaishyas from his thighs, and the Shudras

from his feet. It is clear there is some ranking here, but the full-scale hierarchy based on degrees of purity and pollution emerged later, and untouchable castes became a category as *avarnas*, without *varna*, probably sometime after the fourth century C.E.

We find a development of this idea in the law books called *Dharmashastras* (300 B.C.E. to 500 C.E.). The first three *varnas* are known as the twice-born and are composed of Brahman priests and advisers, warriors and rulers, and merchants, all of whom undergo a ceremony in their youth admitting them into high status. Shudras, generally any caste that did manual work, were denied the privilege of studying the Vedas and were cast into a servant position. Untouchables were and are below the Shudras in any ranking, considered polluting to all and generally given the work in society that is filthy or demeaning.

In both law books and the epics, we find references to burning ghat workers, individuals who generally worked in the burning ghats with corpses and are considered unclean. A play from around the fifth century C.E., *Mrichcha katika* (The little clay cart) by Shudraka, includes two executioners who are actually quite intelligent and humorous but nevertheless untouchable. Burning ghat workers and executioners are two of the occupations still considered most polluting. The idea of persons who pollute was present early on, but the phenomenon of polluting castes developed later.

Parallel to the *varnas* and outside scripture were *jatis*, meaning “by birth” and also translated as *castes*. A *jati* is an endogamous group, sharing many customs and often an occupation, usually based in one language area. There were hundreds of *jatis* within each *varna*, and while untouchables were *avarna*, without *varna*, they were members of specific *jatis*.

The Origin of Untouchability

There are many theories about the origin of caste and, subsequent to that, the origin of untouchable castes. The untouchable leader B. R. Ambedkar (1891–1956) held theories on both. He wrote that the caste system originated from the Brahman requirement of endogamy to preserve its purity and from that was spread to lower castes. Untouchables, he held, had been Buddhists isolated and despised when Brahmanism became dominant about the fourth century. His theory is important both because it led to his conversion to Buddhism and because it represents the need of all untouchables to explain their status. Most untouchable castes have a myth of origin usually relating to a cosmic mistake; almost none assume that a past karma of bad deeds has resulted in an untouchable status in this life. On the other hand, most caste Hindus think that sins or good deeds or the careful fulfillment of duty in a previous life produce the karma that determines the caste into which one is born.

Vivekananda Jha agrees on the time period of Ambedkar but disagrees with the idea of untouchables’ Buddhist past, as do most caste Hindu writers. An influential book by Louis Dumont (1970) focuses exclusively on the concept of purity and pollution as determinants of the entire Hindu hierarchy. For Dumont, untouchables are necessary for the purity of Brahmins: “It is clear that the impurity of the Untouchable is conceptually inseparable from the purity of the Brahman. . . . In particular, untouchability will not truly disappear until the

purity of the Brahman is itself radically devalued” (p. 54). Other theorists limit the role of purity and pollution, holding chiefly that the purity needed for ritual spread to other occasions in life. A Marxist approach presumes tribal groups coming into the caste system found a ranking dependent on their economic opportunities. Many inside and outside of India hold that race is behind caste distinctions, especially that of Brahman and untouchable, and this belief is reflected in many untouchable belief systems, such as the supposition that untouchables were indigenous people ruling the land, forced to submit to invading Aryans (people speaking an Indo-European language and coming from outside India). Whatever their beginnings, untouchable groups were clearly delineated by the seventh century, when the Chinese traveler Xuanzang listed butchers, fishermen, public performers, executioners, and scavengers as marked castes living outside the city.

The Voices of Untouchables

In the medieval period a few voices of untouchables emerged. In the fourteenth century in Maharashtra, Cokhamela and his family of the untouchable Mahar caste were part of a religious movement generally called *bhakti* devotional religion. Intensely personal, the movement included all castes, and their songs have come down through the ages. Cokhamela complained bitterly about the concept of purity, and one of his poems calls out, “We are born in impurity, we die in impurity, O God, who is pure?” (unpublished translation by Anne Murphy). He is saddened by his inability to enter the temple of his god. According to legend, he was born to a mother and father whose duty as Mahars was to take the village produce to the ruler, and he died while mending the village wall. Eknath, a Brahman *bhakta*, wrote two centuries later as if he were a Mahar, and more duties can be noted: caring for the horses of government officials, sweeping the village streets and hauling out the dead cattle, getting firewood for the village headman, and guarding the village.

Another poet-saint’s voice is that of the Ravidas in the sixteenth century, who refers to his caste as an untouchable Chamar and his duties as working with leather: “O, people of the city! My notorious caste is Chamar! In my heart is the essence of all good qualities. . . . I carry cattle-hides all around Benaras.” He believed in purity beyond caste: “Whether one’s heart is Brahmin or Vashiya, Shudra or Kshatriya, Dom, Chandala, or Malech (a foreigner), through the worship of the Lord, one becomes pure” (unpublished translations by Anne Murphy). Ravidas is honored by both Sikhs and Hindus. Untouchables who convert to Sikhism from Chamar castes often take the name Ravidasi. It should be noted that anything to do with a dead cow or its hide is the work only of untouchables. A caste of drummers in the south known as the Parayan contributed the word *pariah* (outcaste) to English. In this case, the drumhead made of hide is polluting.

We do not hear from untouchables again until the nineteenth century. Then there are again direct voices: a plea from Mahars to be allowed to reenter the British army, closed to them after a century of employment; an adi-Hindu (first or pre-Hindu) movement in the north, an adi-Dravida (original Dravidians) movement in the south; a movement among toddy

tappers to secure their economic base, become educated, and be considered no longer untouchable. Toward the end of the nineteenth century, the British began recording and codifying caste, and more untouchable castes based usually on occupation emerged: Bhangis or removers of human waste in the north; Doms, the caretakers of the extensive burning grounds in the holy city of Benaras (Varanasi); Dhobis, laundrymen who handle polluted clothing.

The Beginnings of “Affirmative Action”

The British government had allowed separate electorates for “depressed classes” in the 1932 announcement of future government in India made after the Round Table Conferences in England. This provision was made at the insistence of the untouchable representatives, B. R. Ambedkar from the province of Bombay and Rao Bahadur Rettamalla Srinivasan of Madras—the two most active areas of reform—who felt, in the face of demands for separate constituencies from all other minorities, that proper elected representatives could only be elected by untouchables themselves. Mohandas K. Gandhi, then in prison for activities against the government in the interests of independence, thought separate electorates were too divisive and began a “fast unto death.” Ambedkar gave in but bargained for reserved seats for untouchables in all elected bodies to be elected by the general electorate. Gandhi then began the Harijan Sevak Sangh (Organization for the Service of the People of God), which was intended to bring the issue of untouchability as an evil to the public mind and to bring change to the hearts of caste Hindus. *Harijan* became the most popular word for the general public, replacing *depressed classes*, *exterior castes*, *outcastes*, and *untouchables*, terms previously used. Ambedkar and other politically awakened untouchables rejected the word as patronizing and meaningless. The basic disagreement was between belief in a change of heart and belief in legal and political means of securing human rights.

By 1935 it had become clear that untouchable castes must be listed to determine who exactly would be eligible for the reserved seats and for educational and economic benefits. The criteria for listing stipulated specific castes in specific areas that were denied religious rights of entry into temples and civil rights of entry to public places and the use of wells. The word *specific* was necessary because the ways of identifying who is an untouchable can vary. Occupation is not always a reliable guide. Laundrymen (Dhobis) and barbers may be untouchables in certain areas of the north but not in the state of Maharashtra. The new term *scheduled castes*, those on a list or schedule, was applied to 429 castes. (By 1993 the number was given in a survey conducted by K. S. Singh as 4,635, using the same criteria but noting subcastes and small castes not previously identified.)

The background for these concessions, probably the first “affirmative action” in the world, was from movements among untouchables themselves, which were especially important in Madras and Bombay, provinces that in the early decades of the twentieth century decreed that “depressed classes” should be represented in government bodies and, in the case of Bombay, that public places should be open to all. There were a number of leaders in various movements for dignity and human rights in many areas, but the dominant figure since the

late 1920s was B. R. Ambedkar, who continued to be important in the early twenty-first century.

Ambedkar was born to a Mahar army schoolteacher and was urged to secure education both by his father and by caste Hindus interested in reform. He graduated from Elphinston College in Bombay, one of very few untouchables in western India to do so, and with the help of the reform-minded non-Brahman princes of the princely states of Baroda and Kolhapur was given a chance to secure an M.A. and a Ph.D. in economics from Columbia University in New York and a D.Sc. from the University of London. He also became a barrister in the course of his two periods overseas. He returned to India as one of the most highly educated men in western India and an instant source of pride to untouchables. From then on, Ambedkar tried to convince the British to give attention to untouchable needs and to awaken all untouchables to progress through conferences, newspapers (although the literacy rate was very low), and an occasional public demonstration for rights. He founded political parties as well as social organizations and an educational system, and in 1947 he was asked to serve as law minister in newly independent India’s first cabinet. In that capacity, he was chair of the drafting committee of the Indian constitution.

The Contemporary Period

Five phenomena mark the contemporary period: the reservation policy’s results and disputes; the increased violence against untouchables; the growth of Dalit literature; the presence of a new and effective political party; and the image of Ambedkar all over India as a symbol of achievement and a claimant to all human rights. The reservation policy that provided a quota system for scheduled castes in all governmental political bodies and services and in educational institutions aided by the state was extended to “backward castes” in 1991 and produced a backlash from Brahman students who feared they would not be employed. Since that time higher castes have also claimed the right for reservation on economic grounds, but with the privatization of much government enterprise, the possibility of government positions for any caste is greatly lessened. Meanwhile, the years of reservation have created a large middle class among untouchables.

Increased violence, usually in the rural areas, when untouchables claim economic, religious, or social rights disputed by higher castes, is reported from all parts of India. The practice of untouchability was prohibited by law in the constitution, and there are many court cases, but much injustice is still handed out by police and higher castes, as detailed in the Human Rights Watch’s publication *Broken People*.

A flowering of Dalit literature, “the literature of the oppressed,” began in Marathi in the early 1970s with the poetry of the Dalit Panthers in Bombay and has now spread to almost every language area in India. *Dalit* means “ground down, broken up,” as in the title *Broken People*. But like the African-American use of the word *black*, it is not a term indicative of victimization but a proud term indicating that an untouchable is not polluting but oppressed by others and that even a middle-class untouchable should identify with those still oppressed. The organization of young men who called themselves Dalit Panthers in imitation of the Black Panthers in the United States is

no longer active, but *Dalit* has replaced the words *untouchable* and *harijan* in most public pronouncements and the press.

The name of the Bahujan Samaj Party (BSP) means the party of the majority, and in its founding by Kanshi Ram, an untouchable Sikh, in 1984 it was intended to include all nonelite groups, the majority in India. It has been very successful in the northern state of Uttar Pradesh, where Mayawati, a Chamar woman, served three terms as chief minister. Mayawati stressed the importance of Ambedkar and his liberal political philosophy but joined with the Bharatiya Janata Party (BJP), a conservative party led by Brahmins, in order to secure power to make changes in the state.

It is impossible to ignore the role of B. R. Ambedkar in any discussion of untouchables or Dalits in the early twenty-first century. His image is in every town and many villages, often represented by a statue of a man in suit and tie, the dress of most of the educated, holding a book that represents the constitution. He is a symbol of pride and revolt, an inspiration for continuing progress.

Untouchability outside Hinduism

The caste system has permeated other religions in India, and untouchables exist in Christianity, Islam, and Sikhism, although without scriptural legitimacy. A movement among Dalit Christians for equal rights within the church is especially strong.

Many Dalits attended the 2001 United Nations conference on racism in Durban, contending that “descent-based” groups suffer the same discrimination as racial groups, a concept opposed by the government of India. Caste-like discrimination has been found in some other countries, with the Burakumin of Japan suffering in much the same way as Indian untouchables, although the rest of the caste hierarchy was not present.

See also *Hinduism; Untouchability: Menstrual Taboos; Untouchability: Taboos.*

BIBLIOGRAPHY

- Ambedkar, B. R. “Castes in India.” In *Dr. Babasaheb Ambedkar, Writings and Speeches*, edited by Vasant Moon, vol. 1. Bombay: Education Department, Government of Maharashtra, 1979.
- . “The Untouchables.” In *Dr. Babasaheb Ambedkar, Writings and Speeches*, edited by Vasant Moon, vol. 7. Bombay: Education Department, Government of Maharashtra, 1990.
- Broken People: Caste Violence against India's Untouchables*. New York: Human Rights Watch, 1999.
- Chokhamela. *On the Threshold: Songs of Chokhamela*. Translated by Rohini Mokashi-Punekar. Delhi: Book Review Literary Trust, 2002.
- Deliége, Robert. *The Untouchables of India*. Translated by Nora Scott. Oxford: Berg, 1999.
- Dumont, Louis. *Homo Hierarchicus: The Caste System and Its Implications*. Translated by Mark Sainsbury, Louis Dumont, and Basia Gulati. Rev. ed. Chicago: University of Chicago Press, 1980.
- Jha, Vivekananda. “Stages in the History of Untouchables.” *Indian Historical Review* 2 (1975): 14–31.
- Mendelsohn, Oliver, and Marika Vicziany. *The Untouchables: Subordination, Poverty, and the State in Modern India*. Cambridge, U.K.: Cambridge University Press, 1998.

Moon, Vasant. *Growing Up Untouchable: A Dalit Autobiography*. Translated by Gail Omvedt. Lanham, Md.: Rowman and Littlefield, 2001.

Singh, K. S. *The Scheduled Castes*. Delhi: Oxford University Press, 1993.

Valmiki, Omprakash. *Joothan: An Untouchable's Life*. Translated by Arun Prabha Mukherjee. New York: Columbia University Press, 2003.

Zelliot, Eleanor. *From Untouchable to Dalit: Essays on the Ambedkar Movement*. 3rd ed. New Delhi: Manohar, 2001.

Zelliot, Eleanor, and Rohini Mokashi-Punekar, eds. *Untouchable Saints: An Indian Phenomenon*. New Delhi: Manohar, 2004.

Eleanor Zelliot

MENSTRUAL TABOOS

Menstruation is a physiological process often imbued with powerful cultural and religious symbols. For men, it is a mysterious and sometimes frightening phenomenon—the shedding of blood without visible injury. For women, it has been a double-edged sword. Far too often, it has been used in misogynist ideologies as evidence of the defiling and ungodly nature of the female body, leading many societies to subject menstruating women to taboos that limit their autonomy and agency. However, not all societies have interpreted menstruation in the same way: in some cultures it has been perceived as relatively unimportant, subject to neither stigma nor taboo; in others, menstruation has been a sign of the magical power of the female body, in all its mysterious fecundity. Indeed many societies exhibit profound ambivalence where menstruation is concerned, imbuing it with both positive and negative meanings, making it difficult to arrive at a single interpretation of menstrual taboos.

Menstrual Taboos in Tribal and Band Societies

The more positive or neutral associations of menstruation typically are found in small-scale, relatively egalitarian societies, where misogyny is in general less well developed. In many such societies, the menstruating woman was perceived as emitting a supernatural power, or mana; as anthropologists such as Mary Douglas have found, this sacred power is neither inherently good nor inherently bad. It is, however, extremely powerful, with a potential to be creative and energetic or destructive and even deadly. Thus menstruating women, like women who have recently given birth, had to observe strict taboos and to remain segregated from ordinary society, especially from men, who could be inadvertently hurt by a menstruating woman's mana. (It is noteworthy that males who had shed blood in war typically suffered similar proscriptions.)

Foragers such as the Eskimo feared the perceived danger of menstruating women on men's ability to hunt. The attitudes of Australian Aborigines, in contrast, are more complex and not altogether negative. Agricultural peoples too exhibit a variety of attitudes, with some making positive connections between agricultural fertility, the moon, and women's cycles, whereas others constructed symbolic oppositions between breast milk and menstrual blood as representations of birth and death and so found menstruating women to be a danger

to crops and animals, and still others, such as Andean peoples, attached little significance to menstrual blood.

Menstrual taboos also serve to underline the gender segregation characteristic of many tribal societies, such as the Maori of New Zealand or the Arapesh of New Guinea. Sexual intercourse, in the case of the Mae Enga of the Central Highlands, was strictly limited in order to preserve male vitality, with menstrual blood, according to Mervyn Meggitt, perceived as especially corrupting to men's "vital juices."

Menstruating women, for the Lele of Africa, were prohibited from poking the fire or cooking for their husbands due to their polluting presence, while Bemba women feared pollution from the adulterous actions of men. These often rigid demarcations of sexual roles were thought to be necessary in upholding the foundation of community and preventing "sex pollution" from outside intermingling; the result, however, especially in the rigidly segregated societies of highland New Guinea, reflected and perpetuated a view that men and women belonged to two mutually distinct, hostile, and antagonistic spheres, both of which constituted a danger to the other.

Many such societies feature a special enclosed space, referred to in the anthropological literature as a "menstrual hut"—a nomenclature that reveals the unconscious biases of earlier scholars, who routinely referred to male ritual spaces as "men's houses," even when the "huts and "houses" were of similar size and construction. The retreat into sacred space protected the women themselves—as vulnerable carriers of a divine power—as well as other members of their society, who could be injured by a glance alone. Not all retreats to the hut constituted a punishment, however; for the Mbuti of Zaire, seclusion among women in the hut, or *elima*, gave rise to a spirit of community as younger and older women sang special songs to one another, sometimes to be joined by the musical replies of men who stood outside. Menstruation and isolation were also connected in rites of passage for young girls. Existing in a marginal state between childhood and adulthood, such girls could undergo seclusion followed by a ritual deflowerment, mortification, and beatings (as with the Uaupes of Brazil) or, in the case of the Deshast Brahmins of India, joyous celebrations, feasts, and the exchange of presents.

Menstruation and Civilization

In general, however, the greater social inequalities and restrictions that accompany the rise of civilization brought with them an increase in negative attitudes toward women and their bodies and a greater attention to controlling female agency and reproductive powers. This can be seen in many of the great religions of the world and in the cultural traditions of the West. Among the ancient Greeks, for example, Pliny wrote that menstrual blood could "[turn] new wine sour," render crops barren, dull the "gleam of ivory," drive dogs mad, and even cause "very tiny creatures" such as ants to turn away in disgust from a grain of corn that had suffered contact with the offending woman. But what was an affliction—a curse—could also constitute a sacred gift or what the Romans called *sacra*; enclosed within male boundaries, women were graced as well as burdened by the cyclical days of blood they had to bear.

The great religions that developed with the rise of civilization tended to further these ideas in religious texts and doctrines, especially when it came to delineating rules of sacred and ritual cleanliness and pollution. Zoroastrianism placed purity as one of the most important tenets in the upholding of the faith, with those deemed impure—including women during their menses but also priests with bleeding sores—prohibited from entering the fire temple. In Hinduism, where rules of un-touchability could be vast and complex, bleeding women were expected to avoid worship, cooking, and members of their own family through restrictions that were precisely proscribed; according to the *Vendidad* (16.4), a woman in her menses "should keep fifteen paces from fire, fifteen from water . . . and three paces from a holy man." Visiting a consecrated holy place during menses was highly contaminating and therefore forbidden, as were women's involvement in ritualistic worship practices in general. Such a stigma was explained in part by the *Bhagavata Purana*, which described the menstrual cycle as constituting a partial karmic reaction to Indra's inadvertent killing of a brahmana; according to the text, after Indra killed the brahmana, he proceeded to negotiate with four groups who agreed to absorb one-quarter of the karmic reaction in exchange for a blessing. Women received the blessing of engaging in sex during pregnancy without endangering the embryo in exchange for accepting the monthly menstrual cycle.

In the Judeo-Christian tradition, the biblical Book of Leviticus was the most central and influential text in postulating rules having to do with cleanliness and uncleanness or what the anthropologist Mary Douglas called purity and danger. Leviticus stated that while menstruating, a woman would be considered unclean for seven days and anyone who touched her would also be unclean. The taboo continued to be recognized by Orthodox Jews, who relegated bleeding women to their own secluded sphere or enjoined them to abstain from sexual intercourse for seven days, followed by immersion in the *mikveh*, or ritual bath. Such isolation accorded with what was thought to be women's special burdens—or Eve's multiplying sorrows—as the prophet Micah enjoined them to "Be in pain, and labour to bring forth, O daughter of Zion, like a woman in travail" (Mic. 4:10). Such rites were also, however, continuous with other treatments in the Old Testament concerning the mundane and symbolic use of blood, which was seen as life-giving as well as defiling and all-important in the preparation of food or the act of sacrifice.

In the New Testament, Jesus encounters and cures a "woman with issue" who has been menstruating continuously for twelve years when she touches the hem of his garment—not his body—and is told, "Thy faith hath made thee whole" (Matt. 9:20–22). But Levitical notions of cleanliness and uncleanness, isolation and contamination, continued to pervade the early Christian world in such debates as the acceptability of menstruating women entering churches or receiving communion. In early Syrian Christian texts as well as the writing of Origen, women undergoing menses were prohibited, like their Jewish counterparts, from entering church or "mixing" reproductive blood with the sacrificial blood at the altar; it would therefore become a notable development when Pope Gregory I (590–604) informed Augustine, the monk and

bishop of Canterbury, that menstruating women should not be forbidden from entering church or receiving communion, though “if [she] out of a sense of deep reverence does not presume to receive communion, she must be praised” (Bede, 1:27). Despite such leniency, penitential texts as well as a later archbishop of Canterbury, Theodore, chose to uphold the prohibition, which continued well into the Middle Ages.

Medical Variations and Modern Interpretations

Ancient medical writers onward believed menstrual blood constituted a toxic substance that needed to purge itself from the body, with Hippocrates arguing that that fermentation in the blood precipitated menstruation because women were unable to rid themselves of their impurities in the blood through sweat alone. Aristotle for his part assumed that menstruation represented the excess blood not incorporated into the fetus, while Galen believed it to originate in part from residual blood in food that women were unable to digest. During the Middle Ages, menstruation continued to be regarded as malignant and unclean, emanating from the “imperfection” of women, though by the end of the sixteenth century, according to Ian Maclean, there was far less stress on the noxious nature of menses, and the majority of texts “stress their harmless excremental nature” (Maclean, p. 40). Still, sexual intercourse during the menstruation cycle, for example, continued to be a particularly charged subject for theologians and medical writers, with Thomas Aquinas in the thirteenth century rendering the deed a mortal sin, unless the woman’s cycle was unusually prolonged and consummation was absolutely necessary. Such medical and theological ideas would decline only slightly in the early modern period, when Cardinal Cajetan demoted intercourse during menstruation to a “minor sin,” though it remained, in Thomas Sanchez’s words, “unseemly.” Seventeenth-century writers continued to perpetuate the stigma that attached itself around the menstrual cycle, with the Englishman Helkiah Crooke questioning, “What pleasure of contentment could any man finde in a wife so lothsomely defiled, and that perpetually.” The notion that a woman had to remain sexually untouchable, for her own sake as well as for her partner’s, became especially pronounced in the nineteenth century, for example, when it was believed that gonorrhoea could be transmitted to men through menstrual blood or that such emissions in general constituted a physiological as well as psychological threat. The new preoccupation with women’s hysteria, and the frequent recommendation that such women be isolated in bed rest or asylum, was inexorably attached to the menstrual cycle, while a minority of physicians as late as 1920 could describe menstrual blood as containing highly toxic substances.

In the twentieth century anthropologists and psychoanalysts recognized the opportunity of examining culture through the prism of such a powerful taboo, which reflected a society’s cosmological, symbolic, and social attitudes toward women, sex, blood, hygiene, and power. For Freud, the segregation of a woman during her menses might have served a hygienic purpose, though it above all reflected ambivalent notions and phobic fears about women as a whole; in the 1960s William Stephens continued the psychoanalytic treatment of the taboo, arguing that castration anxiety, from the sight of bleeding

genitals, resided behind the imposition of untouchability onto menstruating women across cultures. Bruno Bettelheim, on the other hand, argued that male envy had originally attached itself to the biologically powerful act of menstruation, with quarantine an attempt to level the playing field between the sexes. Feminist and matriarchalist theories would advance Bettelheim’s relatively positive treatment of the powers inherent in menstruation, arguing for a more subtle approach in which the “forbidden” and the “holy” are conjoined and the very terms *taboo* and *defilement* contain more complex associations than those that cohere around *oppression* alone. Such ideas also harkened back to the interpretations of Émile Durkheim and Sir James Frazer, who argued that society’s repulsion actually reflected the positive, or at least formidable and respected, “sacred,” or “priestly,” power inherent in menstruation, with women segregated not for their inferior status but rather their power. Still, negative vestiges of the taboo linger in euphemisms or “red humor” jokes, in the politicization and stigmatization of premenstrual syndrome, or even in continuing claims over menstruation’s “toxicity”—evidence of the continuation of the myth of the bleeding woman who bears “Eve’s curse” in silence and sorrow.

See also *Anthropology; Motherhood and Maternity; Untouchability: Overview; Untouchability: Taboos.*

BIBLIOGRAPHY

- Bede, the Venerable Saint. *Bede’s Ecclesiastical History of the English People*. Edited by Bertram Colgrave and R. A. B. Mynors. Oxford: Clarendon, 1969.
- Buckley, Thomas, and Alma Gottlieb. *Blood Magic: The Anthropology of Menstruation*. Berkeley: University of California Press, 1988.
- Delaney, Janice, Mary Jane Lupton, and Emily Toth. *The Curse: A Cultural History of Menstruation*. New York: E. P. Dutton, 1976.
- Grahn, Judy. *Blood, Bread, and Roses: How Menstruation Created the World*. Boston: Beacon Press, 1993.
- Houppert, Karen. *The Curse: Confronting the Last Unmentionable Taboo; Menstruation*. New York: Farrar, Straus, and Giroux, 1999.
- Knight, Chris. *Blood Relations: Menstruation and the Origins of Culture*. New Haven, Conn.: Yale University Press, 1991.
- Lander, Louise. *Images of Bleeding: Menstruation as Ideology*. New York: Orlando Press, 1988.
- Lupton, Mary Jane. *Menstruation and Psychoanalysis*. Urbana and Chicago: University of Illinois Press, 1993.
- Maclean, Ian. *The Renaissance Notions of Woman: A Study in the Fortunes of Scholasticism and Medical Science in European Intellectual Life*. Cambridge, U.K.: Cambridge University Press, 1980.
- Ruether, Rosemary Radford. “Women’s Body and Blood: The Sacred and the Impure.” In *Through the Devil’s Gateway: Women, Religion, and Taboo*, edited by Alison Joseph. London: SPCK, 1990.

Sarah Covington

TABOOS

The notion of *taboo* has a peculiar history: it was originally a Polynesian term referring to a ritual prohibition against contact with a thing, an animal, or a person. The term eventually

became a widely discussed anthropological concept, and finally, in its last avatar, has been adopted by most languages to refer to something that is strictly and collectively forbidden. This wide recognition stems from the fact that every culture has things that are forbidden for religious reasons. Certain beings or objects are thought to possess a kind of substance that renders them untouchable or unapproachable. In some cases, they may be thought of as particularly pure; in other cases, on the contrary, it is their extreme impurity that entails the obligation to keep them apart. The violation of a taboo has different consequences: sometimes it leads only to some temporary defilement but, in other cases, it can be considered a crime. Finally, as far as people are concerned, the notion of *taboo* applies to persons at both ends of the social ladder: kings as well as untouchables, priests as well as hermits. But in some ritual circumstances, nearly everyone can be the object of some kind of taboo: in transitory states, for instance during the liminal stages of rites of passage, ordinary people are also considered to be taboo.

The word *taboo* was first used in the English language by Captain James Cook, who, as early as 1777, reported that some chiefs in Tonga were not allowed to behave like common people: they were *taboo*, Cook explained. The first European observers were not quite sure whether *taboo* meant “sacred” or “defiled.” This uncertainty is probably due to the fact that the concept is ambivalent, and can mean both, depending on the case. Later scholars often pointed out this paradox: in his major study on the subject, Franz Steiner insisted that the Brahman was just as taboo as the untouchable. In the Polynesian context, the word *taboo* has largely been thought to be inseparable from the idea of *mana*, a term that refers to the religious power or force attached to some people or objects. A chief is said to possess *mana*, and is considered to be taboo by virtue of this power. The idea of *mana* was once given great importance in some anthropological writings: Marcel Mauss (1872–1950), for example, devotes a great deal of attention to the idea of *mana* in his studies of the gift and magic. Yet later observers noticed that *mana* was finally an empty concept that meant hardly more than a “thing” or a “thingamajig”: and as it means nothing, it can be taken to mean anything.

The concept of *taboo* soon became part of the English language, but even before then it was widely discussed by early anthropologists. While it had fallen out of fashion by the end of the twentieth century and was hardly considered an essential anthropological concept, this was not the case in the nineteenth century, when it was seen as something that had to be explained by anthropologists. The “primitives,” it was then thought, lived in a world dominated by taboo. James Frazer, for instance, regarded taboo as a symptom of irrationality: primitive man, he argued, believed he lived in a world full of supernatural dangers, and he protected himself by maintaining a distance between himself and those threats. Frazer’s description of numerous cases of taboo and his interpretation of it were deeply influential and permeated Sigmund Freud’s views on “primitive” societies. According to Freud (1856–1939), society derived from psychology, and this was particularly clear in “primitive” societies. In *Totem and Taboo* (1913),

Freud assimilates the primitive human to a neurotic, and the concept of *taboo* plays a significant role in supporting this equation. According to the father of psychoanalysis, the multitude of fears and prohibitions in which the “savage” lives parallels the world of the neurotic. Furthermore, people forbid only what they desire and are therefore always ambivalent toward their prohibitions. This is particularly true of the incest prohibition, which Freud labeled the *incest taboo*: the mother is a forbidden sexual partner because she is the object of an intense desire. All other taboos, such as food taboos, are only extensions of the fundamental incest taboo.

Like his contemporaries, Freud considerably exaggerated the importance of fear and prohibition in preindustrial societies. Modern anthropologists soon realized that the people they studied did not live in a world dominated by prohibitions of all kinds. It is interesting to note that Captain Cook had seen the Polynesians’ taboos as more funny than frightening, and later, modernist anthropologists such as Bronislaw Malinowski (1884–1942) and native authors from tribal societies alike commented on the variability of attitudes toward taboos. At one extreme is the strict adherence of the religious to dietary restrictions, an attitude as likely to be found among urban sophisticates as isolated tribesmen, and at the other the relaxed and humorous attention noted by Cook. In the early 2000s anthropologists no longer considered *taboo* to be a unitary category. Malinowski opined that taboos are most strictly observed in arenas where technical competence is least likely to yield predictable results, an observation later extended to the study of contemporary professional athletes, who often observe personal rituals and taboos with great rigor before major games.

The term itself remains useful, as there is no other word to refer to what is both dangerous and forbidden. It resurfaced in the mid-twentieth century in the work of the anthropologist Marvin Harris, who considered that all prohibitions, and food taboos in particular, are not arbitrary but result from the material conditions in which people live: the taboo on eating cow or pig was dictated by the economic conditions in which Hindus and Arabs lived. On the whole, Harris’s explanations are rather unconvincing and certainly fail to establish a true determination. In another vein, Mary Douglas notes that purity taboos cannot be explained by considerations of cleanliness. Dirtiness, she maintains, has first of all to be understood within a system of symbols and cannot be taken as an isolated phenomenon: what is pure exists only as the contrary of what is impure. Thus, taboos belong to a category or a system of classification.

As a general category, the concept of *taboo* illustrates the differences that divide contemporary anthropologists: those who seek a general understanding of humanity find some usefulness in broad concepts such as this. Others argue that it can be useful only at the cost of a serious impoverishment of social realities. Yet the fact remains that we have no other concept to describe socioreligious prohibitions.

See also Anthropology; Untouchability: Overview; Untouchability: Menstrual Taboos.

BIBLIOGRAPHY

- Douglas, Mary. *Purity and Danger: An Analysis of Concepts of Pollution and Taboo*. London: Routledge and Kegan Paul, 1966.
- Frazer, James G. *The Golden Bough: A Study in Comparative Religion*. London: Macmillan, 1894.
- Freud, Sigmund. *Totem and Taboo: Some Points of Agreement between the Mental Lives of Savages and Neurotics*. Authorized translation by James Strachey. London: Routledge and Paul, 1950.
- Harris, Marvin. *Cows, Pigs, Wars, and Witches: The Riddles of Culture*. New York: Vintage, 1974.
- Steiner, Franz. *Taboo*. With a preface by E. E. Evans-Pritchard. London: Cohen and West, 1956.

Robert Delègue

UPANISHADS. See **Communication of Ideas: Asia and Its Influence; Hinduism.**

UTILITARIANISM. *Utilitarianism* is the name of a group of ethical theories that judges the rightness of acts, choices, decisions, and policies by their consequences for human (and possibly animal) welfare. These theories have been widely influential among philosophers, economists, and political and social scientists, and, in the early twenty-first century, in the general area of applied or practical ethics. It would not be too much to say that utilitarian thinking undergirds one of the contending positions on virtually each of the issues in debate, whether to do with animal rights, euthanasia and physician-assisted suicide, health care coverage, or punishment. This is so, moreover, even as critics of utilitarianism as a normative ethical theory have become more numerous.

Classically, utilitarianism is the view that acts are right or wrong if they produce best consequences—that is, consequences with regard to human welfare that are at least as good as those of any alternative. This is the view normally associated with Jeremy Bentham (1748–1832), James Mill (1773–1836), and John Stuart Mill (1806–1873); with Henry Sidgwick (1838–1900) and G. E. (George Edward) Moore (1873–1958); more recently, with J. J. C. Smart (b. 1920) and Richard Mervyn Hare (1919–2002); and, more recently still, Peter Singer (b. 1946). It began, thus, in the nineteenth century in Britain, though traces of it can be found in earlier thinkers there, such as Francis Hutcheson (1694–1746), David Hume (1711–1776), and William Godwin (1756–1836). This classical version of the theory is also the view that contemporary critics, such as Amartya Sen (b. 1933), Bernard Williams (1929–2003), and Samuel Scheffler, attack. In fact, different versions of utilitarianism have been distinguished from classical- or act-utilitarianism, such as rule-utilitarianism, utilitarian generalization, motive utilitarianism, and so on, though it remains hotly debated how far these versions are ultimately distinct from the utilitarianism (and, to critics, from the objections directed against it).

Act-utilitarianism as it has come down to the present has three main components, and each has generated discussion in

its own right. These are the consequence component, the value component, and the range component.

The consequence component maintains that rightness is tied to the production of good consequences (specifically, to consequences better than those of any alternative or best consequences). It may be argued that something in addition to consequences helps to determine an act's rightness, but consequentialism is the view that consequences alone determine this; act-utilitarians are consequentialists. Consequentialism in the early 2000s is the object of a good deal of criticism, though even in the nineteenth century it was sometimes controversial, as in the debates between Cardinal Newman (1801–1890) and Charles Kingsley (1801–1890). To some it is self-defeating, in that an effort to produce best consequences on each occasion may fail to produce best consequences overall. To others it seems inherently evil because it cannot exclude certain acts as intrinsically wrong or wrong independently of consequences (for example, lying). More recent criticisms have been equally strong. To John Rawls (b. 1921) impersonal accounts of rightness, such as best consequences, fail to take seriously the separateness of persons and so fail to treat people as autonomous individuals with their own individuality, plans, and worth. To Bernard Williams impersonal accounts of rightness run the risk of severing one from one's integrity, in the sense that pursuit of best consequences may not be compatible with pursuit of one's own projects, commitments, and relationships. Of course, some act-utilitarians, such as R. M. Hare (1919–2002), have resisted the Rawls-Williams objections, but others influenced by the theory, such as L. Wayne Sumner, have responded by trying to build a scheme of individual moral rights into the theory on the ground that doing so gives one the best chance of producing best consequences. (See indirect utilitarianism below.) Still more recent criticisms move in an epistemological direction. One cannot know at the time of acting, it is said, what (all) the consequences of one's proposed act will be. Some have seen this as demanding a role for rules as a guide; others, such as Peter Railton, have viewed it as a reason for not trying to act upon consequentialism in the first place and so for not using this account of rightness as if it were a decision procedure. He suggests a role for the concept of (good) character in determining how individuals shall act.

The value component has from Bentham onward spurred debate. It maintains that consequences are to be assessed by some standard of intrinsic goodness, the presence of which in the world is to be maximized. In the early twenty-first century this good in the case of act-utilitarianism is construed to be human welfare, but how "welfare" is to be understood is contentious. Thus, Bentham is a hedonist, maintaining that all and only pleasure (which his felicific calculus was supposed to be able to calculate) is intrinsically good; not surprisingly, Friedrich Nietzsche (1844–1900) referred to utilitarianism as a pig philosophy. John Stuart Mill spoke of happiness and pleasure and tried to introduce a distinction between higher and lower pleasures, and the mentor of the Bloomsbury Group, G. E. Moore, maintained that other things, such as beauty and friendship, as well as pleasure and/or happiness, were good in themselves. Most act-utilitarians have followed Moore in moving away from hedonism and from the emphasis upon happiness.

Three types of issues have dominated recent critical discussion of the value component. First, there has been a movement away from the old mental-state accounts of goodness (e.g., pleasure) to desire- or preference-satisfaction accounts. Economists have helped spur this development. It is unclear, however, upon which desires one is to focus. Problems to do with present or future desires have led theorists to an emphasis upon informed desires—that is, those desires one would have if one were fully informed, detached, free from bias and pressure, and so on. The thought seems to be that, in the appropriate circumstances, informed desires become actual, and so those desires upon which one (rightly) acts. (This thought, so construed, can then be wedded, in economics, to “revealed preference” accounts of goodness, which are widespread.) Second, there has been a movement away from agent-neutral values toward agent-relative ones. Values, it is said, are subjective, in the sense of being agent-relative; they are the values of agents. Utilitarianism, however, requires that desires be aggregated, weighed, and balanced in terms of, for example, agent-neutral concerns to do with the amount of desire-satisfaction produced, irrespective of which individual agents obtain that satisfaction. The question then arises whether any particular agent has reason to value pursuit of overall desire-satisfaction, in addition to or in place of his or her own. Third, if one focuses upon desires, then a question about moral filtering devices obviously arises. If one takes into account the desires of all those party to a situation, does one filter out the desires of evildoers? This seems contrary to the spirit of utilitarianism and its emphasis upon agent-neutral values. But if one does not filter out the desires of evildoers, does this mean that the utilitarian weighs and balances their desires, according to strength, with the desires of those against whom evildoers act?

The range component maintains that all those affected by the act are to have their desires taken into account. This has led notoriously, from the nineteenth century onward, to the problem of interpersonal comparisons of (pains and pleasures) or desire-satisfaction. One can only maximize desire-satisfaction across all those affected by the act if one can compare the effect of the act upon the desire sets of each individual involved, judge the strength and extent of that effect, and then compare the different results. How one does this, what measures or scales of comparison are used, is not obvious. Another problem with the range component that stirs debate in the early twenty-first century has been whether to include animals within the scope of utilitarianism. Bentham did, on the grounds that animals could suffer. But if informed desires are the focus of the value component, can animals have informed desires? The point is not obvious (just as it is not obvious that all humans can have informed desires). Some utilitarians want to keep a pain/pleasure standard of goodness for animals, but endorse desire-satisfaction accounts for humans. Still another problem for the range component has to do with the emphasis in utilitarianism upon maximization of what is deemed to be intrinsically good. Something short of this, of increasing the amount of good to some extent less than the greatest extent possible, is both possible and less problematic, at least if one treats Derek Parfit’s “repugnant conclusion”—that one can increase the greatest total happiness (or desire-satisfaction) in the world by eliminating those at the bottom of the happiness

ladder—as tied to the general thrust of maximization of the good.

To a large extent, discussion of utilitarianism in the late twentieth to early twenty-first century has moved away from earlier concerns. It has centered around three developments. First, R. M. Hare and others have urged a kind of indirect utilitarianism, wherein one does not employ consequentialism at the level of practice, in order to decide what it would be right to do. Hare urges a two-level account of moral thinking, which is rule-utilitarian at the level of practice but act-utilitarian at the level of theory or rule/institutional design. In his hands, act-utilitarian thinking at the critical level will select as guides at the intuitive or practical level those rules whose general acceptance will give one the best chance of producing best consequences. In this way, it is only in exceptional circumstances that one’s practical guides are exposed to consequentialist thinking. Thus, Hare hopes to avoid many of the problems that are held to beset the act-utilitarian, through the employment of consequentialism as a way of deciding what it would be right to do. Hare’s two-level account of moral thinking can seem, then, a way of developing a further case for act-utilitarianism; other two-level theorists, it should be noted, do not see the split-level innovation as furthering this particular case. In fact, on Hare’s account, since the focus of his theory is no longer acts, on a case-by-case basis, the name *act-utilitarianism* is something of a misnomer.

Second, because so many of the objections to act-utilitarianism (and consequentialism) have always centered around clashes with “ordinary moral convictions” or “commonsense morality,” the question has arisen of whether our ordinary moral intuitions have probative force in ethics. To those who feel that they do have probative force, the problem has been to make it appear that certain of one’s intuitions are more secure than others, so that they are believed to be more “true” or “correct” than the dictates of any normative ethical theory. Accordingly, one needs to identify which these crucial intuitions are. Different ways of doing this have been suggested, including Rawls’s reflective equilibrium method. But it is clear, even in Rawls, that some intuitions survive intact, such as the wrongness of slavery. This intuition of his needs no revision. Other theorists privilege other of their intuitions about particular acts or classes of acts. Over privileging in this way, serious doubts can arise, no matter how secure one feels one’s intuitions to be. Yet, it is from this very privileging that condemnations of act-utilitarianism typically begin. It is wrong to lie, and the act-utilitarian mounts a case for lying on this occasion; it is wrong to kill, but the act-utilitarian mounts a case in favor of active euthanasia or abortion or suicide. In this way, arguments about the probative force of certain of one’s intuitions have taken on a life of their own and are often used in moral debate in the early twenty-first century. This is especially true in medical ethics, where some want to draw a distinction between killing and letting die and where act-utilitarians on the whole deny that such a distinction is morally significant or where some want to distinguish, say, between giving someone a pill which, if they take it, will kill them and giving someone an injection of a sufficiently large dose of morphine to hasten their death while intending only to relieve their pain.

Third, the enormous growth of applied or practical ethics, especially medical ethics, has brought act-utilitarianism and consequentialism into the public domain. Almost without exception, virtually every issue, whether to do with killing, the allocation of resources, or the case for animal experimentation, features a utilitarian line of argument, and this line of argument is also, typically, act-utilitarian in character. This in a way is odd: while theorists are developing more and different types of indirect utilitarianisms, most of the examples of applied ethics feature the direct application of consequentialism on a case-by-case basis, with, it is held, morally shocking results. To be sure, not everyone will be shocked any longer by a case in support of a doctor assisting a competent patient who voluntarily requests assistance in dying, but the case can be discussed from the level of rule or institutional design, as well as from the consequentialist realities of the situation in question. Moreover, there are more general questions that arise in the various areas of applied ethics, where act-utilitarians are taken to adopt a particular kind of stand. Thus, one can intentionally kill a patient or one can knowingly bring about or cause a patient's death: are these morally different? One can directly bring about a person's death or one can indirectly bring it about: are these morally different? One can bring about a person's death by action or one can bring it about by omission: are these morally different? One can bring about a person's death actively or passively: are these morally different? If the consequences appear the same or very similar, the act-utilitarian will be held to think there is no difference among these things. Because Hare and others favor an indirect form of utilitarianism, it is not uncommon in the early 2000s to treat these practical issues as if they involved direct consequentialists and leave until another occasion whether these consequentialists are also act-utilitarians. In this way, applied ethics has helped consequentialism to come to dwarf the other components of act-utilitarianism.

For Hare, moral education plays an important role in one's moral thinking. He rejects the employment of consequentialism on a case-by-case basis for deciding what to do and rejects as well the thought that consequentialism indicates the kind of thinking one should do at the intuitive or practical level. Instead, he emphasizes the role of character and character development: by education, individuals turn themselves into people whose actions flow from their character, in which the traits and dispositions that comprise character are inculcated in them overseen by the utilitarian goal of maximizing human welfare. This further reduces clashes with certain privileged moral intuitions, but it does not require that one treat those intuitions as having probative force. In this way, the moral thinking for Hare is much more intimately connected with one making one's self into the sort of creature who behaves out of certain dispositions than into the sort of creature who acts only out of consequentialist concerns.

Utilitarianism, then, has in latter years undergone a significant transformation at the hands of theorists. It is no longer the relatively simple, straightforward rubric that Bentham and John Stuart Mill took it to be; its statement, even by those who remain sympathetic to it, such as Hare and those influenced by him, is complicated and layered. An account of its

historical development in terms of ideas, as can be seen here, shows that it has become sufficiently encumbered with distinctions and technicalities that it no longer really resembles the earlier view. Yet, in the twenty-first century, it is still common to find thinkers objecting to some particular view in moral, political, or social policy as "utilitarian," where the view they have in mind is the direct application of consequentialist thinking to decisions on how to behave. Thus, in modern medical ethics, there is little concern to get right the niceties of utilitarian theory; rather, the point is to protest about the "shocking" results that the direct application of consequentialist thinking can appear to produce in some instances.

See also *Happiness and Pleasure in European Thought; Hedonism in European Thought; Liberalism; Rational Choice; Virtue Ethics.*

BIBLIOGRAPHY

- Bentham, Jeremy. *An Introduction to the Principles of Morals and Legislation*. 1789. Reprint, New York: Hafner, 1948.
- Hare, Richard Mervyn. *Moral Thinking: Its Levels, Method and Point*. Oxford: Clarendon, 1981.
- Mill, John Stuart. *Utilitarianism*. 1861. Reprint, Englewood Cliffs, N.J.: Prentice-Hall, 1957.
- Moore, George Edward. *Ethics*. 1912. Reprint, New York: Oxford University Press, 1961.
- Nietzsche, Friedrich. *Beyond Good and Evil*. 1886. Reprint, Middlesex, U.K.: Penguin, 1990.
- Parfit, Derek. *Reasons and Persons*. Oxford: Clarendon, 1984.
- Railton, Peter. "Alienation, Consequentialism, and the Demands of Morality." *Philosophy and Public Affairs* 13 (1984): 134–171.
- Rawls, John. *A Theory of Justice*. Cambridge, U.K.: Harvard University Press, 1971.
- Scheffler, Samuel. *The Rejection of Consequentialism*. Oxford: Clarendon, 1982.
- Sen, Amartya K. "Utilitarianism and Welfarism." *Journal of Philosophy* 76, no. 9 (September 1979): 463–489.
- Sidgwick, Henry. *Methods of Ethics*. 7th ed. 1874. Reprint, London: Macmillan, 1907.
- Singer, Peter. *Practical Ethics*. Cambridge, U.K.: Cambridge University Press, 1993.
- Smart, John Jameison Carswell. "An Outline of a System of Utilitarian Ethics." In *Utilitarianism: For and Against*, by J. J. C. Smart and Bernard Williams. Cambridge, U.K.: Cambridge University Press, 1973.
- Sumner, L. Wayne. *The Moral Foundations of Rights*. Oxford: Clarendon, 1987.
- Williams, Bernard. "A Critique of Utilitarianism." In *Utilitarianism: For and Against*, by J. J. C. Smart and Bernard Williams. Cambridge, U.K.: Cambridge University Press, 1973.

R. G. Frey

UTOPIA. The word *utopia* was coined by Thomas More (1478–1535) as the name of the island described in his *Libellus vere aureus nec minus salutaris quam festivus de optimo reip[ublicae] statu, deque] noua Insula Vtopia* (1516). While More wrote in Latin, he based his new word on Greek. More combined *topos* (place or where) with *u* or *ou* (no or not) to create *nowhere*, but in "Six Lines on the Island of Utopia,"



1518 woodcut by Ambrosius Holbein from Thomas More's *Utopia*. Although the concept of utopia has existed in many different religions and societies since ancient times, the term itself was originated by Thomas More in his early-sixteenth-century work.

part of the larger work, he suggests that the word *eutopia*, or good place, is a better descriptor. Thus, from the time of More's original coinage, the word *utopia* has been conflated with *eutopia* to mean a nonexistent good place.

The word *utopia* entered Western languages quickly—the book was translated into German in 1524, Italian in 1548, French in 1550, English in 1551, and Dutch in 1553, and the word itself often entered these languages before the book was translated. In the eighteenth century, the word *dystopia* was first used to characterize a nonexistent bad place, but the word did not become standard usage until the mid-twentieth century.

While More coined the word and invented the genre of literature that grew from the book, he was not the first to imagine the possibility of a society better than the one currently existing and to describe such a society. Examples of such imaginings can be found in ancient Sumer, classical Greek, and Latin literature, the Old Testament, Buddhism, Confucianism, and Hinduism, among other predecessors.

While it is no longer possible to see utopia as a product of the Christian West, the role of utopia in Christianity has long been an area of dispute. Eden, the millennium, and heaven all have clear utopian elements, but the extent to which they can be achieved through human action is open to dispute. The Fall and the resultant emphasis on sinful human nature has led some commentators to view utopia as anti-Christian and heretical. Human beings are simply not capable of a utopia in this life. But other commentators, like the theologian Paul Tillich (1886–1965) and the founders of Liberation Theology, have argued that utopia is central to any understanding of the social message of Christianity.

Expressions of Utopianism

Today dreaming of or imagining better societies is usually called “utopianism,” and utopianism can be expressed in a variety of ways. Utopian literature, the creation of intentional communities or communes, formerly called utopian experiments, and utopian social theory are the most commonly noted forms in which utopianism is expressed, but there are other means of expressing utopianism, such as the design of ideal cities.

Utopian literature. Utopian literature is most common in the English-speaking world, with particularly strong traditions in England, the United States, and New Zealand. Brazil, France, Germany, Greece, Italy, Russia, and Spanish America also have strong utopian traditions, and we now know that there are substantial utopian traditions in other European countries and in the non-Western world. The strongest non-Western utopian tradition is found in China, but such traditions exist throughout the Middle East and in India and Southeast Asia; there are also developing utopian traditions in various African countries. Even Japan, which was once thought to have no such tradition, has recently been shown by young Japanese scholars to have one.

Although early scholarship in the field treated utopias from all times and places as if they were alike, these utopian literatures differ from each other in significant ways, and national

and cultural differences are now recognized. Also, as a direct result of the influence of feminist scholarship, we are now more aware of both the similarities and differences found in utopias written by men and woman, and recently such awareness has been extended to differences and similarities based on ethnicity, race, religion, and other such characteristics.

From its earliest expression to the present, a basic human utopia is found in which everyone has adequate food, shelter, and clothing gained without debilitating labor and in which people lead secure lives without fear of, in early versions, wild animals, and in later versions, other human beings. But these basic elements are expressed in different ways in different times and places and also reflect individual concerns; as a result, the range of utopias present throughout history is immense.

Much utopian literature, particularly the dystopian, has been marketed as science fiction, and one minor scholarly controversy had some arguing that utopias were a subgenre of science fiction and others arguing that historically it was the other way around. In the late twentieth and early twenty-first century, there was clearly an intellectual as well as a marketing overlap with the most prolific writers of utopias, like Ursula K. Le Guin (b. 1929) and Mack (Dallas McCord) Reynolds (1917–1983), using science fictional motifs and tropes. In *Scraps of the Untainted Sky* (2000), Tom Moylan carefully considers the relationships between utopia, dystopia, and science fiction.

Scholarship on utopian literature increased in both quantity and quality in the 1970s and 1980s with the publication of definitional essays by Lyman Tower Sargent and Darko Suvin that helped clarify the conceptual muddle; bibliographies by Arthur O. Lewis, Glenn Negley, and Sargent that transformed the understanding of the subject; and important books by Krishan Kumar, Frank E. and Fritzie P. Manuel, Tom Moylan, and Kenneth M. Roemer that rewrote the history of utopian literature. At the same time, there was a major revival of utopian writing, the most important works being Le Guin's *The Dispossessed* (1974), significantly subtitled *An Ambiguous Utopia*, and *The Left Hand of Darkness* (1969); Joanna Russ's (b. 1937) *Female Man* (1975); Marge Piercy's (b. 1936) *Woman on the Edge of Time* (1976); Samuel R. Delany's (b. 1942) *Dhalgren* (1975) and *Triton* (1976); and Margaret Atwood's (b. 1939) *The Handmaid's Tale* (1985).

A major contribution to our understanding of the changes utopias were undergoing was Moylan's development in *Demand the Impossible* (1986) of the “critical utopia.” Moylan wrote:

A central concern in the critical utopia is the awareness of the limitations of the utopian tradition, so that these texts reject utopia as a blueprint while preserving it as a dream. Furthermore, the novels dwell on the conflict between the originary world and the utopian society opposed to it so that the process of social change is more directly articulated. Finally, the novels focus on the continuing presence of difference and imperfection within the utopian society itself and thus render more recognizable and dynamic alternatives. (pp. 10–11)

Even though positive utopias were published in every year of the twentieth century, the dystopia has been the most frequently published form of utopian literature from World War I to the early twenty-first century. The dystopia uses the depiction of a usually extrapolated negative future as a means of warning the present to change its behavior. The message of the dystopia is that if the human race continues in the direction it is now heading, this is what will happen. The dystopia, thus, has a positive element in that it suggests the possibility of change. In this, the dystopia is in the tradition of the *Jeremiad*, or a work modeled on the Book of Jeremiah, in which a condemnation of contemporary behavior and a warning of retribution also holds out hope of improvement if the warning is heeded.

Although there were precursors, the dystopia came to prominence through four works: *We* (1924), by Yevgeny Zamyatin (1884–1937); *Brave New World* (1932), by Aldous Huxley (1894–1963); and *Animal Farm* (1945) and *Nineteen Eighty-Four* (1949), by George Orwell (Eric Arthur Blair; 1903–1950). They were concerned with the effects of the dominant ideologies of the twentieth century and each raised the question of the potential danger of a utopia based on one of these ideologies being imposed on some country. Such works continued to be written, albeit rarely as well, throughout the rest of the century. Later the dystopia was applied to other areas. Two works by John Brunner (1934–1995) are outstanding examples: *Stand on Zanzibar* (1968), focusing on the effects of overpopulation, and *The Sheep Look Up* (1972), focusing on the effects of pollution.

Some authors, such as Fredric Jameson and Sargent, have made a distinction between dystopia and anti-utopia. Sargent reserves the latter for works written against positive utopias or utopianism. Jameson does the same, but in doing so makes a political point by arguing that anti-utopianism has dominated the late twentieth century.

The most important twentieth-century theme of positive utopias has been feminism. The discovery of *Herland* (published serially in 1915) by Charlotte Perkins Gilman (1860–1935) with its first book publication in 1979 led to the discovery or rediscovery of many early feminist utopias, particularly *The Description of a New World, Called the Blazing World* (1666), by Margaret Cavendish, duchess of Newcastle (1623?–1674); *A Serious Proposal to the Ladies* (1694), by Mary Astell (1668–1731); and *A Description of Millenium Hall* (1762), by Sarah Scott (1723–1795).

Such feminist utopias are found throughout the history of utopian literature, but the greatest number were published from the mid-1970s through the end of the twentieth century, with the most important being those by Le Guin, Piercy, and Russ. Small feminist presses published many of these novels, and the many lesbian utopias were published almost exclusively by lesbian presses. Such lesbian utopias included *Retreat: As It Was!* (1979), by Donna J. Young; *Daughters of a Coral Dawn* (1984), by Katherine Forrest (b. 1939); and *Womankind: A Vision* (1986), by Sunlight.

The other major theme of the late twentieth century was environmentalism. *Ecotopia* (1975), by Ernest Callenbach

(b. 1929), the most influential of the environmental utopias, was initially published by a small press and then reissued by a mass-market publisher. Later, environmentalism and feminism combined in ecofeminism, and most utopias that are feminist or reflect environmentalism include the other perspective.

Intentional communities. The aspect of turn-of-the-twenty-first-century utopian studies that might appear least connected to the tradition of utopianism is intentional communities, but most such communities had a clear vision of how they hoped to live, which was in many cases explicitly utopian. In most cases, the actuality of the communities had little to do with the visions. Still, the visions were there, and they attracted and continue to attract people who choose to try to live the vision, even if they regularly fail to do so.

Many intentional communities were founded in the late 1960s through the 1970s, and while most were short-lived, there are a substantial number of such communities, like Twin Oaks in Virginia and The Farm in Tennessee, that are well past their thirtieth anniversary. And there are individual communities in various countries that are past fifty or seventy-five years. The phenomenon continues to grow, with more communities planned and some founded each year, and although members now downplay the utopian aspects, they are still there.

Utopian social theory. The first major theorist to use utopia as an aspect of social theory was Karl Mannheim (1893–1947). Mannheim's sociology of knowledge is concerned with the social origins of thought systems, and to understand them he contrasts ideology and utopia. Ideology characterizes dominant social groupings who unconsciously obscure the fragility of their position. Utopia characterizes subordinate social positions; it reflects the desire to escape from reality. The utopian mentality is at the base of all serious social change.

Karl R. Popper (1902–1994) objected to utopianism in his *The Open Society and Its Enemies* (1945). Popper argued that utopianism leads to violence and totalitarianism, saying, “the Utopian approach can be saved only by the Platonic belief in one absolute and unchanging ideal, together with two further assumptions, namely (a) that there are rational methods to determine once and for all what this ideal is, and (b) what the best means of its realization are” (vol. 1, p. 161). Popper's position came to dominate discussions of utopianism.

Those opposing Popper and supporting utopianism, like Ernst Bloch (1885–1977) and Frederik L. Polak (1907–1985), argued that utopianism was an essential element of all positive social theory. Polak argues that it is fundamental to the continuance of civilization, saying:

if Western man now stops thinking and dreaming the materials of new images of the future and attempts to shut himself up in the present, out of longing for security and for fear of the future, his civilization will come to an end. He has no choice but to dream or to die, condemning the whole of Western society to die with him. (vol. 1, p. 53)

Others have argued that while some people may be willing to impose their vision on others if they have the power to do so, this is not a problem with utopianism but with people misusing power.

Karl Marx (1818–1883) and his followers argued that their version of socialism was scientific, in contrast to the socialism of the so-called utopian socialists. This position was most famously expressed by Friedrich Engels (1820–1895) in his *Socialism: Utopian and Scientific* (1882), but Marxists have always been more ambivalent about utopianism than this simple division suggests, and while many Marxists were anti-utopian, others were clearly utopian themselves.

Thus, while Bloch was a Marxist, he did not have the negative attitude to utopias of many Marxists because his philosophy stressed the end or goal of human life. He saw utopia as an aspect of present reality, saying, in his *Principle of Hope* (1955–1959):

So far does utopia extend, so vigorously does this raw material spread to all human activities, so essentially must every anthropology and science of the world contain it. *There is no realism worthy of the name if it abstracts from this strongest element in reality, as an unfinished reality.* (p. 624; emphasis in the original)

Bloch makes a key distinction between “abstract” and “concrete” utopia. “Abstract utopia” includes the wishful thinking or fanciful elements found in the utopian tradition, such as the golden ages, earthly paradises, and cockaignes that occur early in most utopian traditions but also continue throughout their histories. “Concrete utopia” anticipates and affects the future, something like Polak’s idea that our images of the future are part of the creation of our actual future. But for Bloch, as a Marxist, utopia must be part of praxis, it must grow out of present reality and influence actual political activity. Utopia, for Bloch, is a mechanism that has the potential of being reached. As Oscar Wilde famously put it, “A map of the world that does not include Utopia is not worth even glancing at, for it leaves out the one country at which Humanity is always landing. And when Humanity lands there, it looks out, and, seeing a better country, sets sail. Progress is the realization of utopias (p. 27).”

Bloch’s approach is based on the joined concepts of “hope” and “desire,” in which desire can become an active agent of change. In *The Concept of Utopia* (1990), Ruth Levitas uses Bloch’s approach to develop an understanding of utopia as a politically important tool whose essence is desire.

Postmodernism

The coming of postmodernism, with its rejection of universals, posed a problem for those utopians who see utopias as generalizable solutions. But as Moylan points out in *Demand the Impossible*, writers of utopias had begun to change their approach even as postmodernism became influential. Le Guin’s subtitle, *An Ambiguous Utopia*, signaled an explicit rejection of perfection and the recognition that utopias will face problems and will change over time.

Fredric Jameson, one of the most important theorists of postmodernism, has written extensively on utopianism. Jameson, like Bloch, argues that the literary utopia is a form of praxis rather than representation. But for Jameson, utopias are not goals, as they are for Bloch, but critiques of the present that help reeducate us regarding the present.

Both positive and negative utopias continue to be published. Intentional communities continue to be founded, and while most will fail, some will last for many years, fulfilling at least some of the expectations of their members. And attempts to understand the roles played by utopianism in human thought continue. Utopias have always expressed both the hopes and fears of humanity, the highest aspirations for human life and the deep-seated fear that we may not be capable of our own aspirations.

Non-Western Utopianism

While some well-regarded scholars argue that utopianism is a Western phenomenon and that utopias do not appear outside the West until the influence of More’s *Utopia* was felt, others have argued that utopianism developed independently in non-Western cultures. Thomas More invented a literary genre, but there are texts in the West and outside it that predate More’s *Utopia* that describe a nonexistent society that is identifiably better than the existing society. Probably the best-known early non-Western utopia is “The Peach Blossom Spring,” a poem of T’ao Yüan Ming (also known as T’ao Ch’ien) (365–427), that describes a peaceful peasant society, but there are golden ages, earthly paradises, and other forms of utopianism found in Sumerian clay tablets and within Buddhism, Confucianism, Hinduism, Islam, and Daoism.

Once it is established that there are utopian traditions that are certainly non-Western, there are problems that confront a scholar approaching the subject at the beginning of the twenty-first century. One is the issue of what is non-Western. Scholars disagree profoundly over what constitutes non-Western and Western. Some would limit Western to Europe, North America, Australia, and New Zealand and thereby exclude the substantial Portuguese and Spanish literatures published in Central and South America, which contain many utopias. Others would include these literatures. A second problem is that there are no good bibliographies of any non-Western utopianism not written in English. A related problem is that there are debates in a number of countries, even in countries such as India, where English is an official language, over the status of works written in English, particularly those written by authors who choose to live outside the country.

In ancient China, Moist and Legalist thought had utopian elements, and the same can be said for neo-Confucianism and Daoism. In twentieth-century China, Mao Zedong (1893–1976) was clearly utopian in his desire to transform Chinese society along the lines of his vision for it, and it can be argued that Mao’s Communism was both Marxist and rooted in Confucianism.

There have been a number of twentieth-century political movements with utopian dimensions. In India, Mohandas K. Gandhi (1869–1948) was a utopian and used the Hindu

notion of Ramaraja (the rule of the Rama), the golden age, as a means of communicating his ideas. The vision of the Islamic republic developed by Ayatollah Ruhollah Khomeini (1900?–1989) and by the Taliban for Afghanistan were also clearly utopian and fit Popper's analysis of the dangers of utopianism.

There are oral utopian traditions among the aborigines in Australia, the first nations in Canada, the Maori in New Zealand, and the Native American Indians in the United States. The struggle against colonialism produced millennial movements with strong utopian elements, such as the Taiping Rebellion (1851–1864) in China and the Ghost Dance movement in the United States. There were dozens of such movements in South America and movements among the Maori in New Zealand, some of whose successors still exist in the early twenty-first century, such as the Maori's Ratana Church.

Also, there is a strong communitarian tradition in both Buddhism and Hinduism, and there is a traditional communitarianism among various indigenous peoples that has redeveloped since around 1980 as chosen, better ways of living, particularly among the Maori in New Zealand.

Most non-Western utopianism is post-More and clearly connected with the genre of literature he invented, and as a result are deeply influenced by the West. Since China had the strongest pre-More utopian tradition, it is not surprising that it has the strongest post-More tradition. The Chinese utopias that are best-known in the West are Li Ju-Chen's (c. 1760–c. 1830) *Flowers in the Mirror* (1828), which favors the rights of women, and Kang Youwei's (1858–1929) *Da Tung Shu* (1935), which is concerned with world unity.

Works that most nearly fit the genre of utopian literature appear to be most common in former colonies, and aspects of Chinese utopianism fit this model. There are utopias in English in various African countries, including South Africa, where utopias are in Afrikaans, English, and indigenous languages. In addition, there are utopias (because of limited research, how many is not known) in various indigenous languages in other African countries and in India.

African utopias in English are the works most widely read in the West. They come from many different countries and have a strong dystopian flavor. But as with many contemporary Western utopias, they often hold out hope of positive change. Ali A. Mazrui (1933–), who was born in Kenya, wrote *The Trial of Christopher Okigbo* (1971), which is mostly dystopian but still holds out hope. Authors born in Nigeria include Buchi Emechta (1944–), whose *The Rape of Shavi* (1983) shows the destruction of traditional utopia by colonialism; Wole Soyinka (1934–), whose *Seasons of Anomy* (1973) is primarily dystopian but includes the possibility of a better life; and Ben Okri (1959–), whose *Astonishing the Gods* (1995) presents the search for utopia. Bessie Head (1937–1986) was born in South Africa and lived in Botswana; her *When Rain Clouds Gather* (1969) presents a village that is both described as a utopia and is the location of an attempt to create a utopia.

The best-known Indian utopia in English is probably Salman Rushdie's (1947–) *Grimus* (1975), which includes a society that is described in the text as "utopian" because it functions on a basis of rough equality and with no money. Other Indian utopias do not appear to have gained much of an audience outside India.

Comparative studies on Western and non-Western utopianism are only just beginning. (An early-twenty-first-century example is Zhang Longxi's "The Utopian Vision, East and West" in the journal *Utopian Studies* [2002].)

See also *Equality; Paradise on Earth; Society*.

BIBLIOGRAPHY

- Al-Azmeh, Aziz. "Utopia and Islamic Political Thought." *History of Political Thought* 11 (1990): 9–19.
- Bloch, Ernst. *The Principle of Hope*. 3 vols. Translated by Neville Plaice, Stephen Plaice, and Paul Knight. Cambridge, Mass.: MIT Press, 1986.
- Jameson, Fredric. *The Seeds of Time*. New York: Columbia University Press, 1994.
- Kumar, Krishan. *Utopia and Anti-Utopia in Modern Times*. Oxford: Blackwell, 1987.
- Levitas, Ruth. *The Concept of Utopia*. Syracuse, N.Y.: Syracuse University Press, 1990.
- Lewis, Arthur O. *Utopian Literature in The Pennsylvania State University Libraries: A Selected Bibliography*. University Park: Pennsylvania State University Libraries, 1984.
- Mannheim, Karl. *Ideology and Utopia: An Introduction to the Sociology of Knowledge*. Translated by Louis Wirth and Edward Shils. New ed. London: Routledge, 1991.
- Manuel, Frank E., and Fritzie P. Manuel. *Utopian Thought in the Western World*. Cambridge, Mass.: Harvard University Press, 1979.
- Moylan, Tom. *Demand the Impossible: Science Fiction and the Utopian Imagination*. London: Methuen, 1986.
- . *Scraps of the Untainted Sky: Science Fiction, Utopia, Dystopia*. Boulder, Colo.: Westview, 2000.
- Negley, Glenn. *Utopian Literature*. Lawrence: Regents Press of Kansas, 1977.
- Polak, Fred[erik] L. *The Image of the Future; Enlightening the Past, Orientating the Present, Forecasting the Future*. 2 vols. Translated by Elise Boulding. New York: Oceana, 1961.
- Popper, Karl R. *The Open Society and Its Enemies*. 4th rev. ed. 2 vols. London: Routledge and Kegan Paul, 1962. Originally published in 1945.
- Pordzik, Ralph. *The Quest for Postcolonial Utopia: A Comparative Introduction to the Utopian Novel in the New English Literatures*. New York: Peter Lang, 2001.
- Pordzik, Ralph, and Hans Ulrich Seeber, eds. *Utopie und Dystopie in den Neuen Englischen Literaturen*. Heidelberg, Germany: Universitätsverlag C. Winter, 2002.
- Roemer, Kenneth M. *The Obsolete Necessity: America in Utopian Writings, 1888–1900*. Kent, Ohio: Kent State University Press, 1976.
- Sargent, Lyman Tower. *British and American Utopian Literature, 1516–1985: An Annotated, Chronological Bibliography*. New York: Garland, 1988.
- . "The Three Faces of Utopianism Revisited." *Utopian Studies* 5, no. 1 (1994): 1–37.
- Schaer, Roland, Gregory Claeys, and Lyman Tower Sargent, eds.

- Utopia: The Search for the Ideal Society in the Western World.* New York: New York Public Library and Oxford University Press, 2000.
- Suvín, Darko. *Metamorphoses of Science Fiction: On the Poetics and History of a Literary Genre.* New Haven, Conn.: Yale University Press, 1979.
- Wilde, Oscar. *The Soul of Man under Socialism.* Boston: Luce, 1910.
- Zhang Longxi. "The Utopian Vision, East and West." *Utopian Studies* 13 (2002): 1–20.

Lyman Tower Sargent



V

VEDA. See *Communication of Ideas: Asia and Its Influence; Hinduism.*

VICTORIANISM. Even seemingly unshakeable axioms are prone to reassessment by historians, and Victorianism is no exception. Even the very period of Victorianism itself stands challenged: historians no longer refer unquestioningly to the

“Victorian Age” as the precise years associated with the monarch but instead concentrate on a shorter period—a “high age”—from about 1830 to 1880. Yet critics shadowed the entire period in question, and the negative connotations were fired dramatically forward soon after the period ended, notably with Lytton Strachey’s (1880–1932) mocking attack *Eminent Victorians* (1918). Moralizing, prudish, repressed (and repressive), and old-fashioned (rather than traditional)—each of these notions captures what Victorianism has meant to later generations.



North-West Passage (1874) by John Everett Millais. Oil on canvas. A strong patriarchal influence and the importance of family were prominent values in the Victorian Age, possibly, some say, because there were so many societal obstacles for families to overcome. © THE ART ARCHIVE/TATE GALLERY LONDON/EILEEN TWEEDY

Early Victorianism

The early Victorian years witnessed the emergence of a cluster of values and beliefs that represented the central ideas of Victorianism. These years are associated with developments in governance, economic and social life, science, and learning that capture the essential features of Victorianism. In governance, one can look to the reforms which, if not immediately democratic, changed the structure of parliament, ushering in a tradition of evolutionary change (with major Reforms Acts in 1832, 1867, 1884) and the expansion of local, middle-class political power with the Municipal Corporations Act (1835). In economic life, the hard-nosed essentials of political economy and utilitarianism reached a high point prior to the 1850s. Associated with such notable names as Jeremy Bentham (1748–1832), James Mill (1773–1836), and David Ricardo (1772–1823), and later refined and developed by luminaries such as John Stuart Mill (1806–1873), political economy helped to shape the policy conditions for the reform of the Elizabethan Poor Law (in the form of the Poor Law Amendment Act, 1834), and the ideology of self-help which, for a while, attained the status of mantra. By the time Samuel Smiles (1812–1904) penned the popularized guide to the joys of this creed (*Self Help*, 1859), the concept had already begun to be pushed to one side by a creeping state and the tendency of the working class to collectivize in the face of demands for Smilesian individualism: hence, the staggering rise of friendly societies, trade unions, the co-operative movement, and countless other examples of collective identification by the people.

Values and Beliefs

In religion, Victorianism balanced the ancient regime Anglicanism of the Church of England with a growing pluralism through alternative Christianities, new faiths, and the toleration of unbelief. The backdrop to this was a crisis of faith for Anglicans, dating to the early Victorian years, when the Church of England was rocked by fierce debates about Tractarianism, “Romish” rituals, and the intellectual contribution of the Oxford movement. At a more prosaic level, the Religious Census of 1851 revealed a general weakening of popular interest in the established church and many dissenting faiths, whilst Roman Catholicism prospered through Irish migration. Victorianism may be equated with spiritual piety and Christian morality, but alternative and opposite forces also had some importance. Agnosticism, advocated most notably by Thomas H. Huxley (1825–1895), offered, by the 1870s, an alternative to faith in the attempt to answer profound questions about the nature of being.

Victorianism came to be associated with patriarchal social values, stressing the importance of family and an image of motherhood captured well in Alfred Lord Tennyson’s (1809–1892) poem, *The Princess* (1847):

Man for the field and woman for the hearth;
for the sword, and for the needle she;
Man with the head, and women with the heart;
Man to command, and woman to obey;
All else is confusion.

Thus, poetry, as well as prose, painting, and music, reflected hegemonic notions. Yet, the stereotype of the Victorian family perhaps assumed its importance precisely because there were so many challenges to it. In the cities, drink and crime denied many children the full influence of parental guidance, and the critics of industrialism saw in female and child labor a collection of evils that had to be addressed. But economic conditions placed women and children in this position. Poverty, drunkenness, and alcoholism were sometimes causes of prostitution. Charles Dickens’s (1812–1870) portrayal of Nancy, the pathetic, doomed heroine of *Oliver Twist* (1837–1839), obliquely, and somewhat coyly, suggested how easy it was for a woman to fall prey to professional gangs. In *Mary Barton* (1848), Elizabeth Gaskell (1810–1901) captured the horror that Victorian society felt at the sight of a “fallen woman” in her portrayal of the stunted relationship of the widower John Barton and his sister-in-law, the fallen woman. Social reportage also emphasized this aspect of Victorianism: Bracebridge Hemyng’s (1809–1898) study of prostitution suggested that, in 1857, London had 8,600 who plied this trade.

Anti-Victorianism

Behind the facade of staidness there was another sort of Victorianism—a kind of anti-Victorianism. Here, stifling mores were replaced by more adventurous and plural sexualities. Liaisons outside marriage, such as Dickens’s longstanding affair with the actress Nelly Ternan, were common. William Gladstone’s (1809–1898) self-flagellation—a habit the four-time prime minister shared with the bohemian Algernon Swinburne (1837–1909)—was his punishment for the sexual feelings (though there are no known sexual acts) aroused by his attempts to rescue London’s prostitutes. Pornographic pictures and texts were readily available in the nineteenth century. Peep shows were commonplace and provided titillation to a broad spectrum of male society. As Simon Winchester’s *The Surgeon of Crowthorne* (1999) demonstrates, William Chester Minor (1834–1920), the American military doctor, murderer, and prolific contributor to the *Oxford English Dictionary*, aggressively pursued a sex life that utterly contradicted the conventional image of his age. Obsessed with sex and a regular user of prostitutes—prior to his incarceration in 1872 in the new Broadmoor Criminal Lunatic Asylum for murdering a man in London—Minor harbored such a strong sense of self-loathing that he cut off his own penis. Homosexuality may have scandalized Victorian sensibilities, but it was not invisible. Literary works with a homosexual theme, such as *Teleny* (1883), were produced; Oscar Wilde’s (1854–1900) trial and imprisonment reminded Victorians that homosexuality and pedophilia were part of their worlds; while the artist and aesthete Aubrey Beardsley (1872–1898) helped to create a self-image of sexual radicalism, including an unfinished pornographic novel, *Under the Hill* (1894). Not long after, in 1899, Lord Longford was recorded for posterity in *Hansard* with a telling contribution to a parliamentary debate: “Of course I have seen people recover from homosexuality. A boy at Eton assaulted my elder brother in the bath there and was later expelled for repeating the offence on another boy. Later he became a pillar of society and captained the county cricket team” (Sweet, p. 190).



Symbolic photograph of guardian angels watching over children. British, c. 1860s. Religion in Victorian Britain was marked by a loss of faith in the Church of England. The period saw the creation of several new religions, a branching out of Christianity, and a growing rise of agnosticism. © HULTON-DEUTSCH COLLECTION/CORBIS

Victorianism and Progress

No other age was quite so strongly associated with a faith in the progress of technologies. Victorianism is correctly and inextricably intertwined with inventions and the rise of the machine. Steam locomotion, iron, and then steel ships, telegraphy, and many other developments receive attention from historians, for the Victorians triumphed over so many challenges of distance and power that had held up such progress in earlier times. Justifiably, Victorianism remains associated with industrialism, urbanization, transport, technologies, travel, and communication. The essential character of Victorian technological determinism was that science and the practical men could change the world through invention and implementation.

Leaps in technology were matched by developments in social thought. Prophets of progress and the enemies of industrial modernity competed for space, and both groups contributed to the sense of what Victorianism was about. From the 1830s, the critics of Victorianism grew. Modernity was feared by many and loathed by some. Tories, such as the “Young England” group (which included Benjamin Disraeli [1804–1881]) looked back to a bygone age of preindustrial harmony, where deference, social equilibrium, and a more agreeable life was once thought to exist. Disraeli’s classic, *Sybil; or the Two Nations* (1845), captured these sentiments brilliantly. Another stern early critic, the Scot Thomas Carlyle (1795–1881), shared the “Young England” aversion to modernity but

looked forward, not back. He abhorred the Victorian tendency to seek mechanical solutions to human problems and sought, instead, a reinvention of an earlier morality, but in a future setting. This style of criticism connected many early nineteenth-century thinkers, such as Carlyle and Robert Owen (1771–1858), to later socialists, such as William Morris (1834–1896). By the 1880s the critique of Victorianism was powerful indeed. Unlike on the continent, where Marxism was much more influential and where anarchism and communism posed a seemingly greater challenge, most British socialism sought accommodation with capitalism and was reformist in character. The Fabian, Sidney Webb (1859–1947), represented an administrative type of socialism, based upon efficiency and organization. William Morris’s utopian socialism was characterized by a more fundamental attack upon capitalism and a pursuit of an alternative moral and spiritual way of life. Socialist criticism of modernity also had echoes in the growing feminist challenge to Victorianism. Although suffragism achieved its ends beyond the Victorian period, its seeds were sprouting long before Victoria’s end.

Traditional interpretations of society as a static entity were undermined as the period progressed. Charles Darwin’s (1809–1882) theories of evolution and Herbert Spencer’s (1820–1903) considerations upon human development were to have a startling impact, radically altering classic Victorian notions of society and how to manage it. A social science, borrowed from evolutionary theory, that downplayed contractual in favor of organic ideas of society emerged. Social Darwinism and other evolutionary theories played some part in the development of a philosophy of state interventionism, which marked later Victorian, and particularly twentieth-century, thought (though recent studies, for example, H. S. Jones’s *Victorian Political Thought* [2000], sound more cautious and complicated notes). The search for perfectibility in society, which echoed nature’s selection of the fittest, could be set up for *or* against the collectivization of social welfare.

Victorianism Beyond Britain

Victorianism—in architecture, science, governance, and culture—impacted heavily upon the wider world. Britain’s short-lived preeminence as an imperial power bequeathed a rather hardier cultural imprint on the world. After the globalization of the English language, the most striking effect was in the character of civic culture in the English-speaking colonies and dominions: Canada, Australia, and New Zealand. In these places, political systems, bureaucracies, and education took on a clearly Victorian character. Victorianism also affected street design and civic building programs—in India, parts of Africa, and the Far East, as well as in the Dominions. Urbanism marked the Victorian world outside of Britain, as well as within. So great was the growth in Sydney, for example, that in 1901 that city (not Liverpool or Glasgow) boasted “it now stands as the second city of the British Empire, as estimated by the annual value of its rateable property” (Briggs, p. 310).

Even when it stood at the leading edge of world culture, exercising a hegemonic power over large swaths of the globe, Victorianism had its critics. In politics, social thought, and economics, interventionism and a demand for action pushed



Victorian-style house at Longwood, Natchez, Mississippi (1860–1862). In the mid-to-late-nineteenth century, buildings—especially in the United States—became elaborate and complex in design and decoration, with architects drawing upon several different styles, from Italianate to Queen Anne. © G. E. KIDDER SMITH/CORBIS

classical *laissez-faire* ideologies to one side. Sexual repressiveness was challenged; many on the left of politics rejected capitalism; and an imperial rot set in after the arduous struggles of the Boer War (1899–1902). The challenge to Victorianism often came in the shape of a wholesale anti-Victorianism from a disparate array of groups: workers, women, socialists, bohemians, and from anticolonialists beyond the metropolitan stage.

See also *Empire and Imperialism; Europe, Idea of; Progress, Idea of; Social Darwinism; Utilitarianism.*

BIBLIOGRAPHY

- Benson, E. F. *As We Were: A Victorian Peepshow*. London: Penguin, 2001.
- Best, Geoffrey. *Mid-Victorian Britain, 1851–75*. London: Fontana, 1985.
- Briggs, Asa. *Victorian Cities*. Berkeley: University of California Press, 1993.
- Francis, Mark, and John Morrow. *A History of English Political Thought in the Nineteenth Century*. London: Duckworth, 1994.
- Harrison, John F. C. *Late Victorian Britain, 1875–1901*. London: Fontana, 1990.
- Hoppen, K. Theodore. *The Mid-Victorian Generation, 1846–1886*. Oxford: Oxford University Press, 1999.
- Jones, H. Stuart. *Victorian Political Thought*. Basingstoke, U.K.: Macmillan, 2000.
- Marcus, Steven. *The Other Victorians: A Study of Sexuality and Pornography in Mid-Nineteenth Century England*. London: Weidenfeld and Nicolson, 1966.
- Mason, Michael. *The Making of Victorian Sexuality*. Oxford: Oxford University Press, 1995.
- Read, Donald. *The Age of Urban Democracy, 1868–1914*. London: Longman, 1994.

Sweet, Matthew. *Inventing the Victorians*. London: Faber and Faber, 2001.

Tomalin, Claire. *The Invisible Woman: The Story of Nellie Ternan and Charles Dickens*. London: Penguin, 1991.

Walkowitz, Judith. *City of Dreadful Delight: Narratives of Sexual Danger in Late-Victorian London*. London: Virago Press, 1992.

Wilson, A. N. *The Victorians*. London: Arrow Books, 2003.

Winchester, Simon. *The Surgeon of Crowthorne*. London: Penguin, 1999.

Zimmerman, Bonnie, ed. *Lesbian Histories and Cultures*. New York: Garland, 2000.

Donald M. MacRaild

VIRTUAL REALITY. *Virtual reality*, a term that became popularized in the late 1980s with the advent of critical research and new technologies developed by Scott Fisher at NASA-Ames Research Center, has its roots in a broad and colorful evolution of art, technology, and communications. The creation of virtual reality is essentially concerned with the quality and experience of immersion, whether real or simulated. The idea of immersion in this sense is related to the artistic concept of “representation,” in which the world is translated into visual form. Virtual reality often extends this notion of representation by engaging other senses as well, such as sound and touch, to bring about multisensory experience.

The first part of this essay is an overview of the leading pioneers in the arts and sciences who introduced new technologies, concepts, and artistic innovation that led to the contemporary definition of virtual reality. The second part focuses on artists and theorists who have chronicled new media and virtual reality and its impact on the social condition, revealing transformations in cultural norms and the psychological effects of extending our reach into virtual space.

Historical Overview

By 15,000 B.C.E. Cro-Magnon had evolved with a brain capable of modern intelligence. With this new intelligence, artistic renderings were installed deep in subterranean grottos in the Dordogne region of southern France, in caves such as the well-known Lascaux. This birth of drawing and painting was among the first attempts at representation, in the modern sense of the word, in which animal figures (bison, reindeer, horses) and coded shamanist scrawls and motifs were brought to life on the walls of the caves. This recreation of both the external world of nature and the inner world of magic in the immersive space and controlled atmospheric conditions of the underground cavern was an early attempt at artistic expression for the purpose of the preservation of culture. Here, in the prehistoric caves, the human concept of virtual reality began with the multisensory, totalizing experience that engaged sight, sound, smell, and touch—the first conscious virtualization of the physical world.

The Gothic Cathedral of Notre Dame in Chartres, one of the greatest of the European Gothic cathedrals, was built in central France beginning in the late twelfth century. With its magnificent rose windows and stained glass, resonant chambers,

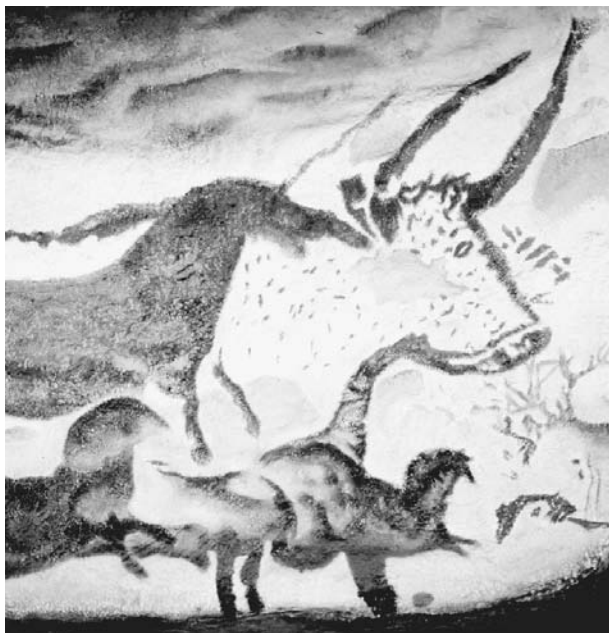

Prehistoric cave paintings in Lascaux Cave, Dordogne, France. Cave paintings were one of the first known attempts to visually recreate the physical world as a means of cultural preservation. PHOTO CREDIT: ART RESOURCE, NY

vaulted ceilings, and sacred labyrinth, the sanctuary transposed the virtues of the church by transporting the individual through the experience of immersion. The cathedral served as an architectural canvas for the depiction of the scriptures, figures from the Old Testament, and the narrative of the Crucifixion, as told through the elements of light, sculpture, glass, sound, and stone. The enigmatic labyrinth inlaid on the floor of Chartres invites the viewer to navigate its complex pattern as a spiritual exercise. From the interior of the space, the great height of the cathedral evokes the ascent of heaven. The immersive and totalizing depiction of religious life invites the visitor to consider virtual reality as a mystical realization and transformation from the material to the immateriality of human existence.

German composer Richard Wagner's (1813–1883) *Gesamtkunstwerk* (total artwork), as implemented at the Festpielhaus in Bayreuth, Germany, in 1876, illuminates our understanding of the artistic impulse behind the creation of virtual worlds as it corresponds to the theatrical environment. Wagner understood the power of virtualization through music theater, and he mastered techniques of sensory immersion in order to heighten the audience experience of the “suspension of disbelief.” The composer employed a powerful articulation of this age-old theatrical device to render stage action “believable,” which has been used as long as humanity has employed the

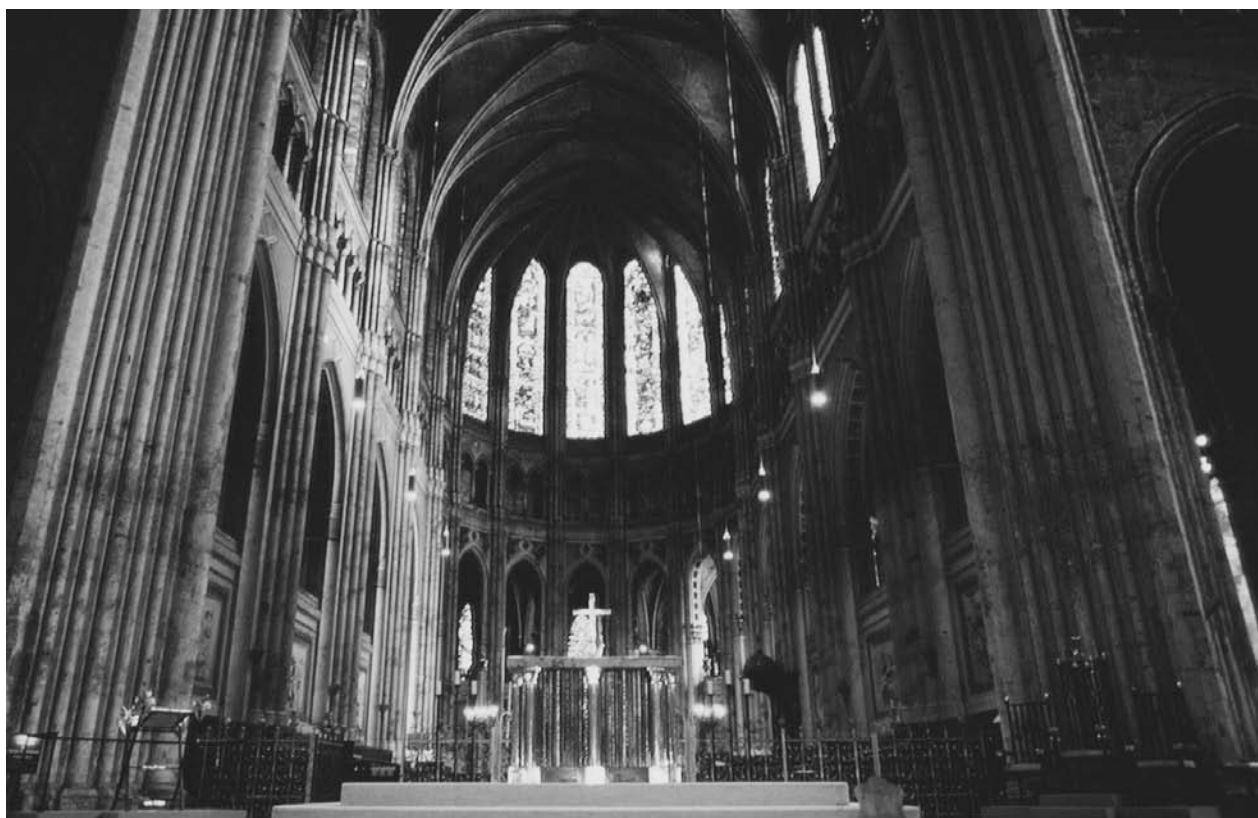

Interior of Chartres cathedral. The design and detailed ornamentation of the High Gothic cathedral at Chartres, France, built in the early twelfth century, served to draw the visitor into the spiritual world. © GIRAUD PHILIPPE/CORBIS SYGMA



San Francisco Opera rehearses a 1990 performance of Wagner's *Siegfried*. When staging his compositions, Richard Wagner sought to use various theatrical devices, such as placing the orchestra out of sight, to immerse the audience completely in the world depicted in his works. © IRA NOWINSKI/CORBIS

artifice of live performance to represent, recreate, and transform reality—transcending the notion of the sole possibility of the things that “are,” replacing them with what “might be.” Wagner used the mechanisms of the theater, as the computer would be used in the early twenty-first century, to transport the viewer’s mind, emotion, and senses to an otherworldly virtualization where reality is reconfigured. As he stated in his essay “Artwork of the Future,” “the spectator transplants himself upon the stage, by means of all his visual and aural faculties.” This illustrates Wagner’s desire to construct a totalizing experience through the narrative of music drama, one that fully engages the viewer’s consciousness. The composer’s invention of such theatrical devices as darkening the house, hiding the musicians in the orchestra pit, and reintroducing Greek amphitheatrical seating to orient audience perspective directly to the stage all contributed to the powerful illusion that takes place within the frame or “interface” of the proscenium arch—the portal to the imaginary space of the theatrical stage.

In the late 1940s, MIT scientist Norbert Wiener founded the field of cybernetics (derived from the Greek word for “steersman,” or “governor”) to explore the sociological impact of communications between human and machine. This research is critical to an understanding of the impact of virtual

reality, as Wiener opened the door to the study of human relationship to technology and the cyberborgian (cybernetic organism) nature of the symbiosis of the two. Wiener describes an increasingly technological society reliant on machines, and he explains how the nature of those interactions affects the quality of life. The design of virtual reality technologies that extend our reach, such as tele-robotic devices (the control of robots at a distance), is informed by Wiener’s research in cybernetics and his concern with the nature of sending messages and the reciprocal feedback inherent in those systems.

The virtualization of reality and the simulation of human consciousness by engaging the full range of the viewer’s sensory mechanisms is illustrated by cinematographer Morton Heilig’s claim in the 1950s that the cinema of the future—a medium already transformed by such innovations as the panoramic perspective of Cinerama—would “no longer be a ‘visual art,’ but an art of consciousness . . . [a] simulation so lifelike that it gives the spectator the sensation of being *physically* in the scene” (p. 250; emphasis in original). The experience of “being there” has since been a paramount quest in the development of virtual reality. Heilig’s Sensorama, for example, a nickelodeon-style arcade prototyped in the 1960s, immersed the viewer in a multisensory excursion through the

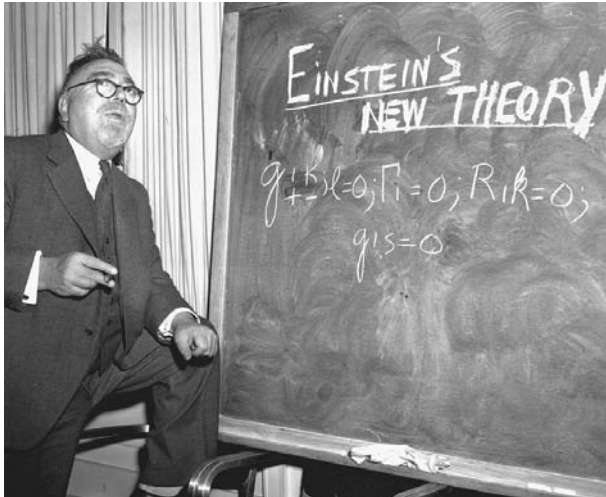

Norbert Wiener. Mathematician Norbert Wiener introduced the study of cybernetics, which sought to explain how information is transformed into performance by examining both machines and the human nervous system. © UPI/CORBIS-BETTMANN

streets of Brooklyn that engaged all the senses through the synchronization of media using the technology of film.

In the mid-1960s, the engineer Douglas Engelbart conducted critical research at the Augmentation Research Center at Stanford Research Institute, which resulted in the invention of the computer mouse, hypertext, and other interactive information technologies. For the first time, one could virtually navigate information space as an alternative to the linear methods of earlier forms of computing. The mouse pointer (cursor) and keyboard in conjunction with the visual display extended the intellectual reach of the individual. Engelbart believed that this intuitive and cybernetic approach to information processing would lead to the “augmentation of human intellect,” by engaging the individual in new methodologies of complex problem solving, far beyond the scope of previous tools.

Computer graphics specialist Ivan Sutherland, the first scientist to bring real-time graphics simulation to the computer screen, advanced the possibilities of reality construction, claiming, “the ultimate display would, of course, be a room



A NASA researcher wearing Virtual Interactive Environment Workstation (VIEW) apparatus. Created in the late twentieth century, VIEW manipulated sensory input to transport a person to another reality in which they could manipulate objects. NASA/PHOTO RESEARCHERS, INC.



Nantes Triptych (1992) by Bill Viola. Video and installation artist Viola likened the memory storage of computers to that of ancient structures, such as cathedrals and mystical temples, and uses it in his art to create cultural histories. TATE GALLERY, LONDON, GREAT BRITAIN, 1992. © ART RESOURCE, NY



Science fiction cyberpunk author William Gibson. Gibson, the first person to coin the term *cyberspace*, writes novels portraying decentralized future societies where humanity is often subjugated by technology. © MATTHEW MCVAY/CORBIS

within which the computer can control the existence of matter . . . a bullet displayed in such a room would be fatal” (p. 256). At the University of Utah in 1970, Sutherland introduced the first head-mounted display (miniaturized graphics display) that enabled the superimposition of low-resolution computer graphics in the physical environment. Expressing the

spirit of Lewis Carroll’s *Alice in Wonderland*, Sutherland believed in a new mathematical wonderland that transformed the abstract nature of mathematical constructions into virtual objects and imaginary worlds.

The defining development in virtual reality was carried out in the late 1980s at the NASA-Ames Research Center in northern California by the artist and scientist Scott Fisher, who sought to render virtual worlds even more closely coupled to our sensory mechanisms. Fisher oversaw the creation of the VIEW system (Virtual Interactive Environment Workstation), the first virtual reality (VR) system that integrated the head-mounted display, dataglove (sensing device worn as a glove), voice recognition, and three-dimensional (3-D) audio, which enables the listener to experience the location and movement of specific sounds more realistically than the two-dimensional stereo field of left to right. As a result of this research, Fisher established the field of telepresence, in which one could virtually transport oneself to another place, real or imaginary, experiencing remote spaces and controlling objects at a distance. According to Fisher, virtual reality’s potential was now as limitless as reality itself.

In the early 1990s, Daniel Sandin, along with his colleagues Thomas DeFanti and Carolina Cruz-Neira, developed the CAVE System (Cave Automatic Virtual Environment) to project interactive, computer-generated 3-D imagery and audio into a physical space defined by multiple projection screens and a surround-sound system. The immersive nature of CAVE was intended as an allusion to Plato’s Cave, evoking the shadowy presence of the representation of reality. The CAVE System also returns full circle to the earliest attempts at virtualization and multisensory experience, as practiced in the prehistoric caves of Lascaux, seventeen thousand years earlier.

Cultural Implications

While a graduate student at MIT in 1979, the artist Michael Naimark collaborated on the *Aspen Movie Map*, the navigable

laserdisc tour through Aspen, Colorado. Using a touch screen monitor and interactive display, the viewer navigates the streets of Aspen, exploring the environment virtually by controlling the direction and speed of the video. The *Aspen Movie Map* was Naimark's first exploration into what he refers to as "surrogate travel," in which the viewer is transported virtually to another place. Naimark's research opened up new interest in virtual forms of navigation in real or imagined places, in which the possibilities for nonlinear storytelling and interactive experience might alter our perception of time and space.

The video artist Bill Viola has been concerned with the idea of "dataspace" since the 1980s as a means to record cultural history in electronic or virtual space, inspired by the "memory palaces" of Greek temples and Gothic cathedrals. Viola compared these ancient architectural vessels of knowledge to the contemporary personal computer with its capacity for storage and instant-access retrieval of information. According to Viola, the symbolic ornamentation, paintings, and stained-glass windows of the European cathedrals might serve as a model for the branching pathways and hypermediated environments of computer-controlled video works, resulting in what he refers to as "idea space"—the conceptual basis for

recent virtual reality applications that employ 3-D simulation of information space.

William Gibson coined the term *cyberspace* in his 1984 science fiction novel *Neuromancer*. By adding this term to contemporary vocabulary, Gibson gave literary meaning to the wires, hubs, networks, and computers that constitute the material manifestation of the more abstract virtual information space. Gibson foresaw a habitable, immersive terrain that would become a new environment for the staging of narratives concerned with the far-reaching possibilities of cyber activity. This reconstruction of the material world through the emerging information technologies would, in Gibson's terms, spark an age of the "posthuman," in which utopian dreams and dystopian nightmares are imagined and realized in digital form.

The computer scientist Pavel Curtis developed one of the first multiuser environments at Xerox PARC (Palo Alto Research Center) in the early 1990s, entitled LambdaMOO, and designed as a text-based virtual reality. The purpose of his research was to explore social phenomena in real-time virtual space—the forerunner of the chat room. Curtis's observation of social behavior in cyberspace is fundamental to our understanding of the



Performance artist Laurie Anderson. Anderson's performances frequently utilize varied forms of media such as dance, music, and computer technology. Often the pieces are interactive and audience members are invited to participate. AP/WIDE WORLD PHOTOS

sociological implications of communications in virtual reality. His research also explored the new paradigms of anonymity, the fluidity of multiple identity creation, and the extensibility of world building in digital spaces, and how they might come to transform social interaction.

Marcos Novak, a digital architect, describes his 3-D designs as "liquid architectures," digital spaces that are composed to virtually situate the viewer into complex "fourth-dimensional" environments. He has conceived of these immersive spaces as "navigable music" and "habitable cinema," with their allusion to musical and narrative forms. Novak poetically describes his research: "liquid architectures . . . is an architecture without doors and hallways, where the next room is always where I need it to be and what I need it to be" (p. 259). In Novak's renderings, architecture need no longer be experienced as a fixed or finite space, but rather engages the viewer in the interactive, fluid, and transformational properties of digital media. He has created a vocabulary and set of paradigms for future architects who will no longer work within the physical constraints of solid materials.

In 1993, *Virtual Reality: An Emerging Medium* opened at the SOHO Guggenheim Museum in New York City, one of the first exhibitions to investigate new artistic directions in virtual reality. The show featured two virtual worlds by Jenny Holzer. The first, *The Lost Ones*, was inspired by one of Samuel Beckett's short stories. The second, *Bosnia*, offered a response to the violence against women in the Bosnian war. The observer enters and discovers a vast patterned desert of striking color: bright orange earth and deep blue sky. As one travels across the landscape, one reaches villages with block huts. Each hut harbors a different voice, and each village has a different story to tell. *Bosnia* points to a form of interactive storytelling in which the viewer virtually enters into and inhabits the "narrative space," where the narrative unfolds according to viewer's interactions.

The multimedia artist Laurie Anderson created large-scale theatrical works during the 1980s that integrated dance, music, performance art, and technology. In 1995 she explored the interactive medium, creating the CD-ROM *Puppet Motel* as a nonlinear sequence of scenes and vignettes based on previous theater pieces. *Puppet Motel* is a new form of performance art that takes place on the virtual stage of the computer desktop; the audience becomes the performer, controlling the flow of time and the movement of the narrative. Anderson's experimentation with interactive multimedia can be viewed as a new form of "digital *Gesamtkunstwerk*," in which the theatrical "fourth wall" dissolves; the fourth wall is the mechanism that traditionally separates the audience from the stage to preserve the illusion of the stage. Here the viewer enters into, inhabits, and interacts with objects in an illusionary world conceived as theater in digital space.

The artist Char Davies has explored new ways to interface with the technologies of virtual reality: the apparatus worn by an "immersant" in her work *Osmose* (1995), which includes a head-mounted display and harness, incorporates breath and movement as a means for navigating a sequence of virtual environments. The viewer uses body motion similar to the scuba diver to negotiate the floating, meditative worlds of the artwork—the contemplation of self, space, nature, and sound, has a powerful effect in the evocation of otherworldly conditions. As Davies describes her work, "The medium of 'immersive virtual space' or virtual reality . . . has intriguing potential as an arena for constructing metaphors about our existential being-in-the-world and for exploring consciousness as it is experienced subjectively, as it is felt" (p. 295). *Osmose* reveals the potential for virtual reality to transform the inner being, similar to the effects of drugs or meditation to induce mind-altering or "out-of-body" experience.

In viewing virtual reality's historical evolution and cultural impact, we see the timelessness and cyclical nature of human expression—from the dreams and representations as depicted in the prehistoric caves of Lascaux; to the totalizing experience of the *Gesamtkunstwerk*; to recent digital forms of immersive experience and altered states of consciousness. The Japanese curator Toshiharu Ito, describing *conFiguring the CAVE*, an immersive artwork created in 1997 by Jeffrey Shaw, Agnes Hegedues, Bernd Linterman, and Leslie Stück for the CAVE

System at the InterCommunication Center (ICC) in Tokyo, Japan, refers to a fourth dimension that exists between the work and the viewer, a space in which the viewer's awareness and bodily experiences can be restructured and recreated.

In describing immersive forms, "we cannot," according to Margaret Morse, "fully anticipate what it means to experience that realm until we are inside." Virtual reality is experiential and sensory—one does not simply observe the object, one is the object. One is not merely a detached observer—one enters into and becomes part of the landscape. The medium of virtual reality functions as an extension of the self, a reconfiguration of identity, intellect, dreams, and memories—ultimately blurring the boundary between self and exterior, between the real and the imaginary.

See also *Cinema; Computer Science; Landscape in the Arts; Sacred Places; Visual Order to Organizing Collections.*

BIBLIOGRAPHY

- Campbell, Joseph. *The Masks of God: Primitive Mythology*. New York: Penguin Books, 1991.
- Curtis, Pavel. "Mudding: Social Phenomena in Text-Based Virtual Realities." In *Multimedia: From Wagner to Virtual Reality*, edited by Randall Packer and Ken Jordan. New York: Norton, 2001.
- Davies, Char. "Changing Space: Virtual Reality as an Arena of Embodied Being." In *Multimedia: From Wagner to Virtual Reality*, edited by Randall Packer and Ken Jordan. New York: Norton, 2001.
- Engelbart, Douglas. "Augmenting Human Intellect: A Conceptual Framework." In *Multimedia: From Wagner to Virtual Reality*, edited by Randall Packer and Ken Jordan. New York: Norton, 2001.
- Fisher, Scott. "Virtual Interface Environments." In *Multimedia: From Wagner to Virtual Reality*, edited by Randall Packer and Ken Jordan. New York: Norton, 2001.
- Gibson, William. *Neuromancer*. New York: Ace Books, 1984.
- Heilig, Morton. "Cinema of the Future." In *Multimedia: From Wagner to Virtual Reality*, edited by Randall Packer and Ken Jordan. New York: Norton, 2001.
- Morse, Margaret. *Virtualities: Television, Media Art, and Cyberculture*. Bloomington: Indiana University Press, 1998.
- Novak, Marcos. "Liquid Architectures in Cyberspace." In *Multimedia: From Wagner to Virtual Reality*, edited by Randall Packer and Ken Jordan. New York: Norton, 2001.
- Sandin, Daniel, Thomas DeFanti, and Carolina Cruz-Neira. "A Room with a View." In *Multimedia: From Wagner to Virtual Reality*, edited by Randall Packer and Ken Jordan. New York: Norton, 2001.
- Sutherland, Ivan. "Ultimate Display." In *Multimedia: From Wagner to Virtual Reality*, edited by Randall Packer and Ken Jordan. New York: Norton, 2001.
- Viola, Bill. "Will There be Condominiums in Cyberspace." In *Multimedia: From Wagner to Virtual Reality*, edited by Randall Packer and Ken Jordan. New York: Norton, 2001.
- Wagner, Richard. "Artwork of the Future." In *Multimedia: From Wagner to Virtual Reality*, edited by Randall Packer and Ken Jordan. New York: Norton, 2001.
- Wiener, Norbert. *Cybernetics; or, Control and Communication in the Animal and the Machine*. Boston: MIT Press, 1948.

Randall Packer

VIRTUE ETHICS. Virtue ethics is one of the three major ethical approaches in modern moral philosophy, the other two being utilitarianism and deontology. Unlike the latter two, it focuses on the virtues. In the Western tradition of philosophy, virtue ethics begins with the ethical writings of Plato and Aristotle, but in the Eastern tradition its origins are even earlier. Confucius discussed in detail what might be regarded from a Western perspective as the virtuous character traits of charity, righteousness (the virtue pertaining to public affairs), propriety, wisdom, and sincerity and subscribed to something like Aristotle's doctrine of the mean regarding virtue. Siddhartha Gautama, the Buddha, recognized such virtues—perfections of character—as patience, self-restraint, contentment, sympathy, mildness, courage, meditation, and knowledge. All the ancient ethical writers, from East and West, shared the view that there is an answer to the question "How should a human being live?" and that the answer is "virtuously."

The later Greek and Christian writers continued to emphasize the central importance of the virtues in human life, Augustine being the first Christian writer to place the theological virtues of the New Testament—faith, hope, and charity (*caritas*, or love)—beside Plato's four "cardinal" virtues—courage, temperance, justice, and wisdom. Aquinas took more from Aristotle than from Plato, in particular Aristotle's view that our emotions and appetites can, through habituation, be brought into harmony with our reason. The striking consequence of this view is that, if perfect virtue is acquired, the agent does what is right, as reason directs, without inner conflict.

In Aquinas, and in later Christian writers, discussion of the virtues ran alongside discussions of God's, or "natural," law, but the rise of natural law jurisprudence in the seventeenth century saw this increasingly replaced by discussion of rules or principles intended to identify right—and in particular, just—acts, regardless of the motive or character from which they sprang. This trend was rejected by Hume, who insisted that all right actions derive their merit only from virtuous motives and devoted most of his second *Enquiry* to a discussion of the virtues.

The real break with the virtue ethics tradition came with the emergence of the theoretical alternatives, deontology and utilitarianism, offered by Immanuel Kant and then John Stuart Mill. Although the tradition continued to some extent among Continental philosophers, it disappeared from Anglo-American moral philosophy for about a hundred years.

The Rise of Modern Virtue Ethics

Modern virtue ethics is generally assumed to have been launched by G. E. M. Anscombe's 1958 article "Modern Moral Philosophy," in which she roundly criticized utilitarian and Kantian ethics, briefly indicated "how Plato and Aristotle talk" about ethics, and startlingly claimed that we should give up doing moral philosophy until we had "an adequate philosophy of psychology." The latter turns out to involve, particularly, "an account of what *type of characteristic* a virtue is . . . and how it relates to the actions in which it is instanced."

Fortunately, Anscombe's article did not deter moral philosophers from sticking to their subject. In the 1970s and

1980s Philippa Foot, Iris Murdoch, Alasdair MacIntyre, Bernard Williams, John McDowell, and Julia Annas followed her in criticizing contemporary moral philosophy from the perspective of their reading of the ancient Greeks (and in some cases Aquinas), in which talk about the virtues and vices naturally occurred.

They were not alone in finding the prevailing ethical literature unsatisfactory. By the 1970s, it had become respectable for moral philosophers to do applied ethics. (In the first half of the century they had concentrated almost exclusively on the methodology of ethical theory, metaethics, and the language of moral discourse.) But, despite the fact that articles on contemporary moral issues had become common, moral philosophy seemed to some almost as abstract and removed from everyday life as what had been done in the first half of the century. If “real life” was what was being discussed, why was there no mention of friendship and family relationships, of the morality of the emotions, of motives and moral character, or of moral education? Why did no one ever address the questions of what sort of people we should be and how we should live? Why was the concept of happiness, when it was employed, so unrealistically shallow? The writings of Anscombe’s early followers alerted the dissatisfied to the exciting fact that all of these topics were discussed in Aristotle in connection with the topic of virtue.

By the early 1980s, a flood of books and articles had been published, enough to justify a survey article, Gregory Pence’s 1984 “Recent Work on Virtues.” Its title, however, was significant. The work surveyed was mostly on the virtues themselves, often on a single virtue such as courage or integrity, or on a group such as the virtues involving sympathy, or on the virtues’ relation to knowledge or the emotions. Most of the writings discussed were not explicitly on what we would now call “virtue ethics,” an approach that could replace the traditional deontological or utilitarian theories—though, as Pence notes, many of them made “grand claims” about this possibility. Nevertheless, they frequently contained passing and sometimes sustained criticism of the prevailing orthodoxy and illustrated, albeit perhaps in relation to only one virtue, how “a return to the virtues” avoided the problem identified.

Virtue Ethics’s Criticisms of Prevailing Orthodoxy

A constant target of this criticism of the contemporary forms of deontology and utilitarianism was their shared conception of the task of ethical theory—that it was to come up with a set (possibly one-membered in the case of act-utilitarianism) of general rules or principles that, applied to particular cases, would provide a decision procedure for determining what the right action was. The theory would reveal what was right about the actions everyone already agreed were right, by showing them to be grounded, or justified, by the rules in question. Even more importantly, it would resolve any moral disagreements about what it would be right to do in problematic situations. The virtue ethicists’ attack on the idea that moral dilemmas were best resolved by finding general principles received unexpected support from Carol Gilligan’s 1982 book attacking the principles-based view of moral development espoused by the educational psychologist Lawrence Kohlberg.

Closely related to the criticism of deontology and utilitarianism as obsessed with the formulation of general rules that would deliver cut-and-dried answers were trenchant objections to their use in ideal moral decision making. According to a prevailing view, a truly moral motive involved acting for the sake of duty, but in an influential 1976 paper, Michael Stocker highlighted the oddity of supposing that ideally your friend should visit you in the hospital because it was his duty rather than simply because you were his friend. Similar objections were pressed against the prevailing assumption that taking up “the moral point of view” involved being impartial—according all rational autonomous agents, or the interests of all sentient beings, equal value. The virtue ethicists stressed that impartiality or justice was but one virtue among many and that how one should act in relation to one’s own children, partners, parents, friends, students, patients, and so on was a central aspect of morality that was being ignored.

Before the reemergence of virtue ethics, Anglo-American moral philosophy had accepted as gospel John Rawls’s claim (in *A Theory of Justice*, 1971) that there are just two “main” or “basic” concepts in ethics, “the right” and “the good.” It is a mark of the extent to which virtue ethics has prevailed that it is now widely (though by no means universally) accepted that the concept of virtue is as important as the other two. This has had a beneficial effect on the other two approaches. Now that the significance of virtue has been recognized, deontologists and utilitarians are seeking ways to incorporate it into their theories, to the extent that it has become necessary to distinguish between virtue theory—an account of virtue or the virtues within the framework of any ethical approach—and virtue ethics. There is thus revived interest in Kant’s *Doctrine of Virtue* and in the new wave of character-based versions of consequentialism.

Another way in which virtue ethics has made its mark can be seen in the extent to which moral philosophers have retreated from their earlier position that a normative theory must come up with a decision procedure that will provide specific practical guidance in difficult situations. The virtue ethicists’ stress on the importance of *phronesis* (practical or moral wisdom) eventually brought recognition that such wisdom is needed to apply rules or principles correctly (since we all know that the Devil can quote Scripture to his own purposes), and that they cannot be usefully applied in difficult situations by people who lack experience, insight, and moral sensitivity.

Current Debates about Virtue Ethics

Notwithstanding this concession, the claim that virtue ethics, unlike the other two approaches, cannot provide adequate guidance on actions persists as the most common objection to it. This is reflected in what is increasingly becoming the new commonplace among moderate anti-virtue ethicists, namely that “what we need” (for a complete ethical theory) is “an ethics of virtue AND an ethics of rules.”

In the earlier days of modern virtue ethics, this was a plausible objection. It was based on the premise that the only guidance virtue ethics could come up with was that you should do what the virtuous agent would do in the circumstances. It is

true that the earlier virtue ethics literature offered little more. But then it was pointed out by Rosalind Hursthouse (1991) that every virtue generates a prescription (Do what is honest, Do what is charitable/benevolent) and every vice a prohibition (Do not do what is dishonest, uncharitable/malevolent). The existence of these “v-rules,” expressed in the vocabulary of the virtues and vices and hence part of “an ethics of virtue,” refutes (literally) the premise on which the objection was based; what plausibility, if any, is retained by the claim that an ethics of virtue needs to be supplemented by an ethics of rules or principles is now the central debate.

In some instances, the claim seems no more than a verbal flourish; the v-rules must be “supplemented” by a principle of benevolence, a principle of nonmalevolence, and so on. Why so, one might ask, but why not indeed if people think it sounds more authoritative? Many criticisms of the v-rules fall foul of an obvious *tu quoque* (this applies to you, too) response. Of course, the requirements of the different virtues may, at least apparently, conflict. Honesty points to telling the hurtful truth, kindness or compassion to remaining silent or even lying. But so too do the related deontologists’ and rule-utilitarians’ rules, rightly reflecting the fact (ignored by the old act-utilitarians) that life does present us with dilemmas whose resolution, even if correct, should leave us with a remainder of regret. Like the other two approaches, virtue ethics seeks resolutions of such conflicts in a more refined or nuanced understanding or application of the rules involved; and as with the other approaches, its proponents may disagree about the correct resolution.

Perhaps overimpressed by Alasdair MacIntyre’s early work, critics of virtue ethics have commonly asserted that the v-rules are inherently culturally specific and conservative because they are developed within existing traditions and societies. Virtue ethicists are amused by the implicit assumption that what their rivals find “reasonable” or “rationally acceptable” is not shaped by modern Western culture and (predominantly) American society, and are more than willing to admit that they have no reason to suppose that their own lists of rules are complete.

However, they do point out that their lists of rules—particularly perhaps the list of vice-rules—is remarkably long in comparison with any that their rivals have produced, and grows naturally (albeit within our own culture) as people’s experience of modern life contributes new terms. And they appeal to their list to rebut the charge that the guidance they offer is less specific than that provided by others. “Tell the truth,” even if filled out to provide plausible answers to “All of it? Always? To anyone?” is still much less specific than what is yielded by “Do what is honest,” “Do not do what is disingenuous, rude, insensitive, spiteful, hypocritical, untrustworthy, treacherous, manipulative, phony, sneaky,” and so on. The issue is still hotly contested.

See also Natural Law; Philosophy, Moral; Utilitarianism; Wealth.

BIBLIOGRAPHY

Annas, Julia. *The Morality of Happiness*. New York: Oxford University Press, 1993.

Anscombe, G. E. M. “Modern Moral Philosophy.” In *Virtue Ethics*, edited by Roger Crisp and Michael Slote. Oxford and New York: Oxford University Press, 1997. Originally published in 1958.

Crisp, Roger, and Michael Slote, eds. *Virtue Ethics*. Oxford and New York: Oxford University Press, 1997.

Foot, Philippa. *Virtues and Vices*. Oxford: Oxford University Press, 2002.

Gilligan, Carol. *In a Different Voice*. Cambridge, Mass.: Harvard University Press, 1982.

Hursthouse, Rosalind. *Dependent Rational Animals*. Chicago: Open Court, 1999.

———. *On Virtue Ethics*. Oxford: Oxford University Press, 1999.

———. “Virtue Theory and Abortion.” In *Virtue Ethics*, edited by Daniel Statman. Edinburgh: Edinburgh University Press, 1997. Originally published in 1991.

MacIntyre, Alasdair. *After Virtue*. 2nd ed. Notre Dame, Ind.: University of Notre Dame Press, 1984.

Pence, Gregory E. “Recent Work on the Virtues.” *American Philosophical Quarterly* 21 (1984): 281–297.

Stocker, Michael. “The Schizophrenia of Modern Ethical Theories.” *Journal of Philosophy* 14 (1976): 453–466.

Swanton, Christine. *Virtue Ethics: A Pluralistic View*. Oxford: Oxford University Press, 2003.

Rosalind Hursthouse

VIRTUOSO. *See Genius.*

VISUAL CULTURE. While visual culture has certainly been around as long as culture itself, the phrase *visual culture* used to denote a specific component of culture in general, a set of visual practices, or an academic discipline is quite recent. James Elkins, one of this emerging field’s leading scholars, dates the term from 1972, saying that it “was used—perhaps for the first time . . . —in Michael Baxandall’s *Painting and Experience in Fifteenth Century Italy*” (p. 2). The recent provenance of the term *visual culture* is important because it indexes a historical shift in the importance of vision itself that has led to an ongoing reconceptualization of the visual and what has been called, in another neologism, *visuality*. Elkins locates the origins of visual culture as an emerging academic discipline in the cultural studies movement that started in England during the late 1950s, and sees visual culture as an American (U.S.) extension of that project (with an emphasis on the visual that did not really get off the ground until the 1990s). What is visible, how it appears, and how it affects nearly every other aspect of social life is suddenly of paramount concern.

The emergence of an idea called *visual culture* surely implies the emergence of a set of urgent problems for which the idea should enable some kind of answers. At a certain moment in the late twentieth century, a new consideration of the role of the visual, of perception, of images, and of the technologies and subjectivities that are embroiled in these relations became an urgent matter for scholars. This moment, which may be identified with what has been called from various corners and with differing emphasis as poststructuralism, the information

age, media society, postindustrial society, postmodernism, postcolonialism, and/or globalization, is marked above all else by a new degree of saturation of social space by visual technologies, and, one must assume, a related shift in their social function and significance.

The Visual Turn

While it is arguable that this visual turn is indeed the meta-event that might show the deep interrelationships and common logic of the other periodizing categories mentioned above, it is true that the conditions of possibility for the emergence of the idea of visual culture were a long time in the making. As noted, culture always and necessarily has had a visual component. However, the shift in emphasis toward an increasing importance of the visible (and its manipulation) is due principally to two related factors: the organization of economies and societies with and by images and the related hyperdevelopment and intensification of visual technologies. Of course, this claim raises more questions than it answers. Image technologies from photography to cinema, television, and computerization are more and more deeply woven into the very fabric of reality. Such interweaving is imbricated to the point where the function of images has become inseparable from any consideration of what might be called the contemporary human condition, including the situation of other categories of analysis central to the humanities including race, class, nation, gender, and sexuality. What might be thought of as an industrialization of the visible is not, strictly speaking, a natural emergence, any more than it is natural that there be skyscrapers or music television. Rather, the visual turn is the contingent result of a matrix of historical and economic forces. In particular (and this is an argument, not a mere statement of fact), the rise of visual culture is a response to the need to efficiently organize and manage huge populations composed of disparate cultures and/or races, in multiple locations and with varying degrees of economic power in what has become the capitalist world-system. The emergence of visual culture is the historical answer to a complex set of organization questions posed at the scale of the human species.

Visuality

Many scholars locate the emergence of visual culture in relationship to the development of visual technologies, the history of pictorial art, and the emerging recognition of the priority of the visual as the king of the senses. Most, if not all, see this new field as being connected to the streams of images and information that continuously assault spectators from all corners of their environments. No one seems to doubt that, from an experiential standpoint, that which is visible—its intensity, its demands, its possibilities, as these come to us via television, cinema, video, DVD, Internet, electronic billboard, or Mars rover—is something qualitatively new. Yet a smaller number of scholars (Arjun Appadurai, Jonathan Crary, Nicholas Mirzoeff, Sean Cubitt, and a few others) see the emergence of the visual as part of a necessary and practical reconfiguration of subjectivity. The cutting edge of visual cultural studies, however, understands that visuality and the visual technologies that mediate it are part of a larger social project in which the interiority of concrete individuals is being reconfigured. As the

British art historian Norman Bryson writes, “Between subject and the world is inserted the entire sum of discourses which make up visuality, *that cultural construct*, and make visuality different from vision, the notion of unmediated visual experience” (pp. 90–91, italics added). We should add here that visuality is constructed via the interweaving of the discourses that would capture vision and the technologies that utilize it.

Stated dramatically, the social project being undertaken by ostensibly external visual technologies and the economics thereof is not only a reorganization of social macro-structures on a planetary scale but also a total reconfiguration of the interiority of persons. This reconfiguration, which enables and indeed necessitates persons to effectively retool themselves as media for the reception and transmission of social vectors of force—to become mediators among the mediations, implies a new modality of what used to be thought of as human being. It is around these questions that the debates regarding visual culture are perhaps most interesting and fruitful. As nearly all persons, from U.S. presidents, to Hollywood directors, to international consumers, to middle-class workers, to television viewers, to war victims, to dollar-a-day sweatshop chip manufacturers are locked into an economy that passes through the visual, and as the visual is mediated by new technologies, financial institutions, and the military industrial complex, it is fair to say that humanity, if one can still call it that, has become at once more profoundly collective and more inexorably cybernetic than ever before.

Historical Emergence of the Field of Vision as a Site of Power and Social Control

In Nicholas Mirzoeff’s “The Subject of Visual Culture,” an essay that serves as an introduction to his important edited volume *The Visual Culture Reader*, he writes that “By the visual subject I mean a person who is both constituted as an agent of sight and as the effect of a series of categories of visual subjectivity” (p. 10). Sketching the emergence of some of these categories, Mirzoeff traces an arc from René Descartes (1596–1650) to roughly Jean-Paul Sartre (1905–1980) and Jacques Lacan (1901–1981). This arc spans the early modern Cartesian notion of “I think, therefore I am” to what Mirzoeff calls “a new mantra of visual subjectivity: ‘I am seen and I see that I am seen’” (p. 10). Notably, the modern subject who first emerges through the negation of the visual field (Descartes begins his meditations by doubting the veracity of vision itself, specifically whether it is his hand he sees before his face), and after being subject to a variety of disciplinary regimes of surveillance (in the work of Michel Foucault [1926–1984]), is later constituted in and through the visual (Lacan’s “I see myself seeing myself”). The Lacanian analysis of the visual field derives a great proportion of the algebra of subjectivity from scopic relations. Marking a shift in the development and organization of a subject who was effectively located at the (0,0) Cartesian coordinate point in a visible universe of axonometric space developed by Leon Battista Alberti (1404–1472) and point perspective and formalized by Descartes, Mirzoeff astutely sites the utilitarian philosopher Jeremy Bentham’s (1748–1832) prison design known as the Panopticon (1786) as emblematic of the utilization of visual surveillance for

disciplinary purposes. Brilliantly analyzed by Foucault in “The Eye of Power,” Bentham’s prison design created a circular array of fully transparent prison cells forming a perimeter around a central hub—a guard tower of smoked glass. The genius of the panopticon was in its economy: the prisoners knew that they could always be seen by the guard in the tower wherever they were in their cells; because they could not tell whether the guard tower was occupied (guards were changed via an underground tunnel), the prisoners effectively watched themselves, that is, policed themselves. Foucault called this form of self-surveillance the “internalization of the gaze of power.” While Foucault notes the efficient advance in disciplinary technology marked by the panopticon (it is much cheaper to have people police themselves than to have to continuously beat them into submission), what is at least as important here is that the visual is explicitly grasped as a medium of organization and social control, and that the visual field can be structured via architecture and therefore via design and technology.

The fact that vision and the gaze become the media for the orchestration of social control is in no way confined to technologies of surveillance. As suggested above, the organization of the visual is for many thinkers constitutive of subjectivity, of modern psychology, and therefore of conceptualization of self and other. The fact that Freudian psychoanalysis and the origins of cinema (developed by the Lumiere brothers) share 1895 as an inaugural date might therefore be viewed as more than mere coincidence. Although the majority of psychoanalytic work during the twentieth century believed itself to be embarking on a description and analysis of the deep and therefore ontological structures of human desire and the psyche, it has been argued that the psychic structures available for analysis by the new discipline of psychoanalysis are in fact instantiated and developed by visual technologies themselves (Beller, 2002). Film theory includes extensive work on cinema’s modulation of the gaze and its skilled and satisfying manipulation of visual pleasure, but it is at least as likely as not that the structures of perception capable of deriving the pleasures that cinema offers emerge in dialectical relation to cinematic technologies themselves, rather than having always already been there, lying in wait.

Historicity of the Senses

As early as 1844, Karl Marx in his *Economic and Philosophic Manuscripts* of that year argued from a historical-materialist perspective that the senses themselves developed in dialectical relationships to society’s objects. New modes of perception, sensibility, and appropriation were developed for the objects and processes of industrialization.

It is only when the objective world becomes everywhere for man in society the world of man’s essential powers—human reality, and for that reason the reality of his own essential powers—that all objects become for him the objectification of himself. . . . The manner in which they become *his* depends upon the *nature of the objects* and on the nature of the *essential power* corresponding *to it*; for it is precisely the *determinateness* of this relationship which shapes the particular, *real* mode of affirmation. To the eye an object comes to be other than

it is to the ear, and the object of the eye is another object than the object of the ear. The peculiarity of each essential power is precisely its *peculiar essence*, and therefore also the peculiar mode of its objectification, of it objectively *actual* living *being*. Thus man is affirmed in the objective world not only in the act of thinking, but with *all* his senses.

On the other hand, looking at this in its subjective aspect: just as music alone awakens in man the sense of music, and just as the most beautiful music has *no* sense for the unmusical ear—is no object for it because my object can only be the confirmation of one of my essential powers and can therefore only be so for me as my essential power is present for itself as a subjective capacity, because the sense of an object for me goes only so far as *my* senses go (has only sense for a sense corresponding to that object)—for this reason the *senses* of the social man are other senses than those of the non-social man. . . . The *forming* of the five senses is a labor of the entire history of the world down to the present (pp. 74–75).

Marx writes here both of the historical disarticulation (separation) of the senses and of the historico-social elaboration of their capacities. If the forming of the five senses is indeed a labor of the entire history of the world down to the present, then it is also true that “the psychic structures which are then derived from this organization of the senses by the objective conditions of production” are also preeminently historical. The theorist Hal Foster, in his landmark essay “Scopic Regimes of Modernity,” sketches some of the varied scopic regimes (the organization of subjects and objects by differing visual systems of representation) in early modern Europe and discusses their historical basis. His work provides concrete examples of varied scopic regimes embedded in different cultural and historical moments.

Although it may not seem like much to show that the organization and development of the senses (and therefore the structures of the psyche) are historical rather than ontologically hard-wired, this insight is of great import for an understanding of the historicity of the idea of visual culture. For the idea of visual culture emerges when and only when social production itself has entered definitively into the visual realm and the site of the visual becomes indeed the privileged realm of social production.

Race and Photo-Graphics

It is essential here to see that the processes of industrialization and then computerization that produced the new objects and eventually machines for the development of the visual do not occur in some spatio-temporal vacuum occupied by abstract individual bodies all subjected to regimes of visibility in precisely the same manner. Rather, industrialization developed on the laboring backs of specific bodies in tandem with the entire European and American projects of colonization and imperialism. If industrialization was linked to the development of capitalism, the development of capitalism was linked to the conquest

of regions formerly on the periphery of capitalism: Africa, Asia, the Americas—in short, the world. Thus one must observe that the development of the various racisms (which are themselves relatively new and certainly not transhistorical) are nothing less than a complementary technology of exploitation—a process of othering that enabled and legitimated the violence done unto populations subject to conquest, genocide, enslavement, and the twenty-first century's continued neocolonialism.

That this racism has a visual component is an understatement. It is indeed ironic that the French critic Roland Barthes (1915–1980), in his celebrated work *Camera Lucida*, locates what he considers “the essence of photography” in a discussion of a lost photograph of a slave auction. That photograph would indicate the “this-has-beeness” of the abhorrent reality of slavery, and yet Barthes displaces slavery itself in order to talk about photography. The technology, finally, is for Barthes more significant than the social conditions of its emergence. However, one might also think that photography emerges alongside the social need to graph people onto a social hierarchy vis-à-vis their appearance—that slavery haunts photography. Such a graphing via the skin, a process of capture, objectification, classification, and control, defines both slavery and photography. Photography partakes of and intensifies many of the logics of racialization and the violence that is inseparable from it. There are other works, such as Vicente Rafael's work in *White Love* on census photography in the Philippines, that would support such a line of analysis.

Many black writers have commented on the visual aspects of racism directly or indirectly. Harriet Jacobs's slave narrative, *Incidents in the Life of a Slave Girl: Written by Herself* (1870?), details Jacobs's effective incarceration hidden in the attic of a shed where, for seven years as an immobilized prisoner of plantation society and invisible to everyone, she watches her own children play just below her while being unable to tell them that she loves them, is okay or even alive. This autobiographical passage creates an extraordinary image of the violence of the black/white divide imposed by white supremacist society in which black subjects were rendered invisible in their subjectivity to white subjects. Not only did slave labor produce the wealth necessary to sustain and develop plantation society (its lands, its culture, its wealth, and its dominant subjects), but the objectification of slaves as property, as Other, by whites was essential in order that they *not see* the consequences of who and what slaveholders and other whites were for slaves.

The consciousness produced by the violence of racism and the mapping of subjects via their appearance is a topic of long-standing critique, lament, and rage. W. E. B. Du Bois (1868–1963) wrote in *The Souls of Black Folk* (1903) of “a world which yields him no true self-consciousness, but only lets him see himself through the revelation of the other world. It is a peculiar sensation, this double-consciousness, this sense of always looking at one's self through the eyes of others. . . .” In the 1950s, the author Ralph Ellison declared the American black an invisible man. And in France, the political theorist Frantz Fanon, who was born and first educated in colonial Martinique, wrote in a chapter in *Black Skin, White Masks* (1952), entitled “The Fact of Blackness,” of his existential

crises of being perceived as black in a French context. What emerges in Fanon's writing is not only the crisis of being perceived to be black and thus other, but the constitutive and universalist racism of France. In response to his experiences, he recalls a moment of being othered while on a train by a child who says, “Look, a negro!” Fanon writes:

I was responsible at the same time for my body, my race, for my ancestors. I subjected myself to objective examination, I discovered my blackness, my ethnic characteristics; and I was battered down by tom-toms, cannibalism, intellectual deficiency, fetishism, racial defects, slave-ships, and above all else, above all: “Sho' good eatin'.”

On that day, completely dislocated, unable to be abroad with the other, the white man, who unmercifully imprisoned me, I took myself far off from my own presence, far indeed, and made myself an object. What else could it be for me but an amputation, an excision, a hemorrhage that spattered my whole body with black blood? (p. 112)

The violent structuring of the visual field along racial lines, which led to violent critique of this violence by many cultural producers and revolutionaries, remains subject to an ongoing critique by subjects who identify as or with numerous races and/or ethnicities. One of the most important aspects of the study of visual culture in the early twenty-first century is the analysis and unpacking of visibility in terms of race and the allied histories of colonization and imperialism. For the structuring of visibility is tied to the production and reproduction of representations (and erasures) of racialized subjects, and these images, whether through the stimulation of fantasy or the production of perceptions of what is ostensibly reality, in turn enable much of the ongoing violence of contemporary society.

Gender, Sexuality, and the Image

In addition to race-based critiques of dominant visual representation and its profound connection both to dominant modalities of the visual and to socio-subjective organization, scholars—particularly film theorists—have also examined the visual field in terms of its implantation in the organization of gender and sexuality. Most famously here, perhaps, is Laura Mulvey's work “Visual Pleasure and Narrative Cinema” (1975). Undertaking an analysis of Hollywood's development of scopophilia or “pleasure in looking,” Mulvey understood Hollywood narrative cinema to be developing and narrativizing a particular image of woman: “Woman . . . stands in patriarchal culture as signifier for the male other, bound by a symbolic order in which man can live out his fantasies and obsessions through linguistic command by imposing them on the silent image of woman still tied to her place as bearer of meaning, not maker of meaning” (p. 199). She further comments, “As an advanced representation system, the cinema poses questions of the ways the unconscious (formed by the dominant order) structures ways of seeing and pleasure in looking” (p. 199). Though it has already been suggested here that cinema itself may be considered to be part of the dominant order that forms the unconscious itself, this dialectic for Mulvey results in the effective evacuation of the subjectivity of woman as representation,

and perhaps (this has been debated in terms of the question of female spectatorship) as a concrete individual person. Without rehearsing the entire argument, suffice it to say that Mulvey sets out to attack the film industry's "satisfaction and reinforcement of the [male] ego," and understands the film industry to be effectively maintaining if not producing and intensifying patriarchal society and its domination/exploitation of women. In writing, "It is said that analyzing pleasure, or beauty, destroys it. That is the intention of this article" (p. 200), Mulvey crystallized a central point of her analysis: the link between pleasure, the production of subjectivity, and domination in patriarchal society.

While other theorists of cinema and of the visual, including Mary Ann Doane, Judith Butler, Judith Halberstam, Kaja Silverman, Linda Williams, and many others, offer differing and sometimes conflicting analysis of the organization and function of the visual in contemporary society, nearly all agree that what takes place in cinematic, televisual, and later digital media regarding the organization of gender and sexuality is not to be understood as a collection of unique instances but rather as at once symptomatic of social life and often productive of aspects of social life. Taken as a whole, mass media exert tremendous pressure on the organization of the psyche and the patterning of social performance. The critique of mass media's function has the power to alter its reception and therefore to transform its function. The possibility of such an analysis of images, and of an understanding of their processes, has been put forward under various nomenclatures, from semiotics to visual literacy to media theory.

Alternative Media

Many people seeking social justice share the perception that the dominant media—from the Hollywood studio system to the formation of television and later cable networks—exercised a tremendous, often racist, sexist, and anti-democratic power, leading to the emergence of a variety of visual forms of resistance. These included the Third Cinema movement of the late 1960s and following, which encouraged Third World revolutionary filmmakers and fellow travelers to work "with the camera in one hand and a rock in the other," in order to enable the decolonization of spectators. Additionally, a tremendous number of experimental film and alternative video production projects took root. In the realm of film, endeavors from the French New Wave to experimental sixteen-millimeter filmmaking (especially the work of the American filmmaker Stan Brakhage) tried to investigate the materiality of the medium and its conventions for creating the most persuasive of illusions. Filmmakers such as Yvonne Rainer and Marlene Gorris, among many others, also worked on creating a feminist film corpus. Additionally, with the rise of the video portapak and the general dissemination of inexpensive video technology in the early 1970s, a whole generation of alternative video and video art began to make inroads not only in the field of what could be represented on television, but at least as importantly into the ways in which images were perceived, processed, and understood. The artists Nam June Paik, Lynda Benglis, and Linda Montano in the 1970s and 1980s and Bill Viola in the 1990s and 2000s, among many others, created video artworks, while organizations such as New York's Downtown

Community Television Center, with Jon Alpert and Keiko Tsuno, covered topics like access to healthcare and minority experiences in a documentary style. These U.S. efforts at alternative video and video art had their counterparts in Latin America, Southeast Asia, and elsewhere.

Advertising, Attention, and Society of the Spectacle

French situationist Guy Debord began his enduring work *Society of the Spectacle* (1967) with, "The spectacle is not a collection of images; rather, it is a social relationship between people that is mediated by images" (p. 12). While this thesis is true of the spectacle in general, it is perhaps most readily intelligible from a study of advertising. Theorists from Marshall McLuhan to Robin Andersen and Sut Jhally chart the extension and penetration of advertising into both the format of media productions—particularly television, but also with product placement, the cinema—and simultaneously into the psychology and fantasy of consumers. Up until the 1920s, advertisements in print venues were principally informational (e.g., if your dentures are falling out, we make this denture cream). By the 1950s, advertisers were not selling products but a whole way of life in which consumption itself would begin to solve life's ailments. The purpose of advertising became to produce consumers. Advertising's messages overall are designed to produce feelings of lack and inadequacy that might then be treated by the consumption of a product, or more particularly, the image of that product. In the twenty-first century, these campaigns are mounted by specialized agencies that employ PhDs in psychology and use statistical techniques and brainstorming sessions (called "the theater of the mind") to elicit unconscious associations from consumers. Advertising operates through what this author calls a "calculus of affect" in order to continuously refine the efficiency by which spectators are manipulated not by rational arguments but by emotional and visceral appeals to their unconscious and sometimes conscious fantasy. Without a doubt, many of these fantasies are shot through with variants of the racism and sexism discussed above. Since corporate media exist principally for profit and their profits come from paid advertisements, it is easy to see how, structurally at least, these very media serve first and foremost as vehicles for advertisers.

The American critic Jonathan Beller's work on visual culture and media extends the idea that mass media sell eyeballs to advertisers and elaborates "the attention theory of value." In brief, this theory is a development of Marx's labor theory of value in which the production of all value for capital has its basis in human labor. It argues that attention is the superset of labor (and thus labor is a subset of attention). Just as workers labor in the factory, spectators labor in the social mechanisms known as media, building value for capital and oftentimes disenfranchising themselves. Television functions like a deterritorialized factory for the production and reproduction of consumer-citizen-subjects. The theory proposes a cybernetic model of production in which the image is the paradigmatic interface between bodies and the social armature. The logistics of media society, its modalities of operation, its affects, and its production of history, space, time, and fantasy are fully integrated into spectatorial consciousness. Imagination itself is engaged as an engine of production: attending bodies validate

media pathways and simultaneously transform themselves. Indeed, as spectators are posited as nodes on media circuits that are fundamental to the production and reproduction of the global, it becomes increasingly difficult to say where mediation ends and personhood begins. As noted above, humanity itself is increasingly cybernetic.

Visuality, Mediation, Simulation, and Cybernetics

The integration of the machinery of media circuits, the imagination of spectators, financial markets, and the military-industrial complex—all on a global scale—compose what Beller calls the world-media system. This idea of a world-media system that endeavors to fully integrate modes of perception and the requisites of social production and reproduction is connected to several critical ideas. One such idea is the German philosophers Theodor Adorno and Max Horkheimer's idea of "the culture industry," in which commercial cultural products were understood "as an after-image of the work process" and in effect designed to reconcile workers to their own powerlessness and exploitation by giving them compensatory images of satisfactions that were denied to them in life. Debord begins *Society of the Spectacle* with the idea that "The whole life of those societies in which modern conditions of production prevail presents itself as an immense accumulation of spectacles. All that was once directly lived has become mere representation" (p. 12). The political theorist Paul Virilio has shown the intimate developmental relationships between war machines and the cinematic apparatus, as well as the role of visual technologies in surveillance and the rendering of targets abstract, virtual, and therefore more easily destroyable, both practically and in terms of the conscience of the killers. Murder becomes technologized and as easy as the touch of a button. The French sociologist Jean Baudrillard has written about the connections between mass media and what he calls *simulation*, a process that creates copies without originals. Images for Baudrillard are "hyperreal," that is more real than real, and have, for him at least, effectively rendered reality impossible and consequently short circuited genuine thought. What is clear from the work of these thinkers and others whom they have inspired is that the media environment has radically altered the very fabric of reality, the character of the human sensorium, and the nature of the consciousness that might mediate between the two.

Along these lines, the French intellectual Régis Debray, in his important work *Media Manifestos* (1996), has argued that the word *communication* is a radical misconception of what transpires in the messaging process and should thus be replaced by the word *mediation*, because messages don't just travel from A to B. Rather, "sender and receiver are modified from the inside by the message they exchange, and the message itself modified by its circulation" (p. 44). Instead of looking at particular cultural products or texts, Debray's analysis is more interested in "change[s] in the system of manufacture/circulation/storage of signs" (p. 19) and charts a historical, planetary shift from what he dubs the *logosphere* to the *graphosphere* to the *videosphere*—that is, regimes of the written word, the printed word, and the image respectively. His study of "the ways and means of symbolic efficacy" (p. 7) is more interested in the

effects of mediations rather than their meanings or contents, and points toward the techno-cultural apparatuses that manage the circulation of signs as something like the unthought of human historical process. The visual, and what is now called visual culture, is the latest and most powerful development in the management and organization of human society.

The Future of Visual Culture and Visual Studies

It seems clear that visual culture is not about to disappear but, rather, with the growing perception that visuality is one of the profound operators of our times and therefore a site of the twenty-first century's most important questions, we may expect critical approaches to visual culture to develop quite rapidly and with tremendous diversity. The American theorist Lisa Cartwright has written about medical imaging and its sociocultural implications in *Screening the Body: Tracing Medicine's Visual Culture*. The legal scholars Kimberle Williams Crenshaw and Garry Peller have written on the evidentiary character of amateur video and the way in which racist, state, and aesthetic ideologies overcode the image. Writers from Raymond Williams to Lynn Spigel have analyzed television's reorganization of social space. Linda Williams considers pornography to be of central importance. Political scientist Armand Mattelart and sociologist Manuel Castells discuss the manner in which media and information flows are linked to the movement of capital and the restructuring of imaginary and built environments. Still others (such as the philosopher Douglas Kellner) have written on the connections between commercial television, ideology, and the waging of war. The theorist and artist Lev Manovich has written on the possibilities and implications of digital cinema, and Cubitt has broached the questions of digital aesthetics with tremendous insight and erudition. The media theorist Lisa Parks has written on "satellite and cyber visualities."

Looking toward the future and toward possible forms of the institutionalization of what he pointedly calls visual studies, the art historian James Elkins suggests that visual literacy courses should include history of Western art and mass media, but also an understanding and analysis of multicultural as well as multidisciplinary image making processes, including non-Western aesthetic productions, and scientific and satellite imaging. This author's view is that visual studies will amount to little more than an accommodation to shifting conditions of domination and the intensification of global inequality unless it is also imbued with the commitment to demonstrate both the preconditions for the production of images as well as the consequences of different modes of reception of these images.

See also Aesthetics; Arts; Cinema; Cultural Studies; Media, History of; Other, The, European Views of; Postmodernism; Propaganda; Third Cinema.

BIBLIOGRAPHY

- Adorno, Theodor, and Max Horkheimer. *Dialectic of Enlightenment*. Translated by John Cumming. New York: Seabury Press, 1972.
- Andersen, Robin. *Consumer Culture and TV Programming*. Boulder, Colo.: Westview Press, 1995.
- Appadurai, Arjun. *Modernity at Large: Cultural Dimensions of Globalization*. Minneapolis: University of Minnesota Press, 1996.

- Baudrillard, Jean. *Simulacra and Simulation*. Translated by Sheila Faria Glaser. Ann Arbor: University of Michigan Press, 1994.
- Barthes, Roland. *Camera Lucida: Reflections on Photography*. Translated by Richard Howard. New York: Hill and Wang, 1981.
- Beller, Jonathan. *Acquiring Eyes: Philippine Visuality, Nationalism and the World-Media-System*. Manila, Philippines: Ateneo de Manila University Press, 2004.
- . “Kino-Eye, Kino World: Notes on the Cinematic Mode of Production.” In *The Visual Culture Reader*, 2nd ed., edited by Nicholas Mirzoeff. London: Routledge, 2002.
- Benjamin, Walter. *Illuminations*. Edited by Hannah Arendt. Translated by Harry Zohn. New York: Harcourt, Brace, and World, 1968.
- Berger, John. *Ways of Seeing*. London: British Broadcasting Corporation, 1972.
- Boyle, Deirdre. *Subject to Change: Guerrilla Television Revisited*. New York: Oxford University Press, 1997.
- Bryson, Norman. “The Gaze in the Expanded Field.” In *Vision and Visuality*, edited by Hal Foster. Seattle: Bay Press, 1988.
- Butler, Judith. *Bodies That Matter: On the Discursive Limits of “Sex.”* New York: Routledge, 1993.
- Cartwright, Lisa. *Screening the Body: Tracing Medicine’s Visual Culture*. Minneapolis: University of Minnesota Press, 1995.
- Castells, Manuel. *The Internet Galaxy: Reflections on the Internet, Business, and Society*. Oxford: Oxford University Press, 2001.
- Crary, Jonathan. *Suspensions of Perception: Attention, Spectacle, and Modern Culture*. Cambridge, Mass.: MIT Press, 1999.
- Crenshaw, Kimberle Williams, and Garry Peller. “Reel Time/Real Justice.” In *Reading Rodney King/Reading Urban Uprising*, edited by Robert Gooding-Williams. New York: Routledge, 1993.
- Cubitt, Sean. *Digital Aesthetics*. London: Sage, 1998.
- Debord, Guy. *La société du spectacle*. Paris: Buchet-Chastel, 1967. Translated by Donald Nicholson-Smith as *The Society of the Spectacle*. New York: Zone Books, 1994.
- Debray, Régis. *Media Manifestos*. Translated by Eric Rauth. London: Verso, 1996.
- Doane, Mary Ann. *The Emergence of Cinematic Time: Modernity, Contingency, the Archive*. Cambridge, Mass.: Harvard University Press, 2002.
- Du Bois, W. E. B. *The Souls of Black Folk*. Chicago: A. C. McClurg, 1903. Reprint, New York: Penguin Books, 1996.
- Elkins, James. *Visual Studies: A Skeptical Introduction*. New York: Routledge, 2003.
- Fanon, Frantz. *Black Skin, White Masks*. Translated by Charles Lam Markmann. New York: Grove Press, 1967.
- Foster, Hal. “Scopic Regimes of Modernity.” In his *Vision and Visuality*. Seattle: Bay Press, 1988.
- Foucault, Michel. *Power/Knowledge: Selected Interviews and Other Writings 1972–77*. Translated by Colin Gordon, et al. New York: Pantheon, 1980.
- Halberstam, Judith, and Ira Livingston, eds. *Posthuman Bodies*. Bloomington: Indiana University Press, 1995.
- Hall, Doug, and Sally Jo Fifer, eds. *Illuminating Video: An Essential Guide to Video Art*. New York: Aperture, 1991.
- Jacobs, Harriet A. *Incidents in the Life of a Slave Girl: Written by Herself*. Cambridge, Mass.: Harvard University Press, 1987.
- Jhally, Sut. *The Codes of Advertising: Fetishism and the Political Economy of Meaning in the Consumer Society*. London: F. Pinter, 1987.
- Lacan, Jacques. *The Four Fundamental Concepts of Psycho-analysis*. Translated by Alain Sheridan. London: Hogarth, 1977.
- Manovich, Lev. *The Language of New Media*. Cambridge, Mass.: MIT Press, 2001.
- Marx, Karl. *Economic and Philosophic Manuscripts of 1844*. In *The Marx-Engels Reader*, edited by Robert C. Tucker. New York: Norton, 1972.
- Mattelart, Armand. *The Information Society: An Introduction*. Translated by Susan G. Taponier and James A. Cohen. London: Sage, 2003.
- McLuhan, Marshall. *Understanding Media: The Extensions of Man*. New York: McGraw-Hill, 1964.
- Mirzoeff, Nicholas, ed. *The Visual Culture Reader*. 2nd ed. London: Routledge, 2002.
- Mitchell, W. J. T. *Picture Theory: Essays on Verbal and Visual Representation*. Chicago: University of Chicago Press, 1994.
- Mulvey, Laura. “Visual Pleasure and Narrative Cinema.” In *Narrative, Apparatus, Ideology: A Film Theory Reader*, edited by Philip Rosen. New York: Columbia University Press, 1986.
- Rafael, Vicente L. *White Love: And Other Events in Filipino History*. Durham, N.C.: Duke University Press, 2003.
- Silverman, Kaja. *The Subject of Semiotics*. New York: Oxford University Press, 1983.
- Solanas, Fernando, and Octavio Getino. “Towards a Third Cinema: Notes and Experiences for the Development of a Cinema of Liberation in the Third World.” In *Movies and Methods: An Anthology*, 2 vols., edited by Bill Nichols. Berkeley: University of California Press, 1976–1985.
- Spigel, Lynn. *Make Room for TV: Television and the Family Ideal in Postwar America*. Chicago: University of Chicago Press, 1992.
- Sturken, Marita, and Lisa Cartwright. *Practices of Looking: An Introduction to Visual Culture*. Oxford: Oxford University Press, 2001.
- Virilio, Paul. *The Vision Machine*. Bloomington: Indiana University Press, 1994.
- . *War and Cinema: The Logistics of Perception*. Translated by Patrick Camiller. London: Verso, 1989.
- Williams, Raymond. *Television: Technology and Cultural Form*. New York: Schocken, 1974.

Jonathan Beller

VISUAL ORDER TO ORGANIZING COLLECTIONS.

A generation trained to select icons on a desktop computer is able to take a fresh approach to the visual cues within early rooms of collection. Visual cues often preceded catalogs and inventories, helping users to situate themselves in the room and to locate items of the collection. In searching out the modes of conceptualizing, mapping, and classifying of collections, we shall see that the distinctive details of ceilings, walls, cabinets, or furniture of a collection room may be functional elements organizing manuscripts or other valuable objects in the room. Scholars Alain Besson, André Masson, Eric Garberson, and Maryanne Cline Horowitz have examined visual classification schemes, especially in libraries and studies, but a plethora of extant as well as defunct rooms of collections might similarly be examined. The *Journal of the History of Collections* (founded 1989) might be the appropriate venue.

Each section of this entry features a distinctive type of iconography for rooms of collection: hunting, horticulture, cabinets of curiosity, author portraits, imperial busts, the

disciplines of knowledge, the circle of knowledge, secular temples, and towers of knowledge.

Hunting for Precious Objects

Excavations in the basement of the Louvre reveal the circular fortress of the Tour de la Fauconnerie (Tower of Falconry), where medieval French kings sent birds out tower windows and stored their hunting gear. In 1367, imitating the three floors of manuscripts of the Tour de la Garde-Robe (Tower of the Vestments) of the papal palace in Avignon, King Charles V (r. 1364–1380) moved the royal collection of books to this tower, renaming it the Tour de la Librairie. Christine de Pisan in her 1405 book about wise King Charles V of France notes the orderly arrangement of his library. The reference to “hunting” for manuscripts is most evident in the frescos completed about 1345 on the four walls of the Chambre du Cerf (Room of the Deer) in the Tour de la Garde-Robe, Avignon. The frescos of hunting with birds, hunting with dogs, fowling in trees, and fishing in ponds would help a cleric to locate a handwritten animal-skin manuscript on one of the tables in the room (Horowitz, 1998, pp. 123–128). By ancient rhetorical theory, a trained student is a huntsman finding the locations of hidden knowledge, and from Petrarch onward humanists were praised as manuscript-hunters.

Isabella d’Este (1474–1539), in setting up her second suite of rooms in the ducal palace of Mantua, transformed the *scalcheria* (the room where meat, vegetables, and other delicacies were previously prepared for banquets) into a room for sorting and arranging her collection of antiquities. With good humor, she commissioned Lorenzo Leonbruno to paint on the upper walls female hunters hunting for deer; seen from below, the Amazons appear to be pointing their arrows down toward the objects in the room. Isabella d’Este—who to acquire desired antiquities wrote both the duke of Milan and Andrea



Caesar Travelling Library constructed for Sir Julius Caesar (1558–1636). Throughout the centuries, some collections have been mobile, allowing for their display in multiple locations. BY PERMISSION OF THE BRITISH LIBRARY, C.20.F.15–58

Mantegna on their deathbeds—with Amazonian imagery likened hunting to collecting.

The Boston Public Library in Boston, Massachusetts, opened in 1896, was noted for its large card-catalog room with a decorative frieze of the search for the Holy Grail; the published dissertation on the topic (Ferris Greenslet, *The Quest of the Holy Grail*, 1902) misses the humor of the implied analogy between the adventures within medieval legends of seeking the cup from which Jesus drank and the often time-consuming, circuitous paths between card-catalog entries and

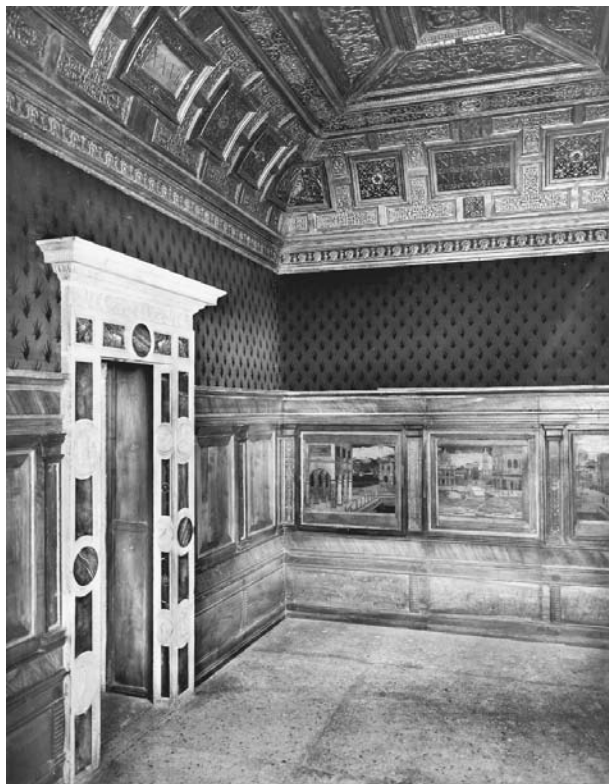

Studiolo of Isabella d'Este, Palazzo Ducale, Mantua, Italy. D'Este's elaborately detailed grotto in Corte Vecchia is one example of a cabinet of curiosity, a type of collection popular in the sixteenth and seventeenth centuries. PHOTO CREDIT: ALINARI/ART RESOURCE, NY

shelves to finding the ideal cup of knowledge (or book) for which one longs.

Horticulture and Culture

Thirteenth-century Richard de Fournival discusses his “garden” of manuscripts in *La biblionomia*. This catalog shows the rows of his plantings: about three hundred manuscripts entered the founding collection of the Sorbonne of which forty of Fournival's have survived. The duke of Berry, most famous for his manuscript of the calendar months, utilized the insignia of vegetative “roots” to designate his manuscripts. Piero de' Medici, father of Lorenzo the Magnificent, created a *studiolo* (a study) in the Medici Palace, Via Larga, Florence. The twelve calendar months by Luca della Robbia on the ceiling are a visual cataloging system pointing out the twelve categories of Piero's classical and Christian books below, color-coded in the written catalogs of 1456 and 1464–1465 (Horowitz, 2003).

Isabella d'Este's second suite of *schalera*, *studiolo*, grotto, and garden created an atmosphere of a garden of virtues, as in the Mantegna painting *Pallas Expelling the Vices from the Garden of Virtue* (1499–1502) which hung in the *studiolo* (now in the Louvre). Hovering in a cloud on the right are the three cardinal virtues; below in the distance, a pleasant landscape seen through the tree-lined archways reveals vices fleeing and new growth

growing from old roots; in the foreground on the left is the Mother of Virtue imprisoned in a tree; and in the center, vices pollute the pond. Minerva (Pallas Athene) and two goddesses enter and seek to bring about a return to a garden of virtue.

The analogy of “culture” and horti“culture” is evident in many languages. The tree catalog of the library of Saint-Lambrecht, a painted panel by Michel Boeckyn (1688–1742), utilizes the common image of a tree of knowledge, with the various branches of knowledge rising from a trunk (fig. 4, Masson, 1981). One might plant a collection of books or other valuables, many might labor in the fields of scholarship and the arts, and a society devoted to cultivating the arts might create an abundant culture. French King Francis I (r. 1515–1547) was praised by his courtiers for his cultivation of the humanist virtues, which are equally evident in his manuscript collection, in the flowery ephemeral art of his royal entries, and in the flowers and fruit ornamenting the wall paintings in the Galerie Francis I, Fontainebleau. The analogy of writing to agricultural productivity, like the analogy of collecting to hunting, also helped make these cultural activities appropriately aristocratic.

Agricultural abundance ornamenting cultural institutions was so prevalent in the eighteenth century that it barely receives comment; note especially the decoration of the rotunda library of the Radcliffe Camera, Oxford, and of the stucco ceiling at the entrance to the Ashmolean Museum, Oxford. In the mid-nineteenth century, the upper walls of the main reading room of the Bibliothèque nationale were painted with illusionistic windows revealing sky and treetops. The implication that natural vegetative growth encourages the growth of the mind was expressed in the medieval tradition of drawings of a scholar in a study with an open cupboard showing fruit. (John Clark, in *The Care of Books* [1901], asks why the fruit are there [p. 313].)

Cabinets of Curiosity

In the sixteenth and seventeenth centuries, collectors arranged a diversity of natural and crafted objects within decorative furniture cabinets, as well as within rooms that served as cabinets of curiosity. When one enters Isabella d'Este's grotto in Corte Vecchia, one feels that one is inside an elaborate jewelry box. Ornate marquetry woodwork decorates the doors to the cabinets that once contained her valuables; the distinctive perspective pictures would remind her of the exact location of her antiquities protected in this room.

At the corner of the Hall of the Five Hundred in the Palazzo Vecchio, Florence, is the restored study of Francesco I, the work of Giorgio Vasari in 1570–1575. Under the vaulted ceiling, there are numerous paintings. A door behind the sixth painting, Alessandro Allori's *Cleopatra's Feast*, with his *Pearl-fishing* above, opens to a staircase leading to the *tesoretto*, a small treasure room with eleven cupboards, one of which leads to a further room below. In the context of Francesco I's collecting, Allori's *Cleopatra's Feast* is his *Pearl-fishing*, a playful allusion to the hunting for treasure below.

The *studiolo* in the ducal palace of Urbino plays with this genre by appearing to show the contents of cabinets in its



Pallas Expelling the Vices from the Garden of Virtue (1499–1502) by Andrea Mantegna. Oil on canvas. Some early collectors drew a parallel between culture and horticulture, a view reflected in Mantegna's painting, in which order is restored in a garden setting. RÉUNION DES MUSÉES NATIONAUX / ART RESOURCE

elaborate marquetry. While the open door at the front of the protruding central panel of squirrel and flower bowl is not in fact a door, a door on the right side of that panel does in fact open. Duke Federigo da Montelfeltro kept treasures in two cubicles below his *studiolo*: a temple to the muses for antiquities and a chapel to God for his relics. Also, his library contained several hundred manuscripts; some of those authors are featured in the portraits on the upper walls above the marquetry of his *studiolo*.

“Portraits” of Authors

Providing a portrait, even if fictional, of the key authors of one's set of manuscripts helped individualize the books and encouraged the illusion that those select guests invited to the room were conversing amid the authorities. The pairs of portraits on the upper walls of the duke's *studiolo* in the Palazzo Ducale, Urbino—somewhat representative as in Petrarch, Dante, and contemporary churchmen, and fictive as in Moses (right corner) and Solomon—relate to valued manuscripts in the library a floor below.

In Julius II's (r. 1503–1513) study in the Vatican, the Stanza della Segnatura, bookcases were attached to the walls under the now famous paintings *School of Athens*, *Parnassus*, *Dispute over the Sacrament*, and *Jurisprudence*. Plato, Aristotle, Homer, and others are portrayed with their books, which would have been in the room for Julius's usage. Two hundred eighteen of Julius's books were in this room, known in his lifetime as “the upper library.” As André Masson pointed out, the *Dispute over the Sacrament* and the *School of Athens* were imitated later in the library of Jesuits of Valenciennes (1740–1742) to distinguish the collecting of classical works from the collecting of Christian disputations.

The frieze of over two hundred authors in the Bodleian Library, Oxford University, depicted in 1616–1618 in the three-sided gallery (now the Upper Reading Room), have numerical references in each author's portrayal to the shelf location of the author's respective books in the neighboring Duke Humphrey's Library, where the books remain chained today. The Bodleian Gallery displays the innovative wall shelves with heroes above (except for one heroine, Sappho) of the respective faculties of



Reading Room at the Bibliothèque Nationale, Paris, France. Decorative motifs involving vegetation as an allegory for learning were prevalent during the eighteenth century, such as the trees painted in the reading room of the Bibliothèque Nationale. © PAUL ALMASY

theology, arts, medicine, and law. First one walks between the theologians seeming to vie with each other across the room, then one peruses the classical authors of the liberal arts, and then one walks between the teachers of medicine and the teachers of law. The visual cues of the arts section lead one to the referenced manuscripts of classical and “modern” authors in Duke Humphrey’s Library.

David Rogers has suggested that the frieze portrait imitates and enlivens the manuscript image of Roger Bacon. Further research might be done on the respective pictorial examples,

seeking sources for the particular image, gesture, sayings, and symbols, as in André Thevet’s *Portraits des hommes illustres*, 1584, and in Théodore de Bèze’s (Beza; 1519–1605) *Icones vivorum illustrium*, 1580. The author frieze, the 1604 catalog, and the 1620 catalog are alternative Renaissance innovations in the area of indexing an exclusive collection for members of Oxford University, government dignitaries, and foreigners (either university students or graduates).

An alternative type of frieze is not of authors but of dignitary patrons or users of a local library. Sixty-seven portraits of



Portraits on walls of Federico da Montefeltro's Studiolo (study), c. 1472–1476, Palazzo Ducale, Urbino, Italy. The use of author portraits in libraries gave the collections an air of legitimacy. Da Montefeltro's study featured several such portraits of prominent writers. SCALA/ART RESOURCE, NY

fathers of the Abbaye de Saint-Victor adorn their library in Paris (1684); the architectural construction of the frieze high above the wall bookshelves is modeled on the Ambrosiana Library in Milan, designed by Federigo Borromeo, 1603–1609 (Masson, 1972, pp. 107, 117, fig. 58).

Imperial Busts

To collect imperial coins or busts and to organize one's objects in the categories of Suetonius's twelve emperors suggests an appearance of imperial activity. Many Renaissance collections of ancient Roman imperial coins are displayed in room two of the Archaeological Museum, Venice, and busts of the emperors are displayed in the Room of the Emperors in the Palazzo Borghese. A common pastime among Italian humanists and antiquarians was the collection of coins with heads of the twelve Caesars discussed in Suetonius's *Lives of the Caesars*. Most influential, Petrarch collected such coins of the emperors and utilized both image and inscription to corroborate

information. Furthermore, applying such numismatics to challenging church history and policy, Lorenza Valla wrote in 1440 the *Declamation Concerning the False Donation of Constantine*. Filarete, in discussing the collection in Piero de' Medici's *studiolo* of the 1450s to 1460s, mentioned intaglios of Caesar, Octavian, Vespasian, Tiberius, Hadrian, Trajan, Domitian, Nero, and Antonius Pius, as well as Faustina, and viewed them as a more accurate record than writing. Humanists learned from Pliny, *Natural History* 35.2.9–10, that portraits and busts inspired readers in ancient libraries, and some humanists and collectors, such as Piero's brother, Giovanni de' Medici (d. 1463), organized a *studiolo* by busts of emperors.

The culmination of organizing via busts of emperors is the continuing use of imperial names as the cataloging system of the Cotton collection of the British Library, a collection visually central to the new British Library. Colin C. Tite has argued that in the 1620s the Cotton House displayed busts of the twelve emperors and of Cleopatra and Faustina

above the presses containing the books labeled by that imperial name.

Cotton's many coins gave him full examples of Roman images of the emperors. The British Library manuscript room contains the first catalog of Cotton manuscripts arranged in accordance with the emperor system, Additional MS 36682, fols. 14v–15 (approximately 1638). It places the books marked Cleopatra and Faustina after the books marked Julius and Augustus, and then continues the line of emperors; on the other hand, the Thomas Smith *Catalogue*, 1696 (reprint, 1984) lists the books marked Cleopatra and the books marked Faustina after the books of the twelve emperors. An imagined reconstruction focuses on the noncontroversial location of the presses of the first two emperors Julius and Augustus. Books and objects were arranged by size within the fourteen categories.

Disciplines of Knowledge

Classification of books by disciplines occurs in the Chinese, Islamic, and European traditions. Starting in the third century, the imperial library of China classified books into four disciplines: canonical and classical, historical, philosophical, and literary, and there was a corresponding color-coding scheme. Chinese encyclopedism, which began in the fourth century B.C.E., reached a culmination under Emperor Quianlong, whose reign extended from 1736 to 1795. A devotee of

arts and letters who personally painted and did calligraphy according to the great masters, Quianlong in 1772 launched a copying project for over ten thousand books and manuscripts. The project—involving 16 directors, 361 scholars, and 4,000 assistants or copyists—resulted in an extensive collection of over ten thousand books and manuscripts. Likewise, Quianlong commissioned the covers of the books in the traditional color scheme: green for classics, red for history, blue for philosophy, gray for literature. The catalog of 10,254 entries follows the four-part scheme; three original copies have survived (Schaer, pp. 350–367).

Piero de' Medici, father of Lorenzo the Magnificent, used color-coding in his catalog of books and in his book bindings in his *studiolo* in the Medici Palace, Florence. Many of these hand-illuminated works are in good condition in the Biblioteca Laurenziana, Florence. The main room designed by Michelangelo opened in 1571; the subject names still survive on the sides of the lecterns where the books were then chained. Likewise, the Latin words for “Grammar books” and “Medical books” appear on window inscriptions of the library of the cathedral chapter of Bayeux (c. 1464) and correspond in location to that indicated in the catalog of 1480.

In the Escorial Library of Philip II of Spain, designed by Juan de Herrera and constructed 1575–1792, as a great hall 212 feet by 35 feet with a barrel vault 35 feet from the floor, paintings of personifications of the liberal arts rise from above the wall bookcases. These are Philosophy, Grammar, Rhetoric, Dialectics, Arithmetic, Music, Geometry, Astrology, and Theology. The figure of Grammar thus rose above the shelves designated for grammar in the Escorial Library (fig. 31, Masson, 1972). While decorating a library with muses or personifications of the liberal arts was not new, lining a rectangular room with wood bookcases was a new innovation, allowing those entering to see and grasp the unity of the open-spaced room and



Interior view of San Lorenzo dell'Escorial library, near Madrid, Spain. The Escorial library, built for Phillip II of Spain, introduced the concept of wall bookcases, an innovation that quickly became a standard fixture of Italian libraries and collection houses. THE ART ARCHIVE/DAGLI ORTI (A)

to use the books stacked horizontally on the shelves (Frey Jose de Siguenza, *Fundacion del Monasterio de El Escorial*, 1595 (reprint, 1963), pp. 279–280). The Ambrosian Library, Milan, 1603–1609, established wall bookcases as the norm for Italy.

Until about 1700, earlier in Italy, upper wall and ceiling figures of muses might correlate with the matching books inspired by that muse. The books in lecterns, cases, or shelves would correlate with the appropriate decor of that classification. For example, Garberson has studied a transition library, the Austrian Bibliotheca Windhagiana, built 1650–1673, which gave more decorative space to theology to match the extensive collection in that field on the shelves below. Allowing for a unified decor despite continuing purchase of books in varying fields, later libraries allowed the architectural space to designate a balanced distribution of design illustrating the overall purposes of the library. Nevertheless, in the 1764 first printing of *Descripcion del Real Monasterio de San Lorenzo del Escorial*, Andres Ximenez classified his partial list of four thousand volumes by the muses in Pellegrino Tibaldi's paintings decorating the ceiling and archway of the main floor of the library.

Through the nineteenth century, the muses remained a popular decorative scheme in libraries, as well as in opera houses, where they are often dancing in a circle. Above the

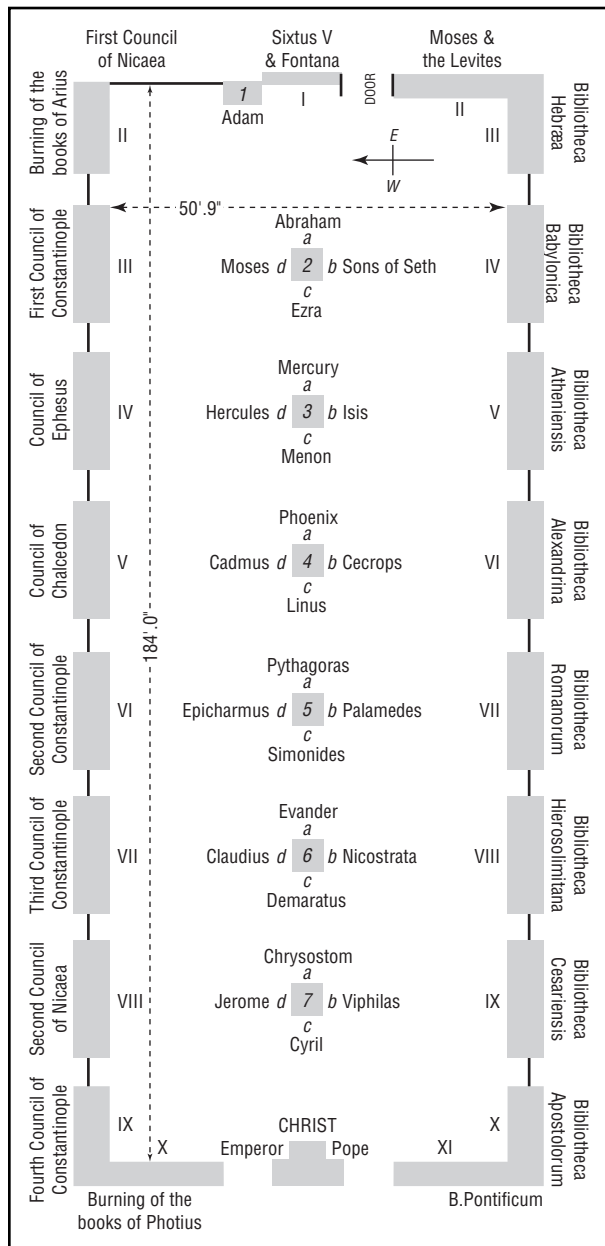

Outline of the Salone Sistino of Pope Sixtus, Vatican Library.

The Vatican Library took a strong interest in preserving previous cultures, as is shown in this depiction of the libraries of various civilizations throughout history. ADAPTED FROM FIGURE 18 IN *THE CARE OF BOOKS* BY JOHN WILLIS CLARK, 1901.

entry hall staircase of the Boston Public Library, Pierre-Cécile Puvis de Chavannes painted the muse of history viewing ancient ruins, as well as a new iconography for physics, represented by figures of good and bad news holding the telegraph pole.

Extensive collections required division not simply by a section of a room, but by multiple rooms. Avicenna (Ibn Sina), awed by the size of the Islamic library at Bukhara at the end of the tenth century, reported that each room was designated

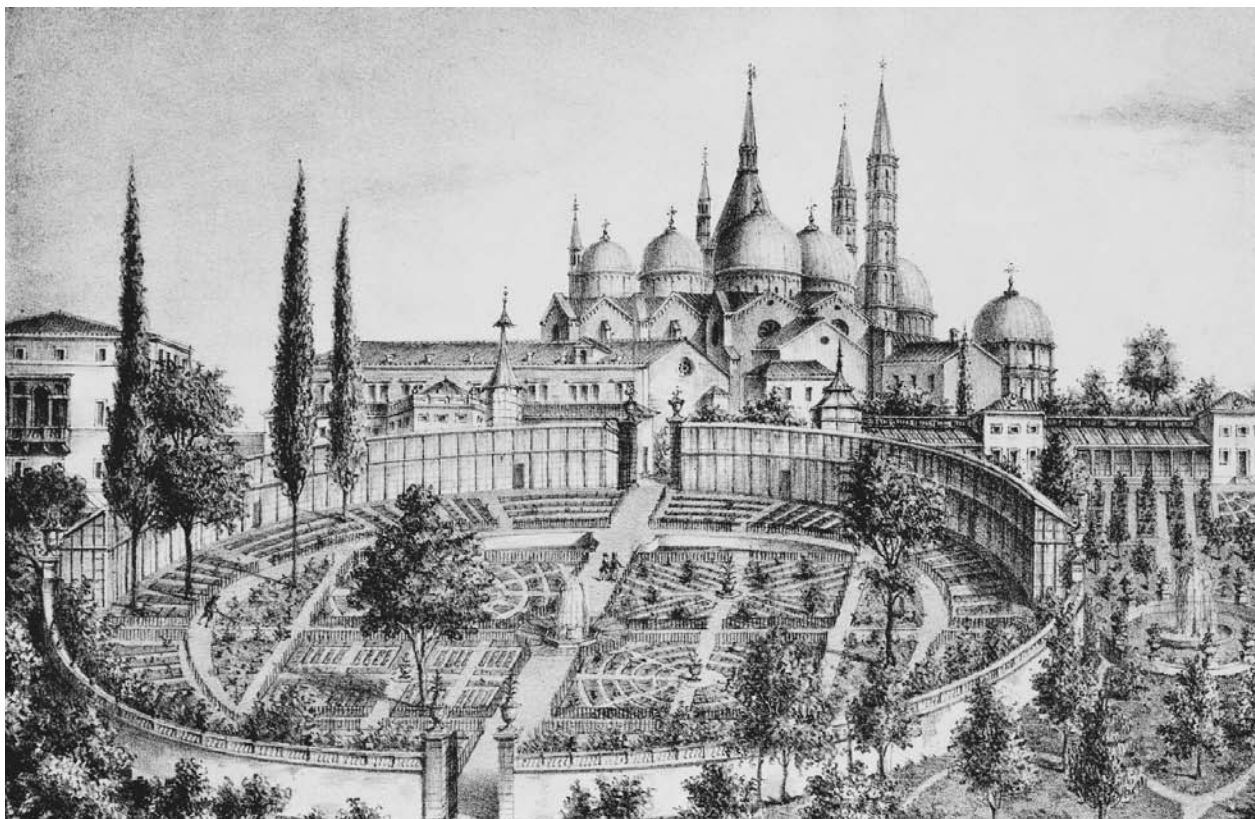

The circular botanical garden at Padua, Italy. Founded in 1545, the famous botanical garden at the Padua medical university occupies an area of two hectares and has a circular design that was popular during the Renaissance period. © DAVID LEES/CORBIS

for a particular discipline of knowledge and contained trunks of books: poetry and Arabic philology, jurisprudence, and others. Sorting knowledge into “rooms” is a theme in the Roman Quintillian’s (c. 35–c. 100) *Art of Rhetoric*. In the Institute of Research in History in the Senate House of the University of London, there is virtually a house of history with, for example, rooms for specific national histories in specific centuries. On a smaller scale, in his influential 1885 design for a history seminar room on German precedent at Johns Hopkins University, Herbert Baxter Adams planned the room to house alcoves of histories, of related disciplines such as political science and economics, and of primary sources such as laws and public documents; nearby rooms were designated for ancillary tools such as maps and statistics (Smith, p. 1159, illustration).

Succession of Collections

Great book collections, as well as large museums, have absorbed within them previous collections. The Vatican Library took pride in its role as a preserver of and successor to previous cultures. Sixtus V (r. 1585–1590) commemorated that tradition by commissioning fictive fresco images of some of the libraries contained within his collecting project. The graphical design shows the arrangement of images of great libraries of diverse peoples and the great council meetings that set church doctrine. Works that in private hands might cause an accusation of heresy

against their owner were safely stored in the closed cabinets five feet high on the perimeter wall and around the columns of this rectangular great hall, 184 by 57 feet.

The neo-Gothic library of the London Guild House also has visual renditions of earlier libraries. Starting with the Louvre in the late eighteenth century, great museums sought to collect works from a succession of great civilizations: the Egyptian, the Greek, the Roman, the Christian, the Italian Renaissance, the French Classical, and so forth. With changing tastes in the nineteenth century, curators added additional works of medieval art and of Northern Renaissance art.

Circles of Knowledge

In the Renaissance, the sphere and the circle were viewed as perfect forms. The medical school in Padua, in initiating one of the earliest and most famous botanical gardens, chose a circular arrangement. Plants from the Americas were transplanted there.

Reading rooms imitating the ancient Roman Pantheon dome became an engineering feat and architectural possibility in the mid-nineteenth century.

In 1857 Sidney Smirke worked with Anthony Panizzi to construct the reading room within the courtyard of the British Museum. Ten years later in 1867, Henri Labrousse, having

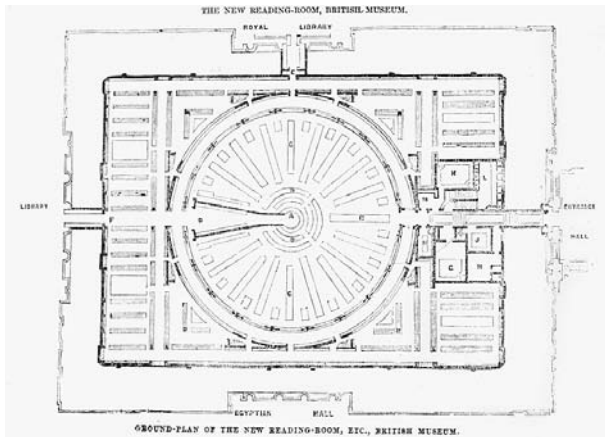

Floor plan of the British Museum reading room (1857). Commissioned in 1857, the main reading room at the British Museum was designed by Sidney Smirke and built in the Great Court of the museum. © CORBIS

studied the London feat and applying the analogy of culture to horticulture, which he already had applied in the tree decoration of the bibliothèque Sainte-Geneviève, created the main reading room of the Bibliothèque nationale, Richelieu.

Readers in either room were encircled by topically organized reference books; they literally might walk around the circle of knowledge. This central wheel of essential knowledge has spokes leading out to the stacks of more detailed books retrieved by librarians at the reader's request desk.

The United States imitated both great circular reading rooms in the 1886–1897 construction of the Main Reading Room of the Jefferson Building of the Library of Congress. The figures painted on the dome depict a chronological sequence of civilizations contributing to the collection: Egypt, Judea, Greece, Rome, Islam, Middle Ages, Italy, Germany, Spain, England, France, America. Statues of eight personifications of disciplines and of two great male achievers for each discipline encircle readers seeking knowledge of Philosophy, Art, History, Commerce, Religion, Science, Law, and Poetry.

Awe-Inspiring Temples

Some of the earliest rooms of collection of Chinese Buddhist art are in Toshodaiji near Nara, Japan. In the Kondo (main hall) at Toshodaiji, 759 C.E., one sees an arrangement reminiscent of an emperor with courtiers in the rendition of a large seated Buddha with Bodhisattvas on either side. The entire complex of buildings at Toshodaiji is symmetrical, the great Buddha hall as the center with twin pagodas on either side. Museum goers may thus study ancient Chinese culture within Japanese temples.

During the Italian Renaissance, Venice was a good location for studying ancient Greek culture. La Libreria Sansoviniana in the Biblioteca Nazionale Marciana is on the second floor of a columned building across from the ducal palace and basilica of Venice. Built by architect Jacopo Sansovino in 1591, it is especially famous for its ceiling painting by Titian of

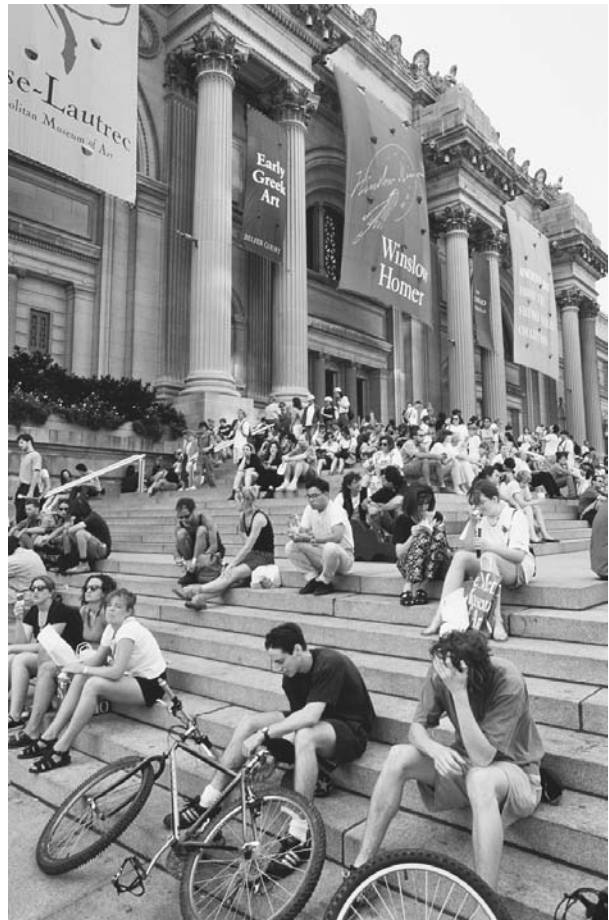

New York's Metropolitan Museum of Art. Some institutions that house artistic collections feature large-scale, impressive architectural components which reflect the importance of that which is housed within. © BOB KRIST/CORBIS

Wisdom. Nicola Ivanoff has elaborated on the Neoplatonic iconography of the ceiling and wall decoration of the room containing the rare manuscripts. The scheme involves personifications for virtues and for the disciplines (Ricciardi, pp. 33–44 with illustrations). Slanted desks housed the valuable possessions of Greek manuscripts collected by Cardinal Bessarion and donated to the city of Venice in 1468.

Considering this special room in the context of the path to it, one finds large caryatids by Alessandro Vittoria (1553–1555) guarding the original entrance, which leads up a winding vaulted staircase to a vestibule heavily decorated with classical sculpture donated in 1587 by the cardinal and patriarch of Aquileia, Giovanni Grimani.

In ancient Greek temple sites, as in Athens, one walked up a holy path to the hilltop temple and then stood outside the temple housing the statue of the god or goddess. To reach the collection of Greek manuscripts, one walks up a holy way and stands in a vestibule of ancient sculpture. The holy of holies in La Libreria Sansoviniana is not the effigies of gods but the Greek manuscripts.



Bibliothèque Nationale, Paris, France. France's new national library is a complex consisting of a garden surrounding four towers—shaped like open books—that house the institution's collections. AP/WIDE WORLD PHOTOS

Monumental staircases, grandiose like ancient Egyptian or Aztec step pyramids, became the pathway to grandiose collections, such as the Louvre, the Widener Library, the Columbia University Library, and the Metropolitan Art Museum. The winged victory goddess, which has become the insignia of Niketown, marks the turn in the grand internal staircase of

the Louvre, Paris; the Chicago Art Institute imitated the design. At the end of the twentieth century, a glass pyramid entrance downward displaced the grand staircase as the main entryway to the Louvre. The crowds of diverse population line the outdoor staircase to the Metropolitan Museum of Art, New York.



The Shrine of the Book. Part of the Israel Museum in Jerusalem, the Shrine of the Book contains the Dead Sea Scrolls. © DAVID RUBINGER/CORBIS

The Shrine of the Book in Jerusalem enlarges the lid of an ancient clay jar in which the Dead Sea Scrolls were found in 1947 into a monumental white dome museum housing the seven ancient scrolls in Hebrew and Aramaic. Designed by Frederick J. Kiesler and Armand P. Bartos, the white dome juxtaposes with a black wall, representing the struggle of light and darkness, good and evil, in the ancient biblical texts enclosed within.



King's Library at the British Library. Many institutions store collections in tower form, such as the British Library, which houses certain of its books—including those of King George III—in six-story bookcases. © IRENE RHODEN; REPRODUCED BY PERMISSION OF THE BRITISH LIBRARY

Towers of Knowledge

In the basement of the Louvre, one can still observe the walls of the tower wherein King Charles V set his library. An M. C.

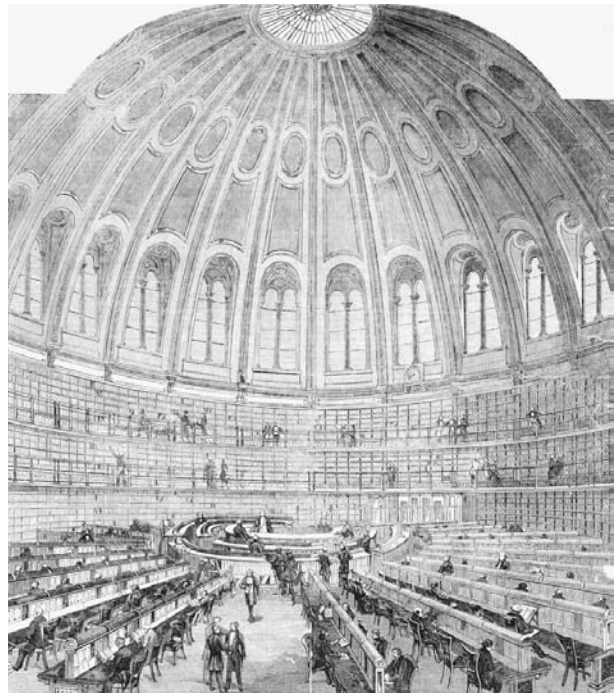

British Museum reading room. Nineteenth-century engraving. Constructed in the domed style of ancient Roman architecture, the reading room at the British Museum served as the main reading room for the British Library until 1997. © BETTMANN/CORBIS

Escher-influenced medieval tower is featured in the scene of manuscripts burning in the film *The Name of the Rose*, therein one sees Richard de Fournival portrayed rescuing manuscripts that will later enter into the library of the Sorbonne. In the upper story tower study of Château de Montaigne, Michel de Montaigne in the 1570s, 1580s, and early 1590s utilized the book collections of his father and of his friend Étienne de La Boétie to nourish his own thoughts on numerous important social concerns of his day in his *Essais*. Imagining his mind as an infertile field and as a galloping horse, he recommends as a remedy proper

VISUAL CUES TO A COLLECTION

This British Library miniature library for the traveler is related to three others extant. It has clear visual cues to its collection. Books of theology and philosophy are on the top shelf and listed in the left column, books of history are on the middle shelf and listed in the middle column, and books of poetry are on the bottom shelf and listed on the right column. The theology and philosophy books have a floral ornament on the

spine and originally had blue ties, the history books have a flaming heart on the spine and red ties, and the poetry books have either a six-pointed star or a rosette on the spine and have green ties. While the history and poetry texts are primarily from ancient Greece and Rome, theology includes Old and New Testament and Christian texts, and philosophy emphasizes Stoic philosophers to Justus Lipsius.

sowing and careful reining (*Essais* 1.8 on idleness, “De l’oisiveté”). With self-discipline, he inscribed on the beams of his ceiling his favorite literary and philosophical sayings. After his death in 1592, Marie de Gournay worked in the book-lined tower study to prepare the 1595 posthumous edition of his essays and to track down the original sources of Montaigne’s Greek and Latin classical quotes.

The newest Bibliothèque nationale, at François-Mitterrand/Tolbiac in Paris, rises in four towers of books from the rectangular garden of trees. The Tower of Time, the Tower of Letters, the Tower of Numbers, and the Tower of Law appear to grow from the arboretum. The “Haut-de-Jardin,” the upper garden, serves to cultivate the general public while the “Rez-de-Jardin” encourages the deeper cultivation of the research scholar.

While the new library in Paris stores the books in towers, the new British Library in the St. Pancras Building, opened by the queen in June 1998, stores the books underground. Both great national and international collections utilize the latest technology for online reader requests as well as automated, mechanical means for book retrieval. Nevertheless, the British especially value the books extant from John Cotton’s Library as well as the rest of King George III’s books, which King George IV gave to the nation in 1823. These books rise in a six-story bronze and glass tower in the center of the new British Library.

See also *Classification of Arts and Sciences, Early Modern; Communication of Ideas; Iconography; Knowledge; Museums.*

BIBLIOGRAPHY

- Béguin, Sylvie, ed. *Le studiolo d’Isabelle d’Este: Catalogue*. Paris: Edition des Musées Nationaux, 1975.
- Besson, Alain. *Medieval Classification and Cataloguing from the Twelfth to Fifteenth Centuries*. Biggleswade, U.K.: Clover, 1980.
- Chartier, Roger. *The Order of Books: Readers, Authors, and Libraries in Europe between the Fourteenth and Eighteenth Centuries*. Translated by Lydia G. Cochrane. Stanford, Calif.: Stanford University Press, 1994.
- Cheles, Luciano. *The Studiolo of Urbino: An Iconographic Investigation*. University Park: Pennsylvania State University Press, 1986.
- Clark, John. *The Care of Books: An Essay on the Development of Libraries and Their Fittings, from the Earliest Times to the End of the Eighteenth Century*. Cambridge, U.K.: Cambridge University Press, 1901.
- Findlen, Paula. *Possessing Nature: Museums, Collecting, and Scientific Culture in Early Modern Italy*. Berkeley: University of California Press, 1994.
- Garberson, Eric. “Bibliotheca Windhagiana: A Seventeenth-Century Austrian Library and Its Decoration.” *Journal of the History of Collections* 5, no. 2 (1993): 109–128.
- Gulik, W. R. Van et al., eds. *From Field-Case to Show-Case: Research, Acquisition, and Presentation in the Rijksmuseum voor Volkenkunde (National Museum of Ethnology) Leiden*. Amsterdam: Gieben, 1980.
- Hall, Marcia, ed. *Raphael’s “School of Athens.”* Cambridge, U.K.: Cambridge University Press, 1997. See especially pp. 6–13.
- Hobson, Anthony. *Great Libraries*. London: Weidenfeld and Nicolson, 1970.
- Hooper-Greenhill, Eilean. *Museums and the Shaping of Knowledge*. London: Routledge, 1992.
- Horowitz, Maryanne. “Humanist Horticulture: Twelve Agricultural Months and Twelve Categories of Books in Piero de’ Medici’s Studiolo.” *Viator: Medieval and Renaissance Studies* 34 (2003): 272–307.
- . *Seeds of Virtue and Knowledge*. Princeton, N.J.: Princeton University Press, 1998. See especially pp. 120–128 on Chambre du Cerf, Tour de la Garde-Robe, Palais des Papes, Avignon.
- Hudson, Kenneth. *Museums of Influence*. Cambridge, U.K.: Cambridge University Press, 1987.
- Impey, Oliver, and Arthur MacGregor, eds. *The Origins of Museums: The Cabinet of Curiosities in Sixteenth- and Seventeenth-Century Europe*. Oxford: Clarendon, 1985.
- Kobayashi, Takeshi. *Nara Buddhist Art: Todai-ji*. Translated and adapted by Richard L. Gage. New York: Weatherhill, 1975.
- Liebenwein, Wolfgang. *Studiolo: Die Entstehung eines Raumtyps und seine Entwicklung bis um 1600*. Berlin: Mann, 1977.
- Makowiecka, Elzbieta. *The Origin and Evolution of Architectural Form of Roman Library*. Warsaw: Wydawnictwa University, 1978.
- Masson, André. *Le décor des bibliothèques du Moyen Age à la Révolution*. Geneva: Droz, 1972.
- . *The Pictorial Catalogue: Mural Decoration in Libraries*. Translated by David Gerard. Oxford: Clarendon, 1981.
- Pomian, Krzysztof. *Collectors and Curiosities: Paris and Venice, 1500–1800*. Translated by Elizabeth Wiles-Portier. Cambridge, U.K.: Polity, 1990.
- Raggio, Olga. “The Liberal Arts Studiolo from the Ducal Palace at Gubbio.” *Metropolitan Museum of Art Bulletin* 53 (spring 1996).
- Ricciardi, Maria Luisa. *Biblioteche dipinte: Una storia nelle immagini*. Rome: Bulzoni, 1996.
- Rogers, David. *The Bodleian Library and Its Treasures, 1320–1720*. Henley-on-Thames, U.K.: Aidan Ellis, 1991.
- Schaer, Roland. *Tous les saviors du monde: Encyclopédies et bibliothèques, de Sumer au XXIe siècle*. Paris: Bibliothèque nationale/Flammarion, 1996.
- Signorelli, Luigi. *The Palazzo Vecchio and the Piazza della Signoria: Handbook and Itinerary*. Translated by Hilda M. R. Cox. Florence, Italy: Arnaud, 1952.
- Smith, Bonnie G. “Gender and the Practices of Scientific History.” *American Historical Review* 100 (1995): 1150–1176.
- Staikos, Konstantinos Sp. *The Great Libraries from Antiquity to the Renaissance*. London: Oak Knoll Press and the British Library, 2000.
- Stam, David H., ed. *International Dictionary of Library Histories*. 2 vols. Chicago: Dearborn, 2001. See especially Edwin Wolff II, “Library Buildings,” and Mohamed Taher, “Islamic Libraries.”
- Tite, Colin G. C. *The Manuscript Library of Sir Robert Cotton*. London: The British Library, 1994.
- Ventura, Leandro, Daniela Ferrari et al. *Isabella d’Este: I luoghi del collezionismo: Mantova, Palazzo ducale, appartamenti isabelliani*. Modena: Bulino, 1995.
- Verheyen, Egon. *The Paintings in the Studiolo of Isabella d’Este at Mantua*. New York: New York University Press, 1971.

Maryanne Cline Horowitz

VOLKSGEIST. *Volksgeist* (folk or national spirit) is perhaps the best known of a family of terms referring to sets of mental, intellectual, moral, and cultural traits that define particular human groups represented as being “nations” or “peoples.” Additional related words include *Volksseele* (“folk soul”),

“national character,” *esprit de la nation* (“spirit of the nation”), and a host of others. These terms have never had narrowly fixed meanings, either individually or in comparison with each other. Sometimes they have been used to denote irreducible, irrational spiritual forces that lie close to the foundations of perception and behavior and explain why people of one nation must differ radically from those of another. More often, they have served as platforms for arraying ranges of cultural characteristics in such a way that distinctions between nationalities can be identified, the moral and political implications of the distinctions can be developed, and the cultural similarities among people of the same nationality can be used to construct a conscious national community. Regardless of their stated intentions, writers employing these terms have tended to apply them both descriptively and judgmentally and seldom have avoided tautology. *Volksgeist* (which will stand here for the entire family) has not been a popular word among intellectuals since the middle of the twentieth century, but concepts closely related to it are far from uncommon in contemporary public discourse.

Benedict Anderson has argued that nations are “imagined communities.” *Volksgeist* originated mainly in the efforts of early modern Europeans to imagine communities that corresponded either to the extensive, politically centralized territorial states emerging around them (France, for instance) or to groups of people of similar language who were not experiencing such political developments but might do so in the near future (Germans and Italians). Its relationship to actual states in the eighteenth century was quite complex. *Volksgeist* was created as much by the critics of the major nation-states as by their apologists. Charles-Louis de Secondat, baron de Montesquieu (1689–1755), one of the originators of the concept, argued that the cultural identities—the “spirits”—of peoples derived mainly from their interactions with their environments over time, which suggested that the efforts of the French state to establish cultural uniformity among the various nations of which France was composed was as illegitimate as its attempts to extend its imperial control over nations beyond its borders and to impose a single, authoritarian political hegemony over the diverse orders of French society. Johann Gottfried Herder (1744–1803), generally acknowledged as the person who first brought most of the conventional elements of *Volksgeist* together into a coherent whole, represented nations as embodiments of unique sets of cultural characteristics in explicit opposition to attempts to define nations politically.

Herder bears the reputation of being the father both of *Volksgeist* and of modern nationalism. In each case the reputation is only partly deserved, but his contribution was profound nonetheless. Herder used extended expressions such as *Geist des Volkes* rather than *Volksgeist*, but in representing peoples (*Völker*) as actual humans with individual differences, sharing cultural traits shaped by their ancestors’ history and experience of a particular physical environment and mentally constructing their world through language and law inherited from earlier generations, he expressed the essence of the concept and laid the groundwork for what would later be called ethnology. Herder’s presentation shows that there was more to the creation of *Volksgeist* than simply engagement with the implications of the nation-state. It was also a reaction to the

inadequacies of the model of the abstract rational individual that underpinned the Lockean interpretation of society. With regard to nationalism, Herder did not call for a unified state defined by the German *Volksgeist*, even though he argued against imposing French political and cultural hegemony on Germans. He did, however, claim that the only effective and legitimate governments were ones that developed naturally among particular nations and that reflected, in their differences from other polities, the cultures of the peoples they governed. Whether such a relationship was possible between nations defined as natural cultural entities and governments that ruled very extensive areas was, to Herder, at best questionable. He did not foresee the massive efforts of nineteenth-century nation-states to create common nationalities among their diverse citizens by such means as public education.

The word *Volksgeist* itself was coined by Georg Wilhelm Friedrich Hegel (1770–1831) to denote the separate spiritual essences of the diverse nations that characterized the present stage of human history and that would, through a dialectical process, produce the uniform “world-spirit” which spelled history’s end. Hegel’s formulation had some resonance later in the nineteenth century, but the most important versions of the idea followed more directly the line established by Herder. Early nineteenth-century Romantic philologists such as Jacob and Wilhelm Grimm (1785–1863, 1786–1859) focused on the centrality of language in framing the distinctive ways in which particular peoples interpret the world, on the history of languages as the key to the real history of nations, and on the study of folk tales as a means of comprehending the spiritual realities of peoples that lay hidden beneath layers of sophistication and cultural borrowing. These intellectual concerns were often bound up with political ones, as national character was commonly cited as a justification for claiming political autonomy within imperial states or asserting independence (Hungarians and Czechs in the Austrian Empire, for example, or the Irish with respect to Great Britain) or for insisting on the union of peoples of similar language (as in Germany). *Volksgeist* was also frequently connected with democratic, or at least anti-hierarchical, political tendencies. If the core of a genuine nation lay not in the power or civilization of its elite, but rather in the language and folk heritage of its common people, it followed that in some manifest way those people should participate in the political life of the national state.

Apart from its political implications, the most important consequence of the formulation of *Volksgeist* was its influence on the formulation of the concept of *culture* in the middle years of the nineteenth century. The idea that “peoples” identified by particular, but wide, arrays of traits could be taken as the fundamental units of social and historical study was basic to the establishment of ethnology as a science. The comparative ethnology of both the diffusionist and the functionalist schools was predicated on this assumption, which dominated cultural science until past the middle of the twentieth century. Comparative studies of folk culture, pioneered in Germany by Wilhelm Heinrich Riehl (1823–1897), were also strongly affected by the concept of *Volksgeist*. Such studies found echoes in many countries. Another human science that incorporated *Volksgeist* was *Völkerpsychologie* (folk psychology), which aimed at distinguishing psychological charac-

teristics and mental operations that were common to all people from those derived from their varied cultures. The broad complex of cultural studies affected by the idea of *Volksgeist* provided discursive and conceptual frameworks to intellectuals throughout the world—to George Eliot (1819–1880), for example, and to W. E. B. DuBois (1868–1963), whose book, *The Souls of Black Folk* (1903), examines in great depth the relationship between a people, the larger political nation to which it belongs, and the distinctive forms of perception that it derives from its history and culture.

In the late nineteenth and early twentieth centuries, *Volksgeist* came to be associated with the fashion for biological racialism that swept through social thought in Europe and America, helping to produce what has been called “*völkisch*” ideology. It was this association that, perhaps more than anything else, caused the sudden decline of *Volksgeist* as a respectable term in intellectual discourse after World War II.

See also *Cultural History; Ethnicity and Race; Nation; Nationalism; Regions and Regionalism, Eastern Europe.*

BIBLIOGRAPHY

- Anderson, Benedict. *Imagined Communities: Reflections on the Origin and Spread of Nationalism*. London: Verso Editions, 1983.
- Berlin, Isaiah. *Vico and Herder: Two Studies in the History of Ideas*. New York: The Viking Press, 1976.
- Greenfield, Liah. *Nationalism: Five Roads to Modernity*. Cambridge, Mass., and London: Harvard University Press, 1992.
- Herder, Johann Gottfried. *Philosophical Writings*. Translated and edited by Michael N. Forster. Cambridge and New York: Cambridge University Press, 2002. See especially Part IV.
- Smith, Woodruff D. *Politics and the Sciences of Culture in Germany, 1840–1920*. New York: Oxford University Press, 1991.

Woodruff D. Smith

VOLUNTEERISM, U.S. The meaning of volunteerism is contingent on the nature of government, particularly the extent and ways in which it enables individuals to make uncompensated donations of money and labor to some form of collective activity or shared purpose.

Over the course of the five centuries since European colonists first occupied North America, the meaning and practice of volunteerism has changed as part of the broader evolution of legal and government structures.

Volunteerism first appeared within the framework of state action in the form of donations of land, money, and labor to public purposes. Some of these are outlined in the Statute of Charitable Uses, a 1601 act of Parliament intended to regulate charitable abuses. They include assisting the poor, sick, and injured, education, caring for orphans, tax relief, ransoming captives, helping young tradesmen, and constructing public works. To these ends charitable gifts were given to municipal corporations, the church, and other public bodies. Privately funded schools, hospitals, and other institutions required the sanction of the state, either through the granting of corporate charters or court approval.

Early voluntary giving in England was strictly regulated by the state, which not only limited the purposes for which funds could be donated (a donor could not, for example, support any other religion but the Church of England), but also placed the authority with the Lord Chancellor and the chancery courts.

Eamon Duffy’s studies of English religious life before the Protestant Reformation depict a rich culture of what appears to be voluntary activity (1992, 2001). But like most early volunteerism, failure to serve was punishable by fines—suggesting that it was viewed as a public obligation, much like paying taxes, rather than a genuinely voluntary act. Duffy suggests that the English Reformation ruthlessly eliminated broad-based lay participation in congregational life, centralizing sacramental and administrative functions in the hands of clergy and community leaders. Their service on vestries and other parochial boards may have been voluntary to the extent that such notables were not compelled to serve. But to the extent that it constituted one of the central functions of the aristocracy and gentry as governing classes, it could hardly be considered private in the modern sense.

Old World traditions of public volunteerism were carried to the colonies. Colonists were compelled to attend and support churches. Colonial government required all men of military age to serve in the militia. Townships levied on citizens’ labor to maintain roads and other public works (McKinney, 1995).

Private volunteerism emerged from the complex politics of English Protestantism. Henry VIII’s break with Rome was not intended to radically alter English religious life. But at a time when mechanical printing made the wide circulation of ideas possible, England could not be insulated from the religious ferment of the Protestant Reformation, then unfolding on the Continent. England became a battleground between religious factions, some favoring traditional Catholic conceptions of religious authority, others favoring Lutheran, Calvinist, and Anabaptist ideas that emphasized the spiritual sovereignty of believers (Dickens, 1964; Marsh, 1998).

For much of the period before 1689, the Church of England was a broad tent, permitting wide ranges of practices. This gave encouragement to a kind of spiritual volunteerism under which worshipers gravitated to preachers with whose views they sympathized, rather than being constrained by the geographical boundaries of the parishes to which the law assigned them. This practice of “gadding sermons” helped to produce the national subculture of religious individualism that gave rise first to efforts by the British state to enforce religious uniformity under the Stuarts and, ultimately, to the Puritan Revolution of 1640–1665. “Liberty of conscience” became a byword not only for religious toleration but for more encompassing conceptions of political freedom.

Volunteerism in Colonial America

The early migrations to New England exemplify the coexistence and common roots of public and private volunteerism. The Pilgrims who settled in Plymouth in 1620 were adherents

of a Protestantism that rejected the idea of a state church in favor of a church as a voluntary gathering of believers (Ahlstrom, 1972). Rejecting ecclesiastical hierarchy and the authority of the priesthood, these “separatists” established independent self-governing congregations in which members covenanted with one another to live under a common religious discipline and accept responsibility for maintaining the church and its ministry. Though an important step toward modern forms of private volunteerism, the separatists nonetheless rejected religious toleration—the existence of competing congregations—and their congregations maintained many of the characteristics of state churches.

By contrast, the settlers of the Massachusetts Bay Colony, while embracing many of the theological positions and ecclesiastical practices of their Plymouth neighbors, saw themselves as operating within the Church of England and sustained the hope that their mode of worship would set an example for the reform of the church in the old country. Because the Massachusetts Bay Colony drew on a far broader range of the spectrum of Puritan belief and practice, the first decade of settlement was fraught with intense conflict between factions on a number of issues, including the civil role of the church. Though ultimately embracing a state church model—intolerant of religious diversity and depending on taxation for its support—the Massachusetts Bay churches nonetheless regarded themselves as covenanted bodies of believers and, to this extent, embodied important characteristics of modern volunteerism.

Conflicts over theology and church polity in the 1630s resulted in the fracturing of Puritan unity. A number of Massachusetts groups, including most notably the antinomian followers of Roger Williams, were expelled from the colony. The new colony they established on Narragansett Bay (Rhode Island) permitted complete religious tolerance, requiring all churches to be supported by their members and rejecting state support. The Baptist and other congregations of Rhode Island offer the first examples of completely private volunteerism.

Ironically, the new colony’s religious diversity stood in the way of any large-scale voluntarily supported enterprises. As the Massachusetts colonists moved to define and enforce religious orthodoxy, they were able to allocate public funds and to encourage private philanthropy to found Harvard College in 1636. Harvard was in no sense a private institution: most of its revenues came from government rather than from private donations; the members of its governing boards were *ex officio* ministers and magistrates. Nonetheless, to the extent that it solicited gifts and bequests from individuals, it did embody elements that would become basic elements of private institutions when they ultimately emerged. Colonies with religious establishments—Massachusetts, Connecticut, and Virginia—all established colleges by the first decade of the eighteenth century. In contrast, the colleges that embraced religious tolerance—Rhode Island, New York, New Jersey, and Pennsylvania—would not do so until decades later.

Even in Massachusetts, where the precursors of modern volunteerism would first take root, authorities were not entirely comfortable with the idea of voluntary activity outside the

purview of the state. In 1638, when a group of Boston merchants petitioned the Massachusetts General Court requesting a charter for a private artillery company, worried legislators pondered “how dangerous it might be to erect a standing authority of military men, which might easily, in time, overthrow the civil power” (quoted in Bremer, p. 309). The Ancient and Honorable Artillery Company was allowed to organize, but was denied corporate status.

In the later years of the seventeenth century, a variety of kinds of secular volunteerism began to flourish in England (Jordan, 1959, 1960, 1962). The most important of these were mutual benefit organizations—fraternal societies like the Freemasons, friendly societies, and social clubs—membership associations that enabled participants to assist one another in times of illness and death, to share resources like books, and to provide places of entertainment and relaxation. By the first decades of the eighteenth century, variants of these types of voluntary associations began to appear in North America. As early as 1710, Boston’s preeminent religious leader, Reverend Cotton Mather (1663–1728), urged readers of his pamphlet *Bonifacius* to organize neighborhood “societies” to worship privately and to identify and care for residents in need. He also encouraged people to create associations to suppress disorders, to visit the sick and needy, and to enable young artisans to help one another.

Mather’s writings had a profound influence on Benjamin Franklin, who, during his apprenticeship in London in the 1730s, had an opportunity to see firsthand the potent possibilities of voluntary association. On his return to America, he helped to introduce Freemasonry (which soon became one of the most important translocal organizations in the colonies) and, later, was instrumental in organizing young men’s associations (the Junto), voluntary fire companies, an academy, and a hospital (Franklin, 1993).

Volunteerism in the Early Republic

Volunteerism, both public and private, played an important part in the American Revolution (Fischer, 1994; Bullock, 1996). Freemasonry, which embraced Enlightenment political and religious ideals, helped to consolidate the emergent revolutionary elite, while at the same time serving as a model for such radical organizations as the Sons of Liberty (Hammill, 1998). The voluntary religious activity that grew out of the Great Awakening of the 1730s and 1740s helped to create political, social, and economic networks friendly to the cause of independence. Together these facilitated a loosening of ties between volunteerism and government. Early in the revolutionary struggle, many militias—military bodies nominally subject to the authority of civil government—were persuaded to volunteer their services to fight the British. After the battles at Lexington and Concord, local militias throughout New England defied local authorities and marched to Boston to join the revolutionary forces gathering in and around the city.

The centrality of volunteerism to the success of the American Revolution helped to kindle hostility toward it once independence was achieved. When veteran officers of the Continental Army organized the Society of the Cincinnati in 1783, its

enemies viewed it as a covert effort to overthrow republican institutions and replace them with a hereditary aristocracy (Burke, 1784). In *Federalist* no.10, James Madison warned of the hazards that factions—by which he meant private political groups—posed to republican institutions. In the mid-1790s, when opponents of the new Federalist regime began organizing “democratic societies”—precursors of modern party organizations—President Washington warned against “self-created societies” intended to “subvert the Power of the People, and to usurp for themselves the reins of Government; destroying afterwards the very engines which have lifted them to unjust domination” (Washington, 1948).

The U.S. Constitution established conditions that made the growth of volunteerism inevitable. By mandating majoritarian decision-making while at the same time guaranteeing individual rights of expression, worship, and assembly, the Constitution posed an unresolvable tension between political equality and individual voice. Groups that did not prevail at the ballot box would be drawn to extragovernmental instruments—the press and voluntary associations—to advance their views and to work for victory in future elections.

Citizens of the early republic found themselves compelled to use voluntary associations, despite the uneasiness that they engendered. Because Americans feared government power, states and municipalities strictly limited the range of services they provided citizens. At the same time, the dismantling of religious establishments in the decades following the Revolution made volunteerism the central organizing principle of religious life throughout the nation. Like it or not, if Americans wanted to be educated, healed, entertained, politically represented, or provided with places of worship, they had to be willing to join with like-minded private citizens to pursue these ends.

The rise of voluntary action preceded the articulation of coherent ideas about the practice. The evangelical preacher Lyman Beecher (1775–1863), one of the first Americans to attempt to understand the role of volunteerism in institutional and political life, describes his plunge into promoting voluntary activity—in connection with early temperance efforts—as impulsive rather than deliberate. Only later, when he saw how powerful voluntary activity could be, did he begin to understand that the “voluntary system” could be used to organize all sorts of enterprises, from political reform movements, through schools, colleges, and religious crusades (Beecher, 1961). In the course of building his reputation as one of the nation’s most influential evangelists, Beecher made the promotion of volunteerism one of the central themes of his efforts. For Beecher and his coreligionists, uncoerced voluntary action became an important source of moral and spiritual development for individuals and communities (Bacon, 1832; Mathews, 1969).

Beecher played a particularly important role in the development of American volunteerism. Concerned about growing numbers of unchurched and uneducated citizens, Beecher came to recognize that voluntary activity, literacy, and broadly shared public values were the precondition for religious conversion. Accordingly, he and his colleagues devoted their

energies to secular reforms that could attract broad coalitions of citizens and citizen organizations such as temperance, anti-slavery, education, and the relief of poverty. Appealing to a broad rather than a sectarian public, Beecher not only helped teach countless numbers of Americans the skills of volunteerism, but also to overcome attitudes that had equated volunteerism with destructive factionalism.

By the time Alexis de Tocqueville visited the United States in the late 1820s, private volunteerism was well on the way to becoming one of the most distinctive expressions of American democracy. Taking note of the temperance movement, he was quick to draw comparisons between European and American styles of civic action. “The first time I heard in the United States that a hundred thousand men had bound themselves publicly to abstain from spirituous liquors,” he wrote,

it appeared to me more like a joke than a serious engagement, and I did not at once perceive why these temperate citizens did not content themselves with drinking water by their own firesides. I at last understood that these hundred thousand Americans, alarmed by the progress of drunkenness around them, had made up their minds to patronize temperance. They acted in just the same way as a man of high rank who should dress very plainly in order to inspire the humbler orders with a contempt of luxury. It is probable that if these hundred thousand men had lived in France, each of them would singly have memorialized the government to watch the public houses all over the kingdom. (vol. 1, pp. 109–110)

Although he observed the importance of voluntary association as a counterpoise to the potential for majoritarian tyranny in democracies and to the hazards of overly powerful government, Tocqueville undoubtedly exaggerated the ubiquity of private volunteerism in the United States. Many states adopted laws that discouraged private philanthropy (in Mississippi, for example, it was illegal to establish charitable trusts until well into the twentieth century) and kept voluntary organizations under strict regulatory scrutiny (i.e., New York’s Regents of the University of the State of New York, which oversaw the activities of all educational, charitable, cultural, and professional organizations) (Zollmann, 1924). Only in New England and the upper Midwest was private volunteerism allowed to flourish relatively unimpeded—and even there, prominent leaders like Unitarian theologian William Ellery Channing and Baptist political economist Francis Wayland wrote widely circulated critiques of voluntary associations as posing dangers to republican government (Channing, 1900; Wayland, 1838).

In the antebellum era, voluntary associations began to play crucial roles in empowering Americans who, because of gender, race, or ethnicity, were disenfranchised. By the late eighteenth century, as whites began excluding free blacks from their congregations, black religious leaders organized their own churches. Women, generally barred from full economic and political participation, carved out a “separate sphere” of civic activism, using voluntary associations to expand their traditional

domestic helping and caring roles to the dependent, disabled, unchurched, and uneducated (Scott, 1991). Immigrant associations helped those newly arrived from Europe to find economic opportunities, show their political muscle, and meet their needs in times of distress.

Volunteerism during and after the Civil War

The Civil War helped Americans to overcome whatever qualms they may have had about volunteerism. Though the war gave rise to a strong national government, it also strengthened the voluntary impulse. Armies on both sides—at least in the first years of the war—depended on volunteer soldiers. In the North, caring for the wounded and attending to the public health needs of the armed forces depended on national voluntary associations, the United States Sanitary Commission and the United States Christian Commission. These national bodies used local chapters to raise funds, produce medical supplies, and raise morale (Brockett, 1864; Frederickson, 1965).

After the war, voluntary associations flourished on an unprecedented scale (Skocpol, 2003). Fraternal and sororal organizations proliferated in countryside and city alike. Veterans' organizations with chapters in every city and village advocated for the interests of those who had served in the armed forces. The growth of cities and the increasing corruption of the political system encouraged the growth of associations advocating civil service, sanitary, and education reform. The growth of industry gave rise not only to national trade associations to advance the interests of merchants and manufacturers, but to labor organizations to defend the rights of working people. As demands for specialized expertise grew, professionals of every sort—physicians, lawyers, clergy, architects, engineers, and educators—organized membership associations to set professional standards and advance their collective legislative interests.

The rapid growth of voluntary associations among a people that, on the whole, had little experience with them led inevitably to considerable organizational disorder. Union army officer Henry M. Robert (1837–1923), assigned to posts in Washington State, California, Massachusetts, and Wisconsin, encountered what he described as “virtual parliamentary anarchy” in voluntary organizations (Doyle, 1980). This moved him to write his famous *Rules of Order*—which became the national standard for Americans swept up in the tidal wave of association building in the closing decades of the nineteenth century.

By the beginning of the twentieth century, two parallel traditions of volunteerism, one public, the other private, were firmly in place. On the public side, most municipalities depended on the voluntary energies of citizens, who served on boards and commissions and ran key municipal services (such as fire protection) on a voluntary basis. On the private side, many public services, such as social welfare and health care, had become largely dependent on voluntary donations of money and labor. But even when formally private, volunteerism sought not merely to serve members in their private capacities—it was almost always linked to government, seeking to sway public opinion on civic issues or to elicit government commitment. During the 1920s, Herbert Hoover sought to create an “associative state”

based on partnerships between voluntary associations and government agencies (Hoover, 1922; Hawley, 1977).

Volunteerism served both democratic and undemocratic purposes. Organizations like the American Protective Association and the Ku Klux Klan—both voluntary associations—sought to disempower and terrorize racial, ethnic, and religious minorities. Elite art museums, symphony orchestras, and universities sought both to enlighten the public and to shape its values in ways favorable to the interests of monied elites (DiMaggio, 1986). Professional associations often used efforts to elevate professional standards as ways of excluding Catholics and Jews (Auerbach, 1976). At the same time, voluntary associations were vehicles for national and international efforts to oppose lynching, promote economic and social justice, and advance women's suffrage (see, for example, Dray, 2002).

Inevitably, as the twentieth century advanced, hitherto voluntary activity began to be affected by professionalization. As the revenue needs of educational, health, and social welfare institutions grew, they were increasingly likely to turn to professional fundraising firms instead of depending on the efforts of volunteers (Cutlip, 1990). As medical and social work practice increasingly required higher levels of expertise, professionals and managers began to replace volunteers as key decision makers in health and welfare agencies (Starr, 1982; Perrow, 1963). By the late 1920s, the establishment training programs for volunteer trustees and directors in schools, libraries, and social agencies suggest that even volunteering itself began to require trained expertise (Hall, 2000). Inevitably, professionals pushed volunteers to the margins in most large nonprofit organizations.

Volunteerism and the Rise and Fall of the Welfare State

As the World War II ended, American policymakers began to take the full measure of the domestic and international responsibilities the nation had taken on as leader of the free world. International leadership would require the development of capacities to manage the domestic economy, to maintain internal political stability, and to sustain military preparedness. This would require a vast expansion of government.

The realities of the U.S. federal system, with its divided and subordinated responsibilities, combined with continuing popular distrust of big government prevented the creation of a European-style centralized bureaucratic state. The American welfare/warfare state, as it emerged, concentrated revenue gathering and policy powers in the national government while allocating most of the tasks of implementing national policies to states, localities, and private sector actors (Webber and Wildavsky, 1986; Donahue, 1989).

Tax policy became one of the most important instruments of the welfare state. The universalization of income taxation and steeply progressive individual and corporate taxes provided a powerful tool for influencing the activities of citizens and citizen organizations. Although the federal government used grants and contracts to influence private sector activity, the deductibility of donations and bequests and exemption from

corporate income and other forms of taxation became effective ways of encouraging transfers of funds between private sector actors. Implementing this system required a revolution in the tax treatment of charitable enterprises. Between 1947 and 1954, Congress rewrote the tax code, creating powerful incentives for charitable, educational, and religious organizations to incorporate and seek certification of charitable status from the federal government.

Depriving many voluntary membership organizations of tax exemptions that they had historically enjoyed, in combination with the establishment of federal social insurance programs, eliminated the *raison d'être* for the mutual benefit organizations that comprised the majority of secular voluntary associations in the United States. By the 1960s, traditional voluntary membership associations were dying out and, as Robert Putnam has noted, volunteerism of every sort was declining (Putnam, 2000; Skocpol, 2003).

The place of voluntary membership associations was being taken by charitable tax-exempt “nonprofit organizations” that were increasingly likely to be run by professional managers and funded by a mix of donations, commercial revenues, and foundation and government grants and contracts. Though volunteers still played a role in the nonprofit sector, they were increasingly likely to be involved with start-up organizations (which, if successful, quickly became professionalized) and religious bodies. There were exceptions to this pattern: religious organizations continued to command nearly two-thirds of the volunteer labor in the nonprofit sector; self-help groups, like Alcoholics Anonymous, explicitly rejected professionalism and depended entirely on the voluntary support of their members (Wuthnow, 1994); character building organizations like the Girl Scouts and Boy Scouts also continued to depend almost entirely on volunteers.

The last decades of the twentieth century witnessed a revival of public volunteerism. The Peace Corps, established in the early 1960s, sent American volunteers to developing countries. During the War on Poverty of the late 1960s, VISTA (Volunteers in Service to America) drew volunteers to impoverished urban and rural areas within the United States. The conservative revolution, which began in earnest with the election of President Ronald Reagan in 1980, advocated voluntary community efforts as a substitute for big government programs that, conservatives argued, perpetuated a culture of poverty. Some of these efforts, like Americorps, were government-sponsored. Others, like Habitat for Humanity, enlisted private citizens to help address public problems, such as poor housing. Colleges and universities became enthusiastic promoters of student voluntarism and community service as forms of experiential learning.

Dismantling big government through devolution (shifting burdens from the national government to states and localities) and privatization (shifting government responsibilities to private sector actors) was the central project of the conservative revolution. George H. W. Bush's speeches following his nomination as Republican candidate for the presidency in 1988 were not only high-profile official endorsements of volunteerism, but also suggested a peculiar blurring of public and private conceptions of volunteerism at the end of the

twentieth century. In his 1989 inaugural speech, the president declared

I have spoken of a thousand points of light, of all the community organizations that are spread like stars throughout the Nation, doing good. We will work hand in hand, encouraging, sometimes leading, sometimes being led, rewarding. We will work on this in the White House, in the Cabinet agencies. I will go to the people and the programs that are the brighter points of light, and I will ask every member of my government to become involved. The old ideas are new again because they are not old, they are timeless: duty, sacrifice, commitment, and a patriotism that finds its expression in taking part and pitching in.

At the end of the twentieth century, the traditions of public and private volunteerism that had diverged two centuries earlier were evidently converging as institutions—government, business, and universities—promoted volunteering as ways of fulfilling their responsibilities to the public. Such institutionally sponsored efforts—which often contain coercive elements (such as being requisites for graduation or promotion)—raise questions about the voluntariness of contemporary volunteerism.

See also *Citizenship; Civil Society*.

BIBLIOGRAPHY

- Ahlstrom, Sydney E. *A Religious History of the American People*. New Haven, Conn.: Yale University Press, 1972.
- Auerbach, Jerold S. *Unequal Justice: Lawyers and Social Change in Modern America*. New York: Oxford University Press, 1976.
- Bacon, Leonard. *The Christian Doctrine of Stewardship in Respect to Property*. New Haven, Conn.: Printed by Nathan Whiting, 1832.
- Bremer, Francis J. *John Winthrop: America's Forgotten Founding Father*. New York: Oxford University Press, 2003.
- Brockett, L. P. (Linus Pierpont). *The Philanthropic Results of the War in America. Collected from Official and Other Authentic Sources, by an American Citizen*. New York: Sheldon, 1864.
- Bullock, Steven C. *Revolutionary Brotherhood: Freemasonry and the Transformation of the American Social Order, 1730–1840*. Chapel Hill: University of North Carolina Press.
- Burke, Aedanus. *Considerations on the Society or Order of Cincinnati*. Hartford, Conn.: Reprinted by Hudson and Goodwin, 1784.
- Channing, William Ellery. “Associations.” In *The Works of William E. Channing, D.D.* Boston: American Unitarian Association, 1900. Originally published in 1828.
- Cutlip, Scott M. *Fund Raising in the United States: Its Role in America's Philanthropy*. New Brunswick, N.J.: Transaction Publishers, 1900.
- De Tocqueville, Alexis. *Democracy in America*. Translated by Henry Reeve. New York: Knopf, 1945.
- Dickens, A. G. *The English Reformation*. New York: Schocken Books, 1964.
- DiMaggio, Paul J. “Cultural Entrepreneurship in Nineteenth-Century Boston.” In his *Nonprofit Enterprise in the Arts: Studies in Mission and Constraint*. New York: Oxford University Press, 1989.

- Donahue, John D. *The Privatization Decision: Public Ends, Private Means*. New York: Basic Books, 1989.
- Doyle, Don H. "Rules of Order: Henry Martyn Robert and the Popularization of American Parliamentary Law." *American Quarterly* 32, no. 3 (1980): 3–18.
- Dray, Philip. *At the Hands of Persons Unknown: The Lynching of Black America*. New York: Random House, 2002.
- Duffy, Eamon. *The Stripping of the Altars: Traditional Religion in England, c. 1400–c. 1580*. New Haven, Conn.: Yale University Press, 1992.
- . *The Voices of Morebath: Reformation and Rebellion in an English Village*. New Haven: Yale University Press, 2001.
- Fischer, David Hackett. *Paul Revere's Ride*. New York: Oxford University Press, 1994.
- Franklin, Benjamin. *Autobiography and Other Writings*. Edited by Ormond Seavey. New York: Oxford University Press, 1993.
- Hall, Peter Dobkin. "Faith, Practice, and Civic Engagement: A Historical Case Study." In *Religion and Democracy*, edited by Mary Jo Bane and Brent Coffin. Cambridge, Mass.: Harvard University Press. Forthcoming.
- . "Resolving the Dilemmas of Democratic Governance: The Historical Development of Trusteeship in America, 1636–1996." In *Philanthropic Foundations: New Scholarships, New Possibilities*, edited by Ellen Condliffe. Bloomington: Indiana University Press, 1999.
- Hamill, John. *Freemasonry*. London: Salamander, 1998.
- Hawley, Ellis W. "Herbert Hoover, the Commerce Secretariat, and the Vision of an 'Associative State.'" In *Men and Organizations*, edited by Edwin J. Perkins. New York: G. P. Putnam, 1977.
- Hoover, Herbert. *American Individualism*. Garden City, N.Y.: Doubleday, Page, 1922.
- Jordan, W. K. *The Charities of London, 1480–1660: The Aspirations and the Achievements of the Urban Society*. London: Allen and Unwin, 1960.
- . *The Charities of Rural England, 1480–1660: The Aspirations and the Achievements of the Rural Society*. New York: Russell Sage Foundation, 1962.
- . *Philanthropy in England, 1480–1660: A Study of the Changing Pattern of English Social Aspirations*. London: George Allen and Unwin, 1959.
- Marsh, Christopher. *Popular Religion in Sixteenth-Century England*. New York: St. Martin's, 1998.
- Mather, Cotton. *Bonifacius. An Essay upon the Good . . .* Edited by David Levin. Cambridge, Mass.: Belknap Press of Harvard University Press, 1966. Originally published in 1710.
- Mathews, Donald G. "The Great Awakening as an Organizing Process, 1780–1830: An Hypothesis." *American Quarterly* 21, no. 1 (1969): 23–43.
- McKinney, Hannah J. *The Development of Local Public Services, 1650–1860: Lessons from Middletown, Connecticut*. Westport, Conn.: Greenwood Press, 1995.
- Perrow, Charles. "Goals and Power Structures: A Historical Case Study." In *The Hospital in Modern Society*, edited by Eliot Friedson. New York: Free Press, 1963.
- Putnam, Robert D. *Bowling Alone: The Collapse and Revival of American Community*. New York: Simon and Schuster, 2000.
- Scott, Anne Firor. *Natural Allies: Women's Associations in American History*. Urbana: University of Illinois Press, 1991.
- Skocpol, Theda. *Diminished Democracy: From Membership to Management in American Civic Life*. Norman: University of Oklahoma Press, 2003.
- Starr, Paul. *The Social Transformation of American Medicine*. New York: Basic Books, 1982.
- Washington, George. "Sixth Annual Address to Congress (1796)." In *Basic Writings of George Washington*, edited by Saxe Commins. New York: Random House, 1948.
- Wayland, Francis. *The Limitations of Human Responsibility*. New York: D. Appleton, 1838.
- Webber, Carolyn, and Aaron Wildavsky. *A History of Taxation and Expenditure in the Western World*. New York: Simon and Schuster, 1986.
- Wuthnow, Robert. *"I Come Away Stronger": How Small Groups are Shaping American Religion*. Grand Rapids, Mich.: W. B. Eerdmans, 1994.
- Zollmann, Carl. *American Law of Charities*. Milwaukee: The Bruce Publishing Company, 1924.

Peter Dobkin Hall

VOODOO (VODUN). See **Religion: Africa; Religion: African Diaspora.**

VOTING. See **Democracy.**



W

WAR. How does one define a war? How can one distinguish between the war on drugs, the war on terrorism, jihad, anarchy, and wars between states? Definitions are relevant as they provide the rationale for considering a war legitimate and just and contribute to decisions about international interventions, aid, and protocol. This has become particularly important in contemporary international affairs, when the most prevalent conflicts have been nationalist and or ethnic in character and international terrorism has escalated. War has been defined in a number of ways: as “organized violence carried out by political units against each other” (Bull, p. 184); as “the legal condition which equally permits two or more hostile groups to carry on a conflict by armed force” (Wright, p. 698); and as “an act of force to compel our enemy to do our will” (Clausewitz, p. 75). These definitions encapsulate the notion of war as political, as organized violence carried out by a collective, and as ordered in that it has rules and customs of behavior. An underlying assumption is that war is a regular occurrence in the international arena and is an inevitable outcome of organized human societies.

This latter idea has been critiqued by Margaret Mead, who sees warfare as one of many inventions constructed to order our lives, in the same realm as “writing, marriage, cooking” and so on. War, like culture, takes on the veneer of an ancient tradition, something having historical depth, and has prevailed since early organized human societies. Mead suggests that war is an invented and learned activity and is not inherent to human behavior. The contending opinion emphasizes the “innateness” of human aggression, the consequences of which are sometimes violence and war. Without denying the complex interplay between genetic and environmental variables, these theories see human aggression as biologically driven. Humans fight over land, resources, and personal relationships in much the same way as other primates do, hence war in this perspective is not a social or cultural invention.

John Vasquez sees war as learned but also includes the notion that war comes out of a long-term process, is a product of interaction, is a way of making decisions, and is multicausal, and he recognizes that there are many different types of wars. Although this is a more comprehensive list of defining characteristics of war, the emphasis is on “interstate” wars and international peace and security.

Defining States as Warring Units

Should we assume states to be the main contending parties in war? Many influential definitions of war place states as a key variable. They assume that states are rational actors made up

of coherent territorial units with recognized leaders, governmental institutions, and discernable civil societies. However, in many of the major conflicts in the 1980s and 1990s, transnational activity reduced the significance of states as key actors. Post-Cold War central Africa and eastern Europe exemplify instances where intra- and interethnic conflicts within states sparked violent confrontations between states. Should these conflicts be classified as wars even though individual states did not declare war against other states? In some instances, belligerent ethnic groups within one state declared war on ethnic groups in another state, as in the Serbian Serb-Bosnian Muslim conflict in the former Yugoslavia from 1992 to 1995. In an attempt to answer the question of the types of nationalism that are most likely to cause war, Stephen Van Evera isolates four attributes: the movement’s political status with respect to statehood, its relationships with its national diaspora, its stance toward other nations, and its treatment of its own minorities. Using this scheme, it might be possible to evaluate the potential of a nationalist (or ethnic) conflict to escalate into a war. Theorists such as Van Evera have attempted to shift attention from states to nationalist movements as indicators showing the potential for war.

In other cases, there was no legitimate and overarching ruling authority within the state, as in Somalia from 1992 to 1994, when political anarchy prevailed and rival clan leaders battled each other. There refugees, guerrilla groups, and targeted factions fled across borders, initiating conflicts and instability in these regions. How should these conflicts be classified? If such conflicts are considered “domestic,” falling under the purview of sovereign states, then international interventions become extremely difficult. Given the regional instability that such conflicts produce, the devastation that follows, and the gross human rights violations that are committed, defining this as a national issue has many negative repercussions.

The havoc wrought by terrorists also challenges definitions of war. Highly skilled, trained, motivated, and ordered like soldiers in conventional armies, international terrorists have instigated some of our most intense wars. The U.S. invasion of Afghanistan in 2002 and Iraq in 2003 are good examples of the repercussions terrorists can invoke, in this case, the 9/11/2001 attack on the World Trade Center and the Pentagon. In pursuit of the masterminds behind the attacks, the United States believed that Osama Bin Laden (thought to be residing in Afghanistan) and Saddam Hussein (of Iraq) were key players, hence prompting the invasions. Should the citizenship of terrorists determine the belligerent state? Must we assume that all states are able to control all their citizens and



For the Common Grave, an etching by Francisco José de Goya y Lucientes from his *Disasters of War* series (1810–1820). The consequences of a war, whether it is considered justified or not, are often terrible, testing the humanity and mores of the participating combatants. © ARCHIVO ICONOGRAFICO

must take responsibility for their actions? How do we determine the target state when some terrorists have multiple citizenships and divided loyalties? Can we isolate a particular state as belligerent when some terrorists fight for political ideals and religious doctrines that transcend national state borders? Can we classify an attack by terrorists as an act of war? These questions challenge the assumption that states are the key units in war and challenge ideas of the causes and rules of war.

Jus ad bellum

Can war be morally justified? Most war doctrines include two considerations: first, the conditions under which one may have recourse to war (*jus ad bellum*); second, the rules and codes by which war may be conducted (*jus in bello*). The act of war, a license to kill, tests our adherence to morality, our acceptance of what we assume are human and civilized codes of behavior, our notion of the distinctions between the divine and the profane, our understanding of authority and legitimacy, and our sense of self- and moral consciousness. There are two main discourses dealing with *jus ad bellum*. The first makes a distinction between just and unjust wars, and the second makes distinctions between offensive and defensive wars.

St. Augustine of Hippo (354–430 C.E.) first grappled with the Christian ideal of love that prohibited killing and wounding in one's own defense but also obliged Christians to aid others, thus justifying the use of force on the aggressors. Yet Augustine did not provide a theory that isolated causes for a just war, nor did he suggest that a Christian cause was most just. Instead, he proposed that Christian ethics gave people and their leaders a capacity to know the moral limits of armed action but did not provide them with the attributes to “compare unerringly the over-all justice of regimes and nations” (Ramsey, p. 32). For Augustine, as all parties in war are engaging in wrongdoing, the warring parties cannot be divided into good versus bad, but rather Christian ethics provide guidance and the parameters for conduct in war of all parties involved.

St. Thomas Aquinas (1225–1274) expanded the idea of a just war and also initiated a shift from “voluntarism” to “rationalism” in understanding the nature of the political community, emphasizing a natural-law notion of justice (Ramsey, p. 32). According to Aquinas, a just war had three necessary requirements: declaration by a legitimate constitutional authority, a just cause, and the right intention. Francisco de Vitoria



United States soldier during Persian Gulf War. In 1990, Iraqi forces under the control of military dictator Saddam Hussein occupied the country of Kuwait, prompting the deployment of an international coalition of forces that repelled the invasion. © YVES DEBAY/CORBIS

(1486?–1546) and Francisco Suárez (1548–1617) added further conditions: the means of war should be proportional to the injustices being prevented or remedied by war, all peaceful means to remedy injustices should be exhausted, and the war should have a reasonable hope of success.

The recognized rules of *jus ad bellum*, as outlined by Aquinas and others, are often used to determine whether or not a war is justifiable. Some of the objections to these criteria are that they are overly subjective, leaving ample space for self-interested rationalization; that they rest on normative criteria about the nature of good and evil; that these categories were designed for evaluating the causes of war in the Middle Ages; and that in the nuclear age, with its emphasis on deterrence, they provide little guidance as to how to evaluate the “moral significance of different levels of threat and of risk” (Adeney, p. 97).

There are also those who question the very notion of war as having moral legitimacy. Reinhold Niebuhr, for example, argues that “Christianity should recognize that all historic struggles are struggles between sinful men.” Given this, he adds that “it is just as important to save what relative decency and justice the western world still has, against the most demonic tyranny of history” (Niebuhr, p. 35). Niebuhr recognizes that



“Sniper’s Alley” in Sarajevo, 1994. Shortly after the disintegration of Yugoslavia in 1991, Serbians in the region began a military campaign for ethnic supremacy. During the three-year-long battle, Serb forces laid siege to the Bosnian capital of Sarajevo, causing widespread destruction in the city. © CHRIS RAINIER/CORBIS

JUS AD BELLUM: UNITED NATIONS CHARTER OF 1945

Chapter 1, Article 2(4)

All Members shall refrain in their international relations from the threat or use of force against the territorial integrity or political independence of any state, or in any other manner inconsistent with the Purposes of the United Nations.

Chapter 7, Article 51

Nothing in the present Charter shall impair the inherent right of individual or collective self-defence if an armed attack occurs.

Chapter 7, Article 42

Should the Security Council consider that measures provided for in Article 41 would be inadequate . . . it may take such action by air, sea, or land forces as may be necessary to maintain or restore international peace and security. Such action may include demonstrations, blockade, and other operation by air, sea, or land forces of Members of the United Nations.

while war can never be morally justified, it might be the only way to safeguard liberal democratic values.

In reflecting on the morality of the Gulf War, several authors came up with different conclusions. George Weigel argues that opposing the aggression of Saddam Hussein's invasion of Kuwait was justified in both intention and execution according to the criteria set out by just-war theory. Jean Bethke Elshtain, on the other hand, argues that war cannot be justified merely by checking off the list of criteria associated with the just-war theory. Instead, she suggests that the theory begs us to pause, to think about the ramifications of war, and to show some skepticism and queasiness about war. Above all, she asks that in drawing the balance sheet for the Gulf War, we evaluate technological accuracy and military might alongside the devastation and long-term effects of war on Iraqi children and society.

The just-war mode of reasoning attempts to reconcile the requirements of national defense with the moral obligations of protecting the innocent. In the age of modern warfare, where nuclear deterrence is the most significant element in preventing wars, the ideas behind just-war theory require a lot of tweaking before it begins to make any sense at all. In evaluating the justifiability of a contemporary war, some of the rules pertaining to *jus ad bellum*, particularly the rules of proportionality and reasonable hope of success, are seriously challenged. With the capacity and probability of killing large numbers of innocent people in warfare, the tensions inherent between *jus ad bellum* and *jus in bello* become sharper.

When looking specifically at modern warfare, Bernard T. Adeney sees deterrence as an “embarrassment and a puzzle” with respect to just-war theory. In terms of the criteria laid out under *jus ad bellum*, deterrence appears to be the “only

possible means of resisting unjust aggression” (Adeney, p. 112). Yet deterrence has the inherent ability to violate the basis of *jus in bello*. The Catholic Church responded to the Gulf War in a statement that put the very idea of just war in peril. The theory of just war, they said, was “indefensible and has been abandoned. In reality—with the sole exception of a purely defensive war against acts of aggression—we can say that there are no ‘just wars,’ and there is no ‘right’ to wage war” (La civiltà cattolica, p. 118). For many pacifists, who recognize the existence of political conflict, war is an unjustifiable means of resolution.

Jus in bello

Can war be controlled? Carl von Clausewitz says war is an act of force, and “there is no logical limit to the application” of force (Clausewitz, p. 77). However, others see war as a social activity that demands social organization and control, requiring a military that uses violence with deliberation for political objectives. As instruments of the state, the military employs violence (or uses force) in a purposeful, deliberate, and legitimate manner. Two criteria that maintain order and military discipline in war are the general value system of culture and the presupposition that the cost of war should not outweigh its benefits.

Focusing on the notion that language reflects “the moral world and gives us access to it” and that “our understanding of moral vocabulary is sufficiently common and stable so that shared judgments are possible,” Michael Walzer makes an argument for moments when the rules of *jus in bello* can be overridden (Walzer, p. 52). In a “supreme emergency,” determined by the “imminence of danger” and the “nature” of the threat, one might be “required to override the rights of innocent people and shatter the war convention” (Walzer, p. 259). Nazism,

JUS IN BELLO

Hague Convention IV of 1907

Governs methods and means of warfare, such as weapons that are restricted and tactical battlefield restraints.

Geneva Conventions of 1949

Concerned with the protection of victims of armed conflict—defined as the wounded, sick and/or shipwrecked, prisoners of war and civilians.

1977 Protocol I Additional to the 1949 Geneva Conventions (Article 1[4])

Armed conflicts in which peoples are fighting against colonial domination and alien occupation and against racist regimes in the exercise of their rights of national self-determination, as enshrined in the Charter of the United Nations.

1977 Protocol II Additional to the 1949 Geneva Conventions (Article 1[1])

Covers conflicts that take place in the territory of a High Contracting Party between its armed forces and dissident armed forces or other organized armed groups which, under responsible command, exercise such control over part of its territory as to enable them to carry out sustained and concerted military operations and to implement this Protocol.

which represented the “ultimate threat to everything decent in our lives,” constituted a supreme emergency, and Walzer sees the decision by Winston Churchill to bomb German cities in 1940 as a legitimate and justifiable decision. Although the initial decision qualified as a supreme emergency, according to Walzer, the decision to continue bombing cities after 1942, when the Russians and Americans had entered the war, was not justified, and Churchill ought to have asked his army to resort to attacking legitimate military targets.

A justified war is not necessarily a just war, as we also need to be concerned about justifiable moral means of behaving in war. Most theorists argue that the ends justify or structure the means, in that if the cause is justified, the use of all necessary and appropriate means is also justified. But some see an independent standard for judging *jus in bello*, especially in prohibiting all intentional killing of innocent people. However, it is difficult to know exactly what the appropriate means are until the war ends. For example, because the U.S. military has not found the weapons of mass destruction purportedly manufactured in Iraq for use by terrorists and the Hussein regime, it is difficult to evaluate whether the destruction of property and deaths of civilians and soldiers was indeed justified in the U.S. invasion of Iraq in 2003. Justice in the waging of war (that is, the justifiability of the violence and killing that is intrinsic to warfare) is a necessary condition for *jus ad bellum* and *jus in bello*.

Contention over the parameters of *jus in bello* during the nuclear arms race invigorated the debate between realists and idealists in international relations. The characteristics of

human nature lay at the basis of contention. Drawing on Thucydides (d. c. 401 B.C.E.), Niccolò Machiavelli (1469–1527), and Thomas Hobbes (1588–1679), realists start with the premise that human nature is inherently bad, self-serving, evil, and desirous of power. States in the international system also reflect these characteristics and exist in a state of anarchy where war is constant and insecurity is the norm. In this perspective deterrence is one of the ways in which states can prevent wars, in that their military capabilities act as a deterrent against possible attack. For idealists, human nature is essentially good, and bad behavior is due mainly to evil institutions that encourage people to act selfishly. For example, Mahatma Gandhi (1869–1948) maintained that the means justified the ends, and in this perspective nonviolence and *Satyagraha* (soul-force) were the appropriate ways in which to achieve equality and a just system. Idealists believe that war is an international problem that requires collective, multilateral cooperation and diplomacy.

The notion of the appropriate means necessary to fulfill desired ends became particularly pertinent in the nuclear age. Some argued that if nuclear weapons were used in an all-out war scenario, it would be a “monstrously disproportionate response to aggression on the part of any nation” (U.S. Catholic Bishops, p. 103). The bishops argued that good ends could not justify “immoral means” and urged the superpowers to invest in diplomacy, peacemaking, and disarmament.

Other theorists have argued that nuclear deterrence is necessary if we are to defend our freedom and fundamental rights, that deterrence in fact works to prevent war and destruction.

Nuclear deterrence in this perspective is necessary to prevent war and to enable peace and security. John J. Mearsheimer adds that the Cold War period was largely peaceful because of the bipolar distribution of power, the “rough equality of military power between the two polar states,” and the presence of nuclear weapons that made deterrence “far more robust” (Mearsheimer, p. 9). Proponents of this view add that while we have to be judicious in the decisions to engage in war to preserve our values, we also have to develop military capabilities suited to our moral commitments. Although increasing military capacity might increase tensions, they act as a deterrent to possible attacks, but most importantly, they will be adequate means to defend our values if we are forced to do so.

International organizations that attempt to create a forum for international diplomacy and peacemaking have less significance in the realist perspective. John Gerard Ruggie argues that realism has failed to grasp the integral role of international institutions like the United Nations in promoting cooperative and multilateral ways of maintaining peace and preventing wars. Criticisms against the notion that nuclear deterrence is one of the strongest means of preventing wars are prolific. Although quite varied, many of them see world politics as socially constructed, that is, that international politics are social rather than material and that structures shape identities interests and behavior. Structures are considered “discourses” made up of shared knowledge, material resources, and practices. Here the emphasis is not on human nature but rather on the social relationships that are forged and the complex interplay between leaders, state structures, and civil society. Feminists critique the realist paradigm by questioning the “denial of female images and female-linked imperatives” in the foundational assumptions about human nature, the character of states, and the international system (Elshtain, “Just War as Politics,” p. 261). Even in just-war theory, men are considered the soldiers or just Christian warriors, while women are relegated to the private sphere, the “beautiful soul” who is peaceful, frugal, and self-sacrificing. A reevaluation of war and peace from a feminist perspective energizes the debate on the causes of war and appropriate and acceptable behavior during war. The use of rape as a weapon of war, used in Italy in 1943 and in Bosnia in the early 1990s, has become part of the international human rights agenda but is also crucial to determining the parameters of *ius in bello* and to the idea that with constantly changing “means” of war, the war conventions must be open to change as well.

See also *Christianity; Machiavellism; Peace; Terror.*

BIBLIOGRAPHY

- Adeney, Bernard T. *Just War, Political Realism, and Faith*. Philadelphia: American Theological Library Association; Metuchen, N.J.: Scarecrow Press, 1988.
- Bull, Hedley. *The Anarchical Society*. New York: Columbia University Press, 1977.
- Clausewitz, Carl von. *On War*. Edited and Translated by Michael Howard and Peter Paret. Princeton, N.J.: Princeton University Press, 1984.
- Elshtain, Jean Bethke. “Just War as Politics: What the Gulf War Told Us about Contemporary American Life.” In *But Was It*

- Just? Reflections on the Morality of the Persian Gulf War*, edited by David E. Decosse. New York: Doubleday, 1992.
- . ed. *Just War Theory*. New York: New York University Press, 1992.
- Johnson, James Turner. *Can Modern War Be Just?* New Haven, Conn.: Yale University Press, 1984.
- . *Just War Tradition and the Restraint of War: A Moral and Historical Inquiry*. Princeton, N.J.: Princeton University Press, 1981.
- La civiltà cattolica. “Modern War and the Christian Conscience.” Translated by Peter Heinegg. In *But Was It Just? Reflections on the Morality of the Persian Gulf War*, edited by David E. Decosse. New York: Doubleday, 1992.
- Mead, Margaret. “Warfare Is Only an Invention—Not a Biological Necessity.” *Asia* 40 (1940): 402–405.
- Mearsheimer, John J. “Back to the Future: Instability in Europe after the Cold War.” In *Theories of War and Peace: An International Security Reader*, edited by Michael E. Brown et al. Cambridge, Mass.: MIT Press, 1998.
- Niebuhr, Reinhold. *Christianity and Power Politics*. New York: Charles Scribner’s Sons, 1940.
- Ramsey, Paul. *War and the Christian Conscience: How Shall Modern War Be Conducted Justly?* Durham, N.C.: Duke University Press, 1961.
- Ruggie, John Gerard. “The False Premise of Realism.” *International Security* 20, no. 1 (Summer 1995): 62–70.
- U.S. Catholic Bishops. “The Challenge of Peace: God’s Promise and Our Response: The Pastoral Letter on War and Peace.” Reprinted in *Just War Theory*, edited by Jean Bethke Elshtain. New York: New York University Press, 1992.
- Van Evera, Stephen. “Hypotheses on Nationalism and War.” In *Theories of War and Peace: An International Security Reader*, edited by Michael E. Brown et al. Cambridge, Mass.: MIT Press, 1998.
- Vasquez, John A. *The War Puzzle*. Cambridge, U.K.: Cambridge University Press, 1993.
- Walzer, Michael. *Just and Unjust Wars: A Moral Argument with Historical Illustrations*. New York: Basic Books, 1977.
- Weigel, George. “From Last Resort to Endgame: Morality, the Gulf War, and the Peace Process.” In *But Was It Just? Reflections on the Morality of the Persian Gulf War*, edited by David E. Decosse. New York: Doubleday, 1992.
- Wright, Quincy. *A Study of War*. Vol. 2. Chicago: University of Chicago Press, 1942.

Movindri Reddy

WAR AND PEACE IN THE ARTS. Depictions of violence have been part of human culture for millennia. What began as an effort of early humans to come to terms with the awe-inspiring power of weapons to kill their prey, and thus sustain human life, or ward off danger (for example, the cave paintings of Altamira, Spain) has evolved into a complex social code to help us try to make sense of total war, which industrialization and the modern nation-state made possible during the twentieth century.

The Military Leader

The most common image of war is that of the military leader, typically depicted on horseback or in a chariot, leading his troops into battle, and vanquishing the enemy. Before the late

nineteenth and twentieth centuries, a king or an emperor had to be a skilled military leader in order to seek, obtain, and maintain political power. Thus, depictions of his military successes were an important means of demonstrating to his subjects and would-be challengers the king's legitimacy as a ruler. These images were displayed on the bas reliefs of public buildings and temples, and as statuary in public places where as many people as possible could see and admire their achievements. Such images were also created for private viewing, usually to remind the ruling elite of the king's power and legitimacy. Paintings commissioned by the king or emperor would show the leader in various idealized poses as brilliant battlefield commander or god-anointed ruler.

The Heroic Soldier

The second most commonly depicted individual in war art is the heroic soldier. In the Western world the characteristics of the archetypal hero were defined in Homer's ninth-century epic poems about the Trojan War, the *Iliad* and the *Odyssey*. The Homeric hero, as personified by Achilles, was courageous in battle, loyal to his friends and comrades, and quick to anger. He suffered grievous loss, sometimes even death, and was curiously attracted to the thrill of battle but was equally appalled by its horrifying consequences. In the visual arts the Homeric heroes were repeatedly depicted in the red and black figures of painted Ancient Greek pottery. The image of Ajax carrying the body of Achilles is particularly poignant as it reminds the viewer that death often accompanies heroic actions on the battlefield.

More commonly the hero has been depicted as the protector of society who symbolically defeats the enemy as snake or dragon, as demonstrated by the innumerable depictions of Saint George, who was adopted as the patron saint of England in the fourteenth century. Or the hero is depicted, often on horseback, leading his troops into battle with firm conviction of the high moral purpose of the battle about to be fought, as when William the Conqueror leads his troops into the Battle of Hastings (1066) in an early piece of war propaganda, the Bayeux Tapestry.

It was sometimes acknowledged that to be a hero one had to be a little bit mad. To willingly face physical harm or death and to be able to urge one's fellows to do likewise and to lead them into battle required a sense of commitment that might appear to verge on madness. Albrecht Dürer caught this in his copper engraving *Knight, Death, and the Devil* (1513), where the steadfast knight, accompanied by his loyal dog, looks intently forward, trying to avoid the distractions of Death, who brandishes his hourglass, and of the Devil, who leers at him.

Two countertypes stand in contrast to the model of the heroic soldier: the heroic female soldier, or "warrior queen," and the antihero. Many warrior queens who led nations but not armies into battle wished to show themselves the equal of their male counterparts, at least in works of art. A coronation painting of Empress Catherine II of Russia (r. 1762–1796) shows her on horseback, in uniform, holding a sword but with armed troops almost hidden in the background; Maria Theresa of Austria also wanted to be painted on horseback but, although

she brandishes a sword, she wears robes, not a military uniform, and sits side-saddle.

Actual warrior heroines like the ancient Briton, Boadicea, are depicted riding a chariot (a bronze statue by Thomas Thornycroft, 1902) or standing on a slight rise above her troops exhorting them to battle; Amazons were depicted on an equal footing with Greeks in art; Joan of Arc is often depicted wearing full armor but kneeling in prayer or standing with a battle standard, and less frequently on horseback. In India, the Rani of Jhansi, who led men into battle against the British in 1858, is depicted on horseback and brandishing a sword.

The Robin Hood of legend was the classic antihero—an aristocrat who donned the garb of ordinary peasants and took up their cause of opposing taxation and other feudal obligations while an absentee king fought in foreign wars. Courage and resistance are among the hallmarks of the antihero. John Simpson Kirkpatrick, an Australian soldier who served in the Gallipoli front (Turkey, 1915) in World War I, demonstrated his courage not by killing the enemy but by rescuing the injured, often under fire, and bringing them back to the first aid stations on the back of his donkey. The image of "Simpson and his donkey" became a potent one in photographs, posters, and, later, statues. It was used both as propaganda for Australian recruitment and as an antiwar statement of how one man turned his back on the killing and sought to save life.

Civilian Casualties in War

Jacques Callot's series of etchings *The Miseries of War* (mid-seventeenth century) was the first attempt to depict the impact of war on civilians. Callot's finely detailed etchings of war-ravaged Lorraine during the Thirty Years' War (1618–1648) show pillaged farm houses, burning churches, and the raping and killing of peasants by marauding soldiers and deserters. But this is not a thoroughgoing antiwar perspective; rather, it shows what happens when legitimate authority temporarily breaks down and soldiers become an ill-disciplined rabble as a result. A good Catholic and monarchist, Callot concludes his series with the just punishment and rewards meted out by the absolute monarch according to God's will, no doubt—the wicked soldiers are hung en masse and the well-disciplined officers get their monetary rewards and promotions.

Francisco Goya (1746–1828) achieves a more consistent antiwar perspective in his graphic depiction of the horrors of guerrilla warfare in Spain under the occupation of Napoleon's troops (1808–1813). His adoption of enlightened ideas of reason and the natural rights of man meant that Goya regarded as a crime and a disaster what others had accepted previously as inevitable, namely the killing of civilians. The particular circumstances of the guerrilla war in Spain brought this aspect of war into particularly sharp focus. His series of eighty-three etchings, *The Disasters of War* (1810–1814; published posthumously because of their radical perspective and graphic depiction of atrocities), documents the horrors committed by both sides—the Spanish people fighting a foreign occupying army and the French rooting out "terrorists" in order to bring the ideals of the French Revolution to an apparently unwilling populace.

THE WORLD WARS IN FILM

From the earliest years of moving pictures the topic of war provided exciting and attractive material. At first, directors “restaged” current events such as the Spanish-American War, the Boxer Rebellion in China, or the Boer War in South Africa in order to entertain and “inform” movie-goers. During World War I all sides rushed propaganda movies into production in order to show the enemy in the worst possible light and to bolster popular support for the war. The need of the modern military for intelligence and training required people skilled in photography, so it is ironic that many individuals who would go on to make war movies in the 1920s and 1930s (sometimes anti-war movies) got their training during World War I serving in military intelligence. One such individual was the American Lewis Milestone who went on to make the classic antiwar movie *All Quiet on the Western Front* (1930).

Important films about World War I include William Wellman’s *Wings* (1927) with its spectacular and thrilling aerial combat sequences; Milestone’s *All Quiet on the Western Front*, which defined the genre of the anti-war film for decades to come; Jean Renoir’s *The Grand Illusion* (1937), a subtle French film about how class, race, and language divide men even more than nationality; Stanley Kubrick’s *Paths of Glory* (1957), which shows how ambitious generals use war to promote their own careers at the expense of the enlisted men; Joseph Losey’s *King and Country* (1964), a grim film that questions the British policy of executing soldiers for suffering mental breakdown under extreme combat stress or “shell shock”; and Peter Weir’s *Gallipoli* (1981), which forces Australians to question the wisdom of fighting for the concept of “Empire” so far from home.

During World War II Hollywood threw its whole-hearted support behind the war effort and produced a large number of “combat films” designed to boost recruitment into the armed forces and morale on the home front. The formula for these movies was to take a diverse group of “typical Americans” (e.g., an Italian from New York,

a Texan, a midwesterner, a Californian, a Jew, an Hispanic, and so on) and show how they overcame their differences to become a coherent fighting unit dedicated to achieving the government’s war aims. Typical of this genre is *Bataan* (1943), directed by Tay Garnett, and *Guadalcanal Diary* (1943), directed by Lewis Seiler.

Only rarely toward the end of the war and occasionally afterwards did more critical and thoughtful films emerge that looked beyond the established stereotypes. John Ford’s *They Were Expendable* (1945) hints at the futility of what some men were asked to do, while Sam Fuller’s autobiographical film *The Big Red One* (1980) suggests that personal survival and loyalty to the platoon is what motivated men, not grandiose schemes dreamed up by politicians; Keith Gordon’s *A Midnight Clear* (1992), based upon William Wharton’s autobiographical novel set during the Battle of the Bulge in December 1944, suggests that fear, chaos, and incompetence determined the outcome of battle.

Hollywood continued to produce blockbuster movies about World War II well into the 1960s, until the Vietnam War began to sour the taste for celebratory war movies. *The Longest Day* (1962), directed by a committee of Andrew Marton, Ken Annakin, and Bernhard Wicki, based on the book by Cornelius Ryan about the Normandy invasion in June 1944, and *The Battle of the Bulge* (1965), also directed by Ken Annakin about the last counterattack by the Germans in December 1944, were the last gasp of this type of World War II movie.

The European and Japanese perspective on World War II was quite different, as one might expect. Societies that either had done the conquering and occupying (like Germany and Japan), or had been conquered, occupied, and then divided into resisters and collaborators (like the French, Italians, Poles, Russians, and so on) would be expected to see the war in a different light than the Americans, Britons, and Australians who had not been conquered and occupied.

(continued on the next page)

THE WORLD WARS IN FILM

(continued from previous page)

German war films about World War II have been understandably few and far between. In the last months of the Nazi regime, enormous resources were expended in the making of “historical films” like *Kolberg* (1945), directed by Veit Harlan; these were designed to rally the German people to one last stand against the “invading” allied armies by reminding them of successful heroic last stands put up by German Baltic towns like Kolberg as Napoleon was marching toward Moscow. But generally Germans preferred to forget the war years as they rebuilt their lives and enjoyed the benefits of the post-war economic miracle. Low budget films like Bernhard Wicki’s *Die Brücke* (*The Bridge*; 1959) sometimes appeared but they were rare. Wicki shows a group of conscript teenage boys forced to pointlessly defend a minor bridge against advancing American tanks as the Nazi regime crumbles. Death for all naturally ensues. Higher production values were used to make *Die Blechtrommel* (*The Tin Drum*; 1979), directed by Volcker Schlöndorff and based on the novel by Günter Grass, but the point it may have been trying to make is lost in the bravura performances of the cast. A major international success came with the submarine drama *Das Boot* (*The Boat*; 1981), directed by Wolfgang Petersen, which brilliantly shows the claustrophobic nature of submarine warfare in the Atlantic, but which completely clouds the issue of why men fought so desperately for the Nazi regime. It took an American director, Sam Peckinpah, notorious for his violent westerns, to take a German autobiographical novel about the appalling conflict on the Eastern Front and turn it into a film designed to debunk comfortable Hollywood films about World War II—*Cross of Iron* (1977). Its depiction of the brutal fighting on this front is only equaled by the Russian director Elem Klimov’s *Idi i smotri* (*Come and See*; 1985).

The French were also reluctant to confront the painful issues raised by defeat, collaboration, and

resistance. An early film by René Clément, *La Bataille du Rail* (1946), depicts French railway workers as resistance fighters, and thus by extension all French people as heroic, thereby glossing over the issue of collaboration or apathy. A later film by Clément, *Jeux interdits* (*Forbidden Games*; 1952), follows parentless children traumatized by the 1940 invasion of France as they retreat into parodies of Catholic death and the burial rituals, their subjects deceased farm animals.

The very few Japanese films about World War II did not appear until the late 1950s as the Japanese people, like the German people, either strove to forget the war or were prevented by the censorship laws of the occupying Americans, which forbade patriotic war films or films that were critical of the United States. Kon Ichikawa made a pair of disturbing films, *Biruma no tategoto* (*The Harp of Burma*; 1956), about a Japanese soldier in Burma who refuses to be repatriated with his unit at the end of the war until he has made amends by dressing as a Buddhist monk, searching out the unburied corpses of the war dead and burying them himself; and *Nobi* (*Fires on the Plain*; 1962), about a soldier who is trapped in the jungle by the advancing American forces in the Philippines, in February 1945, and is forced to endure hunger and disease rather than surrender. At the same time, Masaki Kobayashi made a nine-hour trilogy, *Ningen no joken* (*The Human Condition*; 1959–62), about a young man who worked as a manager in a mine in Manchuria that uses Chinese slave labor; he is conscripted to fight in the Imperial Japanese Army in China and endures the brutality of Japanese army discipline, and then, after the Japanese army collapses, is forced to walk back to his homeland to escape the advancing Red Army. After this very promising start, Japanese treatment of war in film virtually disappears as the “economic miracle” of the 1960s preoccupies everyone’s mind. So when distribution in 1990 is sought for *Blood Oath* (directed by Stephen Wallace, it is also known as *Prisoners of the Sun*), an Australian film about the

(continued on the next page)

THE WORLD WARS IN FILM

(continued from previous page)

brutal treatment of POWs on the island of Ambon in Indonesia, few Japanese people have ever heard of these events (Japanese school textbooks carry no mention of them) and no mainstream cinemas are willing to show the film.

After having dropped out of fashion due to the traumas resulting from the Vietnam War, the

World War II movie made a come-back in the late 1990s with Steven Spielberg's *Saving Private Ryan* (1998). This film cleverly combines many elements of the traditional World War II combat movie with just a hint of the criticism that had emerged previously in films like Fuller's *The Big Red One*, namely that men fight more for their immediate comrades and in order to survive, rather than for abstract, lofty ideals.

In the twentieth century the widespread use of the camera made possible the depiction of the impact of war, especially total war, on civilian populations in much greater detail: whole cities reduced to rubble by "carpet bombing" during World War II; a naked Vietnamese girl running toward the camera with her napalm wounds exposed; a room full of human skulls in Cambodia. In the early twenty-first century the small and cheap digital camera made possible the graphic depiction of the treatment of Iraqi prisoners in Abu Ghraib prison camp. Among the outright pornographic is the iconic image of a hooded and cloaked Iraqi with arms outstretched, Christlike, with wires from his extremities hooked up to some source of electricity. The camera is able to capture and reveal two extremes of war's impact—the personal and individual suffering that war causes, and the panorama of mass destruction—but the middle ground seems to be missing.

Photographic images that have become closely associated with the Holocaust are pictures of rooms full of victim's shorn hair, spectacles, shoes, empty suitcases, and boxes of gold fillings extracted from inmates' teeth—the by-products of the industrialized process of killing human beings and recycling their property. In camps like Theresienstadt, art work by inmates was sometimes officially commissioned or tolerated by the Nazis as a useful diversion. In other camps, making sketches or drawing was strictly forbidden, and inmates were severely punished if they were caught. Yet, many did make a visual record of their experience in the camps, and some returned to the topic in paintings they made after the war ended. The themes dealt with by camp artists include portraits, images of daily hardships, images of death and dying, and gallows or black humor. The art produced in the Nazi camps is extraordinary testimony to the will to survive of human beings and to the deeply felt need to document human experience.

The atomic bombing of Hiroshima and Nagasaki, Japan, by the United States in World War II also gave rise to new images of war. The image of the mushroom-shaped cloud produced by the explosion of an atomic bomb is now universally recognized. What is less well known is the art produced by the people on the ground who lived through the explosion. In 1976 the Japanese Broadcasting Corporation, NHK, collected images drawn by survivors of the atomic bomb blast. The

pictures (published in *Unforgettable Fire*), all drawn by amateur artists, provide a moving and very different set of images of atomic warfare. A number of images that appear repeatedly in their work include bloodshot and bleeding eyes; people walking about naked; and people walking about with what appear to be rags or cloth draped over their bodies but which are in fact sheets of burnt skin that have peeled away. Many walked with their arms outstretched, held away from their body in order to prevent the burnt flesh from rubbing. In Japanese culture, this is the way ghosts walk. The atomic bomb victims had been transformed into living ghosts.

In spite of the camera's success in capturing the experience of war in the twentieth century, perhaps the most powerful and best-known depiction of innocent civilians in war is Pablo Picasso's mural *Guernica* (1937), inspired by the bombing of a Basque town by German fighter bombers serving with the Nationalists during the Spanish Civil War. In a complex, triangular structured painting Picasso depicts burning houses surrounding a square, a woman calling out a warning to others, a mother holding her dead baby, a woman running from the mayhem, a fallen and broken statue of a warrior, a stabbed and screaming horse. In spite of the fact that much worse atrocities against civilians were perpetrated and depicted in the second half of the twentieth century (or perhaps because of it), the power of this painting still shocks nearly seventy years after its creation.

The Ordinary Soldier in Battle

Like civilians, the ordinary soldier was largely invisible in war art until the nineteenth century. Only when mass conscript armies of citizens took to the field after the French Revolution and the Napoleonic Wars had revolutionized the nature of warfare did artists and photographers begin to take notice. The emergence of mass circulation newspapers, the technology to cheaply reproduce sketches and photos, a reading public interested in the fate of their fathers and sons on the battlefield, and a growing liberal concern for the welfare of the ordinary soldier, were also contributing factors.

During the American Civil War, artists like Winslow Homer (1836–1910) produced a steady stream of illustrations of battles (usually not personally witnessed but reconstructed

afterward) and of the life of the ordinary soldiers in their camps. Many of these camp illustrations show the boredom of soldiers with nothing to do while they wait for the next bloody battle. Photographers like Matthew Brady, Alexander Gardner, and Timothy H. O'Sullivan revolutionized the depiction of war with their images of the dead littering the battlefield, or of the execution of rebels by hanging.

World War I produced a number of gifted war artists whose visual record of the war is significant. Among these is the German graphic artist Otto Dix, who served from 1914 to 1918 and saw action on the Western Front. His most interesting work consists of a set of fifty etchings simply called *Der Krieg* (1924; *The war*) and some oil paintings, especially the disturbing *War Triptych* (1929–1932). Iconic images of World War I include the desolation of the landscape caused by the incessant shelling and the digging of trenches along the Western Front. In *Der Krieg* Dix shows how ordinary soldiers dealt with these appalling conditions—they became one with the earth in both death and life. In death their bodies were literally consumed by the soil and the worms (the worm-riddled *Skull*); in life they spent their lives covered in dirt and living in holes and trenches dug in the earth (*Feeding-Time in the Trench*). The only hope for life seems to be the flowers and worms that grow out of the craters and skulls of men. In the *War Triptych* Dix takes the traditional Christian image used to portray the life, death, and resurrection of Christ and applies it to the front-line soldier in the trenches.

The experience of ordinary soldiers who were captured by the enemy was largely hidden from public view during World War II and did not surface until well after their release. Cameras were forbidden, of course, and those prisoners who were caught keeping diaries or making sketches were severely punished. Nevertheless, some prisoners of war (POWs) were able to keep their diaries and sketches and publish them after the war. British soldier-artists such as Ronald Searle and Jack Chalker, captured after the fall of Singapore in 1942, were sent to work building the Thai-Burma railways as slave workers for the Imperial Japanese Army. In their art they document the brutal treatment the POWs received as many of their comrades were worked to death. They produced images that have a number of similarities to those produced by European victims of the Nazi Holocaust—emaciated, sick bodies lying on flimsy beds and brutal captors with batons and rifle butts ready to beat them. Of the 60,000 POWs who worked on the railway nearly one third died. Not surprisingly, their anger at their treatment tinges their art with racist depictions of their oppressors.

Bringing War to an End

The formal ending of a state of war is commonly achieved by means of a surrender, armistice, or peace treaty. For the losing party there is no pleasant way to accept defeat. For the victor, there is an opportunity for propaganda, as a number of works of art demonstrate. The seventeenth-century Spanish painter Diego Velasquez was commissioned by the Spanish court to contribute to a series of victory paintings during the Thirty Years' War. His *Surrender of Breda* (1634–1635) shows Justin of Nassau handing the keys of the besieged Dutch city of Breda to the marchese Spinola in 1625 after the city had

endured a terrible ten-month siege. Both men have their hats off, as equals might greet each other, and the Spaniard has his arm on the Dutchman's shoulder in a conciliatory gesture. Given the impact of a siege on a civilian city such a gesture might seem somewhat inadequate, but it was how the Spaniard wished to be seen in victory.

A less generous depiction of a surrender, but no less propagandistic, is a popular Japanese woodcut that shows the Russian surrender of the fortress of Port Arthur to the Japanese in 1905, also after a long siege. The Japanese officers stand with their hats on under the shelter of a tent that flies the Japanese flag. The Russian officers stand humiliated in the snow outside the tent with their hats off submissively, waiting to sign the surrender papers. The battle is significant because it was the first time an Asian military power had defeated one of the great powers of Europe. Thus the Europeans had to be humiliated as well as defeated.

The humiliation was returned forty years later, when the Japanese formally signed surrender documents on the deck of the U.S. battleship *Missouri* on 2 September 1945. The official American military photograph shows the Japanese party literally surrounded by Allied personnel as they approach the signing table. Immediately above them and to the side, dozens of American enlisted men sit on the ship's giant guns with their feet dangling over the side. They will not show any respect by standing for the Japanese delegation. Directly overhead, at the moment of the signing, 400 B-29 bombers and 1,500 naval fighters flew past, drowning out all words. The surrender was total, unconditional, and utterly humiliating.

The American painter Winslow Homer took a different approach to the end of war. In *The Veteran in a New Field* (1865), a Northern veteran has taken off his jacket and canteen and put them to one side. He has taken up a scythe and begins to harvest a field of wheat. We can imagine that, like the Roman leader Cincinnatus (b. c. 519 B.C.E.), who left his farm to assume the dictatorship of Rome and defend it from its enemies only to relinquish that power and return to his farm, this veteran has turned his back on war and taken up peaceful and productive agricultural labor. The image brings to mind the biblical verse: "And they shall beat their swords into ploughshares, and their spears into pruning hooks; nations shall not lift up sword against nation, neither shall they learn war any more" (Isaiah 2:4).

See also Arts; Cinema; Gender in Art; Humanity in the Arts; Pacifism; Peace; War.

BIBLIOGRAPHY

- Basinger, Jeanine. *The World War II Combat Film: Anatomy of a Genre*. New York: Columbia University Press, 1986.
- Bohm-Duchen, Monica ed. *After Auschwitz: Responses to the Holocaust in Contemporary Art*. Sunderland: Northern Centre for Contemporary Art, 1995.
- Chipp, Herschel B. *Picasso's Guernica: History, Transformations, Meaning*. Berkeley: University of California Press, 1988.
- Cochrane, Peter. *Simpson and the Donkey: The Making of a Legend*. Portland, Ore.: International Specialized Book, 1992.
- De Silva, Amil, and Otto von Simson, eds. *War and Peace*. Vol. 1 of *Man through His Art*. London: Educational Productions, 1963.

- Doherty, Thomas Patrick. *Projections of War: Hollywood, American Culture, and World War II*. New York: Columbia University Press, 1993.
- Eberle, Matthias. *World War I and the Weimar Artists: Dix, Grosz, Beckmann, Schlemmer*. New Haven, Conn.: Yale University Press, 1985.
- Fox, Robert. *The Hulton Getty Picture Collection: Camera in Conflict: Armed Conflict*. Köln: Könemann Verlagsgesellschaft, 1996.
- Fraser, Antonia. *The Warrior Queens*. New York: Knopf, 1989.
- Gassier, Pierre. *Goya: A Witness of His Times*. Translated by Helga Harrison. Secaucus, N.J.: Chartwell, 1983.
- Kelly, Andrew. *Cinema and the Great War*. New York: Routledge, 1997.
- Moyes, Norman B. *Battle Eye: A History of American Combat Photography*. New York: Metro, 1996.
- Schonberger, Howard et al., trans. *Unforgettable Fire: Pictures Drawn by Atomic Bomb Survivors*. Tokyo: Nippon Hoso Shuppan Kyokai, 1977.
- Warner, Marina. *Joan of Arc: The Image of Female Heroism*. Berkeley: University of California Press, 1999.
- Welch, David. *Propaganda and the German Cinema, 1933–1945*. Oxford: Clarendon Press, 1989.
- Woodford, Susan. *The Trojan War in Ancient Art*. Ithaca, N.Y.: Cornell University Press, 1993.

David M. Hart

WEALTH. Wealth has been viewed as a blessing and as a curse; as a prerequisite of virtue and an embodiment of vice; as an expression of merit and of fault. This nonexhaustive list illustrates that not only is the history of wealth a history of contention, it is also intimately bound up with moral evaluations. These differing evaluations themselves indicate a range of divergent cultural judgments. “Wealth,” however, is not simply an item of moral discourse. It has a central place in political and economic vocabularies. While there is, perhaps, a core linkage with the notion of “resources,” that itself is an elastic category, referring to “goods” both tangible and immaterial (such as clean air, a healthy environment, and general quality of life). Wealth with all its cultural and ethical connotations is applied descriptively to an individual (the “rich man”), to a group or class of individuals (“the wealthy”), and to a country or, as in the title of Adam Smith’s famous book, to nations.

With this range of reference it is unsurprising that most of the established “great thinkers” in what is unreflectively labeled the “Western tradition,” from Aristotle to St. Thomas Aquinas to Jean-Jacques Rousseau to Karl Marx to Thorstein Veblen, have had something to say on the topic. But the issues and debates are neither exclusively Western nor intellectual. Most of the great religions include in their teaching some reference to wealth, though not without manifesting the idea’s contentiousness. In addition, wealth plays a ubiquitous role in social and cultural life from grave goods to potlatch ceremonies. An attempt will be made in this entry to represent this range of concern, though its major focus will be on the place of wealth in Western intellectual debates.

The entry is organized along two axes—thematic and chronological. Thematically, the discussion is organized in

terms of two basic associations—wealth and virtue, and wealth and power. Each theme is explored in rough chronological order—charting the history of wealth’s interactions with virtue and with power. Throughout these explorations three questions will implicitly recur: What is wealth? that is, what is supposed, in different times, with respect to virtue and power, to constitute it; Who has it? that is, what is supposed similarly about its distribution; and, closely related, Why or on what grounds does X rather than Y have that item of wealth? that is, what is supposed to justify or legitimate the distribution.

Wealth and Virtue

Historically the association between wealth and virtue has been viewed both positively and negatively. These will be examined in turn.

Positive. Aristotle (384–322 B.C.E.) identifies “liberality” as a virtue that is the mean between prodigality and illiberality. The context is money or wealth. The liberal man (the gender is not incidental) will “give with a fine end in view, and in the right way; because he will give to the right people, and the right amounts, and at the right time” (Aristotle [1976] p. 143:1120a25). When acting liberally, it is the disposition that matters, not the sum or sort of resources. Though giving is more virtuous than receiving, nonetheless, the “liberal” will accept wealth under similar constraints. The most important source of wealth is the ownership of property, especially landed property. This ownership is associated with other estimable traits such as responsibility, prudence, and steadfastness. By exercising these virtues, wealth qua landed property is sustained so that, accordingly, there are resources available with which to act liberally. Importantly, wealth thus understood imposes obligations; it does not reflect an acquisitive mentality and it is not valued for its own sake.

Although worked up theoretically by Aristotle, this link between wealth and obligation and the stress on the use made of wealth is pervasive. The early Christian theologian St. Clement of Alexandria (c. 150–between 211 and 215) does not subscribe to the asceticism prescribed by many of the church fathers but, nonetheless, instructs that wealth is to be used for charitable purposes and not retained possessively. This is echoed in the Koran, and, somewhat similarly, in Hindu teaching wealth (*artha*) needs to be cultivated but by virtuous means so that the wherewithal is possessed that goodness may be exercised. This is an attribute of many cultures. The form this often takes is of hospitality. The Israelites in the Old Testament are enjoined to give succor to the improvident, while for Kalahari bushmen, and many others, wealth exists to be shared. In these latter examples it is less that wealth calls forth individual virtue than it manifests a cultural norm of reciprocity. In both cases, however, wealth is justified as a means to further good ends.

This understanding of the importance of wealth, and its justification, has endured beyond its presence in Aristotelian theory and cultural practice. Only if one is wealthy can generosity or charity—whether by the Good Samaritan or by millionaires—be exercised and only if a society is wealthy can it support extensive welfare programs. In a just society, according to

John Rawls (1921–2002), the wealth enjoyed by the more fortunate, as a consequence of arbitrarily distributed natural talents, could be viewed as a “collective asset” to be used, once freedom has been accorded priority, to further the interests of the worse-off (p. 179). However, supporting welfare need not mean collective provision. F. A. Hayek (1899–1992) justified retaining wealth within families as an expression of freedom, which includes making responsible welfare decisions. This was also an essential means to prevent the concentration of wealth in the hands of the state.

Hayek is here making a consequentialist case for inheritance. This pays little attention to the source of wealth, but a positive case for wealth is that its possession is the deserved outcome of the virtue of industry or hard work. The Protestant ethic, as articulated by Max Weber (1864–1920) in his *Die protestantische Ethik und der Geist des Kapitalismus* (1920; *Protestant Ethic and the Spirit of Capitalism*), psychologically compelled the “elect” (those chosen for salvation by God) to seek proof of their election. This took the form of diligence and industriousness, which led to success in worldly activity, but since waste was also proscribed, and frugality prescribed, it meant that wealth was accumulated. In a historically important argument, John Locke (1632–1704) developed a version of this. He argued that God enjoined everyone to be industrious and that through mixing their labor (as he termed it) to natural resources they were entitled to the fruits of that labor as their private property. Provided they did not accrue wastefully all the resources to themselves, the inequality of holdings derived from greater industry was justified. Nonetheless, true to his own Nonconformist (Calvinist) background, Locke also held that if people lived providently without the desire for luxuries then wealth would be increased even more. Locke here broaches the negative link between wealth and virtue.

Negative. While Aristotle does link wealth with virtue positively, his more sustained and influential argument (in the *Politics*) is that the former can lead to a corruption of the latter. Wealth and its maintenance is properly an attribute of household management (of economics, *oikonomikē*), its purpose being to give the male head of the household the freedom to act virtuously—not only via liberality but also via participation in the affairs of the community (the polis), an activity that is natural since man is by nature a political animal. Wealth is limited to this instrumental function. However, it is liable to transgress those limits. Some exchange is permissible, when it serves to meet the naturally limited consumption needs of the household, but once it is undertaken for its own sake, and not as a means to an end of consumption, then it becomes money-making (*chrēmastikē*). This activity can be engaged upon without limit. There is a natural limit, for example, to how much food can be consumed but not to how much money is possessed. A transgression of the proper purpose or end of activity represents a corruption, a perversion of virtue.

This moral critique of wealth has been enormously influential. One particularly potent occurrence was its linkage with the fall of the Roman republic. Originally austere virtuous, the republic became corrupted once riches were imported from abroad (“Asia”). This wealth-induced corruption in the form

People look for a different kind of wealth and wealth acquisition and rightly so for natural wealth and wealth acquisition are different. Natural wealth acquisition is a part of household management, whereas commerce has to do with the production of goods, not in the full sense, but through their exchange. . . . The wealth that derives from this kind of wealth is without limit.

SOURCE: Aristotle, *The Politics*, trans. C. Reeve (Indianapolis: Hackett, 1998), 14, 17 [1256b27–33, 1257b16–25].

of avarice and luxury was condemned by Stoic moralists such as Seneca (4 B.C.E.–65 C.E.) or Epictetus (c. 55–c. 135 C.E.) and was illustrated through the normatively loaded narrative of historians of Rome like Sallust (86–35 or 34 B.C.E.) and Livy (59 B.C.E.–17 C.E.). The latter, for example, opened his *History of Rome* by contrasting Rome’s virtuous beginnings with the ruin that the influx of wealth or riches (*divitiae*) had wrought. The undermining of Roman virtues by the spread of wealth and luxury also became the object of satirical poets like Horace (65–8 B.C.E.) and Juvenal (c. 55 or 60–in or after 127 C.E.). Due to the importance that a “classical education” had in the pedagogy of Europe from the Renaissance onward, the “fall of Rome,” and the role of wealth therein, became a clichéd commonplace.

This culturally received wisdom was abetted by the appropriation, for their own end of demonstrating the transience and superficiality of worldly goods, by Christians. The early Christians, such as Saints Ambrose (339–397), Augustine of Hippo (354–430), and John Chrysostom (c. 347–407), took up this moral critique of wealth. It was an important source of their advocacy of asceticism but it built also upon Paul’s (who was himself influenced by the Stoics) pronouncement in his Epistle to Timothy that the love of money was the root of all evil. The message was reiterated by Thomas Aquinas (1225–1274) and by other Christian philosophers upon the rediscovery of Aristotle’s works. It received a significant boost in the republican tradition that was reenergized by Niccolò Machiavelli (1469–1527), though here the “political” rather than the moral dimension (see below) is dominant. Much the same can be said of Jean-Jacques Rousseau (1712–1778), perhaps the last great exemplar of this tradition.

This critique was responsible for significant ripostes. David Hume (1711–1776)—followed by his fellow Scot, Adam Smith (1723–1790)—turned the tables. Hume, in his essay *Of Luxury* (1752), linked virtue with wealth, and not with ascetic poverty, and identified this linkage as the definitive characteristic of ages of refinement or commerce. He stressed both the intrinsic benefit of the pleasure that accrued from being

The natural effort of every individual to better his own condition, when suffered to exert itself with freedom and security, is so powerful a principle, that it is alone, and without any assistance, not only capable of carrying on the society to wealth and prosperity, but of surmounting a hundred impertinent obstructions with which the folly of human laws too often incumbers its operations.

SOURCE: Adam Smith, *An Inquiry into the Nature and Causes of the Wealth of Nations*, ed. R. Campbell and A. Skinner (Indianapolis: Liberty, 1976), vol. 1, p. 540.

able to enjoy goods that gratified the senses and the great instrumental benefits that came from the industry that was undertaken to obtain the wealth that permitted such goods to be enjoyed. The commercialism that Hume and others defended has not been without critics. In the twentieth century it expressed itself in the critique of consumerism. In an effective rerun of Aristotle, the acquisition of goods, the accumulation of wealth, or what C. B. Macpherson (1911–1987) labeled the legitimization of possessive individualism, has been subject to condemnation. A culture committed to consumerism is judged deleterious to the individual who, lacking a proper instrumental perspective, is at the mercy of the fads of fashion and the interests of those who benefit from the manufacture of demand. It is also bad for society because it embodies a misdirection of resources away from societally advantageous investment and entrenches the gap between wealthy and poor economies. The celebration of consumption and the desire to emulate the supposed spending power of the rich also led, in the latter decades of the twentieth century, to the development of “Green” thought, which argues that this entire emphasis on gratification is practically disastrous for the environment and symptomatic of a hubristic arrogance toward Nature. E. F. Schumacher (1911–1977), for example, advocated, in his popular essay *Small Is Beautiful* (1973), what he termed Buddhist economics as a way to halt this degradation.

Wealth and Power

In all stratified societies (which includes virtually all societies for which records exist) the hierarchy is significantly determined by differential access to, and possession of, wealth. To be wealthy enables one to exercise economic and political power. This exercise is frequently related to the question of virtue. Hence the resources at the disposal of Aristotle’s “liberal man” stemmed from what was under his control. Sociologically this man was the head of the household whose position rested upon his command of his wife and slaves as they created the “leisure” time for him to pursue intrinsically

worthwhile ends. True wealth for Aristotle consisted in a store of goods that were sufficient for life and useful for the good life. This wealth had to be secure and it was best obtained through land ownership in marked contrast to the insecure foundation of commerce and money.

This secure source of wealth sustained political independence. This association between landed wealth and political activity has been one of the most historically enduring linkages. The crux of the corruption of Rome was held to be the replacement of a commitment to the public good, which was sustained by relative equality and independence, by a devotion to private satisfaction, which followed from the emergence of the rich, who used their wealth to advance their own personal ambition. Machiavelli drew an evocative picture of this pattern as it appeared in Renaissance Italy. He depicted the gentry (*gentiluomini*) as “a pest” because they use their wealth to hire others to work for them. Crucially these hired hands, being dependent on their masters for their livelihood, could be used to support their selfish ambitions. The only way to end this corrupting dependency is to (re)establish equality through fostering a sense of civic virtue. To further this objective, Machiavelli advocated, drawing on Roman precedents, an Agrarian law that precluded the accumulation of large estates. Other republicans took a similar line. James Harrington (1611–1677) went into minute detail in his imagined constitutional republic of *Oceana* (1656). In Rousseau’s legitimate polity there should be a level of equality such that no one is wealthy enough to be able to create dependents and no one poor enough to become dependent on others. With the economic structure in this way forestalling the emergence of dependency—creating differential wealth, there is more chance, he believed, that acting for the common good (or willing “the general will”), rather than out of private self-interest, will occur.

In Rousseau’s republican vision political power was possessed by equal citizens, but that meant it was restricted to those who were independent. On that criterion Aristotle excluded from citizenship slaves, manual laborers, and women (also excluded by Rousseau) and, when it came to the franchise, the exclusion of the latter two categories lasted into the twentieth century. It was a received commonplace that the privilege of political citizenship (the right to vote for a representative as well as to be a representative) required sufficient wealth to ensure economic independence. It followed that those economically dependent were without a direct political voice. In the eighteenth century Edmund Burke (1729–1797) defended the restricted franchise on the grounds that only those individuals with a direct stake in the country could be entrusted with its well-being. Thanks to their economic status they were able to exhibit the crucial political virtues of “constancy, gravity, magnanimity, fortitude, fidelity and firmness” (p. 427). Burke explicitly called these masculine virtues, but their possession meant that the interests of women, as well as the bulk of the disenfranchised population, would be properly looked after. Certainly the schemes for greater equality that were fomented by the Revolution in France would be disastrous. Much of the political history of the nineteenth century concerned the continual redefinitions of what constituted economic independence (and later how women were to be accommodated).

This history, and the surrounding debates, not only saw the increasing articulation of a modern idea of democracy but also the growth of socialism. Of course, the effect of the possession of wealth on sustaining dependency was not a uniquely Western phenomenon. The *jajmani* caste system in southern India (especially) operated in such a way that the lowest caste, in exchange for the lease of land owned by members of the high caste, had to provide the latter with labor service and a portion of their crop output. The fact that the caste system was integral to the belief systems of Hindus did not make it immune to criticism. Some of these criticisms were internal (as by Dayananda Sarasvati [1824–1883] or Mahatma Gandhi [1869–1948]), but the challenges to such inequality that the Western ideas of democracy and socialism articulated were also influential.

The socialist critique. The most powerful Western voice was Karl Marx (1818–1883). Marx saw the key to history in the association between wealth and power. The source of wealth for Marx lay in ownership of what he called the forces of production. These had developed over time from slaves (human labor) to land to capital. Those who owned the forces—slave owners, landlords, capitalists, or bourgeoisie—were able because of that control to rule over nonowners—slaves, serfs, the proletariat. Ownership appears to be legal title, but law for Marx is part of society’s “superstructure,” which is determined by the economic base. Political power, which is used to enforce legal title, also upholds the interests of the dominant economic power; in a celebrated phrase, “the executive of the modern State is but a committee for managing the common affairs of the whole bourgeoisie” (Marx and Engels, p. 475). These interests are for Marx obviously opposed to the interests of those without economic power, and history reveals a struggle between the class of the owners of wealth and the class of nonowners.

Marx devoted most attention to the contemporary struggle within capitalism. His major work, *Das Kapital* (1867; *Capital*), identified the particular form that wealth took under that mode of production. The rationale of capitalism was accumulation. For Marx, the only source for this was the “surplus value” extracted from the worker in the process of production. The exchange-value received in the form of wages by the worker for “his” labor-power is less than the exchange-value received by the capitalist for the commodity made by that power. This exploitative extraction was disguised because the level of wages appeared to be the consequence of a free contract between employer and employee. While Marx saw the initial source of the wealth in the blatant form of expropriation, forcing the landless into factories, the capitalists’ ongoing accumulation of wealth was derived from this exploitation inherent to the system. However, he argued this was an unsustainable and self-defeating process that resulted in the immiserization of the workers whose labor-power was the source of accumulation. That misery, he predicted, would generate a proletarian revolution and the ushering in of a communist society. Here (though Marx was not very forthcoming) there would be equality and sufficient wealth to be shared since production would be geared to meeting needs, not accumulation.

Although Marx’s predicted revolutionary trajectory did not transpire, revolutions did occur in his name. These inspired a

The greater the social wealth, the functioning capital, the extent and energy of its growth, and, therefore, also the absolute mass of the proletariat and the productiveness of its labor, the greater is the industrial reserve army. The same causes which develop the expansive power of capital, develop also the labor-power at its disposal. The relative mass of the industrial reserve army increases therefore with the potential energy of wealth. . . . This is the absolute law of capital accumulation. . . . Accumulation of wealth at one pole is, therefore, at the same time the accumulation of misery, agony of toil, slavery, ignorance, brutality, mental degradation, at the opposite pole.

SOURCE: Karl Marx, *Capital*, trans. S. Moore and S. Aveling. In *Marx Engels Reader*, 2nd ed., ed. R. Tucker (New York: Norton, 1978), 429–431.

vast literature both in lands like Russia (in the form of Leninism) and China (Maoism), where these revolutions were sited, as well as in the West, where Marx’s ideas were the dominant source of criticism of capitalism. Increasingly these critiques paid less attention to Marx’s economic analysis and more to his early philosophical writings, with their focus on alienation. While the issue of wealth correspondingly lost some of its salience, the association between the economic and the political was resilient. The universalizing power of capitalism, which Marx did predict, seems to have been reinforced since 1989 and the fall of the Soviet Union. One prominent expression of this has been debate on the meaning and morality of “globalization.” The focus has been on the relative impotence of national governments when confronted by worldwide markets and the power of the institutions of global finance like the World Bank and the International Monetary Fund. The least powerful are the least wealthy (the most indebted), effectively the non-Western world.

Mercantilism and its critique. Marx was not original in seeing historically a development between wealth and economic-political power. Adam Smith had argued that societies (though not universally and unexceptionally) went through four stages—hunting/herding, herding, farming, and commercial. In each case there was a system of subordination, which, although based on personal qualities in the first stage, in the next two rested on control of the dominant means of wealth, that is, of herds and land. He was explicit that government was instituted to protect the propertied (the owner of the herds and of the land) against those without property. The fourth commercial stage saw a difference because the impartial rule of law was established to

In order to gain and to hold the esteem of men it is not sufficient merely to possess wealth or power. The wealth or power must be put in evidence, for esteem is awarded only on evidence. And not only does the evidence of wealth serve to impress one's importance on others and to keep their sense of importance alive and alert but it is scarcely less use in building up and preserving one's self-complacency. . . . Abstention from labor is the conventional evidence of wealth and is therefore the conventional mark of social standing; and this insistence on the meritoriousness of wealth leads to a more strenuous insistence on leisure. . . . According to well-established laws of human nature, prescription presently seizes upon this conventional evidence of wealth and fixes it in men's habits of thoughts as something that is itself substantially meritorious and ennobling.

SOURCE: Thorstein Veblen, *The Theory of the Leisure Class* (New York: Dover, 1994), 42, 44–45.

provide a formal equality. In his *Wealth of Nations* (1776) he analyzes the basis of wealth in the modern world. Part of his task was to assault the then dominant understanding of the linkage between wealth and economic-political power.

According to this prevalent view (usually labeled “mercantilism”), as expressed by Thomas Mun (1571–1641), the way to increase wealth is “to sell more to strangers yearly than we consume of theirs in value” (p. 125). Mun distinguished between natural wealth, essentially minerals and direct agricultural products, and artificial wealth, which was the manufacture of materials (clothing rather than wool or flax). He thought more profit (exports) could be earned from the latter source. To achieve this it was necessary—and this is central to the mercantilist view—to maintain a favorable balance of trade. This maintenance needed to be managed or regulated and, as such, had to be an item of policy, the ultimate objective of which was the promotion of the wealth, and thence of the power and security, of the state. Indeed, the very idea of the “state” as an impersonal entity emerged at this time.

Whether mercantilism ever constituted a coherent theoretical position, as opposed to practical responses, has been contested, but Smith gave it an identity. Smith judged the mercantilist method of acquiring and maintaining wealth/power as theoretically misconceived. For Smith the real wealth of a nation lay in the annual produce of the land and labor of the society. The way to increase this wealth is through what

he called the system of natural liberty. This entailed removing the panoply of regulations and restrictions characteristic of mercantilism, such as those on employment, like guild-sponsored apprenticeships; on the mobility of property, like entails; on consumption, like sumptuary laws; and on trade, like tariffs. Without these obstacles, a free economy would produce a growth in wealth that would benefit the entire population (the “trickle-down” effect).

Smith, although he has become by far the most famous, was not alone in reevaluating the meaning of wealth. One significant dimension had always been population. The wealthier a country, the more people it could sustain, and that in turn would provide both economic and political-cum-military clout. In the Aristotelian tradition, one of the attacks made on commerce was that it enfeebled nations because its citizens were too busily engaged in their private tasks of money-making to devote themselves to their civic responsibilities, which included fighting. For Machiavelli and his intellectual heirs, a citizen militia was the appropriate martial institution, and professional standing armies were not only a threat to civic liberty but also less effective as fighting machines. Smith rejected this. He countered that the wealthier a country was, the more resources were at its disposal to provide sophisticated weaponry and to train soldiers effectively. It was one consequence of this that population by the nineteenth century ceased to have the same value as a marker of national strength; indeed the worries were rather that industrialization was producing too many people to be provided for adequately.

Status

The link between wealth and power can also be expressed indirectly. Thorstein Veblen (1857–1929) in his *Theory of the Leisure Class* (1899) articulated this through his notion of conspicuous consumption. He argued that to enjoy esteem it was not sufficient merely to be wealthy, others had to be made aware of that fact (it had to be conspicuous). In its purest form, consuming conspicuously is consumption of the totally useless, but (less perfectly) it is the consumption of “high maintenance” goods like white clothes in a dirty industrial environment. While there were predecessors (including Adam Smith), Veblen's analysis was free of the moralizing that often appeared in economists. The leading contemporary economist of Veblen's time, Alfred Marshall (1842–1924) in his *Principles of Economics* (1890), declared the desire for wealth as a means of display to be unwholesome. Marshall was here following his most distinguished predecessor, John Stuart Mill (1806–1873), who had declared that the subject of political economy itself was wealth, which he defined (after a critique of the mercantilist version) as “all useful or agreeable things that possess exchangeable value” (p. 15). However, he proceeded to maintain that the English needed instruction in the use of wealth and how to appreciate those objects of desire that wealth cannot purchase. Mill here implied a distinction between the pursuit of wealth (the art of “getting on” as he put it) and the worthwhileness of what is being pursued (the art of living).

This implicit distinction is made explicit and its moralism exposed by Veblen. He distinctively drew attention to the divergence between the drive to accumulate wealth, as a symbol

of reward for industry, and the desire, once it has been accumulated, to look upon its possession as intrinsically worthy. Since social status is attributed to the possession of wealth, the imperative is to exhibit leisure (the nonproductive consumption of time) and dissociate thereby the actual possession of the wealth from the effort expended to attain it. Later economists have developed his ideas in their analysis of consumption in the form of the “demonstration effect” and what they call nonfunctional demand. A “Veblen effect” has been identified where, in an exact reversal of the assumed practice of the rational consumer, the demand increases when the price rises. Only the “truly” wealthy can afford to flout that rationality.

Of course, at another level there is a rationality at work—namely that of demonstrating one’s wealth and impressing others by its possession. Under that guise this indirect linkage between wealth and power is a recurrent feature. One of its most striking manifestations is the practice of “potlatch.” The status system of the tribes of northwest America is maintained by display, as exhibited in the hosting of great feasts. In the Nootka tribe the chief is presented with the first catch of the salmon traps, the first pickings of ripe fruit, and so on, but having received these, he then holds a feast where the gifts are communally consumed. This pattern is also characteristic of the so-called big man systems of the Pacific. Among the Kaoka of Guadalcanal, reputation is enhanced not by accumulating wealth but by giving it away. The more one can bestow upon others, the greater one’s social standing. Hence every significant event such as a birth or wedding is celebrated by a feast, and the more feasts, and the more lavish the fare, that can be “afforded,” the greater the prestige. The social leaders (the holders of political power) in all such systems are those whose wealth is manifest by being able to give away most.

The Dangers of Wealth

That the possession of wealth conveys political power has long been a source of suspicion. For both Plato (428–348 or 347 B.C.E.), in *The Republic*, and Aristotle an oligarchic constitution was associated with rule by the wealthy “few.” In both cases this was a negative association. The wealthy used their economic power to rule politically in their own interest, as opposed to the interests of all. In the idea of a “cycle of constitutions” propounded by Polybius (c. 200–118 B.C.E.), in his *Histories* [of Rome] (and reiterated many times over during the succeeding centuries), oligarchy represented a corrupt falling away from good rule by the few (aristocracy) but that was itself displaced in reaction to its self-serving rule by the initially virtuous rule of the many (what became called democracy).

Contemporary (liberal) democracies all have practices and policies that in some way aim to forestall any pernicious effects that might follow from concentration of wealth in a few hands. Some of these are direct. The buying of votes is universally made illegal but frequently, in addition, there are restrictions on the use of money in political campaigns. Other prescriptions are indirect, for example, wealth taxes, and other redistributive fiscal mechanisms. One of the intentions behind such policies is to enhance the possibility of the equality of opportunity. If jobs are “open to the talents,” if individuals are provided with the educational resources (in particular) to enable

them to compete, then the differing amount of wealth subsequently earned is justified. However, for that differential to pass down to the next generation undiluted is, it is argued, to undermine that equality. It remains, however, one of the longest running disputes in modern political philosophy the extent to which policies designed to neutralize the inequalities associated with wealth infringe upon the value of liberty and autonomy. A libertarian thinker like Robert Nozick (1938–2002), in his *Anarchy, State, and Utopia* (1974), argues that attempts to impose a preferred distribution of assets illicitly infringe on the rights of individuals. More egalitarian writers, like Michael Walzer (b. 1937) in his *Spheres of Justice* (1983) or, from very different premises, Jürgen Habermas (b. 1929) in a range of writings, seek to keep the political or civic sphere free of the baneful effects of the economic power and reach of wealth.

Conclusion

Wealth continues to be a subject of debate. Its distribution and effects on social and public policy and welfare are a matter of both practical and academic concern. Its generation and allocation is a central topic in economics; its justification similarly is a major issue in moral and political philosophy. These current disputes without much distortion carry with them the weight of millennia of speculation and in so doing demonstrate that the history of the idea of wealth encapsulates a wealth of ideas.

See also **Christianity; Communism; Economics; Power; Property; Virtue Ethics.**

BIBLIOGRAPHY

PRIMARY SOURCES

- Aristotle. *The Ethics of Aristotle: The Nicomachean Ethics*. Translated by J. Thomson. Harmondsworth, U.K.: Penguin, 1976.
- . *The Politics*. Translated by C. Reeve. Indianapolis: Hackett, 1998.
- Burke, Edmund. *Speech on American Taxation*. 1774. In *Works*, vol. 2. London: George Bell, 1882.
- Locke, John. *Second Treatise of Government*. 1689. Edited by P. Laslett. Cambridge, U.K.: Cambridge University Press, 1970.
- Machiavelli, Niccolò. *Discourses on Livy*. 1531. Translated by L. Walker (trans. revised by B. Richardson). Harmondsworth, U.K.: Penguin, 1974.
- Marx, Karl. “Preface to a Critique of Political Economy.” 1857. In *Marx-Engels Reader*, 2nd ed., edited by R. Tucker. New York: Norton, 1978.
- Marx, Karl, and Engels Friedrich. *Communist Manifesto*. 1848. In *Marx-Engels Reader*, 2nd ed., edited by R. Tucker. New York: Norton, 1978.
- Mill, John Stuart. *Principles of Political Economy*. 1848. In *Collected Works*, vols. 2 and 3, edited by J. Robson. Toronto: University of Toronto Press, 1964.
- Mun, T. *English Treasure by Foreign Trade*. 1664. Reprinted in *Early English Tracts on Commerce*, edited by John Ramsey McCulloch. Cambridge, U.K.: Economic History Society, 1952.
- Rousseau, Jean-Jacques. *Social Contract*. 1765. Edited by V. Gourevitch. Cambridge, U.K.: Cambridge University Press, 1997.
- Smith, Adam. *An Inquiry into the Nature and Causes of the Wealth of Nations*. 1776. Edited by R. H. Campbell and A. S. Skinner. New York: Oxford University Press, 1976.

Veblen, Thorstein. *The Theory of the Leisure Class*. 1899. New York: Dover, 1994.

SECONDARY SOURCES

Berry, Christopher. *The Idea of Luxury: A Conceptual and Historical Investigation*. Cambridge, U.K.: Cambridge University Press, 1994. Covers episodically issues and debates from the Greeks to the present day.

Coates, Alfred. *On the History of Economic Thought*. London: Routledge, 1992. A collection of previously published essays, a number of which summarize and discuss mercantilism, Smith, and nineteenth-century economists.

Hayek, F. A. *Law, Liberty, and Legislation*. 3 vols. London: Routledge, 1982.

Leibenstein, H. "Bandwagon, Snob, and Veblen Effects in the Theory of Consumers." *Quarterly Journal of Economics* 64 (1950): 183–207.

Macpherson, Crawford B. *The Political Theory of Possessive Individualism*. Oxford: Clarendon, 1962.

Price, B. B., ed. *Ancient Economic Thought*. London: Routledge, 1997. A collection of essays covering Greek, Roman, Indian, and Hebraic ideas.

Rawls, John A. *A Theory of Justice*. Oxford: Clarendon, 1972.

Sahlins, Marshall. *Stone Age Economics*. London: Tavistock, 1974. At times controversial but informative essays in anthropological economics.

Troeltsch, Ernst. *The Social Teaching of the Christian Churches*. 2 vols. Translated by Olive Wyon. New York: Macmillan, 1931. A classic work and still of value. German edition, 1911.

Christopher J. Berry

WESTERNIZATION.

This entry includes three subentries:

Africa

Middle East

Southeast Asia

AFRICA

As applied to non-Western societies, the term *Westernization* is almost always equated with modernization. It is important, however, to distinguish between the two, for modernization, considered as an overhauling of African societies, predates the incursion of the West on the continent. Before the Europeans, the most important agents of modernization in Africa were the Arabs, who, after their settlement in North Africa, introduced Islam into West Africa and thus set in motion a profound transformation of societies and cultures in the region. Similarly, the coastal peoples of East Africa were in touch with external civilizations long before the arrival of Europeans; the influence of the Arabs in this area has been as deep and durable as in West Africa. Internally, the Zulu leader Chaka's (1786–1828) conquests of and his creation of the Zulu nation out of diverse ethnicities over an extensive area in South Africa entailed a restructuring of their societies; the same can be said of Ashanti hegemony exercised over neighboring societies and peoples drawn into its sphere of imperial authority and cultural influ-

ence. In all these cases, what is involved is not merely a process of adjustment consequent upon conquest, but an extensive re-fashioning of the institutions and cultural practices of the societies affected in conformity with a new model of the world.

There is, however, a fundamental difference between these earlier processes of change and modernization as it is understood in the twenty-first century: that is, as the transition from an agrarian to an industrial-technological civilization. The origins of this process in the West and its global character constitute this civilization as a universal paradigm. It is in this sense that Westernization can be said to be synonymous with modernization in relation to the impact of the West on Africa.

The historical context of Westernization in Africa is the encounter with Europe, under the specific conditions of the Atlantic slave trade and the European colonial adventure, which was its logical extension. The forced acculturation of the black populations in the New World, already in full swing by the mid-eighteenth century, represents the first sustained assimilation of Western culture by Africans. It is significant to note the contribution that diaspora blacks were later to make to the process of Westernization in Africa, notably through their role in Christian evangelization and education.

The colonial factor was essential to the process of Westernization in Africa itself. The comprehensive reorganization of African societies in every sphere of life signaled a new dispensation that functioned as the comprehensive framework of the African experience under colonialism. The boundaries that resulted from the nineteenth century partition of Africa were determined without regard to antecedent institutions and cultures; the entities that emerged from partition represented a patchwork of administrative territories that in the twenty-first century have evolved into "modular states," each encompassing a diversity of languages and ethnicities. The colonial powers, especially the French and the Portuguese, undertook a systematic dismantling of indigenous institutions in order to establish colonial rule as the primary source of legitimacy in the territories they controlled. Moreover, they imposed new legal systems based upon European concepts of law, often at variance with indigenous legal systems and almost always with serious implications for such questions as property and inheritance.

A major effect of European colonialism was the progressive integration of Africa into the world capitalist system, within which Africa functioned primarily as a source of raw materials for Western industrial production. This required a total reorganization of African economic life, beginning with the introduction of the cash nexus and the imposition of taxation, which forced Africans into wage labor, a more intense and problematic variant of which was the migrant labor created by the mining industry in Southern Africa. Colonial economy also caused agriculture to be diverted toward the production of primary products and cash crops: cocoa, groundnut, palm oil, sisal, and so on. In the settler colonies—notably in Kenya and Rhodesia—the alienation of native land complicated the economic situation of the indigenous populations. The infrastructure undertaken by the colonial administrations was minimal, developed strictly as a function of the requirements of the new economy, which saw the rise of the colonial cities such as

Dakar, Lagos, Nairobi, and Luanda. Urbanization led to rural exodus and the displacement of large segments of the population.

It is against this background of the disaggregation of African societies and the destabilization of African life that the impact of Christianity has to be considered, for this has been the most important single factor in the process of Westernization in Africa. Western education, involving literacy and the mastery of a European language, became the condition for entry into the modern sector. For most of the colonial period, education was in the hands of the Christian missions, who sought not only to convert Africans but also to inculcate Western values. In West Africa, the assimilation of Western lifestyles was mediated by returnees from the diaspora—the West Indians, Brazilians, and Sierra Leoneans—whose education and skills enabled them to play an effective role in Christian evangelization and the nascent colonial civil service; their relatively privileged status enabled them to serve as a major reference group for indigenous Africans.

Christianity challenged traditional belief systems and promoted the diffusion of new ideas and modes of life; in particular, it sought to impose monogamy and the nuclear family as the norm. Romantic love and new conceptions of the self emerged, a development that was reinforced in the postwar period by the influence of the cinema and popular literature from the West. All over the continent throughout the colonial period, Africans were adopting new habits and acquiring new tastes derived from Western culture, often considered progressive in relation to traditional culture. This cultural revolution came to be associated with the new elite that was spawned by Christian education, an elite developed from an initial body of clerks, interpreters, and later, of teachers and lay preachers, expanding with time to include professionals, especially lawyers and doctors.

The ranks of the elite swelled with the establishment of the universities after World War II. Because they were linked at first with the metropolitan universities and staffed by Europeans, and the structure and content of the education they dispensed, they functioned essentially as outposts of Western culture, which thus proved a determining factor of modern cultural expression. This is attested by the dominance of Western-educated Africans, products of the new universities, in the genesis and evolution of a new literature written in the European languages, for which the forms and conventions of the metropolitan literatures have served as reference. Western cultural forms also provided expressive channels in other areas of aesthetic manifestation. This was most notable in music, where Western instruments such as the piano, the trumpet, and the guitar have been adopted by African artists to fashion a new musical idiom fusing indigenous and foreign modes, a creative syncretism that is forcefully demonstrated in African popular music, and that can be observed in other areas such as the visual arts.

The transformations provoked by the pressures of colonial rule in all spheres of life are sufficiently extensive and pervasive to qualify as the signs of a new modernity in Africa. In no area is the association of Westernization with modernization clearer than in the impact of science and technology on

African experience and consciousness. Modern medicine has largely taken precedence over traditional methods in matters of health; ironically, the drastic reduction of infant mortality it has made possible has also complicated the demographic issues in Africa, with consequences for agriculture and social services. Although no major effort of industrialization took place during the colonial period, and there has been no significant development since, Western technology has long entered the lives of Africans through familiarity with manufactured products imported from the West.

As with other societies and cultures in the so-called Third World, the impact of Western civilization on Africa has occasioned a discontinuity in forms of life throughout the continent. This has led to a cultural dualism that often presents itself as a real dilemma in concrete, real-life situations. In other words, the African experience of modernity is fraught with tensions at every level of the communal and individual apprehension. African nationalism was predicated on the conjugation of nation-building and economic development as a means for the improvement in standards of living. Beyond these immediate objectives, it was concerned more fundamentally with the establishment of a new order informed by modern concepts of political life and behavior and by a rationality in conformity with a modern world outlook. The upheavals of the postindependence era have derived from the stresses arising from the quest for this ideal. It is thus fair to observe that the fundamental issue with which the contemporary societies of Africa are confronted is that of their full and orderly accession to modernity, that is, to a mode of collective organization based on the model of the liberal and democratic nation-state and of the industrial-technological civilization, a model that is associated with the West.

This is not to restrict Africans to a single model, nor to deny the capacity for adaptation manifested by African societies. There is an undeniable energy in the movement toward a new integration evident in the original forms of life and expression that have been evolved on the continent since the encounter with Europe. As Melville Herskovits and William Bascom have observed, "There is no African culture which has not been affected in some way by European contact, and there is none which has entirely given way before it" (p. 3).

Indeed, the significant fact about African cultural history is the convergence upon the indigenous tradition of the two external influences—the Arab-Islamic and the European-Christian—to which the continent has been exposed for well over a millennium. The values and lifestyles associated with these traditions have been assimilated and to a large extent indigenized on the continent. This observation provides a broader perspective on the phenomenon of Westernization in Africa, an observation made as early as the late nineteenth century by the great African cultural theorist Edward Wilmot Blyden and summed up in the late twentieth century by Ali Mazrui as "the triple heritage."

See also Arts: Africa; Colonialism: Africa; Diasporas: African Diaspora; Religion: Africa; Religion: African Diaspora; Third World; University: Postcolonial.

BIBLIOGRAPHY

- Ajayi, J. F. Ade. *Christian Missions in Nigeria, 1841–1891: The Making of a New Elite*. Evanston, Ill.: Northwestern University Press, 1969.
- Anderson, Benedict R. *Imagined Communities: Reflections on the Origin and Spread of Nationalism*. London: Verso Editions/NLB, 1983.
- Herskovits, Melville J., and William B. Bascom. "The Problem of Stability and Change in African Culture." In *Continuity and Change in African Cultures*, edited by Melville J. Herskovits and William B. Bascom. Chicago: University of Chicago Press, 1959.

F. Abiola Irele

MIDDLE EAST

The notion of Westernization in the Middle East raises a number of interrelated issues. First, it refers to a period (nineteenth to twentieth centuries) in which Middle Eastern intellectuals engaged Western political philosophy in a self-conscious search for modernity. Albert Hourani, in his groundbreaking *Arabic Thought in the Liberal Age, 1798–1939* (1983), dates this engagement from Napoleon Bonaparte's invasion of Egypt in 1798. This defeat revealed the weaknesses of Ottoman government and sent shockwaves throughout the Ottoman Empire. How had the Europeans gained such superiority, and how could the Muslims catch up? Selim III (1761–1808), the Ottoman sultan in Istanbul, and Muhammad Ali (1769?–1849), the Ottoman governor of Egypt, enlisted European advisors to implement military and governmental reforms on the Western model (*tanzimat*). A generation of "new men," many graduates of these European-style schools, began a period of intense reflection and critique. They studied Rousseau, the Manchester textile mills, and parliamentary government for clues to European power. They also criticized traditional Islamic institutions and advocated reform of education, government, and the Arabic language.

These two avenues of reform raise a second issue: did the reform movement mark "Westernization" or a local modernity forged by traditional intellectuals? Many historians have defined Westernization narrowly as the "all-out adoption of the Western model," which they contrast to "modernization," an Islamic response to political, economic, and social pressures from the West. Modernity and Westernization cannot be separated, however. Islamic modernist thought was formulated as a specific response to the European challenge. Thinkers from Muhammad Abduh (1849–1905) to Ali Shari'ati (1933–1977) had to explain European superiority and propose specific solutions for Muslim decline. Even when Western models were not adopted, the West provided the terms of the debate: industrialization, women's rights, secular law, the bureaucratic state, and popular sovereignty. Finally, modernism itself, a self-conscious effort to organize and govern society according to rational principles, was invented in the West. Islamic modernizers embraced the centrality of reason, which led them back to a classical question: "What is the relationship of reason to revelation?"

Yet the Muslim modernizers posed the question in a new way. How could reason and religion be reconciled to reform

Islam, and how could this purified Islam be applied to society? Thus, our subject is actually the reform of Islam and its new transformative role, a program formulated in engagement with the West. The relationship between the Middle East and the West occurred at a number of levels. First, the reforms on the Western model (*tanzimat*) centralized the states in Egypt and Anatolia, disciplined their populations, and laid the social foundations of modern Egyptian and Turkish nationalisms. Second, the modernizers adapted Western ideologies (liberalism, socialism, nationalism) to create cultural hybrids. Colonial industrialization was part of this process, for changes in labor and production produced new classes and new consciousness. Finally, even those intellectuals who rejected the West unwittingly adopted Western approaches to knowledge. Islamic modernizers rejected Gnostic knowledge and mysticism (Sufism), much as Western positivists tried to fit all knowledge into a rational framework. This helps to explain a central puzzle in Islamic history: the secularists and the Islamic fundamentalists (one branch of the *Salafiyya*) spring from the same intellectual root.

At first contact, Egyptians were not impressed with liberalism and the French Republic. Consider the Egyptian chronicler Abd al-Rahman al-Jabarti's reaction to the French and their political ideas:

[Napoléon] saying "[all people] are equal in the eyes of God the Almighty," this is a lie and stupidity. How can this be when God has made some superior to others as is testified by the dwellers in the Heavens and on the Earth . . . those people are opposed to both Christians and Muslims, and do not hold fast to any religion. You see that they are materialists, who deny all God's attributes. . . . (p. 31).

Yet as Ottoman rulers adopted European institutions, a new generation of intellectuals adopted French political ideas. The Egyptian Rifa'a Rafi'a al-Tahtawi (1801–1873) tried to reconcile the republic with the *umma* (community of believers), secular law with the *shari'a* (Islamic law), the *ulema* (religious scholars) with the republican legislator. Tahtawi argued that Muslims had failed to develop theories of government; they saw the executive only as a guardian of Islamic law and spiritual guidance. However, government also gave order to society and should thus be used to promote the public welfare. Creating the just society and upholding the will of God were thus compatible if not identical projects. Drawing on the thought of al-Farabi, Ibn Sina, and the Mu'tazili school of the Middle Ages, al-Tahtawi argued that reason and philosophy were two paths to the same ultimate reality and thus must be reconcilable. Al-Tahtawi was the first to articulate the notion of an Egyptian nation, a historical community of the Muslim and Christian occupants of Egypt, and a brotherhood "over and above the brotherhood in religion." He attributed Egyptian decadence to foreign rule, specifically that of the Turkish overlords (Mamluks and later Ottomans) who ruled Egypt from the thirteenth century.

Yet Tahtawi's project failed to address a basic tension between secular and religious law. In a republic, the people are sovereign and the social contract defines the members of the

political body. The law is the expression of the general will and thus utilitarian and subject to change. In the *umma*, the community is defined in relation to God; the Muslims are those who submit to God's will, (a Muslim is "he who submits [to God]"). Since God is sovereign and the law is the expression of his will, many Muslim jurists argued that once the Koran and hadith had been elaborated into a legal code (*shar'ia*), by the fourteenth century, it was universally valid and permanent, and so "the gates of *ijtihad* [independent legal reasoning] are closed." A second question arose: if Islamic law is divine, what checks, if any, should there be on the executive? Finally, Muslim scholars feared that Western institutions might be inseparable from a secular worldview. Indeed, historians of the scientific revolution have argued that elements of Western modernity could not be conceived before the "paradigm shift," the replacement of religious worldviews by a Newtonian universe. Finally, Muslims had to answer Orientalists like Ernest Renan, who claimed that Islam was antithetical to science.

In response to all of this, Muhammad Abduh and Jamal al-Din al-Afghani (1839–1897) presented a synthesis that "rationalized" Islam and opened the door to both secularism and Islamic fundamentalism. Abduh argued that the true Islam of the Companions (*al-salaf*) of the prophet Muhammad was the tool for social modernity. Islam must be freed of antiquated scholarship; he demanded that the traditional Islamic institutions like Al-Azhar in Egypt replace rote memorization with a new *ijtihad* and teach the modern sciences. Islam must be unified into a single creed: Shiism was a "heresy" and Shiites must be brought into the fold. Abduh suggested unifying the four Sunni schools of Islamic law (Hanafi, Hanbali, Shaf'ī, Maliki) into a single school. Islam was to be purified of heterodoxy and foreign elements; thus the modernizers condemned Sufism (mystical Islam), visitation of the graves of the *awliya'* (holy men), and other popular practices (amulet-writing, healing) as *shirk*, or worship of things other than God.

Abduh collapsed the divide between the secular and the religious in *The Sociological Laws of the Qur'an*. He argued that Islam and Western civilization were of the same order of knowledge and that a purified Islam held the answers to all modern social problems. Parliaments, railroads, and space travel were anticipated in the Koran and fully compatible with its message. He translated legal conceptions of the medieval period to the "modern day": *ijma'* (consensus of the jurists) was "public opinion," *shura'* (consultation, especially in the selection of the caliph) was "parliamentary democracy." Among his disciples, this synthesis split into two strands.

One strand was secular nationalism (1900–1939), and nationalists in Egypt, Lebanon, Syria, Turkey, Morocco, Algeria, Tunisia, Iraq, and Iran embraced the institutions of political liberalism under French and British "protection." Secularists dropped the project of "Islamic government" because, as they argued, the Koran contained or prefigured (or so they believed) Western institutions. Religious minorities—Copts, Druze, Maronites, Jews—welcomed the opportunity for full participation in political life. The Egyptian Qasim Amin advocated women's emancipation as a national project. However, as liberals failed to address growing labor and social

problems or bring an end to colonial rule, liberal constitutionalism lost popular support.

Other secularists turned to Marxist socialism. Lenin's *Imperialism: The Highest Stage of Capitalism* provided an economic critique of colonialism and a plan of revolutionary action. The 1952 "Arab Socialist" revolution of Jamal 'Abd al-Nasser (1918–1970) proposed social equality for all citizens through state capitalism. Nationalism in Algeria and Tunisia grew from the trade unionism of migrant labor in France (Étoile Nord-Africaine). However, the materialism of Marx was difficult to reconcile with Islam, and the Iranian Islamist intellectual Ali Shari'ati rejected Marxism as a solution to social ills.

Finally, the second group of Abduh's successors, led by Muhammad Rashid Rida (1865–1935), focused on the rationalization of Islam to create a "true Islamic state." Rida believed that Sufism (mystical Islam) had created division in the Islamic community and that westernizers undermined its moral foundation; only a strict adherence to *shari'a* and the Islam of the *salaf* would rejuvenate the *umma*. This strain of thought found various expressions in the work of Islamists such as Sayyid Qutb, the premier theoretician of the Egyptian Muslim Brotherhood, and Shii form in the work of Ayatollah Ruholla Khomeini (1900–1989), leader of the 1978–1979 Islamic Revolution in Iran. Thus, even the ideas of the contemporary Islamist radicals were formulated in dialogue with the West.

See also *Anticolonialism: Middle East; Empire and Imperialism: Middle East; Nationalism: Middle East*.

BIBLIOGRAPHY

- Hourani, Albert. *Arabic Thought in the Liberal Age, 1789–1939*. Cambridge, U.K., and New York: Cambridge University Press, 1983.
- Jabarti, Abd al-Rahman al-. *Napoleon in Egypt: Al-Jabarti's Chronicle of the French Occupation, 1798*. Translation by Shmuel Moreh. Princeton, N.J.: Markus Wiener, 2001.
- Keddie, Nikki. *Sayyid Jamāl ad-Dīn "al-Afghānī"*. Berkeley: University of California Press, 1972.
- Laqueur, Walter. *A History of Zionism: From the French Revolution to the Establishment of the State of Israel*. New York: MJF Books, 1972.
- Rahnema, Ali. *An Islamic Utopian: A Political Biography of Ali Shari'ati*. London: Taurus, 2000. This essay has been devoted exclusively to Islamic modernism, but there are significant parallels in the development of Zionism and the *haskala* movement.
- Renan, Ernest, and Jamal al-Din Afghani. *L'Islam et la science: Avec la réponse d'Afghani*. Montpellier, France: Archange Minotaure, 2003.
- Sirriyeh, Elizabeth. *Sufis and Anti-Sufis: The Defence, Rethinking and Rejection of Sufism in the Modern World*. Richmond, U.K.: Curzon, 1999.
- Tibi, Bassam. *Arab Nationalism: Between Islam and the Nation-State*. 3rd ed. New York: St. Martin's, 1997.
- Weismann, Itzhak. *Taste of Modernity: Sufism, Salafiyya, and Arabism in Late Ottoman Damascus*. Leiden, Netherlands: Brill, 2001.

Ellen Amster

SOUTHEAST ASIA

Westernization in world history can refer to the transmission and reception of European ideas, technology, lifestyles, and institutions throughout the globe. Much of the scholarly attention has tended to concentrate on the intensity and nature of that transmission during the era of European colonialism and its attempts to transform the very consciousness of the peoples it encountered. Although the modes of transfer, the locales of interaction, and the intellectual capital are no longer the sole domain of Europe, the nature of Westernization continues to be relevant as local traditions become more integrated (or subsumed) within supposed “universal” values. Societies that are unable to cope with the blistering pace of technological change, the fluctuations of an interdependent world economy, or the insensitivity of an “international” community often find fault with “Westernization,” which is associated with these uncontrollable and unfamiliar pressures on local societies. As a result, the idea of Westernization continues to be a part of twenty-first-century historical discourse, framing the ways in which scholars examine the interactions among cultures, regions, and nations.

Approaching Westernization in Eurasian History

Contemporary ideas of what constitutes “Western culture” reflect its postcolonial origins and twentieth-century politics, just as the idea of the “West” may have had slightly different meanings between the fifteenth and nineteenth centuries. In the history of Southeast Asia, Europeans had competing ideas about the cultural values they represented and were attempting to infuse into the societies they encountered. Spanish policy in the Philippines was exceptionally different from Dutch policy in Indonesia, and the Spaniards and the Dutch certainly did not see each other as representing a single, unified, cultural domain. These motivations were often couched in religious or political agendas that many times reveal tensions between empires as much as they disclose the tensions within. Scholars gazing toward the past sometimes project “Westernization” into the histories of exploration, trade, and colonialism, despite the fact that those participating in these global exchanges probably saw and articulated their missions in slightly different ways. Caution must be employed when considering Westernization as a process because it was often much more disparate in nature than coherent. Nonetheless, using Westernization as a category of analysis can provide a useful lens into the history of global interactions with Europe.

In the history of colonialism, the term *Westernization* reveals the geographic context and self-referential perspective that would inform the ways in which peoples of Asia would be categorized and understood, though elites within these societies would also adopt the term to represent their notion of “modernity.” This association can be attributed partly to the rhetoric of colonialism, which blended Europe’s cultural forms with theories of human development in order to organize and tabulate the communities and societies that came under colonial authority. Colonized elites would appropriate these conceptions of modernity and apply them to their own societies, fundamentally changing their own identity in relation to the world. Within these discourses, the “East” or the “Orient” was

seen as something homogenous, unified, and fundamentally opposite to that which was European, even though the idea of a coherent “West” encountering a coherent “East” tended to overstate the complexity, nature, and composition of these societies. In addition to Asia, this process of European interaction also occurred in Africa and the Americas, producing very similar narratives of exchange, acculturation, and domination. Whatever the context, early European scholars, traders, soldiers, and missionaries viewed themselves and the people they encountered as coming from very different worlds. In some instances, Europeans would view Westernization as the process of making others more like themselves, though they probably did not consider this transformation as “Westernization” per se. Throughout history, Westernization would come to have different meanings, effects, and forms, but in essence it refers to one of many global processes that have characterized the interaction of human societies.

From a regional perspective, the history of Westernization in Southeast Asia can be seen in much the same way: It is but one of many continuing processes that have contributed to the region’s character. For a millennium, Southeast Asia has benefited from its unique geographic location of being both a mainland and maritime crossroad between the Indian and Chinese cultural zones. This vital location has given it exposure to three great religions (Buddhism, Islam, and Christianity), global trade, and the movement of peoples from all over the world. Many scholars have chosen to consider the dynamics of regional change in the context of Islamization, Indianization, and Sinicization (modification under Chinese influence), to which Westernization might be compared. While these regionally specific processes may be associated with particular times in Southeast Asia’s deep past, closer readings of how these exchanges occurred in specific cases reveal that all four processes continue to interact, intersect, and overlap, thereby illustrating the complexity of these ideas and their interrelatedness in the Southeast Asian context.

The Structure of Westernization in Southeast Asian History

Most scholars have approached the structure of Westernization in Southeast Asia as a process that has developed over stages and varying intensities according to location, internal receptiveness, and the circumstances in which the encounter took place. One of the most important mechanisms contributing to the transmission of Western culture to the region was trade. In this context, trade consists of the movement, over the centuries, of peoples, goods, and ideas between the Mediterranean, Bengal, and Southeast Asian waters. With this in mind, Western interaction with Southeast Asia can be organized chronologically into four stages.

In the first stage, labeled Early Maritime Influence (1511–1670), initial contacts were made through the agency of European and Southeast Asian traders. The nature of interaction here could be described as minimal in terms of cultural penetration, but certain important technological exchanges did occur. During this period the Portuguese and the Spanish began to make headway into the region, securing the regional port of Malacca in the case of the former and Cebu in the case of

the latter. The Dutch also began to initiate activity in the Southeast Asian waters, but powerful Muslim states and trading networks still continued to thrive, producing minor levels of exchange. Although Portuguese firearms would contribute to the reintegration of the Burmese kingdom in the 1550s, European influence was marginal on the Southeast Asian mainland.

By 1670, Dutch penetration of the regional trade networks intensified as they slowly began to involve themselves in internal political issues of succession and power relations. Under this second stage of Accelerated Influence (1670–1820), the main Muslim kingdoms disintegrated and regional trading networks fragmented as the Dutch (in particular) increased their influence in the island interiors. Similarly it is during this period that the Spanish increased their role in the Philippines, inserting the religious-political structures that would become the foundation of their strong presence among the local communities there. While the islands of Southeast Asia were beginning to be exposed to Western technology, religion, and economic pressures, the mainland on the other hand was left on its own, as the spices and other natural resources of the island world continued to draw Europe's attention.

By the early nineteenth century, however, the mainland was to bear the brunt of new European initiatives in the form of Full Scale Conquest (1820–1870). Because of European political maneuvering and competition, and the promise of the Chinese market, mainland Southeast Asia was conquered during this period by the British (Burma) and the French (Indochina). With the establishment of colonial governments, mainland Southeast Asian communities were slowly integrated into new economic, political, and ideological shadows of empire. For the most part, because of the limitations of military operations, coastal sections of the mainland were more intensely affected than the interior, leaving the people in the latter area and their ways of life somewhat unaffected.

With the opening of the Suez Canal, the improvements in steam technology, and the development of the telegraph, Southeast Asian societies experienced an intensification of Western influence under High Imperialism (1870–1942). Because of changing world demands for natural resources, the potential for capital from the taxing of local populations, and the influence of new theories of European cultural superiority, Europeans began to actively pursue and initiate programs designed to colonize the consciousness of ordinary Southeast Asian people. Colonial bureaucracies, churches, schools, and other institutions produced a consolidated view of the world that placed European civilization at the peak of humanity's development, self-justifying the role and influence Europeans had on indigenous peoples of Southeast Asia. New standards of language, authority, health, and knowledge were produced, professed, and dictated that fundamentally questioned the role and place of indigenous values and beliefs. Throughout the region, colonialism would change the character of Westernization by restructuring the nature of this global exchange through the reduction of local autonomy.

Yet the contribution by Southeast Asians to the shape of Westernization was not minimal in any regard. Southeast Asians adapted, modified, and reshaped colonial influences to

fit their needs and concerns—just as they had done for centuries through Indianization, Sinicization, and Islamization. Colonialism produced a particular body of knowledge and symbols that were consciously (and at times unintentionally) adopted by indigenous elites in order to improve local power and prestige. The idea of nationalism in Southeast Asia developed in just this manner, through local innovation and appropriation of ideas either introduced in schools or through the mechanics of the civil service. Southeast Asians contributed to the construction of what was Western and especially what was not—by identifying and constructing elements of “traditional” Southeast Asian culture (using Western modes of knowledge production) that might stand independent of Western influence. In the case of Thailand, the monarchy actively engaged European education, nation-building, and popular culture in order to transform itself into a modern country based on European definitions. Though not formally colonized, it initiated reforms that paralleled colonial legislation in British Burma, French Indochina, and Dutch Indonesia. In short, Westernization was as much a part of Southeast Asian regional processes as it was an encounter between cultures.

In postcolonial Southeast Asia, the nature of engagement continued in much the same way, though the colonial powers were no longer formally (except in the case of Vietnam) dictating the nature of this exchange. Southeast Asians continued to view Western technological and economic influences with interest in some cases and distrust in others. Burma withdrew into itself and limited interaction with what it viewed as the colonial “West,” though it continued to adopt certain principles of European economic planning in order to craft a locally sensitive state policy called the “Burmese Way to Socialism.” Because of its history of direct colonialism and the disruption of its most important cultural institutions, Burma's postcolonial history has viewed Western influences with considerable hesitation. Understandably, measures to “de-Westernize” or decolonize itself have even included changing the nation's name back to its precolonial form, Myanmar. In contrast, Thailand's autonomy throughout the age of High Imperialism has left it more culturally secure, with its institutions intact, and less wary of Western influences. While sharing a similar historical and cultural trajectory as its Western neighbor, it has chosen a completely different path from Burma, choosing to adopt Western forms and ideas at a ferocious pace while at the same time applying adjustments along the way. In short, the intensity of colonialism has affected the intensity of the response to colonialism and its cultural features.

Shaping Westernization in Southeast Asian Studies

Scholarship has addressed the concept of Westernization in Southeast Asia indirectly through alternative themes and interests. That the early histories of Southeast Asia by colonial officials were actually the history of Westerners in Asia and their perspective on the region's culture reveals something about the idea of Westernization. As many early accounts describing this process were involved in the spreading of ideas, technology, or goods, their assessments tended to reflect their interests and their unfamiliarity with the region as a whole. One aspect of this approach was to view Southeast Asian

history within the chronological and narrative framework of the West's own history, leading to judgments proclaiming the region's political, social, and technological levels to be inherently backward. It was believed that through colonial policies, Southeast Asia under European tutelage would be emancipated from itself, joining the civilized world by emulating it. Thus, early assessments by colonial officials saw the process of Westernization as the process through which traditional cultures could be made modern.

This view was shared to some degree by Southeast Asian observers as well. The emerging class of indigenous elites who were trained in Western schools began considering the idea that European culture had something to offer and could improve their situation. These groups began to speak in European languages, adopt European modes of dress, and evaluate the world through European conceptions of it. For many scholars following World War II, Westernization became viewed in terms of nationalism and its specific role in the process of constructing the nation-state. Histories were produced that de-emphasized pre-European elements and themes in favor of more "modern" narratives that embraced the structures, ideas, and values of "Western" historical writing. As a result, nationalist histories supported the idea that Westernization and the formation of the nation were inevitable and inextricably linked. Ironically, colonial and nationalist historians envisioned Westernization and its role in history in much the same way.

In response to colonial and nationalist histories, attempts were made toward writing histories that promoted "Southeast Asian" perspectives, with the emphasis placed on alternative, locally defined categories upon which new narratives of regional history could be written. Scholars began to question the role and place of European influence on the superstructure of Southeast Asian beliefs. Many began to see Westernization as a "thin and flaking glaze" over more enduring ideas and institutions that had defined the region for centuries. With this shift in perspective, Westernization was perceived as having far less of an impact in Southeast Asia than previously held before, swinging the pendulum to the other side. Studies of anticolonial movements, economic systems, nationalism, rituals, and identity deemphasized the impact of Westernization in order to accentuate Southeast Asia's cultural integrity more clearly. As a result, the reappraisal of colonialism led to a different reading of Southeast Asia's Westernization. Where the colonial period might have previously represented a significant conjuncture in the region's long history, scholars now viewed more continuity with the precolonial past and its traditions.

With changes in the world of the early twenty-first century, and most notably in postcolonial scholarship, the shape of Westernization has once again taken a more prominent place in Southeast Asian studies. The realization that many of the categories once thought "Southeast Asian" were actually colonial constructions led to important reappraisals of European and U.S. influence in the region. This shift has thus reinserted the importance of European culture back into the mix that is Southeast Asian culture. Scholarship since the late 1990s has also shown that, in the last two centuries of the colonial encounter, the distinctions between "West" and "East" were

much more ambiguous than once held; that identities of race, ethnicity, gender, and religion were openly contested; and that the nature of Westernization in relation to the idea of modernity has not only changed in terms of its receptiveness, but that it was also losing its distinctiveness as being derived from Europe. Popular culture from Japan, technological innovation from India, and cultural tourism have redefined the relationship between what is perceived as Western influence and what is not, while growing economic, political, and technological integration has moved the region much closer to its neighbors around the world.

See also *Anticolonialism: Southeast Asia; Colonialism: Southeast Asia; Empire and Imperialism.*

BIBLIOGRAPHY

- Cooper, Frederick, and Ann Laura Stoler, eds. *Tensions of Empire: Colonial Cultures in a Bourgeois World*. Berkeley and Los Angeles: University of California Press, 1997.
- Dirks, Nicholas B., ed. *Colonialism and Culture*. Ann Arbor: University of Michigan Press, 1992.
- Lieberman, Victor. *Strange Parallels: Southeast Asia in Global Context, c. 800–1830*, Vol. 1: *Integration on the Mainland*. New York: Cambridge University Press, 2003.
- Lieberman, Victor, ed. *Beyond Binary Histories: Re-imagining Eurasia to c. 1830*. Ann Arbor: University of Michigan Press, 1999.
- Reid, Anthony. *Southeast Asia in the Age of Commerce, 1450–1680*, Vol. 1: *The Lands below the Winds*. New Haven, Conn.: Yale University Press, 1988.
- . *Southeast Asia in the Age of Commerce, 1450–1680*, Vol. 2: *Expansion and Crisis*. New Haven, Conn.: Yale University Press, 1993.
- Reid, Anthony, ed. *Southeast Asia in the Early Modern Era: Trade, Power, and Belief*. Ithaca, N.Y.: Cornell University Press, 1993.
- Steinberg, David Joel, ed. *In Search of Southeast Asia: A Modern History*. Rev. ed. Honolulu: University of Hawaii Press, 1987.
- Tarling, Nicholas. *Southeast Asia: A Modern History*. South Melbourne, Australia: Oxford University Press, 2001.
- Tarling, Nicholas, ed. *The Cambridge History of Southeast Asia*, Vol. 2: *The Nineteenth and Twentieth Centuries*. Cambridge, U.K.: Cambridge University Press, 1992.

Mairii Aung-Thwin

WILDLIFE. Prehistory makes clear that our ancestors continuously conceptualized their relations with the myriad forms of plants and animals with whom their existence was interwoven. These ancient musings, more mythological than scientific, were the first sustained efforts to comprehend the order of nature. The noun *wildlife* has been in use no more than 125 years. But the swirl of ideas around wildlife, however inchoate, is nearly as old as the human species.

Reconstructions of the conceptual dimensions of wildlife prior to the advent of agriculture are based on carvings, paintings, burial, and other material artifacts as well as the study of contemporaneous indigenous cultures living outside the cocoon of industrial civilization. While generalization remains provisional, the Paleolithic era of hunting and gathering has

marked by notions of plants and especially animals as totems and dual presences. As totems the other species taught their two-legged kin the ways of the world: survival more than anything else. As dual presences the others encouraged the notion that all creatures were shape-shifters, bound up in the ongoing cyclical process of life in relationships based on reciprocity rather than dominion. The “economy of nature” (itself a modern term) was conceptualized as sacramental, based on the myth of the eternal return.

The New Stone Age (c. 15,000–10,000 B.P.) slowly but inexorably overturned the established notion of one creation binding all creatures together. The cultivation of cereal grasses and domestication of animals led to a binary categorization of the wild and tame. The wild encompassed the plants and animals not under human control. Unwanted plants intruding upon fields became weeds. Population blooms of insects that ravaged the fields became plagues. Animals that preyed on livestock became predators.

The tame included the lands and domesticated species under the control of civilization. Domestication entails selection for characteristics that, however desirable for human purposes, would in many cases be lethal in a natural environment. Cereal grasses were valued because their seeds were retained in the head so that they could be harvested. Domesticated cattle were valued because they were docile and amenable to herding.

As permanent settlement spread, lingering memories of a time before agriculture when humans were intimately entwined with the others were expressed in sources such as the *Gilgamesh* epic and the Old Testament. Psalm 104 praises the glory of a creator god and the intricacy of the living creation. Even as the psalmist sang, there was a dawning realization that humankind was not a good steward: “I brought you into a fruitful land, to enjoy its fruit and the goodness of it; but when you entered upon it you defiled my land, and made the home I gave you an abomination” (Jeremiah 2:7).

Changing Conceptions of Wildlife in Darwin’s Century

Nineteenth-century evolutionary theory and the discovery of Paleolithic archeological materials established three fundamental ideas. First, that biophysical evolution existed on a temporal scale far beyond conventional schemes of history and culture. Second, the human species itself had a natural history that, however poorly understood, clearly linked the “Descent of Man,” as Charles Darwin put it, with an ancient and continuing evolutionary stream. And third, evolutionary theory made clear that the domestication of plants and animals was little more than tinkering with natural history for human purposes, especially economic ones.

While the nineteenth century did not overturn the modern notion that humankind was the master and possessor of nature, a somewhat chastened estimate of our place in nature emerged. Henry David Thoreau (1817–1862) observed in 1838 that hunting and trapping had eliminated the mountain lion and black bear from most of New England. He challenged his coevals to reconsider the fate of a culture that was losing

connection with wild places and creatures. Near the end of the century, John Muir (1838–1914) argued for the creation of national parks as refugia for wildlife and as places to nourish the human spirit. While protective legislation dates to the early 1600s (e.g., Bermuda’s protection of the cahow and the green turtle), the late nineteenth and early twentieth centuries marked the beginnings of systematic approach to the conservation of wildlife. Yellowstone (1872) was the first national park in America. Created primarily to protect unique geological features, Yellowstone’s value for wildlife preservation soon became apparent. President Theodore Roosevelt’s (1858–1919) and Gifford Pinchot’s (1865–1946) efforts around the turn of the century were instrumental in legislative efforts to create a system of public lands that offered protection for wildlife. Progressive resource conservation found many allies, such as sport hunters, who reacted vigorously to the depredations of market hunting on wildlife. (Predators did not enjoy legislative protection until passage of the Endangered Species Act near the end of the twentieth century).

Wildlife in the Twentieth Century

The early- to mid-twentieth century was marked by an increased scientific understanding of wildlife and an increased willingness on the part of nations to protect it. The International Union for the Protection of Nature (now the World Conservation Union) was established in 1948 and gave birth shortly thereafter to the World Wildlife Fund. These and other global organizations, such as the United Nations, and conventions, such as the Convention Concerning the Protection of World Cultural and Natural Heritage (1972), were dedicated to protecting wildlife through a variety of strategies. These included moratoriums on trade in endangered species and the creation of reserves, such as those designated as World Natural Heritage Sites.

Despite such efforts, the continuing humanization of the planet made the long-term survival prospects for wildlife increasingly uncertain. As the twentieth century ended, the biological sciences conclusively established the reality of an anthropogenic mass extinction of terrestrial flora and fauna. Estimates of human-caused extinction rates ranged from a low of one hundred to a high of one thousand times greater than natural rates. Humankind’s increasing population and subsequent levels of economic demand led to rapid development of the few remaining areas, such as Amazonia, that were primary habitats for wildlife. Patterns of human settlement in developed nations, including sprawl, urbanization, and the fragmentation of habitat, increasingly impacted remnant populations of wild plants and animals. Less direct impacts on wildlife were the consequence of the increase in global temperature, predicted by the Intergovernmental Panel on Climate Change to increase by 5 to 10 degrees Fahrenheit over the twenty-first century. Given such dramatic increase, the possibility of retreat by heat sensitive species appeared doubtful.

Progress in scientific understanding was paralleled by ethical advance. The pioneering work of Thoreau and Muir was followed in the twentieth century by a variety of ecological ethics that charged humanity with obligations to conserve wild places and things, and to restore those species, such as the wolf,

that had been thoughtlessly endangered. These ranged from the secular, such as Aldo Leopold's (1887–1948) land ethic, *A Sand County Almanac* (1949), to the religious caring for creation movement that followed Lynn White, Jr.'s charge in a 1967 issue of *Science* magazine that Jews and Christians were to blame for ecological crisis.

Rachel Carson's *Silent Spring* (1961), which focused on the consequences for avian species of the toxic chemicals used in a war against nature, marked the point where the environmental movement became a mass phenomenon. Membership in organizations dedicated to the conservation, preservation, and restoration of wildlife soared. As public interest increased in America, legislative action, such as the passage of the Wilderness Act (1964), the National Environmental Policy Act (1969), and the Endangered Species Act (1973), followed. Such laws, and similar ones passed in other nations, are the cornerstone of wildlife protection.

Wildlife in the New Millennium

As the twenty-first century begins, our ideas of wildlife are being transformed through the advance of the natural and human sciences. Humankind has engendered a mass extinction event and caused "the death of birth" (i.e., disrupted the processes of speciation), thus creating uncertain prospects for plants and animals, and ourselves, over the millennium. Three pivotal themes stand out.

Economically considered, the value of nature, including the plant and animal species (the total number of which are unknown to the nearest order of magnitude), has been calculated to exceed the value of the artifice of the human economy by two to one. Potential uses of great significance in medicine and agriculture alone give ample reason to work toward international solutions for the biodiversity crisis.

Humanistically considered, interdisciplinary inquiry has established a close connection between the extinction of experience and the extinction of wildlife. Cultural diversity goes hand in hand with biodiversity. The almost unchecked processes of globalization, legitimated under the banner of progress, and euphemistically termed cultural homogenization and assimilation, are rushing literally thousands of indigenous cultures, their languages, and the associated wild places and things to extinction.

Finally, humankind vitally needs the others in ways that we barely comprehend. Our natural history reveals that continual close interactions with the plants and animals are the norm. The small interval of time beginning with the Neolithic revolution and continuing to the present is a mere moment in that long history. There is increasing agreement across a variety of scientific communities that we ignore our continued need for and value of the others at great peril.

See also **Biology; Ecology; Environment; Nature.**

BIBLIOGRAPHY

- Ackerman, Diane. *The Rarest of the Rare: Vanishing Animals, Timeless Worlds*. New York: Vintage Books, 1997.
- Crosby, Alfred W. *Ecological Imperialism: The Biological Expansion of Europe, 900–1900*. Cambridge, U.K., and New York: Cambridge University Press, 1986.

Grumbine, Edward. *Ghost Bears: Exploring the Biodiversity Crisis*. Washington, D.C.: Island Press, 1992.

Maffi, Luisa, ed. *On Biocultural Diversity: Linking Language, Knowledge, and the Environment*. Washington, D.C., and London: Smithsonian Institution Press, 2001.

Matthiessen, Peter. *Wildlife in America*. 2nd ed. New York: Viking, 1987.

Mighetto, Lisa. *Wild Animals and American Environmental Ethics*. Tucson: University of Arizona Press, 1991.

Oelschlaeger, Max. *The Idea of Wilderness: From Prehistory to the Age of Ecology*. New Haven and London: Yale University Press, 1991.

Shepard, Paul. *The Others: How Animals Made Us Human*. Washington, D.C.: Island Press, 1995.

White, Lynn, Jr. "The Historical Roots of Our Ecological Crisis." *Science* 155 (1967): 1203–1207.

Max Oelschlaeger

WISDOM, HUMAN. Wisdom is irretrievably linked with age and experience in human societies. If wisdom comes mainly through age and experience, it also requires "sense" to achieve. It is associated with the capacity to deal with experience in a constructive manner. If someone acts in a way that seems sensible, we may use the phrase "he has sense." Sense is the internal quality that promotes the learning process.

The question of the knowledge of creative activity, of intellectuals, of originality, even if this is viewed in a more limited way as only having a better memory, has little directly to do with the notion of wisdom but it has some overlap. A wise individual is definitely someone who knows about human affairs, or at least some segment of these affairs such as midwifery (*sage femme*, wise woman in French). Equally, the three kings in the story of the magi at the birth of Christ were wise men, not only in realizing the importance of that event, but also perhaps in the way they carried out their ritual and religious roles. Wisdom, knowledge, and common sense are all interrelated in complex ways.

Oral Cultures

Unwritten languages do not lack abstraction, as has sometimes been suggested; language use itself depends on that very process. But in purely oral cultures words do tend to be more concrete in their reference, established as they are by face-to-face interaction. There seem to be relatively few nouns for qualities such as *wisdom* (nouns in any case being more common in written languages).

In an oral culture, one acquires wisdom and more generally knowledge through the aging process. The young can hardly be wiser or more knowledgeable than the old since they have had less experience, on which wisdom is based, and have acquired less knowledge, which in any case comes from the elders. There are no books that the young can read to acquire wisdom and learning independently of their seniors, who are largely members of the same family.

The discussion of wisdom ties up with the question of whether we find "intellectuals" in oral cultures. Clearly there are not only different levels of knowledge about cultural

affairs, but also differences in the ability to create that knowledge. In his work on the cosmology of the Dogon of Mali, Marcel Griaule offers his *Conversations with Ogotemméli* (1948) as if they presented a picture of the people's worldview. It is not altogether clear how much of this account comes from the actor's mouth and how much from the interpreter and the anthropologist. But what is apparent is that Ogotemméli was an exceptional man who was capable of shaping his own view of the world. Exceptional, but not all that rare. In nonliterate societies, in the absence of a written text to which they can refer, many elaborate their own version in areas of what is often thought to be "common knowledge."

Bagre. The Bagre is an association found in various groups in northern Ghana to which the majority of the inhabitants belong in order to ward off disease. It consists of a series of initiatory performances over six months at which elders repeat a recitation in two parts, the White and the Black, that comprises an account of the ceremony itself and, in the Black, a version of how the people came to have the culture they do and the problems they face as humans. The extensive Bagre recitations of the LoDagaa, which display some features of later philosophic discourse (for example, an awareness of "the problem of evil"), do not refer to anything that has been translated as "wisdom." On the other hand, "wise" as an adjective is something used in the translations.

In the Bagre, the notion of *wisdom* is closely connected with age. In the Black Bagre, the "deepest" of the two parts, a repeated phrase has been translated as "little old woman"; in the other, White Bagre, a similar phrase has been translated as "wise old woman." The shift could be an error of transcription, but it is not all that important, since the notion of aged already implies *wisdom*. While you may find foolish old men or women, generally age proclaims wisdom.

For the LoDagaa, the capacity to act in a wise manner is helped by learning from one's elders, who are more experienced in the ways of the world. But it also comes from one's knowledge of "oral literature," with having a wide range of reference to common culture, starting with proverbs, running to folk tales (mainly told to children, often with a "moral" ending, though not of the Rudyard Kipling sort), but more thoroughly with the knowledge of the Bagre recitation. Not everyone belongs to the association whose members have this "myth" repeatedly recited to them, but the majority of men are initiated and so too are women, at least as far as the lower White Bagre, as a result of which restriction they lack some ritual knowledge, though they acquire this after menopause, when they count "as men." In this recitation, especially in the Black, many matters concerning the human experience are discussed, including the problem of evil. But the role of God as Creator and as Supreme Being is also frequently referred to, especially in what has elsewhere been called the First Bagre (Goody, 1972).

In the Bagre a great deal of attention is paid to learning and to knowledge that brings wisdom. In a way, the whole of the recitation is about how humans *learned* to do what they do, who taught them, who deceived them. The knowledge comes from supernatural agencies, ultimately from the creator god,

more immediately from the beings of the wild who can deceive. It was they who instructed our ancestor(s), who in turn passed the knowledge on to us, often in the course of recitals such as the Bagre. We have to *understand* (hear) this knowledge with the aid of our *sense* (*yen*). Wisdom consists in the judicious application of knowledge and experience to actual situations; it is based on a knowledge not so much of the supernatural as of the natural world, the world of man. While there is no general quality translatable as "wisdom," the wise application of knowledge both religious and secular does seem to be recognized by the actors. And part of the knowledge on which it is based does emerge from the recitation of the Bagre, which could be seen as a kind of "schooling" process—that is, it aims to transfer knowledge to the initiates. However, it is possible for elders of either sex to be perceived as wise without actually being a member. There are other ways of becoming a sound counselor and solving disputes in the course of ordinary life.

While wisdom is a feature of human relationships, sense is also an internal quality that can manifest itself in the young. In the Bagre, God's child is said to have

had much sense
in his head (Goody, 1972, First Black Bagre, l. 1480–1481)

At one point in the recitation, he has just been told by his father, who claims possession, that a woman passing by was not his mother:

"You have no mother."
The boy
laughed softly
and asked his father,
"Have you seen anyone
who has no mother
and yet has a father?" (l. 1438–1444)

While this child has sense, mainly it is the old who are wise. When the father and mother of God's child are quarrelling about the ownership, "the wise old woman"

laughed loudly
and said
that one child
is causing two people
to quarrel. (l. 864–868)

She takes the case before God himself (a bearded old man sitting on a cow's hide), who asks them to keep calm and "resolve" the problem by asking the mother and the father to urinate down a hollow stalk. This arbitrary task hardly matches the wisdom of Solomon in similar circumstances and in fact resolves nothing. The quarrel continues, but the problem of the duality of parenthood has been made explicit. This situation seems not atypical of oral cultures.

As is shown by the various published versions of the LoDagaa recitation of the Bagre, memory is rarely verbatim, and the performers are therefore "forced to be free," obliged to fill

in the gaps and in many cases wanting to make their own contribution. Changes, often creative changes, are frequent. And there is considerable difference in that creative ability, which is recognized in the recitation itself in the injunction to new initiates to learn to recite. In the recorded versions, the First Bagre, both Black and White, is considerably more sophisticated, partly because the speaker was more of an “intellectual,” a person who gave more thought to the nature of things, which is how later philosophers like to think of themselves.

Written Cultures

In written cultures, wisdom is often associated with the elders and their experience. But it is largely expressed in their writings, in the wisdom literature of the ancient world, in Proverbs and the wisdom of Solomon in the Bible, the wisdom books of ancient Egypt, of the *Baghavat Gita* in Hinduism, and of the equivalents in Buddhist writings. Once again these texts are concerned with relations between humans rather than about relations of humans with gods. There are right and wrong ways of conducting the latter, but in general wisdom is not a notable feature. Wisdom literature, however, is concerned not with the more abstract questions of the ethical philosopher, whose activities are involved with general principles, but with the immediate problems of daily life.

Priests may be knowledgeable, even wise, about the ways of the gods, but there is no special wisdom automatically attached to being a priest, although they are often expected to conduct themselves in a restrained manner. Wisdom is more likely to be seen as the result of reading the works of secular authors, especially philosophers, interested in morality and the daily conduct of human affairs.

Societies with writing were heavily divided, until very recently, into those who could read and those who could not. The latter are sometimes spoken of as belonging to an oral culture; some would rather see them as attached to an oral tradition, one that has been significantly affected by the “high culture” of the written. An oral tradition, when combined with a written culture such as the biblical, has its own characteristics. The written culture may incorporate and transform earlier oral culture and myth and produce a “folk wisdom” that enters into oral repetition. That may consist in the appropriate reference to proverbs, such as “a stitch in time,” but it also produces a kind of wisdom, more often associated with the country rather than the town, that draws on a wider experience not of books but of life as it is lived in the round. The paradigmatic example of such unlettered wisdom is provided by the peasant Karataev in Leo Tolstoy’s *War and Peace*, whose “wisdom” is contrasted with the anxious cleverness of the aristocratic, cosmopolitan Pierre, a great reader.

The unlettered still had a wisdom to offer in a society many of whose activities were dominated by the written text. By contrast, in mixed societies too much reading is sometimes seen as leading to the loss of wits, of “sense,” of contact with the real world. The text is distanced from human affairs and may prevent the profound contact that encourages wisdom, at least folk wisdom, and that comes from an unmediated experience of human affairs.

See also *Knowledge; Life Cycle: Elders/Old Age; Oral Traditions; Philosophy.*

BIBLIOGRAPHY

- Goody, Jack. *The Domestication of the Savage Mind*. Cambridge, U.K.: Cambridge University Press, 1977.
- , ed. *The Myth of the Bagre*. Oxford: Clarendon, 1972.
- Griaule, Marcel. *Conversations with Ogotemméli: An Introduction to Dogon Religious Ideas*. Oxford: Oxford University Press, 1965.
- Lévi-Strauss, Claude. *The Savage Mind*. Chicago: University of Chicago Press, 1966.

Jack Goody

WITCHCRAFT. The word *witchcraft* is used in many different ways. The word *witch* is derived from Old English *wicca* (masc., “wizard”) and *wicce* (fem., “witch”). The term *wiccan* (“witchcraft”) referred to human acts intended to influence nature, usually through the use of power unavailable to all human beings. This use of the word *witchcraft* is synonymous with the more general word *magic*. The acts associated with witchcraft were sometimes called spells (Old English “talk, tale”). The person could conduct these acts for his or her benefit, or for others who did not have access to the necessary power. In contemporary academic work and in popular culture, however, it is still generally assumed that the influence or change resulting from the act is harmful. With these negative associations, *witchcraft* is also used for diabolism, acts performed with the assistance of the devil. Other acts, those that attempt to influence nature in a beneficial way, are usually not considered. *Witchcraft* also refers to ideas and practices believed to influence nature that emerged in the twentieth century, largely in Europe and North America, sometimes referred to as neo-paganism. This use of *witchcraft* is similar to the one derived from the Old English *wiccan*.

Witchcraft is the term most commonly used in the social science literature, and the practices it refers to can be found in all societies. Over the years there has been some debate about the similarities and differences between the practices of witchcraft and sorcery, and in the social sciences there are several traditions. Studies conducted in Asia tend to use the term *sorcery* for the practices referred to by *magic*, while studies in South America use *shamanism* in a similar way. Studies in Africa use both *sorcery* and *witchcraft*, and the use of both terms usually assumes that the magical acts are intended to be harmful.

In the twentieth century, there were debates about whether different terms should be applied to rituals that were conducted with and without the assistance of spirits. There were also discussions about distinguishing between practitioners whose power was innate and those who learned the knowledge and skills from existing practitioners. In the social sciences, it is generally assumed that both *witchcraft* and *sorcery* can be used interchangeably, but it is important for the scholar to explain the particular way each term is being used, as well as its relationship to local terms.

The Social and Political History of Witchcraft in Europe

The ancient Greeks made distinctions among forms of magic, although they differ from the categories found in contemporary thought. The Greeks considered all magic to be performed with the assistance of spirit entities called *diamones* (“demons”) that could be either harmful or helpful. During the Hellenistic period, a new belief emerged that developed the notion that evil spirits were led by Satan. Christians then began to divide the *diamones* into good angels and harmful demons. People involved in magic were thought to use the power of demons. During the Renaissance, this idea expanded into a full-fledged belief in diabolical witchcraft. The idea of the devil in Christianity overshadowed all other ideas concerning magic, and the fear of witchcraft took a central place in the religious imagination.

During the period of the European witch craze (1450–1700), many beliefs and practices rooted in paganism and folklore came to be associated with influences from the devil. The idea of diabolical witchcraft also came to be applied to medieval heretics, who were imagined to be involved in a pact with witches and with Satan himself. In Spain and its colonies, the Inquisition, which provided a legal forum for persecuting those identified as witches and heretics, further collapsed the concepts of magic and diabolical witchcraft. Gradually, any form of magic came to be viewed in Europe as diabolical witchcraft.

During the witch craze, patterns in accusation show that the accused generally had a low social status, already had been faulted for other transgressions, and exhibited difficult personality traits. Many were practitioners of medicine, and a disproportionately large number were women, as discussed below. Although there were no witch hunts in Europe during the eighteenth and nineteenth centuries, many colonial societies developed new versions of witchcraft laws that were used to stigmatize the religious ideas and practices of colonized peoples.

The Functions of Witchcraft

In the 1940s and 1950s sociologists and anthropologists explored the many positive functions of witchcraft and illustrated them with detailed studies. As E. E. Evans-Pritchard (1902–1973) observed in his classic study of the belief in witches in an African society, the Azande, witchcraft can be understood as an explanation for unfortunate events. That explanation enabled people to maintain a sense of control over their lives and feel that they understood their world. Understandings about witchcraft could also help to define values and moral standards in a society.

The ideas that a society creates about witches can be seen to support norms and values in that society, and, when analyzed along with a structural model of the society, can also provide insights into the organization of the culture and society. Ideas about the negative characteristics of the witch can be a way to guide behavior, as functionalist anthropologists argued in a series of studies showing that the belief in witchcraft served as a social control mechanism. In his work on the Navajo, Clyde Kluckhohn found that the fear of becoming the victim of witchcraft encouraged them to cooperate, share resources, and minimize public displays of anger. The socially permitted

form of aggression toward the witch allowed other hostilities to be displaced onto an individual, a useful outlet in situations where in-group hostilities could threaten the survival of the group or damage people’s abilities to act collectively.

The central problem with studies that assumed a cohesive function for witchcraft was that, like other functional analyses, the theory could not be proved or falsified. Some sociologists and anthropologists such as Max Marwick were more interested in analyzing the social basis of witchcraft accusations and the life conditions that placed particular strain on these relationships. Against the dominant functionalist trend, Robert Murphy proposed that beliefs about witchcraft and accusations could have disruptive effects. Working with the Mundurucú in Brazil, he found that witchcraft accusations, combined with a rubber economic boom, created group divisions and family migration, which eventually supported a more dispersed settlement pattern. From her comparative analysis of African Studies, Mary Douglas (1963) came to a similar conclusion.

It has been observed that people in relatively marginal positions in society might be able to use witchcraft, or the threat of witchcraft, as a form of social power. The relatively weak could then influence people with more power or wealth to redistribute it and minimize some of the inequalities in the society. In his study of the Maka in Cameroon, Peter Geschiere shows that witchcraft can work both to promote accumulation and leveling.

Symbolic and Ideological Aspects of Witchcraft

Largely through the influence of Claude Lévi-Strauss’s structuralist approach, anthropologists have placed great emphasis on the position of witches in symbolic systems. In ethnographic studies, it has often been observed that witches are associated with the left hand and with wild or nondomestic realms, and are placed in opposition to the moral standards of a society. Actors’ understandings of witchcraft are extremely important, although most anthropologists are cautious in interpreting these exegeses, placing them within more comprehensive analyses that also examine symbolic meanings more generally, as well as their relationship to the social, political, and economic processes in the society. This approach is best shown in the work of Bruce Knauft in New Guinea.

Scholarship has also explored the role of witchcraft beliefs in diverting people’s attention from economic and political explanations for untoward events. This kind of argument, similar to Karl Marx’s (1818–1883) understanding of ideology, claims that witchcraft as a form of explanation functions to maintain the existing sociopolitical structure of a society. According to George Bond, witchcraft explanations in Muyombe, Zambia, work to obfuscate the changing labor and property relationships among villagers. While their participation in accusations emphasizes their common membership in the community, it deemphasizes their increasingly unequal economic status.

Witchcraft and Gender Relations

Scholarly works from many different societies and time periods have shown that witch-finding rituals, popularly called witch hunts, are used by more powerful segments of a society

to persecute people who are opponents or who present a threat to established power. Christina Lerner shows that in sixteenth- and seventeenth-century England the church and state entered new forms of cooperation and identification that especially targeted women as witches. Her explanation is that men identified themselves as the proper professional group to offer healing services, and women were persecuted because their healing traditions competed with this new system.

It is important to understand that the disproportionate number of women targeted by European and American witchcraft accusations should not be taken to mean that this focus is a universal. In some societies, men are more commonly accused of witchcraft and represent that society's ideal witch. Diane Ciekawy (1999) shows that among Mijikenda in Kenya witchcraft accusations are primarily directed toward men. In her analysis of the witchcraft accusation process, women collect evidence and shape ideas about culpability in the homestead, thereby wielding a great deal of power. The work of Rosalind Shaw with Temne women in Sierra Leone illustrates the ways that women are active agents in diviner consultations. She shows how women can select from diviner consultations the explanations for their problems that they most favor. These chosen explanations can resist patriarchal explanations that disadvantage them or create less favorable power relations.

Witchcraft: Questions of Translation and Meaning

Scholars continue to debate the question of how well scholarly concepts like witchcraft convey the meanings of local terms, and how much a term like *witchcraft* can reduce the diversity and complexity of ideas and actions to which it is applied. Regarding the history of scholarship around the terms *magic*, *sorcery*, and *witchcraft*, we see that, although magic can be indigenously conceived as having both harmful and helpful potentials, the latter can be deemphasized by scholars who are more interested in its harmful potential. While these questions are not entirely new—both Victor Turner and Malcolm Crick encouraged anthropologists to use local terms and their specific meanings as much as possible in their work—current scholarship is more sensitive to the possibility of misrepresenting the cultures it attempts to describe. In view of the political history of witch hunts in Europe, and the ways non-Christian religious ideas and practices were demonized, it is possible to ask if a similar process continues in the structure of contemporary academic discourse.

Some scholars regard witchcraft as a discourse of power that requires knowledge about the historical and ethnographic conditions that shape understandings about it. This might entail a more careful analysis of the semantic range of terms for magic and harmful magic, with an attempt to separate local discourses from wider regional or national ones. Ciekawy (1998) does this in her analysis of the application of the Witchcraft Act in colonial and postcolonial coastal Kenya. She describes different words that Mijikenda people use for harmful magic: *utsai* is a Kimijikenda term, the kiSwahili words are *uchawi* and *ulozi*, and some people use *witchcraft*. Mijikenda employ these terms in different contexts. She concludes that, for conceptual and analytical purposes, the terms must be distinguished because *utsai* refers to a discourse on harmful magic that is

created and operates within local social and political settings largely under the control of Mijikenda who use them, while *witchcraft* is best understood as a technology of power that emerged under European colonialism, supported largely through discourses of mission Christianity and colonial law and administration.

Witchcraft as a Discourse of Power

Jeanne Favret-Saada's study of witchcraft in the Bocage of western France examines the power of words used by people to talk about witchcraft. She distinguishes this approach to witchcraft as power from its more conventional use in anthropology as knowledge or information, pointing out that in the Bocage there is no neutral position that a person can have when it concerns such socially and politically powerful speech. She also questions the way academics have viewed witchcraft as the backward and untrue beliefs of people who do not use academic forms of reasoning. This is consistent with the general approach used to study many forms of magic offered by Arens and Karp. Rather than use the words *magic* and *witchcraft*, they advocate the use of the terms *transformational capacity* and *power*.

The Modernity of Witchcraft

Contemporary scholarly work indicates that the study of witchcraft is as relevant today as it has been in the past. Ideas about witchcraft address new circumstances and are very much a part of people's understanding of how their lives are connected to events and processes both near and far. It is common for witchcraft discourses to relate to the countryside, town, state, and world. Few current studies see witchcraft only as a social construction; it is also understood to be a concept that meaningfully provides people with a representation of the complexity of the order in which they live, including power and inequality, individual and collective interests, and resources and their allocation. Witchcraft addresses issues of globalization and transformations within the state, and continues to explain events and the mechanics of their integration into daily life. It is also important to remember that the constructions of witchcraft can be powerful realities, and have the ability to maintain or transform social relationships.

See also Anthropology; Astrology; Overview; Demonology; Evil; Gender Studies; Anthropology; Heresy and Apostasy; Magic; Miracles; Nature; Superstition; Witchcraft; African Studies of.

BIBLIOGRAPHY

- Arens, W., and Ivan Karp. *Creativity of Power: Cosmology and Action in African Societies*. Washington, D.C.: Smithsonian Institution Press, 1989.
- Bond, George. "Ancestors and Protestants: Religious Coexistence in the Social Field of a Zambian Community." *American Ethnologist* 14, no. 8 (1986): 55–72.
- Boyer, Paul S., and Stephen Nissenbaum. *Salem Possessed: The Social Origins of Witchcraft*. Cambridge, Mass.: Harvard University Press, 1974.
- Caro Baroja, Julio. *The World of the Witches*. Translated by O. N. V. Glendinning. Chicago: University of Chicago Press, 1964.

- Ciekawy, Diane. "Witchcraft and Statecraft: Five Technologies of Power in Colonial and Postcolonial Coastal Kenya." *African Studies Review* 41, no. 3 (1998): 119–141.
- . "Women's 'Work' and the Construction of Witchcraft Accusation in Coastal Kenya." *Women's Studies International Forum* 22, no. 2 (1999): 225–235.
- Cohn, Norman R. C. *Europe's Inner Demons: The Demonization of Christians in Medieval Christendom*. Chicago: University of Chicago Press, 1993.
- Crick, Malcolm. *Explorations in Language and Meaning: Towards a Semantic Anthropology*. New York: Wiley, 1976.
- Demos, John. *Entertaining Satan: Witchcraft and the Culture of Early New England*. New York: Oxford University Press, 1982.
- Evans-Pritchard, E. E. *Witchcraft, Oracles, and Magic among the Azande*. Oxford: Clarendon, 1937.
- Favret-Saada, Jeanne. *Deadly Words: Witchcraft in the Bocage*. Translated by Catherine Cullen. New York: Cambridge University Press, 1980.
- Geschiere, Peter. *The Modernity of Witchcraft: Politics and the Occult in Postcolonial Africa*. Charlottesville: University Press of Virginia, 1997.
- Gluckhohn, Clyde. *Navaho Witchcraft*. Boston: Beacon, 1962. Originally published in 1944.
- Knauff, Bruce M. *Good Company and Violence: Sorcery and Social Action in a Lowland New Guinea Society*. Berkeley: University of California Press, 1985.
- Larner, Christina. *Witchcraft and Religion: The Politics of Popular Belief*. Oxford: Blackwell, 1984.
- Macfarlane, Alan. *Witchcraft in Tudor and Stuart England: A Regional and Comparative Study*. London: Routledge and Kegan Paul, 1970.
- Mair, Lucy P. *Witchcraft*. New York: McGraw-Hill, 1969.
- Marwick, Max. *Sorcery in Its Social Setting*. Manchester, U.K.: Manchester University Press, 1965.
- Middleton, John. *Lugbara Religion: Ritual and Authority among an East African People*. London: Oxford University Press, 1960.
- Murphy, Robert F. *Mundurucú Religion*. Berkeley: University of California Press, 1958.
- Russell, Jeffrey B. *A History of Witchcraft: Sorcerers, Heretics, and Pagans*. London: Thames and Hudson, 1980.
- Shaw, Rosalind. "Gender and the Structuring of Reality in Temne Divination: An Interactive Study." *Africa* 53, no. 3 (1985): 286–303.
- Trevor-Roper, Hugh R. *The European Witch-Craze of the Sixteenth and Seventeenth Centuries, and Other Essays*. New York: Harper and Row, 1969.
- Turner, Victor. *The Forest of Symbols: Aspects of Ndembu Ritual*. Ithaca, N.Y.: Cornell University Press, 1967.

Diane Ciekawy

WITCHCRAFT, AFRICAN STUDIES OF. In contemporary scholarly and popular discourse, the term *witchcraft* refers to a wide variety of ideas, practices, and institutions. Among most social science scholars of Africa, particularly anthropologists, *witchcraft* is defined as an act of magic that results in harming a person or aspects of the material world on which he or she depends. In this context, *witchcraft* and *magic* are used interchangeably; it is assumed that magic used

for harm and magic used for healing, or enhancement, can be distinguished, either conceptually or in practice.

The work of anthropologists from the 1930s on made the greatest contributions to the study of social and political institutions in African societies, as well as their systems of belief and logic. Their methodological and theoretical achievements influenced many disciplines in Western scholarship, notably history and philosophy. During the past forty years, witchcraft has occupied a controversial place in African Studies scholarship. As a general term that describes the harmful use of magic, *witchcraft* is not specific with respect to the societies or peoples who use it. Witchcraft and magic exist in all societies, but, as many scholars have shown, in the history of Western thought and popular culture, and in much of contemporary European-American scholarship, witchcraft has been positioned as a backward or erroneous system of thought. In the study of African religions, it is also interesting to note that Western scholarship has given it great prominence. As noted by John Mbiti in *African Religions and Philosophies*, Western scholarship has often presented witchcraft ideas out of context and emphasized their association with harm, which has resulted in a fundamental misrepresentation of African religions.

One of the central achievements of E. E. Evans-Pritchard's (1902–1973) work was to show that witchcraft among the Azande provided explanations for everyday events and presented a theory of causality. From a contemporary critical perspective, however, it can be faulted for making the assumption that it did not have the same explanatory power as scientific modes of thought and reasoning. African philosophy has been at the forefront of critical assessment of the biases of Western scholarship and the quest to develop discourses and ways of re-representing African religious life.

The study of witchcraft now involves a broader range of scholars who have extended debates and included in their studies many new areas of interest. Some of these concern questions of representation and meaning and new questions about the ability of disciplinary concepts to address local knowledge and experience.

Early Anthropological Contributions

Witchcraft serves many different social functions. In ethnographic studies of peoples around the world, anthropologists have detailed many of the positive social functions of witchcraft. As popularized in Evans-Pritchard's work, witchcraft can be understood as an explanation for misfortune, which might function to provide people with a sense of control over their own lives and the ability to understand forces in their world. These could be called empowering functions of witchcraft. Understandings about witchcraft can be used to define values and moral standards in a society, thus contributing to a society's definition of itself or distinction from other groups. Also, people who are in relatively weak and marginal positions in society might be able to use witchcraft, or the threat of witchcraft, as a form of power. In this way, the ideas and practices of witchcraft could work to mediate social, political, or economic inequalities.

Witchcraft also serves more overtly political functions. The complex of ideas associated with witchcraft can involve rituals

that identify people responsible for practicing witchcraft. Early anthropological works on African societies noted the existence of movements against witchcraft, sometimes known as anti-witchcraft movements or witchcraft eradication movements, that borrowed from these cultural institutions. Audry Richards's important essay on a witch-finding movement in Zambia shows how the movement drew from responses to the influences of colonialism, yet also drew from rituals that are part of a common complex in central African societies.

Politics of Witchcraft: Local and Global

Building on anthropological methods for studying the politics of witchcraft, several important works demonstrate relationships between local and global worlds in the construction of witchcraft ideas and practices. Peter Geschiere's *The Modernity of Witchcraft* shows how the many different fields of everyday experience that shape witchcraft for the Maka in Cameroon are influenced by regional, national, and global forces. In her study of legal and administrative institutions in Kenya, Diane Ciekawy (1998) shows how local religious practice is both constrained and encouraged to develop in ways that further strengthen the power of state institutions. Scholars also acknowledge the challenge of segregating local discourses concerning magical harm from wider regional or national ones, particularly when the English term *witchcraft* is used in African communities.

Philosophical Approaches to the Study of Witchcraft

African philosophy has provided some of the most critical assessments of Western scholarly traditions. In *The Invention of Africa*, V. Y. Mudimbe shows how concepts and terms used in the study of African religion, including witchcraft, developed through colonial practices and Western prejudices about African peoples and their cultures. African philosophy has also engaged in discussion about the importance of acknowledging the role of individual philosophers in the creation of knowledge (Hallen and Sodipo; Karp and Masolo).

Moral and Ethical Relevance

Scholars are now more interested in exploring the moral and ethical questions that witchcraft presents. Elias Bongmba is also attentive to the ways that witchcraft discourse contributes to problems within African societies. Bongmba, himself from Wimbun society, uses his experience as well as fieldwork. Drawing on notions of intersubjectivity from philosophy, he examines notions of *tfu*, used by Wimbun in Cameroon. He shows that it is part of a discourse of power that includes both helpful and harmful aspects, and concludes that it gives people an opportunity to engage in face-to-face encounters. In a similar way, Ciekawy examines Mijikenda interpretations of the magical practice of *utsai*. She argues that it is a way for people to conceptualize inequality and the exploitation of one human being by another, which makes it particularly useful for comprehending the world and considering the ethical choices available to human beings.

Modernity

Contemporary ideas of witchcraft provide an idiom for expressing individualism, innovation, and human agency that are

much a part of modern life. During this period of rapid globalization and incorporation within the postcolonial state, ideas of witchcraft have been used by African peoples as frameworks of interpretation. As interpretive constructs, they also help to shape the political world, and they are, therefore, powerful forces that can both help to maintain or transform social and political worlds.

Conclusions

In the study of witchcraft in African societies, the concern with systems of logic and thought that has long engaged anthropology and philosophy continues. More recently, there has been a focus on indigenous systems of knowledge and hermeneutical traditions. More contemporary scholars are interested in forms of interpretation, skepticism, and cultural critique that come from within local thought traditions. Scholarship is now, more than ever before, poised to counter the academic practice of maintaining distinctions in forms of thought from Western and African societies.

See also Anthropology; Demonology; Ethnography; Eurocentrism; Magic; Neocolonialism; Philosophies: African; Religion: Africa; Subjectivism; Superstition; Witchcraft.

BIBLIOGRAPHY

- Austen, Ralph A. "The Moral Economy of Witchcraft: An Essay in Comparative History." In *Modernity and Its Malcontents: Ritual and Power in Postcolonial Africa*, edited by Jean Comaroff and John Comaroff, 89–110. Chicago: University of Chicago Press, 1993.
- Bockie, Simon. *Death and the Invisible Powers: The World of Kongo Belief*. Bloomington: Indiana University Press, 1993.
- Bond, George C. "Religion, Ideology, and Property in Northern Zambia." In *Studies in Power and Class in Africa*, edited by Irving L. Markovitz, 70–188. London: Oxford University Press, 1987.
- Bongmba, Elias. *African Witchcraft and Otherness: A Philosophical and Theological Critique of Intersubjective Relations*. Charlottesville: University of Virginia Press, 2001.
- Ciekawy, Diane. "Policing Religious Practice in Contemporary Coastal Kenya." *Political and Legal Anthropology Review* 20, no. 1 (1997): 62–72.
- . "Utsai as Ethical Discourse: A Critique of Power from Mijikenda in Coastal Kenya." In *Dialogues of Witchcraft: Anthropological and Philosophical Exchanges*, edited by George C. Bond and Diane Ciekawy, 158–189. Athens: University of Ohio Press, 1991.
- . "Witchcraft in Statecraft: Five Technologies of Power in Colonial and Postcolonial Coastal Kenya." *African Studies Review* 41, no. 3 (1998): 119–141.
- de Boeck, Filip. "Beyond the Grave: History, Memory, and Death in Postcolonial Congo/Zaire." In *Memory and the Postcolony: African Anthropology and the Critique of Power*, edited by Richard Werbner, 21–57. London: Zed, 1998.
- Devisch, René. *Weaving the Threads of Life: The Khita Gyn-Eco-Logical Healing Cult among the Yaka*. Chicago: University of Chicago Press, 1993.
- Evans-Pritchard, E. E. *Witchcraft, Oracles, and Magic among the Azande*. Oxford: Clarendon, 1937.
- Fisiy, Cyprian F., and Peter Geschiere. "Judges and Witches, or How Is the State to Deal with Witchcraft? Examples from

- Southeastern Cameroon." *Cahiers d'études africaines* 118 (1990): 135–156.
- Fisiy, Cyprian F., and Michael Rowlands. "Sorcery and Law in Modern Cameroon." *Culture and History* 6 (1990): 63–84.
- Geschiere, Peter. "Globalization and the Power of Indeterminate Meaning: Witchcraft and Spirit Cults in Africa and East Asia." *Development and Change* 29 (1998): 811–837.
- . *The Modernity of Witchcraft: Politics and the Occult in Post-colonial Africa*. Charlottesville: University of Virginia Press, 1997.
- Hallen, Barry, and J. Olubi Sodipo. *Knowledge, Belief, and Witchcraft: Analytic Experiments in African Philosophy*. London: Ethnographica, 1986.
- Heald, Suzanne. "Witches and Thieves: Deviant Motivations in Gisu Society." *Man* 21, no. 1 (1986): 65–78.
- Jackson, Michael. *Allegories of the Wilderness: Ethics and Ambiguity in Kuranko Narratives*. Bloomington: Indiana University Press, 1982.
- Karp, Ivan, and D. A. Masolo. "Introduction." In their *African Philosophy as Cultural Inquiry*, 1–18. Bloomington: Indiana University Press, 2000.
- Lévi-Strauss, Claude. *The Savage Mind*. London: Weidenfeld and Nicolson, 1966.
- Marwick, Max. "Another Modern Anti-Witchcraft Movement in East Central Africa." *Africa* 20, no. 2 (1950): 100–112.
- Marwick, Max. *Sorcery and Its Social Setting: A Study of the Northern Rhodesian Cewa*. Manchester, U.K.: Manchester University Press, 1965.
- Mbiti, John S. *African Religions and Philosophy*. New York: Doubleday, 1970.
- Meyer, Birgit. *Translating the Devil: Religion and Modernity among the Ewe in Ghana*. Trenton, N.J.: Africa World Press, 1999.
- Mudimbe, V. Y. *The Idea of Africa*. Bloomington: Indiana University Press, 1994.
- Niehaus, Isak. *Witchcraft, Power, and Politics: Exploring the Occult in the South African Lowveld*. Sterling, Va.: Pluto, 2001.
- Piot, Charles. *Remotely Global: Village Modernity in West Africa*. Chicago: University of Chicago Press, 1999.
- Richards, Audry. "A Modern Movement of Witch-Finders." *Africa* 8, no. 4 (1935): 448–461.
- Shaw, Rosalind. *Memories of the Slave Trade: Ritual and the Historical Imagination in Sierra Leone*. Chicago: University of Chicago Press, 2002.

Diane Ciekawy

WOMANISM. The term *womanist* first appeared in Alice Walker's *In Search of Our Mothers' Gardens: Womanist Prose* (1983), in which the author attributed the word's origin to

the black folk expression of mothers to female children, 'You acting womanish,' i.e. like a woman . . . usually referring to outrageous, audacious, courageous, or *willful* behavior. Wanting to know more and in greater depth than is considered 'good' for one . . . [A womanist is also] a woman who loves other women sexually and/or nonsexually. Appreciates and prefers women's culture . . . and women's strength . . . committed to survival and wholeness of entire people, male and female. Not a separatist . . . Womanist is to feminist as purple is to lavender. (pp. xi–xii)

Although Walker states that a womanist is a black feminist or feminist of color, she insists that a black feminist as womanist talks back to feminism, brings new demands and different perspectives to feminism, and compels the expansion of feminist horizons in theory and practice.

The introduction of "womanism" in the feminist lexicon in the early 1980s marks a historic moment in feminist engagement in the United States. The late 1970s and the 1980s witnessed an internal insurgency in feminism led by women of color who participated in fighting vigorously against sexual politics of the previous decade only to be confronted by the feminist politics of exclusion a decade later. Excluded from and alienated by feminist theorizing and thinking, women of color insisted that feminism must account for different subjectivities and locations in its analysis of women, thus bringing into focus the issue of difference, particularly with regard to race and class.

If feminism were not able to fully account for the experiences of black women, it would be necessary, then, to find other terminologies that could carry the weight of those experiences. It is in this regard that Alice Walker's "womanism" intervenes to make an important contribution. As Walker noted in the *New York Times Magazine* in 1984, "I don't choose womanism because it is 'better' than feminism . . . I choose it because I prefer the sound, the feel, the fit of it; because I cherish the spirit of the women (like Sojourner) the word calls to mind, and because I share the old ethnic-American habit of offering society a new word when the old word it is using fails to describe behavior and change that only a new word can help it more fully see" (p. 94). In other words, feminism needed a new word that would capture its complexity and fullness. Despite Walker's claims to the contrary, she suggests in her definitions of womanism (e.g., "womanist is to feminism as purple is to lavender") that the womanist/black woman is stronger and superior to the feminist/white woman.

Walker's construction of womanism and the different meanings she invests in it is an attempt to situate the black woman in history and culture and at the same time rescue her from the negative and inaccurate stereotypes that mask her in American society. First, Walker inscribes the black woman as a knowing/thinking subject who is always in pursuit of knowledge, "wanting to know more and in greater depth than is considered 'good' for one," thus, interrogating the epistemological exclusions she endures in intellectual life in general and feminist scholarship in particular. Second, she highlights the black woman's agency, strength, capability, and independence. Opposed to the gender separatism that bedevils feminism, womanism presents an alternative for black women by framing their survival in the context of the survival of their community where the fate of women and that of men are inextricably linked. As Patricia Hill Collins aptly notes, "many black women view feminism as a movement that at best, is exclusively for women, and, at worst, dedicated to attacking or eliminating men . . . Womanism seemingly supplies a way for black women to address gender-oppression without attacking black men" (p. 11).

In 1993 the word *womanism* with the meanings Alice Walker bestowed on it was added to *The American Heritage*

Dictionary. The concept has had a profound influence in the formulation of theories and analytical frameworks in women/gender studies, religious studies, black studies, and literary studies. Because of the linking of black women and spirituality in Walker's project, many African-American female theologians have incorporated womanist perspectives in their work. Drawing on African-American history in general and the black church in particular, black womanist theologians interrogate the subordination of women and assume a leadership role in reconstructing knowledge about women. Prominent black womanist theologians and scholars of religion—such as Cheryl Townsend Gilkes, Katie Geneva Cannon, Delores S. Williams, Emilie Maureen Townes, and Marcia Y. Riggs—bring womanist perspectives to bear on their black church, canon formation, social equality, black women's club movement of the nineteenth century, race, gender, class, and social justice. The impact of womanism goes beyond the United States to Africa where many women scholars and literary critics (Chikwenye Okonjo Ogunyemi, Tuzylina Jita Allan, and Mary Modupe Kolawole, in particular) have embraced it as an analytical tool.

Alice Walker's womanism has also generated debates and controversies. Prominent among those who challenge the terminology's appropriateness for framing and explaining the lives of women of African descent is Clenora Hudson-Weems, who proposes an alternative terminology—*Africana womanism*—that is different from Black feminism, African feminism, and Walker's womanism. Many of the debates and controversies about womanism focus on the differences and tension between womanism and black feminism. Patricia Hill Collins offers an excellent critique of both womanism and black feminism. Hill Collins notes that the debate about whether to label black women's standpoint womanist or black feminist is indicative of the diversity among black women. According to Hill Collins, "Walker's definition thus manages to invoke three important yet contradictory philosophies that frame black social and political thought, namely, black nationalism via her claims of black women's moral and epistemological superiority via suffering under racial and gender oppression, pluralism via cultural integrity provided by the metaphor of the garden, and integration/assimilation via her claims that black women are 'traditionally universalist'" (p. 11). While weaving the separatism and black moral superiority of the black nationalist philosophy, the pluralism of the black empowerment variant, and the interrogation of white feminism, womanism seeks to give a voice, a standpoint to black women but fails to adequately take into account the heterogeneity of women of African descent with their different histories and realities.

See also *Feminism: Africa and African Diaspora; Philosophies: African; Women's History: Africa*.

BIBLIOGRAPHY

- Allan, Tuzylina Jita. *Womanist and Feminist Aesthetic Comparative Review*. Athens: Ohio University Press, 1995.
- Cannon, Katie Geneva. *Black Womanist Ethics*. Atlanta: Scholars Press, 1988.
- Collins, Patricia Hill. "What's in a Name? Womanism, Black Feminism, and Beyond." *The Black Scholar* 26, no. 1 (1996): 9–17.

- Gilkes, Cheryl Townsend. *"If It Wasn't for Women": Black Women's Experience and Womanist Culture in Church and Community*. Maryknoll, N.Y.: Orbis Books, 2001.
- Hudson-Weems, Clenora. "African Womanism." In *Sisterhood, Feminisms, and Power: From Africa to the Diaspora*, edited by Obioma Nnaemeka. Trenton, N.J.: Africa World Press, 1998.
- . *African Womanism: Reclaiming Ourselves*. Detroit: Bedford Press, 1993.
- Kolawole, Mary Eibun Modupe. *Womanism and African Consciousness*. Trenton, N.J.: Africa World Press, 1997.
- Ogunyemi, Chikwenye Okonjo. "Womanism: The Dynamics of the Contemporary Black Female Novel in English." *Signs: Journal of Women in Culture and Society* 11, no. 1 (1985): 63–80.
- Riggs, Marcia Y. *Awake, Arise, and Act: A Womanist Call for Black Liberation*. Cleveland, Ohio: Pilgrim Press, 1994.
- Sanders, Cheryl J., ed. *Living the Intersection: Womanism and Afrocentricism in Theology*. Minneapolis, Minn.: Fortress Press, 1995.
- Townes, Emilie Maureen. *Womanist Justice, Womanist Hope*. Atlanta, Ga.: Scholars Press, 1993.
- Townes, Emilie Maureen, ed. *Embracing the Spirit: Womanist Perspectives on Hope, Salvation, and Transformation*. Maryknoll, N.Y.: Orbis Books, 1997.
- Townes, Emilie Maureen, ed. *A Troubling in My Soul: Womanist Perspectives on Evil and Suffering*. Maryknoll, N.Y.: Orbis Books, 1993.
- Walker, Alice. "The Black Woman's Story." *New York Times Sunday Magazine*, February 12, 1984, p. 94.
- . *In Search of Our Mothers' Gardens: Womanist Prose*. San Diego, Calif.: Harcourt Brace Jovanovich, 1983.
- Williams, Delores S. *Sisters in the Wilderness: The Challenge of Womanist God-Talk*. Maryknoll, N.Y.: Orbis Books, 1993.
- Williams, Sherley Ann. "Some Implications of Womanist Theory." In *Reading Black, Reading Feminist: A Critical Anthology*, edited by Henry Louis Gates, Jr., 68–75. New York: Meridian, 1990.

Obioma Nnaemeka

WOMEN AND FEMININITY IN U.S. POPULAR CULTURE.

Before the women's movement and deconstruction, the term *femininity* was understood as the opposite of the more obvious *masculinity*. Femininity represented those traits, characteristics, behaviors, or thought patterns not associated with a given society's expectations of men. Until the cultural upheaval of the late 1960s in the United States and elsewhere, the sweetly patient "angel of the house" persisted as the womanly ideal. Women learned to be feminine "in the image that suited the masculine desires" (quoted in Costa, p. 222), an image that included deference, respect, and obedience to males. In compensation, the woman held the passive power of the dispossessed. Submissive, soft-voiced, empathic, and maternal, the feminine woman would be willing to subordinate her own needs in order to better please others.

Femininity as a principle or "exquisite esthetic," as Susan Brownmiller puts it in *Femininity* (1984), "pleases men because it makes them appear more masculine by contrast . . . conferring an extra portion of unearned gender distinction on men, an unchallenged space in which to breathe freely and feel stronger, wiser, more competent, is femininity's special

gift" (p. 16). This gift, however, costs the giver. Girls and young women learn they must adhere to standards of comportment, physical presentation, and appearance according to the demands and currency of their respective cultures and classes or face disapproval, even social failure, ostracism, rejection.

In a postbinary world, however, definitions of femininity as well as masculinity have blurred. Definitions of femininity are no longer standardized and are therefore seemingly open, writes Maggie Mulqueen in *On Our Own Terms*. They arise "only from the culture, not from theory. . . . In reality, though, the cultural prescriptions about femininity (and masculinity) are very narrow and influential" (p. 13). These influential prescriptions consist of social expectations and the pressure to conform, particularly in adolescence. A girl's sexual awakening and turbulent maturation eventually steer her toward pleasing boys and winning admiration, envy, and acceptance from her peers.

Beauty and Class

In addition, the reigning elements of femininity and their effect on women resonate according to one's class and race, criteria that can locate a woman along the continuum of behavior and attractiveness. Class is a fluid or changeable category; race is generally not, though beauty treatments can "standardize" ethnic features like hair color and texture (see below) or influence acceptable limits of body size.

Related to class are the awareness of and access to proper nutrition as well as the availability of leisure time for exercise, factors associated with the maintenance of lean body mass. The proportion of lean mass to body fat contributes to the impression of overall girth and therefore health. Few men, young or old, strive to be gaunt, and fewer men than women are dissatisfied with their bodies even if they are somewhat overweight. Instead, they value size especially if the bulk is muscle rather than fat. Men's "perceptions serve to keep them satisfied with their bodies, whereas women's serve to keep them dissatisfied," writes Sarah Grogan (pp. 144–145). American women of any age, however, find thinness the only tolerable size, despite evidence that men prefer somewhat rounder female bodies than women think they do.

Preferred body size and proportion reflect class-related tastes or expectations. Researchers have suggested that different social classes have distinct ideas of attractiveness, and magazines gear to these readers. The fleshiness of magazine models varies according to the social class of the targeted audience, be it male or female. Magazines for upwardly mobile homemakers have trim but not skinny models. Family-oriented magazines present more modest images typical of pleasant-looking housewives. So-called pulp magazines feature curvier bodies: "the lower the social class ranking of the magazine the bigger the chest and hip measurements of the models," observes Nora Scott Kinzer (p. 165). Magazine models are rarely if ever overweight; in fact, compared with their counterparts from the 1950s, they generally weigh less and have smaller measurements.

Viewing and Being Seen

Because she frequently feels on display, a woman monitors her physical appearance in mirrors, in store windows, and in the

eyes and expressions of people who see her. Self-criticism originates not only in the woman herself but also from the internalized voice of male culture and the parents who teach her how to dress and present herself. John Berger's *Ways of Seeing* (1972) articulates the concepts of viewer and viewed by noting that the observer is generally male and the object observed, female. Though intended as an assessment of the subject in Western European painting, Berger's remarks apply equally to contemporary representations of women in the media: "Women watch themselves being looked at. . . . The surveyor of woman in herself is male: the surveyed female" (p. 47).

Women internalize femininity's burden of self-monitoring along with this same male gaze as they compare themselves, usually unfavorably, with the ideal face and body that they imagine the male conjures up in his mind's eye. In her article "The Persistence of Vision," Donna Haraway rejects the power that the male gaze assumes as it "mythically inscribes all the marked [e.g., female] bodies, that makes the unmarked category claim the power to see and not be seen, to represent while escaping representation. This gaze signifies the unmarked positions of Man and White" (quoted in Conboy, Medina, and Stanbury, p. 282). White males, the cliché goes, see a generic human being when they view themselves in the mirror; everyone else sees the markings of gender, race, or both.

Femininity, Attractiveness, and Science

Scientifically measurable differences in male and female prenatal hormone levels and in brain development, among other areas, have rekindled questions of the origins of, tendencies toward, and social reinforcements of masculinity and femininity as well as gender identity. Because the data lend themselves to different conclusions as to whether or not physical attractiveness has a scientific basis beyond its aesthetic component, studies from social theorists could lead to one set of interpretations; studies by sociobiologists and evolutionary psychologists to quite another.

Genetic survival, or maximizing the number of genes passed on in successive generations, is consistent with the latter's viewpoint regarding physical attractiveness. Sociobiologists and evolutionary psychologists would associate good looks with reproductive fitness and health. Traits like waist-to-hip ratio (WHR) and signs of overall health (luster of hair, vigor) attract attention from the opposite sex presumably because they indicate reproductive vigor. This paradigm, though, does not explain popular culture's preference for thin women rather than voluptuous or even overweight bodies with the optimal WHR; nor the preference for larger breasts, despite the irrelevance of breast size to milk production.

Moreover, while a wide pelvis should indicate a desirable mate for childbearing capacity, such was not the case in the last quarter of the twentieth century. Since the exaggerated thinness of the English model Twiggy, the ideal female figure of international supermodels resembles more the body of a twelve-year-old boy with long, slim limbs and small hips— androgynous rather than womanly. This preferred body type, however, seems unconnected to carrying and suckling an infant. The trend for a flat torso and stomach has replaced the

breast as the focus of the female body. So prevalent are breast implants that one no longer can assume that a generous bra size is natural. A flat, well-muscled abdomen, on the other hand, indicates controlled food intake and a fitness routine. One anthropologist terms it “a modern-day virginity symbol” that suggests “a woman who has never borne children and thus has all of her years of fertility in front of her” (quoted in Bellafante, p. 9).

The American author Kim Chernin has discussed the relationship of female slimness to the power of the mother over infant sons, a power which a more robust-sized woman would recall unconsciously in men and which would threaten them. In fact, potential mothers are expected to be physically smaller and more delicate than men—thinner and less well-muscled than their protectors—but at the same time tall enough and long enough of bone to indicate good childhood nutrition and thus reproductive vitality. Today, particularly in puritanical America, slimness suggests self-control and mastery of sensuality in a society when fattening food is readily available and sex as much a sport as an erotic or intimate experience. Yet historically, a well-padded body was considered ideal as it indicated health and prosperity in centuries when starvation and illness were a constant threat.

Sociobiologists and evolutionary psychologists would identify reproduction as the main source of aggression and display in males and females. Despite social variations in these areas, reproductive rivalry, assertive courtship behaviors, and conflicts seem universal among males as they compete for potential mates. Feminine behavior appears to confer a further advantage in public by not threatening strangers. Women displaying such qualities as compliance, warmth, receptivity, and responsiveness can disarm interpersonal tension. The Norwegian social scientist Tore Bjerke notes that “the woman who looks and acts the most feminine (stereotypically speaking) is least likely to provoke an aggressive response after intruding on others” (Van der Dennen, p. 118).

Social constructionists could argue, however, that these trends become exaggerated by class, race, status, and any given society’s standards of a pleasing physical appearance—what one could label an attractiveness quotient. This quotient differs for males and females according to their biological imperatives: for men, the need to inseminate as much as possible; for women, the need to choose the male who promises the greatest stability and capacity to provide materially for offspring.

Bionic Beauty and Distorted Views of the Self

In a culture saturated with idealized and retouched photos of models, comparisons of “ideal” and ordinary bodies seem inescapable, whether by others or by oneself. The American sociologist Leon Festinger’s Social Comparison Theory of self-evaluation based on external models “would predict that people might use images projected by the media as standards for comparison” (Grogan, p. 100). Constant bombardment with an unattainable ideal of “models’ bodies (slim and carefully arranged in the most flattering poses) would be expected to lead to unfavorable evaluation of the body of the perceiver” (Grogan, pp. 100–101). Some women do indeed report greater

dissatisfaction with their own appearance than before exposure, others “no change,” and some even report increased satisfaction. Grogan cites another study that correlates exposure and more negative body image to pre-test attitudes about the body. Clearly, studies of women exposed to media images have yielded mixed results.

In any case, such comparisons increase a young woman’s sense that her appearance is substandard and urgently in need of repair. Forgotten is the reality that hair and makeup artists spend hours preparing models for these photos. Even then, the images can be airbrushed and pasted together. One actress (Julia Roberts) found magazine photos of herself to be a composite of different shots. Another (Kate Winslet) was displeased to find that her thighs had been slimmed in a picture airbrushed without her permission.

In their real lives, not even models or media stars resemble their carefully staged professional photos. How, then, can any woman without such resources escape disappointment with her appearance? Media images are partly to blame for the wounding and deflation so many feel in our narcissistic culture. Psychologists “argue that a failure to match the ideal leads to self-criticism, guilt and lowered self-worth”; this effect is stronger for women than for men because of more frequent exposure to photographs and the “cultural pressures on women to conform to an idealized body shape are more powerful and more widespread than those on men,” says Grogan (p. 100).

In addition to this psychological need to repair perceived flaws, consumerism creates appetites for products that respond to the newly-awakened need to improve one’s appearance. If not born beautiful, one can own the paraphernalia of beauty. Thus marketing in tandem with industry and the media motivate women to try to remedy their disappointment in their looks. Sandra Lee Bartky refers to this in *Femininity and Domination* as the “fashion-beauty complex” (p. 42), parallel to the “military-industrial complex” in that both are “major articulation[s] of capitalist patriarchy . . . a vast system of corporations—some of which manufacture products, others services and still others information, images, and ideologies” (p. 39). The fashion-beauty complex, argues Bartky, has replaced the family as the regulator of femininity.

The American feminist Naomi Wolf addresses the conflict between social and biological requirements for attractiveness in *The Beauty Myth*. The Professional Beauty Qualification, or PBQ as she terms it, reflects the demands of a capitalist economy and the exploitation of sex and fantasy as incentives to consume and as criteria for hiring in the job market. The connection between publicity and success, status, sex appeal, and the admiration of others has long directed print and other forms of media.

Real-life achievements, based on talent, discipline, frustration, and hard work as much as on luck, seem disconnected from these images. Competency does not always help to secure or keep employment, according to widely publicized lawsuits of wrongful job termination for reasons other than weak performance. Some women have been fired because they were neither pretty enough nor slim enough to sell products in

department stores, to read the news as television anchors, to work as flight attendants, or even to sing in the opera—an art form traditionally dependent on talent rather than appearance. The internationally respected soprano Deborah Voigt was dropped from a scheduled production of Richard Strauss's *Ariadne auf Naxos* because her weight strained both the costume and her credibility in the role. “Tenorissimo” Luciano Pavarotti, in contrast, was not fired for his enormous body. Rather, he chose to retire because he no longer could move on stage.

Of particular concern is the early-twenty-first century phenomenon of “makeover” programs (*What Not to Wear*, *How Do I Look*, *Date Patrol*, *Style Court*, and *Extreme Makeover*). The last is the most serious challenge to women’s (and men’s) health and well-being, fostering the fantasy that with enough money and cosmetic surgery or other procedures, anyone can have Hollywood-style glamour and, in fact, should. The program features multiple surgical procedures over a period of many hours and with good results. No information emerges about how the potential candidate’s health history, suitability for extreme surgery, or physical condition are evaluated before selection is made. Minimal attention is spent on pain or complications of recovery. Television programs on stomach stapling (gastric bypass surgery) provide more information on the potential dangers of this last-chance solution to morbid obesity. Indeed, either way the patient is at serious risk. The problems with silicone breast implants are better publicized, but still women of all ages continue to desire large breasts that change the proportions of their bodies. Younger and younger adolescents ask for cosmetic surgery, a phenomenon that should not surprise a society with ever-growing numbers of young women suffering from eating disorders and body dysmorphic disorder.

“How healthy is the Surgical Age?” asks Wolf (p. 229), citing deaths caused by smoking, fasting, and other extreme methods of weight control and cosmetic surgery known as “body sculpting.” She correctly aligns such practices with an intense stress that, she suggests, can contribute to mental instability. “Narcissists feel that what happens to their bodies does not happen to them” (p. 230). In other words, paying attention to various body parts or facial features contributes to a fragmented and fragmenting view of the self, a distorted sense of the body as abnormal or diseased. “The Surgical Age’s definition of female ‘health’ is not healthy” (p. 231).

Wolf’s Surgical Age goes hand-in-hand with “body dysmorphic disorder” (formerly “dysmorphophobia”), a somatoform disorder described in the *Diagnostic and Statistical Manual (DSM-IV)* (number 300.7 in the *International Classification of Diseases*). Intense preoccupation with minor flaws, real or imagined, in facial or body features can lead to excessive, almost compulsive grooming rituals to try to undo or control one’s “deformity.” Symptoms range from both avoiding and seeking out one’s reflection in mirrors or windows to “significant distress or impairment in social, occupational, or other areas of functioning . . . [and] may be underrecognized in settings in which cosmetic procedures are performed” (*DSM-IV*, p. 467). Short of calling the Surgical Age pathological, this statement infers that genuine psychological disorders may be

masked in a society that promotes an exaggerated level of self-scrutiny.

A woman who chooses to submit to multiple plastic surgeries over a period of years in order to achieve a “Barbie-doll” look for her face and body may be determined to enjoy the attention, success, and glamorous social life she thinks beauty will bring. There may be a relationship between good looks and social success, in that attractiveness increases self-confidence, an appealing trait that draws people’s attention. Self-confidence can be learned, however, and does not result from physical appearance alone.

Beauty and Race

Variations of the elements of female attractiveness have entered the beauty discourse through the popular media over the last decades. Audiences are exposed to a more inclusive standard of good looks represented by models, actresses, or contestants in international beauty pageants from various ethnic origins. Young women of color have seen more fashion icons, celebrities, and video artists of their own ethnic backgrounds in mainstream media, particularly in rap and hip-hop culture and, in some North American cities, in soap operas and talk-shows on Spanish-language television. Some of these figures—Lil’ Kim, Foxy Brown, Queen Latifah—present images of beauty and sexuality different from the dominant culture’s version of attractiveness or “vanilla” sex appeal. Others, like Tyra Banks, Salma Hayek, and Halle Berry, blend anglicized and ethnic features. These contrasting aesthetics bespeak an ongoing conflict between the preference for the silky blond hair and light skin or skin darkened only with a tan and of traditional Western culture with the “exotic” appearance of women of color. A mixed message underlies these images: on the one hand, a superficial acceptance of a broader range of beauty and sexual desirability; on the other, a limit to the degree of identifiable ethnicity that impinges upon the Anglo norm. Thus, in order to be considered beautiful, the faces and bodies of multiracial women must display only minor departures from the standard white Western European look.

This fusion of facial features has long been the subject of psychological studies of female appearance. German researchers at the Universities of Regensburg and Rostock have tested various theories of female facial attractiveness, including the “attractiveness is averageness” hypothesis; the “facial symmetry” hypothesis; and the theory of “multidimensional beauty perception,” which suggests that faces combining child-like characteristics with more mature features are judged most attractive. Their results partially confirm the averageness hypothesis: computer-generated composite faces are considered most beautiful, but only if the features to be morphed are not unattractive to begin with.

The question of hair resonates in particular for women of color. Madame C. J. Walker (1867–1919), born into slavery, invented and marketed her hair-straightening method in the early twentieth century. Ironically, African-American women have seen curls, Afros, corn rows, and dreadlocks appropriated by white women while they themselves still turn to chemical treatments, hot irons, hair weaving, and extensions to recreate

the impossible and unforgiving image of the “good hair” of the dominant culture.

The very concept of “good hair” represents another battle in the beauty wars. Kasey West, in an article about hair and identity titled “Nappy Hair: A Marker of Identity and Difference” (for the Web site *Beauty Worlds*), writes:

A return to African-based hairstyling practices by many black women in the 1960s . . . marked an assertion of national identity and heritage in the face of oppressive Western ideals of beauty and continuing disenfranchisement. Although the popular Afro was achieved by blowing hair out to straighten the curls, it was representative as an expression of beauty ideals centered on an African identity. In other words, hairstyling became a political statement of connection to the black community. . . . [B]lack hairstyles retained a cultural and political significance.

Noting the “political complexities of African-American hair and beauty culture,” West quotes the sociologist Ingrid Banks, who interviewed more than fifty black girls and women between 1996 and 1998 for her book *Hair Matters* (2000) and who concluded that “hair shapes black women’s ideas about race, gender, class, sexuality, images of beauty and power.”

Other African-American women writers address the issue in fiction and nonfiction. Toni Morrison’s novel *The Bluest Eye* exposes these conflicts through the young heroine’s poignant resentment and despair as she realizes she never will attain her dream of waking up blond and blue-eyed. bell hooks’ article “Selling Hot Pussy” continues the examination of bodies and race. Black women still find themselves represented as savage, primitive sex machines and are objectified and dehumanized by this image. The “black female body gains attention only when it is synonymous with accessibility, availability, when it is sexually deviant” (in Conboy, Medina, and Stanbury, p. 117; see also Gilman). In this context, beauty and racism conflate to doubly oppress women, whatever their background.

Some American women of color, Latinas among them, trace their ethnic heritage to cultures whose ideal female body differs noticeably from the bony fashion icons of today’s dominant white culture. A Mexican-American woman prized by her relatives for her rounded womanly body might be judged overweight in fitness-conscious California, for example. African-American culture embraces as beautiful a range of body sizes and shapes that would fall in the “full-figured” category in fashion advertising, despite the fact that models of color featured in the edgy, glamorous photos of high fashion publications possess the characteristic tall and ultraslim body. Kathryn Zerbe notes, “In comparison to white girls, fewer African-American girls report trying to lose weight. In cultures where plumpness is valued, eating disorders are rare” (p. 160). Additionally, curvy hips and ample bust lines, the hallmarks of a female figure, can fuel racist views of hypersexuality in people of color. In *Face Value: The Politics of Beauty* (1984), by Robin Tolmach Lakoff and Raquel Scherr, Scherr recalls her adolescence filled with taunts for resembling her Mexican-Indian mother rather than

her white father. At first outraged, later she agreed with a friend’s remark that “discrimination based on beauty is more prevalent than discrimination based on race” (p. 7).

At the other extreme is the very thin African-American model Gerren Taylor, who was twelve years old in April 2003 when the *Los Angeles Times* profiled her nascent modeling career: Taylor had the prepubescent and scrawny silhouette that dominates the catwalk and fashion shoots and becomes the standard to which girls and women aspire. “The debate over the sexualization of girls at younger and younger ages waxes and wanes; Gerren’s mother understands that sexuality is a part of fashion and believes she can protect her child from exploitation,” writes Booth Moore (p. E9).

Immigrant women of color cannot escape their adopted culture’s view of body size. In order to be appealing and noticed, American women “are supposed to be thin—and if they are not, the culture assumes they are unhappy, dissatisfied, lazy, slovenly, and ugly” (Zerbe, p. 159). Zerbe cites a study of African immigrants to Great Britain. Those “who have resided in Britain for only four years will have adopted the British viewpoint with respect to size and shape. These immigrants tend to desire a smaller physique than their African peers,” who “in general enjoy their fuller figures” (p. 101). Zerbe offers examples suggesting that as immigrant women acculturate in a society that places a high value on thinness, they are likely to adopt “the more stringent eating attitudes of the prevailing culture” (p. 101).

Beyond Questions of Science

The body, writes the American feminist Susan Bordo, is a “culturally mediated form” (in Conboy, Medina, and Stanbury, p. 103), in that its appearance reflects the discourse of its society and the state of women’s power or lack thereof in that society. Beyond aesthetics, the ideal appearance and female body exist in relation to the bondage of dependency, racism, and social roles. The body, in other words, is territory conquered by masculine spectatorship, the site of a struggle over ownership of resources.

Women’s beauty rituals comprise part of this cultural mediation. Rituals are the repeated acts of grooming beyond basic hygiene that serve to embellish according to the tastes and standards she has internalized from her peer group, magazines, and other media. Rituals can be as innocent as preteen makeup parties, as painful as piercing or tattoos, and as life-threatening as eating disorders for weight control. Some girls choose rituals to feel good about what is asked of them; some to bind the anxiety they feel as they dodge threats to their still-formulating sense of self; and some to overcome perceived shortcomings of which they are constantly reminded by advertising.

Successful advertising seeks to address a consumer’s pleasure-seeking tendencies before the reality principal dampens her impulse to buy. Along with products, companies sell fantasies of pleasure, excitement, or well-being that will arise from the act of buying and using advertised items. Scenes of arousal need not include a partner. Pampering oneself with soothing lotions satisfies the need for attention without the risks involved in a relationship. Contemporary television and print commercials

feature women experiencing what looks like self-stimulation and sexual arousal from shampoo and soap use in the shower.

In addition to bath and skin treatments, creamy foods like yogurts are advertised as sensual indulgences enjoyed by oneself. But for women, eating is already overdetermined. Intentionally or not, advertising can contribute to “emotionally induced compensatory eating,” says Suzanne Z. Grunert (quoted in Costa, p. 68), and thus heighten the dilemma between the immediate comfort of eating and the potential for weight gain. Perhaps in compensation, shades of lipstick, eye shadow, and nail polish often are named after food. Instead of ingesting chocolate or cinnamon, one can wear them.

Ads for beauty and grooming aids fuel self-consciousness and vulnerability by making women aware of flaws they did not know they had. They stimulate an often-panicky desire to improve and, not surprisingly, create markets for products that promise to remedy imperfections from acne to wrinkles. Magazine articles, infomercials, and niche-marketed television programs bombard young women with images and messages they ignore at their own peril. Well-socialized girls change their hairstyles and adopt fashion trends in part to conform to the standards of their peer groups—actions that indicate how well they understand and respond to peer influences as seen in their shopping patterns. Product boycotts or grassroots truth-in-advertising campaigns fight to expose the “marketization” of cultural expression, but cannot fully counteract the impact of advertising and mass marketing and their by-product, peer pressure.

Women at times can resist the expectation of prettiness by refusing to dress for the pleasure of the beholder. In renouncing what Bartky calls “institutionalized heterosexuality,” lesbians, for example, can disengage from the “panoptical male connoisseur” who “resides within the consciousness of most women” (p. 72). Some remove themselves from the beauty game altogether and thus dislocate and interrupt the male gaze whether external or internalized. Comfort, serious athleticism, modesty, indifference to attention-seeking, and rejection of so-called female vanity lead others to free themselves from adornment. Young adolescents often respond to their own ambivalence about their developing bodies by dressing in shapeless t-shirts and baggy pants. This camouflage enables them to feel they can escape the judgmental stares of peers as well as surprised looks from family members unused to their daughters’ emerging secondary sex characteristics.

Lesbian dressing evolved through the last decades of the twentieth century from a hard-core butch style to the appearance known as “lipstick lesbianism” and a greater repertory of looks, writes Barbara Creed in a 1999 essay titled “Lesbian Bodies.” From the 1970s, when “the true lesbian” was expected to “reject all forms of clothing that might associate her image with that of the heterosexual woman and ultimately with patriarchal capitalism,” to the “butch-femme renaissance of the 1980s,” to the so-called heterosexual lesbians of 1990s queer culture, lesbians have renounced the “lesbian uniform” as well as “the patriarchal stereotypes of feminine dress and appearance” (pp. 122–123). In so doing they reveal the

sacrifice required of women who conform to feminine attractiveness.

The cult of beauty in women represents an attempt to counteract an externally imposed sense of inadequacy. Feelings of failure arise from “a context where body image is subjective and socially determined. . . . A person’s body image is not determined by the actual shape and size of that body, but by that person’s subjective evaluation of what it means to have that kind of body within their particular culture,” writes Grogan (p. 166). For women of any race, class, or gender identification, femininity becomes an investment of resources and discipline in order to gain fleeting attention “and some admiration but little real respect and rarely any social power” (Bartky, p. 73). Late-twentieth-century studies cited in Grogan (pp. 180–192) suggest that positive body image is linked to self-esteem and a sense of personal control over one’s environment, both of which are problematic for women in a capitalist patriarchy. As long as societies teach women to evaluate themselves principally in terms of their femininity and attractiveness, self-assurance will belong more often to those who successfully conform to the cultural ideal. If instead girls and young women learn to appreciate their bodies as healthy, well-functioning instruments that enable them to lead productive lives, they will be closer to changing the conditions that relegate them to objectification.

*See also **Body, The; Feminism; Gender; Men and Masculinity; Motherhood and Maternity.***

BIBLIOGRAPHY

- Bartky, Sandra Lee. *Femininity and Domination: Studies in the Phenomenology of Oppression*. New York: Routledge, 1990.
- Bellafante, Ginia. “At Gender’s Last Frontier.” *New York Times*, June 8, 2003, section 9, p. 9.
- Bordo, Susan. *The Male Body: A New Look at Men in Public and in Private*. New York: Farrar, Straus and Giroux, 1999.
- Brownmiller, Susan. *Femininity*. New York: Linden Press/Simon and Schuster, 1984.
- Chernin, Kim. *The Obsession: Reflections on the Tyranny of Slenderness*. New York: Harper and Row, 1981.
- Conboy, Katie, Nadia Medina, and Sarah Stanbury, eds. *Writing on the Body: Female Embodiment and Feminist Theory*. New York: Columbia University Press, 1997.
- Costa, Janeen Arnold, ed. *Gender Issues and Consumer Behavior*. Thousand Oaks, Calif.: Sage, 1994.
- Creed, Barbara. “Lesbian Bodies: Tribades, Tomboys, and Tarts.” In *Feminist Theory and the Body*, edited by Janet Price and Margrit Shildrick. New York: Routledge, 1999.
- Frost, Liz. *Young Women and the Body: A Feminist Sociology*. Houndsmills, U.K.: Palgrave, 2001.
- Gilman, Sander. *Difference and Pathology: Stereotypes of Sexuality, Race, and Madness*. Ithaca, N.Y.: Cornell University Press, 1985.
- Grogan, Sarah. *Body Image: Understanding Body Dissatisfaction in Men, Women, and Children*. London: Routledge, 1999.
- Halprin, Sara. *Look at My Ugly Face: Myths and Musings on Beauty and Other Perilous Obsessions with Women’s Appearance*. New York: Viking, 1995.
- Kinzer, Nora Scott. *Put Down and Ripped Off: The American Woman and the Beauty Cult*. New York: Crowell, 1977.

WOMEN'S HISTORY

- Lakoff, Robin Tolmach, and Raquel Scherr. *Face Value: The Politics of Beauty*. Boston: Routledge and Kegan Paul, 1984.
- Lippa, Richard. *Gender, Nature, and Nurture*. Mahwah, N.J.: Erlbaum, 2002.
- Malson, Helen. *The Thin Woman: Feminism, Post-structuralism, and the Social Psychology of Anorexia Nervosa*. New York: Routledge, 1998.
- Moore, Booth. "Beyond Her Years." *Los Angeles Times*, April 30, 2003, pp. E1, E9.
- Mulqueen, Maggie. *On Our Own Terms: Redefining Competence and Femininity*. Albany: State University of New York Press, 1992.
- Price, Janet, and Margrit Shildrick, eds. *Feminist Theory and the Body*. Edinburgh, U.K.: Edinburgh University Press, 1999.
- Van der Dennen, J. M. G., ed. *The Nature of the Sexes: The Sociobiology of Sex Differences and the "Battle of the Sexes."* Groningen, The Netherlands: Origin Press, 1992.
- West, Kasey. "Nappy Hair: A Marker of Identity and Difference." Available at <http://www.beautyworlds.com/beautynappyhair.htm>.
- Zerbe, Kathryn. *The Body Betrayed: Women, Eating Disorders, and Treatment*. Washington, D.C.: American Psychiatric Press, 1993.

Susan Grayson

WOMEN'S HISTORY.

This entry includes two subentries:

Africa
Asia

AFRICA

Since 1970 the history of African women has developed into a vital and steadily expanding area of research and study, motivated, as with other areas of women's history, by the development of the international feminist movement. African women's history also paralleled the expansion of African history following World War II, as scholars inside and outside of Africa began to focus on historical transformations on the African continent.

Before the 1970s there was little available research on African women's history per se, though information on women in Africa was found in anthropological and ethnographic studies. This focus has continued in the preponderance of research on African women appearing in development studies. The first publications in the 1970s dealt with women and economic change and with women as political activists. By the mid-1980s there were a number of important extended studies, but only in the 1990s did a substantial number of monographs on specific topics begin to appear, although the bulk of new research is still found in journal and anthology articles.

Earlier historical eras were initially neglected, in part as a result of the difficulty in obtaining historical sources that dealt with women before the nineteenth century. Written materials on earlier eras, especially from an African woman's perspective, were scarce because many African communities were decentralized and nonliterate. Topics that have archival source

materials included elite women such as Queen Nzinga, a seventeenth-century ruler in what became Angola, and market women along the West African coast who interacted with European traders. Eva, a seventeenth-century African woman who settled in the early Dutch community on the Cape in South Africa and married a European colonist, is also found in archival documentation. Egypt was exceptionally strong in sources concerning women in earlier centuries.

Source availability influenced the large number of studies on slave women in the nineteenth century, which is an important issue but did not represent the experience of most women. Slaves within Africa were more likely to be women, a reflection of their productive and reproductive contributions to their communities. Scholars have retrieved information on other aspects of the lives of women in the nineteenth century, as exemplified in research that detailed women's work in Lesotho, elite women in Buganda, women's vulnerability in Central Africa, Swahili women's spirit possession cults, Asante queen mothers' political influence, religious Muslim women in West Africa, and numerous other specific areas of women's activity.

Reexamining familiar issues from a woman's perspective has altered African history more generally. For example, many of the initial studies of women's work during the colonial period showed how they had lost power and economic autonomy with the arrival of cash crops and their exclusion from the global marketplace, in contrast to men, who were more likely to benefit from these economic changes. The emphasis on the formal sector of the economy in African labor history eclipsed women's actual economic activity, which centered on agricultural work. Studying women's economic contributions meant paying attention to rural agricultural work as well as the urban efforts of market vendors, both sectors previously neglected in African labor history. Female agricultural innovations were described as essential to community survival. Women's changing position in arenas formerly seen as only male has been shown in research on mining compounds in Zambia, railway communities in Nigeria, and other urban studies.

Research on women's involvement in political activism changed previously accepted ideas of women's passivity in the face of such changes. In some areas, such as southern Nigeria in the 1920s, women drew on precolonial practices to express their displeasure with the colonial powers. New information about the leadership role of illiterate Muslim women in Dar es Salaam in the nationalist movement of the 1950s fundamentally changed the view that the Tanzanian anticolonial movement was led solely by men who were products of Christian mission education. Research on more recent years has found a proliferation of African women's organizations concerned with bringing peace to conflict-ridden areas, ending female genital cutting or mutilation (erroneously called female circumcision), and training women to get involved in national politics. Women's studies programs have been established at most African universities.

Scholars of women and religion have investigated female spiritual power in local religions and the role of women in developing local churches that were often offshoots of larger

denominations. Research in the 1990s also included a focus on women and missions, with researchers demonstrating that the introduction of European ideas about marriage and family simultaneously brought new oppressions and new opportunities for women. Research on women and Islam has also grown, with new information on women and Koranic education in West Africa and on Muslim women's involvement in nationalist struggles in North Africa.

The earliest publications tended to be descriptive as scholars worked to prove that African women had made an impact on their societies. More recent studies have provided much more nuanced descriptions of the complexities of women's lives, of the changes over time, and of local and outsider ideologies about women in Africa. Helen Bradford's reanalysis of the role of the adolescent girl Nongqawuse in the Xhosa cattle killing of the 1850s has demonstrated that taking women's testimony seriously and focusing on women's experience and expression of history can fundamentally change the explanation of an event. She convincingly suggests that issues of changing sexuality and possibly abuse or incest were of central importance in understanding people's motivations, and conventional reliance on broader economic and political reasons for the upheaval is not completely satisfactory.

Among the issues continuing to appear in writings on African women's history are those of representation (who is writing this history and for what audience), sources and methodology, and periodization, as well as the usual areas of productive work, family life, and public activities such as politics and religion. Tiyambe Zeleza has described the enduring marginalization of African women's history, as the information that has been recovered is omitted from textbooks or included in very limited ways. The absence of African women historians is frequently commented on, as there are regrettably few who publish regularly. The history of women in precolonial Africa continues to be a weak point, while the history of the colonial era (from around 1880 to the 1960s for most of the continent) has shifted from examining the impact of colonialism on women (assessed as mostly negative) to investigating African communities and history from their own perspectives. This approach includes an emphasis on African women's agency and efforts to present African women's own voices. A notable effort in this regard is the Women Writing Africa Project sponsored by Feminist Press, which presents extensive materials written and recorded by African women. A single volume on English-speaking southern Africa has been published and the editors, Tuzyline Jita Allan and Abena Busia, plan several more regional collections. New research reexamines territory already covered and opens new topics while incorporating the voices of African women as both subjects and scholars, indicating the direction African women's history will take in the near future.

See also *Feminism: Africa and African Diaspora; Women's Studies*.

BIBLIOGRAPHY

Badran, Margot. *Feminists, Islam, and Nation: Gender and the Making of Modern Egypt*. Princeton, N.J.: Princeton University Press, 1995.

Berger, Iris, and E. Frances White. *Women in Sub-Saharan Africa: Restoring Women to History*. Bloomington: Indiana University Press, 1999.

Bradford, Helen. "Women, Gender, and Colonialism: Rethinking the History of the British Cape Colony and its Frontier Zones, c. 1806–70." *Journal of African History* 37 (1996): 351–370.

Charrad, Mounira M. *States and Women's Rights: The Making of Postcolonial Tunisia, Algeria, and Morocco*. Berkeley: University of California Press, 2001.

Daymond, M. J., et al. *Women Writing Africa: The Southern Region*. New York: Feminist Press, 2003.

Hodgson, Dorothy L., and Sheryl A. McCurdy, eds. *"Wicked" Women and the Reconfiguration of Gender in Africa*. Portsmouth, N.H.: Heinemann, 2001.

Tripp, Aili Mari, ed. *Sub-Saharan Africa*. Vol. 6 of *The Greenwood Encyclopedia of Women's Issues Worldwide*, edited by Lynn Walter. Westport, Conn.: Greenwood, 2003.

Zeleza, Tiyambe. "Gender Biases in African Historiography." In *Engendering African Social Sciences*, edited by Ayesha M. Imam, Amina Mama, and Fatou Sow, 81–116. Dakar, Senegal: CODESRIA Book Series, 1997.

Kathleen Sheldon

ASIA

The prominent roles occupied by women in the legends and myths of that complex and diverse part of the world called Asia suggest that "histories" of women in Asia have existed for a very long time. That these legends have been shaped, written, and sometimes performed by men operating in androcentric cultural contexts does not negate the impression of power and consequence their narratives convey. From Japan's sun goddess, the original ancestress of the imperial line, to Korean shamans, to the powerful and transgressive women of South and Southeast Asian myth, or China's Hua Mulan, the stories of these legendary women suggest that women in early Asian societies did "make history." Perhaps only in China does the written record present, dynasty after dynasty, legendary women whose experience is embedded in the historicity of China's changing social, political, and economic institutions.

In various parts of Asia, these myths generated questions about matriarchal societies that were reinforced by the nineteenth-century work of Friedrich Engels (1820–1895) and Garrett A. Morgan (1877–1963). This theoretical framework may have encouraged one of Japan's first historians of women, Takamura Itsue (1894–1964), to do research on family registers; that research, parts of which have been reinforced by twentieth-century scholarship, strongly suggests that families in eighth-century Japan were predominantly matrilineal. For other women in Asia, myths and legends provided models for resistance and revolution in the twentieth century (China and Vietnam) and left some, like Hiratsuka Raicho (1886–1971), wondering why and how women had lost the power and authority they once had in Japanese history.

The Confucian Pattern

Few intellectual traditions have had a greater impact on women in Asia than Confucianism, in part because Confucian

traditions were central not only to China but also to other parts of Asia (Japan, Korea, and Southeast Asia) influenced by Chinese culture. The study of women in these cultures has dismantled basic assumptions about Confucianism: its universality, monolithic nature, and immutability. The study of women has shown many different Confucianisms and has made it clear that the continuity of these traditions is the result of accommodation to social change, not stasis.

Scholars of Chinese women's history have, in recent years, moved far beyond an earlier scholarship that focused on Confucianism's role in conceptualizing and rationalizing a patriarchal, patrilineal family in which women were marginalized, victimized, and seemingly left with little opportunity to develop or exercise a sense of their own agency. Overcoming and supplanting this view has come only through the continuing research of historians who, reading against the grain of the Confucian record, have provided a much more complex picture of women's lives and of Chinese culture. Margery Wolf's work on women in Taiwan represents a rare early glimpse of women developing strategies to increase their power in the family; Susan Mann, Patricia Ebrey, and Dorothy Ko have since demonstrated, in a number of different settings, how important women were as contributors to "Chinese civilization" and how effectively they circumvented the institutional barriers ranged against them.

Elsewhere in Asia, Confucian patterns had less continuity as well as less influence. In the Japanese case, Confucian ideas about the family and statecraft were heavily moderated by existing cultural patterns, even in the two periods when Confucianism is thought to have had greatest influence—the eighth and ninth centuries when the Japanese state was being organized, and the seventeenth and eighteenth centuries of the Tokugawa period. Korea, although thoroughly conversant with Confucianism, was really not dominated by these ideas until well after the fourteenth century, and Southeast Asia, particularly Vietnam, encountered the greatest levels of Confucian influence between the fourteenth and sixteenth centuries. Recent scholarship makes it clear how difficult it is to walk the tightrope between establishing a history of women in Asia that speaks to their strengths *and* acknowledges the reality of the constraints they faced. Although historians continue to investigate stereotypical symbols of women's oppression in Asia (sati, footbinding), they do so with a heightened sense of the possibility that Western scholarship "orientalizes" women when it fails to present them as active participants in their own culture, able to find nuanced and effective ways to challenge those constraints.

The Modern Period

There has always been a women's version of the Western civilizing narrative in Asia; in many times and places, Western colonizers sought to use the "oppression of women" in Asian cultures as a rationale for their self-proclaimed civilizing mission. The treatment of women, they often said, was the standard by which civilizations could be judged, and on that basis it was clear that Asia "needed civilizing." The history of women in Asia has convincingly demonstrated that the "Western impact" on Asia not only complicated women's ability to improve

their lives but also generated an anticolonial, nationalist engagement that did not aid, but typically subverted, feminist agendas.

Growing recognition of the intellectual significance of feminism since the late nineteenth century has been coupled with the assumption that feminism's natural competitors—nationalism and socialism—have eclipsed feminism's impact in the modern period. Women have been critical to the development of nationalism and socialism in China, India, Korea, and Southeast Asia: as symbols of "tradition," workers, educators, and soldiers. Women were asked to postpone their agendas in China's great twentieth-century revolution, where leaders pursued a "backward to revolution" strategy, and in India, where connections with nationalism and anti-imperialist movements were complicated by geography, ethnicity, caste, class, and religious diversity. While South Asia may present the greatest challenges for historians of women, it is also true that, in the 1990s, scholars there such as Kumkum Sangari and Sudesh Vaid pointedly demonstrated how much a feminist standpoint adds to our understanding of nationalism, colonialism, and anticolonial movements. Independence may have brought an improvement in the legal status of women, but the partition that created the new states of India and Pakistan ushered in a long period of conflict in which large numbers of women were abducted, raped, and/or killed as part of a continuing political, ethnic, and religious struggle. Until 1990, women were an invisible part of historical analysis of this conflict; since then, historians of women, such as Urvashi Butalia in South Asia, have made clear how important women and gender are to any understanding of these conflicts.

See also *Feminism; Gender; Women's History; Africa; Women's Studies.*

BIBLIOGRAPHY

- Ebrey, Patricia Buckley. *The Inner Quarters: Marriage and the Lives of Chinese Women in the Sung Period*. Berkeley and Los Angeles: University of California Press, 1993.
- Johnson, Kay Ann. *Women, the Family, and Peasant Revolution in China*. Chicago: University of Chicago Press, 1983.
- Ko, Dorothy. *Teachers of the Inner Chambers: Women and Culture in Seventeenth-Century China*. Stanford, Calif.: Stanford University Press, 1994.
- Ko, Dorothy, JaHyun Kim Haboush, and Joan R. Piggott, eds. *Women and Confucian Cultures in Premodern China, Korea, and Japan*. Berkeley, Los Angeles, and London: University of California Press, 2003.
- Mann, Susan. *Precious Records: Women in China's Long Eighteenth Century*. Stanford, Calif.: Stanford University Press, 1997.
- Mann, Susan, and Yu-Yin Cheng, eds. *Under Confucian Eyes. Writings on Gender in Chinese History*. Berkeley, Los Angeles, and London: University of California Press, 2001.
- Mohanty, Chandra Talpade. *Feminism without Borders*. Durham and London: Duke University Press, 2003.
- Ramusack, Barbara N., and Sharon Sievers. *Women in Asia*. Bloomington: Indiana University Press, 1999.
- Ray, Sangeeta. *En-Gendering India: Woman and Nation in Colonial and Postcolonial Narratives*. Durham, N.C.: Duke University Press, 2000.

- Sangari, Kumkum, and Sudesh Vaid. *Recasting Women: Essays in Indian Colonial History*. New Brunswick, N.J.: Rutgers University Press, 1990.
- Sarkar, Tanika, and Urvashi Butalia, eds. *Women and Right-Wing Movements*. London: Zed Books, 1995.
- Sekiguchi, Hiroko. "The Patriarchal Family Paradigm in Eighth-Century Japan." In *Women and Confucian Cultures*, edited by Dorothy Ko, JaHyun Kim Haboush, and Joan R. Piggott. Berkeley, Los Angeles, and London: University of California Press, 2003.
- Sievers, Sharon. *Flowers in Salt: The Beginnings of Feminist Consciousness in Modern Japan*. Stanford, Calif.: Stanford University Press, 1983.
- Stacey, Judith. *Patriarchy and Socialist Revolution in China*. Berkeley and Los Angeles: University of California Press, 1983.
- Tonomura, Hitomi, Ann Walthall, and Wakita Haruko, eds. *Women and Class in Japanese History*. Ann Arbor: Center for Japanese Studies, University of Michigan, 1999.
- Wolf, Margery. *Women and the Family in Rural Taiwan*. Stanford, Calif.: Stanford University Press, 1972.

Sharon Sievers

WOMEN'S STUDIES. In its short history (from the late 1960s in the United States) women's studies has moved around the world as an idea, a concept, a practice, and finally a field or *Fach* (German for specialty or field). As late as 1982 in Germany *Frauenstudium* was not considered a *Fach* and therefore could not be studied in the university but only in special or summer courses. By the early twentieth century women's studies was recognized in higher education from India to Indonesia, from the United States to Uganda, China to Canada, Austria to Australia, England to Egypt, South Africa to South Korea.

Definitions

Women's studies is the study of women and gender in every field. Its basic premise is that traditional education is based on a study of men—usually upper-class, Caucasian, educated men—while other groups of men and all different groups of women are erroneously subsumed under the category "mankind." Early on courses drew especially on history, literature, and sociology, but they quickly expanded to the other humanities (philosophy, religious studies, comparative literature, art, music) and the social sciences (anthropology, political science, economics, psychology, geography). Science and technology have been slower to embrace women's studies, but biology, math, technology, computer science, chemistry, physics, and medicine have all begun to examine their assumptions for sexist bias, and courses in "gender and physics," "women geologists," or "sexism and science" are de rigueur in most programs.

Over the years the term itself and the naming of the enterprise have been contested and changing. The first name was "female studies," but "women's studies" quickly found more adherents. The name "women's studies" has been criticized for its ambiguous apostrophe (the study of or by women?), for its (supposed) assumption that all women can be studied together, and for its "hegemonic narrowness" that does not take into

account transgendered or lesbian identities. Some programs have changed their names to "gender studies," "women and gender studies," or "feminist studies." And of course in the exporting of "women's studies" around the world, various languages are unable to translate "gender" or "women's studies" in satisfactory ways. It is safe to say, however, that all permutations share some commonalities—that women matter and that their own assessment of their experiences is the starting point for description and analysis; that the history of women's subordination is differently experienced but commonly shared; that the elimination of that subordination is a common goal. The concept of gender as a social construction that reflects and determines differences in power and opportunity is employed as the primary analytic category.

Origins

Women's studies, as a concept and a site of learning, really began with the second wave of the women's movement in the late 1960s. But generations of work and information gathering preceded that time, particularly in the nineteenth-century penchant for writing stories of "great women" and gathering them in collections of "women worthies." A later, more democratic strain of the study of women was begun by the historian Mary Beard, who in her 1946 volume *Woman as Force in History* took a different tack. If one looks at "long history," one finds not "great women" only but everyday women, not women as victims but women who influenced their worlds, women who had agency, even within the confines of a limited sphere, within the private realm. Simone de Beauvoir wrote of women as "other" in *The Second Sex* (1953), while Betty Friedan analyzed "the problem that has no name," the malaise and victimization of middle-class women, in *The Feminine Mystique* (1963), and Helen Hacker compared women's position to that of minorities (1951). Yet all these important precursors did not initiate women's studies.

It took a combination of the civil rights movement, the New Left, the peace movement (especially the protests against the war in Vietnam), and the various open university movements in the 1960s to help women coalesce and organize themselves into the women's liberation movement. Many more women were attending colleges and universities, many women were participating in the radical youth movements of the 1960s, and many women students and faculty were leaders in the civil rights and antiwar movements. It was thus almost inevitable that women would begin to question their role in those movements if they always had to make the coffee, do the typing, and be available as sex objects. Stokely Carmichael of the Student Non-Violent Coordinating Committee (SNCC) famously said, "The only position of women in the movement is prone," infuriating many young women. The second wave of the women's movement began with hundreds of small consciousness-raising (CR) groups in many cities and towns; as women collectively started to understand and then study their situation, they initiated courses and classes on women's history, literature, and culture, first on a community, ad hoc basis but quickly moving to the college classroom. There were hundreds of women's studies courses offered at colleges and universities in the United States in the late 1960s, and by 1970 formal women's studies programs were launched, first at San Diego State University in

California and then at Cornell University in New York. Every year after that saw an increase, from 276 programs in 1976 to 680 in 1999. Most of these programs offered minors, certificates, concentrations, or majors. A *Campus Trends* report for the American Council on Education in 1984 found that women's studies courses were offered at a majority of four-year colleges and universities and at 25 percent of community colleges; there are more now. Women's studies at the beginning of the twenty-first century enrolled the largest number of students of any interdisciplinary field. The Department of Education estimates that 12 percent of all undergraduate students in the United States have received credit for a women's studies course. But the growth in formal programs does not tell the whole story; many more students enroll in separate courses than choose to major or minor in the field.

Growth and Institutionalization

Because American educational institutions, especially newer, less-traditional ones, are very flexible in curricular change, women's studies grew and expanded in the United States more quickly than anywhere else. But very soon there were women's studies programs in Japan, Australia, New Zealand, Finland, Sweden, India, South Korea, Taiwan, and the Philippines. By the 1980s there were programs in all countries in Western Europe, plus Thailand, South Africa, China, the Caribbean, and Uganda. Finally, after the change from communism in Eastern Europe, programs were instituted in Slovakia, the Czech Republic, Russia, Ukraine, and others, in addition to Malaysia, Vietnam, and other African nations. Two series of international conferences gave impetus to the growth of women's studies, both within universities and in community-based organizations worldwide. The International Interdisciplinary Congress on Women began in Haifa, Israel, in 1981 and has met every three years since—in the Netherlands (1984), in Ireland (1987), in New York (1990), in Costa Rica (1993), in Australia (1996), in Norway (1999), in Uganda (2002), and in South Korea (2005). Two to three thousand delegates, mostly women, both academics and community organizers, attend to present their work. Each conference draws especially on that continent's practitioners. Thus the Costa Rica conference brought together many indigenous women from Central America as well as Latin American delegates. Languages that year were Spanish, English, and a variety of Indio languages. That this congress continues to meet, without governmental or formal organizational support, is testimony to the personal importance to women all over the world of global scholarship on women.

The United Nations has sponsored four international conferences as a part of its "Decade for Women," in Mexico City (1975), Copenhagen (1980), Nairobi (1985), and Beijing (1995). The nongovernmental organizations (NGO) forums held in conjunction with each conference brought together thousands of activists and women's studies groups from all over the world, thus reminding those from the developed world of the connections between education and broader social justice issues.

Research and Publication

Scholarly journals in women's studies were begun in the United States early on (1972 for *Feminist Studies*; 1975 for

Signs: A Journal of Women in Culture and Society; but not until 1988 for the *National Women's Studies Association Journal*), and soon there were journals published around the world. In 1999 an informal International Network of Women's Studies Journals (now the Feminist Journals Network) was formed, meeting first in Tromsø, Norway, then in Halifax, Canada, in 2001 and in Kampala, Uganda, in 2002. Thirty editors from twenty-seven journals in twenty-one countries were represented in the membership in the early twenty-first century. Joint publishing projects, including a book series by Zed Press, reprinting of articles from journals in the "economic south" (developing nations) by journals in the "economic north" (industrialized nations, mostly in the north but including Australia), a Web site, and a listserv to make members aware of current issues are all part of their work.

Ellen Messer-Davidow surveyed the number of books and scholarly monographs available in English between 1980 and 1998 and estimated that 10,200 feminist books were published during that period. As she says, the print knowledge is so voluminous that scholars cannot keep track, much less read it all. And the topics are superabundant: "everything and anything is gendered, . . . gendering is narrated, quantified, or modeled, . . . and 'gender' as an analytical category is interrogated" (Messer-Davidow, p. 167).

Theories and Assumptions

Even though some practitioners of women's studies disavow any attempt to theorize universally about women or women's studies, most others will subscribe to a discussion of the following kinds of theories. Women's studies course material depends largely on various feminist theories, although these assumptions may not always be made explicit. Most feminist theories can be divided into two basic kinds, based on the answer to the question: How important is the physiological or biological difference between males and females? Put another way: What should one make of the sex-gender difference? Should this difference be noted and positively valued for its unique perspective? Or should it be downplayed in a system that recognizes the common humanity of men and women and attempts to unite women with institutions from which they have historically been excluded? These two basic strains of feminist theory have been variously called equality feminism and difference feminism, minimizer feminism and maximizer feminism, or individualist feminism and relational feminism. In each case, the first term includes those who seek to deemphasize difference and press for the integration of women into masculine institutions, usually emphasizing the individual; the second term includes those who seek to stress and value difference, to transform or abandon masculine systems, often emphasizing the relational qualities of women, especially in regard to children and extended families.

The term *sex-gender* is used here to refer to the biological and social difference between males and females. In the early days, the two words were used separately and distinctly. *Sex* meant the physiological difference between male and female, while *gender* meant the social overlay of education and socialization, constructed differently in different eras and societies. The two terms have become conflated in everyday speech, and

GERDA LERNER

Gerda Lerner could be called “the mother of us all,” that phrase used by Gertrude Stein in her opera about Susan B. Anthony. An American historian by training, Gerda Lerner’s biography exhibits the uniqueness of her life and work. Born and educated through secondary school in Austria, she came to the United States as a part of the Jewish exodus after the 1938 *Anschluss* that brought Nazi power to Austria, first as a part of a nearly phony marriage that enabled her to gain a visa. As a young wife and mother in Los Angeles and then in New York through the war years and the early days of the Cold War, Lerner organized for such groups as the Congress of American Women. Her (second) husband, Carl Lerner, was a screenwriter, editor, and filmmaker. Both were involved in various leftist activities for years. After the war she began writing fiction and taking courses at the New School for Social Research in New York in 1948. Gerda Lerner quickly earned first her B.A. at the New School

and then her M.A. and Ph.D. at Columbia University, using her biography of the Grimké sisters of South Carolina as her Ph.D. dissertation. As a “returning student” in the years before that was a recognized category, Lerner had to persuade the authorities at Columbia to let her study women’s history, not an acceptable field in the early 1960s. Beginning the women’s studies program at Sarah Lawrence College (and one of the first graduate programs in women’s history), Lerner proceeded to teach, write, and lecture around the country, penning several classic volumes in women’s studies: *Black Women in White America* (1972), *The Majority Finds Its Past* (1979), and her two-volume magnum opus, *The Creation of Patriarchy* (1986) and *The Creation of Feminist Consciousness* (1993). In 1982, after the death of her husband, she moved to the University of Wisconsin to found the Ph.D. program in women’s history. Her autobiography of her early years, *Fireweed: A Political Autobiography*, was published in 2002.

many use *gender* where *sex* would have been used earlier. For many theorists, both terms are constructed—that is, the particular culture gives its own meaning to sex and gender. Additionally, we now have much more research and experience with transgendered individuals, such that the binary of male-female is problematic at best. Any particular “sex-gender system” is of course an artifact of a particular historical time and place. Still, the two major types continue to be a useful way of understanding the various forms of the theories that underlie women’s studies.

Each one of the two major types of feminist theories includes several subtypes, from conservative to radical, from positions that imply few changes in the status quo to ones in which the whole society is altered by the shift in women’s status and conceptualization. It is useful to envision the positions—minimizers and maximizers of difference—on two lines that move from the more conservative to the more radical, from right to left. The most conservative feminist position on both continua is that view of women that offers a rationale for the present structure of society. The most radical position offers a call for a future society totally transformed either by the extreme of making males and females no longer different physiologically (for example, by the abolition of female reproductive capacities) or, for the maximizers, the extreme of totally separating the two sexes—physically, geographically, and socially. Beyond the conservative feminist pole, one finds reactionary positions: for the maximizers,

various sociobiologist positions; for the minimizers, the position that fails to recognize that human rights may be an issue. This latter view is based on an unstated assumption that might be expressed thus: “We are all alike; we all stand in the position of white privileged males; we all have equal rights.”

The minimizers. Along the “minimizers” continuum, one moves first from the “human rights” position to “women’s rights,” the stance of various reformist groups and theorists that advocate granting equal rights to women in all areas by working within existing political systems. This nineteenth-century egalitarian position of the first women’s rights activists, such as Elizabeth Cady Stanton and Susan B. Anthony, is also known as liberal feminism. It is the point of view of John Stuart Mill in his important work *The Subjection of Women* (1869) and that of Mary Wollstonecraft in *A Vindication of the Rights of Woman* (1792). The stance is found most conspicuously in the early twenty-first century in views of the U.S. National Organization for Women (NOW).

Next along the continuum are various types of socialist feminists: those who advocate the primacy of socialist revolution, those who advocate wages for housework and other solutions to equate being a housewife (or a househusband) with working outside the home, and others who attempt to make new syntheses of feminist questions and socialist or Marxist answers that begin with an economic analysis. Historically the socialist position on women is stated most dogmatically by Friedrich

Women have been left out of history not because of the evil conspiracies of men in general or male historians in particular, but because we have considered history only in male-centered terms. We have missed women and their activities, because we have asked questions of history which are inappropriate to women. To rectify this and to light up areas of historical darkness we must, for a time, focus on a *woman-centered* inquiry, considering the possibility of the existence of a female culture *within* the general culture shared by men and women. History must include an account of the female experience over time and should include the development of feminist consciousness as an essential aspect of women's past. This is the primary task of women's history. The central question it raises is: What would history be like if it were seen through the eyes of women and ordered by values they define?

What is needed is a new universal history, a holistic history which will be a synthesis of traditional history and women's history. It will be based on close comparative study of given periods in which the historical experiences of men are compared with those of women, their interactions being as much the subject of study as their differences and tensions. Only after a series of such detailed studies has been done and their concepts have entered into the general culture can we hope to find the parameters by which to define the new universal history. But this much can be said already: Only a history based on the recognition that women have always been essential to the making of history and that *men and women* are the measure of significance, will be truly a universal history.

SOURCE: Gerda Lerner, *The Majority Finds Its Past*, pp. 178, 180.

Engels in *The Origin of the Family, Private Property, and the State* (1884), but many other theorists have used economics and class as a starting point. This approach is illustrated by Sheila Rowbotham's influential *Women, Resistance, and Revolution* (1972); Juliet Mitchell's four interlocking female structures (production, the reproduction of children, sexuality, and the socialization of children) in *Woman's Estate* (1971); and Zillah Eisenstein's grid pattern for understanding sex and class in concert in *Capitalist Patriarchy and the Case for Socialist Feminism* (1979). What has come to be called "state feminism" in Europe, especially in the Nordic countries, fits into this position. A women's or equality minister is a part of the government, and socialist solutions to women's traditional inequality are made a part of the law.

The next position on the minimizer continuum is one that advocates the sharing of traditional gender characteristics. In order to remedy the psychosocial tyranny that oppresses both men and women, exclusive female parenting that produced "momism" (as well as the fear and hatred of women) must be ended, these feminists argue. This gender difference is a cultural product, not an inherent biological distinction. The psychologists Nancy Chodorow, in *The Reproduction of Mothering* (1978), and Dorothy Dinnerstein, in *The Mermaid and the Minotaur* (1976), both weigh in with this view, although in different ways. Charlotte Perkins Gilman's *Women and Economics* (1898) is an early work with this perspective. Traditional masculine (and valued) characteristics had been mistakenly monopolized by one sex, she believed, while the "feminine" virtues also needed to be shared.

Those who want to abolish gender distinctions completely, creating a gender-free (but not sexless) society, are next on the continuum. Males and females are more similar to each other

than either is to any other species, these theorists claim. The anthropologist Gayle Rubin proposed this view in her influential article "The Traffic in Women: Notes on the Political Economy of Sex" (1975). Simone de Beauvoir's renowned *Le deuxième sexe* (1949; *The Second Sex*, 1953) can be read as arguing this point as well. Her goal is for women to become the independent, "transcendent" human beings that men have always had the choice of becoming. Ursula Le Guin's fictional *The Left Hand of Darkness* (1977) posits an androgynous society in which people belong to a particular sex for only a few days a month; for most of the time they function androgynously in both physical and psychological ways.

The extreme pole of the minimizer position is represented by those intensely controversial thinkers who want to abolish not only gender and sex roles but also female reproduction (including conception, pregnancy, and birth) or at least their exclusive ownership by women. Gilman wrote one of the first explorations of such a society. Her fictional *Herland* (1915) envisioned a female-only culture where women conceive by parthenogenesis (without male sperm). In the more recent past, both theorists, such as Shulamith Firestone in *The Dialectic of Sex* (1970), and feminist science-fiction writers, such as Marge Piercy in *Woman on the Edge of Time* (1976), have advocated the abolition of exclusive female reproduction. Many believe that reproductive technology, with its artificial fertilization and implantation of a fertilized egg, is close to making this a reality. The film *Junior* (1994), in which Arnold Schwarzenegger's character becomes pregnant, explores this fantasy in a humorous manner.

The maximizers. All feminists on the maximizer continuum are interested in seeking out, recognizing, and valuing sex-gender difference, especially as it relates to women. Women's specific

**PREAMBLE TO THE CONSTITUTION OF THE NATIONAL WOMEN'S STUDIES ASSOCIATION,
ADOPTED 1977, REVISED AND RATIFIED 1982.**

The National Women's Studies Association was formed in 1977 to further the social, political, and professional development of Women's Studies throughout the country and the world, at every educational level and in every educational setting. To this end, this organization is committed to being a forum conducive to dialogue and collective action among women dedicated to feminist education and change.

Women's Studies owes its existence to the movement for the liberation of women; the feminist movement exists because women are oppressed. Women's Studies, diverse as its components are, has at its best shared a vision of a world free from sexism and racism. Freedom from sexism by necessity must include a commitment to freedom from national chauvinism, class and ethnic bias, anti-Semitism, as directed against both Arabs and Jews; ageism; heterosexual bias—from all the ideologies and institutions that have consciously or unconsciously oppressed

and exploited some for the advantage of others. The development of Women's Studies in the past decade, the remarkable proliferation of programs that necessitated this Association, is a history of creative struggle to evolve knowledge, theory, pedagogy, and organizational models appropriate to that vision.

Women's Studies is the educational strategy of a breakthrough in consciousness and knowledge. The uniqueness of Women's Studies has been and remains its refusal to accept sterile divisions between academy and community, between the growth of the mind and the health of the body, between intellect and passion, between the individual and society.

Women's Studies, then, is equipping women not only to enter society as whole, as productive human beings, but to transform the world to one that will be free of all oppression. This constitution reaffirms that commitment.

talents and unique ways of contributing plead for their having a larger role in society. A bumper sticker reading "A Woman's Place is in the House—and in the Senate" uses this maximizer or difference argument, as does one that says "Clean Up Politics—Elect Women."

One notes first the historical "separate spheres" position—that women and men inhabit different physical places in society (private and public) and have different roles, virtues, aptitudes, sensibilities, and "ways of knowing." The nineteenth century saw the first clear use of the separate-spheres philosophy to help ameliorate women's position, in such thinkers as Catharine Beecher and Frances Willard. Later Jane Addams, in *Newer Ideals of Peace* (1907), enunciated the "municipal housekeeping" argument for giving women the vote: women should manage the household, but if they were to do this well, they must be concerned with clean water, pure milk, garbage disposal, and safe streets and parks for their children. They must therefore participate in municipal government by voting and standing for office. People promoting separate spheres in the twenty-first century include conservative women on the New Right and fundamentalist Christians.

The next group on the continuum wants to glorify the "feminine," wherever it may be found, often in writings of male poets. Sometimes identified as postmodern feminists, many of these thinkers are French or influenced by Jacques

Derrida, Jacques Lacan, and other French deconstructionists. Opposed to binary oppositions such as male-female, these feminists wish to assert multiple modes of being and gender. Hélène Cixous, Luce Irigaray, and Julia Kristeva are important writers here, as are Jane Gallop, Joan Scott, and Teresa de Lauretis in the United States and Toril Moi and Gayatri Spivak internationally. Additionally these thinkers would be opposed to the very idea of the two continua, since they often assert that neither "woman" nor "man" can be defined.

Cultural feminists and maternalists occupy a middle position on the maximizer continuum. Cultural feminists celebrate women's spirituality, art, music, and writing, especially in women's bookstores, cafés, theater groups, galleries, holiday centers, and support groups. Both the feminist art movement and the women's music movement, with its annual festivals, have been important in articulating these viewpoints. The maternalists cherish motherhood as the source of woman's difference and superiority. Both practical groups—lesbian parenting, natural and home-birth groups, and the women's health movement—and theorists such as Adrienne Rich in *Of Woman Born: Motherhood as Experience and Institution* (1976) and Sara Ruddick in *Maternal Thinking* (1989) are connected to the maternalist position.

The "woman-as-force" position rejects "woman-as-victim" stances and argues that because of women's close connection

to nature—historically, biologically, mythologically, and psychologically—women can save humanity from the destructive path that men have begun. The historian Mary Beard enunciated the woman-as-force position in 1946, while Carol Gilligan's argument that young women take different ethical stances than young men, articulated in her *In a Different Voice* (1982), has influenced psychological and learning theories on gender differences. Another important work in this vein is Mary Field Belenky and her colleagues' *Women's Ways of Knowing* (1986).

Ecofeminism is an important subcategory of the woman-as-force position; the views of various theorists, such as Ynestra King, Susan Griffin, and Karen Warren, have been influential. The Indian nuclear physicist Vandana Shiva's work, especially *Staying Alive: Women, Ecology, and Development* (1988), explores ecofeminism on the global stage and makes connections with postcolonial and development concerns.

The female supremacists occupy the most radical position on the maximizer continuum. Either lesbian or celibate, these most extreme of the separatists advocate a complete partition of the sexes, believing that only with their own institutions can women find freedom. How far separatism is taken depends on the individual, but some advocates call for separate geographical areas for women, attempting self-sufficiency in various communal living situations. Most influential in this argument are Mary Daly, in *Gyn/Ecology: The Metaethics of Radical Feminism* (1978) and *Websters' First New Intergalactic Wickedary of the English Language* (1987); Sonia Johnson, in *Wildfire: Igniting the Shell Revolution* (1989); Marilyn Frye, in *Some Reflections on Separatism and Power* (1981); and various science-fiction proposals, such as Joanna Russ's *The Female Man* (1975). It should be noted, however, that lesbians are found in all categories of feminism.

Problems with the model; or, mediating the dichotomy.

The dichotomy of equality-difference or minimizers-maximizers is difficult to maintain and often false, asserts the German critic Gisela Bock, since dichotomies are often hierarchies in disguise. Arguing strongly on the side of difference can lead to the dangerous "difference dilemma" because it can confirm women's inferiority. Yet strong arguments from the equality stance produce the "equality dilemma," in which gender differences are completely erased and everyone is presumed to be the same.

The most fruitful way to deal with the two kinds of arguments is to mediate between them, as some contemporary thinkers have done. There is a suggestive link made by African-American and multicultural feminists who argue the need for forms of socialism (a minimizer strategy) while identifying and celebrating the unique assets supplied to the struggle by strong women of color (a maximizer strategy). "The Combahee River Collective Statement," in *Home Girls* (1983), edited by Barbara Smith, and *This Bridge Called My Back: Writings by Radical Women of Color* (1983), edited by Cherríe Moraga and Gloria Anzaldúa, are essential works in this vein. Likewise the historian Gerda Lerner's conceptualization of "woman as majority" in *The Majority Finds Its Past* (1979) connects maximizer arguments about women's different strengths and special institutions with the minimizer insistence on the necessity of abolishing the sex-gender system and sharing gender.

Other creative thinkers have written of "difference in unity" or "equality in difference." Virginia Woolf, in *Three Guineas* (1938), proposes that women need to belong to a society of outsiders who have the same goals as men but must work in their own way on the borders of the patriarchal system, both inside and outside. In a spoof on the religious vows of monks and nuns, she says that women who belong to this society must take vows of poverty, chastity (of the brain), derision of honors, and freedom from the "unreal loyalties" of nation, class, sex, family, or religion. Members of the Society of Outsiders would agree to earn their own livings "expertly," not engage in any profession that promotes war, and criticize the institutions of education and religion. Only in this way can women help prevent war. Contemporary thinkers, especially Latinas and other bicultural women, such as Gloria Anzaldúa in *Borderlands: The New Mestiza = La Frontera* (1987), or African-American women, such as bell hooks in *Feminist Theory: From Margin to Center* (1984), also explore this "border" position. So-called Third or Developing World feminists (also known as postcolonial feminists) clearly mediate the two strands of theory, with their call for support for nationalist struggles ("all issues are women's issues" and "if it's appropriate technology, it's appropriate for women") and their recognition of women's continuing "double day" work (housework, child care, and productive or economic activities) at every level of society around the world.

Controversies

As "the most powerful force affecting women in higher education today," according to Mariam Chamberlain of the Ford Foundation, women's studies stands at the cusp of several controversies. Many of the criticisms of the early days (the standard retort from men in power was "When are we going to have men's studies?") have disappeared into internal controversies among practitioners: Should women's studies attempt to integrate into the regular curriculum or remain an autonomous outsider? Should women's studies opt for discourse theory, forsaking political action on which women's studies was built? Can you teach what you have not experienced? Can a white woman teach multiculturalism? Should people give priority to transgendered and other sexual concerns over against the concerns of postcolonial and developing nations?

The dangers of identity politics and the threatening allegation of essentialism have fractured the unity of women's studies programs. But disciplinary identities can be as dangerous, such that the feminist literary critic or the feminist sociologist hearkens back to her disciplinary language and methodology, even as she is opposed to those disciplines' contents. What often happens now in women's studies programs is that the senior faculty continue their disciplinary identity, leaving the junior faculty to be the "identity reps" of Chicana, Asian, or African-American ethnicity and prey to the charge of essentialism.

Another difficulty is the ubiquitous presentism that is now everywhere in women's studies. Although women's history was one of the earliest and strongest supporters of women's studies, women's and gender history have moved largely into their own field, with dedicated journals and conferences. Few sessions on

history are to be found now at National Women's Studies Association conferences or at the International Interdisciplinary Congress on Women. Both the history of the discipline and women's history itself therefore stand to be marginalized or ghettoized from women's studies. Worse, the disciplines have so embraced women's studies that "translation" is now necessary in moving a course from women's studies to, say, literature or sociology.

There is often a conflict between those faculty who "privilege gender or gender and sexuality, as analytical frameworks, and those who also incorporate race, colonialism, and class," say Laura Donaldson, Anne Donadey, and Jael Silliman, in their article in Robyn Wiegman's edited collection, *Women's Studies on its Own* (Donaldson, Donadey, and Silliman, p. 439). And often in the United States, globalization is little more than "a Cold War production of knowledge," which compares other areas to the United States to their detriment, continuing a dangerous U.S.-centrism.

Still, with all the fragmentation, the "center holds." Women's studies as a concept and a practice is here to stay. It has been so institutionalized, there is so much new knowledge and new scholarship, there have been so many hearts and minds changed through this study that the various splits and positions can only help to proliferate the ideas.

See also Equality; Gender Equality; Feminism; Gender; Human Rights; Women's Rights; Structuralism and Post-structuralism; Women's History.

BIBLIOGRAPHY

- Belenky, Mary Field, Blythe McVicker Clinchy, Nancy Rule Goldberger, and Jill Mattuck Tarule. *Women's Ways of Knowing: The Development of Self, Voice, and Mind*. New York: Basic Books, 1986.
- Bird, Elizabeth. "Women's Studies in European Higher Education." *European Journal of Women's Studies* 3, no. 3 (1996): 151–165.
- Bock, Gisela. "Challenging Dichotomies: Perspectives on Women's History." In *Writing Women's History: International Perspectives*, edited by Karen Offen, Ruth Roach Pierson, and Jane Rendall, 1–24. Bloomington: Indiana University Press, 1991.
- Boxer, Marilyn Jacoby. *When Women Ask the Questions: Creating Women's Studies in America*. Baltimore, Md.: Johns Hopkins University Press, 1998.
- Donaldson, Laura E., Anne Donadey, and Jael Silliman. "Subversive Couplings: On Anti-Racism and Postcolonialism in Graduate Women's Studies." In *Women's Studies on Its Own*, edited by Robyn Wiegman, 438–456. Durham, N.C.: Duke University Press, 2002.
- Frye, Marilyn. *Some Reflections on Separatism and Power*. East Lansing, Mich.: Tea Rose, 1981.
- Grewal, Indrapal, and Caren Kaplan, eds. *Scattered Hegemonies: Postmodernity and Transnational Feminist Practices*. Minneapolis: University of Minnesota Press, 1994.
- Hacker, Helen. "Women as a Minority Group." *Social Forces* 30 (1951): 60–69.
- hooks, bell. *Feminist Theory: From Margin to Center*. 2nd ed. Cambridge, Mass.: South End Press, 2000.

- . *Teaching to Transgress: Education as the Practice of Freedom*. New York: Routledge, 1994.
- Howe, Florence, ed. *The Politics of Women's Studies: Testimony from Thirty Founding Mothers*. New York: Feminist Press, 2000.
- Lerner, Gerda. *Fireweed: A Political Autobiography*. Philadelphia: Temple University Press, 2002.
- . *The Majority Finds Its Past*. New York: Oxford University Press, 1979.
- Lerner, Gerda, ed. *Black Women in White America: A Documentary History*. New York: Pantheon, 1972.
- Messer-Davidow, Ellen. *Disciplining Feminism: From Social Activism to Academic Discourse*. Durham, N.C., and London: Duke University Press, 2002.
- Minnich, Elizabeth Kamarck. *Transforming Knowledge*. Philadelphia: Temple University Press, 1990.
- Moraga, Cherríe, and Gloria Anzaldúa. *This Bridge Called My Back: Writings by Radical Women of Color*. Latham, N.Y.: Kitchen Table/Women of Color Press, 1983.
- O'Barr, Jean Fox. *Feminism in Action: Building Institutions and Community through Women's Studies*. Chapel Hill: University of North Carolina Press, 1984.
- Offen, Karen. "Defining Feminism: A Comparative Historical Approach." *Signs* 17 (Fall 1988): 119–157.
- Scott, Joan Wallach. *Gender and the Politics of History*. Rev. ed. New York: Columbia University Press, 1999.
- Shiva, Vandana. *Staying Alive: Women, Ecology, and Development*. London: Zed Books, 1988.
- Smith, Barbara. *The Truth That Never Hurts: Writings on Race, Gender, and Freedom*. New Brunswick, N.J.: Rutgers University Press, 1998.
- Smith, Barbara, ed. *Home Girls*. Latham, N.Y.: Kitchen Table/Women of Color Press, 1983.
- Tong, Rosemarie. *Feminist Thought: A More Comprehensive Introduction*. 2nd ed. Boulder, Colo.: Westview, 1998.
- Warren, Karen J. *Ecofeminism: Women, Culture, Nature*. Bloomington: Indiana University Press, 1997.
- Woolf, Virginia. *Three Guineas*. New York: Harcourt, Brace, and World, 1966.

Margaret H. McFadden

WORK. Work as a unitary experience, set off in time and place from the rest of life, is a concept bound in the culture of wage labor (see especially Thompson, 1967, on disciplined promptness and time regulation accompanying factory work). Only when effort—physical and mental—is turned into a commodity sold to an employer who then monitors and controls it can we discern an abstract concept of "work." Other concepts stand outside of that context, such as "a work" being a finished product of a craftsperson or artist, or work divided into concrete activities of particular people—warrior, farmer, smith, and so on. The situation where productive activities blend into the overall flow of daily life especially challenges our commonsense notion of work. In the recent past of the Dobe Ju/'hoansi of Botswana, women, men, and children sporadically gathered plant foods and hunted small animals, interspersed with visiting, eating, and relaxing. Hunting large animals, performed by men, stood out from the rest of life because meat was desired and was the basis for much social

interchange. But although the ethnographer Richard Lee could designate specific activities as “work” in his own cultural terms, and count the hours and minutes spent in them (surprisingly little time was needed to produce quite satisfactory subsistence), no clear concept equivalent to abstract work emerged from the Ju/hoansi themselves.

Many cultures do distinguish activities requiring disciplined effort and focus to produce a concrete result, however. Among farmer-fishermen living by Lake Titicaca, Benjamin Orlove found that the general word *work* (Spanish *trabajo* or Quechua *llank'ay*) was used only in conjunction with a specific activity. This demanded concentrated effort, often physical but sometimes mental, and produced a tangible product, so that fishing was “work” while repairing nets while sitting, chatting, and relaxing was not. The richest study of work embedded in culture is Bronislaw Malinowski’s ethnographic classic, *Coral Gardens and Their Magic* (1935), which focuses on the rituals of birth, growth, and death and the magical control over chance that envelop South Pacific farming and fishing. Although there is a long tradition of considering labor to be the defining human characteristic (e.g., Karl Marx, discussed below), when looking across cultures we see instead a pattern of alternation between disciplined routine and vibrant, expressive release. Both qualities, then, must be part of our understanding of humanity.

Another methodological concern in studying work is that upper-class intellectuals have produced most of the texts. There are two serious problems with writing a history of the idea of work based solely on these authors, who may or may not have personally experienced or carefully observed nonintellectual labor. First, they represent the interests, perspectives, and biases of their social origin and position. Second, they often take the articulate words of intellectuals to be the sole or characteristic voice of their era or place. But these authoritative sources do not necessarily represent the full range of ideas within a complex and unequal society, even if they do influence the notions of others. Thus in a society dominated by men, we often hear little about women’s ideas of work; in a society of landowners, artisans, and slaves, we often hear little from the latter two groups. How are we to rectify this? We should locate and listen to working people’s voices as directly as possible, through novels and diaries (e.g., Levi), or at least such voices mediated by careful and sympathetic observers (e.g., Mintz; Nash). And we should be imaginative in uncovering evidence about the conceptual lives of nonintellectuals, paying attention to folklore, jokes, inscriptions on products, and so on.

Pre-Capitalist Civilizations: The Incas, India, and Classical Greece and Rome

Getting beyond the articulate voices of intellectuals is especially a problem for understanding civilizations before the era of widespread printing and literacy. However, cross-cultural comparison allows us to highlight similarities and differences. This article compares concepts of work from three widely separated world regions: the Inca empire of the Andes before the Spanish conquest, the Indian subcontinent (South Asia) before British colonialism, and the Greek and Roman world before the Christian era. In the Andes, archaeological evidence

from the epoch before the Incas shows that large public works (walls, temples, canals) were constructed by multiple communities each working on its own small, essentially equivalent segment. There was no division of labor by task, but rather by community. Similarly, in the Inca period, people paid the principal taxes to the state not in the form of money or goods but as collective labor service, as communities or segments of communities (e.g., all young men of an area would serve as imperial message runners). Conceptually, this labor service took the form of reciprocity between unequal social ranks, from village to regional lord to emperor; for example, harvesting the lands of the emperor and his official religion, the cult of the sun, was reciprocated by extensive gifts of cloth and corn beer. In the late empire, however, what had started as a system of independent agricultural communities giving tribute to the state was radically transformed with new forms of labor that were disarticulated from the local community, and turned into permanent labor forces at the service of the Inca aristocracy.

In South Asia, we see a similar pattern of unequal reciprocity. Under the *jajmani* system, local caste groups owed a variety of work services and products to each other, from tanning to weaving to conducting rituals. Indeed, it is plausibly speculated that castes originated as hereditary occupations. At the level of ideas, work was not thought of as a unitary subject performed by a free (if socially grounded) individual; instead, group productive roles existed, marked by highly unequal but also reciprocal qualities of ritual purity, such as the work of tanners—conceived as polluting—which interlocked with the putatively pure work of Brahmin priests. Clearly, this was an ideology that explains and endorses inequality, though it also allowed space for change (as local castes maneuvered for changed work roles with improved ritual rank) and resistance (as groups dropped out of the system by conversion to egalitarian religions like Buddhism or Islam).

We notice a pattern in these precapitalist class societies in which the idea of work was differentiated into concrete products or tasks associated with specific collective groups, in turn synthesized into a functioning economy through unequal exchanges, mystified as mutual and reciprocal in nature. Though group membership was envisioned in various ways, cultural, linguistic, religious, and so forth, it was often the case that groups consisted of or were identified with a specific kind of work, and that such work carried denigrating or exalting qualities.

With this in mind, we can better situate Greek and Roman ideas about work, which constitute in part the roots of the Western intellectual tradition. The early Greek oral traditions of Homer and Hesiod idealize the work of the farmer, as do early Roman stories about Cincinnatus, the patriotic farmer-general. These “farmers,” however, were owners of large estates and masters of extensive households in which women, slaves, and other subordinates labored, so these ideals highlight not hard work in general but the hands-on management of rural production. By contrast, classical Greek thought turned against work, especially for others (self-sufficient farming was still esteemed). The ideal in Plato (c. 428–348 or 347 B.C.E.) and Aristotle (384–322 B.C.E.) was the man free of necessity, with leisure to engage in politics and contemplation.

There was particular disdain for merchants, who made money by trade rather than production from the land, and for artisans, who crafted goods with their hands. The productive and reproductive work of women was largely ignored. The classic Roman authors, such as Cicero (106–43 B.C.E.), held roughly the same views. This constitutes a characteristic inversion of the social reality surrounding such authors: they lived in commercially vibrant cities whose wealth came from extensive long-distance trade in farm and handcraft products. The idle rich, with time for political and natural theory, drew income from this economy, while distinguishing themselves by denigrating its key actors: slaves, foreigners, and craftsmen.

Unlike the Inca and South Asian examples cited above, in the Greco-Roman case there seems to be no specific mandate to reciprocity (however unequal) between direct laborers and intellectual elites. Perhaps this difference is the result of the greater division of labor and differentiation of roles in the rich commercial Mediterranean, creating more conceptual separation between urban authors and direct producers. The brief glimpses we have of the idea-worlds of artisans differ significantly from the famous classical writers; numerous inscriptions on pottery express pride and status in well-made handcrafts. Also, there were in Rome *collegia*, large clubs of craftsmen, with a rich mythological and ceremonial life. Though inarticulate in the sense of bequeathing to us extended texts, these represent alternative views of work from the famous disdain of Plato or Aristotle.

European Ideas from the Late Roman Era to the Industrial Revolution

Early Christianity turned away from Roman and Greek elite arrogance toward work. Jesus and the Apostles were peasant-craftsmen, and though early Christianity spread among wealthier urban populaces, there was in its communalism little room for denigration of merchants, slaves, and workers. St. Paul, a tentmaker, used the expression, “my fellow workers.” St. Augustine (354–430) extolled work as a means of moral perfection and saw it as an expression of human genius, thereby glorifying God. This line of thought found practical expression in Christian monasticism, which prized hard, focused work—forest clearing, agriculture, manuscript illumination, and so forth. Monks did not value labor in itself, but insofar as it offered dedication and discipline to God, and supported the more important role of prayer. The church viewed non-monastic human work as being in the image of God’s work, a generally favorable attitude to labor that would continue in Catholic thought to the present.

The medieval concept of “estates,” much like the castes of India, organized society by collective work functions, duties, and rights—nobility, church, and peasantry/laborers—but relegated the direct producers of society to the lowest order. However, towns were different. They had merchants and moneylenders, the antecedents of capitalism, and also the craft guilds. Guilds embodied an ideal of gradually accumulated knowledge and dexterity, culminating in personal mastery of the entire production process, including control of the materials, tools, and markets for finished goods. This concept of control and mastery was manifested in group rules and rituals that marked guild members off from nonmembers.

The rise of Protestantism, in conjunction with growing commercialization in cities, transformed Western ideas about work. Martin Luther’s (1483–1546) concepts reflected medieval social orders, in which everyone worked according to the trade in which they were born. However, he rejected the Catholic doctrine of higher and lower “callings” in favor of a singular, individualistic notion of “calling,” a strong incentive to action. More importantly, John Calvin (1509–1564) forged a radically new vision of work. He saw success in life as a sign of God’s predestined favor to the person. In a curious, but profound way, this doctrine that denied free will ended up strongly motivating labor and profit-making, since the individual cherished hard work and success as signs of heavenly election. Consistent with its roots in rising commercial centers, Calvinism also considered trade, profits, and finance as of equal value with direct production. This represents a distinct break with a long previous tradition of disdain for money-making in favor of farming.

Surveying this history, the great German sociologist Max Weber (1864–1920) argued that Protestantism stimulated the rise of European capitalism during the sixteenth to eighteenth centuries, but significant criticisms have emerged. First, Weber overstated the asceticism of early capitalists and underestimated the role of consumption as a stimulus to work and economic growth. Second, mercantile capitalism arose first in Catholic regions of northern Italy and southern Germany. Weber focused on a somewhat later period in its development. Likewise, a distinctive east Asian form of capitalism has taken hold in the twentieth century in a world region without deep Christian traditions (Japan, China, and Korea). It is debatably linked to Confucian and other east Asian worldviews that emphasize group orientation and profound feelings of duty (as opposed to Western individualism). Weber did, however, seem to catch a broadly applicable aspect of the thinking of rising capitalists, their breaking with agrarian traditionalism concerned with protecting inherited class privileges and old-fashioned luxuries. For intellectual history more generally, his work pioneered the exploration of ideas as causes and not just reflections of social change.

The concept that labor was the singular source of value in goods, the ultimate basis of wealth, now emerged in a context of rising landowner-capitalists dedicated to transforming traditional means of production. Unlike in later eras when this “labor theory of value” would serve to highlight conflict between workers and capitalists, the early version emphasized the new landlord’s role, taking private property out of the shared state of nature by adding the specific element of organized effort. This also conformed to the European expropriation of world resources after Columbus—putting the assumed “state of nature” to work, including human populations in the slave trade, land in the plantation colonies, and silver and gold in the mines of the Americas. John Locke’s (1632–1704) *Two Treatises on Government* epitomize this line of argument. It offered a truly radical turn of thought by finding value in secular human action rather than, as in the Middle Ages, from fixed social rank combined with God’s awesome majesty. Instead, the image of God became like that of man: God the maker. This fascination with making was the inspiration of

eighteenth-century French and British Enlightenment attention to mechanisms of all kinds, natural and artificial. Denis Diderot (1713–1784), the son of a prosperous knifemaker, included the mechanical arts in his encyclopedia of natural and philosophical knowledge and insisted on the worth of artisans and artisanry. With these ideas, and with the concurrent rise of global trade, putting out manufacturing of cloth, improved agriculture, and the like, we have set the stage for modern wage labor and capitalism.

The Capitalist Era

Beginning in the late eighteenth century, new theories of work under capitalism emerged.

Smith and Ricardo. In 1776 the United States declared independence and Adam Smith (1723–1790) published *The Wealth of Nations*. Within the history of ideas, this is the year best suited to mark the full birth of capitalism, though as we saw above, the change had been long coming; and it was still to be a few decades before artificially powered factories began to diffuse outward from northern England and Scotland. Smith's view of work must be understood within his wider understanding of markets, since he saw markets as leading to the division of labor in detail, breaking production into a series of discrete operations, performed repetitively and with a focused perfection by different kinds and grades of workers. This concept, which was to become pervasive in capitalist practice, is exactly the opposite of the medieval notion of the unity of all stages of work in a craft. Smith was ambivalent about his vision of the trajectory of work, however, since he feared that this division of labor would dull the mind of the worker. (This worry is characteristic of Smith, who both forecast the power of markets and capitalism and explored moral sentiments that bind otherwise materialistic and competitive people.)

Smith accepted the labor theory of value, but it was propounded most emphatically by David Ricardo (1772–1823) around 1810. In the mid-nineteenth century, it was adopted by Karl Marx (1818–1883) and has been a mainstay of orthodox Marxism since then. The labor theory of value holds that as people make and reshape the raw materials of nature and transform them into objects of use (“use value”), their market values (“exchange value”) come from the physical and mental effort in that work. It is, in part, a theory of price, but more widely it is a theory of the commonality in the values that each individual idiosyncratically attributes to objects. Clearly, a labor theory of value exalts work as a fundamental theme of human life. In Ricardo's hand, it highlighted the producing classes, capital and labor together, against the dead hand of rent-collecting landlords—in other words, it announced the birth of capitalism out of feudalism. In Marx's subsequent version, however, it valued workers against capitalists, the direct producers against the surplus-collecting owners of tools and resources (“means of production”), which are the congealed results of labors past. To Marx, this announced the future birth of communism out of capitalism. Neoclassical economists of the late nineteenth and twentieth centuries avoided the question of intersubjective value and transfer of value between classes altogether, narrowing their concern to how prices are set in particular markets. Other radical perspectives have looked to nonlabor theories of value,

especially energy and other ecological-physical value sources. Flawed as it may be, however, the labor theory of value captures something of the relationship of past work (capital) to present work (laborers), which is both an existential necessity and the basis for unequal and exploitative power relations.

Karl Marx. Marx offered a comprehensive, radical theory of work. In his labor-based worldview, human activity is central to making and transforming all aspects of life, including the concepts we use to understand it. It is important that we recognize that this is not a purely economic perspective, which is often assumed about Marx, but a much wider emphasis on the practice of life rather than the play of unworldly ideas. Likewise, his view of labor is wider than physical effort in factories, though Marx himself focused on this (then new) feature of capitalism. Rather, the term *labor* captures the full range of human capacities, as much mental and creative as physical and forceful.

This understood, we turn to alienation, Marx's central concern about work. At times we labor for ourselves, and though the product may be outside our bodies (e.g., my cleaned desk), we are not highly alienated from it. It is part of our being. At other times, we labor directly for others (e.g., a garden I plant for my wife), rendering a product that someone else will possess, use, and enjoy. But though the product is separated from us, it becomes part of a social bond, a nonalienated relation to another human being. However, under the condition of commodity production (making a good for anonymous sale), and even more importantly in wage labor under capitalism (working on a good that is owned by someone else, in a manner controlled by someone else), the result of our labors has no connection or relation to us. It is alienated. To take, for example, the division of labor in a bank, we will see that one worker will collect data, another sum it up, and a third give it a credit score, based on research by a fourth, fifth, and so on. No one worker has an organic relationship to the owner of the labor (the bank), the final product of labor (the mortgage), or the person who receives the product (the potential homeowner). Alienation is, in Marx, a matter of objective relationships, but it has subjective, felt implications—a sense that the product or the customer or the firm does not matter, that the individual has no control or commitment to work, that the whole goal of labor is vague or even unimaginable.

Within this broad framework, Marx launched a critical analysis of work under capitalism. If capitalists want to profit, labor has to render enough value to cover two funds. One is to pay workers enough to live, that is, to “reproduce” labor power. The other is for capitalists to hold the “surplus value.” Marx thus saw unequal reward for work at the heart of capitalism; assuming the labor theory of value, work activity produces all the value, but the workers receive only part of it. The rest is captured by the owners of past labor, the means of production. If total value can be conceptually divided into the necessary payment to workers and surplus value, then capitalists who seek constantly to add to their invested capital (to “accumulate capital”) have two basic strategies. One is to increase the total length of the working day, so that workers are paid for ten hours, say, enough to survive, but have to work

for two hours beyond that. Marx called this absolute surplus value. The other is to make the workers' efforts during a given period of time more productive. More could be paid to workers, possibly, but the total product would increase even more quickly, rendering yet more surplus value. Obtaining this "relative surplus value" is, according to Marx, the main logic governing work under capitalism: not that work becomes more and more brutal, though sometimes it does, but that it becomes more and more dominated by the efficiency of production, especially via technology, the dead labor of the past used to speed up the live labor of the present.

Marx thus foresaw the ultimate polarization of capital and labor, leading to a revolution by the workers. Capital would accumulate more and more means of production, pushing relative surplus value ever more extremely, and workers would have more and more in common, as each would experience the same alienated and fractured labor. Both classes would become clearer in self-definition and self-understanding, and more openly in struggle between them, until a fundamental historical transformation (a "revolution") would usher in a new state of communism. Marx failed to think clearly about this future, being always focused on the immediate task of criticism and hostile to utopias, but he hints at a life of holistic, undivided labor, producing goods that were directly shared or exchanged in webs of immediate social relations. This recital indicates two major flaws in Marx's thought. Neither workers nor capitalists have become clearly defined and self-recognized classes across national or ethnic lines, though capitalists have come closer than Marx's preferred workers. And actual communism formed a series of dystopias, dedicated to the mass production of commodities in alienating factories with worker's labor unions and other self-expressions (e.g., religion) severely controlled or repressed by domineering political-economic masters: the worst of capitalism without the leavening of democracy and civil liberties. However, no worker, student, or activist in the modern world can ignore Marx's analysis of work, whether one seeks to defend or to transform capitalism.

Non-Marxist and Neo-Marxist Views of Work under Capitalism

Marx looked to the future, embracing the development of work under capitalism as the necessary stage before communism. Other critics looked backward, drawing on (sometimes quite unrealistic) visions of medieval craft guilds or the mutualistic cooperation of the village community. Utopian socialists in the early nineteenth century, such as Charles Fourier (1772–1837) and the Scottish industrialist-turned-radical Robert Owen (1771–1858), sought the productivity of capitalism without alienation and inequality through communal mass production and the equal exchange of products between specialized craftspeople. The late-nineteenth-century artist, designer, and philosopher William Morris put forth an ideal of craft mastery against the division of labor and of creativity rooted in knowledge of the past. The gaffly economist Thorstein Veblen (1857–1929) explored related ideals about productive creativity and disciplined work, but instead of archaic crafts guilds, he envisioned as social carriers the combined figures of industrial engineers and workers. He turned a critical gaze

against financiers, the accumulators and manipulators of money, who he regarded as the parasites (the "leisure class") of otherwise productive capitalism.

Émile Durkheim (1858–1917), a French sociologist-anthropologist who worked at the beginning of the twentieth century, offered perhaps the most perceptive defense of work under capitalism in *The Division of Labor in Society*. In traditional societies, people did pretty much the same work, so they bonded with each other from their sameness ("mechanical solidarity"). But with the advance of the detailed division of labor, people no longer do the same work. Instead, their mutual interdependence creates a new, "organic" solidarity—unity from difference. This denied Marx's postulate of ultimately polarized classes. Durkheim's work is especially important in that he recognizes and confronts some of capitalism's most troubling developments, such as division and inequality (he was, we should note, a vigorous reformer who favored socialism). But his solution represents a mystical hope. Why should the division of labor result in solidarity and not worsening alienation and increasing fractionation of work?

The troubling qualities of contemporary, alienating work sparked two important mid- to late-twentieth-century statements affirming its underlying value. Catholic social teaching, as expressed in Pope John Paul II's *Laborem exercens* (*On Human Work*), views work as a distinguishing feature of humankind. Through work, people come to understand their role in and obligation to a society, and to humanity as a whole. Likewise, work is a crucial source of self-respect and identity. This both establishes ideals of what work can be and provides a basis for critical evaluation of work in capitalism and socialism, where people become the objects rather than the subjects of work. *Laborem exercens* values labor over capital, though it accepts a subordinated role for capitalism. Hannah Arendt also sees work as crucial to the human condition, but she distinguishes between labor and work in an interesting fashion. Labor is the instrumental use of the body to make things that will be consumed and will not last long; work is the use of the mind and the hands to create things that will endure, the world of art and artifacts that surround and enrich human lives. She criticizes contemporary economics for blurring these two categories, for sacrificing the enduring monuments of work in favor of impermanent, mass-produced consumer goods. Insightful as this temporal perspective is, it seems biased toward artists and intellectuals and dismisses the creativity and necessity of daily chores, particularly those associated with women.

In 1974 Harry Braverman refocused the debate over work around the perspective of Marx. He argued that capitalists do not just buy labor power but seek to control the performance of work itself. Work may be considered to have two components, mental and physical (often called manual). To capture control over work is to take its mental side, the skills, knowledge, and initiative, away from the worker and put it in the hands of the employer. This is done through observation and redesign of physical motions (time-motion engineering), by building work skills into technologies and production layouts, and by bureaucratically controlled reward systems. Debate has raged over his reading of work history; for example, some

technologies remove existing skills but introduce new skills. Nor are workers ever completely deskilled; even highly controlled and designed workplaces require subtle tricks and informal group cooperation. But after Braverman, we can no longer view new technology or management reform as simply neutral, as always means of greater efficiency and saving of effort; the forces behind such changes bear critical scrutiny.

In summary, writers of the last two centuries have viewed capitalist work with great ambivalence. From Smith, through Marx, to Arendt and Braverman, there is a sense that capitalism provides us a bounty of goods, but at the cost of controlled, subdivided, unchallenging, and unimaginative labors that do not tap the richness of human creative capacity. Ethnographers of workplaces generally agree with these views, but note that workers often find a sense of play and accomplishment in their jobs. Some bit of humanity peeks through.

The Social Sciences and Work: Key Ideas

Feminism has contributed the social sciences' most important insight about work: that is, work often performed by males, wage work or work outside the household, has been assumed to be the only kind of work, while work often performed by women, such as childcare or gardening, is left invisible or dismissed as mere chores and hobbies (this can be extended to activities of many men, such as tinkering with cars). To think of women's labor as work means to think not only of producing objects but also reproducing (renewing) the conditions of daily life. It means widening our ideas about what work is, for example in Arlie Hochschild's studies of emotional and nurturing care as work. And it challenges everyday language, such as "going out to work" and identifying a person by their paid occupation.

We thus need to keep open minds about what sorts of activities constitute work. The world of work is more diverse than stereotypical images of factories or heavy physical labor. Bureaucrats, for example, engage in "thought-work," the partly rationalized mass production of mental and verbal operations required to classify and regulate other people. Work thus involves tremendously varied experiences and ideas about those experiences, even within wage labor. Different workplaces and occupations have their own subcultural norms and symbols; the so-called "informal" workplace organization of friendship, collaboration, and factionalism often differs from the official organizational chart of power and authority. Participant-observation in workplaces has shown that informal organization surrounding minutely differentiated tasks and pay rates interdigitates with inequalities brought from the wider world, including gender, race, and ethnic background. Workplace friction, then, both reflects and exacerbates wider societal conflicts. The concept of "segmentation" aims to summarize such patterns of inequality of work and employment conditions. It highlights, in particular, the differences between jobs with specific entry requirements (e.g., educational credentials), relative stability, ascending careers, generous fringe benefits, and so on, and jobs that come and go, with few entry requirements, little future, low pay, and poor or no benefits. Working people holding the latter jobs are much more vulnerable to recurrent unemployment, giving rise to patterns of persistent rural and inner-city poverty that we perceive as "social problems."

Social scientists have also debated whether and how work has changed in recent history. Three key phases emerge from this literature. In Taylorism, named after management consultant Frederick Taylor (most active in the 1890s), management controls virtually every motion of workers through a combination of minute subdivision of tasks, detailed instructions, and monetary incentives for rapid and efficient performance. In Fordism, named after automobile manufacturer Henry Ford (most active in the 1910s and 1920s), relatively high rates of pay joined high-speed, high-pressure jobs; its broader social effect was a high-production, high-consumption, joint corporate/labor union economy characteristic of privileged segments of the Western economy from the 1940s to the 1970s. Post-Fordism, also termed flexible production, or Japanese-style management, has emerged since the 1980s. This is a contradictory concept. On the one hand, hierarchies of control are supposedly flattened and cooperative groups promoted. On the other hand, unions are dismissed as old-fashioned, even attacked and broken, workers are treated as "flexible," that is, easy to hire and fire, and corporate culture and human relations are deftly manipulated by management.

A debate has emerged in the literature about post-Fordism over whether, with computers and other advanced technologies, the tedious, Taylorist and Fordist jobs of the past will disappear. The social theorist André Gorz argues that the immense productive capacity of the modern economy makes possible vastly reduced effort, a life of leisure, self-cultivation, or voluntary and avocational work. In abstract terms, Gorz's argument makes sense and is an appealing ideal. Yet in post-Fordist conditions, the demands of work (both in terms of sheer time spent at work and people's tendency to take work "home" via computer, cell phone, etc.) have actually increased (Schor). This debate poses the question of whether the modernist image of labor as factory work and analyses, such as Marx's, that apply to it, are relevant to contemporary (flexible or postmodern) capitalism. Contemporary capitalism involves corporate and governmental entities of enormous size, complexly distributed working processes, rapidity of movement and information transfer, and finely tuned systems of psychological control. Some authors feel that this constitutes a networked capitalism characterized by loose, relaxed relationships, flexibility, and constant change. Others portray systems of power in which external surveillance becomes included as part of the individual's own watchful self. There is a strange mixture of giddy futurism and hopeless surrender in postmodern perspectives. Though often presented as arguments against Marx, these visions extend his notion of alienated labor to the point where the commoditization of the person as worker and consumer has completely colonized the self. The main difference is that they abandon his hope of a revolutionary break with alienation. Yet we should question whether such corporate forms really have eliminated all competing notions of human creativity and self-directed discipline. Likewise, the predicted end of the factory is incorrect and Western-centric; the mind-numbing mass production of everyday goods has shifted to newly developing countries such as China, South Korea, Malaysia, Mexico, Brazil, and others. Though not simply replicas of the past, such places do in their own way re-create the "dark Satanic mills" of William Blake's early industrial Britain.

See also *Capitalism; Economics; Marxism; Poverty; Wealth.*

BIBLIOGRAPHY

- Applebaum, Herbert A. *The Concept of Work: Ancient, Medieval, and Modern*. Albany: State University of New York Press, 1992. An excellent survey of the history of Western ideas about work, on which I have drawn substantially.
- , ed. *Work in Market and Industrial Societies*. Albany: State University of New York Press, 1984. A continuation of the previous entry.
- , ed. *Work in Non-Market and Transitional Societies*. Albany: State University of New York Press, 1984. A valuable anthology about work across cultures.
- Arendt, Hannah. *The Human Condition*. Chicago: University of Chicago Press, 1958.
- Braverman, Harry. *Labor and Monopoly Capital: The Degradation of Work in the Twentieth Century*. New York: Monthly Review Press, 1974.
- Cornfield, Daniel B., and Randy Hodson, eds. *Worlds of Work: Building an International Sociology of Work*. New York: Kluwer Academic/Plenum Publishers, 2002. A comprehensive survey of the social sciences of work in diverse nations.
- Durkheim, Émile. *The Division of Labor in Society*. New York: Free Press, 1964.
- Gordon, David M., Richard Edwards, and Michael Reich. *Segmented Work, Divided Workers: The Historical Transformation of Labor in the United States*. Cambridge, U.K., and New York: Cambridge University Press, 1982. An excellent source on segmentation and changing concepts of industrial work.
- Gorz, André. *Paths to Paradise: On the Liberation from Work*. Translated by Malcolm Imrie. Boston: South End Press, 1985.
- Hochschild, Arlie Russell. *The Managed Heart: Commercialization of Human Feeling*. Berkeley: University of California Press, 1983.
- John Paul II. *On Human Work: Encyclical Laborem exercens*. Washington, D.C.: Office of Publishing Services, United States Catholic Conference, 1981.
- Joyce, Patrick, ed. *The Historical Meanings of Work*. Cambridge, U.K., and New York: Cambridge University Press, 1987. A valuable collection, emphasizing concepts of work beyond those of articulate intellectuals.
- Lee, Richard B. *The !Kung San: Men, Women, and Work in a Foraging Society*. Cambridge, U.K., and New York: Cambridge University Press, 1979.
- Levi, Primo. *The Monkey's Wrench*. Translated by William Weaver. New York: Summit Books, 1986.
- Malinowski, Bronislaw. *Coral Gardens and Their Magic*. 2 vols. Bloomington: Indiana University Press, 1965.
- Marx, Karl, and Friedrich Engels. *The Marx-Engels Reader*. Edited by Robert C. Tucker. New York: Norton, 1972.
- Mintz, Sidney W. *Worker in the Cane: A Puerto Rican Life History*. New Haven, Conn.: Yale University Press, 1960.
- Nash, June. *I Spent My Life in the Mines: The Story of Juan Rojas, Bolivian Tin Miner*. New York: Columbia University Press, 1992.
- Orlove, Benjamin S. *Lines in the Water: Nature and Culture at Lake Titicaca*. Berkeley: University of California Press, 2002.
- Schor, Juliet B. *The Overworked American: The Unexpected Decline of Leisure*. New York: Basic Books, 1991.
- Smith, Adam. *An Inquiry into the Nature and Causes of the Wealth of Nations*. Edited by Edwin Cannan. New York: Modern Library, 1994.

Thompson, E. P., "Time, Work Discipline, and Industrial Capitalism." *Past and Present* 38 (1967): 56–97.

———. *William Morris: Romantic to Revolutionary*. New York: Pantheon Books, 1977. A representative figure of the nineteenth-century romantic critique of industrial work. Originally published in 1955.

Veblen, Thorstein. *The Instinct of Workmanship, and the State of the Industrial Arts*. New York: A. M. Kelley, 1964.

Weber, Max. *The Protestant Ethic and the Spirit of Capitalism*. Translated by Talcott Parson. New York: Charles Scribner's Sons, 1958.

Josiah McC. Heyman

WORLD SYSTEMS THEORY, LATIN AMERICA.

The term *world systems analysis* was coined in 1974 by Immanuel Wallerstein to refer to a broad set of ideas about the global political economy, and especially the relationship between Latin America and the dominant economies of Europe and the United States, which were then gaining currency. The phrase *world system* is explored in detail in Wallerstein's famous book *The Modern World-System: Capitalist Agriculture and the Origins of the European World Economy in the Sixteenth Century* (1976). The form of critical inquiry advanced in this legendary study was then used in varying ways around the globe by such other scholars as Samir Amin of Senegal, Giovanni Arrighi of Italy, and André Gunder Frank of Germany, all of whom collaborated with Wallerstein on a notable book published through Monthly Review Press in 1982 entitled *Dynamics of Global Crisis*.

Landmark theories often emerge when the concrete events of history demand a new politics, and with it a new explanatory framework. Such was the case with world systems theory, and the preceding dependency theory of the 1960s and 1970s. As anthropologist Eric Wolf would later write, these intellectual movements tried to synthesize theoretically informed history with historically informed theory in response to the pressing problem, expressed most acutely during the political upheavals of 1968, "to discover history, a history that would account for the ways in which the social system of the modern world came into being," since "only in this way could we come to comprehend the forces that impel societies and cultures here and now" (p. ix). As this statement—and Wolf's own political activism in the United States during the 1960s—makes clear, world systems theory and its antecedent movements were not merely intellectual exercises; the scholars involved in them were also activists, many of whom risked their lives and suffered political repression, imprisonment, and exile in their efforts to transform the unequal system they abhorred.

The Age of Decolonization and the Failings of Modernization Theory

The period after World War II marked the epoch when the age of colonialism finally crashed, as one national liberation movement after another in Asia and Africa won legal independence (from Asian nations such as India in 1947, China in 1949, and Vietnam in 1974 to African countries such as Egypt in 1951, Ghana in 1957, Nigeria in 1960, Guinea-Bissau in

1974, and Angola in 1975, among many others). Above all, there was also the historic defeat of U.S.-enforced neocolonialism in Latin America by the Cuban Revolution of 1 January 1959—an event that had a tremendous impact on the entire hemisphere at a time when corporate capitalism reigned almost unchallenged in the Americas.

But as Western modernization replaced Western colonialism in former colonies, scholars and activists alike realized that the struggle was far from over, as it became increasingly apparent throughout the “Third World” (as it came to be called in the late 1950s and early 1960s) that Western modernization meant one thing to Western countries and quite another to non-Western countries. One and the same economic project, in the act of producing “modern nations” around the globe, generated unprecedented wealth for the West and abject poverty for the majority of citizens in non-Western countries.

World systems theory was developed by scholars on the left in response to the failures of modernization theory, which had predicted growing prosperity and development in the Third World, rather than the immiserization that befell so many new nations. Few could disagree on the facts about the stark inequalities that divided the former colonial powers from their former colonies, given the grim statistics on such social indicators as infant mortality, average life span, access to health care, and level of literacy. But explanations diverged sharply. Western apologists for mainstream modernization theory, such as W. W. Rostow in *The Stages of Economic Growth: A Non-Communist Manifesto* (1960), made a straightforward threefold argument about the “universal” superiority of capitalist modernization. First, they maintained that the main countries comprising the West had modern economies, while most other nations simply had traditional economies characterized by low levels of industrialization, a small middle class, and hardly any advanced technology. Second, they argued that Western nations had a citizenry who possessed a modern psychology and modern cultures, which together were linked to an understanding of the need for hard work, a habit of punctuality, and a commitment to save money for investment. Conversely, the citizens of non-Western nations supposedly lacked this modern attitude and worldview to varying degrees and their economies suffered accordingly. Third, the Western apologist contended that the countries in the West were governed by modern institutions, such as parliamentary democracy, a multiparty system, an independent judiciary, and excellent public education systems. On the other hand, the “traditional societies” from outside the West were governed instead by “premodern” institutions, often with dictatorial leaders or paternalistic regimes, and no real commitment to public literacy. So, the answer, the modernization theorists maintained, was simple: the rest of the world should learn to behave like the West and to adapt its system of corporate capitalism.

By the late 1950s and early 1960s, however, something else was becoming clear, namely, the precise opposite of what modernization theorists had predicted was in fact occurring. Moreover, this development process often happened in ways that were devastating for the majority of the populations in every

Latin American nation, whether it was more or less “modern.” As Western capital modernized Latin American economies—from the copper mines of Chile, the oil fields of Venezuela, and the agribusinesses of Central America to the bauxite production of Jamaica—they became more contradictory and imbalanced on the national level to the degree that they were modernized by the West. Far from creating a large middle class, for example, corporate capitalism did exactly the opposite. Moreover, it soon became well documented that U.S. multinational corporations in fact preferred to do business with repressive military dictatorships and other premodern, as well as antidemocratic, political formations, in order to support a modernization that generated huge profits for the West, even as it led to very modest infrastructural gains for the host nation. In addition, it was not lost on the popular classes themselves that modernization theory was inaccurate on another count as well, that is, the relation of hard work and high productivity to remuneration. In Latin America, the members of the labor force who worked hardest within corporate capitalism were paid the least.

At this point, the issue simply was no longer one of explaining social injustice as a consequence of European-American-based modernization—these injustices had become patently, even painfully, clear to the Third World intelligentsia and progressive intellectuals in the West—but rather one of disclosing why and how the two phenomena, social injustice and capitalist modernization, were deeply interrelated. Were they incidentally connected through the misapplication of capitalist modernization by corrupt local leaders? Or were they linked through the coercive designs of imperial political policies emanating squarely from the West?

To an increasing number of critics, neither of these types of explanation were sufficient, since they did not begin with a structural economic analysis of what Karl Marx, almost a century earlier, had named the “uneven development” of modern capitalism. What was needed was a theory that began, not with individual examples of corruption or inefficiency, but with the inherent structural logic of corporate capitalism that, based as it is on an unequal “international division of labor,” is unfairly organized by its very nature at the site of production, not just as a result of distribution. In an outpouring of intellectual energy beginning in the late 1950s, a new cohort of intellectuals, many from Third World countries themselves, began to develop such a theory.

Precursors to World Systems Theory

In developing his theory, Wallerstein built upon the nineteenth-century critiques by Marx of capitalism’s structural contradictions and those by the subsequent school of dependency theory that first emerged in the 1950s and 1960s throughout the Americas about the “development of underdevelopment.” The latter school of thought, devoted to analyzing the structural logic of monopoly capitalism, was put forth first by such scholars as Paul Baran, Harry Magdoff, and Paul Sweezy of *Monthly Review*, then developed in interrelated books throughout Latin America by Fernando Henrique Cardoso, Theotonio dos Santos, Jaime Wheelock Román, Fidel Castro, and Orlando Núñez Soto, among several others. World systems theory also

owes an intellectual and political debt to the anticolonial critiques from the Caribbean of C. L. R. James or Frantz Fanon; the celebrated *Annales* school of material history from France exemplified by Fernand Braudel, Marc Bloch, or Georges Duby; and the radical historical analysis in England of Christopher Hill, E. P. Thompson, or E. J. Hobsbawm.

Anticolonialism. In 1952, Frantz Fanon of the Caribbean island of Martinique launched a stirring anticolonial analysis of the ideologically charged ethnocentrism hidden behind European efforts at “modernization” in Africa, entitled *Peau noire, masques blancs* (*Black Skin, White Masks*, 1967). (This work was also very much in the tradition of C. L. R. James’s *sui generis* anticolonial study *The Black Jacobins* [1939] about revolutionary movements in Haiti and the Dominican Republic.)

Development of underdevelopment. In 1957, Paul Baran published a watershed study entitled *The Political Economy of Growth*, which became one of the most popular books about political economy in the history of Latin America. (A Spanish edition of this study had gone through more than twenty different editions, since being published by the National Autonomous University of Mexico.) In it, Baran demonstrated how Western development via modernization unavoidably produced underdevelopment in Latin America, and that it was necessarily based on “uneven development” owing to its peculiar structural logic. Indeed, without major structural adjustments, Western modernization would continually lead to the development of underdevelopment in Latin America and the Third World. Far from being the solution to poverty in Latin America, Western modernization was a primary cause of it. As the formative “core” of a hemispheric system, capital in the United States (and Europe) would thus continue to siphon crucial resources from “peripheral” Latin American countries through hyper-profits generated by the international division of labor.

Latin American dependency theorists. Baran’s book helped to galvanize the position of an entire generation of Latin American intellectuals. They answered the call to document his abstract claims about the deforming effects of Western modernization for the Americas through concrete studies of specific instances of the effects of corporate capitalism, with a series of studies that were extensive, provocative, and often brilliant. One particularly well-known example is Brazilian scholar Fernando Henrique Cardoso’s (with Enzo Faletto) *Dependencia y desarrollo en América Latina* (1969). The context of its publication reveals the increasingly fierce battle between left and right that shaped twentieth-century Latin American politics: it was authored in Chile (on the eve of the Salvadore Allende years) where Cardoso was then in exile, because of a U.S.-backed military coup in Brazil during 1964. The latter opened the way to what Western capital would celebrate as an “economic miracle” (an annual growth rate of 10% for a decade). Yet, as one Brazilian leader of the period admitted: “In my country, the economy is doing fine, but the people aren’t.”

Cardoso’s study, based on what he terms an “*análisis global*” (global analysis), provides a structural analysis of this contradictory process. In 1950 there were at least five large nations from Latin America that, according to the standards of modernization theory, were virtually guaranteed success as modern nations who

would be major players on the world economic stage: Argentina, Brazil, Chile, Columbia, and Mexico. Each of them possessed the following: (1) sufficient internal markets to propel growth; (2) a formidable industrial base; (3) abundant reserves of raw materials; (4) powerful stimuli to grow nationally; and (5) satisfactory formations of domestic capital. Yet despite their enormous structural promise and hardworking labor forces, these five countries ended up being trapped by the West in a type of *desarrollo dependiente* (dependent development) that caused a profound depression of the living standards and welfare of the vast majority of their citizenry. The result was a disadvantageous interdependency with a Western-led modernization that did not make them modern nations by the standards of the West, even as the West itself profited handsomely from this foreign labor force and the region’s raw materials.

An even more extreme case of underdevelopment as a consequence of Western modernization occurred in the seven largely rural countries of Central America, which were far less prepared to succeed in the world system than were the five Latin American nations singled out by Cardoso. Few have encapsulated better in a short aphorism than did Nicaraguan author Sergio Ramírez, how the economy of a Third World region is deformed by capitalist-based underdevelopment simply to serve the consumer patterns of the West. As Ramírez noted, people in Central America figured out fairly soon what their assigned role in the world system would be: cheap desserts for the West, such as coffee, sugar, and fruit. It was another Nicaraguan intellectual and guerrilla leader, Jaime Wheelock Román, who documented extensively and explicated deftly the historical process whereby Central America’s fate would be determined by the international division of labor of corporate capitalism. The latter set of relationships rigidly presupposes the preparation of raw materials on the periphery of the world system and the production of finished industrial goods primarily in the core area. Written in the 1970s, Román’s *Nicaragua: Imperialismo y Dictadura* was an underground classic during the insurrection against Nicaragua’s de facto leader Antonio Somoza Debayle and a guiding text for revolutionary policies by the Sandinistas after their victory over Somoza in 1979.

Even more so than Cardoso, Wheelock Román’s book exemplifies the increasingly high stakes in which Latin American dependency and world systems theorists worked as an underground labor leader during a period of intense political depression. Despite these dangers, he produced one of the most important books on dependency theory ever to come out of Central America. Román carefully traces how the Nicaraguan *economía agroexportadora* based on coffee (and to a lesser extent on bananas, sugar, and cotton) was set up to provide cheap goods for the West, and produced low prices for European-American consumers through the systematic maltreatment of underfed, underpaid, and terrorized workers denied basic human rights. Moreover, the unquestioned accompaniment to this success story of corporate capitalism and its modernization project in Nicaragua was the brutal, U.S.-backed dictatorship of the Somoza family (r. 1934–1979), two of whose members even graduated from West Point. This regime insured that labor discontent in Nicaragua would not be allowed to upset the project of modernization in Central America.

The author whose career epitomizes the mix of politics and scholarship that characterized Caribbean dependency theory is Fidel Castro, who produced a monumental tour de force of dependency theory, *The World Economic and Social Crisis*, together with two teams of researchers at the University of Havana. This analytical report, presented in 1983 by Cuban president Castro to the Seventh Summit Conference of Non-Aligned Countries, compiled evidence from a massive number of nonpartisan scholarly sources to document a world division of labor that is structurally enforced at every stage of development by the forces of corporate capital and the Western militaries that back them. Criticizing the claim by modernization theorists that Third World countries were gradually industrializing and could someday rise to the level of the industrialized West, Castro and his coauthors emphasized that “in spite of some affirmations to the effect that world industry is producing a so-called restructuring . . . the really impressive thing is that 69.2% of the world’s industrial work force is found in the Third World and it generates less than 9% of the world industrial production” (p. 127).

This global division of labor was the main target of Castro’s critique: his book calls for a rejection of the effort to “divide the world into an industrialized area with advanced technology and a primary-commodity-producing area” (p. 67). As examples, he pointed to mining, where “the underdeveloped countries contribute 25.6% of the mining of metals, they produce only 4.1% of the metal manufacture in the world” (p. 123), and textiles, where the manufacture of yarn—“high-labor and low capital intensive” in the Third World increased from “19% in 1950 to almost 40%,” while weaving “which is more capital-intensive and require high automation and concentration, is still controlled by developed countries, and based there” (p. 67). Textiles were then returned back to the Third World to be made into garments, because this industry still demands a high degree of hand labor. But critically, the most important phase of all—the manufacturing and sale of textile machinery—“requires advanced technology and a complex design, on which the future of the entire sector largely reveals the power relationship in the textile sector.” Third World industries produced less than 5 percent of such machinery, and saw few possibilities for increasing their share. It is from this control of the making of machinery, according to Castro and other dependency theorists, that the so-called captive trade system arises, turning international trade into a caricature of itself (pp. 67–68).

It is this control of the machines that make all other machines, that is, the export of machines, but not the technology that reproduces these machines, that is the guiding thread of all Western modernization policy. This is a key locus of power and a primary way of maintaining Western hegemony in the world system.

Wallerstein and World Systems Theory

Inspired by dependency theorists, Wallerstein developed the concept of world systems analysis in the 1970s as a response to the methodological impasse, or *Methodenstreit*, within the social sciences over how to explain the existence of stark inequities among three different worlds within the modern global

economic order: those of societies in the core (the West and Japan), those on the semiperiphery (Eastern Europe and much of Asia), and those on the periphery (most of Africa, Latin America, along with the Middle East, except for Israel, plus some parts of Asia). Wallerstein opposed, on the one hand, what he deemed the “universalizers” in mainstream economics, sociology, and political science, who defend Western modernization theory as an international standard, and, on the other, the “particularizers” in anthropology, history, art history, and other disciplines in the humanities, for whom all economic developments are merely relative to the peculiar regions in which they occur. The latter assertion amounts to a fetishism, or universalization, of relative difference. According to Wallerstein,

Both groups . . . tend to share one premise in common: the unit of analysis was politico-cultural structure . . . whether the term they used for this unit was the state, or the people, or the nation. . . . This book makes a radically different assumption. It assumes that the unit of analysis is an economic entity, the one that is measured by the existence of an effective division of labor, and that the relationship of such economic boundaries to political and cultural boundaries is variable. . . . Once we assume that the unit of analysis is such a “world-system” and not the “state” or the “nation” or the “people,” then much changes in the outcome of the analysis. Most specifically we shift from concern with the attributive characteristics of states to concern with the relational characteristics of states. We shift from seeing classes (and status-groups) as groups within a state to seeing them as groups within a world-economy. (pp. xi–xii)

A critical example of this approach, with its emphasis on underlying economic causes for political and cultural events, was his analysis of the advent of modern society, a process that for Wallerstein begins with the novel emergence of mercantile capitalism in late fifteenth-century Europe, which ultimately produced for the first time an entire world system. Wallerstein divided his analysis of the “determining elements” of the modern world system into four major epochs: the formation of the European world economy from 1450 to 1640; the consolidation of the system between 1640 and 1815; the technological transformation of industrialization from 1815 to 1917; and the “consolidation of this capitalist world-economy from 1917 to the present, and the particular revolutionary tensions this consolidation has provoked” (pp. 10–11).

The breadth of vision and sense of political urgency that underlay this new theoretical approach is evident in the introduction to *Dynamics of Global Crisis*, a manifesto on behalf of world systems theory that included a joint statement by coauthors Wallerstein, Amin, Gunder Frank, and Arrighi in which the following shared premises were declared:

1. We believe that there is a social whole that may be called a capitalist world economy . . . [that emerged] in the sixteenth century, and that is expanded historically from its European origins. . . .

2. We believe that we cannot make an intelligent analysis of the various states taken separately without placing their so-called internal life in the context of the world division of labor, located in the world-economy. . . .
3. We believe that, throughout the history of this capitalist world-economy, there has been increasing organization of oppressed groups within the world-system and increasing opposition to its continuance. . . .
4. After World War II, the United States was the hegemonic power, having commanding power in the economic, political, and military arenas, and able to impose relative order on the world system—a fact which correlated with the world's unprecedented economic system. . . .
5. We do not believe that the struggle between capitalist and socialist forces can be reduced to, or even symbolized by, a struggle between the United States and the USSR, however much the propaganda machines of both assert otherwise. . . .

These premises laid out, it remains only to indicate our prejudices and our visions. We are all on the left. That is, we all believe in the desirability and possibility of a world that is politically democratic and socially and economically egalitarian. We do not think the capitalist world-economy has done very well on any of these accounts. We believe that capitalism, as a historical system, will come to an end. (pp. 9–10)

Developments and Critiques of World Systems Theory since 1980

World systems theory was enormously influential throughout the world for several decades, although its influence was more profound in Third World regions such as Latin America, and in Europe, than in the United States. Even in the United States, however, major works such as Eric Wolf's study of *Peasant Wars of the Twentieth Century* (1969) or Sidney Mintz's magisterial study of the relationship between slavery and capitalism, Europe, and the Caribbean, *Sweetness and Power: The Place of Sugar in Modern History* (1985), took their inspiration directly from world systems theory.

There were always critics on the right, of course, and over time other criticisms arose, and intellectual trends that began as part of world systems theory gradually moved away from it. Conservative development theory gained new ground among politicians and development experts in the 1980s with the popularity of neoliberal reforms; within academic circles, post-modernism has both been influenced by world systems theory, and profoundly suspicious of it. The current emphasis on transnationalism clearly looks back to Wallerstein's insistence that in the face of a global economy, nation-states and local cultures cannot be analyzed in isolation from one another; at the same time, however, a distaste for "master narratives" marked the death knell for the mono-causal insistence on looking for

a single underlying structure with vast explanatory reach. Yet, as postcolonial theorists have shown, a multicausal conception of master narrative, such as colonialism, avoids the problem of any single overarching explanation that homogenizes history.

Thus by 1996, statements such as those made by York Bradshaw and Michael Wallace, two sociologists from the United States, in their book *Global Inequalities*, that despite its historical importance "world-systems analysis" is simply "out of touch with current realities," have become commonplace. Two of their criticisms are especially revealing. First, they say that "just as modernization theory places too much blame on poor countries for their own underdevelopment, [so] world-system theory errs in the other extreme: It places almost total blame for Third World poverty on core countries" (p. 51). This point has been taken up by many activists in Third World countries, who see their own leaders and educated elites using criticism of the First World to evade responsibility for their own failures. Political positions, such as cultural policies, and artistic production are all marked by a "relative autonomy" from the world system that must be acknowledged before much needed local self-criticism is possible and democratic accountability can occur.

Second, Bradshaw and Wallace observe that sometimes "world-system theory had exaggerated the harmful effects" of multinational corporations. They and others point to the relative success story of China and the four "Little Dragons" in Asia (South Korea, Taiwan, Singapore, and Hong Kong) on the advanced semiperiphery of the world system as an instance of how "underdevelopment" is less in evidence as a result of Western-style modernization. This point is related to one made by intellectuals from within the world systems tradition, who in the late 1980s and 1990s began to move from a simple view of world history in which European domination was the single, central fact to a more complex vision of history. New studies of the past looked at the emergence of previous core-and-periphery systems, before the rise of Europe, in which the core might be found in Asian empires, or in the Middle East. In a similar vein, studies of the contemporary world have emphasized a multicentric vision, in which Japanese capitalist expansion in Southeast Asia, Australian neocolonial influence in the Pacific, and the rise of India's technology centers create multiple centers of economic power, while still perpetuating an underlying capitalist system in which the drive for profit overrides all other motives, and drastic inequality is continually reproduced and exacerbated.

Indeed, critics who dismiss world systems theory as irrelevant may be both losing sight of its most critical insights and overlooking current political trends. The much-vaunted neoliberal reforms of the 1990s, modernization theory's successors, seem to have produced a series of economic crises; overall, most Latin Americans lost considerable economic ground during that dismal decade. Enlarging the definition of the core to include the bourgeoisie of Third World nations, and the periphery to include the disenfranchised poor of First World nations such as Britain or the United States, is entirely in keeping with the original vision of unequal development; nor has the brunt of poverty and political repression ceased to fall on the world's

nonwhite population, whether they live in Paris, London, or the Caribbean. Furthermore, presidents elected in some Latin American nations in the early 2000s, including Lula da Silva of Brazil and Hugo Chávez of Venezuela, as well as the rise of powerful new popular movements such as the indigenous movements of Ecuador and Bolivia, or the landless movement of Brazil, and the international antiglobalization movement, may indicate a new wave of political activism on behalf of the poor, which in turn may produce a new intellectual movement that will take off where world systems theory left off.

The underlying global inequalities that motivated world systems theory are still evident: in the early twenty-first century 5 percent of the population (the percentage of the population that resides in the United States) continues to control more than half of the world's resources. Unlike modernization theory, world systems theory not only highlights this grave situation, but also gives compelling reasons for how the world could be more justly organized otherwise.

See also Anticolonialism: Latin America; International Order; Marxism: Latin America; Third World.

BIBLIOGRAPHY

- Amin, Samir, Giovanni Arrighi, Andre Gunder Frank, and Immanuel Wallerstein. *Dynamics of Global Crisis*. New York: Monthly Review Press, 1982.
- Baran, Paul A. *The Political Economy of Growth*. New York: Monthly Review Press, 1957.
- Bradshaw, York W., and Michael Wallace. *Global Inequalities*. Thousand Oaks, Calif.: Pine Forge Press, 1996.
- Cardoso, Fernando Henrique, and Enzo Faletto. *Dependencia y desarrollo en America Latina*. Mexico City: Siglo Veintiuno Editores, 1969.
- Castro, Fidel. *The World Economic and Social Crisis*. Havana, Cuba: Public Office of the Council of State, 1983.
- Fanon, Frantz. *Peau noire, masques blanc*. Paris: Éditions du Seuil, 1952.
- Frank, André Gunder. *Capitalismo y subdesarrollo en América Latina*. Mexico City: Sigloveintiuno, 1987.
- . *Capitalism and Underdevelopment in Latin America: Historical Studies of Chile and Brazil*. New York: Monthly Review Press, 1967.
- González Casanova, Pablo. *Imperialismo y Liberación en América Latina*. Mexico City: Oceano, 1968.
- James, C. L. R. *The Black Jacobins*. New York: Dial Press, 1938.
- King, Anthony D., ed. *Culture, Globalization, and the World-System: Contemporary Conditions for the Representation of Identity*. Binghamton: State University of New York, 1991.
- Kitching, Gavin. *Development and Underdevelopment in Historical Perspective: Populism, Nationalism, and Industrialization*. New York and London: Methuen, 1982.
- Magdoff, Harry. *The Age of Imperialism: The Economics of U.S. Foreign Policy*. New York: Monthly Review Press, 1969.
- Marini, Ruy Mauro. *Subdesarrollo y revolución*. Mexico City: Siglo Veintiuno Editores, 1969.
- Núñez Soto, Orlando, and Roger Burbach. *Democracia y Revolución en las Américas*. Mexico City: Editorial Nuestro Tiempo, 1987.
- Ramírez, Sergio. *Estás en Nicaragua*. Barcelona: Muchnik, 1985.
- Rodney, Walter. *How Europe Underdeveloped Africa*. London: Bogle-L'Ouverture Publications, 1972.
- Wallerstein, Immanuel. *The Modern World-System: Capitalist Agriculture and the Origins of the European World Economy in the Sixteenth Century*. New York: Academic Press, 1976.
- Wolf, Eric R. *Europe and the People without History*. Berkeley: University of California Press, 1982.

David Craven



YZ

YIN AND YANG. In Chinese cosmology, yin and yang are two opposite but complementary principles that regulate the functioning of the cosmos. Their repeated alternation provides the energy necessary for the cosmos to sustain itself, and their continuous joining and separation is at the origin of the rise and the disappearance of the entities and phenomena that exist within the world of the “ten thousand things” (*wanwu*).

According to a celebrated statement, which is found in one of the appendixes to the *Book of Changes (Yijing)*, “one yin and one yang, this is the Dao.” This sentence refers to the Dao that first determines itself as the One (or Oneness) and then through the One gives birth to the two complementary principles. As each of these stages generates the next one, yin and yang are ultimately contained within the Dao itself. At the same time, the phrase “one yin and one yang, this is the Dao” refers to the continuous alternation of yin and yang within the cosmos. When one of the two principles prevails, the other yields, but once one of them has reached the height of its development, it begins to recede; in that very moment, the other principle begins its ascent. This mode of operation is especially visible in the time cycles of the day (alternation of daytime and nighttime) and of the year (alternation of the four seasons).

The origins of these notions are impossible to ascertain. Scholars generally deem that the terms *yin* and *yang* originally denoted the shaded and sunny sides of a hill and later began to be used in an abstract sense as cosmological categories. The earliest extant text that contains a list of items arranged according to their yin and yang qualities is a manuscript found in Mawangdui entitled *Designations (Cheng)*, likely dating from the third century B.C.E. Examples of yang and yin items, respectively, mentioned in this text include heaven and earth; above and below; day and night; summer and winter; spring and autumn; man and woman; father and child; elder brother and younger brother; ruler and minister; soldiers and laborers; speech and silence; giving and receiving; action and nonaction.

Between the third and the second centuries B.C.E., the notion of yin and yang became one of the main pillars of correlative cosmology, a feature of which is the coordination of several preexistent patterns of emblems, including, besides yin and yang, the five agents (*wuxing*) and the eight trigrams and sixty-four hexagrams of the *Book of Changes*. Each of these patterns represents a particular way of explicating the features and functioning of the cosmos. In the system of correlative cosmology, for instance, yin is related to the agents Metal (west/autumn) and Water (north/winter), while yang is related

to Wood (east/spring) and Fire (south/summer), and the balance between them is represented by the central agent Soil. The association with the five agents is likely at the origin of the view that yin and yang are further subdivided into two states each: “minor yang” (Wood), “great yang” (Fire), “minor yin” (Metal), and “great yin” (Water).

The relations among the different cosmological configurations that intervene between the Dao and the “ten thousand things” are illustrated in the well-known *Diagram of the Great Ultimate (Taiji tu)*, which was discussed at length by both Daoist and Neo-Confucian authors. This chart depicts on top the Absolute (*wuji*) as an empty circle. Below it is another circle that represents the Great Ultimate (*taiji*) as harboring the Two, or yin and yang, shown as two semicircles that mirror each other. Each of them is made of black (yin) and white (yang) lines that enclose each other to depict yin containing yang and yang containing yin. The empty circle within these lines corresponds to the empty circle on top; this alludes to the notion that yin and yang are the “function” or “operation” (*yong*) of Emptiness, which in turn is their “substance” or “core” (*ti*). Following this are the five agents, which constitute a further stage in the progressive differentiation of Oneness into multiplicity. The lines that connect them to each other show the sequence in which they are generated, namely Wood, Fire, Soil, Metal, and Water. In this cosmological configuration, the Great Ultimate is represented by the central Soil (which is said to have a “male” and a “female” aspect) and reappears as the small empty circle below, which represents the conjunction of Water and Fire (“great yin” and “great yang”) and of Wood and Metal (“minor yang” and “minor yin”). The circle below the five agents represents heaven and earth or the active and passive principles that respectively give birth to and support the existence of the “ten thousand things,” represented by the circle at the base of the diagram.

The notions of yin and yang have deeply affected Chinese culture as a whole. Representations of these notions are found in religion, art, and several other contexts; as part of the system of correlative cosmology, moreover, yin and yang have played a central role in traditional sciences and techniques, such as divination, medicine, and alchemy. Beyond this, the search for the balance and harmony of yin and yang has had, and continues to have, a pervasive influence on the everyday lives of Chinese people.

See also *Chinese Thought; Cosmology; Asia; Medicine; China.*

He asked: What is the Dao?

I replied: The Dao is Ancestral Pneuma prior to Heaven that generates the creatures. If you want to look at it, you do not see it, if you want to listen to it, you do not hear it, if you want to grasp it, you do not get it. It envelops and enwraps Heaven and Earth and gives life and nourishment to the ten thousand things. It is so great that there is nothing outside it, so small that there is nothing inside it. Confucians call it Great Ultimate, Daoists call it Golden Elixir, and Buddhists call it Complete Awareness. Fundamentally it has no name, but forced to give it a name it is called the Dao. If it is determined, one is in error, and if it is discussed, one loses it. It has no body and no image, it is not form and not emptiness, it is not Being and not Non-being. If it is attributed the images of form and emptiness, of Being and Non-being, it is not the Dao. [That is, if one uses the notions of form and emptiness, Being and Non-being in relation to the Dao, then one is not talking about the Dao, because the Dao is beyond these notions.]

He asked: If the Dao is without body and without image and if it is the One inchoate pneuma, why then does the *Book of Changes* say: “One yin and one yang, this is the Dao”?

I replied: “One yin and one yang, this is the Dao” are words used to express the function (or operation) of the Dao. “Without body and without image” are words used to express the substance (or core) of the Dao. When the Great Ultimate has not yet divided itself [into yin and yang], the Dao envelops yin and yang. After the Great One has divided itself, it is yin and yang that give life to the Dao. If yin and yang were not there, the pneuma of the Dao would not be visible. It is only in the alternation of yin and yang that the pneuma of the Dao can grow and maintain itself for innumerable eons without being damaged. In the state prior to Heaven [this pneuma], it is the Dao; in the state posterior to Heaven, it is yin and yang. The Dao is the foundation of yin and yang; yin and yang are the outgrowth of the Dao. This is what is meant when one says that the Great Ultimate divides itself and becomes yin and yang and that yin and yang joined to each other form the Great Ultimate. It is One but they are Two, they are Two but it is One.

SOURCE: Liu Yiming (1734–1821), *Xiuzhen biannan* [Discussions on the cultivation of reality], translated by Fabrizio Pregadio.

BIBLIOGRAPHY

- Graham, A. C. *Yin-Yang and the Nature of Correlative Thinking*. Singapore: Institute of East Asian Philosophies, National University of Singapore, 1986.
- Granet, Marcel. *La pensée chinoise*. Paris: La Renaissance du Livre, 1934.

Fabrizio Pregadio

YOGA. The word *yoga* comes from a Sanskrit verbal root meaning “to yoke, harness” and in general refers to one or another of the many psycho-physical techniques in Indian religions designed to obtain discipline and control over the body and mind. In its classical contexts, yoga could refer to any one of a whole variety of such self-disciplinary practices. In India, yoga transcended sectarian boundaries. There are, for example, both Hindu and Buddhist forms of yoga and within each of these religious traditions many different kinds of spiritual methods and practices are designated by this term. None of these “yogic” methods is solely physical. All entail some form of mental discipline, which can be labeled meditation; in In-

dian religions yoga and meditation almost always went hand in hand. The physical practices of yoga were usually seen at best to be only preliminary to the more spiritual forms of yoga that utilize various kinds of meditation techniques.

It is possible that yoga goes back to the earliest period of Indian history. Figurines and seals found at sites of the Indus Valley civilization, dating back to the second millennium B.C.E., have sometimes been interpreted to indicate the practice of yoga there. In particular, one seal depicts what appears to be a deity sitting in a posture typical of later yoga. In the earliest Sanskrit texts of the Vedic period (c. 1500–1200 B.C.E.) there are references to ascetics and ecstasies called *munis* (“silent sages”) who are depicted with long hair, are said to be “girdled by the wind” (meaning, possibly, naked), and are described as having some of the superhuman powers later associated with advanced yoga practice. The Atharva Veda mentions a group called the *vratyas* who practice asceticism (they are said to be able to stand for a year) and assume other physical postures as part of their disciplinary regimen. They also seemed to have practiced some kind of breath control and envisioned correlations between their bodies and the cosmos.

Also already in the Vedic texts we encounter the theory and practice of *tapas* or “ascetic heat” which, when obtained by the practitioner through various methods of physical and mental asceticism, was said to impart similar powers and spiritual purity. *Tapas* was in later texts to come to the forefront of the essential disciplinary practices that were involved in yoga.

By the time of the later texts of the Vedic period, the Upanishads of the third or fourth centuries B.C.E., the word and conceptualizations of *yoga* are encountered frequently. In these texts, *yoga* means primarily the control of the mind and the senses. The senses are likened to horses which must be “yoked” or “disciplined” by the yogin (yogi) whose “mind is constantly held firm” and whose “senses are under control like the good horses of a charioteer. . . . They consider yoga to be the firm restraint of the senses. Then one becomes undistracted” (Katha Upanishad 3.6; 6.11). In these texts some of the physical practices of yoga are also described. The practitioner is advised to retreat to a pleasant place in the wilderness where he should assume a particular physical posture (or *asana*) and “breathe through his nostrils with diminished breath” (the practice of breath-control called in later yogic texts by the name of *pranayama*). Yoga is defined in one such Upanishad as “the unity [another possible translation of the word “yoga”] of the breath, mind, and senses, and the relinquishment of all conditions of existence” (Maitri Upanishad 6.25). As the yogin progresses in his practice his body and mind are said to change: “Lightness, healthiness, freedom from desires, clearness of countenance and pleasantness of speech, sweetness of odor and scanty exertions—these, they say, are the first stage in the progress of yoga” (Shvetashvatara Upanishad 2.13). The final stage of the practice, the goal of yoga, is also depicted in the Upanishads—and will become standard in later yogic texts. It is nothing less than the state of deathlessness or eternal life, often imagined in a body of light that never degenerates or grows old.

Yoga was systematized in different ways in two foundational texts dating to around the turn of the Common Era. In the first of these classical treatises, the Bhagavad Gita or “Song of the Lord,” yoga is used to describe three apparently distinct but practically interrelated “paths” or spiritual methods. The first of these is called *jnana yoga* or the “yoga of wisdom.” This path consists of deep contemplation on the nature of reality and recognizing the difference between the phenomenal world of change and the unchanging self. Through such meditation, the yogin penetrates the illusory nature of appearances and realizes the ultimate unity of all things and beings. As the Gita is also a theistic (or pantheistic) text, *jnana yoga* also entails recognizing God or Krishna in all things.

The second kind of yoga in this syncretistic work is *karma yoga*, the yoga of action. This method is one of “doing one’s duty” as it is laid out by the strictures of caste and stage of life (and not renouncing action in the world as seemed to be required by the earlier Upanishadic treatises). Such worldly activity must, however, be performed in a “yogic” and self-disciplined way. While one cannot avoid action, the yogin should act not out of desire for the fruits of action but rather in a desireless and self-sacrificial way. Renouncing the ends or goals, the practitioner of *karma yoga* was to perform

desireless action dedicated to God. The third yoga outlined in the Bhagavad Gita was termed *bhakti*, “devotion,” and was nothing other than the “yoking” or “union” of the self and God. It is depicted as the easiest of the three methods but also the most efficacious.

The other text of this period to synthesize yoga was the Yoga Sutra of Patanjali. Patanjali defines yoga as the “cessation of the turnings of thought,” that is, the purification and calming of the mind and the correlative attainment of higher states of consciousness. Yoga for Patanjali involves eight “limbs” or parts (*ashtanga*), each one leading to the next and culminating in release from suffering and rebirth.

The first two limbs provide the ethical foundation thought to be necessary for any further progress in yoga. The first consists of the five “moral restraints” (*yamas*): nonviolence, truthfulness, not stealing, chastity, and the avoidance of greed. The second limb, the internal “observances” (*niyamas*), provides a second set of five virtues the practitioner should perfect. These are mental and physical purity, contentment, *tapas* or the practice of austerities and asceticism, the study of sacred texts, and devotion to the “Lord” (God or the guru).

The third part of Patanjali’s eightfold path consists of the physical postures or *asanas*. When the yogin has disciplined his or her moral life, the next step is to discipline the physical body. The later traditions of yoga have greatly expanded this dimension of the yogic path. The physical practices are sometimes referred to as *hatha yoga* (the “yoga of exertion”) and are conceived of in terms of a rigorous program of physical exercise and digestive constraint thought to be preparatory to the more advanced and subtle forms of yoga. Some texts claim there are 840,000 yogic physical postures; a standard list gives 84 including, most famously, the “lotus position” (*padma asana*). Such postures are designed to make the practitioner’s body supple and healthy and help in the general training of self-discipline. Patanjali, however, devotes a mere three verses to the purely physical dimension of yoga, saying only that one should take a position that is “steady and comfortable,” for then one is ready to pursue the true goal of yoga, the state of mind wherein one is “unconstrained by opposing dualities.”

More subtle than the physical body is the breath, and it is the “restraining of the breath” (*pranayama*) that forms the fourth limb of the practice. Here again, later yogic texts go into much greater detail about the various practices of breath awareness and control, including methods for retention of the breath over long periods of time. The breath is regarded as the fundamental life force in yoga, and control and manipulation of it is essential for rejuvenating and immortalizing the body. Its power is such that some texts warn about the dangers entailed in the *pranayama* practices and, as always, insist that the yogin should only practice under the watchful guidance of a master. Patanjali has little to say about it, restricting his observations to the fact that it basically refers to the control of inhalation, exhalation, and retention of breath and that it has as its purpose the making of a “mind fit for concentration.”

The next stage of Patanjali’s system is named the “withdrawal of the senses” (*pratyahara*) by which is meant the kind

of “yoking” of the sense organs that was likened to the reining in of horses. Another very common image for this portion of the yogic training is that of a tortoise who withdraws its limbs into its shell. So too should the yogin disengage the sense organs from the objects of senses and, by means of such detachment, gain mastery over them. The ability to turn away from the distractions of the object of senses and to increasingly turn attention to the mind itself in a concentrated fashion is, of course, crucial for the meditative pursuits that describe the highest and most subtle forms of yoga.

The sixth, seventh, and eighth limbs of Patanjali’s yogic system are progressively higher states of meditative ability and attainment. The sixth is called “concentration” (*dharana*), defined as the ability to “bind thought in one place” for long periods of time; it is the essence of what is sometimes known as “one-pointedness” of mind. The mastery of concentration leads the yogin to the next the stage of the path, which is called “meditation” per se (*dhyana*), the unwavering attention of the concentrated mind on the meditative object. The culmination of yoga is the attainment of the eighth limb, pure contemplation accompanied by ecstasy or, otherwise described, the trance-like state of pure “enstasis,” which is termed *samadhi*. The end of the yogic path is defined by Patanjali as “meditation that illumines the object alone, as if the subject were devoid of intrinsic form.” The “yogin yoked in *samadhi*” is, according to a later text in this tradition, completed liberated—free from the “pairs of opposites” or all duality, not bound by the forces of karma, unconquerable, “without inhalation and exhalation,” invulnerable to all weapons, and immortal (Hatha Yoga Pradipika 4.108ff.).

Indeed, much of the third chapter of Patanjali’s classic text is given over to the extraordinary powers (the “accomplishments” or *siddhis*) that are claimed to come along with advanced practice of yoga. These include the ability to know the past and future, the languages of animals, one’s previous lives, the thoughts of others, and so on. It is, in fact, said that the perfected yogin becomes omniscient. He or she also attains the power to become invisible, gets the “strength of an elephant,” and wins the capability to grow larger or smaller at will. In later texts, abilities such as these are summarized as the eight “great powers” (*mahasiddhis*): miniaturization, magnification, levitation, extension, irresistible will, mastery, lordship over the universe, and fulfillment of all desires.

The yoga systematized in Patanjali’s Yoga Sutras is sometimes referred to as “classical” or “royal” yoga (*raja yoga*), especially in contrast to the *hatha yoga*, which is envisioned as preparatory to the higher spiritual practices of Patanjali’s later limbs. It also came to be the charter text of the school of Hindu philosophy (*darshana*) called “Yoga,” which in turn was closely related to the dualistic philosophical school known as “Samkhya” (the main difference being the atheistic quality of the latter, although the “Lord” of the Yoga Sutras is more of a Divine Yogin than a creator god). In these philosophical traditions, the purpose of yoga was understood to be the “distinction” or “discrimination” between material nature and the eternal spirit. The spirit or pure consciousness (*purusha*) is to be “isolated” from both matter and from ordinary awareness

and its afflicted mental experiences. When the *purusha* becomes thus disentangled, its pure nature can shine forth and the yogin becomes liberated.

The term *yoga*, as has already been shown, can be applied to a variety of practices and disciplines. Another important use of the term is in the phrase *mantra yoga*, the “yoga of sacred, efficacious sound.” Here yoga refers to the concentration on and repetition of sacred sounds, utterances, syllables, or prayers composed from the Sanskrit language and thought to have inherent transformative power. Such mantras are transmitted from teacher to pupil in an initiatory setting, and it is indeed thought to be primarily the power of the guru that gives the mantra its efficacy. The most famous of such mantras is the sound “*om*” (sometimes written as “*aum*” to emphasize the three verbal parts of the utterance) which is regarded as the aural essence of the universe itself. While the texts do claim that *mantra yoga* will also lead to liberation, it is usually said to be suitable mainly for the practitioner of inferior intellectual capabilities.

Yoga also plays a major role in both Hindu and Buddhist “tantric” or esoteric traditions, which arose around the middle of the first millennium C.E. In Buddhism, tantric practice is divided into four classes, each one regarded higher than the other: action tantras, performance tantras, yoga tantras, and highest yoga tantras. In all forms of tantra, the goal is to transmute the physical body into a body of light, a “rainbow body,” through the manipulation of the subtle energies, channels, and power centers (*cakras*) of the mystical inner body. This is done through the practices known as *guru yoga*, the “yoking” of oneself to a tutelary deity or *yidam*, and the carrying out of a series of visualizations in which one assumes the being of that deity and meditates in that way. There is also a form of “Taoist yoga” in China that bears comparison to the Indian yogas.

Yoga has entered the West mostly as physical exercise and often not as the holistic worldview it was in its original contexts. Increasingly, however, Westerners are aware of the ethical and meditative dimensions to yoga and these elements are finding their way into the practice of yoga outside of India.

See also *Asceticism: Hindu and Buddhist Asceticism; Buddhism; Hinduism; Meditation, Eastern*.

BIBLIOGRAPHY

- Akers, Brian Dana, trans. *The Hatha Yoga Pradipika*. Woodstock, N.Y.: YogaVidya.com, 2002.
- Eliade, Mircea. *Yoga: Immortality and Freedom*. 2nd ed. Princeton University Press, 1969.
- Feuerstein, Georg. *The Philosophy of Classical Yoga*. Rochester, Vt.: Inner Traditions, 1996.
- . *The Shambhala Encyclopedia of Yoga*. Boston: Shambhala Press, 2000.
- Hume, Robert Ernst, trans. *The Thirteen Principal Upanishads*. 2nd ed. London: Oxford University Press, 1975.
- Miller, Barbara Stoler. *Yoga: Discipline of Freedom*. New York: Bantam Books, 1998.
- Varenne, Jean. *Yoga and the Hindu Tradition*. Chicago: University of Chicago Press, 1976.

Brian Smith

ZEN. One of the most important scholars of Zen Buddhism, Daisetz Suzuki, cogently explained the origins of Zen Buddhism in 1959:

Zen is one of the products of the Chinese mind after its contact with Indian thought, which was introduced into China in the first century C.E. through the medium of Buddhist teachings. There were some aspects of Buddhism in the form in which it came to China that the people of the Middle Kingdom did not quite cherish: for instance, its advocacy of a homeless life, its transcendentalism or world-fleeing and life-denying tendency, and so on. At the same time, its profound philosophy, its subtle dialectics and penetrating analyses and speculations, stirred Chinese thinkers, especially Taoists. (p. 3)

For several centuries in China, it was thought that Buddhism was a form of Daoism returning from India along the Silk Roads. Bernard Faure relates: “At the end of his life Laozi, in the guise of the Buddha, was said to have departed to the west to convert the barbarians. To punish them for their initial lack of faith, he condemned them to celibacy” (p. 39). Conversely, the Buddhists claimed that Laozi and Confucius were sent to China to pave the way for Buddhism. In any event, many forms of Buddhism arrived in China from India.

Between the sixth and tenth centuries, Buddhism reached its apex in China with the appearance of four schools: *Tiantai* (Celestial Platform), *Huayan* (Flower Garland), *Jingtu* (Pure Land), and *Chan* (Meditation). The Sanskrit word *dhyana* is transcribed as *Chan* in Chinese and *Zen* in Japanese, meaning “collectiveness of mind or meditative absorption in which all dualistic distinctions like *I/you*, *subject/object*, and *true/false* are eliminated” (Schuhmacher and Woerner, p. 441). Chan is a melding of Dhyana Buddhism with its emphasis on the stillness of meditation toward enlightenment or awakening (*wu*, *satori*) and Daoism with its emphasis on nonaction (*wuwei*) as the way of the water. Bodhidharma (470–543), the twenty-eighth patriarch after Shakyamuni Buddha, arrived from India at the Shaolin temple in China, where he practiced seated meditation (*zuo chan*, *zazen*) for nine years in front of a wall. This meditation aimed to clear the mind of daily desires while allowing the sitter to connect his or her true nature with the universe through the achieving of *śūnyata* (*kong*, *ku*, emptiness). Ninian Smart states that Bodhidharma, the first patriarch, is reputed to have summarized his teaching as follows: “A special transmission outside the scriptures; No basis in words or writing; Direct pointing to the mind of people; Insight into one’s nature and attainment of Buddhahood” (p. 126).

The sixth patriarch, Huineng (638–713), refined Bodhidharma’s teachings by emphasizing master-student relationships in monasteries and meditation upon what later would become “public documents” (*gongan*, koan) or unsolvable riddles. One day Huineng encountered two monks arguing about a flag waving in the breeze. One monk said that the flag was inanimate and that only the wind made it flutter. The other monk

said there was no flapping at all because only the wind moved. Huineng intervened. He said that neither the flag nor the wind moved, only their minds.

Huineng debated with Shenxiu (606–706) regarding immediate or gradual enlightenment. He relates:

“Good friends, in the Dharma there is no sudden or gradual, but among people some are keen and others dull. The deluded commend the gradual method; the enlightened practice the sudden teaching. To understand the original mind of yourself is to see into your own original nature. Once enlightened, there is from the outset no distinction between these two methods; those who are not enlightened will for long kalpas be caught in the cycle of transmigration” (Yampolsky, p. 137).

Shenxiu’s northern school of gradual enlightenment soon gave way to Huineng’s southern school of immediate enlightenment. Willard Oxtoby observes that Huineng’s school “became known for freedom of expression and respect for the natural. Similar characteristics are associated with Daoism” (p. 270). At this time, China was ripe for Chan Buddhism. Kenneth Ch’en writes: “For over one hundred and thirty years, from 625 to 755, the T’ang Dynasty had enjoyed tranquility, security, and prosperity without any internal rebellion or external invasion to mar the orderly march of events. During this era all phases of Chinese culture, religion, art, and literature enjoyed a long period of free growth and development” (p. 360).

In the ninth century, the *Caodong zong* (Caodong school) and *Linji zong* (Linji school) sects of Chan Buddhism carried on the rivalry of gradual and sudden enlightenment. Caodong favored gradual, silent enlightenment through seated meditation. The gradual stillness of mind is like “the bird hatching the egg” (Oxtoby, p. 272). Linji favored immediate awakening through the practice of shouting, beating, and paradoxical sayings that were later compiled as *gongan*. Unanticipated shouting and blows between master and pupil could result in enlightenment. Similarly, reflection on riddles could end in a sudden awakening, like “the blossoming of a lotus or the sun emerging from behind the clouds” (Oxtoby, p. 272). The Linji master might answer a student’s query “Who is the Buddha?” with the quip “three pounds of flax.” Alternatively, the master might propose the riddle “What is the sound of one hand clapping?” The purpose was to encourage the student to abandon all logic and reasoning while searching for peace in the quietude of meditation.

During the Southern Song dynasty of the twelfth century, the interaction of Chinese and Japanese monks stimulated the migration to Japan of Linji (Rinzai Zen) and Caodong (Soto Zen). Eisai (1141–1215) brought Rinzai and Dogen (1200–1253) brought Soto. The Kamakura period (1185–1333) was a watershed for Zen Buddhism. Rinzai’s emphasis on the controlled discipline of seated meditation and the contemplation of koan became popular among the ruling samurai clans at Kamakura. Soto’s more exclusive focus on seated meditation

appealed to the peasantry. Zen's influence in the arts included painting, literature, and calligraphy and carried on well into the modern era. Zen and the sword, Zen and archery, Zen and tea were intimately connected to samurai culture.

The juxtaposition of Zen's humanity and samurai warfare is difficult for Westerners to understand. At Shaolin, the Chan monks practiced martial arts (*gongfu*) to keep themselves physically fit while defeating their worst enemy: their own desire. In a world of suffering, desire is the root of misery. To do away with desire is to clear a way to the "extinction" of suffering (nirvana). In Japan the samurai were intimately linked to Zen. If Buddhism is the pure negation of the will as the extinguishing of desire, then Bushido (the warrior's way) is the pure will as the negation of the negation or the annihilation of nirvana. The juxtaposition of Zen and the warrior spirit is the essence of samurai culture. This alluring paradox is one reason that Suzuki's style of Rinzai Zen became popular in the Western world after World War II.

See also *Buddhism; Religion: East and Southeast Asia*.

BIBLIOGRAPHY

- Ch'en, Kenneth K. S. *Buddhism in China: A Historical Survey*. Princeton, N.J.: Princeton University Press, 1964.
- Faure, Bernard. *Buddhism*. Translated by Sean Konecky. New York: Konecky and Konecky, 1998.
- Oxtoby, Willard G., ed. *World Religions: Eastern Traditions*. 2nd ed. Don Mills, Ontario, and New York: Oxford University Press, 2002.
- Schuhmacher, Stephan, and Gert Woerner, eds. *The Encyclopedia of Eastern Philosophy and Religion: Buddhism, Hinduism, Taoism, Zen*. Boston: Shambhala, 1989.
- Smart, Ninian. *The World's Religions*. 2nd ed. Cambridge, U.K., and New York: Cambridge University Press, 1998.
- Suzuki, Daisetz T. *Zen and Japanese Culture*. Princeton, N.J.: Princeton University Press, 1959.
- Yampolsky, Philip, trans. *The Platform Sutra of the Sixth Patriarch*. New York: Columbia University Press, 1967.

Jay Goulding

ZIONISM. The historians of nationalism have reached a consensus that modern nationalism began as a secular movement, but almost all its varieties were affected by an undertow of older religious sentiments and loyalties. In many of the nationalisms (for example, in the battles between Greeks and Turks in the second decade of the nineteenth century or in the quarrel between Catholics and Protestants in Northern Ireland) the religious dimension of the quarreling nationalisms was clear and avowed. In the case of Zionism the reverse seemed to be true. When modern Zionism appeared in the nineteenth century, it defined itself in secular terms. It did not come into the world to bring about the age of the messiah that had been foretold in many of the classic texts of the Jewish religion. Zionism offered to answer two major problems that faced contemporary Jews. They were victims of large-scale persecution, most overtly in Eastern Europe, and the Jewish intelligentsia were being all too attracted to the promise of

equality in society—which was apparently only being offered to those who were willing to abandon their separateness and assimilate into the non-Jewish majority. The modern Zionist movement suggested that a Jewish national home would help solve the problems of persecution and assimilation (the Zionists really meant that they wanted a state of their own). Jews would have a homeland that would always gladly receive them, and Jews who were conflicted about their identity would be able to deal with this question in the safe and nurturing environment of a Jewish community in which they were an autonomous majority.

The question of religion did, inevitably, arise at the very beginning of modern Zionism. In the 1830s two rabbis from Central Europe, Yehudah Hai Alkalai and Zvi Hirsch Kalischer, each proposed that with nationalism burgeoning all around them—the Greeks had just won their revolt against the Turks, and other European nationalities were arising to fight for their independence—it was time for the Jews, who could trace their national existence back to biblical times, to assert their own unique identity. Surely, so Alkalai and Kalischer argued, as the oldest of all nationalities, the Jews had the right and even the duty to lead the contemporary parade of nations who were asserting their rebirths. But Alkalai and Kalischer, both of whom were not only rabbis learned in the Talmud but scholars of the Kabbalah (Jewish esoteric mystical teaching), were very careful to deny that they were announcing the beginning of a messianic movement. They held fast to the inherited doctrine that the messiah could come not as the result of human action, but as a free gift from God. The nationalism that Alkalai and Kalischer were suggesting might have some connection to messianic hopes: kabbalistic teaching had allowed that "stirrings down below" might act to remind heaven of the longing of the Jewish people for the messiah, but no political program could be built on this hope. In the nineteenth century peoples were defining themselves by their history and group identity; the Jews should therefore cease to think of themselves as a persecuted minority and begin to assert themselves as a people among the peoples of the earth.

Thus, it is inaccurate to label even the "religious Zionists" as the ancestors of contemporary Zionist messianism. This element in present-day Zionism descends from two sources; the first is the confusion that existed in the minds and hearts of some of the most seemingly secular of the Zionist leaders and thinkers. For example, Chaim Weizmann (1874–1952), the long-time leader of the World Zionist Organization and the first president of Israel, made no secret of the total secularity of his way of life. Nonetheless, at every crucial moment in the debate over the rights of Zionists to a Jewish national home and, ultimately, to a state in the Holy Land, Weizmann invoked sacred Scripture. He kept saying that "the Bible is our charter." The Zionist contemporary who was second only to Weizmann, David Ben Gurion (1886–1973), the first prime minister of Israel and the man who led the country to win its independence, was an even more avowed secularist than Weizmann. After years of studying his work, the author of this entry reached the conclusion that he was best defined by a paradox: there is no God, but he chose the Jewish people and gave them the land of Israel. So, at the time of Israel's as-

ounding victory in June 1967, when it conquered the large territories all the way to the Jordan River and the Suez Canal, the pervasive mood in Israel and among the Jewish people as a whole was that a miracle had happened. Never mind whether it was God or the inherent “spirit of the Jewish people” that had performed the miracle. Most Jews were sure that they were living in a version of messianic times; they were free to carve out their own destiny, at least in much of the land that was now under their control.

The second source of the new messianism was in a change in the theology of the Orthodox Zionists. In the first years of the twentieth century a young and universally respected rabbinic scholar and Kabbalist, Rabbi Abraham Isaac Kook (1865–1935), arrived in Jaffa to assume the post of chief rabbi of its growing Jewish community. Kook insisted that the Jews were indeed living in messianic times. He asserted that the new Zionist movement, despite its pronounced bias against religion, was despite itself an instrument of God’s hands. Modern Zionism was reviving the sacred language, Hebrew. Kook insisted that the religious character of the tongue of the Bible was so deeply ingrained that the revival of Hebrew would inevitably act to bring contemporary Zionists closer to their roots. The secular Zionists, so Kook continued, might think that they were engaged in regaining the soil of the Holy Land for a contemporary Jewish state, but this soil was inherently holy; the labor to regain it and to dwell in it would soon transform the self-avowed secular people who were devoting their lives to this task. When World War I broke out in 1914, Rabbi Kook interpreted this enormous bloodletting as the war of Gog and Magog, the ultimate destructive war that had been foretold as the last preamble to the messianic age. The gentile world was destroying itself, and the moral credit of its achievements was now worthless. So it went after each major turning point in the course of the Zionist revival. Kook saw every event as part of the immediate drama of messianism.

Kook was clearly a holy man, but his teaching contained a unexploded bomb. If the Jewish people were living in the immediate preamble to the messianic age, as he maintained, then what was to be done with the disappointments and the blockages that would occur on the path to redemption? Kook died in 1935, so these questions were left to a lesser figure, his son, Rabbi Zvi Yehudah Kook (1891–1981), to contemplate. He ultimately succeeded his father as the head of the *Mercaz Harav* (“the rabbi’s center”), the *Yeshiva*, the School of Talmudic Learning and Theological Thought, which the father had established. This school taught its students not only the conventional studies in Talmudic literature that were the staples of the other *yeshivot*. At this unique school the students were taught to enter the army and to prepare themselves to be elite combat troops. These young people were imbued by Zvi Yehudah Kook with an activist faith that it was their privilege and duty to help bring the messiah soon, in their own day—and Zvi Yehudah Kook never gave up the dream that all of the land that the Jews had possessed in biblical times, including especially the West Bank, would and must be returned to the Jewish people. The enormous and heady victories of the Six-Day War in 1967 were hailed in this religious circle as proof of their ideology. Yes, the messianic miracle had occurred, and

the whole of the land of biblical Israel must now be possessed and never returned. Jewish settlement on the West Bank was a religious commandment, and those who opposed such settlements or hindered them or threatened to make them impossible were never to be forgiven. The most extreme thinking among this element was expressed by some younger people, especially among the rabbis who ministered to the new communities in the West Bank. Several of them were accused of encouraging Yigal Amir, the assassin who murdered Israel’s prime minister, Yitzhak Rabin, in 1995. Rabin’s “sin” was that he had signed the agreement that Israel and the Palestinians had made secretly in Oslo in 1992. On behalf of Israel, Rabin had agreed to allow the Palestinians ultimately to establish a state of their own on the West Bank. He was therefore regarded by the hard-line believers in the “undivided land of Israel” as leaning toward religious and national treason.

At the start of the twenty-first century the shock of this murder had not abated because the activist minority—probably 20 percent of Israel’s population—made no secret that it would engage in civil, and some even in armed, disobedience against any Israeli government that intends to allow the Palestinians a state of their own on most, or almost all, of the West Bank. This embitterment had the most profound effect on the question of the very nature of the Zionist enterprise. When modern Zionism was created, there was an existing consensus among all its factions that the highest authority within the Zionist movement would be the civil government of the national home that was being established. To be sure, from the very beginning a certain amount of respect was extended to the religious elements within the Jewish community. There was no question that the kitchens of the Israeli army would be kosher everywhere and that the Orthodox rabbinate would be given the ultimate authority on such matters as marriage and divorce among Jews. Through the years some elements in Israel have chafed under these controls, but the majority have made peace with the amount of religious coloration that exists in Israel’s public life, but these issues were essentially peripheral. They did not involve religious judgments on the foreign policy of Israel or the questions of relations with the Arab world. In the aftermath of the Six-Day War of June 1967, the newly awakened messianic believers reframed their Zionist aims as politically maximalist. The new messianists proposed to enact their program in the name of God’s will.

More recently, in the first years of the twenty-first century, modern Zionism is under attack from two other perspectives. The ultraright Zionists are ever more forthright in insisting that if the messiah does not come soon, they will at least solve the problem of keeping a Jewish state Jewish even as it controls a population that, between the Mediterranean and the Jordan River, is already half Arab, either by denying the Arabs full political rights or by creating the conditions for the large-scale “transfer” of Arabs from the land of Israel. Such thinking used to be anathema to the Israeli mainstream, but it has become more thinkable as the armed conflict between Jews and Palestinians has become ever more embittered. By the end of 2003, there were well over two thousand dead among the Palestinians, but there had been nearly a thousand casualties

among the Israelis since the outbreak of the “second intifada” in 2000. These deaths occurred in guerrilla warfare, including suicide bombings by the Palestinians, and in reprisals by the Israelis. In the current struggle, Israel’s moderates have diminished after each suicide bombing, and no new moderates have appeared among the Palestinians. It seems ever less likely that Israelis and Palestinians will find a way to put their hurts behind them and make peace across the table. They will need strong leadership and pressure from the United States and from some of the rest of the international community.

By April 2004 Sharon made the first step toward accepting a notion that no one had ever expected he would accept: the demographic balance in “the undivided land of Israel” was shifting toward an Arab majority. He, therefore, proposed that the Israelis begin by evacuating all 7500 settlers from the Gaza Strip and leaving that to Arab rule. Despite opposition from his own Likud party, Sharon insisted ever more openly that demography commands Israel to cease ruling an unwilling and hostile Arab majority. Sharon’s policies make an Arab state living beside Israel an inevitability, but one that will take much military and political turmoil to work.

On the side of the Palestinians and their sympathizers, especially in the Arab world, there is equally strong awareness that demographic trends are producing an Arab majority in the supposedly “undivided land of Israel.” The basic Arab policy seems to have moved in the direction of waiting out the next few years and then demanding that only one state should exist in this land but that this state should be ruled by the principle of “one man, one vote.” This notion is often dressed up as the realization of the great democratic dream, a binational state of Jews and Arabs, in which Jews can be assured that a growing Arab majority will not treat them harshly. Most of those who argue this view, however, do not manage to hide their indifference, or even glee, at the thought that the Zionist venture would then be over. The Jewish state would be gone; it would be replaced by a state with an Arab majority. All the claims that the Jews have made concerning their need and their right for a state of their own in which they could make their own destiny by their own rights would end in failure. These Jewish notions seemed plausible—so the argument goes—only late in the nineteenth century and early in the twentieth when nationalism and even colonialism still had some credit in the world.

But modern Zionism will not die so easily and certainly not in the pages of left-wing journals in the Western world or in the pronouncements by Islamic nationalists in their own media in the Arab world. The Jews who founded Zionism and their followers who began to come to Palestine more than a century ago to establish the modern Zionist presence did not suffer and die so that, as Chaim Weizmann once said, they might become “Hebrew nationals in a Palestinian State.” Zionists will not allow the state of Israel to pack up and leave but are determined to stay put despite the bitter quarrels. Devotion to Israel’s survival as a Jewish state does, and will, force it to fight. By the same token, the Palestinians are not going to leave. The Arab states in the Middle East have no desire to absorb any substantial number of Palestinian Arabs, and the

world as a whole, especially the West, is not overly hospitable to those who would enter it as part of a new mass migration.

These considerations already existed many decades ago when it became clear that Jews and Palestinian Arabs were, despite themselves, having to find ways of living in some tolerable peace. The reigning suggestion was defined in 1937 by the Peel Commission, the highest-level investigation into the conflict in the Holy Land that the British authorities ever empowered. This body knew very well that there was no happy answer to the conflict between Jews and Arabs, but they ruled that the least obnoxious and most likely mode of making some tolerable peace would be the partition of the land between Jews and Arabs. Ten years later in 1947, the nascent United Nations reiterated the conclusions of the Peel Commission and voted to divide the land between a Jewish and an Arab state. On neither of these two occasions was the recommended solution enacted peacefully because the bulk of the Palestinians and their Arab confederates refused to recognize the legitimacy of giving the Jews even one ell of the land of Palestine for a state of their own.

The most interesting new development lies not in Palestinian and Arab opinion, but in a substantial shift among many political liberals who had traditionally supported the Zionist vision and program. This change in opinion began in some circles in 1967 when parts of the liberal intelligentsia shifted allegiance during and after the Six-Day War. They found reason to be annoyed with the Jews for concentrating on so parochial a purpose as the survival of the Jewish state and not on such wider concerns as America’s misdeeds in the Vietnam War and, more immediately, on the pains and needs of the Palestinians. By 1967 the memory of the Holocaust, the murder of six million defenseless Jews in Europe, had begun to fade, and the Jewish people as a whole were becoming for many in the liberal left an annoying reminder of past deaths and past guilts. Israel was now a going concern—an increasingly powerful one—and thus the Palestinians became the new “victims” of choice. The undertow of this change in political faction was an increasing impatience with the unique demands that the Zionist state was making for special consideration for the Jewish people.

Why, indeed, should the Jews need a state of their own? The main charge that the Arab states have kept raising against the state of Israel is that it is a “rabbinic theocracy” but no one has challenged almost all of the Arab states to not conduct themselves as “Muslim theocracies” with scant concern for the right of minorities. On the contrary, left-liberal doctrine insisted that Jewish nationalism should disappear even as most other nationalisms in the world have an unquestioned right to continue. The most interesting part of this phenomenon is that some of its theories are being advanced by Jews. The older assimilationist doctrines, which stated that the Jews should meld into the majority among whom they lived, are being applied even to the Zionist community in the Middle East: it should accept and gladly welcome absorption among the many million of Arabs in the region.

In the early twenty-first century it is being argued by various spokesmen of the liberal left—many Arabs and some

Jews—that the Zionist state should be dismantled. Let one state be established in which the inevitable Arab majority could supposedly be trusted to treat the Jewish minority fairly according to democratic principles. Anyone who knows the history of the region and has any reasonable assessment of the present tensions knows that this vision is a pipe dream. It is advanced by people who might wring their hands when a supposed democracy of Jews and Arabs in one state does not live up to its promises, but then these thinkers will have lost interest in the problem. Of all the visions that are being held out to the warring Israelis and Palestinians, the one-state solution is by far the least likely because neither side to the conflict can trust the other to rein in its maximalists.

The most sober assessment has to be that the problems will continue and that the conflict will not be easily resolved, but modern Zionism and its creation, the state of Israel, are here to stay. Its future is not guaranteed by the coming of the messiah soon, but Israel is not ultimately threatened even by the intifada and the suicide bombers. It exists and will continue to exist by the will of its own people. Jews will not surrender their claim to a home of their own to which those who need to come may come freely, nor their claim to a national center of their own in which Jewish energies may continue to define what the long past of this people means in the present and what it can be understood to mean in the future.

See also *Judaism; Miracles; Nation; Nationalism.*

BIBLIOGRAPHY

- Antonius, George. *The Arab Awakening: The Story of the Arab National Movement*. New York: Capricorn, 1965.
- Cleveland, William L. *A History of the Modern Middle East*. Boulder, Colo.: Westview, 1994.
- Elon, Amos. *The Israelis: Founders and Sons*. New York: Penguin, 1983.
- Ezrahi, Yaron. *Rubber Bullets: Power and Conscience in Modern Israel*. New York: Farrar, Straus and Giroux, 1997.
- Hertzberg, Arthur. *The Fate of Zionism: A Secular Future for Israel and Palestine*. San Francisco: HarperSanFrancisco, 2003.
- . *The Zionist Idea: A Historical Analysis and Reader*. New York: Atheneum, 1972.
- Khalidi, Walid, ed. *From Haven to Conquest: Readings in Zionism and the Palestine Problem until 1948*. Washington, D.C.: Institute for Palestine Studies, 1987.
- Laqueur, Walter, and Barry M. Rubin, eds. *The Israel-Arab Reader: A Documentary History of the Middle East Conflict*. 5th ed. New York: Penguin, 1995.
- Lustick, Ian. *Arabs in the Jewish State: Israel's Control of a National Minority*. Austin: University of Texas Press, 1980.
- Morris, Benny. *The Birth of the Palestinian Refugee Problem, 1947–1949*. Cambridge, U.K.: Cambridge University Press, 1987.
- Ravitzky, Aviezer. *Messianism, Zionism, and Jewish Radicalism*. Chicago: University of Chicago Press, 1996.
- Said, Edward. *The Question of Palestine*. New York: Vintage, 1992.
- Shipler, David. *Arab and Jew: Wounded Spirits in a Promised Land*. New York: Times Books, 1986.
- Shlaim, Avi. *Collusion across the Jordan: King Abdullah, the Zionist Movement, and the Partition of Palestine*. New York: Columbia University Press, 1988.

Arthur Hertzberg

LIST OF CONTRIBUTORS

JANET L. ABU-LUGHOD

Department of Sociology, Graduate Faculty, New School
University
City, The: The Islamic and Byzantine City

PIUS ADESANMI

Department of Comparative Literature, Pennsylvania
State University
Literature: African Literature

AUSTIN METUMARA AHANOTU

Department of History, California State University,
Stanislaus
Religion and the State: Africa

EVERETT HELMUT AKAM

Department of Political Science, Casper College
Pluralism

SOLA AKINRINADE

Department of History, Obafemi Awolowo University,
Nigeria
Migration: Africa
Oral Traditions: Overview

ROBERT ALBRO

John W. Kluge Center, Library of Congress
Populism: Latin America

ROBERTO ALEJANDRO

Department of Political Science, University of
Massachusetts, Amherst
Justice: Justice in American Thought

BARRY ALLEN

Department of Philosophy, McMaster University
Knowledge

GARLAND E. ALLEN

Department of Biology, Washington University in St.
Louis
Eugenics
Genetics: Contemporary
Life

DWIGHT D. ALLMAN

Department of Political Science, Baylor University
Political, The

ELLEN AMSTER

Department of History, University of Wisconsin—
Milwaukee
Westernization: Middle East

DIANE APOSTOLOS-CAPPADONA

Center for Muslim-Christian Understanding,
Georgetown University
Humanity in the Arts
Landscape in the Arts
Nude, The

THEODORE ARABATZIS

Department of Philosophy and History of Science,
University of Athens
Experiment

ARTHUR AUGHEY

School of Economics and Politics, University of Ulster,
U.K.
Conservatism

MAITRII AUNG-THWIN

Department of History, National University of Singapore
Anticolonialism: Southeast Asia
Colonialism: Southeast Asia
Westernization: Southeast Asia

ANTHONY F. AVENI

Department of Physics and Astronomy, Colgate
University
Astronomy, Pre-Columbian and Latin American

ANITA AVRAMIDES

St. Hilda's College, Oxford
Philosophy of Mind: Overview

LAWRENCE A. BABB

Department of Anthropology and Sociology, Amherst
College
Jainism

SOULEYMANE BACHIR DIAGNE

Department of Philosophy, Northwestern University
Philosophies: African

PETER BAEHR

Department of Politics and Sociology, Lingnan
University, Hong Kong
Totalitarianism

LIST OF CONTRIBUTORS

- ELLEN T. BAIRD
 Department of Art History, University of Illinois at Chicago
City, The: Latin America
- THOMAS BALDWIN
 Department of Philosophy, University of York, U.K.
Analytical Philosophy
- ASOKA BANDARAGE
 Women's Studies Program, Mount Holyoke College
Family Planning
- AHMED S. BANGURA
 Department of Modern and Classical Languages,
 University of San Francisco
Orientalism: African and Black Orientalism
- MOSHE BARASCH
 Hebrew University (Emeritus)
Gesture
- E. J. W. BARBER
 Linguistics and Archaeology, Occidental College
Language, Linguistics, and Literacy
Textiles and Fiber Arts as Catalysts for Ideas
- STEPHEN BARNES
 Department of Philosophy, Northwest Vista College
Populism: United States
Philosophies: American
Pragmatism
- MARLEEN S. BARR
 Hadassah Brandeis Feminist Research Institute, Brandeis University
Science Fiction
- CLYDE W. BARROW
 University of Massachusetts, Dartmouth
State, The: Overview
- J. ROBERT BARTH
 Department of English, Boston College
Imagination
- EDWINA BARVOSA-CARTER
 Department of Chicano/a Studies, University of California at Santa Barbara
Identity, Multiple: Overview
- MICHAEL BAUR
 Philosophy Department, Fordham University
Idealism
- TIMOTHY BAYCROFT
 Department of History, University of Sheffield, U.K.
Nationalism: Overview
- MARC BECKER
 Division of Social Science, Truman State University
Anticolonialism: Latin America
Authoritarianism: Latin America
Dictatorship in Latin America
Extirpation
Republicanism: Latin America
- JASON DAVID BEDUHN
 Northern Arizona University
Manichaeism
- WILLIAM H. BEEZLEY
 Department of History, University of Arizona
Religion and the State: Latin America
- SHULAMITH BEHR
 Courtauld Institute of Art
Expressionism
- RONALD BEINER
 Department of Political Science, University of Toronto
Citizenship: Overview
- JONATHAN BELLER
 Department of English and Humanities, Pratt Institute
Third Cinema
Visual Culture
- BERNADETTE BENSUAUDE-VINCENT
 Département de Philosophie, Université de Paris X
Chemistry
- JANET E. BENSON
 Department of Sociology, Anthropology, and Social Work, Kansas State University
Communication of Ideas: Southeast Asia and Its Influence
- DIRK BERG-SCHLOSSER
 Institute of Political Science, Philipps-University, Marburg, Germany
Authoritarianism: Overview
- ALAN E. BERNSTEIN
 Department of History, University of Arizona
Heaven and Hell
- MARK H. BERNSTEIN
 Department of Philosophy, University of Texas at San Antonio
Fatalism
- CHRISTOPHER J. BERRY
 Department of Politics, University of Glasgow
Poverty
Wealth

- BRENDA L. BETHMAN
Texas A&M University
Jouissance
- RICHARD BETT
Department of Philosophy, Johns Hopkins University
Epistemology: Ancient
- ELIZABETH BISHOP
University of Texas at Austin
Nationalism: Cultural Nationalism
- KALMAN P. BLAND
Department of Religion, Duke University
Judaism: Modern Judaism
- JACK S. BLOCKER JR.
Department of History, Huron University College,
University of Western Ontario
Temperance
- WILLARD BOHN
Department of Foreign Languages, Illinois State
University
Dada
Surrealism
- ELIAS K. BONGMBA
Religious Studies, Rice University
Communitarianism in African Thought
Religion: Africa
Religion: African Diaspora
- MICHAEL BONNER
Department of Near Eastern Studies, University of
Michigan
Jihad
- SUSAN BORDO
Department of English, University of Kentucky
Body, The
- JONATHAN BOYARIN
Independent Scholar, New York, N.Y.
Identity, Multiple: Jewish Multiple Identity
- JOEL T. BRASLOW
Departments of Psychiatry and History, University of
California, Los Angeles
VISN-22 Mental Illness Research, Education and
Clinical Center, Veterans Administration
Psychology and Psychiatry
- SONJA BRENTJES
Institute for the Study of Muslim Civilizations, Aga
Khan University
Islamic Science
- JOHN BREUILLY
Department of Government, London School of
Economics
Nation
- GWEN W. BREWER
Department of English, California State University,
Northridge
Classicism
- ANNE F. BROADBRIDGE
Department of History, University of Massachusetts
Monarchy: Islamic Monarchy
- CHARLOTTE R. BROWN
Department of Philosophy, Illinois Wesleyan University
Moral Sense
- LAURIE M. BROWN
Department of Physics and Astronomy, Northwestern
University
Quantum
- VERN L. BULLOUGH
State University of New York (Emeritus)
Gender: Overview
Love, Western Notions of
Sexuality: Sexual Orientation
- MARTIN J. BURKE
Department of History, Lehman College and the
Graduate Center, City University of New York
Social History, U.S.
- PETER BURKE
Emmanuel College, University of Cambridge
Context
Everyday Life
- WILLIAM E. BURNS
Department of History, Morgan State University
Astrology: Overview
Superstition
- W. F. BYNUM
Wellcome Trust Centre for the History of Medicine,
University College London
Health and Disease
- JOANNE CACCIATORE-GARARD
M.I.S.S. Foundation
Death
- GIUSEPPE CAGLIOTI
Dipartimento Ingegneria Nucleare, Politecnico di Milano
Ambiguity

LIST OF CONTRIBUTORS

- MARTHA M. CAMPBELL
School of Public Health, University of California,
Berkeley
Population
- ARTHUR CAPLAN
Department of Medical Ethics, University of
Pennsylvania
Bioethics
- MICHAEL C. CARHART
University of Nevada
Enlightenment
- JEAN-CLAUDE CARRON
University of California, Los Angeles
Rhetoric: Overview
- TERRELL CARVER
Department of Politics, University of Bristol, U.K.
Historical and Dialectical Materialism
- STEVEN CASSEDY
Department of Literature, University of California, San
Diego
Nihilism
Orthopraxy: Western Orthopraxy
Regions and Regionalism, Eastern Europe
- SUNDIATA KEITA CHA-JUA
Afro-American Studies and Research Program, University
of Illinois at Urbana-Champaign
African-American Ideas
- WELLINGTON K. K. CHAN
Occidental College
Empire and Imperialism: Asia
- JOHN CHARVET
Department of Government, London School of
Economics
Liberalism
- CHUNG-YING CHENG
University of Hawai'i at Manoa
Consciousness: Chinese Thought
- FREDRIC L. CHEYETTE
Department of History, Amherst College
Feudalism, European
- LAURA CHRISMAN
Department of English, University of York, U.K.
Postcolonial Studies
- DIANE CIEKAWY
Department of Sociology and Anthropology, Ohio
University
Magic
- Witchcraft*
Witchcraft, African Studies of
- ALBRECHT CLASSEN
Department of German Studies, University of Arizona
Other, The, European Views of
- DISKIN CLAY
Department of Classical Studies, Duke University
Dialogue and Dialectics: Socratic
- H. FLORIS COHEN
University of Twente
Scientific Revolution
- JEAN COMAROFF
Department of Anthropology, University of Chicago
Ethnography
- BETH A. CONKLIN
Vanderbilt University
Cannibalism
- R.W. CONNELL
Faculty of Education and Social Work, University of
Sydney
Men and Masculinity
- COSTAS M. CONSTANTINOU
School of Politics, Philosophy and International
Relations, University of Keele
Treaty
- DAVID COOK
Rice University
Millenarianism: Islamic
- MIRIAM COOKE
Department of Asian and African Languages and
Literature, Duke University
Feminism: Islamic Feminism
- DAVID D. COREY
Department of Political Science, Baylor University
Sophists, The
- DRUCILLA CORNELL
Department of Political Science, Rutgers University
Universalism
- JORGE F. CORONADO
Department of Spanish and Portuguese, Northwestern
University
Indigenismo
- SARAH COVINGTON
Department of History, Queens College
Etiquette
Untouchability: Menstrual Taboos

- CLIFTON CRAIS
Department of History, Emory University
Resistance and Accommodation
- DAVID CRAVEN
Department of Art and Art History, University of New Mexico
Modernism: Latin America
World Systems Theory, Latin America
- JON CRUZ
University of California, Santa Barbara
Interpretation
- SEAN CUBITT
Screen and Media Studies, University of Waikato, New Zealand
Cinema
Media, History of
- KAREN MARY DAVALOS
Loyola Marymount University
Mestizaje
- CATHY N. DAVIDSON
Department of English, Duke University
Interdisciplinarity
- NATALIE ZEMON DAVIS
Department of History, Princeton University
Gift, The
- ROSA DE JORIO
Department of Sociology, Anthropology, and Criminal Justice, University of North Florida
Kinship
- ALYSSA DEFRAIN
Independent Scholar, Omaha, Neb.
Death
- JOHN DEFRAIN
Department of Family and Consumer Sciences, University of Nebraska
Death
- ADELAIDA R. DEL CASTILLO
Department of Chicana and Chicano Studies, San Diego State University
Citizenship: Cultural Citizenship
- RICHARD DELGADO
University of Pittsburgh School of Law
Critical Race Theory
- ROBERT DELIÈGE
Institut Orientaliste, Université de Louvain-la-Neuve, Belgium
Untouchability: Taboos
- JERRY DENNERLINE
Departments of History and Asian Languages and Civilizations, Amherst College
Confucianism
- WALTER B. DENNY
Department of Art History, University of Massachusetts, Amherst
Paradise on Earth
- HEATHER DEVERE
School of Social Sciences, Auckland University of Technology
Friendship
- PETER DICKENS
Faculty of Social and Political Sciences, University of Cambridge
Department of Sociology, University of Essex
Social Darwinism
- ROBERT W. DIMAND
Department of Economics, Brock University
Game Theory
- LEONARD DINNERSTEIN
Department of History, University of Arizona
Assimilation
- PETER DINZELBACHER
University of Vienna, Austria
Asceticism: Western Asceticism
- MAMADOU DIOUF
Department of History, University of Michigan
Intelligentsia
Modernity: Africa
- FRANCESCA DI POPPA
Department of History and Philosophy of Science, University of Pittsburgh
Dualism
Materialism in Eighteenth-Century European Thought
Monism
- THOMAS DIXON
Department of History, Lancaster University, U.K.
Agnosticism
Altruism
Natural Theology
- ALLEN DOUGLAS
Department of History, Indiana University, Bloomington
Orientalism: Overview
- DOUGLAS C. DOW
School of Social Sciences, University of Texas at Dallas
Punishment

LIST OF CONTRIBUTORS

DONNALEE DOX

Department of Performance Studies, Texas A&M
University
Dance

JOHN DUCKITT

Department of Psychology, University of Auckland, New
Zealand
Prejudice

STEPHEN DUNCOMBE

Gallatin School, New York University
Resistance

TIM DUVAL

Department of Government and Politics, St. John's
University
Epicureanism
Happiness and Pleasure in European Thought
Immortality and the Afterlife
Political Science

MARK DYRESON

Departments of Kinesiology and History, Pennsylvania
State University
Sport

SAMUEL Y. EDGERTON

Department of Art, Williams College
Perspective

JEFFREY EDWARDS

University of Stony Brook, State University of New York
Philosophy, Moral: Modern

JOHN EHRENBERG

Department of Political Science, Long Island University,
Brooklyn, New York
Civil Society: Europe and the United States

DALE F. EICKELMAN

Department of Anthropology, Dartmouth College
Tribalism, Middle East

JAMAL J. ELIAS

Department of Religion, Amherst College
Mysticism: Islamic Mysticism in Asia

NNAMDI ELLEH

College of Design, Architecture, Art and Planning,
University of Cincinnati, Ohio
Architecture: Africa

ELISABETH ELLIS

Department of Political Science, Texas A&M University
Common Sense
Modernity: Overview

STEPHEN ELLIS

Department of Philosophy, University of Oklahoma
Rational Choice

BENJAMIN A. ELMAN

Department of East Asian Studies, Princeton University
Education: China
Examination Systems, China

STANLEY L. ENGERMAN

Departments of Economics and History, University of
Rochester
Slavery

MARC MICHAEL EPSTEIN

Department of Religion and Jewish Studies Program,
Vassar College
Dream

GEORGE ESENWEIN

Department of History, University of Florida
Anarchism
Socialism

G. R. EVANS

Faculty of History, University of Cambridge
Christianity: Overview

DICKSON EYOH

African Studies Program, New College, University of
Toronto
Modernization

STEPHEN M. FABIAN

Writing Program, Princeton University
Ancestor Worship
Calendar

TOYIN FALOLA

Department of History, University of Texas at Austin
Nationalism: Africa
Neocolonialism

PAUL FARBER

Department of History, Oregon State University
Natural History

JOHN E. FARLEY

Department of Sociology and Criminal Justice Studies,
Southern Illinois University at Edwardsville
Minority

MARGARET E. FARRAR

Department of Political Science, Augustana College
City, The: The City as Political Center

RICHARD K. FENN

Princeton Theological Seminary
Time: Traditional and Utilitarian

- DAVID E. W. FENNER
Department of Philosophy, University of North Florida
Taste
- JAMES W. FERNANDEZ
Department of Anthropology, University of Chicago
Trope
- DAVID FIDELER
Editor, *Alexandria, A Journal of Cosmology, Philosophy, Myth, and Culture*
Pythagoreanism
- LES W. FIELD
Department of Anthropology, University of New Mexico
Native Policy
- AUTUMN FIESTER
Department of Medical Ethics, University of Pennsylvania
Bioethics
- GIOVANNI FILORAMO
Department of History, University of Turin Italy
Gnosticism
- JANE FLAX
Department of Political Science, Howard University
Equality: Gender Equality
Essentialism
- TYLER FLEMING
University of Texas at Austin
Nationalism: Africa
- BENEDETTO FONTANA
Department of Political Science, Baruch College, City University of New York
Democracy
Hegemony
- CYNTHIA E. FOOR
Department of Anthropology, Western Michigan University
Family: Family in Anthropology since 1980
- CARLA FRECCERO
Literature Department, University of California, Santa Cruz
Fetishism: Fetishism in Literature and Cultural Studies
- R. G. FREY
Department of Philosophy, Bowling Green State University
Utilitarianism
- ALMA M. GARCIA
Department of Anthropology and Sociology, Santa Clara University
Feminism: Third World U.S. Movement
- EUGENE GARVER
Department of Philosophy, St. John's University, Minnesota
Reason, Practical and Theoretical
- STEPHEN GAUKROGER
Department of Philosophy, University of Sydney, Australia
Cartesianism
- PAULA E. GEYH
Department of English, Yeshiva University
Postmodernism
- ANAT GILBOA
Queen's University, Kingston, Canada
Gender in Art
- CHRISTOPHER GILL
Department of Classics and Ancient History, University of Exeter, United Kingdom
Stoicism
- NATHAN GLAZER
Department of Sociology, Harvard University
Diversity
- THOMAS F. GLICK
Boston University
Communication of Ideas: Middle East and Abroad
- DAVID J. GOA
Provincial Museum of Alberta
Images, Icons, and Idols
- DAVID THEO GOLDBERG
University of California Humanities Research Institute, University of California, Irvine
Ethnocentrism
Interdisciplinarity
- DEENA J. GONZÁLEZ
Department of Chicana/o Studies, Loyola Marymount University
Internal Colonialism
- GLORIA GONZÁLEZ-LÓPEZ
Department of Sociology, University of Texas at Austin
Machismo
- JOSHUA GOODE
Department of History, Occidental College
Race and Racism: Europe
- HOWARD L. GOODMAN
Mysticism: Chinese Mysticism
Time: China

LIST OF CONTRIBUTORS

JACK GOODY

St. John's College, Cambridge, U.K.
Communication of Ideas: Orality and the Advent of Writing
Wisdom, Human

LEWIS R. GORDON

Department of Philosophy, Temple University
Humanism: Africa

JAY GOULDING

Department of Sociology, York University, Toronto, Canada
Barbarism and Civilization
Globalization: Asia
Religion: East and Southeast Asia
Society
Zen

DAVID GRAEBER

Department of Anthropology, Yale University
Alienation

DANIEL W. GRAHAM

Department of Philosophy, Brigham Young University
Change

I. GRATTAN-GUINNESS

Middlesex University at Enfield
Algebras
Logic and Philosophy of Mathematics, Modern Mathematics

JEREMY GRAY

Centre for the History of the Mathematical Sciences, Open University
Geometry

SUSAN GRAYSON

Department of Spanish and French Literary Studies, Occidental College
Women and Femininity in U.S. Popular Culture

SEAN GREENBERG

Department of Philosophy, Johns Hopkins University
Rationalism

FREDERICK GREGORY

Department of History, University of Florida
Naturphilosophie

PAUL F. GRENDLER

Department of History, University of Toronto (Emeritus)
Education: Europe
University: Overview

ROGER GRIFFIN

Department of History, Oxford Brookes University
Fascism

JEFF D. GRISCHOW

Department of History, Wilfrid Laurier University
Capitalism: Africa

ULRICH GROETSCH

Department of History, Rutgers University
Pietism

JEAN GRONDIN

Département de Philosophie, Université de Montréal
Hermeneutics

LAWRENCE GROSSBERG

Department of Communication Studies, University of North Carolina at Chapel Hill
Cultural Studies

ANDREW GROSSMAN

Independent Scholar, Springfield, N.J.
Gay Studies

SEBASTIAN GÜNTHER

Department of Near and Middle Eastern Civilizations, University of Toronto
Education: Islamic Education

MATTHEW C. GUTMANN

Department of Anthropology, Brown University
Machismo

PAUL GUYER

Department of Philosophy, University of Pennsylvania
Kantianism

ALAN HÁJEK

Humanities and Social Sciences 101-40, California Institute of Technology
Probability

PETER DOBKIN HALL

John F. Kennedy School of Government, Harvard University
Volunteerism, U.S.

THOMAS D. HALL

Department of Sociology, DePauw University
Borders, Borderlands, and Frontiers, Global

ELTIGANI ABDELGADIR HAMID

Graduate School of Islamic and Social Sciences
Islam: Africa

JOHN T. HAMILTON

Department of Comparative Literature, Harvard University
Poetry and Poetics

- M. ŞÜKRÜ HANIOĞLU
Department of Near Eastern Studies, Princeton University
Pan-Turkism
- BETTY J. HARRIS
Anthropology and Women's Studies, University of Oklahoma
Apartheid
- GLEN ANTHONY HARRIS
History Department, University of North Carolina at Wilmington
Ethnohistory, U.S.
- DAVID M. HART
Online Library of Liberty, Liberty Fund, Inc.
War and Peace in the Arts
- SEAN HAWKINS
Department of History, University of Toronto
Social Capital
- MATTHEW HEATON
Department of History, University of Texas at Austin
Neocolonialism
- JAMES P. HELFERS
College of Liberal Arts, Grand Canyon University
Travel from Europe and the Middle East
- FRED HENDRICKS
Department of Sociology, Rhodes University, South Africa
Ethnicity and Race: Africa
Multiculturalism, Africa
- ARTHUR HERTZBERG
Department of Religion, Dartmouth College (Emeritus)
Bronfman Visiting Professor of the Humanities, New York University
Anti-Semitism: Overview
Zionism
- WENDY S. HESFORD
Department of English, The Ohio State University
Autobiography
- NORRIS HETHERINGTON
Office for the History of Science and Technology, University of California, Berkeley
Cosmology: Cosmology and Astronomy
- PAUL HEYER
Department of Communication Studies, Wilfrid Laurier University, Waterloo, Ontario, Canada
Communication of Ideas: The Americas and Their Influence
Communication of Ideas: Europe and Its Influence
- JOSIAH MCC. HEYMAN
Department of Sociology and Anthropology, University of Texas at El Paso
Scarcity and Abundance, Latin America
Work
- MARC A. HIGHT
Department of Philosophy, Hampden-Sydney College
Classification of Arts and Sciences, Early Modern
- T. J. HOCHSTRASSER
Department of International History, London School of Economics and Political Science
Natural Law
- DIRK HOERDER
Department of History, University of Bremen
Migration: Migration in World History
Migration: United States
- VALERIE HOLLIDAY
Louisiana State University, Baton Rouge
Genius
- CRISTOPHER HOLLINGSWORTH
Department of English, University of South Alabama
Metaphor
- TED HONDERICH
University College London
Determinism
- CLAIRE HOOKER
Public Health Sciences, University of Toronto
Hygiene
- M. B. HOOKER
Faculty of Law, The Australian National University
Islam: Southeast Asia
- ELLIS HOROWITZ
Department of Computer Science, University of Southern California
Computer Science
- MARYANNE CLINE HOROWITZ
Department of History, Occidental College
Humanity: European Thought
Renaissance
Visual Order to Organizing Collections
- JANET HOSKINS
Department of Anthropology, University of Southern California
Matriarchy
- KEVIN JAMES HOUK
Modern History and Literature, Drew University
Cosmopolitanism

LIST OF CONTRIBUTORS

COLUM HOURIHANE
Princeton University
Iconography

MICHAEL HUGHES
Edgewood College
Philosophy, Moral: Modern

WILLIAM HUGHES
School of English and Creative Studies, Bath Spa
University College
Genre

JONATHAN P. HUNT
Department of English, Santa Clara University
Naturalism

VALERAE M. HURLEY
Department of History, Monmouth University
Radicals/Radicalism

ROSALIND HURSTHOUSE
Department of Philosophy, University of Auckland, New
Zealand
Virtue Ethics

AÍDA HURTADO
Department of Psychology, University of California,
Santa Cruz
Feminism: Chicana Feminisms

PATRICK H. HUTTON
Department of History, University of Vermont
Memory
Presentism

PABLO L.E. IDAHOSA
African Studies, Social Science, York University,
Toronto, Canada
Socialisms, African

MOSHE IDEL
Institute of Jewish Studies, The Hebrew University Mt.
Scopus
Judaism: Judaism to 1800
Mysticism: Kabbalah

F. ABIOLA IRELE
Department of Romance Languages and Literatures,
Harvard University
Westernization: Africa

GERALD N. IZENBERG
Department of History, Washington University
Romanticism in Literature and Politics

ANNAMARIE JAGOSE
University of Auckland, New Zealand
Queer Theory

JAMES JANKOWSKI
University of Colorado (Emeritus)
Ethnicity and Race: Islamic Views
Nationalism: Middle East
Pan-Arabism

MICHEL JANSSEN
Program in History of Science and Technology,
University of Minnesota
Relativity

CHEN JIAN
Corcoran Department of History, University of Virginia
Maoism

ROBERT N. JOHNSON
Department of Philosophy, University of Missouri
Obligation
Relativism

THOMAS PYKE JOHNSON
Mugar Library, Boston University
History Department, University of Massachusetts, Boston
Environmental History

WILLIAM M. JOHNSTON
Department of Church History, Yarra Theological Union
at the Melbourne College of Divinity
Monasticism

DAVID JORAVSKY
Department of History, Northwestern University
Lysenkoism

SARA JORDAN
Texas A&M University
Bureaucracy

MATTHEW KADANE
History and Literature, Harvard University
Deism

ANN M. KAKALIOURAS
Department of Anthropology, Appalachian State
University
Ethnicity and Race: Anthropology

NORIKO KAMACHI
Department of Social Sciences, University of Michigan,
Dearborn
Pan-Asianism

RACHANA KAMTEKAR
Department of Philosophy, University of Michigan
Character

OUSMANE KANE
School of International and Public Affairs, Columbia
University
Sufism

- ANDRZEJ KARCI
University of Kansas
Formalism
- NIKKI R. KEDDIE
Department of History, University of California, Los Angeles
Secularization and Secularism
- DONALD R. KELLEY
Department of History, Rutgers University
Cultural History
Eclecticism
Historicism
History, Idea of
Ideas, History of
Linguistic Turn
Periodization
Prehistory, Rise of
- DOUGLAS KELLNER
Graduate School of Education and Information Studies,
University of California, Los Angeles
Critical Theory
- HENRY ANSGAR KELLY
Center for Medieval and Renaissance Studies, University
of California, Los Angeles
Tragedy and Comedy
- JEFFREY T. KENNEY
Department of Religious Studies, DePauw University
Fundamentalism
Pan-Islamism
- MAXIM KHOMIAKOV
Department of Philosophy, Ural State University
Hierarchy and Order
- MARGARET L. KING
Department of History, Brooklyn College and the
Graduate Center, City University of New York
Childhood and Child Rearing
- ROBERT M. KINGDON
Department of History, University of Wisconsin—
Madison
Reformation
- REBECCA KINGSTON
Department of Political Science, University of Toronto
Citizenship: Overview
- GYULA KLIMA
Department of Philosophy, Fordham University
Form, Metaphysical, in Ancient and Medieval Thought
- GEORGE KLOSKO
Department of Politics, University of Virginia
State of Nature
- RAYMOND KNAPP
Department of Musicology, University of California, Los
Angeles
Absolute Music
*Nationalism: Nationalism in Music, Europe and the United
States*
- ALEXANDRA KOGL
Department of Political Science, University of Northern
Iowa
Equality: Overview
- HELGE KRAGH
History of Science Department, University of Aarhus,
Denmark
Science: Overview
- MARK KRAMER
Cold War Studies Institute, Harvard University
Genocide
Nuclear Age
- ROSALIND KRAUSS
Department of Art History and Archaeology, Columbia
University
Avant-Garde: Militancy
- JILL KRAYE
Warburg Institute
Philosophy, Moral: Medieval and Renaissance
- THERESA A. KULBAGA
Department of English, The Ohio State University
Autobiography
- KRISHAN KUMAR
Department of Sociology, University of Virginia
Revolution
- MARION LEATHERS KUNTZ
Department of Modern and Classical Languages, Georgia
State University
Prophecy
- DAVID KUNZLE
Department of Art History, University of California, Los
Angeles
Protest, Political
- CHARLES KURZMAN
Department of Sociology, University of North Carolina
Reform: Islamic Reform
- PETER LAMARQUE
Department of Philosophy, University of York, U.K.
Aesthetics: Europe and the Americas
- JERUSHA T. LAMPTEY
Independent Scholar, Herndon, Va.
Mysticism: Mysticism in African Thought

LIST OF CONTRIBUTORS

MELISSA LANE

Faculty of History, Cambridge University
Social Contract

MARK LARRIMORE

Eugene Lang College and Graduate Department of
Philosophy, New School University
Evil
Theodicy

NEIL LARSEN

Programs in Comparative Literature and Critical Theory,
University of California, Davis
Third World Literature

MANFRED D. LAUBICHLER

School of Life Sciences, Arizona State University
Development

ROBERT LAUNAY

Department of Anthropology, Northwestern University
Person, Idea of the
Polytheism
Ritual: Religion
Sacred and Profane
Structuralism and Poststructuralism: Anthropology
Totems

JOHN CHRISTIAN LAURSEN

Department of Political Science, University of California,
Riverside
Censorship
Skepticism
Toleration

BABATUNDE LAWAL

Department of Art History, School of the Arts, Virginia
Commonwealth University
Arts: Africa

PATRICK LE GALÈS

CEVIPOF/CNRS/Sciences Po, Paris
City, The: The City as Cultural Center

LUIS LEAL

Department of Chicano Studies, University of California,
Santa Barbara
Aztlán

YANN LEBEAU

Centre for Higher Education Research and Information,
The Open University, U.K.
University: Postcolonial

MICHAEL LEBUFFE

Department of Philosophy, Texas A&M University
Metaphysics: Renaissance to the Present

ARTHUR M. LESLEY

Hebrew Language and Literature, Baltimore Hebrew
University
Ghetto

MICHAEL LEVENSON

Department of English, University of Virginia
Modernism: Overview

HEATHER LEVI

Department of Sociology and Anthropology, Lake Forest
College
Practices
Reflexivity

ALAN MITCHELL LEVINE

Department of Government, American University
America

DAVID LEVINE

Ontario Institute for Studies in Education/University of
Toronto
Marriage and Fertility, European Views

FREDERICK LIERS

Department of Comparative Literature, University of
California, Los Angeles
Biography
Cycles

IVAN LIGHT

Department of Sociology, University of California, Los
Angeles
Cultural Capital

SONYA LIPSETT-RIVERA

Department of History, Carleton University
Honor

C. SCOTT LITTLETON

Department of Anthropology, Occidental College
Anthropology
Demonology
Sacred Places
Syncretism

HAIMING LIU

Ethnic and Women's Studies Department, California
State Polytechnic University, Pomona
Asian-American Ideas (Cultural Migration)
Race and Racism: Reception of Asians to the United States

CHARLES H. LOHR

Theological Faculty, University of Freiburg
Aristotelianism

RUTH LORAND

Department of Philosophy, University of Haifa
Beauty and Ugliness

- BEN LOWE
Department of History, Dorothy F. Schmidt College of
Arts and Letters, Florida Atlantic University
Peace
- JOSEPH A. LOYA
Department of Theology and Religious Studies,
Villanova University
Ecumenism
- MARTIN LYNN
School of History, Queen's University, Belfast
Empire and Imperialism: Europe
- PETER MACHAMER
Department of History and Philosophy of Science,
University of Pittsburgh
Dualism
Materialism in Eighteenth-Century European Thought
Monism
- REYNALDO F. MACÍAS
César E. Chávez Department of Chicana and Chicano
Studies, University of California, Los Angeles
Bilingualism and Multilingualism
- COLIN MACKERRAS
Department of International Business and Asian Studies,
Griffith University
Eurocentrism
- CATHARINE MACKINNON
Faculty of Law, University of Michigan
Sexual Harassment
- DOUGLAS MACLEAN
Department of Philosophy, University of North
Carolina, Chapel Hill
Environmental Ethics
- DONALD M. MACRAILD
Victoria University of Wellington, New Zealand
Victorianism
- GREGORY H. MADDOX
Department of History, Texas Southern University
Black Consciousness
Oral Traditions: Telling, Sharing
- DANIEL A. MADIGAN
Institute for Religions and Cultures, Pontifical Gregorian
University, Rome
Sacred Texts: Koran
- JESS MAGHAN
Forum for Comparative Correction
Hate
- ZINE MAGUBANE
Department of Sociology, University of Illinois at
Urbana-Champaign
Black Atlantic
- PARAMANONDA MAHANTA
Department of Physics, Dibrugarh University
Futurology
- JANE MAIENSCHIN
Department of Philosophy, Arizona State University
Development
- VICTOR H. MAIR
Department of Asian and Middle Eastern Studies,
University of Pennsylvania
Diffusion, Cultural
Language and Linguistics
- W. O. MALOBA
Department of History, University of Delaware
Anticolonialism: Africa
- FEDWA MALTI-DOUGLAS
Departments of Gender Studies and Comparative
Literature, Indiana University, Bloomington
Orientalism: Overview
Sexuality: Islamic Views
- AMINA MAMA
African Gender Institute, University of Cape Town
Feminism: Africa and African Diaspora
- JOHN MARENBO
Faculty of Philosophy, University of Cambridge
Language, Philosophy of: Ancient and Medieval
Logic
Metaphysics: Ancient and Medieval
- MICHAEL MARTIN
Department of Philosophy, Boston University
Atheism
- PHILIP L. MARTIN
Department of Agricultural and Resource Economics,
University of California, Davis
Human Capital
- ALBERTO A. MARTÍNEZ
Program in History and Philosophy of Science,
California Institute of Technology
Field Theories
- MARTIN E. MARTY
Fairfax M. Cone Distinguished Service Professor
Emeritus, University of Chicago
Religion and the State: United States

LIST OF CONTRIBUTORS

MICHELLE MASKIELL

Department of History, Montana State University
Education: India

D. A. MASOLO

Department of Philosophy, University of Louisville
Humanity: African Thought
Sage Philosophy
Sociability in African Thought

CYRUS MASROORI

Department of Political Science, California State
University, San Marcos
Religion and the State: Middle East

MARC MATERA

Department of History, Rutgers University
Pan-Africanism

FRANZ MAYR

Department of Philosophy, University of Portland,
Portland, Oregon
Continental Philosophy

AMA MAZAMA

Department of African American Studies, Temple
University
Afrocentricity

JOHN MUKUM MBAKU

Department of Economics, Weber State University
Corruption in Developed and Developing Countries

ELIZABETH MCCARTNEY

Center for Seventeenth- and Eighteenth-Century Studies,
University of California, Los Angeles
Ritual: Public Ritual

RUSSELL T. MCCUTCHEON

Department of Religious Studies, University of Alabama
Religion: Overview

BONNIE MCDOUGALL

School of Literatures, Languages, and Cultures,
University of Edinburgh
Privacy

MARGARET H. MCFADDEN

Interdisciplinary Studies, Appalachian State University
Women's Studies

RICHARD MCGREGOR

Vanderbilt University
Mysticism: Islamic Mysticism

ROBERT P. MCINTOSH

Department of Biological Science, University of Notre
Dame
Ecology

ALYSON MCLAMORE

Department of Music, California Polytechnic State
University, San Luis Obispo
Motif: Motif in Music
Musical Performance and Audiences

ALLAN MEGILL

Corcoran Department of History, University of Virginia
Marxism: Overview

MAURICE MEISNER

Department of History, University of Wisconsin—
Madison
Marxism: Asia

YITZHAK Y. MELAMED

Department of Philosophy, Yale University
Hegelianism

KIDANE MENGISTEAB

Department of African and African American Studies,
Pennsylvania State University
Globalization: Africa
Globalization: General

RAMDAS MENON

Demography

MELISSA MCBAY MERRITT

Department of Philosophy, Georgia State University
Epistemology: Early Modern

THOMAS J. MERTZ

Department of History, University of Wisconsin—
Madison
Antifeminism

GUY C. Z. MHONE

Graduate School of Public and Development
Management, University of the Witwatersrand
Neoliberalism
Privatization

HEIKKI MIKKELI

Renvall Institute for Area and Cultural Studies,
University of Helsinki
Europe, Idea of

ANN MILES

Department of Anthropology, Western Michigan
University
Family: Family in Anthropology since 1980
Life Cycle: Adolescence

JEFFREY MILLER

Department of Political Science, State University of New
York, New Paltz
Happiness and Pleasure in European Thought

- MARA MILLER
Independent Scholar, Philadelphia, Penn.
Aesthetics: Asia
Garden
- TYRUS MILLER
Department of Literature, University of California, Santa Cruz
Avant-Garde: Overview
- THEODORE R. MITCHELL
History Department, Occidental College
Education: North America
- ALOIS MLAMBO
Department of Historical and Heritage Studies,
University of Pretoria, South Africa
Peasants and Peasantry
- KENNETH MONDSCHEN
Fordham University
Love, Western Notions of
Meme
- JAMES A. MONTMARQUET
Department of Languages, Literature, and Philosophy,
Tennessee State University
Good
- DAVID K. MOORE
Department of Political Science, University of Northern Iowa
Equality: Overview
- IRENE VASQUEZ MORRIS
Department of Social Sciences and Department of Chicano/a Studies, California State University, Dominguez Hills
Chicano Movement
- ROSALIND C. MORRIS
Institute for Research on Women and Gender,
Department of Anthropology, Columbia University
Fetishism: Overview
Gender Studies: Anthropology
- PAUL K. MOSER
Department of Philosophy, Loyola University of Chicago
Foundationalism
- JOHN MOWITT
Department of Cultural Studies and Comparative Literature, University of Minnesota
Text/Textuality
- MPALIVE-HANGSON MSISKA
School of English and Humanities, Birkbeck College,
University of London
Realism, Africa
- JAMES MULDOON
John Carter Brown Library
Empire and Imperialism: Overview
International Order
- PAT MUNDAY
Department of Technical Communication, Montana Tech
Science, History of
- D. E. MUNGELLO
Department of History, Baylor University
Christianity: Asia
- H. ADLAI MURDOCH
Department of French, University of Illinois at Urbana-Champaign
Creolization, Caribbean
Negritude
- ANDREW R. MURPHY
Christ College, Valparaiso University
Corruption
- THOMAS F. MURPHY III
ABC-CLIO
Public Sphere
- ALEXANDER MURRAY
University College, Oxford
Suicide
- WINSTON P. NAGAN
School of Law, University of Florida
Law
- L. E. NAVIA
Department of Social Sciences, New York Institute of Technology
Cynicism
- IAN NEATH
Department of Psychological Sciences, Purdue University
Learning and Memory, Contemporary Views
- CARY J. NEDERMAN
Texas A&M University
Capitalism: Overview
Class
Human Rights: Overview
Humanism: Europe and the Middle East
Individualism
Monarchy: Overview
Organicism
Religion and the State: Europe
Republicanism: Republic
Sovereignty

LIST OF CONTRIBUTORS

CARYN E. NEUMANN

Department of History, The Ohio State University
Loyalties, Dual

JACOB NEUSNER

Institute of Advanced Theology, Bard College
Dialogue and Dialectics: Talmudic

PAUL NEWMAN

Independent Scholar, St Austell, U.K.
Literary History
Terror

THOMAS NICKLES

Department of Philosophy, University of Nevada, Reno
Empiricism
Falsifiability
Positivism

ALLEEN PACE NILSEN

Department of English, Arizona State University
Humor

DON L. F. NILSEN

Department of English, Arizona State University
Humor

EMMANUEL NNADOZIE

Department of Economics, Truman State University
Economics

OBIOMA NNAEMEKA

Departments of French and Women's Studies, Indiana
University, Indianapolis
Womanism

TARA E. NUMMEDAL

Department of History, Brown University
Alchemy: Europe and the Middle East

JOHN NUNLEY

Arts of Africa, Oceania, and the Americas, Saint Louis
Art Museum
Masks

FRANCIS B. NYAMNJOH

Department of Sociology, University of Botswana
Third World

EBENEZER OBADARE

Department of Social Policy, London School of
Economics and Political Science
Civil Society: Responses in Africa and the Middle East

MAX OELSCHLAEGER

Department of Humanities, Northern Arizona University
Nature
Wildlife

ROBERT OLBY

Department of the History and Philosophy of Science,
University of Pittsburgh
Genetics: History of

MICHAEL R. OLNECK

Departments of Educational Policy Studies and
Sociology, University of Wisconsin—Madison
Americanization, U.S.

EBERE ONWUDIWE

Center for African Studies, Central State University
Afropessimism

THOMAS M. OSBORNE JR.

Center for Thomistic Studies, University of St. Thomas
(Houston, Tex.)
Free Will, Determinism, and Predestination

KWADWO OSEI-NYAME JR.

Africa Department, School of Oriental and African
Studies, University of London
Authenticity: Africa

MARGARET J. OSLER

Department of History, University of Calgary
Mechanical Philosophy

KRISTEN LEE OVER

Department of English, Northeastern Illinois University
Motif: Motif in Literature

RANDALL PACKER

Department of Computer Science, Audio Technology,
and Physics, American University
Virtual Reality

DAVID W. PANKENIER

Department of Modern Languages and Literature, Lehigh
University
Astrology: China

ANTHONY PAREL

Department of Political Science, University of Calgary
Civil Disobedience
Nonviolence

JANE L. PARPART

Department of History, Dalhousie University
Dependency

KEVIN PASSMORE

Department of History, Cardiff University
National History

MANOLIS PATINIOTIS

Department of History and Philosophy of Science,
University of Athens
Newtonianism

- HARRY W. PAUL
Department of History, University of Florida
Medicine: Europe and the United States
- VINCENT P. PECORA
Departments of English and Comparative Literature,
University of California, Los Angeles
Literature: Overview
- PETER N. PEREGRINE
Department of Anthropology, Lawrence University
Trade
- CHARMAINE PEREIRA
Centre for Research and Documentation
State, The: The Postcolonial State
- LAUREN F. PFISTER (FÈI LÉRÉN)
Department of Religion and Philosophy, Hong Kong
Baptist University
Justice: Justice in East Asian Thought
- JAMES PHELAN
Department of English, Ohio State University
Narrative
- YURI PINES
Department of East Asian Studies, Hebrew University of
Jerusalem
Legalism, Ancient China
Mohism
- KATHRYN PISARO
Department of Music, California Institute of the Arts
Composition, Musical
- MALCOLM POTTS
School of Public Health, University of California,
Berkeley
Population
- JOHN POWERS
Centre for Asian Societies and Histories, Australian
National University
Communication of Ideas: Asia and Its Influence
Consciousness: Indian Thought
Humanity: Asian Thought
Sacred Texts: Asia
- PAUL R. POWERS
Department of Religious Studies, Lewis and Clark
College
Death and Afterlife, Islamic Understanding of
- FABRIZIO PREGADIO
Department of Religious Studies, Stanford University
Alchemy: China
Daoism
Yin and Yang
- STATHIS PSILLOS
Department of Philosophy and History of Science,
University of Athens
Causality
- NING QIANG
Department of the History of Art, University of
Michigan
Heaven and Hell (Asian Focus)
- JUAN GÓMEZ QUIÑONES
Department of History, University of California, Los
Angeles
Chicano Movement
- ALBERT RABIL JR.
State University of New York, College at Old Westbury
(Emeritus)
Humanism: Renaissance
- SUSAN ELIZABETH RAMIREZ
Department of History, Texas Christian University
Colonialism: Latin America
Empire and Imperialism: Americas
Pre-Columbian Civilization
Religion: Latin America
- DAVID RANDALL
Department of History, Rutgers University
Puritanism
- AMIT RAY
Department of Language and Literature, Rochester
Institute of Technology
New Criticism
- MOVINDRI REDDY
Occidental College
War
- TIM REES
Department of History, University of Exeter
Communism: Europe
- STEVEN P. REMY
Department of History, City University of New
York—Brooklyn College
Generation
- MATTHIAS RIEDL
Department of Political Science, Friedrich-Alexander-
University Erlangen-Nuremberg
Eschatology
Mysticism: Christian Mysticism
- MARY RIZZO
Department of American Studies, University of
Minnesota
Consumerism

LIST OF CONTRIBUTORS

- JESSICA M. ROA
 Department of Psychology, University of California,
 Santa Cruz
Feminism: Chicana Feminisms
- KEVIN C. ROBBINS
 Department of History, Indiana University–Purdue
 University, Indianapolis
Philanthropy
- MARY NOOTER ROBERTS
 UCLA Fowler Museum of Cultural History
Aesthetics: Africa
- THIERRY JEAN ROBOUAM
 Faculty of Comparative Culture, Sophia University,
 Tokyo
Japanese Philosophy, Japanese Thought
- JONATHAN ROSE
 Graduate Program in Modern History and Literature,
 Drew University
Reading
- PHILIPP W. ROSEMANN
 Department of Philosophy, University of Dallas
Scholasticism
- LELAND M. ROTH
 Department of Art History, School of Architecture and
 Allied Arts, University of Oregon
Architecture: Overview
Architecture: Asia
- GILBERT ROZMAN
 Department of Sociology, Princeton University
Modernization Theory
- JAMES H. RUBIN
 Department of Art, Stony Brook, State University of New
 York
Impressionism
Realism
- ERIKA RUMMEL
 Emmanuel College, University of Toronto
Reform: Europe and the United States
- MICHAEL RUSE
 Department of Philosophy, Florida State University
Consilience
Creationism
- MICHAEL RYAN
 English Department, Northeastern University
Structuralism and Poststructuralism: Overview
- NAOKI SAKAI
 Department of Comparative Literature and Department
 of Asian Studies, Cornell University
Translation
- STEVEN B. SAMPLE
 University of Southern California
Leadership
- LYMAN TOWER SARGENT
 Department of Political Science, University of
 Missouri—St. Louis
Utopia
- HENRY M. SAYRE
 Department of Art, Oregon State University
Arts: Overview
- BEN-AMI SCHARFSTEIN
 Department of Philosophy, Tel Aviv University
Machiavellism
- RICHARD SCHEINES
 Department of Philosophy, Carnegie Mellon University
Causation
- FREDERICK F. SCHMITT
 Department of Philosophy, Indiana University
Truth
- RICHARD SCHMITT
 Department of Philosophy, Brown University
Power
- WHIT SCHONBEIN
 Department of Philosophy, Mount Holyoke College
Representation: Mental Representation
- SILVAN S. SCHWEBER
 Department of Physics, Brandeis University
Field Theories
- JOHN T. SCOTT
 Department of Political Science, University of California,
 Davis
General Will
- JOHN R. SEARLE
 Department of Philosophy, University of California,
 Berkeley
Intentionality
- KENNETH SEESKIN
 Department of Philosophy, Northwestern University
Autonomy
- ROBERT A. SEGAL
 Department of Religious Studies, Lancaster University
Myth

- JENNIFER L. SHAW
Department of Art and Art History, Sonoma State
University
Symbolism
- MIRI SHEFER
Department of Middle Eastern and African History, Tel
Aviv University
Medicine: Islamic Medicine
- KATHLEEN SHELDON
Center for the Study of Women, University of
California, Los Angeles
Women's History: Africa
- YU SHEN
Department of History, Indiana University Southeast
Chinese Warlordism
- WILLIAM E. SHEPARD
University of Canterbury, Christchurch, New Zealand
Religion: Middle East
- TAKASHI SHOGIMEN
Department of History, University of Otago, Dunedin,
New Zealand
Constitutionalism
Heresy and Apostasy
Liberty
- SHARON SIEVERS
Department of History, California State University, Long
Beach
Women's History: Asia
- SOEK-FANG SIM
International Studies, Macalester College
Authoritarianism: East Asia
- DEAN KEITH SIMONTON
Department of Psychology, University of California,
Davis
Creativity in the Arts and Sciences
- KIMBERLY SIMS
Trinity College
Platonism
- MAINA CHAWLA SINGH
College of Vocational Studies, University of Delhi, India
Feminism: Overview
Motherhood and Maternity
- DAVID W. SISK
Computing and Information Technology, Macalester
College
Dystopia
- GIULIA SISSA
Department of Classics, University of California at Los
Angeles
Hedonism in European Thought
- NATHAN SIVIN
Department of the History and Sociology of Science,
University of Pennsylvania
Medicine: China
Science: East Asia
- ESTHER M. SKELLEY
School of Public and International Affairs, University of
Georgia
Communism: Latin America
- DIANE SKOSS
Koryu Books
Bushido
- PETER SLUGLETT
Department of History, University of Utah, Salt Lake
City
Anticolonialism: Middle East
- ROBERT SMID
Independent Scholar, Brookline, Mass,
Cosmology: Asia
Orthopraxy: Asia
- BRIAN SMITH
Department of Religious Studies, University of
California, Riverside
Asceticism: Hindu and Buddhist Asceticism
Buddhism
Hinduism
Meditation, Eastern
Time: India
Yoga
- CHARLES D. SMITH
Department of Near Eastern Studies, University of
Arizona
Empire and Imperialism: Middle East
- JUSTIN E. H. SMITH
Department of Philosophy, Concordia University,
Montreal, Quebec, Canada
Philosophy, History of
- WOODRUFF D. SMITH
Department of History, University of Massachusetts
Boston
Volksgeist
- VASSILIKI BETTY SMOCOVITIS
Departments of Zoology and History, University of
Florida
(continued on the next page)

LIST OF CONTRIBUTORS

(continued from page 2537)

Biology
Evolution

HOLLY SNYDER

John Nicholas Brown Center for the Study of American
Civilization, Brown University
Diasporas: Jewish Diaspora

SAMANTHA SOLIMEO

Department of Anthropology, University of Iowa
Life Cycle: Elders/Old Age

ROBERT C. SOLOMON

Department of Philosophy, University of Texas
at Austin
Emotions
Existentialism
Phenomenology
Philosophy: Historical Overview and Recent Developments

CHRISTOPHER SOUTHGATE

Department of Classics and Theology, University of
Exeter
Religion and Science

JULIAN SPALDING

Writer and Broadcaster, Edinburgh, Scotland
Museums

RUSSELL SPEARS

School of Psychology, Cardiff University
Identity: Personal and Social Identity

D. A. SPELLBERG

Department of History and Middle Eastern Studies,
University of Texas at Austin
Gender: Gender in the Middle East

KAYLEE SPENCER-AHRENS

Department of Art and Art History, University of Texas
at Austin
Periodization of the Arts

HORTENSE J. SPILLERS

Department of English, Cornell University
Literary Criticism

GAYATRI CHAKRAVORTY SPIVAK

Department of English, Columbia University
Postcolonial Theory and Literature

SARAH LINSLEY STARKS

Neuropsychiatric Institute Health Services Research
Center, University of California, Los Angeles
Psychology and Psychiatry

RANDOLPH STARN

Department of History and Italian Studies, University of
California, Berkeley
Crisis

WARD STAVIG

Department of History, University of South Florida
*Millenarianism: Latin America and Native North
America*

MICHAEL ST. CLAIR

Department of Psychology, Emmanuel College
Millenarianism: Overview

JEAN STEFANCIC

University of Pittsburgh School of Law
Critical Race Theory

JAMES P. STERBA

Department of Philosophy, University of Notre Dame
Justice: Overview

MATTHIAS STEUP

Department of Philosophy, St. Cloud State University
Epistemology: Modern

DEVIN J. STEWART

Department of Middle Eastern and South Asian Studies,
Emory University
Islam: Shii
Law, Islamic

NORMAN A. STILLMAN

University of Oklahoma
Anti-Semitism: Islamic Anti-Semitism

M. W. F. STONE

Department of Philosophy, Katholieke Universiteit,
Leuven, Belgium
Casuistry
Philosophy: Relations to Other Intellectual Realms
Philosophy and Religion in Western Thought
Philosophy of Religion

GREGORY W. STREICH

Department of Political Science, Central Missouri State
University
Authority
Equality: Racial Equality

DAVID J. STUMP

Department of Philosophy, University of San Francisco
Fallacy, Logical
Paradigm
Pseudoscience

BLAIR SULLIVAN

Center for Medieval and Renaissance Studies, University
of California at Los Angeles
(continued on the next page)

(continued from page 2538)

Harmony
Musicology

CHRIS SWOYER

Department of Philosophy, University of Oklahoma
Rational Choice
Subjectivism

HIDEKI TAKEMURA

Teacher Education Center, Keio University
Education: Japan

CHRISTOPHER S. TAYLOR

Department of Religious Studies, Drew University
Islam: Sunni

LOU TAYLOR

School of Historical and Critical Studies, University of
Brighton
Dress

RICHARD C. TAYLOR

Department of Philosophy, Marquette University
Philosophies: Islamic

UDO THIEL

Department of Philosophy, School of Humanities,
Australian National University
Identity: Identity of Persons

PETER THIELKE

Department of Philosophy, Pomona College
Hegelianism

NORMAN J. W. THROWER

Department of Geography, University of California, Los
Angeles
Geography
Maps and The Ideas They Express

ALAIN TOUWAIDE

Department of Botany, National Museum of Natural
History, Smithsonian Institution
Environment

NANCY TUANA

Department of Philosophy, Pennsylvania State University
Philosophies: Feminist, Twentieth-Century

AVIEZER TUCKER

Australian National University
Consciousness: Overview
Objectivity

THOMAS TURINO

School of Music, University of Illinois at Urbana-
Champaign
Music, Anthropology of

KARIN TYBJERG

Department of History and Philosophy of Science,
University of Cambridge
Greek Science

ARISTOTLE TYMPAS

Department of History and Philosophy of Science,
National and Capodistrian University of Athens
Calculation and Computation
Technology

LAURA UBA

Department of Asian American Studies, California State
University, Northridge
Identity, Multiple: Asian-Americans

MONICA UDVARDY

Department of Anthropology, University of Kentucky
Body, The

CASSANDRA RACHEL VENNEY

Dept. of African and African American Studies and
Women's Studies, The Pennsylvania State University
Abolitionism
Segregation

ANDREW VINCENT

Department of Politics, Sheffield University
Patriotism

HANS VON RAUTENFELD

Department of Philosophy, University of South Carolina
Representation: Political Representation

MATTHEW F. VON UNWERTH

Abraham A. Brill Library, New York Psychoanalytic
Institute
Psychoanalysis

ELINA VUOLA

Institute of Development Studies, University of Helsinki
Liberation Theology

CHAOHUA WANG

Department of Asian Languages and Cultures, University
of California, Los Angeles
Modernity: East Asia

Q. EDWARD WANG

Department of History, Rowan University
Causation in East Asian and Southeast Asian Philosophy
Education: Asia, Traditional and Modern
Occidentalism

JOHN WARD

School of Philosophical and Historical Inquiry,
University of Sydney
Rhetoric: Ancient and Medieval

LIST OF CONTRIBUTORS

EARLE H. WAUGH

University of Alberta, Edmonton, Alberta, Canada
Orthodoxy

JEFFREY WEEKS

Faculty of Humanities and Social Science, South Bank
University
Sexuality: Overview

NADINE WEIDMAN

Department of History of Science, Harvard University
Behaviorism
Phrenology

PATRICK WEIL

CNRS (National Center for Scientific Research),
University of Paris
Citizenship: Naturalization

JERRY WEINBERGER

Michigan State University
Progress, Idea of

GABRIEL P. WEISBERG

Department of Art History, University of Minnesota,
Minneapolis
Naturalism in Art and Literature

G. J. WEISEL

Department of Physics, Penn State Altoona
Physics

MARY J. WEISMANTEL

Department of Anthropology, Northwestern University
Family: Modernist Anthropological Theory
Life Cycle: Overview

DAVID WELCH

School of History, Centre for the Study of Propaganda,
University of Kent, Canterbury
Propaganda

STEPHEN WELDON

University of Oklahoma
Humanism: Secular Humanism in the United States

LEIF WENAR

Department of Philosophy, University of Sheffield
Property

MICHAEL WERNER

Department of History, University of Chicago
Marxism: Latin America

MARGARET WERRY

Department of Theatre Arts and Dance, University of
Minnesota
Cultural Revivals
Theater and Performance

HYLTON WHITE

Department of Anthropology, University of Chicago
Tradition

NORMAN E. WHITTEN JR.

Department of Anthropology, University of Illinois at
Urbana-Champaign
Animism
Religion: Indigenous Peoples' View, South America

HOWARD J. WIARDA

Department of International Affairs, University of
Georgia
Communism: Latin America
Empire and Imperialism: United States

MEREDITH WILLIAMS

Department of Philosophy, Johns Hopkins University
Language, Philosophy of: Modern

HOWARD WINANT

Department of Sociology, University of California, Santa
Barbara
Discrimination
Race and Racism: Overview

KWASI WIREDU

Department of Philosophy, University of South Florida
Personhood in African Thought
Philosophy, Moral: Africa

LAURA R. WOLIVER

Department of Political Science, University of South
Carolina
Political Protest, U.S.

WILLIAM A. WOOD

Department of History and Political Science, Point Loma
Nazarene University
Nomadism

KENNETH L. WOODWARD

Independent Scholar, New York, N.Y.
Miracles

DANIEL WOOLF

University of Alberta
Historiography

CHRISTINE MIN WOTIPKA

International Institute, University of California, Los
Angeles
Human Rights: Women's Rights

LINNEA WREN

Gustavus Adolphus College
Periodization of the Arts

- DOMINIK WUJASTYK
Wellcome Trust Centre for the History of Medicine,
University College London
Medicine: India
- JOHN A. XANTHOPOULOS
Department of Education, University of Montana—
Western
Education: Global Education
- GENZO YAMAMOTO
Department of History, Wheaton College
Education: Japan
Race and Racism: Asia
Shinto
- XINZHONG YAO
Department of Theology and Religious Studies,
University of Wales
Chinese Thought
- RICHARD YEO
Centre for Public Culture and Ideas, Griffith University,
Brisbane, Australia
Encyclopedism
- CHARLES M. YOUNG
Department of Philosophy, Claremont Graduate
University
Philosophy, Moral: Ancient
- NIGEL YOUNG
Department of Sociology and Anthropology, Colgate
University
Pacifism
- JIYUAN YU
Department of Philosophy, State University of New York
at Buffalo
Humanism: Chinese Conception of
- PAUL TIYAMBE ZELEZA
Departments of History and African and African
American Studies, Pennsylvania State University
Africa, Idea of
Colonialism: Africa
Communication of Ideas: Africa and Its Influence
Democracy, Africa
Diasporas: African Diaspora
History, Economic
- ELEANOR ZELLIOT
Carleton College
Untouchability: Overview
- CARL ZIMMER
Independent Scholar, Guilford, Conn.
Mind
- MICHAEL J. ZIMMERMAN
Department of Philosophy, University of North Carolina
at Greensboro
Responsibility
- ROBERT ZIOMKOWSKI
Independent Scholar, Ithaca, N.Y.
Microcosm and Macrocism
Neoplatonism
- SHERIFA ZUHUR
Strategic Studies Institute, U.S. Army War College
Honor, Middle Eastern Notions of
Intercession in Middle Eastern Society
- STEPHEN ZUNES
Department of Politics, University of San Francisco
Terrorism, Middle East
- JACK ZUPKO
Department of Philosophy, Emory University
Philosophy of Mind: Ancient and Medieval